

WW  
**SECTION**  
**WIPER & WASHER**

A  
 B  
 C  
 D  
 E  
 F  
 G  
 H  
 I  
 J  
 K  
 WW  
 M  
 N  
 O  
 P

**CONTENTS**

<p><b>BASIC INSPECTION</b> ..... 3</p> <p><b>DIAGNOSIS AND REPAIR WORK FLOW</b> ..... 3</p> <p style="padding-left: 20px;">Work Flow .....3</p> <p><b>SYSTEM DESCRIPTION</b> ..... 6</p> <p><b>FRONT WIPER AND WASHER SYSTEM</b> ..... 6</p> <p style="padding-left: 20px;">System Diagram .....6</p> <p style="padding-left: 20px;">System Description .....6</p> <p style="padding-left: 20px;">Component Parts Location .....9</p> <p style="padding-left: 20px;">Component Description .....9</p> <p><b>DIAGNOSIS SYSTEM (BCM)</b> .....11</p> <p><b>COMMON ITEM</b> .....11</p> <p style="padding-left: 20px;">COMMON ITEM : CONSULT Function (BCM - COMMON ITEM) ..... 11</p> <p><b>WIPER</b> .....12</p> <p style="padding-left: 20px;">WIPER : CONSULT Function (BCM - WIPER) ..... 12</p> <p><b>DIAGNOSIS SYSTEM (IPDM E/R)</b> .....14</p> <p style="padding-left: 20px;">Diagnosis Description ..... 14</p> <p style="padding-left: 20px;">CONSULT Function (IPDM E/R) ..... 16</p> <p><b>DTC/CIRCUIT DIAGNOSIS</b> .....19</p> <p><b>WIPER AND WASHER FUSE</b> .....19</p> <p style="padding-left: 20px;">Diagnosis Procedure ..... 19</p> <p><b>FRONT WIPER MOTOR LO CIRCUIT</b> .....20</p> <p style="padding-left: 20px;">Component Function Check .....20</p> <p style="padding-left: 20px;">Diagnosis Procedure ..... 20</p> <p><b>FRONT WIPER MOTOR HI CIRCUIT</b> .....22</p> <p style="padding-left: 20px;">Component Function Check .....22</p> <p style="padding-left: 20px;">Diagnosis Procedure ..... 22</p> <p><b>FRONT WIPER STOP POSITION SIGNAL CIRCUIT</b> .....24</p> <p style="padding-left: 20px;">Component Function Check .....24</p> <p style="padding-left: 20px;">Diagnosis Procedure ..... 24</p>	<p><b>FRONT WIPER MOTOR GROUND CIRCUIT</b> ...26</p> <p style="padding-left: 20px;">Diagnosis Procedure .....26</p> <p><b>WASHER SWITCH</b> .....27</p> <p style="padding-left: 20px;">Description .....27</p> <p style="padding-left: 20px;">Component Inspection .....27</p> <p><b>FRONT WIPER AND WASHER SYSTEM</b> .....28</p> <p style="padding-left: 20px;">Wiring Diagram - FRONT WIPER AND WASHER SYSTEM - .....28</p> <p><b>ECU DIAGNOSIS INFORMATION</b> .....32</p> <p><b>BCM (BODY CONTROL MODULE)</b> .....32</p> <p style="padding-left: 20px;">Reference Value .....32</p> <p style="padding-left: 20px;">Wiring Diagram - BCM - .....56</p> <p style="padding-left: 20px;">Fail-safe .....69</p> <p style="padding-left: 20px;">DTC Inspection Priority Chart .....70</p> <p style="padding-left: 20px;">DTC Index .....71</p> <p><b>IPDM E/R (INTELLIGENT POWER DISTRIBUTION MODULE ENGINE ROOM)</b> .....74</p> <p style="padding-left: 20px;">Reference Value .....74</p> <p style="padding-left: 20px;">Wiring Diagram - IPDM E/R - .....81</p> <p style="padding-left: 20px;">Fail-safe .....84</p> <p style="padding-left: 20px;">DTC Index .....86</p> <p><b>SYMPTOM DIAGNOSIS</b> .....87</p> <p><b>FRONT WIPER AND WASHER SYSTEM SYMPTOMS</b> .....87</p> <p style="padding-left: 20px;">Symptom Table .....87</p> <p><b>FRONT WIPER DOES NOT OPERATE</b> .....89</p> <p style="padding-left: 20px;">Description .....89</p> <p style="padding-left: 20px;">Diagnosis Procedure .....89</p> <p><b>NORMAL OPERATING CONDITION</b> .....91</p> <p style="padding-left: 20px;">Description .....91</p> <p><b>PRECAUTION</b> .....92</p> <p><b>PRECAUTIONS</b> .....92</p>
---	---

Precaution for Supplemental Restraint System (SRS) "AIR BAG" and "SEAT BELT PRE-TENSIONER" .....	92	Removal and Installation .....	97
Precaution for Procedure without Cowl Top Cover..	92	Inspection and Adjustment .....	97
Precautions for Removing Battery Terminal .....	93	<b>FRONT WIPER ARM .....</b>	<b>100</b>
<b>REMOVAL AND INSTALLATION .....</b>	<b>94</b>	Exploded View .....	100
<b>WASHER TANK .....</b>	<b>94</b>	Removal and Installation .....	100
Exploded View .....	94	Adjustment .....	101
Removal and Installation .....	94	<b>FRONT WIPER BLADE .....</b>	<b>102</b>
<b>FRONT WASHER PUMP .....</b>	<b>95</b>	Exploded View .....	102
Exploded View .....	95	Removal and Installation .....	102
Removal and Installation .....	95	Replacement .....	103
<b>WASHER LEVEL SWITCH .....</b>	<b>96</b>	<b>FRONT WIPER DRIVE ASSEMBLY .....</b>	<b>104</b>
Removal and Installation .....	96	Exploded View .....	104
<b>FRONT WASHER NOZZLE AND TUBE .....</b>	<b>97</b>	Removal and Installation .....	104
Hydraulic Layout .....	97	Disassembly and Assembly .....	105
		<b>FRONT WIPER AND WASHER SWITCH .....</b>	<b>106</b>
		Exploded View .....	106

# DIAGNOSIS AND REPAIR WORK FLOW

< BASIC INSPECTION >

## BASIC INSPECTION

### DIAGNOSIS AND REPAIR WORK FLOW

Work Flow

INFOID:000000010989033

OVERALL SEQUENCE

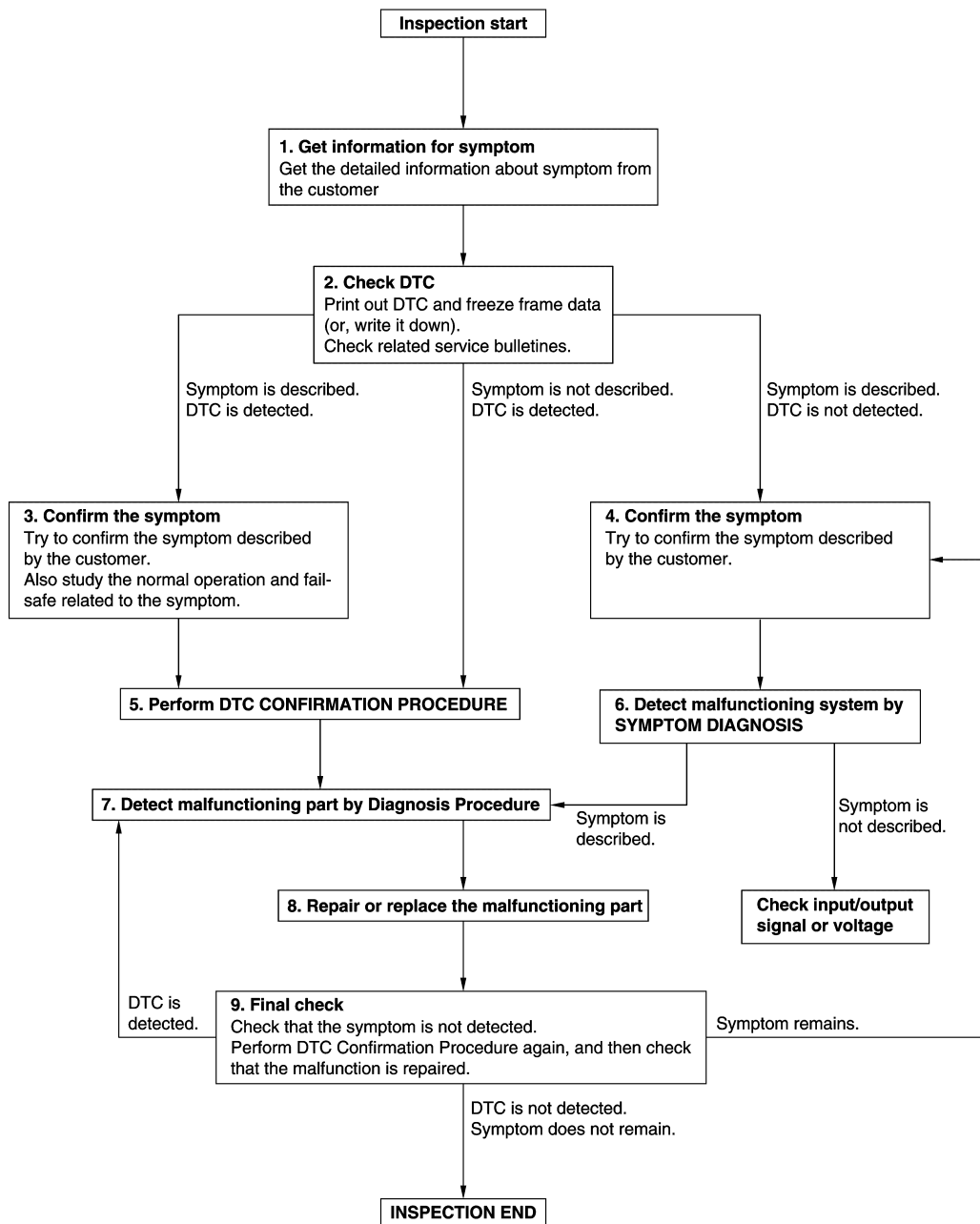

DETAILED FLOW

JMKIA8652GB

# DIAGNOSIS AND REPAIR WORK FLOW

## < BASIC INSPECTION >

---

### 1. GET INFORMATION FOR SYMPTOM

---

1. Get detailed information from the customer about the symptom (the condition and the environment when the incident/malfunction occurs).
2. Check operation condition of the function that is malfunctioning.

>> GO TO 2.

### 2. CHECK DTC

---

1. Check DTC.
2. Perform the following procedure if DTC is detected.
  - Record DTC and freeze frame data (Print them out using CONSULT.)
  - Erase DTC.
  - Study the relationship between the cause detected by DTC and the symptom described by the customer.
3. Check related service bulletins for information.

#### Are any symptoms described and any DTC detected?

Symptom is described, DTC is detected>>GO TO 3.

Symptom is described, DTC is not detected>>GO TO 4.

Symptom is not described, DTC is detected>>GO TO 5.

### 3. CONFIRM THE SYMPTOM

---

Try to confirm the symptom described by the customer.

Also study the normal operation and fail-safe related to the symptom.

Verify relation between the symptom and the condition when the symptom is detected.

>> GO TO 5.

### 4. CONFIRM THE SYMPTOM

---

Try to confirm the symptom described by the customer.

Verify relation between the symptom and the condition when the symptom is detected.

>> GO TO 6.

### 5. PERFORM DTC CONFIRMATION PROCEDURE

---

Perform DTC CONFIRMATION PROCEDURE for the detected DTC, and then check that DTC is detected again. At this time, always connect CONSULT to the vehicle, and check self diagnostic results in real time. If two or more DTCs are detected, refer to DTC INSPECTION PRIORITY CHART, and determine trouble diagnosis order.

#### **NOTE:**

- Freeze frame data is useful if the DTC is not detected.
- Perform Component Function Check if DTC CONFIRMATION PROCEDURE is not included on Service Manual. This simplified check procedure is an effective alternative though DTC cannot be detected during this check.  
If the result of Component Function Check is NG, it is the same as the detection of DTC by DTC CONFIRMATION PROCEDURE.

#### Is DTC detected?

YES >> GO TO 7.

NO >> Check according to [GI-41. "Intermittent Incident"](#).

### 6. DETECT MALFUNCTIONING SYSTEM BY SYMPTOM DIAGNOSIS

---

Detect malfunctioning system according to SYMPTOM DIAGNOSIS based on the confirmed symptom in step 4, and determine the trouble diagnosis order based on possible causes and symptom.

#### Is the symptom described?

YES >> GO TO 7.

NO >> Monitor input data from related sensors or check voltage of related module terminals using CONSULT.

### 7. DETECT MALFUNCTIONING PART BY DIAGNOSIS PROCEDURE

---

# DIAGNOSIS AND REPAIR WORK FLOW

## < BASIC INSPECTION >

---

Inspect according to Diagnosis Procedure of the system.

Is malfunctioning part detected?

YES >> GO TO 8.

NO >> Check according to [GI-41. "Intermittent Incident"](#).

## 8. REPAIR OR REPLACE THE MALFUNCTIONING PART

---

1. Repair or replace the malfunctioning part.
2. Reconnect parts or connectors disconnected during Diagnosis Procedure again after repair and replacement.
3. Check DTC. If DTC is detected, erase it.

>> GO TO 9.

## 9. FINAL CHECK

---

When DTC is detected in step 2, perform DTC CONFIRMATION PROCEDURE again, and then check that the malfunction is repaired securely.

When symptom is described by the customer, refer to confirmed symptom in step 3 or 4, and check that the symptom is not detected.

Is DTC detected and does symptom remain?

YES-1 >> DTC is detected: GO TO 7.

YES-2 >> Symptom remains: GO TO 4.

NO >> Before returning the vehicle to the customer, always erase DTC.

A  
B  
C  
D  
E  
F  
G  
H  
I  
J  
K  
M  
N  
O  
P

WW

# FRONT WIPER AND WASHER SYSTEM

< SYSTEM DESCRIPTION >

## SYSTEM DESCRIPTION

### FRONT WIPER AND WASHER SYSTEM

#### System Diagram

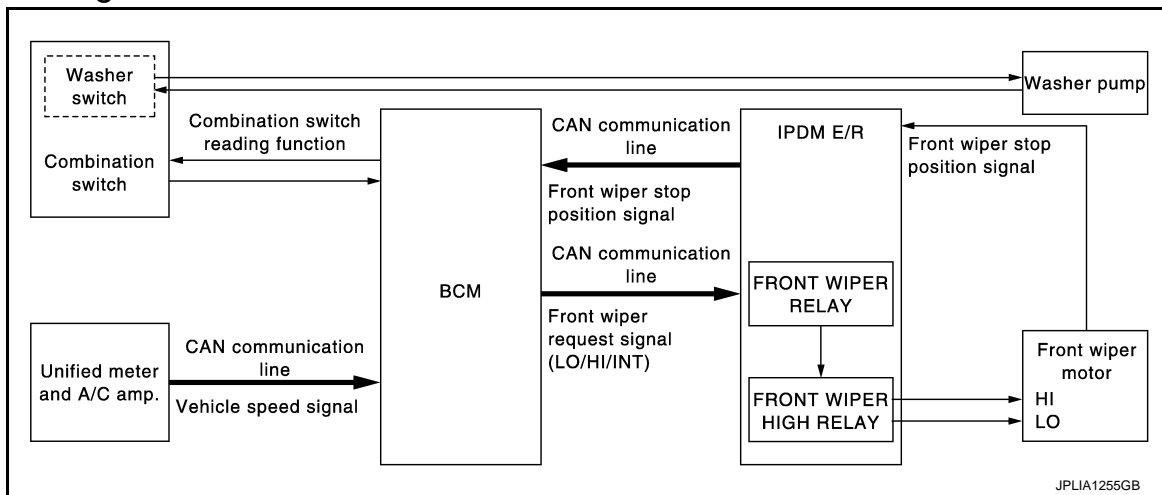

#### System Description

INFOID:000000010989039

#### OUTLINE

The front wiper is controlled by each function of BCM and IPDM E/R.

##### Control by BCM

- Combination switch reading function
- Front wiper control function

##### Control by IPDM E/R

- Front wiper control function
- Relay control function

Combination meter indicates low washer fluid warning judged by the signal from the washer level switch. For details of low washer fluid warning, refer to [MWI-27, "INFORMATION DISPLAY : System Description"](#).

#### FRONT WIPER BASIC OPERATION

- BCM detects the combination switch condition by the combination switch reading function.
- BCM transmits the front wiper request signal to IPDM E/R via CAN communication depending on each operating condition of the front wiper.
- IPDM E/R turns ON/OFF the integrated front wiper relay and the front wiper high relay according to the front wiper request signal. IPDM E/R provides the power supply to operate the front wiper HI/LO operation.

#### FRONT WIPER LO OPERATION

- BCM transmits the front wiper request signal (LO) to IPDM E/R via CAN communication according to the front wiper LO operating condition.

##### Front wiper LO operating condition

- Ignition switch ON
- Front wiper switch LO or front wiper switch MIST (while pressing)
- IPDM E/R turns ON the integrated front wiper relay according to the front wiper request signal (LO).

#### FRONT WIPER HI OPERATION

- BCM transmits the front wiper request signal (HI) to IPDM E/R via CAN communication according to the front wiper HI operating condition.

##### Front wiper HI operating condition

- Ignition switch ON
- Front wiper switch HI
- IPDM E/R turns ON the integrated front wiper relay and the front wiper high relay according to the front wiper request signal (HI).

# FRONT WIPER AND WASHER SYSTEM

## < SYSTEM DESCRIPTION >

### FRONT WIPER INT OPERATION

- BCM transmits the front wiper request signal (INT) to IPDM E/R via CAN communication depending on the front wiper INT operating condition and intermittent operation delay interval according to the wiper intermittent dial position.

Front wiper INT operating condition

- Ignition switch ON
- Front wiper switch INT
- IPDM E/R turns ON the integrated front wiper relay so that the front wiper is operated only once according to the front wiper request signal (INT).
- BCM detects stop position/except stop position of the front wiper motor according to the front wiper stop position signal received from IPDM E/R via CAN communication.
- BCM transmits the front wiper request signal (INT) again after the intermittent operation delay interval.

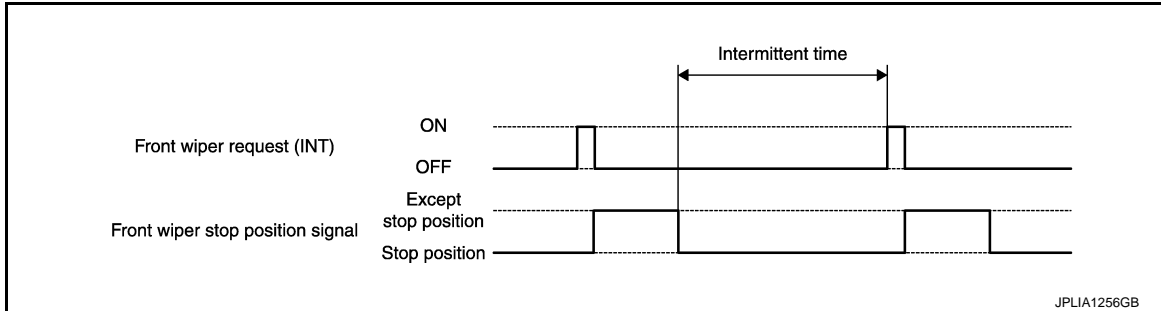

### NOTE:

Factory setting of the front wiper intermittent operation is operation not linked with vehicle speed. Front wiper intermittent operation can be set to operation linked or not linked with vehicle speed using CONSULT. Refer to [WW-12. "WIPER : CONSULT Function \(BCM - WIPER\)"](#).

Front wiper intermittent operation with vehicle speed

- BCM calculates the intermittent operation delay interval from the following
  - Vehicle speed signal
  - Wiper intermittent dial position

Unit: Second

Wiper intermittent dial position	Intermittent operation interval	Intermittent operation delay Interval			
		Vehicle speed			
		0 – 5 km/h (0 – 3.1 MPH)	5 – 35 km/h (3.1 – 21.7 MPH)	35 – 65 km/h (21.7 – 40.4 MPH)*	65 km/h (40.4 MPH) or more
1	Short ↑	0.8	0.6	0.4	0.24
2		4	3	2	1.2
3		10	7.5	5	3
4		16	12	8	4.8
5		24	18	12	7.2
6	Long ↓	32	24	16	9.6
7		42	31.5	21	12.6

\*: When operation setting is not linked with vehicle speed.

### FRONT WIPER AUTO STOP OPERATION

- BCM stops transmitting the front wiper request signal when the front wiper switch is turned OFF.
- IPDM E/R detects the front wiper stop position signal from the front wiper motor and detects the front wiper motor position (stop position/except stop position).

# FRONT WIPER AND WASHER SYSTEM

## < SYSTEM DESCRIPTION >

- When the front wiper request signal is stopped, IPDM E/R turns ON the front wiper relay until the front wiper motor returns to the stop position.

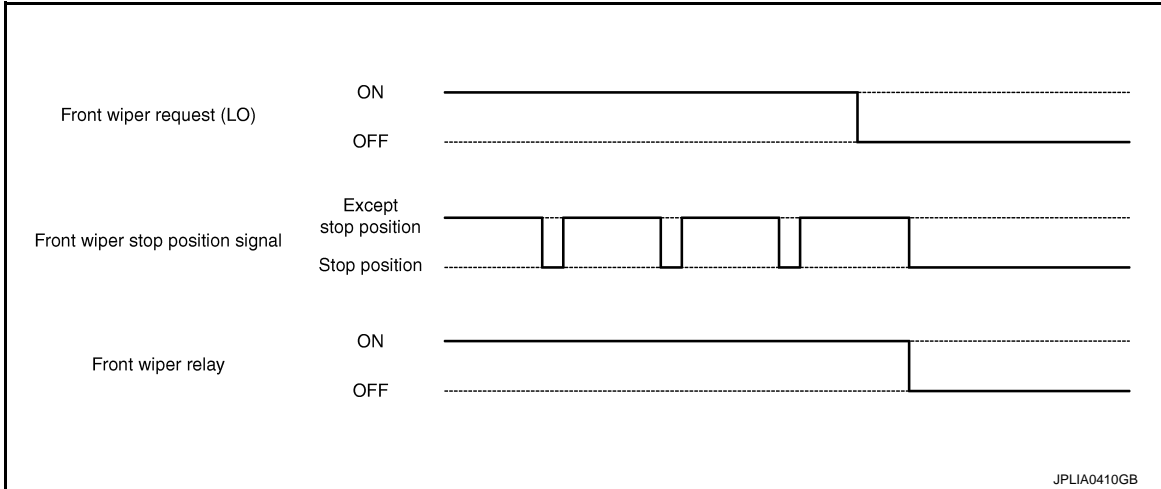

### NOTE:

- BCM stops the transmitting of the front wiper request signal when the ignition switch is OFF.
- IPDM E/R turns the front wiper relay OFF when the ignition switch is OFF.

### FRONT WIPER OPERATION LINKED WITH WASHER

- BCM transmits the front wiper request signal (LO) to IPDM E/R via CAN communication according to the washer linked operating condition of the front wiper.
- BCM transmits the front wiper request signal (LO) so that the front wiper operates approximately 2 times when the front washer switch OFF is detected.

Washer linked operating condition of front wiper

- Ignition switch ON
- Front washer switch ON (0.4 second or more)
- IPDM E/R turns ON the integrated front wiper relay according to the front wiper request signal (LO).
- The washer pump is grounded through the combination switch with the front washer switch ON.

### FRONT WIPER FAIL-SAFE OPERATION

IPDM E/R performs the fail-safe function when the front wiper stop position circuit is malfunctioning. Refer to [PCS-30. "Fail-safe"](#).



# FRONT WIPER AND WASHER SYSTEM

< SYSTEM DESCRIPTION >

## Component Parts Location

INFOID:000000010989040

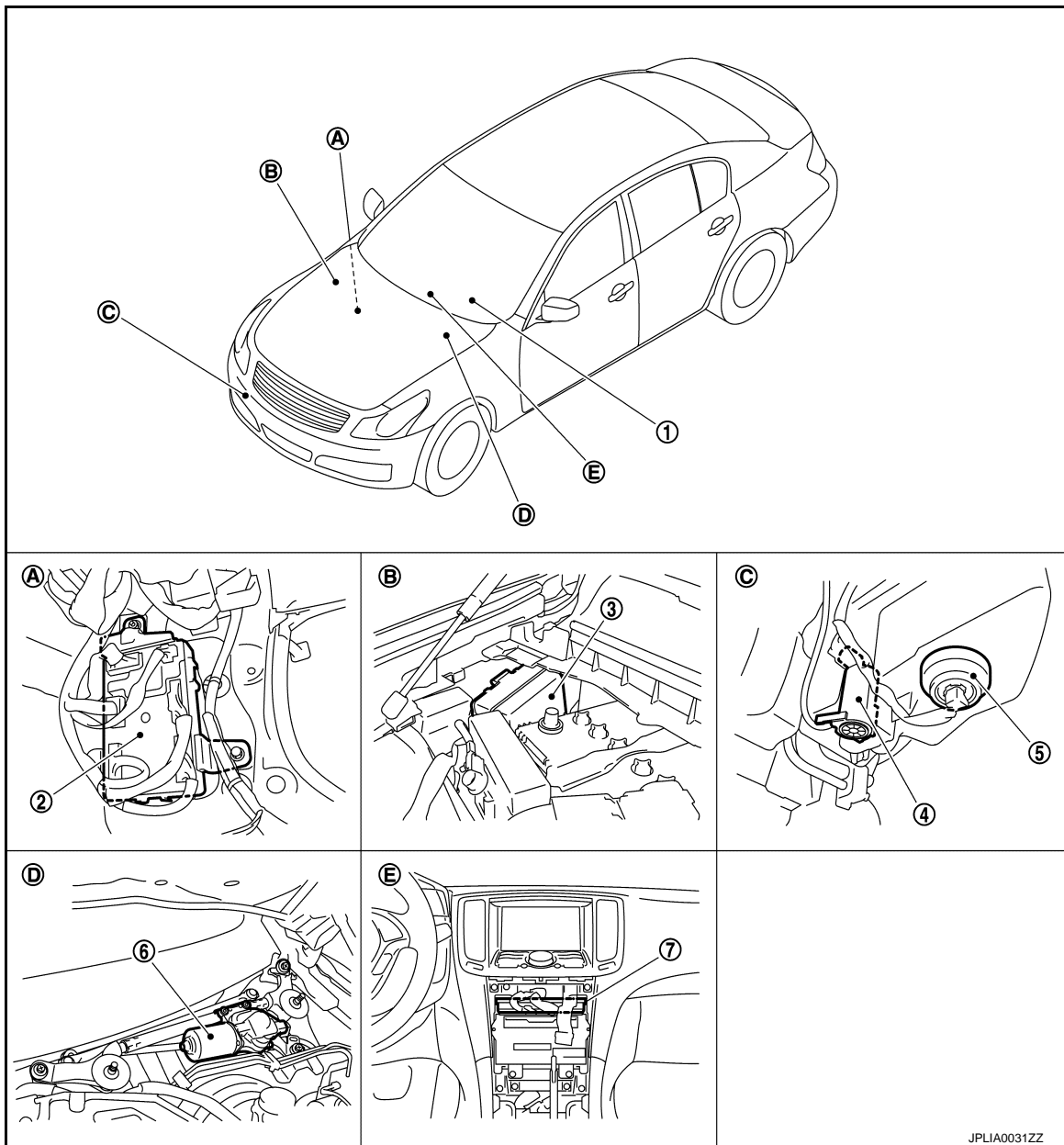

- |                                       |                                |                               |
|---------------------------------------|--------------------------------|-------------------------------|
| 1. Combination switch                 | 2. BCM                         | 3. IPDM E/R                   |
| 4. Washer pump                        | 5. Washer level switch         | 6. Front wiper motor          |
| 7. Unified meter and A/C amp.         |                                |                               |
| A. Dash side lower (Passenger side)   | B. Engine room dash panel (RH) | C. Radiator core support (RH) |
| D. Cowl top, left side of engine room | E. Behind cluster lid C        |                               |

## Component Description

INFOID:000000010989041

Part	Description
BCM	<ul style="list-style-type: none"> <li>Judges the each switch status by the combination switch reading function.</li> <li>Requests (with CAN communication) the front wiper relay and the front wiper high relay ON to IPDM E/R.</li> </ul>
IPDM E/R	<ul style="list-style-type: none"> <li>Controls the integrated relay according to the request (with CAN communication) from BCM.</li> <li>Performs the auto stop control of the front wiper.</li> </ul>

A  
B  
C  
D  
E  
F  
G  
H  
I  
J  
K  
L  
M  
N  
O  
P

WW

## FRONT WIPER AND WASHER SYSTEM

### < SYSTEM DESCRIPTION >

Part	Description
Front wiper motor	<ul style="list-style-type: none"><li>• IPDM E/R controls front wiper operation.</li><li>• Front wiper stop position signal is transmitted to IPDM E/R.</li></ul>
Combination switch (Wiper & washer switch)	Refer to <a href="#">BCS-7, "System Description"</a> .
Washer pump	Washer fluid is sprayed according to washer switch states.
Unified meter and A/C amp.	Transmits the vehicle speed signal to BCM with CAN communication.

# DIAGNOSIS SYSTEM (BCM)

< SYSTEM DESCRIPTION >

## DIAGNOSIS SYSTEM (BCM)

### COMMON ITEM

### COMMON ITEM : CONSULT Function (BCM - COMMON ITEM)

INFOID:000000011405241

### APPLICATION ITEM

CONSULT performs the following functions via CAN communication with BCM.

Diagnosis mode	Function Description
Work Support	Changes the setting for each system function.
Self Diagnostic Result	Displays the diagnosis results judged by BCM.
CAN Diag Support Monitor	Monitors the reception status of CAN communication viewed from BCM.
Data Monitor	The BCM input/output signals are displayed.
Active Test	The signals used to activate each device are forcibly supplied from BCM.
Ecu Identification	The BCM part number is displayed.
Configuration	This function is not used even though it is displayed.

### SYSTEM APPLICATION

BCM can perform the following functions for each system.

#### NOTE:

It can perform the diagnosis modes except the following for all sub system selection items.

x: Applicable item

System	Sub system selection item	Diagnosis mode		
		Work Support	Data Monitor	Active Test
Door lock	DOOR LOCK	x	x	x
Rear window defogger	REAR DEFOGGER		x	x
Warning chime	BUZZER		x	x
Interior room lamp timer	INT LAMP	x	x	x
Exterior lamp	HEAD LAMP	x	x	x
Wiper and washer	WIPER	x	x	x
Turn signal and hazard warning lamps	FLASHER	x	x	x
—	AIR CONDITONER*			
<ul style="list-style-type: none"> <li>Intelligent Key system</li> <li>Engine start system</li> </ul>	INTELLIGENT KEY	x	x	x
Combination switch	COMB SW		x	
Body control system	BCM	x		
IVIS - NATS	IMMU		x	x
Interior room lamp battery saver	BATTERY SAVER	x	x	x
Trunk lid open	TRUNK		x	x
Vehicle security system	THEFT ALM	x	x	x
RAP system	RETAINED PWR		x	
Signal buffer system	SIGNAL BUFFER		x	x
TPMS	AIR PRESSURE MONITOR	x	x	x

#### NOTE:

\*: This item is displayed, but is not used.

### FREEZE FRAME DATA (FFD)

The BCM records the following vehicle condition at the time a particular DTC is detected, and displays on CONSULT.

# DIAGNOSIS SYSTEM (BCM)

## < SYSTEM DESCRIPTION >

CONSULT screen item	Indication/Unit	Description	
Vehicle Speed	km/h	Vehicle speed of the moment a particular DTC is detected	
Odo/Trip Meter	km	Total mileage (Odometer value) of the moment a particular DTC is detected	
Vehicle Condition	SLEEP>LOCK	Power position status of the moment a particular DTC is detected	While turning BCM status from low power consumption mode to normal mode (Power supply position is "LOCK"*)
	SLEEP>OFF		While turning BCM status from low power consumption mode to normal mode (Power supply position is "OFF".)
	LOCK>ACC		While turning power supply position from "LOCK"* to "ACC"
	ACC>ON		While turning power supply position from "ACC" to "IGN"
	RUN>ACC		While turning power supply position from "RUN" to "ACC" (Vehicle is stopping and selector lever is except P position.)
	CRANK>RUN		While turning power supply position from "CRANKING" to "RUN" (From cranking up the engine to run it)
	RUN>URGENT		While turning power supply position from "RUN" to "ACC" (Emergency stop operation)
	ACC>OFF		While turning power supply position from "ACC" to "OFF"
	OFF>LOCK		While turning power supply position from "OFF" to "LOCK"*
	OFF>ACC		While turning power supply position from "OFF" to "ACC"
	ON>CRANK		While turning power supply position from "IGN" to "CRANKING"
	OFF>SLEEP		While turning BCM status from normal mode (Power supply position is "OFF".) to low power consumption mode
	LOCK>SLEEP		While turning BCM status from normal mode (Power supply position is "LOCK"*. ) to low power consumption mode
	LOCK		Power supply position is "LOCK"*
	OFF		Power supply position is "OFF" (Ignition switch OFF)
	ACC		Power supply position is "ACC" (Ignition switch ACC)
	ON		Power supply position is "IGN" (Ignition switch ON with engine stopped)
	ENGINE RUN		Power supply position is "RUN" (Ignition switch ON with engine running)
CRANKING	Power supply position is "CRANKING" (At engine cranking)		
IGN Counter	0 - 39	The number of times that ignition switch is turned ON after DTC is detected <ul style="list-style-type: none"> <li>• The number is 0 when a malfunction is detected now.</li> <li>• The number increases like 1 → 2 → 3...38 → 39 after returning to the normal condition whenever ignition switch OFF → ON.</li> <li>• The number is fixed to 39 until the self-diagnosis results are erased if it is over 39.</li> </ul>	

### NOTE:

\*: Power supply position shifts to "LOCK" from "OFF", when ignition switch is in the OFF position, selector lever is in the P position (A/T models), and any of the following conditions are met.

- Closing door
- Opening door
- Door is locked using door request switch
- Door is locked using Intelligent Key

The power supply position shifts to "ACC" when the push-button ignition switch (push switch) is pushed at "LOCK".

## WIPER

### WIPER : CONSULT Function (BCM - WIPER)

INFOID:000000010989043

### WORK SUPPORT

# DIAGNOSIS SYSTEM (BCM)

## < SYSTEM DESCRIPTION >

Service item	Setting item	Description
WIPER SPEED SETTING	On	Linked with vehicle speed (Front wiper intermittent time linked with the vehicle speed and wiper intermittent dial position)
	Off*	Not linked with vehicle speed (Front wiper intermittent time linked with the wiper intermittent dial position)

\*: Initial setting

## DATA MONITOR

### NOTE:

The following table includes information (items) inapplicable to this vehicle. For information (items) applicable to this vehicle, refer to CONSULT display items.

Monitor Item [Unit]	Description
VEH SPEED 1 [km/h]	Displays the value of the vehicle speed signal received from unified meter and A/C amp. with CAN communication.
PUSH SW [Off/On]	The switch status input from push-button ignition switch.
FR WIPER HI [Off/On]	Status of each switch judged by BCM using the combination switch reading function
FR WIPER LOW [Off/On]	
FR WASHER SW [Off/On]	
FR WIPER INT [Off/On]	
FR WIPER STOP [Off/On]	Displays the status of the front wiper stop position signal received from IPDM E/R with CAN communication.
INT VOLUME [1 – 7]	Status of each switch judged by BCM using the combination switch reading function

## ACTIVE TEST

Test item	Operation	Description
FRONT WIPER	Hi	Transmits the front wiper request signal (HI) to IPDM E/R with CAN communication to operate the front wiper HI operation.
	Lo	Transmits the front wiper request signal (LO) to IPDM E/R with CAN communication to operate the front wiper LO operation.
	INT	Transmits the front wiper request signal (INT) to IPDM E/R with CAN communication to operate the front wiper INT operation.
	Off	Stops transmitting the front wiper request signal to stop the front wiper operation.

# DIAGNOSIS SYSTEM (IPDM E/R)

< SYSTEM DESCRIPTION >

## DIAGNOSIS SYSTEM (IPDM E/R)

### Diagnosis Description

INFOID:000000011435312

#### AUTO ACTIVE TEST

##### Description

In auto active test mode, the IPDM E/R sends a drive signal to the following systems to check their operation.

- Oil pressure warning lamp
- Front wiper (LO, HI)
- Parking lamps
- License plate lamps
- Side maker lamps
- Tail lamps
- Front fog lamps
- Headlamps (LO, HI)
- A/C compressor (magnet clutch)
- Cooling fan (cooling fan control module)

##### Operation Procedure

1. Close the hood and lift the wiper arms from the windshield. (Prevent windshield damage due to wiper operation)  
**NOTE:**  
When auto active test is performed with hood opened, sprinkle water on windshield beforehand.
2. Turn the ignition switch OFF.
3. Turn the ignition switch ON, and within 20 seconds, press the front door switch (driver side) 10 times. Then turn the ignition switch OFF.  
**CAUTION:**  
**Close passenger door.**
4. Turn the ignition switch ON within 10 seconds. After that the horn sounds once and the auto active test starts.
5. The oil pressure warning lamp starts blinking when the auto active test starts.
6. After a series of the following operations is repeated 3 times, auto active test is completed.

##### NOTE:

When auto active test mode has to be cancelled halfway through test, turn the ignition switch OFF.

##### CAUTION:

- If auto active test mode cannot be actuated, check door switch system. Refer to [DLK-66](#), "[Component Function Check](#)".
- Do not start the engine.

##### Inspection in Auto Active Test Mode

When auto active test mode is actuated, the following 6 steps are repeated 3 times.

Operation sequence	Inspection location	Operation
1	Oil pressure warning lamp	Blinks continuously during operation of auto active test
2	Front wiper	LO for 5 seconds → HI for 5 seconds
3	<ul style="list-style-type: none"><li>• Parking lamps</li><li>• License plate lamps</li><li>• Side maker lamps</li><li>• Tail lamps</li><li>• Front fog lamps</li></ul>	10 seconds
4	Headlamps	LO ↔ HI 5 times
5	A/C compressor (magnet clutch)	ON ↔ OFF 5 times
6*	Cooling fan	MID for 5 seconds → HI for 5 seconds

\*: Outputs duty ratio of 50% for 5 seconds → duty ratio of 100% for 5 seconds on the cooling fan control module.

# DIAGNOSIS SYSTEM (IPDM E/R)

## < SYSTEM DESCRIPTION >

### Concept of auto active test

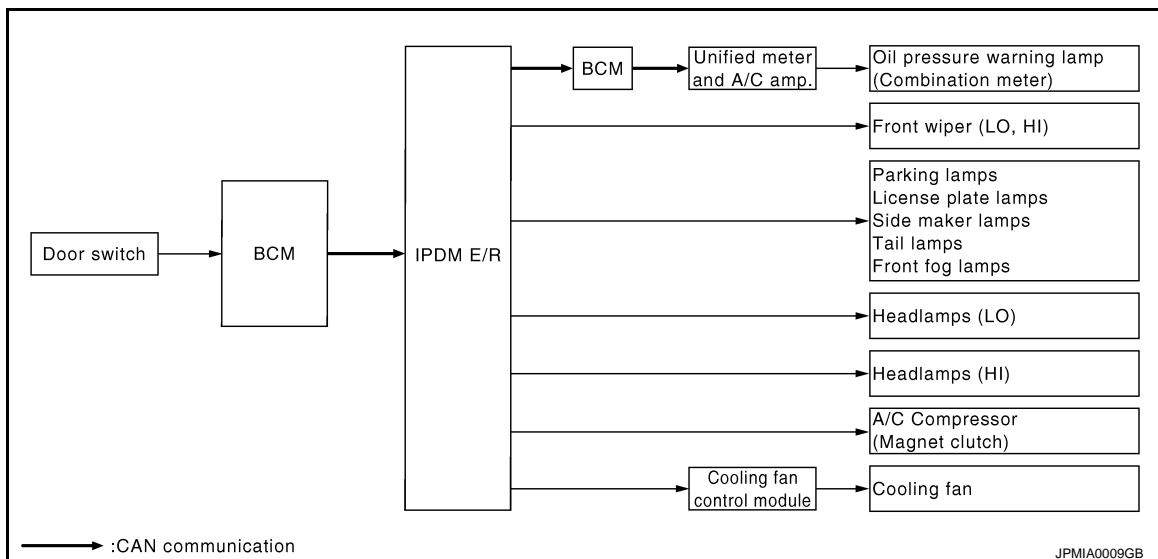

- IPDM E/R starts the auto active test with the door switch signals transmitted by BCM via CAN communication. Therefore, the CAN communication line between IPDM E/R and BCM is considered normal if the auto active test starts successfully.
- The auto active test facilitates troubleshooting if any systems controlled by IPDM E/R cannot be operated.

### Diagnosis chart in auto active test mode

Symptom	Inspection contents	Possible cause
Any of the following components do not operate <ul style="list-style-type: none"> <li>• Parking lamps</li> <li>• License plate lamps</li> <li>• Side maker lamps</li> <li>• Tail lamps</li> <li>• Front fog lamps</li> <li>• Headlamp (HI, LO)</li> <li>• Front wiper (HI, LO)</li> </ul>	Perform auto active test. Does the applicable system operate?	YES BCM signal input circuit
		NO <ul style="list-style-type: none"> <li>• Lamp or motor</li> <li>• Lamp or motor ground circuit</li> <li>• Harness or connector between IPDM E/R and applicable system</li> <li>• IPDM E/R</li> </ul>
A/C compressor does not operate	Perform auto active test. Does the magnet clutch operate?	YES <ul style="list-style-type: none"> <li>• Unified meter and A/C amp. signal input circuit</li> <li>• CAN communication signal between unified meter and A/C amp. and ECM</li> <li>• CAN communication signal between ECM and IPDM E/R</li> </ul>
		NO <ul style="list-style-type: none"> <li>• Magnet clutch</li> <li>• Harness or connector between IPDM E/R and magnet clutch</li> <li>• IPDM E/R</li> </ul>
Oil pressure warning lamp does not operate	Perform auto active test. Does the oil pressure warning lamp blink?	YES <ul style="list-style-type: none"> <li>• Harness or connector between IPDM E/R and oil pressure switch</li> <li>• Oil pressure switch</li> <li>• IPDM E/R</li> </ul>
		NO <ul style="list-style-type: none"> <li>• CAN communication signal between IPDM E/R and BCM</li> <li>• CAN communication signal between BCM and unified meter and A/C amp.</li> <li>• Combination meter</li> </ul>

# DIAGNOSIS SYSTEM (IPDM E/R)

## < SYSTEM DESCRIPTION >

Symptom	Inspection contents	Possible cause	
Cooling fan does not operate	Perform auto active test. Does the cooling fan operate?	YES	<ul style="list-style-type: none"> <li>ECM signal input circuit</li> <li>CAN communication signal between ECM and IPDM E/R</li> </ul>
		NO	<ul style="list-style-type: none"> <li>Cooling fan</li> <li>Harness or connector between cooling fan and cooling fan control module</li> <li>Cooling fan control module</li> <li>Harness or connector between IPDM E/R and cooling fan control module</li> <li>Cooling fan relay</li> <li>Harness or connector between IPDM E/R and cooling fan relay</li> <li>IPDM E/R</li> </ul>

## CONSULT Function (IPDM E/R)

INFOID:000000011435313

### APPLICATION ITEM

CONSULT performs the following functions via CAN communication with IPDM E/R.

Diagnosis mode	Description
Ecu Identification	Allows confirmation of IPDM E/R part number.
Self Diagnostic Result	Displays the diagnosis results judged by IPDM E/R.
Data Monitor	Displays the real-time input/output data from IPDM E/R input/output data.
Active Test	IPDM E/R can provide a drive signal to electronic components to check their operations.
CAN Diag Support Monitor	The results of transmit/receive diagnosis of CAN communication can be read.

### SELF DIAGNOSTIC RESULT

Refer to [PCS-32, "DTC Index"](#).

### DATA MONITOR

#### NOTE:

The following table includes information (items) inapplicable to this vehicle. For information (items) applicable to this vehicle, refer to CONSULT display items.

Monitor Item [Unit]	MAIN SIGNALS	Description
RAD FAN REQ [%]	×	Displays the value of the cooling fan speed signal received from ECM via CAN communication.
AC COMP REQ [Off/On]	×	Displays the status of the A/C compressor request signal received from ECM via CAN communication.
TAIL&CLR REQ [Off/On]	×	Displays the status of the position light request signal received from BCM via CAN communication.
HL LO REQ [Off/On]	×	Displays the status of the low beam request signal received from BCM via CAN communication.
HL HI REQ [Off/On]	×	Displays the status of the high beam request signal received from BCM via CAN communication.
FR FOG REQ [Off/On]	×	Displays the status of the front fog light request signal received from BCM via CAN communication.
FR WIP REQ [Stop/1LOW/Low/Hi]	×	Displays the status of the front wiper request signal received from BCM via CAN communication.
WIP AUTO STOP [STOP P/ACT P]	×	Displays the status of the front wiper auto stop signal judged by IPDM E/R.



# DIAGNOSIS SYSTEM (IPDM E/R)

## < SYSTEM DESCRIPTION >

Monitor Item [Unit]	MAIN SIG- NALS	Description
WIP PROT [Off/BLOCK]	×	Displays the status of the front wiper fail-safe operation judged by IPDM E/R.
IGN RLY1 -REQ [Off/On]		Displays the status of the ignition switch ON signal received from BCM via CAN communication.
IGN RLY [Off/On]	×	Displays the status of the ignition relay judged by IPDM E/R.
PUSH SW [Off/On]		Displays the status of the push-button ignition switch judged by IPDM E/R.
INTER/NP SW [Off/On]		Displays the status of the shift position judged by IPDM E/R.
ST RLY CONT [Off/On]		Displays the status of the starter relay status signal received from BCM via CAN communication.
IHBT RLY -REQ [Off/On]		Displays the status of the starter control relay signal received from BCM via CAN communication.
ST/INHI RLY [Off/ ST ON/INHI ON/UNKWN]		Displays the status of the starter relay and starter control relay judged by IPDM E/R.
DETENT SW [Off/On]		Displays the status of the A/T shift selector (detention switch) judged by IPDM E/R.
S/L RLY -REQ [Off/On]		<b>NOTE:</b> The item is indicated, but not monitored.
S/L STATE [LOCK/UNLOCK/UNKWN]		<b>NOTE:</b> The item is indicated, but not monitored.
DTRL REQ [Off/On]		<b>NOTE:</b> The item is indicated, but not monitored.
OIL P SW [Open/Close]		Displays the status of the oil pressure switch judged by IPDM E/R.
HOOD SW [Off/On]		Displays the status of the hood switch judged by IPDM E/R.
HL WASHER REQ [Off/On]		<b>NOTE:</b> The item is indicated, but not monitored.
THFT HRN REQ [Off/On]		Displays the status of the theft warning horn request signal received from BCM via CAN communication.
HORN CHIRP [Off/On]		Displays the status of the horn reminder signal received from BCM via CAN communication.
CRNRNG LMP REQ [Off/On]		<b>NOTE:</b> The item is indicated, but not monitored.

## ACTIVE TEST

Test item	Operation	Description
CORNERING LAMP	Off	<b>NOTE:</b> The item is indicated, but cannot be tested.
	LH	
	RH	
HORN	On	Operates horn relay 1 and horn relay 2 for 20 ms.
FRONT WIPER	Off	OFF
	Lo	Operates the front wiper relay.
	Hi	Operates the front wiper relay and front wiper high relay.

## DIAGNOSIS SYSTEM (IPDM E/R)

### < SYSTEM DESCRIPTION >

Test item	Operation	Description
MOTOR FAN	1	OFF
	2	Outputs 50% pulse duty signal (PWM signal) to the cooling fan control module.
	3	Outputs 80% pulse duty signal (PWM signal) to the cooling fan control module.
	4	Outputs 100% pulse duty signal (PWM signal) to the cooling fan control module.
HEAD LAMP WASHER	On	<b>NOTE:</b> The item is indicated, but cannot be tested.
EXTERNAL LAMPS	Off	OFF
	TAIL	Operates the tail lamp relay.
	Lo	Operates the headlamp low relay.
	Hi	Operates the headlamp low relay and ON/OFF the headlamp high relay at 1 second intervals.
	Fog	Operates the front fog lamp relay.

# WIPER AND WASHER FUSE

< DTC/CIRCUIT DIAGNOSIS >

## DTC/CIRCUIT DIAGNOSIS

### WIPER AND WASHER FUSE

#### Diagnosis Procedure

INFOID:0000000010989046

#### 1. CHECK FUSES

Check that the following fuses are not fusing.

Unit	Location	Fuse No.	Capacity
Front wiper motor	IPDM E/R	#60	30 A
Washer pump	IPDM E/R	#47	10 A

Is the fuse fusing?

- YES >> Replace the fuse with a new one after repairing the applicable circuit.
- NO >> The fuse is normal.

A  
B  
C  
D  
E  
F  
G  
H  
I  
J  
K  
M  
N  
O  
P

WW

# FRONT WIPER MOTOR LO CIRCUIT

< DTC/CIRCUIT DIAGNOSIS >

## FRONT WIPER MOTOR LO CIRCUIT

### Component Function Check

INFOID:000000010989047

#### 1. CHECK FRONT WIPER LO OPERATION

##### IPDM E/R AUTO ACTIVE TEST

1. Start IPDM E/R auto active test. Refer to [PCS-9, "Diagnosis Description"](#).
2. Check that the front wiper operates at the LO operation.

##### CONSULT ACTIVE TEST

1. Select "FRONT WIPER" of IPDM E/R active test item.
2. With operating the test item, check front wiper operation.

**Lo** : Front wiper (LO) operation

**Off** : Stop the front wiper.

##### Is front wiper (LO) operation normally?

- YES >> Front wiper motor LO circuit is normal.  
NO >> Refer to [WW-20, "Diagnosis Procedure"](#).

### Diagnosis Procedure

INFOID:000000010989048

#### 1. CHECK FRONT WIPER MOTOR (LO) OUTPUT VOLTAGE

1. Turn the ignition switch OFF, and wait for 20 seconds or more.
2. Disconnect front wiper motor connector.
3. Turn the ignition switch ON, and wait for 10 seconds.
4. Check voltage between IPDM E/R harness connector and ground.

Terminals		Ground	Voltage (Approx.)
(+)	(-)		
IPDM E/R		Ground	Battery voltage (10 seconds*)
Connector	Terminal		
E5	4		

\*: According to front wiper protection function, IPDM E/R supplies voltage for 10 seconds (battery voltage) and then stops for 20 seconds (0 V). This operation repeats 5 times, and then IPDM E/R stops voltage supply. To perform the check again, turn ignition switch OFF, wait for 20 seconds or more, and then perform the check.

##### Is the measurement value normal?

- YES >> GO TO 2.  
NO >> Replace IPDM E/R.

#### 2. CHECK FRONT WIPER MOTOR (LO) OPEN CIRCUIT

1. Turn the ignition switch OFF.
2. Disconnect IPDM E/R connector.
3. Check continuity between IPDM E/R harness connector and front wiper motor harness connector.

IPDM E/R		Front wiper motor		Continuity
Connector	Terminal	Connector	Terminal	
E5	4	E42	1	Existed

##### Does continuity exist?

- YES >> GO TO 3.  
NO >> Repair the harness or connector.

#### 3. CHECK FRONT WIPER MOTOR (LO) SHORT CIRCUIT

Check continuity between IPDM E/R harness connector and ground.

# FRONT WIPER MOTOR LO CIRCUIT

## < DTC/CIRCUIT DIAGNOSIS >

IPDM E/R		Ground	Continuity
Connector	Terminal		
E5	4		Not existed

### Does continuity exist?

YES >> Repair the harness or connector.

NO >> Replace front wiper motor.

A

B

C

D

E

F

G

H

I

J

K

WW

M

N

O

P

# FRONT WIPER MOTOR HI CIRCUIT

< DTC/CIRCUIT DIAGNOSIS >

## FRONT WIPER MOTOR HI CIRCUIT

### Component Function Check

INFOID:000000010989049

#### 1. CHECK FRONT WIPER HI OPERATION

##### ⊗ IPDM E/R AUTO ACTIVE TEST

1. Start IPDM E/R auto active test. Refer to [PCS-9, "Diagnosis Description"](#).
2. Check that the front wiper operates at the HI operation.

##### Ⓟ CONSULT ACTIVE TEST

1. Select "FRONT WIPER" of IPDM E/R active test item.
2. With operating the test item, check front wiper operation.

**Hi** : Front wiper (HI) operation

**Off** : Stop the front wiper.

Is front wiper (HI) operation normally?

YES >> Front wiper motor HI circuit is normal.

NO >> Refer to [WW-22, "Diagnosis Procedure"](#).

### Diagnosis Procedure

INFOID:000000010989050

#### 1. CHECK FRONT WIPER MOTOR (HI) OUTPUT VOLTAGE

##### Ⓟ CONSULT ACTIVE TEST

1. Turn the ignition switch OFF, and wait for 20 seconds or more.
2. Disconnect front wiper motor connector.
3. Turn the ignition switch ON.
4. Select "FRONT WIPER" of IPDM E/R active test item.
5. With operating the test item, check voltage between IPDM E/R harness connector and ground.

Terminals		Test item	Voltage (Approx.)
(+)	(-)		
IPDM E/R		FRONT WIPER	Battery voltage (10 seconds*)
Connector	Terminal		
E5	5	Hi	

\*: According to front wiper protection function, IPDM E/R supplies voltage for 10 seconds (battery voltage) and then stops for 20 seconds (0 V). This operation repeats 5 times, and then IPDM E/R stops voltage supply. To perform the check again, turn ignition switch OFF, wait for 20 seconds or more, and then perform the check.

Is the measurement value normal?

YES >> GO TO 2.

NO >> Replace IPDM E/R.

#### 2. CHECK FRONT WIPER MOTOR (HI) OPEN CIRCUIT

1. Turn the ignition switch OFF.
2. Disconnect IPDM E/R connector.
3. Check continuity between IPDM E/R harness connector and front wiper motor harness connector.

IPDM E/R		Front wiper motor		Continuity
Connector	Terminal	Connector	Terminal	
E5	5	E42	4	Existed

Does continuity exist?

YES >> GO TO 3.

NO >> Repair the harness or connector.

#### 3. CHECK FRONT WIPER MOTOR (HI) SHORT CIRCUIT

# FRONT WIPER MOTOR HI CIRCUIT

## < DTC/CIRCUIT DIAGNOSIS >

Check continuity between IPDM E/R harness connector and ground.

IPDM E/R		Ground	Continuity
Connector	Terminal		
E5	5		Not existed

### Does continuity exist?

- YES >> Repair the harness or connector.
- NO >> Replace front wiper motor.

A

B

C

D

E

F

G

H

I

J

K

WW

M

N

O

P

# FRONT WIPER STOP POSITION SIGNAL CIRCUIT

< DTC/CIRCUIT DIAGNOSIS >

## FRONT WIPER STOP POSITION SIGNAL CIRCUIT

### Component Function Check

INFOID:000000010989051

#### 1.CHECK FRONT WIPER STOP POSITION SIGNAL

##### CONSULT DATA MONITOR

1. Select "WIP AUTO STOP" of IPDM E/R data monitor item.
2. Operate the front wiper.
3. With the front wiper operation, check the monitor status.

Monitor item	Condition		Monitor status
WIP AUTO STOP	Front wiper motor	Stop position	STOP P
		Except stop position	ACT P

##### Is the status of item normal?

- YES >> front wiper stop position signal circuit is normal.  
NO >> Refer to [WW-24, "Diagnosis Procedure"](#).

### Diagnosis Procedure

INFOID:000000010989052

#### 1.CHECK FRONT WIPER MOTOR OUTPUT VOLTAGE

1. Turn the ignition switch OFF.
2. Disconnect front wiper motor connector.
3. Turn the ignition switch ON.
4. Check voltage between IPDM E/R harness connector and ground.

Terminals		Voltage (Approx.)
(+)	(-)	
IPDM E/R		Battery voltage
Connector	Terminal	
E5	16	

##### Is the measurement value normal?

- YES >> GO TO 3.  
NO >> GO TO 2.

#### 2.CHECK FRONT WIPER MOTOR SHORT CIRCUIT

1. Turn the ignition switch OFF.
2. Disconnect IPDM E/R connector.
3. Check continuity between IPDM E/R harness connector and ground.

IPDM E/R		Ground	Continuity
Connector	Terminal		
E5	16		Not existed

##### Does continuity exist?

- YES >> Repair the harnesses or connectors.  
NO >> Replace IPDM E/R.

#### 3.CHECK FRONT WIPER MOTOR CIRCUIT CONTINUITY

Check continuity between IPDM E/R harness connector and front wiper motor harness connector.

IPDM E/R		Front wiper motor		Continuity
Connector	Terminal	Connector	Terminal	
E5	16	E42	5	Existed



# FRONT WIPER STOP POSITION SIGNAL CIRCUIT

< DTC/CIRCUIT DIAGNOSIS >

---

Does continuity exist?

YES >> Replace front wiper motor.

NO >> Repair the harnesses or connectors.

A

B

C

D

E

F

G

H

I

J

K

WW

M

N

O

P

# FRONT WIPER MOTOR GROUND CIRCUIT

< DTC/CIRCUIT DIAGNOSIS >

## FRONT WIPER MOTOR GROUND CIRCUIT

### Diagnosis Procedure

INFOID:000000010989053

#### 1. CHECK FRONT WIPER MOTOR (GND) OPEN CIRCUIT

1. Turn the ignition switch OFF.
2. Disconnect front wiper motor connector.
3. Check continuity between front wiper motor harness connector and ground.

Front wiper motor		Ground	Continuity
Connector	Terminal		Existed
E42	2		

#### Does continuity exist?

- YES >> Front wiper motor ground circuit is normal.  
NO >> Repair the harnesses or connectors.

# WASHER SWITCH

< DTC/CIRCUIT DIAGNOSIS >

## WASHER SWITCH

### Description

INFOID:000000010989054

Washer switch is integrated with combination switch.

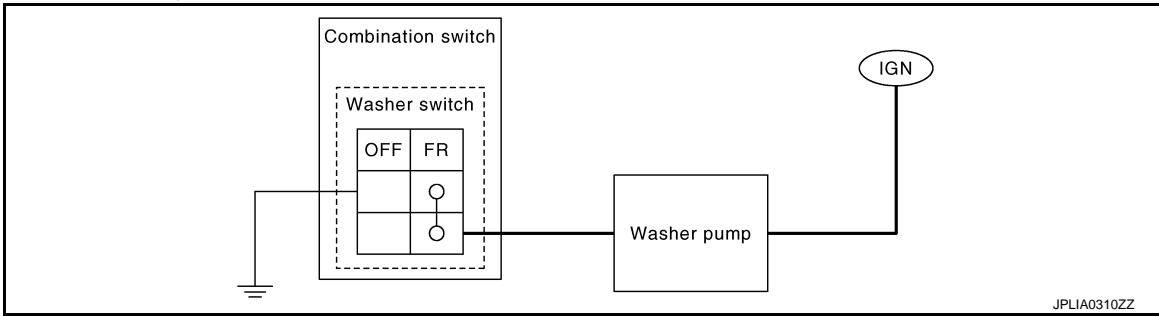

### Component Inspection

INFOID:000000010989055

#### 1. CHECK WIPER SWITCH

1. Turn the ignition switch OFF.
2. Disconnect combination switch connector.
3. Check continuity between the combination switch terminals.

Combination switch		Condition	Continuity
Terminal			
1	6	Front washer switch ON	Existed

#### Does continuity exist?

- YES >> Wiper and washer switch is normal.  
 NO >> Replace wiper and washer switch.

A  
B  
C  
D  
E  
F  
G  
H  
I  
J  
K  
L  
M  
N  
O  
P

WW

# FRONT WIPER AND WASHER SYSTEM

< DTC/CIRCUIT DIAGNOSIS >

## FRONT WIPER AND WASHER SYSTEM

Wiring Diagram - FRONT WIPER AND WASHER SYSTEM -

INFOID:000000010989058

### FRONT WIPER AND WASHER SYSTEM

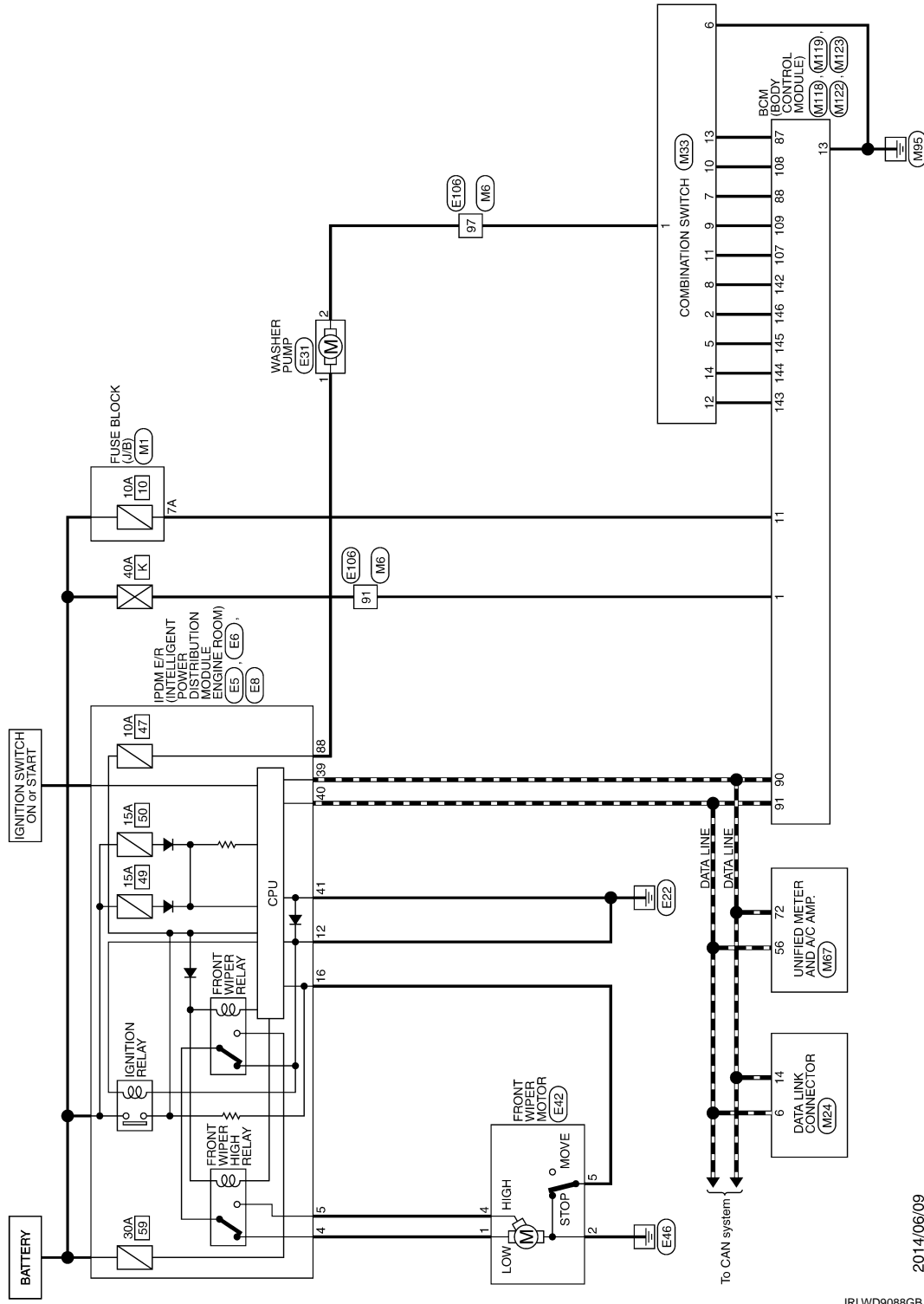

2014/06/09

JRLWD9088GB

# FRONT WIPER AND WASHER SYSTEM

## < DTC/CIRCUIT DIAGNOSIS >

### FRONT WIPER AND WASHER SYSTEM

Connector No.	E5		
Connector Name	IPWLS (INTELLIGENT POWER DISTRIBUTION MODULE ENGINE ROOM)		
Connector Type	TH88FW-C512-1M4-1V		

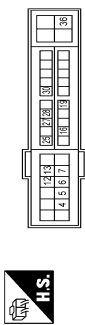

Terminal No.	Color Of Wire	Signal Name [Specification]
4	V	
8	SB	
7	P	
12	B/W	
13	Y	
16	LG	
19	R	
25	G	
27	EG	
28	L	
30	GR	
36	G	

Connector No.	E6		
Connector Name	IPWLS (INTELLIGENT POWER DISTRIBUTION MODULE ENGINE ROOM)		
Connector Type	TH88FW-4H		

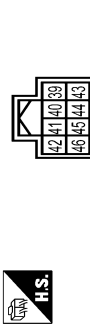

Terminal No.	Color Of Wire	Signal Name [Specification]
42	L	
41	B/W	
40	GR	
39	G	
46	LG	
45	L	
44	LG	

Terminal No.	45	V	
Terminal No.	46	SB	

Connector No.	E8		
Connector Name	IPWLS (INTELLIGENT POWER DISTRIBUTION MODULE ENGINE ROOM)		
Connector Type	NS50FW-C5		



Terminal No.	Color Of Wire	Signal Name [Specification]
83	R	
84	V	
86	W	
87	L	
88	G	
89	BR	
90	P	

Connector No.	E31		
Connector Name	WASHER PUMP		
Connector Type	ED5FCY-RS		



Terminal No.	Color Of Wire	Signal Name [Specification]
1	G	
2	SB	

Connector No.	E42		
Connector Name	FRONT WIPER MOTOR		
Connector Type	HS5BFCY		



Terminal No.	Color Of Wire	Signal Name [Specification]
1	V	
2	B/W	
5	LG	

Connector No.	E106		
Connector Name	WIRE TO WIRE		
Connector Type	TH88FW-C51E-TM4		



Terminal No.	Color Of Wire	Signal Name [Specification]
1	GR	
3	EG	
5	G	
6	Y	
7	V	
9	R	
11	V	
12	R	
13	L	
15	GR	
16	W	
17	SB	
18	EG	
20	LG	

31	L
32	EG
33	SB
37	Y
38	R
39	B
41	R
42	LG
43	G
44	GR
45	BR
46	LG
47	V
48	P
49	GR
56	GR
80	G
81	R
82	G
83	V
84	L
85	W
89	V
91	W
93	GR
95	LG
97	SB
98	SHIELD
99	L
100	P

Connector No.	M1
Connector Name	FUSE BLOCK (J/B)
Connector Type	NS50FW-AZ



A  
B  
C  
D  
E  
F  
G  
H  
I  
J  
K  
M  
N  
O  
P

WW

# FRONT WIPER AND WASHER SYSTEM

## < DTC/CIRCUIT DIAGNOSIS >

### FRONT WIPER AND WASHER SYSTEM

Terminal No.	Color Of Wire	Signal Name [Specification]
1A	V	-
2A	G	-
3A	L	-
4A	P	-
5A	R	-
6A	Y	-
7A	R	-
8A	L	-

Connector No.	M16
Connector Name	WIRE TO WIRE
Connector Type	TH808MP-CS16-TM4



Terminal No.	Color Of Wire	Signal Name [Specification]
1	BG	-
3	R	-
8	G	-
7	W	-
9	G	-
11	V	-
12	R	-
13	L	-
14	GR	-
15	P	-
16	W	-
17	BR	-
18	P	-
20	L	-
31	V	-
32	R	-
37	R	-
38	R	-
39	SB	-
41	V	-
42	LG	-
43	P	-

Terminal No.	Color Of Wire	Signal Name [Specification]
44	B	-
45	BG	-
46	CG	-
47	L	-
48	P	-
49	L	-
65	Y	-
67	G	-
80	SB	-
81	B	-
82	V	-
83	W	-
84	L	-
85	GR	-
86	LG	-
87	Y	-
88	Y	-
89	V	-
99	V	-
100	SB	-

Connector No.	M24
Connector Name <td>DATA LINK CONNECTOR</td>	DATA LINK CONNECTOR
Connector Type <td>BD16FW-P</td>	BD16FW-P

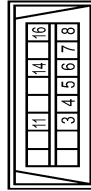

Terminal No.	Color Of Wire	Signal Name [Specification]
3	LG	-
4	B	-
5	B	-
6	L	-
8	G	-
11	SB	-
14	P	-
16	R	-

Connector No.	M33
Connector Name <td>COMBINATION SWITCH</td>	COMBINATION SWITCH
Connector Type <td>TH832FW-NH</td>	TH832FW-NH

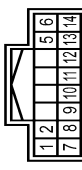

Terminal No.	Color Of Wire	Signal Name [Specification]
1	GR	FR WIPER (-)
2	SB	OUTPUT 2
5	SB	OUTPUT 3
6	B	GROUND
7	BG	INPUT 3
8	BR	OUTPUT 5
9	W	INPUT 2
10	R	INPUT 4
11	LG	INPUT 1
12	P	OUTPUT 1
13	Y	INPUT 5
14	G	OUTPUT 2

Connector No.	M67
Connector Name <td>UNIFIED METER AND A/C AMP.</td>	UNIFIED METER AND A/C AMP.
Connector Type <td>TH832FW-NH</td>	TH832FW-NH

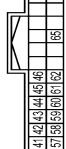

Terminal No.	Color Of Wire	Signal Name [Specification]
41	W	ACC POWER SUPPLY
42	BR	FUEL LEVEL SENSOR SIGNAL
43	BR	INTAKE SENSOR SIGNAL
44	LG	IN-VEHICLE SENSOR SIGNAL
45	V	AMBIENT SENSOR SIGNAL
46	Y	SUNLOAD SENSOR SIGNAL
53	W	IGNITION POWER SUPPLY
54	SB	BATTERY POWER SUPPLY

Terminal No.	Color Of Wire	Signal Name [Specification]
59	B	GROUND
59	B	GROUND
59	LG	BRAKE FLUID LEVEL SWITCH
58	Y	FUEL LEVEL SENSOR GROUND
59	GR	INTAKE SENSOR GROUND
60	W	IN-VEHICLE SENSOR GROUND
61	B	AMBIENT SENSOR GROUND
62	SB	SUNLOAD SENSOR GROUND
65	BG	ECV SIGNAL
69	P	A/C LAN SIGNAL
70	R	EACH DOOR MOTOR POWER SUPPLY
71	GR	GROUND
72	P	CAN-L

Connector No.	M118
Connector Name <td>BCM (BODY CONTROL MODULE)</td>	BCM (BODY CONTROL MODULE)
Connector Type <td>M03FB-LG</td>	M03FB-LG



Terminal No.	Color Of Wire	Signal Name [Specification]
1	W	BAT (+L)
2	Y	POWER WINDOW POWER SUPPLY (BAT)
3	BG	POWER WINDOW POWER SUPPLY (BAP)

Connector No.	M119
Connector Name <td>BCM (BODY CONTROL MODULE)</td>	BCM (BODY CONTROL MODULE)
Connector Type <td>NS16FW-CS</td>	NS16FW-CS



# FRONT WIPER AND WASHER SYSTEM

## < DTC/CIRCUIT DIAGNOSIS >

### FRONT WIPER AND WASHER SYSTEM

Terminal No.	Color Of Wire	Signal Name [Specification]
1	GR	INTERIOR ROOM LAMP POWER SUPPLY
5	LG	PASSENGER DOOR UNLOCK OUTPUT
7	SB	STEER LAMP CONT
8	V	ALL DOOR FUEL LID LOCK OUTPUT
9	G	DRIVER DOOR FUEL LID UNLOCK OUTPUT
10	P	REAR DOOR UNLOCK OUTPUT
11	R	BAT (FUSE)
13	B	GROUND
14	W	PUSH-BUTTON IGNITION SW ILL GND
15	BG	ACC IND
17	W	TURN SIGNAL RH (FRONT)
18	BG	TURN SIGNAL LH (FRONT)
19	V	INT ROOM LAMP CONT

Connector No.	MT22
Connector Name	BCM (BODY CONTROL MODULE)
Connector Type	TH407B-NH



Terminal No.	Color Of Wire	Signal Name [Specification]
72	R	ROOM ANT 2-
73	G	ROOM ANT 2+
74	SB	PASSENGER DOOR ANT-
75	BR	PASSENGER DOOR ANT+
76	V	DRIVER DOOR ANT-
77	LG	DRIVER DOOR ANT+
78	Y	ROOM ANT 1-
79	BR	ROOM ANT 1+
80	GR	NATS ANT AMP
81	W	NATS ANT AMP
82	SB	IGN RELAY (F-B) CONT
83	Y	KEYLESS ENTRY RECEIVER COMM
84	Y	COMPONENT 1
85	BG	COMBI SW INPUT 3
86	P	CAN-H
81	L	CAN-H
92	LG	KEY SLOT ILL CONT
93	GR	ON IND
95	BG	ACC RELAY CONT

96	GR	A/T SHIFT SELECTOR POWER SUPPLY
98	R	STOP LAMP REQUEST SW
99	R	PASSENGER DOOR REQUEST SW
101	P	DRIVER DOOR REQUEST SW
102	BG	BLOWER FAN MOTOR RELAY CONT
103	P	KEYLESS ENTRY RECEIVER POWER SUPPLY
107	LG	COMBI SW INPUT 1
108	R	COMBI SW INPUT 4
109	W	COMBI SW INPUT 2
110	G	HAZARD SW

Connector No.	MT23
Connector Name	BCM (BODY CONTROL MODULE)
Connector Type	TH407G-NH



Terminal No.	Color Of Wire	Signal Name [Specification]
113	BG	OPTICAL SENSOR
116	SB	STOP LAMP SW 1
118	BR	STOP LAMP SW 2
119	SB	DR DOOR LOCK SENSOR
121	SB	REAR LOCK SW
123	V	REAR F/B
124	R	PASSENGER DOOR SW
129	BG	TRUNK LID OPENER CANCEL SW
132	V	POWER WINDOW SW COMM
133	L	PUSH-BUTTON IGNITION SW ILL POWER
134	LG	LOCK IND
137	BG	RECEIVER / SENSOR GND
138	V	RECEIVER / SENSOR POWER SUPPLY
139	L	TIRE PRESSURE RECEIVER COMM
140	B	SHIFT N/P
141	W	SECURITY IND LAMP CONT
142	BR	COMBI SW OUTPUT 5
143	W	COMBI SW OUTPUT 1
144	C	COMBI SW OUTPUT 2
145	L	COMBI SW OUTPUT 3
146	SB	COMBI SW OUTPUT 4
150	GR	DRIVER DOOR SW
151	G	REAR WINDOW DEFROGGER RELAY CONT

A  
B  
C  
D  
E  
F  
G  
H  
I  
J  
K  
M  
N  
O  
P

WW

JRLWD9189GB

# BCM (BODY CONTROL MODULE)

< ECU DIAGNOSIS INFORMATION >

## ECU DIAGNOSIS INFORMATION

### BCM (BODY CONTROL MODULE)

#### Reference Value

INFOID:0000000011405324

#### VALUES ON THE DIAGNOSIS TOOL

**NOTE:**

The following table includes information (items) inapplicable to this vehicle. For information (items) applicable to this vehicle, refer to CONSULT display items.

CONSULT MONITOR ITEM

Monitor Item	Condition	Value/Status
FR WIPER HI	Other than front wiper switch HI	Off
	Front wiper switch HI	On
FR WIPER LOW	Other than front wiper switch LO	Off
	Front wiper switch LO	On
FR WASHER SW	Front washer switch OFF	Off
	Front washer switch ON	On
FR WIPER INT	Other than front wiper switch INT/AUTO	Off
	Front wiper switch INT/AUTO	On
FR WIPER STOP	Front wiper is not in STOP position	Off
	Front wiper is in STOP position	On
INT VOLUME	Wiper volume dial is in a dial position 1 - 7	Wiper volume dial position
TURN SIGNAL R	Other than turn signal switch RH	Off
	Turn signal switch RH	On
TURN SIGNAL L	Other than turn signal switch LH	Off
	Turn signal switch LH	On
TAIL LAMP SW	Other than lighting switch 1ST and 2ND	Off
	Lighting switch 1ST or 2ND	On
HI BEAM SW	Other than lighting switch HI	Off
	Lighting switch HI	On
HEAD LAMP SW 1	Other than lighting switch 2ND	Off
	Lighting switch 2ND	On
HEAD LAMP SW 2	Other than lighting switch 2ND	Off
	Lighting switch 2ND	On
PASSING SW	Other than lighting switch PASS	Off
	Lighting switch PASS	On
AUTO LIGHT SW	Other than lighting switch AUTO	Off
	Lighting switch AUTO	On
FR FOG SW	Front fog lamp switch OFF	Off
	Front fog lamp switch ON	On
RR FOG SW	<b>NOTE:</b> The item is indicated, but not monitored.	Off
DOOR SW-DR	Driver door closed	Off
	Driver door opened	On
DOOR SW-AS	Passenger door closed	Off
	Passenger door opened	On



## BCM (BODY CONTROL MODULE)

### < ECU DIAGNOSIS INFORMATION >

Monitor Item	Condition	Value/Status	
DOOR SW-RR	Rear RH door closed	Off	A
	Rear LH door opened	On	
DOOR SW-RL	Rear LH door closed	Off	B
	Rear LH door opened	On	
DOOR SW-BK	<b>NOTE:</b> The item is indicated, but not monitored.	Off	C
CDL LOCK SW	Other than power door lock switch LOCK	Off	
	Power door lock switch LOCK	On	D
CDL UNLOCK SW	Other than power door lock switch UNLOCK	Off	
	Power door lock switch UNLOCK	On	D
KEY CYL LK-SW	Other than driver door key cylinder LOCK	Off	E
	Driver door key cylinder LOCK	On	
KEY CYL UN-SW	Other than driver door key cylinder UNLOCK	Off	F
	Driver door key cylinder LOCK	On	F
KEY CYL SW-TR	<b>NOTE:</b> The item is indicated, but not monitored.	Off	
HAZARD SW	Hazard switch is OFF	Off	G
	Hazard switch is ON	On	
REAR DEF SW	<b>NOTE:</b> The item is indicated, but not monitored.	Off	H
TR CANCEL SW	Trunk lid opener cancel switch OFF	Off	
	Trunk lid opener cancel switch ON	On	I
TR/BD OPEN SW	Trunk lid opener switch OFF	Off	
	While the trunk lid opener switch is turned ON	On	J
TRNK/HAT MNTR	Trunk lid closed	Off	
	Trunk lid opened	On	J
REVERSE SW	<b>NOTE:</b> The item is indicated, but not monitored.	Off	K
RKE-LOCK	LOCK button of the Intelligent Key is not pressed	Off	
	LOCK button of the Intelligent Key is pressed	On	WW
RKE-UNLOCK	UNLOCK button of the Intelligent Key is not pressed	Off	
	UNLOCK button of the Intelligent Key is pressed	On	
RKE-TR/BD	TRUNK OPEN button of the Intelligent Key is not pressed	Off	M
	TRUNK OPEN button of the Intelligent Key is pressed	On	
RKE-PANIC	PANIC button of the Intelligent Key is not pressed	Off	N
	PANIC button of the Intelligent Key is pressed	On	
RKE-P/W OPEN	UNLOCK button of the Intelligent Key is not pressed	Off	
	UNLOCK button of the Intelligent Key is pressed and held	On	O
RKE-MODE CHG	LOCK/UNLOCK button of the Intelligent Key is not pressed and held simultaneously	Off	
	LOCK/UNLOCK button of the Intelligent Key is pressed and held simultaneously	On	P
OPTICAL SENSOR	Bright outside of the vehicle	Close to 5 V	
	Dark outside of the vehicle	Close to 0 V	
REQ SW -DR	Driver door request switch is not pressed	Off	
	Driver door request switch is pressed	On	

## BCM (BODY CONTROL MODULE)

### < ECU DIAGNOSIS INFORMATION >

Monitor Item	Condition	Value/Status
REQ SW -AS	Passenger door request switch is not pressed	Off
	Passenger door request switch is pressed	On
REQ SW -RR	<b>NOTE:</b> The item is indicated, but not monitored.	Off
REQ SW -RL	<b>NOTE:</b> The item is indicated, but not monitored.	Off
REQ SW -BD/TR	Trunk lid opener request switch is not pressed	Off
	Trunk lid opener request switch is pressed	On
PUSH SW	Push-button ignition switch (push switch) is not pressed	Off
	Push-button ignition switch (push switch) is pressed	On
IGN RLY2 -F/B	<b>NOTE:</b> The item is indicated, but not monitored.	Off
ACC RLY -F/B	<b>NOTE:</b> The item is indicated, but not monitored.	Off
CLUCH SW	<b>NOTE:</b> The item is indicated, but not monitored.	Off
BRAKE SW 1	The brake pedal is depressed when No. 7 fuse is blown	Off
	The brake pedal is not depressed when No. 7 fuse is blown, or No. 7 fuse is normal	On
BRAKE SW 2	The brake pedal is not depressed	Off
	The brake pedal is depressed	On
DETE/CANCL SW	Selector lever in P position	Off
	Selector lever in any position other than P	On
SFT PN/N SW	Selector lever in any position other than P and N	Off
	Selector lever in P or N position	On
S/L -LOCK	<b>NOTE:</b> The item is indicated, but not monitored.	Off
S/L -UNLOCK	<b>NOTE:</b> The item is indicated, but not monitored.	Off
S/L RELAY-F/B	<b>NOTE:</b> The item is indicated, but not monitored.	Off
UNLK SEN -DR	Driver door is unlocked	Off
	Driver door is locked	On
PUSH SW -IPDM	Push-button ignition switch (push-switch) is not pressed	Off
	Push-button ignition switch (push-switch) is pressed	On
IGN RLY1 -F/B	Ignition switch in OFF or ACC position	Off
	Ignition switch in ON position	On
DETE SW -IPDM	Selector lever in any position other than P	Off
	Selector lever in P position	On
SFT PN -IPDM	Selector lever in any position other than P and N	Off
	Selector lever in P or N position	On
SFT P -MET	Selector lever in any position other than P	Off
	Selector lever in P position	On
SFT N -MET	Selector lever in any position other than N	Off
	Selector lever in N position	On

## BCM (BODY CONTROL MODULE)

### < ECU DIAGNOSIS INFORMATION >

Monitor Item	Condition	Value/Status	
ENGINE STATE	Engine stopped	Stop	A
	While the engine stalls	Stall	
	At engine cranking	Crank	B
	Engine running	Run	
S/L LOCK-IPDM	<b>NOTE:</b> The item is indicated, but not monitored.	Off	C
S/L UNLK-IPDM	<b>NOTE:</b> The item is indicated, but not monitored.	Off	
S/L RELAY-REQ	<b>NOTE:</b> The item is indicated, but not monitored.	Off	D
VEH SPEED 1	While driving	Equivalent to speedometer reading	E
VEH SPEED 2	While driving	Equivalent to speedometer reading	
DOOR STAT-DR	Driver door is locked	LOCK	F
	Wait with selective UNLOCK operation (60 seconds)	READY	
	Driver door is unlocked	UNLOCK	G
DOOR STAT-AS	Passenger door is locked	LOCK	H
	Wait with selective UNLOCK operation (60 seconds)	READY	
	Passenger door is unlocked	UNLOCK	I
ID OK FLAG	Driver side door is open after ignition switch is turned OFF (Shift position is in the P position)	Reset	
	Ignition switch ON	Set	I
PRMT ENG STRT	The engine start is prohibited	Reset	J
	The engine start is permitted	Set	
PRMT RKE STRT	<b>NOTE:</b> The item is indicated, but not monitored.	Reset	
KEY SW -SLOT	The Intelligent Key is not inserted into key slot	Off	K
	The Intelligent Key is inserted into key slot	On	
RKE OPE COUN1	During the operation of the Intelligent Key	Operation frequency of the Intelligent Key	WW
RKE OPE COUN2	<b>NOTE:</b> The item is indicated, but not monitored.	—	
CONFIRM ID ALL	The key ID that the key slot receives is not recognized by any key ID registered to BCM.	Yet	M
	The key ID that the key slot receives is recognized by any key ID registered to BCM.	Done	
CONFIRM ID4	The key ID that the key slot receives is not recognized by the fourth key ID registered to BCM.	Yet	N
	The key ID that the key slot receives is recognized by the fourth key ID registered to BCM.	Done	O
CONFIRM ID3	The key ID that the key slot receives is not recognized by the third key ID registered to BCM.	Yet	
	The key ID that the key slot receives is recognized by the third key ID registered to BCM.	Done	P
CONFIRM ID2	The key ID that the key slot receives is not recognized by the second key ID registered to BCM.	Yet	
	The key ID that the key slot receives is recognized by the second key ID registered to BCM.	Done	

## BCM (BODY CONTROL MODULE)

### < ECU DIAGNOSIS INFORMATION >

Monitor Item	Condition	Value/Status
CONFIRM ID1	The key ID that the key slot receives is not recognized by the first key ID registered to BCM.	Yet
	The key ID that the key slot receives is recognized by the first key ID registered to BCM.	Done
TP 4	The ID of fourth Intelligent Key is not registered to BCM	Yet
	The ID of fourth Intelligent Key is registered to BCM	Done
TP 3	The ID of third Intelligent Key is not registered to BCM	Yet
	The ID of third Intelligent Key is registered to BCM	Done
TP 2	The ID of second Intelligent Key is not registered to BCM	Yet
	The ID of second Intelligent Key is registered to BCM	Done
TP 1	The ID of first Intelligent Key is not registered to BCM	Yet
	The ID of first Intelligent Key is registered to BCM	Done
AIR PRESS FL	Ignition switch ON (Only when the signal from the transmitter is received)	Air pressure of front LH tire
AIR PRESS FR	Ignition switch ON (Only when the signal from the transmitter is received)	Air pressure of front RH tire
AIR PRESS RR	Ignition switch ON (Only when the signal from the transmitter is received)	Air pressure of rear RH tire
AIR PRESS RL	Ignition switch ON (Only when the signal from the transmitter is received)	Air pressure of rear LH tire
ID REGST FL1	ID of front LH tire transmitter is registered	Done
	ID of front LH tire transmitter is not registered	Yet
ID REGST FR1	ID of front RH tire transmitter is registered	Done
	ID of front RH tire transmitter is not registered	Yet
ID REGST RR1	ID of rear RH tire transmitter is registered	Done
	ID of rear RH tire transmitter is not registered	Yet
ID REGST RL1	ID of rear LH tire transmitter is registered	Done
	ID of rear LH tire transmitter is not registered	Yet
WARNING LAMP	Tire pressure indicator OFF	Off
	Tire pressure indicator ON	On
BUZZER	Tire pressure warning alarm is not sounding	Off
	Tire pressure warning alarm is sounding	On

# BCM (BODY CONTROL MODULE)

< ECU DIAGNOSIS INFORMATION >

## TERMINAL LAYOUT

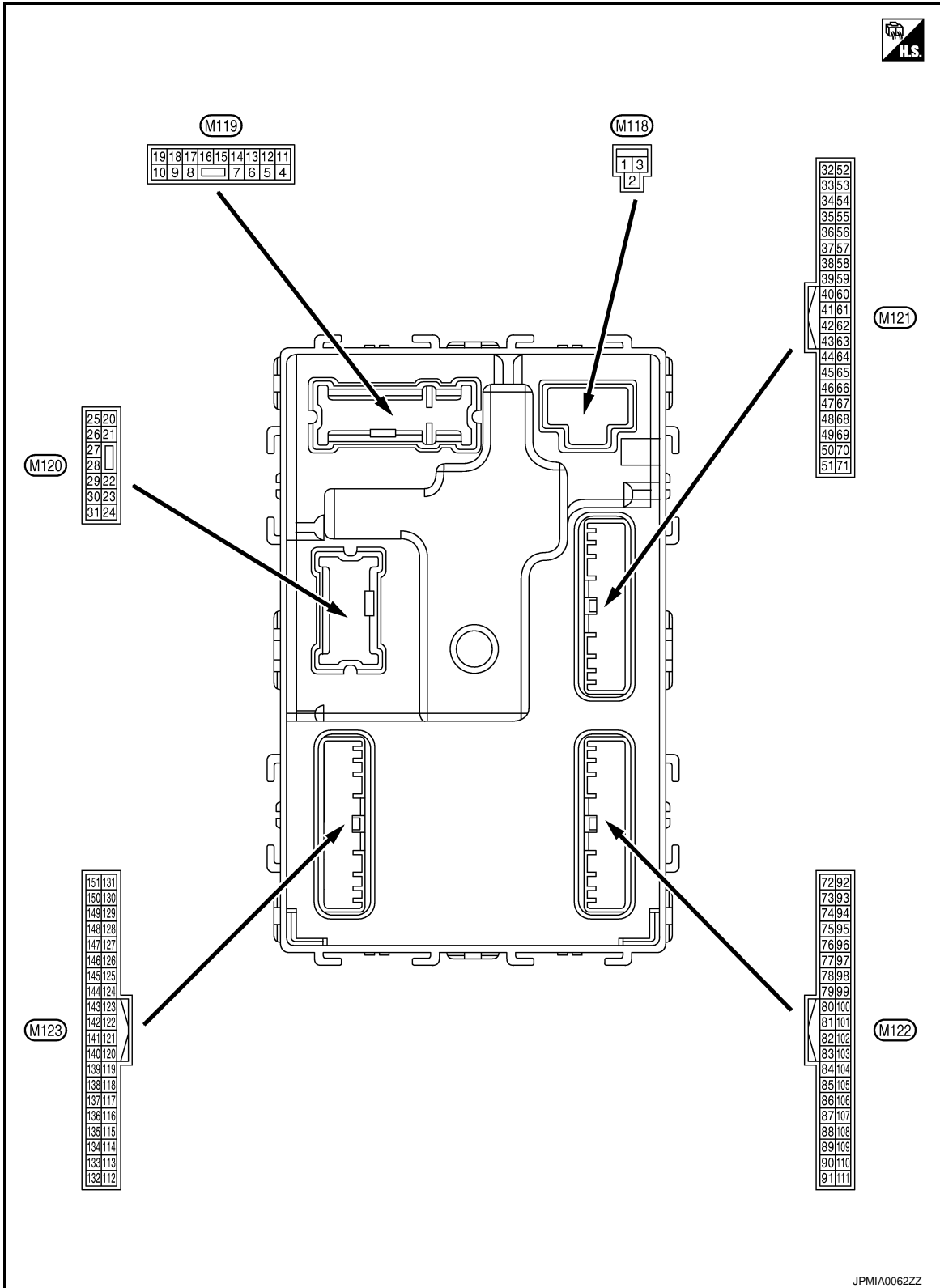

## PHYSICAL VALUES

A  
B  
C  
D  
E  
F  
G  
H  
I  
J  
K  
WW  
M  
N  
O  
P

WW

# BCM (BODY CONTROL MODULE)

## < ECU DIAGNOSIS INFORMATION >

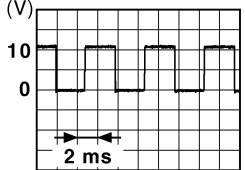
Terminal No. (Wire color)		Description		Condition		Value (Approx.)
		Signal name	Input/ Output			
+	-					
1 (W)	Ground	Battery power supply	Input	Ignition switch OFF		Battery voltage
2 (Y)	Ground	P/W power supply (BAT)	Output	Ignition switch OFF		12 V
3 (BG)	Ground	P/W power supply (RAP)	Output	Ignition switch ON		12 V
4 (LG)	Ground	Interior room lamp power supply	Output	Interior room lamp battery saver is activated. (Cuts the interior room lamp power supply)		0 V
				Interior room lamp battery saver is not activated. (Outputs the interior room lamp power supply)		12 V
5 (P)	Ground	Passenger door UN- LOCK	Output	Passenger door	UNLOCK (Actuator is activated)	12 V
					Other than UNLOCK) Actuator is not activated	0 V
7 (SB)	Ground	Step lamp	Output	Step lamp	ON	0 V
					OFF	12 V
8 (V)	Ground	All doors, fuel lid LOCK	Output	All doors, fuel lid	LOCK (Actuator is activated)	12 V
					Other than LOCK (Actuator is not activated)	0 V
9 (G)	Ground	Driver door, fuel lid UNLOCK	Output	Driver door, fuel lid	UNLOCK (Actuator is activated)	12 V
					Other than UNLOCK (Actuator is not activated)	0 V
10 (P)	Ground	Rear RH door and rear LH door UN- LOCK	Output	Rear RH door and rear LH door	UNLOCK (Actuator is activated)	12 V
					Other than UNLOCK (Actuator is not activated)	0 V
11 (R)	Ground	Battery power supply	Input	Ignition switch OFF		Battery voltage
13 (B)	Ground	Ground	—	Ignition switch ON		0 V
14 (W)	Ground	Push-button ignition switch illumination ground	Output	Tail lamp	OFF	0 V
					ON	<p><b>NOTE:</b> When the illumination brightening/dimming level is in the neutral position.</p>  <p style="text-align: right; font-size: small;">JSNIA0010GB</p>
15 (BG)	Ground	ACC indicator lamp	Output	Ignition switch	OFF (LOCK indicator is not illuminated)	Battery voltage
					ACC	0 V

# BCM (BODY CONTROL MODULE)

## < ECU DIAGNOSIS INFORMATION >

Terminal No. (Wire color)		Description		Condition	Value (Approx.)
+	-	Signal name	Input/ Output		
17 (W)	Ground	Turn signal RH (Front)	Output	Ignition switch ON	0 V
				Turn signal switch OFF	6.5 V
18 (BG)	Ground	Turn signal LH (Front)	Output	Ignition switch ON	0 V
				Turn signal switch OFF	6.5 V
19 (V)	Ground	Interior room lamp control	Output	Interior room lamp	OFF
				ON	12 V
20 (V)	Ground	Turn signal RH (Rear)	Output	Ignition switch ON	0 V
				Turn signal switch OFF	6.5 V
23 (LG)	Ground	Trunk lid open	Output	Trunk lid	OPEN (Trunk lid opener actuator is activated)
				Other than OPEN (Trunk lid opener actuator is not activated)	12 V
					0 V
25 (Y)	Ground	Turn signal LH (Rear)	Output	Ignition switch ON	0 V
				Turn signal switch OFF	6.5 V
30 (P)	Ground	Trunk room lamp	Output	Trunk room lamp	ON
				OFF	12 V

A  
B  
C  
D  
E  
F  
G  
H  
I  
J  
K  
M  
N  
O  
P

WW

# BCM (BODY CONTROL MODULE)

## < ECU DIAGNOSIS INFORMATION >

Terminal No. (Wire color)		Description		Condition	Value (Approx.)
+	-	Signal name	Input/ Output		
34 (SB)	Ground	Trunk room antenna (-)	Output	Ignition switch OFF	<p>JMKIA0062GB</p>
				When Intelligent Key is not in the passenger compart- ment	<p>JMKIA0063GB</p>
35 (V)	Ground	Trunk room antenna (+)	Output	Ignition switch OFF	<p>JMKIA0062GB</p>
				When Intelligent Key is not in the passenger compart- ment	<p>JMKIA0063GB</p>
38 (B)	Ground	Rear bumper anten- na (-)	Output	When the trunk lid opener re- quest switch is operated with ignition switch OFF	<p>JMKIA0062GB</p>
				When Intelligent Key is not in the antenna detection area	<p>JMKIA0063GB</p>



# BCM (BODY CONTROL MODULE)

## < ECU DIAGNOSIS INFORMATION >

Terminal No. (Wire color)		Description		Condition	Value (Approx.)				
+	-	Signal name	Input/ Output						
39 (W)	Ground	Rear bumper antenna (+)	Output	When Intelligent Key is in the antenna detection area	<p style="text-align: right; font-size: small;">JMKIA0062GB</p>				
				When the trunk lid opener request switch is operated with ignition switch OFF	<p style="text-align: right; font-size: small;">JMKIA0063GB</p>				
47 (Y)	Ground	Ignition relay (IPDM E/R) control	Output	Ignition switch	<table border="1" style="width: 100%; border-collapse: collapse;"> <tr> <td>OFF or ACC</td> <td style="text-align: center;">12 V</td> </tr> <tr> <td>ON</td> <td style="text-align: center;">0 V</td> </tr> </table>	OFF or ACC	12 V	ON	0 V
				OFF or ACC	12 V				
ON	0 V								
50 (BG)	Ground	Trunk room lamp switch	Input	Trunk room lamp switch	<table border="1" style="width: 100%; border-collapse: collapse;"> <tr> <td>OFF (Trunk lid is closed)</td> <td> <p style="text-align: right; font-size: small;">JPMIA0011GB</p> </td> </tr> <tr> <td>ON (Trunk lid is opened)</td> <td style="text-align: center;">0 V</td> </tr> </table>	OFF (Trunk lid is closed)	<p style="text-align: right; font-size: small;">JPMIA0011GB</p>	ON (Trunk lid is opened)	0 V
				OFF (Trunk lid is closed)	<p style="text-align: right; font-size: small;">JPMIA0011GB</p>				
ON (Trunk lid is opened)	0 V								
52 (R)	Ground	Starter relay control	Output	Ignition switch ON	<table border="1" style="width: 100%; border-collapse: collapse;"> <tr> <td>When selector lever is in P or N position</td> <td style="text-align: center;">12 V</td> </tr> <tr> <td>When selector lever is not in P or N position</td> <td style="text-align: center;">0 V</td> </tr> </table>	When selector lever is in P or N position	12 V	When selector lever is not in P or N position	0 V
				When selector lever is in P or N position	12 V				
When selector lever is not in P or N position	0 V								
60 (BR)	Ground	Push-button ignition switch (Push switch)	Input	Push-button ignition switch (push switch)	<table border="1" style="width: 100%; border-collapse: collapse;"> <tr> <td>Pressed</td> <td style="text-align: center;">0 V</td> </tr> <tr> <td>Not pressed</td> <td style="text-align: center;">Battery voltage</td> </tr> </table>	Pressed	0 V	Not pressed	Battery voltage
				Pressed	0 V				
Not pressed	Battery voltage								
61 (SB)	Ground	Trunk lid opener request switch	Input	Trunk lid opener request switch	<table border="1" style="width: 100%; border-collapse: collapse;"> <tr> <td>ON (Pressed)</td> <td style="text-align: center;">0 V</td> </tr> <tr> <td>OFF (Not pressed)</td> <td> <p style="text-align: right; font-size: small;">JPMIA0016GB</p> </td> </tr> </table>	ON (Pressed)	0 V	OFF (Not pressed)	<p style="text-align: right; font-size: small;">JPMIA0016GB</p>
				ON (Pressed)	0 V				
OFF (Not pressed)	<p style="text-align: right; font-size: small;">JPMIA0016GB</p>								
64 (G)	Ground	Intelligent Key warning buzzer (Engine room)	Output	Intelligent Key warning buzzer (Engine room)	<table border="1" style="width: 100%; border-collapse: collapse;"> <tr> <td>Sounding</td> <td style="text-align: center;">0 V</td> </tr> <tr> <td>Not sounding</td> <td style="text-align: center;">12 V</td> </tr> </table>	Sounding	0 V	Not sounding	12 V
				Sounding	0 V				
Not sounding	12 V								

A  
B  
C  
D  
E  
F  
G  
H  
I  
J  
K  
M  
N  
O  
P

WW

# BCM (BODY CONTROL MODULE)

## < ECU DIAGNOSIS INFORMATION >

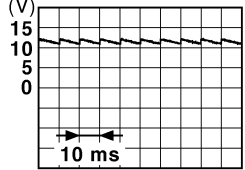
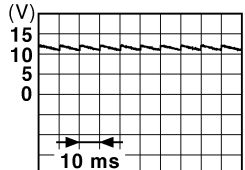
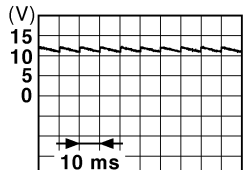
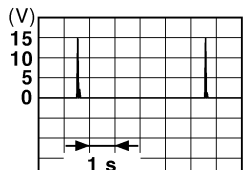
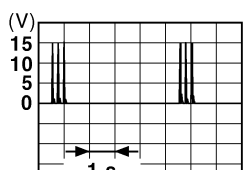
Terminal No. (Wire color)		Description		Condition	Value (Approx.)	
+	-	Signal name	Input/ Output			
67 (GR)	Ground	Trunk lid opener switch	Input	Trunk lid opener switch	Pressed	0 V
					Not pressed	 <p style="text-align: right; font-size: small;">JPMIA0011GB</p>
68 (BG)	Ground	Rear RH door switch	Input	Rear RH door switch	OFF (When rear RH door closes)	 <p style="text-align: right; font-size: small;">JPMIA0011GB</p>
					ON (When rear RH door opens)	0 V
69 (L)	Ground	Rear LH door switch	Input	Rear LH door switch	OFF (When rear LH door closes)	 <p style="text-align: right; font-size: small;">JPMIA0011GB</p>
					ON (When rear LH door opens)	0 V
72 (R)	Ground	Room antenna 2 (-) (Center console)	Output	Ignition switch OFF	When Intelligent Key is in the passenger compartment	 <p style="text-align: right; font-size: small;">JMKIA0062GB</p>
					When Intelligent Key is not in the passenger compartment	 <p style="text-align: right; font-size: small;">JMKIA0063GB</p>

# BCM (BODY CONTROL MODULE)

## < ECU DIAGNOSIS INFORMATION >

Terminal No. (Wire color)		Description		Condition	Value (Approx.)
+	-	Signal name	Input/ Output		
73 (G)	Ground	Room antenna 2 (+) (Center console)	Output	Ignition switch OFF	<p style="text-align: right; font-size: small;">JMKIA0062GB</p>
				When Intelligent Key is not in the passenger compart- ment	<p style="text-align: right; font-size: small;">JMKIA0063GB</p>
74 (SB)	Ground	Passenger door an- tenna (-)	Output	When the pas- senger door re- quest switch is operated with ignition switch OFF	<p style="text-align: right; font-size: small;">JMKIA0062GB</p>
				When Intelligent Key is not in the antenna detection area	<p style="text-align: right; font-size: small;">JMKIA0063GB</p>
75 (BR)	Ground	Passenger door an- tenna (+)	Output	When the pas- senger door re- quest switch is operated with ignition switch OFF	<p style="text-align: right; font-size: small;">JMKIA0062GB</p>
				When Intelligent Key is not in the antenna detection area	<p style="text-align: right; font-size: small;">JMKIA0063GB</p>

A  
B  
C  
D  
E  
F  
G  
H  
I  
J  
K  
M  
N  
O  
P

WW

# BCM (BODY CONTROL MODULE)

## < ECU DIAGNOSIS INFORMATION >

Terminal No. (Wire color)		Description		Condition	Value (Approx.)
+	-	Signal name	Input/ Output		
76 (V)	Ground	Driver door antenna (-)	Output	When Intelligent Key is in the antenna detection area	<p style="text-align: right; font-size: small;">JMKIA0062GB</p>
				When the driver door request switch is operated with ignition switch OFF	<p style="text-align: right; font-size: small;">JMKIA0063GB</p>
77 (LG)	Ground	Driver door antenna (+)	Output	When Intelligent Key is in the antenna detection area	<p style="text-align: right; font-size: small;">JMKIA0062GB</p>
				When the driver door request switch is operated with ignition switch OFF	<p style="text-align: right; font-size: small;">JMKIA0063GB</p>
78 (Y)	Ground	Room antenna 1 (-) (Instrument panel)	Output	Ignition switch OFF	<p style="text-align: right; font-size: small;">JMKIA0062GB</p>
				When Intelligent Key is in the passenger compartment	<p style="text-align: right; font-size: small;">JMKIA0063GB</p>

# BCM (BODY CONTROL MODULE)

## < ECU DIAGNOSIS INFORMATION >



Terminal No. (Wire color)		Description		Condition	Value (Approx.)	
+	-	Signal name	Input/ Output			
79 (BR)	Ground	Room antenna 1 (+) (Instrument panel)	Output	Ignition switch OFF		
				When Intelligent Key is not in the passenger compart- ment		
80 (GR)	Ground	NATS antenna amp.	Input/ Output	During waiting	Ignition switch is pressed while inserting the Intelli- gent Key into the key slot.	Just after pressing ignition switch. Pointer of tester should move.
81 (W)	Ground	NATS antenna amp.	Input/ Output	During waiting	Ignition switch is pressed while inserting the Intelli- gent Key into the key slot.	Just after pressing ignition switch. Pointer of tester should move.
82 (SB)	Ground	Ignition relay [Fuse block (J/B)] control	Output	Ignition switch	OFF or ACC	0 V
					ON	12 V
83 (Y)	Ground	Remote keyless entry receiver communica- tion	Input/ Output	During waiting		
				When operating either button on the Intelli- gent Key		

A  
B  
C  
D  
E  
F  
G  
H  
I  
J  
K  
M  
N  
O  
P

WW



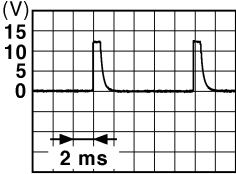

# BCM (BODY CONTROL MODULE)

## < ECU DIAGNOSIS INFORMATION >

Terminal No. (Wire color)		Description		Condition	Value (Approx.)	
+	-	Signal name	Input/ Output			
87 (Y)	Ground	Combination switch INPUT 5	Input	Combination switch	All switches OFF (Wiper volume dial 4)	 <p style="text-align: right; margin-right: 20px;">JPMIA0041GB</p> <p style="text-align: center;">1.4 V</p>
					Front fog lamp switch ON (Wiper volume dial 4)	 <p style="text-align: right; margin-right: 20px;">JPMIA0037GB</p> <p style="text-align: center;">1.3 V</p>
					Any of the conditions below with all switches OFF <ul style="list-style-type: none"> <li>• Wiper volume dial 1</li> <li>• Wiper volume dial 2</li> <li>• Wiper volume dial 6</li> <li>• Wiper volume dial 7</li> </ul>	 <p style="text-align: right; margin-right: 20px;">JPMIA0040GB</p> <p style="text-align: center;">1.3 V</p>

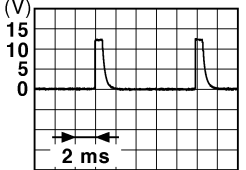
# BCM (BODY CONTROL MODULE)

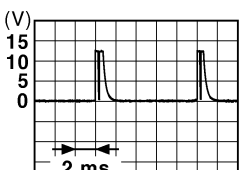
## < ECU DIAGNOSIS INFORMATION >

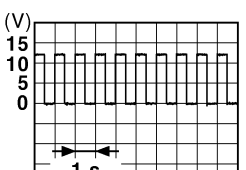
Terminal No. (Wire color)		Description		Condition	Value (Approx.)	
		Signal name	Input/ Output			
+	-					
88 (BG)	Ground	Combination switch INPUT 3	Input	Combination switch	All switches OFF (Wiper volume dial 4)	 <small>JPMIA0041GB</small> 1.4 V
					Lighting switch HI (Wiper volume dial 4)	 <small>JPMIA0036GB</small> 1.3 V
					Lighting switch 2ND (Wiper volume dial 4)	 <small>JPMIA0037GB</small> 1.3 V
					Any of the conditions below with all switches OFF <ul style="list-style-type: none"> <li>• Wiper volume dial 1</li> <li>• Wiper volume dial 2</li> <li>• Wiper volume dial 3</li> </ul>	 <small>JPMIA0040GB</small> 1.3 V
90 (P)	Ground	CAN-L	Input/ Output	—	—	
91 (L)	Ground	CAN-H	Input/ Output	—	—	
92 (LG)	Ground	Key slot illumination	Output	Key slot illumi- nation	OFF	12 V
					Blinking	 <small>JPMIA0015GB</small> 6.5 V
					ON	0 V
93 (GR)	Ground	ON indicator lamp	Output	Ignition switch	OFF (LOCK indicator is not illuminated)	Battery voltage
					ON	0 V

A  
B  
C  
D  
E  
F  
G  
H  
I  
J  
K

WW

M  
N  
O  
P

# BCM (BODY CONTROL MODULE)



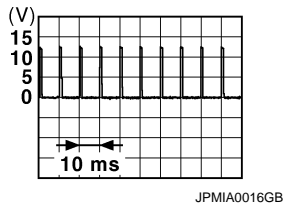
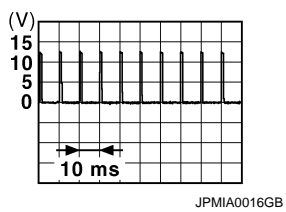

## < ECU DIAGNOSIS INFORMATION >

Terminal No. (Wire color)		Description		Condition		Value (Approx.)
+	-	Signal name	Input/ Output			
95 (BG)	Ground	ACC relay control	Output	Ignition switch	OFF	0 V
					ACC or ON	12 V
96 (GR)	Ground	A/T shift selector (Detention switch) power supply	Output	—		12 V
99 (R)	Ground	Selector lever P position switch	Input	Selector lever	P position	0 V
					Any position other than P	12 V
100 (Y)	Ground	Passenger door request switch	Input	Passenger door request switch	ON (Pressed)	0 V
					OFF (Not pressed)	 1.0 V
101 (P)	Ground	Driver door request switch	Input	Driver door request switch	ON (Pressed)	0 V
					OFF (Not pressed)	 1.0 V
102 (BG)	Ground	Blower fan motor relay control	Output	Ignition switch	OFF or ACC	0 V
					ON	12 V
103 (P)	Ground	Remote keyless entry receiver power supply	Output	Ignition switch OFF		12 V

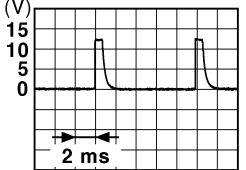

# BCM (BODY CONTROL MODULE)

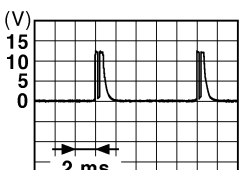
## < ECU DIAGNOSIS INFORMATION >

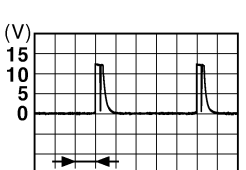

Terminal No. (Wire color)		Description		Condition	Value (Approx.)	
		Signal name	Input/ Output			
+	-					
107 (LG)	Ground	Combination switch INPUT 1	Input	Combination switch (Wiper volume dial 4)	All switches OFF	 <p style="text-align: right;">JPMAI0041GB</p> <p style="text-align: center;">1.4 V</p>
					Turn signal switch LH	 <p style="text-align: right;">JPMAI0037GB</p> <p style="text-align: center;">1.3 V</p>
					Turn signal switch RH	 <p style="text-align: right;">JPMAI0036GB</p> <p style="text-align: center;">1.3 V</p>
					Front wiper switch LO	 <p style="text-align: right;">JPMAI0038GB</p> <p style="text-align: center;">1.3 V</p>
					Front washer switch ON	 <p style="text-align: right;">JPMAI0039GB</p> <p style="text-align: center;">1.3 V</p>

A  
B  
C  
D  
E  
F  
G  
H  
I  
J  
K  
M  
N  
O  
P

WW

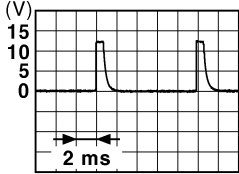

# BCM (BODY CONTROL MODULE)

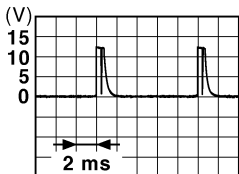
## < ECU DIAGNOSIS INFORMATION >

Terminal No. (Wire color)		Description		Condition	Value (Approx.)
+	-	Signal name	Input/ Output		
108 (R)	Ground	Combination switch INPUT 4	Input	Combination switch	All switches OFF (Wiper volume dial 4)  <small>JPMIA0041GB</small> 1.4 V
					Lighting switch AUTO (Wiper volume dial 4)  <small>JPMIA0038GB</small> 1.3 V
					Lighting switch 1ST (Wiper volume dial 4)  <small>JPMIA0036GB</small> 1.3 V
					Any of the conditions below with all switches OFF <ul style="list-style-type: none"> <li>• Wiper volume dial 1</li> <li>• Wiper volume dial 5</li> <li>• Wiper volume dial 6</li> </ul>  <small>JPMIA0039GB</small> 1.3 V

# BCM (BODY CONTROL MODULE)

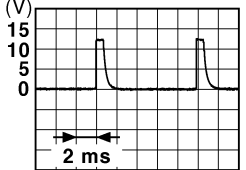
## < ECU DIAGNOSIS INFORMATION >

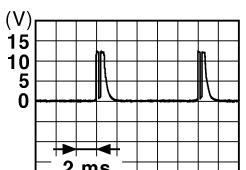
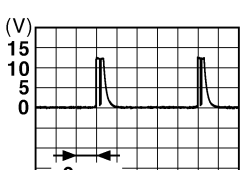
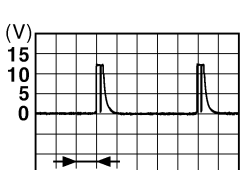
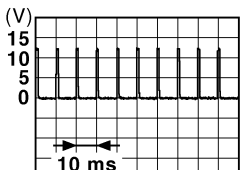
Terminal No. (Wire color)		Description		Condition	Value (Approx.)	
+	-	Signal name	Input/ Output			
109 (W)	Ground	Combination switch INPUT 2	Input	Combination switch (Wiper volume dial 4)	All switches OFF	 <p style="text-align: center;">1.4 V</p>
					Lighting switch PASS	 <p style="text-align: center;">1.3 V</p>
					Lighting switch 2ND	 <p style="text-align: center;">1.3 V</p>
					Front wiper switch INT/ AUTO	 <p style="text-align: center;">1.3 V</p>
					Front wiper switch HI	 <p style="text-align: center;">1.3 V</p>
					ON	0 V
110 (G)	Ground	Hazard switch	Input	Hazard switch	 <p style="text-align: center;">1.1 V</p>	
				OFF		

A  
B  
C  
D  
E  
F  
G  
H  
I  
J  
K  
M  
N  
O  
P

WW

# BCM (BODY CONTROL MODULE)

## < ECU DIAGNOSIS INFORMATION >

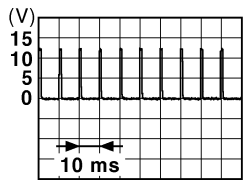
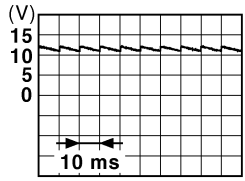
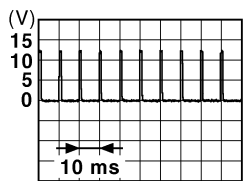
Terminal No. (Wire color)		Description		Condition		Value (Approx.)
		Signal name	Input/ Output			
+	-					
113 (BG)	Ground	Optical sensor	Input	Ignition switch ON	When bright outside of the vehicle	Close to 5 V
					When dark outside of the vehicle	Close to 0 V
116 (SB)	Ground	Stop lamp switch 1	Input	—		Battery voltage
118 (BR)	Ground	Stop lamp switch 2 (Without ICC)	Input	Stop lamp switch	OFF (Brake pedal is not depressed)	0 V
					ON (Brake pedal is de- pressed)	Battery voltage
		Stop lamp switch 2 (With ICC)		Stop lamp switch OFF (Brake pedal is not depressed) and ICC brake hold relay OFF		0 V
				Stop lamp switch ON (Brake pedal is de- pressed) or ICC brake hold relay ON		Battery voltage
119 (SB)	Ground	Front door lock as- sembly driver side (Unlock sensor)	Input	Driver door	LOCK status (Unlock sensor switch OFF)	 <p style="text-align: right; font-size: small;">JPMIA0012GB</p>
					UNLOCK status (Unlock switch sensor ON)	0 V
121 (SB)	Ground	Key slot switch	Input	When the Intelligent Key is inserted into key slot		12 V
				When the Intelligent Key is not inserted into key slot		0 V
123 (V)	Ground	IGN feedback	Input	Ignition switch	OFF or ACC	0 V
					ON	Battery voltage
124 (R)	Ground	Passenger door switch	Input	Passenger door switch	OFF (Door close)	 <p style="text-align: right; font-size: small;">JPMIA0011GB</p>
					ON (Door open)	0 V
129 (BG)	Ground	Trunk lid opener can- cel switch	Input	Trunk lid open- er cancel switch	CANCEL	 <p style="text-align: right; font-size: small;">JPMIA0012GB</p>
					ON	0 V

# BCM (BODY CONTROL MODULE)

## < ECU DIAGNOSIS INFORMATION >

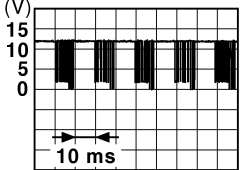
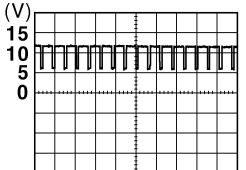
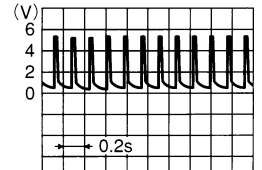
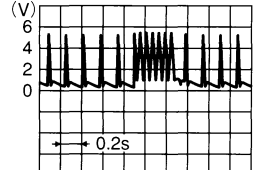
Terminal No. (Wire color)		Description		Condition	Value (Approx.)
+	-				
132 (V)	Ground	Power window switch communication	Input/ Output	Ignition switch ON	 <small>JPMIA0013GB</small> 10.2 V
				Ignition switch OFF or ACC	12 V
133 (L)	Ground	Push-button ignition switch illumination	Output	ON (Tail lamps OFF)	9.5 V
				ON (Tail lamps ON)	<p><b>NOTE:</b> The pulse width of this wave is varied by the illumination brightening/dimming level.</p>  <small>JPMIA0159GB</small>
				OFF	0 V
134 (LG)	Ground	LOCK indicator lamp	Output	LOCK indicator lamp	OFF
				ON	Battery voltage
137 (BG)	Ground	Receiver and sensor ground	Input	Ignition switch ON	0 V
138 (V)	Ground	Receiver and sensor power supply	Output	Ignition switch	OFF
				ACC or ON	5.0 V
139 (L)	Ground	Tire pressure receiver communication	Input/ Output	Ignition switch ON	 <small>OCC3881D</small>
				When receiving the signal from the transmitter	 <small>OCC3880D</small>
140 (B)	Ground	Selector lever P/N position	Input	Selector lever	P or N position
				Except P and N positions	0 V

A  
B  
C  
D  
E  
F  
G  
H  
I  
J  
K  
L  
M  
N  
O  
P

WW

# BCM (BODY CONTROL MODULE)

## < ECU DIAGNOSIS INFORMATION >

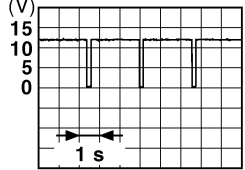
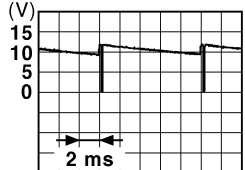
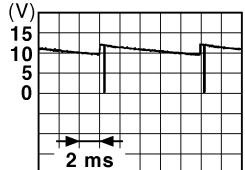
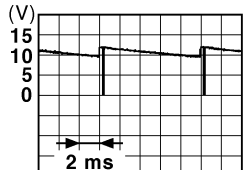
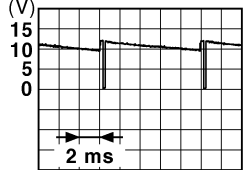
Terminal No. (Wire color)		Description		Condition	Value (Approx.)
+	-	Signal name	Input/ Output		
141 (W)	Ground	Security indicator lamp	Output	Security indicator lamp	0 V
				Blinking	 <p style="text-align: right; font-size: small;">JPMIA0014GB</p>
142 (BR)	Ground	Combination switch OUTPUT 5	Output	Combination switch (Wiper volume dial 4)	12 V
				All switches OFF	0 V
				Lighting switch 1ST	 <p style="text-align: right; font-size: small;">JPMIA0031GB</p>
				Lighting switch HI	
Lighting switch 2ND	10.7 V				
143 (P)	Ground	Combination switch OUTPUT 1	Output	Combination switch	0 V
				All switches OFF (Wiper volume dial 4) Front wiper switch HI (Wiper volume dial 4) Any of the conditions below with all switches OFF <ul style="list-style-type: none"> <li>• Wiper volume dial 1</li> <li>• Wiper volume dial 2</li> <li>• Wiper volume dial 3</li> <li>• Wiper volume dial 6</li> <li>• Wiper volume dial 7</li> </ul>	 <p style="text-align: right; font-size: small;">JPMIA0032GB</p>
144 (G)	Ground	Combination switch OUTPUT 2	Output	Combination switch	0 V
				All switches OFF (Wiper volume dial 4) Front washer switch ON (Wiper volume dial 4) Any of the conditions below with all switches OFF <ul style="list-style-type: none"> <li>• Wiper volume dial 1</li> <li>• Wiper volume dial 5</li> <li>• Wiper volume dial 6</li> </ul>	 <p style="text-align: right; font-size: small;">JPMIA0033GB</p>
145 (L)	Ground	Combination switch OUTPUT 3	Output	Combination switch (Wiper volume dial 4)	0 V
				All switches OFF Front wiper switch INT/AUTO Front wiper switch LO Lighting switch AUTO	 <p style="text-align: right; font-size: small;">JPMIA0034GB</p>
					10.7 V

# BCM (BODY CONTROL MODULE)

## < ECU DIAGNOSIS INFORMATION >

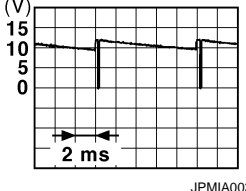
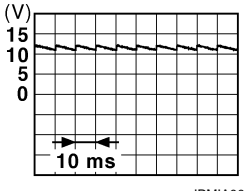
Terminal No. (Wire color)		Description		Condition	Value (Approx.)	
		Signal name	Input/ Output			
+	-					
146 (SB)	Ground	Combination switch OUTPUT 4	Output	Combination switch (Wiper volume dial 4)	All switches OFF	0 V
					Front fog lamp switch ON	
					Lighting switch 2ND	
					Lighting switch PASS	
					Turn signal switch LH	
150 (GR)	Ground	Driver door switch	Input	Driver door switch	OFF (Door close)	
					ON (Door open)	0 V
151 (G)	Ground	Rear window defog- ger relay control	Output	Rear window defogger	Active	0 V
					Not activated	Battery voltage

A  
B  
C  
D  
E  
F  
G  
H  
I  
J  
K  
L  
M  
N  
O  
P

WW

# BCM (BODY CONTROL MODULE)

< ECU DIAGNOSIS INFORMATION >

## Wiring Diagram - BCM -

INFOID:000000011405325

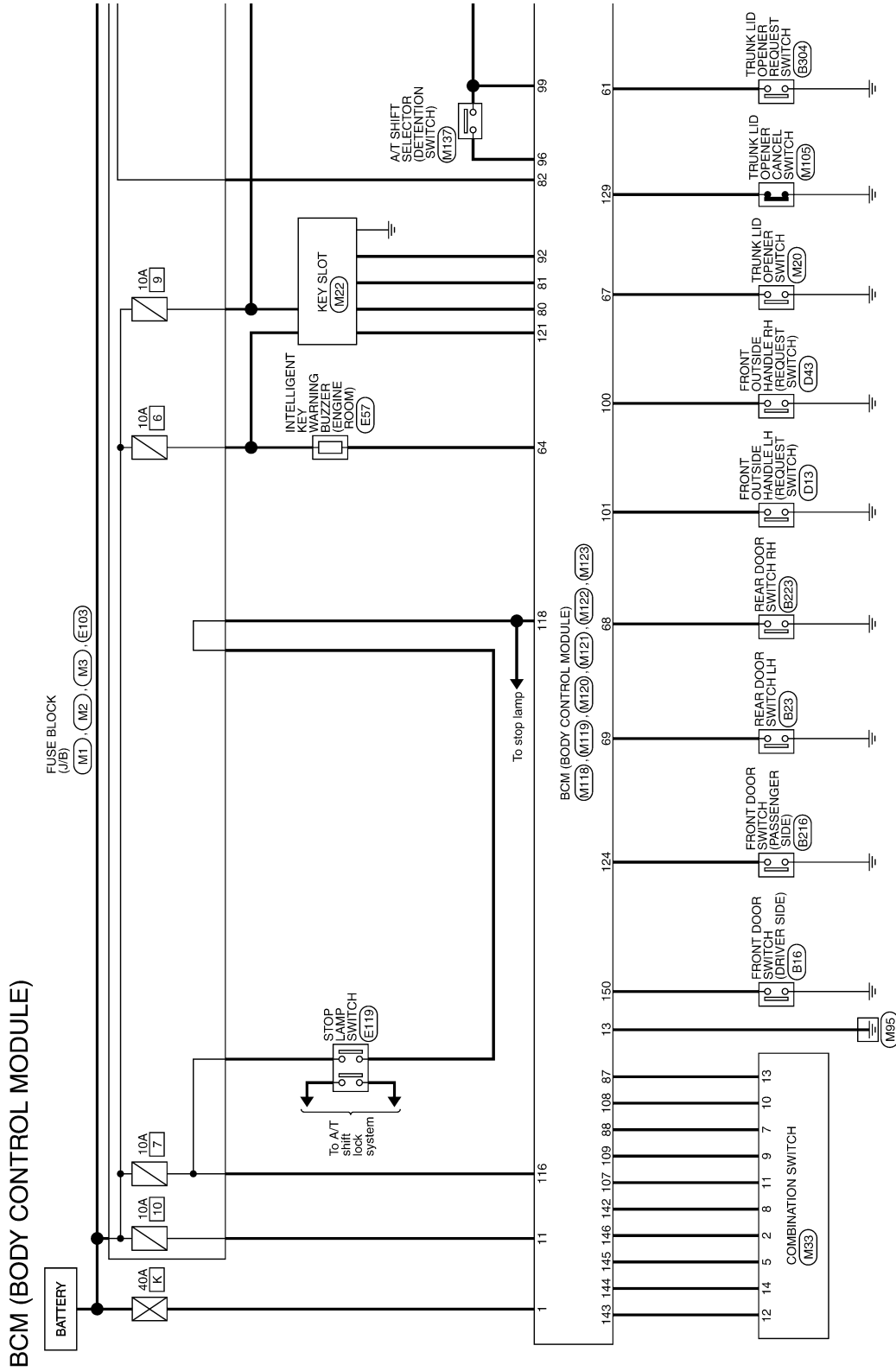

2014/06/09

JRMWF9358GB



# BCM (BODY CONTROL MODULE)

< ECU DIAGNOSIS INFORMATION >

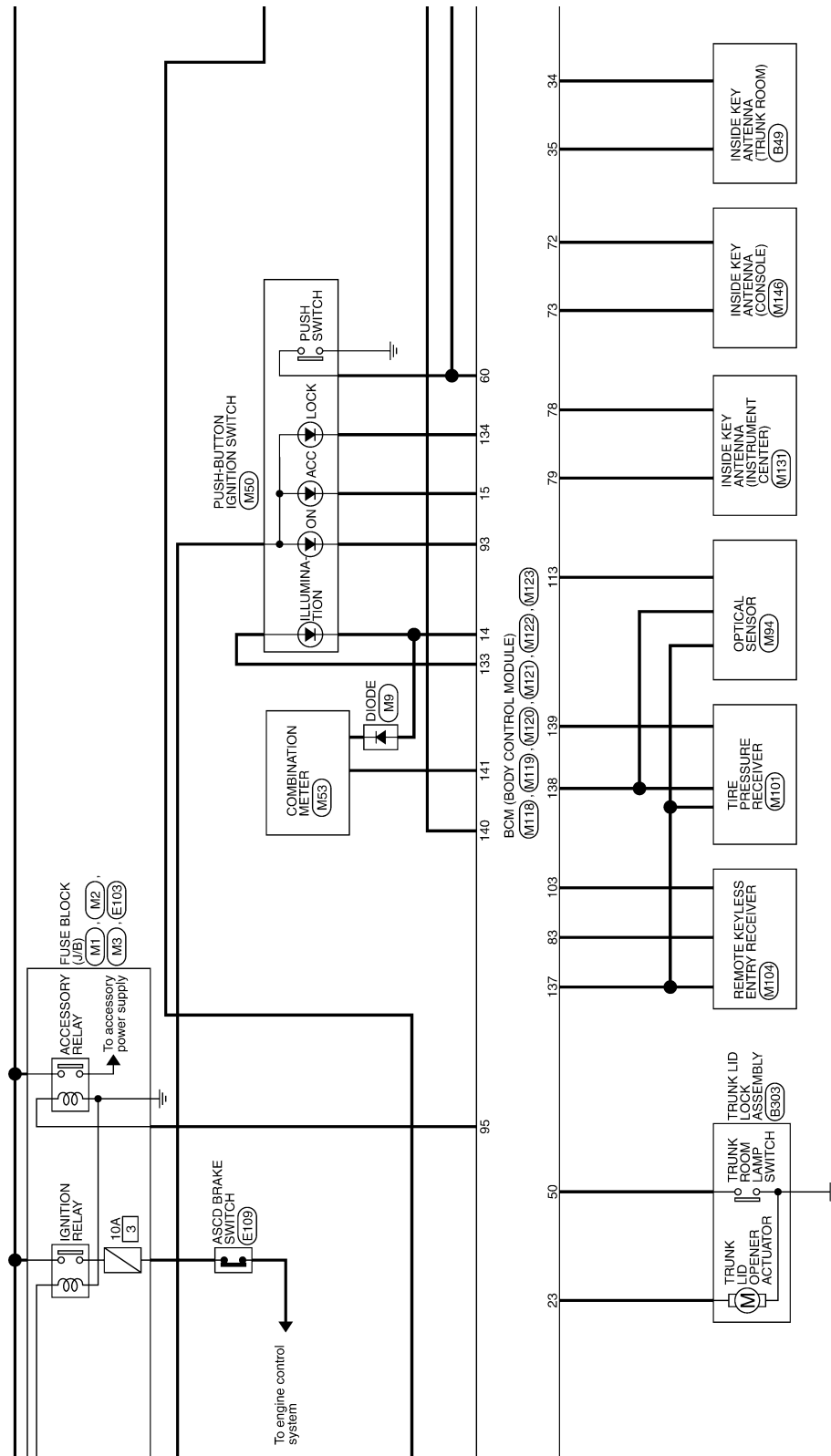

JRMWF9359GB

A  
B  
C  
D  
E  
F  
G  
H  
I  
J  
K  
M  
N  
O  
P

WW

# BCM (BODY CONTROL MODULE)

< ECU DIAGNOSIS INFORMATION >

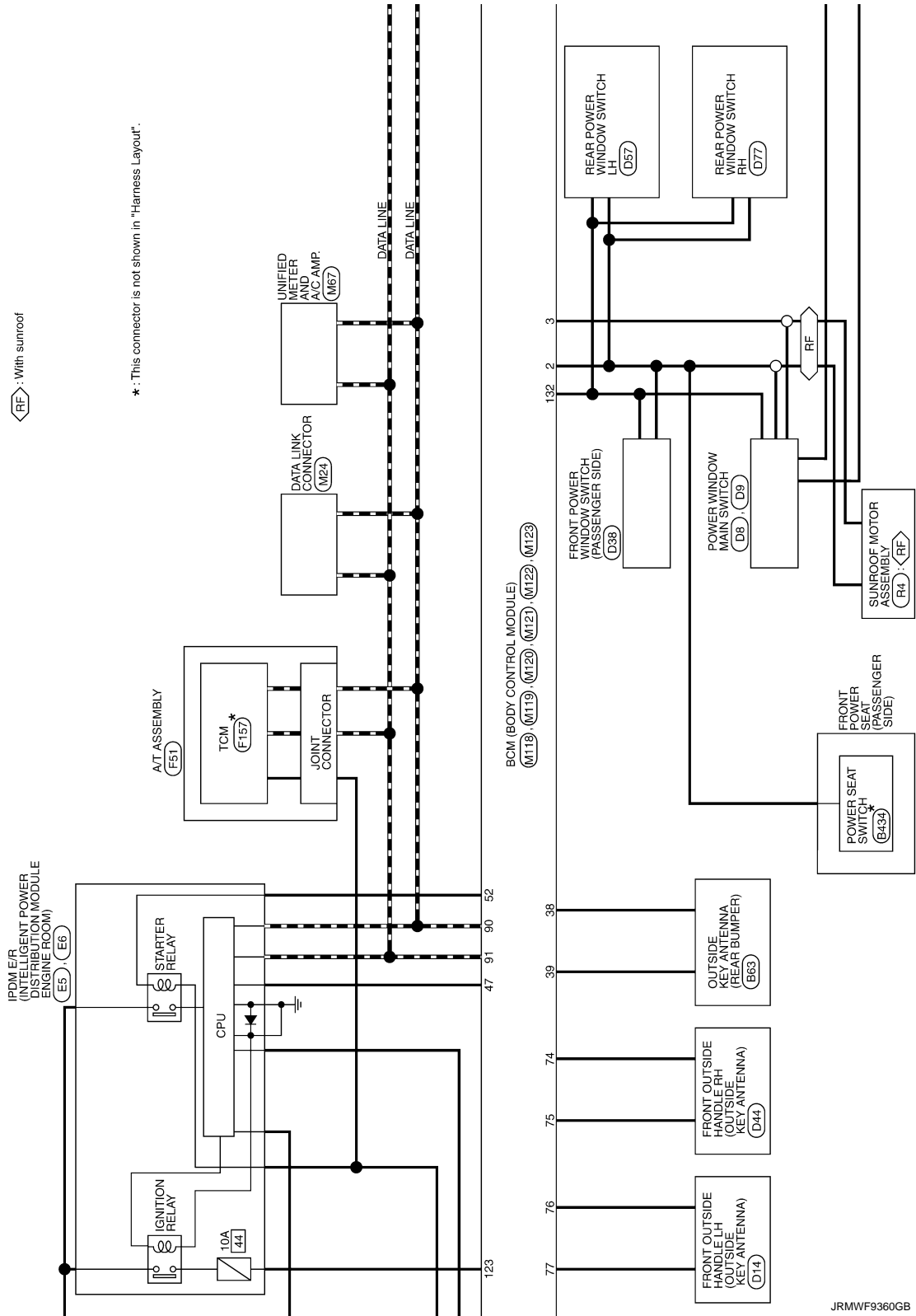

JRMWF9360GB

# BCM (BODY CONTROL MODULE)

< ECU DIAGNOSIS INFORMATION >

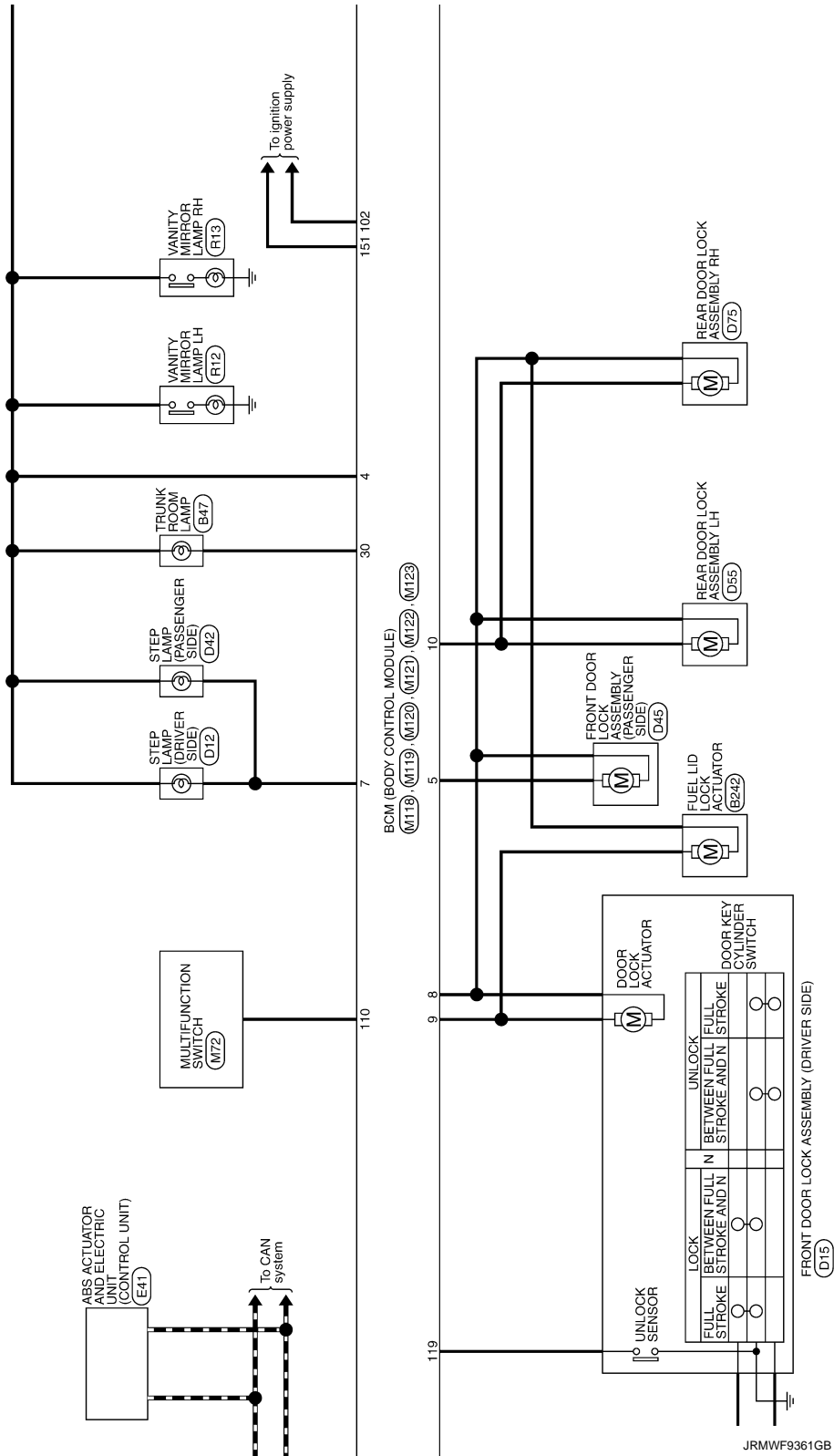

A  
B  
C  
D  
E  
F  
G  
H  
I  
J  
K  
L  
M  
N  
O  
P



# BCM (BODY CONTROL MODULE)

< ECU DIAGNOSIS INFORMATION >

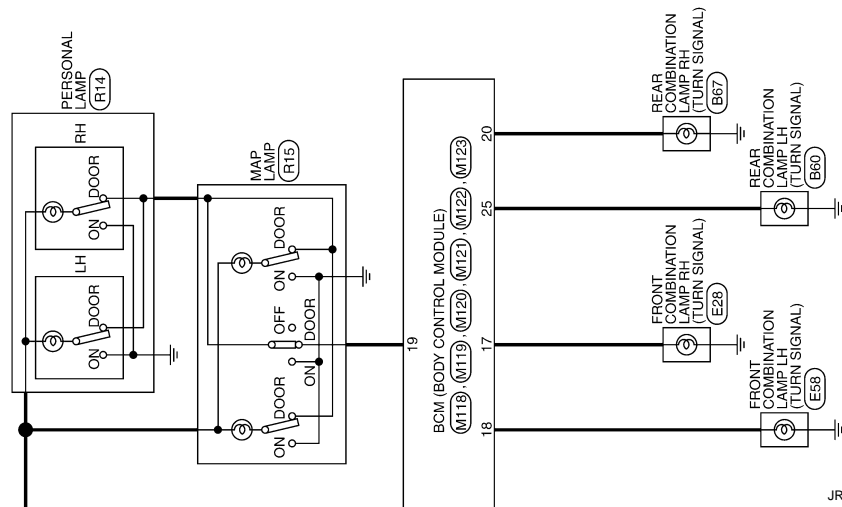

JRMWF9362GB

# BCM (BODY CONTROL MODULE)

< ECU DIAGNOSIS INFORMATION >

## BCM (BODY CONTROL MODULE)

Connector No.	B16
Connector Name	FRONT DOOR SWITCH (DRIVER SIDE)
Connector Type	A03FW

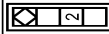

Terminal No.	Color Of Wire	Signal Name [Specification]
1	BR	
2	BR	

Connector No.	B23
Connector Name	REAR DOOR SWITCH LH
Connector Type	A03FW



Terminal No.	Color Of Wire	Signal Name [Specification]
1	Y	
2	Y	

Connector No.	B47
Connector Name	TRUNK ROOM LAMP
Connector Type	S02FW



Terminal No.	Color Of Wire	Signal Name [Specification]
1	SG	
2	GR	

Connector No.	B49
Connector Name	INSIDE KEY ANTENNA (TRUNK ROOM)
Connector Type	RK02FGY



Terminal No.	Color Of Wire	Signal Name [Specification]
1	L	
2	P	

Connector No.	B60
Connector Name	REAR COMBINATION LAMP LH
Connector Type	NS04FW-CS



Terminal No.	Color Of Wire	Signal Name [Specification]
1	V	
2	LG	
3	SB	
4	B	

Connector No.	B83
Connector Name	OUTSIDE KEY ANTENNA (REAR BUMPER)
Connector Type	FR02FGY



Terminal No.	Color Of Wire	Signal Name [Specification]
1	BR	
2	R	

Connector No.	B87
Connector Name	REAR COMBINATION LAMP RH
Connector Type	NS04FW-CS



Terminal No.	Color Of Wire	Signal Name [Specification]
1	R	
2	LG	
3	V	
4	B	

Connector No.	B216
Connector Name	FRONT DOOR SWITCH (PASSENGER SIDE)
Connector Type	A03FW

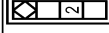

Terminal No.	Color Of Wire	Signal Name [Specification]
1	GR	
2	GR	

Connector No.	B223
Connector Name	REAR DOOR SWITCH RH
Connector Type	A03FW

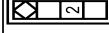

Terminal No.	Color Of Wire	Signal Name [Specification]
1	BR	
2	BR	

Connector No.	B242
Connector Name	FUEL LID LOCK ACTUATOR
Connector Type	MM0FW-LC



































A  
B  
C  
D  
E  
F  
G  
H  
I  
J  
K  
L  
M  
N  
O  
P

WW

JRMWF9505GB

# BCM (BODY CONTROL MODULE)

< ECU DIAGNOSIS INFORMATION >

<b>BCM (BODY CONTROL MODULE)</b> Terminal No.   Color Of Wire   Signal Name [Specification] 1   SB   - 2   V   -		<b>BS03</b> Connector No.   Connector Name   Connector Type TRUNK LID LOCK ASSEMBLY TB03FW		 	
Terminal No.   Color Of Wire   Signal Name [Specification] 1   V   - 2   B   - 3   G   -		<b>BS04</b> Connector No.   Connector Name   Connector Type TRUNK LID OPENER REQUEST SWITCH TR02MGR-P		 	
Terminal No.   Color Of Wire   Signal Name [Specification] 1   G/W   - 2   SB   - 3   L/R   - 4   B   - 5   G/W   - 6   SB   - 7   V   - 8   W   - 9   L/R   - 10   L   -		<b>DB</b> Connector No.   Connector Name   Connector Type POWER WINDOW MAIN SWITCH NS16FW-CS		 	
Terminal No.   Color Of Wire   Signal Name [Specification] 1   G/Y   - 2   L/Y   - 3   L/Y   - 4   B   - 5   G/W   - 6   SB   - 7   V   - 8   W   - 9   L/R   - 10   L   -		<b>B434</b> Connector No.   Connector Name   Connector Type POWER SEAT SWITCH NS10FW-CS		 	
Terminal No.   Color Of Wire   Signal Name [Specification] 1   B   - 2   R   -		<b>D9</b> Connector No.   Connector Name   Connector Type POWER WINDOW MAIN SWITCH NS03FW-CS		 	
Terminal No.   Color Of Wire   Signal Name [Specification] 1   P   - 2   V   -		<b>D13</b> Connector No.   Connector Name   Connector Type FRONT OUTSIDE HANDLE LH (REQUEST SWITCH) RK02FL		 	
Terminal No.   Color Of Wire   Signal Name [Specification] 1   B   - 2   R   -		<b>D12</b> Connector No.   Connector Name   Connector Type STEP LAMP (DRIVER SIDE) TB02FW		 	
Terminal No.   Color Of Wire   Signal Name [Specification] 1   P   - 2   V   -		<b>D14</b> Connector No.   Connector Name   Connector Type FRONT OUTSIDE VOICES LH (OUTSIDE RE-ANTENNA) RK02MGCY		 	
Terminal No.   Color Of Wire   Signal Name [Specification] 1   W   - 2   B   -		<b>ES03</b> Connector No.   Connector Name   Connector Type TRUNK LID LOCK ASSEMBLY TB03FW		 	
Terminal No.   Color Of Wire   Signal Name [Specification] 1   V   - 2   B   - 3   G   -		<b>ES04</b> Connector No.   Connector Name   Connector Type TRUNK LID OPENER REQUEST SWITCH TR02MGR-P		 	
Terminal No.   Color Of Wire   Signal Name [Specification] 1   G/W   - 2   SB   - 3   L/R   - 4   B   - 5   G/W   - 6   SB   - 7   V   - 8   W   - 9   L/R   - 10   L   -		<b>DB</b> Connector No.   Connector Name   Connector Type POWER WINDOW MAIN SWITCH NS16FW-CS		 	
Terminal No.   Color Of Wire   Signal Name [Specification] 1   G/Y   - 2   L/Y   - 3   L/Y   - 4   B   - 5   G/W   - 6   SB   - 7   V   - 8   W   - 9   L/R   - 10   L   -		<b>B434</b> Connector No.   Connector Name   Connector Type POWER SEAT SWITCH NS10FW-CS		 	
Terminal No.   Color Of Wire   Signal Name [Specification] 1   B   - 2   R   -		<b>D9</b> Connector No.   Connector Name   Connector Type POWER WINDOW MAIN SWITCH NS03FW-CS		 	
Terminal No.   Color Of Wire   Signal Name [Specification] 1   P   - 2   V   -		<b>D13</b> Connector No.   Connector Name   Connector Type FRONT OUTSIDE HANDLE LH (REQUEST SWITCH) RK02FL		 	
Terminal No.   Color Of Wire   Signal Name [Specification] 1   B   - 2   R   -		<b>D12</b> Connector No.   Connector Name   Connector Type STEP LAMP (DRIVER SIDE) TB02FW		 	
Terminal No.   Color Of Wire   Signal Name [Specification] 1   P   - 2   V   -		<b>D14</b> Connector No.   Connector Name   Connector Type FRONT OUTSIDE VOICES LH (OUTSIDE RE-ANTENNA) RK02MGCY		 	

JRMWF9506GB

# BCM (BODY CONTROL MODULE)

< ECU DIAGNOSIS INFORMATION >

## BCM (BODY CONTROL MODULE)

Connector No.	D15
Connector Name	FRONT DOOR LOCK ASSEMBLY (DRIVER SIDE)
Connector Type	EDFEGY-RS

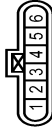

Terminal No.	Color Of Wire	Signal Name [Specification]
1	LG	-
2	P	-
4	B	-
5	Y	-
6	V	-

Connector No.	D38
Connector Name	REAR POWER WINDOW SWITCH (PASSENGER SIDE)
Connector Type	NS16FW-CS

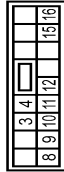

Terminal No.	Color Of Wire	Signal Name [Specification]
3	LG	-
4	B	-
8	L	-
9	G	-
10	Y	-
11	B	-
12	P	-
15	BG	-
16	Y	-

Connector No.	D42
Connector Name	STEP LAMP (PASSENGER SIDE)
Connector Type	TB02FW



Terminal No.	Color Of Wire	Signal Name [Specification]
1	R	-
2	SB	-

Connector No.	D43
Connector Name	FRONT OUTSIDE HANDLE RH (REQUEST SWITCH)
Connector Type	RK02FL



Terminal No.	Color Of Wire	Signal Name [Specification]
1	W	-
2	B	-

Connector No.	D44
Connector Name	FRONT OUTSIDE HANDLE RH (OUTSIDE KEY ANTENNA)
Connector Type	FR04MGY



Terminal No.	Color Of Wire	Signal Name [Specification]
1	P	-
2	V	-

Connector No.	D45
Connector Name	FRONT DOOR LOCK ASSEMBLY (PASSENGER SIDE)
Connector Type	EDFEGY-RS



Terminal No.	Color Of Wire	Signal Name [Specification]
1	P	-
2	LG	-

Connector No.	D55
Connector Name	REAR DOOR LOCK ASSEMBLY LH
Connector Type	EDFEGY-RS

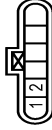

Terminal No.	Color Of Wire	Signal Name [Specification]
1	V	-
2	G	-

Connector No.	D57
Connector Name	REAR POWER WINDOW SWITCH-LH
Connector Type	NS16FW-CS

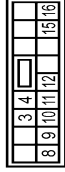

Terminal No.	Color Of Wire	Signal Name [Specification]
3	BR	-
4	SB	-
8	W	-
9	L	-
10	W	-
11	B	-
12	GR	-
15	BG	-
16	Y	-

A  
B  
C  
D  
E  
F  
G  
H  
I  
J  
K  
M  
N  
O  
P

WW

JRMWF9507GB

# BCM (BODY CONTROL MODULE)

< ECU DIAGNOSIS INFORMATION >

## BCM (BODY CONTROL MODULE)

Connector No.	D75
Connector Name	REAR DOOR LOCK ASSEMBLY RH
Connector Type	EMBED-RS



Terminal No.	Color Of Wire	Signal Name [Specification]
1	Y	
2	LG	

Connector No.	D77
Connector Name	REAR POWER WINDOW SWITCH RH
Connector Type	NS16FW-CS

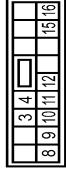

Terminal No.	Color Of Wire	Signal Name [Specification]
3	BR	
4	SB	
8	W	
9	L	
10	W	
11	B	
12	GR	
15	BG	
16	Y	

Connector No.	E5
Connector Name	ENGINE INTELLIGENT POWER DISTRIBUTION MODULE ENGINE ROOM
Connector Type	TH08PW-CS12-M4-1V



Terminal No.	Color Of Wire	Signal Name [Specification]
4	Y	
5	V	
6	SS	
7	P	
12	B/W	
13	Y	
16	LG	
19	R	
25	G	
27	BG	
28	L	
30	GR	
36	G	

Connector No.	E5
Connector Name	ENGINE INTELLIGENT POWER DISTRIBUTION MODULE ENGINE ROOM
Connector Type	TH08PW-NH



Terminal No.	Color Of Wire	Signal Name [Specification]
39	P	
40	L	
41	B/W	
42	GR	
43	G	
44	LG	
45	V	

46	SB	
----	----	--

Connector No.	E28
Connector Name	FRONT COMBINATION LAMP RH
Connector Type	RS08FB-PR



Terminal No.	Color Of Wire	Signal Name [Specification]
3	B	
4	B/W	
5	R	
6	V	
7	BR	
8	G	

Connector No.	E41
Connector Name	ABS ACTUATOR AND ELECTRIC JET CONTROL UNIT
Connector Type	BAM42FB-AH24-LH



Terminal No.	Color Of Wire	Signal Name [Specification]
1	B	GROUND
2	GR	UBMR
3	BG	DBVR
4	D	GRND
5	EG	DS FR
6	EG	DP BR
7	BR	DP FR
9	B	DS FR
10	W	DS FR
11	V	DIAG-K
14	P	CAN-L

29	V	BUS-L
29	LG	DS FL
29	GR	DC RL
28	G	UZ
28	P	DS RR
30	SB	BLS
31	R	VDC OFF SW
35	L	CAN-H
45	B	BUS-H

Connector No.	E57
Connector Name	INTELLIGENT KEY WARNING BUZZER (ENGINE ROOM)
Connector Type	RK03FB-R



Terminal No.	Color Of Wire	Signal Name [Specification]
1	GR	
3	LG	

Connector No.	E58
Connector Name	FRONT COMBINATION LAMP LH
Connector Type	RS08FB-PR



Terminal No.	Color Of Wire	Signal Name [Specification]
3	B	
4	B/W	
5	V	
6	GR	
7	P	
8	BG	

JRMWF9508GB



# BCM (BODY CONTROL MODULE)

< ECU DIAGNOSIS INFORMATION >

## BCM (BODY CONTROL MODULE)

Connector No.	E103
Connector Name	FUSE BLOCK (J/B)
Connector Type	NS16FW-C5

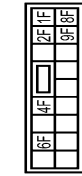

Terminal No.	Color Of Wire	Signal Name [Specification]
1F	SB	-
2F	G	-
4F	BR	-
8F	L	-
9F	P	-

Connector No.	E109
Connector Name	ASC0 BRAKE SWITCH
Connector Type	IS02FL



Terminal No.	Color Of Wire	Signal Name [Specification]
1	G	-
2	SB	-

Connector No.	E119
Connector Name	STOP LAMP SWITCH
Connector Type	MR0FL-C



Terminal No.	Color Of Wire	Signal Name [Specification]
1	L	-
2	G	-
3	Y	-
4	Y	-

Connector No.	F51
Connector Name	A/T ASSEMBLY
Connector Type	RK10FG-DQY



Terminal No.	Color Of Wire	Signal Name [Specification]
1	Y	-
2	R	-
3	L	-
4	V	-
5	B	-
6	G	-
7	R	-
8	P	-
9	GR	-
10	B	-

Connector No.	E157
Connector Name	TCM
Connector Type	SP10EG

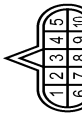

Terminal No.	Color Of Wire	Signal Name [Specification]
1	SHIELD	VIGN
2	SHIELD	IGN
3	SHIELD	IGN
4	SHIELD	IGN
5	SHIELD	GROUND
6	SHIELD	GROUND
7	SHIELD	REV LAMP RLY
8	SHIELD	CAN-L
9	SHIELD	STARTER RLY
10	SHIELD	GROUND

Connector No.	M1
Connector Name	FUSE BLOCK (J/B)
Connector Type	NS06FW-M2

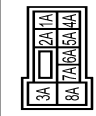

Terminal No.	Color Of Wire	Signal Name [Specification]
1A	V	-
2A	G	-
3A	L	-
4A	P	-
5A	Y	-
6A	Y	-
7A	R	-
8A	L	-

Connector No.	M2
Connector Name	FUSE BLOCK (J/B)
Connector Type	NS10FW-C5

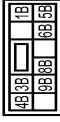

Terminal No.	Color Of Wire	Signal Name [Specification]
1B	SB	-
2B	L	-
3B	G	-
4B	BR	-
5B	RG	-
6B	Y	-
7B	R	-
8B	R	-
9B	SB	-

Connector No.	M3
Connector Name	FUSE BLOCK (J/B)
Connector Type	NS12FW-C5

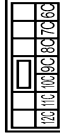

Terminal No.	Color Of Wire	Signal Name [Specification]
10C	L	-
11C	LG	-
12C	G	-
6C	SB	-
7C	B	-
8C	W	-
9C	BG	-

A  
B  
C  
D  
E  
F  
G  
H  
I  
J  
K  
L  
M  
N  
O  
P

WW

# BCM (BODY CONTROL MODULE)

< ECU DIAGNOSIS INFORMATION >

## BCM (BODY CONTROL MODULE)

Connector No.	M19
Connector Name	DIODE
Connector Type	24335.C0900



Terminal No.	Color Of Wire	Signal Name [Specification]
1	R	-
2	R	-

Connector No.	M20
Connector Name	TRUNK LID OPENER SWITCH
Connector Type	T045FW



Terminal No.	Color Of Wire	Signal Name [Specification]
1	GB	-
2	GB	-
3	LG	-
4	R	-

Connector No.	M22
Connector Name	KEY SLOT
Connector Type	TH12FW-NH



Terminal No.	Color Of Wire	Signal Name [Specification]
1	GR	BAT
2	GR	GGCK
3	W	DATA
5	Y	ILL BAT
6	LG	ILL
7	B	GROUND
11	SB	KEY SWITCH SIGNAL

Connector No.	M24
Connector Name	DATA LINK CONNECTOR
Connector Type	BD16FW-P



Terminal No.	Color Of Wire	Signal Name [Specification]
3	LG	-
4	B	-
5	B	-
6	L	-
7	V	-
8	SS	-
14	P	-
16	R	-

Connector No.	M33
Connector Name	COMBINATION SWITCH
Connector Type	TH18FW-NH

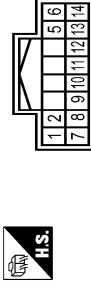

Terminal No.	Color Of Wire	Signal Name [Specification]
1	GR	FR WASHER (-)
2	SB	OUTPUT 3
3	SB	GROUND
5	B	GROUND
6	B	INPUT 3
7	EG	OUTPUT 5
8	BR	INPUT 2
9	W	INPUT 4
10	R	INPUT 1
11	LG	INPUT 1
12	P	INPUT 5
13	Y	INPUT 5
14	G	OUTPUT 2

Connector No.	M49
Connector Name	PUSH-BUTTON IGNITION SWITCH
Connector Type	TK08BER



Terminal No.	Color Of Wire	Signal Name [Specification]
1	B	-
2	B	-
3	I	-
4	BR	-
5	LG	-
6	EG	-
7	GR	-
8	P	-

Connector No.	M53
Connector Name	COMBINATION METER
Connector Type	SAB40FW

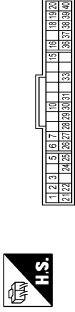

Terminal No.	Color Of Wire	Signal Name [Specification]
1	W	BATTERY POWER SUPPLY
2	LG	COMMUNICATION SIGNAL (METER-AMP)
3	GR	COMMUNICATION SIGNAL (AMP-METER)
5	B	GROUND
6	W	ALTERNATOR SIGNAL
7	LG	AIR BAG SIGNAL
10	W	SECURITY SIGNAL
15	B	GROUND
16	BR	METER CONTROL SWITCH GROUND
18	GR	ILL GND
19	B	ILL GND
20	R	ILL
21	G	IGNITION SIGNAL
22	B	GROUND
24	BR	COMMUNICATION SIGNAL (GPS-IMP)
25	GR	COMMUNICATION SIGNAL (AMP-LED)
26	R	VEHICLE SPEED SIGNAL (E-PHLS SE)
27	P	PARKING BRAKE SWITCH SIGNAL
28	SB	BRAKE FLUID LEVEL SWITCH
29	P	SEAT BELT BUCKLE SW SIGNAL (DRIVER SIDE)
30	G	SEAT BELT BUCKLE SWITCH SIGNAL (PASSENGER SIDE)
31	L	WASHER LEVEL SWITCH SIGNAL
33	R	ILLUMINATION CONTROL SIGNAL
36	LG	SELECT SWITCH SIGNAL
37	Y	ENTER SWITCH SIGNAL
38	G	TRIP A/B RESET SWITCH SIGNAL
39	P	ILLUMINATION CONTROL SWITCH SIGNAL (-)
40	EG	ILLUMINATION CONTROL SWITCH SIGNAL (+)

JRMWF9510GB

# BCM (BODY CONTROL MODULE)

< ECU DIAGNOSIS INFORMATION >

## BCM (BODY CONTROL MODULE)

Connector No.	M67
Connector Name	UNIFIED METER AND A.C. AMP.
Connector Type	TH82FW-4H



Terminal No.	Color Of Wire	Signal Name [Specification]
41	L	A.C. POWER SUPPLY
42	BR	FUEL LEVEL SENSOR SIGNAL
43	BL	IN-VEHICLE SENSOR SIGNAL
44	LG	IN-VEHICLE SENSOR SIGNAL
45	Y	AMBIENT SENSOR SIGNAL
46	V	SUNLOAD SENSOR SIGNAL
53	W	IGNITION POWER SUPPLY
54	SB	BATTERY POWER SUPPLY
55	B	GROUND
56	L	CAN-H
57	LG	BRAKE FLUID LEVEL SWITCH
58	Y	FUEL LEVEL SENSOR GROUND
59	GR	INTAKE SENSOR GROUND
60	W	IN-VEHICLE SENSOR GROUND
61	B	AMBIENT SENSOR GROUND
62	SB	SUNLOAD SENSOR GROUND
66	PG	ECU CAN SIGNAL
68	P	A/C CLAR SIGNAL
70	R	EACH DOOR MOTOR POWER SUPPLY
71	GR	GROUND
72	P	CAN-L

Connector No.	MT2
Connector Name	MULTIFUNCTION SWITCH
Connector Type	TH16FW-4H



Terminal No.	Color Of Wire	Signal Name [Specification]
1	B	GROUND
2	B	ACC
3	EG	ACC
4	B	TLL CONT
5	B	AV COMM (H)
6	SR	AV COMM (L)
8	LG	SW GND
9	BR	DISK EJECT SIGNAL
14	V	HAZARD ON
16	G	

Connector No.	MM4
Connector Name	OPTICAL SENSOR
Connector Type	TK03FW



Terminal No.	Color Of Wire	Signal Name [Specification]
1	Y	POWER
2	EG	OUTPUT
3	B	GROUND

Connector No.	M101
Connector Name	TIRE PRESSURE RECEIVER
Connector Type	TK04FW



Terminal No.	Color Of Wire	Signal Name [Specification]
1	P	GROUND
2	L	SIGNAL
3	L	BATTERY
4	V	

Connector No.	M104
Connector Name	REMOTE KEYLESS ENTRY RECEIVER
Connector Type	JAB04FB



Terminal No.	Color Of Wire	Signal Name [Specification]
1	EG	GROUND
2	Y	SIGNAL OUTPUT
3	BG	BATTERY
4	P	

Connector No.	M105
Connector Name	TRUNK LID OPENER CANCEL SWITCH
Connector Type	S02FW

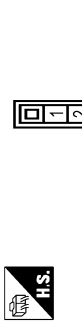

Terminal No.	Color Of Wire	Signal Name [Specification]
1	BG	
2	B	

Connector No.	M118
Connector Name	BCM (BODY CONTROL MODULE)
Connector Type	MD3FB-LC



Terminal No.	Color Of Wire	Signal Name [Specification]
1	W	BAT.(E/L)
2	Y	POWER WINDOW POWER SUPPLY (BAT)
3	BG	POWER WINDOW POWER SUPPLY (RAMP)

JRMWF9511GB

A  
B  
C  
D  
E  
F  
G  
H  
I  
J  
K  
M  
N  
O  
P

WW

# BCM (BODY CONTROL MODULE)

## < ECU DIAGNOSIS INFORMATION >

### BCM (BODY CONTROL MODULE)

Connector No.	M119
Connector Name	BCM (BODY CONTROL MODULE)
Connector Type	NS16FW-C5

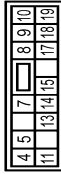

Terminal No.	Color Of Wire	Signal Name [Specification]
1	G	INTERIOR ROOM LAMP POWER SUPPLY
2	G	PASSENGER DOOR UNLOCK OUTPUT
3	SB	STEERING LAMP CONT
4	V	ALL DOOR FUEL LID LOCK OUTPUT
5	P	DRIVER DOOR FUEL LID UNLOCK OUTPUT
6	G	REAR DOOR UNLOCK OUTPUT
7	R	BAT (FUSE)
8	B	GROUND
9	W	ACC IND
10	EG	TURN SIGNAL RH (FRONT)
11	W	TURN SIGNAL LH (FRONT)
12	EG	TURN SIGNAL RH (REAR)
13	W	TURN SIGNAL LH (REAR)
14	EG	INT ROOM LAMP CONT
15	V	

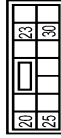

Connector No.	M120
Connector Name	BCM (BODY CONTROL MODULE)
Connector Type	NS12FW-C5



Connector No.	M122
Connector Name	BCM (BODY CONTROL MODULE)
Connector Type	TH40FB-NH



Terminal No.	Color Of Wire	Signal Name [Specification]
20	V	TURN SIGNAL RH (REAR)
23	LG	TRUNK LID OPEN OUTPUT
25	Y	TURN SIGNAL LH (REAR)
30	P	TRUNK ROOM LAMP CONT

Connector No.	M121
Connector Name	BCM (BODY CONTROL MODULE)
Connector Type	TH40FG-NH



Terminal No.	Color Of Wire	Signal Name [Specification]
39	SB	TRUNK ROOM ANT-
40	SB	TRUNK ROOM ANT+
41	B	REAR BUMPER ANT-
42	W	REAR BUMPER ANT+
43	Y	IGN RELAY (PDM) (R) CONT
44	Y	TRUNK ROOM LAMP SW
45	R	STARTER RELAY CONT
46	R	PUSH SW
47	G	TRUNK LID OPENER REQUEST SW
48	G	1-KEY WARN BLIZZER (ENG ROOM)
49	GR	TRUNK LID OPENER SW
50	EG	REAR LH DOOR SW

Connector No.	M123
Connector Name	BCM (BODY CONTROL MODULE)
Connector Type	TH40FC-NH



Connector No.	M123
Connector Name	BCM (BODY CONTROL MODULE)
Connector Type	TH40FC-NH

Terminal No.	Color Of Wire	Signal Name [Specification]
51	EG	OPTICAL SENSOR
52	SB	STOP LAMP SW 1
53	SB	STOP LAMP SW 2
54	SB	DR DOOR UNLOCK SENSOR
55	SB	KEYLESS SW
56	R	PASSENGER DOOR SW
57	EG	TRUNK LID OPENER CANCEL SW
58	V	POWER WINDOW SW COMM
59	L	PUSH-BUTTON IGNITION SW ILL POWER
60	LG	LOCK IND
61	EG	RECEIVER / SENSOR CND

Terminal No.	Color Of Wire	Signal Name [Specification]
79	BR	ROOM ANT 1+
80	GR	MISC ANT LAMP
81	W	MISC ANT AMP
82	SB	IGN RELAY (E) BL CONT
83	Y	KEYLESS ENTRY RECEIVER COMM
84	Y	COMBI SW INPUT 5
85	EG	COMBI SW INPUT 1
86	EG	COMBI SW INPUT 2
87	P	COMBI SW INPUT 3
88	L	CAN-L
89	L	CAN-H
90	P	KEY SLOT ILL CONT
91	LG	ON IND
92	GR	ACC RELAY CONT
93	GR	SHIFT P
94	R	PASSENGER DOOR REQUEST SW
95	B	DRIVER DOOR REQUEST SW
96	EG	BLOWER FAN MOTOR RELAY CONT
97	P	KEYLESS ENTRY RECEIVER POWER SUPPLY
98	LG	COMBI SW INPUT 1
99	R	COMBI SW INPUT 4
100	R	COMBI SW INPUT 2
101	W	HAZARD SW
102	G	
103	G	
104	G	
105	G	
106	G	
107	G	
108	G	
109	G	
110	G	

Terminal No.	Color Of Wire	Signal Name [Specification]
138	V	RECEIVER / SENSOR POWER SUPPLY
139	L	TRIP PRESSURE RECEIVER COMM
140	B	SECURITY ILL LAMP CONT
141	W	SECURITY ILL LAMP CONT
142	BR	COMBI SW OUTPUT 5
143	P	COMBI SW OUTPUT 1
144	G	COMBI SW OUTPUT 2
145	L	COMBI SW OUTPUT 3
146	SB	COMBI SW OUTPUT 4
150	GR	DRIVER DOOR SW
151	G	REAR WINDOW DEFOGGER RELAY CONT

Connector No.	M131
Connector Name	INSIDE KEY ANTENNA (INSTRUMENT CENTER)
Connector Type	PRO2FGY



Terminal No.	Color Of Wire	Signal Name [Specification]
1	BR	
2	Y	

Connector No.	M137
Connector Name	A/T SHIFT SELECTOR
Connector Type	TH12FW-NH

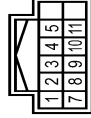

Terminal No.	Color Of Wire	Signal Name [Specification]
1	W	
2	V	
3	L	
4	B	
5	G	

# BCM (BODY CONTROL MODULE)

< ECU DIAGNOSIS INFORMATION >

## BCM (BODY CONTROL MODULE)

7	V	-
8	G	-
9	S	-
10	GR	-
11	R	-

Connector No.	M146
Connector Name	INSIDE KEY ANTENNA (CONSOLE)
Connector Type	RK02FGY



Terminal No.	Color Of Wire	Signal Name [Specification]
1	G	-
2	R	-

Connector No.	R4
Connector Name	SUNROOF MOTOR ASSEMBLY
Connector Type	YEA1BEGY

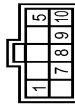

Terminal No.	Color Of Wire	Signal Name [Specification]
1	GR	SW-BIT 1
5	P	SW-BIT -
7	BR	IB
8	V	SPEED SENSOR (2P)
9	L	THICK (3G3)
10	G	GROUND

Connector No.	RI2
Connector Name	VANITY MIRROR LAMP LH
Connector Type	MC40EFW



Terminal No.	Color Of Wire	Signal Name [Specification]
1	B	-
2	R	-

Connector No.	RI3
Connector Name	VANITY MIRROR LAMP RH
Connector Type	MC40DFW



Terminal No.	Color Of Wire	Signal Name [Specification]
1	B	-
2	R	-

Connector No.	RI4
Connector Name	PERSONAL LAMP
Connector Type	TR04FW-NH



Terminal No.	Color Of Wire	Signal Name [Specification]
1	R	-
2	B	-
3	V	-

Connector No.	RI5
Connector Name	MAP LAMP
Connector Type	TK0BFCY



Terminal No.	Color Of Wire	Signal Name [Specification]
1	R	-
2	V	-
3	Y	-
4	B	-
5	SHIELD	-
6	B	-

## Fail-safe

### FAIL-SAFE CONTROL BY DTC

BCM performs fail-safe control when any DTC are detected.

JRMWF9513GB

INFOID:000000011405326

A  
B  
C  
D  
E  
F  
G  
H  
I  
J  
K  
M  
N  
O  
P

WW

# BCM (BODY CONTROL MODULE)

## < ECU DIAGNOSIS INFORMATION >

Display contents of CONSULT	Fail-safe	Cancellation
B2190: NATS ANTENNA AMP	Inhibit engine cranking	Erase DTC
B2191: DIFFERENCE OF KEY	Inhibit engine cranking	Erase DTC
B2192: ID DISCORD BCM-ECM	Inhibit engine cranking	Erase DTC
B2193: CHAIN OF BCM-ECM	Inhibit engine cranking	Erase DTC
B2195: ANTI-SCANNING	Inhibit engine cranking	Ignition switch ON → OFF
B2560: STARTER CONT RELAY	Inhibit engine cranking	500 ms after the following CAN signal communication status becomes consistent <ul style="list-style-type: none"> <li>• Starter control relay signal</li> <li>• Starter relay status signal</li> </ul>
B2608: STARTER RELAY	Inhibit engine cranking	500 ms after the following signal communication status becomes consistent <ul style="list-style-type: none"> <li>• Starter motor relay control signal</li> <li>• Starter relay status signal (CAN)</li> </ul>
B260A: IGNITION RELAY	Inhibit engine cranking	500 ms after the following conditions are fulfilled <ul style="list-style-type: none"> <li>• IGN relay (IPDM E/R) control signal: OFF (12 V)</li> <li>• Ignition ON signal (CAN to IPDM E/R): OFF (Request signal)</li> <li>• Ignition ON signal (CAN from IPDM E/R): OFF (Condition signal)</li> </ul>
B260F: ENG STATE SIG LOST	Maintains the power supply position attained at the time of DTC detection	When any of the following conditions are fulfilled <ul style="list-style-type: none"> <li>• Power position changes to ACC</li> <li>• Receives engine status signal (CAN)</li> </ul>
B2617: BCM	Inhibit engine cranking	1 second after the starter motor relay control inside BCM becomes normal
B2618: BCM	Inhibit engine cranking	1 second after the ignition relay (IPDM E/R) control inside BCM becomes normal
B261E: VEHICLE TYPE	Inhibit engine cranking	BCM initialization

## DTC Inspection Priority Chart

INFOID:000000011405327

If some DTCs are displayed at the same time, perform inspections one by one based on the following priority chart.

Priority	DTC
1	B2562: LOW VOLTAGE
2	<ul style="list-style-type: none"> <li>• U1000: CAN COMM</li> <li>• U1010: CONTROL UNIT(CAN)</li> </ul>
3	<ul style="list-style-type: none"> <li>• B2190: NATS ANTENNA AMP</li> <li>• B2191: DIFFERENCE OF KEY</li> <li>• B2192: ID DISCORD BCM-ECM</li> <li>• B2193: CHAIN OF BCM-ECM</li> <li>• B2195: ANTI-SCANNING</li> </ul>

# BCM (BODY CONTROL MODULE)

## < ECU DIAGNOSIS INFORMATION >

Priority	DTC	
4	• B2553: IGNITION RELAY	A
	• B2555: STOP LAMP	
	• B2556: PUSH-BTN IGN SW	
	• B2557: VEHICLE SPEED	B
	• B2560: STARTER CONT RELAY	
	• B2601: SHIFT POSITION	
	• B2602: SHIFT POSITION	
	• B2603: SHIFT POSI STATUS	C
	• B2604: PNP/CLUTCH SW	
	• B2605: PNP/CLUTCH SW	
	• B2608: STARTER RELAY	
	• B260A: IGNITION RELAY	D
	• B260F: ENG STATE SIG LOST	
	• B2614: BCM	
	• B2615: BCM	
	• B2616: BCM	E
	• B2617: BCM	
	• B2618: BCM	
	• B261A: PUSH-BTN IGN SW	F
	• B261E: VEHICLE TYPE	
• B26EA: KEY REGISTRATION		
• C1729: VHCL SPEED SIG ERR		
• U0415: VEHICLE SPEED	G	
5	• C1704: LOW PRESSURE FL	
	• C1705: LOW PRESSURE FR	
	• C1706: LOW PRESSURE RR	
	• C1707: LOW PRESSURE RL	H
	• C1708: [NO DATA] FL	
	• C1709: [NO DATA] FR	
	• C1710: [NO DATA] RR	
	• C1711: [NO DATA] RL	I
	• C1716: [PRESSDATA ERR] FL	
	• C1717: [PRESSDATA ERR] FR	
	• C1718: [PRESSDATA ERR] RR	J
	• C1719: [PRESSDATA ERR] RL	
	• C1734: CONTROL UNIT	
6	• B2621: INSIDE ANTENNA	K
	• B2622: INSIDE ANTENNA	
	• B2623: INSIDE ANTENNA	

## DTC Index

INFOID:000000011405328

WW

### NOTE:

The details of time display are as follows.

- CRNT: A malfunction is detected now.
- PAST: A malfunction was detected in the past.

IGN counter is displayed on Freeze Frame Data. For details of Freeze Frame Data, refer to [BCS-16. "COMMON ITEM : CONSULT Function \(BCM - COMMON ITEM\)"](#).

CONSULT display	Fail-safe	Freeze Frame Data •Vehicle Speed •Odo/Trip Meter •Vehicle condition	Intelligent Key warning lamp ON	Tire pressure monitor warning lamp ON	Reference
No DTC is detected. further testing may be required.	—	—	—	—	—
U1000: CAN COMM	—	—	—	—	<a href="#">BCS-36</a>
U1010: CONTROL UNIT(CAN)	—	—	—	—	<a href="#">BCS-37</a>
U0415: VEHICLE SPEED	—	—	—	—	<a href="#">BCS-38</a>
B2190: NATS ANTENNA AMP	×	—	—	—	<a href="#">SEC-43</a>

## BCM (BODY CONTROL MODULE)

### < ECU DIAGNOSIS INFORMATION >

CONSULT display	Fail-safe	Freeze Frame Data •Vehicle Speed •Odo/Trip Meter •Vehicle condition	Intelligent Key warning lamp ON	Tire pressure monitor warning lamp ON	Reference
B2191: DIFFERENCE OF KEY	×	—	—	—	<a href="#">SEC-46</a>
B2192: ID DISCORD BCM-ECM	×	—	—	—	<a href="#">SEC-47</a>
B2193: CHAIN OF BCM-ECM	×	—	—	—	<a href="#">SEC-49</a>
B2195: ANTI-SCANNING	×	—	—	—	<a href="#">SEC-50</a>
B2553: IGNITION RELAY	—	×	—	—	<a href="#">PCS-49</a>
B2555: STOP LAMP	—	×	—	—	<a href="#">SEC-51</a>
B2556: PUSH-BTN IGN SW	—	×	×	—	<a href="#">SEC-53</a>
B2557: VEHICLE SPEED	×	×	×	—	<a href="#">SEC-55</a>
B2560: STARTER CONT RELAY	×	×	×	—	<a href="#">SEC-56</a>
B2562: LOW VOLTAGE	—	×	—	—	<a href="#">BCS-39</a>
B2601: SHIFT POSITION	×	×	×	—	<a href="#">SEC-57</a>
B2602: SHIFT POSITION	×	×	×	—	<a href="#">SEC-60</a>
B2603: SHIFT POSI STATUS	×	×	×	—	<a href="#">SEC-63</a>
B2604: PNP/CLUTCH SW	×	×	×	—	<a href="#">SEC-66</a>
B2605: PNP/CLUTCH SW	×	×	×	—	<a href="#">SEC-68</a>
B2608: STARTER RELAY	×	×	×	—	<a href="#">SEC-70</a>
B260A: IGNITION RELAY	×	×	×	—	<a href="#">PCS-51</a>
B260F: ENG STATE SIG LOST	×	×	×	—	<a href="#">SEC-72</a>
B2614: BCM	—	×	×	—	<a href="#">PCS-53</a>
B2615: BCM	—	×	×	—	<a href="#">PCS-55</a>
B2616: BCM	—	×	×	—	<a href="#">PCS-57</a>
B2617: BCM	×	×	×	—	<a href="#">SEC-74</a>
B2618: BCM	×	×	×	—	<a href="#">PCS-59</a>
B261A: PUSH-BTN IGN SW	—	×	×	—	<a href="#">PCS-60</a>
B261E: VEHICLE TYPE	×	×	× (Turn ON for 15 seconds)	—	<a href="#">SEC-76</a>
B2621: INSIDE ANTENNA	—	×	—	—	<a href="#">DLK-59</a>
B2622: INSIDE ANTENNA	—	×	—	—	<a href="#">DLK-61</a>
B2623: INSIDE ANTENNA	—	×	—	—	<a href="#">DLK-63</a>
B26EA: KEY REGISTRATION	—	×	× (Turn ON for 15 seconds)	—	<a href="#">SEC-73</a>
C1704: LOW PRESSURE FL	—	—	—	×	<a href="#">WT-25</a>
C1705: LOW PRESSURE FR	—	—	—	×	
C1706: LOW PRESSURE RR	—	—	—	×	
C1707: LOW PRESSURE RL	—	—	—	×	
C1708: [NO DATA] FL	—	—	—	×	<a href="#">WT-27</a>
C1709: [NO DATA] FR	—	—	—	×	
C1710: [NO DATA] RR	—	—	—	×	
C1711: [NO DATA] RL	—	—	—	×	
C1716: [PRESSDATA ERR] FL	—	—	—	×	<a href="#">WT-30</a>
C1717: [PRESSDATA ERR] FR	—	—	—	×	
C1718: [PRESSDATA ERR] RR	—	—	—	×	
C1719: [PRESSDATA ERR] RL	—	—	—	×	



# BCM (BODY CONTROL MODULE)

## < ECU DIAGNOSIS INFORMATION >

CONSULT display	Fail-safe	Freeze Frame Data •Vehicle Speed •Odo/Trip Meter •Vehicle condition	Intelligent Key warning lamp ON	Tire pressure monitor warning lamp ON	Reference
C1729: VHCL SPEED SIG ERR	—	—	—	×	<a href="#">WT-31</a>
C1734: CONTROL UNIT	—	—	—	×	<a href="#">WT-32</a>

A

B

C

D

E

F

G

H

I

J

K

**WW**

M

N

O

P

# IPDM E/R (INTELLIGENT POWER DISTRIBUTION MODULE ENGINE ROOM)

< ECU DIAGNOSIS INFORMATION >

## IPDM E/R (INTELLIGENT POWER DISTRIBUTION MODULE ENGINE ROOM)

### Reference Value

INFOID:000000011435314

### VALUES ON THE DIAGNOSIS TOOL

#### NOTE:

The following table includes information (items) inapplicable to this vehicle. For information (items) applicable to this vehicle, refer to CONSULT display items.

Monitor Item	Condition		Value/Status
RAD FAN REQ	Engine idle speed	Changes depending on engine coolant temperature, air conditioner operation status, vehicle speed, etc.	0 - 100 %
AC COMP REQ	Engine running	A/C switch OFF	Off
		A/C switch ON (Compressor is operating)	On
TAIL&CLR REQ	Lighting switch OFF		Off
	Lighting switch 1ST, 2ND, HI or AUTO (Light is illuminated)		On
HL LO REQ	Lighting switch OFF		Off
	Lighting switch 2ND HI or AUTO (Light is illuminated)		On
HL HI REQ	Lighting switch OFF		Off
	Lighting switch HI		On
FR FOG REQ	Lighting switch 2ND or AUTO (Light is illuminated)	Front fog lamp switch OFF	Off
		Front fog lamp switch ON	On
FR WIP REQ	Ignition switch ON	Front wiper switch OFF	Stop
		Front wiper switch INT	1LOW
		Front wiper switch LO	Low
		Front wiper switch HI	Hi
WIP AUTO STOP	Ignition switch ON	Front wiper stop position	STOP P
		Any position other than front wiper stop position	ACT P
WIP PROT	Ignition switch ON	Front wiper operates normally	Off
		Front wiper stops at fail-safe operation	BLOCK
IGN RLY1 -REQ	Ignition switch OFF or ACC		Off
	Ignition switch ON		On
IGN RLY	Ignition switch OFF or ACC		Off
	Ignition switch ON		On
PUSH SW	Release the push-button ignition switch		Off
	Press the push-button ignition switch		On
INTER/NP SW	Ignition switch ON	Selector lever in any position other than P or N	Off
	Ignition switch ON	Selector lever in P or N position	On
ST RLY CONT	Ignition switch ON		Off
	At engine cranking		On
IHBT RLY -REQ	Ignition switch ON		Off
	At engine cranking		On

# IPDM E/R (INTELLIGENT POWER DISTRIBUTION MODULE ENGINE ROOM)

## < ECU DIAGNOSIS INFORMATION >

Monitor Item	Condition	Value/Status
ST/INHI RLY	Ignition switch ON	Off
	At engine cranking	INHI ON → ST ON
	The status of starter relay or starter control relay cannot be recognized by the battery voltage malfunction, etc. when the starter relay is ON and the starter control relay is OFF	UNKWN
DETENT SW	Ignition switch ON	<ul style="list-style-type: none"> <li>Press the selector button with selector lever in P position</li> <li>Selector lever in any position other than P</li> </ul> Off
	Release the selector button with selector lever in P position	On
S/L RLY -REQ	<b>NOTE:</b> The item is indicated, but not monitored.	Off
S/L STATE	<b>NOTE:</b> The item is indicated, but not monitored.	UNLOCK
DTRL REQ	<b>NOTE:</b> The item is indicated, but not monitored.	Off
OIL P SW	Ignition switch OFF, ACC or engine running	Open
	Ignition switch ON	Close
HOOD SW	Close the hood	Off
	Open the hood	On
HL WASHER REQ	<b>NOTE:</b> The item is indicated, but not monitored.	Off
THFT HRN REQ	Not operation	Off
	<ul style="list-style-type: none"> <li>Panic alarm is activated</li> <li>Horn is activated with VEHICLE SECURITY (THEFT WARNING) SYSTEM</li> </ul>	On
HORN CHIRP	Not operating	Off
	Door locking with Intelligent Key (horn chirp mode)	On
CRNRNG LMP REQ	<b>NOTE:</b> The item is indicated, but not monitored.	Off

A  
B  
C  
D  
E  
F  
G  
H  
I  
J  
K

WW

M  
N  
O  
P

# IPDM E/R (INTELLIGENT POWER DISTRIBUTION MODULE ENGINE ROOM)

< ECU DIAGNOSIS INFORMATION >

## TERMINAL LAYOUT

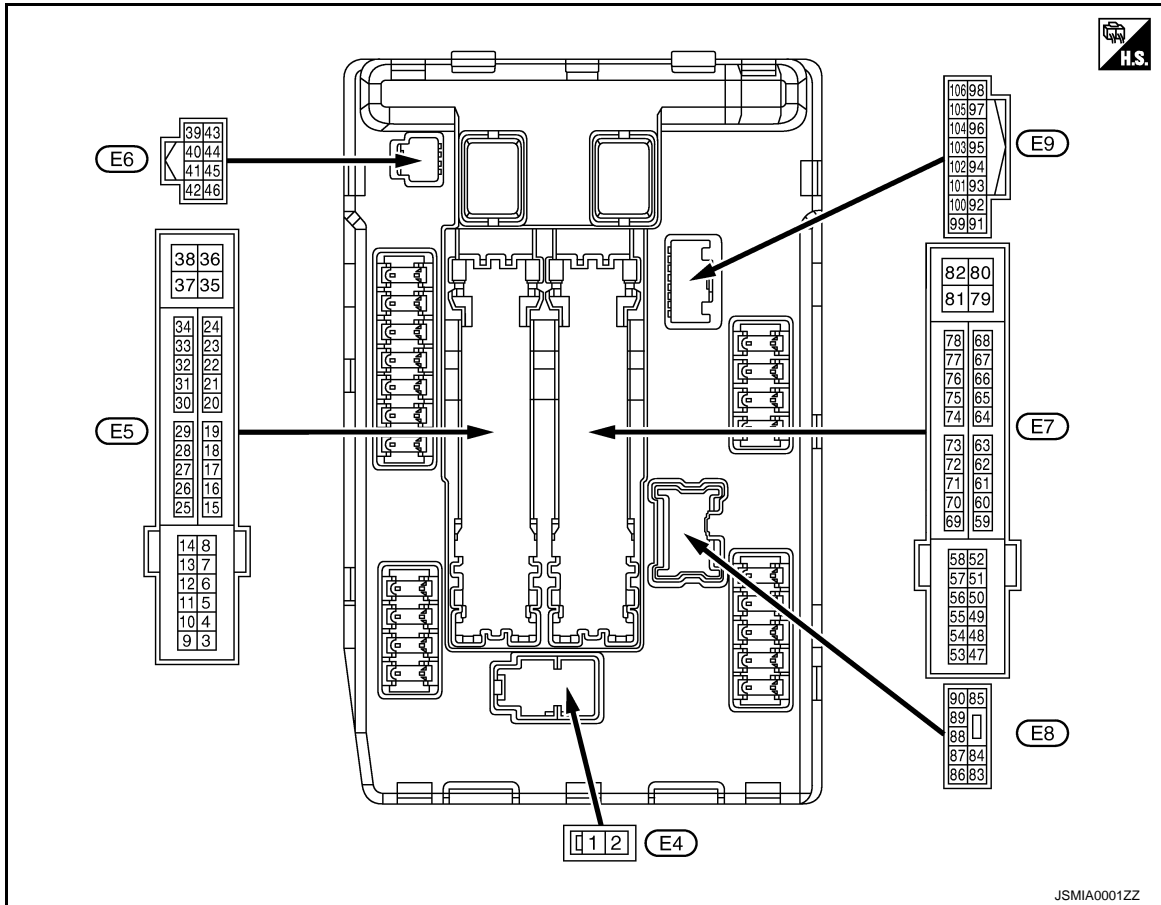

## PHYSICAL VALUES

Terminal No. (Wire color)		Description		Condition		Value (Approx.)
+	-	Signal name	Input/ Output			
1 (W)	Ground	Battery power supply	Input	Ignition switch OFF		Battery voltage
2 (L)	Ground	Battery power supply	Input	Ignition switch OFF		Battery voltage
4 (V)	Ground	Front wiper LO	Output	Ignition switch ON	Front wiper switch OFF	0 V
					Front wiper switch LO	Battery voltage
5 (L)	Ground	Front wiper HI	Output	Ignition switch ON	Front wiper switch OFF	0 V
					Front wiper switch HI	Battery voltage
7 (P)	Ground	Tail, license plate lamps & interior lamps	Output	Ignition switch ON	Lighting switch OFF	0 V
					Lighting switch 1ST	Battery voltage
12 (B/W)	Ground	Ground	—	Ignition switch ON		0 V
13 (Y)	Ground	Fuel pump power supply	Output	Approximately 1 second or more after turning the ignition switch ON		0 V
				<ul style="list-style-type: none"> <li>Approximately 1 second after turning the ignition switch ON</li> <li>Engine running</li> </ul>		Battery voltage
16 (LG)	Ground	Front wiper auto stop	Input	Ignition switch ON	Front wiper stop position	0 V
					Any position other than front wiper stop position	Battery voltage

# IPDM E/R (INTELLIGENT POWER DISTRIBUTION MODULE ENGINE ROOM)

## < ECU DIAGNOSIS INFORMATION >

Terminal No. (Wire color)		Description		Condition	Value (Approx.)		
+	-	Signal name	Input/ Output				
19 (R)	Ground	Ignition relay power supply	Output	Ignition switch OFF	0 V	A	
				Ignition switch ON	Battery voltage	B	
25 (G)	Ground	Ignition relay power supply	Output	Ignition switch OFF	0 V	C	
				Ignition switch ON	Battery voltage	C	
27 (BG)	Ground	Ignition relay monitor	Input	Ignition switch OFF or ACC	Battery voltage	D	
				Ignition switch ON	0 V	D	
28 (L)	Ground	Push-button ignition switch	Input	Press the push-button ignition switch	0 V	E	
				Release the push-button ignition switch	Battery voltage	E	
30 (GR)	Ground	Starter relay control	Input	Selector lever in any position other than P or N (Ignition switch ON)	0 V	F	
				Selector lever P or N (Ignition switch ON)	Battery voltage	F	
36 (G)	Ground	Battery power supply	Input	Ignition switch OFF	Battery voltage	G	
39 (P)	—	CAN-L	Input/ Output	—	—	G	
40 (L)	—	CAN-H	Input/ Output	—	—	H	
41 (B/W)	Ground	Ground	—	Ignition switch ON	0 V	H	
42 (GR)	Ground	Cooling fan relay control	Input	Ignition switch OFF or ACC	0 V	I	
				Ignition switch ON	0.7 V	I	
43 (G)	Ground	A/T shift selector (Detention switch)	Input	Ignition switch ON	<ul style="list-style-type: none"> <li>Press the selector button (selector lever P)</li> <li>Selector lever in any position other than P</li> </ul>	Battery voltage	J
					Release the selector button (selector lever P)	0 V	K
44 (LG)	Ground	Horn relay control	Input	The horn is deactivated	Battery voltage	K	
				The horn is activated	0 V	K	
45 (V)	Ground	Anti theft horn relay control	Input	The horn is deactivated	Battery voltage	WW	
				The horn is activated	0 V	WW	
46 (SB)	Ground	Starter relay control	Input	Selector lever in any position other than P or N (Ignition switch ON)	0 V	M	
				Selector lever P or N (Ignition switch ON)	Battery voltage	M	
				Release the clutch pedal	0 V	N	
				Depress the clutch pedal	Battery voltage	N	
48 (L)	Ground	A/C relay power supply	Output	Engine running	A/C switch OFF	0 V	O
					A/C switch ON (A/C compressor is operating)	Battery voltage	O
49 (BG)	Ground	ECM relay power supply	Output	Ignition switch OFF (More than a few seconds after turning ignition switch OFF)	0 V	P	
				<ul style="list-style-type: none"> <li>Ignition switch ON</li> <li>Ignition switch OFF (For a few seconds after turning ignition switch OFF)</li> </ul>	Battery voltage	P	

# IPDM E/R (INTELLIGENT POWER DISTRIBUTION MODULE ENGINE ROOM)

## < ECU DIAGNOSIS INFORMATION >

Terminal No. (Wire color)		Description		Condition	Value (Approx.)
+	-	Signal name	Input/ Output		
51 (Y)	Ground	Ignition relay power supply	Output	Ignition switch OFF	0 V
				Ignition switch ON	Battery voltage
53 (W)	Ground	ECM relay power supply	Output	Ignition switch OFF (More than a few seconds after turning ignition switch OFF)	0 V
				<ul style="list-style-type: none"> <li>Ignition switch ON</li> <li>Ignition switch OFF (For a few seconds after turning ignition switch OFF)</li> </ul>	Battery voltage
54 (P)	Ground	Throttle control motor relay power supply	Output	Ignition switch OFF (More than a few seconds after turning ignition switch OFF)	0 V
				<ul style="list-style-type: none"> <li>Ignition switch ON</li> <li>Ignition switch OFF (For a few seconds after turning ignition switch OFF)</li> </ul>	Battery voltage
55 (SB)	Ground	ECM power supply	Output	Ignition switch OFF	Battery voltage
56 (BR)	Ground	Ignition relay power supply	Output	Ignition switch OFF	0 V
				Ignition switch ON	Battery voltage
57 (G)	Ground	Ignition relay power supply	Output	Ignition switch OFF	0 V
				Ignition switch ON	Battery voltage
58 (GR)	Ground	Ignition relay power supply	Output	Ignition switch OFF	0 V
				Ignition switch ON	Battery voltage
69 (BR)	Ground	ECM relay control	Output	Ignition switch OFF (More than a few seconds after turning ignition switch OFF)	Battery voltage
				<ul style="list-style-type: none"> <li>Ignition switch ON</li> <li>Ignition switch OFF (For a few seconds after turning ignition switch OFF)</li> </ul>	0 - 1.5 V
70 (BG)	Ground	Throttle control motor relay control	Output	Ignition switch ON → OFF	0 - 1.0 V ↓ Battery voltage ↓ 0 V
				Ignition switch ON	0 - 1.0 V
74 (G)	Ground	Ignition relay power supply	Output	Ignition switch OFF	0 V
				Ignition switch ON	Battery voltage
75 (SB)	Ground	Oil pressure switch	Input	Ignition switch ON	0 V
				Engine running	Battery voltage

# IPDM E/R (INTELLIGENT POWER DISTRIBUTION MODULE ENGINE ROOM)

## < ECU DIAGNOSIS INFORMATION >

Terminal No. (Wire color)		Description		Condition	Value (Approx.)
+	-	Signal name	Input/ Output		
76 (Y)	Ground	Power generation command signal	Output	Ignition switch ON	<p>6.3 V</p>
				40% is set on "ACTIVE TEST", "ALTERNATOR DUTY" of "ENGINE"	<p>3.8 V</p>
				80% is set on "ACTIVE TEST", "ALTERNATOR DUTY" of "ENGINE"	<p>1.4 V</p>
77 (R)	Ground	Fuel pump relay control	Output	<ul style="list-style-type: none"> <li>Approximately 1 second after turning the ignition switch ON</li> <li>Engine running</li> </ul>	0 - 1.0 V
				Approximately 1 second or more after turning the ignition switch ON	Battery voltage
80 (W)	Ground	Starter motor	Output	At engine cranking	Battery voltage
83 (R)	Ground	Headlamp LO (RH)	Output	Ignition switch ON	Lighting switch OFF 0 V
				Lighting switch 2ND	Battery voltage
84 (V)	Ground	Headlamp LO (LH)	Output	Ignition switch ON	Lighting switch OFF 0 V
				Lighting switch 2ND	Battery voltage
86 (W)	Ground	Front fog lamp (RH)	Output	Lighting switch 2ND	Front fog lamp switch OFF 0 V
				Front fog lamp switch ON	Battery voltage
87 (L)	Ground	Front fog lamp (LH)	Output	Lighting switch 2ND	Front fog lamp switch OFF 0 V
				Front fog lamp switch ON	Battery voltage
88 (G)	Ground	Washer pump power supply	Output	Ignition switch ON	Battery voltage
89 (BR)	Ground	Headlamp HI (RH)	Output	Ignition switch ON	Lighting switch OFF 0 V
				<ul style="list-style-type: none"> <li>Lighting switch HI</li> <li>Lighting switch PASS</li> </ul>	Battery voltage
90 (P)	Ground	Headlamp HI (LH)	Output	Ignition switch ON	Lighting switch OFF 0 V
				<ul style="list-style-type: none"> <li>Lighting switch HI</li> <li>Lighting switch PASS</li> </ul>	Battery voltage

A  
B  
C  
D  
E  
F  
G  
H  
I  
J  
K  
M  
N  
O  
P

WW

# IPDM E/R (INTELLIGENT POWER DISTRIBUTION MODULE ENGINE ROOM)

## < ECU DIAGNOSIS INFORMATION >

Terminal No. (Wire color)		Description		Condition		Value (Approx.)
+	-	Signal name	Input/ Output			
91 (G)	Ground	Parking lamp (RH)	Output	Ignition switch ON	Lighting switch OFF	0 V
					Lighting switch 1ST	Battery voltage
92 (BG)	Ground	Parking lamp (LH)	Output	Ignition switch ON	Lighting switch OFF	0 V
					Lighting switch 1ST	Battery voltage
97 (V)	Ground	Cooling fan control	Output	Engine idling		0 - 5 V
104 (LG)	Ground	Hood switch	Input	Close the hood		Battery voltage
				Open the hood		0 V



# IPDM E/R (INTELLIGENT POWER DISTRIBUTION MODULE ENGINE ROOM)

< ECU DIAGNOSIS INFORMATION >

## Wiring Diagram - IPDM E/R -

INFOID:000000011435315

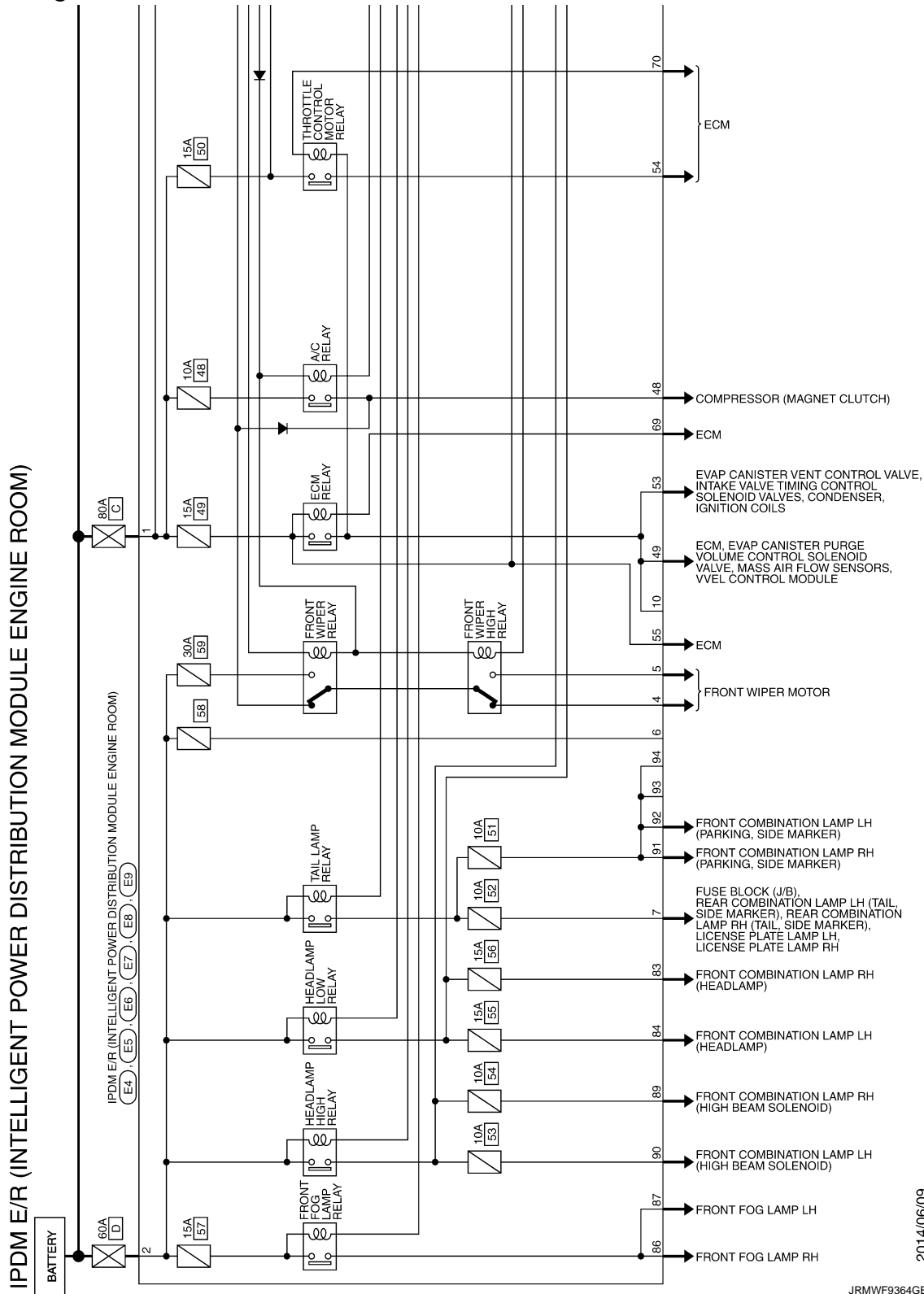

A  
B  
C  
D  
E  
F  
G  
H  
I  
J  
K  
L  
M  
N  
O  
P

WW

2014/06/09

JRMWF9364GB

# IPDM E/R (INTELLIGENT POWER DISTRIBUTION MODULE ENGINE ROOM)

< ECU DIAGNOSIS INFORMATION >

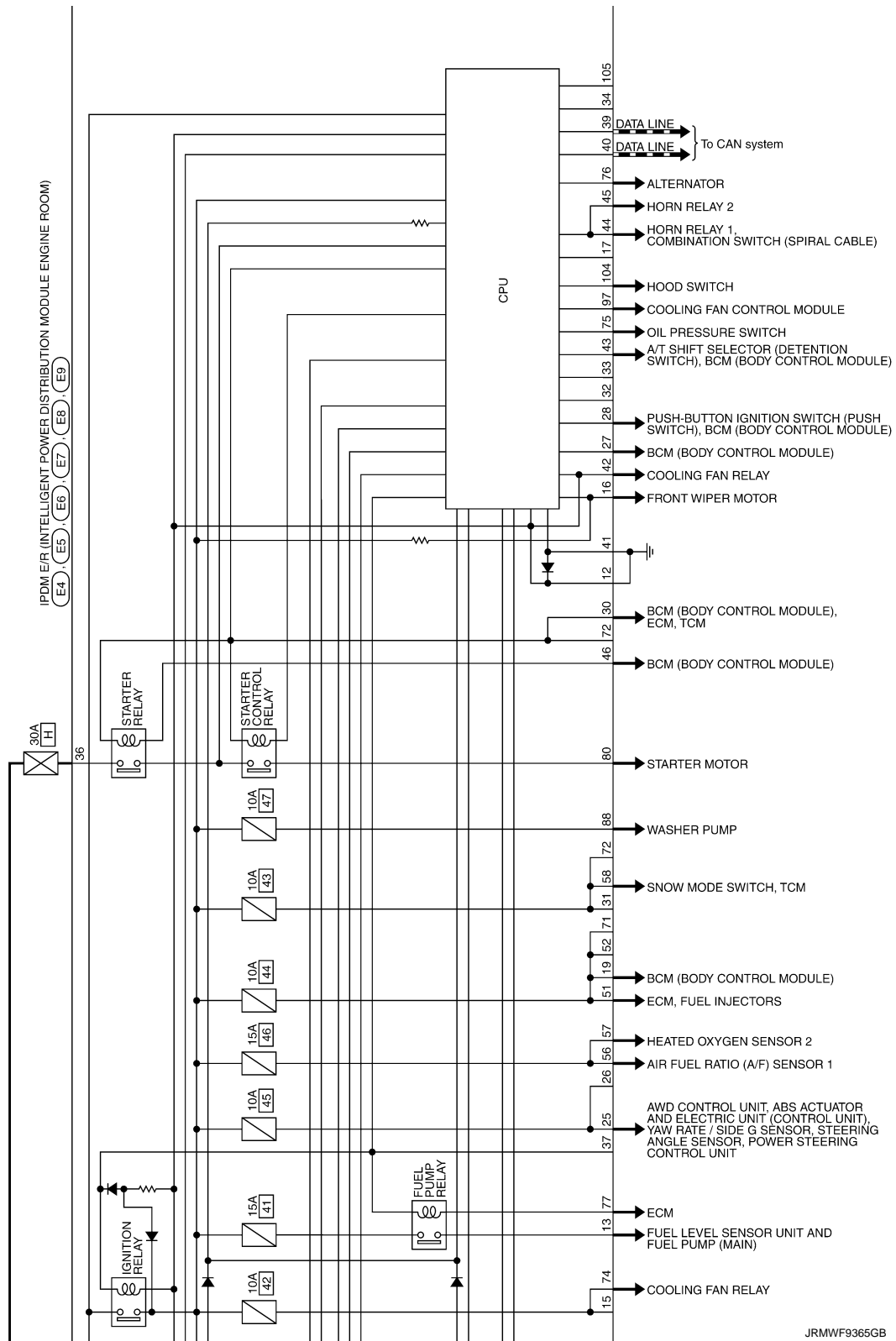

JRMWF9365GB

# IPDM E/R (INTELLIGENT POWER DISTRIBUTION MODULE ENGINE ROOM)

< ECU DIAGNOSIS INFORMATION >

---

A  
B  
C  
D  
E  
F  
G  
H  
I  
J  
K  
M  
N  
O  
P

IPDM E/R  
(INTELLIGENT POWER  
DISTRIBUTION MODULE  
ENGINE ROOM)  
E4 . E5 . E6 .  
E7 . E8 . E9 .

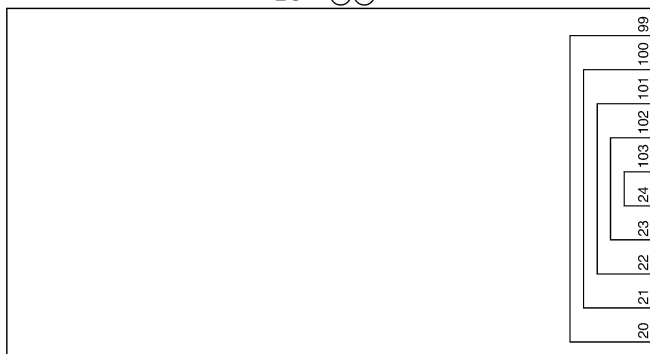

**WW**

JRMWF9366GB



# IPDM E/R (INTELLIGENT POWER DISTRIBUTION MODULE ENGINE ROOM)

## < ECU DIAGNOSIS INFORMATION >

Control part	Fail-safe operation
Cooling fan	<ul style="list-style-type: none"> <li>Outputs the pulse duty signal (PWM signal) 100% when the ignition switch is turned ON</li> <li>Outputs the pulse duty signal (PWM signal) 0% when the ignition switch is turned OFF</li> </ul>
A/C compressor	A/C relay OFF
Alternator	Outputs the power generation command signal (PWM signal) 0%

### If No CAN Communication Is Available With BCM

Control part	Fail-safe operation
Headlamp	<ul style="list-style-type: none"> <li>Turns ON the headlamp low relay when the ignition switch is turned ON</li> <li>Turns OFF the headlamp low relay when the ignition switch is turned OFF</li> <li>Headlamp high relay OFF</li> </ul>
<ul style="list-style-type: none"> <li>Parking lamps</li> <li>Side maker lamp</li> <li>License plate lamps</li> <li>Illuminations</li> <li>Tail lamps</li> </ul>	<ul style="list-style-type: none"> <li>Turns ON the tail lamp relay when the ignition switch is turned ON</li> <li>Turns OFF the tail lamp relay when the ignition switch is turned OFF</li> </ul>
Front wiper	<ul style="list-style-type: none"> <li>The status just before activation of fail-safe control is maintained until the ignition switch is turned OFF while the front wiper is operating at LO or HI speed.</li> <li>The wiper is operated at LO speed until the ignition switch is turned OFF if the fail-safe control is activated while the front wiper is set in the INT mode and the front wiper motor is operating.</li> </ul>
Horn	Horn relay OFF
Ignition relay	The status just before activation of fail-safe is maintained.
Starter motor	Starter control relay OFF

### IGNITION RELAY MALFUNCTION DETECTION FUNCTION

- IPDM E/R monitors the voltage at the contact circuit and excitation coil circuit of the ignition relay inside it.
- IPDM E/R judges the ignition relay error if the voltage differs between the contact circuit and the excitation coil circuit.
- If the ignition relay cannot turn OFF due to contact seizure, it activates the tail lamp relay for 10 minutes to alert the user to the ignition relay malfunction when the ignition switch is turned OFF.

Voltage judgment		IPDM E/R judgment	Operation
Ignition relay contact side	Ignition relay excitation coil side		
ON	ON	Ignition relay ON normal	—
OFF	OFF	Ignition relay OFF normal	—
ON	OFF	Ignition relay ON stuck	<ul style="list-style-type: none"> <li>Detects DTC “B2098: IGN RELAY ON CIRC”</li> <li>Turns ON the tail lamp relay for 10 minutes</li> </ul>
OFF	ON	Ignition relay OFF stuck	Detects DTC “B2099: IGN RELAY OFF CIRC”

### FRONT WIPER CONTROL

IPDM E/R detects front wiper stop position by a front wiper stop position signal. When a front wiper stop position signal is in the conditions listed below, IPDM E/R stops power supply to wiper after repeating a front wiper 10 seconds activation and 20 seconds stop five times.

Ignition switch	Front wiper switch	Front wiper stop position signal
ON	OFF	The front wiper stop position signal (stop position) cannot be input for 10 seconds.
	ON	The front wiper stop position signal does not change for 10 seconds.

#### NOTE:

This operation status can be confirmed on the IPDM E/R “Data Monitor” that displays “BLOCK” for the item “WIP PROT” while the wiper is stopped.

# IPDM E/R (INTELLIGENT POWER DISTRIBUTION MODULE ENGINE ROOM)

## < ECU DIAGNOSIS INFORMATION >

### STARTER MOTOR PROTECTION FUNCTION

IPDM E/R turns OFF the starter control relay to protect the starter motor when the starter control relay remains active for 90 seconds.

### DTC Index

INFOID:000000011435317

#### NOTE:

- The details of time display are as follows.
  - CRNT: A malfunction is detected now.
  - PAST: A malfunction was detected in the past.
- IGN counter is displayed on FFD (Freeze Frame data).
  - The number is 0 when is detected now.
  - The number increases like 1 → 2 ... 38 → 39 after returning to the normal condition whenever IGN OFF → ON.
  - The number is fixed to 39 until the self-diagnosis results are erased if it is over 39.

×: Applicable

CONSULT display	Fail-safe	Refer to
No DTC is detected. further testing may be required.	—	—
U1000: CAN COMM CIRCUIT	×	<a href="#">PCS-14</a>
B2098: IGN RELAY ON CIRC	×	<a href="#">PCS-15</a>
B2099: IGN RELAY OFF CIRC	—	<a href="#">PCS-17</a>
B210B: STR CONT RLY ON CIRC	—	<a href="#">SEC-77</a>
B210C: STR CONT RLY OFF CIRC	—	<a href="#">SEC-78</a>
B210D: STARTER RLY ON CIRC	—	<a href="#">SEC-80</a>
B210E: STARTER RLY OFF CIRC	—	<a href="#">SEC-82</a>
B210F: INTRLCK/PNP SW ON	—	<a href="#">SEC-84</a>
B2110: INTRLCK/PNP SW OFF	—	<a href="#">SEC-86</a>

# FRONT WIPER AND WASHER SYSTEM SYMPTOMS

< SYMPTOM DIAGNOSIS >

## SYMPTOM DIAGNOSIS

### FRONT WIPER AND WASHER SYSTEM SYMPTOMS

Symptom Table

INFOID:0000000010989069

Symptom	Probable malfunction location	Inspection item	
Front wiper does not operate	HI only	<ul style="list-style-type: none"> <li>Combination switch</li> <li>Harness between combination switch and BCM</li> <li>BCM</li> </ul>	Combination switch Refer to <a href="#">BCS-87, "Symptom Table"</a> .
		<ul style="list-style-type: none"> <li>IPDM E/R</li> <li>Harness between IPDM E/R and front wiper motor</li> <li>Front wiper motor</li> </ul>	Front wiper motor (HI) circuit Refer to <a href="#">WW-22, "Component Function Check"</a> .
		Front wiper request signal <ul style="list-style-type: none"> <li>BCM</li> <li>IPDM E/R</li> </ul>	IPDM E/R Data monitor "FR WIP REQ"
	LO and INT	<ul style="list-style-type: none"> <li>Combination switch</li> <li>Harness between combination switch and BCM</li> <li>BCM</li> </ul>	Combination switch Refer to <a href="#">BCS-87, "Symptom Table"</a> .
		<ul style="list-style-type: none"> <li>IPDM E/R</li> <li>Harness between IPDM E/R and front wiper motor</li> <li>Front wiper motor</li> </ul>	Front wiper motor (LO) circuit Refer to <a href="#">WW-20, "Component Function Check"</a> .
		Front wiper request signal <ul style="list-style-type: none"> <li>BCM</li> <li>IPDM E/R</li> </ul>	IPDM E/R Data monitor "FR WIP REQ"
	INT only	<ul style="list-style-type: none"> <li>Combination switch</li> <li>Harness between combination switch and BCM</li> <li>BCM</li> </ul>	Combination switch Refer to <a href="#">BCS-87, "Symptom Table"</a> .
		Front wiper request signal <ul style="list-style-type: none"> <li>BCM</li> <li>IPDM E/R</li> </ul>	IPDM E/R Data monitor "FR WIP REQ"
	HI, LO and INT	SYMPTOM DIAGNOSIS Refer to <a href="#">WW-89, "Diagnosis Procedure"</a> .	
	Front wiper does not stop	HI only	<ul style="list-style-type: none"> <li>Combination switch</li> <li>BCM</li> </ul>
Front wiper request signal <ul style="list-style-type: none"> <li>BCM</li> <li>IPDM E/R</li> </ul>			IPDM E/R Data monitor "FR WIP REQ"
IPDM E/R			—
LO only		<ul style="list-style-type: none"> <li>Combination switch</li> <li>BCM</li> </ul>	Combination switch Refer to <a href="#">BCS-87, "Symptom Table"</a> .
		Front wiper request signal <ul style="list-style-type: none"> <li>BCM</li> <li>IPDM E/R</li> </ul>	IPDM E/R Data monitor "FR WIP REQ"
		IPDM E/R	—
INT only		<ul style="list-style-type: none"> <li>Combination switch</li> <li>BCM</li> </ul>	Combination switch refer to <a href="#">BCS-87, "Symptom Table"</a> .
		Front wiper request signal <ul style="list-style-type: none"> <li>BCM</li> <li>IPDM E/R</li> </ul>	IPDM E/R Data monitor "FR WIP REQ"

A

B

C

D

E

F

G

H

I

J

K

WW

M

N

O

P

## FRONT WIPER AND WASHER SYSTEM SYMPTOMS

### < SYMPTOM DIAGNOSIS >

Symptom		Probable malfunction location	Inspection item
Front wiper does not operate normally	Intermittent adjustment cannot be performed	<ul style="list-style-type: none"> <li>• Combination switch</li> <li>• Harness between combination switch and BCM</li> <li>• BCM</li> </ul>	Combination switch Refer to <a href="#">BCS-87, "Symptom Table"</a> .
		BCM	—
	Intermittent control linked with vehicle speed cannot be performed	Check the wiper setting is linked with vehicle speed. Refer to <a href="#">WW-12, "WIPER : CONSULT Function (BCM - WIPER)"</a> .	
	Wiper is not linked to the washer operation	<ul style="list-style-type: none"> <li>• Combination switch</li> <li>• Harness between combination switch and BCM</li> <li>• BCM</li> </ul>	Combination switch Refer to <a href="#">BCS-87, "Symptom Table"</a> .
BCM		—	
Does not return to stop position [Repeatedly operates for 10 seconds and then stops for 20 seconds. After that, it stops the operation. (Fail-safe)]	<ul style="list-style-type: none"> <li>• IPDM E/R</li> <li>• Harness between IPDM E/R and front wiper motor</li> <li>• Front wiper motor</li> </ul>	Front wiper stop position signal circuit Refer to <a href="#">WW-24, "Component Function Check"</a> .	



# FRONT WIPER DOES NOT OPERATE

< SYMPTOM DIAGNOSIS >

## FRONT WIPER DOES NOT OPERATE

### Description

INFOID:000000010989070

The front wiper does not operate under any operating conditions.

### Diagnosis Procedure

INFOID:000000010989071

#### 1. CHECK WIPER RELAY OPERATION

##### IPDM E/R AUTO ACTIVE TEST

1. Start IPDM E/R auto active test. Refer to [PCS-9, "Diagnosis Description"](#).
2. Check that the front wiper operates at the LO/Hi operation.

##### CONSULT ACTIVE TEST

1. Select "FRONT WIPER" of IPDM E/R active test item.
2. With operating the test item, check that front wiper LO/Hi operation and OFF.

**Lo** : Front wiper LO operation

**Hi** : Front wiper HI operation

**Off** : Stop the front wiper.

##### Does the front wiper operate?

- YES >> GO TO 4.  
NO >> GO TO 2.

#### 2. CHECK FRONT WIPER MOTOR FUSE

1. Turn the ignition switch OFF.
2. Check that the front wiper motor 30 A (#59) fuse is not fusing.

##### Is the fuse fusing?

- YES >> Replace the fuse after repairing the applicable circuit.  
NO >> GO TO 3.

#### 3. CHECK FRONT WIPER MOTOR (GND) OPEN CIRCUIT

1. Disconnect front wiper motor connector.
2. Check continuity between front wiper motor harness connector and ground.

Front wiper motor		Ground	Continuity
Connector	Terminal		Existed
E42	2		Existed

##### Does continuity exist?

- YES >> GO TO 4.  
NO >> Repair the harnesses or connectors.

#### 4. CHECK FRONT WIPER REQUEST SIGNAL INPUT

##### CONSULT DATA MONITOR

1. Select "FR WIP REQ" of IPDM E/R data monitor item.
2. Switch the front wiper switch to HI and LO.
3. With operating the front wiper switch, check the monitor status.

Monitor item	Condition		Monitor status
FR WIPER REQ	Front wiper switch HI	ON	Hi
		OFF	Stop
	Front wiper switch LO	ON	Low
		OFF	Stop

##### Is the status of item normal?

- YES >> Replace IPDM E/R.

A  
B  
C  
D  
E  
F  
G  
H  
I  
J  
K  
M  
N  
O  
P

WW

## FRONT WIPER DOES NOT OPERATE

< SYMPTOM DIAGNOSIS >

---

NO >> GO TO 5.

### 5.CHECK COMBINATION SWITCH

---

Perform the inspection of the combination switch. Refer to [BCS-87, "Symptom Table"](#).

Is combination switch normal?

YES >> Replace BCM. Refer to [BCS-90, "Exploded View"](#).

NO >> Repair or replace the applicable parts.

# NORMAL OPERATING CONDITION

< SYMPTOM DIAGNOSIS >

## NORMAL OPERATING CONDITION

---

### Description

INFOID:000000010989072

#### FRONT WIPER MOTOR PROTECTION FUNCTION

- IPDM E/R may stop the front wiper to protect the front wiper motor if any obstruction (operation resistance) such as a large amount of snow is detected during the front wiper operation.
- At that time turn OFF the front wiper and remove the foreign object. Then wait for approximately 20 seconds or more and reactivate the front wiper. The wiper will operate normally.

A

B

C

D

E

F

G

H

I

J

K

WW

M

N

O

P

# PRECAUTIONS

< PRECAUTION >

## PRECAUTION

### PRECAUTIONS

#### Precaution for Supplemental Restraint System (SRS) "AIR BAG" and "SEAT BELT PRE-TENSIONER"

INFOID:000000010989073

The Supplemental Restraint System such as "AIR BAG" and "SEAT BELT PRE-TENSIONER", used along with a front seat belt, helps to reduce the risk or severity of injury to the driver and front passenger for certain types of collision. This system includes seat belt switch inputs and dual stage front air bag modules. The SRS system uses the seat belt switches to determine the front air bag deployment, and may only deploy one front air bag, depending on the severity of a collision and whether the front occupants are belted or unbelted. Information necessary to service the system safely is included in the "SRS AIR BAG" and "SEAT BELT" of this Service Manual.

#### **WARNING:**

Always observe the following items for preventing accidental activation.

- To avoid rendering the SRS inoperative, which could increase the risk of personal injury or death in the event of a collision that would result in air bag inflation, all maintenance must be performed by an authorized NISSAN/INFINITI dealer.
- Improper maintenance, including incorrect removal and installation of the SRS, can lead to personal injury caused by unintentional activation of the system. For removal of Spiral Cable and Air Bag Module, see "SRS AIR BAG".
- Never use electrical test equipment on any circuit related to the SRS unless instructed to in this Service Manual. SRS wiring harnesses can be identified by yellow and/or orange harnesses or harness connectors.

#### PRECAUTIONS WHEN USING POWER TOOLS (AIR OR ELECTRIC) AND HAMMERS

#### **WARNING:**

Always observe the following items for preventing accidental activation.

- When working near the Air Bag Diagnosis Sensor Unit or other Air Bag System sensors with the ignition ON or engine running, never use air or electric power tools or strike near the sensor(s) with a hammer. Heavy vibration could activate the sensor(s) and deploy the air bag(s), possibly causing serious injury.
- When using air or electric power tools or hammers, always switch the ignition OFF, disconnect the battery, and wait at least 3 minutes before performing any service.

#### Precaution for Procedure without Cowl Top Cover

INFOID:000000010989074

When performing the procedure after removing cowl top cover, cover the lower end of windshield with urethane, etc to prevent damage to windshield.

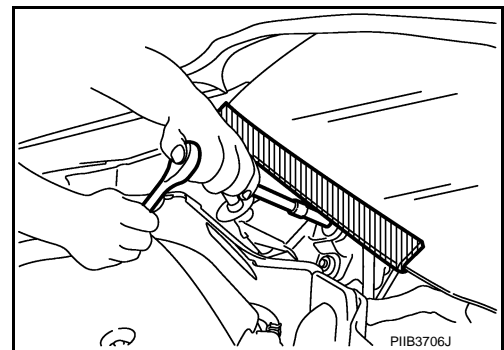

# PRECAUTIONS

< PRECAUTION >

## Precautions for Removing Battery Terminal

INFOID:000000011405329

- When removing the 12V battery terminal, turn OFF the ignition switch and wait at least 30 seconds.

**NOTE:**

ECU may be active for several tens of seconds after the ignition switch is turned OFF. If the battery terminal is removed before ECU stops, then a DTC detection error or ECU data corruption may occur.

- For vehicles with the 2-batteries, be sure to connect the main battery and the sub battery before turning ON the ignition switch.

**NOTE:**

If the ignition switch is turned ON with any one of the terminals of main battery and sub battery disconnected, then DTC may be detected.

- After installing the 12V battery, always check "Self Diagnosis Result" of all ECUs and erase DTC.

**NOTE:**

The removal of 12V battery may cause a DTC detection error.

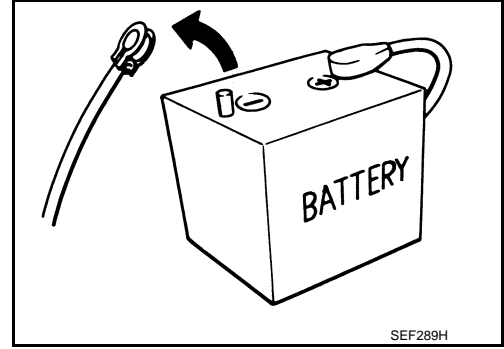

A  
B  
C  
D  
E  
F  
G  
H  
I  
J  
K  
M  
N  
O  
P

WW

# WASHER TANK

< REMOVAL AND INSTALLATION >

## REMOVAL AND INSTALLATION

### WASHER TANK

Exploded View

INFOID:0000000010989075

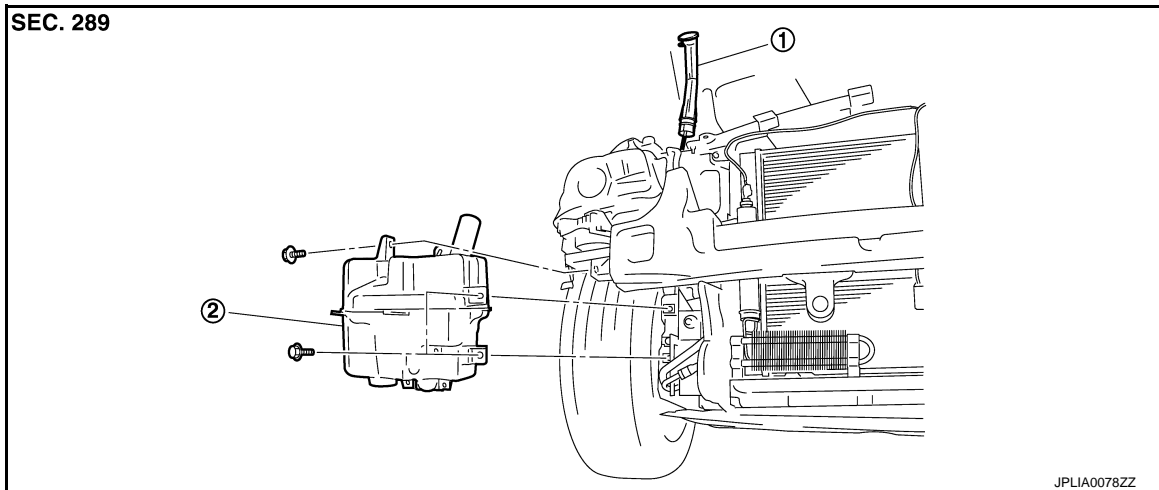

1. Washer tank inlet

2. Washer tank

### Removal and Installation

INFOID:0000000010989076

#### REMOVAL

1. Remove the clip (A).

← : Vehicle front

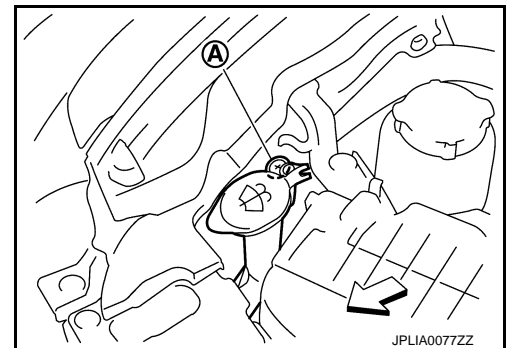

2. Pull out the washer tank inlet from the washer tank.
3. Remove the front bumper fascia. Refer to [EXT-15, "Removal and Installation"](#).
4. Disconnect the washer pump connector.
5. Disconnect the washer level switch connector.
6. Disconnect the washer tube.
7. Remove the washer tank mounting bolts.
8. Remove the washer tank from the vehicle.

#### INSTALLATION

Install in the reverse order of removal.

#### **CAUTION:**

**Add water up to the top of the washer tank inlet after installing. Check that there is no leakage.**

# FRONT WASHER PUMP

< REMOVAL AND INSTALLATION >

## FRONT WASHER PUMP

Exploded View

INFOID:000000010989077

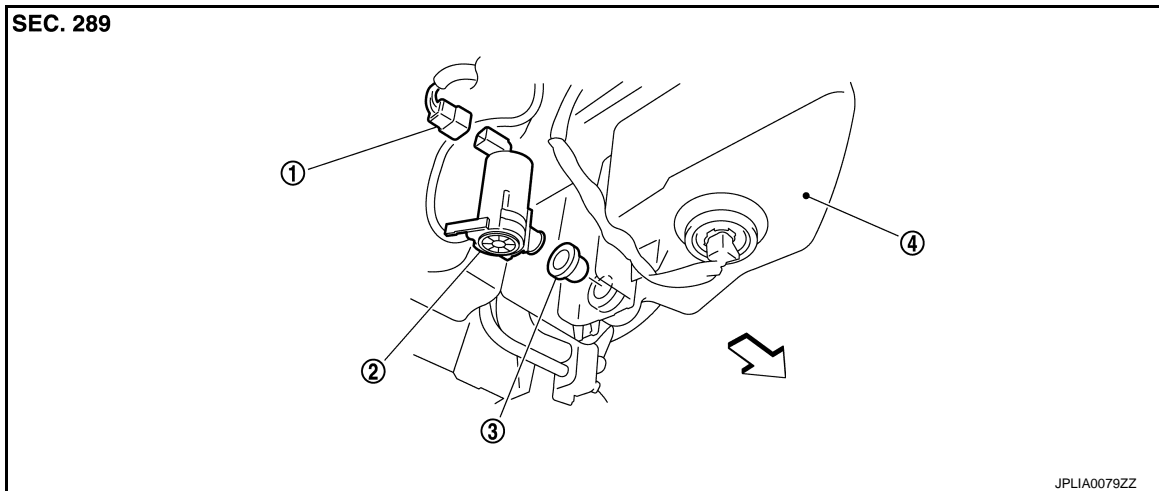

1. Washer pump connector
2. Washer pump
3. Packing
4. Washer tank

↶ : Vehicle front

## Removal and Installation

INFOID:000000010989078

### REMOVAL

1. Remove the fender protector RH (front). Refer to [EXT-27, "FENDER PROTECTOR : Removal and Installation"](#).
2. Disconnect the washer pump connector.
3. Disconnect the washer tube.
4. Remove the washer pump from the washer tank.
5. Remove the packing from the washer tank.

### INSTALLATION

Install in the reverse order of removal.

#### **CAUTION:**

**Never twist the packing when installing the washer pump.**

A  
B  
C  
D  
E  
F  
G  
H  
I  
J  
K  
L  
M  
N  
O  
P

WW

## WASHER LEVEL SWITCH

< REMOVAL AND INSTALLATION >

---

### WASHER LEVEL SWITCH

#### Removal and Installation

INFOID:000000010989079

The washer level switch must be replaced together with the washer tank as an assembly. Refer to [WW-94](#), "[Removal and Installation](#)".



# FRONT WASHER NOZZLE AND TUBE

< REMOVAL AND INSTALLATION >

## FRONT WASHER NOZZLE AND TUBE

### Hydraulic Layout

INFOID:000000010989080

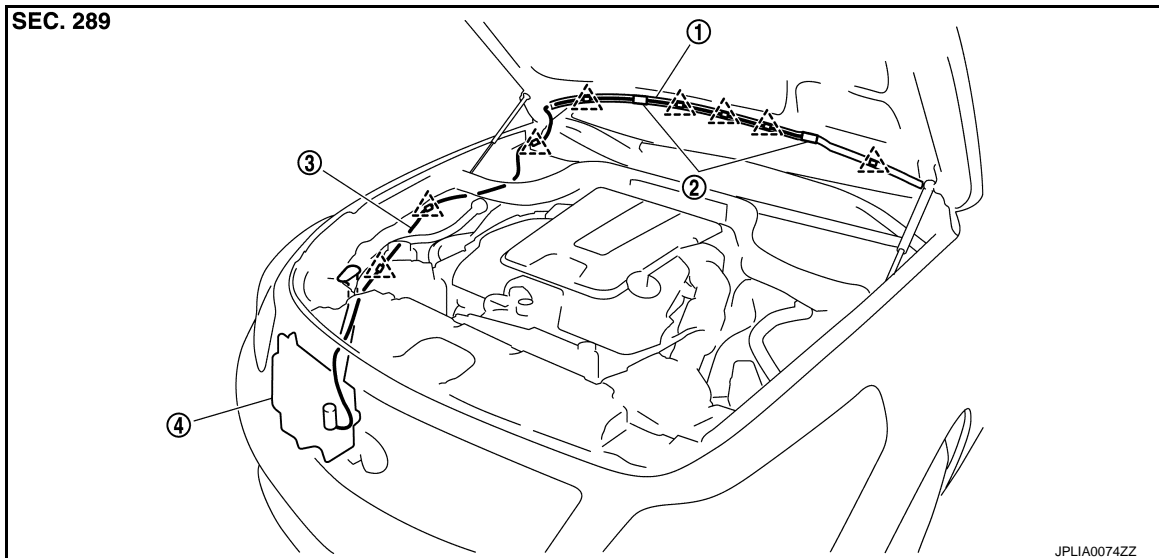

- 1. Seal rubber
- 2. Washer nozzle
- 3. Washer tube
- 4. Washer tank

△ : Clip

### Removal and Installation

INFOID:000000010989081

#### REMOVAL

1. Open the hood.
2. Remove the front washer nozzle in numerical order shown in the figure.

← : Vehicle front

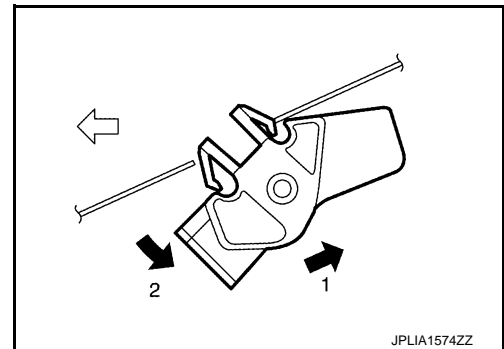

3. Disconnect the front washer tube from the front washer nozzle.

#### INSTALLATION

1. Connect the front washer tube into the front washer nozzle.
2. Install the front washer nozzle to the hood.
3. Adjust the front washer nozzle spray position. Refer to [WW-97, "Inspection and Adjustment"](#).

#### **CAUTION:**

**The spray positions differ. Check that left and right nozzles are installed correctly.**

### Inspection and Adjustment

INFOID:000000010989082

#### INSPECTION

##### Washer Nozzle Inspection

# FRONT WASHER NOZZLE AND TUBE

## < REMOVAL AND INSTALLATION >

Check that air can pass through the hose by blowing forward (toward the nozzle), and check that air cannot pass through by sucking.

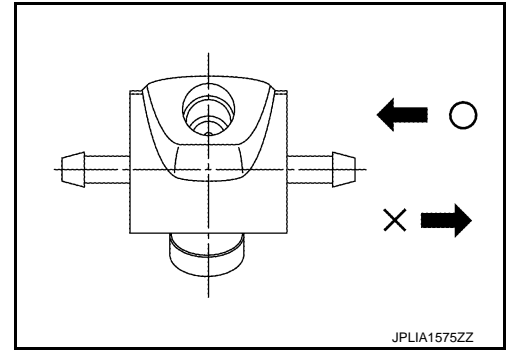

JPLIA1575ZZ

## ADJUSTMENT

### Washer Nozzle Spray Position Adjustment

Adjust spray positions to match the positions shown in the figure below.

#### NOTE:

This figure is for LHD models and is symmetric with RHD models.

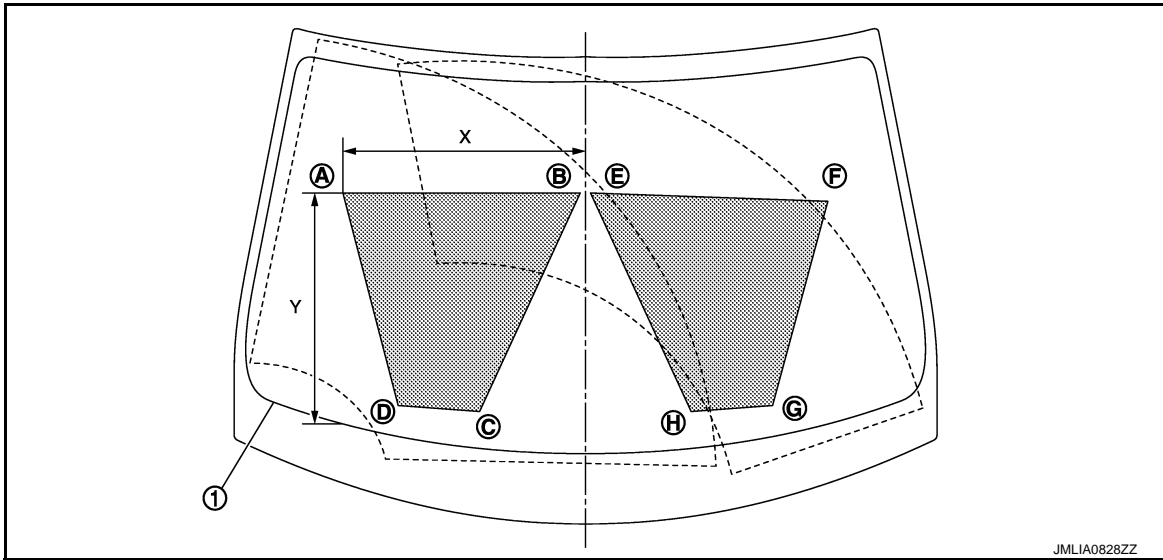

JMLIA0828ZZ

1. Black printed frame line

 : Spray area

Unit: mm (in)

	Passenger side				Driver side			
	A	B	C	D	E	F	G	H
X	478 (18.82)	15 (0.59)	208 (8.19)	368 (14.49)	13 (0.51)	474 (18.66)	367 (14.45)	208 (8.19)
Y	452 (17.80)	500 (19.69)	66 (2.60)	60 (2.36)	501 (19.72)	441 (17.36)	59 (2.32)	66 (2.60)

Check that washer fluid is splayed on 80% or more the splay area () when spraying washer fluid. If the spray area deviates from the specification, adjust the washer nozzle.

#### CAUTION:

## FRONT WASHER NOZZLE AND TUBE

### < REMOVAL AND INSTALLATION >

- Use washer nozzle adjuster\* (A) for nozzle adjustment.
- Never use needle or small pin.
- \*: Washer nozzle adjuster is included with shipment of nozzle.

#### NOTE:

If wax or dust gets into the nozzle, remove wax or dust with a needle or small pin.

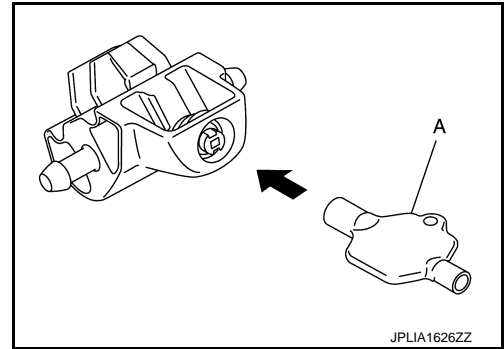

A  
B  
C  
D  
E  
F  
G  
H  
I  
J  
K  
M  
N  
O  
P

WW

# FRONT WIPER ARM

< REMOVAL AND INSTALLATION >

## FRONT WIPER ARM

Exploded View

INFOID:000000010989083

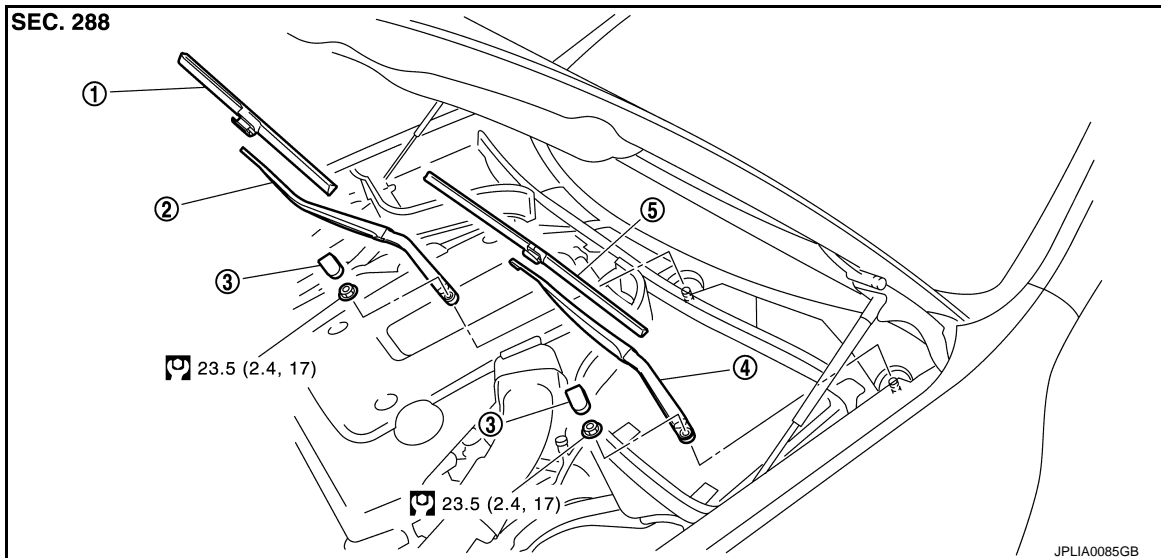

- |                     |                     |                  |
|---------------------|---------------------|------------------|
| 1. Wiper blade (RH) | 2. Wiper arm (RH)   | 3. Wiper arm cap |
| 4. Wiper arm (LH)   | 5. Wiper blade (LH) |                  |

 : N·m (kg·m ft·lb)

## Removal and Installation

INFOID:000000010989084

### REMOVAL

1. Operate the front wiper to move it to the auto stop position.
2. Open the hood.
3. Remove the wiper arm cap.
4. Remove the wiper arm mounting nut.
5. Raise wiper arm, and remove the wiper arm from the vehicle.

### INSTALLATION

1. Clean wiper arm mount as shown in the figure to prevent nuts from being loosened.

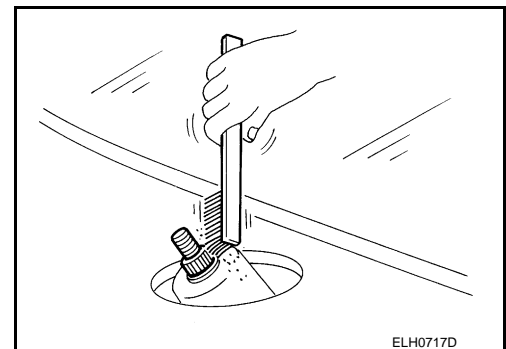

2. Operate the front wiper motor to move the wiper to the auto stop position.
3. Adjust the wiper blade position. Refer to [WW-101, "Adjustment"](#).
4. Install the wiper arm by tightening the mounting nut.
5. Inject the washer fluid.
6. Operate the front wiper to move it to the auto stop position.
7. Check that the wiper blades stop at the specified position.

# FRONT WIPER ARM

## < REMOVAL AND INSTALLATION >

8. Install the wiper arm cap.

### Adjustment

INFOID:000000010989085

#### WIPER BLADE POSITION ADJUSTMENT

Clearance between the end of cowl top cover and the top of wiper blade center

Standard clearance

**R : 35.0 ± 7.5 mm (1.38 ± 0.295 in)**

**L : 72.0 ± 7.5 mm (2.84 ± 0.295 in)**

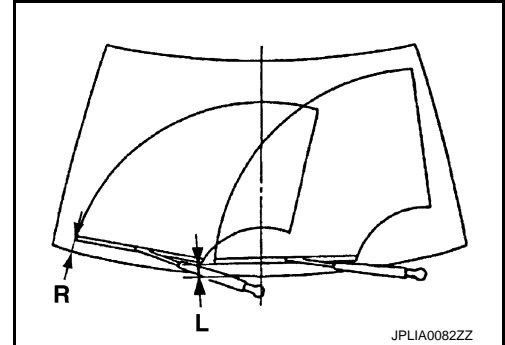

A

B

C

D

E

F

G

H

I

J

K

WW

M

N

O

P

# FRONT WIPER BLADE

< REMOVAL AND INSTALLATION >

## FRONT WIPER BLADE

Exploded View

INFOID:000000010989086

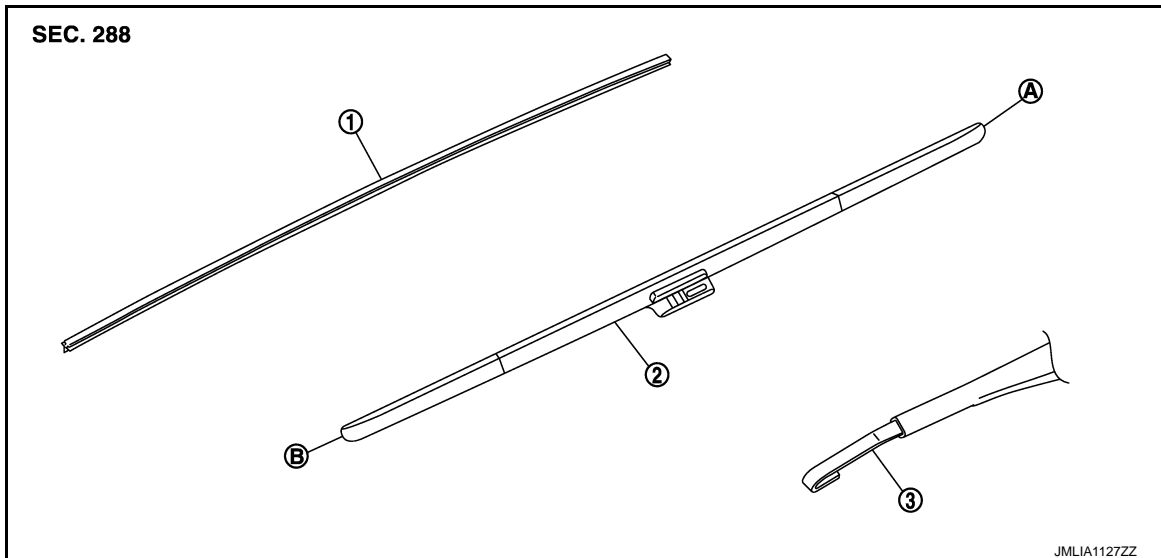

- 1. Wiper refill
  - 2. Wiper blade
  - 3. Wiper arm
- A : Wiper blade end  
B : Wiper blade tip

## Removal and Installation

INFOID:000000010989087

### REMOVAL

1. Push up the lever (A) of wiper blade (1), while sliding wiper blade toward the direction of the arrow, to remove it from wiper arm (2).

**CAUTION:**

**Be careful not to drop the wiper blade onto the windshield glass.**

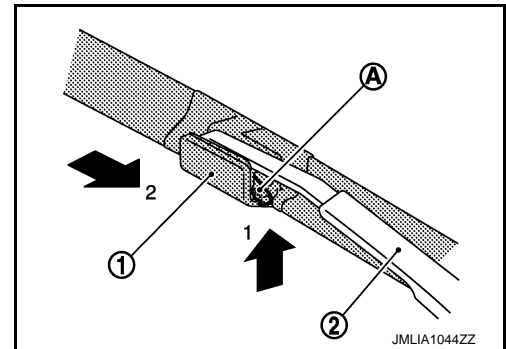

### INSTALLATION

1. Install wiper blade into wiper arm.
2. Install wiper arm.

# FRONT WIPER BLADE

## < REMOVAL AND INSTALLATION >

### Replacement

INFOID:000000010989088

1. Hold the rip of old wiper refill (1) at the rear end of the wiper blade with long-nose pliers, and pull out the wiper refill to the direction (A).

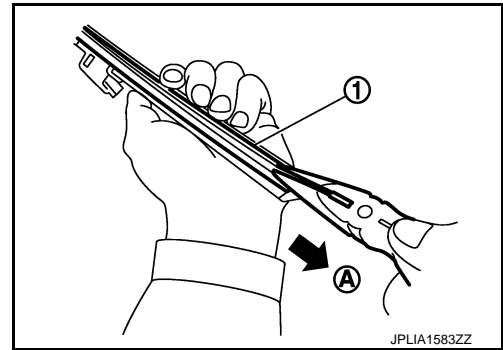

2. Insert the tip of new wiper refill (1) into the rear end of wiper blade (2). Slide the new wiper refill to the direction shown by the arrow while pressing the new wiper refill onto the wiper blade rear end.

**NOTE:**

- Insert the wiper refill to be held securely by tab of wiper blade as shown in section.
- After the wiper refill is fully inserted, remove the holder\* (3).

\*: Attached to service parts.

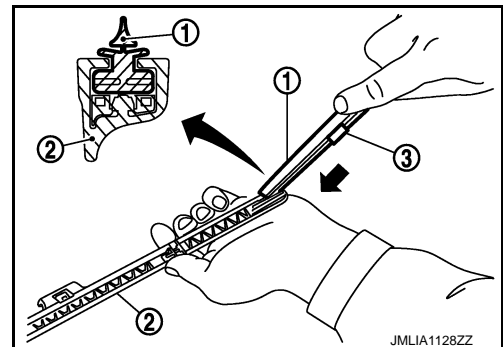

3. Insert the new wiper refill toward the direction shown by the mark "←" until the stopper at the rear end of wiper refill fits in the "SET" mark tab on wiper blade.
4. Untwist the twisted wiper refill at the rear end of wiper blade, if any.
5. Check the following items after replacing wiper refill.
  - Wiper refill is not twisted at all.
  - Wiper refill thoroughly fits in the tab on wiper blade.
  - Wiper refill is inserted from the proper direction.

**NOTE:**

When the vertebra is detached.

- Insert the vertebra (1) into the wiper blade to the same bending direction.
- If a vertebra has a notch, fit it to a protrusion inside the wiper refill.

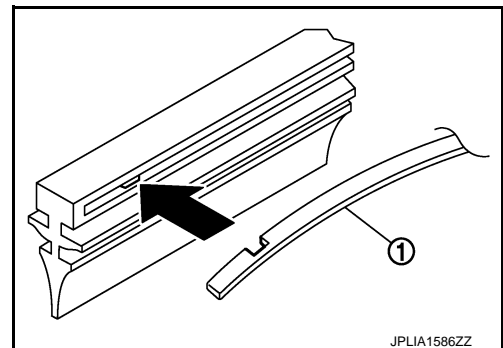
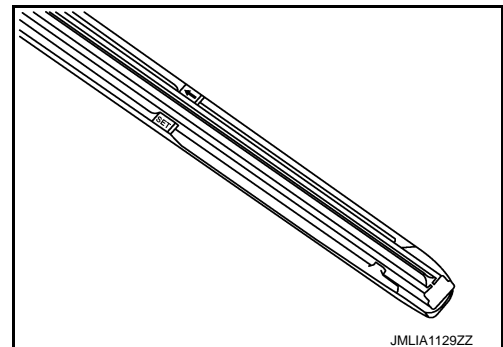

A  
B  
C  
D  
E  
F  
G  
H  
I  
J  
K  
WW  
M  
N  
O  
P

# FRONT WIPER DRIVE ASSEMBLY

< REMOVAL AND INSTALLATION >

## FRONT WIPER DRIVE ASSEMBLY

Exploded View

INFOID:000000010989089

REMOVAL VIEW

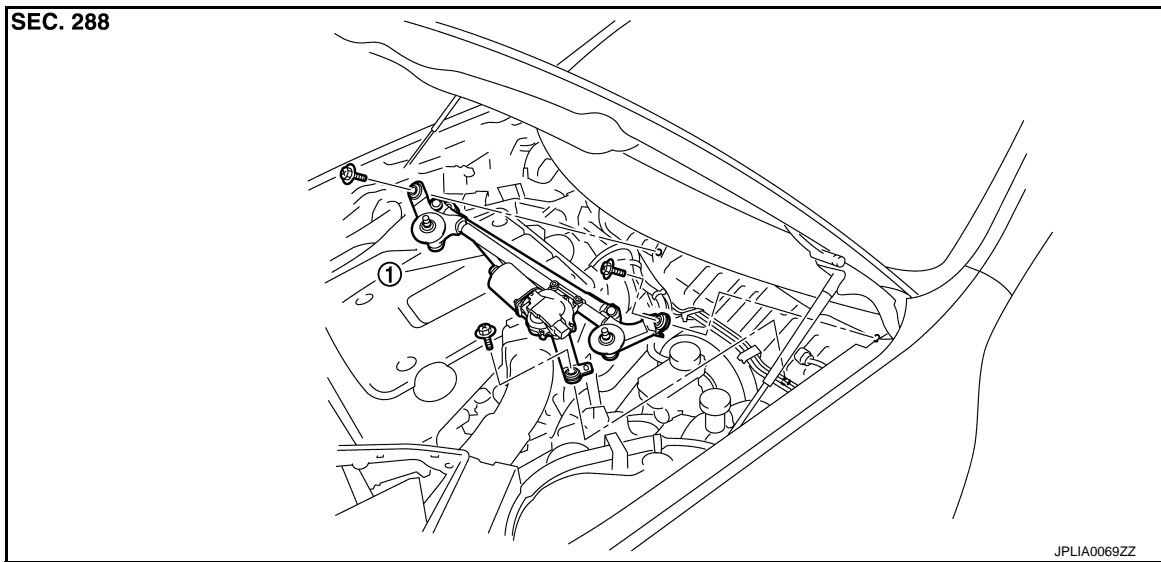

1. Front wiper drive assembly

DISASSEMBLY VIEW

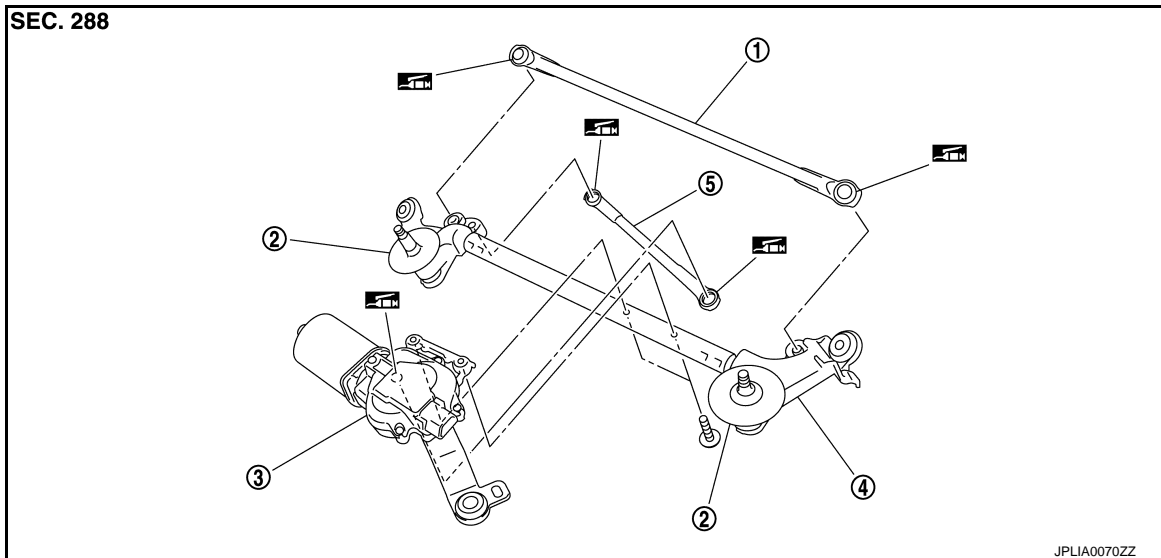

1. Wiper linkage 1
2. Shaft seal
3. Front wiper motor
4. Wiper frame
5. Wiper linkage 2

: Multi-purpose grease or an equivalent.

Removal and Installation

INFOID:000000010989090

REMOVAL

1. Remove the wiper arm. Refer to [WW-100, "Removal and Installation"](#).
2. Remove the cowl top cover. Refer to [EXT-24, "Removal and Installation"](#).
3. Remove bolts from the front wiper drive assembly.



# FRONT WIPER DRIVE ASSEMBLY

## < REMOVAL AND INSTALLATION >

---

4. Disconnect the front wiper motor connector.
5. Remove the front wiper drive assembly from the vehicle.

A

## INSTALLATION

1. Install the front wiper drive assembly to the vehicle.
2. Connect the front wiper motor connector.
3. Operate the front wiper to move it to the auto stop position.
4. Install the cowl top cover. Refer to [EXT-24, "Removal and Installation"](#).
5. Install the wiper arms. Refer to [WW-100, "Removal and Installation"](#).

B

C

## Disassembly and Assembly

INFOID:000000010989091

D

## DISASSEMBLY

1. Remove the wiper linkage 1 and 2 from the front wiper drive assembly.  
**CAUTION:**  
**Never bend the linkage or damage the plastic part of the ball joint when removing the wiper linkage.**
2. Remove the front wiper motor mounting screws, and then remove the front wiper motor from the wiper frame.

E

F

## ASSEMBLY

1. Connect the front wiper motor connector.
2. Operate the front wiper to move it to the auto stop position.
3. Disconnect the front wiper motor connector.
4. Install front wiper motor to wiper frame.
5. Install the wiper linkage 2 to the wiper motor and the wiper frame.
6. Install the wiper linkage 1 to the wiper frame.  
**CAUTION:**
  - **Never drop front wiper motor or cause it to come into contact with other parts.**
  - **Be careful for the grease condition at the wiper motor and wiper linkage joint (retainer). Apply Multi-purpose grease or an equivalent if necessary.**

G

H

I

J

K

WW

M

N

O

P

## FRONT WIPER AND WASHER SWITCH

< REMOVAL AND INSTALLATION >

---

### FRONT WIPER AND WASHER SWITCH

Exploded View

INFOID:000000010989092

Refer to [BCS-91, "Exploded View"](#).