

SECTION **HRN**
HORN

A
B
C
D
E
F
G
H
I
J
K
M
N
O
P

CONTENTS

PRECAUTION	2	HORN	3
PRECAUTIONS	2	Wiring Diagram	3
Precaution for Supplemental Restraint System (SRS) "AIR BAG" and "SEAT BELT PRE-TENSIONER"	2	REMOVAL AND INSTALLATION	4
WIRING DIAGRAM	3	HORN	4
		Exploded View	4
		Removal and Installation	4

HRN

PRECAUTIONS

< PRECAUTION >

PRECAUTION

PRECAUTIONS

Precaution for Supplemental Restraint System (SRS) "AIR BAG" and "SEAT BELT PRE-TENSIONER"

INFOID:000000008273214

The Supplemental Restraint System such as "AIR BAG" and "SEAT BELT PRE-TENSIONER", used along with a front seat belt, helps to reduce the risk or severity of injury to the driver and front passenger for certain types of collision. This system includes seat belt switch inputs and dual stage front air bag modules. The SRS system uses the seat belt switches to determine the front air bag deployment, and may only deploy one front air bag, depending on the severity of a collision and whether the front occupants are belted or unbelted. Information necessary to service the system safely is included in the "SRS AIR BAG" and "SEAT BELT" of this Service Manual.

WARNING:

Always observe the following items for preventing accidental activation.

- To avoid rendering the SRS inoperative, which could increase the risk of personal injury or death in the event of a collision that would result in air bag inflation, all maintenance must be performed by an authorized NISSAN/INFINITI dealer.
- Improper maintenance, including incorrect removal and installation of the SRS, can lead to personal injury caused by unintentional activation of the system. For removal of Spiral Cable and Air Bag Module, see "SRS AIR BAG".
- Never use electrical test equipment on any circuit related to the SRS unless instructed to in this Service Manual. SRS wiring harnesses can be identified by yellow and/or orange harnesses or harness connectors.

PRECAUTIONS WHEN USING POWER TOOLS (AIR OR ELECTRIC) AND HAMMERS

WARNING:

Always observe the following items for preventing accidental activation.

- When working near the Air Bag Diagnosis Sensor Unit or other Air Bag System sensors with the ignition ON or engine running, never use air or electric power tools or strike near the sensor(s) with a hammer. Heavy vibration could activate the sensor(s) and deploy the air bag(s), possibly causing serious injury.
- When using air or electric power tools or hammers, always switch the ignition OFF, disconnect the battery, and wait at least 3 minutes before performing any service.

HORN

< WIRING DIAGRAM >

WIRING DIAGRAM

HORN

Wiring Diagram

INFOID:000000008273215

For connector terminal arrangements, harness layouts, and alphabets in a  (option abbreviation; if not described in wiring diagram), refer to [GI-12. "Connector Information"](#).

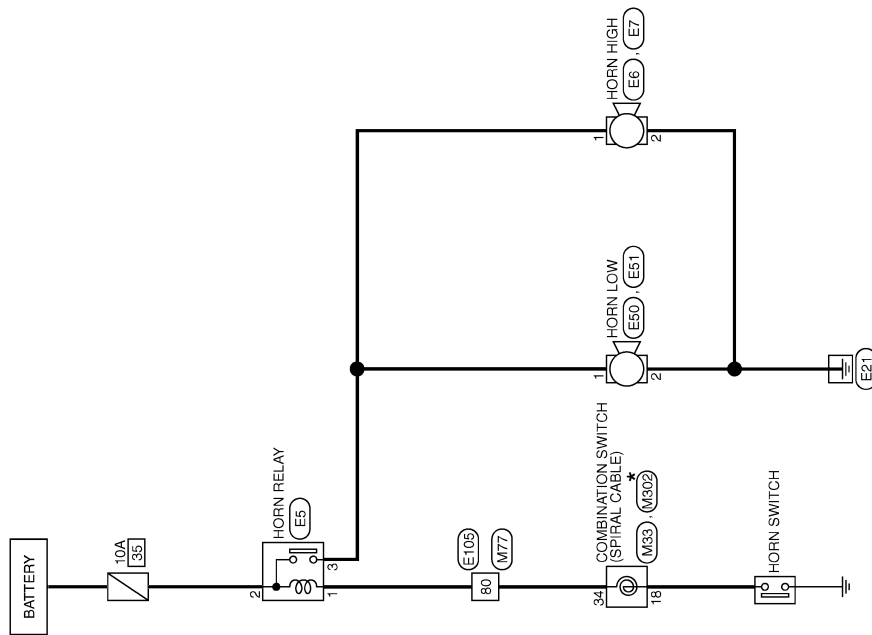

*: This connector is not shown in "Harness Layout".

A
B
C
D
E
F
G
H
I
J
K
L
M
N
O
P

HRN

HORN

2010/08/30

JCLWA4339GB

HORN

< REMOVAL AND INSTALLATION >

REMOVAL AND INSTALLATION

HORN

Exploded View

INFOID:000000008273216

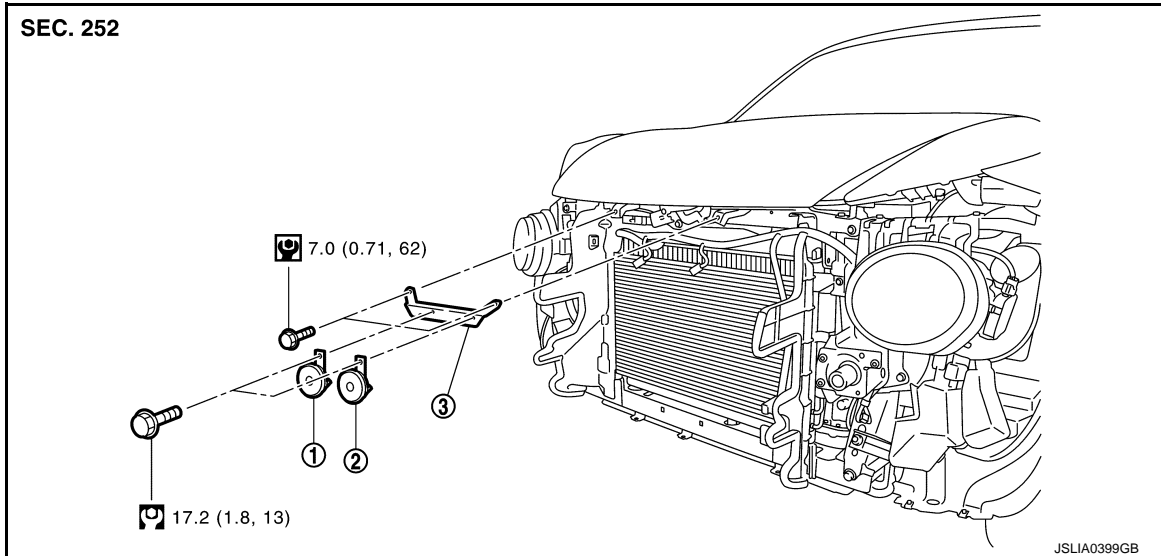

1. Horn high

2. Horn low

3. Horn bracket

 : N·m (kg·m, in·lb)

 : N·m (kg·m, ft·lb)

Removal and Installation

INFOID:000000008273217

REMOVAL

1. Remove the front center grille and front side grille (LH/RH). Refer to [EXT-22. "Removal and Installation"](#).
2. Disconnect the horn (high and low) connectors.
3. Remove the horn mounting bolts (A). Remove the horn high (1) and horn low (2).
4. Remove harness fixing clip from horn bracket.

 : **Harness fixing clip**

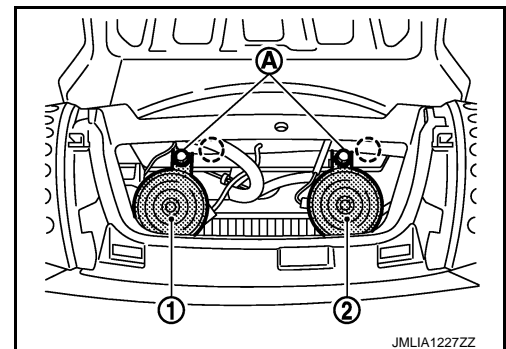

HORN

< REMOVAL AND INSTALLATION >

5. Remove horn bracket mounting bolts (LH/RH) (A). Remove horn bracket (1) from radiator core support upper.

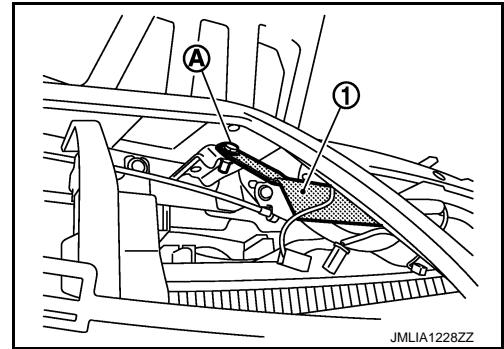

INSTALLATION

Install in the reverse order of removal.

A
B
C
D
E
F
G
H
I
J
K
M
N
O
P

HRN