

SECTION **HRN**
HORN

A
B
C
D
E
F
G
H
I
J
K
M
N
O
P

CONTENTS

PRECAUTION	2	HORN	3	F
PRECAUTIONS	2	Wiring Diagram	3	
Precaution for Supplemental Restraint System (SRS) "AIR BAG" and "SEAT BELT PRE-TEN- SIONER"	2	REMOVAL AND INSTALLATION	6	G
Precautions for Removing Battery Terminal	2	HORN	6	
WIRING DIAGRAM	3	Exploded View	6	H
		Removal and Installation	6	

HRN

PRECAUTIONS

< PRECAUTION >

PRECAUTION

PRECAUTIONS

Precaution for Supplemental Restraint System (SRS) "AIR BAG" and "SEAT BELT PRE-TENSIONER"

INFOID:000000011463355

The Supplemental Restraint System such as "AIR BAG" and "SEAT BELT PRE-TENSIONER", used along with a front seat belt, helps to reduce the risk or severity of injury to the driver and front passenger for certain types of collision. This system includes seat belt switch inputs and dual stage front air bag modules. The SRS system uses the seat belt switches to determine the front air bag deployment, and may only deploy one front air bag, depending on the severity of a collision and whether the front occupants are belted or unbelted. Information necessary to service the system safely is included in the "SRS AIR BAG" and "SEAT BELT" of this Service Manual.

WARNING:

Always observe the following items for preventing accidental activation.

- To avoid rendering the SRS inoperative, which could increase the risk of personal injury or death in the event of a collision that would result in air bag inflation, all maintenance must be performed by an authorized NISSAN/INFINITI dealer.
- Improper maintenance, including incorrect removal and installation of the SRS, can lead to personal injury caused by unintentional activation of the system. For removal of Spiral Cable and Air Bag Module, see "SRS AIR BAG".
- Never use electrical test equipment on any circuit related to the SRS unless instructed to in this Service Manual. SRS wiring harnesses can be identified by yellow and/or orange harnesses or harness connectors.

PRECAUTIONS WHEN USING POWER TOOLS (AIR OR ELECTRIC) AND HAMMERS

WARNING:

Always observe the following items for preventing accidental activation.

- When working near the Air Bag Diagnosis Sensor Unit or other Air Bag System sensors with the ignition ON or engine running, never use air or electric power tools or strike near the sensor(s) with a hammer. Heavy vibration could activate the sensor(s) and deploy the air bag(s), possibly causing serious injury.
- When using air or electric power tools or hammers, always switch the ignition OFF, disconnect the battery, and wait at least 3 minutes before performing any service.

Precautions for Removing Battery Terminal

INFOID:000000011463356

- When removing the 12V battery terminal, turn OFF the ignition switch and wait at least 30 seconds.

NOTE:

ECU may be active for several tens of seconds after the ignition switch is turned OFF. If the battery terminal is removed before ECU stops, then a DTC detection error or ECU data corruption may occur.

- For vehicles with the 2-batteries, be sure to connect the main battery and the sub battery before turning ON the ignition switch.

NOTE:

If the ignition switch is turned ON with any one of the terminals of main battery and sub battery disconnected, then DTC may be detected.

- After installing the 12V battery, always check "Self Diagnosis Result" of all ECUs and erase DTC.

NOTE:

The removal of 12V battery may cause a DTC detection error.

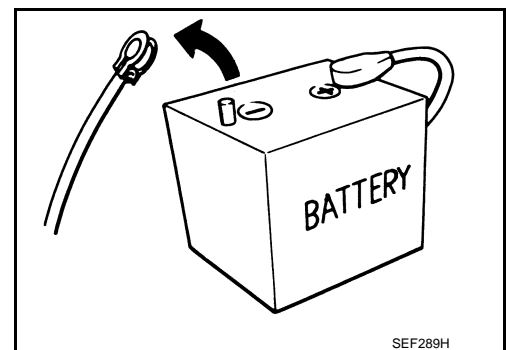

HORN

< WIRING DIAGRAM >

WIRING DIAGRAM

HORN

Wiring Diagram

INFOID:000000011463357

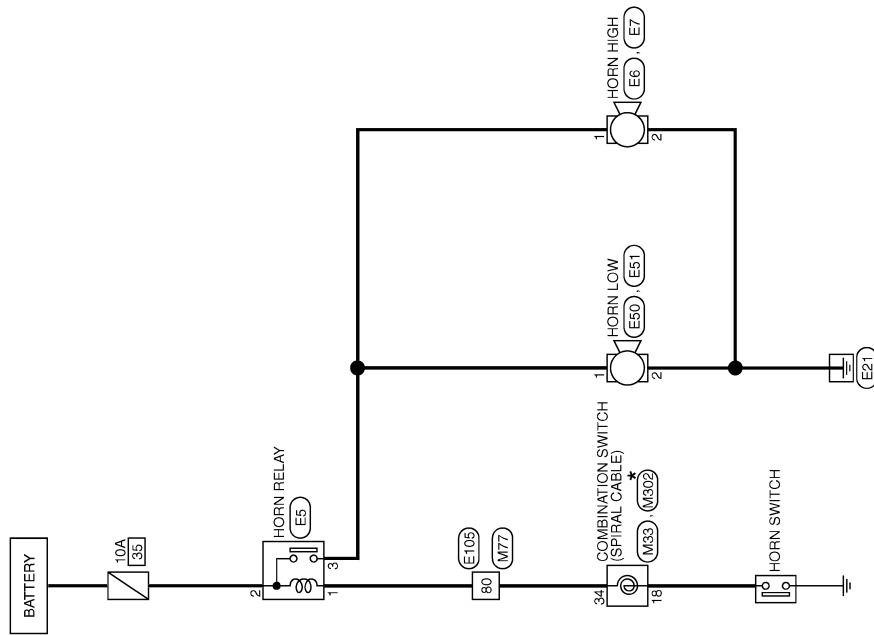

*: This connector is not shown in "Harness Layout".

HORN

2010/08/30

JCLWA4339GB

A
B
C
D
E
F
G
H
I
J
K
L
M
N
O
P

HRN

HORN

< WIRING DIAGRAM >

A
B
C
D
E
F
G
H
I
J
K
HRN
M
N
O
P

HORN

Connector No.	M177
Connector Name	WIRE TO WIRE
Connector Type	TH89FW-CS16-TM4

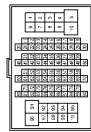

86	LG	--
87	SHIELD	--
88	Y	--
82	BR	--
85	Y	--
86	L	--
97	GR	--
98	G	--
99	R	--
100	LG	--

Terminal No.	Color Of Wire	Signal Name [Specification]
1	L	--
2	Y	--
3	P	--
10	R	--
11	R	--
12	LG	--
13	V	--
14	SHIELD	--
34	LG	--
35	SB	--
36	B	--
37	P	--
52	R	--
53	L	--
54	SB	--
55	B	--
58	LG	--
59	G	--
62	Y	--
63	W	--
64	G	--
65	GR	--
66	Y	--
67	V	--
68	R	--
70	V	--
71	R	--
72	GR	--
73	G	--
74	W	--
78	LG	--
79	V	--
80	LG	--
83	P	--
84	G	--
85	BR	--

Connector No.	M302
Connector Name	COMBINATION SWITCH (SPIRAL CABLE)
Connector Type	TR08FSY



Terminal No.	Color Of Wire	Signal Name [Specification]
13	R	--
14	W	--
15	B	--
16	B	--
17	BR	--
18	G	--
18	P	--
20	Y	--

JRLWE3979GB

HORN

< REMOVAL AND INSTALLATION >

REMOVAL AND INSTALLATION

HORN

Exploded View

INFOID:000000011463358

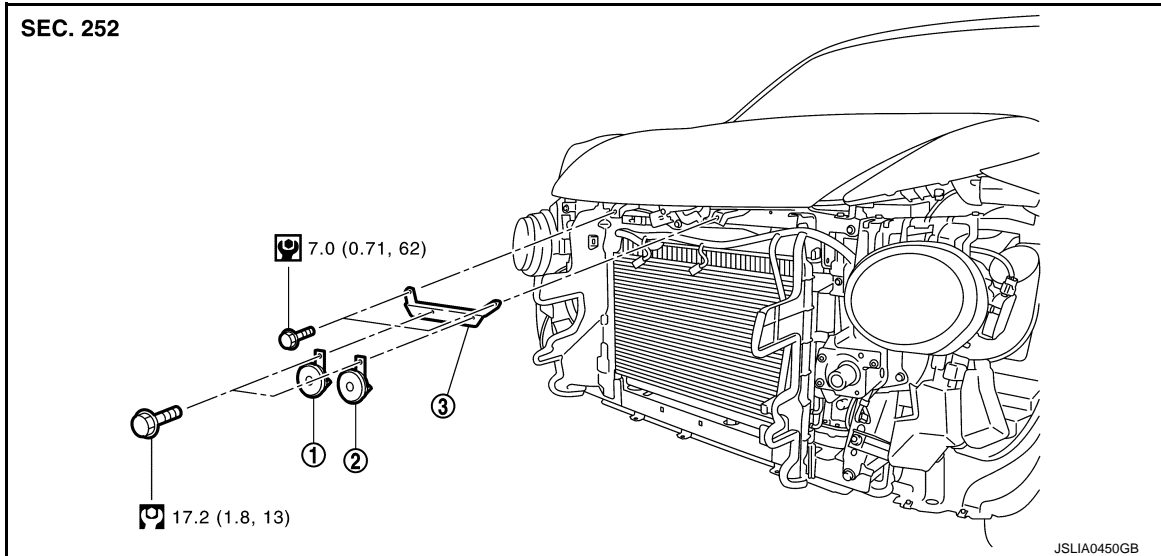

1. Horn high

2. Horn low

3. Horn bracket

 : N·m (kg·m, in·lb)

 : N·m (kg·m, ft·lb)

Removal and Installation

INFOID:000000011463359

REMOVAL

1. Remove the front center grille and front side grille (LH/RH). Refer to [EXT-26. "Removal and Installation"](#).
2. Disconnect the horn (high and low) connectors.
3. Remove the horn mounting bolts (A). Remove the horn high (1) and horn low (2).
4. Remove harness fixing clip from horn bracket.

 : **Harness fixing clip**

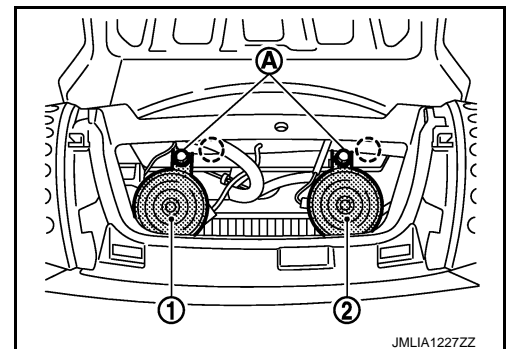

HORN

< REMOVAL AND INSTALLATION >

5. Remove horn bracket mounting bolts (LH/RH) (A). Remove horn bracket (1) from radiator core support upper.

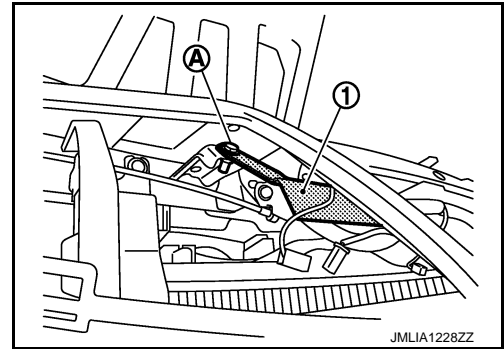

INSTALLATION

Install in the reverse order of removal.

A
B
C
D
E
F
G
H
I
J
K
M
N
O
P

HRN