

SECTION **INT**  
INTERIOR

A  
B  
C  
D  
E  
F  
G  
H  
I  
INT  
K  
L  
M  
N  
O  
P

CONTENTS

<b>PRECAUTION</b> .....	3	<b>KICKING PLATE INNER</b> .....	19
<b>PRECAUTIONS</b> .....	3	KICKING PLATE INNER : Removal and Installation .....	19
Precaution for Supplemental Restraint System (SRS) "AIR BAG" and "SEAT BELT PRE-TENSIONER" .....	3	<b>DASH SIDE FINISHER</b> .....	21
Precaution for Procedure without Cowl Top Cover.....	3	DASH SIDE FINISHER : Removal and Installation .....	21
Precautions for Removing Battery Terminal .....	4	<b>BODY SIDE WELT</b> .....	21
Precaution for Work .....	4	BODY SIDE WELT : Removal and Installation .....	21
<b>PREPARATION</b> .....	5	<b>CENTER PILLAR LOWER GARNISH</b> .....	22
<b>PREPARATION</b> .....	5	CENTER PILLAR LOWER GARNISH : Removal and Installation .....	22
Special Service Tools .....	5	<b>CENTER PILLAR UPPER GARNISH</b> .....	22
Commercial Service Tools .....	5	CENTER PILLAR UPPER GARNISH : Removal and Installation .....	22
<b>CLIP LIST</b> .....	6	<b>FLOOR TRIM</b> .....	24
Clip List .....	6	Exploded View .....	24
<b>SYMPTOM DIAGNOSIS</b> .....	7	Removal and Installation .....	24
<b>SQUEAK AND RATTLE TROUBLE DIAGNOSES</b> .....	7	<b>HEADLINING</b> .....	27
Work Flow .....	7	<b>NORMAL ROOF</b> .....	27
Inspection Procedure .....	9	NORMAL ROOF : Exploded View .....	27
Diagnostic Worksheet .....	11	NORMAL ROOF : Removal and Installation .....	27
<b>REMOVAL AND INSTALLATION</b> .....	13	<b>SUNROOF</b> .....	29
<b>FRONT DOOR FINISHER</b> .....	13	SUNROOF : Exploded View .....	30
Exploded View .....	13	SUNROOF : Removal and Installation .....	30
Removal and Installation .....	13	<b>LUGGAGE FLOOR TRIM</b> .....	33
<b>REAR DOOR FINISHER</b> .....	16	Exploded View .....	33
Exploded View .....	16	<b>LUGGAGE REAR PLATE</b> .....	35
Removal and Installation .....	16	LUGGAGE REAR PLATE : Removal and Installation .....	35
<b>BODY SIDE TRIM</b> .....	18	<b>LUGGAGE SIDE LOWER FINISHER</b> .....	35
Exploded View .....	18	LUGGAGE SIDE LOWER FINISHER : Removal and Installation .....	35
<b>FRONT PILLAR GARNISH</b> .....	18		
FRONT PILLAR GARNISH : Removal and Installation .....	18		

<b>LUGGAGE SIDE UPPER FINISHER .....</b>	<b>36</b>	<b>BACK DOOR LOWER FINISHER .....</b>	<b>39</b>
LUGGAGE SIDE UPPER FINISHER : Removal and Installation .....	36	BACK DOOR LOWER FINISHER : Removal and Installation .....	39
<b>BACK DOOR TRIM .....</b>	<b>38</b>	<b>BACK DOOR SIDE FINISHER .....</b>	<b>39</b>
Exploded View .....	38	BACK DOOR SIDE FINISHER : Removal and In- stallation .....	39
<b>BACK DOOR PULL HANDLE .....</b>	<b>38</b>	<b>EMERGENCY LID .....</b>	<b>40</b>
BACK DOOR PULL HANDLE : Removal and In- stallation .....	38	EMERGENCY LID : Removal and Installation .....	40

# PRECAUTIONS

< PRECAUTION >

## PRECAUTION

### PRECAUTIONS

#### Precaution for Supplemental Restraint System (SRS) "AIR BAG" and "SEAT BELT PRE-TENSIONER"

INFOID:000000011460569

The Supplemental Restraint System such as "AIR BAG" and "SEAT BELT PRE-TENSIONER", used along with a front seat belt, helps to reduce the risk or severity of injury to the driver and front passenger for certain types of collision. This system includes seat belt switch inputs and dual stage front air bag modules. The SRS system uses the seat belt switches to determine the front air bag deployment, and may only deploy one front air bag, depending on the severity of a collision and whether the front occupants are belted or unbelted. Information necessary to service the system safely is included in the "SRS AIR BAG" and "SEAT BELT" of this Service Manual.

#### **WARNING:**

Always observe the following items for preventing accidental activation.

- To avoid rendering the SRS inoperative, which could increase the risk of personal injury or death in the event of a collision that would result in air bag inflation, all maintenance must be performed by an authorized NISSAN/INFINITI dealer.
- Improper maintenance, including incorrect removal and installation of the SRS, can lead to personal injury caused by unintentional activation of the system. For removal of Spiral Cable and Air Bag Module, see "SRS AIR BAG".
- Never use electrical test equipment on any circuit related to the SRS unless instructed to in this Service Manual. SRS wiring harnesses can be identified by yellow and/or orange harnesses or harness connectors.

#### PRECAUTIONS WHEN USING POWER TOOLS (AIR OR ELECTRIC) AND HAMMERS

#### **WARNING:**

Always observe the following items for preventing accidental activation.

- When working near the Air Bag Diagnosis Sensor Unit or other Air Bag System sensors with the ignition ON or engine running, never use air or electric power tools or strike near the sensor(s) with a hammer. Heavy vibration could activate the sensor(s) and deploy the air bag(s), possibly causing serious injury.
- When using air or electric power tools or hammers, always switch the ignition OFF, disconnect the battery, and wait at least 3 minutes before performing any service.

#### Precaution for Procedure without Cowl Top Cover

INFOID:000000011460570

When performing the procedure after removing cowl top cover, cover the lower end of windshield with urethane, etc to prevent damage to windshield.

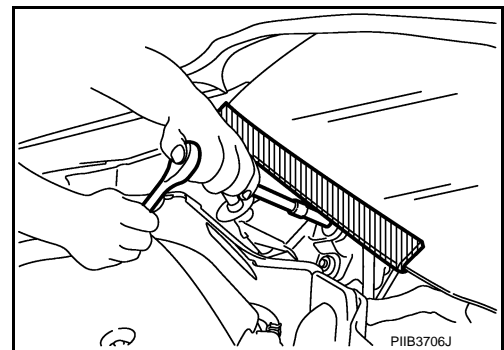

# PRECAUTIONS

## < PRECAUTION >

### Precautions for Removing Battery Terminal

INFOID:000000011460571

- When removing the 12V battery terminal, turn OFF the ignition switch and wait at least 30 seconds.

**NOTE:**

ECU may be active for several tens of seconds after the ignition switch is turned OFF. If the battery terminal is removed before ECU stops, then a DTC detection error or ECU data corruption may occur.

- For vehicles with the 2-batteries, be sure to connect the main battery and the sub battery before turning ON the ignition switch.

**NOTE:**

If the ignition switch is turned ON with any one of the terminals of main battery and sub battery disconnected, then DTC may be detected.

- After installing the 12V battery, always check "Self Diagnosis Result" of all ECUs and erase DTC.

**NOTE:**

The removal of 12V battery may cause a DTC detection error.

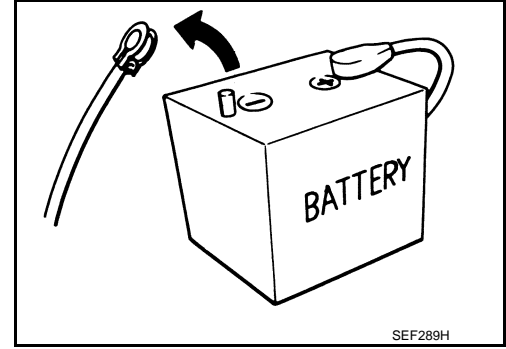

### Precaution for Work

INFOID:000000011460572

- After removing and installing the opening/closing parts, be sure to carry out fitting adjustments to check their operation.
- Check the lubrication level, damage, and wear of each part. If necessary, grease or replace it.

# PREPARATION

< PREPARATION >

## PREPARATION

### PREPARATION

#### Special Service Tools

INFOID:000000011460573

The actual shapes of Kent-Moore tools may differ from those of special service tools illustrated here.

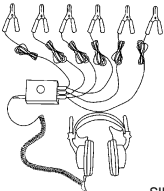
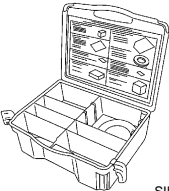
Tool number (Kent-Moore No.) Tool name	Description
(J-39570) Chassis ear   SIIA0993E	Locates the noise
(J-50397) NISSAN Squeak and Rattle Kit   SIIA0994E	Repairs the cause of noise

#### Commercial Service Tools

INFOID:000000011460574

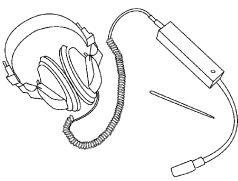
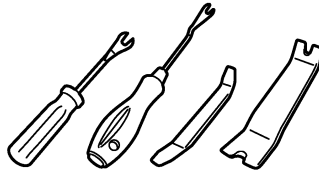
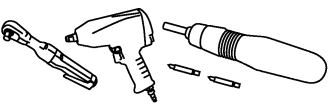
Tool name	Description
Engine ear   SIIA0995E	Locates the noise
Remover tool   JMKIA3050ZZ	Removes clips, pawls and metal clips
Power tool   PIIB1407E	Loosening bolts, nuts and screws

# CLIP LIST

< PREPARATION >

## CLIP LIST

### Clip List

INFOID:000000011460575

Shapes	Removal & Installation	Shapes	Removal & Installation
	<p><b>Removal:</b> Remove by bending up with flat-bladed screwdrivers or clip remover.</p>		<p><b>Removal:</b></p>
	<p><b>Removal:</b> Remove with a clip remover.</p>		<p><b>Removal:</b></p>
	<p><b>Removal:</b> Push center pin to catching position. (Do not remove center pin by hitting it.)</p> <p><b>Installation:</b></p>		<p><b>Removal:</b> Holder portion of clip must be spread out to remove rod.</p>
	<p><b>Removal:</b> Remove by bending up with flat-bladed screwdrivers or clip remover.</p>		<p><b>Removal:</b></p> <ol style="list-style-type: none"> <li>1. Screw out with a Phillips screwdriver.</li> <li>2. Remove female portion with flat-bladed screwdriver.</li> </ol>
	<p><b>Removal:</b></p>		<p><b>Removal:</b></p> <p><b>Installation:</b></p>
	<p><b>Removal:</b></p>		<p><b>Removal:</b></p>

JMJIA3734GB

# SQUEAK AND RATTLE TROUBLE DIAGNOSES

< SYMPTOM DIAGNOSIS >

## SYMPTOM DIAGNOSIS

### SQUEAK AND RATTLE TROUBLE DIAGNOSES

#### Work Flow

INFOID:0000000011460576

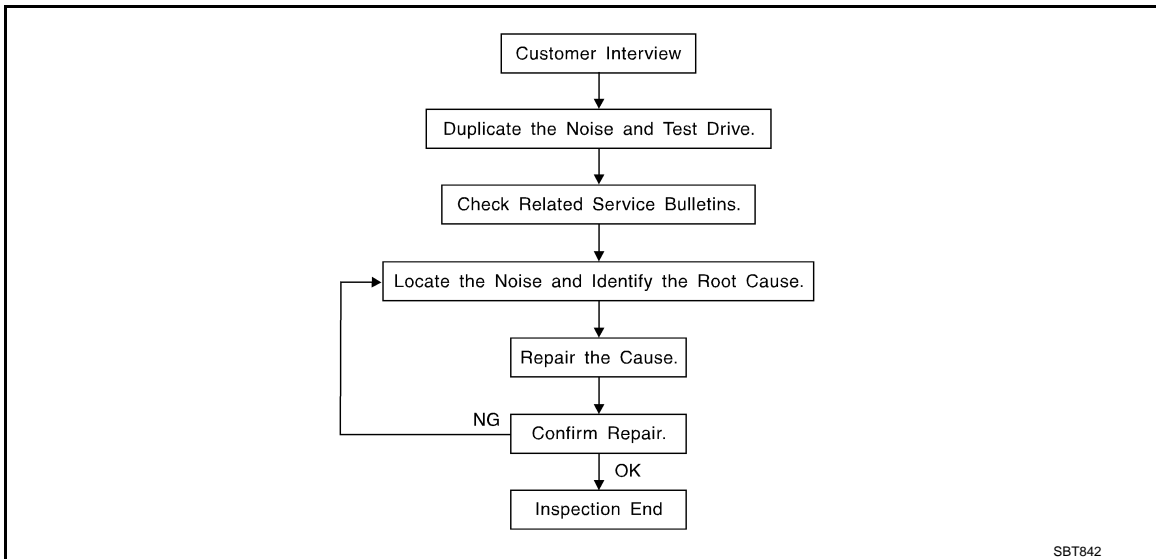

#### CUSTOMER INTERVIEW

Interview the customer if possible, to determine the conditions that exist when the noise occurs. Use the Diagnostic Worksheet during the interview to document the facts and conditions when the noise occurs and any customer comments. Refer to [INT-11, "Diagnostic Worksheet"](#). This information is necessary to duplicate the conditions that exist when the noise occurs.

- The customer may not be able to provide a detailed description or the location of the noise. Attempt to obtain all the facts and conditions that exist when the noise occurs (or does not occur).
- If there is more than one noise in the vehicle, perform a diagnosis and repair the noise that the customer is concerned about. This can be accomplished by performing a test drive with the customer.
- After identifying the type of noise, isolate the noise in terms of its characteristics. The noise characteristics are provided so that the customer, service adviser, and technician use the same language when describing the noise.
- Squeak – (Like tennis shoes on a clean floor)  
Squeak characteristics include the light contact / fast movement / brought on by road conditions / hard surfaces = high-pitched noise / softer surfaces = low-pitched noises / edge to surface = chirping
- Creak – (Like walking on an old wooden floor)  
Creak characteristics include firm contact / slow movement/twisting with a rotational movement / pitch dependent on materials / often brought on by activity.
- Rattle – (Like shaking a baby rattle)  
Rattle characteristics include fast repeated contact / vibration or similar movement / loose parts/missing clip or fastener / incorrect clearance.
- Knock – (Like a knock on a door)  
Knock characteristics include hollow sounds / sometimes repeating / often brought on by driver action.
- Tick – (Like a clock second hand)  
Tick characteristics include gentle contacting of light materials / loose components / can be caused by driver action or road conditions.
- Thump – (Heavy, muffled knock noise)  
Thump characteristics include softer knock / dull sounds often brought on by activity.
- Buzz – (Like a bumblebee)  
Buzz characteristics include high frequency rattle / firm contact.
- Often the degree of acceptable noise level varies depending upon the person. A noise that a technician may judge as acceptable may be very irritating to a customer.
- Weather conditions, especially humidity and temperature, may have a great effect on noise level.

#### DUPLICATE THE NOISE AND TEST DRIVE

# SQUEAK AND RATTLE TROUBLE DIAGNOSES

## < SYMPTOM DIAGNOSIS >

If possible, drive the vehicle with the customer until the noise is duplicated. Note any additional information on the Diagnostic Worksheet regarding the conditions or location of the noise. This information can be used to duplicate the same conditions when the repair is reconfirmed.

If the noise can be duplicated easily during the test drive, do the following with the vehicle stopped to help identify the source of the noise.

- 1) Close a door.
  - 2) Tap or push/pull around the area where the noise appears to be coming from.
  - 3) Rev the engine.
  - 4) Use a floor jack to recreate vehicle "twist".
  - 5) At idle, apply engine load (electrical load, half-clutch on M/T models, drive position on A/T models).
  - 6) Raise the vehicle on a hoist and hit a tire with a rubber hammer.
- Drive the vehicle and attempt to duplicate the conditions the customer states exist when the noise occurs.
  - If it is difficult to duplicate the noise, drive the vehicle slowly on an undulating or rough road to stress the vehicle body.

## CHECK RELATED SERVICE BULLETINS

After verifying the customer concern or symptom, check ASIST for Technical Service Bulletins (TSBs) related to the concern or symptom.

If a TSB relates to the symptom, follow the procedure to repair the noise.

## LOCATE THE NOISE AND IDENTIFY THE ROOT CAUSE

1. Narrow down the noise to a general area. To help pinpoint the source of the noise, use a listening tool (Chassis ear: J-39570, engine ear, and mechanics stethoscope).
2. Narrow down the noise to a more specific area and identify the cause of the noise by:
  - Removing the component(s) in the area(s) that is / are suspected to be the cause of the noise. Do not use too much force when removing clips and fasteners, otherwise clips and fasteners can be broken or lost during the repair, creating a new noise.
  - Tapping or pushing/pulling the component(s) that is / are suspected to be the cause of the noise. Do not tap or push/pull the component(s) with excessive force, otherwise the noise is eliminated only temporarily.
  - Feeling for a vibration by hand by touching the component(s) that is / are suspected to be the cause of the noise.
  - Placing a piece of paper between components that are suspected to be the cause of the noise.
  - Looking for loose components and contact marks.  
Refer to [INT-9, "Inspection Procedure"](#).

## REPAIR THE CAUSE

- If the cause is a loose component, tighten the component securely.
- If the cause is insufficient clearance between components:
  - Separate components by repositioning or loosening and retightening the components, if possible.
  - Insulate components with a suitable insulator such as urethane pads, foam blocks, felt cloth tape, or urethane tape. A NISSAN Squeak and Rattle Kit (J-50397) is available through the authorized NISSAN Parts Department.

### **CAUTION:**

**Never use excessive force as many components are constructed of plastic and may be damaged.**

### **NOTE:**

Always check with the Parts Department for the latest parts information.

The following materials are contained in the NISSAN Squeak and Rattle Kit (J-50397) are listed on the inside cover of the kit; and can each be ordered separately as needed.

URETHANE PADS [1.5 mm (0.059 in) thick]

Insulates connectors, harness, etc.

- 76268-9E005: 100 × 135 mm (3.937 × 5.315 in)
- 76884-71L01: 60 × 85 mm (2.362 × 3.346 in)
- 76884-71L02: 15 × 25 mm (0.591 × 0.984 in)

INSULATOR (Foam blocks)

Insulates components from contact. Can be used to fill space behind a panel.

- 73982-9E000: 45 mm (1.772 in) thick, 50 × 50 mm (1.969 × 1.969 in)
- 73982-50Y00: 10 mm (0.394 in) thick, 50 × 50 mm (1.969 × 1.969 in)

INSULATOR (Light foam block)

80845-71L00: 30 mm (1.18 in) thick, 30 × 50 mm (1.181 × 1.969 in)

FELT CLOTHTAPE



# SQUEAK AND RATTLE TROUBLE DIAGNOSES

## < SYMPTOM DIAGNOSIS >

Used to insulate where movement does not occur. Ideal for instrument panel applications.

- 68370-4B000: 15 × 25 mm (0.591 × 0.984 in) pad
- 68239-13E00: 5 mm (0.197 in) wide tape roll

The following materials, not found in the kit, can also be used to repair squeaks and rattles.

### UHMW (TEFLON) TAPE

Insulates where slight movement is present. Ideal for instrument panel applications.

### SILICONE GREASE

Used in place of UHMW tape that is visible or does not fit. Only lasts a few months.

### SILICONE SPRAY

Used when grease cannot be applied.

### DUCT TAPE

Used to eliminate movement.

## CONFIRM THE REPAIR

After repair is complete, test drive the vehicle to confirm that the cause of noise is repaired by test driving the vehicle. Operate the vehicle under the same conditions as when the noise originally occurred. Refer to the notes on the Diagnostic Worksheet.

## Inspection Procedure

INFOID:000000011460577

Refer to Table of Contents for specific component removal and installation information.

## INSTRUMENT PANEL

Most incidents are caused by contact and movement between:

1. The cluster lid A and instrument panel
2. Acrylic lens and combination meter housing
3. Instrument panel to front pillar garnish
4. Instrument panel to windshield
5. Instrument panel mounting pins
6. Wiring harnesses behind the combination meter
7. A/C defroster duct and duct joint

These incidents can usually be located by tapping or moving the components to duplicate the noise or by pressing on the components while driving to stop the noise. Most of these incidents can be repaired by applying felt cloth tape or silicon spray (in hard to reach areas). Urethane pads can be used to insulate wiring harness.

### **CAUTION:**

**Never use silicone spray to isolate a squeak or rattle. If the area is saturated with silicone, the recheck of repair becomes impossible.**

## CENTER CONSOLE

Components to check include:

1. Shifter assembly cover to finisher
2. A/C control unit and cluster lid C
3. Wiring harnesses behind audio and A/C control unit

The instrument panel repair and isolation procedures also apply to the center console.

## DOORS

Check the following items:

1. Finisher and inner panel making a slapping noise
2. Inside handle escutcheon connection to door finisher
3. Wiring harnesses tapping
4. Door striker out of alignment causing a popping noise on starts and stops

Tapping, moving the components, or pressing on them while driving to duplicate the conditions can isolate many of these incidents. The areas can usually be insulated with felt cloth tape or insulator foam blocks from the NISSAN Squeak and Rattle Kit (J-50397) to repair the noise.

## TRUNK

Trunk noises are often caused by a loose jack or loose items put into the trunk by the customer.

In addition check for the following items:

A

B

C

D

E

F

G

H

I

INT

K

L

M

N

O

P

# SQUEAK AND RATTLE TROUBLE DIAGNOSES

## < SYMPTOM DIAGNOSIS >

---

1. Trunk lid dumpers out of adjustment
2. Trunk lid striker out of adjustment
3. Trunk lid torsion bars knocking together
4. A loose license plate or bracket

Most of these incidents can be repaired by adjusting, securing, or insulating the item(s) or component(s) causing the noise.

## SUNROOF/HEADLINING

Noises in the sunroof / headlining area can often be traced to one of the following items:

1. Sunroof lid, rail, linkage, or seals making a rattle or light knocking noise
2. Sunvisor shaft shaking in the holder
3. Front or rear windshield touching headlining and squeaking

Again, pressing on the components to stop the noise while duplicating the conditions can isolate most of these incidents. Repairs usually consist of insulating with felt cloth tape.

## SEATS

When isolating seat noise it is important to note the position the seat is in and the load placed on the seat when the noise occurs. These conditions should be duplicated when verifying and isolating the cause of the noise.

Causes of seat noise include:

1. Headrest rods and holder
2. A squeak between the seat pad cushion and frame
3. The rear seatback lock and bracket

These noises can be isolated by moving or pressing on the suspected components while duplicating the conditions under which the noise occurs. Most of these incidents can be repaired by repositioning the component or applying urethane tape to the contact area.

## UNDERHOOD

Some interior noise may be caused by components under the hood or on the engine wall. The noise is then transmitted into the passenger compartment.

Causes of transmitted underhood noise include:

1. Any component mounted to the engine wall
2. Components that pass through the engine wall
3. Engine wall mounts and connectors
4. Loose radiator mounting pins
5. Hood bumpers out of adjustment
6. Hood striker out of adjustment

These noises can be difficult to isolate since they cannot be reached from the interior of the vehicle. The best method is to secure, move, or insulate one component at a time and test drive the vehicle. Also, engine RPM or load can be changed to isolate the noise. Repairs can usually be made by moving, adjusting, securing, or insulating the component causing the noise.

# SQUEAK AND RATTLE TROUBLE DIAGNOSES

< SYMPTOM DIAGNOSIS >

## Diagnostic Worksheet

INFOID:000000011460578



### SQUEAK & RATTLE DIAGNOSTIC WORKSHEET

Dear Nissan Customer:

We are concerned about your satisfaction with your Nissan vehicle. Repairing a squeak or rattle sometimes can be very difficult. To help us fix your Nissan right the first time, please take a moment to note the area of the vehicle where the squeak or rattle occurs and under what conditions. You may be asked to take a test drive with a service advisor or technician to ensure we confirm the noise you are hearing.

#### I. WHERE DOES THE NOISE COME FROM? (circle the area of the vehicle)

The illustrations are for reference only, and may not reflect the actual configuration of your vehicle.

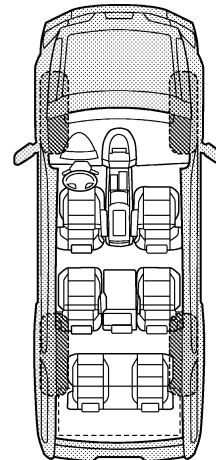
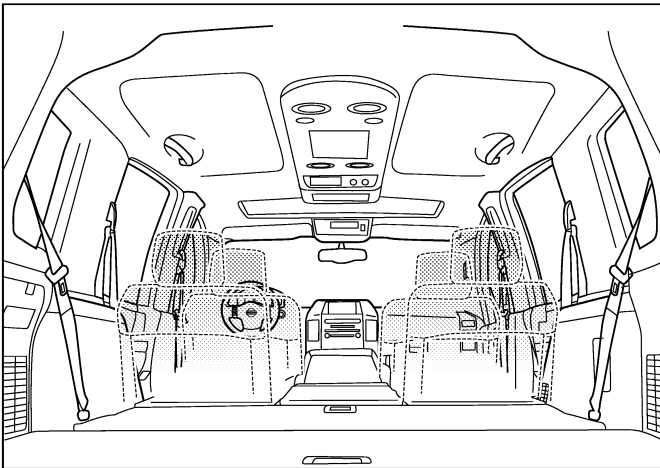
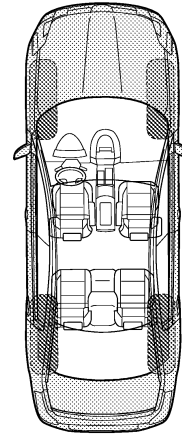
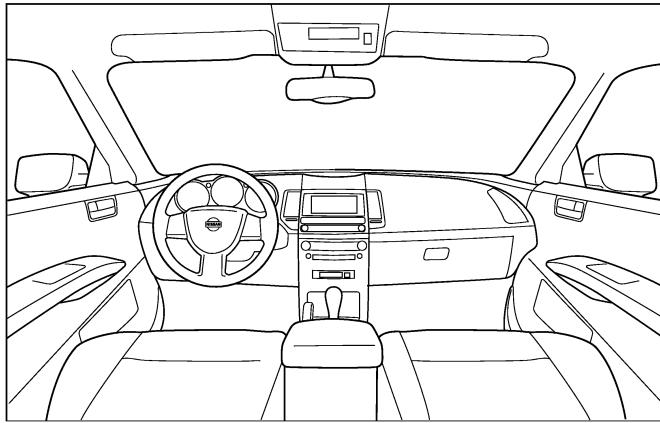

Continue to page 2 of the worksheet and briefly describe the location of the noise or rattle. In addition, please indicate the conditions which are present when the noise occurs.

PIIB8740E

A  
B  
C  
D  
E  
F  
G  
H  
I  
INT  
K  
L  
M  
N  
O  
P

# SQUEAK AND RATTLE TROUBLE DIAGNOSES

< SYMPTOM DIAGNOSIS >

## SQUEAK & RATTLE DIAGNOSTIC WORKSHEET - page 2

Briefly describe the location where the noise occurs:

---

---

### II. WHEN DOES IT OCCUR? (please check the boxes that apply)

- |   |  |
|---|--|
| <input type="checkbox"/> anytime                      | <input type="checkbox"/> after sitting out in the rain |
| <input type="checkbox"/> 1st time in the morning      | <input type="checkbox"/> when it is raining or wet     |
| <input type="checkbox"/> only when it is cold outside | <input type="checkbox"/> dry or dusty conditions       |
| <input type="checkbox"/> only when it is hot outside  | <input type="checkbox"/> other:                        |

### III. WHEN DRIVING:

- through driveways
- over rough roads
- over speed bumps
- only about \_\_\_\_ mph
- on acceleration
- coming to a stop
- on turns: left, right or either (circle)
- with passengers or cargo
- other: \_\_\_\_\_
- after driving \_\_\_\_ miles or \_\_\_\_ minutes

### IV. WHAT TYPE OF NOISE

- squeak (like tennis shoes on a clean floor)
- creak (like walking on an old wooden floor)
- rattle (like shaking a baby rattle)
- knock (like a knock at the door)
- tick (like a clock second hand)
- thump (heavy, muffled knock noise)
- buzz (like a bumble bee)

## TO BE COMPLETED BY DEALERSHIP PERSONNEL

### Test Drive Notes:

---

---

---

	YES	NO	Initials of person performing
Vehicle test driven with customer	<input type="checkbox"/>	<input type="checkbox"/>	_____
- Noise verified on test drive	<input type="checkbox"/>	<input type="checkbox"/>	_____
- Noise source located and repaired	<input type="checkbox"/>	<input type="checkbox"/>	_____
- Follow up test drive performed to confirm repair	<input type="checkbox"/>	<input type="checkbox"/>	_____

VIN: \_\_\_\_\_ Customer Name: \_\_\_\_\_  
W.O.# \_\_\_\_\_ Date: \_\_\_\_\_

This form must be attached to Work Order

PIIB8742E

# FRONT DOOR FINISHER

< REMOVAL AND INSTALLATION >

## REMOVAL AND INSTALLATION

### FRONT DOOR FINISHER

Exploded View

INFOID:000000011460579

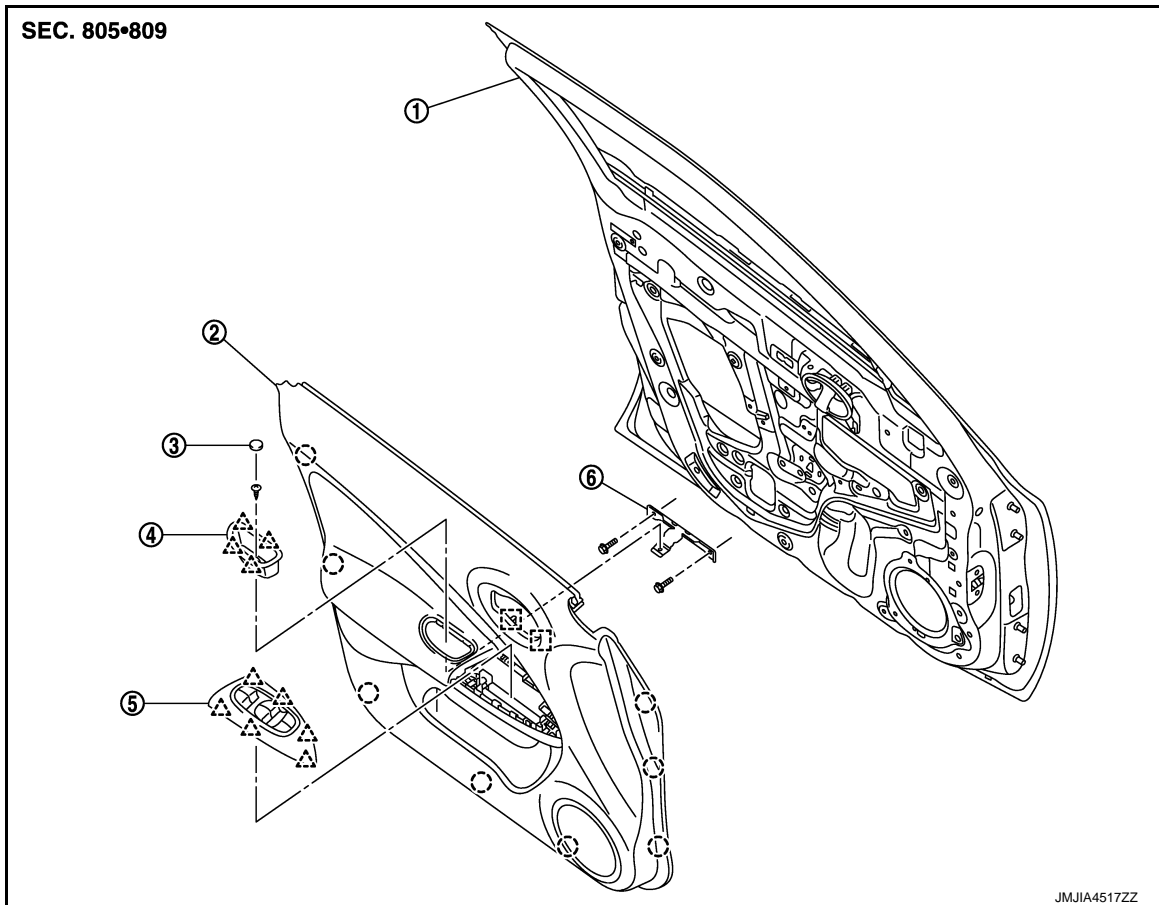

1. Front door panel

4. Pull handle

○ : Clip

△ : Pawl

□ : Metal clip

2. Front door finisher

5. Power window switch finisher

3. Cap

6. Pull handle bracket

### Removal and Installation

INFOID:000000011460580

#### REMOVAL

##### CAUTION:

- When removing, always use a remover tool that is made of plastic.
- Never damage the door panel.

1. Fully open door window.
2. Remove pull handle.

A  
B  
C  
D  
E  
F  
G  
H  
I  
INT  
K  
L  
M  
N  
O  
P

# FRONT DOOR FINISHER

## < REMOVAL AND INSTALLATION >

1. Remove cap in the pull handle.

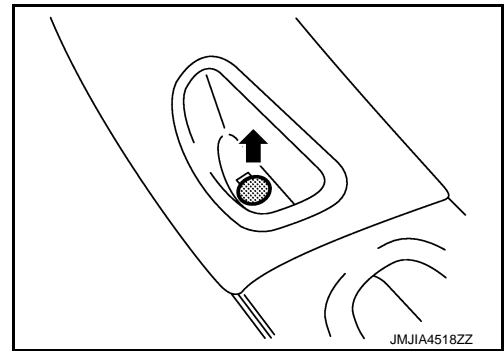

2. Remove pull handle fixing screw.
3. Lift up the pull handle while rotating it in direction indicated by the arrow as shown in the figure. Disengage pawls and remove the pull handle.

: Pawl

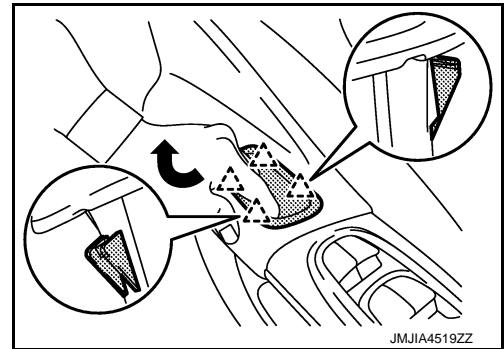

3. Remove power window switch finisher and power window switch in one body.

1. Disengage power window switch finisher fixing pawl with a remover tool (A).

: Pawl

### CAUTION:

Apply protective tape (B) on the parts to protect it from damage.

2. Pull up power window switch finisher and power window switch with one body and disconnect harness connector.

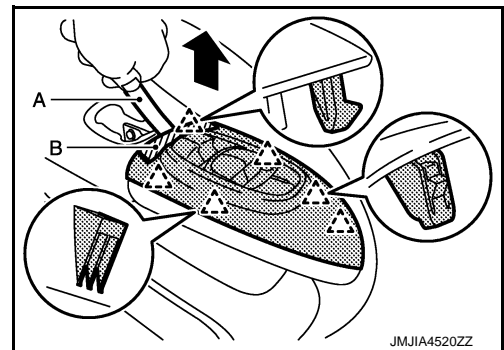

4. Remove door mirror corner cover. Refer to [MIR-17, "DOOR MIRROR ASSEMBLY : Removal and Installation"](#).

5. Disengage front door finisher fixing clips and metal clips with a remover tool (A), and then remove front door finisher.

: Clip

: Metal clip

### CAUTION:

Insert a remover tool between body side panel and clip and disengage pawl.

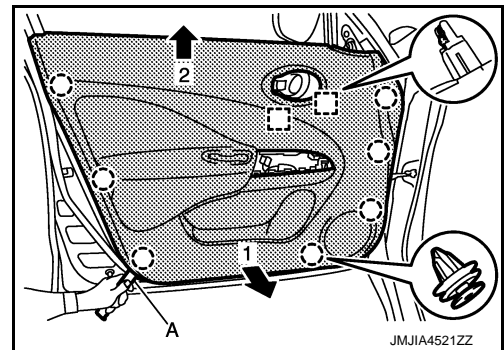

### NOTE:

Remove power window switch. Refer to [PWC-53, "Removal and Installation"](#).

### INSTALLATION

Note the following item, and install in the reverse order of removal.

### CAUTION:

# FRONT DOOR FINISHER

< REMOVAL AND INSTALLATION >

**When installing front door finisher, check that clips, and metal clips are securely in body panel holes, and press them in.**

A

B

C

D

E

F

G

H

I

**INT**

K

L

M

N

O

P

# REAR DOOR FINISHER

< REMOVAL AND INSTALLATION >

## REAR DOOR FINISHER

Exploded View

INFOID:000000011460581

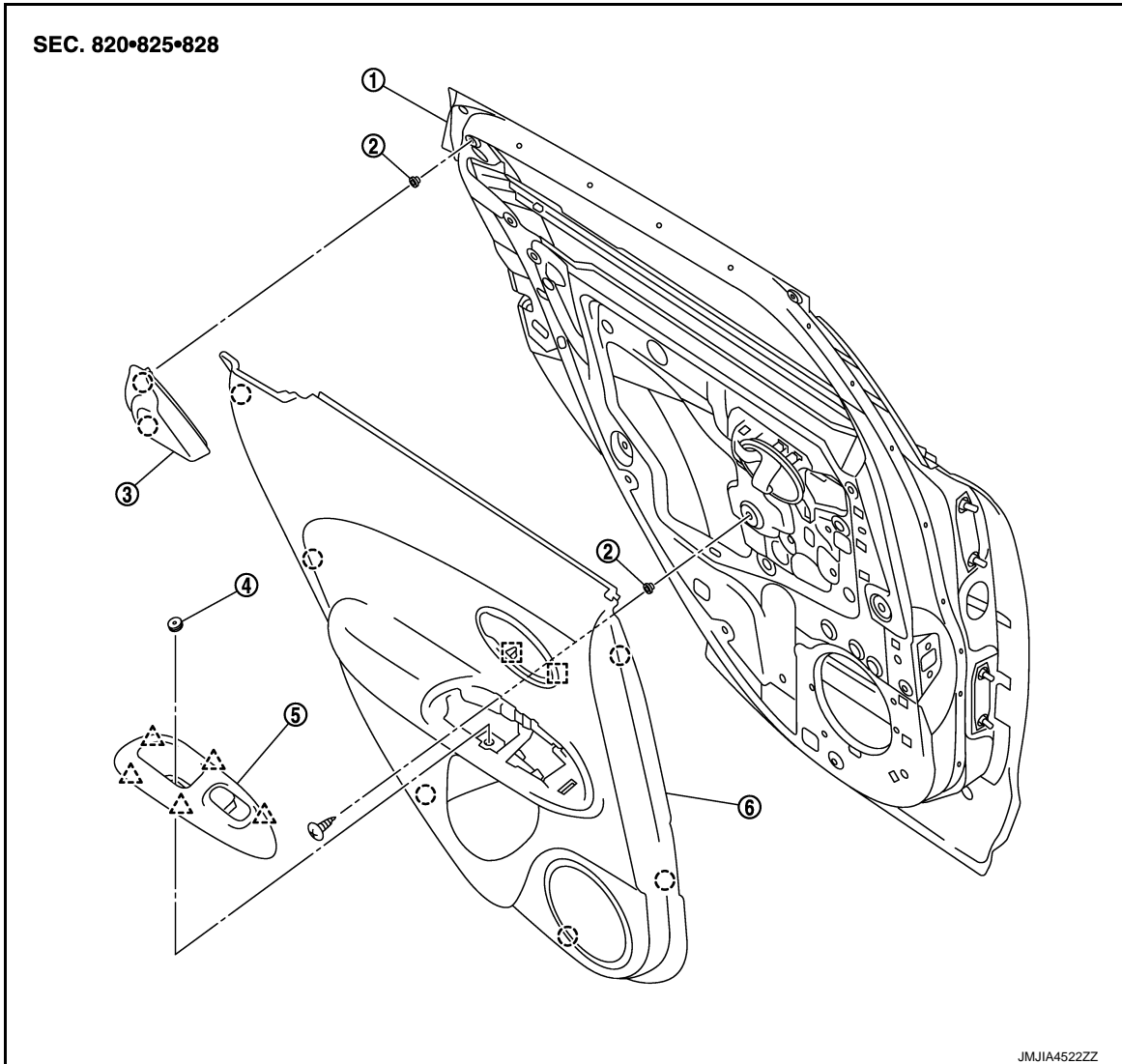

- |                    |                                 |                                 |
|--------------------|---------------------------------|---------------------------------|
| 1. Rear door panel | 2. Grommet                      | 3. Rear door corner cover inner |
| 4. Cap             | 5. Power window switch finisher | 6. Rear door finisher           |

- : Clip  
△ : Pawl  
□ : Metal clip

### Removal and Installation

INFOID:000000011460582

#### REMOVAL

##### CAUTION:

- When removing, always use a remover tool that is made of plastic.
- Never damage the door panel.

1. Fully open door window.
2. Remove rear corner cover inner.



# REAR DOOR FINISHER

## < REMOVAL AND INSTALLATION >

Disengage rear corner cover inner fixing pawl with a remover tool (A).

 : Clip

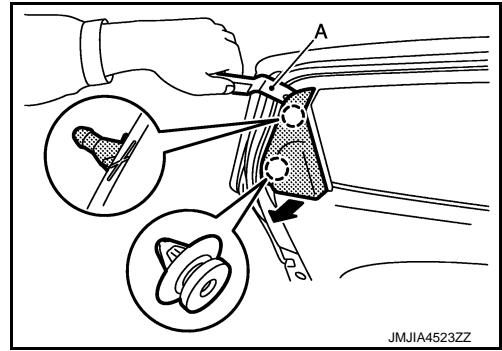

3. Remove power window switch finisher and power window switch in one body.  
Pull up power window switch finisher and power window switch with one body and disconnect harness connector.

 : Pawl

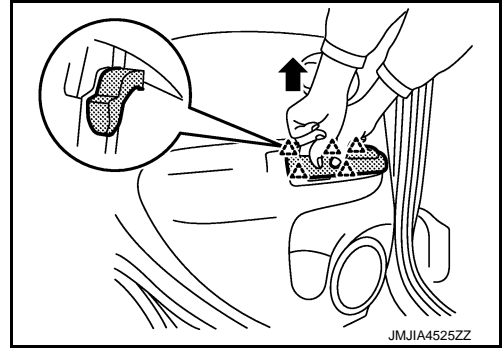

4. Remove rear door finisher fixing screw.
5. Disengage rear door finisher fixing clips and metal clips with a remover tool (A), and then remove rear door finisher.

 : Clip

 : Metal clip

**CAUTION:**  
Insert a remover tool between body side panel and clip and disengage pawl.

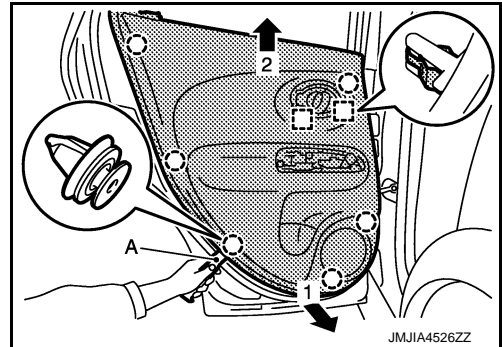

**NOTE:**  
Remove power window switch. Refer to [PWC-53, "Removal and Installation"](#).

## INSTALLATION

Note the following item, and install in the reverse order of removal.

**CAUTION:**  
When installing rear door finisher, check that clips, and metal clips are securely in body panel holes, and press them in.

A  
B  
C  
D  
E  
F  
G  
H  
I  
INT  
K  
L  
M  
N  
O  
P

# BODY SIDE TRIM

< REMOVAL AND INSTALLATION >

## BODY SIDE TRIM

Exploded View

INFOID:000000011460583

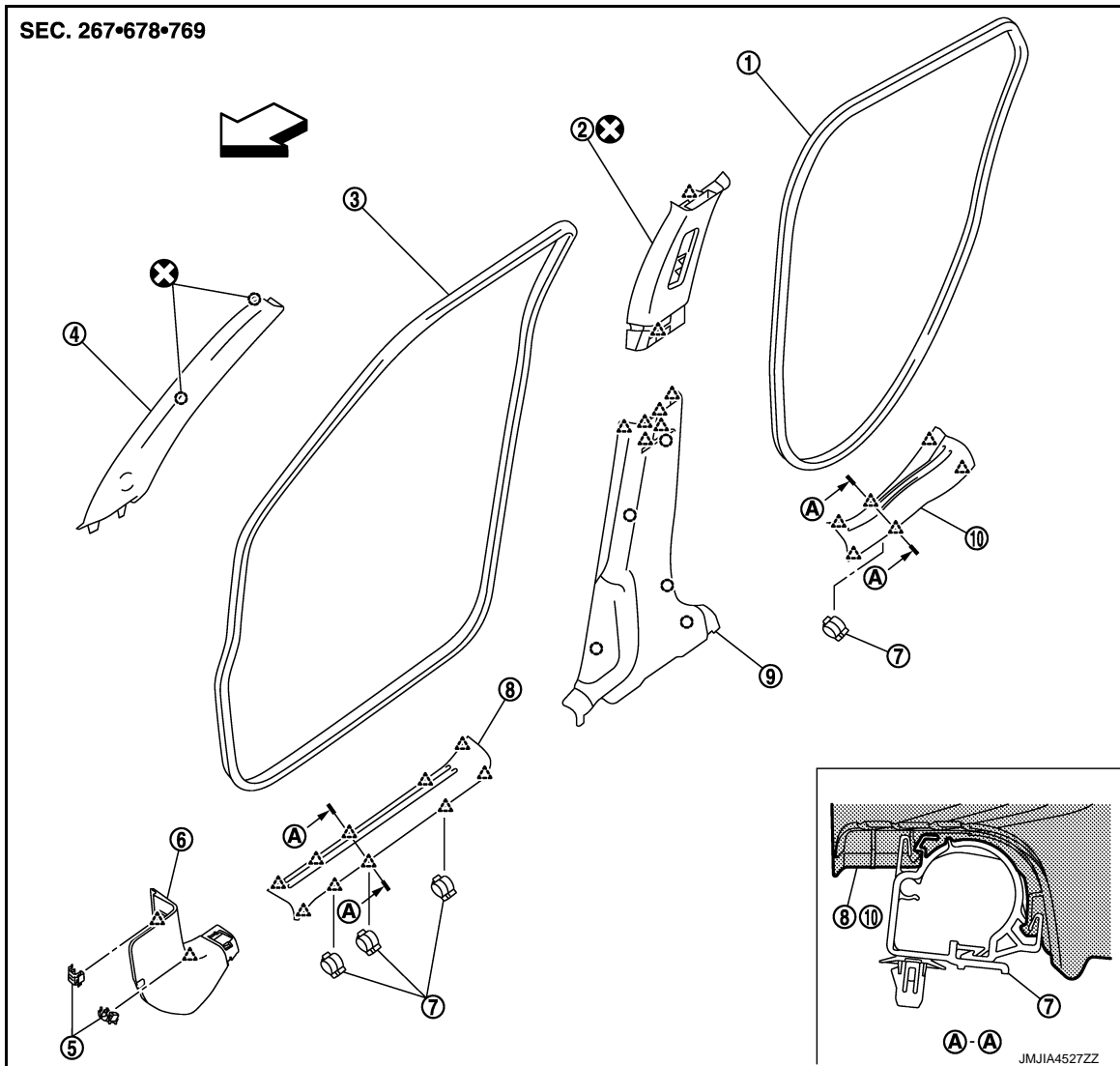

- |                              |                                |                                |
|------------------------------|--------------------------------|--------------------------------|
| 1. Rear body side welt       | 2. Center pillar upper garnish | 3. Front body side welt        |
| 4. Front pillar garnish      | 5. Metal clip                  | 6. Dash side finisher RH       |
| 7. Harness clip              | 8. Front kicking plate inner   | 9. Center pillar lower garnish |
| 10. Rear kicking plate inner |                                |                                |

○ : Clip

△ : Pawl

□ : Metal clip

⇨ : Vehicle front

⊗ : Always replace after every disassembly.

## FRONT PILLAR GARNISH

### FRONT PILLAR GARNISH : Removal and Installation

INFOID:000000011460584

#### REMOVAL

**CAUTION:**

# BODY SIDE TRIM

## < REMOVAL AND INSTALLATION >

- When removing, always use a remover tool that is made of plastic.
  - Never damage the body.
1. Release front pillar garnish portion of front body side welt.
  2. Remove front pillar garnish.
    1. Disengage front pillar garnish fixing anchor clips with a remover tool (A).

 : Anchor Clip

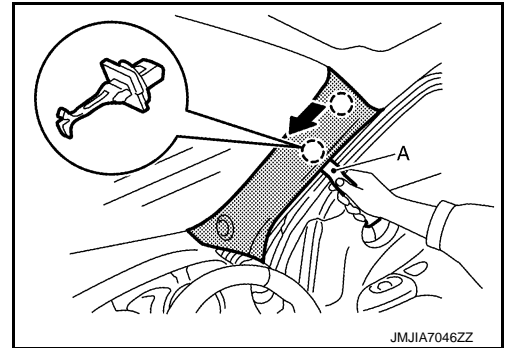

2. Cut anchor clip portion, and then remove front pillar garnish.

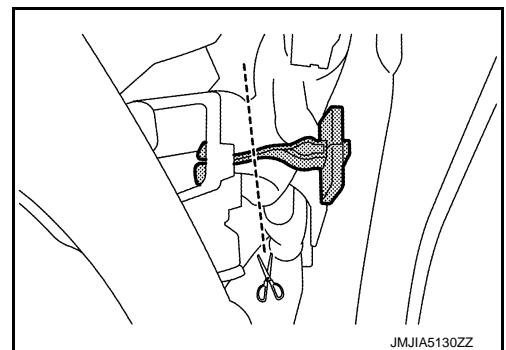

## INSTALLATION

Note the following items, and install in the reverse order of removal.

### CAUTION:

- Replace anchor clip with a new part after removal. Never reuse anchor clip.
- Be sure to install anchor clip to front pillar garnish before installing front pillar garnish to the vehicle body.
- When installing anchor clip to front pillar garnish, be sure to align the notch and then insert anchor clip.

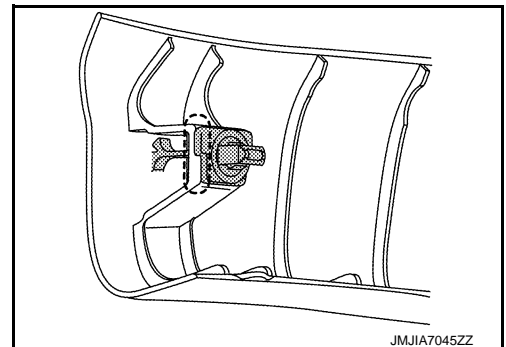

- After installing anchor clip to front pillar garnish, check that anchor clip is engaged securely to front pillar garnish. If anchor clip is not engaged securely, front pillar garnish may be lifted and disengaged from the vehicle body.
- When installing front pillar garnish, check that anchor clips are securely in body panel holes, and press them in.

## KICKING PLATE INNER

### KICKING PLATE INNER : Removal and Installation

INFOID:0000000011460585

## REMOVAL

### CAUTION:

- When removing, always use a remover tool that is made of plastic to prevent damage to the parts.
- Never damage the body.

A  
B  
C  
D  
E  
F  
G  
H  
I  
INT  
K  
L  
M  
N  
O  
P

# BODY SIDE TRIM



## < REMOVAL AND INSTALLATION >

### FRONT KICKING PLATE INNER

1. Disengage fixing pawls on front lower end of front kicking plate inner using a remover tool (A).

**CAUTION:**

Apply protective tape (B) on the parts to protect it from damage.

-  : Pawl
-  : Vehicle front

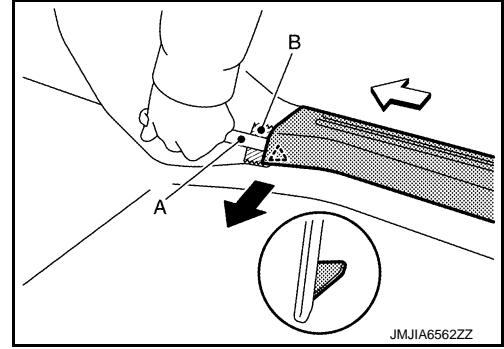

2. Lift up toward vehicle upper and disengage fixing pawls of front kicking plate inner starting from the front.

**CAUTION:**

Never lift up excessively. Otherwise, rear end of front kicking plate inner may be damaged.

-  : Pawl

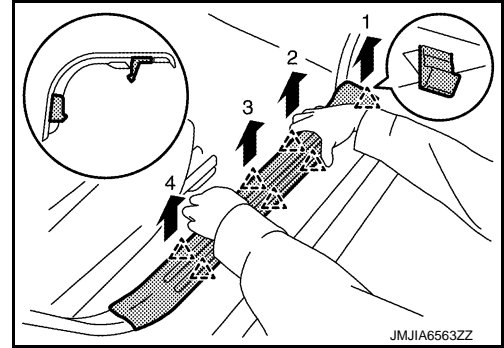

3. Lift up lower rear end of front kicking plate inner while pulling it toward vehicle inside, disengage fixing pawls of front kicking plate inner, and then remove front kicking plate inner.

-  : Pawl

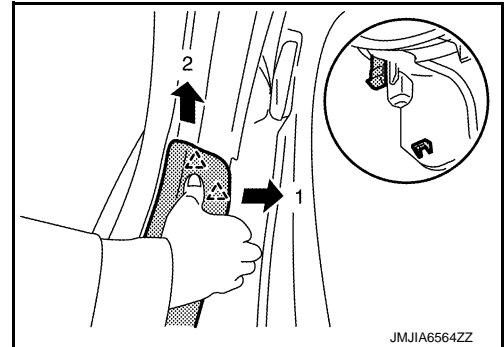

### REAR KICKING PLATE INNER

1. Remove rear seat cushion. Refer to [SE-32, "SEAT CUSHION : Removal and Installation"](#).

2. Disengage fixing pawls on front lower end of rear kicking plate inner using a remover tool (A).

**CAUTION:**

Apply protective tape (B) on the parts to protect it from damage.

-  : Pawl

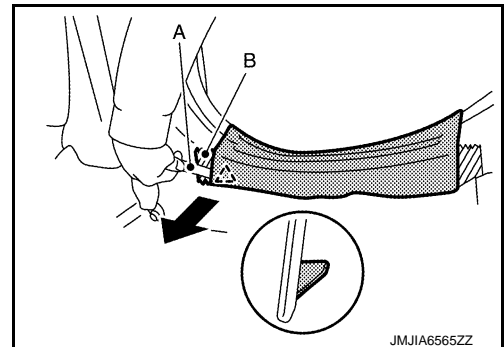

## BODY SIDE TRIM

### < REMOVAL AND INSTALLATION >

- Lift up toward vehicle upper and disengage fixing pawls of rear kicking plate inner starting from the front.

**CAUTION:**

**Never lift up excessively. Otherwise, rear end of rear kicking plate inner may be damaged.**

 : Pawl

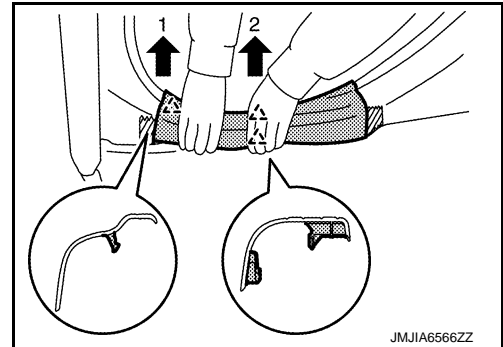

- Using a remover tool (A), lift up lower rear end of rear kicking plate inner while disengaging a fixing pawl on lower rear end of rear kicking plate inner, disengage remaining fixing pawls, and then remove rear kicking plate inner.

**CAUTION:**

**Apply protective tape (B) on the parts to protect it from damage.**

 : Pawl

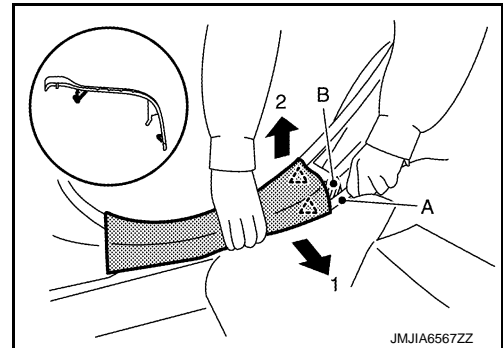

### INSATALLATION

Install in the reverse order of removal.

### DASH SIDE FINISHER

#### DASH SIDE FINISHER : Removal and Installation

INFOID:000000011460586

### REMOVAL

**CAUTION:**

**Never damage the body.**

- Remove front kicking plate inner. Refer to [INT-19. "KICKING PLATE INNER : Removal and Installation"](#).
- Pull back dash side finisher, and then disengage the pawls.

 : Pawl

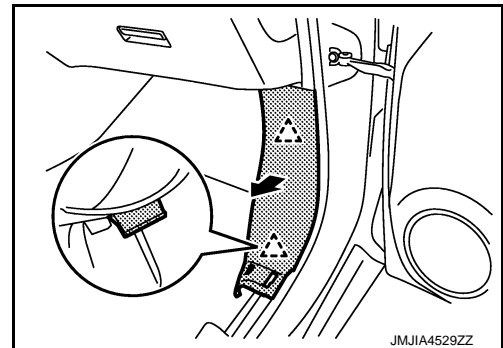

- Disconnect dash side finisher, vehicle front side, from stud bolt and remove dash side finisher.

### INSTALLATION

Install in the reverse order of removal.

### BODY SIDE WELT

#### BODY SIDE WELT : Removal and Installation

INFOID:000000011460587

### REMOVAL

**CAUTION:**

- **Never excessively pull body side welt.**
- **Never damage the body.**

### FRONT BODY SIDE WELT

# BODY SIDE TRIM

## < REMOVAL AND INSTALLATION >

1. Remove front kicking plate inner. Refer to [INT-19, "KICKING PLATE INNER : Removal and Installation"](#).
2. Remove front body side welt.

### REAR BODY SIDE WELT

1. Remove rear kicking plate inner. Refer to [INT-19, "KICKING PLATE INNER : Removal and Installation"](#).
2. Remove rear body side welt.

### INSTALLATION

Install in the reverse order of removal.

## CENTER PILLAR LOWER GARNISH

### CENTER PILLAR LOWER GARNISH : Removal and Installation

INFOID:000000011460588

#### REMOVAL

##### CAUTION:

- When removing, always use a remover tool that is made of plastic.
- Never damage the body.

1. Fully open front door and rear door.
2. Slide front seat to the fully forward position. Tilt seatback forward.
3. Remove Front body side welt and rear body side welt. Refer to [INT-21, "BODY SIDE WELT : Removal and Installation"](#).
4. Disengage center pillar lower garnish fixing clips and pawls with a remover tool (A), and then remove center pillar lower garnish.

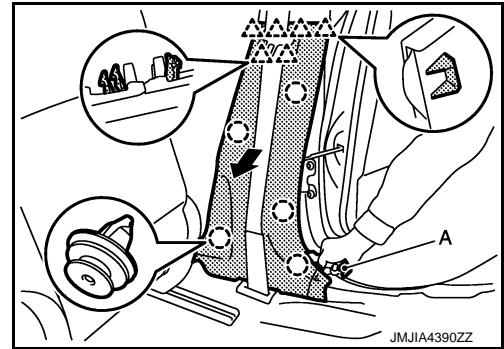
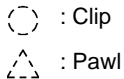

#### INSTALLATION

Note the following item, and install in the reverse order of removal.

##### CAUTION:

When installing center pillar lower garnish, check that clips are securely in body panel holes, and press them in.

## CENTER PILLAR UPPER GARNISH

### CENTER PILLAR UPPER GARNISH : Removal and Installation

INFOID:000000011460589

#### REMOVAL

##### CAUTION:

- When removing, always use a remover tool that is made of plastic.
  - Never damage the body.
1. Remove center pillar lower garnish. Refer to [INT-22, "CENTER PILLAR LOWER GARNISH : Removal and Installation"](#).
  2. Remove front seat belt shoulder anchor. Refer to [SB-5, "SEAT BELT RETRACTOR : Removal and Installation"](#).

## BODY SIDE TRIM

### < REMOVAL AND INSTALLATION >

3. Disengage center pillar upper garnish lower side fixing pawl using a remover tool.

 : Pawl

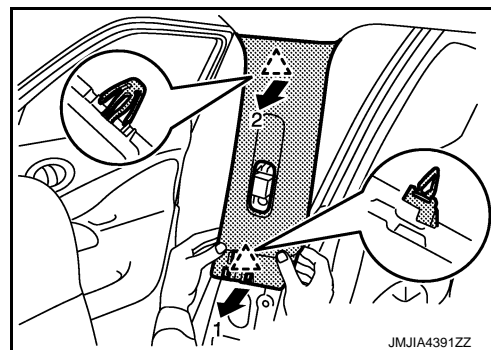

4. Disengage center pillar upper garnish upper side fixing clip using a remover tool (A).

#### NOTE:

Removal operation can be performed easily when pressing pawl by inserting a removal tool from direction (A) as shown in the figure.

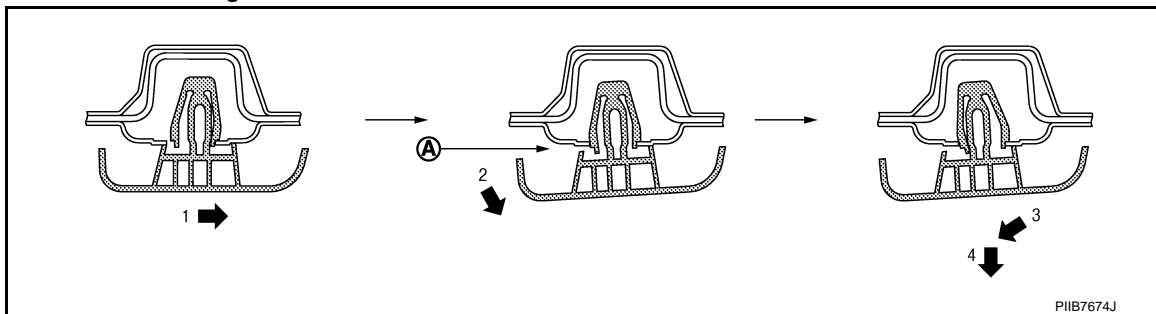

#### CAUTION:

Be careful not to apply excessive force when removing center pillar upper garnish. Otherwise, pawl may be damaged and fragments may drop in panel holes on body.

#### INSTALLATION

Note the following items, and install in the reverse order of removal.

#### CAUTION:

- Replace center pillar upper garnish with a new part after removal. Never reuse center pillar upper garnish.
- When installing center pillar upper garnish, check that pawls are securely in body panel holes, and press them in.

A  
B  
C  
D  
E  
F  
G  
H  
I  
INT  
K  
L  
M  
N  
O  
P

# FLOOR TRIM

< REMOVAL AND INSTALLATION >

## FLOOR TRIM

Exploded View

INFOID:000000011460590

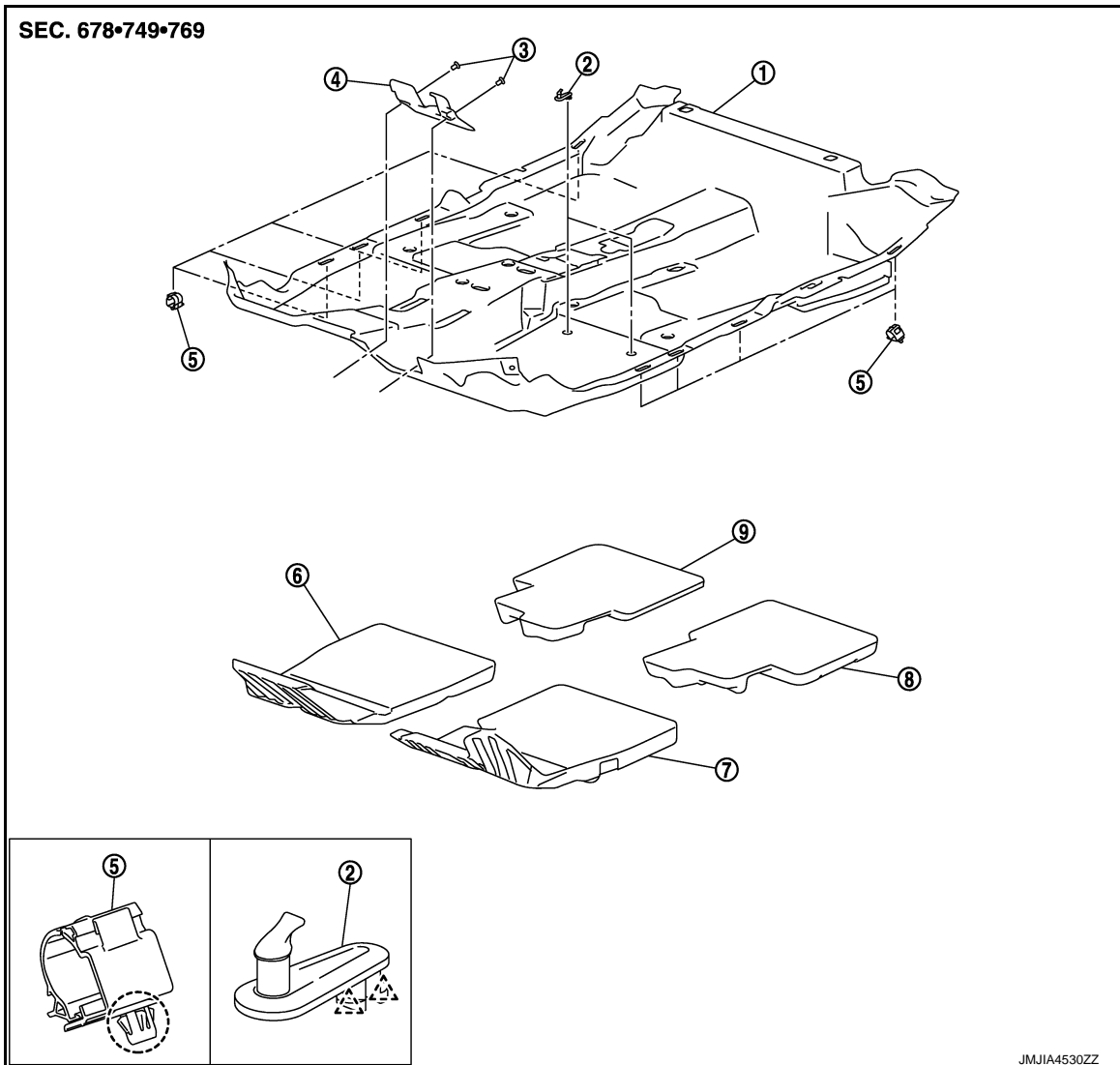

- |                          |                         |                          |
|--------------------------|-------------------------|--------------------------|
| 1. Floor carpet          | 2. Carpet hook          | 3. Trim clip             |
| 4. Column hole cover     | 5. Harness clip         | 6. Front floor spacer RH |
| 7. Front floor spacer LH | 8. Rear floor spacer LH | 9. Rear floor spacer RH  |

○ : Clip  
△ : Pawl

## Removal and Installation

INFOID:000000011460591

### REMOVAL

#### CAUTION:

- When removing, always use a remover tool that is made of plastic.
- Never damage the body.

1. Remove front seat assembly (LH and RH). Refer to [SE-21, "Removal and Installation"](#).
2. Remove rear seat cushion. Refer to [SE-32, "SEAT CUSHION : Removal and Installation"](#).
3. Remove center console assembly. Refer to [IP-24, "Removal and Installation"](#).
4. Remove instrument stay.



# FLOOR TRIM

## < REMOVAL AND INSTALLATION >

Remove instrument stay mounting nuts (A), and then remove instrument stay.

← : Vehicle front

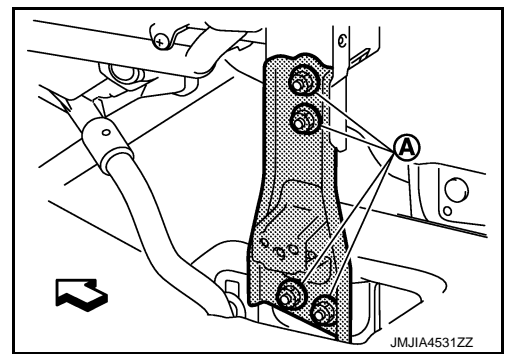

5. Disconnect drain hose. Refer to [HA-43, "A/C UNIT ASSEMBLY : Removal and Installation"](#).
6. Remove foot ducts (LH and RH). Refer to [VTL-13, "FOOT DUCT : Removal and Installation"](#) (Models with foot ducts).
7. Remove sift selector assembly
  - 6MT models: Refer to [TM-25, "Removal and Installation"](#).
  - CVT models: Refer to [TM-313, "Removal and Installation"](#).
8. Remove diagnosis sensor unit. Refer to [SR-28, "Removal and Installation"](#).
9. Remove parking brake lever. Refer to [PB-7, "Removal and Installation"](#).
10. Remove the inside key antenna (console lower). Refer to [DLK-171, "CONSOLE : Removal and Installation"](#) (Models with Intelligent Key system).
11. Remove center pillar lower garnish (LH and RH). Refer to [INT-22, "CENTER PILLAR LOWER GARNISH : Removal and Installation"](#).
12. Remove column hole cover.  
Disengage trim clip (A), and then remove column hole cover.

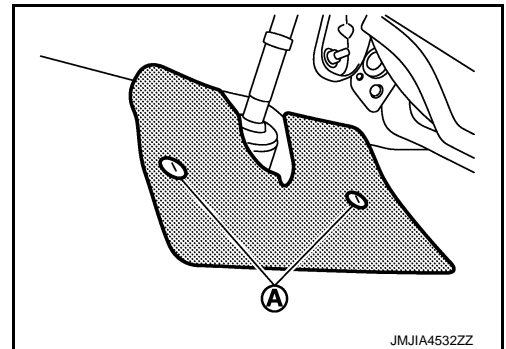

13. Remove dash side finisher (LH and RH). Refer to [INT-21, "DASH SIDE FINISHER : Removal and Installation"](#).
14. Disengage pawl using a remover tool (A) and open the harness clip.

△ : Pawl

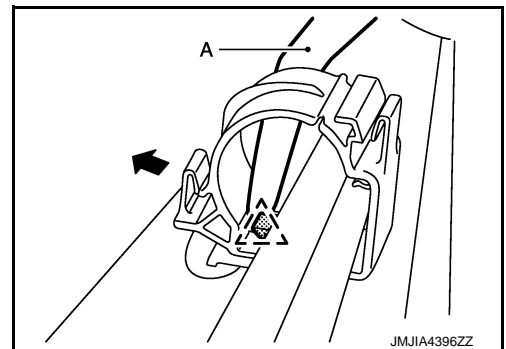

15. Remove floor carpet.

**NOTE:**

## FLOOR TRIM

### < REMOVAL AND INSTALLATION >

Disengage pawls using a remover tool and remove carpet hook.

 : Pawl

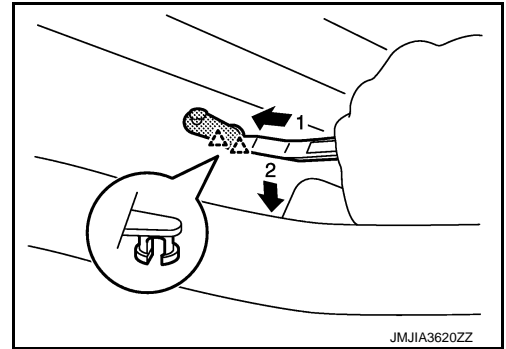

### INSTALLATION

Note the following item, and install in the reverse order of removal.

#### **CAUTION:**

**Replace diagnosis sensor unit fixing bolts with a new part after removal. Never reuse diagnosis sensor unit fixing bolts.**

# HEADLINING

< REMOVAL AND INSTALLATION >

## HEADLINING NORMAL ROOF

### NORMAL ROOF : Exploded View

INFOID:000000011460592

#### NORMAL ROOF

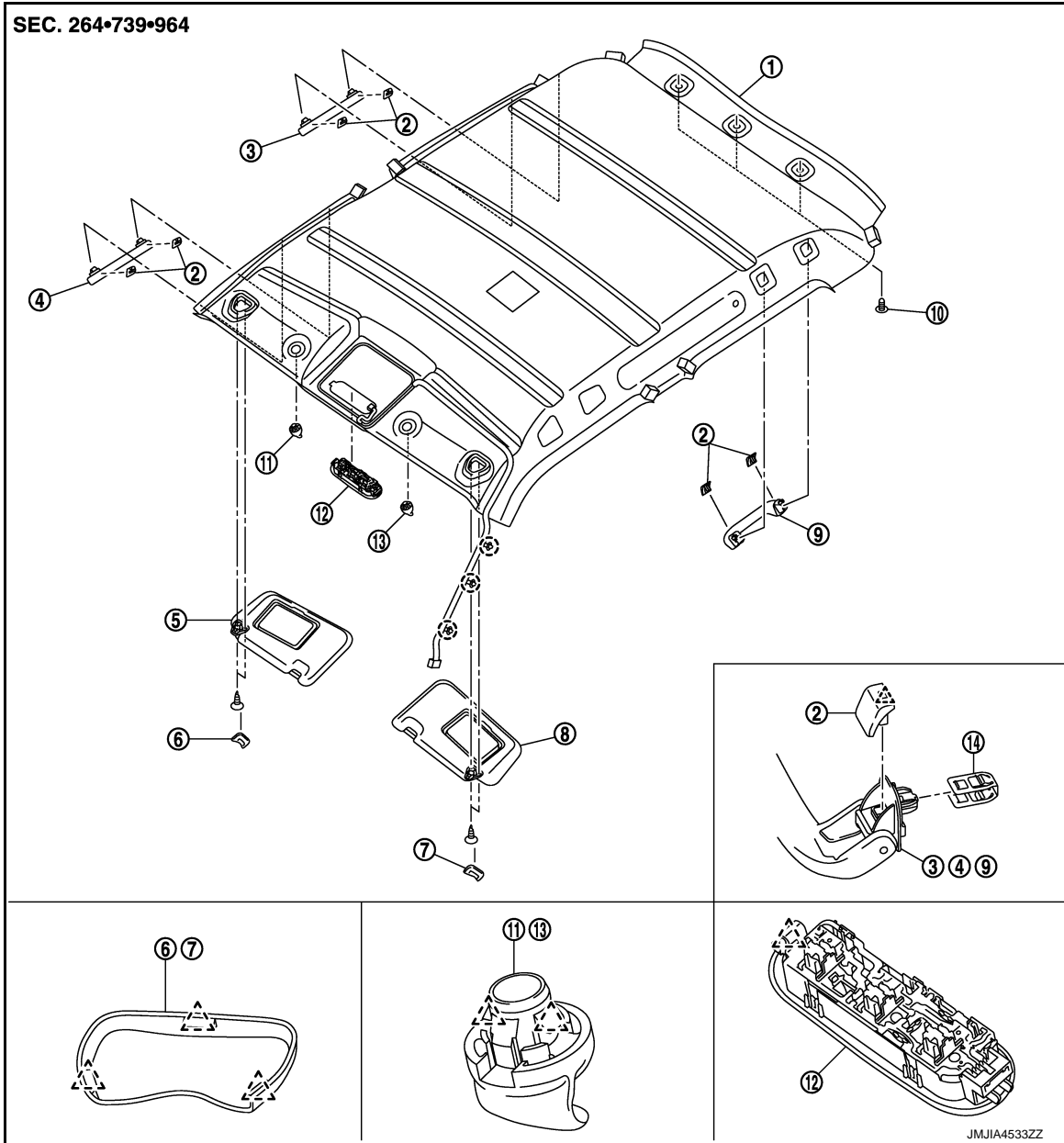

- |                         |                          |                        |
|-------------------------|--------------------------|------------------------|
| 1. Headlining assembly  | 2. Assist grip clip      | 3. Rear assist grip RH |
| 4. Front assist grip RH | 5. Sun visor assembly RH | 6. Sun visor cover RH  |
| 7. Sun visor cover LH   | 8. Sun visor assembly LH | 9. Rear assist grip LH |
| 10. Headlining clip     | 11. Sun visor holder RH  | 12. Map lamp           |
| 13. Sun visor holder LH | 14. Metal clip           |                        |

- : Clip
- △ : Pawl

### NORMAL ROOF : Removal and Installation

INFOID:000000011460593

#### REMOVAL

A  
B  
C  
D  
E  
F  
G  
H  
I  
INT  
K  
L  
M  
N  
O  
P

# HEADLINING

## < REMOVAL AND INSTALLATION >

### CAUTION:

- When removing, always use a remover tool that is made of plastic.
- Never damage the body.

1. Remove front pillar garnish (LH and RH). Refer to [INT-18. "FRONT PILLAR GARNISH : Removal and Installation"](#).
2. Disconnect harness connector (A) from headlining and harness clips

○ : Clip

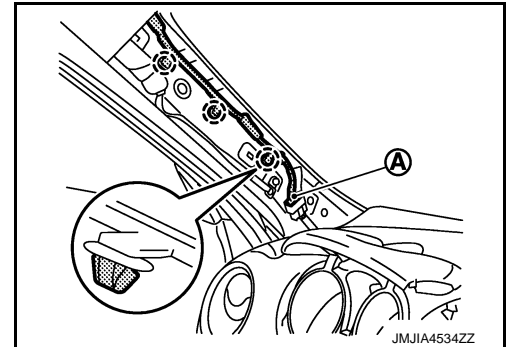

3. Remove center pillar upper garnish (LH and RH). Refer to [INT-22. "CENTER PILLAR UPPER GARNISH : Removal and Installation"](#).
4. Remove back door weather-strip. Refer to [DLK-153. "BACK DOOR WEATHER-STRIP : Removal and Installation"](#) (with Intelligent Key System).
5. Remove luggage side upper finisher (LH and RH). Refer to [INT-36. "LUGGAGE SIDE UPPER FINISHER : Removal and Installation"](#).

6. Remove all assist grips.
  1. Disengage pawl of assist grip clip (1) using a remover tool (A). Slide assist grip clip forward and remove it.

△ : Pawl

2. Slide assist grip (2) forward and remove it.

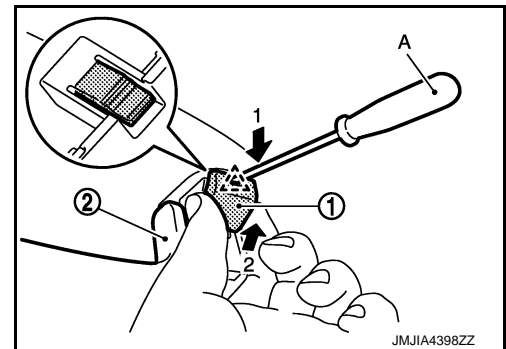

3. Remove metal clips.

7. Remove sun visor assembly (LH and RH).
  1. Disengage sun visor cover fixing pawls with a remover tool (A), and then remove sun visor cover.

△ : Pawl

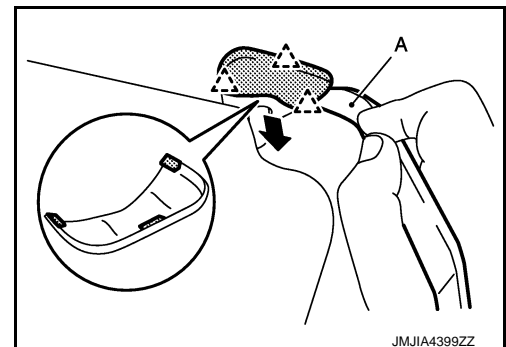

2. Remove sun visor assembly fixing screws, and then slide toward vehicle rear to remove sun visor assembly.

8. Remove map lamp assembly. Refer to [INL-43. "Removal and Installation"](#).
9. Remove front seat assembly (passenger). Refer to [SE-21. "Removal and Installation"](#).
10. Remove sun visor holder (LH and RH).

# HEADLINING

## < REMOVAL AND INSTALLATION >

Rotate 90°. Remove toward vehicle lower.

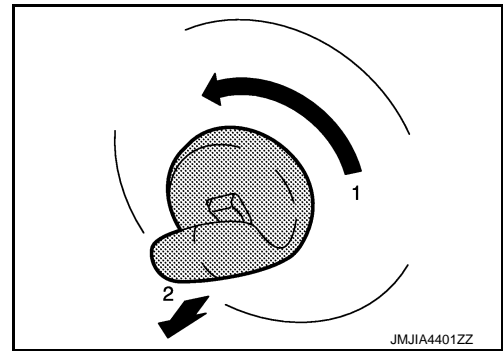

11. Remove headlining clips.
12. Remove headlining assembly through the back door.

### CAUTION:

- Two workers are required for removal in order to prevent damage.
- Apply protective tape to the portion where contact may occur during work.
- Never bend headlining when removing.

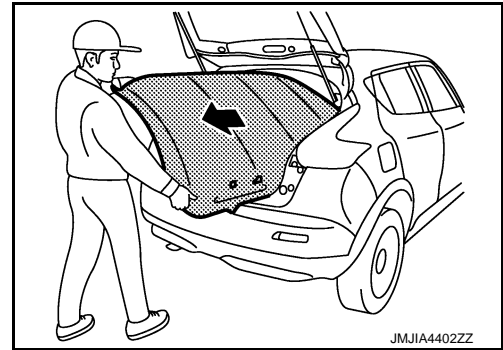

## INSTALLATION

Note the following items, and install in the reverse order of removal.

### CAUTION:

- When installing headlining, start by installing both sun visor holders and headlining clips in order to keep the headlining in position.
- Never bend headlining when installing.
- Be careful that the surface is not wrinkled when installing.

## SUNROOF

A  
B  
C  
D  
E  
F  
G  
H  
I  
INT  
K  
L  
M  
N  
O  
P

# HEADLINING

< REMOVAL AND INSTALLATION >

## SUNROOF : Exploded View

INFOID:000000011460594

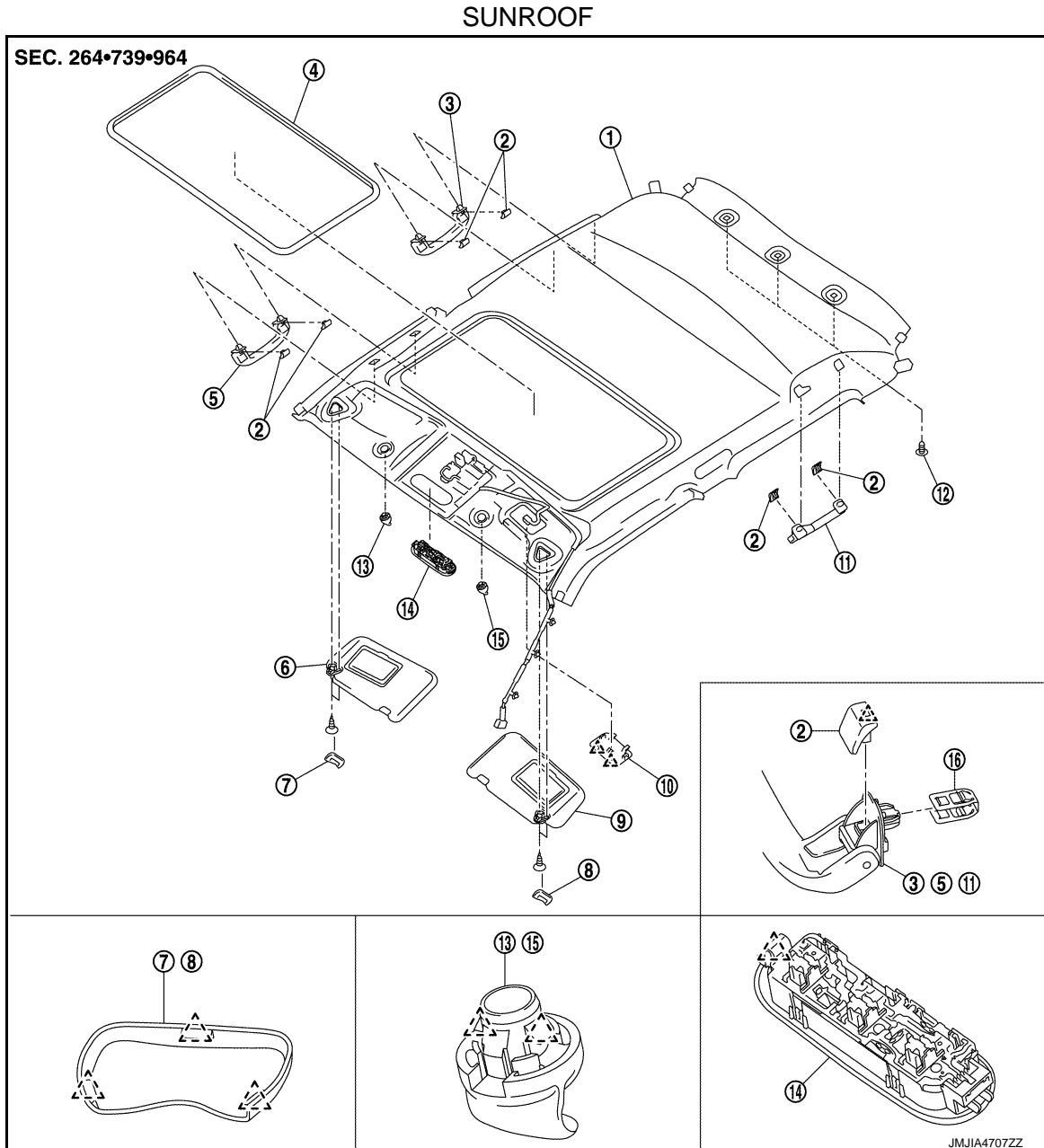

- |                         |                         |                          |
|-------------------------|-------------------------|--------------------------|
| 1. Headlining assembly  | 2. Assist grip clip     | 3. Rear assist grip RH   |
| 4. Sunroof welt         | 5. Front assist grip RH | 6. Sun visor assembly RH |
| 7. Sun visor cover RH   | 8. Sun visor cover LH   | 9. Sun visor assembly LH |
| 10. Front roof finisher | 11. Rear assist grip LH | 12. Headlining clip      |
| 13. Sun visor holder RH | 14. Map lamp            | 15. Sun visor holder LH  |
| 16. Metal clip          |                         |                          |

- : Clip  
 △ : Pawl

## SUNROOF : Removal and Installation

INFOID:000000011460595

### REMOVAL

#### CAUTION:

- When removing, always use a remover tool that is made of plastic.

# HEADLINING

## < REMOVAL AND INSTALLATION >

- **Never damage the body.**

1. Remove front pillar garnish (LH and RH). Refer to [INT-18, "FRONT PILLAR GARNISH : Removal and Installation"](#).
2. Disconnect harness connector (A) from headlining and harness clips

 : Clip

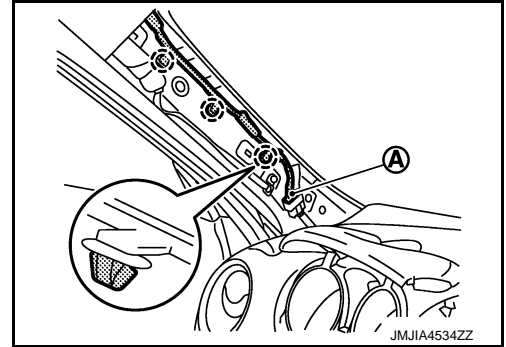

3. Remove center pillar upper garnish (LH and RH). Refer to [INT-22, "CENTER PILLAR UPPER GARNISH : Removal and Installation"](#).
4. Remove back door weather-strip. Refer to [DLK-153, "BACK DOOR WEATHER-STRIP : Removal and Installation"](#) (with Intelligent Key System).
5. Remove luggage side upper finisher (LH and RH). Refer to [INT-36, "LUGGAGE SIDE UPPER FINISHER : Removal and Installation"](#).
6. Remove all assist grips.
  1. Disengage pawl of assist grip clip (1) using a remover tool (A). Slide assist grip clip forward and remove it.

 : Pawl

2. Slide assist grip (2) forward and remove it.

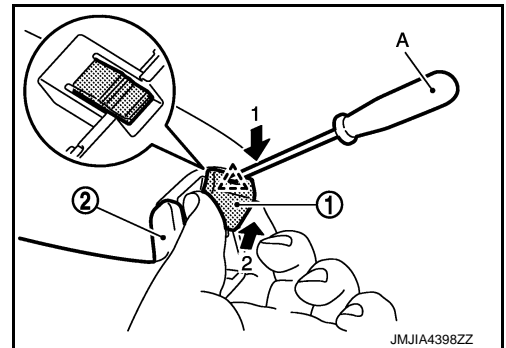

3. Remove metal clips.

7. Remove sun visor assembly (LH and RH).
  1. Disengage sun visor cover fixing pawls with a remover tool (A), and then remove sun visor cover.

 : Pawl

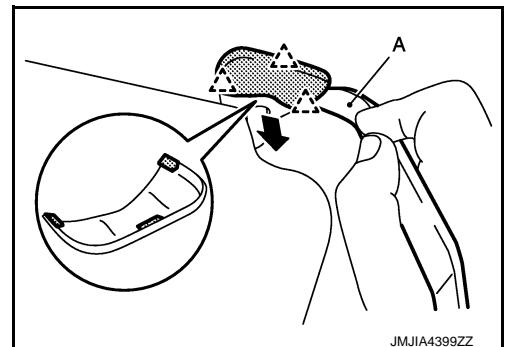

2. Remove sun visor assembly fixing screws, and then slide toward vehicle rear to remove sun visor assembly.

8. Remove inside mirror and inside mirror cover. Refer to [MIR-16, "Removal and Installation"](#).
9. Remove map lamp assembly. Refer to [INL-43, "Removal and Installation"](#).
10. Remove sunroof welt.
11. Remove front roof finisher.

# HEADLINING

## < REMOVAL AND INSTALLATION >

1. Disengage front roof finisher fixing pawls with a remover tool (A).

 : Pawl

2. Disconnect harness connector, and then remove front roof finisher.

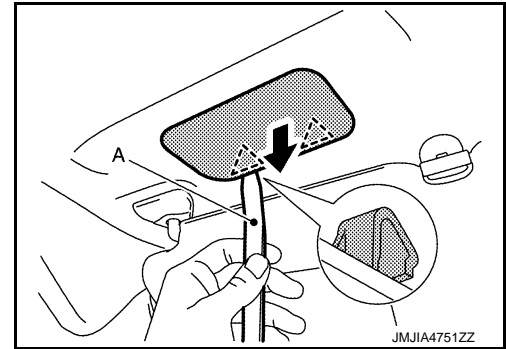

12. Remove front seat assembly (passenger). Refer to [SE-21. "Removal and Installation"](#).
13. Remove sun visor holder (LH and RH)  
Rotate 90°. Remove toward vehicle lower.

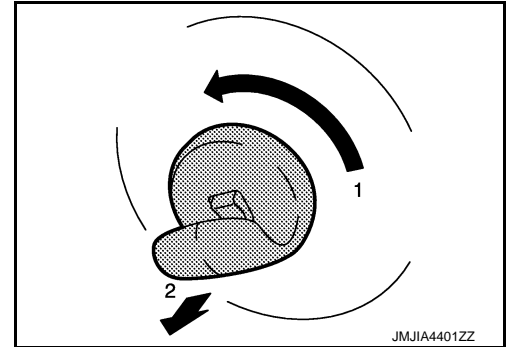

14. Remove headlining clips.
15. Remove headlining assembly through the back door.

### CAUTION:

- Two workers are required for removal in order to prevent damage.
- Apply protective tape to the portion where contact may occur during work.
- Never bend headlining when removing.

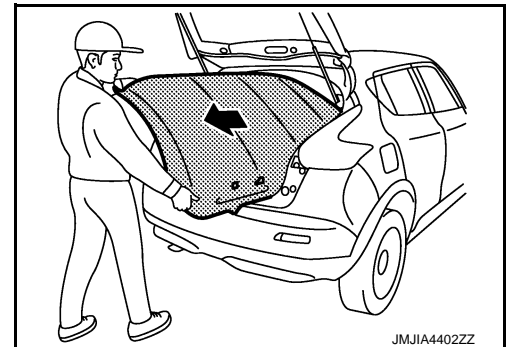

## INSTALLATION

Note the following items, and install in the reverse order of removal.

### CAUTION:

- When installing headlining, start by installing both sun visor holders and headlining clips in order to keep the headlining in position.
- Never bend headlining when installing.
- Be careful that the surface is not wrinkled when installing.
- Align sunroof welt connection (A) to (B) when installing sunroof welt.

 : Vehicle front

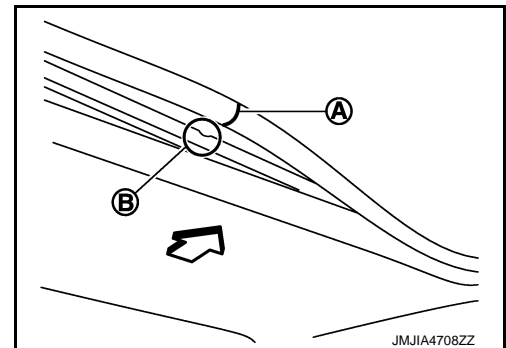



# LUGGAGE FLOOR TRIM

< REMOVAL AND INSTALLATION >

## LUGGAGE FLOOR TRIM

Exploded View

INFOID:000000011460596

2WD models

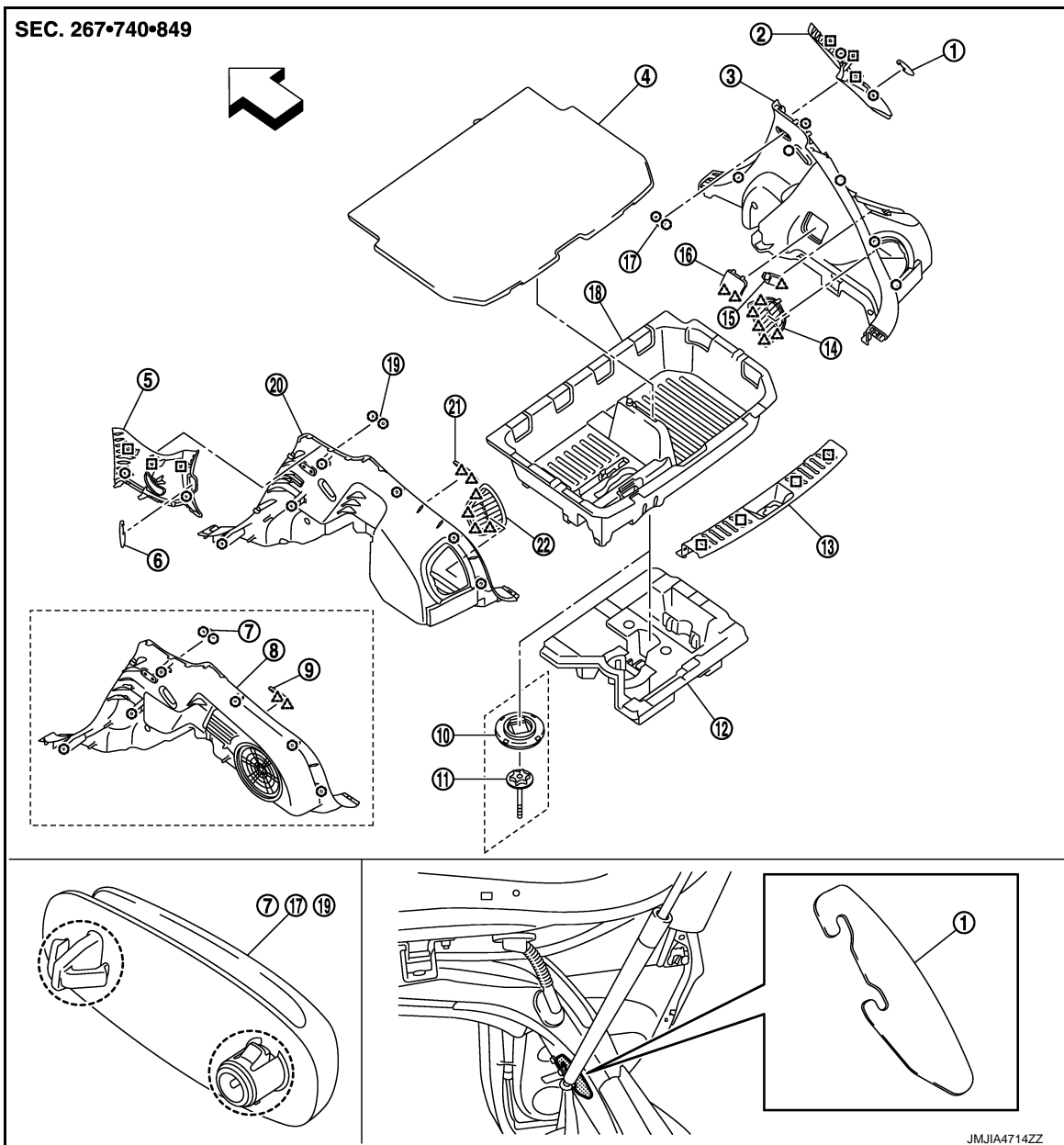

- |  |   |  |
|--|---|--|
| 1. Rear pillar cap RH  | 2. Luggage side upper finisher RH                         | 3. Luggage side lower finisher RH                    |
| 4. Luggage floor board   | 5. Luggage side upper finisher LH                         | 6. Rear pillar cap LH                                |
| 7. Seat belt hook LH<br>(Models with woofer)                     | 8. Luggage side lower finisher LH<br>(Models with woofer) | 9. Shock absorber mask LH<br>(Models with woofer)    |
| 10. Luggage floor rear center spacer<br>(Models with spare tire) | 11. Spare tire clamp<br>(Models with spare tire)          | 12. Repair kit holder<br>(Models without spare tire) |
| 13. Luggage rear plate   | 14. Luggage side lower finisher grille RH                 | 15. Luggage room lamp                                |
| 16. Shock absorber mask RH                                       | 17. Seat belt hook RH                                     | 18. Luggage floor box                                |
| 19. Seat belt hook LH  | 20. Luggage side lower finisher LH                        | 21. Shock absorber mask LH                           |
| 22. Luggage side lower finisher grille LH                        |   |  |



- : Clip  
 △ : Pawl

JMJIA4714ZZ

A  
B  
C  
D  
E  
F  
G  
H  
I  
INT  
K  
L  
M  
N  
O  
P

# LUGGAGE FLOOR TRIM



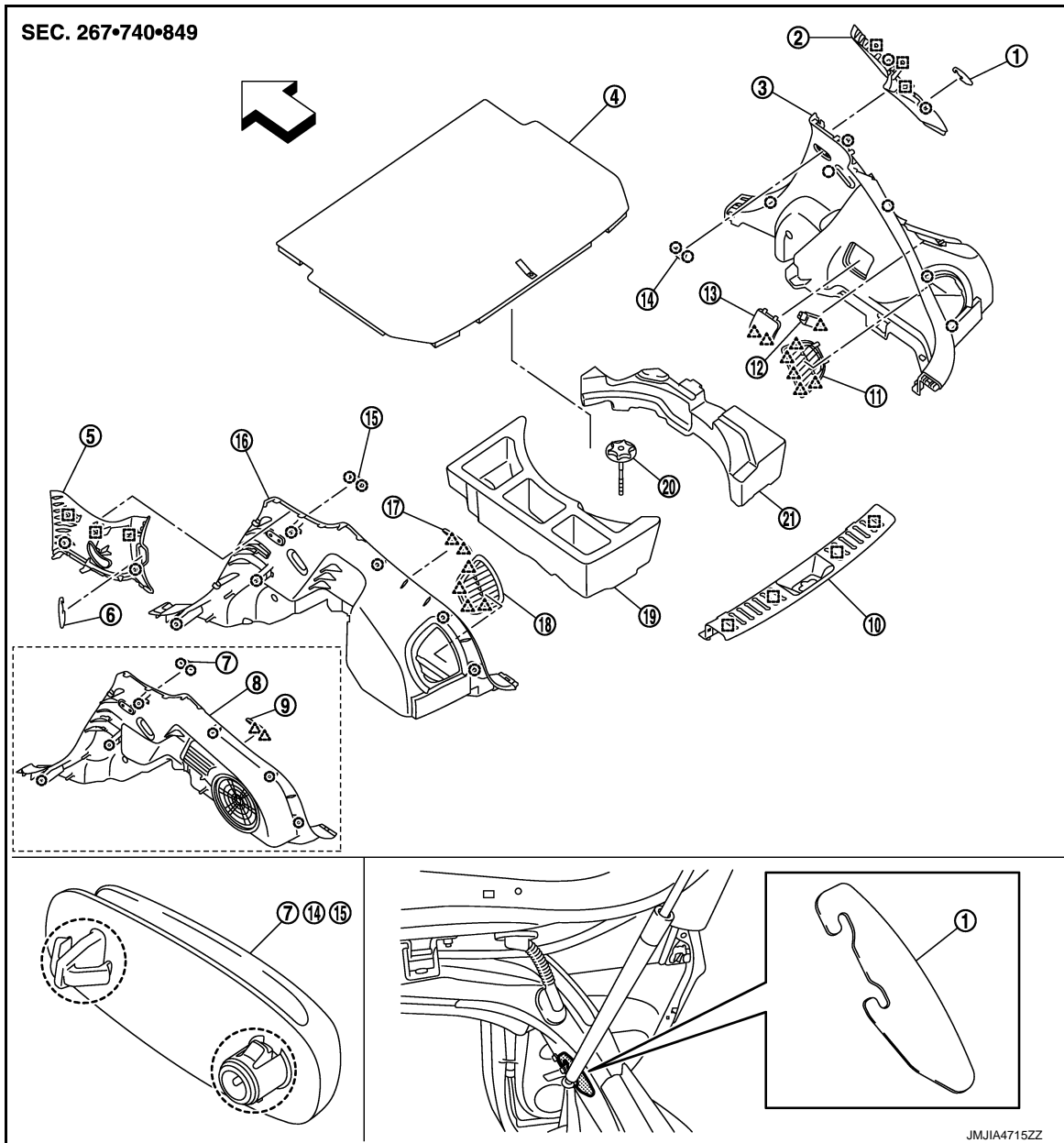

## < REMOVAL AND INSTALLATION >

-  : Metal clip
-  : Vehicle front

AWD models



- |  |   |   |
|--|---|---|
| 1. Rear pillar cap RH                        | 2. Luggage side upper finisher RH                         | 3. Luggage side lower finisher RH                 |
| 4. Luggage floor board                       | 5. Luggage side upper finisher LH                         | 6. Rear pillar cap LH                             |
| 7. Seat belt hook LH<br>(Models with woofer) | 8. Luggage side lower finisher LH<br>(Models with woofer) | 9. Shock absorber mask LH<br>(Models with woofer) |
| 10. Luggage rear plate                       | 11. Luggage side lower finisher grille RH                 | 12. Luggage room lamp                             |
| 13. Shock absorber mask RH                   | 14. Seat belt hook RH                                     | 15. Seat belt hook LH                             |
| 16. Luggage side lower finisher LH           | 17. Shock absorber mask LH                                | 18. Luggage side lower finisher grille LH         |
| 19. Luggage floor rear spacer LH             | 20. Spare tire clamp                                      | 21. Luggage floor rear spacer RH                  |

-  : Clip
-  : Pawl
-  : Metal clip
-  : Vehicle front

JMJIA4715ZZ

# LUGGAGE FLOOR TRIM

< REMOVAL AND INSTALLATION >

## LUGGAGE REAR PLATE

### LUGGAGE REAR PLATE : Removal and Installation

INFOID:0000000011460597

#### CAUTION:

- When removing, always use a remover tool that is made of plastic.
- Never damage the body.

#### REMOVE

1. Remove back door weather-strip. Refer to [DLK-153, "BACK DOOR WEATHER-STRIP : Removal and Installation"](#) (with Intelligent Key System).
2. Disengage luggage rear plate fixing metal clip with a remover tool (A), and then remove luggage rear plate.

 : Metal clip

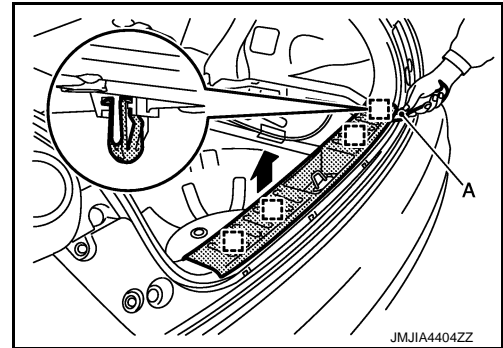

#### INSTALLATION

Note the following items, and install in the reverse order of removal.

#### CAUTION:

When installing luggage rear plate, check that metal clips are securely in body panel holes, and press them in.

## LUGGAGE SIDE LOWER FINISHER

### LUGGAGE SIDE LOWER FINISHER : Removal and Installation

INFOID:0000000011460598

#### REMOVAL

#### CAUTION:

- When removing, always use a remover tool that is made of plastic.
- Never damage the body.

1. Remove luggage room lamp. Refer to [INL-46, "Removal and Installation"](#).
2. Remove luggage floor board.
3. Remove luggage floor box (Models with 2WD).
4. Remove luggage rear plate. Refer to [INT-35, "LUGGAGE REAR PLATE : Removal and Installation"](#).
5. Remove rear body side welt. Refer to [INT-21, "BODY SIDE WELT : Removal and Installation"](#).
6. Remove rear seat cushion. Refer to [SE-32, "SEAT CUSHION : Removal and Installation"](#).
7. Remove rear seat back. Refer to [SE-33, "SEATBACK : Removal and Installation"](#).
8. Remove side hinge of seatback hinge. Refer to [SE-38, "SEATBACK HINGE : Removal and Installation"](#).
9. Disengage luggage side lower finisher fixing clips with a remover tool (A), and then remove luggage side lower finisher.

 : Clip

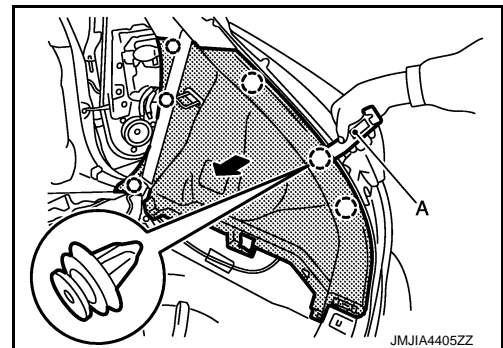

#### INSTALLATION

Note the following item, and install in the reverse order of removal.

# LUGGAGE FLOOR TRIM

## < REMOVAL AND INSTALLATION >

### CAUTION:

When installing luggage side lower finisher, check that clips are securely in body panel holes, and press them in.

### Removal and Installation of Shock Absorber Mask

#### CAUTION:

When removing, always use a remover tool that is made of plastic.

#### REMOVAL

1. Disengage shock absorber mask fixing pawls with a remover tool (A), and then remove shock absorber mask.

 : Pawl

#### CAUTION:

Apply protective tape (B) on the parts to protect it from damage.

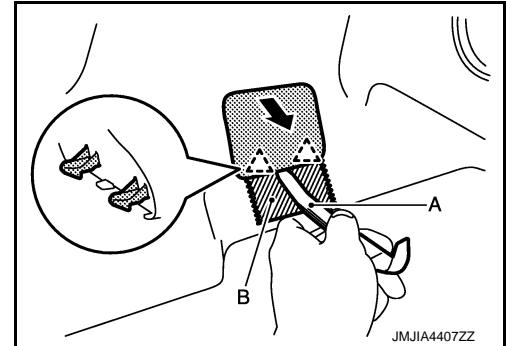

#### INSTALLATION

Install in the reverse order of removal.

### Removal and Installation of Luggage Side Lower Finisher Grille

#### CAUTION:

When removing, always use a remover tool that is made of plastic.

#### REMOVAL

Disengage luggage side lower finisher grille fixing pawls with a remover tool (A), and then remove luggage side lower finisher grille.

 : Pawl

#### CAUTION:

Apply protective tape (B) on the parts to protect it from damage.

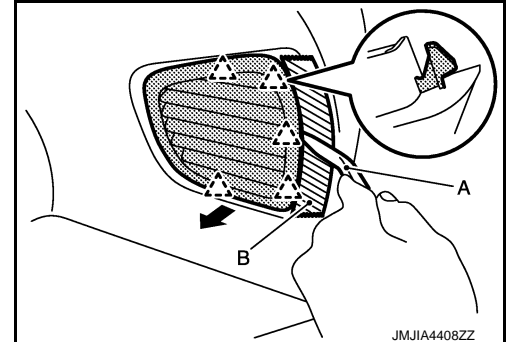

#### INSTALLATION

Install in the reverse order of removal.

## LUGGAGE SIDE UPPER FINISHER

### LUGGAGE SIDE UPPER FINISHER : Removal and Installation

INFOID:000000011460599

#### REMOVAL

#### CAUTION:

- When removing, always use a remover tool that is made of plastic.
- Never damage the body.

1. Remove luggage side lower finisher. Refer to [INT-35. "LUGGAGE SIDE LOWER FINISHER : Removal and Installation"](#).
2. Remove rear seat belt (floor) anchor bolt. Refer to [SB-12. "SEAT BELT RETRACTOR : Removal and Installation"](#).

# LUGGAGE FLOOR TRIM

## < REMOVAL AND INSTALLATION >

3. Disengage luggage side upper finisher fixing clips and metal clips with a remover tool (A), and then remove luggage side upper finisher.

- : Clip
- : Metal clip

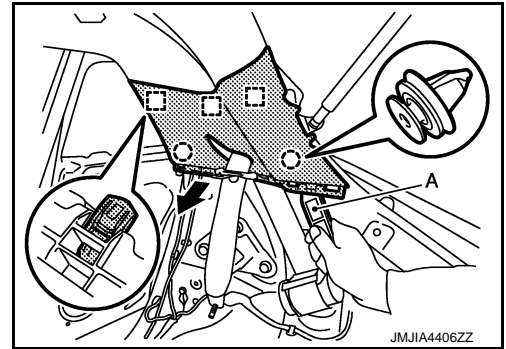

## INSTALLATION

Note the following item, and install in the reverse order of removal.

### CAUTION:

When installing luggage side upper finisher, check that clips, and metal clips are securely in body panel holes, and press them in.

A  
B  
C  
D  
E  
F  
G  
H  
I  
INT  
K  
L  
M  
N  
O  
P

# BACK DOOR TRIM

< REMOVAL AND INSTALLATION >

## BACK DOOR TRIM

Exploded View

INFOID:000000011460600

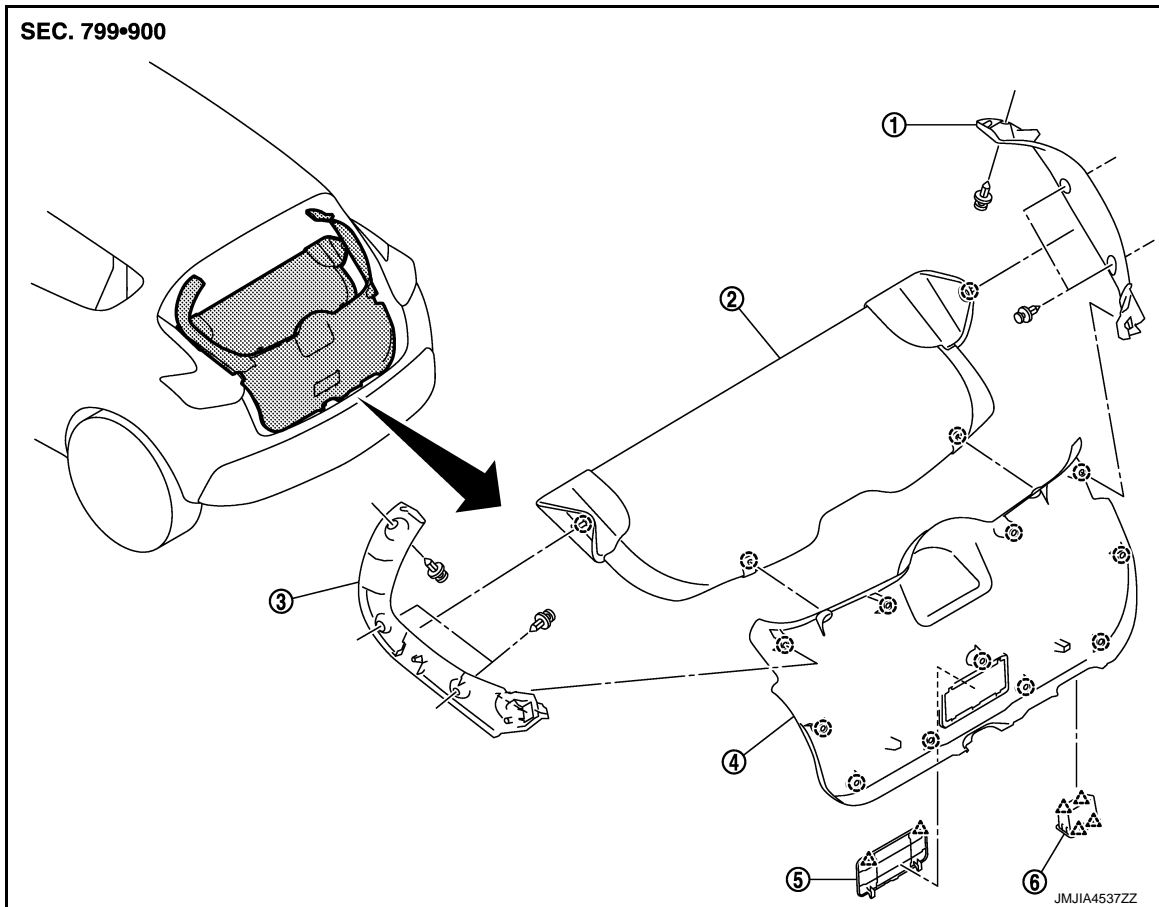

- |                               |                               |                               |
|-------------------------------|-------------------------------|-------------------------------|
| 1. Back door side finisher RH | 2. Rear parcel shelf finisher | 3. Back door side finisher LH |
| 4. Back door lower finisher   | 5. Emergency lid              | 6. Back door pull handle      |

- : Clip  
△ : Pawl

## BACK DOOR PULL HANDLE

### BACK DOOR PULL HANDLE : Removal and Installation

INFOID:000000011460601

#### REMOVAL

#### **CAUTION:**

- When removing, always use a remover tool that is made of plastic.
- Never damage the back door panel.

1. Fully open back door.

# BACK DOOR TRIM

## < REMOVAL AND INSTALLATION >

2. Disengage back door pull handle fixing pawls with a remover tool (A), and then remove back door pull handle.

 : Pawl

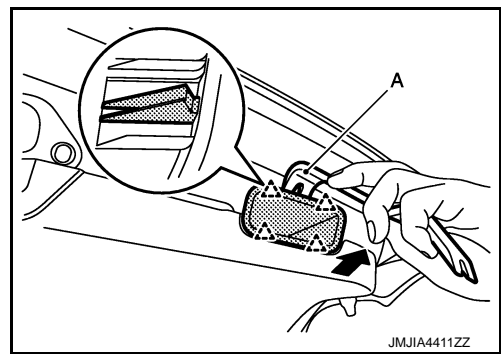

## INSTALLATION

Install in the reverse order of removal.

## BACK DOOR LOWER FINISHER

### BACK DOOR LOWER FINISHER : Removal and Installation

INFOID:000000011460602

## REMOVAL

### CAUTION:

- When removing, always use a remover tool that is made of plastic.
- Never damage the back door panel.

1. Fully open back door.
2. Remove rear parcel shelf finisher. (Models with rear parcel shelf finisher)
3. Disengage back door lower finisher fixing clips with a remover tool (A), and then remove back door lower finisher.

 : Clip

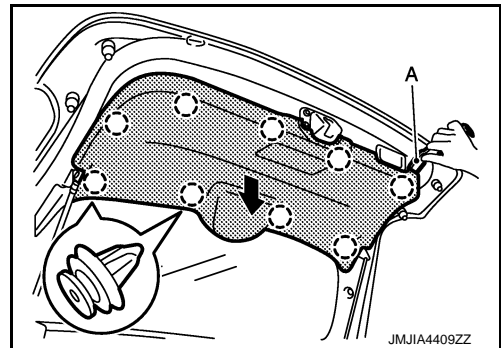

## INSTALLATION

Note the following item, and install in the reverse order of removal.

### CAUTION:

When installing back door lower finisher, check that clips are securely in back door panel holes, and press them in.

## BACK DOOR SIDE FINISHER

### BACK DOOR SIDE FINISHER : Removal and Installation

INFOID:000000011460603

## REMOVAL

### CAUTION:

- When removing, always use a remover tool that is made of plastic.
- Never damage the back door panel.

1. Fully open back door.
2. Remove back door lower finisher. Refer to [INT-39, "BACK DOOR LOWER FINISHER : Removal and Installation"](#).

## BACK DOOR TRIM

### < REMOVAL AND INSTALLATION >

3. Disengage back door side finisher fixing clips (A), and then remove back door side finisher.

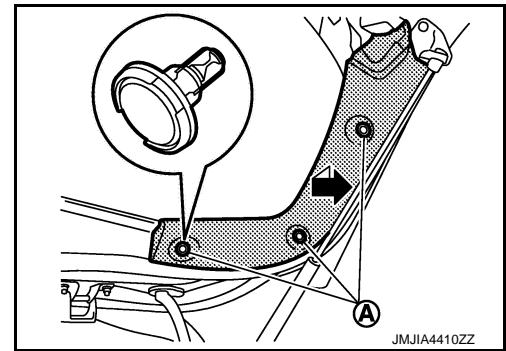

### INSTALLATION

Note the following item, and install in the reverse order of removal.

#### **CAUTION:**

**When installing back door side finisher, check that clips are securely in back door panel holes, and press them in.**

### EMERGENCY LID

#### EMERGENCY LID : Removal and Installation

INFOID:000000011460604

### REMOVAL

#### **CAUTION:**

**When removing, always use a remover tool that is made of plastic.**

1. Fully open back door.
2. Disengage emergency lid fixing pawls with a remover tool (A), and then remove emergency lid.

 : Pawl

#### **CAUTION:**

**Apply protective tape (B) on the parts to protect it from damage.**

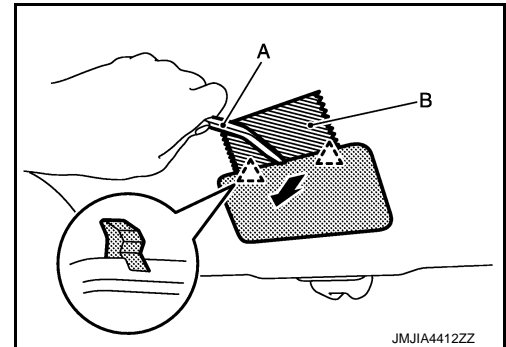

### INSTALLATION

Install in the reverse order of removal.