

SECTION **AV**

AUDIO, VISUAL & NAVIGATION SYSTEM

CONTENTS

AUDIO W/O NAVI (EXCEPT MEXICO)	DIAGNOSIS SYSTEM (BLUETOOTH® CONTROL UNIT)	27	F
PRECAUTION	Diagnosis Description	27	
PRECAUTIONS	Work Flow	27	G
Precaution for Technicians Using Medical Electric... 11	ECU DIAGNOSIS INFORMATION	28	
Precaution for Supplemental Restraint System (SRS) "AIR BAG" and "SEAT BELT PRE-TENSIONER"	AUDIO UNIT	28	H
Precaution for Trouble Diagnosis	Reference Value	28	
Precaution for Harness Repair	BLUETOOTH® CONTROL UNIT	31	I
Precaution for Removing 12V Battery	Reference Value	31	
Precaution for Work	WIRING DIAGRAM	33	J
PREPARATION	AUDIO W/O NAVI (EXCEPT MEXICO)	33	
PREPARATION	Wiring Diagram	33	K
Special Service Tools	BASIC INSPECTION	46	
Commercial Service Tool	DIAGNOSIS AND REPAIR WORKFLOW	46	L
SYSTEM DESCRIPTION	Work Flow	46	
COMPONENT PARTS	DTC/CIRCUIT DIAGNOSIS	48	M
Component Parts Location	POWER SUPPLY AND GROUND CIRCUIT	48	
Audio Unit	AUDIO UNIT	48	AV
Speaker	AUDIO UNIT : Diagnosis Procedure	48	
Bluetooth Control Unit	BLUETOOTH® CONTROL UNIT	48	O
Bluetooth Antenna	BLUETOOTH® CONTROL UNIT : Diagnosis Procedure	48	
Microphone	FRONT DOOR SPEAKER	50	P
USB Connector	Diagnosis Procedure	50	
Steering Switch	REAR DOOR SPEAKER	52	
Rear View Camera	Diagnosis Procedure	52	
Antenna	CAMERA IMAGE SIGNAL CIRCUIT	54	
SYSTEM	Diagnosis Procedure	54	
AUDIO UNIT	BLUETOOTH® VOICE SIGNAL CIRCUIT	56	
AUDIO UNIT : System Description			
DIAGNOSIS SYSTEM (AUDIO UNIT)			
Description			
On Board Diagnosis Function			

Diagnosis Procedure	56	Precaution for Work	80
BLUETOOTH® CONTROL SIGNAL CIRCUIT... 58		Cautions in Removing AV Control Unit (Models with AV Control Unit)	80
Diagnosis Procedure	58	PREPARATION	81
MICROPHONE SIGNAL CIRCUIT	59	PREPARATION	81
Diagnosis Procedure	59	Special Service Tools	81
STEERING SWITCH	61	Commercial Service Tool	81
Diagnosis Procedure	61	SYSTEM DESCRIPTION	82
USB CONNECTOR	63	COMPONENT PARTS	82
Diagnosis Procedure	63	Component Parts Location	82
SYMPTOM DIAGNOSIS	64	AV Control Unit	83
AUDIO SYSTEM	64	Speaker	84
Symptom Table	64	Radio Antenna and Antenna Feeder	85
NORMAL OPERATING CONDITION	67	Steering Switch	87
Description	67	Multifunction Switch	87
REMOVAL AND INSTALLATION	69	USB Connector	87
AUDIO UNIT	69	Microphone	87
Removal and Installation	69	Auxiliary Input Jack	88
FRONT DOOR SPEAKER	70	Around View Monitor Control Unit	88
Removal and Installation	70	Rear View Camera	88
REAR DOOR SPEAKER	71	Side Camera	88
Removal and Installation	71	Front Camera	89
MICROPHONE	72	Steering Angle Sensor	89
Removal and Installation	72	SYSTEM	90
BLUETOOTH® CONTROL UNIT	73	MULTI AV SYSTEM	90
Removal and Installation	73	MULTI AV SYSTEM : System Diagram	90
ANTENNA BASE	74	MULTI AV SYSTEM : System Description	90
Removal and Installation	74	MULTI AV SYSTEM : Fail-safe	97
STEERING SWITCH	75	OPERATION	99
Exploded View	75	Switch name and Function	99
Removal and Installation	75	HANDLING PRECAUTION	101
USB CONNECTOR	76	Display	101
Removal and Installation	76	Audio	101
REAR VIEW CAMERA	77	iPod®	101
Removal and Installation	77	USB Connection	102
AUDIO W/O NAVI (FOR MEXICO)		Hands-Free Phone	102
PRECAUTION	78	SD Card	102
PRECAUTIONS	78	DIAGNOSIS SYSTEM (AV CONTROL UNIT)..103	
Precaution for Technicians Using Medical Electric.. 78		Diagnosis Description	103
Precaution for Supplemental Restraint System (SRS) "AIR BAG" and "SEAT BELT PRE-TENSIONER"	78	On Board Diagnosis Function	103
Precaution for Trouble Diagnosis	79	CONSULT Function	110
Precaution for Harness Repair	79	DIAGNOSIS SYSTEM (AROUND VIEW MONITOR CONTROL UNIT)	112
Precaution for Removing 12V Battery	79	CONSULT Function	112
		ECU DIAGNOSIS INFORMATION	115
		AV CONTROL UNIT	115
		Reference Value	115
		Fail-safe	118
		DTC Index	119

AROUND VIEW MONITOR CONTROL UNIT .. 121	DTC/CIRCUIT DIAGNOSIS 154	
Reference Value 121	U0428 STEERING ANGLE SENSOR 154	A
DTC Index 123	DTC Logic 154	
WIRING DIAGRAM 125	Diagnosis Procedure 154	B
AUDIO W/O NAVI (FOR MEXICO) 125	U1000 CAN COMM CIRCUIT 155	
Wiring Diagram 125	AV CONTROL UNIT 155	C
BASIC INSPECTION 142	AV CONTROL UNIT : Description 155	
DIAGNOSIS AND REPAIR WORK FLOW 142	AV CONTROL UNIT : DTC Logic 155	D
Work Flow 142	AV CONTROL UNIT : Diagnosis Procedure 155	
INSPECTION AND ADJUSTMENT 144	AROUND VIEW MONITOR CONTROL UNIT 155	E
SOFTWARE UPDATE (AV CONTROL UNIT) 144	AROUND VIEW MONITOR CONTROL UNIT :	
SOFTWARE UPDATE (AV CONTROL UNIT) :	Description 155	
Description 144	DTC Logic 155	F
SOFTWARE UPDATE (AV CONTROL UNIT) :	AROUND VIEW MONITOR CONTROL UNIT :	
Work Procedure 144	Diagnosis Procedure 155	
ADDITIONAL SERVICE WHEN REPLACING AV CONTROL UNIT 145	U1010 CONTROL UNIT (CAN) 157	G
ADDITIONAL SERVICE WHEN REPLACING AV CONTROL UNIT : Description 145	AV CONTROL UNIT 157	
ADDITIONAL SERVICE WHEN REPLACING AV CONTROL UNIT : Work Procedure 145	AV CONTROL UNIT : DTC Logic 157	
ADDITIONAL SERVICE WHEN REPLACING AROUND VIEW MONITOR CONTROL UNIT 146	AROUND VIEW MONITOR CONTROL UNIT 157	H
ADDITIONAL SERVICE WHEN REPLACING AROUND VIEW MONITOR CONTROL UNIT :	AROUND VIEW MONITOR CONTROL UNIT :	
Description 146	DTC Logic 157	I
CONFIGURATION (AV CONTROL UNIT) 146	U111A REAR CAMERA IMAGE SIGNAL CIRCUIT 158	J
CONFIGURATION (AV CONTROL UNIT) : Description 146	DTC Logic 158	
CONFIGURATION (AV CONTROL UNIT) : Work Procedure 146	Diagnosis Procedure 158	
CONFIGURATION (AV CONTROL UNIT) : Configuration List 147	U111B SIDE CAMERA RH IMAGE SIGNAL CIRCUIT 160	K
CONFIGURATION (AROUND VIEW MONITOR CONTROL UNIT) 147	DTC Logic 160	
CONFIGURATION (AROUND VIEW MONITOR CONTROL UNIT) : Work Procedure 147	Diagnosis Procedure 160	
PREDICTIVE COURSE LINE CENTER POSITION ADJUSTMENT 148	U111C FRONT CAMERA IMAGE SIGNAL CIRCUIT 162	L
PREDICTIVE COURSE LINE CENTER POSITION ADJUSTMENT : Description 148	DTC Logic 162	
PREDICTIVE COURSE LINE CENTER POSITION ADJUSTMENT : Work Procedure 148	Diagnosis Procedure 162	M
CALIBRATING CAMERA IMAGE (AROUND VIEW MONITOR) 148	U111D SIDE CAMERA LH IMAGE SIGNAL CIRCUIT 164	
CALIBRATING CAMERA IMAGE (AROUND VIEW MONITOR) : Description 148	DTC Logic 164	AV
CALIBRATING CAMERA IMAGE (AROUND VIEW MONITOR) : Work Procedure 148	Diagnosis Procedure 164	
	U121F AV CONTROL UNIT 166	O
	DTC Logic 166	
	U1232 STEERING ANGLE SENSOR 167	P
	AV CONTROL UNIT 167	
	AV CONTROL UNIT : DTC Logic 167	
	AV CONTROL UNIT : Diagnosis Procedure 167	
	AROUND VIEW MONITOR CONTROL UNIT 167	
	AROUND VIEW MONITOR CONTROL UNIT :	
	DTC Logic 167	

AROUND VIEW MONITOR CONTROL UNIT : Di-agnosis Procedure	167	MULTIFUNCTION SWITCH	193
		Removal and Installation	193
U1263 USB	168	FRONT DOOR SPEAKER	194
DTC Logic	168	Removal and Installation	194
Diagnosis Procedure	168	TWEETER	195
U1300 AV COMM CIRCUIT	169	Removal and Installation	195
Description	169	REAR DOOR SPEAKER	196
U1304 CAMERA IMAGE CALIBRATION	170	Removal and Installation	196
DTC Logic	170	MICROPHONE	197
Diagnosis Procedure	170	Removal and Installation	197
U1305 CONFIG UNFINISH	171	ANTENNA FEEDER	198
DTC Logic	171	Antenna Feeder	198
Diagnosis Procedure	171	GPS ANTENNA	199
U1310 AV CONTROL UNIT	172	Removal and Installation	199
DTC Logic	172	ANTENNA BASE	200
POWER SUPPLY AND GROUND CIRCUIT ..	173	Removal and Installation	200
AV CONTROL UNIT	173	STEERING SWITCH	201
AV CONTROL UNIT : Diagnosis Procedure	173	Exploded View	201
AROUND VIEW MONITOR CONTROL UNIT	173	Removal and Installation	201
AROUND VIEW MONITOR CONTROL UNIT : Di-agnosis Procedure	173	AUXILIARY INPUT JACK	202
FRONT DOOR SPEAKER	175	Removal and Installation	202
Diagnosis Procedure	175	USB CONNECTOR	203
TWEETER	177	Removal and Installation	203
Diagnosis Procedure	177	AROUND VIEW MONITOR CONTROL UNIT ..	204
REAR DOOR SPEAKER	179	Removal and Installation	204
Diagnosis Procedure	179	FRONT CAMERA	205
AUXILIARY INPUT JACK	181	Removal and Installation	205
Diagnosis Procedure	181	SIDE CAMERA	206
MICROPHONE SIGNAL CIRCUIT	182	Removal and Installation	206
Diagnosis Procedure	182	REAR VIEW CAMERA	207
STEERING SWITCH	184	Removal and Installation	207
Diagnosis Procedure	184	NAVIGATION WITHOUT BOSE	
USB CONNECTOR	186	PRECAUTION	208
Diagnosis Procedure	186	PRECAUTIONS	208
SYMPTOM DIAGNOSIS	187	Precaution for Technicians Using Medical Electric. 208	
MULTI AV SYSTEM	187	Precaution for Supplemental Restraint System (SRS) "AIR BAG" and "SEAT BELT PRE-TENSIONER"	208
Symptom Table	187	Precaution for Trouble Diagnosis	209
NORMAL OPERATING CONDITION	190	Precaution for Harness Repair	209
Description	190	Precaution for Removing 12V Battery	209
REMOVAL AND INSTALLATION	192	Precaution for Work	210
AV CONTROL UNIT	192	Cautions in Removing AV Control Unit (Models with AV Control Unit)	210
Removal and Installation	192	PREPARATION	211

PREPARATION	211	DIAGNOSIS AND REPAIR WORK FLOW	275	
Special Service Tools	211	Work Flow	275	A
Commercial Service Tool	211	INSPECTION AND ADJUSTMENT	277	
SYSTEM DESCRIPTION	212	ADDITIONAL SERVICE WHEN REMOVING BATTERY NEGATIVE TERMINAL	277	B
COMPONENT PARTS	212	ADDITIONAL SERVICE WHEN REMOVING BATTERY NEGATIVE TERMINAL : Description ..	277	C
Component Parts Location	212	ADDITIONAL SERVICE WHEN REMOVING BATTERY NEGATIVE TERMINAL : Work Procedure	277	D
AV Control Unit	213	SOFTWARE UPDATE (AV CONTROL UNIT)	277	
Speaker	214	SOFTWARE UPDATE (AV CONTROL UNIT) : Description	277	E
Radio Antenna and Antenna Feeder	215	SOFTWARE UPDATE (AV CONTROL UNIT) : Work Procedure	277	
Steering Switch	217	ADDITIONAL SERVICE WHEN REPLACING AV CONTROL UNIT	279	F
Multifunction Switch	217	ADDITIONAL SERVICE WHEN REPLACING AV CONTROL UNIT : Description	279	G
TCU	217	ADDITIONAL SERVICE WHEN REPLACING AV CONTROL UNIT : Work Procedure	279	
GPS Antenna	217	CONFIGURATION (AV CONTROL UNIT)	280	H
USB Connector	218	CONFIGURATION (AV CONTROL UNIT) : Description	280	I
Microphone	218	CONFIGURATION (AV CONTROL UNIT) : Work Procedure	280	J
TEL Antenna	218	CONFIGURATION (AV CONTROL UNIT) : Configuration List	281	
Rear View Camera	218	PREDICTIVE COURSE LINE CENTER POSITION ADJUSTMENT	281	K
Auxiliary Input Jack	219	PREDICTIVE COURSE LINE CENTER POSITION ADJUSTMENT : Description	281	L
SD Card	219	PREDICTIVE COURSE LINE CENTER POSITION ADJUSTMENT : Work Procedure	281	
SYSTEM	220	DTC/CIRCUIT DIAGNOSIS	282	
MULTI AV SYSTEM	220	U1000 CAN COMM CIRCUIT	282	M
MULTI AV SYSTEM : System Diagram	220	Description	282	
MULTI AV SYSTEM : System Description	221	DTC Logic	282	
MULTI AV SYSTEM : Map Data Update	228	Diagnosis Procedure	282	AV
MULTI AV SYSTEM : Fail-safe	228	U1010 CONTROL UNIT (CAN)	283	
OPERATION	230	DTC Logic	283	
Switch name and Function	230	U121F AV CONTROL UNIT	284	O
Menu Display by Pressing Each Switch	231	DTC Logic	284	
HANDLING PRECAUTION	236	U1244 GPS ANTENNA	285	P
Display	236	DTC Logic	285	
Audio	236	Diagnosis Procedure	285	
iPod®	236	U1258 SATELLITE RADIO ANTENNA	286	
USB Connection	237	DTC Logic	286	
CARWINGS	237	Diagnosis Procedure	286	
Hands-Free Phone	237	DIAGNOSIS SYSTEM (AV CONTROL UNIT) ..	238	
SD Card	237	Diagnosis Description	238	
DIAGNOSIS SYSTEM (AV CONTROL UNIT) ..	238	On Board Diagnosis Function	238	
Diagnosis Description	238	CONSULT Function	247	
On Board Diagnosis Function	238	ECU DIAGNOSIS INFORMATION	248	
CONSULT Function	247	AV CONTROL UNIT	248	
ECU DIAGNOSIS INFORMATION	248	Reference Value	248	
AV CONTROL UNIT	248	Fail-safe	252	
Reference Value	248	DTC Index	253	
Fail-safe	252	WIRING DIAGRAM	255	
DTC Index	253	NAVIGATION WITHOUT BOSE	255	
WIRING DIAGRAM	255	Wiring Diagram	255	
NAVIGATION WITHOUT BOSE	255	BASIC INSPECTION	275	
Wiring Diagram	255			
BASIC INSPECTION	275			

U1263 USB	287	REAR DOOR SPEAKER	322
DTC Logic	287	Removal and Installation	322
Diagnosis Procedure	287	GPS ANTENNA	323
U1266 AV CONTROL UNIT	288	Removal and Installation	323
DTC Logic	288	MICROPHONE	324
U1300 AV COMM CIRCUIT	289	Removal and Installation	324
Description	289	ANTENNA FEEDER	325
U1310 AV CONTROL UNIT	290	Antenna Feeder	325
DTC Logic	290	ANTENNA BASE	326
POWER SUPPLY AND GROUND CIRCUIT ..	291	Removal and Installation	326
AV CONTROL UNIT	291	STEERING SWITCH	327
AV CONTROL UNIT : Diagnosis Procedure	291	Exploded View	327
FRONT DOOR SPEAKER	292	Removal and Installation	327
Diagnosis Procedure	292	AUXILIARY INPUT JACK	328
TWEETER	294	Removal and Installation	328
Diagnosis Procedure	294	USB CONNECTOR	329
REAR DOOR SPEAKER	296	Removal and Installation	329
Diagnosis Procedure	296	REAR VIEW CAMERA	330
CAMERA IMAGE SIGNAL CIRCUIT	298	Removal and Installation	330
Diagnosis Procedure	298	NAVIGATION WITH BOSE	
AUXILIARY INPUT JACK	300	PRECAUTION	331
Diagnosis Procedure	300	PRECAUTIONS	331
MICROPHONE SIGNAL CIRCUIT	301	Precaution for Technicians Using Medical Electric. 331	
Diagnosis Procedure	301	Precaution for Supplemental Restraint System (SRS) "AIR BAG" and "SEAT BELT PRE-TENSIONER"	331
STEERING SWITCH	303	Precaution for Trouble Diagnosis	332
Diagnosis Procedure	303	Precaution for Harness Repair	332
USB CONNECTOR	305	Precaution for Removing 12V Battery	332
Diagnosis Procedure	305	Precaution for Work	333
SYMPTOM DIAGNOSIS	306	Cautions in Removing AV Control Unit (Models with AV Control Unit)	333
MULTI AV SYSTEM	306	PREPARATION	334
Symptom Table	306	PREPARATION	334
NORMAL OPERATING CONDITION	309	Special Service Tools	334
Description	309	Commercial Service Tool	334
REMOVAL AND INSTALLATION	318	SYSTEM DESCRIPTION	335
AV CONTROL UNIT	318	COMPONENT PARTS	335
Removal and Installation	318	Component Parts Location	335
MULTIFUNCTION SWITCH	319	AV Control Unit	336
Removal and Installation	319	BOSE Amp.	338
FRONT DOOR SPEAKER	320	Speaker	338
Removal and Installation	320	Radio Antenna and Antenna Feeder	338
TWEETER	321	Steering Switch	341
Removal and Installation	321	Multifunction Switch	341
		TCU	341
		GPS Antenna	341
		USB Connector	342

Microphone	342	Work Flow	418	
TEL Antenna	342	INSPECTION AND ADJUSTMENT	420	A
Around View Monitor Control Unit	342	ADDITIONAL SERVICE WHEN REMOVING BATTERY NEGATIVE TERMINAL	420	B
Rear View Camera	343	ADDITIONAL SERVICE WHEN REMOVING BATTERY NEGATIVE TERMINAL : Description ..	420	C
Side Camera	343	ADDITIONAL SERVICE WHEN REMOVING BATTERY NEGATIVE TERMINAL : Work Procedure	420	D
Front Camera	343	SOFTWARE UPDATE (AV CONTROL UNIT)	420	E
Steering Angle Sensor	343	SOFTWARE UPDATE (AV CONTROL UNIT) : Description	420	F
Auxiliary Input Jack	344	SOFTWARE UPDATE (AV CONTROL UNIT) : Work Procedure	420	G
SD Card	344	ADDITIONAL SERVICE WHEN REPLACING AV CONTROL UNIT	422	H
SYSTEM	345	ADDITIONAL SERVICE WHEN REPLACING AV CONTROL UNIT : Description	422	I
MULTI AV SYSTEM	345	ADDITIONAL SERVICE WHEN REPLACING AV CONTROL UNIT : Work Procedure	422	J
MULTI AV SYSTEM : System Diagram	345	ADDITIONAL SERVICE WHEN REPLACING AROUND VIEW MONITOR CONTROL UNIT	423	K
MULTI AV SYSTEM : System Description	346	ADDITIONAL SERVICE WHEN REPLACING AROUND VIEW MONITOR CONTROL UNIT : Description	423	L
MULTI AV SYSTEM : Map Data Update	357	ADDITIONAL SERVICE WHEN REPLACING AROUND VIEW MONITOR CONTROL UNIT : Work Procedure	423	M
MULTI AV SYSTEM : Fail-safe	357	CONFIGURATION (AV CONTROL UNIT)	423	
OPERATION	359	CONFIGURATION (AV CONTROL UNIT) : Description	423	
Switch name and Function	359	CONFIGURATION (AV CONTROL UNIT) : Work Procedure	423	
Menu Display by Pressing Each Switch	360	CONFIGURATION (AV CONTROL UNIT) : Configuration List	424	
HANDLING PRECAUTION	365	CONFIGURATION (AROUND VIEW MONITOR CONTROL UNIT)	424	
Display	365	CONFIGURATION (AROUND VIEW MONITOR CONTROL UNIT) : Work Procedure	424	
Audio	365	PREDICTIVE COURSE LINE CENTER POSITION ADJUSTMENT	425	
iPod®	365	PREDICTIVE COURSE LINE CENTER POSITION ADJUSTMENT : Description	425	
USB Connection	366	PREDICTIVE COURSE LINE CENTER POSITION ADJUSTMENT : Work Procedure	425	
CARWINGS	366	CALIBRATING CAMERA IMAGE (AROUND VIEW MONITOR)	425	
Hands-Free Phone	366	CALIBRATING CAMERA IMAGE (AROUND VIEW MONITOR) : Description	425	
SD Card	366	CALIBRATING CAMERA IMAGE (AROUND VIEW MONITOR) : Work Procedure	425	
DIAGNOSIS SYSTEM (AV CONTROL UNIT)..	367	DTC/CIRCUIT DIAGNOSIS	431	
Diagnosis Description	367	U0428 STEERING ANGLE SENSOR	431	
On Board Diagnosis Function	367	DTC Logic	431	
CONSULT Function	376			
DIAGNOSIS SYSTEM (AROUND VIEW MONITOR CONTROL UNIT)	377			
CONSULT Function	377			
ECU DIAGNOSIS INFORMATION	380			
AV CONTROL UNIT	380			
Reference Value	380			
Fail-safe	384			
DTC Index	385			
BOSE AMP.	387			
Reference Values	387			
AROUND VIEW MONITOR CONTROL UNIT ..	390			
Reference Value	390			
DTC Index	392			
WIRING DIAGRAM	394			
NAVIGATION WITH BOSE	394			
Wiring Diagram	394			
BASIC INSPECTION	418			
DIAGNOSIS AND REPAIR WORK FLOW	418			

Diagnosis Procedure	431	Diagnosis Procedure	445
U1000 CAN COMM CIRCUIT	432	U1258 SATELLITE RADIO ANTENNA	446
AV CONTROL UNIT	432	DTC Logic	446
AV CONTROL UNIT : Description	432	Diagnosis Procedure	446
AV CONTROL UNIT : DTC Logic	432	U1263 USB	447
AV CONTROL UNIT : Diagnosis Procedure	432	DTC Logic	447
AROUND VIEW MONITOR CONTROL UNIT	432	Diagnosis Procedure	447
AROUND VIEW MONITOR CONTROL UNIT :		U1266 AV CONTROL UNIT	448
Description	432	DTC Logic	448
AROUND VIEW MONITOR CONTROL UNIT :		U1300 AV COMM CIRCUIT	449
DTC Logic	432	Description	449
AROUND VIEW MONITOR CONTROL UNIT :		U1304 CAMERA IMAGE CALIBRATION	450
Diagnosis Procedure	432	DTC Logic	450
U1010 CONTROL UNIT (CAN)	434	Diagnosis Procedure	450
AV CONTROL UNIT	434	U1305 CONFIG UNFINISH	451
AV CONTROL UNIT : DTC Logic	434	DTC Logic	451
AROUND VIEW MONITOR CONTROL UNIT	434	Diagnosis Procedure	451
AROUND VIEW MONITOR CONTROL UNIT :		U1310 AV CONTROL UNIT	452
DTC Logic	434	DTC Logic	452
U111A REAR CAMERA IMAGE SIGNAL CIR-		POWER SUPPLY AND GROUND CIRCUIT ...	453
CUIT	435	AV CONTROL UNIT	453
DTC Logic	435	AV CONTROL UNIT : Diagnosis Procedure	453
Diagnosis Procedure	435	BOSE AMP.	453
U111B SIDE CAMERA RH IMAGE SIGNAL		BOSE AMP. : Diagnosis Procedure	453
CIRCUIT	437	AROUND VIEW MONITOR CONTROL UNIT	454
DTC Logic	437	AROUND VIEW MONITOR CONTROL UNIT : Di-	
Diagnosis Procedure	437	agnosis Procedure	454
U111C FRONT CAMERA IMAGE SIGNAL		FRONT DOOR SPEAKER	456
CIRCUIT	439	Diagnosis Procedure	456
DTC Logic	439	TWEETER	459
Diagnosis Procedure	439	Diagnosis Procedure	459
U111D SIDE CAMERA LH IMAGE SIGNAL		REAR DOOR SPEAKER	462
CIRCUIT	441	Diagnosis Procedure	462
DTC Logic	441	SUBWOOFER	465
Diagnosis Procedure	441	Diagnosis Procedure	465
U121F AV CONTROL UNIT	443	AMP ON SIGNAL CIRCUIT	467
DTC Logic	443	Diagnosis Procedure	467
U1232 STEERING ANGLE SENSOR	444	AUXILIARY INPUT JACK	468
AV CONTROL UNIT	444	Diagnosis Procedure	468
AV CONTROL UNIT : DTC Logic	444	MICROPHONE SIGNAL CIRCUIT	469
AV CONTROL UNIT : Diagnosis Procedure	444	Diagnosis Procedure	469
AROUND VIEW MONITOR CONTROL UNIT	444	STEERING SWITCH	471
AROUND VIEW MONITOR CONTROL UNIT :		Diagnosis Procedure	471
DTC Logic	444	USB CONNECTOR	473
AROUND VIEW MONITOR CONTROL UNIT : Di-			
agnosis Procedure	444		
U1244 GPS ANTENNA	445		
DTC Logic	445		

Diagnosis Procedure	473	REAR VIEW CAMERA	505	
SYMPTOM DIAGNOSIS	474	Removal and Installation	505	A
MULTI AV SYSTEM	474	TELEMATICS SYSTEM		
Symptom Table	474	PRECAUTION	506	B
NORMAL OPERATING CONDITION	479	PRECAUTIONS	506	
Description	479	Precaution for Technicians Using Medical Electric.	506	C
REMOVAL AND INSTALLATION	488	Precaution for Supplemental Restraint System (SRS) "AIR BAG" and "SEAT BELT PRE-TENSIONER"	506	
AV CONTROL UNIT	488	Precaution for Trouble Diagnosis	507	D
Removal and Installation	488	Precaution for Harness Repair	507	
MULTIFUNCTION SWITCH	489	Precaution for Removing 12V Battery	507	E
Removal and Installation	489	Precaution for Work	508	
FRONT DOOR SPEAKER	490	Cautions in Removing AV Control Unit (Models with AV Control Unit)	508	F
Removal and Installation	490	PREPARATION	509	
TWEETER	491	PREPARATION	509	
Removal and Installation	491	Special Service Tools	509	G
REAR DOOR SPEAKER	492	Commercial Service Tool	509	
Removal and Installation	492	SYSTEM DESCRIPTION	510	H
GPS ANTENNA	493	COMPONENT PARTS	510	
Removal and Installation	493	Component Parts Location	510	I
MICROPHONE	494	AV Control Unit	511	
Removal and Installation	494	GPS Antenna	511	J
ANTENNA FEEDER	495	Multifunction Switch	511	
Antenna Feeder	495	TCU	511	K
ANTENNA BASE	496	TEL Antenna	512	
Removal and Installation	496	Antenna Feeder	512	L
STEERING SWITCH	497	SYSTEM	514	
Exploded View	497	TELEMATICS SYSTEM	514	
Removal and Installation	497	TELEMATICS SYSTEM : System Diagram	514	M
AUXILIARY INPUT JACK	498	TELEMATICS SYSTEM : System Description	515	
Removal and Installation	498	OPERATION	520	
USB CONNECTOR	499	Switch Name and Function	520	
Removal and Installation	499	Menu Display by Pressing Each Switch	521	
SUBWOOFER	500	HANDLING PRECAUTION	525	
Removal and Installation	500	Telematics&CARWINGS	525	AV
BOSE SPEAKER AMP	501	DIAGNOSIS SYSTEM (TCU)	526	
Removal and Installation	501	CONSULT Function	526	O
AROUND VIEW MONITOR CONTROL UNIT ..	502	ECU DIAGNOSIS INFORMATION	527	
Removal and Installation	502	TCU	527	
FRONT CAMERA	503	Reference Value	527	P
Removal and Installation	503	DTC Index	528	
SIDE CAMERA	504	WIRING DIAGRAM	529	
Removal and Installation	504	NAVIGATION WITHOUT BOSE	529	
		Wiring Diagram	529	

NAVIGATION WITH BOSE	549	U1A01 TCU	583
Wiring Diagram	549	DTC Logic	583
BASIC INSPECTION	573	U1A02 TCU	584
DIAGNOSIS AND REPAIR WORK FLOW	573	DTC Logic	584
Work Flow	573	U1A03 TCU	585
INSPECTION AND ADJUSTMENT	575	DTC Logic	585
ADDITIONAL SERVICE WHEN USING TELEMATICS SYSTEM (WORK STEP VIEW)	575	U1A04 TCU	586
ADDITIONAL SERVICE WHEN USING		DTC Logic	586
TELEMATICS SYSTEM (WORK STEP VIEW) :		U1A05 TCU	587
Process Chart	575	DTC Logic	587
		Diagnosis Procedure	587
ADDITIONAL SERVICE WHEN USING TELEMATICS SYSTEM FOR THE FIRST TIME/RE-SUBSCRIPTION	575	U1A07 TEL ANTENNA	588
ADDITIONAL SERVICE WHEN USING		DTC Logic	588
TELEMATICS SYSTEM FOR THE FIRST TIME/		Diagnosis Procedure	588
RE-SUBSCRIPTION : Description	575	U1A08 TEL ANTENNA	589
ADDITIONAL SERVICE WHEN USING		DTC Logic	589
TELEMATICS SYSTEM FOR THE FIRST TIME/		Diagnosis Procedure	589
RE-SUBSCRIPTION : Work Procedure	575	POWER SUPPLY AND GROUND CIRCUIT ...	590
ADDITIONAL SERVICE WHEN REPLACING TCU	577	TCU	590
ADDITIONAL SERVICE WHEN REPLACING		TCU : Diagnosis Procedure	590
TCU : Description	577	SYMPTOM DIAGNOSIS	591
ADDITIONAL SERVICE WHEN REPLACING		TELEMATICS SYSTEM	591
TCU : Work Procedure	577	Symptom Table	591
ADDITIONAL SERVICE WHEN TCU CONNECTING CENTER CHANGED	579	NORMAL OPERATING CONDITION	592
ADDITIONAL SERVICE WHEN TCU CONNECTING		Description	592
CENTER CHANGED : Description	579	REMOVAL AND INSTALLATION	593
ADDITIONAL SERVICE WHEN TCU CONNECTING		AV CONTROL UNIT	593
CENTER CHANGED : Work Procedure	579	Removal and Installation	593
DTC/CIRCUIT DIAGNOSIS	580	TCU	594
U1000 CAN COMM CIRCUIT	580	Removal and Installation	594
Description	580	GPS ANTENNA	595
DTC Logic	580	Removal and Installation	595
Diagnosis Procedure	580	MICROPHONE	596
U1010 CONTROL UNIT (CAN)	581	Removal and Installation	596
DTC Logic	581	TEL ANTENNA	597
U1A00 TCU	582	Removal and Installation	597
DTC Logic	582		
Diagnosis Procedure	582		

PRECAUTIONS

< PRECAUTION >

[AUDIO W/O NAVI (EXCEPT MEXICO)]

PRECAUTION

PRECAUTIONS

Precaution for Technicians Using Medical Electric

INFOID:0000000010641675

OPERATION PROHIBITION

WARNING:

- Parts with strong magnet is used in this vehicle.
- Technicians using a medical electric device such as pacemaker must never perform operation on the vehicle, as magnetic field can affect the device function by approaching to such parts.

NORMAL CHARGE PRECAUTION

WARNING:

- If a technician uses a medical electric device such as an implantable cardiac pacemaker or an implantable cardioverter defibrillator, the possible effects on the devices must be checked with the device manufacturer before starting the charge operation.
- As radiated electromagnetic wave generated by PDM (Power Delivery Module) at normal charge operation may affect medical electric devices, a technician using a medical electric device such as implantable cardiac pacemaker or an implantable cardioverter defibrillator must not approach motor room [PDM (Power Delivery Module)] at the hood-opened condition during normal charge operation.

PRECAUTION AT TELEMATICS SYSTEM OPERATION

WARNING:

- If a technician uses implantable cardiac pacemaker or implantable cardioverter defibrillator (ICD), avoid the device implanted part from approaching within approximately 220 mm (8.66 in) from interior/exterior antenna.
- The electromagnetic wave of TCU might affect the function of the implantable cardiac pacemaker or the implantable cardioverter defibrillator (ICD), when using the service, etc.
- If a technician uses other medical electric devices than implantable cardiac pacemaker or implantable cardioverter defibrillator (ICD), the electromagnetic wave of TCU might affect the function of the device. The possible effects on the devices must be checked with the device manufacturer before TCU use.

PRECAUTION AT INTELLIGENT KEY SYSTEM OPERATION

WARNING:

- If a technician uses implantable cardiac pacemaker or implantable cardioverter defibrillator (ICD), avoid the device implanted part from approaching within approximately 220 mm (8.66 in) from interior/exterior antenna.
- The electromagnetic wave of Intelligent Key might affect the function of the implantable cardiac pacemaker or the implantable cardioverter defibrillator (ICD), at door operation, at each request switch operation, or at engine starting.
- If a technician uses other medical electric devices than implantable cardiac pacemaker or implantable cardioverter defibrillator (ICD), the electromagnetic wave of Intelligent Key might affect the function of the device. The possible effects on the devices must be checked with the device manufacturer before Intelligent Key use.

Precaution for Supplemental Restraint System (SRS) "AIR BAG" and "SEAT BELT PRE-TENSIONER"

INFOID:0000000010641676

The Supplemental Restraint System such as "AIR BAG" and "SEAT BELT PRE-TENSIONER", used along with a front seat belt, helps to reduce the risk or severity of injury to the driver and front passenger for certain types of collision. This system includes seat belt switch inputs and dual stage front air bag modules. The SRS system uses the seat belt switches to determine the front air bag deployment, and may only deploy one front air bag, depending on the severity of a collision and whether the front occupants are belted or unbelted. Information necessary to service the system safely is included in the SR and SB section of this Service Manual.

WARNING:

A
B
C
D
E
F
G
H
I
J
K
L
M
AV
O
P

PRECAUTIONS

< PRECAUTION >

[AUDIO W/O NAVI (EXCEPT MEXICO)]

- To avoid rendering the SRS inoperative, which could increase the risk of personal injury or death in the event of a collision which would result in air bag inflation, all maintenance must be performed by an authorized NISSAN/INFINITI dealer.
- Improper maintenance, including incorrect removal and installation of the SRS, can lead to personal injury caused by unintentional activation of the system. For removal of Spiral Cable and Air Bag Module, see the SR section.
- Do not use electrical test equipment on any circuit related to the SRS unless instructed to in this Service Manual. SRS wiring harnesses can be identified by yellow and/or orange harnesses or harness connectors.

PRECAUTIONS WHEN USING POWER TOOLS (AIR OR ELECTRIC) AND HAMMERS

WARNING:

- When working near the Airbag Diagnosis Sensor Unit or other Airbag System sensors with the Ignition ON or engine running, DO NOT use air or electric power tools or strike near the sensor(s) with a hammer. Heavy vibration could activate the sensor(s) and deploy the air bag(s), possibly causing serious injury.
- When using air or electric power tools or hammers, always switch the Ignition OFF, disconnect the battery and wait at least three minutes before performing any service.

Precaution for Trouble Diagnosis

INFOID:000000010641677

AV COMMUNICATION SYSTEM

- Do not apply voltage of 7.0 V or higher to the measurement terminals.
- Use the tester with its open terminal voltage being 7.0 V or less.
- Be sure to turn power switch OFF and disconnect the battery cable from the negative terminal before checking the circuit. Refer to [AV-12, "Precaution for Removing 12V Battery"](#).

Precaution for Harness Repair

INFOID:000000010641678

AV COMMUNICATION SYSTEM

- Solder the repaired parts, and wrap with tape. [Frays of twisted line must be within 110 mm (4.33 in).]

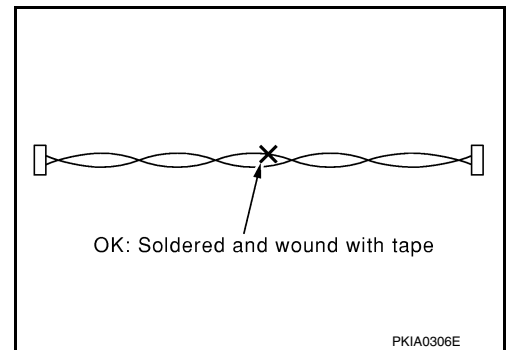

- Do not perform bypass wire connections for the repair parts. (The spliced wire will become separated and the characteristics of twisted line will be lost.)

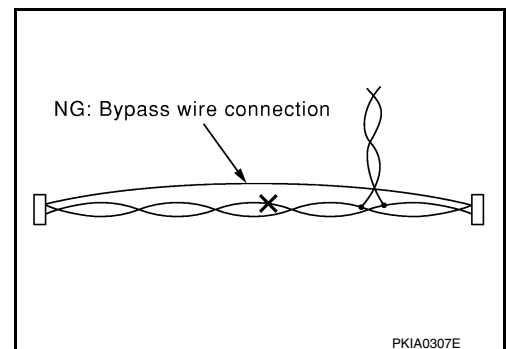

Precaution for Removing 12V Battery

INFOID:000000010641679

1. Check that EVSE is not connected.

NOTE:

If EVSE is connected, the air conditioning system may be automatically activated by the timer A/C function.

PRECAUTIONS

[AUDIO W/O NAVI (EXCEPT MEXICO)]

< PRECAUTION >

2. Turn the power switch OFF → ON → OFF. Get out of the vehicle. Close all doors (including back door).
3. Check that the charge status indicator lamp does not blink and wait for 5 minutes or more.

NOTE:

If the battery is removed within 5 minutes after the power switch is turned OFF, plural DTCs may be detected.

4. Remove 12V battery within 1 hour after turning the power switch OFF → ON → OFF.

NOTE:

- The 12V battery automatic charge control may start automatically even when the power switch is in OFF state.
- Once the power switch is turned ON → OFF, the 12V battery automatic charge control does not start for approximately 1 hour.

CAUTION:

- **After all doors (including back door) are closed, if a door (including back door) is opened before battery terminals are disconnected, start over from Step 1.**
- **After turning the power switch OFF, if “Remote A/C” is activated by user operation, stop the air conditioner and start over from Step 1.**

Precaution for Work

INFOID:0000000011107760

- When removing or disassembling each component, be careful not to damage or deform it. If a component may be subject to interference, be sure to protect it with a shop cloth.
- When removing (disengaging) components with a screwdriver or similar tool, be sure to wrap the component with a shop cloth or vinyl tape to protect it.
- Protect the removed parts with a shop cloth and prevent them from being dropped.
- Replace a deformed or damaged clip.
- If a part is specified as a non-reusable part, always replace it with a new one.
- Be sure to tighten bolts and nuts securely to the specified torque.
- After installation is complete, be sure to check that each part works properly.
- Follow the steps below to clean components:
 - Water soluble dirt:
 - Dip a soft cloth into lukewarm water, wring the water out of the cloth and wipe the dirty area.
 - Then rub with a soft, dry cloth.
 - Oily dirt:
 - Dip a soft cloth into lukewarm water with mild detergent (concentration: within 2 to 3%) and wipe the dirty area.
 - Then dip a cloth into fresh water, wring the water out of the cloth and wipe the detergent off.
 - Then rub with a soft, dry cloth.
 - Do not use organic solvent such as thinner, benzene, alcohol or gasoline.
 - For genuine leather seats, use a genuine leather seat cleaner.

A
B
C
D
E
F
G
H
I
J
K
L
M
O
P

AV

PREPARATION

< PREPARATION >

[AUDIO W/O NAVI (EXCEPT MEXICO)]

PREPARATION

PREPARATION

Special Service Tools

INFOID:000000011107779

The actual shape of the tools may differ from those illustrated here.

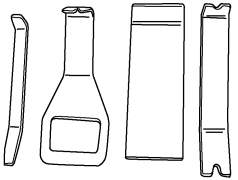
Tool number (TechMate No.) Tool name	Description
— (J-46534) Trim Tool Set  AWJIA0483ZZ	Removing trim components

Commercial Service Tool

INFOID:000000010641680

Tool name	Description
Power tool  PIIB1407E	Loosening nuts, screws and bolts

COMPONENT PARTS

< SYSTEM DESCRIPTION >

[AUDIO W/O NAVI (EXCEPT MEXICO)]

SYSTEM DESCRIPTION

COMPONENT PARTS

Component Parts Location

INFOID:0000000010641681

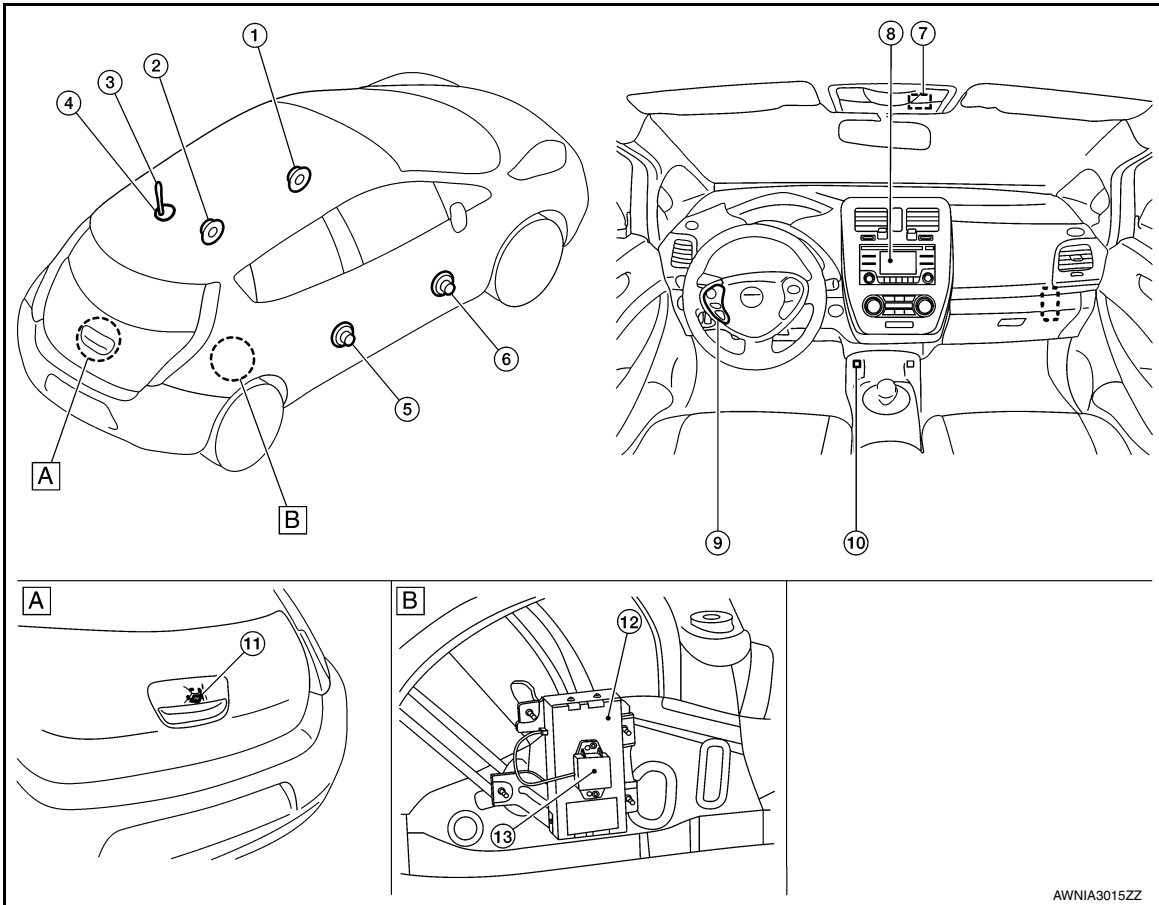

A. Center of back door

B. Luggage side lower finisher (RH) removed

No.	Component	Function
1.	Front door speaker LH	Refer to AV-16. "Speaker" .
2.	Rear door speaker LH	
3.	Rod antenna	Refer to AV-18. "Antenna" .
4.	Antenna base (antenna amp. and satellite radio antenna)	
5.	Rear door speaker RH	Refer to AV-16. "Speaker" .
6.	Front door speaker RH	
7.	Microphone	Refer to AV-17. "Microphone" .
8.	Audio unit	Refer to AV-16. "Audio Unit" .
9.	Steering switch	Refer to AV-17. "Steering Switch" .
10.	USB connector	Refer to AV-17. "USB Connector" .
11.	Rear view camera	Refer to AV-18. "Rear View Camera" .
12.	Bluetooth® Control Unit	Refer to AV-16. "Bluetooth Control Unit" .
13.	Bluetooth® antenna	Refer to AV-17. "Bluetooth Antenna" .

COMPONENT PARTS

< SYSTEM DESCRIPTION >

[AUDIO W/O NAVI (EXCEPT MEXICO)]

Audio Unit

INFOID:000000010641682

- AM/FM electronic tuner radio, satellite radio tuner, CD drive, auxiliary input jack, and camera controller are integrated into the audio unit.
- The display can show audio status and rear view monitor images.
- Music files stored in iPod®/USB memory can be played by using the separate USB connector.
- Audio played back by external audio equipment is output from the vehicle speakers via the auxiliary input jack.

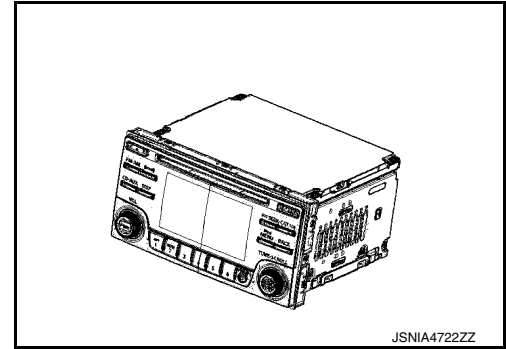

Speaker

INFOID:000000010641683

FRONT DOOR SPEAKER

- 16.5 cm (6.5 in.) speakers are installed in the bottom of the front doors.
- Sound signals are input from the audio unit to output high, mid and low range sounds.

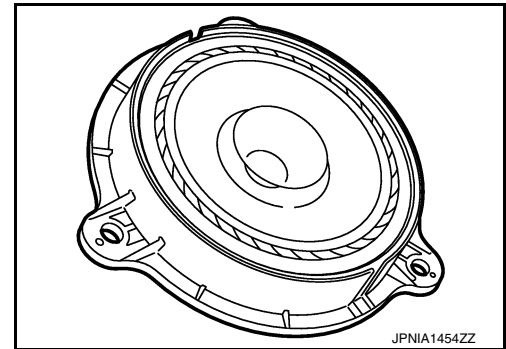

REAR DOOR SPEAKER

- 16.5 cm (6.5 in.) speakers are installed in the bottom of the rear doors.
- Sound signals are input from the audio unit to output high, mid and low range sounds.

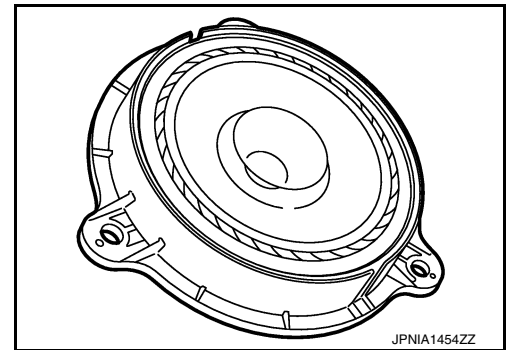

Bluetooth Control Unit

INFOID:000000010641684

- Inputs the Bluetooth® voice signal from Bluetooth® antenna and outputs it to the audio unit
- Connected to the audio unit via AV communication and controlled by the audio unit.

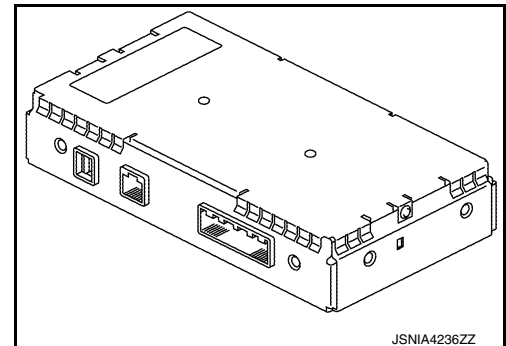

COMPONENT PARTS

< SYSTEM DESCRIPTION >

[AUDIO W/O NAVI (EXCEPT MEXICO)]

Bluetooth Antenna

INFOID:0000000110641685

Receives the Bluetooth[®] voice signal from cellular phone and outputs it to the Bluetooth[®] control unit.

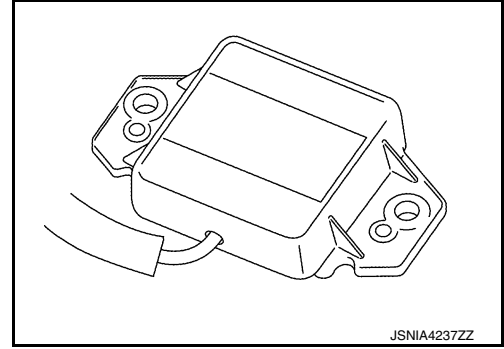

Microphone

INFOID:0000000110641686

- The microphone is installed on the left side of the map lamp assembly.
- Power is supplied to the microphone from the Bluetooth[®] control unit. Sound signals are transmitted to the Bluetooth[®] control unit during hands-free phone communication.

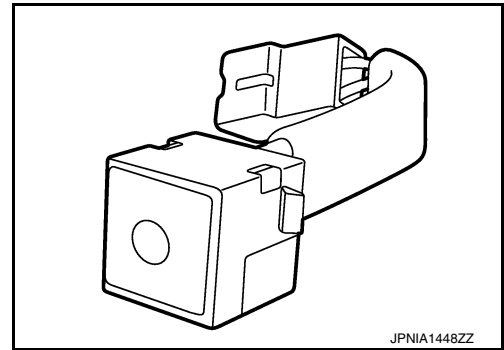

USB Connector

INFOID:0000000110641687

- The USB connector is installed in the console.
- An iPod[®] or USB memory stick can be connected to the audio unit.

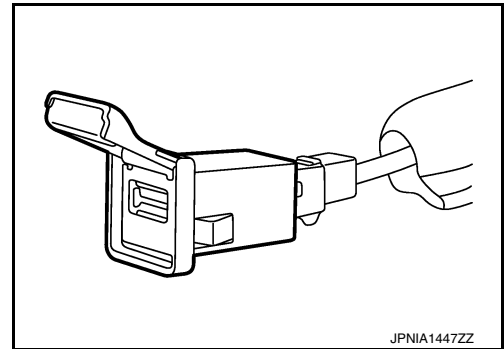

Steering Switch

INFOID:0000000110641688

- Operations for audio and hands-free phone are possible.
- The steering switch is connected to the Bluetooth[®] control unit. Operation signals are transmitted to the audio unit via the Bluetooth[®] control unit.

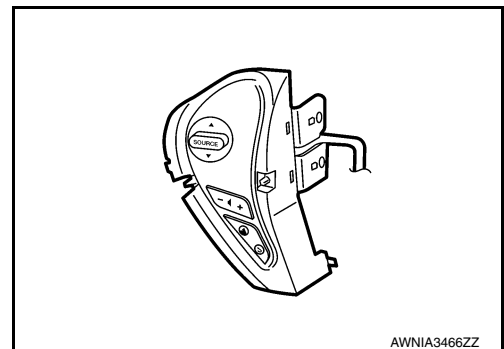

A
B
C
D
E
F
G
H
I
J
K
L
M
AV
O
P

COMPONENT PARTS

< SYSTEM DESCRIPTION >

[AUDIO W/O NAVI (EXCEPT MEXICO)]

Rear View Camera

INFOID:000000010641689

- The rear view camera is installed in the back door finisher.
- Power for the camera is supplied from the audio unit, and the image signal at the rear of the vehicle is sent back to the audio unit.

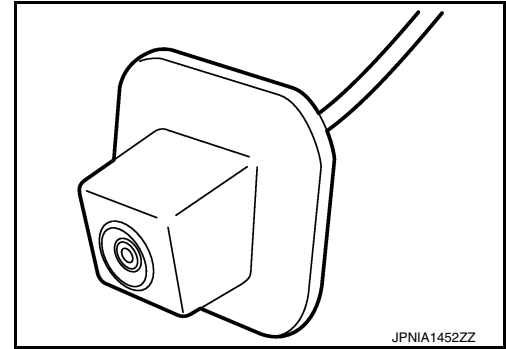

Antenna

INFOID:000000010641690

RADIO ANTENNA

Rod Antenna

A rod antenna is installed in the rear center of the roof.

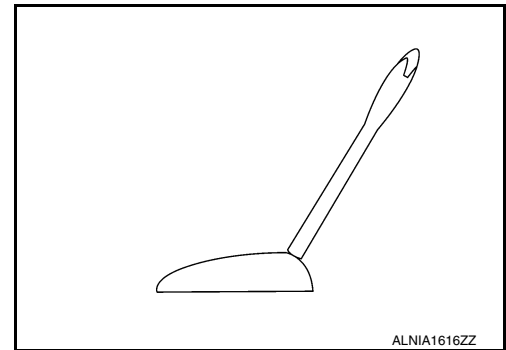

Antenna Base

- An antenna amp. is built into the antenna base.
- Power for the antenna amp. is supplied from the audio unit.
- The radio signals received by the rod antenna are input to the antenna amp. and sent to the audio unit.
- A satellite radio antenna is built into the antenna base.
- Satellite radio signals received by the antenna are sent to the audio unit.

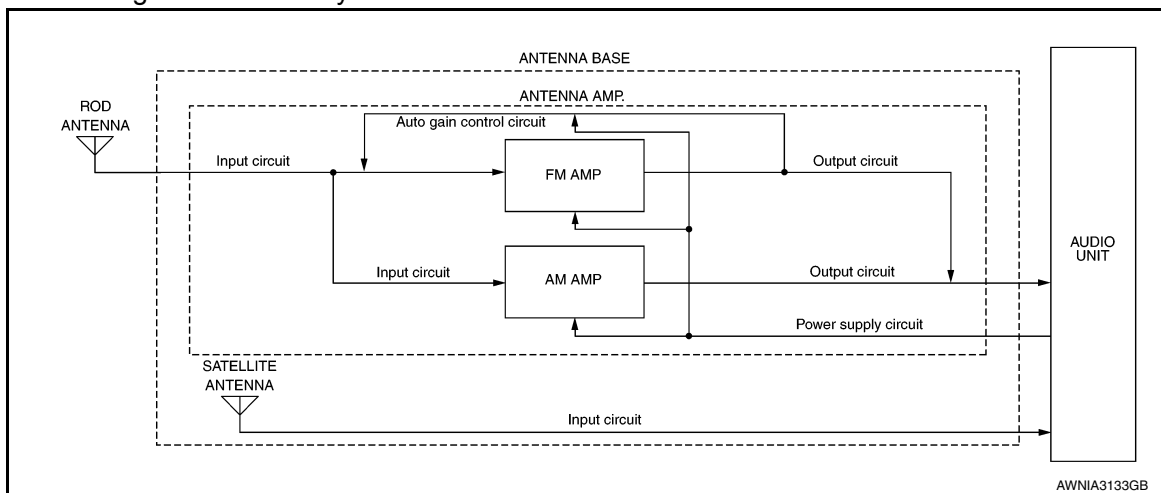

SYSTEM

< SYSTEM DESCRIPTION >

[AUDIO W/O NAVI (EXCEPT MEXICO)]

SYSTEM

AUDIO UNIT

AUDIO UNIT : System Description

INFOID:000000010641691

SYSTEM DIAGRAM

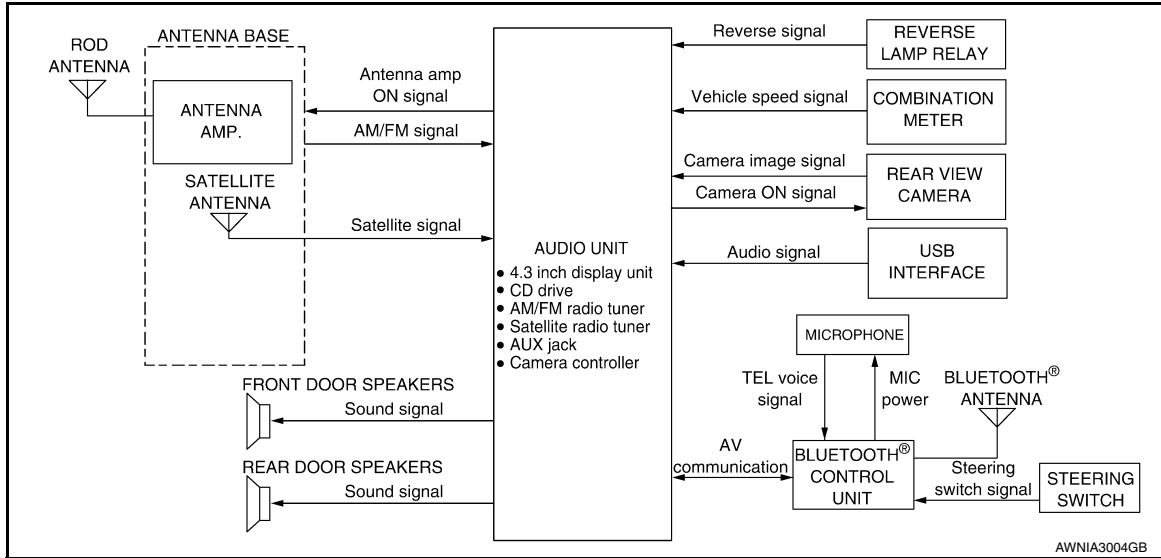

AUDIO SYSTEM

The audio system consists of the following components

- Audio unit
- Front door speakers
- Rear door speakers
- Steering switch
- USB interface
- Antenna base (antenna amp. and satellite antenna)
- Rod antenna

When the audio system is on, AM/FM signals received by the rod antenna are amplified by the antenna amp. and sent to the audio unit. The audio unit then sends audio signals to the front door speakers and rear door speakers.

Refer to Owner's Manual for audio system operating instructions.

HANDS-FREE PHONE SYSTEM

System Operation

NOTE:

Cellular telephones must have their wireless connection set up (paired) before using the Bluetooth® telephone system.

The Bluetooth® telephone system allows users who have a Bluetooth® cellular telephone to make a wireless connection between their cellular telephone and the Bluetooth® control unit. Hands-free cellular telephone calls can be sent and received. Some Bluetooth® cellular telephones may not be recognized by the Bluetooth® control unit. When a cellular telephone or the Bluetooth® control unit is replaced, the telephone must be paired with the Bluetooth® control unit. Different cellular telephones may have different pairing procedures, refer to the cellular telephone operating manual.

Refer to the Owner's Manual for Bluetooth® telephone system operating instructions.

Bluetooth® Control Unit

When the power switch is turned to ACC or ON, the Bluetooth® control unit will power up. During power up, the Bluetooth® control unit is initialized and performs various self-checks. Initialization may take up to 20 seconds. If a phone is present in the vehicle and paired with the Bluetooth® control unit, Nissan Voice Recognition

SYSTEM

< SYSTEM DESCRIPTION >

[AUDIO W/O NAVI (EXCEPT MEXICO)]

will then become active. Bluetooth® telephone functions can be turned off using the Nissan Voice Recognition system.

Steering Switch

When buttons on the steering switch are pushed, the resistance in steering switch circuit changes, depending on which button is pushed. The Bluetooth® control unit uses this signal to perform various functions while navigating through the voice recognition system.

The following functions can be performed using the steering switch:

- Initiate self-diagnosis of the Bluetooth® telephone system
- Start a voice recognition session
- Answer and end telephone calls
- Adjust the volume of calls

Microphone

The microphone is located in the roof console assembly. The microphone sends a signal to the Bluetooth® control unit. The microphone can be actively tested during self-diagnosis.

Audio Unit

The audio unit receives signals from the Bluetooth® control unit and sends audio signals to the speakers.

SPEED SENSITIVE VOLUME SYSTEM

Volume level of this system goes up and down automatically in proportion to the vehicle speed. The control level can be selected by the customer. Refer to Owner's Manual for operating instructions.

REAR VIEW MONITOR FUNCTION

Operation Description

- When the selector lever is shifted to the reverse position, the rear view monitor image is displayed.
- When the selector lever is shifted to any position other than the reverse position, the original image (the image displayed before the rear view monitor image) is displayed.

Camera Image Operation Principle

- The audio unit supplies power to the rear view camera when receiving a reverse signal.
- The rear view camera transmits camera images to the audio unit when power is supplied from the audio unit.
- The audio unit combines a warning message and fixed guide lines with an image received from the rear view camera to display a rear view camera image on the screen.

Vehicle Width and Distance Guide Lines Display Function at Rear View Monitor Display

- The vehicle width and distance guide lines are displayed at the rear view monitor display to allow the driver to more easily judge distances between the vehicle and objects and help the driver back into a parking space.

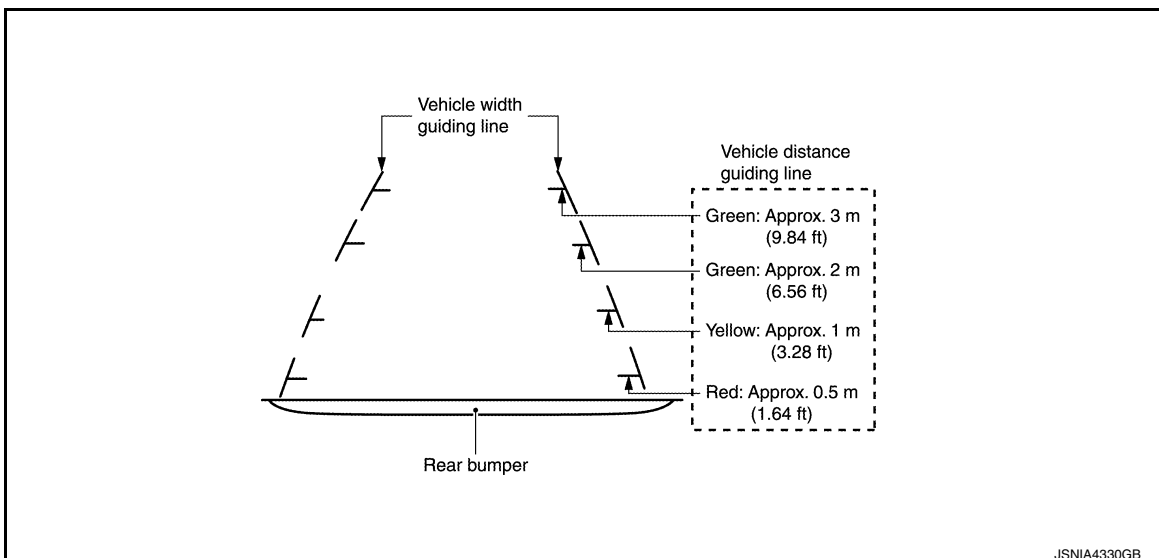

Side Distance Guide Lines and Possible Route Lines Display Function at Rear View Monitor Display

Precautions for Side Distance Guide Lines and predictive course line Display on the Rear View Monitor Display

SYSTEM

< SYSTEM DESCRIPTION >

[AUDIO W/O NAVI (EXCEPT MEXICO)]

Side distance guide lines and predictive course line on the display may be different from actual lines depending on vehicle conditions and road conditions.

A

B

C

D

E

F

G

H

I

J

K

L

M

AV

O

P

DIAGNOSIS SYSTEM (AUDIO UNIT)

[AUDIO W/O NAVI (EXCEPT MEXICO)]

< SYSTEM DESCRIPTION >

DIAGNOSIS SYSTEM (AUDIO UNIT)

Description

INFOID:000000010641692

The audio unit on board diagnosis performs the functions listed in the table below:

Mode		Description
Self Diagnosis		<ul style="list-style-type: none"> • Audio unit diagnosis. • Diagnoses the connections across system components.
Confirmation/ Adjustment	Display Diagnosis	The following check functions are available: color tone check by color bar display and white display, light and shade check by gray scale display.
	Vehicle Signals	Diagnosis of signals can be performed for vehicle speed, lights, reverse, EQ pin, destination and camera type.
	Speaker Test	The connection of a speaker can be confirmed by test tone.
	Error History	The system malfunction and the frequency when occurring in the past are displayed. When the malfunctioning item is selected, the time and place that the selected malfunction last occurred are displayed.
	Camera System	Displayed but not used.
	AV COMM Diagnosis	The communication condition of each unit of display audio system can be monitored.
	Delete Unit Connection Log	Erase the connection history of unit and error history.
	Initialize Setting	Initializes the audio unit memory.

On Board Diagnosis Function

INFOID:000000010641693

METHOD OF STARTING

1. Turn the power ON.
2. Turn the audio system OFF.
3. While pressing the preset 1 button, turn the volume control dial clockwise or counterclockwise for 40 clicks or more. Shifting from current screen to previous screen is performed by pressing BACK button.

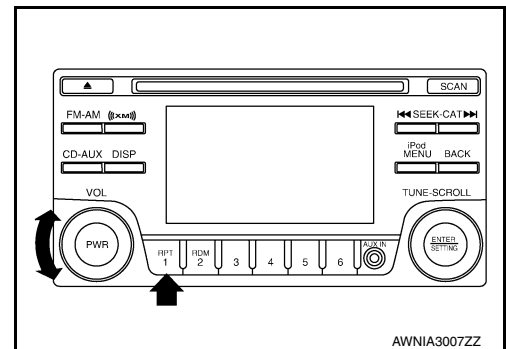

4. The trouble diagnosis initial screen is displayed, and Self Diagnosis or Confirmation/Adjustment can be selected.

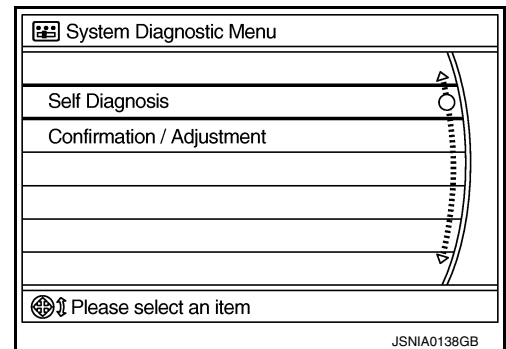

SELF DIAGNOSIS MODE

Audio Unit Self Diagnosis

1. Select Self Diagnosis.

DIAGNOSIS SYSTEM (AUDIO UNIT)

[AUDIO W/O NAVI (EXCEPT MEXICO)]

< SYSTEM DESCRIPTION >

- Self diagnosis screen is displayed. The bar graph visible in center of screen indicates progress of self diagnosis.
- Diagnosis results are displayed after the self diagnosis is completed. The unit names and the connection lines are color coded according to the diagnostic results.

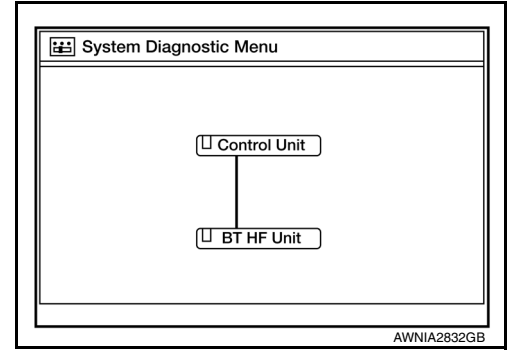

Diagnosis results	Unit	Connection line
Normal	Green	Green
Connection malfunction	Gray	Yellow
Unit malfunction ¹	Red	Green

1: Control unit (audio unit) is displayed in red.

- Replace audio unit if Self Diagnosis did not run because control unit malfunction is indicated. The symptom is audio unit internal error. Refer to [AV-69, "Removal and Installation"](#).
- If multiple errors occur at the same time for a single unit, the screen switch colors are determined according to the following order of priority: red > gray.

Audio Unit Self Diagnosis Results

Only Unit Part Is Displayed In Red		
Screen switch	Description	Possible cause
Control unit	Malfunction is detected in audio unit power supply and ground circuits.	<ul style="list-style-type: none"> Audio unit power supply or ground circuits. Refer to AV-48, "AUDIO UNIT : Diagnosis Procedure". If no malfunction is detected in audio unit power supply and ground circuits, replace audio unit. Refer to AV-69, "Removal and Installation".

A Connecting Cable Between Units Is Displayed In Yellow		
Area with yellow connection lines	Description	Possible cause
Control unit ↔ BTHF Unit	When one of the following is detected: <ul style="list-style-type: none"> malfunction is detected in Bluetooth® control unit power supply and ground circuits. malfunction is detected in AV communication circuits between audio unit and Bluetooth® control unit. 	<ul style="list-style-type: none"> Bluetooth® control unit power supply or ground circuits. Refer to AV-48, "BLUETOOTH® CONTROL UNIT : Diagnosis Procedure". AV communication circuits between audio unit and Bluetooth® control unit.

Audio Unit Confirmation/Adjustment

- Select Confirmation/Adjustment.

DIAGNOSIS SYSTEM (AUDIO UNIT)

[AUDIO W/O NAVI (EXCEPT MEXICO)]

< SYSTEM DESCRIPTION >

- Select each switch on the Confirmation/Adjustment screen to display the relevant trouble diagnosis screen. Press the BACK switch to return to the initial Confirmation/Adjustment screen.

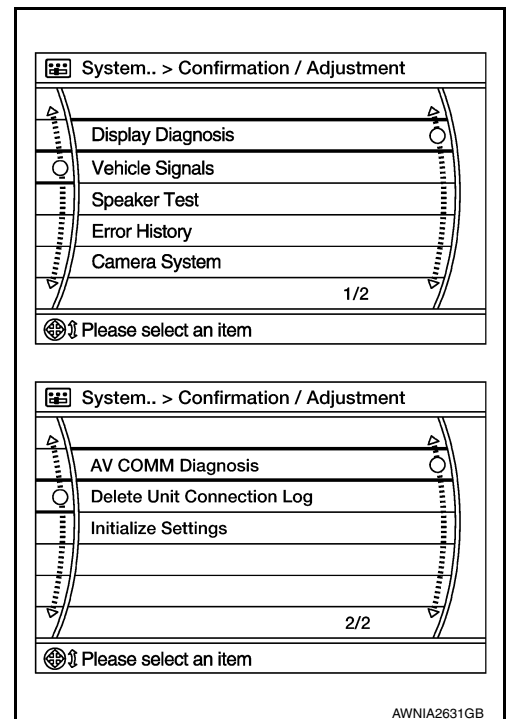

Display Diagnosis

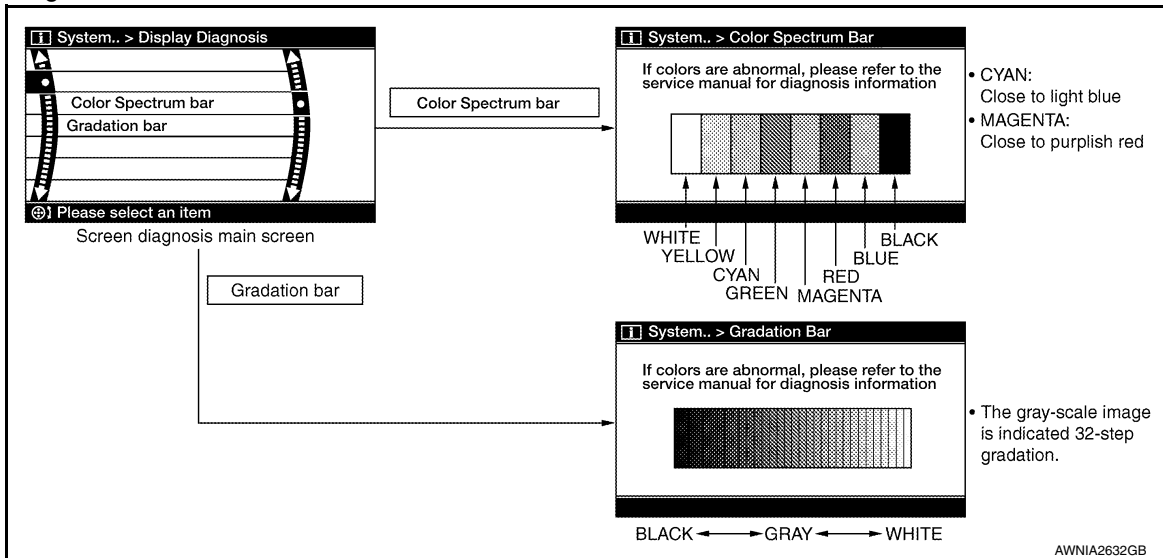

Vehicle Signals

A comparison check can be made of each actual vehicle signal and the signals recognized by the system.

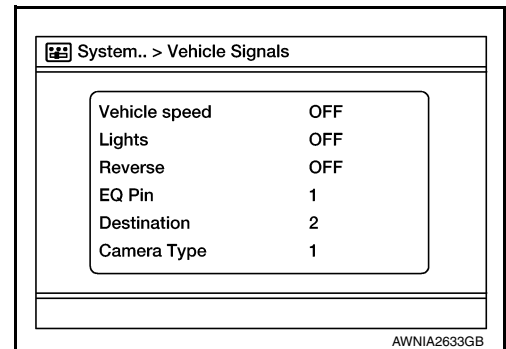

Speaker Test

DIAGNOSIS SYSTEM (AUDIO UNIT)

[AUDIO W/O NAVI (EXCEPT MEXICO)]

< SYSTEM DESCRIPTION >

Select Speaker Test to display the Speaker Diagnosis screen. Press Start to generate a test tone in a speaker. Press Start again to generate a test tone in the next speaker. Press End to stop the test tones.

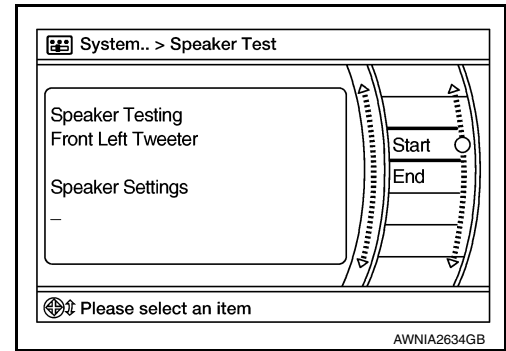

Error History

The self diagnosis results are judged depending on whether any error occurs from when Self Diagnosis is selected until the self diagnosis results are displayed.

However, the diagnosis results are judged normal if an error has occurred before the power switch is turned ON and then no error has occurred until the self diagnosis start. Check the Error Record to detect any error that may have occurred before the self diagnosis start because of this situation.

The frequency of occurrence is displayed in a count up manner. The actual count up method differs depending on the error item.

Count up method A

- The counter is set to 40 if an error occurs. 1 is subtracted from the counter if the condition is normal at a next power ON cycle.
- The counter lower limit is 1. The counter can be reset (no error record display) with the Delete log switch.

Count up method B

- The counter increases by 1 if an error occurs when power switch is ON. The counter will not decrease even if the condition is normal at the next power ON cycle.
- The counter upper limit is 50. Any counts exceeding 50 are ignored. The counter can be reset (no error record display) with the Delete log switch.

Display type of occurrence frequency	Error history display item
Count up method A	AV communication line, control unit (AV)
Count up method B	Other than the above

Error item

Some error items may be displayed simultaneously according to the cause. If some error items are displayed simultaneously, the detection of the cause can be performed by the combination of display items

Error item	Description	Possible cause
CONTROL UNIT (AV)	AV communication circuit initial diagnosis malfunction is detected.	Replace the audio unit if the malfunction occurs constantly. Refer to AV-69, "Removal and Installation"
AV COMM CIRCUIT	When one of the following is detected: <ul style="list-style-type: none"> • malfunction is detected in Bluetooth® control unit power supply and ground circuits. • malfunction is detected in AV communication circuits between audio unit and Bluetooth® control unit. 	<ul style="list-style-type: none"> • Bluetooth® control unit power supply or ground circuits. Refer to AV-48, "BLUETOOTH® CONTROL UNIT : Diagnosis Procedure". • AV communication circuits between audio unit and Bluetooth® control unit.

Camera System

DIAGNOSIS SYSTEM (AUDIO UNIT)

[AUDIO W/O NAVI (EXCEPT MEXICO)]

< SYSTEM DESCRIPTION >

This mode is used to adjust the guide line display position of the rear view camera.

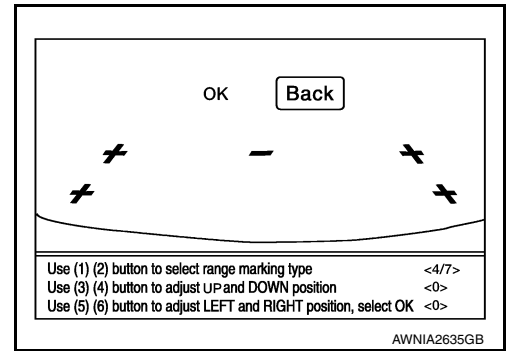

AV COMM Diagnosis

- Displays the communication status between audio unit (master unit) and Bluetooth® control unit.
- The error counter displays OK if any malfunction was not detected in the past and displays 0 if a malfunction is detected. It increases by 1 if the condition is normal at the next power switch ON cycle. The upper limit of the counter is 39.
- The error counter is erased if Reset is pressed.

Items	Status (Current)	Counter (Past)
BUS OFF	OK / ???	OK / 0 – 39
C Rx(BTHF-H/U)	OK / ???	OK / 0 – 39

NOTE:

“???” indicates UNKWN.

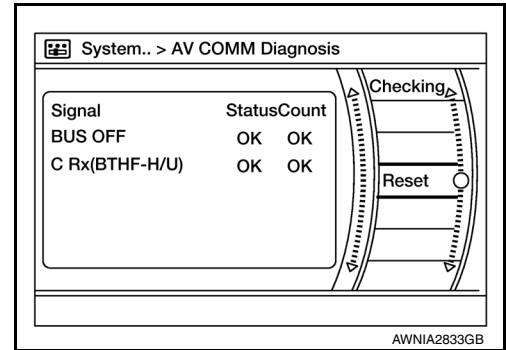

Delete Unit Connection Log

Deletes any unit connection records and error records from the audio unit memory (clears the records of the unit that has been removed).

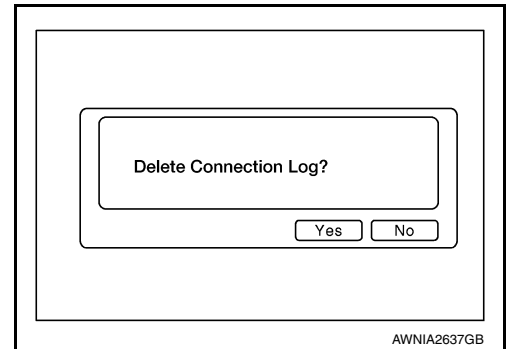

Initialize Settings

Deletes data stored from the audio unit.

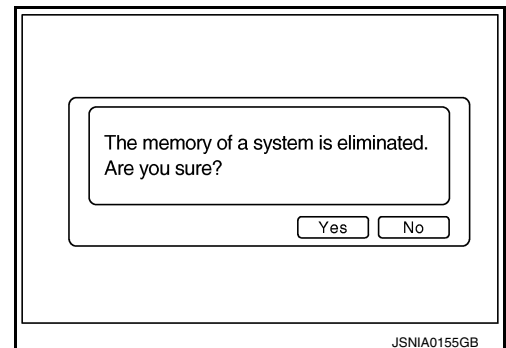

DIAGNOSIS SYSTEM (BLUETOOTH® CONTROL UNIT)

< SYSTEM DESCRIPTION >

[AUDIO W/O NAVI (EXCEPT MEXICO)]

DIAGNOSIS SYSTEM (BLUETOOTH® CONTROL UNIT)

Diagnosis Description

INFOID:000000010641694

The Bluetooth® control unit has two diagnostic checks. The first diagnostic check is performed automatically every power cycle during control unit initialization. The second diagnostic check is performed by the technician using the steering wheel audio control switches prior to trouble diagnosis.

Bluetooth® CONTROL UNIT INITIALIZATION CHECKS

- Internal control unit failure
- Bluetooth® antenna connection open or shorted
- Steering wheel audio control switches [☎ (PHONE/SEND), ⏹ (PHONE/END)] stuck closed
- Vehicle speed pulse count
- Microphone connection test (with playback to operator)
- Bluetooth® inquiry check

OPERATION PROCEDURE

1. Turn power switch to ACC or ON.
2. Wait for the Bluetooth® system to complete initialization. This may take up to 20 seconds.
3. Press and hold the steering wheel audio control switch ☎ (PHONE/SEND) button for at least 5 seconds. The Bluetooth® system will begin to play a verbal prompt.

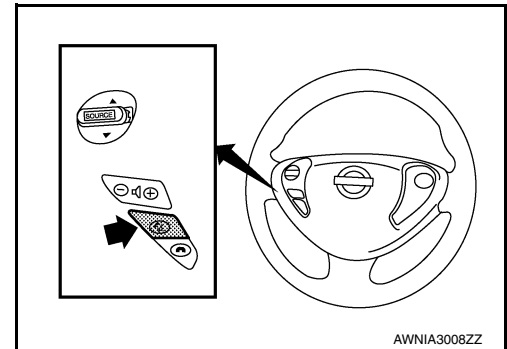

4. While the prompt is playing, press and hold the steering wheel audio control switch ⏹ (PHONE/END) button until you hear the “Diagnostics mode” prompt. The Bluetooth® system will sound a 5-second beep.
5. While the beep is sounding, press and hold the steering wheel audio control switch ⏹ (PHONE/END) button again until you hear prompts.
6. The Bluetooth® system has now entered into the diagnostic mode. Results of the diagnostic checks will be verbalized to the technician. Refer to [AV-27, "Work Flow"](#).
7. After the failure records are reported, an interactive microphone test will be performed. Follow the voice prompt. If the microphone test fails, refer to [AV-27, "Work Flow"](#).

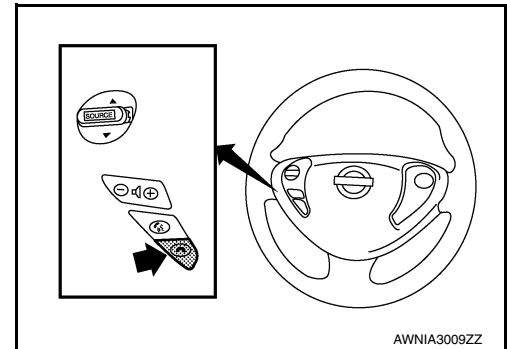

Work Flow

INFOID:000000010641695

Failure Message	Action
“Internal failure”	Replace Bluetooth® control unit. Refer to AV-73, "Removal and Installation" .
“Bluetooth® antenna open”	1. Inspect harness connection. 2. Replace Bluetooth® antenna. Refer to AV-73, "Removal and Installation" .
“Bluetooth® antenna shorted”	
“Phone/Send for Hands Free System is stuck”	Check steering wheel audio control switches. Refer to AV-61, "Diagnosis Procedure" .
“Phone/End for the Hands Free System is stuck”	
“Microphone test” (failed interactive test)	1. Inspect harness between Bluetooth® control unit and microphone. 2. Replace microphone. Refer to AV-72, "Removal and Installation" .

AUDIO UNIT

< ECU DIAGNOSIS INFORMATION >

[AUDIO W/O NAVI (EXCEPT MEXICO)]

ECU DIAGNOSIS INFORMATION

AUDIO UNIT

Reference Value

INFOID:000000010641696

TERMINAL LAYOUT

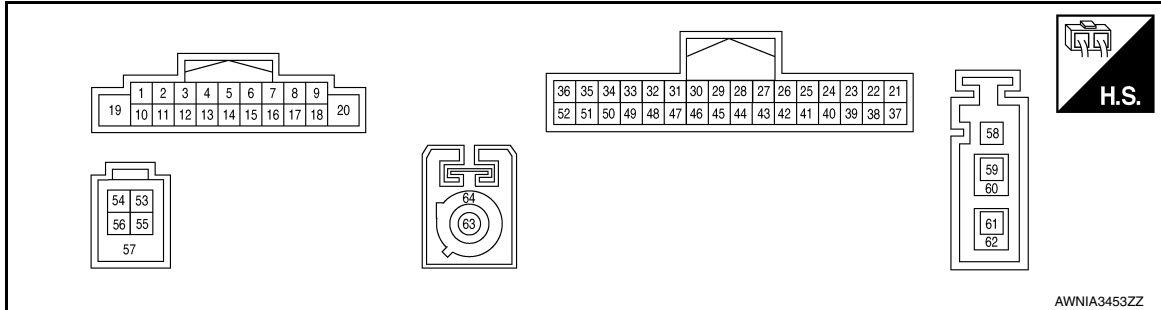







PHYSICAL VALUES

Terminal (Wire color)		Description	Input/Output	Condition		Reference value (Approx.)
+	-			Power switch	Operation	
2 (L)	3 (P)	Sound signal front speaker LH	Output	ON	Sound output	 SKIB3609E
4 (V)	5 (LG)	Sound signal rear speaker LH	Output	ON	Sound output	 SKIB3609E
6 (BR)	15 (SB)	Steering switch signal A	Input	ON	Press SOURCE switch	0V
					Press Δ switch	1.0V
					Press ∇ switch	2.0V
					Press \curvearrowright switch	3.0V
					Except above	5.0V
7 (BR)	Ground	ACC power supply	Input	ACC	—	Battery voltage
9 (W)	8 (B)	Illumination control signal	Input	ON	Headlamps ON	Battery voltage

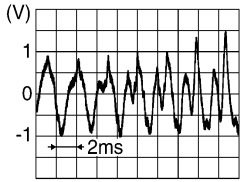
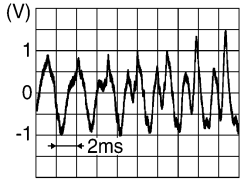
AUDIO UNIT

< ECU DIAGNOSIS INFORMATION >

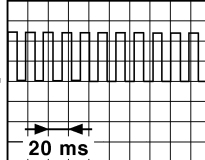
[AUDIO W/O NAVI (EXCEPT MEXICO)]

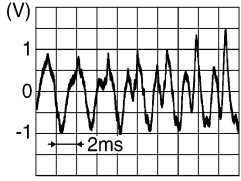
Terminal (Wire color)		Description	Input/ Output	Condition		Reference value (Approx.)
+	-			Power switch	Operation	
11 (G)	12 (R)	Sound signal front speaker RH	Output	ON	Sound output	 SKIB3609E
13 (LG)	14 (P)	Sound signal rear speaker RH	Output	ON	Sound output	 SKIB3609E
16 (V)	15 (SB)	Steering switch signal B	Input	ON	Press -  switch	0V
					Press  switch	1.0V
					Press  switch	2.0V
					Except above	5.0V
18 (GR)	Ground	Vehicle speed signal	Input	ON	When vehicle speed is approx. 40 km/h (25 MPH)	 JSNIA0012GB
19 (BR)	Ground	Battery power supply	Input	OFF	—	Battery voltage
20 (B)	Ground	Ground	—	ON	—	0 V
24 (R)	25 (G)	TEL voice signal	Input	ON	During voice guide output with  switch pressed.	 SKIB3609E
26 (Shield)	—	TEL voice signal shield	—	—	—	—
31 (R)	—	AV communication (H)	Input/ Output	—	—	—
32 (G)	—	AV communication (L)	Input/ Output	—	—	—
33 (B)	Ground	Camera ground	—	ON	—	0 V
34 (W)	Ground	Camera power supply	Output	ON	Selector lever in "R" position	6.0 V

A
B
C
D
E
F
G
H
I
J
K
L
M
O
P

AV

AUDIO UNIT

< ECU DIAGNOSIS INFORMATION >

[AUDIO W/O NAVI (EXCEPT MEXICO)]

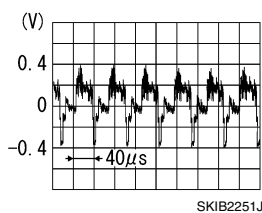
Terminal (Wire color)		Description		Condition		Reference value (Approx.)
+	-	Signal name	Input/ Output	Power switch	Operation	
35 (R)	Ground	Camera image signal	Input	ON	Camera image displayed	
36 (Shield)	—	Camera image signal Shield	—	—	—	—
44 (B)	Ground	Camera detection	—	ON	—	0 V
45 (B)	Ground	EQ1 Ground	—	ON	—	0 V
48 (B)	Ground	EQ4 Ground	—	ON	—	0 V
50 (G)	Ground	Reverse signal	Input	ON	Selector lever in R position.	Battery voltage
					Selector lever in any position other than R.	0 V
53 (W)	—	V BUS signal	—	—	—	—
54 (G)	—	USB ground	—	—	—	—
55 (L)	—	USB D+ signal	—	—	—	—
56 (R)	—	USB D- signal	—	—	—	—
57 (Shield)	—	USB signal shield	—	—	—	—
58 (B)	Ground	Antenna amp. ON signal	Output	ON	—	Battery voltage
59 (B)	Ground	AM/FM antenna signal	Input	ON	—	5.0 V
60 (Shield)	—	AM/FM antenna signal shield	—	—	—	—
63 (B)	Ground	Satellite antenna signal	Input	ON	—	5.0 V
64 (Shield)	—	Satellite antenna signal shield	—	—	—	—

BLUETOOTH® CONTROL UNIT

< ECU DIAGNOSIS INFORMATION >

[AUDIO W/O NAVI (EXCEPT MEXICO)]

BLUETOOTH® CONTROL UNIT

Reference Value

INFOID:000000010641697

TERMINAL LAYOUT

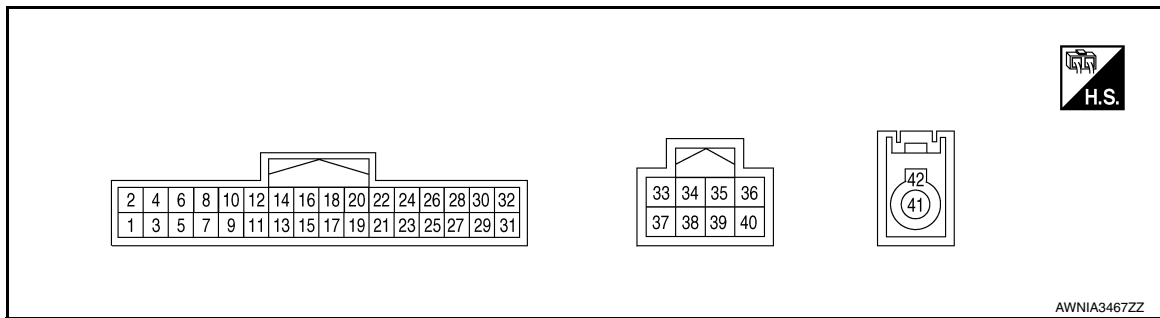





PHYSICAL VALUES

Terminal (wire color)		Description		Condition		Reference value (Approx.)
+	-	Signal name	Input/output	Power switch	Operation	
1 (BR)	Ground	Battery power supply	Input	-	-	Battery voltage
2 (P)	Ground	ACC power supply	Input	ACC or ON	-	Battery voltage
3 (G)	Ground	Power signal	Input	ON or START	-	Battery voltage
4 (B)	Ground	Ground	-	ON	-	0V
7 (L)	8 (Shield)	MIC in signal	Input	-	-	-
9 (R)	10 (L)	Audio out	Output	ACC or ON	Bluetooth® control unit sends audio signal	<p>SKIB3609E</p>
12 (R)	14 (B)	LAD IN 1	Input	ON	Press SOURCE switch	0V
					Press △ switch	1.0V
					Press ▽ switch	2.0V
					Press ↻ switch	3.0V
					Except above	5.0V
13 (W)	14 (B)	LAD IN 2	Input	ON	Press - speaker switch	0V
					Press speaker+ switch	1.0V
					Press speaker switch	2.0V
					Except above	5.0V

BLUETOOTH® CONTROL UNIT

< ECU DIAGNOSIS INFORMATION >

[AUDIO W/O NAVI (EXCEPT MEXICO)]

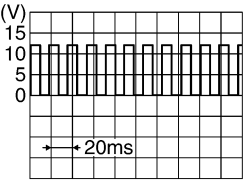
Terminal (wire color)		Description		Condition		Reference value (Approx.)
+	-	Signal name	Input/ output	Power switch	Operation	
17 (LG)	19 (GR)	LAD OUT 1	Output	ON	Press SOURCE switch	0V
					Press Δ switch	1.0V
					Press ∇ switch	2.0V
					Press  Σ switch	3.0V
					Except above	5.0V
18 (V)	19 (GR)	LAD OUT 2	Output	ON	Press $-$  switch	0V
					Press  $+$ switch	1.0V
					Press  switch	2.0V
					Except above	5.0V
24 (B)	Ground	CONT5 Ground	-	ON	-	0V
27 (B)	Ground	CONT6 Ground	-	ON	-	0V
28 (SB)	Ground	Vehicle speed signal (8-pulse)	Input	ON	When vehicle speed is approx. 40 km/h (25 MPH)	 <p style="text-align: right; font-size: small;">PKIA1935E</p>
29 (P)	Ground	Microphone power	Output	ON	-	5V
33 (R)	-	AV communication (H)	-	-	-	-
34 (Shield)	-	AV communication shield	-	-	-	-
35 (SB)	-	AV communication jumper (H)	-	-	-	-
36 (LG)	-	AV communication jumper (L)	-	-	-	-
37 (G)	-	AV communication (L)	-	-	-	-
39 (SB)	-	AV communication (H)	-	-	-	-
40 (LG)	-	AV communication (L)	-	-	-	-
41 (B)	-	Bluetooth® antenna	-	-	-	-
42 (Shield)	-	Bluetooth® antenna shield	-	-	-	-

AUDIO W/O NAVI (EXCEPT MEXICO)

[AUDIO W/O NAVI (EXCEPT MEXICO)]

< WIRING DIAGRAM >

WIRING DIAGRAM

AUDIO W/O NAVI (EXCEPT MEXICO)

Wiring Diagram

INFOID:000000010641698

AUDIO SYSTEM - WITHOUT NAVIGATION (EXCEPT MEXICO)

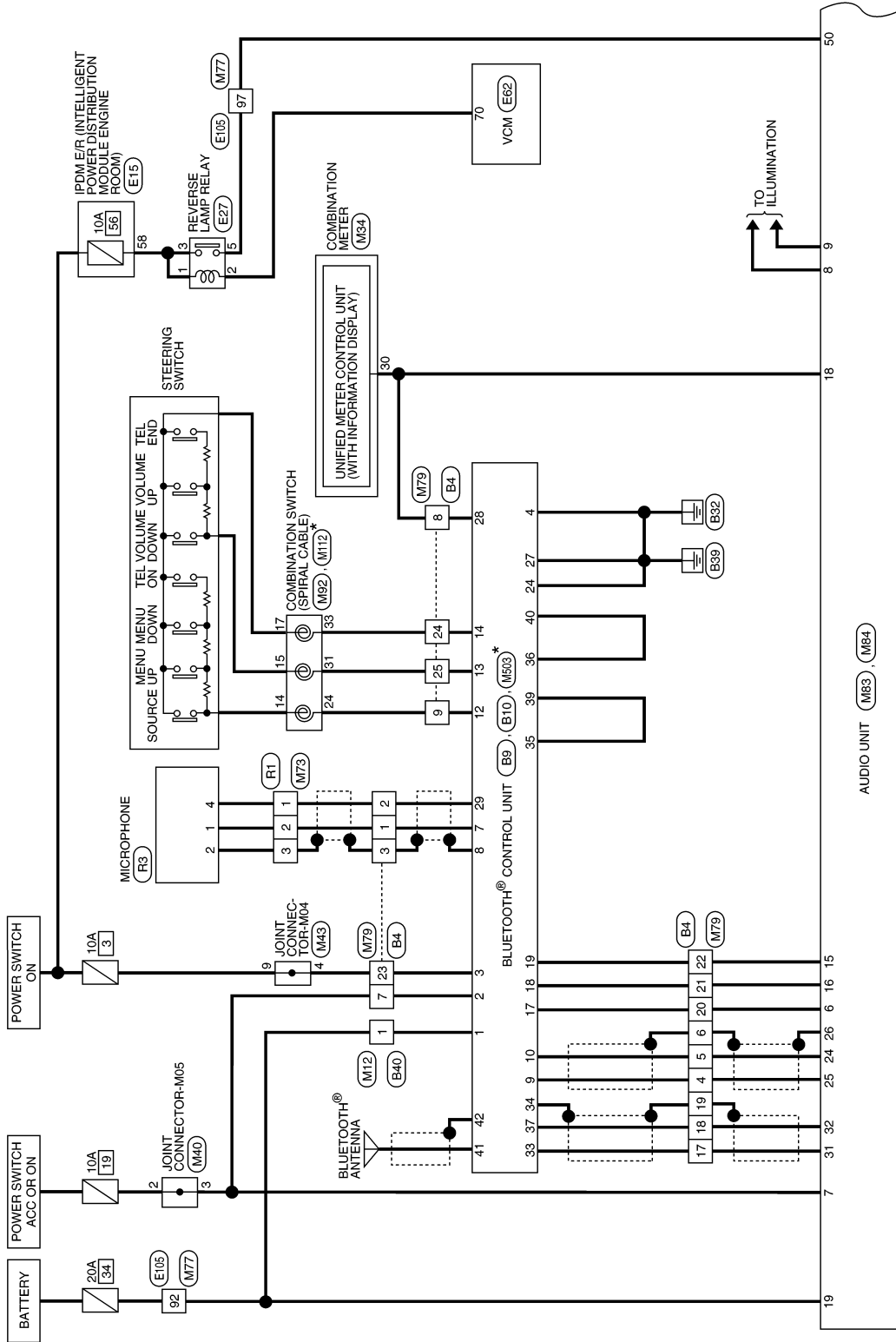

*: THIS CONNECTOR IS NOT SHOWN IN "HARNESS LAYOUT" OF PG SECTION.

AANWA1101GB

A
B
C
D
E
F
G
H
I
J
K
L
M
N
O
P



AUDIO W/O NAVI (EXCEPT MEXICO)

< WIRING DIAGRAM >

[AUDIO W/O NAVI (EXCEPT MEXICO)]

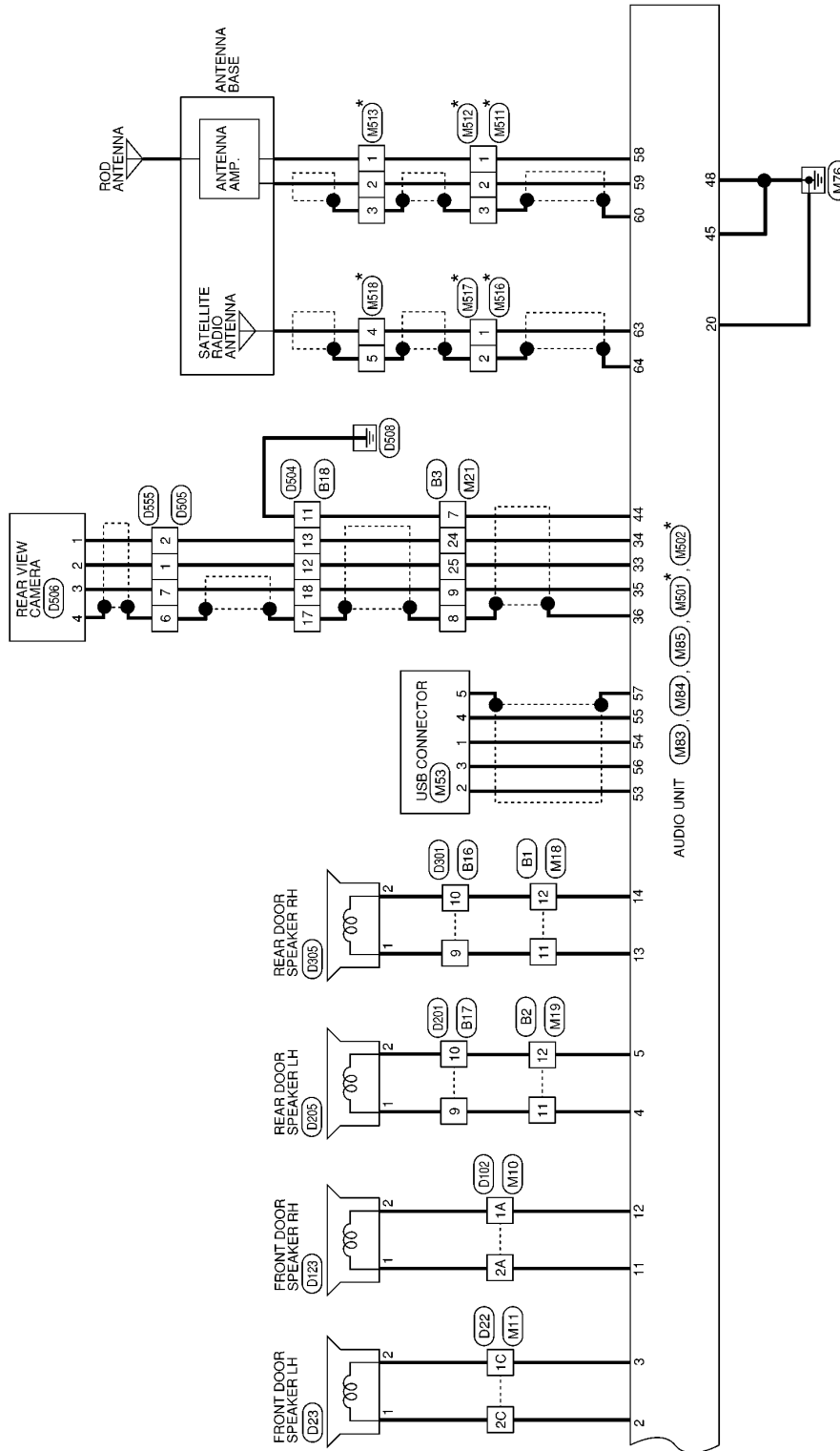

*: THIS CONNECTOR IS NOT SHOWN IN "HARNES LAYOUT" OF PG SECTION

AANWA1102GB

< WIRING DIAGRAM >

AUDIO SYSTEM -WITHOUT NAVIGATION (EXCEPT MEXICO) CONNECTORS

Connector No.	M10
Connector Name	WIRE TO WIRE
Connector Color	WHITE

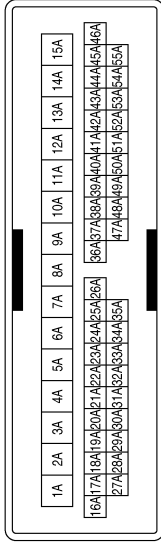

Terminal No.	Color of Wire	Signal Name
1A	R	-(WITHOUT BOSE)
2A	G	-(WITHOUT BOSE)

Connector No.	M11
Connector Name	WIRE TO WIRE
Connector Color	WHITE

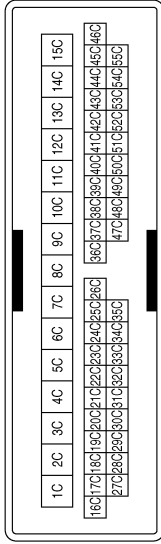

Terminal No.	Color of Wire	Signal Name
1C	P	-(WITHOUT BOSE)
2C	L	-(WITHOUT BOSE)

Connector No.	M12
Connector Name	WIRE TO WIRE
Connector Color	WHITE

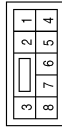

Terminal No.	Color of Wire	Signal Name
1	BR	-(WITHOUT BOSE)

Connector No.	M18
Connector Name	WIRE TO WIRE
Connector Color	WHITE

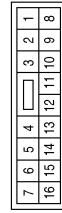

Terminal No.	Color of Wire	Signal Name
11	LG	-
12	P	-

Connector No.	M19
Connector Name	WIRE TO WIRE
Connector Color	WHITE

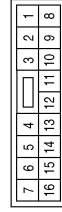

Terminal No.	Color of Wire	Signal Name
11	V	-
12	LG	-

Connector No.	M21
Connector Name	WIRE TO WIRE
Connector Color	WHITE

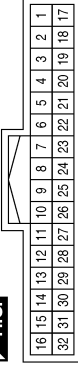

Terminal No.	Color of Wire	Signal Name
7	B	-
8	SHIELD	-
9	R	-
24	W	-
25	B	-

A B C D E F G H I J K L M N O P



AUDIO W/O NAVI (EXCEPT MEXICO)

[AUDIO W/O NAVI (EXCEPT MEXICO)]

< WIRING DIAGRAM >

Connector No.	M43
Connector Name	JOINT CONNECTOR-M04
Connector Color	GRAY

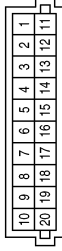

Terminal No.	Color of Wire	Signal Name
4	W	-
9	W	-

Connector No.	M40
Connector Name	JOINT CONNECTOR-M05
Connector Color	BLUE

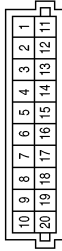

Terminal No.	Color of Wire	Signal Name
2	L	-
3	BR	-

Connector No.	M34
Connector Name	COMBINATION METER
Connector Color	WHITE

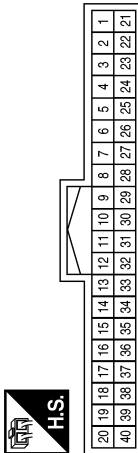

Terminal No.	Color of Wire	Signal Name
30	GR	SPEED 8PR

Connector No.	M77
Connector Name	WIRE TO WIRE
Connector Color	WHITE

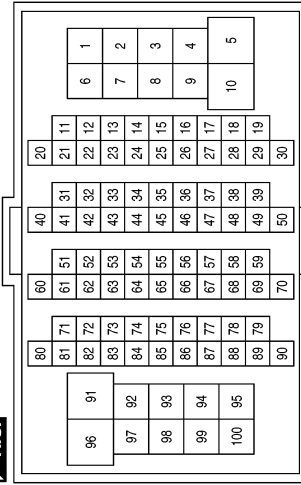

Terminal No.	Color of Wire	Signal Name
92	BR	-
97	G	-

Connector No.	M73
Connector Name	WIRE TO WIRE
Connector Color	WHITE

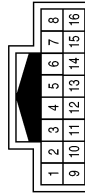

Terminal No.	Color of Wire	Signal Name
1	P	-
2	L	-
3	SHIELD	-

Connector No.	M53
Connector Name	USB CONNECTOR
Connector Color	GREEN

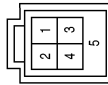

Terminal No.	Color of Wire	Signal Name
1	G	-
2	W	-
3	R	-
4	L	-
5	SHIELD	-

AANIA2852GB

AUDIO W/O NAVI (EXCEPT MEXICO)

< WIRING DIAGRAM >

[AUDIO W/O NAVI (EXCEPT MEXICO)]

Connector No.	M83
Connector Name	AUDIO UNIT
Connector Color	WHITE

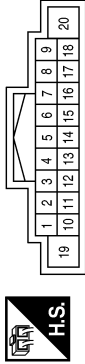

Terminal No.	Color of Wire	Signal Name
1	-	-
2	L	FR LH SP+
3	P	FR LH SP-
4	V	RR LH SP+
5	LG	RR LH SP-
6	BR	STRG SW A
7	BR	ACC
8	B	ILL (-)
9	W	ILL (+)
10	-	-
11	G	FR RH SP+
12	R	FR RH SP-
13	LG	RR RH SP+
14	P	RR RH SP-
15	SB	STRG SW GND
16	V	STRG SW B
17	-	-
18	GR	SPD
19	BR	+B
20	B	GND

Connector No.	M79
Connector Name	WIRE TO WIRE
Connector Color	WHITE

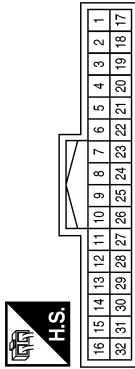

Terminal No.	Color of Wire	Signal Name
1	L	-
2	P	-
3	SHIELD	-
4	G	-
5	R	-
6	SHIELD	-
7	L	-
8	GR	-
9	R	-
17	R	-
18	G	-
19	SHIELD	-
20	BR	-
21	V	-
22	SB	-
23	W	-
24	B	-
25	W	-

AANIA2853GB

A
B
C
D
E
F
G
H
I
J
K
L
M
N
O
P

AV

AUDIO W/O NAVI (EXCEPT MEXICO)

< WIRING DIAGRAM >

[AUDIO W/O NAVI (EXCEPT MEXICO)]

Connector No.	M84
Connector Name	AUDIO UNIT
Connector Color	WHITE

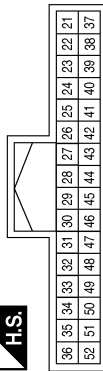

Terminal No.	Color of Wire	Signal Name
21	-	-
22	-	-
23	-	-
24	R	TEL VOICE -
25	G	TEL VOICE +

Terminal No.	Color of Wire	Signal Name
26	SHIELD	TEL VOICE GND
27	-	-
28	-	-
29	-	-
30	-	-
31	R	MCAN1 H
32	G	MCAN1 L
33	B	CAM GND
34	W	CAM 6.2V
35	R	CAM VIDEO
36	SHIELD	VIDEO GND
37	-	-
38	-	-
39	-	-

Terminal No.	Color of Wire	Signal Name
40	-	-
41	-	-
42	-	-
43	-	-
44	B	CAM DET
45	B	EQ1
46	-	-
47	-	-
48	B	EQ4
49	-	-
50	G	REVERSE
51	-	-
52	-	-

Connector No.	M85
Connector Name	AUDIO UNIT
Connector Color	BLUE

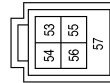

Terminal No.	Color of Wire	Signal Name
53	W	VBUS
54	G	USB GND
55	L	USB D+
56	R	USB D-
57	SHIELD	SHIELD

Connector No.	M92
Connector Name	COMBINATION SWITCH (SPIRAL CABLE)
Connector Color	GRAY

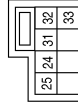

Terminal No.	Color of Wire	Signal Name
24	R	-
31	W	-
33	B	-

Connector No.	M112
Connector Name	COMBINATION SWITCH (SPIRAL CABLE)
Connector Color	GRAY

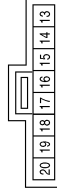

Terminal No.	Color of Wire	Signal Name
14	P	-
15	L	-
17	G	-

AUDIO W/O NAVI (EXCEPT MEXICO)

[AUDIO W/O NAVI (EXCEPT MEXICO)]

< WIRING DIAGRAM >

Connector No.	M503
Connector Name	BLUETOOTH® CONTROL UNIT
Connector Color	GRAY



Terminal No.	Color of Wire	Signal Name
41	B	BT ANTENNA
42	SHIELD	BT SHIELD

Connector No.	M502
Connector Name	AUDIO UNIT
Connector Color	PINK



Terminal No.	Color of Wire	Signal Name
63	B	ANT IN
64	SHIELD	ANT GND

Connector No.	M501
Connector Name	AUDIO UNIT
Connector Color	GRAY

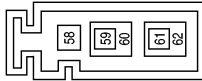

Terminal No.	Color of Wire	Signal Name
58	B	ANT +B
59	B	ANT MAIN
60	SHIELD	MAIN GND
61	-	-
62	-	-

Connector No.	M513
Connector Name	ANTENNA BASE
Connector Color	GRAY



Terminal No.	Color of Wire	Signal Name
1	B	-
2	B	-
3	SHIELD	-

Connector No.	M512
Connector Name	WIRE TO WIRE
Connector Color	GRAY



Terminal No.	Color of Wire	Signal Name
1	B	-
2	B	-
3	SHIELD	-

Connector No.	M511
Connector Name	WIRE TO WIRE
Connector Color	GRAY



Terminal No.	Color of Wire	Signal Name
1	B	-
2	B	-
3	SHIELD	-

AANIA2855GB

A B C D E F G H I J K L M O P



AUDIO W/O NAVI (EXCEPT MEXICO)

< WIRING DIAGRAM >

[AUDIO W/O NAVI (EXCEPT MEXICO)]

Connector No.	M518
Connector Name	ANTENNA BASE
Connector Color	GREEN

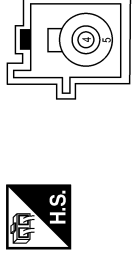

Terminal No.	Color of Wire	Signal Name
4	B	-
5	SHIELD	-

Connector No.	M517
Connector Name	WIRE TO WIRE
Connector Color	BROWN

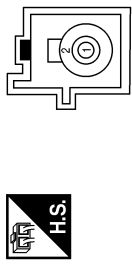

Terminal No.	Color of Wire	Signal Name
1	B	-
2	SHIELD	-

Connector No.	M516
Connector Name	WIRE TO WIRE
Connector Color	BROWN

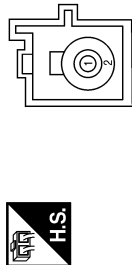

Terminal No.	Color of Wire	Signal Name
1	B	-
2	SHIELD	-

Connector No.	E62
Connector Name	VCN
Connector Color	BROWN

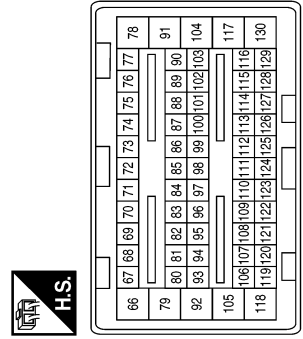

Terminal No.	Color of Wire	Signal Name
70	SB	REVERSE LAMP

Connector No.	E27
Connector Name	REVERSE LAMP RELAY
Connector Color	BLUE



Terminal No.	Color of Wire	Signal Name
1	O	-
2	SB	-
3	O	-
5	G	-

Connector No.	E15
Connector Name	IPDM E/R (INTELLIGENT POWER DISTRIBUTION MODULE ENGINE ROOM)
Connector Color	WHITE

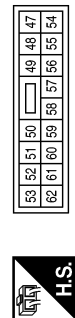

Terminal No.	Color of Wire	Signal Name
58	O	REVERSE LAMP IGN

AANIA2856GB

AUDIO W/O NAVI (EXCEPT MEXICO)

[AUDIO W/O NAVI (EXCEPT MEXICO)]

< WIRING DIAGRAM >

Connector No.	B2
Connector Name	WIRE TO WIRE
Connector Color	WHITE

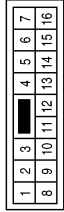

Terminal No.	Color of Wire	Signal Name
11	V	-
12	LG	-

Connector No.	B1
Connector Name	WIRE TO WIRE
Connector Color	WHITE

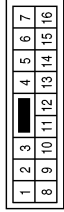

Terminal No.	Color of Wire	Signal Name
11	LG	-
12	P	-

Connector No.	E105
Connector Name	WIRE TO WIRE
Connector Color	WHITE

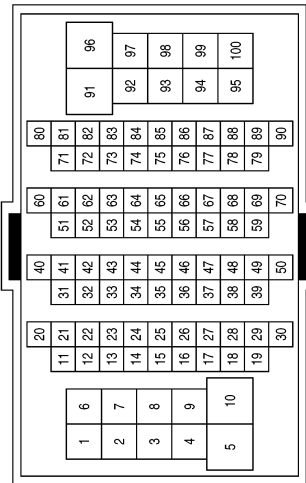

Terminal No.	Color of Wire	Signal Name
92	BR	-
97	G	-

Connector No.	B4
Connector Name	WIRE TO WIRE
Connector Color	WHITE

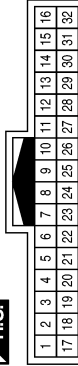

Terminal No.	Color of Wire	Signal Name
1	L	-
2	P	-
3	SHIELD	-
4	R	-
5	L	-

Connector No.	B3
Connector Name	WIRE TO WIRE
Connector Color	WHITE



Terminal No.	Color of Wire	Signal Name
7	B	-
8	SHIELD	-
9	B	-
24	R	-
25	W	-

Terminal No.	Color of Wire	Signal Name
6	SHIELD	-
7	P	-
8	SB	-
9	R	-
17	R	-
18	G	-
19	SHIELD	-
20	LG	-
21	V	-
22	GR	-
23	G	-
24	B	-
25	W	-

AANIA2857GB

A
B
C
D
E
F
G
H
I
J
K
L
M
N
O
P

AV

AUDIO W/O NAVI (EXCEPT MEXICO)

< WIRING DIAGRAM >

[AUDIO W/O NAVI (EXCEPT MEXICO)]

Connector No.	B9
Connector Name	BLUETOOTH® CONTROL UNIT
Connector Color	WHITE



2	4	6	8	10	12	14	16	18	20	22	24	26	28	30	32
1	3	5	7	9	11	13	15	17	19	21	23	25	27	29	31

Terminal No.	Color of Wire	Signal Name
1	BR	B+
2	P	ACC
3	G	IGN
4	B	GND



33	34	35	36
37	38	39	40

Connector No.	B10
Connector Name	BLUETOOTH® CONTROL UNIT
Connector Color	WHITE

Terminal No.	Color of Wire	Signal Name
5	-	-
6	-	-
7	L	MIC IN +
8	SHIELD	MIC IN -(GND)
9	R	AUDIO OUT +
10	L	AUDIO OUT -
11	-	-
12	R	LADDER IN 1
13	W	LADDER IN 2
14	B	LADDER IN 3 (GND)
15	-	-
16	-	-
17	LG	LADDER OUT 1
18	V	LADDER OUT 2



5	4	3	2	1		
12	11	10	9	8	7	6

Connector No.	B16
Connector Name	WIRE TO WIRE
Connector Color	WHITE

Terminal No.	Color of Wire	Signal Name
19	GR	LADDER OUT 3 (GND)
20	-	-
21	-	-
22	-	-
23	-	-
24	B	CONT5
25	-	-
26	-	-
27	B	CONT6
28	SB	SPEED
29	P	MIC POWER
30	-	-
31	-	-
32	-	-



5	4	3	2	1		
12	11	10	9	8	7	6

Connector No.	B17
Connector Name	WIRE TO WIRE
Connector Color	WHITE

Terminal No.	Color of Wire	Signal Name
33	R	CAN H1
34	SHIELD	CAN SHIELD 1
35	SB	CAN JUMPER 1
36	LG	CAN JUMPER 2
37	G	CAN L1
38	-	-
39	SB	CAN H2
40	LG	CAN L2

Terminal No.	Color of Wire	Signal Name
9	LG	-(WITHOUT BOSE EXCEPT MEXICO)
10	P	-(EXCEPT MEXICO)

Terminal No.	Color of Wire	Signal Name
9	V	-(WITHOUT BOSE)
10	LG	-(WITHOUT BOSE)

AUDIO W/O NAVI (EXCEPT MEXICO)

[AUDIO W/O NAVI (EXCEPT MEXICO)]

< WIRING DIAGRAM >

Connector No.	R1
Connector Name	WIRE TO WIRE
Connector Color	WHITE

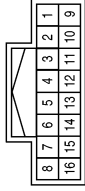

Terminal No.	Color of Wire	Signal Name
1	P	-
2	L	-
3	GR	-

Connector No.	B40
Connector Name	WIRE TO WIRE
Connector Color	WHITE

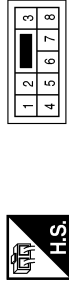

Terminal No.	Color of Wire	Signal Name
1	BR	-(WITHOUT BOSE)

Connector No.	B18
Connector Name	WIRE TO WIRE
Connector Color	WHITE

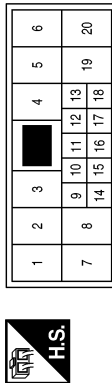

Terminal No.	Color of Wire	Signal Name
11	B	-
12	W	-
13	R	-
17	SHIELD	-
18	B	-

Connector No.	D23
Connector Name	FRONT DOOR SPEAKER LH (WITHOUT BOSE AUDIO SYSTEM)
Connector Color	WHITE



Terminal No.	Color of Wire	Signal Name
1	V	-
2	L	-

Connector No.	D22
Connector Name	WIRE TO WIRE
Connector Color	WHITE

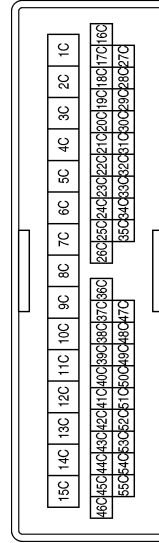

Terminal No.	Color of Wire	Signal Name
1C	L	-
2C	V	-

Connector No.	R3
Connector Name	MICROPHONE
Connector Color	WHITE



Terminal No.	Color of Wire	Signal Name
1	L	-
2	GR	-
3	-	-
4	P	-
5	-	-
6	-	-

AANIA2859GB

A
B
C
D
E
F
G
H
I
J
K
L
M
N
O
P

AV

AUDIO W/O NAVI (EXCEPT MEXICO)

< WIRING DIAGRAM >

[AUDIO W/O NAVI (EXCEPT MEXICO)]

Connector No.	D201
Connector Name	WIRE TO WIRE
Connector Color	WHITE

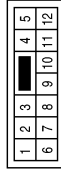

Terminal No.	Color of Wire	Signal Name
9	V	-(WITHOUT BOSE)
10	LG	-(WITHOUT BOSE)

Connector No.	D123
Connector Name	FRONT DOOR SPEAKER RH (WITHOUT BOSE AUDIO SYSTEM)
Connector Color	WHITE



Terminal No.	Color of Wire	Signal Name
1	R	-
2	BR	-

Connector No.	D102
Connector Name	WIRE TO WIRE
Connector Color	WHITE

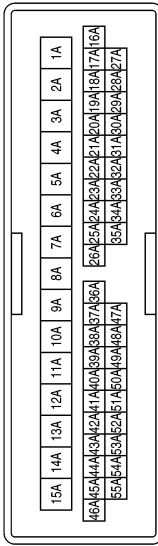

Terminal No.	Color of Wire	Signal Name
1A	BR	-
2A	R	-

Connector No.	D305
Connector Name	REAR DOOR SPEAKER RH
Connector Color	WHITE



Terminal No.	Color of Wire	Signal Name
1	LG	-
2	P	-

Connector No.	D301
Connector Name	WIRE TO WIRE
Connector Color	WHITE

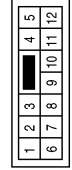

Terminal No.	Color of Wire	Signal Name
9	LG	-
10	P	-

Connector No.	D205
Connector Name	REAR DOOR SPEAKER LH
Connector Color	WHITE



Terminal No.	Color of Wire	Signal Name
1	V	-
2	LG	-

AANIA2860GB

AUDIO W/O NAVI (EXCEPT MEXICO)

[AUDIO W/O NAVI (EXCEPT MEXICO)]

< WIRING DIAGRAM >

Connector No.	D555
Connector Name	WIRE TO WIRE
Connector Color	WHITE

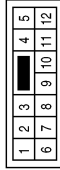

Terminal No.	Color of Wire	Signal Name
1	W	-
2	R	-
6	SHIELD	-
7	B	-

Connector No.	D505
Connector Name	WIRE TO WIRE
Connector Color	WHITE

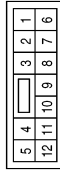

Terminal No.	Color of Wire	Signal Name
1	W	-
2	R	-
6	SHIELD	-
7	Y	-

Connector No.	D504
Connector Name	WIRE TO WIRE
Connector Color	WHITE

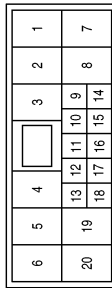

Terminal No.	Color of Wire	Signal Name
11	B	-
12	W	-
13	R	-
17	SHIELD	-
18	Y	-

Connector No.	D556
Connector Name	REAR VIEW CAMERA (WITHOUT AROUND VIEW MONITOR)
Connector Color	WHITE



Terminal No.	Color of Wire	Signal Name
1	R	-
2	W	-
3	B	-
4	SHIELD	-

AANIA2861GB

A
B
C
D
E
F
G
H
I
J
K
L
M
N
O
P

AV

BASIC INSPECTION

DIAGNOSIS AND REPAIR WORKFLOW

Work Flow

INFOID:000000010641699

OVERALL SEQUENCE

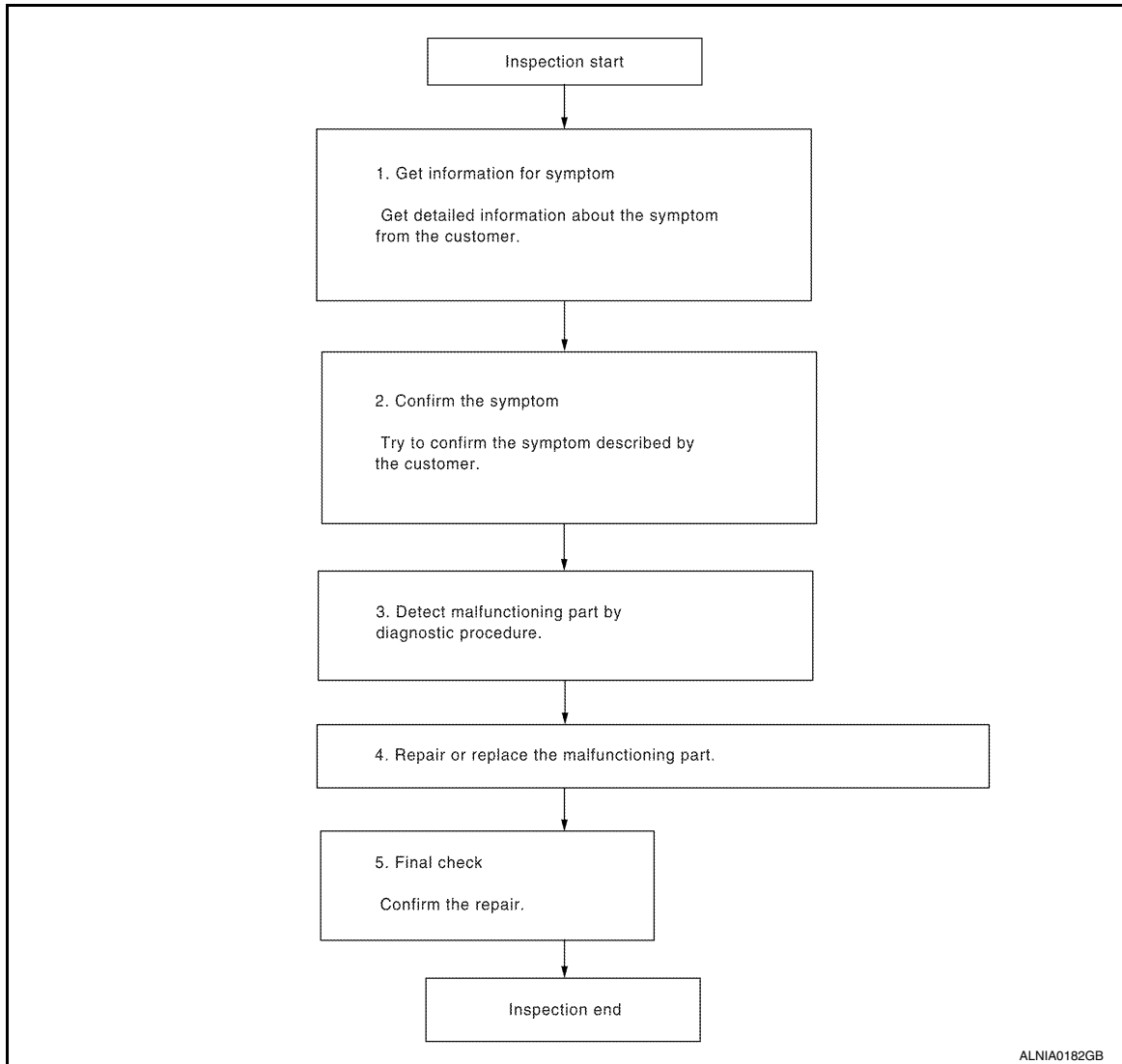

DETAILED FLOW

1.GET INFORMATION FOR SYMPTOM

Get detailed information from the customer about the symptom (the condition and the environment when the incident/malfunction occurred).

>> GO TO 2.

2.CONFIRM THE SYMPTOM

Try to confirm the symptom described by the customer. Verify relation between the symptom and the condition when the symptom is detected.

>> GO TO 3.

3.DETECT MALFUNCTIONING PART BY DIAGNOSTIC PROCEDURE

Inspect according to Diagnostic Procedure of the system.

DIAGNOSIS AND REPAIR WORKFLOW

< BASIC INSPECTION >

[AUDIO W/O NAVI (EXCEPT MEXICO)]

Is malfunctioning part detected?

YES >> GO TO 4.

NO >> GO TO 2.

4.REPAIR OR REPLACE THE MALFUNCTIONING PART

1. Repair or replace the malfunctioning part.
2. Reconnect parts or connectors disconnected during Diagnostic Procedure.

>> GO TO 5.

5.FINAL CHECK

Refer to confirmed symptom in step 2, and make sure that the symptom is not detected.

Was the repair confirmed?

YES >> Inspection End.

NO >> GO TO 2.

A

B

C

D

E

F

G

H

I

J

K

L

M

AV

O

P

POWER SUPPLY AND GROUND CIRCUIT

< DTC/CIRCUIT DIAGNOSIS >

[AUDIO W/O NAVI (EXCEPT MEXICO)]

DTC/CIRCUIT DIAGNOSIS

POWER SUPPLY AND GROUND CIRCUIT AUDIO UNIT

AUDIO UNIT : Diagnosis Procedure

INFOID:000000010641700

Regarding Wiring Diagram information, refer to [AV-33, "Wiring Diagram"](#).

1.CHECK FUSE

Check that the following fuses are not blown.

Terminal No.	Signal name	Fuse No.
7	ACC power supply	19 (10A)
19	Battery power supply	34 (20A)

Are the fuses blown?

- YES >> Replace the blown fuse after repairing the affected circuit.
NO >> GO TO 2.

2.CHECK POWER SUPPLY CIRCUIT

1. Turn power switch OFF.
2. Disconnect audio unit connector M83.
3. Check voltage between audio unit connector M83 and ground.

Audio unit		Ground	Condition	Voltage (Approx.)
Connector	Terminal			
M83	7	—	Power switch: ON	Battery voltage
	19		Power switch: OFF	

Is the inspection result normal?

- YES >> GO TO 3.
NO >> Repair or replace harness or connectors.

3.CHECK GROUND CIRCUIT

1. Turn power switch OFF.
2. Disconnect audio unit connector M84.
3. Check continuity between audio unit connectors and ground.

Audio unit		Ground	Continuity
Connector	Terminal		
M83	20	—	Yes
M84	45		
	48		

Is the inspection result normal?

- YES >> Inspection End.
NO >> Repair or replace harness or connectors.

BLUETOOTH® CONTROL UNIT

BLUETOOTH® CONTROL UNIT : Diagnosis Procedure

INFOID:000000010641701

Regarding Wiring Diagram information, refer to [AV-33, "Wiring Diagram"](#).

POWER SUPPLY AND GROUND CIRCUIT

< DTC/CIRCUIT DIAGNOSIS >

[AUDIO W/O NAVI (EXCEPT MEXICO)]

1. CHECK FUSE

Check that the following fuses are not blown.

Terminal No.	Signal name	Fuse No.
1	Battery power supply	34 (20A)
2	ACC power supply	19 (10A)
3	Power signal	3 (10A)

Are the fuses blown?

YES >> Replace the blown fuse after repairing the affected circuit.

NO >> GO TO 2.

2. CHECK POWER SUPPLY CIRCUIT

1. Turn power switch OFF.
2. Disconnect Bluetooth® control unit connector B9.
3. Check voltage between Bluetooth® control unit connector B9 and ground.

Bluetooth® control unit		Ground	Condition	Voltage (Approx.)
Connector	Terminal			
B9	1	—	Power switch: OFF	Battery voltage
	2		Power switch: ACC	
	3		Power switch: ON	

Is the inspection result normal?

YES >> GO TO 3.

NO >> Repair or replace harness or connectors.

3. CHECK GROUND CIRCUIT

1. Turn power switch OFF.
2. Check continuity between Bluetooth® control unit connector B9 and ground.

Bluetooth® control unit		Ground	Continuity
Connector	Terminal		
B9	4	—	Yes
	24		
	27		

Is the inspection result normal?

YES >> Inspection End.

NO >> Repair or replace harness or connectors.

A
B
C
D
E
F
G
H
I
J
K
L
M
O
P

AV

FRONT DOOR SPEAKER

< DTC/CIRCUIT DIAGNOSIS >

[AUDIO W/O NAVI (EXCEPT MEXICO)]

FRONT DOOR SPEAKER

Diagnosis Procedure

INFOID:000000010641702

Regarding Wiring Diagram information, refer to [AV-33. "Wiring Diagram"](#).

1. CONNECTOR CHECK

Check the audio unit and speaker connectors for the following:

- Proper connection
- Damage
- Disconnected or loose terminals

Is the inspection result normal?

YES >> GO TO 2.

NO >> Repair the terminals or connectors.

2. CHECK FRONT DOOR SPEAKER SIGNAL CIRCUIT CONTINUITY

1. Disconnect audio unit connector M83 and suspect front door speaker connector.
2. Check continuity between audio unit connector M83 and suspect front door speaker connector.

Audio unit		Front door speaker		Continuity
Connector	Terminal	Connector	Terminal	
M83	2	D23 (LH)	1	Yes
	3		2	
	11	D123 (RH)	1	
	12		2	

3. Check continuity between audio unit connector M83 and ground.

Audio unit		Ground	Continuity
Connector	Terminal		
M83	2	—	No
	3		
	11		
	12		

Is the inspection result normal?

YES >> GO TO 3.

NO >> Repair or replace harness or connectors.

3. CHECK FRONT DOOR SPEAKER SIGNAL

1. Connect audio unit connector M83 and suspect front door speaker connector.
2. Turn power switch to ACC.
3. Push audio unit POWER switch.
4. Check signal between the terminals of audio unit connector M83.

Audio unit connector M83		Condition	Reference value
(+)	(-)		
Terminal	Terminal		

FRONT DOOR SPEAKER

< DTC/CIRCUIT DIAGNOSIS >

[AUDIO W/O NAVI (EXCEPT MEXICO)]

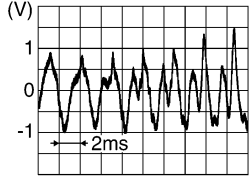
2	3	Audio signal output	
11	12		

Is the inspection result normal?

- YES >> Replace front door speaker. Refer to [AV-70. "Removal and Installation"](#).
- NO >> Replace audio unit. Refer to [AV-69. "Removal and Installation"](#).

A
B
C
D
E
F
G
H
I
J
K
L
M
N
O
P

AV

REAR DOOR SPEAKER

[AUDIO W/O NAVI (EXCEPT MEXICO)]

< DTC/CIRCUIT DIAGNOSIS >

REAR DOOR SPEAKER

Diagnosis Procedure

INFOID:000000010641703

Regarding Wiring Diagram information, refer to [AV-33. "Wiring Diagram"](#).

1. CONNECTOR CHECK

Check the audio unit and speaker connectors for the following:

- Proper connection
- Damage
- Disconnected or loose terminals

Is the inspection result normal?

YES >> GO TO 2.

NO >> Repair the terminals or connectors.

2. CHECK REAR DOOR SPEAKER SIGNAL CIRCUIT CONTINUITY

1. Disconnect audio unit connector M83 and suspect rear door speaker connector.
2. Check continuity between audio unit connector M83 and suspect rear door speaker connector.

Audio unit		Rear speaker		Continuity
Connector	Terminal	Connector	Terminal	
M83	4	D205 (LH)	1	Yes
	5		2	
	13	D305 (RH)	1	
	14		2	

3. Check continuity between audio unit connector M83 and ground.

Audio unit		Ground	Continuity
Connector	Terminal		
M83	4	—	No
	5		
	13		
	14		

Is the inspection result normal?

YES >> GO TO 3.

NO >> Repair or replace harness or connectors.

3. CHECK REAR DOOR SPEAKER SIGNAL

1. Connect audio unit connector M83 and suspect rear door speaker connector.
2. Turn power switch to ACC.
3. Push audio unit POWER switch.
4. Check signal between the terminals of audio unit connector M83.

Audio unit connector M83		Condition	Reference value
(+)	(-)		
Terminal	Terminal		

REAR DOOR SPEAKER

< DTC/CIRCUIT DIAGNOSIS >

[AUDIO W/O NAVI (EXCEPT MEXICO)]

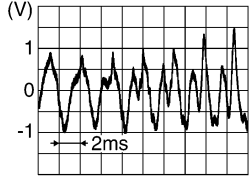
4	5	Audio signal output	
13	14		

Is the inspection result normal?

- YES >> Replace rear door speaker. Refer to [AV-71. "Removal and Installation"](#).
- NO >> Replace audio unit. Refer to [AV-69. "Removal and Installation"](#).

A
B
C
D
E
F
G
H
I
J
K
L
M
O
P

AV

CAMERA IMAGE SIGNAL CIRCUIT

< DTC/CIRCUIT DIAGNOSIS >

[AUDIO W/O NAVI (EXCEPT MEXICO)]

CAMERA IMAGE SIGNAL CIRCUIT

Diagnosis Procedure

INFOID:000000010641704

Regarding Wiring Diagram information, refer to [AV-33. "Wiring Diagram"](#).

1. CHECK REVERSE INPUT SIGNAL

1. Turn power switch ON.
2. Shift the selector lever to R (reverse).
3. Check voltage between audio unit connector M84 and ground.

Audio unit		Ground	Condition	Voltage (Approx.)
(+)		(-)		
Connector	Terminal			
M84	50	—	Selector lever in R (reverse)	Battery Voltage

Is inspection result normal?

YES >> GO TO 2.

NO >> Repair or replace harness or connectors.

2. CHECK CAMERA POWER SUPPLY CIRCUIT CONTINUITY

1. Turn power switch OFF.
2. Disconnect audio unit connector M84 and rear view camera connector.
3. Check continuity between audio unit connector M84 and rear view camera connector D556.

Audio unit		Rear view camera		Continuity
Connector	Terminal	Connector	Terminal	
M84	34	D556	1	Yes

4. Check continuity between audio unit connector M84 and ground.

Audio unit		Ground	Continuity
Connector	Terminal		
M84	34		No

Is inspection result normal?

YES >> GO TO 3.

NO >> Repair or replace harness or connectors.

3. CHECK CAMERA POWER SUPPLY VOLTAGE

1. Connect audio unit connector M84 and rear view camera connector.
2. Turn power switch ON.
3. Shift the selector lever to "R".
4. Check voltage between audio unit connector M84 and ground.

Audio unit		Ground	Condition	Voltage (Approx.)
(+)		(-)		
Connector	Terminal			
M84	34	—	Selector lever is in "R".	6.0 V

Is inspection result normal?

YES >> GO TO 4.

NO >> Replace audio unit. Refer to [AV-69. "Removal and Installation"](#).

CAMERA IMAGE SIGNAL CIRCUIT

< DTC/CIRCUIT DIAGNOSIS >

[AUDIO W/O NAVI (EXCEPT MEXICO)]

4. CHECK CAMERA IMAGE SIGNAL CIRCUIT CONTINUITY

1. Turn power switch OFF.
2. Disconnect audio unit connector M84 and rear view camera connector.
3. Check continuity between audio unit connector M84 and rear view camera connector D556.

Audio unit		Rear view camera		Continuity
Connector	Terminal	Connector	Terminal	
M84	35	D556	3	Yes

4. Check continuity between audio unit connector M84 and ground.

Audio unit		Ground	Continuity
Connector	Terminal		
M84	35		No

Is inspection result normal?

- YES >> GO TO 5.
 NO >> Repair or replace harness or connectors.

5. CHECK CAMERA GROUND CIRCUIT CONTINUITY

Check continuity between audio unit connector M84 and rear view camera connector D556.

Audio unit		Rear view camera		Continuity
Connector	Terminal	Connector	Terminal	
M84	33	D556	2	Yes

Is inspection result normal?

- YES >> GO TO 6.
 NO >> Repair or replace harness or connectors.

6. CHECK CAMERA IMAGE SIGNAL

1. Connect audio unit connector M84 and rear view camera connector.
2. Turn power switch ON.
3. Shift the selector lever to "R".
4. Check signal between audio unit connector M84 and ground.

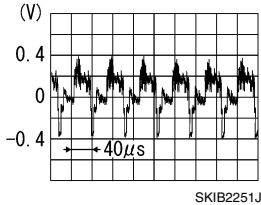
Audio unit		Ground	Condition	Reference value
(+)		(-)		
Connector	Terminal			
M84	35	—	Camera image displayed.	

Is inspection result normal?

- YES >> Replace audio unit. Refer to [AV-69, "Removal and Installation"](#).
 NO >> Replace rear view camera. Refer to [AV-77, "Removal and Installation"](#).

BLUETOOTH® VOICE SIGNAL CIRCUIT

< DTC/CIRCUIT DIAGNOSIS >

[AUDIO W/O NAVI (EXCEPT MEXICO)]

BLUETOOTH® VOICE SIGNAL CIRCUIT

Diagnosis Procedure

INFOID:000000010641705

Regarding Wiring Diagram information, refer to [AV-33. "Wiring Diagram"](#).

1. CHECK BLUETOOTH® VOICE SIGNAL CIRCUIT CONTINUITY

1. Turn power switch OFF.
2. Disconnect audio unit connector M84 and Bluetooth® control unit connector B9.
3. Check continuity between audio unit connector M84 and Bluetooth® control unit connector B9.

Audio unit		Bluetooth® control unit		Continuity
Connector	Terminal	Connector	Terminal	
M84	25	B9	9	Yes

4. Check continuity between audio unit connector M84 and ground.

Audio unit		Ground	Continuity
Connector	Terminal		
M84	25	—	No

Is inspection result normal?

YES >> GO TO 2.

NO >> Repair or replace harness or connectors.

2. CHECK BLUETOOTH® VOICE SIGNAL GROUND CIRCUIT CONTINUITY

Check continuity between audio unit connector M84 and Bluetooth® control unit connector B9.

Audio unit		Bluetooth® control unit		Continuity
Connector	Terminal	Connector	Terminal	
M84	24	B9	10	Yes

Is inspection result normal?

YES >> GO TO 3.

NO >> Repair or replace harness or connectors.

3. CHECK BLUETOOTH® VOICE SIGNAL

1. Connect audio unit connector M84 and Bluetooth® control unit connector B9.
2. Turn power switch to ACC.
3. Press  switch.
4. Check signal between the terminals of audio unit connector M84.

BLUETOOTH® VOICE SIGNAL CIRCUIT

< DTC/CIRCUIT DIAGNOSIS >

[AUDIO W/O NAVI (EXCEPT MEXICO)]

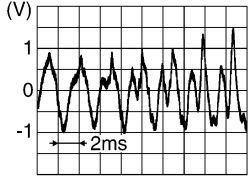
Audio unit connector M84		Condition	Reference value
(+) Terminal	(-) Terminal		
25	24	During voice guide output with  switch pressed.	 <p style="text-align: right; font-size: small;">SKIB3609E</p>

Is the inspection result normal?

- YES >> Replace Bluetooth® control unit. Refer to [AV-73. "Removal and Installation"](#).
- NO >> Replace audio unit. Refer to [AV-69. "Removal and Installation"](#).

A
B
C
D
E
F
G
H
I
J
K
L
M
O
P

AV

BLUETOOTH® CONTROL SIGNAL CIRCUIT

< DTC/CIRCUIT DIAGNOSIS >

[AUDIO W/O NAVI (EXCEPT MEXICO)]

BLUETOOTH® CONTROL SIGNAL CIRCUIT

Diagnosis Procedure

INFOID:000000010641706

Regarding Wiring Diagram information, refer to [AV-33. "Wiring Diagram"](#).

1. CHECK CONTROL SIGNAL CIRCUIT CONTINUITY

1. Turn power switch OFF.
2. Disconnect Bluetooth® control unit connector B9.
3. Check continuity between Bluetooth® control unit connector B9 and ground.

Bluetooth® control unit		Ground	Continuity
Connector	Terminals		
B9	24	—	Yes
	27		

Is the inspection result normal?

- YES >> Replace Bluetooth® control unit. Refer to [AV-73. "Removal and Installation"](#).
NO >> Repair or replace harness or connectors.

MICROPHONE SIGNAL CIRCUIT

< DTC/CIRCUIT DIAGNOSIS >

[AUDIO W/O NAVI (EXCEPT MEXICO)]

MICROPHONE SIGNAL CIRCUIT

Diagnosis Procedure

INFOID:000000010641707

Regarding Wiring Diagram information, refer to [AV-33. "Wiring Diagram"](#).

1. CHECK HARNESS BETWEEN BLUETOOTH® CONTROL UNIT AND MICROPHONE

1. Turn power switch OFF.
2. Disconnect Bluetooth® control unit connector B9 and microphone connector R3.
3. Check continuity between Bluetooth® control unit connector B9 and microphone connector R3.

Bluetooth® control unit		Microphone		Continuity
Connector	Terminal	Connector	Terminal	
B9	7	R3	1	Yes
	8		2	
	29		4	

4. Check continuity between Bluetooth® control unit connector B9 and ground.

Bluetooth® control unit		Ground	Continuity
Connector	Terminal		
B9	7	—	No
	29		

Is the inspection result normal?

YES >> GO TO 2.

NO >> Repair harness or connectors.

2. CHECK MICROPHONE POWER SUPPLY

1. Connect Bluetooth® control unit connector B9 and microphone connector R3.
2. Turn power switch ON.
3. Check voltage between microphone connector R3 and ground.

Microphone		Ground	Voltage (Approx.)
(+)			
Connector	Terminal		
R3	4	—	5V

Is the inspection result normal?

YES >> GO TO 3.

NO >> Replace Bluetooth® control unit. Refer to [AV-73. "Removal and Installation"](#).

3. CHECK MICROPHONE SIGNAL

Check signal between terminals of Bluetooth® control unit connector B9.

MICROPHONE SIGNAL CIRCUIT

< DTC/CIRCUIT DIAGNOSIS >

[AUDIO W/O NAVI (EXCEPT MEXICO)]

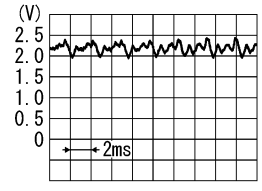
Bluetooth® control unit connector B9		Condition	Reference value
(+)	(-)		
Terminal	Terminal		
7	8	Speak into microphone.	 <p style="text-align: right; font-size: small;">PKIB5037J</p>

Is the inspection result normal?

YES >> Replace Bluetooth® control unit. Refer to [AV-73. "Removal and Installation"](#).

NO >> Replace microphone. Refer to [AV-72. "Removal and Installation"](#).

STEERING SWITCH

< DTC/CIRCUIT DIAGNOSIS >

[AUDIO W/O NAVI (EXCEPT MEXICO)]

STEERING SWITCH





Diagnosis Procedure

INFOID:000000010641708

Regarding Wiring Diagram information, refer to [AV-33. "Wiring Diagram"](#).

1. CHECK STEERING WHEEL AUDIO CONTROL SWITCH RESISTANCE

1. Turn power switch OFF.
2. Disconnect combination switch connector M112.
3. Check resistance between the terminals of combination switch connector M112.

Combination switch connector M112		Condition	Resistance Ω (Approx.)
Terminal	Terminal		
14	17	Depress SOURCE switch.	1
		Depress Δ switch.	121
		Depress ∇ switch.	321
		Depress  switch.	723
15	17	Depress -  switch.	1
		Depress  + switch.	121
		Depress  switch.	321

Is the inspection result normal?

YES >> GO TO 2.

NO >> Replace steering switches. Refer to [AV-75. "Removal and Installation"](#).

2. CHECK HARNESS BETWEEN BLUETOOTH® CONTROL UNIT AND COMBINATION SWITCH

1. Disconnect Bluetooth® control unit connector B9 and combination switch connector M92.
2. Check continuity between Bluetooth® control unit connector B9 and combination switch connector M92.

Bluetooth® control unit		Combination switch		Continuity
Connector	Terminal	Connector	Terminal	
B9	12	M92	24	Yes
	13		31	
	14		33	

3. Check continuity between Bluetooth® control unit connector B9 and ground.

Bluetooth® control unit		Ground	Continuity
Connector	Terminal		
B9	12	—	No
	13		
	14		

Is the inspection result normal?

YES >> GO TO 3.

NO >> Repair or replace harness or connectors.

STEERING SWITCH

< DTC/CIRCUIT DIAGNOSIS >

[AUDIO W/O NAVI (EXCEPT MEXICO)]

3. CHECK COMBINATION SWITCH

Check continuity between combination switch connectors M112 and M92.

Combination switch				Continuity
Connector	Terminal	Connector	Terminal	
M112	14	M92	24	Yes
	15		31	
	17		33	

Is the inspection result normal?

YES >> GO TO 4.

NO >> Replace spiral cable. Refer to [SR-23, "Removal and Installation"](#).

4. CHECK HARNESS BETWEEN BLUETOOTH® CONTROL UNIT AND AUDIO UNIT

1. Disconnect audio unit connector M83.
2. Check continuity between Bluetooth® control unit connector B9 and audio unit connector M83.

Bluetooth® control unit		Audio unit		Continuity
Connector	Terminal	Connector	Terminal	
B9	17	M83	6	Yes
	18		16	
	19		15	

3. Check continuity between Bluetooth® control unit connector B9 and ground.

Bluetooth® control unit		Ground	Continuity
Connector	Terminal		
B9	17	—	No
	18		
	19		

Is the inspection result normal?

YES >> Replace audio unit. Refer to [AV-69, "Removal and Installation"](#).

NO >> Repair or replace harness or connectors.

USB CONNECTOR

< DTC/CIRCUIT DIAGNOSIS >

[AUDIO W/O NAVI (EXCEPT MEXICO)]

USB CONNECTOR

Diagnosis Procedure

INFOID:000000010641709

Regarding Wiring Diagram information, refer to [AV-33, "Wiring Diagram"](#).

1. CHECK USB HARNESS CONTINUITY

1. Turn power switch OFF.
2. Disconnect audio unit connector M85 and USB connector M53.
3. Check continuity between audio unit connector M85 and USB connector M53.

Audio unit		USB		Continuity
Connector	Terminal	Connector	Terminal	
M85	53	M53	2	Yes
	54		1	
	55		4	
	56		3	
	57		5	

4. Check continuity between audio unit connector M85 and ground.

Audio unit		—	Continuity
Connector	Terminal		
M85	53	Ground	No
	55		

Is the inspection result normal?

- YES >> Replace the USB connector. Refer to [AV-76, "Removal and Installation"](#).
NO >> Repair or replace harness or connectors.

A
B
C
D
E
F
G
H
I
J
K
L
M
O
P

AV

AUDIO SYSTEM

< SYMPTOM DIAGNOSIS >

[AUDIO W/O NAVI (EXCEPT MEXICO)]

SYMPTOM DIAGNOSIS

AUDIO SYSTEM

Symptom Table

INFOID:000000010641710

RELATED TO AUDIO

Symptoms	Check items	Probable malfunction location
The disk cannot be removed.	Audio unit	Malfunction in audio unit. Refer to AV-22. "On Board Diagnosis Function" .
No sound comes out or the level of the sound is low.	No sound from all speakers.	<ul style="list-style-type: none"> • Speaker circuit shorted to ground. Refer to AV-33. "Wiring Diagram". • Audio unit power supply and ground circuits malfunction. Refer to AV-48. "AUDIO UNIT : Diagnosis Procedure".
	Only a certain speaker (front door speaker LH, front door speaker RH, rear door speaker LH, rear door speaker RH) does not output sound.	<ul style="list-style-type: none"> • Poor connector connection of speaker. • Sound signal circuit malfunction between audio unit and speaker. Refer to: <ul style="list-style-type: none"> - AV-50. "Diagnosis Procedure" (front door speaker). - AV-52. "Diagnosis Procedure" (rear door speaker). • Malfunction in speaker. Refer to: <ul style="list-style-type: none"> - AV-70. "Removal and Installation" (front door speaker). - AV-71. "Removal and Installation" (rear door speaker). • Malfunction in audio unit. Refer to AV-22. "On Board Diagnosis Function".
Noise is mixed with audio.	Noise comes out from all speakers.	Malfunction in audio unit. Refer to AV-22. "On Board Diagnosis Function" .
	Noise comes out only from a certain speaker (front door speaker LH, front door speaker RH, rear door speaker LH, rear door speaker RH).	<ul style="list-style-type: none"> • Poor connector connection of speaker. • Sound signal circuit malfunction between audio unit and speaker. Refer to: <ul style="list-style-type: none"> - AV-50. "Diagnosis Procedure" (front door speaker). - AV-52. "Diagnosis Procedure" (rear door speaker). • Malfunction in speaker. • Poor Installation of speaker (e.g. backlash and looseness). Refer to: <ul style="list-style-type: none"> - AV-70. "Removal and Installation" (front door speaker). - AV-71. "Removal and Installation" (rear door speaker). • Malfunction in audio unit. Refer to AV-22. "On Board Diagnosis Function".
	Noise is mixed with radio only (when the vehicle hits a bump or while driving over bad roads)	Poor connector connection of antenna or antenna feeder.

AUDIO SYSTEM

< SYMPTOM DIAGNOSIS >

[AUDIO W/O NAVI (EXCEPT MEXICO)]

Symptoms	Check items	Probable malfunction location
No radio reception or poor reception.	<ul style="list-style-type: none"> • Other audio sounds are normal. • Any radio station cannot be received or poor reception is caused even after moving to a service area with good reception (e.g. a place with clear view and no obstacles generating external noises). 	Poor connector connection of antenna or antenna feeder.
No satellite radio reception.	Satellite radio antenna malfunction.	<ul style="list-style-type: none"> • Poor continuity in antenna feeder. • Poor connector connection of antenna or antenna feeder. • Loose satellite radio antenna mounting nut.
Buzz/rattle sound from speaker	The majority of buzz/rattle sounds are not indicative of an issue with the speaker, usually something nearby the speaker is causing the buzz/rattle.	Refer to "SQUEAK AND RATTLE TROUBLE DIAGNOSIS" in the appropriate interior trim section.

RELATED TO HANDS-FREE PHONE

- Before performing diagnosis, confirm that the cellular phone being used by the customer is compatible with the vehicle.
- It is possible that a malfunction is occurring due to a version change of the phone even though the phone is a compatible type. This can be confirmed by changing the cellular phone to another compatible type, and check that it operates normally. It is important to determine whether the cause of the malfunction is the vehicle or the cellular phone.

Check Compatibility

1. Make sure the customer's Bluetooth® related concern is understood.
2. Verify the customer's concern.
 - NOTE:**
The customer's phone may be required, depending upon their concern.
3. Write down the customer's phone brand, model and service provider.
 - NOTE:**
It is necessary to know the service provider. On occasion, a given phone may be on the approved list with one provider, but may not be on the approved list with other providers.
4. Go to "www.nissanusa.com/bluetooth/".
 - a. Using the website's search engine, find out if the customer's phone is on the approved list.
 - b. If the customer's phone is NOT on the approved list:
Stop diagnosis here. The customer needs to obtain a Bluetooth® phone that is on the approved list before any further action.
 - c. If the feature related to the customer's concern shows as "N" (not compatible):
Stop diagnosis here. If the customer still wants the feature to function, they will need to get an approved phone showing the feature as "Y" (compatible) in the "Basic Features".
 - d. If the feature related to the customer's concern shows as "Y" (compatible):
Perform diagnosis as per the following table.

A
B
C
D
E
F
G
H
I
J
K
L
M







AV

O
P

AUDIO SYSTEM

< SYMPTOM DIAGNOSIS >

[AUDIO W/O NAVI (EXCEPT MEXICO)]

Symptoms	Check items	Probable malfunction location
Does not recognize cellular phone connection (no connection is displayed on the display at the guide).	Repeat the registration of cellular phone.	
Hands-free phone cannot be established.	<ul style="list-style-type: none"> • Hands-free phone operation can be made, but the communication cannot be established. • Hands-free phone operation can be performed, however, voice between each other cannot be heard during the conversation. 	Malfunction in audio unit. Replace audio unit. Refer to AV-69, "Removal and Installation" .
The other party's voice cannot be heard by hands-free phone.	Check the "microphone speaker" in Inspection & Adjustment Mode if sound is heard.	
Originating sound is not heard by the other party with hands-free phone communication.	Sound operation function is normal.	
	Sound operation function does not work.	Microphone signal circuit malfunction. Refer to AV-59, "Diagnosis Procedure" .
The system cannot be operated.	<ul style="list-style-type: none"> • The voice recognition can be controlled. • Steering switch's  and  switch works, but  does not work. 	Steering switch malfunction. Replace steering switch. Refer to AV-75, "Removal and Installation" .
	Steering switch's  ,  and  , switches do not work.	Steering switch signal circuit malfunction. Refer to AV-61, "Diagnosis Procedure" .
	All steering switches do not work.	Steering switch ground circuit malfunction. Refer to AV-75, "Removal and Installation" .

RELATED TO REAR VIEW CAMERA

Symptoms	Check items	Probable malfunction location
Rear view camera is inoperative.	Reverse signal circuit malfunction.	Reverse signal circuit malfunction between reverse lamp relay and audio unit. Refer to AV-54, "Diagnosis Procedure" .
	Camera image signal circuit malfunction.	Camera image signal circuit malfunction between rear view camera and audio unit. Refer to AV-54, "Diagnosis Procedure" .
	Rear view camera malfunction.	Replace rear view camera. Refer to AV-77, "Removal and Installation" .

NORMAL OPERATING CONDITION

< SYMPTOM DIAGNOSIS >

[AUDIO W/O NAVI (EXCEPT MEXICO)]

NORMAL OPERATING CONDITION

Description

INFOID:0000000010641711

RELATED TO NOISE

The majority of the audio concerns are the result of outside causes (bad CD, electromagnetic interference, etc.).

The following noise results from variations in field strength, such as fading noise and multi-path noise, or external noise from trains and other sources. It is not a malfunction.

- Fading noise: This noise occurs because of variations in the field strength in a narrow range due to mountains or buildings blocking the signal.
- Multi-path noise: This noise results from the waves sent directly from the broadcast station arriving at the antenna at a different time from the waves which reflect off mountains or buildings.

The vehicle itself can be a source of noise if noise prevention parts or electrical equipment is malfunctioning. Check if noise is caused and/or changed by engine speed, power switch turned to each position, and operation of each piece of electrical equipment, and determine the cause.

NOTE:

The source of the noise can be found easily by listening to the noise while removing the fuses of electrical components, one by one.

Type of Noise and Possible Cause

Occurrence condition		Possible cause
Occurs only when engine is ON.	A continuous growling noise occurs. The speed of the noise varies with changes in the engine speed.	<ul style="list-style-type: none"> • Power components
The occurrence of the noise is linked with the operation of the fuel pump.		<ul style="list-style-type: none"> • Fuel pump condenser
Noise only occurs when various electrical components are operating.	A cracking or snapping sound occurs with the operation of various switches.	<ul style="list-style-type: none"> • Relay malfunction, audio unit malfunction
	The noise occurs when various motors are operating.	<ul style="list-style-type: none"> • Motor case ground • Motor
The noise occurs constantly, not just under certain conditions.		<ul style="list-style-type: none"> • Rear defogger coil malfunction • Open circuit in printed heater • Poor ground of antenna feeder line
A cracking or snapping sound occurs while the vehicle is being driven, especially when it is vibrating excessively.		<ul style="list-style-type: none"> • Ground wire of body parts • Ground due to improper part installation • Wiring connections or a short circuit

RELATED TO HANDS-FREE PHONE

Symptom	Cause and Counter measure
Does not recognize cellular phone connection (No connection is displayed on the display at the guide).	<p>Some Bluetooth® enabled cellular phones may not be recognized by the in-vehicle phone module.</p> <p>Refer to "RELATED TO HANDS-FREE PHONE (Check Compatibility)" in AV-64, "Symptom Table".</p>
Cannot use hands-free phone.	<p>Customer will not be able to use a hands-free phone under the following conditions:</p> <ul style="list-style-type: none"> • The vehicle is outside of the telephone service area. • The vehicle is in an area where it is difficult to receive radio waves; such as in a tunnel, in an underground parking garage, near a tall building or in a mountainous area. • The cellular phone is locked to prevent it from being dialed. <p>NOTE:</p> <p>While a cellular phone is connected through the Bluetooth® wireless connection, the battery power of the cellular phone may discharge quicker than usual. The Bluetooth® Hands-Free Phone System cannot charge cellular phones.</p>

NORMAL OPERATING CONDITION

< SYMPTOM DIAGNOSIS >

[AUDIO W/O NAVI (EXCEPT MEXICO)]

Symptom	Cause and Counter measure
The other party's voice cannot be heard by hands-free phone.	When the radio wave condition is not ideal or ambient sound is too loud, it may be difficult to hear the other person's voice during a call.
Poor sound quality.	Do not place the cellular phone in an area surrounded by metal or far away from the in-vehicle phone module to prevent tone quality degradation and wireless connection disruption.

REMOVAL AND INSTALLATION

AUDIO UNIT

Removal and Installation

INFOID:0000000010641712

REMOVAL

1. Disconnect the 12V negative battery terminal. Refer to [PG-82. "Removal and Installation"](#).
2. Remove cluster lid C. Refer to [IP-17. "Removal and Installation"](#).
3. Remove the audio unit screws, disconnect the harness connectors from the audio unit and remove with the brackets attached.
4. Remove the bracket screws and the brackets from audio unit (if necessary).

INSTALLATION

Note the following, and install in the reverse order of removal.

CAUTION:

- If the audio unit is replaced, input of the user ID and password and time adjustment with VCM are required.
- If the audio unit is not replaced, time adjustment with VCM is required.

Input Method of User ID and Password:

1. Turn power switch ON.
2. Select "Sign in" from the CARWINGS screen.
3. Enter the user ID and password.

NOTE:

Since the user ID and password are determined by the user in advance, they are input by the user.

Time Adjustment and Check Method with VCM

Refer to [AV-46. "Work Flow"](#).

A
B
C
D
E
F
G
H
I
J
K
L
M
O
P

AV

FRONT DOOR SPEAKER

< REMOVAL AND INSTALLATION >

[AUDIO W/O NAVI (EXCEPT MEXICO)]

FRONT DOOR SPEAKER

Removal and Installation

INFOID:000000010641713

REMOVAL

1. Remove the front door finisher. Refer to [INT-19, "Removal and Installation"](#).
2. Remove the screws and disconnect the connector to remove the front door speaker.

INSTALLATION

Install in the reverse order of removal.

REAR DOOR SPEAKER

< REMOVAL AND INSTALLATION >

[AUDIO W/O NAVI (EXCEPT MEXICO)]

REAR DOOR SPEAKER

Removal and Installation

INFOID:000000010641714

REMOVAL

1. Remove the rear door finisher. Refer to [INT-22. "Removal and Installation"](#).
2. Remove the screws and disconnect the connector to remove the rear door speaker.

INSTALLATION

Install in the reverse order of removal.

A

B

C

D

E

F

G

H

I

J

K

L

M

AV

O

P

MICROPHONE

< REMOVAL AND INSTALLATION >

[AUDIO W/O NAVI (EXCEPT MEXICO)]

MICROPHONE

Removal and Installation

INFOID:000000010641715

REMOVAL

1. Remove the map lamp assembly. Refer to [INL-53. "Removal and Installation"](#).
2. Press the pawl to remove the microphone (1) from the map lamp assembly (2).

CAUTION:

Use care when handling the microphone pawl to avoid damaging.

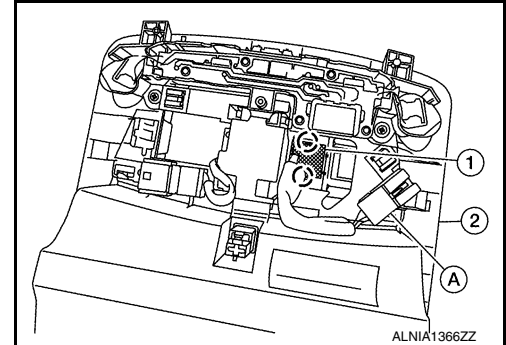

INSTALLATION

Install in the reverse order of removal.

NOTE:

Check the microphone for looseness after the installation.

BLUETOOTH® CONTROL UNIT

< REMOVAL AND INSTALLATION >

[AUDIO W/O NAVI (EXCEPT MEXICO)]

BLUETOOTH® CONTROL UNIT

Removal and Installation

INFOID:000000010641716

REMOVAL

1. Remove the luggage side lower finisher (RH). Refer to [INT-42, "LUGGAGE SIDE LOWER FINISHER : Removal and Installation"](#).
2. Remove the four Bluetooth® control unit nuts (A).

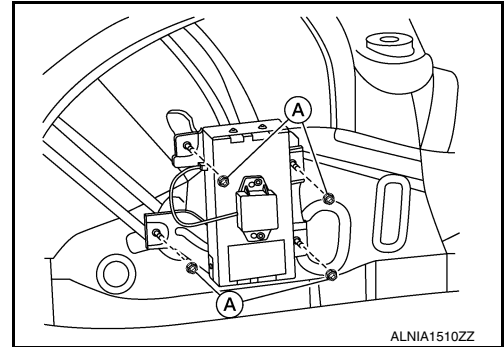

3. Disconnect the harness connectors from the Bluetooth® control unit and remove.
4. Remove the Bluetooth® control unit bracket screws and the brackets (1, 3) from the Bluetooth® control unit (2).

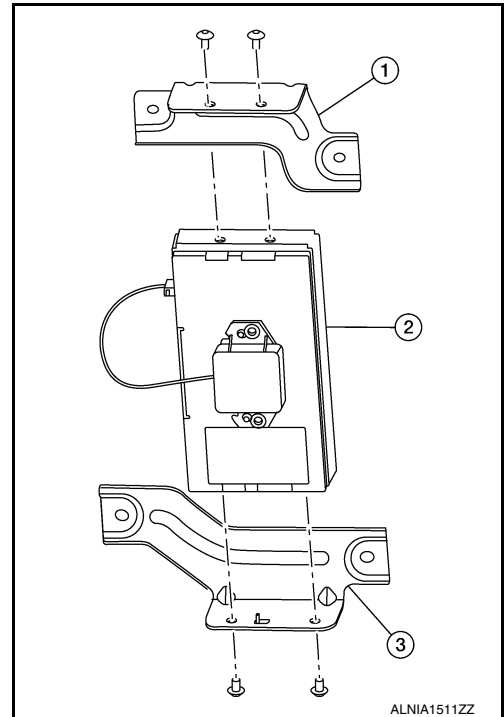

INSTALLATION

Install in the reverse order of removal.

A
B
C
D
E
F
G
H
I
J
K
L
M
AV
O
P

ANTENNA BASE

< REMOVAL AND INSTALLATION >

[AUDIO W/O NAVI (EXCEPT MEXICO)]

ANTENNA BASE

Removal and Installation

INFOID:000000010641717

REMOVAL

1. Partially remove the headlining (rear side) to obtain space to work between vehicle and headlining. Refer to [INT-37, "Removal and Installation"](#).
2. Disconnect the antenna feeder connector.
3. Remove the nut and the antenna base (2) from the vehicle.
(1): Antenna rod

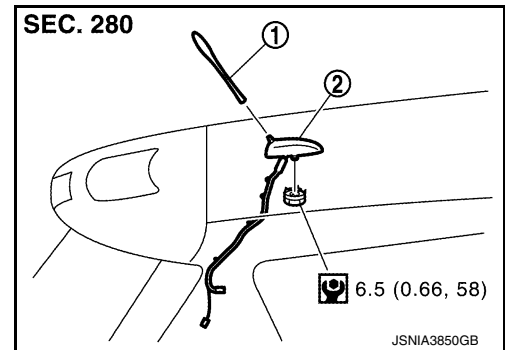

INSTALLATION

Install in the reverse order of removal.

CAUTION:

- Do not bend headlining when pulling down.
- Tighten the antenna base nut to specification.
- If the antenna base nut is less than the specified torque, it could affect the performance of the antenna sensitivity.
- If the antenna base nut is greater than the specified torque, it could damage the roof panel.

STEERING SWITCH

< REMOVAL AND INSTALLATION >

[AUDIO W/O NAVI (EXCEPT MEXICO)]

STEERING SWITCH

Exploded View

INFOID:000000010641718

Refer to [SR-20, "Exploded View"](#).

Removal and Installation

INFOID:000000010641719

REMOVAL

Refer to [SR-20, "Removal and Installation"](#).

INSTALLATION

Install in the reverse order of removal.

A

B

C

D

E

F

G

H

I

J

K

L

M

AV

O

P

USB CONNECTOR

< REMOVAL AND INSTALLATION >

[AUDIO W/O NAVI (EXCEPT MEXICO)]

USB CONNECTOR

Removal and Installation

INFOID:000000010641720

REMOVAL

1. Remove the instrument lower center cover. Refer to [IP-17, "Removal and Installation"](#).
2. Press the tab from the rear of the instrument lower center cover (B) and remove the USB connector (A).

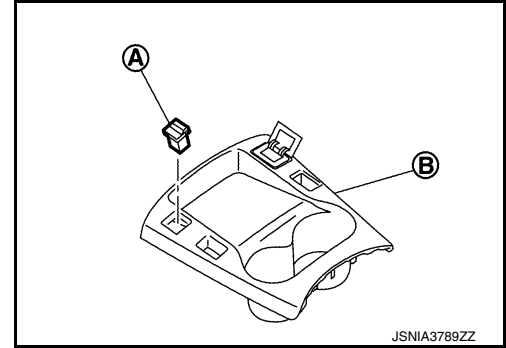

INSTALLATION

Install in the reverse order of removal.

NOTE:

Align the notch of the instrument panel center lower cover and assemble it.

REAR VIEW CAMERA

< REMOVAL AND INSTALLATION >

[AUDIO W/O NAVI (EXCEPT MEXICO)]

REAR VIEW CAMERA

Removal and Installation

INFOID:000000010641721

REMOVAL

1. Remove the back door outside handle. Refer to [DLK-201, "OUTSIDE HANDLE : Removal and Installation"](#).
2. Remove the screws (A) and the rear view camera (1) from back door outside handle (2).

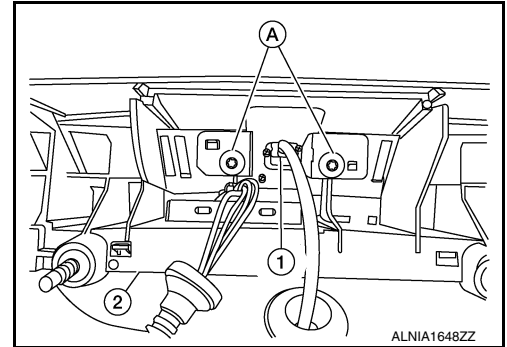

INSTALLATION

Install in the reverse order of removal.

NOTE:

If the side distance guiding lines are dislocated after installation of the rear view camera, refer to [AV-425, "CALIBRATING CAMERA IMAGE \(AROUND VIEW MONITOR\) : Work Procedure"](#) and correct the side distance guiding lines.

A
B
C
D
E
F
G
H
I
J
K
L
M
O
P

AV

< PRECAUTION >

PRECAUTION**PRECAUTIONS**

Precaution for Technicians Using Medical Electric

INFOID:0000000010641722

OPERATION PROHIBITION

WARNING:

- Parts with strong magnet is used in this vehicle.
- Technicians using a medical electric device such as pacemaker must never perform operation on the vehicle, as magnetic field can affect the device function by approaching to such parts.

NORMAL CHARGE PRECAUTION

WARNING:

- If a technician uses a medical electric device such as an implantable cardiac pacemaker or an implantable cardioverter defibrillator, the possible effects on the devices must be checked with the device manufacturer before starting the charge operation.
- As radiated electromagnetic wave generated by PDM (Power Delivery Module) at normal charge operation may affect medical electric devices, a technician using a medical electric device such as implantable cardiac pacemaker or an implantable cardioverter defibrillator must not approach motor room [PDM (Power Delivery Module)] at the hood-opened condition during normal charge operation.

PRECAUTION AT TELEMATICS SYSTEM OPERATION

WARNING:

- If a technician uses implantable cardiac pacemaker or implantable cardioverter defibrillator (ICD), avoid the device implanted part from approaching within approximately 220 mm (8.66 in) from interior/exterior antenna.
- The electromagnetic wave of TCU might affect the function of the implantable cardiac pacemaker or the implantable cardioverter defibrillator (ICD), when using the service, etc.
- If a technician uses other medical electric devices than implantable cardiac pacemaker or implantable cardioverter defibrillator (ICD), the electromagnetic wave of TCU might affect the function of the device. The possible effects on the devices must be checked with the device manufacturer before TCU use.

PRECAUTION AT INTELLIGENT KEY SYSTEM OPERATION

WARNING:

- If a technician uses implantable cardiac pacemaker or implantable cardioverter defibrillator (ICD), avoid the device implanted part from approaching within approximately 220 mm (8.66 in) from interior/exterior antenna.
- The electromagnetic wave of Intelligent Key might affect the function of the implantable cardiac pacemaker or the implantable cardioverter defibrillator (ICD), at door operation, at each request switch operation, or at engine starting.
- If a technician uses other medical electric devices than implantable cardiac pacemaker or implantable cardioverter defibrillator (ICD), the electromagnetic wave of Intelligent Key might affect the function of the device. The possible effects on the devices must be checked with the device manufacturer before Intelligent Key use.

Precaution for Supplemental Restraint System (SRS) "AIR BAG" and "SEAT BELT PRE-TENSIONER"

INFOID:0000000010641723

The Supplemental Restraint System such as "AIR BAG" and "SEAT BELT PRE-TENSIONER", used along with a front seat belt, helps to reduce the risk or severity of injury to the driver and front passenger for certain types of collision. This system includes seat belt switch inputs and dual stage front air bag modules. The SRS system uses the seat belt switches to determine the front air bag deployment, and may only deploy one front air bag, depending on the severity of a collision and whether the front occupants are belted or unbelted. Information necessary to service the system safely is included in the SR and SB section of this Service Manual.

WARNING:

PRECAUTIONS

[AUDIO W/O NAVI (FOR MEXICO)]

< PRECAUTION >

- To avoid rendering the SRS inoperative, which could increase the risk of personal injury or death in the event of a collision which would result in air bag inflation, all maintenance must be performed by an authorized NISSAN/INFINITI dealer.
- Improper maintenance, including incorrect removal and installation of the SRS, can lead to personal injury caused by unintentional activation of the system. For removal of Spiral Cable and Air Bag Module, see the SR section.
- Do not use electrical test equipment on any circuit related to the SRS unless instructed to in this Service Manual. SRS wiring harnesses can be identified by yellow and/or orange harnesses or harness connectors.

PRECAUTIONS WHEN USING POWER TOOLS (AIR OR ELECTRIC) AND HAMMERS

WARNING:

- When working near the Airbag Diagnosis Sensor Unit or other Airbag System sensors with the Ignition ON or engine running, DO NOT use air or electric power tools or strike near the sensor(s) with a hammer. Heavy vibration could activate the sensor(s) and deploy the air bag(s), possibly causing serious injury.
- When using air or electric power tools or hammers, always switch the Ignition OFF, disconnect the battery and wait at least three minutes before performing any service.

Precaution for Trouble Diagnosis

INFOID:000000010641724

AV COMMUNICATION SYSTEM

- Do not apply voltage of 7.0 V or higher to the measurement terminals.
- Use the tester with its open terminal voltage being 7.0 V or less.
- Be sure to turn power switch OFF and disconnect the battery cable from the negative terminal before checking the circuit. Refer to [AV-79, "Precaution for Removing 12V Battery"](#).

Precaution for Harness Repair

INFOID:000000010641725

AV COMMUNICATION SYSTEM

- Solder the repaired parts, and wrap with tape. [Frays of twisted line must be within 110 mm (4.33 in).]

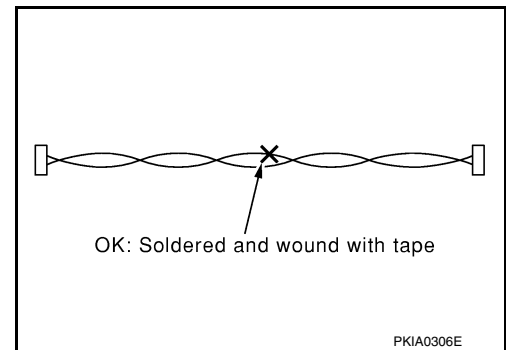

- Do not perform bypass wire connections for the repair parts. (The spliced wire will become separated and the characteristics of twisted line will be lost.)

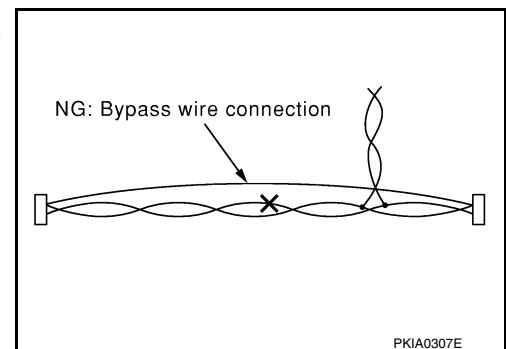

Precaution for Removing 12V Battery

INFOID:000000010641726

1. Check that EVSE is not connected.

NOTE:

If EVSE is connected, the air conditioning system may be automatically activated by the timer A/C function.

PRECAUTIONS

[AUDIO W/O NAVI (FOR MEXICO)]

< PRECAUTION >

2. Turn the power switch OFF → ON → OFF. Get out of the vehicle. Close all doors (including back door).
3. Check that the charge status indicator lamp does not blink and wait for 5 minutes or more.

NOTE:

If the battery is removed within 5 minutes after the power switch is turned OFF, plural DTCs may be detected.

4. Remove 12V battery within 1 hour after turning the power switch OFF → ON → OFF.

NOTE:

- The 12V battery automatic charge control may start automatically even when the power switch is in OFF state.
- Once the power switch is turned ON → OFF, the 12V battery automatic charge control does not start for approximately 1 hour.

CAUTION:

- **After all doors (including back door) are closed, if a door (including back door) is opened before battery terminals are disconnected, start over from Step 1.**
- **After turning the power switch OFF, if “Remote A/C” is activated by user operation, stop the air conditioner and start over from Step 1.**

Precaution for Work

INFOID:000000011107763

- When removing or disassembling each component, be careful not to damage or deform it. If a component may be subject to interference, be sure to protect it with a shop cloth.
- When removing (disengaging) components with a screwdriver or similar tool, be sure to wrap the component with a shop cloth or vinyl tape to protect it.
- Protect the removed parts with a shop cloth and prevent them from being dropped.
- Replace a deformed or damaged clip.
- If a part is specified as a non-reusable part, always replace it with a new one.
- Be sure to tighten bolts and nuts securely to the specified torque.
- After installation is complete, be sure to check that each part works properly.
- Follow the steps below to clean components:
 - Water soluble dirt:
 - Dip a soft cloth into lukewarm water, wring the water out of the cloth and wipe the dirty area.
 - Then rub with a soft, dry cloth.
 - Oily dirt:
 - Dip a soft cloth into lukewarm water with mild detergent (concentration: within 2 to 3%) and wipe the dirty area.
 - Then dip a cloth into fresh water, wring the water out of the cloth and wipe the detergent off.
 - Then rub with a soft, dry cloth.
 - Do not use organic solvent such as thinner, benzene, alcohol or gasoline.
 - For genuine leather seats, use a genuine leather seat cleaner.

Cautions in Removing AV Control Unit (Models with AV Control Unit)

INFOID:000000010641727

CAUTION:

Remove AV control unit after a lapse of 30 seconds or more after turning the power switch OFF.

NOTE:

After the power switch is turned OFF, the AV control unit continues operating for approximately 30 seconds. Therefore, data corruption may occur if 12V battery voltage is cut off within 30 seconds.

PREPARATION

< PREPARATION >

[AUDIO W/O NAVI (FOR MEXICO)]

PREPARATION

PREPARATION

Special Service Tools

INFOID:000000011107780

The actual shape of the tools may differ from those illustrated here.

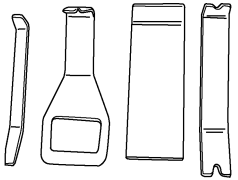
Tool number (TechMate No.) Tool name	Description
— (J-46534) Trim Tool Set  AWJIA0483ZZ	Removing trim components

Commercial Service Tool

INFOID:000000010641728

Tool name	Description
Power tool  PIIB1407E	Loosening nuts, screws and bolts

A
B
C
D
E
F
G
H
I
J
K
L
M
AV
O
P

COMPONENT PARTS

< SYSTEM DESCRIPTION >

[AUDIO W/O NAVI (FOR MEXICO)]

SYSTEM DESCRIPTION

COMPONENT PARTS

Component Parts Location

INFOID:000000010641729

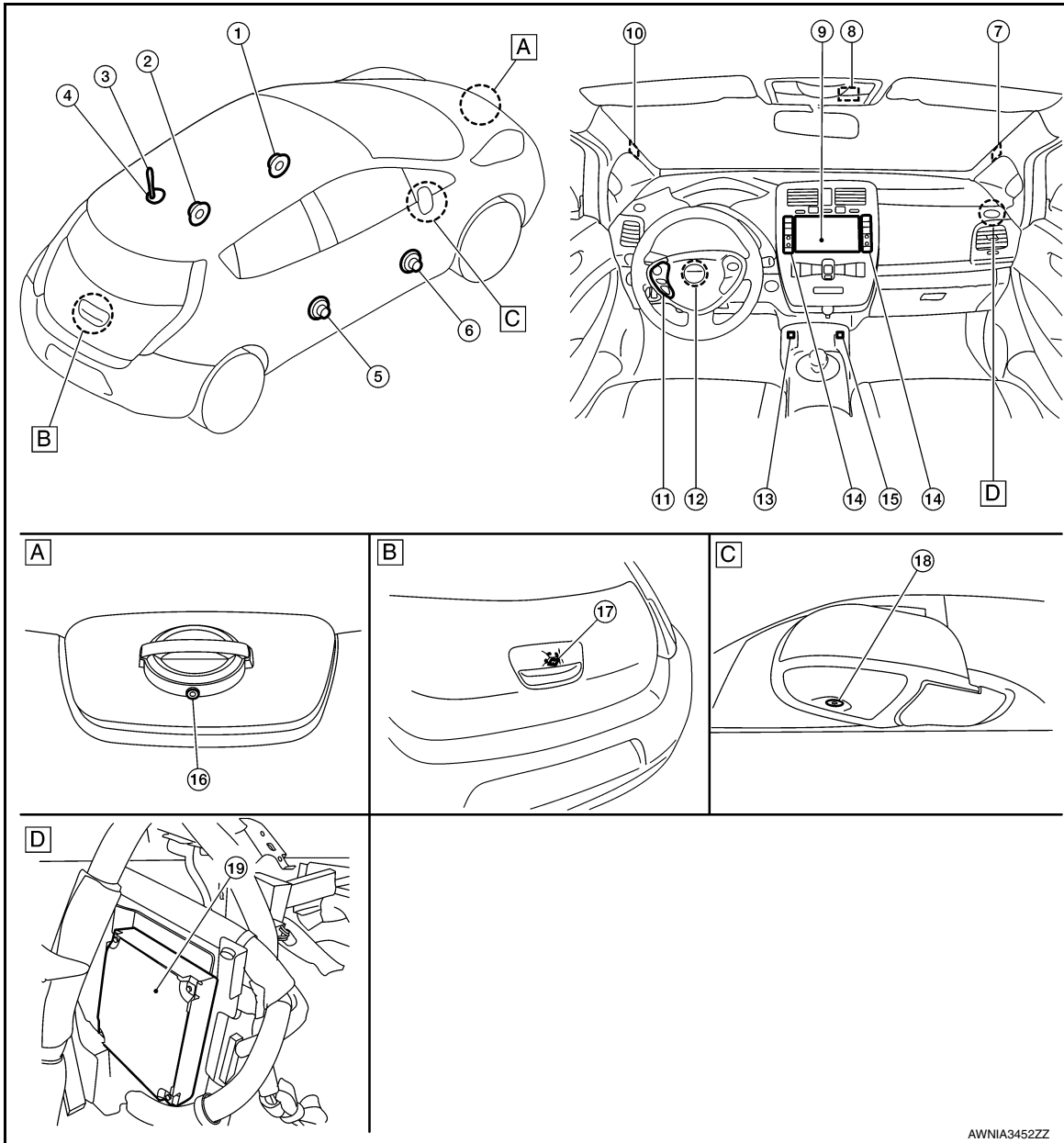

- A. Center of charge lid cover
- B. Center of the back door
- C. Bottom of outside rear view mirror (RH shown, LH similar)
- D. Behind RH side of instrument panel (view with steering member removed)

No.	Component	Function
1.	Front door speaker LH	Refer to AV-84. "Speaker" .
2.	Rear door speaker LH	
3.	Antenna rod	Refer to AV-85. "Radio Antenna and Antenna Feeder" .
4.	Antenna base (antenna amp.)	

COMPONENT PARTS

< SYSTEM DESCRIPTION >

[AUDIO W/O NAVI (FOR MEXICO)]

No.	Component	Function
5.	Rear door speaker RH	Refer to AV-84. "Speaker" .
6.	Front door speaker RH	
7.	Tweeter RH	
8.	Microphone	Refer to AV-87. "Microphone" .
9.	AV control unit	Refer to AV-83. "AV Control Unit" .
10.	Tweeter LH	Refer to AV-84. "Speaker" .
11.	Steering switch	Refer to AV-87. "Steering Switch" .
12.	Steering angle sensor	Refer to AV-89. "Steering Angle Sensor" .
13.	USB connector	Refer to AV-87. "USB Connector" .
14.	Multifunction switch	Refer to AV-87. "Multifunction Switch" .
15.	Auxiliary input jack	Refer to AV-88. "Auxiliary Input Jack" .
16.	Front camera	Refer to AV-89. "Front Camera" .
17.	Rear view camera	Refer to AV-88. "Rear View Camera" .
18.	Side camera	Refer to AV-88. "Side Camera" .
19.	Around view monitor control unit	Refer to AV-88. "Around View Monitor Control Unit" .

AV Control Unit

INFOID:000000010641730

DESCRIPTION

- High-resolution 7-inch wide VGA display integrated AV control unit is installed at the center of the instrument panel.
- The AV control unit is equipped with the following parts. It is the master unit integrated with functions and controls the multi-AV system.

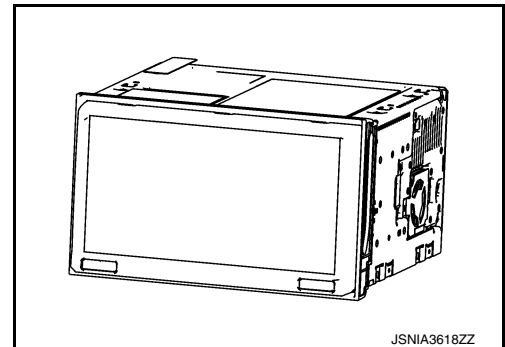

Units equipped
SD card slot
High resolution 7-inch wide VGA LCD monitor
Audio amplifier
AM/FM electronic tuner
CD drive
USB interface
Bluetooth® module

- Signals necessary for the vehicle information display function are received from combination meter via CAN communication.
- Signals necessary for vehicle setting functions are sent and received with BCM via CAN communication.
- It inputs the signal for driving status recognition (vehicle speed signal, reverse signal, and parking brake signal).

NOTE:

For details of each function, refer to [AV-90. "MULTI AV SYSTEM : System Description"](#).

SD Card Slot

With the display opened, the card slot used for software update is located on the left (sub slot).

Display

- High resolution 7-inch wide VGA LCD monitor is adopted to display a high definition image including digital image signals.
- Touch panel function is adopted to improve operability.
- RGB digital image signals are displayed.

Audio Amplifier

- 45W x 4ch amplifiers are installed.

A
B
C
D
E
F
G
H
I
J
K
L
M
O
P

AV

COMPONENT PARTS

[AUDIO W/O NAVI (FOR MEXICO)]

< SYSTEM DESCRIPTION >

- Audio sound and TEL voice are output to each speaker.

AM/FM Electronic Tuner

- The AM/FM electric tuner includes the PLL frequency synthesizer system.

CD Drive

- It is CD-R/CD-RW compliant and enables MP3 and WMA files to play music.
- It displays the artist name, album title or song title recorded to the file by the ID3 tag/WMA tag display function.

USB Interface

- Music can be played by connecting an iPod® or USB memory.

Bluetooth® Module

- Wireless connection to the audio device equipped with Bluetooth® communication can play music.
- Once a Bluetooth® communication compliant phone has been registered in the AV control unit, hands-free phone communication can be carried out without connecting the cellular phone.
- Five units of Bluetooth® communication devices including audio devices and cellular phones can be registered to the AV control unit.

Speaker

INFOID:000000010641731

The 6-speaker system is adopted.

Front door speaker

- ϕ 16.5 cm (6.5 in) speaker is installed to the bottom of the front door.
- Sound signal is input from the AV control unit to output mid and low range sounds.

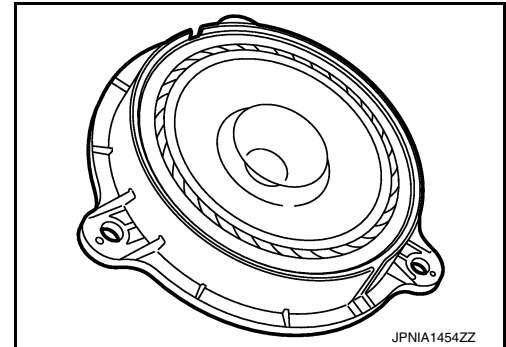

Rear door speaker

- ϕ 16.5 cm (6.5 in) speaker is installed to the bottom of the rear door.
- Sound signal is input from the AV control unit to output high, mid and low range sounds.

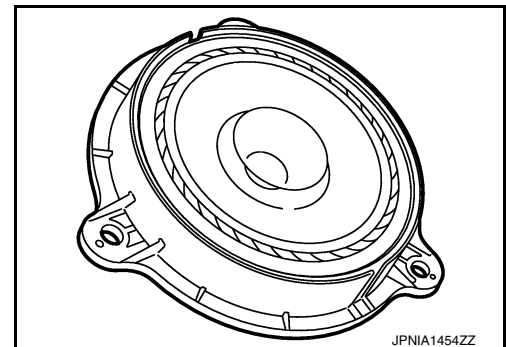

Tweeter

- ϕ 2.5 cm (1 in) tweeter for high-range sounds is installed in the front pillar.

COMPONENT PARTS

< SYSTEM DESCRIPTION >

[AUDIO W/O NAVI (FOR MEXICO)]

- Sound signal is input from the AV control unit to output high range sounds.

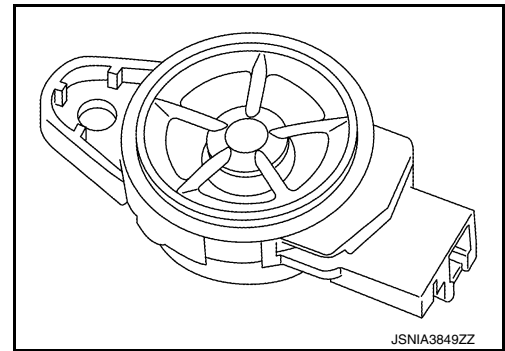

INFOID:000000010641732

Radio Antenna and Antenna Feeder

RADIO ANTENNA

Rod Antenna

A rod antenna is installed to the rear center of the roof.

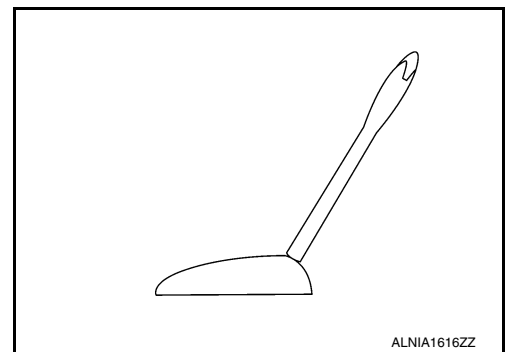

Antenna Base

- To obtain sufficient reception sensitivity, an antenna amplifier is built into the antenna base.
- Power of the antenna amplifier is supplied from the AV control unit.
- The radio signal received by the rod antenna is input to the antenna base and the antenna signal is amplified and sent to the AV control unit.

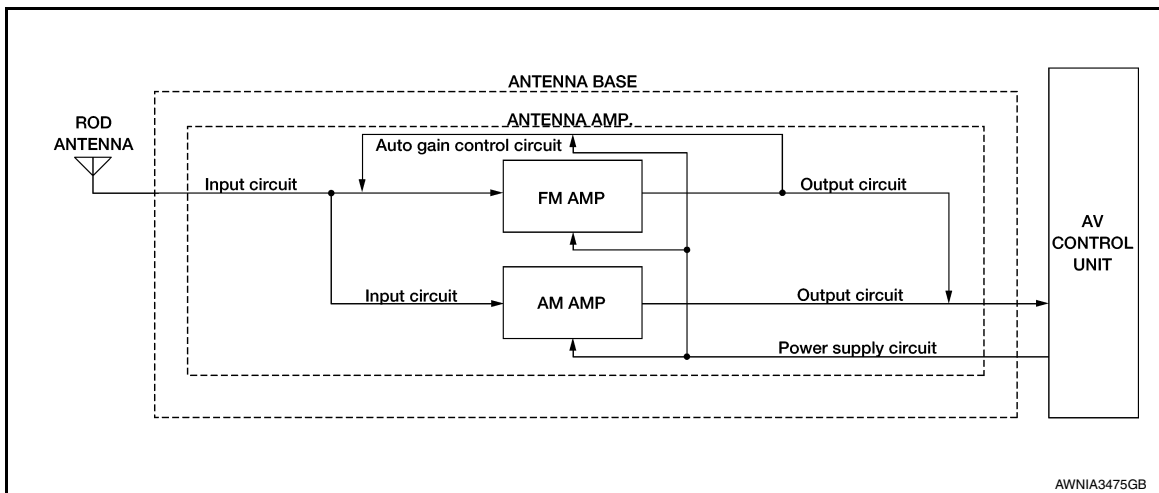

Antenna circuit

COMPONENT PARTS

< SYSTEM DESCRIPTION >

[AUDIO W/O NAVI (FOR MEXICO)]

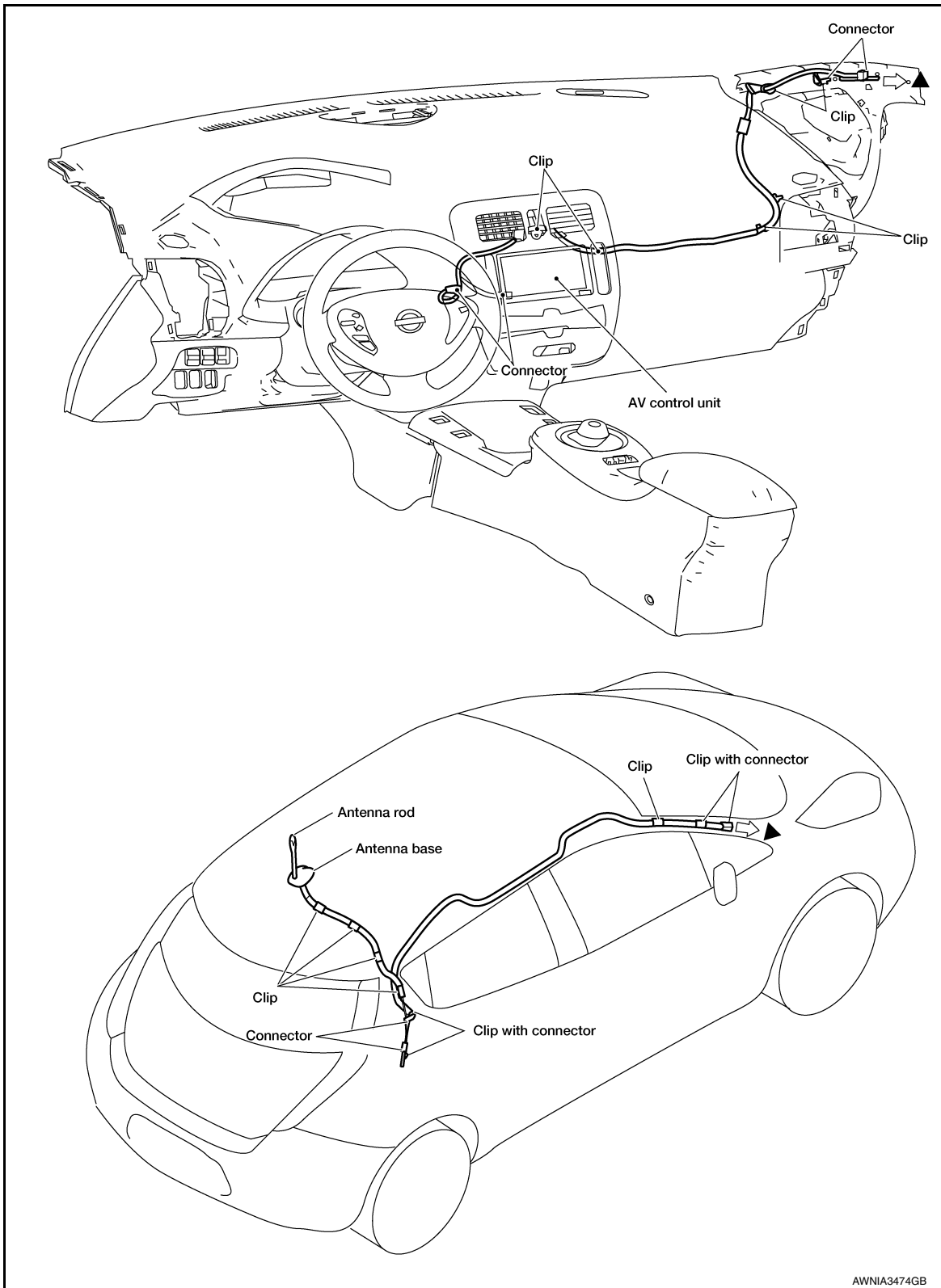

AWNIA3474GB

▲: Indicates that the part is connected at points with same symbol in actual vehicle.

COMPONENT PARTS

< SYSTEM DESCRIPTION >

[AUDIO W/O NAVI (FOR MEXICO)]

Steering Switch

INFOID:0000000110641733

- Hands-free phone, possible driving distance display, voice control, and audio operations can be performed.
- This switch is connected to the AV control unit, and the switch operation signal is transmitted to the AV control unit via voltage multiplex communication.

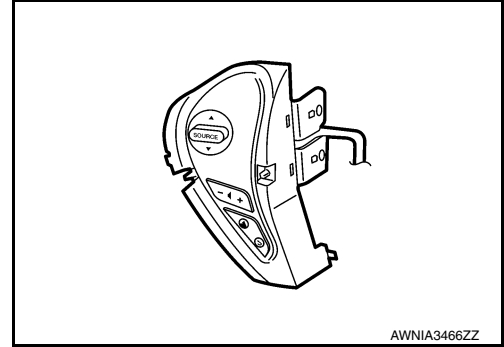

Multifunction Switch

INFOID:0000000110641734

- Audio, navigation, Telematics, etc. can be controlled.
- Switch operation signals are input to the AV control unit via AV communication.

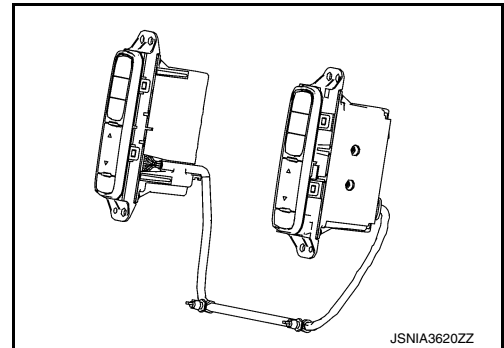

USB Connector

INFOID:0000000110641735

- USB connector is installed on the lower left side of the instrument panel.
- iPod® and USB memory can be connected to the AV control unit.

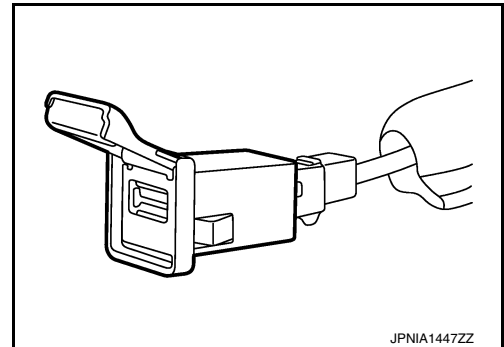

Microphone

INFOID:0000000110641736

- The voice control/TEL microphone is installed on the right side of the map lamp assembly.
- The power is supplied from the AV control unit to the microphone, transmitting sound signals to the AV control unit at the voice control or during hands-free phone communication.

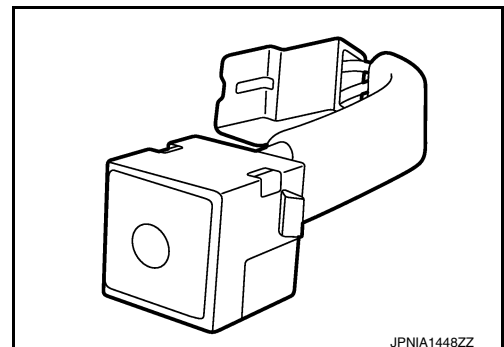

A
B
C
D
E
F
G
H
I
J
K
L
M
O
P

AV

COMPONENT PARTS

< SYSTEM DESCRIPTION >

[AUDIO W/O NAVI (FOR MEXICO)]

Auxiliary Input Jack

INFOID:000000010641737

- AUX jack is installed at the lower right of the instrument panel.
- Connection to an external audio device can provide sound output.

External input terminal for connection ϕ 3.5 mm stereo mini-jack

NOTE:

When connected to monaural mini-jack plug cable, sound may not be output.

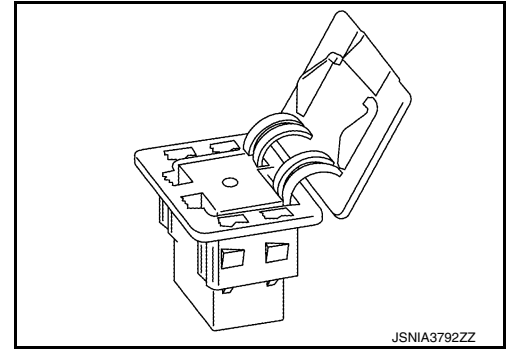

Around View Monitor Control Unit

INFOID:000000010641738

- The around view monitor control unit is installed behind the RH side of the instrument panel.
- Necessary signals are transmitted/received to/from control unit via CAN communication.
- Camera image signals received from each camera are converted/synthesized in the around view monitor control unit and transmitted to the front display unit.
- Vehicle width guide lines, predicted course line, vehicle front guiding line and vehicle side line, and vehicle icon are rendered with the around view monitor control unit and combined with camera image.

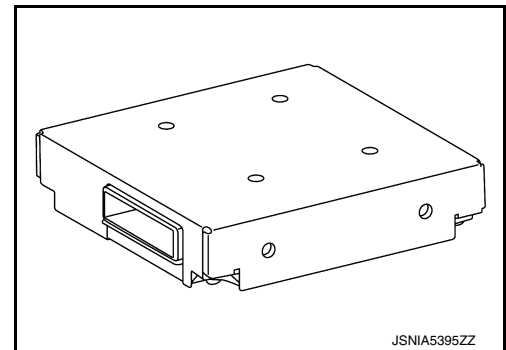

Rear View Camera

INFOID:000000010641739

- The rear camera is installed to the back door finisher.
- Power for the camera is supplied from the around view monitor control unit, and the image at the rear of the vehicle is sent to the around view monitor control unit.

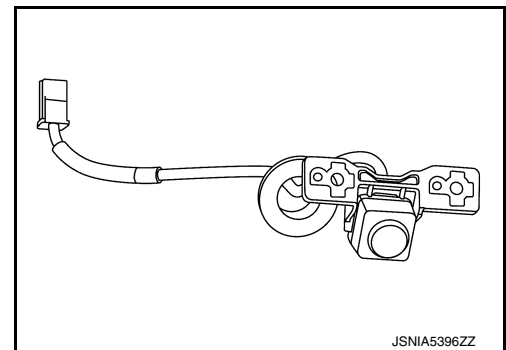

Side Camera

INFOID:000000010641740

- The side camera is installed to the door mirror.
- Power for the camera is supplied from the around view monitor control unit, and the image at the side of the vehicle is sent to the around view monitor control unit.

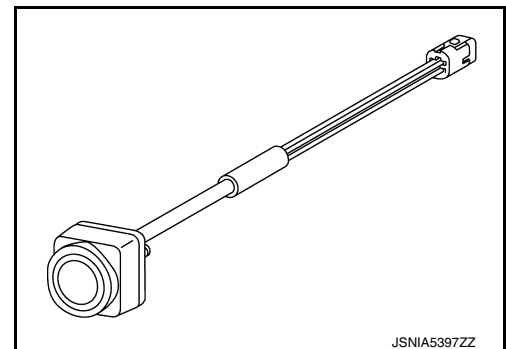

Front Camera

INFOID:000000010641741

- The front camera is installed to the front grille.
- Power for the camera is supplied from the around view monitor control unit, and the image at the front of the vehicle is sent to the around view monitor control unit.

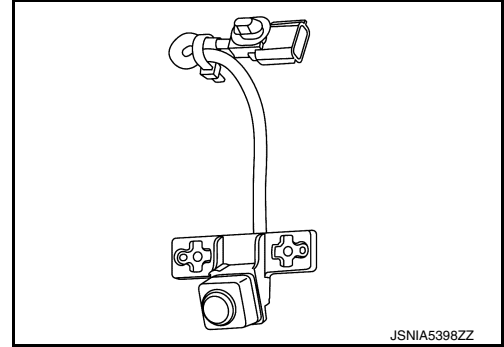

Steering Angle Sensor

INFOID:000000010641742

- Steering sensor is installed to the spiral cable.
- Steering angle sends the steering signal necessary for possible route line of the around view monitor function to the AV control unit via CAN communication.

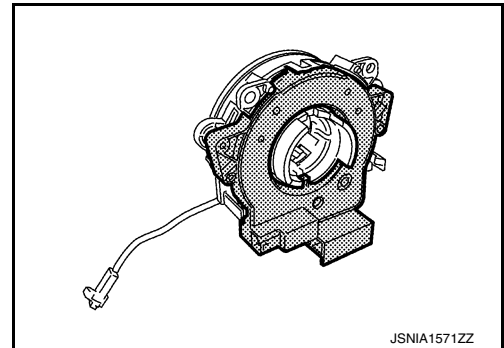

A
B
C
D
E
F
G
H
I
J
K
L
M
O
P

AV

SYSTEM

< SYSTEM DESCRIPTION >

[AUDIO W/O NAVI (FOR MEXICO)]

SYSTEM

MULTI AV SYSTEM

MULTI AV SYSTEM : System Diagram

INFOID:000000010641743

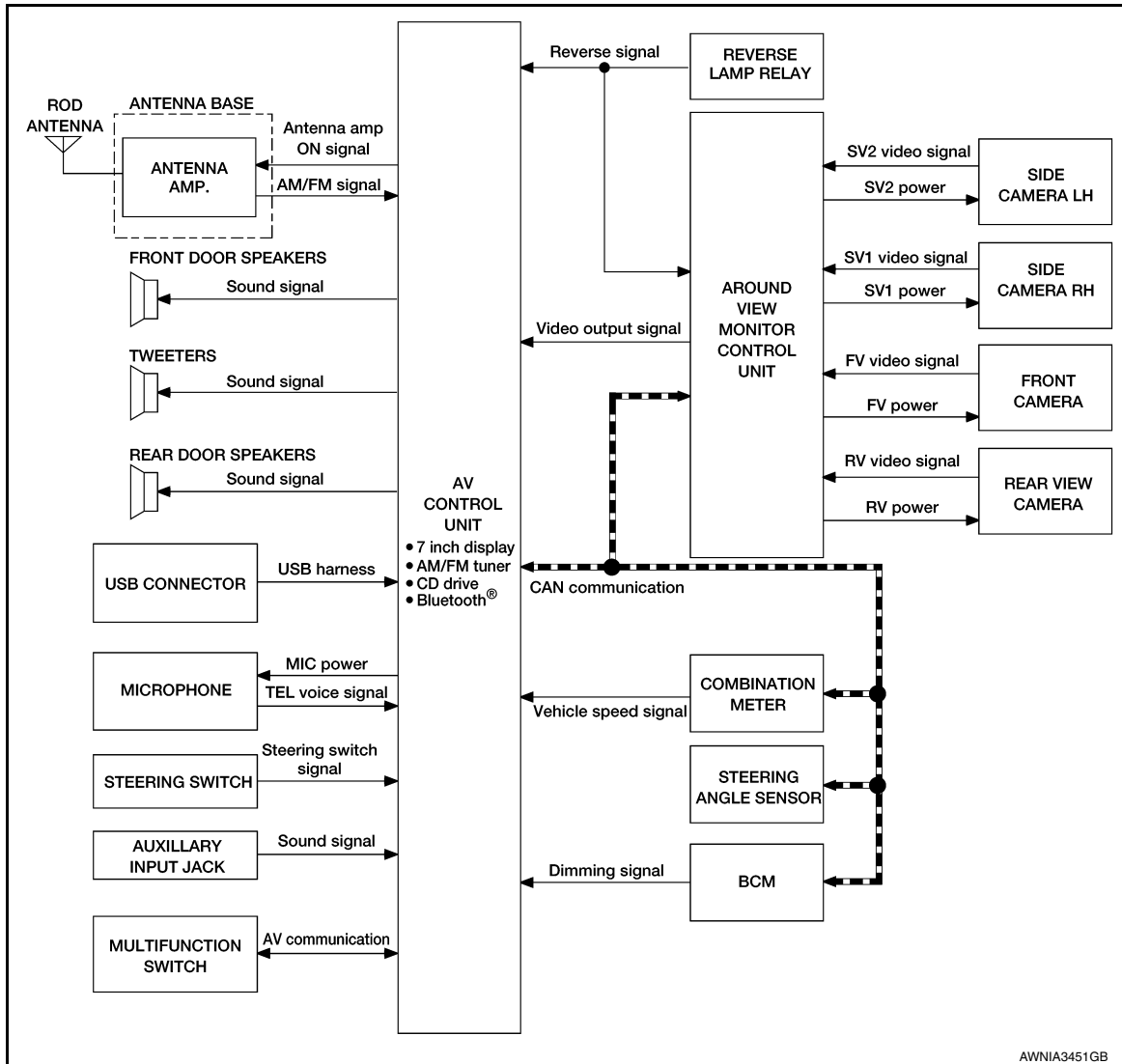

AWNIA3451GB

MULTI AV SYSTEM : System Description

INFOID:000000010641744

- AV control unit is connected to the following parts. It performs power supply, signal input and communication, and it controls the multi-AV system.
 - Radio antenna (radio antenna amplifier)
 - Around view monitor control unit
 - Front camera
 - Side cameras (LH and RH)
 - Rear view camera
 - USB connector
 - Auxiliary input jack
 - BCM
 - Combination meter
 - Steering switch
 - Multifunction switch
 - Microphone
 - Speakers
 - Vehicle signals (reverse signal, vehicle speed signal and illumination signal)
- Data of external device connected to the USB connector is played and transferred.

SYSTEM

[AUDIO W/O NAVI (FOR MEXICO)]

< SYSTEM DESCRIPTION >

- When the selector lever is placed in R (reverse) or the CAMERA switch is pressed, power is supplied to the cameras. The camera image signals supplied by the cameras are input to the around view monitor control unit. The around view monitor control unit sends the signals to the AV control unit. The AV control unit displays the camera images on the display.
- Dimming signal is input from BCM to adjust the brightness of the display.

AUTO LIGHT ADJUSTMENT FUNCTION

Auto light adjustment function automatically dims/brightens the display according to the ambient light when the lighting switch is in the 1st or 2nd position. Whether or not the display is dimmed when the lighting switch is in the 1st position or 2nd position is determined by the output condition of the dimming signal output from the BCM to the AV control unit. Even if the lighting switch is in the 1st position or 2nd position, the display may not be dimmed depending on the ambient light sensed by the auto light sensor. For details, refer to [INL-12. "ILLUMINATION CONTROL SYSTEM : System Description"](#).

CAN COMMUNICATION

- AV control unit is connected via CAN communication, receives data signal from VCM and combination meter, and indicates power consumption information, etc. on the display based on the information obtained.
- The AV control unit, which has the vehicle setting function, transmits and receives data on vehicle setting condition via CAN communication with the BCM.
- AV control unit receives and sends signals necessary for timer charge and A/C-heater timer operation with VCM via CAN communication.

Energy Flow Display Function

The AV control unit receives data signals from the VCM and combination meter via CAN communication and computes each value using the obtained information to display it.

Display function	Receiving signal (transmit unit)	Display method
Instantaneous power consumption display	<ul style="list-style-type: none">• Battery consumption monitor signal (VCM)• Vehicle speed signal (combination meter)	Computes the instantaneous power consumption using the vehicle speed and battery consumption monitor signals, and displays the instantaneous power consumption bar.
Possible driving distance display	<ul style="list-style-type: none">• Possible driving distance signal (Combination meter)	Displays a possible driving distance, based on a possible driving distance signal. When the meter indication of a possible driving distance is "----", it is displayed by "****" on the NAVI screen. Data is retained even with the power switch OFF.
Average power consumption display	<ul style="list-style-type: none">• Battery consumption monitor signal (VCM)• Vehicle speed signal (combination meter)	Computes the average power consumption using the battery consumption monitor and vehicle speed signals, and displays it. The average power consumption is displayed only when 30 seconds have elapsed and the vehicle has been driven 500 m after the average power consumption was reset. Data is retained even with the power switch OFF.

Vehicle Setting Function

The AV control unit transmits and receives data signals via CAN communication with the BCM, allowing the following vehicle settings.

- To turn on the automatic interior room lamp (ON/OFF) when the door is unlocked
- To adjust the auto light sensitivity (+/-)
- To operate the intermittent wiper linked with the vehicle speed (ON/OFF)
- Vehicle setting initialization

NOTE:

The setting items vary depending on the vehicle specification

TYPE OF VOICE SIGNAL

Reception Voice Signal

- Hands-free phone reception voice is output from the cellular phone through the AV control unit to the front speaker via Bluetooth® communication.
- If the hands-free phone is used while the audio is ON, these sounds are muted and only the reception voice is output.

Speech Sound Signal

Hands-free phone speech sound is transmitted from the microphone via the AV control unit and Bluetooth® communication to the cellular phone.

SYSTEM

[AUDIO W/O NAVI (FOR MEXICO)]

< SYSTEM DESCRIPTION >

Guide Sound Signal

- Voice signals output during the route guidance of the navigation system are output from the AV control unit to the front speaker.
- If the voice guidance is output with the audio ON, audio output of the front speaker is turned down 10 dB and then voice guidance is output.
- Adjusting the volume while the voice guidance is being output can change the volume of the guidance.

AUDIO FUNCTION

- The MP3/WMA playback function enables music to play for a long time: the user need not change the CD during a long trip. The text display function is also adopted so that the title name and artist name of the ID3 tag/WMA tag can be displayed.
- Bluetooth® audio function is adopted to play music data in the portable audio via wireless communication.
- The adoption of the vehicle speed interlock sound volume function reduces the burden of the volume adjustment by the difference between the noises when the vehicle is stopped or running. In addition, the vehicle speed interlock sound volume function can perform ON/OFF setting and sound volume adjustment on a scale of one to five.

MP3/WMA Playback Function

This function enables the playback of compressed music files, such as MP3 music files used for the most widespread broadband music distribution and WMA music files played back with a music player generally built in Windows® personal computers.

Vehicle Speed Interlock Volume Function

- The AV control unit receives the vehicle speed signal from the combination meter via CAN communication and changes the sound volume in conjunction with the vehicle speed.
- Using the vehicle speed interlock sound volume function, ON/OFF setting can be carried out as preferred by users, and sound volume variation caused by vehicle speed change can be adjusted on a scale of one to three.

Bluetooth® Audio Function

- Bluetooth® audio function is adopted to play music data in the portable audio in wireless communication.
- Five units of Bluetooth® communication devices including audio devices and cellular phones can be registered to the AV control unit.
- When the Bluetooth® audio is connected to the portable audio through Bluetooth®, it can play the music data in the portable audio.
- When the Bluetooth® audio is playing the data, operations of the other applications are as shown in the following table.

Cellular phone operation (control) status		Bluetooth® audio playback status
Hands-free phone communication	Hands-free phone incoming call	Answering the call stops audio playback temporarily.
		Audio playback does not stop.
Telephone book transfer		For Bluetooth® audio, audio playback stops temporarily. After the telephone book has been transferred, playback resumes.

Bluetooth® compliant profile

Profile name	Abbreviation	Version
Advanced Audio Distribution Profile	A2DP	Ver. 1.2
Audio Video Remote Control Profile	AVRCP	Ver. 1.3

USB CONNECTING FUNCTION

USB connector enables iPod® compliant and playback of music files in the USB memory.

*: iPod® is the trademark of Apple Inc. registered in the United States and other countries.

iPod® Compliant

- By connecting a user's iPod® to the USB connector, music can be played.
- While iPod® is connected, iPod® is charged.
- It is compliant with various playback methods.

SYSTEM

< SYSTEM DESCRIPTION >

[AUDIO W/O NAVI (FOR MEXICO)]

BLUETOOTH® HANDS-FREE PHONE FUNCTION

- When the cellular phone is connected to the AV control unit in Bluetooth® communication, hands-free phone communication can be performed.
- Simply operating the steering switch without releasing hands from the steering wheel allows the driver to make a phone call or receive a phone call.
- When a Bluetooth® communication compliant phone is registered to the AV control unit, hands-free phone communication can be performed. Five units of Bluetooth® communication devices including audio devices and cellular phones can be registered to the AV control unit.
- The content of the memory (telephone book) of the cellular phone can be recorded in the AV control unit.

Bluetooth® compliant profile

Profile name	Abbreviation	Version
Hands-Free Profile	HFP	1.5
Dial-Up Networking Profile	DUN	1.1
Object Push Profile	OPP	1.1

AROUND VIEW MONITOR FUNCTION

- This system is equipped with wide-angle cameras on the front, rear and right and left door mirrors.
- Images from front view, rear view, front-side view (RH side), and birds-eye view are displayed to monitor the vehicle surroundings.
- Around view monitor control unit expands the image received from each camera to create each view.
- In front view and rear view, the vehicle width, distance lines and predictive course lines are displayed.
- In front-side view, the vehicle distance guiding line and vehicle width guiding line are displayed.
- Birds-eye view converts the images from the cameras into an overhead view and displays the status of the vehicle on the display. The vehicle icon that is displayed in the birds-eye view is depicted by the around view monitor control unit.

Display

The around view monitor combines and displays travel direction view (front or rear), front-side view and birds-eye view.

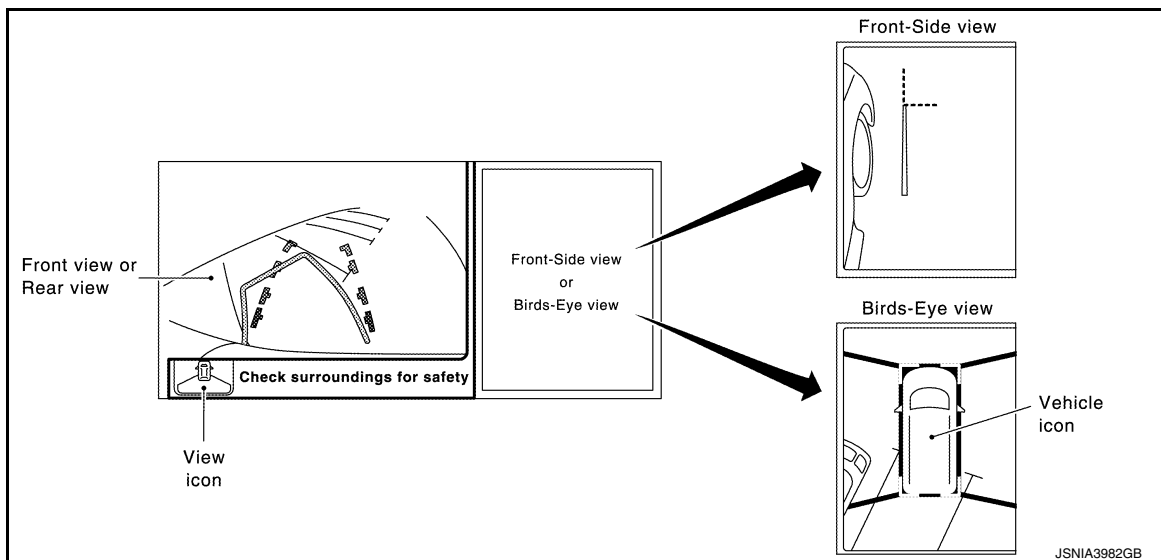

Operation

- The around view monitor operates by pressing the CAMERA switch on the AV control unit or by shifting the selector lever to the R (reverse) position.
- When the selector lever is in any position other than R (reverse) and the CAMERA switch is pressed, the screen displays front travel direction view and birds-eye view. Pressing the CAMERA switch again changes birds-eye view to front-side view
- When the selector lever is placed in R (reverse), the screen displays rear travel direction view and birds-eye view. Pressing the CAMERA switch changes birds-eye view to front-side view
- In birds-eye view, the blind spot area is displayed in black to show the border of the camera images. In addition, red fixed lines are displayed in the 4 corners of the vehicle icon. After pressing the CAMERA switch for

A
B
C
D
E
F
G
H
I
J
K
L
M
O
P

AV

SYSTEM

< SYSTEM DESCRIPTION >

[AUDIO W/O NAVI (FOR MEXICO)]

- the first time or placing the selector lever in R (reverse) for the first time, the blind spot area is highlighted in yellow for 3 seconds and the red fixed lines blink five times.
- With the selector lever in any position other than R (reverse), the around view monitor screen display is cancelled 3 minutes after pressing the CAMERA switch. The screen returns to the AV control unit display.
- With the selector lever in R (reverse) position, the around view monitor screen display remains on constantly. To return to the AV control unit display, place the selector lever in any position other than R (reverse).
- If camera image calibration is incomplete, the applicable camera position is indicated as an error on the birds-eye view display.

NOTE:

Calibration is necessary when replacing each camera or when replacing around view monitor control unit.

Around view monitor screen transition

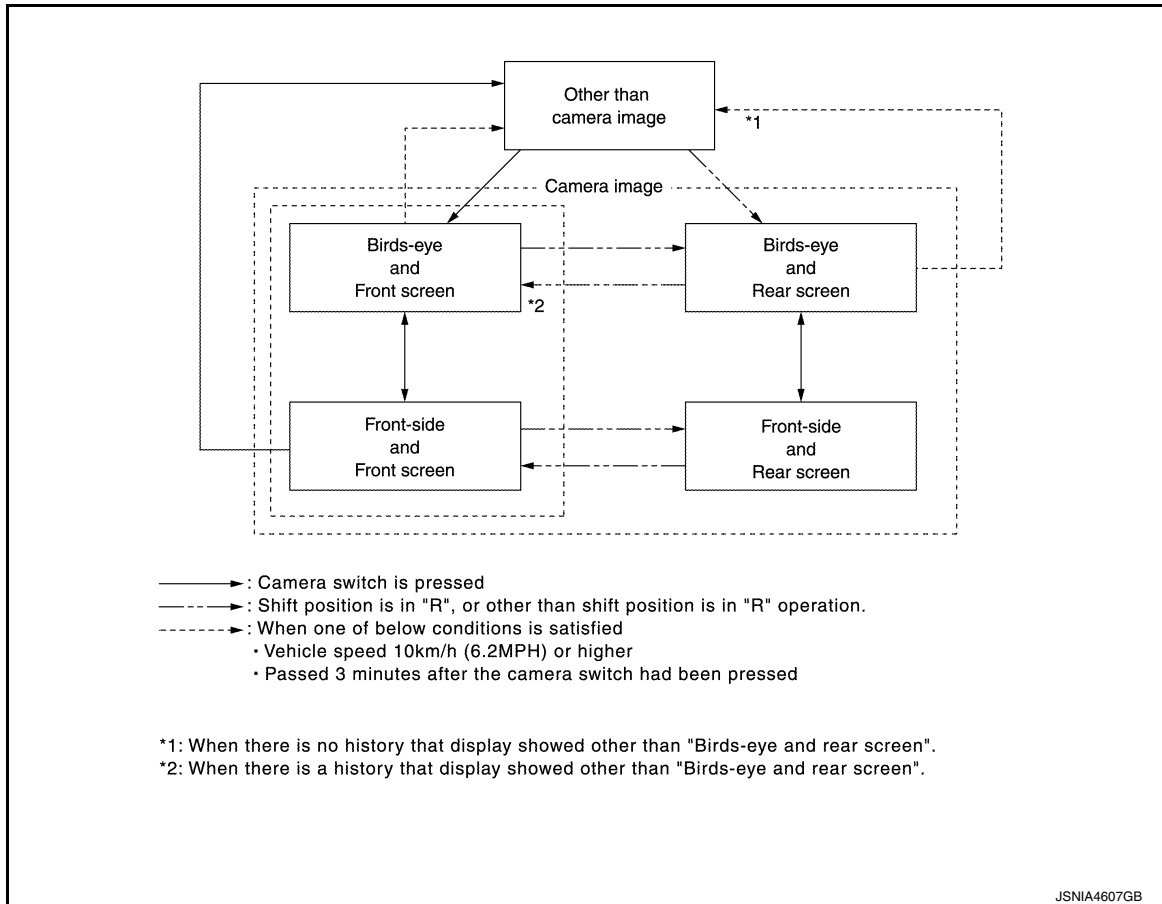

Front View

- The front view image improves the visibility of obstacles in front of the vehicle and assists driving by displaying images from birds-eye view and front-side view.
- The front view image displays the vehicle width guiding line and vehicle distance guiding line, in addition to the predictive course line according to the steering angle.
- If the steering angle is within approximately 90 degrees, the predictive course lines on the left/right side are displayed. If the steering angle exceeds approximately 90 degrees, only the predictive course line on the outside is displayed (opposite side of steering direction).
- The around view monitor control unit receives the steering angle signal from steering angle sensor via CAN communication, and controls the direction and distance of the predictive course line.
- ON/OFF setting of predictive course line can be performed using CONSULT.

SYSTEM

< SYSTEM DESCRIPTION >

[AUDIO W/O NAVI (FOR MEXICO)]

Front view guiding lines

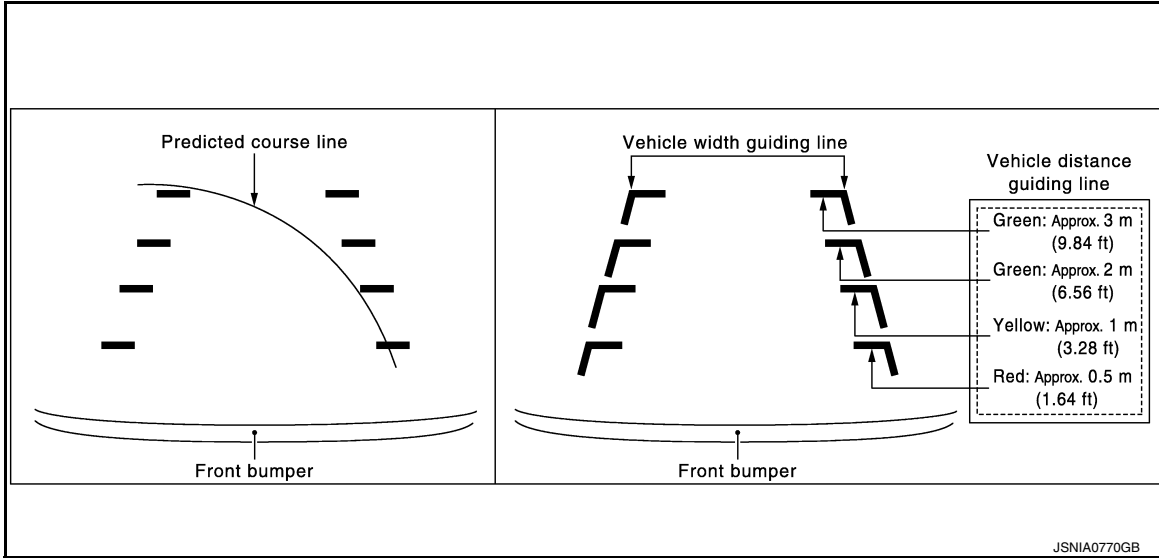

Rear View

- The rear view image improves the visibility of obstacles in the rear of the vehicle and assists backing and parking by displaying images from birds-eye view and front side view.
- The rear view image displays the vehicle width guiding line and vehicle distance guiding line, in addition to the predictive course line according to the steering angle.

NOTE:

The predictive course line is not displayed at the steering neutral position.

- The around view monitor control unit receives the steering angle signal from steering angle sensor via CAN communication, and controls the direction and distance of the predictive course line.
- ON/OFF setting of predictive course line can be performed using CONSULT.

Rear view guiding lines

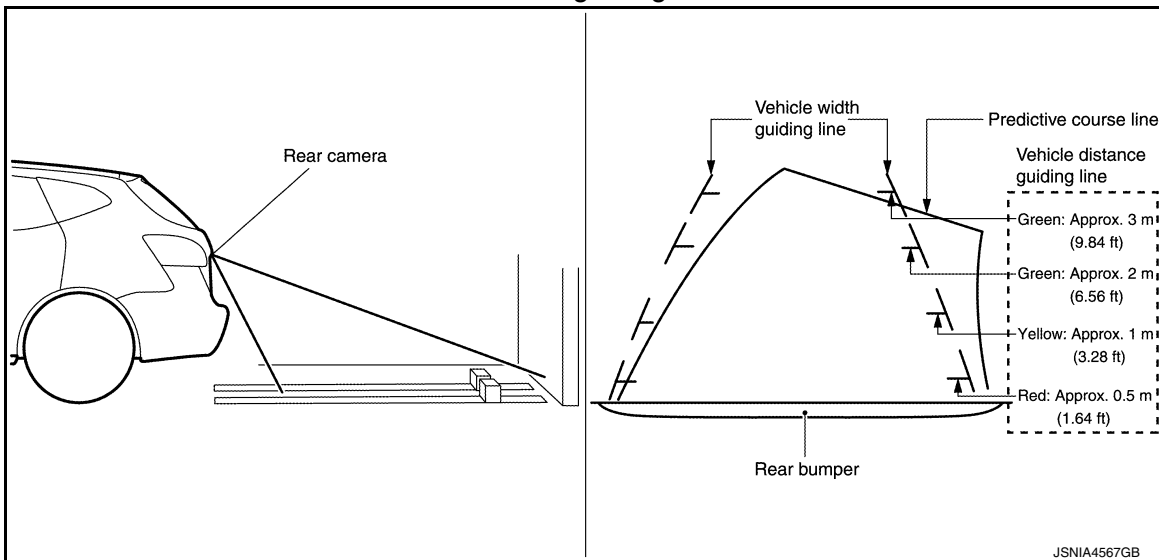

Front-Side View

- The front-side view image improves the visibility of obstacles in the front RH side of the vehicle and assists backing and parking.
- The front-side view image displays the vehicle distance guiding line and vehicle width guiding line.

SYSTEM

< SYSTEM DESCRIPTION >

[AUDIO W/O NAVI (FOR MEXICO)]

Front-side view area and guiding line

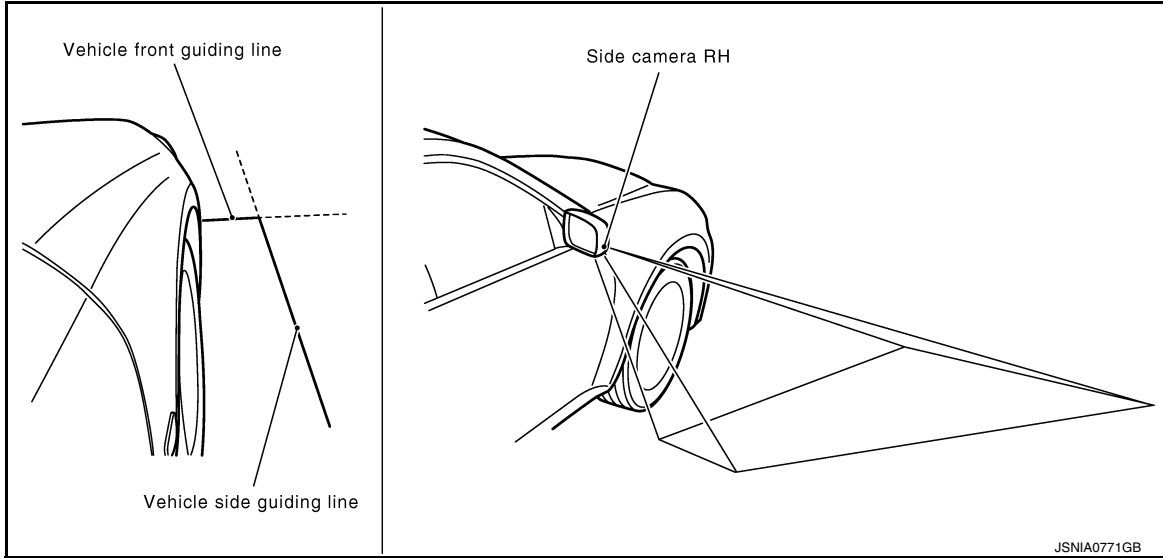

Birds-Eye View

- The birds-eye view image improves the visibility of obstacles all around the vehicle and assists backing and parking.
- The images from the four cameras are converted into an overhead view, and the surroundings of the vehicle are displayed.
- The blind spot area is displayed on the image to specify the boundary of the four cameras.

Birds-Eye view display image

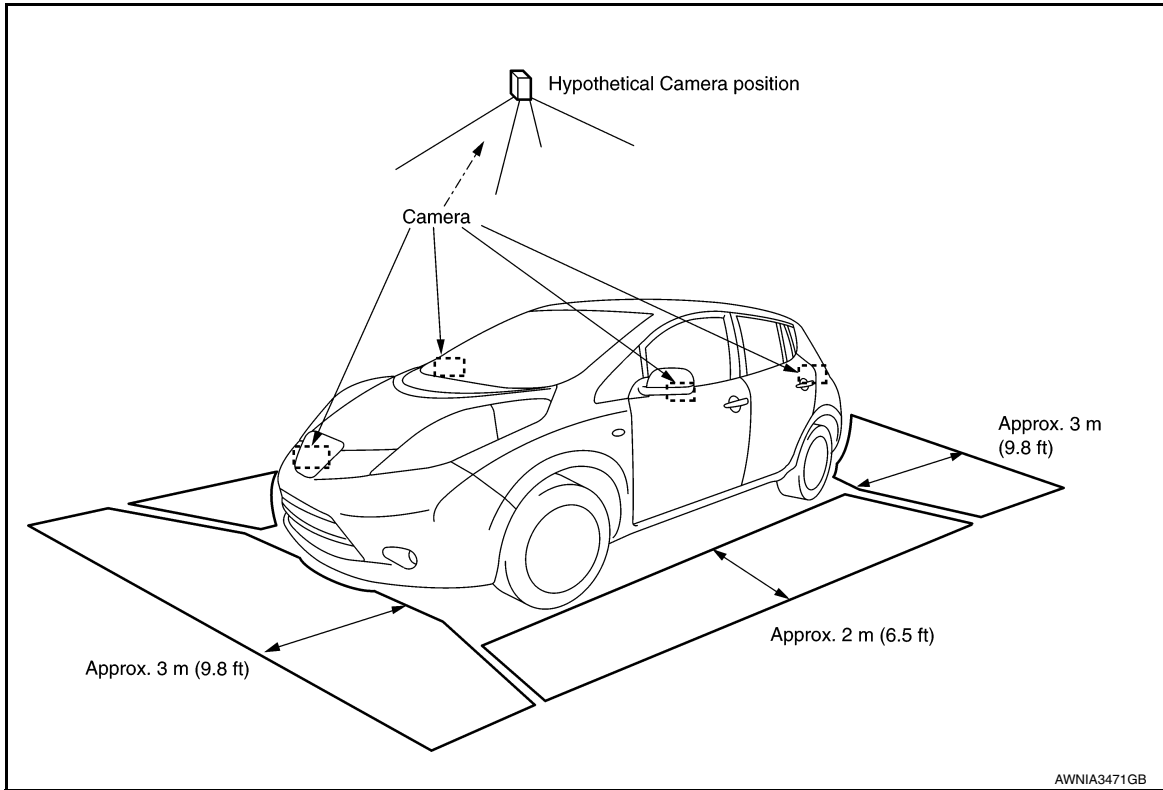

SYSTEM

< SYSTEM DESCRIPTION >

[AUDIO W/O NAVI (FOR MEXICO)]

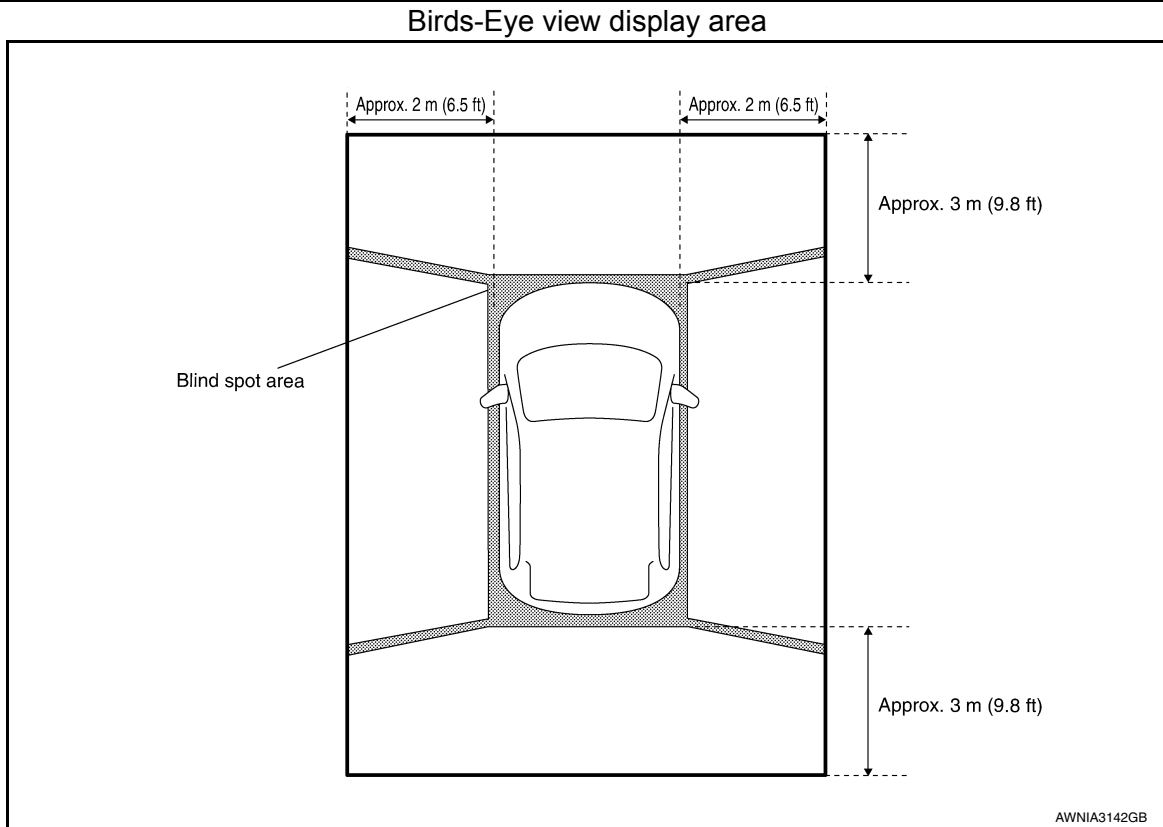

A
B
C
D
E
F
G
H

MULTI AV SYSTEM : Fail-safe

INFOID:000000010641745

When a malfunction occurs within the system, the AV control unit outputs a message on the display, and it restricts the AV control unit functions.

FAIL-SAFE CONDITIONS

SD card not inserted, SD card malfunction, internal malfunction of navigation, etc.

Display Indication

- When the system is in the fail-safe status at the start of the AV control unit, an error message is shown on the display.
- When the system is in the fail-safe status after the start of the AV control unit, an error message is not shown on the display. The MULTI AV system may be rebooted in the fail-safe state. If the fail-safe state is maintained after the system is rebooted, an applicable message is shown.

I
J
K
L

Cause	Display monitor
Malfunction of flash ROM information	TARGET INFO NG
No SD card	NO SD CARD
Unsuccessful security unlock	SD UNLOCK NG
Malfunction of SD card mount	SD INIT NG
Malfunction of SD card access	SD ACCESS NG
No program data	NO NAVI-2 DATA
Malfunction of program data (SUM NG)	NAVI-2DATA READ NG
Inconsistent program version (Flash/SD)	NAVI VERSION NG
Difference of map destination	DIFFERENT MAP CODE
Not compliant with map database version	MAP DATA BASE UNMATCH
Malfunction of navigation	NAVI STARTUP NG

M

AV

O

P

CONTROL

When the system is in the fail-safe status at or after start of the AV control unit, the following functions are restricted.

SYSTEM

< SYSTEM DESCRIPTION >

[AUDIO W/O NAVI (FOR MEXICO)]

Function		In fail-safe mode
A/C	Display	No display (fail-safe status display)
Audio	Operation	Mute audio
	Display	No display (fail-safe status display)
Hands-free phone	Operation	It cannot be operated
Navigation	Operation	It cannot be operated
Display	Operation	Open/close operation is available
	Display	Fail-safe factors are displayed
Self-diagnosis		It cannot be diagnosed
CONSULT diagnosis		It cannot be diagnosed
AV communication diagnosis		It cannot be diagnosed
Frequency transmission for VCM		Normal
SD read access		Access cannot be gained.
SD write access		Access cannot be gained.

CANCELLATION CONDITIONS

The fail-safe status is canceled under the following conditions, and then the system returns to the normal mode.

- When the SD card is not inserted, the SD card is inserted and the power of the AV control unit is turned ON again.
- When the SD card is not functional at the start of navigation due to a malfunction of the SD card, a normal SD card is inserted and the power of the AV control unit is turned ON again.

OPERATION

Switch name and Function

INFOID:000000010641746

Names and functions of AV control unit switches

1. Design

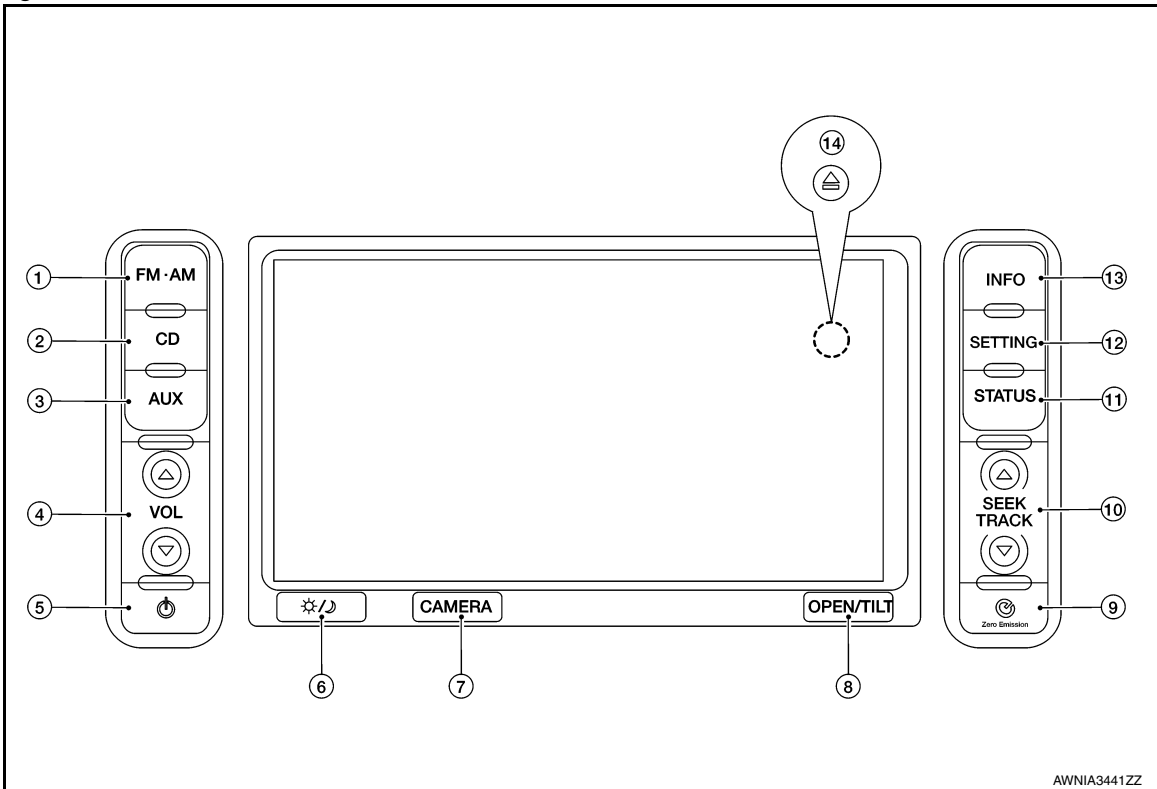

2. Switch name and function

No.	Switch name	Function
1	FM-AM	Press to switch between the FM radio band and the AM radio band.
2	CD	Press to display the CD screen.
3	AUX	Press to switch between USB memory/iPod player ^{*1} /Bluetooth [®] streaming audio ^{*2} /AUX screens.
4	VOL (volume control)	Press to adjust the volume of the stereo.
5	⏻ (audio system ON-OFF)	Press to turn the audio system ON or OFF.
6	☀/🌙 (Day/Night)	<ul style="list-style-type: none"> Press to switch between the day screen (bright) and the night screen (dark). Press and hold to turn off the display, then press again to turn on the display.
7	CAMERA	Press to turn the predictive course lines ON or OFF.
8	OPEN/TILT	<ul style="list-style-type: none"> Press to open the monitor to access the CD slot and the SD card slot. Press and hold to adjust the monitor angle. (3 preset angles) - Press and hold until a chime sounds. When the button is released, the next preset angle will be selected.
9	🔄 (Zero emission)	Press to display the setting screen where several useful functions for electric vehicle driving are determined.
10	SEEK/TRACK	<ul style="list-style-type: none"> Press to select a track/station. Press and hold to search for a track/station automatically or to fast-forward/reverse when listening to music.
11	STATUS	Press to display the current status of the air conditioner, radio, audio and vehicle information (drivable distance and average energy economy).
12	SETTING	Press to access the system settings.

A
B
C
D
E
F
G
H
I
J
K
L
M
O
P

AV

OPERATION

[AUDIO W/O NAVI (FOR MEXICO)]

< SYSTEM DESCRIPTION >

No.	Switch name	Function
13	INFO	Press to display the vehicle information.
14	 (CD eject)	Press to eject a CD.

- *1: Displayed when iPod® is connected.
- *2: Displayed when Bluetooth® audio is registered and “Bluetooth connection” setting is ON.



Names and functions of steering switch

Using the steering switch, operations of the audio and telephone can be performed without releasing hands from the steering wheel.

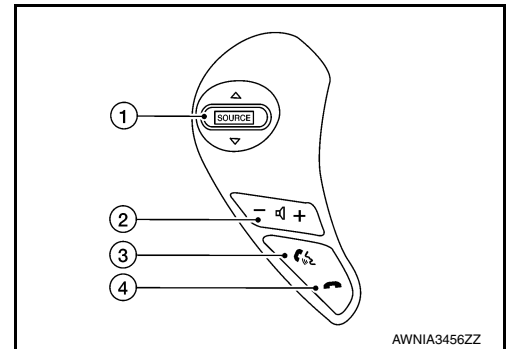
1. Design



2. Switch name and function

No.	switch name	Major functions
1	SOURCE	Press to change the mode to available audio source: <ul style="list-style-type: none"> • AM and FM radio. • iPod. • CD. • USB. • Bluetooth® Audio.
		Tilt up/down for less than 1.5 seconds. <ul style="list-style-type: none"> AM and FM radio: <ul style="list-style-type: none"> • skips up or down through the preset stations. iPod, CD, USB or Bluetooth® Audio: <ul style="list-style-type: none"> • skips up or down through the tracks.
		Tilt up/down for more than 1.5 seconds. <ul style="list-style-type: none"> AM and FM radio: <ul style="list-style-type: none"> • seeks up or down to the next station. CD (except compressed audio files): <ul style="list-style-type: none"> • fast forwards or rewinds through the track. CD (compressed audio files) and USB: <ul style="list-style-type: none"> • skips up or down through the folders.
2	-  + (Volume control)	Press to increase or decrease the volume.
3	 (PHONE SEND)	Press to send or answer calls.
4	 (PHONE END)	Press to end or reject calls.

HANDLING PRECAUTION

Display

INFOID:0000000010641747

- When the compartment temperature is low, the display images may look slower because the LCD response is deteriorated. The system will recover its normal operation when the cabin temperature increases to an appropriate level.
- When the compartment temperature is low (0°C or less), the display images may look slower. It is characteristic of the LCD monitor and should not be considered to be a malfunction. When the temperature is at the operating temperature (0°C to 50°C), the display returns to normal.
- There may be small dark or bright dots in the screen or remaining display content may be found (image lag). These are inherent symptoms to any LCD monitor and should not be considered to be a malfunction.
- The image may look bright or dark when viewed obliquely from the rear. It is inherent to any LCD monitor and should not be considered to be a malfunction.
- Do not apply pressure on the LCD monitor. Doing so may cause irregularities in the screen image or render it inoperative.
- Do not use hard cloth, organic solvent (alcohol, benzene, and thinner), or chemical wipe to clean the LCD monitor. Doing so may affect the panel surface. When cleaning the LCD monitor, always wipe it with a soft cloth after shutting off the power. For severe contamination, use a soft cloth dampened with mild detergent (no droplets can be present).

Audio

INFOID:0000000010641748

- When an MP3/WMA disc is replayed, it may take some time to start the playback after the disc is inserted, because the contents of the disc files must be analyzed.
- The extensions for MP3/WMA files are ".MP3", ".WMA", ".mp3", and ".wma". Any file with a different extension or no extension cannot be played back.
- If trying to play a music CD (CD-DA) containing MP3/WMA file, MP3/WMA file is not played.
- The compatibility of a CD-R depends on the combination of the writing software/hardware and the writing rate. The disc has digital pulse signals written on it. If the specifications for writing depth and width (area) are not compatible, these signals may not be played back correctly or the sounds may be lost or skipped.
- The file recorded with high bit rate* may have sound skipping.
- The playback order of MP3/WMA files may differ from the intended order because the writing software could change the folder and file positions when writing data to a CD-R/CD-RW disc.
- For an MP3 file, the folder name and file name can be displayed as the title on the condition that each name string consists of up to 16 alphanumeric letters (except for the extension). Any MP3 file with a name containing other letters or that is longer than the maximum length cannot be displayed correctly.
- Some MP3/WMA making software, text information editing software, writing software, or software configurations may create files and discs in a format different from the proper specifications. In such a case, the text information display or the playback function may not be available.
- A disc for which no session close or disc close process has been finished may not be played back.
- Some files may have incorrect playback time displays and therefore a part of the music cannot be played back.
- 8 cm disc cannot be used.
- When playing back a Bluetooth® audio data, the sound may be interrupted for a moment. This is due to data communication and should not be considered to be a malfunction. After the data communication finishes, the playback will restart normally.
- Sound skipping may occur depending on the location where the Bluetooth audio device is installed.
- Music data stored in a Bluetooth® audio device at low bit rate has poor sound quality.
- Radio reception may decrease in performance during charge.

NOTE:

*: Bit rate means how many bits of data are processed or transmitted per the unit time.

iPod®

INFOID:0000000010641749

- If a headphone is connected to the iPod®, the iPod® may not be controlled.
- Some iPod® may not be compliant with connection. It is necessary to check compliant models of iPod®.
- If a USB extension cable is used for iPod® connection, iPod® may not be recognized or sound skipping may occur in playback.

HANDLING PRECAUTION

< SYSTEM DESCRIPTION >

[AUDIO W/O NAVI (FOR MEXICO)]

- In playing back iPod® audio, if the EQ function (equalizer function) of the iPod® is ON, sound may be distorted.
- If the number of music in one category is increased to a large number, response may be poor. If the number of music is large and shuffle is ON, operation of the iPod® itself may be slower.

RESTRICTIONS ON iPod®

The following symptoms may occur, but the functions are not compliant and they should not be considered to be a malfunction.

- When a Podcast divided into chapters is played back with iPod nano 3G, the play time may be displayed incorrectly.
- The number of Audiobook is not displayed normally. When iPod® is disconnected and reset, it is displayed.
- When jacket photos are played with iPod nano 3G and iPod Classic, iPod® may be frozen or reset.

USB Connection

INFOID:0000000010641750

If a USB-HUB or USB extension cable is used when a USB is connected, USB is not recognized.

Hands-Free Phone

INFOID:0000000010641751

- In the following cases, the hands-free telephone function is not available.
 - When the vehicle moves out of the communication zone of the cellular phone.
 - When the vehicle is in a location that may block radio waves such as in an underground parking lot, behind a building, or in mountainous areas.
 - When the cellular phone is subject to dial-up limitations such as dial lock, and auto lock, transmission restriction.
- It is not compliant with call waiting function and three-party call function.
- No incoming call can be received just after the key switch is turned to ON.
- Depending on the cellular phone connected, the ring volume may decrease.
- Before connecting a cellular phone, make sure that the operation limitations such as dial lock, auto lock and transmission restriction are cancelled. If any of these settings is found to remain active, disconnect the phone, cancel the setting, and reconnect it.
- When a menu or information is displayed on a cellular phone or when application of standby tool is activated, the function may not be used. Use the cellular phone in the standby status.
- Once a cellular phone is removed, wait at least 10 seconds before reconnecting it.
- When attempting to use a cellular phone, always make sure that the battery charge level is sufficient.
- A snap sound may be heard or the audio signal may be interrupted during a call. This is not a malfunction. It is caused by a switchover to an adjacent cellular zone due to weakening radio waves.
- When the reception status is poor or the surrounding sound level is too large, the voice on the phone may be hard to hear.
- Because the system uses a digital line, the voice on the phone may be distorted or have unpleasant noises due to the surrounding sounds.
- If the vehicle is equipped with a speed trap tracker (radar detector), the speaker may generate noises.
- This unit cannot be used to charge a cellular phone.

SD Card

INFOID:0000000010641752

To remove the SD card, wait for 15 seconds or more after turning the power switch OFF.

DIAGNOSIS SYSTEM (AV CONTROL UNIT)

[AUDIO W/O NAVI (FOR MEXICO)]

< SYSTEM DESCRIPTION >

DIAGNOSIS SYSTEM (AV CONTROL UNIT)

Diagnosis Description

INFOID:0000000010641753

- Diagnosis is performed with the on board diagnosis and CONSULT. Select an appropriate function based on the condition. Perform the on board diagnosis if it starts. If the on board diagnosis does not start such as no display, perform diagnosis with CONSULT.
- In the on board diagnosis, a multifunction switch operation starts the AV control unit diagnosis function and AV control unit performs a diagnosis for each system unit. Diagnosis results are displayed on the screen.
- In the CONSULT diagnosis, a communication signal starts the AV control unit diagnosis function and the AV control unit performs a diagnosis for each system unit.

On Board Diagnosis Function

INFOID:0000000010641754

ON BOARD DIAGNOSIS ITEM

- The on board diagnosis function has a self-diagnosis mode for conducting trouble diagnosis automatically and a confirmation/adjustment mode for operating manually.
- Self-diagnosis mode performs diagnosis of the AV control unit and the connection between AV control unit and multifunction switch. The AV control unit displays the results on the display.
- The confirmation/adjustment mode allows the technician to check, modify or adjust the vehicle signals and set values, as well as to monitor the system error records and system communication status. The check, modify or adjust actions generally require human intervention and judgment (the system cannot judge automatically).

Mode		Description
Self Diagnosis		<ul style="list-style-type: none">• AV control unit diagnosis.• Diagnoses the connection between AV control unit and multifunction switch.
Confirmation/ Adjustment	Display Diagnosis	The following check functions are available: color tone check by Color Spectrum Bar and White Display, light and shade check by Gradation Bar and Touch Panel calibration response check.
	Vehicle Signals	Diagnosis of signals can be performed for vehicle speed, parking brake, lights, power switch and reverse.
	Steering Angle Adjustment	When there is a difference between the actual turning angle and the vehicle mark turning angle, it can be adjusted.
	Error location display	The system malfunction and the frequency when occurring in the past are displayed. When the malfunctioning item is selected, the time and place that the selected malfunction last occurred are displayed.
	AV COMM Diagnosis	The communication condition of each unit of Multi AV system can be monitored.
	Hands-free Phone	<ul style="list-style-type: none">• The received volume adjustment of hands-free phone and microphone speaker check can be performed.• Mileage display of remote maintenance can be turned ON/OFF.
	Clock Settings	The current time can be set.
	Delete Unit Connection Log	Erase the connection history of unit and error history.
	User Data Initialization	Initializes the AV control unit memory.
	Version Information	Version information of the AV control unit is displayed.
	Software Update	The current version of the AV control unit software can be updated.
Export Error Log	AV control unit error log can be exported.	

Starting procedure

1. Turn the power switch ON.
2. Turn the audio system off.

DIAGNOSIS SYSTEM (AV CONTROL UNIT)

[AUDIO W/O NAVI (FOR MEXICO)]

< SYSTEM DESCRIPTION >

- Press the "INFO" switch 3 times. Press the "⏻" switch 2 times. Press the "INFO" switch once.

NOTE:

If the on board self-diagnosis does not start, perform diagnosis using CONSULT. Refer to [AV-110. "CONSULT Function"](#).

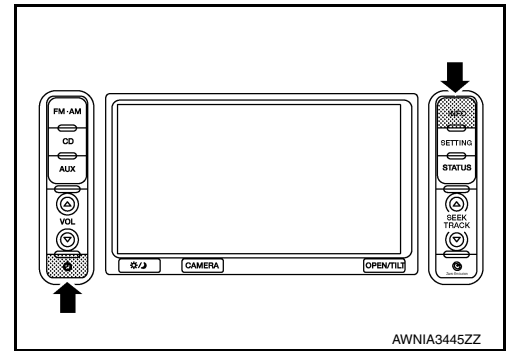

- The initial trouble diagnosis screen displays two choices: "Self-Diagnosis" and "Confirmation/Adjustment".

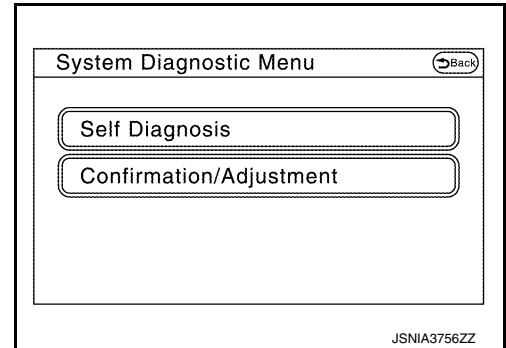

SELF-DIAGNOSIS MODE

- Start the self-diagnosis function and select "Self Diagnosis".
 - Self-diagnosis subdivision screen is displayed, and the self-diagnosis mode starts.
 - The bar graph visible on the center of the self-diagnosis subdivision screen indicates progress of the trouble diagnosis.
- Diagnosis results are displayed after the self-diagnosis is completed. The unit names and the connection lines are color-coded according to the diagnostic results.

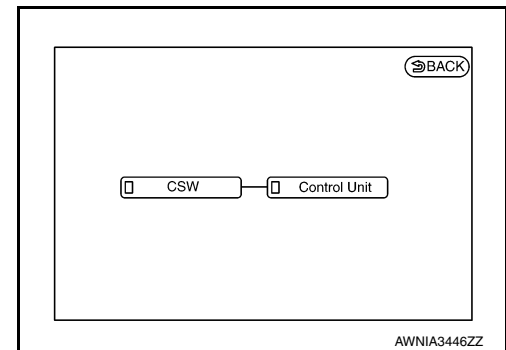

Diagnosis results	Unit	Connection line
Normal	Green	Green
Connection malfunction	Gray	Yellow
Unit malfunction ^{Note}	Red	Green

NOTE:

Control unit (AV control unit) is displayed in red.

- Replace AV control unit if "Self-Diagnosis did not run because of a control unit malfunction" is indicated. The symptom is AV control unit internal error. Refer to [AV-192. "Removal and Installation"](#).
- If multiple errors occur at the same time for a single unit, the screen switch colors are determined according to the following order of priority: red > gray.

DIAGNOSIS SYSTEM (AV CONTROL UNIT)

[AUDIO W/O NAVI (FOR MEXICO)]

< SYSTEM DESCRIPTION >

- The comments of the self-diagnosis results can be viewed with a component in the diagnosis result screen.

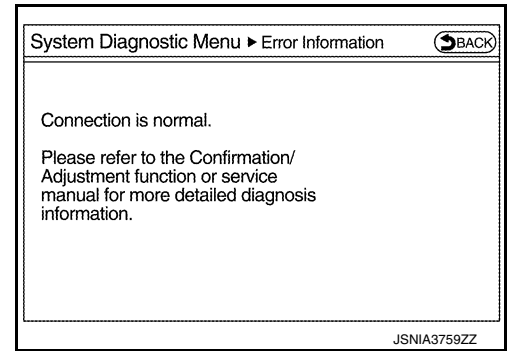

Detection Range of Self-diagnosis Mode

- The self-diagnosis mode allows the technician to diagnose the connection in the communication line between AV control unit and each unit and the internal operation of the AV control unit.
- Because the start condition of diagnosis function is a switch operation, the on board diagnosis function cannot be started up if any malfunction is detected in the communication circuit between AV control unit and multifunction switch.

SELF-DIAGNOSIS RESULTS

Check the applicable display at the following table, and then repair the malfunctioning parts.

Only Unit Part Is Displayed In Red.

Screen switch	Description	Possible malfunction location / Action to take
Control Unit	Malfunction is detected in AV control unit power supply and ground circuits.	<ul style="list-style-type: none"> • Check the power supply and ground circuit. Refer to AV-173. "AV CONTROL UNIT : Diagnosis Procedure". • When the power switch is OFF, remove and insert the SD card to check for contact malfunction of the SD card, and check for an error again. <ul style="list-style-type: none"> - If there is no malfunction, poor contact of the SD card may be possible. Wait and see the condition. - If an malfunction is found, replace the AV control unit. Refer to AV-192. "Removal and Installation".

CONFIRMATION/ADJUSTMENT MODE

1. Start the diagnosis function and select "Confirmation/Adjustment". The confirmation/adjustment mode indicates where each item can be checked or adjusted.
2. Select each switch on the "Confirmation/Adjustment Mode" screen to display the relevant trouble diagnosis screen. Press the "Back" switch to return to the initial Confirmation/Adjustment Mode screen.

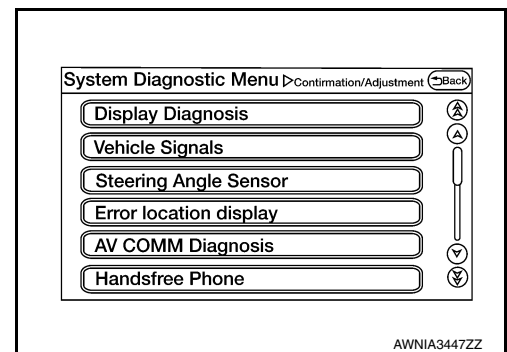

DIAGNOSIS SYSTEM (AV CONTROL UNIT)

< SYSTEM DESCRIPTION >

[AUDIO W/O NAVI (FOR MEXICO)]

Display Diagnosis

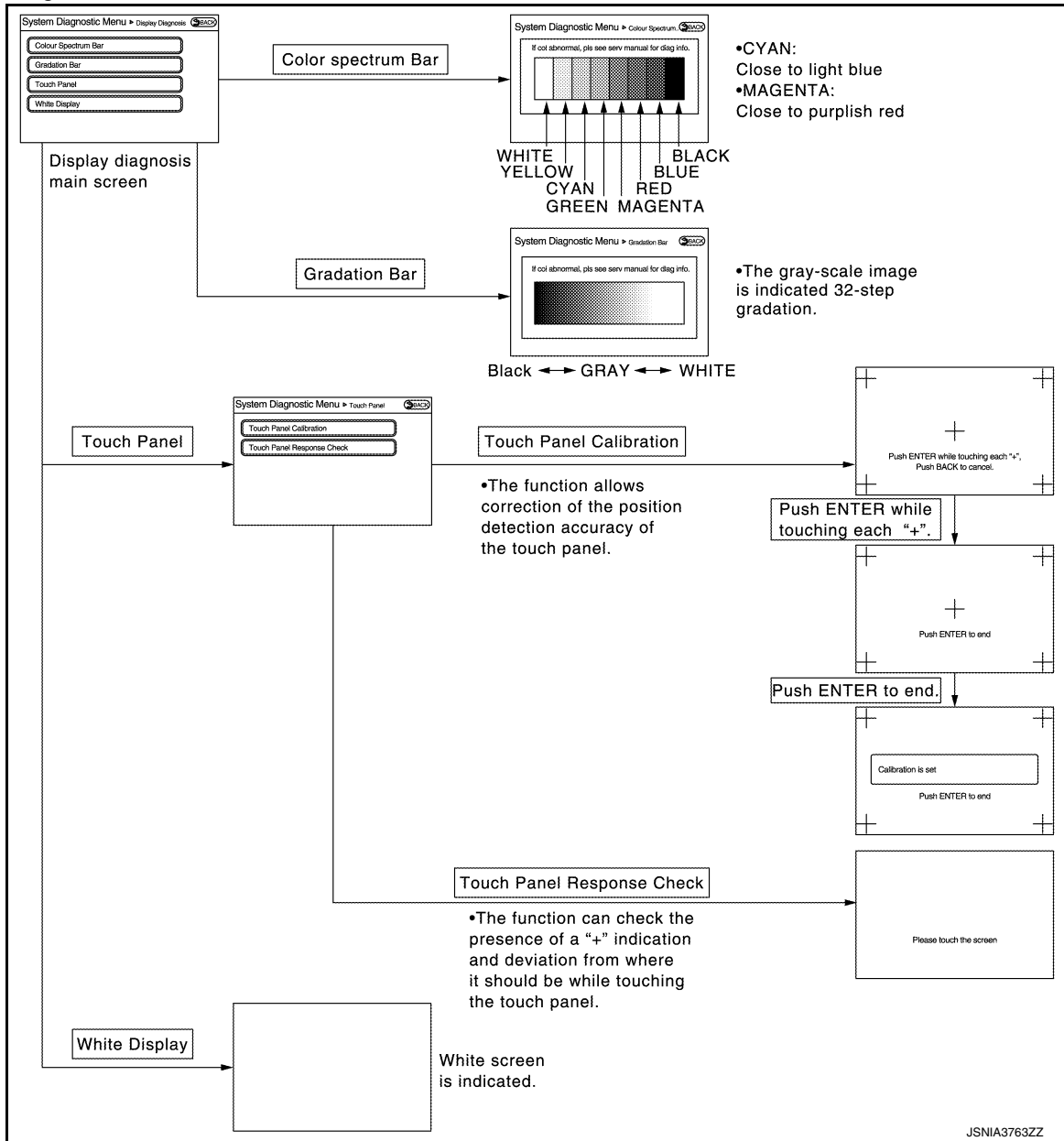

Vehicle Signals

A comparison check can be made of each actual vehicle signal and the signals recognized by the system.

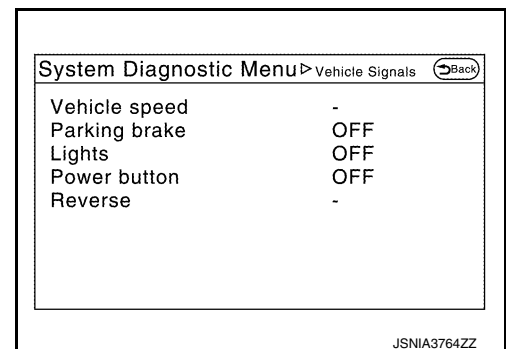

DIAGNOSIS SYSTEM (AV CONTROL UNIT)

< SYSTEM DESCRIPTION >

[AUDIO W/O NAVI (FOR MEXICO)]

Diagnosis item	Display	Vehicle status	Remarks
Vehicle speed	ON	Vehicle speed > 0 km/h (0 MPH)	Changes in indication may be delayed. This is normal.
	OFF	Vehicle speed = 0 km/h (0 MPH)	
Parking brake	ON	Parking brake is applied.	
	OFF	Parking brake is released.	
Lights	ON	Block the light beam from the auto light optical sensor when the light switch is ON.	—
	OFF	Either of the following conditions • Lighting switch OFF • Expose the auto light optical sensor to light when the light switch is ON.	
Power button	ON	Power button ON	—
	OFF	Power button in ACC position	
Reverse	ON	Shift the selector lever to "R" position	Changes in indication may be delayed. This is normal.
	OFF	Shift the selector lever other than "R" position	

Steering Angle Adjustment

- The steering angle output is adjusted.

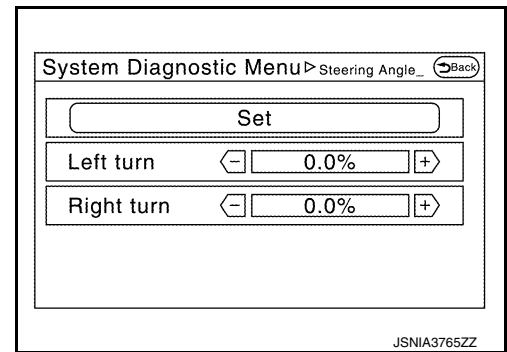

Error location display

The self-diagnosis results are judged depending on whether any error occurs from when "Self-diagnosis" is selected until the self-diagnosis results are displayed.

However, the diagnosis results are judged normal if an error has occurred before the power switch is turned ON and then no error has occurred until the self-diagnosis start. Check the "Error Record" to detect any error that may have occurred before the self-diagnosis start because of this situation.

The error record displays the time and place of the most recent occurrence of that error. However, take note of the following points.

- Place of the error occurrence is represented by the position of the current location mark at the time an error occurred. If current location mark has deviated from the correct position, then the place of the error occurrence cannot be located correctly.
- The frequency of occurrence is displayed in a count up manner. The actual count up method differs depending on the error item.

Count up method A

- The counter resets to 0 if an error occurs when power switch is turned ON. The counter increases by 1 if the condition is normal at a next power ON cycle.
- The counter upper limit is 39. Any counts exceeding 39 are ignored. The counter can be reset (no error record display) with the "Delete log" switch or CONSULT.

Display type of occurrence frequency	Error history display item
Count up method A	CAN communication line, control unit (CAN), AV communication line, control unit (AV)

DIAGNOSIS SYSTEM (AV CONTROL UNIT)

< SYSTEM DESCRIPTION >

[AUDIO W/O NAVI (FOR MEXICO)]

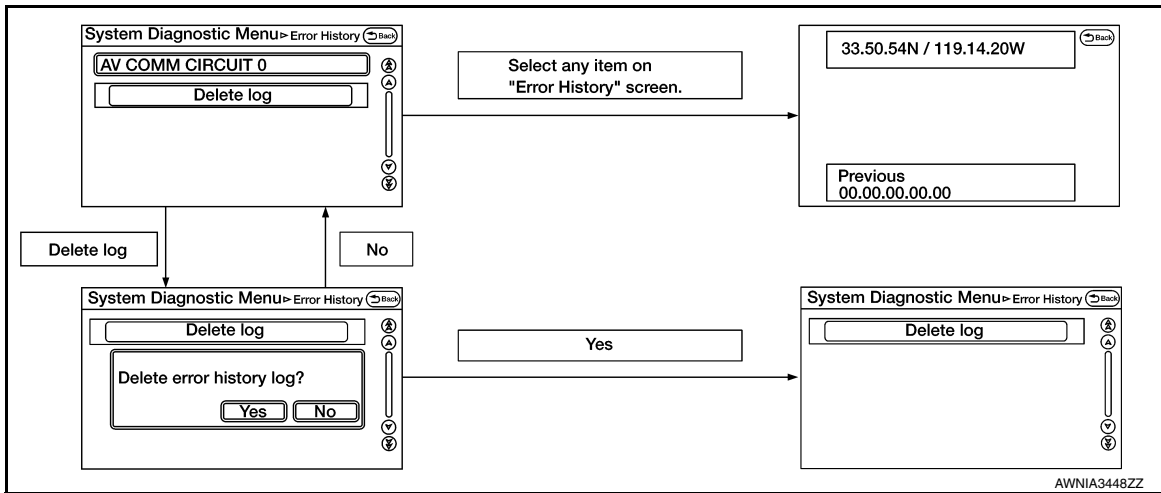

Error item

Some error items may be displayed simultaneously according to the cause. If some error items are displayed simultaneously, the detection of the cause can be performed by the combination of display items

Error item	Description	Possible malfunction factor/Action to take
CAN COMM CIRCUIT	CAN communication malfunction is detected.	Perform diagnosis with CONSULT, and then repair the malfunctioning parts according to the diagnosis results. Refer to AV-110, "CONSULT Function" .
CONTROL UNIT (CAN)	CAN initial diagnosis malfunction is detected.	Replace the AV control unit if the malfunction occurs constantly. Refer to AV-192, "Removal and Installation" .
CONTROL UNIT (AV)	AV communication circuit initial diagnosis malfunction is detected.	
Control Unit Internal Error	AV control unit malfunction is detected.	Replace the AV control unit or multifunction switch if the malfunction occurs constantly. Refer to AV-192, "Removal and Installation" (AV control unit), AV-193, "Removal and Installation" (multifunction switch).
Switch Initial Communication Error	AV control unit or multifunction switch internal malfunction are detected.	
Steer. Angle Sensor Calibration	Predictive course line center position adjustment of the steering angle sensor is incomplete.	Adjust the predictive course line center position of the steering angle sensor. Refer to AV-110, "CONSULT Function" .
USB electric current error	Detection of overcurrent in USB connector.	Check USB harness between the AV control unit and USB connector.
<ul style="list-style-type: none"> • AV COMM CIRCUIT • Switches Connection Error 	When either one of the following items are detected: <ul style="list-style-type: none"> • multifunction switch power supply and ground circuits are malfunctioning. • AV communication circuits between AV control unit and multifunction switch are malfunctioning. 	<ul style="list-style-type: none"> • Multifunction switch power supply and ground circuits. • AV communication circuits between AV control unit and multifunction switch.

AV COMM Diagnosis

DIAGNOSIS SYSTEM (AV CONTROL UNIT)

[AUDIO W/O NAVI (FOR MEXICO)]

< SYSTEM DESCRIPTION >

- Displays the communication status between AV control unit (master unit) and each unit.
- The error counter displays “OK” if any malfunction was not detected in the past and displays “0” if a malfunction is detected. It increases by 1 if the condition is normal at the next power switch ON cycle. The upper limit of the counter is 39.
- The error counter is erased if “Reset” is pressed.

Items	Status (Current)	Counter (Past)
C Tx(ITM-PrimarySW)	OK / ???	OK / 0 – 39
C Rx(PrimarySW-ITM)	OK / ???	OK / 0 – 39

NOTE:

“???” indicates UNKWN

Hands-Free Phone

The hands-free phone reception volume adjustment and microphone and speaker test functions are also available.

NOTE:

If voice cannot be output when the Voice Microphone Test is started, stop and restart the test again.

Clock Setting

The clock can be set.

Delete Unit Connection Log

Deletes any unit connection records and error records from the AV control unit memory. (Clear the records of the unit that has been removed.)

User Data Initialization

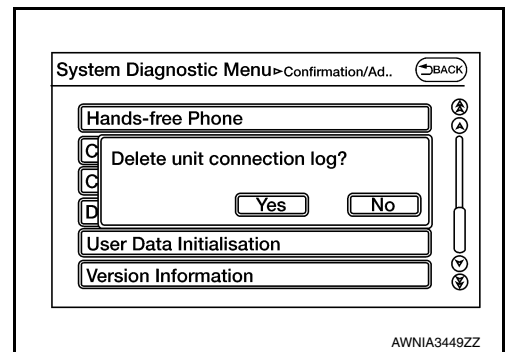
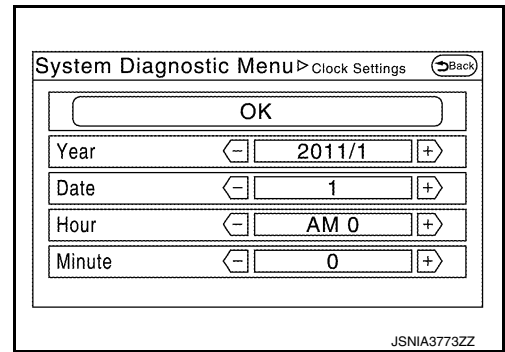
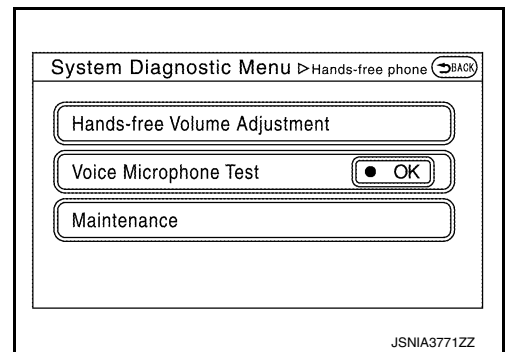
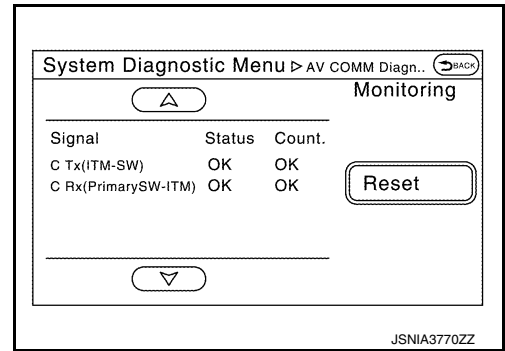

A
B
C
D
E
F
G
H
I
J
K
L
M
AV
O
P

DIAGNOSIS SYSTEM (AV CONTROL UNIT)

[AUDIO W/O NAVI (FOR MEXICO)]

< SYSTEM DESCRIPTION >

Initializes the AV control unit memory.

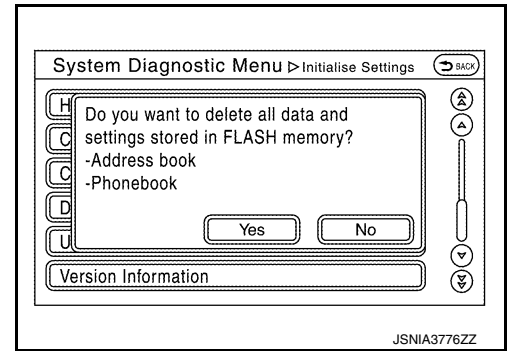

Version Information

Version information of the AV control unit is displayed.

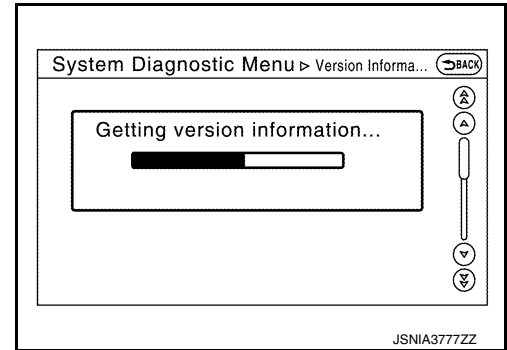

Software Update

Software version of the AV control unit can be update.

For detail of the operation, refer to [AV-144, "SOFTWARE UPDATE \(AV CONTROL UNIT\) : Work Procedure"](#).

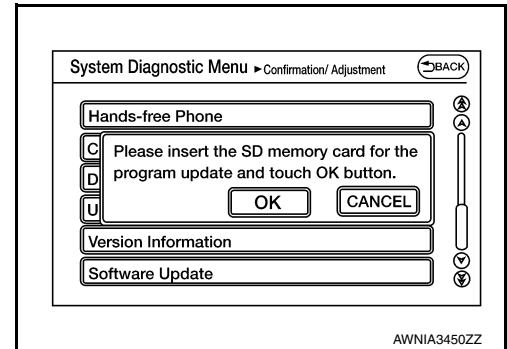

CONSULT Function

INFOID:0000000010641755

CONSULT FUNCTIONS

CONSULT performs the following functions via communication with the AV control unit.

Direct Diagnostic Mode	Description
Ecu Identification	The AV control unit part number is displayed.
Self Diagnostic Result	The AV control unit self diagnostic results are displayed.
Data Monitor	The AV control unit input/output data is displayed in real time.
Work support	The settings for AV control unit functions can be changed.
Configuration	<ul style="list-style-type: none"> The vehicle specification can be read and saved. The vehicle specification can be written when replacing AV control unit.
CAN Diag Support Mntr	<ul style="list-style-type: none"> The result of transmit/receive diagnosis of AV communication is displayed. The result of transmit/receive diagnosis of CAN communication is displayed.

ECU IDENTIFICATION

The part number of AV control unit is displayed.

SELF DIAGNOSTIC RESULT

Refer to [AV-119, "DTC Index"](#).

DIAGNOSIS SYSTEM (AV CONTROL UNIT)

< SYSTEM DESCRIPTION >

[AUDIO W/O NAVI (FOR MEXICO)]

DATA MONITOR

Monitor Item [Unit]	Description
VHCL SPD SIG [On/Off]	Indicates vehicle speed signal received from combination meter on CAN communication line.
PKB SIG [On/Off]	Indicates condition of park brake signal.
ILLUM SIG [On/Off]	Indicates condition of illumination signal for the A/C and AV switch assembly.
IGN SIG [On/Off]	Indicates condition of power signal.
REV SIG [On/Off]	Indicates condition of reverse signal received from BCM.

CONFIGURATION

Refer to [AV-146. "CONFIGURATION \(AV CONTROL UNIT\) : Description"](#).

CAN DIAG SUPPORT MNTR

Refer to [LAN-14. "CAN Diagnostic Support Monitor"](#).

A
B
C
D
E
F
G
H
I
J
K
L
M
O
P

AV

DIAGNOSIS SYSTEM (AROUND VIEW MONITOR CONTROL UNIT)

< SYSTEM DESCRIPTION >

[AUDIO W/O NAVI (FOR MEXICO)]

DIAGNOSIS SYSTEM (AROUND VIEW MONITOR CONTROL UNIT)

CONSULT Function

INFOID:000000010641756

CONSULT FUNCTIONS

CONSULT performs the following functions via communication with the around view monitor control unit.

Direct Diagnostic Mode	Description
Ecu Identification	The around view monitor control unit part number is displayed.
Self Diagnostic Result	The around view monitor control unit self diagnostic results are displayed.
Data Monitor	The around view monitor control unit input/output data is displayed in real time.
Work support	The settings for around view monitor control unit functions can be changed.
Configuration	<ul style="list-style-type: none">The vehicle specification can be read and saved.The vehicle specification can be written when replacing around view monitor control unit.
CAN Diag Support Mntr	The result of transmit/receive diagnosis of CAN communication is displayed.

ECU IDENTIFICATION

The part number of around view monitor control unit is displayed.

SELF DIAGNOSTIC RESULT

Refer to [AV-123, "DTC Index"](#).

DATA MONITOR

Monitor Item	Description
ST ANGLE SENSOR SIGNAL [On/Off]	Indicates condition of steering angle sensor signal.
REVERSE SIGNAL [On/Off]	Indicates selector lever position.
VEHICLE SPEED SIGNAL [mph/km/h]	Indicates condition of vehicle speed signal.
CAMERA SWITCH SIGNAL [On/Off]	Indicates condition of camera switch signal.
CAMERA OFF SIGNAL [On/Off]	Indicates condition of camera OFF signal.
ST ANGLE SENSOR TYPE [Absolute]	Indicates steering angle sensor type.
ST GEAR RATIO TYPE [Type O]	Indicates steering gear ratio type.
STEERING POSITION [LHD/RHD]	Indicates LH or RH drive type.
REAR CAMERA IMAGE SIGNAL [OK/NG]	Indicates condition of camera image signal.
F-CAMERA IMAGE SIGNAL [OK/NG]	Indicates condition of camera image signal.
DR-SIDE CAMERA IMAGE SIG [OK/NG]	Indicates condition of camera image signal.
PA-SIDE CAMERA IMAGE SIG [OK/NG]	Indicates condition of camera image signal.

WORK SUPPORT

Support Item	Setting	Description
NON-VIEWABLE AREA REMINDER	—	ON/OFF setting of non-viewable area can be performed.
PREDICTIVE COURSE LINE DISPLAY	—	ON/OFF setting of predictive course line display can be performed.
INITIALIZE CAMERA IMAGE CALIBRATION	—	Factory image calibration restoration can be performed.
STEERING ANGLE SENSOR ADJUSTMENT	—	Steering angle sensor neutral position adjustment can be performed.

DIAGNOSIS SYSTEM (AROUND VIEW MONITOR CONTROL UNIT)

< SYSTEM DESCRIPTION >

[AUDIO W/O NAVI (FOR MEXICO)]

Support Item	Setting	Description
CALIBRATING CAMERA IMAGE (FRONT CAMERA)	STATUS	Performs calibration of front camera.
	AXIS X	
	AXIS Y	
	ROTATE	
CALIBRATING CAMERA IMAGE (PASS-SIDE CAMERA)	STATUS	Performs calibration of passenger side camera.
	AXIS X	
	AXIS Y	
	ROTATE	
CALIBRATING CAMERA IMAGE (DR-SIDE CAMERA)	STATUS	Performs calibration of driver side camera.
	AXIS X	
	AXIS Y	
	ROTATE	
CALIBRATING CAMERA IMAGE (REAR CAMERA)	STATUS	Performs calibration of rear camera.
	AXIS X	
	AXIS Y	
	ROTATE	
FINE TUNING OF BIRDS-EYE VIEW	STATUS	Confirmation and adjustment of difference between each camera can be performed.
	SELECT	
	AXIS X	
	AXIS Y	
	ROTATE	

Calibrating Camera Image (front camera, pass-side camera, dr-side camera, and rear camera)

Perform the calibration of camera image caused by the incorrect mounting position of each camera, etc. Always perform calibration after performing the following work.

- When each camera or each camera mount (e.g. front grille, door mirror, and others) is removed
- When replacing the around view monitor control unit

Refer to [AV-148. "CALIBRATING CAMERA IMAGE \(AROUND VIEW MONITOR\) : Work Procedure"](#) for the calibration procedure.

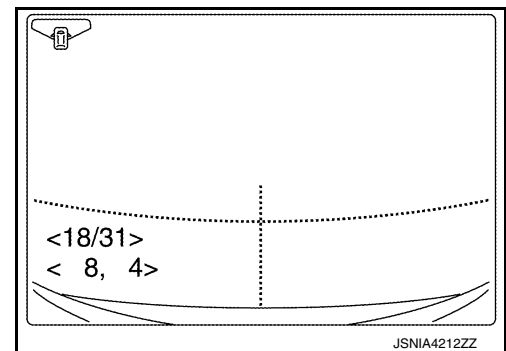

- Adjustment range
- Rotating direction : 31 patterns (16 on the center)
- Upper/lower direction : (-22) – (+22)
- Left/right direction : (-22) – (+22)

Initialize Camera Image Calibration

The calibration can be initialized to NISSAN factory shipment condition.

Select Language of Warning Message

No need to be selected because it can change the language on setting of Navi by customer.

Predictive Course Line Display

ON/OFF setting of predictive course line can be performed.

Steering Angle Sensor Adjustment

Steering angle sensor neutral position can be adjusted and registered.

CAUTION:

A
B
C
D
E
F
G
H
I
J
K
L
M

AV

O
P

DIAGNOSIS SYSTEM (AROUND VIEW MONITOR CONTROL UNIT)

< SYSTEM DESCRIPTION >

[AUDIO W/O NAVI (FOR MEXICO)]

Adjust the steering angle sensor neutral position on the ABS actuator control unit side.

Non-Viewable Area Reminder

ON/OFF setting of the non-viewable area reminder can be performed.

CONFIGURATION

Refer to [AV-147. "CONFIGURATION \(AROUND VIEW MONITOR CONTROL UNIT\) : Work Procedure"](#).

CAN DIAG SUPPORT MNTR

Refer to [LAN-14. "CAN Diagnostic Support Monitor"](#).

AV CONTROL UNIT

< ECU DIAGNOSIS INFORMATION >

[AUDIO W/O NAVI (FOR MEXICO)]

ECU DIAGNOSIS INFORMATION

AV CONTROL UNIT

Reference Value

INFOID:0000000010641757

VALUES ON THE DIAGNOSIS TOOL

Monitor Item	Condition	Value/Status
VHCL SPD SIG	Vehicle speed = 0 km/h (0 MPH).	Off
	Vehicle speed > 0 km/h (0 MPH).	On
PKB SIG	Parking brake released.	Off
	Parking brake applied.	On
ILLUM SIG	Illumination signal is not received.	Off
	Illumination signal is received.	On
IGN SIG	Power switch OFF or ACC.	Off
	Power switch ON.	On
REV SIG	Selector lever in any position other than R.	Off
	Selector lever in R position.	On

TERMINAL LAYOUT

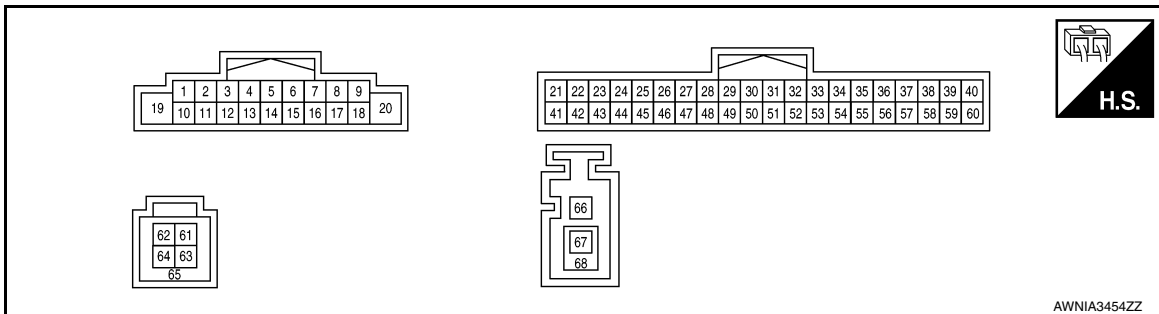

PHYSICAL VALUES

Terminal (Wire color)		Description		Condition		Reference value (Approx.)
+	-	Signal name	Input/Output	Power switch	Operation	
2 (L)	3 (P)	Sound signal front LH	Output	ON	Sound output	<p>SKIB3609E</p>
4 (V)	5 (LG)	Sound signal rear LH	Output	ON	Sound output	<p>SKIB3609E</p>

AV CONTROL UNIT

< ECU DIAGNOSIS INFORMATION >

[AUDIO W/O NAVI (FOR MEXICO)]

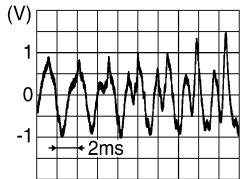
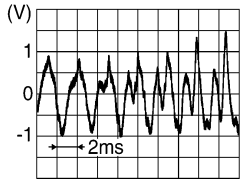
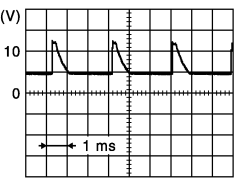
Terminal (Wire color)		Description		Condition		Reference value (Approx.)
+	-	Signal name	Input/ Output	Power switch	Operation	
6 (R)	15 (B)	Steering switch signal A	Input	ON	Press SOURCE switch.	0 V
					Press ▲ switch.	1.0 V
					Press ▼ switch.	2.0 V
					Press switch	3.0 V
					Except above.	5.0 V
7 (BR)	Ground	ACC power supply	Input	ACC	—	Battery voltage
8 (B)	—	Illumination ground	—	—	—	—
9 (W)	Ground	Illumination signal	Input	ON	Lighting switch ON.	Battery voltage
					Lighting switch OFF.	0 V
11 (G)	12 (R)	Sound signal front RH	Output	ON	Sound output	 <small>SKIB3609E</small>
13 (SB)	14 (GR)	Sound signal rear RH	Output	ON	Sound output	 <small>SKIB3609E</small>
16 (W)	15 (B)	Steering switch signal B	Input	ON	Press - switch.	0 V
					Press + switch.	1.0 V
					Press switch	2.0 V
					Except above.	5.0 V
19 (BR)	Ground	Battery power supply	Input	OFF	—	Battery voltage
21 (LG)	—	AV communication signal (L)	Input/ Output	—	—	—
22 (LG)	—	AV communication signal (L)	Input/ Output	—	—	—
23 (P)	—	CAN L	Input/ Output	—	—	—
25 (Y)	Ground	Parking brake signal	Input	ON	Parking brake applied.	0 V
					Parking brake released.	 <small>JSNIA1938ZZ</small>

AV CONTROL UNIT

< ECU DIAGNOSIS INFORMATION >

[AUDIO W/O NAVI (FOR MEXICO)]

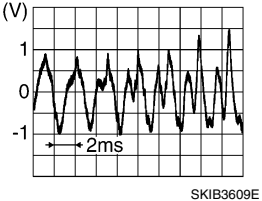
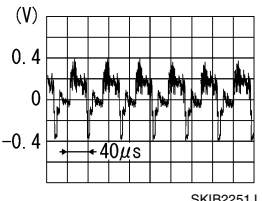
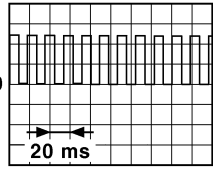
Terminal (Wire color)		Description		Condition		Reference value (Approx.)
+	-	Signal name	Input/ Output	Power switch	Operation	
26 (V)	Ground	Power signal	Input	ON	—	Battery voltage
				OFF	—	0 V
27 (L)	Ground	AVM detection	—	ON	—	0 V
34 (P)	Ground	Microphone VCC	Output	ON	—	5 V
35 (R)	Ground	AUX sound signal LH	Input	ON	AUX mode selected.	
36 (B)	Ground	AUX ground	—	ON	—	0 V
40 (W)	Ground	Camera image signal	Input	ON	AVM image displayed.	
41 (SB)	—	AV communication signal (H)	Input/ Output	—	—	—
42 (SB)	—	AV communication signal (H)	Input/ Output	—	—	—
43 (L)	—	CAN H	Input/ Output	—	—	—
44 (GR)	Ground	Vehicle speed signal (8-pulse)	Input	ON	When vehicle speed is approx. 40 km/h (25 MPH)	<p>NOTE: The maximum voltage varies depending on the specification (destination unit).</p> 
45 (G)	Ground	Reverse signal	Input	ON	Selector lever in R (reverse) position	Battery voltage
				ON	Selector lever in other than R (reverse) position	0 V
46 (R)	Ground	Dimmer signal	Input	ON	One of the following conditions: • Lighting switch OFF • Auto light ON with optical sensor exposed to light.	0 V
				ON	Auto light ON with optical sensor not exposed to light.	Battery voltage

A
B
C
D
E
F
G
H
I
J
K
L
M
O
P

AV

AV CONTROL UNIT

< ECU DIAGNOSIS INFORMATION >

[AUDIO W/O NAVI (FOR MEXICO)]

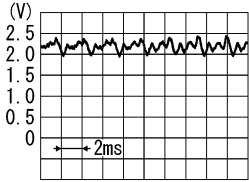
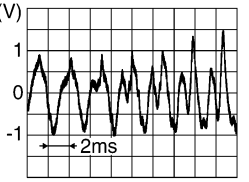
Terminal (Wire color)		Description		Condition		Reference value (Approx.)
+	-	Signal name	Input/ Output	Power switch	Operation	
53 (L)	Ground	Microphone signal	Input	ON	Speak into microphone	 <p style="text-align: right; font-size: small;">PKIB5037J</p>
54 (Shield)	—	Microphone signal shield	—	—	—	—
55 (W)	Ground	AUX sound signal RH	Input	ON	AUX mode selected.	 <p style="text-align: right; font-size: small;">SKIB3609E</p>
56 (Shield)	—	AUX sound signal shield	—	—	—	—
58 (B)	—	Ground	—	—	—	—
60 (Shield)	—	Camera image signal shield	—	—	—	—
61 (W)	Ground	V BUS signal	Output	ON	—	5 V
62 (G)	—	USB ground	—	—	—	—
63 (L)	Ground	USB D+ signal	Input/ Output	—	—	—
64 (R)	Ground	USB D- signal	Input/ Output	—	—	—
65 (Shield)	—	USB signal shield	—	—	—	—
66 (B)	Ground	Antenna amp. ON signal	Output	ACC	—	Battery voltage
67 (B)	—	AM-FM main	Input	—	—	—
68 (Shield)	—	AM-FM main shield	—	—	—	—

Fail-safe

INFOID:000000010641758

When a malfunction occurs within the system, the AV control unit outputs a message on the display, and it restricts the AV control unit functions.

FAIL-SAFE CONDITIONS

SD card not inserted, SD card malfunction, internal malfunction of navigation, etc.

Display Indication

- When the system is in the fail-safe status at the start of the AV control unit, an error message is shown on the display.

AV CONTROL UNIT

< ECU DIAGNOSIS INFORMATION >

[AUDIO W/O NAVI (FOR MEXICO)]

- When the system is in the fail-safe status after the start of the AV control unit, an error message is not shown on the display. The MULTI AV system may be rebooted in the fail-safe state. If the fail-safe state is maintained after the system is rebooted, an applicable message is shown.

Cause	Display monitor
Malfunction of flash ROM information	TARGET INFO NG
No SD card	NO SD CARD
Unsuccessful security unlock	SD UNLOCK NG
Malfunction of SD card mount	SD INIT NG
Malfunction of SD card access	SD ACCESS NG
No program data	NO NAVI-2 DATA
Malfunction of program data (SUM NG)	NAVI-2DATA READ NG
Inconsistent program version (Flash/SD)	NAVI VERSION NG
Difference of map destination	DIFFERENT MAP CODE
Not compliant with map database version	MAP DATA BASE UNMATCH
Malfunction of navigation	NAVI STARTUP NG

CONTROL

When the system is in the fail-safe status at or after start of the AV control unit, the following functions are restricted.

Function		In fail-safe mode
A/C	Display	No display (fail-safe status display)
Audio	Operation	Mute audio
	Display	No display (fail-safe status display)
Hands-free phone	Operation	It cannot be operated
Navigation	Operation	It cannot be operated
Display	Operation	Open/close operation is available
	Display	Fail-safe factors are displayed
Self-diagnosis		It cannot be diagnosed
CONSULT diagnosis		It cannot be diagnosed
AV communication diagnosis		It cannot be diagnosed
Frequency transmission for VCM		Normal
SD read access		Access cannot be gained.
SD write access		Access cannot be gained.

CANCELLATION CONDITIONS

The fail-safe status is canceled under the following conditions, and then the system returns to the normal mode.

- When the SD card is not inserted, the SD card is inserted and the power of the AV control unit is turned ON again.
- When the SD card is not functional at the start of navigation due to a malfunction of the SD card, a normal SD card is inserted and the power of the AV control unit is turned ON again.

DTC Index

INFOID:0000000010641759

AV CONTROL UNIT

< ECU DIAGNOSIS INFORMATION >

[AUDIO W/O NAVI (FOR MEXICO)]

DTC	Display item	Refer to
U1000	CAN COMM CIRC	AV-155, "AV CONTROL UNIT : DTC Logic"
U1010	CONTROL UNIT (CAN)	AV-157, "AV CONTROL UNIT : DTC Logic"
U121F	CONTROL UNIT	AV-166, "DTC Logic"
U1263	USB OVERCURRENT	AV-168, "DTC Logic"
U1310	CONTROL UNIT (AV)	AV-172, "DTC Logic"
U1300 U1240	<ul style="list-style-type: none">• AV COMM CIRCUIT• SWITCH CONN	AV-169, "Description"

AROUND VIEW MONITOR CONTROL UNIT

< ECU DIAGNOSIS INFORMATION >

[AUDIO W/O NAVI (FOR MEXICO)]

AROUND VIEW MONITOR CONTROL UNIT

Reference Value

INFOID:000000010641760

VALUES ON THE DIAGNOSIS TOOL

Monitor Item	Condition	Value/Status
CAMERA OFF SIGNAL	CAMERA switch ON.	Off
	CAMERA switch OFF.	On
CAMERA SWITCH SIGNAL	CAMERA switch OFF.	Off
	CAMERA switch ON.	On
DR-SIDE CAMERA IMAGE SIG	Side camera LH inoperative.	NG
	Side camera LH operative.	OK
F-CAMERA IMAGE SIG	Front camera inoperative.	NG
	Front camera operative.	OK
PA-SIDE CAMERA IMAGE SIG	Side camera RH inoperative.	NG
	Side camera RH operative.	OK
REAR CAMERA IMAGE SIGNAL	Rear camera LH inoperative.	NG
	Rear camera LH operative.	OK
REVERSE SIGNAL	When selector lever is in any position other than R (reverse).	Off
	When selector lever in R (reverse).	On
ST ANGLE SENSOR SIGNAL	Around view monitor control unit is not receiving steering angle sensor signal.	Off
	Around view monitor control unit is receiving steering angle sensor signal.	On
ST ANGLE SENSOR TYPE	Steering angle sensor type.	Absolute
ST GEAR RATIO TYPE	Steering gear ratio type.	Type O
STEERING POSITION	Left hand drive vehicle.	LHD
	Right hand drive vehicle.	RHD
VEHICLE SPEED SIGNAL	While driving, equivalent to speedometer reading	mph, km/h

TERMINAL LAYOUT

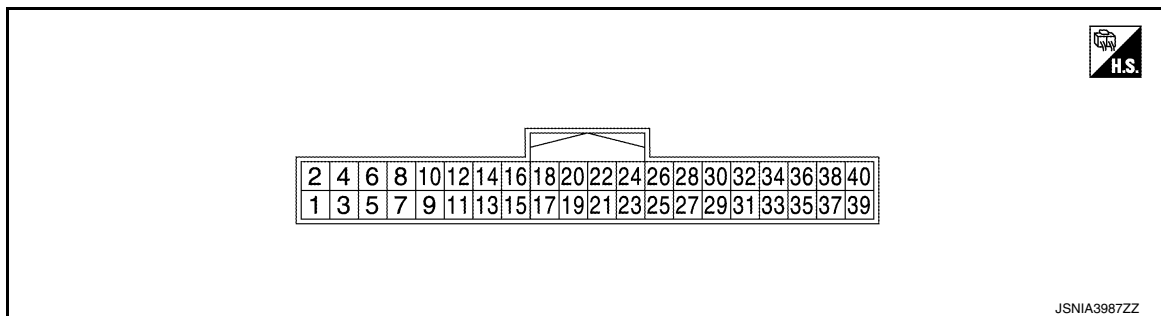

PHYSICAL VALUES

A
B
C
D
E
F
G
H
I
J
K
L
M
O
P

AV

AROUND VIEW MONITOR CONTROL UNIT

< ECU DIAGNOSIS INFORMATION >

[AUDIO W/O NAVI (FOR MEXICO)]

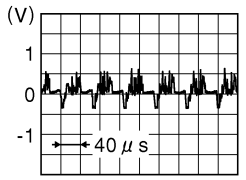
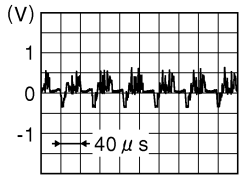
Terminal (Wire color)		Description		Condition		Reference value (Approx.)
+	-	Signal name	Input/ Output	Power switch	Operation	
1 (B)	Ground	Ground	—	ON	—	0 V
2 (SB)	Ground	Battery power supply	Input	OFF	—	Battery voltage
4 (W)	Ground	Power signal	Input	ON	—	Battery voltage
				OFF		0 V
8 (SB)	Ground	Reverse signal	Input	ON	Selector lever in R (re- verse) position	Battery voltage
					Selector lever in other than R (reverse) position	0 V
10 (P)	—	CAN-L	Input/ Output	—	—	—
12 (L)	—	CAN-H	Input/ Output	—	—	—
13 (L)	Ground	AVM detection	—	ON	—	0 V
23 (Shield)	—	Camera image signal shield	—	—	—	—
24 (W)	Ground	Camera image signal	Output	ON	Camera image displayed	
25 (B)	Ground	Rear view camera ground	—	ON	—	0 V
26 (W)	Ground	Rear view camera power supply	Output	ON	CAMERA switch ON or Selector lever in R (re- verse) position	6.2 V
27 (Shield)	—	Rear view camera image signal shield	—	—	—	—
28 (R)	Ground	Rear view camera image signal	Input	ON	CAMERA switch ON or Selector lever in R (re- verse) position	
29 (W)	Ground	Side camera LH ground	—	ON	—	0 V
30 (B)	Ground	Side camera LH power supply	Output	ON	CAMERA switch ON or Selector lever in R (re- verse) position	6.2 V
31 (Shield)	—	Side camera LH image sig- nal shield	—	—	—	—

AROUND VIEW MONITOR CONTROL UNIT

< ECU DIAGNOSIS INFORMATION >

[AUDIO W/O NAVI (FOR MEXICO)]

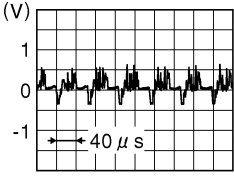
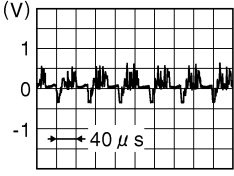
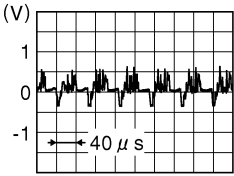
Terminal (Wire color)		Description		Condition		Reference value (Approx.)
+	-	Signal name	Input/ Output	Power switch	Operation	
32 (R)	Ground	Side camera LH image signal	Input	ON	CAMERA switch ON or Selector lever in R (reverse) position	 <p style="text-align: right; font-size: small;">JSNIA0834GB</p>
33 (B)	Ground	Side camera RH side ground	—	ON	—	0 V
34 (W)	Ground	Side camera RH power supply	Output	ON	CAMERA switch ON or Selector lever in R (reverse) position	6.2 V
35 (Shield)	—	Side camera RH image signal shield	—	—	—	—
36 (R)	Ground	Side camera RH image signal	Input	ON	CAMERA switch ON or Selector lever in R (reverse) position	 <p style="text-align: right; font-size: small;">JSNIA0834GB</p>
37 (W)	Ground	Front camera ground	—	ON	—	0 V
38 (R)	Ground	Front camera power supply	Output	ON	CAMERA switch ON or Selector lever in R (reverse) position	6.2 V
39 (Shield)	—	Front camera image signal shield	—	—	—	—
40 (B)	Ground	Front camera image signal	Input	ON	CAMERA switch ON or Selector lever in R (reverse) position	 <p style="text-align: right; font-size: small;">JSNIA0834GB</p>

DTC Index

INFOID:000000010641761

DTC	CONSULT display	Refer to
U0428	ST ANGLE SENSOR CALIBRATION	AV-154, "DTC Logic"
U1000	CAN COMM CIRCUIT	AV-155, "AROUND VIEW MONITOR CONTROL UNIT : DTC Logic"
U1010	CONTROL UNIT (CAN)	AV-157, "AROUND VIEW MONITOR CONTROL UNIT : DTC Logic"
U111A	REAR CAMERA IMAGE SIGNAL	AV-158, "DTC Logic"

AROUND VIEW MONITOR CONTROL UNIT

< ECU DIAGNOSIS INFORMATION >

[AUDIO W/O NAVI (FOR MEXICO)]

DTC	CONSULT display	Refer to
U111B	SIDE CAMERA RH IMAGE SIGNAL	AV-160, "DTC Logic"
U111C	FRONT CAMERA IMAGE SIGNAL	AV-162, "DTC Logic"
U111D	SIDE CAMERA LH IMAGE SIGNAL	AV-164, "DTC Logic"
U1232	ST ANGLE SEN CALIB	AV-167, "AROUND VIEW MONITOR CONTROL UNIT : DTC Logic"
U1304	CAMERA IMAGE CALIB	AV-170, "DTC Logic"
U1305	CONFIG UNFINISH	AV-171, "DTC Logic"

AUDIO W/O NAVI (FOR MEXICO)

< WIRING DIAGRAM >

[AUDIO W/O NAVI (FOR MEXICO)]

WIRING DIAGRAM

AUDIO W/O NAVI (FOR MEXICO)

Wiring Diagram

INFOID:0000000010641762

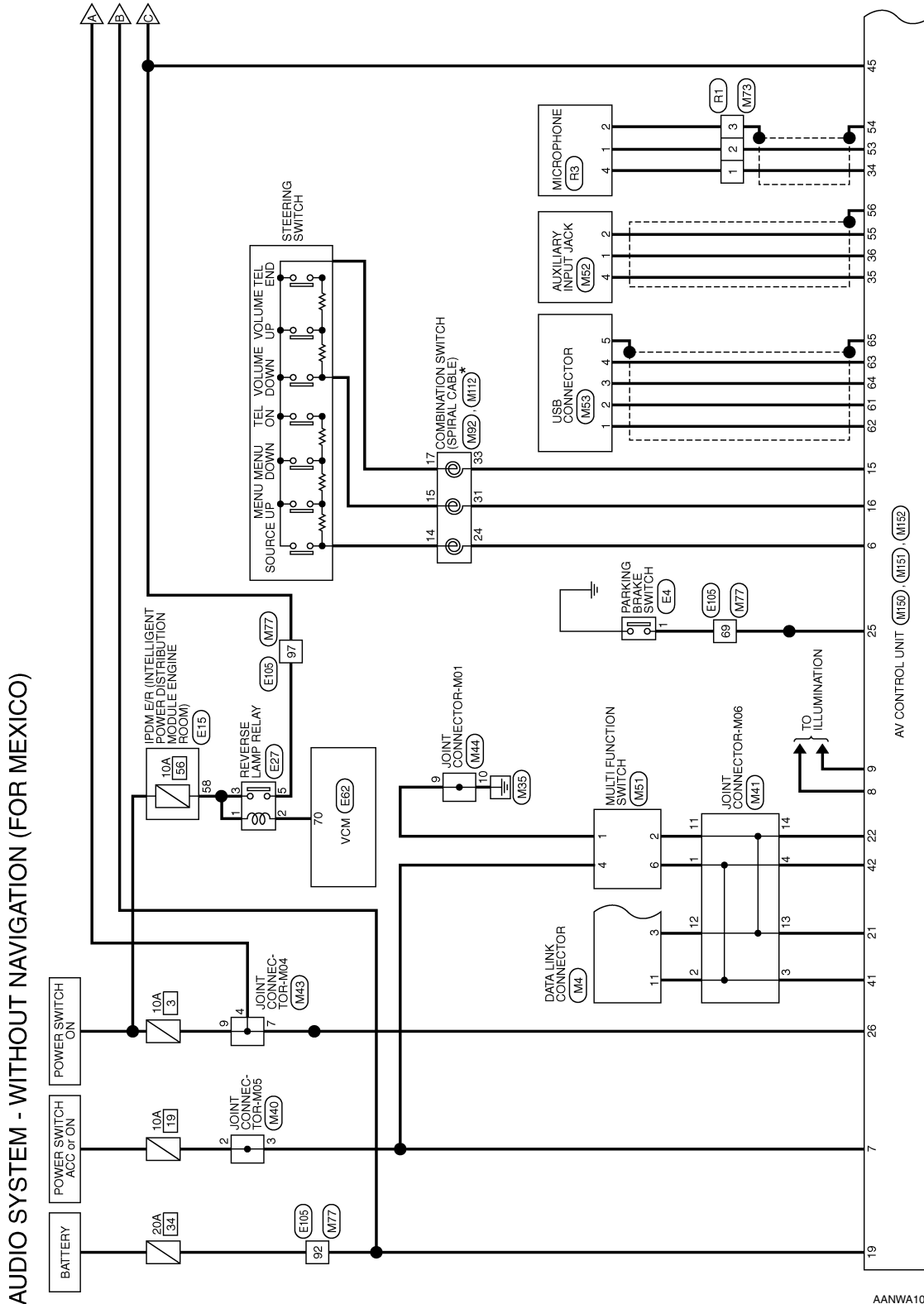

* : THIS CONNECTOR IS NOT SHOWN IN "HARNES LAYOUT" OF PG SECTION.

AANWA1082GB

A
B
C
D
E
F
G
H
I
J
K
L
M
N
O
P

AV

AUDIO W/O NAVI (FOR MEXICO)

< WIRING DIAGRAM >

[AUDIO W/O NAVI (FOR MEXICO)]

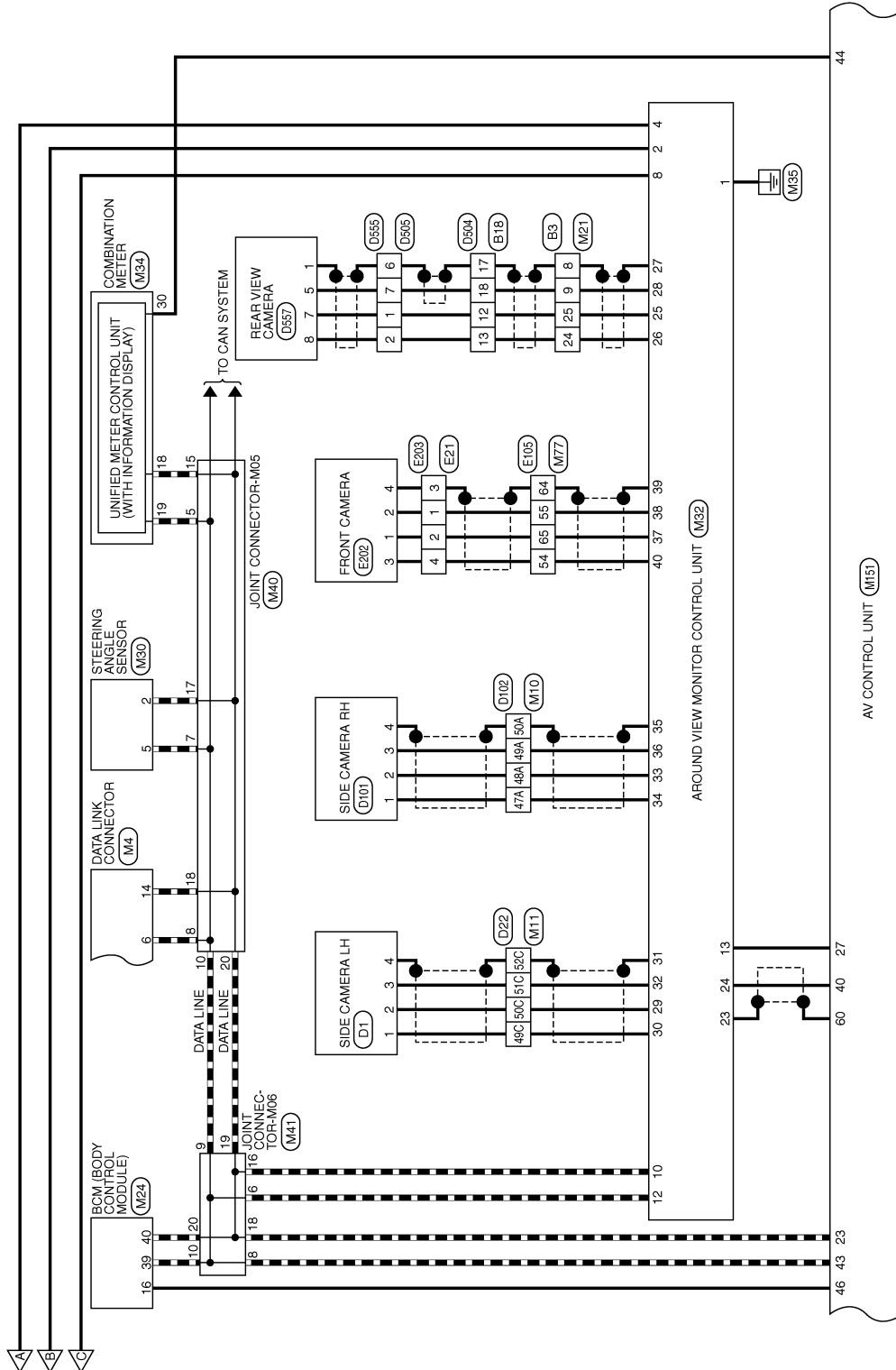

AANWA1083GB

AUDIO W/O NAVI (FOR MEXICO)

< WIRING DIAGRAM >

[AUDIO W/O NAVI (FOR MEXICO)]

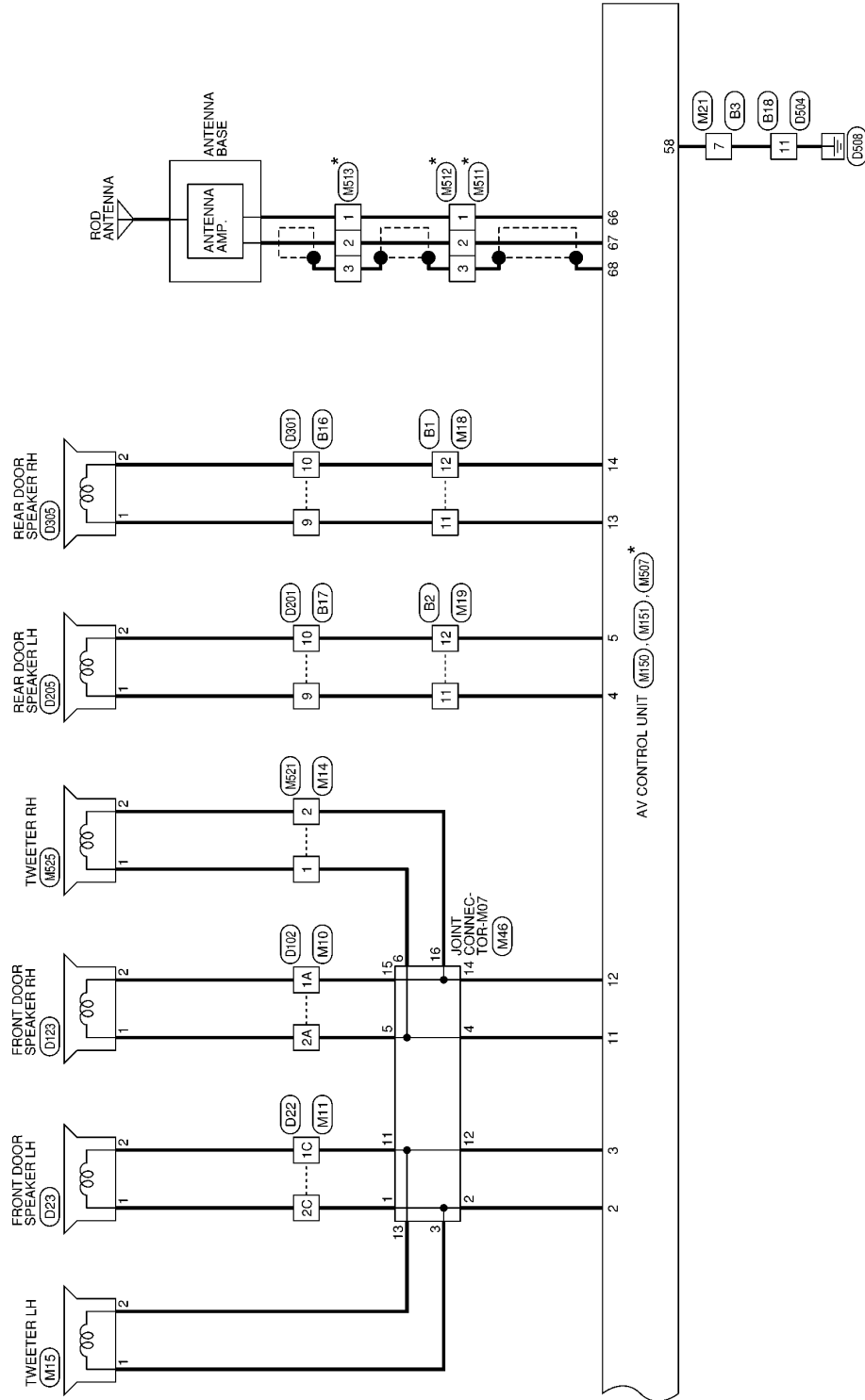

* : THIS CONNECTOR IS NOT SHOWN IN "HARNES LAYOUT" OF PG SECTION.

AANWA1084GB

A
B
C
D
E
F
G
H
I
J
K
L
M
N
O
P

AV

AUDIO SYSTEM - WITHOUT NAVIGATION (FOR MEXICO) CONNECTORS

Connector No.	M4
Connector Name	DATA LINK CONNECTOR
Connector Color	WHITE

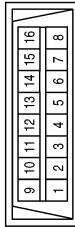

Connector No.	M10
Connector Name	WIRE TO WIRE
Connector Color	WHITE

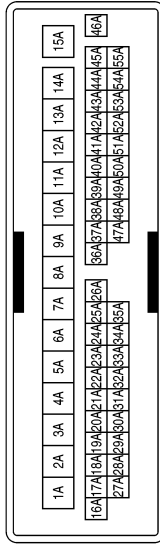

Terminal No.	Color of Wire	Signal Name
3	LG	-
6	L	-
11	SB	-
14	P	-

Terminal No.	Color of Wire	Signal Name
1A	R	-(WITHOUT BOSE)
2A	G	-(WITHOUT BOSE)
47A	W	-
48A	B	-
49A	R	-
50A	SHIELD	-

Connector No.	M11
Connector Name	WIRE TO WIRE
Connector Color	WHITE

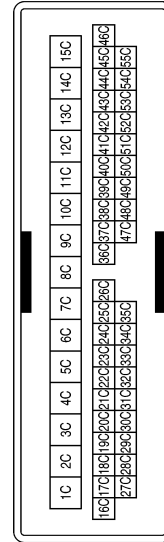

Terminal No.	Color of Wire	Signal Name
1C	P	-(WITHOUT BOSE)
2C	L	-(WITHOUT BOSE)
49C	B	-
50C	W	-
51C	R	-
52C	SHIELD	-

AANIA2777GB

AUDIO W/O NAVI (FOR MEXICO)

< WIRING DIAGRAM >

[AUDIO W/O NAVI (FOR MEXICO)]

Connector No.	M18
Connector Name	WIRE TO WIRE
Connector Color	WHITE

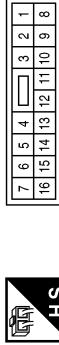

Terminal No.	Color of Wire	Signal Name
11	SB	-(WITHOUT BOSE - FOR MEXICO)
12	GR	-(WITHOUT BOSE - FOR MEXICO)

Connector No.	M15
Connector Name	TWEETER LH
Connector Color	BROWN



Terminal No.	Color of Wire	Signal Name
1	W	-(WITHOUT BOSE)
2	P	-(WITHOUT BOSE)

Connector No.	M14
Connector Name	WIRE TO WIRE
Connector Color	BROWN



Terminal No.	Color of Wire	Signal Name
1	G	-(WITHOUT BOSE)
2	R	-(WITHOUT BOSE)

Connector No.	M24
Connector Name	BCM (BODY CONTROL MODULE)
Connector Color	BLACK

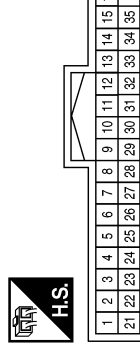

Terminal No.	Color of Wire	Signal Name
16	R	MR OUTPUT
39	L	CAN-H
40	P	CAN-L

Connector No.	M21
Connector Name	WIRE TO WIRE
Connector Color	WHITE

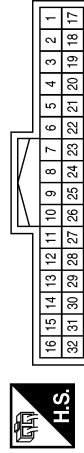

Terminal No.	Color of Wire	Signal Name
7	B	-
8	SHIELD	-
9	R	-
24	W	-
25	B	-

Connector No.	M19
Connector Name	WIRE TO WIRE
Connector Color	WHITE

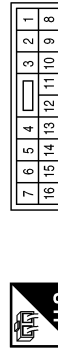

Terminal No.	Color of Wire	Signal Name
11	V	-
12	LG	-

AANIA2778GB

A
B
C
D
E
F
G
H
I
J
K
L
M
AV
O
P

AUDIO W/O NAVI (FOR MEXICO)

[AUDIO W/O NAVI (FOR MEXICO)]

< WIRING DIAGRAM >

Connector No.	M30
Connector Name	STEERING ANGLE SENSOR
Connector Color	WHITE

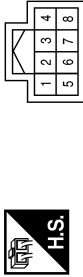

Terminal No.	Color of Wire	Signal Name
2	P	-
5	L	-

Connector No.	M32
Connector Name	AROUND VIEW MONITOR CONTROL UNIT
Connector Color	WHITE

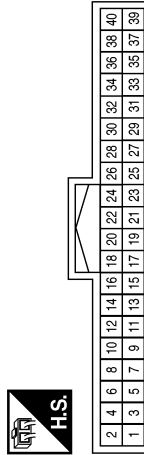

Terminal No.	Color of Wire	Signal Name
1	B	GND
2	SB	+B
3	-	-
4	W	IGN
5	-	-
6	-	-
7	-	-
8	SB	REVERSE

Terminal No.	Color of Wire	Signal Name
9	-	-
10	P	CAN-L
11	-	-
12	L	CAN-H
13	L	LOW-PRICE/AVM DISTINCTION
14	-	-
15	-	-
16	-	-
17	-	-
18	-	-
19	-	-
20	-	-
21	-	-
22	-	-

Terminal No.	Color of Wire	Signal Name
23	SHIELD	VIDEO OUTPUT GND
24	W	VIDEO OUTPUT SIGNAL
25	B	RV-POWER GND
26	W	RV-POWER 6.2V
27	SHIELD	RV-VIDEO GND
28	R	RV-VIDEO SIGNAL
29	W	SV2-POWER GND
30	B	SV2-POWER 6.2V
31	SHIELD	SV2-VIDEO GND
32	R	SV2-VIDEO SIGNAL
33	B	SV1-POWER GND
34	W	SV1-POWER 6.2V
35	SHIELD	SV1-VIDEO GND
36	R	SV1-VIDEO SIGNAL
37	W	FV-POWER GND
38	R	FV-POWER 6.2V
39	SHIELD	FV VIDEO GND
40	B	FV-VIDEO SIGNAL

AANIA2779GB

AUDIO W/O NAVI (FOR MEXICO)

< WIRING DIAGRAM >

[AUDIO W/O NAVI (FOR MEXICO)]

Terminal No.	Color of Wire	Signal Name
17	P	-
18	P	-
20	P	-

Connector No.	M40
Connector Name	JOINT CONNECTOR-M05
Connector Color	BLUE

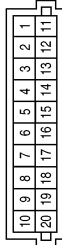

Terminal No.	Color of Wire	Signal Name
2	L	-
3	BR	-
5	L	-
7	L	-
8	L	-
10	L	-
15	P	-

Connector No.	M34
Connector Name	COMBINATION METER
Connector Color	WHITE

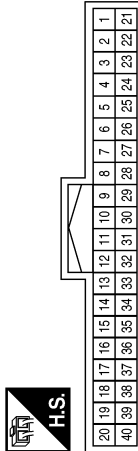

Terminal No.	Color of Wire	Signal Name
18	P	CAN-L
19	L	CAN-H
30	GR	SPEED 8PR

Connector No.	M43
Connector Name	JOINT CONNECTOR-M04
Connector Color	GRAY

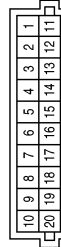

Terminal No.	Color of Wire	Signal Name
4	W	-
7	Y	-
9	W	-

Terminal No.	Color of Wire	Signal Name
8	L	-
9	L	-
10	L	-
11	LG	-
12	LG	-
13	LG	-
14	LG	-
16	P	-
18	P	-
19	P	-
20	P	-

Connector No.	M41
Connector Name	JOINT CONNECTOR-M06
Connector Color	BLUE

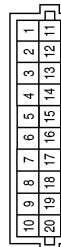

Terminal No.	Color of Wire	Signal Name
1	SB	-
2	SB	-
3	SB	-
4	SB	-
6	L	-

AANIA2780GB

A
B
C
D
E
F
G
H
I
J
K
L
M
AV
O
P

AUDIO W/O NAVI (FOR MEXICO)

< WIRING DIAGRAM >

[AUDIO W/O NAVI (FOR MEXICO)]

Connector No.	M51
Connector Name	MULTIFUNCTION SWITCH
Connector Color	WHITE

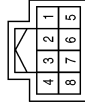

Terminal No.	Color of Wire	Signal Name
1	B	-
2	LG	-
3	-	-
4	L	-
5	-	-
6	SB	-
7	-	-
8	-	-

Connector No.	M46
Connector Name	JOINT CONNECTOR-M07
Connector Color	ORANGE

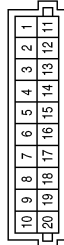

Terminal No.	Color of Wire	Signal Name
1	L	-
2	L	-
3	W	-
4	G	-
5	G	-
6	G	-
11	P	-
12	P	-
13	P	-
14	R	-
15	R	-
16	R	-

Connector No.	M44
Connector Name	JOINT CONNECTOR-M01
Connector Color	GRAY

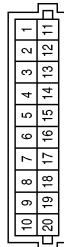

Terminal No.	Color of Wire	Signal Name
9	B	-
10	B	-

Connector No.	M53
Connector Name	USB CONNECTOR
Connector Color	GREEN

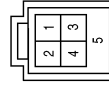

Terminal No.	Color of Wire	Signal Name
1	G	-
2	W	-
3	R	-
4	L	-
5	SHIELD	-

Connector No.	M52
Connector Name	AUXILIARY INPUT JACK
Connector Color	WHITE



Terminal No.	Color of Wire	Signal Name
1	B	-
2	W	-
3	-	-
4	R	-

AANIA2781GB

AUDIO W/O NAVI (FOR MEXICO)

< WIRING DIAGRAM >

[AUDIO W/O NAVI (FOR MEXICO)]

Terminal No.	Color of Wire	Signal Name
54	B	-
55	R	-
64	SHIELD	-
65	W	-
69	BG	-
92	BR	-
97	G	-

Connector No.	M77
Connector Name	WIRE TO WIRE
Connector Color	WHITE

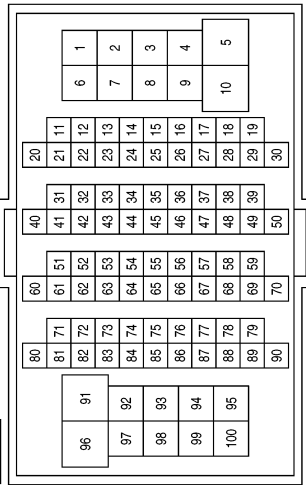

Connector No.	M73
Connector Name	WIRE TO WIRE
Connector Color	WHITE

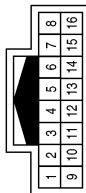

Terminal No.	Color of Wire	Signal Name
1	P	-
2	L	-
3	SHIELD	-

Connector No.	M112
Connector Name	COMBINATION SWITCH (SPIRAL CABLE)
Connector Color	GRAY

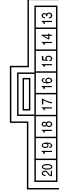

Terminal No.	Color of Wire	Signal Name
14	P	-
15	L	-
17	G	-

Connector No.	M92
Connector Name	COMBINATION SWITCH (SPIRAL CABLE)
Connector Color	GRAY

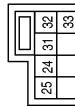

Terminal No.	Color of Wire	Signal Name
24	R	-
31	W	-
33	B	-

AANIA2782GB

A
B
C
D
E
F
G
H
I
J
K
L
M
N
O
P



AUDIO W/O NAVI (FOR MEXICO)

< WIRING DIAGRAM >

[AUDIO W/O NAVI (FOR MEXICO)]

Connector No.	M150
Connector Name	AV CONTROL UNIT (WITHOUT NAVIGATION SYSTEM)
Connector Color	WHITE

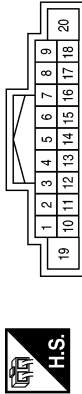

Terminal No.	Color of Wire	Signal Name
1	L	AMP ON
2	L	FR LH PRE+

Terminal No.	Color of Wire	Signal Name
3	P	FR LH PRE-
4	V	RR LH PRE+
5	LG	RR LH PRE-
6	R	STRH SW A
7	BR	ACC
8	B	ILL CONT
9	W	ILL
10	-	-
11	G	FR RH PRE+

Terminal No.	Color of Wire	Signal Name
12	R	FR RH PRE-
13	SB	RR RH PRE+
14	GR	RR RH PRE-
15	B	STRG SW GND
16	W	STRG SW B
17	-	-
18	-	-
19	BR	BAT
20	-	-

Connector No.	M151
Connector Name	AV CONTROL UNIT (WITHOUT NAVIGATION SYSTEM)
Connector Color	WHITE



Terminal No.	Color of Wire	Signal Name
21	LG	M CAN L TRM
22	LG	M CAN L
23	P	CAN-L
24	-	-
25	Y	PKB_SIG
26	V	IGN
27	L	AFFORBABLE_SIG

Terminal No.	Color of Wire	Signal Name
28	-	-
29	-	-
30	-	-
31	-	-
32	-	-
33	-	-
34	P	MIC_VCC
35	R	AUX_AUDIO_LH
36	B	AUX_AUDIO
37	-	-
38	-	-
39	-	-
40	W	R_CAMERA_COMP
41	SB	M CAN H TRM
42	SB	M CAN H
43	L	CAN-H

Terminal No.	Color of Wire	Signal Name
44	GR	SPEED
45	G	REVERSE_SIG
46	R	MR_OUTPUT
47	-	-
48	-	-
49	-	-
50	-	-
51	-	-
52	-	-
53	L	MIC_SIG
54	SHIELD	MIC GND
55	W	AUX_AUDIO_RH
56	SHIELD	AUX SHIELD
57	-	-
58	B	GND
59	-	-
60	SHIELD	R CAMERA SHIELD

AANIA2783GB

AUDIO W/O NAVI (FOR MEXICO)

< WIRING DIAGRAM >

[AUDIO W/O NAVI (FOR MEXICO)]

Connector No.	M511
Connector Name	WIRE TO WIRE
Connector Color	GRAY



Terminal No.	Color of Wire	Signal Name
1	B	-
2	B	-
3	SHIELD	-

Connector No.	M507
Connector Name	AV CONTROL UNIT (WITHOUT NAVIGATION SYSTEM)
Connector Color	GRAY

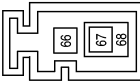

Terminal No.	Color of Wire	Signal Name
66	B	ANTENNA AMP. ON SIGNAL
67	B	RADIO ANTENNA SIGNAL
68	SHIELD	SHIELD

Connector No.	M152
Connector Name	AV CONTROL UNIT (WITHOUT NAVIGATION SYSTEM)
Connector Color	BLUE

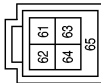

Terminal No.	Color of Wire	Signal Name
61	W	V_BUS
62	G	USB_GND
63	L	USB_D+
64	R	USB_D-
65	SHIELD	SHIELD

Connector No.	M521
Connector Name	WIRE TO WIRE
Connector Color	BROWN



Terminal No.	Color of Wire	Signal Name
1	R	-
2	B	-

Connector No.	M513
Connector Name	ANTENNA BASE
Connector Color	GRAY



Terminal No.	Color of Wire	Signal Name
1	B	-
2	B	-
3	SHIELD	-

Connector No.	M512
Connector Name	WIRE TO WIRE
Connector Color	GRAY



Terminal No.	Color of Wire	Signal Name
1	B	-
2	B	-
3	SHIELD	-

AANIA2784GB

A
B
C
D
E
F
G
H
I
J
K
L
M
N
O
P

AV

AUDIO W/O NAVI (FOR MEXICO)

< WIRING DIAGRAM >

[AUDIO W/O NAVI (FOR MEXICO)]

Connector No.	E15
Connector Name	IPDM E/R (INTELLIGENT POWER DISTRIBUTION MODULE ENGINE ROOM)
Connector Color	WHITE

53	52	51	50	49	48	47
62	61	60	59	58	57	56
55	54					



Terminal No.	58	Color of Wire	O	Signal Name	REVERSE LAMP IGN
--------------	----	---------------	---	-------------	------------------

Connector No.	E4
Connector Name	PARKING BRAKE SWITCH
Connector Color	BLACK



Terminal No.	1	Color of Wire	B	Signal Name	-
--------------	---	---------------	---	-------------	---

Connector No.	M525
Connector Name	TWEETER RH
Connector Color	BROWN



Terminal No.	1	Color of Wire	R	Signal Name	-
2	B	-	-		

Connector No.	E62
Connector Name	VCM
Connector Color	BROWN

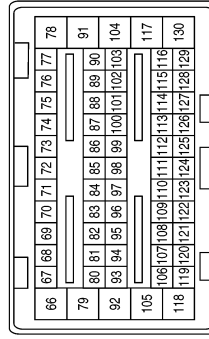

Terminal No.	70	Color of Wire	SB	Signal Name	REVERSE LAMP
--------------	----	---------------	----	-------------	--------------

Connector No.	E27
Connector Name	REVERSE LAMP RELAY
Connector Color	BLUE



Terminal No.	1	Color of Wire	O	Signal Name	-
2	SB	-	-		
3	O	-	-		
5	G	-	-		

Connector No.	E21
Connector Name	WIRE TO WIRE
Connector Color	BLACK



Terminal No.	1	Color of Wire	R	Signal Name	-
2	W	-	-		
3	SHIELD	-	-		
4	B	-	-		

AANIA2785GB

AUDIO W/O NAVI (FOR MEXICO)

< WIRING DIAGRAM >

[AUDIO W/O NAVI (FOR MEXICO)]

Connector No.	E202
Connector Name	FRONT CAMERA
Connector Color	BLACK



Terminal No.	Color of Wire	Signal Name
1	B	-
2	R	-
3	W	-
4	L	-

Terminal No.	Color of Wire	Signal Name
54	B	-
55	R	-
64	SHIELD	-
65	W	-
69	B	-
92	BR	-
97	G	-

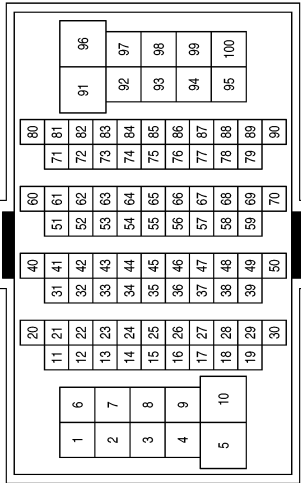

Connector No.	E105
Connector Name	WIRE TO WIRE
Connector Color	WHITE

Connector No.	B2
Connector Name	WIRE TO WIRE
Connector Color	WHITE

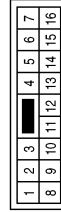

Terminal No.	Color of Wire	Signal Name
11	V	-
12	LG	-

Connector No.	B1
Connector Name	WIRE TO WIRE
Connector Color	WHITE

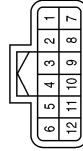

Terminal No.	Color of Wire	Signal Name
11	SB	- (WITHOUT BOSE - FOR MEXICO)
12	GR	- (WITHOUT BOSE - FOR MEXICO)

Connector No.	E203
Connector Name	WIRE TO WIRE
Connector Color	BLACK



Terminal No.	Color of Wire	Signal Name
1	R	-
2	B	-
3	L	-
4	W	-

AANIA2786GB

A
B
C
D
E
F
G
H
I
J
K
L
M
N
O
P

AV

AUDIO W/O NAVI (FOR MEXICO)

< WIRING DIAGRAM >

[AUDIO W/O NAVI (FOR MEXICO)]

Connector No.	B17
Connector Name	WIRE TO WIRE
Connector Color	WHITE

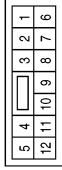

Terminal No.	Color of Wire	Signal Name
9	V	– (WITHOUT BOSE)
10	LG	– (WITHOUT BOSE)

Connector No.	B16
Connector Name	WIRE TO WIRE
Connector Color	WHITE

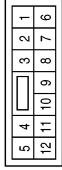

Terminal No.	Color of Wire	Signal Name
9	SB	– (WITHOUT BOSE FOR MEXICO)
10	GR	– (FOR MEXICO)
11	SHIELD	–

Connector No.	B3
Connector Name	WIRE TO WIRE
Connector Color	WHITE

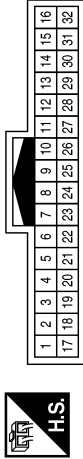

Terminal No.	Color of Wire	Signal Name
7	B	–
8	SHIELD	–
9	B	–
24	R	–
25	W	–

Connector No.	R3
Connector Name	MICROPHONE
Connector Color	WHITE



Terminal No.	Color of Wire	Signal Name
1	L	–
2	GR	–
3	–	–
4	P	–
5	–	–
6	–	–

Connector No.	R1
Connector Name	WIRE TO WIRE
Connector Color	WHITE

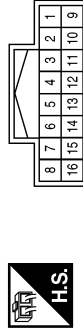

Terminal No.	Color of Wire	Signal Name
1	P	–
2	L	–
3	GR	–

Connector No.	B18
Connector Name	WIRE TO WIRE
Connector Color	WHITE

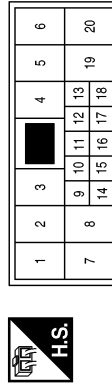

Terminal No.	Color of Wire	Signal Name
11	B	–
12	W	–
13	R	–
17	SHIELD	–
18	B	–

AANIA2787GB

AUDIO W/O NAVI (FOR MEXICO)

[AUDIO W/O NAVI (FOR MEXICO)]

< WIRING DIAGRAM >

Terminal No.	Color of Wire	Signal Name
1C	L	-
2C	V	-
49C	B	-
50C	W	-
51C	R	-
52C	SHIELD	-

Connector No.	D22
Connector Name	WIRE TO WIRE
Connector Color	WHITE

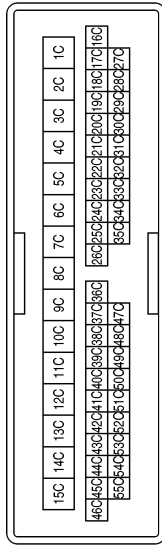

Connector No.	D1
Connector Name	SIDE CAMERA LH
Connector Color	WHITE

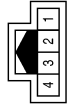

Terminal No.	Color of Wire	Signal Name
1	B	-
2	W	-
3	R	-
4	SHIELD	-

Connector No.	D101
Connector Name	SIDE CAMERA RH
Connector Color	WHITE

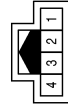

Terminal No.	Color of Wire	Signal Name
1	W	-
2	B	-
3	R	-
4	SHIELD	-

Connector No.	D23
Connector Name	FRONT DOOR SPEAKER LH (WITHOUT BOSE AUDIO SYSTEM)
Connector Color	WHITE



Terminal No.	Color of Wire	Signal Name
1	V	-
2	L	-

AANIA2788GB

A
B
C
D
E
F
G
H
I
J
K
L
M
N
O
P

AV

AUDIO W/O NAVI (FOR MEXICO)

< WIRING DIAGRAM >

[AUDIO W/O NAVI (FOR MEXICO)]

Connector No.	D201
Connector Name	WIRE TO WIRE
Connector Color	WHITE

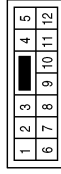

Terminal No.	Color of Wire	Signal Name
9	V	-
10	LG	-

Connector No.	D123
Connector Name	FRONT DOOR SPEAKER RH (WITHOUT BOSE AUDIO SYSTEM)
Connector Color	WHITE



Terminal No.	Color of Wire	Signal Name
1	R	-
2	BR	-

Connector No.	D102
Connector Name	WIRE TO WIRE
Connector Color	WHITE

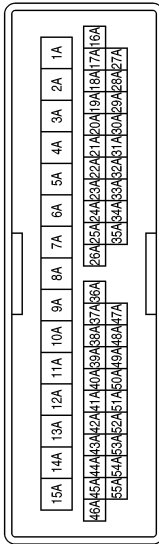

Terminal No.	Color of Wire	Signal Name
1A	BR	-
2A	R	-
47A	W	-
48A	B	-
49A	R	-
50A	SHIELD	-

Connector No.	D305
Connector Name	REAR DOOR SPEAKER RH
Connector Color	WHITE



Terminal No.	Color of Wire	Signal Name
1	LG	-
2	P	-

Connector No.	D301
Connector Name	WIRE TO WIRE
Connector Color	WHITE

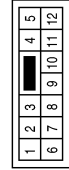

Terminal No.	Color of Wire	Signal Name
9	LG	-
10	P	-

Connector No.	D205
Connector Name	REAR DOOR SPEAKER LH
Connector Color	WHITE



Terminal No.	Color of Wire	Signal Name
1	V	-
2	LG	-

AANIA2789GB

AUDIO W/O NAVI (FOR MEXICO)

[AUDIO W/O NAVI (FOR MEXICO)]

< WIRING DIAGRAM >

Connector No.	D555
Connector Name	WIRE TO WIRE
Connector Color	WHITE

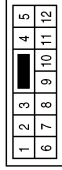

Terminal No.	Color of Wire	Signal Name
1	W	-
2	R	-
6	SHIELD	-
7	B	-

Connector No.	D505
Connector Name	WIRE TO WIRE
Connector Color	WHITE

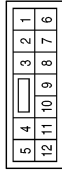

Terminal No.	Color of Wire	Signal Name
1	W	-
2	R	-
6	SHIELD	-
7	Y	-

Connector No.	D504
Connector Name	WIRE TO WIRE
Connector Color	WHITE

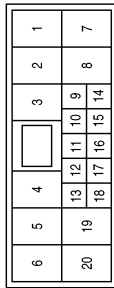

Terminal No.	Color of Wire	Signal Name
11	B	-
12	W	-
13	R	-
17	SHIELD	-
18	Y	-

Terminal No.	Color of Wire	Signal Name
6	-	-
7	W	-
8	R	-

Connector No.	D557
Connector Name	REAR VIEW CAMERA (WITH AROUND VIEW MONITOR)
Connector Color	WHITE

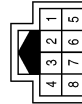

Terminal No.	Color of Wire	Signal Name
1	SHIELD	-
2	-	-
3	-	-
4	-	-
5	B	-

AANIA2790GB

A
B
C
D
E
F
G
H
I
J
K
L
M
N
O
P



BASIC INSPECTION

DIAGNOSIS AND REPAIR WORK FLOW

Work Flow

INFOID:000000010641763

OVERALL SEQUENCE

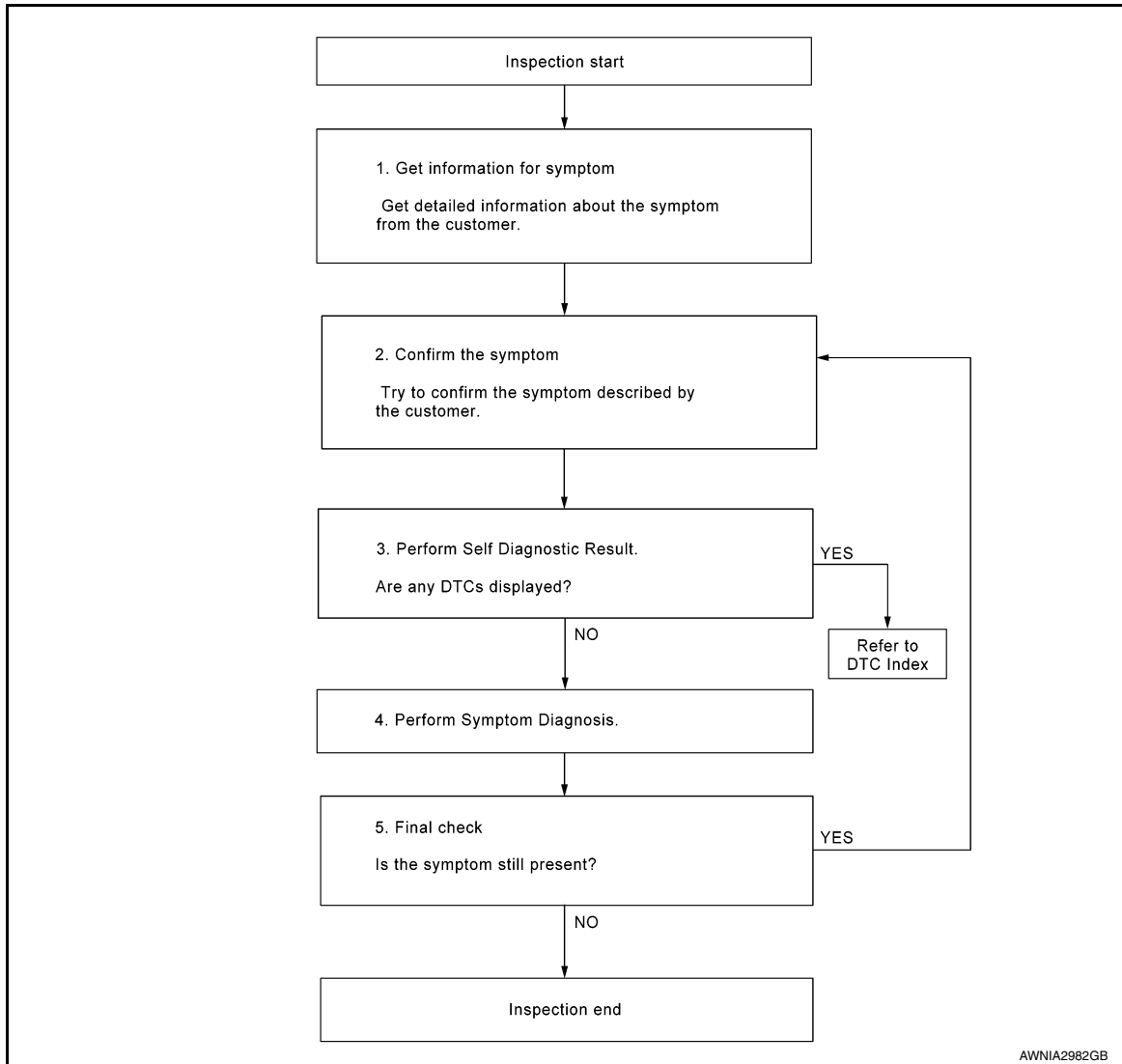

DETAILED FLOW

1. GET INFORMATION FOR SYMPTOM

Get detailed information from the customer about the symptom (the condition and the environment when the incident/malfunction occurred).

>> GO TO 2.

2. CONFIRM THE SYMPTOM

Try to confirm the symptom described by the customer. Verify relation between the symptom and the condition when the symptom is detected.

>> GO TO 3.

3. PERFORM SELF DIAGNOSTIC RESULT

1. Turn power switch ON and wait for 2 seconds or more.

DIAGNOSIS AND REPAIR WORK FLOW

[AUDIO W/O NAVI (FOR MEXICO)]

< BASIC INSPECTION >

2. Depending on system being diagnosed, perform Self Diagnostic Result for:

- MULTI AV.
- AVM.

A

Are any DTCs displayed?

YES >> Refer to [AV-119, "DTC Index"](#) (MULTI AV) or [AV-123, "DTC Index"](#) (AVM).

B

NO >> GO TO 4.

4.PERFORM SYMPTOM DIAGNOSIS

Refer to [AV-187, "Symptom Table"](#).

C

>> GO TO 5

D

5.FINAL CHECK

Refer to symptom described by the customer in step 1.

Is the symptom still present?

E

YES >> GO TO 2

NO >> Inspection End.

F

G

H

I

J

K

L

M

AV

O

P

INSPECTION AND ADJUSTMENT

< BASIC INSPECTION >

[AUDIO W/O NAVI (FOR MEXICO)]

INSPECTION AND ADJUSTMENT SOFTWARE UPDATE (AV CONTROL UNIT)

SOFTWARE UPDATE (AV CONTROL UNIT) : Description

INFOID:000000010641764

The software of the AV control unit can be updated by using an SD card.

SOFTWARE UPDATE (AV CONTROL UNIT) : Work Procedure

INFOID:000000010641765

1. START OF CONFIRMATION/ADJUSTMENT MODE

1. Set the power switch on ACC.
2. With AUDIO OFF, press "INFO" switch three times, "⏻" switch twice, and press "INFO" switch once to start the On Board Diagnosis Function.

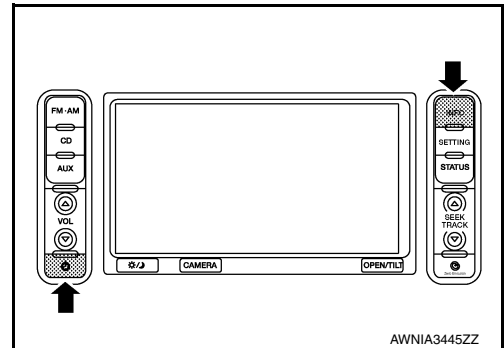

3. Select "Software Update" in Confirmation/Adjustment mode.

>> GO TO 2.

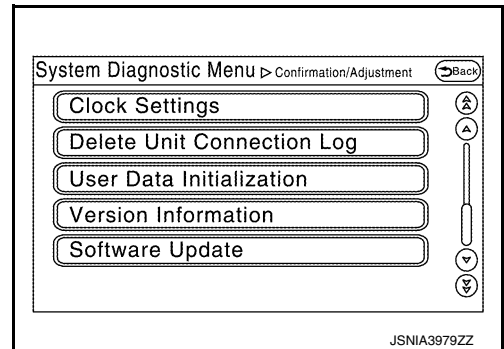

2. UPDATE THE SOFTWARE OF THE AV CONTROL UNIT

1. "Please insert SD Card for the program update and Push OK button" pops up.

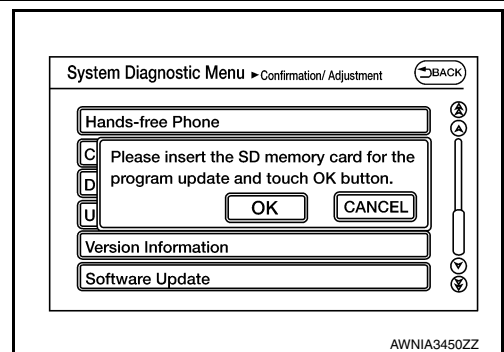

2. Press the OPEN/TILT switch of the AV control unit to open the display.

INSPECTION AND ADJUSTMENT

[AUDIO W/O NAVI (FOR MEXICO)]

< BASIC INSPECTION >

- Remove the cover of the SD slot and insert the SD card for software update into the SD card sub-slot (on the left).
- Press the OPEN/TILT switch of the AV control unit to close the display.
- Select "OK" in the pop-up confirmation to start software update.

NOTE:

The instructions below must be followed during software update.

- Never turn the power switch OFF.
- Never remove the SD card.
- Never use other functions. They are not available.

- When the software update is complete, "The update of the program completed successfully. Please switch the power off and on again to reboot." is shown.
- Press the OPEN/TILT switch of the AV control unit to open the display.
- Remove the SD card for software update from the SD card sub-slot (on the left) and install the cover of the SD slot.
- Turn the power switch OFF.

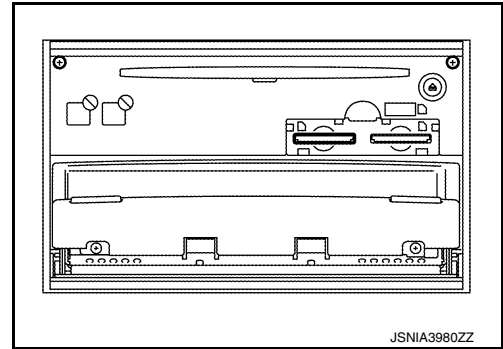

>> GO TO 3.

3. CHECK THE UPDATED SOFTWARE VERSION OF THE AV CONTROL UNIT

- Set the power switch on ACC after a lapse of 15 seconds or more after the power switch is turned OFF.
- With AUDIO OFF, press "INFO" switch three times, "⏻" switch twice, and press "INFO" switch once to start the On Board Diagnosis Function.
- Select "Version Information" in Confirmation/Adjustment mode.
- Check version information to see that the Boot Ware and the Application are updated.

>> End of program.

ADDITIONAL SERVICE WHEN REPLACING AV CONTROL UNIT

ADDITIONAL SERVICE WHEN REPLACING AV CONTROL UNIT : Description

INFOID:0000000010641766

BEFORE REPLACEMENT

When replacing AV control unit, save or print current vehicle specification with CONSULT configuration before replacement.

AFTER REPLACEMENT

CAUTION:

When replacing AV control unit, you must perform "After Replace ECU" or "Manual Configuration" with CONSULT.

- Complete the procedure of "After Replace ECU" or "Manual Configuration" in order.
- If you set incorrect "After Replace ECU" or "Manual Configuration", incidents might occur.
- Configuration is different for each vehicle model. Confirm configuration of each vehicle model.

ADDITIONAL SERVICE WHEN REPLACING AV CONTROL UNIT : Work Procedure

INFOID:0000000010641767

1. SAVING VEHICLE SPECIFICATION

Ⓜ-CONSULT Configuration

Perform "Before Replace ECU" to save or print current vehicle specification. Refer to [AV-146. "CONFIGURATION \(AV CONTROL UNIT\) : Description"](#).

NOTE:

If "Before Replace ECU" can not be used, use the "Manual Configuration".

>> GO TO 2.

2. REPLACE AV CONTROL UNIT

Replace AV control unit. Refer to [AV-192. "Removal and Installation"](#).

>> GO TO 3.

3. WRITING VEHICLE SPECIFICATION

Ⓟ-CONSULT Configuration

Perform "After Replace ECU" or "Manual Configuration" to write vehicle specification. Refer to [AV-146. "CONFIGURATION \(AV CONTROL UNIT\) : Work Procedure"](#).

>> GO TO 4.

4. OPERATION CHECK

Check that the operation of the AV control unit and camera images (fixed guide lines and predictive course lines) are normal.

>> Work End.

ADDITIONAL SERVICE WHEN REPLACING AROUND VIEW MONITOR CONTROL UNIT

ADDITIONAL SERVICE WHEN REPLACING AROUND VIEW MONITOR CONTROL UNIT : Description

INFOID:000000010641768

Perform the calibrating camera image when replacing around view monitor control unit. Refer to [AV-148. "CALIBRATING CAMERA IMAGE \(AROUND VIEW MONITOR\) : Work Procedure"](#).

CONFIGURATION (AV CONTROL UNIT)

CONFIGURATION (AV CONTROL UNIT) : Description

INFOID:000000010641769

- Since vehicle specifications are not included in the AV control unit after replacement, it is required to write vehicle specifications with CONSULT.
- Configuration has three functions as follows.

Function		Description
Read/Write Configuration	Before Replace ECU	Allows the reading of vehicle specification written in AV control unit to store the specification in CONSULT.
	After Replace ECU	Allows the writing of the vehicle information stored in CONSULT into the AV control unit.
Manual Configuration		Allows the writing of the vehicle specification into the AV control unit by hand.

CONFIGURATION (AV CONTROL UNIT) : Work Procedure

INFOID:000000010641770

1. WRITE VEHICLE SPECIFICATION

ⓅCONSULT Configuration

Write vehicle specification into AV control unit.

To write vehicle specification stored in CONSULT into the AV control unit>>GO TO 2.

To write vehicle specification into the AV control unit by hand>>GO TO 3.

2. WRITE STORED DATA

ⓅCONSULT Configuration

Select "After Replace ECU" in "Read/Write Configuration." Write data stored in CONSULT with the "Before Replace ECU" function into the AV control unit.

>> GO TO 4.

3. MANUALLY WRITE VEHICLE SPECIFICATION

INSPECTION AND ADJUSTMENT

< BASIC INSPECTION >

[AUDIO W/O NAVI (FOR MEXICO)]

CONSULT Configuration

Perform "Manual Configuration." Refer to the Configuration List to write vehicle specification into the AV control unit. Refer to [AV-147, "CONFIGURATION \(AV CONTROL UNIT\) : Configuration List"](#).

NOTE:

If selection items are not displayed on the CONSULT screen, touch "NEXT."

>> GO TO 4.

4. OPERATION CHECK

Check that the operation of the AV control unit and camera images (fixed guide lines and predictive course lines) are normal.

>> Work End.

CONFIGURATION (AV CONTROL UNIT) : Configuration List

INFOID:000000010641771

CAUTION:

Check vehicle specifications before servicing.

MANUAL SETTING ITEM	
Items	Setting value
STEERING	LHD
	RHD
SOUND SYSTEM	BASE
	BOSE

CONFIGURATION (AROUND VIEW MONITOR CONTROL UNIT)

CONFIGURATION (AROUND VIEW MONITOR CONTROL UNIT) : Work Procedure

INFOID:000000010641772

1. SAVING VEHICLE SPECIFICATION

CONSULT Configuration

Perform "Before Replace ECU", and save the current vehicle specification in CONSULT.

Is the vehicle specification saved normally?

YES >> GO TO 2.

NO >> GO TO 4.

2. REPLACE AROUND VIEW MONITOR CONTROL UNIT

Replace around view monitor control unit. Refer to [AV-204, "Removal and Installation"](#).

>> GO TO 3.

3. WRITING VEHICLE SPECIFICATION

CONSULT Configuration

Select "Configuration" or "After Replace ECU", and write the vehicle specification saved in CONSULT to around view monitor control unit.

>> GO TO 6.

4. REPLACE AROUND VIEW MONITOR CONTROL UNIT

Replace around view monitor control unit. Refer to [AV-204, "Removal and Installation"](#).

>> GO TO 5.

5. WRITE VEHICLE SPECIFICATION

INSPECTION AND ADJUSTMENT

< BASIC INSPECTION >

[AUDIO W/O NAVI (FOR MEXICO)]

ⓅCONSULT Configuration

Select "Manual Configuration", and write the vehicle specification to around view monitor control unit.

NOTE:

Around view monitor control unit does not have any setting items. Selection of items on "Manual Configuration" screen is not required.

>> GO TO 6.

6.PERFORM SELF-DIAGNOSIS

ⓅCONSULT Self Diagnostic Result

Perform self-diagnosis of CONSULT, and check whether or not DTC U1305 is detected.

Is DTC U1305 detected?

>> GO TO 5.

>> GO TO 7.

7.OPERATION CHECK

Check that the operation of the around view monitor control unit and camera images (fixed guide lines and predictive course lines) are normal.

>> WORK END

PREDICTIVE COURSE LINE CENTER POSITION ADJUSTMENT

PREDICTIVE COURSE LINE CENTER POSITION ADJUSTMENT : Description

INFOID:000000010641773

Adjust the center position of the predictive course line of the rear view monitor if it is shifted.

PREDICTIVE COURSE LINE CENTER POSITION ADJUSTMENT : Work Procedure

INFOID:000000010641774

1.DRIVING

Drive the vehicle straight ahead 100 m (328.1 ft) or more at a speed of 30 km/h (18.6 MPH) or more.

>> END

CALIBRATING CAMERA IMAGE (AROUND VIEW MONITOR)

CALIBRATING CAMERA IMAGE (AROUND VIEW MONITOR) : Description

INFOID:000000010641775

- Calibration must be performed after removing/replacing the cameras, removing parts (e.g. front grille, door mirror, and others) mounted on the cameras, or replacing the Around view monitor control unit.
- The use of CONSULT is required to perform calibration or writing of calibration results to the Around view monitor control unit.
- Align the white lines on the road near the vehicle at the boundary of each camera image by this camera calibration. The white lines far from the vehicle may not be aligned at the boundary of each camera image. The farther the line, the greater the difference is.

CALIBRATING CAMERA IMAGE (AROUND VIEW MONITOR) : Work Procedure

INFOID:000000010641776

CALIBRATION FLOWCHART

INSPECTION AND ADJUSTMENT

< BASIC INSPECTION >

[AUDIO W/O NAVI (FOR MEXICO)]

Following the flowchart shown in the figure, perform the calibration.

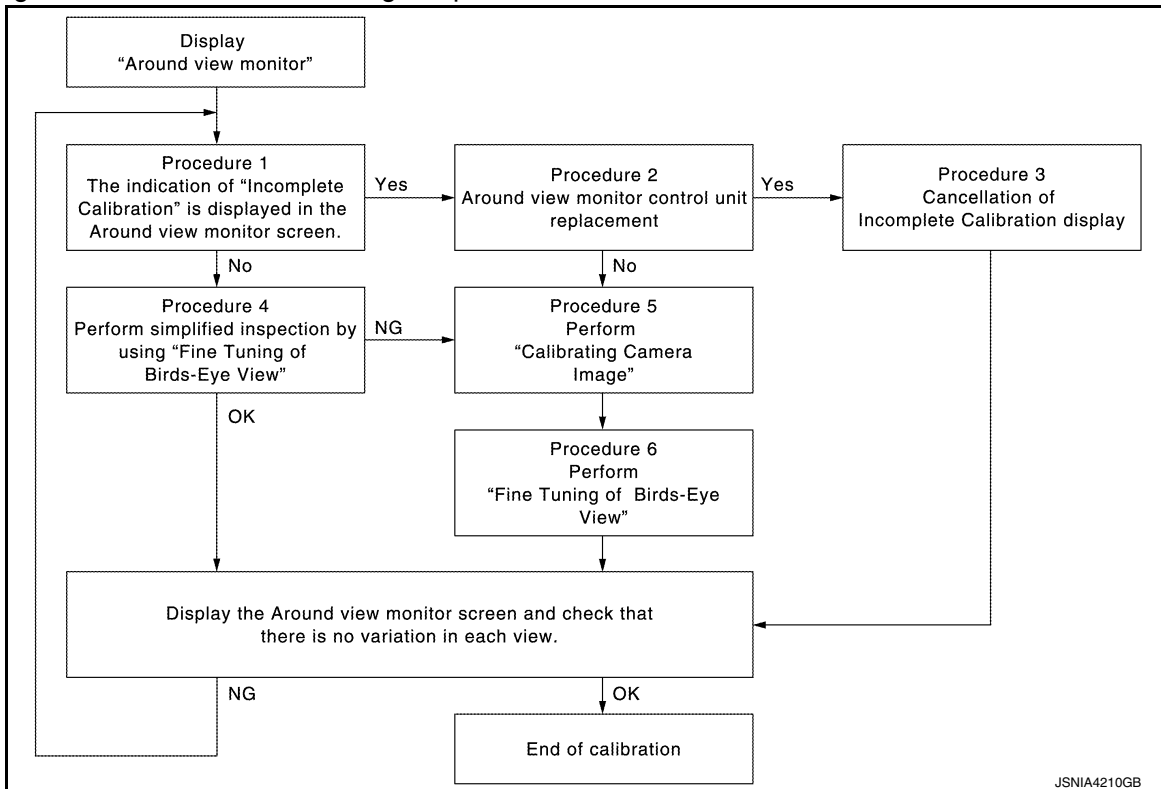

NOTE:

View in the incomplete calibration state is indicated by  on the around view monitor.

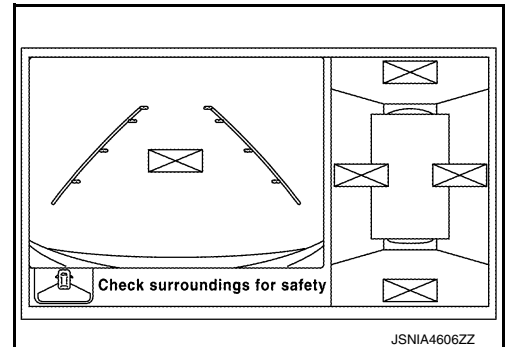

CALIBRATION PROCEDURE

1. AROUND VIEW MONITOR SCREEN CONFIRMATION

Check that there is no indication of "Incomplete calibration".

Is the "Incomplete calibration" display visible?

- YES >> GO TO 2.
- NO >> GO TO 4.

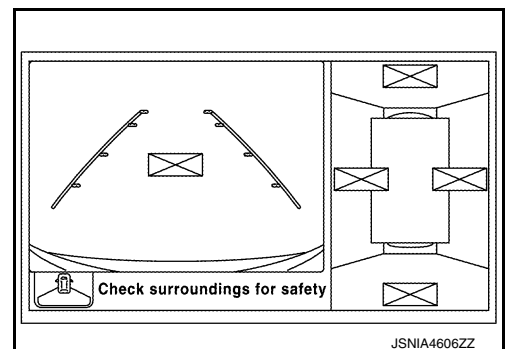

2. CHECK THAT AROUND VIEW MONITOR CONTROL UNIT IS REPLACED

Check that the around view monitor control unit is replaced.

Is the around view monitor control unit replaced?

- YES >> GO TO 3.
- NO >> GO TO 5.

A
B
C
D
E
F
G
H
I
J
K
L
M
AV
O
P

INSPECTION AND ADJUSTMENT

< BASIC INSPECTION >

[AUDIO W/O NAVI (FOR MEXICO)]

3. CANCEL THE INDICATION OF INCOMPLETE CALIBRATION (PERFORM THIS ONLY AFTER REPLACING AROUND VIEW MONITOR CONTROL UNIT.)

Ⓜ CONSULT work support

1. On the CONSULT screen, touch “CALIBRATING CAMERA IMAGE (FRONT CAMERA)”, “CALIBRATING CAMERA IMAGE (PASS-SIDE CAMERA)”, “CALIBRATING CAMERA IMAGE (DR-SIDE CAMERA)”, or “CALIBRATING CAMERA IMAGE (REAR CAMERA)” to accept the selection.

NOTE:

To cancel the indication of Incomplete calibration, select items based on the target camera.

2. On the adjustment screen of each camera, touch “APPLY” button. After this, touch “OK” button.

CAUTION:

- Never perform operations other than those mentioned above.

- Never perform “Initialize Camera Image Calibration”.

3. Display the around view monitor screen to check that there is no errors, such as deviations among the camera images.

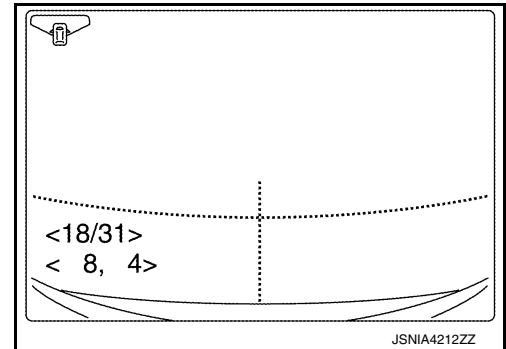

Is there a malfunction?

YES >> Calibration end

NO >> GO TO 1.

4. PERFORM SIMPLIFIED CONFIRMATION/ADJUSTMENT BY “FINE TUNING OF BIRDS-EYE VIEW”

1. Put target line 1 on the ground beside each axle using packing tape, etc.
2. Put target lines 2 equal to the vehicle total length + approximately 1.0 m (39.3 in) from the vehicle side (right and left) at approximately 30 cm (11.8 in) away from the vehicle (make the line as parallel with the vehicle as possible)

Preparation of simplified target line

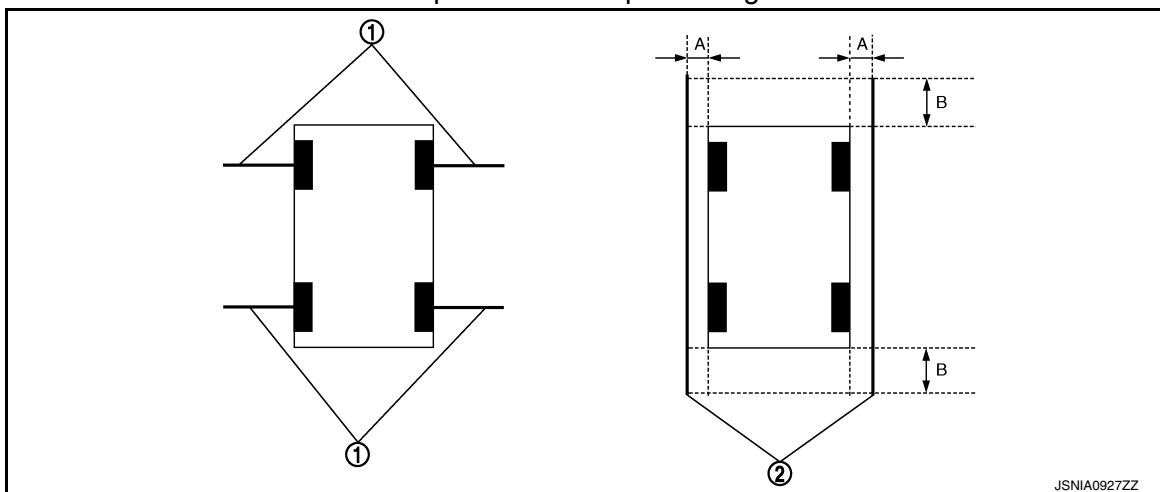

1. Target lines 1

2. Target lines 2

A. Approx. 30 cm (11.8 in)

B. Approx. 1.0 m (39.3 in)

3. Ⓜ CONSULT work support

Touch “FINE TUNING OF BIRDS-EYE VIEW” on the CONSULT screen.

4. On the CONSULT screen, touch “SELECT” button to select right or left camera and perform camera calibration as instructed below:

- If the marker on the screen deviates from Target line 1, touch “AXIS X” button and “AXIS Y” button to adjust so that the marker is placed on the Target line 1.
- If Target line 2 is misaligned among the cameras, adjust each camera image to bring Target line 2 into a straight line.

CAUTION:

Never adjust the front camera and rear camera. Only adjust the right and left cameras.

INSPECTION AND ADJUSTMENT

< BASIC INSPECTION >

[AUDIO W/O NAVI (FOR MEXICO)]

Simplified target line adjustment method

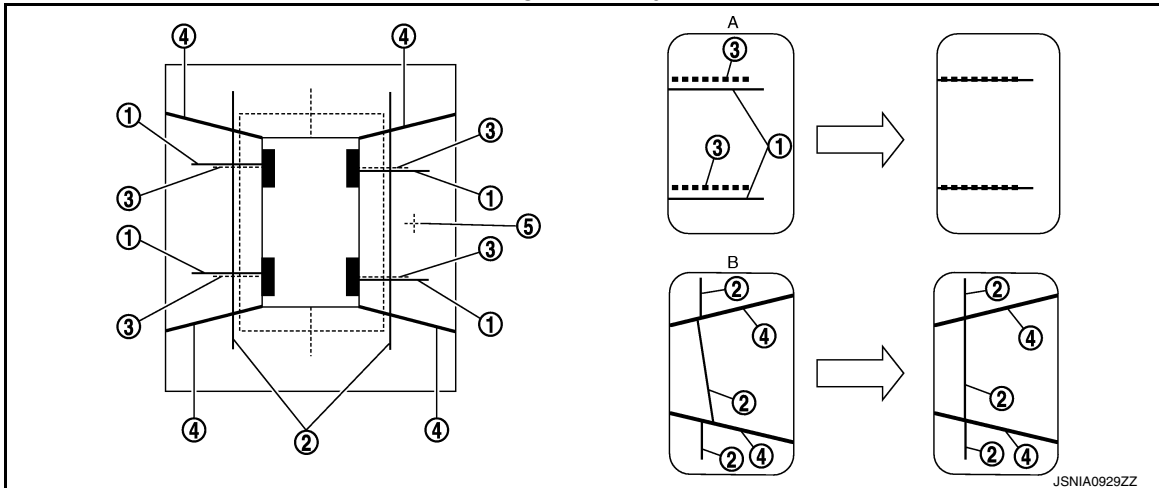

- | | | |
|---|---|-----------------------------|
| 1. Target lines 1 | 2. Target lines 2 | 3. Marker for target line 1 |
| 4. Boundary between cameras | 5. Crosshairs cursor (mark indicated the selected camera) | |
| A. Adjustment method for target lines 1 (right) | B. Adjustment method for target lines 2 (right) | |

- Adjust right and left cameras. Touch "APPLY" on the CONSULT screen to display adjustment results.
- After adjusting right and left cameras, check that the marker is properly placed on the screen and there is no deviation in Target line 1.

NOTE:

- It can be initialized to the NISSAN factory default condition with "Initialize Camera Image Calibration".
- The adjustment value is cancelled on this mode by performing "Initialize Camera Image Calibration".

Is the difference corrected?

- YES >> On the CONSULT screen, touch "OK" button to complete writing to the around view monitor control unit.
- NO >> GO TO 5.

5.PERFORM "CALIBRATING CAMERA IMAGE"

Preparation of target line

- Hang a string with a weight as shown in the figure. Put the points FM0, RM0 (mark) on the ground at the center of the vehicle front end and rear end with white packing tape or a pen.
- Route the vinyl string under the vehicle, and then pull and fix it on the point approximately 1.0 m (39.9 in) to the front and rear of the vehicle through the points FM0 and RM0 using packing tape.

Target line preparation procedure 1

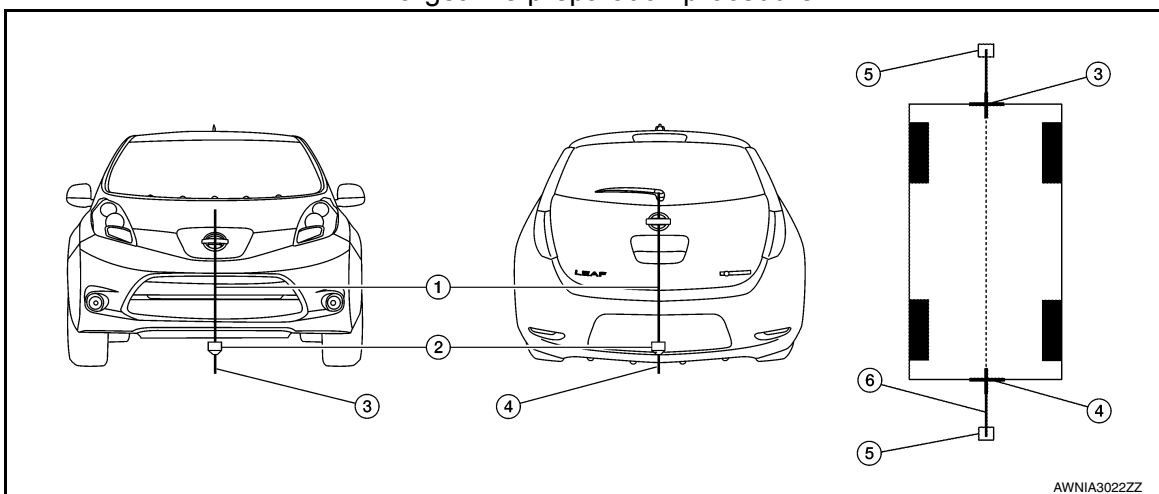

A
B
C
D
E
F
G
H
I
J
K
L
M

AV

O
P

INSPECTION AND ADJUSTMENT

[AUDIO W/O NAVI (FOR MEXICO)]

< BASIC INSPECTION >

1. Thread
 2. Weight
 3. Point FM0 (mark)
 4. Point RM0 (mark)
 5. Packing tape (to fix the vinyl string)
 6. Vinyl string
3. Put the points FM and RM (mark) 75 cm (29.5 in) from the points FM0 and RM0 individually.
 4. Route the vinyl string through the points FM and RM using a triangle scale, and then fix it at approximately 1.5 m (59 in) on both sides with packing tape.
 5. Put the points FL, FR, RL, and RR (mark) to both right and left [vehicle width / 2 + 30 cm (11.8 in)] from the points FM and RM.

Target line preparation procedure 2

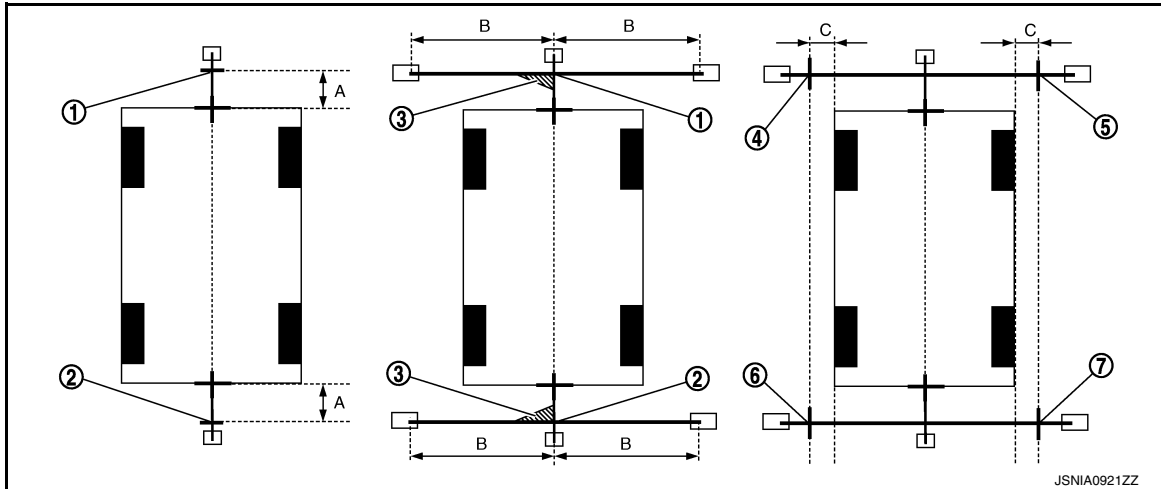

1. Point FM
 2. Point RM
 3. Triangle scale
 4. Point FL (mark)
 5. Point FR (mark)
 6. Point RL (mark)
 7. Point RR (mark)
- A. 75 cm (29.5 in)
- B. Approx. 1.5 m (59 in)
- C. 30 cm (11.8 in)
[Vehicle width / 2 + 30 cm (11.8 in) from the points FM and RM]

6. Draw the lines of the points FL – RL and FR – RR with vinyl string, and fix it with packing tape.
7. Put a mark on the center of each axle, draw vertical lines to the lines of the points FL – RL and FR – RR from the marks on the center of the axle using a triangle scale, and then fix the lines using packing tape.

Target line preparation procedure 3

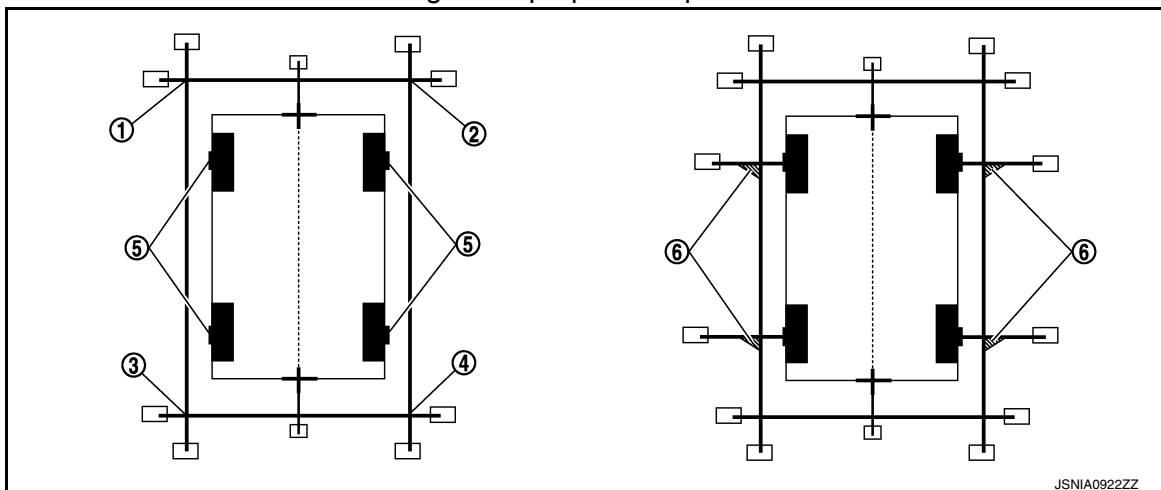

1. Point FL
2. Point FR
3. Point RL
4. Point RR
5. Center position of axle
6. Triangle scale

Perform “Calibrating Camera Image”

CONSULT work support

INSPECTION AND ADJUSTMENT

< BASIC INSPECTION >

[AUDIO W/O NAVI (FOR MEXICO)]

1. On the CONSULT screen, touch “CALIBRATING CAMERA IMAGE (FRONT CAMERA)”, “CALIBRATING CAMERA IMAGE (PASS-SIDE CAMERA)”, “CALIBRATING CAMERA IMAGE (DR-SIDE CAMERA)”, or “CALIBRATING CAMERA IMAGE (REAR CAMERA)” to accept the selection.

NOTE:

To cancel the indication of Incomplete calibration, select items based on the target camera.

2. On the adjustment screen of each camera, adjust the parameter by touching the “AXIS X” button, “AXIS Y” button, and “ROTATE” button to place the calibration marker shown on the camera screen on the target line drawn on the ground.

Adjustment range

Rotation direction (Center dial) : 31 patterns (16 on the center)

Upper/lower direction (upper/lower switch) : -22 – 22

Left/right direction (left/right switch) : -22 – 22

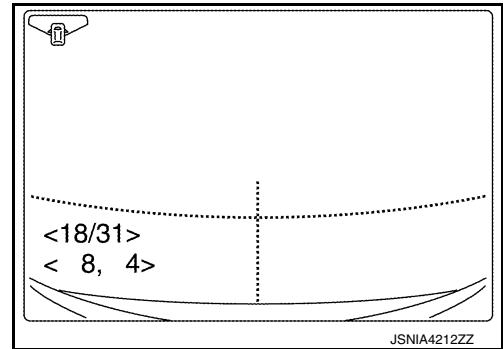

3. Touch “APPLY” button on the CONSULT screen. “PRCSNG” is displayed and adjustment results are shown on the camera screen.

CAUTION:

Check that “PRCSNG” is displayed. Do never perform other operations while “PRCSNG” is displayed.

4. Touch “OK” button on the CONSULT screen. “PRCSNG” is displayed and adjustment results are written to the around view monitor control unit.

CAUTION:

Check that “PRCSNG” is displayed. Do never perform other operations while “PRCSNG” is displayed.

>> GO TO 6.

6. PERFORM “FINE TUNING OF BIRDS-EYE VIEW”

This mode is designed to align the boundary between each camera image that could not be aligned in the “Calibrating Camera Image” mode.

ⓂCONSULT work support

1. Select “FINE TUNING OF BIRDS-EYE VIEW” by touching CONSULT screen.

2. On the adjustment screen of each camera, adjust the parameter by touching the “AXIS X” button, “AXIS Y” button”, and “ROTATE” button to place the calibration marker shown on the camera screen on the target line drawn on the ground.

NOTE:

Touch “SELECT” button on the CONSULT screen to select the target camera.

3. Touch “APPLY” button on the CONSULT screen. “PRCSNG” is displayed and adjustment results are shown on the camera screen.

CAUTION:

Check that “PRCSNG” is displayed. Do never perform other operations while “PRCSNG” is displayed.

4. Touch “OK” button on the CONSULT screen. “PRCSNG” is displayed and adjustment results are written to the around view monitor control unit.

CAUTION:

- Check that “PRCSNG” is displayed. Never perform other operations while “PRCSNG” is displayed.
- After pressing the “OK” button, never press buttons other than the “BACK” button.

NOTE:

- It can be initialized to the NISSAN factory default condition with “Initialize Camera Image Calibration”.
- The adjustment value is cancelled in this mode by performing “Initialize Camera Image Calibration”.

>> Calibration end

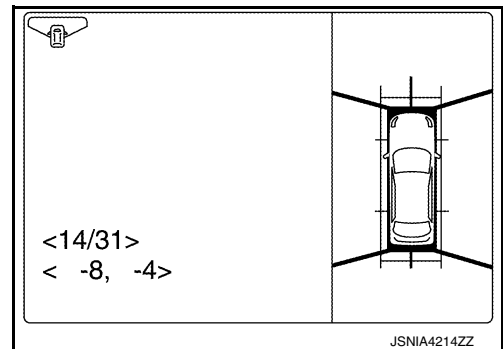

U0428 STEERING ANGLE SENSOR

< DTC/CIRCUIT DIAGNOSIS >

[AUDIO W/O NAVI (FOR MEXICO)]

DTC/CIRCUIT DIAGNOSIS

U0428 STEERING ANGLE SENSOR

DTC Logic

INFOID:000000010641777

CONSULT Display	DTC Detection Condition	Possible Cause
ST ANGLE SENSOR CALI- BRATION [U0428]	The neutral position adjustment of the steering angle sensor is incomplete.	Adjust neutral position of the steering angle sensor.

Diagnosis Procedure

INFOID:000000010641778

1. ADJUST THE NEUTRAL POSITION OF THE STEERING ANGLE SENSOR

When U1232 is detected, adjust the neutral position of the steering angle sensor.

>> Perform adjustment of the neutral position of the steering angle sensor. Refer to [AV-112, "CONSULT Function"](#).

U1000 CAN COMM CIRCUIT

< DTC/CIRCUIT DIAGNOSIS >

[AUDIO W/O NAVI (FOR MEXICO)]

U1000 CAN COMM CIRCUIT

AV CONTROL UNIT

AV CONTROL UNIT : Description

INFOID:0000000010641779

CAN (Controller Area Network) is a serial communication line for real time applications. It is an on board multiplex communication line with high data communication speed and excellent error detection ability. A modern vehicle is equipped with many ECMs, and each control unit shares information and links with other control units during operation (not independent). In CAN communication, 2 control units are connected with 2 communication lines (CAN H-line and CAN L-line) allowing a high rate of information transmission with less wiring. Each control unit transmits/receives data but selectively reads required data only.

Refer to [LAN-37, "CAN COMMUNICATION SYSTEM : CAN Communication Signal Chart"](#) for details of the communication signal.

AV CONTROL UNIT : DTC Logic

INFOID:0000000010641780

DTC DETECTION LOGIC

CONSULT Display	DTC Detection Condition	Possible Cause
CAN COMM CIRC [U1000]	When the AV control unit cannot communicate for 2 seconds or more.	CAN communication system

AV CONTROL UNIT : Diagnosis Procedure

INFOID:0000000010641781

1. PERFORM SELF DIAGNOSTIC RESULT

1. Turn the power switch ON and hold for 2 seconds or more.
2. Check Self Diagnostic Result of MULTI-AV.

Is CAN communication system displayed?

YES >> Refer to [LAN-17, "Trouble Diagnosis Flow Chart"](#).

NO >> Refer to [GI-53, "Intermittent Incident"](#).

AROUND VIEW MONITOR CONTROL UNIT

AROUND VIEW MONITOR CONTROL UNIT : Description

INFOID:0000000010641782

CAN (Controller Area Network) is a serial communication line for real-time application. It is an on-vehicle multiplex communication line with high data communication speed and excellent error detection ability. Many electronic control units are equipped onto a vehicle, and each control unit shares information and links with other control units during operation (not independently). In CAN communication, control units are connected with 2 communication lines (CAN-H, CAN-L) allowing a high rate of information transmission with less wiring. Each control unit transmits/receives data but selectively reads required data only.

CAN Communication Signal Chart. Refer to [LAN-37, "CAN COMMUNICATION SYSTEM : CAN Communication Signal Chart"](#).

AROUND VIEW MONITOR CONTROL UNIT : DTC Logic

INFOID:0000000010641783

DTC DETECTION LOGIC

CONSULT Display	DTC Detection Condition	Possible Cause
CAN COMM CIRCUIT [U1000]	Around view monitor control unit is not transmitting or receiving CAN communication signal for 2 seconds or more.	CAN communication system.

AROUND VIEW MONITOR CONTROL UNIT : Diagnosis Procedure

INFOID:0000000010641784

1. PERFORM SELF-DIAGNOSTIC RESULT

1. Turn power switch ON and wait for 2 seconds or more.
2. Check Self Diagnostic Result of AVM.

Is "CAN COMM CIRCUIT" displayed?

A

B

C

D

E

F

G

H

I

J

K

L

M

AV

O

P

U1000 CAN COMM CIRCUIT

< DTC/CIRCUIT DIAGNOSIS >

[AUDIO W/O NAVI (FOR MEXICO)]

- YES >> Refer to [LAN-17, "Trouble Diagnosis Flow Chart"](#).
- NO >> Refer to [GI-53, "Intermittent Incident"](#).

U1010 CONTROL UNIT (CAN)

< DTC/CIRCUIT DIAGNOSIS >

[AUDIO W/O NAVI (FOR MEXICO)]

U1010 CONTROL UNIT (CAN)

AV CONTROL UNIT

AV CONTROL UNIT : DTC Logic

INFOID:000000010641785

DTC DETECTION LOGIC

CONSULT Display	DTC Detection Condition	Possible Cause
CONTROL UNIT (CAN) [U1010]	Malfunction is detected during initial diagnosis of the AV control unit CAN controller.	Replace the AV control unit if malfunction constantly occurs. Refer to AV-192 . "Removal and Installation".

AROUND VIEW MONITOR CONTROL UNIT

AROUND VIEW MONITOR CONTROL UNIT : DTC Logic

INFOID:000000010641786

DTC DETECTION LOGIC

CONSULT Display	DTC Detection Condition	Possible Cause
CONTROL UNIT (CAN) [U1010]	CAN initial diagnosis malfunction is detected.	Replace the around view monitor control unit if the malfunction occurs constantly. Refer to AV-204 . "Removal and Installation".

A
B
C
D
E
F
G
H
I
J
K
L
M
O
P

AV

U111A REAR CAMERA IMAGE SIGNAL CIRCUIT

< DTC/CIRCUIT DIAGNOSIS >

[AUDIO W/O NAVI (FOR MEXICO)]

U111A REAR CAMERA IMAGE SIGNAL CIRCUIT

DTC Logic

INFOID:000000010641787

CONSULT Display	DTC Detection Condition	Possible Cause
REAR CAMERA IMAGE SIGNAL [U111A]	Rear camera image signal circuit is open or shorted.	Check rear camera image signal circuit between rear camera and around view monitor control unit.

Diagnosis Procedure

INFOID:000000010641788

Regarding Wiring Diagram information, refer to [AV-125. "Wiring Diagram"](#).

1. CHECK REAR VIEW CAMERA POWER SUPPLY AND GROUND CIRCUIT CONTINUITY

1. Turn power switch OFF.
2. Disconnect around view monitor control unit and rear view camera connectors.
3. Check continuity between around view monitor control unit connector M32 and rear view camera connector D557.

Around view monitor control unit		Rear view camera		Continuity
Connector	Terminals	Connector	Terminals	
M32	26	D557	8	Yes
	25		7	

4. Check continuity between around view monitor control unit connector M32 and ground.

Around view monitor control unit		Ground	Continuity
Connector	Terminal		
M32	26	—	No

Is inspection result normal?

YES >> GO TO 2.

NO >> Repair or replace harness or connectors.

2. CHECK REAR VIEW CAMERA POWER SUPPLY VOLTAGE

1. Connect around view monitor control unit and rear view camera connectors.
2. Turn power switch ON.
3. Check voltage between around view monitor control unit connector M32 and ground.

Around view monitor control unit		Ground	Condition	Voltage (Approx.)
Connector	Terminal			
M32	26	—	CAMERA switch ON or Selector lever in R (reverse) position	6.2 V

Is inspection result normal?

YES >> GO TO 3.

NO >> Replace around view monitor control unit. Refer to [AV-204. "Removal and Installation"](#).

3. CHECK REAR VIEW CAMERA IMAGE SIGNAL CIRCUIT CONTINUITY

1. Turn power switch OFF.
2. Disconnect around view monitor control unit and rear view camera connectors.

U111A REAR CAMERA IMAGE SIGNAL CIRCUIT

[AUDIO W/O NAVI (FOR MEXICO)]

< DTC/CIRCUIT DIAGNOSIS >

- Check continuity between around view monitor control unit connector M32 and rear view camera connector D557.

Around view monitor control unit		Rear view camera		Continuity
Connector	Terminals	Connector	Terminals	
M32	28	D557	5	Yes
	27		1	

- Check continuity between around view monitor control unit connector M32 and ground.

Around view monitor control unit		Ground	Continuity
Connector	Terminal		
M32	28	—	No

Is inspection result normal?

YES >> GO TO 4.

NO >> Repair or replace harness or connectors.

4. CHECK REAR VIEW CAMERA IMAGE SIGNAL

- Connect around view monitor control unit and rear view camera connectors.
- Turn power switch ON.
- Check signal between terminals of around view monitor control unit connector M32.

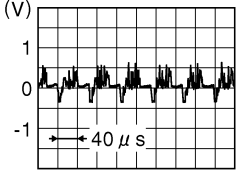
Around view monitor control unit connector M32		Condition	Reference value
(+) Terminal	(-) Terminal		
28	27	CAMERA switch ON or Selector lever in R (reverse) position	

Is inspection result normal?

YES >> Replace around view monitor control unit. Refer to [AV-204, "Removal and Installation"](#).

NO >> Replace rear view camera. Refer to [AV-207, "Removal and Installation"](#).

U111B SIDE CAMERA RH IMAGE SIGNAL CIRCUIT

< DTC/CIRCUIT DIAGNOSIS >

[AUDIO W/O NAVI (FOR MEXICO)]

U111B SIDE CAMERA RH IMAGE SIGNAL CIRCUIT

DTC Logic

INFOID:000000010641789

CONSULT Display	DTC Detection Condition	Possible Cause
SIDE CAMERA RH IMAGE SIGNAL [U111B]	Side camera RH image signal circuit is open or shorted.	Check side camera RH image signal circuit between rear camera and around view monitor control unit.

Diagnosis Procedure

INFOID:000000010641790

Regarding Wiring Diagram information, refer to [AV-125. "Wiring Diagram"](#).

1. CHECK SIDE CAMERA RH POWER SUPPLY AND GROUND CIRCUIT CONTINUITY

1. Turn power switch OFF.
2. Disconnect around view monitor control unit and side camera RH connectors.
3. Check continuity between around view monitor control unit connector M32 and side camera RH connector D101.

Around view monitor control unit		Side camera RH		Continuity
Connector	Terminals	Connector	Terminals	
M32	34	D101	1	Yes
	33		2	

4. Check continuity between around view monitor control unit connector M32 and ground.

Around view monitor control unit		Ground	Continuity
Connector	Terminal		
M32	34	—	No

Is inspection result normal?

YES >> GO TO 2.

NO >> Repair or replace harness or connectors.

2. CHECK SIDE CAMERA RH POWER SUPPLY VOLTAGE

1. Connect around view monitor control unit and side camera RH connectors.
2. Turn power switch ON.
3. Check voltage between around view monitor control unit connector M32 and ground.

Around view monitor control unit		Ground	Condition	Voltage (Approx.)
Connector	Terminal			
M32	34	—	CAMERA switch ON or Selector lever in R (reverse) position	6.2 V

Is inspection result normal?

YES >> GO TO 3.

NO >> Replace around view monitor control unit. Refer to [AV-204. "Removal and Installation"](#).

3. CHECK SIDE CAMERA RH IMAGE SIGNAL CIRCUIT CONTINUITY

1. Turn power switch OFF.
2. Disconnect around view monitor control unit and side camera RH connectors.

U111B SIDE CAMERA RH IMAGE SIGNAL CIRCUIT

[AUDIO W/O NAVI (FOR MEXICO)]

< DTC/CIRCUIT DIAGNOSIS >

- Check continuity between around view monitor control unit connector M32 and side camera RH connector D101.

Around view monitor control unit		Side camera RH		Continuity
Connector	Terminals	Connector	Terminals	
M32	36	D101	3	Yes
	35		4	

- Check continuity between around view monitor control unit connector M32 and ground.

Around view monitor control unit		Ground	Continuity
Connector	Terminal		
M32	36	—	No

Is inspection result normal?

YES >> GO TO 4.

NO >> Repair or replace harness or connectors.

4. CHECK SIDE CAMERA RH IMAGE SIGNAL

- Connect around view monitor control unit and side camera RH connectors.
- Turn power switch ON.
- Check signal between terminals of around view monitor control unit connector M32.

Around view monitor control unit connector M32		Condition	Reference value
(+) Terminal	(-) Terminal		
36	35	CAMERA switch ON or Selector lever in R (reverse) position	

Is inspection result normal?

YES >> Replace around view monitor control unit. Refer to [AV-204, "Removal and Installation"](#).

NO >> Replace side camera RH. Refer to [AV-206, "Removal and Installation"](#).

U111C FRONT CAMERA IMAGE SIGNAL CIRCUIT

< DTC/CIRCUIT DIAGNOSIS >

[AUDIO W/O NAVI (FOR MEXICO)]

U111C FRONT CAMERA IMAGE SIGNAL CIRCUIT

DTC Logic

INFOID:000000010641791

CONSULT Display	DTC Detection Condition	Possible Cause
FRONT CAMERA IMAGE SIGNAL [U111C]	Front camera image signal circuit is open or shorted.	Check front camera image signal circuit between rear camera and around view monitor control unit.

Diagnosis Procedure

INFOID:000000010641792

Regarding Wiring Diagram information, refer to [AV-125. "Wiring Diagram"](#).

1. CHECK FRONT CAMERA POWER SUPPLY AND GROUND CIRCUIT CONTINUITY

1. Turn power switch OFF.
2. Disconnect around view monitor control unit and front camera connectors.
3. Check continuity between around view monitor control unit connector M32 and front camera connector E202.

Around view monitor control unit		Front camera		Continuity
Connector	Terminals	Connector	Terminals	
M32	38	E202	2	Yes
	37		1	

4. Check continuity between around view monitor control unit connector M32 and ground.

Around view monitor control unit		Ground	Continuity
Connector	Terminal		
M32	38	—	No

Is inspection result normal?

YES >> GO TO 2.

NO >> Repair or replace harness or connectors.

2. CHECK FRONT CAMERA POWER SUPPLY VOLTAGE

1. Connect around view monitor control unit and front camera connectors.
2. Turn power switch ON.
3. Check voltage between around view monitor control unit connector M32 and ground.

Around view monitor control unit		Ground	Condition	Voltage (Approx.)
Connector	Terminal			
M32	38	—	CAMERA switch ON or Selector lever in R (reverse) position	6.2 V

Is inspection result normal?

YES >> GO TO 3.

NO >> Replace around view monitor control unit. Refer to [AV-204. "Removal and Installation"](#).

3. CHECK FRONT CAMERA IMAGE SIGNAL CIRCUIT CONTINUITY

1. Turn power switch OFF.
2. Disconnect around view monitor control unit and front camera connectors.

U111C FRONT CAMERA IMAGE SIGNAL CIRCUIT

[AUDIO W/O NAVI (FOR MEXICO)]

< DTC/CIRCUIT DIAGNOSIS >

3. Check continuity between around view monitor control unit connector M32 and front camera connector E202.

Around view monitor control unit		Front camera		Continuity
Connector	Terminals	Connector	Terminals	
M32	40	E202	3	Yes
	39		4	

4. Check continuity between around view monitor control unit connector M32 and ground.

Around view monitor control unit		Ground	Continuity
Connector	Terminal		
M32	40	—	No

Is inspection result normal?

YES >> GO TO 4.

NO >> Repair or replace harness or connectors.

4. CHECK FRONT CAMERA IMAGE SIGNAL

1. Connect around view monitor control unit and front camera connectors.
2. Turn power switch ON.
3. Check signal between terminals of around view monitor control unit connector M32.

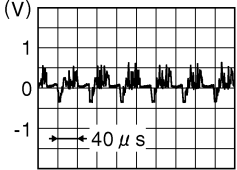
Around view monitor control unit connector M32		Condition	Reference value
(+) Terminal	(-) Terminal		
40	39	CAMERA switch ON or Selector lever in R (reverse) position	

Is inspection result normal?

YES >> Replace around view monitor control unit. Refer to [AV-204, "Removal and Installation"](#).

NO >> Replace front camera. Refer to [AV-205, "Removal and Installation"](#).

U111D SIDE CAMERA LH IMAGE SIGNAL CIRCUIT

< DTC/CIRCUIT DIAGNOSIS >

[AUDIO W/O NAVI (FOR MEXICO)]

U111D SIDE CAMERA LH IMAGE SIGNAL CIRCUIT

DTC Logic

INFOID:000000010641793

CONSULT Display	DTC Detection Condition	Possible Cause
SIDE CAMERA LH IMAGE SIGNAL [U111D]	Side camera LH image signal circuit is open or shorted.	Check side camera LH image signal circuit between rear camera and around view monitor control unit.

Diagnosis Procedure

INFOID:000000010641794

Regarding Wiring Diagram information, refer to [AV-125. "Wiring Diagram"](#).

1. CHECK SIDE CAMERA LH POWER SUPPLY AND GROUND CIRCUIT CONTINUITY

1. Turn power switch OFF.
2. Disconnect around view monitor control unit and side camera LH connectors.
3. Check continuity between around view monitor control unit connector M32 and side camera LH connector D1.

Around view monitor control unit		Side camera LH		Continuity
Connector	Terminals	Connector	Terminals	
M32	30	D1	1	Yes
	29		2	

4. Check continuity between around view monitor control unit connector M32 and ground.

Around view monitor control unit		Ground	Continuity
Connector	Terminal		
M32	30	—	No

Is inspection result normal?

YES >> GO TO 2.

NO >> Repair or replace harness or connectors.

2. CHECK SIDE CAMERA LH POWER SUPPLY VOLTAGE

1. Connect around view monitor control unit and side camera LH connectors.
2. Turn power switch ON.
3. Check voltage between around view monitor control unit connector M32 and ground.

Around view monitor control unit		Ground	Condition	Voltage (Approx.)
Connector	Terminal			
M32	30	—	CAMERA switch ON or Selector lever in R (reverse) position	6.2 V

Is inspection result normal?

YES >> GO TO 3.

NO >> Replace around view monitor control unit. Refer to [AV-204. "Removal and Installation"](#).

3. CHECK SIDE CAMERA LH IMAGE SIGNAL CIRCUIT CONTINUITY

1. Turn power switch OFF.
2. Disconnect around view monitor control unit and side camera LH connectors.

U111D SIDE CAMERA LH IMAGE SIGNAL CIRCUIT

[AUDIO W/O NAVI (FOR MEXICO)]

< DTC/CIRCUIT DIAGNOSIS >

3. Check continuity between around view monitor control unit connector M32 and side camera LH connector D1.

Around view monitor control unit		Side camera LH		Continuity
Connector	Terminals	Connector	Terminals	
M32	32	D1	3	Yes
	31		4	

4. Check continuity between around view monitor control unit connector M32 and ground.

Around view monitor control unit		Ground	Continuity
Connector	Terminal		
M32	32	—	No

Is inspection result normal?

YES >> GO TO 4.

NO >> Repair or replace harness or connectors.

4. CHECK SIDE CAMERA LH IMAGE SIGNAL

1. Connect around view monitor control unit and side camera LH connectors.
2. Turn power switch ON.
3. Check signal between terminals of around view monitor control unit connector M32.

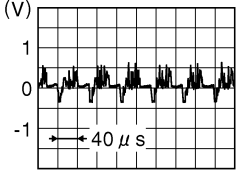
Around view monitor control unit connector M32		Condition	Reference value
(+) Terminal	(-) Terminal		
32	31	CAMERA switch ON or Selector lever in R (reverse) position	 <p style="text-align: right; font-size: small;">JSNIA0834GB</p>

Is inspection result normal?

YES >> Replace around view monitor control unit. Refer to [AV-204, "Removal and Installation"](#).

NO >> Replace side camera LH. Refer to [AV-206, "Removal and Installation"](#).

U121F AV CONTROL UNIT

< DTC/CIRCUIT DIAGNOSIS >

[AUDIO W/O NAVI (FOR MEXICO)]

U121F AV CONTROL UNIT

DTC Logic

INFOID:000000010641795

CONSULT Display	DTC Detection Condition	Possible Cause
CONTROL UNIT [U121F]	AV control unit malfunction is detected	Replace AV control unit if malfunction occurs constantly. Refer to AV-192 , "Removal and Installation".

U1232 STEERING ANGLE SENSOR

< DTC/CIRCUIT DIAGNOSIS >

[AUDIO W/O NAVI (FOR MEXICO)]

U1232 STEERING ANGLE SENSOR

AV CONTROL UNIT

AV CONTROL UNIT : DTC Logic

INFOID:0000000010641796

CONSULT Display	DTC Detection Condition	Possible Cause
Steering angle sensor calibration [U1232]	Neutral position adjustment of the steering angle sensor is not complete.	Perform neutral position adjustment of the steering angle sensor. Refer to AV-110, "CONSULT Function" .

AV CONTROL UNIT : Diagnosis Procedure

INFOID:0000000010641797

1.ADJUST NEUTRAL POSITION OF STEERING ANGLE SENSOR

When U1232 is detected, adjust the neutral position of the steering angle sensor.

>> Perform neutral position adjustment of the steering angle sensor. Refer to [AV-110, "CONSULT Function"](#).

AROUND VIEW MONITOR CONTROL UNIT

AROUND VIEW MONITOR CONTROL UNIT : DTC Logic

INFOID:0000000010641798

CONSULT Display	DTC Detection Condition	Possible Cause
Steering angle sensor calibration [U1232]	Neutral position adjustment of the steering angle sensor is not complete.	Perform neutral position adjustment of the steering angle sensor. Refer to AV-112, "CONSULT Function" .

AROUND VIEW MONITOR CONTROL UNIT : Diagnosis Procedure

INFOID:0000000010641799

1.ADJUST NEUTRAL POSITION OF STEERING ANGLE SENSOR

When U1232 is detected, adjust the neutral position of the steering angle sensor.

>> Perform neutral position adjustment of the steering angle sensor. Refer to [AV-112, "CONSULT Function"](#).

A
B
C
D
E
F
G
H
I
J
K
L
M
O
P

AV

U1263 USB

< DTC/CIRCUIT DIAGNOSIS >

[AUDIO W/O NAVI (FOR MEXICO)]

U1263 USB

DTC Logic

INFOID:000000010641800

DTC DETECTION LOGIC

NOTE:

Before performing the diagnosis, be sure to check that the external input device has no malfunction.

CONSULT Display	Malfunction Detection Condition	Possible Cause
USB overcurrent [U1263]	Overcurrent of the USB connector is detected.	Check the USB harness between the AV control unit and USB connector.

Diagnosis Procedure

INFOID:000000010641801

1.CHECK USB HARNESS

Check the USB harness visually and check if there is any pinching.

Is the check result normal?

- YES >> Replace the AV control unit. Refer to [AV-192. "Removal and Installation"](#).
- NO >> Replace the USB harness. Refer to [AV-203. "Removal and Installation"](#).

U1300 AV COMM CIRCUIT

< DTC/CIRCUIT DIAGNOSIS >

[AUDIO W/O NAVI (FOR MEXICO)]

U1300 AV COMM CIRCUIT

Description

INFOID:000000010641802

U1300 is displayed when the AV signal error is detected for the multi AV system. It is always displayed together with the error of the control unit connected to the AV control unit via AV communication. Determine the possible malfunction cause from the table below.

SELF-DIAGNOSIS RESULTS DISPLAY ITEM

CONSULT Display	DTC Detection Condition	Possible Cause
<ul style="list-style-type: none">• AV COMM CIRCUIT [U1300]• SWITCH CONN [U1240]	<p>When either one of the following items are detected:</p> <ul style="list-style-type: none">• multifunction switch power supply and ground circuits are malfunctioning.• AV communication circuits between the AV control unit and multifunction switch are malfunctioning.	<ul style="list-style-type: none">• Multifunction switch power supply and ground circuits.• AV communication circuits between AV control unit and multifunction switch.

A
B
C
D
E
F
G
H
I
J
K
L
M
N
O
P

AV

U1304 CAMERA IMAGE CALIBRATION

< DTC/CIRCUIT DIAGNOSIS >

[AUDIO W/O NAVI (FOR MEXICO)]

U1304 CAMERA IMAGE CALIBRATION

DTC Logic

INFOID:000000010641803

CONSULT Display	DTC Detection Condition	Possible Cause
CAMERA IMAGE CALIB [U1304]	Camera image calibration is incomplete.	Perform calibration of camera image with CONSULT. Refer to AV-112, "CONSULT Function" .

Diagnosis Procedure

INFOID:000000010641804

1. PERFORM THE SELF-DIAGNOSIS

When U1304 is detected, perform calibration of camera image with CONSULT.

>> Perform calibration of camera image. Refer to [AV-112, "CONSULT Function"](#).

U1305 CONFIG UNFINISH

< DTC/CIRCUIT DIAGNOSIS >

[AUDIO W/O NAVI (FOR MEXICO)]

U1305 CONFIG UNFINISH

DTC Logic

INFOID:000000010641805

CONSULT Display	DTC Detection Condition	Possible Cause
CONFIG UNFINISH [U1305]	Configuration of around view monitor control unit is incomplete.	Perform configuration of around view monitor control unit with CONSULT.

Diagnosis Procedure

INFOID:000000010641806

1. PERFORM THE SELF-DIAGNOSIS

When U1305 is detected, perform configuration of around view monitor control unit with CONSULT.

>> Perform configuration of around view monitor control unit. Refer to [AV-147, "CONFIGURATION \(AROUND VIEW MONITOR CONTROL UNIT\) : Work Procedure"](#).

A
B
C
D
E
F
G
H
I
J
K
L
M

AV

O
P

U1310 AV CONTROL UNIT

< DTC/CIRCUIT DIAGNOSIS >

[AUDIO W/O NAVI (FOR MEXICO)]

U1310 AV CONTROL UNIT

DTC Logic

INFOID:000000010641807

CONSULT Display	DTC Detection Condition	Possible Cause
CONTROL UNIT (AV) [U1310]	AV communication circuit initial diagnosis malfunction is detected	Replace AV control unit if malfunction occurs constantly. Refer to AV-192 , "Removal and Installation".

POWER SUPPLY AND GROUND CIRCUIT

< DTC/CIRCUIT DIAGNOSIS >

[AUDIO W/O NAVI (FOR MEXICO)]

POWER SUPPLY AND GROUND CIRCUIT

AV CONTROL UNIT

AV CONTROL UNIT : Diagnosis Procedure

INFOID:000000010641808

Regarding Wiring Diagram information, refer to [AV-125. "Wiring Diagram"](#).

1.CHECK FUSE

Check that the following fuses are not blown.

Terminal No.	Signal name	Fuse No.
26	Power signal	3 (10A)
7	ACC power supply	19 (10A)
19	Battery power supply	34 (20A)

Are the fuses blown?

YES >> Replace the blown fuse after repairing the affected circuit.

NO >> GO TO 2.

2.CHECK POWER SUPPLY CIRCUIT

1. Turn power switch OFF.
2. Disconnect AV control unit connectors M150 and M151.
3. Check voltage between AV control unit connectors and ground.

AV control unit		Ground	Condition	Voltage (Approx.)
Connector	Terminal			
M151	26	—	Power switch: ON	Battery voltage
M150	7		Power switch: ACC	
	19		Power switch: OFF	

Is the inspection result normal?

YES >> GO TO 3.

NO >> Repair or replace harness or connectors.

3.CHECK GROUND CIRCUIT

1. Turn power switch OFF.
2. Check continuity between AV control unit connector M151 and ground.

AV control unit		Ground	Continuity
Connector	Terminal		
M151	58	—	Yes

Is the inspection result normal?

YES >> Inspection End.

NO >> Repair or replace harness or connectors.

AROUND VIEW MONITOR CONTROL UNIT

AROUND VIEW MONITOR CONTROL UNIT : Diagnosis Procedure

INFOID:000000010641809

Regarding Wiring Diagram information, refer to [AV-394. "Wiring Diagram"](#).

1.CHECK FUSE

POWER SUPPLY AND GROUND CIRCUIT

< DTC/CIRCUIT DIAGNOSIS >

[AUDIO W/O NAVI (FOR MEXICO)]

Check that the following fuses are not blown.

Terminal No.	Signal name	Fuse No.
4	Power signal	3 (10A)
2	Battery power supply	34 (20A)

Are the fuses blown?

YES >> Replace the blown fuse after repairing the affected circuit.

NO >> GO TO 2.

2.CHECK POWER SUPPLY CIRCUIT

1. Turn power switch OFF.
2. Disconnect around view monitor control unit connector M32.
3. Check voltage between around view monitor control unit connector M32 and ground.

Around view monitor control unit		Ground	Condition	Voltage (Approx.)
Connector	Terminal			
M32	4	—	Power switch: ON	Battery voltage
	2		Power switch: OFF	

Is the inspection result normal?

YES >> GO TO 3.

NO >> Repair or replace harness or connectors.

3.CHECK GROUND CIRCUIT

1. Turn power switch OFF.
2. Check continuity between around view monitor control unit connector M32 and ground.

Around view monitor control unit		Ground	Continuity
Connector	Terminal		
M32	1	—	Yes

Is the inspection result normal?

YES >> Inspection End.

NO >> Repair or replace harness or connectors.

FRONT DOOR SPEAKER

< DTC/CIRCUIT DIAGNOSIS >

[AUDIO W/O NAVI (FOR MEXICO)]

FRONT DOOR SPEAKER

Diagnosis Procedure

INFOID:000000010641810

Regarding Wiring Diagram information, refer to [AV-125. "Wiring Diagram"](#).

1. CONNECTOR CHECK

Check the AV control unit and speaker connectors for the following:

- Proper connection
- Damage
- Disconnected or loose terminals

Is the inspection result normal?

YES >> GO TO 2

NO >> Repair the terminals or connectors.

2. CHECK FRONT DOOR SPEAKER SIGNAL CIRCUIT CONTINUITY

1. Disconnect AV control unit connector M150 and suspect front door speaker connector.
2. Check continuity between AV control unit connector M150 and suspect front door speaker connector.

AV control unit		Front door speaker		Continuity
Connector	Terminal	Connector	Terminal	
M150	2	D23 (LH)	1	Yes
	3		2	
	11	D123 (RH)	1	
	12		2	

3. Check continuity between AV control unit connector M150 and ground.

AV control unit		Ground	Continuity
Connector	Terminal		
M150	2	—	No
	3		
	11		
	12		

Is the inspection result normal?

YES >> GO TO 3

NO >> Repair or replace harness or connectors.

3. CHECK FRONT DOOR SPEAKER SIGNAL

1. Connect AV control unit connector M150 and suspect front door speaker connector.
2. Turn power switch to ACC.
3. Push AV control unit POWER switch.
4. Check signal between terminals of AV control unit connector M150.

AV control unit connector M150		Condition	Reference value
(+)	(-)		
Terminal	Terminal		

FRONT DOOR SPEAKER

< DTC/CIRCUIT DIAGNOSIS >

[AUDIO W/O NAVI (FOR MEXICO)]

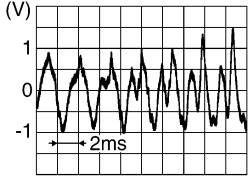
2	3		
11	12	Audio signal output	

Is the inspection result normal?

- YES >> Replace front door speaker. Refer to [AV-194. "Removal and Installation"](#).
- NO >> Replace AV control unit. Refer to [AV-192. "Removal and Installation"](#).

TWEETER

Diagnosis Procedure

INFOID:0000000010641811

Regarding Wiring Diagram information, refer to [AV-125. "Wiring Diagram"](#).

1.CONNECTOR CHECK

Check the AV control unit and speaker connectors for the following:

- Proper connection
- Damage
- Disconnected or loose terminals

Is the inspection result normal?

YES >> GO TO 2

NO >> Repair the terminals or connectors.

2.CHECK TWEETER SIGNAL CIRCUIT CONTINUITY

1. Disconnect AV control unit connector M150 and suspect tweeter connector.
2. Check continuity between AV control unit connector M150 and suspect tweeter connector.

AV control unit		Tweeter		Continuity
Connector	Terminal	Connector	Terminal	
M150	2	M15 (LH)	1	Yes
	3		2	
	11	M525 (RH)	1	
	12		2	

3. Check continuity between AV control unit connector M150 and ground.

AV control unit		Ground	Continuity
Connector	Terminal		
M150	2	—	No
	3		
	11		
	12		

Is the inspection result normal?

YES >> GO TO 3

NO >> Repair or replace harness or connectors.

3.CHECK TWEETER SIGNAL

1. Connect AV control unit connector M150 and suspect tweeter connector.
2. Turn power switch to ACC.
3. Push AV control unit POWER switch.
4. Check signal between terminals of AV control unit connector M150.

AV control unit connector M150		Condition	Reference value
(+)	(-)		
Terminal	Terminal		

A
B
C
D
E
F
G
H
I
J
K
L
M
O
P

AV

TWEETER

< DTC/CIRCUIT DIAGNOSIS >

[AUDIO W/O NAVI (FOR MEXICO)]

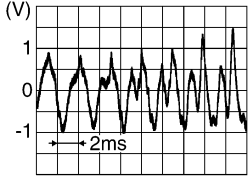
2	3		
11	12	Audio signal output	

Is the inspection result normal?

YES >> Replace tweeter. Refer to [AV-195. "Removal and Installation"](#).

NO >> Replace AV control unit. Refer to [AV-192. "Removal and Installation"](#).

REAR DOOR SPEAKER

< DTC/CIRCUIT DIAGNOSIS >

[AUDIO W/O NAVI (FOR MEXICO)]

REAR DOOR SPEAKER

Diagnosis Procedure

INFOID:000000010641812

Regarding Wiring Diagram information, refer to [AV-125. "Wiring Diagram"](#).

1. CONNECTOR CHECK

Check the AV control unit and speaker connectors for the following:

- Proper connection
- Damage
- Disconnected or loose terminals

Is the inspection result normal?

YES >> GO TO 2

NO >> Repair the terminals or connectors.

2. CHECK REAR DOOR SPEAKER SIGNAL CIRCUIT CONTINUITY

1. Disconnect AV control unit connector M150 and suspect rear door speaker connector.
2. Check continuity between AV control unit connector M150 and suspect rear door speaker connector.

AV control unit		Rear door speaker		Continuity
Connector	Terminal	Connector	Terminal	
M150	4	D205 (LH)	1	Yes
	5		2	
	13	D305 (RH)	1	
	14		2	

3. Check continuity between AV control unit connector M150 and ground.

AV control unit		Ground	Continuity
Connector	Terminal		
M150	4	—	No
	5		
	13		
	14		

Is the inspection result normal?

YES >> GO TO 3

NO >> Repair or replace harness or connectors.

3. CHECK REAR DOOR SPEAKER SIGNAL

1. Connect AV control unit connector M150 and suspect rear door speaker connector.
2. Turn power switch to ACC.
3. Push AV control unit POWER switch.
4. Check signal between terminals of AV control unit connector M150.

AV control unit connector M150		Condition	Reference value
(+)	(-)		
Terminal	Terminal		

REAR DOOR SPEAKER

< DTC/CIRCUIT DIAGNOSIS >

[AUDIO W/O NAVI (FOR MEXICO)]

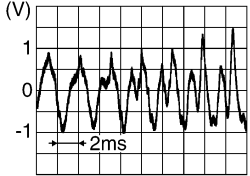
4	5	Audio signal output	
13	14		

SKIB3609E

Is the inspection result normal?

- YES >> Replace rear door speaker. Refer to [AV-196. "Removal and Installation"](#).
- NO >> Replace AV control unit. Refer to [AV-192. "Removal and Installation"](#).

AUXILIARY INPUT JACK

< DTC/CIRCUIT DIAGNOSIS >

[AUDIO W/O NAVI (FOR MEXICO)]

AUXILIARY INPUT JACK

Diagnosis Procedure

INFOID:000000010641813

Regarding Wiring Diagram information, refer to [AV-125. "Wiring Diagram"](#).

1. CHECK AUXILIARY INPUT JACK HARNESS CONTINUITY

1. Turn power switch OFF.
2. Disconnect AV control unit connector M151 and auxiliary input jack connector M52.
3. Check continuity between AV control unit connector M151 and auxiliary input jack connector M52.

AV control unit		Auxiliary input jack		Continuity
Connector	Terminal	Connector	Terminal	
M151	36	M52	1	Yes
	35		4	
	55		2	

4. Check continuity between AV control unit connector M151 and ground.

AV control unit		—	Continuity
Connector	Terminal		
M151	35	Ground	No
	55		

Is the inspection result normal?

- YES >> Replace the auxiliary input jack. Refer to [AV-202. "Removal and Installation"](#).
NO >> Repair or replace harness or connectors.

MICROPHONE SIGNAL CIRCUIT

< DTC/CIRCUIT DIAGNOSIS >

[AUDIO W/O NAVI (FOR MEXICO)]

MICROPHONE SIGNAL CIRCUIT

Diagnosis Procedure

INFOID:000000010641814

Regarding Wiring Diagram information, refer to [AV-125. "Wiring Diagram"](#).

1. CHECK MICROPHONE SIGNAL CIRCUIT CONTINUITY

1. Turn power switch OFF.
2. Disconnect AV control unit connector M151 and microphone connector R3.
3. Check continuity between AV control unit connector M151 and microphone connector R3.

AV control unit		Microphone		Continuity
Connector	Terminal	Connector	Terminal	
M151	34	R3	4	Yes
	53		1	
	54		2	

4. Check continuity between AV control unit connector M151 and ground.

AV control unit		Ground	Continuity
Connector	Terminal		
M151	34	—	No
	53		
	54		

Is inspection result normal?

- YES >> GO TO 2.
NO >> Repair or replace harness or connectors.

2. CHECK MICROPHONE VCC VOLTAGE

1. Connect AV control unit connector M151.
2. Turn power switch ON.
3. Check voltage between terminals of AV control unit connector M151.

AV control unit connector M151		Voltage (Approx.)
(+)	(-)	
Terminal	Terminal	
34	54	5.0 V

Is the inspection result normal?

- YES >> GO TO 3.
NO >> Replace AV control unit. Refer to [AV-192. "Removal and Installation"](#).

3. CHECK MICROPHONE SIGNAL

1. Connect microphone connector.
2. Check signal between terminals of AV control unit connector M151.

MICROPHONE SIGNAL CIRCUIT

< DTC/CIRCUIT DIAGNOSIS >

[AUDIO W/O NAVI (FOR MEXICO)]

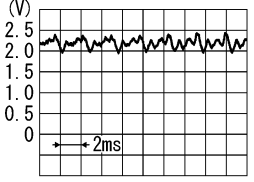
AV control unit connector M151		Condition	Reference value
(+)	(-)		
Terminal	Terminal		
53	54	Speak into microphone.	 <p style="text-align: right;">PKIB5037J</p>

Is the inspection result normal?

- YES >> Replace AV control unit. Refer to [AV-192. "Removal and Installation"](#).
- NO >> Replace microphone. Refer to [AV-197. "Removal and Installation"](#).

A
B
C
D
E
F
G
H
I
J
K
L
M

AV

O
P

STEERING SWITCH

< DTC/CIRCUIT DIAGNOSIS >

[AUDIO W/O NAVI (FOR MEXICO)]

STEERING SWITCH





Diagnosis Procedure

INFOID:000000010641815

Regarding Wiring Diagram information, refer to [AV-125. "Wiring Diagram"](#).

1. CHECK STEERING WHEEL AUDIO CONTROL SWITCH RESISTANCE

1. Turn power switch OFF.
2. Disconnect combination switch connector M112.
3. Check resistance between the terminals of combination switch connector M112.

Combination switch connector M112		Condition	Resistance Ω (Approx.)
Terminal	Terminal		
14	17	Depress SOURCE switch.	1
		Depress Δ switch.	121
		Depress ∇ switch.	321
		Depress  switch.	723
15	17	Depress $-$  switch.	1
		Depress  + switch.	121
		Depress  switch.	321

Is the inspection result normal?

YES >> GO TO 2.

NO >> Replace steering switches. Refer to [AV-201. "Removal and Installation"](#).

2. CHECK COMBINATION SWITCH

Check continuity between combination switch connectors M112 and M92.

Combination switch				Continuity
Connector	Terminal	Connector	Terminal	
M112	14	M92	24	Yes
	15		31	
	17		33	

Is the inspection result normal?

YES >> GO TO 3.

NO >> Replace spiral cable. Refer to [SR-23. "Removal and Installation"](#).

3. CHECK HARNESS BETWEEN COMBINATION SWITCH AND AV CONTROL UNIT

1. Disconnect AV control unit connector M150.
2. Check continuity between combination switch connector M92 and AV control unit connector M150.

Combination switch		AV control unit		Continuity
Connector	Terminal	Connector	Terminal	
M92	24	M150	6	Yes
	31		16	
	33		15	

STEERING SWITCH

< DTC/CIRCUIT DIAGNOSIS >

[AUDIO W/O NAVI (FOR MEXICO)]

3. Check continuity between combination switch connector M92 and ground.

Combination switch		Ground	Continuity
Connector	Terminal		
M92	24	—	No
	31		
	33		

Is the inspection result normal?

- YES >> Replace AV control unit. Refer to [AV-192. "Removal and Installation"](#).
- NO >> Repair or replace harness or connectors.

A
B
C
D
E
F
G
H
I
J
K
L
M
O
P

AV

USB CONNECTOR

< DTC/CIRCUIT DIAGNOSIS >

[AUDIO W/O NAVI (FOR MEXICO)]

USB CONNECTOR

Diagnosis Procedure

INFOID:000000010641816

Regarding Wiring Diagram information, refer to [AV-125. "Wiring Diagram"](#).

1. CHECK USB HARNESS CONTINUITY

1. Turn power switch OFF.
2. Disconnect AV control unit connector M152 and USB connector M53.
3. Check continuity between AV control unit connector M152 and USB connector M53.

AV control unit		USB		Continuity
Connector	Terminal	Connector	Terminal	
M152	61	M53	2	Yes
	62		1	
	63		4	
	64		3	
	65		5	

4. Check continuity between AV control unit connector M152 and ground.

AV control unit		—	Continuity
Connector	Terminal		
M152	61	Ground	No
	63		

Is the inspection result normal?

- YES >> Replace the USB connector. Refer to [AV-203. "Removal and Installation"](#).
NO >> Repair or replace harness or connectors.

MULTI AV SYSTEM

< SYMPTOM DIAGNOSIS >

[AUDIO W/O NAVI (FOR MEXICO)]

SYMPTOM DIAGNOSIS

MULTI AV SYSTEM

Symptom Table

INFOID:000000010641817

RELATED TO AUDIO

Symptoms	Check items	Probable malfunction location
The disk cannot be removed.	AV control unit	Malfunction in AV control unit. Refer to AV-103, "On Board Diagnosis Function" .
No sound comes out or the level of the sound is low.	No sound from all speakers.	<ul style="list-style-type: none"> • Speaker circuit shorted to ground. Refer to AV-125, "Wiring Diagram". • AV control unit power supply and ground circuits malfunction. Refer to AV-173, "AV CONTROL UNIT : Diagnosis Procedure".
	Only a certain speaker (front door speaker LH, front door speaker RH, tweeter LH, tweeter RH, rear door speaker LH, rear door speaker RH) does not output sound.	<ul style="list-style-type: none"> • Poor connector connection of speaker. • Sound signal circuit malfunction between AV control unit and speaker. Refer to: <ul style="list-style-type: none"> - AV-175, "Diagnosis Procedure" (front door speaker). - AV-177, "Diagnosis Procedure" (tweeter). - AV-179, "Diagnosis Procedure" (rear door speaker). • Malfunction in speaker. Refer to: <ul style="list-style-type: none"> - AV-194, "Removal and Installation" (front door speaker). - AV-195, "Removal and Installation" (tweeter). - AV-196, "Removal and Installation" (rear door speaker). • Malfunction in AV control unit. Refer to AV-103, "On Board Diagnosis Function".
Noise is mixed with audio.	Noise comes out from all speakers.	<ul style="list-style-type: none"> • Malfunction in AV control unit. Refer to AV-103, "On Board Diagnosis Function".
	Noise comes out only from a certain speaker (front door speaker LH, front door speaker RH, tweeter LH, tweeter RH, rear door speaker LH, rear door speaker RH).	<ul style="list-style-type: none"> • Poor connector connection of speaker. • Sound signal circuit malfunction between AV control unit and speaker. Refer to: <ul style="list-style-type: none"> - AV-175, "Diagnosis Procedure" (front door speaker). - AV-177, "Diagnosis Procedure" (tweeter). - AV-179, "Diagnosis Procedure" (rear door speaker). • Malfunction in speaker. • Poor Installation of speaker (e.g. backlash and looseness). Refer to: <ul style="list-style-type: none"> - AV-194, "Removal and Installation" (front door speaker). - AV-195, "Removal and Installation" (tweeter). - AV-196, "Removal and Installation" (rear door speaker). • Malfunction in AV control unit. Refer to AV-103, "On Board Diagnosis Function".
	Noise is mixed with radio only (when the vehicle hits a bump or while driving over bad roads)	Poor connector connection of antenna or antenna feeder. Refer to AV-198, "Antenna Feeder" .







MULTI AV SYSTEM

[AUDIO W/O NAVI (FOR MEXICO)]

< SYMPTOM DIAGNOSIS >

Symptoms	Check items	Probable malfunction location
No radio reception or poor reception.	<ul style="list-style-type: none"> Other audio sounds are normal. Any radio station cannot be received or poor reception is caused even after moving to a service area with good reception (e.g. a place with clear view and no obstacles generating external noises). 	Poor connector connection of antenna or antenna feeder. Refer to AV-198. "Antenna Feeder" .
No satellite radio reception.	There is malfunction in the CONSULT self diagnosis result. Refer to AV-110. "CONSULT Function" .	<ul style="list-style-type: none"> Malfunction in antenna, antenna feeder or AV control unit. Perform DTC diagnosis. Refer to AV-110. "CONSULT Function". Poor continuity in antenna feeder. Poor connector connection of antenna or antenna feeder. Refer to AV-198. "Antenna Feeder".
	There is no malfunction in the CONSULT self diagnosis result. Refer to AV-110. "CONSULT Function" .	<ul style="list-style-type: none"> Poor continuity in antenna feeder. Poor connector connection of antenna or antenna feeder. Loose satellite radio antenna mounting nut. Refer to AV-198. "Antenna Feeder".
Buzz/rattle sound from speaker	The majority of buzz/rattle sounds are not indicative of an issue with the speaker, usually something nearby the speaker is causing the buzz/rattle.	Refer to "SQUEAK AND RATTLE TROUBLE DIAGNOSIS" in the appropriate interior trim section.

RELATED TO HANDS-FREE PHONE

Symptoms	Check items	Probable malfunction location
Does not recognize cellular phone connection (no connection is displayed on the display at the guide).	Repeat the registration of cellular phone.	
Hands-free phone cannot be established.	<ul style="list-style-type: none"> Hands-free phone operation can be made, but the communication cannot be established. Hands-free phone operation can be performed, however, voice between each other cannot be heard during the conversation. 	Malfunction in AV control unit. Replace AV control unit. Refer to AV-192. "Removal and Installation" .
The other party's voice cannot be heard by hands-free phone.	Check the "microphone speaker" in Inspection & Adjustment Mode if sound is heard.	
Originating sound is not heard by the other party with hands-free phone communication.	Sound operation function is normal.	
	Sound operation function does not work.	Microphone signal circuit malfunction. Refer to AV-182. "Diagnosis Procedure" .
The system cannot be operated.	<ul style="list-style-type: none"> The voice recognition can be controlled. Steering switch's  and  switch works, but  does not work. 	Steering switch malfunction. Replace steering switch. Refer to AV-201. "Removal and Installation" .
	Steering switch's  ,  and  , switches do not work.	Steering switch signal circuit malfunction. Refer to AV-184. "Diagnosis Procedure" .
	All steering switches do not work.	Steering switch ground circuit malfunction. Refer to AV-184. "Diagnosis Procedure" .

RELATED TO AROUND VIEW MONITOR

MULTI AV SYSTEM

< SYMPTOM DIAGNOSIS >

[AUDIO W/O NAVI (FOR MEXICO)]

Symptoms	Check items	Probable malfunction location
Display does not switch to camera image when CAMERA switch is pressed or selector lever is in R (reverse).	Around view monitor control unit malfunction.	Around view monitor control unit power supply and ground circuits malfunction. Refer to AV-173, "AROUND VIEW MONITOR CONTROL UNIT : Diagnosis Procedure" .
	Camera image signal circuit (output) malfunction.	Camera image signal circuit (output) malfunction between around view monitor control unit and AV control unit. Refer to AV-121, "Reference Value" .
Display switches to camera image when CAMERA switch is pressed or selector lever is in R (reverse), but all views are not displayed.	Camera image signal circuit (input) malfunction.	Camera image signal circuit (input) malfunction between camera and around view monitor control unit. Refer to: <ul style="list-style-type: none"> AV-162, "Diagnosis Procedure" (front camera). AV-158, "Diagnosis Procedure" (rear view camera). AV-164, "Diagnosis Procedure" (side camera LH). AV-160, "Diagnosis Procedure" (side camera RH).
Camera image is rolling.	Camera image signal circuit (output) malfunction.	Camera image signal circuit (output) malfunction between around view monitor control unit and AV control unit. Refer to AV-121, "Reference Value" .
Display does not switch to rear view monitor even when selector lever is in R (reverse).	Reverse signal circuit malfunction.	Reverse signal circuit between BCM and around view monitor control unit. Refer to AV-121, "Reference Value" .
Predicted course line display in front view and rear view is malfunctioning.	Steering angle sensor malfunction.	Predictive course line center position is malfunctioning. Refer to AV-148, "PREDICTIVE COURSE LINE CENTER POSITION ADJUSTMENT : Work Procedure" .
Front view and front of birds-eye view is not displayed.	Front camera malfunction.	<ul style="list-style-type: none"> Front camera power supply and ground circuits malfunction. Front camera image signal circuit malfunction between front camera and around view monitor control unit. Refer to AV-162, "Diagnosis Procedure" .
	Front camera image signal circuit malfunction.	
Rear view and rear of birds-eye view is not displayed.	Rear view camera malfunction.	<ul style="list-style-type: none"> Rear view camera power supply and ground circuits malfunction. Rear view camera image signal circuit malfunction between rear camera and around view monitor control unit. Refer to AV-158, "Diagnosis Procedure" .
	Rear view camera image signal circuit malfunction.	
Front-side and driver side of birds-eye view is not displayed.	Side camera LH malfunction.	<ul style="list-style-type: none"> Side camera LH power supply and ground circuits malfunction. Side camera LH image signal circuit malfunction between side camera LH and around view monitor control unit. Refer to AV-164, "Diagnosis Procedure" .
	Side camera LH image signal circuit malfunction.	
Front-side and passenger side of birds-eye view is not displayed.	Side camera RH malfunction.	<ul style="list-style-type: none"> Side camera RH power supply and ground circuits malfunction. Side camera RH image signal circuit malfunction between side camera RH and around view monitor control unit. Refer to AV-160, "Diagnosis Procedure" .
	Side camera RH image signal circuit malfunction.	
Selector lever is in a position other than R (reverse) and front, rear, front-side and Birds-Eye views are displayed even as vehicle speed increases.	Vehicle speed signal malfunction.	Vehicle speed signal malfunction (CAN communication) between combination meter and around view monitor control unit.

A
B
C
D
E
F
G
H
I
J
K
L
M
AV
O
P

NORMAL OPERATING CONDITION

< SYMPTOM DIAGNOSIS >

[AUDIO W/O NAVI (FOR MEXICO)]

NORMAL OPERATING CONDITION

Description

INFOID:000000010641818

RELATED TO NOISE

The majority of the audio concerns are the result of outside causes (bad CD, electromagnetic interference, etc.).

The following noise results from variations in field strength, such as fading noise and multi-path noise, or external noise from trains and other sources. It is not a malfunction.

- Fading noise: This noise occurs because of variations in the field strength in a narrow range due to mountains or buildings blocking the signal.
- Multi-path noise: This noise results from the waves sent directly from the broadcast station arriving at the antenna at a different time from the waves which reflect off mountains or buildings.

The vehicle itself can be a source of noise if noise prevention parts or electrical equipment is malfunctioning. Check if noise is caused and/or changed by engine speed, power switch turned to each position, and operation of each piece of electrical equipment, and determine the cause.

NOTE:

The source of the noise can be found easily by listening to the noise while removing the fuses of electrical components, one by one.

Type of Noise and Possible Cause

Occurrence condition		Possible cause
Occurs only when engine is ON.	A continuous growling noise occurs. The speed of the noise varies with changes in the engine speed.	<ul style="list-style-type: none"> • Power components
The occurrence of the noise is linked with the operation of the fuel pump.		<ul style="list-style-type: none"> • Fuel pump condenser
Noise only occurs when various electrical components are operating.	A cracking or snapping sound occurs with the operation of various switches.	<ul style="list-style-type: none"> • Relay malfunction, AV control unit malfunction
	The noise occurs when various motors are operating.	<ul style="list-style-type: none"> • Motor case ground • Motor
The noise occurs constantly, not just under certain conditions.		<ul style="list-style-type: none"> • Rear defogger coil malfunction • Open circuit in printed heater • Poor ground of antenna feeder line
A cracking or snapping sound occurs while the vehicle is being driven, especially when it is vibrating excessively.		<ul style="list-style-type: none"> • Ground wire of body parts • Ground due to improper part installation • Wiring connections or a short circuit

RELATED TO HANDS-FREE PHONE

Symptom	Cause and Counter measure
Does not recognize cellular phone connection (No connection is displayed on the display at the guide).	<p>Some Bluetooth[®] enabled cellular phones may not be recognized by the in-vehicle phone module.</p> <p>Refer to "RELATED TO HANDS-FREE PHONE (Check Compatibility)" in AV-187, "Symptom Table".</p>
Cannot use hands-free phone.	<p>Customer will not be able to use a hands-free phone under the following conditions:</p> <ul style="list-style-type: none"> • The vehicle is outside of the telephone service area. • The vehicle is in an area where it is difficult to receive radio waves; such as in a tunnel, in an underground parking garage, near a tall building or in a mountainous area. • The cellular phone is locked to prevent it from being dialed. <p>NOTE:</p> <p>While a cellular phone is connected through the Bluetooth[®] wireless connection, the battery power of the cellular phone may discharge quicker than usual. The Bluetooth[®] Hands-Free Phone System cannot charge cellular phones.</p>

NORMAL OPERATING CONDITION

< SYMPTOM DIAGNOSIS >

[AUDIO W/O NAVI (FOR MEXICO)]

Symptom	Cause and Counter measure
The other party's voice cannot be heard by hands-free phone.	When the radio wave condition is not ideal or ambient sound is too loud, it may be difficult to hear the other person's voice during a call.
Poor sound quality.	Do not place the cellular phone in an area surrounded by metal or far away from the in-vehicle phone module to prevent tone quality degradation and wireless connection disruption.

A

B

C

D

E

F

G

H

I

J

K

L

M

AV

O

P

REMOVAL AND INSTALLATION

AV CONTROL UNIT

Removal and Installation

INFOID:000000010641819

REMOVAL

CAUTION:

Remove AV control unit after a lapse of 30 seconds or more after turning the power switch OFF.

NOTE:

After the power switch is turned OFF, the AV control unit continues operating for approximately 30 seconds. Therefore, data corruption may occur if 12V battery voltage is cut off within 30 seconds.

1. Disconnect the 12V negative battery terminal. Refer to [PG-82, "Removal and Installation"](#).
2. Remove cluster lid C. Refer to [JP-17, "Removal and Installation"](#).
3. Remove the AV control unit screws, disconnect the harness connectors from the AV control unit and remove with the brackets attached.
4. Remove the bracket screws and the brackets from AV control unit (if necessary).

INSTALLATION

Note the following, and install in the reverse order of removal.

CAUTION:

- If the AV control unit is replaced, input of the user ID and password and time adjustment with VCM are required.
- If the AV control unit is not replaced, time adjustment with VCM is required.

Input Method of User ID and Password:

1. Turn power switch ON.
2. Select "Sign in" from the CARWINGS screen.
3. Enter the user ID and password.

NOTE:

Since the user ID and password are determined by the user in advance, they are input by the user.

Time Adjustment and Check Method with VCM

Refer to [AV-142, "Work Flow"](#).

MULTIFUNCTION SWITCH

< REMOVAL AND INSTALLATION >

[AUDIO W/O NAVI (FOR MEXICO)]

MULTIFUNCTION SWITCH

Removal and Installation

INFOID:000000010641820

REMOVAL

1. Remove cluster lid C. Refer to [IP-17. "Removal and Installation"](#).
2. Remove the screws (A), clips (B) and the multifunction switch from cluster lid C.

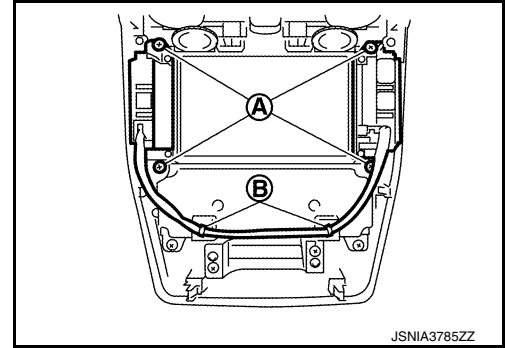

INSTALLATION

Install in the reverse order of removal.

A
B
C
D
E
F
G
H
I
J
K
L
M
AV
O
P

FRONT DOOR SPEAKER

< REMOVAL AND INSTALLATION >

[AUDIO W/O NAVI (FOR MEXICO)]

FRONT DOOR SPEAKER

Removal and Installation

INFOID:000000010641821

REMOVAL

1. Remove the front door finisher. Refer to [INT-19, "Removal and Installation"](#).
2. Remove the screws and disconnect the connector to remove the front door speaker.

INSTALLATION

Install in the reverse order of removal.

TWEETER

Removal and Installation

INFOID:000000010641822

REMOVAL

1. Remove the front pillar garnish. Refer to [INT-26. "FRONT PILLAR GARNISH : Removal and Installation"](#).
2. Remove screw (A) and tweeter (2) from front pillar garnish (1).

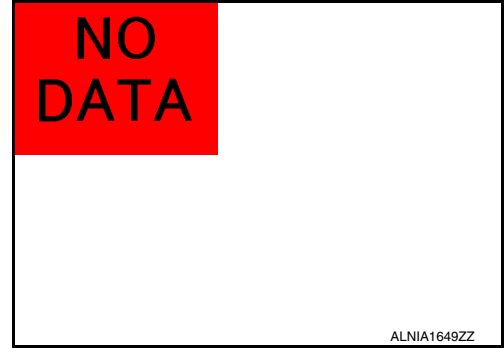

INSTALLATION

Install in the reverse order of removal.

A
B
C
D
E
F
G
H
I
J
K
L
M
AV
O
P

REAR DOOR SPEAKER

< REMOVAL AND INSTALLATION >

[AUDIO W/O NAVI (FOR MEXICO)]

REAR DOOR SPEAKER

Removal and Installation

INFOID:000000010641823

REMOVAL

1. Remove the rear door finisher. Refer to [INT-22. "Removal and Installation"](#).
2. Remove the screws and disconnect the connector to remove the rear door speaker.

INSTALLATION

Install in the reverse order of removal.

MICROPHONE

< REMOVAL AND INSTALLATION >

[AUDIO W/O NAVI (FOR MEXICO)]

MICROPHONE

Removal and Installation

INFOID:000000010641824

REMOVAL

1. Remove the map lamp assembly. Refer to [INL-53, "Removal and Installation"](#).
2. Press the pawl to remove the microphone (1) from the map lamp assembly (2).

CAUTION:

Use care when handling the microphone pawl to avoid damaging.

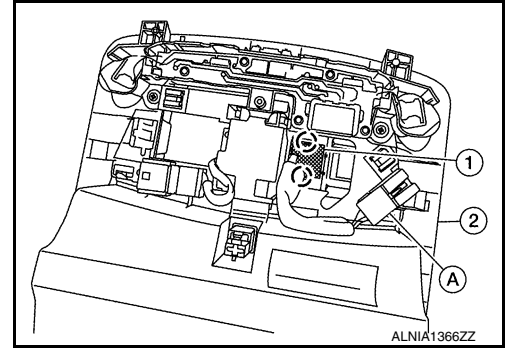

INSTALLATION

Install in the reverse order of removal.

NOTE:

Check the microphone for looseness after the installation.

A
B
C
D
E
F
G
H
I
J
K
L
M
O
P

AV

ANTENNA FEEDER

< REMOVAL AND INSTALLATION >

[AUDIO W/O NAVI (FOR MEXICO)]

ANTENNA FEEDER

Antenna Feeder

INFOID:000000010641825

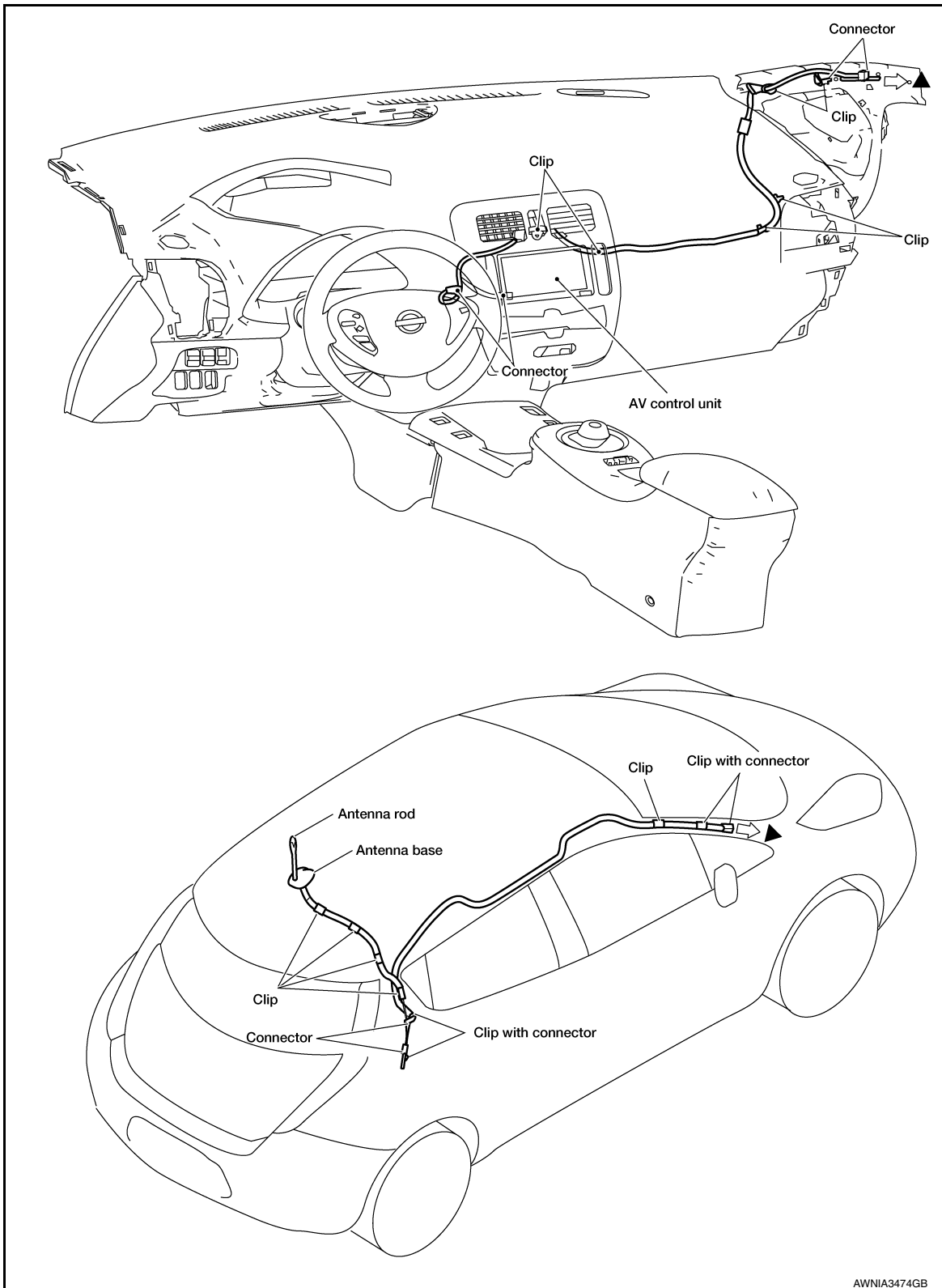

▲: Indicates that the part is connected at points with same symbol in actual vehicle.

GPS ANTENNA

Removal and Installation

INFOID:000000010641826

REMOVAL

1. Remove the instrument panel assembly. Refer to [IP-17, "Removal and Installation"](#).
2. Remove the screws, clips and the GPS antenna.

INSTALLATION

Install in the reverse order of removal.

A
B
C
D
E
F
G
H
I
J
K
L
M
N
O
P

AV

ANTENNA BASE

< REMOVAL AND INSTALLATION >

[AUDIO W/O NAVI (FOR MEXICO)]

ANTENNA BASE

Removal and Installation

INFOID:000000010641827

REMOVAL

1. Partially remove the headlining (rear side) to obtain space to work between vehicle and headlining. Refer to [INT-37, "Removal and Installation"](#).
2. Disconnect the antenna feeder connector.
3. Remove the nut and the antenna base (2) from the vehicle.
(1): Antenna rod

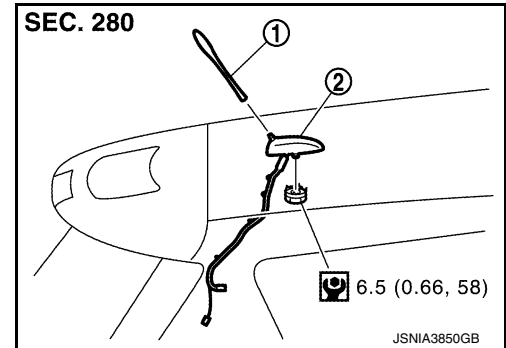

INSTALLATION

Install in the reverse order of removal.

CAUTION:

- Do not bend headlining when pulling down.
- Tighten the antenna base nut to specification.
- If the antenna base nut is less than the specified torque, it could affect the performance of the antenna sensitivity.
- If the antenna base nut is greater than the specified torque, it could damage the roof panel.

STEERING SWITCH

< REMOVAL AND INSTALLATION >

[AUDIO W/O NAVI (FOR MEXICO)]

STEERING SWITCH

Exploded View

INFOID:000000010641828

Refer to [SR-20, "Exploded View"](#).

Removal and Installation

INFOID:000000010641829

REMOVAL

Refer to [SR-20, "Removal and Installation"](#).

INSTALLATION

Install in the reverse order of removal.

A

B

C

D

E

F

G

H

I

J

K

L

M

AV

O

P

AUXILIARY INPUT JACK

< REMOVAL AND INSTALLATION >

[AUDIO W/O NAVI (FOR MEXICO)]

AUXILIARY INPUT JACK

Removal and Installation

INFOID:000000010641830

REMOVAL

1. Remove the instrument lower center cover. Refer to [IP-17, "Removal and Installation"](#).
2. Press the tab from the rear of the instrument lower center cover (B) and remove the auxiliary input jack (A).

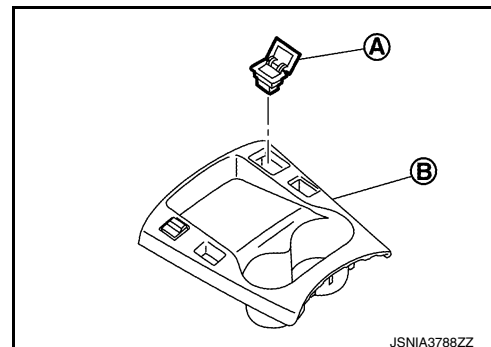

INSTALLATION

Install in the reverse order of removal.

NOTE:

Align the notch of the instrument panel center lower cover and assemble it.

USB CONNECTOR

< REMOVAL AND INSTALLATION >

[AUDIO W/O NAVI (FOR MEXICO)]

USB CONNECTOR

Removal and Installation

INFOID:000000010641831

REMOVAL

1. Remove the instrument lower center cover. Refer to [IP-17. "Removal and Installation"](#).
2. Press the tab from the rear of the instrument lower center cover (B) and remove the USB connector (A).

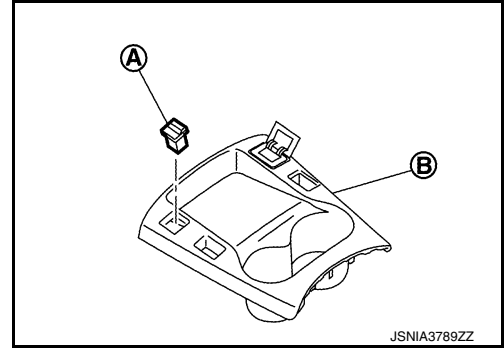

INSTALLATION

Install in the reverse order of removal.

NOTE:

Align the notch of the instrument panel center lower cover and assemble it.

A
B
C
D
E
F
G
H
I
J
K
L
M
O
P

AV

AROUND VIEW MONITOR CONTROL UNIT

< REMOVAL AND INSTALLATION >

[AUDIO W/O NAVI (FOR MEXICO)]

AROUND VIEW MONITOR CONTROL UNIT

Removal and Installation

INFOID:000000010641832

REMOVAL

1. Remove the TCU. Refer to [AV-594. "Removal and Installation"](#).
2. Remove the around view monitor control unit screws.
3. Disconnect the harness connectors from the around view monitor control unit and remove.

INSTALLATION

Install in the reverse order of removal.

NOTE:

Perform camera image calibration. Refer to [AV-425. "CALIBRATING CAMERA IMAGE \(AROUND VIEW MONITOR\) : Work Procedure"](#).

FRONT CAMERA

Removal and Installation

INFOID:000000010641833

REMOVAL

1. Open charge port lid.
2. Release the pawls and remove the access cover on the rear of the charge port lid.
3. Disconnect the harness connector from the front camera.
4. Remove the front camera from the charge port lid.

INSTALLATION

Install in the reverse order of removal.

NOTE:

Perform camera image calibration. Refer to [AV-425, "CALIBRATING CAMERA IMAGE \(AROUND VIEW MONITOR\) : Work Procedure"](#).

A
B
C
D
E
F
G
H
I
J
K
L
M
O
P

AV

SIDE CAMERA

< REMOVAL AND INSTALLATION >

[AUDIO W/O NAVI (FOR MEXICO)]

SIDE CAMERA

Removal and Installation

INFOID:000000010641834

REMOVAL

1. Remove door mirror cover. Refer to [MIR-23. "DOOR MIRROR COVER : Removal and Installation"](#).
2. Disconnect harness connector (A) from side camera.

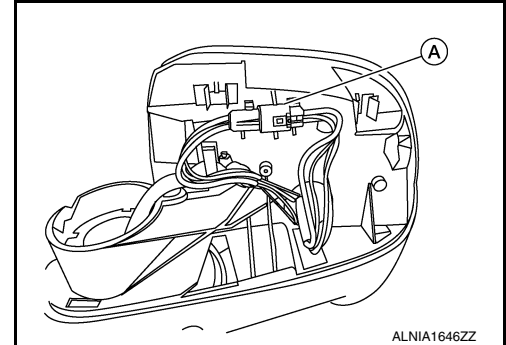

3. Remove screws (A) and remove side camera (1).

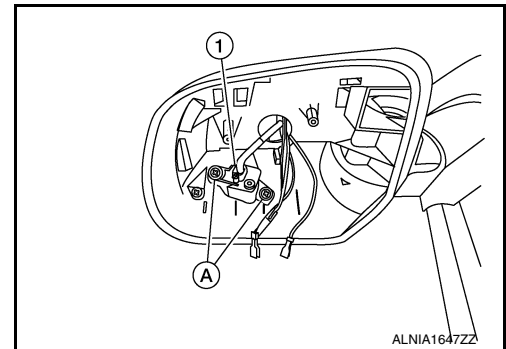

INSTALLATION

Install in the reverse order of removal.

NOTE:

Perform camera image calibration. Refer to [AV-425. "CALIBRATING CAMERA IMAGE \(AROUND VIEW MONITOR\) : Work Procedure"](#).

REAR VIEW CAMERA

< REMOVAL AND INSTALLATION >

[AUDIO W/O NAVI (FOR MEXICO)]

REAR VIEW CAMERA

Removal and Installation

INFOID:000000010641835

REMOVAL

1. Remove the back door outside handle. Refer to [DLK-201, "OUTSIDE HANDLE : Removal and Installation"](#).
2. Remove the screws (A) and the rear view camera (1) from back door outside handle (2).

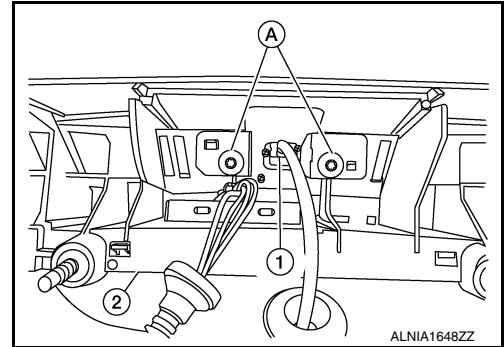

INSTALLATION

Install in the reverse order of removal.

NOTE:

If the side distance guiding lines are dislocated after installation of the rear view camera, refer to [AV-425, "CALIBRATING CAMERA IMAGE \(AROUND VIEW MONITOR\) : Work Procedure"](#) and correct the side distance guiding lines.

A
B
C
D
E
F
G
H
I
J
K
L
M
O
P

AV

PRECAUTION

PRECAUTIONS

Precaution for Technicians Using Medical Electric

INFOID:000000010641836

OPERATION PROHIBITION

WARNING:

- Parts with strong magnet is used in this vehicle.
- Technicians using a medical electric device such as pacemaker must never perform operation on the vehicle, as magnetic field can affect the device function by approaching to such parts.

NORMAL CHARGE PRECAUTION

WARNING:

- If a technician uses a medical electric device such as an implantable cardiac pacemaker or an implantable cardioverter defibrillator, the possible effects on the devices must be checked with the device manufacturer before starting the charge operation.
- As radiated electromagnetic wave generated by PDM (Power Delivery Module) at normal charge operation may affect medical electric devices, a technician using a medical electric device such as implantable cardiac pacemaker or an implantable cardioverter defibrillator must not approach motor room [PDM (Power Delivery Module)] at the hood-opened condition during normal charge operation.

PRECAUTION AT TELEMATICS SYSTEM OPERATION

WARNING:

- If a technician uses implantable cardiac pacemaker or implantable cardioverter defibrillator (ICD), avoid the device implanted part from approaching within approximately 220 mm (8.66 in) from interior/exterior antenna.
- The electromagnetic wave of TCU might affect the function of the implantable cardiac pacemaker or the implantable cardioverter defibrillator (ICD), when using the service, etc.
- If a technician uses other medical electric devices than implantable cardiac pacemaker or implantable cardioverter defibrillator (ICD), the electromagnetic wave of TCU might affect the function of the device. The possible effects on the devices must be checked with the device manufacturer before TCU use.

PRECAUTION AT INTELLIGENT KEY SYSTEM OPERATION

WARNING:

- If a technician uses implantable cardiac pacemaker or implantable cardioverter defibrillator (ICD), avoid the device implanted part from approaching within approximately 220 mm (8.66 in) from interior/exterior antenna.
- The electromagnetic wave of Intelligent Key might affect the function of the implantable cardiac pacemaker or the implantable cardioverter defibrillator (ICD), at door operation, at each request switch operation, or at engine starting.
- If a technician uses other medical electric devices than implantable cardiac pacemaker or implantable cardioverter defibrillator (ICD), the electromagnetic wave of Intelligent Key might affect the function of the device. The possible effects on the devices must be checked with the device manufacturer before Intelligent Key use.

Precaution for Supplemental Restraint System (SRS) "AIR BAG" and "SEAT BELT PRE-TENSIONER"

INFOID:000000010641837

The Supplemental Restraint System such as "AIR BAG" and "SEAT BELT PRE-TENSIONER", used along with a front seat belt, helps to reduce the risk or severity of injury to the driver and front passenger for certain types of collision. This system includes seat belt switch inputs and dual stage front air bag modules. The SRS system uses the seat belt switches to determine the front air bag deployment, and may only deploy one front air bag, depending on the severity of a collision and whether the front occupants are belted or unbelted. Information necessary to service the system safely is included in the SR and SB section of this Service Manual.

WARNING:

PRECAUTIONS

[NAVIGATION WITHOUT BOSE]

< PRECAUTION >

- To avoid rendering the SRS inoperative, which could increase the risk of personal injury or death in the event of a collision which would result in air bag inflation, all maintenance must be performed by an authorized NISSAN/INFINITI dealer.
- Improper maintenance, including incorrect removal and installation of the SRS, can lead to personal injury caused by unintentional activation of the system. For removal of Spiral Cable and Air Bag Module, see the SR section.
- Do not use electrical test equipment on any circuit related to the SRS unless instructed to in this Service Manual. SRS wiring harnesses can be identified by yellow and/or orange harnesses or harness connectors.

PRECAUTIONS WHEN USING POWER TOOLS (AIR OR ELECTRIC) AND HAMMERS

WARNING:

- When working near the Airbag Diagnosis Sensor Unit or other Airbag System sensors with the Ignition ON or engine running, DO NOT use air or electric power tools or strike near the sensor(s) with a hammer. Heavy vibration could activate the sensor(s) and deploy the air bag(s), possibly causing serious injury.
- When using air or electric power tools or hammers, always switch the Ignition OFF, disconnect the battery and wait at least three minutes before performing any service.

Precaution for Trouble Diagnosis

INFOID:000000010641838

AV COMMUNICATION SYSTEM

- Do not apply voltage of 7.0 V or higher to the measurement terminals.
- Use the tester with its open terminal voltage being 7.0 V or less.
- Be sure to turn power switch OFF and disconnect the battery cable from the negative terminal before checking the circuit. Refer to [AV-209, "Precaution for Removing 12V Battery"](#).

Precaution for Harness Repair

INFOID:000000010641839

AV COMMUNICATION SYSTEM

- Solder the repaired parts, and wrap with tape. [Frays of twisted line must be within 110 mm (4.33 in).]

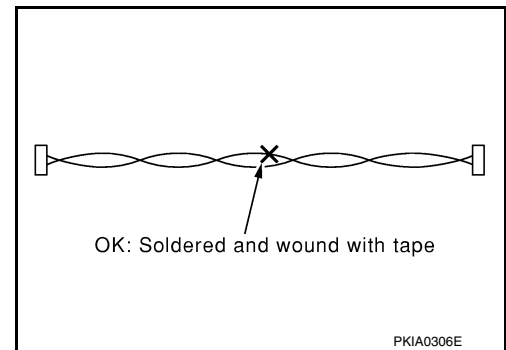

- Do not perform bypass wire connections for the repair parts. (The spliced wire will become separated and the characteristics of twisted line will be lost.)

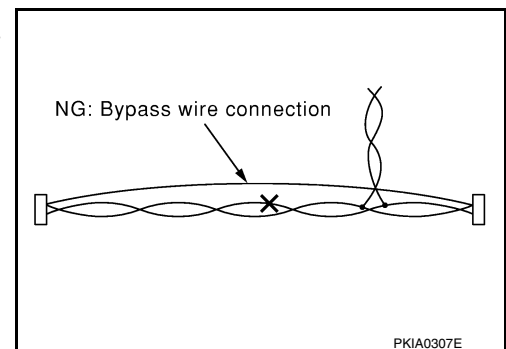

Precaution for Removing 12V Battery

INFOID:000000010641840

1. Check that EVSE is not connected.

NOTE:

If EVSE is connected, the air conditioning system may be automatically activated by the timer A/C function.

PRECAUTIONS

[NAVIGATION WITHOUT BOSE]

< PRECAUTION >

2. Turn the power switch OFF → ON → OFF. Get out of the vehicle. Close all doors (including back door).
3. Check that the charge status indicator lamp does not blink and wait for 5 minutes or more.

NOTE:

If the battery is removed within 5 minutes after the power switch is turned OFF, plural DTCs may be detected.

4. Remove 12V battery within 1 hour after turning the power switch OFF → ON → OFF.

NOTE:

- The 12V battery automatic charge control may start automatically even when the power switch is in OFF state.
- Once the power switch is turned ON → OFF, the 12V battery automatic charge control does not start for approximately 1 hour.

CAUTION:

- **After all doors (including back door) are closed, if a door (including back door) is opened before battery terminals are disconnected, start over from Step 1.**
- **After turning the power switch OFF, if “Remote A/C” is activated by user operation, stop the air conditioner and start over from Step 1.**

Precaution for Work

INFOID:000000011107764

- When removing or disassembling each component, be careful not to damage or deform it. If a component may be subject to interference, be sure to protect it with a shop cloth.
- When removing (disengaging) components with a screwdriver or similar tool, be sure to wrap the component with a shop cloth or vinyl tape to protect it.
- Protect the removed parts with a shop cloth and prevent them from being dropped.
- Replace a deformed or damaged clip.
- If a part is specified as a non-reusable part, always replace it with a new one.
- Be sure to tighten bolts and nuts securely to the specified torque.
- After installation is complete, be sure to check that each part works properly.
- Follow the steps below to clean components:
 - Water soluble dirt:
 - Dip a soft cloth into lukewarm water, wring the water out of the cloth and wipe the dirty area.
 - Then rub with a soft, dry cloth.
 - Oily dirt:
 - Dip a soft cloth into lukewarm water with mild detergent (concentration: within 2 to 3%) and wipe the dirty area.
 - Then dip a cloth into fresh water, wring the water out of the cloth and wipe the detergent off.
 - Then rub with a soft, dry cloth.
 - Do not use organic solvent such as thinner, benzene, alcohol or gasoline.
 - For genuine leather seats, use a genuine leather seat cleaner.

Cautions in Removing AV Control Unit (Models with AV Control Unit)

INFOID:000000010641841

CAUTION:

Remove AV control unit after a lapse of 30 seconds or more after turning the power switch OFF.

NOTE:

After the power switch is turned OFF, the AV control unit continues operating for approximately 30 seconds. Therefore, data corruption may occur if 12V battery voltage is cut off within 30 seconds.

PREPARATION

< PREPARATION >

[NAVIGATION WITHOUT BOSE]

PREPARATION

PREPARATION

Special Service Tools

INFOID:000000011107782

The actual shape of the tools may differ from those illustrated here.

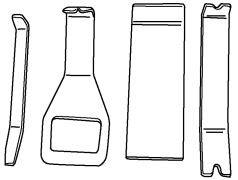
Tool number (TechMate No.) Tool name	Description
— (J-46534) Trim Tool Set  AWJIA0483ZZ	Removing trim components

Commercial Service Tool

INFOID:000000010641842

Tool name	Description
Power tool  PIIB1407E	Loosening nuts, screws and bolts

A
B
C
D
E
F
G
H
I
J
K
L
M
AV
O
P

COMPONENT PARTS

< SYSTEM DESCRIPTION >

[NAVIGATION WITHOUT BOSE]

SYSTEM DESCRIPTION

COMPONENT PARTS

Component Parts Location

INFOID:000000010641843

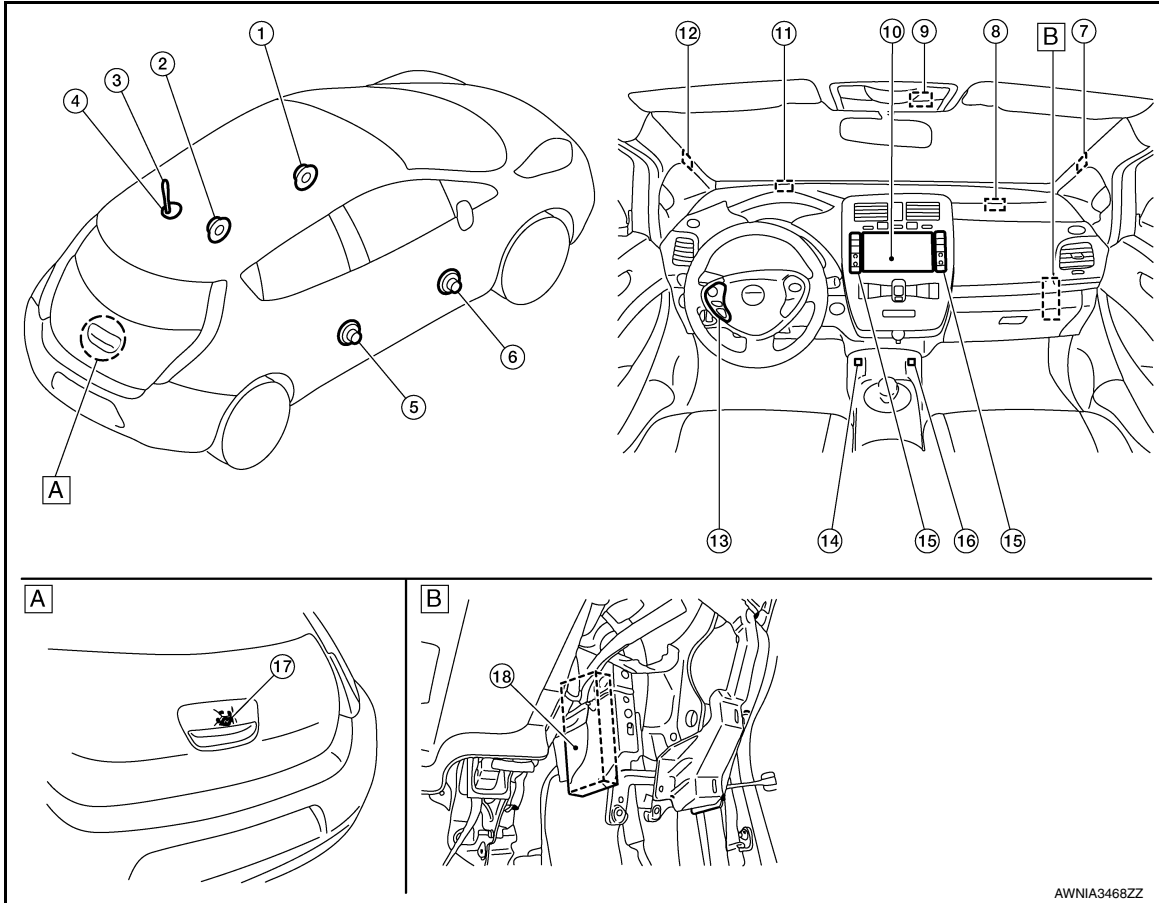

AWNIA3468ZZ

A. Center of the back door

B. Glove box cover assembly is removed.

No.	Component	Function
1.	Front door speaker LH	Refer to AV-214, "Speaker" .
2.	Rear door speaker LH	
3.	Antenna rod	Refer to AV-215, "Radio Antenna and Antenna Feeder" .
4.	Antenna base (antenna amp. and satellite radio antenna)	
5.	Rear door speaker RH	Refer to AV-214, "Speaker" .
6.	Front door speaker RH	
7.	Tweeter RH	Refer to AV-214, "Speaker" .
8.	TEL antenna	Refer to AV-218, "TEL Antenna" .
9.	Microphone	Refer to AV-218, "Microphone" .
10.	AV control unit	Refer to AV-213, "AV Control Unit" .
11.	GPS antenna	Refer to AV-217, "GPS Antenna" .
12.	Tweeter LH	Refer to AV-214, "Speaker" .
13.	Steering switch	Refer to AV-217, "Steering Switch" .

COMPONENT PARTS

< SYSTEM DESCRIPTION >

[NAVIGATION WITHOUT BOSE]

No.	Component	Function
14.	USB connector	Refer to AV-218, "USB Connector"
15.	Multifunction switch	Refer to AV-217, "Multifunction Switch" .
16.	Auxiliary input jack	Refer to AV-219, "Auxiliary Input Jack" .
17.	Rear view camera	Refer to AV-88, "Rear View Camera" .
18.	TCU	Refer to AV-217, "TCU" .

AV Control Unit

INFOID:000000010641844

DESCRIPTION

- High-resolution 7-inch wide VGA display integrated AV control unit is installed at the center of the instrument panel.
- The AV control unit is equipped with the following parts. It is the master unit integrated with functions and controls the multi-AV system.

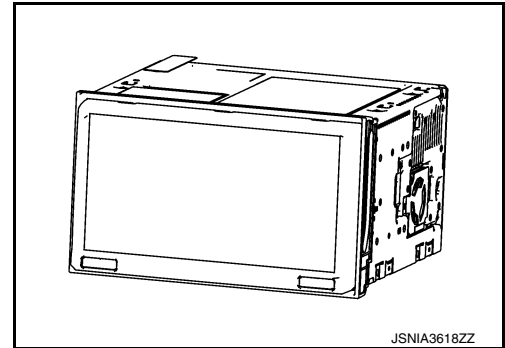

Units equipped
SD card slot
High resolution 7-inch wide VGA LCD monitor
Audio amplifier
AM/FM electronic tuner
Satellite radio tuner
CD drive
USB interface
Bluetooth® module

- Signals necessary for the vehicle information display function are received from ECM and the combination meter via CAN communication.
- It is connected to TCU in USB communication, and signals necessary for the Telematics function and CAR-WINGS function are sent and received.
- Signals necessary for vehicle setting functions are sent and received with BCM via CAN communication.
- It inputs the signal for driving status recognition (vehicle speed signal, reverse signal, and parking brake signal).
- It has the built-in gyro sensor and acceleration sensor as a vehicle position calculation sensor. Map data is read from an SD card in the SD slot.
 - SD card
- It records the map data, traffic control data, and guide information, etc.
 - Gyroscope
- Detects vehicle cornering condition.
 - Acceleration sensor
- Detects the inclination angle and height variation of the vehicle.

NOTE:

For details of each function, refer to [AV-221, "MULTI AV SYSTEM : System Description"](#).

SD Card Slot

With the display opened, the map card slot is located on the right (main slot), and the card slot used for import/export of stored location is located on the left (sub slot).

Display

- High resolution 7-inch wide VGA LCD monitor is adopted to display a high definition image including digital image signals.
- Touch panel function is adopted to improve operability.
- RGB digital image signals (navigation image/menu image) are displayed.

Audio Amplifier

- 45W x 4ch amplifiers are installed.
- Audio sound, TEL voice and guiding voice are output to each speaker.

A
B
C
D
E
F
G
H
I
J
K
L
M
N
O
P

AV

COMPONENT PARTS

[NAVIGATION WITHOUT BOSE]

< SYSTEM DESCRIPTION >

AM/FM Electronic Tuner

- The AM/FM electric tuner includes the PLL frequency synthesizer system.

Satellite Radio Tuner

- The adoption of the PPL synthesizer method allows the signal reception at more accurate frequencies.
- The satellite radio tuner receives a satellite radio antenna signal and converts the signal into an audio sound signal and a data signal.
- The audio sound signal is transmitted to the audio amplifier and the data signal is transmitted to the display.

CD Drive

- It is CD-R/CD-RW compliant and enables MP3 and WMA files to play music.
- It displays the artist name, album title or song title recorded to the file by the ID3 tag/WMA tag display function.

USB Interface

- Music can be played by connecting an iPod® or USB memory.

Bluetooth® Module

- Wireless connection to the audio device equipped with Bluetooth® communication can play music.
- Once a Bluetooth® communication compliant phone has been registered in the AV control unit, hands-free phone communication and connection to the CARWINGS information center can be carried out without connecting the cellular phone to the TEL harness.
- Five units of Bluetooth® communication devices including audio devices and cellular phones can be registered to the AV control unit.

Speaker

INFOID:000000010641845

The 6-speaker system is adopted.

Front door speaker

- ϕ 16.5 cm (6.5 in) speaker is installed to the bottom of the front door.
- Sound signal is input from the AV control unit to output mid and low range sounds.

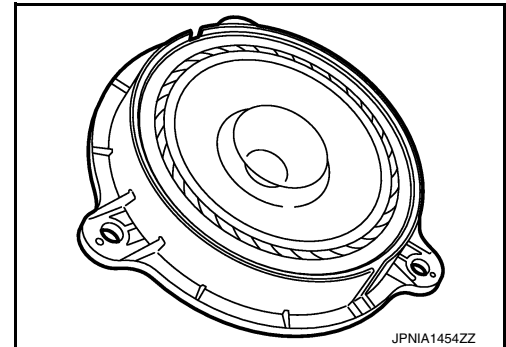

Rear door speaker

- ϕ 16.5 cm (6.5 in) speaker is installed to the bottom of the rear door.
- Sound signal is input from the AV control unit to output high, mid and low range sounds.

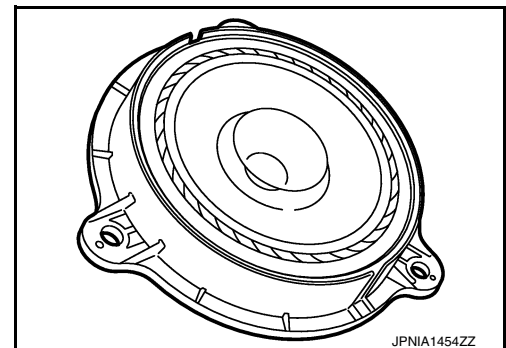

Tweeter

- ϕ 2.5 cm (1 in) tweeter for high-range sounds is installed in the front pillar.

COMPONENT PARTS

[NAVIGATION WITHOUT BOSE]

< SYSTEM DESCRIPTION >

- Sound signal is input from the AV control unit to output high range sounds.

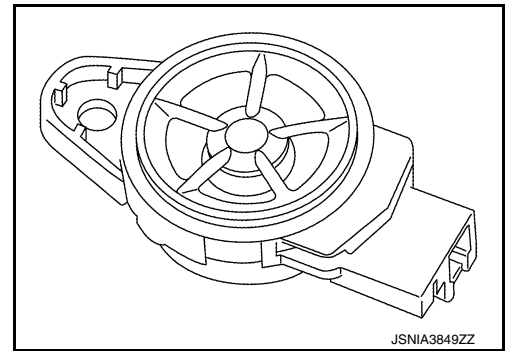

INFOID:000000010641846

Radio Antenna and Antenna Feeder

RADIO ANTENNA

Rod Antenna

A rod antenna is installed to the rear center of the roof.

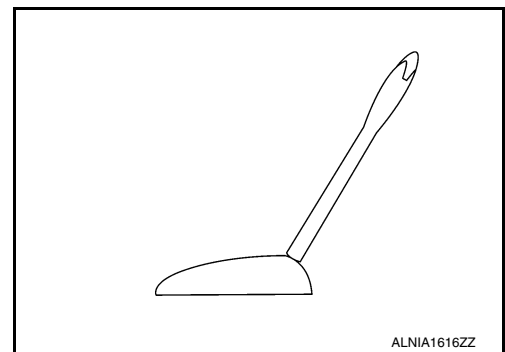

Antenna Base

- To obtain sufficient reception sensitivity, an antenna amplifier is built into the antenna base.
- Power of the antenna amplifier is supplied from the AV control unit.
- The radio signal received by the rod antenna is input to the antenna base and the antenna signal is amplified and sent to the AV control unit.

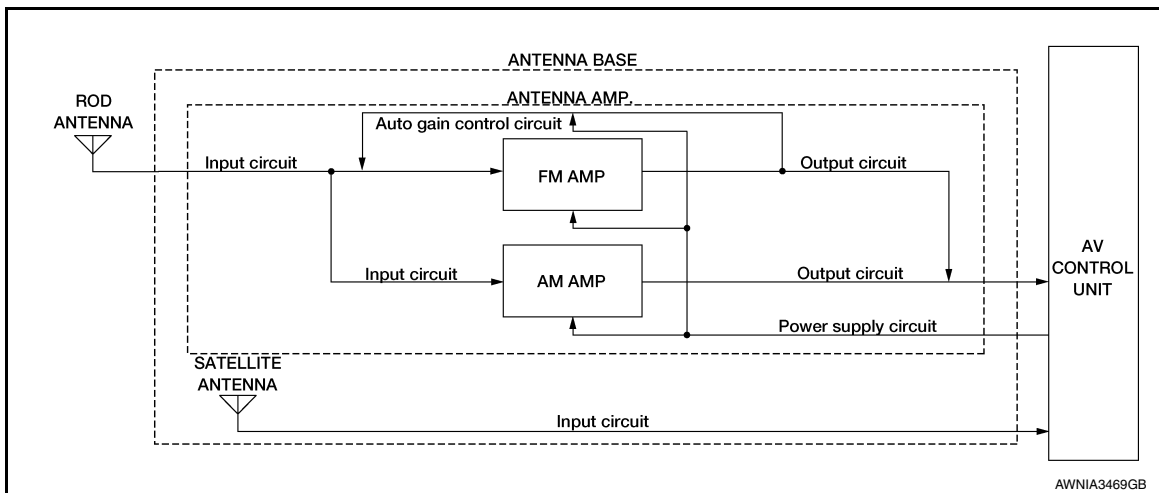

Satellite radio Antenna

- Receives satellite radio waves and outputs it to AV control unit.

Antenna circuit

A
B
C
D
E
F
G
H
I
J
K
L
M
N
O
P

AV

COMPONENT PARTS

< SYSTEM DESCRIPTION >

[NAVIGATION WITHOUT BOSE]

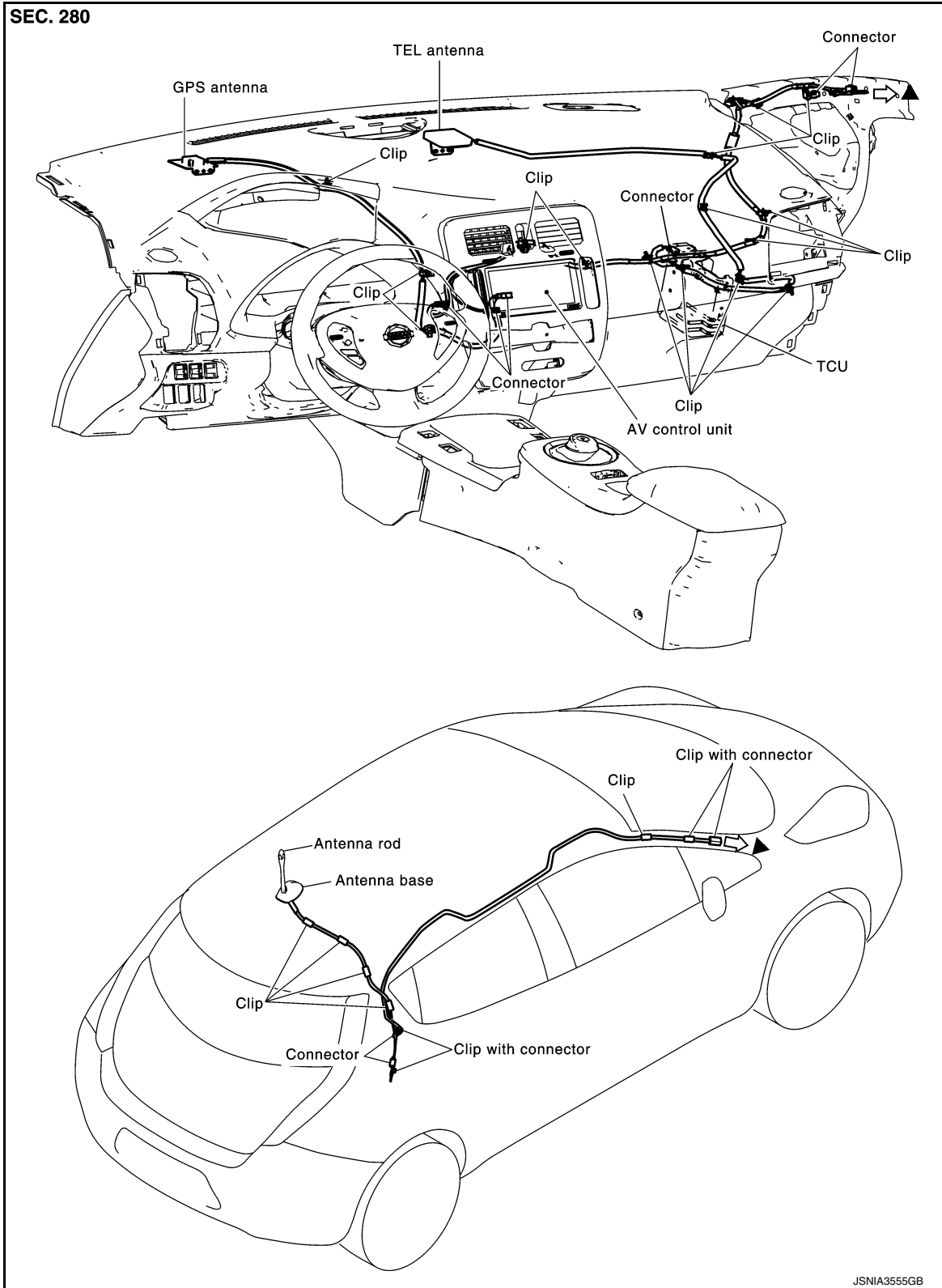

▲: Indicates that the part is connected at points with same symbol in actual vehicle.

Steering Switch

INFOID:0000000110641847

- Hands-free phone, possible driving distance display, voice control, and audio operations can be performed.
- This switch is connected to the AV control unit, and the switch operation signal is transmitted to the AV control unit via voltage multiplex communication.

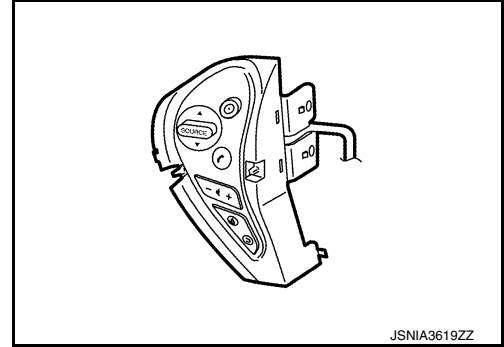

Multifunction Switch

INFOID:0000000110641848

- Audio, navigation, Telematics, etc. can be controlled.
- Switch operation signals are input to the AV control unit via AV communication.

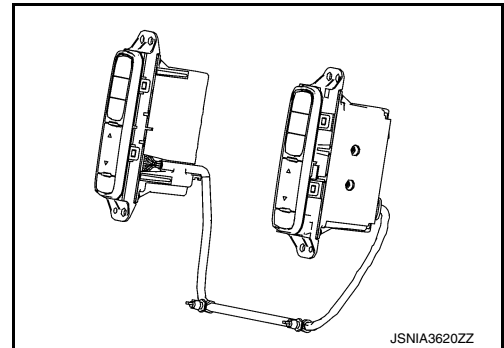

TCU

INFOID:0000000110641849

- TCU is installed on the lower right of the instrument panel.
- A radio communication terminal is built into the unit, and data is sent and received in SMS and packet communication with the NISSAN CARWINGS Data Center through the TEL antenna.
- VIN information necessary for the Telematics service is memorized.

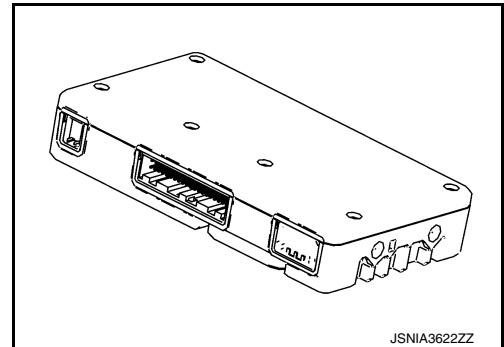

GPS Antenna

INFOID:0000000110641850

- GPS antenna is installed in the instrument panel.
- Power is supplied from the AV control unit.
- This antenna amplifies radio waves received from the GPS satellite and transmits the GPS signal to the AV control unit.

NOTE:

An object on the instrument panel may cause the reception sensitivity to be decreased.

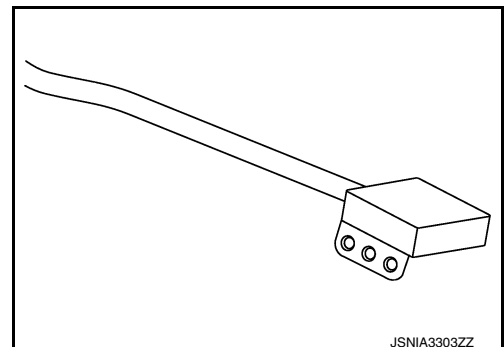

A
B
C
D
E
F
G
H
I
J
K
L
M
O
P

AV

COMPONENT PARTS

< SYSTEM DESCRIPTION >

[NAVIGATION WITHOUT BOSE]

USB Connector

INFOID:000000010641851

- USB connector is installed on the lower left side of the instrument panel.
- iPod® and USB memory can be connected to the AV control unit.

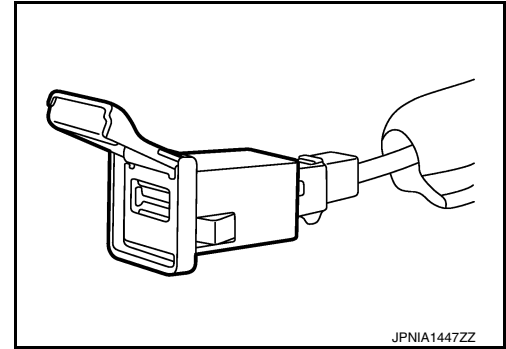

Microphone

INFOID:000000010641852

- The voice control/TEL microphone is installed on the right side of the map lamp assembly.
- The power is supplied from the AV control unit to the microphone, transmitting sound signals to the AV control unit at the voice control or during hands-free phone communication.

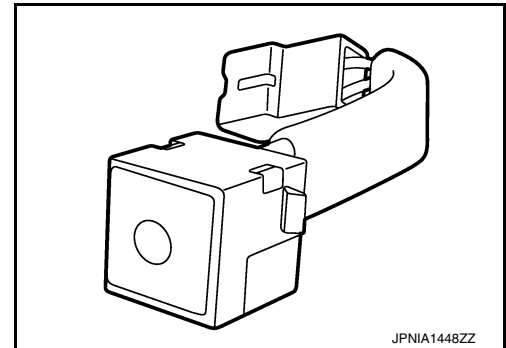

TEL Antenna

INFOID:000000010641853

- The TEL antenna is installed in the instrument panel.
- Power is supplied with TCU activated.

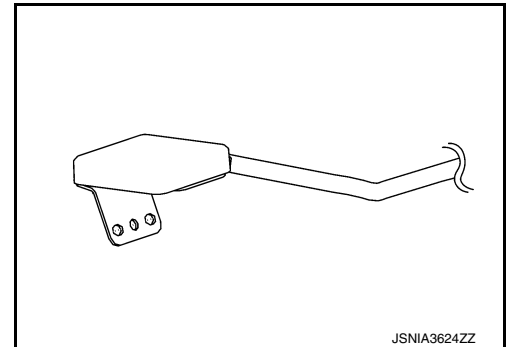

Rear View Camera

INFOID:000000010641854

- The rear camera is installed to the back door finisher.
- Power for the camera is supplied from the AV control unit, and the image signal at the rear of the vehicle is sent back to the AV control unit.

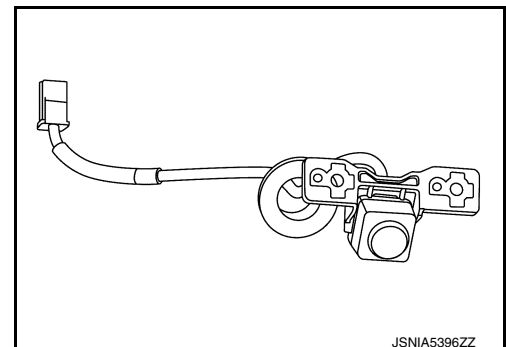

COMPONENT PARTS

< SYSTEM DESCRIPTION >

[NAVIGATION WITHOUT BOSE]

Auxiliary Input Jack

INFOID:000000010641855

- AUX jack is installed at the lower right of the instrument panel.
- Connection to an external audio device can provide sound output.

External input terminal for connection ϕ 3.5 mm stereo mini-jack

NOTE:

When connected to monaural mini-jack plug cable, sound may not be output.

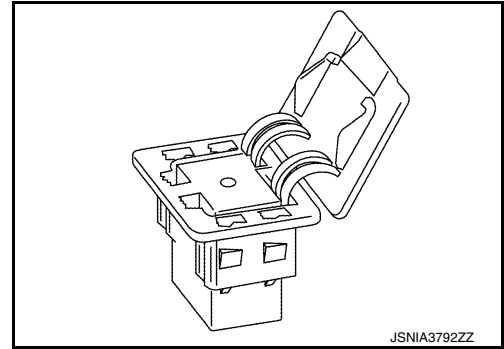

SD Card

INFOID:000000010641856

- Map data is memorized in an 8 GB SDHC* card.
- Map data is sent to the AV control unit from the SD slot.

NOTE:

*SDHC: Abbreviation of SD High-Capacity. It is the upper level standard of the SD memory card. A large quantity of data can be memorized, and the transfer speed of data is high.

A
B
C
D
E
F
G
H
I
J
K
L
M
O
P

AV

SYSTEM

MULTI AV SYSTEM

MULTI AV SYSTEM : System Diagram

INFOID:000000010641857

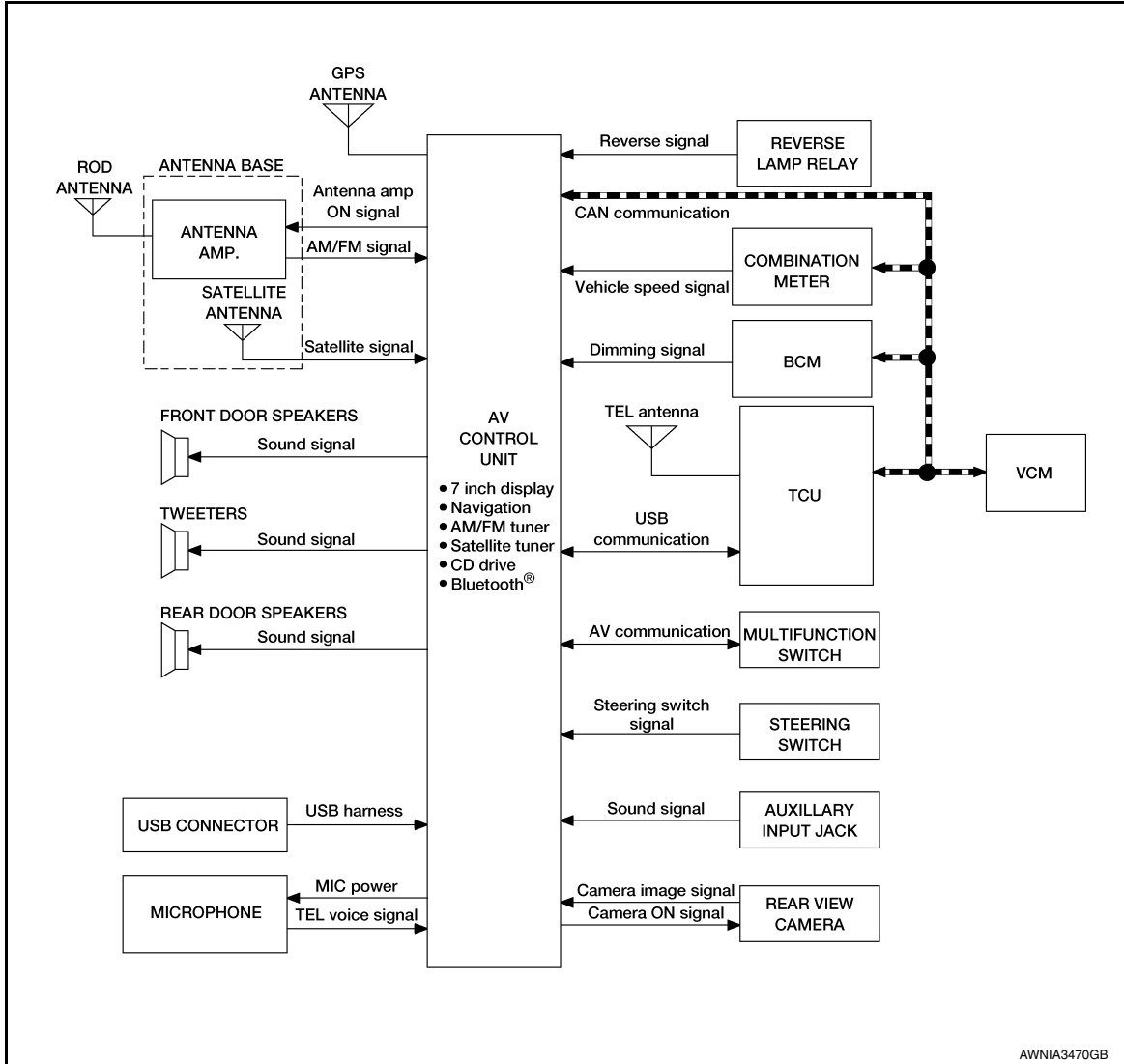

CAN communication

AV control unit Input Signal

Transmit unit	Signal name
Combination meter	Odometer signal
	A/C OFF average electricity consumption for driving range signal
	A/C ON average electricity consumption for driving range signal
	Driving range difference signal

SYSTEM

< SYSTEM DESCRIPTION >

[NAVIGATION WITHOUT BOSE]

Transmit unit	Signal name	
VCM	A/C consumption power status display signal	A
	A/C consumption signal	
	Current motor power signal	B
	ECO tree signal	
	Li-ion battery charging data signal	
	Others consumption signal	C
	Pre-A/C priority signal	
	Pre-A/C timer signal	D
	Remaining time to charge completion (200 V) signal	
	Remaining time to charge completion (100 V) signal	
	Traction motor consumption signal	E
	VCM activation/deactivation command signal	
	VCM status signal	F

TCU Input Signal

Transmit unit	Signal name	
VCM	A/C expected consumption signal	G
	Charge status signal	
	Pre-A/C status signal	H
	Remaining time to charge completion (200 V) signal	
	Remaining time to charge completion (100 V) signal	I
	VCM activation/deactivation command signal	
	VCM status signal	
	Li-ion battery available charge signal	J
	Li-ion battery capacity signal	
Li-battery gradual capacity loss signal	K	
On board charger	AC input type signal	

MULTI AV SYSTEM : System Description

INFOID:0000000010641858

- AV control unit is connected to the following parts. It performs power supply, signal input and communication, and it controls the multi-AV system.
- GPS antenna
- Radio antenna (radio antenna amplifier)
- Rear view camera
- USB connector
- Auxiliary input jack
- BCM
- VCM
- Combination meter
- Steering switch
- Multifunction switch
- Microphone
- TCU
- Speakers
- Vehicle signals (reverse signal, vehicle speed signal and illumination signal)
- Data of external device connected to the USB connector is played and transferred.
- When the selector lever is placed in R (reverse), power is supplied to the rear view camera. The camera image signal supplied by the rear view camera is input to the AV control unit. The AV control unit displays the rear view camera image on the display.
- Dimming signal is input from BCM to adjust the brightness of the display.

AV

< SYSTEM DESCRIPTION >

COMMUNICATION SIGNAL

AV control unit is connected to TCU via USB communication, and it receives the Telematics information received by TCU and gives the display and sound output. Telematics operation signals and sound signals are also sent to TCU.

Auto light adjustment function

Auto light adjustment function automatically dims/brightens the display according to the ambient light when the lighting switch is in the 1st or 2nd position. Whether or not the display is dimmed when the lighting switch is in the 1st position or 2nd position is determined by the output condition of the dimming signal output from the BCM to the AV control unit. Even if the lighting switch is in the 1st position or 2nd position, the display may not be dimmed depending on the ambient light sensed by the auto light sensor. For details, refer to [INL-12, "ILLUMINATION CONTROL SYSTEM : System Description"](#).

CAN COMMUNICATION

- AV control unit is connected via CAN communication, receives data signal from VCM and combination meter, and indicates power consumption information, etc. on the display based on the information obtained.
- The AV control unit, which has the vehicle setting function, transmits and receives data on vehicle setting condition via CAN communication with the BCM.
- AV control unit receives and sends signals necessary for timer charge and A/C-heater timer operation with VCM via CAN communication.

Energy Flow Display Function

The AV control unit receives data signals from the VCM and combination meter via CAN communication and computes each value using the obtained information to display it.

Display function	Receiving signal (transmit unit)	Display method
Instantaneous power consumption display	<ul style="list-style-type: none"> • Battery consumption monitor signal (VCM) • Vehicle speed signal (combination meter) 	Computes the instantaneous power consumption using the vehicle speed and battery consumption monitor signals, and displays the instantaneous power consumption bar.
Possible driving distance display	<ul style="list-style-type: none"> • Possible driving distance signal (Combination meter) 	Displays a possible driving distance, based on a possible driving distance signal. When the meter indication of a possible driving distance is "----", it is displayed by "****" on the NAVI screen. Data is retained even with the power switch OFF.
Average power consumption display	<ul style="list-style-type: none"> • Battery consumption monitor signal (VCM) • Vehicle speed signal (combination meter) 	Computes the average power consumption using the battery consumption monitor and vehicle speed signals, and displays it. The average power consumption is displayed only when 30 seconds have elapsed and the vehicle has been driven 500 m after the average power consumption was reset. Data is retained even with the power switch OFF.

Vehicle Setting Function

The AV control unit transmits and receives data signals via CAN communication with the BCM, allowing the following vehicle settings.

- To turn on the automatic interior room lamp (ON/OFF) when the door is unlocked
- To adjust the auto light sensitivity (+/-)
- To operate the intermittent wiper linked with the vehicle speed (ON/OFF)
- Vehicle setting initialization

NOTE:

The setting items vary depending on the vehicle specification

TYPE OF VOICE SIGNAL

Reception Voice Signal

- Hands-free phone reception voice is output from the cellular phone through the AV control unit to the front speaker via Bluetooth® communication.
- If the hands-free phone is used while the audio is ON and/or the voice guidance is being output, these sounds are muted and only the reception voice is output.

Speech Sound Signal

Hands-free phone speech sound is transmitted from the microphone via the AV control unit and Bluetooth® communication to the cellular phone.

CARWINGS Reading Voice Signal

- In the case of the CARWINGS reading voice, the AV control unit receives text data from the NISSAN CARWINGS Data Center through the USB harness and outputs them to the front speaker.
- If CARWINGS data is read while the audio is ON and/or the voice guidance is being output, these audio sounds are muted and only the CARWINGS reading voice is output.
- Depending on the information from the NISSAN CARWINGS Data Center, not only the CARWINGS reading voice but also background music may be output. In this case, audio output of the front speaker is turned down 10 dB and then the CARWINGS reading voice is output.

Guide Sound Signal

- Voice signals output during the route guidance of the navigation system are output from the AV control unit to the front speaker.
- If the voice guidance is output with the audio ON, audio output of the front speaker is turned down 10 dB and then voice guidance is output.
- Adjusting the volume while the voice guidance is being output can change the volume of the guidance.

AUDIO FUNCTION

- The MP3/WMA playback function enables music to play for a long time: the user need not change the CD during a long trip. The text display function is also adopted so that the title name and artist name of the ID3 tag/WMA tag can be displayed.
- Bluetooth® audio function is adopted to play music data in the portable audio via wireless communication.
- The adoption of the vehicle speed interlock sound volume function reduces the burden of the volume adjustment by the difference between the noises when the vehicle is stopped or running. In addition, the vehicle speed interlock sound volume function can perform ON/OFF setting and sound volume adjustment on a scale of one to five.

MP3/WMA Playback Function

This function enables the playback of compressed music files, such as MP3 music files used for the most widespread broadband music distribution and WMA music files played back with a music player generally built in Windows® personal computers.

Vehicle Speed Interlock Volume Function

- The AV control unit receives the vehicle speed signal from the combination meter via CAN communication and changes the sound volume in conjunction with the vehicle speed.
- Using the vehicle speed interlock sound volume function, ON/OFF setting can be carried out as preferred by users, and sound volume variation caused by vehicle speed change can be adjusted on a scale of one to three.

Bluetooth® Audio Function

- Bluetooth® audio function is adopted to play music data in the portable audio in wireless communication.
- Five units of Bluetooth® communication devices including audio devices and cellular phones can be registered to the AV control unit.
- When the Bluetooth® audio is connected to the portable audio through Bluetooth®, it can play the music data in the portable audio.
- When the Bluetooth® audio is playing the data, operations of the other applications are as shown in the following table.

Cellular phone operation (control) status		Bluetooth® audio playback status
Hands-free phone communication	Hands-free phone incoming call	Answering the call stops audio playback temporarily.
CARWINGS service	Information channel and E-mail	Audio playback does not stop.
		Audio playback stops temporarily during data communication. After the communication has been completed, playback resumes.
Telephone book transfer		Audio playback does not stop.
		For Bluetooth® audio, audio playback stops temporarily. After the telephone book has been transferred, playback resumes.

A
B
C
D
E
F
G
H
I
J
K
L
M
O
P

AV

SYSTEM

< SYSTEM DESCRIPTION >

[NAVIGATION WITHOUT BOSE]

Bluetooth® compliant profile

Profile name	Abbreviation	Version
Advanced Audio Distribution Profile	A2DP	Ver. 1.2
Audio Video Remote Control Profile	AVRCP	Ver. 1.3

Satellite Radio

- Satellite radio tuner is built into AV control unit.
- Audio signal and data signal (satellite radio) are received by satellite antenna. There are input to AV control unit. AV control unit outputs audio signal to each speaker and data signal to display unit.

USB CONNECTING FUNCTION

USB connector enables iPod® compliant and playback of music files in the USB memory.

*: iPod® is the trademark of Apple Inc. registered in the United States and other countries.

iPod® Compliant

- By connecting a user's iPod® to the USB connector, music can be played.
- While iPod® is connected, iPod® is charged.
- It is compliant with various playback methods.

NAVIGATION SYSTEM FUNCTION

Description

- The AV control unit controls navigation function while GPS tuner has built-in map data, GYRO (angle speed sensor), on the SD card.
- The AV control unit inputs operation signal with communication signal, through front display unit (touch panel) and multifunction switch and steering switch.
- Guide sound is output to front speaker through from AV control unit when operating navigation system.
- A vehicle position is calculated with the GYRO (angle speed sensor), vehicle sensor, signal from GPS satellite and map data stored on SD card, and transmits the map image signal (RGB image, RGB area, RGB image synchronizing) to the display.

Position Detection Principle

The navigation system periodically calculates the current vehicle position according to the following three types of signals.

- Travel distance of the vehicle as determined by the vehicle speed sensor
- Vehicle turning angle determined by the gyroscope (angular speed sensor)
- The travel direction of the vehicle determined by the GPS antenna (GPS information)

The current position of the vehicle is then identified by comparing the calculated vehicle position with map data, which is stored in the SD card (map-matching), and indicated on the screen with a current location mark. More accurate data is used by comparing position detection results from GPS to the map-matching.

The current position is calculated by detecting the travel distance from the previous calculation point, and its direction change.

- Travel distance

The travel distance is generated from the vehicle speed sensor input signal. The automatic distance correction function is adopted for preventing a miss-detection of the travel distance because of tire wear etc.

- Travel direction

The gyroscope (angular velocity sensor) and GPS antenna (GPS information) generate the change of the travel direction. Both have advantages and disadvantages as per the following descriptions.

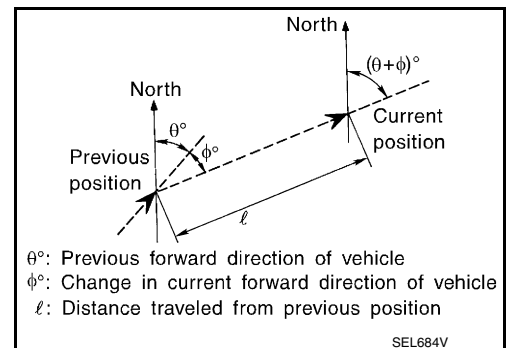
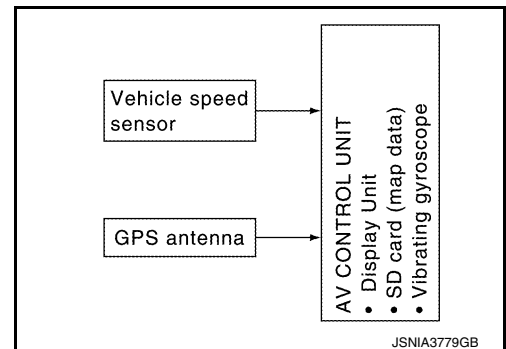

SYSTEM

< SYSTEM DESCRIPTION >

[NAVIGATION WITHOUT BOSE]

Type	Advantage	Disadvantage
Gyroscope (angular velocity sensor)	The turning angle is precisely detected.	Errors are accumulated when driving a long distance without stopping.
GPS antenna (GPS information)	The travel direction (North/South/East/West) is detected.	The travel direction is not precisely detected when driving slowly.

Input signals are prioritized in each situation. However, this order of priority may change in accordance with more detailed travel conditions so that the travel direction is detected more accurately.

Map-matching

Map-matching repositions the vehicle on the road map when a new location is judged to be more accurate. This is done by comparing the current vehicle position (calculated by the normal position detection method) from the map data stored in the SD card.

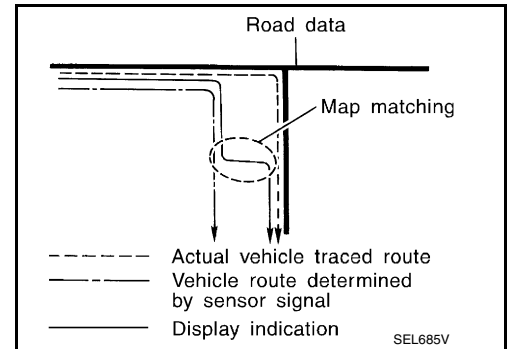

There is a possibility that the vehicle position may not be corrected in the following case, and when vehicle is driven over a certain distance or time in which GPS information is hard to receive. Correct manually the current location mark on the screen.

- In map-matching, several alternative routes are prepared and prioritized in addition to the road judged as currently driving on. Therefore, due to errors in the distance and/or direction, an incorrect road may be prioritized, and the current location mark may be repositioned to the incorrect road. If two roads are running in parallel, they are of the same priority. Therefore, the current location mark may appear on either of them alternately, depending on maneuvering of the steering wheel and configuration of the road, etc.

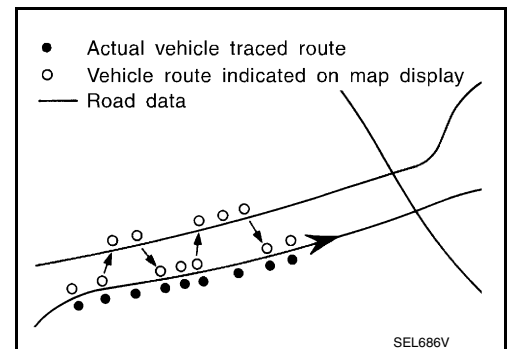

- Map-matching does not function correctly when road on which the vehicle is driving is new, etc. and not recorded in the map data. Also, map-matching does not function correctly when road pattern stored in the map data and the actual road pattern are different due to repair, etc.

Therefore, the map-matching function judges other road as a currently driving road if the road is not in the map, and displays the current location mark on it. Later, the current location mark may be repositioned to the road if the correct road is detected.

- Effective range for comparing the vehicle position and travel direction calculated by the distance and direction with the road data is limited. Therefore, correction by map-matching is not possible when there is an excessive gap between current vehicle position and the position on the map.

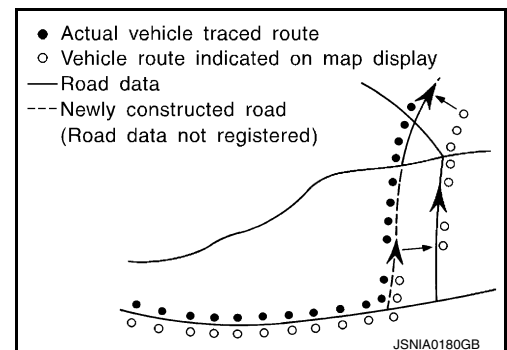

GPS (Global Positioning System)

SYSTEM

< SYSTEM DESCRIPTION >

[NAVIGATION WITHOUT BOSE]

GPS (Global Positioning System) is developed for and is controlled by the US Department of Defense. The system utilizes GPS satellites (NAVSTAR), transmitting out radio waves while flying on an orbit around the earth at an altitude of approximately 21,000 km (13,049 mile).

The receiver calculates the travel position in three dimensions (latitude/longitude/altitude) according to the time lag of the radio waves that four or more GPS satellites transmit (three-dimensional positioning). The GPS receiver calculates the travel position in two dimensions (latitude/longitude) with the previous altitude data if the GPS receiver receives only three radio waves (two-dimensional positioning). GPS position correction is not performed while stopping the vehicle.

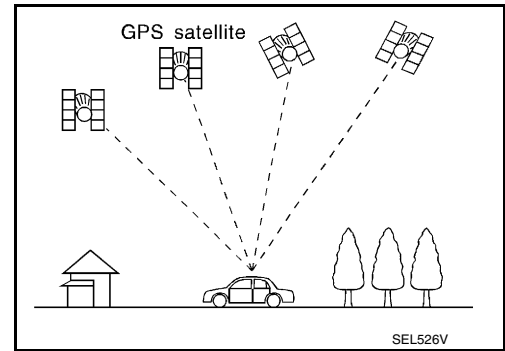

Accuracy of the GPS will deteriorate under the following conditions:

- In two-dimensional positioning, GPS accuracy will deteriorate when altitude of the vehicle position changes.
- The position of GPS satellite affects GPS detection precision. The position detection may not be precisely performed.
- The position detection is not performed if GPS receiver does not receive radio waves from GPS satellites. (Inside a tunnel, parking in a building, under an elevated highway etc.) GPS receiver may not receive radio waves from GPS satellites if any object is placed on the GPS antenna.

NOTE:

- The detection result has an error of approximately 10 m (32.81 ft) even with a high-precision three dimensional positioning.
- There may be cases when the accuracy is lowered and radio waves are stopped intentionally because the GPS satellite signal is controlled by the US trace control center.

BLUETOOTH® HANDS-FREE PHONE FUNCTION

- When the cellular phone is connected to the AV control unit in Bluetooth® communication, hands-free phone communication can be performed.
- Simply operating the steering switch without releasing hands from the steering wheel allows the driver to make a phone call or receive a phone call.
- For the available cellular phone support model, refer to "Compliant model list" on the CARWINGS site.
- When a Bluetooth® communication compliant phone is registered to the AV control unit, hands-free phone communication can be performed. Five units of Bluetooth® communication devices including audio devices and cellular phones can be registered to the AV control unit.
- The content of the memory (telephone book) of the cellular phone can be recorded in the AV control unit.

Bluetooth® compliant profile

Profile name	Abbreviation	Version
Hands-Free Profile	HFP	1.5
Dial-Up Networking Profile	DUN	1.1
Object Push Profile	OPP	1.1

VOICE RECOGNITION FUNCTION

- By speaking a command, operations of navigation and hands-free phone can be performed.
- To perform the voice control, press the  switch of the steering switch. The system changes to the speech reception status. When a command is spoken, the speech recognition result is displayed, and the operation is executed.
- The voice control cannot be performed under the conditions listed below.
 - When the hand-free phone is used
 - When the vehicle is moving backwards

Major Functions

With this function, the list of commands used for telephone, and navigation operation can be checked.

REAR VIEW CAMERA FUNCTION

Operation Description

- When the selector lever is shifted to the reverse position, the rear view monitor image is displayed.

SYSTEM

< SYSTEM DESCRIPTION >

[NAVIGATION WITHOUT BOSE]

- When the selector lever is shifted to any position other than the reverse position, the original image (the image displayed before the rear view monitor image) is displayed.

Camera Image Operation Principle

- The AV control unit receives the reverse signal and supplies power to the rear view camera to create the image signal.
- The AV control unit outputs the rear view camera image to the display when the reverse signal is input.
- The AV control unit generates the warning message, side distance guiding lines and the possible route lines on the image from the rear view camera, and transmits the rear view camera image signal to the display unit.

Side Distance Guide Lines and Possible Route Lines Display Function at Rear View Monitor Display

- The side distance guide lines and the possible route lines that indicate the vehicle route according to the steering angle are displayed at the rear view monitor display to allow the driver to more easily judge distances between the vehicle and objects and help the driver back into a parking space.
- The AV control unit receives the steering signal from the steering sensor via CAN communication and draws a possible route line according to the steering angle.
- When the possible route lines are displayed, the side distance guide lines are displayed translucently.
- The possible route lines are not displayed when the steering is in the neutral position.

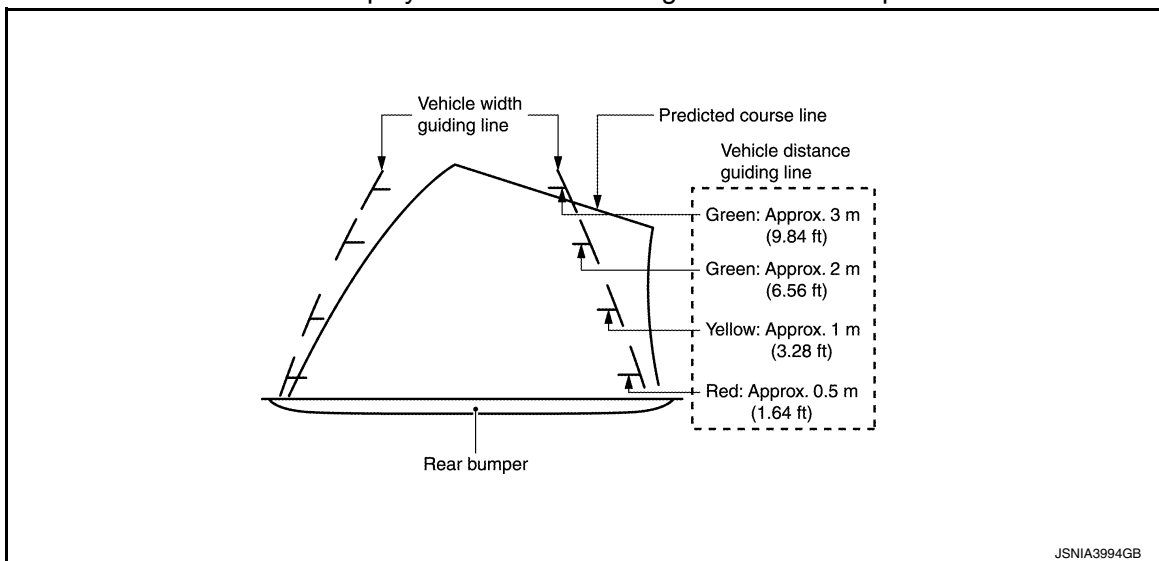

TIMER CHARGE AND A/C-HEATER TIMER FUNCTION

- Time for timer charge and A/C-heater timer can be set from the navigation setting screen.
- The AV control unit sends the current time signal received with GPS antenna to VCM via CAN communication, and it compensates the current VCM time.

Timer Charge Function

- Set the timer charge start time on the navigation setting screen. When the charging plug is connected, the time mode is activated.
- If the charging plug fitting is not sufficient, unplugged status is notified. For details of unplugged status notification, refer to [AV-515. "TELEMATICS SYSTEM : System Description"](#).
- After the power switch is OFF, VCM is activated at the set charge start time and charge is started. (The time of the timer function is controlled by VCM.)
- VCM sends the VCM status signal and VCM wake-up signal to TCU via CAN communication to notify that VCM is activated. For details of the charging function, refer to [VC-17. "VEHICLE CHARGING SYSTEM : System Description"](#).
- Charge is completed.

NOTE:

Information of charge completion sent to the user is also given if charge is abnormally completed for some reason (e.g. disconnection of charging plug).

A/C-Heater Timer Function

- Set the A/C-heater timer start time on the navigation setting screen. When the charging plug is connected, the time mode is activated.
- After the power switch is OFF, VCM is activated at the set air conditioning start time and air conditioning is started. (The time of the timer function is controlled by VCM.)

SYSTEM

< SYSTEM DESCRIPTION >

[NAVIGATION WITHOUT BOSE]

- VCM sends the VCM status signal and VCM wake-up signal to TCU via CAN communication to notify that VCM is activated. For details of air conditioner system, refer to [HAC-30, "AUTOMATIC AIR CONDITIONING SYSTEM : System Description"](#).

NOTE:

- A/C-heater timer performs air conditioning with the settings of temperature 25°C, AUTO, fan AUTO and REC.
- Power consumption of the compressor or the PTC heater is limited according to allowable power from VCM. Sufficient air conditioning may not be performed if charge has priority or 100 V charge is performed.

MULTI AV SYSTEM : Map Data Update

INFOID:0000000010641859

To update map data, use an SD card including new map data.

MULTI AV SYSTEM : Fail-safe

INFOID:0000000010641860

When a malfunction occurs within the system, the AV control unit outputs a message on the display, and it restricts the AV control unit functions.

FAIL-SAFE CONDITIONS

SD card not inserted, SD card malfunction, internal malfunction of navigation, etc.

Display Indication

- When the system is in the fail-safe status at the start of the AV control unit, an error message is shown on the display.
- When the system is in the fail-safe status after the start of the AV control unit, an error message is not shown on the display. The MULTI AV system may be rebooted in the fail-safe state. If the fail-safe state is maintained after the system is rebooted, an applicable message is shown.

Cause	Display monitor
Malfunction of flash ROM information	TARGET INFO NG
No SD card	NO SD CARD
Unsuccessful security unlock	SD UNLOCK NG
Malfunction of SD card mount	SD INIT NG
Malfunction of SD card access	SD ACCESS NG
No program data	NO NAVI-2 DATA
Malfunction of program data (SUM NG)	NAVI-2DATA READ NG
Inconsistent program version (Flash/SD)	NAVI VERSION NG
Difference of map destination	DIFFERENT MAP CODE
Not compliant with map database version	MAP DATA BASE UNMATCH
Malfunction of navigation	NAVI STARTUP NG

CONTROL

When the system is in the fail-safe status at or after start of the AV control unit, the following functions are restricted.

Function		In fail-safe mode
A/C	Display	No display (fail-safe status display)
Audio	Operation	Mute audio
	Display	No display (fail-safe status display)
Hands-free phone	Operation	It cannot be operated
Navigation	Operation	It cannot be operated

SYSTEM

< SYSTEM DESCRIPTION >

[NAVIGATION WITHOUT BOSE]

Function		In fail-safe mode
Display	Operation	Open/close operation is available
	Display	Fail-safe factors are displayed
Self-diagnosis		It cannot be diagnosed
CONSULT diagnosis		It cannot be diagnosed
AV communication diagnosis		It cannot be diagnosed
Frequency transmission for VCM		Normal
SD read access		Access cannot be gained.
SD write access		Access cannot be gained.

CANCELLATION CONDITIONS

The fail-safe status is canceled under the following conditions, and then the system returns to the normal mode.

- When the SD card is not inserted, the SD card is inserted and the power of the AV control unit is turned ON again.
- When the SD card is not functional at the start of navigation due to a malfunction of the SD card, a normal SD card is inserted and the power of the AV control unit is turned ON again.

A
B
C
D
E
F
G
H
I
J
K
L
M
O
P

AV

OPERATION

Switch name and Function

INFOID:000000010641861

Names and functions of AV control unit switches

1. Design

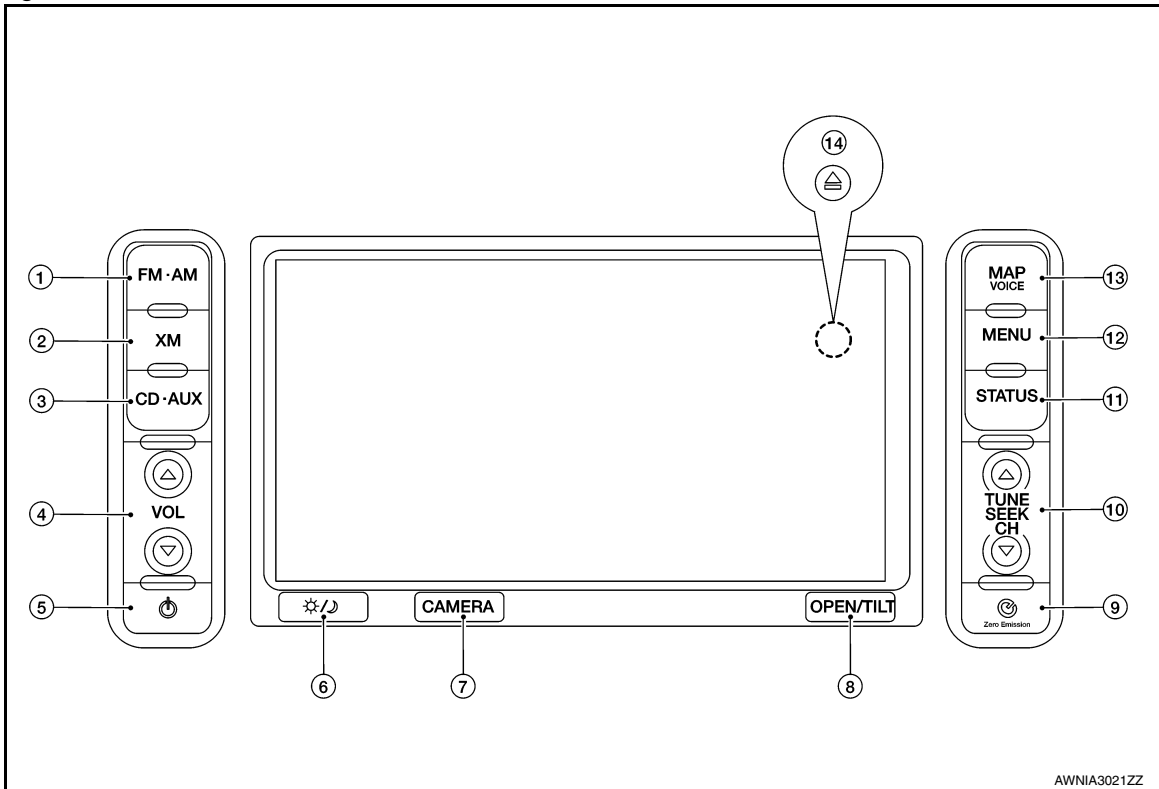

2. Switch name and function

No.	Switch name	Function
1	FM·AM	Press to switch between the FM radio band and the AM radio band.
2	XM	Press to switch to an XM satellite radio band.
3	CD·AUX	Press to switch between USB memory/iPod player ^{*1} /CD/Bluetooth [®] streaming audio ^{*2} / AUX screens.
4	VOL (volume control)	Press to adjust the volume of the stereo.
5	⏻ (audio system ON-OFF)	Press to turn the audio system ON or OFF.
6	☀/🌙 (Day/Night)	<ul style="list-style-type: none"> Press to switch between the day screen (bright) and the night screen (dark). Press and hold to turn off the display, then press again to turn on the display.
7	CAMERA	Press to turn the rear view camera system ON or OFF.
8	OPEN/TILT	<ul style="list-style-type: none"> Press to open the monitor to access the CD slot and the SD card slot. Press and hold to adjust the monitor angle. (6 angles)
9	🌱 (Zero emission)	Press to display the setting screen where several useful functions for electric vehicle driving are determined.
10	TUNE/SEEK/CH	<ul style="list-style-type: none"> Press to select a track/station. Press and hold to search for a track/station automatically or to fast-forward/back-forward when listening to music.
11	STATUS	Press to display the current status of the air conditioner, radio, audio, vehicle information (estimated distance, drivable distance and average energy economy) and navigation systems.
12	MENU	Press to display the setting menu (destination, route, information, settings, phone and carwings) screen.

OPERATION

< SYSTEM DESCRIPTION >

[NAVIGATION WITHOUT BOSE]

No.	Switch name	Function
13	MAP/VOICE	<ul style="list-style-type: none"> • Press to display the current location map screen. • Press and hold to repeat voice guidance.
14	 (Disk eject)	Press to eject a disk.

- *1: Displayed when iPod® is connected.
- *2: Displayed when Bluetooth® audio is registered and “Bluetooth connection” setting is ON.



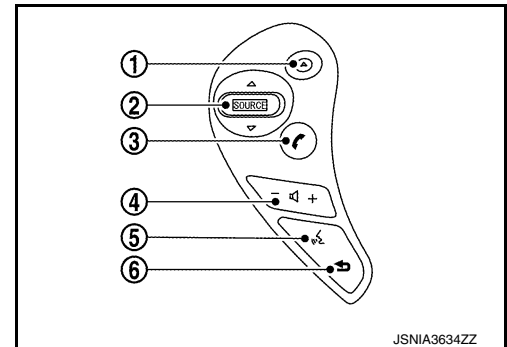

Names and functions of steering switch

By using the steering switch, various operations on the audio, navigation, telephone, and others can be performed without releasing hands from the steering wheel.

1. Design



2. Switch name and function

No.	switch name	Major functions
1	 (Driving range)	Press to display the driving range screen. Press again to return to the previous screen.
2	SOURCE	Press to change source menu.
		Tilt up/down for a short period of time <ul style="list-style-type: none"> • During the radio switches the preset channel. • During the CD mode, USB mode, iPod mode, and Bluetooth audio mode selects the track.
		Tilt up/down for a long period of time <ul style="list-style-type: none"> • During the radio mode, good sensitivity frequency is automatically selected. • The CD mode, iPod mode, or Bluetooth audio mode allows the fast-forwarding and rewinding of a music file. • During the CD mode, a folder selection can be made when an MP3/WMA disc contains a folder. • The USB mode allows folder selection.
3	 (Phone)	<ul style="list-style-type: none"> • Displays the hands-free phone menu. • When this is pressed during call, telephone communication can be started.
4	-  + (Volume control)	<ul style="list-style-type: none"> • Adjust the audio volume. • Other than the audio volume, the volume levels of guide sound (at guide interruption), hands-free phone, and others can be adjusted.
5	 (Talk)	Press to enter the voice recognition mode.
6	 (Cancel)	Press to cancel the voice command.

Menu Display by Pressing Each Switch

INFOID:000000010641862

NOTE:

For Navigation system and Telematics system operation detailed information, refer to Navigation system Owner's Manual.

MENU

OPERATION

< SYSTEM DESCRIPTION >

[NAVIGATION WITHOUT BOSE]

When the MENU switch is pressed, the menu screen is displayed.



Menu list	Description	
Destination	Change Country	When setting a destination, the country can be selected. The country that was last selected is automatically selected by the system as the default.
	New Address	Searches for a destination by address.
	Home	Searches for a route from the current location to the previously stored home destination.
	Points of interest	Searches for a destination from various categories of businesses or locations.
	Charging Station	Searches for the charging stations near the current vehicle location.
	Quick Stop	Searches for points of interest near the current vehicle location, such as restaurants and charging stations, etc.
	Address Book	Searches for a destination from the list of the stored locations.
	History	<ul style="list-style-type: none"> • Sets the previous starting point as destination. • Searches for the destination from the previous destinations.
	M-way Entrance/Exit	Searches for a destination from a motorway entrance/exit.
	Stored Routes	Selects a stored route.
	Latitude/Longitude	Searches for a destination by entering the latitude and the longitude.
Route	Junction	Searches for a destination from junctions.
	Cancel Route/Resume Route	Cancels the current route guidance. A canceled route can also be reactivated. If the suggested route is canceled, "Cancel Route" changes to "Resume Route".
	Edit Route	Edit or add a destination or waypoints to the route that is already set.
	Route Info	Confirm the route by the route information or simulation. The confirmed route can also be stored.
	Guidance Voice	Activates or deactivates route, voice guidance and/or traffic announcement and adjust the volume level of voice guidance.
	Recalculate	Manually search for the route again after changing the search condition and have the system calculate a route.
	Detour	A detour of a specified distance can be calculated.
	Traffic Detour	Manually search for an alternative detour route taking the traffic information into consideration.
Route Calculation Criteria	Changes the route calculation conditions anywhere along the route.	

OPERATION

< SYSTEM DESCRIPTION >

[NAVIGATION WITHOUT BOSE]

Menu list		Description
Info.	Traffic Information	Displays the Traffic Information.
	Energy Info.	Energy information is displayed on the screen.
	Maintenance	Displays the vehicle maintenance information.
	Charging Station Info	Displays charging station information for the current location.
	Where am I?	Displays information regarding the current vehicle location.
	Voice Recognition	Displays the voice command list.
	GPS Position	Displays GPS information regarding the current vehicle location.
	Navigation Version	Displays the current navigation system version.
Settings		The system can be customized the following items.
Phone	Phonebook	Select a telephone number from the phone book, and then make a call. Before making a call, the telephone number must be registered in the phone book.
	Call History	Select a telephone number from the incoming or outgoing history lists, and then make a call.
	Handset Memory	Download the phone book from a cellular phone that is connected to the vehicle, select a telephone number from the phone book, and then make a call. Phone book data should be registered in the system after downloading the phone book from the cellular phone that is connected to the vehicle. If the phone book is not registered, a message that reminds you of phone book data download will be displayed.
	Keypad	Input the phone number manually using the keypad displayed on the screen.
	Volume	Adjust various settings of phone volume.
	Pair Phone	<ul style="list-style-type: none"> When a PIN code appears on the screen, operate the compatible Bluetooth® cellular phone to enter the PIN code. When the connection process is completed, the screen will return to the Phone menu display.
	Paired Phone	The list of the registered cellular phones is displayed.
CARWINGS	Favorite Channels	A maximum of 16 favorite channels selected from the information channels can be stored in a folder.
	Information Channels	Touch the preferred folder. An information channel list is displayed.
	CARWINGS Records	The information channels that were referred to previously are displayed. A maximum of 3 channels are stored in the history.
	Update Stations	Charging station information is updated through connection to the NISSAN CARWINGS Data Center.
	CARWINGS Settings	The CARWINGS system can be customized.

A
B
C
D
E
F
G
H
I
J
K
L
M
AV

ZERO EMISSION MENU

When the  ZERO EMISSION switch is pressed, the menu screen is displayed.



O
P

OPERATION

< SYSTEM DESCRIPTION >

[NAVIGATION WITHOUT BOSE]

Menu list	Description
Driving Range	The estimated driving area within range, including the current position is displayed on the map screen.
Nearby Stations	Charging station information for the current position area is displayed.
Update Stations	Charging station information is updated through connection to the NISSAN CARWINGS Data Center.
Energy Info.	Energy information is displayed on the screen.
Charging Timer	The timer charge function can be set.
A/C-Heater Timer (Climate Ctrl. Timer)	The A/C-Heater Timer (Climate Ctrl. Timer) function can be set.
 CARWINGS	Information channels are displayed and settings for CARWINGS can be performed.
Settings	Setting of the warning message display or the charging status notification can be performed.

MAP MENU

Map menu at current location

If the following operation is performed at the current location, the available map menu is displayed.

- Touch the “Map Menu” switch on the map.

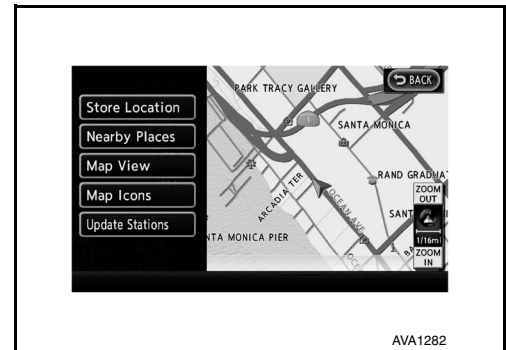

Menu item	Description	
Store Location	Stores the current vehicle location in the Address Book. The stored location can be retrieved as necessary to set it as a destination (waypoint).	
Quick Stop	Searches for points of interest near the current vehicle location, such as restaurants and charging stations, etc.	
Map Settings	Map View	The screen display [Plan view, Birdview [®] , split screen (2D/2D), split screen (2D/2D)] can be changed.
	Split Screen	
	Map Settings	Map Orientation (sets the map direction to North Up or Heading Up), Long Range (on/off), Birdview Angle (Changes the Birdview [®] angle), Left Settings (sets the map settings for the left screen of the split map) and Automatic Display of Highway Mode (on/off) can be set.
	Back to Map.	Return to the current position screen.
Landmark Icons	Displays map icons of certain points of interest (such as restaurants and charging stations, etc.) on the map around the current vehicle location	
Update Station	Charging station information is updated through connection to the NISSAN CARWINGS Data Center.	

Map menu after scroll of map

If the following operation is performed after scrolling the map, the available map menu is displayed.

OPERATION

< SYSTEM DESCRIPTION >

[NAVIGATION WITHOUT BOSE]

- Touch the “Map Menu” switch on the map.

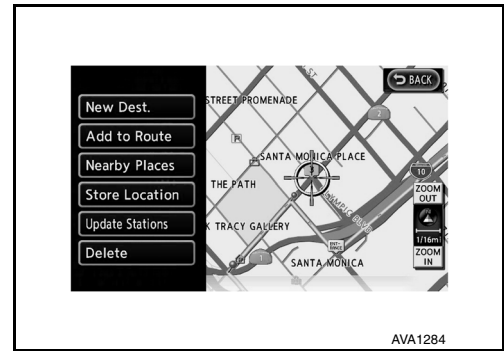

Menu item	Description
New Dest.	Sets the destination to the map location where [New Dest.] was touched. If a destination is already set, the location will be set as the new destination.
Add to Route	Sets the map location where [Add to Route] was touched as the destination or a waypoint. This is available only when a suggested route is already set.
Quick Stop	Searches for points of interest such as restaurants and charging stations, etc. near the location by scrolling the map.
Store Location	Store the map location where [Store location] was touched in the Address Book. The stored location can be retrieved to set it as a destination or waypoint.
Update Stations	Contact the NISSAN CARWINGS Data Center to update charging station around the point of the cursor.
Delete	Deletes a destination, waypoint or stored location. To delete, place the cross pointer over the corresponding icon.

A
B
C
D
E
F
G
H
I
J
K
L
M
AV
O
P

HANDLING PRECAUTION

Display

INFOID:000000010641863

- When the compartment temperature is low, the display images may look slower because the LCD response is deteriorated. The system will recover its normal operation when the cabin temperature increases to an appropriate level.
- When the compartment temperature is low (0°C or less), the display images may look slower. It is characteristic of the LCD monitor and should not be considered to be a malfunction. When the temperature is at the operating temperature (0°C to 50°C), the display returns to normal.
- There may be small dark or bright dots in the screen or remaining display content may be found (image lag). These are inherent symptoms to any LCD monitor and should not be considered to be a malfunction.
- The image may look bright or dark when viewed obliquely from the rear. It is inherent to any LCD monitor and should not be considered to be a malfunction.
- Do not apply pressure on the LCD monitor. Doing so may cause irregularities in the screen image or render it inoperative.
- Do not use hard cloth, organic solvent (alcohol, benzene, and thinner), or chemical wipe to clean the LCD monitor. Doing so may affect the panel surface. When cleaning the LCD monitor, always wipe it with a soft cloth after shutting off the power. For severe contamination, use a soft cloth dampened with mild detergent (no droplets can be present).

Audio

INFOID:000000010641864

- When an MP3/WMA disc is replayed, it may take some time to start the playback after the disc is inserted, because the contents of the disc files must be analyzed.
- The extensions for MP3/WMA files are ".MP3", ".WMA", ".mp3", and ".wma". Any file with a different extension or no extension cannot be played back.
- If trying to play a music CD (CD-DA) containing MP3/WMA file, MP3/WMA file is not played.
- The compatibility of a CD-R depends on the combination of the writing software/hardware and the writing rate. The disc has digital pulse signals written on it. If the specifications for writing depth and width (area) are not compatible, these signals may not be played back correctly or the sounds may be lost or skipped.
- The file recorded with high bit rate* may have sound skipping.
- The playback order of MP3/WMA files may differ from the intended order because the writing software could change the folder and file positions when writing data to a CD-R/CD-RW disc.
- For an MP3 file, the folder name and file name can be displayed as the title on the condition that each name string consists of up to 16 alphanumeric letters (except for the extension). Any MP3 file with a name containing other letters or that is longer than the maximum length cannot be displayed correctly.
- Some MP3/WMA making software, text information editing software, writing software, or software configurations may create files and discs in a format different from the proper specifications. In such a case, the text information display or the playback function may not be available.
- A disc for which no session close or disc close process has been finished may not be played back.
- Some files may have incorrect playback time displays and therefore a part of the music cannot be played back.
- 8 cm disc cannot be used.
- When playing back a Bluetooth® audio data, the sound may be interrupted for a moment. This is due to data communication and should not be considered to be a malfunction. After the data communication finishes, the playback will restart normally.
- If any CARWINGS operation or incoming call takes place during Bluetooth® audio playback, the screen changes to the relevant mode and the audio playback is interrupted.
- Sound skipping may occur depending on the location where the Bluetooth audio device is installed.
- If any operation for traffic information reception is performed during Bluetooth® audio playback, the audio playback is interrupted.
- Music data stored in a Bluetooth® audio device at low bit rate has poor sound quality.
- Radio reception may decrease in performance during charge.

NOTE:

*: Bit rate means how many bits of data are processed or transmitted per the unit time.

iPod®

INFOID:000000010641865

- If a headphone is connected to the iPod®, the iPod® may not be controlled.

HANDLING PRECAUTION

[NAVIGATION WITHOUT BOSE]

< SYSTEM DESCRIPTION >

- Some iPod® may not be compliant with connection. It is necessary to check compliant models of iPod®.
- If a USB extension cable is used for iPod® connection, iPod® may not be recognized or sound skipping may occur in playback.
- In playing back iPod® audio, if the EQ function (equalizer function) of the iPod® is ON, sound may be distorted.
- If the number of music in one category is increased to a large number, response may be poor. If the number of music is large and shuffle is ON, operation of the iPod® itself may be slower.

RESTRICTIONS ON iPod®

The following symptoms may occur, but the functions are not compliant and they should not be considered to be a malfunction.

- When a Podcast divided into chapters is played back with iPod nano 3G, the play time may be displayed incorrectly.
- The number of Audiobook is not displayed normally. When iPod® is disconnected and reset, it is displayed.
- When jacket photos are played with iPod nano 3G and iPod Classic, iPod® may be frozen or reset.

USB Connection

INFOID:000000010641866

If a USB-HUB or USB extension cable is used when a USB is connected, USB is not recognized.

CARWINGS

INFOID:000000010641867

Refer to [AV-525, "Telematics&CARWINGS"](#).

Hands-Free Phone

INFOID:000000010641868

- In the following cases, the hands-free telephone function is not available.
 - When the vehicle moves out of the communication zone of the cellular phone.
 - When the vehicle is in a location that may block radio waves such as in an underground parking lot, behind a building, or in mountainous areas.
 - When the cellular phone is subject to dial-up limitations such as dial lock, and auto lock, transmission restriction.
- It is not compliant with call waiting function and three-party call function.
- No incoming call can be received just after the key switch is turned to ON.
- For further details about the supported models, consult the Supported Cellular Phone Models in the CARWINGS site.
- Depending on the cellular phone connected, the ring volume may decrease.
- Before connecting a cellular phone, make sure that the operation limitations such as dial lock, auto lock and transmission restriction are cancelled. If any of these settings is found to remain active, disconnect the phone, cancel the setting, and reconnect it.
- When a menu or information is displayed on a cellular phone or when application of standby tool is activated, the function may not be used. Use the cellular phone in the standby status.
- Once a cellular phone is removed, wait at least 10 seconds before reconnecting it.
- When attempting to use a cellular phone, always make sure that the battery charge level is sufficient.
- A snap sound may be heard or the audio signal may be interrupted during a call. This is not a malfunction. It is caused by a switchover to an adjacent cellular zone due to weakening radio waves.
- When the reception status is poor or the surrounding sound level is too large, the voice on the phone may be hard to hear.
- Because the system uses a digital line, the voice on the phone may be distorted or have unpleasant noises due to the surrounding sounds.
- If the vehicle is equipped with a speed trap tracker (radar detector), the speaker may generate noises.
- This unit cannot be used to charge a cellular phone.

SD Card

INFOID:000000010641869

To remove the SD card, wait for 15 seconds or more after turning the power switch OFF.

DIAGNOSIS SYSTEM (AV CONTROL UNIT)

< SYSTEM DESCRIPTION >

[NAVIGATION WITHOUT BOSE]

DIAGNOSIS SYSTEM (AV CONTROL UNIT)

Diagnosis Description

INFOID:000000010641870

- Diagnosis is performed with the on board diagnosis and CONSULT. Select an appropriate function based on the condition. Perform the on board diagnosis if it starts. If the on board diagnosis does not start such as no display, perform diagnosis with CONSULT.
- In the on board diagnosis, a multifunction switch operation starts the AV (NAVI) control unit diagnosis function and AV control unit performs a diagnosis for each system unit. Diagnosis results are displayed on the screen.
- In the CONSULT diagnosis, a communication signal starts the AV control unit diagnosis function and the AV control unit performs a diagnosis for each system unit.

On Board Diagnosis Function

INFOID:000000010641871

ON BOARD DIAGNOSIS ITEM

- The on board diagnosis function has a self-diagnosis mode for conducting trouble diagnosis automatically and a confirmation/adjustment mode for operating manually.
- Self-diagnosis mode performs the diagnosis at the AV control unit, connections between each unit that composes the system, and connections between AV control unit and GPS antenna. It displays the results on the display.
- The confirmation/adjustment mode allows the technician to check, modify or adjust the vehicle signals and set values, as well as to monitor the system error records and system communication status. The check, modify or adjust actions generally require human intervention and judgment (the system cannot judge automatically).

Mode	Description
Self Diagnosis	<ul style="list-style-type: none">• AV control unit diagnosis.• Diagnoses the connections across system components, between AV control unit and GPS antenna.

DIAGNOSIS SYSTEM (AV CONTROL UNIT)

< SYSTEM DESCRIPTION >

[NAVIGATION WITHOUT BOSE]

Mode		Description	
Confirmation/ Adjustment	Display Diagnosis	The following check functions are available: color tone check by Color Spectrum Bar and White Display, light and shade check by Gradation Bar and Touch Panel calibration response check.	
	Vehicle Signals	Diagnosis of signals can be performed for vehicle speed, parking brake, lights, power switch and reverse.	
	Navigation	Steering Angle Adjustment	When there is a difference between the actual turning angle and the vehicle mark turning angle, it can be adjusted.
		Speed Calibration	When there is a difference between the current location mark and the actual location, it can be adjusted.
		Sensor information	Displays the reception status of the GPS antenna connector.
		XM Subscription Status	The XM subscription status can be checked.
	Error location display	The system malfunction and the frequency when occurring in the past are displayed. When the malfunctioning item is selected, the time and place that the selected malfunction last occurred are displayed.	
	AV COMM Diagnosis	The communication condition of each unit of Multi AV system can be monitored.	
	Hands-free Phone, CARWINGS	<ul style="list-style-type: none"> The received volume adjustment of hands-free phone and microphone speaker check can be performed. Mileage display of remote maintenance can be turned ON/OFF. 	
	Clock Settings	The current time can be set.	
	Delete Unit Connection Log	Erase the connection history of unit and error history.	
	User Data Initialization	Initializes the AV control unit memory.	
	Version Information	Version information of the AV control unit is displayed.	
	Software Update	The current version of the AV control unit software can be updated.	
	Export Error Log	AV control unit error log can be exported.	
XM	Change Channel	Any necessary channels required to receive traffic information etc. from the satellite radio system can be set.	
	Change Application ID	Any application ID's required to receive traffic information etc. from the satellite radio system can be set.	
	Diag	XM authentication diagnosis.	

Starting procedure

1. Turn the power switch ON.
2. Turn the audio system off.
3. Press the "MAP" switch 3 times. Press the "PWR" switch 2 times. Press the "MAP" switch once.

NOTE:

If the on board self-diagnosis does not start, perform diagnosis using CONSULT. Refer to [AV-247, "CONSULT Function"](#).

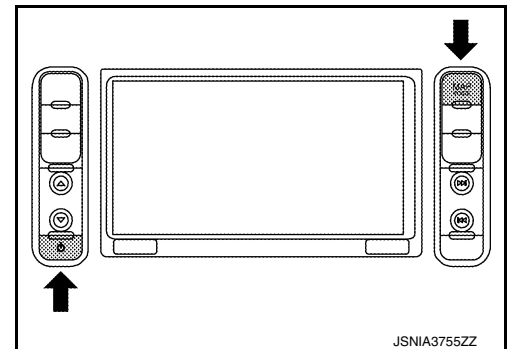

DIAGNOSIS SYSTEM (AV CONTROL UNIT)

[NAVIGATION WITHOUT BOSE]

< SYSTEM DESCRIPTION >

- The initial trouble diagnosis screen displays two choices: "Self-Diagnosis" and "Confirmation/Adjustment".

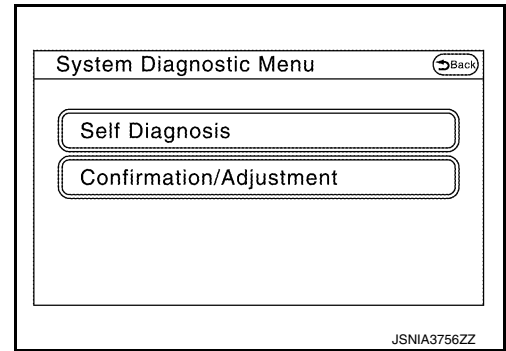

SELF-DIAGNOSIS MODE

- Start the self-diagnosis function and select "Self Diagnosis".
 - Self-diagnosis subdivision screen is displayed, and the self-diagnosis mode starts.
 - The bar graph visible on the center of the self-diagnosis subdivision screen indicates progress of the trouble diagnosis.
- Diagnosis results are displayed after the self-diagnosis is completed. The unit names and the connection lines are color-coded according to the diagnostic results.

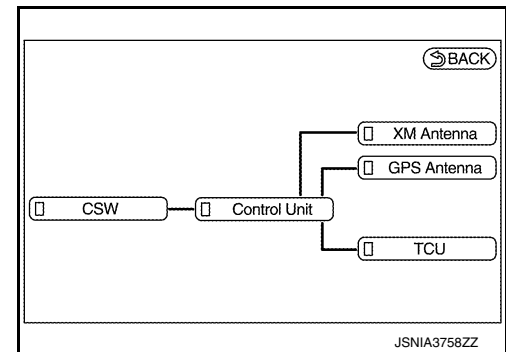

Diagnosis results	Unit	Connection line
Normal	Green	Green
Connection malfunction	Gray	Yellow
Unit malfunction ^{Note}	Red	Green

NOTE:

Control unit (AV control unit) is displayed in red.

- Replace AV control unit if "Self-Diagnosis did not run because of a control unit malfunction" is indicated. The symptom is AV control unit internal error. Refer to [AV-318. "Removal and Installation"](#).
- If multiple errors occur at the same time for a single unit, the screen switch colors are determined according to the following order of priority: red > gray.
- The comments of the self-diagnosis results can be viewed with a component in the diagnosis result screen.

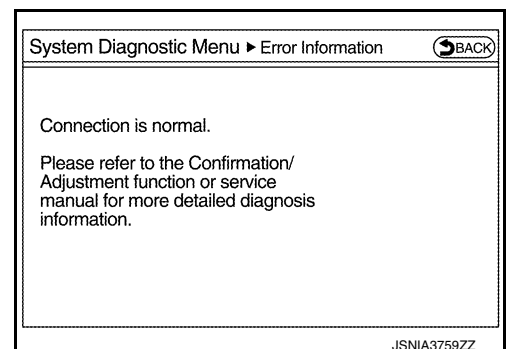

Detection Range of Self-diagnosis Mode

- The self-diagnosis mode allows the technician to diagnose the connection in the communication line between AV control unit and each unit and the internal operation of the AV control unit.

DIAGNOSIS SYSTEM (AV CONTROL UNIT)

[NAVIGATION WITHOUT BOSE]

< SYSTEM DESCRIPTION >

- Because the start condition of diagnosis function is a switch operation, the on board diagnosis function cannot be started up if any malfunction is detected in the communication circuit between AV control unit and multifunction switch.

SELF-DIAGNOSIS RESULTS

Check the applicable display at the following table, and then repair the malfunctioning parts.

Only Unit Part Is Displayed In Red.

Screen switch	Description	Possible malfunction location / Action to take
Control Unit	Malfunction is detected in AV control unit power supply and ground circuits.	<ul style="list-style-type: none"> • Check the power supply and ground circuit. Refer to AV-291, "AV CONTROL UNIT : Diagnosis Procedure". • When the power switch is OFF, remove and insert the SD card to check for contact malfunction of the SD card, and check for an error again. <ul style="list-style-type: none"> - If there is no malfunction, poor contact of the SD card may be possible. Wait and see the condition. - If a malfunction is found, replace the AV control unit. Refer to AV-318, "Removal and Installation".

A Connecting Cable Between Units Is Displayed In Yellow.

Area with yellow connection lines	Description	Possible malfunction location / Action to take
Control unit ↔ GPS Antenna	GPS antenna connection malfunctions detected.	GPS antenna
Control unit ↔ TCU	Malfunction is detected in communication circuits between AV control unit and TCU.	Communication circuits between AV control unit and TCU.
Control unit ↔ SAT Antenna	Satellite radio antenna connection malfunction is detected.	Satellite radio antenna disconnection

CONFIRMATION/ADJUSTMENT MODE

1. Start the diagnosis function and select "Confirmation/Adjustment". The confirmation/adjustment mode indicates where each item can be checked or adjusted.
2. Select each switch on the "Confirmation/Adjustment Mode" screen to display the relevant trouble diagnosis screen. Press the "Back" switch to return to the initial Confirmation/Adjustment Mode screen.

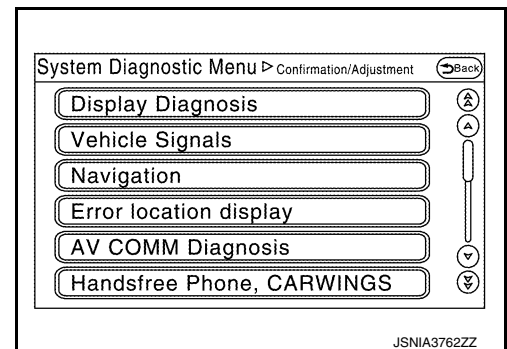

DIAGNOSIS SYSTEM (AV CONTROL UNIT)

< SYSTEM DESCRIPTION >

[NAVIGATION WITHOUT BOSE]

Display Diagnosis

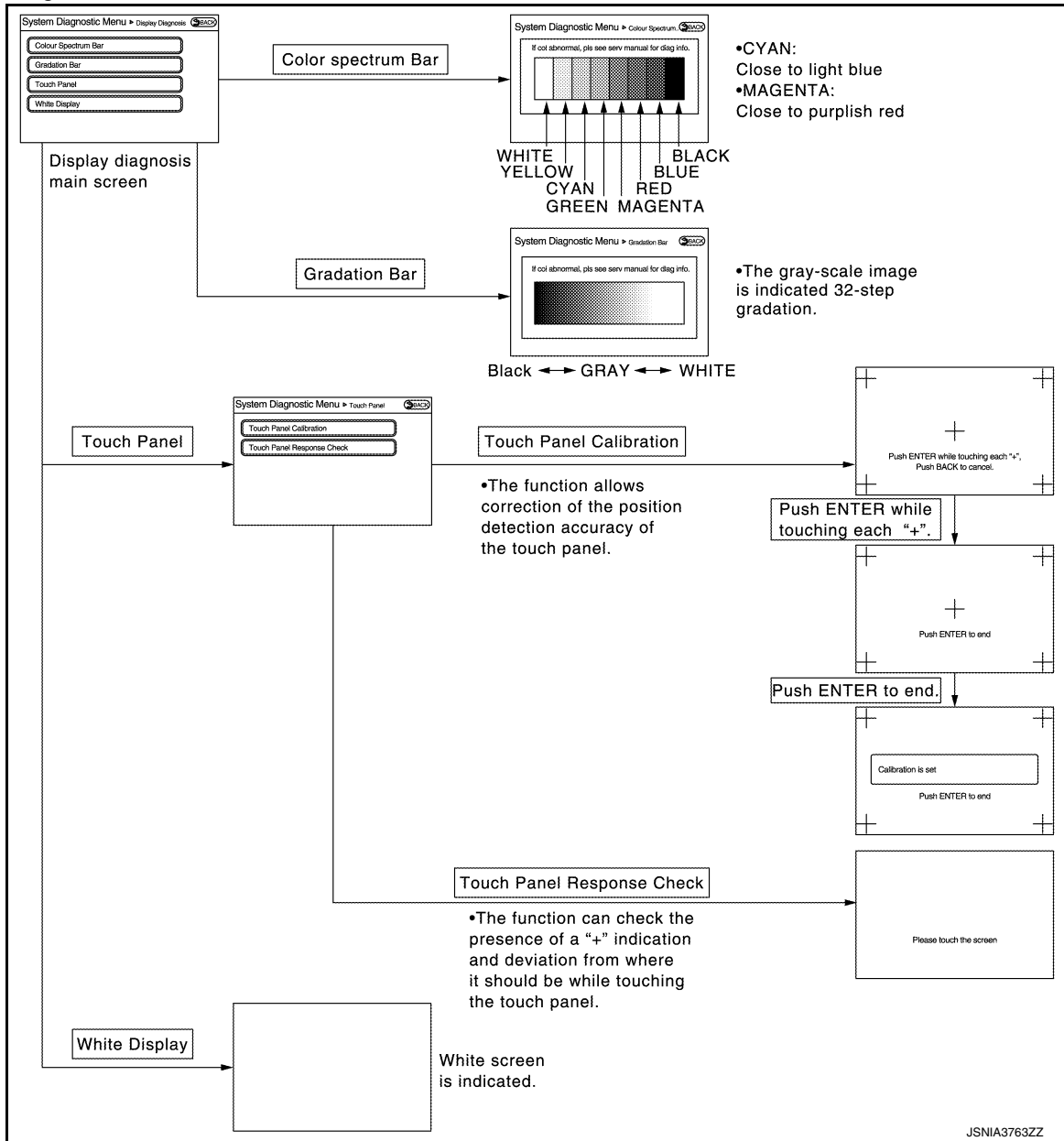

Vehicle Signals

A comparison check can be made of each actual vehicle signal and the signals recognized by the system.

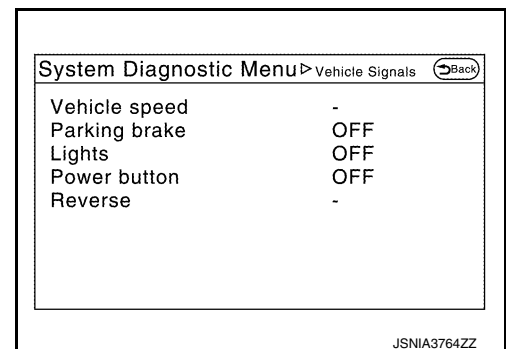

DIAGNOSIS SYSTEM (AV CONTROL UNIT)

< SYSTEM DESCRIPTION >

[NAVIGATION WITHOUT BOSE]

Diagnosis item	Display	Vehicle status	Remarks
Vehicle speed	ON	Vehicle speed > 0 km/h (0 MPH)	Changes in indication may be delayed. This is normal.
	OFF	Vehicle speed = 0 km/h (0 MPH)	
Parking brake	ON	Parking brake is applied.	
	OFF	Parking brake is released.	
Lights	ON	Block the light beam from the auto light optical sensor when the light switch is ON.	—
	OFF	Either of the following conditions • Lighting switch OFF • Expose the auto light optical sensor to light when the light switch is ON.	
Power button	ON	Power button ON	—
	OFF	Power button in ACC position	
Reverse	ON	Shift the selector lever to "R" position	Changes in indication may be delayed. This is normal.
	OFF	Shift the selector lever other than "R" position	

Navigation

STEERING ANGLE ADJUSTMENT

- The steering angle output value detected with the gyroscope is adjusted.

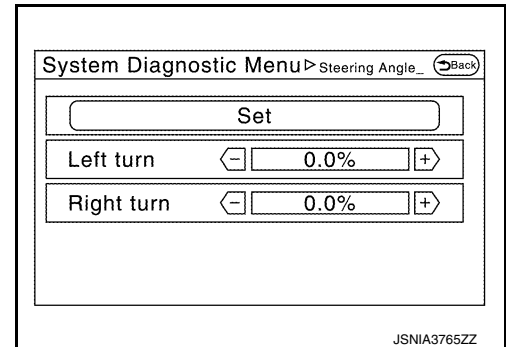

SPEED CALIBRATION

- During normal driving, distance error caused by tire wear and tire pressure change is automatically adjusted for by the automatic distance correction function. This function, on the other hand, is for immediate adjustment, in cases such as driving with tire chain fitted on tires.

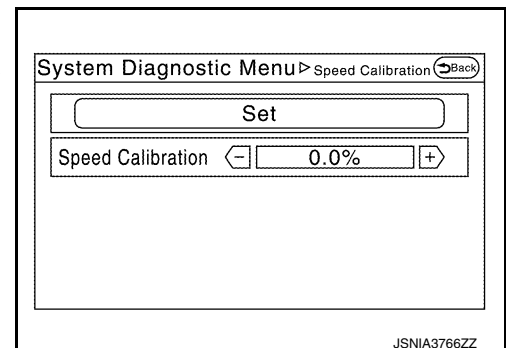

SENSOR INFORMATION

- Displays the reception status of the GPS antenna connector.

XM SUBSCRIPTION STATUS

- The XM subscription status can be checked.

Error location display

The self-diagnosis results are judged depending on whether any error occurs from when "Self-diagnosis" is selected until the self-diagnosis results are displayed.

A
B
C
D
E
F
G
H
I
J
K
L
M
AV
O
P

DIAGNOSIS SYSTEM (AV CONTROL UNIT)

[NAVIGATION WITHOUT BOSE]

< SYSTEM DESCRIPTION >

However, the diagnosis results are judged normal if an error has occurred before the power switch is turned ON and then no error has occurred until the self-diagnosis start. Check the "Error Record" to detect any error that may have occurred before the self-diagnosis start because of this situation.

The error record displays the time and place of the most recent occurrence of that error. However, take note of the following points.

- If there is a malfunction with the GPS antenna circuit board in the AV control unit, the correct date and time of occurrence may not be able to be displayed.
- Place of the error occurrence is represented by the position of the current location mark at the time an error occurred. If current location mark has deviated from the correct position, then the place of the error occurrence cannot be located correctly.
- The frequency of occurrence is displayed in a count up manner. The actual count up method differs depending on the error item.

Count up method A

- The counter resets to 0 if an error occurs when power switch is turned ON. The counter increases by 1 if the condition is normal at a next power ON cycle.
- The counter upper limit is 39. Any counts exceeding 39 are ignored. The counter can be reset (no error record display) with the "Delete log" switch or CONSULT.

Display type of occurrence frequency	Error history display item
Count up method A	CAN communication line, control unit (CAN), AV communication line, control unit (AV)

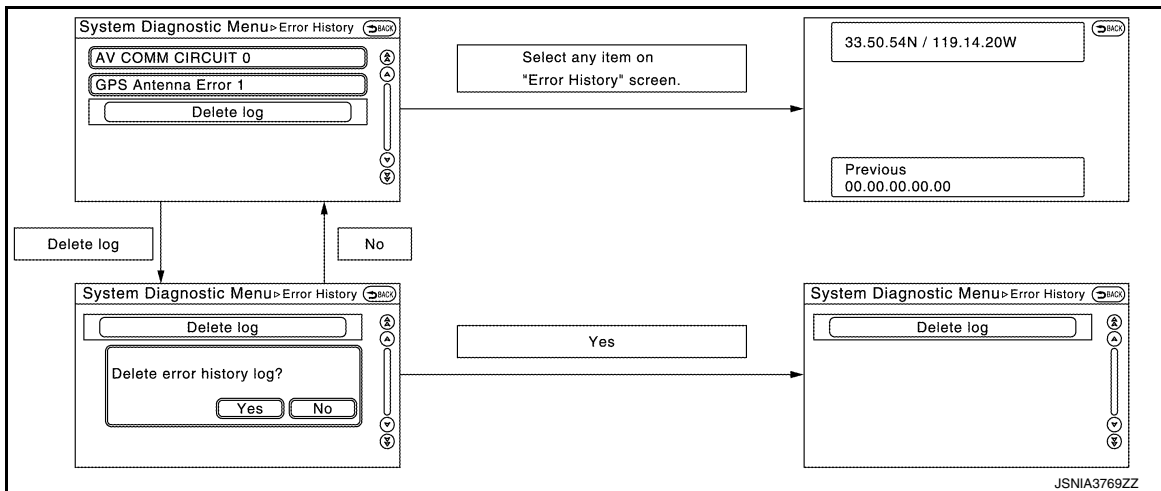

Error item

Some error items may be displayed simultaneously according to the cause. If some error items are displayed simultaneously, the detection of the cause can be performed by the combination of display items

Error item	Description	Possible malfunction factor/Action to take
CAN COMM CIRCUIT	CAN communication malfunction is detected.	Perform diagnosis with CONSULT, and then repair the malfunctioning parts according to the diagnosis results. Refer to AV-247, "CONSULT Function" .
CONTROL UNIT (CAN)	CAN initial diagnosis malfunction is detected.	Replace the AV control unit if the malfunction occurs constantly. Refer to AV-318, "Removal and Installation" .
CONTROL UNIT (AV)	AV communication circuit initial diagnosis malfunction is detected.	
Control Unit Internal Error	AV control unit malfunction is detected.	Replace the AV control unit or multifunction switch if the malfunction occurs constantly. Refer to AV-318, "Removal and Installation" (AV control unit), AV-319, "Removal and Installation" (multifunction switch).
Switch Initial Communication Error	AV control unit or multifunction switch internal malfunction are detected.	
Steer. Angle Sensor Calibration	Predictive course line center position adjustment of the steering angle sensor is incomplete.	Adjust the predictive course line center position of the steering angle sensor. Refer to AV-247, "CONSULT Function" .

DIAGNOSIS SYSTEM (AV CONTROL UNIT)

< SYSTEM DESCRIPTION >

[NAVIGATION WITHOUT BOSE]

Error item	Description	Possible malfunction factor/Action to take
GPS Antenna Error	GPS antenna connection malfunction is detected.	Check the connection of the GPS antenna connector.
XM Antenna Connection Error	Satellite radio antenna connection malfunction is detected.	Satellite radio antenna disconnection.
USB electric current error	Detection of overcurrent in USB connector.	Check USB harness between the AV control unit and USB connector.
TCU Connection Error	TCU connection malfunction is detected.	Check that the connection to the TCU connector is normal.
<ul style="list-style-type: none"> AV COMM CIRCUIT Switches Connection Error 	When either one of the following items are detected: <ul style="list-style-type: none"> multifunction switch power supply and ground circuits are malfunctioning. AV communication circuits between AV control unit and multifunction switch are malfunctioning. 	<ul style="list-style-type: none"> Multifunction switch power supply and ground circuits. AV communication circuits between AV control unit and multifunction switch.

AV COMM Diagnosis

- Displays the communication status between AV control unit (master unit) and each unit.
- The error counter displays "OK" if any malfunction was not detected in the past and displays "0" if a malfunction is detected. It increases by 1 if the condition is normal at the next power switch ON cycle. The upper limit of the counter is 39.
- The error counter is erased if "Reset" is pressed.

Items	Status (Current)	Counter (Past)
C Tx(ITM-PrimarySW)	OK / ???	OK / 0 - 39
C Rx(PrimarySW-ITM)	OK / ???	OK / 0 - 39

NOTE:

"???" indicates UNKWN

Hands-Free Phone, CARWINGS

The hands-free phone reception volume adjustment and microphone and speaker test functions are also available.

NOTE:

If voice cannot be output when the Voice Microphone Test is started, stop and restart the test again.

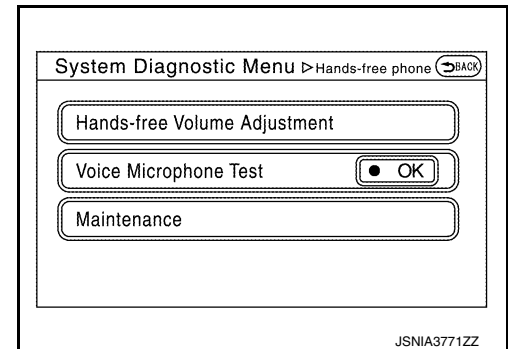
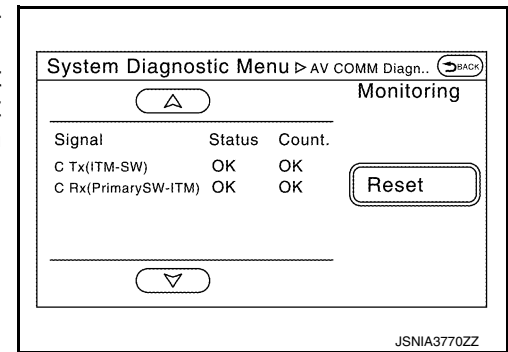

Clock Setting

The clock can be set.

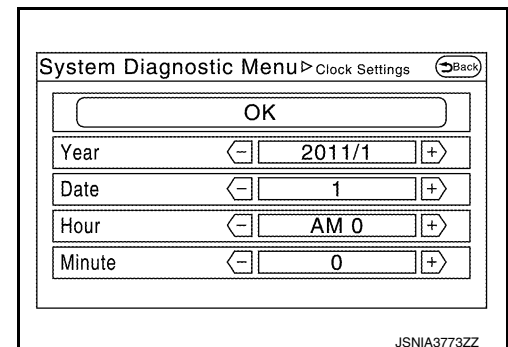

DIAGNOSIS SYSTEM (AV CONTROL UNIT)

[NAVIGATION WITHOUT BOSE]

< SYSTEM DESCRIPTION >

XM

- Change Channel
- Any necessary channels required to receive traffic information from the satellite radio system can be set.
- Change Application ID
- Any application ID's required to receive traffic information from the satellite radio system can be set.
- Diag
- XM authentication diagnosis.

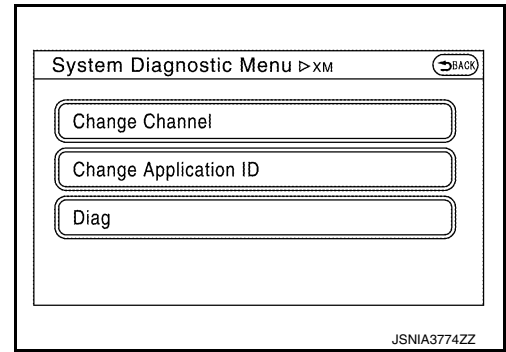

Delete Unit Connection Log

Deletes any unit connection records and error records from the AV control unit memory. (Clear the records of the unit that has been removed.)

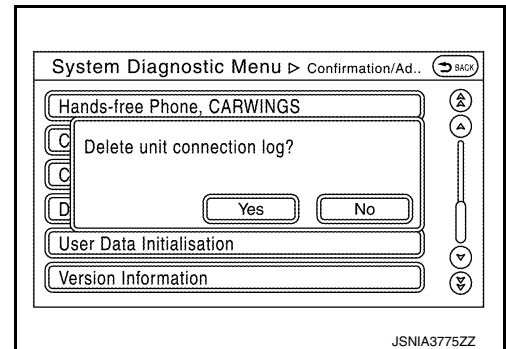

User Data Initialization

Initializes the AV control unit memory.

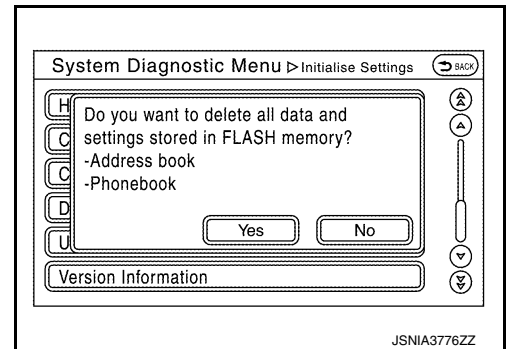

Version Information

Version information of the AV control unit is displayed.

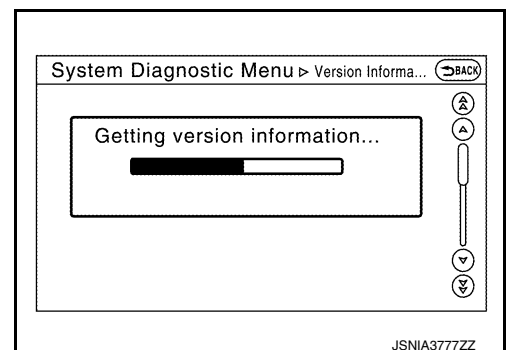

Software Update

Software version of the AV control unit can be update.

DIAGNOSIS SYSTEM (AV CONTROL UNIT)

< SYSTEM DESCRIPTION >

[NAVIGATION WITHOUT BOSE]

For detail of the operation, refer to [AV-277. "SOFTWARE UPDATE \(AV CONTROL UNIT\) : Work Procedure"](#).

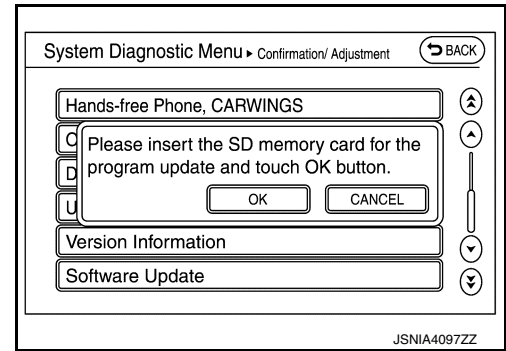

CONSULT Function

INFOID:000000010641872

CONSULT FUNCTIONS

CONSULT performs the following functions via communication with the AV control unit.

Direct Diagnostic Mode	Description
Ecu Identification	The AV control unit part number is displayed.
Self Diagnostic Result	The AV control unit self diagnostic results are displayed.
Data Monitor	The AV control unit input/output data is displayed in real time.
Work support	The settings for AV control unit functions can be changed.
Configuration	<ul style="list-style-type: none"> The vehicle specification can be read and saved. The vehicle specification can be written when replacing AV control unit.
CAN Diag Support Mntr	<ul style="list-style-type: none"> The result of transmit/receive diagnosis of AV communication is displayed. The result of transmit/receive diagnosis of CAN communication is displayed.

ECU IDENTIFICATION

The part number of AV control unit is displayed.

SELF DIAGNOSTIC RESULT

Refer to [AV-253. "DTC Index"](#).

DATA MONITOR

Monitor Item [Unit]	Description
VHCL SPD SIG [On/Off]	Indicates vehicle speed signal received from combination meter on CAN communication line.
PKB SIG [On/Off]	Indicates condition of park brake signal.
ILLUM SIG [On/Off]	Indicates condition of illumination signal for the A/C and AV switch assembly.
IGN SIG [On/Off]	Indicates condition of power signal.
REV SIG [On/Off]	Indicates condition of reverse signal received from BCM.

CONFIGURATION

Refer to [AV-280. "CONFIGURATION \(AV CONTROL UNIT\) : Description"](#).

CAN DIAG SUPPORT MNTR

Refer to [LAN-14. "CAN Diagnostic Support Monitor"](#).

AV CONTROL UNIT

< ECU DIAGNOSIS INFORMATION >

[NAVIGATION WITHOUT BOSE]

ECU DIAGNOSIS INFORMATION

AV CONTROL UNIT

Reference Value

INFOID:000000010641873

VALUES ON THE DIAGNOSIS TOOL

Monitor Item	Condition	Value/Status
VHCL SPD SIG	Vehicle speed = 0 km/h (0 MPH).	Off
	Vehicle speed > 0 km/h (0 MPH).	On
PKB SIG	Parking brake released.	Off
	Parking brake applied.	On
ILLUM SIG	Illumination signal is not received.	Off
	Illumination signal is received.	On
IGN SIG	Power switch OFF or ACC.	Off
	Power switch ON.	On
REV SIG	Selector lever in any position other than R.	Off
	Selector lever in R position.	On

TERMINAL LAYOUT

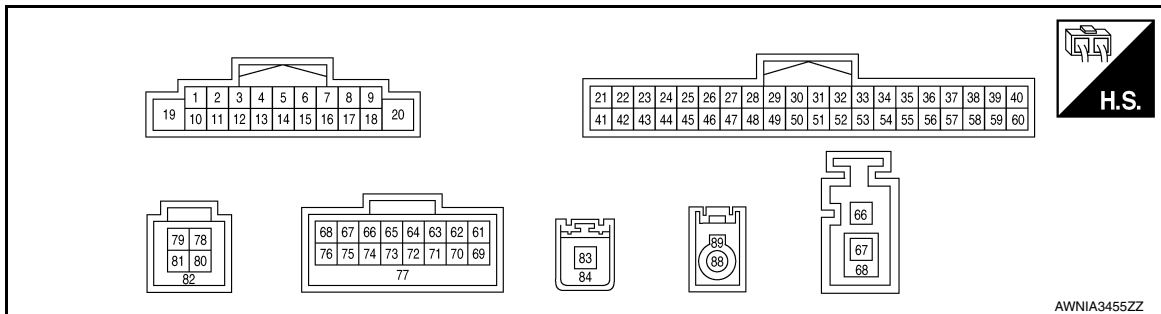

PHYSICAL VALUES

Terminal (Wire color)		Description		Condition		Reference value (Approx.)
+	-	Signal name	Input/ Output	Power switch	Operation	
2 (L)	3 (P)	Sound signal front LH	Output	ON	Sound output	<p>SKIB3609E</p>
4 (V)	5 (LG)	Sound signal rear LH	Output	ON	Sound output	<p>SKIB3609E</p>

AV CONTROL UNIT

< ECU DIAGNOSIS INFORMATION >

[NAVIGATION WITHOUT BOSE]

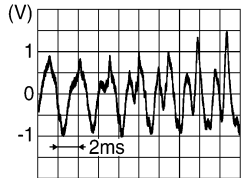
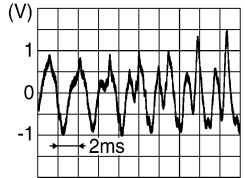
Terminal (Wire color)		Description	Condition		Reference value (Approx.)	
+	-	Signal name	Input/ Output	Power switch		Operation
6 (R)	15 (B)	Steering switch signal A	Input	ON	Press SOURCE switch.	0 V
					Press ▲ switch.	1.0 V
					Press ▼ switch.	2.0 V
					Press ↙ switch.	3.0 V
					Press Ⓢ switch.	4.0 V
					Except above.	5.0 V
7 (BR)	Ground	ACC power supply	Input	ACC	—	Battery voltage
8 (B)	—	Illumination ground	—	—	—	—
9 (W)	Ground	Illumination signal	Input	ON	Lighting switch ON.	Battery voltage
					Lighting switch OFF.	0 V
11 (G)	12 (R)	Sound signal front RH	Output	ON	Sound output	 <small>SKIB3609E</small>
13 (LG)	14 (P)	Sound signal rear RH	Output	ON	Sound output	 <small>SKIB3609E</small>
16 (W)	15 (B)	Steering switch signal B	Input	ON	Press - 🗣️ switch.	0 V
					Press 🗣️+ switch.	1.0 V
					Press 🗣️ switch.	2.0 V
					Press 🔄 switch.	3.0 V
					Except above.	5.0 V
19 (BR)	Ground	Battery power supply	Input	OFF	—	Battery voltage
21 (LG)	—	AV communication signal (L)	Input/ Output	—	—	—
22 (LG)	—	AV communication signal (L)	Input/ Output	—	—	—
23 (P)	—	CAN L	Input/ Output	—	—	—

A
B
C
D
E
F
G
H
I
J
K
L
M
AV
O
P

AV CONTROL UNIT

< ECU DIAGNOSIS INFORMATION >

[NAVIGATION WITHOUT BOSE]

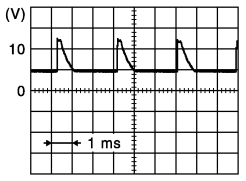
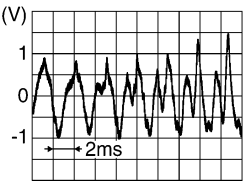
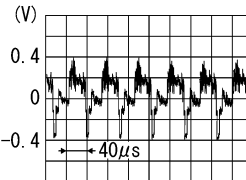
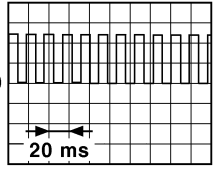
Terminal (Wire color)		Description		Condition		Reference value (Approx.)
+	-	Signal name	Input/ Output	Power switch	Operation	
25 (Y)	Ground	Parking brake signal	Input	ON	Parking brake applied.	0 V
					Parking brake released.	 <p style="text-align: right; font-size: small;">JSNIA1938ZZ</p>
26 (V)	Ground	Power signal	Input	ON	—	Battery voltage
				OFF	—	0 V
34 (P)	Ground	Microphone VCC	Output	ON	—	5 V
35 (R)	Ground	AUX sound signal LH	Input	ON	AUX mode selected.	 <p style="text-align: right; font-size: small;">SKIB3609E</p>
36 (B)	Ground	AUX ground	—	ON	—	0 V
39 (R)	Ground	Camera power supply	Output	ON	Selector lever in "R" position	6.0 V
40 (R)	Ground	Camera image signal	Input	ON	Camera image displayed	 <p style="text-align: right; font-size: small;">SKIB2251J</p>
41 (SB)	—	AV communication signal (H)	Input/ Output	—	—	—
42 (SB)	—	AV communication signal (H)	Input/ Output	—	—	—
43 (L)	—	CAN H	Input/ Output	—	—	—
44 (GR)	Ground	Vehicle speed signal (8-pulse)	Input	ON	When vehicle speed is approx. 40 km/h (25 MPH)	<p>NOTE: The maximum voltage varies depending on the specification (destination unit).</p>  <p style="text-align: right; font-size: small;">JSNIA0012GB</p>

AV CONTROL UNIT

< ECU DIAGNOSIS INFORMATION >

[NAVIGATION WITHOUT BOSE]

Terminal (Wire color)		Description		Condition		Reference value (Approx.)
+	-	Signal name	Input/ Output	Power switch	Operation	
45 (G)	Ground	Reverse signal	Input	ON	Selector lever in R (reverse) position	Battery voltage
					Selector lever in other than R (reverse) position	0 V
46 (R)	Ground	Dimmer signal	Input	ON	One of the following conditions: • Lighting switch OFF • Auto light ON with optical sensor exposed to light.	0 V
					Auto light ON with optical sensor not exposed to light.	Battery voltage
53 (L)	Ground	Microphone signal	Input	ON	Speak into microphone	
54 (Shield)	—	Microphone signal shield	—	—	—	—
55 (W)	Ground	AUX sound signal RH	Input	ON	AUX mode selected.	
56 (Shield)	—	AUX sound signal shield	—	—	—	—
58 (B)	Ground	Camera detection	—	ON	—	0 V
59 (W)	Ground	Camera ground	—	ON	—	0 V
60 (Shield)	—	Camera image signal Shield	—	—	—	—
61 (L)	Ground	USB D- signal (Telematics)	Input/ Output	—	—	—
62 (BR)	Ground	USB V BUS signal (Telematics)	Output	ON	—	—
63 (V)	—	Manufacturer specific signal (Telematics)	—	—	—	—
67 (B)	—	VOICE ground (Telematics)	—	—	—	—
68 (Y)	Ground	U-VOICE signal (Telematics)	Output	ON	—	—
69 (R)	Ground	USB D+ signal (Telematics)	Input/ Output	—	—	—
70 (Shield)	—	USB signal shield (Telematics)	—	—	—	—

A
B
C
D
E
F
G
H
I
J
K
L
M

AV

O
P

AV CONTROL UNIT

< ECU DIAGNOSIS INFORMATION >

[NAVIGATION WITHOUT BOSE]

Terminal (Wire color)		Description	Condition			Reference value (Approx.)
+	-		Signal name	Input/ Output	Power switch	
76 (G)	Ground	D-VOICE signal (Telematics)	Input	—	—	—
77 (Shield)	—	USB signal shield (Telematics)	—	—	—	—
78 (W)	Ground	V BUS signal (USB connector)	Output	ON	—	5 V
79 (G)	—	USB ground (USB connector)	—	—	—	—
80 (L)	Ground	USB D+ signal (USB connector)	Input/ Output	—	—	—
81 (R)	Ground	USB D- signal (USB connector)	Input/ Output	—	—	—
82 (Shield)	—	USB signal shield (USB connector)	—	—	—	—
83 (B)	Ground	GPS antenna signal	Input	ACC	GPS antenna disconnect- ed.	5 V
84 (Shield)	—	GPS antenna signal shield	—	—	—	—
85 (B)	Ground	Antenna amp. ON signal	Output	ACC	—	Battery voltage
86 (B)	—	AM-FM main	Input	—	—	—
87 (Shield)	—	AM-FM main shield	—	—	—	—
88 (B)	Ground	Satellite radio antenna sig- nal	Input	ON	Satellite antenna discon- nected.	5 V
89 (Shield)	—	Satellite radio antenna sig- nal shield	—	—	—	—

Fail-safe

INFOID:0000000010641874

When a malfunction occurs within the system, the AV control unit outputs a message on the display, and it restricts the AV control unit functions.

FAIL-SAFE CONDITIONS

SD card not inserted, SD card malfunction, internal malfunction of navigation, etc.

Display Indication

- When the system is in the fail-safe status at the start of the AV control unit, an error message is shown on the display.
- When the system is in the fail-safe status after the start of the AV control unit, an error message is not shown on the display. The MULTI AV system may be rebooted in the fail-safe state. If the fail-safe state is maintained after the system is rebooted, an applicable message is shown.

Cause	Display monitor
Malfunction of flash ROM information	TARGET INFO NG
No SD card	NO SD CARD
Unsuccessful security unlock	SD UNLOCK NG
Malfunction of SD card mount	SD INIT NG
Malfunction of SD card access	SD ACCESS NG
No program data	NO NAVI-2 DATA

AV CONTROL UNIT

< ECU DIAGNOSIS INFORMATION >

[NAVIGATION WITHOUT BOSE]

Cause	Display monitor
Malfunction of program data (SUM NG)	NAVI-2DATA READ NG
Inconsistent program version (Flash/SD)	NAVI VERSION NG
Difference of map destination	DIFFERENT MAP CODE
Not compliant with map database version	MAP DATA BASE UNMATCH
Malfunction of navigation	NAVI STARTUP NG

CONTROL

When the system is in the fail-safe status at or after start of the AV control unit, the following functions are restricted.

Function		In fail-safe mode
A/C	Display	No display (fail-safe status display)
Audio	Operation	Mute audio
	Display	No display (fail-safe status display)
Hands-free phone	Operation	It cannot be operated
Navigation	Operation	It cannot be operated
Display	Operation	Open/close operation is available
	Display	Fail-safe factors are displayed
Self-diagnosis		It cannot be diagnosed
CONSULT diagnosis		It cannot be diagnosed
AV communication diagnosis		It cannot be diagnosed
Frequency transmission for VCM		Normal
SD read access		Access cannot be gained.
SD write access		Access cannot be gained.

CANCELLATION CONDITIONS

The fail-safe status is canceled under the following conditions, and then the system returns to the normal mode.

- When the SD card is not inserted, the SD card is inserted and the power of the AV control unit is turned ON again.
- When the SD card is not functional at the start of navigation due to a malfunction of the SD card, a normal SD card is inserted and the power of the AV control unit is turned ON again.

DTC Index

INFOID:000000010641875

DTC	Display item	Refer to
U1000	CAN COMM CIRC [U1000]	AV-282, "Diagnosis Procedure"
U1010	CONTROL UNIT (CAN) [U1010]	AV-283, "DTC Logic"
U121F	CONTROL UNIT [U121F]	AV-284, "DTC Logic"
U1244	GPS ANTENNA CONN [U1244]	AV-285, "Diagnosis Procedure"
U1258	XM ANTENNA CONN [U1258]	AV-286, "Diagnosis Procedure"
U1263	USB OVERCURRENT [U1263]	AV-287, "Diagnosis Procedure"
U1266	TCU CONN[U1266]	AV-288, "DTC Logic"

A
B
C
D
E
F
G
H
I
J
K
L
M
O
P

AV

AV CONTROL UNIT

< ECU DIAGNOSIS INFORMATION >

[NAVIGATION WITHOUT BOSE]

DTC	Display item	Refer to
U1310	CONTROL UNIT (AV) [U1310]	AV-290, "DTC Logic"
U1300 U1240	<ul style="list-style-type: none">• AV COMM CIRCUIT [U1300]• SWITCH CONN [U1240]	AV-289, "Description"

WIRING DIAGRAM

NAVIGATION WITHOUT BOSE

Wiring Diagram

INFOID:000000010641876

NAVIGATION SYSTEM - WITHOUT BOSE AUDIO SYSTEM

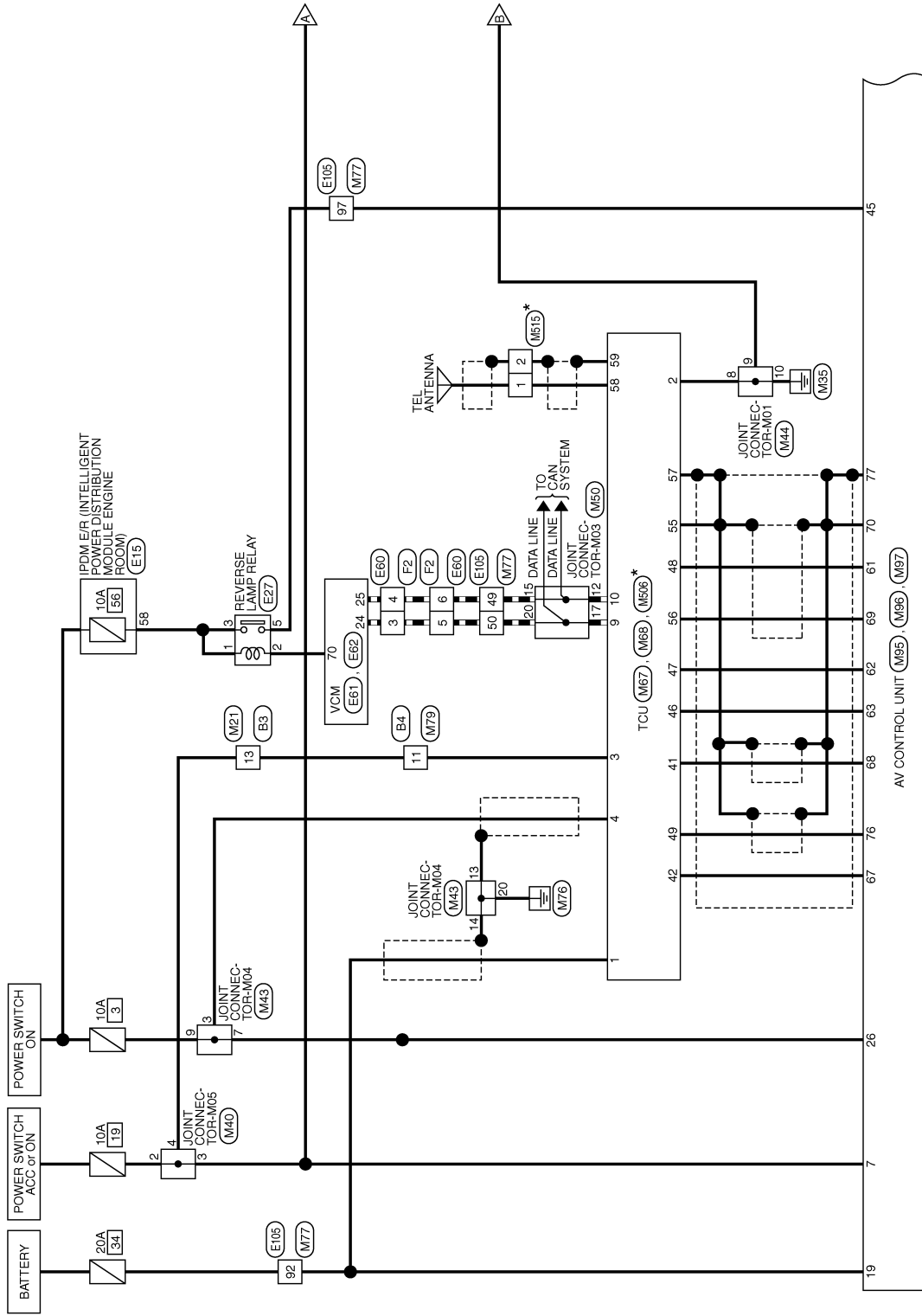

*: THIS CONNECTOR IS NOT SHOWN IN "HARNES LAYOUT" OF PG SECTION.

AANWA1072GB

A
B
C
D
E
F
G
H
I
J
K
L
M
N
O
P

AV

NAVIGATION WITHOUT BOSE

< WIRING DIAGRAM >

[NAVIGATION WITHOUT BOSE]

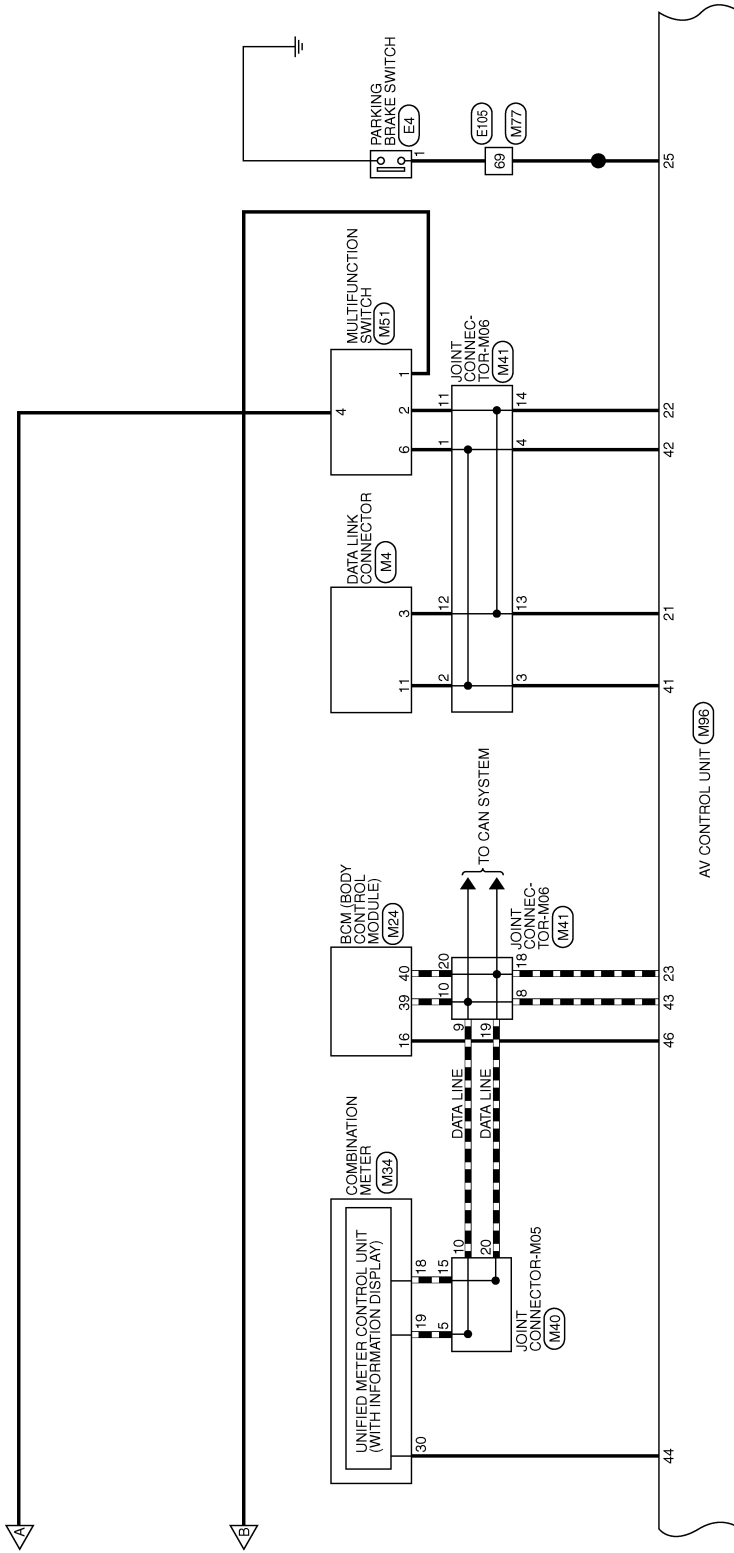

AANWA1073GB

NAVIGATION WITHOUT BOSE

< WIRING DIAGRAM >

[NAVIGATION WITHOUT BOSE]

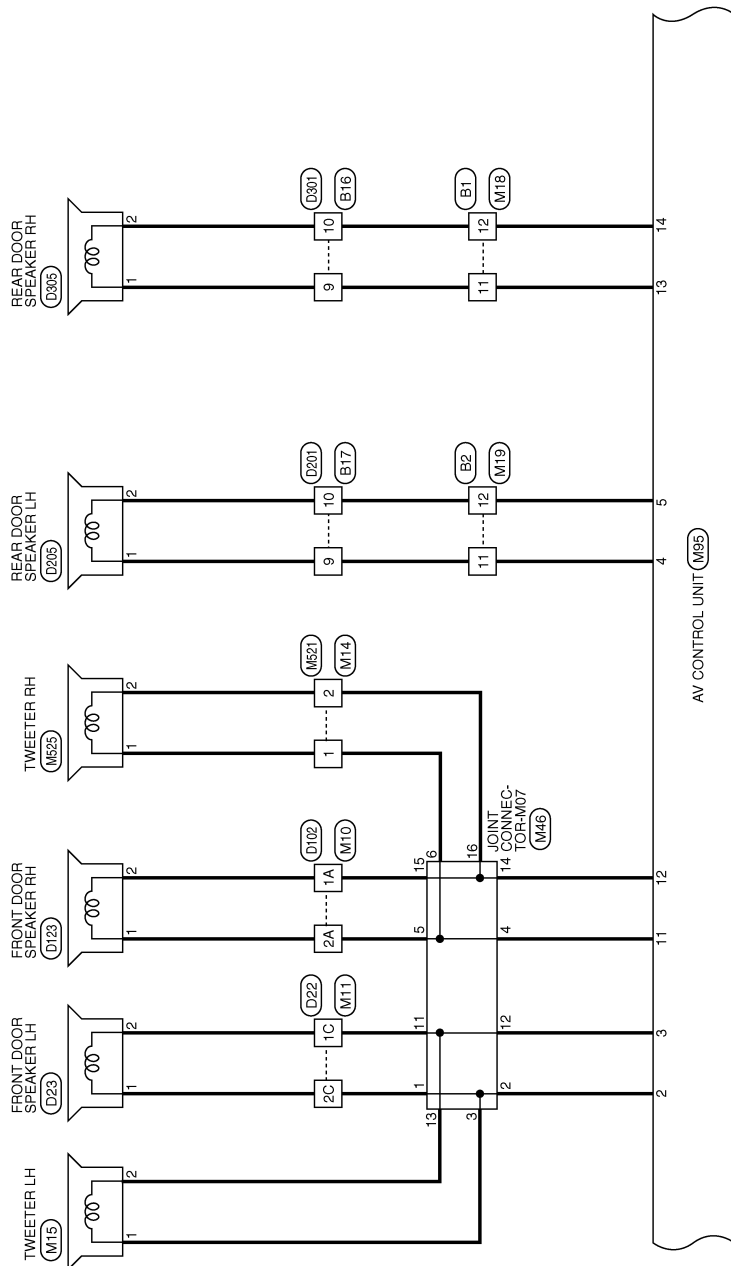

A
B
C
D
E
F
G
H
I
J
K
L
M
N
O
P

AV

AANWA1074GB

NAVIGATION WITHOUT BOSE

< WIRING DIAGRAM >

[NAVIGATION WITHOUT BOSE]

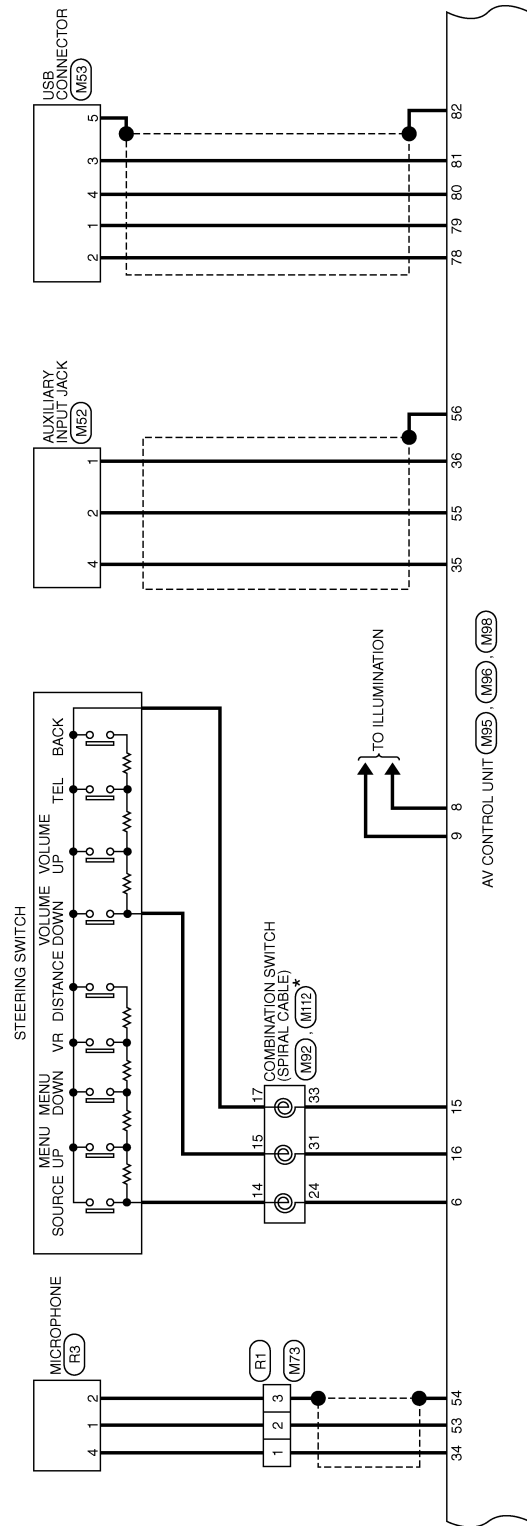

*: THIS CONNECTOR IS NOT SHOWN IN "HARNESS LAYOUT" OF PG SECTION.

AANWA1075GB

NAVIGATION WITHOUT BOSE

< WIRING DIAGRAM >

[NAVIGATION WITHOUT BOSE]

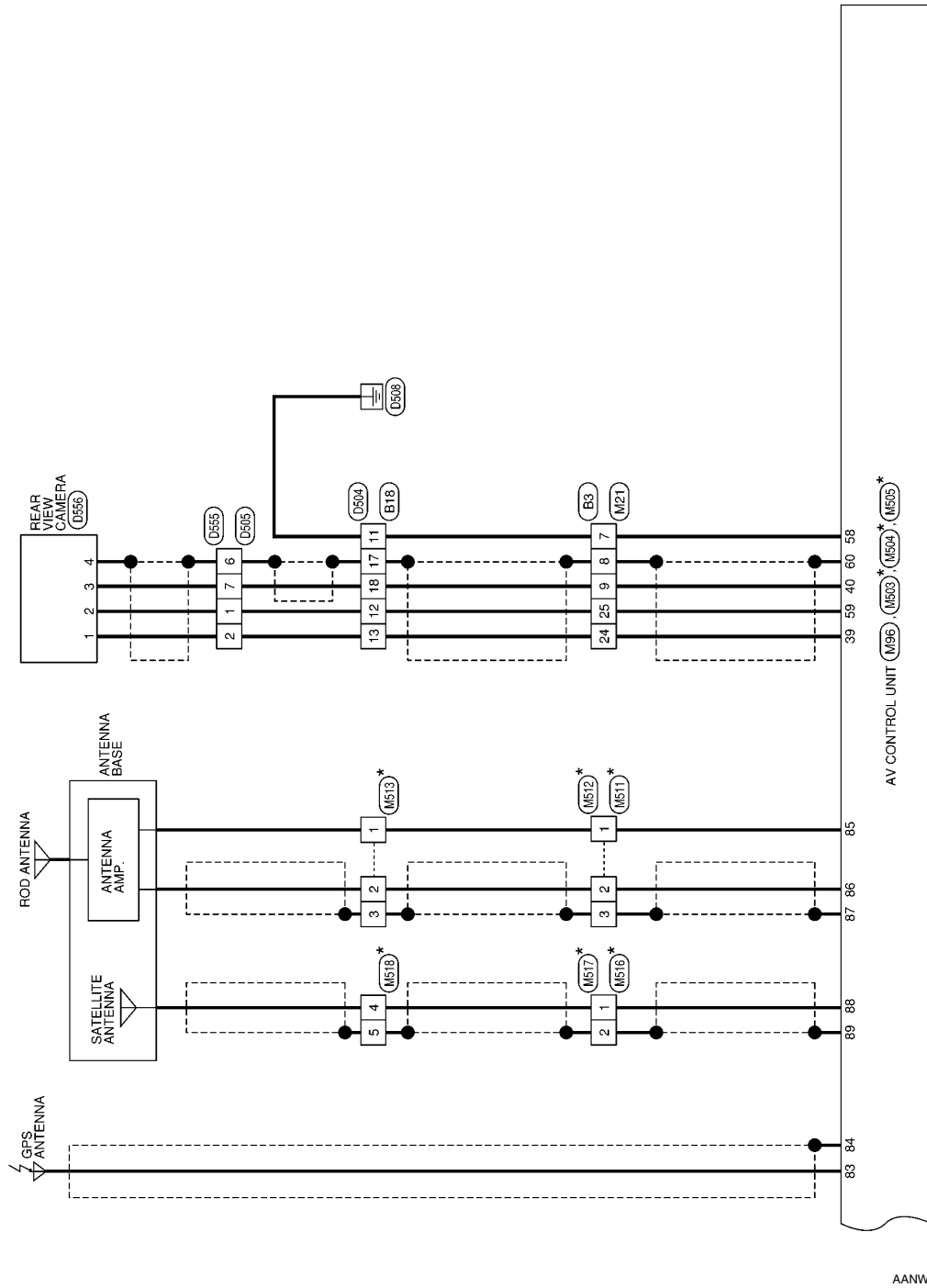

A
B
C
D
E
F
G
H
I
J
K
L
M
N
O
P

AV

NAVIGATION SYSTEM - WITHOUT BOSE AUDIO SYSTEM - CONNECTORS

Connector No.	M4
Connector Name	DATA LINK CONNECTOR
Connector Color	WHITE

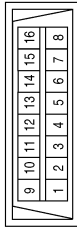

Terminal No.	Color of Wire	Signal Name
3	LG	-
11	SB	-

Connector No.	M10
Connector Name	WIRE TO WIRE
Connector Color	WHITE

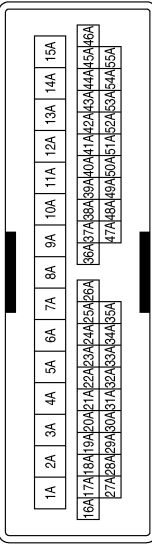

Terminal No.	Color of Wire	Signal Name
1A	R	- (WITHOUT BOSE)
2A	G	- (WITHOUT BOSE)

Connector No.	M11
Connector Name	WIRE TO WIRE
Connector Color	WHITE

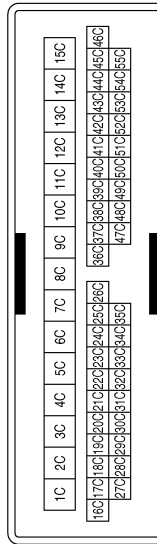

Terminal No.	Color of Wire	Signal Name
1C	P	- (WITHOUT BOSE)
2C	L	- (WITHOUT BOSE)

Connector No.	M14
Connector Name	WIRE TO WIRE
Connector Color	BROWN



Terminal No.	Color of Wire	Signal Name
1	G	- (WITHOUT BOSE)
2	R	- (WITHOUT BOSE)

NAVIGATION WITHOUT BOSE

< WIRING DIAGRAM >

[NAVIGATION WITHOUT BOSE]

Connector No.	M19
Connector Name	WIRE TO WIRE
Connector Color	WHITE

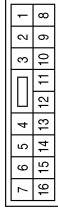

Terminal No.	Color of Wire	Signal Name
11	V	-
12	LG	-

Connector No.	M18
Connector Name	WIRE TO WIRE
Connector Color	WHITE

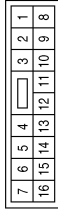

Terminal No.	Color of Wire	Signal Name
11	LG	-(WITHOUT BOSE-EXCEPT MEXICO)
12	P	-(WITHOUT BOSE-EXCEPT MEXICO)

Connector No.	M15
Connector Name	TWEETER LH
Connector Color	BROWN



Terminal No.	Color of Wire	Signal Name
1	W	-(WITHOUT BOSE)
2	P	-(WITHOUT BOSE)

Connector No.	M34
Connector Name	COMBINATION METER
Connector Color	WHITE

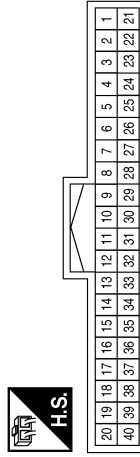

Terminal No.	Color of Wire	Signal Name
18	P	CAN-L
19	L	CAN-H
30	GR	SPEED 8PR

Connector No.	M24
Connector Name	BCM (BODY CONTROL MODULE)
Connector Color	BLACK

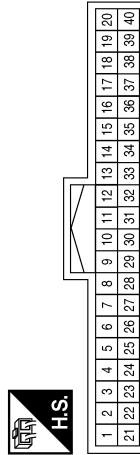

Terminal No.	Color of Wire	Signal Name
16	R	MR OUTPUT
39	L	CAN-H
40	P	CAN-L

Connector No.	M21
Connector Name	WIRE TO WIRE
Connector Color	WHITE

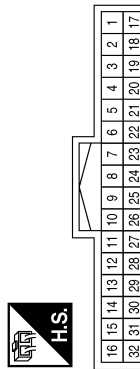

Terminal No.	Color of Wire	Signal Name
7	B	-
8	SHIELD	-
9	R	-
13	GR	-
24	W	-
25	B	-

AANIA2712GB

A
B
C
D
E
F
G
H
I
J
K
L
M
AV
O
P

NAVIGATION WITHOUT BOSE

< WIRING DIAGRAM >

[NAVIGATION WITHOUT BOSE]

Terminal No.	Color of Wire	Signal Name
8	L	-
9	L	-
10	L	-
11	LG	-
12	LG	-
13	LG	-
14	LG	-
18	P	-
19	P	-
20	P	-

Connector No.	M41
Connector Name	JOINT CONNECTOR-M06
Connector Color	BLUE

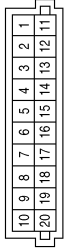

Terminal No.	Color of Wire	Signal Name
1	SB	-
2	SB	-
3	SB	-
4	SB	-

Connector No.	M40
Connector Name	JOINT CONNECTOR-M05
Connector Color	BLUE

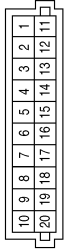

Terminal No.	Color of Wire	Signal Name
2	L	-
3	BR	-
4	GR	-
5	L	-
10	L	-
15	P	-
20	P	-

Connector No.	M44
Connector Name	JOINT CONNECTOR-M01
Connector Color	GRAY

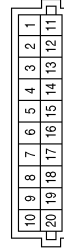

Terminal No.	Color of Wire	Signal Name
8	B	-
9	B	-
10	B	-

Connector No.	M43
Connector Name	JOINT CONNECTOR-M04
Connector Color	GRAY

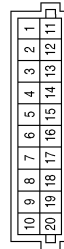

Terminal No.	Color of Wire	Signal Name
3	W	-
7	Y	-
9	W	-
13	B	-
14	B	-
20	B	-

AANIA2713GB

NAVIGATION WITHOUT BOSE

< WIRING DIAGRAM >

[NAVIGATION WITHOUT BOSE]

Connector No.	M50
Connector Name	JOINT CONNECTOR-M03
Connector Color	PINK



Terminal No.	Color of Wire	Signal Name
12	G	-
15	G	-
17	L	-
20	L	-

Terminal No.	Color of Wire	Signal Name
5	G	-
6	G	-
11	P	-
12	P	-
13	P	-
14	R	-
15	R	-
16	R	-

Connector No.	M46
Connector Name	JOINT CONNECTOR-M07
Connector Color	ORANGE

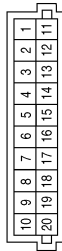

Terminal No.	Color of Wire	Signal Name
1	L	-
2	L	-
3	W	-
4	G	-

Connector No.	M53
Connector Name	USB CONNECTOR
Connector Color	GREEN

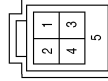

Terminal No.	Color of Wire	Signal Name
1	G	-
2	W	-
3	R	-
4	L	-
5	SHIELD	-

Connector No.	M52
Connector Name	AUXILIARY INPUT JACK
Connector Color	WHITE



Terminal No.	Color of Wire	Signal Name
1	B	-
2	W	-
3	-	-
4	R	-

Connector No.	M51
Connector Name	MULTIFUNCTION SWITCH
Connector Color	WHITE

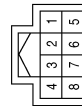

Terminal No.	Color of Wire	Signal Name
1	B	-
2	LG	-
3	-	-
4	L	-
5	-	-
6	SB	-
7	-	-
8	-	-

AANIA2714GB

A
B
C
D
E
F
G
H
I
J
K
L
M
N
O
P

AV

NAVIGATION WITHOUT BOSE

< WIRING DIAGRAM >

[NAVIGATION WITHOUT BOSE]

Terminal No.	Color of Wire	Signal Name
24	-	-
25	-	-
26	-	-
27	-	-
28	-	-
29	-	-
30	-	-
31	-	-
32	-	-
33	-	-
34	-	-
35	-	-
36	-	-
37	-	-
38	-	-
39	-	-
40	-	-

Terminal No.	Color of Wire	Signal Name
7	-	-
8	-	-
9	L	EV CAN H
10	G	EV CAN L
11	-	-
12	-	-
13	-	-
14	-	-
15	-	-
16	-	-
17	-	-
18	-	-
19	-	-
20	-	-
21	-	-
22	-	-
23	-	-

Connector No.	M67
Connector Name	TCU
Connector Color	WHITE



2	4	6	8	10	12	14	16	18	20	22	24	26	28	30	32	34	36	38	40	
1	1	3	5	7	9	11	13	15	17	19	21	23	25	27	29	31	33	35	37	39

Terminal No.	Color of Wire	Signal Name
1	W	B+
2	B	GND
3	L	ACC
4	W	IGN
5	-	-
6	-	-

Connector No.	M73
Connector Name	WIRE TO WIRE
Connector Color	WHITE



1	2	3	4	5	6	7	8
9	10	11	12	13	14	15	16

Terminal No.	Color of Wire	Signal Name
1	P	-
2	L	-
3	SHIELD	-

Terminal No.	Color of Wire	Signal Name
46	V	MANUFACTURE SPECIFIC
47	BR	VBUS
48	L	D-
49	G	D VOICE
50	-	-
51	-	-
52	-	-
53	-	-
54	-	-
55	SHIELD	GND
56	R	D+
57	SHIELD	CONN CHASSIS GND

Connector No.	M68
Connector Name	TCU
Connector Color	GRAY



48	47	46	45	44	43	42	41
56	55	54	53	52	51	50	49

Terminal No.	Color of Wire	Signal Name
41	Y	U VOICE
42	B	VOICE GND
43	-	-
44	-	-
45	-	-

AANIA2715GB

NAVIGATION WITHOUT BOSE

< WIRING DIAGRAM >

[NAVIGATION WITHOUT BOSE]

Connector No.	M79
Connector Name	WIRE TO WIRE
Connector Color	WHITE

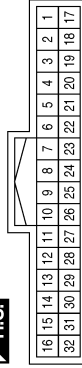

Terminal No.	Color of Wire	Signal Name
11	L	-

Terminal No.	Color of Wire	Signal Name
49	G	-
50	L	-
69	BG	-
92	BR	-
97	G	-

Connector No.	M77
Connector Name	WIRE TO WIRE
Connector Color	WHITE

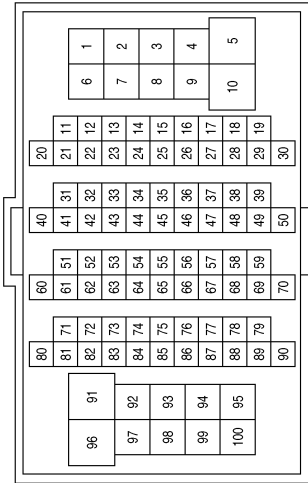

Terminal No.	Color of Wire	Signal Name
7	BR	ACC
8	B	ILL CONT
9	W	ILL
10	-	-
11	G	FR RH PRE+
12	R	FR RH PRE-
13	LG	RR RH PRE+
14	P	RR RH PRE-
15	B	STRG SW GND
16	W	STRG SW B
17	-	-
18	-	-
19	BR	BAT
20	-	-

Connector No.	M95
Connector Name	AV CONTROL UNIT (WITH NAVIGATION SYSTEM WITHOUT BOSE)
Connector Color	WHITE

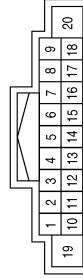

Terminal No.	Color of Wire	Signal Name
1	-	-
2	L	FR LH PRE+
3	P	FR LH PRE-
4	V	RR LH PRE+
5	LG	RR LH PRE-
6	R	STRG SW A

Connector No.	M92
Connector Name	COMBINATION SWITCH (SPIRAL CABLE)
Connector Color	GRAY

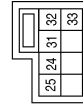

Terminal No.	Color of Wire	Signal Name
24	R	-
31	W	-
33	B	-

AANIA2716GB

A
B
C
D
E
F
G
H
I
J
K
L
M
N
O
P

AV

NAVIGATION WITHOUT BOSE

< WIRING DIAGRAM >

[NAVIGATION WITHOUT BOSE]

Terminal No.	Color of Wire	Signal Name
44	GR	SPEED
45	G	REVERSE SIG
46	R	MR OUTPUT
47	-	-
48	-	-
49	-	-
50	-	-
51	-	-
52	-	-
53	L	MIC SIG
54	SHIELD	MIC GND
55	W	AUX AUDIO RH
56	SHIELD	AUX SHIELD
57	-	-
58	B	RV CAM DETECT
59	W	CAMERA GND
60	SHIELD	R CAMERA SHIELD

Terminal No.	Color of Wire	Signal Name
27	-	-
28	-	-
29	-	-
30	-	-
31	-	-
32	-	-
33	-	-
34	P	MIC VCC
35	R	AUX AUDIO LH
36	B	AUX AUDIO-
37	-	-
38	-	-
39	R	CAMERA V+
40	R	R CAMERA SIG
41	SB	M CAN H TRM
42	SB	M CAN H
43	L	CAN-H

Connector No.	M96
Connector Name	AV CONTROL UNIT (WITH NAVIGATION SYSTEM WITHOUT BOSE)
Connector Color	WHITE

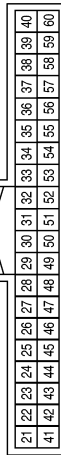

Terminal No.	Color of Wire	Signal Name
21	LG	M CAN L TRM
22	LG	M CAN L
23	P	CAN-L
24	-	-
25	Y	PKB SIG
26	V	IGN

Connector No.	M98
Connector Name	AV CONTROL UNIT (WITH NAVIGATION SYSTEM WITHOUT BOSE)
Connector Color	BLUE



Terminal No.	Color of Wire	Signal Name
78	W	V BUS
79	G	USB GND
80	L	USB D+
81	R	USB D-
82	SHIELD	SHIELD

Terminal No.	Color of Wire	Signal Name
64	-	-
65	-	-
66	-	-
67	B	GND
68	Y	U-VOICE
69	R	USB D+
70	SHIELD	USB GND
71	-	-
72	-	-
73	-	-
74	-	-
75	-	-
76	G	D-VOICE
77	SHIELD	SHIELD

Connector No.	M97
Connector Name	AV CONTROL UNIT (WITH NAVIGATION SYSTEM WITHOUT BOSE)
Connector Color	GRAY

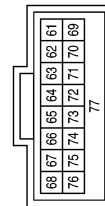

Terminal No.	Color of Wire	Signal Name
61	L	USB D-
62	BR	USB VBUS
63	V	MANUFACTURER SPECIFIC

AANIA2717GB

NAVIGATION WITHOUT BOSE

< WIRING DIAGRAM >

[NAVIGATION WITHOUT BOSE]

Connector No.	M504
Connector Name	AV CONTROL UNIT (WITH NAVIGATION SYSTEM- WITHOUT BOSE AUDIO SYSTEM)
Connector Color	GRAY

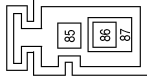

Terminal No.	Color of Wire	Signal Name
85	B	ANTENNA AMP. ON SIGNAL
86	B	RADIO ANTENNA SIGNAL
87	SHIELD	SHIELD

Connector No.	M503
Connector Name	AV CONTROL UNIT (WITH NAVIGATION SYSTEM- WITHOUT BOSE AUDIO SYSTEM)
Connector Color	GRAY



Terminal No.	Color of Wire	Signal Name
83	B	GPS ANTENNA SIGNAL
84	SHIELD	SHIELD

Connector No.	M112
Connector Name	COMBINATION SWITCH (SPIRAL CABLE)
Connector Color	GRAY

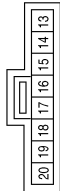

Terminal No.	Color of Wire	Signal Name
14	P	-
15	L	-
17	G	-

Connector No.	M511
Connector Name	WIRE TO WIRE
Connector Color	GRAY



Terminal No.	Color of Wire	Signal Name
1	B	-
2	B	-
3	SHIELD	-

Connector No.	M506
Connector Name	TCU
Connector Color	GRAY



Terminal No.	Color of Wire	Signal Name
58	B	TEL ANT
59	SHIELD	TEL ANT SHIELD

Connector No.	M505
Connector Name	AV CONTROL UNIT (WITH NAVIGATION SYSTEM- WITHOUT BOSE AUDIO SYSTEM)
Connector Color	PINK



Terminal No.	Color of Wire	Signal Name
88	B	SATELLITE ANTENNA
89	SHIELD	SHIELD

AANIA2718GB

A
B
C
D
E
F
G
H
I
J
K
L
M
N
O
P

AV

NAVIGATION WITHOUT BOSE

< WIRING DIAGRAM >

[NAVIGATION WITHOUT BOSE]

Connector No.	M515
Connector Name	TCU ANTENNA
Connector Color	GRAY



Terminal No.	Color of Wire	Signal Name
1	B	-
2	SHIELD	-

Connector No.	M513
Connector Name	ANTENNA BASE
Connector Color	GRAY



Terminal No.	Color of Wire	Signal Name
1	B	-
2	B	-
3	SHIELD	-

Connector No.	M512
Connector Name	WIRE TO WIRE
Connector Color	GRAY



Terminal No.	Color of Wire	Signal Name
1	B	-
2	B	-
3	SHIELD	-

Connector No.	M518
Connector Name	ANTENNA BASE
Connector Color	GREEN

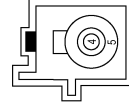

Terminal No.	Color of Wire	Signal Name
4	B	-
5	SHIELD	-

Connector No.	M517
Connector Name	WIRE TO WIRE
Connector Color	BROWN

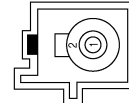

Terminal No.	Color of Wire	Signal Name
1	B	-
2	SHIELD	-

Connector No.	M516
Connector Name	WIRE TO WIRE
Connector Color	BROWN

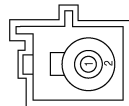

Terminal No.	Color of Wire	Signal Name
1	B	-
2	SHIELD	-

AANIA2719GB

NAVIGATION WITHOUT BOSE

< WIRING DIAGRAM >

[NAVIGATION WITHOUT BOSE]

Connector No.	E4
Connector Name	PARKING BRAKE SWITCH
Connector Color	BLACK



Terminal No.	Color of Wire	Signal Name
1	B	-

Connector No.	M525
Connector Name	TWEETER RH
Connector Color	BROWN



Terminal No.	Color of Wire	Signal Name
1	R	-
2	B	-

Connector No.	M521
Connector Name	WIRE TO WIRE
Connector Color	BROWN



Terminal No.	Color of Wire	Signal Name
1	R	-
2	B	-

Connector No.	E60
Connector Name	WIRE TO WIRE
Connector Color	BLACK



Terminal No.	Color of Wire	Signal Name
3	L	-
4	G	-
5	L	-
6	G	-

Connector No.	E27
Connector Name	REVERSE LAMP RELAY
Connector Color	BLUE



Terminal No.	Color of Wire	Signal Name
1	O	-
2	SB	-
3	O	-
5	G	-

Connector No.	E15
Connector Name	IPDM E/R (INTELLIGENT POWER DISTRIBUTION MODULE ENGINE ROOM)
Connector Color	WHITE

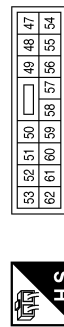

Terminal No.	Color of Wire	Signal Name
58	O	REVERSE LAMP IGN

AANIA2720GB

A
B
C
D
E
F
G
H
I
J
K
L
M
N
O
P

AV

NAVIGATION WITHOUT BOSE

< WIRING DIAGRAM >

[NAVIGATION WITHOUT BOSE]

Connector No.	E61
Connector Name	VCM
Connector Color	BLACK

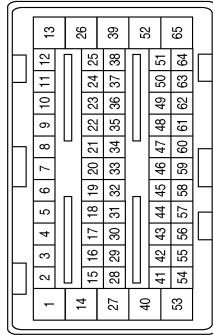

Terminal No.	Color of Wire	Signal Name
24	L	EV CAN-H
25	G	EV CAN-L

Connector No.	E62
Connector Name	VCM
Connector Color	BROWN

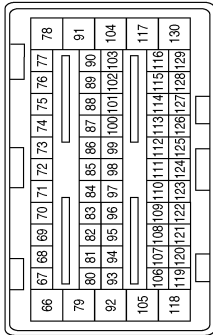

Terminal No.	Color of Wire	Signal Name
70	SB	REVERSE LAMP

Connector No.	E105
Connector Name	WIRE TO WIRE
Connector Color	WHITE

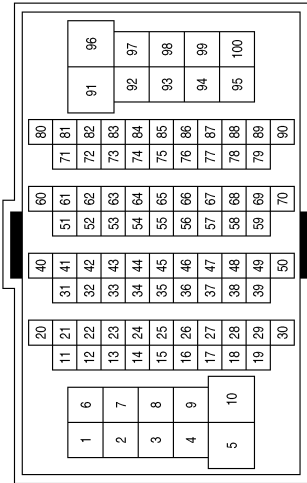

Terminal No.	Color of Wire	Signal Name
49	G	-
50	L	-
69	B	-
92	BR	-
97	G	-

Connector No.	F2
Connector Name	WIRE TO WIRE
Connector Color	BLACK

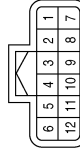

Terminal No.	Color of Wire	Signal Name
3	L	-
4	G	-
5	L	-
6	G	-

NAVIGATION WITHOUT BOSE

< WIRING DIAGRAM >

[NAVIGATION WITHOUT BOSE]

Connector No.	B3
Connector Name	WIRE TO WIRE
Connector Color	WHITE



1	2	3	4	5	6	7	8	9	10	11	12	13	14	15	16
17	18	19	20	21	22	23	24	25	26	27	28	29	30	31	32

Terminal No.	Color of Wire	Signal Name
7	B	-
8	SHIELD	-
9	B	-
13	GR	-
24	R	-
25	W	-

Connector No.	B2
Connector Name	WIRE TO WIRE
Connector Color	WHITE



1	2	3	4	5	6	7
8	9	10	11	12	13	14
15	16					

Terminal No.	Color of Wire	Signal Name
11	V	-
12	LG	-

Connector No.	B1
Connector Name	WIRE TO WIRE
Connector Color	WHITE



6	5	4	3	2	1
12	11	10	9	8	7

Terminal No.	Color of Wire	Signal Name
11	LG	-(WITHOUT BOSE-EXCEPT MEXICO)
12	P	-(WITHOUT BOSE-EXCEPT MEXICO)

Connector No.	B17
Connector Name	WIRE TO WIRE
Connector Color	WHITE



5	4	3	2	1
12	11	10	9	8
7	6			

Terminal No.	Color of Wire	Signal Name
9	V	-(WITHOUT BOSE)
10	LG	-(WITHOUT BOSE)

Connector No.	B16
Connector Name	WIRE TO WIRE
Connector Color	WHITE



5	4	3	2	1
12	11	10	9	8
7	6			

Terminal No.	Color of Wire	Signal Name
9	LG	-(WITHOUT BOSE-EXCEPT MEXICO)
10	P	-(EXCEPT MEXICO)

Connector No.	B4
Connector Name	WIRE TO WIRE
Connector Color	WHITE



1	2	3	4	5	6	7	8	9	10	11	12	13	14	15	16
17	18	19	20	21	22	23	24	25	26	27	28	29	30	31	32

Terminal No.	Color of Wire	Signal Name
11	GR	-

AANIA2722GB

A
B
C
D
E
F
G
H
I
J
K
L
M
N
O
P

AV

NAVIGATION WITHOUT BOSE

< WIRING DIAGRAM >

[NAVIGATION WITHOUT BOSE]

Connector No.	R3
Connector Name	MICROPHONE
Connector Color	WHITE

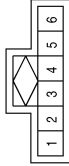

Terminal No.	Color of Wire	Signal Name
1	L	-
2	GR	-
3	-	-
4	P	-
5	-	-
6	-	-

Connector No.	R1
Connector Name	WIRE TO WIRE
Connector Color	WHITE

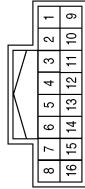

Terminal No.	Color of Wire	Signal Name
1	P	-
2	L	-
3	GR	-

Connector No.	B18
Connector Name	WIRE TO WIRE
Connector Color	WHITE

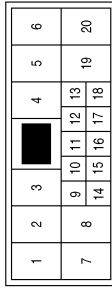

Terminal No.	Color of Wire	Signal Name
11	B	-
12	W	-
13	R	-
17	SHIELD	-
18	B	-

Connector No.	D23
Connector Name	FRONT DOOR SPEAKER LH (WITHOUT BOSE AUDIO SYSTEM)
Connector Color	WHITE



Terminal No.	Color of Wire	Signal Name
1	V	-
2	L	-

Connector No.	D22
Connector Name	WIRE TO WIRE
Connector Color	WHITE

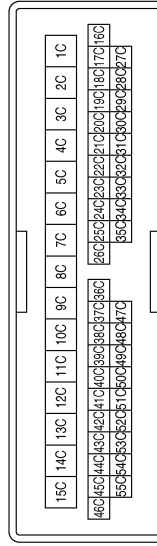

Terminal No.	Color of Wire	Signal Name
1C	L	-
2C	V	-(WITHOUT BOSE)

AANIA2723GB

NAVIGATION WITHOUT BOSE

< WIRING DIAGRAM >

[NAVIGATION WITHOUT BOSE]

Connector No.	D201
Connector Name	WIRE TO WIRE
Connector Color	WHITE

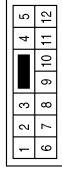

Terminal No.	Color of Wire	Signal Name
9	V	-
10	LG	-

Connector No.	D123
Connector Name	FRONT DOOR SPEAKER RH (WITHOUT BOSE AUDIO SYSTEM)
Connector Color	WHITE



Terminal No.	Color of Wire	Signal Name
1	R	-
2	BR	-

Connector No.	D102
Connector Name	WIRE TO WIRE
Connector Color	WHITE

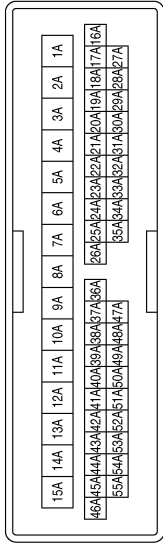

Terminal No.	Color of Wire	Signal Name
1A	BR	-
2A	R	-

Connector No.	D305
Connector Name	REAR DOOR SPEAKER RH
Connector Color	WHITE



Terminal No.	Color of Wire	Signal Name
1	LG	-
2	P	-

Connector No.	D301
Connector Name	WIRE TO WIRE
Connector Color	WHITE

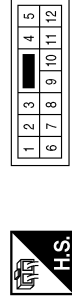

Terminal No.	Color of Wire	Signal Name
9	LG	-
10	P	-

Connector No.	D205
Connector Name	REAR DOOR SPEAKER LH
Connector Color	WHITE



Terminal No.	Color of Wire	Signal Name
1	V	-
2	LG	-

AANIA2724GB

A
B
C
D
E
F
G
H
I
J
K
L
M
AV
O
P

NAVIGATION WITHOUT BOSE

< WIRING DIAGRAM >

[NAVIGATION WITHOUT BOSE]

Connector No.	D555
Connector Name	WIRE TO WIRE
Connector Color	WHITE

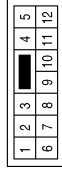

Terminal No.	Color of Wire	Signal Name
1	W	-
2	R	-
6	SHIELD	-
7	B	-

Connector No.	D505
Connector Name	WIRE TO WIRE
Connector Color	WHITE

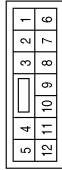

Terminal No.	Color of Wire	Signal Name
1	W	-
2	R	-
6	SHIELD	-
7	Y	-

Connector No.	D504
Connector Name	WIRE TO WIRE
Connector Color	WHITE

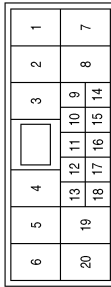

Terminal No.	Color of Wire	Signal Name
11	B	-
12	W	-
13	R	-
17	SHIELD	-
18	Y	-

Connector No.	D556
Connector Name	REAR VIEW CAMERA (WITHOUT AROUND VIEW MONITOR)
Connector Color	WHITE



Terminal No.	Color of Wire	Signal Name
1	R	-
2	W	-
3	B	-
4	SHIELD	-

AANIA2725GB

BASIC INSPECTION

DIAGNOSIS AND REPAIR WORK FLOW

Work Flow

INFOID:000000010641877

OVERALL SEQUENCE

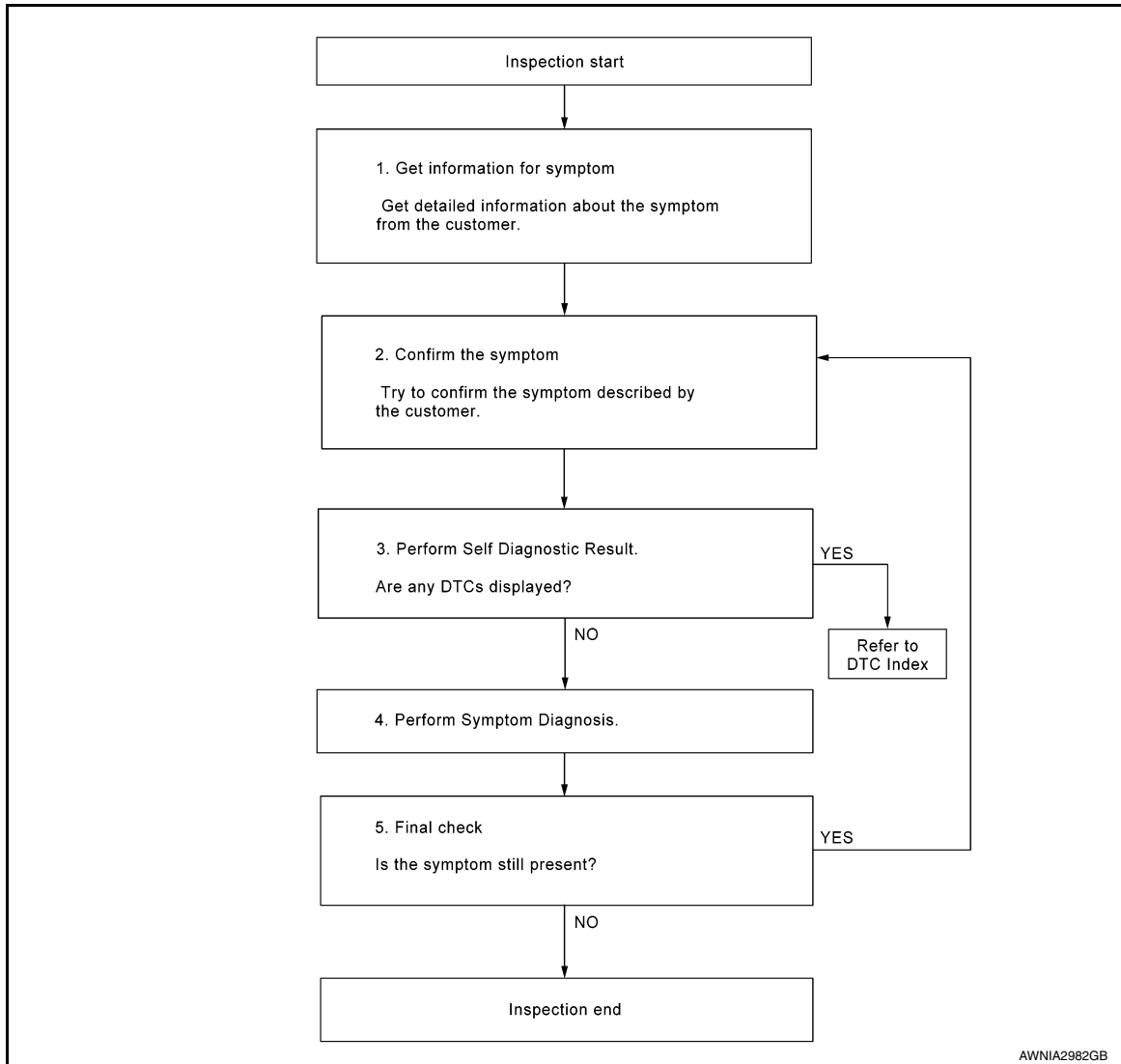

DETAILED FLOW

1. GET INFORMATION FOR SYMPTOM

Get detailed information from the customer about the symptom (the condition and the environment when the incident/malfunction occurred).

>> GO TO 2.

2. CONFIRM THE SYMPTOM

Try to confirm the symptom described by the customer. Verify relation between the symptom and the condition when the symptom is detected.

>> GO TO 3.

3. PERFORM SELF DIAGNOSTIC RESULT

1. Turn power switch ON and wait for 2 seconds or more.

A
B
C
D
E
F
G
H
I
J
K
L
M

AV

O
P

DIAGNOSIS AND REPAIR WORK FLOW

[NAVIGATION WITHOUT BOSE]

< BASIC INSPECTION >

2. Perform "Self Diagnostic Result" for "MULTI AV" using CONSULT.

Are any DTCs displayed?

YES >> Refer to [AV-253, "DTC Index"](#).

NO >> GO TO 4.

4.PERFORM SYMPTOM DIAGNOSIS

Refer to [AV-306, "Symptom Table"](#).

>> GO TO 5

5.FINAL CHECK

Refer to symptom described by the customer in step 1.

Is the symptom still present?

YES >> GO TO 2

NO >> Inspection End.

INSPECTION AND ADJUSTMENT

< BASIC INSPECTION >

[NAVIGATION WITHOUT BOSE]

INSPECTION AND ADJUSTMENT

ADDITIONAL SERVICE WHEN REMOVING BATTERY NEGATIVE TERMINAL

ADDITIONAL SERVICE WHEN REMOVING BATTERY NEGATIVE TERMINAL : Description

INFOID:000000010641878

- Refer to [AV-209, "Precaution for Removing 12V Battery"](#).
- When removing the 12V battery terminal, the following work is required.

WORK AFTER AV CONTROL UNIT REPLACEMENT

- Re-registration of user ID and password to the AV control unit.
- Time adjustment check with VCM check.

WORK AFTER REMOVING THE 12V BATTERY TERMINAL

Time adjustment check with VCM check.

ADDITIONAL SERVICE WHEN REMOVING BATTERY NEGATIVE TERMINAL : Work Procedure

INFOID:000000010641879

When the AV control unit is not replaced, start from step 2.

1. REPLACE AV CONTROL UNIT

1. Refer to [AV-209, "Precaution for Removing 12V Battery"](#).
2. Replace the AV control unit. [AV-318, "Removal and Installation"](#).

>> GO TO 2.

2. OBTAIN THE CURRENT TIME.

1. Turn the power switch to the ON or Ready position in a location where the GPS antenna signal can be received.
2. Start the AV control unit and receive the current time with the GPS antenna.

>> GO TO 3.

3. CHECK THE TIME WITH VCM

1. Press " switch and select "Charging Timer" on the menu screen.
2. Confirm that the time is displayed at the upper right (GPS acquisition time) and lower left (VCM memory time) of the "Charging Timer" screen.
3. If the time does not match after 1 or 2 minutes from the screen display, the update screen is displayed.

Is the update screen displayed?

- NO >> Work End.
- YES >> GO TO 4.

4. TIME ADJUSTMENT CHECK WITH VCM

1. Press "correct time" displayed on the screen to correct the time.
2. After correction, confirm that the time displayed at the upper right (GPS acquisition time) and lower left (VCM memory time) of the "Charging Timer" screen are the same.

>> Work End.

SOFTWARE UPDATE (AV CONTROL UNIT)

SOFTWARE UPDATE (AV CONTROL UNIT) : Description

INFOID:000000010641880

The software of the AV control unit can be updated by using an SD card.

SOFTWARE UPDATE (AV CONTROL UNIT) : Work Procedure

INFOID:000000010641881

1. START OF CONFIRMATION/ADJUSTMENT MODE

A
B
C
D
E
F
G
H
I
J
K
L
M
O
P

AV

INSPECTION AND ADJUSTMENT

< BASIC INSPECTION >

[NAVIGATION WITHOUT BOSE]

1. Set the power switch on ACC.
2. With AUDIO OFF, press "MAP" switch three times, "⏻" switch twice, and press "MAP" switch once to start the On Board Diagnosis Function.

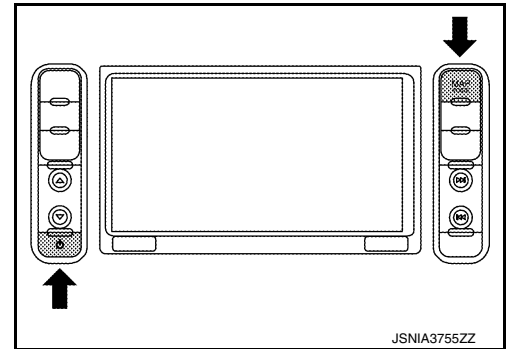

3. Select "Software Update" in Confirmation/Adjustment mode.

>> GO TO 2.

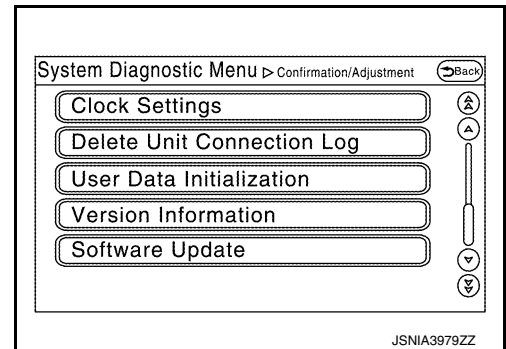

2. UPDATE THE SOFTWARE OF THE AV CONTROL UNIT

1. "Please insert SD Card for the program update and Push OK button" pops up.

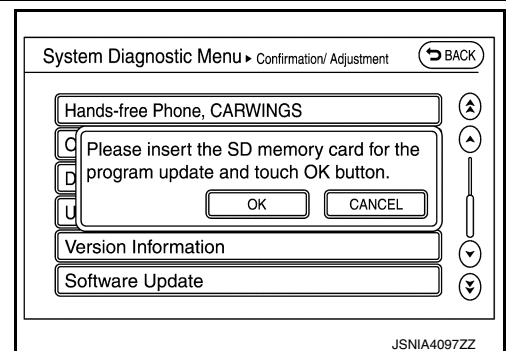

2. Press the OPEN/TILT switch of the AV control unit to open the display.
3. Remove the cover of the SD slot and insert the SD card for software update into the SD card sub-slot (on the left).

NOTE:

Leave the map SD card inserted in the main slot (on the right).

4. Press the OPEN/TILT switch of the AV control unit to close the display.
5. Select "OK" in the pop-up confirmation to start software update.

NOTE:

The instructions below must be followed during software update.

- Never turn the power switch OFF.
- Never remove the SD card.
- Never use other functions. They are not available.

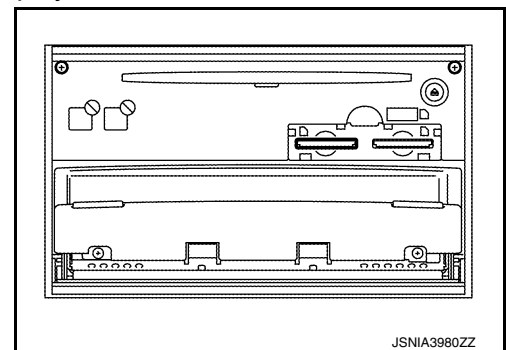

6. When the software update is complete, "The update of the program completed successfully. Please switch the power off and on again to reboot." is shown.
7. Press the OPEN/TILT switch of the AV control unit to open the display.
8. Remove the SD card for software update from the SD card sub-slot (on the left) and install the cover of the SD slot.
9. Turn the power switch OFF.

INSPECTION AND ADJUSTMENT

< BASIC INSPECTION >

[NAVIGATION WITHOUT BOSE]

>> GO TO 3.

3. CHECK THE UPDATED SOFTWARE VERSION OF THE AV CONTROL UNIT

1. Set the power switch on ACC after a lapse of 15 seconds or more after the power switch is turned OFF.
2. With AUDIO OFF, press "MAP" switch three times, "⏻" switch twice, and press "MAP" switch once to start the On Board Diagnosis Function.
3. Select "Version Information" in Confirmation/Adjustment mode.
4. Check version information to see that the Boot ware and the application version are updated.

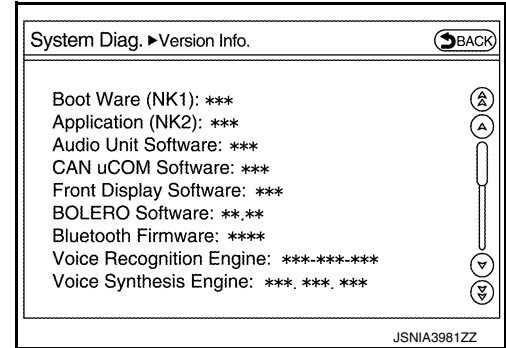

>> End of program.

ADDITIONAL SERVICE WHEN REPLACING AV CONTROL UNIT

ADDITIONAL SERVICE WHEN REPLACING AV CONTROL UNIT : Description

INFOID:000000010641882

BEFORE REPLACEMENT

When replacing AV control unit, save or print current vehicle specification with CONSULT configuration before replacement.

AFTER REPLACEMENT

CAUTION:

When replacing AV control unit, you must perform "After Replace ECU" or "Manual Configuration" with CONSULT.

- Complete the procedure of "After Replace ECU" or "Manual Configuration" in order.
- If you set incorrect "After Replace ECU" or "Manual Configuration", incidents might occur.
- Configuration is different for each vehicle model. Confirm configuration of each vehicle model.

ADDITIONAL SERVICE WHEN REPLACING AV CONTROL UNIT : Work Procedure

INFOID:000000010641883

1. SAVING VEHICLE SPECIFICATION

Ⓜ-CONSULT Configuration

Perform "Before Replace ECU" to save or print current vehicle specification. Refer to [AV-280, "CONFIGURATION \(AV CONTROL UNIT\) : Description"](#).

NOTE:

If "Before Replace ECU" can not be used, use the "Manual Configuration".

>> GO TO 2.

2. REPLACE AV CONTROL UNIT

Replace AV control unit. Refer to [AV-318, "Removal and Installation"](#).

>> GO TO 3.

3. WRITING VEHICLE SPECIFICATION

Ⓜ-CONSULT Configuration

INSPECTION AND ADJUSTMENT

< BASIC INSPECTION >

[NAVIGATION WITHOUT BOSE]

Perform "After Replace ECU" or "Manual Configuration" to write vehicle specification. Refer to [AV-280, "CONFIGURATION \(AV CONTROL UNIT\) : Work Procedure"](#).

>> GO TO 4.

4. OPERATION CHECK

Check that the operation of the AV control unit and camera images (fixed guide lines and predictive course lines) are normal.

>> Work End.

CONFIGURATION (AV CONTROL UNIT)

CONFIGURATION (AV CONTROL UNIT) : Description

INFOID:000000010641884

- Since vehicle specifications are not included in the AV control unit after replacement, it is required to write vehicle specifications with CONSULT.
- Configuration has three functions as follows.

Function		Description
Read/Write Configuration	Before Replace ECU	Allows the reading of vehicle specification written in AV control unit to store the specification in CONSULT.
	After Replace ECU	Allows the writing of the vehicle information stored in CONSULT into the AV control unit.
Manual Configuration		Allows the writing of the vehicle specification into the AV control unit by hand.

CONFIGURATION (AV CONTROL UNIT) : Work Procedure

INFOID:000000010641885

1. WRITE VEHICLE SPECIFICATION

ⓐCONSULT Configuration

Write vehicle specification into AV control unit.

To write vehicle specification stored in CONSULT into the AV control unit>>GO TO 2.

To write vehicle specification into the AV control unit by hand>>GO TO 3.

2. WRITE STORED DATA

ⓐCONSULT Configuration

Select "After Replace ECU" in "Read/Write Configuration." Write data stored in CONSULT with the "Before Replace ECU" function into the AV control unit.

>> GO TO 4.

3. MANUALLY WRITE VEHICLE SPECIFICATION

ⓐCONSULT Configuration

Perform "Manual Configuration." Refer to the Configuration List to write vehicle specification into the AV control unit. Refer to [AV-281, "CONFIGURATION \(AV CONTROL UNIT\) : Configuration List"](#).

NOTE:

If selection items are not displayed on the CONSULT screen, touch "NEXT."

>> GO TO 4.

4. OPERATION CHECK

Check that the operation of the AV control unit and camera images (fixed guide lines and predictive course lines) are normal.

>> Work End.

INSPECTION AND ADJUSTMENT

< BASIC INSPECTION >

[NAVIGATION WITHOUT BOSE]

CONFIGURATION (AV CONTROL UNIT) : Configuration List

INFOID:000000010641886

CAUTION:

Check vehicle specifications before servicing.

MANUAL SETTING ITEM	
Items	Setting value
STEERING	LHD
	RHD
SOUND SYSTEM	BASE
	BOSE

PREDICTIVE COURSE LINE CENTER POSITION ADJUSTMENT

PREDICTIVE COURSE LINE CENTER POSITION ADJUSTMENT : Description

INFOID:000000010641887

Adjust the center position of the predictive course line of the rear view monitor if it is shifted.

PREDICTIVE COURSE LINE CENTER POSITION ADJUSTMENT : Work Procedure

INFOID:000000010641888

1.DRIVING

Drive the vehicle straight ahead 100 m (328.1 ft) or more at a speed of 30 km/h (18.6 MPH) or more.

>> END

A
B
C
D
E
F
G
H
I
J
K
L
M
O
P

AV

DTC/CIRCUIT DIAGNOSIS

U1000 CAN COMM CIRCUIT

Description

INFOID:0000000010641889

CAN (Controller Area Network) is a serial communication line for real time applications. It is an on board multiplex communication line with high data communication speed and excellent error detection ability. A modern vehicle is equipped with many ECMs, and each control unit shares information and links with other control units during operation (not independent). In CAN communication, 2 control units are connected with 2 communication lines (CAN H-line and CAN L-line) allowing a high rate of information transmission with less wiring. Each control unit transmits/receives data but selectively reads required data only. Refer to [LAN-37, "CAN COMMUNICATION SYSTEM : CAN Communication Signal Chart"](#) for details of the communication signal.

DTC Logic

INFOID:0000000010641890

DTC DETECTION LOGIC

DTC	Display contents of CONSULT	Malfunction detection condition	Probable malfunction location
U1000	CAN COMM CIRC [U1000]	When the AV control unit cannot communicate for 2 seconds or more.	CAN communication system

Diagnosis Procedure

INFOID:0000000010641891

1. PERFORM SELF-DIAGNOSIS

1. Turn the power switch ON and hold it for 2 seconds or more.
2. Check the self-diagnosis result of "multi-AV".

Is CAN communication system displayed?

- YES >> Refer to [LAN-17, "Trouble Diagnosis Procedure"](#).
- NO >> Refer to [GI-53, "Intermittent Incident"](#).

U1010 CONTROL UNIT (CAN)

< DTC/CIRCUIT DIAGNOSIS >

[NAVIGATION WITHOUT BOSE]

U1010 CONTROL UNIT (CAN)

DTC Logic

INFOID:000000010641892

DTC DETECTION LOGIC

DTC	Display contents of CONSULT	Malfunction detection condition	Action to take
U1010	CONTROL UNIT (CAN) [U1010]	Malfunction is detected during initial diagnosis of the AV control unit CAN controller.	Replace the AV control unit if malfunction constantly occurs. Refer to AV-318, "Removal and Installation" .

A
B
C
D
E
F
G
H
I
J
K
L
M
O
P

AV

U121F AV CONTROL UNIT

< DTC/CIRCUIT DIAGNOSIS >

[NAVIGATION WITHOUT BOSE]

U121F AV CONTROL UNIT

DTC Logic

INFOID:000000010641893

DTC	Display contents of CONSULT	DTC detection condition	Action to take
U121F	CONTROL UNIT [U121F]	AV control unit malfunction is detected	Replace the AV control unit if the malfunction constantly occurs. Refer to AV-318. "Removal and Installation" .

U1244 GPS ANTENNA

< DTC/CIRCUIT DIAGNOSIS >

[NAVIGATION WITHOUT BOSE]

U1244 GPS ANTENNA

DTC Logic

INFOID:000000010641894

DTC	Display contents of CONSULT	DTC detection condition	Possible malfunction factor/Action to take
U1244	GPS ANTENNA CONN [U1244]	GPS antenna connection malfunction is detected	<ul style="list-style-type: none">• Check the connection status of the GPS antenna.• Replace the GPS antenna. Refer to AV-323, "Removal and Installation".

Diagnosis Procedure

INFOID:000000010641895

Regarding Wiring Diagram information, refer to [AV-255, "Wiring Diagram"](#).

1. CHECK THE GPS ANTENNA CONNECTOR.

Check the connection status of the GPS antenna connector.

Is the check result normal?

YES >> GO TO 2.

NO >> Repair items found in non-standard condition.

2. CHECK THE GPS ANTENNA FEEDER.

Check the GPS antenna feeder visually.

Is the check result normal?

YES >> GO TO 3.

NO >> Replace the GPS antenna. Refer to [AV-323, "Removal and Installation"](#).

3. CHECK AV CONTROL UNIT VOLTAGE

1. Disconnect the GPS antenna connector.
2. Turn power switch ON.
3. Check voltage between AV control unit connector and ground.

AV control unit	Ground	Voltage
Terminal		
83		Approximately 5.0 V

Is the check result normal?

YES >> Replace the GPS antenna. Refer to [AV-323, "Removal and Installation"](#).

NO >> Replace the AV control unit. Refer to [AV-318, "Removal and Installation"](#).

A
B
C
D
E
F
G
H
I
J
K
L
M
O
P

AV

U1258 SATELLITE RADIO ANTENNA

< DTC/CIRCUIT DIAGNOSIS >

[NAVIGATION WITHOUT BOSE]

U1258 SATELLITE RADIO ANTENNA

DTC Logic

INFOID:000000010641896

DTC	Display contents of CONSULT	DTC Detection Condition	Possible causes
U1258	XM ANTENNA CONN [U1258]	Satellite radio antenna connection malfunction is detected.	Satellite radio antenna disconnection.

Diagnosis Procedure

INFOID:000000010641897

Regarding Wiring Diagram information, refer to [AV-255, "Wiring Diagram"](#).

1. SATELLITE RADIO ANTENNA CHECK

Visually check satellite radio antenna and antenna feeder.

Is the inspection result normal?

- YES >> GO TO 2.
- NO >> Repair malfunctioning parts.

2. CHECK AV CONTROL UNIT VOLTAGE

1. Disconnect satellite radio antenna connector.
2. Turn power switch ON.
3. Check voltage between AV control unit and ground.

(+)	(-)	Voltage (Approx.)
AV control unit		
Terminal		
88	Ground	5.0 V

Is the inspection result normal?

- YES >> Inspection End.
- NO >> Replace AV control unit. Refer to [AV-318, "Removal and Installation"](#).

U1263 USB

DTC Logic

INFOID:000000010641898

DTC DETECTION LOGIC

NOTE:

Before performing the diagnosis, be sure to check that the external input device has no malfunction.

DTC	Display contents of CONSULT	Malfunction detection condition	Action to take
U1263	USB overcurrent [U1263]	Overcurrent of the USB connector is detected.	Check the USB harness between the AV control unit and USB connector.

Diagnosis Procedure

INFOID:000000010641899

1.CHECK USB HARNESS

Check the USB harness visually and check if there is any pinching.

Is the check result normal?

- YES >> Replace the AV control unit. Refer to [AV-318. "Removal and Installation"](#).
- NO >> Replace the USB harness. Refer to [AV-329. "Removal and Installation"](#).

A
B
C
D
E
F
G
H
I
J
K
L
M
O
P

AV

U1266 AV CONTROL UNIT

< DTC/CIRCUIT DIAGNOSIS >

[NAVIGATION WITHOUT BOSE]

U1266 AV CONTROL UNIT

DTC Logic

INFOID:000000010641900

DTC	Display contents of CONSULT	DTC detection condition	Action to take
U1266	TCU CONN [U1266]	Malfunction is detected between the AV control unit and TCU.	Check the connection between the AV control unit and TCU.

U1300 AV COMM CIRCUIT

< DTC/CIRCUIT DIAGNOSIS >

[NAVIGATION WITHOUT BOSE]

U1300 AV COMM CIRCUIT

Description

INFOID:000000010641901

U1300 is displayed when the AV signal error is detected for the multi AV system. It is always displayed together with the error of the control unit connected to the AV control unit via AV communication. Determine the possible malfunction cause from the table below.

SELF-DIAGNOSIS RESULTS DISPLAY ITEM

DTC	Display contents of CONSULT	Description	Probable malfunction location
U1300 U1240	<ul style="list-style-type: none">• AV COMM CIRCUIT [U1300]• SWITCH CONN [U1240]	<p>When either one of the following items are detected:</p> <ul style="list-style-type: none">• multifunction switch power supply and ground circuits are malfunctioning.• AV communication circuits between the AV control unit and multifunction switch are malfunctioning.	<ul style="list-style-type: none">• Multifunction switch power supply and ground circuits.• AV communication circuits between AV control unit and multifunction switch.

A
B
C
D
E
F
G
H
I
J
K
L
M
N
O
P

AV

U1310 AV CONTROL UNIT

< DTC/CIRCUIT DIAGNOSIS >

[NAVIGATION WITHOUT BOSE]

U1310 AV CONTROL UNIT

DTC Logic

INFOID:000000010641902

DTC	Display contents of CONSULT	DTC detection condition	Action to take
U1310	CONTROL UNIT (AV) [U1310]	AV communication circuit initial diagnosis malfunction is detected	Replace the AV control unit if the malfunction constantly occurs. Refer to AV-318. "Removal and Installation" .

POWER SUPPLY AND GROUND CIRCUIT

< DTC/CIRCUIT DIAGNOSIS >

[NAVIGATION WITHOUT BOSE]

POWER SUPPLY AND GROUND CIRCUIT

AV CONTROL UNIT

AV CONTROL UNIT : Diagnosis Procedure

INFOID:000000010641903

Regarding Wiring Diagram information, refer to [AV-255. "Wiring Diagram"](#).

1. CHECK FUSE

Check if the following fuses are blown.

Power supply	Fuse No.
BAT	34
Power switch ACC	19

Is the check result normal?

YES >> GO TO 2.

NO >> Replace the blown fuse after repairing the affected circuit.

2. CHECK BATTERY VOLTAGE

Check the voltage between AV control unit harness connector and ground.

Signal	AV control unit Connector	Probe Terminal		Test condition Power switch	Standard	Reference value
		(+)	(-)			
BAT	M95	19	Ground	OFF	9 – 16 V	Battery voltage
ACC		7		ACC	4.5 – 16 V	

Is the check result normal?

YES >> Inspection End.

NO >> Repair or replace harness and connectors.

A
B
C
D
E
F
G
H
I
J
K
L
M
O
P

AV

FRONT DOOR SPEAKER

< DTC/CIRCUIT DIAGNOSIS >

[NAVIGATION WITHOUT BOSE]

FRONT DOOR SPEAKER

Diagnosis Procedure

INFOID:000000010641904

Regarding Wiring Diagram information, refer to [AV-255. "Wiring Diagram"](#).

1. CONNECTOR CHECK

Check the AV control unit and speaker connectors for the following:

- Proper connection
- Damage
- Disconnected or loose terminals

Is the inspection result normal?

YES >> GO TO 2

NO >> Repair the terminals or connectors.

2. CHECK FRONT DOOR SPEAKER SIGNAL CIRCUIT CONTINUITY

1. Disconnect AV control unit connector M95 and suspect front door speaker connector.
2. Check continuity between AV control unit connector M95 and suspect front door speaker connector.

AV control unit		Front door speaker		Continuity
Connector	Terminal	Connector	Terminal	
M95	2	D23 (LH)	1	Yes
	3		2	
	11	D123 (RH)	1	
	12		2	

3. Check continuity between AV control unit connector M95 and ground.

AV control unit		Ground	Continuity
Connector	Terminal		
M95	2	—	No
	3		
	11		
	12		

Is the inspection result normal?

YES >> GO TO 3

NO >> Repair or replace harness or connectors.

3. CHECK FRONT DOOR SPEAKER SIGNAL

1. Connect AV control unit connector M95 and suspect front door speaker connector.
2. Turn power switch to ACC.
3. Push AV control unit POWER switch.
4. Check signal between terminals of AV control unit connector M95.

AV control unit connector M95		Condition	Reference value
(+)	(-)		
Terminal	Terminal		

FRONT DOOR SPEAKER

< DTC/CIRCUIT DIAGNOSIS >

[NAVIGATION WITHOUT BOSE]

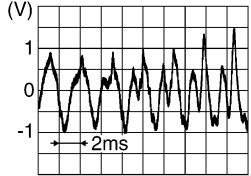
2	3	Audio signal output	
11	12		

Is the inspection result normal?

- YES >> Replace front door speaker. Refer to [AV-320. "Removal and Installation"](#).
- NO >> Replace AV control unit. Refer to [AV-318. "Removal and Installation"](#).

A
B
C
D
E
F
G
H
I
J
K
L
M
O
P

AV

TWEETER

Diagnosis Procedure

INFOID:000000010641905

Regarding Wiring Diagram information, refer to [AV-255. "Wiring Diagram"](#).

1. CONNECTOR CHECK

Check the AV control unit and speaker connectors for the following:

- Proper connection
- Damage
- Disconnected or loose terminals

Is the inspection result normal?

- YES >> GO TO 2
 NO >> Repair the terminals or connectors.

2. CHECK TWEETER SIGNAL CIRCUIT CONTINUITY

1. Disconnect AV control unit connector M95 and suspect tweeter connector.
2. Check continuity between AV control unit connector M95 and suspect tweeter connector.

AV control unit		Tweeter		Continuity
Connector	Terminal	Connector	Terminal	
M95	2	M15 (LH)	1	Yes
	3		2	
	11	M525 (RH)	1	
	12		2	

3. Check continuity between AV control unit connector M95 and ground.

AV control unit		Ground	Continuity
Connector	Terminal		
M95	2	—	No
	3		
	11		
	12		

Is the inspection result normal?

- YES >> GO TO 3
 NO >> Repair or replace harness or connectors.

3. CHECK TWEETER SIGNAL

1. Connect AV control unit connector M95 and suspect tweeter connector.
2. Turn power switch to ACC.
3. Push AV control unit POWER switch.
4. Check signal between terminals of AV control unit connector M95.

AV control unit connector M95		Condition	Reference value
(+)	(-)		
Terminal	Terminal		

TWEETER

< DTC/CIRCUIT DIAGNOSIS >

[NAVIGATION WITHOUT BOSE]

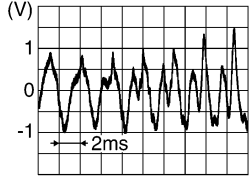
2	3	Audio signal output	
11	12		

Is the inspection result normal?

- YES >> Replace tweeter. Refer to [AV-321. "Removal and Installation"](#).
- NO >> Replace AV control unit. Refer to [AV-318. "Removal and Installation"](#).

A
B
C
D
E
F
G
H
I
J
K
L
M
O
P

AV

REAR DOOR SPEAKER

< DTC/CIRCUIT DIAGNOSIS >

[NAVIGATION WITHOUT BOSE]

REAR DOOR SPEAKER

Diagnosis Procedure

INFOID:000000010641906

Regarding Wiring Diagram information, refer to [AV-255. "Wiring Diagram"](#).

1. CONNECTOR CHECK

Check the AV control unit and speaker connectors for the following:

- Proper connection
- Damage
- Disconnected or loose terminals

Is the inspection result normal?

YES >> GO TO 2

NO >> Repair the terminals or connectors.

2. CHECK REAR DOOR SPEAKER SIGNAL CIRCUIT CONTINUITY

1. Disconnect AV control unit connector M95 and suspect rear door speaker connector.
2. Check continuity between AV control unit connector M95 and suspect rear door speaker connector.

AV control unit		Rear door speaker		Continuity
Connector	Terminal	Connector	Terminal	
M95	4	D205 (LH)	1	Yes
	5		2	
	13	D305 (RH)	1	
	14		2	

3. Check continuity between AV control unit connector M95 and ground.

AV control unit		Ground	Continuity
Connector	Terminal		
M44	4	—	No
	5		
	13		
	14		

Is the inspection result normal?

YES >> GO TO 3

NO >> Repair or replace harness or connectors.

3. CHECK REAR DOOR SPEAKER SIGNAL

1. Connect AV control unit connector M95 and suspect rear door speaker connector.
2. Turn power switch to ACC.
3. Push AV control unit POWER switch.
4. Check signal between terminals of AV control unit connector M95.

AV control unit connector M95		Condition	Reference value
(+)	(-)		
Terminal	Terminal		

REAR DOOR SPEAKER

< DTC/CIRCUIT DIAGNOSIS >

[NAVIGATION WITHOUT BOSE]

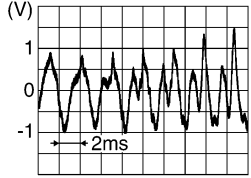
4	5	Audio signal output	
13	14		

Is the inspection result normal?

- YES >> Replace rear door speaker. Refer to [AV-322. "Removal and Installation"](#).
- NO >> Replace AV control unit. Refer to [AV-318. "Removal and Installation"](#).

A
B
C
D
E
F
G
H
I
J
K
L
M
O
P

AV

CAMERA IMAGE SIGNAL CIRCUIT

< DTC/CIRCUIT DIAGNOSIS >

[NAVIGATION WITHOUT BOSE]

CAMERA IMAGE SIGNAL CIRCUIT

Diagnosis Procedure

INFOID:000000010641907

Regarding Wiring Diagram information, refer to [AV-33. "Wiring Diagram"](#).

1. CHECK REVERSE INPUT SIGNAL

1. Turn power switch ON.
2. Shift the selector lever to R (reverse).
3. Check voltage between AV control unit connector M96 and ground.

AV control unit		Ground	Condition	Voltage (Approx.)
(+)		(-)		
Connector	Terminal			
M96	45	—	Selector lever in R (reverse)	Battery Voltage

Is inspection result normal?

YES >> GO TO 2.

NO >> Repair or replace harness or connectors.

2. CHECK CAMERA POWER SUPPLY CIRCUIT CONTINUITY

1. Turn power switch OFF.
2. Disconnect AV control unit connector M96 and rear view camera connector.
3. Check continuity between AV control unit connector M96 and rear view camera connector D556.

AV control unit		Rear view camera		Continuity
Connector	Terminal	Connector	Terminal	
M96	39	D556	1	Yes

4. Check continuity between AV control unit connector M96 and ground.

AV control unit		Ground	Continuity
Connector	Terminal		
M96	39		No

Is inspection result normal?

YES >> GO TO 3.

NO >> Repair or replace harness or connectors.

3. CHECK CAMERA POWER SUPPLY VOLTAGE

1. Connect AV control unit connector M96 and rear view camera connector.
2. Turn power switch ON.
3. Shift the selector lever to "R".
4. Check voltage between AV control unit connector M96 and ground.

AV control unit		Ground	Condition	Voltage (Approx.)
(+)		(-)		
Connector	Terminal			
M96	39	—	Selector lever is in "R".	6.0 V

Is inspection result normal?

YES >> GO TO 4.

NO >> Replace AV control unit. Refer to [AV-69. "Removal and Installation"](#).

CAMERA IMAGE SIGNAL CIRCUIT

< DTC/CIRCUIT DIAGNOSIS >

[NAVIGATION WITHOUT BOSE]

4. CHECK CAMERA IMAGE SIGNAL CIRCUIT CONTINUITY

1. Turn power switch OFF.
2. Disconnect AV control unit connector M96 and rear view camera connector.
3. Check continuity between AV control unit connector M96 and rear view camera connector D556.

AV control unit		Rear view camera		Continuity
Connector	Terminal	Connector	Terminal	
M96	40	D556	3	Yes

4. Check continuity between AV control unit connector M96 and ground.

AV control unit		Ground	Continuity
Connector	Terminal		
M96	40		No

Is inspection result normal?

- YES >> GO TO 5.
 NO >> Repair or replace harness or connectors.

5. CHECK CAMERA GROUND CIRCUIT CONTINUITY

Check continuity between AV control unit connector M96 and rear view camera connector D556.

AV control unit		Rear view camera		Continuity
Connector	Terminal	Connector	Terminal	
M96	59	D556	2	Yes

Is inspection result normal?

- YES >> GO TO 6.
 NO >> Repair or replace harness or connectors.

6. CHECK CAMERA IMAGE SIGNAL

1. Connect AV control unit connector M96 and rear view camera connector.
2. Turn power switch ON.
3. Shift the selector lever to "R".
4. Check signal between AV control unit connector M96 and ground.

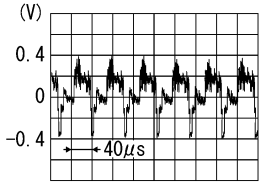
AV control unit		Ground	Condition	Reference value
(+)		(-)		
Connector	Terminal			
M96	40	—	Camera image displayed.	 <p style="text-align: right; font-size: small;">SKIB2251J</p>

Is inspection result normal?

- YES >> Replace AV control unit. Refer to [AV-69, "Removal and Installation"](#).
 NO >> Replace rear view camera. Refer to [AV-77, "Removal and Installation"](#).

A
B
C
D
E
F
G
H
I
J
K
L
M
O
P

AV

AUXILIARY INPUT JACK

< DTC/CIRCUIT DIAGNOSIS >

[NAVIGATION WITHOUT BOSE]

AUXILIARY INPUT JACK

Diagnosis Procedure

INFOID:000000010641908

Regarding Wiring Diagram information, refer to [AV-255. "Wiring Diagram"](#).

1. CHECK AUXILIARY INPUT JACK HARNESS CONTINUITY

1. Turn power switch OFF.
2. Disconnect audio unit connector M96 and auxiliary input jack connector M52.
3. Check continuity between audio unit connector M96 and auxiliary input jack connector M52.

Audio unit		Auxiliary input jack		Continuity
Connector	Terminal	Connector	Terminal	
M96	36	M52	1	Yes
	55		2	
	35		4	

4. Check continuity between audio unit connector M96 and ground.

Audio unit		—	Continuity
Connector	Terminal		
M96	35	Ground	No
	55		

Is the inspection result normal?

- YES >> Replace the auxiliary input jack. Refer to [AV-328. "Removal and Installation"](#).
NO >> Repair or replace harness or connectors.

MICROPHONE SIGNAL CIRCUIT

< DTC/CIRCUIT DIAGNOSIS >

[NAVIGATION WITHOUT BOSE]

MICROPHONE SIGNAL CIRCUIT

Diagnosis Procedure

INFOID:000000010641909

Regarding Wiring Diagram information, refer to [AV-255. "Wiring Diagram"](#).

1. CHECK MICROPHONE SIGNAL CIRCUIT CONTINUITY

1. Turn power switch OFF.
2. Disconnect AV control unit connector M96 and microphone connector R3.
3. Check continuity between AV control unit connector M96 and microphone connector R3.

AV control unit		Microphone		Continuity
Connector	Terminal	Connector	Terminal	
M96	34	R3	4	Yes
	53		1	
	54		2	

4. Check continuity between AV control unit connector M961 and ground.

AV control unit		Ground	Continuity
Connector	Terminal		
M96	34	—	No
	53		
	54		

Is inspection result normal?

- YES >> GO TO 2.
NO >> Repair or replace harness or connectors.

2. CHECK MICROPHONE VCC VOLTAGE

1. Connect AV control unit connector M96.
2. Turn power switch ON.
3. Check voltage between terminals of AV control unit connector M96.

AV control unit connector M96		Voltage (Approx.)
(+)	(-)	
Terminal	Terminal	
34	54	5.0 V

Is the inspection result normal?

- YES >> GO TO 3.
NO >> Replace AV control unit. Refer to [AV-318. "Removal and Installation"](#).

3. CHECK MICROPHONE SIGNAL

1. Connect microphone connector.
2. Check signal between terminals of AV control unit connector M96.

A
B
C
D
E
F
G
H
I
J
K
L
M
AV
O
P

MICROPHONE SIGNAL CIRCUIT

< DTC/CIRCUIT DIAGNOSIS >

[NAVIGATION WITHOUT BOSE]

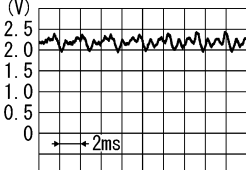
AV control unit connector M96		Condition	Reference value
(+)	(-)		
Terminal	Terminal		
53	54	Speak into microphone.	 <p style="text-align: right;">PKIB5037J</p>

Is the inspection result normal?

- YES >> Replace AV control unit. Refer to [AV-318. "Removal and Installation"](#).
 NO >> Replace microphone. Refer to [AV-324. "Removal and Installation"](#).

STEERING SWITCH

< DTC/CIRCUIT DIAGNOSIS >

[NAVIGATION WITHOUT BOSE]

STEERING SWITCH





Diagnosis Procedure

INFOID:000000010641910

Regarding Wiring Diagram information, refer to [AV-255. "Wiring Diagram"](#).

1. CHECK STEERING WHEEL AUDIO CONTROL SWITCH RESISTANCE

1. Turn power switch OFF.
2. Disconnect combination switch connector M112.
3. Check resistance between the terminals of combination switch connector M112.

Combination switch connector M112		Condition	Resistance Ω (Approx.)
Terminal	Terminal		
14	17	Depress SOURCE switch.	1
		Depress Δ switch.	121
		Depress ∇ switch.	321
		Depress  switch.	723
15	17	Depress $-$  switch.	1
		Depress  + switch.	121
		Depress  switch.	321

Is the inspection result normal?

YES >> GO TO 2.

NO >> Replace steering switches. Refer to [AV-327. "Removal and Installation"](#).

2. CHECK COMBINATION SWITCH

Check continuity between combination switch connectors M112 and M92.

Combination switch				Continuity
Connector	Terminal	Connector	Terminal	
M112	14	M92	24	Yes
	15		31	
	17		33	

Is the inspection result normal?

YES >> GO TO 3.

NO >> Replace spiral cable. Refer to [SR-23. "Removal and Installation"](#).

3. CHECK HARNESS BETWEEN COMBINATION SWITCH AND AV CONTROL UNIT

1. Disconnect AV control unit connector M95.
2. Check continuity between combination switch connector M92 and AV control unit connector M95.

Combination switch		AV control unit		Continuity
Connector	Terminal	Connector	Terminal	
M92	24	M95	6	Yes
	31		16	
	33		15	

STEERING SWITCH

< DTC/CIRCUIT DIAGNOSIS >

[NAVIGATION WITHOUT BOSE]

3. Check continuity between combination switch connector M92 and ground.

Combination switch		Ground	Continuity
Connector	Terminal		
M92	24	—	No
	31		
	33		

Is the inspection result normal?

- YES >> Replace AV control unit. Refer to [AV-318. "Removal and Installation"](#).
- NO >> Repair or replace harness or connectors.

USB CONNECTOR

Diagnosis Procedure

INFOID:000000010641911

Regarding Wiring Diagram information, refer to [AV-255. "Wiring Diagram"](#).

1. CHECK USB HARNESS CONTINUITY

1. Turn power switch OFF.
2. Disconnect AV control unit connector M98 and USB connector M53.
3. Check continuity between AV control unit connector M98 and USB connector M53.

AV control unit		USB		Continuity
Connector	Terminal	Connector	Terminal	
M98	78	M53	2	Yes
	79		1	
	80		4	
	81		3	
	82		5	

4. Check continuity between AV control unit connector M98 and ground.

AV control unit		—	Continuity
Connector	Terminal		
M98	79	Ground	No
	82		

Is the inspection result normal?

- YES >> Replace the USB connector. Refer to [AV-329. "Removal and Installation"](#).
 NO >> Repair or replace harness or connectors.

A
B
C
D
E
F
G
H
I
J
K
L
M
O
P

AV

SYMPTOM DIAGNOSIS

MULTI AV SYSTEM

Symptom Table

INFOID:000000010641912

RELATED TO AUDIO

Symptoms	Check items	Probable malfunction location
The disk cannot be removed.	AV control unit	Malfunction in AV control unit. Refer to AV-238, "On Board Diagnosis Function" .
No sound comes out or the level of the sound is low.	No sound from all speakers.	<ul style="list-style-type: none"> • Speaker circuit shorted to ground. Refer to AV-255, "Wiring Diagram". • AV control unit power supply and ground circuits malfunction. Refer to AV-291, "AV CONTROL UNIT : Diagnosis Procedure".
	Only a certain speaker (front door speaker LH, front door speaker RH, tweeter LH, tweeter RH, rear door speaker LH, rear door speaker RH) does not output sound.	<ul style="list-style-type: none"> • Poor connector connection of speaker. • Sound signal circuit malfunction between AV control unit and speaker. Refer to: <ul style="list-style-type: none"> - AV-292, "Diagnosis Procedure" (front door speaker). - AV-294, "Diagnosis Procedure" (tweeter). - AV-296, "Diagnosis Procedure" (rear door speaker). • Malfunction in speaker. Refer to: <ul style="list-style-type: none"> - AV-320, "Removal and Installation" (front door speaker). - AV-321, "Removal and Installation" (tweeter). - AV-322, "Removal and Installation" (rear door speaker). • Malfunction in AV control unit. Refer to AV-238, "On Board Diagnosis Function".
Noise is mixed with audio.	Noise comes out from all speakers.	<ul style="list-style-type: none"> • Malfunction in AV control unit. Refer to AV-238, "On Board Diagnosis Function".
	Noise comes out only from a certain speaker (front door speaker LH, front door speaker RH, tweeter LH, tweeter RH, rear door speaker LH, rear door speaker RH).	<ul style="list-style-type: none"> • Poor connector connection of speaker. • Sound signal circuit malfunction between AV control unit and speaker. Refer to: <ul style="list-style-type: none"> - AV-292, "Diagnosis Procedure" (front door speaker). - AV-294, "Diagnosis Procedure" (tweeter). - AV-296, "Diagnosis Procedure" (rear door speaker). • Malfunction in speaker. • Poor Installation of speaker (e.g. backlash and looseness). Refer to: <ul style="list-style-type: none"> - AV-320, "Removal and Installation" (front door speaker). - AV-321, "Removal and Installation" (tweeter). - AV-322, "Removal and Installation" (rear door speaker). • Malfunction in AV control unit. Refer to AV-238, "On Board Diagnosis Function".
	Noise is mixed with radio only (when the vehicle hits a bump or while driving over bad roads)	Poor connector connection of antenna or antenna feeder. Refer to AV-325, "Antenna Feeder" .

MULTI AV SYSTEM

< SYMPTOM DIAGNOSIS >

[NAVIGATION WITHOUT BOSE]

Symptoms	Check items	Probable malfunction location
No radio reception or poor reception.	<ul style="list-style-type: none"> Other audio sounds are normal. Any radio station cannot be received or poor reception is caused even after moving to a service area with good reception (e.g. a place with clear view and no obstacles generating external noises). 	Poor connector connection of antenna or antenna feeder. Refer to AV-325. "Antenna Feeder" .
No satellite radio reception.	There is malfunction in the CONSULT self diagnosis result. Refer to AV-247. "CONSULT Function" .	<ul style="list-style-type: none"> Malfunction in antenna, antenna feeder or AV control unit. Perform DTC diagnosis. Refer to AV-247. "CONSULT Function". Poor continuity in antenna feeder. Poor connector connection of antenna or antenna feeder. Refer to AV-325. "Antenna Feeder".
	There is no malfunction in the CONSULT self diagnosis result. Refer to AV-247. "CONSULT Function" .	<ul style="list-style-type: none"> Poor continuity in antenna feeder. Poor connector connection of antenna or antenna feeder. Loose satellite radio antenna mounting nut. Refer to AV-325. "Antenna Feeder".
Buzz/rattle sound from speaker	The majority of buzz/rattle sounds are not indicative of an issue with the speaker, usually something nearby the speaker is causing the buzz/rattle.	Refer to "SQUEAK AND RATTLE TROUBLE DIAGNOSIS" in the appropriate interior trim section.

RELATED TO HANDS-FREE PHONE

Symptoms	Check items	Probable malfunction location
Does not recognize cellular phone connection (no connection is displayed on the display at the guide).	Repeat the registration of cellular phone.	
Hands-free phone cannot be established.	<ul style="list-style-type: none"> Hands-free phone operation can be made, but the communication cannot be established. Hands-free phone operation can be performed, however, voice between each other cannot be heard during the conversation. 	Malfunction in AV control unit. Replace AV control unit. Refer to AV-318. "Removal and Installation" .
The other party's voice cannot be heard by hands-free phone.	Check the "microphone speaker" in Inspection & Adjustment Mode if sound is heard.	
Originating sound is not heard by the other party with hands-free phone communication.	Sound operation function is normal.	
	Sound operation function does not work.	Microphone signal circuit malfunction. Refer to AV-301. "Diagnosis Procedure" .
The system cannot be operated.	<ul style="list-style-type: none"> The voice recognition can be controlled. Steering switch's , , and switch works, but does not work. 	Steering switch malfunction. Replace steering switch. Refer to AV-327. "Removal and Installation" .
	Steering switch's , , , and switches do not work.	Steering switch signal circuit malfunction. Refer to AV-303. "Diagnosis Procedure" .
	All steering switches do not work.	Steering switch ground circuit malfunction. Refer to AV-303. "Diagnosis Procedure" .

RELATED TO NAVIGATION

MULTI AV SYSTEM

< SYMPTOM DIAGNOSIS >

[NAVIGATION WITHOUT BOSE]

Symptoms	Check items	Probable malfunction location
Navigation system is inoperative.	Navigation malfunction.	<ul style="list-style-type: none">• Malfunction in hard disk drive (HDD).• Malfunction in AV control unit. Refer to AV-238, "On Board Diagnosis Function" .
	Steering switches malfunction.	Steering switch signal circuit malfunction. Refer to AV-303, "Diagnosis Procedure" .
	Voice activated control malfunction.	Microphone signal circuit malfunction. Refer to AV-301, "Diagnosis Procedure" . Steering switch signal circuit malfunction. Refer to AV-303, "Diagnosis Procedure" .

NORMAL OPERATING CONDITION

< SYMPTOM DIAGNOSIS >

[NAVIGATION WITHOUT BOSE]

NORMAL OPERATING CONDITION

Description

INFOID:0000000110641913

RELATED TO NOISE

The majority of the audio concerns are the result of outside causes (bad CD, electromagnetic interference, etc.).

The following noise results from variations in field strength, such as fading noise and multi-path noise, or external noise from trains and other sources. It is not a malfunction.

- Fading noise: This noise occurs because of variations in the field strength in a narrow range due to mountains or buildings blocking the signal.
- Multi-path noise: This noise results from the waves sent directly from the broadcast station arriving at the antenna at a different time from the waves which reflect off mountains or buildings.

The vehicle itself can be a source of noise if noise prevention parts or electrical equipment is malfunctioning. Check if noise is caused and/or changed by engine speed, power switch turned to each position, and operation of each piece of electrical equipment, and determine the cause.

NOTE:

The source of the noise can be found easily by listening to the noise while removing the fuses of electrical components, one by one.

Type of Noise and Possible Cause

Occurrence condition		Possible cause
Occurs only when engine is ON.	A continuous growling noise occurs. The speed of the noise varies with changes in the engine speed.	<ul style="list-style-type: none"> • Power components
The occurrence of the noise is linked with the operation of the fuel pump.		<ul style="list-style-type: none"> • Fuel pump condenser
Noise only occurs when various electrical components are operating.	A cracking or snapping sound occurs with the operation of various switches.	<ul style="list-style-type: none"> • Relay malfunction, AV control unit malfunction
	The noise occurs when various motors are operating.	<ul style="list-style-type: none"> • Motor case ground • Motor
The noise occurs constantly, not just under certain conditions.		<ul style="list-style-type: none"> • Rear defogger coil malfunction • Open circuit in printed heater • Poor ground of antenna feeder line
A cracking or snapping sound occurs while the vehicle is being driven, especially when it is vibrating excessively.		<ul style="list-style-type: none"> • Ground wire of body parts • Ground due to improper part installation • Wiring connections or a short circuit

RELATED TO HANDS-FREE PHONE

Symptom	Cause and Counter measure
Does not recognize cellular phone connection (No connection is displayed on the display at the guide).	<p>Some Bluetooth[®] enabled cellular phones may not be recognized by the in-vehicle phone module.</p> <p>Refer to "RELATED TO HANDS-FREE PHONE (Check Compatibility)" in AV-306, "Symptom Table".</p>
Cannot use hands-free phone.	<p>Customer will not be able to use a hands-free phone under the following conditions:</p> <ul style="list-style-type: none"> • The vehicle is outside of the telephone service area. • The vehicle is in an area where it is difficult to receive radio waves; such as in a tunnel, in an underground parking garage, near a tall building or in a mountainous area. • The cellular phone is locked to prevent it from being dialed. <p>NOTE:</p> <p>While a cellular phone is connected through the Bluetooth[®] wireless connection, the battery power of the cellular phone may discharge quicker than usual. The Bluetooth[®] Hands-Free Phone System cannot charge cellular phones.</p>

NORMAL OPERATING CONDITION

< SYMPTOM DIAGNOSIS >

[NAVIGATION WITHOUT BOSE]

Symptom	Cause and Counter measure
The other party's voice cannot be heard by hands-free phone.	When the radio wave condition is not ideal or ambient sound is too loud, it may be difficult to hear the other person's voice during a call.
Poor sound quality.	Do not place the cellular phone in an area surrounded by metal or far away from the in-vehicle phone module to prevent tone quality degradation and wireless connection disruption.

RELATED TO NAVIGATION

Basic Operation

Symptom	Cause	Remedy
No image is shown.	Display brightness adjustment is set fully to DARK side.	Adjust the display brightness.
No guide sound is heard. Audio guide volume is too low or too high.	Volume control is set to OFF, MIN or MAX.	Adjust the audio guide volume.
	Audio guidance is not available while the vehicle is driving on a dark pink route.	System is not malfunctioning.
Screen is too dark. Motion of the image is too slow.	Temperature inside the vehicle is low.	Wait until the temperature inside the vehicle reaches the proper temperature.
Small black or bright spots appear on the screen.	Symptom peculiar to a liquid crystal display (display unit).	System is not malfunctioning.

Vehicle Mark

Symptom	Cause	Remedy
Map screen and BIRDVIEW™ Name of the place vary with the screen.	Some thinning of the character data is done to prevent the display becoming to complex. In some cases and in some locations, the display contents may differ. The same place name, street name, etc. may not be displayed every time on account of the data processing.	System is not malfunctioning.
Vehicle mark is not positioned correctly.	Vehicle is transferred by ferry or by towing after its power switch is turned to OFF.	Drive the vehicle for a while in the GPS satellite signal receiving condition.
Screen will not switch to nighttime mode after the lighting switch is turned ON.	The daytime screen is selected by the "SWITCH SCREENS" when the last time the screen dimming setting is done. Switching between daytime/nighttime screen may be inhibited by the automatic illumination adjustment function.	Perform screen dimming and select the nighttime screen by "SWITCH SCREENS".
Map screen will not scroll in accordance with the vehicle travel.	Current location is not displayed.	Press "MAP" button to display the current location.
Vehicle mark will not be shown.	Current location is not displayed.	Press "MAP" button to display the current location.
Accuracy indicator (GPS satellite mark) on the map screen stays gray.	GPS satellite signal is intercepted because the vehicle is in or behind a building.	Move the vehicle out to an open space.
	GPS satellite signal cannot be received because an obstacle is placed on top of the instrument panel.	Do not place anything on top of the meter display (instrument panel).
	GPS satellites are not visible from current location.	Wait until GPS satellites are visible by moving the vehicle.

NORMAL OPERATING CONDITION

< SYMPTOM DIAGNOSIS >

[NAVIGATION WITHOUT BOSE]

Symptom	Cause	Remedy
Vehicle location accuracy is low.	Accuracy indicator (GPS satellite mark) on the map screen stays gray.	Current location is not determined.
	Vehicle speed setting by the vehicle speed pulse has been deviated (advanced or retarded) from the actual vehicle speed because tire chain is fitted or the system has been used on another vehicle.	Drive the vehicle for a while [for approx. 30 minutes at approx. 30 km/h (19 MPH)] and the deviation will be automatically adjusted. If advancement or retard still occur, perform the distance adjustment by CONFIRMATION/ADJUSTMENT mode of diagnosis function.
	Map data has error or omission. (Vehicle mark is always deviated to the same position.)	As a rule, an updated map DVD-ROM will be released once a year.

Destination, Passing Points and Menu Items Cannot be Selected/Set

Symptom	Cause	Remedy
Destination cannot be set.	Destination to be set is on an expressway.	Set the destination on an ordinary road.
Passing point is not searched when re-searching the route.	The vehicle has already passed the passing point, or the system judged so.	To include the passing points that have been passed into the route again, set the route again.
Route information will not be displayed.	Route searching has not been done.	Set the destination and perform route searching.
	Vehicle mark is not on the recommended route.	Drive on the recommended route.
	Route guide is turned OFF.	Turn route guide ON.
	Route information is not available on the dark pink route.	System is not malfunctioning.
After the route searching, no guide sign will appear as the vehicle goes near the entrance/exit to the toll road.	Vehicle mark is not on the recommended route. (On the display, only guide signs related to the recommended route will be shown.)	Drive on the recommended route.
Automatic route searching is not possible.	Vehicle is driving on a highway (gray route), or no recommended route is available.	Drive on a road to be searched. Or re-search the route manually. In this case, however, the whole route will be searched.
Performed automatic detour search (or detour search). However, the result is the same as that of the previous search.	Performed search with every conditions considered. However, the result is the same as that of the previous search.	System is not malfunctioning.
Passing points cannot be set.	More than five passing points were set.	Passing points can be set up to five. To stop at more than five points, perform sharing in several steps.
When setting the route, the starting point cannot be selected.	The current vehicle location is always set as the starting point of a route.	System is not malfunctioning.
Some menu items cannot be selected.	The vehicle is being driven.	Stop the vehicle at a safe place and then operate the system.

Voice Guide

NORMAL OPERATING CONDITION

< SYMPTOM DIAGNOSIS >

[NAVIGATION WITHOUT BOSE]

Symptom	Cause	Remedy
Voice guide will not operate.	Note: Voice guide is only available at intersections that satisfy certain conditions (indicated by ● on the map). Therefore, guidance may not be given even when the route on the map changes direction.	System is not malfunctioning.
	The vehicle is not on the recommended route.	Return to the recommended route or re-search the route.
	Voice guide is turned OFF.	Turn voice guide ON.
	Route guide is turned OFF.	Turn route guide ON.
Voice guide does not match the actual road pattern.	Voice guide may vary with the direction to which the vehicle is turn and the connection of the road to other roads.	Drive in conformity to the actual traffic rules.

Route Search

Symptom	Cause	Remedy
No route is shown.	No road to be searched is found around the destination.	Find wider road (orange road or wider) nearby and reset the destination and passing points onto it. Take care of the traveling direction when there are separate up and down roads.
	Starting point and the destination are too close.	Set the destination at more distant point.
	Conditional traffic regulation (day of the week/ time of the day) is set at the area around the current location or the destination.	Turn the time-regulating search conditions OFF. Turn "Avoid regulation time" in the search conditions OFF.
Indicated route is intermittent.	In some areas, highways (gray routes) are not used for the search ^(Note) Therefore, the route to the current location or the passing points may be intermittent.	System is not malfunctioning.
When the vehicle has passed the recommended route, it is deleted from the screen.	A recommended route is controlled by each section. When the vehicle has passed the passing point 1, then the map data from the starting point up to the passing point 1 will be deleted. (The data may remain undeleted in some area.)	System is not malfunctioning.
Detouring route is recommended.	In some areas, highways (gray routes) are not used for the search. (Note). Therefore, detour route may be recommended.	Set the route closer to the basic route (gray route).
	A detour route may be shown when some traffic regulation (one-way traffic, etc.) is set at the area around the starting point or the destination.	Slightly move the starting point or the destination, or set the passing point on the route of your choice.
	In the area where highways (gray routes) are used for the search, left turn has priority around the current location and the destination (passing points). For this reason, the recommended route may be detouring.	System is not malfunctioning.
Landmarks on the map do not match the actual ones.	This can be happen due to omission or error in the map data.	As a rule, an updated map DVD-ROM will be released once a year. Wait until the latest map has become available.
Recommended route is far from the starting point, passing points, and destination.	Starting point, passing points, and destination of the route guide were set far from the desired points because route searching data around these area were not stored.	Reset the destination onto the road nearby. If this road is one of the highways (gray routes), an ordinary road nearby may be displayed as the recommended route.

NOTE:

Except for the ordinance-designated cities. (Malfunctioning areas may be changed in the updated map disc.)

Examples of Current-Location Mark Displacement

NORMAL OPERATING CONDITION

< SYMPTOM DIAGNOSIS >

[NAVIGATION WITHOUT BOSE]

Vehicle's travel amount is calculated by reading its travel distance and turning angle. Therefore, if the vehicle is driven in the following manner, an error will occur in the vehicle's current location display. If correct location has not been restored after driving the vehicle for a while, perform location correction.

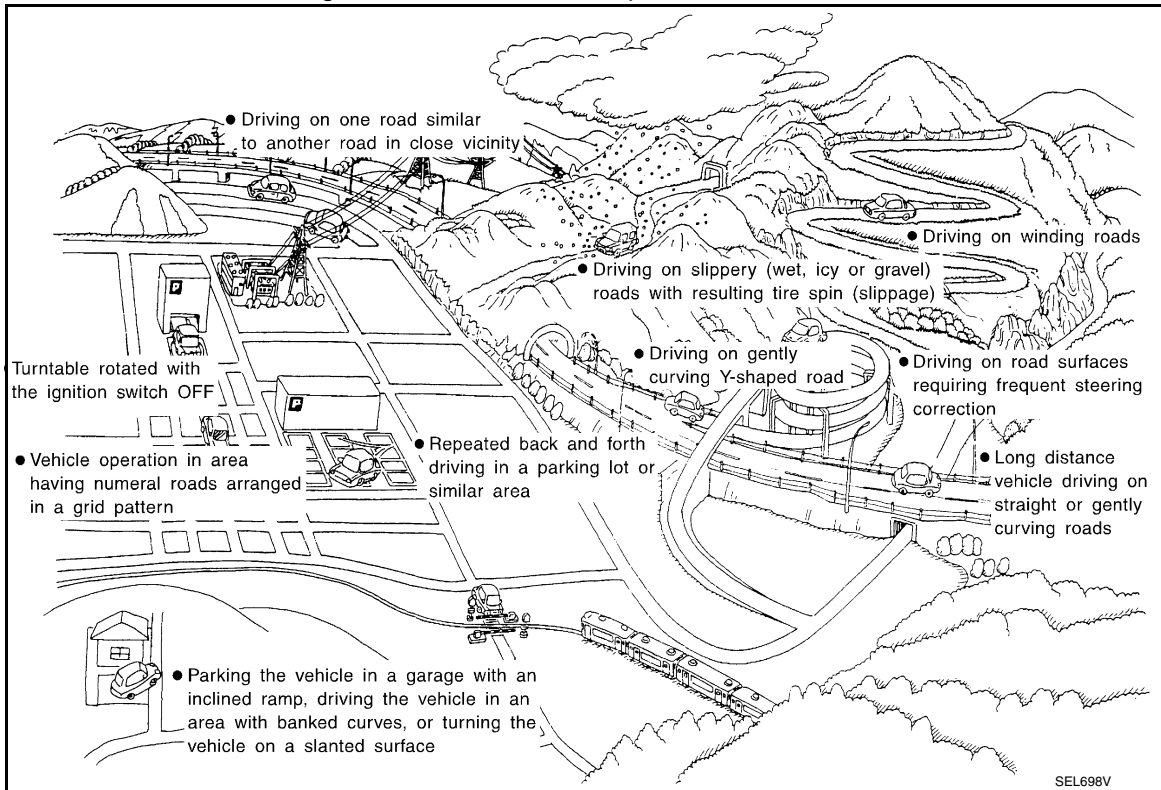

A
B
C
D
E
F
G
H
I
J
K
L
M
AV
O
P

NORMAL OPERATING CONDITION

< SYMPTOM DIAGNOSIS >

[NAVIGATION WITHOUT BOSE]

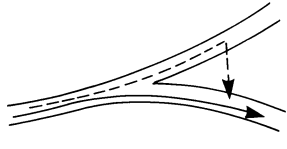
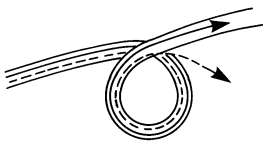
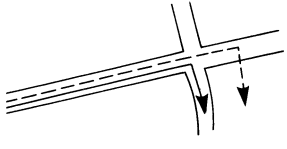
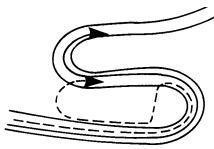
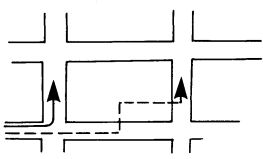
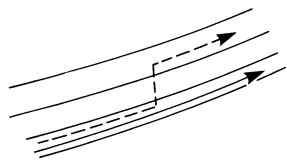
Cause (condition) –: While driving ooo: Display	Driving condition	Remarks (correction, etc.)
<p>Y-intersections</p>  <p style="text-align: center;">ELK0192D</p>	<p>At a Y intersection or similar gradual division of roads, an error in the direction of travel deduced by the sensor may result in the current-location mark appearing on the wrong road.</p>	<p>If after travelling about 10 km (6 miles) the correct location has not been restored, perform location correction and, if necessary, direction correction.</p>
<p>Spiral roads</p>  <p style="text-align: center;">ELK0193D</p>	<p>When driving on a large, continuous spiral road (such as loop bridge), turning angle error is accumulated and the vehicle mark may deviate from the correct location.</p>	
<p>Straight roads</p>  <p style="text-align: center;">ELK0194D</p>	<p>When driving on a long, straight road and slow curve without stopping, map-matching does not work effectively enough and distance errors may accumulate. As a result, the vehicle mark may deviate from the correct location when the vehicle is turned at a corner.</p>	
<p>Zigzag roads</p>  <p style="text-align: center;">ELK0195D</p>	<p>When driving on a zigzag road, the map may be matched to other roads in the similar direction nearby at every turn, and the vehicle mark may deviate from the correct location.</p>	
<p>Roads laid out in a grid pattern</p>  <p style="text-align: center;">ELK0196D</p>	<p>When driving where roads are laid out in a grid pattern, or where many roads are running in the similar direction nearby, the map may be matched to them by mistake and the vehicle mark may deviate from the correct location.</p>	
<p>Parallel roads</p>  <p style="text-align: center;">ELK0197D</p>	<p>When two roads are running in parallel (such as highway and sideway), the map may be matched to the other road by mistake and the vehicle mark may deviate from the correct location.</p>	

NORMAL OPERATING CONDITION

< SYMPTOM DIAGNOSIS >

[NAVIGATION WITHOUT BOSE]

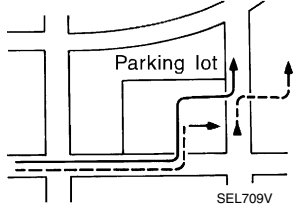
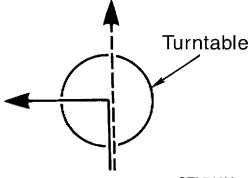
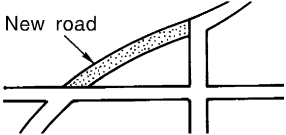
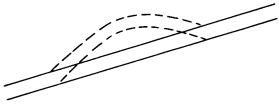
	Cause (condition) -: While driving ooo: Display	Driving condition	Remarks (correction, etc.)
Place	In a parking lot  SEL709V	When driving in a parking lot, or other location where there are no roads on the map, matching may place the vehicle mark on a nearby road. When the vehicle returns to the road, the vehicle mark may have deviated from the correct location. When driving in circle or turning the steering wheel repeatedly, direction errors accumulate, and the vehicle mark may deviate from the correct location.	If after travelling about 10 km (6 miles) the correct location has not been restored, perform location correction and, if necessary, direction correction.
	Turntable  SEL710V	When the power switch is OFF, the navigation system cannot get the signal from the gyroscope (angular speed sensor). Therefore, the displayed direction may be wrong and the correct road may not be easily returned to after rotating the vehicle on a turntable with the power OFF.	
	Slippery roads	On snow, wet roads, gravel, or other roads where tires may slip easily, accumulated mileage errors may cause the vehicle mark to deviate from the correct road.	
	Slopes	When parking in sloped garages, when travelling on banked roads, or in other cases where the vehicle turns when tilted, an error in the turning angle will occur, and the vehicle mark may deviate from the road.	
Map data	Road not displayed on the map screen  SEL699V	When driving on new roads or other roads not displayed on the map screen, map matching does not function correctly and matches the location to a nearby road. When the vehicle returns to a road which is on the map, the vehicle mark may deviate from the correct road.	
	Different road pattern (Changed due to repair)  ELK0201D	If the road pattern stored in the map data and the actual road pattern are different, map matching does not function correctly and matches the location to a nearby road. The vehicle mark may deviate from the correct road.	
Vehicle	Use of tire chains	When tire chains are used, the mileage is not correctly detected, and the vehicle mark may deviate from the correct road.	Drive the vehicle for a while. If the distance still deviates, adjust it by using the distance adjustment function. (If the tire chain is removed, recover the original value.)

A
B
C
D
E
F
G
H
I
J
K
L
M
AV
O
P

NORMAL OPERATING CONDITION

< SYMPTOM DIAGNOSIS >

[NAVIGATION WITHOUT BOSE]

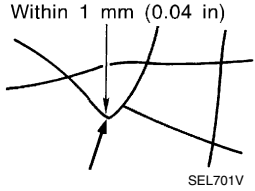
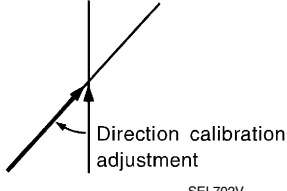
Cause (condition)	-: While driving ooo: Display	Driving condition	Remarks (correction, etc.)
Precautions for driving	Just after the engine is started	If the vehicle is driven just after the engine is started when the gyroscope (angular speed sensor) correction is not completed, the vehicle can lose its direction and may have deviated from the correct location.	Wait for a short while before driving after starting the engine.
	Continuous driving without stopping	When driving long distances without stopping, direction errors may accumulate, and the current-location mark may deviate from the correct road.	Stop and adjust the orientation.
	Abusive driving	Spinning the wheels or engaging in other kinds of abusive driving may result in the system being unable perform correct detection, and may cause the vehicle mark to deviate from the correct road.	If after travelling about 10 km (6 miles) the correct location has not been restored, perform location correction and, if necessary, direction correction.
How to correct location	Position correction accuracy 	If the accuracy of location settings is poor, accuracy may be reduced when the correct road cannot be found, particularly in places where there are many roads.	Enter in the road displayed on the screen with an accuracy of approx. 1mm. Caution: Whenever possible, use detailed map for the correction.
	Direction when location is corrected 	If the accuracy of location settings during correction is poor, accuracy may be reduced afterwards.	Perform direction correction.

Location Correction by Map-Matching is Slow

- The map-matching function needs to refer to the data of the surrounding area. It is necessary to drive some distance for the function to work.
- Because map-matching operates on this principle, when there are many roads running in similar directions in the surrounding area, no matching determination may be made. The location may not be corrected until some special feature is found.

Name of Road is Not Displayed

The current road name may not be displayed if there are no road names displayed on the map screen.

Contents of Display Differ for Birdview™ and the (Flat) Map Screen

Difference of the BIRDVIEW™ screen from the flat map screen are as follows.

- The current place name displays names which are primarily in the direction of vehicle travel.
- The amount of time before the vehicle travel or turn angle is updated on the screen is longer than for the (flat) map display.
- The conditions for display of place names, roads, and other data are different for nearby areas and for more distant areas.
- Some thinning of the character data is done to prevent the display becoming too complex. In some cases and in some locations, the display contents may differ.
- The same place name, street name, etc. may be displayed multiple times.

Vehicle Mark Shows a Position Which is Completely Wrong

In the following cases, the vehicle mark may appear on completely different position in the map depending on the GPS satellite signal receiving conditions. In this case, perform location correction and direction correction.

- When location correction has not been done
- If the receiving conditions of the GPS satellite signal is poor, if the vehicle mark becomes out of place, it may move to a completely different location and not come back if location correction is not done. The position will be corrected if the GPS signal can be received.
- When the vehicle has traveled by ferry, or when the vehicle has been being towed

NORMAL OPERATING CONDITION

< SYMPTOM DIAGNOSIS >

[NAVIGATION WITHOUT BOSE]

- Because calculation of the current location cannot be done when traveling with the power off, for example when traveling by ferry or when being towed, the location before travel is displayed. If the precise location can be detected with GPS, the location will be corrected.

A

Vehicle Mark Jumps

In the following cases, the vehicle mark may appear to jump as a result of automatic correction of the current location.

B

- When map matching has been done
- If the current location and the vehicle mark are different when map matching is done, the vehicle mark may seem to jump. At this time, the location may be “corrected” to the wrong road or to a location which is not on a road.
- When GPS location correction has been done
- If the current location and the vehicle mark are different when the location is corrected using GPS measurements, the vehicle mark may seem to jump. At this time, the location may be “corrected” to a location which is not on a road.

C

D

Vehicle Mark is in a River or Sea

The navigation system moves the vehicle mark with no distinction between land and rivers or sea. If the vehicle mark is somehow out of place, it may appear that the vehicle is driving in a river or the sea.

E

Vehicle Mark Automatically Rotates

The system wrongly memorizes the rotating status as stopping when the power switch is turned ON with the turntable rotating. That causes the vehicle mark to rotate when the vehicle is stopped.

F

When Driving on Same Road, Sometimes Vehicle Mark is in Right Place and Sometimes it is in Wrong Place

The conditions of the GPS antenna (GPS data) and gyroscope (angular speed sensor) change gradually. Depending on the road traveled and the operation of the steering wheel, the location detection results will be different. Therefore, even on a road on which the location has never been wrong, conditions may cause the vehicle mark to deviate.

G

H

I

J

K

L

M

AV

O

P

REMOVAL AND INSTALLATION

AV CONTROL UNIT

Removal and Installation

INFOID:000000010641914

REMOVAL

CAUTION:

Remove AV control unit after a lapse of 30 seconds or more after turning the power switch OFF.

NOTE:

After the power switch is turned OFF, the AV control unit continues operating for approximately 30 seconds. Therefore, data corruption may occur if 12V battery voltage is cut off within 30 seconds.

1. Disconnect the 12V negative battery terminal. Refer to [PG-82, "Removal and Installation"](#).
2. Remove cluster lid C. Refer to [JP-17, "Removal and Installation"](#).
3. Remove the AV control unit screws, disconnect the harness connectors from the AV control unit and remove with the brackets attached.
4. Remove the bracket screws and the brackets from AV control unit (if necessary).

INSTALLATION

Note the following, and install in the reverse order of removal.

CAUTION:

- If the AV control unit is replaced, input of the user ID and password and time adjustment with VCM are required.
- If the AV control unit is not replaced, time adjustment with VCM is required.

Input Method of User ID and Password:

1. Turn power switch ON.
2. Select "Sign in" from the CARWINGS screen.
3. Enter the user ID and password.

NOTE:

Since the user ID and password are determined by the user in advance, they are input by the user.

Time Adjustment and Check Method with VCM

Refer to [AV-277, "ADDITIONAL SERVICE WHEN REMOVING BATTERY NEGATIVE TERMINAL : Work Procedure"](#).

MULTIFUNCTION SWITCH

< REMOVAL AND INSTALLATION >

[NAVIGATION WITHOUT BOSE]

MULTIFUNCTION SWITCH

Removal and Installation

INFOID:000000010641915

REMOVAL

1. Remove cluster lid C. Refer to [IP-17. "Removal and Installation"](#).
2. Remove the screws (A), clips (B) and the multifunction switch from cluster lid C.

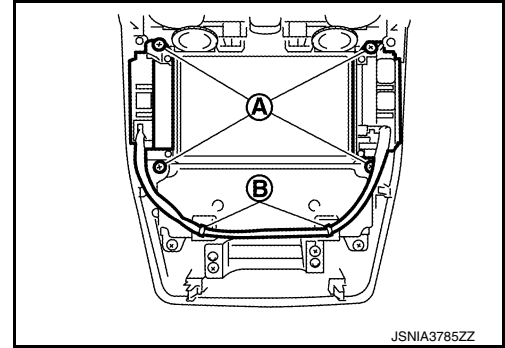

INSTALLATION

Install in the reverse order of removal.

A
B
C
D
E
F
G
H
I
J
K
L
M
AV
O
P

FRONT DOOR SPEAKER

< REMOVAL AND INSTALLATION >

[NAVIGATION WITHOUT BOSE]

FRONT DOOR SPEAKER

Removal and Installation

INFOID:000000010641916

REMOVAL

1. Remove the front door finisher. Refer to [INT-19, "Removal and Installation"](#).
2. Remove the screws and disconnect the connector to remove the front door speaker.

INSTALLATION

Install in the reverse order of removal.

TWEETER**Removal and Installation**

INFOID:000000010641917

REMOVAL

1. Remove the front pillar garnish. Refer to [INT-26. "FRONT PILLAR GARNISH : Removal and Installation"](#).
2. Remove the screws and the tweeter from the front pillar garnish.

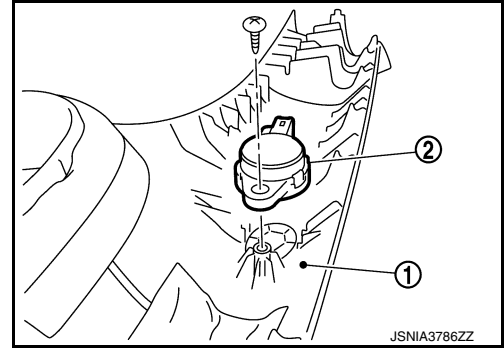
**INSTALLATION**

Install in the reverse order of removal.

A
B
C
D
E
F
G
H
I
J
K
L
M
AV
O
P

REAR DOOR SPEAKER

< REMOVAL AND INSTALLATION >

[NAVIGATION WITHOUT BOSE]

REAR DOOR SPEAKER

Removal and Installation

INFOID:000000010641918

REMOVAL

1. Remove the rear door finisher. Refer to [INT-22. "Removal and Installation"](#).
2. Remove the screws and disconnect the connector to remove the rear door speaker.

INSTALLATION

Install in the reverse order of removal.

GPS ANTENNA

Removal and Installation

INFOID:000000010641919

REMOVAL

1. Remove the instrument panel assembly. Refer to [IP-17, "Removal and Installation"](#).
2. Remove the screws, clips and the GPS antenna.

INSTALLATION

Install in the reverse order of removal.

A
B
C
D
E
F
G
H
I
J
K
L
M
N
O
P

AV

MICROPHONE

Removal and Installation

INFOID:000000010641920

REMOVAL

1. Remove the map lamp assembly. Refer to [INL-53. "Removal and Installation"](#).
2. Press the pawl to remove the microphone (1) from the map lamp assembly (2).

CAUTION:

Use care when handling the microphone pawl to avoid damaging.

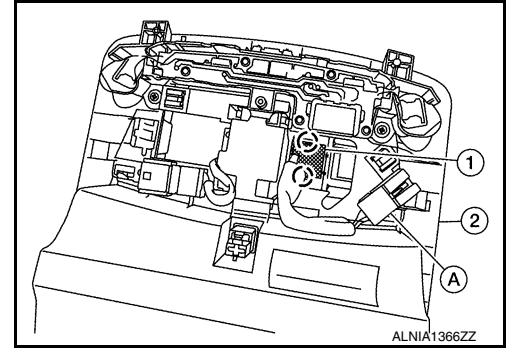

INSTALLATION

Install in the reverse order of removal.

NOTE:

Check the microphone for looseness after the installation.

ANTENNA FEEDER

< REMOVAL AND INSTALLATION >

[NAVIGATION WITHOUT BOSE]

ANTENNA FEEDER

Antenna Feeder

INFOID:000000010641921

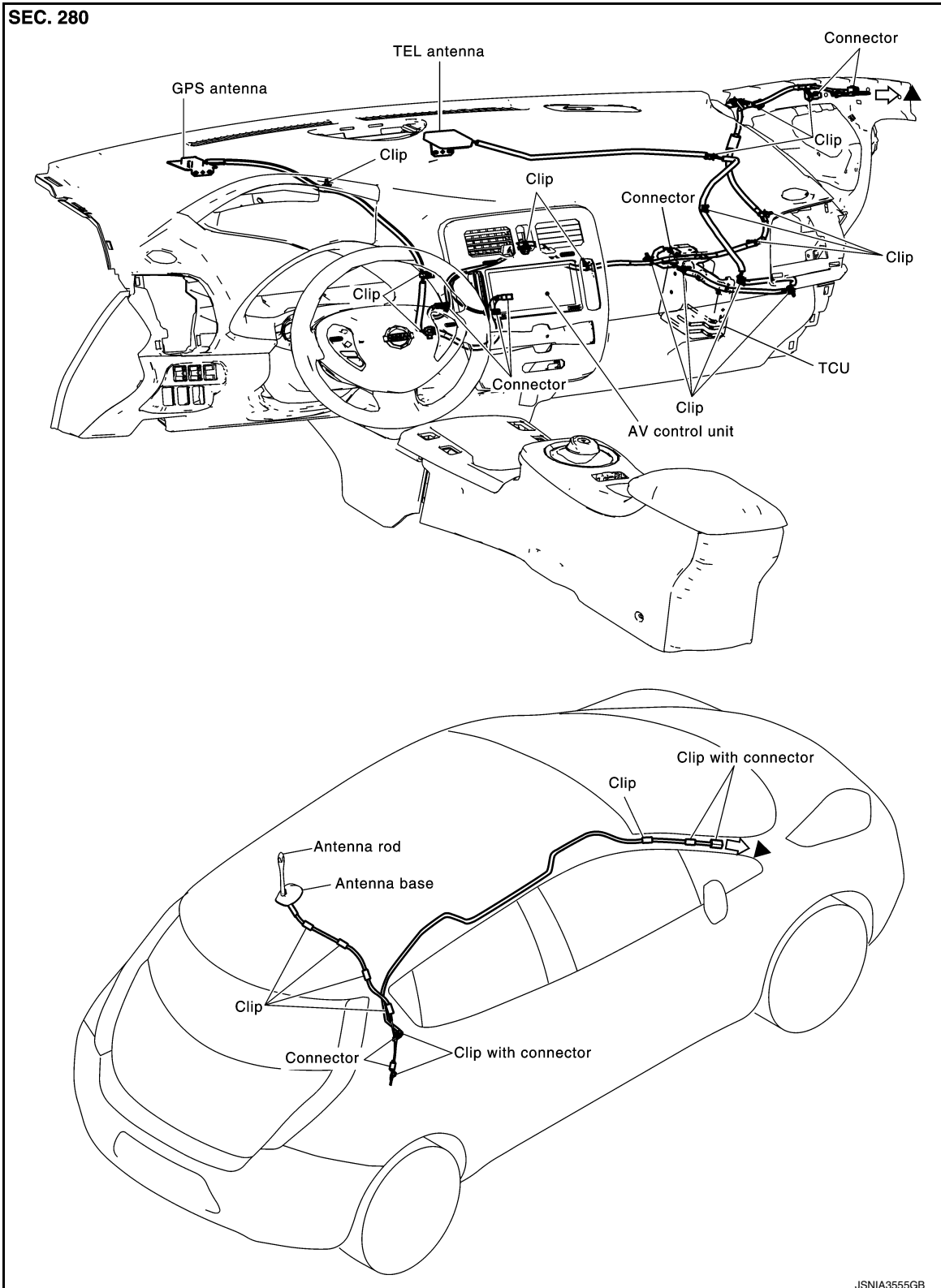

▲: Indicates that the part is connected at points with same symbol in actual vehicle.

A
B
C
D
E
F
G
H
I
J
K
L
M
N
O
P

AV

ANTENNA BASE

Removal and Installation

INFOID:000000010641922

REMOVAL

1. Partially remove the headlining (rear side) to obtain space to work between vehicle and headlining. Refer to [INT-37, "Removal and Installation"](#).
2. Disconnect the antenna feeder connector.
3. Remove the nut and the antenna base (2) from the vehicle.
(1): Antenna rod

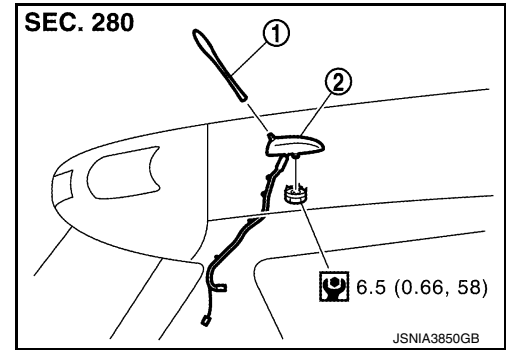

INSTALLATION

Install in the reverse order of removal.

CAUTION:

- Do not bend headlining when pulling down.
- Tighten the antenna base nut to specification.
- If the antenna base nut is less than the specified torque, it could affect the performance of the antenna sensitivity.
- If the antenna base nut is greater than the specified torque, it could damage the roof panel.

STEERING SWITCH

< REMOVAL AND INSTALLATION >

[NAVIGATION WITHOUT BOSE]

STEERING SWITCH

Exploded View

INFOID:000000010641923

Refer to [SR-20, "Exploded View"](#).

Removal and Installation

INFOID:000000010641924

REMOVAL

Refer to [SR-20, "Removal and Installation"](#).

INSTALLATION

Install in the reverse order of removal.

A

B

C

D

E

F

G

H

I

J

K

L

M

AV

O

P

AUXILIARY INPUT JACK

< REMOVAL AND INSTALLATION >

[NAVIGATION WITHOUT BOSE]

AUXILIARY INPUT JACK

Removal and Installation

INFOID:000000010641925

REMOVAL

1. Remove the instrument lower center cover. Refer to [IP-17, "Removal and Installation"](#).
2. Press the tab from the rear of the instrument lower center cover (B) and remove the auxiliary input jack (A).

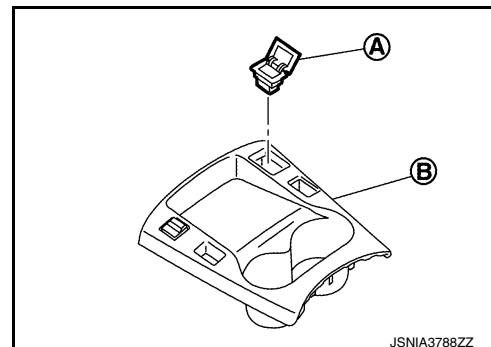

INSTALLATION

Install in the reverse order of removal.

NOTE:

Align the notch of the instrument panel center lower cover and assemble it.

USB CONNECTOR

Removal and Installation

INFOID:000000010641926

REMOVAL

1. Remove the instrument lower center cover. Refer to [IP-17. "Removal and Installation"](#).
2. Press the tab from the rear of the instrument lower center cover (B) and remove the USB connector (A).

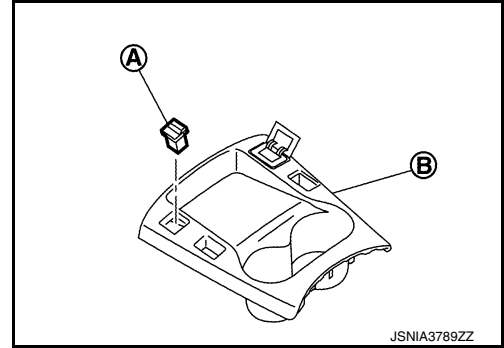

INSTALLATION

Install in the reverse order of removal.

NOTE:

Align the notch of the instrument panel center lower cover and assemble it.

A
B
C
D
E
F
G
H
I
J
K
L
M
AV
O
P

REAR VIEW CAMERA

< REMOVAL AND INSTALLATION >

[NAVIGATION WITHOUT BOSE]

REAR VIEW CAMERA

Removal and Installation

INFOID:000000010641927

REMOVAL

1. Remove the back door outside handle. Refer to [DLK-201. "OUTSIDE HANDLE : Removal and Installation"](#).
2. Remove the screws (A) and the rear view camera (1) from the switch finisher (2).

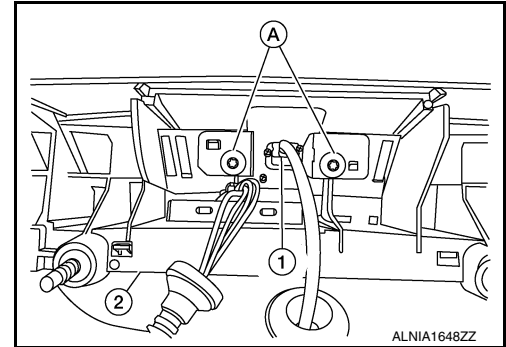

INSTALLATION

Install in the reverse order of removal.

NOTE:

If the side distance guiding lines are dislocated after installation of the rear view camera, refer to [AV-425. "CALIBRATING CAMERA IMAGE \(AROUND VIEW MONITOR\) : Work Procedure"](#) and correct the side distance guiding lines.

PRECAUTION

PRECAUTIONS

Precaution for Technicians Using Medical Electric

INFOID:000000010641928

OPERATION PROHIBITION

WARNING:

- Parts with strong magnet is used in this vehicle.
- Technicians using a medical electric device such as pacemaker must never perform operation on the vehicle, as magnetic field can affect the device function by approaching to such parts.

NORMAL CHARGE PRECAUTION

WARNING:

- If a technician uses a medical electric device such as an implantable cardiac pacemaker or an implantable cardioverter defibrillator, the possible effects on the devices must be checked with the device manufacturer before starting the charge operation.
- As radiated electromagnetic wave generated by PDM (Power Delivery Module) at normal charge operation may affect medical electric devices, a technician using a medical electric device such as implantable cardiac pacemaker or an implantable cardioverter defibrillator must not approach motor room [PDM (Power Delivery Module)] at the hood-opened condition during normal charge operation.

PRECAUTION AT TELEMATICS SYSTEM OPERATION

WARNING:

- If a technician uses implantable cardiac pacemaker or implantable cardioverter defibrillator (ICD), avoid the device implanted part from approaching within approximately 220 mm (8.66 in) from interior/exterior antenna.
- The electromagnetic wave of TCU might affect the function of the implantable cardiac pacemaker or the implantable cardioverter defibrillator (ICD), when using the service, etc.
- If a technician uses other medical electric devices than implantable cardiac pacemaker or implantable cardioverter defibrillator (ICD), the electromagnetic wave of TCU might affect the function of the device. The possible effects on the devices must be checked with the device manufacturer before TCU use.

PRECAUTION AT INTELLIGENT KEY SYSTEM OPERATION

WARNING:

- If a technician uses implantable cardiac pacemaker or implantable cardioverter defibrillator (ICD), avoid the device implanted part from approaching within approximately 220 mm (8.66 in) from interior/exterior antenna.
- The electromagnetic wave of Intelligent Key might affect the function of the implantable cardiac pacemaker or the implantable cardioverter defibrillator (ICD), at door operation, at each request switch operation, or at engine starting.
- If a technician uses other medical electric devices than implantable cardiac pacemaker or implantable cardioverter defibrillator (ICD), the electromagnetic wave of Intelligent Key might affect the function of the device. The possible effects on the devices must be checked with the device manufacturer before Intelligent Key use.

Precaution for Supplemental Restraint System (SRS) "AIR BAG" and "SEAT BELT PRE-TENSIONER"

INFOID:000000010641929

The Supplemental Restraint System such as "AIR BAG" and "SEAT BELT PRE-TENSIONER", used along with a front seat belt, helps to reduce the risk or severity of injury to the driver and front passenger for certain types of collision. This system includes seat belt switch inputs and dual stage front air bag modules. The SRS system uses the seat belt switches to determine the front air bag deployment, and may only deploy one front air bag, depending on the severity of a collision and whether the front occupants are belted or unbelted. Information necessary to service the system safely is included in the SR and SB section of this Service Manual.

WARNING:

A
B
C
D
E
F
G
H
I
J
K
L
M
AV
O
P

PRECAUTIONS

[NAVIGATION WITH BOSE]

< PRECAUTION >

- To avoid rendering the SRS inoperative, which could increase the risk of personal injury or death in the event of a collision which would result in air bag inflation, all maintenance must be performed by an authorized NISSAN/INFINITI dealer.
- Improper maintenance, including incorrect removal and installation of the SRS, can lead to personal injury caused by unintentional activation of the system. For removal of Spiral Cable and Air Bag Module, see the SR section.
- Do not use electrical test equipment on any circuit related to the SRS unless instructed to in this Service Manual. SRS wiring harnesses can be identified by yellow and/or orange harnesses or harness connectors.

PRECAUTIONS WHEN USING POWER TOOLS (AIR OR ELECTRIC) AND HAMMERS

WARNING:

- When working near the Airbag Diagnosis Sensor Unit or other Airbag System sensors with the Ignition ON or engine running, DO NOT use air or electric power tools or strike near the sensor(s) with a hammer. Heavy vibration could activate the sensor(s) and deploy the air bag(s), possibly causing serious injury.
- When using air or electric power tools or hammers, always switch the Ignition OFF, disconnect the battery and wait at least three minutes before performing any service.

Precaution for Trouble Diagnosis

INFOID:000000010641930

AV COMMUNICATION SYSTEM

- Do not apply voltage of 7.0 V or higher to the measurement terminals.
- Use the tester with its open terminal voltage being 7.0 V or less.
- Be sure to turn power switch OFF and disconnect the battery cable from the negative terminal before checking the circuit. Refer to [AV-332, "Precaution for Removing 12V Battery"](#).

Precaution for Harness Repair

INFOID:000000010641931

AV COMMUNICATION SYSTEM

- Solder the repaired parts, and wrap with tape. [Frays of twisted line must be within 110 mm (4.33 in).]

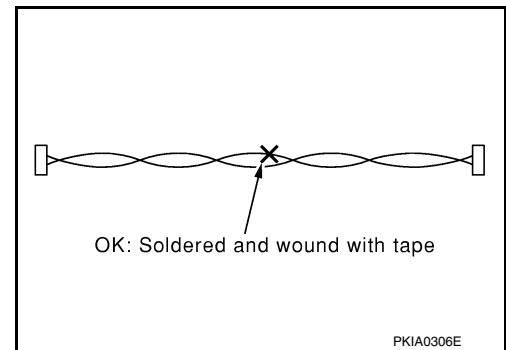

- Do not perform bypass wire connections for the repair parts. (The spliced wire will become separated and the characteristics of twisted line will be lost.)

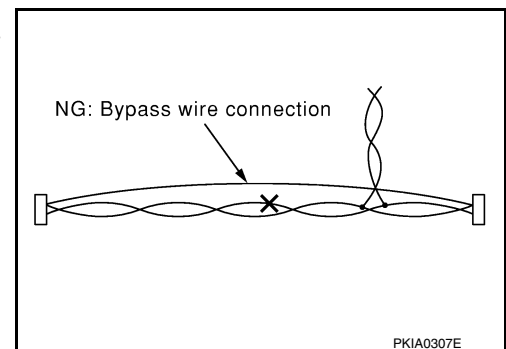

Precaution for Removing 12V Battery

INFOID:000000010641932

1. Check that EVSE is not connected.

NOTE:

If EVSE is connected, the air conditioning system may be automatically activated by the timer A/C function.

PRECAUTIONS

[NAVIGATION WITH BOSE]

< PRECAUTION >

2. Turn the power switch OFF → ON → OFF. Get out of the vehicle. Close all doors (including back door).
3. Check that the charge status indicator lamp does not blink and wait for 5 minutes or more.

NOTE:

If the battery is removed within 5 minutes after the power switch is turned OFF, plural DTCs may be detected.

4. Remove 12V battery within 1 hour after turning the power switch OFF → ON → OFF.

NOTE:

- The 12V battery automatic charge control may start automatically even when the power switch is in OFF state.
- Once the power switch is turned ON → OFF, the 12V battery automatic charge control does not start for approximately 1 hour.

CAUTION:

- **After all doors (including back door) are closed, if a door (including back door) is opened before battery terminals are disconnected, start over from Step 1.**
- **After turning the power switch OFF, if “Remote A/C” is activated by user operation, stop the air conditioner and start over from Step 1.**

Precaution for Work

INFOID:0000000011107769

- When removing or disassembling each component, be careful not to damage or deform it. If a component may be subject to interference, be sure to protect it with a shop cloth.
- When removing (disengaging) components with a screwdriver or similar tool, be sure to wrap the component with a shop cloth or vinyl tape to protect it.
- Protect the removed parts with a shop cloth and prevent them from being dropped.
- Replace a deformed or damaged clip.
- If a part is specified as a non-reusable part, always replace it with a new one.
- Be sure to tighten bolts and nuts securely to the specified torque.
- After installation is complete, be sure to check that each part works properly.
- Follow the steps below to clean components:
 - Water soluble dirt:
 - Dip a soft cloth into lukewarm water, wring the water out of the cloth and wipe the dirty area.
 - Then rub with a soft, dry cloth.
 - Oily dirt:
 - Dip a soft cloth into lukewarm water with mild detergent (concentration: within 2 to 3%) and wipe the dirty area.
 - Then dip a cloth into fresh water, wring the water out of the cloth and wipe the detergent off.
 - Then rub with a soft, dry cloth.
 - Do not use organic solvent such as thinner, benzene, alcohol or gasoline.
 - For genuine leather seats, use a genuine leather seat cleaner.

Cautions in Removing AV Control Unit (Models with AV Control Unit)

INFOID:0000000010641933

CAUTION:

Remove AV control unit after a lapse of 30 seconds or more after turning the power switch OFF.

NOTE:

After the power switch is turned OFF, the AV control unit continues operating for approximately 30 seconds. Therefore, data corruption may occur if 12V battery voltage is cut off within 30 seconds.

A
B
C
D
E
F
G
H
I
J
K
L
M
O
P



< PREPARATION >

PREPARATION

PREPARATION

Special Service Tools

INFOID:000000011107783

The actual shape of the tools may differ from those illustrated here.

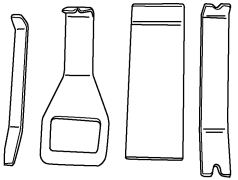
Tool number (TechMate No.) Tool name	Description
<p>— (J-46534) Trim Tool Set</p>  <p style="text-align: center;">AWJIA0483ZZ</p>	<p>Removing trim components</p>

Commercial Service Tool

INFOID:000000010641934

Tool name	Description
<p>Power tool</p>  <p style="text-align: center;">PIIB1407E</p>	<p>Loosening nuts, screws and bolts</p>

COMPONENT PARTS

< SYSTEM DESCRIPTION >

[NAVIGATION WITH BOSE]

SYSTEM DESCRIPTION

COMPONENT PARTS

Component Parts Location

INFOID:000000010641935

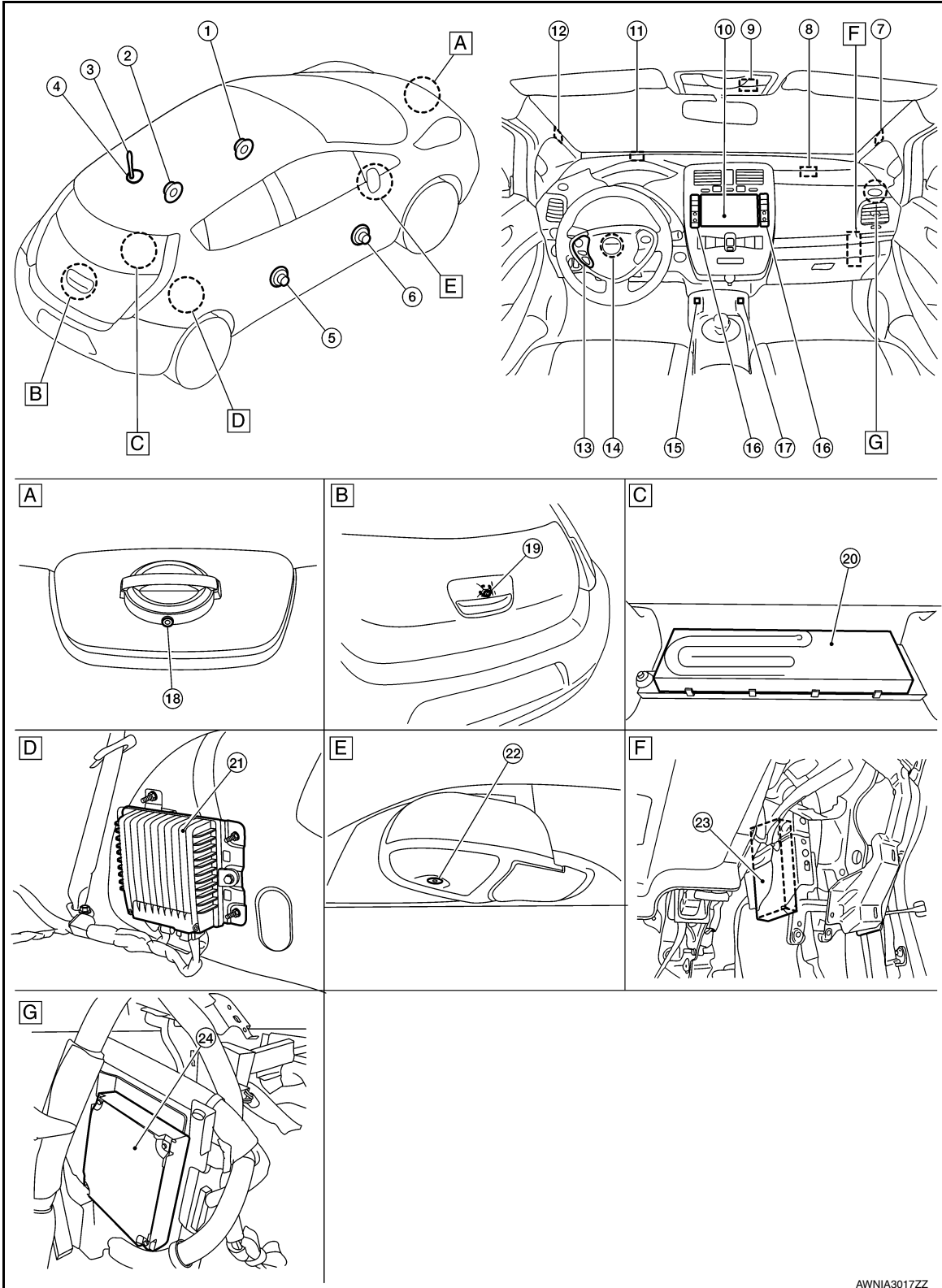

A
B
C
D
E
F
G
H
I
J
K
L
M
AV
O
P

COMPONENT PARTS

[NAVIGATION WITH BOSE]

< SYSTEM DESCRIPTION >

- | | | |
|---|--|-------------------------------------|
| A. Center of charge lid cover | B. Center of the back door | C. Luggage compartment |
| D. Luggage compartment (view with luggage side lower finisher RH removed) | E. Bottom of outside rear view mirror (RH shown, LH similar) | F. Glove box cover assembly removed |
| G. Behind RH side of instrument panel (view with steering member removed) | | |

No.	Component	Function
1.	Front door speaker LH	Refer to AV-338, "Speaker" .
2.	Rear door speaker LH	
3.	Antenna rod	Refer to AV-338, "Radio Antenna and Antenna Feeder" .
4.	Antenna base (antenna amp. and satellite radio antenna)	
5.	Rear door speaker RH	Refer to AV-338, "Speaker" .
6.	Front door speaker RH	
7.	Tweeter RH	Refer to AV-338, "Speaker" .
8.	TEL antenna	Refer to AV-342, "TEL Antenna" .
9.	Microphone	Refer to AV-342, "Microphone" .
10.	AV control unit	Refer to AV-336, "AV Control Unit" .
11.	GPS antenna	Refer to AV-341, "GPS Antenna" .
12.	Tweeter LH	Refer to AV-338, "Speaker" .
13.	Steering switch	Refer to AV-341, "Steering Switch" .
14.	Steering angle sensor	Refer to AV-343, "Steering Angle Sensor" .
15.	USB connector	Refer to AV-342, "USB Connector" .
16.	Multifunction switch	Refer to AV-341, "Multifunction Switch" .
17.	Auxiliary input jack	Refer to AV-344, "Auxiliary Input Jack" .
18.	Front camera	Refer to AV-343, "Front Camera" .
19.	Rear view camera	Refer to AV-343, "Rear View Camera" .
20.	Subwoofer	Refer to AV-338, "Speaker" .
21.	Bose speaker amp.	Refer to AV-338, "BOSE Amp." .
22.	Side camera	Refer to AV-343, "Side Camera" .
23.	TCU	Refer to AV-341, "TCU" .
24.	Around view monitor control unit	Refer to AV-342, "Around View Monitor Control Unit" .

AV Control Unit

INFOID:000000010641936

DESCRIPTION

- High-resolution 7-inch wide VGA display integrated AV control unit is installed at the center of the instrument panel.
- The AV control unit is equipped with the following parts. It is the master unit integrated with functions and controls the multi-AV system.

Units equipped
SD card slot
High resolution 7-inch wide VGA LCD monitor
Audio amplifier
AM/FM electronic tuner
Satellite radio tuner

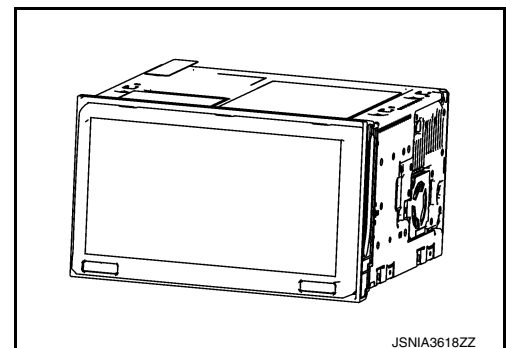

JSNIA3618ZZ

COMPONENT PARTS

[NAVIGATION WITH BOSE]

< SYSTEM DESCRIPTION >

Units equipped	
CD drive	A
USB interface	
Bluetooth® module	B
<ul style="list-style-type: none">• Signals necessary for the vehicle information display function are received from ECM and the combination meter via CAN communication.• It is connected to TCU in USB communication, and signals necessary for the Telematics function and CARWINGS function are sent and received.• Signals necessary for vehicle setting functions are sent and received with BCM via CAN communication.• It inputs the signal for driving status recognition (vehicle speed signal, reverse signal, and parking brake signal).• A possible route line is generated on the camera image from the rear view camera, and it is shown on the display.• It has the built-in gyro sensor and acceleration sensor as a vehicle position calculation sensor. Map data is read from an SD card in the SD slot.	C
<ul style="list-style-type: none">- SD card• It records the map data, traffic control data, and guide information, etc.- Gyroscope• Detects vehicle cornering condition.- Acceleration sensor• Detects the inclination angle and height variation of the vehicle.	D
NOTE: For details of each functions, refer to AV-346. "MULTI AV SYSTEM : System Description" .	E
SD Card Slot With the display opened, the map card slot is located on the right (main slot), and the card slot used for import/export of stored location is located on the left (sub slot).	F
Display <ul style="list-style-type: none">• High resolution 7-inch wide VGA LCD monitor is adopted to display a high definition image including digital image signals.• Touch panel function is adopted to improve operability.• RGB digital image signals (navigation image/menu image) and composite image signals (rear view camera image) are displayed.	G
Audio Amplifier <ul style="list-style-type: none">• 45W x 4ch amplifiers are installed.• Audio sound, TEL voice and guiding voice are output to each speaker.	H
AM/FM Electronic Tuner <ul style="list-style-type: none">• The AM/FM electric tuner includes the PLL frequency synthesizer system.	I
Satellite Radio Tuner <ul style="list-style-type: none">• The adoption of the PPL synthesizer method allows the signal reception at more accurate frequencies.• The satellite radio tuner receives a satellite radio antenna signal and converts the signal into an audio sound signal and a data signal.• The audio sound signal is transmitted to the audio amplifier and the data signal is transmitted to the display.	J
CD Drive <ul style="list-style-type: none">• It is CD-R/CD-RW compliant and enables MP3 and WMA files to play music.• It displays the artist name, album title or song title recorded to the file by the ID3 tag/WMA tag display function.	K
USB Interface <ul style="list-style-type: none">• Music can be played by connecting an iPod® or USB memory.	L
Bluetooth® Module <ul style="list-style-type: none">• Wireless connection to the audio device equipped with Bluetooth® communication can play music.• Once a Bluetooth® communication compliant phone has been registered in the AV control unit, hands-free phone communication and connection to the CARWINGS information center can be carried out without connecting the cellular phone to the TEL harness.	M
	AV
	O
	P

COMPONENT PARTS

< SYSTEM DESCRIPTION >

[NAVIGATION WITH BOSE]

- Five units of Bluetooth® communication devices including audio devices and cellular phones can be registered to the AV control unit.

BOSE Amp.

INFOID:000000010641937

- Installed in the RH side of the luggage compartment.
- Receives sound signal from AV control unit, and outputs sound signal to each speaker and woofer.

Speaker

INFOID:000000010641938

The 7-speaker system is adopted.

Front door speaker

- ϕ 16.5 cm (6.5 in.) speaker is installed to the bottom of the front door.
- Sound signal is input from the Bose speaker amp. to output mid and low range sounds.

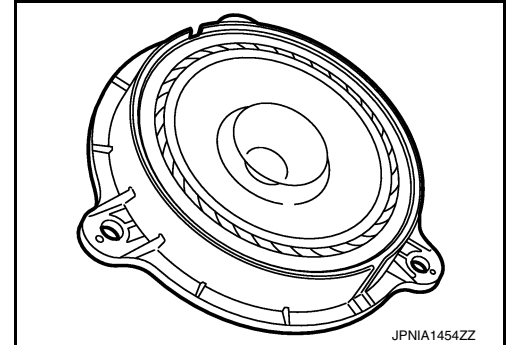

Rear door speaker

- ϕ 16.5 cm (6.5 in.) speaker is installed to the bottom of the rear door.
- Sound signal is input from the Bose speaker amp. to output high, mid and low range sounds.

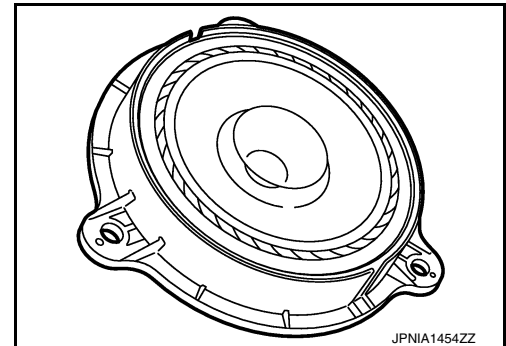

Tweeter

- ϕ 2.5 cm (1 in.) tweeter for high-range sounds is installed in the front pillar.
- Sound signal is input from the Bose speaker amp. to output high range sounds.

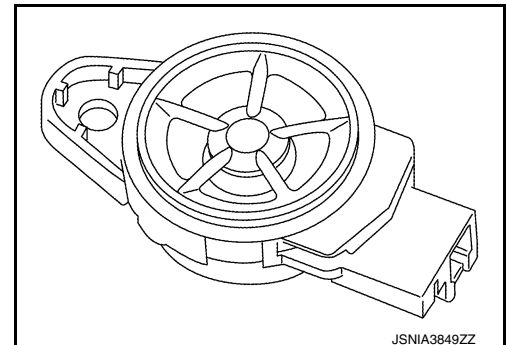

Subwoofer

- ϕ Subwoofer is installed in the luggage compartment.
- Sound signal is input from the Bose speaker amp. to output low range sounds.

Radio Antenna and Antenna Feeder

INFOID:000000010641939

RADIO ANTENNA

COMPONENT PARTS

[NAVIGATION WITH BOSE]

< SYSTEM DESCRIPTION >

Rod Antenna

A rod antenna is installed to the rear center of the roof.

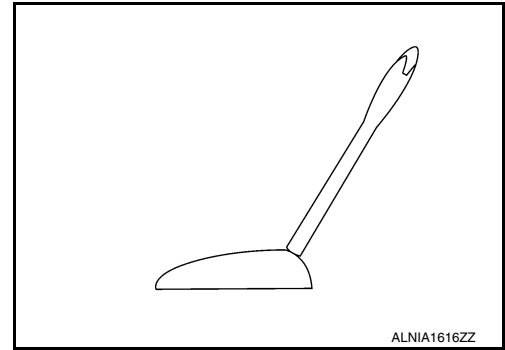

Antenna Base

- To obtain sufficient reception sensitivity, an antenna amplifier is built into the antenna base.
- Power of the antenna amplifier is supplied from the AV control unit.
- The radio signal received by the rod antenna is input to the antenna base and the antenna signal is amplified and sent to the AV control unit.

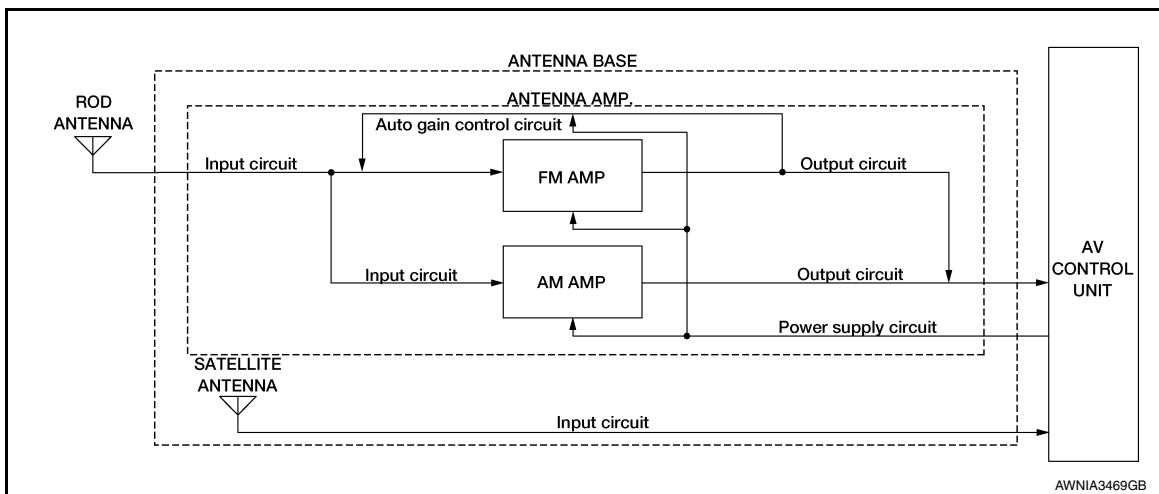

Satellite radio Antenna

- Receives satellite radio waves and outputs it to AV control unit.

Antenna circuit

A
B
C
D
E
F
G
H
I
J
K
L
M
AV
O
P

COMPONENT PARTS

< SYSTEM DESCRIPTION >

[NAVIGATION WITH BOSE]

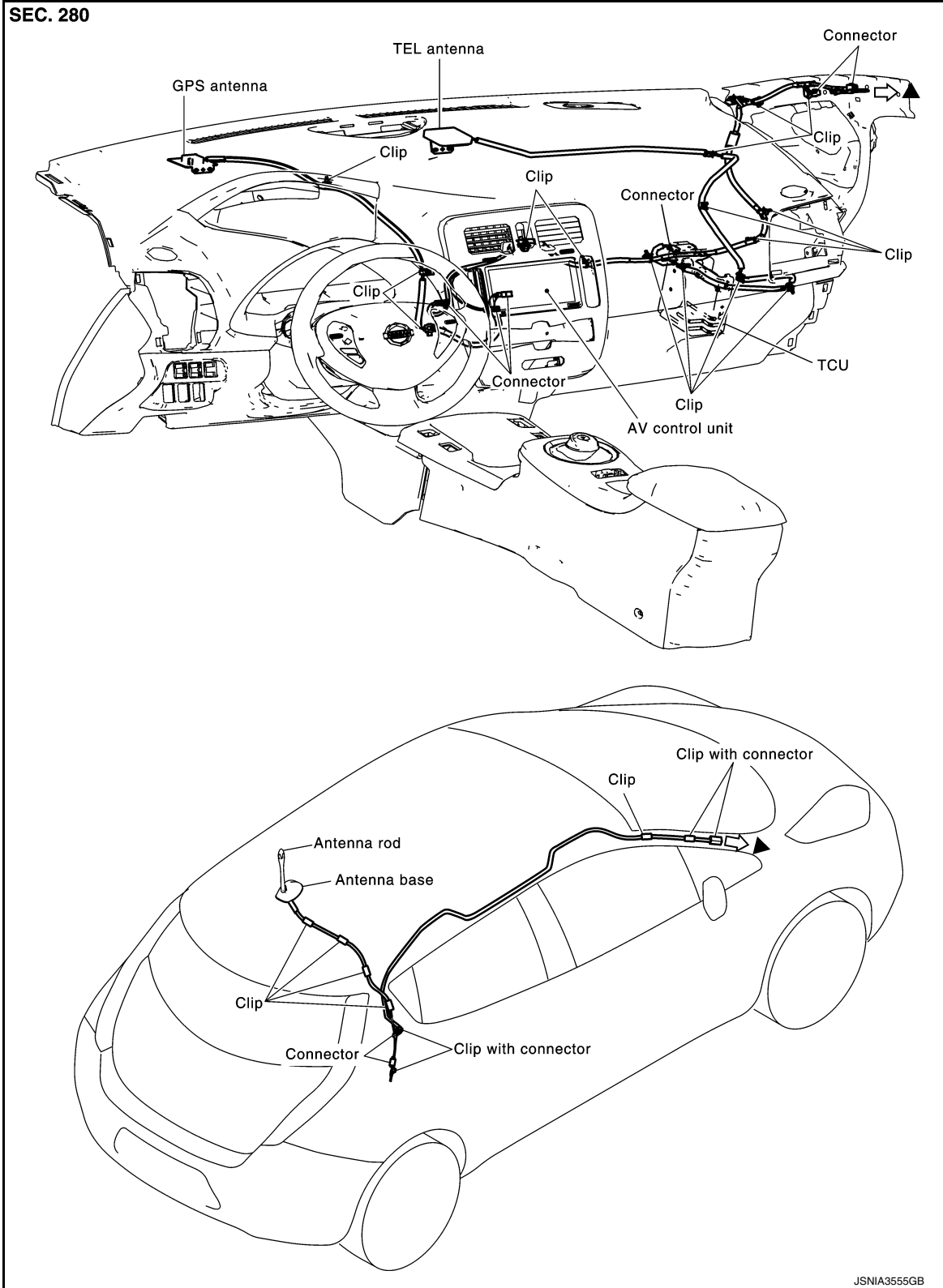

Steering Switch

INFOID:000000010641940

- Hands-free phone, possible driving distance display, voice control, and audio operations can be performed.
- This switch is connected to the AV control unit, and the switch operation signal is transmitted to the AV control unit via voltage multiplex communication.

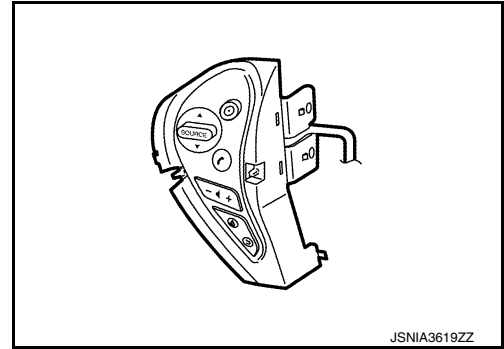

Multifunction Switch

INFOID:000000010641941

- Audio, navigation, Telematics, etc. can be controlled.
- Switch operation signals are input to the AV control unit via AV communication.

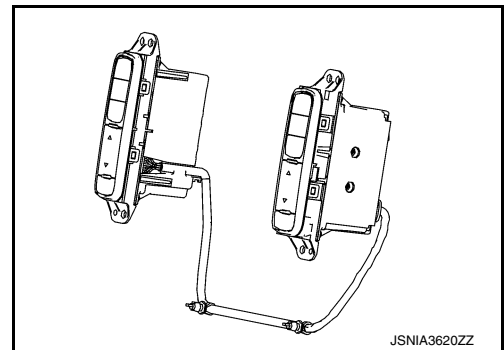

TCU

INFOID:000000010641942

- TCU is installed on the lower right of the instrument panel.
- A radio communication terminal is built into the unit, and data is sent and received in SMS and packet communication with the NISSAN CARWINGS Data Center through the TEL antenna.
- VIN information necessary for the Telematics service is memorized.

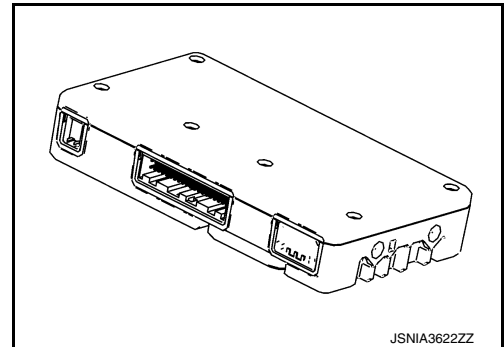

GPS Antenna

INFOID:000000010641943

- GPS antenna is installed in the instrument panel.
- Power is supplied from the AV control unit.
- This antenna amplifies radio waves received from the GPS satellite and transmits the GPS signal to the AV control unit.

NOTE:

An object on the instrument panel may cause the reception sensitivity to be decreased.

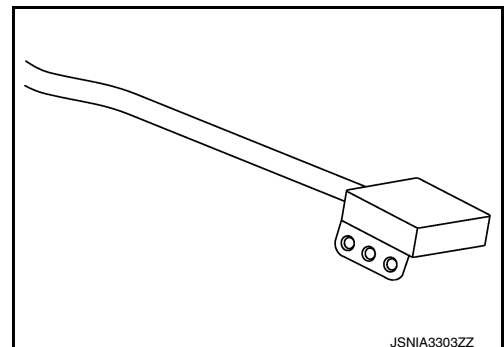

A
B
C
D
E
F
G
H
I
J
K
L
M
O
P

AV

USB Connector

INFOID:000000010641944

- USB connector is installed on the lower left side of the instrument panel.
- iPod® and USB memory can be connected to the AV control unit.

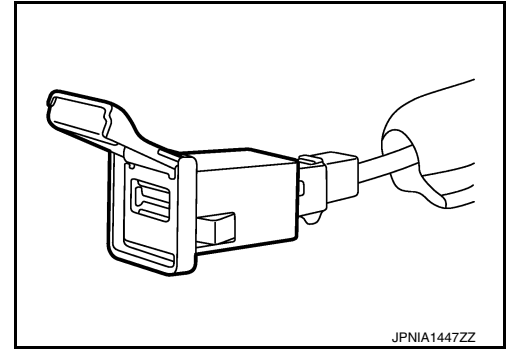

JPNIA1447ZZ

Microphone

INFOID:000000010641945

- The voice control/TEL microphone is installed on the right side of the map lamp assembly.
- The power is supplied from the AV control unit to the microphone, transmitting sound signals to the AV control unit at the voice control or during hands-free phone communication.

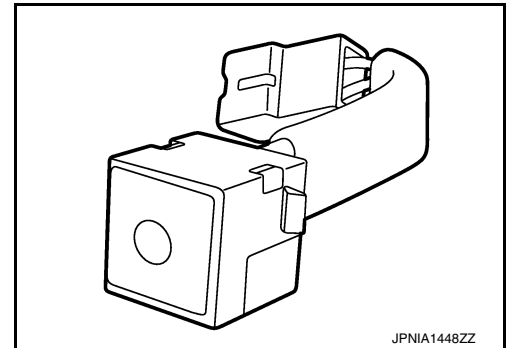

JPNIA1448ZZ

TEL Antenna

INFOID:000000010641946

- The TEL antenna is installed in the instrument panel.
- Power is supplied with TCU activated.

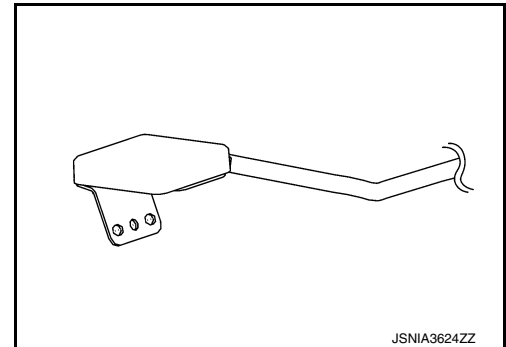

JSNIA3624ZZ

Around View Monitor Control Unit

INFOID:000000010641947

- The around view monitor control unit is installed behind the RH side of the instrument panel.
- Necessary signals are transmitted/received to/from control unit via CAN communication.
- Camera image signals received from each camera are converted/synthesized in the around view monitor control unit and transmitted to the front display unit.
- Vehicle width guide lines, predicted course line, vehicle front guiding line and vehicle side line, and vehicle icon are rendered with the around view monitor control unit and combined with camera image.

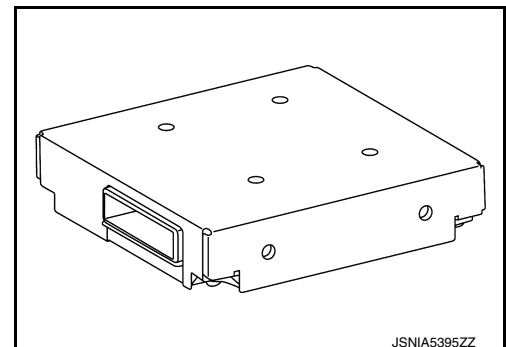

JSNIA5395ZZ

COMPONENT PARTS

< SYSTEM DESCRIPTION >

[NAVIGATION WITH BOSE]

Rear View Camera

INFOID:0000000110641948

- The rear camera is installed to the back door finisher.
- Power for the camera is supplied from the around view monitor control unit, and the image at the rear of the vehicle is sent to the around view monitor control unit.

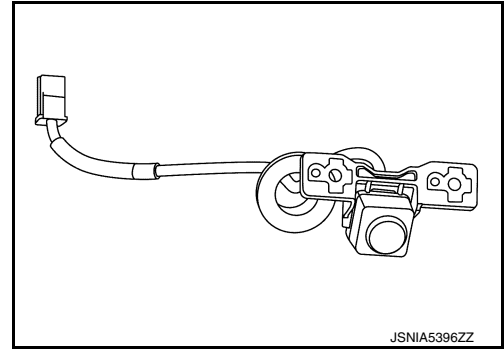

Side Camera

INFOID:0000000110641949

- The side camera is installed to the door mirror.
- Power for the camera is supplied from the around view monitor control unit, and the image at the side of the vehicle is sent to the around view monitor control unit.

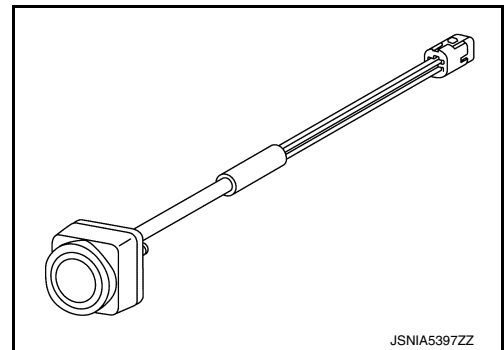

Front Camera

INFOID:0000000110641950

- The front camera is installed to the front grille.
- Power for the camera is supplied from the around view monitor control unit, and the image at the front of the vehicle is sent to the around view monitor control unit.

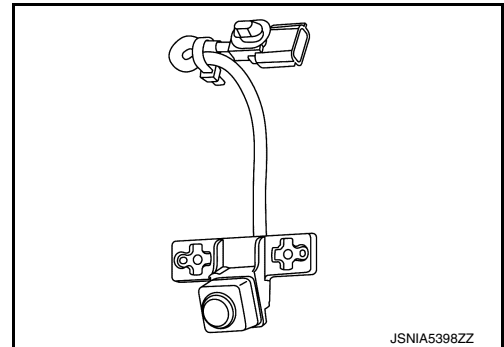

Steering Angle Sensor

INFOID:0000000110641951

- Steering sensor is installed to the spiral cable.
- Steering angle sends the steering signal necessary for possible route line of the around view monitor function to the AV control unit via CAN communication.

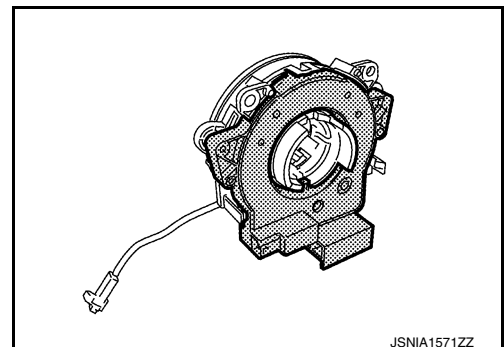

A
B
C
D
E
F
G
H
I
J
K
L
M
AV
O
P

Auxiliary Input Jack

INFOID:000000010641952

- AUX jack is installed at the lower right of the instrument panel.
- Connection to an external audio device can provide sound output.

External input terminal for connection ϕ 3.5 mm stereo mini-jack

NOTE:

When connected to monaural mini-jack plug cable, sound may not be output.

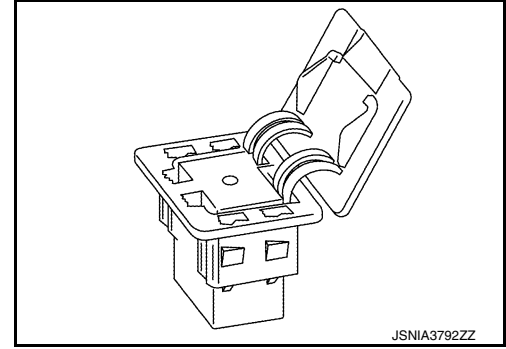

JSNIA3792ZZ

SD Card

INFOID:000000010641953

- Map data is memorized in an 8 GB SDHC* card.
- Map data is sent to the AV control unit from the SD slot.

NOTE:

*SDHC: Abbreviation of SD High-Capacity. It is the upper level standard of the SD memory card. A large quantity of data can be memorized, and the transfer speed of data is high.

SYSTEM
MULTI AV SYSTEM

MULTI AV SYSTEM : System Diagram

INFOID:000000010641954

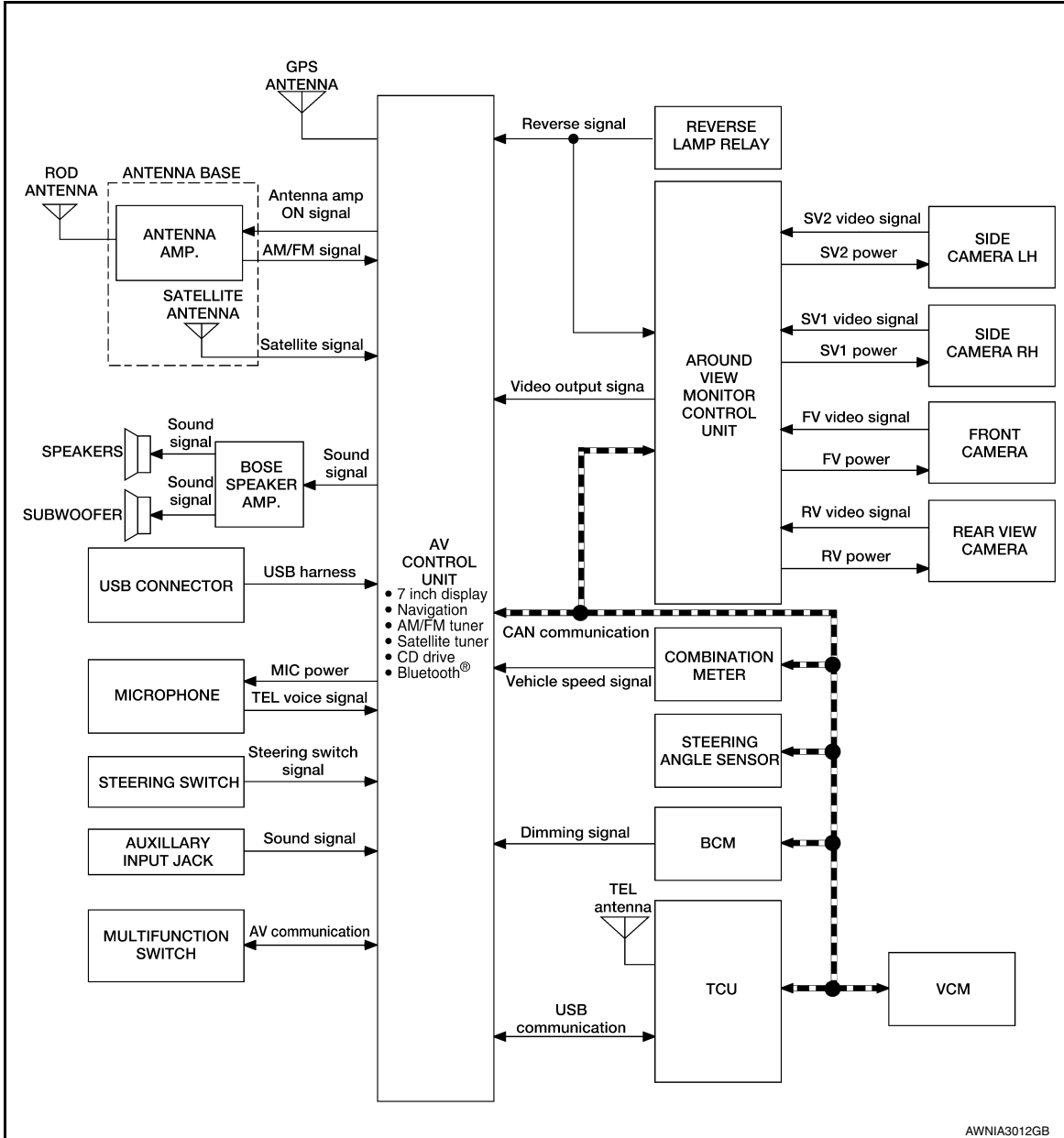

CAN communication

AV control unit Input Signal

Transmit unit	Signal name
Steering angle sensor	Steering angle sensor signal
Combination meter	Odometer signal
	A/C OFF average electricity consumption for driving range signal
	A/C ON average electricity consumption for driving range signal
	Driving range difference signal

A
B
C
D
E
F
G
H
I
J
K
L
M

AV

O
P

SYSTEM

< SYSTEM DESCRIPTION >

[NAVIGATION WITH BOSE]

Transmit unit	Signal name
VCM	A/C consumption power status display signal
	A/C consumption signal
	Current motor power signal
	ECO tree signal
	Li-ion battery charging data signal
	Others consumption signal
	Pre-A/C priority signal
	Pre-A/C timer signal
	Remaining time to charge completion (200 V) signal
	Remaining time to charge completion (100 V) signal
	Traction motor consumption signal
	VCM activation/deactivation command signal
	VCM status signal

TCU Input Signal

Transmit unit	Signal name
VCM	A/C expected consumption signal
	Charge status signal
	Pre-A/C status signal
	Remaining time to charge completion (200 V) signal
	Remaining time to charge completion (100 V) signal
	VCM activation/deactivation command signal
	VCM status signal
	Li-ion battery available charge signal
	Li-ion battery capacity signal
Li-battery gradual capacity loss signal	
On board charger	AC input type signal

MULTI AV SYSTEM : System Description

INFOID:000000010641955

- AV control unit is connected to the following parts. It performs power supply, signal input and communication, and it controls the multi-AV system.
 - GPS antenna
 - Radio antenna (radio antenna amplifier)
 - Around view monitor control unit
 - Front camera
 - Side cameras (LH and RH)
 - Rear view camera
 - USB connector
 - Auxiliary input jack
 - BCM
 - VCM
 - Combination meter
 - Steering switch
 - Multifunction switch
 - Microphone
 - TCU
 - Speakers
 - Vehicle signals (reverse signal, vehicle speed signal and illumination signal)
- Data of external device connected to the USB connector is played and transferred.

< SYSTEM DESCRIPTION >

- When the selector lever is placed in R (reverse) or the CAMERA switch is pressed, power is supplied to the cameras. The camera image signals supplied by the cameras are input to the around view monitor control unit. The around view monitor control unit sends the signals to the AV control unit. The AV control unit displays the camera images on the display.
- Dimming signal is input from BCM to adjust the brightness of the display.

COMMUNICATION SIGNAL

AV control unit is connected to TCU via USB communication, and it receives the Telematics information received by TCU and gives the display and sound output. Telematics operation signals and sound signals are also sent to TCU.

Auto light adjustment function

Auto light adjustment function automatically dims/brightens the display according to the ambient light when the lighting switch is in the 1st or 2nd position. Whether or not the display is dimmed when the lighting switch is in the 1st position or 2nd position is determined by the output condition of the dimming signal output from the BCM to the AV control unit. Even if the lighting switch is in the 1st position or 2nd position, the display may not be dimmed depending on the ambient light sensed by the auto light sensor. For details, refer to [INL-12. "ILLUMINATION CONTROL SYSTEM : System Description"](#).

CAN COMMUNICATION

- AV control unit is connected via CAN communication, receives data signal from VCM and combination meter, and indicates power consumption information, etc. on the display based on the information obtained.
- The AV control unit, which has the vehicle setting function, transmits and receives data on vehicle setting condition via CAN communication with the BCM.
- AV control unit receives steering angle signal from steering angle sensor via CAN communication and performs control of possible route line in around view monitor image.
- AV control unit receives and sends signals necessary for timer charge and A/C-heater timer operation with VCM via CAN communication.

Energy Flow Display Function

The AV control unit receives data signals from the VCM and combination meter via CAN communication and computes each value using the obtained information to display it.

Display function	Receiving signal (transmit unit)	Display method
Instantaneous power consumption display	<ul style="list-style-type: none"> • Battery consumption monitor signal (VCM) • Vehicle speed signal (combination meter) 	Computes the instantaneous power consumption using the vehicle speed and battery consumption monitor signals, and displays the instantaneous power consumption bar.
Possible driving distance display	<ul style="list-style-type: none"> • Possible driving distance signal (Combination meter) 	Displays a possible driving distance, based on a possible driving distance signal. When the meter indication of a possible driving distance is "----", it is displayed by "****" on the NAVI screen. Data is retained even with the power switch OFF.
Average power consumption display	<ul style="list-style-type: none"> • Battery consumption monitor signal (VCM) • Vehicle speed signal (combination meter) 	Computes the average power consumption using the battery consumption monitor and vehicle speed signals, and displays it. The average power consumption is displayed only when 30 seconds have elapsed and the vehicle has been driven 500 m after the average power consumption was reset. Data is retained even with the power switch OFF.

Vehicle Setting Function

The AV control unit transmits and receives data signals via CAN communication with the BCM, allowing the following vehicle settings.

- To turn on the automatic interior room lamp (ON/OFF) when the door is unlocked
- To adjust the auto light sensitivity (+/-)
- To operate the intermittent wiper linked with the vehicle speed (ON/OFF)
- Vehicle setting initialization

NOTE:

The setting items vary depending on the vehicle specification

TYPE OF VOICE SIGNAL

Reception Voice Signal

SYSTEM

< SYSTEM DESCRIPTION >

[NAVIGATION WITH BOSE]

- Hands-free phone reception voice is output from the cellular phone through the AV control unit to the front speaker via Bluetooth® communication.
- If the hands-free phone is used while the audio is ON and/or the voice guidance is being output, these sounds are muted and only the reception voice is output.

Speech Sound Signal

Hands-free phone speech sound is transmitted from the microphone via the AV control unit and Bluetooth® communication to the cellular phone.

CARWINGS Reading Voice Signal

- In the case of the CARWINGS reading voice, the AV control unit receives text data from the NISSAN CARWINGS Data Center through the USB harness and outputs them to the front speaker.
- If CARWINGS data is read while the audio is ON and/or the voice guidance is being output, these audio sounds are muted and only the CARWINGS reading voice is output.
- Depending on the information from the NISSAN CARWINGS Data Center, not only the CARWINGS reading voice but also background music may be output. In this case, audio output of the front speaker is turned down 10 dB and then the CARWINGS reading voice is output.

Guide Sound Signal

- Voice signals output during the route guidance of the navigation system are output from the AV control unit to the front speaker.
- If the voice guidance is output with the audio ON, audio output of the front speaker is turned down 10 dB and then voice guidance is output.
- Adjusting the volume while the voice guidance is being output can change the volume of the guidance.

AUDIO FUNCTION

- The MP3/WMA playback function enables music to play for a long time: the user need not change the CD during a long trip. The text display function is also adopted so that the title name and artist name of the ID3 tag/WMA tag can be displayed.
- Bluetooth® audio function is adopted to play music data in the portable audio via wireless communication.
- The adoption of the vehicle speed interlock sound volume function reduces the burden of the volume adjustment by the difference between the noises when the vehicle is stopped or running. In addition, the vehicle speed interlock sound volume function can perform ON/OFF setting and sound volume adjustment on a scale of one to five.

MP3/WMA Playback Function

This function enables the playback of compressed music files, such as MP3 music files used for the most widespread broadband music distribution and WMA music files played back with a music player generally built in Windows® personal computers.

Vehicle Speed Interlock Volume Function

- The AV control unit receives the vehicle speed signal from the combination meter via CAN communication and changes the sound volume in conjunction with the vehicle speed.
- Using the vehicle speed interlock sound volume function, ON/OFF setting can be carried out as preferred by users, and sound volume variation caused by vehicle speed change can be adjusted on a scale of one to three.

Bluetooth® Audio Function

- Bluetooth® audio function is adopted to play music data in the portable audio in wireless communication.
- Five units of Bluetooth® communication devices including audio devices and cellular phones can be registered to the AV control unit.
- When the Bluetooth® audio is connected to the portable audio through Bluetooth®, it can play the music data in the portable audio.
- When the Bluetooth® audio is playing the data, operations of the other applications are as shown in the following table.

Cellular phone operation (control) status		Bluetooth® audio playback status
Hands-free phone communication	Hands-free phone incoming call	Answering the call stops audio playback temporarily.

SYSTEM

< SYSTEM DESCRIPTION >

[NAVIGATION WITH BOSE]

Cellular phone operation (control) status		Bluetooth® audio playback status
CARWINGS service	Information channel and E-mail	Audio playback does not stop.
		Audio playback stops temporarily during data communication. After the communication has been completed, playback resumes.
Telephone book transfer		Audio playback does not stop. For Bluetooth® audio, audio playback stops temporarily. After the telephone book has been transferred, playback resumes.

Bluetooth® compliant profile

Profile name	Abbreviation	Version
Advanced Audio Distribution Profile	A2DP	Ver. 1.2
Audio Video Remote Control Profile	AVRCP	Ver. 1.3

Satellite Radio

- Satellite radio tuner is built into AV control unit.
- Audio signal and data signal (satellite radio) are received by satellite antenna. There are input to AV control unit. AV control unit outputs audio signal to each speaker and data signal to display unit.

USB CONNECTING FUNCTION

USB connector enables iPod® compliant and playback of music files in the USB memory.

*: iPod® is the trademark of Apple Inc. registered in the United States and other countries.

NAVIGATION SYSTEM FUNCTION

Description

- The AV control unit controls navigation function while GPS tuner has built-in map data, GYRO (angle speed sensor), on the SD card.
- The AV control unit inputs operation signal with communication signal, through front display unit (touch panel) and multifunction switch and steering switch.
- Guide sound is output to front speaker through from AV control unit when operating navigation system.
- A vehicle position is calculated with the GYRO (angle speed sensor), vehicle sensor, signal from GPS satellite and map data stored on SD card, and transmits the map image signal (RGB image, RGB area, RGB image synchronizing) to the display.

Position Detection Principle

The navigation system periodically calculates the current vehicle position according to the following three types of signals.

- Travel distance of the vehicle as determined by the vehicle speed sensor
- Vehicle turning angle determined by the gyroscope (angular speed sensor)
- The travel direction of the vehicle determined by the GPS antenna (GPS information)

The current position of the vehicle is then identified by comparing the calculated vehicle position with map data, which is stored in the SD card (map-matching), and indicated on the screen with a current location mark. More accurate data is used by comparing position detection results from GPS to the map-matching.

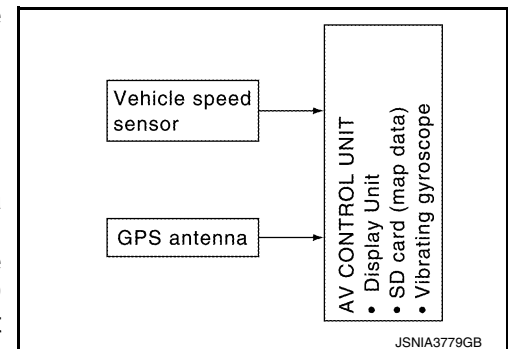

SYSTEM

< SYSTEM DESCRIPTION >

[NAVIGATION WITH BOSE]

The current position is calculated by detecting the travel distance from the previous calculation point, and its direction change.

- Travel distance

The travel distance is generated from the vehicle speed sensor input signal. The automatic distance correction function is adopted for preventing a miss-detection of the travel distance because of tire wear etc.

- Travel direction

The gyroscope (angular velocity sensor) and GPS antenna (GPS information) generate the change of the travel direction. Both have advantages and disadvantages as per the following descriptions.

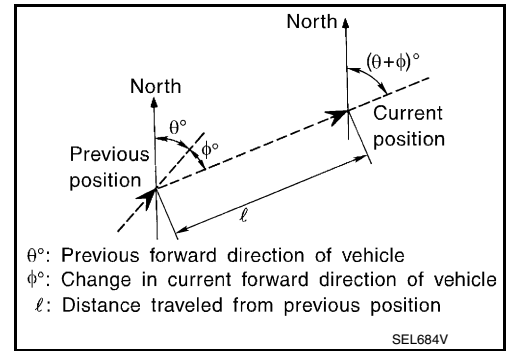

Type	Advantage	Disadvantage
Gyroscope (angular velocity sensor)	The turning angle is precisely detected.	Errors are accumulated when driving a long distance without stopping.
GPS antenna (GPS information)	The travel direction (North/South/East/West) is detected.	The travel direction is not precisely detected when driving slowly.

Input signals are prioritized in each situation. However, this order of priority may change in accordance with more detailed travel conditions so that the travel direction is detected more accurately.

Map-matching

Map-matching repositions the vehicle on the road map when a new location is judged to be more accurate. This is done by comparing the current vehicle position (calculated by the normal position detection method) from the map data stored in the SD card.

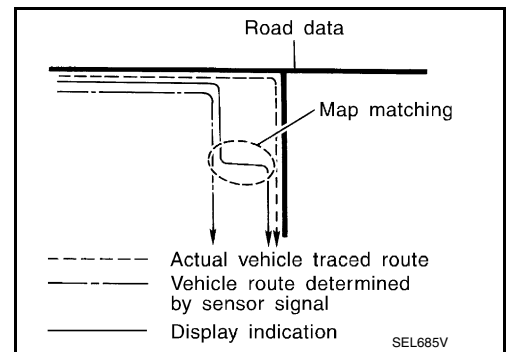

There is a possibility that the vehicle position may not be corrected in the following case, and when vehicle is driven over a certain distance or time in which GPS information is hard to receive. Correct manually the current location mark on the screen.

- In map-matching, several alternative routes are prepared and prioritized in addition to the road judged as currently driving on.

Therefore, due to errors in the distance and/or direction, an incorrect road may be prioritized, and the current location mark may be repositioned to the incorrect road.

If two roads are running in parallel, they are of the same priority. Therefore, the current location mark may appear on either of them alternately, depending on maneuvering of the steering wheel and configuration of the road, etc.

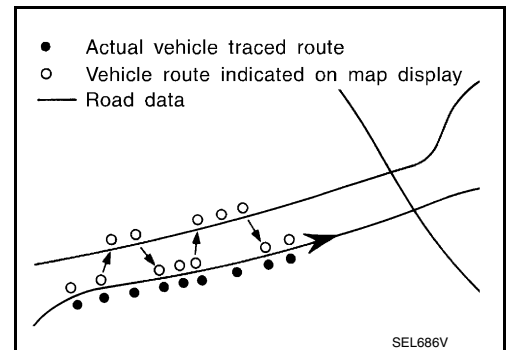

SYSTEM

< SYSTEM DESCRIPTION >

[NAVIGATION WITH BOSE]

- Map-matching does not function correctly when road on which the vehicle is driving is new, etc. and not recorded in the map data. Also, map-matching does not function correctly when road pattern stored in the map data and the actual road pattern are different due to repair, etc.

Therefore, the map-matching function judges other road as a currently driving road if the road is not in the map, and displays the current location mark on it. Later, the current location mark may be repositioned to the road if the correct road is detected.

- Effective range for comparing the vehicle position and travel direction calculated by the distance and direction with the road data is limited. Therefore, correction by map-matching is not possible when there is an excessive gap between current vehicle position and the position on the map.

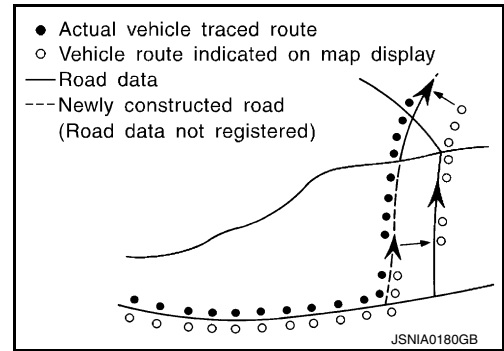

GPS (Global Positioning System)

GPS (Global Positioning System) is developed for and is controlled by the US Department of Defense. The system utilizes GPS satellites (NAVSTAR), transmitting out radio waves while flying on an orbit around the earth at an altitude of approximately 21,000 km (13,049 mile).

The receiver calculates the travel position in three dimensions (latitude/longitude/altitude) according to the time lag of the radio waves that four or more GPS satellites transmit (three-dimensional positioning). The GPS receiver calculates the travel position in two dimensions (latitude/longitude) with the previous altitude data if the GPS receiver receives only three radio waves (two-dimensional positioning). GPS position correction is not performed while stopping the vehicle.

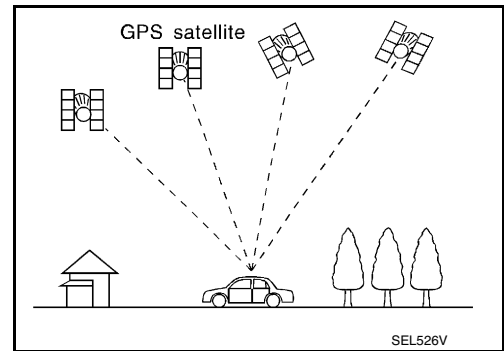

Accuracy of the GPS will deteriorate under the following conditions:

- In two-dimensional positioning, GPS accuracy will deteriorate when altitude of the vehicle position changes.
- The position of GPS satellite affects GPS detection precision. The position detection may not be precisely performed.
- The position detection is not performed if GPS receiver does not receive radio waves from GPS satellites. (Inside a tunnel, parking in a building, under an elevated highway etc.) GPS receiver may not receive radio waves from GPS satellites if any object is placed on the GPS antenna.

NOTE:

- The detection result has an error of approximately 10 m (32.81 ft) even with a high-precision three dimensional positioning.
- There may be cases when the accuracy is lowered and radio waves are stopped intentionally because the GPS satellite signal is controlled by the US trace control center.

BLUETOOTH® HANDS-FREE PHONE FUNCTION

- When the cellular phone is connected to the AV control unit in Bluetooth® communication, hands-free phone communication can be performed.
- Simply operating the steering switch without releasing hands from the steering wheel allows the driver to make a phone call or receive a phone call.
- For the available cellular phone support model, refer to "Compliant model list" on the CARWINGS site.
- When a Bluetooth® communication compliant phone is registered to the AV control unit, hands-free phone communication can be performed. Five units of Bluetooth® communication devices including audio devices and cellular phones can be registered to the AV control unit.
- The content of the memory (telephone book) of the cellular phone can be recorded in the AV control unit.

Bluetooth® compliant profile

Profile name	Abbreviation	Version
Hands-Free Profile	HFP	1.5
Dial-Up Networking Profile	DUN	1.1
Object Push Profile	OPP	1.1

VOICE RECOGNITION FUNCTION

A
B
C
D
E
F
G
H
I
J
K
L
M
AV
O
P

SYSTEM

< SYSTEM DESCRIPTION >

[NAVIGATION WITH BOSE]

- By speaking a command, operations of navigation and hands-free phone can be performed.
- To perform the voice control, press the Σ switch of the steering switch. The system changes to the speech reception status. When a command is spoken, the speech recognition result is displayed, and the operation is executed.
- The voice control cannot be performed under the conditions listed below.
 - When the hand-free phone is used
 - When the vehicle is moving backwards

Major Functions

With this function, the list of commands used for telephone, and navigation operation can be checked.

AROUND VIEW MONITOR FUNCTION

- This system is equipped with wide-angle cameras on the front, rear and right and left door mirrors.
- Images from front view, rear view, front-side view (RH side), and birds-eye view are displayed to monitor the vehicle surroundings.
- Around view monitor control unit expands the image received from each camera to create each view.
- In front view and rear view, the vehicle width, distance lines and predictive course lines are displayed.
- In front-side view, the vehicle distance guiding line and vehicle width guiding line are displayed.
- Birds-eye view converts the images from the cameras into an overhead view and displays the status of the vehicle on the display. The vehicle icon that is displayed in the birds-eye view is depicted by the around view monitor control unit.

Display

The around view monitor combines and displays travel direction view (front or rear), front-side view and birds-eye view.

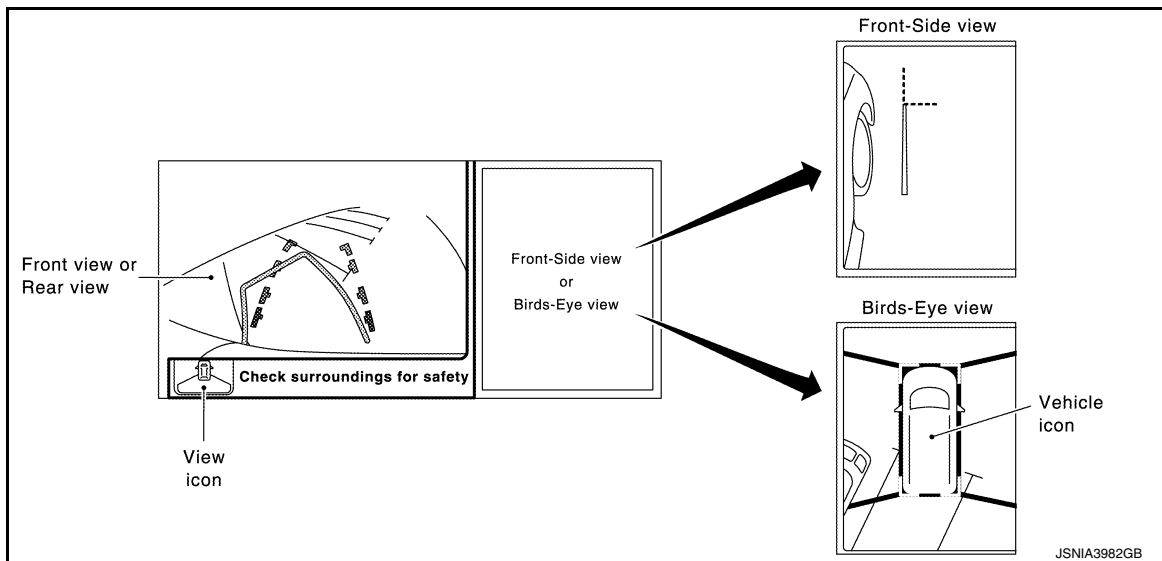

Operation

- The around view monitor operates by pressing the CAMERA switch on the AV control unit or by shifting the selector lever to the R (reverse) position.
- When the selector lever is in any position other than R (reverse) and the CAMERA switch is pressed, the screen displays front travel direction view and birds-eye view. Pressing the CAMERA switch again changes birds-eye view to front-side view
- When the selector lever is placed in R (reverse), the screen displays rear travel direction view and birds-eye view. Pressing the CAMERA switch changes birds-eye view to front-side view
- In birds-eye view, the blind spot area is displayed in black to show the border of the camera images. In addition, red fixed lines are displayed in the 4 corners of the vehicle icon. After pressing the CAMERA switch for the first time or placing the selector lever in R (reverse) for the first time, the blind spot area is highlighted in yellow for 3 seconds and the red fixed lines blink five times.
- With the selector lever in any position other than R (reverse), the around view monitor screen display is cancelled 3 minutes after pressing the CAMERA switch. The screen returns to the AV control unit display.
- With the selector lever in R (reverse) position, the around view monitor screen display remains on constantly. To return to the AV control unit display, place the selector lever is in any position other than R (reverse).

- If camera image calibration is incomplete, the applicable camera position is indicated as an error on the birds-eye view display.

NOTE:

Calibration is necessary when replacing each camera or when replacing around view monitor control unit.

Around view monitor screen transition

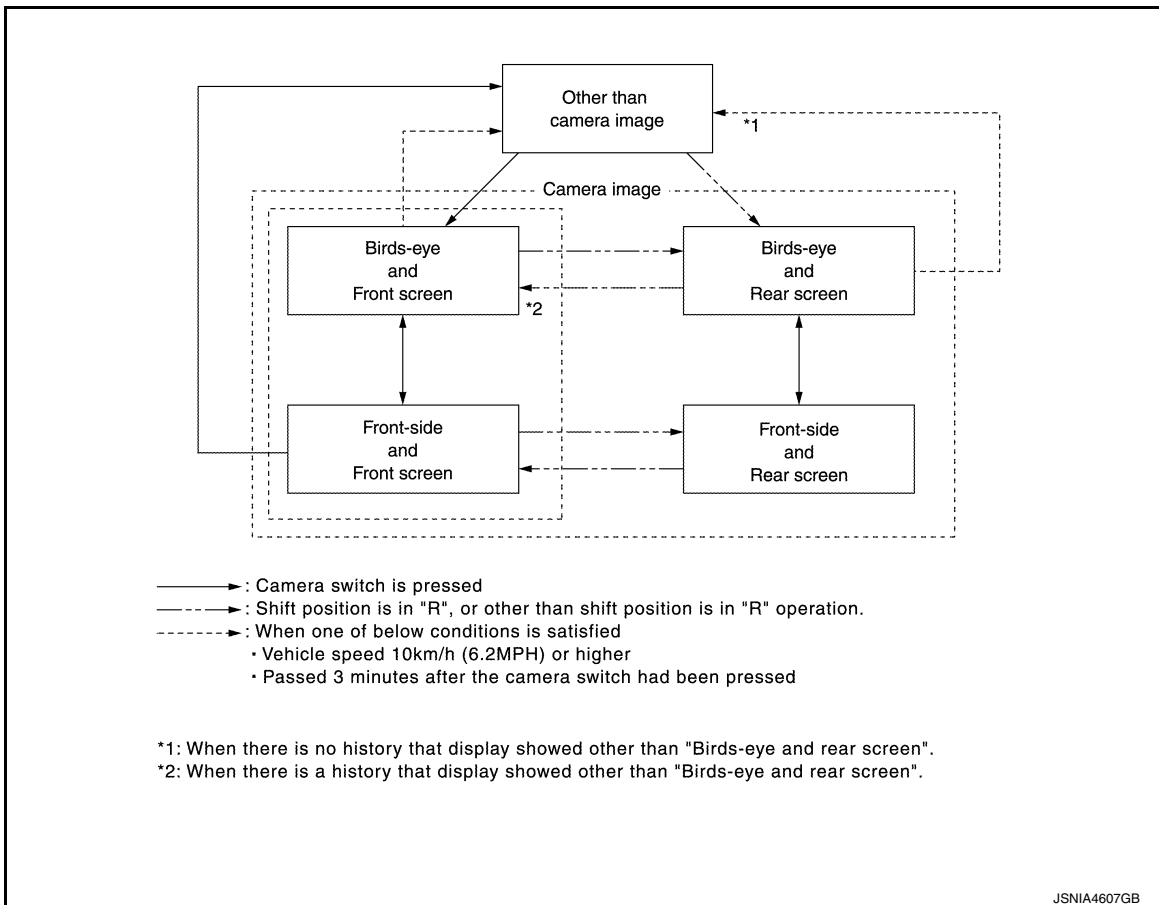

Front View

- The front view image improves the visibility of obstacles in front of the vehicle and assists driving by displaying images from birds-eye view and front-side view.
- The front view image displays the vehicle width guiding line and vehicle distance guiding line, in addition to the predictive course line according to the steering angle.
- If the steering angle is within approximately 90 degrees, the predictive course lines on the left/right side are displayed. If the steering angle exceeds approximately 90 degrees, only the predictive course line on the outside is displayed (opposite side of steering direction).
- The around view monitor control unit receives the steering angle signal from steering angle sensor via CAN communication, and controls the direction and distance of the predictive course line.
- ON/OFF setting of predictive course line can be performed using CONSULT.

AV

SYSTEM

Front view guiding lines

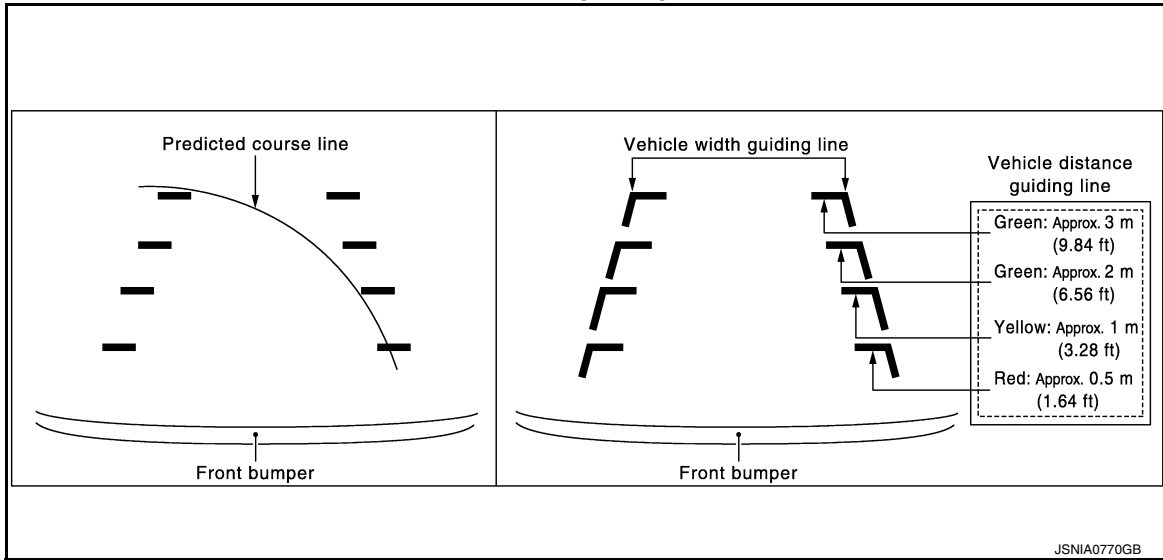

Rear View

- The rear view image improves the visibility of obstacles in the rear of the vehicle and assists backing and parking by displaying images from birds-eye view and front side view.
- The rear view image displays the vehicle width guiding line and vehicle distance guiding line, in addition to the predictive course line according to the steering angle.

NOTE:

The predictive course line is not displayed at the steering neutral position.

- The around view monitor control unit receives the steering angle signal from steering angle sensor via CAN communication, and controls the direction and distance of the predictive course line.
- ON/OFF setting of predictive course line can be performed using CONSULT.

Rear view guiding lines

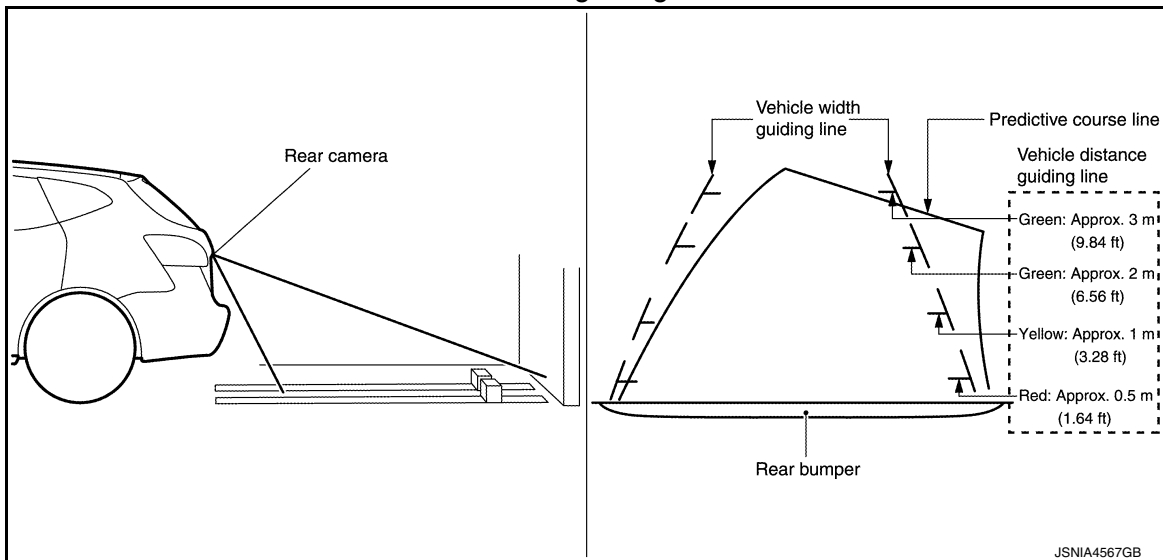

Front-Side View

- The front-side view image improves the visibility of obstacles in the front RH side of the vehicle and assists backing and parking.
- The front-side view image displays the vehicle distance guiding line and vehicle width guiding line.

Front-side view area and guiding line

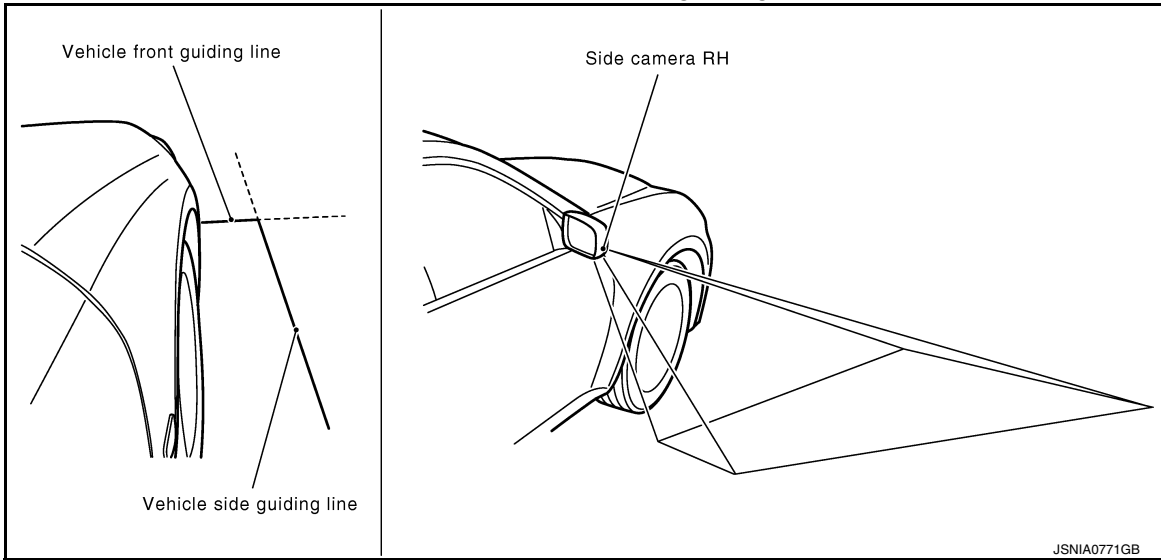

Birds-Eye View

- The birds-eye view image improves the visibility of obstacles all around the vehicle and assists backing and parking.
- The images from the four cameras are converted into an overhead view, and the surroundings of the vehicle are displayed.
- The blind spot area is displayed on the image to specify the boundary of the four cameras.

Birds-Eye view display image

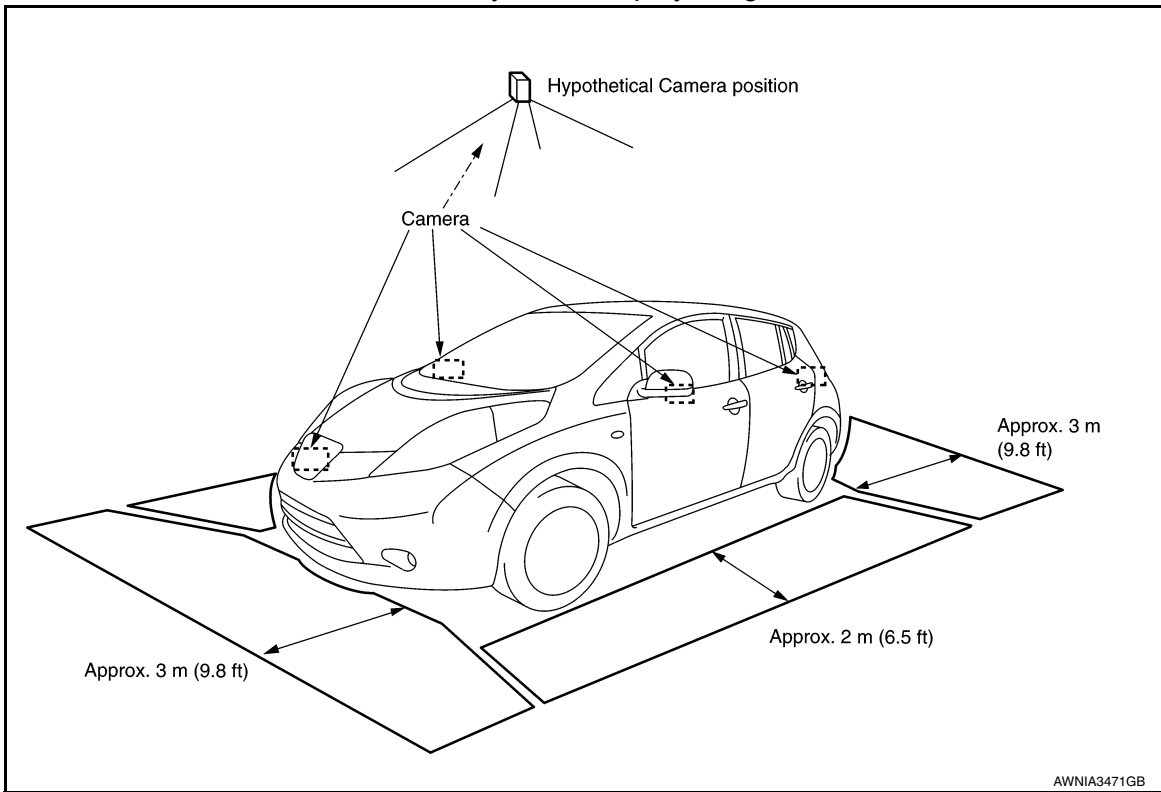

A
B
C
D
E
F
G
H
I
J
K
L
M
AV
O
P

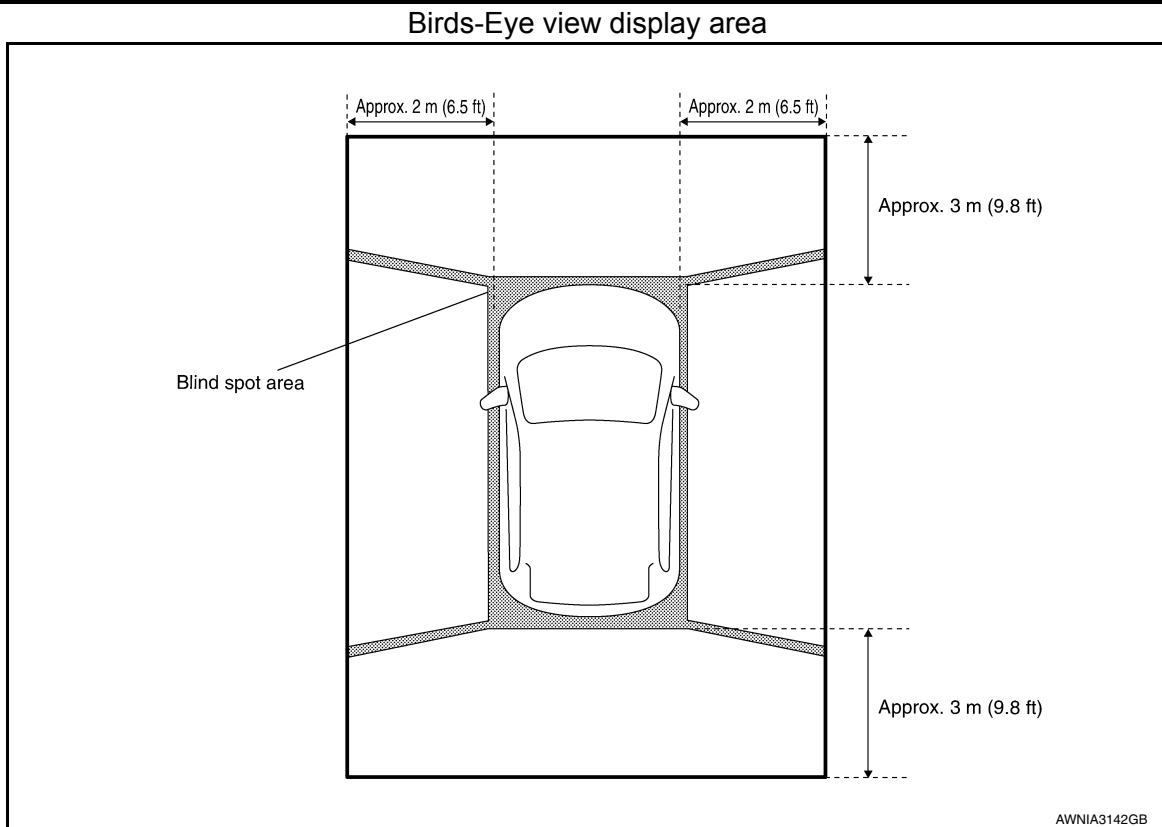

TIMER CHARGE AND A/C-HEATER TIMER FUNCTION

- Time for timer charge and A/C-heater timer can be set from the navigation setting screen.
- The AV control unit sends the current time signal received with GPS antenna to VCM via CAN communication, and it compensates the current VCM time.

Timer Charge Function

- Set the timer charge start time on the navigation setting screen. When the charging plug is connected, the time mode is activated.
- If the charging plug fitting is not sufficient, unplugged status is notified. For details of unplugged status notification, refer to [AV-515. "TELEMATICS SYSTEM : System Description"](#).
- After the power switch is OFF, VCM is activated at the set charge start time and charge is started. (The time of the timer function is controlled by VCM.)
- VCM sends the VCM status signal and VCM wake-up signal to TCU via CAN communication to notify that VCM is activated. For details of the charging function, refer to [VC-17. "VEHICLE CHARGING SYSTEM : System Description"](#).
- Charge is completed.

NOTE:

Information of charge completion sent to the user is also given if charge is abnormally completed for some reason (e.g. disconnection of charging plug).

A/C-Heater Timer Function

- Set the A/C-heater timer start time on the navigation setting screen. When the charging plug is connected, the time mode is activated.
- After the power switch is OFF, VCM is activated at the set air conditioning start time and air conditioning is started. (The time of the timer function is controlled by VCM.)
- VCM sends the VCM status signal and VCM wake-up signal to TCU via CAN communication to notify that VCM is activated. For details of air conditioner system, refer to [EVC-57. "AIR CONDITIONER CONTROL : System Description"](#).

NOTE:

- A/C-heater timer performs air conditioning with the settings of temperature 25°C, AUTO, fan AUTO and REC.
- Power consumption of the compressor or the PTC heater is limited according to allowable power from VCM. Sufficient air conditioning may not be performed if charge has priority or 100 V charge is performed.

MULTI AV SYSTEM : Map Data Update

INFOID:000000010641956

To update map data, use an SD card including new map data.

MULTI AV SYSTEM : Fail-safe

INFOID:000000010641957

When a malfunction occurs within the system, the AV control unit outputs a message on the display, and it restricts the AV control unit functions.

FAIL-SAFE CONDITIONS

SD card not inserted, SD card malfunction, internal malfunction of navigation, etc.

Display Indication

- When the system is in the fail-safe status at the start of the AV control unit, an error message is shown on the display.
- When the system is in the fail-safe status after the start of the AV control unit, an error message is not shown on the display. The MULTI AV system may be rebooted in the fail-safe state. If the fail-safe state is maintained after the system is rebooted, an applicable message is shown.

Cause	Display monitor
Malfunction of flash ROM information	TARGET INFO NG
No SD card	NO SD CARD
Unsuccessful security unlock	SD UNLOCK NG
Malfunction of SD card mount	SD INIT NG
Malfunction of SD card access	SD ACCESS NG
No program data	NO NAVI-2 DATA
Malfunction of program data (SUM NG)	NAVI-2DATA READ NG
Inconsistent program version (Flash/SD)	NAVI VERSION NG
Difference of map destination	DIFFERENT MAP CODE
Not compliant with map database version	MAP DATA BASE UNMATCH
Malfunction of navigation	NAVI STARTUP NG

CONTROL

When the system is in the fail-safe status at or after start of the AV control unit, the following functions are restricted.

Function	In fail-safe mode	
A/C	Dis-play	No display (fail-safe status display)
Audio	Opera-tion	Mute audio
	Dis-play	No display (fail-safe status display)
Camera	Opera-tion	It cannot be operated
	Dis-play	Only composite (camera image) is displayed and superimpose (warning display and image quality display) is not displayed.
Hands-free phone	Opera-tion	It cannot be operated
Navigation	Opera-tion	It cannot be operated
Display	Opera-tion	Open/close operation is available
	Dis-play	Fail-safe factors are displayed

SYSTEM

< SYSTEM DESCRIPTION >

[NAVIGATION WITH BOSE]

Function	In fail-safe mode
Self-diagnosis	It cannot be diagnosed
CONSULT diagnosis	It cannot be diagnosed
AV communication diagnosis	It cannot be diagnosed
Frequency transmission for VCM	Normal
SD read access	Access cannot be gained.
SD write access	Access cannot be gained.

CANCELLATION CONDITIONS

The fail-safe status is canceled under the following conditions, and then the system returns to the normal mode.

- When the SD card is not inserted, the SD card is inserted and the power of the AV control unit is turned ON again.
- When the SD card is not functional at the start of navigation due to a malfunction of the SD card, a normal SD card is inserted and the power of the AV control unit is turned ON again.

OPERATION

Switch name and Function

INFOID:0000000110641958

Names and functions of AV control unit switches

1. Design

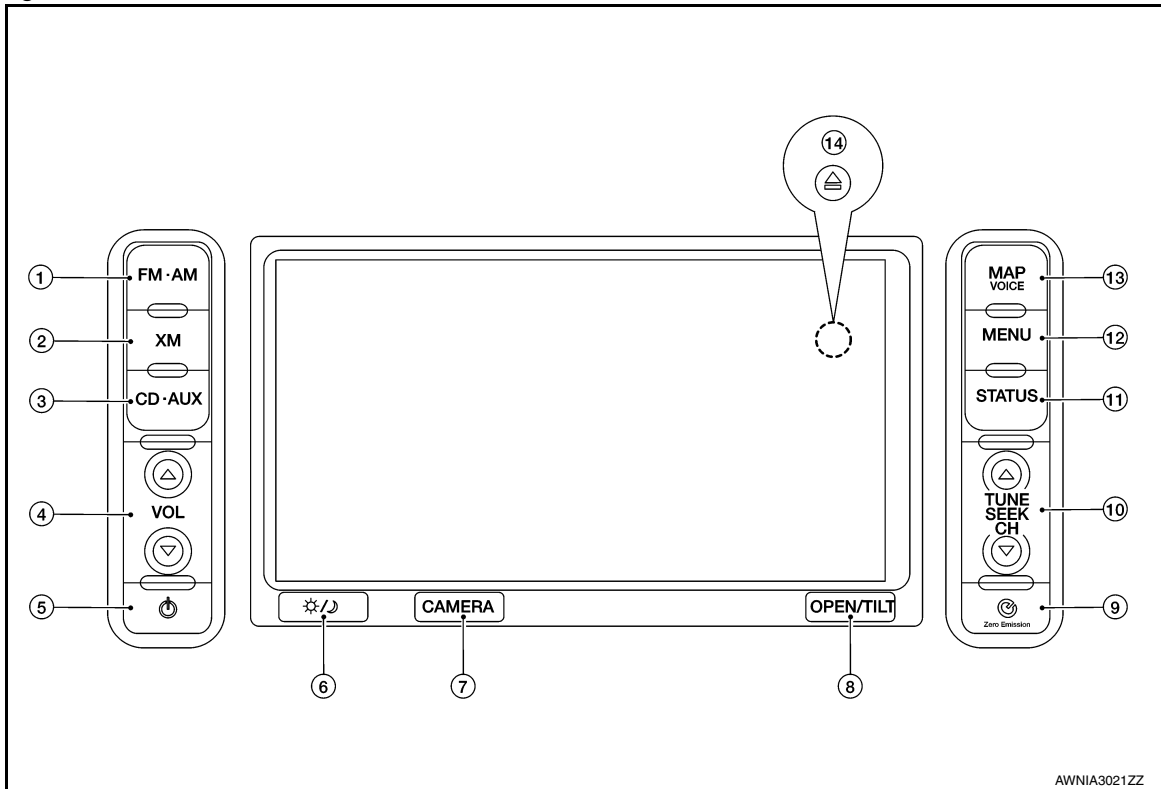

2. Switch name and function

No.	Switch name	Function
1	FM-AM	Press to switch between the FM radio band and the AM radio band.
2	XM	Press to switch to an XM satellite radio band.
3	CD-AUX	Press to switch between USB memory/iPod player ^{*1} /CD/Bluetooth [®] streaming audio ^{*2} /AUX screens.
4	VOL (volume control)	Press to adjust the volume of the stereo.
5	⏻ (audio system ON-OFF)	Press to turn the audio system ON or OFF.
6	☀/🌙 (Day/Night)	<ul style="list-style-type: none"> Press to switch between the day screen (bright) and the night screen (dark). Press and hold to turn off the display, then press again to turn on the display.
7	CAMERA	Press to turn the around view monitor system ON or OFF.
8	OPEN/TILT	<ul style="list-style-type: none"> Press to open the monitor to access the CD slot and the SD card slot. Press and hold to adjust the monitor angle. (6 angles)
9	🌱 (Zero emission)	Press to display the setting screen where several useful functions for electric vehicle driving are determined.
10	TUNE/SEEK/CH	<ul style="list-style-type: none"> Press to select a track/station. Press and hold to search for a track/station automatically or to fast-forward/back-forward when listening to music.
11	STATUS	Press to display the current status of the air conditioner, radio, audio, vehicle information (estimated distance, drivable distance and average energy economy) and navigation systems.
12	MENU	Press to display the setting menu (destination, route, information, settings, phone and carwings) screen.

A
B
C
D
E
F
G
H
I
J
K
L
M
O
P

AV

OPERATION

< SYSTEM DESCRIPTION >

[NAVIGATION WITH BOSE]

No.	Switch name	Function
13	MAP/VOICE	<ul style="list-style-type: none"> • Press to display the current location map screen. • Press and hold to repeat voice guidance.
14	 (Disk eject)	Press to eject a disk.

- *1: Displayed when iPod® is connected.
- *2: Displayed when Bluetooth® audio is registered and “Bluetooth connection” setting is ON.



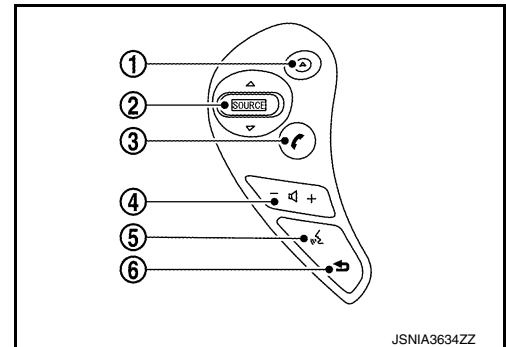

Names and functions of steering switch

By using the steering switch, various operations on the audio, navigation, telephone, and others can be performed without releasing hands from the steering wheel.

1. Design



2. Switch name and function

No.	switch name	Major functions		
1	 (Driving range)	Press to display the driving range screen. Press again to return to the previous screen.		
2	SOURCE	Press to change source menu.		
		<table border="0"> <tr> <td>Tilt up/down for a short period of time</td> <td> <ul style="list-style-type: none"> • During the radio switches the preset channel. • During the CD mode, USB mode, iPod mode, and Bluetooth audio mode selects the track. </td> </tr> <tr> <td>Tilt up/down for a long period of time</td> <td> <ul style="list-style-type: none"> • During the radio mode, good sensitivity frequency is automatically selected. • The CD mode, iPod mode, or Bluetooth audio mode allows the fast-forwarding and rewinding of a music file. • During the CD mode, a folder selection can be made when an MP3/WMA disc contains a folder. • The USB mode allows folder selection. </td> </tr> </table>	Tilt up/down for a short period of time	<ul style="list-style-type: none"> • During the radio switches the preset channel. • During the CD mode, USB mode, iPod mode, and Bluetooth audio mode selects the track.
Tilt up/down for a short period of time	<ul style="list-style-type: none"> • During the radio switches the preset channel. • During the CD mode, USB mode, iPod mode, and Bluetooth audio mode selects the track. 			
Tilt up/down for a long period of time	<ul style="list-style-type: none"> • During the radio mode, good sensitivity frequency is automatically selected. • The CD mode, iPod mode, or Bluetooth audio mode allows the fast-forwarding and rewinding of a music file. • During the CD mode, a folder selection can be made when an MP3/WMA disc contains a folder. • The USB mode allows folder selection. 			
3	 (Phone)	<ul style="list-style-type: none"> • Displays the hands-free phone menu. • When this is pressed during call, telephone communication can be started. 		
4	-  + (Volume control)	<ul style="list-style-type: none"> • Adjust the audio volume. • Other than the audio volume, the volume levels of guide sound (at guide interruption), hands-free phone, and others can be adjusted. 		
5	 (Talk)	Press to enter the voice recognition mode.		
6	 (Cancel)	Press to cancel the voice command.		

Menu Display by Pressing Each Switch

INFOID:000000010641959

NOTE:

For Navigation system and Telematics system operation detailed information, refer to Navigation system Owner's Manual.

MENU

OPERATION

< SYSTEM DESCRIPTION >

[NAVIGATION WITH BOSE]

When the MENU switch is pressed, the menu screen is displayed.



Menu list		Description
Destination	Change Country	When setting a destination, the country can be selected. The country that was last selected is automatically selected by the system as the default.
	New Address	Searches for a destination by address.
	Home	Searches for a route from the current location to the previously stored home destination.
	Points of interest	Searches for a destination from various categories of businesses or locations.
	Charging Station	Searches for the charging stations near the current vehicle location.
	Quick Stop	Searches for points of interest near the current vehicle location, such as restaurants and charging stations, etc.
	Address Book	Searches for a destination from the list of the stored locations.
	History	<ul style="list-style-type: none"> • Sets the previous starting point as destination. • Searches for the destination from the previous destinations.
	M-way Entrance/Exit	Searches for a destination from a motorway entrance/exit.
	Stored Routes	Selects a stored route.
	Latitude/Longitude	Searches for a destination by entering the latitude and the longitude.
	Junction	Searches for a destination from junctions.
Route	Cancel Route/Resume Route	Cancels the current route guidance. A canceled route can also be reactivated. If the suggested route is canceled, "Cancel Route" changes to "Resume Route".
	Edit Route	Edit or add a destination or waypoints to the route that is already set.
	Route Info	Confirm the route by the route information or simulation. The confirmed route can also be stored.
	Guidance Voice	Activates or deactivates route, voice guidance and/or traffic announcement and adjust the volume level of voice guidance.
	Recalculate	Manually search for the route again after changing the search condition and have the system calculate a route.
	Detour	A detour of a specified distance can be calculated.
	Traffic Detour	Manually search for an alternative detour route taking the traffic information into consideration.
Route Calculation Criteria	Changes the route calculation conditions anywhere along the route.	

OPERATION

< SYSTEM DESCRIPTION >

[NAVIGATION WITH BOSE]

Menu list		Description
Info.	Traffic Information	Displays the Traffic Information.
	Energy Info.	Energy information is displayed on the screen.
	Maintenance	Displays the vehicle maintenance information.
	Charging Station Info	Displays charging station information for the current location.
	Where am I?	Displays information regarding the current vehicle location.
	Voice Recognition	Displays the voice command list.
	GPS Position	Displays GPS information regarding the current vehicle location.
	Navigation Version	Displays the current navigation system version.
Settings		The system can be customized the following items.
Phone	Phonebook	Select a telephone number from the phone book, and then make a call. Before making a call, the telephone number must be registered in the phone book.
	Call History	Select a telephone number from the incoming or outgoing history lists, and then make a call.
	Handset Memory	Download the phone book from a cellular phone that is connected to the vehicle, select a telephone number from the phone book, and then make a call. Phone book data should be registered in the system after downloading the phone book from the cellular phone that is connected to the vehicle. If the phone book is not registered, a message that reminds you of phone book data download will be displayed.
	Keypad	Input the phone number manually using the keypad displayed on the screen.
	Volume	Adjust various settings of phone volume.
	Pair Phone	<ul style="list-style-type: none"> When a PIN code appears on the screen, operate the compatible Bluetooth® cellular phone to enter the PIN code. When the connection process is completed, the screen will return to the Phone menu display.
	Paired Phone	The list of the registered cellular phones is displayed.
CARWINGS	Favorite Channels	A maximum of 16 favorite channels selected from the information channels can be stored in a folder.
	Information Channels	Touch the preferred folder. An information channel list is displayed.
	CARWINGS Records	The information channels that were referred to previously are displayed. A maximum of 3 channels are stored in the history.
	Update Stations	Charging station information is updated through connection to the NISSAN CARWINGS Data Center.
	CARWINGS Settings	The CARWINGS system can be customized.

ZERO EMISSION MENU

When the  ZERO EMISSION switch is pressed, the menu screen is displayed.



OPERATION

< SYSTEM DESCRIPTION >

[NAVIGATION WITH BOSE]

Menu list	Description
Driving Range	The estimated driving area within range, including the current position is displayed on the map screen.
Nearby Stations	Charging station information for the current position area is displayed.
Update Stations	Charging station information is updated through connection to the NISSAN CARWINGS Data Center.
Energy Info.	Energy information is displayed on the screen.
Charging Timer	The timer charge function can be set.
A/C-Heater Timer (Climate Ctrl. Timer)	The A/C-Heater Timer (Climate Ctrl. Timer) function can be set.
 CARWINGS	Information channels are displayed and settings for CARWINGS can be performed.
Settings	Setting of the warning message display or the charging status notification can be performed.

MAP MENU

Map menu at current location

If the following operation is performed at the current location, the available map menu is displayed.

- Touch the “Map Menu” switch on the map.



Menu item	Description	
Store Location	Stores the current vehicle location in the Address Book. The stored location can be retrieved as necessary to set it as a destination (waypoint).	
Quick Stop	Searches for points of interest near the current vehicle location, such as restaurants and charging stations, etc.	
Map Settings	Map View	The screen display [Plan view, Birdview [®] , split screen (2D/2D), split screen (2D/2D)] can be changed.
	Split Screen	
	Map Settings	Map Orientation (sets the map direction to North Up or Heading Up), Long Range (on/off), Birdview Angle (Changes the Birdview [®] angle), Left Settings (sets the map settings for the left screen of the split map) and Automatic Display of Highway Mode (on/off) can be set.
	Back to Map.	Return to the current position screen.
Landmark Icons	Displays map icons of certain points of interest (such as restaurants and charging stations, etc.) on the map around the current vehicle location	
Update Station	Charging station information is updated through connection to the NISSAN CARWINGS Data Center.	

Map menu after scroll of map

If the following operation is performed after scrolling the map, the available map menu is displayed.

OPERATION

< SYSTEM DESCRIPTION >

[NAVIGATION WITH BOSE]

- Touch the “Map Menu” switch on the map.

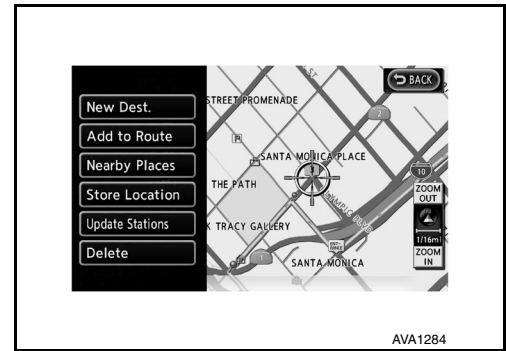

Menu item	Description
New Dest.	Sets the destination to the map location where [New Dest.] was touched. If a destination is already set, the location will be set as the new destination.
Add to Route	Sets the map location where [Add to Route] was touched as the destination or a waypoint. This is available only when a suggested route is already set.
Quick Stop	Searches for points of interest such as restaurants and charging stations, etc. near the location by scrolling the map.
Store Location	Store the map location where [Store location] was touched in the Address Book. The stored location can be retrieved to set it as a destination or waypoint.
Update Stations	Contact the NISSAN CARWINGS Data Center to update charging station around the point of the cursor.
Delete	Deletes a destination, waypoint or stored location. To delete, place the cross pointer over the corresponding icon.

HANDLING PRECAUTION

Display

INFOID:000000010641960

- When the compartment temperature is low, the display images may look slower because the LCD response is deteriorated. The system will recover its normal operation when the cabin temperature increases to an appropriate level.
- When the compartment temperature is low (0°C or less), the display images may look slower. It is characteristic of the LCD monitor and should not be considered to be a malfunction. When the temperature is at the operating temperature (0°C to 50°C), the display returns to normal.
- There may be small dark or bright dots in the screen or remaining display content may be found (image lag). These are inherent symptoms to any LCD monitor and should not be considered to be a malfunction.
- The image may look bright or dark when viewed obliquely from the rear. It is inherent to any LCD monitor and should not be considered to be a malfunction.
- Do not apply pressure on the LCD monitor. Doing so may cause irregularities in the screen image or render it inoperative.
- Do not use hard cloth, organic solvent (alcohol, benzene, and thinner), or chemical wipe to clean the LCD monitor. Doing so may affect the panel surface. When cleaning the LCD monitor, always wipe it with a soft cloth after shutting off the power. For severe contamination, use a soft cloth dampened with mild detergent (no droplets can be present).

Audio

INFOID:000000010641961

- When an MP3/WMA disc is replayed, it may take some time to start the playback after the disc is inserted, because the contents of the disc files must be analyzed.
- The extensions for MP3/WMA files are ".MP3", ".WMA", ".mp3", and ".wma". Any file with a different extension or no extension cannot be played back.
- If trying to play a music CD (CD-DA) containing MP3/WMA file, MP3/WMA file is not played.
- The compatibility of a CD-R depends on the combination of the writing software/hardware and the writing rate. The disc has digital pulse signals written on it. If the specifications for writing depth and width (area) are not compatible, these signals may not be played back correctly or the sounds may be lost or skipped.
- The file recorded with high bit rate* may have sound skipping.
- The playback order of MP3/WMA files may differ from the intended order because the writing software could change the folder and file positions when writing data to a CD-R/CD-RW disc.
- For an MP3 file, the folder name and file name can be displayed as the title on the condition that each name string consists of up to 16 alphanumeric letters (except for the extension). Any MP3 file with a name containing other letters or that is longer than the maximum length cannot be displayed correctly.
- Some MP3/WMA making software, text information editing software, writing software, or software configurations may create files and discs in a format different from the proper specifications. In such a case, the text information display or the playback function may not be available.
- A disc for which no session close or disc close process has been finished may not be played back.
- Some files may have incorrect playback time displays and therefore a part of the music cannot be played back.
- 8 cm disc cannot be used.
- When playing back a Bluetooth® audio data, the sound may be interrupted for a moment. This is due to data communication and should not be considered to be a malfunction. After the data communication finishes, the playback will restart normally.
- If any CARWINGS operation or incoming call takes place during Bluetooth® audio playback, the screen changes to the relevant mode and the audio playback is interrupted.
- Sound skipping may occur depending on the location where the Bluetooth audio device is installed.
- If any operation for traffic information reception is performed during Bluetooth® audio playback, the audio playback is interrupted.
- Music data stored in a Bluetooth® audio device at low bit rate has poor sound quality.
- Radio reception may decrease in performance during charge.

NOTE:

*: Bit rate means how many bits of data are processed or transmitted per the unit time.

iPod®

INFOID:000000010641962

- If a headphone is connected to the iPod®, the iPod® may not be controlled.

HANDLING PRECAUTION

< SYSTEM DESCRIPTION >

[NAVIGATION WITH BOSE]

- Some iPod® may not be compliant with connection. It is necessary to check compliant models of iPod®.
- If a USB extension cable is used for iPod® connection, iPod® may not be recognized or sound skipping may occur in playback.
- In playing back iPod® audio, if the EQ function (equalizer function) of the iPod® is ON, sound may be distorted.
- If the number of music in one category is increased to a large number, response may be poor. If the number of music is large and shuffle is ON, operation of the iPod® itself may be slower.

RESTRICTIONS ON iPod®

The following symptoms may occur, but the functions are not compliant and they should not be considered to be a malfunction.

- When a Podcast divided into chapters is played back with iPod nano 3G, the play time may be displayed incorrectly.
- The number of Audiobook is not displayed normally. When iPod® is disconnected and reset, it is displayed.
- When jacket photos are played with iPod nano 3G and iPod Classic, iPod® may be frozen or reset.

USB Connection

INFOID:0000000010641963

If a USB-HUB or USB extension cable is used when a USB is connected, USB is not recognized.

CARWINGS

INFOID:0000000010641964

Refer to [AV-525, "Telematics&CARWINGS"](#).

Hands-Free Phone

INFOID:0000000010641965

- In the following cases, the hands-free telephone function is not available.
 - When the vehicle moves out of the communication zone of the cellular phone.
 - When the vehicle is in a location that may block radio waves such as in an underground parking lot, behind a building, or in mountainous areas.
 - When the cellular phone is subject to dial-up limitations such as dial lock, and auto lock, transmission restriction.
- It is not compliant with call waiting function and three-party call function.
- No incoming call can be received just after the key switch is turned to ON.
- For further details about the supported models, consult the Supported Cellular Phone Models in the CARWINGS site.
- Depending on the cellular phone connected, the ring volume may decrease.
- Before connecting a cellular phone, make sure that the operation limitations such as dial lock, auto lock and transmission restriction are cancelled. If any of these settings is found to remain active, disconnect the phone, cancel the setting, and reconnect it.
- When a menu or information is displayed on a cellular phone or when application of standby tool is activated, the function may not be used. Use the cellular phone in the standby status.
- Once a cellular phone is removed, wait at least 10 seconds before reconnecting it.
- When attempting to use a cellular phone, always make sure that the battery charge level is sufficient.
- A snap sound may be heard or the audio signal may be interrupted during a call. This is not a malfunction. It is caused by a switchover to an adjacent cellular zone due to weakening radio waves.
- When the reception status is poor or the surrounding sound level is too large, the voice on the phone may be hard to hear.
- Because the system uses a digital line, the voice on the phone may be distorted or have unpleasant noises due to the surrounding sounds.
- If the vehicle is equipped with a speed trap tracker (radar detector), the speaker may generate noises.
- This unit cannot be used to charge a cellular phone.

SD Card

INFOID:0000000010641966

To remove the SD card, wait for 15 seconds or more after turning the power switch OFF.

DIAGNOSIS SYSTEM (AV CONTROL UNIT)

< SYSTEM DESCRIPTION >

[NAVIGATION WITH BOSE]

DIAGNOSIS SYSTEM (AV CONTROL UNIT)

Diagnosis Description

INFOID:000000010641967

- Diagnosis is performed with the on board diagnosis and CONSULT. Select an appropriate function based on the condition. Perform the on board diagnosis if it starts. If the on board diagnosis does not start such as no display, perform diagnosis with CONSULT.
- In the on board diagnosis, a multifunction switch operation starts the AV (NAVI) control unit diagnosis function and AV control unit performs a diagnosis for each system unit. Diagnosis results are displayed on the screen.
- In the CONSULT diagnosis, a communication signal starts the AV control unit diagnosis function and the AV control unit performs a diagnosis for each system unit.

On Board Diagnosis Function

INFOID:000000010641968

ON BOARD DIAGNOSIS ITEM

- The on board diagnosis function has a self-diagnosis mode for conducting trouble diagnosis automatically and a confirmation/adjustment mode for operating manually.
- Self-diagnosis mode performs the diagnosis at the AV control unit, connections between each unit that composes the system, and connections between AV control unit and GPS antenna. It displays the results on the display.
- The confirmation/adjustment mode allows the technician to check, modify or adjust the vehicle signals and set values, as well as to monitor the system error records and system communication status. The check, modify or adjust actions generally require human intervention and judgment (the system cannot judge automatically).

Mode	Description
Self Diagnosis	<ul style="list-style-type: none">• AV control unit diagnosis.• Diagnoses the connections across system components, between AV control unit and GPS antenna.

A
B
C
D
E
F
G
H
I
J
K
L
M
O
P

AV

DIAGNOSIS SYSTEM (AV CONTROL UNIT)

< SYSTEM DESCRIPTION >

[NAVIGATION WITH BOSE]

	Mode	Description	
Confirmation/ Adjustment	Display Diagnosis	The following check functions are available: color tone check by Color Spectrum Bar and White Display, light and shade check by Gradation Bar and Touch Panel calibration response check.	
	Vehicle Signals	Diagnosis of signals can be performed for vehicle speed, parking brake, lights, power switch and reverse.	
	Navigation	Steering Angle Adjustment	When there is a difference between the actual turning angle and the vehicle mark turning angle, it can be adjusted.
		Speed Calibration	When there is a difference between the current location mark and the actual location, it can be adjusted.
		Sensor information	Displays the reception status of the GPS antenna connector.
		XM Subscription Status	The XM subscription status can be checked.
	Error location display	The system malfunction and the frequency when occurring in the past are displayed. When the malfunctioning item is selected, the time and place that the selected malfunction last occurred are displayed.	
	AV COMM Diagnosis	The communication condition of each unit of Multi AV system can be monitored.	
	Hands-free Phone, CARWINGS	<ul style="list-style-type: none"> • The received volume adjustment of hands-free phone and microphone speaker check can be performed. • Mileage display of remote maintenance can be turned ON/OFF. 	
	Clock Settings	The current time can be set.	
	Delete Unit Connection Log	Erase the connection history of unit and error history.	
	User Data Initialization	Initializes the AV control unit memory.	
	Version Information	Version information of the AV control unit is displayed.	
	Software Update	The current version of the AV control unit software can be updated.	
	Export Error Log	AV control unit error log can be exported.	
XM	Change Channel	Any necessary channels required to receive traffic information etc. from the satellite radio system can be set.	
	Change Application ID	Any application ID's required to receive traffic information etc. from the satellite radio system can be set.	
	Diag	XM authentication diagnosis.	

Starting procedure

1. Turn the power switch ON.
2. Turn the audio system off.
3. Press the "MAP" switch 3 times. Press the "PWR" switch 2 times. Press the "MAP" switch once.

NOTE:

If the on board self-diagnosis does not start, perform diagnosis using CONSULT. Refer to [AV-376. "CONSULT Function"](#).

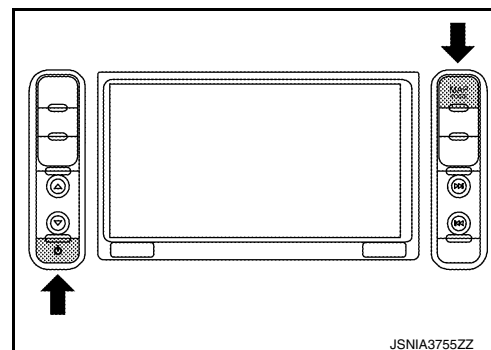

DIAGNOSIS SYSTEM (AV CONTROL UNIT)

< SYSTEM DESCRIPTION >

[NAVIGATION WITH BOSE]

4. The initial trouble diagnosis screen displays two choices: “Self-Diagnosis” and “Confirmation/Adjustment”.

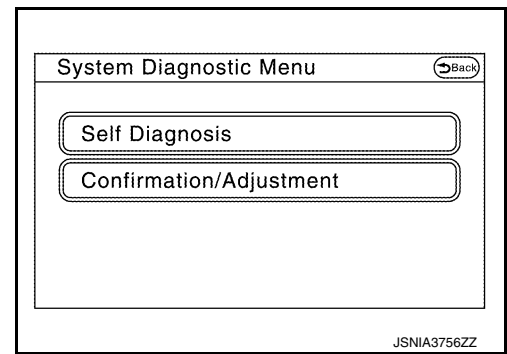

SELF-DIAGNOSIS MODE

- Start the self-diagnosis function and select “Self Diagnosis”.
 - Self-diagnosis subdivision screen is displayed, and the self-diagnosis mode starts.
 - The bar graph visible on the center of the self-diagnosis subdivision screen indicates progress of the trouble diagnosis.
- Diagnosis results are displayed after the self-diagnosis is completed. The unit names and the connection lines are color-coded according to the diagnostic results.

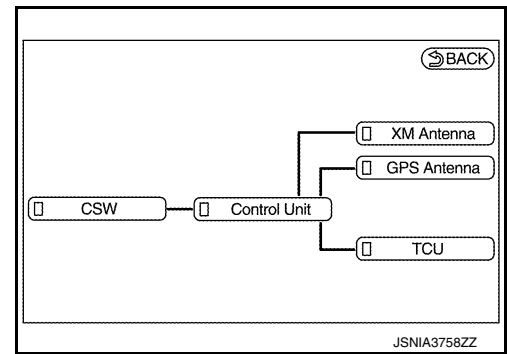

Diagnosis results	Unit	Connection line
Normal	Green	Green
Connection malfunction	Gray	Yellow
Unit malfunction ^{Note}	Red	Green

NOTE:

Control unit (AV control unit) is displayed in red.

- Replace AV control unit if “Self-Diagnosis did not run because of a control unit malfunction” is indicated. The symptom is AV control unit internal error. Refer to [AV-488. "Removal and Installation"](#).
 - If multiple errors occur at the same time for a single unit, the screen switch colors are determined according to the following order of priority: red > gray.
- The comments of the self-diagnosis results can be viewed with a component in the diagnosis result screen.

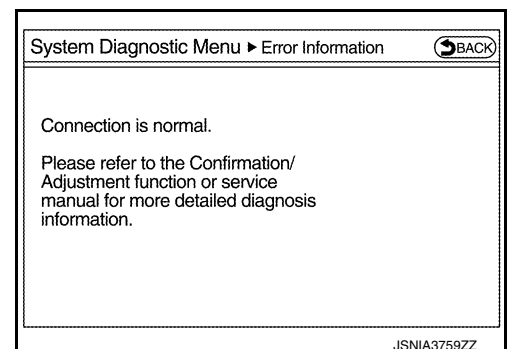

Detection Range of Self-diagnosis Mode

- The self-diagnosis mode allows the technician to diagnose the connection in the communication line between AV control unit and each unit and the internal operation of the AV control unit.

DIAGNOSIS SYSTEM (AV CONTROL UNIT)

[NAVIGATION WITH BOSE]

< SYSTEM DESCRIPTION >

- Because the start condition of diagnosis function is a switch operation, the on board diagnosis function cannot be started up if any malfunction is detected in the communication circuit between AV control unit and multifunction switch.

SELF-DIAGNOSIS RESULTS

Check the applicable display at the following table, and then repair the malfunctioning parts.

Only Unit Part Is Displayed In Red.

Screen switch	Description	Possible malfunction location / Action to take
Control Unit	Malfunction is detected in AV control unit power supply and ground circuits.	<ul style="list-style-type: none"> • Check the power supply and ground circuit. Refer to AV-453, "AV CONTROL UNIT : Diagnosis Procedure". • When the power switch is OFF, remove and insert the SD card to check for contact malfunction of the SD card, and check for an error again. - If there is no malfunction, poor contact of the SD card may be possible. Wait and see the condition. - If an malfunction is found, replace the AV control unit. Refer to AV-488, "Removal and Installation".

A Connecting Cable Between Units Is Displayed In Yellow.

Area with yellow connection lines	Description	Possible malfunction location / Action to take
Control unit ↔ GPS Antenna	GPS antenna connection malfunctions detected.	GPS antenna
Control unit ↔ TCU	Malfunction is detected in communication circuits between AV control unit and TCU.	Communication circuits between AV control unit and TCU.
Control unit ↔ SAT Antenna	Satellite radio antenna connection malfunction is detected.	Satellite radio antenna disconnection

CONFIRMATION/ADJUSTMENT MODE

1. Start the diagnosis function and select "Confirmation/Adjustment". The confirmation/adjustment mode indicates where each item can be checked or adjusted.
2. Select each switch on the "Confirmation/Adjustment Mode" screen to display the relevant trouble diagnosis screen. Press the "Back" switch to return to the initial Confirmation/Adjustment Mode screen.

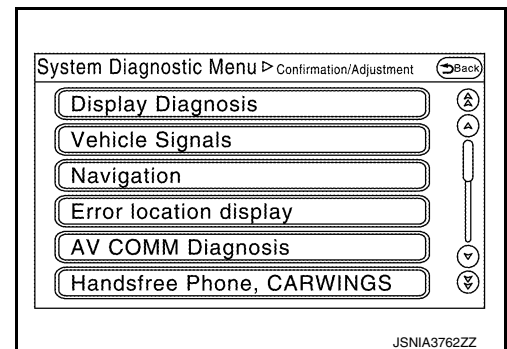

DIAGNOSIS SYSTEM (AV CONTROL UNIT)

< SYSTEM DESCRIPTION >

[NAVIGATION WITH BOSE]

Display Diagnosis

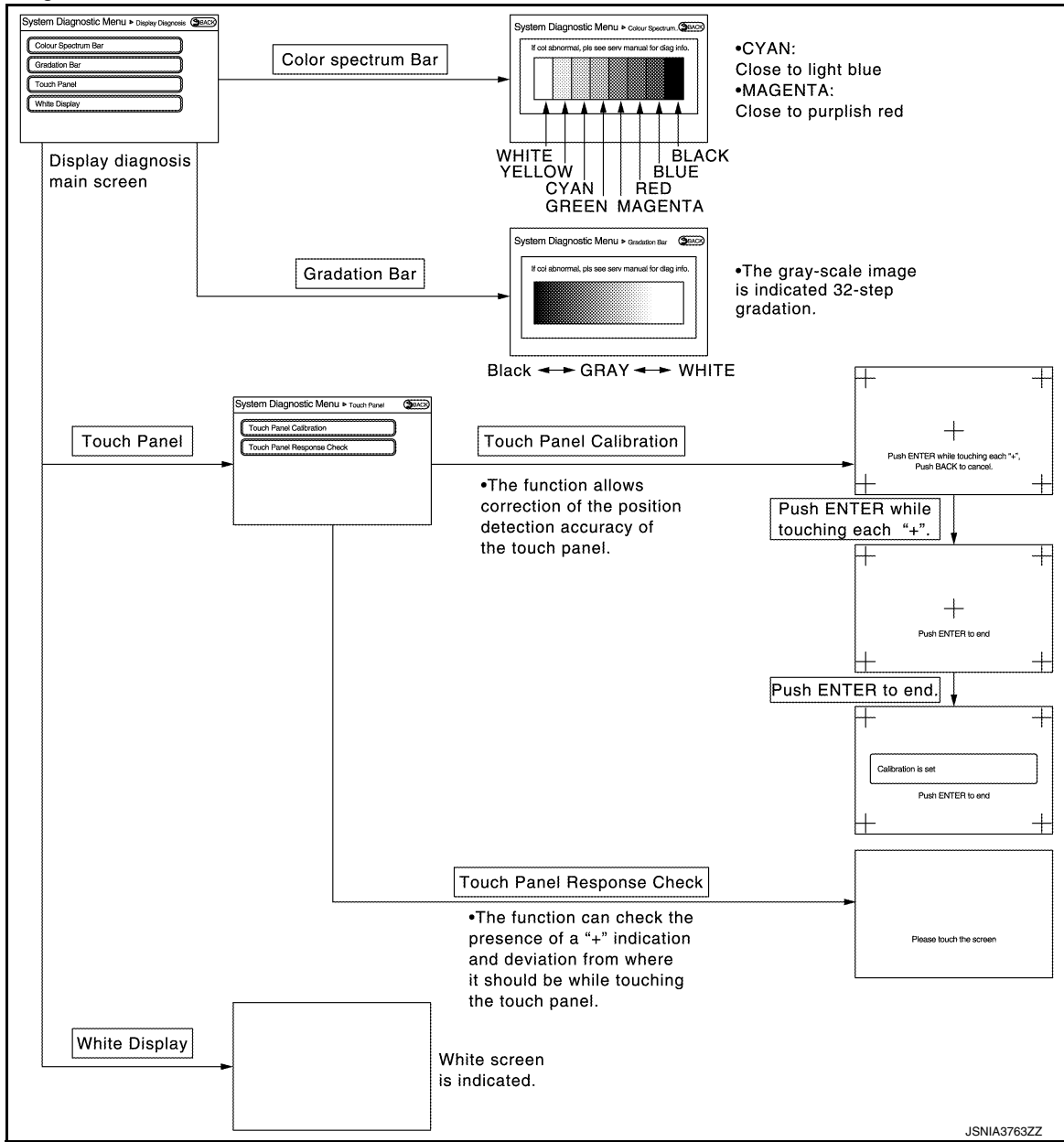

Vehicle Signals

A comparison check can be made of each actual vehicle signal and the signals recognized by the system.

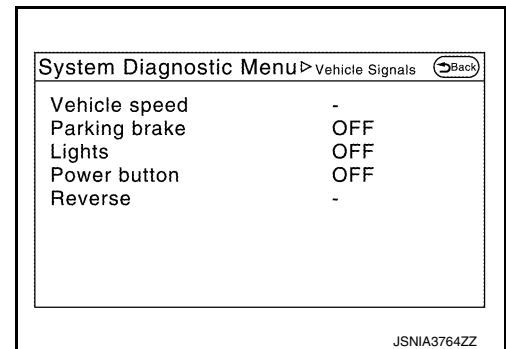

DIAGNOSIS SYSTEM (AV CONTROL UNIT)

< SYSTEM DESCRIPTION >

[NAVIGATION WITH BOSE]

Diagnosis item	Display	Vehicle status	Remarks
Vehicle speed	ON	Vehicle speed > 0 km/h (0 MPH)	Changes in indication may be delayed. This is normal.
	OFF	Vehicle speed = 0 km/h (0 MPH)	
Parking brake	ON	Parking brake is applied.	
	OFF	Parking brake is released.	
Lights	ON	Block the light beam from the auto light optical sensor when the light switch is ON.	—
	OFF	Either of the following conditions <ul style="list-style-type: none"> Lighting switch OFF Expose the auto light optical sensor to light when the light switch is ON. 	
Power button	ON	Power button ON	—
	OFF	Power button in ACC position	
Reverse	ON	Shift the selector lever to “R” position	Changes in indication may be delayed. This is normal.
	OFF	Shift the selector lever other than “R” position	

Navigation

STEERING ANGLE ADJUSTMENT

- The steering angle output value detected with the gyroscope is adjusted.

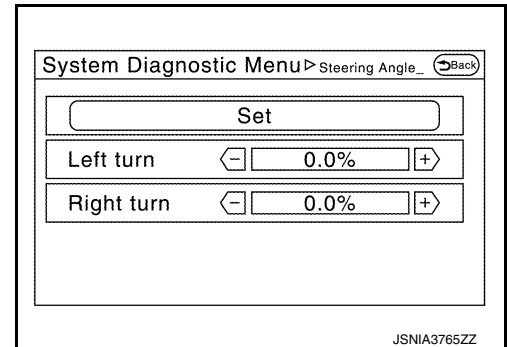

SPEED CALIBRATION

- During normal driving, distance error caused by tire wear and tire pressure change is automatically adjusted for by the automatic distance correction function. This function, on the other hand, is for immediate adjustment, in cases such as driving with tire chain fitted on tires.

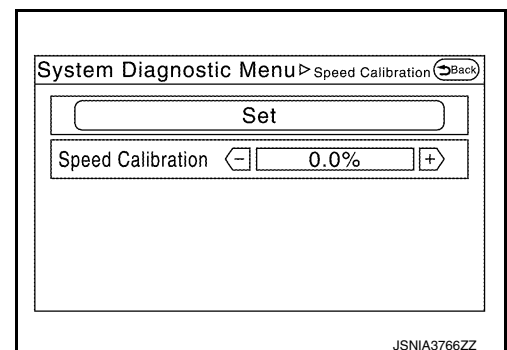

SENSOR INFORMATION

- Displays the reception status of the GPS antenna connector.

XM SUBSCRIPTION STATUS

- The XM subscription status can be checked.

Error location display

The self-diagnosis results are judged depending on whether any error occurs from when “Self-diagnosis” is selected until the self-diagnosis results are displayed.

DIAGNOSIS SYSTEM (AV CONTROL UNIT)

[NAVIGATION WITH BOSE]

< SYSTEM DESCRIPTION >

However, the diagnosis results are judged normal if an error has occurred before the power switch is turned ON and then no error has occurred until the self-diagnosis start. Check the "Error Record" to detect any error that may have occurred before the self-diagnosis start because of this situation.

The error record displays the time and place of the most recent occurrence of that error. However, take note of the following points.

- If there is a malfunction with the GPS antenna circuit board in the AV control unit, the correct date and time of occurrence may not be able to be displayed.
- Place of the error occurrence is represented by the position of the current location mark at the time an error occurred. If current location mark has deviated from the correct position, then the place of the error occurrence cannot be located correctly.
- The frequency of occurrence is displayed in a count up manner. The actual count up method differs depending on the error item.

Count up method A

- The counter resets to 0 if an error occurs when power switch is turned ON. The counter increases by 1 if the condition is normal at a next power ON cycle.
- The counter upper limit is 39. Any counts exceeding 39 are ignored. The counter can be reset (no error record display) with the "Delete log" switch or CONSULT.

Display type of occurrence frequency	Error history display item
Count up method A	CAN communication line, control unit (CAN), AV communication line, control unit (AV)

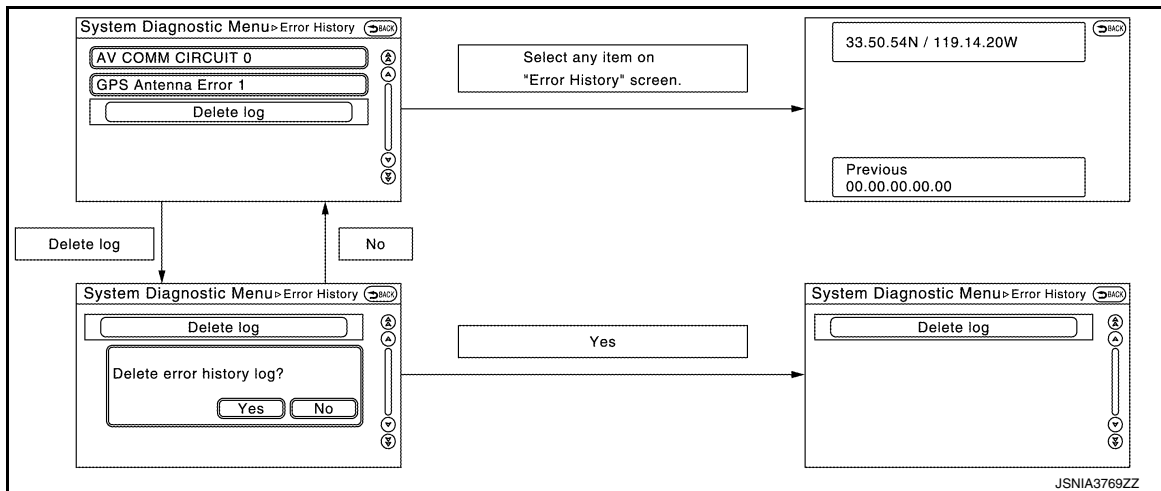

Error item

Some error items may be displayed simultaneously according to the cause. If some error items are displayed simultaneously, the detection of the cause can be performed by the combination of display items

Error item	Description	Possible malfunction factor/Action to take
CAN COMM CIRCUIT	CAN communication malfunction is detected.	Perform diagnosis with CONSULT, and then repair the malfunctioning parts according to the diagnosis results. Refer to AV-376, "CONSULT Function" .
CONTROL UNIT (CAN)	CAN initial diagnosis malfunction is detected.	Replace the AV control unit if the malfunction occurs constantly. Refer to AV-488, "Removal and Installation" .
CONTROL UNIT (AV)	AV communication circuit initial diagnosis malfunction is detected.	
Control Unit Internal Error	AV control unit malfunction is detected.	Replace the AV control unit or multifunction switch if the malfunction occurs constantly. Refer to AV-488, "Removal and Installation" (AV control unit), AV-489, "Removal and Installation" (multifunction switch).
Switch Initial Communication Error	AV control unit or multifunction switch internal malfunction are detected.	
Steer. Angle Sensor Calibration	Predictive course line center position adjustment of the steering angle sensor is incomplete.	Adjust the predictive course line center position of the steering angle sensor. Refer to AV-376, "CONSULT Function" .

DIAGNOSIS SYSTEM (AV CONTROL UNIT)

< SYSTEM DESCRIPTION >

[NAVIGATION WITH BOSE]

Error item	Description	Possible malfunction factor/Action to take
GPS Antenna Error	GPS antenna connection malfunction is detected.	Check the connection of the GPS antenna connector.
XM Antenna Connection Error	Satellite radio antenna connection malfunction is detected.	Satellite radio antenna disconnection.
USB electric current error	Detection of overcurrent in USB connector.	Check USB harness between the AV control unit and USB connector.
TCU Connection Error	TCU connection malfunction is detected.	Check that the connection to the TCU connector is normal.
<ul style="list-style-type: none"> AV COMM CIRCUIT Switches Connection Error 	When either one of the following items are detected: <ul style="list-style-type: none"> multifunction switch power supply and ground circuits are malfunctioning. AV communication circuits between AV control unit and multifunction switch are malfunctioning. 	<ul style="list-style-type: none"> Multifunction switch power supply and ground circuits. AV communication circuits between AV control unit and multifunction switch.

AV COMM Diagnosis

- Displays the communication status between AV control unit (master unit) and each unit.
- The error counter displays "OK" if any malfunction was not detected in the past and displays "0" if a malfunction is detected. It increases by 1 if the condition is normal at the next power switch ON cycle. The upper limit of the counter is 39.
- The error counter is erased if "Reset" is pressed.

Items	Status (Current)	Counter (Past)
C Tx(ITM-PrimarySW)	OK / ???	OK / 0 - 39
C Rx(PrimarySW-ITM)	OK / ???	OK / 0 - 39

NOTE:

"???" indicates UNKWN

Hands-Free Phone, CARWINGS

The hands-free phone reception volume adjustment and microphone and speaker test functions are also available.

NOTE:

If voice cannot be output when the Voice Microphone Test is started, stop and restart the test again.

Clock Setting

The clock can be set.

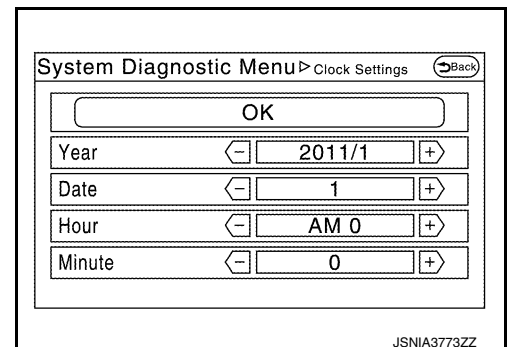
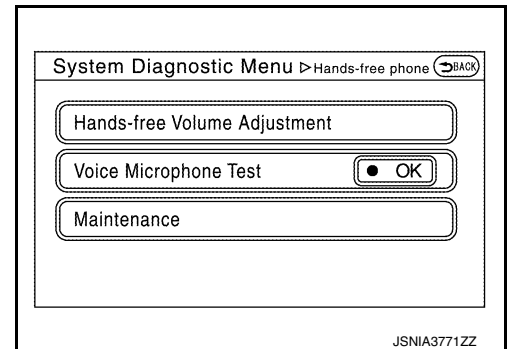
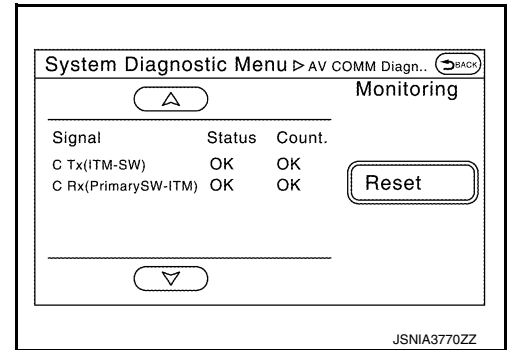

DIAGNOSIS SYSTEM (AV CONTROL UNIT)

[NAVIGATION WITH BOSE]

< SYSTEM DESCRIPTION >

XM

- Change Channel
- Any necessary channels required to receive traffic information from the satellite radio system can be set.
- Change Application ID
- Any application ID'-s required to receive traffic information from the satellite radio system can be set.
- Diag
- XM authentication diagnosis.

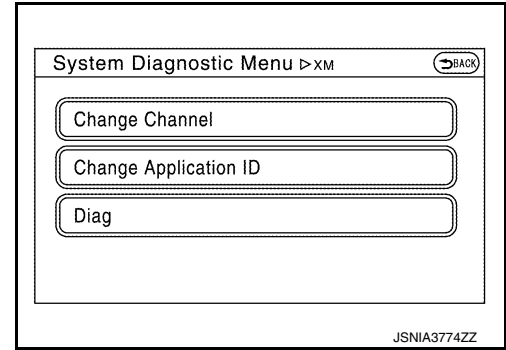

Delete Unit Connection Log

Deletes any unit connection records and error records from the AV control unit memory. (Clear the records of the unit that has been removed.)

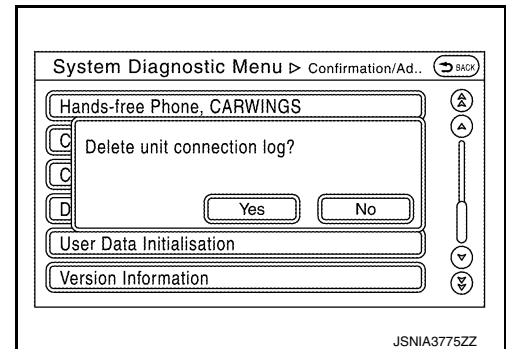

User Data Initialization

Initializes the AV control unit memory.

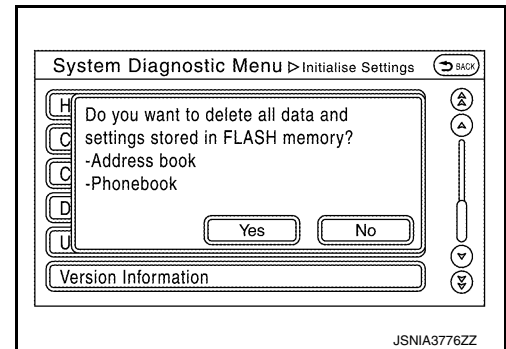

Version Information

Version information of the AV control unit is displayed.

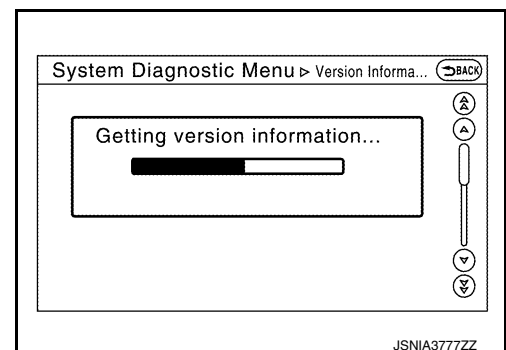

Software Update

Software version of the AV control unit can be update.

A
B
C
D
E
F
G
H
I
J
K
L
M
AV
O
P

DIAGNOSIS SYSTEM (AV CONTROL UNIT)

< SYSTEM DESCRIPTION >

[NAVIGATION WITH BOSE]

For detail of the operation, refer to [AV-420. "SOFTWARE UPDATE \(AV CONTROL UNIT\) : Work Procedure"](#).

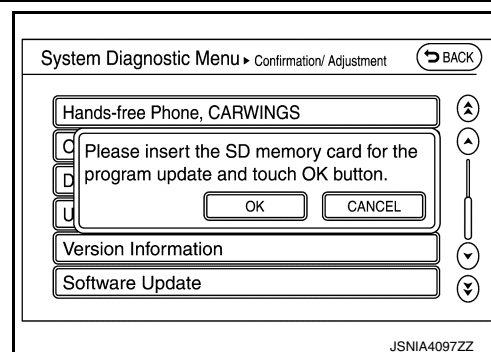

CONSULT Function

INFOID:000000010641969

CONSULT FUNCTIONS

CONSULT performs the following functions via communication with the AV control unit.

Direct Diagnostic Mode	Description
Ecu Identification	The AV control unit part number is displayed.
Self Diagnostic Result	The AV control unit self diagnostic results are displayed.
Data Monitor	The AV control unit input/output data is displayed in real time.
Work support	The settings for AV control unit functions can be changed.
Configuration	<ul style="list-style-type: none"> The vehicle specification can be read and saved. The vehicle specification can be written when replacing AV control unit.
CAN Diag Support Mntr	<ul style="list-style-type: none"> The result of transmit/receive diagnosis of AV communication is displayed. The result of transmit/receive diagnosis of CAN communication is displayed.

ECU IDENTIFICATION

The part number of AV control unit is displayed.

SELF DIAGNOSTIC RESULT

Refer to [AV-385. "DTC Index"](#).

DATA MONITOR

Monitor Item [Unit]	Description
VHCL SPD SIG [On/Off]	Indicates vehicle speed signal received from combination meter on CAN communication line.
PKB SIG [On/Off]	Indicates condition of park brake signal.
ILLUM SIG [On/Off]	Indicates condition of illumination signal for the A/C and AV switch assembly.
IGN SIG [On/Off]	Indicates condition of power signal.
REV SIG [On/Off]	Indicates condition of reverse signal received from BCM.

WORK SUPPORT

Conditions	Description
ST ANGLE SENSOR ADJUSTMENT	Steering angle sensor neutral position adjustment can be performed.

CONFIGURATION

Refer to [AV-423. "CONFIGURATION \(AV CONTROL UNIT\) : Description"](#).

CAN DIAG SUPPORT MNTR

Refer to [LAN-14. "CAN Diagnostic Support Monitor"](#).

DIAGNOSIS SYSTEM (AROUND VIEW MONITOR CONTROL UNIT)

< SYSTEM DESCRIPTION >

[NAVIGATION WITH BOSE]

DIAGNOSIS SYSTEM (AROUND VIEW MONITOR CONTROL UNIT)

CONSULT Function

INFOID:000000010641970

CONSULT FUNCTIONS

CONSULT performs the following functions via communication with the around view monitor control unit.

Direct Diagnostic Mode	Description
Ecu Identification	The around view monitor control unit part number is displayed.
Self Diagnostic Result	The around view monitor control unit self diagnostic results are displayed.
Data Monitor	The around view monitor control unit input/output data is displayed in real time.
Work support	The settings for around view monitor control unit functions can be changed.
Configuration	<ul style="list-style-type: none">The vehicle specification can be read and saved.The vehicle specification can be written when replacing around view monitor control unit.
CAN Diag Support Mntr	The result of transmit/receive diagnosis of CAN communication is displayed.

ECU IDENTIFICATION

The part number of around view monitor control unit is displayed.

SELF DIAGNOSTIC RESULT

Refer to [AV-392, "DTC Index"](#).

DATA MONITOR

Monitor Item	Description
ST ANGLE SENSOR SIGNAL [On/Off]	Indicates condition of steering angle sensor signal.
REVERSE SIGNAL [On/Off]	Indicates selector lever position.
VEHICLE SPEED SIGNAL [mph/km/h]	Indicates condition of vehicle speed signal.
CAMERA SWITCH SIGNAL [On/Off]	Indicates condition of camera switch signal.
CAMERA OFF SIGNAL [On/Off]	Indicates condition of camera OFF signal.
ST ANGLE SENSOR TYPE [Absolute]	Indicates steering angle sensor type.
ST GEAR RATIO TYPE [Type O]	Indicates steering gear ratio type.
STEERING POSITION [LHD/RHD]	Indicates LH or RH drive type.
REAR CAMERA IMAGE SIGNAL [OK/NG]	Indicates condition of camera image signal.
F-CAMERA IMAGE SIGNAL [OK/NG]	Indicates condition of camera image signal.
DR-SIDE CAMERA IMAGE SIG [OK/NG]	Indicates condition of camera image signal.
PA-SIDE CAMERA IMAGE SIG [OK/NG]	Indicates condition of camera image signal.

WORK SUPPORT

Support Item	Setting	Description
NON-VIEWABLE AREA REMINDER	—	ON/OFF setting of non-viewable area can be performed.
PREDICTIVE COURSE LINE DISPLAY	—	ON/OFF setting of predictive course line display can be performed.
INITIALIZE CAMERA IMAGE CALIBRATION	—	Factory image calibration restoration can be performed.
STEERING ANGLE SENSOR ADJUSTMENT	—	Steering angle sensor neutral position adjustment can be performed.

DIAGNOSIS SYSTEM (AROUND VIEW MONITOR CONTROL UNIT)

< SYSTEM DESCRIPTION >

[NAVIGATION WITH BOSE]

Support Item	Setting	Description
CALIBRATING CAMERA IMAGE (FRONT CAMERA)	STATUS	Performs calibration of front camera.
	AXIS X	
	AXIS Y	
	ROTATE	
CALIBRATING CAMERA IMAGE (PASS-SIDE CAMERA)	STATUS	Performs calibration of passenger side camera.
	AXIS X	
	AXIS Y	
	ROTATE	
CALIBRATING CAMERA IMAGE (DR-SIDE CAMERA)	STATUS	Performs calibration of driver side camera.
	AXIS X	
	AXIS Y	
	ROTATE	
CALIBRATING CAMERA IMAGE (REAR CAMERA)	STATUS	Performs calibration of rear camera.
	AXIS X	
	AXIS Y	
	ROTATE	
FINE TUNING OF BIRDS-EYE VIEW	STATUS	Confirmation and adjustment of difference between each camera can be performed.
	SELECT	
	AXIS X	
	AXIS Y	
	ROTATE	

Calibrating Camera Image (front camera, pass-side camera, dr-side camera, and rear camera)

Perform the calibration of camera image caused by the incorrect mounting position of each camera, etc. Always perform calibration after performing the following work.

- When each camera or each camera mount (e.g. front grille, door mirror, and others) is removed
- When replacing the around view monitor control unit

Refer to [AV-425. "CALIBRATING CAMERA IMAGE \(AROUND VIEW MONITOR\) : Work Procedure"](#) for the calibration procedure.

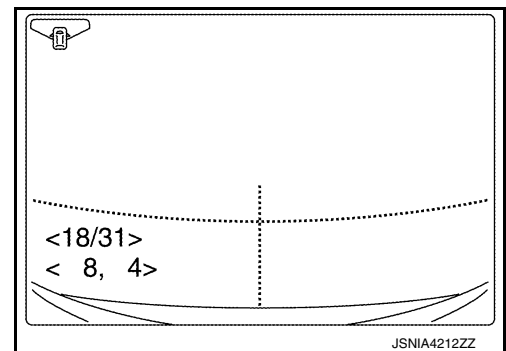

Adjustment range

Rotating direction : 31 patterns (16 on the center)

Upper/lower direction : (-22) – (+22)

Left/right direction : (-22) – (+22)

Initialize Camera Image Calibration

The calibration can be initialized to NISSAN factory shipment condition.

Select Language of Warning Message

No need to be selected because it can change the language on setting of Navi by customer.

Predictive Course Line Display

ON/OFF setting of predictive course line can be performed.

Steering Angle Sensor Adjustment

Steering angle sensor neutral position can be adjusted and registered.

CAUTION:

DIAGNOSIS SYSTEM (AROUND VIEW MONITOR CONTROL UNIT)

< SYSTEM DESCRIPTION >

[NAVIGATION WITH BOSE]

Adjust the steering angle sensor neutral position on the ABS actuator control unit side.

Non-Viewable Area Reminder

ON/OFF setting of the non-viewable area reminder can be performed.

CONFIGURATION

Refer to [AV-424. "CONFIGURATION \(AROUND VIEW MONITOR CONTROL UNIT\) : Work Procedure"](#).

CAN DIAG SUPPORT MNTR

Refer to [LAN-14. "CAN Diagnostic Support Monitor"](#).

A

B

C

D

E

F

G

H

I

J

K

L

M

AV

O

P

AV CONTROL UNIT

< ECU DIAGNOSIS INFORMATION >

[NAVIGATION WITH BOSE]

ECU DIAGNOSIS INFORMATION

AV CONTROL UNIT

Reference Value

INFOID:000000010641971

VALUES ON THE DIAGNOSIS TOOL

Monitor Item	Condition	Value/Status
VHCL SPD SIG	Vehicle speed = 0 km/h (0 MPH).	Off
	Vehicle speed > 0 km/h (0 MPH).	On
PKB SIG	Parking brake released.	Off
	Parking brake applied.	On
ILLUM SIG	Illumination signal is not received.	Off
	Illumination signal is received.	On
IGN SIG	Power switch OFF or ACC.	Off
	Power switch ON.	On
REV SIG	Selector lever in any position other than R.	Off
	Selector lever in R position.	On

TERMINAL LAYOUT

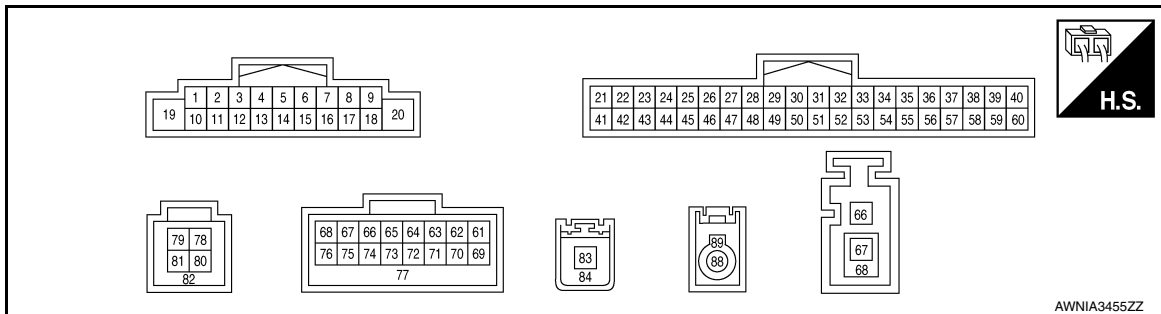

PHYSICAL VALUES

Terminal (Wire color)		Description	Condition		Reference value (Approx.)	
+	-	Signal name	Input/ Output	Power switch		
1 (L)	Ground	BOSE amp. ON signal	Output	ACC	—	Battery voltage
2 (Y)	3 (BR)	Pre amp sound signal front LH	Output	ON	Sound output	 SKIB3609E
4 (P)	5 (L)	Pre amp sound signal rear LH	Output	ON	Sound output	 SKIB3609E

AV CONTROL UNIT

< ECU DIAGNOSIS INFORMATION >

[NAVIGATION WITH BOSE]

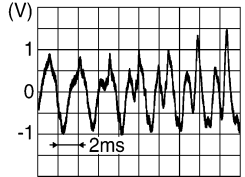
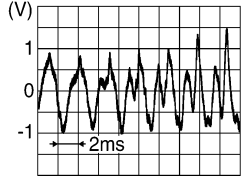
Terminal (Wire color)		Description	Condition		Reference value (Approx.)	
+	-	Signal name	Input/ Output	Power switch		Operation
6 (R)	15 (B)	Steering switch signal A	Input	ON	Press SOURCE switch.	0 V
					Press ▲ switch.	1.0 V
					Press ▼ switch.	2.0 V
					Press ↙ switch.	3.0 V
					Press Ⓢ switch.	4.0 V
					Except above.	5.0 V
7 (BR)	Ground	ACC power supply	Input	ACC	—	Battery voltage
8 (B)	—	Illumination ground	—	—	—	—
9 (W)	Ground	Illumination signal	Input	ON	Lighting switch ON.	Battery voltage
					Lighting switch OFF.	0 V
11 (G)	12 (R)	Pre amp sound signal front RH	Output	ON	Sound output	 <small>SKIB3609E</small>
13 (BR)	14 (Y)	Pre amp sound signal rear RH	Output	ON	Sound output	 <small>SKIB3609E</small>
16 (W)	15 (B)	Steering switch signal B	Input	ON	Press - 🗣️ switch.	0 V
					Press 🗣️+ switch.	1.0 V
					Press 🖱️ switch.	2.0 V
					Press 🔄 switch.	3.0 V
					Except above.	5.0 V
19 (BR)	Ground	Battery power supply	Input	OFF	—	Battery voltage
21 (LG)	—	AV communication signal (L)	Input/ Output	—	—	—
22 (LG)	—	AV communication signal (L)	Input/ Output	—	—	—
23 (P)	—	CAN L	Input/ Output	—	—	—

A
B
C
D
E
F
G
H
I
J
K
L
M
AV
O
P

AV CONTROL UNIT

< ECU DIAGNOSIS INFORMATION >

[NAVIGATION WITH BOSE]

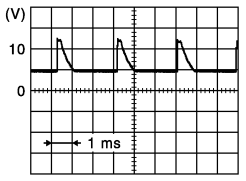
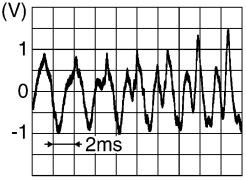
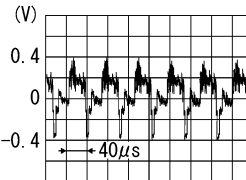
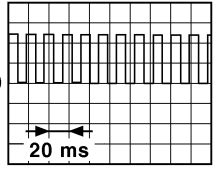
Terminal (Wire color)		Description		Condition		Reference value (Approx.)
+	-	Signal name	Input/ Output	Power switch	Operation	
25 (Y)	Ground	Parking brake signal	Input	ON	Parking brake applied.	0 V
					Parking brake released.	 <p style="text-align: right; font-size: small;">JSNIA1938ZZ</p>
26 (V)	Ground	Power signal	Input	ON	—	Battery voltage
				OFF	—	0 V
27 (L)	Ground	AVM detection	—	ON	—	0 V
34 (P)	Ground	Microphone VCC	Output	ON	—	5 V
35 (R)	Ground	AUX sound signal LH	Input	ON	AUX mode selected.	 <p style="text-align: right; font-size: small;">SKIB3609E</p>
36 (B)	Ground	AUX ground	—	ON	—	0 V
40 (W)	Ground	Camera image signal	Input	ON	AVM image displayed.	 <p style="text-align: right; font-size: small;">SKIB2251J</p>
41 (SB)	—	AV communication signal (H)	Input/ Output	—	—	—
42 (SB)	—	AV communication signal (H)	Input/ Output	—	—	—
43 (L)	—	CAN H	Input/ Output	—	—	—
44 (GR)	Ground	Vehicle speed signal (8-pulse)	Input	ON	When vehicle speed is approx. 40 km/h (25 MPH)	<p>NOTE: The maximum voltage varies depending on the specification (destination unit).</p>  <p style="text-align: right; font-size: small;">JSNIA0012GB</p>

AV CONTROL UNIT

< ECU DIAGNOSIS INFORMATION >

[NAVIGATION WITH BOSE]

Terminal (Wire color)		Description		Condition		Reference value (Approx.)
+	-	Signal name	Input/ Output	Power switch	Operation	
45 (G)	Ground	Reverse signal	Input	ON	Selector lever in R (reverse) position	Battery voltage
					Selector lever in other than R (reverse) position	0 V
46 (R)	Ground	Dimmer signal	Input	ON	One of the following conditions: • Lighting switch OFF • Auto light ON with optical sensor exposed to light.	0 V
					Auto light ON with optical sensor not exposed to light.	Battery voltage
53 (L)	Ground	Microphone signal	Input	ON	Speak into microphone	
54 (Shield)	—	Microphone signal shield	—	—	—	—
55 (W)	Ground	AUX sound signal RH	Input	ON	AUX mode selected.	
56 (Shield)	—	AUX sound signal shield	—	—	—	—
58 (B)	Ground	Ground	—	ON	—	0 V
60 (Shield)	—	Camera image signal shield	—	—	—	—
61 (L)	Ground	USB D- signal (Telematics)	Input/ Output	—	—	—
62 (BR)	Ground	USB V BUS signal (Telematics)	Output	ON	—	—
63 (V)	—	Manufacturer specific signal (Telematics)	—	—	—	—
67 (B)	—	VOICE ground (Telematics)	—	—	—	—
68 (Y)	Ground	U-VOICE signal (Telematics)	Output	ON	—	—
69 (R)	Ground	USB D+ signal (Telematics)	Input/ Output	—	—	—
70 (Shield)	—	USB signal shield (Telematics)	—	—	—	—
76 (G)	Ground	D-VOICE signal (Telematics)	Input	—	—	—

A
B
C
D
E
F
G
H
I
J
K
L
M
AV
O
P

AV CONTROL UNIT

< ECU DIAGNOSIS INFORMATION >

[NAVIGATION WITH BOSE]

Terminal (Wire color)		Description	Condition			Reference value (Approx.)
+	-		Signal name	Input/ Output	Power switch	
77 (Shield)	—	USB signal shield (Telematics)	—	—	—	—
78 (W)	Ground	V BUS signal (USB connector)	Output	ON	—	5 V
79 (G)	—	USB ground (USB connector)	—	—	—	—
80 (L)	Ground	USB D+ signal (USB connector)	Input/ Output	—	—	—
81 (R)	Ground	USB D- signal (USB connector)	Input/ Output	—	—	—
82 (Shield)	—	USB signal shield (USB connector)	—	—	—	—
83 (B)	Ground	GPS antenna signal	Input	ACC	GPS antenna disconnect- ed.	5 V
84 (Shield)	—	GPS antenna signal shield	—	—	—	—
85 (B)	Ground	Antenna amp. ON signal	Output	ACC	—	Battery voltage
86 (B)	—	AM-FM main	Input	—	—	—
87 (Shield)	—	AM-FM main shield	—	—	—	—
88 (B)	Ground	Satellite radio antenna sig- nal	Input	ON	Satellite antenna discon- nected.	5 V
89 (Shield)	—	Satellite radio antenna sig- nal shield	—	—	—	—

Fail-safe

INFOID:0000000010641972

When a malfunction occurs within the system, the AV control unit outputs a message on the display, and it restricts the AV control unit functions.

FAIL-SAFE CONDITIONS

SD card not inserted, SD card malfunction, internal malfunction of navigation, etc.

Display Indication

- When the system is in the fail-safe status at the start of the AV control unit, an error message is shown on the display.
- When the system is in the fail-safe status after the start of the AV control unit, an error message is not shown on the display. The MULTI AV system may be rebooted in the fail-safe state. If the fail-safe state is maintained after the system is rebooted, an applicable message is shown.

Cause	Display monitor
Malfunction of flash ROM information	TARGET INFO NG
No SD card	NO SD CARD
Unsuccessful security unlock	SD UNLOCK NG
Malfunction of SD card mount	SD INIT NG
Malfunction of SD card access	SD ACCESS NG
No program data	NO NAVI-2 DATA
Malfunction of program data (SUM NG)	NAVI-2DATA READ NG
Inconsistent program version (Flash/SD)	NAVI VERSION NG

AV CONTROL UNIT

< ECU DIAGNOSIS INFORMATION >

[NAVIGATION WITH BOSE]

Cause	Display monitor
Difference of map destination	DIFFERENT MAP CODE
Not compliant with map database version	MAP DATA BASE UNMATCH
Malfunction of navigation	NAVI STARTUP NG

CONTROL

When the system is in the fail-safe status at or after start of the AV control unit, the following functions are restricted.

Function	In fail-safe mode
A/C	No display (fail-safe status display)
Audio	Mute audio
	No display (fail-safe status display)
Camera	It cannot be operated
	Only composite (camera image) is displayed and superimpose (warning display and image quality display) is not displayed.
Hands-free phone	It cannot be operated
Navigation	It cannot be operated
Display	Open/close operation is available
	Fail-safe factors are displayed
Self-diagnosis	It cannot be diagnosed
CONSULT diagnosis	It cannot be diagnosed
AV communication diagnosis	It cannot be diagnosed
Frequency transmission for VCM	Normal
SD read access	Access cannot be gained.
SD write access	Access cannot be gained.

CANCELLATION CONDITIONS

The fail-safe status is canceled under the following conditions, and then the system returns to the normal mode.

- When the SD card is not inserted, the SD card is inserted and the power of the AV control unit is turned ON again.
- When the SD card is not functional at the start of navigation due to a malfunction of the SD card, a normal SD card is inserted and the power of the AV control unit is turned ON again.

DTC Index

INFOID:000000010641973

DTC	CONSULT Display	Refer to
U1000	CAN COMM CIRC	AV-432. "AV CONTROL UNIT : Diagnosis Procedure"
U1010	CONTROL UNIT (CAN)	AV-434. "AV CONTROL UNIT : DTC Logic"
U121F	CONTROL UNIT	AV-443. "DTC Logic"
U1232	ST ANGLE SEN CALIB	AV-444. "AV CONTROL UNIT : Diagnosis Procedure"
U1244	GPS ANTENNA CONN	AV-445. "Diagnosis Procedure"

AV CONTROL UNIT

< ECU DIAGNOSIS INFORMATION >

[NAVIGATION WITH BOSE]

DTC	CONSULT Display	Refer to
U1258	XM ANTENNA CONN	AV-446. "Diagnosis Procedure"
U1263	USB OVERCURRENT	AV-447. "Diagnosis Procedure"
U1266	TCU CONN	AV-448. "DTC Logic"
U1310	CONTROL UNIT (AV)	AV-452. "DTC Logic"
U1300 U1240	<ul style="list-style-type: none">• AV COMM CIRCUIT• SWITCH CONN	AV-449. "Description"

BOSE AMP.

< ECU DIAGNOSIS INFORMATION >

[NAVIGATION WITH BOSE]

BOSE AMP.

Reference Values

INFOID:000000010641974

TERMINAL LAYOUT

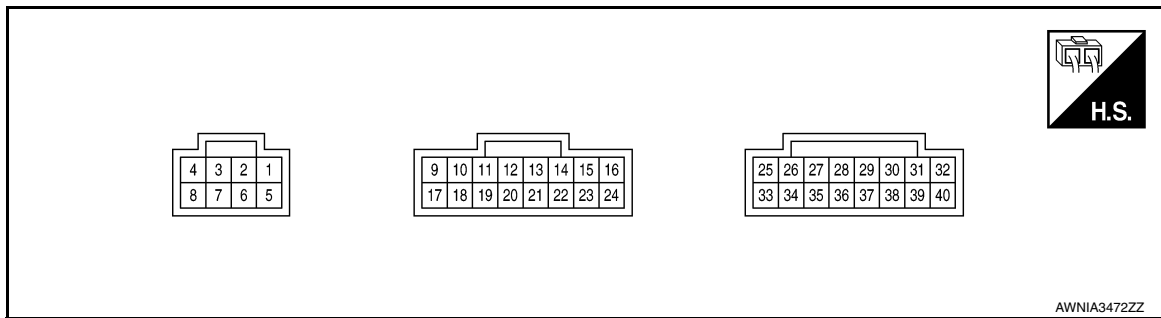

PHYSICAL VALUES

Terminal (Wire color)		Description		Condition		Reference value (Approx.)
+	-	Signal name	Input/ Output	Power switch	Operation	
1 (R)	5 (G)	Sound signal rear door speaker LH	Output	ON	Sound output	 SKIB3609E
4 (R)	Ground	Battery power supply	Input	OFF	—	Battery voltage
6 (P)	2 (L)	Sound signal subwoofer	Output	ON	Sound output	 SKIB3609E
8 (B)	—	Ground	—	ON	—	0 V
9 (G)	17 (R)	Sound signal front door speaker LH	Output	ON	Sound output	 SKIB3609E
10 (P)	11 (L)	Sound signal front door speaker RH	Output	ON	Sound output	 SKIB3609E

A
B
C
D
E
F
G
H
I
J
K
L
M
P

AV

BOSE AMP.

< ECU DIAGNOSIS INFORMATION >

[NAVIGATION WITH BOSE]

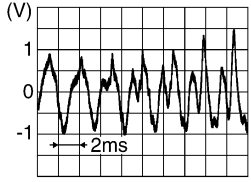
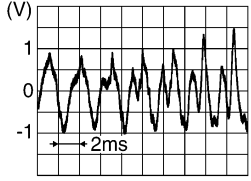
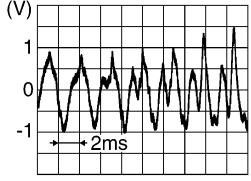
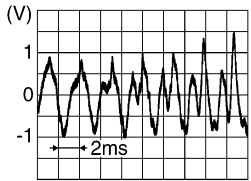
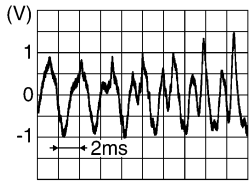
Terminal (Wire color)		Description	Condition			Reference value (Approx.)
+	-		Signal name	Input/ Output	Power switch	
13 (G)	12 (R)	Sound signal tweeter LH	Output	ON	Sound output	 <p style="text-align: right; font-size: small;">SKIB3609E</p>
15 (V)	14 (SB)	Sound signal tweeter RH	Output	ON	Sound output	 <p style="text-align: right; font-size: small;">SKIB3609E</p>
16 (L)	24 (P)	Sound signal rear door speaker RH	Output	ON	Sound output	 <p style="text-align: right; font-size: small;">SKIB3609E</p>
22 (L)	Ground	BOSE amp. ON signal	Input	ON	—	Battery voltage
27 (BR)	35 (Y)	Pre amp sound signal rear RH	Input	ON	Sound output	 <p style="text-align: right; font-size: small;">SKIB3609E</p>
29 (G)	37 (R)	Pre amp sound signal front RH	Input	ON	Sound output	 <p style="text-align: right; font-size: small;">SKIB3609E</p>

BOSE AMP.

< ECU DIAGNOSIS INFORMATION >

[NAVIGATION WITH BOSE]

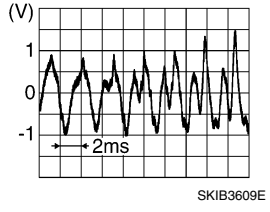
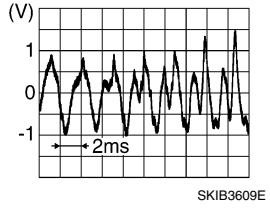
Terminal (Wire color)		Description		Condition		Reference value (Approx.)
+	-	Signal name	Input/ Output	Power switch	Operation	
36 (LG)	28 (V)	Pre amp sound signal rear LH	Input	ON	Sound output	
38 (W)	30 (B)	Pre amp sound signal front LH	Input	ON	Sound output	

A
B
C
D
E
F
G
H
I
J
K
L
M
N
O
P

AV

AROUND VIEW MONITOR CONTROL UNIT

< ECU DIAGNOSIS INFORMATION >

[NAVIGATION WITH BOSE]

AROUND VIEW MONITOR CONTROL UNIT

Reference Value

INFOID:000000010641975

VALUES ON THE DIAGNOSIS TOOL

Monitor Item	Condition	Value/Status
CAMERA OFF SIGNAL	CAMERA switch ON.	Off
	CAMERA switch OFF.	On
CAMERA SWITCH SIGNAL	CAMERA switch OFF.	Off
	CAMERA switch ON.	On
DR-SIDE CAMERA IMAGE SIG	Side camera LH inoperative.	NG
	Side camera LH operative.	OK
F-CAMERA IMAGE SIG	Front camera inoperative.	NG
	Front camera operative.	OK
PA-SIDE CAMERA IMAGE SIG	Side camera RH inoperative.	NG
	Side camera RH operative.	OK
REAR CAMERA IMAGE SIGNAL	Rear camera LH inoperative.	NG
	Rear camera LH operative.	OK
REVERSE SIGNAL	When selector lever is in any position other than R (reverse).	Off
	When selector lever in R (reverse).	On
ST ANGLE SENSOR SIGNAL	Around view monitor control unit is not receiving steering angle sensor signal.	Off
	Around view monitor control unit is receiving steering angle sensor signal.	On
ST ANGLE SENSOR TYPE	Steering angle sensor type.	Absolute
ST GEAR RATIO TYPE	Steering gear ratio type.	Type O
STEERING POSITION	Left hand drive vehicle.	LHD
	Right hand drive vehicle.	RHD
VEHICLE SPEED SIGNAL	While driving, equivalent to speedometer reading	mph, km/h

TERMINAL LAYOUT

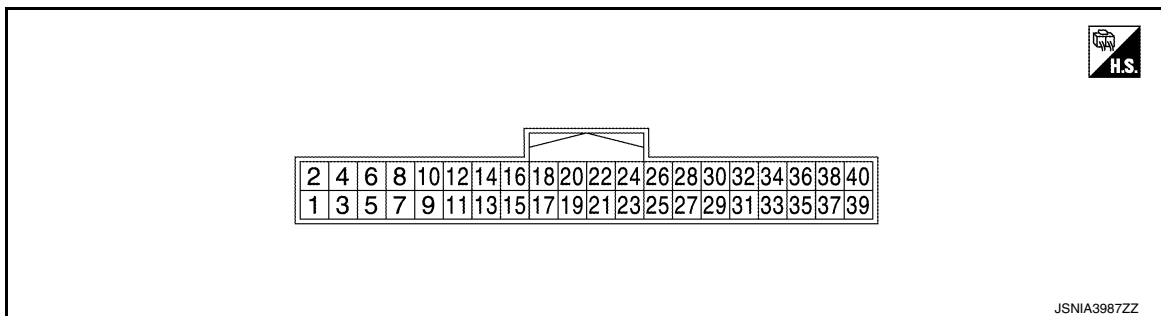

PHYSICAL VALUES

AROUND VIEW MONITOR CONTROL UNIT

< ECU DIAGNOSIS INFORMATION >

[NAVIGATION WITH BOSE]

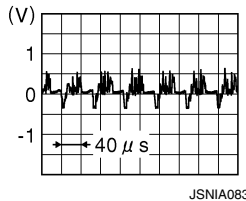
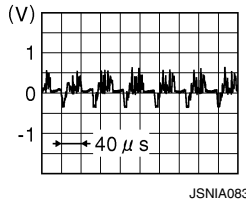
Terminal (Wire color)		Description		Condition		Reference value (Approx.)
+	-	Signal name	Input/ Output	Power switch	Operation	
1 (B)	Ground	Ground	—	ON	—	0 V
2 (SB)	Ground	Battery power supply	Input	OFF	—	Battery voltage
4 (W)	Ground	Power signal	Input	ON	—	Battery voltage
				OFF		0 V
8 (SB)	Ground	Reverse signal	Input	ON	Selector lever in R (re- verse) position	Battery voltage
					Selector lever in other than R (reverse) position	0 V
10 (P)	—	CAN-L	Input/ Output	—	—	—
12 (L)	—	CAN-H	Input/ Output	—	—	—
13 (L)	Ground	AVM detection	—	ON	—	0 V
23 (Shield)	—	Camera image signal shield	—	—	—	—
24 (W)	Ground	Camera image signal	Output	ON	Camera image displayed	
25 (B)	Ground	Rear view camera ground	—	ON	—	0 V
26 (W)	Ground	Rear view camera power supply	Output	ON	CAMERA switch ON or Selector lever in R (re- verse) position	6.2 V
27 (Shield)	—	Rear view camera image signal shield	—	—	—	—
28 (R)	Ground	Rear view camera image signal	Input	ON	CAMERA switch ON or Selector lever in R (re- verse) position	
29 (W)	Ground	Side camera LH ground	—	ON	—	0 V
30 (B)	Ground	Side camera LH power supply	Output	ON	CAMERA switch ON or Selector lever in R (re- verse) position	6.2 V
31 (Shield)	—	Side camera LH image sig- nal shield	—	—	—	—

A
B
C
D
E
F
G
H
I
J
K
L
M
O
P

AV

AROUND VIEW MONITOR CONTROL UNIT

< ECU DIAGNOSIS INFORMATION >

[NAVIGATION WITH BOSE]

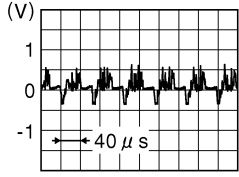
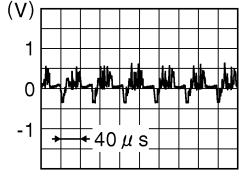
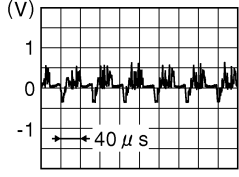
Terminal (Wire color)		Description		Condition		Reference value (Approx.)
+	-	Signal name	Input/ Output	Power switch	Operation	
32 (R)	Ground	Side camera LH image signal	Input	ON	CAMERA switch ON or Selector lever in R (reverse) position	 <p style="text-align: right; font-size: small;">JSNIA0834GB</p>
33 (B)	Ground	Side camera RH side ground	—	ON	—	0 V
34 (W)	Ground	Side camera RH power supply	Output	ON	CAMERA switch ON or Selector lever in R (reverse) position	6.2 V
35 (Shield)	—	Side camera RH image signal shield	—	—	—	—
36 (R)	Ground	Side camera RH image signal	Input	ON	CAMERA switch ON or Selector lever in R (reverse) position	 <p style="text-align: right; font-size: small;">JSNIA0834GB</p>
37 (W)	Ground	Front camera ground	—	ON	—	0 V
38 (R)	Ground	Front camera power supply	Output	ON	CAMERA switch ON or Selector lever in R (reverse) position	6.2 V
39 (Shield)	—	Front camera image signal shield	—	—	—	—
40 (B)	Ground	Front camera image signal	Input	ON	CAMERA switch ON or Selector lever in R (reverse) position	 <p style="text-align: right; font-size: small;">JSNIA0834GB</p>

DTC Index

INFOID:000000010641976

DTC	CONSULT display	Refer to
U0428	ST ANGLE SENSOR CALIBRATION	AV-431, "DTC Logic"
U1000	CAN COMM CIRCUIT	AV-432, "AROUND VIEW MONITOR CONTROL UNIT : DTC Logic"
U1010	CONTROL UNIT (CAN)	AV-434, "AROUND VIEW MONITOR CONTROL UNIT : DTC Logic"
U111A	REAR CAMERA IMAGE SIGNAL	AV-435, "DTC Logic"

AROUND VIEW MONITOR CONTROL UNIT

< ECU DIAGNOSIS INFORMATION >

[NAVIGATION WITH BOSE]

DTC	CONSULT display	Refer to
U111B	SIDE CAMERA RH IMAGE SIGNAL	AV-437, "DTC Logic"
U111C	FRONT CAMERA IMAGE SIGNAL	AV-439, "DTC Logic"
U111D	SIDE CAMERA LH IMAGE SIGNAL	AV-441, "DTC Logic"
U1232	ST ANGLE SEN CALIB	AV-444, "AV CONTROL UNIT : DTC Logic"
U1304	CAMERA IMAGE CALIB	AV-450, "DTC Logic"
U1305	CONFIG UNFINISH	AV-451, "DTC Logic"

A
B
C
D
E
F
G
H
I
J
K
L
M
O
P

AV

WIRING DIAGRAM

NAVIGATION WITH BOSE

Wiring Diagram

INFOID:0000000010641977

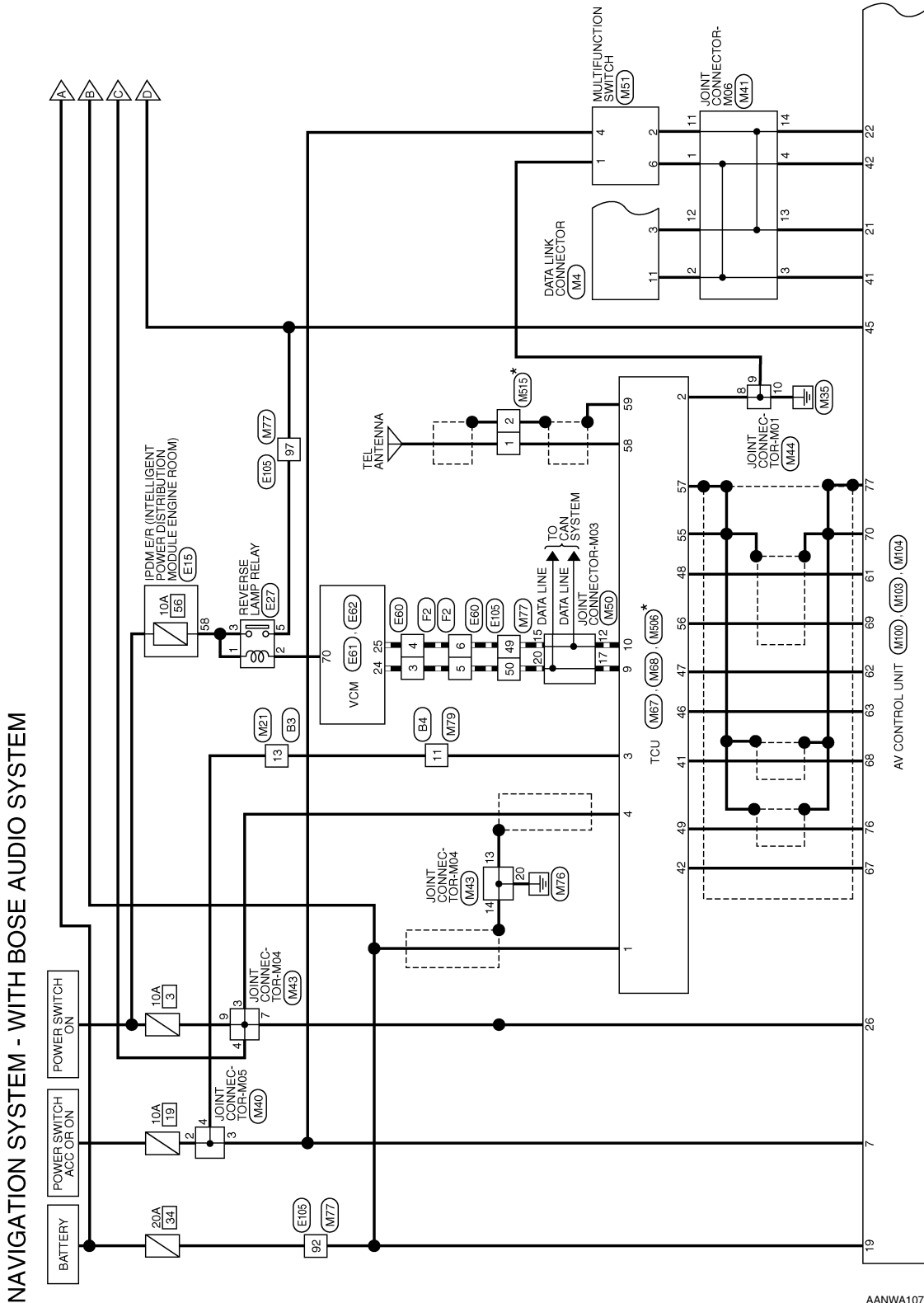

AANWA1077GB

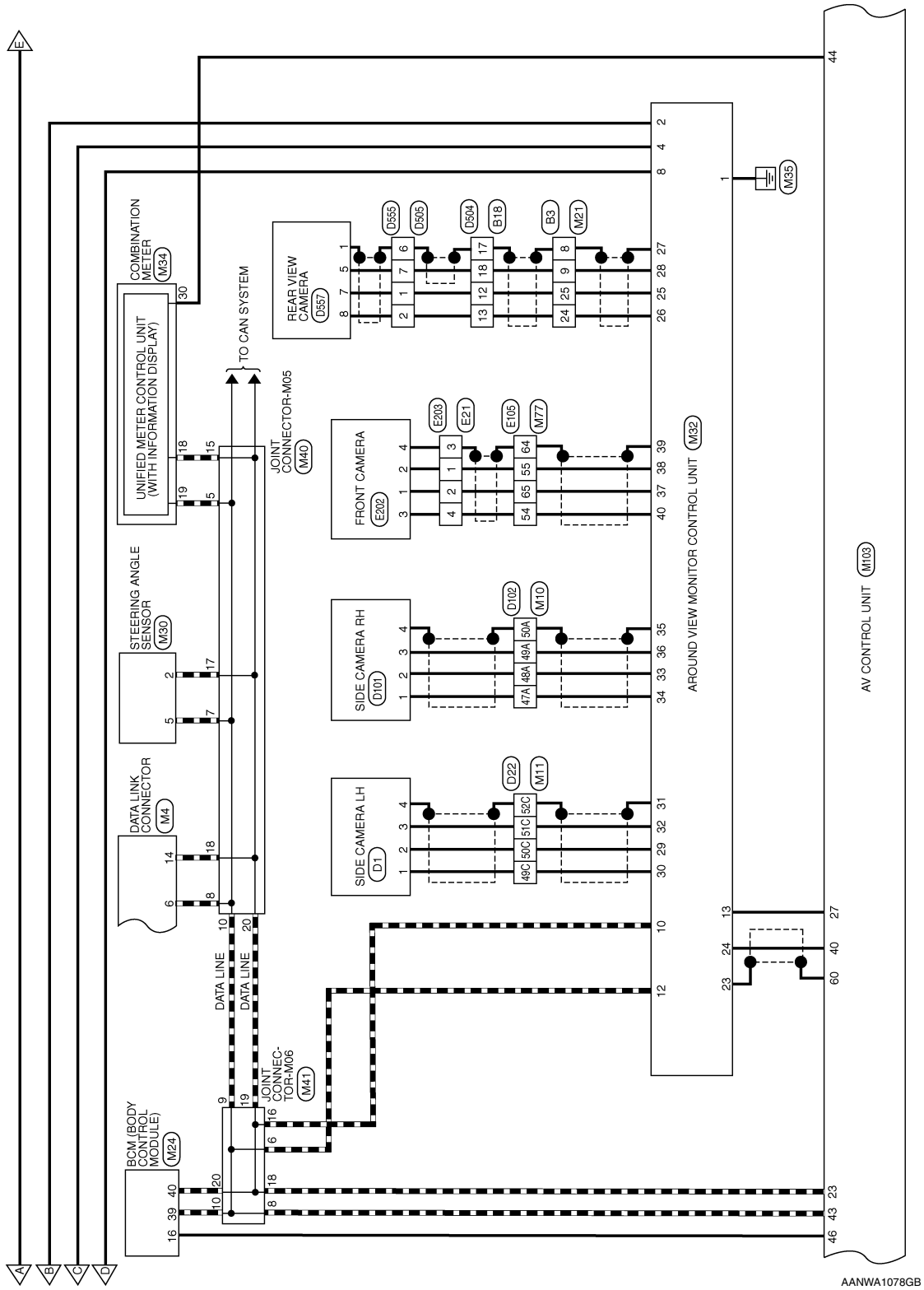

A
B
C
D
E
F
G
H
I
J
K
L
M
AV
O
P

AANWA1078GB

NAVIGATION WITH BOSE

< WIRING DIAGRAM >

[NAVIGATION WITH BOSE]

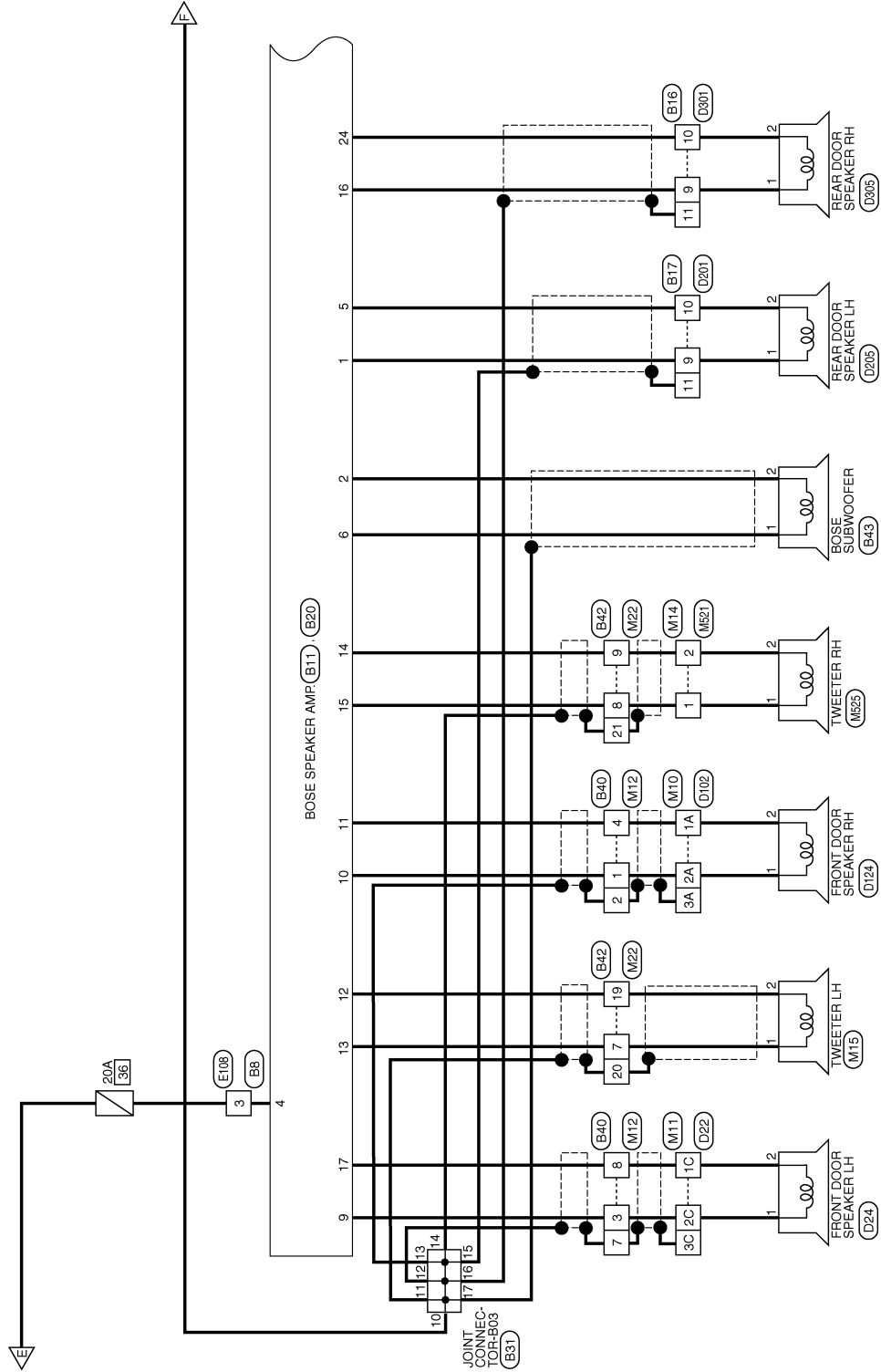

AANWA1079GB

NAVIGATION WITH BOSE

< WIRING DIAGRAM >

[NAVIGATION WITH BOSE]

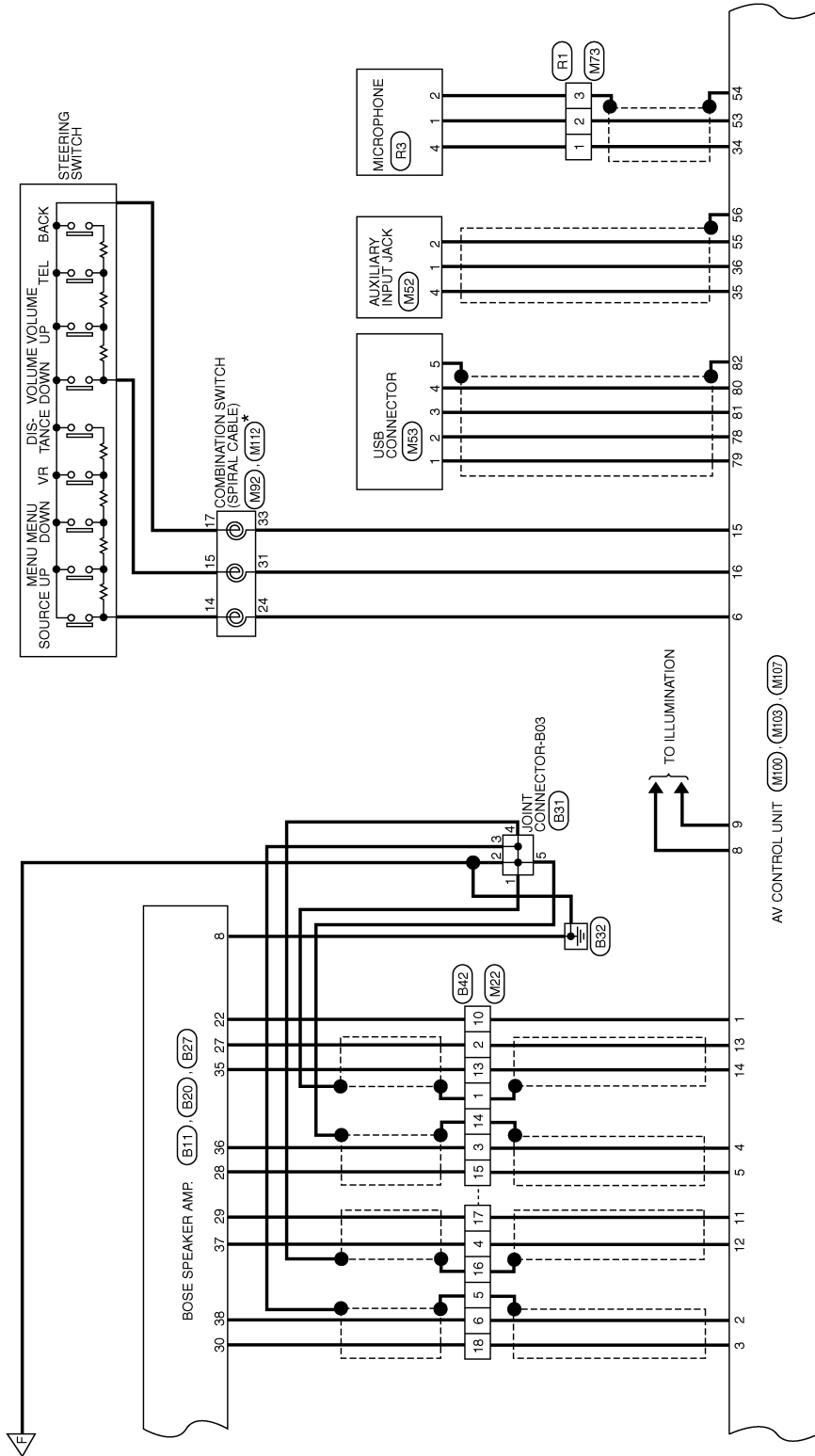

AANWA1080GB

* : THIS CONNECTOR IS NOT SHOWN IN "HARNES LAYOUT" OF PG SECTION.

A
B
C
D
E
F
G
H
I
J
K
L
M
N
O
P

AV

NAVIGATION WITH BOSE

< WIRING DIAGRAM >

[NAVIGATION WITH BOSE]

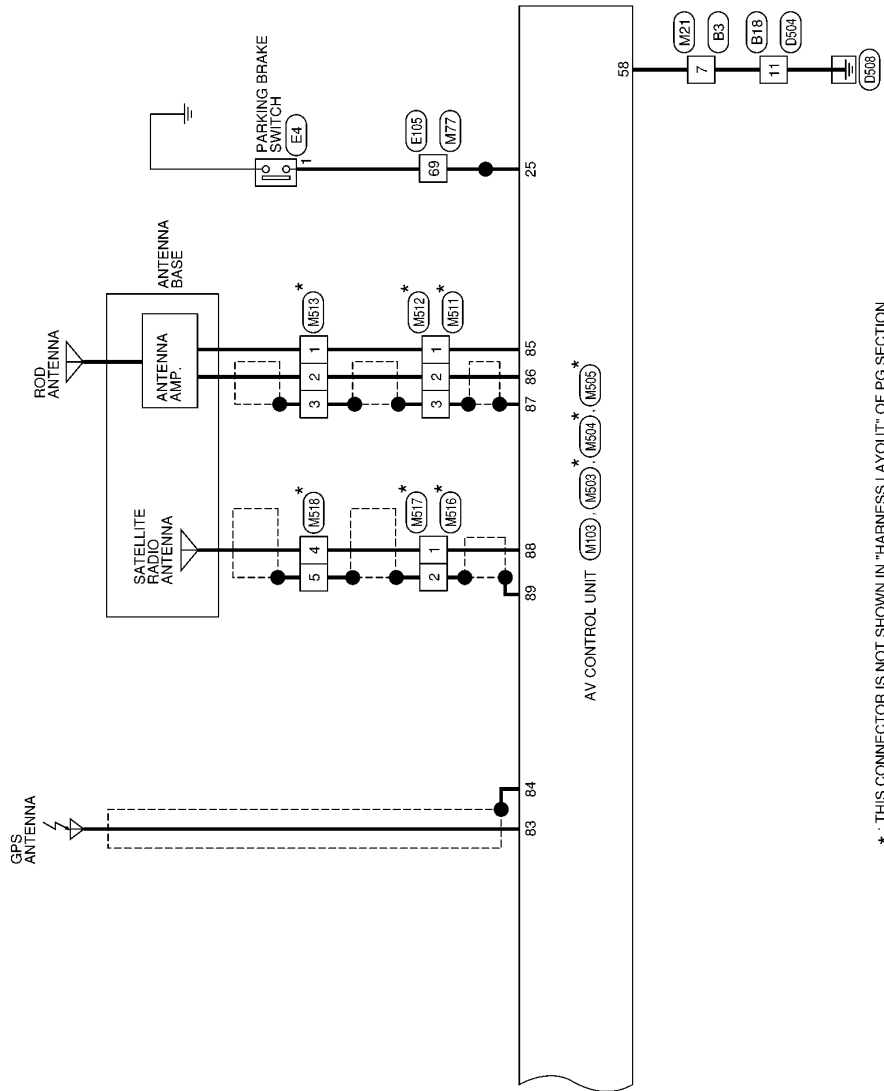

* : THIS CONNECTOR IS NOT SHOWN IN "HARNESS LAYOUT" OF PG SECTION.

AANWA1081GB

NAVIGATION SYSTEM - WITH BOSE AUDIO SYSTEM - CONNECTORS

Connector No.	M4
Connector Name	DATA LINK CONNECTOR
Connector Color	WHITE

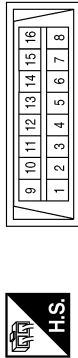

Terminal No.	Color of Wire	Signal Name
3	LG	-
6	L	-
11	SB	-
14	P	-

Connector No.	M10
Connector Name	WIRE TO WIRE
Connector Color	WHITE

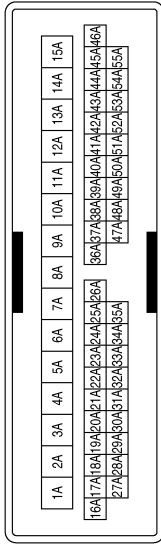

Connector No.	M11
Connector Name	WIRE TO WIRE
Connector Color	WHITE

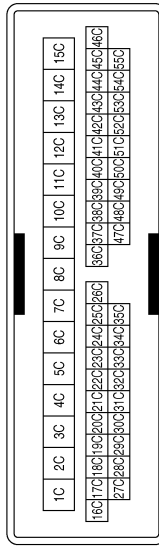

Connector No.	M12
Connector Name	WIRE TO WIRE
Connector Color	WHITE



Terminal No.	Color of Wire	Signal Name
1	P	-- (WITH BOSE)
2	SHIELD	-
3	G	-
4	L	-
7	SHIELD	-
8	R	-

Terminal No.	Color of Wire	Signal Name
1A	L	- (WITH BOSE)
2A	P	- (WITH BOSE)
3A	SHIELD	-
47A	W	-
48A	B	-
49A	R	-
50A	SHIELD	-

Connector No.	M14
Connector Name	WIRE TO WIRE
Connector Color	BROWN



Terminal No.	Color of Wire	Signal Name
1	V	- (WITH BOSE)
2	SB	- (WITH BOSE)

AANIA2738GB

NAVIGATION WITH BOSE

< WIRING DIAGRAM >

[NAVIGATION WITH BOSE]

Connector No.	M15
Connector Name	TWEETER LH
Connector Color	BROWN



Connector No.	M21
Connector Name	WIRE TO WIRE
Connector Color	WHITE

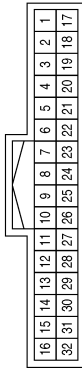

Terminal No.	Color of Wire	Signal Name
1	G	-(WITH BOSE)
2	R	-(WITH BOSE)

Terminal No.	Color of Wire	Signal Name
7	B	-
8	SHIELD	-
9	R	-
13	GR	-
24	W	-
25	B	-

Connector No.	M22
Connector Name	WIRE TO WIRE
Connector Color	WHITE

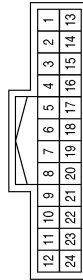

Terminal No.	Color of Wire	Signal Name
1	SHIELD	-
2	BR	-
3	P	-
4	R	-

Terminal No.	Color of Wire	Signal Name
5	SHIELD	-
6	Y	-
7	G	-
8	V	-
9	SB	-
10	L	-
13	Y	-

Terminal No.	Color of Wire	Signal Name
14	SHIELD	-
15	L	-
16	SHIELD	-
17	G	-
18	BR	-
19	R	-
20	SHIELD	-
21	SHIELD	-

AANIA2739GB

Connector No.	M30
Connector Name	STEERING ANGLE SENSOR
Connector Color	WHITE

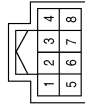

Terminal No.	Color of Wire	Signal Name
2	P	-
5	L	-

Connector No.	M24
Connector Name	BCM (BODY CONTROL MODULE)
Connector Color	BLACK

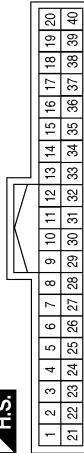

Terminal No.	Color of Wire	Signal Name
16	R	MR OUTPUT
39	L	CAN-H
40	P	CAN-L

Connector No.	M32
Connector Name	AROUND VIEW MONITOR CONTROL UNIT
Connector Color	WHITE



Terminal No.	Color of Wire	Signal Name
1	B	GND
2	SB	+B
3	-	-
4	W	IGN
5	-	-
6	-	-
7	-	-
8	SB	REVERSE

Terminal No.	Color of Wire	Signal Name
23	SHIELD	VIDEO OUTPUT GND
24	W	VIDEO OUTPUT SIGNAL
25	B	RV-POWER GND
26	W	RV-POWER 6.2V
27	SHIELD	RV-VIDEO GND
28	R	RV-VIDEO SIGNAL
29	W	SV2-POWER GND
30	B	SV2-POWER 6.2V
31	SHIELD	SV2-VIDEO GND
32	R	SV2-VIDEO SIGNAL
33	B	SV1-POWER GND
34	W	SV1-POWER 6.2V
35	SHIELD	SV1-VIDEO GND
36	R	SV1-VIDEO SIGNAL
37	W	FV-POWER GND
38	R	FV-POWER 6.2V
39	SHIELD	FV VIDEO GND
40	B	FV-VIDEO SIGNAL

Terminal No.	Color of Wire	Signal Name
9	-	-
10	P	CAN-L
11	-	-
12	L	CAN-H
13	L	LOW-PRICEAVM DISTINCTION
14	-	-
15	-	-
16	-	-
17	-	-
18	-	-
19	-	-
20	-	-
21	-	-
22	-	-

AANIA2740GB

A B C D E F G H I J K L M N O P



Connector No.	M34
Connector Name	COMBINATION METER
Connector Color	WHITE

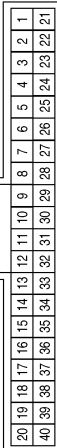

Terminal No.	Color of Wire	Signal Name
18	P	CAN-L
19	L	CAN-H
30	GR	SPEED 8PR

Connector No.	M40
Connector Name	JOINT CONNECTOR-M05
Connector Color	BLUE

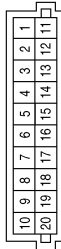

Terminal No.	Color of Wire	Signal Name
2	L	-
3	BR	-
4	GR	-
5	L	-
7	L	-

Terminal No.	Color of Wire	Signal Name
8	L	-
10	L	-
15	P	-
17	P	-
18	P	-
20	P	-

Connector No.	M41
Connector Name	JOINT CONNECTOR-M06
Connector Color	BLUE

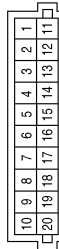

Terminal No.	Color of Wire	Signal Name
1	SB	-
2	SB	-
3	SB	-
4	SB	-
6	L	-
8	L	-
9	L	-
10	L	-
11	LG	-

Terminal No.	Color of Wire	Signal Name
12	LG	-
13	LG	-
14	LG	-
16	P	-
18	P	-
19	P	-
20	P	-

Connector No.	M43
Connector Name	JOINT CONNECTOR-M04
Connector Color	GRAY

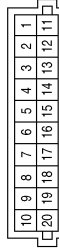

Terminal No.	Color of Wire	Signal Name
3	W	-
4	W	-
7	Y	-
9	W	-
13	B	-
14	B	-
20	B	-

AANIA2741GB

Connector No.	M51
Connector Name	MULTIFUNCTION SWITCH
Connector Color	WHITE

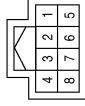

Terminal No.	Color of Wire	Signal Name
1	B	-
2	LG	-
3	-	-
4	L	-
5	-	-
6	SB	-
7	-	-
8	-	-

Connector No.	M50
Connector Name	JOINT CONNECTOR-M03
Connector Color	PINK

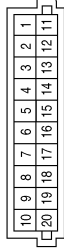

Terminal No.	Color of Wire	Signal Name
12	G	-
15	G	-
17	L	-
20	L	-

Connector No.	M44
Connector Name	JOINT CONNECTOR-M01
Connector Color	GRAY

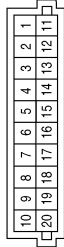

Terminal No.	Color of Wire	Signal Name
8	B	-
9	B	-
10	B	-

Connector No.	M53
Connector Name	USB CONNECTOR
Connector Color	GREEN

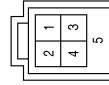

Terminal No.	Color of Wire	Signal Name
1	G	-
2	W	-
3	R	-
4	L	-
5	SHIELD	-

Connector No.	M52
Connector Name	AUXILIARY INPUT JACK
Connector Color	WHITE



Terminal No.	Color of Wire	Signal Name
1	B	-
2	W	-
3	-	-
4	R	-

AANIA2742GB

A
B
C
D
E
F
G
H
I
J
K
L
M
AV
O
P

NAVIGATION WITH BOSE

< WIRING DIAGRAM >

[NAVIGATION WITH BOSE]

Connector No.	M67
Connector Name	TCU
Connector Color	WHITE



2	4	6	8	10	12	14	16	18	20	22	24	26	28	30	32	34	36	38	40
1	3	5	7	9	11	13	15	17	19	21	23	25	27	29	31	33	35	37	39

Terminal No.	Color of Wire	Signal Name
1	W	B+
2	B	GND
3	L	ACC
4	W	IGN
5	-	-
6	-	-

Terminal No.	Color of Wire	Signal Name
7	-	-
8	-	-
9	L	EV CAN H
10	G	EV CAN L
11	-	-
12	-	-
13	-	-
14	-	-
15	-	-
16	-	-
17	-	-
18	-	-
19	-	-
20	-	-
21	-	-
22	-	-
23	-	-

Terminal No.	Color of Wire	Signal Name
24	-	-
25	-	-
26	-	-
27	-	-
28	-	-
29	-	-
30	-	-
31	-	-
32	-	-
33	-	-
34	-	-
35	-	-
36	-	-
37	-	-
38	-	-
39	-	-
40	-	-

Connector No.	M68
Connector Name	TCU
Connector Color	GRAY



48	47	46	45	44	43	42	41
56	55	54	53	52	51	50	49

Terminal No.	Color of Wire	Signal Name
41	Y	U VOICE
42	B	VOICE GND
43	-	-
44	-	-
45	-	-

Terminal No.	Color of Wire	Signal Name
46	V	MANUFACTURE SPECIFIC
47	BR	VBUS
48	L	D-
49	G	D VOICE
50	-	-
51	-	-
52	-	-
53	-	-
54	-	-
55	SHIELD	GND
56	R	D+
57	SHIELD	CONN CHASSIS GND

Connector No.	M73
Connector Name	WIRE TO WIRE
Connector Color	WHITE



1	2	3	4	5	6	7	8
9	10	11	12	13	14	15	16

Terminal No.	Color of Wire	Signal Name
1	P	-
2	L	-
3	SHIELD	-

NAVIGATION WITH BOSE

< WIRING DIAGRAM >

[NAVIGATION WITH BOSE]

Connector No.	M79
Connector Name	WIRE TO WIRE
Connector Color	WHITE

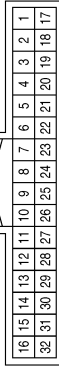

Terminal No.	Color of Wire	Signal Name
11	L	-

Terminal No.	Color of Wire	Signal Name
49	G	-
50	L	-
54	B	-
55	R	-
64	SHIELD	-
65	W	-
69	BG	-
92	BR	-
97	G	-

Connector No.	M77
Connector Name	WIRE TO WIRE
Connector Color	WHITE

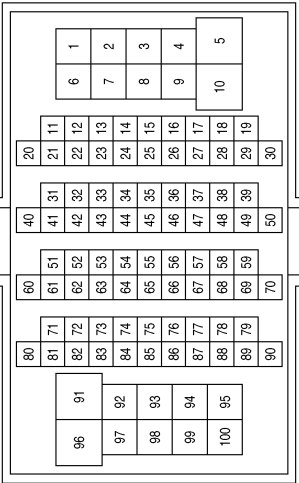

Terminal No.	Color of Wire	Signal Name
8	B	ILL CONT
9	W	ILL
10	-	-
11	G	FR RH PRE+
12	R	FR RH PRE-
13	BR	RR RH PRE+
14	Y	RR RH PRE-
15	B	STRG SW GND
16	W	STRG SW B
17	-	-
18	-	-
19	BR	BAT
20	-	-

Connector No.	M100
Connector Name	AV CONTROL UNIT (WITH NAVIGATION SYSTEM WITH BOSE)
Connector Color	WHITE

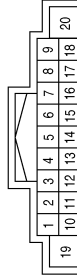

Terminal No.	Color of Wire	Signal Name
1	L	AMP ON
2	Y	FR LH PRE+
3	BR	FR LH PRE-
4	P	RR LH PRE+
5	L	RR LH PRE-
6	R	STRG SW A
7	BR	ACC

Connector No.	M92
Connector Name	COMBINATION SWITCH (SPIRAL CABLE)
Connector Color	GRAY

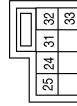

Terminal No.	Color of Wire	Signal Name
24	R	-
31	W	-
33	B	-

AANIA2744GB

A
B
C
D
E
F
G
H
I
J
K
L
M
N
O
P

AV

NAVIGATION WITH BOSE

< WIRING DIAGRAM >

[NAVIGATION WITH BOSE]

Terminal No.	Color of Wire	Signal Name
44	GR	SPEED
45	G	REVERSE_SIG
46	R	MR_OUTPUT
47	-	-
48	-	-
49	-	-
50	-	-
51	-	-
52	-	-
53	L	MIC_SIG
54	SHIELD	MIC_GND
55	W	AUX_AUDIO_RH
56	SHIELD	AUX_SHIELD
57	-	-
58	B	GND
59	-	-
60	SHIELD	R_CAMERA_SHIELD

Terminal No.	Color of Wire	Signal Name
28	-	-
29	-	-
30	-	-
31	-	-
32	-	-
33	-	-
34	P	MIC_VCC
35	R	AUX_AUDIO_LH
36	B	AUX_AUDIO
37	-	-
38	-	-
39	-	-
40	W	R_CAMERA_COMP
41	SB	M_CAN_H TRM
42	SB	M_CAN_H
43	L	CAN-H

Connector No.	M103
Connector Name	AV CONTROL UNIT (WITH NAVIGATION SYSTEM WITH BOSE)
Connector Color	WHITE



21	22	23	24	25	26	27	28	29	30	31	32	33	34	35	36	37	38	39	40
41	42	43	44	45	46	47	48	49	50	51	52	53	54	55	56	57	58	59	60

Terminal No.	Color of Wire	Signal Name
21	LG	M_CAN_L TRM
22	LG	M_CAN_L
23	P	CAN-L
24	-	-
25	Y	PKB_SIG
26	V	IGN
27	L	AFFORBABLE_SIG

Connector No.	M107
Connector Name	AV CONTROL UNIT (WITH NAVIGATION SYSTEM WITH BOSE)
Connector Color	BLUE



79	78	81	80	82
----	----	----	----	----

Terminal No.	Color of Wire	Signal Name
65	-	-
66	-	-
67	B	GND
68	Y	U-VOICE
69	R	USB_D+
70	SHIELD	USB_GND
71	-	-
72	-	-
73	-	-
74	-	-
75	-	-
76	G	D-VOICE
77	SHIELD	SHIELD

Connector No.	M104
Connector Name	AV CONTROL UNIT (WITH NAVIGATION SYSTEM WITH BOSE)
Connector Color	GRAY



68	67	66	65	64	63	62	61
76	75	74	73	72	71	70	69
77							

Terminal No.	Color of Wire	Signal Name
78	W	V_BUS
79	G	USB_GND
80	L	USB_D+
81	R	USB_D-
82	SHIELD	SHIELD

Terminal No.	Color of Wire	Signal Name
61	L	USB_D-
62	BR	USB_VBUS
63	V	MANUFACTURER SPECIFIC
64	-	-

AANIA2745GB

NAVIGATION WITH BOSE

< WIRING DIAGRAM >

[NAVIGATION WITH BOSE]

Connector No.	M504
Connector Name	AV CONTROL UNIT (WITH NAVIGATION SYSTEM- WITH BOSE AUDIO SYSTEM)
Connector Color	GRAY

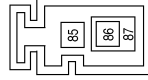

Terminal No.	Color of Wire	Signal Name
85	B	ANTENNA AMP. ON SIGNAL
86	B	RADIO ANTENNA SIGNAL
87	SHIELD	SHIELD

Connector No.	M503
Connector Name	AV CONTROL UNIT (WITH NAVIGATION SYSTEM- WITH BOSE AUDIO SYSTEM)
Connector Color	GRAY



Terminal No.	Color of Wire	Signal Name
83	B	GPS ANTENNA SIGNAL
84	SHIELD	SHIELD

Connector No.	M112
Connector Name	COMBINATION SWITCH (SPIRAL CABLE)
Connector Color	GRAY

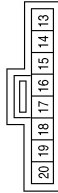

Terminal No.	Color of Wire	Signal Name
14	P	-
15	L	-
17	G	-

Connector No.	M511
Connector Name	WIRE TO WIRE
Connector Color	GRAY



Terminal No.	Color of Wire	Signal Name
1	B	-
2	B	-
3	SHIELD	-

Connector No.	M506
Connector Name	TCU
Connector Color	GRAY



Terminal No.	Color of Wire	Signal Name
58	B	TEL ANT
59	SHIELD	TEL ANT SHIELD

Connector No.	M505
Connector Name	AV CONTROL UNIT (WITH NAVIGATION SYSTEM- WITH BOSE AUDIO SYSTEM)
Connector Color	PINK



Terminal No.	Color of Wire	Signal Name
88	B	SATELLITE ANTENNA
89	SHIELD	SHIELD

AANIA2746GB

A
B
C
D
E
F
G
H
I
J
K
L
M
N
O
P

AV

NAVIGATION WITH BOSE

< WIRING DIAGRAM >

[NAVIGATION WITH BOSE]

Connector No.	M515
Connector Name	TEL ANTENNA
Connector Color	GRAY



Terminal No.	Color of Wire	Signal Name
1	B	-
2	SHIELD	-

Connector No.	M513
Connector Name	ANTENNA BASE
Connector Color	GRAY



Terminal No.	Color of Wire	Signal Name
1	B	-
2	B	-
3	SHIELD	-

Connector No.	M512
Connector Name	WIRE TO WIRE
Connector Color	GRAY



Terminal No.	Color of Wire	Signal Name
1	B	-
2	B	-
3	SHIELD	-

Connector No.	M518
Connector Name	ANTENNA BASE
Connector Color	GREEN

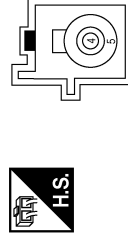

Terminal No.	Color of Wire	Signal Name
4	B	-
5	SHIELD	-

Connector No.	M517
Connector Name	WIRE TO WIRE
Connector Color	BROWN

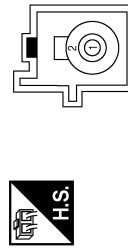

Terminal No.	Color of Wire	Signal Name
1	B	-
2	SHIELD	-

Connector No.	M516
Connector Name	WIRE TO WIRE
Connector Color	BROWN

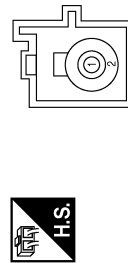

Terminal No.	Color of Wire	Signal Name
1	B	-
2	SHIELD	-

AANIA2747GB

NAVIGATION WITH BOSE

< WIRING DIAGRAM >

[NAVIGATION WITH BOSE]

Connector No.	E4
Connector Name	PARKING BRAKE SWITCH
Connector Color	BLACK



Terminal No.	Color of Wire	Signal Name
1	B	-

Connector No.	M525
Connector Name	TWEETER RH
Connector Color	BROWN



Terminal No.	Color of Wire	Signal Name
1	R	-
2	B	-

Connector No.	M521
Connector Name	WIRE TO WIRE
Connector Color	BROWN



Terminal No.	Color of Wire	Signal Name
1	R	-
2	B	-

Connector No.	E27
Connector Name	REVERSE LAMP RELAY
Connector Color	BLUE



Terminal No.	Color of Wire	Signal Name
1	O	-
2	SB	-
3	O	-
5	G	-

Connector No.	E21
Connector Name	WIRE TO WIRE
Connector Color	BLACK



Terminal No.	Color of Wire	Signal Name
1	R	-
2	W	-
3	SHIELD	-
4	B	-

Connector No.	E15
Connector Name	IPDM E/R (INTELLIGENT POWER DISTRIBUTION MODULE ENGINE ROOM)
Connector Color	WHITE



Terminal No.	Color of Wire	Signal Name
58	O	REVERSE LAMP IGN

AANIA2748GB

A
B
C
D
E
F
G
H
I
J
K
L
M
N
O
P

AV

Connector No.	E60
Connector Name	WIRE TO WIRE
Connector Color	BLACK

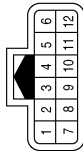

Terminal No.	Color of Wire	Signal Name
3	L	-
4	G	-
5	L	-
6	G	-

Connector No.	E61
Connector Name	VCM
Connector Color	BLACK

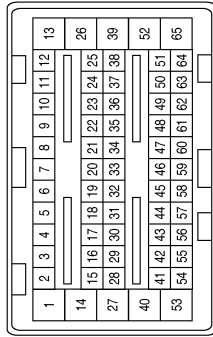

Terminal No.	Color of Wire	Signal Name
24	L	EV SYSTEM CAN-H
25	G	EV SYSTEM CAN-L

Connector No.	E62
Connector Name	VCM
Connector Color	BROWN

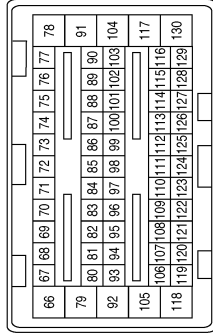

Terminal No.	Color of Wire	Signal Name
70	SB	REVERSE LAMP

Connector No.	E105
Connector Name	WIRE TO WIRE
Connector Color	WHITE

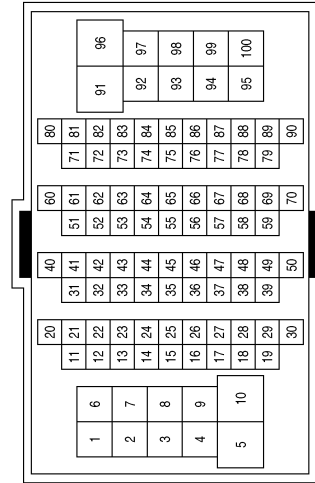

Terminal No.	Color of Wire	Signal Name
49	G	-
50	L	-
54	B	-
55	R	-
64	SHIELD	-
65	W	-
69	B	-
92	BR	-
97	G	-

Connector No.	E108
Connector Name	WIRE TO WIRE
Connector Color	WHITE



Terminal No.	Color of Wire	Signal Name
3	SB	-

AANIA2749GB

NAVIGATION WITH BOSE

< WIRING DIAGRAM >

[NAVIGATION WITH BOSE]

Connector No.	F2
Connector Name	WIRE TO WIRE
Connector Color	BLACK



Terminal No.	Color of Wire	Signal Name
3	L	-
4	G	-
5	L	-
6	G	-

Connector No.	E203
Connector Name	WIRE TO WIRE
Connector Color	BLACK



Terminal No.	Color of Wire	Signal Name
1	R	-
2	B	-
3	L	-
4	W	-

Connector No.	E202
Connector Name	FRONT CAMERA
Connector Color	BLACK



Terminal No.	Color of Wire	Signal Name
1	B	-
2	R	-
3	W	-
4	L	-

Connector No.	B8
Connector Name	WIRE TO WIRE
Connector Color	WHITE



Terminal No.	Color of Wire	Signal Name
3	R	-

Connector No.	B4
Connector Name	WIRE TO WIRE
Connector Color	WHITE

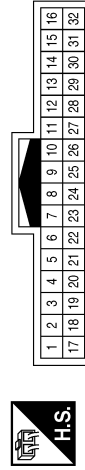

Terminal No.	Color of Wire	Signal Name
11	GR	-

Connector No.	B3
Connector Name	WIRE TO WIRE
Connector Color	WHITE

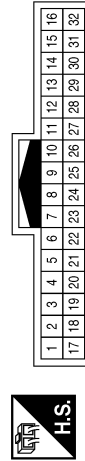

Terminal No.	Color of Wire	Signal Name
7	B	-
8	SHIELD	-
9	B	-
13	GR	-
24	R	-
25	W	-

AANIA2750GB

A
B
C
D
E
F
G
H
I
J
K
L
M
N
O
P

AV

Connector No.	B11
Connector Name	BOSE SPEAKER AMP.
Connector Color	BLACK

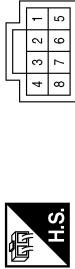

Terminal No.	Color of Wire	Signal Name
1	R	-
2	L	-
3	-	-
4	R	-
5	G	-
6	P	-
7	-	-
8	B	-

Connector No.	B16
Connector Name	WIRE TO WIRE
Connector Color	WHITE

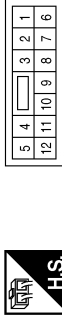

Terminal No.	Color of Wire	Signal Name
9	L	- (WITH BOSE)
10	P	- (EXCEPT MEXICO)
11	SHIELD	-

Connector No.	B17
Connector Name	WIRE TO WIRE
Connector Color	WHITE

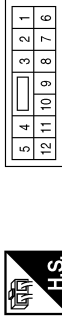

Terminal No.	Color of Wire	Signal Name
9	R	- (WITH BOSE)
10	G	- (WITH BOSE)
11	SHIELD	-

Connector No.	B18
Connector Name	WIRE TO WIRE
Connector Color	WHITE

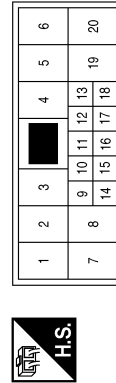

Terminal No.	Color of Wire	Signal Name
11	B	-
12	W	-
13	R	-
17	SHIELD	-
18	B	-

Connector No.	B20
Connector Name	BOSE SPEAKER AMP.
Connector Color	BLACK

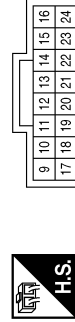

Terminal No.	Color of Wire	Signal Name
9	G	-
10	P	-
11	L	-
12	R	-
13	G	-
14	SB	-

Terminal No.	Color of Wire	Signal Name
15	V	-
16	L	-
17	R	-
18	-	-
19	-	-
20	-	-
21	-	-
22	L	-
23	-	-
24	P	-

AANIA2751GB

NAVIGATION WITH BOSE

< WIRING DIAGRAM >

[NAVIGATION WITH BOSE]

Connector No.	B40
Connector Name	WIRE TO WIRE
Connector Color	WHITE



Terminal No.	Color of Wire	Signal Name
1	P	-(WITH BOSE)
2	SHIELD	-
3	G	-
4	L	-
7	SHIELD	-
8	R	-

Connector No.	B31
Connector Name	JOINT CONNECTOR-B03
Connector Color	BLUE

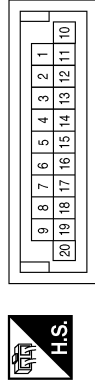

Terminal No.	Color of Wire	Signal Name
1	SHIELD	-
2	B	-
3	SHIELD	-
4	SHIELD	-
5	SHIELD	-
10	B	-
11	SHIELD	-
12	SHIELD	-
13	SHIELD	-
14	SHIELD	-
15	SHIELD	-
16	SHIELD	-
17	SHIELD	-

Connector No.	B27
Connector Name	BOSE SPEAKER AMP.
Connector Color	BLACK

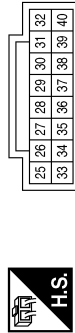

Terminal No.	Color of Wire	Signal Name
25	-	-
26	-	-
27	BR	-
28	V	-
29	G	-
30	B	-
31	-	-
32	-	-
33	-	-
34	-	-
35	Y	-
36	LG	-
37	R	-
38	W	-
39	-	-
40	-	-

Terminal No.	Color of Wire	Signal Name
13	Y	-
14	SHIELD	-
15	V	-
16	SHIELD	-
17	G	-
18	B	-
19	R	-
20	SHIELD	-
21	SHIELD	-

Terminal No.	Color of Wire	Signal Name
2	BR	-
3	LG	-
4	R	-
5	SHIELD	-
6	W	-
7	G	-
8	V	-
9	SB	-
10	L	-

Connector No.	B42
Connector Name	WIRE TO WIRE
Connector Color	WHITE

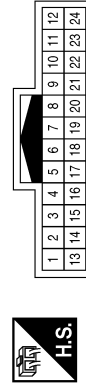

Terminal No.	Color of Wire	Signal Name
1	SHIELD	-

AANIA2752GB

A B C D E F G H I J K L M N O P

AV

Connector No.	R3
Connector Name	MICROPHONE
Connector Color	WHITE



Terminal No.	Color of Wire	Signal Name
1	L	-
2	GR	-
3	-	-
4	P	-
5	-	-
6	-	-

Connector No.	R1
Connector Name	WIRE TO WIRE
Connector Color	WHITE

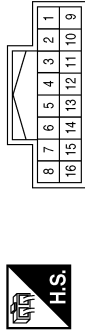

Terminal No.	Color of Wire	Signal Name
1	P	-
2	L	-
3	GR	-

Connector No.	B43
Connector Name	BOSE SUBWOORER
Connector Color	GRAY



Terminal No.	Color of Wire	Signal Name
1	P	-
2	L	-

Terminal No.	Color of Wire	Signal Name
1C	L	-
2C	V	-
49C	B	-
50C	W	-
51C	R	-
52C	SHIELD	-

Connector No.	D22
Connector Name	WIRE TO WIRE
Connector Color	WHITE

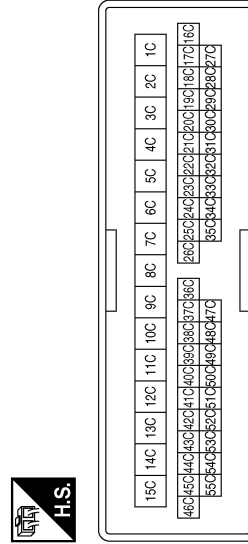

Connector No.	D1
Connector Name	SIDE CAMERA LH
Connector Color	WHITE



Terminal No.	Color of Wire	Signal Name
1	B	-
2	W	-
3	R	-
4	SHIELD	-

AANIA2753GB

NAVIGATION WITH BOSE

< WIRING DIAGRAM >

[NAVIGATION WITH BOSE]

Terminal No.	Color of Wire	Signal Name
2	B	-
3	R	-
4	SHIELD	-

Connector No.	D101
Connector Name	SIDE CAMERA RH
Connector Color	WHITE

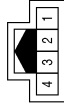

Terminal No.	Color of Wire	Signal Name
1	W	-

Connector No.	D24
Connector Name	FRONT DOOR SPEAKER LH (WITH BOSE AUDIO SYSTEM)
Connector Color	BROWN



Terminal No.	Color of Wire	Signal Name
1	V	-
2	L	-

Connector No.	D201
Connector Name	WIRE TO WIRE
Connector Color	WHITE

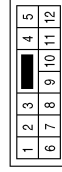

Connector No.	D124
Connector Name	FRONT DOOR SPEAKER RH (WITH BOSE AUDIO SYSTEM)
Connector Color	BROWN



Connector No.	D102
Connector Name	WIRE TO WIRE
Connector Color	WHITE

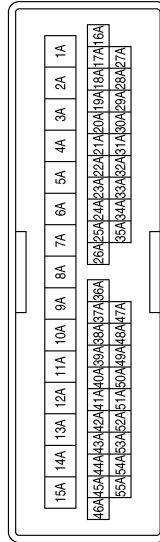

Terminal No.	Color of Wire	Signal Name
9	V	-
10	LG	-

Terminal No.	Color of Wire	Signal Name
1	R	-
2	BR	-

Terminal No.	Color of Wire	Signal Name
1A	BR	-
2A	R	-
47A	W	-
48A	B	-
49A	R	-
50A	SHIELD	-

AANIA2754GB

A
B
C
D
E
F
G
H
I
J
K
L
M
N
O
P

AV

Connector No.	D305
Connector Name	REAR DOOR SPEAKER RH
Connector Color	WHITE



Terminal No.	Color of Wire	Signal Name
1	LG	-
2	P	-

Connector No.	D301
Connector Name	WIRE TO WIRE
Connector Color	WHITE

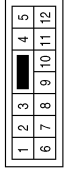

Terminal No.	Color of Wire	Signal Name
9	LG	-
10	P	-

Connector No.	D205
Connector Name	REAR DOOR SPEAKER LH
Connector Color	WHITE



Terminal No.	Color of Wire	Signal Name
1	V	-
2	LG	-

Connector No.	D555
Connector Name	WIRE TO WIRE
Connector Color	WHITE



Terminal No.	Color of Wire	Signal Name
1	W	-
2	R	-
6	SHIELD	-
7	B	-

Connector No.	D505
Connector Name	WIRE TO WIRE
Connector Color	WHITE

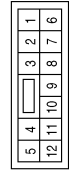

Terminal No.	Color of Wire	Signal Name
1	W	-
2	R	-
6	SHIELD	-
7	Y	-

Connector No.	D504
Connector Name	WIRE TO WIRE
Connector Color	WHITE

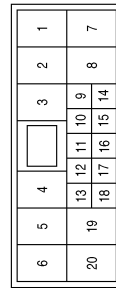

Terminal No.	Color of Wire	Signal Name
11	B	-
12	W	-
13	R	-
17	SHIELD	-
18	Y	-

AANIA2755GB

A
B
C
D
E
F
G
H
I
J
K
L
M
N
O
P

Connector No.	D557
Connector Name	REAR VIEW CAMERA (WITH AROUND VIEW MONITOR)
Connector Color	WHITE

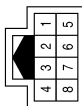

Terminal No.	Color of Wire	Signal Name
1	SHIELD	-
2	-	-
3	-	-
4	-	-
5	B	-
6	-	-
7	W	-
8	R	-

AV

AANIA2756GB

BASIC INSPECTION

DIAGNOSIS AND REPAIR WORK FLOW

Work Flow

INFOID:000000010641978

OVERALL SEQUENCE

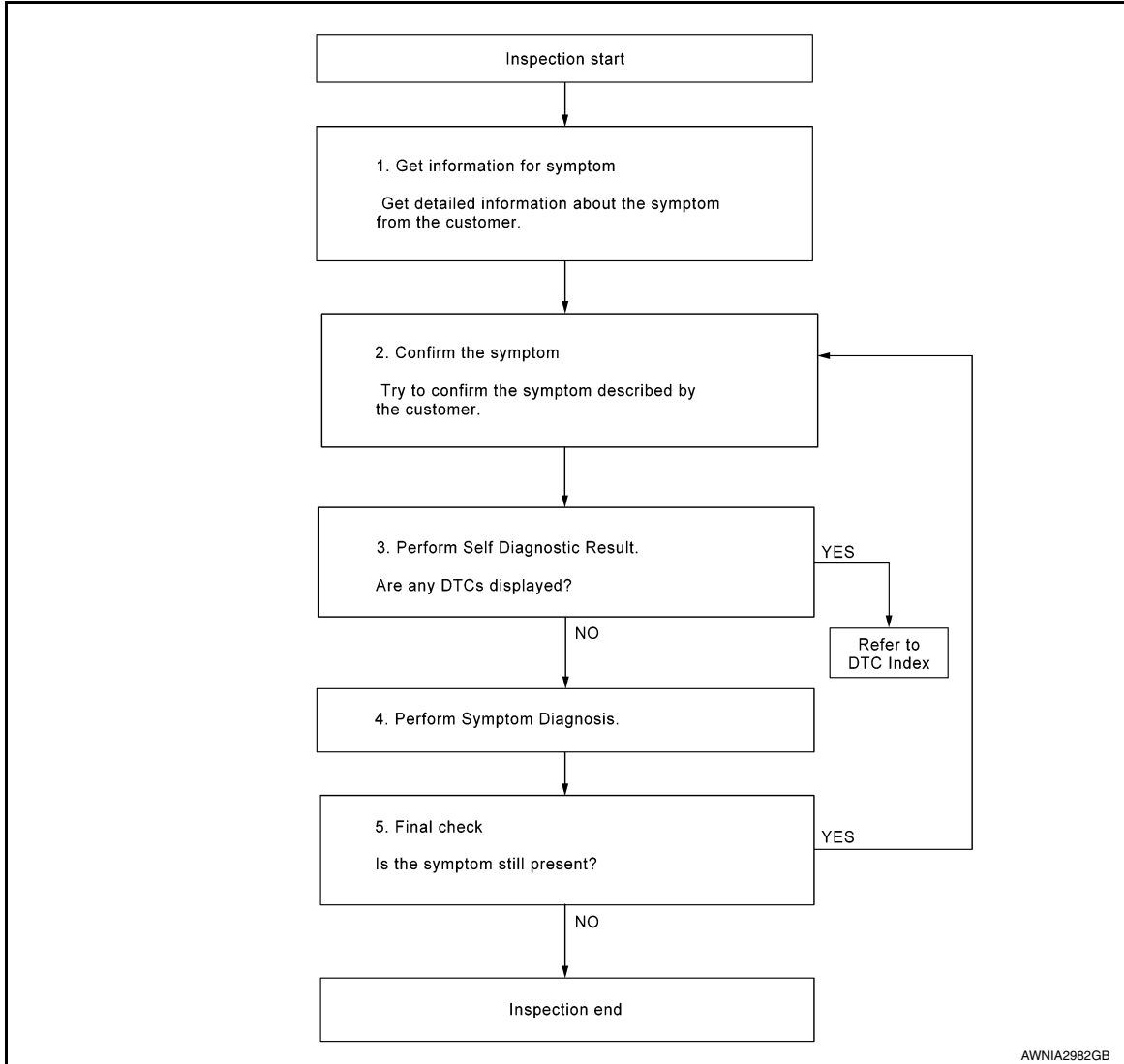

DETAILED FLOW

1. GET INFORMATION FOR SYMPTOM

Get detailed information from the customer about the symptom (the condition and the environment when the incident/malfunction occurred).

>> GO TO 2.

2. CONFIRM THE SYMPTOM

Try to confirm the symptom described by the customer. Verify relation between the symptom and the condition when the symptom is detected.

>> GO TO 3.

3. PERFORM SELF DIAGNOSTIC RESULT

1. Turn power switch ON and wait for 2 seconds or more.

DIAGNOSIS AND REPAIR WORK FLOW

[NAVIGATION WITH BOSE]

< BASIC INSPECTION >

2. Depending on system being diagnosed, perform Self Diagnostic Result for:
- MULTI AV.
 - AVM.

Are any DTCs displayed?

- YES >> Refer to [AV-385, "DTC Index"](#) (MULTI AV) or [AV-392, "DTC Index"](#) (AVM).
NO >> GO TO 4.

4.PERFORM SYMPTOM DIAGNOSIS

Refer to [AV-474, "Symptom Table"](#).

>> GO TO 5

5.FINAL CHECK

Refer to symptom described by the customer in step 1.

Is the symptom still present?

- YES >> GO TO 2
NO >> Inspection End.

A
B
C
D
E
F
G
H
I
J
K
L
M
O
P

AV

INSPECTION AND ADJUSTMENT

ADDITIONAL SERVICE WHEN REMOVING BATTERY NEGATIVE TERMINAL

ADDITIONAL SERVICE WHEN REMOVING BATTERY NEGATIVE TERMINAL : Description

INFOID:000000010641979

- Refer to [AV-332, "Precaution for Removing 12V Battery"](#).
- When removed the 12V battery terminal, the following work is required.

WORK AFTER THE AV CONTROL UNIT REPLACEMENT

- Re-registration of user ID and password to the AV control unit.
- Time adjustment check with VCM check.

WORK AFTER REMOVED THE 12V BATTERY TERMINAL

Time adjustment check with VCM check.

ADDITIONAL SERVICE WHEN REMOVING BATTERY NEGATIVE TERMINAL : Work Procedure

INFOID:000000010641980

When not replace the AV control unit, starting from work procedure 2.

1. REPLACE AV CONTROL UNIT

1. Refer to [AV-332, "Precaution for Removing 12V Battery"](#).
2. Replace the AV control unit. [AV-488, "Removal and Installation"](#).

>> GO TO 2.

2. OBTAIN THE CURRENT TIME.

1. Turn the power switch to the ON or Ready position in a location where the GPS antenna signal can be received.
2. Start the AV control unit and receive the current time with the GPS antenna.

>> GO TO 3.

3. CHECK THE TIME WITH VCM

1. Press "⏻" switch and select "Charging Timer" on the menu screen.
2. Confirm that the time is displayed at the upper right (GPS acquisition time) and lower left (VCM memory time) of the "Charging Timer" screen.
3. If the time does not match after 1 or 2 minutes from the screen display, the update screen is displayed.

Is the update screen displayed?

- NO >> WORK END
YES >> GO TO 4.

4. TIME ADJUSTMENT CHECK WITH VCM

1. Press "correct time" displayed on the screen to correct the time.
2. After correction, confirm that the time displayed at the upper right (GPS acquisition time) and lower left (VCM memory time) of the "Charging Timer" screen are the same.

>> WORK END

SOFTWARE UPDATE (AV CONTROL UNIT)

SOFTWARE UPDATE (AV CONTROL UNIT) : Description

INFOID:000000010641981

The software of the AV control unit can be updated by using SD card.

SOFTWARE UPDATE (AV CONTROL UNIT) : Work Procedure

INFOID:000000010641982

1. START OF CONFIRMATION/ADJUSTMENT MODE

INSPECTION AND ADJUSTMENT

< BASIC INSPECTION >

[NAVIGATION WITH BOSE]

1. Set the power switch on ACC.
2. With AUDIO OFF, press “MAP” switch three times, “” switch twice, and press “MAP” switch once to start the On Board Diagnosis Function.

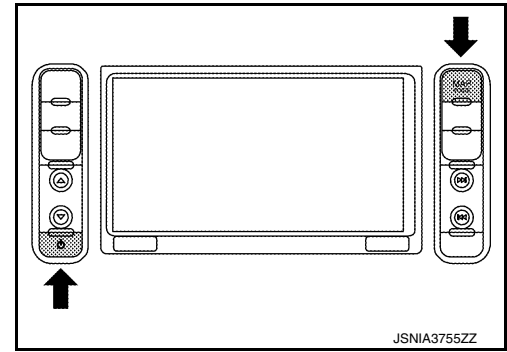

3. Select “Software Update” in Confirmation/Adjustment mode.

>> GO TO 2.

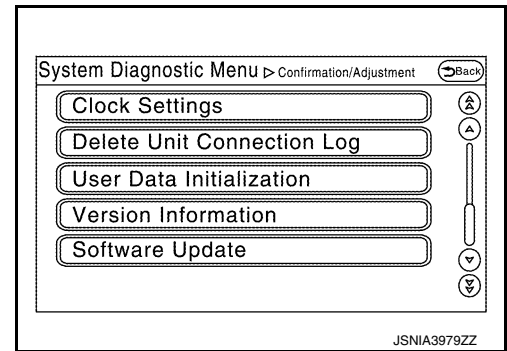

2.UPDATE THE SOFTWARE OF THE AV CONTROL UNIT

1. “Please insert SD Card for the program update and Push OK button” pops up.

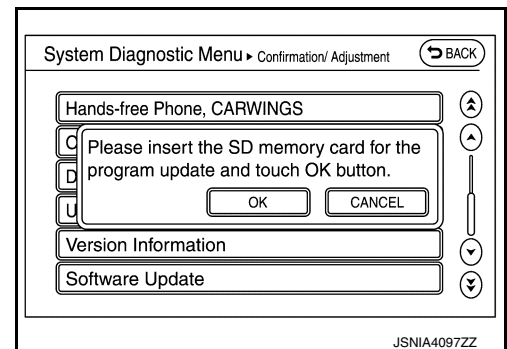

2. Press the OPEN/TILT switch of the AV control unit to open the display.
3. Remove the cover of the SD slot and insert the SD card for software update into the SD card sub-slot (on the left).

NOTE:

Leave the map SD card inserted in the main slot (on the right).

4. Press the OPEN/TILT switch of the AV control unit to close the display.
5. Select “OK” in the pop-up confirmation to start software update.

NOTE:

The instructions below must be followed during software update.

- Never turn the power switch OFF.
- Never remove the SD card.
- Never use other functions. They are not available.

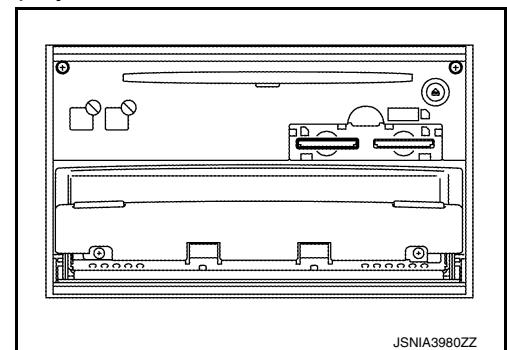

6. When the software update is complete, “The update of the program completed successfully. Please switch the power off and on again to reboot.” is shown.
7. Press the OPEN/TILT switch of the AV control unit to open the display.
8. Remove the SD card for software update from the SD card sub-slot (on the left) and install the cover of the SD slot.
9. Turn the power switch OFF.

>> GO TO 3.

3. CHECK THE UPDATED SOFTWARE VERSION OF THE AV CONTROL UNIT

1. Set the power switch on ACC after a lapse of 15 seconds or more after the power switch is turned OFF.
2. With AUDIO OFF, press “MAP” switch three times, “⏻” switch twice, and press “MAP” switch once to start the On Board Diagnosis Function.
3. Select “Version Information” in Confirmation/Adjustment mode.
4. Check version information to see that the Boot ware and the application version are updated.

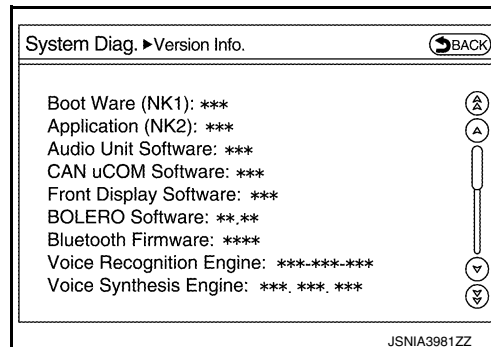

>> End of program.

ADDITIONAL SERVICE WHEN REPLACING AV CONTROL UNIT

ADDITIONAL SERVICE WHEN REPLACING AV CONTROL UNIT : Description

INFOID:000000010641983

BEFORE REPLACEMENT

When replacing AV control unit, save or print current vehicle specification with CONSULT configuration before replacement.

AFTER REPLACEMENT

CAUTION:

When replacing AV control unit, you must perform “After Replace ECU” or “Manual Configuration” with CONSULT.

- Complete the procedure of “After Replace ECU” or “Manual Configuration” in order.
- If you set incorrect “After Replace ECU” or “Manual Configuration”, incidents might occur.
- Configuration is different for each vehicle model. Confirm configuration of each vehicle model.

ADDITIONAL SERVICE WHEN REPLACING AV CONTROL UNIT : Work Procedure

INFOID:000000010641984

1. SAVING VEHICLE SPECIFICATION

Ⓟ-CONSULT Configuration

Perform “Before Replace ECU” to save or print current vehicle specification. Refer to [AV-423. "CONFIGURATION \(AV CONTROL UNIT\) : Description"](#).

NOTE:

If “Before Replace ECU” can not be used, use the “Manual Configuration”.

>> GO TO 2.

2. REPLACE AV CONTROL UNIT

Replace AV control unit. Refer to [AV-488. "Removal and Installation"](#).

>> GO TO 3.

3. WRITING VEHICLE SPECIFICATION

Ⓟ-CONSULT Configuration

INSPECTION AND ADJUSTMENT

< BASIC INSPECTION >

[NAVIGATION WITH BOSE]

Perform "After Replace ECU" or "Manual Configuration" to write vehicle specification. Refer to [AV-423, "CONFIGURATION \(AV CONTROL UNIT\) : Work Procedure"](#).

>> GO TO 4.

4. OPERATION CHECK

Check that the operation of the AV control unit and camera images (fixed guide lines and predictive course lines) are normal.

>> WORK END

ADDITIONAL SERVICE WHEN REPLACING AROUND VIEW MONITOR CONTROL UNIT

ADDITIONAL SERVICE WHEN REPLACING AROUND VIEW MONITOR CONTROL UNIT : Description

INFOID:000000010641985

Perform the calibrating camera image when replacing around view monitor control unit. Refer to [AV-425, "CALIBRATING CAMERA IMAGE \(AROUND VIEW MONITOR\) : Work Procedure"](#).

CONFIGURATION (AV CONTROL UNIT)

CONFIGURATION (AV CONTROL UNIT) : Description

INFOID:000000010641986

- Since vehicle specifications are not included in the AV control unit after replacement, it is required to write vehicle specifications with CONSULT.
- Configuration has three functions as follows.

Function		Description
Read/Write Configuration	Before Replace ECU	Allows the reading of vehicle specification written in AV control unit to store the specification in CONSULT.
	After Replace ECU	Allows the writing of the vehicle information stored in CONSULT into the AV control unit.
Manual Configuration		Allows the writing of the vehicle specification into the AV control unit by hand.

CONFIGURATION (AV CONTROL UNIT) : Work Procedure

INFOID:000000010641987

1. WRITE VEHICLE SPECIFICATION

CONSULT Configuration

Write vehicle specification into AV control unit.

To write vehicle specification stored in CONSULT into the AV control unit>>GO TO 2.

To write vehicle specification into the AV control unit by hand>>GO TO 3.

2. WRITE STORED DATA

CONSULT Configuration

Select "After Replace ECU" in "Read/Write Configuration." Write data stored in CONSULT with the "Before Replace ECU" function into the AV control unit.

>> GO TO 4.

3. MANUALLY WRITE VEHICLE SPECIFICATION

CONSULT Configuration

Perform "Manual Configuration." Refer to the Configuration List to write vehicle specification into the AV control unit. Refer to [AV-424, "CONFIGURATION \(AV CONTROL UNIT\) : Configuration List"](#).

NOTE:

If selection items are not displayed on the CONSULT screen, touch "NEXT."

A
B
C
D
E
F
G
H
I
J
K
L
M
O
P

AV

>> GO TO 4.

4. OPERATION CHECK

Check that the operation of the AV control unit and camera images (fixed guide lines and predictive course lines) are normal.

>> WORK END

CONFIGURATION (AV CONTROL UNIT) : Configuration List

INFOID:000000010641988

CAUTION:

Check vehicle specifications before servicing.

MANUAL SETTING ITEM	
Items	Setting value
STEERING	LHD
	RHD
SOUND SYSTEM	BASE
	BOSE

CONFIGURATION (AROUND VIEW MONITOR CONTROL UNIT)

CONFIGURATION (AROUND VIEW MONITOR CONTROL UNIT) : Work Procedure

INFOID:000000010641989

1. SAVING VEHICLE SPECIFICATION

Ⓟ-CONSULT Configuration

Perform "Before Replace ECU", and save the current vehicle specification in CONSULT.

Is the vehicle specification saved normally?

YES >> GO TO 2.

NO >> GO TO 4.

2. REPLACE AROUND VIEW MONITOR CONTROL UNIT

Replace around view monitor control unit. Refer to [AV-502. "Removal and Installation"](#).

>> GO TO 3.

3. WRITING VEHICLE SPECIFICATION

Ⓟ-CONSULT Configuration

Select "Configuration" or "After Replace ECU", and write the vehicle specification saved in CONSULT to around view monitor control unit.

>> GO TO 6.

4. REPLACE AROUND VIEW MONITOR CONTROL UNIT

Replace around view monitor control unit. Refer to [AV-502. "Removal and Installation"](#).

>> GO TO 5.

5. WRITE VEHICLE SPECIFICATION

ⓅCONSULT Configuration

Select "Manual Configuration", and write the vehicle specification to around view monitor control unit.

NOTE:

Around view monitor control unit does not have any setting items. Selection of items on "Manual Configuration" screen is not required.

>> GO TO 6.

6.PERFORM SELF-DIAGNOSIS

ⓂCONSULT Self Diagnostic Result

Perform self-diagnosis of CONSULT, and check whether or not DTC U1305 is detected.

Is DTC U1305 detected?

>> GO TO 5.

>> GO TO 7.

7.OPERATION CHECK

Check that the operation of the around view monitor control unit and camera images (fixed guide lines and predictive course lines) are normal.

>> WORK END

PREDICTIVE COURSE LINE CENTER POSITION ADJUSTMENT

PREDICTIVE COURSE LINE CENTER POSITION ADJUSTMENT : Description

INFOID:000000010641990

Adjust the center position of the predictive course line of the rear view monitor if it is shifted.

PREDICTIVE COURSE LINE CENTER POSITION ADJUSTMENT : Work Procedure

INFOID:000000010641991

1.DRIVING

Drive the vehicle straight ahead 100 m (328.1 ft) or more at a speed of 30 km/h (18.6 MPH) or more.

>> END

CALIBRATING CAMERA IMAGE (AROUND VIEW MONITOR)

CALIBRATING CAMERA IMAGE (AROUND VIEW MONITOR) : Description

INFOID:000000010641992

- Calibration must be performed after removing/replacing the cameras, removing parts (e.g. front grille, door mirror, and others) mounted on the cameras, or replacing the Around view monitor control unit.
- The use of CONSULT is required to perform calibration or writing of calibration results to the Around view monitor control unit.
- Align the white lines on the road near the vehicle at the boundary of each camera image by this camera calibration. The white lines far from the vehicle may not be aligned at the boundary of each camera image. The farther the line, the greater the difference is.

CALIBRATING CAMERA IMAGE (AROUND VIEW MONITOR) : Work Procedure

INFOID:000000010641993

CALIBRATION FLOWCHART

A
B
C
D
E
F
G
H
I
J
K
L
M
O
P

AV

INSPECTION AND ADJUSTMENT

< BASIC INSPECTION >

[NAVIGATION WITH BOSE]

Following the flowchart shown in the figure, perform the calibration.

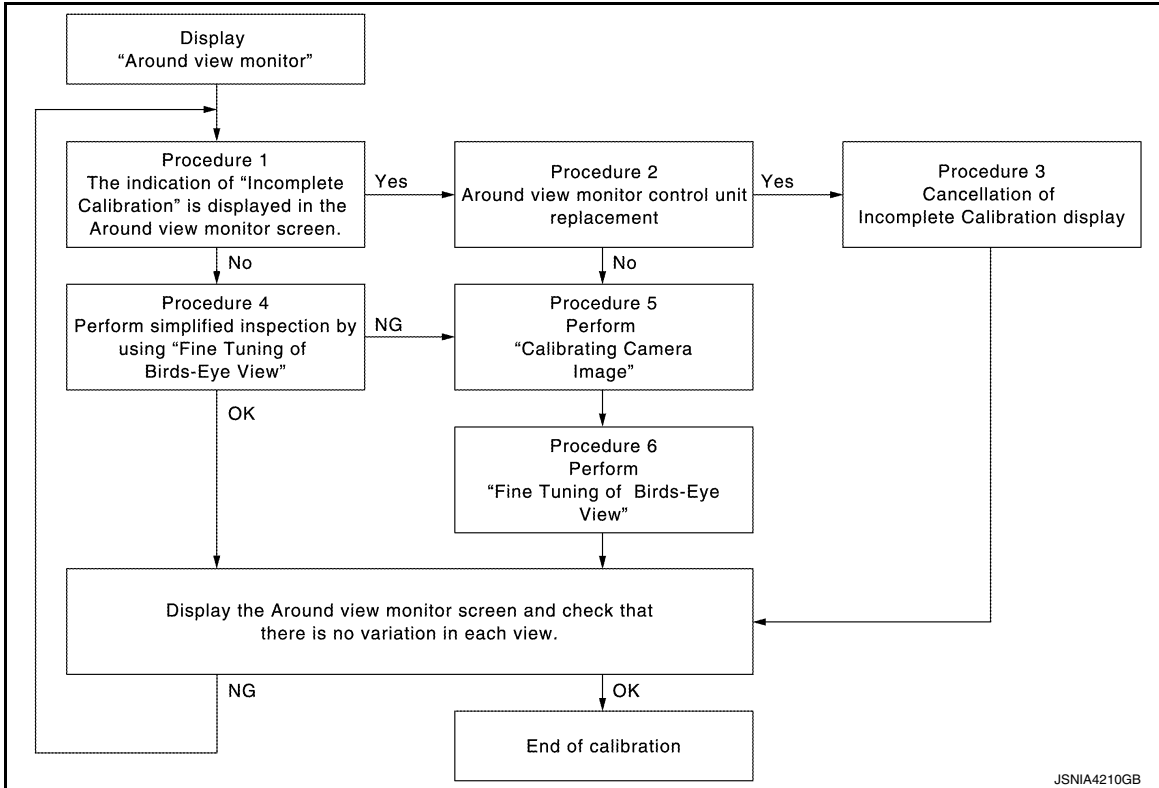

NOTE:

View in the incomplete calibration state is indicated by "⊠" on the around view monitor.

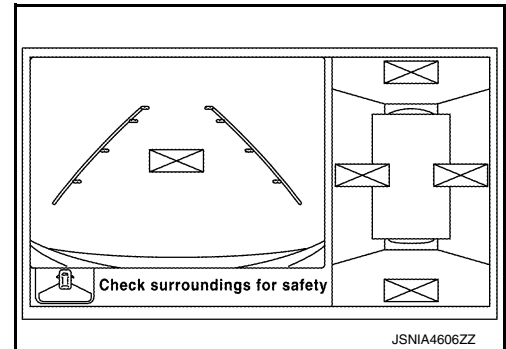

CALIBRATION PROCEDURE

1. AROUND VIEW MONITOR SCREEN CONFIRMATION

Check that there is no indication of "Incomplete calibration".

Is the "Incomplete calibration" display visible?

- YES >> GO TO 2.
- NO >> GO TO 4.

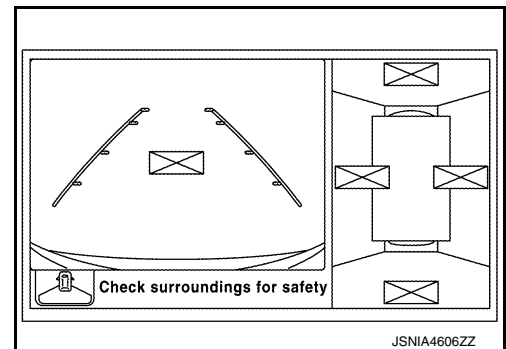

2. CHECK THAT AROUND VIEW MONITOR CONTROL UNIT IS REPLACED

Check that the around view monitor control unit is replaced.

Is the around view monitor control unit replaced?

- YES >> GO TO 3.
- NO >> GO TO 5.

INSPECTION AND ADJUSTMENT

< BASIC INSPECTION >

[NAVIGATION WITH BOSE]

3. CANCEL THE INDICATION OF INCOMPLETE CALIBRATION (PERFORM THIS ONLY AFTER REPLACING AROUND VIEW MONITOR CONTROL UNIT.)

CONSULT work support

- On the CONSULT screen, touch “CALIBRATING CAMERA IMAGE (FRONT CAMERA)”, “CALIBRATING CAMERA IMAGE (PASS-SIDE CAMERA)”, “CALIBRATING CAMERA IMAGE (DR-SIDE CAMERA)”, or “CALIBRATING CAMERA IMAGE (REAR CAMERA)” to accept the selection.

NOTE:

To cancel the indication of Incomplete calibration, select items based on the target camera.

- On the adjustment screen of each camera, touch “APPLY” button. After this, touch “OK” button.

CAUTION:

- Never perform operations other than those mentioned above.
- Never perform “Initialize Camera Image Calibration”.

- Display the around view monitor screen to check that there is no errors, such as deviations among the camera images.

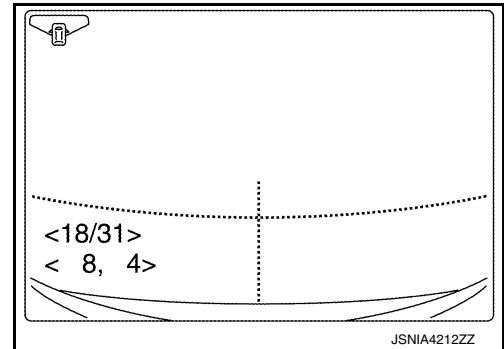

Is there a malfunction?

YES >> Calibration end

NO >> GO TO 1.

4. PERFORM SIMPLIFIED CONFIRMATION/ADJUSTMENT BY “FINE TUNING OF BIRDS-EYE VIEW”

- Put target line 1 on the ground beside each axle using packing tape, etc.
- Put target lines 2 equal to the vehicle total length + approximately 1.0 m (39.3 in) from the vehicle side (right and left) at approximately 30 cm (11.8 in) away from the vehicle (make the line as parallel with the vehicle as possible)

Preparation of simplified target line

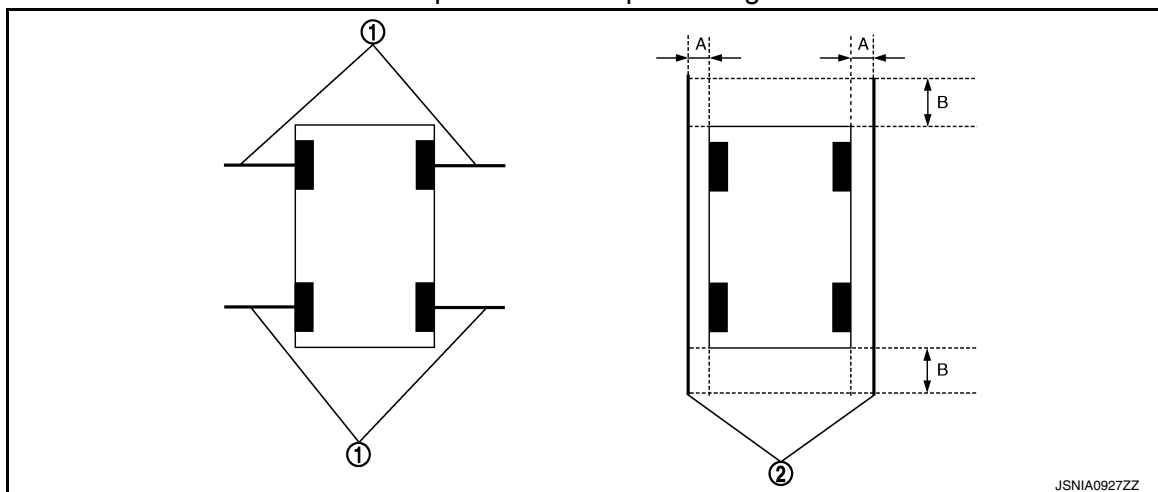

1. Target lines 1

2. Target lines 2

A. Approx. 30 cm (11.8 in)

B. Approx. 1.0 m (39.3 in)

CONSULT work support

Touch “FINE TUNING OF BIRDS-EYE VIEW” on the CONSULT screen.

- On the CONSULT screen, touch “SELECT” button to select right or left camera and perform camera calibration as instructed below:
 - If the marker on the screen deviates from Target line 1, touch “AXIS X” button and “AXIS Y” button to adjust so that the marker is placed on the Target line 1.
 - If Target line 2 is misaligned among the cameras, adjust each camera image to bring Target line 2 into a straight line.

CAUTION:

Never adjust the front camera and rear camera. Only adjust the right and left cameras.

A
B
C
D
E
F
G
H
I
J
K
L
M
O
P

AV

INSPECTION AND ADJUSTMENT

< BASIC INSPECTION >

[NAVIGATION WITH BOSE]

Simplified target line adjustment method

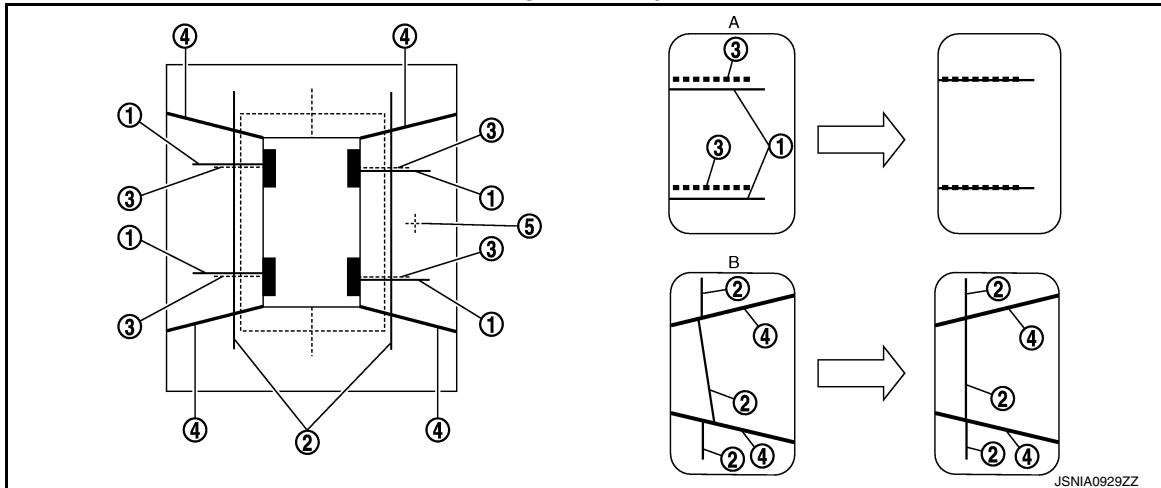

- | | | |
|---|---|-----------------------------|
| 1. Target lines 1 | 2. Target lines 2 | 3. Marker for target line 1 |
| 4. Boundary between cameras | 5. Crosshairs cursor (mark indicated the selected camera) | |
| A. Adjustment method for target lines 1 (right) | B. Adjustment method for target lines 2 (right) | |

- Adjust right and left cameras. Touch "APPLY" on the CONSULT screen to display adjustment results.
- After adjusting right and left cameras, check that the marker is properly placed on the screen and there is no deviation in Target line 1.

NOTE:

- It can be initialized to the NISSAN factory default condition with "Initialize Camera Image Calibration".
- The adjustment value is cancelled on this mode by performing "Initialize Camera Image Calibration".

Is the difference corrected?

- YES >> On the CONSULT screen, touch "OK" button to complete writing to the around view monitor control unit.
- NO >> GO TO 5.

5.PERFORM "CALIBRATING CAMERA IMAGE"

Preparation of target line

- Hang a string with a weight as shown in the figure. Put the points FM0, RM0 (mark) on the ground at the center of the vehicle front end and rear end with white packing tape or a pen.
- Route the vinyl string under the vehicle, and then pull and fix it on the point approximately 1.0 m (39.9 in) to the front and rear of the vehicle through the points FM0 and RM0 using packing tape.

Target line preparation procedure 1

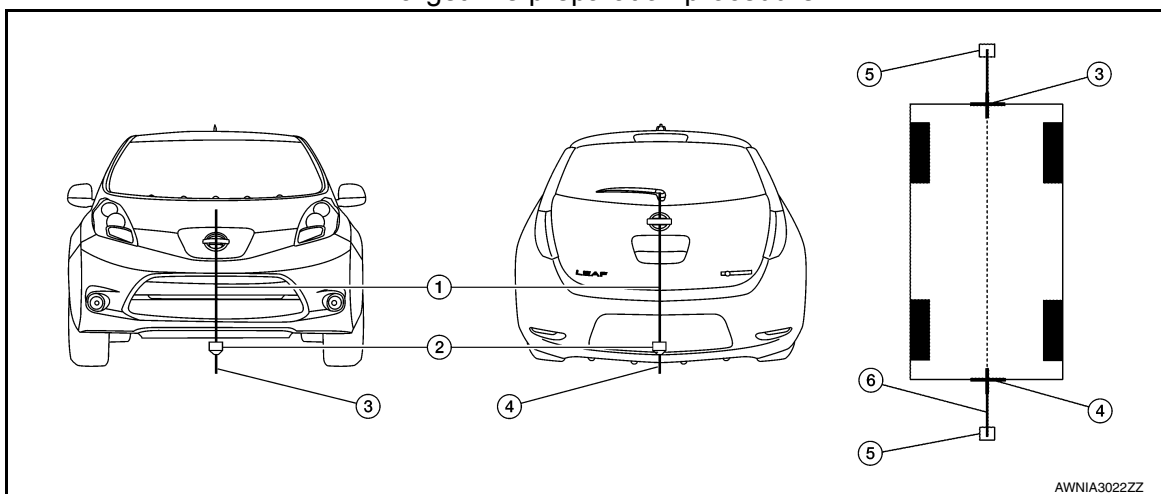

INSPECTION AND ADJUSTMENT

< BASIC INSPECTION >

[NAVIGATION WITH BOSE]

1. Thread
 2. Weight
 3. Point FM0 (mark)
 4. Point RM0 (mark)
 5. Packing tape (to fix the vinyl string)
 6. Vinyl string
3. Put the points FM and RM (mark) 75 cm (29.5 in) from the points FM0 and RM0 individually.
 4. Route the vinyl string through the points FM and RM using a triangle scale, and then fix it at approximately 1.5 m (59 in) on both sides with packing tape.
 5. Put the points FL, FR, RL, and RR (mark) to both right and left [vehicle width / 2 + 30 cm (11.8 in)] from the points FM and RM.

Target line preparation procedure 2

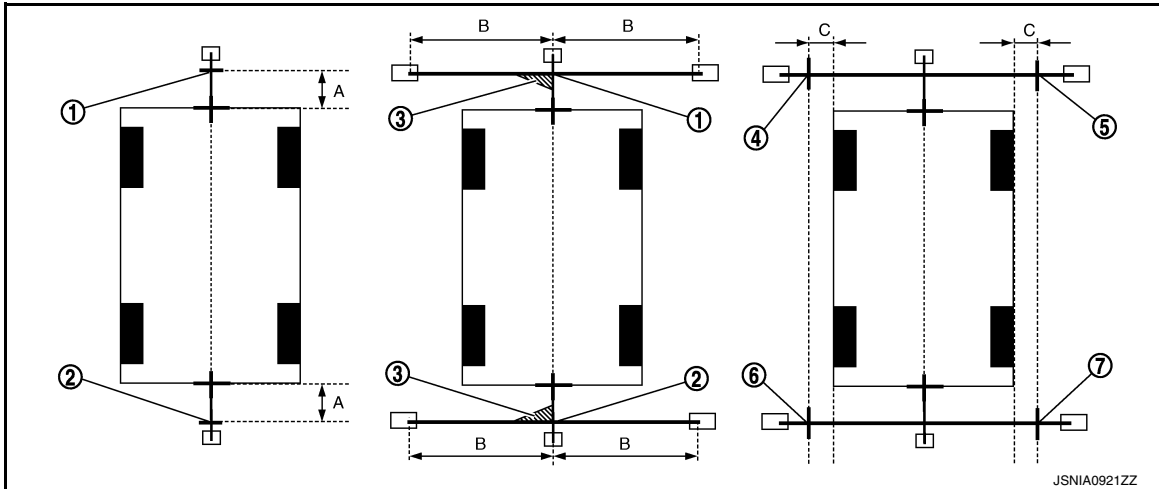

1. Point FM
 2. Point RM
 3. Triangle scale
 4. Point FL (mark)
 5. Point FR (mark)
 6. Point RL (mark)
 7. Point RR (mark)
- A. 75 cm (29.5 in) B. Approx. 1.5 m (59 in) C. [Vehicle width / 2 + 30 cm (11.8 in) from the points FM and RM]

6. Draw the lines of the points FL – RL and FR – RR with vinyl string, and fix it with packing tape.
7. Put a mark on the center of each axle, draw vertical lines to the lines of the points FL – RL and FR – RR from the marks on the center of the axle using a triangle scale, and then fix the lines using packing tape.

Target line preparation procedure 3

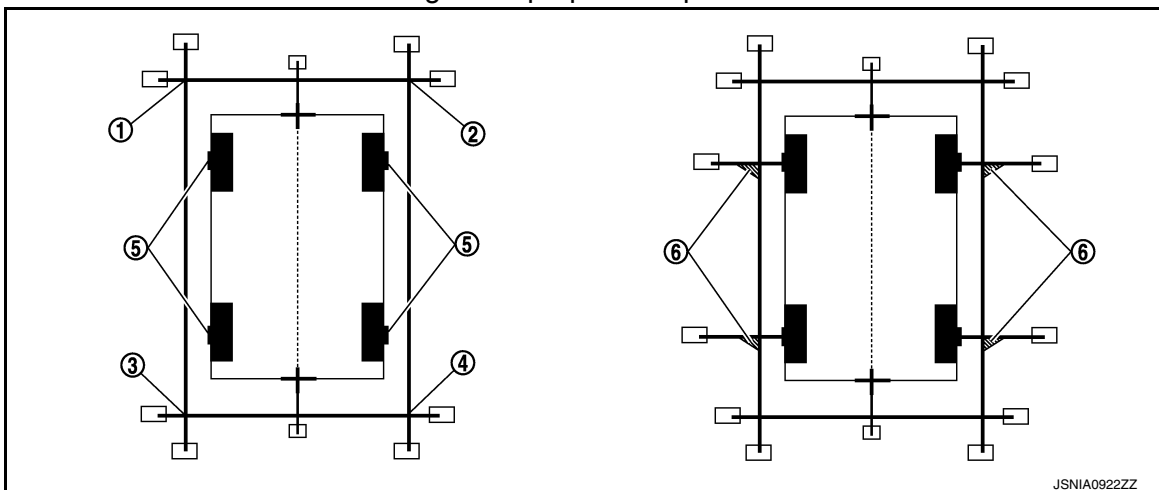

1. Point FL
2. Point FR
3. Point RL
4. Point RR
5. Center position of axle
6. Triangle scale

Perform “Calibrating Camera Image”

CONSULT work support

A
B
C
D
E
F
G
H
I
J
K
L
M
AV
O
P

INSPECTION AND ADJUSTMENT

< BASIC INSPECTION >

[NAVIGATION WITH BOSE]

1. On the CONSULT screen, touch “CALIBRATING CAMERA IMAGE (FRONT CAMERA)”, “CALIBRATING CAMERA IMAGE (PASS-SIDE CAMERA)”, “CALIBRATING CAMERA IMAGE (DR-SIDE CAMERA)”, or “CALIBRATING CAMERA IMAGE (REAR CAMERA)” to accept the selection.

NOTE:

To cancel the indication of Incomplete calibration, select items based on the target camera.

2. On the adjustment screen of each camera, adjust the parameter by touching the “AXIS X” button, “AXIS Y” button, and “ROTATE” button to place the calibration marker shown on the camera screen on the target line drawn on the ground.

Adjustment range

Rotation direction (Center dial) : 31 patterns (16 on the center)

Upper/lower direction (upper/lower switch) : -22 – 22

Left/right direction (left/right switch) : -22 – 22

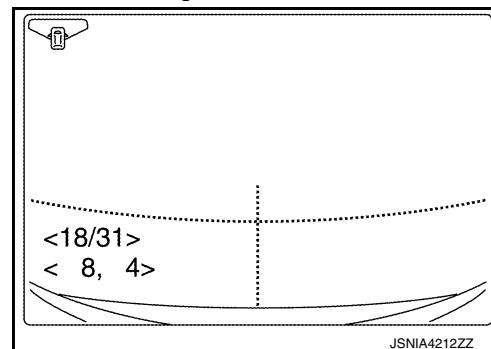

3. Touch “APPLY” button on the CONSULT screen. “PRCSNG” is displayed and adjustment results are shown on the camera screen.

CAUTION:

Check that “PRCSNG” is displayed. Do never perform other operations while “PRCSNG” is displayed.

4. Touch “OK” button on the CONSULT screen. “PRCSNG” is displayed and adjustment results are written to the around view monitor control unit.

CAUTION:

Check that “PRCSNG” is displayed. Do never perform other operations while “PRCSNG” is displayed.

>> GO TO 6.

6. PERFORM “FINE TUNING OF BIRDS-EYE VIEW”

This mode is designed to align the boundary between each camera image that could not be aligned in the “Calibrating Camera Image” mode.

CONSULT work support

1. Select “FINE TUNING OF BIRDS-EYE VIEW” by touching CONSULT screen.

2. On the adjustment screen of each camera, adjust the parameter by touching the “AXIS X” button, “AXIS Y” button”, and “ROTATE” button to place the calibration marker shown on the camera screen on the target line drawn on the ground.

NOTE:

Touch “SELECT” button on the CONSULT screen to select the target camera.

3. Touch “APPLY” button on the CONSULT screen. “PRCSNG” is displayed and adjustment results are shown on the camera screen.

CAUTION:

Check that “PRCSNG” is displayed. Do never perform other operations while “PRCSNG” is displayed.

4. Touch “OK” button on the CONSULT screen. “PRCSNG” is displayed and adjustment results are written to the around view monitor control unit.

CAUTION:

- Check that “PRCSNG” is displayed. Never perform other operations while “PRCSNG” is displayed.
- After pressing the “OK” button, never press buttons other than the “BACK” button.

NOTE:

- It can be initialized to the NISSAN factory default condition with “Initialize Camera Image Calibration”.
- The adjustment value is cancelled in this mode by performing “Initialize Camera Image Calibration”.

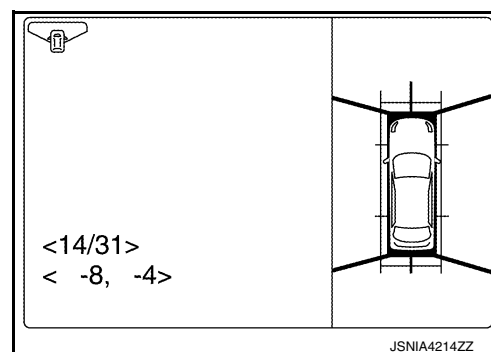

>> Calibration end

U0428 STEERING ANGLE SENSOR

< DTC/CIRCUIT DIAGNOSIS >

[NAVIGATION WITH BOSE]

DTC/CIRCUIT DIAGNOSIS

U0428 STEERING ANGLE SENSOR

DTC Logic

INFOID:000000010641994

CONSULT Display	DTC Detection Condition	Possible Cause
ST ANGLE SENSOR CALI- BRATION [U0428]	The neutral position adjustment of the steering angle sensor is incomplete.	Adjust neutral position of the steering angle sensor.

Diagnosis Procedure

INFOID:000000010641995

1. ADJUST THE NEUTRAL POSITION OF THE STEERING ANGLE SENSOR

When U1232 is detected, adjust the neutral position of the steering angle sensor.

>> Perform adjustment of the neutral position of the steering angle sensor. Refer to [AV-377, "CONSULT Function"](#).

A
B
C
D
E
F
G
H
I
J
K
L
M
O
P

AV

U1000 CAN COMM CIRCUIT

AV CONTROL UNIT

AV CONTROL UNIT : Description

INFOID:000000010641996

CAN (Controller Area Network) is a serial communication line for real time applications. It is an on board multiplex communication line with high data communication speed and excellent error detection ability. A modern vehicle is equipped with many ECMs, and each control unit shares information and links with other control units during operation (not independent). In CAN communication, 2 control units are connected with 2 communication lines (CAN H-line and CAN L-line) allowing a high rate of information transmission with less wiring. Each control unit transmits/receives data but selectively reads required data only.

Refer to [LAN-37, "CAN COMMUNICATION SYSTEM : CAN Communication Signal Chart"](#) for details of the communication signal.

AV CONTROL UNIT : DTC Logic

INFOID:000000010641997

DTC DETECTION LOGIC

CONSULT Display	DTC Detection Condition	Possible Cause
CAN COMM CIRC [U1000]	When the AV control unit cannot communicate for 2 seconds or more.	CAN communication system

AV CONTROL UNIT : Diagnosis Procedure

INFOID:000000010641998

1. PERFORM SELF DIAGNOSTIC RESULT

1. Turn the power switch ON and hold for 2 seconds or more.
2. Check Self Diagnostic Result of MULTI-AV.

Is CAN communication system displayed?

- YES >> Refer to [LAN-17, "Trouble Diagnosis Flow Chart"](#).
 NO >> Refer to [GI-53, "Intermittent Incident"](#).

AROUND VIEW MONITOR CONTROL UNIT

AROUND VIEW MONITOR CONTROL UNIT : Description

INFOID:000000010641999

CAN (Controller Area Network) is a serial communication line for real-time application. It is an on-vehicle multiplex communication line with high data communication speed and excellent error detection ability. Many electronic control units are equipped onto a vehicle, and each control unit shares information and links with other control units during operation (not independently). In CAN communication, control units are connected with 2 communication lines (CAN-H, CAN-L) allowing a high rate of information transmission with less wiring. Each control unit transmits/receives data but selectively reads required data only.

CAN Communication Signal Chart. Refer to [LAN-37, "CAN COMMUNICATION SYSTEM : CAN Communication Signal Chart"](#).

AROUND VIEW MONITOR CONTROL UNIT : DTC Logic

INFOID:000000010642000

DTC DETECTION LOGIC

CONSULT Display	DTC Detection Condition	Possible Cause
CAN COMM CIRCUIT [U1000]	Around view monitor control unit is not transmitting or receiving CAN communication signal for 2 seconds or more.	CAN communication system.

AROUND VIEW MONITOR CONTROL UNIT : Diagnosis Procedure

INFOID:000000010642001

1. PERFORM SELF-DIAGNOSTIC RESULT

1. Turn power switch ON and wait for 2 seconds or more.
2. Check Self Diagnostic Result of AVM.

Is "CAN COMM CIRCUIT" displayed?

U1000 CAN COMM CIRCUIT

< DTC/CIRCUIT DIAGNOSIS >

[NAVIGATION WITH BOSE]

- YES >> Refer to [LAN-17. "Trouble Diagnosis Flow Chart"](#).
- NO >> Refer to [GI-53. "Intermittent Incident"](#).

- A
- B
- C
- D
- E
- F
- G
- H
- I
- J
- K
- L
- M
- AV**
- O
- P

U1010 CONTROL UNIT (CAN)

< DTC/CIRCUIT DIAGNOSIS >

[NAVIGATION WITH BOSE]

U1010 CONTROL UNIT (CAN)

AV CONTROL UNIT

AV CONTROL UNIT : DTC Logic

INFOID:000000010642002

DTC DETECTION LOGIC

CONSULT Display	DTC Detection Condition	Possible Cause
CONTROL UNIT (CAN) [U1010]	Malfunction is detected during initial diagnosis of the AV control unit CAN controller.	Replace the AV control unit if malfunction constantly occurs. Refer to AV-488 . "Removal and Installation".

AROUND VIEW MONITOR CONTROL UNIT

AROUND VIEW MONITOR CONTROL UNIT : DTC Logic

INFOID:000000010642003

DTC DETECTION LOGIC

CONSULT Display	DTC Detection Condition	Possible Cause
CONTROL UNIT (CAN) [U1010]	CAN initial diagnosis malfunction is detected.	Replace the around view monitor control unit if the malfunction occurs constantly. Refer to AV-502 . "Removal and Installation".

U111A REAR CAMERA IMAGE SIGNAL CIRCUIT

< DTC/CIRCUIT DIAGNOSIS >

[NAVIGATION WITH BOSE]

U111A REAR CAMERA IMAGE SIGNAL CIRCUIT

DTC Logic

INFOID:000000010642004

CONSULT Display	DTC Detection Condition	Possible Cause
REAR CAMERA IMAGE SIGNAL [U111A]	Rear camera image signal circuit is open or shorted.	Check rear camera image signal circuit between rear camera and around view monitor control unit.

Diagnosis Procedure

INFOID:000000010642005

Regarding Wiring Diagram information, refer to [AV-394. "Wiring Diagram"](#).

1. CHECK REAR VIEW CAMERA POWER SUPPLY AND GROUND CIRCUIT CONTINUITY

- Turn power switch OFF.
- Disconnect around view monitor control unit and rear view camera connectors.
- Check continuity between around view monitor control unit connector M32 and rear view camera connector D557.

Around view monitor control unit		Rear view camera		Continuity
Connector	Terminals	Connector	Terminals	
M32	26	D557	8	Yes
	25		7	

- Check continuity between around view monitor control unit connector M32 and ground.

Around view monitor control unit		Ground	Continuity
Connector	Terminal		
M32	26	—	No

Is inspection result normal?

- YES >> GO TO 2.
NO >> Repair or replace harness or connectors.

2. CHECK REAR VIEW CAMERA POWER SUPPLY VOLTAGE

- Connect around view monitor control unit and rear view camera connectors.
- Turn power switch ON.
- Check voltage between around view monitor control unit connector M32 and ground.

Around view monitor control unit		Ground	Condition	Voltage (Approx.)
Connector	Terminal			
M32	26	—	CAMERA switch ON or Selector lever in R (reverse) position	6.2 V

Is inspection result normal?

- YES >> GO TO 3.
NO >> Replace around view monitor control unit. Refer to [AV-502. "Removal and Installation"](#).

3. CHECK REAR VIEW CAMERA IMAGE SIGNAL CIRCUIT CONTINUITY

- Turn power switch OFF.
- Disconnect around view monitor control unit and rear view camera connectors.

U111A REAR CAMERA IMAGE SIGNAL CIRCUIT

< DTC/CIRCUIT DIAGNOSIS >

[NAVIGATION WITH BOSE]

3. Check continuity between around view monitor control unit connector M32 and rear view camera connector D557.

Around view monitor control unit		Rear view camera		Continuity
Connector	Terminals	Connector	Terminals	
M32	28	D557	5	Yes
	27		1	

4. Check continuity between around view monitor control unit connector M32 and ground.

Around view monitor control unit		Ground	Continuity
Connector	Terminal		
M32	28	—	No

Is inspection result normal?

- YES >> GO TO 4.
 NO >> Repair or replace harness or connectors.

4. CHECK REAR VIEW CAMERA IMAGE SIGNAL

1. Connect around view monitor control unit and rear view camera connectors.
2. Turn power switch ON.
3. Check signal between terminals of around view monitor control unit connector M32.

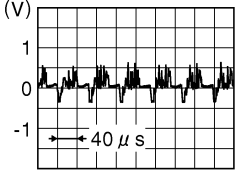
Around view monitor control unit connector M32		Condition	Reference value
(+) Terminal	(-) Terminal		
28	27	CAMERA switch ON or Selector lever in R (reverse) position	 <p style="text-align: right; font-size: small;">JSNIA0834GB</p>

Is inspection result normal?

- YES >> Replace around view monitor control unit. Refer to [AV-502. "Removal and Installation"](#).
 NO >> Replace rear view camera. Refer to [AV-505. "Removal and Installation"](#).

U111B SIDE CAMERA RH IMAGE SIGNAL CIRCUIT

< DTC/CIRCUIT DIAGNOSIS >

[NAVIGATION WITH BOSE]

U111B SIDE CAMERA RH IMAGE SIGNAL CIRCUIT

DTC Logic

INFOID:000000010642006

CONSULT Display	DTC Detection Condition	Possible Cause
SIDE CAMERA RH IMAGE SIGNAL [U111B]	Side camera RH image signal circuit is open or shorted.	Check side camera RH image signal circuit between rear camera and around view monitor control unit.

Diagnosis Procedure

INFOID:000000010642007

Regarding Wiring Diagram information, refer to [AV-394. "Wiring Diagram"](#).

1. CHECK SIDE CAMERA RH POWER SUPPLY AND GROUND CIRCUIT CONTINUITY

1. Turn power switch OFF.
2. Disconnect around view monitor control unit and side camera RH connectors.
3. Check continuity between around view monitor control unit connector M32 and side camera RH connector D101.

Around view monitor control unit		Side camera RH		Continuity
Connector	Terminals	Connector	Terminals	
M32	34	D101	1	Yes
	33		2	

4. Check continuity between around view monitor control unit connector M32 and ground.

Around view monitor control unit		Ground	Continuity
Connector	Terminal		
M32	34	—	No

Is inspection result normal?

YES >> GO TO 2.

NO >> Repair or replace harness or connectors.

2. CHECK SIDE CAMERA RH POWER SUPPLY VOLTAGE

1. Connect around view monitor control unit and side camera RH connectors.
2. Turn power switch ON.
3. Check voltage between around view monitor control unit connector M32 and ground.

Around view monitor control unit		Ground	Condition	Voltage (Approx.)
Connector	Terminal			
M32	34	—	CAMERA switch ON or Selector lever in R (reverse) position	6.2 V

Is inspection result normal?

YES >> GO TO 3.

NO >> Replace around view monitor control unit. Refer to [AV-502. "Removal and Installation"](#).

3. CHECK SIDE CAMERA RH IMAGE SIGNAL CIRCUIT CONTINUITY

1. Turn power switch OFF.
2. Disconnect around view monitor control unit and side camera RH connectors.

U111B SIDE CAMERA RH IMAGE SIGNAL CIRCUIT

[NAVIGATION WITH BOSE]

< DTC/CIRCUIT DIAGNOSIS >

3. Check continuity between around view monitor control unit connector M32 and side camera RH connector D101.

Around view monitor control unit		Side camera RH		Continuity
Connector	Terminals	Connector	Terminals	
M32	36	D101	3	Yes
	35		4	

4. Check continuity between around view monitor control unit connector M32 and ground.

Around view monitor control unit		Ground	Continuity
Connector	Terminal		
M32	36	—	No

Is inspection result normal?

- YES >> GO TO 4.
 NO >> Repair or replace harness or connectors.

4. CHECK SIDE CAMERA RH IMAGE SIGNAL

1. Connect around view monitor control unit and side camera RH connectors.
2. Turn power switch ON.
3. Check signal between terminals of around view monitor control unit connector M32.

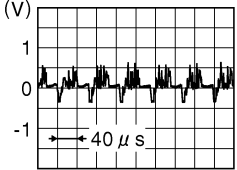
Around view monitor control unit connector M32		Condition	Reference value
(+) Terminal	(-) Terminal		
36	35	CAMERA switch ON or Selector lever in R (reverse) position	 <p style="text-align: right; font-size: small;">JSNIA0834GB</p>

Is inspection result normal?

- YES >> Replace around view monitor control unit. Refer to [AV-502. "Removal and Installation"](#).
 NO >> Replace side camera RH. Refer to [AV-504. "Removal and Installation"](#).

U111C FRONT CAMERA IMAGE SIGNAL CIRCUIT

< DTC/CIRCUIT DIAGNOSIS >

[NAVIGATION WITH BOSE]

U111C FRONT CAMERA IMAGE SIGNAL CIRCUIT

DTC Logic

INFOID:000000010642008

CONSULT Display	DTC Detection Condition	Possible Cause
FRONT CAMERA IMAGE SIGNAL [U111C]	Front camera image signal circuit is open or shorted.	Check front camera image signal circuit between rear camera and around view monitor control unit.

Diagnosis Procedure

INFOID:000000010642009

Regarding Wiring Diagram information, refer to [AV-394. "Wiring Diagram"](#).

1. CHECK FRONT CAMERA POWER SUPPLY AND GROUND CIRCUIT CONTINUITY

- Turn power switch OFF.
- Disconnect around view monitor control unit and front camera connectors.
- Check continuity between around view monitor control unit connector M32 and front camera connector E202.

Around view monitor control unit		Front camera		Continuity
Connector	Terminals	Connector	Terminals	
M32	38	E202	2	Yes
	37		1	

- Check continuity between around view monitor control unit connector M32 and ground.

Around view monitor control unit		Ground	Continuity
Connector	Terminal		
M32	38	—	No

Is inspection result normal?

- YES >> GO TO 2.
NO >> Repair or replace harness or connectors.

2. CHECK FRONT CAMERA POWER SUPPLY VOLTAGE

- Connect around view monitor control unit and front camera connectors.
- Turn power switch ON.
- Check voltage between around view monitor control unit connector M32 and ground.

Around view monitor control unit		Ground	Condition	Voltage (Approx.)
Connector	Terminal			
M32	38	—	CAMERA switch ON or Selector lever in R (reverse) position	6.2 V

Is inspection result normal?

- YES >> GO TO 3.
NO >> Replace around view monitor control unit. Refer to [AV-502. "Removal and Installation"](#).

3. CHECK FRONT CAMERA IMAGE SIGNAL CIRCUIT CONTINUITY

- Turn power switch OFF.
- Disconnect around view monitor control unit and front camera connectors.

U111C FRONT CAMERA IMAGE SIGNAL CIRCUIT

[NAVIGATION WITH BOSE]

< DTC/CIRCUIT DIAGNOSIS >

3. Check continuity between around view monitor control unit connector M32 and front camera connector E202.

Around view monitor control unit		Front camera		Continuity
Connector	Terminals	Connector	Terminals	
M32	40	E202	3	Yes
	39		4	

4. Check continuity between around view monitor control unit connector M32 and ground.

Around view monitor control unit		Ground	Continuity
Connector	Terminal		
M32	40	—	No

Is inspection result normal?

- YES >> GO TO 4.
 NO >> Repair or replace harness or connectors.

4. CHECK FRONT CAMERA IMAGE SIGNAL

1. Connect around view monitor control unit and front camera connectors.
2. Turn power switch ON.
3. Check signal between terminals of around view monitor control unit connector M32.

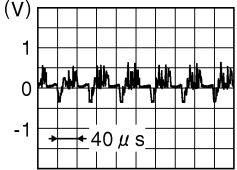
Around view monitor control unit connector M32		Condition	Reference value
(+) Terminal	(-) Terminal		
40	39	CAMERA switch ON or Selector lever in R (reverse) position	 <p style="text-align: right; font-size: small;">JSNIA0834GB</p>

Is inspection result normal?

- YES >> Replace around view monitor control unit. Refer to [AV-502, "Removal and Installation"](#).
 NO >> Replace front camera. Refer to [AV-503, "Removal and Installation"](#).

U111D SIDE CAMERA LH IMAGE SIGNAL CIRCUIT

< DTC/CIRCUIT DIAGNOSIS >

[NAVIGATION WITH BOSE]

U111D SIDE CAMERA LH IMAGE SIGNAL CIRCUIT

DTC Logic

INFOID:000000010642010

CONSULT Display	DTC Detection Condition	Possible Cause
SIDE CAMERA LH IMAGE SIGNAL [U111D]	Side camera LH image signal circuit is open or shorted.	Check side camera LH image signal circuit between rear camera and around view monitor control unit.

Diagnosis Procedure

INFOID:000000010642011

Regarding Wiring Diagram information, refer to [AV-394. "Wiring Diagram"](#).

1. CHECK SIDE CAMERA LH POWER SUPPLY AND GROUND CIRCUIT CONTINUITY

1. Turn power switch OFF.
2. Disconnect around view monitor control unit and side camera LH connectors.
3. Check continuity between around view monitor control unit connector M32 and side camera LH connector D1.

Around view monitor control unit		Side camera LH		Continuity
Connector	Terminals	Connector	Terminals	
M32	30	D1	1	Yes
	29		2	

4. Check continuity between around view monitor control unit connector M32 and ground.

Around view monitor control unit		Ground	Continuity
Connector	Terminal		
M32	30	—	No

Is inspection result normal?

YES >> GO TO 2.

NO >> Repair or replace harness or connectors.

2. CHECK SIDE CAMERA LH POWER SUPPLY VOLTAGE

1. Connect around view monitor control unit and side camera LH connectors.
2. Turn power switch ON.
3. Check voltage between around view monitor control unit connector M32 and ground.

Around view monitor control unit		Ground	Condition	Voltage (Approx.)
Connector	Terminal			
M32	30	—	CAMERA switch ON or Selector lever in R (reverse) position	6.2 V

Is inspection result normal?

YES >> GO TO 3.

NO >> Replace around view monitor control unit. Refer to [AV-502. "Removal and Installation"](#).

3. CHECK SIDE CAMERA LH IMAGE SIGNAL CIRCUIT CONTINUITY

1. Turn power switch OFF.
2. Disconnect around view monitor control unit and side camera LH connectors.

U111D SIDE CAMERA LH IMAGE SIGNAL CIRCUIT

[NAVIGATION WITH BOSE]

< DTC/CIRCUIT DIAGNOSIS >

3. Check continuity between around view monitor control unit connector M32 and side camera LH connector D1.

Around view monitor control unit		Side camera LH		Continuity
Connector	Terminals	Connector	Terminals	
M32	32	D1	3	Yes
	31		4	

4. Check continuity between around view monitor control unit connector M32 and ground.

Around view monitor control unit		Ground	Continuity
Connector	Terminal		
M32	32	—	No

Is inspection result normal?

- YES >> GO TO 4.
 NO >> Repair or replace harness or connectors.

4. CHECK SIDE CAMERA LH IMAGE SIGNAL

1. Connect around view monitor control unit and side camera LH connectors.
2. Turn power switch ON.
3. Check signal between terminals of around view monitor control unit connector M32.

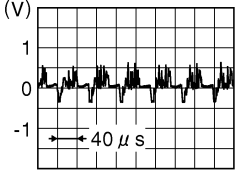
Around view monitor control unit connector M32		Condition	Reference value
(+) Terminal	(-) Terminal		
32	31	CAMERA switch ON or Selector lever in R (reverse) position	 <p style="text-align: right; font-size: small;">JSNIA0834GB</p>

Is inspection result normal?

- YES >> Replace around view monitor control unit. Refer to [AV-502, "Removal and Installation"](#).
 NO >> Replace side camera LH. Refer to [AV-504, "Removal and Installation"](#).

U121F AV CONTROL UNIT

< DTC/CIRCUIT DIAGNOSIS >

[NAVIGATION WITH BOSE]

U121F AV CONTROL UNIT

DTC Logic

INFOID:000000010642012

CONSULT Display	DTC Detection Condition	Possible Cause
CONTROL UNIT [U121F]	AV control unit malfunction is detected	Replace the AV control unit if the malfunction constantly occurs. Refer to AV-488 , "Removal and Installation".

A

B

C

D

E

F

G

H

I

J

K

L

M

AV

O

P

U1232 STEERING ANGLE SENSOR

< DTC/CIRCUIT DIAGNOSIS >

[NAVIGATION WITH BOSE]

U1232 STEERING ANGLE SENSOR

AV CONTROL UNIT

AV CONTROL UNIT : DTC Logic

INFOID:000000010642013

CONSULT Display	DTC Detection Condition	Possible Cause
Steering angle sensor calibration [U1232]	Neutral position adjustment of the steering angle sensor is not complete.	Perform neutral position adjustment of the steering angle sensor. Refer to AV-376, "CONSULT Function" .

AV CONTROL UNIT : Diagnosis Procedure

INFOID:000000010642014

1. ADJUST NEUTRAL POSITION OF STEERING ANGLE SENSOR

When U1232 is detected, adjust the neutral position of the steering angle sensor.

>> Perform neutral position adjustment of the steering angle sensor. Refer to [AV-376, "CONSULT Function"](#).

AROUND VIEW MONITOR CONTROL UNIT

AROUND VIEW MONITOR CONTROL UNIT : DTC Logic

INFOID:000000010642015

CONSULT Display	DTC Detection Condition	Possible Cause
Steering angle sensor calibration [U1232]	Neutral position adjustment of the steering angle sensor is not complete.	Perform neutral position adjustment of the steering angle sensor. Refer to AV-377, "CONSULT Function" .

AROUND VIEW MONITOR CONTROL UNIT : Diagnosis Procedure

INFOID:000000010642016

1. ADJUST NEUTRAL POSITION OF STEERING ANGLE SENSOR

When U1232 is detected, adjust the neutral position of the steering angle sensor.

>> Perform neutral position adjustment of the steering angle sensor. Refer to [AV-377, "CONSULT Function"](#).

U1244 GPS ANTENNA

< DTC/CIRCUIT DIAGNOSIS >

[NAVIGATION WITH BOSE]

U1244 GPS ANTENNA

DTC Logic

INFOID:000000010642017

CONSULT Display	DTC Detection Condition	Possible Cause
GPS ANTENNA CONN [U1244]	GPS antenna connection malfunction is detected	<ul style="list-style-type: none">• Check the connection status of the GPS antenna.• Replace the GPS antenna. Refer to AV-493. "Removal and Installation".

Diagnosis Procedure

INFOID:000000010642018

Regarding Wiring Diagram information, refer to [AV-394. "Wiring Diagram"](#).

1. CHECK THE GPS ANTENNA CONNECTOR.

Check the connection status of the GPS antenna connector.

Is the inspection result normal?

YES >> GO TO 2.

NO >> Repair or replace harness or connectors.

2. CHECK THE GPS ANTENNA FEEDER.

Check the GPS antenna feeder visually.

Is the inspection result normal?

YES >> GO TO 3.

NO >> Replace the GPS antenna. Refer to [AV-493. "Removal and Installation"](#).

3. CHECK AV CONTROL UNIT VOLTAGE

1. Disconnect AV control unit connector M121.
2. Turn power switch ON.
3. Check voltage between AV control unit connector M121 and ground.

AV control unit		Ground	Voltage (Approx.)
Connector	Terminal		
M121	83	—	5.0 V

Is the inspection result normal?

YES >> Replace the GPS antenna. Refer to [AV-493. "Removal and Installation"](#).

NO >> Replace the AV control unit. Refer to [AV-488. "Removal and Installation"](#).

A
B
C
D
E
F
G
H
I
J
K
L
M
O
P

AV

U1258 SATELLITE RADIO ANTENNA

< DTC/CIRCUIT DIAGNOSIS >

[NAVIGATION WITH BOSE]

U1258 SATELLITE RADIO ANTENNA

DTC Logic

INFOID:000000010642019

CONSULT Display	DTC Detection Condition	Possible Cause
XM ANTENNA CONN [U1258]	Satellite radio antenna connection malfunction is detected.	Satellite radio antenna disconnection.

Diagnosis Procedure

INFOID:000000010642020

Regarding Wiring Diagram information, refer to [AV-394. "Wiring Diagram"](#).

1. CHECK THE SATELLITE ANTENNA CONNECTOR.

Check the connection status of the satellite antenna connector.

Is the inspection result normal?

- YES >> GO TO 2.
- NO >> Repair or replace harness or connectors.

2. CHECK THE SATELLITE ANTENNA FEEDER.

Check the satellite antenna feeder visually.

Is the inspection result normal?

- YES >> GO TO 3.
- NO >> Replace the satellite antenna. Refer to [AV-496. "Removal and Installation"](#).

3. CHECK AV CONTROL UNIT VOLTAGE

1. Disconnect AV control unit connector M123.
2. Turn power switch ON.
3. Check voltage between AV control unit connector M123 and ground.

AV control unit		Ground	Voltage (Approx.)
Connector	Terminal		
M123	88	—	5.0 V

Is the inspection result normal?

- YES >> Replace the satellite antenna. Refer to [AV-496. "Removal and Installation"](#).
- NO >> Replace the AV control unit. Refer to [AV-488. "Removal and Installation"](#).

U1263 USB

DTC Logic

INFOID:000000010642021

DTC DETECTION LOGIC

NOTE:

Before performing diagnosis, make sure that the external input device is not malfunctioning.

CONSULT Display	DTC Detection Condition	Possible Cause
USB overcurrent [U1263]	Overcurrent of the USB connector is detected.	Check the USB harness between the AV control unit and USB connector.

Diagnosis Procedure

INFOID:000000010642022

1.CHECK USB HARNESS

Check USB harness visually for pinching.

Is the inspection result normal?

YES >> GO TO 2.

NO >> Replace the USB harness. Refer to [AV-499, "Removal and Installation"](#).

2.CHECK USB HARNESS

Check USB harness continuity. Refer to [AV-473, "Diagnosis Procedure"](#).

Is the inspection result normal?

YES >> Replace the AV control unit. Refer to [AV-488, "Removal and Installation"](#).

NO >> Replace the USB harness. Refer to [AV-499, "Removal and Installation"](#).

A
B
C
D
E
F
G
H
I
J
K
L
M
O
P



U1266 AV CONTROL UNIT

< DTC/CIRCUIT DIAGNOSIS >

[NAVIGATION WITH BOSE]

U1266 AV CONTROL UNIT

DTC Logic

INFOID:000000010642023

CONSULT Display	DTC Detection Condition	Possible Cause
TCU CONN [U1266]	Malfunction is detected between the AV control unit and TCU.	Check connection between the AV control unit and TCU.

U1300 AV COMM CIRCUIT

< DTC/CIRCUIT DIAGNOSIS >

[NAVIGATION WITH BOSE]

U1300 AV COMM CIRCUIT

Description

INFOID:000000010642024

U1300 is displayed when the AV signal error is detected for the multi AV system. It is always displayed together with the error of the control unit connected to the AV control unit via AV communication. Determine the possible malfunction cause from the table below.

SELF-DIAGNOSIS RESULTS DISPLAY ITEM

CONSULT Display	DTC Detection Condition	Possible Cause
<ul style="list-style-type: none">• AV COMM CIRCUIT [U1300]• SWITCH CONN [U1240]	<p>When either one of the following items are detected:</p> <ul style="list-style-type: none">• multifunction switch power supply and ground circuits are malfunctioning.• AV communication circuits between the AV control unit and multifunction switch are malfunctioning.	<ul style="list-style-type: none">• Multifunction switch power supply and ground circuits.• AV communication circuits between AV control unit and multifunction switch.

A
B
C
D
E
F
G
H
I
J
K
L
M

AV

O
P

U1304 CAMERA IMAGE CALIBRATION

< DTC/CIRCUIT DIAGNOSIS >

[NAVIGATION WITH BOSE]

U1304 CAMERA IMAGE CALIBRATION

DTC Logic

INFOID:000000010642025

CONSULT Display	DTC Detection Condition	Possible Cause
CAMERA IMAGE CALIB [U1304]	Camera image calibration is incomplete.	Perform calibration of camera image with CONSULT. Refer to AV-377, "CONSULT Function" .

Diagnosis Procedure

INFOID:000000010642026

1. PERFORM THE SELF-DIAGNOSIS

When U1304 is detected, perform calibration of camera image with CONSULT.

>> Perform calibration of camera image. Refer to [AV-377, "CONSULT Function"](#).

U1305 CONFIG UNFINISH

< DTC/CIRCUIT DIAGNOSIS >

[NAVIGATION WITH BOSE]

U1305 CONFIG UNFINISH

DTC Logic

INFOID:000000010642027

CONSULT Display	DTC Detection Condition	Possible Cause
CONFIG UNFINISH [U1305]	Configuration of around view monitor control unit is incomplete.	Perform configuration of around view monitor control unit with CONSULT.

Diagnosis Procedure

INFOID:000000010642028

1. PERFORM THE SELF-DIAGNOSIS

When U1305 is detected, perform configuration of around view monitor control unit with CONSULT.

>> Perform configuration of around view monitor control unit. Refer to [AV-424, "CONFIGURATION \(AROUND VIEW MONITOR CONTROL UNIT\) : Work Procedure"](#).

A
B
C
D
E
F
G
H
I
J
K
L
M

AV

O
P

U1310 AV CONTROL UNIT

< DTC/CIRCUIT DIAGNOSIS >

[NAVIGATION WITH BOSE]

U1310 AV CONTROL UNIT

DTC Logic

INFOID:000000010642029

CONSULT Display	DTC Detection Condition	Possible Cause
CONTROL UNIT (AV) [U1310]	AV communication circuit initial diagnosis malfunction is detected	Replace the AV control unit if the malfunction constantly occurs. Refer to AV-488, "Removal and Installation" .

POWER SUPPLY AND GROUND CIRCUIT

< DTC/CIRCUIT DIAGNOSIS >

[NAVIGATION WITH BOSE]

POWER SUPPLY AND GROUND CIRCUIT

AV CONTROL UNIT

AV CONTROL UNIT : Diagnosis Procedure

INFOID:000000010642030

Regarding Wiring Diagram information, refer to [AV-394. "Wiring Diagram"](#).

1.CHECK FUSE

Check that the following fuses are not blown.

Terminal No.	Signal name	Fuse No.
26	Power signal	3 (10A)
7	ACC power supply	19 (10A)
19	Battery power supply	34 (20A)

Are the fuses blown?

YES >> Replace the blown fuse after repairing the affected circuit.

NO >> GO TO 2.

2.CHECK POWER SUPPLY CIRCUIT

1. Turn power switch OFF.
2. Disconnect AV control unit connectors M100 and M103.
3. Check voltage between AV control unit connectors and ground.

AV control unit		Ground	Condition	Voltage (Approx.)
Connector	Terminal			
M103	26	—	Power switch: ON	Battery voltage
M100	7		Power switch: ACC	
	19		Power switch: OFF	

Is the inspection result normal?

YES >> GO TO 3.

NO >> Repair or replace harness or connectors.

3.CHECK GROUND CIRCUIT

1. Turn power switch OFF.
2. Check continuity between AV control unit connector M103 and ground.

AV control unit		Ground	Continuity
Connector	Terminal		
M103	58	—	Yes

Is the inspection result normal?

YES >> Inspection End.

NO >> Repair or replace harness or connectors.

BOSE AMP.

BOSE AMP. : Diagnosis Procedure

INFOID:000000010642031

Regarding Wiring Diagram information, refer to [AV-394. "Wiring Diagram"](#).

1.CHECK FUSE

POWER SUPPLY AND GROUND CIRCUIT

< DTC/CIRCUIT DIAGNOSIS >

[NAVIGATION WITH BOSE]

Check that the following fuses are not blown.

Terminal No.	Signal name	Fuse No.
4	Power signal	36 (20A)

Are the fuses blown?

YES >> Replace the blown fuse after repairing the affected circuit.

NO >> GO TO 2.

2.CHECK POWER SUPPLY CIRCUIT

1. Disconnect BOSE speaker amp. connector B11.
2. Check voltage between BOSE speaker amp. connector B11 and ground.

BOSE speaker amp.		Ground	Condition	Voltage (Approx.)
Connector	Terminal			
B11	4	—	Power switch: ON	Battery voltage

Is the inspection result normal?

YES >> GO TO 3.

NO >> Repair or replace harness or connectors.

3.CHECK GROUND CIRCUIT

1. Turn power switch OFF.
2. Check continuity between BOSE speaker amp. connector B11 and ground.

BOSE speaker amp.		Ground	Continuity
Connector	Terminal		
B11	8	—	Yes

Is the inspection result normal?

YES >> Inspection End.

NO >> Repair or replace harness or connectors.

AROUND VIEW MONITOR CONTROL UNIT

AROUND VIEW MONITOR CONTROL UNIT : Diagnosis Procedure

INFOID:0000000010642032

Regarding Wiring Diagram information, refer to [AV-394, "Wiring Diagram"](#).

1.CHECK FUSE

Check that the following fuses are not blown.

Terminal No.	Signal name	Fuse No.
4	Power signal	3 (10A)
2	Battery power supply	34 (20A)

Are the fuses blown?

YES >> Replace the blown fuse after repairing the affected circuit.

NO >> GO TO 2.

2.CHECK POWER SUPPLY CIRCUIT

1. Turn power switch OFF.
2. Disconnect around view monitor control unit connector M32.
3. Check voltage between around view monitor control unit connector M32 and ground.

POWER SUPPLY AND GROUND CIRCUIT

< DTC/CIRCUIT DIAGNOSIS >

[NAVIGATION WITH BOSE]

Around view monitor control unit		Ground	Condition	Voltage (Approx.)
Connector	Terminal			
M32	4	—	Power switch: ON	Battery voltage
	2		Power switch: OFF	

Is the inspection result normal?

YES >> GO TO 3.

NO >> Repair or replace harness or connectors.

3.CHECK GROUND CIRCUIT

1. Turn power switch OFF.
2. Check continuity between around view monitor control unit connector M32 and ground.

Around view monitor control unit		Ground	Continuity
Connector	Terminal		
M32	1	—	Yes

Is the inspection result normal?

YES >> Inspection End.

NO >> Repair or replace harness or connectors.

A
B
C
D
E
F
G
H
I
J
K
L
M
O
P

AV

FRONT DOOR SPEAKER

< DTC/CIRCUIT DIAGNOSIS >

[NAVIGATION WITH BOSE]

FRONT DOOR SPEAKER

Diagnosis Procedure

INFOID:000000010642033

Regarding Wiring Diagram information, refer to [AV-394. "Wiring Diagram"](#).

1. CONNECTOR CHECK

Check the AV control unit, BOSE speaker amp. and speaker connectors for the following:

- Proper connection
- Damage
- Disconnected or loose terminals

Is the inspection result normal?

YES >> GO TO 2.

NO >> Repair the terminals or connectors.

2. CHECK FRONT DOOR SPEAKER SIGNAL CIRCUIT CONTINUITY

1. Disconnect BOSE speaker amp. connector B20 and suspect front door speaker connector.
2. Check continuity between BOSE speaker amp. connector B20 and suspect front door speaker connector.

BOSE speaker amp.		Front door speaker		Continuity
Connector	Terminal	Connector	Terminal	
B20	9	D24 (LH)	1	Yes
	17		2	
	10	D124 (RH)	1	
	11		2	

3. Check continuity between BOSE speaker amp. connector B20 and ground.

BOSE speaker amp.		Ground	Continuity
Connector	Terminal		
B20	9	—	No
	17		
	10		
	11		

Is the inspection result normal?

YES >> GO TO 3.

NO >> Repair or replace harness or connectors.

3. CHECK FRONT DOOR SPEAKER SIGNAL

1. Connect BOSE speaker amp. connector B20 and suspect front door speaker connector.
2. Turn power switch to ACC.
3. Push AV control unit POWER switch.
4. Check the signal between the terminals of BOSE speaker amp. connector B20.

BOSE speaker amp. connector B20		Condition	Reference value
(+)	(-)		
Terminal	Terminal		

FRONT DOOR SPEAKER

< DTC/CIRCUIT DIAGNOSIS >

[NAVIGATION WITH BOSE]

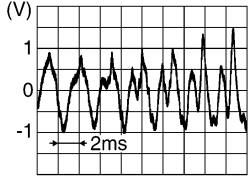
9	17	Audio signal output	
10	11		

Is the inspection result normal?

- YES >> Replace front door speaker. Refer to [AV-490. "Removal and Installation"](#).
- NO >> GO TO 4.

4. CHECK PRE-AMP SIGNAL CIRCUIT CONTINUITY

1. Disconnect AV control unit connector M100 and BOSE speaker amp. connector B27.
2. Check continuity between AV control unit connector M100 and BOSE speaker amp. connector B27.

AV control unit		BOSE speaker amp.		Continuity
Connector	Terminal	Connector	Terminal	
M100	2	B27	38	Yes
	3		30	
	11		29	
	12		37	

3. Check continuity between AV control unit connector M100 and ground.

AV control unit		Ground	Continuity
Connector	Terminal		
M100	2	—	No
	3		
	11		
	12		

Is the inspection result normal?

- YES >> GO TO 5.
- NO >> Repair or replace harness or connectors.

5. CHECK PRE-AMP SIGNAL

1. Connect AV control unit connector M100 and BOSE speaker amp. connector B27.
2. Turn power switch to ACC.
3. Push AV control unit POWER switch.
4. Check signal between the terminals of AV control unit connector M100.

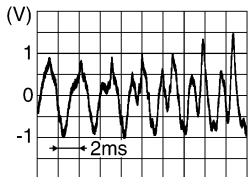
AV control unit connector M100		Condition	Reference value
(+)	(-)		
Terminal	Terminal	Audio signal output	
2	3		
11	12		

Is the inspection result normal?

- YES >> Replace BOSE speaker amp. Refer to [AV-501. "Removal and Installation"](#).

A
B
C
D
E
F
G
H
I
J
K
L
M
O
P

AV

FRONT DOOR SPEAKER

< DTC/CIRCUIT DIAGNOSIS >

[NAVIGATION WITH BOSE]

NO >> Replace AV control unit. Refer to [AV-488. "Removal and Installation"](#).

TWEETER

Diagnosis Procedure

INFOID:000000010642034

Regarding Wiring Diagram information, refer to [AV-394. "Wiring Diagram"](#).

1.CONNECTOR CHECK

Check the AV control unit, BOSE speaker amp. and speaker connectors for the following:

- Proper connection
- Damage
- Disconnected or loose terminals

Is the inspection result normal?

YES >> GO TO 2.

NO >> Repair the terminals or connectors.

2.CHECK TWEETER SIGNAL CIRCUIT CONTINUITY

1. Disconnect BOSE speaker amp. connector B20 and suspect tweeter connector.
2. Check continuity between BOSE speaker amp. connector B20 and suspect tweeter connector.

BOSE speaker amp.		Tweeter		Continuity
Connector	Terminal	Connector	Terminal	
B20	13	M15 (LH)	1	Yes
	12		2	
	15	M525 (RH)	1	
	14		2	

3. Check continuity between BOSE speaker amp. connector B20 and ground.

BOSE speaker amp.		Ground	Continuity
Connector	Terminal		
B20	13	—	No
	12		
	15		
	14		

Is the inspection result normal?

YES >> GO TO 3.

NO >> Repair or replace harness or connectors.

3.CHECK TWEETER SIGNAL

1. Connect BOSE speaker amp. connector B20 and suspect tweeter connector.
2. Turn power switch to ACC.
3. Push AV control unit POWER switch.
4. Check the signal between the terminals of BOSE speaker amp. connector B20.

BOSE speaker amp. connector B20		Condition	Reference value
(+)	(-)		
Terminal	Terminal		

A
B
C
D
E
F
G
H
I
J
K
L
M
O
P

AV

TWEETER

< DTC/CIRCUIT DIAGNOSIS >

[NAVIGATION WITH BOSE]

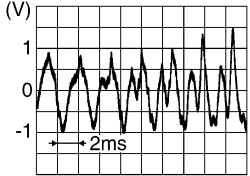
13	12	Audio signal output	
15	14		

Is the inspection result normal?

- YES >> Replace tweeter. Refer to [AV-491. "Removal and Installation"](#).
 NO >> GO TO 4.

4.CHECK PRE-AMP SIGNAL CIRCUIT CONTINUITY

1. Disconnect AV control unit connector M100 and BOSE speaker amp. connector B27.
2. Check continuity between AV control unit connector M100 and BOSE speaker amp. connector B27.

AV control unit		BOSE speaker amp.		Continuity
Connector	Terminal	Connector	Terminal	
M100	2	B27	38	Yes
	3		30	
	11		29	
	12		37	

3. Check continuity between AV control unit connector M100 and ground.

AV control unit		Ground	Continuity
Connector	Terminal		
M100	2	—	No
	3		
	11		
	12		

Is the inspection result normal?

- YES >> GO TO 5.
 NO >> Repair or replace harness or connectors.

5.CHECK PRE-AMP SIGNAL

1. Connect AV control unit connector M100 and BOSE speaker amp. connector B27.
2. Turn power switch to ACC.
3. Push AV control unit POWER switch.
4. Check signal between the terminals of AV control unit connector M100.

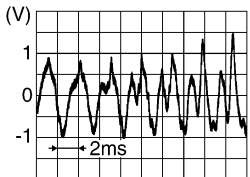
AV control unit connector M100		Condition	Reference value
(+) Terminal	(-) Terminal		
2	3	Audio signal output	
11	12		

Is the inspection result normal?

- YES >> Replace BOSE speaker amp. Refer to [AV-501. "Removal and Installation"](#).

TWEETER

< DTC/CIRCUIT DIAGNOSIS >

[NAVIGATION WITH BOSE]

NO >> Replace AV control unit. Refer to [AV-488, "Removal and Installation"](#).

A

B

C

D

E

F

G

H

I

J

K

L

M

AV

O

P

REAR DOOR SPEAKER

[NAVIGATION WITH BOSE]

< DTC/CIRCUIT DIAGNOSIS >

REAR DOOR SPEAKER

Diagnosis Procedure

INFOID:000000010642035

Regarding Wiring Diagram information, refer to [AV-394. "Wiring Diagram"](#).

1. CONNECTOR CHECK

Check the AV control unit, BOSE speaker amp. and speaker connectors for the following:

- Proper connection
- Damage
- Disconnected or loose terminals

Is the inspection result normal?

YES >> GO TO 2.

NO >> Repair the terminals or connectors.

2. CHECK REAR DOOR SPEAKER SIGNAL CIRCUIT CONTINUITY

1. Disconnect BOSE speaker amp. connectors and suspect rear door speaker connector.
2. Check continuity between BOSE speaker amp. connectors and suspect rear door speaker connector.

BOSE speaker amp.		Rear door speaker		Continuity
Connector	Terminal	Connector	Terminal	
B11	1	D205 (LH)	1	Yes
	5		2	
B20	16	D305 (RH)	1	
	24		2	

3. Check continuity between BOSE speaker amp. connectors and ground.

BOSE speaker amp.		Ground	Continuity
Connector	Terminal		
B11	1	—	No
	5		
B20	16		
	24		

Is the inspection result normal?

YES >> GO TO 3.

NO >> Repair or replace harness or connectors.

3. CHECK REAR DOOR SPEAKER SIGNAL

1. Connect BOSE speaker amp. connectors and suspect rear door speaker connector.
2. Turn power switch to ACC.
3. Push AV control unit POWER switch.
4. Check the signal between the terminals of BOSE speaker amp. connectors.

BOSE speaker amp.			Condition	Reference value
Connector	(+)	(-)		
	Terminal	Terminal		

REAR DOOR SPEAKER

< DTC/CIRCUIT DIAGNOSIS >

[NAVIGATION WITH BOSE]

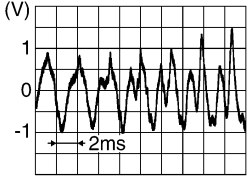
B11	1	5	Audio signal output	
B20	16	24		

Is the inspection result normal?

- YES >> Replace rear door speaker. Refer to [AV-492. "Removal and Installation"](#).
- NO >> GO TO 4.

4. CHECK PRE-AMP SIGNAL CIRCUIT CONTINUITY

1. Disconnect AV control unit connector M100 and BOSE speaker amp. connector B27.
2. Check continuity between AV control unit connector M100 and BOSE speaker amp. connector B27.

AV control unit		BOSE speaker amp.		Continuity
Connector	Terminal	Connector	Terminal	
M100	4	B27	36	Yes
	5		28	
	13		27	
	14		35	

3. Check continuity between AV control unit connector M100 and ground.

AV control unit		Ground	Continuity
Connector	Terminal		
M100	4	—	No
	5		
	13		
	14		

Is the inspection result normal?

- YES >> GO TO 5.
- NO >> Repair or replace harness or connectors.

5. CHECK PRE-AMP SIGNAL

1. Connect AV control unit connector M100 and BOSE speaker amp. connector B27.
2. Turn power switch to ACC.
3. Push AV control unit POWER switch.
4. Check signal between the terminals of AV control unit connector M100.

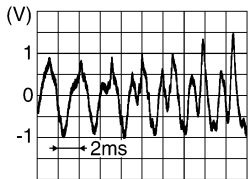
AV control unit connector M100		Condition	Reference value
(+) Terminal	(-) Terminal		
4	5	Audio signal output	
13	14		

Is the inspection result normal?

- YES >> Replace BOSE speaker amp. Refer to [AV-501. "Removal and Installation"](#).

REAR DOOR SPEAKER

< DTC/CIRCUIT DIAGNOSIS >

[NAVIGATION WITH BOSE]

NO >> Replace AV control unit. Refer to [AV-488. "Removal and Installation"](#).

SUBWOOFER

Diagnosis Procedure

INFOID:000000010642036

Regarding Wiring Diagram information, refer to [AV-394. "Wiring Diagram"](#).

1. CONNECTOR CHECK

Check the AV control unit, BOSE speaker amp. and subwoofer connectors for the following:

- Proper connection
- Damage
- Disconnected or loose terminals

Is the inspection result normal?

YES >> GO TO 2.

NO >> Repair the terminal and connector.

2. CHECK SUBWOOFER SIGNAL CIRCUIT CONTINUITY

1. Disconnect BOSE speaker amp. connector B11 and subwoofer connector.
2. Check continuity between BOSE speaker amp. connector B11 and subwoofer connector.

BOSE speaker amp.		Subwoofer		Continuity
Connector	Terminal	Connector	Terminal	
B11	6	B43	1	Yes
	2		2	

3. Check continuity between BOSE speaker amp. connector B11 and ground.

BOSE speaker amp.		Ground	Continuity
Connector	Terminal		
B11	6	—	No
	2		

Is the inspection result normal?

YES >> GO TO 3.

NO >> Repair or replace harness or connectors.

3. CHECK SUBWOOFER SIGNAL

1. Connect BOSE speaker amp. connector B11 and subwoofer connector.
2. Turn power switch to ACC.
3. Push AV control unit POWER switch.
4. Check the signal between the terminals of BOSE speaker amp. connector B11.

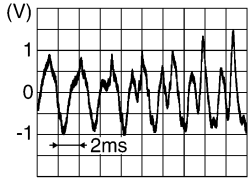
BOSE speaker amp. connector B11		Condition	Reference value
(+) Terminal	(-) Terminal		
6	2	Audio signal output	

Is the inspection result normal?

A
B
C
D
E
F
G
H
I
J
K
L
M

AV

O
P

SUBWOOFER

[NAVIGATION WITH BOSE]

< DTC/CIRCUIT DIAGNOSIS >

- YES >> Replace subwoofer. Refer to [AV-500, "Removal and Installation"](#).
 NO >> GO TO 4.

4. CHECK PRE-AMP SIGNAL CIRCUIT CONTINUITY

1. Disconnect AV control unit connector M100 and BOSE speaker amp. connector B27.
2. Check continuity between AV control unit connector M100 and BOSE speaker amp. connector B27.

AV control unit		BOSE speaker amp.		Continuity
Connector	Terminal	Connector	Terminal	
M100	4	B27	36	Yes
	5		28	
	13		27	
	14		35	

3. Check continuity between AV control unit connector M100 and ground.

AV control unit		Ground	Continuity
Connector	Terminal		
M100	4	—	No
	5		
	13		
	14		

Is the inspection result normal?

- YES >> GO TO 5.
 NO >> Repair or replace harness or connectors.

5. CHECK PRE-AMP SIGNAL

1. Connect AV control unit connector M100 and BOSE speaker amp. connector B27.
2. Turn power switch to ACC.
3. Push AV control unit POWER switch.
4. Check signal between the terminals of AV control unit connector M100.

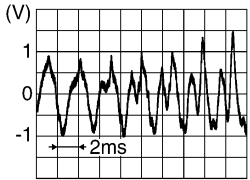
AV control unit connector M100		Condition	Reference value
(+) Terminal	(-) Terminal		
4	5	Audio signal output	
13	14		

Is the inspection result normal?

- YES >> Replace BOSE speaker amp. Refer to [AV-501, "Removal and Installation"](#).
 NO >> Replace AV control unit. Refer to [AV-488, "Removal and Installation"](#).

AMP ON SIGNAL CIRCUIT

Diagnosis Procedure

INFOID:000000010642037

Regarding Wiring Diagram information, refer to [AV-394. "Wiring Diagram"](#).

1. CHECK CONTINUITY BETWEEN AV CONTROL UNIT AND BOSE SPEAKER AMP.

1. Turn power switch OFF.
2. Disconnect AV control unit connector M100 and Bose speaker amp. connector B20.
3. Check continuity between audio unit connector M100 and Bose speaker amp. connector B20.

AV control unit		Bose speaker amp.		Continuity
Connector	Terminal	Connector	Terminal	
M100	1	B20	22	Yes

4. Check continuity between AV control unit connector M100 and ground.

AV control unit		Ground	Continuity
Connector	Terminal		
M100	1	—	No

Is the inspection result normal?

- YES >> GO TO 2.
 NO >> Repair or replace harness or connectors.

2. CHECK AV CONTROL UNIT VOLTAGE

1. Connect AV control unit connector M100.
2. Turn power switch ON.
3. Check voltage between AV control unit connector M100 and ground.

AV control unit (+)		Ground (-)	Voltage (Approx.)
Connector	Terminal		
M100	1	—	Battery voltage

Is the inspection result normal?

- YES >> Replace Bose speaker amp. Refer to [AV-501. "Removal and Installation"](#).
 NO >> Replace AV control unit. Refer to [AV-488. "Removal and Installation"](#).

A
B
C
D
E
F
G
H
I
J
K
L
M
O
P

AV

AUXILIARY INPUT JACK

< DTC/CIRCUIT DIAGNOSIS >

[NAVIGATION WITH BOSE]

AUXILIARY INPUT JACK

Diagnosis Procedure

INFOID:000000010642038

Regarding Wiring Diagram information, refer to [AV-394. "Wiring Diagram"](#).

1. CHECK AUXILIARY INPUT JACK HARNESS CONTINUITY

1. Turn power switch OFF.
2. Disconnect audio unit connector M103 and auxiliary input jack connector M52.
3. Check continuity between audio unit connector M103 and auxiliary input jack connector M52.

Audio unit		Auxiliary input jack		Continuity
Connector	Terminal	Connector	Terminal	
M103	35	M52	4	Yes
	36		1	
	55		2	

4. Check continuity between audio unit connector M103 and ground.

Audio unit		—	Continuity
Connector	Terminal		
M103	35	Ground	No
	55		

Is the inspection result normal?

- YES >> Replace auxiliary input jack. Refer to [AV-498. "Removal and Installation"](#).
NO >> Repair or replace harness or connectors.

MICROPHONE SIGNAL CIRCUIT

< DTC/CIRCUIT DIAGNOSIS >

[NAVIGATION WITH BOSE]

MICROPHONE SIGNAL CIRCUIT

Diagnosis Procedure

INFOID:000000010642039

Regarding Wiring Diagram information, refer to [AV-394. "Wiring Diagram"](#).

1. CHECK MICROPHONE SIGNAL CIRCUIT CONTINUITY

1. Turn power switch OFF.
2. Disconnect AV control unit connector M103 and microphone connector R3.
3. Check continuity between AV control unit connector M103 and microphone connector R3.

AV control unit		Microphone		Continuity
Connector	Terminal	Connector	Terminal	
M103	34	R3	4	Yes
	53		1	
	54		2	

4. Check continuity between AV control unit connector M103 and ground.

AV control unit		Ground	Continuity
Connector	Terminal		
M103	34	—	No
	53		

Is inspection result normal?

- YES >> GO TO 2.
NO >> Repair or replace harness or connectors.

2. CHECK MICROPHONE VCC VOLTAGE

1. Connect AV control unit connector M103.
2. Turn power switch ON.
3. Check voltage between terminals of AV control unit connector M103.

AV control unit connector M103		Voltage (Approx.)
(+) Terminal	(-) Terminal	
34	54	5.0 V

Is the inspection result normal?

- YES >> GO TO 3.
NO >> Replace AV control unit. Refer to [AV-488. "Removal and Installation"](#).

3. CHECK MICROPHONE SIGNAL

1. Connect microphone connector.
2. Check signal between terminals of AV control unit connector M103.

A
B
C
D
E
F
G
H
I
J
K
L
M
O
P

AV

MICROPHONE SIGNAL CIRCUIT

< DTC/CIRCUIT DIAGNOSIS >

[NAVIGATION WITH BOSE]

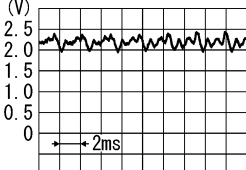
AV control unit connector M103		Condition	Reference value
(+)	(-)		
Terminal	Terminal		
53	54	Speak into microphone.	 <p style="text-align: right; font-size: small;">PKIB5037J</p>

Is the inspection result normal?

- YES >> Replace AV control unit. Refer to [AV-488. "Removal and Installation"](#).
- NO >> Replace microphone. Refer to [AV-494. "Removal and Installation"](#).

STEERING SWITCH

[NAVIGATION WITH BOSE]

< DTC/CIRCUIT DIAGNOSIS >

STEERING SWITCH

Diagnosis Procedure

INFOID:000000010642040

Regarding Wiring Diagram information, refer to [AV-394. "Wiring Diagram"](#).

1. CHECK STEERING WHEEL AUDIO CONTROL SWITCH RESISTANCE

1. Turn power switch OFF.
2. Disconnect combination switch connector M112.
3. Check resistance between the terminals of combination switch connector M112.

Combination switch connector M112		Condition	Resistance Ω (Approx.)
Terminal	Terminal		
14	17	Depress SOURCE switch.	1
		Depress Δ switch.	121
		Depress ∇ switch.	321
		Depress \llcorner switch.	723
		Depress \odot switch.	2023
15	17	Depress $-$ \square switch.	1
		Depress $\square+$ switch.	121
		Depress \curvearrowright switch.	321
		Depress \curvearrowleft switch.	723

Is the inspection result normal?

YES >> GO TO 2.

NO >> Replace steering switches. Refer to [AV-497. "Removal and Installation"](#).

2. CHECK COMBINATION SWITCH

Check continuity between combination switch connectors M112 and M92.

Combination switch				Continuity
Connector	Terminal	Connector	Terminal	
M112	14	M92	24	Yes
	15		31	
	17		33	

Is the inspection result normal?

YES >> GO TO 3.

NO >> Replace spiral cable. Refer to [SR-23. "Removal and Installation"](#).

3. CHECK HARNESS BETWEEN COMBINATION SWITCH AND AUDIO UNIT

1. Disconnect AV control unit connector M100.
2. Check continuity between combination switch connector M92 and AV control unit connector M100.

STEERING SWITCH

< DTC/CIRCUIT DIAGNOSIS >

[NAVIGATION WITH BOSE]

Combination switch		AV control unit		Continuity
Connector	Terminal	Connector	Terminal	
M92	24	M100	6	Yes
	31		16	
	33		15	

3. Check continuity between combination switch connector M92 and ground.

Combination switch		Ground	Continuity
Connector	Terminal		
M92	24	—	No
	31		
	33		

Is the inspection result normal?

YES >> Replace AV control unit. Refer to [AV-488. "Removal and Installation"](#).

NO >> Repair or replace harness or connectors.

USB CONNECTOR

Diagnosis Procedure

INFOID:000000010642041

Regarding Wiring Diagram information, refer to [AV-394. "Wiring Diagram"](#).

1.CHECK USB INTERFACE HARNESS CONTINUITY

1. Turn power switch OFF.
2. Disconnect AV control unit connector M107 and USB connector M53.
3. Check continuity between AV control unit connector M107 and USB connector M53.

AV control unit		USB		Continuity
Connector	Terminal	Connector	Terminal	
M107	78	M53	2	Yes
	79		1	
	80		4	
	81		3	
	82		5	

4. Check continuity between AV control unit connector M107 and ground.

AV control unit		—	Continuity
Connector	Terminal		
M107	78	Ground	No
	80		

Is the inspection result normal?

- YES >> Replace the USB connector. Refer to [AV-499. "Removal and Installation"](#).
 NO >> Repair or replace harness or connectors.

AV

SYMPTOM DIAGNOSIS

MULTI AV SYSTEM

Symptom Table

INFOID:000000010642042

RELATED TO AUDIO

Symptoms	Check items	Probable malfunction location
The disk cannot be removed.	AV control unit	Malfunction in AV control unit. Refer to AV-367, "On Board Diagnosis Function" .
No sound comes out or the level of the sound is low.	No sound from all speakers.	<ul style="list-style-type: none"> • Speaker circuit shorted to ground. Refer to AV-394, "Wiring Diagram". • Bose amp. ON signal circuit malfunction. Refer to AV-467, "Diagnosis Procedure". • Bose speaker amp. power supply and ground circuits malfunction. Refer to AV-453, "BOSE AMP. : Diagnosis Procedure".
	Only a certain speaker (front door speaker LH, front door speaker RH, tweeter LH, tweeter RH, rear door speaker LH, rear door speaker RH, subwoofer) does not output sound.	<ul style="list-style-type: none"> • Poor connector connection of speaker. • Sound signal circuit malfunction between AV control unit and Bose speaker amp. Refer to: <ul style="list-style-type: none"> - AV-456, "Diagnosis Procedure" (front door speaker). - AV-459, "Diagnosis Procedure" (tweeter). - AV-462, "Diagnosis Procedure" (rear door speaker). - AV-465, "Diagnosis Procedure" (subwoofer). • Sound signal circuit malfunction between Bose speaker amp. and speaker. Refer to: <ul style="list-style-type: none"> - AV-456, "Diagnosis Procedure" (front door speaker). - AV-459, "Diagnosis Procedure" (tweeter). - AV-462, "Diagnosis Procedure" (rear door speaker). - AV-465, "Diagnosis Procedure" (subwoofer). • Malfunction in speaker. Refer to: <ul style="list-style-type: none"> - AV-490, "Removal and Installation" (front door speaker). - AV-491, "Removal and Installation" (tweeter). - AV-492, "Removal and Installation" (rear door speaker). - AV-500, "Removal and Installation" (subwoofer). • Malfunction in AV control unit. Refer to AV-367, "On Board Diagnosis Function". • Malfunction in Bose speaker amp. Replace Bose speaker amp. Refer to AV-501, "Removal and Installation".

MULTI AV SYSTEM

< SYMPTOM DIAGNOSIS >

[NAVIGATION WITH BOSE]

Symptoms	Check items	Probable malfunction location
Noise is mixed with audio.	Noise comes out from all speakers.	<ul style="list-style-type: none"> • Malfunction in AV control unit. Refer to AV-367. "On Board Diagnosis Function". • Malfunction in Bose speaker amp. Replace Bose speaker amp. Refer to AV-501. "Removal and Installation".
	Noise comes out only from a certain speaker (front door speaker LH, front door speaker RH, tweeter LH, tweeter RH, rear door speaker LH, rear door speaker RH, subwoofer).	<ul style="list-style-type: none"> • Poor connector connection of speaker. • Sound signal circuit malfunction between AV control unit and Bose speaker amp. Refer to: <ul style="list-style-type: none"> - AV-456. "Diagnosis Procedure" (front door speaker). - AV-459. "Diagnosis Procedure" (tweeter). - AV-462. "Diagnosis Procedure" (rear door speaker). - AV-465. "Diagnosis Procedure" (subwoofer). • Sound signal circuit malfunction between Bose speaker amp. and speaker. Refer to: <ul style="list-style-type: none"> - AV-456. "Diagnosis Procedure" (front door speaker). - AV-459. "Diagnosis Procedure" (tweeter). - AV-462. "Diagnosis Procedure" (rear door speaker). - AV-465. "Diagnosis Procedure" (subwoofer). • Malfunction in speaker. • Poor Installation of speaker (e.g. backlash and looseness). Refer to: <ul style="list-style-type: none"> - AV-490. "Removal and Installation" (front door speaker). - AV-491. "Removal and Installation" (tweeter). - AV-492. "Removal and Installation" (rear door speaker). - AV-500. "Removal and Installation" (subwoofer). • Malfunction in AV control unit. Refer to AV-367. "On Board Diagnosis Function". • Malfunction in Bose speaker amp. Replace Bose speaker amp. Refer to AV-501. "Removal and Installation".
	Noise is mixed with radio only (when the vehicle hits a bump or while driving over bad roads)	Poor connector connection of antenna or antenna feeder. Refer to AV-495. "Antenna Feeder" .
No radio reception or poor reception.	<ul style="list-style-type: none"> • Other audio sounds are normal. • Any radio station cannot be received or poor reception is caused even after moving to a service area with good reception (e.g. a place with clear view and no obstacles generating external noises). 	<ul style="list-style-type: none"> • Antenna amp. ON signal circuit malfunction. Refer to AV-467. "Diagnosis Procedure". • Poor connector connection of antenna or antenna feeder. Refer to AV-495. "Antenna Feeder".

A
B
C
D
E
F
G
H
I
J
K
L
M
O
P

AV









MULTI AV SYSTEM

< SYMPTOM DIAGNOSIS >

[NAVIGATION WITH BOSE]

Symptoms	Check items	Probable malfunction location
No satellite radio reception.	There is malfunction in the CONSULT self diagnosis result. Refer to AV-376. "CONSULT Function" .	<ul style="list-style-type: none"> Malfunction in antenna, antenna feeder or AV control unit. Perform DTC diagnosis. Refer to AV-376. "CONSULT Function". Poor continuity in antenna feeder. Poor connector connection of antenna or antenna feeder. Refer to AV-495. "Antenna Feeder".
	There is no malfunction in the CONSULT self diagnosis result. Refer to AV-376. "CONSULT Function" .	<ul style="list-style-type: none"> Poor continuity in antenna feeder. Poor connector connection of antenna or antenna feeder. Loose satellite radio antenna mounting nut. Refer to AV-495. "Antenna Feeder".
Buzz/rattle sound from speaker	The majority of buzz/rattle sounds are not indicative of an issue with the speaker, usually something nearby the speaker is causing the buzz/rattle.	Refer to "SQUEAK AND RATTLE TROUBLE DIAGNOSIS" in the appropriate interior trim section.

RELATED TO HANDS-FREE PHONE

Symptoms	Check items	Probable malfunction location
Does not recognize cellular phone connection (no connection is displayed on the display at the guide).	Repeat the registration of cellular phone.	Malfunction in AV control unit. Replace AV control unit. Refer to AV-488. "Removal and Installation" .
Hands-free phone cannot be established.	<ul style="list-style-type: none"> Hands-free phone operation can be made, but the communication cannot be established. Hands-free phone operation can be performed, however, voice between each other cannot be heard during the conversation. 	
The other party's voice cannot be heard by hands-free phone.	Check the "microphone speaker" in Inspection & Adjustment Mode if sound is heard.	
Originating sound is not heard by the other party with hands-free phone communication.	Sound operation function is normal.	Microphone signal circuit malfunction. Refer to AV-469. "Diagnosis Procedure" .
	Sound operation function does not work.	
The system cannot be operated.	<ul style="list-style-type: none"> The voice recognition can be controlled. Steering switch's  ,  , and  switch works, but  does not work. 	Steering switch malfunction. Replace steering switch. Refer to AV-497. "Removal and Installation" .
	Steering switch's  ,  ,  , and  switches do not work.	Steering switch signal circuit malfunction. Refer to AV-471. "Diagnosis Procedure" .
	All steering switches do not work.	Steering switch ground circuit malfunction. Refer to AV-471. "Diagnosis Procedure" .

RELATED TO NAVIGATION

MULTI AV SYSTEM

< SYMPTOM DIAGNOSIS >

[NAVIGATION WITH BOSE]

Symptoms	Check items	Probable malfunction location
Navigation system is inoperative.	Navigation malfunction.	<ul style="list-style-type: none"> Malfunction in hard disk drive (HDD). Malfunction in AV control unit. Refer to AV-367, "On Board Diagnosis Function" .
	Steering switches malfunction.	Steering switch signal circuit malfunction. Refer to AV-471, "Diagnosis Procedure" .
	Voice activated control malfunction.	Microphone signal circuit malfunction. Refer to AV-469, "Diagnosis Procedure" . Steering switch signal circuit malfunction. Refer to AV-471, "Diagnosis Procedure" .

RELATED TO AROUND VIEW MONITOR

Symptoms	Check items	Probable malfunction location
Display does not switch to camera image when CAMERA switch is pressed or selector lever is in R (reverse).	Around view monitor control unit malfunction.	Around view monitor control unit power supply and ground circuits malfunction. Refer to AV-454, "AROUND VIEW MONITOR CONTROL UNIT : Diagnosis Procedure" .
	Camera image signal circuit (output) malfunction.	Camera image signal circuit (output) malfunction between around view monitor control unit and AV control unit. Refer to AV-390, "Reference Value" .
Display switches to camera image when CAMERA switch is pressed or selector lever is in R (reverse), but all views are not displayed.	Camera image signal circuit (input) malfunction.	Camera image signal circuit (input) malfunction between camera and around view monitor control unit. Refer to: <ul style="list-style-type: none"> AV-439, "Diagnosis Procedure" (front camera). AV-435, "Diagnosis Procedure" (rear view camera). AV-441, "Diagnosis Procedure" (side camera LH). AV-437, "Diagnosis Procedure" (side camera RH).
Camera image is rolling.	Camera image signal circuit (output) malfunction.	Camera image signal circuit (output) malfunction between around view monitor control unit and AV control unit. Refer to AV-390, "Reference Value" .
Display does not switch to rear view monitor even when selector lever is in R (reverse).	Reverse signal circuit malfunction.	Reverse signal circuit between BCM and around view monitor control unit. Refer to AV-390, "Reference Value" .
Predicted course line display in front view and rear view is malfunctioning.	Steering angle sensor malfunction.	Predicted course line center position is malfunctioning. Refer to AV-425, "PREDICTIVE COURSE LINE CENTER POSITION ADJUSTMENT : Work Procedure" .
Front view and front of birds-eye view is not displayed.	Front camera malfunction.	<ul style="list-style-type: none"> Front camera power supply and ground circuits malfunction. Front camera image signal circuit malfunction between front camera and around view monitor control unit. Refer to AV-439, "Diagnosis Procedure" .
	Front camera image signal circuit malfunction.	
Rear view and rear of birds-eye view is not displayed.	Rear view camera malfunction.	<ul style="list-style-type: none"> Rear view camera power supply and ground circuits malfunction. Rear view camera image signal circuit malfunction between rear camera and around view monitor control unit. Refer to AV-435, "Diagnosis Procedure" .
	Rear view camera image signal circuit malfunction.	
Front-side and driver side of birds-eye view is not displayed.	Side camera LH malfunction.	<ul style="list-style-type: none"> Side camera LH power supply and ground circuits malfunction. Side camera LH image signal circuit malfunction between side camera LH and around view monitor control unit. Refer to AV-441, "Diagnosis Procedure" .
	Side camera LH image signal circuit malfunction.	

MULTI AV SYSTEM

< SYMPTOM DIAGNOSIS >

[NAVIGATION WITH BOSE]

Symptoms	Check items	Probable malfunction location
Front-side and passenger side of birds-eye view is not displayed.	Side camera RH malfunction.	<ul style="list-style-type: none">• Side camera RH power supply and ground circuits malfunction.• Side camera RH image signal circuit malfunction between side camera RH and around view monitor control unit. Refer to AV-437 , "Diagnosis Procedure".
	Side camera RH image signal circuit malfunction.	
Selector lever is in a position other than R (reverse) and front, rear, front-side and Birds-Eye views are displayed even as vehicle speed increases.	Vehicle speed signal malfunction.	Vehicle speed signal malfunction (CAN communication) between combination meter and around view monitor control unit.

NORMAL OPERATING CONDITION

< SYMPTOM DIAGNOSIS >

[NAVIGATION WITH BOSE]

NORMAL OPERATING CONDITION

Description

INFOID:0000000110642043

RELATED TO NOISE

The majority of the audio concerns are the result of outside causes (bad CD, electromagnetic interference, etc.).

The following noise results from variations in field strength, such as fading noise and multi-path noise, or external noise from trains and other sources. It is not a malfunction.

- Fading noise: This noise occurs because of variations in the field strength in a narrow range due to mountains or buildings blocking the signal.
- Multi-path noise: This noise results from the waves sent directly from the broadcast station arriving at the antenna at a different time from the waves which reflect off mountains or buildings.

The vehicle itself can be a source of noise if noise prevention parts or electrical equipment is malfunctioning. Check if noise is caused and/or changed by engine speed, power switch turned to each position, and operation of each piece of electrical equipment, and determine the cause.

NOTE:

The source of the noise can be found easily by listening to the noise while removing the fuses of electrical components, one by one.

Type of Noise and Possible Cause

Occurrence condition		Possible cause
Occurs only when engine is ON.	A continuous growling noise occurs. The speed of the noise varies with changes in the engine speed.	<ul style="list-style-type: none"> • Power components
The occurrence of the noise is linked with the operation of the fuel pump.		<ul style="list-style-type: none"> • Fuel pump condenser
Noise only occurs when various electrical components are operating.	A cracking or snapping sound occurs with the operation of various switches.	<ul style="list-style-type: none"> • Relay malfunction, AV control unit malfunction
	The noise occurs when various motors are operating.	<ul style="list-style-type: none"> • Motor case ground • Motor
The noise occurs constantly, not just under certain conditions.		<ul style="list-style-type: none"> • Rear defogger coil malfunction • Open circuit in printed heater • Poor ground of antenna feeder line
A cracking or snapping sound occurs while the vehicle is being driven, especially when it is vibrating excessively.		<ul style="list-style-type: none"> • Ground wire of body parts • Ground due to improper part installation • Wiring connections or a short circuit

RELATED TO HANDS-FREE PHONE

Symptom	Cause and Counter measure
Does not recognize cellular phone connection (No connection is displayed on the display at the guide).	<p>Some Bluetooth[®] enabled cellular phones may not be recognized by the in-vehicle phone module.</p> <p>Refer to "RELATED TO HANDS-FREE PHONE (Check Compatibility)" in AV-474, "Symptom Table".</p>
Cannot use hands-free phone.	<p>Customer will not be able to use a hands-free phone under the following conditions:</p> <ul style="list-style-type: none"> • The vehicle is outside of the telephone service area. • The vehicle is in an area where it is difficult to receive radio waves; such as in a tunnel, in an underground parking garage, near a tall building or in a mountainous area. • The cellular phone is locked to prevent it from being dialed. <p>NOTE:</p> <p>While a cellular phone is connected through the Bluetooth[®] wireless connection, the battery power of the cellular phone may discharge quicker than usual. The Bluetooth[®] Hands-Free Phone System cannot charge cellular phones.</p>

NORMAL OPERATING CONDITION

< SYMPTOM DIAGNOSIS >

[NAVIGATION WITH BOSE]

Symptom	Cause and Counter measure
The other party's voice cannot be heard by hands-free phone.	When the radio wave condition is not ideal or ambient sound is too loud, it may be difficult to hear the other person's voice during a call.
Poor sound quality.	Do not place the cellular phone in an area surrounded by metal or far away from the in-vehicle phone module to prevent tone quality degradation and wireless connection disruption.

RELATED TO NAVIGATION

Basic Operation

Symptom	Cause	Remedy
No image is shown.	Display brightness adjustment is set fully to DARK side.	Adjust the display brightness.
No guide sound is heard. Audio guide volume is too low or too high.	Volume control is set to OFF, MIN or MAX.	Adjust the audio guide volume.
	Audio guidance is not available while the vehicle is driving on a dark pink route.	System is not malfunctioning.
Screen is too dark. Motion of the image is too slow.	Temperature inside the vehicle is low.	Wait until the temperature inside the vehicle reaches the proper temperature.
Small black or bright spots appear on the screen.	Symptom peculiar to a liquid crystal display (display unit).	System is not malfunctioning.

Vehicle Mark

Symptom	Cause	Remedy
Map screen and BIRDVIEW™ Name of the place vary with the screen.	Some thinning of the character data is done to prevent the display becoming to complex. In some cases and in some locations, the display contents may differ. The same place name, street name, etc. may not be displayed every time on account of the data processing.	System is not malfunctioning.
Vehicle mark is not positioned correctly.	Vehicle is transferred by ferry or by towing after its power switch is turned to OFF.	Drive the vehicle for a while in the GPS satellite signal receiving condition.
Screen will not switch to nighttime mode after the lighting switch is turned ON.	The daytime screen is selected by the "SWITCH SCREENS" when the last time the screen dimming setting is done. Switching between daytime/nighttime screen may be inhibited by the automatic illumination adjustment function.	Perform screen dimming and select the nighttime screen by "SWITCH SCREENS".
Map screen will not scroll in accordance with the vehicle travel.	Current location is not displayed.	Press "MAP" button to display the current location.
Vehicle mark will not be shown.	Current location is not displayed.	Press "MAP" button to display the current location.
Accuracy indicator (GPS satellite mark) on the map screen stays gray.	GPS satellite signal is intercepted because the vehicle is in or behind a building.	Move the vehicle out to an open space.
	GPS satellite signal cannot be received because an obstacle is placed on top of the instrument panel.	Do not place anything on top of the meter display (instrument panel).
	GPS satellites are not visible from current location.	Wait until GPS satellites are visible by moving the vehicle.

NORMAL OPERATING CONDITION

< SYMPTOM DIAGNOSIS >

[NAVIGATION WITH BOSE]

Symptom	Cause	Remedy
Vehicle location accuracy is low.	Accuracy indicator (GPS satellite mark) on the map screen stays gray.	Current location is not determined.
	Vehicle speed setting by the vehicle speed pulse has been deviated (advanced or retarded) from the actual vehicle speed because tire chain is fitted or the system has been used on another vehicle.	Drive the vehicle for a while [for approx. 30 minutes at approx. 30 km/h (19 MPH)] and the deviation will be automatically adjusted. If advancement or retard still occur, perform the distance adjustment by CONFIRMATION/ADJUSTMENT mode of diagnosis function.
	Map data has error or omission. (Vehicle mark is always deviated to the same position.)	As a rule, an updated map DVD-ROM will be released once a year.

Destination, Passing Points and Menu Items Cannot be Selected/Set

Symptom	Cause	Remedy
Destination cannot be set.	Destination to be set is on an expressway.	Set the destination on an ordinary road.
Passing point is not searched when re-searching the route.	The vehicle has already passed the passing point, or the system judged so.	To include the passing points that have been passed into the route again, set the route again.
Route information will not be displayed.	Route searching has not been done.	Set the destination and perform route searching.
	Vehicle mark is not on the recommended route.	Drive on the recommended route.
	Route guide is turned OFF.	Turn route guide ON.
	Route information is not available on the dark pink route.	System is not malfunctioning.
After the route searching, no guide sign will appear as the vehicle goes near the entrance/exit to the toll road.	Vehicle mark is not on the recommended route. (On the display, only guide signs related to the recommended route will be shown.)	Drive on the recommended route.
Automatic route searching is not possible.	Vehicle is driving on a highway (gray route), or no recommended route is available.	Drive on a road to be searched. Or re-search the route manually. In this case, however, the whole route will be searched.
Performed automatic detour search (or detour search). However, the result is the same as that of the previous search.	Performed search with every conditions considered. However, the result is the same as that of the previous search.	System is not malfunctioning.
Passing points cannot be set.	More than five passing points were set.	Passing points can be set up to five. To stop at more than five points, perform sharing in several steps.
When setting the route, the starting point cannot be selected.	The current vehicle location is always set as the starting point of a route.	System is not malfunctioning.
Some menu items cannot be selected.	The vehicle is being driven.	Stop the vehicle at a safe place and then operate the system.

Voice Guide

NORMAL OPERATING CONDITION

< SYMPTOM DIAGNOSIS >

[NAVIGATION WITH BOSE]

Symptom	Cause	Remedy
Voice guide will not operate.	Note: Voice guide is only available at intersections that satisfy certain conditions (indicated by ● on the map). Therefore, guidance may not be given even when the route on the map changes direction.	System is not malfunctioning.
	The vehicle is not on the recommended route.	Return to the recommended route or re-search the route.
	Voice guide is turned OFF.	Turn voice guide ON.
	Route guide is turned OFF.	Turn route guide ON.
Voice guide does not match the actual road pattern.	Voice guide may vary with the direction to which the vehicle is turn and the connection of the road to other roads.	Drive in conformity to the actual traffic rules.

Route Search

Symptom	Cause	Remedy
No route is shown.	No road to be searched is found around the destination.	Find wider road (orange road or wider) nearby and reset the destination and passing points onto it. Take care of the traveling direction when there are separate up and down roads.
	Starting point and the destination are too close.	Set the destination at more distant point.
	Conditional traffic regulation (day of the week/ time of the day) is set at the area around the current location or the destination.	Turn the time-regulating search conditions OFF. Turn "Avoid regulation time" in the search conditions OFF.
Indicated route is intermittent.	In some areas, highways (gray routes) are not used for the search ^(Note) Therefore, the route to the current location or the passing points may be intermittent.	System is not malfunctioning.
When the vehicle has passed the recommended route, it is deleted from the screen.	A recommended route is controlled by each section. When the vehicle has passed the passing point 1, then the map data from the starting point up to the passing point 1 will be deleted. (The data may remain undeleted in some area.)	System is not malfunctioning.
Detouring route is recommended.	In some areas, highways (gray routes) are not used for the search. (Note). Therefore, detour route may be recommended.	Set the route closer to the basic route (gray route).
	A detour route may be shown when some traffic regulation (one-way traffic, etc.) is set at the area around the starting point or the destination.	Slightly move the starting point or the destination, or set the passing point on the route of your choice.
	In the area where highways (gray routes) are used for the search, left turn has priority around the current location and the destination (passing points). For this reason, the recommended route may be detouring.	System is not malfunctioning.
Landmarks on the map do not match the actual ones.	This can be happen due to omission or error in the map data.	As a rule, an updated map DVD-ROM will be released once a year. Wait until the latest map has become available.
Recommended route is far from the starting point, passing points, and destination.	Starting point, passing points, and destination of the route guide were set far from the desired points because route searching data around these area were not stored.	Reset the destination onto the road nearby. If this road is one of the highways (gray routes), an ordinary road nearby may be displayed as the recommended route.

NOTE:

Except for the ordinance-designated cities. (Malfunctioning areas may be changed in the updated map disc.)

Examples of Current-Location Mark Displacement

NORMAL OPERATING CONDITION

< SYMPTOM DIAGNOSIS >

[NAVIGATION WITH BOSE]

Vehicle's travel amount is calculated by reading its travel distance and turning angle. Therefore, if the vehicle is driven in the following manner, an error will occur in the vehicle's current location display. If correct location has not been restored after driving the vehicle for a while, perform location correction.

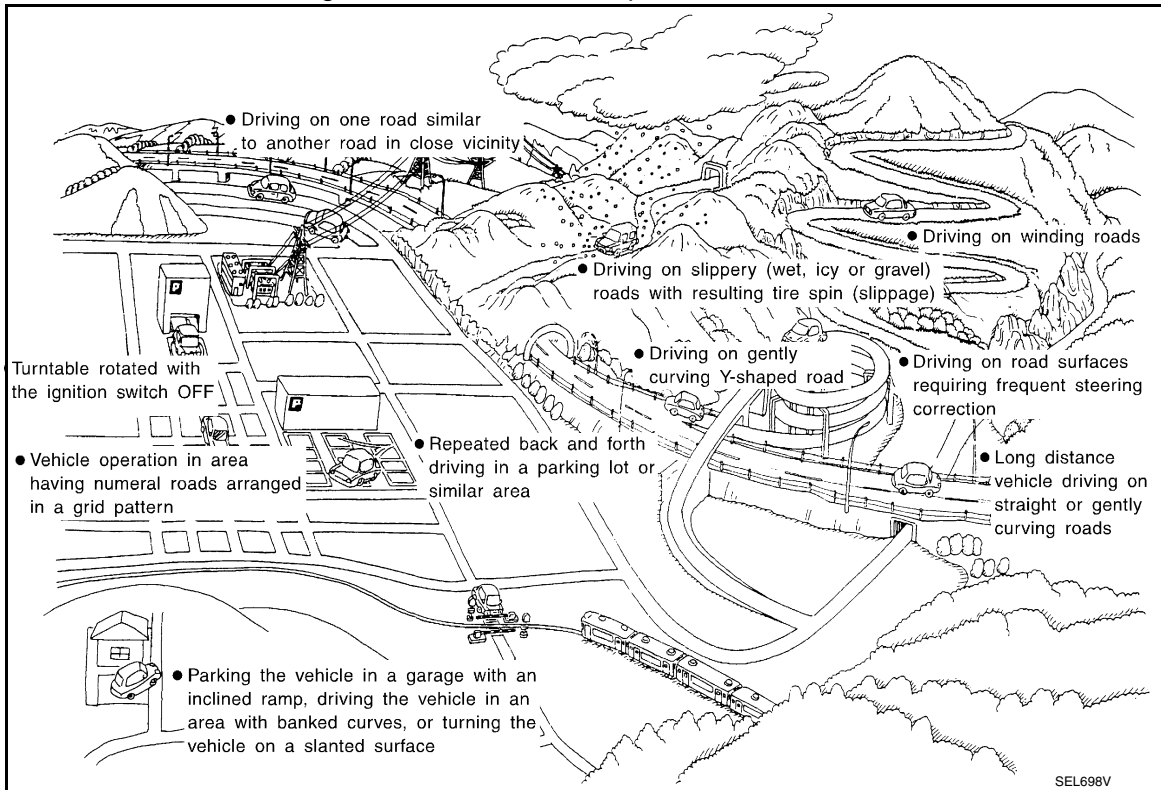

A
B
C
D
E
F
G
H
I
J
K
L
M
AV
O
P

NORMAL OPERATING CONDITION

< SYMPTOM DIAGNOSIS >

[NAVIGATION WITH BOSE]

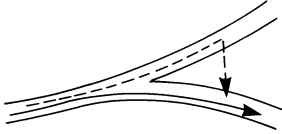
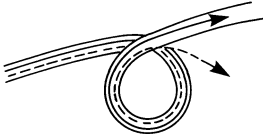
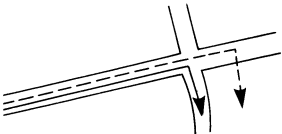
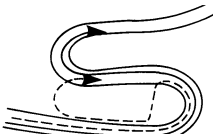
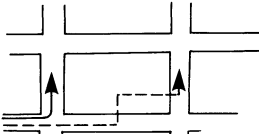
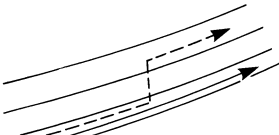
Cause (condition) –: While driving ooo: Display	Driving condition	Remarks (correction, etc.)
<p>Y-intersections</p>  <p style="text-align: center;">ELK0192D</p>	<p>At a Y intersection or similar gradual division of roads, an error in the direction of travel deduced by the sensor may result in the current-location mark appearing on the wrong road.</p>	<p>If after travelling about 10 km (6 miles) the correct location has not been restored, perform location correction and, if necessary, direction correction.</p>
<p>Spiral roads</p>  <p style="text-align: center;">ELK0193D</p>	<p>When driving on a large, continuous spiral road (such as loop bridge), turning angle error is accumulated and the vehicle mark may deviate from the correct location.</p>	
<p>Straight roads</p>  <p style="text-align: center;">ELK0194D</p>	<p>When driving on a long, straight road and slow curve without stopping, map-matching does not work effectively enough and distance errors may accumulate. As a result, the vehicle mark may deviate from the correct location when the vehicle is turned at a corner.</p>	
<p>Zigzag roads</p>  <p style="text-align: center;">ELK0195D</p>	<p>When driving on a zigzag road, the map may be matched to other roads in the similar direction nearby at every turn, and the vehicle mark may deviate from the correct location.</p>	
<p>Roads laid out in a grid pattern</p>  <p style="text-align: center;">ELK0196D</p>	<p>When driving where roads are laid out in a grid pattern, or where many roads are running in the similar direction nearby, the map may be matched to them by mistake and the vehicle mark may deviate from the correct location.</p>	
<p>Parallel roads</p>  <p style="text-align: center;">ELK0197D</p>	<p>When two roads are running in parallel (such as highway and sideways), the map may be matched to the other road by mistake and the vehicle mark may deviate from the correct location.</p>	

NORMAL OPERATING CONDITION

< SYMPTOM DIAGNOSIS >

[NAVIGATION WITH BOSE]

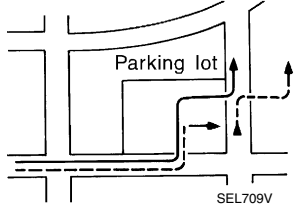
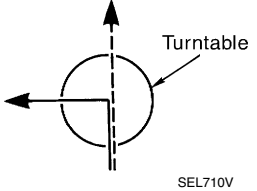
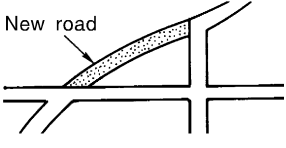
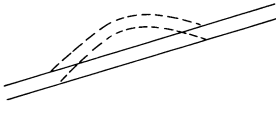
	Cause (condition) -: While driving ooo: Display	Driving condition	Remarks (correction, etc.)
Place	In a parking lot 	When driving in a parking lot, or other location where there are no roads on the map, matching may place the vehicle mark on a nearby road. When the vehicle returns to the road, the vehicle mark may have deviated from the correct location. When driving in circle or turning the steering wheel repeatedly, direction errors accumulate, and the vehicle mark may deviate from the correct location.	A B C D E F G H I J K L M <div style="background-color: black; color: white; padding: 2px; font-weight: bold;">AV</div> O P
	Turntable 	When the power switch is OFF, the navigation system cannot get the signal from the gyroscope (angular speed sensor). Therefore, the displayed direction may be wrong and the correct road may not be easily returned to after rotating the vehicle on a turntable with the power OFF.	
	Slippery roads	On snow, wet roads, gravel, or other roads where tires may slip easily, accumulated mileage errors may cause the vehicle mark to deviate from the correct road.	
	Slopes	When parking in sloped garages, when travelling on banked roads, or in other cases where the vehicle turns when tilted, an error in the turning angle will occur, and the vehicle mark may deviate from the road.	
Map data	Road not displayed on the map screen 	When driving on new roads or other roads not displayed on the map screen, map matching does not function correctly and matches the location to a nearby road. When the vehicle returns to a road which is on the map, the vehicle mark may deviate from the correct road.	
	Different road pattern (Changed due to repair) 	If the road pattern stored in the map data and the actual road pattern are different, map matching does not function correctly and matches the location to a nearby road. The vehicle mark may deviate from the correct road.	
Vehicle	Use of tire chains	When tire chains are used, the mileage is not correctly detected, and the vehicle mark may deviate from the correct road.	Drive the vehicle for a while. If the distance still deviates, adjust it by using the distance adjustment function. (If the tire chain is removed, recover the original value.)

NORMAL OPERATING CONDITION

< SYMPTOM DIAGNOSIS >

[NAVIGATION WITH BOSE]

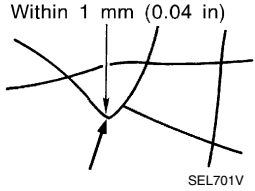
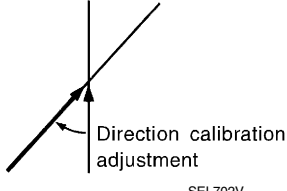
Cause (condition)	-: While driving ooo: Display	Driving condition	Remarks (correction, etc.)
Precautions for driving	Just after the engine is started	If the vehicle is driven just after the engine is started when the gyroscope (angular speed sensor) correction is not completed, the vehicle can lose its direction and may have deviated from the correct location.	Wait for a short while before driving after starting the engine.
	Continuous driving without stopping	When driving long distances without stopping, direction errors may accumulate, and the current-location mark may deviate from the correct road.	Stop and adjust the orientation.
	Abusive driving	Spinning the wheels or engaging in other kinds of abusive driving may result in the system being unable perform correct detection, and may cause the vehicle mark to deviate from the correct road.	If after travelling about 10 km (6 miles) the correct location has not been restored, perform location correction and, if necessary, direction correction.
How to correct location	Position correction accuracy 	If the accuracy of location settings is poor, accuracy may be reduced when the correct road cannot be found, particularly in places where there are many roads.	Enter in the road displayed on the screen with an accuracy of approx. 1mm. Caution: Whenever possible, use detailed map for the correction.
	Direction when location is corrected 	If the accuracy of location settings during correction is poor, accuracy may be reduced afterwards.	Perform direction correction.

Location Correction by Map-Matching is Slow

- The map-matching function needs to refer to the data of the surrounding area. It is necessary to drive some distance for the function to work.
- Because map-matching operates on this principle, when there are many roads running in similar directions in the surrounding area, no matching determination may be made. The location may not be corrected until some special feature is found.

Name of Road is Not Displayed

The current road name may not be displayed if there are no road names displayed on the map screen.

Contents of Display Differ for Birdview™ and the (Flat) Map Screen

Difference of the BIRDVIEW™ screen from the flat map screen are as follows.

- The current place name displays names which are primarily in the direction of vehicle travel.
- The amount of time before the vehicle travel or turn angle is updated on the screen is longer than for the (flat) map display.
- The conditions for display of place names, roads, and other data are different for nearby areas and for more distant areas.
- Some thinning of the character data is done to prevent the display becoming too complex. In some cases and in some locations, the display contents may differ.
- The same place name, street name, etc. may be displayed multiple times.

Vehicle Mark Shows a Position Which is Completely Wrong

In the following cases, the vehicle mark may appear on completely different position in the map depending on the GPS satellite signal receiving conditions. In this case, perform location correction and direction correction.

- When location correction has not been done
- If the receiving conditions of the GPS satellite signal is poor, if the vehicle mark becomes out of place, it may move to a completely different location and not come back if location correction is not done. The position will be corrected if the GPS signal can be received.
- When the vehicle has traveled by ferry, or when the vehicle has been being towed

NORMAL OPERATING CONDITION

< SYMPTOM DIAGNOSIS >

[NAVIGATION WITH BOSE]

- Because calculation of the current location cannot be done when traveling with the power off, for example when traveling by ferry or when being towed, the location before travel is displayed. If the precise location can be detected with GPS, the location will be corrected.

A

Vehicle Mark Jumps

In the following cases, the vehicle mark may appear to jump as a result of automatic correction of the current location.

B

- When map matching has been done
- If the current location and the vehicle mark are different when map matching is done, the vehicle mark may seem to jump. At this time, the location may be “corrected” to the wrong road or to a location which is not on a road.
- When GPS location correction has been done
- If the current location and the vehicle mark are different when the location is corrected using GPS measurements, the vehicle mark may seem to jump. At this time, the location may be “corrected” to a location which is not on a road.

C

D

Vehicle Mark is in a River or Sea

The navigation system moves the vehicle mark with no distinction between land and rivers or sea. If the vehicle mark is somehow out of place, it may appear that the vehicle is driving in a river or the sea.

E

Vehicle Mark Automatically Rotates

The system wrongly memorizes the rotating status as stopping when the power switch is turned ON with the turntable rotating. That causes the vehicle mark to rotate when the vehicle is stopped.

F

When Driving on Same Road, Sometimes Vehicle Mark is in Right Place and Sometimes it is in Wrong Place

The conditions of the GPS antenna (GPS data) and gyroscope (angular speed sensor) change gradually. Depending on the road traveled and the operation of the steering wheel, the location detection results will be different. Therefore, even on a road on which the location has never been wrong, conditions may cause the vehicle mark to deviate.

G

H

I

J

K

L

M

AV

O

P

REMOVAL AND INSTALLATION

AV CONTROL UNIT

Removal and Installation

INFOID:000000010642044

REMOVAL

CAUTION:

Remove AV control unit after a lapse of 30 seconds or more after turning the power switch OFF.

NOTE:

After the power switch is turned OFF, the AV control unit continues operating for approximately 30 seconds. Therefore, data corruption may occur if 12V battery voltage is cut off within 30 seconds.

1. Disconnect the 12V negative battery terminal. Refer to [PG-82, "Removal and Installation"](#).
2. Remove cluster lid C. Refer to [JP-17, "Removal and Installation"](#).
3. Remove the AV control unit screws, disconnect the harness connectors from the AV control unit and remove with the brackets attached.
4. Remove the bracket screws and the brackets from AV control unit (if necessary).

INSTALLATION

Note the following, and install in the reverse order of removal.

CAUTION:

- If the AV control unit is replaced, input of the user ID and password and time adjustment with VCM are required.
- If the AV control unit is not replaced, time adjustment with VCM is required.

Input Method of User ID and Password:

1. Turn power switch ON.
2. Select "Sign in" from the CARWINGS screen.
3. Enter the user ID and password.

NOTE:

Since the user ID and password are determined by the user in advance, they are input by the user.

Time Adjustment and Check Method with VCM

Refer to [AV-277, "ADDITIONAL SERVICE WHEN REMOVING BATTERY NEGATIVE TERMINAL : Work Procedure"](#).

MULTIFUNCTION SWITCH

< REMOVAL AND INSTALLATION >

[NAVIGATION WITH BOSE]

MULTIFUNCTION SWITCH

Removal and Installation

INFOID:000000010642045

REMOVAL

1. Remove cluster lid C. Refer to [IP-17. "Removal and Installation"](#).
2. Remove the screws (A), clips (B) and the multifunction switch from cluster lid C.

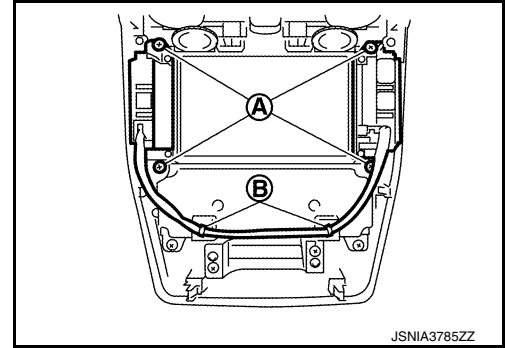

INSTALLATION

Install in the reverse order of removal.

A
B
C
D
E
F
G
H
I
J
K
L
M
AV
O
P

FRONT DOOR SPEAKER

Removal and Installation

INFOID:000000010642046

REMOVAL

1. Remove the front door finisher. Refer to [INT-19, "Removal and Installation"](#).
2. Remove the screws and disconnect the connector to remove the front door speaker.

INSTALLATION

Install in the reverse order of removal.

TWEETER

Removal and Installation

INFOID:000000010642047

REMOVAL

- 1. Remove the front pillar garnish. Refer to [INT-26. "FRONT PILLAR GARNISH : Removal and Installation"](#).
- 2. Remove screw (A) and tweeter (2) from front pillar garnish (1).

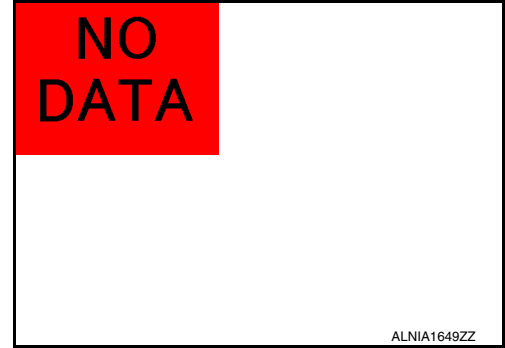

INSTALLATION

Install in the reverse order of removal.

A
B
C
D
E
F
G
H
I
J
K
L
M
AV
O
P

REAR DOOR SPEAKER

Removal and Installation

INFOID:000000010642048

REMOVAL

1. Remove the rear door finisher. Refer to [INT-22. "Removal and Installation"](#).
2. Remove the screws and disconnect the connector to remove the rear door speaker.

INSTALLATION

Install in the reverse order of removal.

GPS ANTENNA

Removal and Installation

INFOID:000000010642049

REMOVAL

1. Remove the instrument panel assembly. Refer to [IP-17, "Removal and Installation"](#).
2. Remove the screws, clips and the GPS antenna.

INSTALLATION

Install in the reverse order of removal.

A
B
C
D
E
F
G
H
I
J
K
L
M
O
P

AV

MICROPHONE

Removal and Installation

INFOID:000000010642050

REMOVAL

1. Remove the map lamp assembly. Refer to [INL-53. "Removal and Installation"](#).
2. Press the pawl to remove the microphone (1) from the map lamp assembly (2).

CAUTION:

Use care when handling the microphone pawl to avoid damaging.

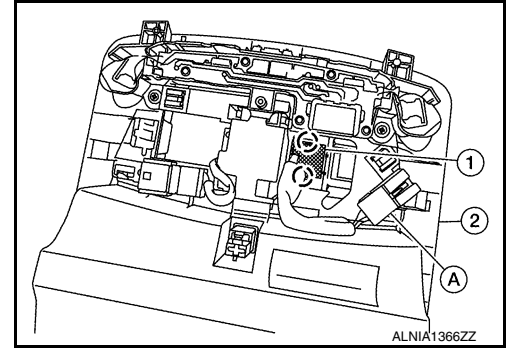

INSTALLATION

Install in the reverse order of removal.

NOTE:

Check the microphone for looseness after the installation.

ANTENNA FEEDER

< REMOVAL AND INSTALLATION >

[NAVIGATION WITH BOSE]

ANTENNA FEEDER

Antenna Feeder

INFOID:000000010642051

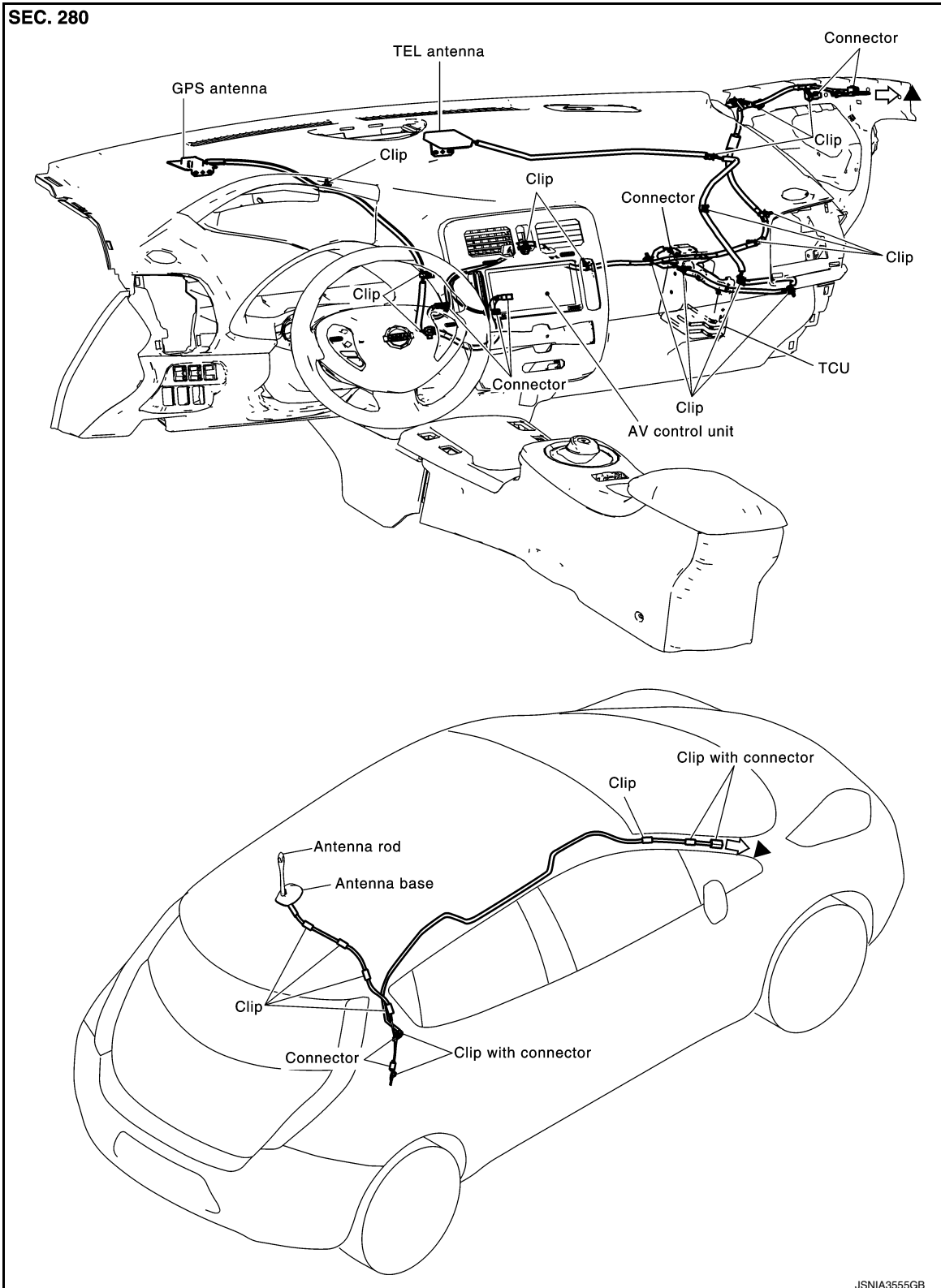

▲: Indicates that the part is connected at points with same symbol in actual vehicle.

A
B
C
D
E
F
G
H
I
J
K
L
M
N
O
P

AV

ANTENNA BASE

Removal and Installation

INFOID:000000010642052

REMOVAL

1. Partially remove the headlining (rear side) to obtain space to work between vehicle and headlining. Refer to [INT-37, "Removal and Installation"](#).
2. Disconnect the antenna feeder connector.
3. Remove the nut and the antenna base (2) from the vehicle.
(1): Antenna rod

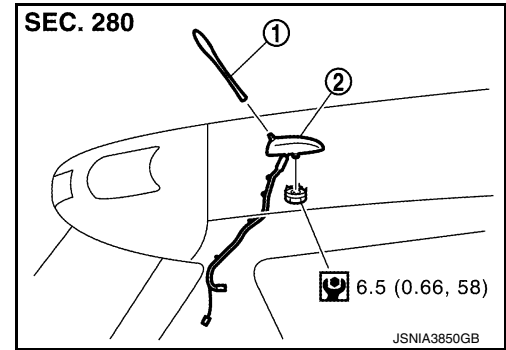

INSTALLATION

Install in the reverse order of removal.

CAUTION:

- Do not bend headlining when pulling down.
- Tighten the antenna base nut to specification.
- If the antenna base nut is less than the specified torque, it could affect the performance of the antenna sensitivity.
- If the antenna base nut is greater than the specified torque, it could damage the roof panel.

STEERING SWITCH

< REMOVAL AND INSTALLATION >

[NAVIGATION WITH BOSE]

STEERING SWITCH

Exploded View

INFOID:000000010642053

Refer to [SR-20, "Exploded View"](#).

Removal and Installation

INFOID:000000010642054

REMOVAL

Refer to [SR-20, "Removal and Installation"](#).

INSTALLATION

Install in the reverse order of removal.

A
B
C
D
E
F
G
H
I
J
K
L
M
O
P

AV

AUXILIARY INPUT JACK

< REMOVAL AND INSTALLATION >

[NAVIGATION WITH BOSE]

AUXILIARY INPUT JACK

Removal and Installation

INFOID:000000010642055

REMOVAL

1. Remove the instrument lower center cover. Refer to [IP-17, "Removal and Installation"](#).
2. Press the tab from the rear of the instrument lower center cover (B) and remove the auxiliary input jack (A).

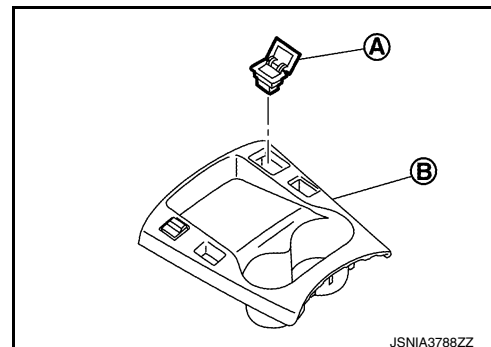

INSTALLATION

Install in the reverse order of removal.

NOTE:

Align the notch of the instrument panel center lower cover and assemble it.

USB CONNECTOR

Removal and Installation

INFOID:000000010642056

REMOVAL

1. Remove the instrument lower center cover. Refer to [IP-17. "Removal and Installation"](#).
2. Press the tab from the rear of the instrument lower center cover (B) and remove the USB connector (A).

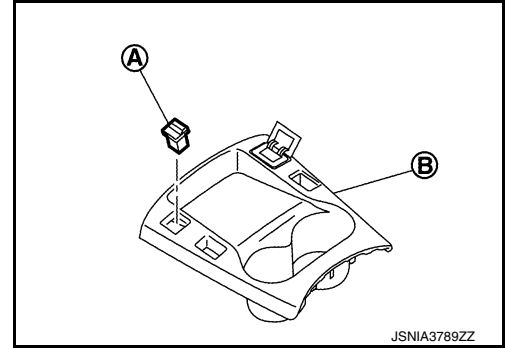

INSTALLATION

Install in the reverse order of removal.

NOTE:

Align the notch of the instrument panel center lower cover and assemble it.

A
B
C
D
E
F
G
H
I
J
K
L
M
O
P

AV

SUBWOOFER

Removal and Installation

INFOID:000000010642057

REMOVAL

1. Open the back door.
2. Remove the three subwoofer bolts.
3. Lift rear of subwoofer (1) to disconnect the harness connector (A) and remove.
↶: Front

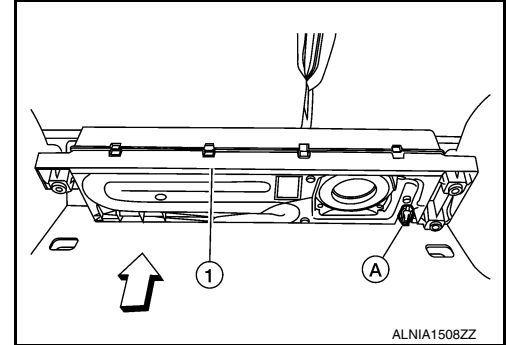

INSTALLATION

Installation is in the reverse order of removal.

BOSE SPEAKER AMP

< REMOVAL AND INSTALLATION >

[NAVIGATION WITH BOSE]

BOSE SPEAKER AMP

Removal and Installation

INFOID:000000010642058

REMOVAL

1. Remove the luggage side lower finisher (RH). Refer to [INT-42, "LUGGAGE SIDE LOWER FINISHER : Removal and Installation"](#).
2. Remove the four Bose speaker amp. bolts (A).
3. Disconnect the harness connectors (B) from the Bose speaker amp. (1) and remove.
⇐: Front

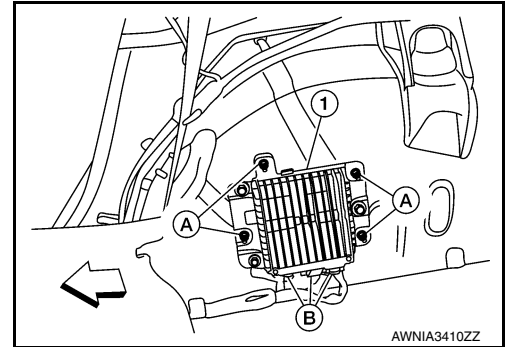

INSTALLATION

Installation is in the reverse order of removal.

A
B
C
D
E
F
G
H
I
J
K
L
M
N
O
P

AV

AROUND VIEW MONITOR CONTROL UNIT

< REMOVAL AND INSTALLATION >

[NAVIGATION WITH BOSE]

AROUND VIEW MONITOR CONTROL UNIT

Removal and Installation

INFOID:000000010642059

REMOVAL

1. Remove the TCU. Refer to [AV-594. "Removal and Installation"](#).
2. Remove the around view monitor control unit screws.
3. Disconnect the harness connectors from the around view monitor control unit and remove.

INSTALLATION

Install in the reverse order of removal.

NOTE:

Perform camera image calibration. Refer to [AV-425. "CALIBRATING CAMERA IMAGE \(AROUND VIEW MONITOR\) : Work Procedure"](#).

FRONT CAMERA

Removal and Installation

INFOID:000000010642060

REMOVAL

1. Open charge port lid.
2. Release the pawls and remove the access cover on the rear of the charge port lid.
3. Disconnect the harness connector from the front camera.
4. Remove the front camera from the charge port lid.

INSTALLATION

Install in the reverse order of removal.

NOTE:

Perform camera image calibration. Refer to [AV-425, "CALIBRATING CAMERA IMAGE \(AROUND VIEW MONITOR\) : Work Procedure"](#).

A
B
C
D
E
F
G
H
I
J
K
L
M
O
P

AV

SIDE CAMERA

Removal and Installation

INFOID:000000010642061

REMOVAL

1. Remove door mirror cover. Refer to [MIR-23. "DOOR MIRROR COVER : Removal and Installation"](#).
2. Disconnect harness connector (A) from side camera.

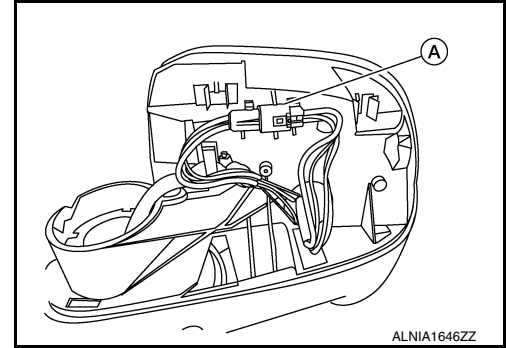

3. Remove screws (A) and remove side camera (1).

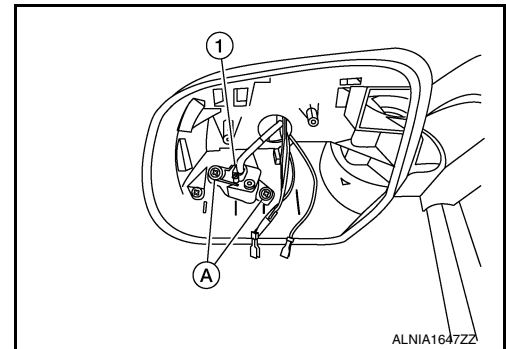

INSTALLATION

Install in the reverse order of removal.

NOTE:

Perform camera image calibration. Refer to [AV-425. "CALIBRATING CAMERA IMAGE \(AROUND VIEW MONITOR\) : Work Procedure"](#).

REAR VIEW CAMERA

Removal and Installation

INFOID:000000010642062

REMOVAL

1. Remove the back door outside handle. Refer to [DLK-201, "OUTSIDE HANDLE : Removal and Installation"](#).
2. Remove the screws (A) and the rear view camera (1) from the switch finisher (2).

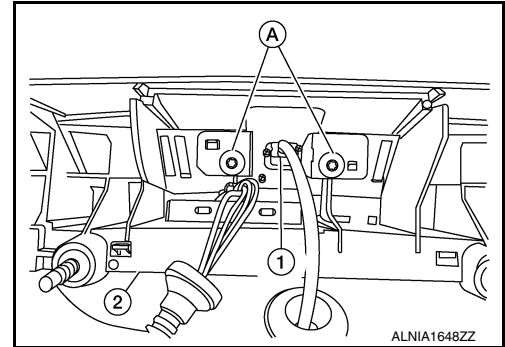

INSTALLATION

Install in the reverse order of removal.

NOTE:

If the side distance guiding lines are dislocated after installation of the rear view camera, refer to [AV-425, "CALIBRATING CAMERA IMAGE \(AROUND VIEW MONITOR\) : Work Procedure"](#) and correct the side distance guiding lines.

A
B
C
D
E
F
G
H
I
J
K
L
M
O
P

AV

PRECAUTION

PRECAUTIONS

Precaution for Technicians Using Medical Electric

INFOID:000000010642063

OPERATION PROHIBITION

WARNING:

- Parts with strong magnet is used in this vehicle.
- Technicians using a medical electric device such as pacemaker must never perform operation on the vehicle, as magnetic field can affect the device function by approaching to such parts.

NORMAL CHARGE PRECAUTION

WARNING:

- If a technician uses a medical electric device such as an implantable cardiac pacemaker or an implantable cardioverter defibrillator, the possible effects on the devices must be checked with the device manufacturer before starting the charge operation.
- As radiated electromagnetic wave generated by PDM (Power Delivery Module) at normal charge operation may affect medical electric devices, a technician using a medical electric device such as implantable cardiac pacemaker or an implantable cardioverter defibrillator must not approach motor room [PDM (Power Delivery Module)] at the hood-opened condition during normal charge operation.

PRECAUTION AT TELEMATICS SYSTEM OPERATION

WARNING:

- If a technician uses implantable cardiac pacemaker or implantable cardioverter defibrillator (ICD), avoid the device implanted part from approaching within approximately 220 mm (8.66 in) from interior/exterior antenna.
- The electromagnetic wave of TCU might affect the function of the implantable cardiac pacemaker or the implantable cardioverter defibrillator (ICD), when using the service, etc.
- If a technician uses other medical electric devices than implantable cardiac pacemaker or implantable cardioverter defibrillator (ICD), the electromagnetic wave of TCU might affect the function of the device. The possible effects on the devices must be checked with the device manufacturer before TCU use.

PRECAUTION AT INTELLIGENT KEY SYSTEM OPERATION

WARNING:

- If a technician uses implantable cardiac pacemaker or implantable cardioverter defibrillator (ICD), avoid the device implanted part from approaching within approximately 220 mm (8.66 in) from interior/exterior antenna.
- The electromagnetic wave of Intelligent Key might affect the function of the implantable cardiac pacemaker or the implantable cardioverter defibrillator (ICD), at door operation, at each request switch operation, or at engine starting.
- If a technician uses other medical electric devices than implantable cardiac pacemaker or implantable cardioverter defibrillator (ICD), the electromagnetic wave of Intelligent Key might affect the function of the device. The possible effects on the devices must be checked with the device manufacturer before Intelligent Key use.

Precaution for Supplemental Restraint System (SRS) "AIR BAG" and "SEAT BELT PRE-TENSIONER"

INFOID:000000010642064

The Supplemental Restraint System such as "AIR BAG" and "SEAT BELT PRE-TENSIONER", used along with a front seat belt, helps to reduce the risk or severity of injury to the driver and front passenger for certain types of collision. This system includes seat belt switch inputs and dual stage front air bag modules. The SRS system uses the seat belt switches to determine the front air bag deployment, and may only deploy one front air bag, depending on the severity of a collision and whether the front occupants are belted or unbelted. Information necessary to service the system safely is included in the SR and SB section of this Service Manual.

WARNING:

PRECAUTIONS

[TELEMATICS SYSTEM]

< PRECAUTION >

- To avoid rendering the SRS inoperative, which could increase the risk of personal injury or death in the event of a collision which would result in air bag inflation, all maintenance must be performed by an authorized NISSAN/INFINITI dealer.
- Improper maintenance, including incorrect removal and installation of the SRS, can lead to personal injury caused by unintentional activation of the system. For removal of Spiral Cable and Air Bag Module, see the SR section.
- Do not use electrical test equipment on any circuit related to the SRS unless instructed to in this Service Manual. SRS wiring harnesses can be identified by yellow and/or orange harnesses or harness connectors.

PRECAUTIONS WHEN USING POWER TOOLS (AIR OR ELECTRIC) AND HAMMERS

WARNING:

- When working near the Airbag Diagnosis Sensor Unit or other Airbag System sensors with the Ignition ON or engine running, DO NOT use air or electric power tools or strike near the sensor(s) with a hammer. Heavy vibration could activate the sensor(s) and deploy the air bag(s), possibly causing serious injury.
- When using air or electric power tools or hammers, always switch the Ignition OFF, disconnect the battery and wait at least three minutes before performing any service.

Precaution for Trouble Diagnosis

INFOID:000000010642065

AV COMMUNICATION SYSTEM

- Do not apply voltage of 7.0 V or higher to the measurement terminals.
- Use the tester with its open terminal voltage being 7.0 V or less.
- Be sure to turn power switch OFF and disconnect the battery cable from the negative terminal before checking the circuit. Refer to [AV-507, "Precaution for Removing 12V Battery"](#).

Precaution for Harness Repair

INFOID:000000010642066

AV COMMUNICATION SYSTEM

- Solder the repaired parts, and wrap with tape. [Frays of twisted line must be within 110 mm (4.33 in).]

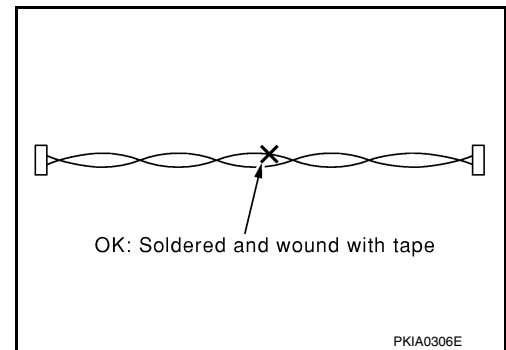

- Do not perform bypass wire connections for the repair parts. (The spliced wire will become separated and the characteristics of twisted line will be lost.)

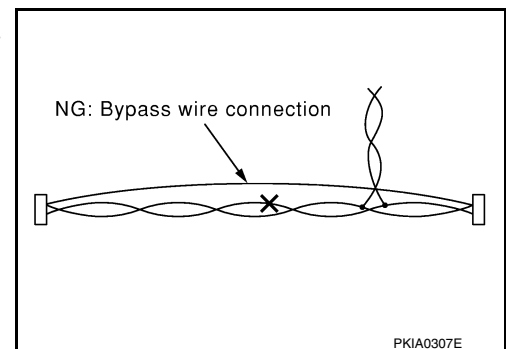

Precaution for Removing 12V Battery

INFOID:000000010642067

1. Check that EVSE is not connected.

NOTE:

If EVSE is connected, the air conditioning system may be automatically activated by the timer A/C function.

PRECAUTIONS

[TELEMATICS SYSTEM]

< PRECAUTION >

2. Turn the power switch OFF → ON → OFF. Get out of the vehicle. Close all doors (including back door).
3. Check that the charge status indicator lamp does not blink and wait for 5 minutes or more.

NOTE:

If the battery is removed within 5 minutes after the power switch is turned OFF, plural DTCs may be detected.

4. Remove 12V battery within 1 hour after turning the power switch OFF → ON → OFF.

NOTE:

- The 12V battery automatic charge control may start automatically even when the power switch is in OFF state.
- Once the power switch is turned ON → OFF, the 12V battery automatic charge control does not start for approximately 1 hour.

CAUTION:

- **After all doors (including back door) are closed, if a door (including back door) is opened before battery terminals are disconnected, start over from Step 1.**
- **After turning the power switch OFF, if “Remote A/C” is activated by user operation, stop the air conditioner and start over from Step 1.**

Precaution for Work

INFOID:000000011107776

- When removing or disassembling each component, be careful not to damage or deform it. If a component may be subject to interference, be sure to protect it with a shop cloth.
- When removing (disengaging) components with a screwdriver or similar tool, be sure to wrap the component with a shop cloth or vinyl tape to protect it.
- Protect the removed parts with a shop cloth and prevent them from being dropped.
- Replace a deformed or damaged clip.
- If a part is specified as a non-reusable part, always replace it with a new one.
- Be sure to tighten bolts and nuts securely to the specified torque.
- After installation is complete, be sure to check that each part works properly.
- Follow the steps below to clean components:
 - Water soluble dirt:
 - Dip a soft cloth into lukewarm water, wring the water out of the cloth and wipe the dirty area.
 - Then rub with a soft, dry cloth.
 - Oily dirt:
 - Dip a soft cloth into lukewarm water with mild detergent (concentration: within 2 to 3%) and wipe the dirty area.
 - Then dip a cloth into fresh water, wring the water out of the cloth and wipe the detergent off.
 - Then rub with a soft, dry cloth.
 - Do not use organic solvent such as thinner, benzene, alcohol or gasoline.
 - For genuine leather seats, use a genuine leather seat cleaner.

Cautions in Removing AV Control Unit (Models with AV Control Unit)

INFOID:000000010642068

CAUTION:

Remove AV control unit after a lapse of 30 seconds or more after turning the power switch OFF.

NOTE:

After the power switch is turned OFF, the AV control unit continues operating for approximately 30 seconds. Therefore, data corruption may occur if 12V battery voltage is cut off within 30 seconds.

PREPARATION

< PREPARATION >

[TELEMATICS SYSTEM]

PREPARATION

PREPARATION

Special Service Tools

INFOID:000000011107784

The actual shape of the tools may differ from those illustrated here.

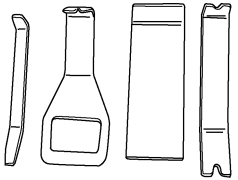
Tool number (TechMate No.) Tool name	Description
— (J-46534) Trim Tool Set  AWJIA0483ZZ	Removing trim components

Commercial Service Tool

INFOID:000000010642069

Tool name	Description
Power tool  PIIB1407E	Loosening nuts, screws and bolts

A
B
C
D
E
F
G
H
I
J
K
L
M
AV
O
P

< SYSTEM DESCRIPTION >

SYSTEM DESCRIPTION

COMPONENT PARTS

Component Parts Location

INFOID:000000010642070

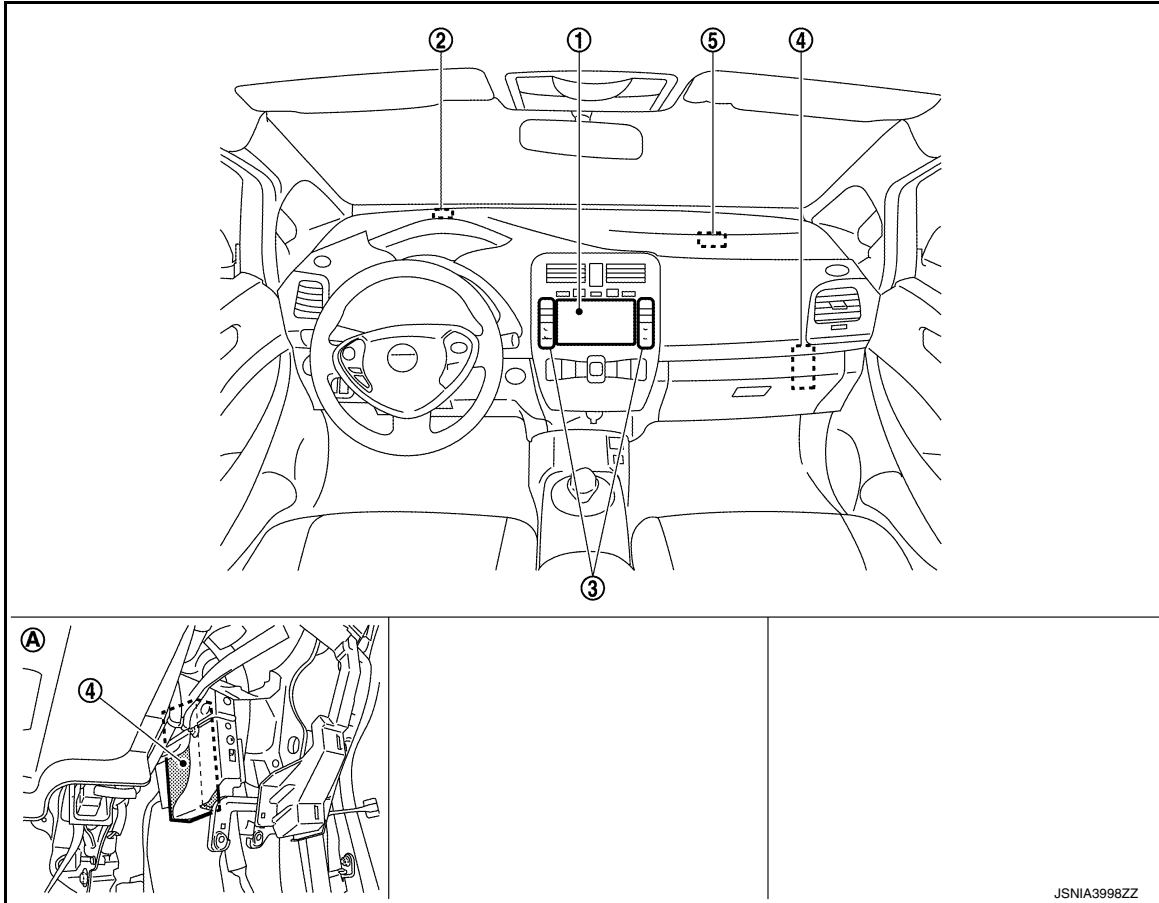

A. Glove box cover assembly removed.

No.	Component	Function
1.	AV control unit	Refer to AV-511, "AV Control Unit" .
2.	GPS antenna	<ul style="list-style-type: none"> For parts explanation, refer to AV-511, "GPS Antenna". For antenna feeder layout, refer to AV-512, "Antenna Feeder"
3.	Multifunction switch	Refer to AV-511, "Multifunction Switch"
4.	TCU	Refer to AV-511, "TCU" .
5.	TEL antenna	<ul style="list-style-type: none"> For parts explanation, refer to AV-512, "TEL Antenna". For antenna feeder layout, refer to AV-512, "Antenna Feeder".

AV Control Unit

INFOID:0000000110642071

- The high-resolution 7-inch wide VGA display integrated AV control unit is installed at the center of the instrument panel.
- AV control unit is connected to TCU with the USB harness, and signals necessary for Telematics function and CARWINGS function are sent and received.
- When the Telematics system is used, the user ID and password registered by the user are memorized.
- Switch operation signals used for the Telematics system are sent to TCU with USB communication via the AV control unit.

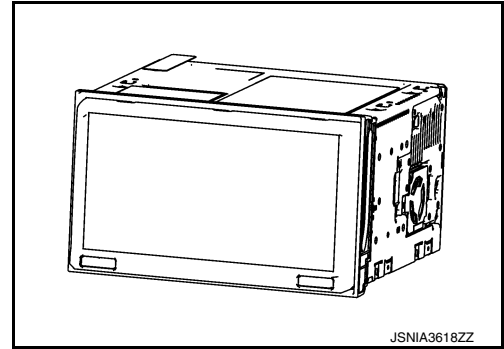

GPS Antenna

INFOID:0000000110642072

- The GPS antenna is installed in the instrument panel.
- Power is supplied from the AV control unit. Radio waves received from the GPS satellite are amplified and sent to the AV control unit as a GPS signal.
- The GPS antenna is used to obtain time information and vehicle position information necessary for probe information.

NOTE:

An object placed on the instrument panel may cause the reception sensitivity to be decreased.

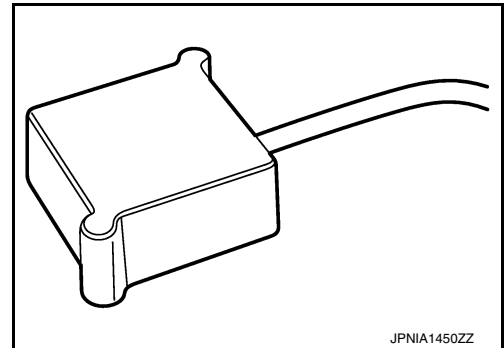

Multifunction Switch

INFOID:0000000110642073

- CARWINGS or Telematics can be controlled using the malfunction switch.
- Switch operation signals are input to the AV control unit with AV communication and sent to TCU.

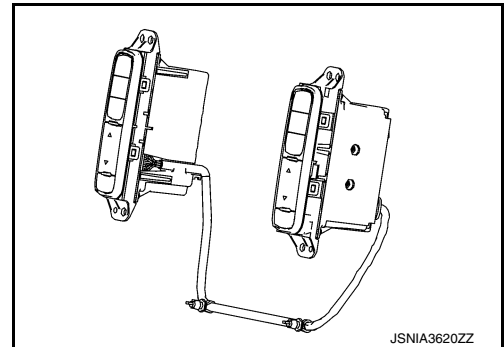

TCU

INFOID:0000000110642074

- TCU is installed on the lower right side of the instrument panel.
- A radio communication terminal and SIM card are built into the unit and data is sent and received in SMS*1 and packet communication*2 with the NISSAN CARWINGS data center via the TEL antenna.

NOTE:

*1: SMS stands for Short Message Service. It is also referred to as Text Messaging, Short Mail, etc. It is the service that performs text-based message communication.

*2: Packet communication is the communication method that sends/receives data in a small packet. Divided data is referred to as a packet and the communication line can be efficiently used.

- TCU is connected to the AV control unit with the USB harness for sound signal input/output and USB communication.
- VIN information necessary for the Telematics service is memorized.

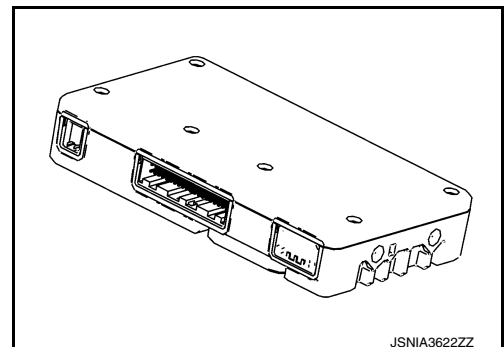

A
B
C
D
E
F
G
H
I
J
K
L
M

AV

O
P

COMPONENT PARTS

< SYSTEM DESCRIPTION >

[TELEMATICS SYSTEM]

TEL Antenna

INFOID:000000010642075

- TEL antenna is installed in the instrument panel.
- Power is supplied with TCU activated.

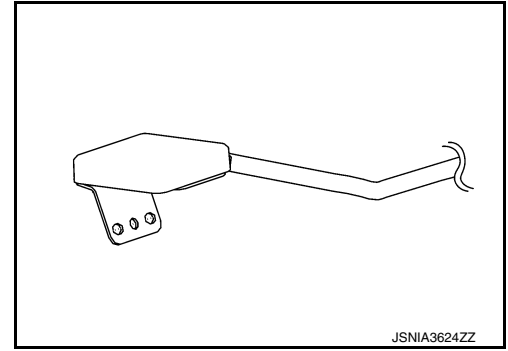

JSNIA3624ZZ

INFOID:000000010642076

Antenna Feeder

FEEDER LAYOUT

COMPONENT PARTS

< SYSTEM DESCRIPTION >

[TELEMATICS SYSTEM]

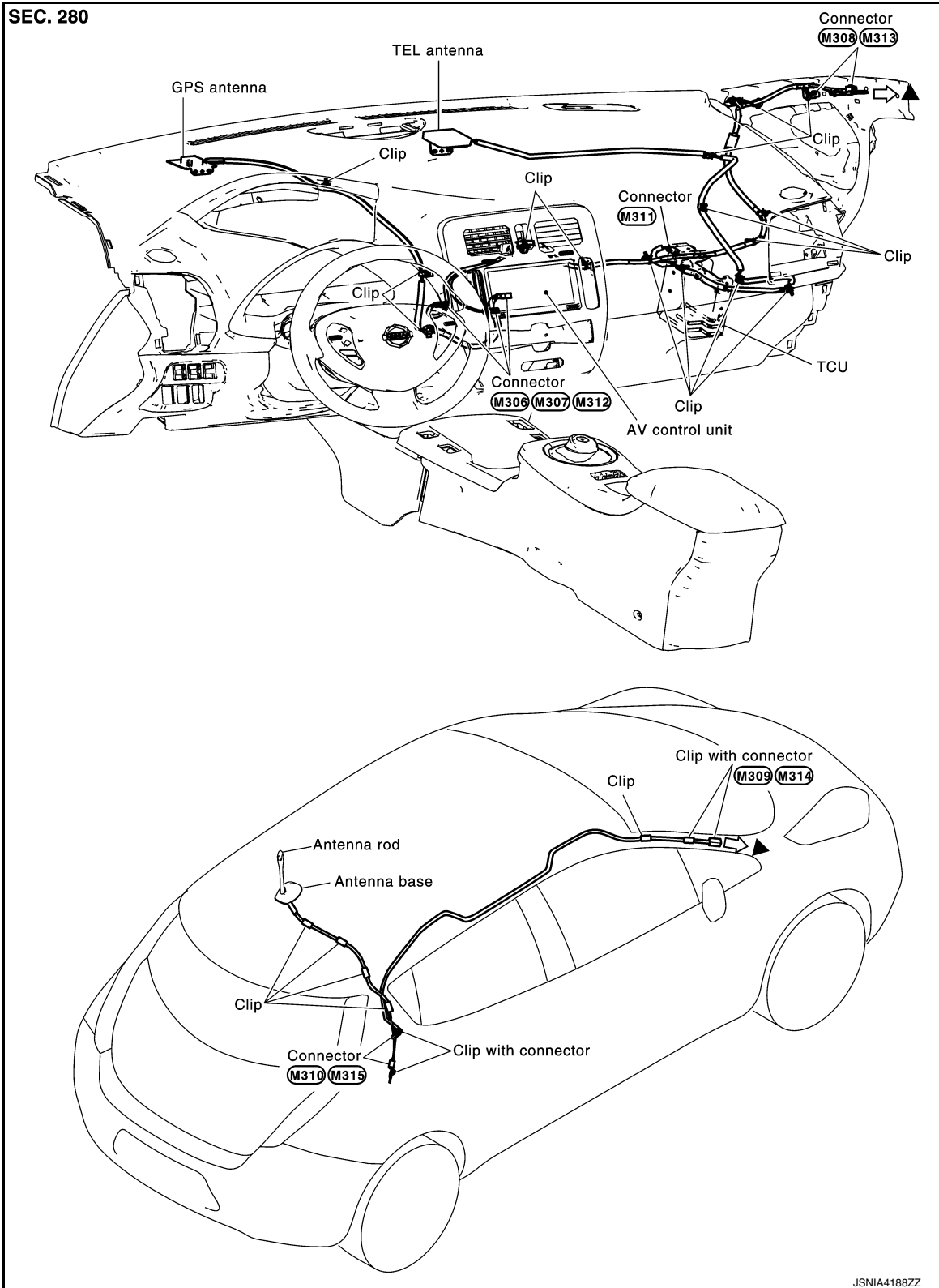

A
B
C
D
E
F
G
H
I
J
K
L
M
N
O
P

AV

SYSTEM
TELEMATICS SYSTEM

TELEMATICS SYSTEM : System Diagram

INFOID:000000010642077

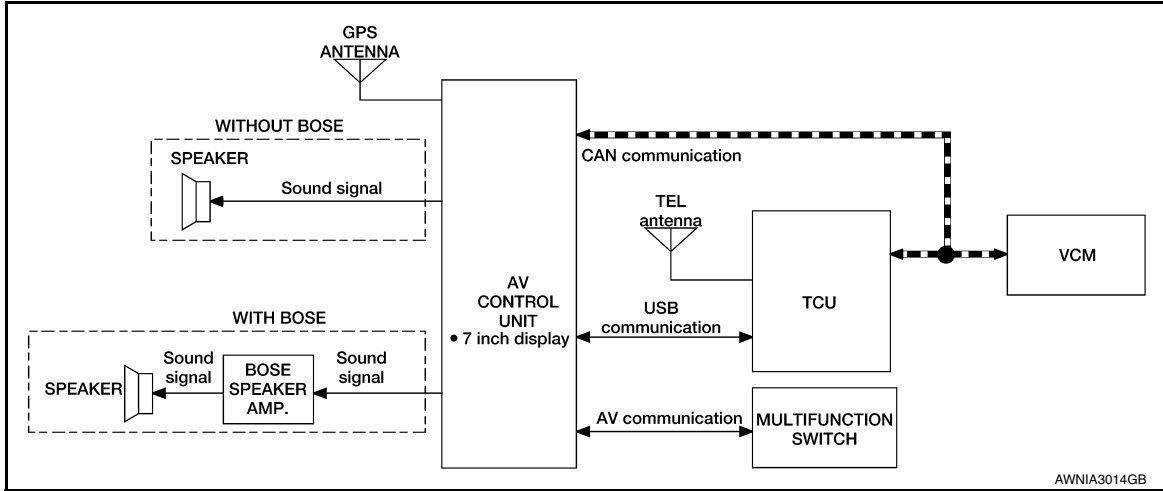

CAN COMMUNICATION

AV Control Unit Input Signal

Transmit unit	Signal name
Steering angle sensor	Steering angle sensor signal
Combination meter	Odometer signal
	A/C OFF average electricity consumption for driving range signal
	A/C ON average electricity consumption for driving range signal
	Driving range difference signal
VCM	A/C consumption power status display signal
	A/C consumption signal
	Current motor power signal
	ECO tree signal
	Li-ion battery charging data signal
	Auxiliary consumption signal
	Pre-A/C priority signal
	Pre-A/C timer signal
	Remaining time to charge completion (200 V) signal
	Remaining time to charge completion (100 V) signal
	Traction motor consumption signal
	VCM activation/deactivation command signal
	VCM status signal

TCU Input Signal

SYSTEM

< SYSTEM DESCRIPTION >

[TELEMATICS SYSTEM]

Transmit unit	Signal name
VCM	A/C expected consumption signal
	Charge status signal
	Pre-A/C status signal
	Remaining time to charge completion (200 V) signal
	Remaining time to charge completion (100 V) signal
	VCM activation/deactivation command signal
	VCM status signal
	Li-ion battery available charge signal
	Li-ion battery capacity signal
Li-battery gradual capacity loss signal	
On board charger	AC input type signal

TELEMATICS SYSTEM : System Description

INFOID:000000010642078

NOTE:

To use the Telematics systems Users must apply for subscription separately.

- The Telematics system provides information and services that can support secure and comfortable use of vehicles by a constant link of the vehicle and user through the Nissan CARWINGS Data Center.
- Available service functions of the Telematics system are CARWINGS service functions.
- TCU integrates a wireless communication terminal and sends/receives data with the Nissan CARWINGS Data Center via TEL antenna using packet communication *1 and SMS *2.

NOTE:

- *1: Packet communication is the communication method that sends/receives data in a small packet. Divided data is referred to as a packet and the communication line can be efficiently used.
- *2: SMS stands for Short Message Service. It is also referred to as Text Messaging, Short Mail, etc. It is the service that performs text based message communication.
- The AV control unit and TCU are connected with the USB communication for sending/receiving operation signals and data signals.
- To use the Telematics system, it is necessary to activate TCU. The necessary conditions are as per the following items.
 - Join the Telematics service.
 - Register the user ID and password in advance. (They are required for activation.)
 - For activation operation, refer to [AV-575. "ADDITIONAL SERVICE WHEN USING TELEMATICS SYSTEM \(WORK STEP VIEW\) : Process Chart"](#).

COMMUNICATION SIGNAL

- TCU is connected to the AV control unit through USB communication (USB 1.0), and it sends/receives reception data of TCU and operation signals of the AV control unit.
- TCU is connected to VCM, HVBAT (Li-ion Battery) and OBC (On-Board Charger) through EV CAN, and it sends/receives vehicle information.

CARWINGS SERVICE FUNCTION

The following services are provided for each situation.

Situation	Service item
On board	Automatic update of charge facility information
	Search for nearest charge station
	Information channel
	Probe information

SYSTEM

< SYSTEM DESCRIPTION >

[TELEMATICS SYSTEM]

Situation		Service item
Before/after on board	Remote operation function	Remote air conditioning (immediate ON/timer reservation)
		Remote charge
		Charge check
	Notifying function	Notification of unplugged status
		Notification of charge status
	User's operation (mobile etc.)	Drive plan (Send-to-car)
ECO drive		

Automatic Update of Charge Facility/Search for Nearest Charge Station

Automatic update of charge facility

- Nearby charge stations around the user's vehicle (area of within a radius of 25 km <15-1/2 miles> from the vehicle) are automatically updated when the low battery warning lamp turns ON.
- Neighborhood charge stations around user's house (area within approximately 160 km <approx. 100 miles>) are automatically updated periodically.

Search for nearest charge station

- If the battery capacity is low during driving, a charge warning is given in 3 steps. If the user follows the warning, data is sent/received to/from the Nissan CARWINGS Data Center. Charge facilities around the vehicle are searched, and guidance is started on the navigation system. The search location is memorized on the AV control unit as charge station information.
- When the user selects update of the charge facilities in the area, data is sent and received to/from the Nissan CARWINGS Data Center. Charge facilities around the area are searched, and the locations searched are memorized to the AV control unit as charge station information.

NOTE:

Up to approximately 1,000 charge stations can be memorized.

Information channel/probe information

- Start the navigation menu or power switch with external signals and perform data communication with the Nissan CARWINGS Data Center through TCU.
- Information channel obtains various kinds of information such as Internet content prepared by the Nissan CARWINGS Data Center and provides voice guidance and display guidance.
- For voice sound used in the information channel, TCU receives the text data from the Nissan CARWINGS Data Center through the TEL antenna in packet communication and sends it to the AV control unit. The AV control unit converts the text data to voice signal and sends it to the front speaker.
- If CARWINGS reading voice is output while the audio is ON and/or the voice guidance is being output, these audio sounds are muted and only the CARWINGS reading voice is output.
- Various vehicle information data (battery condition, driving distance, warning display, etc.) is sent to the Nissan CARWINGS Data Center to store the data. The timing for transmission is the information channel, ECO drive connection, fastest route search and connection to operator service.

Remote Air Conditioning (Immediate ON/Timer Reservation) Operation

Before/after driving the vehicle, remote air conditioning operation can be performed through the Nissan CARWINGS Data Center by operating a user's cellular phone or PC. When using the remote control operation, the vehicle must be stopped in a location where radio waves between the Nissan CARWINGS Data Center and the vehicle can be received.

Immediate ON operation

- Vehicle air conditioning can be turned ON by remote control by operating a user's cellular phone or PC.

NOTE:

If air conditioning is operated with the charging plug inserted, battery power is saved.

OPERATION PRINCIPLE

- The user operates the remote air conditioning with a cellular phone or PC and sends the data to the Nissan CARWINGS Data Center via the web site.
- The Nissan CARWINGS Data Center sends the TCU start signal to the vehicle via SMS.
- The vehicle processes the TCU start signal in TCU that is received by the TEL antenna, and starts TCU.
- After startup, TCU checks the EV-CAN communication status. If it is OK, TCU receives the remote air conditioning operation from the Nissan CARWINGS Data Center via packet communication.

SYSTEM

[TELEMATICS SYSTEM]

< SYSTEM DESCRIPTION >

- TCU sends the EV system start request signal to VCM via hard wire and sends the remote air conditioning request signal via EV-CAN.
- VCM is activated to start the air conditioning. VCM sends the VCM status signal and VCM activate/deactivate signal to TCU to notify that VCM is activated. For A/C-heater operation, refer to [EVC-57. "AIR CONDITIONER CONTROL : System Description"](#).
- When the air conditioning operation is started, TCU receives the pre-A/C signal from VCM and notifies the user's cellular phone or PC through the Nissan CARWINGS Data Center via packet communication that the air conditioning is activated.

Timer reservation operation

- The vehicle air conditioning is turned ON at the time set by the user with a cellular phone or PC.

NOTE:

- If the air conditioning is operated with the charging plug inserted, battery power is saved.
- The timer is controlled by the Nissan CARWINGS Data Center.

OPERATION PRINCIPLE

- The user operates the remote air conditioning timer reservation with a cellular phone or PC and sends the data to the Nissan CARWINGS Data Center via the web site.
- The Nissan CARWINGS Data Center sends the TCU start signal to the vehicle via SMS when the timer reservation time is reached.
- The vehicle processes the TCU start signal in TCU that is received by the TEL antenna, and starts TCU.
- After startup, TCU checks the EV-CAN communication status. If it is OK, TCU receives the remote air conditioning operation from the Nissan CARWINGS Data Center via packet communication.
- TCU sends the EV system start request signal to VCM through hard wire and sends the remote air conditioning request signal via EV-CAN.
- VCM is activated to start the air conditioning. VCM sends the VCM status signal and VCM activate/deactivate signal to TCU to notify that VCM is activated. For A/C-heater operation, refer to [EVC-57. "AIR CONDITIONER CONTROL : System Description"](#).
- When the air conditioning operation is started, TCU receives the pre-A/C signal from VCM and notifies the user's cellular phone or PC through the Nissan CARWINGS Data Center via packet communication that the air conditioning is activated.
- When the operation is completed, TCU sends the VCM sleep signal to VCM via EV-CAN communication to stop operation.

NOTE:

- If the air conditioning is not turned ON, the Nissan CARWINGS Data Center sends an e-mail to the user for notification.
- During operation of the remote air conditioning, the vehicle is operating the air conditioning circuit only.
- If the power switch is turned ON during operation of the remote air conditioning, the operation stops.

Remote Charge Operation

Before/after driving the vehicle, remote charge operation can be performed through the Nissan CARWINGS Data Center by operating a user's cellular phone or PC. When using the remote control operation, the charging plug must be inserted into the vehicle and the vehicle must be stopped in a location where radio waves between the Nissan CARWINGS Data Center and vehicle can be received.

OPERATION PRINCIPLE

1. The user operates remote charge start with a cellular phone or PC and sends the data to the Nissan CARWINGS Data Center via the web site.
2. The Nissan CARWINGS Data Center sends the TCU start signal to the vehicle via SMS.
3. The vehicle processes the TCU start signal in TCU that is received by the TEL antenna, and starts TCU.
4. After startup, TCU checks the EV-CAN communication status. If it is OK, TCU receives the remote charge operation from the Nissan CARWINGS Data Center via packet communication.
5. TCU sends the EV system start request signal to VCM via hard wire and sends the remote air conditioning request signal via EV-CAN.
6. When VCM is activated and charging is started, VCM sends the VCM status signal and VCM activate/deactivate signal to TCU to notify that VCM is activated. For charging operation, refer to [EVC-52. "LI-ION BATTERY CHARGE CONTROL : System Description"](#).
7. When charge is started, TCU receives the charge status signal and the remaining time to charge completion signal from VCM, and the charge status is sent to the user's cellular phone or PC through the Nissan CARWINGS Data Center via packet communication.
8. When charge is completed, TCU receives the charge status signal from VCM that charge is stopped, and notifies the user's cellular phone or PC through the Nissan CARWINGS Data Center via packet communication that the charge is completed.

A

B

C

D

E

F

G

H

I

J

K

L

M

AV

O

P

< SYSTEM DESCRIPTION >

9. When the timer operation is completed, TCU sends the VCM sleep signal to VCM to stop operation.

NOTE:

- If charge is not started, the Nissan CARWINGS Data Center sends an e-mail to the user for notification.
- If charge is abnormally ended for any reason, an e-mail indicating completion of charge in the same manner as a normal charge is notified. After charging, check the charge status.

Automatic Notification for Unplugged Status/Charge Status

TCU detects the charge status and notifies the Nissan CARWINGS Data Center of non-plug insertion and charge stop.

Notification of unplugged status

- When the power switch is OFF, check the charging plug fitting status after the time set on the screen. If the charging plug is not inserted, a notification is sent to the user's cellular phone and PC through the Nissan CARWINGS Data Center.
- The system operates within 100 m of the location registered by the user.

OPERATION PRINCIPLE

- When the charging plug fitting check time is reached after the power switch is OFF, VCM is activated.
- Check the charging plug fitting with the charging plug connection signal and if the charging plug is not inserted, a notification is sent to the user's cellular phone and PC through the Nissan CARWINGS Data Center.

NOTE:

This process is effective only for normal charging plug and it is not compatible with quick charge.

Notification of charge status

- A completion of charge notification is sent to the user's cellular phone and PC through the Nissan CARWINGS Data Center.

OPERATION PRINCIPLE

- When charge is completed, TCU receives the charge status signal from VCM that charge is stopped, and notifies the user's cellular phone or PC through the Nissan CARWINGS Data Center via packet communication that the charge is completed.

NOTE:

- For abnormal completion (loose charging plug for any reason), the function to notify that charge operation is stopped sends an e-mail in the same manner as a normal end.
- Notification of charge status can be set between ON and OFF on the CARWINGS menu screen.

Charge Check

- The vehicle charge condition can be checked.

OPERATION PRINCIPLE

- The user operates a charge check with a cellular phone or PC and the data is sent to the Nissan CARWINGS Data Center through the web site.
- The Nissan CARWINGS Data Center sends the TCU start signal to the vehicle via SMS.
- The vehicle processes the TCU start signal in TCU that is received by the TEL antenna, and starts TCU.
- After startup, TCU checks the EV-CAN communication status. If it is OK, TCU receives the charge status check operation from the Nissan CARWINGS Data Center via packet communication.
- TCU sends the EV system start request signal to VCM via hard wire and sends the remote air conditioning request signal via EV-CAN.
- VCM starts. VCM sends the VCM status signal and VCM activate/deactivate signal to TCU to notify that VCM is activated.
- TCU receives the Li-ion battery capacity signal necessary for the remaining battery indication and full charge capacity indication from VCM and the Li-ion battery deterioration signal from Li-ion battery via EV-CAN communication.
- TCU sends the charge status to the user's cellular phone and PC through the Nissan CARWINGS Data Center via packet communication.
- When the timer operation is completed, TCU sends the VCM sleep signal to VCM to stop operation.

Drive plan

- A drive plan determined in advance can be sent to the vehicle from a PC to the vehicle through the Nissan CARWINGS Data Center.
- TCU receives the data through the TEL antenna and sends it to the AV control unit. The AV control unit converts the data into signals for display on the navigation route guide.

ECO drive

SYSTEM

< SYSTEM DESCRIPTION >

[TELEMATICS SYSTEM]

- Based on the data stored at the Nissan CARWINGS Data Center, ECO drive history, advice, ECO rank, etc. are displayed and checked with probe information.

A
B
C
D
E
F
G
H
I
J
K
L
M
AV
O
P

AV

OPERATION

Switch Name and Function

INFOID:000000010642079

Names and functions of AV control unit switches

1. Design

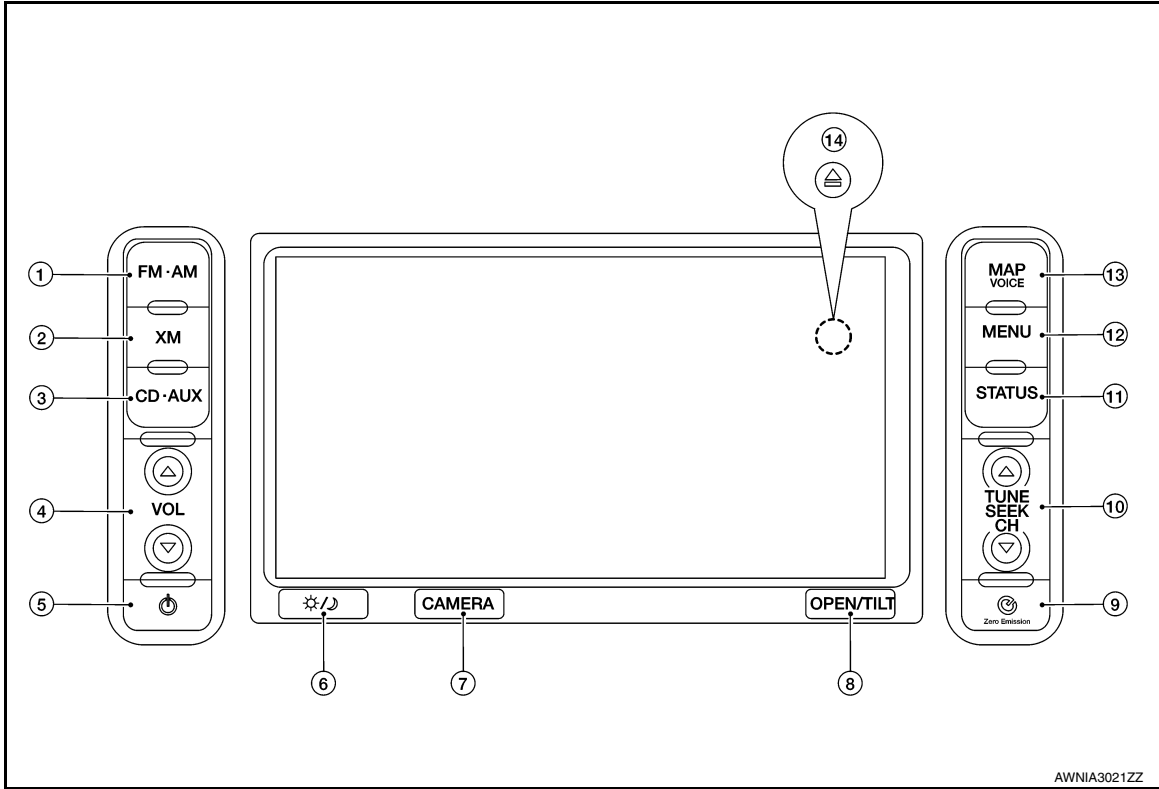

2. Switch name and function

No.	Switch name	Function
1	FM-AM	Press to switch between the FM radio band and the AM radio band.
2	XM	Press to switch to an XM satellite radio band.
3	CD-AUX	Press to switch between USB memory/iPod player ^{*1} /CD/Bluetooth [®] streaming audio ^{*2} / AUX screens.
4	VOL (volume control)	Press to adjust the volume of the stereo.
5	(audio system ON-OFF)	Press to turn the audio system ON or OFF.
6	(Day/Night)	<ul style="list-style-type: none"> Press to switch between the day screen (bright) and the night screen (dark). Press and hold to turn OFF the display, then press again to turn ON the display.
7	CAMERA	Press to turn the around view monitor system ON or OFF.
8	OPEN/TILT	<ul style="list-style-type: none"> Press to open the monitor to access the CD slot and the SD card slot. Press and hold to adjust the monitor angle (6 angles).
9	(Zero emission)	Press to display the setting screen where several useful functions for electric vehicle driving are determined.
10	TUNE/SEEK/CH	<ul style="list-style-type: none"> Press to select a track/station. Press and hold to search for a track/station automatically or to fast-forward/back-forward when listening to music.
11	STATUS	Press to display the current status of the air conditioner, radio, audio, vehicle information (estimated distance, drivable distance and average energy economy) and navigation systems.
12	MENU	Press to display the setting menu (destination, route, information, settings, phone and carwings) screen.

OPERATION

< SYSTEM DESCRIPTION >

[TELEMATICS SYSTEM]

No.	Switch name	Function
13	MAP/VOICE	<ul style="list-style-type: none"> • Press to display the current location map screen. • Press and hold to repeat voice guidance.
14	 (Disk eject)	Press to eject a disk.

- *1: Displayed when iPod® is connected.
- *2: Displayed when Bluetooth® audio is registered and “Bluetooth connection” setting is ON.

Menu Display by Pressing Each Switch

INFOID:0000000010642080

NOTE:

For Navigation system and Telematics system operation detailed information, refer to Navigation system Owner's Manual.

MENU

When the MENU switch is pressed, the menu screen is displayed.



Menu list	Description	
Destination	Change Country	When setting a destination, the country can be selected. The country that is last selected is automatically selected by the system as the default.
	New Address	Searches for a destination by address.
	Home	Searches for a route from the current location to the previously stored home destination.
	Points of interest	Searches for a destination from various categories of businesses or locations.
	Charging Station	Searches for the charging stations near the current vehicle location.
	Quick Stop	Searches for points of interest near the current vehicle location, such as restaurants, charging stations, etc.
	Address Book	Searches for a destination from the list of the stored locations.
	History	<ul style="list-style-type: none"> • Sets the previous starting point as destination. • Searches for the destination from the previous destinations.
	M-way Entrance/Exit	Searches for a destination from a motorway entrance/exit.
	Stored Routes	Selects a stored route.
	Latitude/Longitude	Searches for a destination by entering the latitude and the longitude.
	Junction	Searches for a destination from junctions.

OPERATION

< SYSTEM DESCRIPTION >

[TELEMATICS SYSTEM]

	Menu list	Description
Route	Cancel Route/ Resume Route	Cancels the current route guidance. A cancelled route can also be reactivated. If the suggested route is cancelled, "Cancel Route" changes to "Resume Route".
	Edit Route	Edit or add a destination or waypoints to the route that is already set.
	Route Info	Confirm the route by the route information or simulation. The confirmed route can also be stored.
	Guidance Voice	Activates or deactivates route, voice guidance and/or traffic announcement and adjust the volume level of voice guidance.
	Recalculate	Manually search for the route again after changing the search condition and have the system calculate a route.
	Detour	A detour of a specified distance can be calculated.
	Traffic Detour	Manually search for an alternative detour route taking the traffic information into consideration.
	Route Calculation Criteria	Changes the route calculation conditions anywhere along the route.
Information	Traffic Information	Displays the Traffic Information.
	Energy Info.	Energy information is displayed on the screen.
	Maintenance	Displays the vehicle maintenance information.
	Charging Station Info	Displays charging station information for the current location.
	Where am I?	Displays information regarding the current vehicle location.
	Voice Recognition	Displays the voice command list.
	GPS Position	Displays GPS information regarding the current vehicle location.
	Navigation Version	Displays the current navigation system version.
Settings	The following system items can be customized.	
Phone	Phonebook	Select a telephone number from the phone book, and then make a call. Before making a call, the telephone number must be registered in the phone book.
	Call History	Select a telephone number from the incoming or outgoing history lists, and then make a call.
	Handset Memory	Download the phone book from a cellular phone that is connected to the vehicle, select a telephone number from the phone book, and then make a call. Phone book data should be registered in the system after downloading the phone book from the cellular phone that is connected to the vehicle. If the phone book is not registered, a message that reminds of phone book data download is displayed.
	Keypad	Input the phone number manually using the keypad displayed on the screen.
	Volume	Adjust various settings of phone volume.
	Pair Phone	<ul style="list-style-type: none"> • When a PIN code appears on the screen, operate the compatible Bluetooth[®] cellular phone to enter the PIN code. • When the connection process is completed, the screen will returns to the Phone menu display.
	Paired Phone	The list of the registered cellular phones is displayed.
	 CARWINGS	Favorite Channels
Information Channels		Touch the preferred folder. An information channel list is displayed.
CARWINGS Records		The information channels that are referred to previously are displayed. A maximum of 3 channels are stored in the history.
Update Stations		Charging station information is updated through connection to the Nissan CARWINGS Data Center.
CARWINGS Settings		The CARWINGS system can be customized.

OPERATION

[TELEMATICS SYSTEM]

< SYSTEM DESCRIPTION >

ZERO EMISSION MENU

When the  ZERO EMISSION switch is pressed, the menu screen is displayed.

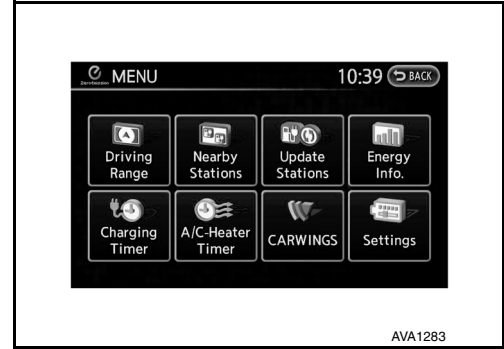

Menu list	Description
Driving Range	The estimated driving area within range, including the current position is displayed on the map screen.
Nearby Stations	Charging station information for the current position area is displayed.
Update Stations	Charging station information is updated through connection to the Nissan CARWINGS Data Center.
Energy Info.	Energy information is displayed on the screen.
Charging Timer	The timer charge function can be set.
A/C-Heater Timer (Climate Ctrl. Timer)	The A/C-Heater Timer (Climate Ctrl. Timer) function can be set.
 CARWINGS	Information channels are displayed and settings for CARWINGS can be performed.
Settings	Setting of the warning message display or the charging status notification can be performed.

MAP MENU

Map menu at current location

If the following operation is performed at the current location, the available map menu is displayed.

- Touch the "Map Menu" switch on the map.

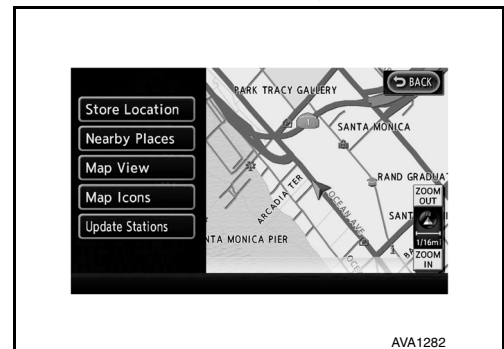

Menu item	Description
Store Location	Stores the current vehicle location in the Address Book. The stored location can be retrieved as necessary to set it as a destination (waypoint).
Quick Stop	Searches for points of interest near the current vehicle location, such as restaurants and charging stations, etc.

A
B
C
D
E
F
G
H
I
J
K
L
M
AV
O
P

OPERATION

< SYSTEM DESCRIPTION >

[TELEMATICS SYSTEM]

Menu item	Description	
Map Settings	Map View	The screen display [Plan view, Birdview [®] , split screen (2D/2D), split screen (2D/2D)] can be changed.
	Split Screen	
	Map Settings	Map Orientation (sets the map direction to North Up or Heading Up), Long Range (on/off), Birdview Angle (Changes the Birdview [®] angle), Left Settings (sets the map settings for the left screen of the split map) and Automatic Display of Highway Mode (on/off) can be set.
	Back to Map.	Return to the current position screen.
Landmark Icons	Displays map icons of certain points of interest (such as restaurants and charging stations, etc.) on the map around the current vehicle location	
Update Station	Contact the Nissan CARWINGS Data Center to update charging station around the current vehicle location.	

Map menu after scroll of map

If the following operation is performed after scrolling the map, the available map menu is displayed.

- Touch the "Map Menu" switch on the map.

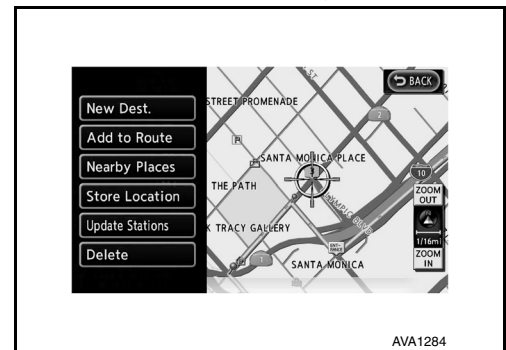

AVA1284

Menu item	Description
New Dest.	Sets the destination to the map location where [New Dest.] is touched. If a destination is already set, the location is set as the new destination.
Add to Route	Sets the map location where [Add to Route] is touched as the destination or a waypoint. This is available only when a suggested route is already set.
Quick Stop	Searches for points of interest such as restaurants and charging stations, etc. near the location by scrolling the map.
Store Location	Store the map location where [Store location] is touched in the Address Book. The stored location can be retrieved to set it as a destination or waypoint.
Update Stations	Contact the Nissan CARWINGS Data Center to update charging station around the point of the cursor.
Delete	Deletes a destination, waypoint or stored location. To delete, place the cross pointer over the corresponding icon.

HANDLING PRECAUTION

Telematics&CARWINGS

INFOID:000000010642081

- In the following cases, no CARWINGS services are available.
 - When the user is not subscribed to the service.
 - When the vehicle moves out of the radio receiving zone
 - When the radio wave reception environment is not suitable for data communication.
 - When the vehicle is in a location that may block radio waves such as in an underground parking lot, behind a building, and in mountainous areas.
- Because the voice exchange with the CARWINGS information center uses the data communication mode, the service area may be narrower and the connection availability may be worse than the normal telephone system.
- Communication and calls to the CARWINGS information center require additional charges.
- If the vehicle is outside the communication area of TCU or the radio wave reception condition is poor, the connection to the CARWINGS information center may not be available or interrupted.
- If the communication is interrupted during a data download through any of the available services, the data must be downloaded again from the beginning.
- Because each of the available services uses data communication services, the connection to the CARWINGS information center may not be available even when the radio reception symbols indicate a good status. This is not a malfunction. In such a case, try to connect again after a short period of time.
- When transferring the vehicle, always cancel the membership. For details about the cancellation procedure, contact the CARWINGS customer center.

A
B
C
D
E
F
G
H
I
J
K
L
M
O
P

AV

DIAGNOSIS SYSTEM (TCU)

CONSULT Function

INFOID:000000010642082

CONSULT FUNCTIONS

CONSULT performs the following functions via communication with the TCU.

Direct Diagnostic Mode	Description
Ecu Identification	The AV control unit part number is displayed.
Self Diagnostic Result	The AV control unit self diagnostic results are displayed.
Data Monitor	The AV control unit input/output data is displayed in real time.
Work support	The settings for AV control unit functions can be changed.
CAN Diag Support Mntr	<ul style="list-style-type: none"> • The result of transmit/receive diagnosis of AV communication is displayed. • The result of transmit/receive diagnosis of CAN communication is displayed.

ECU IDENTIFICATION

The part number of TCU is displayed.

SELF DIAGNOSTIC RESULT

Refer to [AV-528. "DTC Index"](#).

DATA MONITOR

Monitor Item [Unit]	Description
ECHO CANCEL [TYPE 1]	Echo cancel type is displayed.
NOISE CANCEL [TYPE 1]	Noise cancel type is displayed.
TCU STANDBY TIME [2DAYS/14DAYS/30DAYS]	TCU standby time is displayed.
NAD OUTPUT STATUS [On/Off]	TCU activation is displayed.

WORK SUPPORT

Conditions	Description
SAVE VIN DATA	VIN data saved in TCU is stored in CONSULT.
CENTER CONNECTION SETTING	Connection to CARWINGS data center can be set.
TCU ACTIVATE SETTING	Off: TCU activation Off.
	On: TCU activation On.
WRITE VIN DATA	VIN data from SAVE VIN DATA can be written to new TCU.
WRITE VIN DATA (MANUAL)	VIN data can be manually written to new TCU.

CAN DIAG SUPPORT MNTR

Refer to [LAN-14. "CAN Diagnostic Support Monitor"](#).

ECU DIAGNOSIS INFORMATION

TCU

Reference Value

INFOID:0000000010642083

TERMINAL LAYOUT

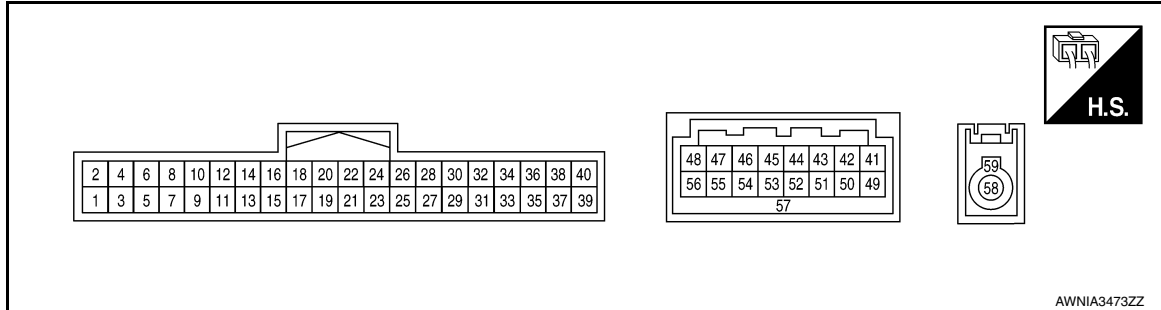

INPUT/OUTPUT SIGNAL STANDARD

Terminal (Wire color)		Description		Condition		Reference value (Approx.)
+	-	Signal name	Input/ Output	Power switch	Operation	
1 (W)	Ground	Battery power supply	Input	OFF	—	Battery Voltage
2 (B)	—	Ground	—	—	—	—
3 (L)	Ground	ACC power supply	Input	ACC	—	Battery Voltage
4 (W)	Ground	Power signal	Input	ON	—	Battery Voltage
9 (L)	—	CAN (H)	Input/ Output	—	—	—
10 (G)	—	CAN (L)	Input/ Output	—	—	—
41 (Y)	Ground	U-VOICE signal	Input	—	—	—
42 (B)	—	VOICE ground	—	—	—	—
46 (V)	Ground	Manufacturer Specific signal	—	—	—	—
47 (BR)	Ground	USB V BUS signal	Input	ON	—	5 V
48 (L)	Ground	USB D- signal	Input/ Output	—	—	—
49 (G)	Ground	D-VOICE signal	Output	—	—	—
55 (Shield)	—	USB ground	—	ON	—	—
56 (R)	Ground	USB D+ signal	Input/ Output	ON	—	—
57 (Shield)	—	USB signal shield	—	—	—	—

TCU

< ECU DIAGNOSIS INFORMATION >

[TELEMATICS SYSTEM]

Terminal (Wire color)		Description		Condition		Reference value (Approx.)
+	-	Signal name	Input/ Output	Power switch	Operation	
58	—	TEL antenna signal	Input	ACC	TEL antenna disconnected.	2.8 V
59 (Shield)	—	TEL antenna signal shield	—	—	—	—

DTC Index

INFOID:000000010642084

DTC	Display item	Refer to
U1000	CAN COMM CIRC [U1000]	AV-580. "Diagnosis Procedure"
U1010	CONTROL UNIT (CAN) [U1010]	AV-581. "DTC Logic"
U1A00	ACC NO CONN [U1A00]	AV-582. "Diagnosis Procedure"
U1A01	INTERNAL ERROR (TCU) [U1A01]	AV-583. "DTC Logic"
U1A02	TEL COMMUNICATION MODULE [U1A02]	AV-584. "DTC Logic"
U1A03	SIM CARD [U1A03]	AV-585. "DTC Logic"
U1A04	VIN UNFINISHED [U1A04]	AV-586. "DTC Logic"
U1A05	USB COMM [U1A05]	AV-587. "Diagnosis Procedure"
U1A07	TEL ANTENNA SHORT [U1A07]	AV-588. "Diagnosis Procedure"
U1A08	TEL ANTENNA NO CONN [U1A08]	AV-589. "Diagnosis Procedure"

WIRING DIAGRAM

NAVIGATION WITHOUT BOSE

Wiring Diagram

INFOID:0000000010642085

NAVIGATION SYSTEM - WITHOUT BOSE AUDIO SYSTEM

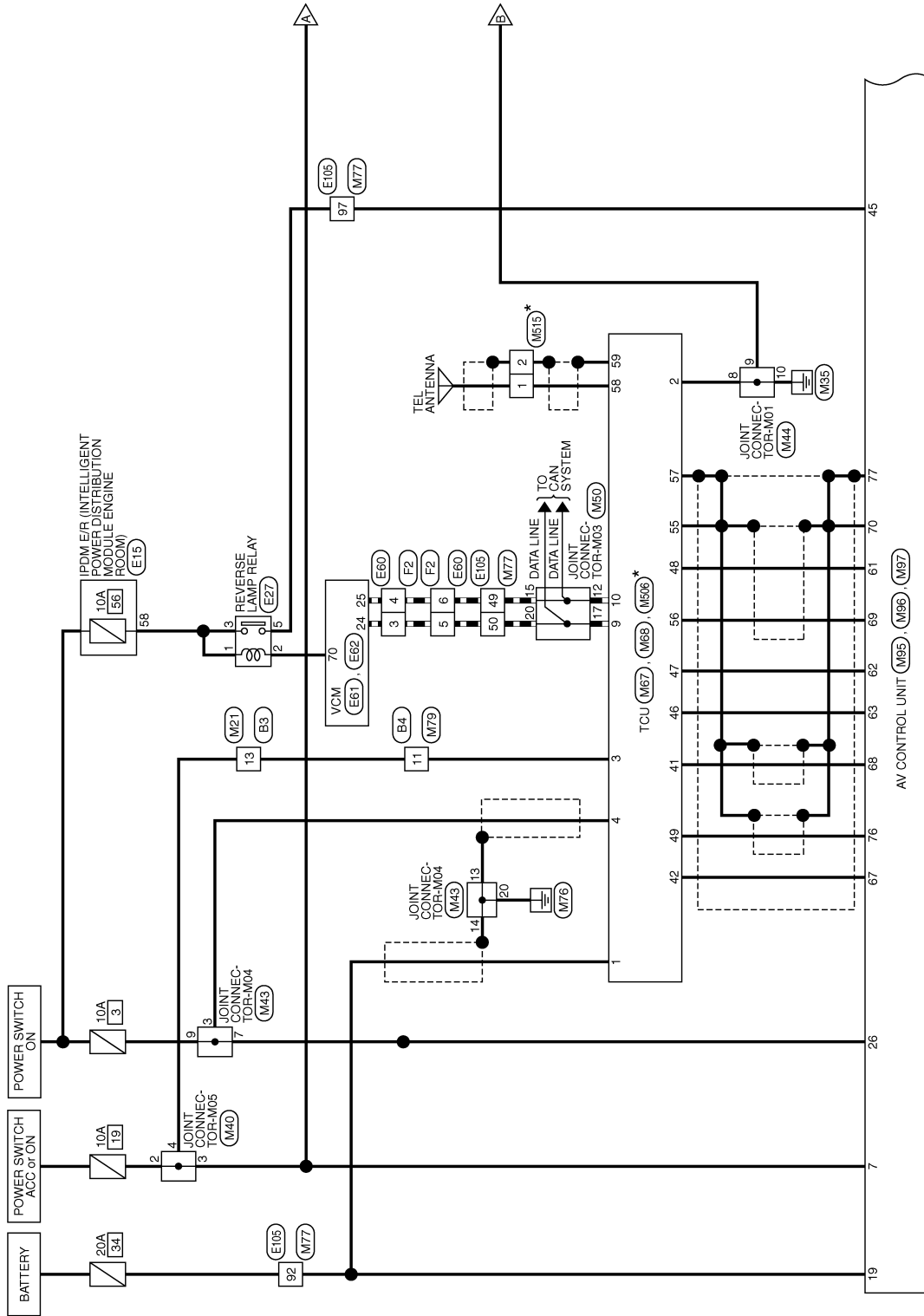

*: THIS CONNECTOR IS NOT SHOWN IN "HARNES LAYOUT" OF PG SECTION.

AANWA1072GB

A
B
C
D
E
F
G
H
I
J
K
L
M
P

AV

NAVIGATION WITHOUT BOSE

< WIRING DIAGRAM >

[TELEMATICS SYSTEM]

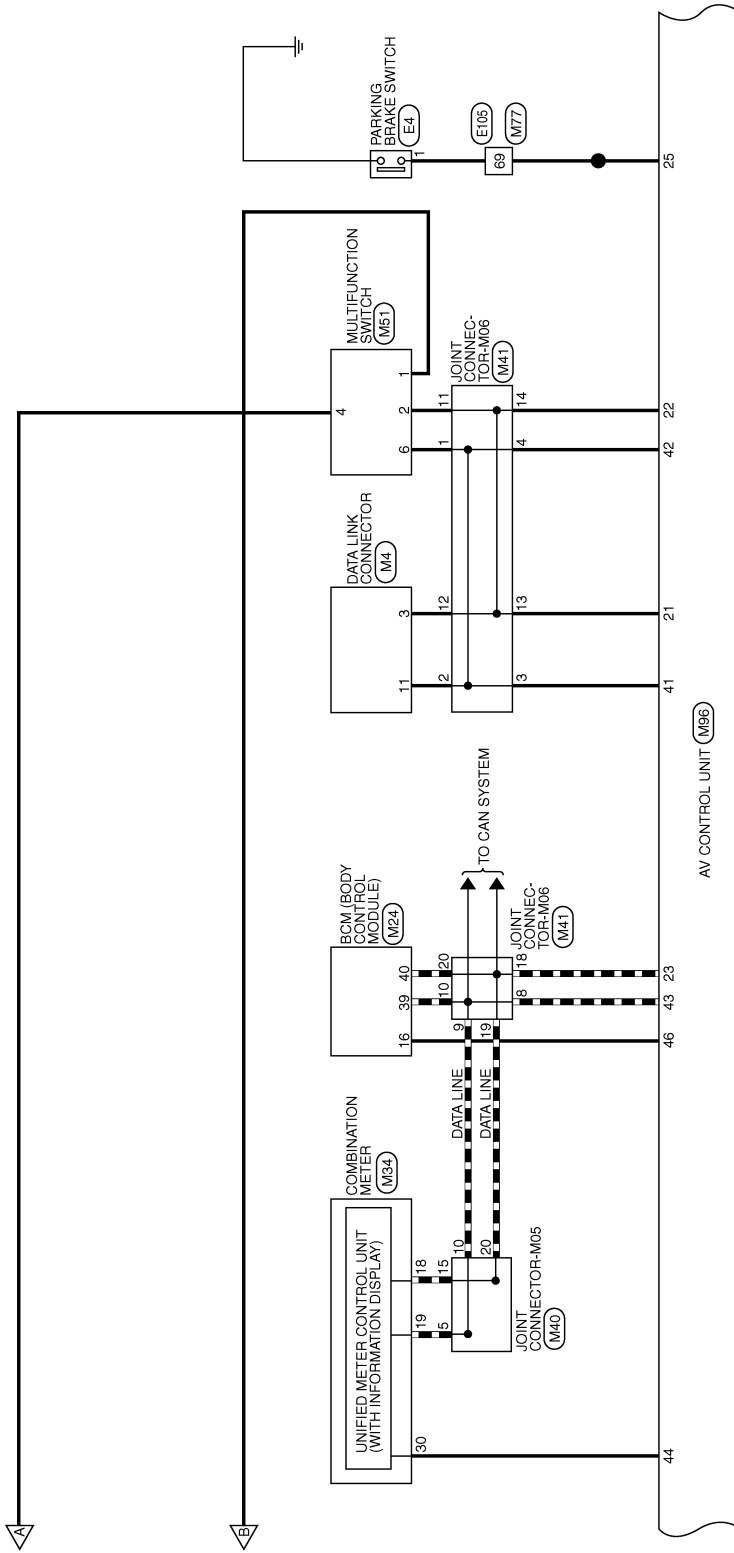

AANWA1073GB

NAVIGATION WITHOUT BOSE

< WIRING DIAGRAM >

[TELEMATICS SYSTEM]

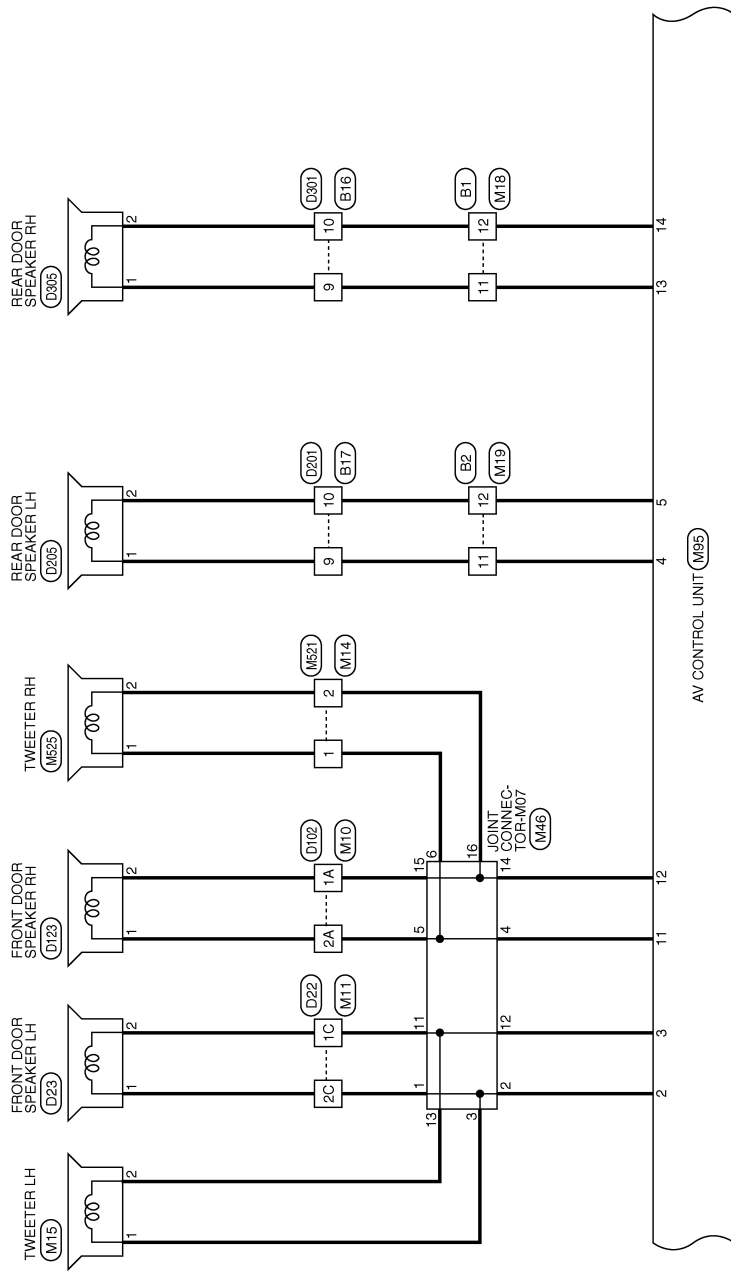

A
B
C
D
E
F
G
H
I
J
K
L
M
N
O
P

AV

AANWA1074GB

NAVIGATION WITHOUT BOSE

< WIRING DIAGRAM >

[TELEMATICS SYSTEM]

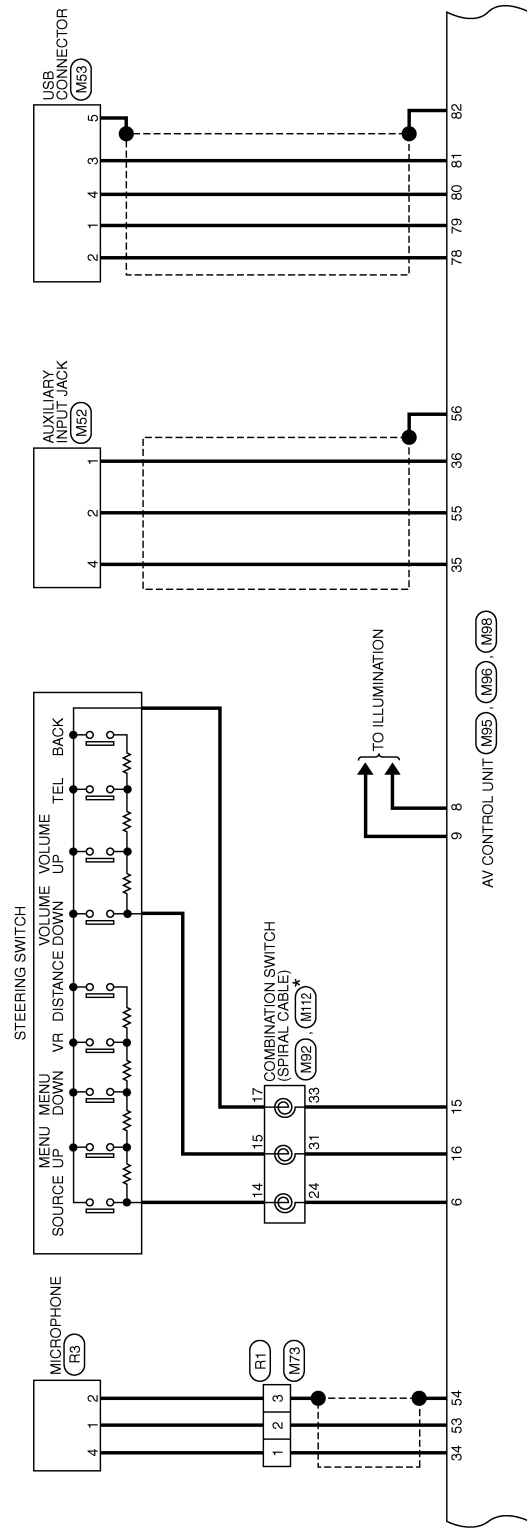

*: THIS CONNECTOR IS NOT SHOWN IN "HARNESS LAYOUT" OF PG SECTION.

AANWA1075GB

NAVIGATION WITHOUT BOSE

< WIRING DIAGRAM >

[TELEMATICS SYSTEM]

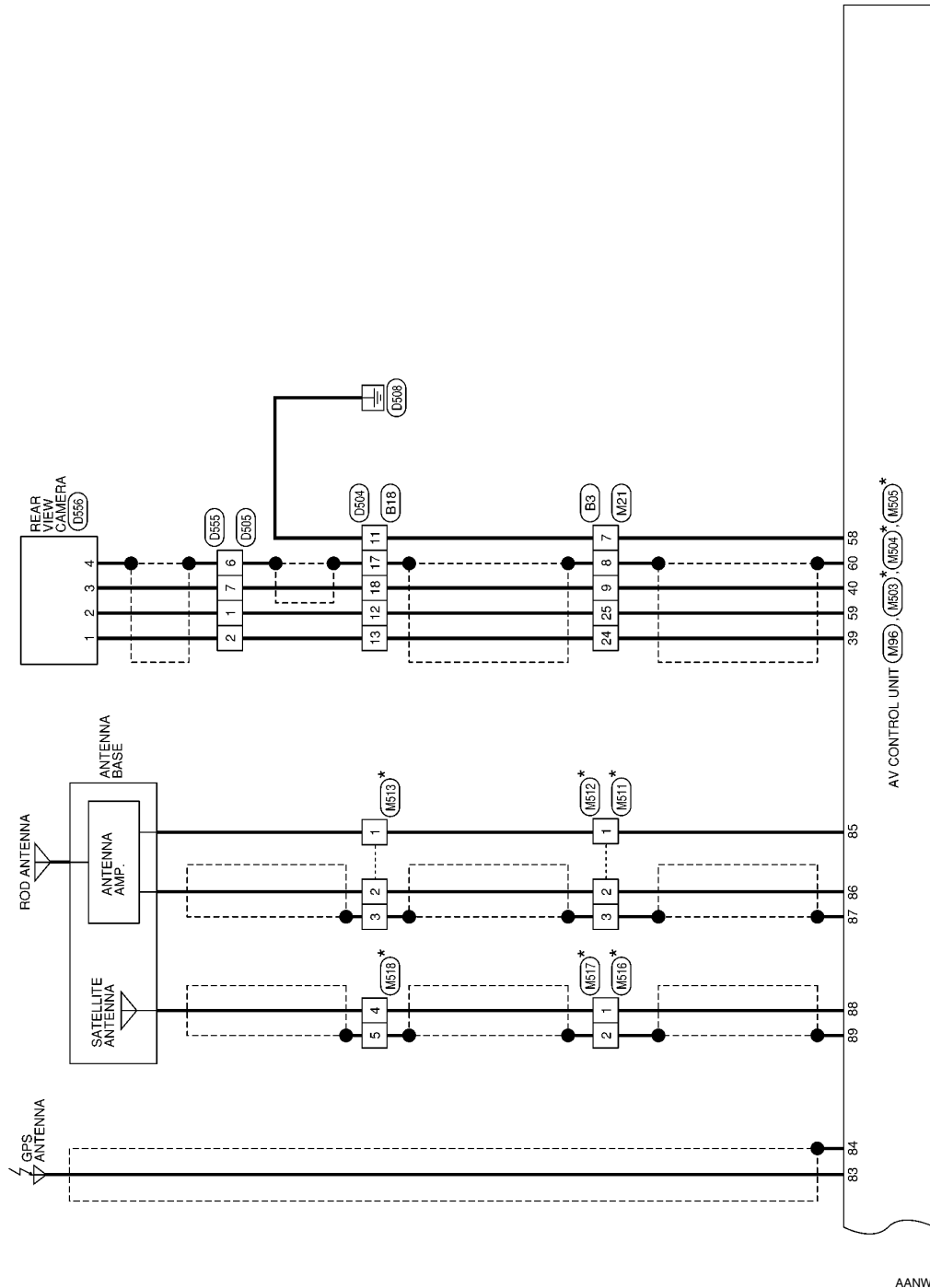

AANWA1076GB

A
B
C
D
E
F
G
H
I
J
K
L
M
O
P

AV

NAVIGATION SYSTEM - WITHOUT BOSE AUDIO SYSTEM - CONNECTORS

Connector No.	M4
Connector Name	DATA LINK CONNECTOR
Connector Color	WHITE

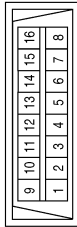

Terminal No.	Color of Wire	Signal Name
3	LG	-
11	SB	-

Connector No.	M10
Connector Name	WIRE TO WIRE
Connector Color	WHITE

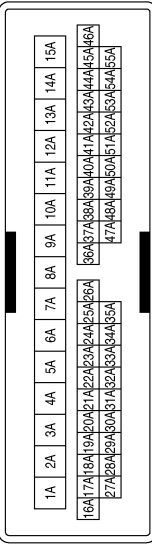

Terminal No.	Color of Wire	Signal Name
1A	R	- (WITHOUT BOSE)
2A	G	- (WITHOUT BOSE)

Connector No.	M11
Connector Name	WIRE TO WIRE
Connector Color	WHITE

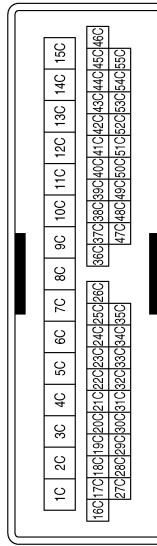

Terminal No.	Color of Wire	Signal Name
1C	P	- (WITHOUT BOSE)
2C	L	- (WITHOUT BOSE)

Connector No.	M14
Connector Name	WIRE TO WIRE
Connector Color	BROWN



Terminal No.	Color of Wire	Signal Name
1	G	- (WITHOUT BOSE)
2	R	- (WITHOUT BOSE)

NAVIGATION WITHOUT BOSE

< WIRING DIAGRAM >

[TELEMATICS SYSTEM]

Connector No.	M15
Connector Name	TWEETER LH
Connector Color	BROWN



Terminal No.	Color of Wire	Signal Name
1	W	-(WITHOUT BOSE)
2	P	-(WITHOUT BOSE)

Connector No.	M18
Connector Name	WIRE TO WIRE
Connector Color	WHITE

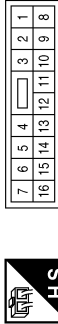

Terminal No.	Color of Wire	Signal Name
11	LG	-(WITHOUT BOSE-EXCEPT MEXICO)
12	P	-(WITHOUT BOSE-EXCEPT MEXICO)

Connector No.	M19
Connector Name	WIRE TO WIRE
Connector Color	WHITE

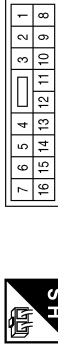

Terminal No.	Color of Wire	Signal Name
11	V	-
12	LG	-

Connector No.	M21
Connector Name	WIRE TO WIRE
Connector Color	WHITE



Terminal No.	Color of Wire	Signal Name
7	B	-
8	SHIELD	-
9	R	-
13	GR	-
24	W	-
25	B	-

Connector No.	M24
Connector Name	BCM (BODY CONTROL MODULE)
Connector Color	BLACK

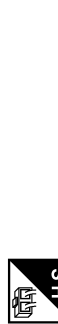

Terminal No.	Color of Wire	Signal Name
16	R	MR OUTPUT
39	L	CAN-H
40	P	CAN-L

Connector No.	M34
Connector Name	COMBINATION METER
Connector Color	WHITE

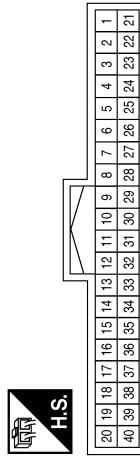

Terminal No.	Color of Wire	Signal Name
18	P	CAN-L
19	L	CAN-H
30	GR	SPEED 8PR

AANIA2712GB

A
B
C
D
E
F
G
H
I
J
K
L
M
N
O
P

AV

NAVIGATION WITHOUT BOSE

< WIRING DIAGRAM >

[TELEMATICS SYSTEM]

Terminal No.	Color of Wire	Signal Name
8	L	-
9	L	-
10	L	-
11	LG	-
12	LG	-
13	LG	-
14	LG	-
18	P	-
19	P	-
20	P	-

Connector No.	M41
Connector Name	JOINT CONNECTOR-M06
Connector Color	BLUE

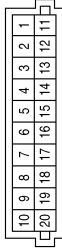

Terminal No.	Color of Wire	Signal Name
1	SB	-
2	SB	-
3	SB	-
4	SB	-

Connector No.	M40
Connector Name	JOINT CONNECTOR-M05
Connector Color	BLUE

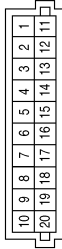

Terminal No.	Color of Wire	Signal Name
2	L	-
3	BR	-
4	GR	-
5	L	-
10	L	-
15	P	-
20	P	-

Connector No.	M44
Connector Name	JOINT CONNECTOR-M01
Connector Color	GRAY

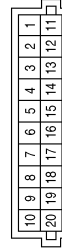

Terminal No.	Color of Wire	Signal Name
8	B	-
9	B	-
10	B	-

Connector No.	M43
Connector Name	JOINT CONNECTOR-M04
Connector Color	GRAY

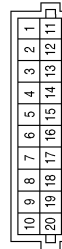

Terminal No.	Color of Wire	Signal Name
3	W	-
7	Y	-
9	W	-
13	B	-
14	B	-
20	B	-

AANIA2713GB

NAVIGATION WITHOUT BOSE

< WIRING DIAGRAM >

[TELEMATICS SYSTEM]

Connector No.	M50
Connector Name	JOINT CONNECTOR-M03
Connector Color	PINK

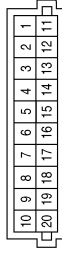

Terminal No.	Color of Wire	Signal Name
12	G	-
15	G	-
17	L	-
20	L	-

Terminal No.	Color of Wire	Signal Name
5	G	-
6	G	-
11	P	-
12	P	-
13	P	-
14	R	-
15	R	-
16	R	-

Connector No.	M46
Connector Name	JOINT CONNECTOR-M07
Connector Color	ORANGE



Terminal No.	Color of Wire	Signal Name
1	L	-
2	L	-
3	W	-
4	G	-

Connector No.	M53
Connector Name	USB CONNECTOR
Connector Color	GREEN

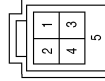

Terminal No.	Color of Wire	Signal Name
1	G	-
2	W	-
3	R	-
4	L	-
5	SHIELD	-

Connector No.	M52
Connector Name	AUXILIARY INPUT JACK
Connector Color	WHITE



Terminal No.	Color of Wire	Signal Name
1	B	-
2	W	-
3	-	-
4	R	-

Connector No.	M51
Connector Name	MULTIFUNCTION SWITCH
Connector Color	WHITE

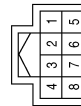

Terminal No.	Color of Wire	Signal Name
1	B	-
2	LG	-
3	-	-
4	L	-
5	-	-
6	SB	-
7	-	-
8	-	-

AANIA2714GB

A
B
C
D
E
F
G
H
I
J
K
L
M
N
O
P

AV

NAVIGATION WITHOUT BOSE

< WIRING DIAGRAM >

[TELEMATICS SYSTEM]

Connector No.	M67
Connector Name	TCU
Connector Color	WHITE



2	4	6	8	10	12	14	16	18	20	22	24	26	28	30	32	34	36	38	40	
1	1	3	5	7	9	11	13	15	17	19	21	23	25	27	29	31	33	35	37	39

Terminal No.	Color of Wire	Signal Name
1	W	B+
2	B	GND
3	L	ACC
4	W	IGN
5	-	-
6	-	-

Terminal No.	Color of Wire	Signal Name
7	-	-
8	-	-
9	L	EV CAN H
10	G	EV CAN L
11	-	-
12	-	-
13	-	-
14	-	-
15	-	-
16	-	-
17	-	-
18	-	-
19	-	-
20	-	-
21	-	-
22	-	-
23	-	-

Terminal No.	Color of Wire	Signal Name
24	-	-
25	-	-
26	-	-
27	-	-
28	-	-
29	-	-
30	-	-
31	-	-
32	-	-
33	-	-
34	-	-
35	-	-
36	-	-
37	-	-
38	-	-
39	-	-
40	-	-

Connector No.	M68
Connector Name	TCU
Connector Color	GRAY



48	47	46	45	44	43	42	41
56	55	54	53	52	51	50	49

Terminal No.	Color of Wire	Signal Name
41	Y	U VOICE
42	B	VOICE GND
43	-	-
44	-	-
45	-	-

Terminal No.	Color of Wire	Signal Name
46	V	MANUFACTURE SPECIFIC
47	BR	VBUS
48	L	D-
49	G	D VOICE
50	-	-
51	-	-
52	-	-
53	-	-
54	-	-
55	SHIELD	GND
56	R	D+
57	SHIELD	CONN CHASSIS GND

Connector No.	M73
Connector Name	WIRE TO WIRE
Connector Color	WHITE



1	2	3	4	5	6	7	8
9	10	11	12	13	14	15	16

Terminal No.	Color of Wire	Signal Name
1	P	-
2	L	-
3	SHIELD	-

Connector No.	M79
Connector Name	WIRE TO WIRE
Connector Color	WHITE

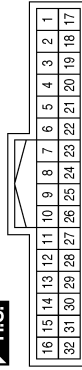

Terminal No.	Color of Wire	Signal Name
11	L	-

Terminal No.	Color of Wire	Signal Name
49	G	-
50	L	-
69	BG	-
92	BR	-
97	G	-

Connector No.	M77
Connector Name	WIRE TO WIRE
Connector Color	WHITE

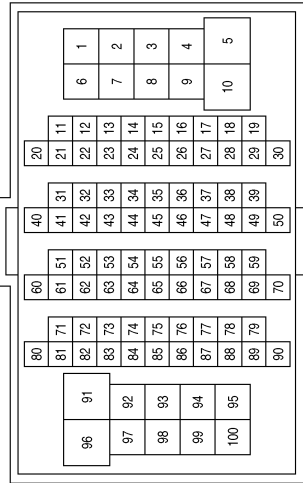

Terminal No.	Color of Wire	Signal Name
7	BR	ACC
8	B	ILL CONT
9	W	ILL
10	-	-
11	G	FR RH PRE+
12	R	FR RH PRE-
13	LG	RR RH PRE+
14	P	RR RH PRE-
15	B	STRG SW GND
16	W	STRG SW B
17	-	-
18	-	-
19	BR	BAT
20	-	-

Connector No.	M95
Connector Name	AV CONTROL UNIT (WITH NAVIGATION SYSTEM WITHOUT BOSE)
Connector Color	WHITE

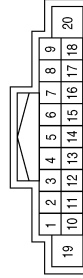

Terminal No.	Color of Wire	Signal Name
1	-	-
2	L	FR LH PRE+
3	P	FR LH PRE-
4	V	RR LH PRE+
5	LG	RR LH PRE-
6	R	STRG SW A

Connector No.	M92
Connector Name	COMBINATION SWITCH (SPIRAL CABLE)
Connector Color	GRAY

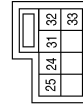

Terminal No.	Color of Wire	Signal Name
24	R	-
31	W	-
33	B	-

AANIA2716GB

A
B
C
D
E
F
G
H
I
J
K
L
M
N
O
P

AV

NAVIGATION WITHOUT BOSE

< WIRING DIAGRAM >

[TELEMATICS SYSTEM]

Terminal No.	Color of Wire	Signal Name
44	GR	SPEED
45	G	REVERSE SIG
46	R	MR OUTPUT
47	-	-
48	-	-
49	-	-
50	-	-
51	-	-
52	-	-
53	L	MIC SIG
54	SHIELD	MIC GND
55	W	AUX AUDIO RH
56	SHIELD	AUX SHIELD
57	-	-
58	B	RV CAM DETECT
59	W	CAMERA GND
60	SHIELD	R CAMERA SHIELD

Terminal No.	Color of Wire	Signal Name
27	-	-
28	-	-
29	-	-
30	-	-
31	-	-
32	-	-
33	-	-
34	P	MIC VCC
35	R	AUX AUDIO LH
36	B	AUX AUDIO-
37	-	-
38	-	-
39	R	CAMERA V+
40	R	R CAMERA SIG
41	SB	M CAN H TRM
42	SB	M CAN H
43	L	CAN-H

Connector No.	M96
Connector Name	AV CONTROL UNIT (WITH NAVIGATION SYSTEM WITHOUT BOSE)
Connector Color	WHITE

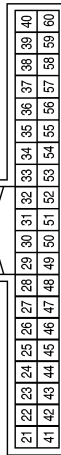

Terminal No.	Color of Wire	Signal Name
21	LG	M CAN L TRM
22	LG	M CAN L
23	P	CAN-L
24	-	-
25	Y	PKB SIG
26	V	IGN

Connector No.	M98
Connector Name	AV CONTROL UNIT (WITH NAVIGATION SYSTEM WITHOUT BOSE)
Connector Color	BLUE



Terminal No.	Color of Wire	Signal Name
78	W	V BUS
79	G	USB GND
80	L	USB D+
81	R	USB D-
82	SHIELD	SHIELD

Terminal No.	Color of Wire	Signal Name
64	-	-
65	-	-
66	-	-
67	B	GND
68	Y	U-VOICE
69	R	USB D+
70	SHIELD	USB GND
71	-	-
72	-	-
73	-	-
74	-	-
75	-	-
76	G	D-VOICE
77	SHIELD	SHIELD

Connector No.	M97
Connector Name	AV CONTROL UNIT (WITH NAVIGATION SYSTEM WITHOUT BOSE)
Connector Color	GRAY

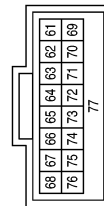

Terminal No.	Color of Wire	Signal Name
61	L	USB D-
62	BR	USB VBUS
63	V	MANUFACTURER SPECIFIC

AANIA2717GB

NAVIGATION WITHOUT BOSE

< WIRING DIAGRAM >

[TELEMATICS SYSTEM]

Connector No.	M504
Connector Name	AV CONTROL UNIT (WITH NAVIGATION SYSTEM- WITHOUT BOSE AUDIO SYSTEM)
Connector Color	GRAY

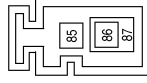

Terminal No.	Color of Wire	Signal Name
85	B	ANTENNA AMP. ON SIGNAL
86	B	RADIO ANTENNA SIGNAL
87	SHIELD	SHIELD

Connector No.	M503
Connector Name	AV CONTROL UNIT (WITH NAVIGATION SYSTEM- WITHOUT BOSE AUDIO SYSTEM)
Connector Color	GRAY



Terminal No.	Color of Wire	Signal Name
83	B	GPS ANTENNA SIGNAL
84	SHIELD	SHIELD

Connector No.	M112
Connector Name	COMBINATION SWITCH (SPIRAL CABLE)
Connector Color	GRAY

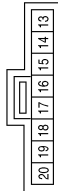

Terminal No.	Color of Wire	Signal Name
14	P	-
15	L	-
17	G	-

Connector No.	M511
Connector Name	WIRE TO WIRE
Connector Color	GRAY



Terminal No.	Color of Wire	Signal Name
1	B	-
2	B	-
3	SHIELD	-

Connector No.	M506
Connector Name	TCU
Connector Color	GRAY



Terminal No.	Color of Wire	Signal Name
58	B	TEL ANT
59	SHIELD	TEL ANT SHIELD

Connector No.	M505
Connector Name	AV CONTROL UNIT (WITH NAVIGATION SYSTEM- WITHOUT BOSE AUDIO SYSTEM)
Connector Color	PINK



Terminal No.	Color of Wire	Signal Name
88	B	SATELLITE ANTENNA
89	SHIELD	SHIELD

AANIA2718GB

A
B
C
D
E
F
G
H
I
J
K
L
M
N
O
P

AV

NAVIGATION WITHOUT BOSE

< WIRING DIAGRAM >

[TELEMATICS SYSTEM]

Connector No.	M515
Connector Name	TCU ANTENNA
Connector Color	GRAY



Terminal No.	Color of Wire	Signal Name
1	B	-
2	SHIELD	-

Connector No.	M513
Connector Name	ANTENNA BASE
Connector Color	GRAY



Terminal No.	Color of Wire	Signal Name
1	B	-
2	B	-
3	SHIELD	-

Connector No.	M512
Connector Name	WIRE TO WIRE
Connector Color	GRAY



Terminal No.	Color of Wire	Signal Name
1	B	-
2	B	-
3	SHIELD	-

Connector No.	M518
Connector Name	ANTENNA BASE
Connector Color	GREEN

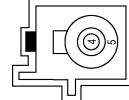

Terminal No.	Color of Wire	Signal Name
4	B	-
5	SHIELD	-

Connector No.	M517
Connector Name	WIRE TO WIRE
Connector Color	BROWN

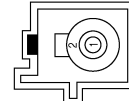

Terminal No.	Color of Wire	Signal Name
1	B	-
2	SHIELD	-

Connector No.	M516
Connector Name	WIRE TO WIRE
Connector Color	BROWN

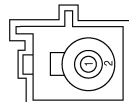

Terminal No.	Color of Wire	Signal Name
1	B	-
2	SHIELD	-

AANIA2719GB

NAVIGATION WITHOUT BOSE

< WIRING DIAGRAM >

[TELEMATICS SYSTEM]

Connector No.	E4
Connector Name	PARKING BRAKE SWITCH
Connector Color	BLACK



Terminal No.	Color of Wire	Signal Name
1	B	-

Connector No.	M525
Connector Name	TWEETER RH
Connector Color	BROWN



Terminal No.	Color of Wire	Signal Name
1	R	-
2	B	-

Connector No.	M521
Connector Name	WIRE TO WIRE
Connector Color	BROWN



Terminal No.	Color of Wire	Signal Name
1	R	-
2	B	-

Connector No.	E60
Connector Name	WIRE TO WIRE
Connector Color	BLACK



Terminal No.	Color of Wire	Signal Name
3	L	-
4	G	-
5	L	-
6	G	-

Connector No.	E27
Connector Name	REVERSE LAMP RELAY
Connector Color	BLUE



Terminal No.	Color of Wire	Signal Name
1	O	-
2	SB	-
3	O	-
5	G	-

Connector No.	E15
Connector Name	IPDM E/R (INTELLIGENT POWER DISTRIBUTION MODULE ENGINE ROOM)
Connector Color	WHITE

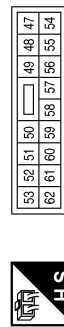

Terminal No.	Color of Wire	Signal Name
58	O	REVERSE LAMP IGN

AANIA2720GB

A
B
C
D
E
F
G
H
I
J
K
L
M
N
O
P

AV

NAVIGATION WITHOUT BOSE

< WIRING DIAGRAM >

[TELEMATICS SYSTEM]

Connector No.	E61
Connector Name	VCM
Connector Color	BLACK

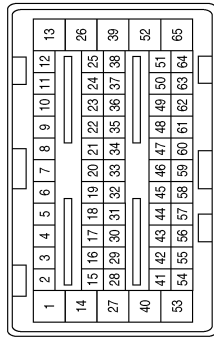

Terminal No.	Color of Wire	Signal Name
24	L	EV CAN-H
25	G	EV CAN-L

Connector No.	E62
Connector Name	VCM
Connector Color	BROWN

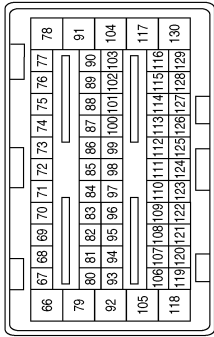

Terminal No.	Color of Wire	Signal Name
70	SB	REVERSE LAMP

Connector No.	E105
Connector Name	WIRE TO WIRE
Connector Color	WHITE

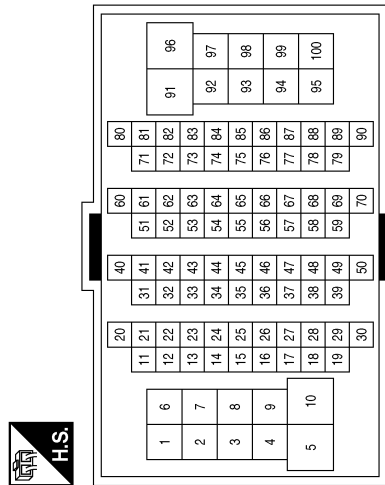

Terminal No.	Color of Wire	Signal Name
49	G	-
50	L	-
69	B	-
92	BR	-
97	G	-

Connector No.	F2
Connector Name	WIRE TO WIRE
Connector Color	BLACK

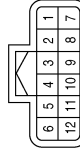

Terminal No.	Color of Wire	Signal Name
3	L	-
4	G	-
5	L	-
6	G	-

AANIA2721GB

NAVIGATION WITHOUT BOSE

< WIRING DIAGRAM >

[TELEMATICS SYSTEM]

Connector No.	B3
Connector Name	WIRE TO WIRE
Connector Color	WHITE



1	2	3	4	5	6	7	8	9	10	11	12	13	14	15	16
17	18	19	20	21	22	23	24	25	26	27	28	29	30	31	32

Terminal No.	Color of Wire	Signal Name
7	B	-
8	SHIELD	-
9	B	-
13	GR	-
24	R	-
25	W	-

Connector No.	B2
Connector Name	WIRE TO WIRE
Connector Color	WHITE



1	2	3	4	5	6	7
8	9	10	11	12	13	14
15	16					

Terminal No.	Color of Wire	Signal Name
11	V	-
12	LG	-

Connector No.	B1
Connector Name	WIRE TO WIRE
Connector Color	WHITE



6	5	4	3	2	1
12	11	10	9	8	7

Terminal No.	Color of Wire	Signal Name
11	LG	-(WITHOUT BOSE-EXCEPT MEXICO)
12	P	-(WITHOUT BOSE-EXCEPT MEXICO)

Connector No.	B17
Connector Name	WIRE TO WIRE
Connector Color	WHITE



5	4	3	2	1
12	11	10	9	8
7	6			

Terminal No.	Color of Wire	Signal Name
9	V	-(WITHOUT BOSE)
10	LG	-(WITHOUT BOSE)

Connector No.	B16
Connector Name	WIRE TO WIRE
Connector Color	WHITE



5	4	3	2	1
12	11	10	9	8
7	6			

Terminal No.	Color of Wire	Signal Name
9	LG	-(WITHOUT BOSE-EXCEPT MEXICO)
10	P	-(EXCEPT MEXICO)

Connector No.	B4
Connector Name	WIRE TO WIRE
Connector Color	WHITE



1	2	3	4	5	6	7	8	9	10	11	12	13	14	15	16
17	18	19	20	21	22	23	24	25	26	27	28	29	30	31	32

Terminal No.	Color of Wire	Signal Name
11	GR	-

AANIA2722GB

A
B
C
D
E
F
G
H
I
J
K
L
M
N
O
P

AV

NAVIGATION WITHOUT BOSE

< WIRING DIAGRAM >

[TELEMATICS SYSTEM]

Connector No.	R3
Connector Name	MICROPHONE
Connector Color	WHITE

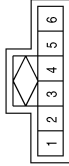

Terminal No.	Color of Wire	Signal Name
1	L	-
2	GR	-
3	-	-
4	P	-
5	-	-
6	-	-

Connector No.	R1
Connector Name	WIRE TO WIRE
Connector Color	WHITE

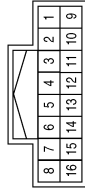

Terminal No.	Color of Wire	Signal Name
1	P	-
2	L	-
3	GR	-

Connector No.	B18
Connector Name	WIRE TO WIRE
Connector Color	WHITE

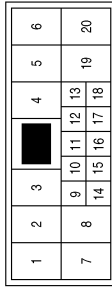

Terminal No.	Color of Wire	Signal Name
11	B	-
12	W	-
13	R	-
17	SHIELD	-
18	B	-

Connector No.	D23
Connector Name	FRONT DOOR SPEAKER LH (WITHOUT BOSE AUDIO SYSTEM)
Connector Color	WHITE



Terminal No.	Color of Wire	Signal Name
1	V	-
2	L	-

Connector No.	D22
Connector Name	WIRE TO WIRE
Connector Color	WHITE

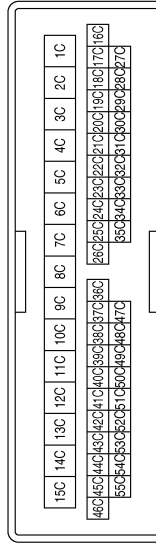

Terminal No.	Color of Wire	Signal Name
1C	L	-
2C	V	-(WITHOUT BOSE)

AANIA2723GB

NAVIGATION WITHOUT BOSE

< WIRING DIAGRAM >

[TELEMATICS SYSTEM]

Connector No.	D201
Connector Name	WIRE TO WIRE
Connector Color	WHITE

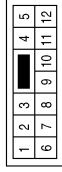

Terminal No.	Color of Wire	Signal Name
9	V	-
10	LG	-

Connector No.	D123
Connector Name	FRONT DOOR SPEAKER RH (WITHOUT BOSE AUDIO SYSTEM)
Connector Color	WHITE



Terminal No.	Color of Wire	Signal Name
1	R	-
2	BR	-

Connector No.	D102
Connector Name	WIRE TO WIRE
Connector Color	WHITE

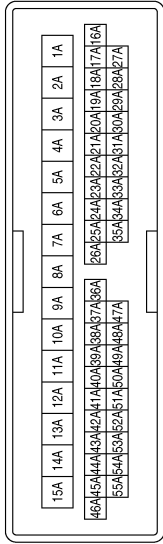

Terminal No.	Color of Wire	Signal Name
1A	BR	-
2A	R	-

Connector No.	D305
Connector Name	REAR DOOR SPEAKER RH
Connector Color	WHITE



Terminal No.	Color of Wire	Signal Name
1	LG	-
2	P	-

Connector No.	D301
Connector Name	WIRE TO WIRE
Connector Color	WHITE

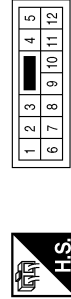

Terminal No.	Color of Wire	Signal Name
9	LG	-
10	P	-

Connector No.	D205
Connector Name	REAR DOOR SPEAKER LH
Connector Color	WHITE



Terminal No.	Color of Wire	Signal Name
1	V	-
2	LG	-

AANIA2724GB

A
B
C
D
E
F
G
H
I
J
K
L
M
AV
O
P

NAVIGATION WITHOUT BOSE

< WIRING DIAGRAM >

[TELEMATICS SYSTEM]

Connector No.	D555
Connector Name	WIRE TO WIRE
Connector Color	WHITE

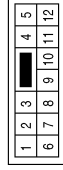

Terminal No.	Color of Wire	Signal Name
1	W	-
2	R	-
6	SHIELD	-
7	B	-

Connector No.	D505
Connector Name	WIRE TO WIRE
Connector Color	WHITE

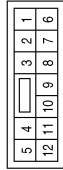

Terminal No.	Color of Wire	Signal Name
1	W	-
2	R	-
6	SHIELD	-
7	Y	-

Connector No.	D504
Connector Name	WIRE TO WIRE
Connector Color	WHITE

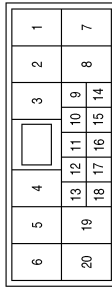

Terminal No.	Color of Wire	Signal Name
11	B	-
12	W	-
13	R	-
17	SHIELD	-
18	Y	-

Connector No.	D556
Connector Name	REAR VIEW CAMERA (WITHOUT AROUND VIEW MONITOR)
Connector Color	WHITE



Terminal No.	Color of Wire	Signal Name
1	R	-
2	W	-
3	B	-
4	SHIELD	-

AANIA2725GB

NAVIGATION WITH BOSE

Wiring Diagram

INFOID:000000010642086

NAVIGATION SYSTEM - WITH BOSE AUDIO SYSTEM

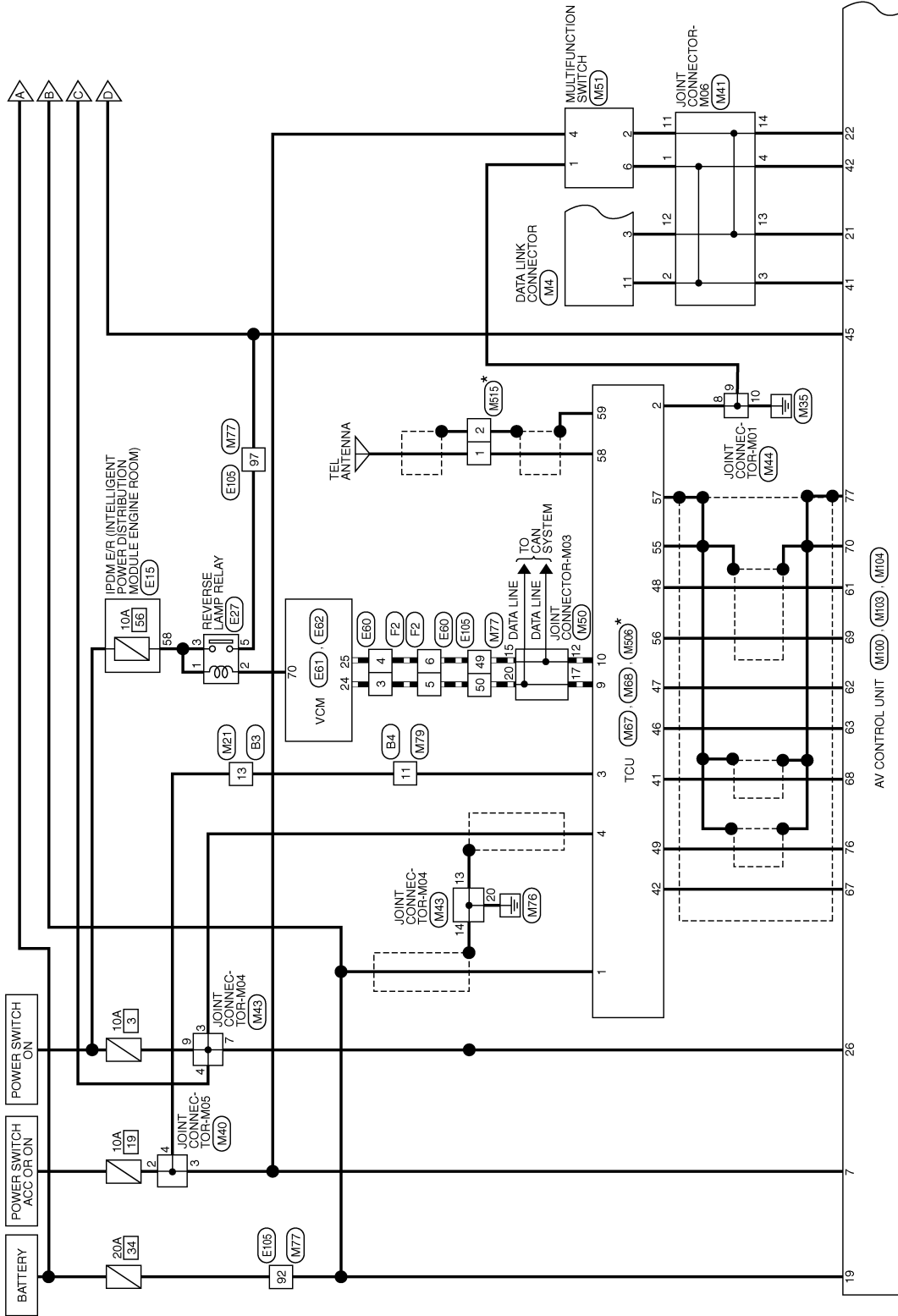

AANWA1077GB

A
B
C
D
E
F
G
H
I
J
K
L
M
N
O
P

AV

NAVIGATION WITH BOSE

< WIRING DIAGRAM >

[TELEMATICS SYSTEM]

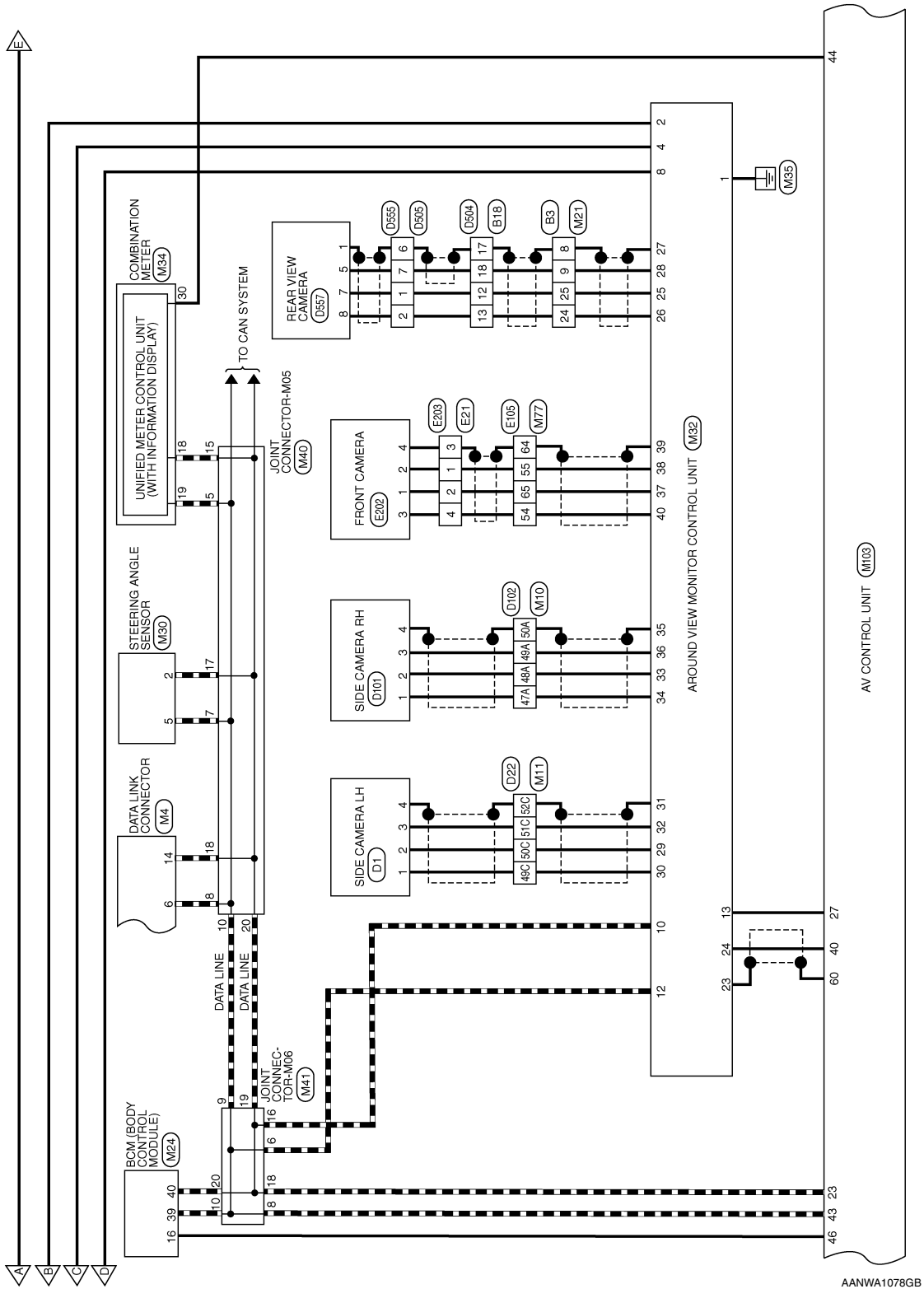

NAVIGATION WITH BOSE

< WIRING DIAGRAM >

[TELEMATICS SYSTEM]

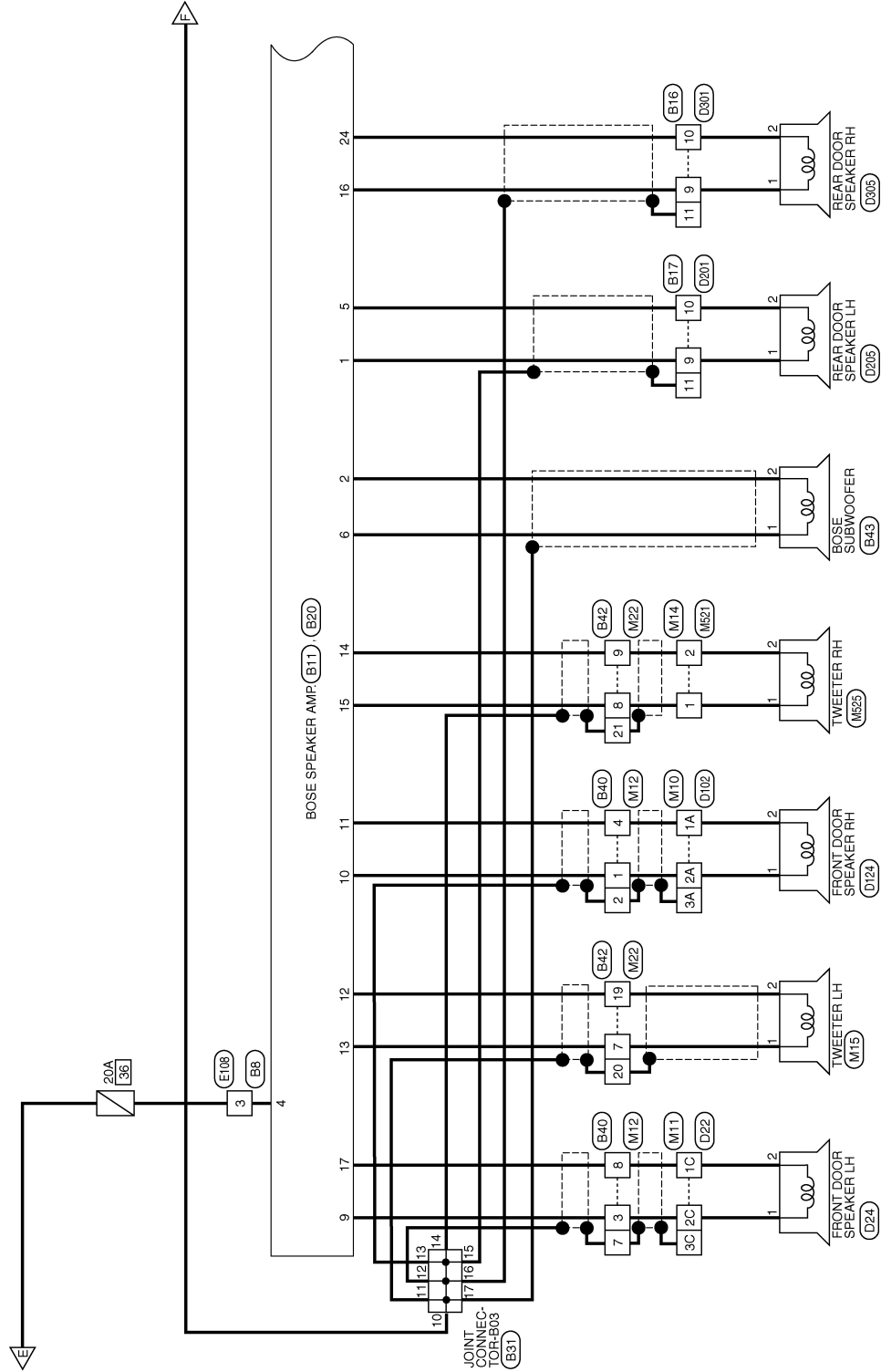

AANWA1079GB

A
B
C
D
E
F
G
H
I
J
K
L
M
AV
O
P

NAVIGATION WITH BOSE

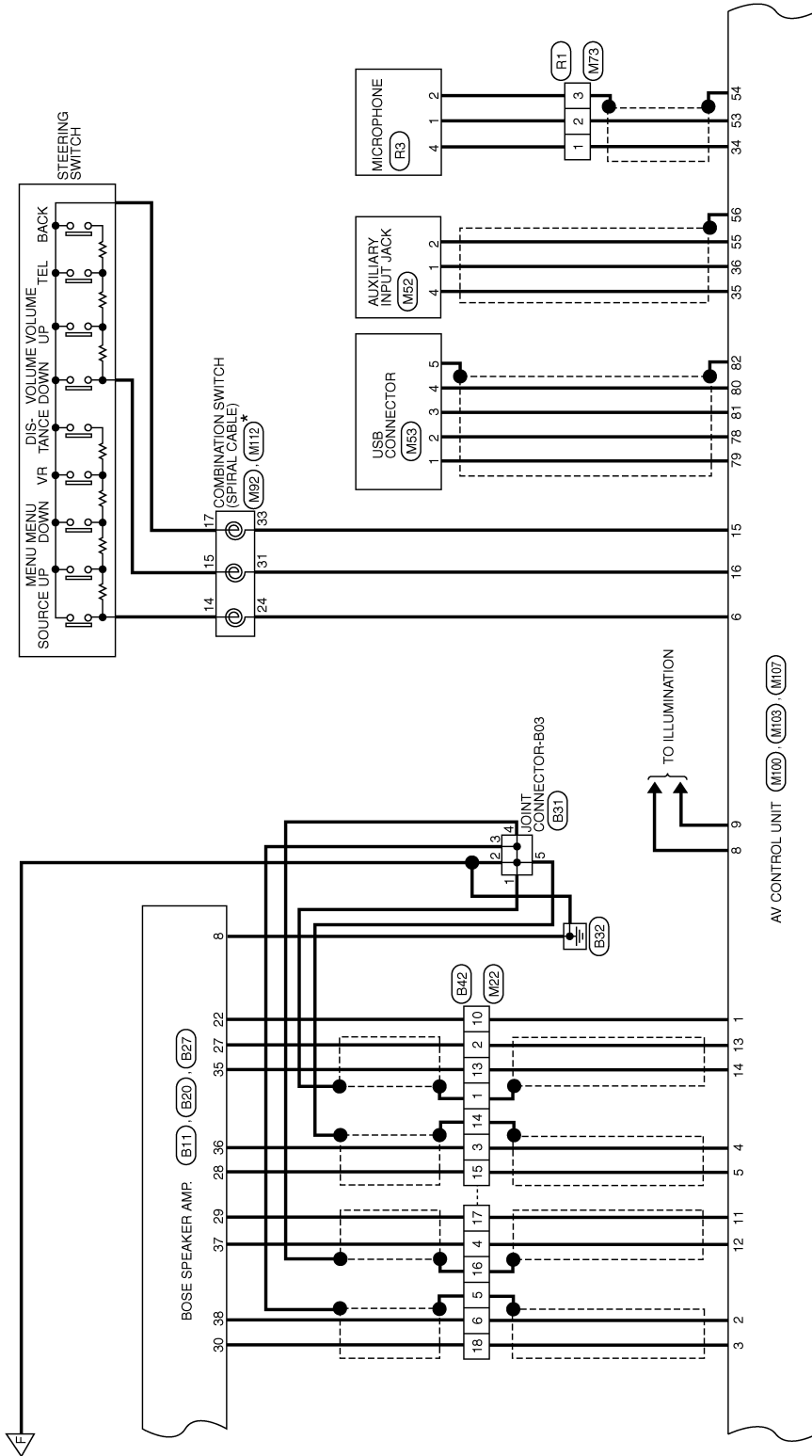

*: THIS CONNECTOR IS NOT SHOWN IN "HARNES LAYOUT" OF PG SECTION.

AANWA1080GB

NAVIGATION WITH BOSE

< WIRING DIAGRAM >

[TELEMATICS SYSTEM]

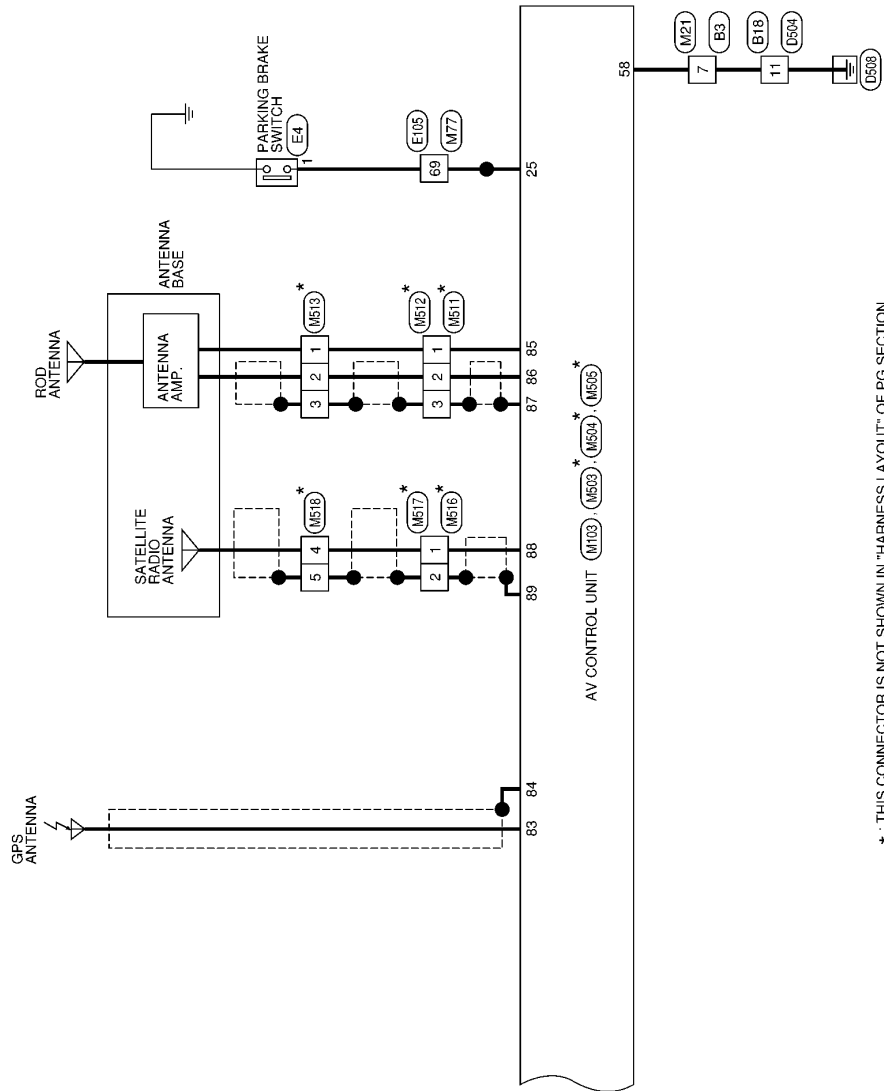

* : THIS CONNECTOR IS NOT SHOWN IN "HARNES LAYOUT" OF PG SECTION.

AANWA1081GB

A
B
C
D
E
F
G
H
I
J
K
L
M
N
O
P

AV

NAVIGATION SYSTEM - WITH BOSE AUDIO SYSTEM - CONNECTORS

Connector No.	M4
Connector Name	DATA LINK CONNECTOR
Connector Color	WHITE

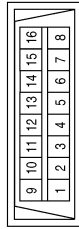

Terminal No.	Color of Wire	Signal Name
3	LG	-
6	L	-
11	SB	-
14	P	-

Connector No.	M10
Connector Name	WIRE TO WIRE
Connector Color	WHITE

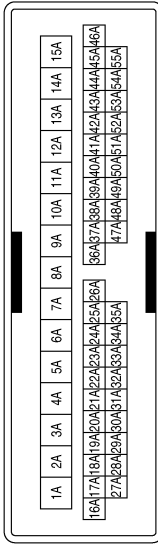

Terminal No.	Color of Wire	Signal Name
1A	L	- (WITH BOSE)
2A	P	- (WITH BOSE)
3A	SHIELD	-
47A	W	-
48A	B	-
49A	R	-
50A	SHIELD	-

Connector No.	M11
Connector Name	WIRE TO WIRE
Connector Color	WHITE

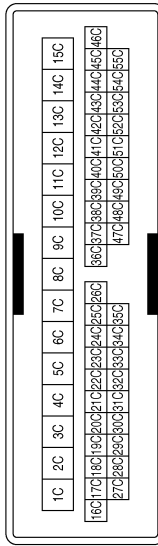

Connector No.	M12
Connector Name	WIRE TO WIRE
Connector Color	WHITE



Terminal No.	Color of Wire	Signal Name
1	P	- (WITH BOSE)
2	SHIELD	-
3	G	-
4	L	-
7	SHIELD	-
8	R	-

Connector No.	M14
Connector Name	WIRE TO WIRE
Connector Color	BROWN



Terminal No.	Color of Wire	Signal Name
1	V	- (WITH BOSE)
2	SB	- (WITH BOSE)

AANIA2738GB

NAVIGATION WITH BOSE

< WIRING DIAGRAM >

[TELEMATICS SYSTEM]

Connector No.	M15
Connector Name	TWEETER LH
Connector Color	BROWN



Terminal No.	Color of Wire	Signal Name
1	G	-(WITH BOSE)
2	R	-(WITH BOSE)

Connector No.	M21
Connector Name	WIRE TO WIRE
Connector Color	WHITE

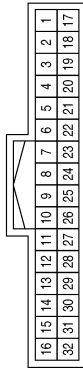

Terminal No.	Color of Wire	Signal Name
7	B	-
8	SHIELD	-
9	R	-
13	GR	-
24	W	-
25	B	-

Connector No.	M22
Connector Name	WIRE TO WIRE
Connector Color	WHITE

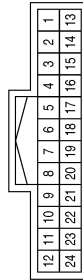
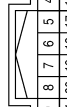

Terminal No.	Color of Wire	Signal Name
1	SHIELD	-
2	BR	-
3	P	-
4	R	-

Terminal No.	Color of Wire	Signal Name
5	SHIELD	-
6	Y	-
7	G	-
8	V	-
9	SB	-
10	L	-
13	Y	-

Terminal No.	Color of Wire	Signal Name
14	SHIELD	-
15	L	-
16	SHIELD	-
17	G	-
18	BR	-
19	R	-
20	SHIELD	-
21	SHIELD	-

AANIA2739GB

A
B
C
D
E
F
G
H
I
J
K
L
M
N
O
P

AV

Connector No.	M30
Connector Name	STEERING ANGLE SENSOR
Connector Color	WHITE

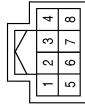

Terminal No.	Color of Wire	Signal Name
2	P	-
5	L	-

Connector No.	M24
Connector Name	BCM (BODY CONTROL MODULE)
Connector Color	BLACK

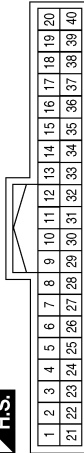

Terminal No.	Color of Wire	Signal Name
16	R	MR OUTPUT
39	L	CAN-H
40	P	CAN-L

Connector No.	M32
Connector Name	AROUND VIEW MONITOR CONTROL UNIT
Connector Color	WHITE



Terminal No.	Color of Wire	Signal Name
1	B	GND
2	SB	+B
3	-	-
4	W	IGN
5	-	-
6	-	-
7	-	-
8	SB	REVERSE

Terminal No.	Color of Wire	Signal Name
23	SHIELD	VIDEO OUTPUT GND
24	W	VIDEO OUTPUT SIGNAL
25	B	RV-POWER GND
26	W	RV-POWER 6.2V
27	SHIELD	RV-VIDEO GND
28	R	RV-VIDEO SIGNAL
29	W	SV2-POWER GND
30	B	SV2-POWER 6.2V
31	SHIELD	SV2-VIDEO GND
32	R	SV2-VIDEO SIGNAL
33	B	SV1-POWER GND
34	W	SV1-POWER 6.2V
35	SHIELD	SV1-VIDEO GND
36	R	SV1-VIDEO SIGNAL
37	W	FV-POWER GND
38	R	FV-POWER 6.2V
39	SHIELD	FV VIDEO GND
40	B	FV-VIDEO SIGNAL

Terminal No.	Color of Wire	Signal Name
9	-	-
10	P	CAN-L
11	-	-
12	L	CAN-H
13	L	LOW-PRICEAVM DISTINCTION
14	-	-
15	-	-
16	-	-
17	-	-
18	-	-
19	-	-
20	-	-
21	-	-
22	-	-

AANIA2740GB

Terminal No.	Color of Wire	Signal Name
8	L	-
10	L	-
15	P	-
17	P	-
18	P	-
20	P	-

Connector No.	M40
Connector Name	JOINT CONNECTOR-M05
Connector Color	BLUE

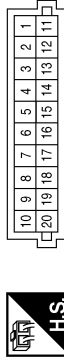

Terminal No.	Color of Wire	Signal Name
2	L	-
3	BR	-
4	GR	-
5	L	-
7	L	-

Connector No.	M34
Connector Name	COMBINATION METER
Connector Color	WHITE

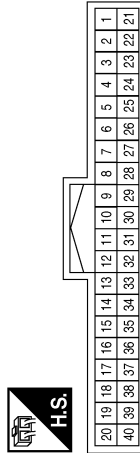

Terminal No.	Color of Wire	Signal Name
18	P	CAN-L
19	L	CAN-H
30	GR	SPEED 8PR

Connector No.	M43
Connector Name	JOINT CONNECTOR-M04
Connector Color	GRAY

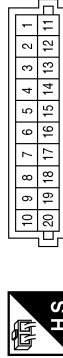

Terminal No.	Color of Wire	Signal Name
3	W	-
4	W	-
7	Y	-
9	W	-
13	B	-
14	B	-
20	B	-

Terminal No.	Color of Wire	Signal Name
12	LG	-
13	LG	-
14	LG	-
16	P	-
18	P	-
19	P	-
20	P	-

Connector No.	M41
Connector Name	JOINT CONNECTOR-M06
Connector Color	BLUE

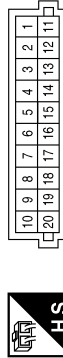

Terminal No.	Color of Wire	Signal Name
1	SB	-
2	SB	-
3	SB	-
4	SB	-
6	L	-
8	L	-
9	L	-
10	L	-
11	LG	-

AANIA2741GB

A
B
C
D
E
F
G
H
I
J
K
L
M
N
O
P

AV

Connector No.	M51
Connector Name	MULTIFUNCTION SWITCH
Connector Color	WHITE

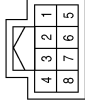

Terminal No.	Color of Wire	Signal Name
1	B	-
2	LG	-
3	-	-
4	L	-
5	-	-
6	SB	-
7	-	-
8	-	-

Connector No.	M50
Connector Name	JOINT CONNECTOR-M03
Connector Color	PINK



Terminal No.	Color of Wire	Signal Name
12	G	-
15	G	-
17	L	-
20	L	-

Connector No.	M44
Connector Name	JOINT CONNECTOR-M01
Connector Color	GRAY



Terminal No.	Color of Wire	Signal Name
8	B	-
9	B	-
10	B	-

Connector No.	M53
Connector Name	USB CONNECTOR
Connector Color	GREEN

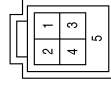

Terminal No.	Color of Wire	Signal Name
1	G	-
2	W	-
3	R	-
4	L	-
5	SHIELD	-

Connector No.	M52
Connector Name	AUXILIARY INPUT JACK
Connector Color	WHITE

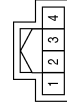

Terminal No.	Color of Wire	Signal Name
1	B	-
2	W	-
3	-	-
4	R	-

AANIA2742GB

NAVIGATION WITH BOSE

< WIRING DIAGRAM >

[TELEMATICS SYSTEM]

Terminal No.	Color of Wire	Signal Name
24	-	-
25	-	-
26	-	-
27	-	-
28	-	-
29	-	-
30	-	-
31	-	-
32	-	-
33	-	-
34	-	-
35	-	-
36	-	-
37	-	-
38	-	-
39	-	-
40	-	-

Terminal No.	Color of Wire	Signal Name
7	-	-
8	-	-
9	L	EV CAN H
10	G	EV CAN L
11	-	-
12	-	-
13	-	-
14	-	-
15	-	-
16	-	-
17	-	-
18	-	-
19	-	-
20	-	-
21	-	-
22	-	-
23	-	-

Connector No.	M67
Connector Name	TCU
Connector Color	WHITE



2	4	6	8	10	12	14	16	18	20	22	24	26	28	30	32	34	36	38	40
1	3	5	7	9	11	13	15	17	19	21	23	25	27	29	31	33	35	37	39

Terminal No.	Color of Wire	Signal Name
1	W	B+
2	B	GND
3	L	ACC
4	W	IGN
5	-	-
6	-	-

Connector No.	M73
Connector Name	WIRE TO WIRE
Connector Color	WHITE



1	2	3	4	5	6	7	8
9	10	11	12	13	14	15	16

Terminal No.	Color of Wire	Signal Name
1	P	-
2	L	-
3	SHIELD	-

Terminal No.	Color of Wire	Signal Name
46	V	MANUFACTURE SPECIFIC
47	BR	VBUS
48	L	D-
49	G	D VOICE
50	-	-
51	-	-
52	-	-
53	-	-
54	-	-
55	SHIELD	GND
56	R	D+
57	SHIELD	CONN CHASSIS GND

Connector No.	M68
Connector Name	TCU
Connector Color	GRAY



48	47	46	45	44	43	42	41
56	55	54	53	52	51	50	49

Terminal No.	Color of Wire	Signal Name
41	Y	U VOICE
42	B	VOICE GND
43	-	-
44	-	-
45	-	-

AANIA2743GB

A
B
C
D
E
F
G
H
I
J
K
L
M
N
O
P

AV

NAVIGATION WITH BOSE

< WIRING DIAGRAM >

[TELEMATICS SYSTEM]

Connector No.	M79
Connector Name	WIRE TO WIRE
Connector Color	WHITE

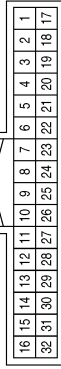

Terminal No.	Color of Wire	Signal Name
11	L	-

Terminal No.	Color of Wire	Signal Name
49	G	-
50	L	-
54	B	-
55	R	-
64	SHIELD	-
65	W	-
69	BG	-
92	BR	-
97	G	-

Connector No.	M77
Connector Name	WIRE TO WIRE
Connector Color	WHITE

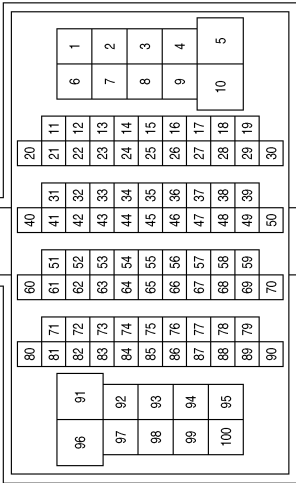

Terminal No.	Color of Wire	Signal Name
8	B	ILL CONT
9	W	ILL
10	-	-
11	G	FR RH PRE+
12	R	FR RH PRE-
13	BR	RR RH PRE+
14	Y	RR RH PRE-
15	B	STRG SW GND
16	W	STRG SW B
17	-	-
18	-	-
19	BR	BAT
20	-	-

Connector No.	M100
Connector Name	AV CONTROL UNIT (WITH NAVIGATION SYSTEM WITH BOSE)
Connector Color	WHITE

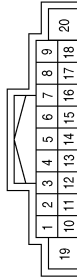

Terminal No.	Color of Wire	Signal Name
1	L	AMP ON
2	Y	FR LH PRE+
3	BR	FR LH PRE-
4	P	RR LH PRE+
5	L	RR LH PRE-
6	R	STRG SW A
7	BR	ACC

Connector No.	M92
Connector Name	COMBINATION SWITCH (SPIRAL CABLE)
Connector Color	GRAY

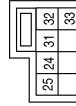

Terminal No.	Color of Wire	Signal Name
24	R	-
31	W	-
33	B	-

AANIA2744GB

NAVIGATION WITH BOSE

< WIRING DIAGRAM >

[TELEMATICS SYSTEM]

Terminal No.	Color of Wire	Signal Name
44	GR	SPEED
45	G	REVERSE_SIG
46	R	MR_OUTPUT
47	-	-
48	-	-
49	-	-
50	-	-
51	-	-
52	-	-
53	L	MIC_SIG
54	SHIELD	MIC_GND
55	W	AUX_AUDIO_RH
56	SHIELD	AUX_SHIELD
57	-	-
58	B	GND
59	-	-
60	SHIELD	R_CAMERA_SHIELD

Terminal No.	Color of Wire	Signal Name
28	-	-
29	-	-
30	-	-
31	-	-
32	-	-
33	-	-
34	P	MIC_VCC
35	R	AUX_AUDIO_LH
36	B	AUX_AUDIO
37	-	-
38	-	-
39	-	-
40	W	R_CAMERA_COMP
41	SB	M_CAN_H TRM
42	SB	M_CAN_H
43	L	CAN-H

Connector No.	M103
Connector Name	AV CONTROL UNIT (WITH NAVIGATION SYSTEM WITH BOSE)
Connector Color	WHITE



21	22	23	24	25	26	27	28	29	30	31	32	33	34	35	36	37	38	39	40
41	42	43	44	45	46	47	48	49	50	51	52	53	54	55	56	57	58	59	60

Terminal No.	Color of Wire	Signal Name
21	LG	M_CAN_L TRM
22	LG	M_CAN_L
23	P	CAN-L
24	-	-
25	Y	PKB_SIG
26	V	IGN
27	L	AFFORBABLE_SIG

Connector No.	M107
Connector Name	AV CONTROL UNIT (WITH NAVIGATION SYSTEM WITH BOSE)
Connector Color	BLUE



79	78	81	80	82
----	----	----	----	----

Terminal No.	Color of Wire	Signal Name
65	-	-
66	-	-
67	B	GND
68	Y	U-VOICE
69	R	USB_D+
70	SHIELD	USB_GND
71	-	-
72	-	-
73	-	-
74	-	-
75	-	-
76	G	D-VOICE
77	SHIELD	SHIELD

Connector No.	M104
Connector Name	AV CONTROL UNIT (WITH NAVIGATION SYSTEM WITH BOSE)
Connector Color	GRAY



68	67	66	65	64	63	62	61
76	75	74	73	72	71	70	69
77							

Terminal No.	Color of Wire	Signal Name
78	W	V_BUS
79	G	USB_GND
80	L	USB_D+
81	R	USB_D-
82	SHIELD	SHIELD

Terminal No.	Color of Wire	Signal Name
61	L	USB_D-
62	BR	USB_VBUS
63	V	MANUFACTURER SPECIFIC
64	-	-

AANIA2745GB

A
B
C
D
E
F
G
H
I
J
K
L
M
N
O
P

AV

NAVIGATION WITH BOSE

< WIRING DIAGRAM >

[TELEMATICS SYSTEM]

Connector No.	M504
Connector Name	AV CONTROL UNIT (WITH NAVIGATION SYSTEM- WITH BOSE AUDIO SYSTEM)
Connector Color	GRAY

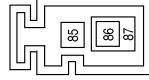

Terminal No.	Color of Wire	Signal Name
85	B	ANTENNA AMP. ON SIGNAL
86	B	RADIO ANTENNA SIGNAL
87	SHIELD	SHIELD

Connector No.	M503
Connector Name	AV CONTROL UNIT (WITH NAVIGATION SYSTEM- WITH BOSE AUDIO SYSTEM)
Connector Color	GRAY



Terminal No.	Color of Wire	Signal Name
83	B	GPS ANTENNA SIGNAL
84	SHIELD	SHIELD

Connector No.	M112
Connector Name	COMBINATION SWITCH (SPIRAL CABLE)
Connector Color	GRAY

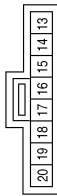

Terminal No.	Color of Wire	Signal Name
14	P	-
15	L	-
17	G	-

Connector No.	M511
Connector Name	WIRE TO WIRE
Connector Color	GRAY



Terminal No.	Color of Wire	Signal Name
1	B	-
2	B	-
3	SHIELD	-

Connector No.	M506
Connector Name	TCU
Connector Color	GRAY



Terminal No.	Color of Wire	Signal Name
58	B	TEL ANT
59	SHIELD	TEL ANT SHIELD

Connector No.	M505
Connector Name	AV CONTROL UNIT (WITH NAVIGATION SYSTEM- WITH BOSE AUDIO SYSTEM)
Connector Color	PINK



Terminal No.	Color of Wire	Signal Name
88	B	SATELLITE ANTENNA
89	SHIELD	SHIELD

AANIA2746GB

NAVIGATION WITH BOSE

< WIRING DIAGRAM >

[TELEMATICS SYSTEM]

Connector No.	M515
Connector Name	TEL ANTENNA
Connector Color	GRAY



Terminal No.	Color of Wire	Signal Name
1	B	-
2	SHIELD	-

Connector No.	M513
Connector Name	ANTENNA BASE
Connector Color	GRAY



Terminal No.	Color of Wire	Signal Name
1	B	-
2	B	-
3	SHIELD	-

Connector No.	M512
Connector Name	WIRE TO WIRE
Connector Color	GRAY



Terminal No.	Color of Wire	Signal Name
1	B	-
2	B	-
3	SHIELD	-

Connector No.	M518
Connector Name	ANTENNA BASE
Connector Color	GREEN

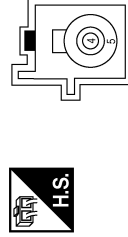

Terminal No.	Color of Wire	Signal Name
4	B	-
5	SHIELD	-

Connector No.	M517
Connector Name	WIRE TO WIRE
Connector Color	BROWN

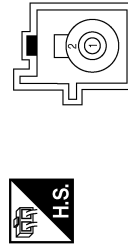

Terminal No.	Color of Wire	Signal Name
1	B	-
2	SHIELD	-

Connector No.	M516
Connector Name	WIRE TO WIRE
Connector Color	BROWN

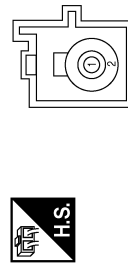

Terminal No.	Color of Wire	Signal Name
1	B	-
2	SHIELD	-

AANIA2747GB

A
B
C
D
E
F
G
H
I
J
K
L
M
N
O
P



AV

NAVIGATION WITH BOSE

< WIRING DIAGRAM >



[TELEMATICS SYSTEM]

Connector No.	M521
Connector Name	WIRE TO WIRE
Connector Color	BROWN



Terminal No.	Color of Wire	Signal Name
1	R	-
2	B	-

Connector No.	M525
Connector Name	TWEETER RH
Connector Color	BROWN

Terminal No.	Color of Wire	Signal Name
1	R	-
2	B	-

Connector No.	E4
Connector Name	PARKING BRAKE SWITCH
Connector Color	BLACK



Terminal No.	Color of Wire	Signal Name
1	B	-

Connector No.	E15
Connector Name	IPDM E/R (INTELLIGENT POWER DISTRIBUTION MODULE ENGINE ROOM)
Connector Color	WHITE

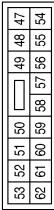

Terminal No.	Color of Wire	Signal Name
58	O	REVERSE LAMP IGN

Connector No.	E21
Connector Name	WIRE TO WIRE
Connector Color	BLACK

Terminal No.	Color of Wire	Signal Name
1	R	-
2	W	-
3	SHIELD	-
4	B	-

Connector No.	E27
Connector Name	REVERSE LAMP RELAY
Connector Color	BLUE

Terminal No.	Color of Wire	Signal Name
1	O	-
2	SB	-
3	O	-
5	G	-

Connector No.	E60
Connector Name	WIRE TO WIRE
Connector Color	BLACK

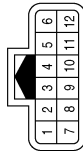

Terminal No.	Color of Wire	Signal Name
3	L	-
4	G	-
5	L	-
6	G	-

Connector No.	E61
Connector Name	VCM
Connector Color	BLACK



Terminal No.	Color of Wire	Signal Name
24	L	EV SYSTEM CAN-H
25	G	EV SYSTEM CAN-L

Connector No.	E62
Connector Name	VCM
Connector Color	BROWN



Terminal No.	Color of Wire	Signal Name
70	SB	REVERSE LAMP

Connector No.	E105
Connector Name	WIRE TO WIRE
Connector Color	WHITE



Terminal No.	Color of Wire	Signal Name
49	G	-
50	L	-
54	B	-
55	R	-
64	SHIELD	-
65	W	-
69	B	-
92	BR	-
97	G	-

Connector No.	E108
Connector Name	WIRE TO WIRE
Connector Color	WHITE



Terminal No.	Color of Wire	Signal Name
3	SB	-

AANIA2749GB

A B C D E F G H I J K L M O P AV

NAVIGATION WITH BOSE

< WIRING DIAGRAM >

[TELEMATICS SYSTEM]

Connector No.	F2
Connector Name	WIRE TO WIRE
Connector Color	BLACK

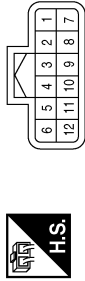

Terminal No.	Color of Wire	Signal Name
3	L	-
4	G	-
5	L	-
6	G	-

Connector No.	E203
Connector Name	WIRE TO WIRE
Connector Color	BLACK



Terminal No.	Color of Wire	Signal Name
1	R	-
2	B	-
3	L	-
4	W	-

Connector No.	E202
Connector Name	FRONT CAMERA
Connector Color	BLACK

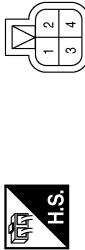

Terminal No.	Color of Wire	Signal Name
1	B	-
2	R	-
3	W	-
4	L	-

Connector No.	B8
Connector Name	WIRE TO WIRE
Connector Color	WHITE



Terminal No.	Color of Wire	Signal Name
3	R	-

Connector No.	B4
Connector Name	WIRE TO WIRE
Connector Color	WHITE

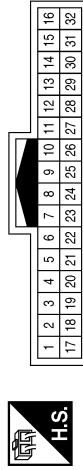

Terminal No.	Color of Wire	Signal Name
11	GR	-

Connector No.	B3
Connector Name	WIRE TO WIRE
Connector Color	WHITE

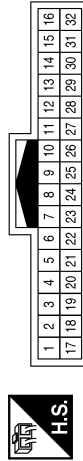

Terminal No.	Color of Wire	Signal Name
7	B	-
8	SHIELD	-
9	B	-
13	GR	-
24	R	-
25	W	-

AANIA2750GB

Connector No.	B17
Connector Name	WIRE TO WIRE
Connector Color	WHITE

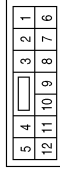

Terminal No.	Color of Wire	Signal Name
9	R	– (WITH BOSE)
10	G	– (WITH BOSE)
11	SHIELD	–

Connector No.	B16
Connector Name	WIRE TO WIRE
Connector Color	WHITE

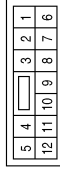

Terminal No.	Color of Wire	Signal Name
9	L	– (WITH BOSE)
10	P	– (EXCEPT MEXICO)
11	SHIELD	–

Connector No.	B11
Connector Name	BOSE SPEAKER AMP.
Connector Color	BLACK

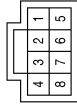

Terminal No.	Color of Wire	Signal Name
1	R	–
2	L	–
3	–	–
4	R	–
5	G	–
6	P	–
7	–	–
8	B	–

Terminal No.	Color of Wire	Signal Name
15	V	–
16	L	–
17	R	–
18	–	–
19	–	–
20	–	–
21	–	–
22	L	–
23	–	–
24	P	–

Connector No.	B20
Connector Name	BOSE SPEAKER AMP.
Connector Color	BLACK

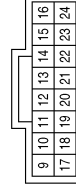

Terminal No.	Color of Wire	Signal Name
9	G	–
10	P	–
11	L	–
12	R	–
13	G	–
14	SB	–

Connector No.	B18
Connector Name	WIRE TO WIRE
Connector Color	WHITE

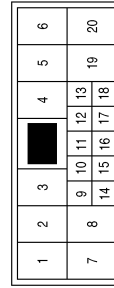

Terminal No.	Color of Wire	Signal Name
11	B	–
12	W	–
13	R	–
17	SHIELD	–
18	B	–

AANIA2751GB

A
B
C
D
E
F
G
H
I
J
K
L
M
N
O
P



NAVIGATION WITH BOSE

< WIRING DIAGRAM >

[TELEMATICS SYSTEM]

Connector No.	B40
Connector Name	WIRE TO WIRE
Connector Color	WHITE



Terminal No.	Color of Wire	Signal Name
1	P	-(WITH BOSE)
2	SHIELD	-
3	G	-
4	L	-
7	SHIELD	-
8	R	-

Connector No.	B31
Connector Name	JOINT CONNECTOR-B03
Connector Color	BLUE

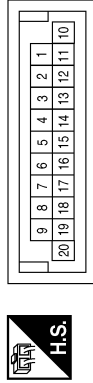

Terminal No.	Color of Wire	Signal Name
1	SHIELD	-
2	B	-
3	SHIELD	-
4	SHIELD	-
5	SHIELD	-
10	B	-
11	SHIELD	-
12	SHIELD	-
13	SHIELD	-
14	SHIELD	-
15	SHIELD	-
16	SHIELD	-
17	SHIELD	-

Connector No.	B27
Connector Name	BOSE SPEAKER AMP.
Connector Color	BLACK

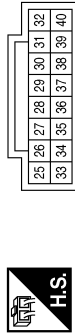

Terminal No.	Color of Wire	Signal Name
25	-	-
26	-	-
27	BR	-
28	V	-
29	G	-
30	B	-
31	-	-
32	-	-
33	-	-
34	-	-
35	Y	-
36	LG	-
37	R	-
38	W	-
39	-	-
40	-	-

Terminal No.	Color of Wire	Signal Name
13	Y	-
14	SHIELD	-
15	V	-
16	SHIELD	-
17	G	-
18	B	-
19	R	-
20	SHIELD	-
21	SHIELD	-

Terminal No.	Color of Wire	Signal Name
2	BR	-
3	LG	-
4	R	-
5	SHIELD	-
6	W	-
7	G	-
8	V	-
9	SB	-
10	L	-

Connector No.	B42
Connector Name	WIRE TO WIRE
Connector Color	WHITE

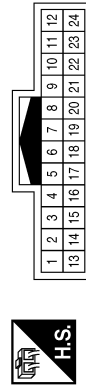

Terminal No.	Color of Wire	Signal Name
1	SHIELD	-

AANIA2752GB

Connector No.	R3
Connector Name	MICROPHONE
Connector Color	WHITE



Terminal No.	Color of Wire	Signal Name
1	L	-
2	GR	-
3	-	-
4	P	-
5	-	-
6	-	-

Connector No.	R1
Connector Name	WIRE TO WIRE
Connector Color	WHITE

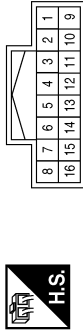

Terminal No.	Color of Wire	Signal Name
1	P	-
2	L	-
3	GR	-

Connector No.	B43
Connector Name	BOSE SUBWOORER
Connector Color	GRAY

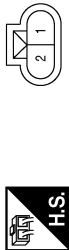

Terminal No.	Color of Wire	Signal Name
1	P	-
2	L	-

Terminal No.	Color of Wire	Signal Name
1C	L	-
2C	V	-
49C	B	-
50C	W	-
51C	R	-
52C	SHIELD	-

Connector No.	D22
Connector Name	WIRE TO WIRE
Connector Color	WHITE

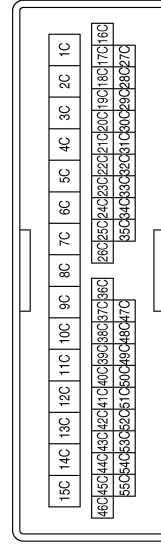

Connector No.	D1
Connector Name	SIDE CAMERA LH
Connector Color	WHITE



Terminal No.	Color of Wire	Signal Name
1	B	-
2	W	-
3	R	-
4	SHIELD	-

AANIA2753GB

A
B
C
D
E
F
G
H
I
J
K
L
M
N
O
P

AV

NAVIGATION WITH BOSE

< WIRING DIAGRAM >

[TELEMATICS SYSTEM]

Terminal No.	Color of Wire	Signal Name
2	B	-
3	R	-
4	SHIELD	-

Connector No.	D101
Connector Name	SIDE CAMERA RH
Connector Color	WHITE

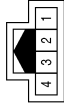

Terminal No.	Color of Wire	Signal Name
1	W	-

Connector No.	D24
Connector Name	FRONT DOOR SPEAKER LH (WITH BOSE AUDIO SYSTEM)
Connector Color	BROWN



Terminal No.	Color of Wire	Signal Name
1	V	-
2	L	-

Connector No.	D201
Connector Name	WIRE TO WIRE
Connector Color	WHITE

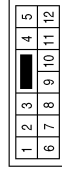

Connector No.	D124
Connector Name	FRONT DOOR SPEAKER RH (WITH BOSE AUDIO SYSTEM)
Connector Color	BROWN



Terminal No.	Color of Wire	Signal Name
9	V	-
10	LG	-

Connector No.	D102
Connector Name	WIRE TO WIRE
Connector Color	WHITE

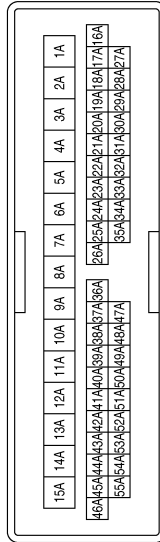

Terminal No.	Color of Wire	Signal Name
1	R	-
2	BR	-

Terminal No.	Color of Wire	Signal Name
1A	BR	-
2A	R	-
47A	W	-
48A	B	-
49A	R	-
50A	SHIELD	-

AANIA2754GB

NAVIGATION WITH BOSE

< WIRING DIAGRAM >

[TELEMATICS SYSTEM]

Connector No.	D305
Connector Name	REAR DOOR SPEAKER RH
Connector Color	WHITE



Terminal No.	Color of Wire	Signal Name
1	LG	-
2	P	-

Connector No.	D301
Connector Name	WIRE TO WIRE
Connector Color	WHITE

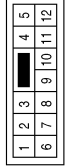

Terminal No.	Color of Wire	Signal Name
9	LG	-
10	P	-

Connector No.	D205
Connector Name	REAR DOOR SPEAKER LH
Connector Color	WHITE



Terminal No.	Color of Wire	Signal Name
1	V	-
2	LG	-

Connector No.	D555
Connector Name	WIRE TO WIRE
Connector Color	WHITE

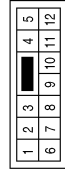

Terminal No.	Color of Wire	Signal Name
1	W	-
2	R	-
6	SHIELD	-
7	B	-

Connector No.	D505
Connector Name	WIRE TO WIRE
Connector Color	WHITE

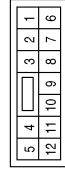

Terminal No.	Color of Wire	Signal Name
1	W	-
2	R	-
6	SHIELD	-
7	Y	-

Connector No.	D504
Connector Name	WIRE TO WIRE
Connector Color	WHITE

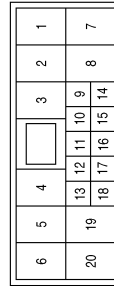

Terminal No.	Color of Wire	Signal Name
11	B	-
12	W	-
13	R	-
17	SHIELD	-
18	Y	-

AANIA2755GB

A
B
C
D
E
F
G
H
I
J
K
L
M
N
O
P

AV

Connector No.	D557
Connector Name	REAR VIEW CAMERA (WITH AROUND VIEW MONITOR)
Connector Color	WHITE



Terminal No.	Color of Wire	Signal Name
1	SHIELD	-
2	-	-
3	-	-
4	-	-
5	B	-
6	-	-
7	W	-
8	R	-

AANIA2756GB

BASIC INSPECTION

DIAGNOSIS AND REPAIR WORK FLOW

Work Flow

INFOID:0000000010642087

OVERALL SEQUENCE

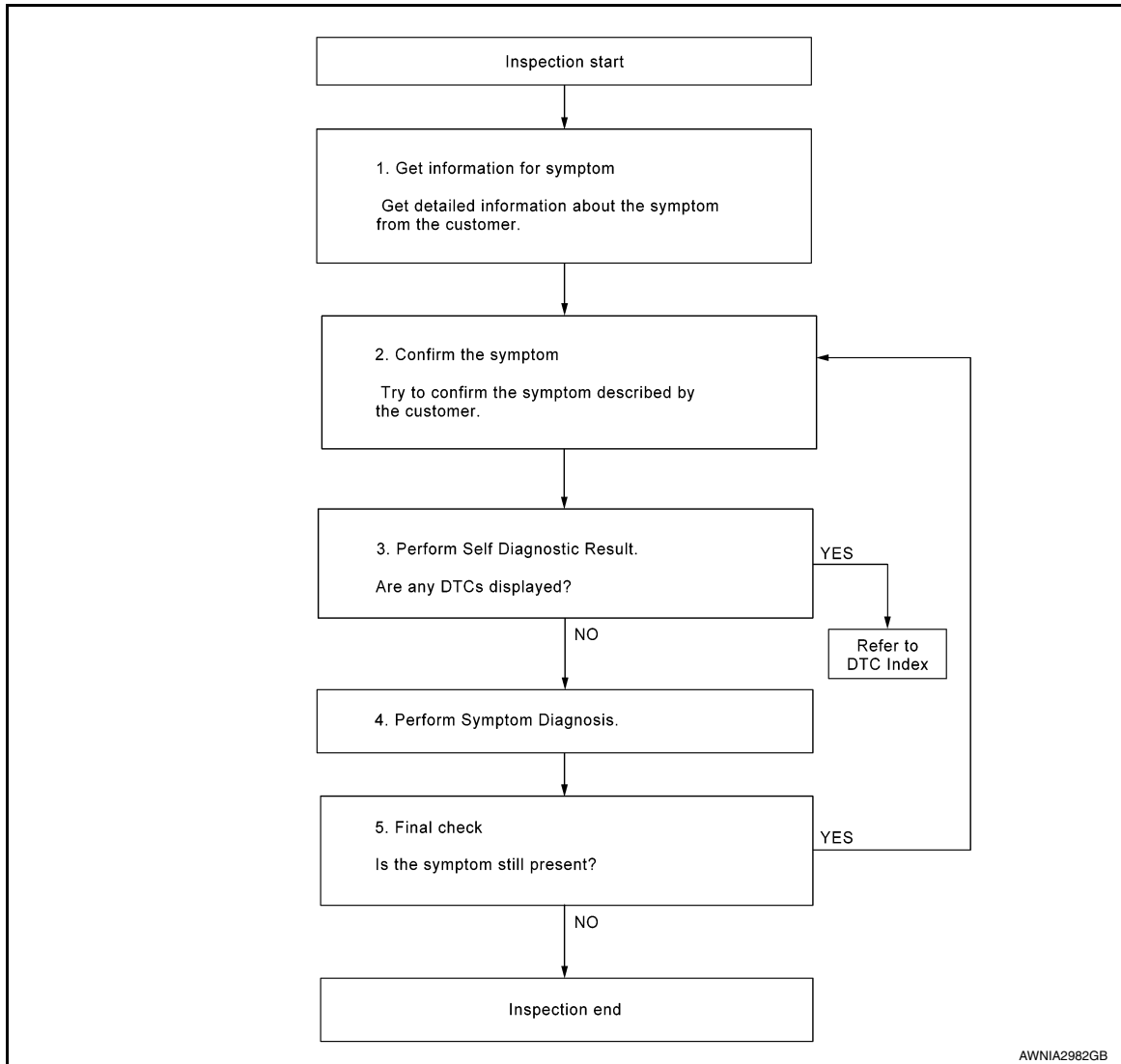

DETAILED FLOW

1.GET INFORMATION FOR SYMPTOM

Get detailed information from the customer about the symptom (the condition and the environment when the incident/malfunction occurred).

>> GO TO 2.

2.CONFIRM THE SYMPTOM

Try to confirm the symptom described by the customer. Verify relation between the symptom and the condition when the symptom is detected.

>> GO TO 3.

3.PERFORM SELF DIAGNOSTIC RESULT

1. Turn power switch ON and wait for 2 seconds or more.

A
B
C
D
E
F
G
H
I
J
K
L
M

AV

O
P

DIAGNOSIS AND REPAIR WORK FLOW

[TELEMATICS SYSTEM]

< BASIC INSPECTION >

2. Perform "Self Diagnostic Result" for "TELEMATICS" using CONSULT:

Are any DTCs displayed?

YES >> Refer to [AV-528, "DTC Index"](#).

NO >> GO TO 4.

4.PERFORM SYMPTOM DIAGNOSIS

Refer to [AV-591, "Symptom Table"](#).

>> GO TO 5

5.FINAL CHECK

Refer to symptom described by the customer in step 1.

Is the symptom still present?

YES >> GO TO 2

NO >> Inspection End.

INSPECTION AND ADJUSTMENT

< BASIC INSPECTION >

[TELEMATICS SYSTEM]

INSPECTION AND ADJUSTMENT

ADDITIONAL SERVICE WHEN USING TELEMATICS SYSTEM (WORK STEP VIEW)

ADDITIONAL SERVICE WHEN USING TELEMATICS SYSTEM (WORK STEP VIEW) : Process Chart

INFOID:000000010642088

	Initial Sub- scription (AV-575)	TCU Replace- ment (AV-577)	Cancellation/ Scrap	Re-subscrip- tion (AV-575)	Data Center relocate (AV-579)
TCU; Read VIN data		1			
TCU; Remove and Install		2			
TCU; Write VIN data		3			
TCU; Turn on RF	1	4			
Multi channel to confirm connection	2	5		1	
VIN Check	3	6		2	
SIM ID; Notice to Carrier (Activation New TCU)		7			
SIM ID; Notice to Carrier (Deactivation Old TCU)		8	1		
TCU; Input User ID & Password	4	9		3	
Telematics system; Confirmation of operation	5	10		4	
Change of APN Manually					1

ADDITIONAL SERVICE WHEN USING TELEMATICS SYSTEM FOR THE FIRST TIME/RE-SUBSCRIPTION

ADDITIONAL SERVICE WHEN USING TELEMATICS SYSTEM FOR THE FIRST TIME/RE-SUBSCRIPTION : Description

INFOID:000000010642089

When the driver uses telematics system for the first time/re-subscription, TCU activation operation is required.

PREPARATION FOR ACTIVATION

- Subscribe to telematics service.
- Pre-register user ID and password (can be performed from owner homepage).

ADDITIONAL SERVICE WHEN USING TELEMATICS SYSTEM FOR THE FIRST TIME/RE-SUBSCRIPTION : Work Procedure

INFOID:000000010642090

1. TCU ACTIVATION (1)

Ⓜ With CONSULT

1. Connect CONSULT to vehicle.
2. Check that "TELEMATICS" is displayed on the CONSULT screen.

Is the inspection result normal?

YES >> GO TO 2.

NO >> Perform steps, referring to [AV-507, "Precaution for Removing 12V Battery"](#). After disconnecting battery terminal, let it stand for 1 second or more. Reconnect the battery terminal to perform "1.TCU ACTIVATION (1)" again.

2. TCU ACTIVATION (2)

Ⓜ CONSULT work support

1. Wait for 5 seconds or more after turning the power switch ON.
2. Touch "TELEMATICS" on the CONSULT screen.

A
B
C
D
E
F
G
H
I
J
K
L
M
O
P

AV

INSPECTION AND ADJUSTMENT

< BASIC INSPECTION >

[TELEMATICS SYSTEM]

3. After performing System Call of CONSULT, touch the “Work support” tab.
4. On the work support screen of CONSULT, select “TCU ACTIVATE SETTING” and touch “Start.”
5. On the TCU ACTIVATE SETTING screen, touch “Start” to set to “ON”. Touch “End.”
6. Exit from CONSULT.
7. Turn the power switch OFF.
8. Wait (at least 10 seconds) until the power switch indicator turns OFF to shut down TCU.

>> GO TO 3.

3.COMMUNICATION TEST (1)

NOTE:

If communicated with the NISSAN CARWINGS Data Center with TCU turned ON before establishing the connections of the network line, TCU cannot perform communications. In this case, “The connection to the center failed.” is shown on the display, and the communication function of TCU is deactivated.

To restore the communication function, turn OFF the TCU battery power and turn it ON again (after disconnecting battery negative terminal, reconnect it) to reset the shutdown condition of TCU communication function. The communication function recovers 20 seconds after turning ON the power again.

1. Perform TCU communication test by vehicle operation.
2. Turn the power switch ON. Select “OK” on the START-UP SCREEN screen. Wait for 2 minutes or more.
3. Press “ (Zero emission)” of multifunction switch.
4. Select “CARWINGS” and check radio wave status of TELEMATICS indicated on the top right.

- A. Radio wave state (Service Area)
- B. Radio wave state (Out of Service Area)

Does the radio wave status show Service Area?

YES >> GO TO 4.

NO >> TCU activation error or vehicle is in an out of service area. Move vehicle to a service area. GO TO 2.

NO DISPLAY>>Refer to [AV-306. "Symptom Table"](#) (Navigation without Bose) or [AV-474. "Symptom Table"](#) (Navigation with Bose).

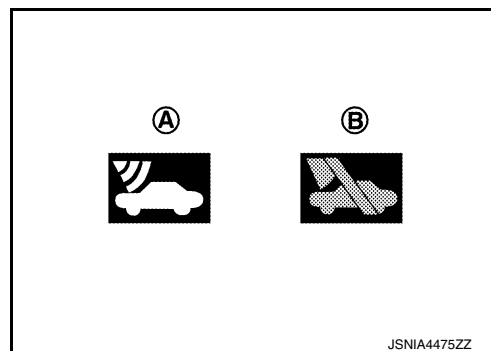

4.COMMUNICATION TEST (2)

1. Select “All Information Feeds”→“Info from NISSAN”→“Info from NISSAN (Simple Electrical Efficiency Channel).”
2. Voice guidance is heard, and the communication test starts.
3. Test results from the Information Center are shown on the display.

Check displayed results.

Displays message “Subscription is required to receive service. Please confirm subscription and password.” >> GO TO 5.

Announce voice message “To use CARWINGS service, you need to create an account.”>>GO TO 5.

Displays “Can't connect to center”>>GO TO 2.

5.INPUT OF PERSONAL ID AND PASSWORD (USER OPERATION)

1. Enter personal ID and password by vehicle operation.
2. Press “ (Zero emission)” of multifunction switch.
3. Select “CARWINGS”→“CARWINGS settings”→“Sign in.”
4. Enter user ID and password to select “Register.”
5. Voice guidance is heard, and the communication with the Information Center starts.
6. Test results from the Information Center are shown on the display.

Check displayed results.

Displays Security Settings Activated.>>GO TO 6.

The connection to the center failed.>>Check user ID and password. Go back to Step 5 [5.INPUT OF PERSONAL ID AND PASSWORD (USER OPERATION)].

6.CONFIRMATION OF OPERATION

1. Press “ (Zero emission)” of multifunction switch.

INSPECTION AND ADJUSTMENT

[TELEMATICS SYSTEM]

< BASIC INSPECTION >

2. Select "CARWINGS"→"All Information Feeds"→Contents of Info from NISSAN.

Check displayed results.

Displays contents of All Information Feeds.>>WORK END

Displays "Can't connect to center">>Select and check a different item of All Information Feeds, or GO TO 3.

ADDITIONAL SERVICE WHEN REPLACING TCU

ADDITIONAL SERVICE WHEN REPLACING TCU : Description

INFOID:000000010642091

When TCU is replaced, TCU activation operation is required.

Preparation before activation operation

- Subscribe to telematics service
- Preregister user ID and password (can be performed from owner homepage)

ADDITIONAL SERVICE WHEN REPLACING TCU : Work Procedure

INFOID:000000010642092

1. READING OF VIN DATA

ⓂCONSULT work support

Select "SAVE VIN DATA", "START SAVE VIN DATA" then "YES" on START SAVE VIN DATA screen to save the VIN data stored in replaced TCU in CONSULT. If it cannot be saved, writing operation must be performed manually.

>> GO TO 2.

2. TCU REPLACEMENT

Replace TCU. Refer to [AV-594, "Removal and Installation"](#).

>> GO TO 3.

3. NOTICE TO CARRIER "ATX HELP DESK"

Contact ATX help desk to notice the termination of replaced TCU and connection of new TCU. (VIN is required)

Can ID data be saved to CONSULT at 1st step?

YES >> GO TO 4.

NO >> GO TO 5.

4. AUTOMATIC WRITING OF VIN DATA TO TCU

ⓂCONSULT work support

Select "WRITE VIN DATA", "WRITE SAVED VIN DATA" then "YES" at WRITE SAVED VIN DATA screen to write the VIN data saved in CONSULT into new TCU.

>> GO TO 6.

5. MANUAL WRITING OF VIN DATA TO TCU

ⓂCONSULT work support

Select "WRITE VIN DATA (MANUAL)", "WRITE VIN DATA" then "START" on changing screen to write the VIN data saved into new TCU.

>> GO TO 6.

6. TCU ACTIVATION

ⓂCONSULT work support

1. Wait for 5 seconds or more after turning the power switch ON.
2. Touch "TELEMATICS" on the CONSULT screen.
3. After performing System Call of CONSULT, touch the "Work support" tab.
4. On the work support screen of CONSULT, select "TCU ACTIVATE SETTING" and touch "Start."
5. On the TCU ACTIVATE SETTING screen, touch "Start" to set to "ON". Touch "End."

A
B
C
D
E
F
G
H
I
J
K
L
M
O
P

AV

INSPECTION AND ADJUSTMENT

[TELEMATICS SYSTEM]

< BASIC INSPECTION >

6. Exit from CONSULT.
7. Turn the power switch OFF.
8. Wait (at least 10 seconds) until the power switch indicator turns OFF to shut down TCU.

>> GO TO 7.

7.COMMUNICATION TEST (1)

NOTE:

If communicated with the NISSAN CARWINGS Data Center with TCU turned ON before establishing the connections of the network line, TCU cannot perform communications. In this case, "The connection to the center failed." is shown on the display, and the communication function of TCU is deactivated.

To restore the communication function, turn OFF the TCU battery power and turn it ON again (after disconnecting battery negative terminal, reconnect it) to reset the shutdown condition of TCU communication function. The communication function recovers 20 seconds after turning ON the power again.

1. Perform TCU communication test by vehicle operation.
2. Turn the power switch ON. Select "OK" on the START-UP SCREEN screen. Wait for 2 minutes or more.
3. Press "⓪ (Zero emission)" of multifunction switch.
4. Select "CARWINGS" and check radio wave status of TELEMATICS indicated on the top right.

- A. Radio wave state (Service Area)
- B. Radio wave state (Out of Service Area)

Does the radio wave status show Service Area?

YES >> GO TO 8.

NO >> TCU activation error or vehicle is in an out of service area. Move vehicle to a service area. GO TO 6.

NO DISPLAY>>Refer to [AV-306. "Symptom Table"](#) (Navigation without Bose) or [AV-474. "Symptom Table"](#) (Navigation with Bose).

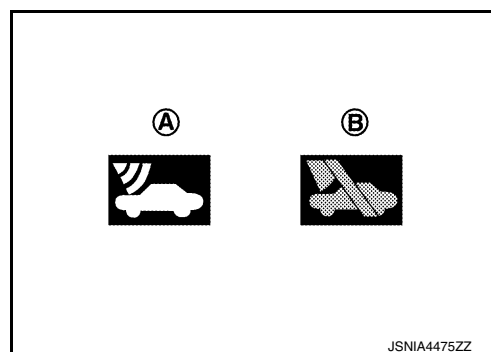

8.COMMUNICATION TEST (2)

1. Select "CARWINGS"→"All Information Feeds"→"ID Check"→"ID Check."
2. Communication test is performed and the result of communication with Nissan CARWINGS Data Center is displayed on the monitor.

Is communication test result normal?

"Change" is displayed for "VIN">>VIN data write error. GO TO 4.

Displays "Can't connect to center">>TCU ACTIVATION setting is "OFF". GO TO 6.

"Change" is displayed for "TCU" and "SIM">>GO TO 9.

9.INPUT OF PERSONAL ID AND PASSWORD (USER OPERATION)

1. Enter personal ID and password by vehicle operation.
2. Press "⓪ (Zero emission)" of multifunction switch.
3. Select "CARWINGS"→"CARWINGS settings"→"Sign in."
4. Enter user ID and password to select "Register."
5. Voice guidance is heard, and the communication with the Information Center starts.
6. Test results from the Information Center are shown on the display.

Check displayed results.

Displays Security Settings Activated.>>GO TO 10.

The connection to the center failed.>>Check user ID and password. Go back to Step 9 [9.INPUT OF PERSONAL ID AND PASSWORD (USER OPERATION)].

10.CONFIRMATION OF OPERATION

1. Press "⓪ (Zero emission)" of multifunction switch.
2. Select "CARWINGS"→"All Information Feeds"→Contents of Info from NISSAN.

Check displayed results.

Displays contents of All Information Feeds.>>WORK END

Displays "Can't connect to center">>Select and check a different item of All Information Feeds, or GO TO 7.

ADDITIONAL SERVICE WHEN TCU CONNECTING CENTER CHANGED

ADDITIONAL SERVICE WHEN TCU CONNECTING CENTER CHANGED : Description

INFOID:000000010642093

When TCU connecting center change must be performed manually, below operation is required.

Operation to change the connecting center

Use CONSULT and enter connecting center of TCU.

ADDITIONAL SERVICE WHEN TCU CONNECTING CENTER CHANGED : Work Procedure

INFOID:000000010642094

1. INFORMATION CENTER CONNECTION SETTINGS

 CONSULT work support

1. Wait for 5 seconds or more after turning the power switch ON.
2. Touch "TELEMATICS" on the CONSULT screen.
3. After performing System Call of CONSULT, touch the "Work support" tab.
4. On the work support screen of CONSULT, select "CENTER CONNECTION SETTING" and touch "Start."
5. On the CENTER CONNECTION SETTING screen, touch "Start."

>> GO TO 2.

2. INPUT OF PERSONAL ID AND PASSWORD (USER OPERATION)

1. Enter personal ID and password by vehicle operation.
2. Press " (Zero emission)" of multifunction switch.
3. Select "CARWINGS" and check radio wave status of TELEMATICS indicated on the top right.
 - A. Radio wave state (Service Area)
 - B. Radio wave state (Out of Service Area)
4. Select "CARWINGS" → "CARWINGS settings" → "Sign in."
5. Enter user ID and password to select "Register."
6. Voice guidance is heard, and the communication with the Information Center starts.
7. Test results from the Information Center are shown on the display.

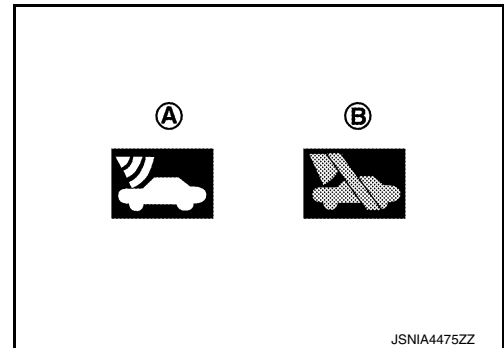
Check displayed results.

Displays registration completion screen.>>GO TO 3.

Displays "Can't connect to center">>Check user ID and password. Go back to Step 2 [2.INPUT OF PERSONAL ID AND PASSWORD (USER OPERATION)].

3. CONFIRMATION OF OPERATION

1. Press " (Zero emission)" of multifunction switch.
2. Select "CARWINGS" → "All Information Feeds" → Contents of Info from NISSAN.

Check displayed results.

Displays contents of All Information Feeds.>>WORK END

Displays "Can't connect to center">>Select and check a different item of All Information Feeds, or GO TO 2.

DTC/CIRCUIT DIAGNOSIS

U1000 CAN COMM CIRCUIT

Description

INFOID:0000000010642095

CAN (Controller Area Network) is a serial communication line for real time applications. It is an on board multiplex communication line with high data communication speed and excellent error detection ability. A modern vehicle is equipped with many ECMs, and each control unit shares information and links with other control units during operation (not independent). In CAN communication, 2 control units are connected with 2 communication lines (CAN H-line and CAN L-line) allowing a high rate of information transmission with less wiring. Each control unit transmits/receives data but selectively reads required data only.

Refer to [LAN-37, "CAN COMMUNICATION SYSTEM : CAN Communication Signal Chart"](#) for details of the communication signal.

DTC Logic

INFOID:0000000010642096

DTC DETECTION LOGIC

DTC	Display contents of CONSULT	Malfunction detection condition	Probable malfunction location
U1000	CAN COMM CIRC [U1000]	When the AV control unit cannot communicate for 2 seconds or more.	CAN communication system

Diagnosis Procedure

INFOID:0000000010642097

1. PERFORM SELF-DIAGNOSIS

1. Turn the power switch ON and hold it for 2 seconds or more.
2. Check the self-diagnosis result of "multi-AV".

Is CAN communication system displayed?

- YES >> Refer to [LAN-17, "Trouble Diagnosis Procedure"](#).
 NO >> Refer to [GI-53, "Intermittent Incident"](#).

U1010 CONTROL UNIT (CAN)

< DTC/CIRCUIT DIAGNOSIS >

[TELEMATICS SYSTEM]

U1010 CONTROL UNIT (CAN)

DTC Logic

INFOID:0000000110642098

DTC DETECTION LOGIC

DTC	Display contents of CONSULT	Malfunction detection condition	Action to take
U1010	CONTROL UNIT (CAN) [U1010]	Malfunction is detected during initial diagnosis of the AV control unit CAN controller.	Replace the AV control unit if malfunction constantly occurs. Refer to AV-593, "Removal and Installation" .

A
B
C
D
E
F
G
H
I
J
K
L
M

AV

O
P

U1A00 TCU

< DTC/CIRCUIT DIAGNOSIS >

[TELEMATICS SYSTEM]

U1A00 TCU

DTC Logic

INFOID:000000010642099

DTC	Display contents of CONSULT	DTC detection condition	Action to take
U1A00	ACC NO CONN [U1A00]	No input of ACC signal	<ul style="list-style-type: none">• Check the ACC power circuit. Refer to AV-590, "TCU : Diagnosis Procedure".• If the ACC circuit is normal, replace TCU. Refer to AV-594, "Removal and Installation".

Diagnosis Procedure

INFOID:000000010642100

1. CHECK ACC POWER CIRCUIT

1. Check the ACC power circuit. Refer to [AV-590, "TCU : Diagnosis Procedure"](#).

Is the check result normal?

- YES >> Replace TCU. Refer to [AV-594, "Removal and Installation"](#).
NO >> Repair or replace the harness or connectors.

U1A01 TCU

< DTC/CIRCUIT DIAGNOSIS >

[TELEMATICS SYSTEM]

U1A01 TCU

DTC Logic

INFOID:000000010642101

DTC	Display contents of CONSULT	DTC detection condition	Action to take
U1A01	INTERNAL ERROR (TCU) [U1A01]	Malfunction in TCU is detected.	<ul style="list-style-type: none">• Check the connector wiring and erase DTC.• Replace TCU if the malfunction constantly occurs. Refer to AV-594, "Removal and Installation".

A
B
C
D
E
F
G
H
I
J
K
L
M
AV
O
P

U1A02 TCU

< DTC/CIRCUIT DIAGNOSIS >

[TELEMATICS SYSTEM]

U1A02 TCU

DTC Logic

INFOID:000000010642102

DTC	Display contents of CONSULT	DTC detection condition	Action to take
U1A02	TEL COMMUNICATION MODULE [U1A02]	Malfunction on the communication module in TCU is detected.	<ul style="list-style-type: none">• Check the harness connection and erase DTC.• Replace TCU if the malfunction constantly occurs. Refer to AV-594. "Removal and Installation".

U1A03 TCU

< DTC/CIRCUIT DIAGNOSIS >

[TELEMATICS SYSTEM]

U1A03 TCU

DTC Logic

INFOID:000000010642103

DTC	Display contents of CONSULT	DTC detection condition	Action to take
U1A03	SIM CARD [U1A03]	SIM card is not inserted or unable to be read.	<ul style="list-style-type: none">• Check if there is a contact malfunction at the SIM card and card slot.• Check the harness connection and erase DTC.• Replace TCU if the malfunction constantly occurs. Refer to AV-594. "Removal and Installation".

A
B
C
D
E
F
G
H
I
J
K
L
M
N
O
P

AV

U1A04 TCU

< DTC/CIRCUIT DIAGNOSIS >

[TELEMATICS SYSTEM]

U1A04 TCU

DTC Logic

INFOID:000000010642104

DTC	Display contents of CONSULT	DTC detection condition	Action to take
U1A04	VIN UNFINISHED [U1A04]	No write of VIN number is detected.	<ul style="list-style-type: none">• Write VIN number using CONSULT. Refer to AV-577. "ADDITIONAL SERVICE WHEN REPLACING TCU : Work Procedure".• Replace TCU if the malfunction is detected after VIN number is written. Refer to AV-594. "Removal and Installation".

U1A05 TCU

< DTC/CIRCUIT DIAGNOSIS >

[TELEMATICS SYSTEM]

U1A05 TCU

DTC Logic

INFOID:000000010642105

DTC	Display contents of CONSULT	DTC detection condition	Action to take
U1A05	USB COMM [U1A05]	It is detected for malfunction of the USB communication module (communication disabled) between TCU and AV control unit.	<ul style="list-style-type: none"> Check the USB harness connection and erase DTC. Replace TCU if the malfunction constantly occurs. Refer to AV-594. "Removal and Installation" .

Diagnosis Procedure

INFOID:000000010642106

Regarding Wiring Diagram information, refer to [AV-529. "Wiring Diagram"](#) (NAVIGATION WITHOUT BOSE) or [AV-549. "Wiring Diagram"](#) (NAVIGATION WITH BOSE).

1. CHECK USB HARNESS CONTINUITY

- Turn the power switch OFF.
- Disconnect TCU and AV control unit connectors.
- Check the continuity between TCU harness connector and AV control unit harness connector.

TCU		AV control unit		Continuity
Connector	Terminal	Connector	Terminal	
M68	47	M97 (without Bose) M104 (with Bose)	62	Yes
	48		61	
	55		70	
	56		69	

- Check the continuity between TCU harness connector and ground.

TCU		Ground	Continuity
Connector	Terminal		
M68	47		No
	48		
	56		

Is the check result normal?

- YES >> Replace TCU. Refer to [AV-594. "Removal and Installation"](#).
 NO >> Repair or replace the harness or connectors.

AV

U1A07 TEL ANTENNA

DTC Logic

INFOID:000000010642107

DTC	Display contents of CONSULT	DTC detection condition	Action to take
U1A07	TEL ANTENNA SHORT [U1A07]	TEL antenna was short-circuited.	<ul style="list-style-type: none"> Check the TEL antenna harness connection and the harness condition, and erase DTC. If poor harness condition or the malfunction constantly occurs, replace the TEL antenna. Refer to AV-597. "Removal and Installation".

Diagnosis Procedure

INFOID:000000010642108

Regarding Wiring Diagram information, refer to [AV-529. "Wiring Diagram"](#) (NAVIGATION WITHOUT BOSE) or [AV-549. "Wiring Diagram"](#) (NAVIGATION WITH BOSE).

1. HARNESS INSPECTION

1. Turn the power switch OFF.
2. Disconnect the TEL antenna feeder connector of TCU.
3. Check the continuity between TEL antenna-side harness connector.

TEL antenna			Continuity
Connector	Terminal		
M113	58	59	No

Is the check result normal?

- YES >> Replace TCU. Refer to [AV-594. "Removal and Installation"](#).
- NO >> Replace the TEL antenna. Refer to [AV-597. "Removal and Installation"](#).

U1A08 TEL ANTENNA

< DTC/CIRCUIT DIAGNOSIS >

[TELEMATICS SYSTEM]

U1A08 TEL ANTENNA

DTC Logic

INFOID:000000010642109

DTC	Display contents of CONSULT	DTC detection condition	Action to take
U1A08	TEL ANTENNA NO CONN [U1A08]	TEL ANTENNA NO CONN	<ul style="list-style-type: none"> Check the harness connection and erase DTC. Replace TCU if the malfunction constantly occurs. Refer to AV-594, "Removal and Installation".

Diagnosis Procedure

INFOID:000000010642110

Regarding Wiring Diagram information, refer to [AV-529, "Wiring Diagram"](#) (NAVIGATION WITHOUT BOSE) or [AV-549, "Wiring Diagram"](#) (NAVIGATION WITH BOSE).

1. CHECK OF TEL ANTENNA

- Turn the power switch OFF.
- Disconnect the TEL antenna feeder connector.
- Visually check TEL antenna and antenna feeder.

Is the inspection result normal?

YES >> GO TO 2.

NO >> Repair malfunctioning parts.

2. CHECK AV CONTROL UNIT VOLTAGE

- Disconnect TEL antenna connector.
- Turn power switch ON.
- Check voltage between TCU and ground.

(+)		(-)	Reference value
TCU			
Terminal	Connector		
M113	58	Ground	2.8 V

Is the inspection result normal?

YES >> Replace TEL antenna. Refer to [AV-597, "Removal and Installation"](#).

NO >> Replace TCU. Refer to [AV-594, "Removal and Installation"](#).

A
B
C
D
E
F
G
H
I
J
K
L
M

AV

O
P

POWER SUPPLY AND GROUND CIRCUIT

< DTC/CIRCUIT DIAGNOSIS >

[TELEMATICS SYSTEM]

POWER SUPPLY AND GROUND CIRCUIT

TCU

TCU : Diagnosis Procedure

INFOID:000000010642111

Regarding Wiring Diagram information, refer to [AV-529. "Wiring Diagram"](#) (NAVIGATION WITHOUT BOSE) or [AV-549. "Wiring Diagram"](#) (NAVIGATION WITH BOSE).

1.CHECK FUSE

Check if the fuse is blown.

Power supply	Fuse No.
BAT	34
Power switch ACC or ON	19
Power switch ON	3

Is the check result normal?

YES >> GO TO 2.

NO >> Replace the blown fuse after repairing the affected circuit.

2.CHECK TCU VOLTAGE CIRCUITS

Check the voltage between the TCU harness connector and ground.

Signal	TCU	Terminal		Test condition	Standard	Reference value
	Connector	(+)	(-)	Power switch		
BAT	M67	1	2	OFF	9 – 16 V	Battery Voltage
ACC		3		ACC	9 – 16 V	12 V
ON		4		ON	9 – 16 V	12 V

Is the check result normal?

YES >> GO TO 3.

NO >> Repair or replace the harness or connectors.

3.CHECK TCU GROUND CIRCUIT

1. Turn the power switch OFF.
2. Disconnect the TCU connector.
3. Check the continuity between TCU harness connector and ground.

Signal	Connector	Terminal	Power switch	Continuity
Ground	M67	2	OFF	Yes

Is the check result normal?

YES >> Inspection End.

NO >> Repair or replace the harness or connectors.



SYMPTOM DIAGNOSIS

TELEMATICS SYSTEM

Symptom Table

INFOID:000000010642112

TELEMATICS SYSTEM

Symptom	Display icon	Error message	Possible cause
Telematics operation not available.	—	Telematics unit is not connected.	Perform self-diagnosis with CONSULT. Refer to AV-526, "CONSULT Function" .
		The connection to the center failed.	Check ON/OFF status of TCU using the data monitor of CONSULT. • Replace TCU if it is ON. Refer to AV-594, "Removal and Installation" . • Turn it ON again if it is OFF. Replace TCU if ON is switched to OFF. Refer to AV-594, "Removal and Installation" .
		No service.	Use a cellular phone to check reception. • If service is available, replace TCU or TEL antenna. - For TCU replacement, refer to AV-594, "Removal and Installation" . - For TEL antenna replacement, refer to AV-597, "Removal and Installation" . • If the service is not available, move the vehicle to the position where service is available and perform the operation again.
		Service inoperative due to poor reception.	Use a cellular phone to check reception. • If it is OK, there may be a cause at the INFINITI CONNECTION Data Center. Check connection after a short period of time. If there is no problem at the INFINITI CONNECTION Data Center, replace TCU or TEL antenna. - For TCU replacement, refer to AV-594, "Removal and Installation" . - For TEL antenna replacement, refer to AV-597, "Removal and Installation" . • If it is NG, check connection again after a short period of time.
		Service not registered.	Check input of user ID and password from the navigation setting screen. If malfunction such as input or no memory despite input is detected, replace AV control unit. Refer to AV-318, "Removal and Installation" (without Bose Audio) or AV-488, "Removal and Installation" (with Bose Audio).
		TCU line is used.	Check connection after a short period of time. Replace TCU if it is frequently displayed. Refer to AV-594, "Removal and Installation" .
		The connection to the center failed.	There may be a cause at the INFINITI CONNECTION Data Center. Check connection after a short period of time. If there is no problem at the INFINITI CONNECTION Data Center, replace TCU or TEL antenna. • For TCU replacement, refer to AV-594, "Removal and Installation" . • For TEL antenna replacement, refer to AV-597, "Removal and Installation" .

A
B
C
D
E
F
G
H
I
J
K
L
M
O
P

AV

NORMAL OPERATING CONDITION

< SYMPTOM DIAGNOSIS >

[TELEMATICS SYSTEM]

NORMAL OPERATING CONDITION

Description

INFOID:000000010642113

NOTE:

For Telematics system operation detail information, refer to Navigation system Owner's Manual.

Symptom	Possible cause	Possible solution
The system cannot connect to the NISSAN CONNECT Data Center.	A subscription for the CONNECT service has not been established.	Sign up for a subscription to the CONNECT service. For details about subscriptions, contact a NISSAN certified LEAF dealer or visit the NISSAN CONNECT Data Center website.
	The user ID and password are not entered.	Enter the user ID and password.
	The communication line is busy.	Try again after a short period of time.
	The vehicle is in a location where reception is difficult.	When the vehicle moves to an area where radio waves can be transmitted sufficiently, communication will be restored. When the icon on the display shows that the vehicle is inside the communication area, the system can be used.
	TCU reception is insufficient.	When the vehicle moves to an area where radio waves can be transmitted sufficiently, communication will be restored. When the icon on the display shows that the vehicle is inside the communication area, the system can be used.
Some of the items that are displayed on the menu screen cannot be selected.	The vehicle is being driven and some menu items are disabled.	The vehicle is being driven. Stop the vehicle in a safe location and apply the parking brake before operating the functions.
Some parts of the screen are not displayed		Operate the system after stopping the vehicle in a safe location and applying the parking brake.
The system does not announce information.	The volume level is set to the minimum.	Adjust the volume level by operating the VOL switches located on the control panel or on the steering wheel switch while the system is announcing information.

REMOVAL AND INSTALLATION

AV CONTROL UNIT

Removal and Installation

INFOID:000000010642114

REMOVAL

CAUTION:

Remove AV control unit after a lapse of 30 seconds or more after turning the power switch OFF.

NOTE:

After the power switch is turned OFF, the AV control unit continues operating for approximately 30 seconds. Therefore, data corruption may occur if 12V battery voltage is cut off within 30 seconds.

1. Disconnect the 12V negative battery terminal. Refer to [PG-82, "Removal and Installation"](#).
2. Remove cluster lid C. Refer to [IP-17, "Removal and Installation"](#).
3. Remove the AV control unit screws, disconnect the harness connectors from the AV control unit and remove with the brackets attached.
4. Remove the bracket screws and the brackets from AV control unit (if necessary).

INSTALLATION

Note the following, and install in the reverse order of removal.

CAUTION:

- If the AV control unit is replaced, input of the user ID and password and time adjustment with VCM are required.
- If the AV control unit is not replaced, time adjustment with VCM is required.

Input Method of User ID and Password

1. Turn power switch ON.
2. Select "Sign in" from the CARWINGS screen.
3. Enter the user ID and password.

NOTE:

Since the user ID and password are determined by the user in advance, they are input by the user.

Time Adjustment and Check Method with VCM

Refer to [AV-277, "ADDITIONAL SERVICE WHEN REMOVING BATTERY NEGATIVE TERMINAL : Work Procedure"](#).

A
B
C
D
E
F
G
H
I
J
K
L
M
O
P

AV

TCU

Removal and Installation

INFOID:000000010642115

REMOVAL

1. Check the SIM ID. Refer to [AV-526. "CONSULT Function"](#).
2. When replacing TCU, perform activation. Refer to [AV-577. "ADDITIONAL SERVICE WHEN REPLACING TCU : Work Procedure"](#).
3. Remove the glove box cover assembly. Refer to [IP-17. "Removal and Installation"](#).
4. Remove the harness clip (1) and antenna feeder clip (2) from the upper bracket.

NOTE:

If it is difficult to remove the harness clip and the antenna feeder clip, remove the TCU screw first and pull TCU forward together with the bracket. Use care not to damage the harness.

5. Remove the TCU screws, disconnect the harness connectors and remove the TCU with the bracket attached.
6. Remove the bracket screw and the bracket from TCU (if necessary).

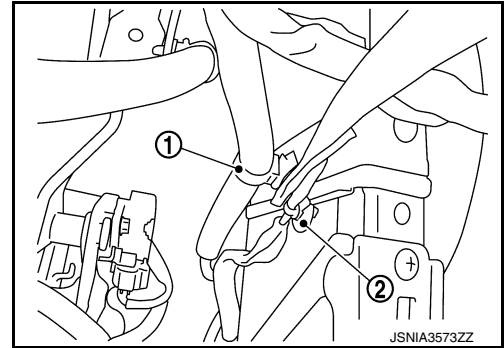

INSTALLATION

1. Install in the reverse order of removal.
2. When replacing TCU, perform activation. Refer to [AV-577. "ADDITIONAL SERVICE WHEN REPLACING TCU : Work Procedure"](#).

NOTE:

When replacing the TCU, it is necessary to contact the communications service provider to activate the new TCU. Please refer to the appropriate Nissan LEAF Technical Service Bulletin for the correct TCU activation procedure and communications provider contact information.

GPS ANTENNA

Removal and Installation

INFOID:000000010642116

REMOVAL

1. Remove the instrument panel assembly. Refer to [IP-17, "Removal and Installation"](#).
2. Remove the screws, clips and the GPS antenna.

INSTALLATION

Install in the reverse order of removal.

A
B
C
D
E
F
G
H
I
J
K
L
M
O
P

AV

MICROPHONE

Removal and Installation

INFOID:000000010642117

REMOVAL

1. Remove the map lamp assembly. Refer to [INL-53. "Removal and Installation"](#).
2. Press the pawl to remove the microphone (1) from the map lamp assembly (2).

CAUTION:

Use care when handling the microphone pawl to avoid damaging.

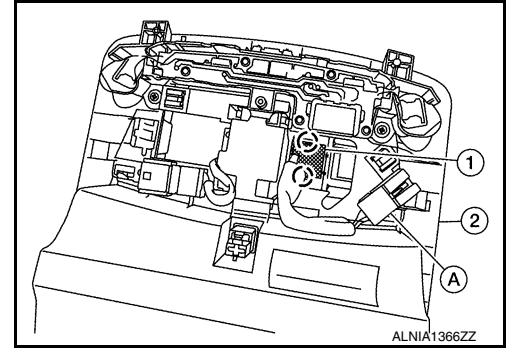

INSTALLATION

Install in the reverse order of removal.

NOTE:

Check the microphone for looseness after the installation.

TEL ANTENNA

Removal and Installation

INFOID:000000010642118

REMOVAL

1. Remove the front defroster duct. Refer to [VTL-15. "FRONT DEFROSTER DUCT : Removal and Installation"](#).
2. Remove screws and tel antenna from the front defroster duct.

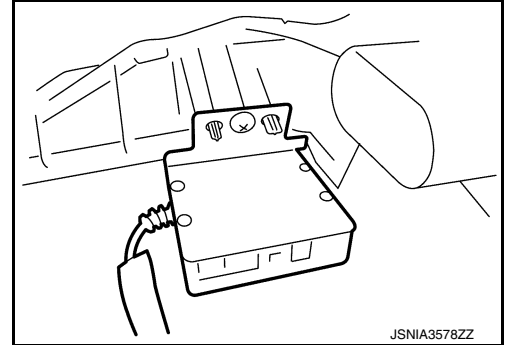

INSTALLATION

Install in the reverse order of removal.

A
B
C
D
E
F
G
H
I
J
K
L
M
O
P

AV