

SECTION **INT**  
INTERIOR

A  
B  
C  
D  
E  
F  
G  
H  
I  
INT  
K  
L  
M  
N  
O  
P

CONTENTS

<b>PRECAUTION</b> .....	3	<b>INSTRUMENT SIDE PANEL</b> .....	20
<b>PRECAUTIONS</b> .....	3	INSTRUMENT SIDE PANEL : Removal and Installation .....	20
Precaution for Technicians Using Medical Electric.....	3	<b>FRONT PILLAR GARNISH</b> .....	21
Point to Be Checked Before Starting Maintenance Work .....	3	FRONT PILLAR GARNISH : Removal and Installation .....	21
Precautions for Removing Battery Terminal .....	4	<b>KICKING PLATE OUTER</b> .....	22
Precaution for Supplemental Restraint System (SRS) "AIR BAG" and "SEAT BELT PRE-TENSIONER" .....	4	KICKING PLATE OUTER : Removal and Installation .....	22
Precaution for Procedure without Cowl Top Cover.....	5	<b>KICKING PLATE INNER</b> .....	23
Precaution for Work .....	5	KICKING PLATE INNER : Removal and Installation .....	23
<b>PREPARATION</b> .....	6	<b>BODY SIDE WELT</b> .....	24
<b>PREPARATION</b> .....	6	BODY SIDE WELT : Removal and Installation .....	24
Special Service Tools .....	6	<b>DASH SIDE FINISHER</b> .....	24
Commercial Service Tools .....	6	DASH SIDE FINISHER : Removal and Installation .....	24
<b>CLIP LIST</b> .....	7	<b>CENTER PILLAR LOWER GARNISH</b> .....	25
Clip List .....	7	CENTER PILLAR LOWER GARNISH : Removal and Installation .....	25
<b>SYMPTOM DIAGNOSIS</b> .....	8	<b>CENTER PILLAR UPPER GARNISH</b> .....	25
<b>SQUEAK AND RATTLE TROUBLE DIAGNOSES</b> .....	8	CENTER PILLAR UPPER GARNISH : Removal and Installation .....	26
Work Flow .....	8	<b>REAR PILLAR FINISHER</b> .....	26
Inspection Procedure .....	10	REAR PILLAR FINISHER : Removal and Installation .....	26
Diagnostic Worksheet .....	12	<b>FLOOR TRIM</b> .....	28
<b>REMOVAL AND INSTALLATION</b> .....	14	Exploded View .....	28
<b>FRONT DOOR FINISHER</b> .....	14	Removal and Installation .....	28
Exploded View .....	14	<b>HEADLINING</b> .....	31
Removal and Installation .....	14	Exploded View .....	31
<b>REAR DOOR FINISHER</b> .....	17	Removal and Installation .....	32
Exploded View .....	17	<b>LUGGAGE FLOOR TRIM</b> .....	35
Removal and Installation .....	17		
<b>BODY SIDE TRIM</b> .....	20		
Exploded View .....	20		

Exploded View .....	35	<b>LUGGAGE SIDE LOWER FINISHER .....</b>	<b>38</b>
<b>REAR PARCEL SHELF FINISHER .....</b>	<b>35</b>	LUGGAGE SIDE LOWER FINISHER : Removal and Installation .....	38
REAR PARCEL SHELF FINISHER : Removal and Installation .....	35	<b>BACK DOOR TRIM .....</b>	<b>41</b>
<b>LUGGAGE FLOOR BOARD .....</b>	<b>36</b>	Exploded View .....	41
LUGGAGE FLOOR BOARD : Removal and Instal- lation .....	36	<b>BACK DOOR UPPER FINISHER .....</b>	<b>41</b>
<b>LUGGAGE REAR PLATE .....</b>	<b>36</b>	BACK DOOR UPPER FINISHER : Removal and Installation .....	41
LUGGAGE REAR PLATE : Removal and Installa- tion .....	36	<b>BACK DOOR SIDE FINISHER .....</b>	<b>42</b>
<b>LUGGAGE FLOOR UPPER FINISHER .....</b>	<b>36</b>	BACK DOOR SIDE FINISHER : Removal and In- stallation .....	42
LUGGAGE FLOOR UPPER FINISHER : Removal and Installation .....	37	<b>BACK DOOR PULL HANDLE .....</b>	<b>43</b>
<b>LUGGAGE FINISHER MASK .....</b>	<b>37</b>	BACK DOOR PULL HANDLE : Removal and In- stallation .....	43
LUGGAGE FINISHER MASK : Removal and In- stallation .....	37	<b>BACK DOOR LOWER FINISHER .....</b>	<b>43</b>
<b>LUGGAGE FLOOR FRONT FINISHER .....</b>	<b>38</b>	BACK DOOR LOWER FINISHER : Removal and Installation .....	43
LUGGAGE FLOOR FRONT FINISHER : Removal and Installation .....	38	<b>EMERGENCY LID .....</b>	<b>44</b>
		EMERGENCY LID : Removal and Installation .....	44

# PRECAUTIONS

< PRECAUTION >

## PRECAUTION

### PRECAUTIONS

#### Precaution for Technicians Using Medical Electric

INFOID:000000007632079

##### OPERATION PROHIBITION

###### **WARNING:**

- Parts with strong magnet is used in this vehicle.
- Technicians using a medical electric device such as pacemaker must never perform operation on the vehicle, as magnetic field can affect the device function by approaching to such parts.

##### NORMAL CHARGE PRECAUTION

###### **WARNING:**

- If a technician uses a medical electric device such as an implantable cardiac pacemaker or an implantable cardioverter defibrillator, the possible effects on the devices must be checked with the device manufacturer before starting the charge operation.
- As radiated electromagnetic wave generated by on board charger at normal charge operation may effect medical electric devices, a technician using a medical electric device such as implantable cardiac pacemaker or an implantable cardioverter defibrillator must not enter the vehicle compartment (including luggage room) during normal charge operation.

##### PRECAUTION AT TELEMATICS SYSTEM OPERATION

###### **WARNING:**

- If a technician uses implantable cardiac pacemaker or implantable cardioverter defibrillator (ICD), avoid the device implanted part from approaching within approximately 220 mm (8.66 in) from interior/exterior antenna.
- The electromagnetic wave of TCU might affect the function of the implantable cardiac pacemaker or the implantable cardioverter defibrillator (ICD), when using the service, etc.
- If a technician uses other medical electric devices than implantable cardiac pacemaker or implantable cardioverter defibrillator (ICD), the electromagnetic wave of TCU might affect the function of the device. The possible effects on the devices must be checked with the device manufacturer before TCU use.

##### PRECAUTION AT INTELLIGENT KEY SYSTEM OPERATION

###### **WARNING:**

- If a technician uses implantable cardiac pacemaker or implantable cardioverter defibrillator (ICD), avoid the device implanted part from approaching within approximately 220 mm (8.66 in) from interior/exterior antenna.
- The electromagnetic wave of Intelligent Key might affect the function of the implantable cardiac pacemaker or the implantable cardioverter defibrillator (ICD), at door operation, at each request switch operation, or at engine starting.
- If a technician uses other medical electric devices than implantable cardiac pacemaker or implantable cardioverter defibrillator (ICD), the electromagnetic wave of Intelligent Key might affect the function of the device. The possible effects on the devices must be checked with the device manufacturer before Intelligent Key use.

#### Point to Be Checked Before Starting Maintenance Work

INFOID:000000007632080

The high voltage system may starts automatically. It is required to check that the timer air conditioner and timer charge (during EVSE connection) are not set before starting maintenance work.

###### **NOTE:**

If the timer air conditioner or timer charge (during EVSE connection) is set, the high voltage system starts automatically even when the power switch is in OFF state.

# PRECAUTIONS

## < PRECAUTION >

### Precautions for Removing Battery Terminal

INFOID:000000007632081

- When removing the 12V battery terminal, turn OFF the power switch and wait at least 5 minutes.

**NOTE:**

ECU may be active for several minutes after the power switch is turned OFF. If the battery terminal is removed before ECU stops, then a DTC detection error or ECU data corruption may occur.

- Always disconnect the battery terminal within 60 minutes after turning OFF the power switch. Even when the power switch is OFF, the 12V battery automatic charge control may automatically start after a lapse of 60 minutes from power switch OFF.
- Disconnect 12V battery terminal according to the following steps.

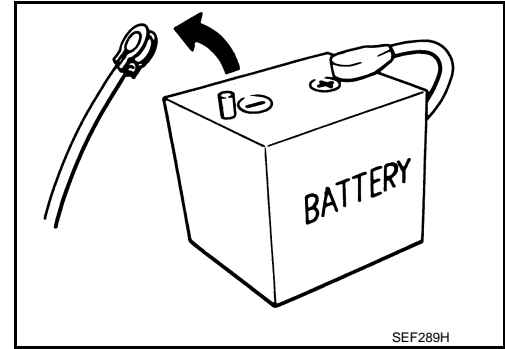

### WORK PROCEDURE

1. Check that EVSE is not connected.

**NOTE:**

If EVSE is connected, the air conditioning system may be automatically activated by the timer A/C function.

2. Turn the power switch OFF → ON → OFF. Get out of the vehicle. Close all doors (including back door).
3. Check that the charge status indicator lamp does not blink and wait for 5 minutes or more.

**NOTE:**

If the battery is removed within 5 minutes after the power switch is turned OFF, plural DTCs may be detected.

4. Remove 12V battery terminal within 60 minutes after turning the power switch OFF → ON → OFF.

**CAUTION:**

- After all doors (including back door) are closed, if a door (including back door) is opened before battery terminals are disconnected, start over from Step 1.
- After turning the power switch OFF, if "Remote A/C" is activated by user operation, stop the air conditioner and start over from Step 1.

**NOTE:**

Once the power switch is turned ON → OFF, the 12V battery automatic charge control does not start for approximately 1 hour.

- For vehicles with the 2-batteries, be sure to connect the main battery and the sub battery before turning ON the power switch.

**NOTE:**

If the power switch is turned ON with any one of the terminals of main battery and sub battery disconnected, then DTC may be detected.

- After installing the 12V battery, always check "Self Diagnosis Result" of all ECUs and erase DTC.

**NOTE:**

The removal of 12V battery may cause a DTC detection error.

### Precaution for Supplemental Restraint System (SRS) "AIR BAG" and "SEAT BELT PRE-TENSIONER"

INFOID:000000007632082

The Supplemental Restraint System such as "AIR BAG" and "SEAT BELT PRE-TENSIONER", used along with a front seat belt, helps to reduce the risk or severity of injury to the driver and front passenger for certain types of collision. This system includes seat belt switch inputs and dual stage front air bag modules. The SRS system uses the seat belt switches to determine the front air bag deployment, and may only deploy one front air bag, depending on the severity of a collision and whether the front occupants are belted or unbelted. Information necessary to service the system safely is included in the "SRS AIR BAG" and "SEAT BELT" of this Service Manual.

**WARNING:**

Always observe the following items for preventing accidental activation.

- To avoid rendering the SRS inoperative, which could increase the risk of personal injury or death in the event of a collision that would result in air bag inflation, all maintenance must be performed by an authorized NISSAN/INFINITI dealer.

# PRECAUTIONS

## < PRECAUTION >

- Improper maintenance, including incorrect removal and installation of the SRS, can lead to personal injury caused by unintentional activation of the system. For removal of Spiral Cable and Air Bag Module, see “SRS AIR BAG”.
- Never use electrical test equipment on any circuit related to the SRS unless instructed to in this Service Manual. SRS wiring harnesses can be identified by yellow and/or orange harnesses or harness connectors.

## PRECAUTIONS WHEN USING POWER TOOLS (AIR OR ELECTRIC) AND HAMMERS

### **WARNING:**

Always observe the following items for preventing accidental activation.

- When working near the Air Bag Diagnosis Sensor Unit or other Air Bag System sensors with the power switch ON, never use air or electric power tools or strike near the sensor(s) with a hammer. Heavy vibration could activate the sensor(s) and deploy the air bag(s), possibly causing serious injury.
- When using air or electric power tools or hammers, always switch the power switch OFF, disconnect the 12V battery, and wait at least 3 minutes before performing any service.

## Precaution for Procedure without Cowl Top Cover

INFOID:000000007632083

When performing the procedure after removing cowl top cover, cover the lower end of windshield with urethane, etc to prevent damage to windshield.

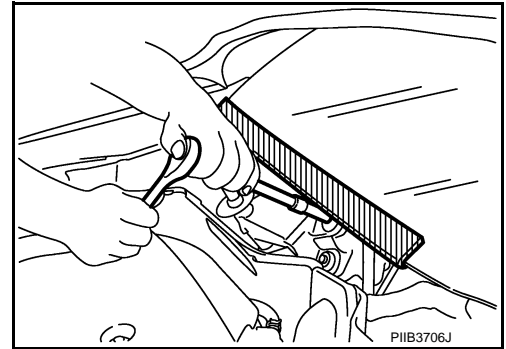

## Precaution for Work

INFOID:000000007632084

- After removing and installing the opening/closing parts, be sure to carry out fitting adjustments to check their operation.
- Check the lubrication level, damage, and wear of each part. If necessary, grease or replace it.

INT

# PREPARATION

< PREPARATION >

## PREPARATION

### PREPARATION

#### Special Service Tools

INFOID:000000007632085

The actual shapes of Kent-Moore tools may differ from those of special service tools illustrated here.

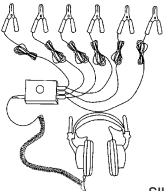
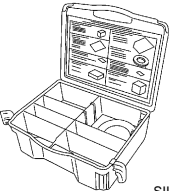
Tool number (Kent-Moore No.) Tool name	Description
(J-39570) Chassis ear   SIIA0993E	Locates the noise
(J-43980) NISSAN Squeak and Rattle Kit   SIIA0994E	Repairs the cause of noise

#### Commercial Service Tools

INFOID:000000007632086

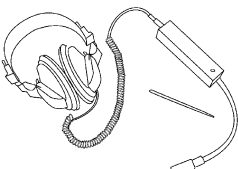
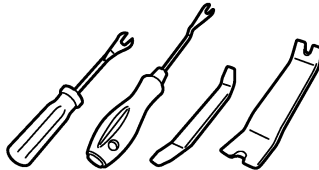
Tool name	Description
Engine ear   SIIA0995E	Locates the noise
Remover tool   JMKIA3050ZZ	Removes clips, pawls and metal clips

# CLIP LIST

< PREPARATION >

## CLIP LIST

### Clip List

INFOID:000000007632087

Shapes	Removal & Installation	Shapes	Removal & Installation
	<p><b>Removal:</b> Remove by bending up with flat-bladed screwdrivers or clip remover.</p>		<p><b>Removal:</b></p>
	<p><b>Removal:</b> Remove with a clip remover.</p>		<p><b>Removal:</b></p>
	<p><b>Removal:</b> Push center pin to catching position. (Do not remove center pin by hitting it.)</p> <p><b>Installation:</b></p>		<p><b>Removal:</b> Holder portion of clip must be spread out to remove rod.</p>
	<p><b>Removal:</b> Remove by bending up with flat-bladed screwdrivers or clip remover.</p>		<p><b>Removal:</b></p> <ol style="list-style-type: none"> <li>Screw out with a Phillips screwdriver.</li> <li>Remove female portion with flat-bladed screwdriver.</li> </ol>
	<p><b>Removal:</b></p>		<p><b>Removal:</b></p> <p>Rotate 45° to remove.</p> <p><b>Installation:</b></p>
	<p><b>Removal:</b></p>		<p><b>Removal:</b></p>

JMJIA3734GB

A  
B  
C  
D  
E  
F  
G  
H  
I  
INT  
K  
L  
M  
N  
O  
P

# SQUEAK AND RATTLE TROUBLE DIAGNOSES

< SYMPTOM DIAGNOSIS >

## SYMPTOM DIAGNOSIS

### SQUEAK AND RATTLE TROUBLE DIAGNOSES

#### Work Flow

INFOID:000000007632088

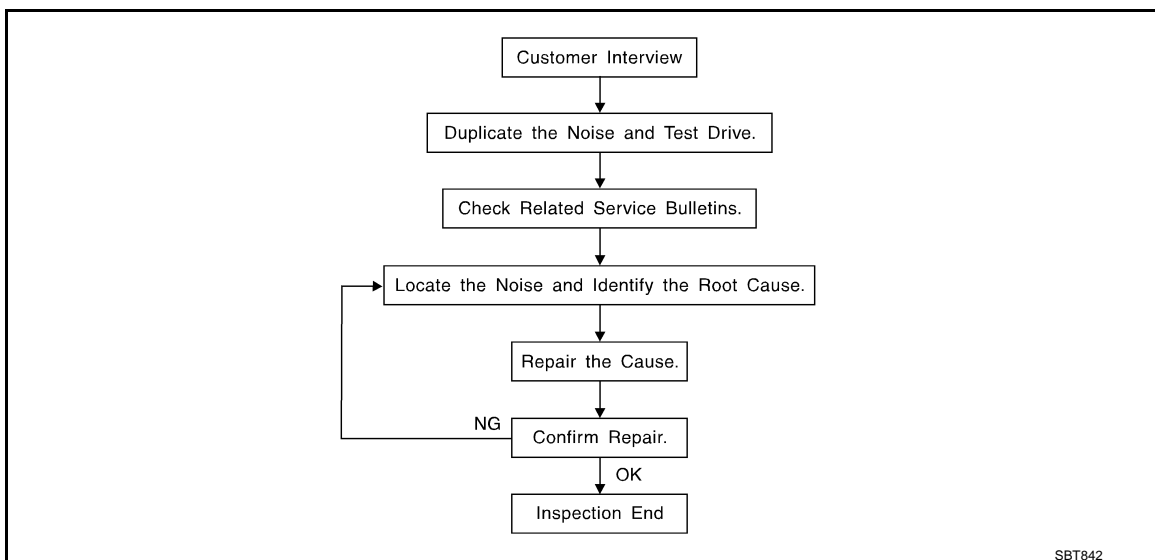

#### CUSTOMER INTERVIEW

Interview the customer if possible, to determine the conditions that exist when the noise occurs. Use the Diagnostic Worksheet during the interview to document the facts and conditions when the noise occurs and any customer comments. Refer to [INT-12. "Diagnostic Worksheet"](#). This information is necessary to duplicate the conditions that exist when the noise occurs.

- The customer may not be able to provide a detailed description or the location of the noise. Attempt to obtain all the facts and conditions that exist when the noise occurs (or does not occur).
- If there is more than one noise in the vehicle, perform a diagnosis and repair the noise that the customer is concerned about. This can be accomplished by performing a test drive with the customer.
- After identifying the type of noise, isolate the noise in terms of its characteristics. The noise characteristics are provided so that the customer, service adviser, and technician use the same language when describing the noise.
- Squeak – (Like tennis shoes on a clean floor)  
Squeak characteristics include the light contact / fast movement / brought on by road conditions / hard surfaces = high-pitched noise / softer surfaces = low-pitched noises / edge to surface = chirping
- Creak – (Like walking on an old wooden floor)  
Creak characteristics include firm contact / slow movement/twisting with a rotational movement / pitch dependent on materials / often brought on by activity.
- Rattle – (Like shaking a baby rattle)  
Rattle characteristics include fast repeated contact / vibration or similar movement / loose parts/missing clip or fastener / incorrect clearance.
- Knock – (Like a knock on a door)  
Knock characteristics include hollow sounds / sometimes repeating / often brought on by driver action.
- Tick – (Like a clock second hand)  
Tick characteristics include gentle contacting of light materials / loose components / can be caused by driver action or road conditions.
- Thump – (Heavy, muffled knock noise)  
Thump characteristics include softer knock / dull sounds often brought on by activity.
- Buzz – (Like a bumblebee)  
Buzz characteristics include high frequency rattle / firm contact.
- Often the degree of acceptable noise level varies depending upon the person. A noise that a technician may judge as acceptable may be very irritating to a customer.
- Weather conditions, especially humidity and temperature, may have a great effect on noise level.

#### DUPLICATE THE NOISE AND TEST DRIVE



# SQUEAK AND RATTLE TROUBLE DIAGNOSES

## < SYMPTOM DIAGNOSIS >

If possible, drive the vehicle with the customer until the noise is duplicated. Note any additional information on the Diagnostic Worksheet regarding the conditions or location of the noise. This information can be used to duplicate the same conditions when the repair is reconfirmed.

If the noise can be duplicated easily during the test drive, to help identify the source of the noise, try to duplicate the noise with the vehicle stopped by doing one or all of the following items:

- 1) Close a door.
  - 2) Tap or push/pull around the area where the noise appears to be coming from.
  - 3) Rev the motor.
  - 4) Use a floor jack to recreate vehicle "twist".
  - 5) At idle, apply motor load (electrical load, half-clutch on M/T models, drive position on A/T models).
  - 6) Raise the vehicle on a hoist and hit a tire with a rubber hammer.
- Drive the vehicle and attempt to duplicate the conditions the customer states exist when the noise occurs.
  - If it is difficult to duplicate the noise, drive the vehicle slowly on an undulating or rough road to stress the vehicle body.

## CHECK RELATED SERVICE BULLETINS

After verifying the customer concern or symptom, check ASIST for Technical Service Bulletins (TSBs) related to the concern or symptom.

If a TSB relates to the symptom, follow the procedure to repair the noise.

## LOCATE THE NOISE AND IDENTIFY THE ROOT CAUSE

1. Narrow down the noise to a general area. To help pinpoint the source of the noise, use a listening tool (Chassis ear: J-39570, engine ear, and mechanics stethoscope).
2. Narrow down the noise to a more specific area and identify the cause of the noise by:
  - Removing the component(s) in the area that is / are suspected to be the cause of the noise. Do not use too much force when removing clips and fasteners, otherwise clips and fasteners can be broken or lost during the repair, resulting in the creation of new noise.
  - Tapping or pushing/pulling the component(s) that is / are suspected to be the cause of the noise. Do not tap or push/pull the component(s) with excessive force, otherwise the noise is eliminated only temporarily.
  - Feeling for a vibration by hand by touching the component(s) that is / are suspected to be the cause of the noise.
  - Placing a piece of paper between components that are suspected to be the cause of the noise.
  - Looking for loose components and contact marks.  
Refer to [INT-10, "Inspection Procedure"](#).

## REPAIR THE CAUSE

- If the cause is a loose component, tighten the component securely.
- If the cause is insufficient clearance between components:
  - Separate components by repositioning or loosening and retightening the components, if possible.
  - Insulate components with a suitable insulator such as urethane pads, foam blocks, felt cloth tape, or urethane tape. A NISSAN Squeak and Rattle Kit (J-43980) is available through the authorized NISSAN Parts Department.

### **CAUTION:**

**Never use excessive force as many components are constructed of plastic and may be damaged.**

### **NOTE:**

Always check with the Parts Department for the latest parts information.

The following materials are contained in the NISSAN Squeak and Rattle Kit (J-43980). Each item can be ordered separately as needed.

URETHANE PADS [1.5 mm (0.059 in) thick]

Insulates connectors, harness, etc.

- 76268-9E005: 100 × 135 mm (3.937 × 5.315 in)
- 76884-71L01: 60 × 85 mm (2.362 × 3.346 in)
- 76884-71L02: 15 × 25 mm (0.591 × 0.984 in)

INSULATOR (Foam blocks)

Insulates components from contact. Can be used to fill space behind a panel.

- 73982-9E000: 45 mm (1.772 in) thick, 50 × 50 mm (1.969 × 1.969 in)
- 73982-50Y00: 10 mm (0.394 in) thick, 50 × 50 mm (1.969 × 1.969 in)

INSULATOR (Light foam block)

80845-71L00: 30 mm (1.181 in) thick, 30 × 50 mm (1.181 × 1.969 in)

FELT CLOTHTAPE

# SQUEAK AND RATTLE TROUBLE DIAGNOSES

## < SYMPTOM DIAGNOSIS >

---

Used to insulate where movement does not occur. Ideal for instrument panel applications.

- 68370-4B000: 15 × 25 mm (0.591 × 0.984 in) pad
- 68239-13E00: 5 mm (0.197 in) wide tape roll

The following materials, not found in the kit, can also be used to repair squeaks and rattles.

### UHMW (TEFLON) TAPE

Insulates where slight movement is present. Ideal for instrument panel applications.

### SILICONE GREASE

Used in place of UHMW tape that is visible or does not fit. Only lasts a few months.

### SILICONE SPRAY

Used when grease cannot be applied.

### DUCT TAPE

Used to eliminate movement.

## CONFIRM THE REPAIR

After repair is complete, test drive the vehicle to confirm that the cause of noise is repaired by test driving the vehicle. Operate the vehicle under the same conditions as when the noise originally occurred. Refer to the notes on the Diagnostic Worksheet.

## Inspection Procedure

INFOID:000000007632089

Refer to Table of Contents for specific component removal and installation information.

## INSTRUMENT PANEL

Most incidents are caused by contact and movement between:

1. The cluster lid A and instrument panel
2. Acrylic lens and combination meter housing
3. Instrument panel to front pillar garnish
4. Instrument panel to windshield
5. Instrument panel mounting pins
6. Wiring harnesses behind the combination meter
7. A/C defroster duct and duct joint

These incidents can usually be located by tapping or moving the components to duplicate the noise or by pressing on the components while driving to stop the noise. Most of these incidents can be repaired by applying felt cloth tape or silicon spray (in hard to reach areas). Urethane pads can be used to insulate wiring harness.

### **CAUTION:**

**Never use silicone spray to isolate a squeak or rattle. If the area is saturated with silicone, the recheck of repair becomes impossible.**

## CENTER CONSOLE

Components to check include:

1. Shifter assembly cover to finisher
2. A/C control unit and cluster lid C
3. Wiring harnesses behind audio and A/C control unit

The instrument panel repair and isolation procedures also apply to the center console.

## DOORS

Check the following items:

1. Finisher and inner panel making a slapping noise
2. Inside handle escutcheon connection to door finisher
3. Wiring harnesses tapping
4. Door striker out of alignment causing a popping noise on starts and stops

Tapping, moving the components, or pressing on them while driving to duplicate the conditions can isolate many of these incidents. The areas can usually be insulated with felt cloth tape or insulator foam blocks from the NISSAN Squeak and Rattle Kit (J-43980) to repair the noise.

## TRUNK

Trunk noises are often caused by a loose jack or loose items put into the trunk by the customer.

In addition check for the following items:

# SQUEAK AND RATTLE TROUBLE DIAGNOSES

## < SYMPTOM DIAGNOSIS >

---

1. Trunk lid dumpers out of adjustment
2. Trunk lid striker out of adjustment
3. Trunk lid torsion bars knocking together
4. A loose license plate or bracket

Most of these incidents can be repaired by adjusting, securing, or insulating the item(s) or component(s) causing the noise.

## SUNROOF/HEADLINING

Noises in the sunroof / headlining area can often be traced to one of the following items:

1. Sunroof lid, rail, linkage, or seals making a rattle or light knocking noise
2. Sunvisor shaft shaking in the holder
3. Front or rear windshield touching headlining and squeaking

Again, pressing on the components to stop the noise while duplicating the conditions can isolate most of these incidents. Repairs usually consist of insulating with felt cloth tape.

## SEATS

When isolating seat noise it is important to note the position the seat is in and the load placed on the seat when the noise occurs. These conditions should be duplicated when verifying and isolating the cause of the noise.

Causes of seat noise include:

1. Headrest rods and holder
2. A squeak between the seat pad cushion and frame
3. The rear seatback lock and bracket

These noises can be isolated by moving or pressing on the suspected components while duplicating the conditions under which the noise occurs. Most of these incidents can be repaired by repositioning the component or applying urethane tape to the contact area.

## UNDERHOOD

Some interior noise may be caused by components under the hood or on the motor wall. The noise is then transmitted into the passenger compartment.

Causes of transmitted underhood noise include:

1. Any component mounted to the motor wall
2. Components that pass through the motor wall
3. Motor wall mounts and connectors
4. Loose radiator mounting pins
5. Hood bumpers out of adjustment
6. Hood striker out of adjustment

These noises can be difficult to isolate since they cannot be reached from the interior of the vehicle. The best method is to secure, move, or insulate one component at a time and test drive the vehicle. Also, motor RPM or load can be changed to isolate the noise. Repairs can usually be made by moving, adjusting, securing, or insulating the component causing the noise.

A

B

C

D

E

F

G

H

I

INT

K

L

M

N

O

P

# SQUEAK AND RATTLE TROUBLE DIAGNOSES

< SYMPTOM DIAGNOSIS >

## Diagnostic Worksheet

INFOID:000000007632090



### SQUEAK & RATTLE DIAGNOSTIC WORKSHEET

Dear Nissan Customer:

We are concerned about your satisfaction with your Nissan vehicle. Repairing a squeak or rattle sometimes can be very difficult. To help us fix your Nissan right the first time, please take a moment to note the area of the vehicle where the squeak or rattle occurs and under what conditions. You may be asked to take a test drive with a service advisor or technician to ensure we confirm the noise you are hearing.

#### I. WHERE DOES THE NOISE COME FROM? (circle the area of the vehicle)

The illustrations are for reference only, and may not reflect the actual configuration of your vehicle.

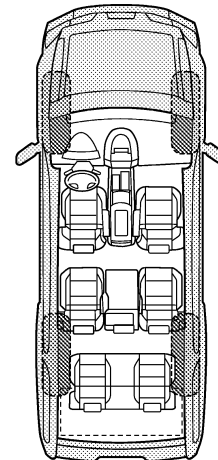
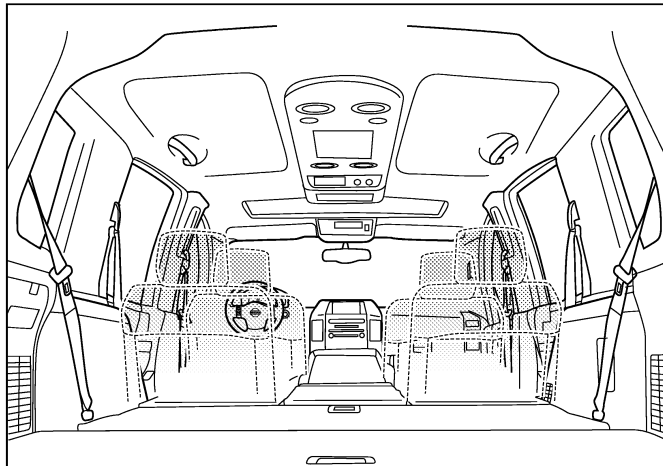
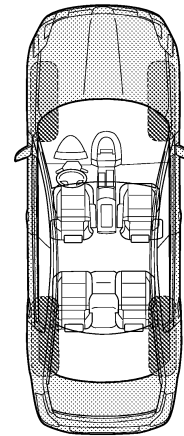
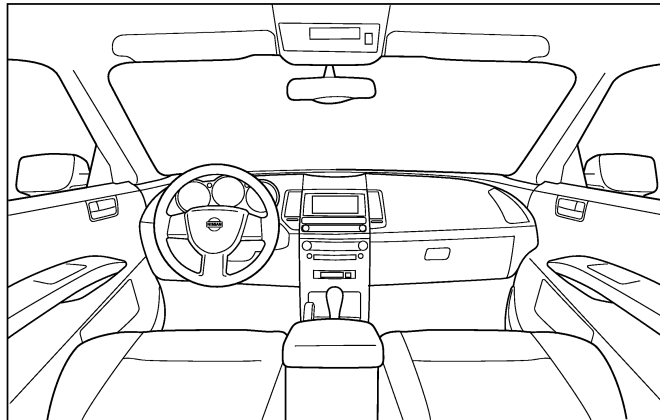

Continue to page 2 of the worksheet and briefly describe the location of the noise or rattle. In addition, please indicate the conditions which are present when the noise occurs.

PIIB8740E

# SQUEAK AND RATTLE TROUBLE DIAGNOSES

< SYMPTOM DIAGNOSIS >

## SQUEAK & RATTLE DIAGNOSTIC WORKSHEET - page 2

Briefly describe the location where the noise occurs:

---

---

### II. WHEN DOES IT OCCUR? (please check the boxes that apply)

- |   |  |
|---|--|
| <input type="checkbox"/> anytime                      | <input type="checkbox"/> after sitting out in the rain |
| <input type="checkbox"/> 1st time in the morning      | <input type="checkbox"/> when it is raining or wet     |
| <input type="checkbox"/> only when it is cold outside | <input type="checkbox"/> dry or dusty conditions       |
| <input type="checkbox"/> only when it is hot outside  | <input type="checkbox"/> other:                        |

### III. WHEN DRIVING:

- through driveways
- over rough roads
- over speed bumps
- only about \_\_\_\_ mph
- on acceleration
- coming to a stop
- on turns: left, right or either (circle)
- with passengers or cargo
- other: \_\_\_\_\_
- after driving \_\_\_\_ miles or \_\_\_\_ minutes

### IV. WHAT TYPE OF NOISE

- squeak (like tennis shoes on a clean floor)
- creak (like walking on an old wooden floor)
- rattle (like shaking a baby rattle)
- knock (like a knock at the door)
- tick (like a clock second hand)
- thump (heavy, muffled knock noise)
- buzz (like a bumble bee)

### TO BE COMPLETED BY DEALERSHIP PERSONNEL

#### Test Drive Notes:

---

---

---

	YES	NO	Initials of person performing
Vehicle test driven with customer	<input type="checkbox"/>	<input type="checkbox"/>	_____
- Noise verified on test drive	<input type="checkbox"/>	<input type="checkbox"/>	_____
- Noise source located and repaired	<input type="checkbox"/>	<input type="checkbox"/>	_____
- Follow up test drive performed to confirm repair	<input type="checkbox"/>	<input type="checkbox"/>	_____

VIN: \_\_\_\_\_ Customer Name: \_\_\_\_\_  
W.O.# \_\_\_\_\_ Date: \_\_\_\_\_

This form must be attached to Work Order

PIIB8742E

A  
B  
C  
D  
E  
F  
G  
H  
I  
INT  
K  
L  
M  
N  
O  
P

# FRONT DOOR FINISHER

< REMOVAL AND INSTALLATION >

## REMOVAL AND INSTALLATION

### FRONT DOOR FINISHER

Exploded View

INFOID:000000007632091

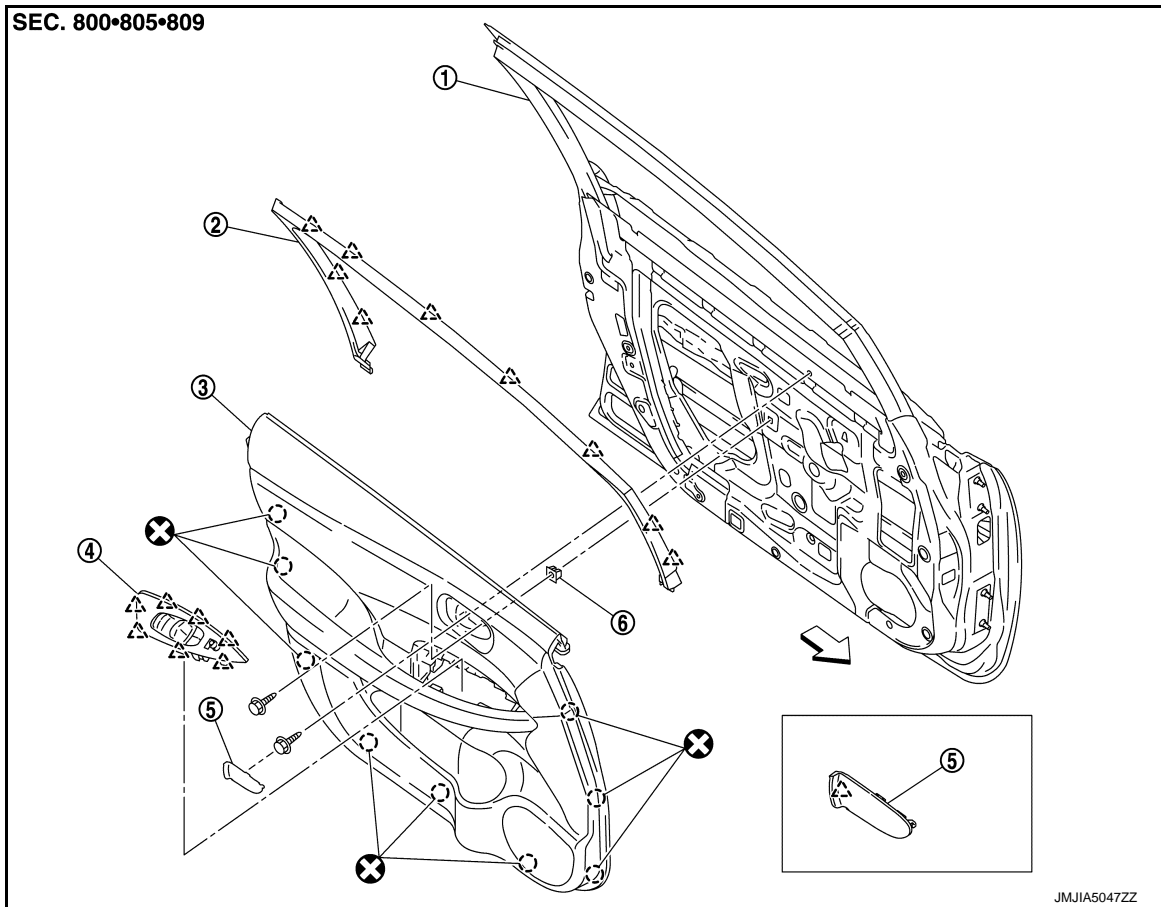

- |                                 |                                |                        |
|---------------------------------|--------------------------------|------------------------|
| 1. Front door panel             | 2. Front door sash inner cover | 3. Front door finisher |
| 4. Power window switch finisher | 5. Inside handle escutcheon    | 6. Grommet             |

○ : Clip

△ : Pawl

← : Vehicle front

⊗ : Always replace after every disassembly.

### Removal and Installation

INFOID:000000007632092

#### CAUTION:

- When removing, always use a remover tool that is made of plastic to prevent damage to the parts.
- Never damage the door panel.

#### REMOVAL

1. Fully open door window.
2. Remove power window switch finisher.

# FRONT DOOR FINISHER

## < REMOVAL AND INSTALLATION >

- a. Apply protective tape (A) on the part to protect it from damage.

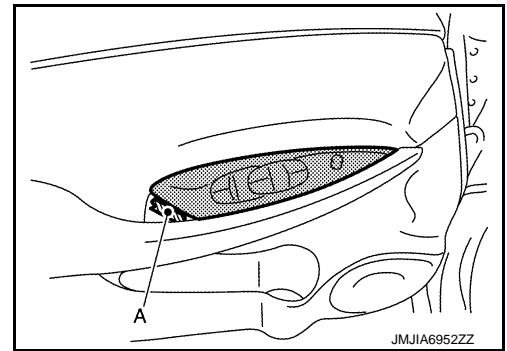

- b. Disengage power window switch finisher fixing pawls with a remover tool (A).

**CAUTION:**

**Always insert a remover tool from the rear of power window switch finisher.**  
**The parts may be damaged when inserting a remover tool to the front.**

 : Pawl

- c. Pull up power window switch finisher and power window switch as a unit and disconnect harness connector, and then remove power window switch finisher.

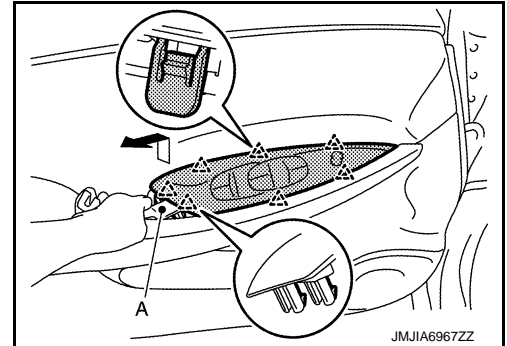

3. Remove inside handle escutcheon.  
Disengage inside handle escutcheon fixing pawls with a remover tool (A), and then remove inside handle escutcheon.

 : Pawl

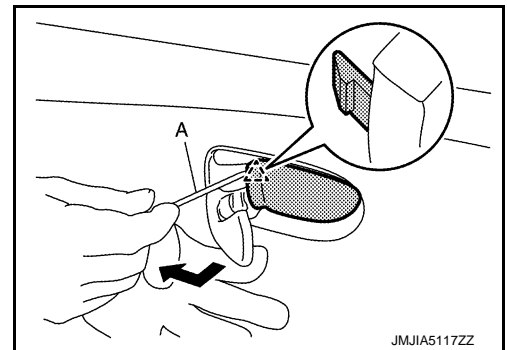

4. Remove front door finisher.  
a. Remove front door finisher mounting bolts (A).

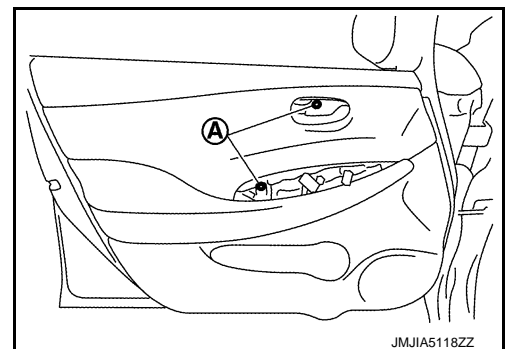

A  
B  
C  
D  
E  
F  
G  
H  
I  
INT  
K  
L  
M  
N  
O  
P

# FRONT DOOR FINISHER

## < REMOVAL AND INSTALLATION >

- b. Disengage front door finisher fixing clips with a remover tool (A).

**CAUTION:**

**Insert a remover tool between door panel and disengage clips to prevent damage to the parts.**

- c. Remove front door finisher according to the numerical order 1 → 2 as shown in the figure.

 : Clip

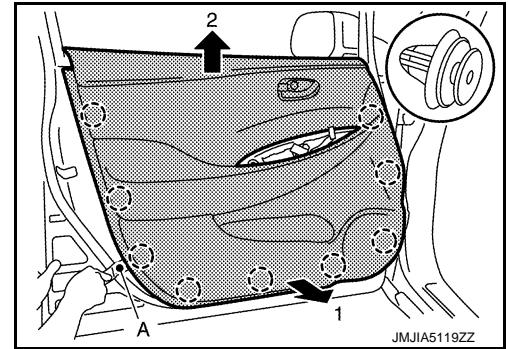

- d. Disconnect lock knob cable (1) and inside handle cable (2) according to the numerical order 1 → 4 as shown in the figure, and then remove front door finisher.

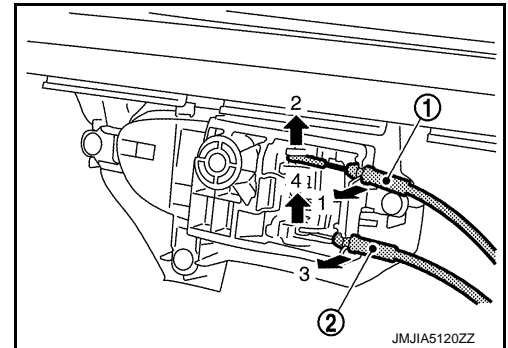

5. Remove the following parts after removing the front door finisher.

- Remove front door sash inner cover.

Disengage front door sash inner cover fixing pawls according to the numerical order 1 → 3 as shown in the figure, and then remove front door sash inner cover.

 : Pawl

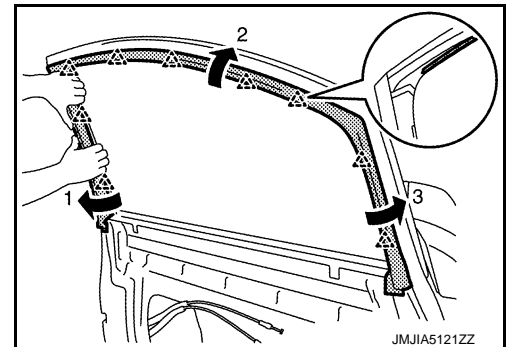

- Remove power window switch. Refer to [PWC-51. "Removal and Installation"](#).

## INSTALLATION

Note the following items, and install in the reverse order of removal.

**CAUTION:**

- Replace front door finisher fixing clips with a new part after removal of front door finisher. Never reuse front door finisher fixing clips.
- When installing, check in advance that clips are accurately aligned with the holes on door side, and then install by pressing in.



# REAR DOOR FINISHER

< REMOVAL AND INSTALLATION >

## REAR DOOR FINISHER

Exploded View

INFOID:000000007632093

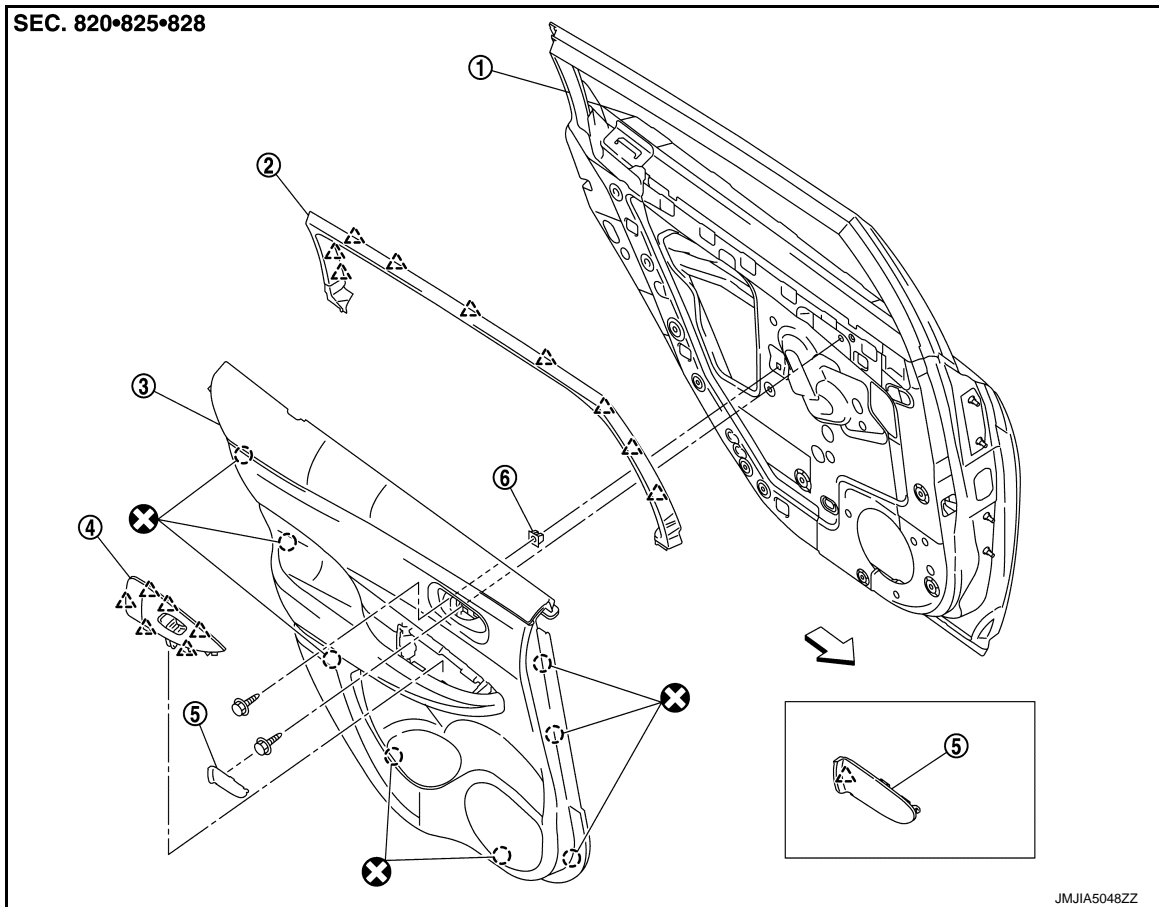

- |                                 |                               |                       |
|---------------------------------|-------------------------------|-----------------------|
| 1. Rear door panel              | 2. Rear door sash inner cover | 3. Rear door finisher |
| 4. Power window switch finisher | 5. Inside handle escutcheon   | 6. Grommet            |

○ : Clip

△ : Pawl

⇐ : Vehicle front

⊗ : Always replace after every disassembly.

### Removal and Installation

INFOID:000000007632094

#### **CAUTION:**

- When removing, always use a remover tool that is made of plastic to prevent damage to the parts.
- Never damage the door panel.

#### REMOVAL

1. Fully open door window.
2. Remove power window switch finisher.

A  
B  
C  
D  
E  
F  
G  
H  
I  
INT  
K  
L  
M  
N  
O  
P

# REAR DOOR FINISHER

## < REMOVAL AND INSTALLATION >

- a. Apply protective tape (A) on the parts to protect it from damage.

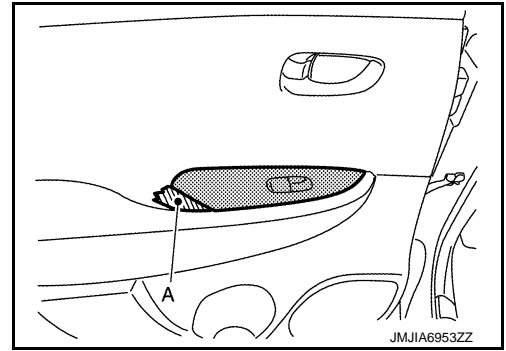

- b. Disengage power window switch finisher fixing pawls with a remover tool (A).

**CAUTION:**

**Always insert a remover tool from the rear of power window switch finisher.**  
**The parts may be damaged when inserting a remover tool to the front.**

 : Pawl

- c. Pull up power window switch finisher and power window switch as a unit and disconnect harness connector, and then remove power window switch finisher.

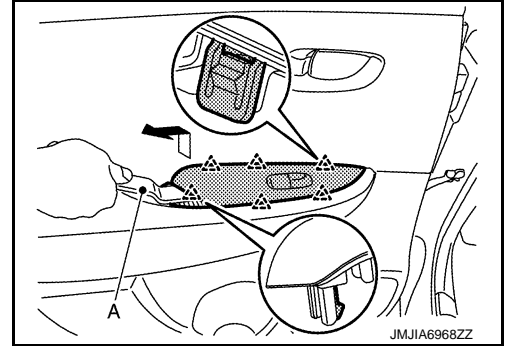

- 3. Remove inside handle escutcheon.  
Disengage inside handle escutcheon fixing pawl with a remover tool (A).

 : Pawl

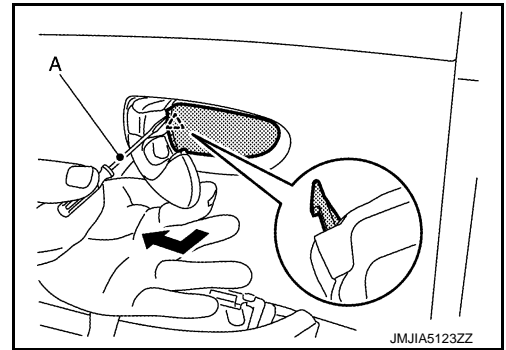

- 4. Remove rear door finisher.
  - a. Remove rear door finisher mounting bolts (A).

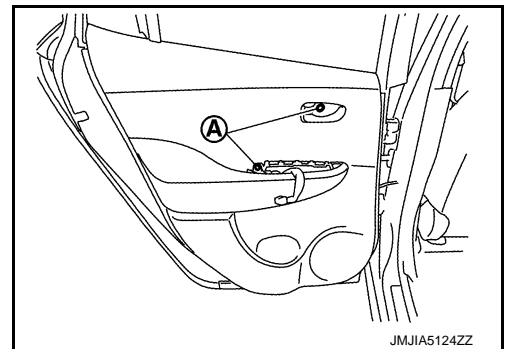

# REAR DOOR FINISHER

## < REMOVAL AND INSTALLATION >

- b. Disengage rear door finisher fixing clips with a remover tool (A).

**CAUTION:**

**Insert a remover tool between door panel and disengage clips to prevent damage to the parts.**

- c. Remove rear door finisher according to the numerical order 1 → 2 as shown in the figure.

 : Clip

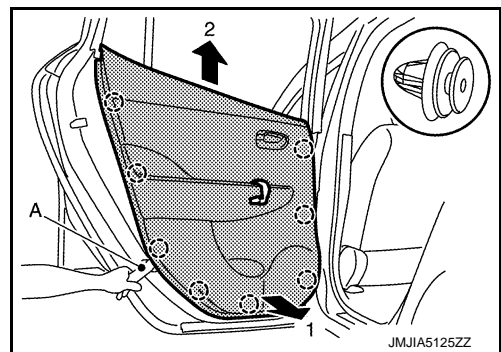

- d. Disconnect lock knob cable (1) and inside handle cable (2) according to the numerical order 1 → 4 as shown in the figure, and then remove rear door finisher.

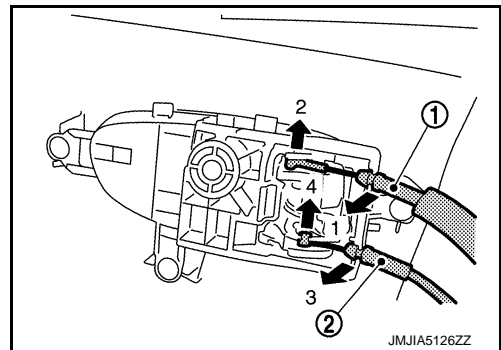

5. Remove the following parts after removing the rear door finisher.

- Remove rear door sash inner cover.

Disengage rear door sash inner cover fixing pawls according to the numerical order 1 → 3 as shown in the figure, and then remove rear door sash inner cover.

 : Pawl

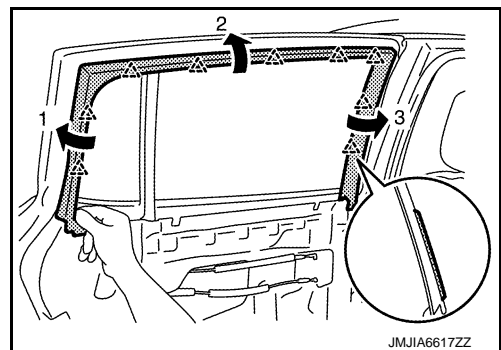

- Remove power window switch. Refer to [PWC-51. "Removal and Installation"](#).

## INSTALLATION

Note the following items, and install in the reverse order of removal.

**CAUTION:**

- **Replace rear door finisher fixing clips with a new part after removal of rear door finisher. Never reuse rear door finisher fixing clips.**
- **When installing, check in advance that clips are accurately aligned with the holes on door side, and then install by pressing in.**

# BODY SIDE TRIM

< REMOVAL AND INSTALLATION >

## BODY SIDE TRIM

Exploded View

INFOID:000000007632095

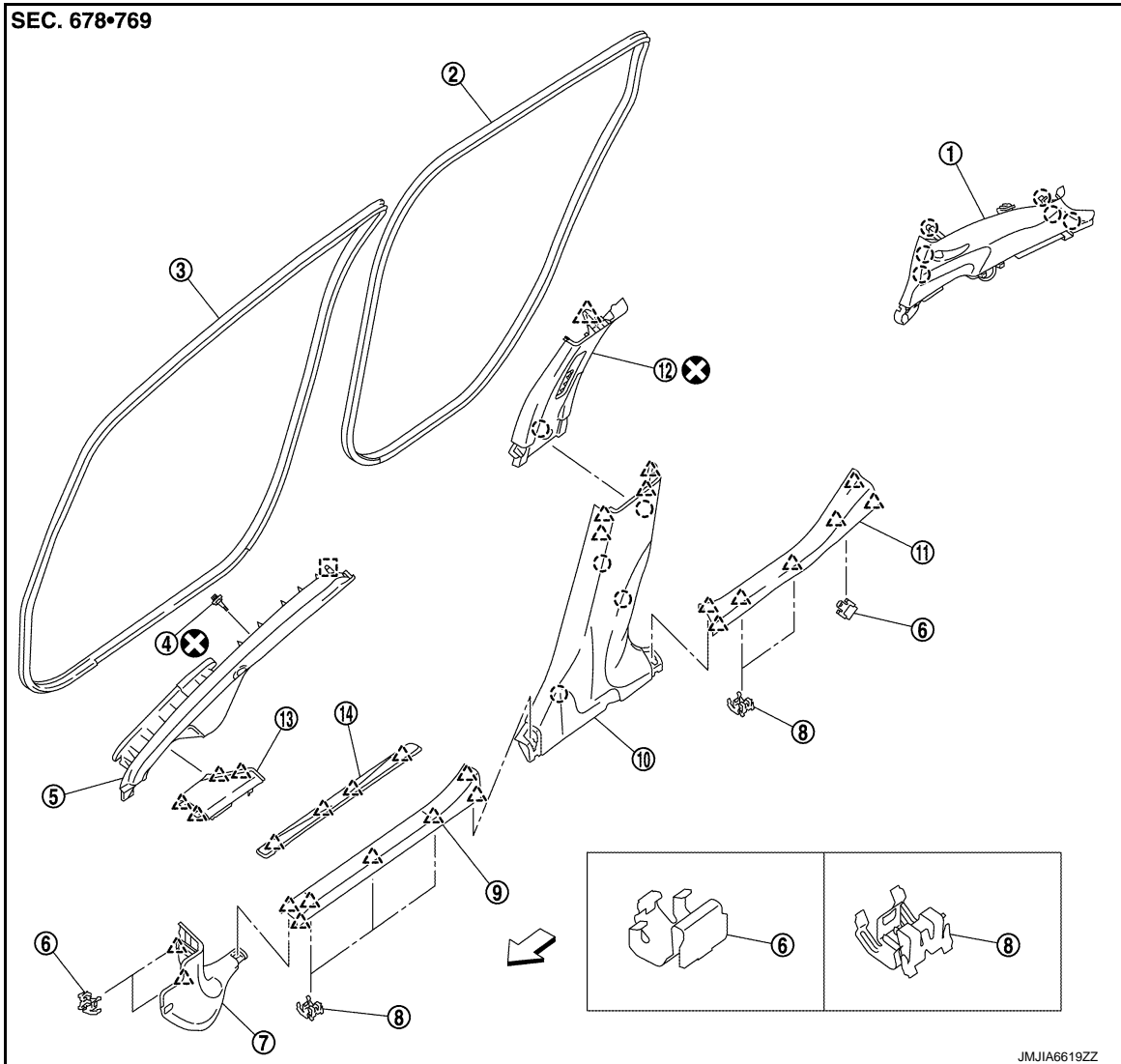

- |                                 |                               |                                 |
|---------------------------------|-------------------------------|---------------------------------|
| 1. Rear pillar finisher         | 2. Rear body side welt        | 3. Front body side welt         |
| 4. Clip                         | 5. Front pillar garnish       | 6. Metal clip A                 |
| 7. Dash side finisher           | 8. Metal clip B               | 9. Front kicking plate inner    |
| 10. Center pillar lower garnish | 11. Rear kicking plate inner  | 12. Center pillar upper garnish |
| 13. Instrument side panel       | 14. Front kicking plate outer |                                 |

○ : Clip

△ : Pawl

□ : Metal clip

← : Vehicle front

⊗ : Always replace after every disassembly.

## INSTRUMENT SIDE PANEL

### INSTRUMENT SIDE PANEL : Removal and Installation

INFOID:000000007632096

**CAUTION:**

# BODY SIDE TRIM

## < REMOVAL AND INSTALLATION >

- When removing, always use a remover tool that is made of plastic to prevent damage to the parts.
- Never damage the body.

### REMOVAL

1. Apply protective tape (A) on the parts to protect it from damage.

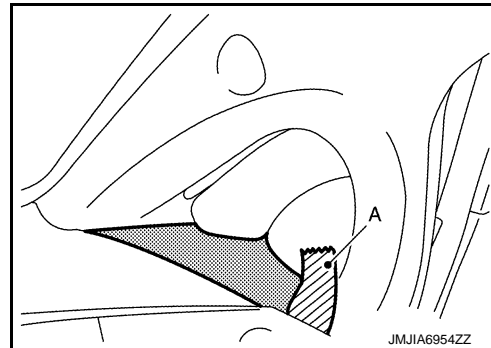

2. Disengage instrument side panel fixing pawls with a remover tool (A) according to the numerical order 1 → 2 as shown in the figure, and then remove instrument side panel.

 : Pawl

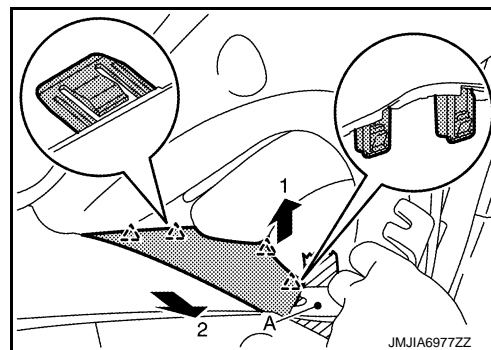

### INSTALLATION

Install in the reverse order of removal.

## FRONT PILLAR GARNISH

### FRONT PILLAR GARNISH : Removal and Installation

INFOID:000000007632097

#### CAUTION:

- When removing, always use a remover tool that is made of plastic to prevent damage to the parts.
- Never damage the body.

### REMOVAL

1. Remove instrument side panel. Refer to [INT-20, "INSTRUMENT SIDE PANEL : Removal and Installation"](#).
2. Remove front body side welt. Refer to [INT-24, "BODY SIDE WELT : Removal and Installation"](#).
3. Remove front pillar garnish.
- a. Disengage front pillar garnish fixing metal clip and clip with a remover tool (A) according to the numerical order 1 → 2 as shown in the figure.

 : Clip

 : Metal clip

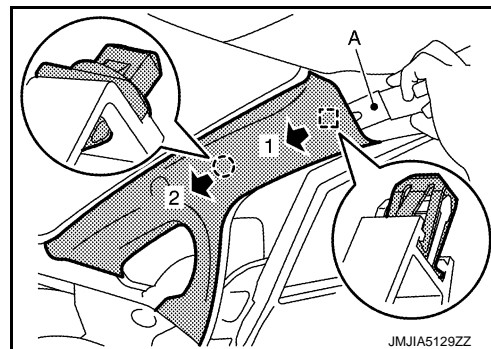

## BODY SIDE TRIM

### < REMOVAL AND INSTALLATION >

- b. Cut clip anchor portion.

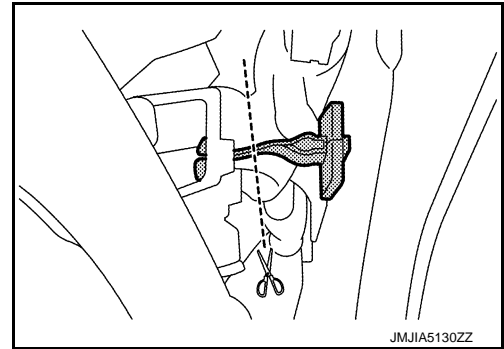

- c. Pull front pillar garnish forward the direction of the arrow, disconnect tweeter harness connector and then remove front pillar garnish.

**NOTE:**

Remove tweeter from front pillar garnish. Refer to [AV-113](#), "[Removal and Installation](#)".

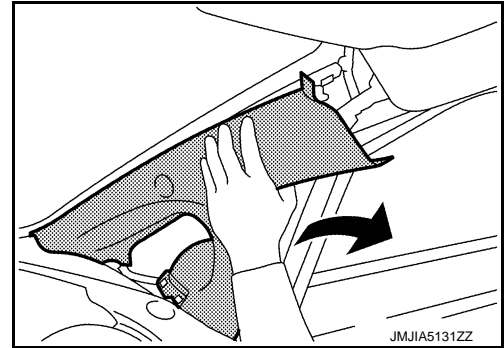

### INSTALLATION

Note the following items, and install in the reverse order of removal.

**CAUTION:**

- Replace clip anchor with a new part after removal. Never reuse clip anchor.
- When installing, check in advance that clip and metal clip are accurately aligned with the holes on body side, and then install by pressing in.

### KICKING PLATE OUTER

#### KICKING PLATE OUTER : Removal and Installation

INFOID:000000007632098

**CAUTION:**

- When removing, always use a remover tool that is made of plastic to prevent damage to the parts.
- Never damage the body.

### REMOVAL

#### FRONT KICKING PLATE OUTER

1. Apply protective tape (A) on the parts to protect it from damage.

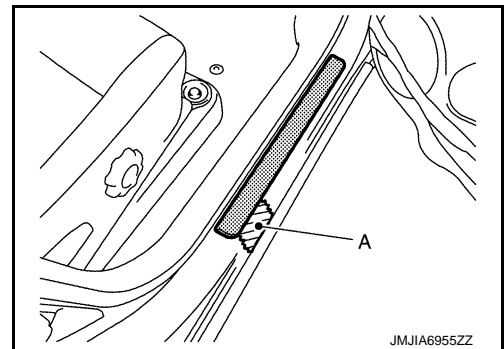

# BODY SIDE TRIM

## < REMOVAL AND INSTALLATION >

2. Disengage front kicking plate outer fixing pawls with a remover tool (A), and then remove front kicking plate outer.

 : Pawl

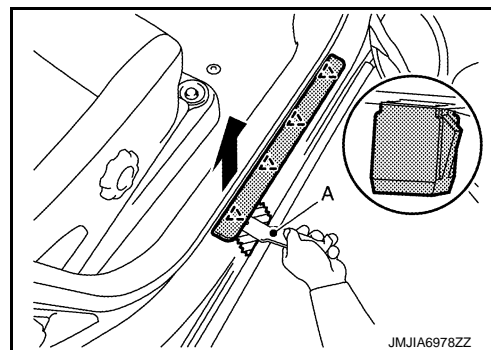

## INSATALLATION

Install in the reverse order of removal.

## KICKING PLATE INNER

### KICKING PLATE INNER : Removal and Installation

INFOID:000000007632099

#### CAUTION:

- When removing, always use a remover tool that is made of plastic to prevent damage to the parts.
- Never damage the body.

#### REMOVAL

##### FRONT KICKING PLATE INNER

1. Apply protective tape (A) on the parts to protect it from damage.

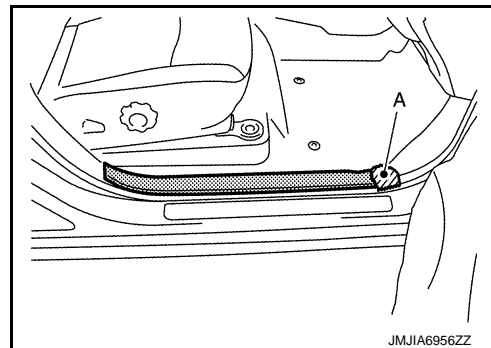

2. Disengage front kicking plate inner fixing pawls with a remover tool (A) according to the numerical order 1 → 5 as shown in the figure, and then remove front kicking plate inner.

#### CAUTION:

Pawls may be damaged. Always remove from vehicle front.

 : Pawl

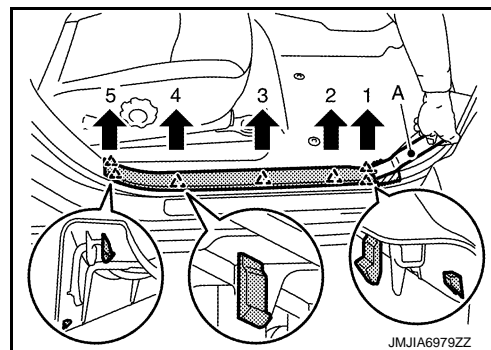

##### REAR KICKING PLATE INNER

1. Apply protective tape (A) on the parts to protect it from damage.

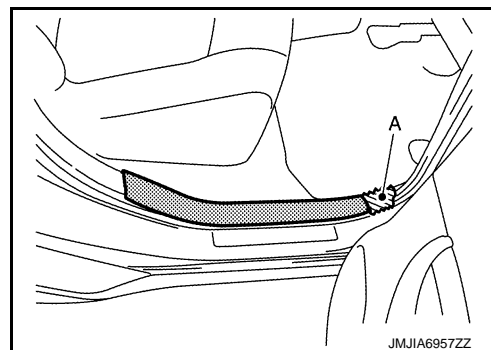

A  
B  
C  
D  
E  
F  
G  
H  
I  
INT  
K  
L  
M  
N  
O  
P

## BODY SIDE TRIM

### < REMOVAL AND INSTALLATION >

2. Disengage rear kicking plate inner fixing pawls with a remover tool (A) according to the numerical order 1 → 5 as shown in the figure, and then remove rear kicking plate inner.

**CAUTION:**

**Pawls may be damaged. Always remove from vehicle front.**

 : Pawl

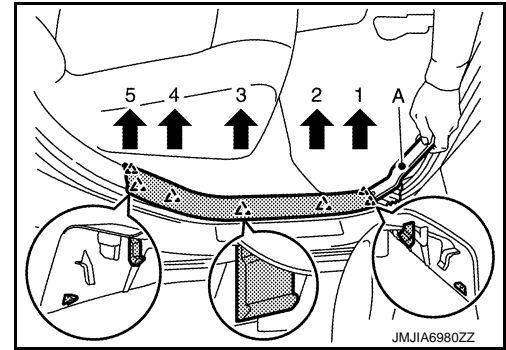

### INSATALLATION

Note the following item. and install in the reverse order of removal.

**CAUTION:**

The parts cannot be installed when the vehicle side metal clip (A) and metal clip (B) are not aligned normally. Check that the positions of metal clip (A) and metal clip (B) are correct. Refer to [INT-20, "Exploded View"](#).

### BODY SIDE WELT

#### BODY SIDE WELT : Removal and Installation

INFOID:000000007632100

**CAUTION:**

- Never excessively pull body side welt to prevent damage to the parts.
- Never damage the body.

### REMOVAL

#### FRONT BODY SIDE WELT

1. Remove center pillar lower garnish. Refer to [INT-25, "CENTER PILLAR LOWER GARNISH : Removal and Installation"](#).
2. Remove front body side welt.

#### REAR BODY SIDE WELT

1. Remove center pillar lower garnish. Refer to [INT-25, "CENTER PILLAR LOWER GARNISH : Removal and Installation"](#).
2. Remove rear body side welt.

### INSTALLATION

Install in the reverse order of removal.

### DASH SIDE FINISHER

#### DASH SIDE FINISHER : Removal and Installation

INFOID:000000007632101

**CAUTION:**

**Never damage the body.**

### REMOVAL

1. Remove front kicking plate inner. Refer to [INT-23, "KICKING PLATE INNER : Removal and Installation"](#).
2. Remove front body side welt. Refer to [INT-24, "BODY SIDE WELT : Removal and Installation"](#).
3. Remove dash side finisher.



## BODY SIDE TRIM

### < REMOVAL AND INSTALLATION >

- a. Disengage stud bolt (A).

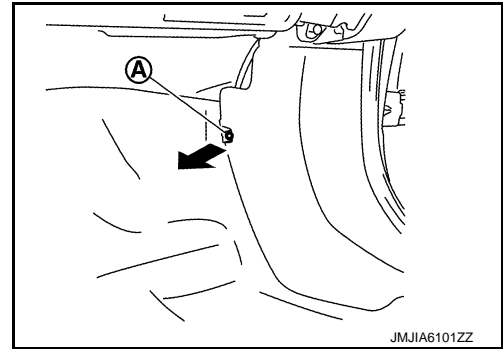

- b. Pull back dash side finisher, and then disengage dash side finisher fixing pawls, and then remove dash side finisher.

**CAUTION:**

**Pull dash side finisher straight toward vehicle rear. Otherwise, pawls may be damaged if front end of dash side finisher opens toward vehicle inside.**

 : Pawl

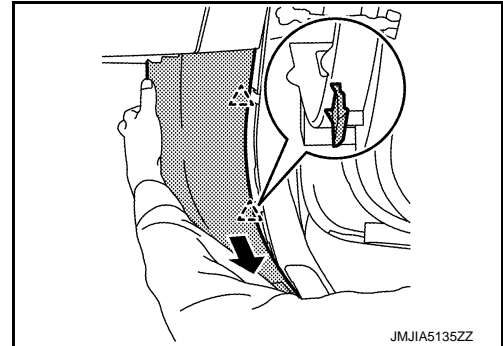

### INSTALLATION

Install in the reverse order of removal.

### CENTER PILLAR LOWER GARNISH

#### CENTER PILLAR LOWER GARNISH : Removal and Installation

INFOID:000000007632102

**CAUTION:**

- When removing, always use a remover tool that is made of plastic to prevent damage to the parts.
- Never damage the body.

### REMOVAL

1. Fully open front door and rear door.
2. Slide front seat to the fully forward position. Tilt seatback forward.
3. Remove front kicking plate inner and rear kicking plate inner. Refer to [INT-23, "KICKING PLATE INNER : Removal and Installation"](#).
4. Remove center pillar lower garnish.  
Disengage center pillar lower garnish fixing clips with a remover tool (A), and then remove center pillar lower garnish.

 : Clip

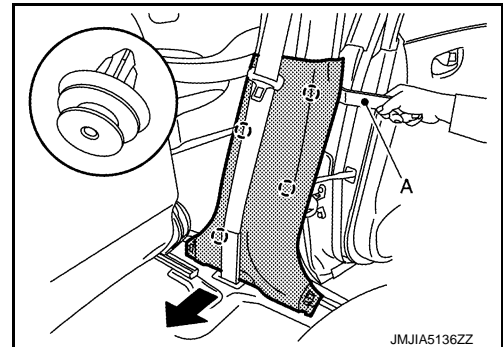

### INSTALLATION

Note the following item, and install in the reverse order of removal.

**CAUTION:**

**When installing, check in advance that clips are accurately aligned with the holes on body side, and then install by pressing in.**

### CENTER PILLAR UPPER GARNISH

# BODY SIDE TRIM

< REMOVAL AND INSTALLATION >

## CENTER PILLAR UPPER GARNISH : Removal and Installation

INFOID:000000007632103

### CAUTION:

- When removing, always use a remover tool that is made of plastic to prevent damage to the parts.
- Never damage the body.

### REMOVAL

1. Remove front seat belt shoulder anchor. Refer to [SB-8, "SEAT BELT RETRACTOR : Removal and Installation"](#).
2. Remove center pillar lower garnish. Refer to [INT-25, "CENTER PILLAR LOWER GARNISH : Removal and Installation"](#).
3. Remove front body side welt and rear body side welt. refer to [INT-24, "BODY SIDE WELT : Removal and Installation"](#).
4. Remove center pillar upper garnish.
  - a. Disengage center pillar upper garnish lower side fixing clip with a remover tool (A).

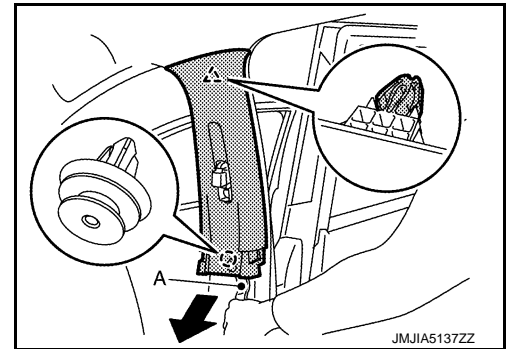
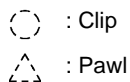

- b. Disengage center pillar upper garnish upper side fixing pawl, and then remove center pillar upper garnish.

### NOTE:

Removal operation can be performed easily according to the numerical order 1 → 4 as shown in the figure when pressing pawl by inserting a removal tool from direction (A) as shown in the figure.

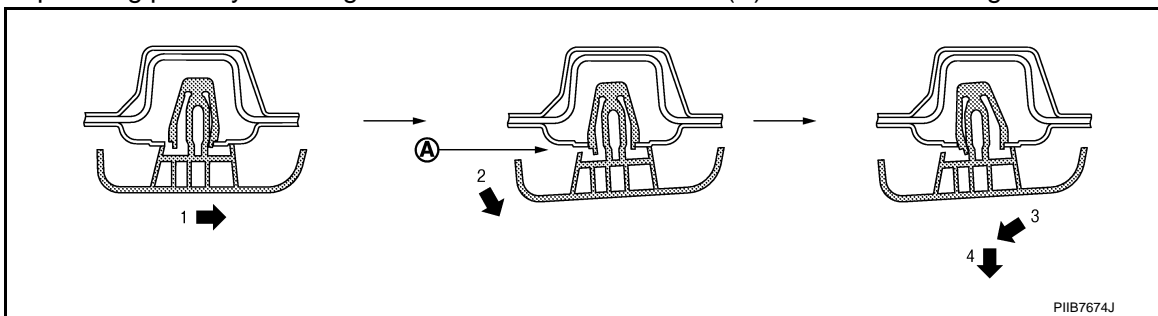

### CAUTION:

Be careful not to apply excessive force when removing center pillar upper garnish. Otherwise, pawl may be damaged and fragments may drop in panel holes on body.

### INATALLATION

Note the following items, and install in the reverse order of removal.

### CAUTION:

- Replace center pillar upper garnish with a new part after removal. Never reuse center pillar upper garnish.
- When installing, check in advance that clip and pawl are accurately aligned with the holes on body side, and then install by pressing in.

## REAR PILLAR FINISHER

### REAR PILLAR FINISHER : Removal and Installation

INFOID:000000007632104

### CAUTION:

- When removing, always use a remover tool that is made of plastic to prevent damage to the parts.
- Never damage the body.

### REMOVAL

## BODY SIDE TRIM

### < REMOVAL AND INSTALLATION >

1. Fully open rear door and back door.
2. Remove rear body side welt. Refer to [INT-24, "BODY SIDE WELT : Removal and Installation"](#).
3. Remove back door weather-strip. Refer to [DLK-165, "BACK DOOR WEATHER-STRIP : Removal and Installation"](#).
4. Remove rear parcel shelf finisher. Refer to [INT-35, "REAR PARCEL SHELF FINISHER : Removal and Installation"](#).
5. Remove luggage side lower finisher. Refer to [INT-38, "LUGGAGE SIDE LOWER FINISHER : Removal and Installation"](#).
6. Remove rear seat belt anchor bolt. Refer to [SB-15, "SEAT BELT RETRACTOR : Removal and Installation"](#).
7. Remove rear pillar finisher.  
Disengage rear pillar finisher fixing clips with a remover tool (A), and then remove rear pillar finisher.

**CAUTION:**

**Be careful not to damage parts when inserting seat belt anchor bolt into seat belt opening hole of rear pillar finisher.**

 : Clip

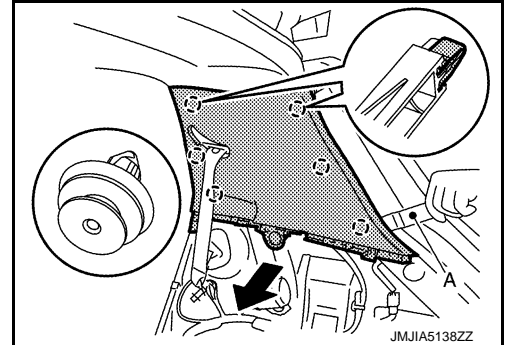

### INSTALLATION

Note the following item, and install in the reverse order of removal.

**CAUTION:**

**When installing, check in advance that clips are accurately aligned with the holes on body side, and then install by pressing in.**

A  
B  
C  
D  
E  
F  
G  
H  
I  
K  
L  
M  
N  
O  
P

INT

# FLOOR TRIM

< REMOVAL AND INSTALLATION >

## FLOOR TRIM

Exploded View

INFOID:000000007632105

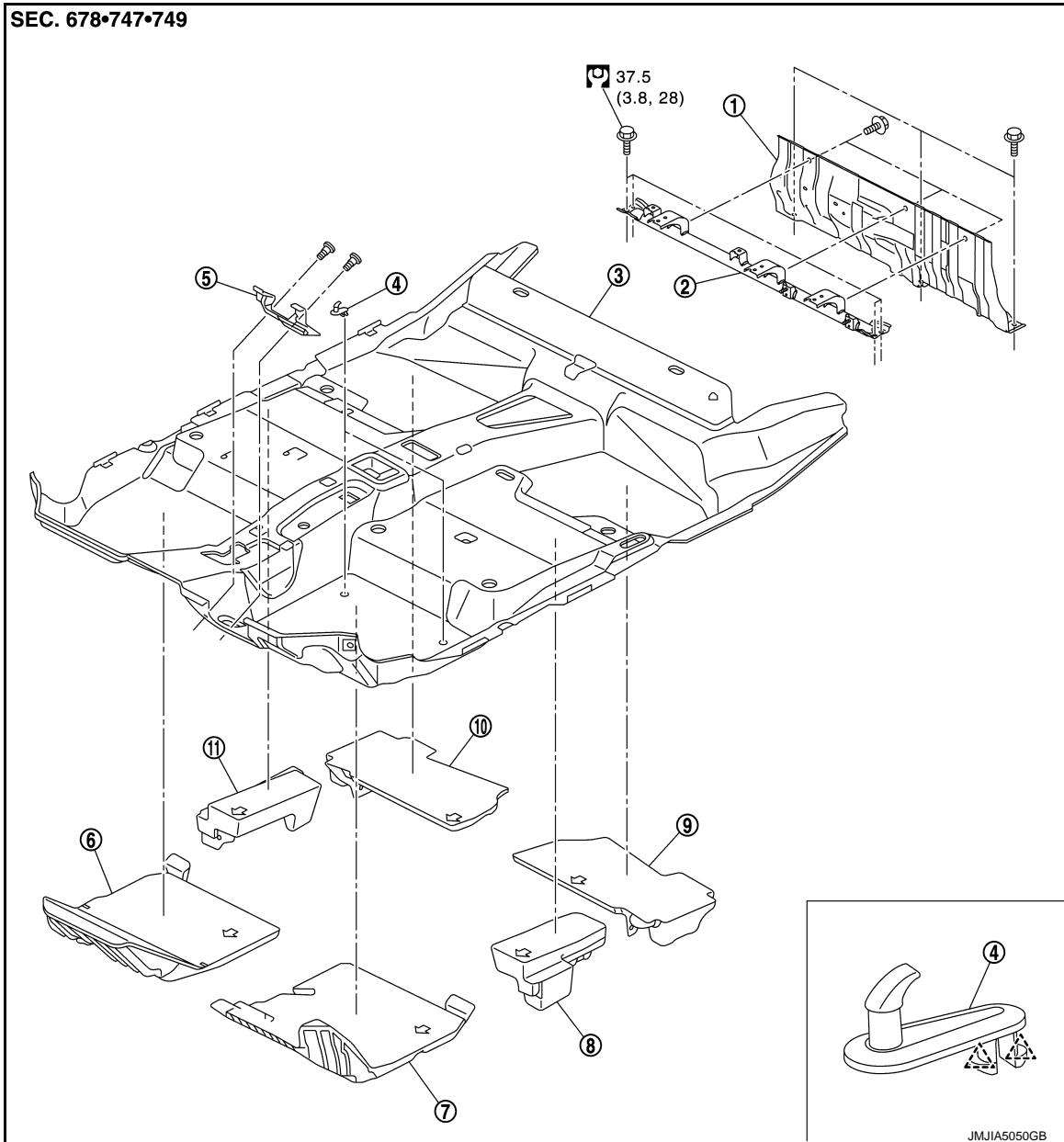

- |                              |                                  |                          |
|------------------------------|----------------------------------|--------------------------|
| 1. Rear seat back rear panel | 2. Luggage bar assembly          | 3. Floor carpet          |
| 4. Carpet hook               | 5. Steering column hole cover    | 6. Front floor spacer RH |
| 7. Front floor spacer LH     | 8. Front floor center spacer LH  | 9. Rear floor spacer LH  |
| 10. Rear floor spacer RH     | 11. Front floor center spacer RH |                          |

 : Pawl

 : N·m (kg·m, ft·lb)

### Removal and Installation

INFOID:000000007632106

#### CAUTION:

- When removing, always use a remover tool that is made of plastic to prevent damage to the parts.
- Never damage the body.

# FLOOR TRIM

## < REMOVAL AND INSTALLATION >

### REMOVAL

1. Remove center console assembly. Refer to [IP-27. "Removal and Installation"](#).
2. Remove front seat assembly (LH and RH). Refer to [SE-22. "Removal and Installation"](#).
3. Remove rear seat cushion. Refer to [SE-35. "SEAT CUSHION : Removal and Installation"](#).
4. Remove diagnosis sensor unit. Refer to [SR-35. "Removal and Installation"](#).
5. Remove instrument stay.  
Remove instrument stay fixing nuts (A), and then remove instrument stay (1).
6. Disconnect drain hose (2). Refer to [HA-62. "A/C UNIT ASSEMBLY : Removal and Installation"](#).

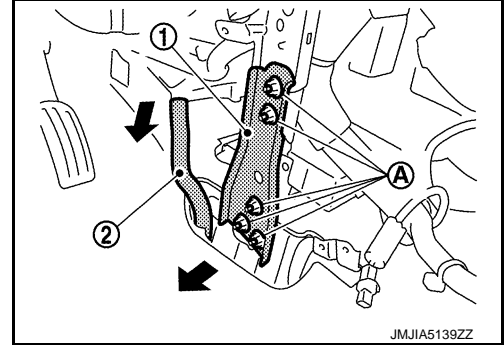

7. Remove sift selector assembly. Refer to [TM-131. "Removal and Installation"](#).
8. Remove electric shift control module. Refer to [TM-130. "Removal and Installation"](#).
9. Remove steering column hole cover.  
Disengage trim clips (A), and then remove steering column hole cover.

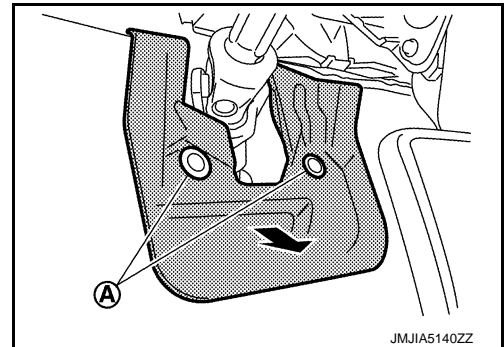

10. Remove center pillar lower garnish (LH and RH). Refer to [INT-25. "CENTER PILLAR LOWER GARNISH : Removal and Installation"](#).
11. Remove dash side finisher (LH and RH). Refer to [INT-24. "DASH SIDE FINISHER : Removal and Installation"](#).
12. Remove rear foot duct (with rear foot duct). Refer to [VTL-20. "REAR FOOT DUCT 1 : Removal and Installation"](#).
13. Remove floor carpet.

### NOTE:

Disengage pawls using a remover tool according to the numerical order 1 → 2 as shown in the figure, and then remove carpet hook.

 : Pawl

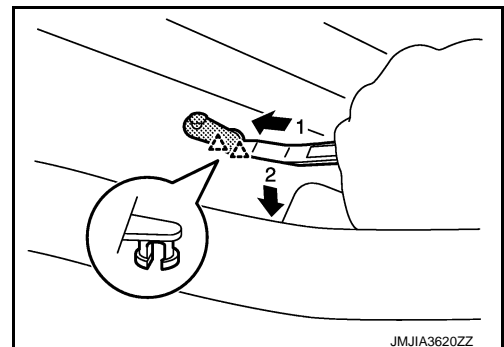

### INSTALLATION

## FLOOR TRIM

### < REMOVAL AND INSTALLATION >

---

Note the following item, and install in the reverse order of removal.

**CAUTION:**

Replace diagnosis sensor unit fixing bolts with a new part after removal. Never reuse diagnosis sensor unit fixing bolts.

# HEADLINING

< REMOVAL AND INSTALLATION >

## HEADLINING

Exploded View

INFOID:000000007632107

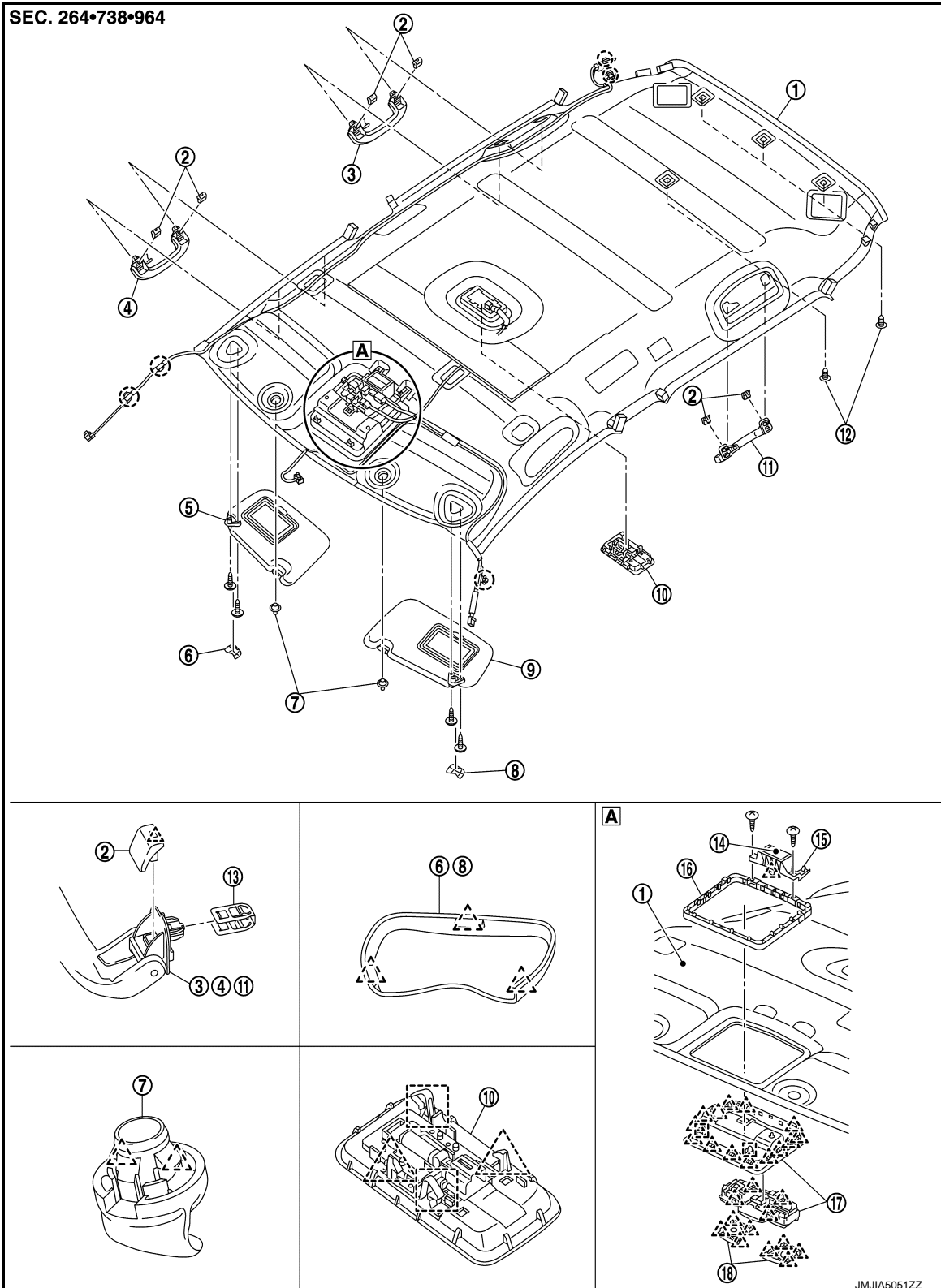

- |                         |                          |                          |
|-------------------------|--------------------------|--------------------------|
| 1. Headlining assembly  | 2. Assist grip clip      | 3. Rear assist grip RH   |
| 4. Front assist grip RH | 5. Sun visor assembly RH | 6. Sun visor cover RH    |
| 7. Sun visor holder     | 8. Sun visor cover LH    | 9. Sun visor assembly LH |

JMJIA5051ZZ

A  
B  
C  
D  
E  
F  
G  
H  
I  
INT  
K  
L  
M  
N  
O  
P

# HEADLINING

## < REMOVAL AND INSTALLATION >

- |                        |                         |                     |
|------------------------|-------------------------|---------------------|
| 10. Room lamp assembly | 11. Rear assist grip LH | 12. Headlining clip |
| 13. Metal clip         | 14. Dual lock fastener  | 15. Bracket         |
| 16. Map lamp plate     | 17. Map lamp assembly   | 18. Lens            |

 : Clip

 : Pawl

 : Metal clip

## Removal and Installation

INFOID:000000007632108

### CAUTION:

- When removing, always use a remover tool that is made of plastic to prevent damage to the parts.
- Never damage the body.

### REMOVAL

1. Remove front pillar garnish (LH and RH). Refer to [INT-21, "FRONT PILLAR GARNISH : Removal and Installation"](#).
2. Disconnect harness connectors (A) from headlining and harness clips.

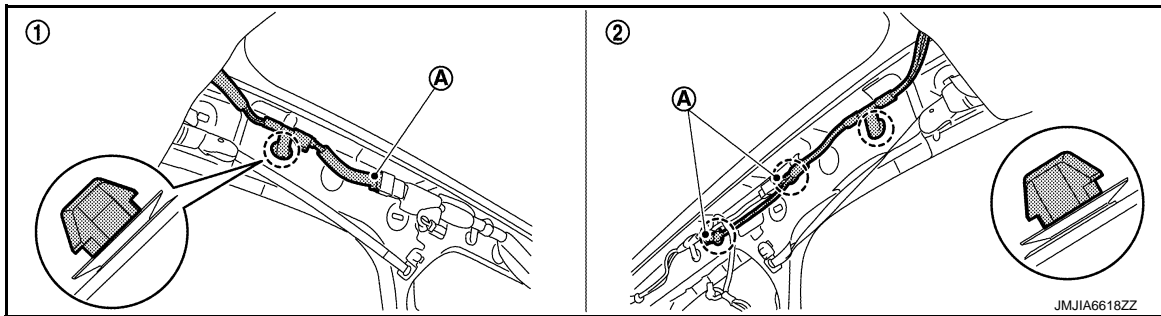

1. Left side pillar

2. Right side pillar

 : Clip

3. Remove center pillar upper garnish (LH and RH). Refer to [INT-26, "CENTER PILLAR UPPER GARNISH : Removal and Installation"](#).
4. Remove rear pillar finisher. (LH and RH). Refer to [INT-26, "REAR PILLAR FINISHER : Removal and Installation"](#).
5. Disconnect harness connectors (A) from headlining and harness clips.

 : Clip

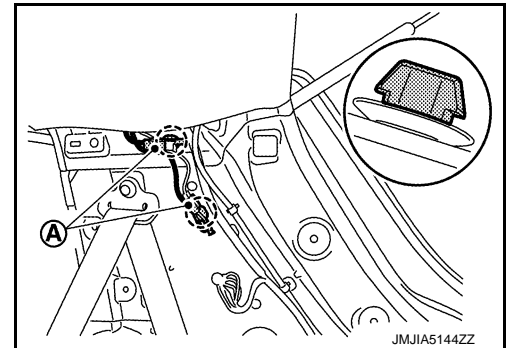



# HEADLINING

## < REMOVAL AND INSTALLATION >

6. Remove all assist grips.
  - a. Remove assist grip clip
    - i. Disengage pawl of assist grip clip (1) using a remover tool (A) according to the numerical order 1 as shown in the figure.

 : Pawl

- ii. Slide assist grip clip forward according to the numerical order 2 as shown in the figure, and then remove assist grip clip.
  - b. Slide assist grip (2) forward and remove it.
  - c. Remove metal clips.

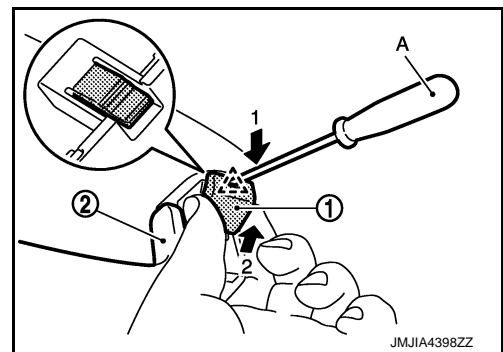

7. Remove sun visor assembly (LH and RH).
  - a. Disengage sun visor cover fixing pawls with a remover tool (A), and then remove sun visor cover.

 : Pawl

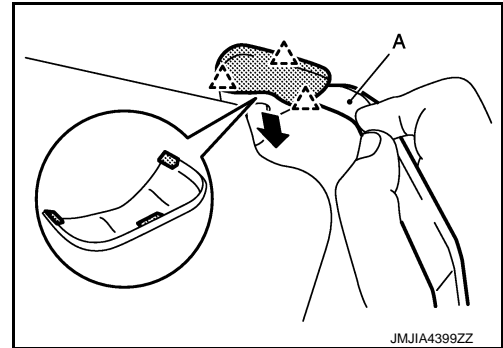

- b. Remove sun visor assembly fixing screw, and then remove sun visor assembly.
8. Remove room lamp assembly. Refer to [INL-44. "Removal and Installation"](#).
9. Remove lamp unit of map lamp assembly. Refer to [INL-39. "Removal and Installation"](#).

### CAUTION:

**The map lamp assembly can only be removed from back side after headlining is removed.**

10. Remove sun visor holder (LH and RH).
  - a. Rotate 90° according to the numerical order 1 as shown in the figure.
  - b. Remove toward vehicle lower according to the numerical order 2 as shown in the figure.

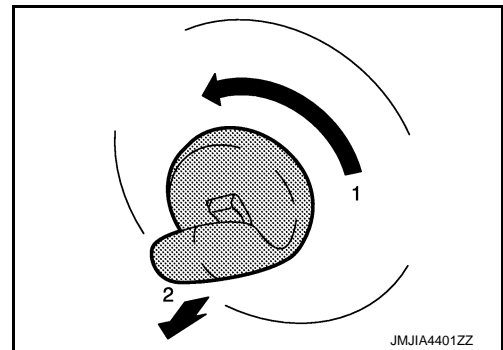

11. Disengage bracket fixing dual lock fastener (A).
12. Disengage map lamp fixing metal clips.

 : Metal clip

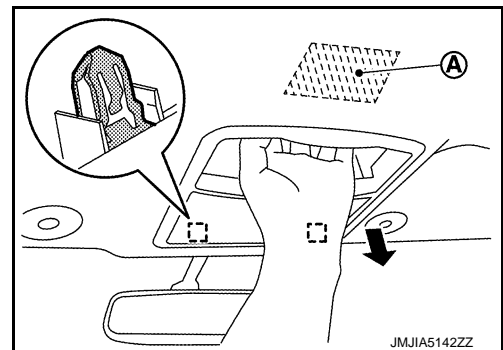

13. Remove headlining clips.

A  
B  
C  
D  
E  
F  
G  
H  
I  
INT  
K  
L  
M  
N  
O  
P

# HEADLINING

## < REMOVAL AND INSTALLATION >

14. Remove headlining assembly through the back door.

**CAUTION:**

- Two workers are required for removal in order to prevent damage.
- Apply protective tape to the portion where contact may occur during work.
- Never bend headlining when removing to prevent damage to the parts.

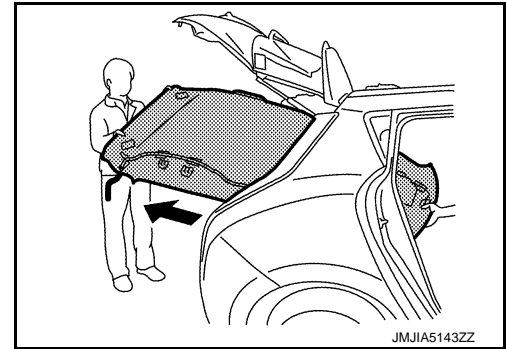

## INSTALLATION

Note the following items, and install in the reverse order of removal.

**CAUTION:**

- When installing headlining, start by installing both sun visor holders and headlining clips in order to keep the headlining in position.
- Never bend headlining when installing to prevent damage to the parts.
- Be careful that the surface is not wrinkled when installing.

# LUGGAGE FLOOR TRIM

< REMOVAL AND INSTALLATION >



## LUGGAGE FLOOR TRIM

Exploded View

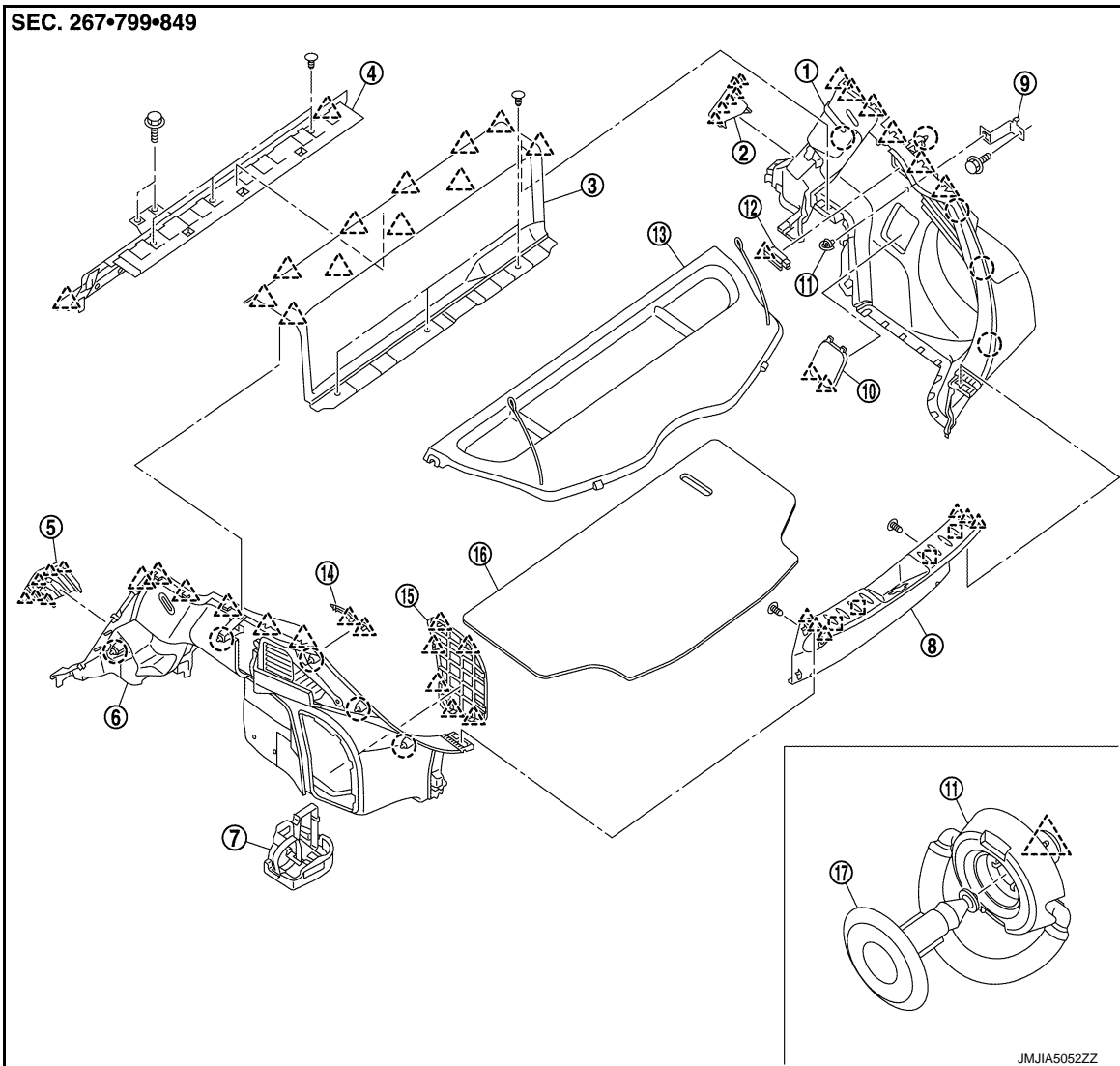
INFOID:000000007632109



- |                                   |                             |                                   |
|-----------------------------------|-----------------------------|-----------------------------------|
| 1. Luggage side lower finisher RH | 2. Luggage finisher mask RH | 3. Luggage floor upper finisher   |
| 4. Luggage floor front finisher   | 5. Luggage finisher mask LH | 6. Luggage side lower finisher LH |
| 7. Luggage side box               | 8. Luggage rear plate       | 9. Luggage side lower bracket     |
| 10. Shock absorber mask RH        | 11. Luggage net hook        | 12. Luggage room lamp             |
| 13. Rear parcel shelf finisher    | 14. Shock absorber mask LH  | 15. Tool lid mask                 |
| 16. Luggage floor board           | 17. Net hook pin            |                                   |

-  : Clip
-  : Pawl
-  : Metal clip

## REAR PARCEL SHELF FINISHER

### REAR PARCEL SHELF FINISHER : Removal and Installation

INFOID:000000007632110

#### REMOVAL

1. Remove strap from back door side finisher hook.

A  
B  
C  
D  
E  
F  
G  
H  
I  
INT  
K  
L  
M  
N  
O  
P

# LUGGAGE FLOOR TRIM

## < REMOVAL AND INSTALLATION >

2. Disengage and remove luggage side lower finisher.

### INSTALLATION

Install in the reverse order of removal.

## LUGGAGE FLOOR BOARD

### LUGGAGE FLOOR BOARD : Removal and Installation

INFOID:000000007632111

#### CAUTION:

**Never damage the body.**

### REMOVAL

Remove luggage floor board from back door opening portion.

### INSTALLATION

Install in the reverse order of removal.

## LUGGAGE REAR PLATE

### LUGGAGE REAR PLATE : Removal and Installation

INFOID:000000007632112

#### CAUTION:

- When removing, always use a remover tool that is made of plastic to prevent damage to the parts.
- Never damage the body.

### REMOVE

1. Remove back door weather-strip. Refer to [DLK-165, "BACK DOOR WEATHER-STRIP : Removal and Installation"](#).
2. Remove luggage floor board. Refer to [INT-36, "LUGGAGE FLOOR BOARD : Removal and Installation"](#).
3. Remove luggage rear plate.
  - a. Disengage luggage rear plate fixing clips (A).

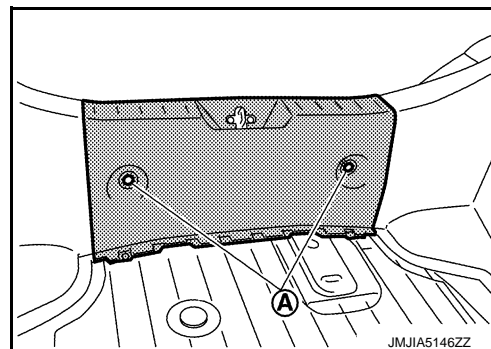

- b. Disengage luggage rear plate fixing pawls and metal clips with a remover tool (A), and then remove luggage rear plate.

#### CAUTION:

**Always remove the part while lifting it up toward vehicle upper. Or otherwise, the parts that are stuck in luggage side lower finisher may be damaged.**

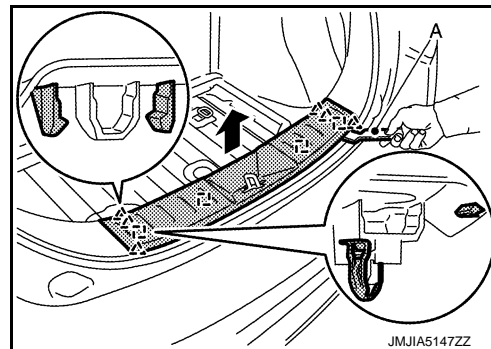
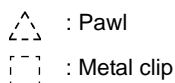

### INSTALLATION

Note the following item, and install in the reverse order of removal.

#### CAUTION:

**When installing, check in advance that pawls and metal clips are accurately aligned with the holes on body side, and then install by pressing in.**

## LUGGAGE FLOOR UPPER FINISHER

# LUGGAGE FLOOR TRIM

< REMOVAL AND INSTALLATION >

## LUGGAGE FLOOR UPPER FINISHER : Removal and Installation

INFOID:000000007632113

### CAUTION:

- When removing, always use a remover tool that is made of plastic to prevent damage to the parts.
- Never damage the body.

### REMOVE

1. Remove rear parcel shelf finisher. Refer to [INT-35, "REAR PARCEL SHELF FINISHER : Removal and Installation"](#).
2. Remove luggage floor board. Refer to [INT-36, "LUGGAGE FLOOR BOARD : Removal and Installation"](#).
3. Remove luggage floor upper finisher.
- a. Apply protective tape (A) on the parts to protect it from damage.

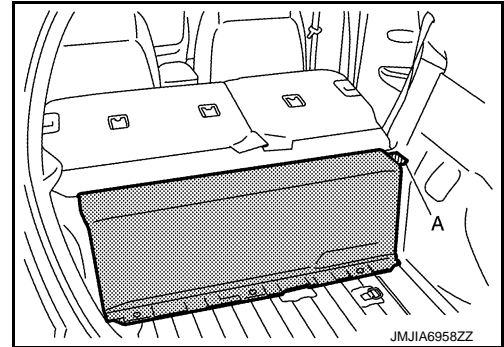

- b. Remove luggage floor upper finisher fixing clips (A).
- c. Disengage luggage floor upper finisher fixing pawls with a remover tool (B), and then remove luggage floor upper finisher.

### CAUTION:

Always remove the part while lifting it up toward vehicle upper. Or otherwise, the parts that are stuck in luggage side lower finisher may be damaged.

 : Pawl

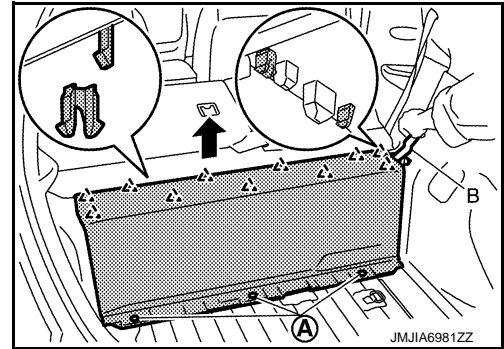

### INSTALLATION

Note the following item, and install in the reverse order of removal.

### CAUTION:

When installing, check in advance that pawls are accurately aligned with the holes on body side, and then install by pressing in.

## LUGGAGE FINISHER MASK

### LUGGAGE FINISHER MASK : Removal and Installation

INFOID:000000007632114

### CAUTION:

- When removing, always use a remover tool that is made of plastic to prevent damage to the parts.
- Never damage the body.

### REMOVE

# LUGGAGE FLOOR TRIM

## < REMOVAL AND INSTALLATION >

1. Apply protective tape (A) on the parts to protect it from damage.

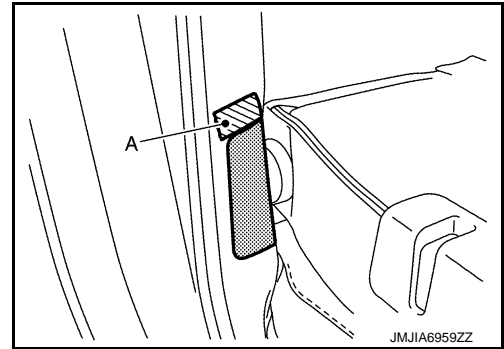

2. Disengage luggage finisher mask fixing pawls with a remover tool (A), and then remove luggage finisher mask.

 : Pawl

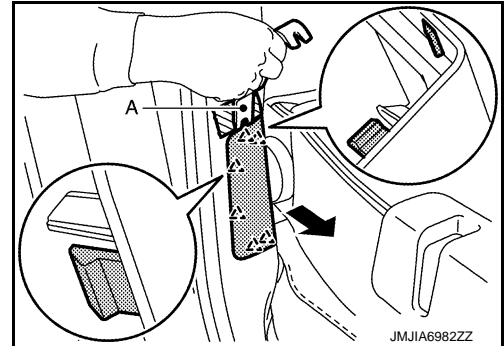

## INSTALLATION

Install in the reverse order of removal.

## LUGGAGE FLOOR FRONT FINISHER

### LUGGAGE FLOOR FRONT FINISHER : Removal and Installation

INFOID:000000007632115

#### CAUTION:

- When removing, always use a remover tool that is made of plastic to prevent damage to the parts.
- Never damage the body.

#### REMOVE

1. Remove rear seat cushion. Refer to [SE-35, "SEAT CUSHION : Removal and Installation"](#).
2. Remove rear seatback. Refer to [SE-30, "SEATBACK : Removal and Installation"](#).
3. Remove luggage floor upper finisher. Refer to [INT-37, "LUGGAGE FLOOR UPPER FINISHER : Removal and Installation"](#).
4. Remove luggage floor front finisher.
  - a. Remove luggage floor front finisher fixing pawls (A) and screws (B).
  - b. Pull up luggage floor front finisher, and then disengage luggage floor front finisher fixing pawls, and then remove luggage floor front finisher.

#### CAUTION:

Always remove the part while lifting it up toward vehicle upper. Or otherwise, the parts that are stuck in luggage side lower finisher may be damaged.

 : Pawl

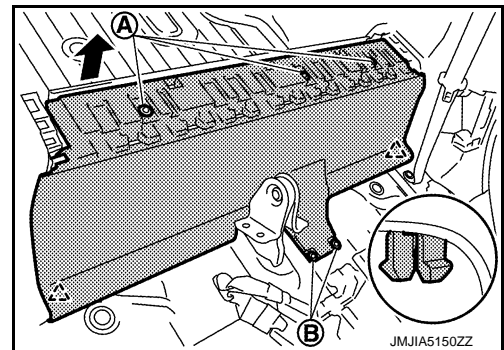

## INSTALLATION

Install in the reverse order of removal.

## LUGGAGE SIDE LOWER FINISHER

### LUGGAGE SIDE LOWER FINISHER : Removal and Installation

INFOID:000000007632116

#### CAUTION:

# LUGGAGE FLOOR TRIM

## < REMOVAL AND INSTALLATION >

**Never damage the body.**

### REMOVAL

1. Remove rear body side welt. Refer to [INT-24, "BODY SIDE WELT : Removal and Installation"](#).
2. Remove luggage rear plate. Refer to [INT-36, "LUGGAGE REAR PLATE : Removal and Installation"](#).
3. Remove luggage floor front finisher. Refer to [INT-38, "LUGGAGE FLOOR FRONT FINISHER : Removal and Installation"](#).
4. Remove luggage net hook.  
Disengage net hook pin fixing pawl with a remover tool (A), and then remove luggage net hook.

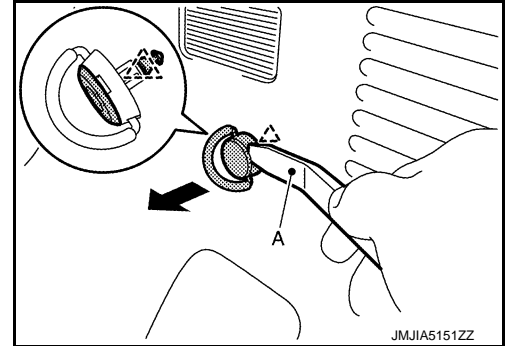

 : Pawl

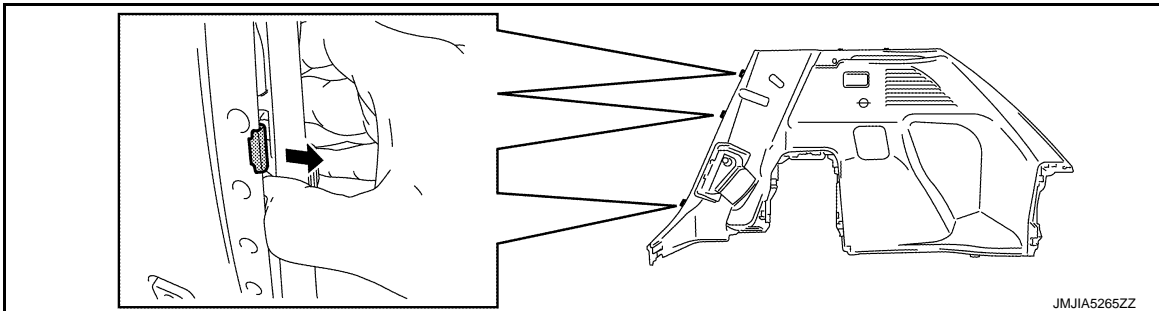

5. Remove luggage room lamp. Refer to [INL-47, "Removal and Installation"](#).
6. Remove luggage side lower finisher.
  - a. Remove hook that is hooked to body panel.



- b. Disengage luggage side lower finisher fixing clips and pawls with a remover tool (A), and then remove luggage side lower finisher.

 : Clip  
 : Pawl

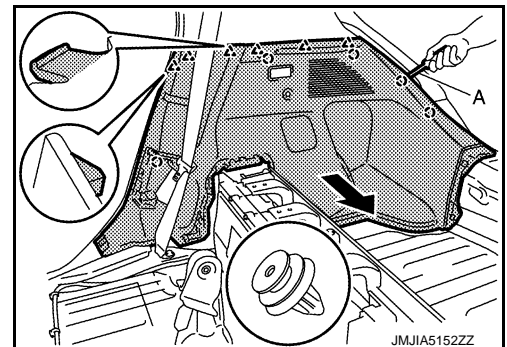

### INSTALLATION

Note the following item, and install in the reverse order of removal.

#### **CAUTION:**

**When installing, check in advance that clips and pawls are accurately aligned with the holes on body side, and then install by pressing in.**

Removal and installation of shock absorber mask

#### **CAUTION:**

**When removing, always use a remover tool that is made of plastic to prevent damage to the parts.**

### REMOVAL

# LUGGAGE FLOOR TRIM

## < REMOVAL AND INSTALLATION >

1. Apply protective tape (A) on the parts to protect it from damage.

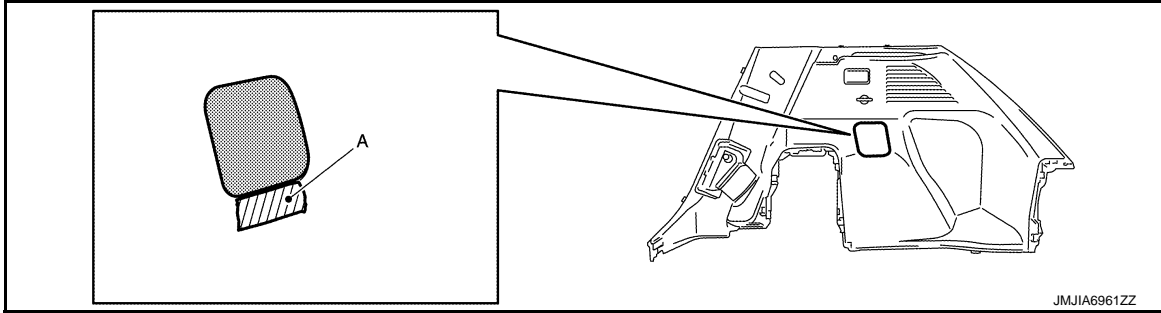

2. Disengage shock absorber mask fixing pawls with a remover tool (A), and then remove shock absorber mask.

 : Pawl

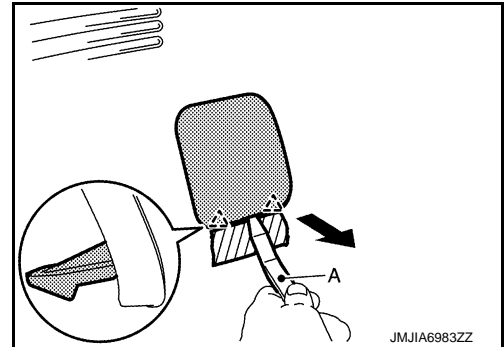

## INSTALLATION

Install in the reverse order of removal.



# BACK DOOR TRIM

< REMOVAL AND INSTALLATION >

## BACK DOOR TRIM

Exploded View

INFOID:000000007632117

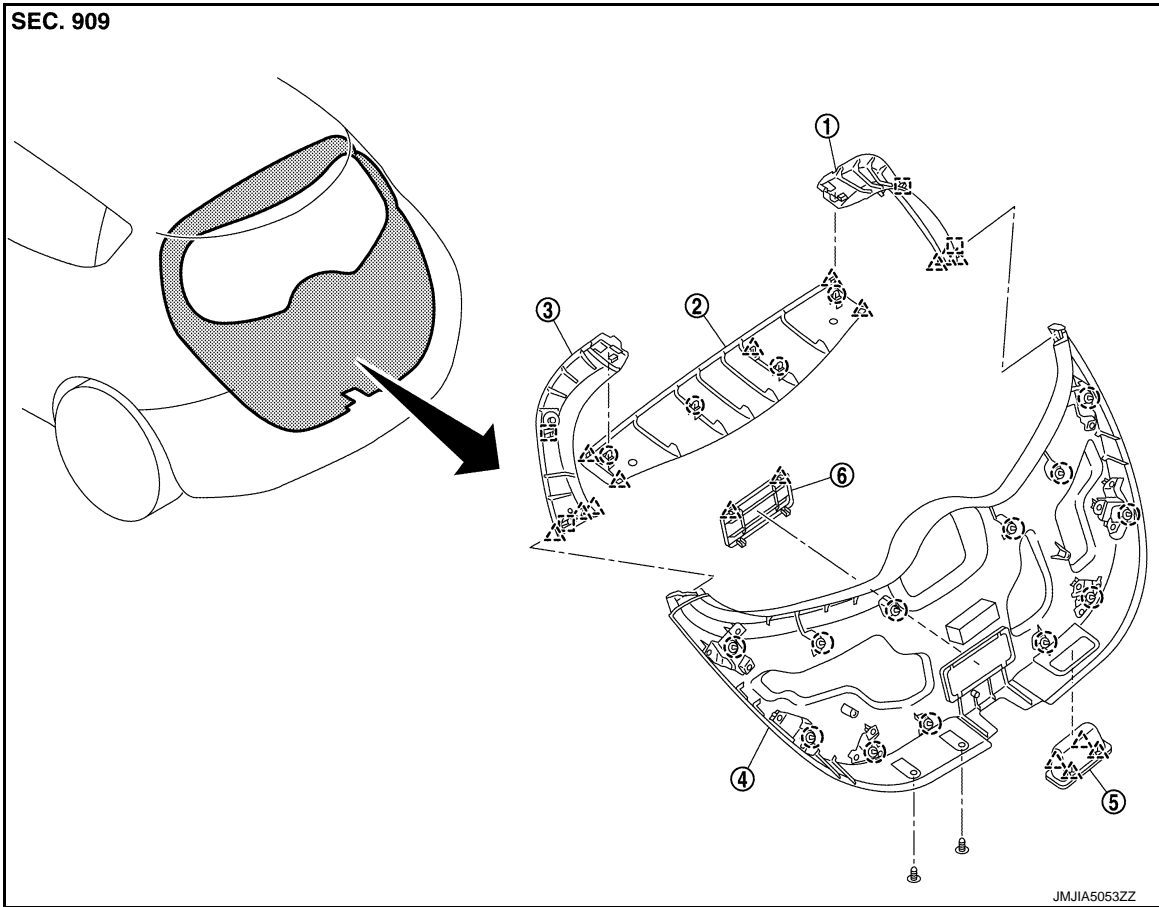

- |                               |                             |                               |
|-------------------------------|-----------------------------|-------------------------------|
| 1. Back door side finisher RH | 2. Back door upper finisher | 3. Back door side finisher LH |
| 4. Back door lower finisher   | 5. Back door pull handle    | 6. Emergency lid              |

- : Clip  
△ : Pawl  
□ : Metal clip

## BACK DOOR UPPER FINISHER

### BACK DOOR UPPER FINISHER : Removal and Installation

INFOID:000000007632118

#### CAUTION:

- When removing, always use a remover tool that is made of plastic to prevent damage to the parts.
- Never damage the back door panel.

#### REMOVAL

1. Fully open back door.
2. Remove back door upper finisher.

A  
B  
C  
D  
E  
F  
G  
H  
I

INT

K  
L  
M  
N  
O  
P

# BACK DOOR TRIM

## < REMOVAL AND INSTALLATION >

- a. Apply protective tape (A) on the parts to protect it from damage.

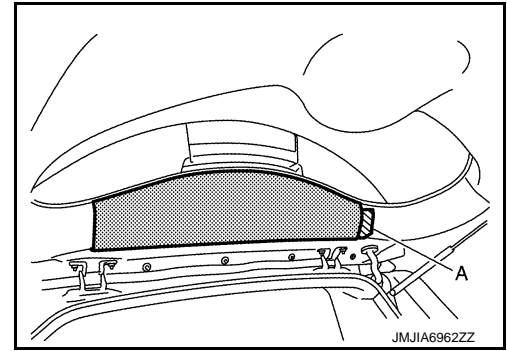

- b. Disengage back door upper finisher fixing clips and pawls with a remover tool (A), and then remove back door upper finisher.

- : Clip  
△ : Pawl

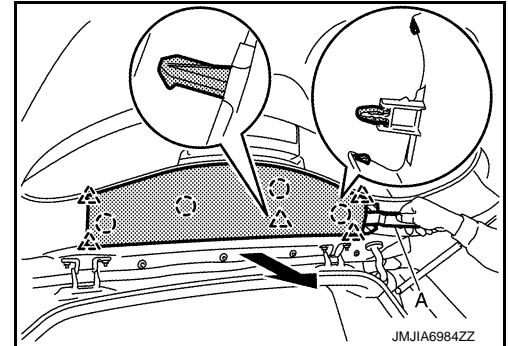

## INATALLATION

Note the following item, and install in the reverse order of removal.

### CAUTION:

When installing, check in advance that clips and pawls are accurately aligned with the holes on back door side, and then install by pressing in.

## BACK DOOR SIDE FINISHER

### BACK DOOR SIDE FINISHER : Removal and Installation

INFOID:000000007632119

### CAUTION:

- When removing, always use a remover tool that is made of plastic to prevent damage to the parts.
- Never damage the back door panel.

## REMOVAL

1. Remove rear parcel shelf finisher. Refer to [INT-35, "REAR PARCEL SHELF FINISHER : Removal and Installation"](#).
2. Remove back door upper finisher. Refer to [INT-41, "BACK DOOR UPPER FINISHER : Removal and Installation"](#).
3. Remove back door side finisher.
  - a. Pull back door side finisher from vehicle inside to outside, and then remove back door side finisher fixing clip.

- : Clip

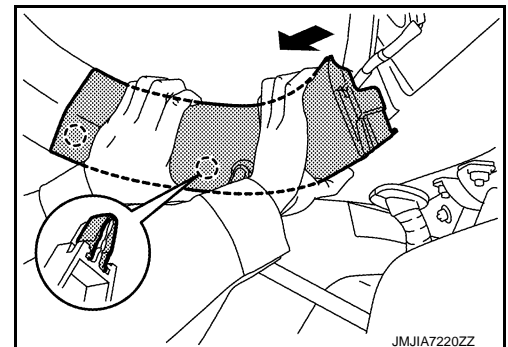

# BACK DOOR TRIM

## < REMOVAL AND INSTALLATION >

- b. Pull back door side finisher, and then remove back door side finisher fixing pawl and clip.

- : Clip  
△ : Pawl

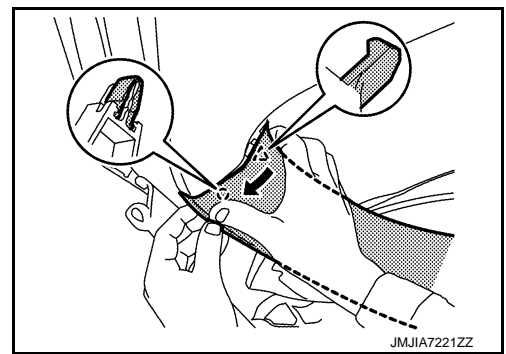

## INSTALLATION

Note the following item, and install in the reverse order of removal.

### CAUTION:

When installing, check in advance that clip are accurately aligned with the holes on back door side, and then install by pressing in.

## BACK DOOR PULL HANDLE

### BACK DOOR PULL HANDLE : Removal and Installation

INFOID:000000007632120

### CAUTION:

- When removing, always use a remover tool that is made of plastic to prevent damage to the parts.
- Never damage the back door panel.

## REMOVAL

1. Fully open back door.
2. Remove back door pull handle.
  - a. Apply protective tape (A) on the parts to protect it from damage.

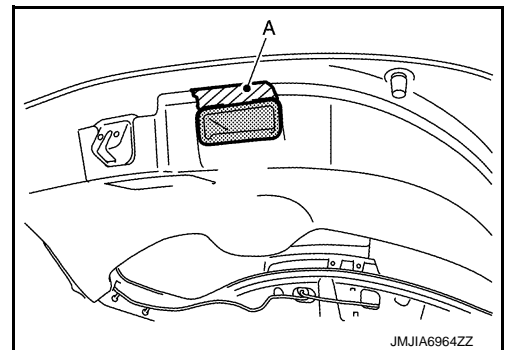

- b. Disengage back door pull handle fixing pawls with a remover tool (A), and then remove back door pull handle.

- △ : Pawl

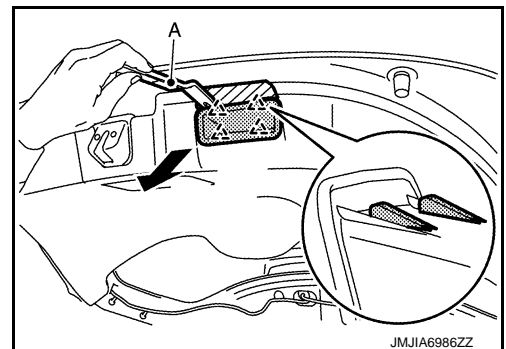

## INSTALLATION

Install in the reverse order of removal.

## BACK DOOR LOWER FINISHER

### BACK DOOR LOWER FINISHER : Removal and Installation

INFOID:000000007632121

### CAUTION:

- When removing, always use a remover tool that is made of plastic to prevent damage to the parts.

A  
B  
C  
D  
E  
F  
G  
H  
I  
INT  
K  
L  
M  
N  
O  
P

# BACK DOOR TRIM

## < REMOVAL AND INSTALLATION >

- **Never damage the back door panel.**

### REMOVAL

1. Fully open back door.
2. Remove back door side finisher. Refer to [INT-42, "BACK DOOR SIDE FINISHER : Removal and Installation"](#).
3. Remove back door pull handle. Refer to [INT-43, "BACK DOOR PULL HANDLE : Removal and Installation"](#).
4. Remove back door finisher.
  - a. Apply protective tape (A) on the parts to protect it from damage.

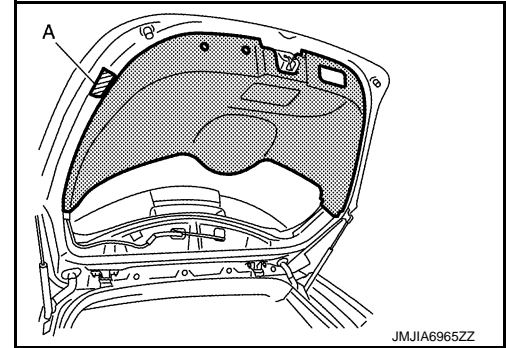

- b. Remove back door lower fixing clips (A).

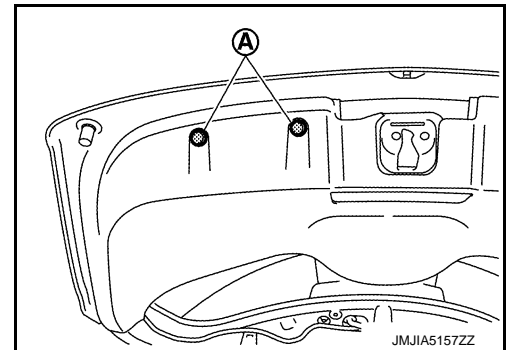

- c. Disengage back door lower finisher fixing clips with a remover tool (A), and then remove back door lower finisher.

 : Clip

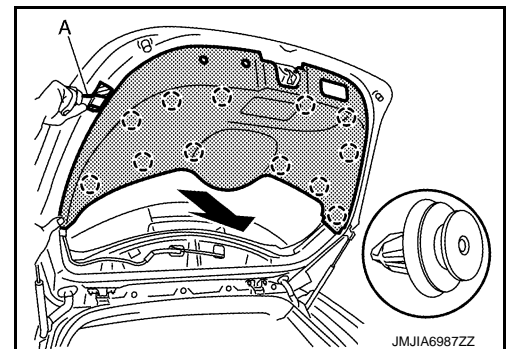

### INSTALLATION

Note the following item, and install in the reverse order of removal.

#### **CAUTION:**

**When installing, check in advance that clips are accurately aligned with the holes on back door side, and then install by pressing in.**

### EMERGENCY LID

#### EMERGENCY LID : Removal and Installation

INFOID:000000007632122

#### **CAUTION:**

**When removing, always use a remover tool that is made of plastic to prevent damage to the parts.**

### REMOVAL

1. Fully open back door.

# BACK DOOR TRIM

## < REMOVAL AND INSTALLATION >

2. Remove emergency lid.
  - a. Apply protective tape (A) on the parts to protect it from damage.

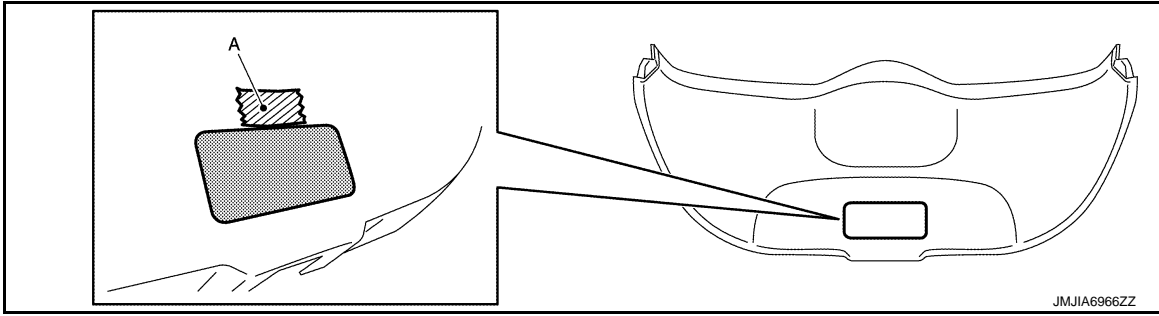

- b. Disengage emergency lid fixing pawls with a remover tool (A), and then remove emergency lid.

 : Pawl

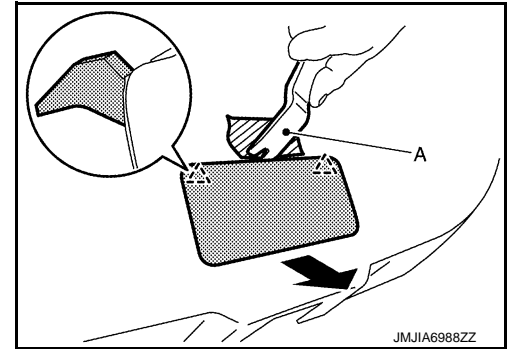

## INSTALLATION

Install in the reverse order of removal.

A  
B  
C  
D  
E  
F  
G  
H  
I  
K  
L  
M  
N  
O  
P

INT