

MWI

SECTION

METER, WARNING LAMP & INDICATOR

A
B
C
D
E
F
G
H
I
J
K
L
M
N
O
P

CONTENTS

PRECAUTION	3	LI-ION BATTERY CAPACITY LEVEL GAUGE : System Description	20
PRECAUTIONS	3	LI-ION BATTERY AVAILABLE CHARGE GAUGE ...23	
Precaution for Technicians Using Medical Electric.....3		LI-ION BATTERY AVAILABLE CHARGE GAUGE	
Point to Be Checked Before Starting Maintenance		: System Description	24
Work	3	ECO INDICATOR	26
Precaution for Supplemental Restraint System		ECO INDICATOR : System Description	27
(SRS) "AIR BAG" and "SEAT BELT PRE-TENSIONER"	3	DRIVING RANGE DISPLAY	28
Precaution for Removing 12V Battery	4	DRIVING RANGE DISPLAY : System Description...	28
PREPARATION	5	OUTSIDE AIR TEMPERATURE DISPLAY	29
PREPARATION	5	OUTSIDE AIR TEMPERATURE DISPLAY : Sys-	
Commercial Service Tools	5	tem Description	29
SYSTEM DESCRIPTION	6	TIMER CHARGE AND A/C-HEATER TIMER (CLIMATE CTRL. TIMER) (WITHOUT NAVIGATION)30	
COMPONENT PARTS	6	TIMER CHARGE AND A/C-HEATER TIMER	
METER SYSTEM	6	(CLIMATE CTRL. TIMER) (WITHOUT NAVIGATION) : System Description	30
METER SYSTEM : Component Parts Location	6	MASTER WARNING LAMP	31
METER SYSTEM : Upper Meter	6	MASTER WARNING LAMP : System Description...	31
METER SYSTEM : Combination Meter	6	METER ILLUMINATION CONTROL	32
METER SYSTEM : Meter Control Switch	7	METER ILLUMINATION CONTROL : System Description	33
SYSTEM	8	METER EFFECT FUNCTION	33
METER SYSTEM	8	METER EFFECT FUNCTION : System Description	34
METER SYSTEM : System Description	8	INFORMATION DISPLAY	35
METER SYSTEM : Fail-Safe	15	INFORMATION DISPLAY : System Description	35
SPEEDOMETER	16	OPERATION	47
SPEEDOMETER : System Description	16	Switch Name and Function	47
POWER METER	17	DIAGNOSIS SYSTEM (COMBINATION METER)	48
POWER METER : System Description	17	Description	48
LI-ION BATTERY TEMPERATURE GAUGE	19	CONSULT Function (METER/M&A)	49
LI-ION BATTERY TEMPERATURE GAUGE :			
System Description	19		
LI-ION BATTERY CAPACITY LEVEL GAUGE	20		

MWI

ECU DIAGNOSIS INFORMATION	54	PARKING BRAKE SWITCH SIGNAL CIRCUIT	93
COMBINATION METER	54	Diagnosis Procedure	93
Reference Value	54	Component Inspection	93
Fail-Safe	64	SYMPTOM DIAGNOSIS	95
DTC Index	65	THE METER CONTROL SWITCH IS INOPERATIVE	95
UPPER METER	66	Description	95
Reference Value	66	Diagnosis Procedure	95
WIRING DIAGRAM	68	THE DOOR OPEN WARNING CONTINUES DISPLAYING, OR DOES NOT DISPLAY	96
METER SYSTEM	68	Description	96
Wiring Diagram	68	Diagnosis Procedure	96
BASIC INSPECTION	80	UPPER METER DOES NOT OPERATE	97
DIAGNOSIS AND REPAIR WORKFLOW (METER SYSTEM)	80	Description	97
Work flow	80	Diagnosis Procedure	97
DTC/CIRCUIT DIAGNOSIS	82	THE OUTSIDE AIR TEMPERATURE DISPLAY IS INCORRECT	98
U1000 CAN COMM CIRCUIT	82	Description	98
Description	82	Diagnosis Procedure	98
DTC Logic	82	THE LOW WASHER FLUID WARNING CONTINUES DISPLAYING, or DOES NOT DISPLAY	99
Diagnosis Procedure	82	Description	99
U1010 CONTROL UNIT (CAN)	83	Diagnosis Procedure	99
Description	83	THE PARKING BRAKE RELEASE WARNING CONTINUES DISPLAYING, OR DOES NOT DISPLAY	100
DTC Logic	83	Description	100
Diagnosis Procedure	83	Diagnosis Procedure	100
B2205 VEHICLE SPEED	84	NORMAL OPERATING CONDITION	101
Description	84	INFORMATION DISPLAY	101
DTC Logic	84	INFORMATION DISPLAY : Description	101
Diagnosis Procedure	84	REMOVAL AND INSTALLATION	102
POWER SUPPLY AND GROUND CIRCUIT	85	COMBINATION METER	102
COMBINATION METER	85	Exploded View	102
COMBINATION METER : Diagnosis Procedure ...	85	Removal and Installation	102
UPPER METER	85	Disassembly and Assembly	102
UPPER METER : Diagnosis Procedure	85	UPPER METER	103
COMMUNICATION SIGNAL (METERÆUPPER) CIRCUIT	87	Exploded View	103
Description	87	Removal and Installation	103
Diagnosis Procedure	87	Disassembly and Assembly	103
METER CONTROL SWITCH SIGNAL CIRCUIT	89	METER CONTROL SWITCH	104
Diagnosis Procedure	89	Exploded View	104
Component Inspection	90	Removal and Installation	104
WASHER FLUID LEVEL SWITCH CIRCUIT ...	91		
Diagnosis Procedure	91		
Component Inspection	91		

PRECAUTIONS

< PRECAUTION >

PRECAUTION

PRECAUTIONS

Precaution for Technicians Using Medical Electric

INFOID:000000010122379

OPERATION PROHIBITION

WARNING:

- Parts with strong magnet is used in this vehicle.
- Technicians using a medical electric device such as pacemaker must never perform operation on the vehicle, as magnetic field can affect the device function by approaching to such parts.

NORMAL CHARGE PRECAUTION

WARNING:

- If a technician uses a medical electric device such as an implantable cardiac pacemaker or an implantable cardioverter defibrillator, the possible effects on the devices must be checked with the device manufacturer before starting the charge operation.
- As radiated electromagnetic wave generated by on board charger at normal charge operation may effect medical electric devices, a technician using a medical electric device such as implantable cardiac pacemaker or an implantable cardioverter defibrillator must not enter the vehicle compartment (including luggage room) during normal charge operation.

PRECAUTION AT TELEMATICS SYSTEM OPERATION

WARNING:

- If a technician uses implantable cardiac pacemaker or implantable cardioverter defibrillator (ICD), avoid the device implanted part from approaching within approximately 220 mm (8.66 in) from interior/exterior antenna.
- The electromagnetic wave of TCU might affect the function of the implantable cardiac pacemaker or the implantable cardioverter defibrillator (ICD), when using the service, etc.
- If a technician uses other medical electric devices than implantable cardiac pacemaker or implantable cardioverter defibrillator (ICD), the electromagnetic wave of TCU might affect the function of the device. The possible effects on the devices must be checked with the device manufacturer before TCU use.

PRECAUTION AT INTELLIGENT KEY SYSTEM OPERATION

WARNING:

- If a technician uses implantable cardiac pacemaker or implantable cardioverter defibrillator (ICD), avoid the device implanted part from approaching within approximately 220 mm (8.66 in) from interior/exterior antenna.
- The electromagnetic wave of intelligent key might affect the function of the implantable cardiac pacemaker or the implantable cardioverter defibrillator (ICD), at door operation, at each request switch operation, or at engine starting.
- If a technician uses other medical electric devices than implantable cardiac pacemaker or implantable cardioverter defibrillator (ICD), the electromagnetic wave of intelligent key might affect the function of the device. The possible effects on the devices must be checked with the device manufacturer before intelligent key use.

Point to Be Checked Before Starting Maintenance Work

INFOID:000000010122380

The high voltage system may starts automatically. It is required to check that the timer air conditioner and timer charge (during EVSE connection) are not set before starting maintenance work.

NOTE:

If the timer air conditioner or timer charge (during EVSE connection) is set, the high voltage system starts automatically even when the power switch is in OFF state.

Precaution for Supplemental Restraint System (SRS) "AIR BAG" and "SEAT BELT PRE-TENSIONER"

INFOID:000000010122381

The Supplemental Restraint System such as "AIR BAG" and "SEAT BELT PRE-TENSIONER", used along with a front seat belt, helps to reduce the risk or severity of injury to the driver and front passenger for certain types of collision. This system includes seat belt switch inputs and dual stage front air bag modules. The SRS

A
B
C
D
E
F
G
H
I
J
K
L
M
MWI

PRECAUTIONS

< PRECAUTION >

system uses the seat belt switches to determine the front air bag deployment, and may only deploy one front air bag, depending on the severity of a collision and whether the front occupants are belted or unbelted. Information necessary to service the system safely is included in the SR and SB section of this Service Manual.

WARNING:

- To avoid rendering the SRS inoperative, which could increase the risk of personal injury or death in the event of a collision which would result in air bag inflation, all maintenance must be performed by an authorized NISSAN/INFINITI dealer.
- Improper maintenance, including incorrect removal and installation of the SRS, can lead to personal injury caused by unintentional activation of the system. For removal of Spiral Cable and Air Bag Module, see the SR section.
- Do not use electrical test equipment on any circuit related to the SRS unless instructed to in this Service Manual. SRS wiring harnesses can be identified by yellow and/or orange harnesses or harness connectors.

PRECAUTIONS WHEN USING POWER TOOLS (AIR OR ELECTRIC) AND HAMMERS

WARNING:

- When working near the Airbag Diagnosis Sensor Unit or other Airbag System sensors with the Ignition ON or engine running, DO NOT use air or electric power tools or strike near the sensor(s) with a hammer. Heavy vibration could activate the sensor(s) and deploy the air bag(s), possibly causing serious injury.
- When using air or electric power tools or hammers, always switch the Ignition OFF, disconnect the battery and wait at least three minutes before performing any service.

Precaution for Removing 12V Battery

INFOID:000000010122382

1. Check that EVSE is not connected.

NOTE:

If EVSE is connected, the air conditioning system may be automatically activated by the timer A/C function.

2. Turn the power switch OFF → ON → OFF. Get out of the vehicle. Close all doors (including back door).
3. Check that the charge status indicator lamp does not blink and wait for 5 minutes or more.

NOTE:

If the battery is removed within 5 minutes after the power switch is turned OFF, plural DTCs may be detected.

4. Remove 12V battery within 1 hour after turning the power switch OFF → ON → OFF.

NOTE:

- The 12V battery automatic charge control may start automatically even when the power switch is in OFF state.
- Once the power switch is turned ON → OFF, the 12V battery automatic charge control does not start for approximately 1 hour.

CAUTION:

- After all doors (including back door) are closed, if a door (including back door) is opened before battery terminals are disconnected, start over from Step 1.
- After turning the power switch OFF, if "Remote A/C" is activated by user operation, stop the air conditioner and start over from Step 1.

PREPARATION

< PREPARATION >

PREPARATION

PREPARATION

Commercial Service Tools

INFOID:000000010122383

Tool name	Description
<p data-bbox="167 415 277 443">Power tool</p>  <p data-bbox="831 632 906 646">PIIB1407E</p>	<p data-bbox="1013 415 1349 443">Loosening nuts, screws and bolts</p>

A
B
C
D
E
F
G
H
I
J
K
L
M
N
O
P

MWI

COMPONENT PARTS

< SYSTEM DESCRIPTION >

SYSTEM DESCRIPTION

COMPONENT PARTS

METER SYSTEM

METER SYSTEM : Component Parts Location

INFOID:0000000010122384

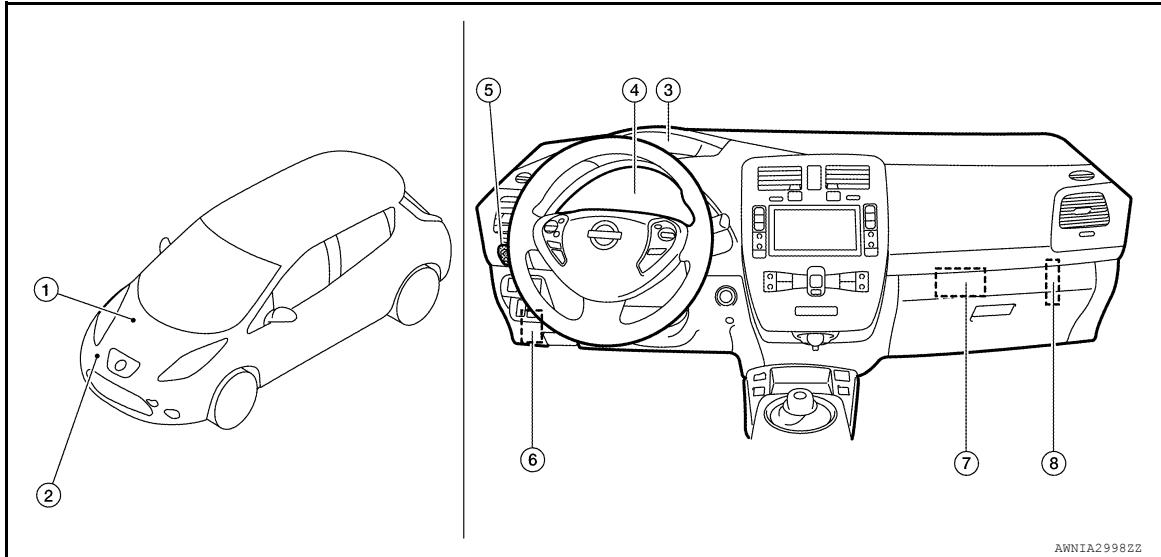

AWNIA2998ZZ

Component	Description
1. ABS actuator and electric unit (control unit)	Transmits the vehicle speed signal to the combination meter via CAN communication. Refer to BRC-10, "Component Parts Location" for detailed installation location.
2. Washer fluid level switch (For Canada)	Transmits the washer fluid level switch signal to the combination meter. Refer to WW-5, "Component Parts Location" for detailed installation location.
3. Upper meter	Refer to MWI-6, "METER SYSTEM : Upper Meter" .
4. Combination meter	Refer to MWI-6, "METER SYSTEM : Combination Meter" .
5. Meter control switch	Refer to MWI-7, "METER SYSTEM : Meter Control Switch" .
6. Parking brake switch	Transmits the parking brake switch signal to the combination meter.
7. VCM	For the signals transmitted to the combination meter via CAN communication, refer to MWI-8, "METER SYSTEM : System Description" . Refer to EVC-15, "Component Parts Location" for detailed installation location.
8. BCM	For the signals transmitted to the combination meter via CAN communication, refer to MWI-8, "METER SYSTEM : System Description" . Refer to BCS-5, "BODY CONTROL SYSTEM : Component Parts Location" for detailed installation location.

METER SYSTEM : Upper Meter

INFOID:0000000010122385

- The upper meter controls the following items according to the signals received via communications from the combination meter:
 - Speedometer
 - Eco indicator (Instant ECO indicator, ECO tree)
 - Clock
 - Outside air temperature display
 - Master warning lamps
 - Turn signal indicator lamps
- Power is supplied from the combination meter.

METER SYSTEM : Combination Meter

INFOID:0000000010122386

The combination meter controls the following items according to the signals received from each unit via CAN communication and the signals from switches and sensors:

COMPONENT PARTS

< SYSTEM DESCRIPTION >



- Power meter
- Li-ion battery temperature gauge
- Li-ion battery capacity level gauge
- Li-ion battery available charge gauge
- Driving range display
- Indicator lamps
- Warning lamps
- Time charge and A/C-heater timer (climate control timer) (without navigation)
- Meter illumination control
- Meter effect function
- Information display

METER SYSTEM : Meter Control Switch

INFOID:000000010122387

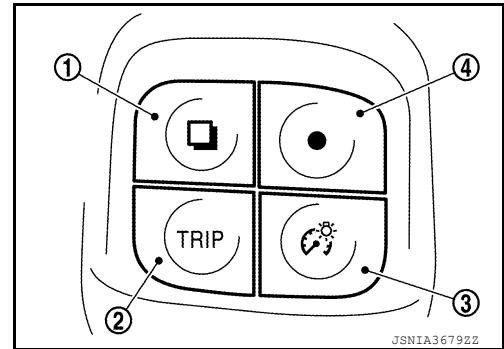
- The meter control switch is located on the side ventilator grille LH.
- The meter control switch can be used to control the combination meter functions listed below and to change the display of vehicle information.



No.	Switch name	Description
1.	 switch (Enter switch)	<ul style="list-style-type: none"> • The information display screen can be switched. • The item indicated on the information display can be confirmed.
2.	Trip reset switch	<ul style="list-style-type: none"> • The trip meter can be switched between A and B. • Trip meter A/B can be reset by pressing and holding the trip reset switch.
3.	 switch (Illumination control switch)	An illuminance level of the back light of the combination meter and upper meter can be adjusted.
4.	 switch (Select switch)	When plural items are shown on the information display, a selected item can be changed to the other item.

- Transmits the following signals to the combination meter:
 - Enter switch signal
 - Select switch signal
 - Trip reset switch signal
 - Illumination control switch signal

A
B
C
D
E
F
G
H
I
J
K
L
M
N
O
P

MWI

SYSTEM

< SYSTEM DESCRIPTION >

SYSTEM

METER SYSTEM

METER SYSTEM : System Description

INFOID:000000010122388

SYSTEM DIAGRAM

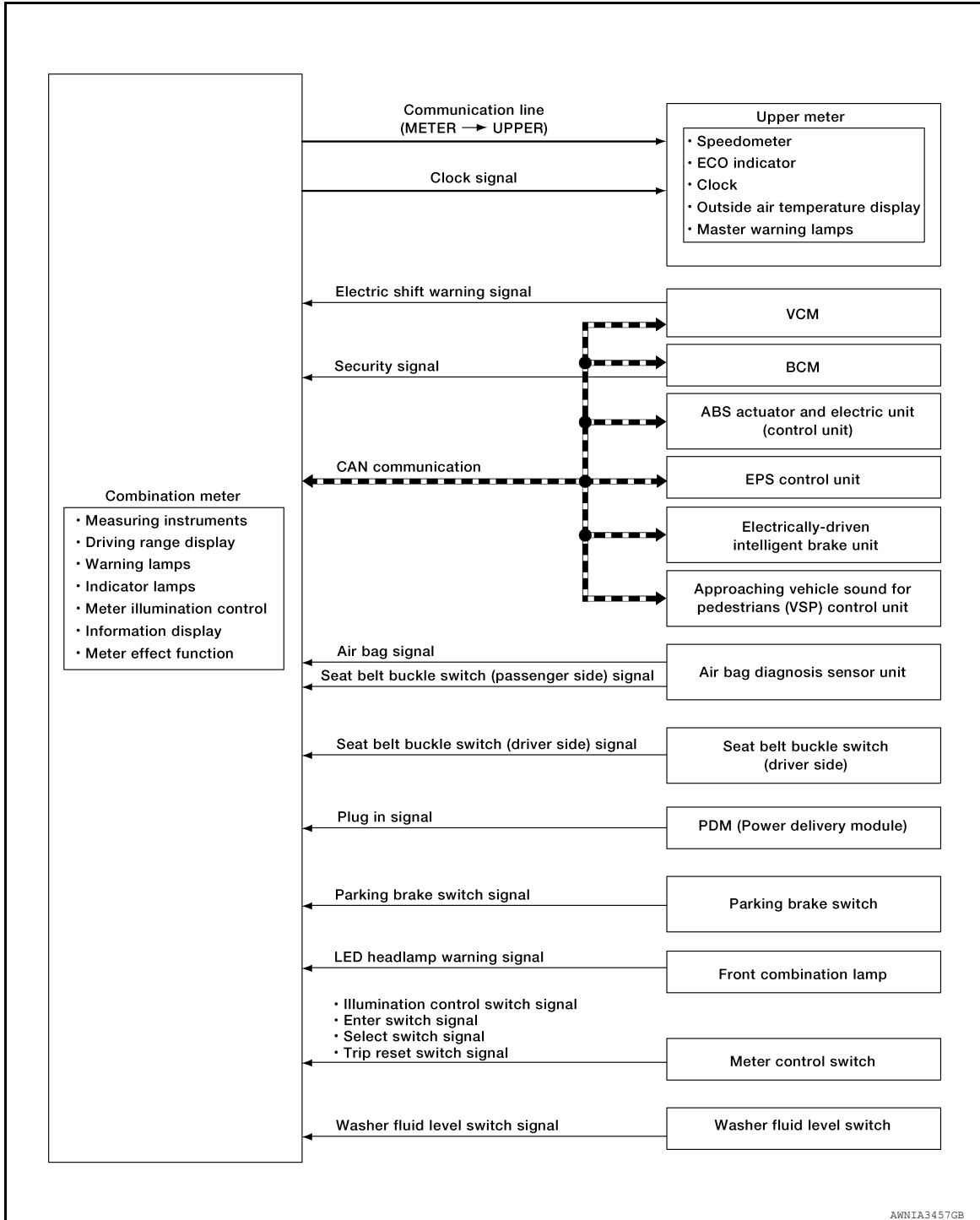

AWNIA3457GB

Combination Meter Input Signal (CAN Communication)

SYSTEM

< SYSTEM DESCRIPTION >

Transmit unit	Signal name	
ABS actuator and electric unit (control unit)	Vehicle speed signal	A
	ABS warning lamp signal	
	Brake warning lamp signal	B
	VDC OFF switch signal	
	VDC warning lamp signal	C
VCM	Current motor power signal	
	Maximum motor output power signal	
	Maximum regenerable power signal	D
	Li-ion battery temperature signal	
	Li-ion battery gradual capacity loss signal	
	Li-ion battery capacity signal	E
	Li-ion battery available charge signal	
	Instant ECO indicator signal	F
	ECO tree signal	
	Ambient sensor signal	
	Low battery charge warning lamp request signal	G
	Power limitation indicator lamp request signal	
	EV system warning lamp request signal	H
	READY to drive indicator lamp request signal	
	ASCD status signal	
	Remaining time to charge completion (200 V) signal	I
	Remaining time to charge completion (100 V) signal	
	Electricity consumption signal	J
	A/C consumption signal	
	Others consumption signal	
	Plug in warning display signal	K
	Electric shift warning lamp signal	
	Electric shift warning message signal	L
	Power limitation cause signal	
	12-volt battery charge warning lamp request signal	
	Vehicle stop and parking brake operation request signal	M
	Next charge time signal	
	Next departure time signal	MWI
	Next pre-A/C time signal	
	Driving range signal	
	Driving range flashing request signal	O
	Driving range request signal	
Shift position signal	P	

SYSTEM

< SYSTEM DESCRIPTION >

Transmit unit	Signal name
BCM	Door switch signal
	Position light request signal
	Meter display signal
	Low tire pressure warning lamp signal
	TPMS warning lamp signal
	Dimmer signal
	Buzzer output signal
EPS control unit	EPS warning lamp signal
Electrically-driven intelligent brake unit	Brake system warning lamp signal

Combination Meter Output Signal (CAN Communication)

Reception unit	Signal name
BCM	Seat belt buckle switch signal (driver side)
VCM	Clock signal
	A/C-heater timer setting time signal
Approaching vehicle sound for pedestrians control unit	READY to drive indicator lamp signal
	Power switch ON signal
	Vehicle speed signal
	Sound set request signal
	Sound signal
	Shift position signal
	Reverse warning buzzer signal

Combination Meter Output Signal (Communication line)

Reception unit	Signal name
Upper meter	Vehicle speed signal
	Instant ECO indicator signal
	ECO tree signal
	Outside air temperature signal
	Master warning signal
	Illumination control signal
	Meter effect signal
	On board diagnosis signal
Clock signal	

DESCRIPTION

Combination Meter

- The combination meter receives necessary signals from each unit, switch, and sensor to control the following functions:
 - Measuring instruments
 - Driving range display
 - Warning lamps
 - Indicator lamps
 - Timer charge and A/C-heater timer (climate control timer) (without navigation)
 - Meter illumination control
 - Meter effect function
 - Information display

SYSTEM

< SYSTEM DESCRIPTION >

- The combination meter receives the signals needed for control of the upper meter from the units, switches, and sensors, and it sends them via the communication line. A
- The combination meter incorporates a buzzer function that sounds an audible alarm with the integrated buzzer device. Refer to [WCS-6. "WARNING CHIME SYSTEM : System Description"](#) for further details.
- The combination meter includes an on board diagnosis function. B
- The combination meter can be diagnosed with CONSULT.

Upper Meter

- The upper meter controls the following items based on the signals received from the combination meter via the communication line: C
 - Measuring instruments
 - Outside air temperature display
 - Master warning lamps
 - Meter illumination control
 - Meter effect function
 - Clock
 - Turn signal indicator lamps
- The upper meter includes an on board diagnosis function. D

LIST OF COMMUNICATIONS SIGNALS SENT BETWEEN COMBINATION METER AND UPPER METER

Communication line	Signal name	Application
Meter → upper	Vehicle speed signal	Speedometer
	Instant ECO indicator signal	Instant ECO indicator
	ECO tree signal	ECO tree
	Outside air temperature signal	Outside air temperature display
	Master warning signal	Master warning lamps
	Meter effect signal	Meter effect
	Illumination control signal	Meter illumination
	Clock signal	Clock
	Turn indicator signal	Turn signal indicator lamps
On board diagnosis signal	On board diagnosis function	

METER CONTROL FUNCTION LIST

Combination Meter Function List

MWI

SYSTEM

< SYSTEM DESCRIPTION >

System		Description	Reference	
Measuring instruments	Power meter	Indicates the power levels listed below: <ul style="list-style-type: none"> • Current motor power • Maximum motor output power • Maximum regenerable power 	MWI-17. "POWER METER : System Description"	
	Li-ion battery temperature gauge	Indicates Li-ion battery temperature.	MWI-19. "LI-ION BATTERY TEMPERATURE GAUGE : System Description"	
	Li-ion battery capacity level gauge	Indicates Li-ion battery capacity level.	MWI-20. "LI-ION BATTERY CAPACITY LEVEL GAUGE : System Description"	
	Li-ion battery available charge gauge	Indicates Li-ion battery available charge.	MWI-24. "LI-ION BATTERY AVAILABLE CHARGE GAUGE : System Description"	
Driving range display		Displays driving range.	MWI-28. "DRIVING RANGE DISPLAY : System Description"	
Meter illumination control	Meter illumination control function	Controls the illumination of the combination meter and upper meter.	MWI-33. "METER ILLUMINATION CONTROL : System Description"	
Meter effect function	READY effect function	When the vehicle status is READY to drive, the segments and illumination are controlled to produce this effect. NOTE: The READY effect sound is controlled by the approaching vehicle sound for pedestrians control unit. Refer to VSP-12. "System Description" .	MWI-34. "METER EFFECT FUNCTION : System Description"	
Information display	Odo/trip meter	Displays mileage.	MWI-35. "INFORMATION DISPLAY : System Description"	
	Shift indicator	Displays shift position.		
	Trip computer	Current electricity consumption		Displays current electricity consumption.
		Average electricity consumption		Displays average electricity consumption.
		Average vehicle speed		Displays average vehicle speed.
		Travel time		Displays travel time.
		Travel distance		Displays mileage.
	Timer status reminder display	Displays the timer settings information.		
Charging time display	Displays the estimated full charging time (80% or 100% charging time) from the current time.			
ASCD status display	Displays the ASCD status.			

SYSTEM

< SYSTEM DESCRIPTION >

System			Description	Reference	
Information display	Interrupt indication	WARNING	Push start display	Displays push start information.	A
			Remove charge connector warning display	Displayed if the power switch is pressed when the charge connector is connected.	B
			Door open warning display	Displayed when any door is open.	C
			Electric shift warning display	Displayed when there is a malfunction in the electric shift system.	D
			Li-ion battery low charge warning display	Displayed when the Li-ion battery remaining energy is low.	E
			Power limitation warning display	Displayed when drive power output is being limited.	F
			Light remainder warning display	Displayed when the light reminder display conditions are met.	G
			Check tire pressure warning	Displayed when the tire pressure warning display conditions are met.	H
			DC/DC converter warning display	Displayed when there is a malfunction in the DC/DC converter.	I
			Intelligent Key system warning display	Displayed when there is a malfunction in the Intelligent Key system.	J
			Low washer fluid warning (For Canada)	Displayed when washer fluid level is low.	K
			Alarms	Drive alert	Causes an interrupt when exceeding a randomly set time.
	Outside temp	Causes an interrupt when the low outside temperature reaches below 37°F (3°C).		M	
	Maintenance	Tire	Causes an interrupt when exceeding a randomly set distance.	MWI	
		Other 1	Causes an interrupt when exceeding a randomly set distance.		
		Other 2	Causes an interrupt when exceeding a randomly set distance.		
	Other 3	Causes an interrupt when exceeding a randomly set distance.	O		
	Meter illumination level	Indicates the brightness of the meter illumination in stages.	P		

[MWI-35. "INFORMATION DISPLAY : System Description"](#)

SYSTEM

< SYSTEM DESCRIPTION >

System		Description	Reference	
Information display	Warning check display	Door open warning display	Can be checked on the warning check screen when the door open warning is displayed as an interrupt display.	
		Electric shift warning display	Can be checked on the warning check screen when the electric shift warning is displayed as an interrupt display.	
		Power limitation warning display	Can be checked on the warning check screen when the power limitation warning is displayed as an interrupt display.	
		Li-ion battery low charge warning display	Can be checked on the warning check screen when the Li-ion battery low charge warning is displayed as an interrupt display.	
		Take away warning display (Push start display)	Can be checked on the warning check screen when the take away warning is displayed as an interrupt display.	
		Intelligent Key system warning display	Can be checked on the warning check screen when the Intelligent Key system warning is displayed as an interrupt display.	
	Setting	Clock	Set clock	Allows the user to set the time.
			24/12 Hr	Allows the user to set the 12-hour or 24-hour display.
		Alarms	Drive alert	Allows the user to set the display time for the driving time alarm.
			Outside temp	Allows the user to set whether or not to display the outside temp alarm.
		Maintenance	Tire	Allows the user to set the replacement distance for the tire warning.
			Other 1	Allows the user to set the replacement distance for other warnings.
			Other 2	Allows the user to set the replacement distance for other warnings.
		Units	Temperature	Allows the user to set the units for the outside air temperature.
			Speed	Allows the user to set the units for the vehicle speed and electricity consumption.
		Language	Allows the user to set the language for the information display.	
		Effects	Allows the user to set the start up sound of the approaching vehicle sound for pedestrians.	
		Factory	Allows the user to reset all settings other than the odometer.	

MWI-35, "INFORMATION DISPLAY : System Description"

Upper Meter Function List

System		Description	Reference
Measuring instruments	Speedometer	Indicates vehicle speed.	MWI-16. "SPEEDOMETER : System Description"
	ECO indicator	Indicates ECO drive level.	MWI-27. "ECO INDICATOR : System Description"

SYSTEM

< SYSTEM DESCRIPTION >

System	Description	Reference
Outside air temperature	Displays the outside air temperature.	MWI-29, "OUT-SIDE AIR TEMPERATURE DISPLAY : System Description"
Warning lamp	Master warning lamps	The master warning lamps turn ON according to the illumination status of the combination meter warning lamps and indicator lamps.
Clock	Displays the time.	—

ARRANGEMENT OF COMBINATION METER

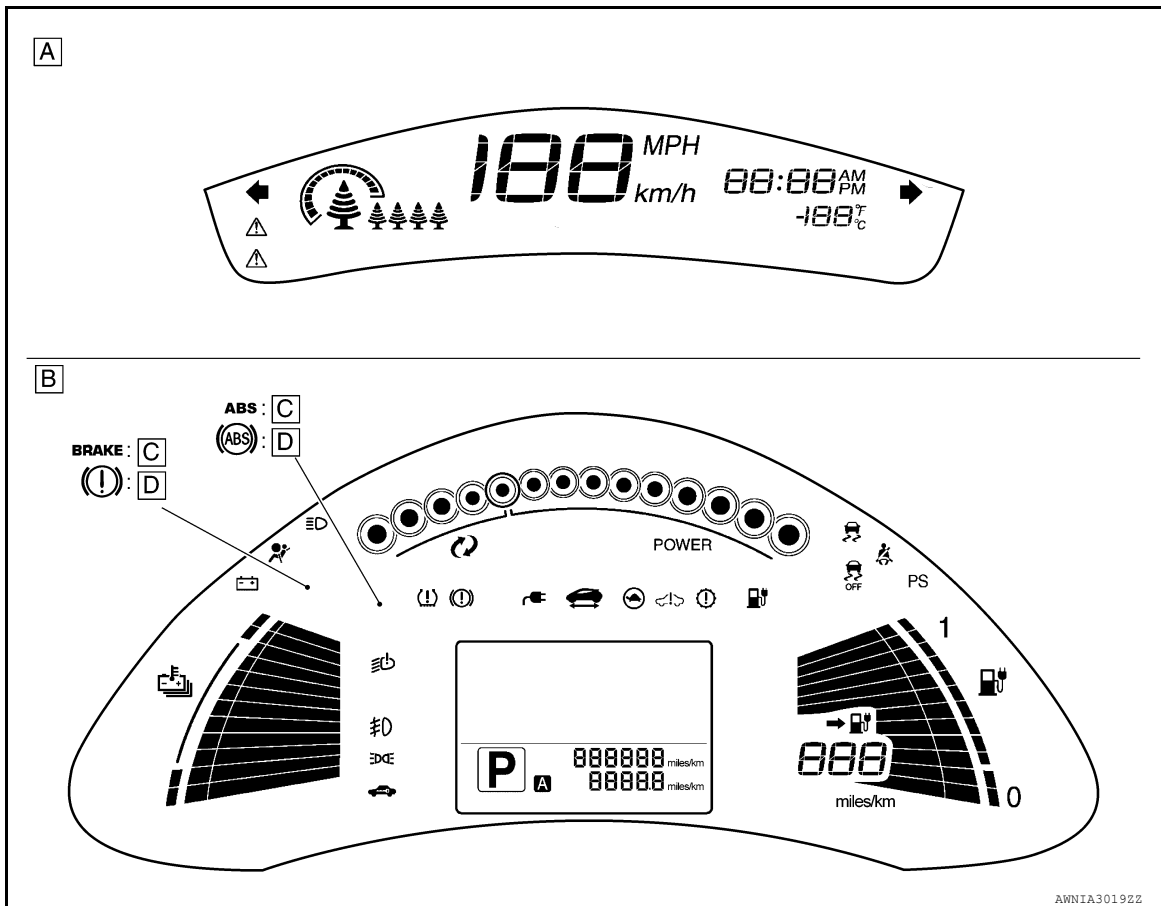

- A. Upper meter
- B. Combination meter
- C. For U.S.A.
- D. For Canada and Mexico

METER SYSTEM : Fail-Safe

INFOID:000000010546221

FAIL-SAFE

- The combination meter activates the fail-safe control if CAN communication with each unit is malfunctioning.

Function	Specifications
Power meter	The display turns OFF by suspending communication.
Li-ion battery temperature gauge	
Li-ion battery capacity level gauge	
Li-ion battery available charge gauge	
Driving range display	The display turns "—" by suspending communication.

A
B
C
D
E
F
G
H
I
J
K
L
M
O
P



SYSTEM

< SYSTEM DESCRIPTION >

Function		Specifications
Illumination control		When suspending communication, changes to nighttime mode.
Information display	Odo/trip meter	An indicated value is maintained at communications blackout.
	Shift indicator	The display turns OFF by suspending communication.
	Li-ion low battery charge warning display	The display turns ON by suspending communication.
	Electric shift warning display	
Other than the above		The display turns OFF by suspending communication.
Buzzer		The buzzer turns OFF by suspending communication.
Warning lamp/indicator lamp	ABS warning lamp	The lamp turns ON by suspending communication.
	VDC warning lamp	
	Brake warning lamp	
	Front fog lamp indicator lamp	
	Brake system warning lamp	
	EPS warning lamp	
	Low battery charge warning lamp	
	Electric shift warning lamp	
	TPMS warning lamp	The lamp turns OFF by suspending communication.
	High beam indicator lamp	
	VDC OFF indicator lamp	
	Tail lamp indicator lamp	
	READY to drive indicator lamp	
	12-volt battery charge warning lamp	
	Power limitation indicator lamp	
	EV system warning lamp	

- The upper meter performs the fail-safe control when a breakdown of communications between the upper meter and the combination meter occurs.

Function	Specifications
Speedometer	The display turns OFF by suspending communication.
Eco indicator	
Outside air temperature display	The last result calculated during normal condition is indicated.
Illumination control	When suspending communication, changes to nighttime mode.
Turn signal indicator lamp	The lamp turns OFF by suspending communication.

SPEEDOMETER

SPEEDOMETER : System Description

INFOID:000000010122390

SYSTEM DIAGRAM

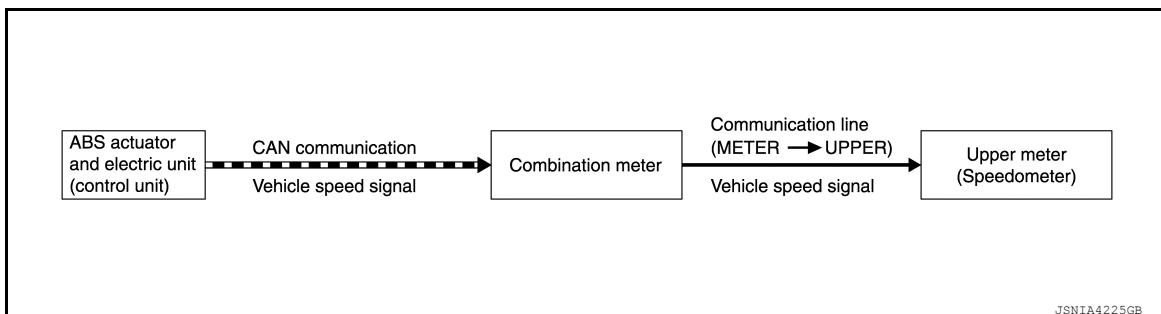

J5NIA4225GB



SYSTEM

< SYSTEM DESCRIPTION >

DESCRIPTION

- ABS actuator and electric unit (control unit) transmits a vehicle speed signal to the combination meter via CAN communication.
- The combination meter receives the vehicle speed signal from the ABS actuator and electric unit (control unit) with CAN communication line and transmits it to the upper meter by means of communication line.
- The upper meter indicates the vehicle speed according to the vehicle speed signal received from the combination meter by means of communication line.

SIGNAL PATH

Signal name	Signal path
Vehicle speed signal	ABS actuator and electric unit (control unit)  Combination meter  Upper meter

POWER METER

POWER METER : System Description

INFOID:000000010122391

SYSTEM DIAGRAM

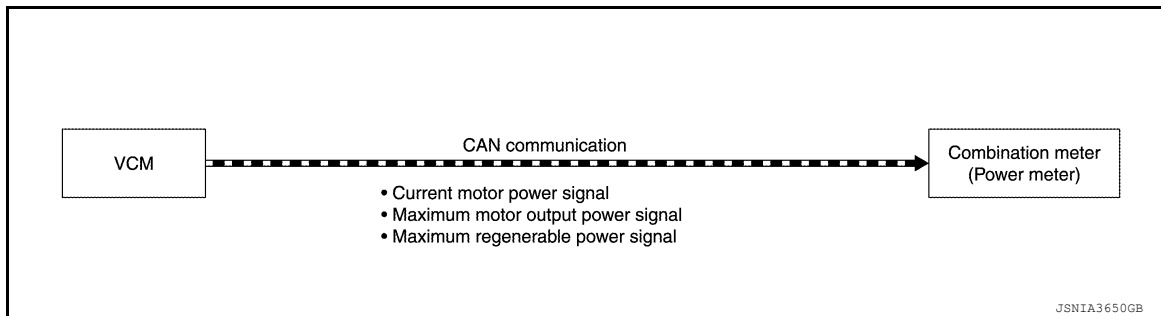

DESCRIPTION

- The following power levels can be checked on the power meter of the combination meter:
 - Current motor power
 - Maximum motor output power
 - Maximum regenerable power
- VCM sends the signals below to the combination meter via CAN communication.
 - Current motor power signal
 - Maximum motor output power signal
 - Maximum regenerable power signal
- Based on the signals received via CAN communication from VCM, the combination meter displays the power levels on the power meter.

SIGNAL PATH

Signal name	Signal path
Current motor power signal	VCM  Combination meter
Maximum motor output power signal	
Maximum regenerable power signal	

A
B
C
D
E
F
G
H
I
J
K
L
M
O
P

MWI

SYSTEM

< SYSTEM DESCRIPTION >

LIST OF POWER METER FUNCTIONS

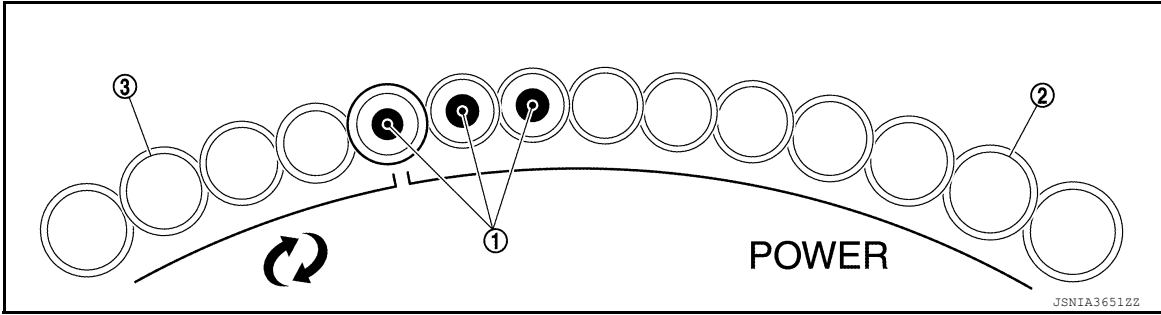

	Function	Description	Signal name
1.	Current motor power	Indicates the current motor power or re-generation power.	Current motor power signal
2.	Maximum motor output power	Indicates the maximum motor power which can be output at that time.	Maximum motor output power signal
3.	Maximum regeneration power	Indicates the maximum regeneration power which can be output at that time.	Maximum regenerable power signal

TIMING CHART

Power meter segments ON/OFF timing

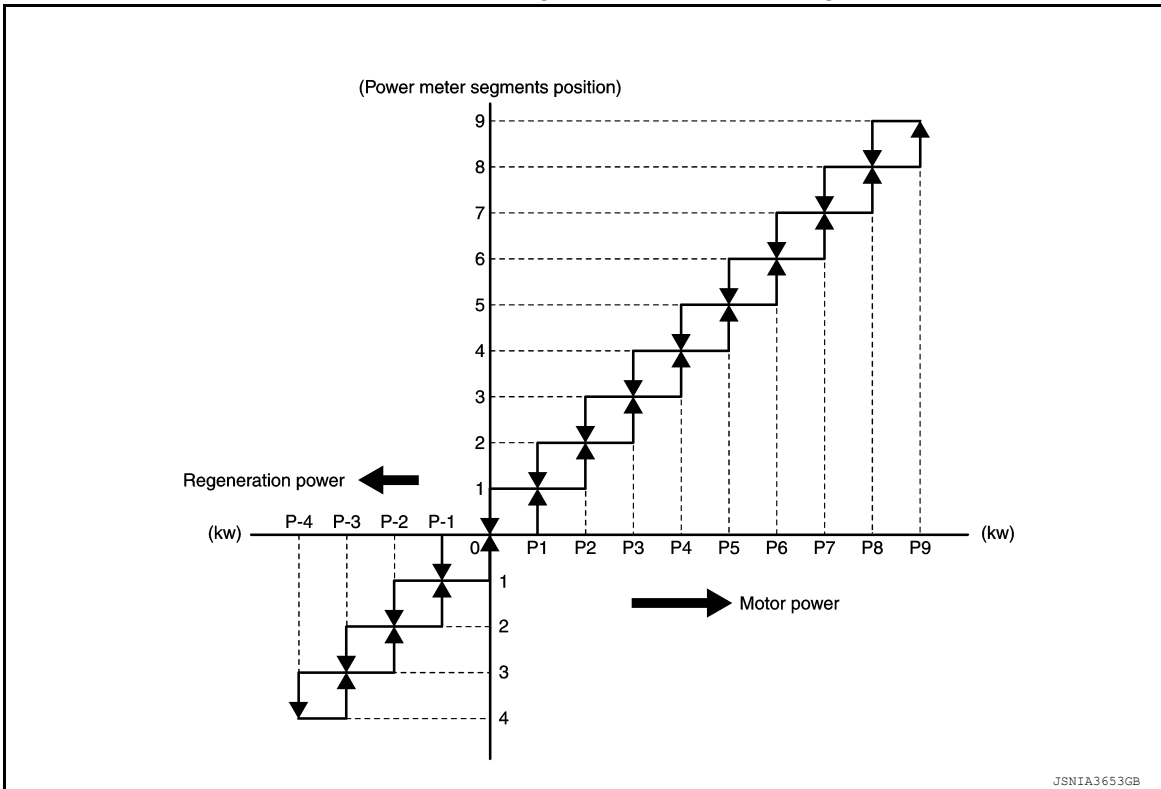

SYSTEM

< SYSTEM DESCRIPTION >

Power meter segments ON/OFF parameters

Segments		Power (kW)	—
9	Motor power	72	P9
8		64	P8
7		56	P7
6		48	P6
5		40	P5
4		32	P4
3		24	P3
2		16	P2
1		8	P1
0	—	0	0
1	Regeneration power	6	P-1
2		12	P-2
3		18	P-3
4		24	P-4

LI-ION BATTERY TEMPERATURE GAUGE

LI-ION BATTERY TEMPERATURE GAUGE : System Description

INFOID:000000010122392

SYSTEM DIAGRAM

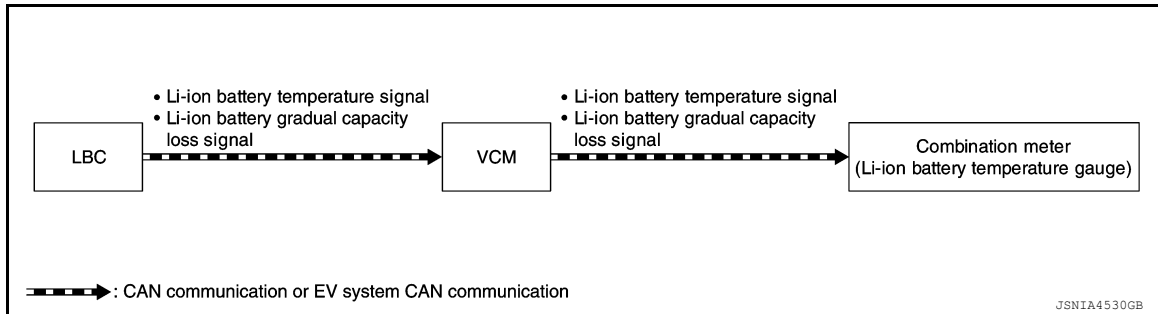

DESCRIPTION

- LBC transmits a Li-ion battery temperature signal and a Li-ion battery gradual capacity loss signal to VCM via EV system CAN communication.
- VCM transmits a Li-ion battery temperature signal and a Li-ion battery gradual capacity loss signal to the combination meter via CAN communication.
- The combination meter corrects a Li-ion battery temperature recognized by a Li-ion battery temperature signal, based on battery capacity recognized by a Li-ion battery gradual capacity loss signal. The combination meter then judges the number of segments to be lit.

NOTE:

The number of lighting segments of the Li-ion battery temperature gauge depends on gradual loss of Li-ion battery capacity.

SIGNAL PATH

Signal name	Signal path
Li-ion battery temperature signal	LBC VCM Combination meter
Li-ion battery gradual capacity loss signal	LBC VCM Combination meter

RELATIONSHIPS OF THE NUMBER OF LIGHTING SEGMENTS OF LI-ION BATTERY TEMPERA-

A
B
C
D
E
F
G
H
I
J
K
L
M
N
O
P

MWI

SYSTEM

< SYSTEM DESCRIPTION >

Li-ION BATTERY TEMPERATURE GAUGE AND LI-ION BATTERY TEMPERATURE

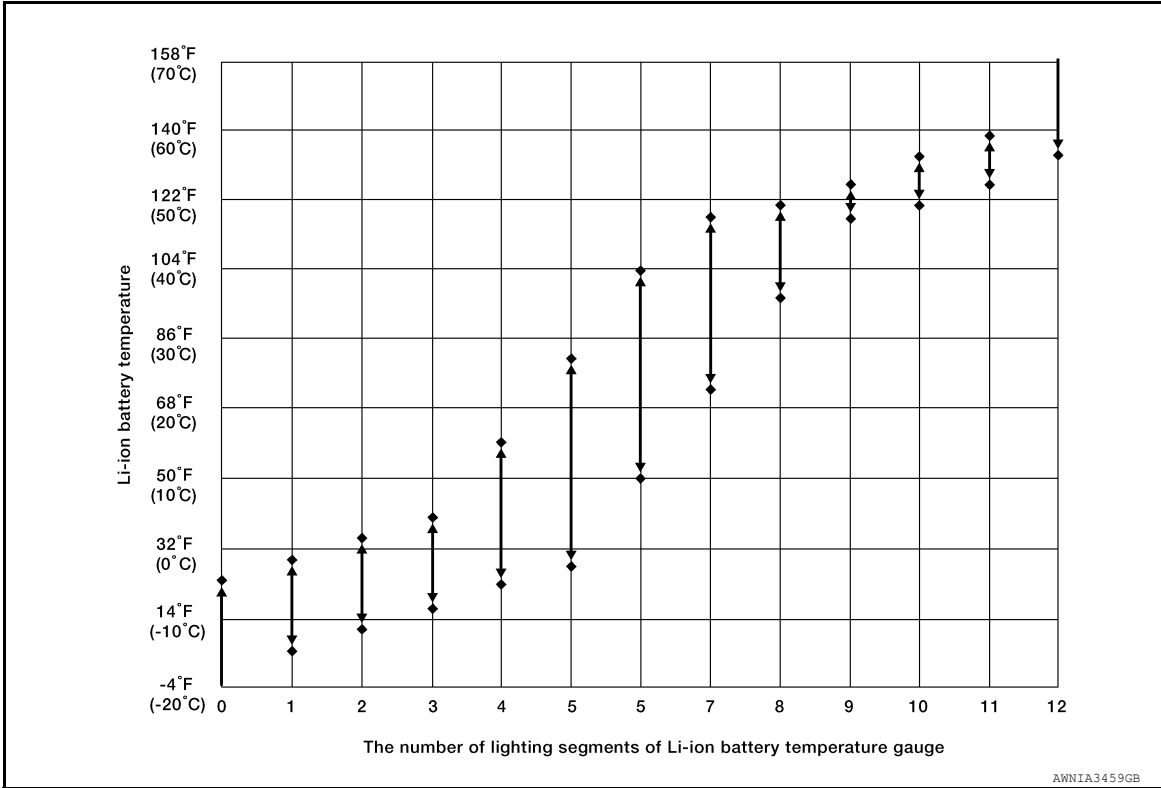

NOTE:

- Li-ion battery temperature gauge shows Li-ion battery temperature by correcting it according to the battery capacity. Consequently, the number of lighting segments of Li-ion battery temperature gauge can be different regardless of the same Li-ion battery temperature.
- This graph shows corrected temperatures. These do not agree with the CONSULT temperature shown in data monitor item "BAT TEMP".

LI-ION BATTERY CAPACITY LEVEL GAUGE

LI-ION BATTERY CAPACITY LEVEL GAUGE : System Description

INFOID:0000000010122393

SYSTEM DIAGRAM

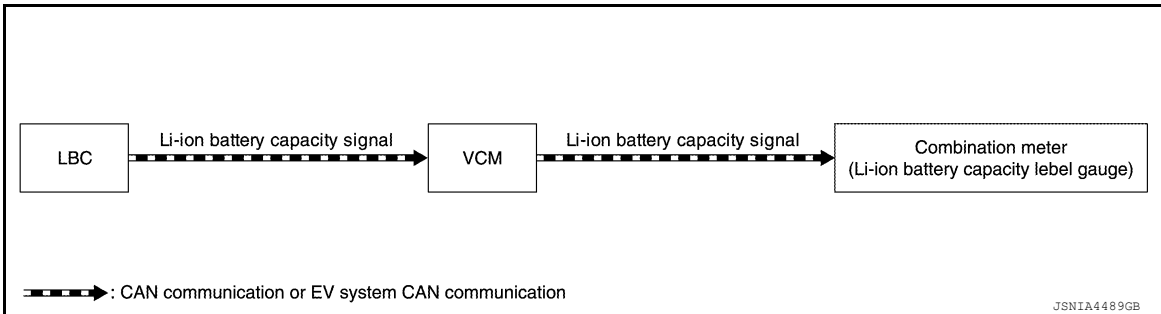

DESCRIPTION

- LBC transmits a Li-ion battery capacity signal to VCM via EV system CAN communication.
- VCM transmits a Li-ion battery capacity signal to the combination meter via CAN communication.
- The combination meter indicates the Li-ion battery capacity to the Li-ion battery capacity level gauge according to the Li-ion battery capacity signal received via CAN communication.

NOTE:

- Li-ion battery capacity signal is a signal which requires the number of lighting segments of the Li-ion battery capacity level gauge. The number of lighting segments is judged by LBC, according to Li-ion battery capacity. When receiving a Li-ion battery capacity signal, the combination meter shows the number of lighting segments requested via Li-ion battery capacity signal on the Li-ion battery capacity level gauge.
- When gradual loss of capacity occurs in the Li-ion battery, the number of lighting segments of the Li-ion battery capacity level gauge decreases.

SYSTEM

< SYSTEM DESCRIPTION >

SIGNAL PATH

Signal name	Signal path
Li-ion battery capacity signal	LBC $\xrightarrow{\text{CAN}}$ VCM $\xrightarrow{\text{CAN}}$ Combination meter

RELATIONSHIPS OF LI-ION BATTERY CAPACITY LEVEL GAUGE AND LI-ION BATTERY AVAILABLE CHARGE GAUGE

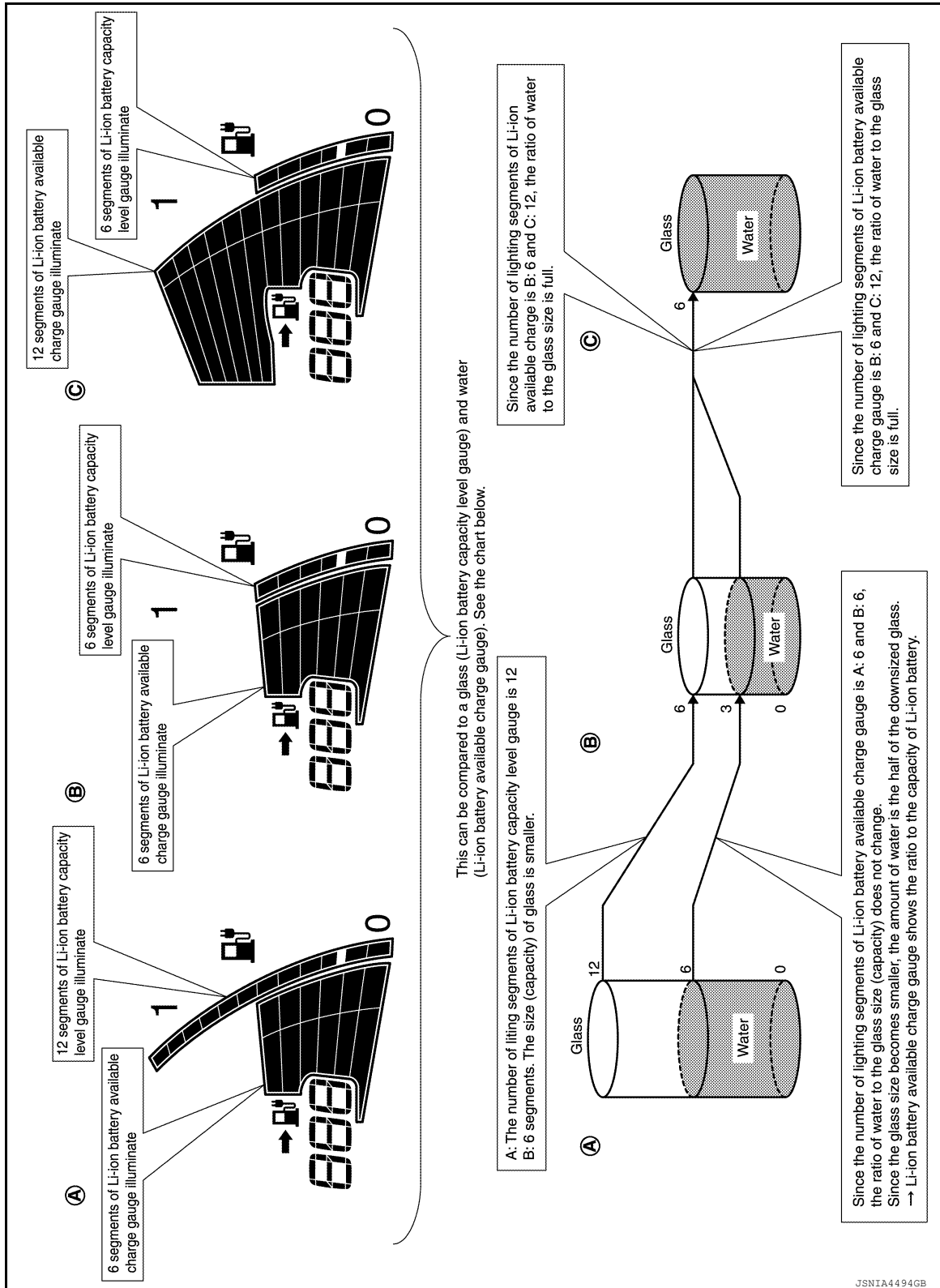

A
B
C
D
E
F
G
H
I
J
K
L
M
N
O
P



SYSTEM

< SYSTEM DESCRIPTION >

LI-ION BATTERY CAPACITY LEVEL GAUGE INDICATION CHANGE CAUSED BY GRADUAL CAPACITY LOSS

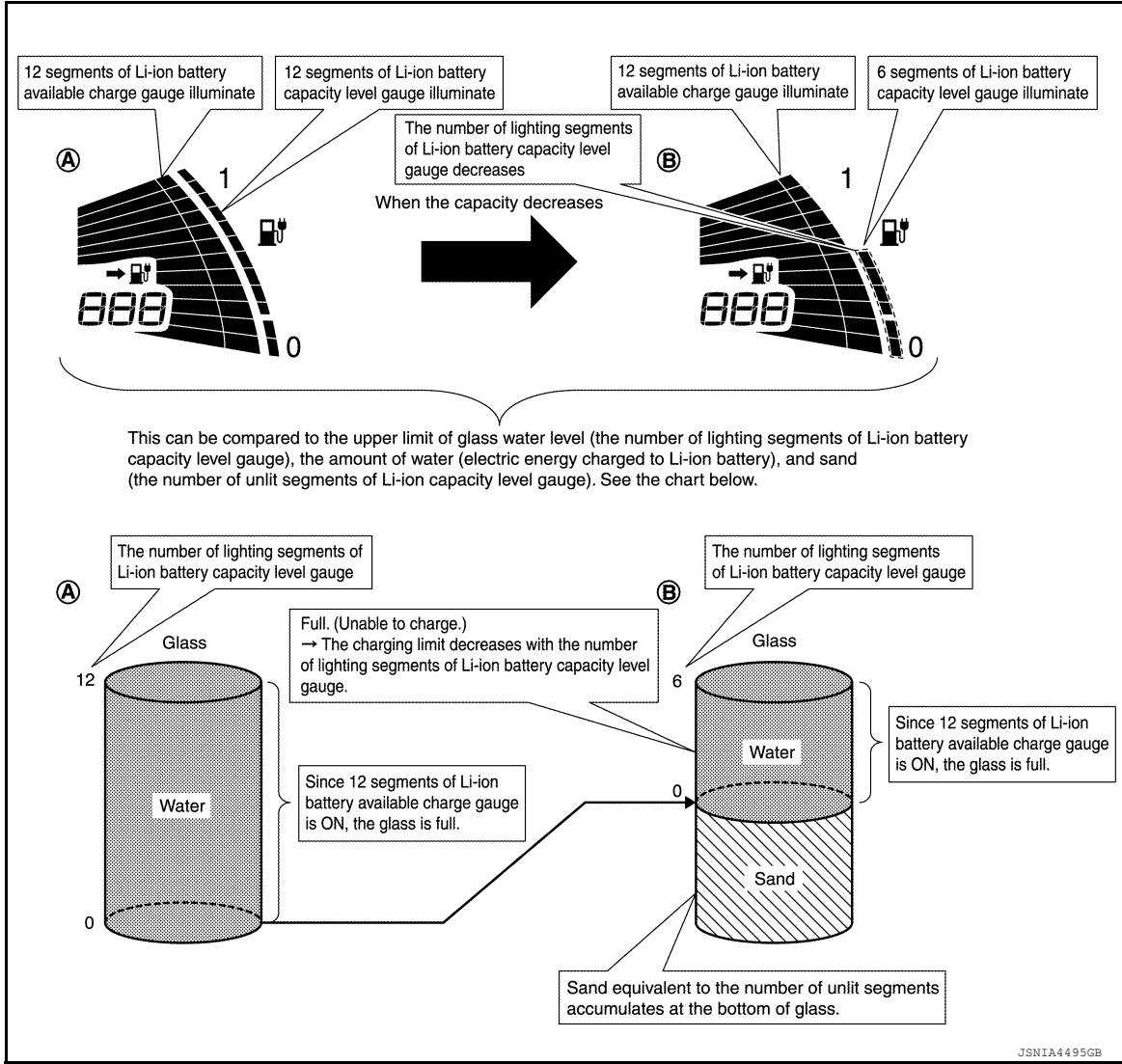

LI-ION BATTERY CAPACITY LEVEL GAUGE INDICATION CHANGE CAUSED BY TEMPERATURE

SYSTEM

< SYSTEM DESCRIPTION >

CHANGE

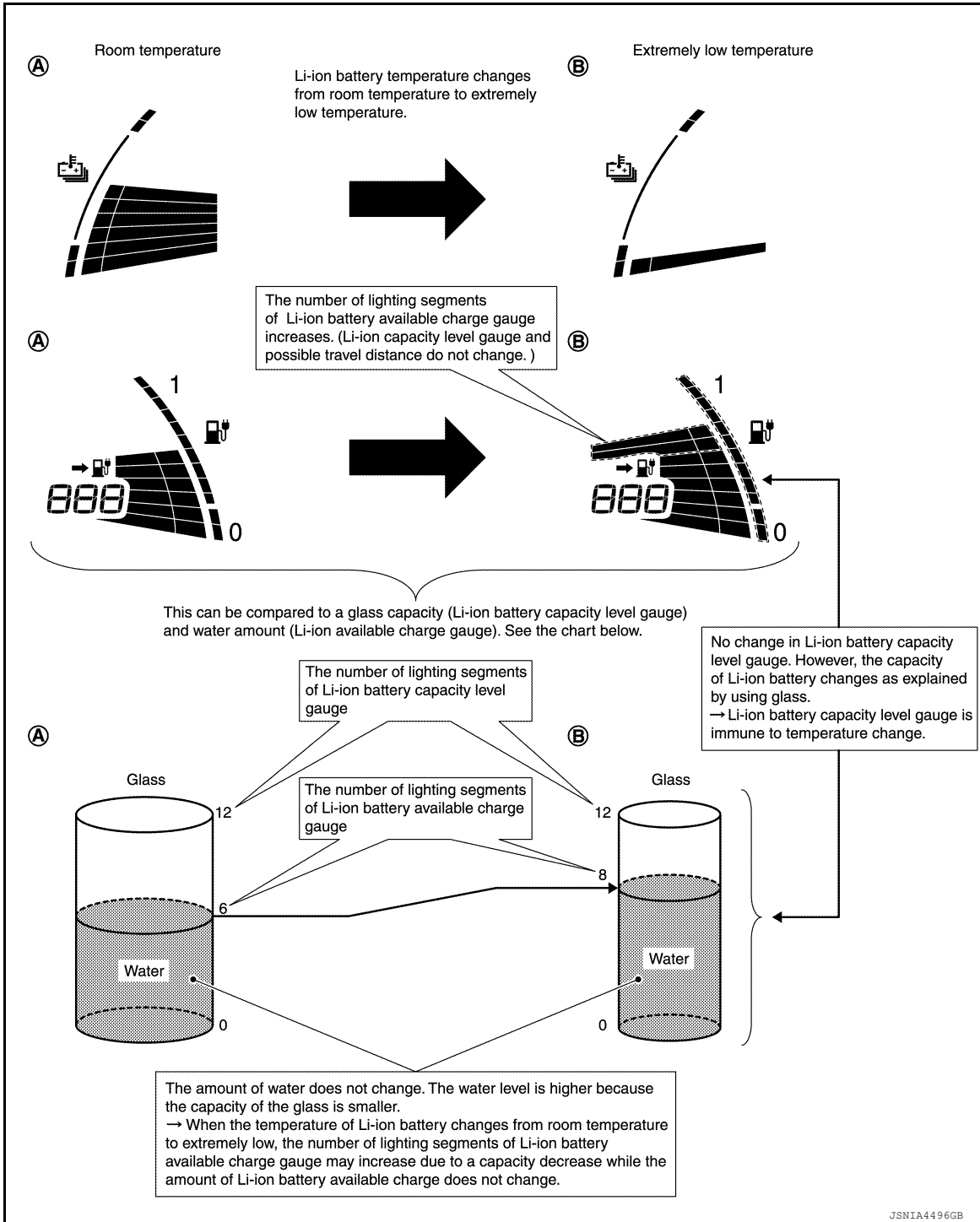

LI-ION BATTERY AVAILABLE CHARGE GAUGE

A
B
C
D
E
F
G
H
I
J
K
L
M
N
O
P

MWI

SYSTEM

< SYSTEM DESCRIPTION >

LI-ION BATTERY AVAILABLE CHARGE GAUGE : System Description

INFOID:000000010122394

SYSTEM DIAGRAM

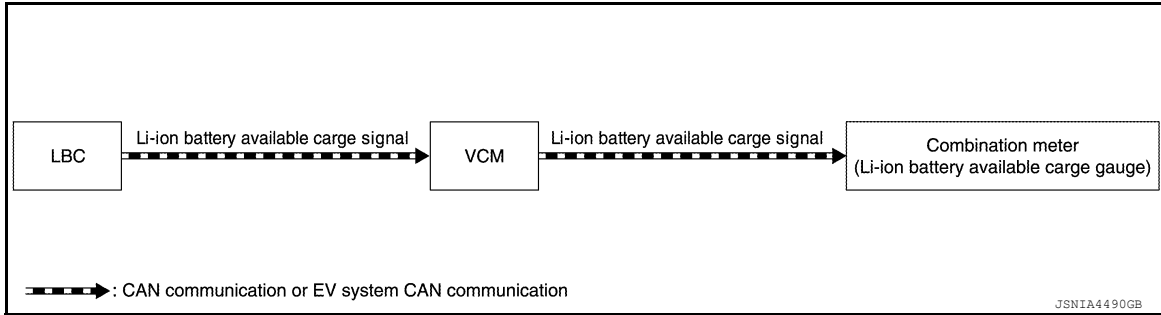

DESCRIPTION

- LBC transmits a Li-ion battery available charge signal to VCM via EV system CAN communication.
- VCM transmits a Li-ion battery available charge signal to the combination meter via CAN communication.
- The combination meter indicates the Li-ion battery available charge to the Li-ion battery available charge gauge according to the Li-ion battery available charge signal received via CAN communication.

NOTE:

- Li-ion battery available charge signal is a signal which requests the number of lighting segments of the Li-ion battery available charge gauge. The number of lighting segments is judged by LBC, according to Li-ion battery available charge level. When receiving a Li-ion battery available charge signal, the combination meter shows the number of lighting segments requested via Li-ion battery available charge signal on the Li-ion battery available charge gauge.
- Li-ion battery available charge level is displayed by the ratio to the full capacity.
- Since Li-ion battery capacity changes with Li-ion battery temperature, the indication of Li-ion battery available charge gauge may change.

SIGNAL PATH

Signal name	Signal path
Li-ion battery available charge signal	LBC $\xrightarrow{\text{CAN}}$ VCM $\xrightarrow{\text{CAN}}$ Combination meter

LI-ION BATTERY AVAILABLE CHARGE GAUGE PARAMETER

The number of lighting segments of Li-ion battery available charge gauge	Li-ion battery available charge level (%)	
	When driving	When charging
12	More than 92	96 or more
11	More than 84 and 92 or less	88 or more and less than 96
10	More than 76 and 84 or less	80 or more and less than 88
9	More than 68 and 76 or less	72 or more and less than 80
8	More than 60 and 68 or less	64 or more and less than 72
7	More than 52 and 60 or less	56 or more and less than 64
6	More than 44 and 52 or less	48 or more and less than 56
5	More than 36 and 44 or less	40 or more and less than 48
4	More than 28 and 36 or less	32 or more and less than 40
3	More than 20 and 28 or less	24 or more and less than 32
2	More than 12 and 20 or less	16 or more and less than 24
1	More than 4 and 12 or less	8 or more and less than 16
0	4 or less	Less than 8

NOTE:

SYSTEM

< SYSTEM DESCRIPTION >

Since the indication method of available charge level is different between Li-ion battery available charge gauge and quick charger, the above Li-ion battery available charge level (%) does not agree with levels displayed on quick charger.

RELATIONSHIPS OF LI-ION BATTERY CAPACITY LEVEL GAUGE AND LI-ION BATTERY AVAILABLE CHARGE GAUGE

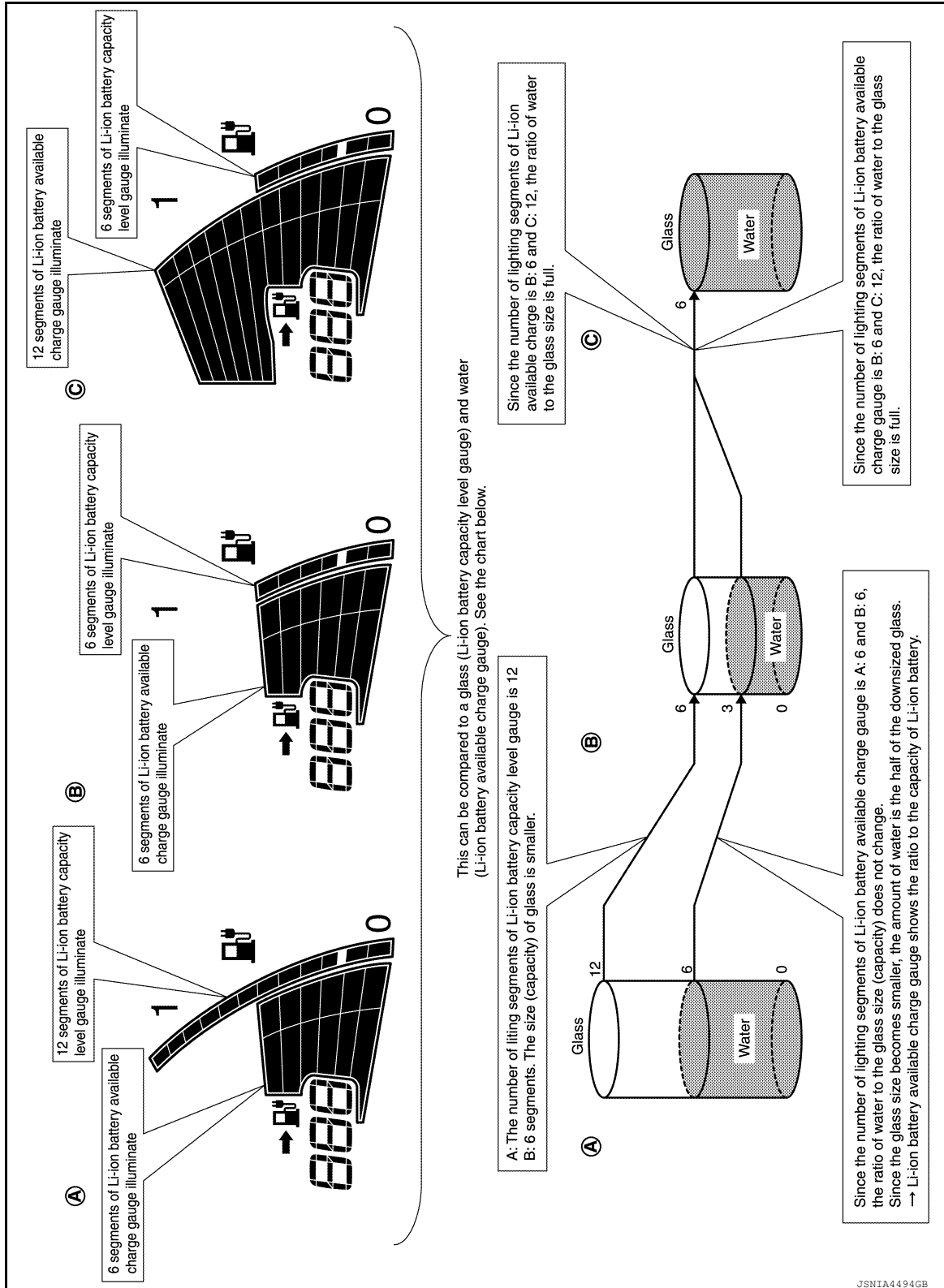

LI-ION BATTERY AVAILABLE CHARGE GAUGE INDICATION CHANGE CAUSED BY TEMPERA-

A
B
C
D
E
F
G
H
I
J
K
L
M
N
O
P



SYSTEM

< SYSTEM DESCRIPTION >

TURE CHANGE

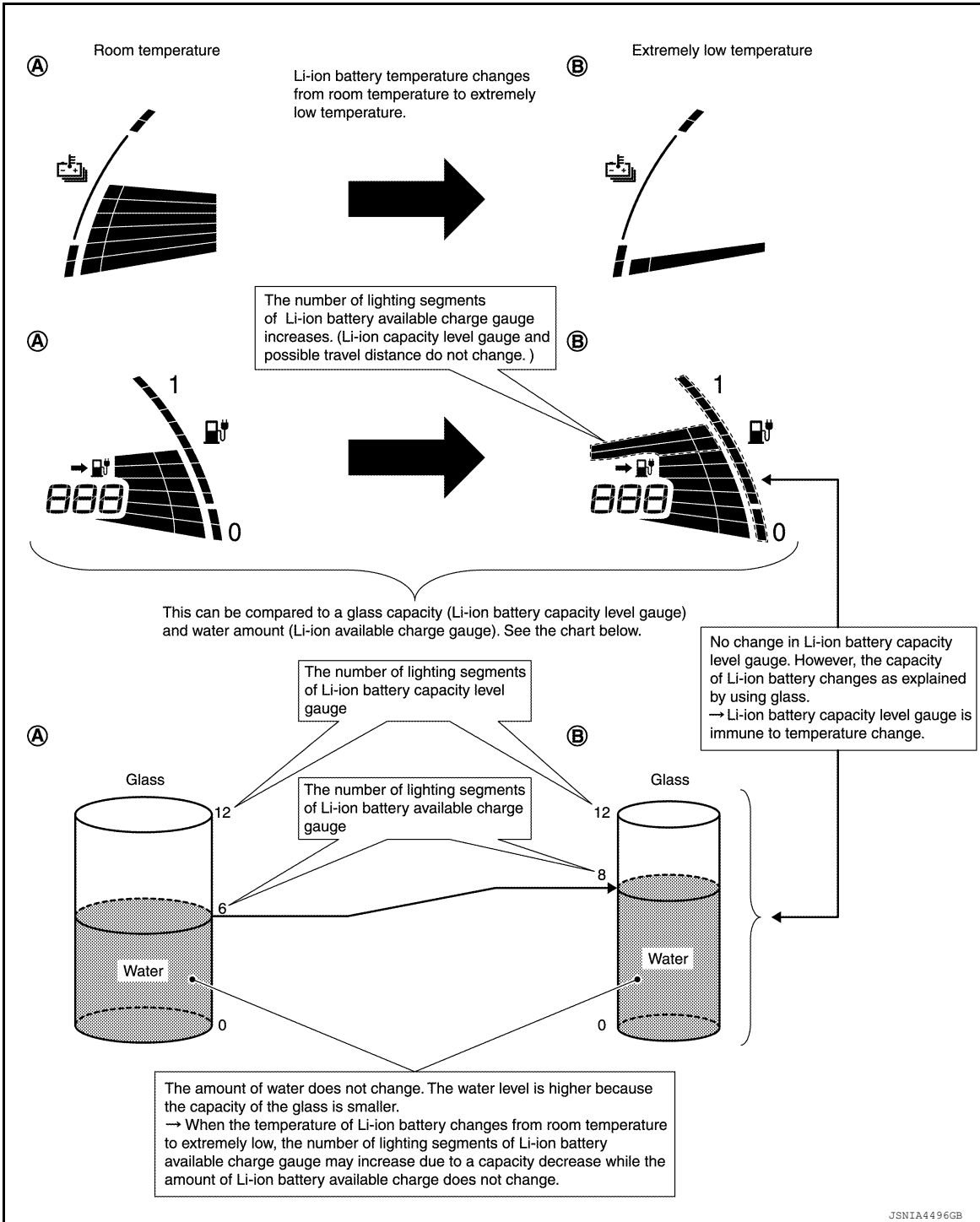

ECO INDICATOR

SYSTEM

< SYSTEM DESCRIPTION >

ECO INDICATOR : System Description

INFOID:000000010122395

SYSTEM DIAGRAM

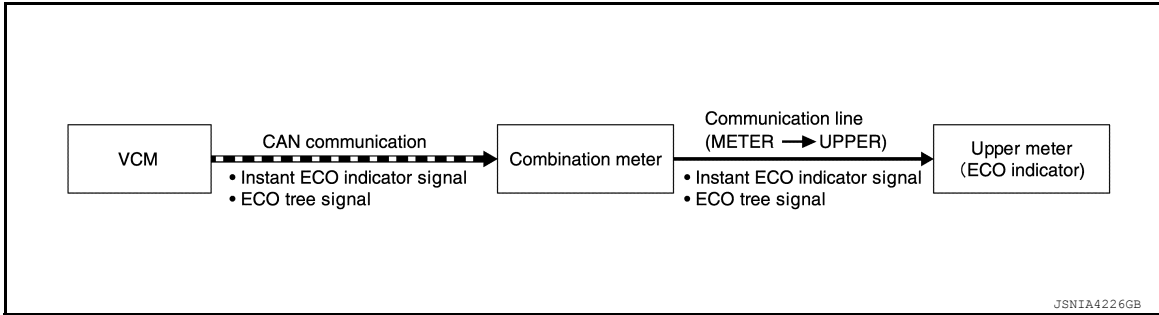

DESCRIPTION

- The following ECO drive levels can be checked on the ECO indicator of upper meter:
 - Instant ECO drive level
 - Cumulative ECO drive level
- VCM sends the signals below to the combination meter via CAN communication:
 - Instant ECO indicator signal
 - ECO tree signal
- The combination meter sends the signals it received via CAN communication from VCM to the upper meter.
- Based on the signals received via the communication line, the upper meter indicates the ECO drive level on the ECO indicator.

SIGNAL PATH

Signal name	Signal path
Instant ECO indicator signal	VCM $\xrightarrow{\text{CAN}}$ Combination meter $\xrightarrow{\text{COMM}}$ Upper meter
ECO tree signal	

LIST OF ECO INDICATOR FUNCTIONS

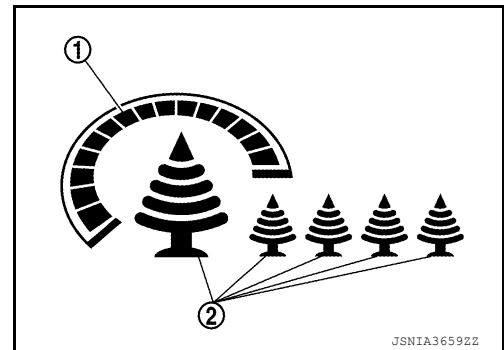

	Function	Description	Signal name
1.	Instant ECO indicator	Indicates the instantaneous ECO drive level based on the driving conditions.	Instant ECO indicator signal
2.	ECO tree	Totals the instantaneous ECO drive levels and indicates the cumulative ECO drive level during driving (from power switch READY to OFF).	ECO tree signal

ECO TREE GROWTH PATTERN

A
B
C
D
E
F
G
H
I
J
K
L
M
N
O
P

MWI

SYSTEM

< SYSTEM DESCRIPTION >

- The cumulative instant ECO indicator (1) results are displayed in the ECO tree (2).
- When all ECO tree (2) segments are ON, ECO tree (3) turns ON (all segments) and ECO tree (2) turns OFF.
- The cumulative instant ECO indicator (1) results are again displayed in the ECO tree (2).
- When all ECO tree (2) segments are ON, ECO tree (4), ECO tree (5), and ECO tree (6) turn ON in sequence.

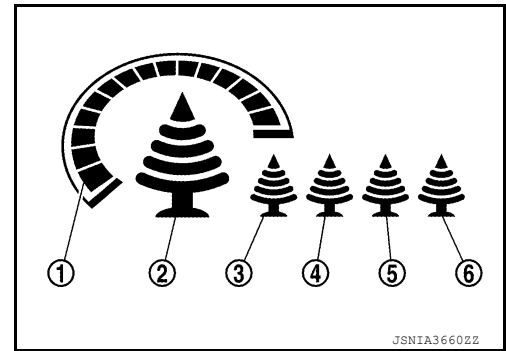

Flow of ECO Tree Growth

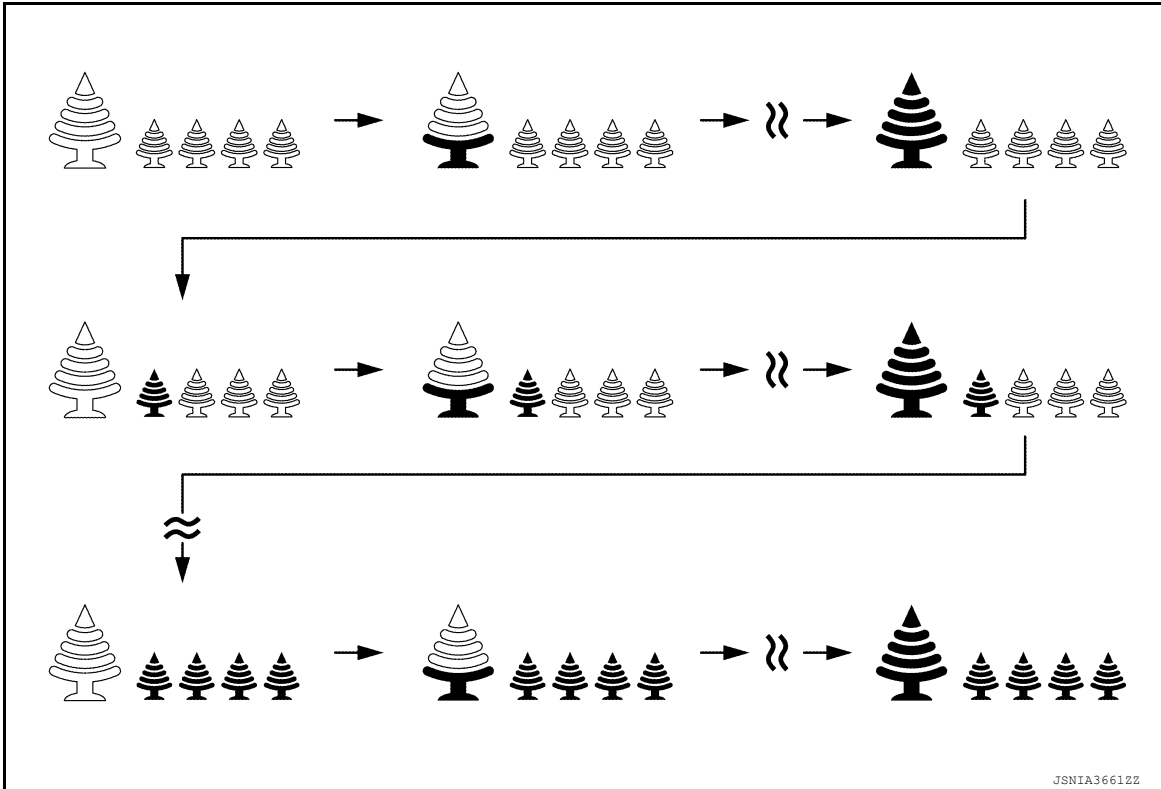

DRIVING RANGE DISPLAY

DRIVING RANGE DISPLAY : System Description

INFOID:000000010122396

SYSTEM DIAGRAM

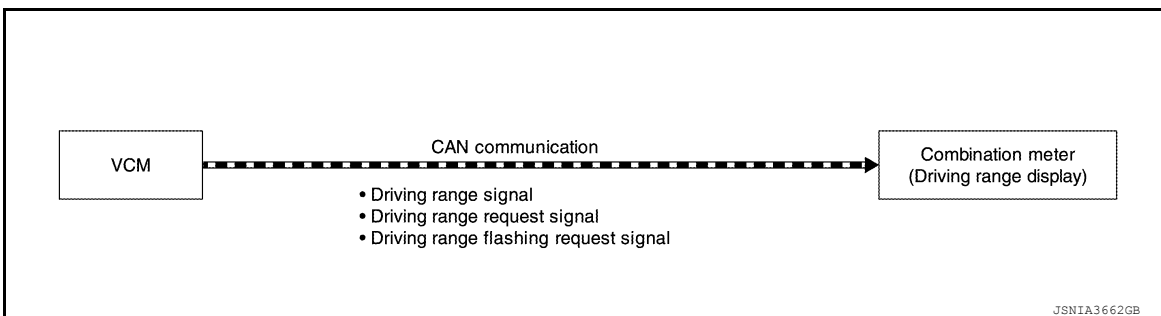

DESCRIPTION

- VCM sends the signals below to the combination meter via CAN communication:
 - Driving range signal
 - Driving range request signal
 - Driving range flashing request signal

SYSTEM

< SYSTEM DESCRIPTION >

- Based on the signals received via CAN communication from VCM, the combination meter displays the driving range on the driving range display (1).

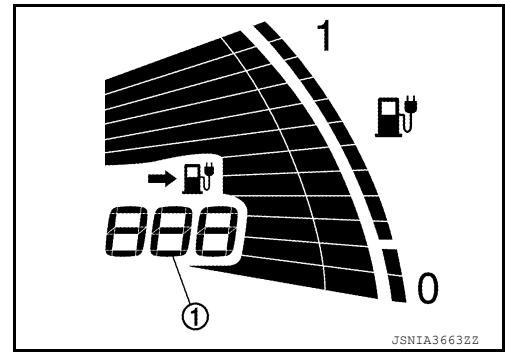

Driving Range Display Pattern

Driving range display status	DESCRIPTION	Signal path
Driving range display	Displays the driving range.	Driving range signal
Driving range blinking	When the low battery charge warning lamp is ON (when the battery remaining energy is 4 kWh or less).	Driving range blinking request signal
"---" display	When the batter remaining energy is 2 kWh or less.	Driving range request signal

NOTE:

- If the power switch is turned from OFF to READY, the value that is last received is displayed.
- The driving range is updated approximately every 0.06 mile (100 m) of driving.

SIGNAL PATH

Signal name	Signal path
Driving range signal	VCM $\xrightarrow{\text{CAN}}$ Combination meter
Driving range flashing request signal	
Driving range request signal	

OUTSIDE AIR TEMPERATURE DISPLAY

OUTSIDE AIR TEMPERATURE DISPLAY : System Description

INFOID:000000010122397

SYSTEM DIAGRAM

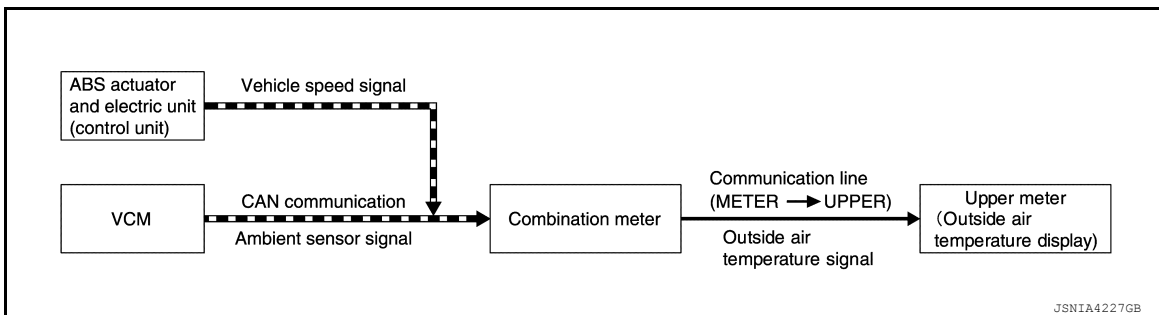

DESCRIPTION

- VCM transmits a ambient sensor signal to the combination meter via CAN communication.
- ABS actuator and electric unit (control unit) transmits a vehicle speed signal to the combination meter via CAN communication.
- The combination meter calculates the outside air temperature based on the signals received from VCM and ABS actuator and electric unit (control unit) via CAN communication.
- The combination meter sends the calculated outside air temperature signal to the upper meter via the communications line.

SYSTEM



< SYSTEM DESCRIPTION >

- The upper meter indicates the outside air temperature according to the outside air temperature signal received from the combination meter by means of communication line.
- For outside temp (Alert), refer to [MWI-35. "INFORMATION DISPLAY : System Description"](#).

NOTE:

- The indicated temperature is corrected based on a power switch signal, ambient temperature detected by the ambient sensor, and vehicle speed signal. The indicated temperature is not raised under vehicle speed less than 20 km/h (12 MPH).
- The ambient sensor input value that is displayed on "Data Monitor" of CONSULT is the value before the correction. It may not match the indicated temperature on the outside air temperature display.
- Depending on motor heat or heat on the road surfaces, an ambient temperature may be indicated higher than actual one.

SIGNAL PATH

Signal name	Signal path
Vehicle speed signal	ABS actuator and electric unit (control unit)  Combination meter
Ambient sensor signal	VCM  Combination meter
Outside air temperature signal	Combination meter  Upper meter

TIMER CHARGE AND A/C-HEATER TIMER (CLIMATE CTRL. TIMER) (WITHOUT NAVIGATION)

TIMER CHARGE AND A/C-HEATER TIMER (CLIMATE CTRL. TIMER) (WITHOUT NAVIGATION) : System Description

INFOID:000000010122398

SYSTEM DIAGRAM

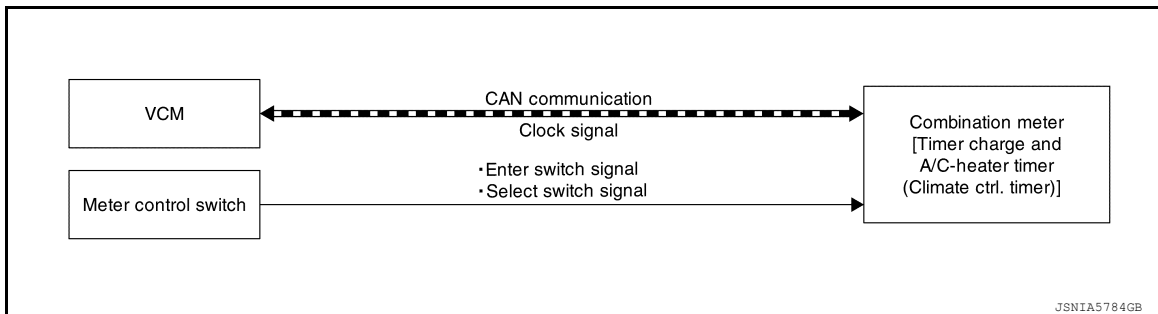

DESCRIPTION

- Time for timer charge and A/C-Heater Timer (Climate Ctrl. Timer) can be set from the information display setting screen.
- The combination meter transmits the (manually set) clock signal to VCM via CAN communication and compensates the VCM current time.

Timer Charge Function

- Timer charge stop time can be set on the settings screen of the information display. For the setting method, refer to [MWI-35. "INFORMATION DISPLAY : System Description"](#).
- After the power switch is turned OFF, VCM starts at a set charge start time. (The time of the timer function is controlled by VCM.)
- VCM starts, and then charge starts. For details of the charging function, refer to [EVC-51. "LI-ION BATTERY CHARGE CONTROL : System Description"](#).
- Charge is completed.

A/C-Heater Timer (Climate Ctrl. Timer) Function

- Estimated time of departure can be set on the settings screen of the information display. For the setting method, refer to [MWI-35. "INFORMATION DISPLAY : System Description"](#).

SYSTEM



< SYSTEM DESCRIPTION >

- When charge plug is connected, the mode goes into timer mode.
- After the power switch is turned OFF, VCM starts at a set air conditioner start time. (The time of the timer function is controlled by VCM.)
- VCM starts and turns ON the air conditioner. For details of air conditioner system, refer to [HAC-30, "AUTOMATIC AIR CONDITIONING SYSTEM : System Description"](#) (With heat pump) or [HAC-228, "AUTOMATIC AIR CONDITIONING SYSTEM : System Description"](#) (Without heat pump).

NOTE:

A/C-Heater Timer (Climate Ctrl. Timer) performs air conditioning with the settings of temperature 25°C (77°F).

SIGNAL PATH

Signal name	Signal path
Clock signal	Combination meter  VCM  Combination meter

MASTER WARNING LAMP

MASTER WARNING LAMP : System Description

INFOID:000000010122399

SYSTEM DIAGRAM

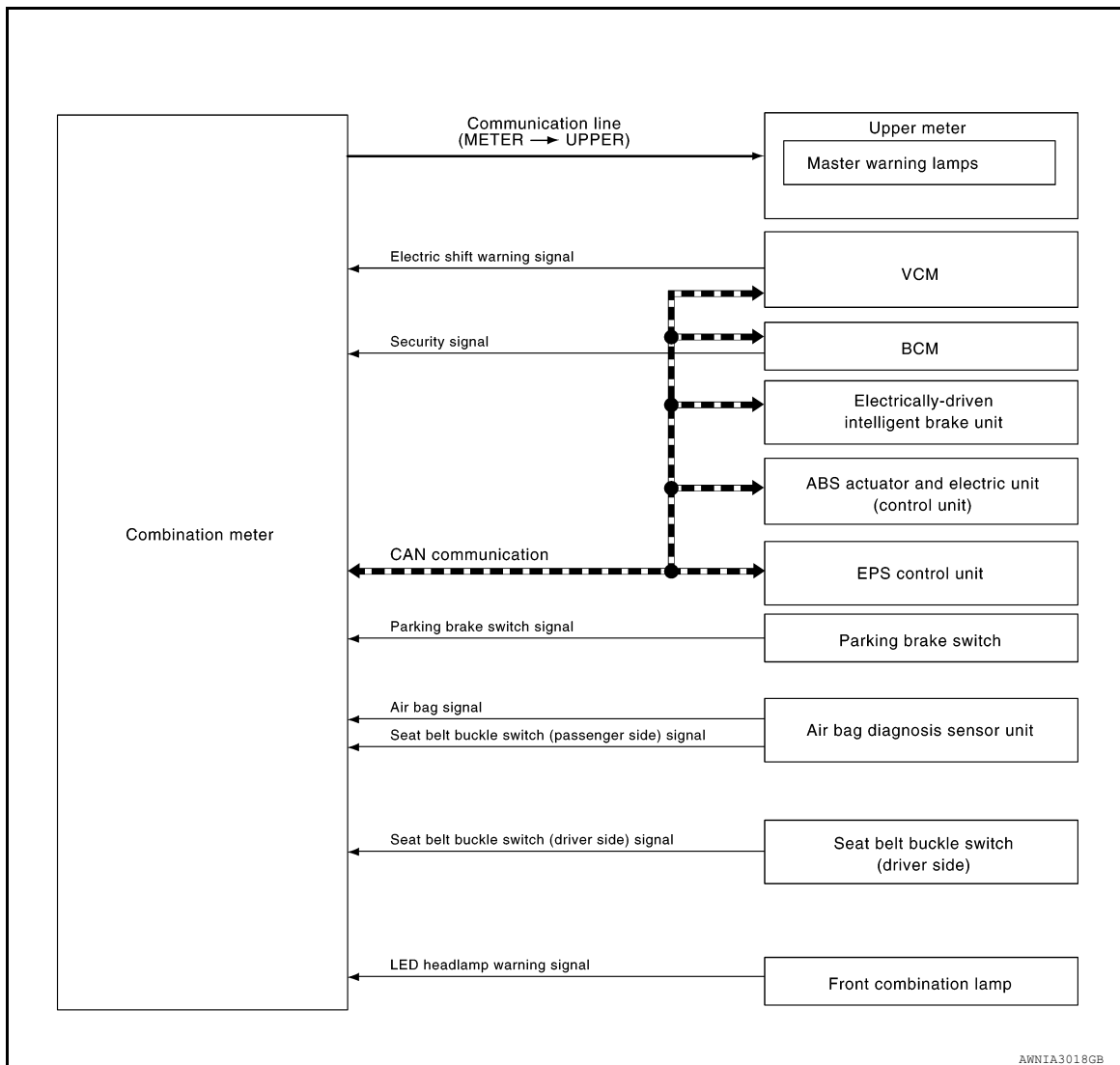

Combination Meter Input Signal (CAN Communication)

A
B
C
D
E
F
G
H
I
J
K
L
M
N
O
P



SYSTEM

< SYSTEM DESCRIPTION >

Transmit unit	Signal name
ABS actuator and electric unit (control unit)	ABS warning lamp signal
	Brake warning lamp signal
	VDC OFF switch signal
	VDC warning lamp signal
VCM	Low battery charge warning lamp signal
	12-volt battery charge warning lamp request signal
	Power limitation indicator lamp request signal
	Power limitation cause signal
	Electric shift warning lamp signal
	Electric shift warning message signal
	EV system warning lamp signal
Vehicle stop and parking brake operation request display signal	
EPS control unit	EPS warning lamp signal
Electrically-driven intelligent brake unit	Brake system warning lamp signal
BCM	Door switch signal
	Meter display signal

Combination Meter Output Signal (Communication Line)

Reception unit	Signal name
Upper meter	Master warning signal

DESCRIPTION

- The master warning lamp (red) and master warning lamp (yellow) turn ON/OFF in coordination with the combination meter warning lamp or warning information display.
- The master warning lamp (red) turns ON/OFF in coordination with the warnings listed below:
 - Brake warning lamp
 - Seat belt warning lamp
 - 12-volt battery charge warning lamp
 - Air bag warning lamp
 - Security warning lamp
 - Electric shift warning lamp
- The master warning lamp (red) turns ON/OFF in coordination with the information displays listed below:
 - Door open warning display (while driving)
 - Electric shift warning display (“When park apply parking brake”)
 - DC/DC converter warning display (“Stop vehicle”)
 - DC/DC converter warning display (“Apply parking brake”)
- The master warning lamp (yellow) turns ON/OFF in coordination with the warnings listed below:
 - ABS warning lamp
 - VDC OFF indicator
 - VDC warning lamp
 - EPS warning lamp
 - Brake system warning lamp
 - Power limitation indicator
 - Low battery charge warning lamp
 - EV system warning lamp
 - Headlamp warning lamp
- The master warning lamp (yellow) turns ON/OFF in coordination with the information displays listed below:
 - Door open warning display (while not driving)
 - Electric shift warning display (“T/M system malfunction visit dealer”, “Check position of shift lever”)
 - Li-ion battery low charge warning display
 - Power limitation warning display
 - Intelligent Key system warning

METER ILLUMINATION CONTROL

SYSTEM

< SYSTEM DESCRIPTION >

METER ILLUMINATION CONTROL : System Description

INFOID:000000010122400

SYSTEM DIAGRAM

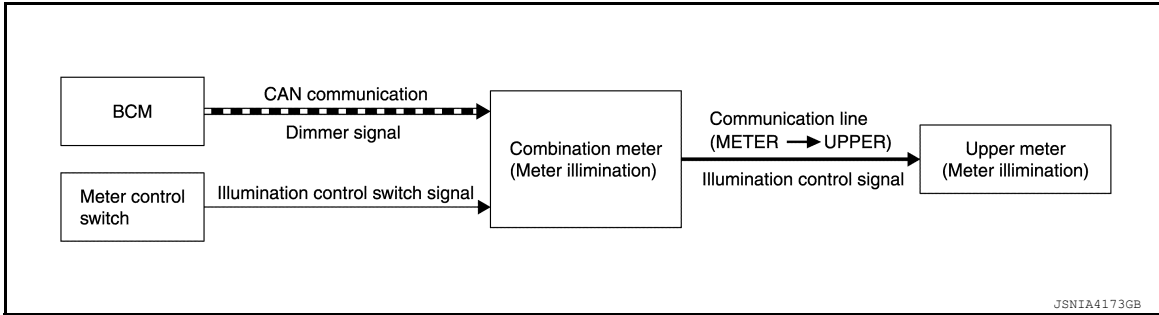

DESCRIPTION

- Combination meter controls meter illumination, based on the following signals:
 - Dimmer signal
 - Illumination control switch signal
- The combination meter and upper meter switches mode between Daytime mode and Nighttime mode, according to the following conditions:

Condition		Meter illumination	
Combination switch (lighting switch)	1ST or 2ND position	Outdoor: Bright*	Daytime mode
		Outdoor: Dark*	Nighttime mode
	AUTO POSITION	Outdoor: Bright*	Daytime mode
		Outdoor: Dark*	Nighttime mode
Off		Daytime mode	



*: For further information, refer to [INL-12, "AUTO LIGHT ADJUSTMENT SYSTEM : System Description"](#).

- The operation of the illumination control switch allows the brightness adjustment of meter and upper meter illumination.

Meter illumination	The number of adjustable steps
Daytime	12 step
Nighttime	12 step

SIGNAL PATH

The combination meter controls the meter illumination based on the signals below.

Signal name	Signal path
Dimmer signal	BCM  Combination meter
Illumination control switch signal	Meter control switch  Combination meter

METER EFFECT FUNCTION

A
B
C
D
E
F
G
H
I
J
K
L
M
O
P

MWI

SYSTEM

< SYSTEM DESCRIPTION >

METER EFFECT FUNCTION : System Description

INFOID:000000010122401

SYSTEM DIAGRAM

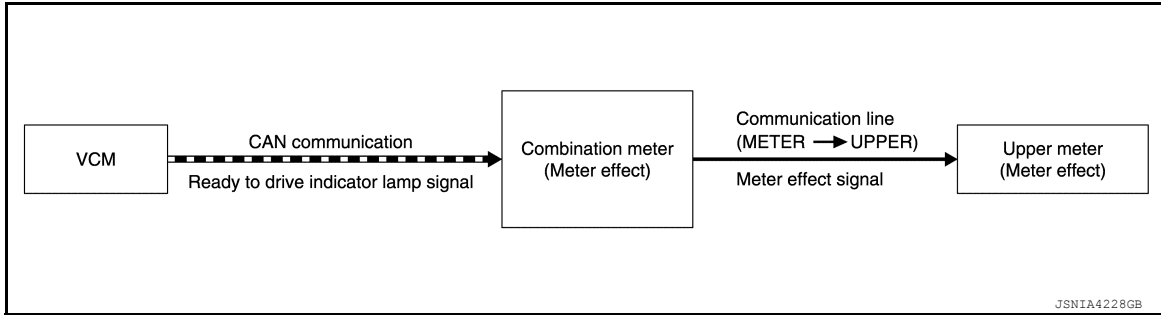

DESCRIPTION

READY Effect Function

When the vehicle is READY to be driven, the combination meter controls the following to start the effect:

- Power meter
- Li-ion battery capacity level gauge
- Li-ion battery available charge gauge
- Li-ion battery temperature gauge
- Instant ECO indicator
- Information display illumination

Operation of gauges and illuminations during READY effect.

During the READY effect, the combination meter controls the following items:

Control item	Operation
Power meter	Effect control is performed in the following sequence: 1. Segments are all turned ON, 1 segment at a time. 2. After all segments are ON, all segments turn OFF, 1 segment at a time. 3. After all segments are OFF, the segments turn ON according to the data that is input at that time.
Li-ion battery capacity level gauge	
Li-ion battery available charge gauge	
Li-ion battery temperature gauge	
Instant ECO indicator	
Information display illumination	Turns on the illumination at the effect level.

READY effect Judgment.

When all of the following conditions are met, the system judges that the READY effect is necessary and the effect is carried out exactly once:

Operational condition	
Power switch	READY
Vehicle speed	Less than 0.6 MPH (1 km/h)
READY to drive indicator	ON

NOTE:

If any of the above conditions are no longer met while the ready effect is in progress, the READY effect is stopped.

SIGNAL PATH

The combination meter controls the READY effect function based on the signals below:

Signal name	Signal path
Power switch ON signal	—

SYSTEM

< SYSTEM DESCRIPTION >

Signal name	Signal path
Vehicle speed signal	ABS actuator and electric unit (control unit) → Combination meter
READY to drive indicator lamp request signal	VCM → Combination meter

INFORMATION DISPLAY

INFORMATION DISPLAY : System Description

INFOID:000000010122402

SYSTEM DIAGRAM

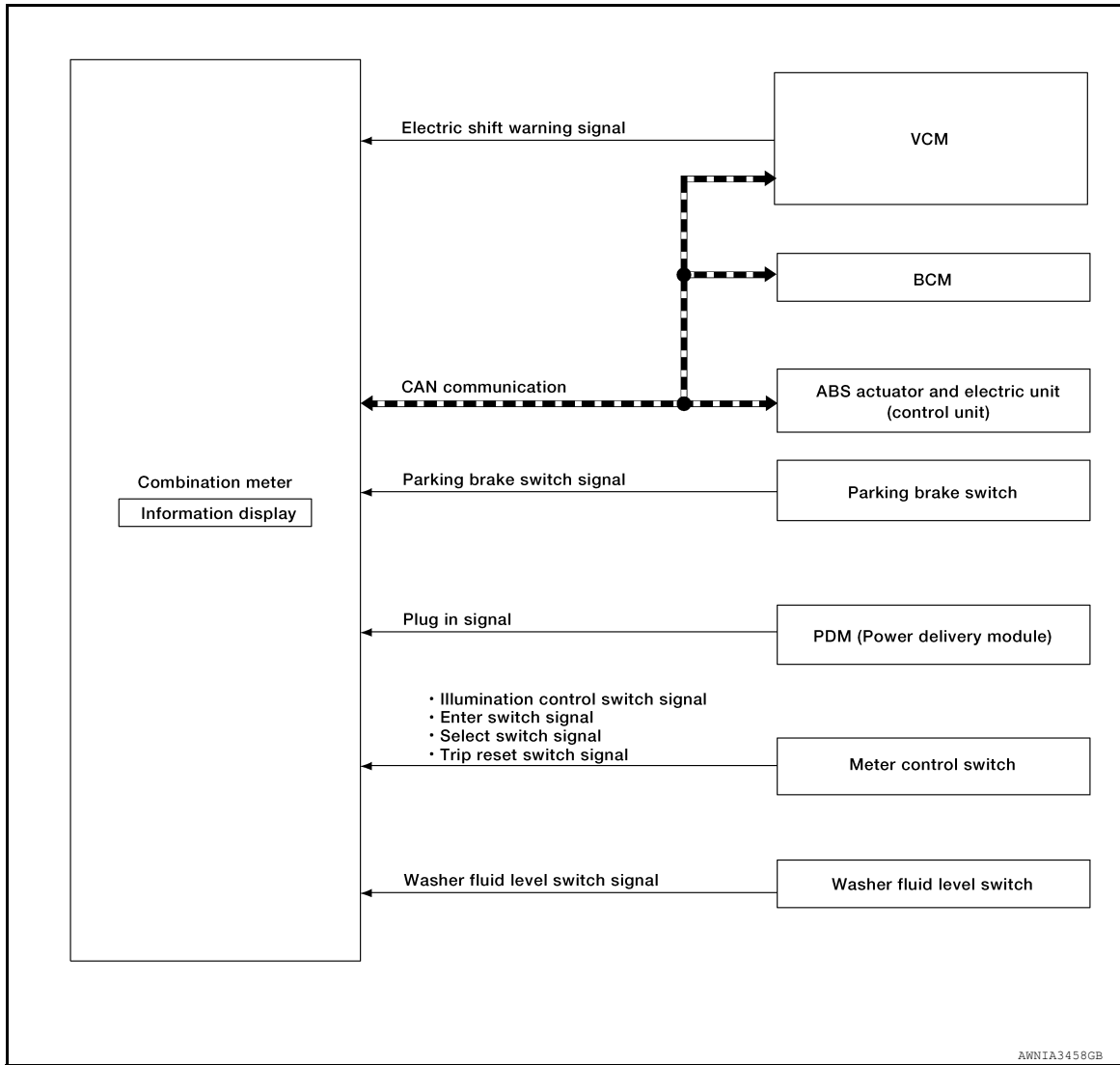

Combination Meter Input Signal (CAN Communication)

Transmit unit	Signal name
ABS actuator and electric unit (control unit)	Vehicle speed signal

A
B
C
D
E
F
G
H
I
J
K
L
M
O
P



SYSTEM

< SYSTEM DESCRIPTION >

Transmit unit	Signal name
VCM	Ambient sensor signal
	ASCD status signal
	Remaining time to charge completion (200 V) signal
	Remaining time to charge completion (100 V) signal
	Electricity consumption signal
	A/C consumption signal
	Others consumption signal
	Plug in warning display signal
	Vehicle stop and parking brake operation request display signal
	Electric shift warning lamp signal
	Electric shift warning message signal
	Low battery charge warning lamp request signal
	Power limitation cause signal
	Next charge time signal
	Next departure time signal
	Next pre-A/C time signal
BCM	Shift position signal
	Meter display signal
	Door switch signal
	Low tire pressure warning lamp signal
	Buzzer output signal

DESCRIPTION

- The information display is an LCD positioned inside the combination meter. It is used to inform the driver of a variety of vehicle information.
- The combination meter receives the signals required to control the operation of the information display from each unit, switch, and sensor.
- Based on the received signals, the combination meter displays the following information on the information display:
 - Odo/trip meter
 - Shift indicator
 - Trip computer
 - Interrupt indication
 - Warning check indication
 - Setting
 - Timer status remained display
 - Charging time display
 - Meter illumination control
 - ASCD status display
- The information display screen is divided into sections (A) – (C), and the items displayed in each section are different.

Display	Display item
A	ASCD status display

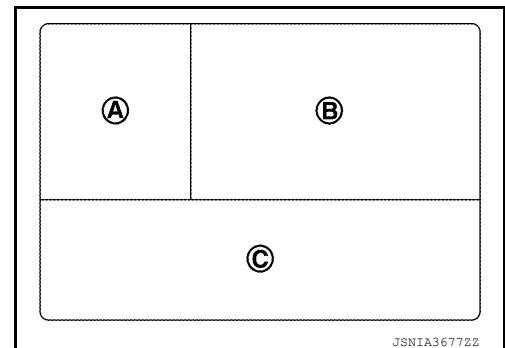

JSNIA3677Z2

SYSTEM

< SYSTEM DESCRIPTION >

Display	Display item
B	Trip computer
	Interrupt indication
	Warning check indication
	Setting
	Timer status reminder display
	Charging time display
	Meter illumination control function
C	Odo/trip meter
	Shift indicator

A
B
C
D

NOTE:

If there are no items to display in display section (A), the items in display section (B) are displayed larger.

- Pressing the  switch (enter switch) changes the item displayed in display section (B) in the following sequence:
 "Charging time" ⇒ "Average electricity consumption/Current electricity consumption" ⇒ "Average vehicle speed" ⇒ "Travel Distance/Travel Time" ⇒ "Setting" ⇒ "Warning"

E
F

ASCD STATUS DISPLAY

Based on the signals listed below, the combination meter displays the ASCD status.

G

Signal name	Signal path
ASCD status signal	VCM  Combination meter

H

For details, refer to [EVC-64, "AUTOMATIC SPEED CONTROL DEVICE \(ASCD\) : System Description"](#).

I

TRIP COMPUTER

Based on the signals received from each unit, switch, and sensor, the combination meter displays the items shown below:



- Current electricity consumption
- Average electricity consumption
- Average vehicle speed
- Travel distance
- Travel time

J
K

Current Electricity Consumption

The combination meter calculates current electricity consumption based on the following signals, and the calculated value is displayed on the information display:

L

Signal name	Signal path
Power switch ON signal	—
Electricity consumption signal	VCM  Combination meter
A/C consumption signal	
Others consumption signal	
Vehicle speed signal	ABS actuator and electric unit (control unit)  Combination meter

M

MWI

O

NOTE:

- Current electricity consumption on the information display is updated approximately every 0.5 seconds.
- Current electricity consumption on the information display shows 0 kWh/miles (0 kWh/km) when vehicle speed is 0 MPH (0 km/h).



P

Average Electricity Consumption

The combination meter calculates average electricity consumption based on the following signals, and the calculated value is displayed on the information display:

SYSTEM

< SYSTEM DESCRIPTION >

Signal name	Signal path
Power switch ON signal	—
Electricity consumption signal	VCM  Combination meter
A/C consumption signal	
Others consumption signal	
Vehicle speed signal	ABS actuator and electric unit (control unit)  Combination meter

NOTE:

Average electricity consumption on the information display is updated approximately every 30 seconds.

Average Vehicle Speed

The combination meter calculates average vehicle speed based on the following signals, and the calculated value is displayed on the information display:

Signal name	Signal path
Power switch ON signal	—
Vehicle speed signal	ABS actuator and electric unit (control unit)  Combination meter

NOTE:

- Average vehicle speed on the information display is updated approximately every 30 seconds.
- Soon after a reset or when the power switch is turned READY right after battery removal and installation, “—” is displayed until after a 30 seconds.

Travel Distance

The combination meter calculates mileage, based on the following signals and displays the mileage on the information display:

Signal name	Signal path
Power switch ON signal	—
Vehicle speed signal	ABS actuator and electric unit (control unit)  Combination meter

Travel Time

The combination meter measures and displays travel time (power switch ON time).

CHARGING TIME DISPLAY

Based on the signals below, the combination meter displays the charge time.

Signal name	Signal path
Remaining time to charge completion (200 V) signal	VCM  Combination meter
Remaining time to charge completion (100 V) signal	

INTERRUPT INDICATION

- The combination meter displays an interrupt regarding a warning, alert, and maintenance on the information display, based on signals received from each unit and switch.
- When conditions are satisfied, the normal screen switches to a warning screen to display an interrupt.

Interrupt Display Items

SYSTEM

< SYSTEM DESCRIPTION >

	Display item	
Display/warning	Push start display	A
	Remove charge connector warning display	B
	Door open warning display	C
	Electric shift warning display	D
	Li-ion battery low charge warning display	E
	Power limitation warning display	F
	Light remainder warning display	G
	Check tire pressure warning display	H
	DC/DC converter warning display	I
	Intelligent Key system warning display	J
Alarms	Driver alert	K
	Outside temp	L
Maintenance	Tire	M
	Other 1	N
	Other 2	O
	Other 3	P
Meter illumination level		Q

Push Start Display

- The combination meter judges showing/hiding of “push start display”, according to the signal below.

Signal name	Signal path
Meter display signal	BCM → Combination meter
Plug in signal	PDM (Power delivery module) → Combination meter

- For the display items and conditions, refer to [DLK-32, "WARNING FUNCTION : System Description"](#).
- When the charge connector is connected, the “plug in indicator” is displayed.

Remove Charge Connector Warning Display

- When turning the power switch ON or changing the READY to driving mode with the charge connector connected, “Charge connector removal warning” may be displayed.
- The combination meter judges showing/hiding of the “remove charge connector warning”, according to the signal below.

Signal name	Signal path
Plug in warning display signal	VCM → Combination meter

Door Open Warning

- When all the following operating conditions are satisfied, the combination meter displays a “door open warning” on the information display by an interrupt:

Operating condition	
Power switch	ON
Door	Any door is open

- The combination meter judges showing/hiding of “door open warning”, according to the signal below.

SYSTEM

< SYSTEM DESCRIPTION >

Signal name	Signal path
Power switch ON signal	—
Door switch signal	Door switch \longrightarrow BCM $\xrightarrow{\text{CAN}}$ Combination meter

Electric Shift Warning

- If a malfunction occurs in the electronic shift system, the “electric shift warning” is displayed.
- The combination meter judges showing/hiding of “electric shift warning”, according to the signal below.

Signal name	Signal path
Electric shift warning lamp signal	VCM $\xrightarrow{\text{CAN}}$ Combination meter
Electric shift warning message signal	
Electric shift warning signal	VCM \longrightarrow Combination meter

Li-ion Battery Low Charge Warning

- When the battery remaining energy is 4 kWh or less, the “Li-ion battery low charge warning” is displayed. (low battery charge warning lamp turns ON and warning is displayed.)
- The combination meter judges showing/hiding of “Li-ion batter low charge warning”, according to the signal below.

Signal name	Signal path
Low battery charge warning lamp request signal	VCM $\xrightarrow{\text{CAN}}$ Combination meter

Power Limitation Warning

- When drive power is 40 kW or less, the “power limitation display” is displayed.
- The combination meter judges showing/hiding of “power limitation display”, according to the signal below.

Signal name	Signal path
Power limitation cause signal	VCM $\xrightarrow{\text{CAN}}$ Combination meter

Light Reminder Warning

- When all of the following conditions are met, the combination meter displays the “light reminder warning”:

Operating condition	
Power switch	LOCK, OFF or ACC position
Combination switch (Lighting switch)	1st or 2nd position
Driver side door	Open [front door switch LH ON]

- Based on the following signals, BCM judges “light reminder warning” and sends the buzzer output signal (light reminder warning) to the combination meter via CAN communications:

Signal name	Signal path
Power switch ON signal	—
Combination switch signal	Combination switch (Lighting switch) \longrightarrow BCM
Front door switch LH signal	Front door switch LH \longrightarrow BCM

- The combination meter judges showing/hiding of “light reminder warning”, according to the signal below.

SYSTEM

< SYSTEM DESCRIPTION >

Signal name	Signal path
Buzzer output signal (light reminder warning)	BCM → Combination meter

Check Tire Pressure Warning

The combination meter judges showing/hiding of “check tire pressure warning”, according to the signal below.

Signal name	Signal path
Low tire pressure warning lamp signal	BCM → Combination meter

DC/DC Converter Warning

- If a malfunction occurs in the DC/DC converter system, the “DC/DC converter warning” is displayed.
- The combination meter judges showing/hiding of “DC/DC converter warning”, according to the signal below.

Signal name	Signal path
Vehicle stop and parking brake operation request signal	VCM → Combination meter

Intelligent Key System Warning

- If a malfunction occurs in the Intelligent Key system, the “Intelligent Key system warning” is displayed.
- The combination meter judges showing/hiding of “Intelligent Key system warning”, according to the signal below.

Signal name	Signal path
Meter display signal	BCM → Combination meter

Low Washer Fluid Warning

- When all the following operating conditions are satisfied, the combination meter displays a low washer fluid warning on the information display by an interrupt:

Operating condition	
Power switch	ON
Washer fluid level switch	Low washer fluid level (washer fluid level switch ON for more than 180 seconds)

TIMING CHART

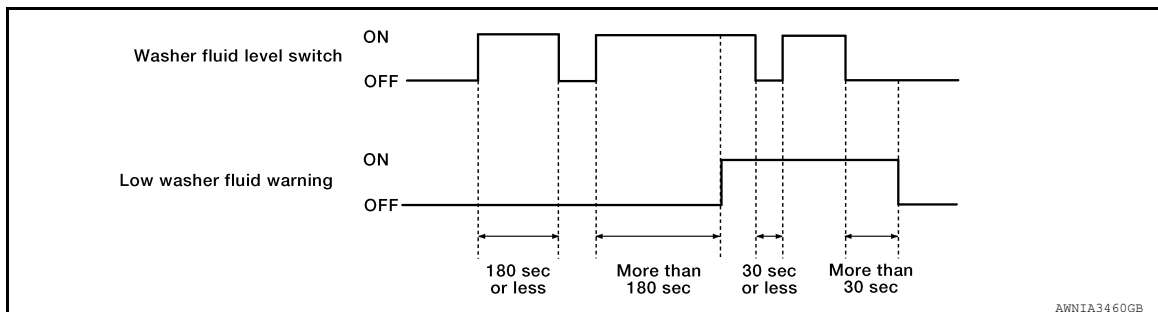

- The combination meter displays the “low washer fluid warning”, according to the signals below:

SYSTEM

< SYSTEM DESCRIPTION >

Signal name	Signal Path
Power switch signal	—
Washer fluid level switch signal	Washer fluid level switch Combination meter

Driver alert (Alarms)

- When all the following operating conditions are satisfied, the combination meter displays a driver alert on the information display by an interrupt:

Operating condition	
Power switch	Switch-ON time

- The combination meter judges showing/hiding of “driver alert”, according to the signal below:

Signal name	Signal path
Power switch ON signal	—

Outside temp (Alarms)

- When all the following operating conditions are satisfied, the combination meter displays a outside temp on the information display by an interrupt:

Operating condition	
Power switch	ON
Low outside air temperature	37 °F (3 °C) or less
information display	“ON” is selected in “SETTING”

- The combination meter cancels the warning of “outside temp” when the following cancel condition is satisfied.

Cancel condition	
Outside air temperature	More than 37 °F (3 °C)

- For outside air temperature display, refer to [MWI-29, "OUTSIDE AIR TEMPERATURE DISPLAY : System Description"](#).
- The combination meter judges showing/hiding of “outside temp”, according to the signals below:

Signal name	Signal path
Power switch ON signal	—
Ambient sensor signal	VCM Combination meter

Tire (Maintenance)

- When all the following operating conditions are satisfied, the combination meter displays a tire warning on the information display by an interrupt:

Operating condition	
Power switch	ON
Mileage	More than value set in “SETTING”

- The combination meter judges showing/hiding of “tire warning”, according to the signals below:

SYSTEM

< SYSTEM DESCRIPTION >

Signal name	Signal path
Power switch ON signal	—
Vehicle speed signal	ABS actuator and electric unit (control unit)  → Combination meter

Other 1, Other 2, Other 3 (Maintenance)

- When all the following operating conditions are satisfied, the combination meter displays an other warning on the information display by an interrupt:

Operating condition	
Power switch	ON
Mileage	More than value set in “SETTING”

- The combination meter judges showing/hiding of “other warning”, according to the signals below:

Signal name	Signal path
Power switch ON signal	—
Vehicle speed signal	ABS actuator and electric unit (control unit)  → Combination meter

Meter Illumination Level Indication

When receiving the following signals, the combination meter causes an interrupt on the information display to indicate an illumination level:

Signal name	Signal path
Power switch ON signal	—
Illumination control switch signal	Meter control switch  → Combination meter

TIMER STATUS REMINDER DISPLAY

- The combination meter receives the next charge time signal, next departure time signal or next pre-A/C time signal when the power switch is READY and displays the timer charging after the power switch is turned OFF.
- Pressing the  switch (enter switch) changes the displayed item in the following sequence: Timer charging ON/OFF, timer A/C ON/OFF → Next charge start time / end time → Charging time → Timer A/C start time
- If no switches are operated for 10 seconds, the display screen turns OFF.
- The combination meter judges showing/hiding of the “timer status reminder display” according to the signals below.

Signal name	Signal path
Next charge time signal	VCM  → Combination meter
Next departure time signal	
Next pre-A/C time signal	

WARNING CHECK INDICATION

- The combination meter can cause an interrupt on the information display to indicate a warning, based on signals received from each unit and switch.
- The indicated warning can be checked with “WARNING” during the satisfaction of an interrupt indication condition for each warning.

Warning Display Items

- Door open warning
- Electric shift warning
- Power limitation warning

A
B
C
D
E
F
G
H
I
J
K
L
M

MWI

O
P

SYSTEM

< SYSTEM DESCRIPTION >

- Li-ion battery low charge warning
- Take away warning (push start display)
- Intelligent Key system warning

SETTING

Warning indication timing and time can be set.

Target Amount of Charge (Without Navigation)

Allows the user to set the target amount of charge at 100 % or 80 % of full charge.

Setting Item	
Target amount of charge	80%, 100%

Timer charge (Without Navigation)

The settings of timer charge ON/OFF and stop time can be adjusted arbitrarily.

Setting Item	
Timer charge	The settings of ON/OFF and stop time can be adjusted arbitrarily.

NOTE:

- For further information about timer charge, refer to [MWI-30, "TIMER CHARGE AND A/C-HEATER TIMER \(CLIMATE CTRL. TIMER\) \(WITHOUT NAVIGATION\) : System Description"](#).
- For models with navigation system, settings can be performed on the AV control unit display. When the AV control unit is removed, the settings screen of timer charge may be displayed on the information display.

A/C-heater timer (Climate Ctrl. Timer) (Without Navigation)

The settings of A/C-heater timer (Climate Ctrl. Timer) ON/OFF and estimated time of departure can be adjusted arbitrarily.

Setting Item	
A/C-heater timer (Climate Ctrl. Timer)	The settings of ON/OFF and estimated time of departure can be adjusted arbitrarily.

NOTE:

- For further information about A/C-heater timer (Climate Ctrl. Timer), refer to [MWI-30, "TIMER CHARGE AND A/C-HEATER TIMER \(CLIMATE CTRL. TIMER\) \(WITHOUT NAVIGATION\) : System Description"](#).
- For models with navigation system, settings can be performed on the AV control unit display. When the AV control unit is removed, the settings screen of A/C-heater timer (Climate Ctrl. Timer) may be displayed on the information display.

Clock

Setting values for "Set clock", and "24/12 Hr" can be adjusted to meet the user's needs.

Setting item	
Set clock	Adjusting the time
24/12 Hr	12 h, 24h

Maintenance

Setting values for tire and other maintenance items can be adjusted to meet the user's needs.

SYSTEM

< SYSTEM DESCRIPTION >

Setting item		Setting range
Maintenance	Tire	No setting, 250 mile - 18,500 mile (No setting, 500 km - 30,000 km)
	Other 1	No setting, 250 mile - 18,500 mile (No setting, 500 km - 30,000 km)
	Other 2	No setting, 250 mile - 18,500 mile (No setting, 500 km - 30,000 km)
	Other 3	No setting, 250 mile - 18,500 mile (No setting, 500 km - 30,000 km)

Alarms

Setting values for “Driver Alert”, and “Outside Temp” can be adjusted to meet the user's needs.

Setting item		Setting range	Setting unit
Alarms	Drive Alert	No setting, 0.5 h - 6 h	0.5 h
	Outside Temp	ON/OFF	—

Units

Setting values for “TEMPERATURE” and “SPEED” items can be adjusted to meet the user's needs.

Setting item	
TEMPERATURE	Deg F
	Deg C
SPEED	MPH, mile/kWh
	km/h, km/kWh

Language

Setting values for “Language” items can be adjusted to meet the user's needs.

Setting item	
Language	English
	Francais
	Espanol

Effects

Setting values for “Effects” items can be adjusted to meet the user's needs.

Setting item	
Effects	Sound 1
	Sound 2
	Sound 3
	OFF

For the effects function, refer to [VSP-13. "START UP SOUND SYSTEM : System Description"](#).

Factory

Allows the user to reset all settings other than the odometer.

Settings-reject Indication

- Regarding settings-reject indications, “SETTING CAN BE OPERATED WHEN STOPPED” is shown on the information display when indication conditions are satisfied.
- When reaching 3.1 MPH (5 km/h) after accelerating from a stopping condition, a settings-reject indication is displayed.
- When reaching less than 0.6 MPH (1 km/h) after decelerating from 3.1 MPH (5 km/h), a settings-reject indication is cancelled to allow settings.

A

B

C

D

E

F

G

H

I

J

K

L

M

MWI

O

P

SYSTEM

< SYSTEM DESCRIPTION >

- The combination meter judges a vehicle condition based on the following signals and displays a settings-reject indication on the information display:

Signal name	Signal path
Power switch ON signal	—
Vehicle speed signal	ABS actuator and electric unit (control unit)  Combination meter

TIMING CHART

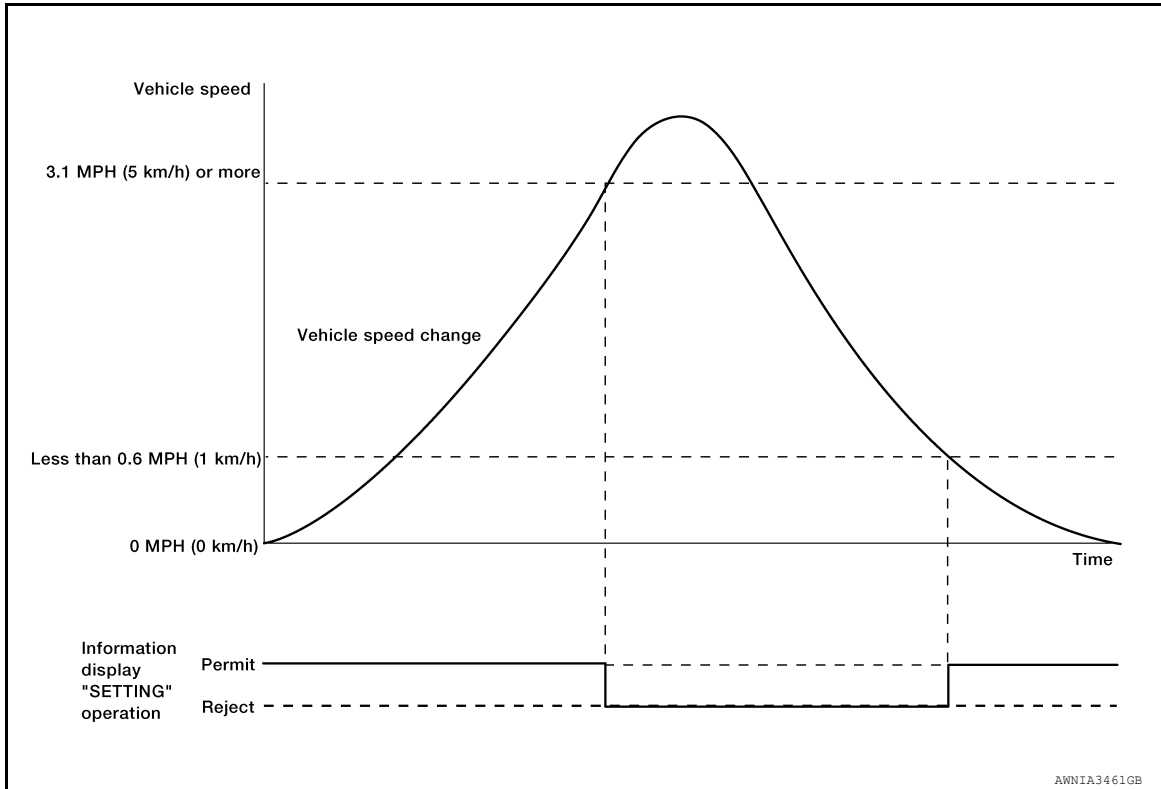

ODO/TRIP METER

The combination meter calculates mileage, based on the following signals and displays the mileage on the information display:

Signal name	Signal path
Power switch ON signal	—
Vehicle speed signal	ABS actuator and electric unit (control unit)  Combination meter

SHIFT INDICATOR

The combination meter displays the shift position based on the signals below.

Signal name	Signal path
Power switch ON signal	—
Shift position signal	VCM  Combination meter

OPERATION

< SYSTEM DESCRIPTION >

OPERATION

Switch Name and Function

INFOID:000000010122403

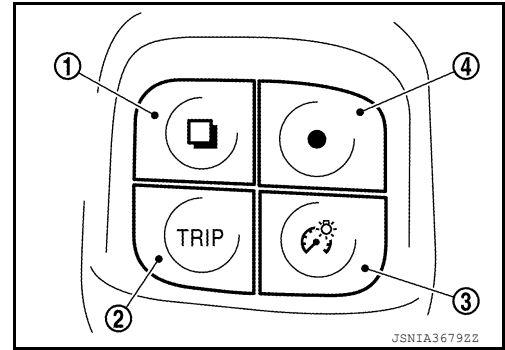

Switch name	Operation	Description
<input type="checkbox"/> switch (1) (Enter switch)	Press	<ul style="list-style-type: none"> The information display screen can be switched. The item indicated on the information display can be confirmed.
Trip reset switch (2)		<ul style="list-style-type: none"> The trip meter can be switched between A and B. Trip meter A/B can be reset by pressing and holding the trip reset switch.
<input type="checkbox"/> switch (3) (Illumination control switch)		An illuminance level of the back light of the combination meter can be adjusted.
<input type="radio"/> switch (4) (Select switch)		When plural items are shown on the information display, a selected item can be changed to the other item.

A
B
C
D
E
F
G
H
I
J
K
L
M
N
O
P

MWI

DIAGNOSIS SYSTEM (COMBINATION METER)

< SYSTEM DESCRIPTION >

DIAGNOSIS SYSTEM (COMBINATION METER)

Description

INFOID:000000010122404

COMBINATION METER SELF-DIAGNOSIS MODE

The following meter function can be checked during the Combination Meter Self-Diagnosis Mode:

Diagnosis item	
LCD (liquid crystal display) check	<ul style="list-style-type: none">• Speedometer• Power meter• Li-ion battery temperature gauge• Li-ion battery capacity level gauge• Li-ion battery available charge gauge• Eco indicator• Driving range display• Outside air temperature display• Clock display• Information display

STARTING COMBINATION METER SELF-DIAGNOSIS MODE

NOTE:

- Check combination meter power supply and ground circuit if the self-diagnosis mode does not start. Refer to [MWI-85, "COMBINATION METER : Diagnosis Procedure"](#). Replace combination meter if power supply and ground circuits are found to be normal and self-diagnosis mode does not start. Refer to [MWI-102, "Removal and Installation"](#).
- Check upper meter power supply, ground circuit and communication signal circuits if the self-diagnosis mode does not start. Refer to [MWI-85, "UPPER METER : Diagnosis Procedure"](#) for power supply and ground circuit and [MWI-87, "Diagnosis Procedure"](#) for communication signal circuit. Replace upper meter if power supply, ground circuit and communication signal circuits are found to be normal and self-diagnosis mode does not start. Refer to [MWI-103, "Removal and Installation"](#).
- Combination meter self-diagnosis mode will function with the power switch in ON. Combination meter self-diagnosis mode will exit upon turning the power switch to OFF.

How to Initiate Self-Diagnosis Mode

1. Power switch OFF.
2. Turn the power switch ON while holding down the trip reset switch (1).

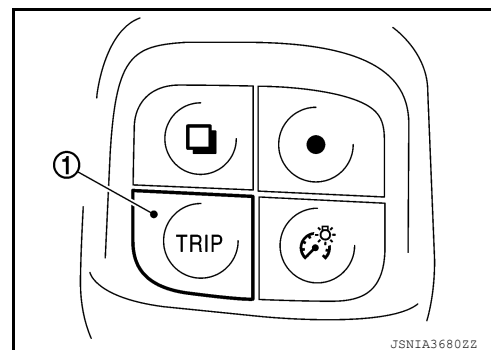

3. If the diagnosis function is activated with "trip A" displayed, the mileage on "trip A" is reset to "0000.0". (The same way for "trip B".)
4. Make sure that the trip meter displays "0000.0".
5. Press the trip reset switch at least 3 times (within 7 seconds after power ON).
6. The upper meter (A) and combination meter (B) is turned to self-diagnosis mode.
 - The following items are OFF:
 - Speedometer
 - Power meter
 - Li-ion battery temperature gauge
 - Li-ion battery capacity level gauge
 - Li-ion battery available charge gauge
 - Eco indicator

DIAGNOSIS SYSTEM (COMBINATION METER)

< SYSTEM DESCRIPTION >

- Driving range display
- Outside air temperature display
- Clock display
- Information display

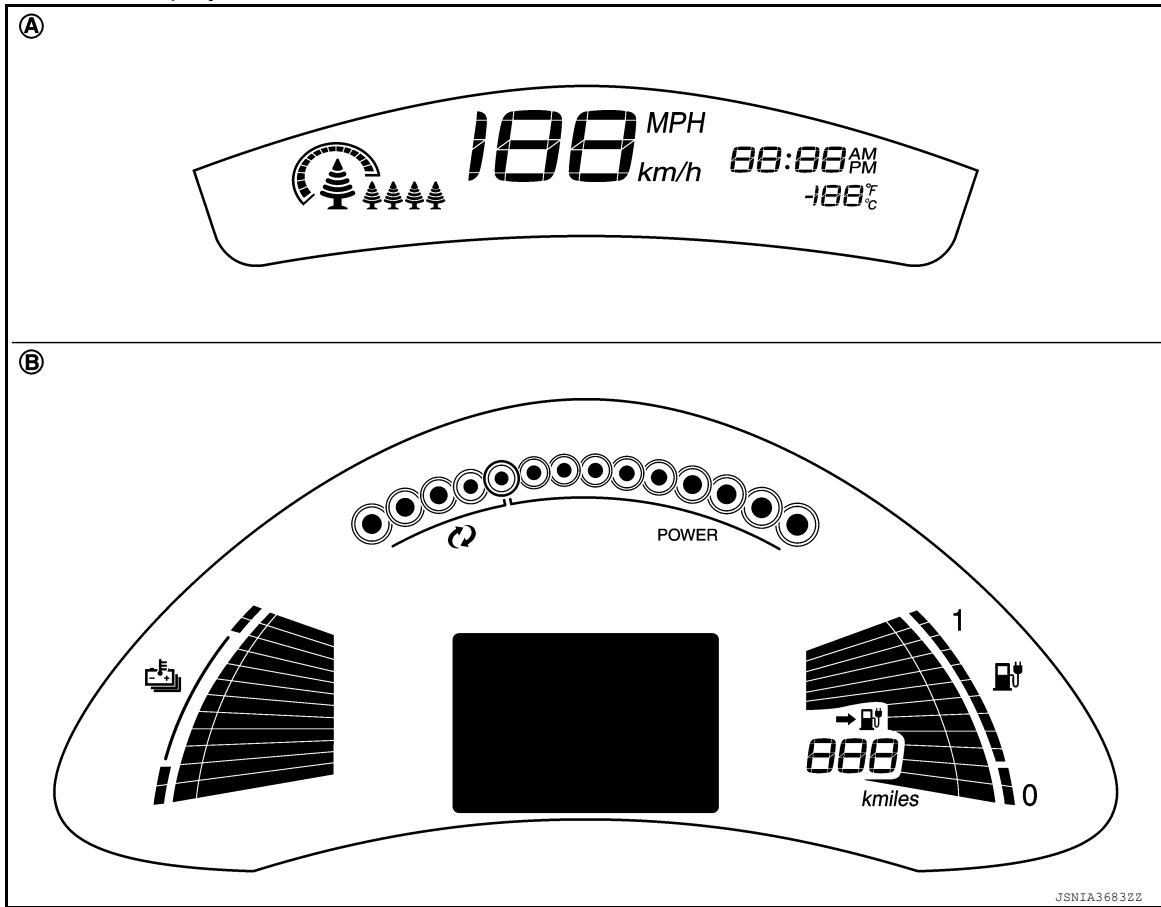

7. The segments and information display turn ON while the trip reset switch is depressed.

NOTE:

- If there is a segment that does not turn ON, replace the combination meter or upper meter.
- If the information display does not turn ON, replace the combination meter.

CONSULT Function (METER/M&A)

INFOID:0000000010122405

CONSULT APPLICATION ITEMS

CONSULT can perform the following diagnosis modes via CAN communication and the combination meter.

System	Diagnosis mode	Description
METER/M&A	Self Diagnostic Result	The combination meter checks the conditions and displays memorized errors.
	Data Monitor	Displays the combination meter input/output data in real time.
	Work support	Allows quick and precise adjustment of component parts and systems.
	Warning History	Lighting history of the warning lamp and indicator lamp can be checked.

SELF DIAG RESULT

Refer to [MWI-65, "DTC Index"](#).

DATA MONITOR

Display Item List

DIAGNOSIS SYSTEM (COMBINATION METER)

< SYSTEM DESCRIPTION >

X: Applicable

Display item [Unit]	MAIN SIGNALS	Description
SPEED METER [mph or km/h]	X	Value of vehicle speed signal received from ABS actuator and electric unit (control unit) via CAN communication. NOTE: 655.35 is displayed when the malfunction signal is received.
SPEED OUTPUT [mph or km/h]	X	Vehicle speed signal value transmitted to other units via CAN communication. NOTE: 655.35 is displayed when the malfunction signal is received.
BUZZER [On/Off]	X	Buzzer status (in the combination meter) is detected from the buzzer output signal received from each unit via CAN communication and the warning output condition of the combination meter.
ODO OUTPUT [mph or km/h]		Odometer signal value transmitted to other units via CAN communication.
ABS W/L [On/Off]		Status of ABS warning lamp detected from ABS warning lamp signal is received from ABS actuator and electric unit (control unit) via CAN communication.
VDC/TCS IND [On/Off]		Status of VDC OFF indicator lamp detected from VDC OFF indicator lamp signal is received from ABS actuator and electric unit (control unit) via CAN communication.
SLIP IND [On/Off]		Status of VDC warning lamp detected from VDC warning lamp signal received from ABS actuator and electric unit (control unit) via CAN communication.
BRAKE W/L [On/Off]		Status of brake warning lamp detected from brake warning lamp signal is received from ABS actuator and electric unit (control unit) via CAN communication. NOTE: Displays "Off" if the brake warning lamp is illuminated when the valve check starts, the parking brake switch is turned ON or the brake fluid level switch is turned ON.
DOOR W/L [On/Off]		Status of door open warning detected from door switch signal received from BCM via CAN communication.
HI-BEAM IND [On/Off]		Status of high beam indicator lamp detected from high beam request signal is received from BCM via CAN communication.
TURN IND [On/Off]		Status of turn indicator lamp detected from turn indicator signal is received from BCM via CAN communication.
FR FOG IND [On/Off]		Status of front fog light indicator lamp detected from front fog light request signal is received from BCM via CAN communication.
LIGHT IND [On/Off]		Status of tail lamp indicator lamp detected from position light request signal is received from BCM via CAN communication.
CRUISE IND [On/Off]		Status of CRUISE indicator detected from ASCD status signal is received from VCM via CAN communication.
SET IND [On/Off]		Status of SET indicator detected from ASCD status signal is received from ECM via CAN communication.
KEY G/Y W/L [On/Off]		Status of Intelligent Key system malfunction detected from meter display signal is received from BCM via CAN communication.
EPS W/L [On/Off]		Status of EPS warning lamp detected from EPS warning lamp signal is received from EPS control unit via CAN communication.
SLOW IND [On/Off]		Status of power limitation indicator detected from power limitation indication lamp request signal is received from VCM via CAN communication.
READY IND [On/Off]		Status of READY to drive indicator lamp detected from READY to drive indicator lamp request signal is received from VCM via CAN communication.
CHAGE W/L [On/Off]		Status of 12-volt battery charge warning lamp detected from 12-volt battery charge warning lamp request signal is received from VCM via CAN communication.
LCD [B&PN, B&P I, ID NG, ROTAT, IN-SRT, BATT, NO KY, OUTKY,LK WN, KY>PSW, Off]		Status of Intelligent Key system warning judged from meter display signal received from BCM with CAN communication line.

DIAGNOSIS SYSTEM (COMBINATION METER)

< SYSTEM DESCRIPTION >

Display item [Unit]	MAIN SIGNALS	Description	A
SHIFT IND [P, R, N, D]		Status of shift indicator display judged based on the shift position signal received from VCM via CAN communication.	A
BUCKLE SW [On/Off]		Status of seat belt buckle switch (driver side).	B
BRAKE OIL SW [On/Off]		Status of brake fluid level switch.	C
MODE A SW [On/Off]		Status of enter switch.	D
MODE B SW [On/Off]		Status of select switch.	D
PASS BUCKLE SW [On/Off]		Status of seat belt buckle switch (passenger side).	E
LED LMP R OPEN [On/Off]		Status of front combination lamp RH judged based on LED headlamp (RH) warning signal input from front combination lamp RH.	F
LED LMP L OPEN [On/Off]		Status of front combination lamp LH judged based on LED headlamp (LH) warning signal input from front combination lamp LH.	F
CHG CONCT DET [On/Off]		Charge connector connection status judged based plug in signal input from PDM (power delivery module).	G
ALL PWER MTER [kW]		Status of current power meter display, judged based on current motor power signal received from VCM via CAN communication.	H
TPMS PRESS L [On/Off]		Status of check low tire pressure warning detected from TPMS warning lamp signal received from BCM via CAN communication.	H
ASCD SPD BLINK [On/Off]		Blinking status of ASCD set vehicle speed judged by the ASCD status signal received from VCM via CAN communication.	I
ASCD STATUS [Off, ASCD, CRUISE, SL ON, SL SET]		Status of ASCD status display judged by the ASCD status signal received from VCM via CAN communication.	J
ASCD REQ SPD [mph, km/h or Off]		ASCD set vehicle speed value judged by the ASCD status signal received from VCM via CAN communication.	J
BAT REMAIN [kWh]		Value of Li-ion battery available charge signal received from VCM via CAN communication.	K
BAT REMAIN LEV [LEV 1-12]		ON segment value of Li-ion battery available charge gauge received from VCM via CAN communication.	L
BAT CHG CAP LEV [LEV 1-12]		ON segment value of Li-ion battery capacity level gauge received from VCM via CAN communication.	L
BAT TEMP [°F or °C]		Value of Li-ion battery temperature signal received from VCM via CAN communication.	M
POWER MAX [kW]		Value of maximum motor output power signal received from VCM via CAN communication.	MWI
REGENE MAX [kW]		Value of maximum regenerable power signal received from VCM via CAN communication.	MWI
ECO IND1 [0-15]		ON segment value of instant ECO indicator received from VCM via CAN communication.	O
ECO IND2 [OFF, seg11-seg15+seg24]		ON segment value of ECO tree received from VCM via CAN communication.	P
SFT W/L [On/Off]		Status of electric shift warning lamp judged based on electric shift warning lamp signal received from VCM via CAN communication.	P
REGENE W/L [On/Off]		Status of brake system warning lamp judged based on brake system warning lamp signal received from electrically-driven intelligent brake unit via CAN communication.	P
EV SYSTEM W/L [On/Off]		Status of EV system warning lamp judged based on EV system warning lamp request signal received from VCM via CAN communication.	P

DIAGNOSIS SYSTEM (COMBINATION METER)

< SYSTEM DESCRIPTION >

Display item [Unit]	MAIN SIGNALS	Description
SFT P W DSP [On/Off]		This item is displayed, but cannot be monitored.
SFT DSP [Off, PKB, SFT MALF, SFT POSI]		Status of electric shift warning display judged based on electric shift warning message signal received from VCM via CAN communication.
PUSH SW W DSP [On/Off]		Status of remove charge connector warning display judged based on plug in warning display signal received from VCM via CAN communication.
100V CHG TIME [min]		Value of remaining time to charge completion (100 V) signal received from VCM via CAN communication.
200V CHG TIME [min]		Value of remaining time to charge completion (200 V) signal received from VCM via CAN communication.
CHARGE STATE [100V, 200V, QICK CHG, OFF]		Charge status judged based on charge status signal received from VCM via CAN communication.
DCDC W DSP [OFF,STOP,CRUISE]		Status of DC/DC converter warning display judged based on vehicle stop and parking brake operation request display signal received from VCM via CAN communication.
SFT W/L [On/Off]		Status of electric shift warning signal input from VCM.
DTE DIF [mi or km]		Value of driving range difference signal received from VCM via CAN communication.
DTE INPUT [mi or km]		Value of driving range signal received from VCM via CAN communication.
DTE 2ND W [On, BLINK, Off]		Status of driving range display (“--”) blinking, judged based on driving range flashing request signal received from VCM via CAN communication.
BAT LOW W/L [On/Off]		Status of low battery charge warning lamp judged based on low battery charge warning lamp request signal received from VCM via CAN communication.
ELE COMPR OFF [kW/h]		Value of A/C OFF average electricity consumption for driving range signal received from VCM via CAN communication.
ELE COMPR ON [kW/h]		Value of A/C ON average electricity consumption for driving range signal received from VCM via CAN communication.
DTE BLINK [On/Off]		Status of driving range display blinking, judged based on driving range flashing request signal received from VCM via CAN communication/

W/L ON HISTORY

- Stores histories when warning/indicator lamp is turned on.
- “W/L ON HISTORY” indicates the “TIME” when the warning/indicator lamp is turned on.
- The “TIME” above is:
 - 0: The condition that the warning/indicator lamp has been turned on 1 or more times after starting the engine and waiting for 30 seconds.
 - 1 - 39: The number of times the engine was restarted after the 0 condition.
 - NO W/L ON HISTORY: Stores NO (0) turning on history of warning/indicator lamp.

NOTE:

- W/L ON HISTORY is not stored for approximately 30 seconds after the engine starts.
- Brake warning lamp does not store any history when the parking brake is applied or the brake fluid level gets low.

Display Item

Display item	Description
ABS W/L	Lighting history of ABS warning lamp.
VDC/TCS IND	Lighting history of VDC OFF indicator lamp.
SLIP IND	Lighting history of VDC warning lamp.
BRAKE W/L	Lighting history of brake warning lamp.
DOOR W/L	Lighting history of door open warning.
CRUISE IND	Lighting history of CRUISE indicator.

DIAGNOSIS SYSTEM (COMBINATION METER)

< SYSTEM DESCRIPTION >

Display item	Description
SET IND	Lighting history of SET indicator.
AIR PRES W/L	Lighting history of low tire pressure warning lamp.
EPS W/L	Lighting history of EPS warning lamp.
CHAGE W/L	Lighting history of 12-volt battery charge warning lamp.
REGENE BRAKE W/L	Lighting history of brake system warning lamp.
SLOW	Lighting history of power limitation indicator.
LED LAMP W/L	Lighting history of headlamp warning lamp.

A

B

C

D

E

F

G

H

I

J

K

L

M

MWI

O

P

COMBINATION METER

< ECU DIAGNOSIS INFORMATION >

ECU DIAGNOSIS INFORMATION

COMBINATION METER

Reference Value

INFOID:000000010122406

VALUES ON THE DIAGNOSIS TOOL

Monitor item	Condition		Value/Status
SPEED METER [mph or km/h]	Power switch ON	While driving	Input value of vehicle speed signal (CAN communication signal) NOTE: 655.35 is displayed when the malfunction signal is received
SPEED OUTPUT [mph or km/h]	Power switch ON	While driving	Output value of vehicle speed signal (CAN communication signal) NOTE: 655.35 is displayed when the malfunction signal is received
ODO OUTPUT [mph or km/h]	Power switch ON	—	Output value of odometer signal (CAN communication signal)
ABS W/L	Power switch ON	ABS warning lamp ON	On
		ABS warning lamp OFF	Off
VDC/TCS IND	Power switch ON	ESP (VDC) OFF indicator lamp ON	On
		ESP (VDC) OFF indicator lamp OFF	Off
SLIP IND	Power switch ON	ESP (VDC) warning lamp ON	On
		ESP (VDC) warning lamp OFF	Off
BRAKE W/L	Power switch ON	Brake warning lamp ON	On
		Brake warning lamp OFF	Off
DOOR W/L	Power switch ON	Door open warning ON	On
		Door open warning OFF	Off
HI-BEAM IND	Power switch ON	High-beam indicator lamp ON	On
		High-beam indicator lamp OFF	Off
TURN IND	Power switch ON	Turn indicator lamp ON	On
		Turn indicator lamp OFF	Off
FR FOG IND	Power switch ON	Front fog lamp indicator lamp ON	On
		Front fog lamp indicator lamp OFF	Off
LIGHT IND	Power switch ON	Position lamp indicator lamp ON	On
		Position lamp indicator lamp OFF	Off
CRUISE IND	Power switch ON	CRUISE indicator ON	On
		CRUISE indicator OFF	Off
SET IND	Power switch ON	SET indicator ON	On
		SET indicator OFF	Off
KEY G/Y W/L	Power switch ON	During Intelligent Key warning malfunction indication	On
		Other than the above	Off
EPS W/L	Power switch ON	EPS warning lamp ON	On
		EPS warning lamp OFF	Off
SLOW IND	Power switch ON	Power limitation indicator lamp ON	On
		Power limitation indicator lamp OFF	Off

COMBINATION METER

< ECU DIAGNOSIS INFORMATION >

Monitor item	Condition		Value/Status	
READY IND	Power switch ON	READY to drive indicator lamp ON	On	A
		READY to drive indicator lamp OFF	Off	
CHAGE W/L	Power switch ON	12V battery charge warning lamp ON	On	B
		12V battery charge warning lamp OFF	Off	
LCD	Power switch ON	During engine start information indication	B&P I	C
	Power switch ACC	During engine start information indication	B&P N	
	Power switch LOCK	During key ID warning indication	ID NG	D
	Power switch LOCK	During steering lock information indication	ROTAT	E
	Power switch LOCK	During P position warning indication	SFT P	
	Power switch LOCK	During Intelligent Key insert information indication	INSRT	F
	Power switch LOCK	During Intelligent Key low battery warning indication	BATT	G
	Power switch ON	During take away warning indication	NO KY	
	Power switch LOCK	During key warning indication	OUTKY	H
	Power switch ON	During ACC warning indication	LK WN	I
	Power switch LOCK	During key ID verification information indication	KY>PSW	
	Power switch ON	Other than above	Off	J
SHIFT IND	Power switch ON	During the indication of "P" by shift position indicator	P	K
		During the indication of "R" by shift position indicator	R	
		During the indication of "N" by shift position indicator	N	L
		During the indication of "D" by shift position indicator	D	
		During the indication of "B" by shift position indicator	B	M
BUCKLE SW	Power switch ON	Driver seat belt not fastened	On	MWI
		Driver seat belt fastened	Off	
BRAKE OIL SW	Power switch ON	Brake fluid level switch ON	On	O
		Brake fluid level switch OFF	Off	
PASS BUCKLE SW	Power switch ON	Passenger seat belt not fastened	On	P
		Passenger seat belt fastened	Off	
MODE A SW	Power switch ON	When enter switch is pressed	On	
		Other than above	Off	
MODE B SW	Power switch ON	When select switch is pressed	On	
		Other than above	Off	
LED LMP R OPEN	Power switch ON	Front combination lamp RH malfunction	On	
		Front combination lamp RH normal	Off	

COMBINATION METER

< ECU DIAGNOSIS INFORMATION >

Monitor item	Condition		Value/Status
LED LMP L OPEN	Power switch ON	Front combination lamp LH malfunction	On
		Front combination lamp LH normal	Off
CHG CONCT DET	Power switch ON	Charge connector connected	On
		Charge connector not connected	Off
BUZZER	Power switch ON	Buzzer ON	On
		Buzzer OFF	Off
TPMS PRESS L	Power switch ON	During check tire pressure warning indication	On
		Other than above	Off
ALL PWER MTER [kW]	Power switch ON	While driving	Input value of current power signal
ASC D STATUS	Power switch ON	ASC D and speed limiter system OFF	Off
		ASC D system ON	ON
		ASC D set vehicle speed	CRUISE
		Speed limiter system ON	SL ON
		Speed limiter set vehicle speed	SL SET
ASC D SPD BLNK	Power switch ON	Set vehicle speed indicator blinking	On
		Set vehicle speed indicator not blinking	Off
ASC D REQ SPD [mph, km/h or Off]	Power switch ON	While driving	Same value as ASC D or speed limiter set vehicle speed.
BAT REMAIN [kWh]	Power switch ON	—	Input value of Li-ion battery available charge signal
BAT REMAIN LEV	Power switch ON	1 segment of Li-ion battery available charge gauge illuminates	LV.1
		2 segments of Li-ion battery available charge gauge illuminate	LV.2
		3 segments of Li-ion battery available charge gauge illuminate	LV.3
		4 segments of Li-ion battery available charge gauge illuminate	LV.4
		5 segments of Li-ion battery available charge gauge illuminate	LV.5
		6 segments of Li-ion battery available charge gauge illuminate	LV.6
		7 segments of Li-ion battery available charge gauge illuminate	LV.7
		8 segments of Li-ion battery available charge gauge illuminate	LV.8
		9 segments of Li-ion battery available charge gauge illuminate	LV.9
		10 segments of Li-ion battery available charge gauge illuminate	LV.10
		11 segments of Li-ion battery available charge gauge illuminate	LV.11
		12 segments of Li-ion battery available charge gauge illuminate	LV.12

COMBINATION METER

< ECU DIAGNOSIS INFORMATION >

Monitor item	Condition		Value/Status	
BAT CHG CAP LEV	Power switch ON	1 segment of Li-ion battery capacity level gauge illuminates	LV.1	A
		2 segments of Li-ion battery capacity level gauge illuminate	LV.2	B
		3 segments of Li-ion battery capacity level gauge illuminate	LV.3	C
		4 segments of Li-ion battery capacity level gauge illuminate	LV.4	D
		5 segments of Li-ion battery capacity level gauge illuminate	LV.5	E
		6 segments of Li-ion battery capacity level gauge illuminate	LV.6	F
		7 segments of Li-ion battery capacity level gauge illuminate	LV.7	G
		8 segments of Li-ion battery capacity level gauge illuminate	LV.8	H
		9 segments of Li-ion battery capacity level gauge illuminate	LV.9	
		10 segments of Li-ion battery capacity level gauge illuminate	LV.10	
		11 segments of Li-ion battery capacity level gauge illuminate	LV.11	
		12 segments of Li-ion battery capacity level gauge illuminate	LV.12	
BAT TEMP [°F or °C]	Power switch ON	—	Input value of Li-ion battery temperature signal	I
POWER MAX [kW]	Power switch ON	While driving	Input value of maximum motor output power signal	J
REGENE MAX [kW]	Power switch ON	While driving	Input value of maximum regenerable power signal	K

A
B
C
D
E
F
G
H
I
J
K
L
M
O
P

MWI

COMBINATION METER

< ECU DIAGNOSIS INFORMATION >

Monitor item	Condition		Value/Status
ECO IND1	Power switch ON	1 segment of Instant ECO indicator illuminates	1
		2 segments of Instant ECO indicator illuminate	2
		3 segments of Instant ECO indicator illuminate	3
		4 segments of Instant ECO indicator illuminate	4
		5 segments of Instant ECO indicator illuminate	5
		6 segments of Instant ECO indicator illuminate	6
		7 segments of Instant ECO indicator illuminate	7
		8 segments of Instant ECO indicator illuminate	8
		9 segments of Instant ECO indicator illuminate	9
		10 segments of Instant ECO indicator illuminate	10
		11 segments of Instant ECO indicator illuminate	11
		12 segments of Instant ECO indicator illuminate	12
		13 segments of Instant ECO indicator illuminate	13
		14 segments of Instant ECO indicator illuminate	14
		15 segments of Instant ECO indicator illuminate	15
	Other than the above	0	
ECO IND2	Power switch ON	—	Displays number of ON segments of ECO tree*
SFT W/L	Power switch ON	Electric shift warning lamp ON	On
		Electric shift warning lamp OFF	Off
REGENE W/L	Power switch ON	Brake system warning lamp ON	On
		Brake system warning lamp OFF	Off
EV SYSTEM W/L	Power switch ON	EV system warning lamp ON	On
		EV system warning lamp OFF	Off
SFT P W DSP	Power switch ON	NOTE: This item is displayed, but cannot be monitored	Off
SFT DSP Power switch ON		During electric shift warning (“T/M system malfunction visit dealer”) indication	SFT MALF
		During electric shift warning (“check position of shift lever”) indication	SFT POSI
		Other than the above	Off
PUSH SW W DSP	Power switch ON	During remove charge connector warning indication	On
		Other than the above	Off

COMBINATION METER

< ECU DIAGNOSIS INFORMATION >

Monitor item	Condition		Value/Status
100V CHG TIME	Power switch ON	—	Displays 100 V charging time.
200V CHG TIME	Power switch ON	—	Displays 200 V charging time.
CHARGE STATE	Power switch ON	100 V charging	100 V
		200 V charging	200 V
		In Quick Charging	QICK CHG
		Other than the above	Off
DCDC W DSP	Power switch ON	During DC/DC converter warning (“stop vehicle”) indication	STOP
		During DC/DC converter warning (“apply parking brake”) indication	CRUISE
		Other than the above	Off
SFT W/L	Power switch ON	Electric shift warning lamp ON	On
		Electric shift warning lamp OFF	Off
DTE DIF [mi or km]	Power switch ON	—	Input value of driving range difference signal
DTE INPUT [mi or km]	Power switch ON	—	Input value of driving range signal
DTE 2ND W	Power switch ON	Driving range display “— — —” display	On
		Driving range display “— — —” blinking	BLINK
		Other than the above	Off
BAT LOW W/L	Power switch ON	Low battery charge warning lamp ON	On
		Low battery charge warning lamp OFF	Off
ELE COMPR OFF [mi or km]	Power switch ON	—	Input value of A/C OFF average electricity consumption for driving range signal
ELE COMPR ON [mi or km]	Power switch ON	—	Input value of A/C ON average electricity consumption for driving range signal
DTE BLINK	Power switch ON	Driving range display blinking	On
		Other than the above	Off

*: “ECO IND2” displays the items in the Status column of the following table.

Displays number of ON segments of ECO tree	Status
1 segment of ECO tree (1) illuminates	SEG11
2 segments of ECO tree (1) illuminate	SEG12
3 segments of ECO tree (1) illuminate	SEG13
4 segments of ECO tree (1) illuminate	SEG14
5 segments of ECO tree (1) illuminate	SEG15
ECO tree (2) illuminates	SEG21
<ul style="list-style-type: none"> • ECO tree (2) illuminates • 1 segments of ECO tree (1) illuminate 	SEG11+SEG21
<ul style="list-style-type: none"> • ECO tree (2) illuminates • 2 segments of ECO tree (1) illuminate 	SEG12+SEG21
<ul style="list-style-type: none"> • ECO tree (2) illuminates • 3 segments of ECO tree (1) illuminate 	SEG13+SEG21
<ul style="list-style-type: none"> • ECO tree (2) illuminates • 4 segments of ECO tree (1) illuminate 	SEG14+SEG21

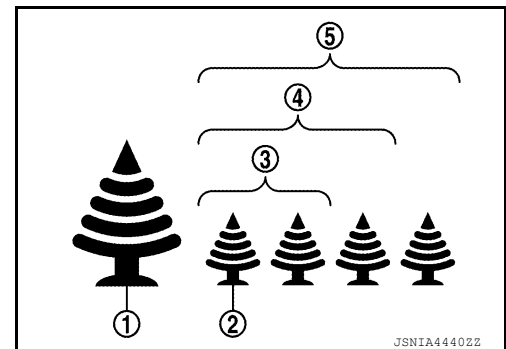

COMBINATION METER

< ECU DIAGNOSIS INFORMATION >

Displays number of ON segments of ECO tree	Status
<ul style="list-style-type: none"> • ECO tree (2) illuminates • 5 segments of ECO tree (1) illuminate 	SEG15+SEG21
ECO tree (3) illuminates	SEG22
<ul style="list-style-type: none"> • ECO tree (3) illuminates • 1 segment of ECO tree (1) illuminate 	SEG11+SEG22
<ul style="list-style-type: none"> • ECO tree (3) illuminates • 2 segments of ECO tree (1) illuminate 	SEG12+SEG22
<ul style="list-style-type: none"> • ECO tree (3) illuminates • 3 segments of ECO tree (1) illuminate 	SEG13+SEG22
<ul style="list-style-type: none"> • ECO tree (3) illuminates • 4 segments of ECO tree (1) illuminate 	SEG14+SEG22
<ul style="list-style-type: none"> • ECO tree (3) illuminates • 5 segments of ECO tree (1) illuminate 	SEG15+SEG22
ECO tree (4) illuminates	SEG23
<ul style="list-style-type: none"> • ECO tree (4) illuminates • 1 segment of ECO tree (1) illuminate 	SEG11+SEG23
<ul style="list-style-type: none"> • ECO tree (4) illuminates • 2 segments of ECO tree (1) illuminate 	SEG12+SEG23
<ul style="list-style-type: none"> • ECO tree (4) illuminates • 3 segments of ECO tree (1) illuminate 	SEG13+SEG23
<ul style="list-style-type: none"> • ECO tree (4) illuminates • 4 segments of ECO tree (1) illuminate 	SEG14+SEG23
<ul style="list-style-type: none"> • ECO tree (4) illuminates • 5 segments of ECO tree (1) illuminate 	SEG15+SEG23
ECO tree (5) illuminates	SEG24
<ul style="list-style-type: none"> • ECO tree (5) illuminates • 1 segment of ECO tree (1) illuminate 	SEG11+SEG24
<ul style="list-style-type: none"> • ECO tree (5) illuminates • 2 segments of ECO tree (1) illuminate 	SEG12+SEG24
<ul style="list-style-type: none"> • ECO tree (5) illuminates • 3 segments of ECO tree (1) illuminate 	SEG13+SEG24
<ul style="list-style-type: none"> • ECO tree (5) illuminates • 4 segments of ECO tree (1) illuminate 	SEG14+SEG24
<ul style="list-style-type: none"> • ECO tree (5) illuminates • 5 segments of ECO tree (1) illuminate 	SEG15+SEG24
Other than the above	Off

TERMINAL LAYOUT

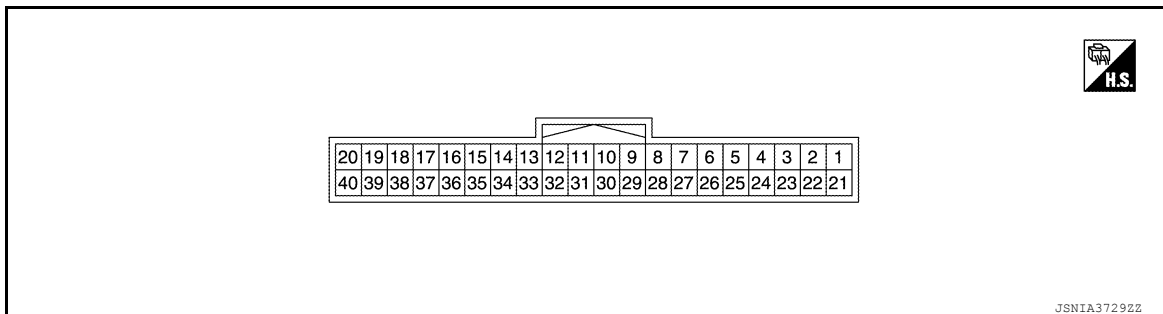

PHYSICAL VALUES

COMBINATION METER

< ECU DIAGNOSIS INFORMATION >

Terminal No. (Wire color)		Description		Condition		Value (Approx.)
+	-	Signal name	Input/ Output			
1 (LG)	Ground	Battery power supply	Input	Power switch OFF	—	Battery voltage
2 (Y)	Ground	Battery power supply (for upper meter)	Output	Power switch OFF	—	Battery voltage
3 (GR)	Ground	Power switch ON signal	Input	Power switch ON	—	Battery voltage
4 (BG)	Ground	Power switch ON signal (for upper meter)	Output	Power switch ON	—	Battery voltage
5 (B)	Ground	Ground	—	Power switch ON	—	0 V
6 (B)	Ground	Ground	—	Power switch ON	—	0 V
8 (Y)	Ground	Washer fluid level switch signal	Input	Power switch ON	Washer fluid level switch ON	0 V
					Washer fluid level switch OFF	5 V
9 (BR)	Ground	Plug in signal	Input	Power switch ON	Charge connector connect- ed	0 V
					Charge connector not con- nected	Battery voltage
12 (V)	Ground	Sw ground	—	—	—	—
13 (G)	Ground	Select switch signal	Input	Power switch ON	When ● switch (select switch) is pressed	0 V
					Other than the above	5 V
14 (Y)	Ground	Enter switch signal	Input	Power switch ON	When □ switch (enter switch) is pressed	0 V
					Other than the above	5 V
15 (BR)	Ground	Trip reset switch signal	Input	Power switch ON	When trip reset switch is pressed	0 V
					Other than the above	5 V
16 (P)	Ground	Illumination control switch signal	Input	Power switch ON	When ⚙ switch (illumina- tion control switch) is pressed	0 V
					Other than the above	5 V

COMBINATION METER

< ECU DIAGNOSIS INFORMATION >

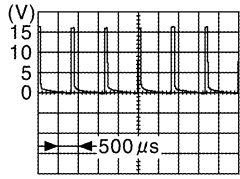
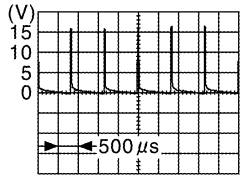
Terminal No. (Wire color)		Description		Condition	Value (Approx.)	
+	-	Signal name	Input/ Output			
17 (G)	Ground	Illumination control signal (for upper meter)	Output	Power switch ON	<ul style="list-style-type: none"> Lighting switch 1ST position When meter illumination is maximum  <p style="text-align: right; font-size: small;">JSNIA3745GB</p>	
					<ul style="list-style-type: none"> Lighting switch 1ST position When meter illumination is step 6  <p style="text-align: right; font-size: small;">JSNIA3746GB</p>	
					<ul style="list-style-type: none"> Lighting switch 1ST position When meter illumination is minimum 	0 V
18 (P)	—	CAN-L	—	—	—	
19 (L)	—	CAN-H	—	—	—	
20 (LG)	Ground	Seat belt buckle switch signal (passenger side)	Input	Power switch ON	<ul style="list-style-type: none"> When getting in the passenger seat When passenger seat belt is fastened 	Battery voltage
					<ul style="list-style-type: none"> When getting in the passenger seat When passenger seat belt is unfastened 	0 V
22 (GR)	Ground	Ground (for upper meter)	—	Power switch ON	—	0 V
24 (BG)	Ground	Parking brake switch signal	Input	Power switch ON	Parking brake applied	0 V
					Parking brake released	Battery voltage
25 (SB)	Ground	Brake fluid level switch signal	Input	Power switch ON	Brake fluid level is normal	Battery voltage
					The brake fluid level is lower than the low level	0 V

COMBINATION METER

< ECU DIAGNOSIS INFORMATION >

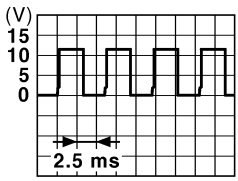
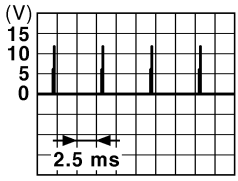
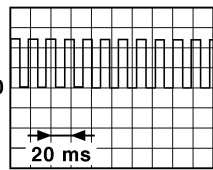
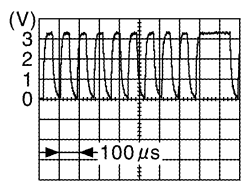
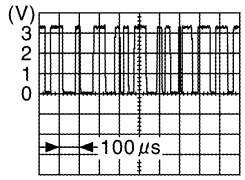
Terminal No. (Wire color)		Description		Condition	Value (Approx.)
+	-	Signal name	Input/ Output		
26 (B)	Ground	Illumination control signal	Output	Power switch ON	<ul style="list-style-type: none"> Lighting switch 1ST position When meter illumination is maximum <p style="text-align: center;">Battery voltage</p>
					<ul style="list-style-type: none"> Lighting switch 1ST position When meter illumination is step 6 
					<ul style="list-style-type: none"> Lighting switch 1ST position When meter illumination is minimum <p style="text-align: center;">0 V</p> 
27 (R)	Ground	Air bag signal	Input	Power switch ON	<ul style="list-style-type: none"> Air bag warning lamp ON <p style="text-align: center;">Battery voltage</p>
				Power switch ON	<ul style="list-style-type: none"> Air bag warning lamp OFF <p style="text-align: center;">0 V</p>
28 (R)	Ground	Security signal	Input	Power switch ON	<ul style="list-style-type: none"> Security indicator lamp ON <p style="text-align: center;">0 V</p>
					<ul style="list-style-type: none"> Security indicator lamp OFF <p style="text-align: center;">Battery voltage</p>
30 (GR)	Ground	Vehicle speed signal (8-pulse)	Output	Power switch ON	<p>NOTE: The maximum voltage varies depending on the specification (destination unit).</p> 
32 (W)	Ground	Communication signal (METER → UPPER)	Output	Power switch ON	<p>NOTE: Reference waveform</p> 
33 (G)	Ground	Clock signal	Output	Power switch ON	<p>NOTE: Reference waveform</p> 

A
B
C
D
E
F
G
H
I
J
K
L
M
N
O
P

MWI

COMBINATION METER

< ECU DIAGNOSIS INFORMATION >

Terminal No. (Wire color)		Description		Condition		Value (Approx.)
+	-	Signal name	Input/ Output			
34 (L)	Ground	Plug in indicator lamp signal	Input	Power switch ON	Plug in indicator lamp ON	0 V
					Plug in indicator lamp OFF	Battery voltage
38 (V)	Ground	LED headlamp (RH) warning signal	Input	Power switch ON	Front combination lamp RH malfunction	Battery voltage
					Front combination lamp RH normal	0 V
39 (LG)	Ground	LED headlamp (LH) warning signal	Input	Power switch ON	Front combination lamp LH malfunction	Battery voltage
					Front combination lamp LH normal	0 V
40 (W)	Ground	Seat belt buckle switch signal (driver side)	Input	Power switch ON	When driver seat belt is fastened	Battery voltage
					When driver seat belt is unfastened	0 V

Fail-Safe

INFOID:000000010122407

FAIL-SAFE

- The combination meter activates the fail-safe control if CAN communication with each unit is malfunctioning.

Function		Specifications
Power meter		The display turns OFF by suspending communication.
Li-ion battery temperature gauge		
Li-ion battery capacity level gauge		
Li-ion battery available charge gauge		
Driving range display		The display turns "--" by suspending communication.
Illumination control		When suspending communication, changes to nighttime mode.
Information display	Odo/trip meter	An indicated value is maintained at communications blackout.
	Shift indicator	The display turns OFF by suspending communication.
	Li-ion low battery charge warning display	The display turns ON by suspending communication.
	Electric shift warning display	
	Other than the above	The display turns OFF by suspending communication.
Buzzer		The buzzer turns OFF by suspending communication.

COMBINATION METER

< ECU DIAGNOSIS INFORMATION >

Function		Specifications	
Warning lamp/indicator lamp	ABS warning lamp	The lamp turns ON by suspending communication.	A
	VDC warning lamp		B
	Brake warning lamp		C
	Front fog lamp indicator lamp		D
	Brake system warning lamp		E
	EPS warning lamp		F
	Low battery charge warning lamp		G
	Electric shift warning lamp		
	TPMS warning lamp	The lamp turns OFF by suspending communication.	H
	High beam indicator lamp		I
	VDC OFF indicator lamp		J
	Tail lamp indicator lamp		K
	READY to drive indicator lamp		L
	12-volt battery charge warning lamp		M
	Power limitation indicator lamp		
	EV system warning lamp		

- The upper meter performs the fail-safe control when a breakdown of communications between the upper meter and the combination meter occurs.

Function		Specifications	
Speedometer	Eco indicator	The display turns OFF by suspending communication.	
Outside air temperature display			
Illumination control		When suspending communication, changes to nighttime mode.	
Turn signal indicator lamp		The lamp turns OFF by suspending communication.	

DTC Index

INFOID:000000010122408

Display contents of CONSULT	Diagnostic item is detected when...	Refer to	
CAN COMM CIRCUIT [U1000]	When combination meter is not transmitting or receiving CAN communication signal for 2 seconds or more.	MWI-82	L
CONTROL UNIT (CAN) [U1010]	When detecting error during the initial diagnosis of the CAN controller of combination meter.	MWI-83	M
VEHICLE SPEED [B2205]	The abnormal vehicle speed signal is input from the ABS actuator and electric unit (control unit) for 2 seconds or more.	MWI-84	

MWI

UPPER METER

< ECU DIAGNOSIS INFORMATION >

UPPER METER

Reference Value

INFOID:000000010122409

TERMINAL LAYOUT

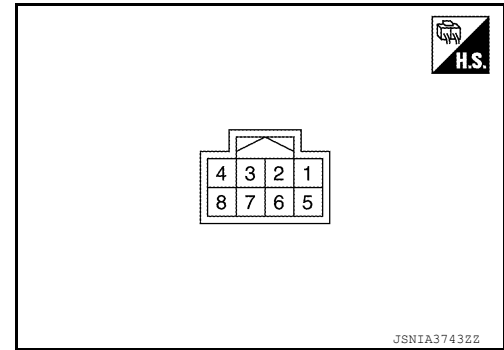

PHYSICAL VALUES

Terminal No. (Wire color)		Description		Condition		Value (Approx.)
+	-	Signal name	Input/ Output			
1 (Y)	Ground	Battery power supply	Input	Power switch OFF	—	Battery voltage
2 (BG)	Ground	Power switch supply	Input	Power switch ON	—	Battery voltage
3 (G)	Ground	Illumination control signal (for upper meter)	Input	Power switch ON	<ul style="list-style-type: none"> Lighting switch 1ST position When meter illumination is maximum 	
					<ul style="list-style-type: none"> Lighting switch 1ST position When meter illumination is step 6 	
					<ul style="list-style-type: none"> Lighting switch 1ST position When meter illumination is minimum 	0 V
4 (G)	Ground	Clock signal	Output	Power switch ON	—	<p>NOTE: Reference waveform</p>

UPPER METER

< ECU DIAGNOSIS INFORMATION >

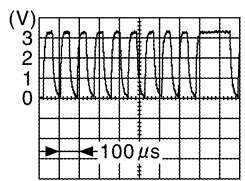
Terminal No. (Wire color)		Description		Condition		Value (Approx.)
+	-	Signal name	Input/ Output			
6 (GR)	Ground	Ground	—	Power switch ON	—	0 V
8 (W)	Ground	Communication signal (METER → UPPER)	Output	Power switch ON	—	<p>NOTE: Reference waveform</p>  <p style="text-align: right; font-size: small;">JSNIA3767GB</p>

A
B
C
D
E
F
G
H
I
J
K
L
M
O
P

MWI

METER SYSTEM

< WIRING DIAGRAM >

WIRING DIAGRAM

METER SYSTEM

Wiring Diagram

INFOID:000000010122410

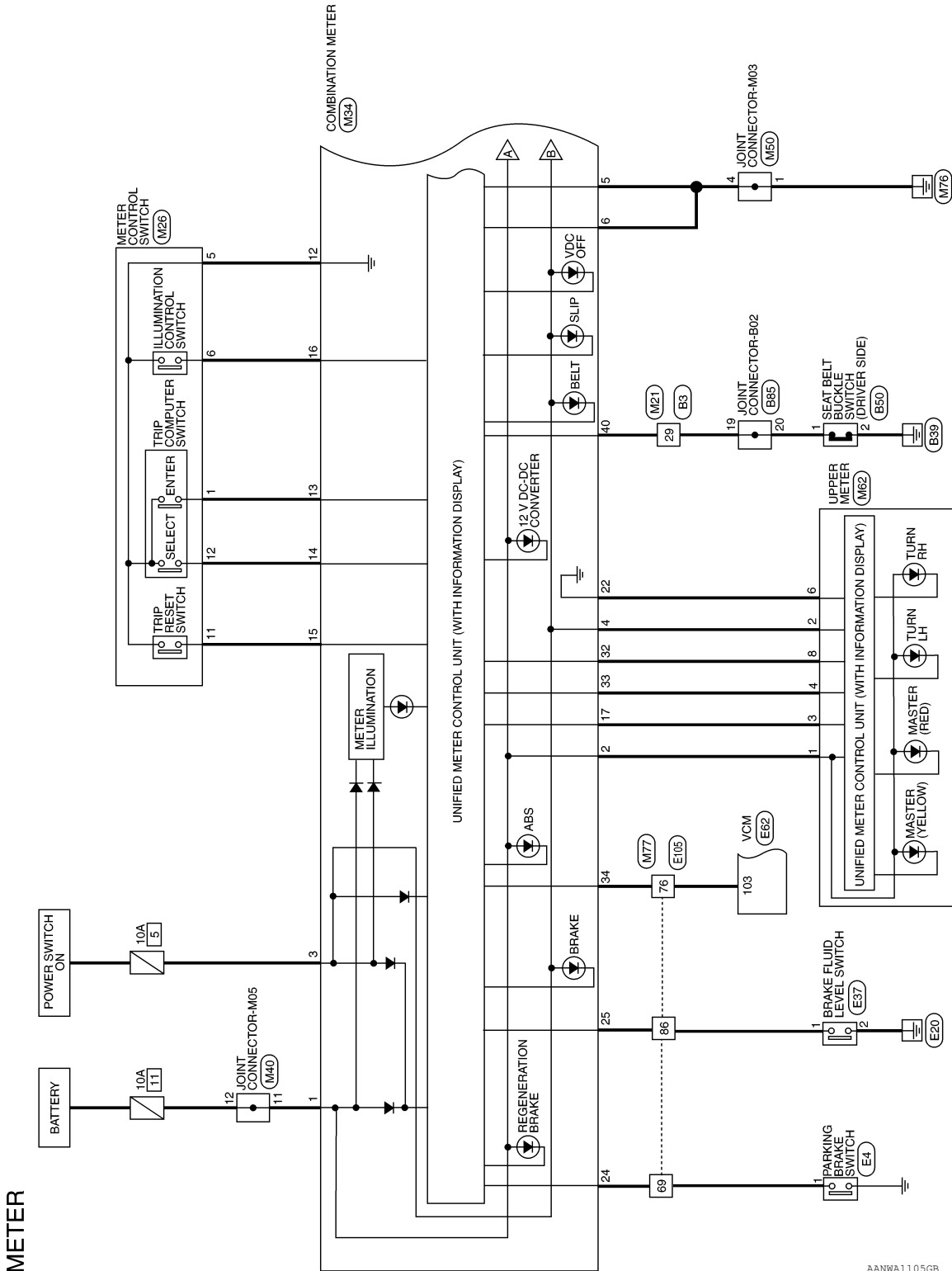

AANWA1105GB

METER SYSTEM

< WIRING DIAGRAM >

- : WITH HALOGEN HEADLAMPS
- : WITH LED HEADLAMPS
- : FOR CANADA

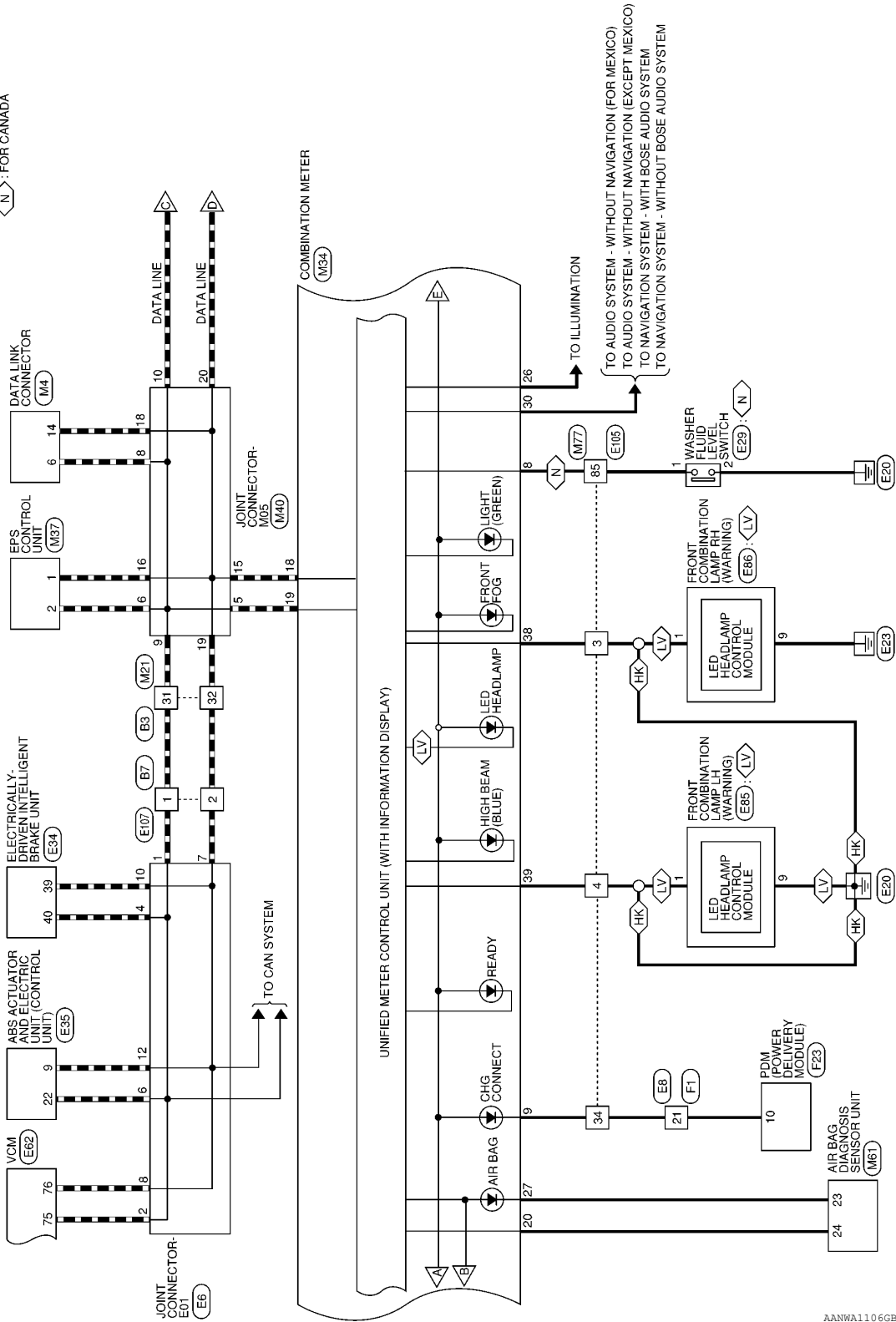

AANWA1106GB

A
B
C
D
E
F
G
H
I
J
K
L
M
N
O
P

MWI

METER SYSTEM

< WIRING DIAGRAM >

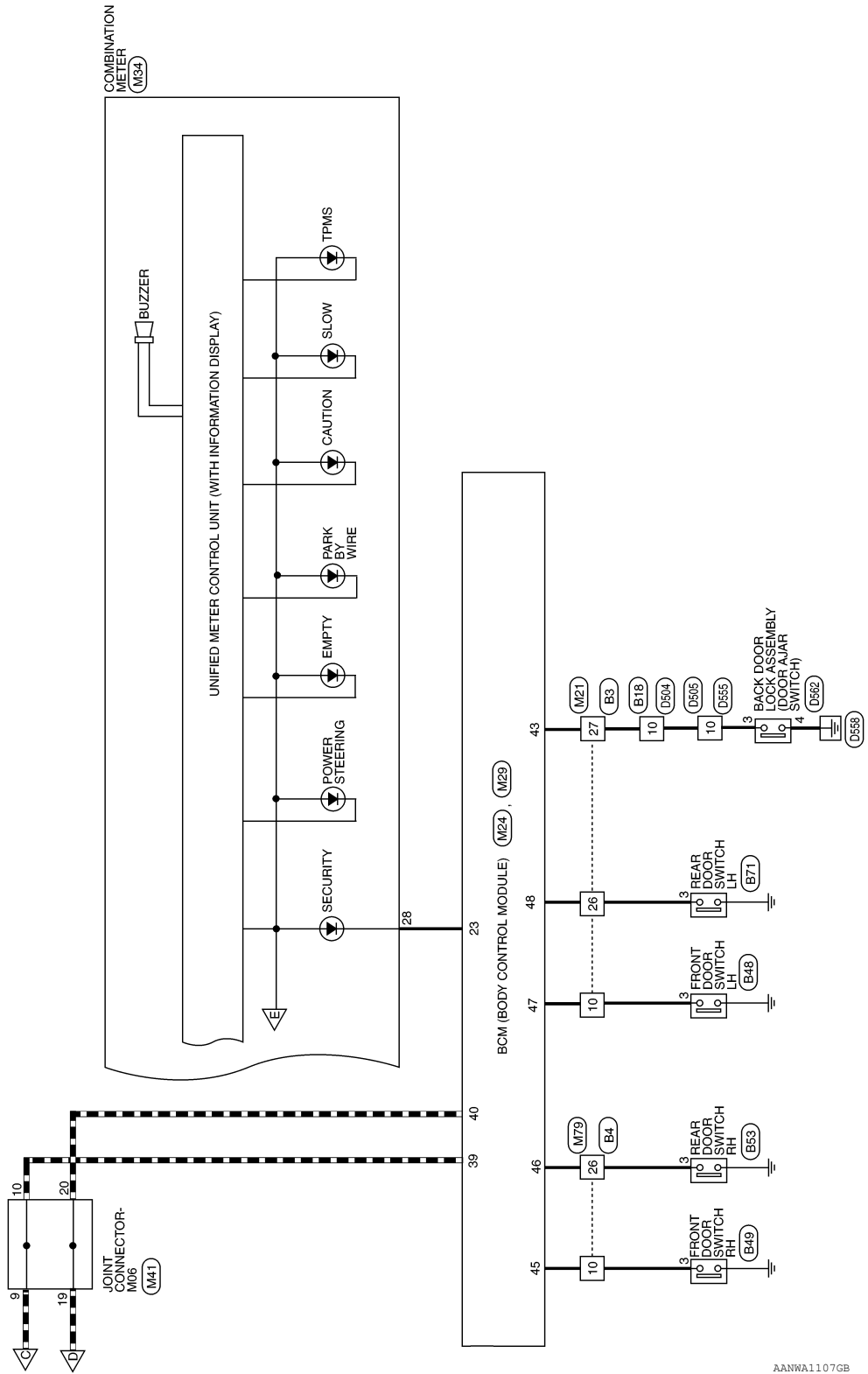

AANWA1107GB

METER SYSTEM

< WIRING DIAGRAM >

METER - CONNECTORS

Connector No.	M4
Connector Name	DATA LINK CONNECTOR
Connector Color	WHITE

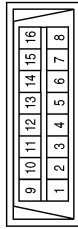

Terminal No.	Color of Wire	Signal Name
6	L	-
14	P	-

Connector No.	M21
Connector Name	WIRE TO WIRE
Connector Color	WHITE

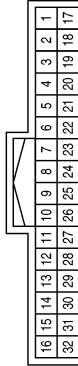

Terminal No.	Color of Wire	Signal Name
10	SB	-
26	W	-
27	Y	-
29	W	-
31	L	-
32	P	-

Connector No.	M24
Connector Name	BCM (BODY CONTROL MODULE)
Connector Color	BLACK

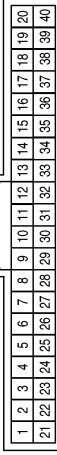

Terminal No.	Color of Wire	Signal Name
23	R	SECURITY INDICATOR OUTPUT
39	L	CAN-H
40	P	CAN-L

Connector No.	M26
Connector Name	METER CONTROL SWITCH
Connector Color	WHITE

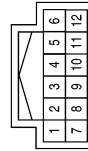

Terminal No.	Color of Wire	Signal Name
1	G	-
5	V	-
6	P	-
11	BR	-
12	Y	-

Connector No.	M29
Connector Name	BCM (BODY CONTROL MODULE)
Connector Color	BLACK

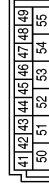

Terminal No.	Color of Wire	Signal Name
43	Y	DOOR SW (BACK)
45	BR	DOOR SW (AS)
46	R	DOOR SW (RR)
47	SB	DOOR SW (DR)
48	W	DOOR SW (RL)

A B C D E F G H I J K L M MWI O P

METER SYSTEM

< WIRING DIAGRAM >

Connector No.	M34
Connector Name	COMBINATION METER
Connector Color	WHITE

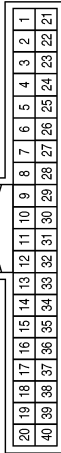

Terminal No.	Color of Wire	Signal Name
1	LG	BAT
2	Y	BAT (FOR UPPER)
3	GR	IGN
4	BG	IGN (FOR UPPER)
5	B	GND1
6	B	GND2
7	-	-

Terminal No.	Color of Wire	Signal Name
8	Y	WASHER SW
9	BR	CHARGE CONNECT
10	-	-
11	-	-
12	V	SW GND
13	G	MODE B SW
14	Y	MODE A SW
15	BR	TRIP RESET SW
16	P	ILL CONT UP
17	G	UPPER ILL CONT
18	P	CAN-L
19	L	CAN-H
20	LG	AS SEATBELT W/L
21	-	-
22	GR	GND (FOR UPPER)
23	-	-

Terminal No.	Color of Wire	Signal Name
24	BG	PKB SW
25	SB	BRAKE OIL
26	B	ILL CONT OUT
27	R	A/BAG WARIN
28	R	SECURITY
29	-	-
30	GR	8 P/R O/P
31	-	-
32	W	SDA (12C)
33	G	SCL (12C)
34	L	CHARGE LAMP
35	-	-
36	-	-
37	-	-
38	V	LED H LAMP R
39	LG	LED H LAMP L
40	W	BUCKLE SW FR DR

Connector No.	M37
Connector Name	EPS CONTROL UNIT
Connector Color	WHITE

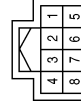

Terminal No.	Color of Wire	Signal Name
1	P	CAN-L
2	L	CAN-H

Connector No.	M40
Connector Name	JOINT CONNECTOR-M05
Connector Color	BLUE

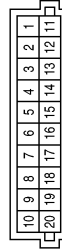

Terminal No.	Color of Wire	Signal Name
5	L	-
6	L	-

Terminal No.	Color of Wire	Signal Name
8	L	-
9	L	-
10	L	-
11	LG	-
12	LG	-
15	P	-
16	P	-
18	P	-
19	P	-
20	P	-

METER SYSTEM

< WIRING DIAGRAM >

Connector No.	M61
Connector Name	AIR BAG DIAGNOSIS SENSOR UNIT
Connector Color	YELLOW

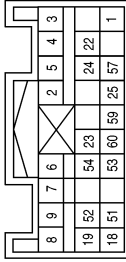

Terminal No.	Color of Wire	Signal Name
23	R	AIRBAG W/L
24	LG	SEATBELT REMINDER / TELLTALE LAMP-B

Connector No.	M50
Connector Name	JOINT CONNECTOR-M03
Connector Color	PINK

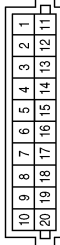

Terminal No.	Color of Wire	Signal Name
1	B	-
4	B	-

Connector No.	M41
Connector Name	JOINT CONNECTOR-M06
Connector Color	BLUE

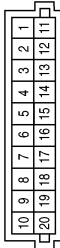

Terminal No.	Color of Wire	Signal Name
9	L	-
10	L	-
19	P	-
20	P	-

Terminal No.	Color of Wire	Signal Name
3	V	-
4	LG	-
34	BR	-
69	BG	-
76	L	-
85	Y	-
86	SB	-

Connector No.	M77
Connector Name	WIRE TO WIRE
Connector Color	WHITE

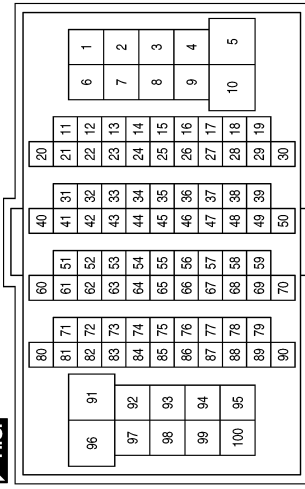

Connector No.	M62
Connector Name	UPPER METER
Connector Color	WHITE

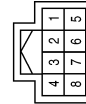

Terminal No.	Color of Wire	Signal Name
1	Y	BAT (UPPER METER)
2	BG	IGN (UPPER METER)
3	G	ILL CONT IN
4	G	SCL (12C)
6	GR	GND (UPPER)
8	W	SDA (12C)

AANIA2876GB

A
B
C
D
E
F
G
H
I
J
K
L
M
N
O
P

MWI

METER SYSTEM

< WIRING DIAGRAM >

Connector No.	E6
Connector Name	JOINT CONNECTOR-E01
Connector Color	BLUE

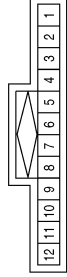

Terminal No.	Color of Wire	Signal Name
1	L	-
2	L	-
4	L	-
6	L	-
7	P	-
8	P	-
10	P	-
12	P	-

Connector No.	E4
Connector Name	PARKING BRAKE SWITCH
Connector Color	BLACK



Terminal No.	Color of Wire	Signal Name
1	B	-

Connector No.	M79
Connector Name	WIRE TO WIRE
Connector Color	WHITE

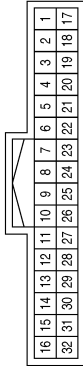

Terminal No.	Color of Wire	Signal Name
10	BR	-
26	R	-

Connector No.	E29
Connector Name	WASHER FLUID LEVEL SWITCH
Connector Color	BROWN



Terminal No.	Color of Wire	Signal Name
1	O	-
2	B/Y	-

Terminal No.	Color of Wire	Signal Name
21	BR	-

Connector No.	E8
Connector Name	WIRE TO WIRE
Connector Color	BLACK

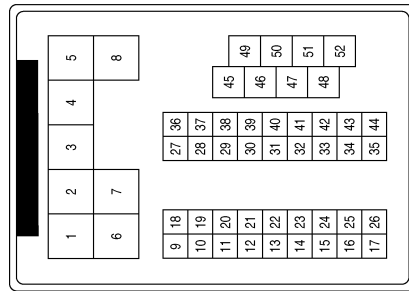

AANIA2877GB

METER SYSTEM

< WIRING DIAGRAM >

Connector No.	E37
Connector Name	BRAKE FLUID LEVEL SWITCH
Connector Color	GRAY



Terminal No.	Color of Wire	Signal Name
1	BR	-
2	B/W	-

Connector No.	E35
Connector Name	ABS ACTUATOR AND ELECTRIC UNIT (CONTROL UNIT)
Connector Color	BLACK



Terminal No.	Color of Wire	Signal Name
9	P	CAN-L
22	L	CAN-H

Connector No.	E34
Connector Name	ELECTRICALLY-DRIVEN INTELLIGENT BRAKE UNIT
Connector Color	BLACK

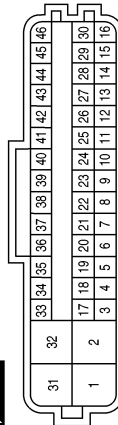

Terminal No.	Color of Wire	Signal Name
39	P	CAN-L
40	L	CAN-H

Connector No.	E86
Connector Name	FRONT COMBINATION LAMP RH (WITH LED HEADLAMPS)
Connector Color	BLACK

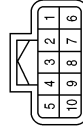

Terminal No.	Color of Wire	Signal Name
1	R	-
9	B	-(WITH DTRL)
9	B/Y	-(WITHOUT DTRL)

Connector No.	E85
Connector Name	FRONT COMBINATION LAMP LH (WITH LED HEADLAMPS)
Connector Color	BLACK

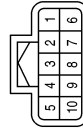

Terminal No.	Color of Wire	Signal Name
1	LG	-
9	B	-(WITH DTRL)
9	B/W	-(WITHOUT DTRL)

Connector No.	E62
Connector Name	VCM
Connector Color	BROWN

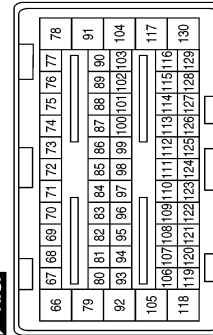

Terminal No.	Color of Wire	Signal Name
75	L	CAN-H
76	P	CAN-L
103	L	PLUG IN INDICATOR LAMP

AANIA2878GB

A B C D E F G H I J K L M N O P



METER SYSTEM

< WIRING DIAGRAM >

Connector No.	E107
Connector Name	WIRE TO WIRE
Connector Color	WHITE



Terminal No.	Color of Wire	Signal Name
1	L	-
2	P	-

Terminal No.	Color of Wire	Signal Name
3	BW	-(WITH HALOGEN HEADLAMPS)
3	R	-(WITH LED HEADLAMPS)
4	LG	-(WITH LED HEADLAMPS)
4	B/W	-(WITH HALOGEN HEADLAMPS)
34	BR	-
69	B	-
76	L	-
85	O	-
86	BR	-

Connector No.	E105
Connector Name	WIRE TO WIRE
Connector Color	WHITE

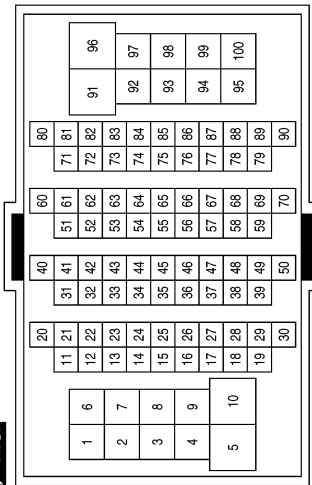

Connector No.	F23
Connector Name	PDM (POWER DELIVERY MODULE)
Connector Color	GREEN

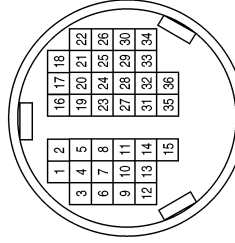

Terminal No.	Color of Wire	Signal Name
10	LG	CSTATE

Terminal No.	Color of Wire	Signal Name
21	LG	-

Connector No.	F1
Connector Name	WIRE TO WIRE
Connector Color	BLACK

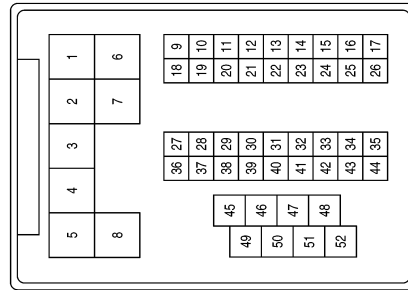

AANIA2879GB

METER SYSTEM

< WIRING DIAGRAM >

Connector No.	B7
Connector Name	WIRE TO WIRE
Connector Color	WHITE



12	11	10	9	8	7	6	5	4	3	2	1
24	23	22	21	20	19	18	17	16	15	14	13

Terminal No.	Color of Wire	Signal Name
1	L	-
2	P	-

Connector No.	B4
Connector Name	WIRE TO WIRE
Connector Color	WHITE



1	2	3	4	5	6	7	8	9	10	11	12	13	14	15	16
17	18	19	20	21	22	23	24	25	26	27	28	29	30	31	32

Terminal No.	Color of Wire	Signal Name
10	BR	-
26	R	-

Connector No.	B3
Connector Name	WIRE TO WIRE
Connector Color	WHITE



1	2	3	4	5	6	7	8	9	10	11	12	13	14	15	16
17	18	19	20	21	22	23	24	25	26	27	28	29	30	31	32

Terminal No.	Color of Wire	Signal Name
10	SB	-
26	LG	-
27	Y	-
29	R	-
31	L	-
32	P	-

Connector No.	B49
Connector Name	FRONT DOOR SWITCH RH
Connector Color	WHITE



1	2	3	4
---	---	---	---

Terminal No.	Color of Wire	Signal Name
3	BR	-

Connector No.	B48
Connector Name	FRONT DOOR SWITCH LH
Connector Color	WHITE



1	2	3	4
---	---	---	---

Terminal No.	Color of Wire	Signal Name
3	SB	-

Connector No.	B18
Connector Name	WIRE TO WIRE
Connector Color	WHITE



1	2	3	4	5	6								
7	8	9	10	11	12	13	14	15	16	17	18	19	20

Terminal No.	Color of Wire	Signal Name
10	Y	-

AANIA2880GB

A
B
C
D
E
F
G
H
I
J
K
L
M
N
O
P

MWI

METER SYSTEM

< WIRING DIAGRAM >

Connector No.	B71
Connector Name	REAR DOOR SWITCH LH
Connector Color	WHITE



Terminal No.	Color of Wire	Signal Name
3	LG	-

Connector No.	B53
Connector Name	REAR DOOR SWITCH RH
Connector Color	WHITE



Terminal No.	Color of Wire	Signal Name
3	R	-

Connector No.	B50
Connector Name	SEAT BELT BUCKLE SWITCH (DRIVER SIDE)
Connector Color	WHITE



Terminal No.	Color of Wire	Signal Name
1	R	-
2	B	-

Connector No.	D505
Connector Name	WIRE TO WIRE
Connector Color	WHITE

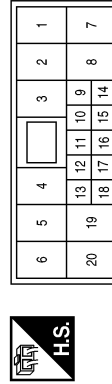

Terminal No.	Color of Wire	Signal Name
10	SB	-

Connector No.	D504
Connector Name	WIRE TO WIRE
Connector Color	WHITE

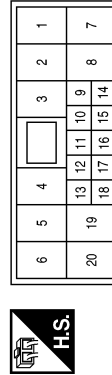

Terminal No.	Color of Wire	Signal Name
10	SB	-

Connector No.	B85
Connector Name	JOINT CONNECTOR-B02
Connector Color	BLACK

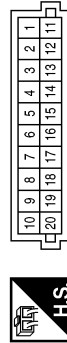

Terminal No.	Color of Wire	Signal Name
19	R	-
20	R	-

AANIA2881GB

METER SYSTEM

< WIRING DIAGRAM >

A
B
C
D
E
F
G
H
I
J
K
L
M
MWI
O
P

Connector No.	D562
Connector Name	BACK DOOR LOCK ASSEMBLY
Connector Color	WHITE

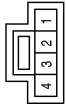

Terminal No.	Color of Wire	Signal Name
3	SB	-
4	B	-

Connector No.	D555
Connector Name	WIRE TO WIRE
Connector Color	WHITE

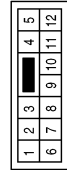

Terminal No.	Color of Wire	Signal Name
10	SB	-

AANIA2882GB

DIAGNOSIS AND REPAIR WORKFLOW (METER SYSTEM)

< BASIC INSPECTION >

BASIC INSPECTION

DIAGNOSIS AND REPAIR WORKFLOW (METER SYSTEM)

Work flow

INFOID:000000010122411

OVERALL SEQUENCE

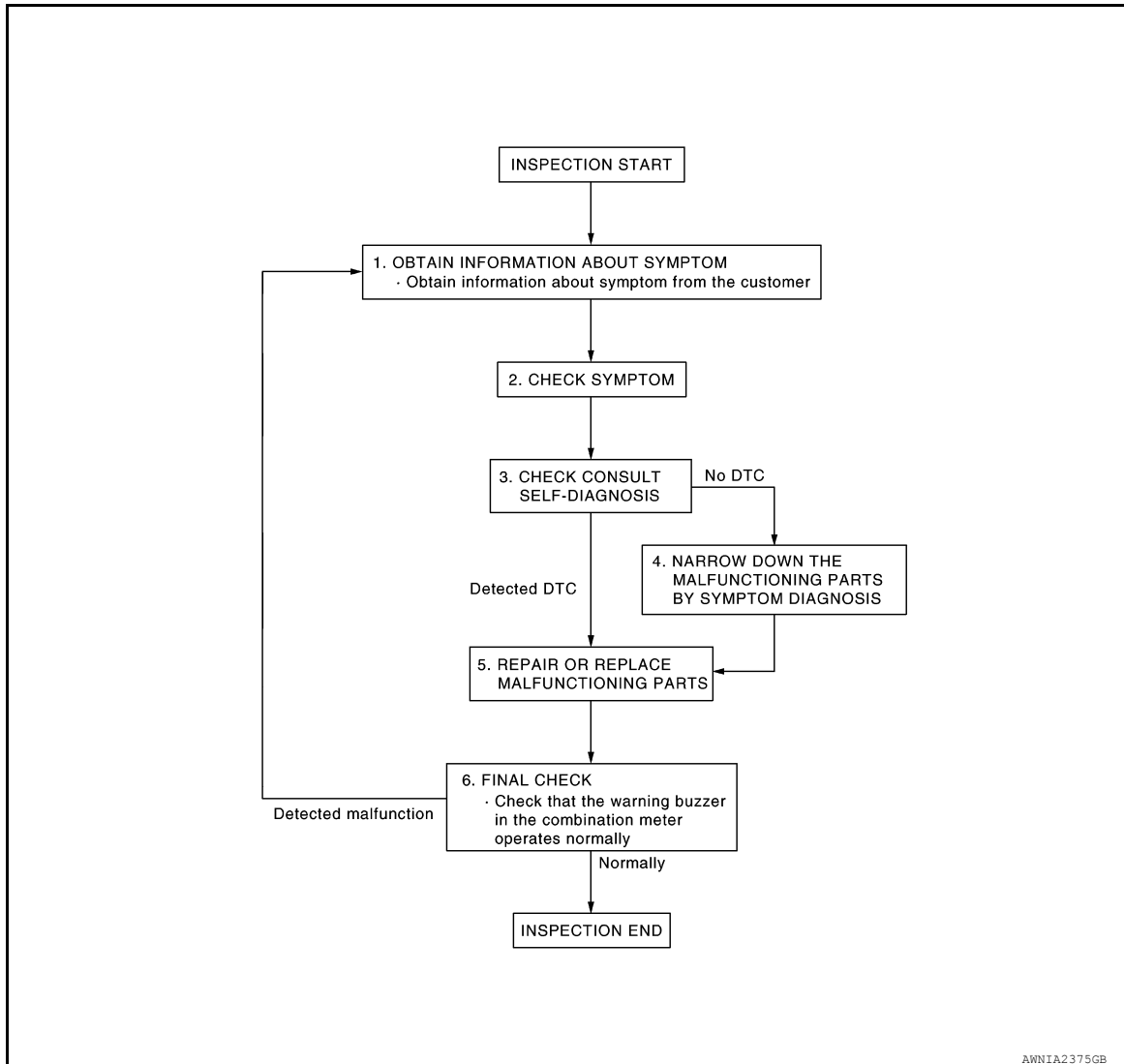

DETAILED FLOW

1. OBTAIN INFORMATION ABOUT SYMPTOM

Interview the customer to obtain as much information as possible about the conditions and environment under which the malfunction occurred.

>> GO TO 2.

2. CHECK SYMPTOM

- Check the symptom based on the information obtained from the customer.
- Check if any other malfunctions are present.

>> GO TO 3.

3. CHECK CONSULT SELF-DIAGNOSIS RESULTS

Connect CONSULT and perform "self-diagnosis". Refer to [MWI-65, "DTC Index"](#).

DIAGNOSIS AND REPAIR WORKFLOW (METER SYSTEM)

< BASIC INSPECTION >

Are self-diagnosis results normal?

YES >> GO TO 4.

NO >> GO TO 5.

4.NARROW DOWN MALFUNCTIONING PARTS BY SYMPTOM DIAGNOSIS

Perform symptom diagnosis and narrow down the malfunctioning parts.

>> GO TO 5.

5.REPAIR OR REPLACE MALFUNCTIONING PARTS

Repair or replace malfunctioning parts.

NOTE:

If DTC is displayed, erase DTC after repairing or replacing malfunctioning parts.

>> GO TO 6.

6.FINAL CHECK

Check that the warning buzzer in the combination meter operates normally.

Does it operate normally?

YES >> Inspection End.

NO >> GO TO 1.

A
B
C
D
E
F
G
H
I
J
K
L
M
O
P

MWI

U1000 CAN COMM CIRCUIT

< DTC/CIRCUIT DIAGNOSIS >

DTC/CIRCUIT DIAGNOSIS

U1000 CAN COMM CIRCUIT

Description

INFOID:0000000010122412

CAN (Controller Area Network) is a serial communication system for real time application. It is an on-vehicle multiplex communication system with high data communication speed and excellent error detectability. Many electronic control units are equipped onto vehicles, and each control unit shares information and links with other control units during operation (not independent). In CAN communication, control units are connected with two communication lines (CAN-H line, CAN-L line) allowing a high rate of information transmission with less wiring. Each control unit transmits/receives data but selectively reads required data only.

CAN Communication Signal Chart. Refer to [LAN-37, "CAN COMMUNICATION SYSTEM : CAN Communication Signal Chart"](#).

DTC Logic

INFOID:0000000010122413

DTC DETECTION LOGIC

DTC	Display contents of CONSULT	Diagnostic item is detected when...	Probable malfunction location
U1000	CAN COMM CIRCUIT [U1000]	When combination meter is not transmitting or receiving CAN communication signal for 2 seconds or more.	CAN communication system

Diagnosis Procedure

INFOID:0000000010122414

1. PERFORM SELF DIAGNOSTIC RESULT

1. Turn power switch ON and wait for 2 seconds or more.
2. Check "Self Diagnostic Result" of "METER/M&A".

Is "CAN COMM CIRCUIT" displayed?

- YES >> Refer to [LAN-17, "Trouble Diagnosis Flow Chart"](#).
NO >> Refer to [GI-53, "Intermittent Incident"](#).

U1010 CONTROL UNIT (CAN)

< DTC/CIRCUIT DIAGNOSIS >

U1010 CONTROL UNIT (CAN)

Description

INFOID:000000010122415

Initial diagnosis of combination meter.

DTC Logic

INFOID:000000010122416

DTC DETECTION LOGIC

DTC	Display contents of CONSULT	Diagnostic item is detected when...	Probable malfunction location
U1010	CONTROL UNIT (CAN) [U1010]	When detecting error during the initial diagnosis of the CAN controller of combination meter.	Combination meter

Diagnosis Procedure

INFOID:000000010122417

1. REPLACE COMBINATION METER

When DTC "U1010" is detected, replace combination meter.

>> Replace combination meter. Refer to [MWI-102, "Removal and Installation"](#).

A
B
C
D
E
F
G
H
I
J
K
L
M
O
P

MWI

B2205 VEHICLE SPEED

< DTC/CIRCUIT DIAGNOSIS >

B2205 VEHICLE SPEED

Description

INFOID:000000010122418

Vehicle speed signal is transmitted from ABS actuator and electric unit (control unit) via CAN communication to combination meter.

DTC Logic

INFOID:000000010122419

DTC DETECTION LOGIC

DTC	Display contents of CONSULT	Diagnostic item is detected when...	Probable malfunction location
B2205	VEHICLE SPEED [B2205]	An abnormal vehicle speed signal is input from ABS actuator and electric unit (control unit) for 2 seconds or more.	<ul style="list-style-type: none">• Wheel sensor• ABS actuator and electric unit (control unit)

Diagnosis Procedure

INFOID:000000010122420

1. PERFORM SELF-DIAGNOSIS OF ABS ACTUATOR AND ELECTRIC UNIT (CONTROL UNIT)

Perform "Self Diagnostic Result" of "ABS", and repair or replace malfunctioning parts.

>> Refer to [BRC-46, "CONSULT Function"](#).

POWER SUPPLY AND GROUND CIRCUIT

< DTC/CIRCUIT DIAGNOSIS >

POWER SUPPLY AND GROUND CIRCUIT COMBINATION METER

COMBINATION METER : Diagnosis Procedure

INFOID:0000000010122421

Regarding Wiring Diagram information, refer to [MWI-68. "Wiring Diagram"](#).

1. CHECK FUSES

Check that the following fuses are not blown:

Power source	Fuse No.
Battery	11
Power switch ON	5

Is the fuse blown?

YES >> Replace the blown fuse after repairing the affected circuit.

NO >> GO TO 2.

2. CHECK POWER SUPPLY CIRCUIT

Check voltage between combination meter harness connector and ground.

Terminals		Power switch position	Voltage (Approx.)
(+)	(-)		
Combination meter		OFF	Battery voltage
Connector	Terminal		
M34	1		
	3		
		ON	

Is the inspection result normal?

YES >> GO TO 3.

NO >> Repair or replace harness or connector.

3. CHECK GROUND CIRCUIT

1. Power switch OFF.
2. Disconnect combination meter connector.
3. Check continuity between combination meter harness connector and ground.

Combination meter		Ground	Continuity
Connector	Terminal		
M34	5		Yes
	6		

Is the inspection result normal?

YES >> Inspection End.

NO >> Repair or replace harness or connector.

UPPER METER

UPPER METER : Diagnosis Procedure

INFOID:0000000010122422

Regarding Wiring Diagram information, refer to [MWI-68. "Wiring Diagram"](#).

POWER SUPPLY AND GROUND CIRCUIT

< DTC/CIRCUIT DIAGNOSIS >

1. CHECK POWER SUPPLY CIRCUIT

Check voltage between upper meter harness connector and ground.

Terminals		Power switch position	Voltage (Approx.)
(+)	(-)		
Upper meter		OFF	Battery voltage
Connector	Terminal		
M62	1		
	2	ON	

Is the inspection result normal?

YES >> GO TO 2.

NO >> Repair or replace harness or connector.

2. CHECK GROUND CIRCUIT

1. Power switch OFF.
2. Disconnect upper meter connector.
3. Check continuity between upper meter harness connector and ground.

Upper meter		Ground	Continuity
Connector	Terminal		
M62	6		Yes

Is the inspection result normal?

YES >> Inspection End.

NO >> Repair or replace harness or connector.

COMMUNICATION SIGNAL (METER→UPPER) CIRCUIT

< DTC/CIRCUIT DIAGNOSIS >

COMMUNICATION SIGNAL (METER→UPPER) CIRCUIT

Description

INFOID:000000010122423

The communication line (METER → UPPER) is used to communicate signals between the combination meter and the upper meter in order to control the upper meter.

Diagnosis Procedure

INFOID:000000010122424

Regarding Wiring Diagram information, refer to [MWI-68, "Wiring Diagram"](#).

1. CHECK CONNECTOR

Check combination meter, upper meter and terminals (combination meter side, upper meter side, and harness side) for looseness or bent.

Is the inspection result normal?

YES >> GO TO 2.

NO >> Repair or replace harness or connector.

2. CHECK COMMUNICATION LINE (METER → UPPER) SIGNAL CIRCUIT

1. Power switch OFF.
2. Disconnect combination meter and upper meter connector.
3. Check continuity between combination meter harness connector and upper harness connector.

Combination meter		Upper meter		Continuity
Connector	Terminal	Connector	Terminal	
M34	32	M62	8	Yes
	33		4	

4. Check continuity between combination meter harness connector and ground.

Combination meter		Ground	Continuity
Connector	Terminal		
M34	32		No
	33		

Is the inspection result normal?

YES >> GO TO 3.

NO >> Repair or replace harness or connector.

3. CHECK COMMUNICATION LINE (METER → UPPER) OUTPUT SIGNAL

1. Connect combination meter and upper meter connector.
2. Power switch ON.
3. Check voltage between combination meter and ground.

A
B
C
D
E
F
G
H
I
J
K
L
M
O
P

MWI

COMMUNICATION SIGNAL (METER→UPPER) CIRCUIT

< DTC/CIRCUIT DIAGNOSIS >

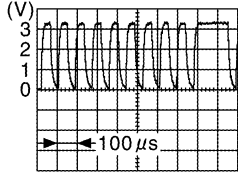
Terminal		Voltage (Approx.)
(+)	(-)	
Combination meter		NOTE: Reference waveform
Connector	Terminal	
M34	32	 <p style="text-align: right; font-size: small;">JSN1A3767GB</p>
	33	

Is the inspection result normal?

- YES >> Replace upper meter. Refer to [MWI-103, "Removal and Installation"](#).
- NO >> Replace combination meter. Refer to [MWI-102, "Removal and Installation"](#).

METER CONTROL SWITCH SIGNAL CIRCUIT

< DTC/CIRCUIT DIAGNOSIS >

METER CONTROL SWITCH SIGNAL CIRCUIT



Diagnosis Procedure

INFOID:000000010122425

Regarding Wiring Diagram information, refer to [MWI-68. "Wiring Diagram"](#).

1. CHECK COMBINATION METER INPUT SIGNAL

1. Power switch ON.
2. Check voltage between the following terminals of the combination meter.

Combination meter		Condition	Voltage (Approx.)
Connector	Terminals		
	(+) (-)		
M34	13	When  switch (enter switch) is pressed	0 V
		Other than the above	5 V
	14	When  switch (select switch) is pressed	0 V
		Other than the above	5 V
	15	When trip reset switch is pressed	0 V
		Other than the above	5 V
	16	When  switch (illumination control switch) is pressed	0 V
		Other than the above	5 V

Is the inspection result normal?

- YES >> Inspection End.
 NO >> GO TO 2.

2. CHECK METER CONTROL SWITCH SIGNAL CIRCUIT

1. Power switch OFF.
2. Disconnect combination meter connector and meter control switch connector.
3. Check continuity between combination meter harness connector and meter control switch harness connector.

Terminals				Continuity
Combination meter		Meter control switch		
Connector	Terminal	Connector	Terminal	
M34	12	M26	5	Yes
	13		1	
	14		12	
	15		11	
	16		6	

4. Check continuity between combination meter harness connector and ground.

A
B
C
D
E
F
G
H
I
J
K
L
M
O
P

MWI

METER CONTROL SWITCH SIGNAL CIRCUIT

< DTC/CIRCUIT DIAGNOSIS >

Combination meter		Ground	Continuity
Connector	Terminal		
M34	12		No
	13		
	14		
	15		
	16		

Is the inspection result normal?



- YES >> Inspection End.
 NO >> Repair or replace harness or connector.

Component Inspection

INFOID:000000010122426

1. CHECK METER CONTROL SWITCH

1. Power switch OFF.
2. Disconnect meter control switch connector.
3. Check meter control switch.

Terminals		Condition	Continuity
Meter control switch			
1	5	When  switch (enter switch) is pressed	Yes
		Other than the above	No
6		When  switch (illumination control switch) is pressed	Yes
		Other than the above	No
11		When trip reset switch is pressed	Yes
		Other than the above	No
12		When  switch (select switch) is pressed	Yes
		Other than the above	No

Is the inspection result normal?

- YES >> Inspection End.
 NO >> Replace meter control switch. Refer to [MWI-104, "Removal and Installation"](#).

WASHER FLUID LEVEL SWITCH CIRCUIT

< DTC/CIRCUIT DIAGNOSIS >

WASHER FLUID LEVEL SWITCH CIRCUIT

Diagnosis Procedure

INFOID:000000010122427

Regarding Wiring Diagram information, refer to [MWI-68. "Wiring Diagram"](#).

1. CHECK WASHER FLUID LEVEL SWITCH SIGNAL CIRCUIT

1. Power switch OFF.
2. Disconnect combination meter connector and washer fluid level switch connector.
3. Check continuity between combination meter harness connector and washer fluid level switch harness connector.

Terminals				Continuity
Combination meter		Washer fluid level switch		
Connector	Terminal	Connector	Terminal	
M34	8	E29	1	Yes

4. Check continuity between combination meter harness connector and ground.

Terminals			Continuity
Combination meter		Ground	
Connector	Terminal		
M34	8		No

Is the inspection result normal?

YES >> GO TO 2.

NO >> Repair or replace harness or connector.

2. CHECK WASHER FLUID LEVEL SWITCH GROUND CIRCUIT

Check continuity between washer fluid level switch connector and ground.

Terminals			Continuity
Washer fluid level switch		Ground	
Connector	Terminal		
E29	2		Yes

Is the inspection result normal?

YES >> Inspection End.

NO >> Repair or replace harness or connector.

Component Inspection

INFOID:000000010122428

MWI

1. CHECK WASHER FLUID LEVEL SWITCH

1. Power switch OFF.
2. Disconnect washer fluid level switch connector.
3. Check washer fluid level switch.

Terminals		Condition	Continuity
Washer fluid level switch			
1	2	Washer fluid level switch ON	Yes
		Washer fluid level switch OFF	No

Is the inspection result normal?

WASHER FLUID LEVEL SWITCH CIRCUIT

< DTC/CIRCUIT DIAGNOSIS >

YES >> Inspection End.

NO >> Replace washer fluid level switch. Refer to [WW-45, "Removal and Installation"](#).

PARKING BRAKE SWITCH SIGNAL CIRCUIT

< DTC/CIRCUIT DIAGNOSIS >

PARKING BRAKE SWITCH SIGNAL CIRCUIT

Diagnosis Procedure

INFOID:000000010122429

Regarding Wiring Diagram information, refer to [MWI-68. "Wiring Diagram"](#).

1. CHECK COMBINATION METER INPUT SIGNAL

1. Power switch ON.
2. Check voltage between combination meter harness connector and ground.

(+)		(-)	Condition		Voltage (Approx.)
Combination meter		Ground			
Connector	Terminal				
M34	24		Power switch ON	When parking brake is applied	0 V
		When parking brake is released		Battery voltage	

Is the inspection result normal?

- YES >> Inspection End.
NO >> GO TO 2.

2. CHECK PARKING BRAKE SWITCH SIGNAL CIRCUIT

1. Power switch OFF.
2. Disconnect combination meter connector and parking brake switch connector.
3. Check continuity between combination meter harness connector and parking brake switch harness connector.

Terminals				Continuity
Combination meter		Parking brake switch		
Connector	Terminal	Connector	Terminal	
M34	24	E4	1	Yes

4. Check continuity between combination meter harness connector and ground.

Terminals			Continuity
Combination meter		Ground	
Connector	Terminal		
M34	24		No

Is the inspection result normal?

- YES >> Inspection End.
NO >> Repair or replace harness or connector.

Component Inspection

INFOID:000000010122430

1. CHECK PARKING BRAKE SWITCH

Check continuity between parking brake switch terminal 1 and switch case ground.

Component	Terminal	Condition	Continuity
Parking brake switch	1	Parking brake applied	Yes
		Parking brake released	No

Is the inspection result normal?

- YES >> Inspection End.

A
B
C
D
E
F
G
H
I
J
K
L
M
O
P

MWI

PARKING BRAKE SWITCH SIGNAL CIRCUIT

< DTC/CIRCUIT DIAGNOSIS >

NO >> Replace parking brake switch. Refer to [PB-8. "Exploded View"](#).

THE METER CONTROL SWITCH IS INOPERATIVE

< SYMPTOM DIAGNOSIS >

SYMPTOM DIAGNOSIS

THE METER CONTROL SWITCH IS INOPERATIVE

Description

INFOID:000000010122431

If any of the following malfunctions is found for the meter control switch operation.

- All switches are inoperative
- The specified switch cannot be operated

Diagnosis Procedure

INFOID:000000010122432

1. CHECK METER CONTROL SWITCH SIGNAL CIRCUIT

Check the meter control switch signal circuit. Refer to [MWI-89. "Diagnosis Procedure"](#).

Is the inspection result normal?

YES >> GO TO 2.

NO >> Repair or replace harness or connector.

2. CHECK METER CONTROL SWITCH

Check the meter control switch. Refer to [MWI-90. "Component Inspection"](#).

Is the inspection result normal?

YES >> Replace combination meter. Refer to [MWI-102. "Removal and Installation"](#).

NG >> Replace meter control switch. Refer to [MWI-104. "Removal and Installation"](#).

A
B
C
D
E
F
G
H
I
J
K
L
M
O
P

MWI

THE DOOR OPEN WARNING CONTINUES DISPLAYING, OR DOES NOT DISPLAY

< SYMPTOM DIAGNOSIS >

THE DOOR OPEN WARNING CONTINUES DISPLAYING, OR DOES NOT DISPLAY

Description

INFOID:000000010122433

- The door ajar warning is displayed even though all of the doors are closed.
- The door ajar warning is not displayed even though a door is ajar.

Diagnosis Procedure

INFOID:000000010122434

1. CHECK BCM INPUT SIGNAL

Check the BCM input signal. Refer to [DLK-102. "Component Function Check"](#).

Is the inspection result normal?

- YES >> GO TO 2.
- NO >> GO TO 3.

2. CHECK COMBINATION METER INPUT SIGNAL

Select "Data Monitor" of "METER/MA" and check the "DOOR W/L" monitor value while opening and closing door.

Monitor item	Condition	Status
DOOR W/L	Door open	ON
	Door closed	OFF

Is the inspection result normal?

- YES >> Replace combination meter. Refer to [MWI-102. "Removal and Installation"](#).
- NO >> Replace BCM. Refer to [BCS-72. "Removal and Installation"](#).

3. CHECK DOOR SWITCH SIGNAL CIRCUIT

Check the door switch signal circuit. Refer to [DLK-102. "Diagnosis Procedure"](#).

Is the inspection result normal?

- YES >> GO TO 4.
- NO >> Repair or replace harness or connector.

4. CHECK DOOR SWITCH

Check the door switch. Refer to [DLK-103. "Component Inspection"](#).

Is the inspection result normal?

- YES >> Replace combination meter. Refer to [MWI-102. "Removal and Installation"](#).
- NO >> Replace applicable door switch. Refer to [DLK-203. "Removal and Installation"](#).

UPPER METER DOES NOT OPERATE

< SYMPTOM DIAGNOSIS >

UPPER METER DOES NOT OPERATE

Description

INFOID:000000010122435

The upper meter function all do not operate.

Diagnosis Procedure

INFOID:000000010122436

1.CHECK UPPER METER POWER SUPPLY AND GROUND CIRCUIT

Check the upper meter power supply and ground circuit. Refer to [MWI-85, "UPPER METER : Diagnosis Procedure"](#).

Is the inspection result normal?

YES >> GO TO 2.

NO >> Repair or replace harness or connector.

2.CHECK COMMUNICATION LINE (METER → UPPER) SIGNAL CIRCUIT

Check the communication line (METER → UPPER) signal circuit. Refer to [MWI-87, "Diagnosis Procedure"](#).

Is the inspection result normal?

YES >> Replace upper meter. Refer to [MWI-103, "Removal and Installation"](#).

NO >> Replace combination meter. Refer to [MWI-102, "Removal and Installation"](#).

A
B
C
D
E
F
G
H
I
J
K
L
M
O
P

MWI

THE OUTSIDE AIR TEMPERATURE DISPLAY IS INCORRECT

< SYMPTOM DIAGNOSIS >

THE OUTSIDE AIR TEMPERATURE DISPLAY IS INCORRECT

Description

INFOID:000000010122437

- The displayed ambient air temperature is higher than the actual temperature.
- The displayed ambient air temperature is lower than the actual temperature.

Diagnosis Procedure

INFOID:000000010122438

NOTE:

Check that the symptom is not applicable to the normal operating condition before starting diagnosis. Refer to [MWI-101, "INFORMATION DISPLAY : Description"](#).

1. CHECK AMBIENT SENSOR SIGNAL CIRCUIT

Check the ambient sensor signal circuit. Refer to [HAC-92, "Diagnosis Procedure"](#) (Auto A/C with heat pump) or [HAC-283, "Diagnosis Procedure"](#) (Auto A/C without heat pump).

Is the inspection result normal?

- YES >> GO TO 2.
NO >> Repair or replace harness or connector.

2. CHECK AMBIENT SENSOR

Check the ambient sensor. Refer to [HAC-94, "Component Inspection"](#) (Auto A/C with heat pump) or [HAC-285, "Component Inspection"](#) (Auto A/C without heat pump).

Is the inspection result normal?

- YES >> Replace combination meter. Refer to [MWI-102, "Removal and Installation"](#).
NO >> Replace ambient sensor. Refer to [HAC-189, "Removal and Installation"](#) (Auto A/C with heat pump) or [HAC-348, "Removal and Installation"](#) (Auto A/C without heat pump).

THE LOW WASHER FLUID WARNING CONTINUES DISPLAYING, OR DOES NOT DISPLAY

< SYMPTOM DIAGNOSIS >

THE LOW WASHER FLUID WARNING CONTINUES DISPLAYING, OR DOES NOT DISPLAY

Description

INFOID:000000010122439

- The warning is still displayed even after washer fluid is added.
- The warning is not displayed even though the washer tank is empty.

Diagnosis Procedure

INFOID:000000010122440

1. CHECK WASHER FLUID LEVEL SWITCH SIGNAL CIRCUIT

Check the washer fluid level switch signal circuit. Refer to [MWI-91. "Diagnosis Procedure"](#).

Is the inspection result normal?

- YES >> GO TO 2.
- NO >> Repair or replace harness or connector.

2. CHECK WASHER FLUID LEVEL SWITCH UNIT

Check the washer fluid level switch. Refer to [MWI-91. "Component Inspection"](#).

Is the inspection result normal?

- YES >> Replace combination meter. Refer to [MWI-102. "Removal and Installation"](#).
- NO >> Replace washer fluid level switch. Refer to [WW-45. "Removal and Installation"](#).

A
B
C
D
E
F
G
H
I
J
K
L
M
O
P

MWI

THE PARKING BRAKE RELEASE WARNING CONTINUES DISPLAYING, OR DOES NOT DISPLAY

< SYMPTOM DIAGNOSIS >

THE PARKING BRAKE RELEASE WARNING CONTINUES DISPLAYING, OR DOES NOT DISPLAY

Description

INFOID:000000010122441

- The parking brake warning is displayed during vehicle travel even though the parking brake is released.
- The parking brake warning is not displayed even though driving the vehicle with the parking brake applied.

Diagnosis Procedure

INFOID:000000010122442

1. CHECK PARKING BRAKE WARNING LAMP OPERATION

1. Power switch ON.
2. Check the operation of the brake warning lamp while operating the parking brake.

Condition	Warning lamp status
Parking brake applied	ON
Parking brake released	OFF

Is the inspection result normal?

- YES >> Replace combination meter. Refer to [MWI-102, "Removal and Installation"](#).
NO >> GO TO 2.

2. CHECK PARKING BRAKE SWITCH SIGNAL CIRCUIT

1. Power switch OFF.
2. Check the parking brake switch signal circuit. Refer to [MWI-93, "Diagnosis Procedure"](#).

Is the inspection result normal?

- YES >> GO TO 3.
NO >> Repair or replace harness or connector.

3. CHECK PARKING BRAKE SWITCH

Check the parking brake switch. Refer to [MWI-93, "Component Inspection"](#).

Is the inspection result normal?

- YES >> Replace combination meter. Refer to [MWI-102, "Removal and Installation"](#).
NO >> Replace parking brake switch. Refer to [PB-8, "Exploded View"](#).

NORMAL OPERATING CONDITION

< SYMPTOM DIAGNOSIS >

NORMAL OPERATING CONDITION INFORMATION DISPLAY

INFORMATION DISPLAY : Description

INFOID:0000000010122443

OUTSIDE AIR TEMPERATURE

The displayed outside air temperature display may differ from the actual temperature because it is a corrected value calculated from the outside air temperature sensor signal by the combination meter. Refer to [MWI-29, "OUTSIDE AIR TEMPERATURE DISPLAY : System Description"](#) for details on the correction process.

A
B
C
D
E
F
G
H
I
J
K
L
M
O
P

MWI

COMBINATION METER

< REMOVAL AND INSTALLATION >

REMOVAL AND INSTALLATION

COMBINATION METER

Exploded View

INFOID:000000010122444

REMOVAL

Refer to [IP-16. "Exploded View"](#).

DISASSEMBLY

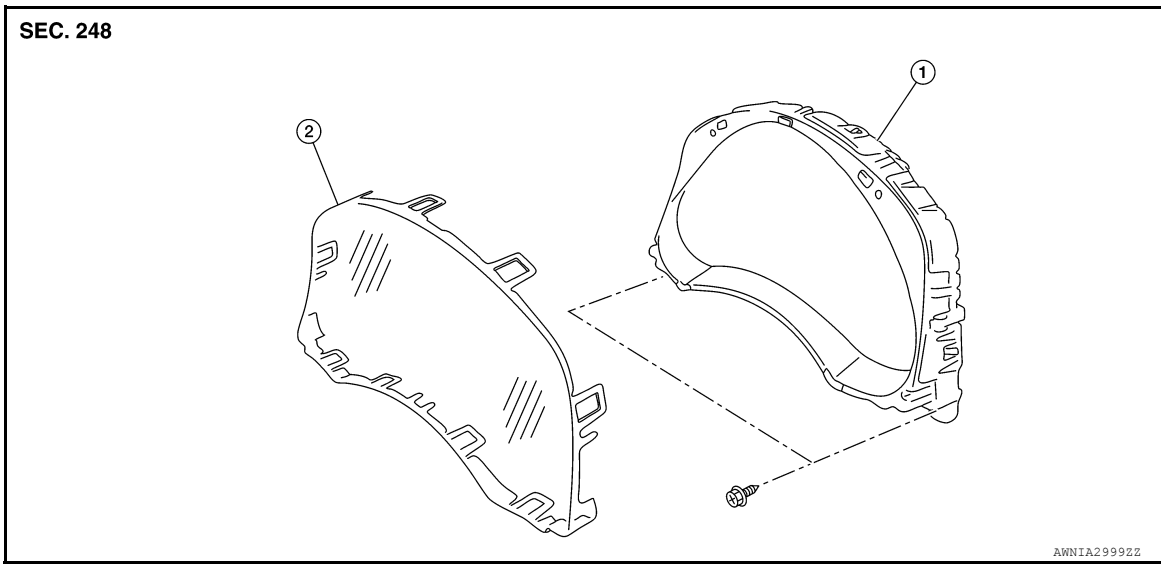

1. Unified meter control unit

2. Front cover

Removal and Installation

INFOID:000000010122445

REMOVAL

1. Remove the upper meter. Refer to [MWI-103. "Removal and Installation"](#).
2. Remove the cluster lid A. Refer to [IP-17. "Removal and Installation"](#).
3. Remove screws and connector, and then remove combination meter.

INSTALLATION

Install in the reverse order of removal.

Disassembly and Assembly

INFOID:000000010122446

DISASSEMBLY

Disengage the tabs to separate front cover.

ASSEMBLY

Assemble in the reverse order of disassembly.

UPPER METER

< REMOVAL AND INSTALLATION >

UPPER METER

Exploded View

INFOID:000000010122447

REMOVAL

Refer to [IP-16. "Exploded View"](#).

DISASSEMBLY

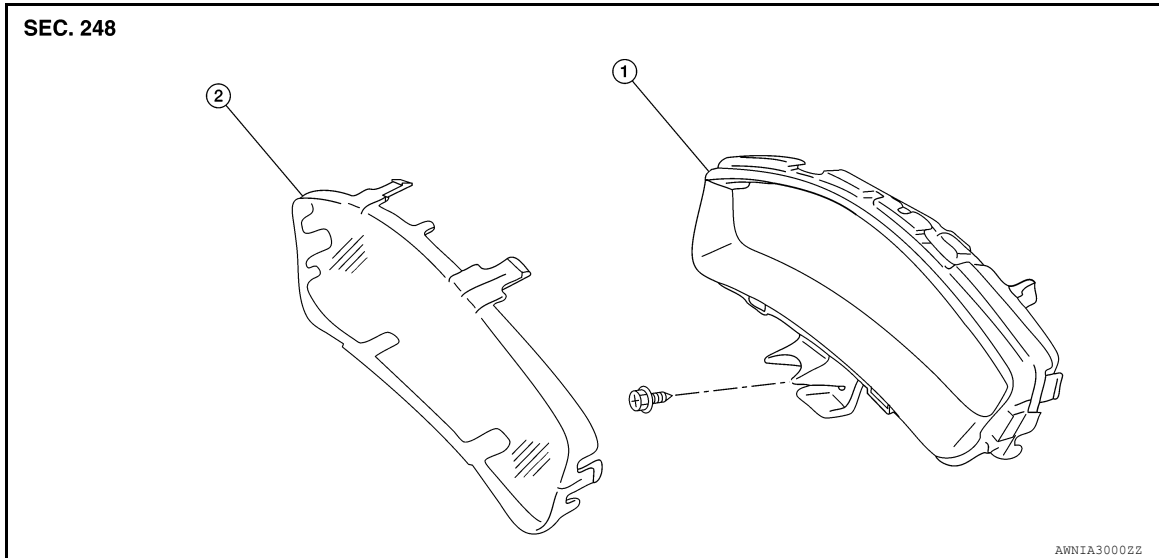

1. Upper meter

2. Front cover

Removal and Installation

INFOID:000000010122448

REMOVAL

1. Remove the cluster lid finisher. Refer to [IP-17. "Removal and Installation"](#).
2. Remove screws and connector, and then remove upper meter.

INSTALLATION

Install in the reverse order of removal.

Disassembly and Assembly

INFOID:000000010122449

DISASSEMBLY

Disengage the tabs to separate front cover.

ASSEMBLY

Assemble in the reverse order of disassembly.

A
B
C
D
E
F
G
H
I
J
K
L
M
O
P

MWI

METER CONTROL SWITCH

< REMOVAL AND INSTALLATION >

METER CONTROL SWITCH

Exploded View

INFOID:000000010122450

REMOVAL

Refer to [IP-16. "Exploded View"](#).

DISASSEMBLY

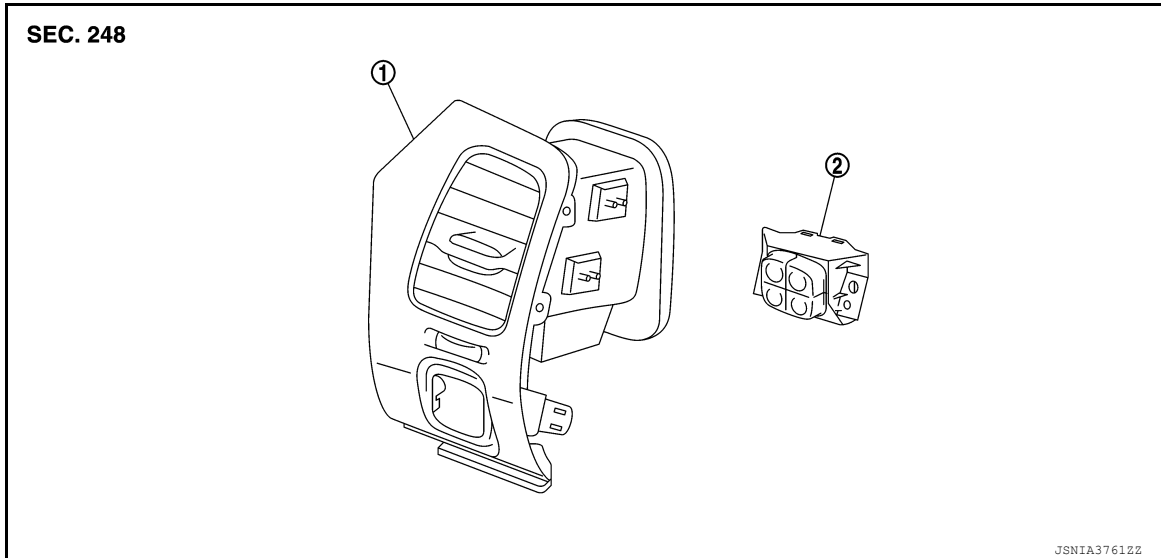

1. Side ventilator grille LH

2. Meter control switch

Removal and Installation

INFOID:000000010122451

REMOVAL

1. Remove side ventilator grille LH. Refer to [IP-17. "Removal and Installation"](#).
2. Remove connector.
3. Remove screws, and then remove meter control switch.

INSTALLATION

Install in the reverse order of removal.