

SECTION **SEC**

SECURITY CONTROL SYSTEM

A
B
C
D
E
F
G
H
I
J
L
M
N
O
P

CONTENTS

<p>WITH INTELLIGENT KEY SYSTEM</p> <p>PRECAUTION 4</p> <p>PRECAUTIONS 4</p> <p style="padding-left: 20px;">Precaution for Technicians Using Medical Electric.....4</p> <p style="padding-left: 20px;">Precaution for Removing 12V Battery4</p> <p style="padding-left: 20px;">Precaution for Procedure without Cowl Top Cover.....5</p> <p style="padding-left: 20px;">Precaution for Supplemental Restraint System (SRS) "AIR BAG" and "SEAT BELT PRE-TENSIONER"5</p> <p style="padding-left: 20px;">Point to Be Checked Before Starting Maintenance Work5</p> <p>PREPARATION 7</p> <p>PREPARATION 7</p> <p style="padding-left: 20px;">Special Service Tools7</p> <p style="padding-left: 20px;">Commercial Service Tools7</p> <p>SYSTEM DESCRIPTION 9</p> <p>COMPONENT PARTS 9</p> <p style="padding-left: 20px;">Component Parts Location9</p> <p style="padding-left: 20px;">NATS Antenna Amp.11</p> <p>SYSTEM12</p> <p>INTELLIGENT KEY SYSTEM/READY SET FUNCTION 12</p> <p style="padding-left: 20px;">INTELLIGENT KEY SYSTEM/READY SET FUNCTION : System Description 12</p> <p>NISSAN VEHICLE IMMOBILIZER SYSTEM-NATS... 14</p> <p style="padding-left: 20px;">NISSAN VEHICLE IMMOBILIZER SYSTEM-NATS : System Description 15</p> <p>VEHICLE SECURITY SYSTEM17</p> <p style="padding-left: 20px;">VEHICLE SECURITY SYSTEM : System Description (Except for Canada) 18</p> <p style="padding-left: 20px;">VEHICLE SECURITY SYSTEM : System Description (For Canada)21</p>	<p>DIAGNOSIS SYSTEM (BCM)26</p> <p>COMMON ITEM26</p> <p style="padding-left: 20px;">COMMON ITEM : CONSULT Function (BCM - COMMON ITEM)26</p> <p>INTELLIGENT KEY26</p> <p style="padding-left: 20px;">INTELLIGENT KEY : CONSULT Function (BCM - INTELLIGENT KEY)27</p> <p>THEFT ALM29</p> <p style="padding-left: 20px;">THEFT ALM : CONSULT Function (BCM - THEFT)29</p> <p>IMMU30</p> <p style="padding-left: 20px;">IMMU : CONSULT Function (BCM - IMMU)30</p> <p>DIAGNOSIS SYSTEM (IPDM E/R)31</p> <p style="padding-left: 20px;">CONSULT Function (IPDM E/R)31</p> <p>ECU DIAGNOSIS INFORMATION33</p> <p>VCM, IPDM E/R, BCM33</p> <p style="padding-left: 20px;">List of ECU Reference33</p> <p>WIRING DIAGRAM34</p> <p>INTELLIGENT KEY SYSTEM/ENGINE START FUNCTION34</p> <p style="padding-left: 20px;">Wiring Diagram34</p> <p>NVIS42</p> <p style="padding-left: 20px;">Wiring Diagram42</p> <p>VEHICLE SECURITY SYSTEM50</p> <p style="padding-left: 20px;">Wiring Diagram50</p> <p>BASIC INSPECTION62</p> <p>DIAGNOSIS AND REPAIR WORK FLOW62</p> <p style="padding-left: 20px;">Work Flow62</p> <p>ADDITIONAL SERVICE WHEN REPLACING CONTROL UNIT65</p>
---	---

SEC

VCM	65	B2602 SHIFT POSITION	86
VCM : Description	65	DTC Logic	86
VCM : Work Procedure	65	Diagnosis Procedure	86
BCM	65	B2603 SHIFT POSITION	88
BCM : Description	65	DTC Logic	88
BCM : Work Procedure	65	Diagnosis Procedure	88
DTC/CIRCUIT DIAGNOSIS	67	B2604 SHIFT POSITION	90
P1610 LOCK MODE	67	DTC Logic	90
Description	67	Diagnosis Procedure	90
DTC Logic	67	B2617 READY SIGNAL CIRCUIT	92
Diagnosis Procedure	67	DTC Logic	92
P1611 ID DISCORD, IMMU-VCM	68	Diagnosis Procedure	92
DTC Logic	68	B261A POWER SWITCH	94
Diagnosis Procedure	68	DTC Logic	94
P1612 CHAIN OF VCM-IMMU	69	Diagnosis Procedure	94
DTC Logic	69	B261E VEHICLE TYPE	96
Diagnosis Procedure	69	Description	96
B2192 ID DISCORD, IMMU-ECM	70	DTC Logic	96
DTC Logic	70	Diagnosis Procedure	96
Diagnosis Procedure	70	B26F7 BCM	97
B2193 CHAIN OF ECM-IMMU	71	DTC Logic	97
DTC Logic	71	Diagnosis Procedure	97
Diagnosis Procedure	71	B26FC KEY REGISTRATION	98
B2195 ANTI-SCANNING	72	DTC Logic	98
DTC Logic	72	Diagnosis Procedure	98
Diagnosis Procedure	72	HEADLAMP FUNCTION	99
B2196 DONGLE UNIT	73	Component Function Check	99
Description	73	Diagnosis Procedure	99
DTC Logic	73	HOOD SWITCH	100
Diagnosis Procedure	73	Component Function Check	100
B2198 NATS ANTENNA AMP.	75	Diagnosis Procedure	100
DTC Logic	75	Component Inspection	101
Diagnosis Procedure	75	HORN FUNCTION	102
B2555 STOP LAMP	78	Component Function Check	102
DTC Logic	78	Diagnosis Procedure	102
Diagnosis Procedure	78	SECURITY INDICATOR LAMP	103
Component Inspection	79	Component Function Check	103
B2556 POWER SWITCH	81	Diagnosis Procedure	103
DTC Logic	81	SYMPTOM DIAGNOSIS	105
Diagnosis Procedure	81	VEHICLE CANNOT BE SET TO READY	
Component Inspection	82	WHEN INTELLIGENT KEY IS INSIDE OF VE-	
B2557 VEHICLE SPEED	83	HICLE	105
DTC Logic	83	Description	105
Diagnosis Procedure	83	Diagnosis Procedure	105
B2601 SHIFT POSITION	84	SECURITY INDICATOR LAMP DOES NOT	
DTC Logic	84	TURN ON OR BLINK	106
Diagnosis Procedure	84	Description	106
		Diagnosis Procedure	106

VEHICLE SECURITY SYSTEM CANNOT BE SET	107	DOOR LOCK AND UNLOCK SWITCH : Diagnosis Procedure (Except for Canada)	109	A
INTELLIGENT KEY	107	DOOR LOCK AND UNLOCK SWITCH : Diagnosis Procedure (For Canada)	110	B
INTELLIGENT KEY : Description	107	VEHICLE SECURITY ALARM DOES NOT ACTIVATE	111	C
INTELLIGENT KEY : Diagnosis Procedure (Except for Canada)	107	Description	111	D
INTELLIGENT KEY : Diagnosis Procedure (For Canada)	107	Diagnosis Procedure (Except for Canada)	111	E
DOOR REQUEST SWITCH	107	Diagnosis Procedure (For Canada)	111	F
DOOR REQUEST SWITCH : Description	107	REMOVAL AND INSTALLATION	113	G
DOOR REQUEST SWITCH : Diagnosis Procedure (Except for Canada)	108	NATS ANTENNA AMP.	113	H
DOOR REQUEST SWITCH : Diagnosis Procedure (For Canada)	108	Removal and Installation	113	I
DOOR KEY CYLINDER	108	POWER SWITCH	114	J
DOOR KEY CYLINDER : Description	108	Removal and Installation	114	
DOOR KEY CYLINDER : Diagnosis Procedure (Except for Canada)	109	VEHICLE SECURITY HORN	115	
DOOR KEY CYLINDER : Diagnosis Procedure (For Canada)	109	Removal and Installation	115	
DOOR LOCK AND UNLOCK SWITCH	109	HOOD SWITCH	116	
DOOR LOCK AND UNLOCK SWITCH : Description	109	Removal and Installation	116	
		DONGLE UNIT	117	
		Removal and Installation	117	

SEC

PRECAUTION

PRECAUTIONS

Precaution for Technicians Using Medical Electric

INFOID:000000010119221

OPERATION PROHIBITION

WARNING:

- Parts with strong magnet is used in this vehicle.
- Technicians using a medical electric device such as pacemaker must never perform operation on the vehicle, as magnetic field can affect the device function by approaching to such parts.

NORMAL CHARGE PRECAUTION

WARNING:

- If a technician uses a medical electric device such as an implantable cardiac pacemaker or an implantable cardioverter defibrillator, the possible effects on the devices must be checked with the device manufacturer before starting the charge operation.
- As radiated electromagnetic wave generated by PDM (Power Delivery Module) at normal charge operation may affect medical electric devices, a technician using a medical electric device such as implantable cardiac pacemaker or an implantable cardioverter defibrillator must not approach motor room [PDM (Power Delivery Module)] at the hood-opened condition during normal charge operation.

PRECAUTION AT TELEMATICS SYSTEM OPERATION

WARNING:

- If a technician uses implantable cardiac pacemaker or implantable cardioverter defibrillator (ICD), avoid the device implanted part from approaching within approximately 220 mm (8.66 in) from interior/exterior antenna.
- The electromagnetic wave of TCU might affect the function of the implantable cardiac pacemaker or the implantable cardioverter defibrillator (ICD), when using the service, etc.
- If a technician uses other medical electric devices than implantable cardiac pacemaker or implantable cardioverter defibrillator (ICD), the electromagnetic wave of TCU might affect the function of the device. The possible effects on the devices must be checked with the device manufacturer before TCU use.

PRECAUTION AT INTELLIGENT KEY SYSTEM OPERATION

WARNING:

- If a technician uses implantable cardiac pacemaker or implantable cardioverter defibrillator (ICD), avoid the device implanted part from approaching within approximately 220 mm (8.66 in) from interior/exterior antenna.
- The electromagnetic wave of Intelligent Key might affect the function of the implantable cardiac pacemaker or the implantable cardioverter defibrillator (ICD), at door operation, at each request switch operation, or at engine starting.
- If a technician uses other medical electric devices than implantable cardiac pacemaker or implantable cardioverter defibrillator (ICD), the electromagnetic wave of Intelligent Key might affect the function of the device. The possible effects on the devices must be checked with the device manufacturer before Intelligent Key use.

Precaution for Removing 12V Battery

INFOID:000000010119222

1. Check that EVSE is not connected.

NOTE:

If EVSE is connected, the air conditioning system may be automatically activated by the timer A/C function.

2. Turn the power switch OFF → ON → OFF. Get out of the vehicle. Close all doors (including back door).
3. Check that the charge status indicator lamp does not blink and wait for 5 minutes or more.

NOTE:

If the battery is removed within 5 minutes after the power switch is turned OFF, plural DTCs may be detected.

4. Remove 12V battery within 1 hour after turning the power switch OFF → ON → OFF.

NOTE:

PRECAUTIONS

[WITH INTELLIGENT KEY SYSTEM]

< PRECAUTION >

- The 12V battery automatic charge control may start automatically even when the power switch is in OFF state.
- Once the power switch is turned ON → OFF, the 12V battery automatic charge control does not start for approximately 1 hour.

CAUTION:

- After all doors (including back door) are closed, if a door (including back door) is opened before battery terminals are disconnected, start over from Step 1.
- After turning the power switch OFF, if "Remote A/C" is activated by user operation, stop the air conditioner and start over from Step 1.

Precaution for Procedure without Cowl Top Cover

INFOID:000000010119223

When performing the procedure after removing cowl top cover, cover the lower end of windshield with urethane, etc to prevent damage to windshield.

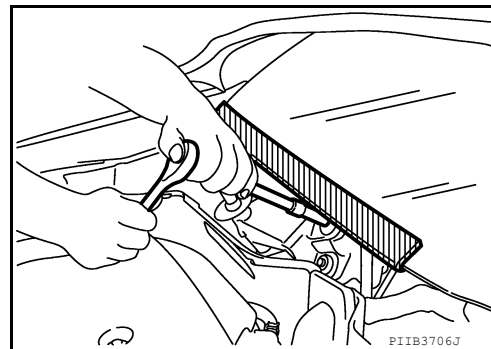

Precaution for Supplemental Restraint System (SRS) "AIR BAG" and "SEAT BELT PRE-TENSIONER"

INFOID:000000010119224

The Supplemental Restraint System such as "AIR BAG" and "SEAT BELT PRE-TENSIONER", used along with a front seat belt, helps to reduce the risk or severity of injury to the driver and front passenger for certain types of collision. This system includes seat belt switch inputs and dual stage front air bag modules. The SRS system uses the seat belt switches to determine the front air bag deployment, and may only deploy one front air bag, depending on the severity of a collision and whether the front occupants are belted or unbelted. Information necessary to service the system safely is included in the SR and SB section of this Service Manual.

WARNING:

- To avoid rendering the SRS inoperative, which could increase the risk of personal injury or death in the event of a collision which would result in air bag inflation, all maintenance must be performed by an authorized NISSAN/INFINITI dealer.
- Improper maintenance, including incorrect removal and installation of the SRS, can lead to personal injury caused by unintentional activation of the system. For removal of Spiral Cable and Air Bag Module, see the SR section.
- Do not use electrical test equipment on any circuit related to the SRS unless instructed to in this Service Manual. SRS wiring harnesses can be identified by yellow and/or orange harnesses or harness connectors.

PRECAUTIONS WHEN USING POWER TOOLS (AIR OR ELECTRIC) AND HAMMERS

WARNING:

- When working near the Airbag Diagnosis Sensor Unit or other Airbag System sensors with the Ignition ON or engine running, DO NOT use air or electric power tools or strike near the sensor(s) with a hammer. Heavy vibration could activate the sensor(s) and deploy the air bag(s), possibly causing serious injury.
- When using air or electric power tools or hammers, always switch the Ignition OFF, disconnect the battery and wait at least three minutes before performing any service.

Point to Be Checked Before Starting Maintenance Work

INFOID:000000010119225

The high voltage system may start automatically. It is required to check that the timer air conditioner and timer charge (during EVSE connection) are not set before starting maintenance work.

NOTE:

PRECAUTIONS

< PRECAUTION >

[WITH INTELLIGENT KEY SYSTEM]

If the timer air conditioner or timer charge (during EVSE connection) is set, the high voltage system starts automatically even when the power switch is in OFF state.

PREPARATION

< PREPARATION >

[WITH INTELLIGENT KEY SYSTEM]

PREPARATION

PREPARATION

Special Service Tools

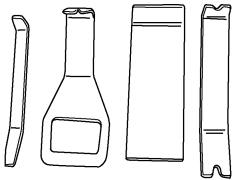

INFOID:000000010119226

The actual shape of the tools may differ from those illustrated here.

Tool number (TechMate No.) Tool name	Description
<p>— (J-46534) Trim Tool Set</p>  <p style="text-align: center;">AWJIA0463ZZ</p>	<p>Removing trim components</p>

Commercial Service Tools

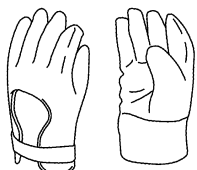

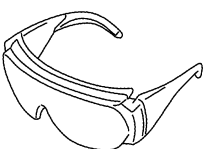
INFOID:000000010119227

(TechMate No.) Tool name	Description
<p>Insulated gloves [Guaranteed insulation performance for 1000V/300A]</p>  <p style="text-align: center;">JMCIA0149ZZ</p>	<p>Removing and installing high voltage components</p>
<p>Leather gloves [Use leather gloves that can fasten the wrist tight]</p>  <p style="text-align: center;">JPCIA0066ZZ</p>	<ul style="list-style-type: none"> • Removing and installing high voltage components • Protect insulated gloves
<p>Insulated safety shoes</p>  <p style="text-align: center;">JPCIA0011ZZ</p>	<p>Removing and installing high voltage components</p>
<p>Safety glasses [ANSI Z87.1]</p>  <p style="text-align: center;">JPCIA0012ZZ</p>	<ul style="list-style-type: none"> • Removing and installing high voltage components • To protect eye from the spatter on the work to electric line

PREPARATION

< PREPARATION >

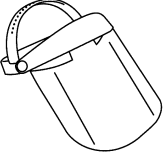
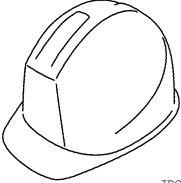
[WITH INTELLIGENT KEY SYSTEM]

(TechMate No.) Tool name	Description
Face shield  JPCIA0167ZZ	<ul style="list-style-type: none">• Removing and installing high voltage components• To protect eye from the spatter on the work to electric line
Insulated helmet  JPCIA0013ZZ	Removing and installing high voltage components
Power tool  PIIB1407E	Loosening nuts, screws and bolts

COMPONENT PARTS

< SYSTEM DESCRIPTION >

[WITH INTELLIGENT KEY SYSTEM]

SYSTEM DESCRIPTION

COMPONENT PARTS

Component Parts Location

INFOID:0000000010119228

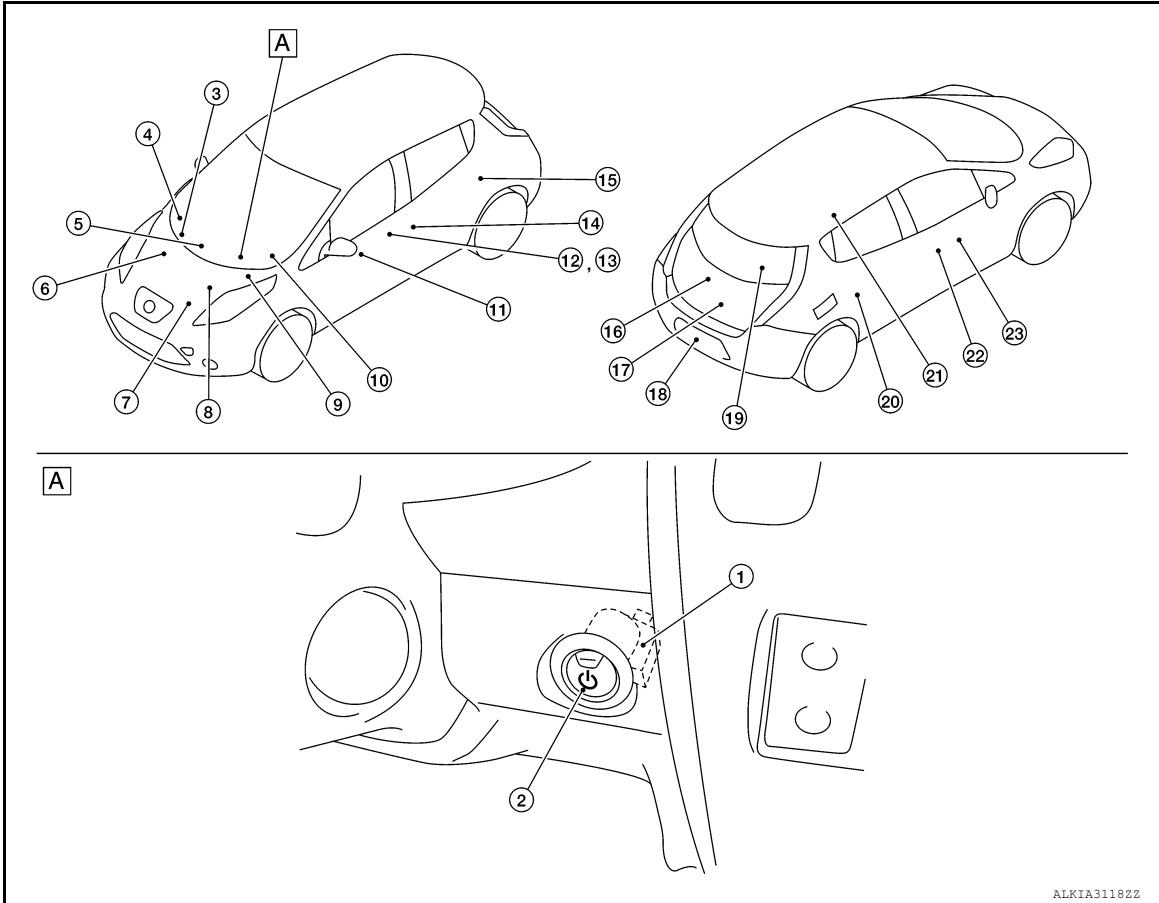

A. Behind power switch

No.	Component	Function
1.	NATS antenna amp.	SEC-11. "NATS Antenna Amp."
2.	Power switch	Power switch has push switch inside which detects that power switch is pressed, and then transmits the signal to BCM. BCM changes the power supply position with the operation of power switch. BCM maintains the power supply position status while power switch is not operated. Refer to PCS-34. "Power Switch" for detailed installation location.
3.	BCM	BCM controls INTELLIGENT KEY SYSTEM (READY SET FUNCTION), NISSAN VEHICLE IMMOBILIZER SYSTEM-NATS [NVIS (NATS)] and VEHICLE SECURITY SYSTEM. BCM performs the ID verification between BCM and Intelligent Key when the Intelligent Key is carried into the detection area of inside key antenna, and power switch is pressed. If the ID verification result is OK, power switch operation is available. Then, when the power switch is turned to the ON position, BCM performs ID verification between BCM and VCM. If the ID verification result is OK, vehicle can be set to READY. Refer to BCS-5. "BODY CONTROL SYSTEM : Component Parts Location" for detailed installation location.
4.	Remote keyless entry receiver	Remote keyless entry receiver receives each button operation signal and electronic key ID signal from Intelligent Key, and then transmits the signal to BCM. Refer to DLK-18. "Remote Keyless Entry Receiver" for detailed installation location.

A
B
C
D
E
F
G
H
I
J
L
M
N
O
P

SEC

COMPONENT PARTS

< SYSTEM DESCRIPTION >

[WITH INTELLIGENT KEY SYSTEM]

No.	Component	Function
5.	Inside key antenna (Instrument center)	Inside key antenna (Instrument center) detects whether Intelligent Key is inside the vehicle or not, and transmits the signal to BCM. Refer to DLK-17, "Inside Key Antenna (Instrument Center)" for detailed installation location.
6.	VCM	<ul style="list-style-type: none"> • VCM controls the vehicle. When power switch is turned to the ON position, BCM starts communication with VCM and performs the ID verification between BCM and VCM. If the verification result is OK, the vehicle can be set to READY. If the verification result is NG, the vehicle can not be set to READY. • VCM detects the shift position, and then transmits the P position signal to BCM and IPDM E/R. And VCM transmits the P/N position signal to BCM. • BCM confirms the shift position with the following 4 signals. <ul style="list-style-type: none"> - P position signal from electric shift selector - P/N position signal from electric shift selector - P position signal from IPDM E/R (CAN) Refer to EVC-15, "Component Parts Location" for detailed installation location.
7.	Stop lamp switch	Stop lamp switch detects that brake pedal is depressed, and then transmits the signal to BCM. Refer to BRC-10, "Component Parts Location" for detailed installation location.
8.	ABS actuator and electric unit (control unit)	ABS actuator and electric unit (control unit) transmits the vehicle speed signal to BCM via CAN communication. BCM also receives the vehicle speed signal from combination meter via CAN communication. BCM compares both signals to detect the vehicle speed. Refer to BRC-10, "Component Parts Location" for detailed installation location.
9.	IPDM E/R	IPDM E/R has headlamp relays inside. Headlamp relays are used for the vehicle security function. IPDM E/R controls these relays while communicating with BCM. When IPDM E/R receives the alarm request signal from BCM, IPDM E/R activates vehicle security horn and headlamps intermittently. Refer to PCS-6, "Component Parts Location" for detailed installation location.
10.	Combination meter	Combination meter transmits the vehicle speed signal to BCM via CAN communication. BCM also receives the vehicle speed signal from ABS actuator and electric unit (control unit) via CAN communication. BCM compares both signals to detect the vehicle speed. Security indicator lamp is located on combination meter. Security indicator lamp blinks when power switch is in any position other than ON to warn that NISSAN VEHICLE IMMOBILIZER SYSTEM-NATS [NVIS (NATS)] is on board. Refer to MWI-6, "METER SYSTEM : Component Parts Location" for detailed installation location.
11.	Door lock and unlock switch	Door lock and unlock switch is integrated into the main power window and lock/unlock switch and power window and door lock/unlock switch RH. Door lock and unlock switch transmits door lock/unlock operation signal to BCM. Refer to DLK-19, "Door Lock and Unlock Switch" for detailed installation location.
12.	Front outside handle LH	Outside key antenna and door request switch are integrated into the front outside handle LH. <ul style="list-style-type: none"> • Outside key antenna detects whether Intelligent Key is within the detection area or not, and then transmits signal to BCM. • Front door request switch transmits door lock/unlock request signal to BCM. • Refer to DLK-19, "Front Door Request Switch (LH)" and DLK-18, "Outside Key Antenna (LH)" for detailed installation location.
13.	Door key cylinder switch	Door key cylinder switch is integrated into front door lock assembly (LH). Door key cylinder switch detects door LOCK/UNLOCK operation using mechanical key, and then transmits door lock/unlock operation signal to BCM. Refer to DLK-15, "Component Parts Location" for detailed installation location.
14.	Front door switch (LH)	Door switch detects door open/close condition, and then transmits ON/OFF signal to BCM. Refer to DLK-20, "Door Switch" for detailed installation location.
15.	Rear door switch LH	Door switch detects door open/close condition, and then transmits ON/OFF signal to BCM. Refer to DLK-20, "Door Switch" for detailed installation location.
16.	Back door opener switch assembly	Back door opener switch and back door request switch are integrated into back door switch assembly. <ul style="list-style-type: none"> • Back door opener switch transmits back door opening operation signal to BCM. • Back door request switch transmits door lock/unlock request signal to BCM. • Refer to DLK-20, "Back Door Opener Switch" and DLK-20, "Back Door Request Switch" for detailed installation location.

COMPONENT PARTS

< SYSTEM DESCRIPTION >

[WITH INTELLIGENT KEY SYSTEM]

No.	Component	Function
17.	Back door lock assembly	Back door switch is integrated into back door lock assembly. Back door switch detects back door open/close condition, and then transmits ON/OFF signal to BCM. Refer to DLK-19, "Back Door Lock Assembly" for detailed installation location.
18.	Outside key antenna (Rear bumper)	Outside key antenna (Rear bumper) detects whether Intelligent Key is within the detection area or not, and then transmits signal to BCM. Refer to DLK-17, "Outside Key Antenna (Rear Bumper)" for detailed installation location.
19.	Inside key antenna (Luggage room)	Inside key antenna (Luggage room) detects whether Intelligent Key is inside the vehicle or not, and transmits the signal to BCM. Refer to DLK-17, "Inside Key Antenna (Luggage Room)" for detailed installation location.
20.	Rear door switch RH	Door switch detects door open/close condition, and then transmits ON/OFF signal to BCM.
21.	Inside key antenna (Rear seat)	Inside key antenna (Rear seat) detects whether Intelligent Key is inside the vehicle or not, and then transmits the signal to BCM. Refer to DLK-17, "Inside Key Antenna (Rear Seat)" for detailed installation location.
22.	Front door switch (RH)	Door switch detects door open/close condition, and then transmits ON/OFF signal to BCM. Refer to DLK-20, "Door Switch" for detailed installation location.
23.	Front outside handle RH	Outside key antenna and door request switch are integrated into the front outside handle RH. <ul style="list-style-type: none"> • Outside key antenna detects whether Intelligent Key is within the detection area or not, and then transmits signal to BCM. • Front door request switch transmits door lock/unlock request signal to BCM. • Refer to DLK-20, "Front Door Request Switch (RH)" and DLK-18, "Outside Key Antenna (RH)" for detailed installation location.

NATS Antenna Amp.

INFOID:000000010119229

The ID verification is performed between BCM and transponder integrated into Intelligent Key via NATS antenna amp. when Intelligent Key backside is contacted to power switch in case that Intelligent Key battery is discharged. If the ID verification result is OK, the operation of power switch is available.

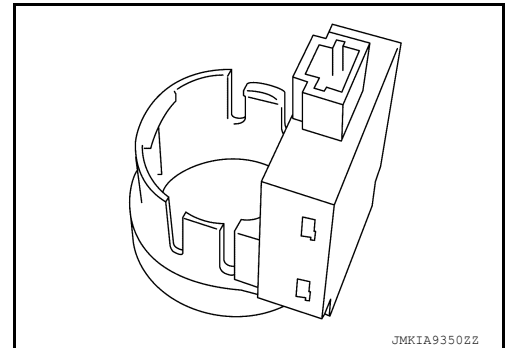

A
B
C
D
E
F
G
H
I
J
L
M
N
O
P

SEC

SYSTEM

[WITH INTELLIGENT KEY SYSTEM]

< SYSTEM DESCRIPTION >

SYSTEM

INTELLIGENT KEY SYSTEM/READY SET FUNCTION

INTELLIGENT KEY SYSTEM/READY SET FUNCTION : System Description

INFOID:000000010119230

SYSTEM DIAGRAM

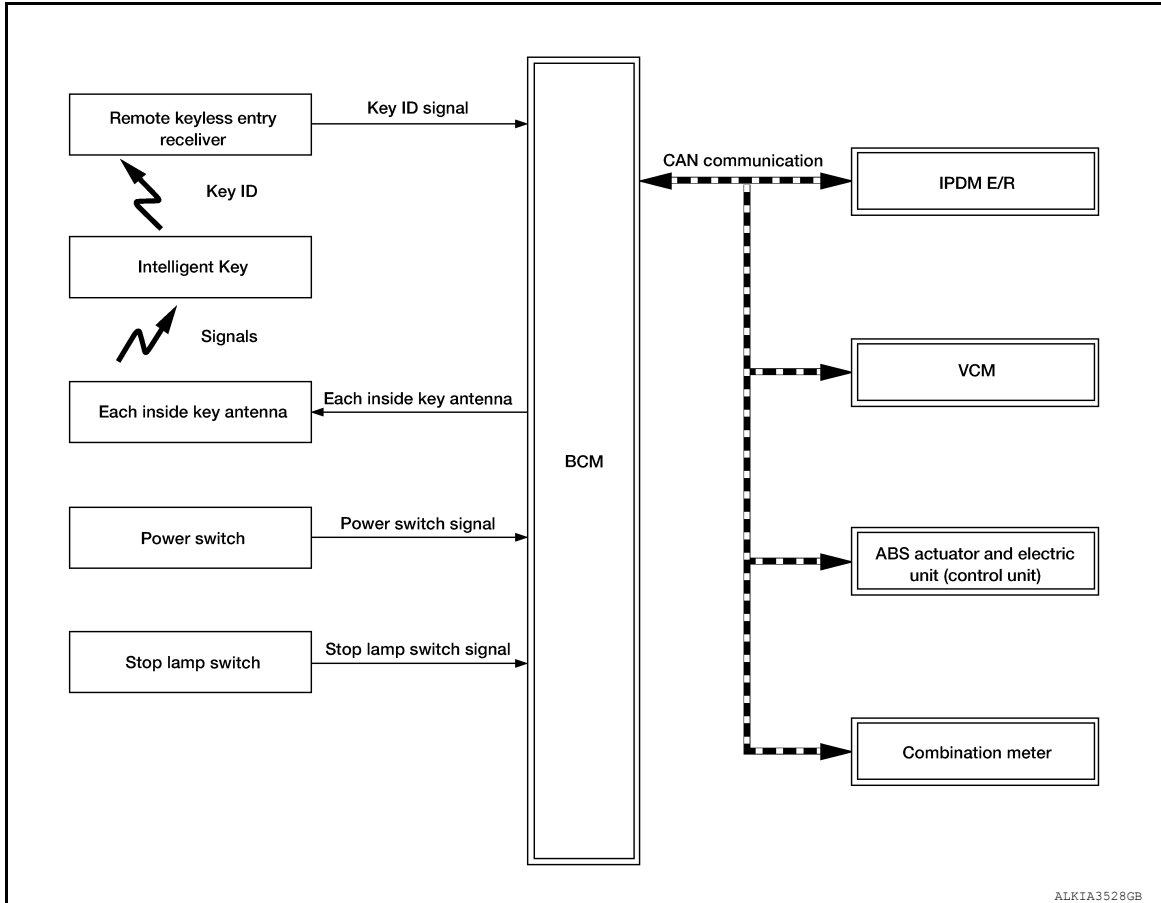

INPUT/OUTPUT SIGNAL CHART

Input Signal Item

Transmit unit	Signal name	
VCM	CAN communication	ID verification signal
		VCM status signal
		READY set signal
		Shift position signal
IPDM E/R		Power switch status signal
		P position signal
Combination meter		Vehicle speed signal
ABS actuator and electric unit (control unit)		Vehicle speed signal
Remote keyless entry receiver	Key ID signal	
Power switch	Power switch operation signal	
Stop lamp switch	Brake pedal operation signal	

Output Signal Item

SYSTEM

< SYSTEM DESCRIPTION >

[WITH INTELLIGENT KEY SYSTEM]

Reception unit	Signal name	
Combination meter	CAN communication	Key warning lamp signal
VCM		ID verification signal
	READY signal	
Inside key antenna	Key ID request signal	

SYSTEM DESCRIPTION

- The READY set function of Intelligent Key system makes it possible to set the vehicle to READY without using the key, based on the electronic ID verification. The electronic ID verification is performed between BCM and Intelligent Key when the power switch is pressed while the Intelligent Key is within the detection area of inside key antenna.

NOTE:

The driver should carry the Intelligent Key at all times.

- Intelligent Key has 2 IDs [Intelligent Key ID and NVIS (NATS) ID]. It can perform the door lock/unlock operation and the power switch operation when the registered Intelligent Key is carried.
- If the ID is successfully verified, power switch operation can be available and the vehicle can be set to READY.
- Up to 4 Intelligent Keys can be registered upon request from the customer.

NOTE:

Refer to [DLK-24. "INTELLIGENT KEY SYSTEM : System Description"](#) for any functions other than the READY set function of Intelligent Key system.

PRECAUTIONS FOR INTELLIGENT KEY SYSTEM

The transponder [the chip for NVIS (NATS) ID verification] is integrated into the Intelligent Key. Therefore, ID verification cannot be performed using mechanical key only.

When Intelligent Key battery is discharged, the NVIS (NATS) ID verification can be performed by operating power switch after contacting Intelligent Key backside to power switch. If verification result is OK, the vehicle can be set to READY.

OPERATION WHEN INTELLIGENT KEY IS CARRIED

1. When the power switch is pressed, BCM activates the inside key antenna and transmits the request signal to the Intelligent Key.
2. The Intelligent Key receives the request signal and transmits the Intelligent Key ID signal to BCM.
3. BCM receives the Intelligent Key ID signal via remote keyless entry receiver, and verifies it with the registered ID.
4. BCM turns ACC relay ON and transmits ON power supply signal to IPDM E/R if the verification results are OK.
5. IPDM E/R turns the ignition relay ON to start ON power supply.
6. BCM detects that the shift position and brake pedal operating condition.
7. BCM transmits READY signal to VCM if BCM judges that the READY set condition* is satisfied.
*: For READY set condition, refer to "READY SET CONDITION TABLE BY POWER SWITCH OPERATION" below.

NOTE:

- If a malfunction is detected in the Intelligent Key system, "I-KEY system fault" on information display appears. In this case, BCM does not transmits READY signal.
 - When the Intelligent Key is carried outside of the vehicle (inside key antenna detection area) while the power switch position is ACC or ON, BCM does not transmits READY signal even if READY set condition* is satisfied.
8. When BCM receives feedback signal from VCM indicating that the vehicle is set to READY, BCM stops transmitting READY signal.

OPERATION RANGE

Vehicle can be set to READY when Intelligent Key is inside the vehicle. However, sometimes vehicle may not be set to READY when Intelligent Key is on instrument panel or in glove box.

READY SET OPERATION WHEN INTELLIGENT KEY IS CONTACTED TO POWER SWITCH

SYSTEM

< SYSTEM DESCRIPTION >

[WITH INTELLIGENT KEY SYSTEM]

When Intelligent Key battery is discharged, the NVIS (NATS) ID verification between transponder integrated into Intelligent Key and BCM is performed when Intelligent Key backside is contacted to power switch. If the verification result is OK, vehicle can be set to READY.

READY SET CONDITION TABLE BY POWER SWITCH OPERATION

The vehicle can be set to READY by the following operations.

For details for the power supply position, refer to [PCS-35, "POWER DISTRIBUTION SYSTEM : System Description"](#).

NOTE:

- When an Intelligent Key is within the detection area of inside key antenna and when Intelligent Key backside is contacted to power switch, it is equivalent to the operations below.
- When setting the vehicle to READY, the BCM monitors READY set conditions,
 - Brake pedal operating condition
 - Shift position
 - Vehicle speed

Vehicle speed: less than 4 km/h (2.5 MPH)

	Vehicle condition		Power switch operation frequency
	Shift position	Brake pedal operation condition	
OFF → ACC	—	Not depressed	1
OFF → ACC → ON	—	Not depressed	2
OFF → ACC → ON → OFF	—	Not depressed	3
OFF → READY ACC → READY ON → READY	P or N	Depressed	1
READY → OFF	—	—	1

Vehicle speed: 4 km/h (2.5 MPH) or more

	Vehicle condition		Power switch operation frequency
	Shift position	Brake pedal operation condition	
READY → ACC	—	—	Emergency stop operation
ACC → READY (Return operation after emergency stop operation while driving)	N position	—	1

Emergency stop operation

- Press and hold the power switch for 2 seconds or more.
- Press the power switch 3 times or more within 1.5 seconds.

NISSAN VEHICLE IMMOBILIZER SYSTEM-NATS

SYSTEM

< SYSTEM DESCRIPTION >

[WITH INTELLIGENT KEY SYSTEM]

NISSAN VEHICLE IMMOBILIZER SYSTEM-NATS : System Description

INFOID:000000010119231

SYSTEM DIAGRAM

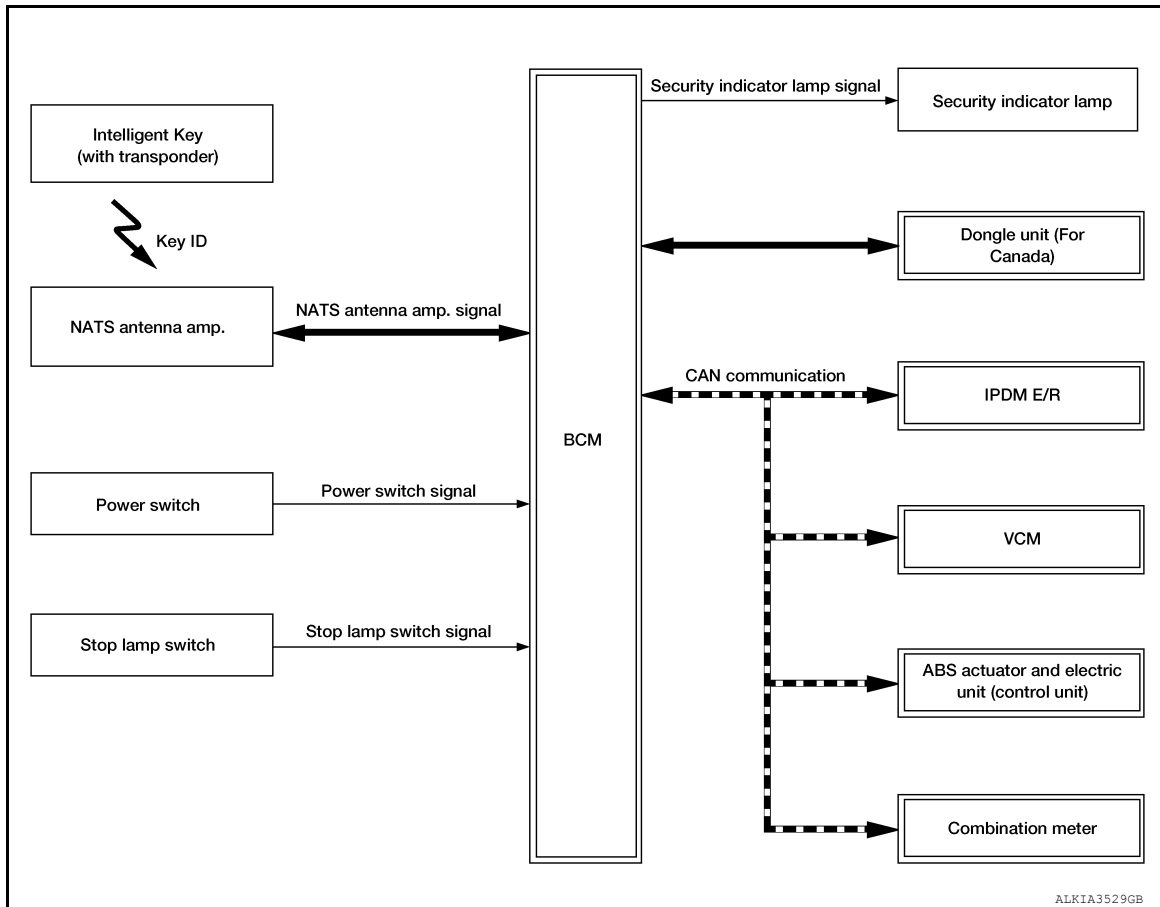

INPUT/OUTPUT SIGNAL CHART

Input Signal Item

Transmit unit	Signal name	
VCM	CAN communication	ID verification signal VCM status signal READY set signal Shift position signal
IPDM E/R		Power switch status signal P position signal
Combination meter		Vehicle speed signal
ABS actuator and electric unit (control unit)		Vehicle speed signal
NATS antenna amp.	Key ID signal	
Power switch	Power switch operation signal	
Stop lamp switch	Brake pedal operation signal	

Output Signal Item

Reception unit	Signal name	
VCM	CAN communication	ID verification signal
	READY signal	
Combination meter	Security indicator lamp signal	

SYSTEM DESCRIPTION

A
B
C
D
E
F
G
H
I
J

SEC

L
M
N
O
P

SYSTEM

< SYSTEM DESCRIPTION >

[WITH INTELLIGENT KEY SYSTEM]

- The NISSAN VEHICLE IMMOBILIZER SYSTEM-NATS [NVIS (NATS)] prevents the vehicle from being set to READY by Intelligent Key whose ID is not registered to the vehicle (BCM). It has higher protection against auto theft involving the duplication of mechanical keys.
- The mechanical key integrated into the Intelligent Key cannot set the vehicle to READY. When the Intelligent Key battery is discharged, the NVIS (NATS) ID verification is performed between the transponder integrated into Intelligent Key and BCM via NATS antenna amp. when the Intelligent Key backside is contacted to power switch. If the verification results are OK, the vehicle can be set to READY by the power switch operation.
- Security indicator lamp is located on combination meter, and always blinks when the power switch is in any position other than ON to warn that the vehicle is equipped with NVIS (NATS).
- Up to 4 Intelligent Keys can be registered upon request from the owner.
- When replacing VCM, BCM or Intelligent Key, the specified procedure (Initialization and registration) using CONSULT is required.
- Possible symptom of NVIS (NATS) malfunction is "Vehicle cannot be set to READY". This symptom also occurs because of other than NVIS (NATS) malfunction, so start the trouble diagnosis according to [SEC-62, "Work Flow"](#).
- If VCM other than genuine part is installed, the vehicle cannot be set to READY. For VCM replacement procedure, refer to [EVC-423, "Removal and Installation"](#).

PRECAUTIONS FOR KEY REGISTRATION

- When registering the Intelligent Key, perform the procedure following the instruction of CONSULT display.
- The ID registration procedure erases the current NVIS (NATS) ID once, and then reregisters a new ID. Therefore before starting the registration procedure, collect all registered Intelligent Keys from the customer.

SECURITY INDICATOR LAMP

Security indicator lamp always blinks when the power switch is in any position other than ON, to warn that the vehicle is equipped with NVIS (NATS).

NOTE:

Because security indicator lamp is highly efficient, the 12V battery is barely affected.

OPERATION WHEN INTELLIGENT KEY IS CONTACTED TO POWER SWITCH

1. When brake pedal is depressed while shift position is P, BCM activates NATS antenna amp. which is located behind power switch.
2. When Intelligent Key (transponder built-in) backside is contacted to power switch, BCM starts NVIS (NATS) ID verification between BCM and Intelligent Key (transponder built-in) via NATS antenna amp.
3. When the NVIS (NATS) ID verification result is OK, buzzer in combination meter sounds.
4. BCM turns ACC relay ON and transmits ON power supply signal to IPDM E/R.
5. IPDM E/R turns the ignition relay ON to start ON power supply.
6. BCM detects that the shift position and brake pedal operating position.
7. BCM transmits READY signal to VCM if BCM judges that the READY set condition* is satisfied.
*: For READY set condition, refer to "READY SET CONDITION TABLE BY POWER SWITCH OPERATION" below.
8. When BCM receives feedback signal from VCM indicating that the vehicle is set to READY, BCM stops transmitting READY signal.

READY SET CONDITION TABLE BY POWER SWITCH OPERATION

The vehicle can be set to READY by the following operations.

For details for the power supply position, refer to [PCS-35, "POWER DISTRIBUTION SYSTEM : System Description"](#).

NOTE:

- When an Intelligent Key is within the detection area of inside key antenna and when Intelligent Key backside is contacted to power switch, it is equivalent to the operations below.
- When setting the vehicle to READY, the BCM monitors READY set conditions,
 - Brake pedal operating condition
 - Shift position
 - Vehicle speed

Vehicle speed: less than 4 km/h (2.5 MPH)

SYSTEM

< SYSTEM DESCRIPTION >

[WITH INTELLIGENT KEY SYSTEM]

	Vehicle condition		Power switch operation frequency
	Shift position	Brake pedal operation condition	
OFF → ACC	—	Not depressed	1
OFF → ACC → ON	—	Not depressed	2
OFF → ACC → ON → OFF	—	Not depressed	3
OFF → READY ACC → READY ON → READY	P or N	Depressed	1
READY → OFF	—	—	1

Vehicle speed: 4 km/h (2.5 MPH) or more

	Vehicle condition		Power switch operation frequency
	Shift position	Brake pedal operation condition	
READY → ACC	—	—	Emergency stop operation
ACC → READY (Return operation after emergency stop operation while driving)	N position	—	1

Emergency stop operation

- Press and hold the power switch for 2 seconds or more.
- Press the power switch 3 times or more within 1.5 seconds.

VEHICLE SECURITY SYSTEM

A
B
C
D
E
F
G
H
I
J
L
M
N
O
P

SEC

SYSTEM

< SYSTEM DESCRIPTION >

[WITH INTELLIGENT KEY SYSTEM]

VEHICLE SECURITY SYSTEM : System Description (Except for Canada) INFOID:000000010119232

SYSTEM DIAGRAM

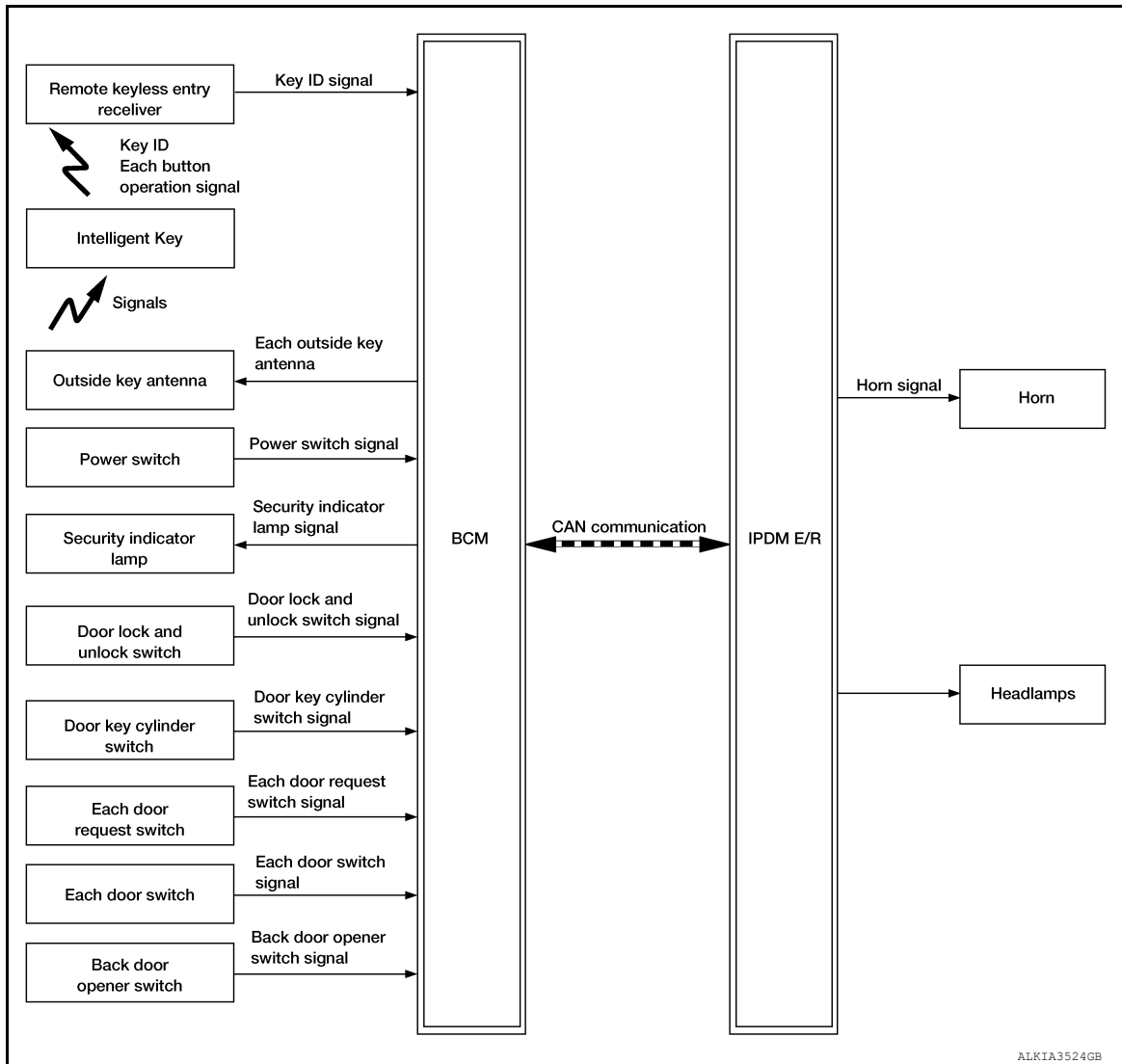

INPUT/OUTPUT SIGNAL CHART

Input Signal Item

Transmit unit	Signal name	
IPDM E/R	CAN communication	Power switch status signal
Remote keyless entry receiver	Key ID signal Intelligent Key button operation signal	
Power switch	Power switch operation signal	
Each door switch	Door open/close condition signal	
Each door request switch	Door lock/unlock request signal	
Back door opener switch	Back door opener operation signal	
Door key cylinder switch	Door key cylinder lock/unlock switch signal	
Door lock and unlock switch	Door lock/unlock switch operation signal	

Output Signal Item

SYSTEM

< SYSTEM DESCRIPTION >

[WITH INTELLIGENT KEY SYSTEM]

Reception unit	Signal name	
Combination meter	CAN communication	Security indicator lamp signal
IPDM E/R		Vehicle security horn request signal
		High beam request signal
Outside key antenna	Key ID request signal	

SYSTEM DESCRIPTION

- The vehicle security system has two alarm functions (theft warning alarm and panic alarm), and reduces the possibility of a theft or mischief by activating horns and headlamps intermittently.
 - The panic alarm does not start when the theft warning alarm is activating, and the panic alarm stops when the theft warning alarm is activated.
- The priority of the functions are as per the following.

Priority	Function
1	Theft warning alarm
2	Panic alarm

THEFT WARNING ALARM

- The theft warning alarm function activates horns and headlamps intermittently when BCM detects that any door is opened by unauthorized means, while the system is in the ARMED state.
- Security indicator lamp on combination meter always blinks when power supply position is any position other than ON. Security indicator lamp blinking warns that the vehicle is equipped with a vehicle security system.

Operation Flow

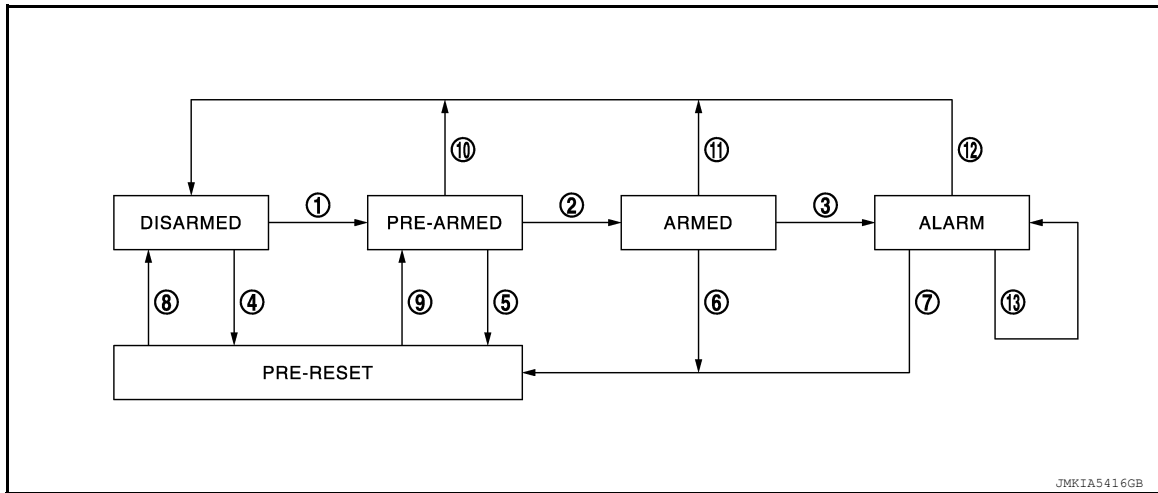

No.	System state	Switching condition	Switching condition	
			A	B
1	DISARMED to PRE-ARMED	When all conditions of A and one condition of B is satisfied.	<ul style="list-style-type: none"> Power switch: OFF All doors: Closed 	All doors are locked by: <ul style="list-style-type: none"> Door key cylinder LOCK switch LOCK button of Intelligent Key Door request switch Door lock and unlock switch
2	PRE-ARMED to ARMED	When all of the following conditions are satisfied for 30 seconds.	<ul style="list-style-type: none"> Power switch: OFF All doors: Locked 	
3	ARMED to ALARM	When all conditions of A and B are satisfied.	A	B
			Intelligent Key: Not used	<ul style="list-style-type: none"> Any door: Open

SYSTEM

< SYSTEM DESCRIPTION >

[WITH INTELLIGENT KEY SYSTEM]

No.	System state	Switching condition	
4	DISARMED to PRE-RESET	No conditions.	
5	PRE-ARMED to PRE-RESET		
6	ARMED to PRE-RESET		
7	ALARM to PRE-RESET		
8	PRE-RESET to DISARMED		
9	PRE-RESET to PRE-ARMED		
10	PRE-ARMED to DISARMED	When one of the following condition is satisfied.	<ul style="list-style-type: none"> • Power switch: ACC/ON • Door key cylinder UNLOCK switch: ON • UNLOCK button of Intelligent Key: ON • Door request switch: ON • Back door opener switch: ON • Any door: Open
11	ARMED to DISARMED	When one of the following condition is satisfied.	<ul style="list-style-type: none"> • Power switch: ACC/ON • Door key cylinder UNLOCK switch: ON • UNLOCK button of Intelligent Key: ON • Door request switch: ON • Back door opener switch: ON
12	ALARM to DISARMED		
13	RE-ALARM	When the following condition is satisfied after the ALARM operation is finished.	<ul style="list-style-type: none"> • Any door: Open

NOTE:

- BCM ignores the door key cylinder UNLOCK switch signal input for 1 second after the door key cylinder LOCK switch signal input.
- To lock/unlock all doors by operating remote controller button of Intelligent Key or door request switch, Intelligent Key must be within the detection area of outside key antenna. For details, refer to [DLK-25. "DOOR LOCK FUNCTION : System Description"](#).
- To open back door by operating back door opener switch, Intelligent Key must be within the detection area of outside key antenna. For details, refer to [DLK-25. "DOOR LOCK FUNCTION : System Description"](#).

DISARMED Phase

The vehicle security system is not set in the DISARMED phase. The vehicle security system stays in this phase while any door is open, because it is assumed that the owner is inside or nearby the vehicle. Security indicator lamp blinks every 2.4 seconds.

When the vehicle security system is reset, each phase switches to the DISARMED phase directly.

PRE-ARMED Phase

The PRE-ARMED phase is the transient state between the DISARMED phase and the ARMED phase. This phase is maintained for 30 seconds, so that the owner can reset the setting due to a mis-operation. This phase switches to the ARMED phase when vehicle conditions are not changed for 30 seconds. Security indicator lamp illuminates while being in this phase.

To reset the PRE-ARMED phase, refer to the switching condition of No. 10 in the table above.

ARMED Phase

The vehicle security system is set, and BCM monitors all necessary inputs. If any door is opened without using Intelligent Key, vehicle security system switches to the ALARM phase. Security indicator lamp blinks every 2.4 seconds.

To reset the ARMED phase, refer to the switching condition of No. 11 in the table above.

ALARM Phase

BCM transmits "Theft Warning Horn Request" signal and "High Beam Request" signal intermittently to IPDM E/R via CAN communication. In this phase, horns and headlamps are activated intermittently for approximately 50 seconds to warn that the vehicle is accessed by unauthorized means. ON/OFF timing of horns and headlamps are synchronized. After 50 seconds, the vehicle security system returns to the ARMED phase. At this time, if BCM still detects unauthorized access to the vehicle, the system is switched to the ALARM phase again. This RE-ALARM operation is carried out a maximum of 2 times.

SYSTEM

< SYSTEM DESCRIPTION >

[WITH INTELLIGENT KEY SYSTEM]

To cancel the ALARM operation, refer to the switching condition of No. 12 in the table above.

NOTE:

If a battery terminal is disconnected during the ALARM phase, theft warning alarm stops. But when the battery terminal is reconnected, theft warning alarm is activated again.

PRE-RESET Phase

The PRE-RESET phase is the transient state between each phase and DISARMED phase.

The PRE-RESET phase is not available for this models.

PANIC ALARM

- The panic alarm function activates horns and headlamps intermittently when the owner presses the PANIC ALARM button of Intelligent Key outside the vehicle while the power supply position is OFF.
- When BCM receives panic alarm signal from Intelligent Key, BCM transmits "Theft Warning Horn Request" signal and "High Beam Request" signal intermittently to IPDM E/R via CAN communication. To prevent the activation due to mis-operation of Intelligent Key by owner, the panic alarm function is activated when BCM receives the signal for 0.4 - 0.6 seconds.
- Panic alarm operation is maintained for 25 seconds.
- Panic alarm operation is cancelled when BCM receives one of the following signals.
 - LOCK button of Intelligent Key: ON
 - UNLOCK button of Intelligent Key: ON
 - PANIC ALARM button of Intelligent Key: Long pressed
 - Any door request switch: ON

VEHICLE SECURITY SYSTEM : System Description (For Canada)

INFOID:000000010119233

SYSTEM DIAGRAM

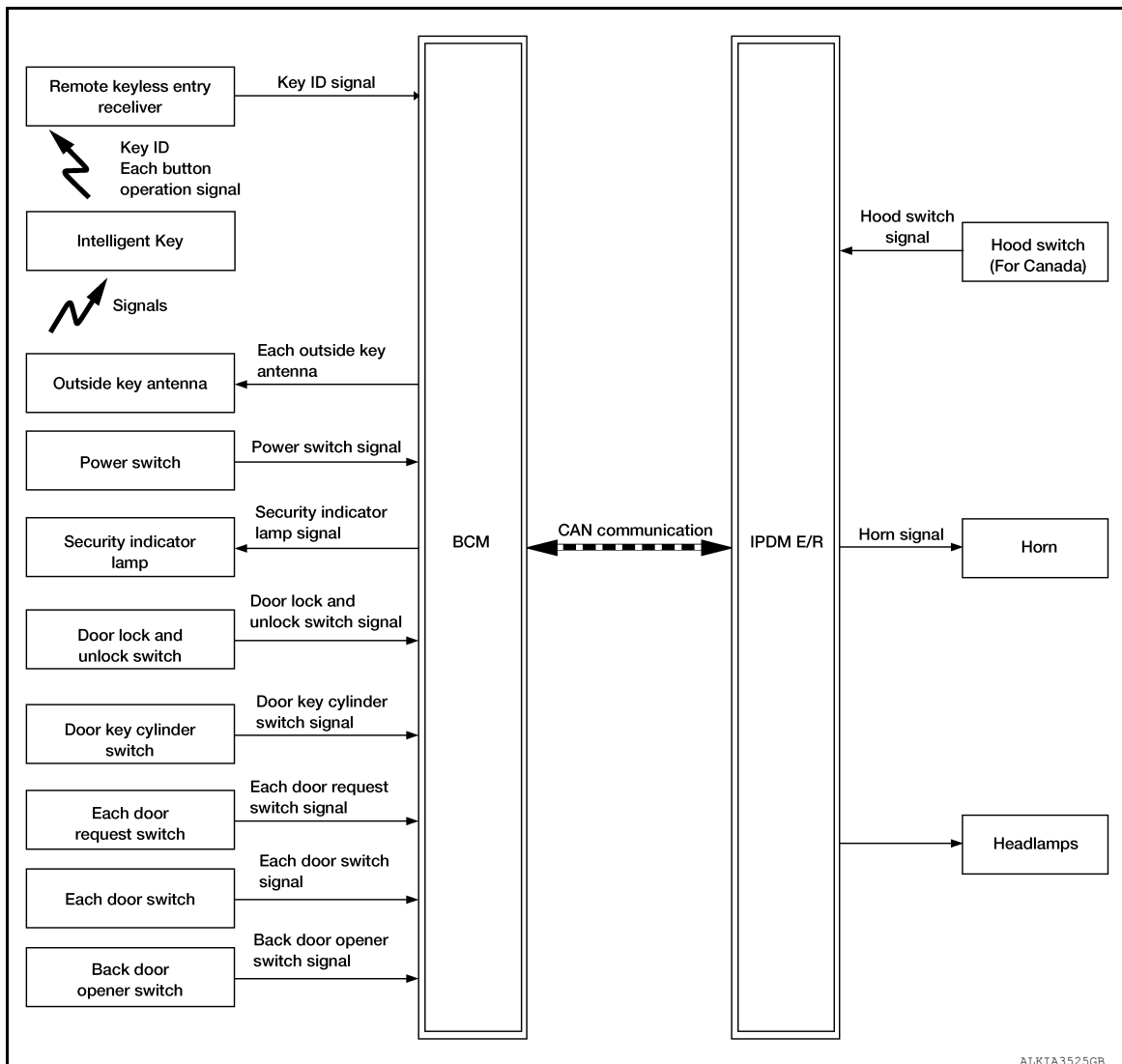

A
B
C
D
E
F
G
H
I
J
L
M
N
O
P

SEC

SYSTEM

< SYSTEM DESCRIPTION >

[WITH INTELLIGENT KEY SYSTEM]

INPUT/OUTPUT SIGNAL CHART

Input Signal Item

Transmit unit	Signal name	
IPDM E/R	CAN communication	Power switch status signal
Remote keyless entry receiver	Key ID signal Intelligent Key button operation signal	
Hood switch	CAN communication	Hood switch signal
Power switch	Power switch operation signal	
Each door switch	Door open/close condition signal	
Each door request switch	Door lock/unlock request signal	
Back door opener switch	Back door opener operation signal	
Door key cylinder switch	Door key cylinder lock/unlock switch signal	
Door lock and unlock switch	Door lock/unlock switch operation signal	

Output Signal Item

Reception unit	Signal name	
Combination meter	CAN communication	Security indicator lamp signal
IPDM E/R		Vehicle security horn request signal
		High beam request signal
Outside key antenna	Key ID request signal	

SYSTEM DESCRIPTION

- The vehicle security system has two alarm functions (theft warning alarm and panic alarm), and reduces the possibility of a theft or mischief by activating horns and headlamps intermittently.
- The panic alarm does not start when the theft warning alarm is activating, and the panic alarm stops when the theft warning alarm is activated.

The priority of the functions are as per the following.

Priority	Function
1	Theft warning alarm
2	Panic alarm

THEFT WARNING ALARM

- The theft warning alarm function activates horns and headlamps intermittently when BCM detects that any door or hood is opened by unauthorized means, while the system is in the ARMED state.
- Security indicator lamp on combination meter always blinks when power supply position is any position other than ON. Security indicator lamp blinking warns that the vehicle is equipped with a vehicle security system.

SYSTEM

< SYSTEM DESCRIPTION >

[WITH INTELLIGENT KEY SYSTEM]

Operation Flow

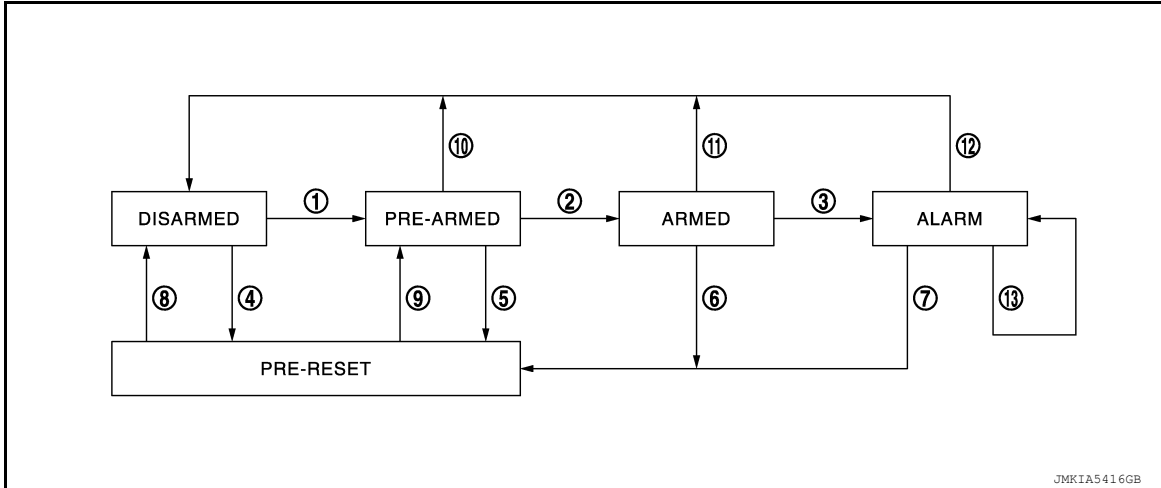

A
B
C
D
E
F
G
H
I
J
L
M
N
O
P

SEC

No.	System state	Switching condition					
1	DISARMED to PRE-ARMED	When all conditions of A and one condition of B is satisfied.	<table border="1" style="width: 100%; border-collapse: collapse;"> <tr> <th style="width: 50%;">A</th> <th style="width: 50%;">B</th> </tr> <tr> <td> <ul style="list-style-type: none"> • Power switch: OFF • All doors: Closed • Hood: Closed </td> <td> All doors are locked by: <ul style="list-style-type: none"> • Door key cylinder LOCK switch • LOCK button of Intelligent Key • Door request switch • Door lock and unlock switch </td> </tr> </table>	A	B	<ul style="list-style-type: none"> • Power switch: OFF • All doors: Closed • Hood: Closed 	All doors are locked by: <ul style="list-style-type: none"> • Door key cylinder LOCK switch • LOCK button of Intelligent Key • Door request switch • Door lock and unlock switch
A	B						
<ul style="list-style-type: none"> • Power switch: OFF • All doors: Closed • Hood: Closed 	All doors are locked by: <ul style="list-style-type: none"> • Door key cylinder LOCK switch • LOCK button of Intelligent Key • Door request switch • Door lock and unlock switch 						
2	PRE-ARMED to ARMED	When all of the following conditions are satisfied for 30 seconds.	<ul style="list-style-type: none"> • Power switch: OFF • All doors: Locked • Hood: Closed 				
3	ARMED to ALARM	When condition A and one condition of B are satisfied.	<table border="1" style="width: 100%; border-collapse: collapse;"> <tr> <th style="width: 50%;">A</th> <th style="width: 50%;">B</th> </tr> <tr> <td>Intelligent Key: Not used</td> <td> <ul style="list-style-type: none"> • Any door: Open • Hood: Open </td> </tr> </table>	A	B	Intelligent Key: Not used	<ul style="list-style-type: none"> • Any door: Open • Hood: Open
A	B						
Intelligent Key: Not used	<ul style="list-style-type: none"> • Any door: Open • Hood: Open 						
4	DISARMED to PRE-RESET	When all conditions of A and one condition of B are satisfied.	<table border="1" style="width: 100%; border-collapse: collapse;"> <tr> <th style="width: 50%;">A</th> <th style="width: 50%;">B</th> </tr> <tr> <td> <ul style="list-style-type: none"> • Power switch: OFF • All doors: Closed • Hood: Open </td> <td> All doors are locked by: <ul style="list-style-type: none"> • Door key cylinder LOCK switch • LOCK button of Intelligent Key • Door request switch </td> </tr> </table>	A	B	<ul style="list-style-type: none"> • Power switch: OFF • All doors: Closed • Hood: Open 	All doors are locked by: <ul style="list-style-type: none"> • Door key cylinder LOCK switch • LOCK button of Intelligent Key • Door request switch
A	B						
<ul style="list-style-type: none"> • Power switch: OFF • All doors: Closed • Hood: Open 	All doors are locked by: <ul style="list-style-type: none"> • Door key cylinder LOCK switch • LOCK button of Intelligent Key • Door request switch 						
5	PRE-ARMED to PRE-RESET	When the following condition is satisfied.	Hood: Open				
6	ARMED to PRE-RESET	No conditions.					
7	ALARM to PRE-RESET						
8	PRE-RESET to DISARMED	When one of the following condition is satisfied.	<ul style="list-style-type: none"> • Power switch: ACC/ON • Door key cylinder UNLOCK switch: ON • UNLOCK button of Intelligent Key: ON • Door request switch: ON • Back door opener switch: ON • UNLOCK switch of door lock and unlock switch: ON • Any door: Open 				
9	PRE-RESET to PRE-ARMED	When one of the following condition is satisfied.	<ul style="list-style-type: none"> • Power switch: OFF • All doors: Locked • Hood: Closed 				
10	PRE-ARMED to DISARMED	When one of the following condition is satisfied.	<ul style="list-style-type: none"> • Power switch: ACC/ON • Door key cylinder UNLOCK switch: ON • UNLOCK button of Intelligent Key: ON • Door request switch: ON • Back door opener switch: ON • Any door: Open 				

SYSTEM

< SYSTEM DESCRIPTION >

[WITH INTELLIGENT KEY SYSTEM]

No.	System state	Switching condition	
11	ARMED to DISARMED	When one of the following condition is satisfied.	<ul style="list-style-type: none">• Power switch: ACC/ON• Door key cylinder UNLOCK switch: ON• UNLOCK button of Intelligent Key: ON• Door request switch: ON• Back door opener switch: ON
12	ALARM to DISARMED		
13	RE-ALARM	When the following condition is satisfied after the ALARM operation is finished.	<ul style="list-style-type: none">• Any door: Open• Hood: Open

NOTE:

- BCM ignores the door key cylinder UNLOCK switch signal input for 1 second after the door key cylinder LOCK switch signal input.
- To lock/unlock all doors by operating remote controller button of Intelligent Key or door request switch, Intelligent Key must be within the detection area of outside key antenna. For details, refer to [DLK-25. "DOOR LOCK FUNCTION : System Description"](#).
- To open back door by operating back door opener switch, Intelligent Key must be within the detection area of outside key antenna. For details, refer to [DLK-25. "DOOR LOCK FUNCTION : System Description"](#).

DISARMED Phase

The vehicle security system is not set in the DISARMED phase. The vehicle security system stays in this phase while any door is open, because it is assumed that the owner is inside or nearby the vehicle. Security indicator lamp blinks every 2.4 seconds.

When the vehicle security system is reset, each phase switches to the DISARMED phase directly.

PRE-ARMED Phase

The PRE-ARMED phase is the transient state between the DISARMED phase and the ARMED phase. This phase is maintained for 30 seconds, so that the owner can reset the setting due to a mis-operation. This phase switches to the ARMED phase when vehicle conditions are not changed for 30 seconds. Security indicator lamp illuminates while being in this phase.

To reset the PRE-ARMED phase, refer to the switching condition of No. 10 in the table above.

ARMED Phase

The vehicle security system is set, and BCM monitors all necessary inputs. If any door or hood is opened without using Intelligent Key, vehicle security system switches to the ALARM phase. Security indicator lamp blinks every 2.4 seconds.

To reset the ARMED phase, refer to the switching condition of No. 11 in the table above.

ALARM Phase

BCM transmits "Theft Warning Horn Request" signal and "High Beam Request" signal intermittently to IPDM E/R via CAN communication. In this phase, horns and headlamps are activated intermittently for approximately 50 seconds to warn that the vehicle is accessed by unauthorized means. ON/OFF timing of horns and headlamps are synchronized. After 50 seconds, the vehicle security system returns to the ARMED phase. At this time, if BCM still detects unauthorized access to the vehicle, the system is switched to the ALARM phase again. This RE-ALARM operation is carried out a maximum of 2 times.

To cancel the ALARM operation, refer to the switching condition of No. 12 in the table above.

NOTE:

If a battery terminal is disconnected during the ALARM phase, theft warning alarm stops. But when the battery terminal is reconnected, theft warning alarm is activated again.

PRE-RESET Phase

The PRE-RESET phase is the transient state between each phase and DISARMED phase. If only the condition of hood is not satisfied, the system switches to the PRE-RESET phase. Then, when any condition is changed, the system switches to the DISARMED phase or PRE-ARMED phase.

PANIC ALARM

- The panic alarm function activates horns and headlamps intermittently when the owner presses the PANIC ALARM button of Intelligent Key outside the vehicle while the power supply position is OFF.
- When BCM receives panic alarm signal from Intelligent Key, BCM transmits "Theft Warning Horn Request" signal and "High Beam Request" signal intermittently to IPDM E/R via CAN communication. To prevent the activation due to mis-operation of Intelligent Key by owner, the panic alarm function is activated when BCM receives the signal for 0.4 - 0.6 seconds.
- Panic alarm operation is maintained for 25 seconds.
- Panic alarm operation is cancelled when BCM receives one of the following signals.
 - LOCK button of Intelligent Key: ON
 - UNLOCK button of Intelligent Key: ON

SYSTEM

[WITH INTELLIGENT KEY SYSTEM]

< SYSTEM DESCRIPTION >

- PANIC ALARM button of Intelligent Key: Long pressed
- Any door request switch: ON

A

B

C

D

E

F

G

H

I

J

SEC

L

M

N

O

P

DIAGNOSIS SYSTEM (BCM)

[WITH INTELLIGENT KEY SYSTEM]

< SYSTEM DESCRIPTION >

DIAGNOSIS SYSTEM (BCM)

COMMON ITEM

COMMON ITEM : CONSULT Function (BCM - COMMON ITEM)

INFOID:0000000010546212

APPLICATION ITEM

CONSULT performs the following functions via CAN communication with BCM.

Direct Diagnostic Mode	Description
Ecu Identification	The BCM part number is displayed.
Self Diagnostic Result	The BCM self diagnostic results are displayed.
Data Monitor	The BCM input/output data is displayed in real time.
Active Test	The BCM activates outputs to test components.
Work support	The settings for BCM functions can be changed.
Configuration	<ul style="list-style-type: none"> The vehicle specification can be read and saved. The vehicle specification can be written when replacing BCM.
CAN Diag Support Mntr	The result of transmit/receive diagnosis of CAN communication is displayed.

SYSTEM APPLICATION

BCM can perform the following functions.

System	Sub System	Direct Diagnostic Mode						
		Ecu Identification	Self Diagnostic Result	Data Monitor	Active Test	Work support	Configuration	CAN Diag Support Mntr
Door lock	DOOR LOCK		×	×	×	×		
Rear window defogger	REAR DEFOGGER			×	×			
Warning chime	BUZZER			×	×			
Interior room lamp timer	INT LAMP			×	×	×		
Exterior lamp	HEADLAMP			×	×	×		
Wiper and washer	WIPER			×	×	×		
Turn signal and hazard warning lamps	FLASHER			×	×	×		
Air conditioner	AIR CONDITIONER			×	×			
Intelligent Key system	INTELLIGENT KEY		×	×	×	×		
Combination switch	COMB SW			×				
BCM	BCM	×	×			×	×	×
Immobilizer	IMMU		×	×	×	×		
Interior room lamp battery saver	BATTERY SAVER			×	×	×		
Trunk open	TRUNK			×				
Vehicle security system	THEFT ALM			×	×	×		
RAP system	RETAINED PWR			×				
Signal buffer system	SIGNAL BUFFER			×				
TPMS	AIR PRESSURE MONITOR		×	×	×	×		

INTELLIGENT KEY

DIAGNOSIS SYSTEM (BCM)

[WITH INTELLIGENT KEY SYSTEM]

< SYSTEM DESCRIPTION >

INTELLIGENT KEY : CONSULT Function (BCM - INTELLIGENT KEY)

INFOID:000000010546213

SELF DIAGNOSTIC RESULT

Refer to [BCS-48. "DTC Index"](#).

DATA MONITOR

Monitor Item [Unit]	Main	Description
REQ SW -DR [On/Off]	×	Indicates condition of door request switch LH.
REQ SW -AS [On/Off]	×	Indicates condition of door request switch RH.
REQ SW -BD/TR [On/Off]	×	Indicates condition of back door request switch.
PUSH SW [On/Off]		Indicates condition of power switch.
BRAKE SW 1 [On/Off]	×	Indicates condition of brake switch.
BRAKE SW 2 [On/Off]		Indicates condition of brake switch.
DETE/CANCL SW [On/Off]	×	Indicates condition of P (park) position.
SFT PN/N SW [On/Off]	×	Indicates condition of P (park) or N (neutral) position.
UNLK SEN -DR [On/Off]	×	Indicates condition of door unlock sensor.
PUSH SW -IPDM [On/Off]		Indicates condition of power switch received from IPDM E/R on CAN communication line.
IGN RLY1 -F/B [On/Off]		Indicates condition of ignition relay 1 received from IPDM E/R on CAN communication line.
DETE SW -IPDM [On/Off]		Indicates condition of detent switch received from TCM on CAN communication line.
SFT P -MET [On/Off]		Indicates condition of P (park) position from TCM on CAN communication line.
SFT N -MET [On/Off]		Indicates condition of N (neutral) position from IPDM E/R on CAN communication line.
ENGINE STATE [Stop/Start/Crank/Run]	×	Indicates condition of engine state from ECM on CAN communication line.
VEH SPEED 1 [mph/km/h]	×	Indicates condition of vehicle speed signal received from ABS on CAN communication line.
VEH SPEED 2 [mph/km/h]	×	Indicates condition of vehicle speed signal received from combination meter on CAN communication line.
DOOR STAT -DR [LOCK/READY/UNLK]	×	Indicates condition of driver side door status.
DOOR STAT -AS [LOCK/READY/UNLK]	×	Indicates condition of passenger side door status.
ID OK FLAG [Set/Reset]		Indicates condition of Intelligent Key ID.
PRMT ENG STRT [Set/Reset]		Indicates condition of engine start possibility.
RKE OPE COUN1 [0-19]	×	When remote keyless entry receiver receives the signal transmitted while operating the Intelligent Key, the numerical value starts changing.
RKE-LOCK [On/Off]		Indicates condition of lock signal from Intelligent Key.
RKE-UNLOCK [On/Off]		Indicates condition of unlock signal from Intelligent Key.
RKE-PANIC [On/Off]		Indicates condition of panic signal from Intelligent Key.
RKE-MODE CHG [On/Off]		Indicates condition of mode change signal from Intelligent Key.

ACTIVE TEST

Test Item	Description
INSIDE BUZZER	This test is able to check combination meter warning chime operation [Off/Take Out/Knob/Key].

A
B
C
D
E
F
G
H
I
J
SEC
L
M
N
O
P

DIAGNOSIS SYSTEM (BCM)

[WITH INTELLIGENT KEY SYSTEM]

< SYSTEM DESCRIPTION >

Test Item	Description	
LCD	B&P N	This test is able to check combination meter traction motor start information.
	B&P I	
	ID NG	This test is able to check combination meter key ID warning information.
	ROTAT	This item is displayed, but is not used.
	SFT P	
	INSRT	
	BATT	This test is able to check combination meter Intelligent Key low battery warning information.
	NO KY	This item is displayed, but is not used.
	OUTKEY	This test is able to check combination meter take away warning information.
	LK WN	This test is able to check combination meter OFF position warning information.
	Off	—
BATTERY SAVER	This test is able to check interior room lamp battery saver operation [Off/On].	
ENGINE SW ILLUMI	This test is able to check power switch illumination operation [Off/On].	
PUSH SWITCH INDICATOR	This test is able to check power switch ACC/ON indicator operation [Off/On].	
TRUNK/BACK DOOR	This test is able to check back door opener actuator operation [Open].	
INT LAMP	This test is able to check interior room lamp operation [Off/On].	
INDICATOR	This test is able to check combination meter warning lamp operation [Off/KEY ON/KEY IND].	
FLASHER	This test is able to check security hazard lamp operation [RH/LH/Off].	
OUTSIDE BUZZER	This test is able to check Intelligent Key warning buzzer operation [On/Off].	
HORN	This test is able to check horn operation [On].	

WORK SUPPORT

Support Item	Setting	Description
LOCK/UNLOCK BY I-KEY	On*	Door lock/unlock function from request switch ON.
	Off	Door lock/unlock function from request switch OFF.
ANTI KEY LOCK IN-FUNCTI	On*	Key reminder function ON.
	Off	Key reminder function OFF.
ANS BACK I-KEY UNLOCK	On*	Buzzer reminder function when doors are unlocked with request switch ON.
	Off	Buzzer reminder function when doors are unlocked with request switch OFF.
ANS BACK I-KEY LOCK	Horn Chirp	Horn chirp reminder function when doors are locked with request switch.
	Buzzer*	Buzzer reminder function when doors are locked with request switch.
	Off	No reminder function when doors are locked with request switch.
HORN WITH KEYLESS LOCK	On*	Horn reminder function when doors are locked with Intelligent Key ON.
	Off	Horn reminder function when doors are locked with Intelligent Key OFF.
HAZARD ANSWER BACK	Lock/Unlock*	Horn reminder function when doors are locked or unlocked with request switch or Intelligent Key.
	Unlock Only	Horn reminder function when doors are unlocked with request switch or Intelligent Key.
	Lock Only	Horn reminder function when doors are locked with request switch or Intelligent Key.
	Off	Horn reminder function when doors are locked or unlocked with request switch or Intelligent Key OFF.

DIAGNOSIS SYSTEM (BCM)

[WITH INTELLIGENT KEY SYSTEM]

< SYSTEM DESCRIPTION >

Support Item	Setting	Description	
INSIDE ANT DIAGNOSIS	—	This function allows inside key antenna self-diagnosis.	
CONFIRM KEY FOB ID	MEMORY 1	Intelligent Key ID code can be checked.	
	MEMORY 2		
	MEMORY 3		
	MEMORY 4		
	NON REGIST		
PANIC ALARM SET	MODE 3	1.5 sec.	Panic alarm button set time on Intelligent Key can be set.
	MODE 2	OFF	
	MODE 1*	0.5 sec.	
AUTO LOCK SET	MODE7	5 min.	Auto door lock time can be set.
	MODE6	4 min.	
	MODE5	3 min.	
	MODE4	2 min.	
	MODE3*	1 min.	
	MODE2	30 sec.	
	MODE1	OFF	

*: Initial Setting

THEFT ALM

THEFT ALM : CONSULT Function (BCM - THEFT)

INFOID:0000000010546214

DATA MONITOR

Monitored Item	Description
REQ SW -DR [On/Off]	Indicates condition of door request switch LH.
REQ SW -AS [On/Off]	Indicates condition of door request switch RH.
REQ SW -BD/TR [On/Off]	Indicates condition of back door request switch.
PUSH SW [On/Off]	Indicates condition of power switch.
UNLK SEN -DR [On/Off]	Indicates condition of door unlock sensor.
DOOR SW-DR [On/Off]	Indicates condition of front door switch LH.
DOOR SW-AS [On/Off]	Indicates condition of front door switch RH.
DOOR SW-RR [On/Off]	Indicates condition of rear door switch RH.
DOOR SW-RL [On/Off]	Indicates condition of rear door switch LH.
DOOR SW-BK [On/Off]	Indicates condition of trunk switch.
CDL LOCK SW [On/Off]	Indicates condition of lock signal from door lock and unlock switch.
CDL UNLOCK SW [On/Off]	Indicates condition of unlock signal from door lock and unlock switch.
KEY CYL LK-SW [On/Off]	Indicates condition of lock signal from door key cylinder switch.
KEY CYL UN-SW [On/Off]	Indicates condition of unlock signal from door key cylinder switch.
TR/BD OPEN SW [On/Off]	Indicates condition of back door opener switch.
RKE-LOCK [On/Off]	Indicates condition of lock signal from Intelligent Key.
RKE-UNLOCK [On/Off]	Indicates condition of unlock signal from Intelligent Key.

ACTIVE TEST

Test Item	Description
VEHICLE SECURITY HORN	This test is able to check vehicle security horn operation [On].
FLASHER	This test is able to check turn signal lamp operation [RH/LH/Off].

DIAGNOSIS SYSTEM (BCM)

[WITH INTELLIGENT KEY SYSTEM]

< SYSTEM DESCRIPTION >

Test Item	Description
THEFT IND	This test is able to check security indicator lamp operation [Off/On].
HEADLAMP(HI)	This test is able to check vehicle security lamp operation [On].

WORK SUPPORT

Support Item	Setting	Description
THEFT ALM TRG	Off/On	The switch that triggered vehicle security alarm is recorded [On].
	CLEAR	Trigger data can be erased.
SECURITY ALARM SET	On	Security alarm ON.
	Off	Security alarm OFF.

IMMU

IMMU : CONSULT Function (BCM - IMMU)

INFOID:000000010546215

SELF DIAGNOSTIC RESULT

Refer to [BCS-48, "DTC Index"](#).

DATA MONITOR

Monitor Item [Unit]	Description
CONFIRM ID ALL [Yet/DONE]	Switches to DONE when an Intelligent Key is registered.
CONFIRM ID4 [Yet/DONE]	
CONFIRM ID3 [Yet/DONE]	
CONFIRM ID2 [Yet/DONE]	
CONFIRM ID1 [Yet/DONE]	
NOT REGISTERED [ID OK/ID NG]	ID OK indicates Intelligent Key being registered is registered.
TP 4 [Yet/DONE]	DONE indicates the number of Intelligent Key ID that has been registered.
TP 3 [Yet/DONE]	
TP 2 [Yet/DONE]	
TP 1 [Yet/DONE]	
PUSH SW [On/Off]	Indicates condition of power switch.

ACTIVE TEST

Test Item	Description
THEFT IND	This test is able to check security indicator operation [Off/On].

WORK SUPPORT

Service item	Description
CONFIRM DONGLE ID	Checks that dongle unit is applied to the vehicle.

DIAGNOSIS SYSTEM (IPDM E/R)

< SYSTEM DESCRIPTION >

[WITH INTELLIGENT KEY SYSTEM]

DIAGNOSIS SYSTEM (IPDM E/R)

CONSULT Function (IPDM E/R)

INFOID:000000010546216

APPLICATION ITEM

CONSULT performs the following functions via CAN communication with IPDM E/R.

Direct Diagnostic Mode	Description
Ecu Identification	The IPDM E/R part number is displayed.
Self Diagnostic Result	The IPDM E/R self diagnostic results are displayed.
Data Monitor	The IPDM E/R input/output data is displayed in real time.
Active Test	The IPDM E/R activates outputs to test components.
CAN Diag Support Mntr	The result of transmit/receive diagnosis of CAN communication is displayed.

SELF DIAGNOSTIC RESULT

Refer to [PCS-18, "DTC Index"](#).

DATA MONITOR

Monitor Item [Unit]	Main Signals	Description
TAIL&CLR REQ [On/Off]	×	Indicates position light request signal received from BCM on CAN communication line
HL LO REQ [On/Off]	×	Indicates low beam request signal received from BCM on CAN communication line
HL HI REQ [On/Off]	×	Indicates high beam request signal received from BCM on CAN communication line
FR FOG REQ [On/Off]	×	Indicates front fog light request signal received from BCM on CAN communication line
FR WIP REQ [Stop/1LOW/Low/Hi]	×	Indicates front wiper request signal received from BCM on CAN communication line
WIP AUTO STOP [STOP P/ACT P]	×	Indicates condition of front wiper auto stop signal
WIP PROT [Off/BLOCK]	×	Indicates condition of front wiper fail-safe operation
IGN RLY1 -REQ [On/Off]		Indicates power switch ON signal received from BCM on CAN communication line
IGN RLY [On/Off]	×	Indicates condition of ignition relay-1
PUSH SW [On/Off]		Indicates condition of power switch
DETENT SW [On/Off]		Indicates condition of shift position (park position switch)
DTRL REQ [Off]		Indicates daytime light request signal received from BCM on CAN communication line
HOOD SW [On/Off]		Indicates condition of hood switch
THFT HRN REQ [On/Off]		Indicates theft warning horn request signal received from BCM on CAN communication line
HORN CHIRP [On/Off]		Indicates horn reminder signal received from BCM on CAN communication line

ACTIVE TEST

Test item	Description
HORN	This test is able to check horn operation [On].
REAR DEFOGGER	This test is able to check rear window defogger operation [On/Off].
FRONT WIPER	This test is able to check wiper motor operation [Hi/Lo/Off].
EXTERNAL LAMPS	This test is able to check external lamp operation [Fog/Hi/Lo/TAIL/Off].

CAN DIAG SUPPORT MNTR

A
B
C
D
E
F
G
H
I
J
L
M
N
O
P

SEC

DIAGNOSIS SYSTEM (IPDM E/R)

[WITH INTELLIGENT KEY SYSTEM]

< SYSTEM DESCRIPTION >

Refer to [LAN-14. "CAN Diagnostic Support Monitor"](#).

ECU DIAGNOSIS INFORMATION

VCM, IPDM E/R, BCM

List of ECU Reference

INFOID:0000000010119239

ECU		Reference
VCM	Reference Value	EVC-84, "Reference Value"
	Fail-safe	EVC-97, "Fail-Safe"
	DTC Inspection Priority Chart	EVC-100, "DTC Inspection Priority Chart"
	DTC Index	EVC-102, "DTC Index"
IPDM E/R	Reference Value	PCS-14, "Reference Value"
	Fail-safe	PCS-17, "Fail-Safe"
	DTC Index	PCS-18, "DTC Index"
BCM	Reference Value	BCS-28, "Reference Value"
	Fail-safe	BCS-46, "Fail-safe"
	DTC Inspection Priority Chart	BCS-47, "DTC Inspection Priority Chart"
	DTC Index	BCS-48, "DTC Index"

A
B
C
D
E
F
G
H
I
J
L
M
N
O
P

SEC

INTELLIGENT KEY SYSTEM/ENGINE START FUNCTION

< WIRING DIAGRAM >

[WITH INTELLIGENT KEY SYSTEM]

WIRING DIAGRAM

INTELLIGENT KEY SYSTEM/ENGINE START FUNCTION

Wiring Diagram

INFOID:000000010119240

INTELLIGENT KEY SYSTEM - ENGINE START FUNCTION

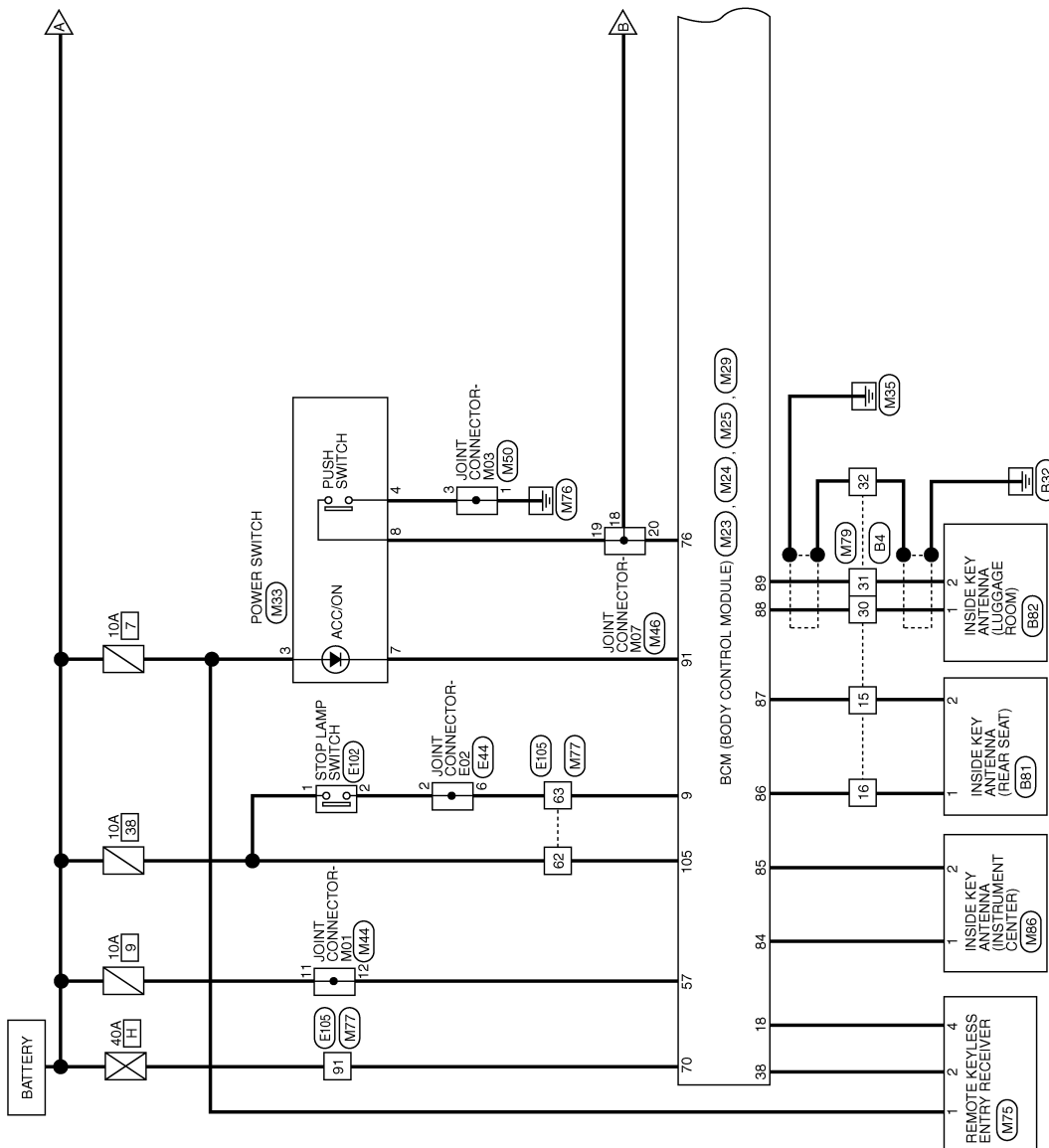

AAKWA0836GB

INTELLIGENT KEY SYSTEM/ENGINE START FUNCTION

< WIRING DIAGRAM >

[WITH INTELLIGENT KEY SYSTEM]

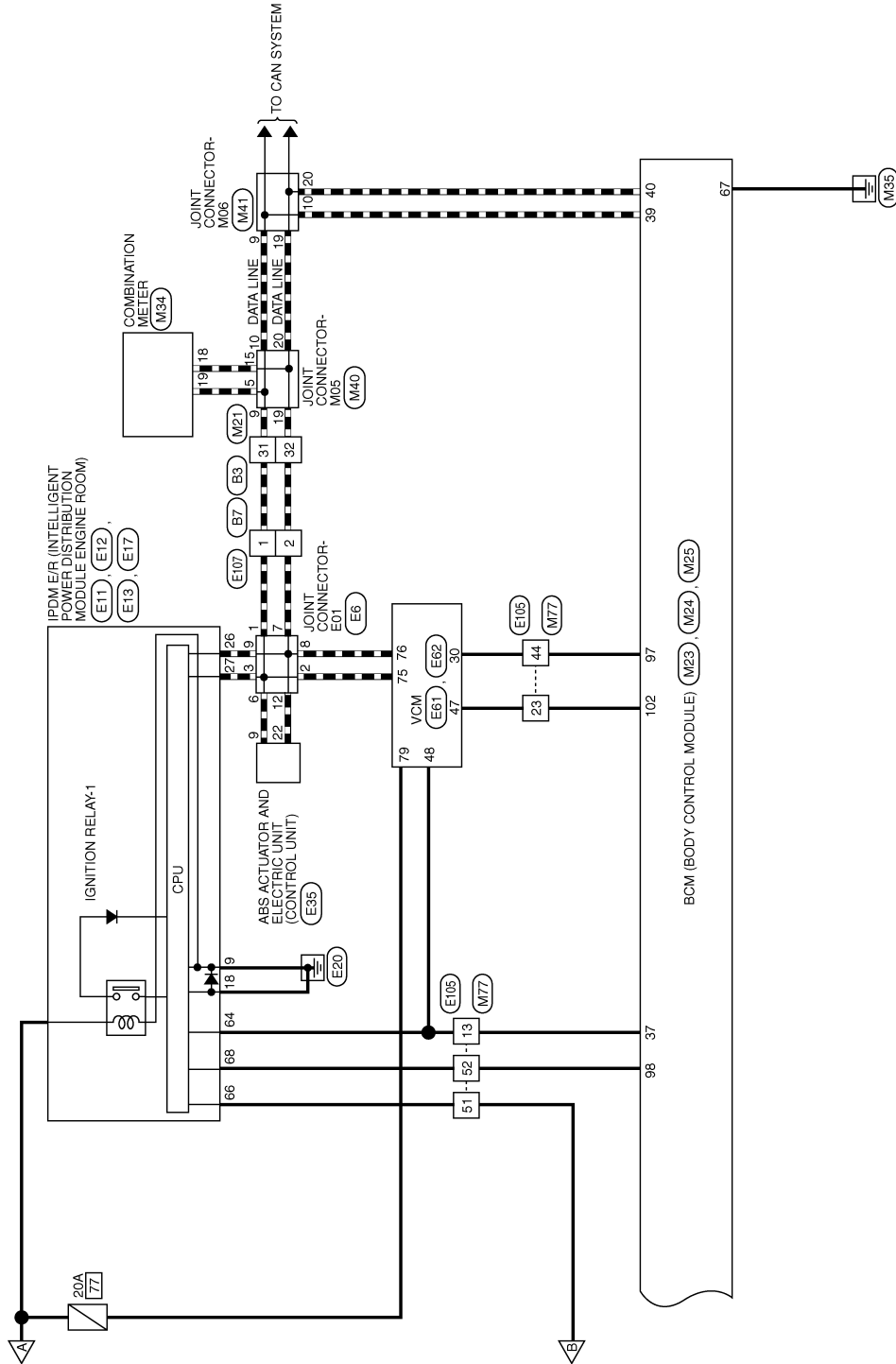

A
B
C
D
E
F
G
H
I
J
K
L
M
N
O
P

SEC

AAKWA0837GB

INTELLIGENT KEY SYSTEM/ENGINE START FUNCTION

< WIRING DIAGRAM >

[WITH INTELLIGENT KEY SYSTEM]

INTELLIGENT KEY SYSTEM - ENGINE START FUNCTION CONNECTORS

Connector No.	M21
Connector Name	WIRE TO WIRE
Connector Color	WHITE

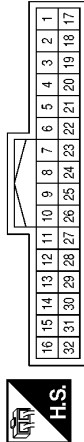

Terminal No.	Color of Wire	Signal Name
31	L	-
32	P	-

Connector No.	M23
Connector Name	BCM (BODY CONTROL MODULE)
Connector Color	WHITE

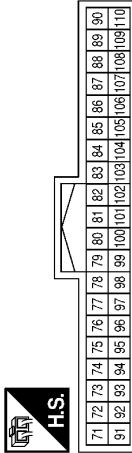

Terminal No.	Color of Wire	Signal Name
76	SB	ENGINE START SW
84	BR	ROOM ANTENNA 1+

Terminal No.	Color of Wire	Signal Name
85	Y	ROOM ANTENNA 1-
86	G	ROOM ANTENNA 2+
87	R	ROOM ANTENNA 2-
88	G	ROOM ANTENNA 3+
89	R	ROOM ANTENNA 3-
91	V	POWER POSITION LED (LOCK POSITION LED)
97	LG	STARTER RELAY OUTPUT
98	L	IGN RELAY OUTPUT1 (USM)
102	BG	SHIFT N, P
105	W	BRAKE SW2

Connector No.	M24
Connector Name	BCM (BODY CONTROL MODULE)
Connector Color	BLACK

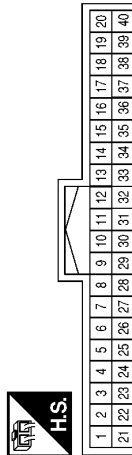

Terminal No.	Color of Wire	Signal Name
9	BR	BRAKE SW1
18	L	KEYLESS TUNER, AUTO LIGHT SENSOR GND
37	V	SHIFT P POSITION PARKING POSITION SW
38	SB	INTELLIGENT TUNER
39	L	CAN-H
40	P	CAN-L

Connector No.	M25
Connector Name	BCM (BODY CONTROL MODULE)
Connector Color	WHITE

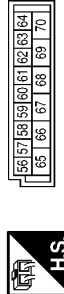

Terminal No.	Color of Wire	Signal Name
57	P	BATTERY (FUSE)
67	B	GND
70	Y	BATTERY (F/L)

Connector No.	M33
Connector Name	POWER SWITCH
Connector Color	WHITE



Terminal No.	Color of Wire	Signal Name
3	G	-
4	B	-
7	V	-
8	SB	-

INTELLIGENT KEY SYSTEM/ENGINE START FUNCTION

< WIRING DIAGRAM >

[WITH INTELLIGENT KEY SYSTEM]

Connector No.	M41
Connector Name	JOINT CONNECTOR-M06
Connector Color	BLUE

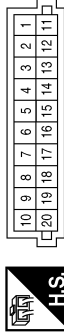

Terminal No.	Color of Wire	Signal Name
9	L	-
10	L	-
19	P	-
20	P	-

Connector No.	M50
Connector Name	JOINT CONNECTOR-M03
Connector Color	PINK

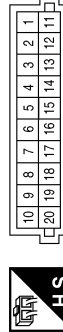

Terminal No.	Color of Wire	Signal Name
1	B	-
3	B	-

Connector No.	M40
Connector Name	JOINT CONNECTOR-M05
Connector Color	BLUE

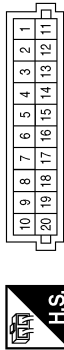

Terminal No.	Color of Wire	Signal Name
5	L	-
9	L	-
10	L	-
15	P	-
19	P	-
20	P	-

Connector No.	M46
Connector Name	JOINT CONNECTOR-M07
Connector Color	ORANGE

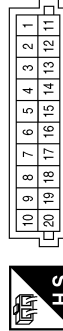

Terminal No.	Color of Wire	Signal Name
18	SB	-
19	SB	-
20	SB	-

Connector No.	M34
Connector Name	COMBINATION METER
Connector Color	WHITE

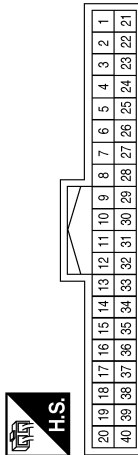

Terminal No.	Color of Wire	Signal Name
18	P	CAN-L
19	L	CAN-H

Connector No.	M44
Connector Name	JOINT CONNECTOR-M01
Connector Color	GRAY



Terminal No.	Color of Wire	Signal Name
11	P	-
12	P	-

AAKIA2030GB

A
B
C
D
E
F
G
H
I
J
L
M
N
O
P

SEC

INTELLIGENT KEY SYSTEM/ENGINE START FUNCTION

< WIRING DIAGRAM >

[WITH INTELLIGENT KEY SYSTEM]

Terminal No.	Color of Wire	Signal Name
13	V	-
23	BG	-
44	LG	-
51	SB	-
52	L	-
62	W	-
63	BR	-
91	Y	-

Connector No.	M77
Connector Name	WIRE TO WIRE
Connector Color	WHITE

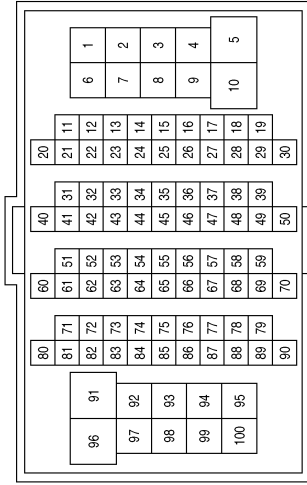

Connector No.	M75
Connector Name	REMOTE KEYLESS ENTRY RECEIVER
Connector Color	WHITE

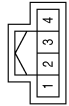

Terminal No.	Color of Wire	Signal Name
1	G	-
2	SB	-
4	L	-

Connector No.	E6
Connector Name	JOINT CONNECTOR-E01
Connector Color	BLUE

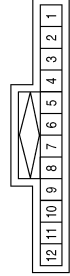

Connector No.	M86
Connector Name	INSIDE KEY ANTENNA (INSTRUMENT CENTER)
Connector Color	BLUE



Connector No.	M79
Connector Name	WIRE TO WIRE
Connector Color	WHITE

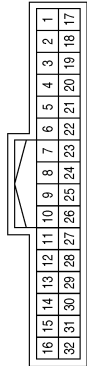

Terminal No.	Color of Wire	Signal Name
1	L	-
2	L	-
3	L	-
6	L	-
7	P	-
8	P	-
9	P	-
12	P	-

Terminal No.	Color of Wire	Signal Name
1	BR	-
2	Y	-

Terminal No.	Color of Wire	Signal Name
15	R	-
16	G	-
30	G	-
31	R	-
32	SHIELD	-

AAKIA2031GB

INTELLIGENT KEY SYSTEM/ENGINE START FUNCTION

< WIRING DIAGRAM >

[WITH INTELLIGENT KEY SYSTEM]

Connector No.	E13
Connector Name	IPDM E/R (INTELLIGENT POWER DISTRIBUTION MODULE ENGINE ROOM)
Connector Color	WHITE

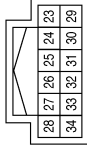

Terminal No.	Color of Wire	Signal Name
26	P	CAN-L
27	L	CAN-H

Connector No.	E12
Connector Name	IPDM E/R (INTELLIGENT POWER DISTRIBUTION MODULE ENGINE ROOM)
Connector Color	BROWN

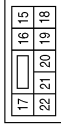

Terminal No.	Color of Wire	Signal Name
18	B/W	SGND

Connector No.	E11
Connector Name	IPDM E/R (INTELLIGENT POWER DISTRIBUTION MODULE ENGINE ROOM)
Connector Color	BLACK



Terminal No.	Color of Wire	Signal Name
9	B	POWER GROUND

Connector No.	E44
Connector Name	JOINT CONNECTOR-E02
Connector Color	BLUE

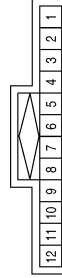

Terminal No.	Color of Wire	Signal Name
2	SB	-
6	SB	-

Connector No.	E35
Connector Name	ABS ACTUATOR AND ELECTRIC UNIT (CONTROL UNIT)
Connector Color	BLACK

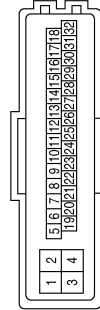

Terminal No.	Color of Wire	Signal Name
9	L	CAN-H
22	P	CAN-L

Connector No.	E17
Connector Name	IPDM E/R (INTELLIGENT POWER DISTRIBUTION MODULE ENGINE ROOM)
Connector Color	BLACK

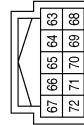

Terminal No.	Color of Wire	Signal Name
64	W	DETENT SW
66	W	PUSH START SW
68	O	IGN SIGNAL

AAKIA2032GB

A
B
C
D
E
F
G
H
I
J
K
L
M
N
O
P

SEC

INTELLIGENT KEY SYSTEM/ENGINE START FUNCTION

< WIRING DIAGRAM >

[WITH INTELLIGENT KEY SYSTEM]

Connector No.	E102
Connector Name	STOP LAMP SWITCH
Connector Color	WHITE



Terminal No.	Color of Wire	Signal Name
1	W	-
2	SB	-

Connector No.	E62
Connector Name	VCM
Connector Color	BROWN

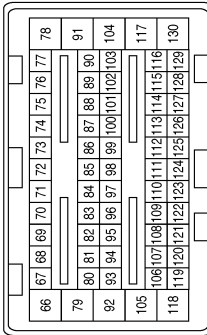

Terminal No.	Color of Wire	Signal Name
75	L	CAN-H
76	P	CAN-L
79	R	BATT1

Connector No.	E61
Connector Name	VCM
Connector Color	BLACK

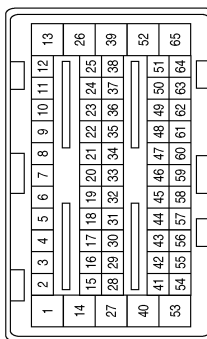

Terminal No.	Color of Wire	Signal Name
30	W	STSW
47	LG	PNOUT
48	W	NOTB

Connector No.	E107
Connector Name	WIRE TO WIRE
Connector Color	WHITE



Terminal No.	Color of Wire	Signal Name
1	L	-
2	P	-

Terminal No.	13	23	44	51	52	62	63	91
Color of Wire	W	LG	W	W	O	W	SB	Y
Signal Name	-	-	-	-	-	-	-	-

Connector No.	E105
Connector Name	WIRE TO WIRE
Connector Color	WHITE

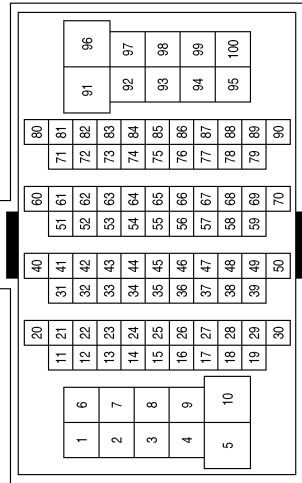

AAKIA2033GB

INTELLIGENT KEY SYSTEM/ENGINE START FUNCTION

< WIRING DIAGRAM >

[WITH INTELLIGENT KEY SYSTEM]

Connector No.	B7
Connector Name	WIRE TO WIRE
Connector Color	WHITE

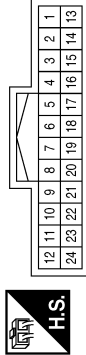

Terminal No.	Color of Wire	Signal Name
1	L	-
2	P	-

Connector No.	B4
Connector Name	WIRE TO WIRE
Connector Color	WHITE

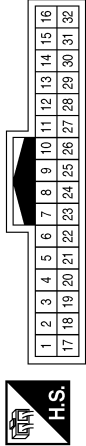

Terminal No.	Color of Wire	Signal Name
15	R	-
16	G	-
30	V	-
31	LG	-
32	SHIELD	-

Connector No.	B3
Connector Name	WIRE TO WIRE
Connector Color	WHITE

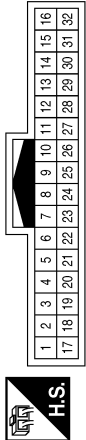

Terminal No.	Color of Wire	Signal Name
31	L	-
32	P	-

Connector No.	B82
Connector Name	INSIDE KEY ANTENNA (LUGGAGE ROOM)
Connector Color	BLUE



Terminal No.	Color of Wire	Signal Name
1	V	-
2	LG	-

Connector No.	B81
Connector Name	INSIDE KEY ANTENNA (REAR SEAT)
Connector Color	BLUE



Terminal No.	Color of Wire	Signal Name
1	G	-
2	R	-

AAKIA2034GB

A
B
C
D
E
F
G
H
I
J
L
M
N
O
P

SEC

NVIS

Wiring Diagram

INFOID:000000010546211

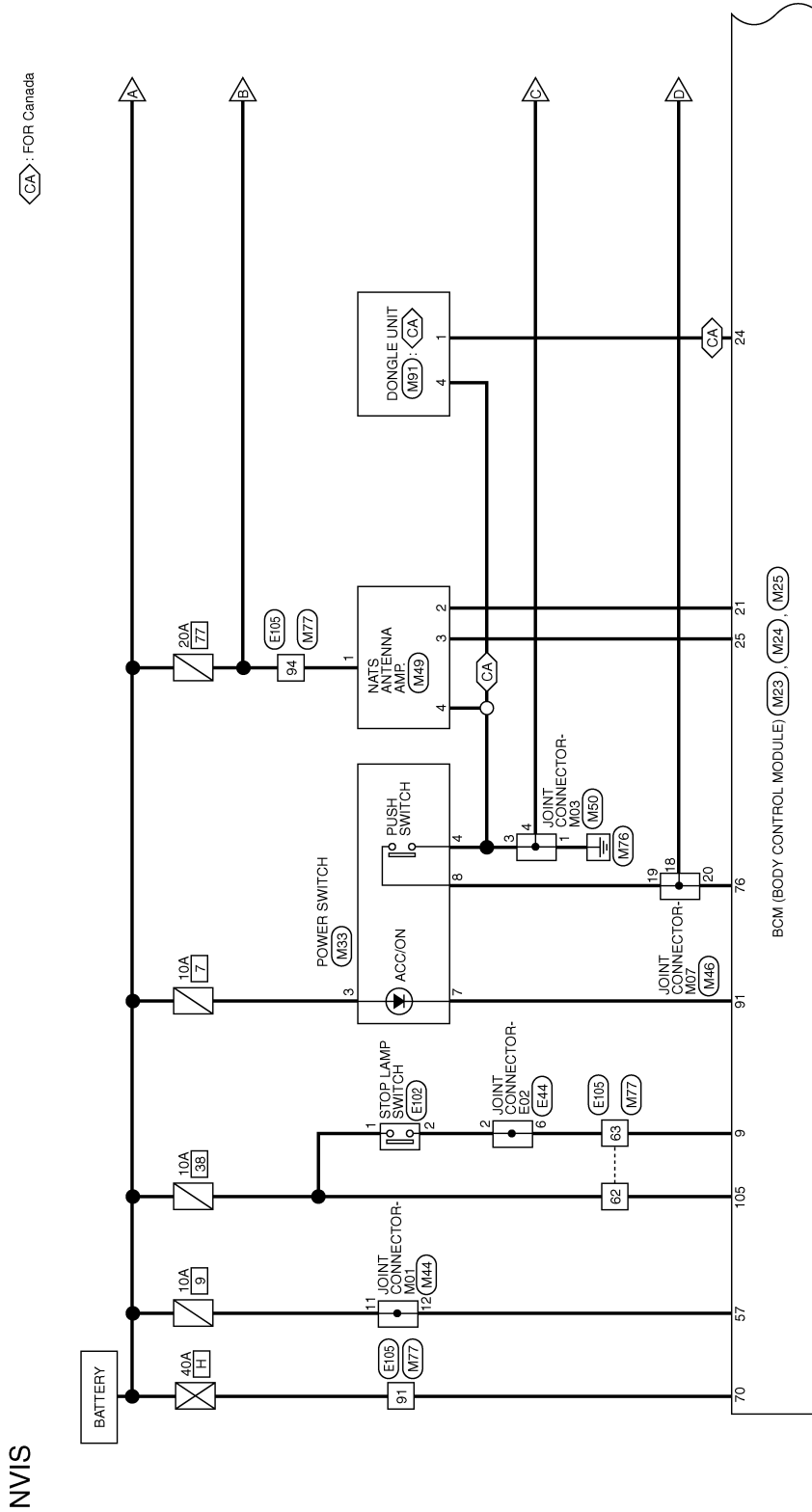

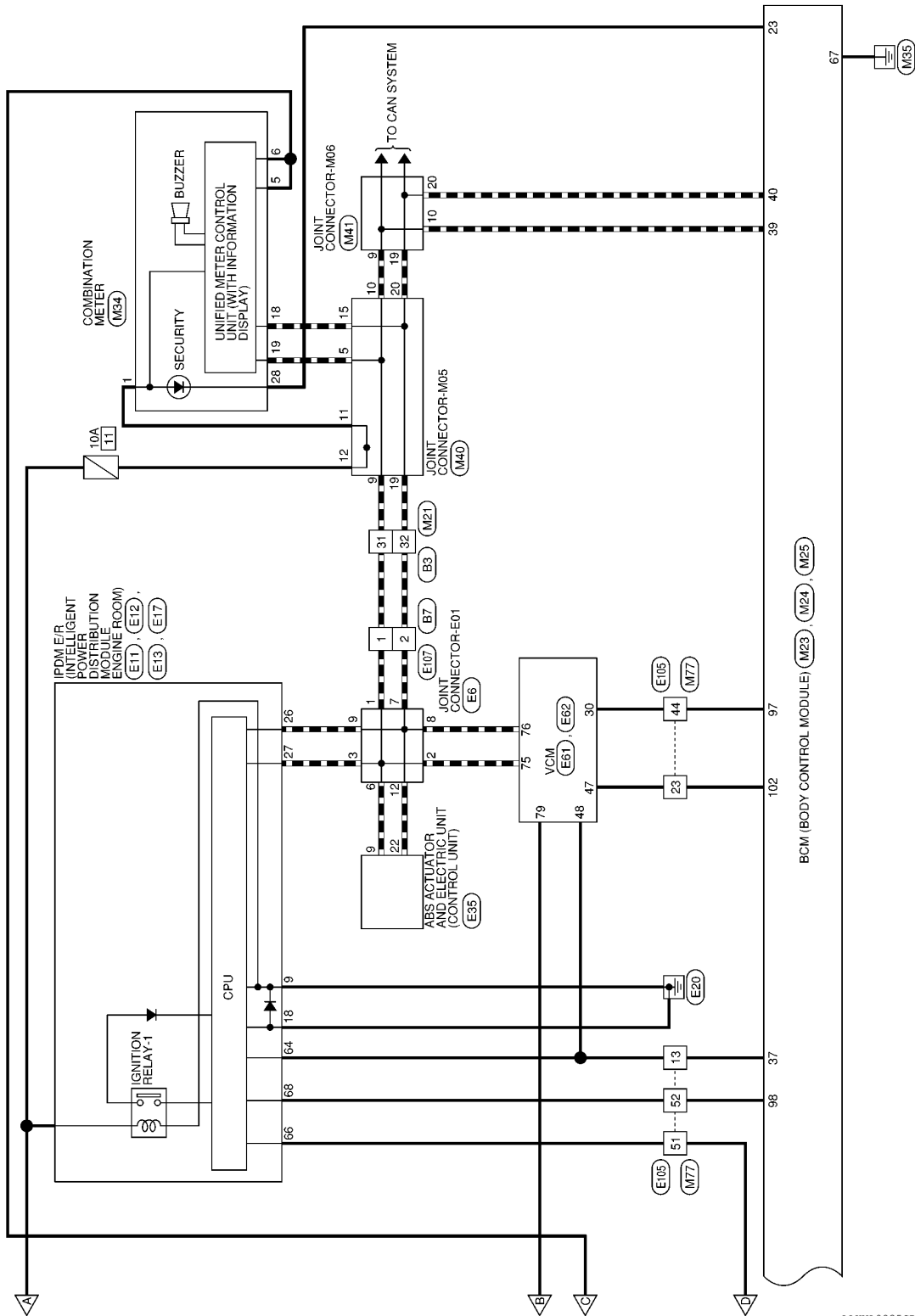

AAKWA0835GB

A
B
C
D
E
F
G
H
I
J
K
L
M
N
O
P

SEC

NVIS CONNECTORS

Connector No.	M21
Connector Name	WIRE TO WIRE
Connector Color	WHITE

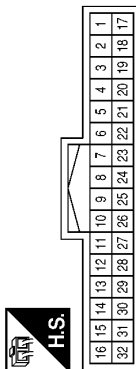

Terminal No.	Color of Wire	Signal Name
31	L	-
32	P	-

Connector No.	M23
Connector Name	BCM (BODY CONTROL MODULE)
Connector Color	WHITE

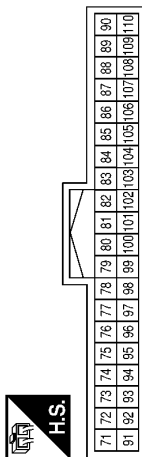

Terminal No.	Color of Wire	Signal Name
76	SB	ENGINE START SW
91	V	POWER POSITION LED (LOCK POSITION LED)
97	LG	STARTER RELAY OUTPUT
98	L	IGN RELAY OUTPUT1 (USM)
102	BG	SHIFT N, P
105	W	BRAKE SW2

Connector No.	M25
Connector Name	BCM (BODY CONTROL MODULE)
Connector Color	WHITE

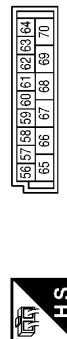

Terminal No.	Color of Wire	Signal Name
57	P	BATTERY (FUSE)
67	B	GND (POWER)
70	Y	BATTERY (F/L)

Connector No.	M24
Connector Name	BCM (BODY CONTROL MODULE)
Connector Color	BLACK

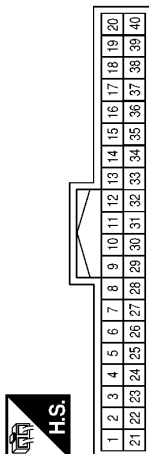

Terminal No.	Color of Wire	Signal Name
9	BR	BRAKE SW1
21	P	IMMOBILIZER ONE WAY COMMUNICATION (CLOCK)
23	R	SECURITY INDICATOR OUTPUT
24	SB	AUDIO/DONGLE LINK (SERIAL)
25	LG	IMMOBILIZER TWO WAY COMMUNICATION
37	V	SHIFT P POSITION, PARKING POSITION SW
39	L	CAN-H
40	P	CAN-L

Terminal No.	Color of Wire	Signal Name
3	G	-
4	B	-
7	V	-
8	SB	-

Connector No.	M33
Connector Name	POWER SWITCH
Connector Color	WHITE



AAKIA2023GB

Connector No.	M41
Connector Name	JOINT CONNECTOR-M06
Connector Color	BLUE

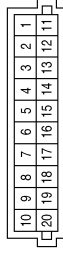

Terminal No.	Color of Wire	Signal Name
9	L	-
10	L	-
19	P	-
20	P	-

Connector No.	M40
Connector Name	JOINT CONNECTOR-M05
Connector Color	BLUE

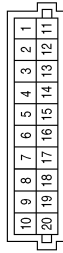

Terminal No.	Color of Wire	Signal Name
5	L	-
9	L	-
10	L	-
11	LG	-
12	LG	-
15	P	-
19	P	-
20	P	-

Connector No.	M34
Connector Name	COMBINATION METER
Connector Color	WHITE

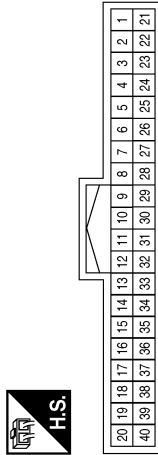

Terminal No.	Color of Wire	Signal Name
1	LG	BAT
5	B	GND1
6	B	GND2
18	P	CAN-L
19	L	CAN-H
28	R	SECURITY

Connector No.	M49
Connector Name	NATS ANTENNA AMP.
Connector Color	WHITE

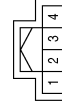

Terminal No.	Color of Wire	Signal Name
1	P	-
2	P	-
3	LG	-
4	B	-

Connector No.	M46
Connector Name	JOINT CONNECTOR-M07
Connector Color	ORANGE



Terminal No.	Color of Wire	Signal Name
18	SB	-
19	SB	-
20	SB	-

Connector No.	M44
Connector Name	JOINT CONNECTOR-M01
Connector Color	GRAY

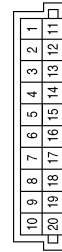

Terminal No.	Color of Wire	Signal Name
11	P	-
12	P	-

AAKIA2024GB

A
B
C
D
E
F
G
H
I
J
K
L
M
N
O
P

SEC

Terminal No.	Color of Wire	Signal Name
13	V	-
23	BG	-
44	LG	-
51	SB	-
52	L	-
62	W	-
63	BR	-
91	Y	-
94	P	-

Connector No.	M77
Connector Name	WIRE TO WIRE
Connector Color	WHITE

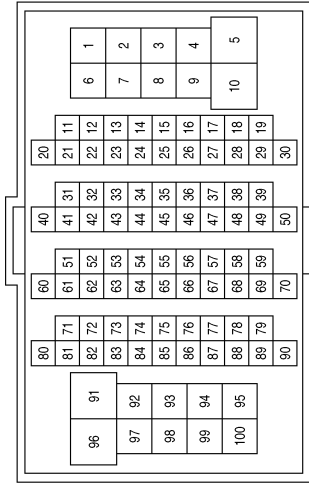

Connector No.	M50
Connector Name	JOINT CONNECTOR-M03
Connector Color	PINK



Terminal No.	Color of Wire	Signal Name
1	B	-
3	B	-
4	B	-

Connector No.	E11
Connector Name	IPDM E/R (INTELLIGENT POWER DISTRIBUTION MODULE ENGINE ROOM)
Connector Color	BLACK



Connector No.	E6
Connector Name	JOINT CONNECTOR-E01
Connector Color	BLUE



Connector No.	M91
Connector Name	DONGLE UNIT
Connector Color	WHITE



Terminal No.	9
Color of Wire	B
Signal Name	POWER GROUND

Terminal No.	Color of Wire	Signal Name
1	L	-
2	L	-
3	L	-
7	P	-
8	P	-
9	P	-

Terminal No.	Color of Wire	Signal Name
1	SB	-
4	B	-

AAKIA2025GB

Connector No.	E17
Connector Name	IPDM E/R (INTELLIGENT POWER DISTRIBUTION MODULE ENGINE ROOM)
Connector Color	BLACK

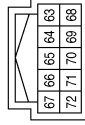

Terminal No.	Color of Wire	Signal Name
64	W	DETENT SW
66	W	PUSH START SW
68	O	IGN SIGNAL

Connector No.	E13
Connector Name	IPDM E/R (INTELLIGENT POWER DISTRIBUTION MODULE ENGINE ROOM)
Connector Color	WHITE

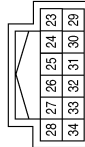

Terminal No.	Color of Wire	Signal Name
26	P	CAN-L
27	L	CAN-H

Connector No.	E12
Connector Name	IPDM E/R (INTELLIGENT POWER DISTRIBUTION MODULE ENGINE ROOM)
Connector Color	BROWN

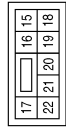

Terminal No.	Color of Wire	Signal Name
18	B/W	SGND

Connector No.	E61
Connector Name	VCM
Connector Color	BLACK

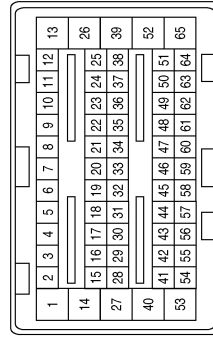

Terminal No.	Color of Wire	Signal Name
30	W	READY SIGNAL
47	LG	P/N POSITION SIGNAL
48	W	P POSITION SIGNAL

Connector No.	E44
Connector Name	JOINT CONNECTOR-E02
Connector Color	BLUE

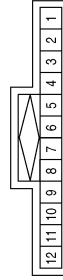

Terminal No.	Color of Wire	Signal Name
2	SB	-
6	SB	-

Connector No.	E35
Connector Name	ABS ACTUATOR AND ELECTRIC UNIT (CONTROL UNIT)
Connector Color	BLACK

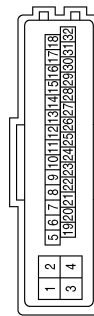

Terminal No.	Color of Wire	Signal Name
9	P	CAN-L
22	L	CAN-H

AAKIA2026GB

A
B
C
D
E
F
G
H
I
J
K
L
M
N
O
P

SEC

Connector No.	E102
Connector Name	STOP LAMP SWITCH
Connector Color	WHITE



Terminal No.	Color of Wire	Signal Name
1	W	-
2	SB	-

Connector No.	E62
Connector Name	VCM
Connector Color	BROWN

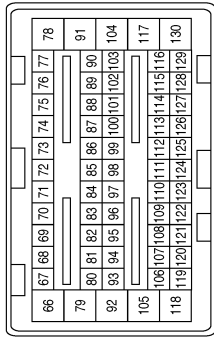

Terminal No.	Color of Wire	Signal Name
75	L	CAN-H
76	P	CAN-L
79	R	12V BATTERY POWER SUPPLY

Connector No.	E107
Connector Name	WIRE TO WIRE
Connector Color	WHITE



Terminal No.	Color of Wire	Signal Name
1	L	-
2	P	-

Terminal No.	Color of Wire	Signal Name
13	W	-
23	LG	-
44	W	-
51	W	-
52	O	-
62	W	-
63	SB	-
91	Y	-
94	R	-

Connector No.	E105
Connector Name	WIRE TO WIRE
Connector Color	WHITE

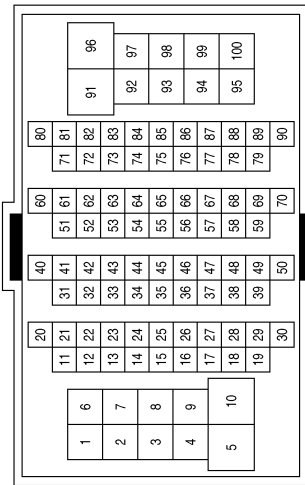

AAKIA20276B

A
B
C
D
E
F
G
H
I
J
L
M
N
O
P

Connector No.	B7
Connector Name	WIRE TO WIRE
Connector Color	WHITE

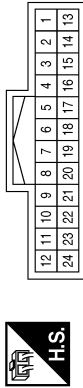

Terminal No.	Color of Wire	Signal Name
1	L	-
2	P	-

Connector No.	B3
Connector Name	WIRE TO WIRE
Connector Color	WHITE

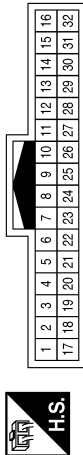

Terminal No.	Color of Wire	Signal Name
31	L	-
32	P	-

SEC

AAKIA2028GB

VEHICLE SECURITY SYSTEM

[WITH INTELLIGENT KEY SYSTEM]

< WIRING DIAGRAM >

VEHICLE SECURITY SYSTEM

Wiring Diagram

INFOID:000000010546209

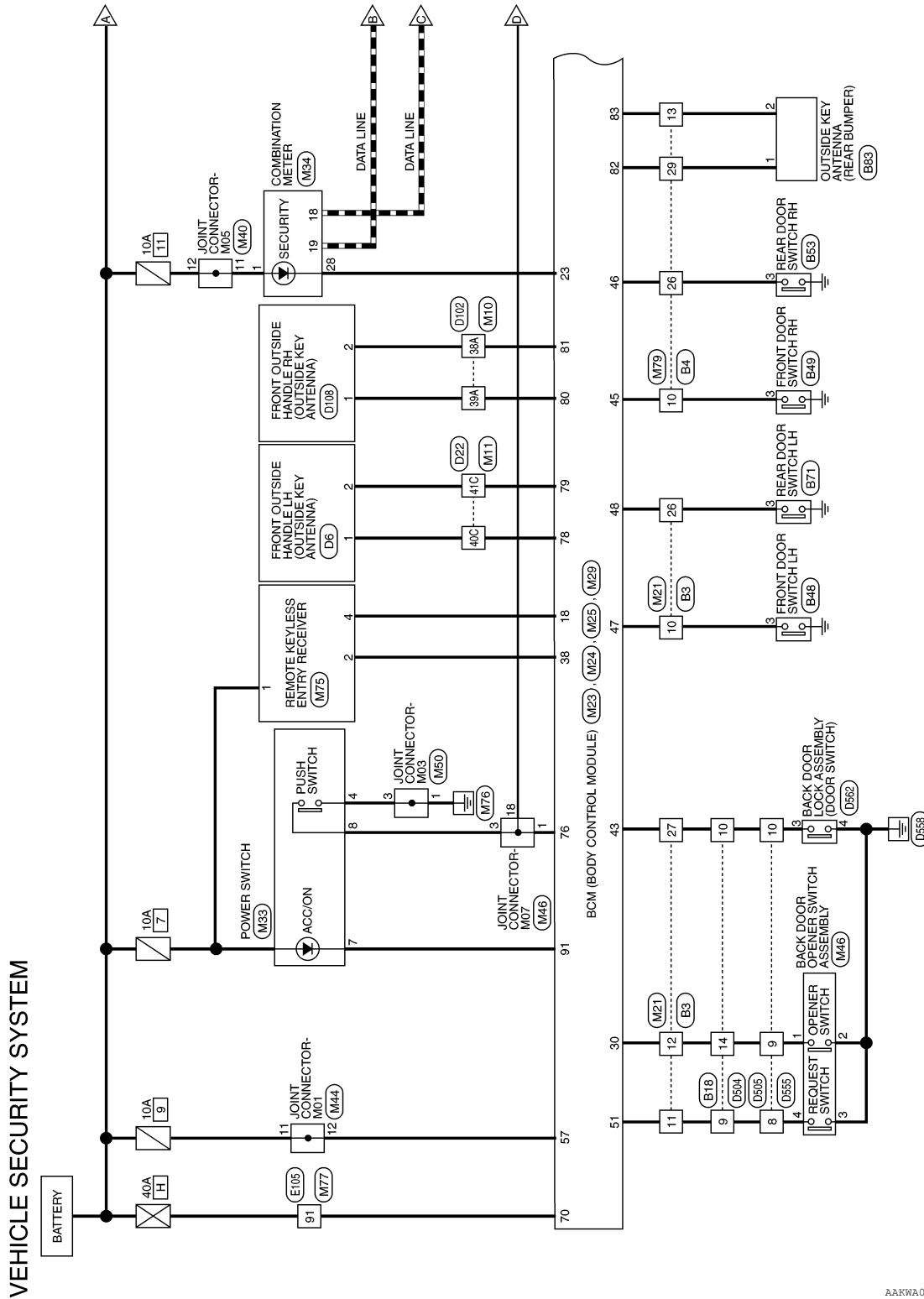

AAKWA0832GB

VEHICLE SECURITY SYSTEM

[WITH INTELLIGENT KEY SYSTEM]

< WIRING DIAGRAM >

CA FOR CANADA

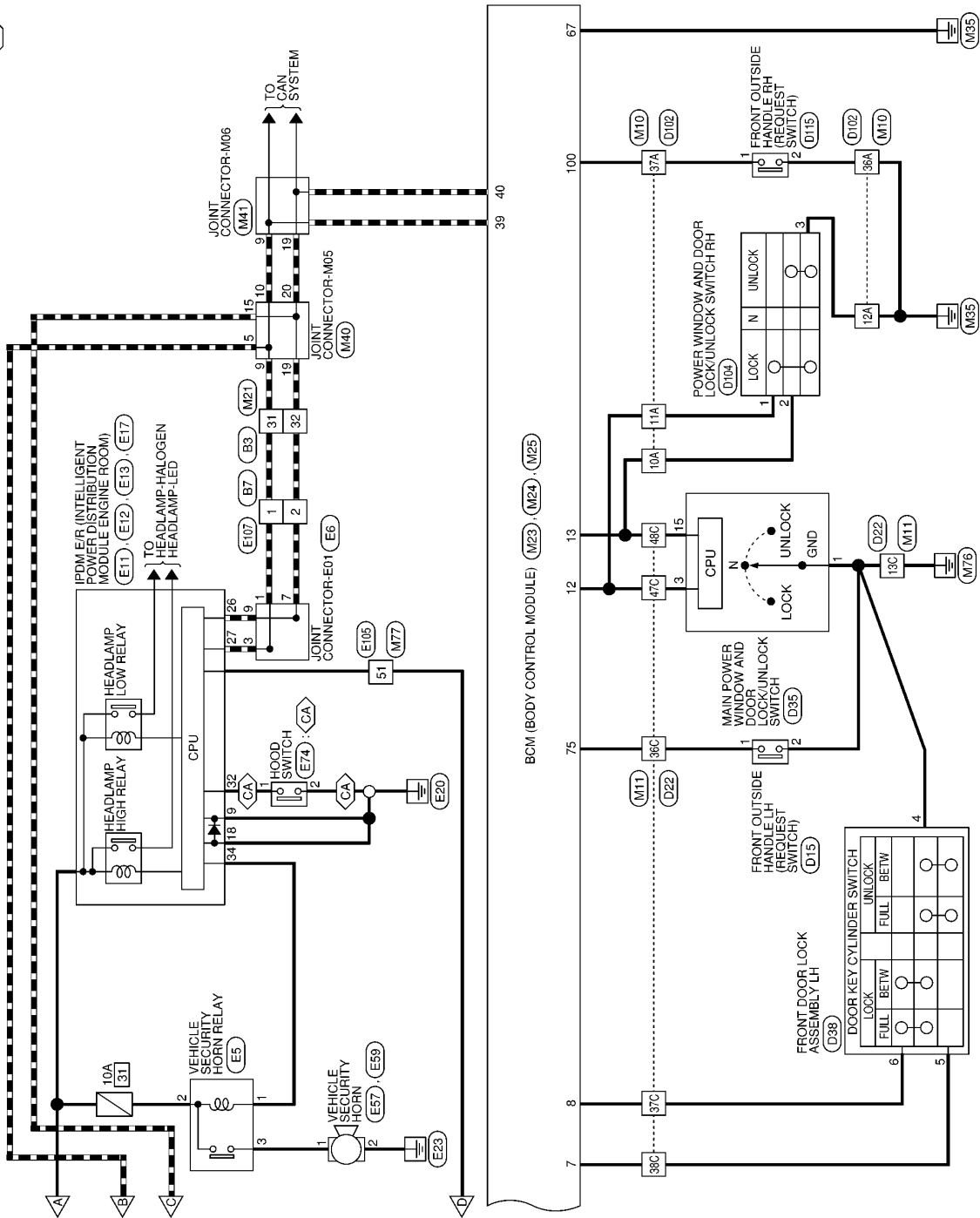

AAKWA0833GB

A
B
C
D
E
F
G
H
I
J
K
L
M
N
O
P

SEC

VEHICLE SECURITY SYSTEM

[WITH INTELLIGENT KEY SYSTEM]

< WIRING DIAGRAM >

VEHICLE SECURITY SYSTEM CONNECTORS

Connector No.	M10
Connector Name	WIRE TO WIRE
Connector Color	WHITE

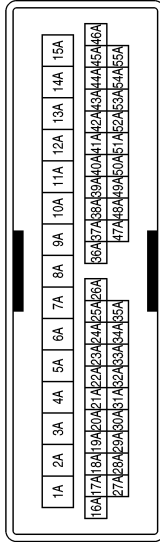

Connector No.	M11
Connector Name	WIRE TO WIRE
Connector Color	WHITE

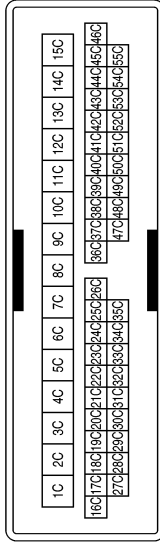

Terminal No.	Color of Wire	Signal Name
10A	BR	-
11A	Y	-
12A	B	-
36A	B	-
37A	P	-
38A	Y	-
39A	LG	-

Terminal No.	Color of Wire	Signal Name
13C	B	-
36C	LG	-
37C	R	-
38C	GR	-
40C	P	-
41C	V	-
47C	Y	-
48C	BR	-

Connector No.	M21
Connector Name	WIRE TO WIRE
Connector Color	WHITE

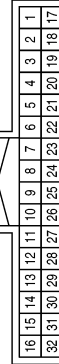

Terminal No.	Color of Wire	Signal Name
10	SB	-
11	P	-
12	V	-
26	W	-
27	Y	-
31	L	-
32	P	-

AAKIA2013GB

VEHICLE SECURITY SYSTEM

[WITH INTELLIGENT KEY SYSTEM]

< WIRING DIAGRAM >

Terminal No.	Color of Wire	Signal Name
82	W	BACK DOOR ANTENNA +
83	B	BACK DOOR ANTENNA -
91	V	POWER POSITION LED (LOCK POSITION LED)
100	P	REQUEST SWITCH (AS)

Connector No.	M23
Connector Name	BCM (BODY CONTROL MODULE)
Connector Color	WHITE



71	72	73	74	75	76	77	78	79	80	81	82	83	84	85	86	87	88	89	90
91	92	93	94	95	96	97	98	99	100	101	102	103	104	105	106	107	108	109	110

Terminal No.	Color of Wire	Signal Name
75	LG	REQUEST SW (DR)
76	SB	ENGINE START SW
78	P	DOOR ANTENNA (DR) +
79	V	DOOR ANTENNA (DR) -
80	LG	DOOR ANTENNA (AS) +
81	Y	DOOR ANTENNA (AS) -

Connector No.	M25
Connector Name	BCM (BODY CONTROL MODULE)
Connector Color	WHITE



56	57	58	59	60	61	62	63	64
65	66	67	68	69	70			

Terminal No.	Color of Wire	Signal Name
12	Y	CENTRAL DOOR LOCK SW
13	BR	CENTRAL DOOR UNLOCK SW
18	L	KEYLESS TUNER, AUTO LIGHT SENSOR GND
23	R	SECURITY INDICATOR OUTPUT
30	V	TRUNK/BACK DOOR OPENER SW
38	SB	INTELLIGENT TUNER
39	L	CAN-H
40	P	CAN-L

Connector No.	M24
Connector Name	BCM (BODY CONTROL MODULE)
Connector Color	BLACK



1	2	3	4	5	6	7	8	9	10	11	12	13	14	15	16	17	18	19	20
21	22	23	24	25	26	27	28	29	30	31	32	33	34	35	36	37	38	39	40

Terminal No.	Color of Wire	Signal Name
7	GR	KEY CYLINDER UNLOCK SW
8	R	KEY CYLINDER LOCK SW

Terminal No.	Color of Wire	Signal Name
57	P	BATTERY (FUSE)
67	B	GND
70	Y	BATTERY (F/L)

AAKIA2014GB

A
B
C
D
E
F
G
H
I
J
K
L
M
N
O
P

SEC

VEHICLE SECURITY SYSTEM

[WITH INTELLIGENT KEY SYSTEM]

< WIRING DIAGRAM >

Connector No.	M29
Connector Name	BCM (BODY CONTROL MODULE)
Connector Color	BLACK

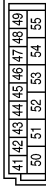

Terminal No.	Color of Wire	Signal Name
43	Y	DOOR SW (BACK)
45	BR	DOOR SW (AS)
46	R	DOOR SW (RR)
47	SB	DOOR SW (DR)
48	W	DOOR SW (RL)
51	P	REQUEST SW (TRUNK/BACK DOOR)

Connector No.	M34
Connector Name	COMBINATION METER
Connector Color	WHITE

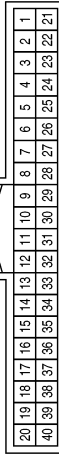

Terminal No.	Color of Wire	Signal Name
1	LG	BAT
18	P	CAN-L
19	L	CAN-H
28	R	SECURITY

Connector No.	M40
Connector Name	JOINT CONNECTOR-M05
Connector Color	BLUE

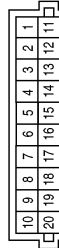

Terminal No.	Color of Wire	Signal Name
5	L	-
9	L	-
10	L	-
11	LG	-
12	LG	-
15	P	-
19	P	-
20	P	-

Connector No.	M41
Connector Name	JOINT CONNECTOR-M06
Connector Color	BLUE

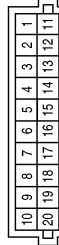

Terminal No.	Color of Wire	Signal Name
9	L	-
10	L	-
19	P	-
20	P	-

Connector No.	M44
Connector Name	JOINT CONNECTOR-M01
Connector Color	GRAY

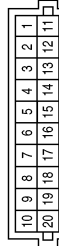

Terminal No.	Color of Wire	Signal Name
11	P	-
12	P	-

AAKIA2015GB

VEHICLE SECURITY SYSTEM

[WITH INTELLIGENT KEY SYSTEM]

< WIRING DIAGRAM >

Connector No.	M46
Connector Name	JOINT CONNECTOR-M07
Connector Color	ORANGE

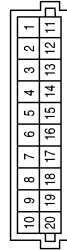

Terminal No.	Color of Wire	Signal Name
18	SB	-
19	SB	-
20	SB	-

Connector No.	M75
Connector Name	REMOTE KEYLESS ENTRY RECEIVER
Connector Color	WHITE

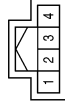

Terminal No.	Color of Wire	Signal Name
1	G	-
2	SB	-
4	L	-

Connector No.	M77
Connector Name	WIRE TO WIRE
Connector Color	WHITE

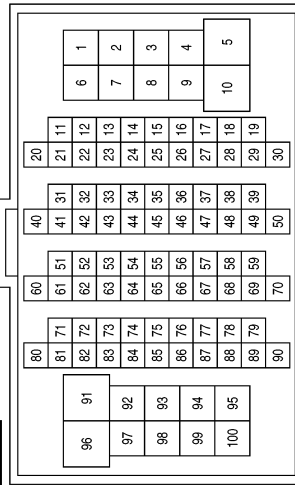

Terminal No.	Color of Wire	Signal Name
91	Y	-

Connector No.	M79
Connector Name	WIRE TO WIRE
Connector Color	WHITE

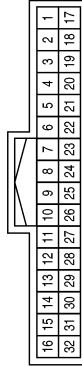

Terminal No.	Color of Wire	Signal Name
10	BR	-
13	B	-
26	R	-
29	W	-

Connector No.	E5
Connector Name	VEHICLE SECURITY HORN RELAY
Connector Color	WHITE



Terminal No.	Color of Wire	Signal Name
1	R	-
2	O	-
3	G	-

AAKIA2016GB

A
B
C
D
E
F
G
H
I
J
K
L
M
N
O
P

SEC

VEHICLE SECURITY SYSTEM

< WIRING DIAGRAM >

[WITH INTELLIGENT KEY SYSTEM]

Connector No.	E6
Connector Name	JOINT CONNECTOR-E01
Connector Color	BLUE

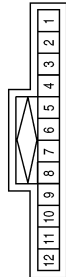

Terminal No.	Color of Wire	Signal Name
1	L	-
3	L	-
7	P	-
9	P	-

Connector No.	E11
Connector Name	IPDM/ER (INTELLIGENT POWER DISTRIBUTION MODULE ENGINE ROOM)
Connector Color	BLACK



Terminal No.	Color of Wire	Signal Name
9	B	GND (POWER)

Connector No.	E12
Connector Name	IPDM/ER (INTELLIGENT POWER DISTRIBUTION MODULE ENGINE ROOM)
Connector Color	BROWN

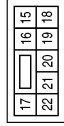

Terminal No.	Color of Wire	Signal Name
18	B/W	GND (SIGNAL)

Connector No.	E13
Connector Name	IPDM/ER (INTELLIGENT POWER DISTRIBUTION MODULE ENGINE ROOM)
Connector Color	WHITE

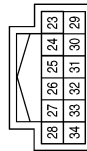

Terminal No.	Color of Wire	Signal Name
26	P	CAN-L
27	L	CAN-H
32	SB	HOOD SW
34	R	HORN RLY CONT

Connector No.	E17
Connector Name	IPDM/ER (INTELLIGENT POWER DISTRIBUTION MODULE ENGINE ROOM)
Connector Color	BLACK

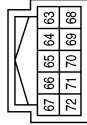

Terminal No.	Color of Wire	Signal Name
66	W	PUSH START SW

Connector No.	E57
Connector Name	VEHICLE SECURITY HORN
Connector Color	BROWN



Terminal No.	Color of Wire	Signal Name
1	G	-

VEHICLE SECURITY SYSTEM

[WITH INTELLIGENT KEY SYSTEM]

< WIRING DIAGRAM >

Connector No.	E74
Connector Name	HOOD SWITCH
Connector Color	GRAY



Terminal No.	Color of Wire	Signal Name
1	SB	-
2	B/W	-

Connector No.	E59
Connector Name	VEHICLE SECURITY HORN
Connector Color	BLACK



Terminal No.	Color of Wire	Signal Name
2	B/Y	-

Connector No.	B3
Connector Name	WIRE TO WIRE
Connector Color	WHITE

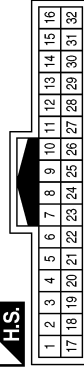

Terminal No.	Color of Wire	Signal Name
10	SB	-
11	P	-
12	BR	-
26	LG	-
27	Y	-
31	L	-
32	P	-

Connector No.	E107
Connector Name	WIRE TO WIRE
Connector Color	WHITE

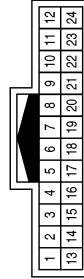

Terminal No.	Color of Wire	Signal Name
1	L	-
2	P	-

Connector No.	E105
Connector Name	WIRE TO WIRE
Connector Color	WHITE

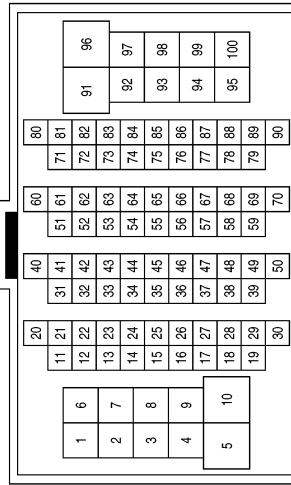

Terminal No.	Color of Wire	Signal Name
51	W	-
91	Y	-

AAKIA2018GB

A
B
C
D
E
F
G
H
I
J
L
M
N
O
P

SEC

VEHICLE SECURITY SYSTEM

[WITH INTELLIGENT KEY SYSTEM]

< WIRING DIAGRAM >

Connector No.	B18
Connector Name	WIRE TO WIRE
Connector Color	WHITE

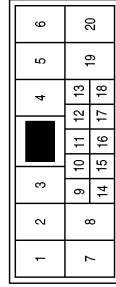

Terminal No.	Color of Wire	Signal Name
9	P	--
10	Y	--
14	BR	--

Connector No.	B7
Connector Name	WIRE TO WIRE
Connector Color	WHITE

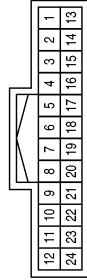

Terminal No.	Color of Wire	Signal Name
1	L	--
2	P	--

Connector No.	B4
Connector Name	WIRE TO WIRE
Connector Color	WHITE



Terminal No.	Color of Wire	Signal Name
10	BR	--
13	B	--
26	R	--
29	W	--

Connector No.	B53
Connector Name	REAR DOOR SWITCH RH
Connector Color	WHITE

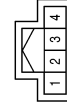

Terminal No.	Color of Wire	Signal Name
3	R	--

Connector No.	B49
Connector Name	FRONT DOOR SWITCH RH
Connector Color	WHITE

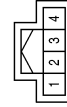

Terminal No.	Color of Wire	Signal Name
3	BR	--

Connector No.	B48
Connector Name	FRONT DOOR SWITCH LH
Connector Color	WHITE

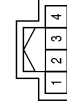

Terminal No.	Color of Wire	Signal Name
3	SB	--

AAKIA2019GB

VEHICLE SECURITY SYSTEM

[WITH INTELLIGENT KEY SYSTEM]

< WIRING DIAGRAM >

Connector No.	B71
Connector Name	REAR DOOR SWITCH LH
Connector Color	WHITE

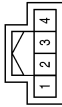

Terminal No.	Color of Wire	Signal Name
3	LG	-

Connector No.	B83
Connector Name	OUTSIDE KEY ANTENNA (REAR BUMPER)
Connector Color	BLUE



Terminal No.	Color of Wire	Signal Name
1	W	-
2	B	-

Connector No.	D6
Connector Name	FRONT OUTSIDE HANDLE LH (OUTSIDE KEY ANTENNA)
Connector Color	BLUE



Terminal No.	Color of Wire	Signal Name
1	P	-
2	V	-

Connector No.	D15
Connector Name	FRONT OUTSIDE HANDLE LH (REQUEST SWITCH)
Connector Color	BLACK



Terminal No.	Color of Wire	Signal Name
1	LG	-
2	B	-

Connector No.	D22
Connector Name	WIRE TO WIRE
Connector Color	WHITE

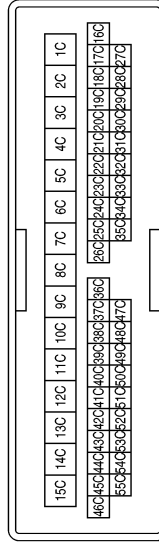

Connector No.	D35
Connector Name	POWER WINDOW MAIN SWITCH
Connector Color	WHITE

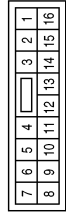

Terminal No.	Color of Wire	Signal Name
1	B	GND
3	Y	LOCK SW
15	BR	UNLOCK SW

Terminal No.	Color of Wire	Signal Name
13C	B	-
36C	LG	-
37C	R	-
38C	L	-
40C	P	-
41C	V	-
47C	Y	-
48C	BR	-

AAKIA2020GB

A
B
C
D
E
F
G
H
I
J
K
L
M
N
O
P

SEC

VEHICLE SECURITY SYSTEM

[WITH INTELLIGENT KEY SYSTEM]

< WIRING DIAGRAM >

Connector No.	D38
Connector Name	FRONT DOOR LOCK ASSEMBLY LH
Connector Color	GRAY

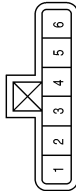

Terminal No.	Color of Wire	Signal Name
4	B	-
5	L	-
6	R	-

Connector No.	D102
Connector Name	WIRE TO WIRE
Connector Color	WHITE

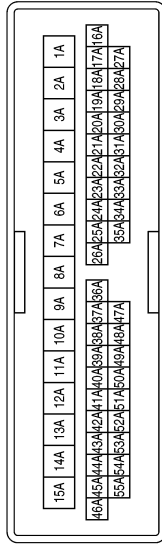

Terminal No.	Color of Wire	Signal Name
10A	BR	-
11A	Y	-
12A	B	-
36A	B	-
37A	P	-

Connector No.	D104
Connector Name	POWER WINDOW AND DOOR LOCK/UNLOCK SWITCH RH
Connector Color	WHITE

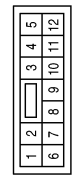

Terminal No.	Color of Wire	Signal Name
1	Y	-
2	BR	-
3	B	-

Connector No.	D108
Connector Name	FRONT OUTSIDE HANDLE RH (OUTSIDE KEY ANTENNA)
Connector Color	BLUE



Terminal No.	Color of Wire	Signal Name
1	LG	-
2	Y	-

Connector No.	D115
Connector Name	FRONT OUTSIDE HANDLE RH (REQUEST SWITCH)
Connector Color	BLACK



Terminal No.	Color of Wire	Signal Name
1	P	-
2	B	-

VEHICLE SECURITY SYSTEM

[WITH INTELLIGENT KEY SYSTEM]

< WIRING DIAGRAM >

Connector No.	D555
Connector Name	WIRE TO WIRE
Connector Color	WHITE



1	2	3	4	5
6	7	8	9	10
11	12			

Terminal No.	Color of Wire	Signal Name
8	P	-
9	L	-
10	SB	-

Connector No.	D505
Connector Name	WIRE TO WIRE
Connector Color	WHITE



5	4	3	2	1
12	11	10	9	8
7	6			

Terminal No.	Color of Wire	Signal Name
8	P	-
9	L	-
10	SB	-

Connector No.	D504
Connector Name	WIRE TO WIRE
Connector Color	WHITE



6	5	4	3	2	1
20	19	18	17	16	15
					14
					13
					12
					11
					10
					9
					8
					7

Terminal No.	Color of Wire	Signal Name
9	P	-
10	SB	-
14	L	-

Connector No.	D563
Connector Name	BACK DOOR OPENER SWITCH
Connector Color	GRAY



1	2	3	4
---	---	---	---

Terminal No.	Color of Wire	Signal Name
1	L	-
2	B	-
3	B	-
4	P	-

Connector No.	D562
Connector Name	BACK DOOR LOCK ASSEMBLY
Connector Color	WHITE



4	3	2	1
---	---	---	---

Terminal No.	Color of Wire	Signal Name
3	SB	-
4	B	-

AAKIA2022GB

A
B
C
D
E
F
G
H
I
J
K
L
M
N
O
P

SEC

DIAGNOSIS AND REPAIR WORK FLOW

< BASIC INSPECTION >

[WITH INTELLIGENT KEY SYSTEM]

BASIC INSPECTION

DIAGNOSIS AND REPAIR WORK FLOW

Work Flow

INFOID:000000010119241

OVERALL SEQUENCE

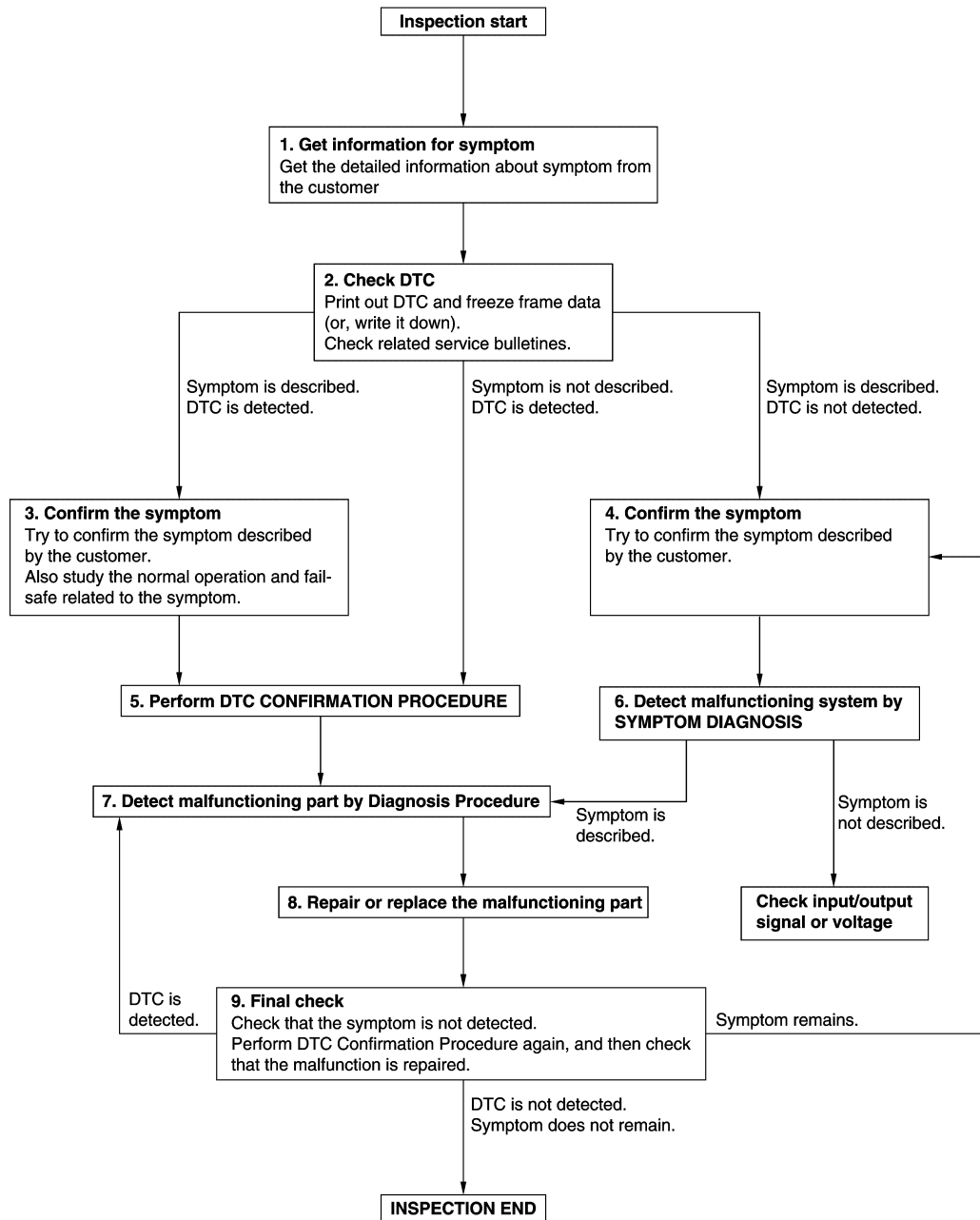

DETAILED FLOW

Revision: May 2014

SEC-62

2014 LEAF

JMKIA8652GB

DIAGNOSIS AND REPAIR WORK FLOW

[WITH INTELLIGENT KEY SYSTEM]

< BASIC INSPECTION >

1.GET INFORMATION FOR SYMPTOM

1. Get detailed information from the customer about the symptom (the condition and the environment when the incident/malfunction occurs).
2. Check operation condition of the function that is malfunctioning.

>> GO TO 2.

2.CHECK DTC

1. Check DTC.
2. Perform the following procedure if DTC is detected.
 - Record DTC and freeze frame data (Print them out using CONSULT.)
 - Erase DTC.
 - Study the relationship between the cause detected by DTC and the symptom described by the customer.
3. Check related service bulletins for information.

Are any symptoms described and any DTC detected?

Symptom is described, DTC is detected>>GO TO 3.

Symptom is described, DTC is not detected>>GO TO 4.

Symptom is not described, DTC is detected>>GO TO 5.

3.CONFIRM THE SYMPTOM

Try to confirm the symptom described by the customer.

Also study the normal operation and fail-safe related to the symptom.

Verify relation between the symptom and the condition when the symptom is detected.

>> GO TO 5.

4.CONFIRM THE SYMPTOM

Try to confirm the symptom described by the customer.

Verify relation between the symptom and the condition when the symptom is detected.

>> GO TO 6.

5.PERFORM DTC CONFIRMATION PROCEDURE

Perform DTC CONFIRMATION PROCEDURE for the detected DTC, and then check that DTC is detected again. At this time, always connect CONSULT to the vehicle, and check self diagnostic results in real time.

If two or more DTCs are detected, refer to [BCS-47. "DTC Inspection Priority Chart"](#) and determine trouble diagnosis order.

NOTE:

- Freeze frame data is useful if the DTC is not detected.
- Perform Component Function Check if DTC CONFIRMATION PROCEDURE is not included on Service Manual. This simplified check procedure is an effective alternative though DTC cannot be detected during this check.

If the result of Component Function Check is NG, it is the same as the detection of DTC by DTC CONFIRMATION PROCEDURE.

Is DTC detected?

YES >> GO TO 7.

NO >> Check according to [GI-53. "Intermittent Incident"](#).

6.DETECT MALFUNCTIONING SYSTEM BY SYMPTOM DIAGNOSIS

Detect malfunctioning system according to SYMPTOM DIAGNOSIS based on the confirmed symptom in step 4, and determine the trouble diagnosis order based on possible causes and symptom.

Is the symptom described?

YES >> GO TO 7.

NO >> Monitor input data from related sensors or check voltage of related module terminals using CONSULT.

7.DETECT MALFUNCTIONING PART BY DIAGNOSTIC PROCEDURE

A
B
C
D
E
F
G
H
I
J
L
M
N
O
P

SEC

DIAGNOSIS AND REPAIR WORK FLOW

[WITH INTELLIGENT KEY SYSTEM]

< BASIC INSPECTION >

Inspect according to Diagnostic Procedure of the system.

Is malfunctioning part detected?

YES >> GO TO 8.

NO >> Check according to [GI-53. "Intermittent Incident"](#).

8. REPAIR OR REPLACE THE MALFUNCTIONING PART

1. Repair or replace the malfunctioning part.
2. Reconnect parts or connectors disconnected during Diagnostic Procedure again after repair and replacement.
3. Check DTC. If DTC is detected, erase it.

>> GO TO 9.

9. FINAL CHECK

When DTC is detected in step 2, perform DTC CONFIRMATION PROCEDURE again, and then check that the malfunction is repaired securely.

When symptom is described by the customer, refer to confirmed symptom in step 3 or 4, and check that the symptom is not detected.

Is DTC detected and does symptom remain?

YES-1 >> DTC is detected: GO TO 7.

YES-2 >> Symptom remains: GO TO 4.

NO >> Before returning the vehicle to the customer, always erase DTC.

ADDITIONAL SERVICE WHEN REPLACING CONTROL UNIT

< BASIC INSPECTION >

[WITH INTELLIGENT KEY SYSTEM]

ADDITIONAL SERVICE WHEN REPLACING CONTROL UNIT

VCM

VCM : Description

INFOID:0000000010119242

Performing the following procedure can automatically activate recommunication of VCM and BCM, but only when the VCM is replaced with a new one*.

*: New one means a replacement VCM that has never been energized on-board.

(In this step, initialization procedure using CONSULT is not necessary)

NOTE:

- When the replaced VCM is not brand new, the initialization of BCM using CONSULT is necessary.
- If multiple keys are attached to the key holder, separate them before beginning work.
- Distinguish keys with unregistered key IDs from those with registered IDs.

VCM : Work Procedure

INFOID:0000000010119243

1.PERFORM VCM RECOMMUNICATING FUNCTION

1. Install VCM.
2. Contact backside of registered Intelligent key* to power switch while brake pedal is depressed, then turn power switch to the ON position.
*: To perform this step, use the key that is used before performing VCM replacement.
3. Maintain power switch in the ON position for at least 5 seconds.
4. Turn power switch to the OFF position.
5. Check that the vehicle can be set to READY.

>> GO TO 2.

2.PERFORM ADDITIONAL SERVICE WHEN REPLACING VCM

Perform the following procedure [EVC-423, "Removal and Installation"](#).

>> Inspection End.

BCM

BCM : Description

INFOID:0000000010119244

SEC

BEFORE REPLACEMENT

When replacing BCM, save or print current vehicle specification with CONSULT configuration before replacement.

NOTE:

If "Before Replace ECU" cannot be used, use the "After Replace ECU" or "Manual Configuration" after replacing BCM.

AFTER REPLACEMENT

CAUTION:

- When replacing BCM, you must perform "After Replace ECU" with CONSULT.
- Complete the procedure of "After Replace ECU" in order.
- If you set incorrect "After Replace ECU", incidents might occur.
- Configuration is different for each vehicle model. Confirm configuration of each vehicle model.
- When replacing BCM, perform the system initialization (NATS).

BCM : Work Procedure

INFOID:0000000010119245

1.SAVING VEHICLE SPECIFICATION

CONSULT

Enter "Re/Programming, Configuration" and perform "Before Replace ECU" to save or print current vehicle specification.

NOTE:

ADDITIONAL SERVICE WHEN REPLACING CONTROL UNIT

< BASIC INSPECTION >

[WITH INTELLIGENT KEY SYSTEM]

If "Before Replace ECU" cannot be used, use the "After Replace ECU" or "Manual Configuration" after replacing BCM.

>> GO TO 2.

2. REPLACE BCM

Replace BCM. Refer to [BCS-72, "Removal and Installation"](#).

>> GO TO 3.

3. WRITING VEHICLE SPECIFICATION

ⓐ CONSULT

1. Enter "Re/Programming, Configuration".
2. If "Before Replace ECU" operation was performed, automatically an "Operation Log Selection" screen will be displayed. Select the applicable file from the "Saved Data List" and press "Confirm" to write vehicle specification. Refer to [BCS-58, "CONFIGURATION \(BCM\) : Work Procedure"](#).
3. If "Before Replace ECU" operation was not performed, select "After Replace ECU" or "Manual Configuration" to write vehicle specification. Refer to [BCS-58, "CONFIGURATION \(BCM\) : Work Procedure"](#).

>> GO TO 4.

4. INITIALIZE BCM (NATS)

Perform BCM initialization. (NATS)

>> Work End.

DTC/CIRCUIT DIAGNOSIS

P1610 LOCK MODE

Description

INFOID:0000000010119246

VCM forcibly switches to the mode that inhibits vehicle to be READY, when READY set operation is performed 5 times or more while communication between VCM and BCM is not normal.

DTC Logic

INFOID:0000000010119247

DTC DETECTION LOGIC

NOTE:

If DTC P1610 is displayed with other DTC (for BCM or EV/HEV), first perform the trouble diagnosis for other DTC.

DTC No.	Trouble diagnosis name	DTC detecting condition	Possible cause
P1610	LOCK MODE	When VCM detects a communication malfunction between VCM and BCM 5 times or more.	—

DTC CONFIRMATION PROCEDURE

1. PERFORM DTC CONFIRMATION PROCEDURE

1. Turn power switch ON.
2. Check DTC in “Self Diagnostic Result” of “EV/HEV” using CONSULT.

Is DTC detected?

- YES >> Go to [SEC-67. "Diagnosis Procedure"](#).
- NO >> Inspection End.

Diagnosis Procedure

INFOID:0000000010119248

1. CHECK VEHICLE READY SET FUNCTION

1. Check that DTC except DTC P1610 is not detected.
If detected, erase the DTC after fixing.
2. Turn power switch OFF.
3. Contact the registered Intelligent Key backside to power switch and wait 5 seconds.
4. Turn power switch ON.
5. Turn power switch OFF and wait 5 seconds.
6. Repeat steps 3 and 5 twice (a total of 3 times).
7. Check that vehicle can be set to READY.

>> Inspection End.



A
B
C
D
E
F
G
H
I
J
L
M
N
O
P

P1611 ID DISCORD, IMMU-VCM

< DTC/CIRCUIT DIAGNOSIS >

[WITH INTELLIGENT KEY SYSTEM]

P1611 ID DISCORD, IMMU-VCM

DTC Logic

INFOID:000000010119249

DTC DETECTION LOGIC

DTC No.	Trouble diagnosis name	DTC detecting condition	Possible cause
P1611	ID DISCORD, IMMU-VCM	The ID verification results between BCM and VCM are NG.	<ul style="list-style-type: none">• BCM• VCM

DTC CONFIRMATION PROCEDURE

1.PERFORM DTC CONFIRMATION PROCEDURE

1. Turn power switch ON.
2. Check DTC in "Self Diagnostic Result" of "EV/HEV" using CONSULT.

Is DTC detected?

- YES >> Go to [SEC-68. "Diagnosis Procedure"](#).
NO >> Inspection End.

Diagnosis Procedure

INFOID:000000010119250

1.PERFORM INITIALIZATION

1. Perform initialization of BCM and registration of all Intelligent Keys using CONSULT. Refer to the CONSULT Immobilizer mode and follow the on screen instructions.
2. Check that the vehicle can be set to READY using registered Intelligent Key.

Is the inspection result normal?

- YES >> Inspection End.
NO >> GO TO 2.

2.CHECK SELF DIAGNOSTIC RESULT

1. Select "Self Diagnostic Result" of "EV/HEV" using CONSULT.
2. Erase DTC.
3. Perform DTC CONFIRMATION PROCEDURE for DTC P1611. Refer to [SEC-68. "DTC Logic"](#).

Is DTC detected?

- YES >> GO TO 3.
NO >> Inspection End.

3.REPLACE BCM

1. Replace BCM. Refer to [BCS-72. "Removal and Installation"](#).
2. Perform initialization of BCM and registration of all Intelligent Keys using CONSULT. Refer to the CONSULT Immobilizer mode and follow the on screen instructions.
3. Check that the vehicle can be set to READY using registered Intelligent Key.

Is the inspection result normal?

- YES >> Inspection End.
NO >> GO TO 4.

4.REPLACE VCM

Replace VCM. Refer to [EVC-423. "Removal and Installation"](#).

>> Inspection End.

P1612 CHAIN OF VCM-IMMU

< DTC/CIRCUIT DIAGNOSIS >

[WITH INTELLIGENT KEY SYSTEM]

P1612 CHAIN OF VCM-IMMU

DTC Logic

INFOID:0000000010119251

DTC DETECTION LOGIC

NOTE:

- If DTC P1612 is displayed with DTC U1000 (for BCM), first perform the trouble diagnosis for DTC U1000. Refer to [BCS-61, "DTC Logic"](#).
- If DTC P1612 is displayed with DTC U1010 (for BCM), first perform the trouble diagnosis for DTC U1010. Refer to [BCS-62, "DTC Logic"](#).

DTC No.	Trouble diagnosis name	DTC detecting condition	Possible cause
P1612	CHAIN OF VCM-IMMU	Inactive communication between VCM and BCM	<ul style="list-style-type: none">• Harness or connectors (The CAN communication line is open or shorted.)• BCM• VCM

DTC CONFIRMATION PROCEDURE

1.PERFORM DTC CONFIRMATION PROCEDURE

1. Turn power switch ON.
2. Check DTC in "Self Diagnostic Result" of "EV/HEV" using CONSULT.

Is DTC detected?

- YES >> Go to [SEC-69, "Diagnosis Procedure"](#).
NO >> Inspection End.

Diagnosis Procedure

INFOID:0000000010119252

1.REPLACE BCM

1. Replace BCM. Refer to [BCS-72, "Removal and Installation"](#).
2. Perform initialization of BCM and registration of all Intelligent Keys using CONSULT. Refer to the CONSULT Immobilizer mode and follow the on screen instructions.
3. Check that the vehicle can be set to READY using registered Intelligent Key.

Is the inspection result normal?

- YES >> Inspection End.
NO >> GO TO 2.

2.REPLACE VCM

Replace VCM. Refer to [EVC-423, "Removal and Installation"](#).

>> Inspection End.

B2192 ID DISCORD, IMMUECM

< DTC/CIRCUIT DIAGNOSIS >

[WITH INTELLIGENT KEY SYSTEM]

B2192 ID DISCORD, IMMUECM

DTC Logic

INFOID:000000010119253

DTC DETECTION LOGIC

DTC No.	Trouble diagnosis name	DTC detecting condition	Possible cause
B2192	ID DISCORD BCM-ECM*	The ID verification results between BCM and VCM are NG.	<ul style="list-style-type: none">• BCM• VCM

*: "ECM" is indicated on CONSULT display, however this means VCM on this vehicle.

DTC CONFIRMATION PROCEDURE

1. PERFORM DTC CONFIRMATION PROCEDURE

1. Turn power switch ON.
2. Check DTC in "Self Diagnostic Result" of "BCM" using CONSULT.

Is DTC detected?

- YES >> Go to [SEC-70, "Diagnosis Procedure"](#).
NO >> Inspection End.

Diagnosis Procedure

INFOID:000000010119254

1. PERFORM INITIALIZATION

1. Perform initialization of BCM and registration of all Intelligent Keys using CONSULT. Refer to the CONSULT Immobilizer mode and follow the on screen instructions.
2. Check that the vehicle can be set to READY using registered Intelligent Key.

Is the inspection result normal?

- YES >> Inspection End.
NO >> GO TO 2.

2. CHECK SELF-DIAGNOSIS RESULT

1. Select "Self Diagnostic Result" of "BCM" using CONSULT.
2. Erase DTC.
3. Perform DTC CONFIRMATION PROCEDURE for DTC B2192. Refer to [SEC-70, "DTC Logic"](#).

Is DTC detected?

- YES >> GO TO 3.
NO >> Inspection End.

3. REPLACE BCM

1. Replace BCM. Refer to [BCS-72, "Removal and Installation"](#).
2. Perform initialization of BCM and registration of all Intelligent Keys using CONSULT. Refer to the CONSULT Immobilizer mode and follow the on screen instructions.
3. Check that the vehicle can be set to READY using registered Intelligent Key.

Is the inspection result normal?

- YES >> Inspection End.
NO >> GO TO 4.

4. REPLACE VCM

Replace VCM. Refer to [EVC-423, "Removal and Installation"](#).

>> Inspection End.

B2193 CHAIN OF ECM-IMMU

< DTC/CIRCUIT DIAGNOSIS >

[WITH INTELLIGENT KEY SYSTEM]

B2193 CHAIN OF ECM-IMMU

DTC Logic

INFOID:0000000010119255

DTC DETECTION LOGIC

NOTE:

- If DTC B2193 is displayed with DTC U1000, first perform the trouble diagnosis for DTC U1000. Refer to [BCS-61, "DTC Logic"](#).
- If DTC B2193 is displayed with DTC U1010, first perform the trouble diagnosis for DTC U1010. Refer to [BCS-62, "DTC Logic"](#).

DTC No.	Trouble diagnosis name	DTC detecting condition	Possible cause
B2193	CHAIN OF BCM-ECM*	Inactive communication between BCM and VCM	<ul style="list-style-type: none">• Harness or connectors (The CAN communication line is open or shorted.)• BCM• VCM

*: "ECM" is indicated on CONSULT display, however this means VCM on this vehicle.

DTC CONFIRMATION PROCEDURE

1. PERFORM DTC CONFIRMATION PROCEDURE

1. Turn power switch ON.
2. Check DTC in "Self Diagnostic Result" of "BCM" using CONSULT.

Is DTC detected?

- YES >> Go to [SEC-71, "Diagnosis Procedure"](#).
NO >> Inspection End.

Diagnosis Procedure

INFOID:0000000010119256

1. REPLACE BCM

1. Replace BCM. Refer to [BCS-72, "Removal and Installation"](#).
2. Perform initialization of BCM and registration of all Intelligent Keys using CONSULT. Refer to the CONSULT Immobilizer mode and follow the on screen instructions.
3. Check that the vehicle can be set to READY using registered Intelligent Key.

Is the inspection result normal?

- YES >> Inspection End.
NO >> GO TO 2.

2. REPLACE VCM

Replace VCM. Refer to [EVC-423, "Removal and Installation"](#).

>> Inspection End.

B2195 ANTI-SCANNING

< DTC/CIRCUIT DIAGNOSIS >

[WITH INTELLIGENT KEY SYSTEM]

B2195 ANTI-SCANNING

DTC Logic

INFOID:000000010119257

DTC DETECTION LOGIC

DTC No.	Trouble diagnosis name	DTC detecting condition	Possible cause
B2195	ANTI-SCANNING	ID verification between BCM and VCM that is out of the specified specification is detected.	ID verification request out of the specified specification

DTC CONFIRMATION PROCEDURE

1. PERFORM DTC CONFIRMATION PROCEDURE

1. Turn power switch ON.
2. Check DTC in "Self Diagnostic Result" of "BCM" using CONSULT.

Is DTC detected?

- YES >> Refer to [SEC-72, "Diagnosis Procedure"](#).
NO >> Inspection End.

Diagnosis Procedure

INFOID:000000010119258

1. CHECK SELF DIAGNOSTIC RESULT 1

1. Select "Self Diagnostic Result" of "BCM" using CONSULT.
2. Erase DTC.
3. Perform DTC CONFIRMATION PROCEDURE for DTC B2195. Refer to [SEC-72, "DTC Logic"](#).

Is DTC detected?

- YES >> GO TO 2.
NO >> Inspection End.

2. CHECK EQUIPMENT OF THE VEHICLE

Check that unspecified accessory part related to set vehicle to READY is not installed.

Is unspecified accessory part installed?

- YES >> GO TO 3.
NO >> GO TO 4.

3. CHECK SELF DIAGNOSTIC RESULT 2

1. Obtain the customers approval to remove unspecified accessory part related to set vehicle to READY, and then remove it.
2. Select "Self Diagnostic Result" of "BCM" using CONSULT.
3. Erase DTC.
4. Perform DTC CONFIRMATION PROCEDURE for DTC B2195. Refer to [SEC-72, "DTC Logic"](#).

Is DTC detected?

- YES >> GO TO 4.
NO >> Inspection End.

4. REPLACE BCM

1. Replace BCM. Refer to [BCS-72, "Removal and Installation"](#).
2. Perform initialization of BCM and registration of all Intelligent Keys using CONSULT. Refer to the CONSULT Immobilizer mode and follow the on screen instructions.

>> Inspection End.

B2196 DONGLE UNIT

< DTC/CIRCUIT DIAGNOSIS >

[WITH INTELLIGENT KEY SYSTEM]

B2196 DONGLE UNIT

Description

INFOID:0000000010119259

BCM performs ID verification between BCM and dongle unit.
When verification result is OK, BCM permits cranking.

DTC Logic

INFOID:0000000010119260

DTC DETECTION LOGIC

DTC No.	Trouble diagnosis name	DTC detecting condition	Possible cause
B2196	DONGLE NG	The ID verification results between BCM and dongle unit is NG.	<ul style="list-style-type: none">• Harness or connectors (Dongle unit circuit is open or shorted.)• Dongle unit

DTC CONFIRMATION PROCEDURE

1.PERFORM DTC CONFIRMATION PROCEDURE

1. Turn ignition switch ON.
2. Turn ignition switch OFF.
3. Turn ignition switch ON.
4. Check DTC in "Self Diagnostic Result" of "BCM" using CONSULT.

Is the DTC detected?

- YES >> Refer to [SEC-73. "Diagnosis Procedure"](#).
NO >> Inspection End.

Diagnosis Procedure

INFOID:0000000010119261

Regarding Wiring Diagram information, refer to [SEC-42. "Wiring Diagram"](#).

1.PERFORM INITIALIZATION

1. Perform initialization of BCM and registration of all Intelligent Keys using CONSULT. Refer to the CONSULT Immobilizer mode and follow the on screen instructions.
2. Start the engine.

Dose the engine start?

- YES >> Inspection End.
NO >> GO TO 2.

2.CHECK DONGLE UNIT CIRCUIT

1. Turn ignition switch OFF.
2. Disconnect BCM connector and dongle unit connector.
3. Check continuity between BCM harness connector and dongle unit harness connector.

BCM		Dongle unit		Continuity
Connector	Terminal	Connector	Terminal	
M24	24	M91	1	Yes

4. Check continuity between BCM harness connector and ground.

BCM		Ground	Continuity
Connector	Terminal		
M24	24		No

Is the inspection result normal?

- YES >> GO TO 3.

A
B
C
D
E
F
G
H
I
J
L
M
N
O
P

SEC

B2196 DONGLE UNIT

< DTC/CIRCUIT DIAGNOSIS >

[WITH INTELLIGENT KEY SYSTEM]

NO >> Repair or replace harness.

3. CHECK DONGLE UNIT GROUND CIRCUIT

Check continuity between dongle unit harness connector and ground.

Dongle unit		Ground	Continuity
Connector	Terminal		
M91	4		Yes

Is the inspection result normal?

YES >> Replace dongle unit. Refer to [SEC-117. "Removal and Installation"](#).

NO >> Repair or replace harness.

B2198 NATS ANTENNA AMP.

< DTC/CIRCUIT DIAGNOSIS >

[WITH INTELLIGENT KEY SYSTEM]

B2198 NATS ANTENNA AMP.

DTC Logic

INFOID:0000000010119262

DTC DETECTION LOGIC

DTC No.	Trouble diagnosis name	DTC detecting condition	Possible cause
B2198	IMMOBI ANT NG	Inactive communication between NATS antenna amp. and BCM is detected when BCM enters in the low power consumption mode (BCM sleep condition)	<ul style="list-style-type: none"> • Harness or connectors (NATS antenna amp. circuit is open or shorted.) • NATS antenna amp. • BCM

DTC CONFIRMATION PROCEDURE

1. PERFORM DTC CONFIRMATION PROCEDURE

1. Make the conditions that BCM enters in the low power consumption mode (BCM sleep condition), and wait 15 to 60 minutes. Refer to [BCS-12. "POWER CONSUMPTION CONTROL SYSTEM : System Description"](#).
2. Turn power switch ON.
3. Check DTC in "Self Diagnostic Result" of "BCM" using CONSULT.

Is DTC detected?

- YES >> Go to [SEC-75. "Diagnosis Procedure"](#).
 NO >> Inspection End.

Diagnosis Procedure

INFOID:0000000010119263

Regarding Wiring Diagram information, refer to [SEC-42. "Wiring Diagram"](#).

1. CHECK FUSE

1. Turn power switch OFF.
2. Check that the following fuse in the fuse, fusible link and relay block 2 is not blown.

Signal name	Fuse No.
Battery power supply	77

Is the inspection result normal?

- YES >> GO TO 2.
 NO >> Replace the blown fuse after repairing the cause of blowing.

2. CHECK NATS ANTENNA AMP. POWER SUPPLY

1. Disconnect NATS antenna amp. connector.
2. Check voltage between NATS antenna amp. harness connector and ground.

(+)		(-)	Voltage (V) (Approx.)
NATS antenna amp.			
Connector	Terminal		
M49	1	Ground	Battery voltage

Is the inspection result normal?

- YES >> GO TO 4.
 NO >> GO TO 3.

3. CHECK NATS ANTENNA AMP. POWER SUPPLY CIRCUIT

Check the following.

- 12V battery

A
B
C
D
E
F
G
H
I
J
L
M
N
O
P

SEC

B2198 NATS ANTENNA AMP.

[WITH INTELLIGENT KEY SYSTEM]

< DTC/CIRCUIT DIAGNOSIS >

- Harness for short or open between 12V battery and 20A fuse (No. 77)
- 20A fuse (No. 77)
- Harness for short or open between 20A fuse (No. 77) and NATS antenna amp.

Is the inspection result normal?

- YES >> GO TO 4.
 NO >> Repair or replace damaged parts.

4. CHECK NATS ANTENNA AMP. GROUND CIRCUIT

Check continuity between NATS antenna amp. harness connector and ground.

NATS antenna amp.		Ground	Continuity
Connector	Terminal		
M49	4		Yes

Is the inspection result normal?

- YES >> GO TO 5.
 NO >> Repair or replace harness.

5. CHECK NATS ANTENNA AMP. COMMUNICATION SIGNAL 1

Check voltage signal between NATS antenna amp. harness connector and ground using an oscilloscope.

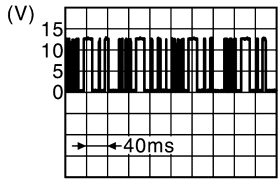
(+)		(-)	Condition	Voltage (V) (Approx.)
NATS antenna amp.				
Connector	Terminal			
M49	2	Ground	Intelligent Key: Intelligent Key battery is removed	 <p style="text-align: right; font-size: small;">JMkia6232JP</p>
			Brake pedal: Depressed NOTE: Waveform varies each time when brake pedal is depressed	
			Brake pedal: Released	Battery voltage

Is the inspection result normal?

- YES >> GO TO 7.
 NO >> GO TO 6.

6. CHECK NATS ANTENNA AMP. OUTPUT SIGNAL CIRCUIT 1

1. Disconnect BCM connector.
2. Check continuity between NATS antenna amp. harness connector and BCM connector.

NATS antenna amp.		BCM		Continuity
Connector	Terminal	Connector	Terminal	
M49	2	M24	21	Yes

3. Check continuity between NATS antenna amp. harness connector and ground.

NATS antenna amp.		Ground	Continuity
Connector	Terminal		
M49	2		No

Is the inspection result normal?

- YES >> GO TO 9.
 NO >> Repair or replace harness.

7. CHECK NATS ANTENNA AMP. COMMUNICATION SIGNAL 2

Check voltage signal between NATS antenna amp. harness connector and ground using an oscilloscope.

B2198 NATS ANTENNA AMP.

< DTC/CIRCUIT DIAGNOSIS >

[WITH INTELLIGENT KEY SYSTEM]

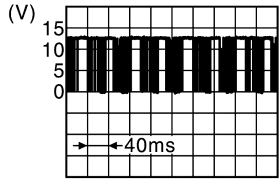
(+)		(-)	Condition		Voltage (V) (Approx.)
NATS antenna amp.					
Connector	Terminal				
M49	3	Ground	Intelligent Key: Intelligent Key battery is removed	Brake pedal: Depressed	 <p style="text-align: right; font-size: small;">JMK1A6233JP</p>
				Brake pedal: Released	

Is the inspection result normal?

YES >> Replace NATS antenna amp. Refer to [SEC-113, "Removal and Installation"](#).

NO >> GO TO 8.

8. CHECK NATS ANTENNA AMP. OUTPUT SIGNAL CIRCUIT 2

1. Disconnect BCM connector.
2. Check continuity between NATS antenna amp. harness connector and BCM connector.

NATS antenna amp.		BCM		Continuity
Connector	Terminal	Connector	Terminal	
M49	3	M24	25	Yes

3. Check continuity between NATS antenna amp. harness connector and ground.

NATS antenna amp.		Ground	Continuity
Connector	Terminal		
M49	3		No

Is the inspection result normal?

YES >> GO TO 9.

NO >> Repair or replace harness.

9. REPLACE BCM

1. Replace BCM. Refer to [BCS-72, "Removal and Installation"](#).
2. Perform initialization of BCM and registration of all Intelligent Keys using CONSULT. Refer to the CONSULT Immobilizer mode and follow the on screen instructions.

>> Inspection End.

A
B
C
D
E
F
G
H
I
J
L
M
N
O
P

SEC

B2555 STOP LAMP

< DTC/CIRCUIT DIAGNOSIS >

[WITH INTELLIGENT KEY SYSTEM]

B2555 STOP LAMP

DTC Logic

INFOID:000000010119264

DTC DETECTION LOGIC

DTC No.	Trouble diagnosis name	DTC detecting condition	Possible cause
B2555	STOP LAMP CIRCUIT	BCM makes a comparison between the upper voltage and the lower voltage of stop lamp switch. It judges from their values to detect the malfunctioning circuit.	<ul style="list-style-type: none"> • Harness or connectors (Stop lamp switch circuit is open or shorted.) • Stop lamp switch • Fuse • BCM

DTC CONFIRMATION PROCEDURE

1. PERFORM DTC CONFIRMATION PROCEDURE

1. Depress brake pedal and wait 1 second or more.
2. Check DTC in "Self Diagnostic Result" of "BCM" using CONSULT.

Is DTC detected?

- YES >> Go to [SEC-78. "Diagnosis Procedure"](#).
 NO >> Inspection End.

Diagnosis Procedure

INFOID:000000010119265

Regarding Wiring Diagram information, refer to [SEC-42. "Wiring Diagram"](#).

1. CHECK STOP LAMP SWITCH INPUT SIGNAL 1

1. Turn power switch OFF.
2. Disconnect BCM connector.
3. Check voltage between BCM harness connector and ground.

(+)		(-)	Voltage (V) (Approx.)
BCM			
Connector	Terminal		
M23	105	Ground	Battery voltage

Is the inspection normal?

- YES >> GO TO 2.
 NO-1 >> Check 10 A fuse [No. 38, located in the fuse block (J/B)].
 NO-2 >> Check harness for open or short between BCM and fuse.

2. CHECK STOP LAMP SWITCH POWER SUPPLY CIRCUIT

1. Disconnect stop lamp switch connector.
2. Check voltage between stop lamp switch harness connector and ground.

(+)		(-)	Voltage (V) (Approx.)
Stop lamp switch			
Connector	Terminal		
E102	1	Ground	Battery voltage

Is the inspection result normal?

- YES >> GO TO 3.
 NO >> Check harness for open or short between stop lamp switch and fuse.

3. CHECK STOP LAMP SWITCH INPUT SIGNAL 2

B2555 STOP LAMP

[WITH INTELLIGENT KEY SYSTEM]

< DTC/CIRCUIT DIAGNOSIS >

1. Connect stop lamp switch connector.
2. Check voltage between BCM harness connector and ground.

(+)		(-)	Condition		Voltage (V) (Approx.)
BCM					
Connector	Terminal	Ground	Brake pedal	Depressed	Battery voltage
M24	9				

Is the inspecting result normal?

- YES >> GO TO 4.
NO >> GO TO 5.

4. REPLACE BCM

1. Replace BCM. Refer to [BCS-72, "Removal and Installation"](#).
2. Perform initialization of BCM and registration of all Intelligent Keys using CONSULT. Refer to the CONSULT Immobilizer mode and follow the on screen instructions.

>> Inspection End.

5. CHECK STOP LAMP SWITCH CIRCUIT

1. Disconnect stop lamp switch connector.
2. Check continuity between stop lamp switch harness connector and BCM harness connector.

Stop lamp switch		BCM		Continuity
Connector	Terminal	Connector	Terminal	
E102	2	M24	9	Yes

3. Check continuity between stop lamp switch harness connector and ground.

Stop lamp switch		Ground	Continuity
Connector	Terminal		
E102	2		No

Is the inspection result normal?

- YES >> GO TO 6.
NO >> Repair or replace harness.

6. CHECK STOP LAMP SWITCH

Refer to [SEC-79, "Component Inspection"](#).

Is the inspection result normal?

- YES >> GO TO 7.
NO >> Replace stop lamp switch. Refer to [BR-500, "Removal and Installation"](#).

7. CHECK INTERMITTENT INCIDENT

Refer to [GI-53, "Intermittent Incident"](#).

>> Inspection End.

Component Inspection

INFOID:0000000010119266

1. CHECK STOP LAMP SWITCH

1. Turn power switch OFF.
2. Disconnect stop lamp switch connector.
3. Check continuity between stop lamp switch terminals.

B2555 STOP LAMP

< DTC/CIRCUIT DIAGNOSIS >

[WITH INTELLIGENT KEY SYSTEM]

Stop lamp switch		Condition		Continuity
Terminal				
1	2	Brake pedal	Not depressed	No
			Depressed	Yes

Is the inspection result normal?

YES >> Inspection End.

NO >> Replace stop lamp switch. Refer to [BR-500, "Removal and Installation"](#).

B2556 POWER SWITCH

< DTC/CIRCUIT DIAGNOSIS >

[WITH INTELLIGENT KEY SYSTEM]

B2556 POWER SWITCH

DTC Logic

INFOID:0000000010119267

DTC DETECTION LOGIC

DTC No.	Trouble diagnosis name	DTC detecting condition	Possible cause
B2556	ENG START SW*	BCM detects the power switch stuck at ON for 100 seconds or more.	<ul style="list-style-type: none"> • Harness or connectors (Power switch circuit is shorted.) • Power switch • BCM

*: "ENG START SW" is indicated on CONSULT screen, however this means power switch on this vehicle.

DTC CONFIRMATION PROCEDURE

1. PERFORM DTC CONFIRMATION PROCEDURE

1. Press power switch under the following condition.
 - Brake pedal: Not depressed
2. Release power switch and wait 100 seconds or more.
3. Check DTC in "Self Diagnostic Result" of "BCM" using CONSULT.

Is DTC detected?

- YES >> Go to [SEC-81. "Diagnosis Procedure"](#).
 NO >> Inspection End.

Diagnosis Procedure

INFOID:0000000010119268

Regarding Wiring Diagram information, refer to [SEC-42. "Wiring Diagram"](#).

1. CHECK POWER SWITCH INPUT SIGNAL

1. Turn power switch OFF.
2. Disconnect power switch connector.
3. Check voltage between power switch harness connector and ground.

(+)		(-)	Voltage (V) (Approx.)
Power switch			
Connector	Terminal	Ground	Battery voltage
M33	8		

Is the inspection result normal?

- YES >> GO TO 4.
 NO >> GO TO 2.

2. CHECK POWER SWITCH CIRCUIT

1. Disconnect BCM connector and IPDM E/R connector.
2. Check continuity between power switch harness connector and BCM harness connector.

Power switch		BCM		Continuity
Connector	Terminal	Connector	Terminal	
M33	8	M23	76	Yes

3. Check continuity between power switch harness connector and ground.

Power switch		Ground	Continuity
Connector	Terminal		
M33	8		No

A
B
C
D
E
F
G
H
I
J
L
M
N
O
P

SEC

B2556 POWER SWITCH

[WITH INTELLIGENT KEY SYSTEM]

< DTC/CIRCUIT DIAGNOSIS >

Is the inspection result normal?

- YES >> GO TO 3.
- NO >> Repair or replace harness.

3.REPLACE BCM

1. Replace BCM. Refer to [BCS-72. "Removal and Installation"](#).
2. Perform initialization of BCM and registration of all Intelligent Keys using CONSULT. Refer to the CONSULT Immobilizer mode and follow the on screen instructions.

>> Inspection End.

4.CHECK POWER SWITCH GROUND CIRCUIT

Check continuity between power switch harness connector and ground.

Power switch		Ground	Continuity
Connector	Terminal		
M33	4		Yes

Is the inspection result normal?

- YES >> GO TO 5.
- NO >> Repair or replace harness.

5.CHECK POWER SWITCH

Refer to [SEC-82. "Component Inspection"](#).

Is the inspection result normal?

- YES >> GO TO 6.
- NO >> Replace power switch. Refer to [SEC-114. "Removal and Installation"](#).

6.CHECK INTERMITTENT INCIDENT

Refer to [GI-53. "Intermittent Incident"](#).

>> Inspection End.

Component Inspection

INFOID:000000010119269

1.CHECK POWER SWITCH

1. Turn power switch OFF.
2. Disconnect power switch connector.
3. Check continuity between power switch terminals.

Power switch		Condition	Continuity
Terminal			
8	4	Power switch	Pressed Yes
			Not pressed No

Is the inspection result normal?

- YES >> Inspection End.
- NO >> Replace power switch. Refer to [SEC-114. "Removal and Installation"](#).

B2557 VEHICLE SPEED

< DTC/CIRCUIT DIAGNOSIS >

[WITH INTELLIGENT KEY SYSTEM]

B2557 VEHICLE SPEED

DTC Logic

INFOID:0000000010119270

DTC DETECTION LOGIC

NOTE:

- If DTC B2557 is displayed with DTC U1000, first perform the trouble diagnosis for DTC U1000. Refer to [BCS-61. "DTC Logic"](#).
- If DTC B2557 is displayed with DTC U1010, first perform the trouble diagnosis for DTC U1010. Refer to [BCS-62. "DTC Logic"](#).

DTC No.	Trouble diagnosis name	DTC detecting condition	Possible causes
B2557	VEHICLE SPEED	BCM detects one of the following conditions for 10 seconds continuously. <ul style="list-style-type: none">• Vehicle speed signal from combination meter is 10 km/h (6.2 MPH) or more, and vehicle speed signal from ABS actuator and electric unit (control unit) is 4 km/h (2.5 MPH) or less.• Vehicle speed signal from combination meter is 4 km/h (2.5 MPH) or less, and vehicle speed signal from ABS actuator and electric unit (control unit) is 10 km/h (6.2 MPH) or more.	<ul style="list-style-type: none">• Harness or connectors (The CAN communication line is open or shorted.)• Combination meter• ABS actuator and electric unit (control unit)

DTC CONFIRMATION PROCEDURE

1. PERFORM DTC CONFIRMATION PROCEDURE

1. Set vehicle to READY and wait 10 seconds or more.
2. Drive vehicle at a vehicle speed of 10 km/h (6.2 MPH) or more for 10 seconds or more.
3. Check DTC in "Self Diagnostic Result" of "BCM" using CONSULT.

Is DTC detected?

- YES >> Go to [SEC-83. "Diagnosis Procedure"](#).
NO >> Inspection End.

Diagnosis Procedure

INFOID:0000000010119271

1. CHECK DTC OF ABS ACTUATOR AND ELECTRIC UNIT (CONTROL UNIT)

Check DTC in "Self Diagnostic Result" of "ABS" using CONSULT.

Is DTC detected?

- YES >> Perform the trouble diagnosis related to the detected DTC. Refer to [BRC-56. "DTC Index"](#).
NO >> GO TO 2.

2. CHECK DTC OF COMBINATION METER

Check DTC in "Self Diagnostic Result" of "METER/M&A" using CONSULT.

Is DTC detected?

- YES >> Perform the trouble diagnosis related to the detected DTC. Refer to [MWI-65. "DTC Index"](#).
NO >> GO TO 3.

3. CHECK INTERMITTENT INCIDENT

Refer to [GI-53. "Intermittent Incident"](#).

>> Inspection End.

B2601 SHIFT POSITION

< DTC/CIRCUIT DIAGNOSIS >

[WITH INTELLIGENT KEY SYSTEM]

B2601 SHIFT POSITION

DTC Logic

INFOID:000000010119272

DTC DETECTION LOGIC

NOTE:

- If DTC B2601 is displayed with DTC U1000, first perform the trouble diagnosis for DTC U1000. Refer to [BCS-61, "DTC Logic"](#).
- If DTC B2601 is displayed with DTC U1010, first perform the trouble diagnosis for DTC U1010. Refer to [BCS-61, "DTC Logic"](#).

DTC No.	Trouble diagnosis name	DTC detecting condition	Possible cause
B2601	SHIFT P SIGNAL	When there is a difference between P position signal from VCM and P position signal from IPDM E/R (CAN).	<ul style="list-style-type: none"> • Harness or connectors (CAN communication line is open or shorted.) • Harness or connectors (VCM circuit is open or shorted.) • IPDM E/R • BCM

DTC CONFIRMATION PROCEDURE

1. PERFORM DTC CONFIRMATION PROCEDURE

1. Turn power switch ON.
2. Operate electric shift selector to change shift position to P, and wait 2 seconds or more.
3. Operate electric shift selector to change shift position to any position other than P, and wait 2 seconds or more.
4. Check DTC in "Self Diagnostic Result" of "BCM" using CONSULT.

Is DTC detected?

- YES >> Go to [SEC-84, "Diagnosis Procedure"](#).
 NO >> Inspection End.

Diagnosis Procedure

INFOID:000000010119273

Regarding Wiring Diagram information, refer to [SEC-42, "Wiring Diagram"](#).

1. CHECK P POSITION SIGNAL CIRCUIT 1

1. Turn power switch OFF.
2. Disconnect BCM connector.
3. Disconnect VCM connector.
4. Check continuity between BCM harness connector and VCM harness connector.

BCM		VCM		Continuity
Connector	Terminal	Connector	Terminal	
M24	37	E61	48	Yes

Is the inspection result normal?

- YES >> GO TO 2.
 NO >> Repair or replace harness.

2. CHECK P POSITION SIGNAL CIRCUIT 2

1. Disconnect IPDM E/R connector.
2. Check continuity between IPDM E/R harness connector and VCM harness connector.

B2601 SHIFT POSITION

< DTC/CIRCUIT DIAGNOSIS >

[WITH INTELLIGENT KEY SYSTEM]

IPDM E/R		VCM		Continuity
Connector	Terminal	Connector	Terminal	
E17	64	E61	48	Yes

Is the inspection result normal?

YES >> GO TO 3.

NO >> Repair or replace harness.

3. REPLACE BCM

1. Replace BCM. Refer to [BCS-72. "Removal and Installation"](#).
2. Perform initialization of BCM and registration of all Intelligent Keys using CONSULT. Refer to the CONSULT Immobilizer mode and follow the on screen instructions.
3. Perform DTC CONFIRMATION PROCEDURE for B2601. Refer to [SEC-84. "DTC Logic"](#).

Is DTC detected?

YES >> Replace IPDM E/R. Refer to [PCS-29. "Removal and Installation"](#).

NO >> Inspection End.

A
B
C
D
E
F
G
H
I
J
L
M
N
O
P

SEC

B2602 SHIFT POSITION

< DTC/CIRCUIT DIAGNOSIS >

[WITH INTELLIGENT KEY SYSTEM]

B2602 SHIFT POSITION

DTC Logic

INFOID:000000010119274

DTC DETECTION LOGIC

NOTE:

- If DTC B2602 is displayed with DTC U1000, first perform the trouble diagnosis for DTC U1000. Refer to [BCS-61, "DTC Logic"](#).
- If DTC B2602 is displayed with DTC U1010, first perform the trouble diagnosis for DTC U1010. Refer to [BCS-62, "DTC Logic"](#).

DTC No.	Trouble diagnosis name	DTC detecting condition	Possible cause
B2602	SHIFT P DIAG	BCM detects the following status for 10 seconds. <ul style="list-style-type: none">• Electric shift selector is in the P position• Vehicle speed is 4 km/h (2.5 MPH) or more• Power switch is in the ON position	<ul style="list-style-type: none">• Harness or connectors (CAN communication line is open or shorted.)• Harness or connectors (VCM circuit is open or shorted.)• VCM• ABS actuator and electric unit (control unit)• Combination meter• BCM

DTC CONFIRMATION PROCEDURE

1.PERFORM DTC CONFIRMATION PROCEDURE

1. Set vehicle to READY.
2. Drive vehicle at a speed of 4 km/h (2.5 MPH) or more for 10 seconds or more.
3. Check DTC in "Self Diagnostic Result" of "BCM" using CONSULT.

Is DTC detected?

- YES >> Go to [SEC-86, "Diagnosis Procedure"](#).
NO >> Inspection End.

Diagnosis Procedure

INFOID:000000010119275

Regarding Wiring Diagram information, refer to [SEC-42, "Wiring Diagram"](#).

1.CHECK DTC OF ABS ACTUATOR AND ELECTRIC UNIT (CONTROL UNIT)

Check DTC in "Self Diagnostic Result" of "ABS" using CONSULT.

Is DTC detected?

- YES >> Perform the trouble diagnosis related to the detected DTC. Refer to [BRC-56, "DTC Index"](#).
NO >> GO TO 2.

2.CHECK DTC OF COMBINATION METER

Check DTC in "Self Diagnostic Result" of "METER/M&A" using CONSULT.

Is DTC detected?

- YES >> Perform the trouble diagnosis related to the detected DTC. Refer to [MWI-65, "DTC Index"](#).
NO >> GO TO 3.

3.CHECK DTC OF VCM

Check DTC in "Self Diagnostic Result" of "SHIFT" using CONSULT.

Is DTC detected?

- YES >> Perform the trouble diagnosis related to the detected DTC. Refer to [TM-50, "DTC Index"](#).
NO >> GO TO 4.

4.CHECK P POSITION SIGNAL CIRCUIT

B2602 SHIFT POSITION

[WITH INTELLIGENT KEY SYSTEM]

< DTC/CIRCUIT DIAGNOSIS >

1. Turn power switch OFF.
2. Disconnect BCM connector.
3. Disconnect VCM connector.
4. Check continuity between BCM harness connector and VCM harness connector.

BCM		VCM		Continuity
Connector	Terminal	Connector	Terminal	
M24	37	E61	48	Yes

5. Check continuity between BCM harness connector and ground.

BCM		Ground	Continuity
Connector	Terminal		
M24	37		No

Is the inspection result normal?

- YES >> GO TO 5.
NO >> Repair or replace harness.

5.REPLACE BCM

1. Replace BCM. Refer to [BCS-72, "Removal and Installation"](#).
2. Perform initialization of BCM and registration of all Intelligent Keys using CONSULT. Refer to the CONSULT Immobilizer mode and follow the on screen instructions.

>> Inspection End.

A
B
C
D
E
F
G
H
I
J
L
M
N
O
P

SEC

B2603 SHIFT POSITION

< DTC/CIRCUIT DIAGNOSIS >

[WITH INTELLIGENT KEY SYSTEM]

B2603 SHIFT POSITION

DTC Logic

INFOID:000000010119276

DTC DETECTION LOGIC

NOTE:

- If DTC B2603 is displayed with DTC B2601, first perform the trouble diagnosis for DTC B2601. Refer to [SEC-84, "DTC Logic"](#).

DTC No.	Trouble diagnosis name	DTC detecting condition	Possible causes
B2603	SHIFT POSITION	BCM detects the following status. <ul style="list-style-type: none">• P position signal from VCM: approx. 0 V (P position)• P/N position signal from VCM: approx. 0 V (Other than P/N position)	<ul style="list-style-type: none">• Harness or connector (VCM circuit is open or shorted.)• VCM• BCM

DTC CONFIRMATION PROCEDURE

1. PERFORM DTC CONFIRMATION PROCEDURE 1

1. Turn power switch ON.
2. Operate electric shift selector to change shift position to P, and wait 1 second or more.
3. Check DTC in "Self Diagnostic Result" of "BCM" using CONSULT.

Is DTC detected?

- YES >> Go to [SEC-88, "Diagnosis Procedure"](#).
NO >> GO TO 2.

2. PERFORM DTC CONFIRMATION PROCEDURE 2

1. Operate electric shift selector to change shift position to any position other than P, and wait 1 second or more.
2. Check DTC in "Self Diagnostic Result" of "BCM" using CONSULT.

Is DTC detected?

- YES >> Go to [SEC-88, "Diagnosis Procedure"](#).
NO >> Inspection End.

Diagnosis Procedure

INFOID:000000010119277

Regarding Wiring Diagram information, refer to [SEC-42, "Wiring Diagram"](#).

1. INSPECTION START

Perform inspection in accordance with the procedure that confirms DTC.

Which procedure confirms DTC?

- DTC confirmation procedure 1 >> GO TO 2.
DTC confirmation procedure 2 >> GO TO 5.

2. CHECK DTC OF VCM

Check DTC in "Self Diagnostic Result" of "SHIFT" using CONSULT.

Is DTC detected?

- YES >> Perform the trouble diagnosis related to the detected DTC. Refer to [TM-50, "DTC Index"](#).
NO >> GO TO 3.

3. CHECK P/N POSITION SIGNAL CIRCUIT

1. Turn power switch OFF.
2. Disconnect BCM connector.
3. Disconnect VCM connector.
4. Check continuity between BCM harness connector and VCM harness connector.

B2603 SHIFT POSITION

< DTC/CIRCUIT DIAGNOSIS >

[WITH INTELLIGENT KEY SYSTEM]

BCM		VCM		Continuity
Connector	Terminal	Connector	Terminal	
M23	102	E61	47	Yes

5. Check continuity between BCM harness connector and ground.

BCM		Ground	Continuity
Connector	Terminal		
M23	102		No

Is the inspection result normal?

- YES >> GO TO 4.
NO >> Repair or replace harness.

4.REPLACE BCM

1. Replace BCM. Refer to [BCS-72, "Removal and Installation"](#).
2. Perform initialization of BCM and registration of all Intelligent Keys using CONSULT. Refer to the CONSULT Immobilizer mode and follow the on screen instructions.

>> Inspection End.

5.CHECK DTC OF VCM

Check DTC in "Self Diagnostic Result" of "SHIFT" using CONSULT.

Is DTC detected?

- YES >> Perform the trouble diagnosis related to the detected DTC. Refer to [TM-50, "DTC Index"](#).
NO >> GO TO 6.

6.CHECK P POSITION SIGNAL CIRCUIT

1. Turn power switch OFF.
2. Disconnect BCM connector.
3. Disconnect VCM connector.
4. Check continuity between BCM harness connector and VCM harness connector.

BCM		VCM		Continuity
Connector	Terminal	Connector	Terminal	
M24	37	E61	48	Yes

5. Check continuity between BCM harness connector and ground.

BCM		Ground	Continuity
Connector	Terminal		
M24	37		No

Is the inspection result normal?

- YES >> GO TO 7.
NO >> Repair or replace harness.

7.REPLACE BCM

1. Replace BCM. Refer to [BCS-72, "Removal and Installation"](#).
2. Perform initialization of BCM and registration of all Intelligent Keys using CONSULT. Refer to the CONSULT Immobilizer mode and follow the on screen instructions.

>> Inspection End.

B2604 SHIFT POSITION

< DTC/CIRCUIT DIAGNOSIS >

[WITH INTELLIGENT KEY SYSTEM]

B2604 SHIFT POSITION

DTC Logic

INFOID:000000010119278

DTC DETECTION LOGIC

NOTE:

- If DTC B2604 is displayed with DTC U1000, first perform the trouble diagnosis for DTC U1000. Refer to [BCS-61, "DTC Logic"](#).
- If DTC B2604 is displayed with DTC U1010, first perform the trouble diagnosis for DTC U1010. Refer to [BCS-62, "DTC Logic"](#).

DTC No.	Trouble diagnosis name	DTC detecting condition	Possible cause
B2604	SHIFT PN DIAG CAN	<p>The following states are detected for 5 seconds while power switch is ON:</p> <ul style="list-style-type: none"> • P/N position signal is sent from VCM but shift position signal input (CAN) from VCM is other than P and N • P/N position signal is not sent from VCM but shift position signal input (CAN) from VCM is P or N 	<ul style="list-style-type: none"> • Harness or connectors (CAN communication line is open or shorted.) • Harness or connectors (VCM circuit is open or shorted.) • VCM • BCM

DTC CONFIRMATION PROCEDURE

1. PERFORM DTC CONFIRMATION PROCEDURE

1. Turn power switch ON.
2. Operate electric shift selector to change shift position to P, and wait 5 seconds or more.
3. Operate electric shift selector to change shift position to N, and wait 5 seconds or more.
4. Operate electric shift selector to change shift position to any position other than P and N, and wait 5 seconds or more.
5. Check DTC in "Self Diagnostic Result" of "BCM" using CONSULT.

Is DTC detected?

- YES >> Go to [SEC-90, "Diagnosis Procedure"](#).
 NO >> Inspection End.

Diagnosis Procedure

INFOID:000000010119279

Regarding Wiring Diagram information, refer to [SEC-42, "Wiring Diagram"](#).

1. CHECK DTC OF VCM

Check DTC in "Self Diagnostic Result" of "EV/HEV" using CONSULT.

Is DTC detected?

- YES >> Perform the trouble diagnosis related to the detected DTC. Refer to [EVC-102, "DTC Index"](#).
 NO >> GO TO 2.

2. CHECK BCM INPUT SIGNAL

1. Turn power switch ON.
2. Check voltage between BCM harness connector and ground.

(+)		(-)	Condition	Voltage (V) (Approx.)
BCM				
Connector	Terminal			
M23	102	Ground	Shift position	Battery voltage
			P or N	
			Other than above	0 – 1.5

Is the inspection result normal?

- YES >> GO TO 3.

B2604 SHIFT POSITION

[WITH INTELLIGENT KEY SYSTEM]

< DTC/CIRCUIT DIAGNOSIS >

NO >> GO TO 4.

3. REPLACE BCM

1. Replace BCM. Refer to [BCS-72, "Removal and Installation"](#).
2. Perform initialization of BCM and registration of all Intelligent Keys using CONSULT. Refer to the CONSULT Immobilizer mode and follow the on screen instructions.

>> Inspection End.

4. CHECK BCM INPUT SIGNAL CIRCUIT

1. Turn power switch OFF.
2. Disconnect BCM connector.
3. Disconnect VCM connector.
4. Check continuity between BCM harness connector and VCM harness connector.

BCM		VCM		Continuity
Connector	Terminal	Connector	Terminal	
M23	102	E61	47	Yes

5. Check continuity between BCM harness connector and ground.

BCM		Ground	Continuity
Connector	Terminal		
M23	102		No

Is the inspection result normal?

YES >> GO TO 5.

NO >> Repair or replace harness.

5. CHECK INTERMITTENT INCIDENT

Refer to [GI-53, "Intermittent Incident"](#).

>> Inspection End.

A
B
C
D
E
F
G
H
I
J
L
M
N
O
P

SEC

B2617 READY SIGNAL CIRCUIT

< DTC/CIRCUIT DIAGNOSIS >

[WITH INTELLIGENT KEY SYSTEM]

B2617 READY SIGNAL CIRCUIT

DTC Logic

INFOID:000000010119280

DTC DETECTION LOGIC

NOTE:

- If DTC B2617 is displayed with DTC U1000, first perform the trouble diagnosis for DTC U1000. Refer to [BCS-61, "DTC Logic"](#).
- If DTC B2617 is displayed with DTC U1010, first perform the trouble diagnosis for DTC U1010. Refer to [BCS-62, "DTC Logic"](#).

DTC No.	Trouble diagnosis name	DTC detecting condition	Possible cause
B2617	ST RELAY REQ F/B	An immediate operation of setting vehicle to READY is requested by BCM, but there is no response for more than 1 second from VCM.	<ul style="list-style-type: none">• Harness or connectors (READY signal circuit is open or shorted.)• BCM• VCM

DTC CONFIRMATION PROCEDURE

1. PERFORM DTC CONFIRMATION PROCEDURE

1. Press power switch under the following conditions, and wait at least 1 second.
 - Shift position: P or N
 - Brake pedal: Depressed
2. Check DTC in "Self Diagnostic Result" of "BCM" using CONSULT.

Is DTC detected?

- YES >> Go to [SEC-92, "Diagnosis Procedure"](#).
NO >> Inspection End.

Diagnosis Procedure

INFOID:000000010119281

Regarding Wiring Diagram information, refer to [SEC-42, "Wiring Diagram"](#).

1. CHECK DTC OF VCM

Check DTC in "Self Diagnostic Result" of "EV/HEV" using CONSULT.

Is DTC detected?

- YES >> Perform the trouble diagnosis related to the detected DTC. Refer to [EVC-102, "DTC Index"](#).
NO >> GO TO 2.

2. CHECK READY SIGNAL

1. Turn power switch ON.
2. Check voltage between VCM harness connector and ground.

(+)		(-)	Condition	Voltage (V) (Approx.)
VCM				
Connector	Terminal			
E61	30	Ground	Power switch ON	Battery voltage
			Power switch ON → Vehicle READY	0 – 0.5

Is the inspection result normal?

- YES >> GO TO 5.
NO >> GO TO 3.

3. CHECK READY SIGNAL CIRCUIT

1. Turn power switch OFF.

B2617 READY SIGNAL CIRCUIT

[WITH INTELLIGENT KEY SYSTEM]

< DTC/CIRCUIT DIAGNOSIS >

2. Disconnect BCM connector and VCM connector.
3. Check continuity between BCM harness connector and VCM harness connector.

BCM		VCM		Continuity
Connector	Terminal	Connector	Terminal	
M23	97	E61	30	Yes

4. Check continuity between BCM harness connector and ground.

BCM		Ground	Continuity
Connector	Terminal		
M23	97		No

Is the inspection result normal?

- YES >> GO TO 4.
NO >> Repair or replace harness or connector.

4. CHECK INTERMITTENT INCIDENT

Refer to [GI-53. "Intermittent Incident"](#).

>> Inspection End.

5. REPLACE BCM

1. Replace BCM. Refer to [BCS-72. "Removal and Installation"](#).
2. Perform initialization of BCM and registration of all Intelligent Keys using CONSULT. Refer to the CONSULT Immobilizer mode and follow the on screen instructions.

>> Inspection End.

A
B
C
D
E
F
G
H
I
J
L
M
N
O
P

SEC

B261A POWER SWITCH

< DTC/CIRCUIT DIAGNOSIS >

[WITH INTELLIGENT KEY SYSTEM]

B261A POWER SWITCH

DTC Logic

INFOID:000000010119282

DTC DETECTION LOGIC

NOTE:

- If DTC B261A is displayed with DTC U1000, first perform the trouble diagnosis for DTC U1000. Refer to [BCS-61, "DTC Logic"](#).
- If DTC B261A is displayed with DTC U1010, first perform the trouble diagnosis for DTC U1010. Refer to [BCS-62, "DTC Logic"](#).

DTC No.	Trouble diagnosis name	DTC detecting condition	Possible cause
B261A	ENGINE SW*	BCM detects the mismatch between the following for 1 second or more: <ul style="list-style-type: none">• Power switch status judged by push switch signal• Power switch status signal from IPDM E/R (CAN)	<ul style="list-style-type: none">• Harness or connectors (Power switch circuit is open or shorted)- Between BCM and power switch- Between IPDM E/R and power switch• IPDM E/R• BCM

*: "ENGINE SW" is indicated on CONSULT screen, however this means power switch on this vehicle.

DTC CONFIRMATION PROCEDURE

1. PERFORM DTC CONFIRMATION PROCEDURE

1. Press power switch for 1 second under the following conditions:
 - Shift position: P
 - Brake pedal: Not depressed
2. Release power switch and wait 1 second.
3. Check DTC in "Self Diagnostic Result" of "BCM" using CONSULT.

Is DTC detected?

- YES >> Go to [SEC-94, "Diagnosis Procedure"](#)
NO >> Inspection End.

Diagnosis Procedure

INFOID:000000010119283

Regarding Wiring Diagram information, refer to [SEC-42, "Wiring Diagram"](#).

1. CHECK POWER SWITCH POWER SUPPLY CIRCUIT

1. Turn power switch OFF.
2. Disconnect power switch connector.
3. Disconnect IPDM E/R connector.
4. Check voltage between power switch harness connector and ground.

(+)		(-)	Voltage (V) (Approx.)
Power switch			
Connector	Terminal		
M33	8	Ground	Battery voltage

Is the inspection result normal?

- YES >> GO TO 2.
NO >> GO TO 3.

2. CHECK POWER SWITCH CIRCUIT 1

1. Check continuity between power switch harness connector and IPDM E/R harness connector.

B261A POWER SWITCH

< DTC/CIRCUIT DIAGNOSIS >

[WITH INTELLIGENT KEY SYSTEM]

Power switch		IPDM E/R		Continuity
Connector	Terminal	Connector	Terminal	
M33	8	E17	66	Yes

2. Check continuity between power switch harness connector and ground.

Power switch		Ground	Continuity
Connector	Terminal		
M33	8		No

Is the inspection result normal?

YES >> Replace IPDM E/R. Refer to [PCS-29, "Removal and Installation"](#).

NO >> Repair harness or connector.

3. CHECK POWER SWITCH CIRCUIT 2

1. Disconnect BCM connector.
2. Check continuity between power switch harness connector and BCM harness connector.

Power switch		BCM		Continuity
Connector	Terminal	Connector	Terminal	
M33	8	M23	76	Yes

3. Check continuity between power switch harness connector and ground.

Power switch		Ground	Continuity
Connector	Terminal		
M33	8		No

Is the inspection result normal?

YES >> GO TO 4.

NO >> Repair harness or connector.

4. REPLACE BCM

1. Replace BCM. Refer to [BCS-72, "Removal and Installation"](#).
2. Perform initialization of BCM and registration of all Intelligent Keys using CONSULT. Refer to the CONSULT Immobilizer mode and follow the on screen instructions.

>> Inspection End.

A
B
C
D
E
F
G
H
I
J
L
M
N
O
P

SEC

B261E VEHICLE TYPE

[WITH INTELLIGENT KEY SYSTEM]

< DTC/CIRCUIT DIAGNOSIS >

B261E VEHICLE TYPE

Description

INFOID:000000010119284

There are two types of vehicle.

- EV/HEV
- Conventional

DTC Logic

INFOID:000000010119285

DTC DETECTION LOGIC

NOTE:

- If DTC B261E is displayed with DTC U1000, first perform the trouble diagnosis for DTC U1000. Refer to [BCS-61, "DTC Logic"](#).
- If DTC B261E is displayed with DTC U1010, first perform the trouble diagnosis for DTC U1010. Refer to [BCS-62, "DTC Logic"](#).

DTC No.	Trouble diagnosis name	DTC detecting condition	Possible cause
B261E	FUEL MIS CONFIG	Difference of BCM configuration	BCM

DTC CONFIRMATION PROCEDURE

1. PERFORM DTC CONFIRMATION PROCEDURE

1. Turn power switch ON.
2. Check DTC in "Self Diagnostic Result" of "BCM" using CONSULT.

Is DTC detected?

- YES >> Go to [SEC-96, "Diagnosis Procedure"](#).
NO >> Inspection End.

Diagnosis Procedure

INFOID:000000010119286

1. INSPECTION START

1. Turn power switch ON.
2. Select "Self Diagnostic Result" of "BCM" using CONSULT.
3. Touch "ERASE".
4. Perform DTC CONFIRMATION PROCEDURE for DTC B261E. Refer to [SEC-96, "DTC Logic"](#).

Is the DTC B261E detected again?

- YES >> GO TO 2.
NO >> Inspection End.

2. REPLACE BCM

1. Replace BCM. Refer to [BCS-72, "Removal and Installation"](#).
2. Perform initialization of BCM and registration of all Intelligent Keys using CONSULT. Refer to the CONSULT Immobilizer mode and follow the on screen instructions.

>> Inspection End.

B26F7 BCM

DTC Logic

INFOID:0000000010119287

DTC DETECTION LOGIC

DTC No.	Trouble diagnosis name	DTC detecting condition	Possible cause
B26F7	LF DRIVER COMMUNICATION	Inside key antenna output circuit in BCM is malfunctioning.	BCM

DTC CONFIRMATION PROCEDURE

1. PERFORM DTC CONFIRMATION PROCEDURE

1. Press door request switch.
2. Turn power switch ON.
3. Check DTC in "Self Diagnostic Result" of "BCM" using CONSULT.

Is DTC detected?

- YES >> Go to [SEC-97, "Diagnosis Procedure"](#).
- NO >> Inspection End.

Diagnosis Procedure

INFOID:0000000010119288

1. INSPECTION START

1. Turn power switch ON.
2. Select "Self Diagnostic Result" of "BCM" using CONSULT.
3. Touch "ERASE".
4. Perform DTC CONFIRMATION PROCEDURE for DTC B26F7. Refer to [SEC-97, "DTC Logic"](#).

Is DTC detected?

- YES >> GO TO 2.
- NO >> Inspection End.

2. REPLACE BCM

1. Replace BCM. Refer to [BCS-72, "Removal and Installation"](#).
2. Perform initialization of BCM and registration of all Intelligent Keys using CONSULT. Refer to the CONSULT Immobilizer mode and follow the on screen instructions.

>> Inspection End.

A
B
C
D
E
F
G
H
I
J
L
M
N
O
P



B26FC KEY REGISTRATION

< DTC/CIRCUIT DIAGNOSIS >

[WITH INTELLIGENT KEY SYSTEM]

B26FC KEY REGISTRATION

DTC Logic

INFOID:000000010119289

DTC DETECTION LOGIC

DTC No.	Trouble diagnosis name	DTC detecting condition	Possible cause
B26FC	KEYFOB MISS REGISTRATION	Intelligent Key that does not match the vehicle is registered.	<ul style="list-style-type: none">• Improper registration operation• Intelligent Key• BCM

DTC CONFIRMATION PROCEDURE

1.PERFORM DTC CONFIRMATION PROCEDURE

1. Perform initialization of BCM and registration of all Intelligent Keys using CONSULT. Refer to the CONSULT Immobilizer mode and follow the on screen instructions.
2. Check DTC in "Self Diagnostic Result" of "BCM" using CONSULT.

Is DTC detected?

- YES >> Go to [SEC-98, "Diagnosis Procedure"](#)
NO >> Inspection End.

Diagnosis Procedure

INFOID:000000010119290

1.REPLACE INTELLIGENT KEY

1. Prepare Intelligent Key that matches the vehicle.
2. Perform initialization of BCM and registration of Intelligent Key using CONSULT. Refer to the CONSULT Immobilizer mode and follow the on screen instructions.
3. Check DTC in "Self Diagnostic Result" of "BCM" using CONSULT.

Is DTC detected?

- YES >> GO TO 2.
NO >> Inspection End.

2.REPLACE BCM

1. Replace BCM. Refer to [BCS-72, "Removal and Installation"](#).
2. Perform initialization of BCM and registration of all Intelligent Keys using CONSULT. Refer to the CONSULT Immobilizer mode and follow the on screen instructions.

>> Inspection End.

HEADLAMP FUNCTION

< DTC/CIRCUIT DIAGNOSIS >

[WITH INTELLIGENT KEY SYSTEM]

HEADLAMP FUNCTION

Component Function Check

INFOID:0000000010119291

1.CHECK FUNCTION

1. Perform "HEAD LAMP(HI)" in "Active Test" of "THEFT ALM" in "BCM" using CONSULT.
2. Check headlamps operation.

Test item		Description	
HEAD LAMP (HI)	ON	Headlamps (Hi)	Light
	OFF		Do not light

Is the inspection result normal?

- YES >> Inspection End.
NO >> Refer to [SEC-99, "Diagnosis Procedure"](#).

Diagnosis Procedure

INFOID:0000000010119292

1.CHECK HEADLAMP FUNCTION

Refer to [EXL-84, "WITHOUT DAYTIME RUNNING LIGHT SYSTEM : Component Function Check"](#).

Is the inspection result normal?

- YES >> GO TO 2.
NO >> Repair or replace the malfunctioning parts.

2.CHECK INTERMITTENT INCIDENT

Refer to [GI-53, "Intermittent Incident"](#).

>> Inspection End.

A
B
C
D
E
F
G
H
I
J
L
M
N
O
P

SEC

HOOD SWITCH

< DTC/CIRCUIT DIAGNOSIS >

[WITH INTELLIGENT KEY SYSTEM]

HOOD SWITCH

Component Function Check

INFOID:000000010119293

1.CHECK FUNCTION

1. Select "HOOD SW" in "Data Monitor" of "IPDM E/R" using CONSULT.
2. Check "HOOD SW" indication under the following condition:

Monitor item	Condition		Indication
HOOD SW	Hood	Open	ON
		Close	OFF

Is the indication normal?

- YES >> Hood switch is OK.
NO >> Go to [SEC-100, "Diagnosis Procedure"](#).

Diagnosis Procedure

INFOID:000000010119294

Regarding Wiring Diagram information, refer to [SEC-50, "Wiring Diagram"](#).

1.CHECK HOOD SWITCH SIGNAL CIRCUIT 1

1. Turn ignition switch OFF.
2. Disconnect hood switch connector.
3. Check voltage between hood switch harness connector and ground.

(+)		(-)	Voltage (Approx.)
Hood switch			
Connector	Terminal	Ground	Battery voltage
E74	1		

Is the inspection result normal?

- YES >> GO TO 3.
NO >> GO TO 2.

2.CHECK HOOD SWITCH SIGNAL CIRCUIT 2

1. Disconnect IPDM E/R connector.
2. Check continuity between IPDM E/R harness connector and hood switch harness connector.

IPDM E/R		Hood switch		Continuity
Connector	Terminal	Connector	Terminal	
E13	32	E74	1	Yes

3. Check continuity between IPDM E/R harness connector and ground.

IPDM E/R		Ground	Continuity
Connector	Terminal		
E13	32		No

Is the inspection result normal?

- YES >> Replace IPDM E/R. Refer to [PCS-29, "Removal and Installation"](#).
NO >> Repair or replace harness.

3.CHECK HOOD SWITCH GROUND CIRCUIT

Check continuity between hood switch harness connector and ground.

HOOD SWITCH

< DTC/CIRCUIT DIAGNOSIS >

[WITH INTELLIGENT KEY SYSTEM]

Hood switch		Ground	Continuity
Connector	Terminal		
E74	2		Yes

Is the inspection result normal?

- YES >> GO TO 4.
- NO >> Repair or replace harness.

4.CHECK HOOD SWITCH

Refer to [SEC-101. "Component Inspection"](#).

Is the inspection result normal?

- YES >> GO TO 5.
- NO >> Replace hood switch.

5.CHECK INTERMITTENT INCIDENT

Refer to [GI-53. "Intermittent Incident"](#).

>> Inspection End.

Component Inspection

INFOID:0000000010119295

1.CHECK HOOD SWITCH

1. Turn ignition switch OFF.
2. Disconnect hood switch connector.
3. Check continuity between hood switch terminals.

Hood switch		Condition	Continuity	
Terminal				
1	2	Hood switch	Press	No
			Release	Yes

Is the inspection result normal?

- YES >> Inspection End.
- NO >> Replace hood switch.

SEC

HORN FUNCTION

< DTC/CIRCUIT DIAGNOSIS >

[WITH INTELLIGENT KEY SYSTEM]

HORN FUNCTION

Component Function Check

INFOID:000000010119296

1.CHECK FUNCTION 1

1. Perform "VEHICLE SECURITY HORN" in "Active Test" of "THEFT ALM" in "BCM" using CONSULT.
2. Check the vehicle security horn operation.

Test item		Description	
VEHICLE SECURITY HORN	ON	Vehicle security horn	Sounds (for 0.5 sec)

Is the operation normal?

- YES >> Inspection End.
 NO >> Go to [SEC-102, "Diagnosis Procedure"](#).

Diagnosis Procedure

INFOID:000000010119297

Regarding Wiring Diagram information, refer to [SEC-50, "Wiring Diagram"](#).

1.CHECK VEHICLE SECURITY HORN RELAY POWER SUPPLY

1. Disconnect vehicle security horn relay.
2. Check voltage between vehicle security horn relay harness connector and ground.

(+)		(-)	Voltage (Approx.)
Vehicle security horn relay			
Connector	Terminal		
E5	2	Ground	Battery voltage

Is the inspection result normal?

- YES >> GO TO 2.
 NO >> Repair or replace harness.

2.CHECK HORN CONTROL CIRCUIT 1

1. Disconnect IPDM E/R connector.
2. Check continuity between IPDM E/R harness connector and vehicle security horn relay harness connector.

IPDM E/R		Vehicle security horn relay		Continuity
Connector	Terminal	Connector	Terminal	
E13	34	E5	1	Yes

3. Check continuity between IPDM E/R harness connector and ground.

IPDM E/R		Ground	Continuity
Connector	Terminal		
E13	34		No

Is the inspection result normal?

- YES >> Replace IPDM E/R. Refer to [PCS-29, "Removal and Installation"](#).
 NO >> Repair or replace harness.

SECURITY INDICATOR LAMP

[WITH INTELLIGENT KEY SYSTEM]

< DTC/CIRCUIT DIAGNOSIS >

SECURITY INDICATOR LAMP

Component Function Check

INFOID:000000010119298

1.CHECK FUNCTION

1. Perform "THEFT IND" in "Active Test" of "IMMU" in "BCM" using CONSULT.
2. Check security indicator lamp operation.

Test item		Description	
THEFT IND	ON	Security indicator lamp	Illuminates
	OFF		Does not illuminate

Is the inspection result normal?

- YES >> Inspection End.
 NO >> Go to [SEC-103, "Diagnosis Procedure"](#).

Diagnosis Procedure

INFOID:000000010119299

Regarding Wiring Diagram information, refer to [SEC-42, "Wiring Diagram"](#).

1.CHECK SECURITY INDICATOR LAMP POWER SUPPLY CIRCUIT

1. Turn power switch OFF.
2. Disconnect combination meter connector.
3. Check voltage between combination meter harness connector and ground.

(+)		(-)	Voltage (V) (Approx.)
Combination meter			
Connector	Terminal	Ground	Battery voltage
M34	1		

Is the inspection result normal?

- YES >> GO TO 2.
 NO-1 >> Check 10 A fuse [No. 11, located in the fuse block (J/B)].
 NO-2 >> Check harness for open or short between combination meter and fuse.

2.CHECK SECURITY INDICATOR LAMP SIGNAL

1. Connect combination meter connector.
2. Disconnect BCM connector.
3. Check voltage between BCM harness connector and ground.

(+)		(-)	Voltage (V) (Approx.)
BCM			
Connector	Terminal	Ground	Battery Voltage
M24	23		

Is the inspection result normal?

- YES >> GO TO 3.
 NO >> GO TO 4.

3.REPLACE BCM

1. Replace BCM. Refer to [BCS-72, "Removal and Installation"](#).
2. Perform initialization of BCM and registration of all Intelligent Keys using CONSULT. Refer to the CONSULT Immobilizer mode and follow the on screen instructions.

>> Inspection End.

A
B
C
D
E
F
G
H
I
J
L
M
N
O
P

SEC

SECURITY INDICATOR LAMP

< DTC/CIRCUIT DIAGNOSIS >

[WITH INTELLIGENT KEY SYSTEM]

4. CHECK SECURITY INDICATOR LAMP CIRCUIT

1. Disconnect combination meter connector.
2. Check continuity between combination meter harness connector and BCM harness connector.

Combination meter		BCM		Continuity
Connector	Terminal	Connector	Terminal	
M34	28	M24	23	Yes

3. Check continuity between combination meter harness connector and ground.

Combination meter		Ground	Continuity
Connector	Terminal		
M34	28		No

Is the inspection result normal?

- YES >> Replace combination meter. Refer to [MWI-102. "Removal and Installation"](#).
NO >> Repair or replace harness.

VEHICLE CANNOT BE SET TO READY WHEN INTELLIGENT KEY IS INSIDE OF VEHICLE

< SYMPTOM DIAGNOSIS >

[WITH INTELLIGENT KEY SYSTEM]

SYMPTOM DIAGNOSIS

VEHICLE CANNOT BE SET TO READY WHEN INTELLIGENT KEY IS INSIDE OF VEHICLE

Description

INFOID:0000000010119300

Vehicle cannot be set to READY when brake pedal is depressed and power switch is pressed while carrying Intelligent Key.

NOTE:

- Check that vehicle is under the condition shown in “Conditions of vehicle” before starting diagnosis, and check each symptom.
- The vehicle READY set function, door lock function, power distribution system, and NATS-IVIS/NVIS in the Intelligent Key system are closely related to each other regarding control. The vehicle security function can operate only when the door lock and power distribution system are operating normally.

Conditions of Vehicle (Operating Conditions)

- “ENGINE START BY I-KEY”: ON
Check the setting of “ENGINE START BY I-KEY” in “Work Support” of “INTELLIGENT KEY” in “BCM” using CONSULT.
- One or more of Intelligent Keys with registered Intelligent Key ID is in the vehicle.

Diagnosis Procedure

INFOID:0000000010119301

1.PERFORM WORK SUPPORT

Perform “INSIDE ANT DIAGNOSIS” in “Work Support” of “INTELLIGENT KEY” of “BCM” using CONSULT. Refer to [BCS-20. "INTELLIGENT KEY : CONSULT Function \(BCM - INTELLIGENT KEY\)"](#).

>> GO TO 2.

2.CHECK SELF DIAGNOSTIC RESULT

Select “Self Diagnostic Result” of “BCM” using CONSULT, and check whether or not DTC of inside key antenna is detected.

Is DTC detected?

- YES >> Perform the trouble diagnosis for detected DTC. Refer to [BCS-48. "DTC Index"](#).
- NO >> GO TO 3.

3.CHECK POWER SWITCH

Check power switch.

Refer to [PCS-64. "Component Function Check"](#).

Is the inspection result normal?

- YES >> GO TO 4.
- NO >> Repair or replace malfunctioning parts.

4.CHECK STOP LAMP SWITCH

Check stop lamp switch.

Refer to [SEC-79. "Component Inspection"](#).

Is the inspection result normal?

- YES >> GO TO 5.
- NO >> Repair or replace malfunctioning parts.

5.CONFIRM THE OPERATION

Confirm the operation again.

Is the inspection result normal?

- YES >> Check intermittent incident. Refer to [GI-53. "Intermittent Incident"](#).
- NO >> GO TO 1.

A
B
C
D
E
F
G
H
I
J
L
M
N
O
P

SEC

SECURITY INDICATOR LAMP DOES NOT TURN ON OR BLINK

< SYMPTOM DIAGNOSIS >

[WITH INTELLIGENT KEY SYSTEM]

SECURITY INDICATOR LAMP DOES NOT TURN ON OR BLINK

Description

INFOID:000000010119302

Security indicator lamp does not blink when power switch is in a position other than ON

NOTE:

- Before performing the diagnosis, check “Work Flow”. Refer to [SEC-62, "Work Flow"](#).
- Check that vehicle is under the condition shown in “Conditions of vehicle” before starting diagnosis, and check each symptom.

Conditions of Vehicle (Operating Conditions)

Power switch is not in the ON position.

Diagnosis Procedure

INFOID:000000010119303

1. CHECK SECURITY INDICATOR LAMP

Check security indicator lamp.

Refer to [SEC-103, "Component Function Check"](#).

Is the inspection result normal?

YES >> GO TO 2.

NO >> Repair or replace the malfunctioning parts.

2. CONFIRM THE OPERATION

Confirm the operation again.

Is the result normal?

YES >> Check intermittent incident. Refer to [GI-53, "Intermittent Incident"](#).

NO >> GO TO 1.

VEHICLE SECURITY SYSTEM CANNOT BE SET

< SYMPTOM DIAGNOSIS >

[WITH INTELLIGENT KEY SYSTEM]

VEHICLE SECURITY SYSTEM CANNOT BE SET INTELLIGENT KEY

INTELLIGENT KEY : Description

INFOID:0000000010119304

Armed phase is not activated when all doors are locked using Intelligent Key.

NOTE:

Check that vehicle is under the condition shown in "CONDITIONS OF VEHICLE (OPERATING CONDITIONS)" before starting diagnosis, and check each symptom.

CONDITION OF VEHICLE (OPERATING CONDITIONS)

"SECURITY ALARM SET": ON

Check the setting of "SECURITY ALARM SET" in "Work Support" of "THEFT ALM" in "BCM" using CONSULT.

INTELLIGENT KEY : Diagnosis Procedure (Except for Canada)

INFOID:0000000010119305

1.CHECK INTELLIGENT KEY SYSTEM (REMOTE KEYLESS ENTRY FUNCTION)

Lock/unlock door with Intelligent Key.

Refer to [DLK-25. "DOOR LOCK FUNCTION : System Description"](#).

Is the inspection result normal?

YES >> GO TO 2.

NO >> Check Intelligent Key system (remote keyless entry function). Refer to [DLK-131. "Diagnosis Procedure"](#).

2.CONFIRM THE OPERATION

Confirm the operation again.

Is the result normal?

YES >> Check intermittent incident. Refer to [GI-53. "Intermittent Incident"](#).

NO >> GO TO 1.

INTELLIGENT KEY : Diagnosis Procedure (For Canada)

INFOID:0000000010119306

1.CHECK INTELLIGENT KEY SYSTEM (REMOTE KEYLESS ENTRY FUNCTION)

Lock/unlock door with Intelligent Key.

Refer to [DLK-25. "DOOR LOCK FUNCTION : System Description"](#).

Is the inspection result normal?

YES >> GO TO 2.

NO >> Check Intelligent Key system (remote keyless entry function). Refer to [DLK-131. "Diagnosis Procedure"](#).

2.CHECK HOOD SWITCH

Check hood switch.

Refer to [SEC-100. "Component Function Check"](#).

Is the inspection result normal?

YES >> GO TO 3.

NO >> Repair or replace hood switch.

3.CONFIRM THE OPERATION

Confirm the operation again.

Is the result normal?

YES >> Check intermittent incident. Refer to [GI-53. "Intermittent Incident"](#).

NO >> GO TO 1.

DOOR REQUEST SWITCH

DOOR REQUEST SWITCH : Description

INFOID:0000000010119307

Armed phase is not activated when all doors are locked using door request switch.

A
B
C
D
E
F
G
H
I
J
L
M
N
O
P

SEC

VEHICLE SECURITY SYSTEM CANNOT BE SET

[WITH INTELLIGENT KEY SYSTEM]

< SYMPTOM DIAGNOSIS >

NOTE:

Check that vehicle is under the condition shown in “CONDITIONS OF VEHICLE (OPERATING CONDITIONS)” before starting diagnosis, and check each symptom.

CONDITION OF VEHICLE (OPERATING CONDITIONS)

“SECURITY ALARM SET”: ON

Check the setting of “SECURITY ALARM SET” in “Work Support” of “THEFT ALM” of “BCM” using CONSULT.

DOOR REQUEST SWITCH : Diagnosis Procedure (Except for Canada)

INFOID:0000000010119308

1. CHECK INTELLIGENT KEY SYSTEM (DOOR LOCK FUNCTION)

Lock/unlock door with door request switch.

Refer to [DLK-25, "DOOR LOCK FUNCTION : System Description"](#).

Is the inspection result normal?

YES >> GO TO 2.

NO >> Check Intelligent Key system (door lock function). Refer to [DLK-127, "ALL DOOR REQUEST SWITCHES : Diagnosis Procedure"](#).

2. CONFIRM THE OPERATION

Confirm the operation again.

Is the result normal?

YES >> Check intermittent incident. Refer to [GI-53, "Intermittent Incident"](#).

NO >> GO TO 1.

DOOR REQUEST SWITCH : Diagnosis Procedure (For Canada)

INFOID:0000000010119309

1. CHECK INTELLIGENT KEY SYSTEM (DOOR LOCK FUNCTION)

Lock/unlock door with door request switch.

Refer to [DLK-25, "DOOR LOCK FUNCTION : System Description"](#).

Is the inspection result normal?

YES >> GO TO 2.

NO >> Check Intelligent Key system (door lock function). Refer to [DLK-127, "ALL DOOR REQUEST SWITCHES : Diagnosis Procedure"](#).

2. CHECK HOOD SWITCH

Check hood switch.

Refer to [SEC-100, "Component Function Check"](#).

Is the inspection result normal?

YES >> GO TO 3.

NO >> Repair or replace hood switch.

3. CONFIRM THE OPERATION

Confirm the operation again.

Is the result normal?

YES >> Check intermittent incident. Refer to [GI-53, "Intermittent Incident"](#).

NO >> GO TO 1.

DOOR KEY CYLINDER

DOOR KEY CYLINDER : Description

INFOID:0000000010119310

ARMED phase is not activated when all doors are locked using mechanical key.

NOTE:

Check that vehicle is under the condition shown in “Conditions of vehicle” before starting diagnosis, and check each symptom.

CONDITION OF VEHICLE (OPERATING CONDITION)

• SECURITY ALARM SET: ON

VEHICLE SECURITY SYSTEM CANNOT BE SET

[WITH INTELLIGENT KEY SYSTEM]

< SYMPTOM DIAGNOSIS >

Check the setting of "SECURITY ALARM SET" in "Work Support" of "THEFT ALM" in "BCM" using CONSULT.

DOOR KEY CYLINDER : Diagnosis Procedure (Except for Canada)

INFOID:0000000010119311

1. CHECK POWER DOOR LOCK SYSTEM

Lock or unlock doors using mechanical key.

Refer to [DLK-25, "DOOR LOCK FUNCTION : System Description"](#).

Is the inspection result normal?

YES >> GO TO 2.

NO >> Check power door lock system. Refer to [DLK-130, "Diagnosis Procedure"](#).

2. CONFIRM THE OPERATION

Confirm the operation again.

Is the result normal?

YES >> Check intermittent incident. Refer to [GI-53, "Intermittent Incident"](#).

NO >> GO TO 1.

DOOR KEY CYLINDER : Diagnosis Procedure (For Canada)

INFOID:0000000010119312

1. CHECK POWER DOOR LOCK SYSTEM

Lock or unlock doors using mechanical key.

Refer to [DLK-25, "DOOR LOCK FUNCTION : System Description"](#).

Is the inspection result normal?

YES >> GO TO 2.

NO >> Check power door lock system. Refer to [DLK-130, "Diagnosis Procedure"](#).

2. CHECK HOOD SWITCH

Check hood switch.

Refer to [SEC-100, "Component Function Check"](#).

Is the inspection result normal?

YES >> GO TO 3.

NO >> Repair or replace hood switch.

3. CONFIRM THE OPERATION

Confirm the operation again.

Is the result normal?

YES >> Check intermittent incident. Refer to [GI-53, "Intermittent Incident"](#).

NO >> GO TO 1.

DOOR LOCK AND UNLOCK SWITCH

DOOR LOCK AND UNLOCK SWITCH : Description

INFOID:0000000010119313

Armed phase is not activated when all doors are locked by door lock and unlock switch.

NOTE:

Check that vehicle is under the condition shown in "CONDITIONS OF VEHICLE (OPERATING CONDITIONS)" before starting diagnosis, and check each symptom.

CONDITION OF VEHICLE (OPERATING CONDITIONS)

"SECURITY ALARM SET": ON

Check the setting of "SECURITY ALARM SET" in "Work Support" of "THEFT ALM" in "BCM" using CONSULT.

DOOR LOCK AND UNLOCK SWITCH : Diagnosis Procedure (Except for Canada)

INFOID:0000000010119314

1. CHECK DOOR LOCK FUNCTION

Lock/unlock door using mechanical key inserted into door key cylinder.

Refer to [DLK-25, "DOOR LOCK FUNCTION : System Description"](#).

A

B

C

D

E

F

G

H

I

J

SEC

L

M

N

O

P

VEHICLE SECURITY SYSTEM CANNOT BE SET

[WITH INTELLIGENT KEY SYSTEM]

< SYMPTOM DIAGNOSIS >

Is the inspection result normal?

YES >> GO TO 2.

NO >> Check Intelligent Key system (remote keyless entry function). Refer to [DLK-24. "INTELLIGENT KEY SYSTEM : System Description"](#).

2. CONFIRM THE OPERATION

Confirm the operation again.

Is the result normal?

YES >> Check intermittent incident. Refer to [GI-53. "Intermittent Incident"](#).

NO >> GO TO 1.

DOOR LOCK AND UNLOCK SWITCH : Diagnosis Procedure (For Canada)

INFOID:000000010119315

1. CHECK DOOR LOCK FUNCTION

Lock/unlock door using mechanical key inserted into door key cylinder.

Refer to [DLK-25. "DOOR LOCK FUNCTION : System Description"](#).

Is the inspection result normal?

YES >> GO TO 2.

NO >> Check Intelligent Key system (remote keyless entry function). Refer to [DLK-24. "INTELLIGENT KEY SYSTEM : System Description"](#).

2. CHECK HOOD SWITCH

Check hood switch.

Refer to [SEC-100. "Component Function Check"](#).

Is the inspection result normal?

YES >> GO TO 3.

NO >> Repair or replace hood switch.

3. CONFIRM THE OPERATION

Confirm the operation again.

Is the result normal?

YES >> Check intermittent incident. Refer to [GI-53. "Intermittent Incident"](#).

NO >> GO TO 1.

VEHICLE SECURITY ALARM DOES NOT ACTIVATE

< SYMPTOM DIAGNOSIS >

[WITH INTELLIGENT KEY SYSTEM]

VEHICLE SECURITY ALARM DOES NOT ACTIVATE

Description

INFOID:0000000010119316

Alarm does not operate when alarm operating condition is satisfied.

NOTE:

Check that vehicle is under the condition shown in "CONDITIONS OF VEHICLE (OPERATING CONDITIONS)" before starting diagnosis, and check each symptom.

CONDITION OF VEHICLE (OPERATING CONDITIONS)

"SECURITY ALARM SET": ON

Check the setting of "SECURITY ALARM SET" in "Work Support" of "THEFT ALM" in "BCM" using CONSULT.

Diagnosis Procedure (Except for Canada)

INFOID:0000000010119317

1.CHECK DOOR SWITCH

Check door switch.

Refer to [DLK-102, "Component Function Check"](#).

Is the inspection result normal?

YES >> GO TO 2.

NO >> Replace the malfunctioning door switch

2.CHECK HEADLAMPS FUNCTION

Check head lamps function.

Refer to [SEC-99, "Component Function Check"](#).

Is the inspection result normal?

YES >> GO TO 3.

NO >> Repair or replace the malfunctioning parts.

3.CHECK HORN FUNCTION

Check horn function.

Refer to [SEC-102, "Component Function Check"](#).

Is the inspection result normal?

YES >> GO TO 4.

NO >> Repair or replace the malfunctioning parts.

4.CONFIRM THE OPERATION

Confirm the operation again.

Is the result normal?

YES >> Check intermittent incident. Refer to [GI-53, "Intermittent Incident"](#).

NO >> GO TO 1.

Diagnosis Procedure (For Canada)

INFOID:0000000010119318

1.CHECK DOOR SWITCH

Check door switch.

Refer to [DLK-102, "Component Function Check"](#).

Is the inspection result normal?

YES >> GO TO 2.

NO >> Replace the malfunctioning door switch.

2.CHECK HOOD SWITCH

Check hood switch.

Refer to [SEC-100, "Component Function Check"](#).

Is the inspection result normal?

YES >> GO TO 3.

NO >> Replace the hood switch.

A
B
C
D
E
F
G
H
I
J
L
M
N
O
P

SEC

VEHICLE SECURITY ALARM DOES NOT ACTIVATE

< SYMPTOM DIAGNOSIS >

[WITH INTELLIGENT KEY SYSTEM]

3. CHECK HEADLAMPS FUNCTION

Check head lamps function.

Refer to [SEC-99, "Component Function Check"](#).

Is the inspection result normal?

YES >> GO TO 4.

NO >> Repair or replace the malfunctioning parts.

4. CHECK HORN FUNCTION

Check horn function.

Refer to [SEC-102, "Component Function Check"](#).

Is the inspection result normal?

YES >> GO TO 5.

NO >> Repair or replace the malfunctioning parts.

5. CONFIRM THE OPERATION

Confirm the operation again.

Is the result normal?

YES >> Check intermittent incident. Refer to [GI-53, "Intermittent Incident"](#).

NO >> GO TO 1.

NATS ANTENNA AMP.

< REMOVAL AND INSTALLATION >

[WITH INTELLIGENT KEY SYSTEM]

REMOVAL AND INSTALLATION

NATS ANTENNA AMP.

Removal and Installation

INFOID:000000010119319

REMOVAL

1. Remove instrument lower panel LH. Refer to [IP-16. "Exploded View"](#).
2. Remove the NATS antenna amp.
 1. Disengage the NATS antenna amp. (1) fixing pawls using remover tool etc.
 2. Pull NATS antenna amp. to remove it from power switch (2).

 : Pawl

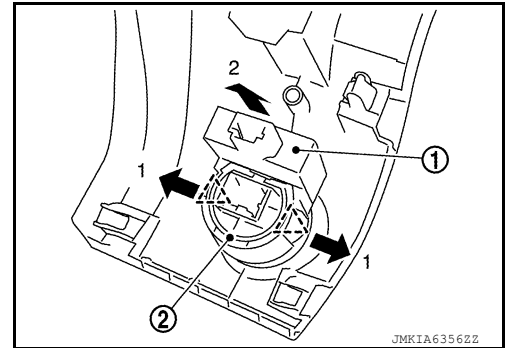

INSTALLATION

Install in the reverse order of removal.

A
B
C
D
E
F
G
H
I
J
L
M
N
O
P

SEC

POWER SWITCH

Removal and Installation

INFOID:000000010119320

REMOVAL

1. Remove the NATS antenna amp. Refer to [SEC-113. "Removal and Installation"](#).
2. Remove the power switch (1).
 1. Disengage the power switch fixing pawls.
 2. Press the power switch to remove it from instrument lower panel (LH) (2).

 : Pawl

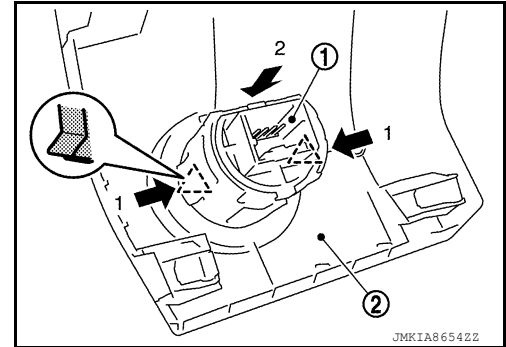

INSTALLATION

Install in the reverse order of removal.

VEHICLE SECURITY HORN

< REMOVAL AND INSTALLATION >

[WITH INTELLIGENT KEY SYSTEM]

VEHICLE SECURITY HORN

Removal and Installation

INFOID:000000010119321

REMOVAL

1. Remove the front under cover. Refer to [EXT-23. "FRONT UNDER COVER : Removal and Installation"](#).
2. Disconnect the harness connectors (A) from the vehicle security horn (1).
3. Remove the vehicle security horn bolt (B) and the vehicle security horn (1).

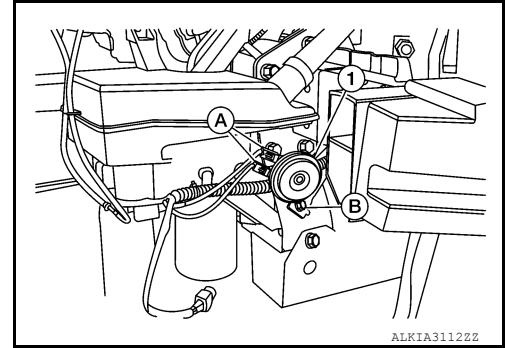

INSTALLATION

Installation is in the reverse order of removal.

A
B
C
D
E
F
G
H
I
J
L
M
N
O
P

SEC

HOOD SWITCH

< REMOVAL AND INSTALLATION >

[WITH INTELLIGENT KEY SYSTEM]

HOOD SWITCH

Removal and Installation

INFOID:000000010119322

NOTE:

The hood switch is available for Mexico only.

The hood switch is part of the hood lock assembly. For removal and installation refer to [DLK-187, "HOOD LOCK : Removal and Installation"](#).

DONGLE UNIT

< REMOVAL AND INSTALLATION >

[WITH INTELLIGENT KEY SYSTEM]

DONGLE UNIT

Removal and Installation

INFOID:000000010119323

REMOVAL

1. Remove the glove box lid. Refer to [JP-17. "Removal and Installation"](#)
2. Disconnect the harness connector to the dongle unit.
3. Remove the dongle unit bolt and dongle unit.

INSTALLATION

Installation is in the reverse order of removal.

A

B

C

D

E

F

G

H

I

J

SEC

L

M

N

O

P