

# SECTION **WCS**

## WARNING CHIME SYSTEM

A  
B  
C  
D  
E  
F  
G  
H  
I  
J  
K  
L  
M  
N  
O  
P

### CONTENTS

<p><b>PRECAUTION</b> ..... 3</p> <p><b>PRECAUTIONS</b> ..... 3</p> <p style="padding-left: 20px;">Precaution for Supplemental Restraint System (SRS) "AIR BAG" and "SEAT BELT PRE-TENSIONER" .....3</p> <p style="padding-left: 20px;">Precaution for Technicians Using Medical Electric.....3</p> <p style="padding-left: 20px;">Point to Be Checked Before Starting Maintenance Work .....4</p> <p><b>SYSTEM DESCRIPTION</b> ..... 5</p> <p><b>COMPONENT PARTS</b> ..... 5</p> <p style="padding-left: 20px;">Component Parts Location .....5</p> <p style="padding-left: 20px;">Combination Meter .....5</p> <p><b>SYSTEM</b> ..... 6</p> <p><b>WARNING CHIME SYSTEM</b> .....6</p> <p style="padding-left: 20px;">WARNING CHIME SYSTEM : System Description .....6</p> <p style="padding-left: 20px;">WARNING CHIME SYSTEM : Fail-Safe .....7</p> <p><b>LIGHT REMINDER WARNING CHIME</b> .....8</p> <p style="padding-left: 20px;">LIGHT REMINDER WARNING CHIME : System Description .....8</p> <p><b>SEAT BELT WARNING CHIME</b> .....9</p> <p style="padding-left: 20px;">SEAT BELT WARNING CHIME : System Description ..... 10</p> <p><b>PARKING BRAKE RELEASE WARNING CHIME</b>..... 11</p> <p style="padding-left: 20px;">PARKING BRAKE RELEASE WARNING CHIME : Parking Brake Release Warning Chime ..... 11</p> <p><b>DIAGNOSIS SYSTEM (COMBINATION METER)</b> .....13</p> <p style="padding-left: 20px;">Description .....13</p> <p style="padding-left: 20px;">CONSULT Function (METER/M&amp;A) ..... 14</p> <p><b>DIAGNOSIS SYSTEM (BCM)</b> .....19</p> <p><b>COMMON ITEM</b> ..... 19</p>	<p style="padding-left: 20px;">COMMON ITEM : CONSULT Function (BCM - COMMON ITEM) .....19</p> <p><b>BUZZER</b> .....19</p> <p style="padding-left: 20px;">BUZZER : CONSULT Function (BCM - BUZZER)...20</p> <p><b>ECU DIAGNOSIS INFORMATION</b> .....21</p> <p><b>COMBINATION METER</b> .....21</p> <p style="padding-left: 20px;">Reference Value .....21</p> <p style="padding-left: 20px;">Fail-Safe .....31</p> <p style="padding-left: 20px;">DTC Index .....32</p> <p><b>BCM</b> .....33</p> <p style="padding-left: 20px;">List of ECU Reference .....33</p> <p><b>WIRING DIAGRAM</b> .....34</p> <p><b>WARNING CHIME SYSTEM</b> .....34</p> <p style="padding-left: 20px;">Wiring Diagram .....34</p> <p><b>BASIC INSPECTION</b> .....39</p> <p><b>DIAGNOSIS AND REPAIR WORKFLOW</b> .....39</p> <p style="padding-left: 20px;">Work Flow .....39</p> <p><b>DTC/CIRCUIT DIAGNOSIS</b> .....41</p> <p><b>POWER SUPPLY AND GROUND CIRCUIT</b> ....41</p> <p><b>COMBINATION METER</b> .....41</p> <p style="padding-left: 20px;">COMBINATION METER : Diagnosis Procedure ....41</p> <p><b>BCM</b> .....41</p> <p style="padding-left: 20px;">BCM : Diagnosis Procedure .....41</p> <p><b>METER BUZZER CIRCUIT</b> .....43</p> <p style="padding-left: 20px;">Component Function Check .....43</p> <p style="padding-left: 20px;">Diagnosis Procedure .....43</p> <p><b>SEAT BELT BUCKLE SWITCH SIGNAL CIRCUIT (DRIVER SIDE)</b> .....44</p> <p style="padding-left: 20px;">Component Function Check .....44</p> <p style="padding-left: 20px;">Diagnosis Procedure .....44</p>
--	---

WCS

---

Component Inspection .....	45	<b>THE SEAT BELT WARNING CONTINUES SOUNDING, OR DOES NOT SOUND .....</b>	<b>47</b>
<b>SYMPTOM DIAGNOSIS .....</b>	<b>46</b>	Description .....	47
<b>THE LIGHT REMINDER WARNING DOES NOT SOUND .....</b>	<b>46</b>	Diagnosis Procedure .....	47
Description .....	46	<b>THE PARKING BRAKE RELEASE WARNING CONTINUES SOUNDING, OR DOES NOT SOUND .....</b>	<b>48</b>
Diagnosis Procedure .....	46	Description .....	48
		Diagnosis Procedure .....	48

# PRECAUTIONS

< PRECAUTION >

## PRECAUTION

### PRECAUTIONS

#### Precaution for Supplemental Restraint System (SRS) "AIR BAG" and "SEAT BELT PRE-TENSIONER"

INFOID:000000010534045

The Supplemental Restraint System such as "AIR BAG" and "SEAT BELT PRE-TENSIONER", used along with a front seat belt, helps to reduce the risk or severity of injury to the driver and front passenger for certain types of collision. This system includes seat belt switch inputs and dual stage front air bag modules. The SRS system uses the seat belt switches to determine the front air bag deployment, and may only deploy one front air bag, depending on the severity of a collision and whether the front occupants are belted or unbelted. Information necessary to service the system safely is included in the SR and SB section of this Service Manual.

#### **WARNING:**

- To avoid rendering the SRS inoperative, which could increase the risk of personal injury or death in the event of a collision which would result in air bag inflation, all maintenance must be performed by an authorized NISSAN/INFINITI dealer.
- Improper maintenance, including incorrect removal and installation of the SRS, can lead to personal injury caused by unintentional activation of the system. For removal of Spiral Cable and Air Bag Module, see the SR section.
- Do not use electrical test equipment on any circuit related to the SRS unless instructed to in this Service Manual. SRS wiring harnesses can be identified by yellow and/or orange harnesses or harness connectors.

#### PRECAUTIONS WHEN USING POWER TOOLS (AIR OR ELECTRIC) AND HAMMERS

#### **WARNING:**

- When working near the Airbag Diagnosis Sensor Unit or other Airbag System sensors with the Ignition ON or engine running, DO NOT use air or electric power tools or strike near the sensor(s) with a hammer. Heavy vibration could activate the sensor(s) and deploy the air bag(s), possibly causing serious injury.
- When using air or electric power tools or hammers, always switch the Ignition OFF, disconnect the battery and wait at least three minutes before performing any service.

#### Precaution for Technicians Using Medical Electric

INFOID:000000010505309

#### OPERATION PROHIBITION

#### **WARNING:**

- Parts with strong magnet is used in this vehicle.
- Technicians using a medical electric device such as pacemaker must never perform operation on the vehicle, as magnetic field can affect the device function by approaching to such parts.

#### NORMAL CHARGE PRECAUTION

#### **WARNING:**

- If a technician uses a medical electric device such as an implantable cardiac pacemaker or an implantable cardioverter defibrillator, the possible effects on the devices must be checked with the device manufacturer before starting the charge operation.
- As radiated electromagnetic wave generated by on board charger at normal charge operation may effect medical electric devices, a technician using a medical electric device such as implantable cardiac pacemaker or an implantable cardioverter defibrillator must not enter the vehicle compartment (including luggage room) during normal charge operation.

#### PRECAUTION AT TELEMATICS SYSTEM OPERATION

#### **WARNING:**

- If a technician uses implantable cardiac pacemaker or implantable cardioverter defibrillator (ICD), avoid the device implanted part from approaching within approximately 220 mm (8.66 in) from interior/exterior antenna.
- The electromagnetic wave of TCU might affect the function of the implantable cardiac pacemaker or the implantable cardioverter defibrillator (ICD), when using the service, etc.

A

B

C

D

E

F

G

H

I

J

K

L

M

WCS

O

P

## PRECAUTIONS

### < PRECAUTION >

---

- If a technician uses other medical electric devices than implantable cardiac pacemaker or implantable cardioverter defibrillator (ICD), the electromagnetic wave of TCU might affect the function of the device. The possible effects on the devices must be checked with the device manufacturer before TCU use.

### PRECAUTION AT INTELLIGENT KEY SYSTEM OPERATION

#### **WARNING:**

- If a technician uses implantable cardiac pacemaker or implantable cardioverter defibrillator (ICD), avoid the device implanted part from approaching within approximately 220 mm (8.66 in) from interior/exterior antenna.
- The electromagnetic wave of intelligent key might affect the function of the implantable cardiac pacemaker or the implantable cardioverter defibrillator (ICD), at door operation, at each request switch operation, or at engine starting.
- If a technician uses other medical electric devices than implantable cardiac pacemaker or implantable cardioverter defibrillator (ICD), the electromagnetic wave of intelligent key might affect the function of the device. The possible effects on the devices must be checked with the device manufacturer before intelligent key use.

### Point to Be Checked Before Starting Maintenance Work

INFOID:000000010505310

**The high voltage system may starts automatically. It is required to check that the timer air conditioner and timer charge (during EVSE connection) are not set before starting maintenance work.**

#### **NOTE:**

If the timer air conditioner or timer charge (during EVSE connection) is set, the high voltage system starts automatically even when the power switch is in OFF state.

# COMPONENT PARTS

< SYSTEM DESCRIPTION >

## SYSTEM DESCRIPTION

### COMPONENT PARTS

#### Component Parts Location

INFOID:000000010121620

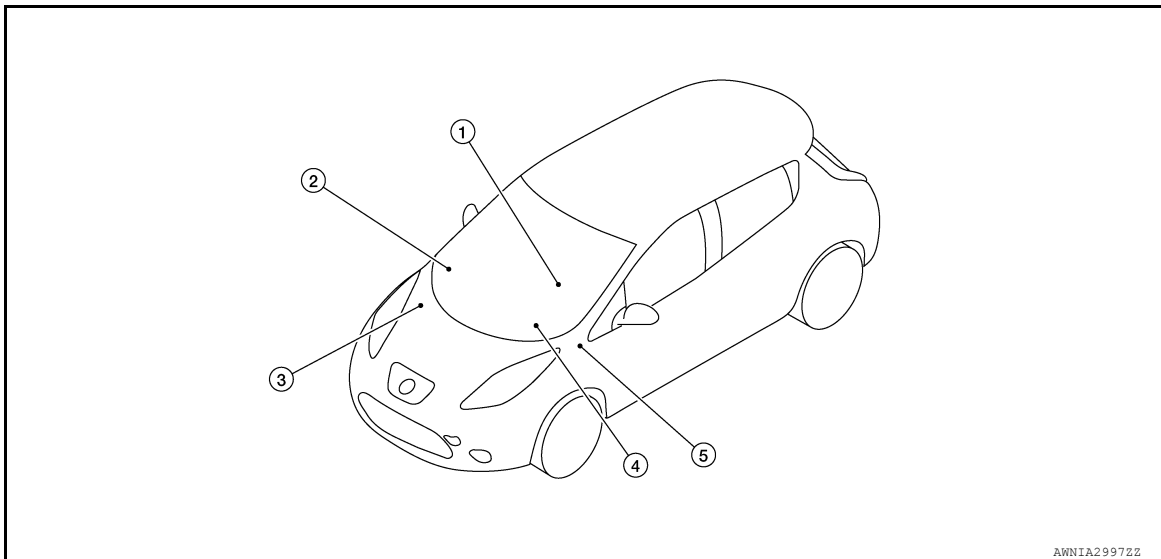

AWNIA2997ZZ

No.	Component	Function
1.	Seat belt buckle switch (driver side)	Transmits the seat belt buckle switch signal (driver side) to the combination meter.
2.	BCM	Based on the signals received from various units and switches, transmits the buzzer output signal to the combination meter via CAN communication. Refer to <a href="#">BCS-5, "BODY CONTROL SYSTEM : Component Parts Location"</a> for detailed installation location.
3.	ABS actuator and electric unit (control unit)	Transmits the vehicle speed signal to the combination meter via CAN communication. Refer to <a href="#">BRC-10, "Component Parts Location"</a> for detailed installation location.
4.	Combination meter	<ul style="list-style-type: none"> <li>Receives a buzzer output signal from the BCM with CAN communication line and sounds the buzzer.</li> <li>Judges whether the parking brake is released using the vehicle speed signal and the parking brake switch signal, and sounds the buzzer if necessary.</li> </ul>
5.	Parking brake switch	Transmits the parking brake switch signal to the combination meter.

#### Combination Meter

INFOID:000000010121621

The buzzer (1) for the warning chime system is integrated in the combination meter.

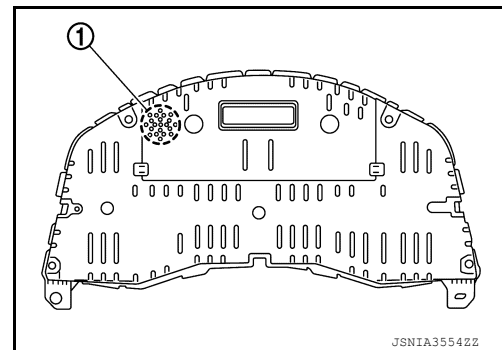

JSNIA3554ZZ

A  
B  
C  
D  
E  
F  
G  
H  
I  
J  
K  
L  
M  
O  
P

WCS

# SYSTEM

< SYSTEM DESCRIPTION >

## SYSTEM

### WARNING CHIME SYSTEM

#### WARNING CHIME SYSTEM : System Description

INFOID:000000010121622

#### SYSTEM DIAGRAM

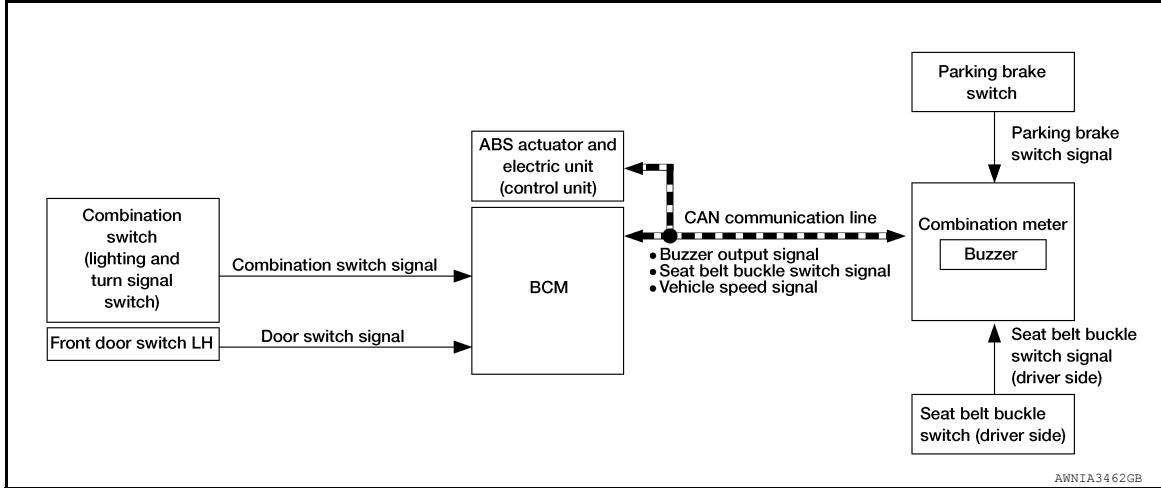

#### COMBINATION METER INPUT/OUTPUT SIGNAL (CAN COMMUNICATION SIGNAL)

Input signal

Signal name	Transmit unit
Buzzer output signal	BCM
Vehicle speed signal	ABS actuator and electric unit (control unit)

Output signal

Signal name	Reception unit
Seat belt buckle switch signal (driver side)	BCM

#### BCM INPUT/OUTPUT SIGNAL (CAN COMMUNICATION SIGNAL)

Input signal

Signal name	Transmit unit
Seat belt buckle switch signal (driver side)	Combination meter

Output signal

Signal name	Reception unit
Buzzer output signal	Combination meter

#### COMBINATION METER

The combination meter sounds the alarm buzzer installed in the combination meter when receiving the buzzer output signal transmitted from each unit.

#### BCM

BCM receives signals from various units and transmits a buzzer output signal to the combination meter via CAN communication if it judges that the warning buzzer should be activated.

#### WARNING CHIME FUNCTION LIST

# SYSTEM

## < SYSTEM DESCRIPTION >

Warning functions	Outline	Warning judgment unit	Refer to
Light reminder warning chime	The warning chime sounds when the power switch is in LOCK, OFF or ACC position with the combination switch (lighting switch) in the 1st or 2nd position and the driver side door open.	BCM	<a href="#">WCS-8. "LIGHT REMINDER WARNING CHIME : System Description"</a>
Seat belt warning chime	The warning chime sounds when the driver seat belt is unfastened with the power switch in ON or READY position.	BCM	<a href="#">WCS-10. "SEAT BELT WARNING CHIME : System Description"</a>
Parking brake release warning chime	The warning chime sounds when the parking brake is applied and the vehicle speed 4.3 MPH (7 km/h) or more.	Combination meter	<a href="#">WCS-11. "PARKING BRAKE RELEASE WARNING CHIME : Parking Brake Release Warning Chime"</a>

## WARNING CHIME SYSTEM : Fail-Safe

INFOID:000000010546302

### FAIL-SAFE

- The combination meter activates the fail-safe control if CAN communication with each unit is malfunctioning.

Function		Specifications
Power meter		The display turns OFF by suspending communication.
Li-ion battery temperature gauge		
Li-ion battery capacity level gauge		
Li-ion battery available charge gauge		
Driving range display		The display turns "--" by suspending communication.
Illumination control		When suspending communication, changes to nighttime mode.
Information display	Odo/trip meter	An indicated value is maintained at communications blackout.
	Shift indicator	The display turns OFF by suspending communication.
	Li-ion low battery charge warning display	The display turns ON by suspending communication.
	Electric shift warning display	
Other than the above		The display turns OFF by suspending communication.
Buzzer		The buzzer turns OFF by suspending communication.

WCS

# SYSTEM

## < SYSTEM DESCRIPTION >

Function	Specifications	
Warning lamp/indicator lamp	ABS warning lamp	The lamp turns ON by suspending communication.
	VDC warning lamp	
	Brake warning lamp	
	Front fog lamp indicator lamp	
	Brake system warning lamp	
	EPS warning lamp	
	Low battery charge warning lamp	
	Electric shift warning lamp	
	TPMS warning lamp	
Warning lamp/indicator lamp	High beam indicator lamp	The lamp turns OFF by suspending communication.
	VDC OFF indicator lamp	
	Tail lamp indicator lamp	
	READY to drive indicator lamp	
	12-volt battery charge warning lamp	
	Power limitation indicator lamp	
	EV system warning lamp	

- The upper meter performs the fail-safe control when a breakdown of communications between the upper meter and the combination meter occurs.

Function	Specifications
Speedometer	The display turns OFF by suspending communication.
Eco indicator	
Outside air temperature display	The last result calculated during normal condition is indicated.
Illumination control	When suspending communication, changes to nighttime mode.
Turn signal indicator lamp	The lamp turns OFF by suspending communication.

## LIGHT REMINDER WARNING CHIME

### LIGHT REMINDER WARNING CHIME : System Description

INFOID:000000010121624

#### SYSTEM DIAGRAM

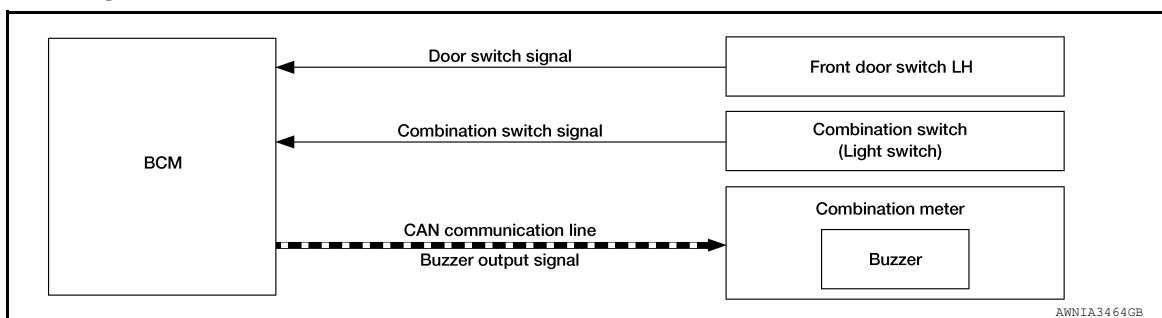

#### WARNING CHIME OPERATION CONDITIONS

If all of the following conditions are fulfilled:

Operation conditions	
Power switch	LOCK, OFF or ACC position
Combination switch (Lighting switch)	1st or 2nd position
Driver side door	Open [front door switch LH ON]

#### WARNING CHIME CANCEL CONDITIONS



# SYSTEM

## < SYSTEM DESCRIPTION >

Warning is canceled if any of the following conditions is fulfilled:

Operation conditions	
Power switch	ON or READY position
Combination switch (Lighting switch)	OFF or AUTO position
Driver side door	Close [front door switch LH OFF]

### SIGNAL PATH

1. BCM requires warning chime output to combination meter when it judges light reminder warning chime is necessary from signals below.

Signal name	Signal path
Power switch ON signal	—
Combination switch signal	Combination switch (Lighting switch) → BCM
Front door switch LH signal	Front door switch LH → BCM

2. Combination meter sounds integrated buzzer, following the warning chime output requirement (below signal) from BCM.

Signal name	Signal path
Buzzer output signal	BCM <sup>CAN</sup> → Combination meter

### TIMING CHART

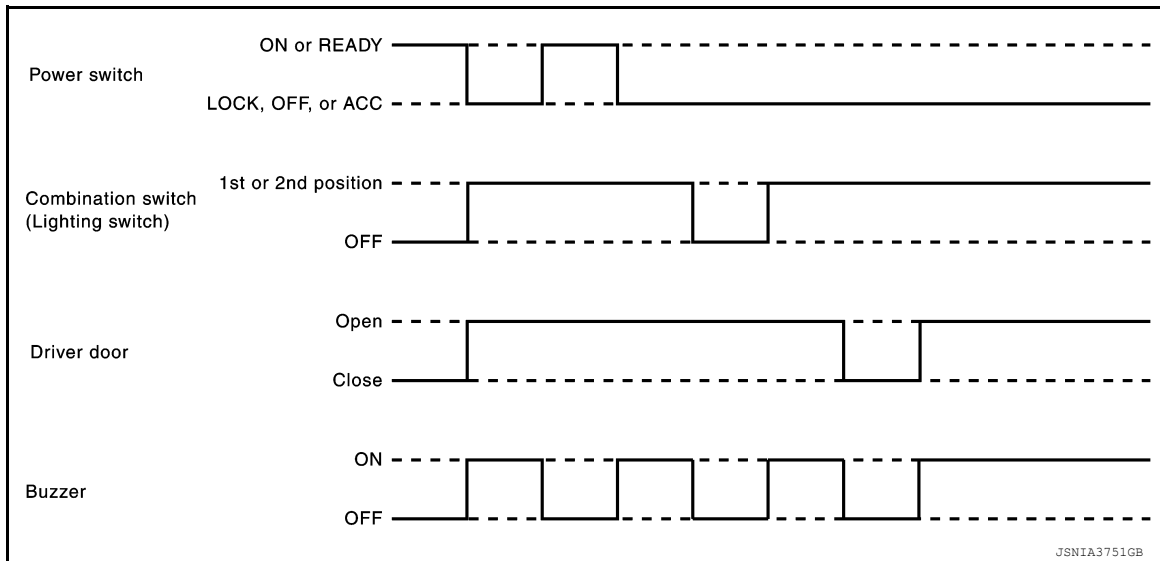

## SEAT BELT WARNING CHIME

A  
B  
C  
D  
E  
F  
G  
H  
I  
J  
K  
L  
M  
O  
P

WCS

# SYSTEM

< SYSTEM DESCRIPTION >

## SEAT BELT WARNING CHIME : System Description

INFOID:000000010121625

### SYSTEM DIAGRAM

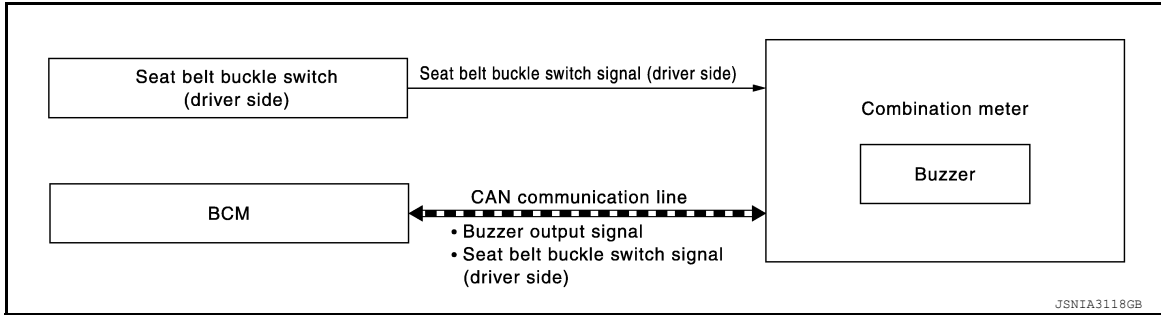

### WARNING OPERATION CONDITIONS

If all of the following conditions are fulfilled:

Operation conditions	
Power switch	ON or READY position
Driver seat belt	Unfastened [seat belt buckle switch (driver side) ON]

### WARNING CANCEL CONDITIONS

Warning is canceled if any of the following conditions is fulfilled:

Operation conditions	
Power switch	LOCK, OFF, or ACC position
Driver seat belt	Fastened [seat belt buckle switch (driver side) OFF]
6 seconds after the start of warning sound	

### SIGNAL PATH

1. BCM requires warning chime output to combination meter when it judges seat belt warning chime is necessary from signals below.

Signal name	Signal path
Power switch ON signal	—
Seat belt buckle switch signal (driver side)	Seat belt buckle switch (driver side) → Combination meter → CAN → BCM

2. Combination meter sounds integrated buzzer, following the warning chime output requirement (below signal) from BCM.

Signal name	Signal path
Buzzer output signal	BCM → CAN → Combination meter

# SYSTEM

## < SYSTEM DESCRIPTION >

### TIMING CHART

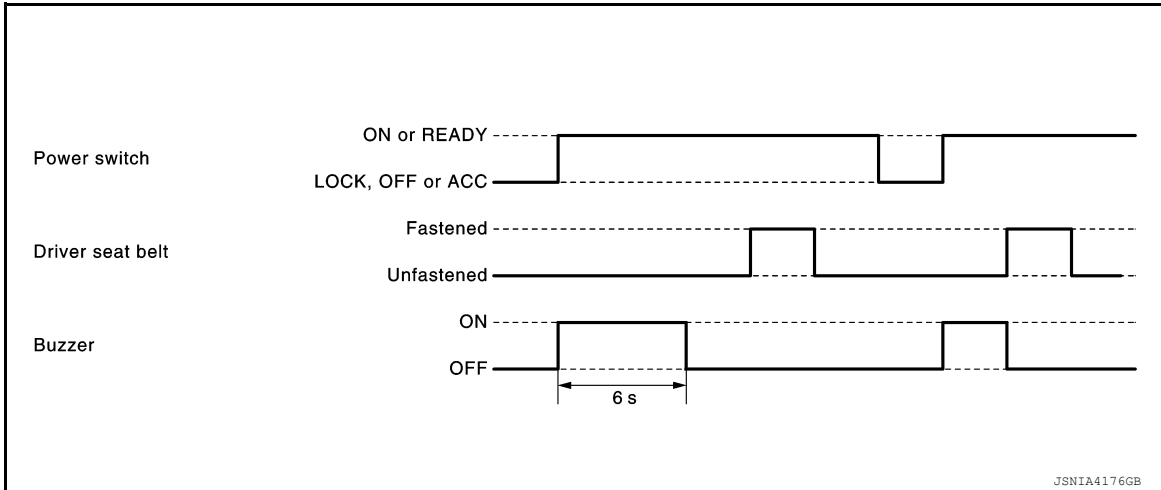

### SOUND SPECIFICATION

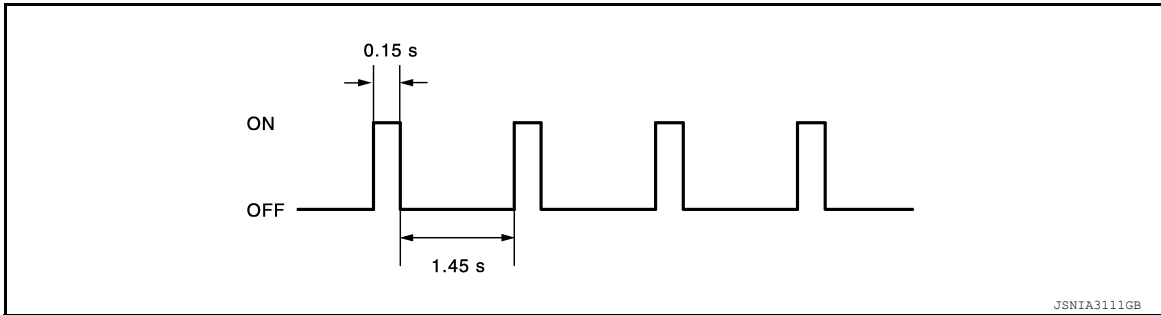

### PARKING BRAKE RELEASE WARNING CHIME

### PARKING BRAKE RELEASE WARNING CHIME : Parking Brake Release Warning Chime

INFOID:000000010121626

### SYSTEM DIAGRAM

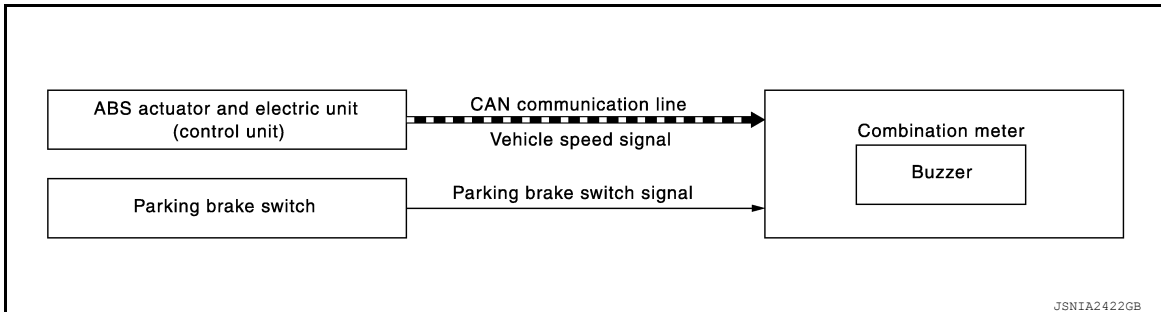

### WARNING OPERATION CONDITIONS

If all of the following conditions are fulfilled:

Operation conditions	
Power switch	ON
Parking brake	During the operation (parking brake switch ON)
Vehicle speed	Approximately 4.3 MPH (7 km/h) or more

### WARNING CANCEL CONDITIONS

Warning is canceled if any of the following conditions are fulfilled:

A  
B  
C  
D  
E  
F  
G  
H  
I  
J  
K  
L  
M

WCS

O  
P

# SYSTEM

## < SYSTEM DESCRIPTION >

Operation conditions	
Power switch	OFF
Parking brake	Release condition (parking brake switch OFF)
Vehicle speed	Approximately 1.9 MPH (3 km/h) or less

### SIGNAL PATH

Combination meter sounds integrated buzzer when it judges that parking brake release warning chime is necessary from signals below.

Signal name	Signal source
Power switch signal	—
Parking brake switch signal	Parking brake switch  Combination meter
Vehicle speed signal	ABS actuator and electric unit (control unit)  Combination meter

### TIMING CHART

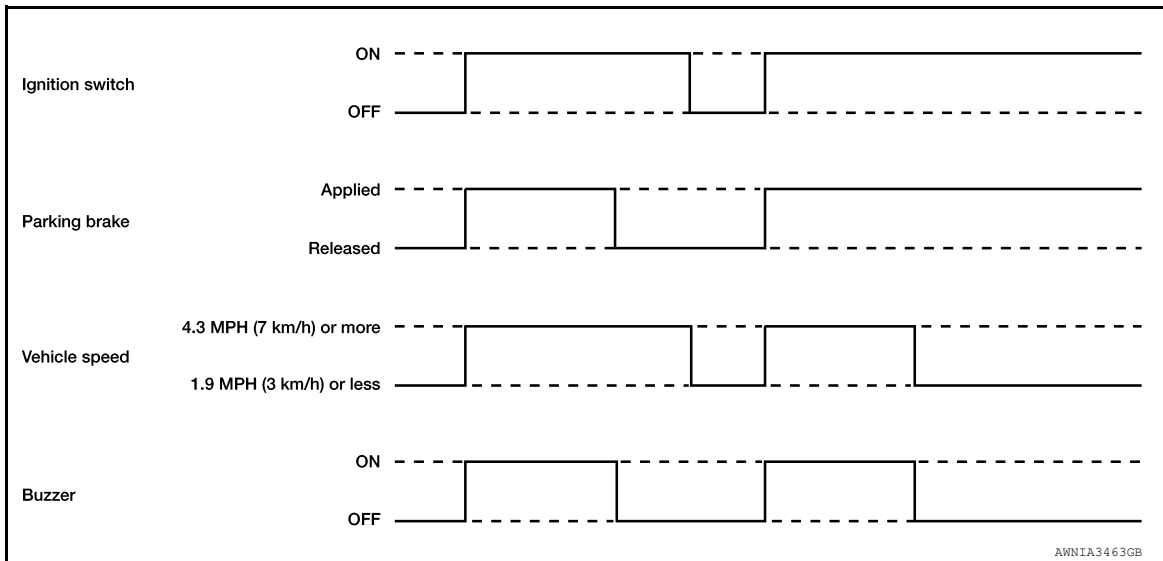

# DIAGNOSIS SYSTEM (COMBINATION METER)

< SYSTEM DESCRIPTION >

## DIAGNOSIS SYSTEM (COMBINATION METER)

### Description

INFOID:000000010505311

### COMBINATION METER SELF-DIAGNOSIS MODE

The following meter function can be checked during the Combination Meter Self-Diagnosis Mode:

Diagnosis item	
LCD (liquid crystal display) check	<ul style="list-style-type: none"><li>• Speedometer</li><li>• Power meter</li><li>• Li-ion battery temperature gauge</li><li>• Li-ion battery capacity level gauge</li><li>• Li-ion battery available charge gauge</li><li>• Eco indicator</li><li>• Driving range display</li><li>• Outside air temperature display</li><li>• Clock display</li><li>• Information display</li></ul>

### STARTING COMBINATION METER SELF-DIAGNOSIS MODE

#### NOTE:

- Check combination meter power supply and ground circuit if the self-diagnosis mode does not start. Refer to [MWI-85, "COMBINATION METER : Diagnosis Procedure"](#). Replace combination meter if power supply and ground circuits are found to be normal and self-diagnosis mode does not start. Refer to [MWI-102, "Removal and Installation"](#).
- Check upper meter power supply, ground circuit and communication signal circuits if the self-diagnosis mode does not start. Refer to [MWI-85, "UPPER METER : Diagnosis Procedure"](#) for power supply and ground circuit and [MWI-87, "Diagnosis Procedure"](#) for communication signal circuit. Replace upper meter if power supply, ground circuit and communication signal circuits are found to be normal and self-diagnosis mode does not start. Refer to [MWI-103, "Removal and Installation"](#).
- Combination meter self-diagnosis mode will function with the power switch in ON. Combination meter self-diagnosis mode will exit upon turning the power switch to OFF.

#### How to Initiate Self-Diagnosis Mode

1. Power switch OFF.
2. Turn the power switch ON while holding down the trip reset switch (1).

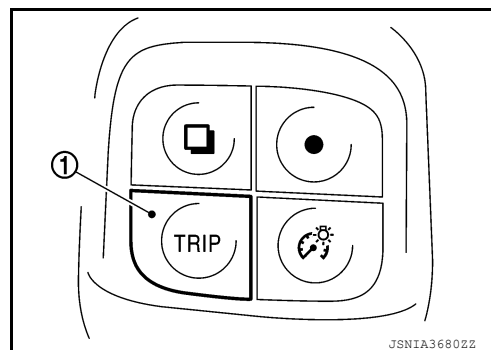

3. If the diagnosis function is activated with "trip A" displayed, the mileage on "trip A" is reset to "0000.0". (The same way for "trip B".)
4. Make sure that the trip meter displays "0000.0".
5. Press the trip reset switch at least 3 times (within 7 seconds after power ON).
6. The upper meter (A) and combination meter (B) is turned to self-diagnosis mode.
  - The following items are OFF:
    - Speedometer
    - Power meter
    - Li-ion battery temperature gauge
    - Li-ion battery capacity level gauge
    - Li-ion battery available charge gauge
    - Eco indicator

# DIAGNOSIS SYSTEM (COMBINATION METER)

## < SYSTEM DESCRIPTION >

- Driving range display
- Outside air temperature display
- Clock display
- Information display

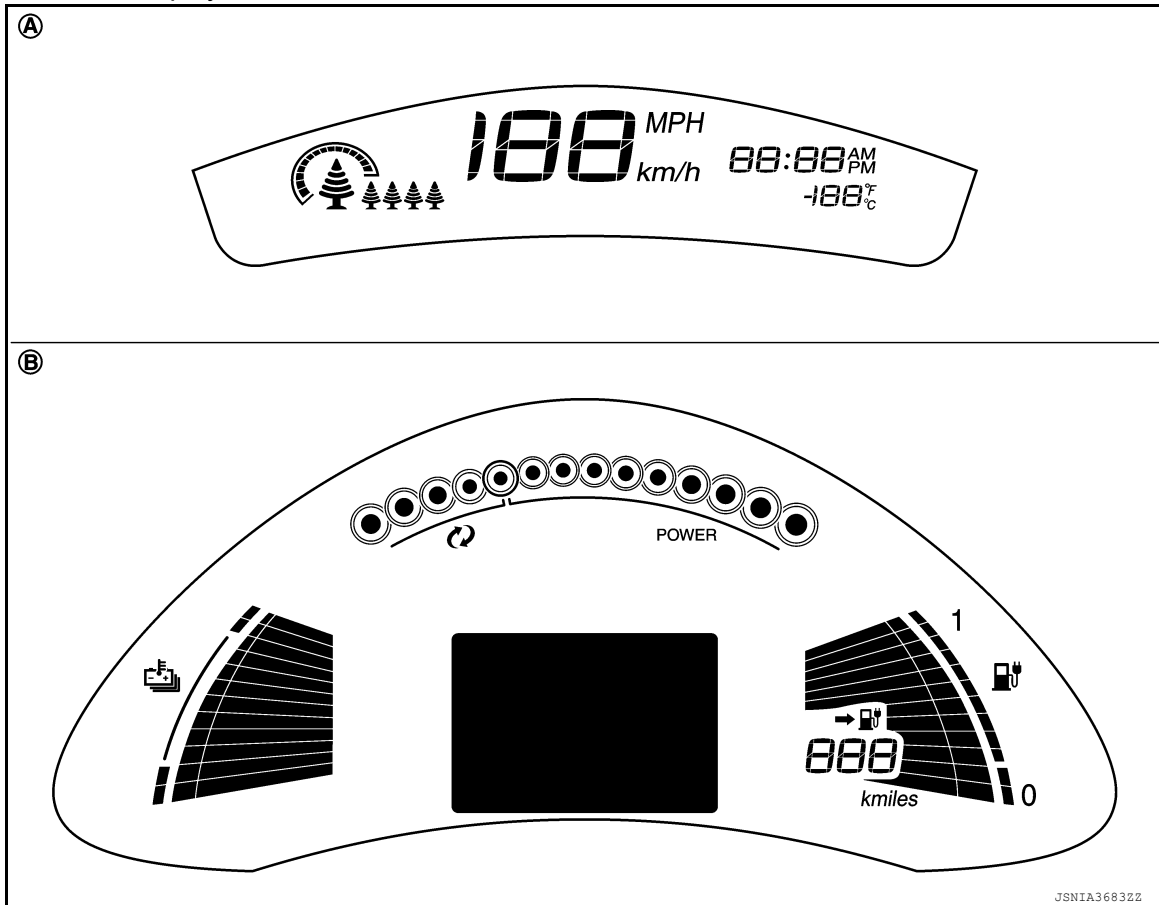

7. The segments and information display turn ON while the trip reset switch is depressed.

### NOTE:

- If there is a segment that does not turn ON, replace the combination meter or upper meter.
- If the information display does not turn ON, replace the combination meter.

## CONSULT Function (METER/M&A)

INFOID:000000010505312

### CONSULT APPLICATION ITEMS

CONSULT can perform the following diagnosis modes via CAN communication and the combination meter.

System	Diagnosis mode	Description
METER/M&A	Self Diagnostic Result	The combination meter checks the conditions and displays memorized errors.
	Data Monitor	Displays the combination meter input/output data in real time.
	Work support	Allows quick and precise adjustment of component parts and systems.
	Warning History	Lighting history of the warning lamp and indicator lamp can be checked.

### SELF DIAG RESULT

Refer to [WCS-32. "DTC Index"](#).

### DATA MONITOR

Display Item List

# DIAGNOSIS SYSTEM (COMBINATION METER)

## < SYSTEM DESCRIPTION >

X: Applicable

Display item [Unit]	MAIN SIGNALS	Description	A
SPEED METER [mph or km/h]	X	Value of vehicle speed signal received from ABS actuator and electric unit (control unit) via CAN communication. <b>NOTE:</b> 655.35 is displayed when the malfunction signal is received.	B
SPEED OUTPUT [mph or km/h]	X	Vehicle speed signal value transmitted to other units via CAN communication. <b>NOTE:</b> 655.35 is displayed when the malfunction signal is received.	C
BUZZER [On/Off]	X	Buzzer status (in the combination meter) is detected from the buzzer output signal received from each unit via CAN communication and the warning output condition of the combination meter.	D
ODO OUTPUT [mph or km/h]		Odometer signal value transmitted to other units via CAN communication.	E
ABS W/L [On/Off]		Status of ABS warning lamp detected from ABS warning lamp signal is received from ABS actuator and electric unit (control unit) via CAN communication.	F
VDC/TCS IND [On/Off]		Status of VDC OFF indicator lamp detected from VDC OFF indicator lamp signal is received from ABS actuator and electric unit (control unit) via CAN communication.	G
SLIP IND [On/Off]		Status of VDC warning lamp detected from VDC warning lamp signal received from ABS actuator and electric unit (control unit) via CAN communication.	H
BRAKE W/L [On/Off]		Status of brake warning lamp detected from brake warning lamp signal is received from ABS actuator and electric unit (control unit) via CAN communication. <b>NOTE:</b> Displays "Off" if the brake warning lamp is illuminated when the valve check starts, the parking brake switch is turned ON or the brake fluid level switch is turned ON.	I
DOOR W/L [On/Off]		Status of door open warning detected from door switch signal received from BCM via CAN communication.	J
HI-BEAM IND [On/Off]		Status of high beam indicator lamp detected from high beam request signal is received from BCM via CAN communication.	K
TURN IND [On/Off]		Status of turn indicator lamp detected from turn indicator signal is received from BCM via CAN communication.	L
FR FOG IND [On/Off]		Status of front fog light indicator lamp detected from front fog light request signal is received from BCM via CAN communication.	M
LIGHT IND [On/Off]		Status of tail lamp indicator lamp detected from position light request signal is received from BCM via CAN communication.	WCS
CRUISE IND [On/Off]		Status of CRUISE indicator detected from ASCD status signal is received from VCM via CAN communication.	O
SET IND [On/Off]		Status of SET indicator detected from ASCD status signal is received from ECM via CAN communication.	P
KEY G/Y W/L [On/Off]		Status of Intelligent Key system malfunction detected from meter display signal is received from BCM via CAN communication.	
EPS W/L [On/Off]		Status of EPS warning lamp detected from EPS warning lamp signal is received from EPS control unit via CAN communication.	
SLOW IND [On/Off]		Status of power limitation indicator detected from power limitation indication lamp request signal is received from VCM via CAN communication.	
READY IND [On/Off]		Status of READY to drive indicator lamp detected from READY to drive indicator lamp request signal is received from VCM via CAN communication.	
CHAGE W/L [On/Off]		Status of 12-volt battery charge warning lamp detected from 12-volt battery charge warning lamp request signal is received from VCM via CAN communication.	
LCD [B&PN, B&P I, ID NG, ROTAT, IN-SRT, BATT, NO KY, OUTKY,LK WN, KY>PSW, Off]		Status of Intelligent Key system warning judged from meter display signal received from BCM with CAN communication line.	

## DIAGNOSIS SYSTEM (COMBINATION METER)

### < SYSTEM DESCRIPTION >

Display item [Unit]	MAIN SIGNALS	Description
SHIFT IND [P, R, N, D]		Status of shift indicator display judged based on the shift position signal received from VCM via CAN communication.
BUCKLE SW [On/Off]		Status of seat belt buckle switch (driver side).
BRAKE OIL SW [On/Off]		Status of brake fluid level switch.
MODE A SW [On/Off]		Status of enter switch.
MODE B SW [On/Off]		Status of select switch.
PASS BUCKLE SW [On/Off]		Status of seat belt buckle switch (passenger side).
LED LMP R OPEN [On/Off]		Status of front combination lamp RH judged based on LED headlamp (RH) warning signal input from front combination lamp RH.
LED LMP L OPEN [On/Off]		Status of front combination lamp LH judged based on LED headlamp (LH) warning signal input from front combination lamp LH.
CHG CONCT DET [On/Off]		Charge connector connection status judged based plug in signal input from PDM (power delivery module).
ALL PWER MTER [kW]		Status of current power meter display, judged based on current motor power signal received from VCM via CAN communication.
TPMS PRESS L [On/Off]		Status of check low tire pressure warning detected from TPMS warning lamp signal received from BCM via CAN communication.
ASCD SPD BLINK [On/Off]		Blinking status of ASCD set vehicle speed judged by the ASCD status signal received from VCM via CAN communication.
ASCD STATUS [Off, ASCD, CRUISE, SL ON, SL SET]		Status of ASCD status display judged by the ASCD status signal received from VCM via CAN communication.
ASCD REQ SPD [mph, km/h or Off]		ASCD set vehicle speed value judged by the ASCD status signal received from VCM via CAN communication.
BAT REMAIN [kWh]		Value of Li-ion battery available charge signal received from VCM via CAN communication.
BAT REMAIN LEV [LEV 1-12]		ON segment value of Li-ion battery available charge gauge received from VCM via CAN communication.
BAT CHG CAP LEV [LEV 1-12]		ON segment value of Li-ion battery capacity level gauge received from VCM via CAN communication.
BAT TEMP [°F or °C]		Value of Li-ion battery temperature signal received from VCM via CAN communication.
POWER MAX [kW]		Value of maximum motor output power signal received from VCM via CAN communication.
REGENE MAX [kW]		Value of maximum regenerable power signal received from VCM via CAN communication.
ECO IND1 [0-15]		ON segment value of instant ECO indicator received from VCM via CAN communication.
ECO IND2 [OFF, seg11-seg15+seg24]		ON segment value of ECO tree received from VCM via CAN communication.
SFT W/L [On/Off]		Status of electric shift warning lamp judged based on electric shift warning lamp signal received from VCM via CAN communication.
REGENE W/L [On/Off]		Status of brake system warning lamp judged based on brake system warning lamp signal received from electrically-driven intelligent brake unit via CAN communication.
EV SYSTEM W/L [On/Off]		Status of EV system warning lamp judged based on EV system warning lamp request signal received from VCM via CAN communication.



# DIAGNOSIS SYSTEM (COMBINATION METER)

## < SYSTEM DESCRIPTION >

Display item [Unit]	MAIN SIGNALS	Description	
SFT P W DSP [On/Off]		This item is displayed, but cannot be monitored.	A
SFT DSP [Off, PKB, SFT MALF, SFT POSI]		Status of electric shift warning display judged based on electric shift warning message signal received from VCM via CAN communication.	B
PUSH SW W DSP [On/Off]		Status of remove charge connector warning display judged based on plug in warning display signal received from VCM via CAN communication.	C
100V CHG TIME [min]		Value of remaining time to charge completion (100 V) signal received from VCM via CAN communication.	
200V CHG TIME [min]		Value of remaining time to charge completion (200 V) signal received from VCM via CAN communication.	D
CHARGE STATE [100V, 200V, QICK CHG, OFF]		Charge status judged based on charge status signal received from VCM via CAN communication.	E
DCDC W DSP [OFF,STOP,CRUISE]		Status of DC/DC converter warning display judged based on vehicle stop and parking brake operation request display signal received from VCM via CAN communication.	F
SFT W/L [On/Off]		Status of electric shift warning signal input from VCM.	
DTE DIF [mi or km]		Value of driving range difference signal received from VCM via CAN communication.	G
DTE INPUT [mi or km]		Value of driving range signal received from VCM via CAN communication.	
DTE 2ND W [On, BLINK, Off]		Status of driving range display (“--”) blinking, judged based on driving range flashing request signal received from VCM via CAN communication.	H
BAT LOW W/L [On/Off]		Status of low battery charge warning lamp judged based on low battery charge warning lamp request signal received from VCM via CAN communication.	I
ELE COMPR OFF [kW/h]		Value of A/C OFF average electricity consumption for driving range signal received from VCM via CAN communication.	J
ELE COMPR ON [kW/h]		Value of A/C ON average electricity consumption for driving range signal received from VCM via CAN communication.	
DTE BLINK [On/Off]		Status of driving range display blinking, judged based on driving range flashing request signal received from VCM via CAN communication/	K

### W/L ON HISTORY

- Stores histories when warning/indicator lamp is turned on.
- “W/L ON HISTORY” indicates the “TIME” when the warning/indicator lamp is turned on.
- The “TIME” above is:
  - 0: The condition that the warning/indicator lamp has been turned on 1 or more times after starting the engine and waiting for 30 seconds.
  - 1 - 39: The number of times the engine was restarted after the 0 condition.
  - NO W/L ON HISTORY: Stores NO (0) turning on history of warning/indicator lamp.

#### NOTE:

- W/L ON HISTORY is not stored for approximately 30 seconds after the engine starts.
- Brake warning lamp does not store any history when the parking brake is applied or the brake fluid level gets low.

### Display Item

Display item	Description
ABS W/L	Lighting history of ABS warning lamp.
VDC/TCS IND	Lighting history of VDC OFF indicator lamp.
SLIP IND	Lighting history of VDC warning lamp.
BRAKE W/L	Lighting history of brake warning lamp.
DOOR W/L	Lighting history of door open warning.
CRUISE IND	Lighting history of CRUISE indicator.

A  
B  
C  
D  
E  
F  
G  
H  
I  
J  
K  
L  
M  
O  
P

WCS

## DIAGNOSIS SYSTEM (COMBINATION METER)

### < SYSTEM DESCRIPTION >

Display item	Description
SET IND	Lighting history of SET indicator.
AIR PRES W/L	Lighting history of low tire pressure warning lamp.
EPS W/L	Lighting history of EPS warning lamp.
CHAGE W/L	Lighting history of 12-volt battery charge warning lamp.
REGENE BRAKE W/L	Lighting history of brake system warning lamp.
SLOW	Lighting history of power limitation indicator.
LED LAMP W/L	Lighting history of headlamp warning lamp.

# DIAGNOSIS SYSTEM (BCM)

< SYSTEM DESCRIPTION >

## DIAGNOSIS SYSTEM (BCM)

### COMMON ITEM

COMMON ITEM : CONSULT Function (BCM - COMMON ITEM)

INFOID:0000000010505317

### APPLICATION ITEM

CONSULT performs the following functions via CAN communication with BCM.

Direct Diagnostic Mode	Description
Ecu Identification	The BCM part number is displayed.
Self Diagnostic Result	The BCM self diagnostic results are displayed.
Data Monitor	The BCM input/output data is displayed in real time.
Active Test	The BCM activates outputs to test components.
Work support	The settings for BCM functions can be changed.
Configuration	<ul style="list-style-type: none"> <li>The vehicle specification can be read and saved.</li> <li>The vehicle specification can be written when replacing BCM.</li> </ul>
CAN Diag Support Mntr	The result of transmit/receive diagnosis of CAN communication is displayed.

### SYSTEM APPLICATION

BCM can perform the following functions.

System	Sub System	Direct Diagnostic Mode						
		Ecu Identification	Self Diagnostic Result	Data Monitor	Active Test	Work support	Configuration	CAN Diag Support Mntr
Door lock	DOOR LOCK		×	×	×	×		
Rear window defogger	REAR DEFOGGER			×	×			
Warning chime	BUZZER			×	×			
Interior room lamp timer	INT LAMP			×	×	×		
Exterior lamp	HEADLAMP			×	×	×		
Wiper and washer	WIPER			×	×	×		
Turn signal and hazard warning lamps	FLASHER			×	×	×		
Air conditioner	AIR CONDITIONER			×	×			
Intelligent Key system	INTELLIGENT KEY		×	×	×	×		
Combination switch	COMB SW			×				
BCM	BCM	×	×			×	×	×
Immobilizer	IMMU		×	×	×	×		
Interior room lamp battery saver	BATTERY SAVER			×	×	×		
Trunk open	TRUNK			×				
Vehicle security system	THEFT ALM			×	×	×		
RAP system	RETAINED PWR			×				
Signal buffer system	SIGNAL BUFFER			×				
TPMS	AIR PRESSURE MONITOR		×	×	×	×		

### BUZZER

A  
B  
C  
D  
E  
F  
G  
H  
I  
J  
K  
L  
M  
O  
P

WCS

## DIAGNOSIS SYSTEM (BCM)

< SYSTEM DESCRIPTION >

### BUZZER : CONSULT Function (BCM - BUZZER)

INFOID:000000010505318

#### DATA MONITOR

Monitor Item [Unit]	Description
PUSH -SW [On/Off]	Indicates condition of power switch.
UNLK SEN -DR [On/Off]	Indicates condition of door unlock sensor.
VEH SPEED 1 [km/h]	Indicates vehicle speed signal received from ABS on CAN communication line.
TAIL LAMP SW [On/Off]	Indicates condition of combination switch.
FR FOG SW [On/Off]	Indicates condition of front fog lamp switch.
DOOR SW-DR [On/Off]	Indicates condition of front door switch LH.
CDL LOCK SW [On/Off]	Indicates condition of lock signal from door lock and unlock switch.

#### ACTIVE TEST

Test Item	Description
ID REGIST WARNING	This test is able to check TPMS transmitter ID regist warning chime operation [On/Off].
SEAT BELT WARN TEST	This test is able to check seat belt warning chime operation [On/Off].
LIGHT WARN ALM	This test is able to check light warning chime operation [On/Off].

# COMBINATION METER

< ECU DIAGNOSIS INFORMATION >

## ECU DIAGNOSIS INFORMATION

### COMBINATION METER

Reference Value

INFOID:0000000010505313

#### VALUES ON THE DIAGNOSIS TOOL

Monitor item	Condition		Value/Status
SPEED METER [mph or km/h]	Power switch ON	While driving	Input value of vehicle speed signal (CAN communication signal) <b>NOTE:</b> 655.35 is displayed when the malfunction signal is received
SPEED OUTPUT [mph or km/h]	Power switch ON	While driving	Output value of vehicle speed signal (CAN communication signal) <b>NOTE:</b> 655.35 is displayed when the malfunction signal is received
ODO OUTPUT [mph or km/h]	Power switch ON	—	Output value of odometer signal (CAN communication signal)
ABS W/L	Power switch ON	ABS warning lamp ON	On
		ABS warning lamp OFF	Off
VDC/TCS IND	Power switch ON	ESP (VDC) OFF indicator lamp ON	On
		ESP (VDC) OFF indicator lamp OFF	Off
SLIP IND	Power switch ON	ESP (VDC) warning lamp ON	On
		ESP (VDC) warning lamp OFF	Off
BRAKE W/L	Power switch ON	Brake warning lamp ON	On
		Brake warning lamp OFF	Off
DOOR W/L	Power switch ON	Door open warning ON	On
		Door open warning OFF	Off
HI-BEAM IND	Power switch ON	High-beam indicator lamp ON	On
		High-beam indicator lamp OFF	Off
TURN IND	Power switch ON	Turn indicator lamp ON	On
		Turn indicator lamp OFF	Off
FR FOG IND	Power switch ON	Front fog lamp indicator lamp ON	On
		Front fog lamp indicator lamp OFF	Off
LIGHT IND	Power switch ON	Position lamp indicator lamp ON	On
		Position lamp indicator lamp OFF	Off
CRUISE IND	Power switch ON	CRUISE indicator ON	On
		CRUISE indicator OFF	Off
SET IND	Power switch ON	SET indicator ON	On
		SET indicator OFF	Off
KEY G/Y W/L	Power switch ON	During Intelligent Key warning malfunction indication	On
		Other than the above	Off
EPS W/L	Power switch ON	EPS warning lamp ON	On
		EPS warning lamp OFF	Off
SLOW IND	Power switch ON	Power limitation indicator lamp ON	On
		Power limitation indicator lamp OFF	Off

A  
B  
C  
D  
E  
F  
G  
H  
I  
J  
K  
L  
M  
O  
P

WCS

# COMBINATION METER

## < ECU DIAGNOSIS INFORMATION >

Monitor item	Condition		Value/Status
READY IND	Power switch ON	READY to drive indicator lamp ON	On
		READY to drive indicator lamp OFF	Off
CHAGE W/L	Power switch ON	12V battery charge warning lamp ON	On
		12V battery charge warning lamp OFF	Off
LCD	Power switch ON	During engine start information indication	B&P I
	Power switch ACC	During engine start information indication	B&P N
	Power switch LOCK	During key ID warning indication	ID NG
	Power switch LOCK	During steering lock information indication	ROTAT
	Power switch LOCK	During P position warning indication	SFT P
	Power switch LOCK	During Intelligent Key insert information indication	INSRT
	Power switch LOCK	During Intelligent Key low battery warning indication	BATT
	Power switch ON	During take away warning indication	NO KY
	Power switch LOCK	During key warning indication	OUTKY
	Power switch ON	During ACC warning indication	LK WN
	Power switch LOCK	During key ID verification information indication	KY>PSW
	Power switch ON	Other than above	Off
SHIFT IND	Power switch ON	During the indication of "P" by shift position indicator	P
		During the indication of "R" by shift position indicator	R
		During the indication of "N" by shift position indicator	N
		During the indication of "D" by shift position indicator	D
		During the indication of "B" by shift position indicator	B
BUCKLE SW	Power switch ON	Driver seat belt not fastened	On
		Driver seat belt fastened	Off
BRAKE OIL SW	Power switch ON	Brake fluid level switch ON	On
		Brake fluid level switch OFF	Off
PASS BUCKLE SW	Power switch ON	Passenger seat belt not fastened	On
		Passenger seat belt fastened	Off
MODE A SW	Power switch ON	When enter switch is pressed	On
		Other than above	Off
MODE B SW	Power switch ON	When select switch is pressed	On
		Other than above	Off
LED LMP R OPEN	Power switch ON	Front combination lamp RH malfunction	On
		Front combination lamp RH normal	Off

# COMBINATION METER

## < ECU DIAGNOSIS INFORMATION >

Monitor item	Condition		Value/Status	
LED LMP L OPEN	Power switch ON	Front combination lamp LH malfunction	On	A
		Front combination lamp LH normal	Off	
CHG CONCT DET	Power switch ON	Charge connector connected	On	B
		Charge connector not connected	Off	
BUZZER	Power switch ON	Buzzer ON	On	C
		Buzzer OFF	Off	
TPMS PRESS L	Power switch ON	During check tire pressure warning indication	On	D
		Other than above	Off	
ALL PWER MTER [kW]	Power switch ON	While driving	Input value of current power signal	E
ASCDC STATUS	Power switch ON	ASCDC and speed limiter system OFF	Off	F
		ASCDC system ON	ON	
		ASCDC set vehicle speed	CRUISE	
		Speed limiter system ON	SL ON	
		Speed limiter set vehicle speed	SL SET	
ASCDC SPD BLNK	Power switch ON	Set vehicle speed indicator blinking	On	G
		Set vehicle speed indicator not blinking	Off	
ASCDC REQ SPD [mph, km/h or Off]	Power switch ON	While driving	Same value as ASCDC or speed limiter set vehicle speed.	H
BAT REMAIN [kWh]	Power switch ON	—	Input value of Li-ion battery available charge signal	I
BAT REMAIN LEV	Power switch ON	1 segment of Li-ion battery available charge gauge illuminates	LV.1	J
		2 segments of Li-ion battery available charge gauge illuminate	LV.2	
		3 segments of Li-ion battery available charge gauge illuminate	LV.3	
		4 segments of Li-ion battery available charge gauge illuminate	LV.4	
		5 segments of Li-ion battery available charge gauge illuminate	LV.5	
		6 segments of Li-ion battery available charge gauge illuminate	LV.6	
		7 segments of Li-ion battery available charge gauge illuminate	LV.7	
		8 segments of Li-ion battery available charge gauge illuminate	LV.8	
		9 segments of Li-ion battery available charge gauge illuminate	LV.9	
		10 segments of Li-ion battery available charge gauge illuminate	LV.10	
		11 segments of Li-ion battery available charge gauge illuminate	LV.11	
		12 segments of Li-ion battery available charge gauge illuminate	LV.12	

WCS

# COMBINATION METER

## < ECU DIAGNOSIS INFORMATION >

Monitor item	Condition		Value/Status
BAT CHG CAP LEV	Power switch ON	1 segment of Li-ion battery capacity level gauge illuminates	LV.1
		2 segments of Li-ion battery capacity level gauge illuminate	LV.2
		3 segments of Li-ion battery capacity level gauge illuminate	LV.3
		4 segments of Li-ion battery capacity level gauge illuminate	LV.4
		5 segments of Li-ion battery capacity level gauge illuminate	LV.5
		6 segments of Li-ion battery capacity level gauge illuminate	LV.6
		7 segments of Li-ion battery capacity level gauge illuminate	LV.7
		8 segments of Li-ion battery capacity level gauge illuminate	LV.8
		9 segments of Li-ion battery capacity level gauge illuminate	LV.9
		10 segments of Li-ion battery capacity level gauge illuminate	LV.10
		11 segments of Li-ion battery capacity level gauge illuminate	LV.11
		12 segments of Li-ion battery capacity level gauge illuminate	LV.12
BAT TEMP [°F or °C]	Power switch ON	—	Input value of Li-ion battery temperature signal
POWER MAX [kW]	Power switch ON	While driving	Input value of maximum motor output power signal
REGENE MAX [kW]	Power switch ON	While driving	Input value of maximum regenerable power signal



# COMBINATION METER

## < ECU DIAGNOSIS INFORMATION >

Monitor item	Condition		Value/Status	
ECO IND1	Power switch ON	1 segment of Instant ECO indicator illuminates	1	A
		2 segments of Instant ECO indicator illuminate	2	B
		3 segments of Instant ECO indicator illuminate	3	
		4 segments of Instant ECO indicator illuminate	4	C
		5 segments of Instant ECO indicator illuminate	5	D
		6 segments of Instant ECO indicator illuminate	6	
		7 segments of Instant ECO indicator illuminate	7	E
		8 segments of Instant ECO indicator illuminate	8	F
		9 segments of Instant ECO indicator illuminate	9	
		10 segments of Instant ECO indicator illuminate	10	G
		11 segments of Instant ECO indicator illuminate	11	H
		12 segments of Instant ECO indicator illuminate	12	
		13 segments of Instant ECO indicator illuminate	13	I
		14 segments of Instant ECO indicator illuminate	14	J
		15 segments of Instant ECO indicator illuminate	15	
	Other than the above	0	K	
ECO IND2	Power switch ON	—	Displays number of ON segments of ECO tree*	
SFT W/L	Power switch ON	Electric shift warning lamp ON	On	L
		Electric shift warning lamp OFF	Off	
REGENE W/L	Power switch ON	Brake system warning lamp ON	On	M
		Brake system warning lamp OFF	Off	
EV SYSTEM W/L	Power switch ON	EV system warning lamp ON	On	WCS
		EV system warning lamp OFF	Off	
SFT P W DSP	Power switch ON	<b>NOTE:</b> This item is displayed, but cannot be monitored	Off	O
SFT DSP Power switch ON		During electric shift warning ("T/M system malfunction visit dealer") indication	SFT MALF	
		During electric shift warning ("check position of shift lever") indication	SFT POSI	P
		Other than the above	Off	
PUSH SW W DSP	Power switch ON	During remove charge connector warning indication	On	
		Other than the above	Off	

# COMBINATION METER

## < ECU DIAGNOSIS INFORMATION >

Monitor item	Condition		Value/Status
100V CHG TIME	Power switch ON	—	Displays 100 V charging time.
200V CHG TIME	Power switch ON	—	Displays 200 V charging time.
CHARGE STATE	Power switch ON	100 V charging	100 V
		200 V charging	200 V
		In Quick Charging	QICK CHG
		Other than the above	Off
DCDC W DSP	Power switch ON	During DC/DC converter warning (“stop vehicle”) indication	STOP
		During DC/DC converter warning (“apply parking brake”) indication	CRUISE
		Other than the above	Off
SFT W/L	Power switch ON	Electric shift warning lamp ON	On
		Electric shift warning lamp OFF	Off
DTE DIF [mi or km]	Power switch ON	—	Input value of driving range difference signal
DTE INPUT [mi or km]	Power switch ON	—	Input value of driving range signal
DTE 2ND W	Power switch ON	Driving range display “---” display	On
		Driving range display “---” blinking	BLINK
		Other than the above	Off
BAT LOW W/L	Power switch ON	Low battery charge warning lamp ON	On
		Low battery charge warning lamp OFF	Off
ELE COMPR OFF [mi or km]	Power switch ON	—	Input value of A/C OFF average electricity consumption for driving range signal
ELE COMPR ON [mi or km]	Power switch ON	—	Input value of A/C ON average electricity consumption for driving range signal
DTE BLINK	Power switch ON	Driving range display blinking	On
		Other than the above	Off

\*: “ECO IND2” displays the items in the Status column of the following table.

Displays number of ON segments of ECO tree	Status
1 segment of ECO tree (1) illuminates	SEG11
2 segments of ECO tree (1) illuminate	SEG12
3 segments of ECO tree (1) illuminate	SEG13
4 segments of ECO tree (1) illuminate	SEG14
5 segments of ECO tree (1) illuminate	SEG15
ECO tree (2) illuminates	SEG21
• ECO tree (2) illuminates • 1 segments of ECO tree (1) illuminate	SEG11+SEG21
• ECO tree (2) illuminates • 2 segments of ECO tree (1) illuminate	SEG12+SEG21
• ECO tree (2) illuminates • 3 segments of ECO tree (1) illuminate	SEG13+SEG21
• ECO tree (2) illuminates • 4 segments of ECO tree (1) illuminate	SEG14+SEG21

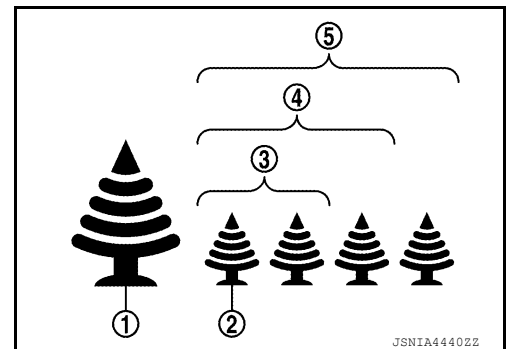

# COMBINATION METER

## < ECU DIAGNOSIS INFORMATION >

Displays number of ON segments of ECO tree	Status
<ul style="list-style-type: none"> <li>• ECO tree (2) illuminates</li> <li>• 5 segments of ECO tree (1) illuminate</li> </ul>	SEG15+SEG21
ECO tree (3) illuminates	SEG22
<ul style="list-style-type: none"> <li>• ECO tree (3) illuminates</li> <li>• 1 segment of ECO tree (1) illuminate</li> </ul>	SEG11+SEG22
<ul style="list-style-type: none"> <li>• ECO tree (3) illuminates</li> <li>• 2 segments of ECO tree (1) illuminate</li> </ul>	SEG12+SEG22
<ul style="list-style-type: none"> <li>• ECO tree (3) illuminates</li> <li>• 3 segments of ECO tree (1) illuminate</li> </ul>	SEG13+SEG22
<ul style="list-style-type: none"> <li>• ECO tree (3) illuminates</li> <li>• 4 segments of ECO tree (1) illuminate</li> </ul>	SEG14+SEG22
<ul style="list-style-type: none"> <li>• ECO tree (3) illuminates</li> <li>• 5 segments of ECO tree (1) illuminate</li> </ul>	SEG15+SEG22
ECO tree (4) illuminates	SEG23
<ul style="list-style-type: none"> <li>• ECO tree (4) illuminates</li> <li>• 1 segment of ECO tree (1) illuminate</li> </ul>	SEG11+SEG23
<ul style="list-style-type: none"> <li>• ECO tree (4) illuminates</li> <li>• 2 segments of ECO tree (1) illuminate</li> </ul>	SEG12+SEG23
<ul style="list-style-type: none"> <li>• ECO tree (4) illuminates</li> <li>• 3 segments of ECO tree (1) illuminate</li> </ul>	SEG13+SEG23
<ul style="list-style-type: none"> <li>• ECO tree (4) illuminates</li> <li>• 4 segments of ECO tree (1) illuminate</li> </ul>	SEG14+SEG23
<ul style="list-style-type: none"> <li>• ECO tree (4) illuminates</li> <li>• 5 segments of ECO tree (1) illuminate</li> </ul>	SEG15+SEG23
ECO tree (5) illuminates	SEG24
<ul style="list-style-type: none"> <li>• ECO tree (5) illuminates</li> <li>• 1 segment of ECO tree (1) illuminate</li> </ul>	SEG11+SEG24
<ul style="list-style-type: none"> <li>• ECO tree (5) illuminates</li> <li>• 2 segments of ECO tree (1) illuminate</li> </ul>	SEG12+SEG24
<ul style="list-style-type: none"> <li>• ECO tree (5) illuminates</li> <li>• 3 segments of ECO tree (1) illuminate</li> </ul>	SEG13+SEG24
<ul style="list-style-type: none"> <li>• ECO tree (5) illuminates</li> <li>• 4 segments of ECO tree (1) illuminate</li> </ul>	SEG14+SEG24
<ul style="list-style-type: none"> <li>• ECO tree (5) illuminates</li> <li>• 5 segments of ECO tree (1) illuminate</li> </ul>	SEG15+SEG24
Other than the above	Off

A  
B  
C  
D  
E  
F  
G  
H  
I  
J  
K  
L  
M

## TERMINAL LAYOUT

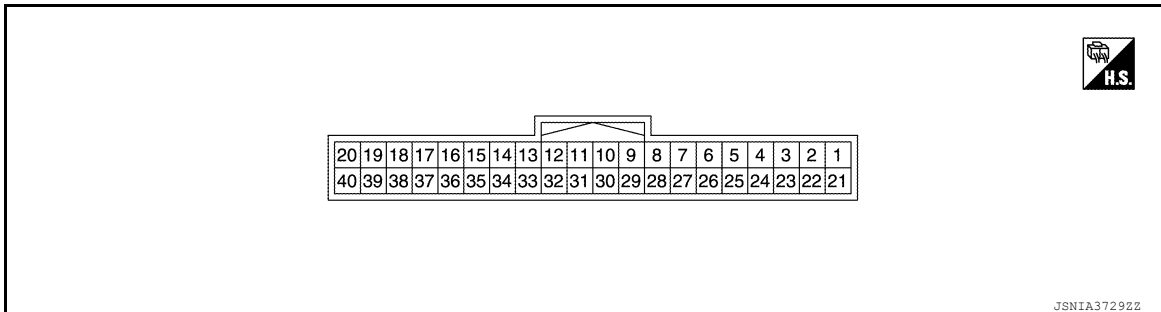



WCS

O  
P

## PHYSICAL VALUES

# COMBINATION METER

## < ECU DIAGNOSIS INFORMATION >

Terminal No. (Wire color)		Description		Condition		Value (Approx.)
+	-	Signal name	Input/ Output			
1 (LG)	Ground	Battery power supply	Input	Power switch OFF	—	Battery voltage
2 (Y)	Ground	Battery power supply (for upper meter)	Output	Power switch OFF	—	Battery voltage
3 (GR)	Ground	Power switch ON signal	Input	Power switch ON	—	Battery voltage
4 (BG)	Ground	Power switch ON signal (for upper meter)	Output	Power switch ON	—	Battery voltage
5 (B)	Ground	Ground	—	Power switch ON	—	0 V
6 (B)	Ground	Ground	—	Power switch ON	—	0 V
8 (Y)	Ground	Washer fluid level switch signal	Input	Power switch ON	Washer fluid level switch ON	0 V
					Washer fluid level switch OFF	5 V
9 (BR)	Ground	Plug in signal	Input	Power switch ON	Charge connector connect- ed	0 V
					Charge connector not con- nected	Battery voltage
12 (V)	Ground	Sw ground	—	—	—	—
13 (G)	Ground	Select switch signal	Input	Power switch ON	When  switch (select switch) is pressed	0 V
					Other than the above	5 V
14 (Y)	Ground	Enter switch signal	Input	Power switch ON	When  switch (enter switch) is pressed	0 V
					Other than the above	5 V
15 (BR)	Ground	Trip reset switch signal	Input	Power switch ON	When trip reset switch is pressed	0 V
					Other than the above	5 V
16 (P)	Ground	Illumination control switch signal	Input	Power switch ON	When  switch (illumina- tion control switch) is pressed	0 V
					Other than the above	5 V

# COMBINATION METER

## < ECU DIAGNOSIS INFORMATION >

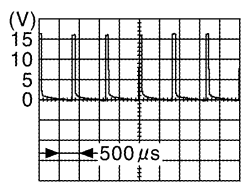
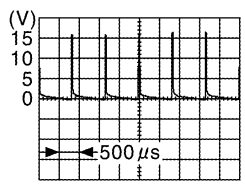
Terminal No. (Wire color)		Description		Condition	Value (Approx.)	
+	-	Signal name	Input/ Output			
17 (G)	Ground	Illumination control signal (for upper meter)	Output	Power switch ON	<ul style="list-style-type: none"> <li>Lighting switch 1ST position</li> <li>When meter illumination is maximum</li> </ul> 	
				Power switch ON	<ul style="list-style-type: none"> <li>Lighting switch 1ST position</li> <li>When meter illumination is step 6</li> </ul> 	
				Power switch ON	<ul style="list-style-type: none"> <li>Lighting switch 1ST position</li> <li>When meter illumination is minimum</li> </ul> <p style="text-align: center;">0 V</p>	
18 (P)	—	CAN-L	—	—	—	
19 (L)	—	CAN-H	—	—	—	
20 (LG)	Ground	Seat belt buckle switch signal (passenger side)	Input	Power switch ON	<ul style="list-style-type: none"> <li>When getting in the passenger seat</li> <li>When passenger seat belt is fastened</li> </ul> <p style="text-align: center;">Battery voltage</p>	
				Power switch ON	<ul style="list-style-type: none"> <li>When getting in the passenger seat</li> <li>When passenger seat belt is unfastened</li> </ul> <p style="text-align: center;">0 V</p>	
22 (GR)	Ground	Ground (for upper meter)	—	Power switch ON	0 V	
24 (BG)	Ground	Parking brake switch signal	Input	Power switch ON	Parking brake applied	0 V
				Power switch ON	Parking brake released	Battery voltage
25 (SB)	Ground	Brake fluid level switch signal	Input	Power switch ON	Brake fluid level is normal	Battery voltage
				Power switch ON	The brake fluid level is lower than the low level	0 V

A  
B  
C  
D  
E  
F  
G  
H  
I  
J  
K  
L  
M  
N  
O  
P

WCS

# COMBINATION METER

## < ECU DIAGNOSIS INFORMATION >

Terminal No. (Wire color)		Description		Condition	Value (Approx.)
+	-	Signal name	Input/ Output		
26 (B)	Ground	Illumination control signal	Output	Power switch ON	<ul style="list-style-type: none"> <li>Lighting switch 1ST position</li> <li>When meter illumination is maximum</li> </ul> <p style="text-align: center;">Battery voltage</p>
					<ul style="list-style-type: none"> <li>Lighting switch 1ST position</li> <li>When meter illumination is step 6</li> </ul> <p style="text-align: right; font-size: small;">JPNIA1686GB</p>
					<ul style="list-style-type: none"> <li>Lighting switch 1ST position</li> <li>When meter illumination is minimum</li> </ul> <p style="text-align: center;">0 V</p> <p style="text-align: right; font-size: small;">JPNIA1687GB</p>
27 (R)	Ground	Air bag signal	Input	Power switch ON	Air bag warning lamp ON Battery voltage
				Power switch OFF	Air bag warning lamp OFF 0 V
28 (R)	Ground	Security signal	Input	Power switch ON	Security indicator lamp ON 0 V
				Power switch OFF	Security indicator lamp OFF Battery voltage
30 (GR)	Ground	Vehicle speed signal (8-pulse)	Output	Power switch ON	<p>Speedometer operated [When vehicle speed is approx. 40 km/h (25 MPH)]</p> <p style="text-align: right; font-size: small;">JSNIA0012GB</p>
32 (W)	Ground	Communication signal (METER → UPPER)	Output	Power switch ON	<p><b>NOTE:</b> Reference waveform</p> <p style="text-align: right; font-size: small;">JSNIA3767GB</p>
33 (G)	Ground	Clock signal	Output	Power switch ON	<p><b>NOTE:</b> Reference waveform</p> <p style="text-align: right; font-size: small;">JSNIA3768GB</p>

# COMBINATION METER

## < ECU DIAGNOSIS INFORMATION >

Terminal No. (Wire color)		Description		Condition		Value (Approx.)
+	-	Signal name	Input/ Output			
34 (L)	Ground	Plug in indicator lamp signal	Input	Power switch ON	Plug in indicator lamp ON	0 V
					Plug in indicator lamp OFF	Battery voltage
38 (V)	Ground	LED headlamp (RH) warning signal	Input	Power switch ON	Front combination lamp RH malfunction	Battery voltage
					Front combination lamp RH normal	0 V
39 (LG)	Ground	LED headlamp (LH) warning signal	Input	Power switch ON	Front combination lamp LH malfunction	Battery voltage
					Front combination lamp LH normal	0 V
40 (W)	Ground	Seat belt buckle switch signal (driver side)	Input	Power switch ON	When driver seat belt is fastened	Battery voltage
					When driver seat belt is unfastened	0 V

### Fail-Safe

INFOID:000000010505314

### FAIL-SAFE

- The combination meter activates the fail-safe control if CAN communication with each unit is malfunctioning.

Function	Specifications	
Power meter	The display turns OFF by suspending communication.	
Li-ion battery temperature gauge		
Li-ion battery capacity level gauge		
Li-ion battery available charge gauge		
Driving range display	The display turns "--" by suspending communication.	
Illumination control	When suspending communication, changes to nighttime mode.	
Information display	Odo/trip meter	An indicated value is maintained at communications blackout.
	Shift indicator	The display turns OFF by suspending communication.
	Li-ion low battery charge warning display	The display turns ON by suspending communication.
	Electric shift warning display	
Other than the above	The display turns OFF by suspending communication.	
Buzzer	The buzzer turns OFF by suspending communication.	

WCS

# COMBINATION METER

## < ECU DIAGNOSIS INFORMATION >

Function		Specifications
Warning lamp/indicator lamp	ABS warning lamp	The lamp turns ON by suspending communication.
	VDC warning lamp	
	Brake warning lamp	
	Front fog lamp indicator lamp	
	Brake system warning lamp	
	EPS warning lamp	
	Low battery charge warning lamp	
	Electric shift warning lamp	
	TPMS warning lamp	The lamp turns OFF by suspending communication.
	High beam indicator lamp	
	VDC OFF indicator lamp	
	Tail lamp indicator lamp	
	READY to drive indicator lamp	
	12-volt battery charge warning lamp	
	Power limitation indicator lamp	
	EV system warning lamp	

- The upper meter performs the fail-safe control when a breakdown of communications between the upper meter and the combination meter occurs.

Function	Specifications
Speedometer	The display turns OFF by suspending communication.
Eco indicator	
Outside air temperature display	The last result calculated during normal condition is indicated.
Illumination control	When suspending communication, changes to nighttime mode.
Turn signal indicator lamp	The lamp turns OFF by suspending communication.

## DTC Index

INFOID:000000010505315

Display contents of CONSULT	Diagnostic item is detected when...	Refer to
CAN COMM CIRCUIT [U1000]	When combination meter is not transmitting or receiving CAN communication signal for 2 seconds or more.	<a href="#">MWI-82</a>
CONTROL UNIT (CAN) [U1010]	When detecting error during the initial diagnosis of the CAN controller of combination meter.	<a href="#">MWI-83</a>
VEHICLE SPEED [B2205]	The abnormal vehicle speed signal is input from the ABS actuator and electric unit (control unit) for 2 seconds or more.	<a href="#">MWI-84</a>



# BCM

< ECU DIAGNOSIS INFORMATION >

## BCM

### List of ECU Reference

INFOID:000000010121634

ECU	Reference
BCM	<a href="#">BCS-28. "Reference Value"</a>
	<a href="#">BCS-46. "Fail-safe"</a>
	<a href="#">BCS-47. "DTC Inspection Priority Chart"</a>
	<a href="#">BCS-48. "DTC Index"</a>

A  
B  
C  
D  
E  
F  
G  
H  
I  
J  
K  
L  
M

WCS

O  
P

# WARNING CHIME SYSTEM

< WIRING DIAGRAM >

## WIRING DIAGRAM

### WARNING CHIME SYSTEM

Wiring Diagram

INFOID:0000000010121635

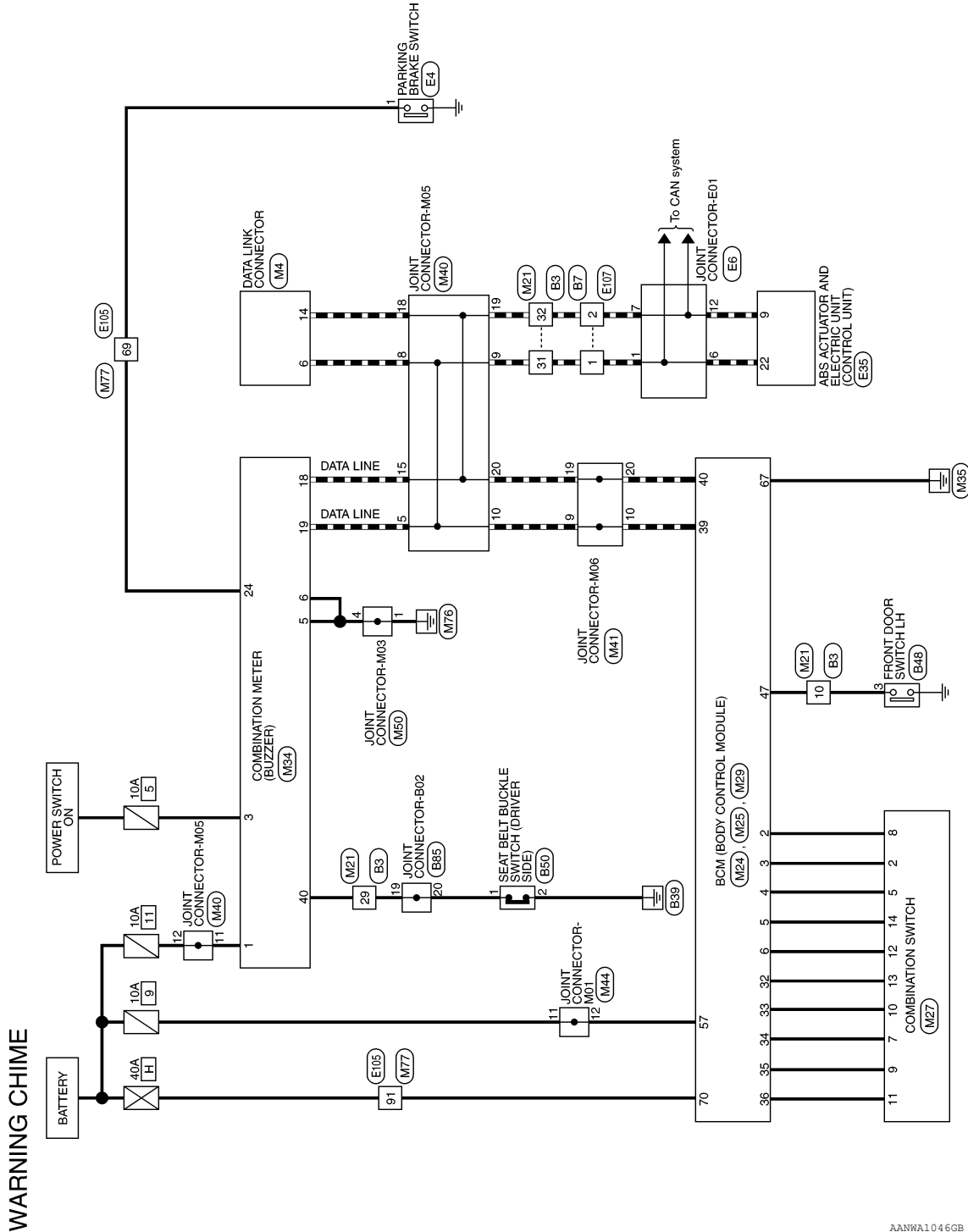

AANWA1046GB

# WARNING CHIME SYSTEM

< WIRING DIAGRAM >

## WARNING CHIME - CONNECTORS

Connector No.	M4
Connector Name	DATA LINK CONNECTOR
Connector Color	WHITE

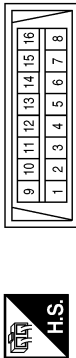

Terminal No.	Color of Wire	Signal Name
6	L	-
14	P	-

Connector No.	M21
Connector Name	WIRE TO WIRE
Connector Color	WHITE

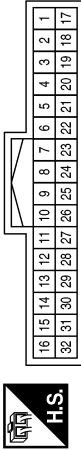

Terminal No.	Color of Wire	Signal Name
31	L	-
32	P	-

Connector No.	M24
Connector Name	BCM (BODY CONTROL MODULE)
Connector Color	BLACK

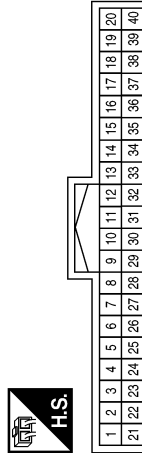

Terminal No.	Color of Wire	Signal Name
2	L	COMBINATION SW INPUT 5
3	GR	COMBINATION SW INPUT 4
4	BR	COMBINATION SW INPUT 3
5	G	COMBINATION SW INPUT 2

Terminal No.	Color of Wire	Signal Name
6	V	COMBINATION SW INPUT 1
32	GR	COMBINATION SW OUTPUT 5
33	Y	COMBINATION SW OUTPUT 4
34	W	COMBINATION SW OUTPUT 3
35	BG	COMBINATION SW OUTPUT 2
36	P	COMBINATION SW OUTPUT 1
39	L	CAN-H
40	P	CAN-L

Connector No.	M25
Connector Name	BCM (BODY CONTROL MODULE)
Connector Color	WHITE

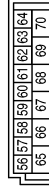

Terminal No.	Color of Wire	Signal Name
57	P	BATTERY (FUSE)
67	B	GND
70	Y	BATTERY (F/L)

AANIA2579GB

A  
B  
C  
D  
E  
F  
G  
H  
I  
J  
K  
L  
M  
O  
P

WCS

# WARNING CHIME SYSTEM

< WIRING DIAGRAM >

Connector No.	M27
Connector Name	COMBINATION SWITCH
Connector Color	WHITE

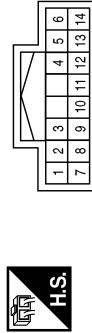

Terminal No.	Color of Wire	Signal Name
2	GR	-
5	BR	-
7	W	-
8	L	-
9	BG	-
10	Y	-
11	P	-
12	V	-
13	GR	-
14	G	-

Connector No.	M29
Connector Name	BCM (BODY CONTROL MODULE)
Connector Color	BLACK



Terminal No.	Color of Wire	Signal Name
47	SB	DOOR SW (DR)

Connector No.	M34
Connector Name	COMBINATION METER
Connector Color	WHITE

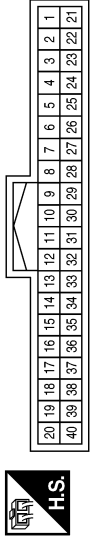

Terminal No.	Color of Wire	Signal Name
1	LG	-
3	GR	-
5	B	-
6	B	-
18	P	-
19	L	-
24	BG	-
40	W	-

Connector No.	M40
Connector Name	JOINT CONNECTOR-M05
Connector Color	BLUE

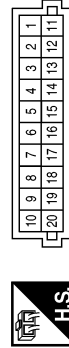

Terminal No.	Color of Wire	Signal Name
5	L	-
9	L	-
10	L	-
11	LG	-
12	LG	-
15	P	-
19	P	-
20	P	-

Connector No.	M41
Connector Name	JOINT CONNECTOR-M06
Connector Color	BLUE

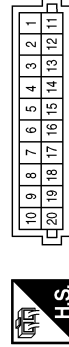

Terminal No.	Color of Wire	Signal Name
9	L	-
10	L	-
19	P	-
20	P	-

Connector No.	M44
Connector Name	JOINT CONNECTOR-M01
Connector Color	GRAY

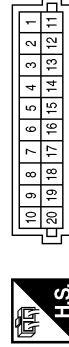

Terminal No.	Color of Wire	Signal Name
11	P	-
12	P	-

AANIA2580GB

# WARNING CHIME SYSTEM

< WIRING DIAGRAM >

Connector No.	E4
Connector Name	PARKING BRAKE SWITCH
Connector Color	BLACK



Terminal No.	Color of Wire	Signal Name
1	B	-

Connector No.	M77
Connector Name	WIRE TO WIRE
Connector Color	WHITE

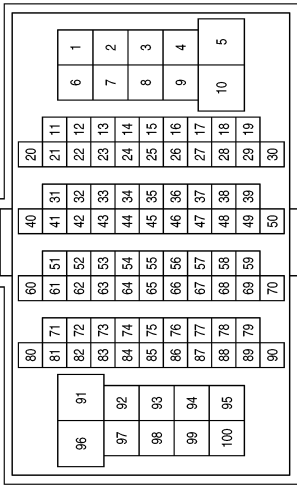

Terminal No.	Color of Wire	Signal Name
69	BG	-
91	Y	-

Connector No.	M50
Connector Name	JOINT CONNECTOR-M03
Connector Color	PINK

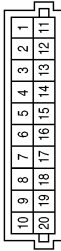

Terminal No.	Color of Wire	Signal Name
1	B	-
4	B	-

Connector No.	E6
Connector Name	JOINT CONNECTOR-E01
Connector Color	BLUE



Terminal No.	Color of Wire	Signal Name
1	L	-
6	L	-
7	P	-
12	P	-

Connector No.	E35
Connector Name	ABS ACTUATOR AND ELECTRIC UNIT (CONTROL UNIT)
Connector Color	BLACK



Terminal No.	Color of Wire	Signal Name
9	P	CAN-L
22	L	CAN-H

Connector No.	E105
Connector Name	WIRE TO WIRE
Connector Color	WHITE

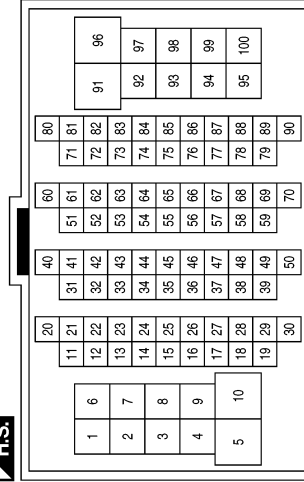

Terminal No.	Color of Wire	Signal Name
69	B	-
91	Y	-

AANIA2581GB

A  
B  
C  
D  
E  
F  
G  
H  
I  
J  
K  
L  
M  
N  
O  
P

WCS

# WARNING CHIME SYSTEM

< WIRING DIAGRAM >

Connector No.	B7
Connector Name	WIRE TO WIRE
Connector Color	WHITE

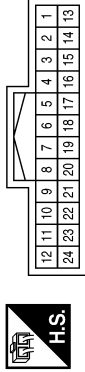

Terminal No.	Color of Wire	Signal Name
1	L	-
2	P	-

Connector No.	B3
Connector Name	WIRE TO WIRE
Connector Color	WHITE

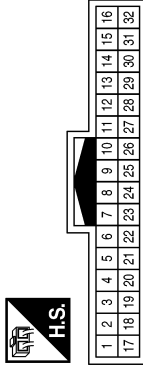

Terminal No.	Color of Wire	Signal Name
10	SB	-
29	R	-
31	L	-
32	P	-

Connector No.	E107
Connector Name	WIRE TO WIRE
Connector Color	WHITE

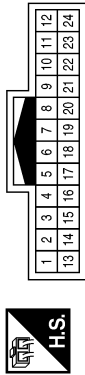

Terminal No.	Color of Wire	Signal Name
1	L	-
2	P	-

Connector No.	B85
Connector Name	JOINT CONNECTOR-B02
Connector Color	BLACK

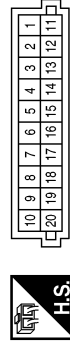

Terminal No.	Color of Wire	Signal Name
19	R	-
20	R	-

Connector No.	B50
Connector Name	SEAT BELT BUCKLE SWITCH (DRIVER SIDE)
Connector Color	WHITE

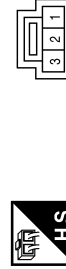

Terminal No.	Color of Wire	Signal Name
1	R	-
2	B	-

Connector No.	B48
Connector Name	FRONT DOOR SWITCH LH
Connector Color	WHITE



Terminal No.	Color of Wire	Signal Name
3	SB	-

AANIA2582GB

# DIAGNOSIS AND REPAIR WORKFLOW

< BASIC INSPECTION >

## BASIC INSPECTION

### DIAGNOSIS AND REPAIR WORKFLOW

Work Flow

INFOID:000000010121636

#### OVERALL SEQUENCE

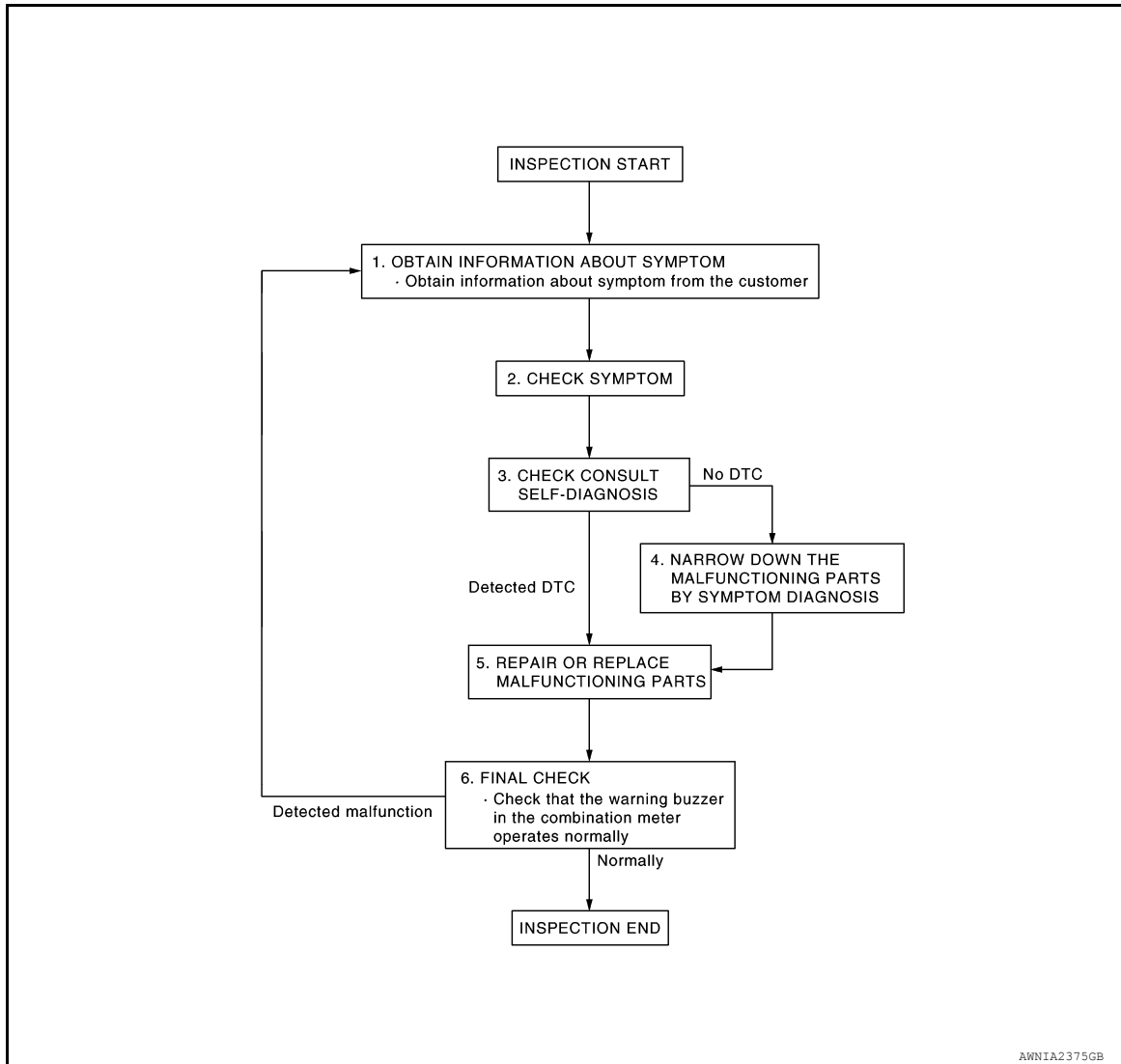

#### DETAILED FLOW

##### 1. OBTAIN INFORMATION ABOUT SYMPTOM

Interview the customer to obtain as much information as possible about the conditions and environment under which the malfunction occurred.

>> GO TO 2.

##### 2. CHECK SYMPTOM

- Check the symptom based on the information obtained from the customer.
- Check if any other malfunctions are present.

>> GO TO 3.

##### 3. CHECK CONSULT SELF-DIAGNOSIS RESULTS

Connect CONSULT and perform "Self Diagnosis". Refer to [MWI-65, "DTC Index"](#).

A  
B  
C  
D  
E  
F  
G  
H  
I  
J  
K  
L  
M

WCS

O  
P

## DIAGNOSIS AND REPAIR WORKFLOW

< BASIC INSPECTION >

---

Are self-diagnosis results normal?

YES >> GO TO 4.

NO >> GO TO 5.

### 4.NARROW DOWN MALFUNCTIONING PARTS BY SYMPTOM DIAGNOSIS

---

Perform symptom diagnosis and narrow down the malfunctioning parts.

>> GO TO 5.

### 5.REPAIR OR REPLACE MALFUNCTIONING PARTS

---

Repair or replace malfunctioning parts.

**NOTE:**

If DTC is displayed, erase DTC after repairing or replacing malfunctioning parts.

>> GO TO 6.

### 6.FINAL CHECK

---

Check that the warning buzzer in the combination meter operates normally.

Does it operate normally?

YES >> Inspection End.

NO >> GO TO 1.



# POWER SUPPLY AND GROUND CIRCUIT

< DTC/CIRCUIT DIAGNOSIS >

## DTC/CIRCUIT DIAGNOSIS

### POWER SUPPLY AND GROUND CIRCUIT COMBINATION METER

#### COMBINATION METER : Diagnosis Procedure

INFOID:000000010505316

Regarding Wiring Diagram information, refer to [MWI-68. "Wiring Diagram"](#).

#### 1. CHECK FUSES

Check that the following fuses are not blown:

Power source	Fuse No.
Battery	11
Power switch ON	5

Is the fuse blown?

YES >> Replace the blown fuse after repairing the affected circuit.

NO >> GO TO 2.

#### 2. CHECK POWER SUPPLY CIRCUIT

Check voltage between combination meter harness connector and ground.

Terminals		Power switch position	Voltage (Approx.)
(+)	(-)		
Combination meter		OFF	Battery voltage
Connector	Terminal		
M34	1		
	3	ON	

Is the inspection result normal?

YES >> GO TO 3.

NO >> Repair or replace harness or connector.

#### 3. CHECK GROUND CIRCUIT

1. Power switch OFF.
2. Disconnect combination meter connector.
3. Check continuity between combination meter harness connector and ground.

Combination meter		Ground	Continuity
Connector	Terminal		
M34	5		Yes
	6		

Is the inspection result normal?

YES >> Inspection End.

NO >> Repair or replace harness or connector.

#### BCM

#### BCM : Diagnosis Procedure

INFOID:000000010563527

Regarding Wiring Diagram information, refer to [BCS-50. "Wiring Diagram"](#).

A  
B  
C  
D  
E  
F  
G  
H  
I  
J  
K  
L  
M  
O  
P

WCS

# POWER SUPPLY AND GROUND CIRCUIT

< DTC/CIRCUIT DIAGNOSIS >

## 1. CHECK FUSE AND FUSIBLE LINK

Check that the following fuse and fusible link are not blown.

Terminal No.	Signal name	Fuse and fusible link No.
57	Battery power supply	9 (10A)
70		H (40A)

Is the fuse or fusible link blown?

YES >> Replace the blown fuse or fusible link after repairing the affected circuit.

NO >> GO TO 2.

## 2. CHECK POWER SUPPLY CIRCUIT

1. Disconnect BCM connector M25.
2. Check voltage between BCM connector M25 and ground.

BCM		Ground	Voltage (Approx.)
Connector	Terminal		
M25	57	—	Battery voltage
	70		

Is the inspection result normal?

YES >> GO TO 3.

NO >> Repair or replace harness or connectors.

## 3. CHECK GROUND CIRCUIT

Check continuity between BCM connector M25 and ground.

BCM		Ground	Continuity
Connector	Terminal		
M25	67	—	Yes

Is the inspection result normal?

YES >> Inspection End.

NO >> Repair or replace harness or connectors.

# METER BUZZER CIRCUIT

< DTC/CIRCUIT DIAGNOSIS >

## METER BUZZER CIRCUIT

### Component Function Check

INFOID:000000010121638

#### 1.CHECK OPERATION OF METER BUZZER

1. Select "BUZZER" of "BCM" using CONSULT.
2. Perform "LIGHT WARN ALM" in "Active Test".

Does meter buzzer beep?

- YES >> Inspection End.  
NO >> GO TO 2.

#### 2.CHECK COMBINATION METER INPUT SIGNAL

Select "Data Monitor" of "METER/M&A" using CONSULT and check the "BUZZER" monitor value.

BUZZER  
Under the condition of buzzer input : On  
Except above : Off

Is the inspection result normal?

- YES >> Replace combination meter. Refer to [MWI-102. "Removal and Installation"](#).  
NO >> Replace BCM. Refer to [BCS-72. "Removal and Installation"](#).

### Diagnosis Procedure

INFOID:000000010121639

#### 1.CHECK POWER SUPPLY OF COMBINATION METER

Check power supply of combination meter. Refer to [MWI-85. "COMBINATION METER : Diagnosis Procedure"](#).

Is the inspection result normal?

- YES >> Inspection End.  
NO >> Repair or replace harness or connector.

A  
B  
C  
D  
E  
F  
G  
H  
I  
J  
K  
L  
M  
O  
P

WCS

# SEAT BELT BUCKLE SWITCH SIGNAL CIRCUIT (DRIVER SIDE)

< DTC/CIRCUIT DIAGNOSIS >

## SEAT BELT BUCKLE SWITCH SIGNAL CIRCUIT (DRIVER SIDE)

### Component Function Check

INFOID:000000010121640

#### 1. CHECK COMBINATION METER INPUT SIGNAL

Select "Data Monitor" of "METER/M&A" using CONSULT and check the "BUCKLE SW" monitor value.

Monitor Item	Condition	Status
BUCKLE SW	When seat belt buckle (driver side) is fastened	OFF
	When seat belt buckle (driver side) is unfastened	ON

Is the inspection result normal?

YES >> Inspection End.

NO >> Refer to [WCS-44, "Diagnosis Procedure"](#).

### Diagnosis Procedure

INFOID:000000010121641

Regarding Wiring Diagram information, refer to [WCS-34, "Wiring Diagram"](#).

#### 1. CHECK COMBINATION METER INPUT SIGNAL

1. Turn power switch ON.
2. Check voltage between combination meter harness connector and ground.

Terminals		Condition	Voltage (Approx.)
(+)	(-)		
Combination meter		When seat belt buckle (driver side) is fastened When seat belt buckle (driver side) is unfastened	Battery voltage 0 V
Connector	Terminal		
M34	40		

Is the inspection result normal?

YES >> Replace combination meter. Refer to [MWI-102, "Removal and Installation"](#).

NO >> GO TO 2.

#### 2. CHECK SEAT BELT BUCKLE SWITCH (DRIVER SIDE) CIRCUIT

1. Turn power switch OFF.
2. Disconnect combination meter connector and seat belt buckle switch (driver side) connector.
3. Check continuity between combination meter harness connector and seat belt buckle switch (driver side) harness connector.

Combination meter		Seat belt buckle switch (driver side)		Continuity
Connector	Terminal	Connector	Terminal	
M34	40	B50	1	Yes

4. Check harness continuity between combination meter harness connector and ground.

Combination meter		Ground	Continuity
Connector	Terminal		
M34	40		No

Is the inspection result normal?

YES >> GO TO 3.

NO >> Repair or replace harness or connector.

# SEAT BELT BUCKLE SWITCH SIGNAL CIRCUIT (DRIVER SIDE)

< DTC/CIRCUIT DIAGNOSIS >

## 3. CHECK SEAT BELT BUCKLE SWITCH (DRIVER SIDE) GROUND CIRCUIT

Check harness continuity between seat belt buckle switch (driver side) harness connector and ground.

Seat belt buckle switch (driver side)		Ground	Continuity
Connector	Terminal		
B50	2		Yes

Is the inspection result normal?

YES >> Inspection End.

NO >> Repair or replace harness or connector.

## Component Inspection

INFOID:000000010121642

## 1. CHECK SEAT BELT BUCKLE SWITCH (DRIVER SIDE)

1. Turn power switch OFF.
2. Disconnect the seat belt buckle switch (driver side) connector.
3. Check continuity between terminals.

Terminal		Condition	Continuity
1	2	When seat belt buckle (driver side) is fastened	No
		When seat belt buckle (driver side) is unfastened	Yes

Is the inspection result normal?

YES >> Inspection End.

NO >> Replace seat belt buckle (driver side). Refer to [SB-14, "SEAT BELT BUCKLE : Removal and Installation"](#).

A  
B  
C  
D  
E  
F  
G  
H  
I  
J  
K  
L  
M  
O  
P

WCS

# THE LIGHT REMINDER WARNING DOES NOT SOUND

< SYMPTOM DIAGNOSIS >

---

## SYMPTOM DIAGNOSIS

### THE LIGHT REMINDER WARNING DOES NOT SOUND

#### Description

INFOID:000000010121643

Light reminder warning chime does not sound even though headlamp is illuminated.

#### Diagnosis Procedure

INFOID:000000010121644

#### 1. CHECK COMBINATION SWITCH (LIGHTING SWITCH) OPERATION

---

Check that the headlamps operate normally by operating the combination switch (lighting switch).

Do they operate normally?

YES >> GO TO 2.

NO >> Refer to [EXL-114, "WITHOUT DAYTIME RUNNING LIGHT SYSTEM : Symptom Table"](#).

#### 2. CHECK FRONT DOOR SWITCH LH SIGNAL CIRCUIT

---

Check the front door switch LH signal circuit. Refer to [DLK-102, "Diagnosis Procedure"](#).

Is the inspection result normal?

YES >> GO TO 3.

NO >> Repair or replace harness or connector.

#### 3. CHECK FRONT DOOR SWITCH LH

---

Check the front door switch LH. Refer to [DLK-103, "Component Inspection"](#).

Is the inspection result normal?

YES >> Replace BCM. Refer to [BCS-72, "Removal and Installation"](#).

NO >> Replace front door switch LH. Refer to [DLK-203, "Removal and Installation"](#).

# THE SEAT BELT WARNING CONTINUES SOUNDING, OR DOES NOT SOUND

< SYMPTOM DIAGNOSIS >

## THE SEAT BELT WARNING CONTINUES SOUNDING, OR DOES NOT SOUND

### Description

INFOID:000000010121645

- Seat belt reminder warning does not sound.
- Seat belt reminder warning sounds continuously.

### Diagnosis Procedure

INFOID:000000010121646

#### 1.CHECK SEAT BELT WARNING LAMP

1. Turn power switch ON.
2. Check the operation of the seat belt warning lamp in the combination meter.

Driver seat belt fastened : OFF  
Driver seat belt unfastened : ON

#### Is the inspection result normal?

- YES >> GO TO 2.  
NO >> GO TO 4.

#### 2.CHECK BCM OUTPUT SIGNAL

1. Select "BUZZER" of "BCM" using CONSULT.
2. Perform "SEAT BELT WARN TEST" in "ACTIVE TEST".

#### Is the inspection result normal?

- YES >> Inspection End.  
NO >> GO TO 3.

#### 3.CHECK COMBINATION METER INPUT SIGNAL

Select "Data Monitor" of "METER/M&A" using CONSULT and check the "BUZZER" monitor value.

Buzzer active condition : On  
Buzzer non-active condition : Off

#### Is the inspection result normal?

- YES >> Replace combination meter. Refer to [MWI-102. "Removal and Installation"](#).  
NO >> Replace BCM. Refer to [BCS-72. "Removal and Installation"](#).

#### 4.CHECK SEAT BELT BUCKLE SWITCH (DRIVER SIDE) CIRCUIT

Check the seat belt buckle switch (driver side) circuit. Refer to [WCS-44. "Diagnosis Procedure"](#).

#### Is the inspection result normal?

- YES >> GO TO 5.  
NO >> Repair or replace harness or connector.

#### 5.CHECK SEAT BELT BUCKLE SWITCH (DRIVER SIDE)

Check the seat belt buckle switch (driver side). Refer to [WCS-45. "Component Inspection"](#).

#### Is the inspection result normal?

- YES >> Replace combination meter. Refer to [MWI-102. "Removal and Installation"](#).  
NO >> Replace seat belt buckle (driver side). Refer to [SB-14. "SEAT BELT BUCKLE : Removal and Installation"](#).

A  
B  
C  
D  
E  
F  
G  
H  
I  
J  
K  
L  
M  
WCS  
O  
P

# THE PARKING BRAKE RELEASE WARNING CONTINUES SOUNDING, OR DOES NOT SOUND

< SYMPTOM DIAGNOSIS >

## THE PARKING BRAKE RELEASE WARNING CONTINUES SOUNDING, OR DOES NOT SOUND

### Description

INFOID:000000010121647

- The parking brake warning buzzer sounds continuously during vehicle travel though the parking brake is released.
- The parking brake warning buzzer does not sound at all even though driving the vehicle with the parking brake applied.

### Diagnosis Procedure

INFOID:000000010121648

#### 1.CHECK PARKING BRAKE WARNING LAMP

Check the operation of the brake warning lamp by operating the parking brake.

Condition	Warning lamp status
Parking brake applied	ON
Parking brake released	OFF

Is the inspection result normal?

- YES >> Replace combination meter. Refer to [MWI-102. "Removal and Installation"](#).  
NO >> GO TO 2.

#### 2.CHECK PARKING BRAKE SWITCH SIGNAL CIRCUIT

Check the parking brake switch signal circuit. Refer to [MWI-93. "Diagnosis Procedure"](#).

Is the inspection result normal?

- YES >> GO TO 3.  
NO >> Repair or replace harness or connector.

#### 3.CHECK PARKING BRAKE SWITCH

Check the parking brake switch. Refer to [MWI-93. "Component Inspection"](#).

Is the inspection result normal?

- YES >> Replace combination meter. Refer to [MWI-102. "Removal and Installation"](#).  
NO >> Replace parking brake switch. Refer to [PB-8. "Exploded View"](#).