

SECTION **DEF**  
 DEFOGGER

A  
B  
C  
D  
E  
F  
G  
H  
I  
J  
K  
DEF  
M  
N  
O  
P

CONTENTS

<b>PRECAUTION</b> .....	3	<b>REAR WINDOW DEFOGGER SYSTEM</b> .....	14
<b>PRECAUTIONS</b> .....	3	Wiring Diagram .....	14
Precaution for Technicians Using Medical Electric.....	3	<b>BASIC INSPECTION</b> .....	22
Point to Be Checked Before Starting Maintenance		<b>DIAGNOSIS AND REPAIR WORK FLOW</b> .....	22
Work .....	3	Work Flow .....	22
Precaution for Supplemental Restraint System		<b>DTC/CIRCUIT DIAGNOSIS</b> .....	25
(SRS) "AIR BAG" and "SEAT BELT PRE-TENSIONER" .....	3	<b>REAR WINDOW DEFOGGER SWITCH</b> .....	25
Precaution for Removing 12V Battery .....	4	Component Function Check .....	25
<b>SYSTEM DESCRIPTION</b> .....	5	Diagnosis Procedure .....	25
<b>COMPONENT PARTS</b> .....	5	<b>REAR WINDOW DEFOGGER RELAY</b> .....	27
Component Parts Location .....	5	Component Function Check .....	27
Rear window defogger .....	6	Diagnosis Procedure .....	27
Door mirror defogger .....	6	<b>REAR WINDOW DEFOGGER</b> .....	28
<b>SYSTEM</b> .....	7	Component Function Check .....	28
System Description .....	7	Diagnosis Procedure .....	28
<b>DIAGNOSIS SYSTEM (BCM)</b> .....	8	Component Inspection .....	29
<b>COMMON ITEM</b> .....	8	<b>DOOR MIRROR DEFOGGER LH</b> .....	30
COMMON ITEM : CONSULT Function (BCM -		Component Function Check .....	30
COMMON ITEM) .....	8	Diagnosis Procedure .....	30
<b>REAR WINDOW DEFOGGER</b> .....	8	<b>DOOR MIRROR DEFOGGER RH</b> .....	31
REAR WINDOW DEFOGGER : CONSULT Func-		Component Function Check .....	31
tion (BCM - REAR DEFOGGER) .....	9	Diagnosis Procedure .....	31
<b>DIAGNOSIS SYSTEM (IPDM E/R)</b> .....	10	<b>SYMPTOM DIAGNOSIS</b> .....	32
Diagnosis Description .....	10	<b>REAR WINDOW DEFOGGER AND DOOR</b>	
CONSULT Function (IPDM E/R) .....	11	<b>MIRROR DEFOGGERS DO NOT OPERATE</b> ...	32
<b>ECU DIAGNOSIS INFORMATION</b> .....	13	Diagnosis Procedure .....	32
<b>BCM, IPDM E/R</b> .....	13	<b>REAR WINDOW DEFOGGER DOES NOT</b>	
List of ECU Reference .....	13	<b>OPERATE BUT BOTH DOOR MIRROR DE-</b>	
<b>WIRING DIAGRAM</b> .....	14	<b>FOGGERS OPERATE</b> .....	33
		Diagnosis Procedure .....	33

---

<b>BOTH DOORS MIRROR DEFOGGER DON'T OPERATE BUT REAR WINDOW DEFOGGER OPERATES</b> .....	34
Diagnosis Procedure .....	34

<b>DOOR MIRROR DEFOGGER DOES NOT OPERATE</b> .....	35
Diagnosis Procedure .....	35

<b>REAR WINDOW DEFOGGER SWITCH DOES NOT LIGHT, BUT REAR WINDOW DEFOGGER OPERATES</b> .....	36
Diagnosis Procedure .....	36

<b>REMOVAL AND INSTALLATION</b> .....	37
---------------------------------------	----

<b>FILAMENT</b> .....	37
Inspection and Repair .....	37

<b>CONDENSER</b> .....	39
Removal and Installation .....	39

# PRECAUTIONS

< PRECAUTION >

## PRECAUTION

### PRECAUTIONS

#### Precaution for Technicians Using Medical Electric

INFOID:000000010642266

##### OPERATION PROHIBITION

###### **WARNING:**

- Parts with strong magnet is used in this vehicle.
- Technicians using a medical electric device such as pacemaker must never perform operation on the vehicle, as magnetic field can affect the device function by approaching to such parts.

##### NORMAL CHARGE PRECAUTION

###### **WARNING:**

- If a technician uses a medical electric device such as an implantable cardiac pacemaker or an implantable cardioverter defibrillator, the possible effects on the devices must be checked with the device manufacturer before starting the charge operation.
- As radiated electromagnetic wave generated by PDM (Power Delivery Module) at normal charge operation may affect medical electric devices, a technician using a medical electric device such as implantable cardiac pacemaker or an implantable cardioverter defibrillator must not approach motor room [PDM (Power Delivery Module)] at the hood-opened condition during normal charge operation.

##### PRECAUTION AT TELEMATICS SYSTEM OPERATION

###### **WARNING:**

- If a technician uses implantable cardiac pacemaker or implantable cardioverter defibrillator (ICD), avoid the device implanted part from approaching within approximately 220 mm (8.66 in) from interior/exterior antenna.
- The electromagnetic wave of TCU might affect the function of the implantable cardiac pacemaker or the implantable cardioverter defibrillator (ICD), when using the service, etc.
- If a technician uses other medical electric devices than implantable cardiac pacemaker or implantable cardioverter defibrillator (ICD), the electromagnetic wave of TCU might affect the function of the device. The possible effects on the devices must be checked with the device manufacturer before TCU use.

##### PRECAUTION AT INTELLIGENT KEY SYSTEM OPERATION

###### **WARNING:**

- If a technician uses implantable cardiac pacemaker or implantable cardioverter defibrillator (ICD), avoid the device implanted part from approaching within approximately 220 mm (8.66 in) from interior/exterior antenna.
- The electromagnetic wave of Intelligent Key might affect the function of the implantable cardiac pacemaker or the implantable cardioverter defibrillator (ICD), at door operation, at each request switch operation, or at engine starting.
- If a technician uses other medical electric devices than implantable cardiac pacemaker or implantable cardioverter defibrillator (ICD), the electromagnetic wave of Intelligent Key might affect the function of the device. The possible effects on the devices must be checked with the device manufacturer before Intelligent Key use.

#### Point to Be Checked Before Starting Maintenance Work

INFOID:000000010642267

The high voltage system may starts automatically. It is required to check that the timer air conditioner and timer charge (during EVSE connection) are not set before starting maintenance work.

###### **NOTE:**

If the timer air conditioner or timer charge (during EVSE connection) is set, the high voltage system starts automatically even when the power switch is in OFF state.

#### Precaution for Supplemental Restraint System (SRS) "AIR BAG" and "SEAT BELT PRE-TENSIONER"

INFOID:000000010642268

The Supplemental Restraint System such as "AIR BAG" and "SEAT BELT PRE-TENSIONER", used along with a front seat belt, helps to reduce the risk or severity of injury to the driver and front passenger for certain types of collision. This system includes seat belt switch inputs and dual stage front air bag modules. The SRS

A  
B  
C  
D  
E  
F  
G  
H  
I  
J  
K  
DEF  
M  
N  
O  
P

# PRECAUTIONS

## < PRECAUTION >

system uses the seat belt switches to determine the front air bag deployment, and may only deploy one front air bag, depending on the severity of a collision and whether the front occupants are belted or unbelted. Information necessary to service the system safely is included in the SR and SB section of this Service Manual.

### **WARNING:**

- To avoid rendering the SRS inoperative, which could increase the risk of personal injury or death in the event of a collision which would result in air bag inflation, all maintenance must be performed by an authorized NISSAN/INFINITI dealer.
- Improper maintenance, including incorrect removal and installation of the SRS, can lead to personal injury caused by unintentional activation of the system. For removal of Spiral Cable and Air Bag Module, see the SR section.
- Do not use electrical test equipment on any circuit related to the SRS unless instructed to in this Service Manual. SRS wiring harnesses can be identified by yellow and/or orange harnesses or harness connectors.

## PRECAUTIONS WHEN USING POWER TOOLS (AIR OR ELECTRIC) AND HAMMERS

### **WARNING:**

- When working near the Airbag Diagnosis Sensor Unit or other Airbag System sensors with the Ignition ON or engine running, DO NOT use air or electric power tools or strike near the sensor(s) with a hammer. Heavy vibration could activate the sensor(s) and deploy the air bag(s), possibly causing serious injury.
- When using air or electric power tools or hammers, always switch the Ignition OFF, disconnect the battery and wait at least three minutes before performing any service.

## Precaution for Removing 12V Battery

INFOID:000000010642269

1. Check that EVSE is not connected.

### **NOTE:**

If EVSE is connected, the air conditioning system may be automatically activated by the timer A/C function.

2. Turn the power switch OFF → ON → OFF. Get out of the vehicle. Close all doors (including back door).
3. Check that the charge status indicator lamp does not blink and wait for 5 minutes or more.

### **NOTE:**

If the battery is removed within 5 minutes after the power switch is turned OFF, plural DTCs may be detected.

4. Remove 12V battery within 1 hour after turning the power switch OFF → ON → OFF.

### **NOTE:**

- The 12V battery automatic charge control may start automatically even when the power switch is in OFF state.
- Once the power switch is turned ON → OFF, the 12V battery automatic charge control does not start for approximately 1 hour.

### **CAUTION:**

- After all doors (including back door) are closed, if a door (including back door) is opened before battery terminals are disconnected, start over from Step 1.
- After turning the power switch OFF, if "Remote A/C" is activated by user operation, stop the air conditioner and start over from Step 1.

# COMPONENT PARTS

< SYSTEM DESCRIPTION >

## SYSTEM DESCRIPTION

### COMPONENT PARTS

#### Component Parts Location

INFOID:0000000010642270

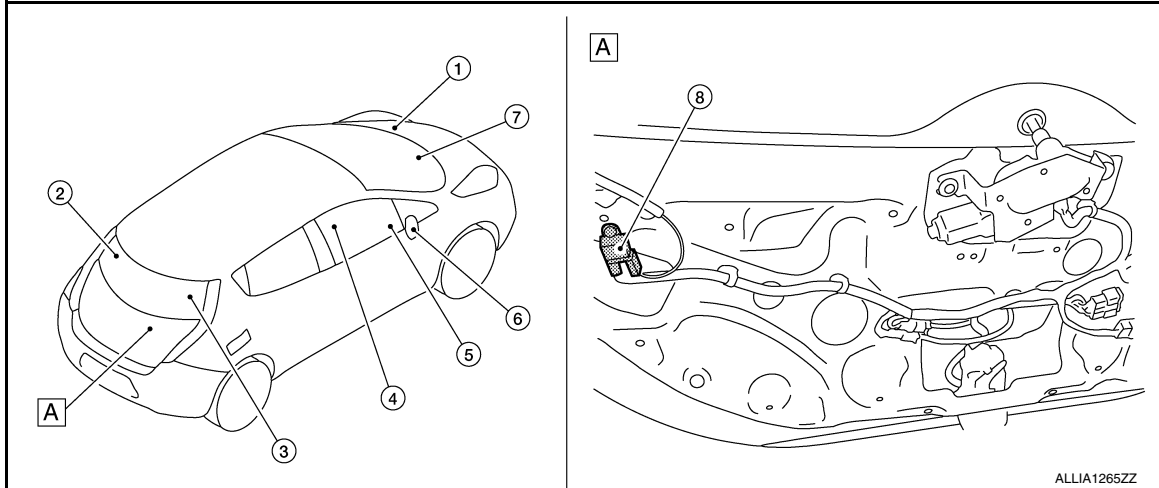

A. View with back door lower finisher removed.

No.	Component	Function
1.	IPDM E/R	<ul style="list-style-type: none"> <li>The rear window defogger relay is installed.</li> <li>Receives rear window defogger control signal from BCM via CAN communication.</li> <li>Controls rear window defogger relay to operate rear window defogger and door mirror defogger.</li> </ul> Refer to <a href="#">PCS-7. "Component Parts Location"</a> for detailed installation location.
2.	Rear window defogger connector	Refer to <a href="#">DEF-6. "Rear window defogger"</a> .
3.	(Rear window defogger)	
4.	A/C auto amp. (Rear window defogger switch)	<ul style="list-style-type: none"> <li>The rear window defogger switch is installed.</li> <li>The rear window defogger and door mirror defogger are operated by turning the rear window defogger switch ON.</li> <li>The indicator lamp in the rear window defogger switch illuminates when the rear window defogger is operating.</li> </ul> Refer to <a href="#">HAC-19. "AUTOMATIC AIR CONDITIONING SYSTEM : Component Parts Location"</a> (with heat pump) or <a href="#">HAC-219. "AUTOMATIC AIR CONDITIONING SYSTEM : Component Parts Location"</a> (without heat pump) for detailed installation location.
5.	VCM	VCM receives rear window defogger control signal from IPDM E/R, and transmits rear window defogger status signal to A/C auto amp. via EV system CAN communication. Refer to <a href="#">EVC-15. "Component Parts Location"</a> for detailed installation location.
6.	Door mirror defogger RH (LH similar)	Refer to <a href="#">DEF-6. "Door mirror defogger"</a> .
7.	BCM	<ul style="list-style-type: none"> <li>Detects rear window defogger switch signal and transmits rear window defogger control signal to IPDM E/R via CAN communication.</li> <li>Performs the timer control of rear window defogger.</li> </ul> Refer to <a href="#">BCS-5. "BODY CONTROL SYSTEM : Component Parts Location"</a> for detailed installation location.
8.	Condenser	Removes the noise that is generated when rear window defogger turns ON/OFF.

# COMPONENT PARTS

## < SYSTEM DESCRIPTION >

### Rear window defogger

INFOID:000000010642271

Heats the heating wire with the power supply from the rear window defogger relay to prevent the rear window from fogging up.

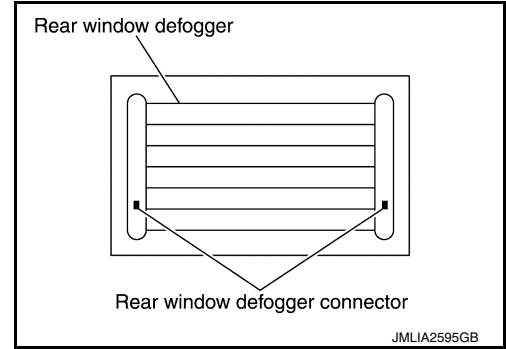

### Door mirror defogger

INFOID:000000010642272

Heats the heating wire with the power supply from the rear window defogger relay to prevent the door mirror from fogging up.

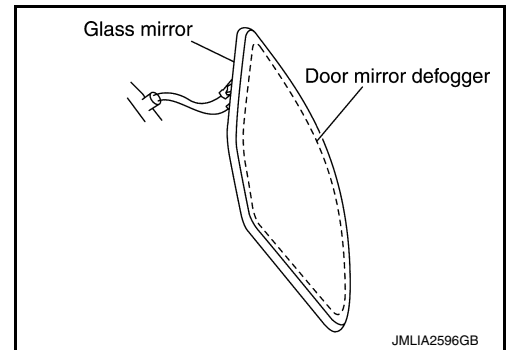

# SYSTEM

< SYSTEM DESCRIPTION >

## SYSTEM

### System Description

INFOID:0000000110642273

### SYSTEM DIAGRAM

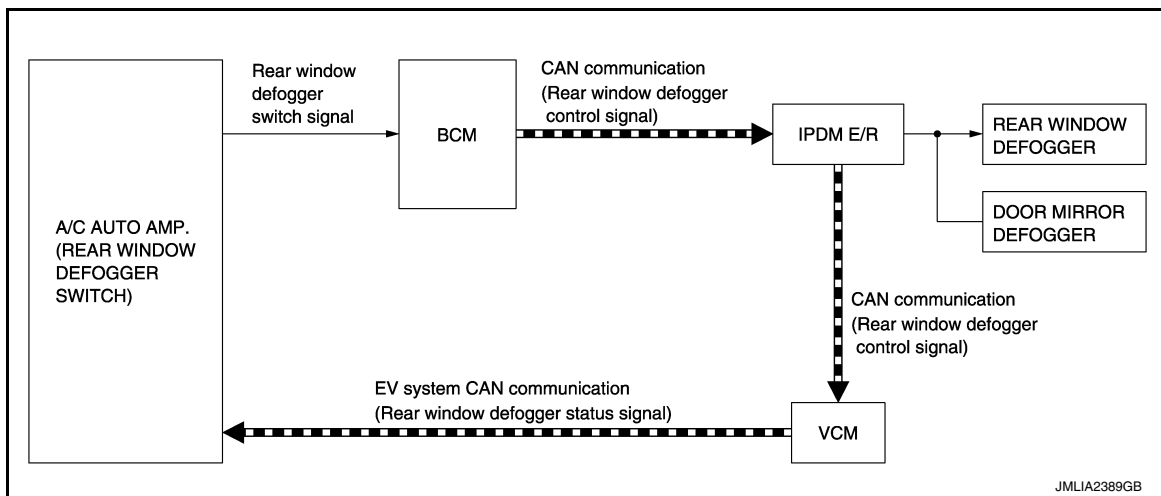

### OPERATION DESCRIPTION

- Turn rear window defogger switch ON while power switch is ON. Then A/C auto amp. transmits rear window defogger switch signal to BCM.
- BCM transmits rear window defogger control signal to IPDM E/R via CAN communication for approximately 15 minutes.
- IPDM E/R turns rear window defogger relay ON when rear window defogger control signal is received.
- When rear window defogger relay turns ON, IPDM E/R transmits rear window defogger control signal to VCM via CAN communication. VCM transmits rear window defogger status signal to A/C auto amp. via EV system CAN communication.
- When rear window defogger is activated, indicator lamp on rear window defogger switch turns ON.

### TIMER FUNCTION

- BCM transmits the rear window defogger control signal to IPDM E/R for approximately 15 minutes when the rear window defogger switch turns ON while power switch is ON. Then IPDM E/R activates rear window defogger and door mirror defogger.
- The timer is cancelled if the rear window defogger switch is pressed again during timer operation. BCM stops the output of rear window defogger control signal. The same action occurs during timer operation if the power switch is turned OFF.

A  
B  
C  
D  
E  
F  
G  
H  
I  
J  
K  
DEF  
M  
N  
O  
P

# DIAGNOSIS SYSTEM (BCM)

< SYSTEM DESCRIPTION >

## DIAGNOSIS SYSTEM (BCM)

### COMMON ITEM

COMMON ITEM : CONSULT Function (BCM - COMMON ITEM)

INFOID:000000010642274

### APPLICATION ITEM

CONSULT performs the following functions via CAN communication with BCM.

Direct Diagnostic Mode	Description
Ecu Identification	The BCM part number is displayed.
Self Diagnostic Result	The BCM self diagnostic results are displayed.
Data Monitor	The BCM input/output data is displayed in real time.
Active Test	The BCM activates outputs to test components.
Work support	The settings for BCM functions can be changed.
Configuration	<ul style="list-style-type: none"> <li>The vehicle specification can be read and saved.</li> <li>The vehicle specification can be written when replacing BCM.</li> </ul>
CAN Diag Support Mntr	The result of transmit/receive diagnosis of CAN communication is displayed.

### SYSTEM APPLICATION

BCM can perform the following functions.

System	Sub System	Direct Diagnostic Mode						
		Ecu Identification	Self Diagnostic Result	Data Monitor	Active Test	Work support	Configuration	CAN Diag Support Mntr
Door lock	DOOR LOCK		×	×	×	×		
Rear window defogger	REAR DEFOGGER			×	×			
Warning chime	BUZZER			×	×			
Interior room lamp timer	INT LAMP			×	×	×		
Exterior lamp	HEADLAMP			×	×	×		
Wiper and washer	WIPER			×	×	×		
Turn signal and hazard warning lamps	FLASHER			×	×	×		
Air conditioner	AIR CONDITIONER			×	×			
Intelligent Key system	INTELLIGENT KEY		×	×	×	×		
Combination switch	COMB SW			×				
BCM	BCM	×	×			×	×	×
Immobilizer	IMMU		×	×	×	×		
Interior room lamp battery saver	BATTERY SAVER			×	×	×		
Trunk open	TRUNK			×				
Vehicle security system	THEFT ALM			×	×	×		
RAP system	RETAINED PWR			×				
Signal buffer system	SIGNAL BUFFER			×				
TPMS	AIR PRESSURE MONITOR		×	×	×	×		

### REAR WINDOW DEFOGGER



# DIAGNOSIS SYSTEM (BCM)

< SYSTEM DESCRIPTION >

## REAR WINDOW DEFOGGER : CONSULT Function (BCM - REAR DEFOGGER)

INFOID:0000000010642275

### DATA MONITOR

Monitor Item [Unit]	Description
PUSH SW [On/Off]	Indicates condition of power switch.
REAR DEF SW [On/Off]	Indicates condition of rear window defogger switch.

### ACTIVE TEST

Test Item	Description
REAR DEFOGGER	This test is able to check rear window defogger operation [Off/On].

A  
B  
C  
D  
E  
F  
G  
H  
I  
J  
K  
DEF  
M  
N  
O  
P

# DIAGNOSIS SYSTEM (IPDM E/R)

< SYSTEM DESCRIPTION >

## DIAGNOSIS SYSTEM (IPDM E/R)

### Diagnosis Description

INFOID:000000010642276

#### AUTO ACTIVE TEST

##### Description

In auto active test mode, the IPDM E/R sends a drive signal to the following systems to check their operation.

- Rear window defogger
- Front wiper motor
- Parking lamp
- License plate lamp
- Tail lamp
- Front fog lamp
- Side marker lamp
- Headlamp (LO, HI)

##### Operation Procedure

###### NOTE:

Never perform auto active test in the following conditions.

- CONSULT is connected.
  - Passenger door is open.
1. Turn the power switch OFF.
  2. Turn the power switch ON, and within 20 seconds, press the driver door switch 10 times. Then turn the power switch OFF.
  3. Turn the power switch ON within 10 seconds. After that the horn sounds once and the auto active test starts.

###### NOTE:

Never depress brake pedal while operating power switch so that auto active test is not activated.

4. After a series of the following operations is repeated 3 times, auto active test is completed.

###### NOTE:

- When auto active test mode has to be cancelled halfway through test, turn the power switch OFF.
- When auto active test is not activated, door switch may be the cause. Check door switch. Refer to [DLK-103, "Component Function Check"](#).

##### Inspection in Auto Active Test Mode

When auto active test mode is actuated, the following operation sequence is repeated 3 times.

Operation sequence	Inspection location	Operation
1	Rear window defogger	10 seconds
2	Front wiper motor	LO for 5 seconds → HI for 5 seconds
3	<ul style="list-style-type: none"><li>• Parking lamp</li><li>• License plate lamp</li><li>• Tail lamp</li><li>• Front fog lamp</li><li>• Side marker lamp</li></ul>	10 seconds
4	Headlamp	LO for 10 seconds → HI ON ⇔ OFF 5 times

# DIAGNOSIS SYSTEM (IPDM E/R)

## < SYSTEM DESCRIPTION >

Concept of auto active test

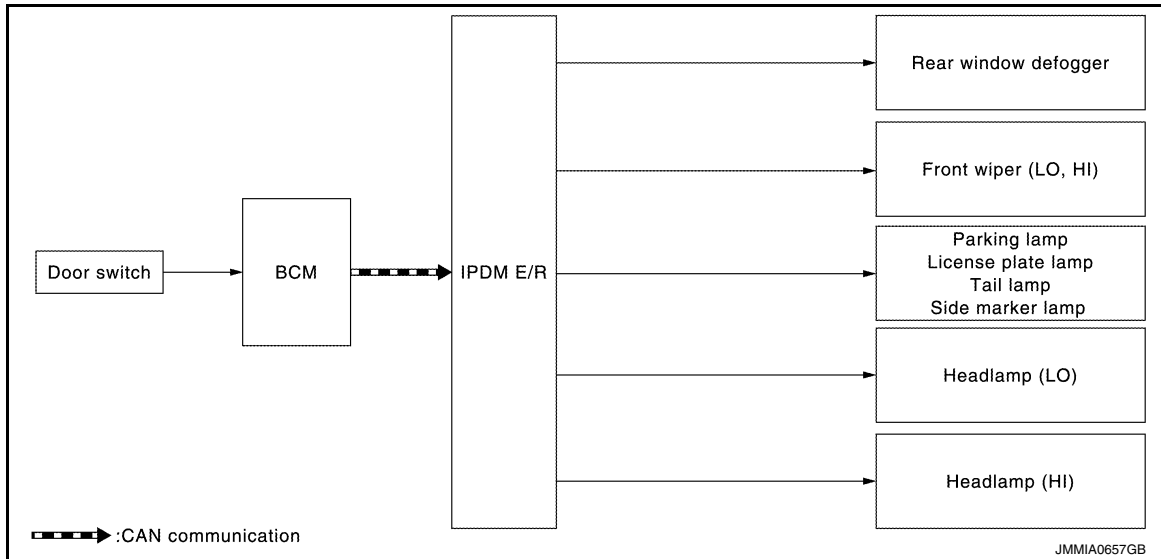

- IPDM E/R starts the auto active test with the door switch signals transmitted by BCM via CAN communication. Therefore, the CAN communication line between IPDM E/R and BCM is considered normal if the auto active test starts successfully.
- The auto active test facilitates troubleshooting if any systems controlled by IPDM E/R cannot be operated.

Diagnosis chart in auto active test mode

Symptom	Inspection contents	Possible cause
Rear window defogger does not operate	Perform auto active test. Does the rear window defogger operate?	YES BCM signal input circuit
		NO <ul style="list-style-type: none"> <li>• Rear window defogger</li> <li>• Rear window defogger ground circuit</li> <li>• Harness or connector between IPDM E/R and rear window defogger</li> <li>• IPDM E/R</li> </ul>
Any of the following components do not operate <ul style="list-style-type: none"> <li>• Parking lamp</li> <li>• License plate lamp</li> <li>• Tail lamp</li> <li>• Front fog lamp</li> <li>• Headlamp (HI, LO)</li> <li>• Side marker lamp</li> <li>• Front wiper motor</li> </ul>	Perform auto active test. Does the applicable system operate?	YES BCM signal input circuit
		NO <ul style="list-style-type: none"> <li>• Lamp or motor</li> <li>• Lamp or motor ground circuit</li> <li>• Harness or connector between IPDM E/R and applicable system</li> <li>• IPDM E/R</li> </ul>

## CONSULT Function (IPDM E/R)

INFOID:000000010642277

### APPLICATION ITEM

CONSULT performs the following functions via CAN communication with IPDM E/R.

Direct Diagnostic Mode	Description
Ecu Identification	The IPDM E/R part number is displayed.
Self Diagnostic Result	The IPDM E/R self diagnostic results are displayed.
Data Monitor	The IPDM E/R input/output data is displayed in real time.
Active Test	The IPDM E/R activates outputs to test components.
CAN Diag Support Mntr	The result of transmit/receive diagnosis of CAN communication is displayed.

### SELF DIAGNOSTIC RESULT

Refer to [PCS-19, "DTC Index"](#).

### DATA MONITOR

## DIAGNOSIS SYSTEM (IPDM E/R)

### < SYSTEM DESCRIPTION >

Monitor Item [Unit]	Main Signals	Description
TAIL&CLR REQ [On/Off]	×	Indicates position light request signal received from BCM on CAN communication line
HL LO REQ [On/Off]	×	Indicates low beam request signal received from BCM on CAN communication line
HL HI REQ [On/Off]	×	Indicates high beam request signal received from BCM on CAN communication line
FR FOG REQ [On/Off]	×	Indicates front fog light request signal received from BCM on CAN communication line
FR WIP REQ [Stop/1LOW/Low/Hi]	×	Indicates front wiper request signal received from BCM on CAN communication line
WIP AUTO STOP [STOP P/ACT P]	×	Indicates condition of front wiper auto stop signal
WIP PROT [Off/BLOCK]	×	Indicates condition of front wiper fail-safe operation
IGN RLY1 -REQ [On/Off]		Indicates power switch ON signal received from BCM on CAN communication line
IGN RLY [On/Off]	×	Indicates condition of ignition relay-1
PUSH SW [On/Off]		Indicates condition of power switch
DETENT SW [On/Off]		Indicates condition of shift position (park position switch)
DTRL REQ [Off]		Indicates daytime light request signal received from BCM on CAN communication line
HOOD SW [On/Off]		Indicates condition of hood switch
THFT HRN REQ [On/Off]		Indicates theft warning horn request signal received from BCM on CAN communication line
HORN CHIRP [On/Off]		Indicates horn reminder signal received from BCM on CAN communication line

### ACTIVE TEST

Test item	Description
HORN	This test is able to check horn operation [On].
REAR DEFOGGER	This test is able to check rear window defogger operation [On/Off].
FRONT WIPER	This test is able to check wiper motor operation [Hi/Lo/Off].
EXTERNAL LAMPS	This test is able to check external lamp operation [Fog/Hi/Lo/TAIL/Off].

### CAN DIAG SUPPORT MNTR

Refer to [LAN-14, "CAN Diagnostic Support Monitor"](#).

# BCM, IPDM E/R

< ECU DIAGNOSIS INFORMATION >

## ECU DIAGNOSIS INFORMATION

BCM, IPDM E/R

List of ECU Reference

INFOID:0000000010642278

ECU	Reference
BCM	<a href="#">BCS-28. "Reference Value"</a>
	<a href="#">BCS-46. "Fail-safe"</a>
	<a href="#">BCS-47. "DTC Inspection Priority Chart"</a>
	<a href="#">BCS-48. "DTC Index"</a>
IPDM E/R	<a href="#">PCS-15. "Reference Value"</a>
	<a href="#">PCS-18. "Fail-Safe"</a>
	<a href="#">PCS-19. "DTC Index"</a>

A  
B  
C  
D  
E  
F  
G  
H  
I  
J  
K  
DEF  
M  
N  
O  
P

# REAR WINDOW DEFOGGER SYSTEM

< WIRING DIAGRAM >

## WIRING DIAGRAM

### REAR WINDOW DEFOGGER SYSTEM

Wiring Diagram

INFOID:000000010642279

DEFOGGER

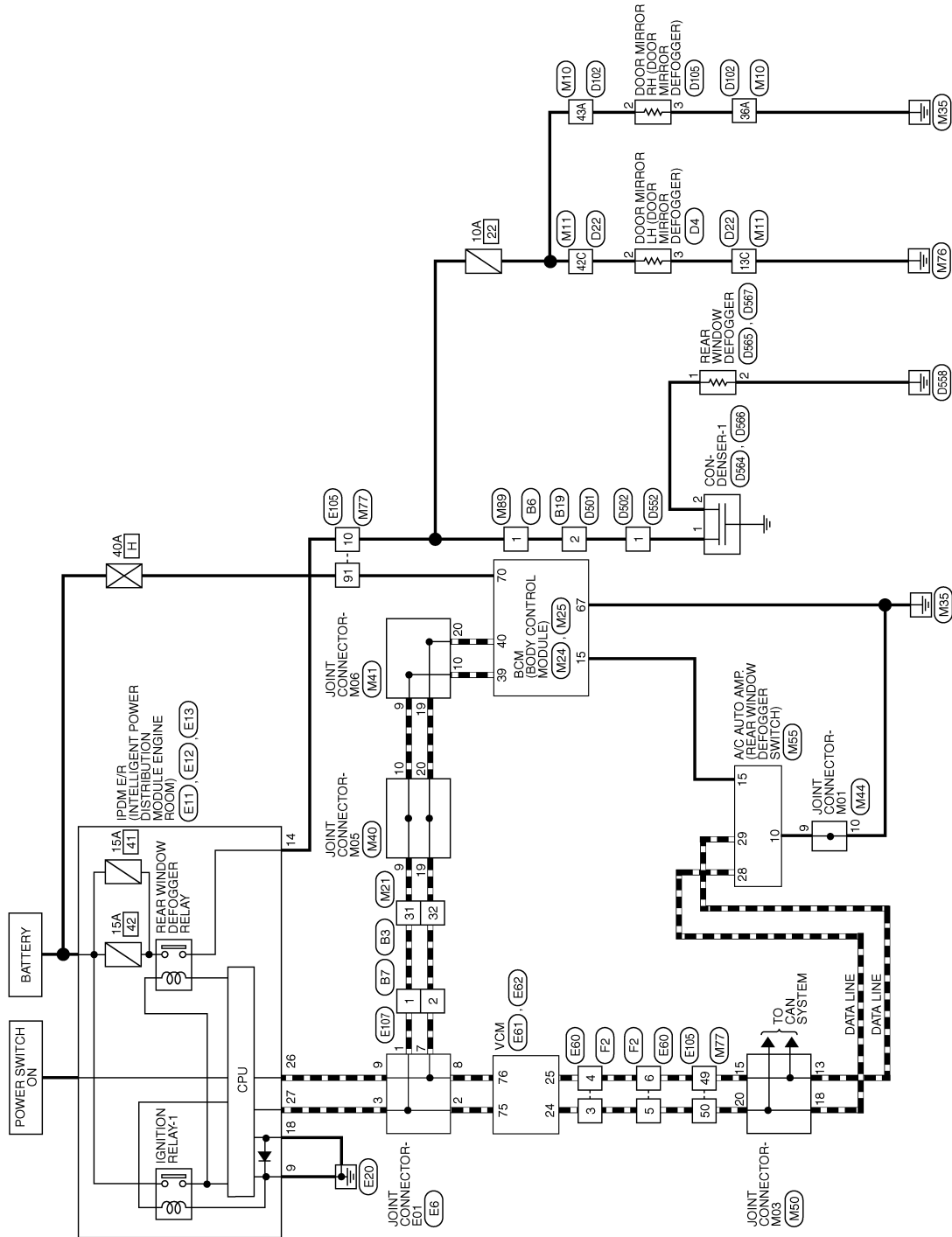

# REAR WINDOW DEFOGGER SYSTEM

< WIRING DIAGRAM >

## DEFOGGER - CONNECTORS

Connector No.	M10
Connector Name	WIRE TO WIRE
Connector Color	WHITE

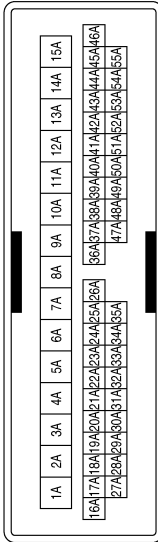

Terminal No.	Color of Wire	Signal Name
36A	B	-
43A	V	-

Connector No.	M11
Connector Name	WIRE TO WIRE
Connector Color	WHITE

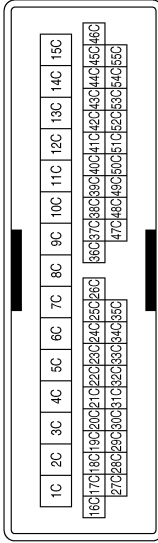

Terminal No.	Color of Wire	Signal Name
13C	B	-
42C	V	-

Connector No.	M21
Connector Name	WIRE TO WIRE
Connector Color	WHITE

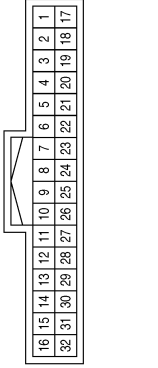

Terminal No.	Color of Wire	Signal Name
31	L	-
32	P	-

Connector No.	M24
Connector Name	BCM (BODY CONTROL MODULE)
Connector Color	BLACK

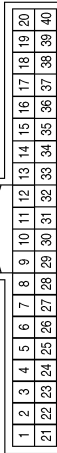

Terminal No.	Color of Wire	Signal Name
15	W	REAR DEFOGGER SW
39	L	CAN-H
40	P	CAN-L

Connector No.	M25
Connector Name	BCM (BODY CONTROL MODULE)
Connector Color	WHITE

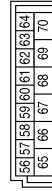

Terminal No.	Color of Wire	Signal Name
67	B	GND (POWER)
70	Y	BATT (F/L)

Connector No.	M40
Connector Name	JOINT CONNECTOR-M05
Connector Color	BLUE

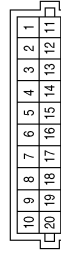

Terminal No.	Color of Wire	Signal Name
9	L	-
10	L	-
19	P	-
20	P	-

AALIA2435GB

A  
B  
C  
D  
E  
F  
G  
H  
I  
J  
K  
DEF  
M  
N  
O  
P

# REAR WINDOW DEFOGGER SYSTEM

< WIRING DIAGRAM >

Connector No.	M50
Connector Name	JOINT CONNECTOR-M03
Connector Color	PINK

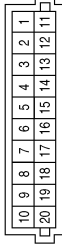

Terminal No.	Color of Wire	Signal Name
13	G	-
15	G	-
18	L	-
20	L	-

Connector No.	M44
Connector Name	JOINT CONNECTOR-M01
Connector Color	GRAY

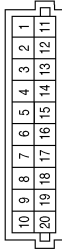

Terminal No.	Color of Wire	Signal Name
9	B	-
10	B	-

Connector No.	M41
Connector Name	JOINT CONNECTOR-M06
Connector Color	BLUE

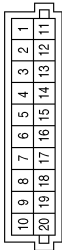

Terminal No.	Color of Wire	Signal Name
9	L	-
10	L	-
19	P	-
20	P	-

Terminal No.	Color of Wire	Signal Name
10	L	-
49	G	-
50	L	-
91	Y	-

Connector No.	M77
Connector Name	WIRE TO WIRE
Connector Color	WHITE

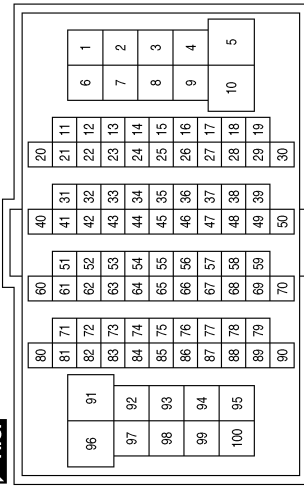

Connector No.	M55
Connector Name	A/C AUTO AMP.
Connector Color	WHITE

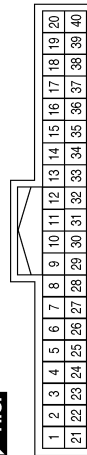

Terminal No.	Color of Wire	Signal Name
10	B	GND
15	W	RR DEF
28	L	EV CAN-H
29	G	EV CAN-L

AALIA2436GB



# REAR WINDOW DEFOGGER SYSTEM

< WIRING DIAGRAM >

Connector No.	E11
Connector Name	IPDM E/R (INTELLIGENT POWER DISTRIBUTION MODULE ENGINE ROOM)
Connector Color	BLACK



Terminal No.	Color of Wire	Signal Name
9	B	GND (POWER)
14	R	RR DEF

Connector No.	E6
Connector Name	JOINT CONNECTOR-E01
Connector Color	BLUE

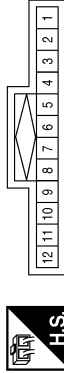

Terminal No.	Color of Wire	Signal Name
1	L	-
2	L	-
3	L	-
7	P	-
8	P	-
9	P	-

Connector No.	M89
Connector Name	WIRE TO WIRE
Connector Color	WHITE



Terminal No.	Color of Wire	Signal Name
1	L	-

Connector No.	E60
Connector Name	WIRE TO WIRE
Connector Color	BLACK



Terminal No.	Color of Wire	Signal Name
3	L	-
4	G	-
5	L	-
6	G	-

Connector No.	E13
Connector Name	IPDM E/R (INTELLIGENT POWER DISTRIBUTION MODULE ENGINE ROOM)
Connector Color	WHITE



Terminal No.	Color of Wire	Signal Name
26	P	CAN-L
27	L	CAN-H

Connector No.	E12
Connector Name	IPDM E/R (INTELLIGENT POWER DISTRIBUTION MODULE ENGINE ROOM)
Connector Color	BROWN



Terminal No.	Color of Wire	Signal Name
18	B/W	GND (SIGNAL)

AALIA2437GB

A  
B  
C  
D  
E  
F  
G  
H  
I  
J  
K  
DEF  
M  
N  
O  
P

# REAR WINDOW DEFOGGER SYSTEM

< WIRING DIAGRAM >

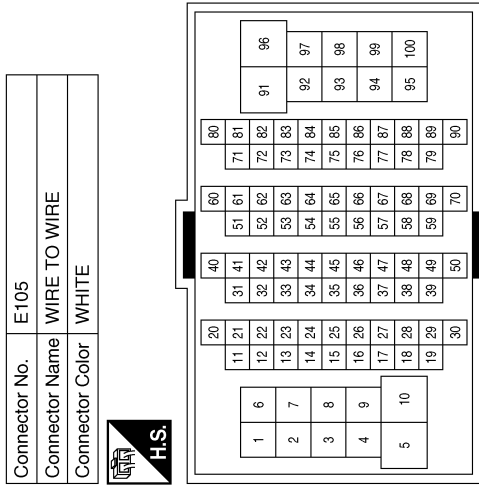

Terminal No.	Color of Wire	Signal Name
10	R	-
49	G	-
50	L	-
91	Y	-



Terminal No.	Color of Wire	Signal Name
31	L	-
32	P	-

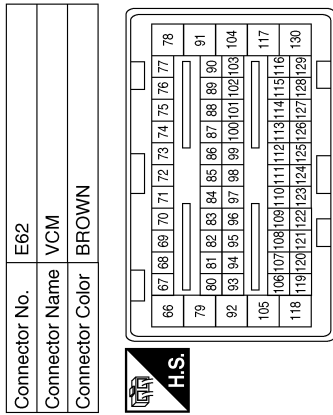

Terminal No.	Color of Wire	Signal Name
75	L	CAN-H
76	P	CAN-L



Terminal No.	Color of Wire	Signal Name
3	L	-
4	G	-
5	L	-
6	G	-

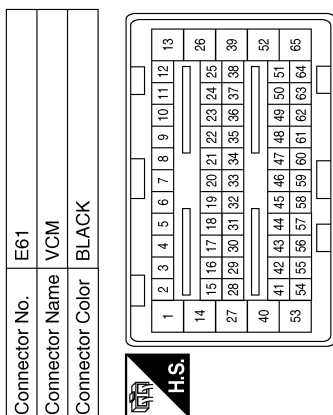

Terminal No.	Color of Wire	Signal Name
24	L	EV CAN-H
25	G	EV CAN-L



Terminal No.	Color of Wire	Signal Name
1	L	-
2	P	-

AALIA2438GB

# REAR WINDOW DEFOGGER SYSTEM

< WIRING DIAGRAM >

Connector No.	B19
Connector Name	WIRE TO WIRE
Connector Color	WHITE



Terminal No.	Color of Wire	Signal Name
2	R	-

Connector No.	B7
Connector Name	WIRE TO WIRE
Connector Color	WHITE

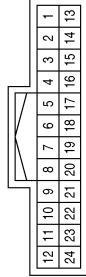

Terminal No.	Color of Wire	Signal Name
1	L	-
2	P	-

Connector No.	B6
Connector Name	WIRE TO WIRE
Connector Color	WHITE



Terminal No.	Color of Wire	Signal Name
1	R	-

Connector No.	D102
Connector Name	WIRE TO WIRE
Connector Color	WHITE

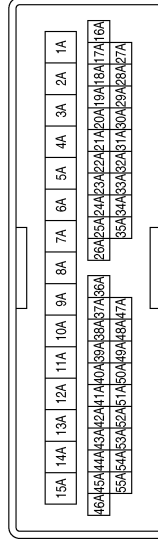

Connector No.	D22
Connector Name	WIRE TO WIRE
Connector Color	WHITE

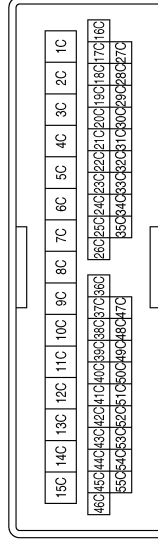

Connector No.	D4
Connector Name	DOOR MIRROR LH
Connector Color	WHITE

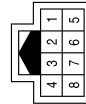

Terminal No.	Color of Wire	Signal Name
2	P	-
3	B	-

Terminal No.	Color of Wire	Signal Name
36A	B	-
43A	V	-

Terminal No.	Color of Wire	Signal Name
13C	B	-
42C	P	-

AALIA2439GB

A  
B  
C  
D  
E  
F  
G  
H  
I  
J  
K  
DEF  
M  
N  
O  
P

# REAR WINDOW DEFOGGER SYSTEM

< WIRING DIAGRAM >

Connector No.	D502
Connector Name	WIRE TO WIRE
Connector Color	WHITE



Terminal No.	Color of Wire	Signal Name
1	R	-

Connector No.	D501
Connector Name	WIRE TO WIRE
Connector Color	WHITE



Terminal No.	Color of Wire	Signal Name
2	R	-

Connector No.	D105
Connector Name	DOOR MIRROR RH
Connector Color	WHITE

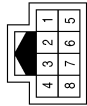

Terminal No.	Color of Wire	Signal Name
2	V	-
3	B	-

Connector No.	D565
Connector Name	REAR WINDOW DEFOGGER
Connector Color	BLACK



Terminal No.	Color of Wire	Signal Name
2	B	-

Connector No.	D564
Connector Name	CONDENSER-1
Connector Color	BLACK



Terminal No.	Color of Wire	Signal Name
1	R	-

Connector No.	D552
Connector Name	WIRE TO WIRE
Connector Color	WHITE



Terminal No.	Color of Wire	Signal Name
1	R	-

AALIA2440GB

# REAR WINDOW DEFOGGER SYSTEM

< WIRING DIAGRAM >

Connector No.	D567
Connector Name	REAR WINDOW DEFOGGER
Connector Color	BLACK



Terminal No.	Color of Wire	Signal Name
1	B	-

Connector No.	D566
Connector Name	CONDENSER-1
Connector Color	BLACK



Terminal No.	Color of Wire	Signal Name
2	B	-

A  
B  
C  
D  
E  
F  
G  
H  
I  
J  
K  
DEF  
M  
N  
O  
P

AALIA2441GB

# DIAGNOSIS AND REPAIR WORK FLOW

< BASIC INSPECTION >

## BASIC INSPECTION

### DIAGNOSIS AND REPAIR WORK FLOW

Work Flow

INFOID:000000010642280

OVERALL SEQUENCE

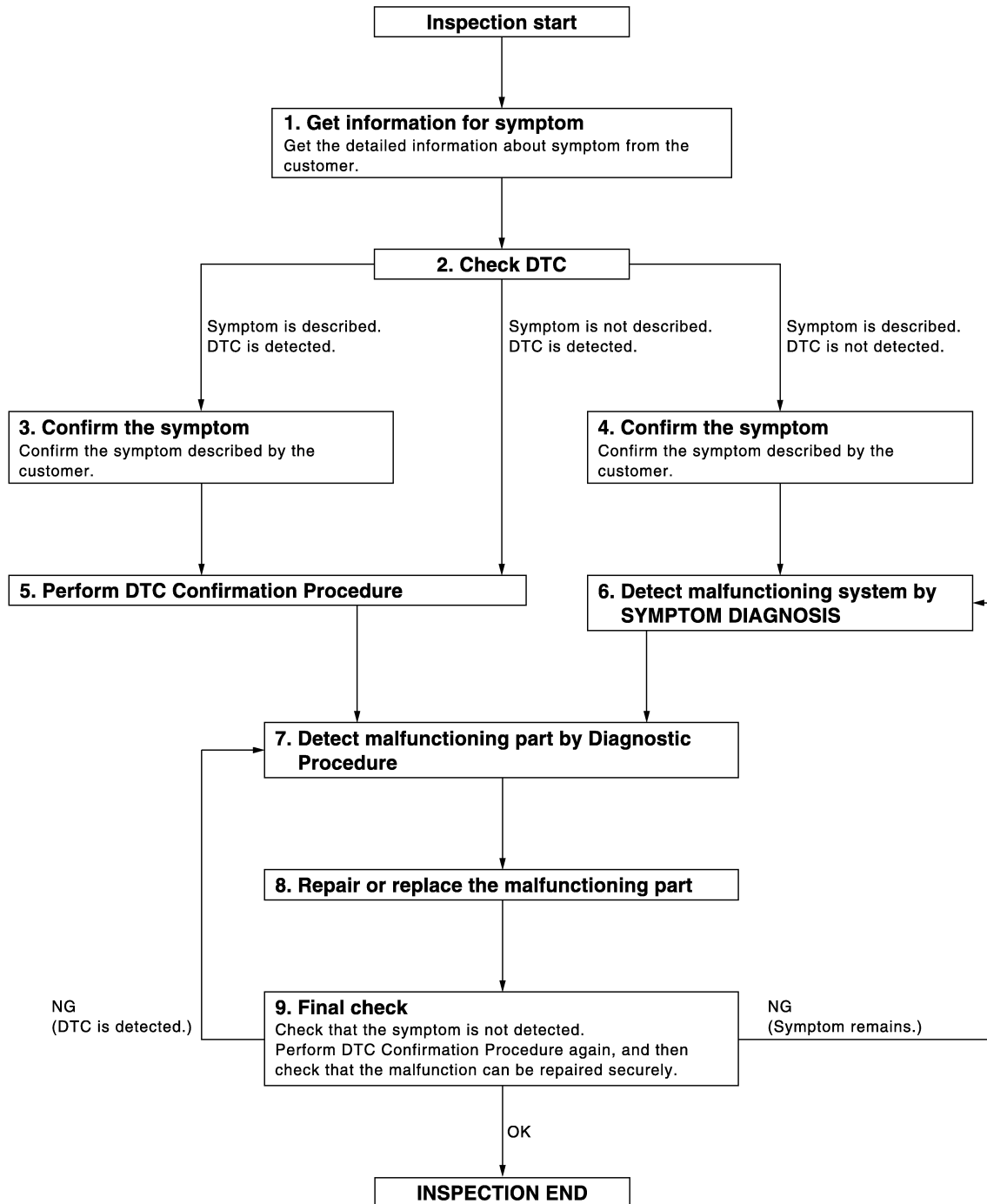

JMKIA2270GB

DETAILED FLOW

Revision: June 2014

DEF-22

2015 Leaf NAM

# DIAGNOSIS AND REPAIR WORK FLOW

## < BASIC INSPECTION >

---

### 1. GET INFORMATION FOR SYMPTOM

---

Get the detailed information from the customer about the symptom (the condition and the environment when the incident/malfunction occurred).

>> GO TO 2.

---

### 2. CHECK DTC

---

1. Check DTC.
2. Perform the following procedure if DTC is displayed.
  - Record DTC and freeze frame data (Print them out with CONSULT.)
  - Erase DTC.
  - Study the relationship between the cause detected by DTC and the symptom described by the customer.
3. Check related service bulletins for information.

#### Is any symptom described and any DTC detected?

- Symptom is described, DTC is displayed>>GO TO 3.
- Symptom is described, DTC is not displayed>>GO TO 4.
- Symptom is not described, DTC is displayed>>GO TO 5.

---

### 3. CONFIRM THE SYMPTOM

---

Confirm the symptom described by the customer.  
Connect CONSULT to the vehicle in "Data Monitor" mode and check real time diagnosis results.  
Verify relation between the symptom and the condition when the symptom is detected.

>> GO TO 5.

---

### 4. CONFIRM THE SYMPTOM

---

Confirm the symptom described by the customer.  
Connect CONSULT to the vehicle in "Data Monitor" mode and check real time diagnosis results.  
Verify relation between the symptom and the condition when the symptom is detected.

>> GO TO 6.

---

### 5. PERFORM DTC CONFIRMATION PROCEDURE

---

Perform DTC Confirmation Procedure for the displayed DTC, and then check that DTC is detected again.  
At this time, always connect CONSULT to the vehicle, and check diagnostic results in real time.  
If two or more DTCs are detected, refer to [BCS-47. "DTC Inspection Priority Chart"](#) and determine trouble diagnosis order.

#### **NOTE:**

- Freeze frame data is useful if the DTC is not detected.
- Perform Component Function Check if DTC Confirmation Procedure is not included in Service Manual. This simplified check procedure is an effective alternative though DTC cannot be detected during this check.  
If the result of Component Function Check is NG, it is the same as the detection of DTC by DTC Confirmation Procedure.

#### Is DTC detected?

- YES >> GO TO 7.
- NO >> Refer to [GI-53. "Intermittent Incident"](#).

---

### 6. DETECT MALFUNCTIONING SYSTEM BY SYMPTOM TABLE

---

Detect malfunctioning system according to [DEF-7. "System Description"](#) based on the confirmed symptom in step 4, and determine the trouble diagnosis order based on possible causes and symptom.

>> GO TO 7.

---

### 7. DETECT MALFUNCTIONING PART BY DIAGNOSTIC PROCEDURE

---

Inspect according to Diagnostic Procedure of the system.

#### **NOTE:**

A  
B  
C  
D  
E  
F  
G  
H  
I  
J  
K  
DEF  
M  
N  
O  
P

## DIAGNOSIS AND REPAIR WORK FLOW

### < BASIC INSPECTION >

---

The Diagnostic Procedure described is based on open circuit inspection. A short circuit inspection is also required for the circuit check in the Diagnostic Procedure.

#### Is malfunctioning part detected?

YES >> GO TO 8.

NO >> Check voltage of related BCM terminals using CONSULT.

### 8. REPAIR OR REPLACE THE MALFUNCTIONING PART

---

1. Repair or replace the malfunctioning part.
2. Reconnect parts or connectors disconnected during Diagnostic Procedure again after repair and replacement.
3. Check DTC. If DTC is displayed, erase it.

>> GO TO 9.

### 9. FINAL CHECK

---

When DTC was detected in step 2, perform DTC Confirmation Procedure or Component Function Check again, and then check that the malfunction has been repaired securely.

When symptom was described from the customer, refer to confirmed symptom in step 3 or 4, and check that the symptom is not detected.

#### Does the symptom reappear?

YES (DTC is detected)>>GO TO 7.

YES (Symptom remains)>>GO TO 6.

NO >> Inspection End.



# REAR WINDOW DEFOGGER SWITCH

< DTC/CIRCUIT DIAGNOSIS >

## DTC/CIRCUIT DIAGNOSIS

### REAR WINDOW DEFOGGER SWITCH

#### Component Function Check

INFOID:0000000010642281

#### 1. CHECK REAR WINDOW DEFOGGER SWITCH OPERATION

Ⓜ With CONSULT

1. Select "REAR DEFOGGER" of "BCM" using CONSULT.
2. Select "REAR DEF SW" in "Data Monitor".
3. Check "REAR DEF SW" indication under the following conditions:

Monitor item	Condition		Status
REAR DEF SW	Rear window defogger switch	Pressed	On
		Not Pressed	Off

Is the inspection result normal?

- YES >> Rear window defogger switch is OK.  
 NO >> Refer to [DEF-25, "Diagnosis Procedure"](#).

#### Diagnosis Procedure

INFOID:0000000010642282

Regarding Wiring Diagram information, refer to [DEF-14, "Wiring Diagram"](#).

#### 1. CHECK REAR WINDOW DEFOGGER SWITCH OPERATION

1. Turn power switch OFF.
2. Disconnect A/C auto amp. connector.
3. Turn power switch ON.
4. Check signal between A/C auto amp. harness connector and ground using oscilloscope.

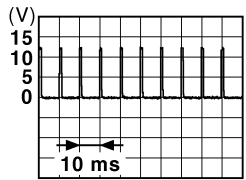
(+)		(-)	Voltage (V) (Approx.)
A/C auto amp.			
Connector	Terminal	Ground	
M55	15		

Is the inspection result normal?

- YES >> GO TO 3.  
 NO >> GO TO 2.

#### 2. CHECK REAR WINDOW DEFOGGER SWITCH CIRCUIT

1. Turn power switch OFF.
2. Disconnect BCM connector.
3. Check continuity between BCM harness connector and A/C auto amp. harness connector.

BCM		A/C auto amp.		Continuity
Connector	Terminal	Connector	Terminal	
M24	15	M55	15	Yes

## REAR WINDOW DEFOGGER SWITCH

### < DTC/CIRCUIT DIAGNOSIS >

4. Check continuity between BCM harness connector and ground.

BCM		Ground	Continuity
Connector	Terminal		
M24	15	Ground	No

Is the inspection result normal?

YES >> Replace BCM. Refer to [BCS-72. "Removal and Installation"](#).

NO >> Repair or replace harness.

### 3. CHECK REAR WINDOW DEFOGGER SWITCH GROUND CIRCUIT

Check continuity between A/C auto amp. harness connector and ground.

A/C auto amp.		Ground	Continuity
Connector	Terminal		
M55	10	Ground	Yes

Is the inspection result normal?

YES >> Replace A/C auto amp. Refer to [HAC-187. "Removal and Installation"](#) (auto A/C with heat pump) or [HAC-348. "Removal and Installation"](#) (auto A/C without heat pump).

NO >> Repair or replace harness.

# REAR WINDOW DEFOGGER RELAY

< DTC/CIRCUIT DIAGNOSIS >

## REAR WINDOW DEFOGGER RELAY

### Component Function Check

INFOID:000000010642283

#### 1.CHECK FUNCTION

Ⓜ With CONSULT

1. Select "REAR DEFOGGER" in "Active Test" of "IPDM E/R" using CONSULT.
2. Touch "On".
3. Check that the rear window heating wire is getting warmer.

Is the inspection result normal?

- YES >> Rear window defogger relay function is OK.  
 NO >> Refer to [DEF-27. "Diagnosis Procedure"](#).

### Diagnosis Procedure

INFOID:000000010642284

Regarding Wiring Diagram information, refer to [DEF-14. "Wiring Diagram"](#).

#### 1.CHECK FUSE

1. Turn power switch OFF.
2. Check that the following fuse is not blown.

Location	Fuse No.	Capacity
IPDM E/R	41	15A
	42	

Is the inspection result normal?

- YES >> GO TO 2.  
 NO >> Replace the blown fuse after repairing the affected circuit.

#### 2.CHECK IPDM E/R OUTPUT SIGNAL

1. Turn power switch ON.
2. Check voltage between IPDM E/R harness connector and ground.

(+)		(-)	Condition	Voltage (V) (Approx.)
IPDM E/R				
Connector	Terminal			
E11	14	Ground	Rear window defogger switch	ON Battery voltage
				OFF 0

Is the inspection result normal?

- YES >> Check intermittent incident. Refer to [GI-53. "Intermittent Incident"](#).  
 NO >> Replace IPDM E/R. Refer to [PCS-30. "Removal and Installation"](#).

A  
B  
C  
D  
E  
F  
G  
H  
I  
J  
K  
M  
N  
O  
P

DEF

# REAR WINDOW DEFOGGER

< DTC/CIRCUIT DIAGNOSIS >

## REAR WINDOW DEFOGGER

### Component Function Check

INFOID:000000010642285

#### 1.CHECK FUNCTION

Ⓜ With CONSULT

1. Select "REAR DEFOGGER" in "Active Test" of "IPDM E/R" using CONSULT.
2. Touch "On".
3. Check that the rear window heating wire is getting warmer.

Is the inspection result normal?

- YES >> Rear window defogger is OK.  
NO >> Refer to [DEF-28, "Diagnosis Procedure"](#).

### Diagnosis Procedure

INFOID:000000010642286

Regarding Wiring Diagram information, refer to [DEF-14, "Wiring Diagram"](#).

#### 1.CHECK REAR WINDOW DEFOGGER POWER SUPPLY CIRCUIT

1. Turn power switch OFF.
2. Disconnect rear window defogger connector.
3. Turn power switch ON.
4. Check voltage between rear window defogger harness connector and ground.

(+)		(-)	Condition	Voltage (V) (Approx.)	
Connector	Terminal				
D565	1	Ground	Rear window defogger switch	ON	Battery voltage
				OFF	0

Is the inspection result normal?

- YES >> GO TO 2.  
NO >> GO TO 4.

#### 2.CHECK REAR WINDOW DEFOGGER GROUND CIRCUIT

1. Turn power switch OFF.
2. Check continuity between rear window defogger harness connector and ground.

Rear window defogger		Ground	Continuity
Connector	Terminal		
D567	2		Yes

Is the inspection result normal?

- YES >> GO TO 3.  
NO >> Repair or replace harness.

#### 3.CHECK FILAMENT

Refer to [DEF-37, "Inspection and Repair"](#).

Is the inspection result normal?

- YES >> GO TO 7.  
NO >> Repair filament.

#### 4.CHECK REAR WINDOW DEFOGGER POWER SUPPLY CIRCUIT 1

1. Turn power switch OFF.
2. Disconnect condenser connector.
3. Check continuity between condenser harness connector and rear window defogger harness connector.

# REAR WINDOW DEFOGGER

## < DTC/CIRCUIT DIAGNOSIS >

Condenser		Rear window defogger		Continuity
Connector	Terminal	Connector	Terminal	
D566	2	D565	1	Yes

Is the inspection result normal?

YES >> GO TO 5.

NO >> Repair or replace harness.

### 5.CHECK REAR WINDOW DEFOGGER POWER SUPPLY CIRCUIT 2

1. Disconnect IPDM E/R connectors.
2. Check continuity between IPDM E/R harness connector and condenser harness connector.

IPDM E/R		Condenser		Continuity
Connector	Terminal	Connector	Terminal	
E11	14	D564	1	Yes

Is the inspection result normal?

YES >> GO TO 6.

NO >> Repair or replace harness.

### 6.CHECK CONDENSER

Refer to [DEF-29. "Component Inspection"](#).

Is the inspection result normal?

YES >> GO TO 7.

NO >> Replace condenser. Refer to [DEF-39. "Removal and Installation"](#).

### 7.CHECK INTERMITTENT INCIDENT

Refer to [GI-53. "Intermittent Incident"](#).

>> Inspection End.

## Component Inspection

INFOID:000000010642287

### 1.CHECK CONDENSER

1. Turn power switch OFF.
2. Disconnect condenser connector.
3. Check continuity between condenser terminals.

Condenser		Continuity
Terminal	Terminal	
1	2	Yes

Is the inspection result normal?

YES >> Inspection End.

NO >> Replace condenser. Refer to [DEF-39. "Removal and Installation"](#).

A  
B  
C  
D  
E  
F  
G  
H  
I  
J  
K  
DEF  
M  
N  
O  
P

# DOOR MIRROR DEFOGGER LH

< DTC/CIRCUIT DIAGNOSIS >

## DOOR MIRROR DEFOGGER LH

### Component Function Check

INFOID:000000010642288

#### 1. CHECK DOOR MIRROR DEFOGGER LH

1. Select "REAR DEFOGGER" in "Active Test" of "IPDM E/R" using CONSULT.
2. Touch "ON".
3. Check that the LH door mirror glass is getting warmer.

Is the inspection result normal?

- YES >> Door mirror defogger LH is OK.  
NO >> Refer to [DEF-30, "Diagnosis Procedure"](#).

### Diagnosis Procedure

INFOID:000000010642289

Regarding Wiring Diagram information, refer to [DEF-14, "Wiring Diagram"](#).

#### 1. CHECK DOOR MIRROR DEFOGGER CIRCUIT

1. Turn power switch OFF.
2. Disconnect IPDM E/R connector and door mirror LH connector.
3. Check continuity between IPDM E/R harness connector and door mirror LH harness connector.

IPDM E/R		Door mirror LH		Continuity
Connector	Terminal	Connector	Terminal	
E11	14	D4	2	Yes

Is the inspection result normal?

- YES >> GO TO 2.  
NO >> Repair or replace harness.

#### 2. CHECK GROUND CIRCUIT

Check continuity between door mirror LH harness connector and ground.

Door mirror LH		Ground	Continuity
Connector	Terminal		
D4	3		Yes

Is the inspection result normal?

- YES >> Replace door mirror defogger LH. Refer to [MIR-23, "GLASS MIRROR : Removal and Installation"](#).  
NO >> Repair or replace harness.

# DOOR MIRROR DEFOGGER RH

< DTC/CIRCUIT DIAGNOSIS >

## DOOR MIRROR DEFOGGER RH

### Component Function Check

INFOID:000000010642290

#### 1.CHECK DOOR MIRROR DEFOGGER RH

1. Select "REAR DEFOGGER" in "Active Test" of "IPDM E/R" using CONSULT.
2. Touch "ON".
3. Check that the RH door mirror glass is getting warmer.

Is the inspection result normal?

- YES >> Door mirror defogger RH is OK.  
NO >> Refer to [DEF-31, "Diagnosis Procedure"](#).

### Diagnosis Procedure

INFOID:000000010642291

Regarding Wiring Diagram information, refer to [DEF-14, "Wiring Diagram"](#).

#### 1.CHECK DOOR MIRROR DEFOGGER CIRCUIT

1. Turn power switch OFF.
2. Disconnect IPDM E/R connector and door mirror RH connector.
3. Check continuity between IPDM E/R harness connector and door mirror RH harness connector.

IPDM E/R		Door mirror RH		Continuity
Connector	Terminal	Connector	Terminal	
E11	14	D105	2	Yes

Is the inspection result normal?

- YES >> GO TO 2.  
NO >> Repair or replace harness.

#### 2.CHECK GROUND CIRCUIT

Check continuity between door mirror RH harness connector and ground.

Door mirror RH		Ground	Continuity
Connector	Terminal		
D105	3		Yes

Is the inspection result normal?

- YES >> Replace door mirror defogger RH. Refer to [MIR-23, "GLASS MIRROR : Removal and Installation"](#).  
NO >> Repair or replace harness.

A  
B  
C  
D  
E  
F  
G  
H  
I  
J  
K  
DEF  
M  
N  
O  
P

# REAR WINDOW DEFOGGER AND DOOR MIRROR DEFOGGER DO NOT OPERATE

< SYMPTOM DIAGNOSIS >

---

## SYMPTOM DIAGNOSIS

### REAR WINDOW DEFOGGER AND DOOR MIRROR DEFOGGER DO NOT OPERATE

#### Diagnosis Procedure

INFOID:000000010642292

#### 1. CHECK REAR WINDOW DEFOGGER SWITCH

---

Check rear window defogger switch.

Refer to [DEF-25. "Component Function Check"](#).

Is the inspection result normal?

YES >> GO TO 2.

NO >> Repair or replace the malfunctioning parts.

#### 2. CHECK REAR WINDOW DEFOGGER RELAY

---

Check rear window defogger relay.

Refer to [DEF-27. "Component Function Check"](#).

Is the inspection result normal?

YES >> GO TO 3.

NO >> Repair or replace the malfunctioning parts.

#### 3. CONFIRM THE OPERATION

---

Confirm the operation again.

Is the inspection result normal?

YES >> Check intermittent incident. Refer to [GI-53. "Intermittent Incident"](#).

NO >> GO TO 1.



# REAR WINDOW DEFOGGER DOES NOT OPERATE BUT BOTH DOOR MIRROR DEFOGGER OPERATE

< SYMPTOM DIAGNOSIS >

## REAR WINDOW DEFOGGER DOES NOT OPERATE BUT BOTH DOOR MIRROR DEFOGGER OPERATE

### Diagnosis Procedure

INFOID:000000010642293

#### 1. CHECK REAR WINDOW DEFOGGER

Check rear window defogger.

Refer to [DEF-28. "Component Function Check"](#).

Is the inspection result normal?

YES >> GO TO 2.

NO >> Repair or replace the malfunctioning parts.

#### 2. CONFIRM THE OPERATION

Confirm the operation again

Is the inspection result normal?

YES >> Check intermittent incident. Refer to [GI-53. "Intermittent Incident"](#).

NO >> GO TO 1.

A  
B  
C  
D  
E  
F  
G  
H  
I  
J  
K  
DEF  
M  
N  
O  
P

# BOTH DOORS MIRROR DEFOGGER DON'T OPERATE BUT REAR WINDOW DEFOGGER OPERATES

< SYMPTOM DIAGNOSIS >

## BOTH DOORS MIRROR DEFOGGER DON'T OPERATE BUT REAR WINDOW DEFOGGER OPERATES

### Diagnosis Procedure

INFOID:000000010642294

#### 1. CHECK DOOR MIRROR DEFOGGER FUSE

Check if the following fuse in fuse block (J/B) is blown.

COMPONENT PARTS	AMPERE	FUSE NO.
Fuse block (J/B)	10A	22

Is the inspection result normal?

YES >> GO TO 2.

NO >> Replace the blown fuse after repairing the affected circuit.

#### 2. CHECK BOTH DOOR MIRROR DEFOGGER

1. Check door mirror defogger LH. Refer to [DEF-30. "Component Function Check"](#).
2. Check door mirror defogger RH. Refer to [DEF-31. "Component Function Check"](#).

Is the inspection result normal?

YES >> Check intermittent incident. Refer to [GI-53. "Intermittent Incident"](#).

NO >> Repair or replace the malfunctioning parts.

# DOOR MIRROR DEFOGGER DOES NOT OPERATE

< SYMPTOM DIAGNOSIS >

---

## DOOR MIRROR DEFOGGER DOES NOT OPERATE

### Diagnosis Procedure

INFOID:000000010642295

#### 1. CHECK DOOR MIRROR DEFOGGER

---

Check door mirror defogger.

Refer to [DEF-30. "Component Function Check"](#) (LH) or [DEF-31. "Component Function Check"](#) (RH).

Is the inspection result normal?

- YES >> Refer to [GI-53. "Intermittent Incident"](#).
- NO >> Repair or replace the malfunctioning parts.

A  
B  
C  
D  
E  
F  
G  
H  
I  
J  
K  
DEF  
M  
N  
O  
P

# REAR WINDOW DEFOGGER SWITCH DOES NOT LIGHT, BUT REAR WINDOW DEFOGGER OPERATES

< SYMPTOM DIAGNOSIS >

---

## REAR WINDOW DEFOGGER SWITCH DOES NOT LIGHT, BUT REAR WINDOW DEFOGGER OPERATES

### Diagnosis Procedure

INFOID:000000010642296

#### 1. REPLACE A/C AUTO AMP. (REAR WINDOW DEFOGGER SWITCH)

Replace A/C auto amp. (Rear window defogger switch). Refer to [HAC-187, "Removal and Installation"](#) (auto A/C with heat pump) or [HAC-348, "Removal and Installation"](#) (auto A/C without heat pump).

>> GO TO 2.

#### 2. CONFIRM THE OPERATION

Confirm the operation again.

Is the inspection result normal?

- YES >> Check intermittent incident. Refer to [GI-53, "Intermittent Incident"](#).  
NO >> GO TO 1.

# FILAMENT

< REMOVAL AND INSTALLATION >

## REMOVAL AND INSTALLATION

### FILAMENT

#### Inspection and Repair

INFOID:000000010642297

#### INSPECTION

1. When measuring voltage, wrap tin foil around the top of the negative probe. Then press the foil against the wire with your finger.

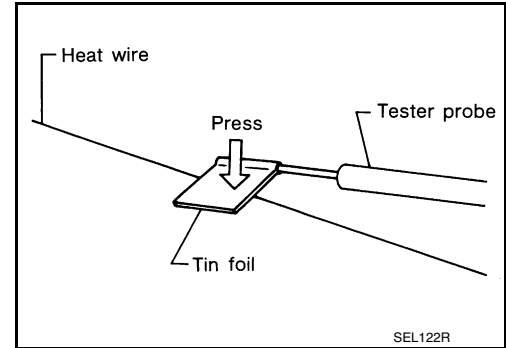

2. Attach probe circuit tester (in Volt range) to middle portion of each filament.

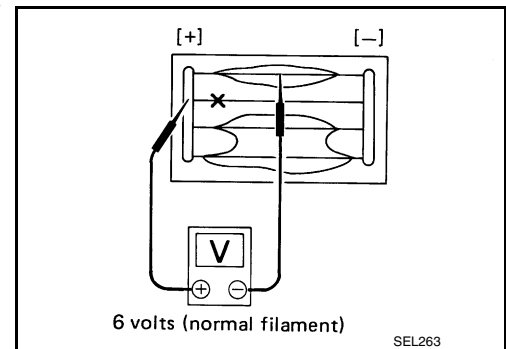

3. If a filament is burned out, circuit tester registers 0 or battery voltage.
4. To locate burned out point, move probe to left and right along filament. Test needle will swing abruptly when probe passes the point.

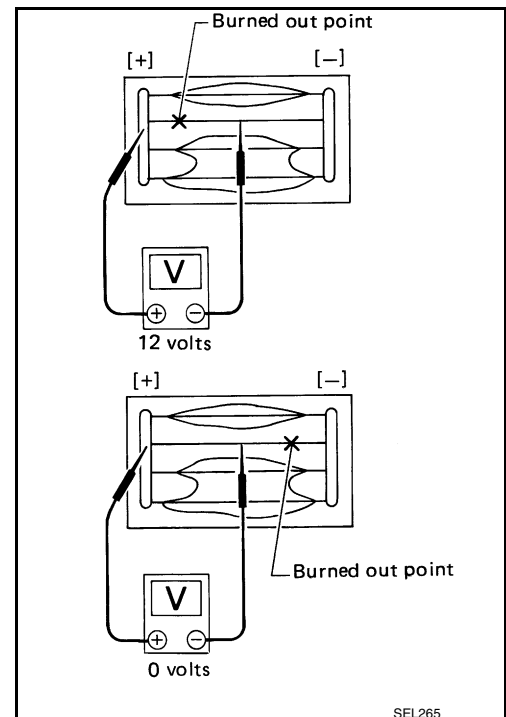

#### REPAIR

##### REPAIR EQUIPMENT

- Conductive silver composition (Dupont No. 4817 or equivalent)

A  
B  
C  
D  
E  
F  
G  
H  
I  
J  
K  
DEF  
M  
N  
O  
P

# FILAMENT

## < REMOVAL AND INSTALLATION >

- Ruler 30 cm (11.8 in) long
- Drawing pen
- Heat gun
- Alcohol
- Cloth

### REPAIRING PROCEDURE

1. Wipe broken heat wire and its surrounding area clean with a cloth dampened in alcohol.
2. Apply a small amount of conductive silver composition to tip of drawing pen. Shake silver composition container before use.
3. Place ruler on glass along broken line. Deposit conductive silver composition on break with drawing pen. Slightly overlap existing heat wire on both sides [preferably 5 mm (0.20 in)] of the break.

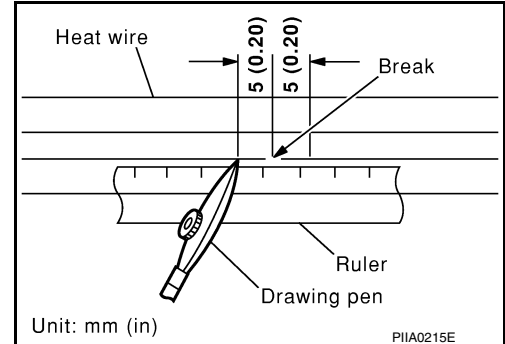

4. After repair has been completed, check repaired wire for continuity. This check should be conducted 10 minutes after silver composition is deposited. Do not touch repaired area while test is being conducted.

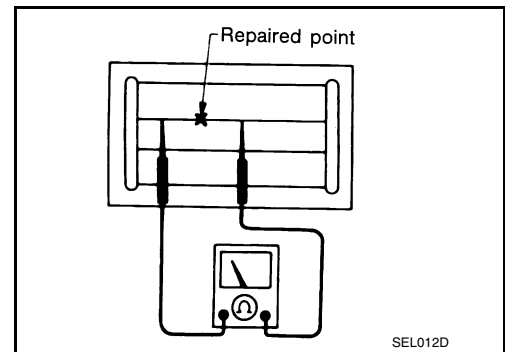

5. Apply a constant stream of hot air directly to the repaired area for approximately 20 minutes with a heat gun. A minimum distance of 3 cm (1.2 in) should be kept between repaired area and hot air outlet. If a heat gun is not available, let the repaired area dry for 24 hours.

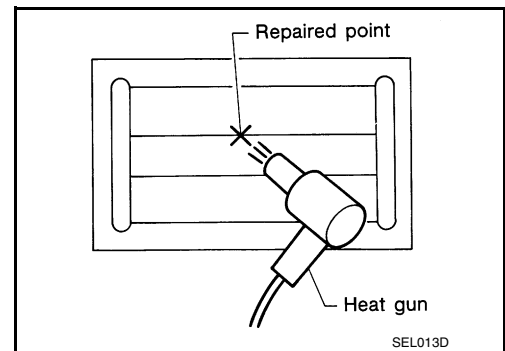

# CONDENSER

< REMOVAL AND INSTALLATION >

## CONDENSER

### Removal and Installation

INFOID:000000010642298

#### REMOVAL

1. Remove the back door lower finisher. Refer to [INT-46. "BACK DOOR LOWER FINISHER : Removal and Installation"](#).
2. Disconnect the harness connectors from the condenser.
3. Remove bolt (A), and then remove condenser (1) from the vehicle body.

**NOTE:**

RH shown, LH similar.

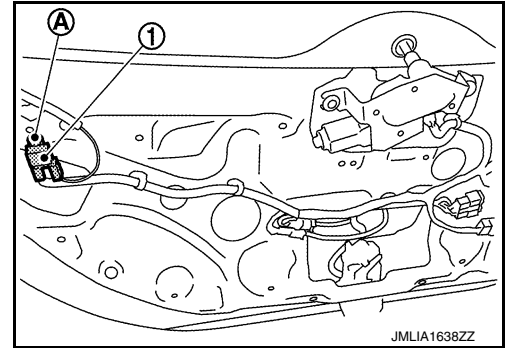

#### INSTALLATION

Installation is in the reverse order of removal.

A  
B  
C  
D  
E  
F  
G  
H  
I  
J  
K

DEF

M  
N  
O  
P