

SECTION **AV**

AUDIO, VISUAL & NAVIGATION SYSTEM

A
B
C
D
E
F
G
H
I
J
K
L
M
AV
O
P

CONTENTS

BASE AUDIO WITHOUT NAVIGATION	Reference Value	33
	DTC Index	39
PRECAUTION		7
PRECAUTIONS		7
Precaution for Supplemental Restraint System (SRS) "AIR BAG" and "SEAT BELT PRE-TENSIONER"		7
Precaution for Trouble Diagnosis		7
Precaution for Harness Repair		7
PREPARATION		9
PREPARATION		9
Commercial Service Tools		9
SYSTEM DESCRIPTION		10
COMPONENT PARTS		10
Component Parts Location		10
Component Description		11
SYSTEM		13
MULTI AV SYSTEM		13
MULTI AV SYSTEM : System Diagram		13
MULTI AV SYSTEM : System Description		14
DIAGNOSIS SYSTEM (AV CONTROL UNIT)		17
Description		17
On Board Diagnosis Function		17
CONSULT - III Function		26
DIAGNOSIS SYSTEM (ACTIVE NOISE CONTROL UNIT)		29
On Board Diagnosis Function		29
DIAGNOSIS SYSTEM (TEL ADAPTER UNIT) ...31		31
On Board Diagnosis Function		31
ECU DIAGNOSIS INFORMATION		33
AV CONTROL UNIT		33
	Reference Value	33
	DTC Index	39
DISPLAY UNIT		41
Reference Value		41
ACTIVE NOISE CONTROL UNIT		44
Reference Value		44
SATELLITE RADIO TUNER		47
Reference Value		47
TEL ADAPTER UNIT		49
Reference Value		49
WIRING DIAGRAM		51
BASE AUDIO WITH REAR VIEW CAMERA		51
Wiring Diagram		51
BASIC INSPECTION		74
DIAGNOSIS AND REPAIR WORKFLOW		74
Work Flow		74
ADDITIONAL SERVICE WHEN REPLACING (AV CONTROL UNIT)		76
Description		76
Work Procedure		76
CONFIGURATION (AV CONTROL UNIT)		77
Description		77
Work Procedure		77
Configuration List		77
DTC/CIRCUIT DIAGNOSIS		79
U1000 CAN COMM CIRCUIT		79
Description		79
DTC Logic		79
Diagnosis Procedure		79
U1010 CONTROL UNIT (CAN)		80

DTC Logic	80	CAMERA IMAGE SIGNAL CIRCUIT	99
U1200 AV CONTROL UNIT	81	Description	99
DTC Logic	81	Diagnosis Procedure	99
U1216 AV CONTROL UNIT	82	COMPOSITE IMAGE SIGNAL CIRCUIT	101
DTC Logic	82	Description	101
U1232 STEERING ANGLE SENSOR	83	Diagnosis Procedure	101
DTC Logic	83	HORIZONTAL SYNCHRONIZING (HP) SIG-	
Diagnosis Procedure	83	NAL CIRCUIT	102
U1243 DISPLAY UNIT	84	Description	102
DTC Logic	84	Diagnosis Procedure	102
Diagnosis Procedure	84	VERTICAL SYNCHRONIZING (VP) SIGNAL	
U1255 SATELLITE RADIO TUNER	86	CIRCUIT	103
DTC Logic	86	Description	103
Diagnosis Procedure	86	Diagnosis Procedure	103
U1300 AV COMM CIRCUIT	88	DISK EJECT SIGNAL CIRCUIT	104
Description	88	Description	104
U1310 AV CONTROL UNIT	89	Diagnosis Procedure	104
DTC Logic	89	MICROPHONE SIGNAL CIRCUIT	105
POWER SUPPLY AND GROUND CIRCUIT	90	Description	105
AV CONTROL UNIT	90	Diagnosis Procedure	105
AV CONTROL UNIT : Diagnosis Procedure	90	CONTROL SIGNAL CIRCUIT	107
DISPLAY UNIT	90	Description	107
DISPLAY UNIT : Diagnosis Procedure	90	Diagnosis Procedure	107
ACTIVE NOISE CONTROL UNIT	91	STEERING SWITCH SIGNAL A CIRCUIT	108
ACTIVE NOISE CONTROL UNIT : Diagnosis Pro-		Description	108
cedure	92	Diagnosis Procedure	108
SATELLITE RADIO TUNER	92	Component Inspection	108
SATELLITE RADIO TUNER : Diagnosis Proce-		STEERING SWITCH SIGNAL B CIRCUIT	110
cedure	92	Description	110
TEL ADAPTER UNIT	93	Diagnosis Procedure	110
TEL ADAPTER UNIT : Diagnosis Procedure	93	Component Inspection	110
RGB (R: RED) SIGNAL CIRCUIT	94	STEERING SWITCH GROUND CIRCUIT	112
Description	94	Description	112
Diagnosis Procedure	94	Diagnosis Procedure	112
RGB (G: GREEN) SIGNAL CIRCUIT	95	Component Inspection	112
Description	95	SYMPTOM DIAGNOSIS	114
Diagnosis Procedure	95	MULTI AV SYSTEM SYMPTOMS	114
RGB (B: BLUE) SIGNAL CIRCUIT	96	Symptom Table	114
Description	96	NORMAL OPERATING CONDITION	118
Diagnosis Procedure	96	Description	118
RGB SYNCHRONIZING SIGNAL CIRCUIT	97	REMOVAL AND INSTALLATION	120
Description	97	AV CONTROL UNIT	120
Diagnosis Procedure	97	Removal and Installation	120
RGB AREA (YS) SIGNAL CIRCUIT	98	FRONT DOOR SPEAKER	121
Description	98	Removal and Installation	121
Diagnosis Procedure	98	FRONT DOOR SQUAWKER	122

Removal and Installation	122	Precaution for Supplemental Restraint System (SRS) "AIR BAG" and "SEAT BELT PRE-TENSIONER"	141	A
REAR DOOR SPEAKER	123	Precaution for Trouble Diagnosis	141	
Removal and Installation	123	Precaution for Harness Repair	141	B
ACTIVE NOISE CONTROL UNIT	124	PREPARATION	143	
Removal and Installation	124	PREPARATION	143	C
FRONT MICROPHONE (ACTIVE NOISE CONTROL SYSTEM)	125	Commercial Service Tools	143	
Removal and Installation	125	SYSTEM DESCRIPTION	144	D
REAR MICROPHONE (ACTIVE NOISE CONTROL SYSTEM)	126	COMPONENT PARTS	144	
Removal and Installation	126	Component Parts Location	144	E
ANTENNA AMP.	127	Component Description	147	
Removal and Installation	127	SYSTEM	149	F
DISPLAY UNIT	128	MULTI AV SYSTEM	149	
Removal and Installation	128	MULTI AV SYSTEM : System Diagram	149	G
SATELLITE RADIO TUNER	129	MULTI AV SYSTEM : System Description	150	
Removal and Installation	129	MULTI AV SYSTEM : Fail-Safe	157	H
SATELLITE RADIO ANTENNA	130	DIAGNOSIS SYSTEM (AV CONTROL UNIT) .	158	
Exploded View	130	Description	158	I
Removal and Installation	130	On Board Diagnosis Function	158	
MULTIFUNCTION SWITCH	131	CONSULT - III Function	172	J
Removal and Installation	131	DIAGNOSIS SYSTEM [BOSE AMP.(ACTIVE NOISE CONTROL SYSTEM)]	177	
PRESET SWITCH	132	On Board Diagnosis Function	177	K
Removal and Installation	132	ECU DIAGNOSIS INFORMATION	179	
STEERING SWITCH	133	AV CONTROL UNIT	179	L
Removal and Installation	133	Reference Value	179	
USB CONNECTOR	134	Fail-Safe	184	M
Removal and Installation	134	DTC Index	185	
MICROPHONE	135	DISPLAY UNIT	187	
Removal and Installation	135	Reference Value	187	
TEL ADAPTER UNIT	136	BOSE AMP.	189	
Removal and Installation	136	Reference Value	189	
REAR VIEW CAMERA	137	WIRING DIAGRAM	199	AV
Removal and Installation	137	BOSE AUDIO WITH NAVIGATION	199	
Adjustment	137	Wiring Diagram	199	
STEERING ANGLE SENSOR	139	BASIC INSPECTION	225	O
Removal and Installation	139	DIAGNOSIS AND REPAIR WORKFLOW	225	
ANTENNA FEEDER	140	Work Flow	225	P
Feeder Layout	140	ADDITIONAL SERVICE WHEN REPLACING (AV CONTROL UNIT)	227	
BOSE AUDIO WITH NAVIGATION		Description	227	
PRECAUTION	141	Work Procedure	227	
PRECAUTIONS	141	CONFIGURATION (AV CONTROL UNIT)	228	
		Description	228	

Work Procedure	228	U121C AV CONTROL UNIT	245
Configuration List	228	DTC Logic	245
DTC/CIRCUIT DIAGNOSIS	230	Diagnosis Procedure	245
U1000 CAN COMM CIRCUIT	230	U121D AV CONTROL UNIT	246
Description	230	DTC Logic	246
DTC Logic	230	Diagnosis Procedure	246
Diagnosis Procedure	230	U121E AV CONTROL UNIT	247
U1010 CONTROL UNIT (CAN)	231	DTC Logic	247
DTC Logic	231	Diagnosis Procedure	247
U1200 AV CONTROL UNIT	232	U1225 AV CONTROL UNIT	248
DTC Logic	232	DTC Logic	248
U1201 AV CONTROL UNIT	233	U1227 AV CONTROL UNIT	249
DTC Logic	233	DTC Logic	249
U1202 AV CONTROL UNIT	234	Diagnosis Procedure	249
DTC Logic	234	U1228 AV CONTROL UNIT	250
U1204 AV CONTROL UNIT	235	DTC Logic	250
Description	235	U1229 AV CONTROL UNIT	251
DTC Logic	235	DTC Logic	251
Diagnosis Procedure	235	U122A AV CONTROL UNIT	252
U1205 AV CONTROL UNIT	236	DTC Logic	252
Description	236	Diagnosis Procedure	252
DTC Logic	236	U122E AV CONTROL UNIT	253
Diagnosis Procedure	236	DTC Logic	253
U1206 AV CONTROL UNIT	237	U1231 BOSE AMP.	254
Description	237	DTC Logic	254
DTC Logic	237	U1232 STEERING ANGLE SENSOR	255
Diagnosis Procedure	237	DTC Logic	255
U1207 AV CONTROL UNIT	238	Diagnosis Procedure	255
Description	238	U1243 DISPLAY UNIT	256
DTC Logic	238	DTC Logic	256
Diagnosis Procedure	238	Diagnosis Procedure	256
U1216 AV CONTROL UNIT	239	U1244 GPS ANTENNA	258
DTC Logic	239	DTC Logic	258
U1217 AV CONTROL UNIT	240	Diagnosis Procedure	258
DTC Logic	240	U1258 SATELLITE RADIO ANTENNA	259
U1218 AV CONTROL UNIT	241	DTC Logic	259
DTC Logic	241	Diagnosis Procedure	259
Diagnosis Procedure	241	U1263 USB	260
U1219 AV CONTROL UNIT	242	DTC Logic	260
DTC Logic	242	Diagnosis Procedure	260
Diagnosis Procedure	242	U1264 ANTENNA AMP.	261
U121A AV CONTROL UNIT	243	DTC Logic	261
DTC Logic	243	Diagnosis Procedure	261
Diagnosis Procedure	243	U1300 AV COMM CIRCUIT	262
U121B AV CONTROL UNIT	244	Description	262
DTC Logic	244	U1310 AV CONTROL UNIT	263
Diagnosis Procedure	244		

DTC Logic	263	Description	282	
U1601, U1609 FRONT DOOR WOOFER	264	Diagnosis Procedure	282	A
DTC Logic	264	Component Inspection	282	
Diagnosis Procedure	264	STEERING SWITCH SIGNAL B CIRCUIT	284	B
U1602, U160A FRONT DOOR SQUAWKER/ TWEETER	265	Description	284	
DTC Logic	265	Diagnosis Procedure	284	C
Diagnosis Procedure	265	Component Inspection	284	
U162A CENTER SPEAKER	266	STEERING SWITCH GROUND CIRCUIT	286	D
DTC Logic	266	Description	286	
Diagnosis Procedure	266	Diagnosis Procedure	286	D
U1632, U163A, U163E SEAT SPEAKER	267	Component Inspection	286	
DTC Logic	267	SYMPTOM DIAGNOSIS	288	E
Diagnosis Procedure	267	MULTI AV SYSTEM SYMPTOMS	288	
U1708, U1710 REAR DOOR SPEAKER	268	Symptom Table	288	
DTC Logic	268	NORMAL OPERATING CONDITION	292	F
Diagnosis Procedure	268	Description	292	
U1725 REAR WOOFER	269	REMOVAL AND INSTALLATION	298	G
DTC Logic	269	AV CONTROL UNIT	298	
Diagnosis Procedure	269	Removal and Installation	298	H
U190C FRONT/REAR MICROPHONE	270	FRONT DOOR WOOFER	299	
DTC Logic	270	Removal and Installation	299	I
Diagnosis Procedure	270	FRONT DOOR SQUAWKER	300	
POWER SUPPLY AND GROUND CIRCUIT ...	272	Removal and Installation	300	J
AV CONTROL UNIT	272	TWEETER	301	
AV CONTROL UNIT : Diagnosis Procedure	272	Removal and Installation	301	K
DISPLAY UNIT	272	REAR DOOR SPEAKER	302	
DISPLAY UNIT : Diagnosis Procedure	272	Removal and Installation	302	L
BOSE AMP.	273	SATELLITE SPEAKER	303	
BOSE AMP. : Diagnosis Procedure	273	Removal and Installation	303	M
RGB DIGITAL IMAGE SIGNAL CIRCUIT	275	CENTER SPEAKER	304	
Description	275	Removal and Installation	304	M
Diagnosis Procedure	275	REAR WOOFER	305	
COMPOSITE IMAGE SIGNAL CIRCUIT	276	Removal and Installation	305	
Description	276	SEAT SPEAKER	306	AV
Diagnosis Procedure	276	Removal and Installation	306	
DISK EJECT SIGNAL CIRCUIT	277	BOSE AMP.	307	O
Description	277	Removal and Installation	307	
Diagnosis Procedure	277	FRONT MICROPHONE (ACTIVE NOISE CONTROL SYSTEM/AUDIPILOT® 2)	308	P
MICROPHONE SIGNAL CIRCUIT	278	Removal and Installation	308	
Description	278	REAR MICROPHONE (ACTIVE NOISE CON- TROL SYSTEM)	309	
Diagnosis Procedure	278	Removal and Installation	309	
CAMERA IMAGE SIGNAL CIRCUIT	280	ANTENNA AMP.	310	
Description	280			
Diagnosis Procedure	280			
STEERING SWITCH SIGNAL A CIRCUIT	282			

Removal and Installation	310	Removal and Installation	316
DISPLAY UNIT	311	GPS ANTENNA	317
Removal and Installation	311	Exploded View	317
SATELLITE RADIO ANTENNA	312	Removal and Installation	317
Exploded View	312	MICROPHONE	319
Removal and Installation	312	Removal and Installation	319
MULTIFUNCTION SWITCH	313	REAR VIEW CAMERA	320
Removal and Installation	313	Removal and Installation	320
PRESET SWITCH	314	Adjustment	320
Removal and Installation	314	STEERING ANGLE SENSOR	322
STEERING SWITCH	315	Removal and Installation	322
Removal and Installation	315	ANTENNA FEEDER	323
USB CONNECTOR	316	Feeder Layout	323

PRECAUTIONS

< PRECAUTION >

[BASE AUDIO WITHOUT NAVIGATION]

PRECAUTION

PRECAUTIONS

Precaution for Supplemental Restraint System (SRS) "AIR BAG" and "SEAT BELT PRE-TENSIONER"

INFOID:000000005913126

The Supplemental Restraint System such as "AIR BAG" and "SEAT BELT PRE-TENSIONER", used along with a front seat belt, helps to reduce the risk or severity of injury to the driver and front passenger for certain types of collision. This system includes seat belt switch inputs and dual stage front air bag modules. The SRS system uses the seat belt switches to determine the front air bag deployment, and may only deploy one front air bag, depending on the severity of a collision and whether the front occupants are belted or unbelted. Information necessary to service the system safely is included in the "SRS AIR BAG" and "SEAT BELT" of this Service Manual.

WARNING:

- To avoid rendering the SRS inoperative, which could increase the risk of personal injury or death in the event of a collision that would result in air bag inflation, all maintenance must be performed by an authorized NISSAN/INFINITI dealer.
- Improper maintenance, including incorrect removal and installation of the SRS, can lead to personal injury caused by unintentional activation of the system. For removal of Spiral Cable and Air Bag Module, see the "SRS AIR BAG".
- Do not use electrical test equipment on any circuit related to the SRS unless instructed to in this Service Manual. SRS wiring harnesses can be identified by yellow and/or orange harnesses or harness connectors.

PRECAUTIONS WHEN USING POWER TOOLS (AIR OR ELECTRIC) AND HAMMERS

WARNING:

- When working near the Air Bag Diagnosis Sensor Unit or other Air Bag System sensors with the ignition ON or engine running, DO NOT use air or electric power tools or strike near the sensor(s) with a hammer. Heavy vibration could activate the sensor(s) and deploy the air bag(s), possibly causing serious injury.
- When using air or electric power tools or hammers, always switch the ignition OFF, disconnect the battery, and wait at least 3 minutes before performing any service.

Precaution for Trouble Diagnosis

INFOID:000000005913127

AV COMMUNICATION SYSTEM

- Do not apply voltage of 7.0 V or higher to the measurement terminals.
- Use the tester with its open terminal voltage being 7.0 V or less.
- Be sure to turn ignition switch OFF and disconnect the battery cable from the negative terminal before checking the circuit.

Precaution for Harness Repair

INFOID:000000005913128

AV COMMUNICATION SYSTEM

- Solder the repaired parts, and wrap with tape. [Frays of twisted line must be within 110 mm (4.33 in).]

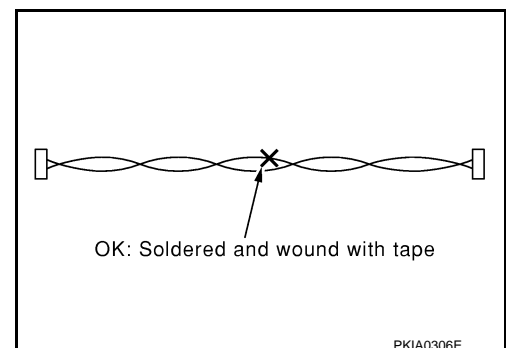

PRECAUTIONS

< PRECAUTION >

[BASE AUDIO WITHOUT NAVIGATION]

- Do not perform bypass wire connections for the repair parts. (The spliced wire will become separated and the characteristics of twisted line will be lost.)

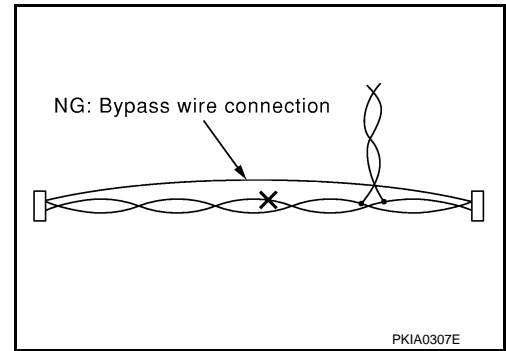

PREPARATION

< PREPARATION >

[BASE AUDIO WITHOUT NAVIGATION]

PREPARATION

PREPARATION

Commercial Service Tools

INFOID:000000005913129

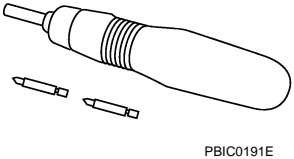
Tool	Description
<p>Power tool</p>  <p>PBIC0191E</p>	<p>Loosening screws</p>

A

B

C

D

E

F

G

H

I

J

K

L

M

AV

O

P

COMPONENT PARTS

< SYSTEM DESCRIPTION >

[BASE AUDIO WITHOUT NAVIGATION]

SYSTEM DESCRIPTION

COMPONENT PARTS

Component Parts Location

INFOID:000000005913130

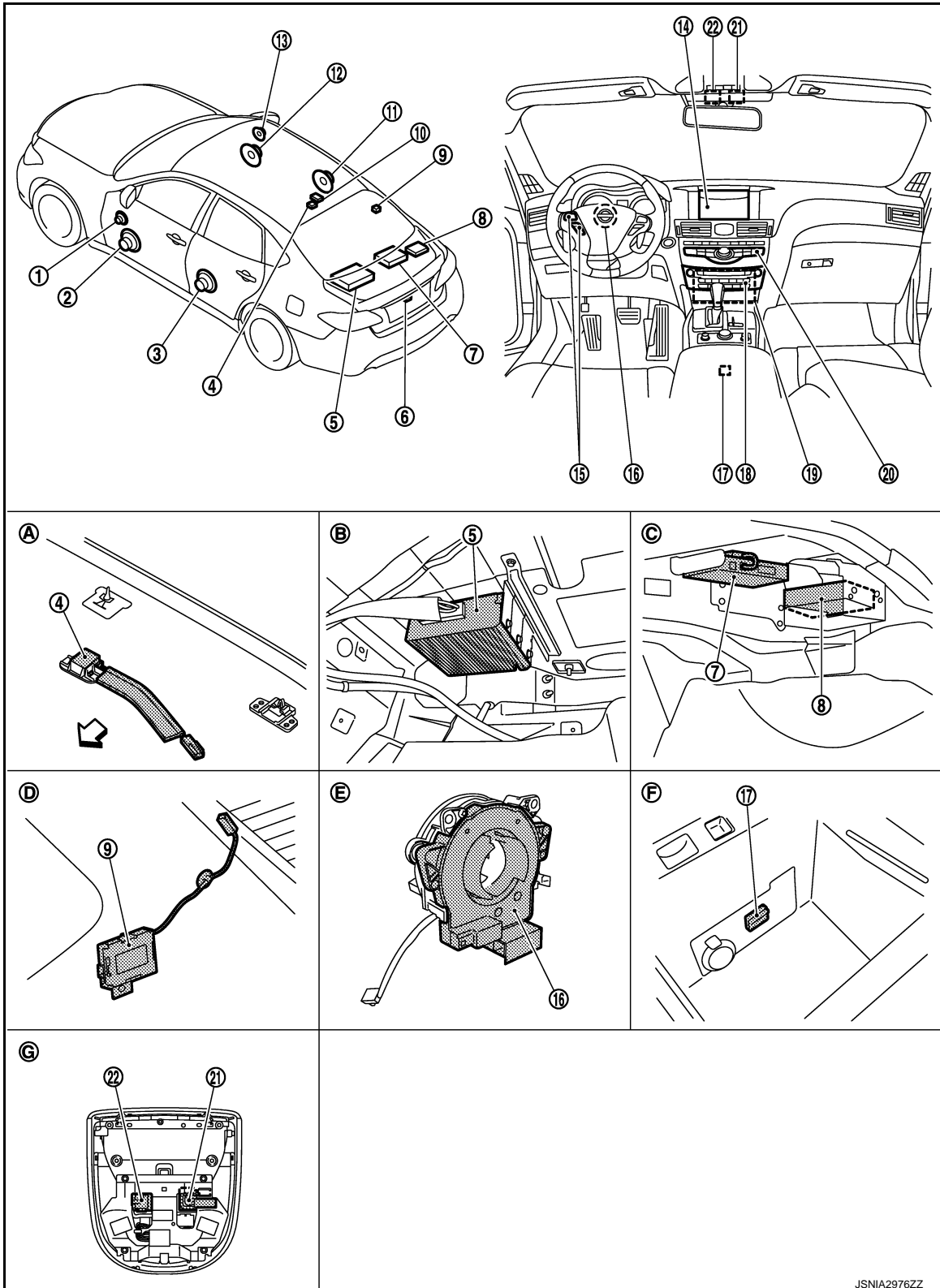

JSNIA2976ZZ

COMPONENT PARTS

< SYSTEM DESCRIPTION >

[BASE AUDIO WITHOUT NAVIGATION]

- | | | | |
|--|---|--|---|
| 1. Front door squawker LH | 2. Front door speaker LH | 3. Rear door speaker LH | A |
| 4. Rear microphone (for active noise control system) | 5. Active noise control unit | 6. Rear view camera | B |
| 7. TEL adapter unit | 8. Satellite radio tuner | 9. Antenna amp. | B |
| 10. Satellite radio antenna | 11. Rear door speaker RH | 12. Front door speaker RH | C |
| 13. Front door squawker RH | 14. Display unit | 15. Steering switch | C |
| 16. Steering angle sensor | 17. USB connector | 18. Preset switch | D |
| 19. AV control unit | 20. Multifunction switch | 21. Front microphone (for active noise control system) | D |
| 22. Microphone (for TEL) | | | D |
| A. Headlining rear center | B. Rear parcel shelf left side (trunk room) | C. Rear parcel shelf right side (trunk room) | E |
| D. Rear pillar finisher RH removed condition | E. Spiral cable removed condition | F. Within center console | E |
| G. Map lamp ASSY removed condition | | | F |
- ⇨: Vehicle front

Component Description

INFOID:000000005913131

Part name	Description
AV control unit	<ul style="list-style-type: none"> It is the master unit of the MULTI AV system, and it is connected to each control unit by communication. It operates each system according to communication signals from the AV control unit. The AV control unit includes the audio, USB connection and vehicle status functions. It is connected to each control unit via CAN communication to obtain necessary information for the vehicle information function. It receives a steering angle signal from the steering angle sensor via CAN communication and controls an expected course line during rear view monitor operation. It inputs the illumination signals that are required for the display dimming control. It inputs the signals for driving status recognition (vehicle speed, reverse and parking brake). TEL voice signal and voice guidance signal are input from TEL adapter unit. Camera image signal is received and transmitted to display unit.
Display unit	<ul style="list-style-type: none"> Display image is controlled by the serial communication from AV control unit. It receives the power (signal VCC and inverter VCC) from the AV control unit and operates. RGB image signal is input from AV control unit (RGB image, RGB area and RGB synchronizing). Composite image signals are input from AV control unit. Synchronizing signal (HP, VP) is output to AV control unit.
Active noise control unit	<ul style="list-style-type: none"> Generates an antiphase sound weakening interior engine booming noise, mixes the antiphase sound with a sound signal transmitted from the AV control unit, and transmits the mixed sound signal to each speaker. Input microphone signal from front/rear microphone (for active noise control system).
Front door speaker	<ul style="list-style-type: none"> Outputs sound signal from active noise control unit. Outputs high, mid and low range sounds.
Front door squawker	<ul style="list-style-type: none"> Outputs sound signal from active noise control unit. Outputs high and mid range sounds.
Rear door speaker	<ul style="list-style-type: none"> Outputs sound signal from active noise control unit. Outputs high, mid and low range sounds.
Front microphone (for active noise control system)	Detects interior engine booming noise and transmits a sound signal picked up by the front microphone to the active noise control unit.
Rear microphone (for active noise control system)	Detects interior engine booming noise and transmits a sound signal picked up by the rear microphone to the active noise control unit.

COMPONENT PARTS

< SYSTEM DESCRIPTION >

[BASE AUDIO WITHOUT NAVIGATION]

Part name	Description
Multifunction switch	<ul style="list-style-type: none">• Operation panel is equipped with the centralized switch where audio and air conditioner, etc. operations are integrated.• Connected with preset switch via cable, and operation signal is transmitted to AV control unit via AV communication.• The disk ejection operating signal is performed by hardwire.
Preset switch	<ul style="list-style-type: none">• Operation panel is equipped with the centralized switch where audio operations are integrated.• Connected with multifunction switch via cable, and operation signal is transmitted to AV control unit via AV communication.
Rear view camera	<ul style="list-style-type: none">• Camera power supply is input from AV control unit.• The image of vehicle rear view is transmitted to display unit via AV control unit.
Steering angle sensor	It is connected to the AV control unit and transmits the steering angle sensor signal via CAN communication.
Steering switch	<ul style="list-style-type: none">• Operations for audio, hands-free phone and voice recognition etc. are possible.• Steering switch signal (operation signal) is output to AV control unit.
Microphone (for TEL)	<ul style="list-style-type: none">• Used for hands-free phone and voice recognition operation.• Microphone signal is transmitted to TEL adapter unit.• Power (Microphone VCC) is supplied from TEL adapter unit.
Antenna amp.	<ul style="list-style-type: none">• Radio signal received by window antenna is amplified and transmitted to AV control unit.• Power (antenna amp. ON signal) is supplied from AV control unit.
Satellite radio tuner	<ul style="list-style-type: none">• Inputs the satellite radio signal from satellite radio antenna and outputs the sound signal to the AV control unit.• It is controlled with the AV control unit and serial communication (communication signal and request signal).
Satellite radio antenna	Satellite radio signal is received and transmitted to satellite radio tuner.
TEL adapter unit	<ul style="list-style-type: none">• Inputs the TEL voice signal from TEL antenna and outputs it to the AV control unit.• It is connected with the AV control unit via AV communication and controlled with the AV control unit.
TEL antenna	Receives the TEL voice signal and outputs it to the TEL adapter unit.
USB connector	Sound signal of USB input is transmitted to AV control unit.

SYSTEM
MULTI AV SYSTEM

MULTI AV SYSTEM : System Diagram

INFOID:000000005913132

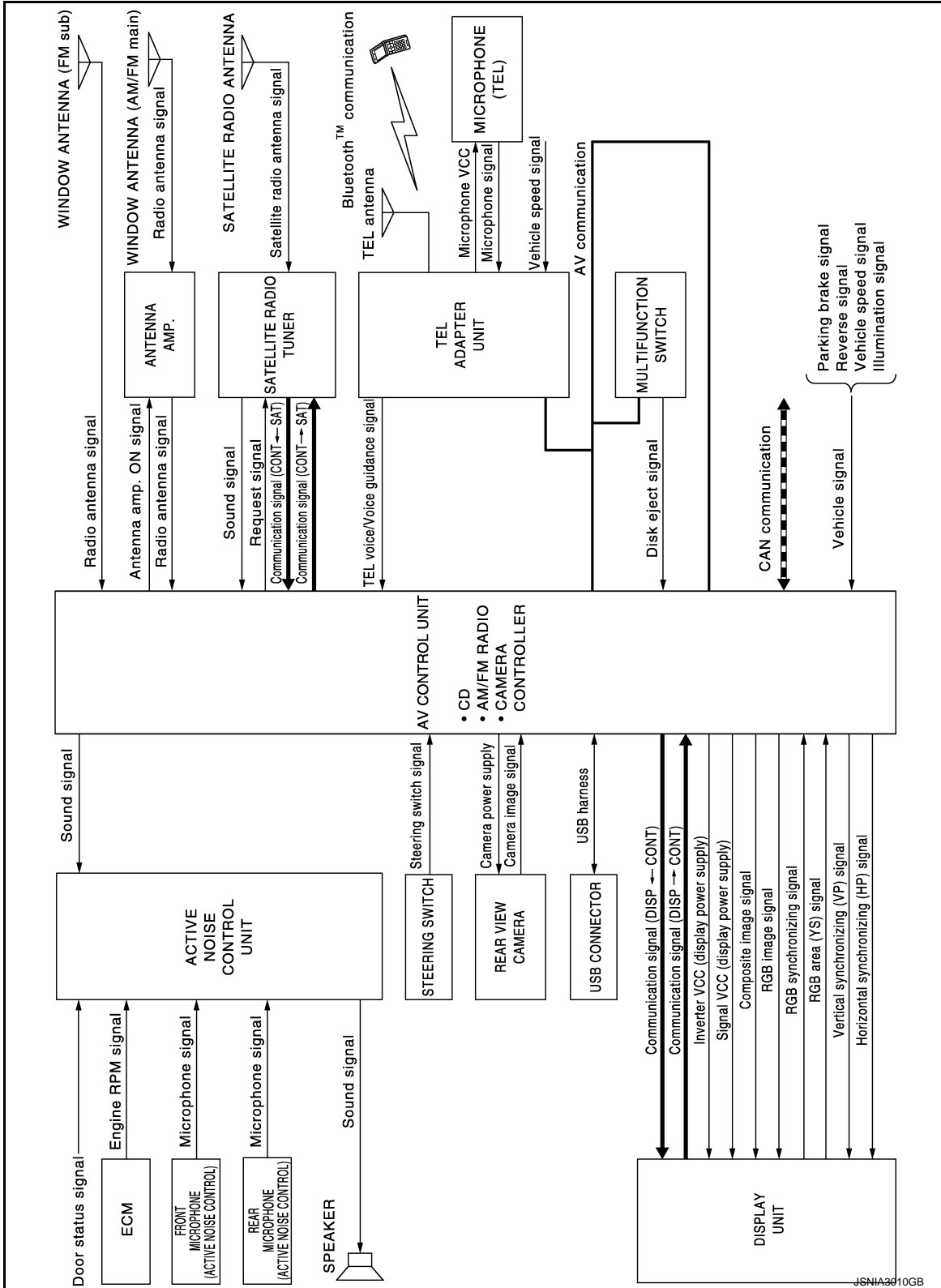

NOTE:

The name MULTIFUNCTION SWITCH indicates the integration of PRESET SWITCH and MULTIFUNCTION SWITCH virtually.

A
B
C
D
E
F
G
H
I
J
K
L
M
N
O
P

AV

MULTI AV SYSTEM : System Description

INFOID:000000005913133

Multi AV system means that the following systems are integrated.

FUNCTION NAME
Audio function
Hands-free phone function
Rear view monitor function
Vehicle information function

COMMUNICATION SIGNAL

- AV control unit function by transmitting/receiving data one by one with each unit (slave unit) that configures them completely as a master unit by connecting between units that configure MULTI AV system with two AV communication lines (H, L).
- Two AV communication lines (H, L) adopt a twisted pair line that is resistant to noise.
- The AV control unit is connected by CAN communication, and it receives data signal from ECM and combination meter. It computes and displays fuel economy information value with the obtained information.
- The AV control unit is connected with display unit and serial communication, and it transmits the required signal of display and display control and receives the response signal from display unit.
- The AV control unit is receives a steering angle signal from the steering angle sensor via CAN communication and controls an expected course line during rear view monitor operation.

AUDIO FUNCTION

The audio system is equipped with the following functions. Each function is operated with multifunction switch, preset switch or steering switch. Operation status of audio is indicated at display unit.

FUNCTION
AM/FM radio
Satellite radio
CD
USB connection function
Active noise control system

Operating Signal

Audio system operation can be performed with multifunction switch, preset switch or steering switch.

- Operating signal is transmitted to AV control unit with AV communication when it is operated by multifunction switch or preset switch. The disk ejection operating signal is performed by hardware.
- Operating signal is transmitted to AV control unit with steering switch signal when it is operated by steering switch.

Screen Display

- Switching of display is performed with serial communication between display unit and AV control unit.
- The image signal to display operating condition is performed with RGB image signal, RGB area signal and RGB image synchronizing signal.

AM/FM Radio Mode

- AM/FM radio tuner is built into AV control unit.
- Sound signals (AM/FM radio) are received via window antenna.
- AM/FM main antenna signal is amplified via antenna amp. and FM sub antenna signal is transmitted to AV control unit.
- AV control unit outputs sound signal is input to active noise control unit, and active noise control unit outputs to each speaker.

Satellite Radio Mode

- Satellite radio tuner is controlled by communication signal and request signal with AV control unit.
- Sound signal (satellite radio) is received by satellite radio antenna and transmitted to AV control unit via satellite radio tuner. AV control unit is output the sound signal (satellite radio) to active noise control unit.

CD Mode

SYSTEM

< SYSTEM DESCRIPTION >

[BASE AUDIO WITHOUT NAVIGATION]

- CD function is built into AV control unit.
- AV control unit outputs the sound signal to active noise control unit, and active noise control unit output the signal to each speaker during playback.

USB Connection Function

- Connecting iPod® or USB memory allows the driver to play iPod® music files or USB memory-stored music files.
- Sound signals of music files stored in iPod® or USB memory is transmitted from the USB connector to the AV control unit. The AV control unit transmits the sound signals to the each speaker via active noise control unit.
- iPod® is recharged when connected to USB connector.
- Only files that meet the following conditions will be played.

	Music file
File format	"MP3", "WMA"
File extension	".mp3", ".wma"
Maximum file size	2 GB

NOTE:

- iPod® is a trademark of Apple inc., registered in the U.S. and other countries.
- Image signals cannot be received from iPod® or USB memory.
- Use the enclosed USB harness when connecting iPod® to USB connector.

Active Noise Control System

- The active noise control system outputs an antiphase sound from the speakers (front door speaker and rear door speaker) against unpleasant engine booming noise (2nd and/or 3rd engine rev at 700 - 5000 rpm) and reduce sound pressure level by the interference with engine booming noise.
- The active noise control unit receives an engine speed signal from ECM and receives microphone signals from the front and rear microphone.
- The active noise control unit receives a door state signal. The active noise control system does not operate with any door open.
- Based on signals detected by the front and rear microphones, the active noise control unit generates an antiphase sound (microphone signal) weakening interior engine booming noise in real time according to a unique algorithm*1 by a micro computer built in the active noise control unit. Then, the active noise control unit mixes the antiphase sound with a sound signal received from the AV control unit to transmit the mixed sound signal to each speaker.

NOTE:

*1: Algorithm means a fixed procedure to solve a question.

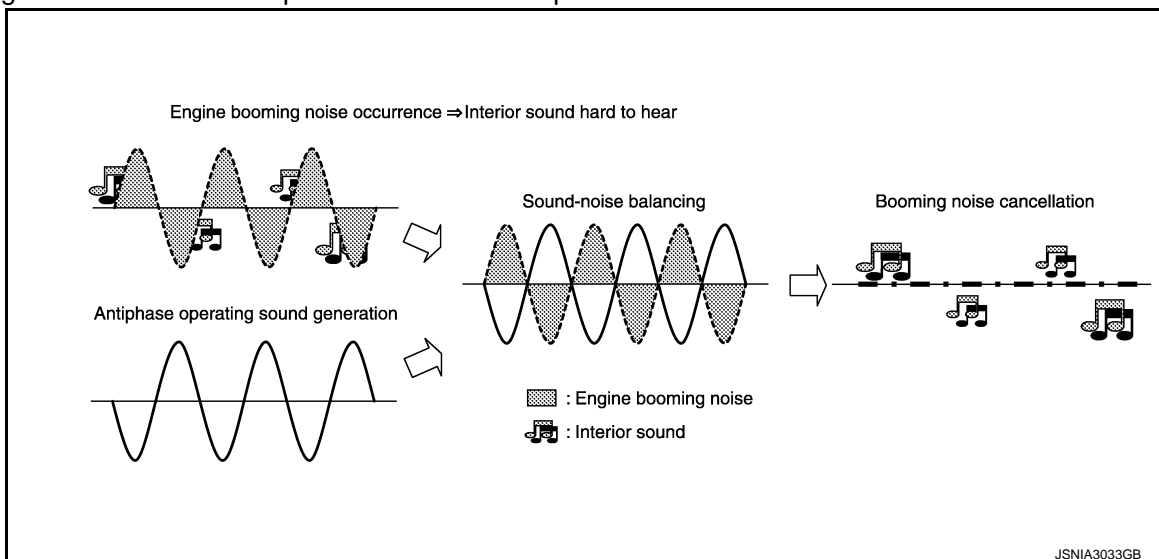

HANDS-FREE PHONE SYSTEM

- TEL adapter unit is controlled with AV communication from AV control unit.
- The connection between cellular phone and TEL adapter unit is performed with Bluetooth™ communication.

SYSTEM

< SYSTEM DESCRIPTION >

[BASE AUDIO WITHOUT NAVIGATION]

- The voice guidance signal is input from the TEL adapter unit to the AV control unit and output to the front speaker when operating the cellular phone.
- TEL adapter unit has the on board self-diagnosis function. Refer to [AV-31, "On Board Diagnosis Function"](#).

When A Call Is Originated

- Spoken voice sound output from the microphone (microphone signal) is input to TEL adapter unit.
- TEL adapter unit outputs to cellular phone with Bluetooth™ communication as a TEL voice signal.
- Voice sound is then heard at the other party.

When Receiving A Call

- Voice sound is input to own cellular phone from the other party.
- TEL voice signal is input to TEL adapter unit by establishing Bluetooth™ communication from cellular phone, and the signal is output to front speaker.

REAR VIEW MONITOR FUNCTION

- The AV control unit supplies power to the rear view camera when receiving a reverse signal.
- The rear view camera transmits camera images to the AV control unit when power is supplied from the AV control unit.
- The AV control unit transmits a warning message, fixed guide lines, and predictive course lines to the display unit by RGB image signal. Rear view monitor images are displayed by combining the RGB image signal and the camera image signals from the rear view camera.
- Predictive course lines are controlled by a steering angle sensor signal received the AV control unit via CAN communication.

VEHICLE INFORMATION FUNCTION

Status of audio, climate control system, fuel economy and maintenance etc. are displayed.

DIAGNOSIS SYSTEM (AV CONTROL UNIT)

< SYSTEM DESCRIPTION >

[BASE AUDIO WITHOUT NAVIGATION]

DIAGNOSIS SYSTEM (AV CONTROL UNIT)

Description

INFOID:000000005913134

- The AV control unit diagnosis function starts up with multifunction switch operation and the AV control unit performs a diagnosis for each unit in the system during the on board diagnosis.
- Perform a CONSULT-III diagnosis if the on board diagnosis does not start, e.g., the screen does not display anything, the multifunction switch does not function, etc.

On Board Diagnosis Function

INFOID:000000005913135

MULTIFUNCTION SWITCH AND PRESET SWITCH SELF-DIAGNOSIS FUNCTION

The ON/OFF operation (continuity) of each switch in the multifunction switch and preset switch can be checked.

Self-diagnosis Mode

- Press the "BACK" switch and the "UP" switch of the multifunction switches within 10 seconds after turning the ignition switch from OFF to ACC and hold them for 3 seconds or more. Then the buzzer sounds, all indicators of the multifunction switch and preset switch illuminate, and the self-diagnosis mode starts.
- The continuity of each switch at the ON position can be checked by pressing the switch. The buzzer sounds if the switch is normal.

NOTE:

The hazard switch and disk eject switch cannot be checked.

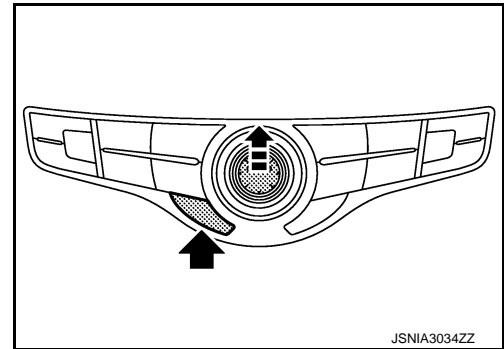

Finishing Self-diagnosis Mode

Self-diagnosis mode is canceled when turning the ignition switch OFF.

ON BOARD DIAGNOSIS ITEM

Description

- The trouble diagnosis function has a self-diagnosis mode for conducting trouble diagnosis automatically and a confirmation/adjustment mode for operating manually.
- Self-diagnosis mode performs the AV control unit diagnosis and the connection diagnosis between each of the units that make up the system, and it indicates the results to the display unit.
- The confirmation/adjustment mode allows the technician to check, modify or adjust the vehicle signals and set values, as well as to monitor the system error records and system communication status. The checking, modifying or adjusting generally require human intervention and judgment (the system cannot make judgment automatically).

On Board Diagnosis Item

Mode	Description
Self Diagnosis	<ul style="list-style-type: none">• AV control unit diagnosis.• Diagnoses the connections across system components, between AV control unit and each unit.

AV

DIAGNOSIS SYSTEM (AV CONTROL UNIT)

< SYSTEM DESCRIPTION >

[BASE AUDIO WITHOUT NAVIGATION]

	Mode	Description
Confirmation/ Adjustment	Display Diagnosis	The following check functions are available: color tone check by color spectrum bar display and white display, light and shade check by gradation bar display.
	Vehicle Signals	Diagnosis of signals can be performed for vehicle speed, parking brake, lights, ignition and reverse.
	Speaker Test	The connection of a speaker can be confirmed by test tone.
	Climate Control	Start auto air conditioner system self-diagnosis.
	Error History	The system malfunction and the frequency when occurring in the past are displayed. When the malfunctioning item is selected, the time and place that the selected malfunction last occurred are displayed.
	Camera Cont.	<ul style="list-style-type: none"> Guiding line position that overlaps rear view camera image can be adjusted. Configuration stored in the AV control unit can be checked.
	Vehicle CAN Diagnosis	The transmitting/receiving of CAN communication can be monitored.
	AV COMM Diagnosis	The communication condition of each unit of Multi AV system can be monitored.
	Delete Unit Connection Log	Erase the connection history of unit and error history.
	Initialize Settings	Initializes the AV control unit memory.

METHOD OF STARTING

1. Start the engine.
2. Turn the audio system OFF.
3. While pressing the "SETTING" button, turn the volume control dial clockwise or counterclockwise for 40 clicks or more. (When the self-diagnosis mode is started, a short beep will be heard.)
 - Shifting from current screen to previous screen is performed by pressing "BACK" button.

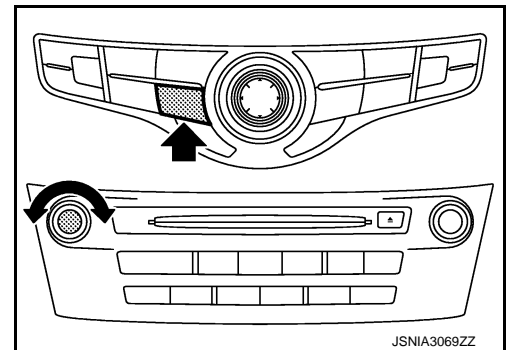

4. The trouble diagnosis initial screen is displayed, and then the items of "Self Diagnosis" and "Confirmation/Adjustment" can be selected.

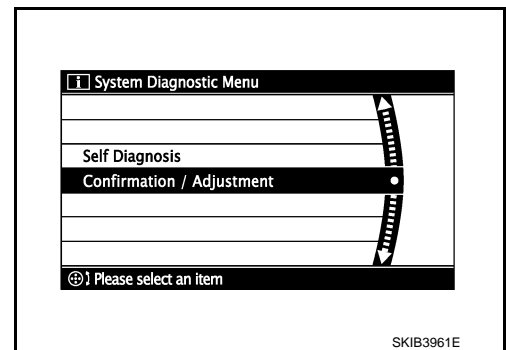

SELF-DIAGNOSIS MODE

1. Start the self-diagnosis function and select "Self Diagnosis".
 - Self-diagnosis subdivision screen is displayed, and the self-diagnosis mode starts.
 - The bar graph visible on the center of the self-diagnosis subdivision screen indicates progress of the trouble diagnosis.

DIAGNOSIS SYSTEM (AV CONTROL UNIT)

[BASE AUDIO WITHOUT NAVIGATION]

< SYSTEM DESCRIPTION >

2. Diagnosis results are displayed after the self-diagnosis is completed. The unit names and the connection lines are color-coded according to the diagnostic results.

Diagnosis results	Unit	Connection line
Normal	Green	Green
Connection malfunction	Gray	Yellow
Unit malfunction ^{Note}	Red	Green

NOTE:

Control unit (AV control unit) is displayed in red.

- Replace AV control unit if "Self-Diagnosis did not run because of a control unit malfunction" is indicated. The symptom is AV control unit internal error. Refer to [AV-120, "Removal and Installation"](#).
- If multiple errors occur at the same time for a single unit, the screen switch colors are determined according to the following order of priority: red > gray.

- The comments of the self-diagnosis results can be viewed with a component in the diagnosis result screen.

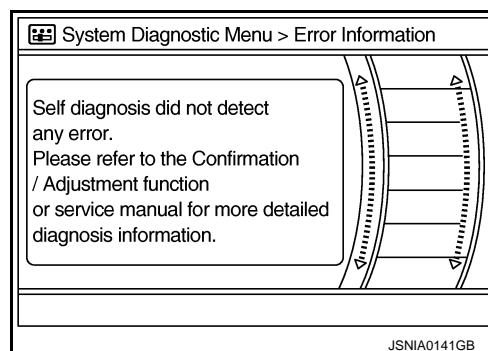
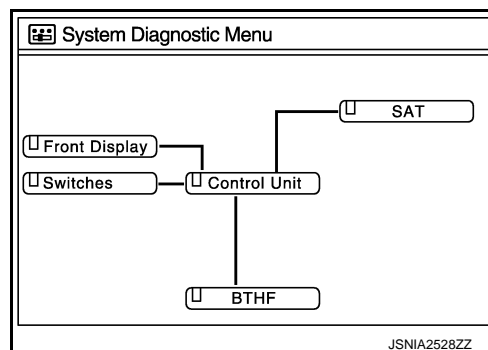

Detection Range of Self-diagnosis Mode

- The self-diagnosis mode allows the technician to diagnose the connection in the communication line between AV control unit and each unit and the internal operation of the AV control unit.
- Because the start condition of diagnosis function is a switch operation, the on board diagnosis function cannot be started up if any malfunction is detected in the communication circuit between AV control unit and multifunction switch.

SELF-DIAGNOSIS RESULTS

Check the applicable display at the following table, and then repair the malfunctioning parts.

Only Unit Part Is Displayed In Red.

Screen switch	Description	Possible malfunction location / Action to take
Control unit	Malfunction is detected in AV control unit power supply and ground circuits.	Check AV control unit power supply and ground circuits. Refer to AV-90, "AV CONTROL UNIT : Diagnosis Procedure" . When detecting no malfunction in those components, replace AV control unit. Refer to AV-120, "Removal and Installation" .

A Connecting Cable Between Units Is Displayed In Yellow.

DIAGNOSIS SYSTEM (AV CONTROL UNIT)

< SYSTEM DESCRIPTION >

[BASE AUDIO WITHOUT NAVIGATION]

Area with yellow connection lines	Description	Possible malfunction location / Action to take
Control unit ↔ Front Display	Malfunction is detected in serial communication circuits between AV control unit and display unit.	Serial communication circuits between AV control unit and display unit.
Control unit ↔ SAT	When either one of the following items is detected: <ul style="list-style-type: none"> satellite radio tuner power supply and ground circuit are malfunctioning. communication circuits between AV control unit and satellite radio tuner are malfunctioning. request signal circuit between AV control unit and satellite radio tuner are malfunctioning. 	<ul style="list-style-type: none"> Satellite radio tuner power supply and ground circuit. Refer to AV-92, "SATELLITE RADIO TUNER : Diagnosis Procedure". Communication circuit between AV control unit and satellite radio tuner. Request signal circuit between AV control unit and satellite radio tuner.
Control unit ↔ BTHF	When either one of the following items is detected: <ul style="list-style-type: none"> TEL adapter unit power supply and ground circuits are malfunctioning. AV communication circuits between AV control unit and TEL adapter unit are malfunctioning. 	<ul style="list-style-type: none"> TEL adapter unit power supply and ground circuits. Refer to AV-93, "TEL ADAPTER UNIT : Diagnosis Procedure". AV communication circuits between AV control unit and TEL adapter unit.

CONFIRMATION/ADJUSTMENT MODE

1. Start the diagnosis function and select "Confirmation/Adjustment". The confirmation/adjustment mode indicates where each item can be checked or adjusted.
2. Select each switch on the "Confirmation/Adjustment Mode" screen to display the relevant trouble diagnosis screen. Press the "BACK" switch to return to the initial Confirmation/Adjustment Mode screen.

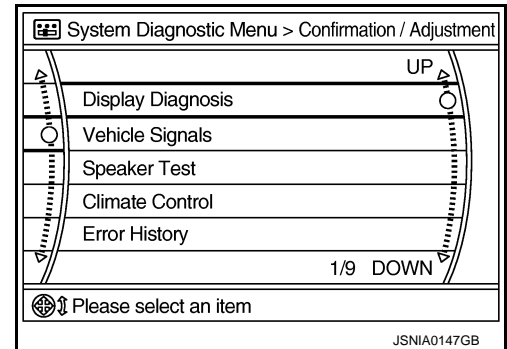

DIAGNOSIS SYSTEM (AV CONTROL UNIT)

< SYSTEM DESCRIPTION >

[BASE AUDIO WITHOUT NAVIGATION]

Display Diagnosis

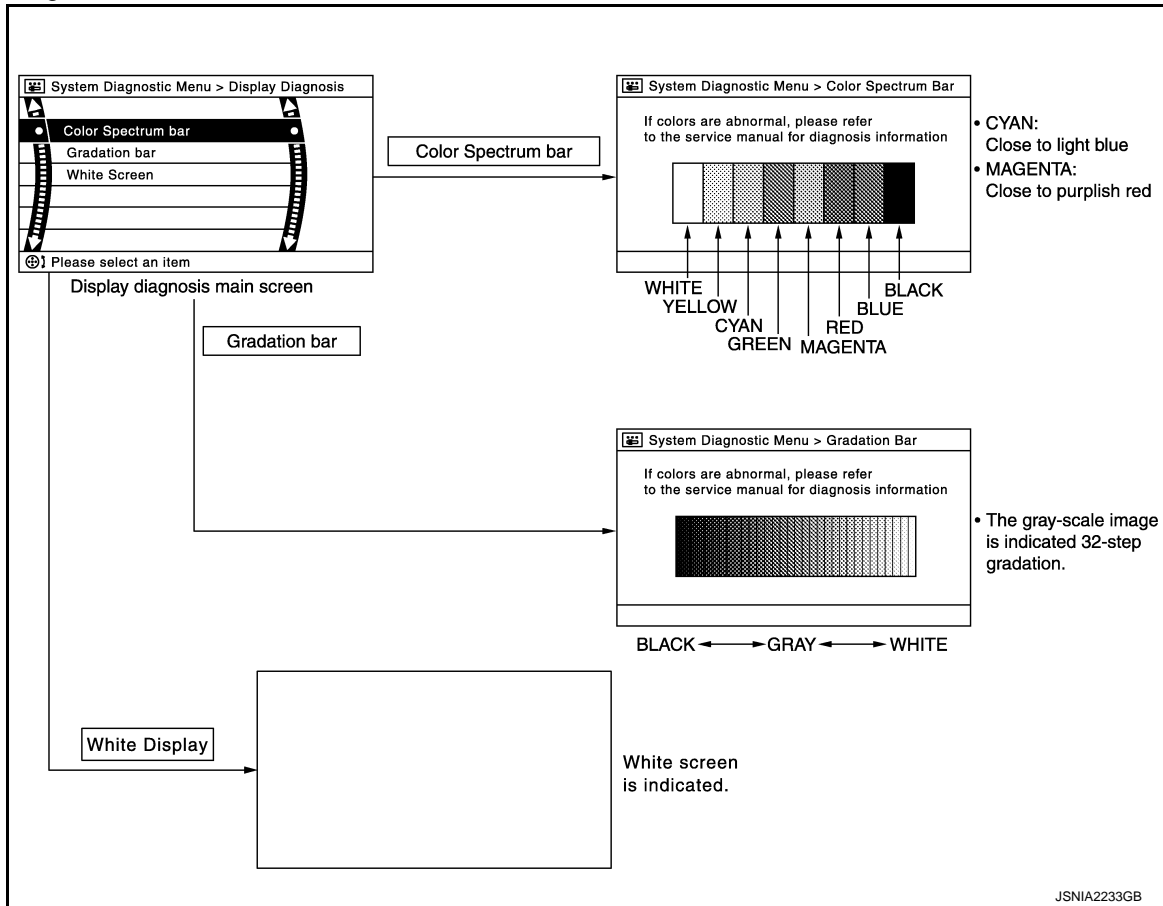

Vehicle Signals

A comparison check can be made of each actual vehicle signal and the signals recognized by the system.

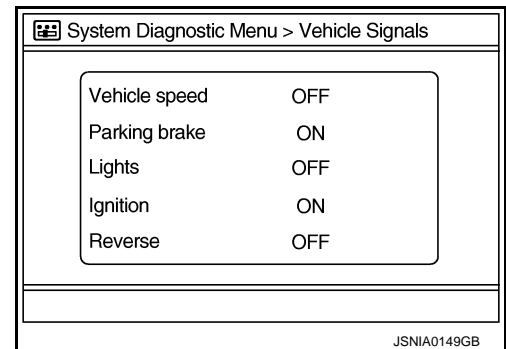

Diagnosis item	Display	Vehicle status	Remarks
Vehicle speed	ON	Vehicle speed > 0 km/h (0 MPH)	Changes in indication may be delayed. This is normal.
	OFF	Vehicle speed = 0 km/h (0 MPH)	
Parking brake	ON	Parking brake is applied.	
	OFF	Parking brake is released.	
Lights	ON	Light switch ON	—
	OFF	Light switch OFF	—
Ignition	ON	Ignition switch ON	—
	OFF	Ignition switch in ACC position	—

DIAGNOSIS SYSTEM (AV CONTROL UNIT)

< SYSTEM DESCRIPTION >

[BASE AUDIO WITHOUT NAVIGATION]

Diagnosis item	Display	Vehicle status	Remarks
Reverse	ON	Shift the selector lever to "R" position	Changes in indication may be delayed. This is normal.
	OFF	Shift the selector lever other than "R" position	

Speaker Test

Select "Speaker Test" to display the Speaker Diagnosis screen. Press "Start" to generate a test tone in a speaker. Press "Start" again to generate a test tone in the next speaker. Press "End" to stop the test tones.

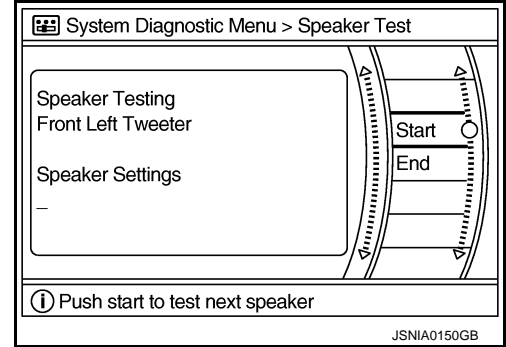

Climate Control

Refer to "HEATER & AIR CONDITIONING CONTROL SYSTEM" for details.

Error History

The self-diagnosis results are judged depending on whether any error occurs from when "Self-diagnosis" is selected until the self-diagnosis results are displayed.

However, the diagnosis results are judged normal if an error has occurred before the ignition switch is turned ON and then no error has occurred until the self-diagnosis start. Check the "Error Record" to detect any error that may have occurred before the self-diagnosis start because of this situation.

The frequency of occurrence is displayed in a count up manner. The actual count up method differs depending on the error item.

Count up method A

- The counter resets to 0 if an error occurs when ignition switch is turned ON. The counter increases by 1 if the condition is normal at a next ignition ON cycle.
- The counter upper limit is 39. Any counts exceeding 39 are ignored. The counter can be reset (no error record display) with the "Delete log" switch or CONSULT-III.

Count up method B

- The counter increases by 1 if an error occurs when ignition switch is ON. The counter will not decrease even if the condition is normal at the next ignition ON cycle.
- The counter upper limit is 50. Any counts exceeding 50 are ignored. The counter can be reset (no error record display) with the "Delete log" switch or CONSULT-III.

Display type of occurrence frequency	Error history display item
Count up method A	CAN communication line, control unit (CAN), AV communication line, control unit (AV)
Count up method B	Other than the above

DIAGNOSIS SYSTEM (AV CONTROL UNIT)

< SYSTEM DESCRIPTION >

[BASE AUDIO WITHOUT NAVIGATION]

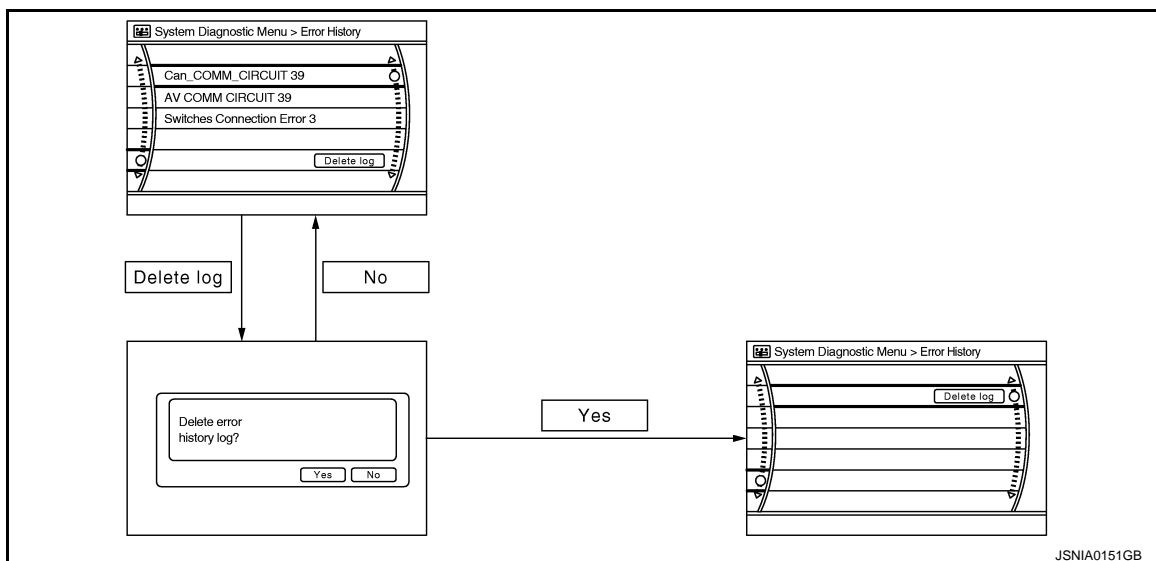

Error item

Some error items may be displayed simultaneously according to the cause. If some error items are displayed simultaneously, the detection of the cause can be performed by the combination of display items

Error item	Description	Possible malfunction factor/Action to take
CAN COMM CIRCUIT	CAN communication malfunction is detected.	Perform diagnosis with CONSULT-III, and then repair the malfunctioning parts according to the diagnosis results. Refer to AV-26, "CONSULT - III Function" .
CONTROL UNIT (CAN)	CAN initial diagnosis malfunction is detected.	Replace the AV control unit if the malfunction occurs constantly. Refer to AV-120, "Removal and Installation" .
CONTROL UNIT (AV)	AV communication circuit initial diagnosis malfunction is detected.	
FLASH-ROM Error Of Control Unit CAN Controller Memory Error	AV control unit malfunction is detected.	
Steer. Angle Sensor Calibration	Predictive course line center position adjustment of the steering angle sensor is incomplete.	Adjust the predictive course line center position of the steering angle sensor. Refer to BRC-68, "Work Procedure" .
Front Display Connection Error	When either one of the following items is detected: <ul style="list-style-type: none"> display unit power supply and ground circuits are malfunctioning. communication circuits between AV control unit and display unit are malfunctioning. 	<ul style="list-style-type: none"> Display unit power supply and ground circuits. Refer to AV-90, "DISPLAY UNIT : Diagnosis Procedure". Communication circuits between AV control unit and display unit.
XM Connection Error	When either one of the following items is detected: <ul style="list-style-type: none"> satellite radio tuner power supply and ground circuit are malfunctioning. communication circuits between AV control unit and satellite radio tuner are malfunctioning. request signal circuit between AV control unit and satellite radio tuner are malfunctioning. 	<ul style="list-style-type: none"> Satellite radio tuner power supply and ground circuit. Refer to AV-92, "SATELLITE RADIO TUNER : Diagnosis Procedure". Communication circuit between AV control unit and satellite radio tuner. Request signal circuit between AV control unit and satellite radio tuner.
<ul style="list-style-type: none"> AV COMM CIRCUIT Switches Connection Error 	When either one of the following items is detected: <ul style="list-style-type: none"> multifunction switch power supply and ground circuits are malfunctioning. AV communication circuits between AV control unit and multifunction switch are malfunctioning. 	<ul style="list-style-type: none"> Multifunction switch power supply and ground circuits. AV communication circuits between AV control unit and multifunction switch.

A
B
C
D
E
F
G
H
I
J
K
L
M

AV

O
P

DIAGNOSIS SYSTEM (AV CONTROL UNIT)

[BASE AUDIO WITHOUT NAVIGATION]

< SYSTEM DESCRIPTION >

Error item	Description	Possible malfunction factor/Action to take
<ul style="list-style-type: none"> AV COMM CIRCUIT H/F Unit Connection Error 	When either one of the following items is detected: <ul style="list-style-type: none"> TEL adapter unit power supply and ground circuits are malfunctioning. AV communication circuits between AV control unit and TEL adapter unit are malfunctioning. 	<ul style="list-style-type: none"> TEL adapter unit power supply and ground circuits. Refer to AV-93, "TEL ADAPTER UNIT : Diagnosis Procedure". AV communication circuits between AV control unit and TEL adapter unit.
<ul style="list-style-type: none"> AV COMM CIRCUIT Switches Connection Error H/F Unit Connection Error 	Malfunction is detected in AV communication circuits between AV control unit and multifunction switch are malfunctioning.	AV communication circuits between AV control unit and multifunction switch.

Camera Cont.

The two functions of "Correct Draw Line of Rear view Cam", "Confirm Configuration" are available.

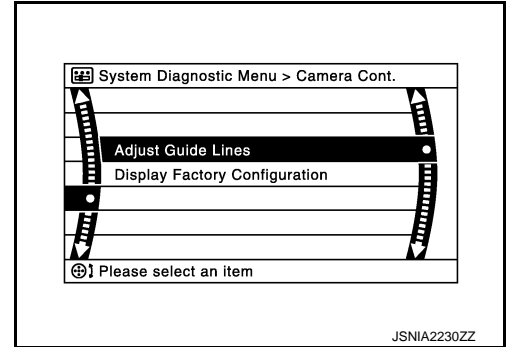

Adjust Offset of Rear view Camera

- Use this mode to adjust the guide line display position of the rear view monitor if necessary after removing the rear view monitor camera.

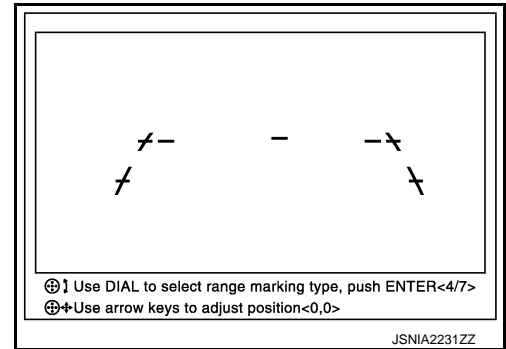

Factory Configuration Confirmation

- Configuration stored in the AV control unit can be checked.

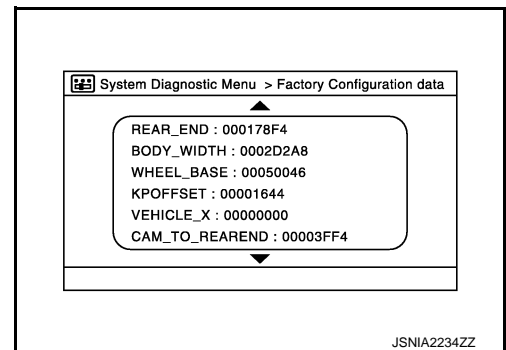

Vehicle CAN Diagnosis

DIAGNOSIS SYSTEM (AV CONTROL UNIT)

[BASE AUDIO WITHOUT NAVIGATION]

< SYSTEM DESCRIPTION >

- CAN communication status and error counter is displayed.
- The error counter displays “OK” if any malfunction was not detected in the past and displays “0” if a malfunction is detected. It increases by 1 if the condition is normal at the next ignition switch ON cycle. The upper limit of the counter is 39.
- The error counter is erased if “Reset” is pressed.

Items	Display (Current)	Malfunction counter (Past)
Tx(HVAC)	OK / ???	OK / 0 – 39
Rx(ECM)	OK / ???	OK / 0 – 39
Rx(Cluster)	OK / ???	OK / 0 – 39
Rx(BCM)	OK / ???	OK / 0 – 39
Rx(HVAC)	OK / ???	OK / 0 – 39
Rx(USM)	OK / ???	OK / 0 – 39
Rx(VDC)	OK / ???	OK / 0 – 39
Rx(STRG)	OK / ???	OK / 0 – 39

NOTE:

“???” indicates UNKWN.

AV COMM Diagnosis

- Displays the communication status between AV control unit (master unit) and each unit.
- The error counter displays “OK” if any malfunction was not detected in the past and displays “0” if a malfunction is detected. It increases by 1 if the condition is normal at the next ignition switch ON cycle. The upper limit of the counter is 39.
- The error counter is erased if “Reset” is pressed.

Items	Status (Current)	Counter (Past)
C Tx(ITM-SW)	OK / ???	OK / 0 – 39
C Rx(PrimarySW-ITM)	OK / ???	OK / 0 – 39
C Rx(BTHF-ITM)	OK / ???	OK / 0 – 39

NOTE:

“???” indicates UNKWN.

Delete Unit Connection Log

Deletes any unit connection records and error records from the AV control unit memory. (Clear the records of the unit that has been removed.)

Initialize Settings

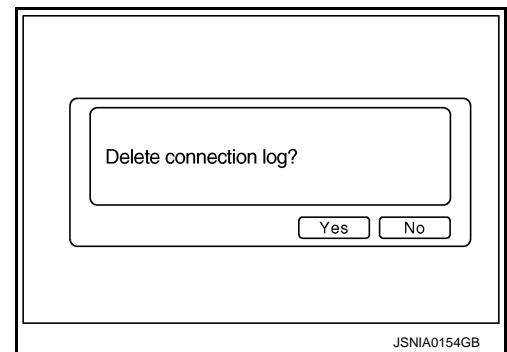
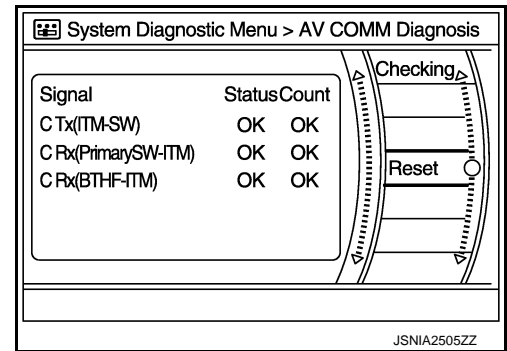
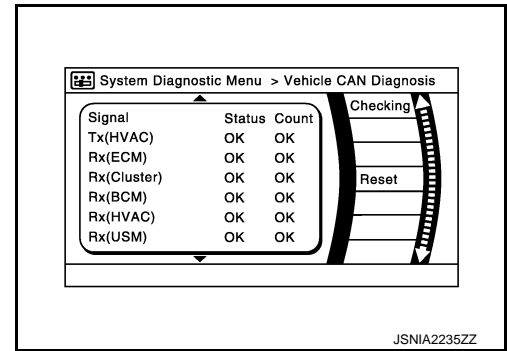

A
B
C
D
E
F
G
H
I
J
K
L
M
AV
O
P

DIAGNOSIS SYSTEM (AV CONTROL UNIT)

< SYSTEM DESCRIPTION >

[BASE AUDIO WITHOUT NAVIGATION]

“User Data Initialization” and “Accessory Number Initialization” are possible.

CAUTION:

- Never perform Accessory Number Initialization except when configuration is unsuccessful.
- Accessory Number Initialization requires configuration. For details, refer to [AV-77, "Description"](#).

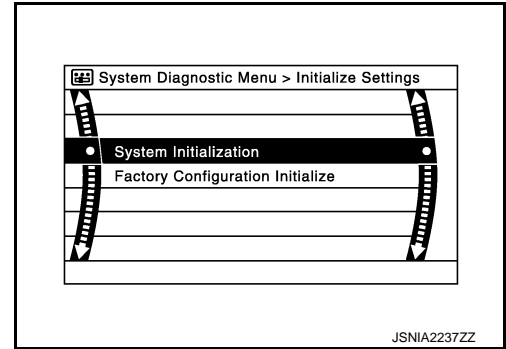

JSNIA2237ZZ

CONSULT - III Function

INFOID:000000005913136

CONSULT-III FUNCTIONS

CONSULT-III performs the following functions via the communication with the AV control unit.

Diagnosis mode	Description
Ecu Identification	The part number of AV control unit can be checked.
Self Diagnostic Result	Performs a diagnosis on the AV control unit and a connection diagnosis for the communication circuit of the Multi AV system, and displays the current and past malfunctions collectively.
Data Monitor	The diagnosis of vehicle signal that is input to the AV control unit can be performed.
Work Support	Steering angle sensor can be adjusted.
Configuration	<ul style="list-style-type: none"> • Read and save the vehicle specification. • Write the vehicle specification when replacing AV control unit.

AV Communication

When “AV communication” of “CAN Diag Support Monitor” is selected, the following function will be performed.

AV communication	AV&NAVI C/U	Displays the communication status from AV control unit to each unit as well as the error counter.
	AUDIO	Displays the AV control unit communication status and the error counter.

ECU IDENTIFICATION

The part number of AV control unit is displayed.

SELF DIAGNOSIS RESULT

- In CONSULT-III self-diagnosis, self-diagnosis results and error history are displayed collectively.
- The current malfunction indicates “CRNT”. The past malfunction indicates “PAST”.
- The timing is displayed as “0” if any of the error codes [U1000], [U1010], [U1300] and [U1310] is detected. The counter increases by 1 if the condition is normal at the next ignition switch ON cycle.

Self-diagnosis Results Display Item

Error item	Description	Possible malfunction factor/Action to take
CAN COMM CIRCUIT [U1000]	CAN communication malfunction is detected.	Refer to AV-79, "Diagnosis Procedure" .
CONTROL UNIT (CAN) [U1010]	CAN initial diagnosis malfunction is detected.	Replace the AV control unit if the malfunction occurs constantly. Refer to AV-120, "Removal and Installation" .
CONTROL UNIT (AV) [U1310]	AV communication circuit initial diagnosis malfunction is detected.	
Cont Unit [U1200] CAN CONT [U1216]	AV control unit malfunction is detected.	
ST ANGLE SEN CALIB [U1232]	Predictive course line center position adjustment of the steering angle sensor is incomplete.	Adjust the predictive course line center position of the steering angle sensor. Refer to BRC-68, "Work Procedure" .

DIAGNOSIS SYSTEM (AV CONTROL UNIT)

< SYSTEM DESCRIPTION >

[BASE AUDIO WITHOUT NAVIGATION]

Error item	Description	Possible malfunction factor/Action to take
FRONT DISP CONN [U1243]	When either one of the following items is detected: <ul style="list-style-type: none"> display unit power supply and ground circuits are malfunctioning. communication circuits between AV control unit and display unit are malfunctioning. 	<ul style="list-style-type: none"> Display unit power supply and ground circuits. Refer to AV-90. "DISPLAY UNIT : Diagnosis Procedure". Communication circuits between AV control unit and display unit.
SAT CONN [U1255]	When either one of the following items is detected: <ul style="list-style-type: none"> satellite radio tuner power supply and ground circuit are malfunctioning. communication circuits between AV control unit and satellite radio tuner are malfunctioning. request signal circuit between AV control unit and satellite radio tuner are malfunctioning. 	<ul style="list-style-type: none"> Satellite radio tuner power supply and ground circuit. Refer to AV-92. "SATELLITE RADIO TUNER : Diagnosis Procedure". Communication circuit between AV control unit and satellite radio tuner. Request signal circuit between AV control unit and satellite radio tuner.
<ul style="list-style-type: none"> AV COMM CIRCUIT [U1300] SWITCH CONN [U1240] 	When either one of the following items is detected: <ul style="list-style-type: none"> multifunction switch power supply and ground circuits are malfunctioning. AV communication circuits between AV control unit and multifunction switch are malfunctioning. 	<ul style="list-style-type: none"> Multifunction switch power supply and ground circuits. AV communication circuits between AV control unit and multifunction switch.
<ul style="list-style-type: none"> AV COMM CIRCUIT [U1300] HAND FREE CONN [U1256] 	When either one of the following items is detected: <ul style="list-style-type: none"> TEL adapter unit power supply and ground circuits are malfunctioning. AV communication circuits between AV control unit and TEL adapter unit are malfunctioning. 	<ul style="list-style-type: none"> TEL adapter unit power supply and ground circuits. Refer to AV-93. "TEL ADAPTER UNIT : Diagnosis Procedure". AV communication circuits between AV control unit and TEL adapter unit.
<ul style="list-style-type: none"> AV COMM CIRCUIT [U1300] SWITCH CONN [U1240] HAND FREE CONN [U1256] 	Malfunction is detected in AV communication circuits between AV control unit and multifunction switch.	AV communication circuits between AV control unit and multifunction switch.

DATA MONITOR

ALL SIGNALS

- Displays the status of the following vehicle signals inputted into the AV control unit.
- For each signal, actual signal can be compared with the condition recognized on the system.

Display Item	Display	Vehicle status	Remarks	
VHCL SPD SIG	On	Vehicle speed > 0 km/h (0 MPH)	Changes in indication may be delayed. This is normal.	
	Off	Vehicle speed = 0 km/h (0 MPH)		
PKB SIG	On	Parking brake is applied.		
	Off	Parking brake is released.		
ILLUM SIG	On	Block the light beam from the auto light optical sensor when the light SW is ON.	—	
	Off	Expose the auto light optical sensor to light when the light SW is OFF or ON.		
IGN SIG	On	Ignition switch ON		
	Off	Ignition switch in ACC position		
REV SIG	On	Selector lever in R position		Changes in indication may be delayed. This is normal.
	Off	Selector lever in any position other than R		

DIAGNOSIS SYSTEM (AV CONTROL UNIT)

< SYSTEM DESCRIPTION >

[BASE AUDIO WITHOUT NAVIGATION]

SELECTION FROM MENU

Allows the technician to select which vehicle signals should be displayed and displays the status of the selected vehicle signals.

Item to be selected	Description
VHCL SPD SIG	The same as when "ALL SIGNALS" is selected.
PKB SIG	
ILLUM SIG	
IGN SIG	
REV SIG	

WORK SUPPORT

Adjusts the neutral position of the steering angle sensor.

CAUTION:

For vehicles with VDC, adjust the steering angle sensor neutral position on the ABS actuator control unit side. Refer to [BRC-68, "Work Procedure"](#).

Item	Description
ST ANGLE SENSOR ADJUSTMENT	Adjusts the neutral position of the steering angle sensor.

CONFIGURATION

Configuration has three functions as follows.

Function	Description
READ CONFIGURATION	<ul style="list-style-type: none">• Reads the vehicle configuration of current AV control unit.• Saves the read vehicle configuration.
WRITE CONFIGURATION-Manual selection	Writes the vehicle configuration with manual selection.
WRITE CONFIGURATION-Config file	Writes the vehicle configuration with saved data.

DIAGNOSIS SYSTEM (ACTIVE NOISE CONTROL UNIT)

< SYSTEM DESCRIPTION >

[BASE AUDIO WITHOUT NAVIGATION]

DIAGNOSIS SYSTEM (ACTIVE NOISE CONTROL UNIT)

On Board Diagnosis Function

INFOID:000000006014944

ON BOARD DIAGNOSIS ITEM

Starting with the operation of the door switch, the Self-diagnosis function allows the diagnoses of the active noise control unit internal circuit, the input state of each signal, and a microphone connection state. The diagnosis results are indicated by a sound.

METHOD OF STARTING

A

B

C

D

E

F

G

H

I

J

K

L

M

AV

O

P

DIAGNOSIS SYSTEM (ACTIVE NOISE CONTROL UNIT)

[BASE AUDIO WITHOUT NAVIGATION]

< SYSTEM DESCRIPTION >

Perform Self-diagnosis, according to the following steps:

Step	Check item	Operation	Judgment	Output sound pattern (0.5 to 4.5 sec)	Next Step	Remarks
-	Preparation	Turn on the radio to check that the speakers are normal.	-		1	All self-diagnosis results are notified by the output sound from the speaker.
1	Self-diagnosis mode startup	Within 5 seconds after starting the engine with all doors closed, press the driver seat door switch 6 times or more during a time interval of 4 seconds.	-		2	Specifically, within 5 seconds after turning the ignition switch to ACC, the self-diagnosis mode starts. The self-diagnosis mode starts to ACC. Self-diagnosis can be activated by turning the ignition switch to ACC without starting the engine. In this case, the judgment performed at Step 2 becomes NG because engine speed cannot be detected.
2	Diagnoses of engine speed signal and the microphone for active noise control system	Identify a sound heard after the notification sound (Step 1).	OK NG	OK: After the end of the last beep of the triple short beeps heard in Step 1, silence follows for approx. 1 second and a sound is heard according to a check result (Step 3) of the number of cylinders. NG: After the end of the last beep of the triple short beeps heard in Step 1, silence follows for approx. 1 second and a sound is heard according to a check result (Step 3) of the number of cylinders.	3	* If NG, a beep is heard for 30 seconds after 10-second-silence.
3	Checking the judgment of the number of cylinders	Identify a sound (Step 2).	6-cylinder engine 8-cylinder engine	x MAX 40 cycles x MAX 40 cycles	4	A beep sounds for 60 seconds at maximum in either case (1 cycle for approx. 1.5 sec. x 40 cycles)
4	(Interruption of cylinder judge result notification sound)	Press the door switch 6 times or more during a time interval of 4 seconds.	-	1 cycle only	5	The same sound is heard after a lapse of 60 seconds without pressing the door switch. (1 cycle only)
5	Sample sound for the active noise control system	Identify a sound heard after the notification sound (Step 3).	-		6	A sample sound (beats) for 20 seconds at maximum is emitted. (1 cycle for approx. 4 seconds x 5 cycles)
6	End of self-diagnosis	Press the door switch 6 times or more during a time interval of 4 seconds while a prolonged sound is ringing. Wait for 20 seconds until the sound stops.	-	1 cycle only	End of diagnosis	After the completion of self-diagnosis, the active noise control system starts normal operation. (1 cycle only)
7	Start of malfunctioning part judgment (1) or end of self-diagnosis (2)	(1) Within 30 seconds while the prolonged sound is ringing (Step 2), press the door switch 6 times or more during a time interval of 4 seconds. (2) Wait for 30 seconds until the prolonged sound stops.	-	1 cycle only	8	After the completion of self-diagnosis, the active noise control system starts normal operation. (1 cycle only)
8	Active noise control system microphone check	Identify the sound pattern.	Front microphone: OK Rear microphone: OK Front microphone: NG Rear microphone: OK Front microphone: OK Rear microphone: NG Front microphone: NG Rear microphone: NG	x MAX 4 cycles x MAX 4 cycles x MAX 4 cycles x MAX 4 cycles x MAX 4 cycles	9	A beep sounds for 60 seconds at maximum in either case (1 cycle for approx. 4.25 sec. x 14 cycles)
9	Start of self-diagnosis for malfunctioning part judgment (2) or end of self-diagnosis (3)	(1) Within 60 seconds while the prolonged sound is ringing, press the door switch 6 times or more during a time interval of 4 seconds. (2) Wait for 60 seconds until the prolonged sound stops.	-	1 cycle only	10	After the completion of self-diagnosis, the active noise control system starts normal operation. (1 cycle only)
10	Engine speed signal check	Identify the sound pattern.	OK NG	x MAX 60 cycles	11	A beep sounds for 60 seconds at maximum in either case (1 cycle for approx. 0.75 sec. x 80 cycles)
11	End of self-diagnosis	Press the door switch 6 times or more during a time interval of 4 seconds. Wait for 60 seconds until the prolonged sound stops.	-	1 cycle only	End of diagnosis	After the completion of self-diagnosis, the active noise control system starts normal operation. (1 cycle only)

JSNIA3066GB

- When a sound is not outputted from the speakers as a result of the preparation, check the AV control unit, active noise control unit, connector connections, or speakers.
- When Self-diagnosis mode does not start at Step 1, check the door state signal circuit.
- When a malfunction is detected in the microphone at Step 8, check the signal circuit of each microphone.
- When an error is detected in an engine speed signal at Step 10, check the engine speed signal circuit.

DIAGNOSIS SYSTEM (TEL ADAPTER UNIT)

< SYSTEM DESCRIPTION >

[BASE AUDIO WITHOUT NAVIGATION]

DIAGNOSIS SYSTEM (TEL ADAPTER UNIT)

On Board Diagnosis Function

INFOID:000000005913137

HANDS-FREE PHONE SYSTEM ON BOARD DIAGNOSIS

During on board diagnosis the diagnosis function of TEL adapter unit starts with the operation of the steering switch and performs the diagnosis when ignition switch ACC.

ON BOARD DIAGNOSIS ITEM

The on board diagnosis has 3 modes: the self-diagnosis mode that performs the trouble diagnosis, the speaker adaptation data deleting mode and the hands-free phone system initialization mode.

CAUTION:

- Perform the diagnosis with the vehicle stopped.
- Perform STEP2 if necessary.

STEP	MODE	Description
STEP1	Self-diagnosis	The self-diagnosis mode performs the microphone test and the diagnosis of TEL adapter unit, TEL antenna and steering unit, and then reads out the results with the sound and indicates them on the display.
STEP2	Speaker adaptation data deleting	The speaker adaptation data deleting mode can delete the speaker adaptation data.
	Hands-free phone system initialization	Hands-free phone system initialization mode can perform the initialization of hands-free phone system.

Self-diagnosis results

Self-diagnosis mode reads out the self-diagnosis results.

NOTE:

- Error count is read out simultaneously when reading out the DTC name.
- The errors are read out continuously when some errors occur at the same time.

Self-diagnosis results

DTC	DTC name	Possible causes
DTC 10000	INTERNAL FAILURE	TEL adapter unit
DTC 01000	ANT. SHORT TO BATT OR OPEN	TEL antenna
DTC 00100	ANT. SHORT TO GROUND	
DTC 00010	STEERING REMOTE BUTTON STUCK A	Steering switch
DTC 00001	STEERING REMOTE BUTTON STUCK B	
DTC 00000	THERE ARE NO FAILURE RECORDS TO REPORT	—

The Details of Error Count

The error count guides "0" when the error occurs. The next time it counts up "1" if it is normal with the ignition switch ON. It continues the count up unless the initialization of hands-free phone system is performed.

A
B
C
D
E
F
G
H
I
J
K
L
M
N
O
P

AV

DIAGNOSIS SYSTEM (TEL ADAPTER UNIT)

< SYSTEM DESCRIPTION >

[BASE AUDIO WITHOUT NAVIGATION]

FLOW CHART OF TROUBLE DIAGNOSIS

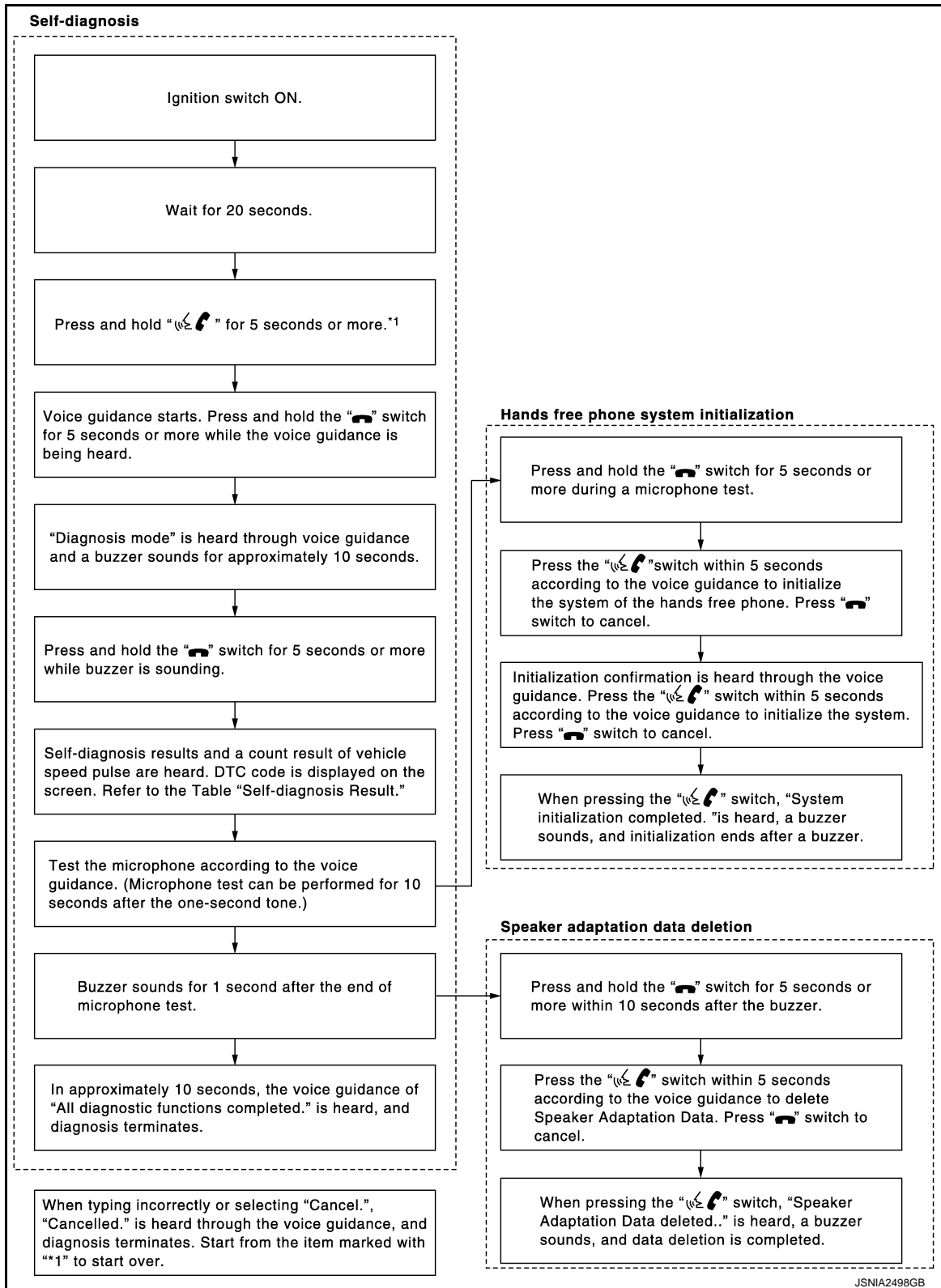

AV CONTROL UNIT

< ECU DIAGNOSIS INFORMATION >

[BASE AUDIO WITHOUT NAVIGATION]

ECU DIAGNOSIS INFORMATION

AV CONTROL UNIT

Reference Value

INFOID:000000005913138

VALUES ON THE DIAGNOSIS TOOL

CONSULT-III MONITOR ITEM

Monitor Item	Condition	Value/Status
VHCL SPD SIG	Ignition switch ON Vehicle speed > 0 km/h (0 MPH)	On
	Vehicle speed = 0 km/h (0 MPH)	Off
PKB SIG	Ignition switch ON Parking brake is applied.	On
	Parking brake is released.	Off
ILLUM SIG	Ignition switch ON Light switch ON	On
	Light switch OFF	Off
IGN SIG	Ignition switch ON —	On
	Ignition switch ACC —	Off
REV SIG	Ignition switch ON Selector lever in R position	On
	Selector lever in any position other than R	Off

TERMINAL LAYOUT

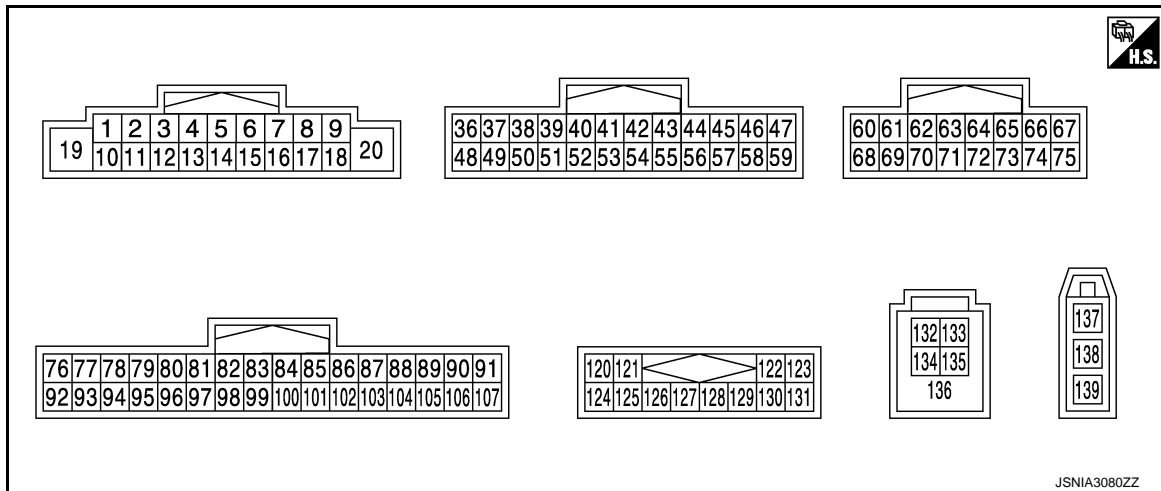

PHYSICAL VALUES



A
B
C
D
E
F
G
H
I
J
K
L
M
O
P

AV

AV CONTROL UNIT

< ECU DIAGNOSIS INFORMATION >

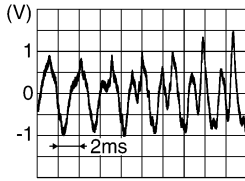
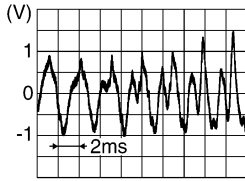
[BASE AUDIO WITHOUT NAVIGATION]

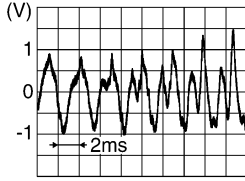
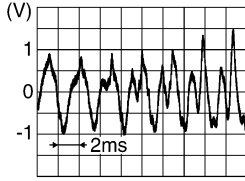
Terminal (Wire color)		Description		Condition		Reference value (Approx.)
+	-	Signal name	Input/ Output			
2 (G)	3 (L)	Sound signal front LH	Output	Ignition switch ON	Sound output	 <small>SKIB3609E</small>
4 (GR)	5 (G)	Sound signal rear LH	Output	Ignition switch ON	Sound output	 <small>SKIB3609E</small>
6 (P)	15 (B)	Steering switch signal A	Input	Ignition switch ON	Keep pressing SOURCE switch.	0 V
					Keep pressing MENU UP switch.	0.7 V
					Keep pressing MENU DOWN switch.	1.3 V
					Keep pressing  switch	2.0 V
					Except for above.	3.3 V
7 (V)	Ground	ACC power supply	Input	Ignition switch ACC	—	Battery voltage
9 (SB)	Ground	Illumination signal	Input	Ignition switch OFF	Lighting switch is OFF.	0 V
					Lighting switch is ON.	12.0 V
11 (BR)	12 (R)	Sound signal front RH	Output	Ignition switch ON	Sound output	 <small>SKIB3609E</small>
13 (P)	14 (V)	Sound signal rear RH	Output	Ignition switch ON	Sound output	 <small>SKIB3609E</small>

AV CONTROL UNIT

< ECU DIAGNOSIS INFORMATION >

[BASE AUDIO WITHOUT NAVIGATION]

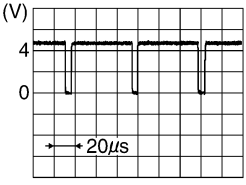
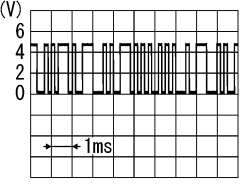
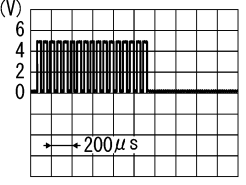
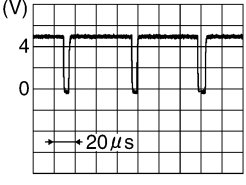
Terminal (Wire color)		Description		Condition		Reference value (Approx.)
+	-	Signal name	Input/ Output			
16 (L)	15 (B)	Steering switch signal B	Input	Ignition switch ON	Keep pressing VOL DOWN switch.	0 V
					Keep pressing VOL UP switch.	0.7 V
					Keep pressing switch.	1.3 V
					Except for above.	3.3 V
19 (Y)	Ground	Battery power supply	Input	Ignition switch OFF	—	Battery voltage
20 (B)	Ground	Ground	—	Ignition switch ON	—	0 V
36 (BG)	Ground	Signal VCC	Output	Ignition switch ACC	—	9.0 V
37 (B)	Ground	Signal ground	—	Ignition switch OFF	—	0 V
38 (G)	Ground	Horizontal synchronizing (HP) signal	Input	Ignition switch ON	—	 <small>SKIB3601E</small>
39 (Y)	Ground	Communication signal (DISP→CONT)	Input	Ignition switch ON	When adjusting display brightness.	 <small>PKIB5039J</small>
40 (R)	Ground	RGB area (YS) signal	Output	Ignition switch ON	At RGB image is displayed.	5.0 V
					At DVD image is displayed.	 <small>PKIB4948J</small>
41	—	Shield	—	—	—	—
42 (W)	Ground	RGB synchronizing signal	Output	Ignition switch ON	—	 <small>SKIB3603E</small>

A
B
C
D
E
F
G
H
I
J
K
L
M
O
P

AV

AV CONTROL UNIT

< ECU DIAGNOSIS INFORMATION >

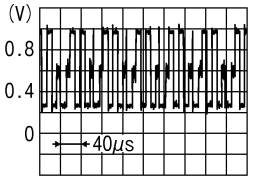
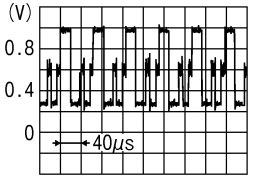
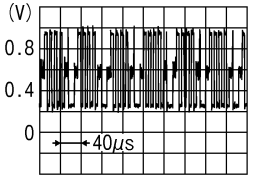
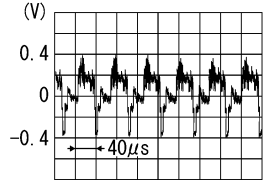
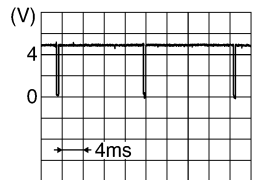

[BASE AUDIO WITHOUT NAVIGATION]

Terminal (Wire color)		Description		Condition		Reference value (Approx.)
+	-	Signal name	Input/ Output			
43 (R)	Ground	RGB signal (R: red)	Output	Ignition switch ON	Start Confirmation/Adjustment mode, and then display color bar by selecting "Color Spectrum Bar" on Display Diagnosis screen.	 <p style="text-align: right; font-size: small;">JSNIA1029ZZ</p>
44 (B)	Ground	RGB signal (G: green)	Output	Ignition switch ON	Start Confirmation/Adjustment mode, and then display color bar by selecting "Color Spectrum Bar" on Display Diagnosis screen.	 <p style="text-align: right; font-size: small;">JSNIA1030ZZ</p>
45 (W)	Ground	RGB signal (B: blue)	Output	Ignition switch ON	Start Confirmation/Adjustment mode, and then display color bar by selecting "Color Spectrum Bar" on Display Diagnosis screen.	 <p style="text-align: right; font-size: small;">JSNIA1031ZZ</p>
46 (V)	Ground	Composite image ground	—	Ignition switch ON	—	0 V
47 (SB)	Ground	Composite image signal	Output	Ignition switch ON	At rear view camera image is displayed.	 <p style="text-align: right; font-size: small;">SKIB2251J</p>
48 (L)	Ground	Inverter VCC	Output	Ignition switch ACC	—	9.0 V
49 (LG)	Ground	Inverter ground	—	Ignition switch OFF	—	0 V
50 (B)	Ground	Vertical synchronizing (VP) signal	Input	Ignition switch ON	—	 <p style="text-align: right; font-size: small;">SKIB3598E</p>

AV CONTROL UNIT

< ECU DIAGNOSIS INFORMATION >

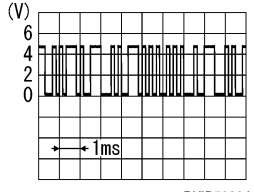
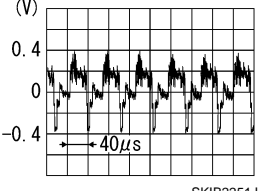
[BASE AUDIO WITHOUT NAVIGATION]

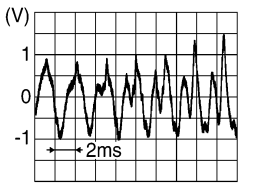
Terminal (Wire color)		Description		Condition		Reference value (Approx.)
+	-	Signal name	Input/ Output			
51 (BR)	Ground	Communication signal (CONT→DISP)	Output	Ignition switch ON	When adjusting display brightness.	 <p style="text-align: right; font-size: small;">PKIB5039J</p>
52	—	Shield	—	—	—	—
57	—	Shield	—	—	—	—
58	—	Shield	—	—	—	—
62 (W)	Ground	Camera image signal	Input	Ignition switch ON	At rear view camera image is displayed.	 <p style="text-align: right; font-size: small;">SKIB2251J</p>
71	—	Shield	—	—	—	—
72 (B)	Ground	Camera ground	—	Ignition switch ON	—	0 V
73 (W)	Ground	Camera power supply	Output	Ignition switch ON	At rear view camera image is displayed.	6.0 V
76 (LG)	—	AV communication signal (L)	Input/ Output	—	—	—
77 (SB)	—	AV communication signal (H)	Input/ Output	—	—	—
78 (SB)	—	AV communication signal (H)	Input/ Output	—	—	—
79 (LG)	—	AV communication signal (L)	Input/ Output	—	—	—
80 (P)	—	CAN-L	Input/ Output	—	—	—
81 (L)	—	CAN-H	Input/ Output	—	—	—
82 (BR)	Ground	Switch ground	—	Ignition switch ON	—	0 V
86	—	Shield	—	—	—	—
87 (P)	88 (L)	TEL voice signal	Input	Ignition switch ON	During voice guide output with the  switch pressed.	 <p style="text-align: right; font-size: small;">SKIB3609E</p>

A
B
C
D
E
F
G
H
I
J
K
L
M
AV
O
P

AV CONTROL UNIT

< ECU DIAGNOSIS INFORMATION >

[BASE AUDIO WITHOUT NAVIGATION]

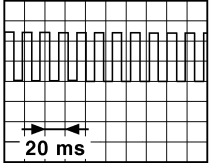
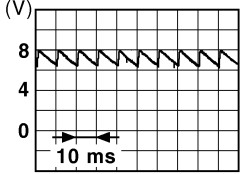
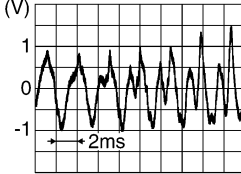
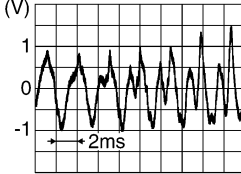
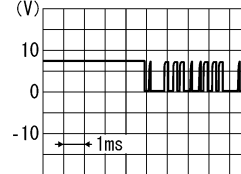
Terminal (Wire color)		Description		Condition		Reference value (Approx.)
+	-	Signal name	Input/ Output			
92 (R)	Ground	Vehicle speed signal (8-pulse)	Input	Ignition switch ON	When vehicle speed is ap- prox. 40 km/h (25 MPH)	NOTE: The maximum voltage varies de- pending on the specification (destination unit).  <small>JSNIA0012GB</small>
93 (V)	Ground	Parking brake signal	Input	Ignition switch ON	Parking brake is ON.	0 V
					Parking brake is OFF.	 <small>JSNIA0007GB</small>
94 (BG)	Ground	Reverse signal	Input	Ignition switch ON	R position	12.0 V
					Other than R position	0 V
95 (W)	Ground	Ignition signal	Input	Ignition switch ON	—	Battery voltage
96 (SB)	Ground	Disk eject signal	Input	Ignition switch ON	Pressing the eject switch.	0 V
					Except for above.	3.3 V
120 (B)	124 (W)	Satellite radio sound signal LH	Input	Ignition switch ON	When satellite radio mode is selected.	 <small>SKIB3609E</small>
121 (G)	125 (R)	Satellite radio sound signal RH	Input	Ignition switch ON	When satellite radio mode is selected.	 <small>SKIB3609E</small>
122 (O)	Ground	Communication signal (CONT→SAT)	Output	Ignition switch ON	When satellite radio mode is selected.	 <small>SKIA9301J</small>
126	—	Shield	—	—	—	—

AV CONTROL UNIT

< ECU DIAGNOSIS INFORMATION >

[BASE AUDIO WITHOUT NAVIGATION]

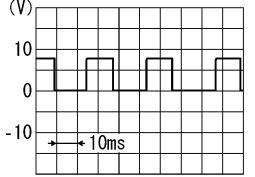
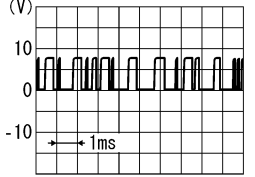
Terminal (Wire color)		Description		Condition		Reference value (Approx.)
+	-	Signal name	Input/ Output			
127	—	Shield	—	—	—	—
129 (Y)	Ground	Request signal (SAT→CONT)	Input	Ignition switch ON	When satellite radio mode is selected.	 <p style="text-align: right; font-size: small;">SKIA9299J</p>
130 (BR)	Ground	Communication signal (SAT→CONT)	Input	Ignition switch ON	When satellite radio mode is selected.	 <p style="text-align: right; font-size: small;">SKIA9300J</p>
132 (G)	—	USB ground	—	—	—	—
133 (W)	—	V BUS signal	—	—	—	—
134 (R)	—	USB D- signal	—	—	—	—
135 (L)	—	USB D+ signal	—	—	—	—
136	—	Shield	—	—	—	—
137	Ground	Antenna amp. ON signal	Output	Ignition switch ACC	—	12.0 V
138	—	AM-FM main	Input	—	—	—
139	—	FM sub	Input	—	—	—

DTC Index

INFOID:000000005913139

SELF-DIAGNOSIS RESULTS DISPLAY ITEM

DTC	Display item	Refer to
U1000	CAN COMM CIRCUIT [U1000]	AV-79. "Diagnosis Procedure"
U1010	CONTROL UNIT (CAN) [1010]	AV-80. "DTC Logic"
U1200	Cont Unit [U1200]	AV-81. "DTC Logic"
U1216	CAN CONT [U1216]	AV-82. "DTC Logic"
U1232	ST ANGLE SEN CALIB [1232]	AV-83. "Diagnosis Procedure"
U1243	FRONT DISP CONN [U1243]	AV-84. "Diagnosis Procedure"
U1255	SAT CONN [U1255]	AV-86. "Diagnosis Procedure"
U1310	CONTROL UNIT (AV) [U1310]	AV-89. "DTC Logic"
U1300 U1240	<ul style="list-style-type: none"> AV COMM CIRCUIT [U1300] SWITCH CONN [U1240] 	AV-88. "Description"

AV CONTROL UNIT

< ECU DIAGNOSIS INFORMATION >

[BASE AUDIO WITHOUT NAVIGATION]

DTC	Display item	Refer to
U1300 U1256	<ul style="list-style-type: none">• AV COMM CIRCUIT [U1300]• HAND FREE CONN [U1256]	AV-88, "Description"
U1300 U1240 U1256	<ul style="list-style-type: none">• AV COMM CIRCUIT [U1300]• SWITCH CONN [U1240]• HAND FREE CONN [U1256]	AV-88, "Description"

DISPLAY UNIT

< ECU DIAGNOSIS INFORMATION >

[BASE AUDIO WITHOUT NAVIGATION]

DISPLAY UNIT

Reference Value

INFOID:000000005913140

TERMINAL LAYOUT

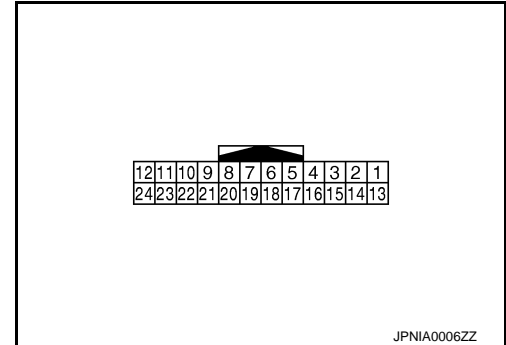

PHYSICAL VALUES

Terminal (Wire color)		Description		Condition		Reference value (Approx.)
+	-	Signal name	Input/ Output			
1 (B)	Ground	Ground	—	Ignition switch ON	—	0 V
2 (L)	Ground	Inverter VCC	Input	Ignition switch ACC	—	9.0 V
3 (BG)	Ground	Signal VCC	Input	Ignition switch ACC	—	9.0 V
4 (V)	Ground	Composite image ground	—	Ignition switch ON	—	0 V
5	—	Shield	—	—	—	—
6 (B)	Ground	RGB signal (G: green)	Input	Ignition switch ON	Start Confirmation/Adjust- ment mode, and then dis- play color bar by selecting "Color Spectrum Bar" on Display Diagnosis screen.	<p style="text-align: right;">JSNIA1030ZZ</p>
7	—	Shield	—	—	—	—
8 (G)	Ground	Horizontal synchronizing (HP) signal	Output	Ignition switch ON	—	<p style="text-align: right;">SKIB3601E</p>

A
B
C
D
E
F
G
H
I
J
K
L
M
N
O
P

AV

DISPLAY UNIT

< ECU DIAGNOSIS INFORMATION >

[BASE AUDIO WITHOUT NAVIGATION]

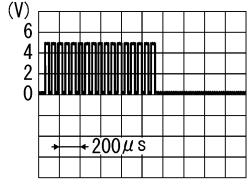
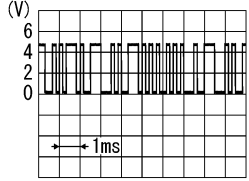
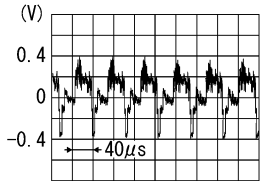
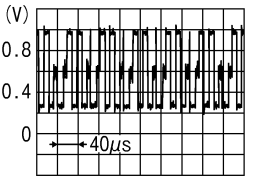
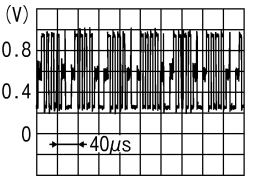
Terminal (Wire color)		Description		Condition	Reference value (Approx.)	
+	-	Signal name	Input/ Output			
9 (R)	Ground	RGB area (YS) signal	Input	Ignition switch ON	At RGB image is displayed. 5.0 V	
				At DVD image is displayed.	 <p style="text-align: right;">PKIB4948J</p>	
11 (BR)	Ground	Communication signal (CONT→DISP)	Input	Ignition switch ON	When adjusting display brightness.	 <p style="text-align: right;">PKIB5039J</p>
13 (LG)	Ground	Inverter ground	—	Ignition switch ON	—	0 V
14 (B)	Ground	Signal ground	—	Ignition switch ON	—	0 V
15 (SB)	Ground	Composite image signal	Input	Ignition switch ON	At rear view camera image is displayed.	 <p style="text-align: right;">SKIB2251J</p>
17 (R)	Ground	RGB signal (R: red)	Input	Ignition switch ON	Start Confirmation/Adjustment mode, and then display color bar by selecting "Color Spectrum Bar" on Display Diagnosis screen.	 <p style="text-align: right;">JSNIA1029ZZ</p>
18 (W)	Ground	RGB signal (B: blue)	Input	Ignition switch ON	Start Confirmation/Adjustment mode, and then display color bar by selecting "Color Spectrum Bar" on Display Diagnosis screen.	 <p style="text-align: right;">JSNIA1031ZZ</p>

DISPLAY UNIT

< ECU DIAGNOSIS INFORMATION >

[BASE AUDIO WITHOUT NAVIGATION]

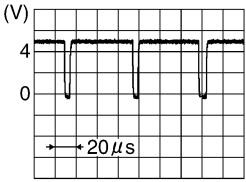
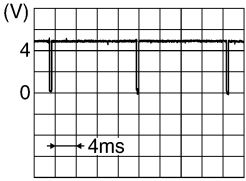
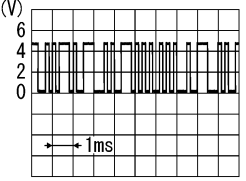
Terminal (Wire color)		Description		Condition		Reference value (Approx.)
+	-	Signal name	Input/ Output			
19 (W)	Ground	RGB synchronizing signal	Input	Ignition switch ON	—	 <p>SKIB3603E</p>
20 (B)	Ground	Vertical synchronizing (VP) signal	Output	Ignition switch On	—	 <p>SKIB3598E</p>
21	—	Shield	—	—	—	—
22 (Y)	Ground	Communication signal (DISP→CONT)	Output	Ignition switch ON	When adjusting display brightness.	 <p>PKIB5039J</p>
23	—	Shield	—	—	—	—

A
B
C
D
E
F
G
H
I
J
K
L
M
AV
O
P

AV

ACTIVE NOISE CONTROL UNIT

< ECU DIAGNOSIS INFORMATION >

[BASE AUDIO WITHOUT NAVIGATION]

ACTIVE NOISE CONTROL UNIT

Reference Value

INFOID:000000006015135

TERMINAL LAYOUT

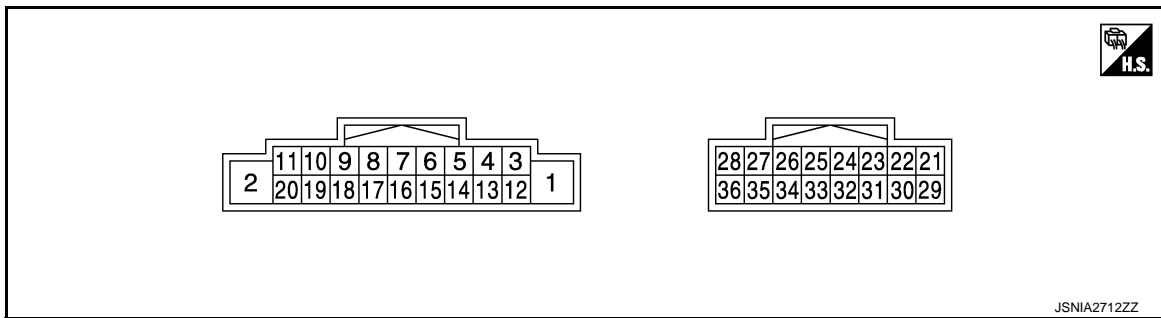

PHYSICAL VALUES

Terminal (Wire color)		Description		Condition		Reference value (Approx.)
+	-	Signal name	Input/ Output			
1 (B/R)	Ground	Ground	—	Igni- tion switch OFF	—	0 V
2 (Y)	Ground	Battery power supply	Input	Igni- tion switch OFF	—	Battery voltage
3 (Y)	12 (L)	Sound signal front LH	Input	Igni- tion switch ON	Sound output	 SKIB3609E
4 (V)	13 (GR)	Sound signal front RH	Input	Igni- tion switch ON	Sound output	 SKIB3609E
5 (LG)	14 (W)	Sound signal rear LH	Input	Igni- tion switch ON	Sound output	 SKIB3609E

ACTIVE NOISE CONTROL UNIT

< ECU DIAGNOSIS INFORMATION >

[BASE AUDIO WITHOUT NAVIGATION]

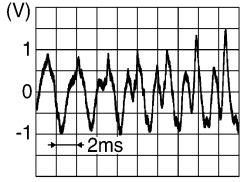
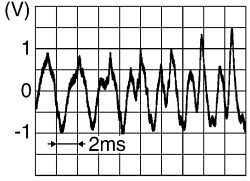
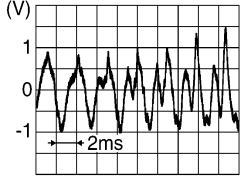
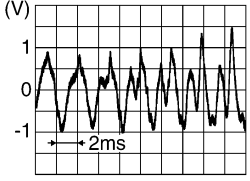
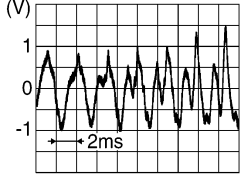
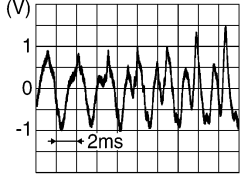
Terminal (Wire color)		Description		Condition		Reference value (Approx.)
+	-	Signal name	Input/ Output			
6 (O)	15 (SB)	Sound signal rear RH	Input	Igni- tion switch ON	Sound output	 <p style="text-align: right; font-size: small;">SKIB3609E</p>
8 (W)	17 (B)	Sound signal front door speaker LH	Output	Igni- tion switch ON	Sound output	 <p style="text-align: right; font-size: small;">SKIB3609E</p>
9 (B)	18 (W)	Sound signal front door speaker RH	Output	Igni- tion switch ON	Sound output	 <p style="text-align: right; font-size: small;">SKIB3609E</p>
10 (G)	19 (R)	Sound signal rear door speaker LH	Output	Igni- tion switch ON	Sound output	 <p style="text-align: right; font-size: small;">SKIB3609E</p>
11 (R)	20 (G)	Sound signal rear door speaker RH	Output	Igni- tion switch ON	Sound output	 <p style="text-align: right; font-size: small;">SKIB3609E</p>
23 (Y)	31 (BR)	Front microphone signal	Input	Igni- tion switch ON	When inputting interior sound	 <p style="text-align: right; font-size: small;">SKIB3609E</p>

A
B
C
D
E
F
G
H
I
J
K
L
M
AV
O
P

ACTIVE NOISE CONTROL UNIT

< ECU DIAGNOSIS INFORMATION >

[BASE AUDIO WITHOUT NAVIGATION]

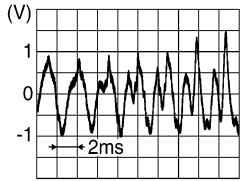
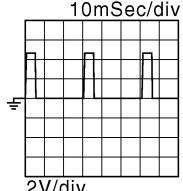
Terminal (Wire color)		Description		Condition		Reference value (Approx.)
+	-	Signal name	Input/ Output			
24 (L)	32 (LG)	Rear microphone signal	Input	Igni- tion switch ON	When inputting interior sound	 <p style="text-align: right; font-size: small;">SKIB3609E</p>
25 (P)	Ground	Step lamp signal	Input	Igni- tion switch ON	When anything door open	0 V
				Igni- tion switch ON	All doors are closed	12.0 V
33 (SB)	Ground	Engine speed output sig- nal	Input	Igni- tion switch ON	Idle speed	 <p style="text-align: right; font-size: small;">JMBIA0076GB</p>
36 (V)	Ground	ACC power supply	Input	Igni- tion switch ACC	—	Battery voltage

SATELLITE RADIO TUNER

< ECU DIAGNOSIS INFORMATION >

[BASE AUDIO WITHOUT NAVIGATION]

SATELLITE RADIO TUNER

Reference Value

INFOID:000000005913141

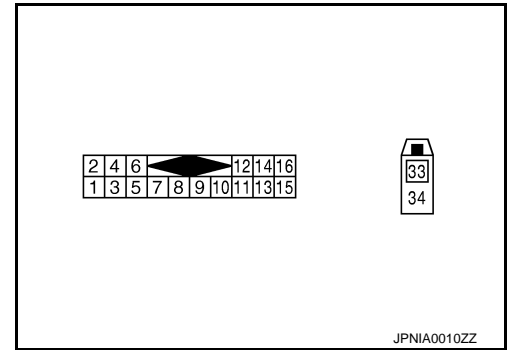

PHYSICAL VALUES

Terminal		Description		Condition		Reference value (Approx.)
+	-	Signal name	Input/Output			
2 (R)	1 (G)	Satellite radio sound signal LH	Output	Ignition switch ON	When satellite radio mode is selected.	<p>SKIB3609E</p>
4 (B)	3 (W)	Satellite radio sound signal RH	Output	Ignition switch ON	When satellite radio mode is selected	<p>SKIB3609E</p>
5	—	Shield	—	—	—	—
6	—	Shield	—	—	—	—
8 (R)	Ground	Request signal (SAT→CONT)	Output	Ignition switch ON	When satellite radio mode is selected	<p>SKIA9299J</p>
9 (B)	Ground	Communication signal (SAT→CONT)	Output	Ignition switch ON	When satellite radio mode is selected	<p>SKIA9300J</p>

A
B
C
D
E
F
G
H
I
J
K
L
M
O
P

AV

SATELLITE RADIO TUNER

< ECU DIAGNOSIS INFORMATION >

[BASE AUDIO WITHOUT NAVIGATION]

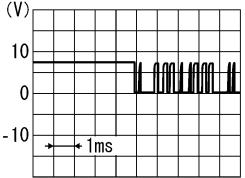
Terminal		Description		Condition		Reference value (Approx.)
+	-	Signal name	Input/ Output			
10 (W)	Ground	Communication signal (CONT→SAT)	Input	Ignition switch ON	When satellite radio mode is selected	 <p style="text-align: right; font-size: small;">SKIA9301J</p>
12 (Y)	Ground	Battery power supply	Input	Ignition switch OFF	—	Battery voltage
16 (V)	Ground	ACC power supply	Input	Ignition switch ACC	—	Battery voltage
33	—	Satellite radio antenna	Input	—	—	—
34	—	Shield	—	—	—	—

TEL ADAPTER UNIT

< ECU DIAGNOSIS INFORMATION >

[BASE AUDIO WITHOUT NAVIGATION]

TEL ADAPTER UNIT

Reference Value

INFOID:000000005913142

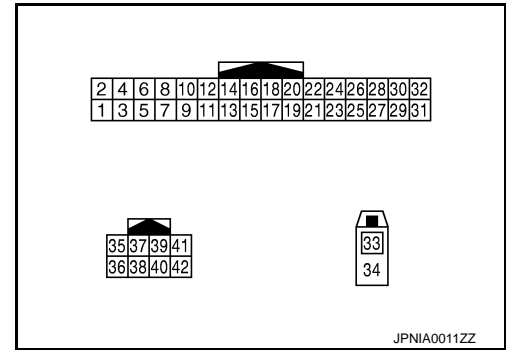

PHYSICAL VALUES

Terminal (Wire color)		Description		Condition		Reference value (Approx.)
+	-	Signal name	Input/Output			
1 (LG)	Ground	Battery power supply	Input	Ignition switch OFF	—	Battery voltage
2 (L)	Ground	ACC power supply	Input	Ignition switch ACC	—	Battery voltage
3 (P)	Ground	Ignition signal	Input	Ignition switch ON	—	Battery voltage
4 (B/R)	Ground	Ground	—	Ignition switch ON	—	0 V
7 (W/R)	8	Microphone signal	Input	Ignition switch ON	Give a voice	<p>PKIB5037J</p>
9 (W/L)	10 (GR/V)	TEL voice signal	Output	Ignition switch ON	During voice guide output with the switch pressed	<p>SKIB3609E</p>
14 (B/R)	Ground	Ground	—	Ignition switch ON	—	0 V
19 (B/R)	Ground	Ground	—	Ignition switch ON	—	0 V

TEL ADAPTER UNIT

< ECU DIAGNOSIS INFORMATION >

[BASE AUDIO WITHOUT NAVIGATION]

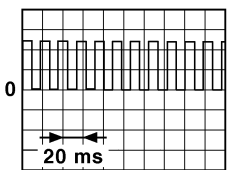
Terminal (Wire color)		Description		Condition		Reference value (Approx.)
+	-	Signal name	Input/ Output			
21 (B/R)	Ground	Control signal	Input	Ignition switch ON	—	0 V
23 (B/R)	Ground	Control signal	Input	Ignition switch ON	—	0 V
24 (B/R)	Ground	Control signal	Input	Ignition switch ON	—	0 V
28 (W)	Ground	Vehicle speed signal (8-pulse)	Input	Ignition switch ON	When vehicle speed is ap- prox. 40 km/h (25 MPH)	<p>NOTE: The maximum voltage varies de- pending on the specification (destination unit).</p>  <p style="text-align: right; font-size: small;">JSNIA0012GB</p>
29 (B/R)	8	Microphone VCC	Output	Ignition switch ON	—	5.0 V
33	—	TEL antenna	Input	—	—	—
34	—	Shield	—	—	—	—
35 (GR)	—	AV communication signal (H)	Input/ Output	—	—	—
36 (SB)	—	AV communication signal (L)	Input/ Output	—	—	—

BASE AUDIO WITH REAR VIEW CAMERA

[BASE AUDIO WITHOUT NAVIGATION]

< WIRING DIAGRAM >

WIRING DIAGRAM

BASE AUDIO WITH REAR VIEW CAMERA

Wiring Diagram

INFOID:000000005913143

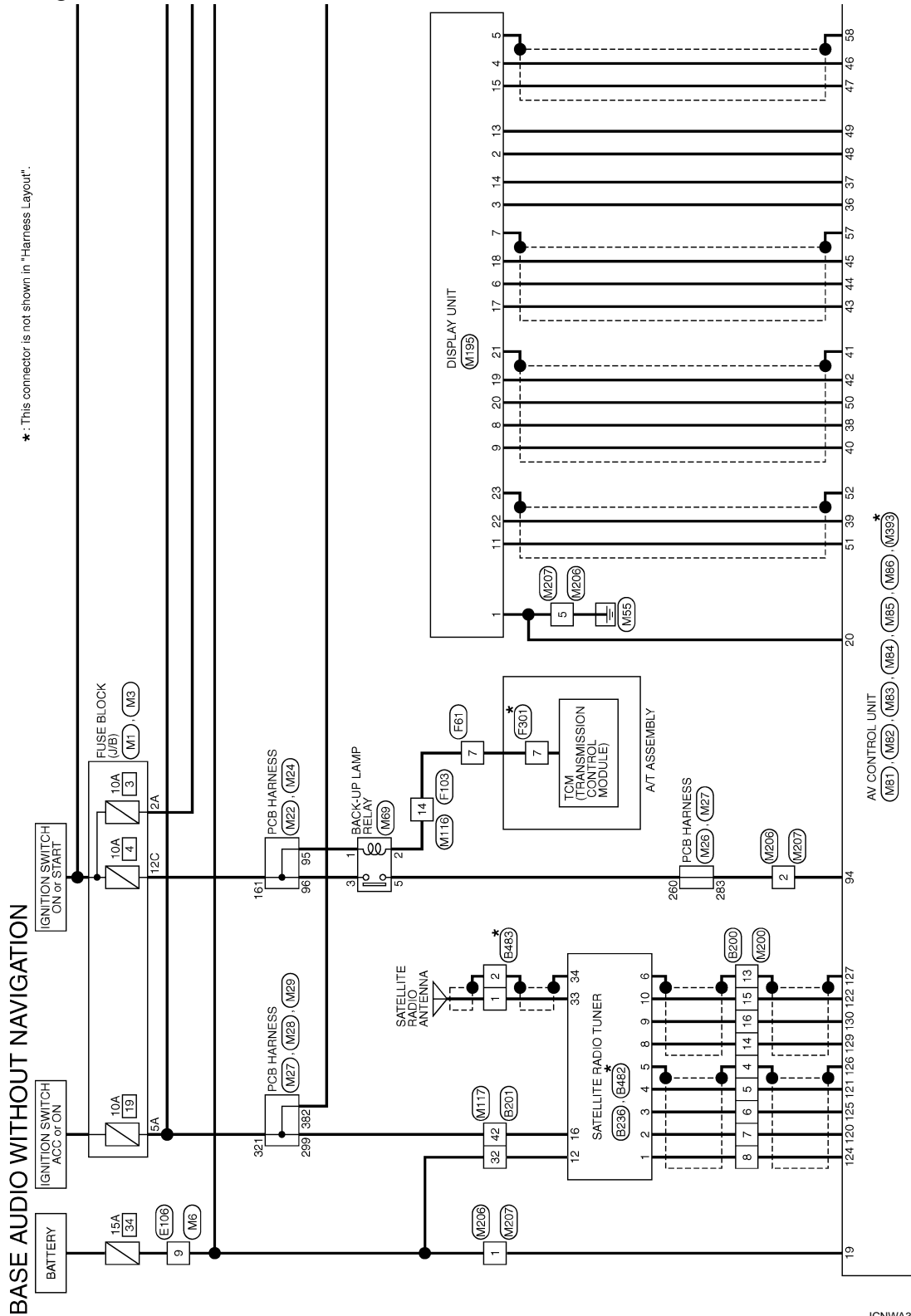

*: This connector is not shown in "Harness Layout".

2010/02/03

JCNWA3217GB

A
B
C
D
E
F
G
H
I
J
K
L
M
N
O
P

AV

BASE AUDIO WITH REAR VIEW CAMERA

[BASE AUDIO WITHOUT NAVIGATION]

< WIRING DIAGRAM >

*: This connector is not shown in "Harness Layout".

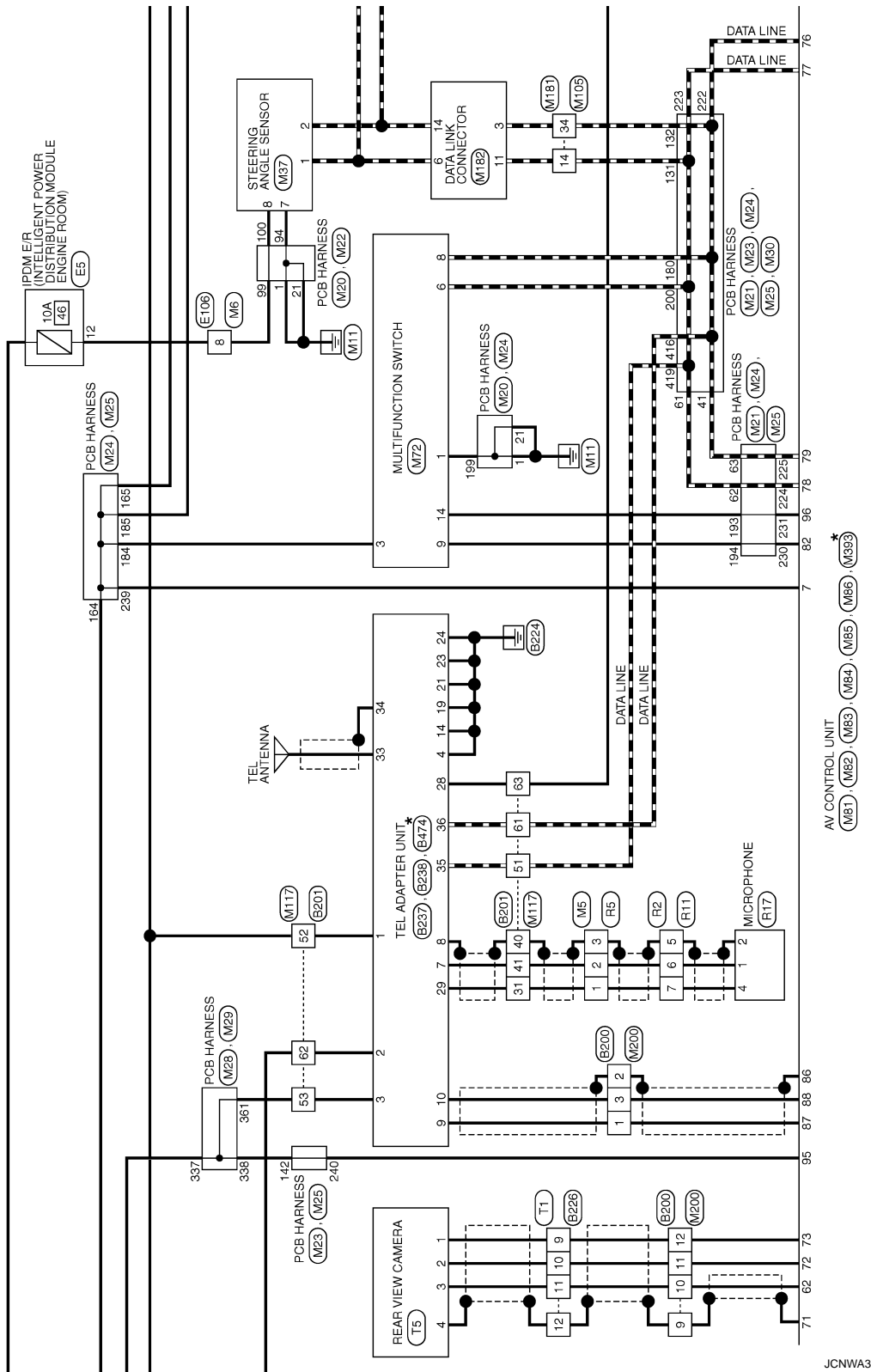

JCNWA3218GB

BASE AUDIO WITH REAR VIEW CAMERA

[BASE AUDIO WITHOUT NAVIGATION]

< WIRING DIAGRAM >

*: This connector is not shown in "Harness Layout".

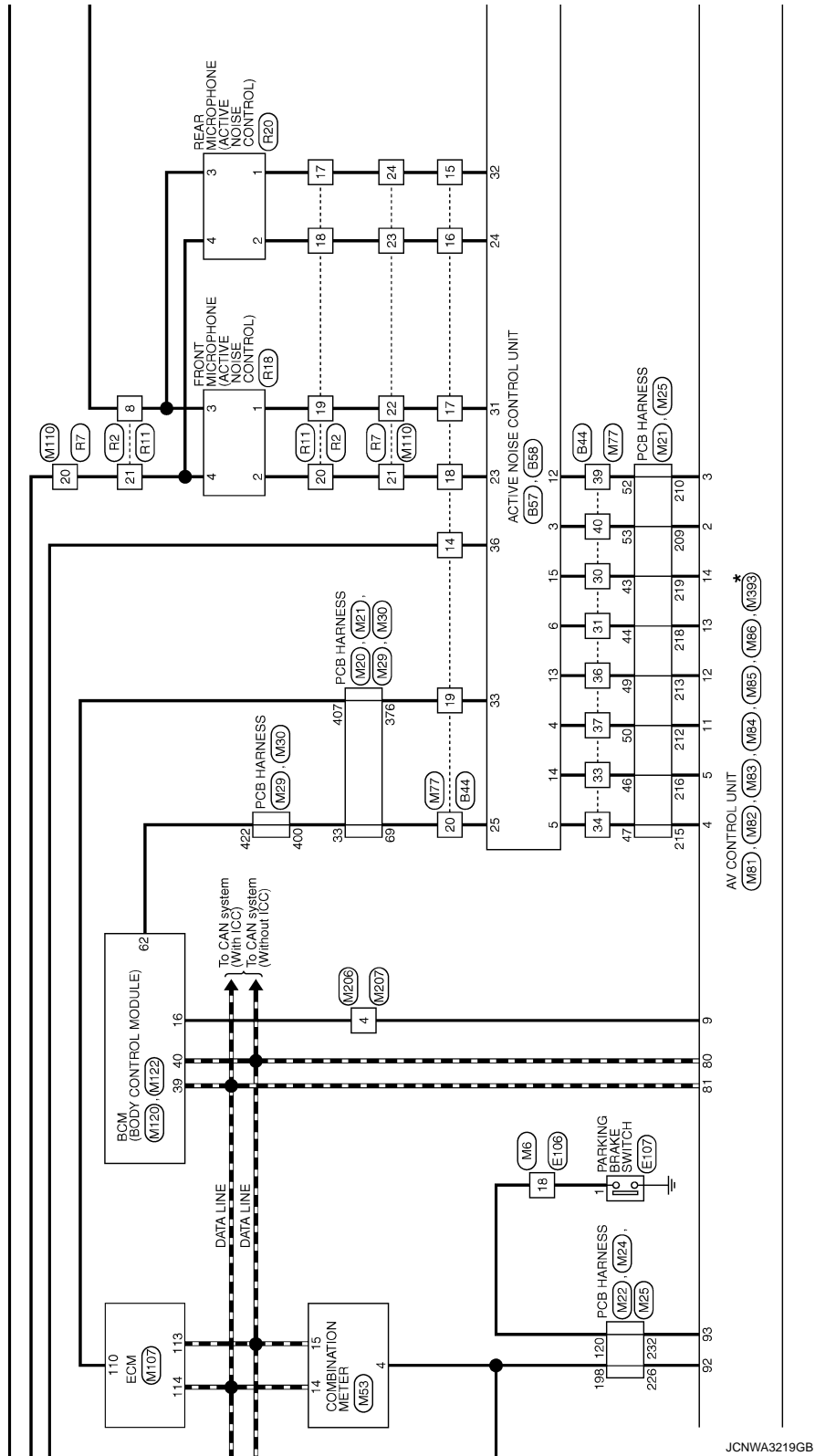

JCNWA3219GB

A
B
C
D
E
F
G
H
I
J
K
L
M
N
O
P

AV

BASE AUDIO WITH REAR VIEW CAMERA

[BASE AUDIO WITHOUT NAVIGATION]

< WIRING DIAGRAM >

*: This connector is not shown in "Harness Layout".

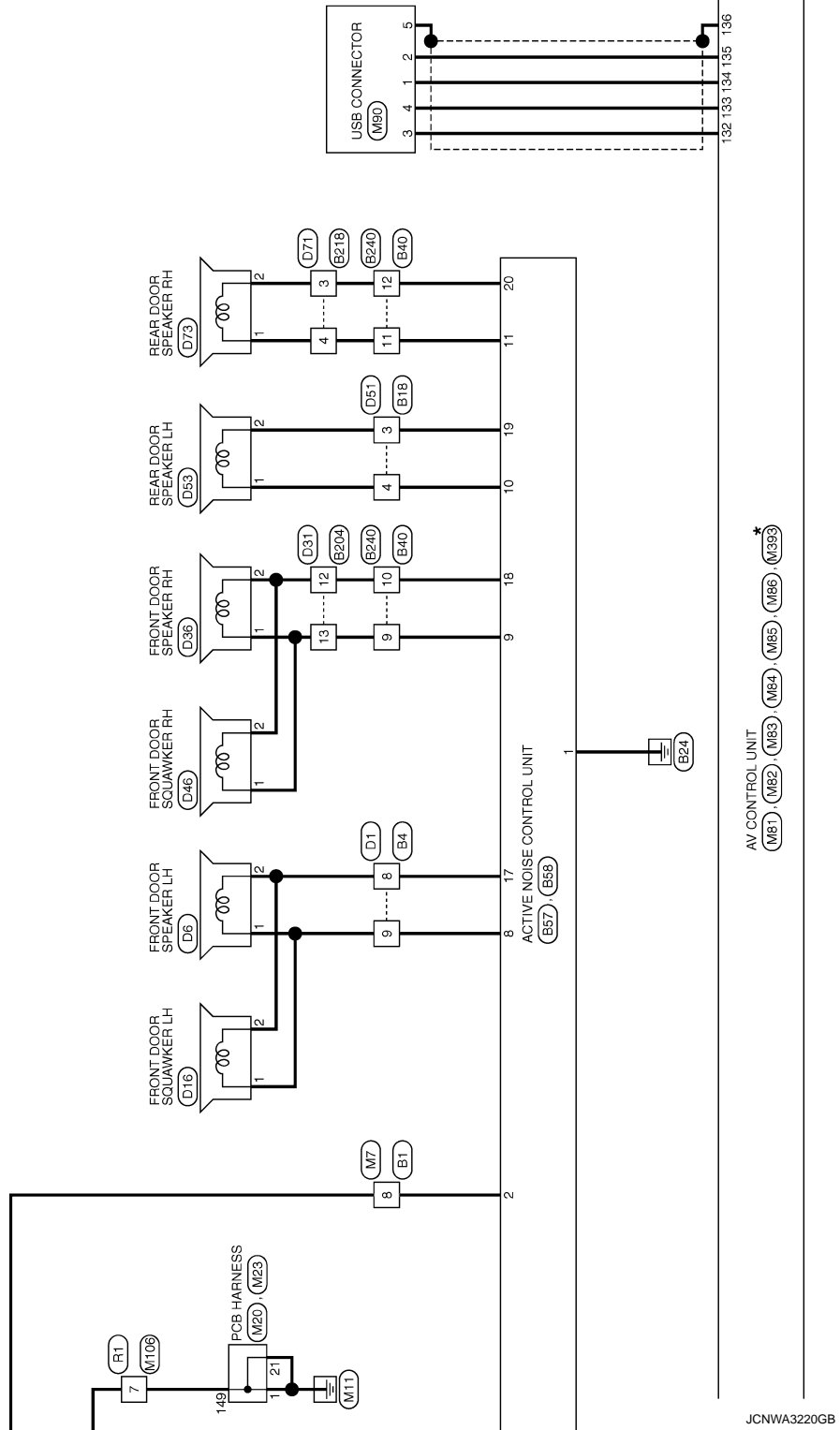

JCNWA3220GB

BASE AUDIO WITH REAR VIEW CAMERA

[BASE AUDIO WITHOUT NAVIGATION]

< WIRING DIAGRAM >

*: This connector is not shown in "Harness Layout".

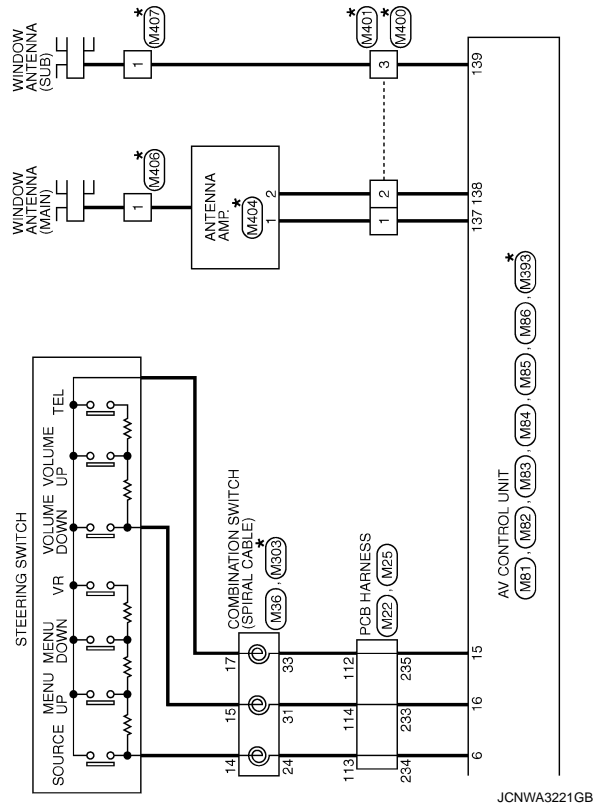

A
B
C
D
E
F
G
H
I
J
K
L
M
N
O
P

AV

BASE AUDIO WITH REAR VIEW CAMERA

[BASE AUDIO WITHOUT NAVIGATION]

< WIRING DIAGRAM >

BASE AUDIO WITHOUT NAVIGATION

Connector No.	B1
Connector Name	WIRE TO WIRE
Connector Type	TH0PW-CS16-TM4



Terminal No.	Color of Wire	Signal Name [Specification]
1	R	-
2	W	-
4	LG	-
5	P	-
6	V	-
7	GR	-
8	Y	-
9	LG	-
10	V	-
11	GR	- [With Climate controlled seat]
11	L	- [With heated seat]
12	P	- [With Climate controlled seat]
12	GR	- [With heated seat]
13	BR	-
14	R	-
15	O	-
16	V	-
17	B	-
18	R	-
19	W	-
20	R	-
21	B	-
22	LG	-
23	V	-
24	Y	-
25	G	-
26	GR	-
27	SB	-
28	P	- [With Pre-crash seat belt system]
28	L/O	- [Without Pre-crash seat belt system]
29	L	- [With Pre-crash seat belt system]
29	W/L	- [Without Pre-crash seat belt system]
30	SHIELD	-
32	L	-
33	R	-
34	L	-
35	R	-
36	G	-

Connector No.	B4
Connector Name	WIRE TO WIRE
Connector Type	TH40MM-CS15

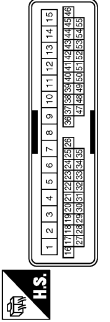

Terminal No.	Color of Wire	Signal Name [Specification]
5	B/W	-
6	L	-
7	R	-
8	B	-
9	W	-
10	LG	-
11	P	-
12	GR	-
13	B/W	-
14	SB	-
15	O	-
16	G	-
17	Y	-
18	BR	-
19	GR	-
20	O	-
21	LG	-
22	L	-
23	SB	-
24	V	-
27	V	-
28	W	-
29	SB	-
30	L	-
31	LG	-
32	O	-
33	V	-
34	BR	-
35	B/R	-
36	P	-
37	BR	-
38	W	-
39	O	-
40	L	-
41	SHIELD	-
42	L	- [With Pre-crash seat belt system]
42	W/L	- [Without Pre-crash seat belt system]
43	P	- [With Pre-crash seat belt system]

43	L/O	- [Without Pre-crash seat belt system]
44	R	-
45	Y	-
46	V	-
47	SB	-
48	GR	-
49	LG	-
50	B	-
51	G	-
52	R	-
53	B	-
54	V	-
55	W	-

Connector No.	B18
Connector Name	WIRE TO WIRE
Connector Type	NH10PW-CS10

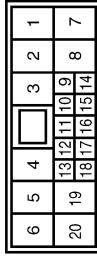

Terminal No.	Color of Wire	Signal Name [Specification]
1	LG	-
2	P	-
3	R	-
4	G	-
7	B/W	-
8	W	-
9	V	-
10	Y	-
11	L	-
12	Y	-
13	B	-

BASE AUDIO WITH REAR VIEW CAMERA

[BASE AUDIO WITHOUT NAVIGATION]

< WIRING DIAGRAM >

BASE AUDIO WITHOUT NAVIGATION

Connector No.	B40
Connector Name	WIRE TO WIRE
Connector Type	HS16MW-CS



1	2	3	4	5	6	7		
8	9	10	11	12	13	14	15	16

Terminal No.	Color of Wire	Signal Name [Specification]
1	P	-
2	O	-
3	LG	-
4	L	-
5	B/W	-
6	SHIELD	-
9	B	-
10	W	-
11	R	-
12	G	-
13	Y	-
14	BR	-
15	SHIELD	-
16	LG	-

Connector No.	B44
Connector Name	WIRE TO WIRE
Connector Type	TH10PW-NH



1	2	3	4	5	6	7	8	9	10	11	12	13	14	15	16	17	18	19	20	21	22	23	24	25	26	27	28	29	30	31	32	33	34	35	36	37	38	39	40	41	42	43	44	45	46	47	48	49	50	51	52	53	54	55	56	57	58	59	60	61	62	63	64	65	66	67	68	69	70	71	72	73	74	75	76	77	78	79	80	81	82	83	84	85	86	87	88	89	90	91	92	93	94	95	96	97	98	99	100
---	---	---	---	---	---	---	---	---	----	----	----	----	----	----	----	----	----	----	----	----	----	----	----	----	----	----	----	----	----	----	----	----	----	----	----	----	----	----	----	----	----	----	----	----	----	----	----	----	----	----	----	----	----	----	----	----	----	----	----	----	----	----	----	----	----	----	----	----	----	----	----	----	----	----	----	----	----	----	----	----	----	----	----	----	----	----	----	----	----	----	----	----	----	----	----	----	----	----	-----

Terminal No.	Color of Wire	Signal Name [Specification]
9	R	-
10	G	-
11	R	-
12	G	-
13	O	-
14	V	-
15	LG	-
16	L	-

17	BR	-
18	Y	-
19	SB	-
20	P	-
21	B	-
22	B	-
23	B	-
29	SHIELD	-
30	P	- [With BOSE system]
30	SB	- [Without BOSE system]
31	L	- [Without BOSE system]
31	O	-
32	SHIELD	-
33	Y	- [With BOSE system]
33	W	- [Without BOSE system]
34	BR	- [With BOSE system]
34	LG	- [Without BOSE system]
35	SHIELD	-
36	L	- [With BOSE system]
36	GR	- [Without BOSE system]
37	R	- [With BOSE system]
37	V	- [Without BOSE system]
38	SHIELD	-
39	B	- [With BOSE system]
39	L	- [Without BOSE system]
40	W	- [With BOSE system]
40	Y	- [Without BOSE system]

Connector No.	B57
Connector Name	ACTIVE NOISE CONTROL UNIT
Connector Type	TH18FW-CS2



1	2	3	4	5	6	7	8	9	10	11	12	13	14	15	16	17	18	19	20	21	22	23	24	25	26	27	28	29	30	31	32	33	34	35	36	37	38	39	40	41	42	43	44	45	46	47	48	49	50	51	52	53	54	55	56	57	58	59	60	61	62	63	64	65	66	67	68	69	70	71	72	73	74	75	76	77	78	79	80	81	82	83	84	85	86	87	88	89	90	91	92	93	94	95	96	97	98	99	100
---	---	---	---	---	---	---	---	---	----	----	----	----	----	----	----	----	----	----	----	----	----	----	----	----	----	----	----	----	----	----	----	----	----	----	----	----	----	----	----	----	----	----	----	----	----	----	----	----	----	----	----	----	----	----	----	----	----	----	----	----	----	----	----	----	----	----	----	----	----	----	----	----	----	----	----	----	----	----	----	----	----	----	----	----	----	----	----	----	----	----	----	----	----	----	----	----	----	----	-----

Terminal No.	Color of Wire	Signal Name [Specification]
1	B/R	GND
2	Y	BATTERY
3	Y	SOUND SIGNAL FRONT LH+
4	V	SOUND SIGNAL FRONT RH+
5	LG	SOUND SIGNAL REAR LH+
6	O	SOUND SIGNAL REAR RH+
7	W	SOUND SIGNAL FRONT DOOR SPEAKER/SUBWOOFER LH
8	B	SOUND SIGNAL FRONT DOOR SPEAKER/SUBWOOFER RH
10	G	SOUND SIGNAL REAR DOOR SPEAKER LH-

11	R	SOUND SIGNAL REAR DOOR SPEAKER RH+
12	L	SOUND SIGNAL FRONT LH-
13	GR	SOUND SIGNAL FRONT RH-
14	W	SOUND SIGNAL REAR LH-
15	SB	SOUND SIGNAL REAR RH-
17	B	SOUND SIGNAL FRONT DOOR SPEAKER/SUBWOOFER LH
18	W	SOUND SIGNAL FRONT DOOR SPEAKER/SUBWOOFER RH
19	R	SOUND SIGNAL REAR DOOR SPEAKER LH-
20	G	SOUND SIGNAL REAR DOOR SPEAKER RH-

Connector No.	B58
Connector Name	ACTIVE NOISE CONTROL UNIT
Connector Type	TH16FW-NH



1	2	3	4	5	6	7	8	9	10	11	12	13	14	15	16	17	18	19	20	21	22	23	24	25	26	27	28	29	30	31	32	33	34	35	36	37	38	39	40	41	42	43	44	45	46	47	48	49	50	51	52	53	54	55	56	57	58	59	60	61	62	63	64	65	66	67	68	69	70	71	72	73	74	75	76	77	78	79	80	81	82	83	84	85	86	87	88	89	90	91	92	93	94	95	96	97	98	99	100
---	---	---	---	---	---	---	---	---	----	----	----	----	----	----	----	----	----	----	----	----	----	----	----	----	----	----	----	----	----	----	----	----	----	----	----	----	----	----	----	----	----	----	----	----	----	----	----	----	----	----	----	----	----	----	----	----	----	----	----	----	----	----	----	----	----	----	----	----	----	----	----	----	----	----	----	----	----	----	----	----	----	----	----	----	----	----	----	----	----	----	----	----	----	----	----	----	----	----	-----

Terminal No.	Color of Wire	Signal Name [Specification]
23	Y	FRONT MICROPHONE FOR ACTIVE NOISE CONTROL SYSTEM
24	L	REAR MICROPHONE FOR ACTIVE NOISE CONTROL SYSTEM
24	P	STEP LAMP CONT
23	BR	FRONT MICROPHONE FOR ACTIVE NOISE CONTROL SYSTEM
32	LG	REAR MICROPHONE FOR ACTIVE NOISE CONTROL SYSTEM
33	SB	TACHO
36	V	ACC

Connector No.	B200
Connector Name	WIRE TO WIRE
Connector Type	TH16MW-NH



1	2	3	4	5	6	7	8	9	10	11	12	13	14	15	16	17	18	19	20	21	22	23	24	25	26	27	28	29	30	31	32	33	34	35	36	37	38	39	40	41	42	43	44	45	46	47	48	49	50	51	52	53	54	55	56	57	58	59	60	61	62	63	64	65	66	67	68	69	70	71	72	73	74	75	76	77	78	79	80	81	82	83	84	85	86	87	88	89	90	91	92	93	94	95	96	97	98	99	100
---	---	---	---	---	---	---	---	---	----	----	----	----	----	----	----	----	----	----	----	----	----	----	----	----	----	----	----	----	----	----	----	----	----	----	----	----	----	----	----	----	----	----	----	----	----	----	----	----	----	----	----	----	----	----	----	----	----	----	----	----	----	----	----	----	----	----	----	----	----	----	----	----	----	----	----	----	----	----	----	----	----	----	----	----	----	----	----	----	----	----	----	----	----	----	----	----	----	----	-----

Terminal No.	Color of Wire	Signal Name [Specification]
1	W/L	-
2	SHIELD	-
3	GR/V	-
4	SHIELD	-

5	B	-
6	W	-
7	P	-
8	G	-
9	SHIELD	-
10	W	- [With NAV]
10	L/R	- [Without NAV]
11	L/W	-
12	L	-
13	SHIELD	-
14	R	-
15	W	-
16	B	-

A
B
C
D
E
F
G
H
I
J
K
L
M
N
O
P



BASE AUDIO WITH REAR VIEW CAMERA

[BASE AUDIO WITHOUT NAVIGATION]

< WIRING DIAGRAM >

BASE AUDIO WITHOUT NAVIGATION

Connector No.	E201
Connector Name	WIRE TO WIRE
Connector Type	TH80MW-CS16-1M4



Terminal No.	Color of Wire	Signal Name [Specification]
3	R	-
17	GR	-
18	P	-
19	BR	-
20	GR	-
21	Y	-
22	GR	-
23	R	-
24	V	-
25	B	-
26	W	-
27	O	-
28	V	-
29	P	-
30	O	-
31	B/R	-
40	SHIELD	-
41	W/R	-
42	V	-
44	P	-
45	SB	-
46	R	- [With Climate controlled seat]
47	G	- [With heated seat]
47	GR	- [With Climate controlled seat]
47	GR	- [With heated seat]
48	V	-
49	O	-
50	R	-
51	GR	-
52	LG	-
53	P	-
56	P	-
57	W	-
58	O	-
59	Y	-
61	SB	-
62	L	-

63	W	-
66	L	-
67	Y	-
68	SB	-
69	GR	-
70	P	-
76	SHIELD	-
77	G	-
78	R	-
79	P	-
80	G	-
81	P	-
82	BR	-
83	GR	-
84	V	-
85	LG	-
86	W	-
87	O	-
88	Y	-
89	BR	-
90	L	-
91	BR	-
93	Y	- [With Climate controlled seat]
93	O	- [With heated seat]
94	GR	-
96	W	-
97	P	-
98	LG	-
99	LG	-
100	Y	-

Connector No.	E204
Connector Name	WIRE TO WIRE
Connector Type	TH40MW-CS15

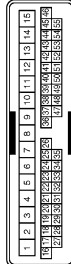

Terminal No.	Color of Wire	Signal Name [Specification]
2	B/W	-
3	B/W	-
5	Y	-
8	P	-
10	P	-
11	V	-

12	Y	-
13	BR	-
14	LG	-
15	GR	-
16	G	-
17	P	-
18	BR	-
19	GR	-
20	V	-
21	LG	-
22	W	-
23	O	-
24	Y	-
25	BR	-
26	L	-
32	G	-
33	R	-
34	SHIELD	-
35	P	-
36	B/R	-
37	BR	-
38	SB	-
39	P	-
44	SB	-
45	R	-
46	B	-

Connector No.	E218
Connector Name	WIRE TO WIRE
Connector Type	NH10FW-CS10

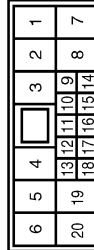

Terminal No.	Color of Wire	Signal Name [Specification]
1	LG	-
2	GR	-
3	O	-
4	P	-
7	B	-
8	P	-
9	O	-
10	W	-
11	O	-
12	Y	-

13	B	-
----	---	---

Connector No.	E226
Connector Name	WIRE TO WIRE
Connector Type	NS12MH-CS

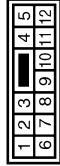

Terminal No.	Color of Wire	Signal Name [Specification]
1	R	-
2	GR	-
3	V	-
5	W	-
6	B	-
7	O	-
8	B/R	-
9	L	-
10	L/W	-
11	W	- [With NAV]
11	L/R	- [Without NAV]
12	SHIELD	-

BASE AUDIO WITH REAR VIEW CAMERA

[BASE AUDIO WITHOUT NAVIGATION]

< WIRING DIAGRAM >

BASE AUDIO WITHOUT NAVIGATION

Connector No.	B236
Connector Name	SATELLITE RADIO TUNER
Connector Type	16PFW



2	4	6	8	10	12	16
1	3	5	7	9	11	15

Terminal No.	Color of Wire	Signal Name [Specification]
1	G	SATELLITE RADIO SOUND SIGNAL LH (-)
2	R	SATELLITE RADIO SOUND SIGNAL LH (+)
3	W	SATELLITE RADIO SOUND SIGNAL RH (-)
4	B	SATELLITE RADIO SOUND SIGNAL RH (+)
5	SHIELD	SHIELD
6	SHIELD	SHIELD
8	R	REQUEST (SAT->CONT)
9	B	COMM (SAT->CONT)
10	W	COMM (CONT->SAT)
12	Y	BATTERY
16	V	ACC

Connector No.	B237
Connector Name	TEL ADAPTER UNIT
Connector Type	TH02FW-NH



2	4	6	8	10	14	16	22	24	28
1	3	5	7	9	11	13	15	17	19

Terminal No.	Color of Wire	Signal Name [Specification]
1	LG	BATTERY
2	L	ACC
3	P	IGNITION
4	B/R	GND
7	W/R	MICROPHONE SIGNAL
8	SHIELD	MICROPHONE GND
9	W/L	TEL VOICE SIGNAL (+)
10	GR/V	TEL VOICE SIGNAL (-)
14	B/R	GND
18	B/R	GND
21	B/R	CONTROL SIGNAL

23	B/R	CONTROL SIGNAL
24	B/R	CONTROL SIGNAL
28	W	VEHICLE SPEED (R-SULSE)
29	B/R	MICROPHONE VCC

Connector No.	B238
Connector Name	TEL ADAPTER UNIT
Connector Type	TH08FW-NH



35	36	40	42
----	----	----	----

Terminal No.	Color of Wire	Signal Name [Specification]
35	GR	AV COMM (H)
36	SB	AV COMM (L)

Connector No.	B240
Connector Name	WIRE TO WIRE
Connector Type	NS16FW-CS



7	6	5	4	3	2	1
16	15	14	13	12	11	10

Terminal No.	Color of Wire	Signal Name [Specification]
1	GR	-
2	V	-
3	P	-
4	Y	-
5	BR	-
6	SHIELD	-
9	BR	-
10	Y	-
11	P	-
12	O	-
13	L	-
14	B/W	-
15	SHIELD	-
16	LG	-

Connector No.	B474
Connector Name	TEL ADAPTER UNIT
Connector Type	GT16C-1S-HU



33	34
----	----

Terminal No.	Color of Wire	Signal Name [Specification]
33	-	TEL ANTENNA
34	SHIELD	SHIELD

Connector No.	B482
Connector Name	SATELLITE RADIO TUNER
Connector Type	FAKRA



33	34
----	----

Terminal No.	Color of Wire	Signal Name [Specification]
33	-	SATELLITE RADIO ANTENNA
34	SHIELD	SHIELD

Connector No.	B483
Connector Name	SATELLITE RADIO ANTENNA
Connector Type	GT16C-1PP-HU



1	2
---	---

Terminal No.	Color of Wire	Signal Name [Specification]
1	-	-
2	SHIELD	-

JCNWA3225GB

A
B
C
D
E
F
G
H
I
J
K
L
M
N
O
P

AV

BASE AUDIO WITH REAR VIEW CAMERA

[BASE AUDIO WITHOUT NAVIGATION]

< WIRING DIAGRAM >

BASE AUDIO WITHOUT NAVIGATION

Connector No.	D1
Connector Name	WIRE TO WIRE
Connector Type	TH40PW-CS15

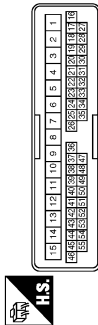

45	LG	-
46	BR	-
47	L	-
48	Y	-
49	P	-
50	B/W	-
51	G	-
52	Y	-
53	B/W	-
54	W	-
55	W	-

Terminal No.	Color of Wire	Signal Name [Specification]
5	B	-
6	L	-
7	R	-
8	GR	-
9	G	-
10	LG	-
11	P	-
12	LG	-
13	B/W	-
14	Y	-
15	O	-
16	R	-
17	Y	-
18	BR	-
19	W	-
20	O	-
21	GR	-
22	G	-
23	LG	-
24	B	-
27	V	-
28	W	-
29	GR	-
30	G	-
31	Y	-
32	O	-
33	BR	-
34	L	-
35	P	-
36	V	-
37	GR	-
38	O	-
39	W	-
40	R	-
41	SHIELD	-
42	L	-
43	P	-
44	V	-

Connector No.	D6
Connector Name	FRONT DOOR SPEAKER LH
Connector Type	NS02FW-CS



Terminal No.	Color of Wire	Signal Name [Specification]
1	G	-
2	GR	-

Connector No.	D16
Connector Name	FRONT DOOR SQUAWKER LH
Connector Type	TK02FBR



Terminal No.	Color of Wire	Signal Name [Specification]
1	G	-
2	GR	-

Connector No.	D31
Connector Name	WIRE TO WIRE
Connector Type	TH40PW-CS15

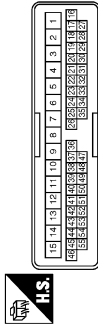

Connector No.	D36
Connector Name	FRONT DOOR SPEAKER RH
Connector Type	NS02FW-CS



Terminal No.	Color of Wire	Signal Name [Specification]
2	B	-
3	B/W	-
5	GR	-
9	V	-
10	R	-
11	L	-
12	Y	-
13	BR	-
14	G	-
15	SB	-
16	G	-
17	O	-
18	BR	-
19	GR	-
20	V	-
21	LG	-
22	SB	-
23	G	-
24	Y	-
25	BR	-
26	L	-
32	L/O	-
33	W/L	-
34	SHIELD	-
35	W	-
36	L	-
37	P	-
38	SB	-
39	O	-
44	SB	-
45	R	-
46	B/W	-

Terminal No.	Color of Wire	Signal Name [Specification]
1	BR	-
2	Y	-

Connector No.	D46
Connector Name	FRONT DOOR SQUAWKER RH
Connector Type	TK02FBR



Terminal No.	Color of Wire	Signal Name [Specification]
1	BR	-
2	Y	-

JCNWA3226GB

BASE AUDIO WITH REAR VIEW CAMERA

[BASE AUDIO WITHOUT NAVIGATION]

< WIRING DIAGRAM >

BASE AUDIO WITHOUT NAVIGATION

Connector No.	B51
Connector Name	WIRE TO WIRE
Connector Type	INT10MW-CS10

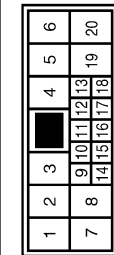

Terminal No.	Color of Wire	Signal Name [Specification]
1	BR	-
2	V	-
3	R	-
4	L	-
5	B	-
6	P	-
7	W	-
8	9	-
9	10	-
10	11	-
11	L	-
12	LG	-
13	B	-

Connector No.	B53
Connector Name	REAR DOOR SPEAKER LH
Connector Type	INS02FW-CS



Terminal No.	Color of Wire	Signal Name [Specification]
1	L	-
2	R	-

Connector No.	D71
Connector Name	WIRE TO WIRE
Connector Type	INT10MW-CS10

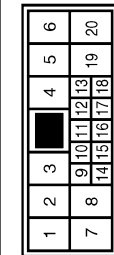

Terminal No.	Color of Wire	Signal Name [Specification]
1	BR	-
2	V	-
3	R	-
4	L	-
5	B	-
6	P	-
7	W	-
8	9	-
9	10	-
10	11	-
11	L	-
12	LG	-
13	B	-

Connector No.	D73
Connector Name	REAR DOOR SPEAKER RH
Connector Type	INS02FW-CS



Terminal No.	Color of Wire	Signal Name [Specification]
1	L	-
2	R	-

Connector No.	E5
Connector Name	ENGINE INTELLIGENT POWER DISTRIBUTION MODULE (ENGINE ROOM)
Connector Type	INT02FW-CS12E-M4-1V

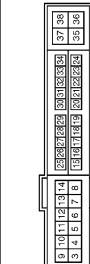

Terminal No.	Color of Wire	Signal Name [Specification]
4	W	-
5	P	-
6	R	-
7	Y	-
8	L	-
10	V	-
11	B	-
12	G	-
13	GR	-
16	V	-
18	Y	-
22	BR	-
23	SB	-
24	O	-
25	LG	-
30	BR	-
31	W	-
32	L	-
34	P	-
36	GR	-

JCNWA3227GB

A
B
C
D
E
F
G
H
I
J
K
L
M
AV
O
P

BASE AUDIO WITH REAR VIEW CAMERA

[BASE AUDIO WITHOUT NAVIGATION]

< WIRING DIAGRAM >

BASE AUDIO WITHOUT NAVIGATION

Connector No.	E106
Connector Name	WIRE TO WIRE
Connector Type	TH80PW-CS16-TM4



Terminal No.	Color of Wire	Signal Name [Specification]
1	P	-
2	W	-
3	SB	-
4	LG	-
5	O	-
7	GR	-
8	G	-
9	Y	-
10	BR	-
11	SB	-
12	V	-
13	GR	-
14	GR	-
15	V	-
16	Y	-
17	GR	-
18	V	-
20	BR	-
21	P	-
22	L	-
23	P	-
27	SHIELD	-
28	L/O	-
29	W/L	-
31	BR	-
32	G	-
33	O	-
34	Y	-
40	BR	-
41	BR	-
42	L	-
43	P	-
44	W	-
45	L	-
46	GR	-
47	V	-
48	G	-
49	O	-

50	LG	-
60	W	-
61	G	-
62	Y	-
63	BR	-
64	V	-
65	Y	-
66	R	-
67	SB	-
77	O	-
78	SB	-
80	G	-
81	R	-
82	SB	-
83	GR	-
84	Y	-
85	Y	-
86	L	-
87	V	-
88	BR	-
89	LG	-
90	W	-
91	W	-
92	P	-
93	LG	-
94	BR	-
95	W	-
96	R	-
87	R	-
98	Y	-
99	V	-
100	V	-

Connector No.	E107
Connector Name	PARKING BRAKE SWITCH
Connector Type	TB01FW-LC



Terminal No.	Color of Wire	Signal Name [Specification]
1	V	-

Connector No.	F61
Connector Name	A/T ASSEMBLY
Connector Type	RK10FG-DGY



Terminal No.	Color of Wire	Signal Name [Specification]
1	Y	-
2	R	-
3	L	-
4	V	-
5	B	-
6	G	-
7	SB	-
8	P	-
9	LG	-
10	B	-

Connector No.	F103
Connector Name	WIRE TO WIRE
Connector Type	TK36PW-NS10

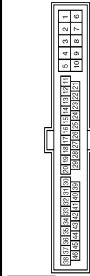

Terminal No.	Color of Wire	Signal Name [Specification]
2	L	-
3	G	-
4	B	- [With VK engine]
4	R	- [With VQ engine]
5	GR	- [With VK engine]
5	B	- [With VQ engine]
7	LG	-
8	Y	-
9	W	- [With VK engine]
9	SB	- [With VQ engine]
10	BR	- [With VK engine]
10	V	- [With VQ engine]

11	L	-
12	P	-
13	V	-
14	SB	-
15	W	-
16	R	-
17	GR	-
18	LG	-
21	LG	-
22	B	-
23	G	-
24	BR	-
25	O	-

Connector No.	F301
Connector Name	TGM (TRANSMISSION CONTROL MODULE)
Connector Type	SPT0FG

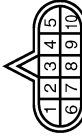

Terminal No.	Color of Wire	Signal Name [Specification]
1	W	VGN
2	B	BATT
3	R	CAN-H
4	O	K LINE
5	G	GND
6	GR	VGN
7	L	REV LAMP RLY
8	BR	CAN-L
9	Y	START RLY
10	W/B	GND

JCNWA3228GB

BASE AUDIO WITH REAR VIEW CAMERA

[BASE AUDIO WITHOUT NAVIGATION]

< WIRING DIAGRAM >

BASE AUDIO WITHOUT NAVIGATION

Connector No.	M1
Connector Name	FUSE BLOCK (U/B)
Connector Type	NSDBF-MZ

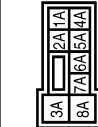

Terminal No.	Color of Wire	Signal Name [Specification]
1A	R	-
2A	W	-
3A	Y	-
4A	W	-
5A	V	-
6A	Y	-
8A	Y	-

Connector No.	M3
Connector Name	FUSE BLOCK (U/B)
Connector Type	NSJ2FW-GS



Terminal No.	Color of Wire	Signal Name [Specification]
6C	R	-
7C	B	-
8C	L	-
9C	L	-
10C	LG	-
11C	LG	-
12C	BG	-

Connector No.	M5
Connector Name	WIRE TO WIRE
Connector Type	A03RW



Terminal No.	Color of Wire	Signal Name [Specification]
1	G	-
2	R	-
3	SHIELD	-

Connector No.	M6
Connector Name	WIRE TO WIRE
Connector Type	TH80MW-CS16-TM4



Terminal No.	Color of Wire	Signal Name [Specification]
1	W	-
2	W	-
3	SB	-
4	LG	-
5	W	-
7	BG	-
8	G	-
9	Y	-
10	W	-
11	R	-
12	V	-
13	LG	-
14	L	-
15	V	-
16	B	-
17	GR	-
18	V	-
20	SB	-
21	BR	-

22	L	-
23	P	-
27	SHIELD	-
28	V	-
29	SB	-
31	BG	-
32	P	-
33	R	-
34	EG	-
40	BR	-
41	BR	-
42	L	-
43	P	-
44	BR	-
45	Y	-
46	BG	-
47	V	-
48	G	-
49	BG	-
50	W	-
60	GR	-
61	B	-
62	LG	-
63	BR	-
64	L	-
65	R	-
66	P	-
67	L	-
77	B	-
78	V	-
80	G	-
81	L	-
82	B	-
83	BG	-
84	SB	-
85	Y	-
86	L	-
87	V	-
88	V	-
89	LG	-
90	BG	-
91	W	-
92	BG	-
93	G	-
94	Y	-
95	W	-
96	R	-
97	SB	-
98	R	-
99	W	-
100	L	-

A
B
C
D
E
F
G
H
I
J
K
L
M
O
P

AV

JCNWA3229GB

BASE AUDIO WITH REAR VIEW CAMERA

[BASE AUDIO WITHOUT NAVIGATION]

< WIRING DIAGRAM >

BASE AUDIO WITHOUT NAVIGATION

Connector No.	M7
Connector Name	WIRE TO WIRE
Connector Type	TH80MW-CS16-TM4



Terminal No.	Color of Wire	Signal Name [Specification]
1	G	-
2	Y	-
4	BR	-
5	P	-
6	W	-
7	G	-
8	Y	-
9	G	-
10	V	-
11	V	- [With Climate controlled seat]
12	P	- [With heated seat]
13	GR	- [With Climate controlled seat]
14	BR	- [With heated seat]
15	GR	-
16	V	-
17	BG	- [With ICC]
18	L	- [Without ICC]
19	W	-
20	R	-
21	B	-
22	LG	-
23	W	-
24	V	-
25	G	-
26	BR	-
27	SB	-
28	P	-
29	L	-
30	SHIELD	-
32	L	-
33	P	-
34	L	-
35	P	-
36	BG	-
37	SB	-

40	SHIELD	-
41	SR	-
42	V	-
45	W	-
47	L	-
48	LG	-
49	BR	-
50	V	-
51	V	-
52	P	-
53	BG	-
56	SB	-
57	P	-
58	LG	-
59	Y	-
60	GR	-
61	B	-
62	LG	-
63	BR	-
65	W	-
66	R	-
67	V	-
68	LG	-
69	SB	-
70	V	-
72	L	-
73	P	-
74	L	-
75	P	-
76	P	-
77	Y	-
78	SB	-
79	W	-
81	LG	-
82	BR	-
83	BG	-
84	B	-
85	W	-
86	G	-
87	R	-
88	G	-
91	W	-
92	G	-
96	W	-
97	BG	-
98	Y	-
99	LG	-

Connector No.	M20
Connector Name	POB HARNESS
Connector Type	TH40FB-NH

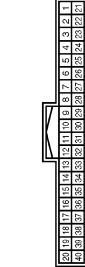

Terminal No.	Color of Wire	Signal Name [Specification]
1	B	-
11	BR	-
12	R	-
14	L	-
15	B	-
17	R	-
19	W	-
20	R	-
21	B	-
22	R	-
23	L	-
24	L	-
27	P	-
30	SHIELD	-
31	V	-
33	V	-
35	L	-
36	P	-
38	L	-
40	Y	-

Connector No.	M21
Connector Name	POB HARNESS
Connector Type	TH40FW-NH

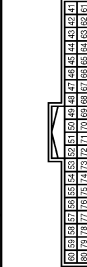

Terminal No.	Color of Wire	Signal Name [Specification]
41	LG	-
42	SHIELD	-

43	Y	- [With BOSE system]
43	V	- [Without BOSE system]
44	BR	- [With BOSE system]
44	P	- [Without BOSE system]
45	SHIELD	-
46	SB	- [With BOSE system]
46	G	- [Without BOSE system]
47	V	- [With BOSE system]
47	GR	- [Without BOSE system]
48	SHIELD	-
49	R	-
50	G	- [With BOSE system]
50	BR	- [Without BOSE system]
51	SHIELD	-
52	P	- [With BOSE system]
52	L	- [Without BOSE system]
53	L	- [With BOSE system]
53	G	- [Without BOSE system]
54	Y	-
55	BR	-
56	G	-
57	R	-
61	SB	-
62	SB	-
63	LG	-
64	B	-
65	L	-
66	R	-
68	R	-
69	V	-

BASE AUDIO WITH REAR VIEW CAMERA

[BASE AUDIO WITHOUT NAVIGATION]

< WIRING DIAGRAM >

BASE AUDIO WITHOUT NAVIGATION

Connector No.	M22
Connector Name	POB HARNESS
Connector Type	TH40FB-NH

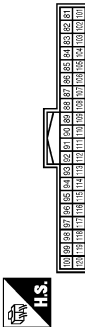

Connector No.	M23
Connector Name	POB HARNESS
Connector Type	TH40FW-NH

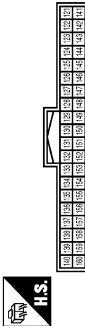

Connector No.	M24
Connector Name	POB HARNESS
Connector Type	TH40FW-NH

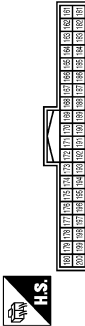

Connector No.	M25
Connector Name	POB HARNESS
Connector Type	TH40FB-NH

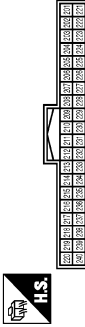

Terminal No.	Color of Wire	Signal Name [Specification]
81	L	-
82	P	-
83	B	-
84	B	-
85	B	-
86	B	-
87	B	-
88	B	-
89	Y	-
91	V	-
92	V	-
93	B	-
94	B	-
95	LG	-
96	BR	-
97	G	-
98	G	-
99	G	-
100	G	-
101	L	-
102	P	-
103	B	-
104	BR	-
105	R	-
107	Y	-
108	Y	-
109	BR	-
110	Y	-
112	B	-
113	P	-
114	L	-
116	B	-
117	B	-
117	BG	- [With VK engine]
118	B	- [With YG engine]
119	G	-
120	V	-

Terminal No.	Color of Wire	Signal Name [Specification]
121	R	-
122	V	-
123	BG	-
124	BG	-
128	BR	-
130	B	-
131	SB	-
132	LG	-
133	L	-
135	P	-
137	Y	-
138	L	-
139	P	-
140	L	-
141	W	-
142	W	-
144	P	-
145	R	-
146	LG	-
147	B	-
148	L	-
149	B	-
150	P	-
151	L	-
152	B	-
153	W	-
154	W	-
155	W	-
157	W	-
158	R	-
159	R	-

Terminal No.	Color of Wire	Signal Name [Specification]
161	BG	-
162	BG	-
163	G	-
164	V	-
165	V	-
166	R	-
167	LG	-
168	R	-
169	R	-
170	B	-
172	B	-
174	W	-
175	B	-
176	L	-
177	P	-
178	Y	-
179	L	-
180	LG	-
182	BR	-
183	G	-
184	V	-
185	P	-
185	V	-
186	R	-
187	L	-
188	Y	-
189	B	-
190	V	-
191	G	-
192	B	-
193	SB	-
194	BR	-
198	R	-
199	B	-
200	SB	-

Terminal No.	Color of Wire	Signal Name [Specification]
201	L	-
209	G	-
209	L	- [With BOSE system]
209	G	- [Without BOSE system]
210	P	- [With BOSE system]
210	L	- [Without BOSE system]
211	SHIELD	-
212	G	- [With BOSE system]
212	BR	- [Without BOSE system]
213	R	-
214	SHIELD	-
215	V	- [With BOSE system]
216	CR	- [Without BOSE system]
218	LG	- [With BOSE system]
218	G	- [Without BOSE system]
217	SHIELD	-
218	BR	- [With BOSE system]
218	P	- [Without BOSE system]
219	GR	- [With BOSE system]
219	V	- [Without BOSE system]
220	SHIELD	-
221	P	-
222	LG	-
223	SB	-
224	SB	-
225	LG	-
226	R	-
230	BR	-
231	SB	-
232	V	-
233	L	-
234	P	-
235	B	-
239	V	-
240	W	-

A
B
C
D
E
F
G
H
I
J
K
L
M
O
P

AV

JCNWA3231GB

BASE AUDIO WITH REAR VIEW CAMERA

[BASE AUDIO WITHOUT NAVIGATION]

< WIRING DIAGRAM >

BASE AUDIO WITHOUT NAVIGATION

Connector No.	M836
Connector Name	COMBINATION SWITCH (SPIRAL CABLE)
Connector Type	TH8BFGY-IV

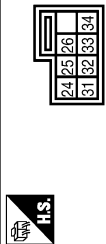

Connector No.	M53
Connector Name	COMBINATION METER
Connector Type	TH40FW-NH

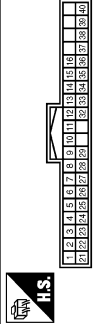

Connector No.	M89
Connector Name	BACK-UP LAMP RELAY
Connector Type	MS32FL-ME-LC



Connector No.	M77
Connector Name	WIRE TO WIRE
Connector Type	TH40MFW-NH

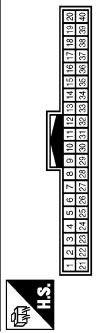

Terminal No.	Color of Wire	Signal Name [Specification]
24	P	-
25	SB	IGNITION SIGNAL
26	B	VEHICLE SPEED SIGNAL (2-PULSE)
31	L	VEHICLE SPEED SIGNAL (8-PULSE)
32	Y	ILLUMINATION CONTROL SIGNAL
33	B	METER CONTROL SWITCH GROUND
34	LG	ENTER SWITCH SIGNAL

Connector No.	M837
Connector Name	STEERING ANGLE SENSOR
Connector Type	TH8BFW-NH



Terminal No.	Color of Wire	Signal Name [Specification]
1	W	BATTERY POWER SUPPLY
2	BG	IGNITION SIGNAL
3	GR	VEHICLE SPEED SIGNAL (2-PULSE)
4	R	VEHICLE SPEED SIGNAL (8-PULSE)
5	B	ILLUMINATION CONTROL SIGNAL
6	B	METER CONTROL SWITCH GROUND
7	SB	ENTER SWITCH SIGNAL
8	LG	SELECT SWITCH SIGNAL
9	G	ILLUMINATION CONTROL SWITCH SIGNAL (+)
10	GR	ILLUMINATION CONTROL SWITCH SIGNAL (-)
11	L	TRIP RESET SWITCH SIGNAL
12	B	GROUND
14	L	CAN-H
15	P	CAN-L
16	R	AIR BAG SIGNAL
23	B	GROUND
24	B	FUEL LEVEL SENSOR GROUND
25	W	ALTERNATOR SIGNAL
26	V	PARKING BRAKE SWITCH SIGNAL
27	V	BRAKE FLUID LEVEL SWITCH SIGNAL
28	G	SECURITY SIGNAL
29	L	WASHER LEVEL SWITCH SIGNAL
32	G	PADDLE SHIFTER SHIFT DOWN SIGNAL
33	BG	PADDLE SHIFTER SHIFT UP SIGNAL
34	G	FUEL LEVEL SENSOR SIGNAL
35	W	SEAT BELT BUCKLE SWITCH SIGNAL (DRIVER SIDE)
36	G	PASSENGER SEAT BELT WARNING SIGNAL
37	G	NON-MANUAL MODE SIGNAL
38	V	MANUAL MODE SHIFT DOWN SIGNAL
39	L	MANUAL MODE SHIFT UP SIGNAL
40	W	MANUAL MODE SIGNAL

Terminal No.	Color of Wire	Signal Name [Specification]
1	LG	-
2	R	-
3	BR	-
5	BG	-

Connector No.	M72
Connector Name	MULTIFUNCTION SWITCH
Connector Type	TH18FW-NH

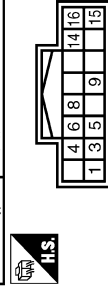

Terminal No.	Color of Wire	Signal Name [Specification]
9	LG	-
10	SB	-
11	LG	-
12	SB	-
13	B	-
14	V	- [With BOSE system]
15	P	- [Without BOSE system]
16	L	-
17	G	-
18	R	-
19	V	-
20	V	-
21	B	-
22	B	-
23	B	-
29	SHIELD	-
30	Y	- [With BOSE system]
31	BR	- [Without BOSE system]
32	SHIELD	- [Without BOSE system]
33	SB	- [With BOSE system]
34	V	- [Without BOSE system]
35	SHIELD	- [With BOSE system]
36	R	- [Without BOSE system]
37	G	- [With BOSE system]
38	SHIELD	- [Without BOSE system]
39	P	- [With BOSE system]
40	L	- [Without BOSE system]
41	L	- [With BOSE system]
42	G	- [Without BOSE system]

Terminal No.	Color of Wire	Signal Name [Specification]
1	B	GROUND
3	V	ACC
4	R	ILL
5	B	ILL CONT
6	SB	AV COMM (H)
8	LG	AV COMM (L)
9	BR	SW GND
14	SB	DISK EJECT SIGNAL
15	R	AIR BAG CUT OFF
16	G	HAZARD ON

Terminal No.	Color of Wire	Signal Name [Specification]
1	L	CAN-H
2	P	CAN-L
7	B	GND
8	G	IGN

JCNWA3233GB

A
B
C
D
E
F
G
H
I
J
K
L
M
N
O
P

AV

BASE AUDIO WITH REAR VIEW CAMERA

[BASE AUDIO WITHOUT NAVIGATION]

< WIRING DIAGRAM >

BASE AUDIO WITHOUT NAVIGATION

Connector No.	M81
Connector Name	AV CONTROL UNIT
Connector Type	TH18FW-GSZ

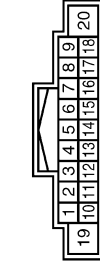

Terminal No.	Color of Wire	Signal Name [Specification]
1	G	SOUND SIGNAL FRONT LH (+)
2	L	SOUND SIGNAL FRONT LH (-)
3	GR	SOUND SIGNAL FRONT RH (+)
4	G	SOUND SIGNAL FRONT RH (-)
5	P	STRG SW A
6	V	ACC
7	SB	ILLUMINATION
8	BR	SOUND SIGNAL FRONT RH (+)
9	R	SOUND SIGNAL FRONT RH (-)
10	P	SOUND SIGNAL REAR RH (+)
11	V	SOUND SIGNAL REAR RH (-)
12	B	STRG SW B
13	L	BATTERY
14	Y	GND
15	B	GND
16	W	GND
17	W	GND
18	W	GND
19	W	GND

Connector No.	M82
Connector Name	AV CONTROL UNIT
Connector Type	TH24FW-NH

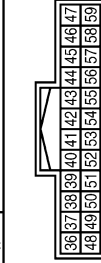

Terminal No.	Color of Wire	Signal Name [Specification]
36	BG	SIGNAL VCC
37	B	SIGNAL GND
38	G	HP
39	Y	COMM (DISP->CONT)
40	R	RGB AREA (YS) SIGNAL
41	SHIELD	SHIELD
42	W	RGB SYNC

43	R	RGB (RED) SIGNAL
44	B	RGB (GREEN) SIGNAL
45	W	RGB (BLUE) SIGNAL
46	V	COMPOSITE IMAGE GND
47	SB	COMPOSITE IMAGE SIGNAL
48	L	INVERTER VCC
49	LG	INVERTER GND
50	B	VP
51	BR	COMM (CONT->DISP)
52	SHIELD	SHIELD
53	SHIELD	SHIELD
54	SHIELD	SHIELD
55	SHIELD	SHIELD
56	SHIELD	SHIELD
57	SHIELD	SHIELD
58	SHIELD	SHIELD

Connector No.	M83
Connector Name	AV CONTROL UNIT
Connector Type	TH18FW-NH

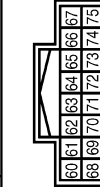

Terminal No.	Color of Wire	Signal Name [Specification]
60	B	CAMERA IMAGE SIGNAL
61	W	SHIELD
62	W	SHIELD
63	W	CAMERA GND
64	W	CAMERA GND
65	W	CAMERA GND
66	W	CAMERA GND
67	W	CAMERA GND
68	W	CAMERA POWER SUPPLY
69	W	CAMERA POWER SUPPLY
70	W	CAMERA POWER SUPPLY
71	W	CAMERA POWER SUPPLY
72	W	CAMERA POWER SUPPLY
73	W	CAMERA POWER SUPPLY
74	W	CAMERA POWER SUPPLY
75	W	CAMERA POWER SUPPLY

Connector No.	M84
Connector Name	AV CONTROL UNIT
Connector Type	TH32FW-NH

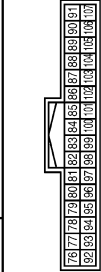

Terminal No.	Color of Wire	Signal Name [Specification]
76	LG	AV COMM (L)
77	SB	AV COMM (H)
78	SB	AV COMM (H)
79	LG	AV COMM (L)

80	P	CAN-L
81	L	CAN-H
82	BR	SW GND
83	R	SHIELD
84	SHIELD	SHIELD
85	P	TEL VOICE SIGNAL (+)
86	L	TEL VOICE SIGNAL (-)
87	R	VEHICLE SPEED (2-PULSE)
88	V	PARKING BRAKE
89	EG	REVERSE
90	W	IGNITION
91	W	DISK EJECT SIGNAL
92	SB	DISK EJECT SIGNAL

Connector No.	M85
Connector Name	AV CONTROL UNIT
Connector Type	A12FW

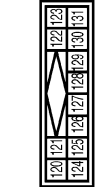

Terminal No.	Color of Wire	Signal Name [Specification]
120	B	SATELLITE RADIO SOUND SIGNAL LH (+)
121	G	SATELLITE RADIO SOUND SIGNAL RH (+)
122	O	COMM (CONT->SAT)
123	W	SATELLITE RADIO SOUND SIGNAL LH (-)
124	R	SATELLITE RADIO SOUND SIGNAL RH (-)
125	SHIELD	SHIELD
126	SHIELD	SHIELD
127	Y	REQUEST (SAT->CONT)
128	Y	REQUEST (SAT->CONT)
129	Y	REQUEST (SAT->CONT)
130	BR	COMM (SAT->CONT)
131	BR	COMM (SAT->CONT)

Connector No.	M86
Connector Name	AV CONTROL UNIT
Connector Type	HAA4GF



Terminal No.	Color of Wire	Signal Name [Specification]
132	W	USB SIGNAL
133	R	USB D- SIGNAL
134	L	USB D+ SIGNAL
135	SHIELD	SHIELD

132	G	USB GND
133	W	V BUS SIGNAL
134	R	USB D- SIGNAL
135	L	USB D+ SIGNAL
136	SHIELD	SHIELD

Connector No.	M89
Connector Name	USB CONNECTOR
Connector Type	HAA4DFG



Terminal No.	Color of Wire	Signal Name [Specification]
1	W	-
2	L	-
3	G	-
4	R	-
5	SHIELD	-

BASE AUDIO WITH REAR VIEW CAMERA

[BASE AUDIO WITHOUT NAVIGATION]

< WIRING DIAGRAM >

BASE AUDIO WITHOUT NAVIGATION

Connector No.	M105
Connector Name	WIRE TO WIRE
Connector Type	TH4DFW-NH

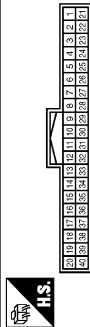

Connector No.	M106
Connector Name	WIRE TO WIRE
Connector Type	NS08MW-CS



112	V	GND PDPRES/FTPRES
113	P	VEHCAN-L
114	L	VEHCAN-H
117	V	CL-INE
121	G	GDSV
122	P	BRAKE
123	B	GND
124	B	GND
125	SB	VBR
126	BR	BNC SW
127	B	GND
128	B	GND

Connector No.	M110
Connector Name	WIRE TO WIRE
Connector Type	TH24MW-NH

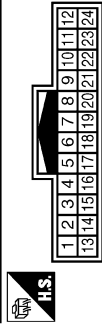

Connector No.	M116
Connector Name	WIRE TO WIRE
Connector Type	TK38MW-NS10

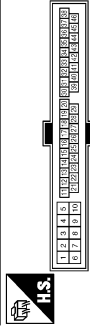

Terminal No.	Color of Wire	Signal Name [Specification]
2	R	-
3	B	-
5	LG	-
6	P	-
7	L	-
8	P	-
9	B	-
10	W	-
11	W	-
12	SB	-
14	SB	-
15	BR	-
16	V	-
18	G	-
19	B	-
20	V	-
22	BG	-
23	B	-
25	W	-
30	R	-
31	BR	-
32	L	-
33	P	-
34	LG	-
35	W	-
36	LG	-
37	L	-
38	R	-

Terminal No.	Color of Wire	Signal Name [Specification]
1	B	-
3	R	-
4	BG	-
5	Y	-
6	R	-
7	B	-
8	L	-

Connector No.	M107
Connector Name	ECM
Connector Type	RH24FCY-R26-R-RH-Z

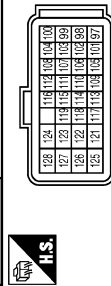

Terminal No.	Color of Wire	Signal Name [Specification]
2	SB	-
3	Y	-
4	B	- [With VK engine]
4	SB	- [With VQ engine]
5	B	-
7	W	-
8	Y	-
9	W	- [With VK engine]
9	SB	- [With VQ engine]
10	SB	-
11	L	-
12	P	-
13	V	-
14	R	-
15	R	-
16	SB	-
17	BR	-
18	LG	-
21	LG	-
22	B	-
23	W	-
24	W	-
25	BG	-

Terminal No.	Color of Wire	Signal Name [Specification]
1	G	-
2	Y	-
3	W	-
4	R	-
7	BR	-
8	R	-
9	B	-
13	L	-
14	B	-
15	LG	-
16	Y	-
17	W	-
18	R	-
19	B	-
20	V	-
21	R	-
22	G	-
23	L	-
24	LG	-

Terminal No.	Color of Wire	Signal Name [Specification]
97	R	APSI
98	Y	APSZ
99	G	AVCC1-APSI
100	W	GND-APSI
101	SB	ASOD SW
102	P	FTPRES
103	L	AVCC2-APSZ
104	BR	GND-APSZ [With ICC]
104	B	GND-APSZ [Without ICC]
105	LG	POPPRES
106	P	TF
107	BG	AVCC2 PDPRES/FTPRES
108	W	GND-ASOD SW
109	BR	NEUT-R
110	V	TACHO

JCNWA3235GB

A
B
C
D
E
F
G
H
I
J
K
L
M
O
P



BASE AUDIO WITH REAR VIEW CAMERA

[BASE AUDIO WITHOUT NAVIGATION]

< WIRING DIAGRAM >

BASE AUDIO WITHOUT NAVIGATION

Connector No.	M117
Connector Name	WIRE TO WIRE
Connector Type	TH00PW-CS16-TM4



Terminal No.	Color of Wire	Signal Name [Specification]
3	Y	-
17	GR	-
18	P	-
19	BR	-
20	GR	-
21	Y	-
22	LG	-
23	R	-
24	BG	-
25	LG	-
26	W	-
27	R	-
28	V	-
29	P	-
30	B	-
31	G	-
32	Y	-
40	SHIELD	-
41	R	-
42	V	-
44	W	-
45	SB	-
46	L	- [With Climate controlled seat] - [With heated seat]
47	G	- [With Climate controlled seat] - [With heated seat]
48	V	-
49	BG	-
50	LG	-
51	SB	-
52	Y	-
53	W	-
56	B	-
57	G	-
58	R	-
59	W	-
60	LG	-
62	V	-



Connector No.	M120
Connector Name	BCM (BODY CONTROL MODULE)
Connector Type	TH40FB-NH



Terminal No.	Color of Wire	Signal Name [Specification]
1	G	RR WINDOW DEFG RLY CONT
2	BG	COMBI SW INPUT 5
3	SB	COMBI SW INPUT 4
4	G	COMBI SW INPUT 3
5	G	COMBI SW INPUT 2
6	P	COMBI SW INPUT 1

Terminal No.	Color of Wire	Signal Name [Specification]
8	V	POWER WINDOW SW COMM
9	P	STOP LAMP SW 1
11	R	RAIN SENSOR SERIAL LINK
14	W	OPTICAL SENSOR
16	SB	DIMMER SIGNAL
17	Y	SENSOR PWR SPLY
18	B	RECEIVER / SENSOR GND
19	R	RECEIVER PWR SPLY
20	BR	KYLS ENT RECEIVER COMM
21	P	NATS ANT AMP
22	GR	KYLS ENT RECEIVER HSSI
23	G	SECURITY IND CONT
24	L	DONGLE LINK
25	G	NATS ANT AMP
26	GR	I-KEY IDENTIFICATION
29	G	HAZARD SW
30	BG	TR LID OPNR SW
31	W	DR DOOR UNLOCK SENSOR
32	BR	COMBI SW OUTPUT 5
33	R	COMBI SW OUTPUT 4
34	V	COMBI SW OUTPUT 3
35	Y	COMBI SW OUTPUT 2
36	LG	COMBI SW OUTPUT 1
37	R	P POSITION
39	L	CAN-H
40	P	CAN-L

Connector No.	M122
Connector Name	BCM (BODY CONTROL MODULE)
Connector Type	FEA09FW-FH46-SA

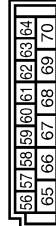

Terminal No.	Color of Wire	Signal Name [Specification]
56	R	INT ROOM LAMP PWR SPLY
57	R	BAT (FUSE)
58	L	AIR BAG
59	G	PASS DOOR UNLK OUTPUT
60	G	TURN SIG LH OUTPUT
61	V	TURN SIG RH OUTPUT
62	V	STEP LAMP CONT
63	L	ROOM LAMP TIME CONT
65	V	ALL DOOR FL ID LOCK OUTPUT
66	LG	DR DOOR FL ID UNLK OUTPUT

67	B	GND
68	BG	PW PWR SPLY (IGN)
69	Y	PW PWR SPLY (BAT)
70	W	BAT (E/L)

Connector No.	M181
Connector Name	WIRE TO WIRE
Connector Type	TH40MW-NH



Terminal No.	Color of Wire	Signal Name [Specification]
2	R	-
3	B	-
5	R	-
6	BR	-
7	L	-
8	P	-
9	B	-
10	W	-
11	LG	-
12	SB	-
14	SB	-
15	BR	-
16	V	-
18	G	-
19	B	-
20	V	-
22	BG	-
23	B	-
25	W	-
30	R	-
31	BR	-
32	L	-
33	P	-
34	LG	-
35	W	-
36	LG	-
37	L	-
38	R	-

BASE AUDIO WITH REAR VIEW CAMERA

[BASE AUDIO WITHOUT NAVIGATION]

< WIRING DIAGRAM >

BASE AUDIO WITHOUT NAVIGATION

Connector No.	M182
Connector Name	DATA LINK CONNECTOR
Connector Type	ED16FW

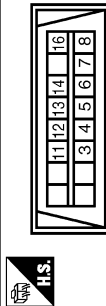

Terminal No.	Color of Wire	Signal Name [Specification]
3	LG	-
4	B	-
5	B	-
6	L	-
7	V	-
8	LG	-
11	SB	-
12	P	-
13	L	-
14	P	-
15	W	-
16	W	-

Connector No.	M185
Connector Name	DISPLAY UNIT
Connector Type	TH24FW-NH

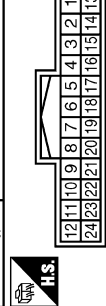

Terminal No.	Color of Wire	Signal Name [Specification]
1	B	GND
2	L	INVERTER VCC
3	BG	SIGNAL VCC
4	V	SIGNAL VCC
5	SHIELD	COMPOSITE IMAGE SIGNAL GND
6	B	SHIELD
7	SHIELD	RGB (G.GREEN) SIGNAL
8	G	SHIELD
9	R	SHIELD
10	R	RGB AREA (VS) SIGNAL
11	BR	COMM (CONT->DISP)
13	LG	INVERTER GND

14	B	SIGNAL GND
15	SR	COMPOSITE IMAGE SIGNAL
17	P	RGB (R.RED) SIGNAL
18	W	RGB (G.BLUE) SIGNAL
19	W	RGB (G.BLUE) SIGNAL
20	B	RGB SYNC
21	SHIELD	VP
22	Y	SHIELD
23	SHIELD	COMM (DISP->CONT)
		SHIELD

Connector No.	M200
Connector Name	WIRE TO WIRE
Connector Type	TH16FW-NH

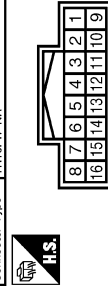

Terminal No.	Color of Wire	Signal Name [Specification]
1	P	-
2	SHIELD	-
3	L	-
4	SHIELD	-
5	G	-
6	R	-
7	B	-
8	W	-
9	SHIELD	-
10	R	-
11	B	-
12	W	-
13	SHIELD	-
14	Y	-
15	O	-
16	BR	-

Connector No.	M206
Connector Name	WIRE TO WIRE
Connector Type	NS308MM-CS



Terminal No.	Color of Wire	Signal Name [Specification]
1	Y	-
2	BG	-
4	SB	-
5	B	-
6	G	-
7	R	-
8	SHIELD	-

Connector No.	M207
Connector Name	WIRE TO WIRE
Connector Type	NS308FW-CS



Terminal No.	Color of Wire	Signal Name [Specification]
1	Y	-
2	BG	-
4	SB	-
5	B	-
6	G	-
7	R	-
8	SHIELD	-

Connector No.	M303
Connector Name	COMBINATION SWITCH (SPIRAL CABLE)
Connector Type	TK08FGY



Terminal No.	Color of Wire	Signal Name [Specification]
13	-	-
14	-	-
15	-	-
16	-	-
17	-	-
18	-	-
19	-	-
20	-	-

Connector No.	M393
Connector Name	AV CONTROL UNIT
Connector Type	GT15SP 2/IS-HU



Terminal No.	Color of Wire	Signal Name [Specification]
137	-	ANTENNA AMP. ON SIGNAL
138	-	AM-FM MAIN
139	-	FM SUB

A
B
C
D
E
F
G
H
I
J
K
L
M
N
O
P

AV

JCNWA3237GB

BASE AUDIO WITH REAR VIEW CAMERA

[BASE AUDIO WITHOUT NAVIGATION]

< WIRING DIAGRAM >

BASE AUDIO WITHOUT NAVIGATION

Connector No.	M400
Connector Name	WIRE TO WIRE
Connector Type	GT13SC-2/1S-HU

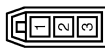

Terminal No.	Color of Wire	Signal Name [Specification]
1	-	-
2	-	-
3	-	-

Connector No.	M401
Connector Name	WIRE TO WIRE
Connector Type	GT13SCN-2/1PP-HU



Terminal No.	Color of Wire	Signal Name [Specification]
1	-	-
2	-	-
3	-	-

Connector No.	M404
Connector Name	ANTENNA AMP.
Connector Type	GT13SC-1/1S-HU



Terminal No.	Color of Wire	Signal Name [Specification]
1	-	-
2	-	-

1	B	AM-FM MAIN
2	-	ANTENNA AMP. ON SIGNAL

Connector No.	M406
Connector Name	WINDOW ANTENNA (MAIN)
Connector Type	P01FB-A



Terminal No.	Color of Wire	Signal Name [Specification]
1	-	-

Connector No.	M407
Connector Name	WINDOW ANTENNA (SUB)
Connector Type	P01FB-A



Terminal No.	Color of Wire	Signal Name [Specification]
1	-	-

Connector No.	R1
Connector Name	WIRE TO WIRE
Connector Type	NS08FW-CS



Terminal No.	Color of Wire	Signal Name [Specification]
1	-	-

1	B	-
3	R	-
4	EG	-
5	Y	-
6	GR	-
7	B	-
8	BR	-

Connector No.	R2
Connector Name	WIRE TO WIRE
Connector Type	TH24MF-NH

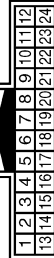

Terminal No.	Color of Wire	Signal Name [Specification]
5	SHIELD	-
6	R	-
7	G	-
8	B	-
9	B	-
10	B	-
11	BR	-
12	R	-
17	LG	-
18	L	-
19	G	-
20	R	-
21	R	-
22	B	-
23	GR	-
24	P	-

Connector No.	R5
Connector Name	WIRE TO WIRE
Connector Type	A03MW

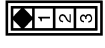

Terminal No.	Color of Wire	Signal Name [Specification]
1	G	-
2	R	-
3	SHIELD	-

Connector No.	R7
Connector Name	WIRE TO WIRE
Connector Type	TH24FW-NH



Terminal No.	Color of Wire	Signal Name [Specification]
1	G	-
2	Y	-
3	W	-
4	R	-
7	R	-
8	P	-
9	B	-
13	L	-
14	L	-
15	LG	-
16	Y	-
17	W	-
18	R	-
19	B	-
20	R	-
21	R	-
22	G	-
23	L	-
24	LG	-

JCNWA3238GB

BASE AUDIO WITH REAR VIEW CAMERA

[BASE AUDIO WITHOUT NAVIGATION]

< WIRING DIAGRAM >

BASE AUDIO WITHOUT NAVIGATION

Connector No.	R11
Connector Name	WIRE TO WIRE
Connector Type	TH04FW-NH

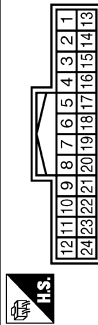

Connector No.	R18
Connector Name	FRONT MICROPHONE (ACTIVE NOISE CONTROL)
Connector Type	TH04FW-NH



Terminal No.	Color of Wire	Signal Name [Specification]
1	R	-
2	LG	-
3	W	-
4	P	-
5	O	-
6	L	-
7	V	-
8	W	-
9	W	-
10	B	-
11	R	-
12	GR	-

Terminal No.	Color of Wire	Signal Name [Specification]
5	SHIELD	-
6	L	-
7	R	-
8	B	-
9	B/Y	-
10	G	-
11	SB	-
12	V	-
17	GR	-
18	BR	-
19	W	-
20	LG	-
21	P	-
22	O	-
23	WR	-
24	L/B	-

Terminal No.	Color of Wire	Signal Name [Specification]
1	LG	-
2	W	-
3	B	-
4	P	-

Connector No.	R20
Connector Name	REAR MICROPHONE (ACTIVE NOISE CONTROL)
Connector Type	TH04FW-NH



Connector No.	T3
Connector Name	REAR VIEW CAMERA
Connector Type	TH04MY-NH



Connector No.	R17
Connector Name	MICROPHONE
Connector Type	TK04FW



Terminal No.	Color of Wire	Signal Name [Specification]
1	BR	-
2	GR	-
3	B	-
4	P	-

Connector No.	T1
Connector Name	WIRE TO WIRE
Connector Type	NS12FW-CS

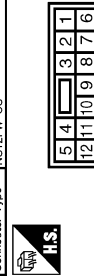

Terminal No.	Color of Wire	Signal Name [Specification]
1	W	CAMERA POWER SUPPLY
2	B	CAMERA GND
3	R	CAMERA IMAGE SIGNAL
4	SHIELD	SHIELD

Terminal No.	Color of Wire	Signal Name [Specification]
1	L	-
2	SHIELD	-
4	R	-

JCNWA3239GB

A
B
C
D
E
F
G
H
I
J
K
L
M
N
O
P

AV

BASIC INSPECTION

DIAGNOSIS AND REPAIR WORKFLOW

Work Flow

INFOID:000000005913144

OVERALL SEQUENCE

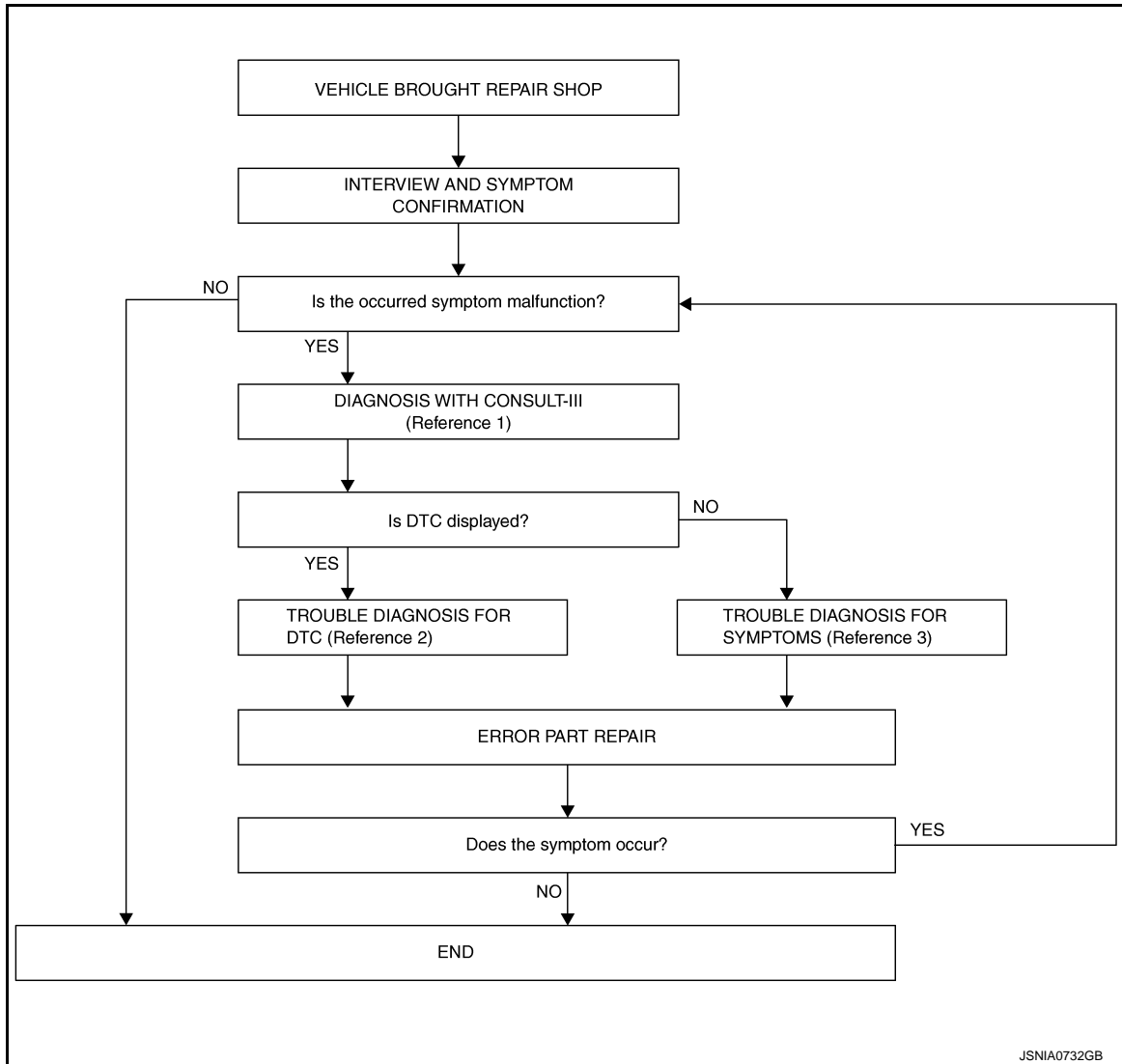

- Reference 1... Refer to [AV-26, "CONSULT - III Function"](#).
- Reference 2... Refer to [AV-39, "DTC Index"](#).
- Reference 3... Refer to [AV-114, "Symptom Table"](#).

DETAILED FLOW

1. INTERVIEW AND SYMPTOM CONFIRMATION

Check the malfunction symptoms by performing the following items.

- Interview the customer to obtain the malfunction information (conditions and environment when the malfunction occurred).
- Check the symptom.

Is the occurred symptom malfunction?

YES >> GO TO 2.

NO >> INSPECTION END

2. DIAGNOSIS WITH CONSULT-III

DIAGNOSIS AND REPAIR WORKFLOW

[BASE AUDIO WITHOUT NAVIGATION]

< BASIC INSPECTION >

1. Connect CONSULT-III and perform a self-diagnosis for "MULTI AV". Refer to [AV-26, "CONSULT - III Function"](#).

NOTE:

Skip to step 4 of the diagnosis procedure if "MULTI AV" is not displayed.

2. Check if any DTC is displayed in the "Self-Diagnosis Results".

Is DTC displayed?

YES >> GO TO 3.

NO >> GO TO 4.

3. TROUBLE DIAGNOSIS FOR DTC

1. Check the DTC indicated in the "Self-Diagnosis Results".
2. Perform the relevant diagnosis referring to the DTC Index. Refer to [AV-39, "DTC Index"](#).

>> GO TO 5.

4. TROUBLE DIAGNOSIS FOR SYMPTOMS

Perform the relevant diagnosis referring to the diagnosis chart by symptom. Refer to [AV-114, "Symptom Table"](#).

>> GO TO 5.

5. ERROR PART REPAIR

1. Repair or replace the identified malfunctioning parts.
2. Perform a self-diagnosis for "MULTI AV" with CONSULT-III.

NOTE:

Erase the stored self-diagnosis results after repairing or replacing the relevant components if any DTC has been indicated in the "Self-Diagnosis Results".

3. Check that the symptom does not occur.

Does the symptom occur?

YES >> GO TO 1.

NO >> INSPECTION END

A
B
C
D
E
F
G
H
I
J
K
L
M

AV

O
P

ADDITIONAL SERVICE WHEN REPLACING (AV CONTROL UNIT)

< BASIC INSPECTION >

[BASE AUDIO WITHOUT NAVIGATION]

ADDITIONAL SERVICE WHEN REPLACING (AV CONTROL UNIT)

Description

INFOID:000000005913145

BEFORE REPLACEMENT

When replacing AV control unit, save or print current vehicle specification with CONSULT-III configuration before replacement.

AFTER REPLACEMENT

CAUTION:

When replacing AV control unit, you must perform "WRITE CONFIGURATION" with CONSULT-III.

- Complete the procedure of "WRITE CONFIGURATION" in order.
- If you set incorrect "WRITE CONFIGURATION", incidents might occur.
- Configuration is different for each vehicle model. Confirm configuration of each vehicle model.

Work Procedure

INFOID:000000005913146

1. SAVING VEHICLE SPECIFICATION

Ⓟ-CONSULT-III Configuration

Perform "READ CONFIGURATION" to save or print current vehicle specification. Refer to [AV-77, "Description"](#).

NOTE:

If "READ CONFIGURATION" can not be used, use the "WRITE CONFIGURATION - Manual selection".

>> GO TO 2.

2. REPLACE AV CONTROL UNIT

Replace AV control unit. Refer to [AV-120, "Removal and Installation"](#).

>> GO TO 3.

3. WRITING VEHICLE SPECIFICATION

Ⓟ-CONSULT-III Configuration

Perform "WRITE CONFIGURATION - Config file" or "WRITE CONFIGURATION - Manual selection" to write vehicle specification. Refer to [AV-77, "Work Procedure"](#).

>> GO TO 4.

4. OPERATION CHECK

Check that the operation of the AV control unit and camera images (fixed guide lines and predictive course lines) are normal.

>> WORK END

CONFIGURATION (AV CONTROL UNIT)

< BASIC INSPECTION >

[BASE AUDIO WITHOUT NAVIGATION]

CONFIGURATION (AV CONTROL UNIT)

Description

INFOID:000000005913147

- Since vehicle specifications are not included in the AV control unit after replacement, it is required to write vehicle specifications with CONSULT-III.
- Configuration has three functions as follows.

Function	Description
READ CONFIGURATION	<ul style="list-style-type: none">• Reads the vehicle configuration of current AV control unit.• Saves the read vehicle configuration.
WRITE CONFIGURATION-Manual selection	Writes the vehicle configuration with manual selection.
WRITE CONFIGURATION-Config file	Writes the vehicle configuration with saved data.

Work Procedure

INFOID:000000005913148

NOTE:

If "WRITE CONFIGURATION" is unsuccessful, perform "Accessory Number Initialization". For details, refer to [AV-17, "On Board Diagnosis Function"](#).

After performing "Accessory Number Initialization", reboot the AV control unit to perform "WRITE CONFIGURATION".

1. WRITING MODE SELECTION

ⓂCONSULT-III Configuration
Select "CONFIGURATION" of "MULTI AV".

When writing saved data>>GO TO 2.

When writing manually>>GO TO 3.

2. PERFORM "WRITE CONFIGURATION-CONFIG FILE"

ⓂCONSULT-III Configuration
Perform "WRITE CONFIGURATION-Config file".

>> WORK END

3. PERFORM "WRITE CONFIGURATION-MANUAL SELECTION"

ⓂCONSULT-III Configuration
Select "WRITE CONFIGURATION-Manual selection" to write vehicle specifications into the AV control unit. For data to write, refer to [AV-77, "Configuration List"](#).

>> GO TO 4.

4. OPERATION CHECK

Check that the operation of the AV control unit and camera images (fixed guide lines and predictive course lines) are normal.

>> WORK END

Configuration List

INFOID:000000005913149

CAUTION:

Check vehicle specifications before servicing.

CONFIGURATION (AV CONTROL UNIT)

< BASIC INSPECTION >

[BASE AUDIO WITHOUT NAVIGATION]

MANUAL SETTING ITEM	
Items	Setting value
STEERING	LHD
	RHD
SOUND SYSTEM	BASE
	BOSE

U1000 CAN COMM CIRCUIT

< DTC/CIRCUIT DIAGNOSIS >

[BASE AUDIO WITHOUT NAVIGATION]

DTC/CIRCUIT DIAGNOSIS

U1000 CAN COMM CIRCUIT

Description

INFOID:000000005913150

CAN (Controller Area Network) is a serial communication line for real-time application. It is an on-vehicle multiplex communication line with high data communication speed and excellent error detection ability. Many electronic control units are equipped onto a vehicle, and each control unit shares information and links with other control units during operation (not independently). In CAN communication, control units are connected with 2 communication lines (CAN-H, CAN-L) allowing a high rate of information transmission with less wiring. Each control unit transmits/receives data but selectively reads required data only.

CAN Communication Signal Chart. Refer to [LAN-35, "CAN COMMUNICATION SYSTEM : CAN Communication Signal Chart"](#).

DTC Logic

INFOID:000000005913151

DTC DETECTION LOGIC

DTC	Display contents of CONSULT-III	DTC detection condition	Probable malfunction location
U1000	CAN COMM CIRCUIT [U1000]	AV control unit is not transmitting or receiving CAN communication signal for 2 seconds or more.	CAN communication system.

Diagnosis Procedure

INFOID:000000005913152

1.PERFORM SELF-DIAGNOSTIC

1. Turn ignition switch ON and wait for 2 seconds or more.
2. Check "Self Diagnostic Result" of "MULTI AV".

Is "CAN COMM CIRCUIT" displayed?

- YES >> Refer to [LAN-25, "Trouble Diagnosis Flow Chart"](#).
NO >> Refer to [GI-38, "Intermittent Incident"](#).

A
B
C
D
E
F
G
H
I
J
K
L
M
O
P

AV

U1010 CONTROL UNIT (CAN)

< DTC/CIRCUIT DIAGNOSIS >

[BASE AUDIO WITHOUT NAVIGATION]

U1010 CONTROL UNIT (CAN)

DTC Logic

INFOID:000000005913153

DTC DETECTION LOGIC

DTC	Display contents of CONSULT-III	DTC detection condition	Probable malfunction factor
U1010	CONTROL UNIT (CAN) [U1010]	CAN initial diagnosis malfunction is detected.	Replace the AV control unit if the malfunction occurs constantly. Refer to AV-120, "Removal and Installation" .

U1200 AV CONTROL UNIT

< DTC/CIRCUIT DIAGNOSIS >

[BASE AUDIO WITHOUT NAVIGATION]

U1200 AV CONTROL UNIT

DTC Logic

INFOID:000000005913154

DTC	Display contents of CONSULT-III	DTC detection condition	Possible malfunction factor
U1200	Cont Unit [U1200]	AV control unit malfunction is detected.	Replace the AV control unit if the malfunction occurs constantly. Refer to AV-120, "Removal and Installation" .

A
B
C
D
E
F
G
H
I
J
K
L
M
N
O
P

AV

U1216 AV CONTROL UNIT

< DTC/CIRCUIT DIAGNOSIS >

[BASE AUDIO WITHOUT NAVIGATION]

U1216 AV CONTROL UNIT

DTC Logic

INFOID:000000005913155

DTC	Display contents of CONSULT-III	DTC detection condition	Possible malfunction factor
U1216	CAN CONT [U1216]	AV control unit malfunction is detected.	Replace the AV control unit if the malfunction occurs constantly. Refer to AV-120, "Removal and Installation" .

U1232 STEERING ANGLE SENSOR

< DTC/CIRCUIT DIAGNOSIS >

[BASE AUDIO WITHOUT NAVIGATION]

U1232 STEERING ANGLE SENSOR

DTC Logic

INFOID:000000005913156

DTC	Display contents of CONSULT-III	DTC detection condition	Possible malfunction factor
U1232	ST ANGLE SEN CALIB [1232]	Predictive course line center position adjustment of the steering angle sensor is incomplete.	Adjust the predictive course line center position of the steering angle sensor. Refer to BRC-68. "Work Procedure" .

Diagnosis Procedure

INFOID:000000005913157

1. ADJUST THE PREDICTIVE COURSE LINE CENTER POSITION OF THE STEERING ANGLE SENSOR

When U1232 is detected, adjust the predictive course line center position of the steering angle sensor.

>> Adjusts the steering angle sensor neutral position on ABS actuator and electrical unit (control unit) side. Refer to [BRC-68. "Work Procedure"](#).

A
B
C
D
E
F
G
H
I
J
K
L
M
AV
O
P



U1243 DISPLAY UNIT

< DTC/CIRCUIT DIAGNOSIS >

[BASE AUDIO WITHOUT NAVIGATION]

U1243 DISPLAY UNIT

DTC Logic

INFOID:000000005913158

DTC	Display contents of CONSULT-III	DTC detection condition	Possible malfunction factor
U1243	FRONT DISP CONN [U1243]	When either one of the following items is detected: <ul style="list-style-type: none"> display unit power supply and ground circuit are malfunctioning. communication circuit between AV control unit and display unit are malfunctioning. 	<ul style="list-style-type: none"> Display unit power supply and ground circuit. Refer to AV-90. "DISPLAY UNIT : Diagnosis Procedure". Communication circuit between AV control unit and display unit.

Diagnosis Procedure

INFOID:000000005913159

1. CHECK DISPLAY UNIT POWER SUPPLY AND GROUND CIRCUIT

Check display unit power supply and ground circuit. Refer to [AV-90. "DISPLAY UNIT : Diagnosis Procedure"](#).

Is the inspection result normal?

YES >> GO TO 2.

NO >> Repair malfunctioning parts.

2. CHECK CONTINUITY COMMUNICATION CIRCUIT

- Turn ignition switch OFF.
- Disconnect display unit connector and AV control unit connector.
- Check continuity between display unit harness connector and AV control unit harness connector.

Display unit		AV control unit		Continuity
Connector	Terminals	Connector	Terminals	
M195	11	M82	51	Existed
	22		39	

- Check continuity between display unit harness connector and ground.

Display unit		Ground	Continuity
Connector	Terminals		
M195	11		Not existed
	22		

Is the inspection result normal?

YES >> GO TO 3.

NO >> Repair harness or connector.

3. CHECK COMMUNICATION SIGNAL

- Connect display unit connector and AV control unit connector.
- Turn ignition switch ON.
- Check signal between display unit harness connector and ground.

U1243 DISPLAY UNIT

< DTC/CIRCUIT DIAGNOSIS >

[BASE AUDIO WITHOUT NAVIGATION]

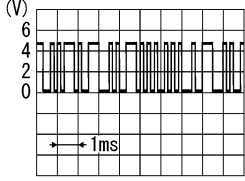
(+)		(-)	Condition	Reference value
Display unit				
Connector	Terminal			
M195	11	Ground	When adjusting display brightness.	 <p>PKIB5039J</p>

Is the inspection result normal?

YES >> GO TO 4.

NO >> Replace AV control unit. Refer to [AV-120. "Removal and Installation"](#).

4. CHECK COMMUNICATION SIGNAL

Check signal between display unit harness connector and ground.

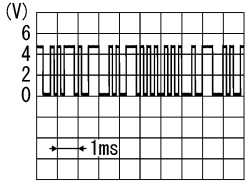
(+)		(-)	Condition	Reference value
Display unit				
Connector	Terminal			
M195	22	Ground	When adjusting display brightness.	 <p>PKIB5039J</p>

Is the inspection result normal?

YES >> INSPECTION END

NO >> Replace display unit. Refer to [AV-128. "Removal and Installation"](#).

A
B
C
D
E
F
G
H
I
J
K
L
M
O
P

AV

U1255 SATELLITE RADIO TUNER

< DTC/CIRCUIT DIAGNOSIS >

[BASE AUDIO WITHOUT NAVIGATION]

U1255 SATELLITE RADIO TUNER

DTC Logic

INFOID:000000005913160

DTC	Display contents of CONSULT-III	DTC Detection Condition	Possible causes
U1255	SAT CONN [U1255]	When either one of the following items is detected: <ul style="list-style-type: none"> satellite radio tuner power supply and ground circuit are malfunctioning. communication circuits between AV control unit and satellite radio tuner are malfunctioning. request signal circuit between AV control unit and satellite radio tuner are malfunctioning. 	<ul style="list-style-type: none"> Satellite radio tuner power supply and ground circuit. Refer to AV-92. "SATELLITE RADIO TUNER : Diagnosis Procedure". Communication circuit between AV control unit and satellite radio tuner. Request signal circuit between AV control unit and satellite radio tuner.

Diagnosis Procedure

INFOID:000000005913161

1. CHECK SATELLITE RADIO TUNER POWER SUPPLY AND GROUND CIRCUIT

Check satellite radio tuner power supply and ground circuit. Refer to [AV-92. "SATELLITE RADIO TUNER : Diagnosis Procedure"](#).

Is the inspection result normal?

YES >> GO TO 2.

NO >> Repair malfunctioning parts.

2. CHECK CONTINUITY COMMUNICATION CIRCUIT AND REQUEST SIGNAL CIRCUIT

- Turn ignition switch OFF.
- Disconnect AV control unit connector and satellite radio tuner connector.
- Check continuity between AV control unit harness connector and satellite radio tuner harness connector.

AV control unit		Satellite radio tuner		Continuity
Connector	Terminals	Connector	Terminals	
M85	122	B236	10	Existed
	129		8	
	130		9	

- Check continuity between AV control unit harness connector.

AV control unit		Ground	Continuity
Connector	Terminals		
M85	122	Ground	Not existed
	129		
	130		

Is the inspection result normal?

YES >> GO TO 3.

NO >> Repair harness or connector.

3. CHECK AV CONTROL UNIT VOLTAGE

- Connect AV control unit connector.
- Turn ignition switch ON.
- Check signal between AV control unit harness connector and ground.

U1255 SATELLITE RADIO TUNER

< DTC/CIRCUIT DIAGNOSIS >

[BASE AUDIO WITHOUT NAVIGATION]

(+)		(-)	Voltage (Approx.)
AV control unit			
Connector	Terminals		
M85	129	Ground	7.0 V
	130		7.0 V

Is the inspection result normal?

YES >> GO TO 4.

NO >> Replace AV control unit. Refer to [AV-120. "Removal and Installation"](#).

4. CHECK SATELLITE RADIO TUNER VOLTAGE

1. Turn ignition switch OFF.
2. Disconnect AV control unit connector.
3. Connect satellite radio tuner.
4. Turn ignition switch ON.
5. Check signal between satellite radio tuner harness connector and ground.

(+)		(-)	Voltage (Approx.)
Satellite radio tuner			
Connector	Terminal		
B236	10	Ground	7.0 V

Is the inspection result normal?

YES >> INSPECTION END

NO >> Replace satellite radio tuner. Refer to [AV-129. "Removal and Installation"](#).

A
B
C
D
E
F
G
H
I
J
K
L
M
O
P

AV

U1300 AV COMM CIRCUIT

< DTC/CIRCUIT DIAGNOSIS >

[BASE AUDIO WITHOUT NAVIGATION]

U1300 AV COMM CIRCUIT

Description

INFOID:000000005913162

U1300 is indicated when malfunction occurs in communication signal of multi AV system. Indicated simultaneously, without fail, with the malfunction of control units connected to AV control unit with communication line. Determine the possible malfunction cause from the table below.

SELF-DIAGNOSIS RESULTS DISPLAY ITEM

DTC	Display contents of CONSULT-III	DTC detection condition	Possible malfunction factor
U1300 U1240	<ul style="list-style-type: none">• AV COMM CIRCUIT [U1300]• SWITCH CONN [U1240]	When either one of the following items is detected: <ul style="list-style-type: none">• multifunction switch power supply and ground circuits are malfunctioning.• AV communication circuits between AV control unit and multifunction switch are malfunctioning.	<ul style="list-style-type: none">• Multifunction switch power supply and ground circuits.• AV communication circuits between AV control unit and multifunction switch.
U1300 U1256	<ul style="list-style-type: none">• AV COMM CIRCUIT [U1300]• HAND FREE CONN [U1256]	When either one of the following items is detected: <ul style="list-style-type: none">• TEL adapter unit power supply and ground circuits are malfunctioning.• AV communication circuits between AV control unit and TEL adapter unit are malfunctioning.	<ul style="list-style-type: none">• TEL adapter unit power supply and ground circuits. Refer to AV-93. "TEL ADAPTER UNIT : Diagnosis Procedure".• AV communication circuits between AV control unit and TEL adapter unit.
U1300 U1240 U1256	<ul style="list-style-type: none">• AV COMM CIRCUIT [U1300]• SWITCH CONN [U1240]• HAND FREE CONN [U1256]	Malfunction is detected in AV communication circuits between AV control unit and multifunction switch.	AV communication circuits between AV control unit and multifunction switch.

U1310 AV CONTROL UNIT

< DTC/CIRCUIT DIAGNOSIS >

[BASE AUDIO WITHOUT NAVIGATION]

U1310 AV CONTROL UNIT

DTC Logic

INFOID:000000005913163

DTC	Display contents of CONSULT-III	DTC detection condition	Possible malfunction factor
U1310	CONTROL UNIT (AV) [U1310]	An initial diagnosis error is detected in AV communication circuit.	Replace AV control unit. If the malfunction occurs constantly. Refer to AV-90. "AV CONTROL UNIT : Diagnosis Procedure" .

A
B
C
D
E
F
G
H
I
J
K
L
M
N
O
P

AV

POWER SUPPLY AND GROUND CIRCUIT

< DTC/CIRCUIT DIAGNOSIS >

[BASE AUDIO WITHOUT NAVIGATION]

POWER SUPPLY AND GROUND CIRCUIT

AV CONTROL UNIT

AV CONTROL UNIT : Diagnosis Procedure

INFOID:000000005913164

1.CHECK FUSE

Check for blown fuses.

Power source	Fuse No.
Battery	34
Ignition switch ACC or ON	19

Is the inspection result normal?

YES >> GO TO 2.

NO >> Be sure to eliminate cause of malfunction before installing new fuse.

2.CHECK POWER SUPPLY CIRCUIT

Check voltage between AV control unit harness connectors and ground.

Signal name	(+)		(-)	Ignition switch position	Voltage (Approx.)
	AV control unit				
	Connector	Terminal			
Battery power supply	M81	19	Ground	OFF	Battery voltage
ACC power supply		7		ACC	

Is the inspection result normal?

YES >> GO TO 3.

NO >> Check harness between AV control unit and fuse.

3.CHECK GROUND CIRCUIT

1. Turn ignition switch OFF.
2. Disconnect AV control unit connectors.
3. Check continuity between AV control unit harness connectors and ground.

AV control unit		Ground	Continuity
Connector	Terminal		
M81	20		Existed

Is the inspection result normal?

YES >> INSPECTION END

NO >> Repair harness or connector.

DISPLAY UNIT

DISPLAY UNIT : Diagnosis Procedure

INFOID:000000005913165

1.CHECK POWER SUPPLY CIRCUIT (DISPLAY SIDE)

1. Turn ignition switch ACC.
2. Check voltage between display unit harness connector and ground.

Signal name	(+)		(-)	Voltage (Approx.)
	Display unit			
	Connector	Terminal		
Inverter VCC	M195	2	Ground	9.0 V
Signal VCC		3		

POWER SUPPLY AND GROUND CIRCUIT

[BASE AUDIO WITHOUT NAVIGATION]

< DTC/CIRCUIT DIAGNOSIS >

Is the inspection result normal?

YES >> GO TO 4.

NO >> GO TO 2.

2.CHECK POWER SUPPLY CIRCUIT (CONTINUITY)

1. Turn ignition switch OFF.
2. Disconnect the harness connector between display unit and AV control unit.
3. Check continuity between display unit harness connector and AV control unit harness connector.

Display unit		AV control unit		Continuity
Connector	Terminal	Connector	Terminal	
M195	2	M82	48	Existed
	3		36	

4. Check continuity between display unit harness connector and ground.

Display unit		Ground	Continuity
Connector	Terminal		
M195	2		Not existed
	3		

Is the inspection result normal?

YES >> GO TO 3.

NO >> Repair harness or connector.

3.CHECK POWER SUPPLY CIRCUIT (AV CONTROL UNIT SIDE)

1. Connect the AV control unit harness connector.
2. Turn ignition switch ACC.
3. Check voltage between AV control unit harness connector and ground.

Signal name	(+)		(-)	Voltage (Approx.)
	AV control unit			
	Connector	Terminal		
Inverter VCC	M82	48	Ground	9.0 V
Signal VCC		36		9.0 V

Is the inspection result normal?

YES >> INSPECTION END

NO >> Replace AV control unit. Refer to [AV-120, "Removal and Installation"](#).

4.CHECK GROUND CIRCUIT

1. Turn ignition switch OFF.
2. Disconnect display unit connector.
3. Check continuity between display unit harness connectors and ground.

Display unit		Ground	Continuity
Connector	Terminal		
M195	1		Existed

Is the inspection result normal?

YES >> INSPECTION END

NO >> Repair harness or connector.

ACTIVE NOISE CONTROL UNIT

A
B
C
D
E
F
G
H
I
J
K
L
M
O
P

AV

POWER SUPPLY AND GROUND CIRCUIT

< DTC/CIRCUIT DIAGNOSIS >

[BASE AUDIO WITHOUT NAVIGATION]

ACTIVE NOISE CONTROL UNIT : Diagnosis Procedure

INFOID:000000006055439

1.CHECK FUSE

Check for blown fuses.

Power source	Fuse No.
Battery	34
Ignition switch ACC or ON	19

Is the inspection result normal?

YES >> GO TO 2.

NO >> Be sure to eliminate cause of malfunction before installing new fuse.

2.CHECK POWER SUPPLY CIRCUIT

Check voltage between active noise control unit harness connector and ground.

Signal name	(+)		(-)	Ignition switch position	Voltage (Approx.)
	Active noise control unit				
	Connector	Terminal			
Battery power supply	B57	2	Ground	OFF	Battery voltage
ACC power supply	B58	36		ACC	

Is the inspection result normal?

YES >> GO TO 3.

NO >> Check harness between active noise control unit and fuse.

3.CHECK GROUND CIRCUIT

1. Turn ignition switch OFF.
2. Disconnect active noise control unit connector.
3. Check continuity between active noise control unit harness connector and ground.

Active noise control unit		Ground	Continuity
Connector	Terminal		
B57	1		Existed

Is the inspection result normal?

YES >> INSPECTION END

NO >> Repair harness or connector.

SATELLITE RADIO TUNER

SATELLITE RADIO TUNER : Diagnosis Procedure

INFOID:000000005913166

1.CHECK FUSE

Check for blown fuses.

Power source	Fuse No.
Battery	34
Ignition switch ACC or ON	19

Is the inspection result normal?

YES >> GO TO 2.

NO >> Be sure to eliminate cause of malfunction before installing new fuse.

2.CHECK POWER SUPPLY CIRCUIT

Check voltage between satellite radio tuner harness connector and ground.

POWER SUPPLY AND GROUND CIRCUIT

< DTC/CIRCUIT DIAGNOSIS >

[BASE AUDIO WITHOUT NAVIGATION]

Signal name	(+)		(-)	Ignition switch position	Voltage (Approx.)
	Satellite radio tuner				
	Connector	Terminal			
Battery power supply	B236	12	Ground	OFF	Battery voltage
ACC power supply		16		ACC	

Is the inspection result normal?

YES >> INSPECTION END

NO >> Check harness between satellite radio tuner and fuse.

TEL ADAPTER UNIT

TEL ADAPTER UNIT : Diagnosis Procedure

INFOID:000000005913167

1.CHECK FUSE

Check for blown fuses.

Power source	Fuse No.
Battery	34
Ignition switch ACC or ON	19

Is the inspection result normal?

YES >> GO TO 2.

NO >> Be sure to eliminate cause of malfunction before installing new fuse.

2.CHECK POWER SUPPLY CIRCUIT

Check voltage between TEL adapter unit harness connector and ground.

Signal name	(+)		(-)	Ignition switch position	Voltage (Approx.)
	TEL adapter unit				
	Connector	Terminal			
Battery power supply	B237	1	Ground	OFF	Battery voltage
ACC power supply		2		ACC	

Is the inspection result normal?

YES >> GO TO 3.

NO >> Check harness between TEL adapter unit and fuse.

3.CHECK GROUND CIRCUIT

1. Turn ignition switch OFF.
2. Disconnect TEL adapter unit connector.
3. Check continuity between TEL adapter unit harness connector and ground.

TEL adapter unit		Ground	Continuity
Connector	Terminal		
B237	4		Existed
	14		
	19		

Is the inspection result normal?

YES >> INSPECTION END

NO >> Repair harness or connector.

RGB (R: RED) SIGNAL CIRCUIT

< DTC/CIRCUIT DIAGNOSIS >

[BASE AUDIO WITHOUT NAVIGATION]

RGB (R: RED) SIGNAL CIRCUIT

Description

INFOID:000000005913168

Transmit the image displayed with AV control unit with RGB signal to the display unit.

Diagnosis Procedure

INFOID:000000005913169

1. CHECK CONTINUITY RGB (R: RED) SIGNAL CIRCUIT

1. Turn ignition switch OFF.
2. Disconnect display unit connector and AV control unit connector.
3. Check continuity between display unit harness connector and AV control unit harness connector.

Display unit		AV control unit		Continuity
Connector	Terminal	Connector	Terminal	
M195	17	M82	43	Existed

4. Check continuity between display unit harness connector and ground.

Display unit		Ground	Continuity
Connector	Terminal		
M195	17		Not existed

Is inspection result normal?

- YES >> GO TO 2.
 NO >> Repair harness or connector.

2. CHECK RGB (R: RED) SIGNAL

1. Connect display unit connector and AV control unit connector.
2. Turn ignition switch ON.
3. Check signal between display unit harness connector and ground.

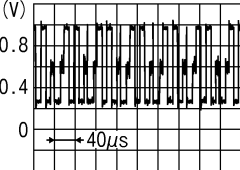
(+)		(-)	Condition	Reference value
Display unit				
Connector	Terminal			
M195	17	Ground	Start confirmation/adjustment mode, and then display color bar by selecting "Color Spectrum Bar" on DISPLAY DIAGNOSIS screen.	 <p style="text-align: right;">JSNIA1029ZZ</p>

Is inspection result normal?

- YES >> Replace display unit. Refer to [AV-128. "Removal and Installation"](#).
 NO >> Replace AV control unit. Refer to [AV-120. "Removal and Installation"](#).

RGB (G: GREEN) SIGNAL CIRCUIT

< DTC/CIRCUIT DIAGNOSIS >

[BASE AUDIO WITHOUT NAVIGATION]

RGB (G: GREEN) SIGNAL CIRCUIT

Description

INFOID:000000005913170

Transmit the image displayed with AV control unit with RGB signal to the display unit.

Diagnosis Procedure

INFOID:000000005913171

1. CHECK CONTINUITY RGB (G: GREEN) SIGNAL CIRCUIT

1. Turn ignition switch OFF.
2. Disconnect display unit connector and AV control unit connector.
3. Check continuity between display unit harness connector and AV control unit harness connector.

Display unit		AV control unit		Continuity
Connector	Terminal	Connector	Terminal	
M195	6	M82	44	Existed

4. Check continuity between display unit harness connector and ground.

Display unit		Ground	Continuity
Connector	Terminal		
M195	6		Not existed

Is inspection result normal?

- YES >> GO TO 2.
 NO >> Repair harness or connector.

2. CHECK RGB (G: GREEN) SIGNAL

1. Connect display unit connector and AV control unit connector.
2. Turn ignition switch ON.
3. Check signal between display unit harness connector and ground.

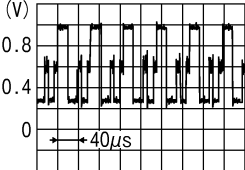
(+) Display unit		(-)	Condition	Reference value
Connector	Terminal			
M195	6	Ground	Start confirmation/adjustment mode, and then display color bar by selecting "Color Spectrum Bar" on DISPLAY DIAGNOSIS screen.	 <p>(V)</p> <p>0.8</p> <p>0.4</p> <p>0</p> <p>40µs</p> <p>JSNIA1030ZZ</p>

Is inspection result normal?

- YES >> Replace display unit. Refer to [AV-128. "Removal and Installation"](#).
 NO >> Replace AV control unit. Refer to [AV-120. "Removal and Installation"](#).

A
B
C
D
E
F
G
H
I
J
K
L
M
AV
O
P

RGB (B: BLUE) SIGNAL CIRCUIT

< DTC/CIRCUIT DIAGNOSIS >

[BASE AUDIO WITHOUT NAVIGATION]

RGB (B: BLUE) SIGNAL CIRCUIT

Description

INFOID:000000005913172

Transmit the image displayed with AV control unit with RGB signal to the display unit.

Diagnosis Procedure

INFOID:000000005913173

1. CHECK CONTINUITY RGB (B: BLUE) SIGNAL CIRCUIT

1. Turn ignition switch OFF.
2. Disconnect display unit connector and AV control unit connector.
3. Check continuity between display unit harness connector and AV control unit harness connector.

Display unit		AV control unit		Continuity
Connector	Terminal	Connector	Terminal	
M195	18	M82	45	Existed

4. Check continuity between display unit harness connector and ground.

Display unit		Ground	Continuity
Connector	Terminal		
M195	18		Not existed

Is inspection result normal?

- YES >> GO TO 2.
NO >> Repair harness or connector.

2. CHECK RGB (B: BLUE) SIGNAL

1. Connect display unit connector and AV control unit connector.
2. Turn ignition switch ON.
3. Check signal between display unit harness connector and ground.

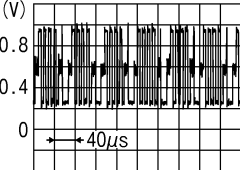
(+)		(-)	Condition	Reference value
Display unit				
Connector	Terminal			
M195	18	Ground	Start confirmation/adjustment mode, and then display color bar by selecting "Color Spectrum Bar" on DISPLAY DIAGNOSIS screen.	 <p>(V)</p> <p>0.8</p> <p>0.4</p> <p>0</p> <p>← 40µs</p> <p>JSNIA1031ZZ</p>

Is inspection result normal?

- YES >> Replace display unit. Refer to [AV-128. "Removal and Installation"](#).
NO >> Replace AV control unit. Refer to [AV-120. "Removal and Installation"](#).

RGB SYNCHRONIZING SIGNAL CIRCUIT

< DTC/CIRCUIT DIAGNOSIS >

[BASE AUDIO WITHOUT NAVIGATION]

RGB SYNCHRONIZING SIGNAL CIRCUIT

Description

INFOID:000000005913174

Transmit the RGB synchronizing signal to the display unit so as to synchronize the RGB image displayed with AV control unit.

Diagnosis Procedure

INFOID:000000005913175

1. CHECK CONTINUITY RGB SYNCHRONIZING SIGNAL CIRCUIT

1. Turn ignition switch OFF.
2. Disconnect display unit connector and AV control unit connector.
3. Check continuity between display unit harness connector and AV control unit harness connector.

Display unit		AV control unit		Continuity
Connector	Terminal	Connector	Terminal	
M195	19	M82	42	Existed

4. Check continuity between display unit harness connector and ground.

Display unit		Ground	Continuity
Connector	Terminal		
M195	19		Not existed

Is the inspection result normal?

YES >> GO TO 2.

NO >> Repair harness or connector.

2. CHECK RGB SYNCHRONIZING SIGNAL

1. Connect display unit connector and AV control unit connector.
2. Turn ignition switch ON.
3. Check signal between display unit harness connector and ground.

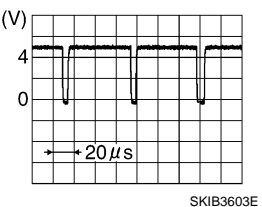
(+) Display unit		(-)	Reference value
Connector	Terminal		
M195	19	Ground	

Is the inspection result normal?

YES >> Replace display unit. Refer to [AV-128, "Removal and Installation"](#).

NO >> Replace AV control unit. Refer to [AV-120, "Removal and Installation"](#).

RGB AREA (YS) SIGNAL CIRCUIT

< DTC/CIRCUIT DIAGNOSIS >

[BASE AUDIO WITHOUT NAVIGATION]

RGB AREA (YS) SIGNAL CIRCUIT

Description

INFOID:000000005913176

Transmits the display area of RGB image displayed by AV control unit with RGB area (YS) signal to display unit.

Diagnosis Procedure

INFOID:000000005913177

1. CHECK CONTINUITY RGB AREA (YS) SIGNAL CIRCUIT

1. Turn ignition switch OFF.
2. Disconnect display unit connector and AV control unit connector.
3. Check continuity between display unit harness connector and AV control unit harness connector.

Display unit		AV control unit		Continuity
Connector	Terminal	Connector	Terminal	
M195	9	M82	40	Existed

4. Check continuity between display unit harness connector and ground.

Display unit		Ground	Continuity
Connector	Terminal		
M195	9		Not existed

Is the inspection result normal?

- YES >> GO TO 2.
 NO >> Repair harness or connector.

2. CHECK RGB AREA (YS) SIGNAL

1. Connect display unit connector and AV control unit connector.
2. Turn ignition switch ON.
3. Check signal between display unit harness connector and ground.

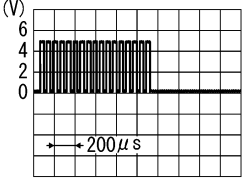
(+)		(-)	Condition	Reference value (Approx.)
Connector	Terminal			
M195	9	Ground	At RGB image is displayed.	5.0 V
			At camera image is displayed.	 <p style="text-align: right; font-size: small;">PKIB4948J</p>

Is the inspection result normal?

- YES >> Replace display unit. Refer to [AV-128. "Removal and Installation"](#).
 NO >> Replace AV control unit. Refer to [AV-120. "Removal and Installation"](#).

CAMERA IMAGE SIGNAL CIRCUIT

< DTC/CIRCUIT DIAGNOSIS >

[BASE AUDIO WITHOUT NAVIGATION]

CAMERA IMAGE SIGNAL CIRCUIT

Description

INFOID:000000005913178

- AV control unit outputs camera power supply to rear view camera and inputs rear view camera image signal from rear view camera when the reverse signal is input.
- The AV control unit that inputs the camera image signal transmits the camera image signal to the display unit.

Diagnosis Procedure

INFOID:000000005913179

1. CHECK CONTINUITY CAMERA POWER SUPPLY CIRCUIT

1. Turn ignition switch OFF.
2. Disconnect AV control unit connector and rear view camera connector.
3. Check continuity between AV control unit harness connector and rear view camera harness connector.

AV control unit		Rear view camera		Continuity
Connector	Terminal	Connector	Terminal	
M83	73	T5	1	Existed

4. Check continuity between AV control unit harness connector and ground.

AV control unit		Ground	Continuity
Connector	Terminal		
M83	73		Not existed

Is inspection result normal?

YES >> GO TO 2.

NO >> Repair harness or connector.

2. CHECK VOLTAGE CAMERA POWER SUPPLY

1. Connect AV control unit connector and rear view camera connector.
2. Turn ignition switch ON.
3. Shift the selector lever to "R".
4. Check voltage between AV control unit harness connector and ground.

(+)		(-)	Condition	Voltage (Approx.)
Connector	Terminal			
M83	73	Ground	Shift position is "R".	6.0 V

Is inspection result normal?

YES >> GO TO 3.

NO >> Replace AV control unit. Refer to [AV-120. "Removal and Installation"](#).

3. CHECK CONTINUITY CAMERA IMAGE SIGNAL CIRCUIT

1. Turn ignition switch OFF.
2. Disconnect AV control unit connector and rear view camera connector.
3. Check continuity between AV control unit harness connector and rear view camera harness connector.

AV control unit		Rear view camera		Continuity
Connector	Terminal	Connector	Terminal	
M83	62	T5	3	Existed

4. Check continuity between AV control unit harness connector and ground.

A
B
C
D
E
F
G
H
I
J
K
L
M
O
P

AV

CAMERA IMAGE SIGNAL CIRCUIT

< DTC/CIRCUIT DIAGNOSIS >

[BASE AUDIO WITHOUT NAVIGATION]

AV control unit		Ground	Continuity
Connector	Terminal		
M83	62		Not existed

Is inspection result normal?

YES >> GO TO 4.

NO >> Repair harness or connector.

4. CHECK CAMERA IMAGE SIGNAL

1. Connect AV control unit connector and rear view camera connector.
2. Turn ignition switch ON.
3. Shift the selector lever to "R".
4. Check signal between AV control unit harness connector and ground.

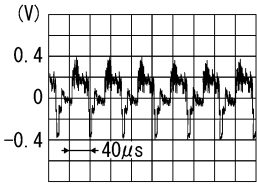
(+)		(-)	Condition	Reference value
AV control unit				
Connector	Terminal			
M83	62	Ground	At rear view camera image is displayed.	

Is inspection result normal?

YES >> Replace AV control unit. Refer to [AV-120, "Removal and Installation"](#).

NO >> Replace rear view camera. Refer to [AV-128, "Removal and Installation"](#).

COMPOSITE IMAGE SIGNAL CIRCUIT

< DTC/CIRCUIT DIAGNOSIS >

[BASE AUDIO WITHOUT NAVIGATION]

COMPOSITE IMAGE SIGNAL CIRCUIT

Description

INFOID:000000005913180

AV control unit that inputs the camera image signal transmits the composite image signal to the display unit.

Diagnosis Procedure

INFOID:000000005913181

1. CHECK CONTINUITY COMPOSITE IMAGE SIGNAL CIRCUIT

1. Turn ignition switch OFF.
2. Disconnect AV control unit connector and display unit connector.
3. Check continuity between AV control unit harness connector and display unit harness connector.

AV control unit		Display unit		Continuity
Connector	Terminal	Connector	Terminal	
M82	47	M195	15	Existed

4. Check continuity between AV control unit harness connector and ground.

AV control unit		Ground	Continuity
Connector	Terminal		
M82	47		Not existed

Is the inspection result normal?

- YES >> GO TO 2.
 NO >> Repair harness or connector.

2. CHECK COMPOSITE IMAGE SIGNAL

1. Connect AV control unit connector and display unit connector.
2. Turn ignition switch ON.
3. Check signal between AV control unit harness connector and ground.

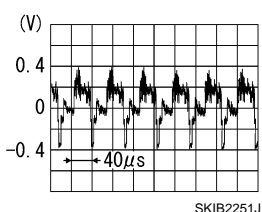
(+)		(-)	Condition	Reference value
AV control unit				
Connector	Terminal			
M82	47	Ground	At camera image is displayed.	

Is the inspection result normal?

- YES >> Replace display unit. Refer to [AV-128. "Removal and Installation"](#).
 NO >> Replace AV control unit. Refer to [AV-120. "Removal and Installation"](#).

A
B
C
D
E
F
G
H
I
J
K
L
M
AV
O
P

HORIZONTAL SYNCHRONIZING (HP) SIGNAL CIRCUIT

< DTC/CIRCUIT DIAGNOSIS >

[BASE AUDIO WITHOUT NAVIGATION]

HORIZONTAL SYNCHRONIZING (HP) SIGNAL CIRCUIT

Description

INFOID:000000005913182

In composite image (camera image), transmit the vertical synchronizing (VP) signal and horizontal synchronizing (HP) signal from display unit to AV control unit so as to synchronize the RGB images displayed with AV control unit such as the image quality adjusting menu, etc.

Diagnosis Procedure

INFOID:000000005913183

1. CHECK CONTINUITY HORIZONTAL SYNCHRONIZING (HP) SIGNAL CIRCUIT

1. Turn ignition switch OFF.
2. Disconnect display unit connector and AV control unit connector.
3. Check continuity between display unit harness connector and AV control unit harness connector.

Display unit		AV control unit		Continuity
Connector	Terminal	Connector	Terminal	
M195	8	M82	38	Existed

4. Check continuity between display unit harness connector and ground.

Display unit		Ground	Continuity
Connector	Terminal		
M195	8		Not existed

Is the inspection result normal?

YES >> GO TO 2.

NO >> Repair harness or connector.

2. CHECK HORIZONTAL SYNCHRONIZING (HP) SIGNAL

1. Connect display unit connector and AV control unit connector.
2. Turn ignition switch ON.
3. Check signal between display unit harness connector and ground.

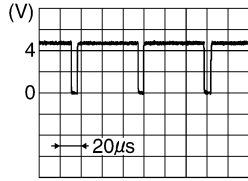
(+)		(-)	Reference value
Display unit			
Connector	Terminal		
M195	8	Ground	 SKIB3601E

Is the inspection result normal?

YES >> Replace AV control unit. Refer to [AV-120, "Removal and Installation"](#).

NO >> Replace display unit. Refer to [AV-128, "Removal and Installation"](#).

VERTICAL SYNCHRONIZING (VP) SIGNAL CIRCUIT

< DTC/CIRCUIT DIAGNOSIS >

[BASE AUDIO WITHOUT NAVIGATION]

VERTICAL SYNCHRONIZING (VP) SIGNAL CIRCUIT

Description

INFOID:000000005913184

In composite image (camera image), transmit the vertical synchronizing (VP) signal and horizontal synchronizing (HP) signal from display unit to AV control unit so as to synchronize the RGB images displayed with AV control unit such as the image quality adjusting menu, etc.

Diagnosis Procedure

INFOID:000000005913185

1. CHECK CONTINUITY VERTICAL SYNCHRONIZING (VP) SIGNAL CIRCUIT

1. Turn ignition switch OFF.
2. Disconnect display unit connector and AV control unit connector.
3. Check continuity between display unit harness connector and AV control unit harness connector.

Display unit		AV control unit		Continuity
Connector	Terminal	Connector	Terminal	
M195	20	M82	50	Existed

4. Check continuity between display unit harness connector and ground.

Display unit		Ground	Continuity
Connector	Terminal		
M195	20		Not existed

Is the inspection result normal?

YES >> GO TO 2.

NO >> Repair harness or connector.

2. CHECK VERTICAL SYNCHRONIZING (VP) SIGNAL

1. Connect display unit connector and AV control unit connector.
2. Turn ignition switch ON.
3. Check signal between display unit harness connector and ground.

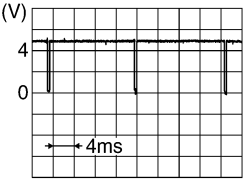
(+) Display unit		(-)	Reference value
Connector	Terminal		
M195	20	Ground	

Is the inspection result normal?

YES >> Replace AV control unit. Refer to [AV-120, "Removal and Installation"](#).

NO >> Replace display unit. Refer to [AV-128, "Removal and Installation"](#).

A
B
C
D
E
F
G
H
I
J
K
L
M
O
P

AV

DISK EJECT SIGNAL CIRCUIT

< DTC/CIRCUIT DIAGNOSIS >

[BASE AUDIO WITHOUT NAVIGATION]

DISK EJECT SIGNAL CIRCUIT

Description

INFOID:000000005913186

The eject signal is output to AV control unit when the eject switch of multifunction switch is pressed.

Diagnosis Procedure

INFOID:000000005913187

1. CHECK CONTINUITY DISK EJECT SIGNAL CIRCUIT

1. Turn ignition switch OFF.
2. Disconnect multifunction switch connector and AV control unit connector.
3. Check continuity between multifunction switch harness connector and AV control unit harness connector.

Multifunction switch		AV control unit		Continuity
Connector	Terminal	Connector	Terminal	
M72	14	M84	96	Existed

4. Check continuity between multifunction switch harness connector and ground.

Multifunction switch		Ground	Continuity
Connector	Terminal		
M72	14		Not existed

Is the inspection result normal?

- YES >> GO TO 2.
 NO >> Repair harness or connector.

2. CHECK AV CONTROL UNIT VOLTAGE

1. Connect multifunction switch connector and AV control unit connector.
2. Turn ignition switch ON.
3. Check voltage between AV control unit harness connector and ground.

(+) AV control unit		(-)	Condition	Voltage (Approx.)
Connector	Terminal			
M84	96	Ground	Pressing the eject switch	0 V
			Except for above	3.3 V

Is the inspection result normal?

- YES >> Replace preset switch. Refer to [AV-132. "Removal and Installation"](#).
 NO >> Replace AV control unit. Refer to [AV-120. "Removal and Installation"](#).

MICROPHONE SIGNAL CIRCUIT

< DTC/CIRCUIT DIAGNOSIS >

[BASE AUDIO WITHOUT NAVIGATION]

MICROPHONE SIGNAL CIRCUIT

Description

INFOID:000000005913188

Supply power from TEL adapter unit to microphone. The microphone transmits the sound/voice to the microphone.

Diagnosis Procedure

INFOID:000000005913189

1. CHECK CONTINUITY BETWEEN TEL ADAPTER UNIT AND MICROPHONE CIRCUIT

1. Turn ignition switch OFF.
2. Disconnect TEL adapter unit connector and microphone connector.
3. Check continuity between TEL adapter unit harness connector and microphone harness connector.

TEL adapter unit		Microphone		Continuity
Connector	Terminals	Connector	Terminals	
B237	7	R17	1	Existed
	8		2	
	29		4	

4. Check continuity between TEL adapter unit harness connector and ground.

TEL adapter unit		Ground	Continuity
Connector	Terminals		
M237	7		Not existed
	29		

Is the inspection result normal?

YES >> GO TO 2.

NO >> Repair harness or connector.

2. CHECK VOLTAGE MICROPHONE VCC

1. Connect TEL adapter unit connector.
2. Turn ignition switch ON.
3. Check voltage between TEL adapter unit harness connector.

(+)		(-)		Voltage (Approx.)
TEL adapter unit		TEL adapter unit		
Connector	Terminal	Connector	Terminal	
B237	29	B237	8	5.0 V

Is the inspection result normal?

YES >> GO TO 3.

NO >> Replace TEL adapter unit. Refer to [AV-136. "Removal and Installation"](#).

3. CHECK MICROPHONE SIGNAL

1. Connect microphone connector.
2. Check signal between TEL adapter unit harness connector.

A
B
C
D
E
F
G
H
I
J
K
L
M
AV
O
P

MICROPHONE SIGNAL CIRCUIT

< DTC/CIRCUIT DIAGNOSIS >

[BASE AUDIO WITHOUT NAVIGATION]

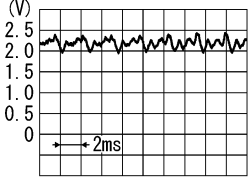
(+)		(-)		Condition	Reference value
TEL adapter unit		TEL adapter unit			
Connector	Terminal	Connector	Terminal		
B237	7	B237	8	give a voice.	 <p style="text-align: right;">PKIB5037J</p>

Is the inspection result normal?

- YES >> Replace TEL adapter unit. Refer to [AV-136, "Removal and Installation"](#).
 NO >> Replace microphone. Refer to [AV-135, "Removal and Installation"](#).

CONTROL SIGNAL CIRCUIT

< DTC/CIRCUIT DIAGNOSIS >

[BASE AUDIO WITHOUT NAVIGATION]

CONTROL SIGNAL CIRCUIT

Description

INFOID:000000005913190

TEL adapter unit identifies the vehicle model according to the control signal and performs the control.

Diagnosis Procedure

INFOID:000000005913191

1. CHECK CONTINUITY CONTROL SIGNAL CIRCUIT

1. Turn ignition switch OFF.
2. Disconnect TEL adapter unit connector.
3. Check continuity between TEL adapter unit harness connector and ground.

TEL adapter unit		Ground	Continuity
Connector	Terminals		
B237	21	Ground	Existed
	23		
	24		

Is the inspection result normal?

- YES >> Replace TEL adapter unit. Refer to [AV-136, "Removal and Installation"](#).
NO >> Repair harness or connector.

A
B
C
D
E
F
G
H
I
J
K
L
M

AV

O
P

STEERING SWITCH SIGNAL A CIRCUIT

< DTC/CIRCUIT DIAGNOSIS >

[BASE AUDIO WITHOUT NAVIGATION]

STEERING SWITCH SIGNAL A CIRCUIT

Description

INFOID:000000005913192

Transmits the steering switch signal to AV control unit.

Diagnosis Procedure

INFOID:000000005913193

1. CHECK STEERING SWITCH SIGNAL A CIRCUIT

1. Disconnect AV control unit connector and spiral cable connector.
2. Check continuity between AV control unit harness connector and spiral cable harness connector.

AV control unit		Spiral cable		Continuity
Connector	Terminal	Connector	Terminal	
M81	6	M36	24	Existed

3. Check continuity between AV control unit harness connector and ground.

AV control unit		Ground	Continuity
Connector	Terminal		
M81	6		Not existed

Is the inspection result normal?

- YES >> GO TO 2.
NO >> Repair harness or connector.

2. CHECK SPIRAL CABLE

Check spiral cable.

Is the inspection result normal?

- YES >> GO TO 3.
NO >> Replace spiral cable. Refer to [SR-14, "Exploded View"](#).

3. CHECK AV CONTROL UNIT VOLTAGE

1. Connect AV control unit connector and spiral cable connector.
2. Turn ignition switch ON.
3. Check voltage between AV control unit harness connector.

(+)		(-)		Voltage (Approx.)
AV control unit		AV control unit		
Connector	Terminal	Connector	Terminal	
M81	6	M81	15	3.3 V

Is the inspection result normal?

- YES >> GO TO 4.
NO >> Replace AV control unit. Refer to [AV-120, "Removal and Installation"](#).

4. CHECK STEERING SWITCH

1. Turn ignition switch OFF.
2. Check steering switch. Refer to [AV-108, "Component Inspection"](#).

Is the inspection result normal?

- YES >> INSPECTION END
NO >> Replace steering switch. Refer to [AV-133, "Removal and Installation"](#).

Component Inspection

INFOID:000000005913194

Measure the resistance between the steering switch connector terminals 14 to 17 and 15 to 17.

STEERING SWITCH SIGNAL A CIRCUIT

[BASE AUDIO WITHOUT NAVIGATION]

< DTC/CIRCUIT DIAGNOSIS >

Standard

Between terminals 14 and 17

 switch ON	: 716 – 730 Ω
MENU DOWN switch ON	: 318 – 324 Ω
MENU UP switch ON	: 120 – 122 Ω
SOURCE switch ON	: 0 Ω

Between terminals 15 and 17

 switch ON	: 318 – 324 Ω
VOL UP switch ON	: 120 – 122 Ω
VOL DOWN switch ON	: 0 Ω

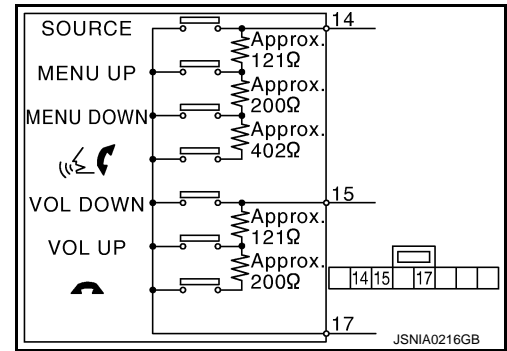

A
B
C
D
E
F
G
H
I
J
K
L
M

AV

O
P

STEERING SWITCH SIGNAL B CIRCUIT

< DTC/CIRCUIT DIAGNOSIS >

[BASE AUDIO WITHOUT NAVIGATION]

STEERING SWITCH SIGNAL B CIRCUIT

Description

INFOID:000000005913195

Transmits the steering switch signal to AV control unit.

Diagnosis Procedure

INFOID:000000005913196

1. CHECK STEERING SWITCH SIGNAL B CIRCUIT

1. Disconnect AV control unit connector and spiral cable connector.
2. Check continuity between AV control unit harness connector and spiral cable harness connector.

AV control unit		Spiral cable		Continuity
Connector	Terminal	Connector	Terminal	
M81	16	M36	31	Existed

3. Check continuity between AV control unit harness connector and ground.

AV control unit		Ground	Continuity
Connector	Terminal		
M81	16		Not existed

Is the inspection result normal?

- YES >> GO TO 2.
NO >> Repair harness or connector.

2. CHECK SPIRAL CABLE

Check spiral cable.

Is the inspection result normal?

- YES >> GO TO 3.
NO >> Replace spiral cable. Refer to [SR-14, "Exploded View"](#).

3. CHECK AV CONTROL UNIT VOLTAGE

1. Connect AV control unit connector and spiral cable connector.
2. Turn ignition switch ON.
3. Check voltage between AV control unit harness connector.

(+)		(-)		Voltage (Approx.)
AV control unit		AV control unit		
Connector	Terminal	Connector	Terminal	
M81	16	M81	15	3.3 V

Is the inspection result normal?

- YES >> GO TO 4.
NO >> Replace AV control unit. Refer to [AV-120, "Removal and Installation"](#).

4. CHECK STEERING SWITCH

1. Turn ignition switch OFF.
2. Check steering switch. Refer to [AV-110, "Component Inspection"](#).

Is the inspection result normal?

- YES >> INSPECTION END
NO >> Replace steering switch. Refer to [AV-133, "Removal and Installation"](#).

Component Inspection

INFOID:000000005913197

Measure the resistance between the steering switch connector terminals 14 to 17 and 15 to 17.

STEERING SWITCH SIGNAL B CIRCUIT

[BASE AUDIO WITHOUT NAVIGATION]

< DTC/CIRCUIT DIAGNOSIS >

Standard

Between terminals 14 and 17

 switch ON	: 716 – 730 Ω
MENU DOWN switch ON	: 318 – 324 Ω
MENU UP switch ON	: 120 – 122 Ω
SOURCE switch ON	: 0 Ω

Between terminals 15 and 17

 switch ON	: 318 – 324 Ω
VOL UP switch ON	: 120 – 122 Ω
VOL DOWN switch ON	: 0 Ω

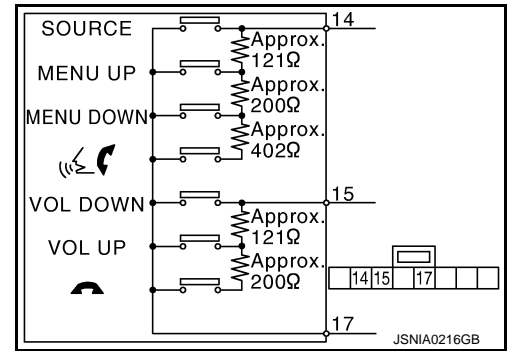

A
B
C
D
E
F
G
H
I
J
K
L
M

AV

O
P

STEERING SWITCH GROUND CIRCUIT

< DTC/CIRCUIT DIAGNOSIS >

[BASE AUDIO WITHOUT NAVIGATION]

STEERING SWITCH GROUND CIRCUIT

Description

INFOID:000000005913198

Transmits the steering switch signal to AV control unit.

Diagnosis Procedure

INFOID:000000005913199

1. CHECK STEERING SWITCH SIGNAL GROUND CIRCUIT

1. Disconnect AV control unit connector and spiral cable connector.
2. Check continuity between AV control unit harness connector and spiral cable harness connector.

AV control unit		Spiral cable		Continuity
Connector	Terminal	Connector	Terminal	
M81	15	M36	33	Existed

3. Connect AV control unit connector.

Is the inspection result normal?

- YES >> GO TO 2.
NO >> Repair harness or connector.

2. CHECK SPIRAL CABLE

Check spiral cable.

Is the inspection result normal?

- YES >> GO TO 3.
NO >> Replace spiral cable. Refer to [SR-14, "Exploded View"](#).

3. CHECK GROUND CIRCUIT

1. Connect AV control unit connector.
2. Check continuity between AV control unit harness connector and ground.

AV control unit		Ground	Continuity
Connector	Terminal		
M81	15		Existed

Is the inspection result normal?

- YES >> GO TO 4.
NO >> Replace AV control unit. Refer to [AV-120, "Removal and Installation"](#).

4. CHECK STEERING SWITCH

1. Turn ignition switch OFF.
2. Check steering switch. Refer to [AV-112, "Component Inspection"](#).

Is the inspection result normal?

- YES >> INSPECTION END
NO >> Replace steering switch. Refer to [AV-133, "Removal and Installation"](#).

Component Inspection

INFOID:000000005913200

Measure the resistance between the steering switch connector terminals 14 to 17 and 15 to 17.

STEERING SWITCH GROUND CIRCUIT

[BASE AUDIO WITHOUT NAVIGATION]

< DTC/CIRCUIT DIAGNOSIS >

Standard

Between terminals 14 and 17

-  switch ON : 716 – 730 Ω
- MENU UP switch ON : 318 – 324 Ω
- MENU DOWN switch ON : 120 – 122 Ω
- SOURCE switch ON : 0 Ω

Between terminals 15 and 17

-  switch ON : 318 – 324 Ω
- VOL UP switch ON : 120 – 122 Ω
- VOL DOWN switch ON : 0 Ω

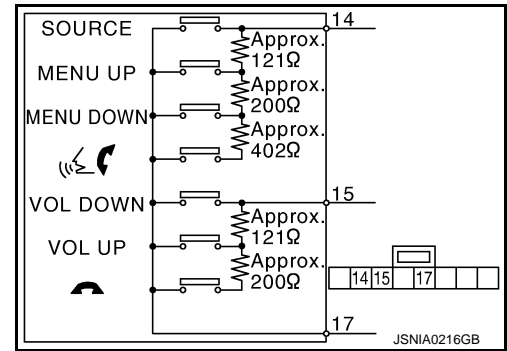

A
B
C
D
E
F
G
H
I
J
K
L
M

AV

O
P

SYMPTOM DIAGNOSIS

MULTI AV SYSTEM SYMPTOMS

Symptom Table

INFOID:000000005913201

OPERATION

Symptoms	Check items	Possible malfunction location / Action to take
Multifunction switch and preset switch operation does not work.	<ul style="list-style-type: none"> All switches cannot be operated. "MULTI AV" is displayed on system selection screen when the CONSULT-III is started. 	<ul style="list-style-type: none"> Multifunction switch power supply and ground circuit. AV communication circuit between AV control unit and multifunction switch. Perform "Self diagnosis Result" of "MULTI AV" with CONSULT-III. Refer to AV-26, "CONSULT - III Function" .
	<ul style="list-style-type: none"> All switches cannot be operated. "MULTI AV" is not displayed on system selection screen when the CONSULT-III is initialized. 	AV control unit power supply and ground circuit malfunction. Refer to AV-90, "AV CONTROL UNIT : Diagnosis Procedure" .
	Only specified switch cannot be operated.	Multifunction switch or preset switch malfunction. Perform multifunction switch and preset switch self-diagnosis function. Refer to AV-17, "On Board Diagnosis Function" .
Fuel economy display, vehicle setting operation is abnormal.	There is malfunction in the CONSULT-III self-diagnosis result. Refer to AV-26, "CONSULT - III Function" .	Perform detected DTC diagnosis. Refer to AV-39, "DTC Index" .
	There is no malfunction in the self-diagnosis results. Refer to AV-26, "CONSULT - III Function" .	Ignition signal circuit malfunction. (AV control unit)

RELATED TO HANDS-FREE PHONE

Simple Check for Bluetooth™ Communication

If cellular phone and AV control unit cannot be connected with Bluetooth™ communication, following procedure allows the technician to judge which device has malfunction.

- Turn on a cellular phone, not connecting Bluetooth™ communication.
- Start CONSULT-III, then start Windows®.
- Set CONSULT-III near a cellular phone.
- When operated Bluetooth™ registration by cellular phone, check if CONSULT-III* would be displayed on the device name. (If other Bluetooth™ device is located near cellular phone, a name of the device would be displayed also.)

NOTE:

*:Displayed device name is "NISSAN-*****".

- If no device name is displayed, cellular phone is malfunctioning. Repair the cellular phone first, then perform diagnosis.
- If CONSULT-III is displayed on device name, cellular phone is normal. Perform diagnosis as per the following table.

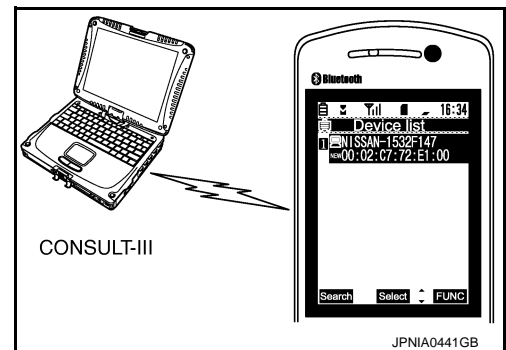

Trouble Diagnosis Chart by Symptom

MULTI AV SYSTEM SYMPTOMS

< SYMPTOM DIAGNOSIS >

[BASE AUDIO WITHOUT NAVIGATION]

Symptoms	Check items	Probable malfunction location	
Does not recognize cellular phone connection. (No connection is displayed on the display at the guide.)	Repeat the registration of cellular phone.	TEL adapter unit malfunction. Refer to AV-136, "Removal and Installation" .	A
Hands-free phone cannot be established.	Both the reception and the speech cannot be performed	<ul style="list-style-type: none"> Perform "Self diagnosis Result" of "MULTI AV" with CONSULT-III. Refer to AV-26, "CONSULT - III Function". No malfunction. TEL adapter unit malfunction. Refer to AV-136, "Removal and Installation". Malfunction is detected. Perform detected DTC diagnosis. Refer to AV-39, "DTC Index". 	B
The other party's voice cannot be heard by hands-free phone.	The operation of the "☞" switch can be performed.	TEL voice signal circuit malfunction between TEL adapter unit and AV control unit.	C
	The operation of the "☞" switch cannot be performed.	Control signal circuit.	D
Originating sound is not heard by the other party with hands-free phone communication.	Sound operation function is normal.	TEL adapter unit. Refer to AV-136, "Removal and Installation" .	E
	Sound operation function does not work.	Microphone signal circuit malfunction. Refer to AV-135, "Removal and Installation" .	F
The system cannot be operated.	"SOURCE", "MENU UP", and "MENU DOWN" switches are operated. But "☞" switch is not operated.	<ul style="list-style-type: none"> Check steering switch. Refer to AV-108, "Component Inspection". Malfunction is detected. Replace steering switch. Refer to AV-133, "Removal and Installation". 	G
	"SOURCE", "MENU UP", "MENU DOWN" and "☞" switches are not operated.	Steering switch signal A circuit malfunction. Refer to AV-108, "Diagnosis Procedure" .	H
	All steering switches do not work.	Steering switch ground circuit malfunction. Refer to AV-112, "Diagnosis Procedure" .	I

RELATED TO RGB IMAGE

Symptoms	Check items	Possible malfunction location / Action to take	
RGB image is not shown.	There is malfunction in the CONSULT-III self-diagnosis result. Refer to AV-26, "CONSULT - III Function" .	Perform detected DTC diagnosis. Refer to AV-39, "DTC Index" .	K
	There is no malfunction in CONSULT-III self-diagnosis results. Refer to AV-26, "CONSULT - III Function" .	Vertical synchronizing (VP) signal circuit. Refer to AV-103, "Diagnosis Procedure" .	L
Color of RGB image is not proper.	Light blue (Cyan) tint.	RGB signal (R: red) circuit. Refer to AV-94, "Diagnosis Procedure" .	M
	Purple (Magenta) tint.	RGB signal (G: green) circuit. Refer to AV-95, "Diagnosis Procedure" .	AV
	Screen looks yellowish.	RGB signal (B: blue) circuit. Refer to AV-96, "Diagnosis Procedure" .	O
RGB screen is rolling.	—	RGB synchronizing signal circuit. Refer to AV-97, "Diagnosis Procedure" .	P

RELATED TO AUDIO

MULTI AV SYSTEM SYMPTOMS

< SYMPTOM DIAGNOSIS >

[BASE AUDIO WITHOUT NAVIGATION]

Symptoms	Check items	Possible malfunction location / Action to take
The disk cannot be removed.	—	Disk eject signal circuit. Refer to AV-104, "Diagnosis Procedure" .
Audio sound is not heard.	No sound from all speakers.	<ul style="list-style-type: none"> Active noise control unit power supply and ground circuit malfunction. Refer to AV-92, "ACTIVE NOISE CONTROL UNIT : Diagnosis Procedure". Active noise control unit malfunction. Refer to AV-124, "Removal and Installation". AV control unit malfunction. Refer to AV-120, "Removal and Installation".
	Sound is heard only from specific places.	Sound signals circuit of suspect system.
Satellite radio is not received.	There is no malfunction in CONSULT-III self-diagnosis results. Refer to AV-26, "CONSULT - III Function" .	Perform the following inspection procedure. <ol style="list-style-type: none"> Check satellite radio antenna mounting nut for looseness. NOTE: Tightening torque: 6.5 N·m (0.66 kg·m, 58 in·lb.) Visually check for satellite radio antenna feeder.
	There is malfunction in the CONSULT-III self-diagnosis result. Refer to AV-26, "CONSULT - III Function" .	Perform detected DTC diagnosis. Refer to AV-39, "DTC Index" .
The sound of satellite radio is not heard.	Other audio sounds are normal.	Satellite radio sound signal circuit between AV control unit and satellite radio tuner.
It does not change to satellite radio mode.	There is malfunction in the CONSULT-III self-diagnosis result. Refer to AV-26, "CONSULT - III Function" .	Perform detected DTC diagnosis. Refer to AV-39, "DTC Index" .
AM/FM radio is not received.	Other audio sounds are normal.	<ul style="list-style-type: none"> Antenna amp. ON signal circuit. Antenna feeder.

RELATED TO USB

NOTE:

Check that there is no malfunction of USB equipment main body before performing a diagnosis.

Symptoms	Check items	Possible malfunction location / Action to take
iPod® or USB memory can not be recognized.	—	<ul style="list-style-type: none"> USB harness malfunction. USB connector malfunction.

iPod® is a trademark of Apple inc., registered in the U.S. and other countries.

RELATED TO STEERING SWITCH

Symptoms	Probable malfunction location
None of the steering switch operations work.	Steering switch ground circuit malfunction. Refer to AV-112, "Diagnosis Procedure" .
Only specified switch cannot be operated.	<ul style="list-style-type: none"> Check steering switch. Refer to AV-108, "Component Inspection". Malfunction is detected. Replace steering switch. Refer to AV-133, "Removal and Installation".
"SOURCE", "MENU UP", "MENU DOWN" and "⏪ ⏩" switches are not operated.	Steering switch signal A circuit. Refer to AV-108, "Diagnosis Procedure" .
"VOL UP", "VOL DOWN" and "⏮ ⏭" switches are not operated.	Steering switch signal B circuit. Refer to AV-110, "Diagnosis Procedure" .

RELATED TO CAMERA

Trouble Diagnosis Chart by Symptom

MULTI AV SYSTEM SYMPTOMS

< SYMPTOM DIAGNOSIS >

[BASE AUDIO WITHOUT NAVIGATION]

Symptoms	Check items	Probable malfunction location	
Camera image is not shown. (Vehicle width and possible route line is displayed.)	—	<ul style="list-style-type: none"> • Camera image signal circuit. Refer to AV-99, "Diagnosis Procedure". • Composite image signal circuit. Refer to AV-101, "Diagnosis Procedure". 	A B
Camera image does not switch.	"Reverse" is not turned ON on "Vehicle Signals" screen of "Confirmation/Adjustment".	Reverse signal circuit malfunction.	C
	"Reverse" is turned ON on "Vehicle Signals" screen of "Confirmation/Adjustment".	AV control unit malfunction. Replace AV control unit. Refer to AV-120, "Removal and Installation" .	D

E

F

G

H

I

J

K

L

M

AV

O

P

NORMAL OPERATING CONDITION

< SYMPTOM DIAGNOSIS >

[BASE AUDIO WITHOUT NAVIGATION]

NORMAL OPERATING CONDITION

Description

INFOID:000000005913202

BASIC OPERATIONS

Symptom	Possible cause	Possible solution
No image is displayed.	The brightness is at the lowest setting.	Adjust the brightness of the display.
	The systems in the video mode.	Press "DISC-AUX" to change the mode.
	The display is turned off.	Press "☀/☾ OFF" to turn on the display.
The screen is too dim. The movement is slow.	The temperature in the interior of the vehicle is low.	Wait until the interior of the vehicle has warmed up.
Some pixels in the display are darker or brighter than others.	This condition is an inherent characteristic of liquid crystal displays.	This is not a malfunction.
Some menu items cannot be selected.	Some menu items become unavailable while the vehicle is driven.	Park the vehicle in a safe location, and then operate the multi AV system.

RELATED TO VOICE RECOGNITION

Related to Telephone

The system should respond correctly to all voice commands without difficulty. If problems are encountered, try the following solutions.

Where the solutions are listed by number, try each solution in turn, starting with number 1, until the problem is resolved.

Symptom	Solution
System fails to interpret the command correctly.	1. Ensure that the command is valid.
	2. Ensure that the command is spoken after the tone.
	3. Speak clearly without pausing between words and at level appropriate to the ambient noise level in the vehicle.
	4. Ensure that the ambient noise level is not excessive (for example, windows open or defroster on). NOTE: If it is too noisy to use the phone, it is likely that the voice commands will not be recognized.
	5. If more than one command was said at a time, try saying the commands separately.
	6. If the system consistently fails to recognize commands, the voice training procedure should be carried out to improve the recognition response for the speaker. See "Speaker adaptation (SA) mode" earlier in this section. Refer to "OWNER'S MANUAL".
The system consistently selects the wrong voicetag	1. Ensure that the phone book entry name requested matches what was originally stored. This can be confirmed by using the "List Names" command.
	2. Replace one of the names being confused with a new name.

RELATED TO AUDIO

- The majority of the audio malfunctions are the result of outside causes (bad CD, electromagnetic interference, etc.). Check the symptoms below to diagnose the malfunction.
- The vehicle itself can be a source of noise if noise prevention parts or electrical equipment is malfunctioning. Check if noise is caused and/or changed by engine speed, ignition switch turned to each position, and operation of each piece of electrical equipment, and then determine the cause.

NOTE:

- CD-R is not guaranteed to play because they can contain compressed audio (MP3, WMA) or could be incorrectly mastered by the customer on a computer.
- Check if the CDs carry the Compact Disc Logo. If not, the disc is not mastered to the "red book" Compact Disc Standard and may not play.

NORMAL OPERATING CONDITION

< SYMPTOM DIAGNOSIS >

[BASE AUDIO WITHOUT NAVIGATION]

Symptom	Cause and Counter measure	A
Cannot play	Check if the CD was inserted correctly.	A
	Check if the CD is scratched or dirty.	B
	Check if there is condensation inside the player, and if there is, wait until the condensation is gone (about 1 hour) before using the player.	B
	If there is a temperature increase error, the player will play correctly after it returns to the normal temperature.	C
	If there is a mixture of music CD files (CD-DA data) and MP3/WMA files on a CD, only the music CD files (CD-DA data) will be played.	D
	Files with extensions other than ".MP3", ".WMA", ".mp3" or ".wma" cannot be played. In addition, the character codes and number of characters for folder names and file names should be in compliance with the specifications.	D
	Check if the disc or the file is generated in an irregular format, This may occur depending on the variation or the setting of MP3/WMA writing applications or other text editing applications.	E
	Check if the finalization process, such as session close and disc close, is done for the disc.	F
	Check if the CD is protected by copyright.	F
Poor sound quality	Discs recorded in live file system format are not supported. (For Microsoft Windows Vista, check the settings.)	G
	Check if the CD is scratched or dirty.	G
It takes a relatively long time before the music starts playing.	If there are many folder or file levels on the MP3/WMA CD, or if it is a multisession disc, some time may be required before the music starts playing.	H
Music cuts off or skips	The writing software and hardware combination might not match, or the writing speed, writing depth, writing width might not match the specifications. Try using the slowest writing speed.	H
Skipping with high bit rate files	Skipping may occur with large quantities if data such as for high bit rate data.	I
Move immediately to the next song when playing	When a non-MP3/WMA file has been given an extension of ".MP3", ".WMA", ".mp3" or ".wma" or when play is prohibited by copyright protection, the player will skip to the next song.	I
The songs do not play back in the desired order.	The playback order is the order in which the files were written by the software, so the files might not play in the desired order.	J

Noise resulting from variations in field strength, such as fading noise and multi-path noise, or external noise from trains and other sources, is not a malfunction.

NOTE:

- Fading noise: This noise occurs because of variations in the field strength in a narrow range due to mountains or buildings blocking the signal.
- Multi-path noise: This noise results from a time difference between the broadcast waves directly from the station arriving at the antenna and the waves reflected by mountains or buildings.

AV

REMOVAL AND INSTALLATION

AV CONTROL UNIT

Removal and Installation

INFOID:000000006022031

REMOVAL

CAUTION:

Before replacing AV control unit, perform “READ CONFIGURATION” to save or print current vehicle specification. For details, refer to [AV-76, "Work Procedure"](#).

1. Remove the preset switch. Refer to [AV-132, "Removal and Installation"](#).
2. After removing the AV control unit mounting screws to disconnect the connectors, remove the AV control unit with the bracket attached.
3. Remove the bracket screws to remove the bracket from the AV control unit.

INSTALLATION

Install in the reverse order of removal.

CAUTION:

Be sure to perform “WRITE CONFIGURATION” when replacing AV control unit. For details, refer to [AV-77, "Work Procedure"](#).

FRONT DOOR SPEAKER

< REMOVAL AND INSTALLATION >

[BASE AUDIO WITHOUT NAVIGATION]

FRONT DOOR SPEAKER

Removal and Installation

INFOID:000000006022032

REMOVAL

1. Remove the front door finisher. Refer to [INT-31, "FRONT DOOR FINISHER : Removal and Installation"](#).
2. Remove the screws and disconnect the connector to remove the front door speaker.

INSTALLATION

Installation is the reverse order of removal.

A
B
C
D
E
F
G
H
I
J
K
L
M
O
P

AV

FRONT DOOR SQUAWKER

< REMOVAL AND INSTALLATION >

[BASE AUDIO WITHOUT NAVIGATION]

FRONT DOOR SQUAWKER

Removal and Installation

INFOID:000000006022033

REMOVAL

1. Remove the front door finisher. Refer to [INT-31, "FRONT DOOR FINISHER : Removal and Installation"](#).
2. Remove the screws to remove the front door squawker from the door finisher.

INSTALLATION

Installation is the reverse order of removal.

REAR DOOR SPEAKER

< REMOVAL AND INSTALLATION >

[BASE AUDIO WITHOUT NAVIGATION]

REAR DOOR SPEAKER

Removal and Installation

INFOID:000000006022034

REMOVAL

1. Remove the rear door finisher. Refer to [INT-33. "REAR DOOR FINISHER : Removal and Installation"](#).
2. Remove the screws and disconnect the connector to remove the rear door speaker.

INSTALLATION

Installation is the reverse order of removal.

A

B

C

D

E

F

G

H

I

J

K

L

M

AV

O

P

ACTIVE NOISE CONTROL UNIT

Removal and Installation

INFOID:000000006022035

REMOVAL

1. Remove the trunk front finisher. Refer to [INT-53, "Exploded View"](#).
2. Remove the rear parcel shelf finisher. Refer to [INT-43, "Removal and Installation"](#).
3. Remove the active noise control unit mounting bolts.
4. Disconnect the connectors to remove the active noise control unit from the rear parcel shelf (trunk room side).

NOTE:

The active noise control unit has urethane foam as a holder to facilitate removal and installation procedure.

INSTALLATION

Install in the reverse order of removal.

FRONT MICROPHONE (ACTIVE NOISE CONTROL SYSTEM)

< REMOVAL AND INSTALLATION >

[BASE AUDIO WITHOUT NAVIGATION]

FRONT MICROPHONE (ACTIVE NOISE CONTROL SYSTEM)

Removal and Installation

INFOID:000000006022036

REMOVAL

1. Remove the map lamp assembly. Refer to [INL-67, "Removal and Installation"](#).
2. Press the pawl to remove the front microphone from the map lamp assembly.

CAUTION:

Carefully handle the pawl fixing the front microphone because the pawl is fragile.

INSTALLATION

Install in the reverse order of removal.

NOTE:

Check the front microphone for looseness after the installation.

A

B

C

D

E

F

G

H

I

J

K

L

M

AV

O

P

REAR MICROPHONE (ACTIVE NOISE CONTROL SYSTEM)

< REMOVAL AND INSTALLATION >

[BASE AUDIO WITHOUT NAVIGATION]

REAR MICROPHONE (ACTIVE NOISE CONTROL SYSTEM)

Removal and Installation

INFOID:000000006022037

REMOVAL

1. Remove the headlining. Refer to [INT-49. "Removal and Installation"](#).
2. Remove the rear microphone from the headlining.

INSTALLATION

Install in the reverse order of removal.

ANTENNA AMP.

< REMOVAL AND INSTALLATION >

[BASE AUDIO WITHOUT NAVIGATION]

ANTENNA AMP.

Removal and Installation

INFOID:000000006022038

REMOVAL

1. Remove the rear pillar finisher RH. Refer to [INT-42. "REAR PILLAR FINISHER : Removal and Installation"](#).
2. Remove the screw and disconnect the connector to remove the antenna amp.

INSTALLATION

Installation is the reverse order of removal.

A
B
C
D
E
F
G
H
I
J
K
L
M

AV

O
P

DISPLAY UNIT

Removal and Installation

INFOID:000000006022039

REMOVAL

1. Remove the center ventilator assembly. Refer to [IP-13. "Removal and Installation"](#).
2. Remove the screws and disconnect the connector to remove the display unit.

INSTALLATION

Install in the reverse order of removal.

SATELLITE RADIO TUNER

< REMOVAL AND INSTALLATION >

[BASE AUDIO WITHOUT NAVIGATION]

SATELLITE RADIO TUNER

Removal and Installation

INFOID:000000005913216

REMOVAL

1. Remove the trunk front finisher. Refer to [INT-53, "Exploded View"](#).
2. Remove the rear parcel shelf finisher. Refer to [INT-43, "Exploded View"](#).
3. Remove the satellite radio tuner bracket mounting screws.
4. Disconnect the connectors to remove the satellite radio tuner with the bracket attached.
5. Remove the bracket screws to remove the bracket from the satellite radio tuner.

INSTALLATION

Installation is the reverse order of removal.

A

B

C

D

E

F

G

H

I

J

K

L

M

AV

O

P

SATELLITE RADIO ANTENNA

< REMOVAL AND INSTALLATION >

[BASE AUDIO WITHOUT NAVIGATION]

SATELLITE RADIO ANTENNA

Exploded View

INFOID:000000006022040

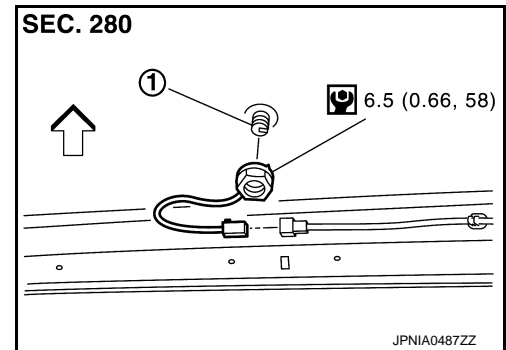

- 1. Satellite radio antenna
- ⇨: Vehicle front

Removal and Installation

INFOID:000000006022041

REMOVAL

1. Remove the head lining assembly. Refer to [INT-49, "Removal and Installation"](#).
2. Remove the nut and disconnect the connector to remove the satellite radio antenna from the roof panel.

INSTALLATION

Installation is the reverse order of removal.

CAUTION:

Be careful about tightening torque. Antenna sensitivity becomes poor, and when it is excessive, roof panel may be deformed, when satellite radio antenna mounting nut tightening torque is loose.

MULTIFUNCTION SWITCH

< REMOVAL AND INSTALLATION >

[BASE AUDIO WITHOUT NAVIGATION]

MULTIFUNCTION SWITCH

Removal and Installation

INFOID:000000006022042

REMOVAL

1. Remove the cluster lid D. Refer to [IP-13. "Removal and Installation"](#).
2. Remove the screws (A) to remove the multifunction switch from the cluster lid D.

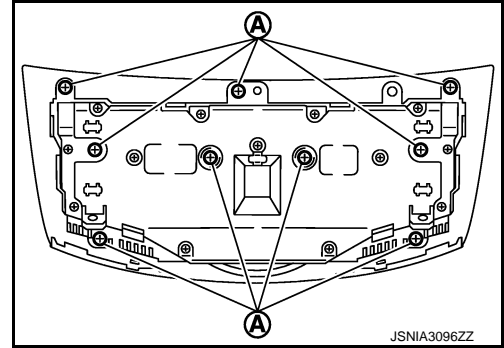

INSTALLATION

Install in the reverse order of removal.

A
B
C
D
E
F
G
H
I
J
K
L
M
AV
O
P

PRESET SWITCH

< REMOVAL AND INSTALLATION >

[BASE AUDIO WITHOUT NAVIGATION]

PRESET SWITCH

Removal and Installation

INFOID:000000006022043

REMOVAL

1. Remove the Instrument side panel LH and RH. Refer to [IP-24, "Removal and Installation"](#).
2. Remove the preset switch straight from the instrument panel assembly while disengaging the resin clips and pawls with a remover.

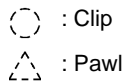
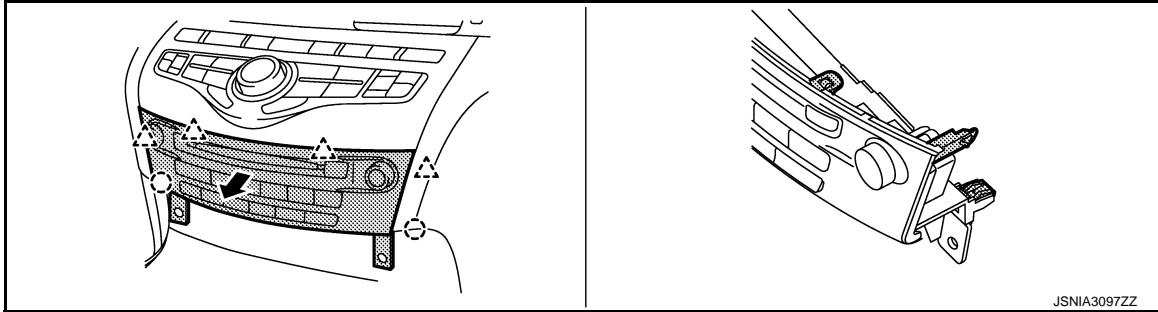

CAUTION:

- The resin clips and pawls must be disengaged slowly to avoid damage to the pawls and the preset switch.
- Place protective tape on the area of using the remover to avoid damage.

STEERING SWITCH

< REMOVAL AND INSTALLATION >

[BASE AUDIO WITHOUT NAVIGATION]

STEERING SWITCH

Removal and Installation

INFOID:000000006022044

REMOVAL

Refer to [ST-34. "Removal and Installation"](#).

INSTALLATION

Install in the reverse order of removal.

A

B

C

D

E

F

G

H

I

J

K

L

M

AV

O

P

USB CONNECTOR

Removal and Installation

INFOID:000000006022045

REMOVAL

1. Remove the console center finisher. Refer to [IP-24. "Removal and Installation"](#).
2. Push the pawl from the back of the console center finisher to remove the USB connector.

INSTALLATION

Install in the reverse order of removal.

MICROPHONE

Removal and Installation

INFOID:000000006022048

REMOVAL

1. Remove the map lamp assembly. Refer to [INL-67, "Removal and Installation"](#).
2. Press the pawl to remove the microphone from the map lamp assembly.

CAUTION:

Carefully handle the pawl fixing the microphone because the pawl is fragile.

INSTALLATION

Install in the reverse order of removal.

NOTE:

Check the microphone for looseness after the installation.

A
B
C
D
E
F
G
H
I
J
K
L
M
N
O
P

AV

TEL ADAPTER UNIT

< REMOVAL AND INSTALLATION >

[BASE AUDIO WITHOUT NAVIGATION]

TEL ADAPTER UNIT

Removal and Installation

INFOID:000000005913232

REMOVAL

1. Remove the trunk front finisher. Refer to [INT-53. "Exploded View"](#).
2. Remove the screws and disconnect the connector to remove the TEL adapter unit.

INSTALLATION

Installation is the reverse order of removal.

REAR VIEW CAMERA

< REMOVAL AND INSTALLATION >

[BASE AUDIO WITHOUT NAVIGATION]

REAR VIEW CAMERA

Removal and Installation

INFOID:000000006022049

REMOVAL

1. Remove the trunk lid inner finisher. Refer to [INT-56, "Removal and Installation"](#).
2. Disconnect the connector.
3. Insert a tool shown in the figure in the groove and push the pawl to remove the rear view camera (2) from the inner bracket (1) of the trunk lid finisher.

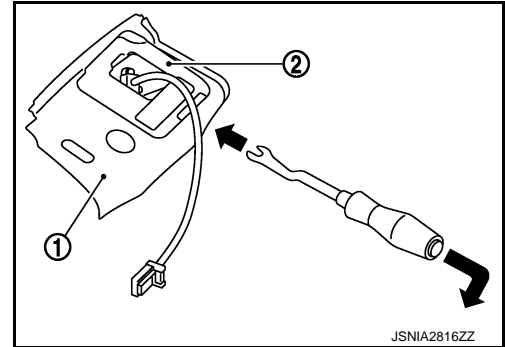

INSTALLATION

Install in the reverse order of removal.

NOTE:

Adjust the guide line position if the guide line position is shifted after installing the rear view camera. Refer to [AV-137, "Adjustment"](#).

Adjustment

INFOID:000000006022050

Adjust the guide line position if the guide line position is shifted after installing the rear view camera.

1. Draw lines on rearward area of the vehicle passing through the following points: 200 mm (7.87 in) from both sides of the vehicle, and 0.5 m (1.64 ft), 1.0 m (3.28 ft) from the rear end of the bumper.
2. Set into "Adjust Guide Lines" mode of "Confirmation/Adjustment" mode.

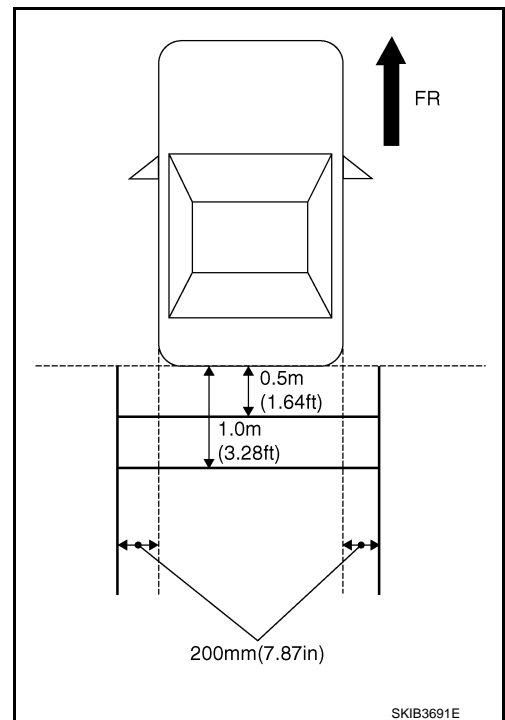

REAR VIEW CAMERA

< REMOVAL AND INSTALLATION >

[BASE AUDIO WITHOUT NAVIGATION]

3. Rotate the center dial, and then select the guiding line pattern so that its angle is aligned with the correction line of the rear of the vehicle.

Selected pattern : 7

4. Make fine adjustment to the correction line of the rear of the vehicle with up/down/left/right switches so that its position is aligned with the guiding line. Press "OK" switch and record the adjusted guiding line position to the AV control unit.

Up/Down adjustment range : (-20°) – (20°)

Left/Right adjustment range : (-20°) – (20°)

CAUTION:

Never operate other function such as pressing BACK while writing index data.

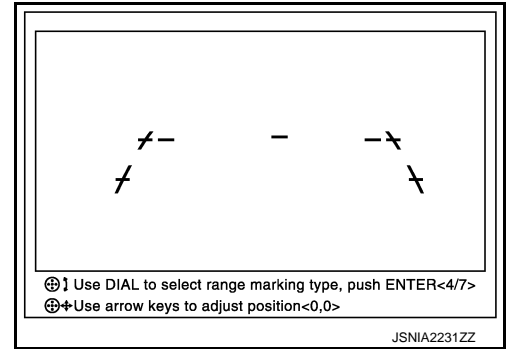

STEERING ANGLE SENSOR

< REMOVAL AND INSTALLATION >

[BASE AUDIO WITHOUT NAVIGATION]

STEERING ANGLE SENSOR

Removal and Installation

INFOID:000000006022051

REMOVAL

1. Remove the spiral cable. Refer to [SR-14, "Removal and Installation"](#).
2. Remove the screws to remove the steering angle sensor from the spiral cable.

INSTALLATION

Install in the reverse order of removal.

A

B

C

D

E

F

G

H

I

J

K

L

M

AV

O

P

ANTENNA FEEDER

< REMOVAL AND INSTALLATION >

[BASE AUDIO WITHOUT NAVIGATION]

ANTENNA FEEDER

Feeder Layout

INFOID:000000005913238

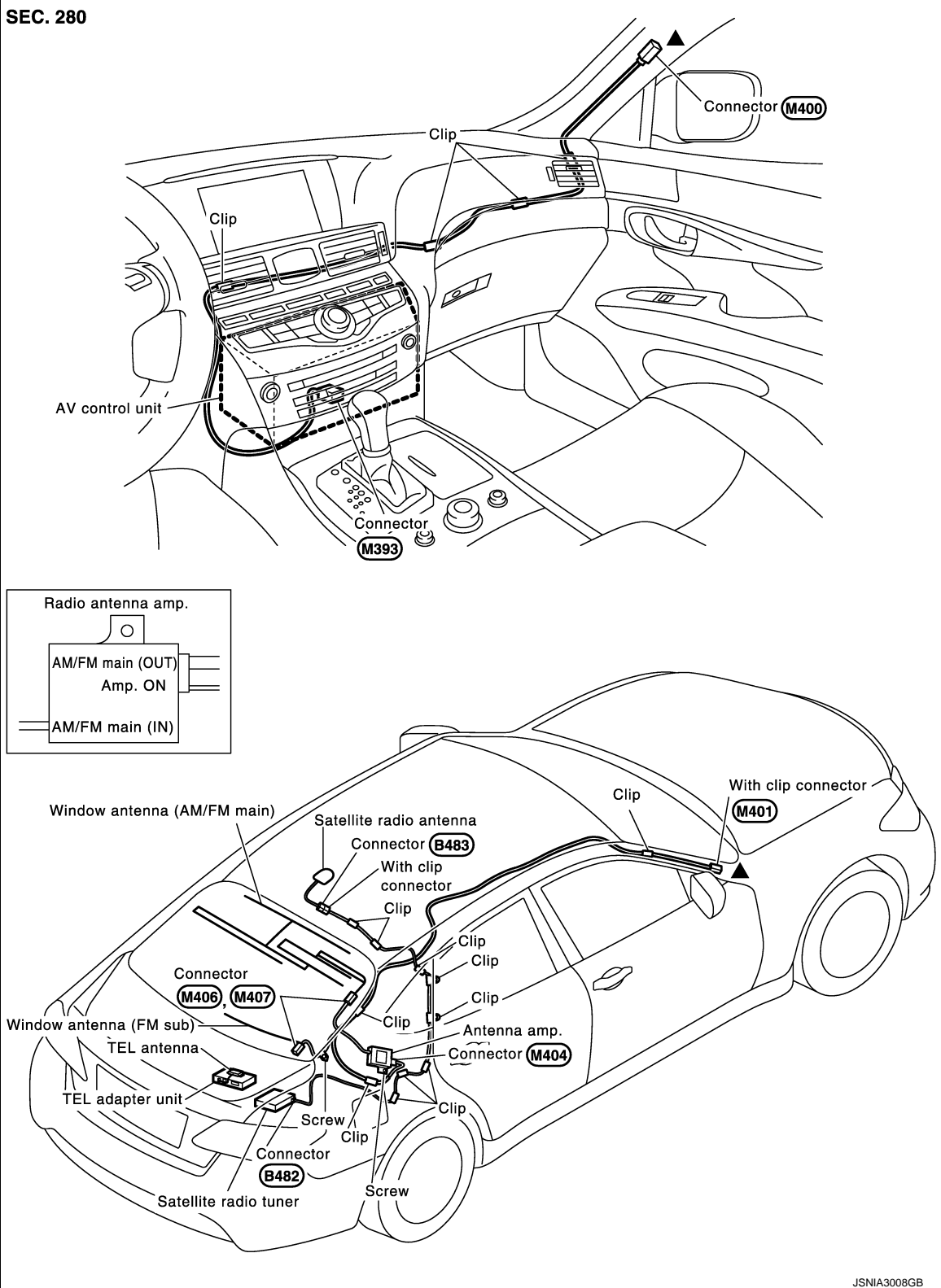

JSNIA3008GB

PRECAUTION

PRECAUTIONS

Precaution for Supplemental Restraint System (SRS) "AIR BAG" and "SEAT BELT PRE-TENSIONER"

INFOID:000000005912961

The Supplemental Restraint System such as "AIR BAG" and "SEAT BELT PRE-TENSIONER", used along with a front seat belt, helps to reduce the risk or severity of injury to the driver and front passenger for certain types of collision. This system includes seat belt switch inputs and dual stage front air bag modules. The SRS system uses the seat belt switches to determine the front air bag deployment, and may only deploy one front air bag, depending on the severity of a collision and whether the front occupants are belted or unbelted. Information necessary to service the system safely is included in the "SRS AIR BAG" and "SEAT BELT" of this Service Manual.

WARNING:

- To avoid rendering the SRS inoperative, which could increase the risk of personal injury or death in the event of a collision that would result in air bag inflation, all maintenance must be performed by an authorized NISSAN/INFINITI dealer.
- Improper maintenance, including incorrect removal and installation of the SRS, can lead to personal injury caused by unintentional activation of the system. For removal of Spiral Cable and Air Bag Module, see the "SRS AIR BAG".
- Do not use electrical test equipment on any circuit related to the SRS unless instructed to in this Service Manual. SRS wiring harnesses can be identified by yellow and/or orange harnesses or harness connectors.

PRECAUTIONS WHEN USING POWER TOOLS (AIR OR ELECTRIC) AND HAMMERS

WARNING:

- When working near the Air Bag Diagnosis Sensor Unit or other Air Bag System sensors with the ignition ON or engine running, DO NOT use air or electric power tools or strike near the sensor(s) with a hammer. Heavy vibration could activate the sensor(s) and deploy the air bag(s), possibly causing serious injury.
- When using air or electric power tools or hammers, always switch the ignition OFF, disconnect the battery, and wait at least 3 minutes before performing any service.

Precaution for Trouble Diagnosis

INFOID:000000005912964

AV COMMUNICATION SYSTEM

- Do not apply voltage of 7.0 V or higher to the measurement terminals.
- Use the tester with its open terminal voltage being 7.0 V or less.
- Be sure to turn ignition switch OFF and disconnect the battery cable from the negative terminal before checking the circuit.

Precaution for Harness Repair

INFOID:000000005912965

AV COMMUNICATION SYSTEM

- Solder the repaired parts, and wrap with tape. [Frays of twisted line must be within 110 mm (4.33 in).]

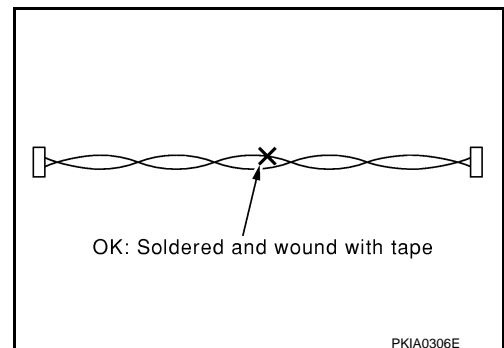

A
B
C
D
E
F
G
H
I
J
K
L
M
O
P

AV

PRECAUTIONS

< PRECAUTION >

[BOSE AUDIO WITH NAVIGATION]

- Do not perform bypass wire connections for the repair parts. (The spliced wire will become separated and the characteristics of twisted line will be lost.)

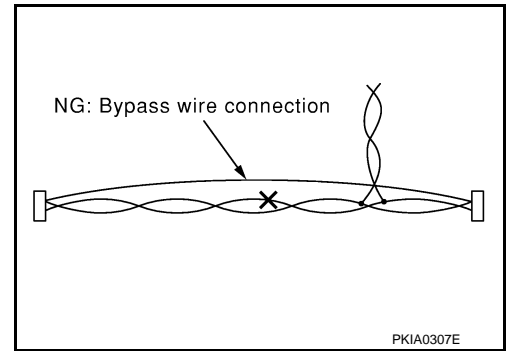

PREPARATION

PREPARATION

Commercial Service Tools

INFOID:000000005912966

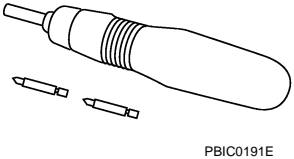
Tool	Description
<p>Power tool</p>  <p>PBIC0191E</p>	<p>Loosening screws</p>

A
B
C
D
E
F
G
H
I
J
K
L
M
AV
O
P

AV

COMPONENT PARTS

< SYSTEM DESCRIPTION >

[BOSE AUDIO WITH NAVIGATION]

SYSTEM DESCRIPTION

COMPONENT PARTS

Component Parts Location

INFOID:000000005912967

BOSE® STEREO SOUND SYSTEM

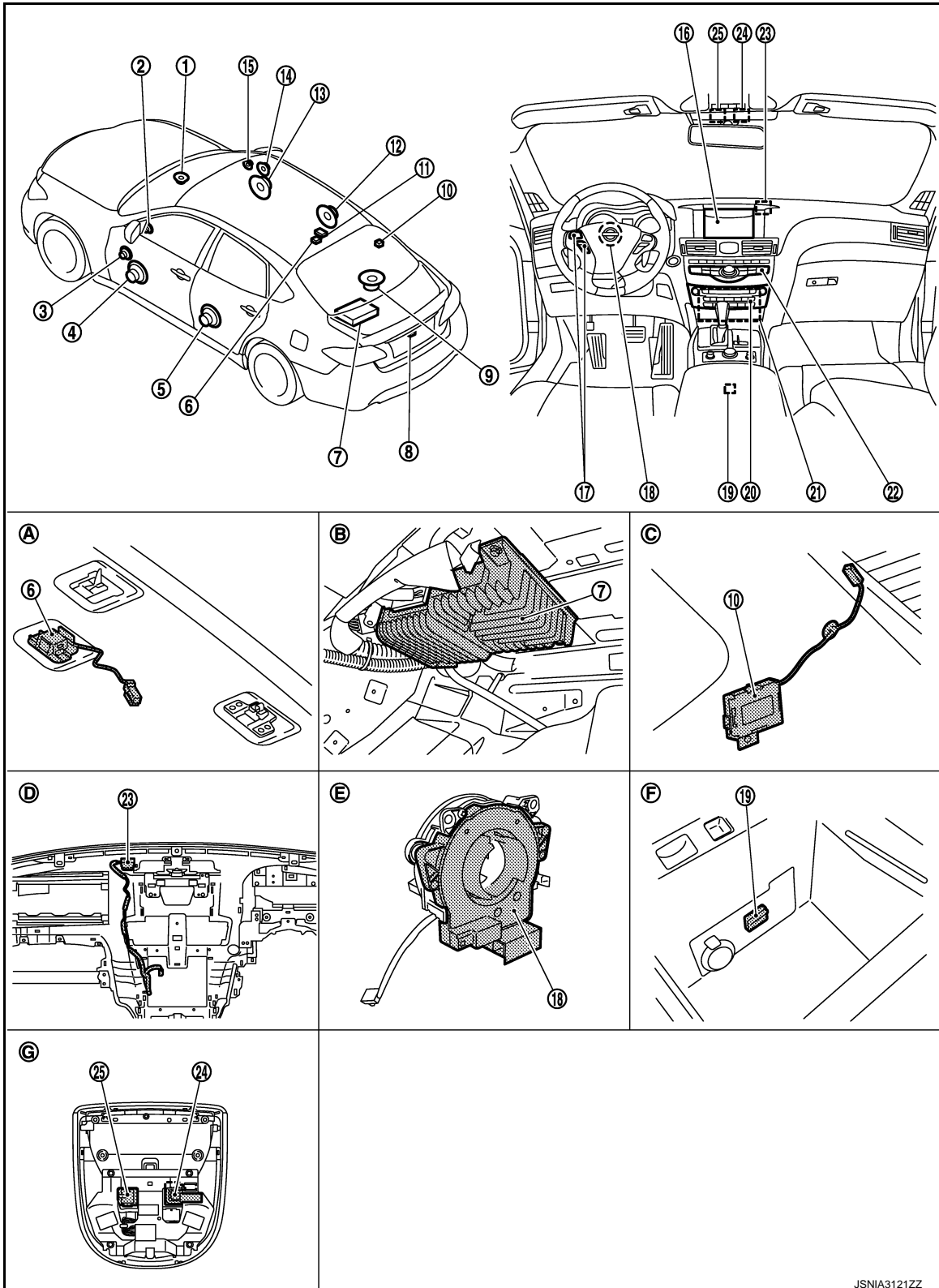

COMPONENT PARTS

< SYSTEM DESCRIPTION >

[BOSE AUDIO WITH NAVIGATION]

- | | | | |
|--|---|--|---|
| 1. Center speaker | 2. Tweeter LH | 3. Front door squawker LH | A |
| 4. Front door woofer LH | 5. Rear door speaker LH | 6. Rear microphone (for active noise control system) | |
| 7. BOSE amp. | 8. Rear view camera | 9. Rear woofer | B |
| 10. Antenna amp. | 11. Satellite radio antenna | 12. Rear door speaker RH | |
| 13. Front door woofer RH | 14. Front door squawker RH | 15. Tweeter RH | |
| 16. Display unit | 17. Steering switch | 18. Steering angle sensor | C |
| 19. USB connector | 20. Preset switch | 21. AV control unit | |
| 22. Multifunction switch | 23. GPS antenna | 24. Front microphone (for active noise control system/AudioPilot® 2) | D |
| 25. Microphone (for TEL/voice recognition) | | | |
| A. Headlining rear center | B. Rear parcel shelf left side (trunk room) | C. Rear pillar finisher RH remove condition | E |
| D. Instrument panel removed condition | E. | F. Within center console | |
| G. Map lamp ASSY removed condition | | | F |

BOSE® STUDIO SURROUND® SOUND SYSTEM

F

G

H

I

J

K

L

M

AV

O

P

COMPONENT PARTS

< SYSTEM DESCRIPTION >

[BOSE AUDIO WITH NAVIGATION]

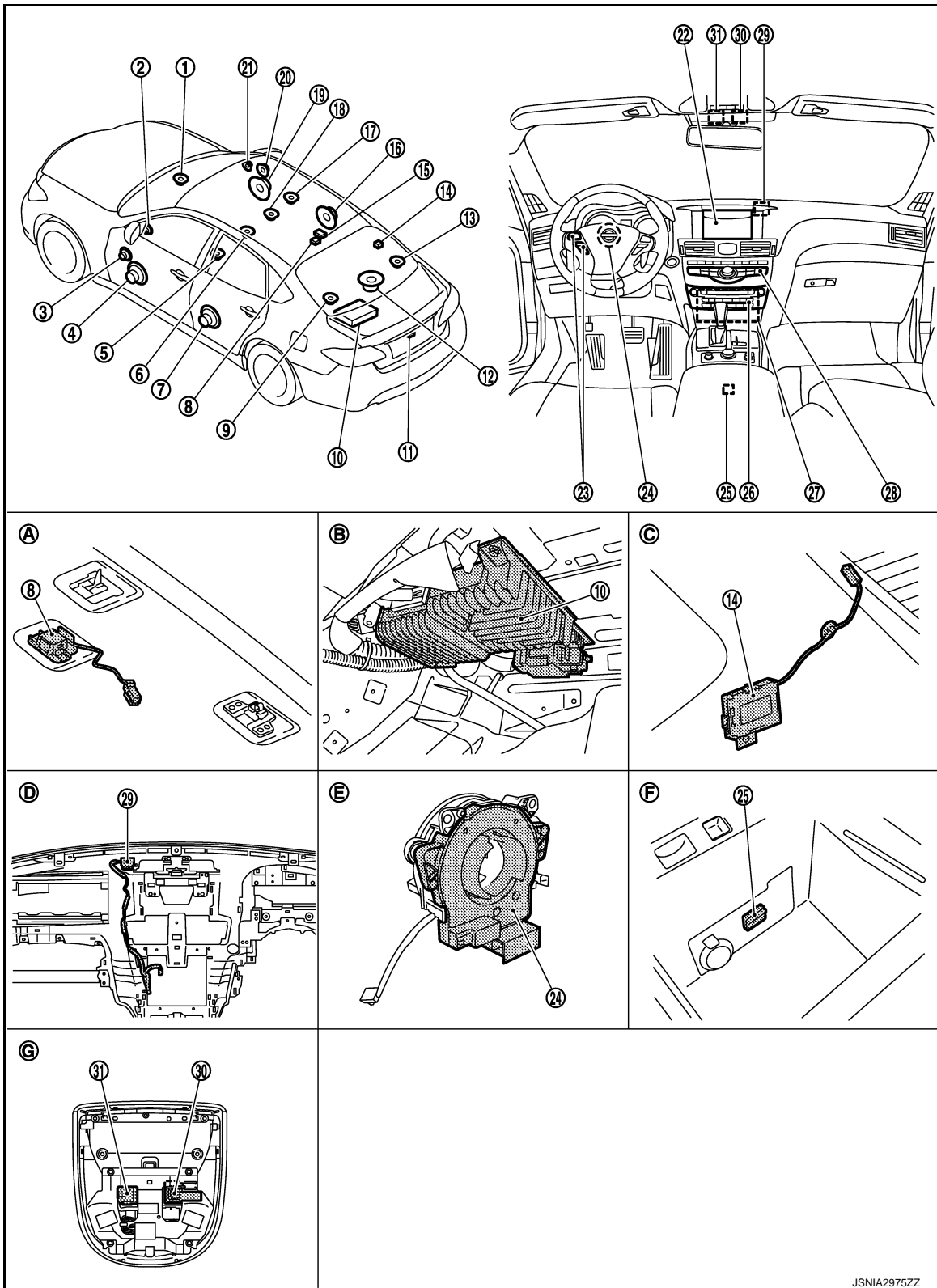

JSNIA2975ZZ

- | | | |
|--------------------------|--|-----------------------------|
| 1. Center speaker | 2. Tweeter LH | 3. Front door squawker LH |
| 4. Front door woofer LH | 5. Driver seat speaker LH | 6. Driver seat speaker RH |
| 7. Rear door speaker LH | 8. Rear microphone (for active noise control system) | 9. Satellite speaker LH |
| 10. BOSE amp. | 11. Rear view camera | 12. Rear woofer |
| 13. Satellite speaker RH | 14. Antenna amp. | 15. Satellite radio antenna |

COMPONENT PARTS

< SYSTEM DESCRIPTION >

[BOSE AUDIO WITH NAVIGATION]

- | | | |
|--|---|--|
| 16. Rear door speaker RH | 17. Passenger seat speaker RH | 18. Passenger seat speaker LH |
| 19. Front door woofer RH | 20. Front door squawker RH | 21. Tweeter RH |
| 22. Display unit | 23. Steering switch | 24. Steering angle sensor |
| 25. USB connector | 26. Preset switch | 27. AV control unit |
| 28. Multifunction switch | 29. GPS antenna | 30. Front microphone (for active noise control system/AudioPilot® 2) |
| 31. Microphone (for TEL/voice recognition) | | |
| A. Headlining rear center | B. Rear parcel shelf left side (trunk room) | C. Rear pillar finisher RH remove condition |
| D. Instrument panel removed condition | E. | F. Within center console |
| G. Map lamp ASSY removed condition | | |

Component Description

INFOID:000000005912968

Part name	Description
AV control unit	<ul style="list-style-type: none"> Integrates hard disk drive (HDD) allowing map data and music data to be stored. It is the master unit of the MULTI AV system, and it is connected to each control unit by communication. It operates each system according to communication signals from the AV control unit. The AV control unit includes the audio, hands-free phone, voice control, navigation, USB connection, DVD play, satellite radio and vehicle status functions. It is connected to each control unit via CAN communication to obtain necessary information for the vehicle information function. It receives a steering angle signal from the steering angle sensor via CAN communication and controls an expected course line during rear view monitor operation. It inputs the dimmer signals that are required for the display dimming control. It inputs the signals for driving status recognition (vehicle speed, reverse and parking brake). The RGB digital image signal and composite image signal are output to display unit. It receives an intelligent key recognition signal necessary for the intelligent key interlocking function from BCM via a hard wire Update of map data is performed with the DVD-ROM.
Display unit	<ul style="list-style-type: none"> Display image is controlled by the serial communication from AV control unit. The RGB digital image signal and composite image signal are input to display unit. Camera image signal is input from rear view camera. Touch panel function can be operated for each system by touching a display directly.
BOSE amp.	<ul style="list-style-type: none"> BOSE amp. include active noise control system and AudioPilot® 2 noise compensation technology. (BOSE stereo sound system models) BOSE amp. include active noise control system, AudioPilot® 2 noise compensation technology and BOSE® Centerpoint® 2 function. (BOSE® Studio Surround® sound system models) Generates an antiphase sound weakening interior engine booming noise, mixes the antiphase sound with a sound signal transmitted from the AV control unit, and transmits the mixed sound signal to each speaker. Input microphone signal transmitted from front microphone (for AudioPilot® 2 noise compensation technology). Input microphone signal transmitted from both front and rear microphone (for active noise control system).
Front door woofer	<ul style="list-style-type: none"> Outputs sound signal from BOSE amp. Outputs low range sound.
Front door squawker	<ul style="list-style-type: none"> Outputs sound signal from BOSE amp. Outputs mid range sound.
Tweeter	<ul style="list-style-type: none"> Outputs sound signal from BOSE amp. Outputs high range sound.

COMPONENT PARTS

< SYSTEM DESCRIPTION >

[BOSE AUDIO WITH NAVIGATION]

Part name	Description
Rear door speaker	<ul style="list-style-type: none"> • Outputs sound signal from BOSE amp. • Outputs high, mid and low range sound.
Satellite speaker*1	<ul style="list-style-type: none"> • Outputs sound signal from BOSE amp. • Outputs mid and high range sound.
Center speaker	<ul style="list-style-type: none"> • Outputs sound signal from BOSE amp. • Outputs mid range sounds.
Rear woofer	<ul style="list-style-type: none"> • Outputs sound signal from BOSE amp. • Outputs low range sound.
Seat speaker*1	<ul style="list-style-type: none"> • Outputs sound signal from BOSE amp. • Outputs mid range sound.
Front microphone (for active noise control system/AudioPilot® 2 noise compensation technology)	<ul style="list-style-type: none"> • Used for active noise control system and AudioPilot® 2 noise compensation technology • Detects interior engine booming noise and transmits a sound signal to the BOSE amp.
Rear microphone (for active noise control system)	<ul style="list-style-type: none"> • Used for active noise control system • Detects interior engine booming noise and transmits a sound signal to the BOSE amp.
Multifunction switch	<ul style="list-style-type: none"> • Operation panel is equipped with the centralized switch where navigation and air conditioner, etc. operations are integrated. • Connected with preset switch via cable, and operation signal is transmitted to AV control unit via AV communication.
Preset switch	<ul style="list-style-type: none"> • Operation panel is equipped with the centralized switch where audio, etc. operations are integrated. • Connected with multifunction switch via cable, and operation signal is transmitted to AV control unit via AV communication. • The disk ejection operating signal is performed by hardwire.
Rear view camera	<ul style="list-style-type: none"> • Camera power supply is input from AV control unit. • The image of vehicle rear view is transmitted to display unit.
Steering angle sensor	It is connected to the AV control unit and transmits the steering angle sensor signal via CAN communication.
Steering switch	<ul style="list-style-type: none"> • Operations for audio, hands-free phone, voice recognition and navigation, etc. are possible. • Steering switch signal (operation signal) is output to AV control unit.
Microphone (for TEL/voice recognition)	<ul style="list-style-type: none"> • Used for hands-free phone operation and voice recognition. • Microphone signal is transmitted to AV control unit. • Power (Microphone VCC) is supplied from AV control unit.
Antenna amp.	<ul style="list-style-type: none"> • Radio signal received by window antenna is amplified and transmitted to AV control unit. • Power (antenna amp. ON signal) is supplied from AV control unit.
Satellite radio antenna.	Receives the satellite radio waves and outputs it to AV control unit.
GPS antenna	GPS signal is received and transmitted to AV control unit.
USB connector	Image signal*2 and sound signal of USB input is transmitted to AV control unit.

*1: BOSE® Studio Surround® sound system models

*2: Image signals cannot be received from iPod®

SYSTEM
MULTI AV SYSTEM

MULTI AV SYSTEM : System Diagram

INFOID:000000005912969

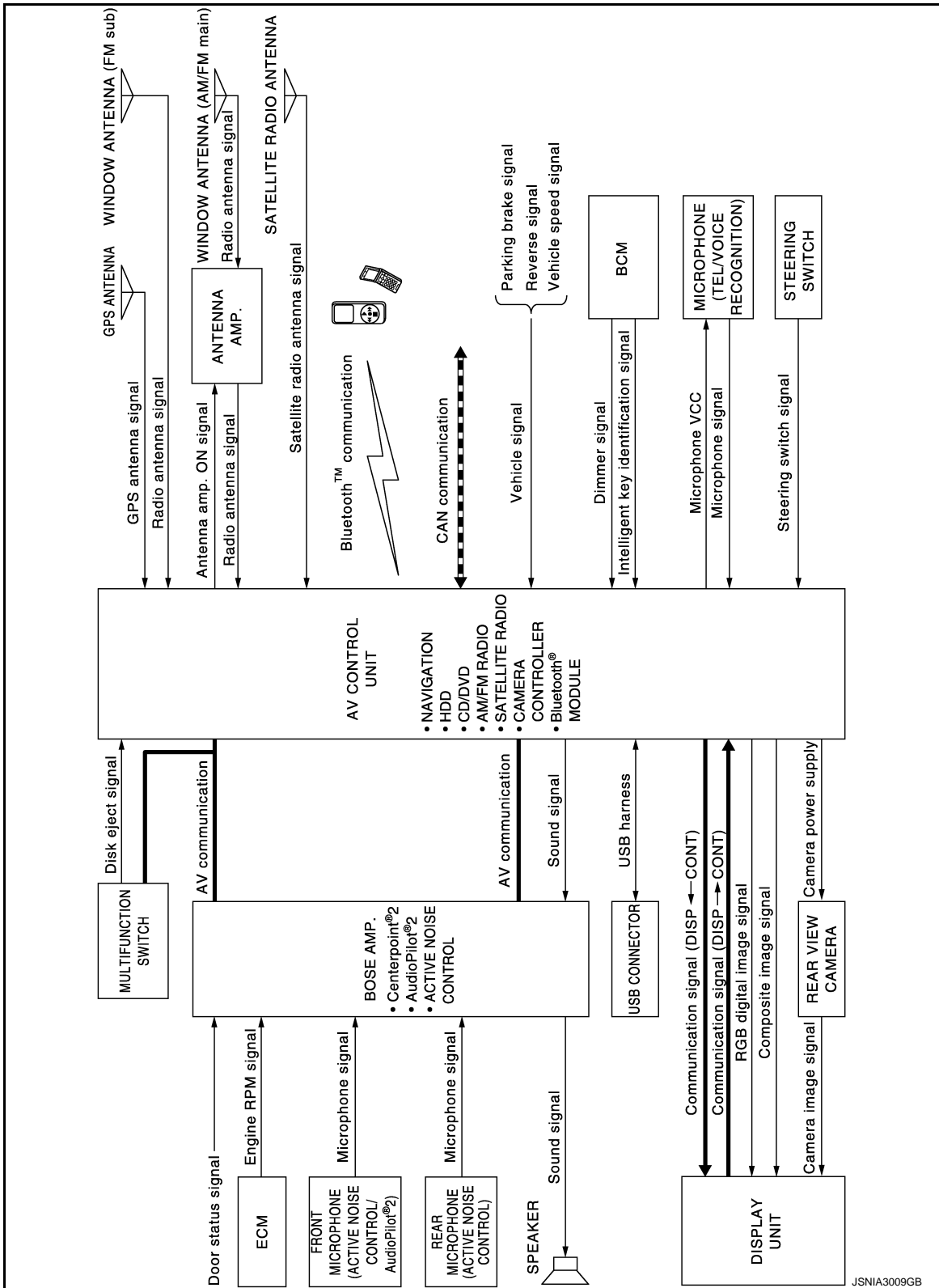

NOTE:

- The name MULTIFUNCTION SWITCH indicates the integration of PRESET SWITCH and MULTIFUNCTION SWITCH virtually.
- BOSE Centerpoint® 2 function has only BOSE® Studio Surround® sound system models.

A
B
C
D
E
F
G
H
I
J
K
L
M
N
O
P

AV

MULTI AV SYSTEM : System Description

INFOID:000000005912970

Multi AV system means that the following systems are integrated.

FUNCTION NAME
Navigation system function
Audio function
DVD playback function
Hands-free phone function
USB connection function
Voice recognition function
Touch panel function
Rear view monitor function
Vehicle information function
Intelligent key interlocking function
Auto Light Adjustment System

COMMUNICATION SIGNAL

- AV control unit function by transmitting/receiving data one by one with each unit (slave unit) that configures them completely as a master unit by connecting between units that configure MULTI AV system with two AV communication lines (H, L).
- Two AV communication lines (H, L) adopt a twisted pair line that is resistant to noise.
- The AV control unit is connected by CAN communication, and it receives data signal from ECM and combination meter. It computes and displays fuel economy information value with the obtained information.
- The AV control unit is connected with display unit and serial communication, and it transmits the required signal of display and display control and receives the response signal from display unit.
- The AV control unit has a vehicle setting function and transmits/receives vehicle setting state data to/from BCM via CAN communication.
- The AV control unit receives a steering angle signal from the steering angle sensor via CAN communication and controls an expected course line during rear view monitor operation.
- The AV control unit transmits an ECO pedal reaction force setting signal (STANDARD/SOFT/OFF) to ECM that is necessary for ECO mode setting.
- The AV control unit transmits ON/OFF signals of DCA (distance control system), LDP (lane deviation prevention support system) and BSI (blind spot intervention) necessary for drive support system settings.

NAVIGATION SYSTEM FUNCTION

Description

- The AV control unit controls navigation function while GPS tuner has built-in map data, GYRO (angle speed sensor), on the HDD (Hard Disk Drive).
- The AV control unit inputs operation signal with communication signal, through display unit (touch panel) and multifunction switch and steering switch.
- Guide sound is output to front speaker through BOSE amp. from AV control unit when operating navigation system.
- A vehicle position is calculated with the GYRO (angle speed sensor), vehicle sensor, signal from GPS satellite and map data stored on HDD (Hard Disk Drive), and transmits the map image signal (RGB image, RGB area, RGB image synchronizing) to the display.

Position Detection Principle

SYSTEM

< SYSTEM DESCRIPTION >

[BOSE AUDIO WITH NAVIGATION]

The navigation system periodically calculates the current vehicle position according to the following three types of signals.

- Travel distance of the vehicle as determined by the vehicle speed sensor
- Vehicle turning angle determined by the gyroscope (angular speed sensor)
- The travel direction of the vehicle determined by the GPS antenna (GPS information)

The current position of the vehicle is then identified by comparing the calculated vehicle position with map data, which is stored in the HDD (Hard Disk Drive) (map-matching), and indicated on the screen with a current location mark. More accurate data is used by comparing position detection results from GPS to the map-matching.

The current position is calculated by detecting the travel distance from the previous calculation point, and its direction change.

- Travel distance

The travel distance is generated from the vehicle speed sensor input signal. The automatic distance correction function is adopted for preventing a miss-detection of the travel distance because of tire wear etc.

- Travel direction

The gyroscope (angular velocity sensor) and GPS antenna (GPS information) generate the change of the travel direction. Both have advantages and disadvantages as per the following descriptions.

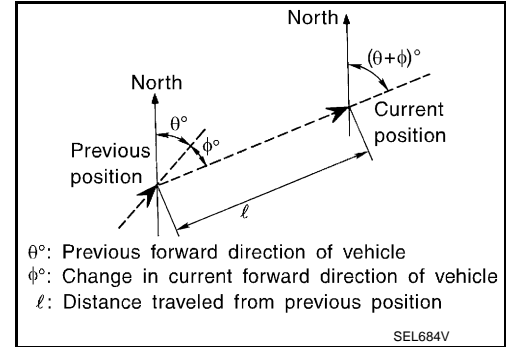
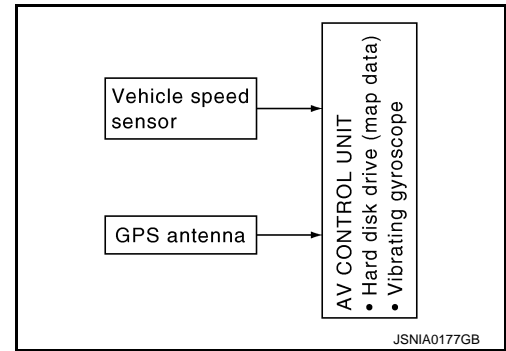

Type	Advantage	Disadvantage
Gyroscope (angular velocity sensor)	The turning angle is precisely detected.	Errors are accumulated when driving a long distance without stopping.
GPS antenna (GPS information)	The travel direction (North/South/East/West) is detected.	The travel direction is not precisely detected when driving slowly.

Input signals are prioritized in each situation. However, this order of priority may change in accordance with more detailed travel conditions so that the travel direction is detected more accurately.

Map-matching

Map-matching repositions the vehicle on the road map when a new location is judged to be more accurate. This is done by comparing the current vehicle position (calculated by the normal position detection method) from the map data stored in the HDD (Hard Disk Drive).

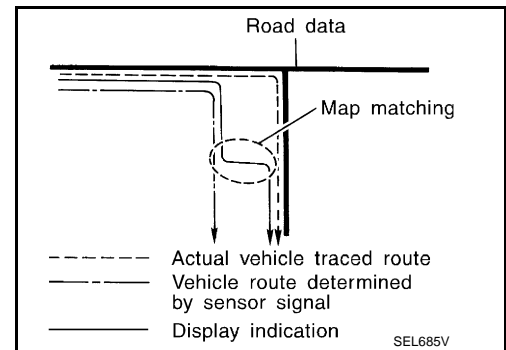

There is a possibility that the vehicle position may not be corrected in the following case, and when vehicle is driven over a certain distance or time in which GPS information is hard to receive. Correct manually the current location mark on the screen.

SYSTEM

< SYSTEM DESCRIPTION >

[BOSE AUDIO WITH NAVIGATION]

- In map-matching, several alternative routes are prepared and prioritized in addition to the road judged as currently driving on. Therefore, due to errors in the distance and/or direction, an incorrect road may be prioritized, and the current location mark may be repositioned to the incorrect road.

If two roads are running in parallel, they are of the same priority. Therefore, the current location mark may appear on either of them alternately, depending on maneuvering of the steering wheel and configuration of the road, etc.

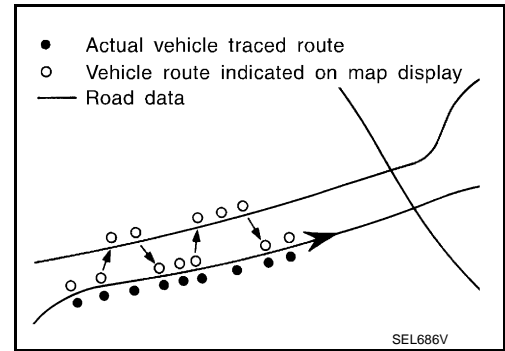

- Map-matching does not function correctly when road on which the vehicle is driving is new, etc. and not recorded in the map data. Also, map-matching does not function correctly when road pattern stored in the map data and the actual road pattern are different due to repair, etc.

Therefore, the map-matching function judges other road as a currently driving road if the road is not in the map, and displays the current location mark on it. Later, the current location mark may be repositioned to the road if the correct road is detected.

- Effective range for comparing the vehicle position and travel direction calculated by the distance and direction with the road data is limited. Therefore, correction by map-matching is not possible when there is an excessive gap between current vehicle position and the position on the map.

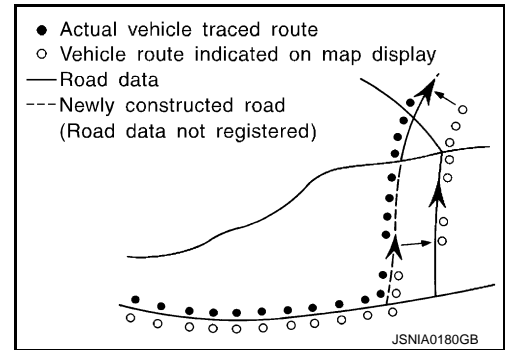

GPS (Global Positioning System)

GPS (Global Positioning System) is developed for and is controlled by the US Department of Defense. The system utilizes GPS satellites (NAVSTAR), transmitting out radio waves while flying on an orbit around the earth at an altitude of approximately 21,000 km (13,049 mile).

The receiver calculates the travel position in three dimensions (latitude/longitude/altitude) according to the time lag of the radio waves that four or more GPS satellites transmit (three-dimensional positioning). The GPS receiver calculates the travel position in two dimensions (latitude/longitude) with the previous altitude data if the GPS receiver receives only three radio waves (two-dimensional positioning). GPS position correction is not performed while stopping the vehicle.

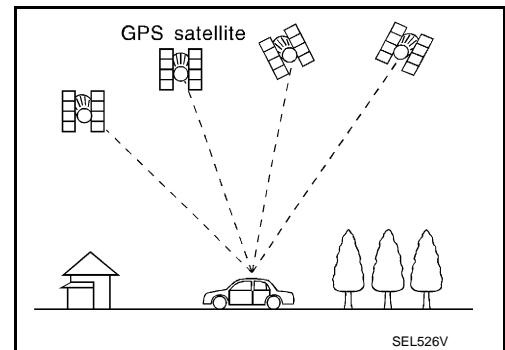

Accuracy of the GPS will deteriorate under the following conditions:

- In two-dimensional positioning, GPS accuracy will deteriorate when altitude of the vehicle position changes.
- The position of GPS satellite affects GPS detection precision. The position detection may not be precisely performed.
- The position detection is not performed if GPS receiver does not receive radio waves from GPS satellites. (Inside a tunnel, parking in a building, under an elevated highway etc.) GPS receiver may not receive radio waves from GPS satellites if any object is placed on the GPS antenna.

NOTE:

- The detection result has an error of approximately 10 m (32.81 ft) even with a high-precision three dimensional positioning.
- There may be cases when the accuracy is lowered and radio waves are stopped intentionally because the GPS satellite signal is controlled by the US trace control center.

AUDIO FUNCTION

Description

- The audio function is adoption of the following system, and it is equipped with the following functions.

SYSTEM

< SYSTEM DESCRIPTION >

[BOSE AUDIO WITH NAVIGATION]

FUNCTION	SYSTEM	
	BOSE® Studio Surround® Sound System (16 speaker models)	BOSE Stereo Sound System (10 speaker models)
AM/FM radio	X	X
Satellite radio	X	X
CD/DVD	X	X
Bluetooth™ audio	X	X
Music Box (Hard Disk Drive)	X	X
Active noise control system	X	X
AudioPilot® 2 Noise Compensation Technology	X	X
BOSE® Centerpoint® 2	X	

X: Applicable

- The adoption of the AudioPilot® 2 Noise Compensation Technology enables the correction of frequency bands which tend to be masked by driving noise.
- The BOSE Stereo Sound System features 8-channel amplifier and ten high-performance 3-way speakers integrated into the front doors. Furthermore, the 6x9-inch woofers mounted in the front doors provide deep bass sound.
- With the adoption of 14EQch digital amplifier and 16 speakers, BOSE® Studio Surround® Sound System provides smooth and natural sound over the range from bass to treble through the optimum placement of speakers for each seat and the control of amplifier.
- BOSE® Studio Surround® Sound System is adoption of BOSE® Centerpoint® 2 enables sound effects with a sense of realism even to playback sound of two-channel audio.
- The table below shows speakers mounted to each system.

SPEAKER		SYSTEM	
		BOSE® Studio Surround® Sound System (16 speaker models)	BOSE Stereo Sound System (10 speaker models)
Front door 3 Way speaker	Front door woofer	X	X
	Front door squawker	X	X
	Tweeter	X	X
Rear door speaker		X	X
Rear woofer		X	X
Center speaker		X	X
Satellite speaker		X	
Seat speaker		X	

X: Applicable

Operating Signal

Audio system operation can be performed with multifunction switch, preset switch, steering switch, touch panel function or voice recognition function.

- Operating signal is transmitted to AV control unit with AV communication when it is operated by multifunction switch or preset switch. The disk ejection operating signal is performed by hardware.
- Operating signal is transmitted to AV control unit with steering switch signal when it is operated by steering switch.

Screen Display

Switching of display is performed with serial communication between display unit and AV control unit.

Operation status of audio is indicated at display unit.

AM/FM Radio Mode

- AM/FM radio tuner is built into AV control unit.

SYSTEM

[BOSE AUDIO WITH NAVIGATION]

< SYSTEM DESCRIPTION >

- Sound signals (AM/FM radio) are received via window antenna.
- AM/FM main antenna signal is amplified via antenna amp. and FM sub antenna signal is transmitted to AV control unit.
- AV control unit outputs sound signal is input to BOSE amp., and BOSE amp. outputs to each speaker.

Satellite Radio Mode

- Satellite radio tuner is built into AV control unit.
- Sound signal (satellite radio) is received by satellite radio antenna and is transmitted to AV control unit. AV control unit outputs sound signal to BOSE amp. The signal is also outputted from BOSE amp. to each speaker.

CD Mode

- CD function is built into AV control unit.
- AV control unit outputs sound signal to BOSE amp., and BOSE amp. outputs the signal to each speaker during playback.

Bluetooth™ Audio Mode

- Bluetooth™ audio function is built into AV control unit.
- Bluetooth™ audio can play music data in the portable audio by means of Bluetooth™ communications between the portable audio and the AV control unit.
- AV control unit outputs sound signal to BOSE amp., and BOSE amp. outputs to each speaker.

Music Box Mode

- Music CD data is stored on HDD that is built into AV control unit, and it can be played.
- AV control unit outputs music (sound signal) that is stored on HDD to BOSE amp., and BOSE amp. outputs to each speaker.

AudioPilot® 2 Noise Compensation Technology

- AudioPilot® 2 continuously corrects audio signals to compensate for background noise.
- AudioPilot® 2 noise compensation technology is a sound improving system that picks up by a front microphone any noises or the sound of music coming into the vehicle, and that uses the BOSE amp. to revise the frequency feature of music in real time in response to the frequency feature of the noise while driving and listening to music.

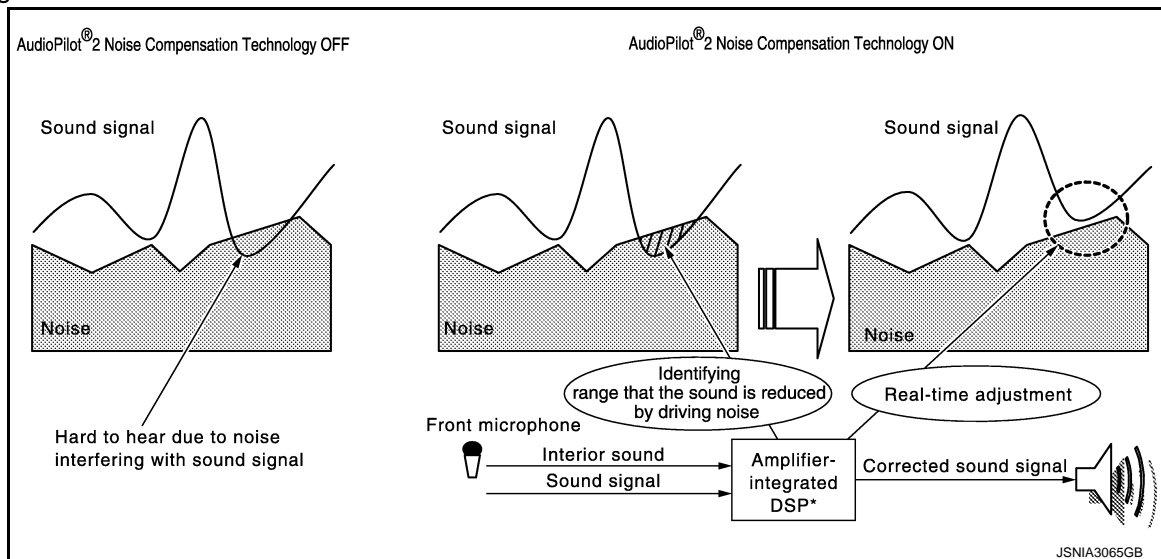

*: DSP stands for Digital Signal Processor and enables digital processing of sound signals. DSP features precise signal processing and calculation with the digital technology on a small scale that analog methods find it difficult to process and calculate.

BOSE® Centerpoint® 2 (BOSE® Studio Surround® Sound System)

- BOSE® Centerpoint® 2 provides a surround-sound effect, based on a stereo sound source, such as CD or MP3.
- The BOSE amp. receives a BOSE® Centerpoint® 2 ON signal during a stereophonic sound playback and divides the sound among five channels to add a sense of simulated surround playback sound.

Active Noise Control System

SYSTEM

< SYSTEM DESCRIPTION >

[BOSE AUDIO WITH NAVIGATION]

- The active noise control system incorporates the BOSE Engine Harmonic Cancellation (EHC) technology.
- The active noise control system outputs an antiphase sound from the speakers (front door speaker, rear door speaker and rear woofer) against unpleasant engine booming noise (2nd and/or 3rd engine rev at 700 - 5000 rpm) and reduces sound pressure level by the interference with engine booming noise. (VQ37VHR models)
- The active noise control system outputs an antiphase sound from the speakers (front door speaker, rear door speaker and rear woofer) against unpleasant engine booming noise (4th engine rev at Idle speed - 2500 rpm) and reduces sound pressure level by the interference with engine booming noise. (VK56VD models)
- The BOSE amp. receives an engine speed signal from ECM and receives microphone signals from the front and rear microphone.
- The BOSE amp. receives a door state signal. The active noise control system does not operate with any door open.
- Based on signals detected by the front and rear microphones, the BOSE amp. generates an antiphase sound (microphone signal) weakening interior engine booming noise in real time according to a unique algorithm^{*1} by a DSP^{*2} built in the BOSE amp. Then, the BOSE amp. mixes the antiphase sound with a sound signal received from the AV control unit to transmit the mixed sound signal to each speaker.

NOTE:

*1: Algorithm means a fixed procedure to solve a question.

*2: DSP stands for Digital Signal Processor and enables digital processing of sound signals. DSP features precise signal processing and calculation with the digital technology on a small scale that analog methods find it difficult to process and calculate.

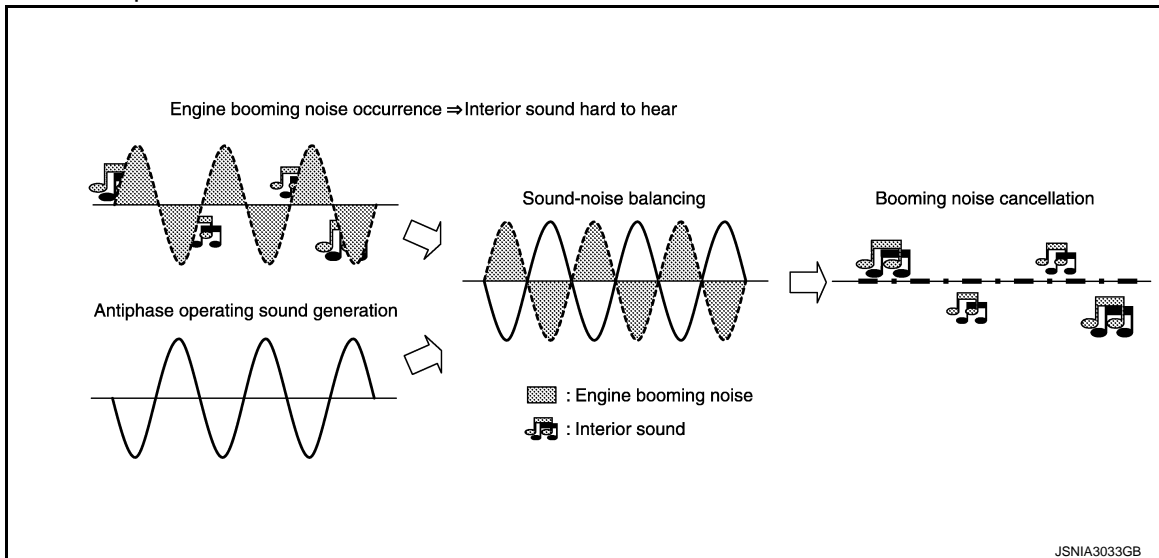

DVD PLAYBACK FUNCTION

- DVD is played by inserting DVD into the AV control unit.
- DVD image signals are transmitted to the display unit and DVD sound signals are transmitted to each speaker via BOSE amp.

HANDS-FREE PHONE FUNCTION

- AV control unit includes hands-free phone function.
- Hands-free communication can be operated by connecting using Bluetooth[™] communication with cellular phone.
- Operation is performed by steering switch, and operating condition is indicated on display unit.
- Guide sound that is heard during operation is input from AV control unit to BOSE amp., and is output from front speaker and center speaker.

When A Call Is Originated

Spoken voice sound output from the microphone (microphone signal) is input to AV control unit. AV control unit outputs to cellular phone with Bluetooth[™] communication as a TEL voice signal. Voice sound is then heard at the other party.

When Receiving A Call

A
B
C
D
E
F
G
H
I
J
K
L
M
O
P

AV

SYSTEM

< SYSTEM DESCRIPTION >

[BOSE AUDIO WITH NAVIGATION]

Voice sound is input to own cellular phone from the other party. TEL voice signal is output to door speaker, and the signal is input to BOSE amp. via AV control unit by establishing Bluetooth™ communication from cellular phone.

USB CONNECTION FUNCTION

- Connecting iPod® or USB memory allows the driver to play iPod® music files or USB memory-stored music files, video data, and image viewer data.
- Sound signals of music files stored in iPod® or USB memory is transmitted from the USB connector to the AV control unit. The AV control unit transmits the sound signals to the woofer and each speaker via BOSE amp.
- Video signals and image viewer file signals are transmitted from the USB connector to the AV control unit. The data and files are displayed on the front display unit screen.
- iPod® is recharged when connected to USB connector.
- Only files that meet the following conditions will be played.

	Music file	Video file	Image viewer file
File format	"MP3", "WMA", "AAC", "M4A"	"DivX", "MPEG4 (ASF)"	"JPEG"
File extension	".mp3", ".wma", ".aac", ".m4a"	".divx", ".afs", ".avi"	".jpg", ".jpeg"
Maximum file size	2 GB	2 GB	2 MB

NOTE:

- iPod® is a trademark of Apple inc., registered in the U.S. and other countries.
- Image signals cannot be received from iPod®.
- Use the enclosed USB harness when connecting iPod® to USB connector.

VOICE RECOGNITION FUNCTION

- Each operation of multi AV system can be performed by inputting sound to microphone.
- Start of sound recognition system can be performed by steering switch.

TOUCH PANEL SYSTEM

Each operation of multi AV system can be performed by directly touching a display.

REAR VIEW MONITOR FUNCTION

- The AV control unit supplies power to the rear view camera when receiving a reverse signal.
- The rear view camera transmits camera images to the display unit when power is supplied from the AV control unit.
- The AV control unit transmits a warning message, fixed guide lines, and predictive course lines to the display unit by RGB digital image signal. Rear view monitor images are displayed by combining the RGB digital image signal and the camera image signals from the rear view camera.
- Predictive course lines are controlled by a steering angle sensor signal received the AV control unit via CAN communication.

VEHICLE INFORMATION FUNCTION

Status of audio, climate control system, fuel economy, maintenance and navigation etc. are displayed.

INTELLIGENT KEY INTERLOCKING FUNCTION

The AV control unit recognizes a door-unlocked state of intelligent key according to an intelligent key recognition signal transmitted from BCM and saves two different types of audio settings and navigation settings.

Settings saved in the AV control unit

- Map display
- Route guidance
- Locator
- Route search
- Sound quality
- Radio preset
- Language

AUTO LIGHT ADJUSTMENT SYSTEM

SYSTEM

< SYSTEM DESCRIPTION >

[BOSE AUDIO WITH NAVIGATION]

When the light switch is in the 1st or 2nd position, the dimming of the display is judged according to a dimming signal transmitted from BCM to the AV control unit. Display illuminance is independent of vehicle exterior illuminance detected by the auto light detecting sensor even when the light switch is in 1st or 2nd position.

MULTI AV SYSTEM : Fail-Safe

INFOID:000000005912971

When the ambient temperature becomes extremely low or extremely high, AV control unit displays the message and limits the AV control unit function.

FAIL-SAFE CONDITIONS

When the ambient temperature is -20°C (-4°F) or lower, or when it is 70°C (158°F) or higher

Display

The messages displayed on fail-safe conditions are as shown below:

Fail-safe mode	Display (display of the fail-safe condition)
When HDD temperature is low	HDD system is experiencing problems due to extreme low temperature. Normal operation will resume when temperature rises.
When HDD temperature is high	HDD system is experiencing problems due to extreme high temperature. Normal operation will resume when temperature drops.

DESCRIPTION OF CONTROLS

Function		When Fail-safe Function is activated
Air conditioner	Operation	Only multifunction switch (preset switch) can be operated.
	Display	<ul style="list-style-type: none"> • LED of multifunction switch (preset switch) illuminates. • Aimed temperature, blow angle, and flow rate are displayed in simplified mode.
Audio	Operation	Only ON/OFF and volume control operations by multifunction switch (preset switch) are possible.
	Display	No display ("Fail-safe mode" is displayed)
Camera	Operation	Image tone cannot be controlled.
	Display	Cannot be superimposed. (warning display, tone control display)
Hands-free phone	Operation	Cannot be operated.
Navigation	Operation	Cannot be operated.
Self diagnosis		The display in simplified mode of fail-safe condition
CONSULT-III diagnosis		Cannot be operated.

Ability Operation Mode

There is an ability operation mode for Fail-safes due to low or high ambient temperature.

If HDD data can be read, fail-safe is shown, then normal displays are displayed only for functions which can be operated.

RELEASE CONDITIONS OF FAIL-SAFE

Fail-safe is released on following conditions and normal mode is restored.

When The Temperature of HDD Is Low or High

If the ambient temperature becomes out of fail-safe condition range, normal mode is restored.

A
B
C
D
E
F
G
H
I
J
K
L
M
O
P

AV

DIAGNOSIS SYSTEM (AV CONTROL UNIT)

[BOSE AUDIO WITH NAVIGATION]

< SYSTEM DESCRIPTION >

DIAGNOSIS SYSTEM (AV CONTROL UNIT)

Description

INFOID:000000005912972

- The AV control unit diagnosis function starts up with multifunction switch operation and the AV control unit performs a diagnosis for each unit in the system during the on board diagnosis.
- Perform a CONSULT-III diagnosis if the on board diagnosis does not start, e.g., the screen does not display anything, the multifunction switch does not function, etc.

On Board Diagnosis Function

INFOID:000000005912973

MULTIFUNCTION SWITCH AND PRESET SWITCH SELF-DIAGNOSIS FUNCTION

The ON/OFF operation (continuity) of each switch in the multifunction switch and preset switch can be checked.

Self-diagnosis Mode

- Press the "BACK" switch and the "UP" switch of the multifunction switches within 10 seconds after turning the ignition switch from OFF to ACC and hold them for 3 seconds or more. Then the buzzer sounds, all indicators of the multifunction switch and preset switch illuminate, and the self-diagnosis mode starts.
- The continuity of each switch at the ON position can be checked by pressing the switch. The buzzer sounds if the switch is normal.

NOTE:

The hazard switch and disk eject switch cannot be checked.

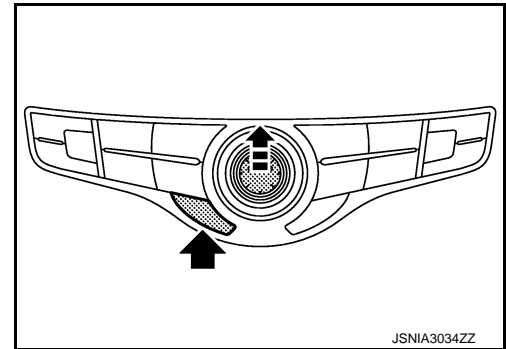

Finishing Self-diagnosis Mode

Self-diagnosis mode is canceled when turning the ignition switch OFF.

ON BOARD DIAGNOSIS ITEM

Description

- The trouble diagnosis function has a self-diagnosis mode for conducting trouble diagnosis automatically and a confirmation/adjustment mode for operating manually.
- The self-diagnosis mode performs diagnoses on the AV control unit, connections between system components as well as connections between AV control unit and GPS antenna. Then it displays the diagnosis results on the display.
- The confirmation/adjustment mode allows the technician to check, modify or adjust the vehicle signals and set values, as well as to monitor the system error records and system communication status. The checking, modifying or adjusting generally require human intervention and judgment (the system cannot make judgment automatically).

On Board Diagnosis Item

Mode	Description
Self Diagnosis	<ul style="list-style-type: none">• AV control unit diagnosis.• Diagnoses the connections across system components, between AV control unit and GPS antenna.

DIAGNOSIS SYSTEM (AV CONTROL UNIT)

< SYSTEM DESCRIPTION >

[BOSE AUDIO WITH NAVIGATION]

	Mode	Description	
Confirmation/ Adjustment	Display Diagnosis	The following check functions are available: color tone check by color bar display and white display, light and shade check by gray scale display and touch panel calibration response check.	
	Vehicle Signals	Diagnosis of signals can be performed for vehicle speed, parking brake, lights, ignition, reverse, side view switch and room lamp.	
	Speaker Test	The connection of a speaker can be confirmed by test tone.	
	Navigation	Steering Angle Adjustment	When there is a difference between the actual turning angle and the vehicle mark turning angle, it can be adjusted.
		Speed Calibration	When there is a difference between the current location mark and the actual location, it can be adjusted.
		XM SAT Subscription Status	The XM NavTraffic subscription status can be checked.
	Error History	The system malfunction and the frequency when occurring in the past are displayed. When the malfunctioning item is selected, the time and place that the selected malfunction last occurred are displayed.	
	Synchronizer FES Clock	-	
	Vehicle CAN Diagnosis	The transmitting/receiving of CAN communication can be monitored.	
	AV COMM Diagnosis	The communication condition of each unit of Multi AV system can be monitored.	
	Hands-free Phone	The received volume adjustment of hands-free phone and microphone speaker check can be performed.	
	Camera	The signal connected to camera control unit can be checked and the guiding line position that overlaps rear view camera image can be adjusted.	
	XM	XM NavTraffic	Change Channel • Any necessary channels required to receive traffic information etc. from the satellite radio system can be set. Change Application ID • Any application ID's required to receive traffic information etc. from the satellite radio system can be set.
		XM NavWeather	
		XM CGS	
		Diag	
	Delete Unit Connection Log	Erase the connection history of unit and error history.	
	Initialize Settings	Initializes the AV control unit memory.	
Version Information	Version information of the AV control unit is displayed.		

METHOD OF STARTING

1. Start the engine.
2. Turn the audio system OFF.
3. While pressing the "SETTING" button, turn the volume control dial clockwise or counterclockwise for 40 clicks or more. (When the self-diagnosis mode is started, a short beep will be heard.)
 - Shifting from current screen to previous screen is performed by pressing "BACK" button.

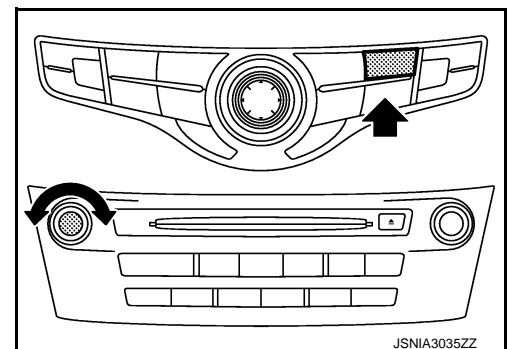

A
B
C
D
E
F
G
H
I
J
K
L
M
N
O
P

AV

DIAGNOSIS SYSTEM (AV CONTROL UNIT)

[BOSE AUDIO WITH NAVIGATION]

< SYSTEM DESCRIPTION >

- The trouble diagnosis initial screen is displayed, and then the items of "Self Diagnosis" and "Confirmation/Adjustment" can be selected.

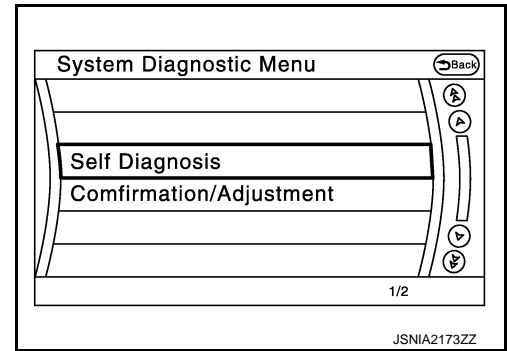

SELF-DIAGNOSIS MODE

- Start the self-diagnosis function and select "Self Diagnosis".
 - Self-diagnosis subdivision screen is displayed, and the self-diagnosis mode starts.
 - The bar graph visible on the center of the self-diagnosis subdivision screen indicates progress of the trouble diagnosis.
- Diagnosis results are displayed after the self-diagnosis is completed. The unit names and the connection lines are color-coded according to the diagnostic results.

Diagnosis results	Unit	Connection line
Normal	Green	Green
Connection malfunction	Gray	Yellow
Unit malfunction ^{Note}	Red	Green

NOTE:

Control unit (AV control unit) and amplifier (BOSE amp.) are displayed in red.

- Replace AV control unit if "Self-Diagnosis did not run because of a control unit malfunction" is indicated. The symptom is AV control unit internal error. Refer to [AV-298, "Removal and Installation"](#).
- If multiple errors occur at the same time for a single unit, the screen switch colors are determined according to the following order of priority: red > gray.

- The comments of the self-diagnosis results can be viewed with a component in the diagnosis result screen.

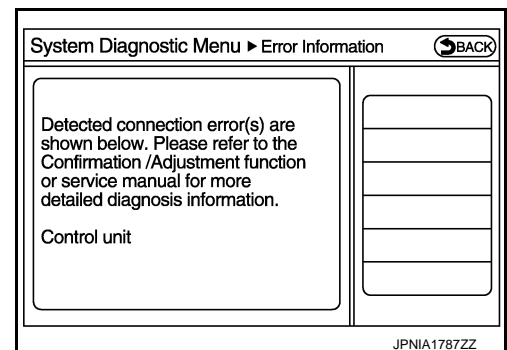
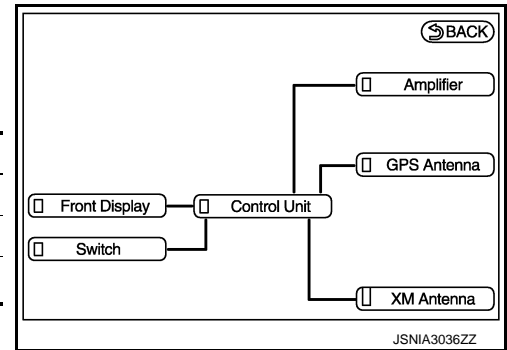

Detection Range of Self-diagnosis Mode

- The self-diagnosis mode allows the technician to diagnose the connection in the communication line between AV control unit and each unit and the internal operation of the AV control unit.
- Because the start condition of diagnosis function is a switch operation, the on board diagnosis function cannot be started up if any malfunction is detected in the communication circuit between AV control unit and multifunction switch.

SELF-DIAGNOSIS RESULTS

Check the applicable display at the following table, and then repair the malfunctioning parts.

Only Unit Part Is Displayed In Red.

DIAGNOSIS SYSTEM (AV CONTROL UNIT)

< SYSTEM DESCRIPTION >

[BOSE AUDIO WITH NAVIGATION]

Screen switch	Description	Possible malfunction location / Action to take
Control Unit	Malfunction is detected in AV control unit power supply and ground circuits.	Check AV control unit power supply and ground circuits. Refer to AV-272, "AV CONTROL UNIT : Diagnosis Procedure" . When detecting no malfunction in those components, replace AV control unit. Refer to AV-298, "Removal and Installation" .
Amplifier	When either one of the following items are detected: <ul style="list-style-type: none"> • sound signal circuits between BOSE amp. and each speaker are malfunctioning. • sound signal circuits between BOSE amp. and either front or rear microphone is malfunctioning. • BOSE amp. malfunction is detected. 	<ul style="list-style-type: none"> • Malfunctioning speaker circuits • Malfunctioning front or rear microphone circuits • Replace BOSE amp. Refer to AV-307, "Removal and Installation".

A Connecting Cable Between Units Is Displayed In Yellow.

Area with yellow connection lines	Description	Possible malfunction location / Action to take
Control unit ↔ Front Display	Malfunction is detected in serial communication circuits between AV control unit and display unit.	Serial communication circuits between AV control unit and display unit.
Control unit ↔ GPS Antenna	GPS antenna connection malfunctions detected.	GPS antenna
Control unit ↔ SAT Antenna	Satellite radio antenna connection malfunction is detected.	Satellite radio antenna disconnection
Control unit ↔ Amplifier	When either one of the following items are detected: <ul style="list-style-type: none"> • BOSE amp. power supply and ground circuits are malfunctioning. • AV communication circuits between multifunction switch and BOSE amp. are malfunctioning. 	<ul style="list-style-type: none"> • BOSE amp. power supply and ground circuits. Refer to AV-273, "BOSE AMP. : Diagnosis Procedure". • AV communication circuits between multifunction switch and BOSE amp.

CONFIRMATION/ADJUSTMENT MODE

1. Start the diagnosis function and select "Confirmation/Adjustment". The confirmation/adjustment mode indicates where each item can be checked or adjusted.
2. Select each switch on the "Confirmation/Adjustment Mode" screen to display the relevant trouble diagnosis screen. Press the "Back" switch to return to the initial Confirmation/Adjustment Mode screen.

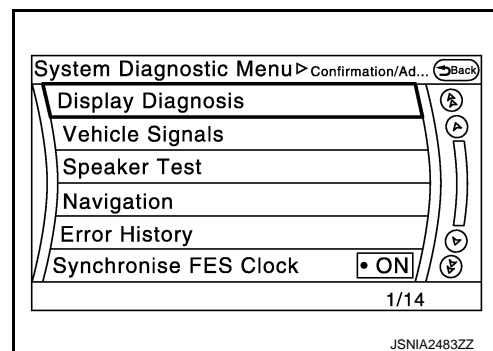

DIAGNOSIS SYSTEM (AV CONTROL UNIT)

< SYSTEM DESCRIPTION >

[BOSE AUDIO WITH NAVIGATION]

Display Diagnosis

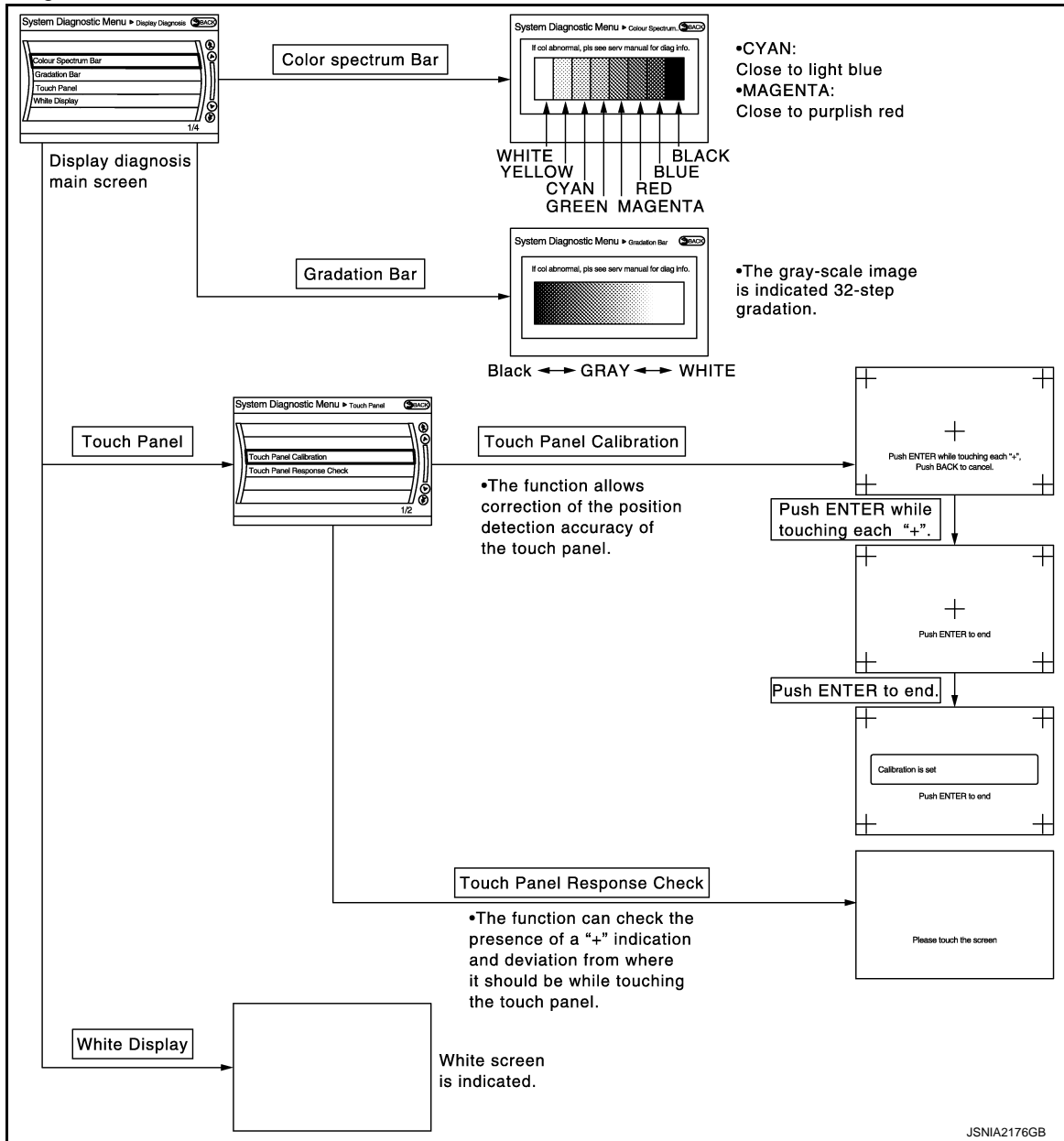

Vehicle Signals

A comparison check can be made of each actual vehicle signal and the signals recognized by the system.

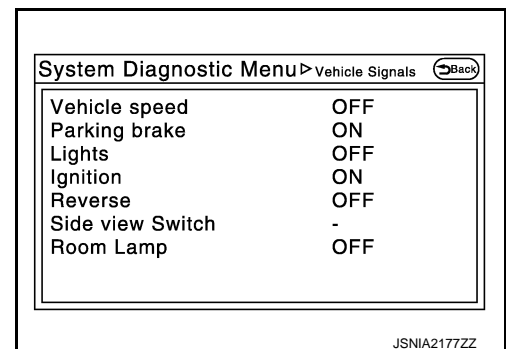

DIAGNOSIS SYSTEM (AV CONTROL UNIT)

< SYSTEM DESCRIPTION >

[BOSE AUDIO WITH NAVIGATION]

Diagnosis item	Display	Vehicle status	Remarks
Vehicle speed	ON	Vehicle speed > 0 km/h (0 MPH)	Changes in indication may be delayed. This is normal.
	OFF	Vehicle speed = 0 km/h (0 MPH)	
Parking brake	ON	Parking brake is applied.	
	OFF	Parking brake is released.	
Lights	ON	Block the light beam from the auto light optical sensor when the light switch is ON.	—
	OFF	Either of the following conditions <ul style="list-style-type: none"> Lighting switch OFF Expose the auto light optical sensor to light when the light switch is ON. 	
Ignition	ON	Ignition switch ON	—
	OFF	Ignition switch in ACC position	
Reverse	ON	Shift the selector lever to "R" position	Changes in indication may be delayed. This is normal.
	OFF	Shift the selector lever other than "R" position	
SIDE VIEW SW	—	—	This item is displayed, but cannot be monitored.
ROOM LAMP	OFF	—	This item is displayed, but cannot be monitored.

Speaker Test

Select "SPEAKER DIAGNOSIS" to display the Speaker Diagnosis screen. Press "Start" to generate a test tone in a speaker. Press "Start" to generate a test tone in the next speaker. Press "Stop" to stop the test tones.

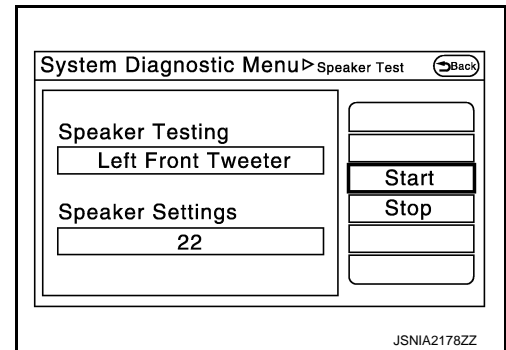

Navigation

STEERING ANGLE ADJUSTMENT

The steering angle output value detected with the gyroscope is adjusted.

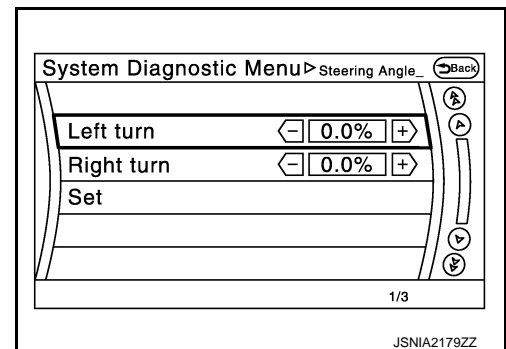

SPEED CALIBRATION

DIAGNOSIS SYSTEM (AV CONTROL UNIT)

< SYSTEM DESCRIPTION >

[BOSE AUDIO WITH NAVIGATION]

During normal driving, distance error caused by tire wear and tire pressure change is automatically adjusted for by the automatic distance correction function. This function, on the other hand, is for immediate adjustment, in cases such as driving with tire chain fitted on tires.

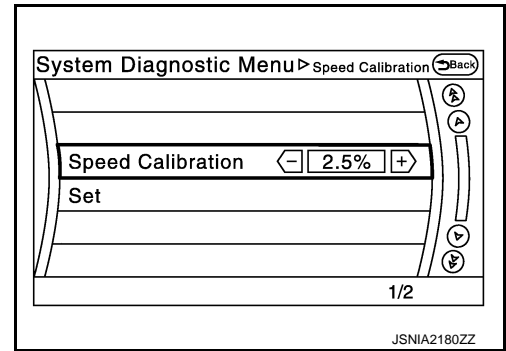

XM SAT SUBSCRIPTION STATUS

The XM NavTraffic subscription status can be checked.

Error History

The self-diagnosis results are judged depending on whether any error occurs from when “Self-diagnosis” is selected until the self-diagnosis results are displayed.

However, the diagnosis results are judged normal if an error has occurred before the ignition switch is turned ON and then no error has occurred until the self-diagnosis start. Check the “Error Record” to detect any error that may have occurred before the self-diagnosis start because of this situation.

The error record displays the time and place of the most recent occurrence of that error. However, take note of the following points.

- If there is a malfunction with the GPS antenna circuit board in the AV control unit, the correct date and time of occurrence may not be able to be displayed.
- Place of the error occurrence is represented by the position of the current location mark at the time an error occurred. If current location mark has deviated from the correct position, then the place of the error occurrence cannot be located correctly.
- The frequency of occurrence is displayed in a count up manner. The actual count up method differs depending on the error item.

Count up method A

- The counter resets to 0 if an error occurs when ignition switch is turned ON. The counter increases by 1 if the condition is normal at a next ignition ON cycle.
- The counter upper limit is 39. Any counts exceeding 39 are ignored. The counter can be reset (no error record display) with the “Delete log” switch or CONSULT-III.

Count up method B

- The counter increases by 1 if an error occurs when ignition switch is ON. The counter will not decrease even if the condition is normal at the next ignition ON cycle.
- The counter upper limit is 50. Any counts exceeding 50 are ignored. The counter can be reset (no error record display) with the “Delete log” switch or CONSULT-III.

Display type of occurrence frequency	Error history display item
Count up method A	CAN communication line, control unit (CAN), AV communication line, control unit (AV)
Count up method B	Other than the above

DIAGNOSIS SYSTEM (AV CONTROL UNIT)

< SYSTEM DESCRIPTION >

[BOSE AUDIO WITH NAVIGATION]

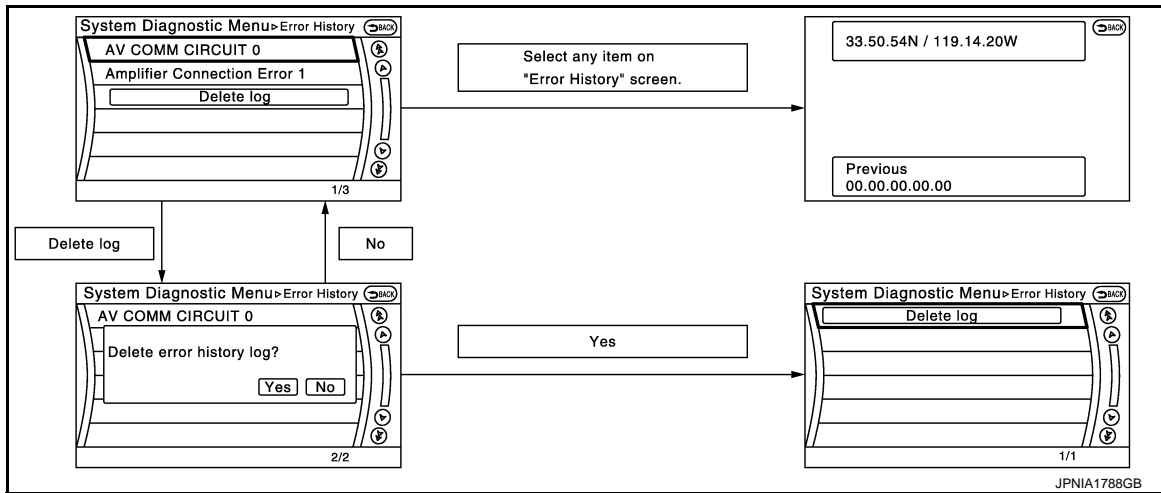

Error item

Some error items may be displayed simultaneously according to the cause. If some error items are displayed simultaneously, the detection of the cause can be performed by the combination of display items

Error item	Description	Possible malfunction factor/Action to take
CAN COMM CIRCUIT	CAN communication malfunction is detected.	Perform diagnosis with CONSULT-III, and then repair the malfunctioning parts according to the diagnosis results. Refer to AV-172, "CONSULT - III Function" .
CONTROL UNIT (CAN)	CAN initial diagnosis malfunction is detected.	Replace the AV control unit if the malfunction occurs constantly. Refer to AV-298, "Removal and Installation" .
CONTROL UNIT (AV)	AV communication circuit initial diagnosis malfunction is detected.	
FLASH-ROM Error Of Control Unit	AV control unit malfunction is detected.	Replace the AV control unit if the malfunction occurs constantly. Refer to AV-298, "Removal and Installation" .
Connection Of Gyro		
Connection of G Sensor		
CAN Controller Memory Error		
Bluetooth Module Connection Error		
Sub CPU Connection Error		
iPod authentication chip error		
Audio connection error		
DSP Connection Error	AV control unit malfunction is detected.	<ul style="list-style-type: none"> If a disc can be played, then there is a possibility of the detection of a temporary malfunction. Replace the AV control unit if the malfunction occurs constantly. Refer to AV-298, "Removal and Installation".
DSP Communication Error		
HDD Connection Error	AV control unit malfunction is detected.	<ul style="list-style-type: none"> If the music box function has no malfunctions, then there is a possibility of the detection of a temporary malfunction. Replace the AV control unit if the malfunction occurs constantly. Refer to AV-298, "Removal and Installation".
HDD Read Error		
HDD Write Error		
HDD Communication Error		
HDD Access Error		

A
B
C
D
E
F
G
H
I
J
K
L
M
O
P

AV

DIAGNOSIS SYSTEM (AV CONTROL UNIT)

< SYSTEM DESCRIPTION >

[BOSE AUDIO WITH NAVIGATION]

Error item	Description	Possible malfunction factor/Action to take
GPS Communication Error	GPS malfunction is detected.	An intermittent error caused by strong radio interference may be detected unless any symptom (GPS reception error, etc.) occurs. Replace the AV control unit if the malfunction occurs constantly. Refer to AV-298, "Removal and Installation" .
GPS ROM Error		
GPS RAM Error		
GPS RTC Error		
Unfinished configuration	The writing of configuration data is incomplete.	Write configuration data with CONSULT-III. Refer to AV-172, "CONSULT - III Function" .
USB Controller Communication Error	USB connection malfunction is detected.	Check that the connection to the USB connector is normal.
DVD Mechanism Communication Error	AV control unit malfunction is detected.	<ul style="list-style-type: none"> • If DVD can be played, then there is a possibility of the detection of a temporary malfunction. • Replace the AV control unit if the malfunction occurs constantly. Refer to AV-298, "Removal and Installation".
Steer. Angle Sensor Calibration	Predictive course line center position adjustment of the steering angle sensor is incomplete.	Adjust the predictive course line center position of the steering angle sensor. Refer to AV-172, "CONSULT - III Function" .
Amplifier Temperature Error	BOSE amp. malfunction is detected.	Replace the BOSE amp. Refer to AV-307, "Removal and Installation" .
Front Display Connection Error	When either one of the following items are detected: <ul style="list-style-type: none"> • display unit power supply and ground circuits are malfunctioning. • communication circuits between AV control unit and display unit are malfunctioning. 	<ul style="list-style-type: none"> • Display unit power supply and ground circuits. Refer to AV-272, "DISPLAY UNIT : Diagnosis Procedure". • Communication circuits between AV control unit and display unit.
GPS Antenna Error	GPS antenna connection malfunction is detected.	Check the connection of the GPS antenna connector.
XM Antenna Connection Error	Satellite radio antenna connection malfunction is detected.	Satellite radio antenna disconnection.
USB electric current Error	Detection of overcurrent in USB connector.	Check USB harness between the AV control unit and USB connector.
AM/FM antenna amplifier short to ground	Antenna amp. ON signal circuit malfunction is detected.	Antenna amp. ON signal circuit between AV control unit and antenna base.
AM/FM antenna amplifier open		
FL-DOOR WOOFER OUT: open	Malfunction is detected sound signal circuits between BOSE amp. and front door woofer LH.	Sound signal circuits between BOSE amp. and front door woofer LH.
FL-DOOR WOOFER OUT: short		
FL-DOOR WOOFER OUT: short to ground		
FL-DOOR WOOFER OUT: short to battery		
FL-DOOR SQUAWKER OUT: open	When either one of the following items is detected: <ul style="list-style-type: none"> • sound signal circuits between BOSE amp. and front door squawker LH are malfunctioning. • sound signal circuits between BOSE amp. and tweeter LH are malfunctioning. 	<ul style="list-style-type: none"> • Sound signal circuits between BOSE amp. and front door squawker LH. • Sound signal circuits between BOSE amp. and tweeter LH.
FL-DOOR SQUAWKER OUT: short		
FL-DOOR SQUAWKER OUT: short to ground		
FL-DOOR SQUAWKER OUT: short to battery		
FR-DOOR WOOFER OUT: open	Malfunction is detected sound signal circuits between BOSE amp. and front door woofer RH.	Sound signal circuits between BOSE amp. and front door woofer RH.
FR-DOOR WOOFER OUT: short		
FR-DOOR WOOFER OUT: short to ground		
FR-DOOR WOOFER OUT: short to battery		

DIAGNOSIS SYSTEM (AV CONTROL UNIT)

< SYSTEM DESCRIPTION >

[BOSE AUDIO WITH NAVIGATION]

Error item	Description	Possible malfunction factor/Action to take	
FR-DOOR SQUAWKER OUT: open	When either one of the following items is detected: • sound signal circuits between BOSE amp. and front door squawker RH are malfunctioning. • sound signal circuits between BOSE amp. and tweeter RH are malfunctioning.	<ul style="list-style-type: none"> • Sound signal circuits between BOSE amp. and front door squawker RH. • Sound signal circuits between BOSE amp. and tweeter RH. 	A
FR-DOOR SQUAWKER OUT: short			B
FR-DOOR SQUAWKER OUT: short to ground			C
FR-DOOR SQUAWKER OUT: short to battery			D
FC-INST SQUAWKER OUT: open	Malfunction is detected sound signal circuits between BOSE amp. and center speaker.	Sound signal circuits between BOSE amp. and center speaker.	E
FC-INST SQUAWKER OUT: short			F
FC-INST SQUAWKER OUT: short to ground			G
FC-INST SQUAWKER OUT: short to battery			H
FL-SEAT L-SQUAWKER OUT: open	Malfunction is detected sound signal circuits between BOSE amp. and driver seat speaker LH.	Sound signal circuits between BOSE amp. and driver seat speaker LH.	I
FL-SEAT L-SQUAWKER OUT: short			J
FL-SEAT L-SQUAWKER OUT: short to ground			K
FL-SEAT L-SQUAWKER OUT: short to battery			L
FL-SEAT R-SQUAWKER OUT: open	Malfunction is detected sound signal circuits between BOSE amp. and driver seat speaker RH.	Sound signal circuits between BOSE amp. and driver seat speaker RH.	M
FL-SEAT R-SQUAWKER OUT: short			N
FL-SEAT R-SQUAWKER OUT: short to ground			O
FL-SEAT R-SQUAWKER OUT: short to battery			P
FR-SEAT L-SQUAWKER OUT: open	Malfunction is detected sound signal circuits between BOSE amp. and passenger seat speaker LH.	Sound signal circuits between BOSE amp. and passenger seat speaker LH.	Q
FR-SEAT L-SQUAWKER OUT: short			R
FR-SEAT L-SQUAWKER OUT: short to ground			S
FR-SEAT L-SQUAWKER OUT: short to battery			T
FR-SEAT R-SQUAWKER OUT: open	Malfunction is detected sound signal circuits between BOSE amp. and passenger seat speaker RH.	Sound signal circuits between BOSE amp. and passenger seat speaker RH.	U
FR-SEAT R-SQUAWKER OUT: short			V
FR-SEAT R-SQUAWKER OUT: short to ground			W
FR-SEAT R-SQUAWKER OUT: short to battery			X
RL-DOOR SPEAKER OUT: open	Malfunction is detected sound signal circuits between BOSE amp. and rear door speaker LH.	Sound signal circuits between BOSE amp. and rear door speaker LH.	Y
RL-DOOR SPEAKER OUT: short			Z
RL-DOOR SPEAKER OUT: short to ground			AA
RL-DOOR SPEAKER OUT: short to battery			AB
RR-DOOR SPEAKER OUT: open	Malfunction is detected sound signal circuits between BOSE amp. and rear door speaker RH.	Sound signal circuits between BOSE amp. and rear door speaker RH.	AC
RR-DOOR SPEAKER OUT: short			AD
RR-DOOR SPEAKER OUT: short to ground			AE
RR-DOOR SPEAKER OUT: short to battery			AF

A
B
C
D
E
F
G
H
I
J
K
L
M
N
O
P
Q
R
S
T
U
V
W
X
Y
Z
AA
AB
AC
AD
AE
AF

AV

DIAGNOSIS SYSTEM (AV CONTROL UNIT)

< SYSTEM DESCRIPTION >

[BOSE AUDIO WITH NAVIGATION]

Error item	Description	Possible malfunction factor/Action to take
RL-PSHELF SQUAWKER OUT: open	Malfunction is detected sound signal circuits between BOSE amp. and satellite speaker LH.	Sound signal circuits between BOSE amp. and satellite speaker LH.
RL-PSHELF SQUAWKER OUT: short		
RL-PSHELF SQUAWKER OUT: short to ground		
RL-PSHELF SQUAWKER OUT: short to battery		
RC-PSHELF WOOFER OUT: open	Malfunction is detected sound signal circuits between BOSE amp. and rear woofer.	Sound signal circuits between BOSE amp. and rear woofer.
RC-PSHELF WOOFER OUT: short		
RC-PSHELF WOOFER OUT: short to ground		
RC-PSHELF WOOFER OUT: short to battery		
RR-PSHELF SQUAWKER OUT: open	Malfunction is detected sound signal circuits between BOSE amp. and satellite speaker RH.	Sound signal circuits between BOSE amp. and satellite speaker RH.
RR-PSHELF SQUAWKER OUT: short		
RR-PSHELF SQUAWKER OUT: short to ground		
RR-PSHELF SQUAWKER OUT: short to battery		
Compensat. mic IN: open	Malfunction is detected in sound signal circuits between BOSE amp. and either front or rear microphone.	Sound signal circuits between BOSE amp. and front or rear microphone.
Compensat. mic IN: short		
Compensat. mic IN: short to ground		
Compensat. mic IN: short to battery		
<ul style="list-style-type: none"> • AV COMM CIRCUIT • Switches Connection Error 	When either one of the following items are detected: <ul style="list-style-type: none"> • multifunction switch power supply and ground circuits are malfunctioning. • AV communication circuits between AV control unit and multifunction switch are malfunctioning. 	<ul style="list-style-type: none"> • Multifunction switch power supply and ground circuits. • AV communication circuits between AV control unit and multifunction switch.
<ul style="list-style-type: none"> • AV COMM CIRCUIT • Amplifier Connection Error 	When either one of the following items are detected: <ul style="list-style-type: none"> • BOSE amp. power supply and ground circuits are malfunctioning. • AV communication circuits between multifunction switch and BOSE amp. are malfunctioning. 	<ul style="list-style-type: none"> • BOSE amp. power supply and ground circuits. Refer to AV-273, "BOSE AMP. : Diagnosis Procedure". • AV communication circuits between multifunction switch and BOSE amp.
<ul style="list-style-type: none"> • AV COMM CIRCUIT • Switches Connection Error • Amplifier Connection Error 	AV communication circuits between AV control unit and multifunction switch are malfunctioning.	AV communication circuits between AV control unit and multifunction switch.

Vehicle CAN Diagnosis

- CAN communication status and error counter is displayed.
- The error counter displays "OK" if any malfunction was not detected in the past and displays "0" if a malfunction is detected. It increases by 1 if the condition is normal at the next ignition switch ON cycle. The upper limit of the counter is 39.
- The error counter is erased if "Reset" is pressed.

Items	Display (Current)	Malfunction counter (Past)
Tx(HVAC)	OK / ???	OK / 0 - 39
Rx(ECM)	OK / ???	OK / 0 - 39
Rx(Cluster)	OK / ???	OK / 0 - 39

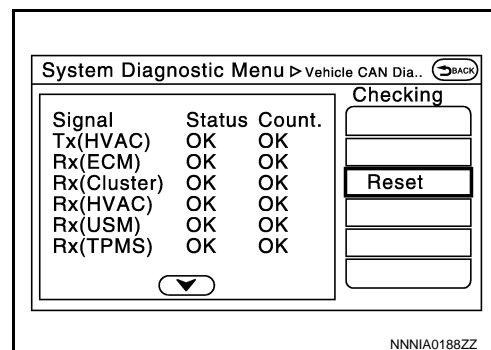

DIAGNOSIS SYSTEM (AV CONTROL UNIT)

[BOSE AUDIO WITH NAVIGATION]

< SYSTEM DESCRIPTION >

Items	Display (Current)	Malfunction counter (Past)
Rx(HVAC)	OK / ???	OK / 0 – 39
Rx(USM)	OK / ???	OK / 0 – 39
Rx(TPMS)	OK / ???	OK / 0 – 39
Rx(STRG)	OK / ???	OK / 0 – 39
Rx(ACC)	OK / ???	OK / 0 – 39
Rx(AT)	OK / ???	OK / 0 – 39

NOTE:

“???” indicates UNKWN.

AV COMM Diagnosis

- Displays the communication status between AV control unit (master unit) and each unit.
- The error counter displays “OK” if any malfunction was not detected in the past and displays “0” if a malfunction is detected. It increases by 1 if the condition is normal at the next ignition switch ON cycle. The upper limit of the counter is 39.
- The error counter is erased if “Reset” is pressed.

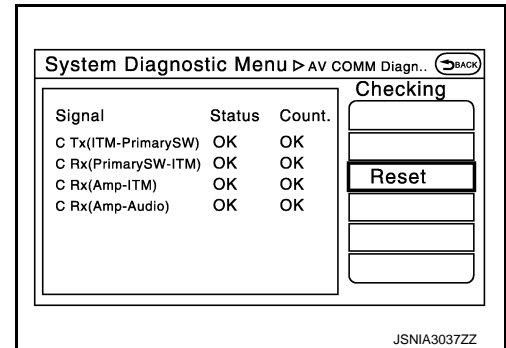

Items	Status (Current)	Counter (Past)
C Tx(ITM-PrimarySW)	OK / ???	OK / 0 – 39
C Rx(PrimarySW-ITM)	OK / ???	OK / 0 – 39
C Rx(Amp-ITM)	OK / ???	OK / 0 – 39
C Rx(Amp-Audio)	OK / ???	OK / 0 – 39

NOTE:

“???” indicates UNKWN

Hands-Free Phone

The hands-free phone reception volume adjustment and microphone and speaker test functions are also available.

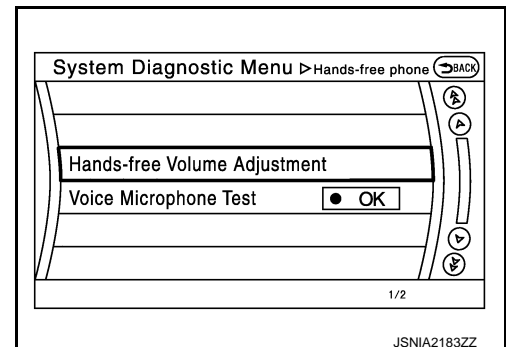

Camera

The four functions of “Correct Draw Line of Rear view Camera”, “Alter/Confirm Configuration”, “Reset Configuration” and “Camera Syst Type” are available.

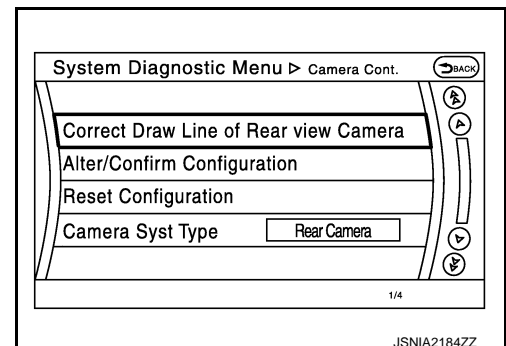

Correct Draw Line of Rear view Camera

A
B
C
D
E
F
G
H
I
J
K
L
M
AV
O
P

DIAGNOSIS SYSTEM (AV CONTROL UNIT)

[BOSE AUDIO WITH NAVIGATION]

< SYSTEM DESCRIPTION >

- Use this mode to adjust the guide line display position of the rear view monitor if necessary after removing the rear view monitor camera.

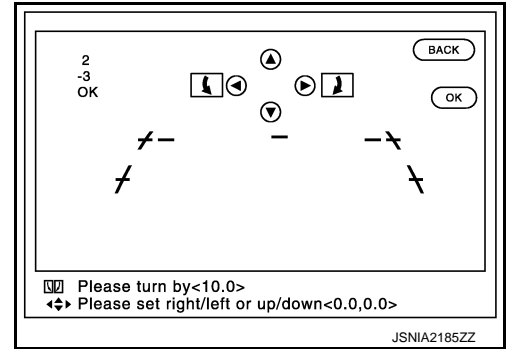

Alter/Confirm Configuration

- Configuration stored in the AV control unit can be checked and modified.

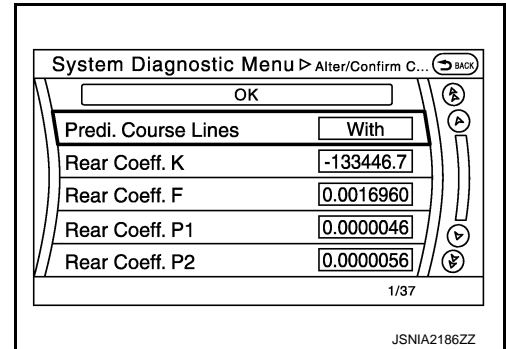

Configuration list

Setting item	Setting		Setting item	Setting	
	Without 4WAS	With 4WAS		Without 4WAS	With 4WAS
Predi. Course Lines	With		Wheelbase	2.9000001	
Rear Coeff. K	-38009.06		Total Length	4.9489002	
Rear Coeff. F	0.0014260		Steering Gear Ratio	16.704000	13.464000
Rear Coeff. P1	0.0000062		Side Coeff. K	0.0000000	
Rear Coeff. P2	0.0000056		Side Coeff. F	0.0000000	
Rear Coeff. C1	823.00000		Side Coeff. P1	0.0000000	
Rear Coeff. C2	480.00000		Side Coeff. P2	0.0000000	
Rear Coeff. D1	800.00000		Side Coeff. C1	0.0000000	
Rear Coeff. D2	494.00000		Side Coeff. C2	0.0000000	
Car Width	1.8479000		Side Coeff. D1	0.0000000	
Rear Offset	0.0330000		Side Coeff. D2	0.0000000	
Rear Height	0.9336000		Side Offset	0.0000000	
Rear L/R Angle	0.0000000		Overall Height	0.0000000	
Rear Up/Dn Angle	48.830001		Side L/R Angle	0.0000000	
Rear Roll Angle	0.0000000		Side Up/Dn Angle	0.0000000	
Bumper Rear Dist.	0.1230000		Side Roll Angle	0.0000000	
Bumper Rear Ax Dist	1.1476001		Side Front End Dist	0.0000000	
Steer. Max Angle	524.33856	422.63496	Total Width	0.0000000	
Min. Turning Red.	5.3000002		—	—	

Reset Configuration

DIAGNOSIS SYSTEM (AV CONTROL UNIT)

[BOSE AUDIO WITH NAVIGATION]

< SYSTEM DESCRIPTION >

- Configuration stored in the AV control unit can be initialized.

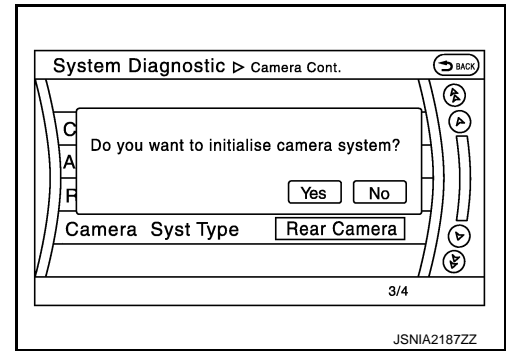

Camera Syst Type

- Type of camera system is selectable.

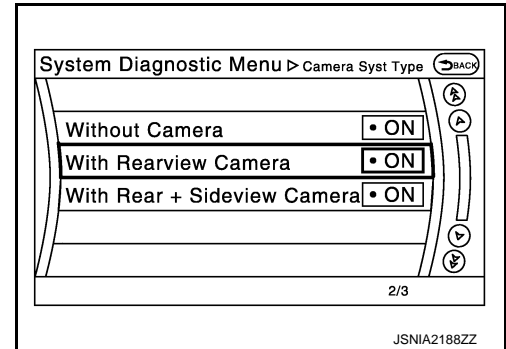

XM

- Change Channel
 - Any necessary channels required to receive traffic information from the satellite radio system can be set.
- Change Application ID
 - Any application ID'-s required to receive traffic information from the satellite radio system can be set.

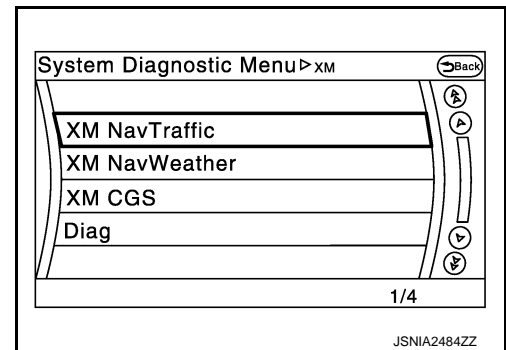

Delete Unit Connection Log

Deletes any unit connection records and error records from the AV control unit memory. (Clear the records of the unit that has been removed.)

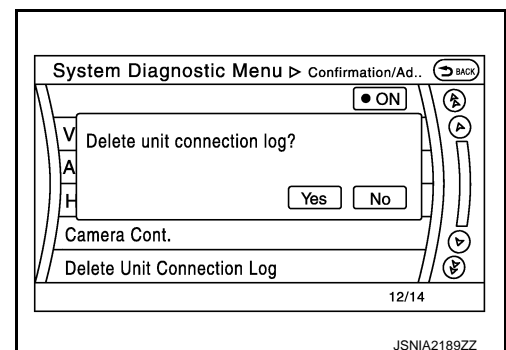

Initialize Settings

A
B
C
D
E
F
G
H
I
J
K
L
M
AV
O
P

DIAGNOSIS SYSTEM (AV CONTROL UNIT)

[BOSE AUDIO WITH NAVIGATION]

< SYSTEM DESCRIPTION >

“User Data Initialization” and “Accessory Number Initialization” are possible.

CAUTION:

- Never perform Accessory Number Initialization except when configuration is unsuccessful.
- Accessory Number Initialization requires configuration. For details, refer to [AV-228. "Description"](#).

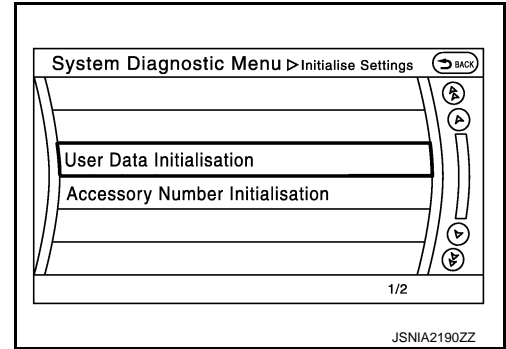

Version Information

Version information of the AV control unit is displayed.

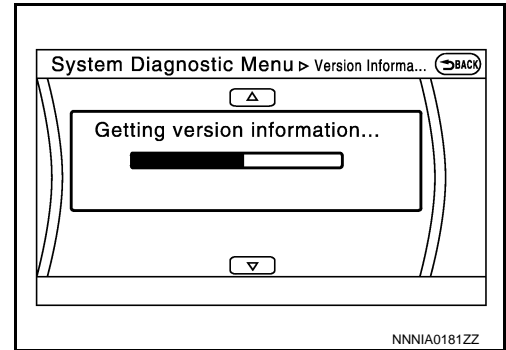

CONSULT - III Function

INFOID:000000005912974

APPLICATION ITEMS

CONSULT-III performs the following functions via the communication with the AV control unit.

Diagnosis mode	Description
Ecu Identification	The part number of AV control unit can be checked.
Self Diagnostic Result	Performs a diagnosis on the AV control unit and a connection diagnosis for the communication circuit of the Multi AV system, and displays the current and past malfunctions collectively.
Data Monitor	The diagnosis of vehicle signal that is input to the AV control unit can be performed.
Work Support	Steering angle sensor can be adjusted.
Configuration	<ul style="list-style-type: none"> • Read and save the vehicle specification. • Write the vehicle specification when replacing AV control unit.

AV communication

When “AV communication” of “CAN Diag Support Monitor” is selected, the following function will be performed.

AV communication	AV&NAVI C/U	Displays the communication status from AV control unit to each unit as well as the error counter.
	AUDIO	Displays the AV control unit communication status and the error counter.

ECU IDENTIFICATION

The part number of AV control unit is displayed.

SELF DIAGNOSIS RESULT

- In CONSULT-III self-diagnosis, self-diagnosis results and error history are displayed collectively.
- The current malfunction indicates “CRNT”. The past malfunction indicates “PAST”.
- The timing is displayed as “0” if any of the error codes [U1000], [U1010], [U1300] and [U1310] is detected. The counter increases by 1 if the condition is normal at the next ignition switch ON cycle.

Self-diagnosis Results Display Item

DIAGNOSIS SYSTEM (AV CONTROL UNIT)

< SYSTEM DESCRIPTION >

[BOSE AUDIO WITH NAVIGATION]

Error item	Description	Possible malfunction factor/Action to take
CAN COMM CIRCUIT [U1000]	CAN communication malfunction is detected.	Refer to AV-230, "Diagnosis Procedure" .
CONTROL UNIT (CAN) [U1010]	CAN initial diagnosis malfunction is detected.	
CONTROL UNIT (AV) [U1310]	AV communication circuit initial diagnosis malfunction is detected.	
Cont Unit [U1200]	AV control unit malfunction is detected.	Replace the AV control unit if the malfunction occurs constantly. Refer to AV-298, "Removal and Installation" .
GYRO NO CONN [U1201]		
G-SENSOR NO CONN [U1202]		
CAN CONT [U1216]		
BLUETOOTH MODULE [U1217]		
SUB CPU CONN [U1228]		
iPod CERTIFICATION [U1229]		
Built-in AUDIO CONN [U122E]		
HDD CONN [U1218]		
HDD READ [U1219]		
HDD WRITE [U121A]		
HDD COMM [U121B]		
HDD ACCESS [U121C]		
GPS COMM [U1204]	GPS malfunction is detected.	An intermittent error caused by strong radio interference may be detected unless any symptom (GPS reception error, etc.) occurs. Replace the AV control unit if the malfunction occurs constantly. Refer to AV-298, "Removal and Installation" .
GPS ROM [U1205]		
GPS RAM [U1206]		
GPS RTC [U1207]		
USB CONTROLLER [U1225]	USB connection malfunction is detected.	Check that the connection to the USB connector is normal.
DSP CONN [U121D]	AV control unit malfunction is detected.	<ul style="list-style-type: none"> If a disc can be played, then there is a possibility of the detection of a temporary malfunction. Replace the AV control unit if the malfunction occurs constantly. Refer to AV-298, "Removal and Installation".
DSP COMM [U121E]		
DVD COMM [U1227]	AV control unit malfunction is detected.	<ul style="list-style-type: none"> If DVD can be played, then there is a possibility of the detection of a temporary malfunction. Replace the AV control unit if the malfunction occurs constantly. Refer to AV-298, "Removal and Installation".
CONFIG UNFINISH [U122A]	The writing of configuration data is incomplete.	Write configuration data with CONSULT-III. Refer to AV-227, "Description" .
AMP TEMP [U1231]	BOSE amp. malfunction is detected.	Replace the BOSE amp. if the malfunction occurs constantly. Refer to AV-307, "Removal and Installation" .
ST ANGLE SEN CALIB [U1232]	Predictive course line center position adjustment of the steering angle sensor is incomplete.	Adjust the predictive course line center position of the steering angle sensor. Refer to BRC-68, "Work Procedure" .

A

B

C

D

E

F

G

H

I

J

K

L

M

AV

O

P

DIAGNOSIS SYSTEM (AV CONTROL UNIT)

< SYSTEM DESCRIPTION >

[BOSE AUDIO WITH NAVIGATION]

Error item	Description	Possible malfunction factor/Action to take
FRONT DISP CONN [U1243]	When either one of the following items are detected: <ul style="list-style-type: none"> • display unit power supply and ground circuits are malfunctioning. • communication circuits between AV control unit and display unit are malfunctioning. 	<ul style="list-style-type: none"> • Display unit power supply and ground circuits. Refer to AV-272. "DISPLAY UNIT : Diagnosis Procedure". • Communication circuits between AV control unit and display unit.
GPS ANTENNA CONN [U1244]	GPS antenna connection malfunction is detected.	Check the connection of the GPS antenna connector.
XM ANTENNA CONN [U1258]	Satellite radio antenna connection malfunction is detected.	Satellite radio antenna disconnection.
USB OVERCURRENT [U1263]	Detection of overcurrent in USB connector.	Check USB harness between the AV control unit and USB connector.
ANTENNA AMP TERMINAL [OPEN or SHORT] [U1264]	Antenna amp. ON signal circuit malfunction is detected.	Antenna amp. ON signal circuit between AV control unit and antenna base.
FL-DOOR WOOFER [OPEN, SHORT, GND-SHORT or VB-SHOR] [U1601]	Malfunction is detected sound signal circuits between BOSE amp. and front door woofer LH.	Sound signal circuits between BOSE amp. and front door woofer LH.
FL-DOOR SQUAWK [OPEN, SHORT, GND-SHORT or VB-SHOR] [U1602]	When either one of the following items are detected: <ul style="list-style-type: none"> • sound signal circuits between BOSE amp. and front door squawker LH are malfunctioning. • sound signal circuits between BOSE amp. and tweeter LH are malfunctioning. 	<ul style="list-style-type: none"> • Sound signal circuits between BOSE amp. and front door squawker LH. • Sound signal circuits between BOSE amp. and tweeter LH.
FR-DOOR WOOFER [OPEN, SHORT, GND-SHORT or VB-SHOR] [U1609]	Malfunction is detected sound signal circuits between BOSE amp. and front door woofer RH.	Sound signal circuits between BOSE amp. and front door woofer RH.
FR-DOOR SQAWK [OPEN, SHORT, GND-SHORT or VB-SHOR] [U160A]	When either one of the following items are detected: <ul style="list-style-type: none"> • sound signal circuits between BOSE amp. and front door squawker RH are malfunctioning. • sound signal circuits between BOSE amp. and tweeter RH are malfunctioning. 	<ul style="list-style-type: none"> • Sound signal circuits between BOSE amp. and front door squawker RH. • Sound signal circuits between BOSE amp. and tweeter RH.
F-INST C-SQAWK [OPEN, SHORT, GND-SHORT or VB-SHOR] [U162A]	Malfunction is detected sound signal circuits between BOSE amp. and center speaker.	Sound signal circuits between BOSE amp. and center speaker.
FL-SEAT L-SQAWK [OPEN, SHORT, GND-SHORT or VB-SHOR] [U1632]	Malfunction is detected sound signal circuits between BOSE amp. and driver seat speaker LH.	Sound signal circuits between BOSE amp. and driver seat speaker LH.
FL-SEAT R-SQAWK [OPEN, SHORT, GND-SHORT or VB-SHOR] [U163A]	Malfunction is detected sound signal circuits between BOSE amp. and driver seat speaker RH.	Sound signal circuits between BOSE amp. and driver seat speaker RH.
FR-SEAT L-SQAWK [OPEN, SHORT, GND-SHORT or VB-SHOR] [U163E]	Malfunction is detected sound signal circuits between BOSE amp. and passenger seat speaker LH.	Sound signal circuits between BOSE amp. and passenger seat speaker LH.
RL-DOOR SPEAKER [OPEN, SHORT, GND-SHORT or VB-SHOR] [U1708]	Malfunction is detected sound signal circuits between BOSE amp. and rear door speaker LH.	Sound signal circuits between BOSE amp. and rear door speaker LH.
RR-DOOR SPEAKER [OPEN, SHORT, GND-SHORT or VB-SHOR] [U1710]	Malfunction is detected sound signal circuits between BOSE amp. and rear door speaker RH.	Sound signal circuits between BOSE amp. and rear door speaker RH.

DIAGNOSIS SYSTEM (AV CONTROL UNIT)

[BOSE AUDIO WITH NAVIGATION]

< SYSTEM DESCRIPTION >

Error item	Description	Possible malfunction factor/Action to take
R-PSHELF C-WOOFER [OPEN, SHORT, GND-SHORT or VB-SHOR] [U1725]	Malfunction is detected sound signal circuits between BOSE amp. and rear woofer.	Sound signal circuits between BOSE amp. and rear woofer.
CORRECT MICROPHONE [OPEN, SHORT, GND-SHORT or VB-SHOR] [U190C]	Malfunction is detected in sound signal circuits between BOSE amp. and either front or rear microphone.	Sound signal circuits between BOSE amp. and front or rear microphone.
<ul style="list-style-type: none"> AV COMM CIRCUIT [U1300] SWITCH CONN [U1240] 	When either one of the following items are detected: <ul style="list-style-type: none"> multifunction switch power supply and ground circuits are malfunctioning. AV communication circuits between AV control unit and multifunction switch are malfunctioning. 	<ul style="list-style-type: none"> Multifunction switch power supply and ground circuits. AV communication circuits between AV control unit and multifunction switch.
<ul style="list-style-type: none"> AV COMM CIRCUIT [U1300] AMP CONN [U124E] 	When either one of the following items are detected: <ul style="list-style-type: none"> BOSE amp. power supply and ground circuits are malfunctioning. AV communication circuits between multifunction switch and BOSE amp. are malfunctioning. 	<ul style="list-style-type: none"> BOSE amp. power supply and ground circuits. Refer to AV-273, "BOSE AMP. : Diagnosis Procedure". AV communication circuits between multifunction switch and BOSE amp.
<ul style="list-style-type: none"> AV COMM CIRCUIT [U1300] SWITCH CONN [U1240] AMP CONN [U124E] 	AV communication circuits between AV control unit and multifunction switch are malfunctioning.	AV communication circuits between AV control unit and multifunction switch.

DATA MONITOR

ALL SIGNALS

- Displays the status of the following vehicle signals inputted into the AV control unit.
- For each signal, actual signal can be compared with the condition recognized on the system.

Display Item	Display	Vehicle status	Remarks
VHCL SPD SIG	On	Vehicle speed > 0 km/h (0 MPH)	Changes in indication may be delayed. This is normal.
	Off	Vehicle speed = 0 km/h (0 MPH)	
PKB SIG	On	Parking brake is applied.	
	Off	Parking brake is released.	
ILLUM SIG	On	Block the light beam from the auto light optical sensor when the light switch is ON.	—
	Off	Either of the following conditions <ul style="list-style-type: none"> Lighting switch OFF Expose the auto light optical sensor to light when the light switch is ON. 	
IGN SIG	On	Ignition switch ON	
	Off	Ignition switch in ACC position	
REV SIG	On	Selector lever in R position	Changes in indication may be delayed. This is normal.
	Off	Selector lever in any position other than R	
SIDE VIEW SW	Off	—	This item is displayed, but cannot be monitored.
ROOM LAMP	Off	—	This item is displayed, but cannot be monitored.

SELECTION FROM MENU

Allows the technician to select which vehicle signals should be displayed and displays the status of the selected vehicle signals.

DIAGNOSIS SYSTEM (AV CONTROL UNIT)

< SYSTEM DESCRIPTION >

[BOSE AUDIO WITH NAVIGATION]

Item to be selected	Description
VHCL SPD SIG	The same as when "ALL SIGNALS" is selected.
PKB SIG	
ILLUM SIG	
IGN SIG	
REV SIG	
SIDE VIEW SW	
ROOM LAMP	

WORK SUPPORT

Adjusts the neutral position of the steering angle sensor.

CAUTION:

For vehicles with VDC, adjust the steering angle sensor neutral position on the ABS actuator control unit side. Refer to [BRC-68, "Work Procedure"](#).

Item	Description
ST ANGLE SENSOR ADJUSTMENT	Adjusts the neutral position of the steering angle sensor.

CONFIGURATION

Configuration has three functions as follows.

Function	Description
READ CONFIGURATION	<ul style="list-style-type: none">• Reads the vehicle configuration of current AV control unit.• Saves the read vehicle configuration.
WRITE CONFIGURATION-Manual selection	Writes the vehicle configuration with manual selection.
WRITE CONFIGURATION-Config file	Writes the vehicle configuration with saved data.

DIAGNOSIS SYSTEM [BOSE AMP.(ACTIVE NOISE CONTROL SYSTEM)]

< SYSTEM DESCRIPTION >

[BOSE AUDIO WITH NAVIGATION]

DIAGNOSIS SYSTEM [BOSE AMP.(ACTIVE NOISE CONTROL SYSTEM)]

On Board Diagnosis Function

INFOID:000000005988505

ON BOARD DIAGNOSIS ITEM

Starting with the operation of the door switch, the Self-diagnosis function allows the diagnoses of the active noise control unit internal circuit, the input state of each signal, and a microphone connection state. The diagnosis results are indicated by a sound.

METHOD OF STARTING

A
B
C
D
E
F
G
H
I
J
K
L
M
O
P

AV

DIAGNOSIS SYSTEM [BOSE AMP.(ACTIVE NOISE CONTROL SYSTEM)]

< SYSTEM DESCRIPTION >

[BOSE AUDIO WITH NAVIGATION]

Perform Self-diagnosis, according to the following steps:

Step	Check Item	Operation	Judgment	Output sound pattern (MAX: 100dB, : No sound, □: 1 cycle)	Next Step	Remarks
-	Preparation	Turn on the radio to check that the speakers are normal.	-		1	All self-diagnosis results are notified by the output sound from the speaker.
1	Self-diagnosis mode startup	Within 5 seconds after starting the engine with all doors closed, press the driver seat door switch 6 times or more during a time interval of 4 seconds.	-		2	Specifically, within 5 seconds after turning the ignition switch to ACC, the self-diagnosis mode starts. The self-diagnosis switch to ACC. *Self-diagnosis can be activated by turning the ignition switch to ACC without starting the engine. In this case, the judgment performed at Step 2 becomes NG because engine pulse cannot be detected.
2	Diagnoses of engine speed signal and the microphone for active noise control system	Identify a sound heard after the notification sound (Step 1).	OK	OK: After the end of the last beep of the triple short beeps heard in Step 1, silence follows for approx. 1 second and a sound is heard according to a check result (Step 3) of the number of cylinders.	3	
			NG	(Apply only for this item) 1 sec. time, 1/2 seconds of silence	7	* If NG, a beep is heard for 30 seconds after 10-second-silence.
3	Checking the judgment of the number of cylinders	Identify a sound (Step 2).	6-cylinder engine	x MAX 40 cycles	4	A beep sounds for 60 seconds at maximum in either case (1 cycle for approx. 1.5 sec. x 40 cycles)
			8-cylinder engine	x MAX 40 cycles		
4	(Interruption of cylinder judge result notification sound)	Press the door switch 6 times or more during a time interval of 4 seconds.	-	1 cycle only	5	The same sound is heard after a lapse of 60 seconds without pressing the door switch. (1 cycle only)
5	Sample sound for the active noise control system	Identify a sound heard after the notification sound (Step 3).	-		6	A sample sound (hearsible for 20 seconds at maximum) for the active noise control system is emitted. (1 cycle for approx. 4 seconds x 5 cycles)
6	End of self-diagnosis	Press the door switch 6 times or more during a time interval of 4 seconds while a prolonged sound is ringing. Wait for 20 seconds until the sound stops.	-	1 cycle only	End of diagnosis	After the completion of self-diagnosis, the active noise control system starts normal operation. (1 cycle only)
7	Start of malfunctioning part judgment (1) or end of self-diagnosis (2)	(1) Within 30 seconds while the prolonged sound is ringing (Step 2), press the door switch 6 times or more during a time interval of 4 seconds. (2) Wait for 30 seconds until the prolonged sound stops.	-	1 cycle only	8	After the completion of self-diagnosis, the active noise control system starts normal operation. (1 cycle only)
			-	1 cycle only	End of diagnosis	
8	Active noise control system microphone check	Identify the sound pattern.	Front microphone: OK Rear microphone: OK	x MAX 4 cycles	9	A beep sounds for 60 seconds at maximum in either case (1 cycle for approx. 4.2 sec. x 14 cycles)
			Front microphone: NG Rear microphone: OK	x MAX 4 cycles		
			Front microphone: OK Rear microphone: NG	x MAX 4 cycles		
			Front microphone: NG Rear microphone: NG	x MAX 4 cycles		
9	Start of self-diagnosis for malfunctioning part judgment (2) or end of self-diagnosis (3)	(1) Within 60 seconds while the prolonged sound is ringing, press the door switch 6 times or more during a time interval of 4 seconds. (2) Wait for 60 seconds until the prolonged sound stops.	-	1 cycle only	10	After the completion of self-diagnosis, the active noise control system starts normal operation. (1 cycle only)
			-	1 cycle only	End of diagnosis	
10	Engine speed signal check	Identify the sound pattern.	OK	x MAX 60 cycles	11	A beep sounds for 60 seconds at maximum in either case. (1 cycle for approx. 0.75 sec. x 80 cycles)
			NG	(Apply only for this item) 1 sec. time, 1/2 seconds of silence		A beep is heard for 60 seconds after 10-second-silence.
11	End of self-diagnosis	Press the door switch 6 times or more during a time interval of 4 seconds. Wait for 60 seconds until the prolonged sound stops.	-	1 cycle only	End of diagnosis	After the completion of self-diagnosis, the active noise control system starts normal operation. (1 cycle only)

JSNIA3067GB

- When a sound is not outputted from the speakers as a result of the preparation, check the AV control unit, BOSE amp., connector connections, or speakers.
- When Self-diagnosis mode does not start at Step 1, check the door signal circuit.
- When a malfunction is detected in the microphone at Step 8, check the signal circuit of each microphone.
- When the actual number of cylinders is different from the diagnosis sound of the cylinder identification, check the cylinder identification signal circuit.

AV CONTROL UNIT

< ECU DIAGNOSIS INFORMATION >

[BOSE AUDIO WITH NAVIGATION]

ECU DIAGNOSIS INFORMATION

AV CONTROL UNIT

Reference Value

INFOID:000000005912975

VALUES ON THE DIAGNOSIS TOOL

CONSULT-III MONITOR ITEM

Monitor Item	Condition	Value/Status
VHCL SPD SIG	Ignition switch ON Vehicle speed > 0 km/h (0 MPH)	On
	Vehicle speed = 0 km/h (0 MPH)	Off
PKB SIG	Ignition switch ON Parking brake is applied.	On
	Parking brake is released.	Off
ILLUM SIG	Ignition switch ON Block the light beam from the auto light optical sensor when the light switch is ON.	On
	Expose the auto light optical sensor to light when the light switch is OFF or ON.	Off
IGN SIG	Ignition switch ON	On
	Ignition switch ACC	Off
REV SIG	Ignition switch ON Selector lever in R position	On
	Selector lever in any position other than R	Off
SIDE VIEW SW*	Ignition switch ON	Off
ROOM LAMP*	Ignition switch ON	Off

*: This item is displayed, but cannot be monitored.

TERMINAL LAYOUT

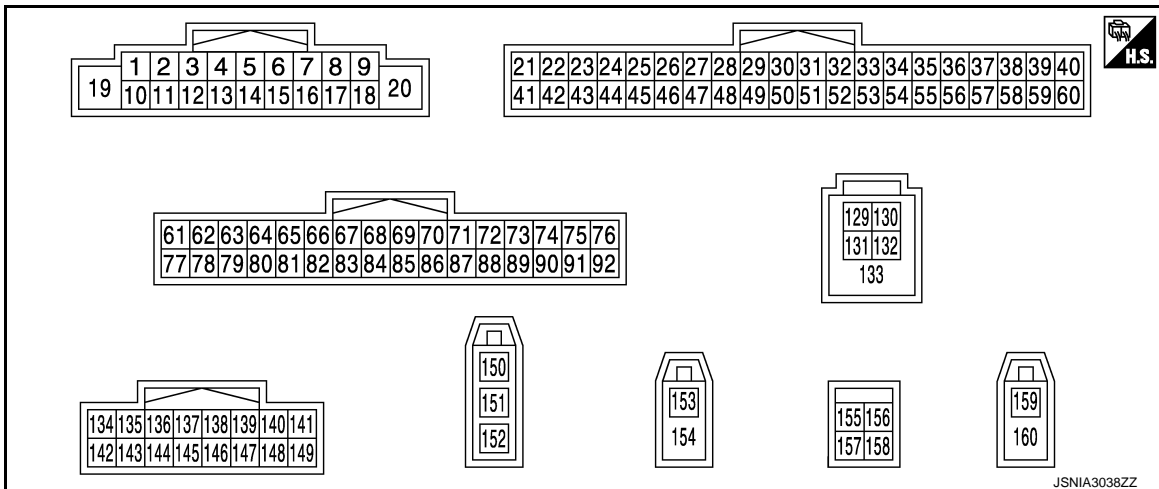



PHYSICAL VALUES

AV CONTROL UNIT

< ECU DIAGNOSIS INFORMATION >

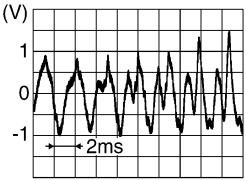
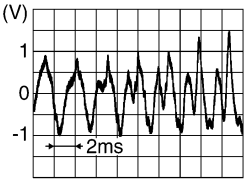
[BOSE AUDIO WITH NAVIGATION]

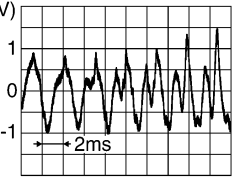
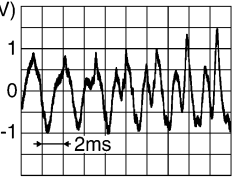
Terminal (Wire color)		Description		Condition		Reference value (Approx.)
+	-	Signal name	Input/ Output			
2 (L)	3 (P)	Sound signal front LH	Output	Ignition switch ON	Sound output	 <p style="text-align: right; font-size: small;">SKIB3609E</p>
4 (V)	5 (LG)	Sound signal rear LH	Output	Ignition switch ON	Sound output	 <p style="text-align: right; font-size: small;">SKIB3609E</p>
6 (P)	15 (B)	Steering switch signal A	Input	Ignition switch ON	Keep pressing SOURCE switch.	0 V
					Keep pressing MENU UP switch.	1.0 V
					Keep pressing MENU DOWN switch.	2.0 V
					Keep pressing  switch	3.0 V
					Keep pressing ENTER switch.	4.0 V
					Except for above.	5.0 V
7 (V)	Ground	ACC power supply	Input	Ignition switch ACC	—	Battery voltage
10	—	Shield	—	—	—	—
11 (G)	12 (R)	Sound signal front RH	Output	Ignition switch ON	Sound output	 <p style="text-align: right; font-size: small;">SKIB3609E</p>
13 (BR)	14 (GR)	Sound signal rear RH	Output	Ignition switch ON	Sound output	 <p style="text-align: right; font-size: small;">SKIB3609E</p>

AV CONTROL UNIT

< ECU DIAGNOSIS INFORMATION >

[BOSE AUDIO WITH NAVIGATION]

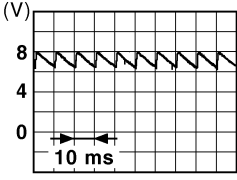
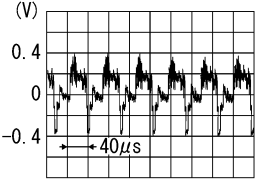
Terminal (Wire color)		Description		Condition	Reference value (Approx.)	
+	-	Signal name	Input/ Output			
16 (L)	15 (B)	Steering switch signal B	Input	Ignition switch ON	Keep pressing VOL DOWN switch.	0 V
					Keep pressing VOL UP switch.	1.0 V
					Keep pressing switch.	2.0 V
					Keep pressing switch.	3.0 V
					Except for above.	5.0 V
19 (Y)	Ground	Battery power supply	Input	Ignition switch OFF	—	Battery voltage
20 (B)	Ground	Ground	—	Ignition switch ON	—	0 V
22 (W)	Ground	Camera power supply	Output	Ignition switch ON	At rear view camera image is displayed.	6.0 V
					Except for above.	0 V
29 (SB)	Ground	Disk eject signal	Input	Ignition switch ON	Pressing the eject switch.	0 V
					Except for above.	5.0 V
42 (B)	Ground	Camera ground	—	Ignition switch ON	—	0 V
49 (BR)	Ground	Switch ground	—	Ignition switch ON	—	0 V
65 (V)	Ground	Parking brake signal	Input	Ignition switch ON	Parking brake is ON.	0 V
					Parking brake is OFF.	 <p style="text-align: right; font-size: small;">JSNIA0007GB</p>
67 (R)	Ground	Composite image ground	—	Ignition switch ON	—	0 V
68 (W)	Ground	Composite image signal	Output	Ignition switch ON	At DVD image is displayed.	 <p style="text-align: right; font-size: small;">SKIB2251J</p>
69 (G)	Ground	Intelligent key identification signal	Input	Ignition switch ACC	At door unlock Key 1.	5.0 V
					At door unlock Key 2.	0 V
71	—	Shield (microphone ground)	—	—	—	—

A
B
C
D
E
F
G
H
I
J
K
L
M
AV
O
P

AV CONTROL UNIT

< ECU DIAGNOSIS INFORMATION >

[BOSE AUDIO WITH NAVIGATION]

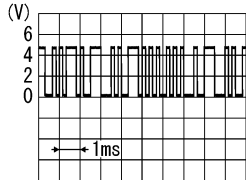
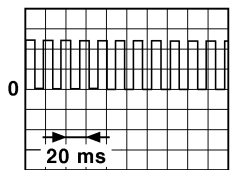
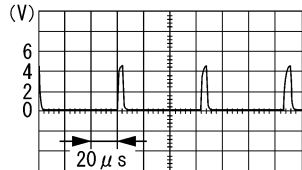
Terminal (Wire color)		Description		Condition		Reference value (Approx.)
+	-	Signal name	Input/ Output			
72 (G)	Ground	Microphone VCC	Output	Ignition switch ON	—	5.0 V
73 (BR)	Ground	Communication signal (CONT→DISP)	Output	Ignition switch ON	When adjusting display brightness.	 <p style="text-align: right; font-size: small;">PKIB5039J</p>
74 (P)	—	CAN-L	Input/ Output	—	—	—
75 (LG)	—	AV communication signal (L)	Input/ Output	—	—	—
76 (LG)	—	AV communication signal (L)	Input/ Output	—	—	—
79 (SB)	Ground	Dimmer signal	Input	Ignition switch ON	Either of the following con- ditions	0 V
					<ul style="list-style-type: none"> • Lighting switch OFF • Expose the auto light opti- cal sensor to light when the light switch is ON. 	12.0 V
80 (W)	Ground	Ignition signal	Input	Ignition switch ON	—	Battery voltage
81 (BG)	Ground	Reverse signal	Input	Ignition switch ON	R position	12.0 V
					Other than R position	0 V
82 (R)	Ground	Vehicle speed signal (8-pulse)	Input	Ignition switch ON	When vehicle speed is ap- prox. 40 km/h (25 MPH)	<p>NOTE: The maximum voltage varies de- pending on the specification (destination unit).</p>  <p style="text-align: right; font-size: small;">JSNIA0012GB</p>
83	—	Shield	—	—	—	—
84 (B)	Ground	Composite synchronizing signal	Output	Ignition switch ON	At DVD image is displayed	 <p style="text-align: right; font-size: small;">SKIA0187E</p>

AV CONTROL UNIT

< ECU DIAGNOSIS INFORMATION >

[BOSE AUDIO WITH NAVIGATION]

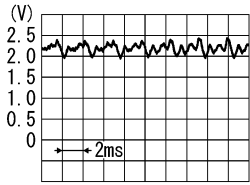
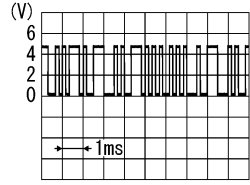
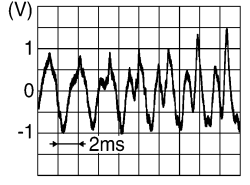
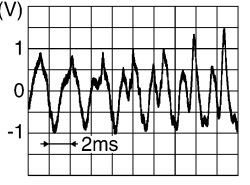
Terminal (Wire color)		Description		Condition		Reference value (Approx.)
+	-	Signal name	Input/ Output			
87 (R)	71	Microphone signal	Input	Ignition switch ON	Give a voice	 <p style="text-align: right; font-size: small;">PKIB5037J</p>
88	—	Shield	—	—	—	—
89 (Y)	Ground	Communication signal (DISP→CONT)	Input	Ignition switch ON	When adjusting display brightness.	 <p style="text-align: right; font-size: small;">PKIB5039J</p>
90 (L)	—	CAN-H	Input/ Output	—	—	—
91 (SB)	—	AV communication signal (H)	Input/ Output	—	—	—
92 (SB)	—	AV communication signal (H)	Input/ Output	—	—	—
129 (G)	—	USB ground	—	—	—	—
130 (W)	—	V BUS signal	—	—	—	—
131 (R)	—	USB D- signal	—	—	—	—
132 (L)	—	USB D+ signal	—	—	—	—
133	—	Shield	—	—	—	—
135 (G)	136 (R)	Voice guidance signal	Output	Ignition switch ON	Sound output	 <p style="text-align: right; font-size: small;">SKIB3609E</p>
137 (SB)	145 (V)	Sound signal rear woofer	Output	Ignition switch ON	Sound output	 <p style="text-align: right; font-size: small;">SKIB3609E</p>

A
B
C
D
E
F
G
H
I
J
K
L
M
N
O
P

AV

AV CONTROL UNIT

< ECU DIAGNOSIS INFORMATION >

[BOSE AUDIO WITH NAVIGATION]

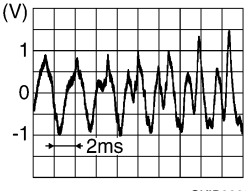
Terminal (Wire color)		Description		Condition		Reference value (Approx.)
+	-	Signal name	Input/ Output			
138 (L)	146 (P)	Sound signal center speaker	Output	Ignition switch ON	Sound output	
139 (B)	—	Shield	—	—	—	—
144	—	Shield	—	—	—	—
150	Ground	Antenna amp. ON signal	Input	Ignition switch ON	—	12.0 V
151	—	AM-FM main	Input	—	—	—
152	—	FM sub	Input	—	—	—
153	Ground	GPS antenna signal	Input	Ignition switch ON	Not connected GPS antenna connector.	5.0 V
154	—	Shield	—	—	—	—
157	Ground	RGB digital image signal (+)	Output	Ignition switch ON	Not connected connector.	1.3 V
158	Ground	RGB digital image signal (-)	Output	Ignition switch ON	Not connected connector.	1.3 V
159	Ground	Satellite radio antenna signal	Input	Ignition switch ON	Not connected satellite antenna connector.	5.0 V

Fail-Safe

INFOID:000000005912976

When the ambient temperature becomes extremely low or extremely high, AV control unit displays the message and limits the AV control unit function.

FAIL-SAFE CONDITIONS

When the ambient temperature is -20°C (-4°F) or lower, or when it is 70°C (158°F) or higher

Display

The messages displayed on fail-safe conditions are as shown below:

Fail-safe mode	Display (display of the fail-safe condition)
When HDD temperature is low	HDD system is experiencing problems due to extreme low temperature. Normal operation will resume when temperature rises.
When HDD temperature is high	HDD system is experiencing problems due to extreme high temperature. Normal operation will resume when temperature drops.

DESCRIPTION OF CONTROLS

Function	When Fail-safe Function is activated	
Air conditioner	Operation	Only multifunction switch (preset switch) can be operated.
	Display	<ul style="list-style-type: none"> LED of multifunction switch (preset switch) illuminates. Aimed temperature, blow angle, and flow rate are displayed in simplified mode.

AV CONTROL UNIT

< ECU DIAGNOSIS INFORMATION >

[BOSE AUDIO WITH NAVIGATION]

Function		When Fail-safe Function is activated
Audio	Operation	Only ON/OFF and volume control operations by multifunction switch (preset switch) are possible.
	Display	No display ("Fail-safe mode" is displayed)
Camera	Operation	Image tone cannot be controlled.
	Display	Cannot be superimposed. (warning display, tone control display)
Hands-free phone	Operation	Cannot be operated.
Navigation	Operation	Cannot be operated.
Self diagnosis		The display in simplified mode of fail-safe condition
CONSULT-III diagnosis		Cannot be operated.

Ability Operation Mode

There is an ability operation mode for Fail-safes due to low or high ambient temperature.

If HDD data can be read, fail-safe is shown, then normal displays are displayed only for functions which can be operated.

RELEASE CONDITIONS OF FAIL-SAFE

Fail-safe is released on following conditions and normal mode is restored.

When The Temperature of HDD Is Low or High

If the ambient temperature becomes out of fail-safe condition range, normal mode is restored.

DTC Index

INFOID:000000005912977

SELF-DIAGNOSIS RESULTS DISPLAY ITEM

DTC	Display item	Refer to
U1000	CAN COMM CIRCUIT [U1000]	AV-230, "Diagnosis Procedure"
U1010	CONTROL UNIT (CAN) [1010]	AV-231, "DTC Logic"
U1200	Cont Unit [U1200]	AV-232, "DTC Logic"
U1201	GYRO NO CONN [U1201]	AV-233, "DTC Logic"
U1202	G-SENSOR NO CONN [U1202]	AV-234, "DTC Logic"
U1204	GPS COMM [U1204]	AV-235, "Diagnosis Procedure"
U1205	GPS ROM [U1205]	AV-236, "Diagnosis Procedure"
U1206	GPS RAM [U1206]	AV-237, "Diagnosis Procedure"
U1207	GPS RTC [U1207]	AV-238, "Diagnosis Procedure"
U1216	CAN CONT [U1216]	AV-239, "DTC Logic"
U1217	BLUETOOTH MODULE [U1217]	AV-240, "DTC Logic"
U1218	HDD CONN [U1218]	AV-241, "Diagnosis Procedure"
U1219	HDD READ [U1219]	AV-242, "Diagnosis Procedure"
U121A	HDD WRITE [U121A]	AV-243, "Diagnosis Procedure"
U121B	HDD COMM [U121B]	AV-244, "Diagnosis Procedure"
U121C	HDD ACCESS [U121C]	AV-245, "Diagnosis Procedure"
U121D	DSP CONN [U121D]	AV-246, "Diagnosis Procedure"
U121E	DSP COMM [U121E]	AV-247, "Diagnosis Procedure"
U1225	USB CONTROLLER [U1225]	AV-248, "DTC Logic"
U1227	DVD COMM [U1227]	AV-249, "Diagnosis Procedure"
U1228	SUB CPU CONN [U1228]	AV-250, "DTC Logic"
U1229	iPod CERTIFICATION [U1229]	AV-251, "DTC Logic"
U122A	CONFIG UNFINISH [U122A]	AV-252, "Diagnosis Procedure"
U122E	Built-in AUDIO CONN [U122E]	AV-253, "DTC Logic"

AV CONTROL UNIT

< ECU DIAGNOSIS INFORMATION >

[BOSE AUDIO WITH NAVIGATION]

DTC	Display item	Refer to
U1231	AMP TEMP [U1231]	AV-254, "DTC Logic"
U1232	ST ANGLE SEN CALIB [1232]	AV-255, "Diagnosis Procedure"
U1243	FRONT DISP CONN [U1243]	AV-256, "Diagnosis Procedure"
U1244	GPS ANTENNA CONN [U1244]	AV-258, "Diagnosis Procedure"
U1258	XM ANTENNA CONN [U1258]	AV-259, "Diagnosis Procedure"
U1263	USB OVERCURRENT [U1263]	AV-260, "Diagnosis Procedure"
U1264	ANTENNA AMP TERMINAL [OPEN or SHORT] [U1264]	AV-261, "Diagnosis Procedure"
U1310	CONTROL UNIT (AV) [U1310]	AV-263, "DTC Logic"
U1601	FL-DOOR WOOFER [OPEN, SHORT, GND-SHORT or VB-SHOR] [U1601]	AV-264, "Diagnosis Procedure"
U1602	FL-DOOR SQUAWK [OPEN, SHORT, GND-SHORT or VB-SHOR] [U1602]	AV-265, "Diagnosis Procedure"
U1609	FR-DOOR WOOFER [OPEN, SHORT, GND-SHORT or VB-SHOR] [U1609]	AV-264, "Diagnosis Procedure"
U160A	FR-DOOR SQUAWK [OPEN, SHORT, GND-SHORT or VB-SHOR] [U160A]	AV-265, "Diagnosis Procedure"
U162A	F-INST C-SQUAWK [OPEN, SHORT, GND-SHORT or VB-SHOR] [U162A]	AV-266, "Diagnosis Procedure"
U1632	FL-SEAT L-SQUAWK [OPEN, SHORT, GND-SHORT or VB-SHOR] [U1632]	AV-267, "Diagnosis Procedure"
U163A	FL-SEAT R-SQUAWK [OPEN, SHORT, GND-SHORT or VB-SHOR] [U163A]	AV-267, "Diagnosis Procedure"
U163E	FR-SEAT L-SQUAWK [OPEN, SHORT, GND-SHORT or VB-SHOR] [U163E]	AV-267, "Diagnosis Procedure"
U1708	RL-DOOR SPEAKER [OPEN, SHORT, GND-SHORT or VB-SHOR] [U1708]	AV-268, "Diagnosis Procedure"
U1710	RR-DOOR SPEAKER [OPEN, SHORT, GND-SHORT or VB-SHOR] [U1710]	AV-268, "Diagnosis Procedure"
U1725	R-PSHELF C-WOOFER [OPEN, SHORT, GND-SHORT or VB-SHOR] [U1725]	AV-269, "Diagnosis Procedure"
U190C	CORRECT MICROPHONE [OPEN, SHORT, GND-SHORT or VB-SHOR] [U190C]	AV-270, "Diagnosis Procedure"
U1300 U1240	<ul style="list-style-type: none"> • AV COMM CIRCUIT [U1300] • SWITCH CONN [U1240] 	AV-262, "Description"
U1300 U124E	<ul style="list-style-type: none"> • AV COMM CIRCUIT [U1300] • AMP CONN [U124E] 	AV-262, "Description"
U1300 U1240 U124E	<ul style="list-style-type: none"> • AV COMM CIRCUIT [U1300] • SWITCH CONN [U1240] • AMP CONN [U124E] 	AV-262, "Description"

DISPLAY UNIT

< ECU DIAGNOSIS INFORMATION >

[BOSE AUDIO WITH NAVIGATION]

DISPLAY UNIT

Reference Value

INFOID:000000005912978

TERMINAL LAYOUT

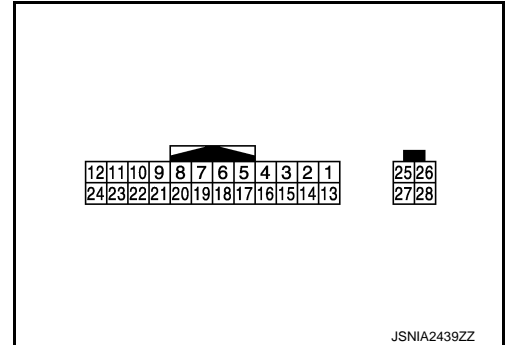

PHYSICAL VALUES

Terminal (Wire color)		Description		Condition		Reference value (Approx.)
+	-	Signal name	Input/ Output			
6	—	Shield	—	—	—	—
7	—	Shield	—	—	—	—
8 (R)	Ground	Camera image signal	Input	Ignition switch ON	At rear view camera image is displayed.	
9 (Y)	Ground	Communication signal (DISP→CONT)	Output	Ignition switch ON	When adjusting display brightness.	
10 (BR)	Ground	Communication signal (CONT→DISP)	Input	Ignition switch ON	When adjusting display brightness.	
11 (Y)	Ground	Battery power supply	Input	Ignition switch OFF	—	Battery voltage
12 (B)	Ground	Ground	—	Ignition switch ON	—	0 V

A
B
C
D
E
F
G
H
I
J
K
L
M
O
P

AV

DISPLAY UNIT

< ECU DIAGNOSIS INFORMATION >

[BOSE AUDIO WITH NAVIGATION]

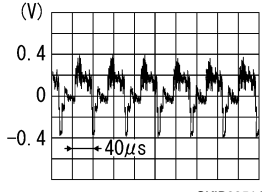
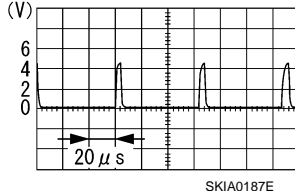
Terminal (Wire color)		Description		Condition		Reference value (Approx.)
+	-	Signal name	Input/ Output			
18 (W)	Ground	Composite image signal	Input	Ignition switch ON	At DVD image is displayed.	
19 (R)	Ground	Composite image ground	—	Ignition switch ON	—	0 V
20 (B)	Ground	Composite synchronizing signal	Input	Ignition switch ON	At DVD image is displayed	
22	—	Shield	—	—	—	—
23 (V)	Ground	ACC power supply	Input	Ignition switch ACC	—	Battery voltage
27	—	RGB digital image signal (+)	Input	—	—	—
28	—	RGB digital image signal (-)	Input	—	—	—

BOSE AMP.

< ECU DIAGNOSIS INFORMATION >

[BOSE AUDIO WITH NAVIGATION]

BOSE AMP.

Reference Value

INFOID:000000005912979

BOSE® STUDIO SURROUND® SOUND SYSTEM MODELS

Terminal Layout

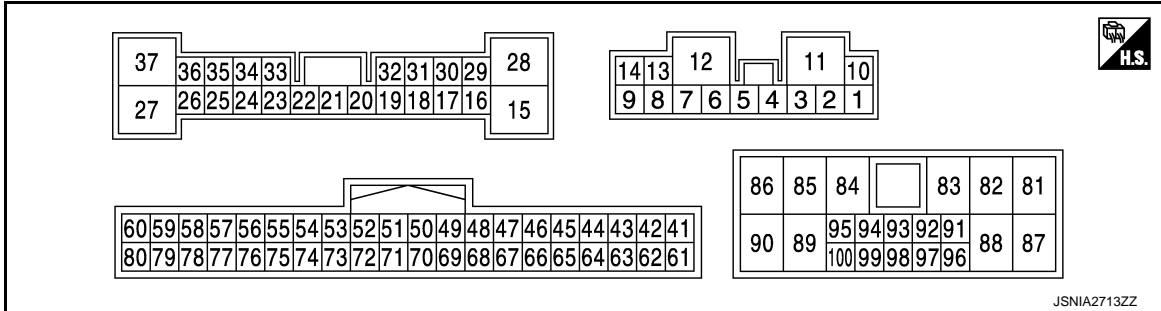

Physical Values

Terminal (Wire color)		Description		Condition		Reference value (Approx.)
+	-	Signal name	Input/ Output			
1 (O)	2 (LG)	Sound signal front door woofer RH	Output	Ignition switch ON	Sound output	 SKIB3609E
5 (R)	6 (L)	Sound signal front door woofer LH	Output	Ignition switch ON	Sound output	 SKIB3609E
7 (B/R)	Ground	Ground	—	Ignition switch ON	—	0 V
10 (V)	Ground	Battery power supply	Input	Ignition switch OFF	—	Battery voltage
11 (G)	Ground	Battery power supply	Input	Ignition switch OFF	—	Battery voltage
12 (B/R)	Ground	Ground	—	Ignition switch ON	—	0 V

BOSE AMP.

< ECU DIAGNOSIS INFORMATION >

[BOSE AUDIO WITH NAVIGATION]

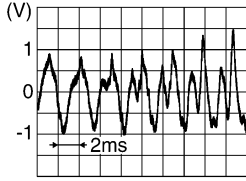
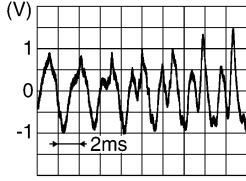
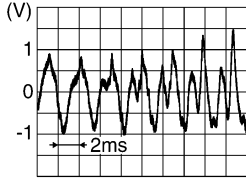
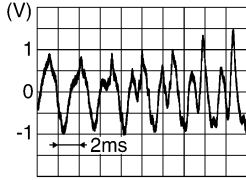
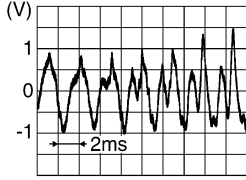
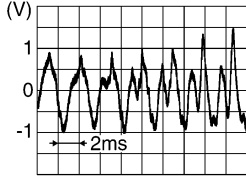
Terminal (Wire color)		Description		Condition		Reference value (Approx.)
+	-	Signal name	Input/ Output			
13 (R/L)	8 (P/L)	Sound signal rear woofer	Output	Ignition switch ON	Sound output	 <p style="text-align: right; font-size: small;">SKIB3609E</p>
14 (B)	9 (W)	Sound signal front door squawker & tweeter RH	Output	Ignition switch ON	Sound output	 <p style="text-align: right; font-size: small;">SKIB3609E</p>
15 (G)	Ground	Amp. ON signal	Output	Ignition switch ACC	—	11.0 V
16 (G)	29 (R)	Sound signal rear door speaker LH	Output	Ignition switch ON	Sound output	 <p style="text-align: right; font-size: small;">SKIB3609E</p>
17 (W)	18 (B)	Sound signal front door squawker & tweeter LH	Output	Ignition switch ON	Sound output	 <p style="text-align: right; font-size: small;">SKIB3609E</p>
19 (B/R)	32 (BR)	Sound signal driver seat speaker LH	Output	Ignition switch ON	Sound output	 <p style="text-align: right; font-size: small;">SKIB3609E</p>
22 (L)	33 (B/W)	Sound signal driver seat speaker RH	Output	Ignition switch ON	Sound output	 <p style="text-align: right; font-size: small;">SKIB3609E</p>

BOSE AMP.

< ECU DIAGNOSIS INFORMATION >

[BOSE AUDIO WITH NAVIGATION]

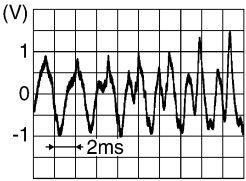
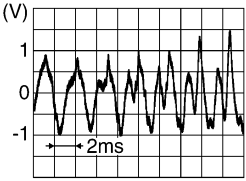
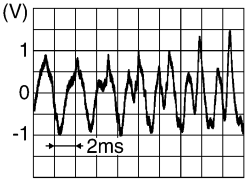
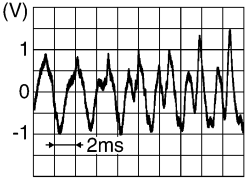
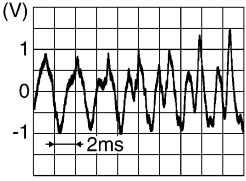
Terminal (Wire color)		Description		Condition		Reference value (Approx.)
+	-	Signal name	Input/ Output			
23 (Y)	34 (BR)	Sound signal passenger seat speaker LH	Output	Ignition switch ON	Sound output	 <p style="text-align: right; font-size: small;">SKIB3609E</p>
24 (R)	35 (G)	Sound signal rear door speaker RH	Output	Ignition switch ON	Sound output	 <p style="text-align: right; font-size: small;">SKIB3609E</p>
26 (O)	36 (W/L)	Sound signal passenger seat speaker RH	Output	Ignition switch ON	Sound output	 <p style="text-align: right; font-size: small;">SKIB3609E</p>
27 (O/L)	37 (W)	Sound signal satellite speaker LH	Output	Ignition switch ON	Sound output	 <p style="text-align: right; font-size: small;">SKIB3609E</p>
31 (V)	30 (P)	Sound signal center speak- er	Output	Ignition switch ON	Sound output	 <p style="text-align: right; font-size: small;">SKIB3609E</p>
54 (R)	—	AV communication signal (L)	Input/ Output	—	—	—
55 (R)	—	AV communication signal (L)	Input/ Output	—	—	—
56 (V)	Ground	ACC power supply	Input	Ignition switch ACC	—	12.0 V
58 (O)	Ground	Engine type signal (V8)	Input	Ignition switch ON	—	0 V

A
B
C
D
E
F
G
H
I
J
K
L
M
P

AV

BOSE AMP.

< ECU DIAGNOSIS INFORMATION >

[BOSE AUDIO WITH NAVIGATION]

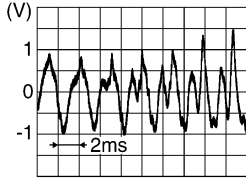
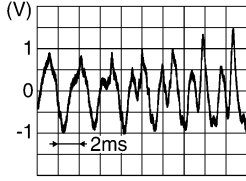
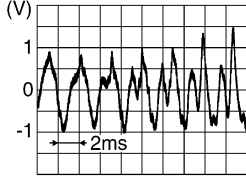
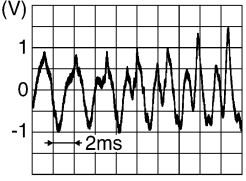
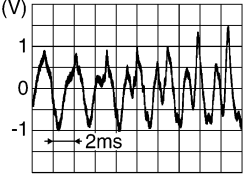
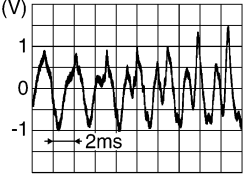
Terminal (Wire color)		Description		Condition		Reference value (Approx.)
+	-	Signal name	Input/ Output			
61 (BR)	41 (B/R)	Sound signal satellite speaker RH	Output	Ignition switch ON	Sound output	 <p style="text-align: right; font-size: small;">SKIB3609E</p>
63 (L)	43 (LG)	Rear microphone signal	Input	Ignition switch ON	When inputting interior sound	 <p style="text-align: right; font-size: small;">SKIB3609E</p>
64 (G)	44 (R)	Voice guidance signal	Input	Ignition switch ON	Sound output	 <p style="text-align: right; font-size: small;">SKIB3609E</p>
65 (W)	45 (B)	Sound signal front LH	Input	Ignition switch ON	Sound output	 <p style="text-align: right; font-size: small;">SKIB3609E</p>
66 (R)	46 (L)	Sound signal front RH	Input	Ignition switch ON	Sound output	 <p style="text-align: right; font-size: small;">SKIB3609E</p>
67 (BR)	47 (Y)	Sound signal rear LH	Input	Ignition switch ON	Sound output	 <p style="text-align: right; font-size: small;">SKIB3609E</p>

BOSE AMP.

< ECU DIAGNOSIS INFORMATION >

[BOSE AUDIO WITH NAVIGATION]

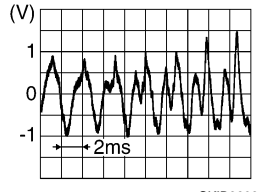
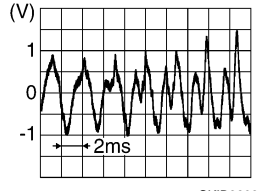
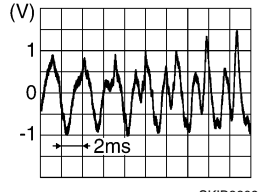
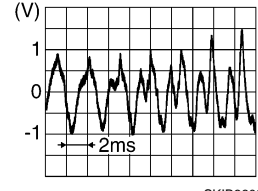
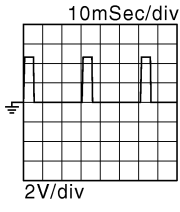
Terminal (Wire color)		Description		Condition		Reference value (Approx.)
+	-	Signal name	Input/ Output			
68 (L)	48 (P)	Sound signal rear RH	Input	Ignition switch ON	Sound output	
69 (W/L)	49 (W/R)	Sound signal center speaker	Input	Ignition switch ON	Sound output	
70 (LG)	50 (V)	Sound signal rear woofer	Input	Ignition switch ON	Sound output	
72 (Y)	52 (BR)	Front microphone signal	Input	Ignition switch ON	When inputting interior sound	
74 (G)	—	AV communication signal (H)	Input/ Output	—	—	—
75 (G)	—	AV communication signal (H)	Input/ Output	—	—	—
76 (P)	Ground	Step lamp signal	Input	Ignition switch ON	When opened any doors.	0 V
					When closed all doors.	12.0 V
78 (SB)	Ground	Engine speed signal	Input	Ignition switch ON	Idle speed	
79	—	Shield	—	—	—	—

A
B
C
D
E
F
G
H
I
J
K
L
M
AV
O
P

AV

BOSE AMP.

< ECU DIAGNOSIS INFORMATION >

[BOSE AUDIO WITH NAVIGATION]

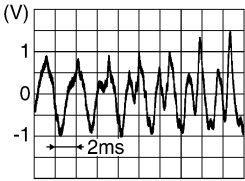
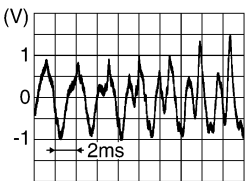
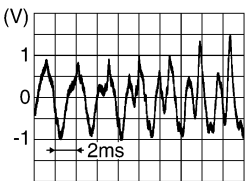
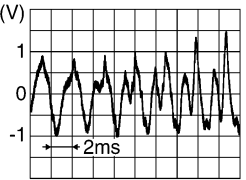
Terminal (Wire color)		Description		Condition		Reference value (Approx.)
+	-	Signal name	Input/ Output			
81 (L)	82 (B/W)	Sound signal passenger seat speaker RH	Output	Ignition switch ON	Sound output	 SKIB3609E
83 (B/R)	Ground	Ground	—	Ignition switch ON	—	0 V
84 (Y)	Ground	Battery power supply	Input	Ignition switch OFF	—	Battery voltage
85 (O)	86 (P)	Sound signal satellite speaker RH	Output	Ignition switch ON	Sound output	 SKIB3609E
87 (G)	88 (R)	Sound signal satellite speaker LH	Output	Ignition switch ON	Sound output	 SKIB3609E
89 (B/R)	Ground	Ground	—	Ignition switch ON	—	0 V
90 (Y)	Ground	Battery power supply	Input	Ignition switch OFF	—	Battery voltage
91 (G)	Ground	Amp. ON signal	Input	Ignition switch ACC	—	11.0 V
92 (G)	Ground	Amp. ON signal	Input	Ignition switch ACC	—	11.0 V
93 (BR)	94 (B/R)	Sound signal satellite speaker RH	Input	Ignition switch ON	Sound output	 SKIB3609E
95	—	Shield	—	—	—	—

BOSE AMP.

< ECU DIAGNOSIS INFORMATION >

[BOSE AUDIO WITH NAVIGATION]

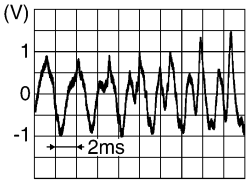
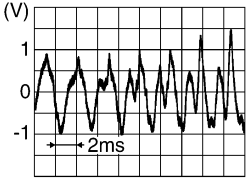
Terminal (Wire color)		Description		Condition		Reference value (Approx.)
+	-	Signal name	Input/ Output			
96 (O)	97 (W/L)	Sound signal passenger seat speaker RH	Input	Ignition switch ON	Sound output	 SKIB3609E
98	—	Shield	—	—	—	—
99 (O/L)	100 (W)	Sound signal satellite speaker LH	Input	Ignition switch ON	Sound output	 SKIB3609E

BOSE SOUND SYSTEM MODELS

TERMINAL LAYOUT

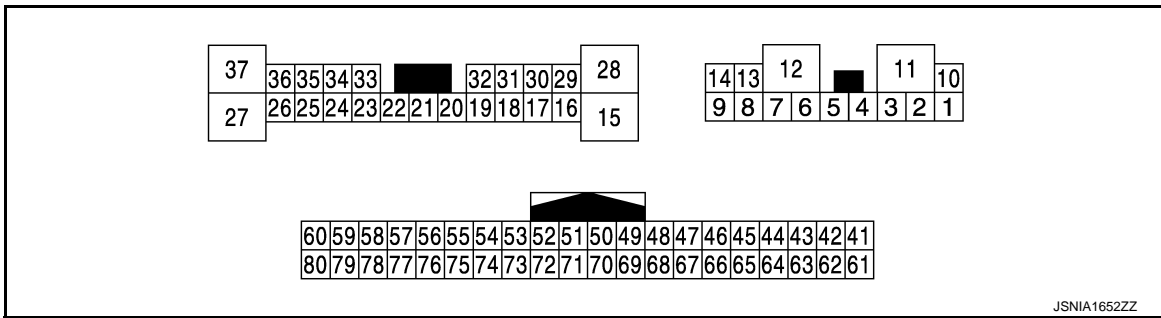

PHYSICAL VALUES

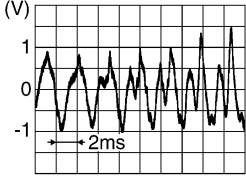
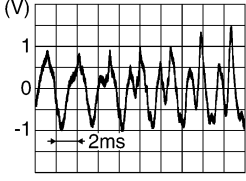
Terminal (Wire color)		Description		Condition		Reference value (Approx.)
+	-	Signal name	Input/ Output			
1 (O)	2 (LG)	Sound signal front door woofer RH	Output	Ignition switch ON	Sound output	 SKIB3609E
5 (R)	6 (L)	Sound signal front door woofer LH	Output	Ignition switch ON	Sound output	 SKIB3609E

BOSE AMP.

< ECU DIAGNOSIS INFORMATION >

[BOSE AUDIO WITH NAVIGATION]

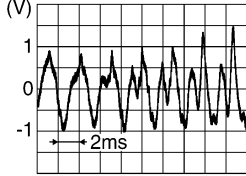
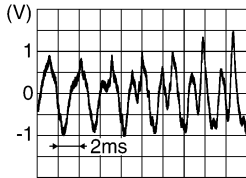
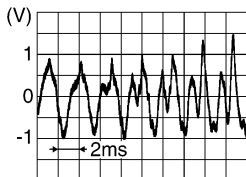
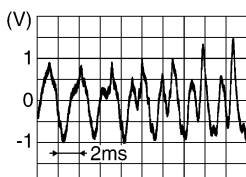
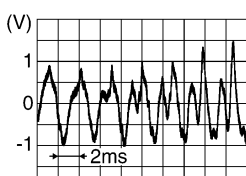
Terminal (Wire color)		Description		Condition		Reference value (Approx.)
+	-	Signal name	Input/ Output			
7 (B/R)	Ground	Ground	—	Ignition switch ON	—	0 V
10 (V)	Ground	Battery power supply	Input	Ignition switch OFF	—	Battery voltage
11 (G)	Ground	Battery power supply	Input	Ignition switch OFF	—	Battery voltage
12 (B/R)	Ground	Ground	—	Ignition switch ON	—	0 V
13 (R/L)	8 (P/L)	Sound signal rear woofer	Output	Ignition switch ON	Sound output	 <p style="text-align: right; font-size: small;">SKIB3609E</p>
14 (B)	9 (W)	Sound signal front door squawker & tweeter RH	Output	Ignition switch ON	Sound output	 <p style="text-align: right; font-size: small;">SKIB3609E</p>
16 (G)	29 (R)	Sound signal rear door speaker LH	Output	Ignition switch ON	Sound output	 <p style="text-align: right; font-size: small;">SKIB3609E</p>
17 (W)	18 (B)	Sound signal front door squawker & tweeter LH	Output	Ignition switch ON	Sound output	 <p style="text-align: right; font-size: small;">SKIB3609E</p>
24 (R)	35 (G)	Sound signal rear door speaker RH	Output	Ignition switch ON	Sound output	 <p style="text-align: right; font-size: small;">SKIB3609E</p>

BOSE AMP.

< ECU DIAGNOSIS INFORMATION >

[BOSE AUDIO WITH NAVIGATION]

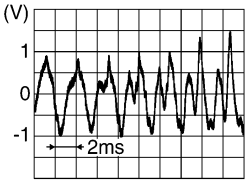
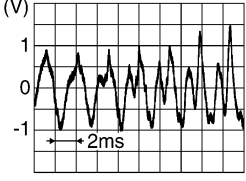
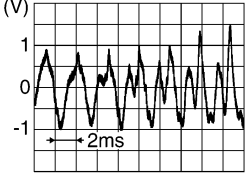
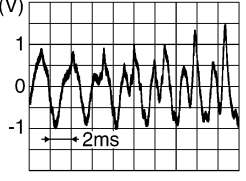
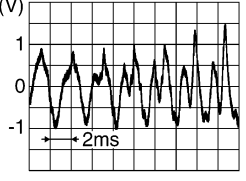
Terminal (Wire color)		Description		Condition		Reference value (Approx.)
+	-	Signal name	Input/ Output			
31 (V)	30 (P)	Sound signal center speaker	Output	Ignition switch ON	Sound output	 SKIB3609E
54 (R)	—	AV communication signal (L)	Input/ Output	—	—	—
55 (R)	—	AV communication signal (L)	Input/ Output	—	—	—
56 (V)	Ground	ACC power supply	Input	Ignition switch ACC	—	12.0 V
58 (O)	Ground	Engine type signal (V8)	Input	Ignition switch ON	—	0 V
63 (L)	43 (LG)	Rear microphone signal	Input	Ignition switch ON	When inputting interior sound	 SKIB3609E
64 (G)	44 (R)	Voice guidance signal	Input	Ignition switch ON	Sound output	 SKIB3609E
65 (W)	45 (B)	Sound signal front LH	Input	Ignition switch ON	Sound output	 SKIB3609E
66 (R)	46 (L)	Sound signal front RH	Input	Ignition switch ON	Sound output	 SKIB3609E

A
B
C
D
E
F
G
H
I
J
K
L
M
O
P

AV

BOSE AMP.

< ECU DIAGNOSIS INFORMATION >

[BOSE AUDIO WITH NAVIGATION]

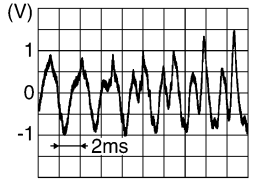
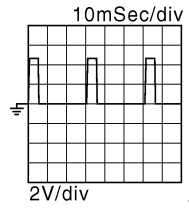
Terminal (Wire color)		Description		Condition		Reference value (Approx.)
+	-	Signal name	Input/ Output			
72 (Y)	52 (BR)	Front microphone signal	Input	Ignition switch ON	When inputting interior sound	 <p style="text-align: right; font-size: small;">SKIB3609E</p>
74 (G)	—	AV communication signal (H)	Input/ Output	—	—	—
75 (G)	—	AV communication signal (H)	Input/ Output	—	—	—
76 (P)	Ground	Step lamp signal	Input	Ignition switch ON	When opened any doors.	0 V
					When closed all doors.	12.0 V
78 (SB)	Ground	Engine speed signal	Input	Ignition switch ON	Idle speed	 <p style="text-align: right; font-size: small;">JMBIA0076GB</p>
79	—	Shield	—	—	—	—

BOSE AUDIO WITH NAVIGATION

[BOSE AUDIO WITH NAVIGATION]

< WIRING DIAGRAM >

VK : With VK engine
SP : With 16 speakers

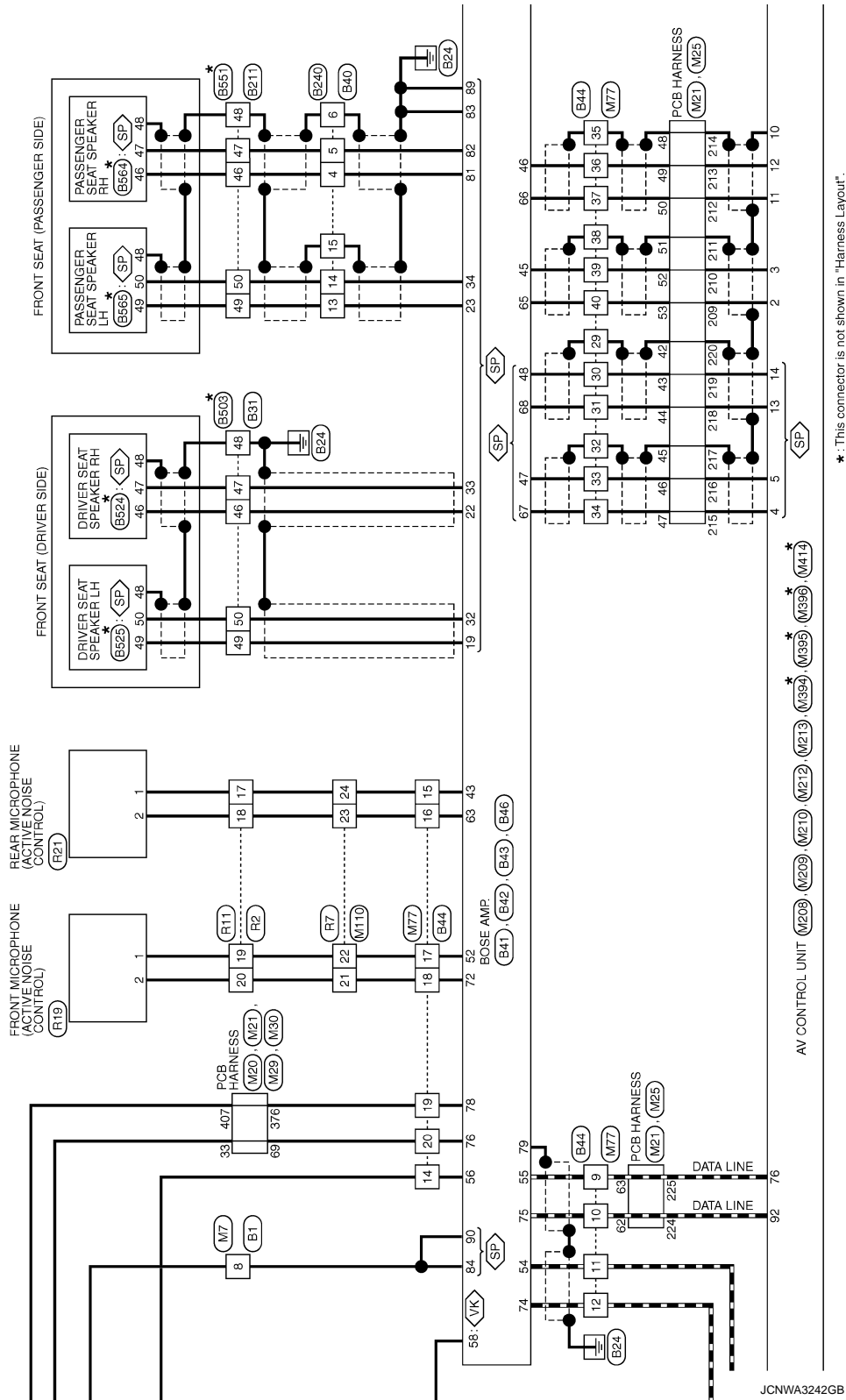

A
B
C
D
E
F
G
H
I
J
K
L
M
N
O
P

AV

BOSE AUDIO WITH NAVIGATION

[BOSE AUDIO WITH NAVIGATION]

< WIRING DIAGRAM >

SP With 16 speakers

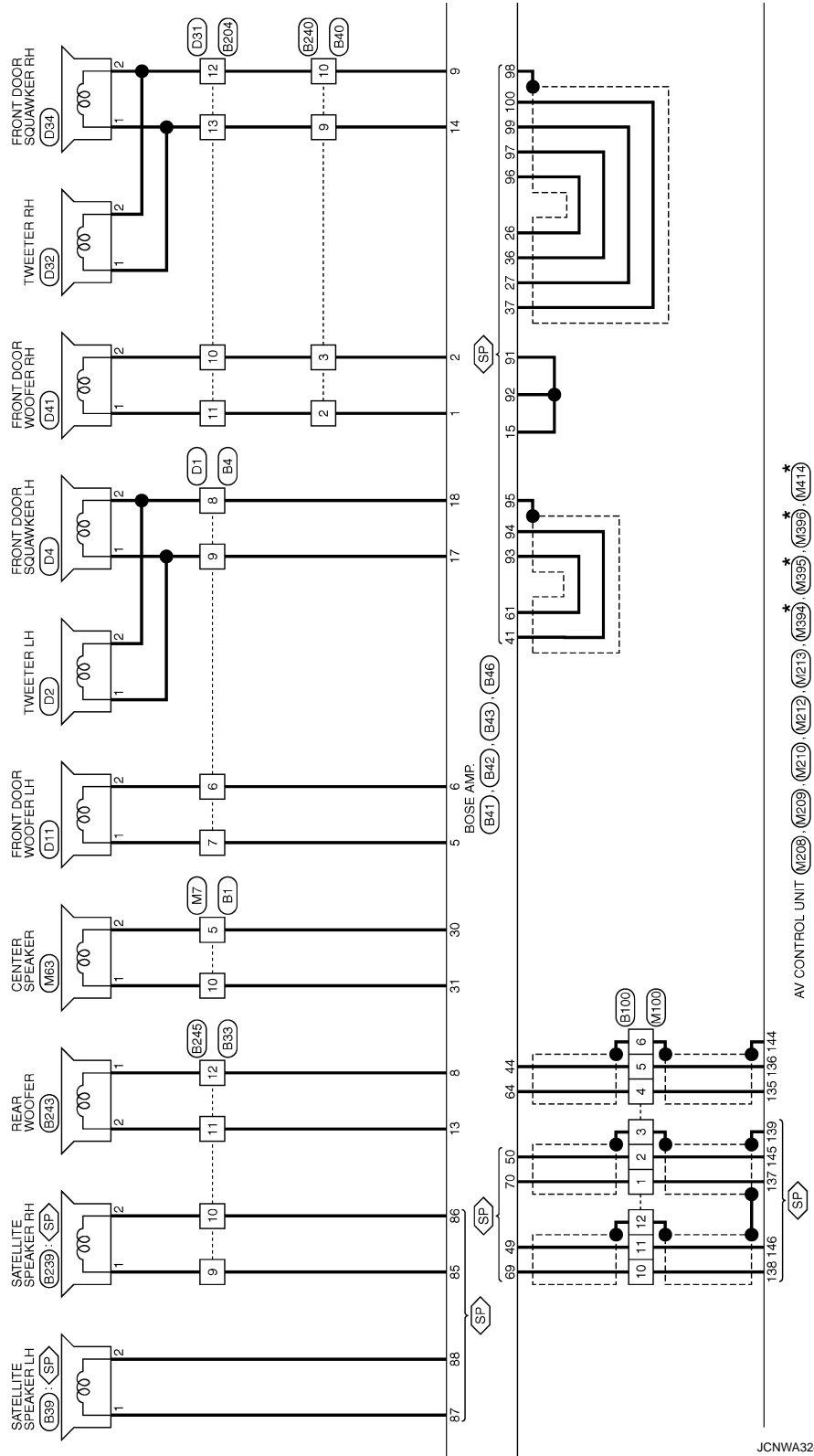

*: This connector is not shown in "Harness Layout".

JCNWA3243GB

BOSE AUDIO WITH NAVIGATION

< WIRING DIAGRAM >

[BOSE AUDIO WITH NAVIGATION]

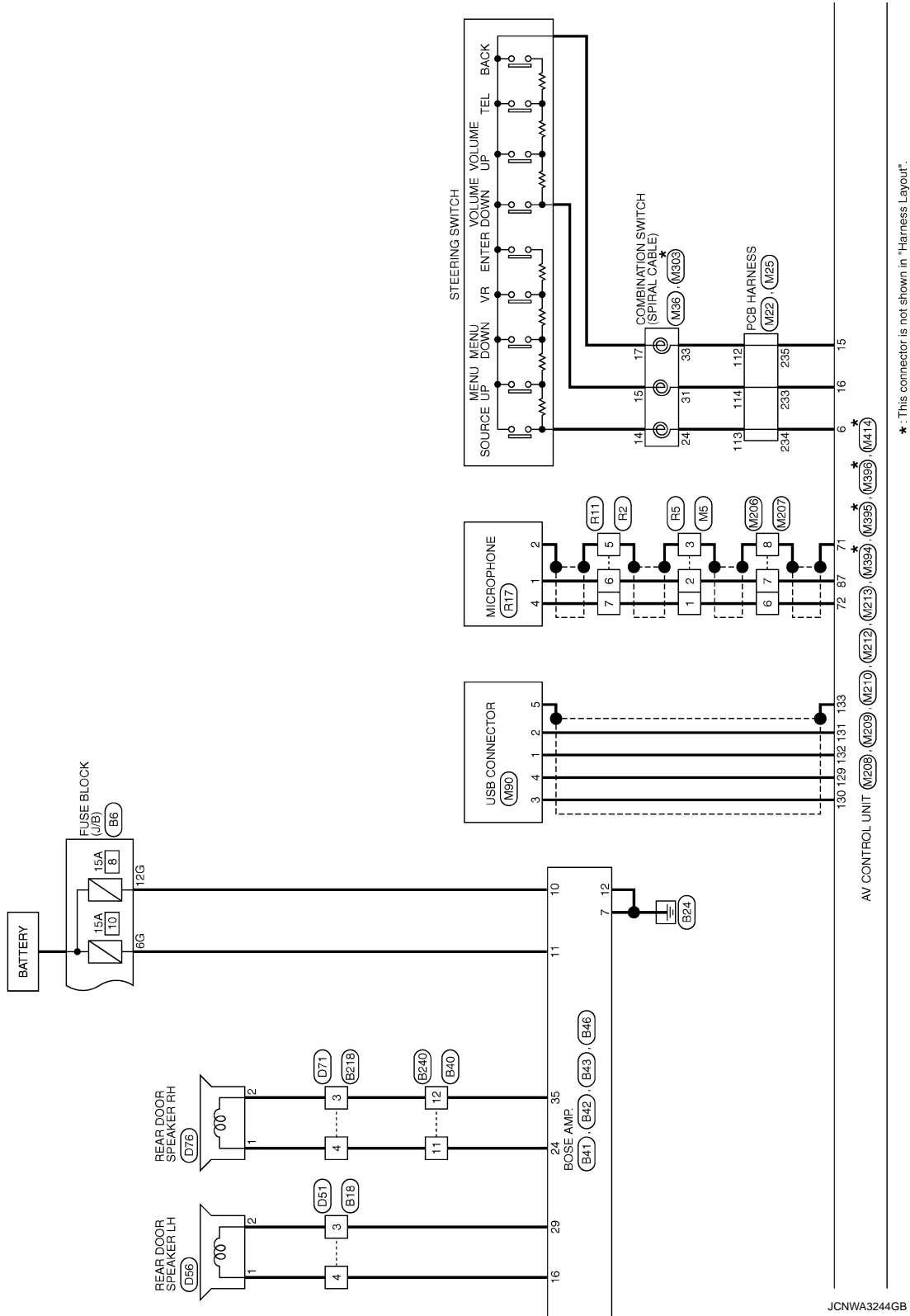

A
B
C
D
E
F
G
H
I
J
K
L
M
N
O
P

AV

BOSE AUDIO WITH NAVIGATION

< WIRING DIAGRAM >

[BOSE AUDIO WITH NAVIGATION]

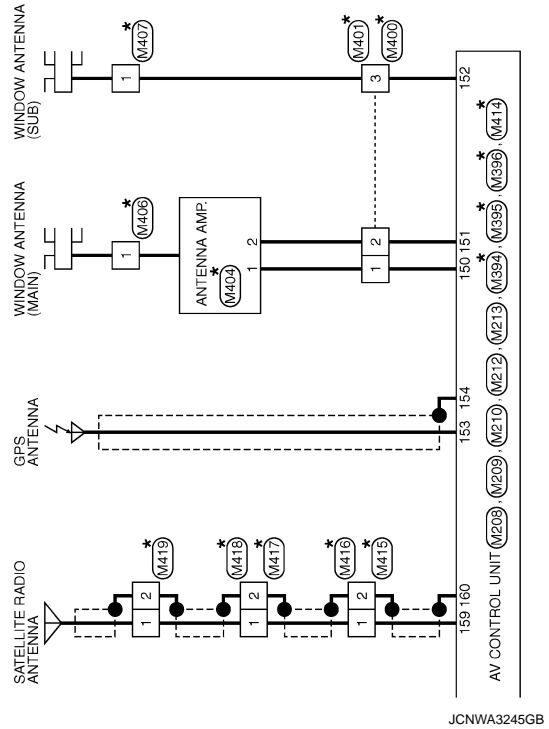

BOSE AUDIO WITH NAVIGATION

[BOSE AUDIO WITH NAVIGATION]

< WIRING DIAGRAM >

BOSE AUDIO WITH NAVIGATION

Connector No.	B1
Connector Name	WIRE TO WIRE
Connector Type	TH0DPW-CS16-TM4



Terminal No.	Color of Wire	Signal Name [Specification]
1	R	-
2	W	-
4	LG	-
5	P	-
6	V	-
7	GR	-
8	Y	-
9	LG	-
10	V	-
11	GR	- [With Climate controlled seat] - [With heated seat]
12	P	- [With Climate controlled seat] - [With heated seat]
13	GR	- [With heated seat]
14	R	-
15	O	-
16	V	-
17	B	-
18	R	-
19	W	-
20	R	-
21	B	-
22	LG	-
23	V	-
24	Y	-
25	G	-
26	GR	-
27	SB	-
28	P	- [With Pre-crash seat belt system]
29	L/O	- [Without Pre-crash seat belt system]
29	L	- [With Pre-crash seat belt system]
29	W/L	- [Without Pre-crash seat belt system]
30	SHIELD	-
32	R	-
33	R	-
34	L	-
35	R	-
36	G	-

37	SB	SHIELD	-
40	GR/V	GR/V	-
41	W/L	W/L	-
42	W	W	-
45	O	O	-
47	Y	Y	-
48	BR	BR	-
49	SB	SB	-
50	V	V	-
51	LG	LG	-
52	G	G	-
53	P	P	-
57	BR	BR	-
58	LG	LG	-
59	Y	Y	-
60	W	W	-
61	B	B	-
62	LG	LG	-
63	BR	BR	- [With ICC and 4WAS system] - [Without ICC and 4WAS system]
65	O	O	-
66	BR	BR	-
67	V	V	-
68	LG	LG	-
69	GR	GR	-
70	R	R	-
72	L	L	-
73	P	P	-
74	L	L	-
75	P	P	-
76	Y	Y	-
77	R	R	-
78	W	W	-
79	G	G	-
81	LG	LG	-
82	BR	BR	-
83	SB	SB	-
84	Y	Y	-
85	W	W	-
86	R	R	-
87	G	G	-
88	GR	GR	-
91	SB	SB	-
92	G	G	-
96	Y	Y	-
97	O	O	-
98	SB	SB	-
99	LG	LG	-

Connector No.	B4
Connector Name	WIRE TO WIRE
Connector Type	TH40MM-CS15

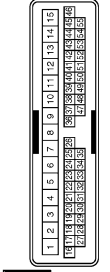

Terminal No.	Color of Wire	Signal Name [Specification]
5	B/W	-
6	L	-
7	R	-
8	B	-
9	W	-
10	LG	-
11	P	-
12	GR	-
13	B/W	-
14	SB	-
15	O	-
16	G	-
17	Y	-
18	BR	-
19	GR	-
20	O	-
21	LG	-
22	L	-
23	SB	-
24	V	-
27	V	-
28	W	-
29	SB	-
30	L	-
31	LG	-
32	O	-
33	V	-
34	BR	-
35	B/R	-
36	P	-
37	BR	-
38	W	-
39	O	-
40	L	-
41	SHIELD	-
42	L	- [With Pre-crash seat belt system] - [Without Pre-crash seat belt system]
42	W/L	- [Without Pre-crash seat belt system]
43	P	- [With Pre-crash seat belt system]

43	L/O	- [Without Pre-crash seat belt system]
44	R	-
45	Y	-
46	V	-
47	SB	-
48	GR	-
49	LG	-
50	B	-
51	G	-
52	R	-
53	B	-
54	V	-
55	W	-

Connector No.	B6
Connector Name	FUSE BLOCK (J/B)
Connector Type	NS1ZPER-CS



Terminal No.	Color of Wire	Signal Name [Specification]
1G	GR	-
2G	P	-
4G	L	-
5G	P/L	- [With VK engine] - [With VQ engine]
6G	G	-
10G	W	-
11G	W	-
12G	V	-

JCNWA3246GB

A
B
C
D
E
F
G
H
I
J
K
L
M
AV
O
P

BOSE AUDIO WITH NAVIGATION

[BOSE AUDIO WITH NAVIGATION]

< WIRING DIAGRAM >

BOSE AUDIO WITH NAVIGATION

Connector No.	B18
Connector Name	WIRE TO WIRE
Connector Type	NS10PW-CS10

6	5	4	3	2	1
13	12	11	10	9	8
20	19	18	17	16	15
14	8	7			



Terminal No.	Color of Wire	Signal Name [Specification]
1	LG	-
2	P	-
3	R	-
4	G	-
7	B/W	-
8	W	-
9	V	-
10	Y	-
11	L	-
12	Y	-
13	B	-

Connector No.	B31
Connector Name	WIRE TO WIRE
Connector Type	NS12PW-CS



46	47	55	56	57
48	49	50	52	58
53	54	59	63	64

Terminal No.	Color of Wire	Signal Name [Specification]
46	L	-
47	B/W	-
48	SHIELD	-
49	B/R	-
50	BR	-
52	O	- [With Climate controlled seat]
53	BR	- [With Climate controlled seat]
54	GR	- [With heated seat]
59	P	- [With Climate controlled seat]
63	L	- [With heated seat]
64	L	- [With heated seat]

55	G	-
56	GR	-
57	R	-
58	B	-

Connector No.	B33
Connector Name	WIRE TO WIRE
Connector Type	NS16FGY-CS



7	6	5	4	3	2	1
16	15	14	13	12	11	10
9	8					

Terminal No.	Color of Wire	Signal Name [Specification]
1	P	-
2	L	-
3	O	-
8	GR	-
9	O	-
10	P	-
11	P/L	-
12	P/L	-
13	L	-
14	Y	-

Connector No.	B39
Connector Name	SATELLITE SPEAKER LH
Connector Type	TK02FBR



2	1
---	---

Terminal No.	Color of Wire	Signal Name [Specification]
1	G	-
2	R	-

Connector No.	B40
Connector Name	WIRE TO WIRE
Connector Type	NS16MM-CS



1	2	3	4	5	6	7
8	9	10	11	12	13	14
15	16					

Terminal No.	Color of Wire	Signal Name [Specification]
1	P	-
2	O	-
3	LG	-
4	L	-
5	B/W	-
6	SHIELD	-
9	B	-
10	W	-
11	R	-
12	G	-
13	Y	-
14	BR	-
15	SHIELD	-
16	LG	-

Connector No.	B41
Connector Name	BOSE AMP.
Connector Type	SCA12FBR-SJA2



9	8	7	6	5	4	3	2	1
14	13	12						
11	10							

Terminal No.	Color of Wire	Signal Name [Specification]
1	O	SOUND SIGNAL FRONT DOOR WOOFER RH (-)
2	LG	SOUND SIGNAL FRONT DOOR WOOFER RH (-)
5	R	SOUND SIGNAL FRONT DOOR WOOFER LH (-)
6	L	SOUND SIGNAL FRONT DOOR WOOFER LH (-)
7	B/R	GND
8	P/L	SOUND SIGNAL REAR WOOFER (-)
9	W	SOUND SIGNAL FRONT DOOR SPEAKERS & TWEETERS RH (-)
10	V	BATTERY

11	G	BATTERY
12	B/R	GND
13	P/L	SOUND SIGNAL REAR WOOFER (-)
14	B	SOUND SIGNAL FRONT DOOR SPEAKERS & TWEETERS RH (-)

Connector No.	B42
Connector Name	BOSE AMP.
Connector Type	SCA19FBR-SGA4



27	26	24	23	22
37	36	35	34	33
32	31	30	29	28

Terminal No.	Color of Wire	Signal Name [Specification]
15	G	AMP_ON SIGNAL
16	G	SOUND SIGNAL REAR DOOR SPEAKER LH (-)
17	W	SOUND SIGNAL FRONT DOOR SPEAKERS & TWEETERS LH (-)
18	B	SOUND SIGNAL FRONT DOOR SPEAKERS & TWEETERS LH (-)
19	B/R	SOUND SIGNAL DRIVER SEAT SPEAKER LH (-)
22	L	SOUND SIGNAL DRIVER SEAT SPEAKER RH (-)
23	Y	SOUND SIGNAL PASSENGER SEAT SPEAKER LH (-)
24	R	SOUND SIGNAL REAR DOOR SPEAKER RH (-)
26	O	SOUND SIGNAL PASSENGER SEAT SPEAKER RH (-)
27	O/L	SOUND SIGNAL SATELLITE SPEAKER LH (-)
29	R	SOUND SIGNAL REAR DOOR SPEAKER LH (-)
30	P	SOUND SIGNAL CENTER SPEAKER (-)
31	V	SOUND SIGNAL CENTER SPEAKER (+)
32	BR	SOUND SIGNAL DRIVER SEAT SPEAKER LH (-)
33	B/W	SOUND SIGNAL DRIVER SEAT SPEAKER RH (-)
34	BR	SOUND SIGNAL PASSENGER SEAT SPEAKER LH (-)
35	G	SOUND SIGNAL REAR DOOR SPEAKER RH (-)
36	W/L	SOUND SIGNAL PASSENGER SEAT SPEAKER RH (-)
37	W	SOUND SIGNAL SATELLITE SPEAKER LH (-)

BOSE AUDIO WITH NAVIGATION

[BOSE AUDIO WITH NAVIGATION]

< WIRING DIAGRAM >

BOSE AUDIO WITH NAVIGATION

Connector No.	B43
Connector Name	BOSE AMP.
Connector Type	TH40PW-NH

1	2	3	4	5	6	7	8	9	10	11	12	13	14	15	16	17	18	19	20	21	22	23	24	25	26	27	28	29	30	31	32	33	34	35	36	37	38	39	40	41	42	43	44	45	46	47	48	49	50	51	52	53	54	55	56	57	58	59	60	61	62	63	64	65	66	67	68	69	70	71	72	73	74	75	76	77	78	79	80	81	82	83	84	85	86	87	88	89	90	91	92	93	94	95	96	97	98	99	100	101	102	103	104	105	106	107	108	109	110	111	112	113	114	115	116	117	118	119	120	121	122	123	124	125	126	127	128	129	130	131	132	133	134	135	136	137	138	139	140	141	142	143	144	145	146	147	148	149	150	151	152	153	154	155	156	157	158	159	160	161	162	163	164	165	166	167	168	169	170	171	172	173	174	175	176	177	178	179	180	181	182	183	184	185	186	187	188	189	190	191	192	193	194	195	196	197	198	199	200	201	202	203	204	205	206	207	208	209	210	211	212	213	214	215	216	217	218	219	220	221	222	223	224	225	226	227	228	229	230	231	232	233	234	235	236	237	238	239	240	241	242	243	244	245	246	247	248	249	250	251	252	253	254	255	256	257	258	259	260	261	262	263	264	265	266	267	268	269	270	271	272	273	274	275	276	277	278	279	280	281	282	283	284	285	286	287	288	289	290	291	292	293	294	295	296	297	298	299	300	301	302	303	304	305	306	307	308	309	310	311	312	313	314	315	316	317	318	319	320	321	322	323	324	325	326	327	328	329	330	331	332	333	334	335	336	337	338	339	340	341	342	343	344	345	346	347	348	349	350	351	352	353	354	355	356	357	358	359	360	361	362	363	364	365	366	367	368	369	370	371	372	373	374	375	376	377	378	379	380	381	382	383	384	385	386	387	388	389	390	391	392	393	394	395	396	397	398	399	400	401	402	403	404	405	406	407	408	409	410	411	412	413	414	415	416	417	418	419	420	421	422	423	424	425	426	427	428	429	430	431	432	433	434	435	436	437	438	439	440	441	442	443	444	445	446	447	448	449	450	451	452	453	454	455	456	457	458	459	460	461	462	463	464	465	466	467	468	469	470	471	472	473	474	475	476	477	478	479	480	481	482	483	484	485	486	487	488	489	490	491	492	493	494	495	496	497	498	499	500	501	502	503	504	505	506	507	508	509	510	511	512	513	514	515	516	517	518	519	520	521	522	523	524	525	526	527	528	529	530	531	532	533	534	535	536	537	538	539	540	541	542	543	544	545	546	547	548	549	550	551	552	553	554	555	556	557	558	559	560	561	562	563	564	565	566	567	568	569	570	571	572	573	574	575	576	577	578	579	580	581	582	583	584	585	586	587	588	589	590	591	592	593	594	595	596	597	598	599	600	601	602	603	604	605	606	607	608	609	610	611	612	613	614	615	616	617	618	619	620	621	622	623	624	625	626	627	628	629	630	631	632	633	634	635	636	637	638	639	640	641	642	643	644	645	646	647	648	649	650	651	652	653	654	655	656	657	658	659	660	661	662	663	664	665	666	667	668	669	670	671	672	673	674	675	676	677	678	679	680	681	682	683	684	685	686	687	688	689	690	691	692	693	694	695	696	697	698	699	700	701	702	703	704	705	706	707	708	709	710	711	712	713	714	715	716	717	718	719	720	721	722	723	724	725	726	727	728	729	730	731	732	733	734	735	736	737	738	739	740	741	742	743	744	745	746	747	748	749	750	751	752	753	754	755	756	757	758	759	760	761	762	763	764	765	766	767	768	769	770	771	772	773	774	775	776	777	778	779	780	781	782	783	784	785	786	787	788	789	790	791	792	793	794	795	796	797	798	799	800	801	802	803	804	805	806	807	808	809	810	811	812	813	814	815	816	817	818	819	820	821	822	823	824	825	826	827	828	829	830	831	832	833	834	835	836	837	838	839	840	841	842	843	844	845	846	847	848	849	850	851	852	853	854	855	856	857	858	859	860	861	862	863	864	865	866	867	868	869	870	871	872	873	874	875	876	877	878	879	880	881	882	883	884	885	886	887	888	889	890	891	892	893	894	895	896	897	898	899	900	901	902	903	904	905	906	907	908	909	910	911	912	913	914	915	916	917	918	919	920	921	922	923	924	925	926	927	928	929	930	931	932	933	934	935	936	937	938	939	940	941	942	943	944	945	946	947	948	949	950	951	952	953	954	955	956	957	958	959	960	961	962	963	964	965	966	967	968	969	970	971	972	973	974	975	976	977	978	979	980	981	982	983	984	985	986	987	988	989	990	991	992	993	994	995	996	997	998	999	1000	1001	1002	1003	1004	1005	1006	1007	1008	1009	1010	1011	1012	1013	1014	1015	1016	1017	1018	1019	1020	1021	1022	1023	1024	1025	1026	1027	1028	1029	1030	1031	1032	1033	1034	1035	1036	1037	1038	1039	1040	1041	1042	1043	1044	1045	1046	1047	1048	1049	1050	1051	1052	1053	1054	1055	1056	1057	1058	1059	1060	1061	1062	1063	1064	1065	1066	1067	1068	1069	1070	1071	1072	1073	1074	1075	1076	1077	1078	1079	1080	1081	1082	1083	1084	1085	1086	1087	1088	1089	1090	1091	1092	1093	1094	1095	1096	1097	1098	1099	1100	1101	1102	1103	1104	1105	1106	1107	1108	1109	1110	1111	1112	1113	1114	1115	1116	1117	1118	1119	1120	1121	1122	1123	1124	1125	1126	1127	1128	1129	1130	1131	1132	1133	1134	1135	1136	1137	1138	1139	1140	1141	1142	1143	1144	1145	1146	1147	1148	1149	1150	1151	1152	1153	1154	1155	1156	1157	1158	1159	1160	1161	1162	1163	1164	1165	1166	1167	1168	1169	1170	1171	1172	1173	1174	1175	1176	1177	1178	1179	1180	1181	1182	1183	1184	1185	1186	1187	1188	1189	1190	1191	1192	1193	1194	1195	1196	1197	1198	1199	1200	1201	1202	1203	1204	1205	1206	1207	1208	1209	1210	1211	1212	1213	1214	1215	1216	1217	1218	1219	1220	1221	1222	1223	1224	1225	1226	1227	1228	1229	1230	1231	1232	1233	1234	1235	1236	1237	1238	1239	1240	1241	1242	1243	1244	1245	1246	1247	1248	1249	1250	1251	1252	1253	1254	1255	1256	1257	1258	1259	1260	1261	1262	1263	1264	1265	1266	1267	1268	1269	1270	1271	1272	1273	1274	1275	1276	1277	1278	1279	1280	1281	1282	1283	1284	1285	1286	1287	1288	1289	1290	1291	1292	1293	1294	1295	1296	1297	1298	1299	1300	1301	1302	1303	1304	1305	1306	1307	1308	1309	1310	1311	1312	1313	1314	1315	1316	1317	1318	1319	1320	1321	1322	1323	1324	1325	1326	1327	1328	1329	1330	1331	1332	1333	1334	1335	1336	1337	1338	1339	1340	1341	1342	1343	1344	1345	1346	1347	1348	1349	1350	1351	1352	1353	1354	1355	1356	1357	1358	1359	1360	1361	1362	1363	1364	1365	1366	1367	1368	1369	1370	1371	1372	1373	1374	1375	1376	1377	1378	1379	1380	1381	1382	1383	1384	1385	1386	1387	1388	1389	1390	1391	1392	1393	1394	1395	1396	1397	1398	1399	1400	1401	1402	1403	1404	1405	1406	1407	1408	1409	1410	1411	1412	1413	1414	1415	1416	1417	1418	1419	1420	1421	1422	1423	1424	1425	1426	1427	1428	1429	1430	1431	1432	1433	1434	1435	1436	1437	1438	1439	1440	1441	1442	1443	1444	1445	1446	1447	1448	1449	1450	1451	1452	1453	1454	1455	1456	1457	1458	1459	1460	1461	1462	1463
---	---	---	---	---	---	---	---	---	----	----	----	----	----	----	----	----	----	----	----	----	----	----	----	----	----	----	----	----	----	----	----	----	----	----	----	----	----	----	----	----	----	----	----	----	----	----	----	----	----	----	----	----	----	----	----	----	----	----	----	----	----	----	----	----	----	----	----	----	----	----	----	----	----	----	----	----	----	----	----	----	----	----	----	----	----	----	----	----	----	----	----	----	----	----	----	----	----	----	-----	-----	-----	-----	-----	-----	-----	-----	-----	-----	-----	-----	-----	-----	-----	-----	-----	-----	-----	-----	-----	-----	-----	-----	-----	-----	-----	-----	-----	-----	-----	-----	-----	-----	-----	-----	-----	-----	-----	-----	-----	-----	-----	-----	-----	-----	-----	-----	-----	-----	-----	-----	-----	-----	-----	-----	-----	-----	-----	-----	-----	-----	-----	-----	-----	-----	-----	-----	-----	-----	-----	-----	-----	-----	-----	-----	-----	-----	-----	-----	-----	-----	-----	-----	-----	-----	-----	-----	-----	-----	-----	-----	-----	-----	-----	-----	-----	-----	-----	-----	-----	-----	-----	-----	-----	-----	-----	-----	-----	-----	-----	-----	-----	-----	-----	-----	-----	-----	-----	-----	-----	-----	-----	-----	-----	-----	-----	-----	-----	-----	-----	-----	-----	-----	-----	-----	-----	-----	-----	-----	-----	-----	-----	-----	-----	-----	-----	-----	-----	-----	-----	-----	-----	-----	-----	-----	-----	-----	-----	-----	-----	-----	-----	-----	-----	-----	-----	-----	-----	-----	-----	-----	-----	-----	-----	-----	-----	-----	-----	-----	-----	-----	-----	-----	-----	-----	-----	-----	-----	-----	-----	-----	-----	-----	-----	-----	-----	-----	-----	-----	-----	-----	-----	-----	-----	-----	-----	-----	-----	-----	-----	-----	-----	-----	-----	-----	-----	-----	-----	-----	-----	-----	-----	-----	-----	-----	-----	-----	-----	-----	-----	-----	-----	-----	-----	-----	-----	-----	-----	-----	-----	-----	-----	-----	-----	-----	-----	-----	-----	-----	-----	-----	-----	-----	-----	-----	-----	-----	-----	-----	-----	-----	-----	-----	-----	-----	-----	-----	-----	-----	-----	-----	-----	-----	-----	-----	-----	-----	-----	-----	-----	-----	-----	-----	-----	-----	-----	-----	-----	-----	-----	-----	-----	-----	-----	-----	-----	-----	-----	-----	-----	-----	-----	-----	-----	-----	-----	-----	-----	-----	-----	-----	-----	-----	-----	-----	-----	-----	-----	-----	-----	-----	-----	-----	-----	-----	-----	-----	-----	-----	-----	-----	-----	-----	-----	-----	-----	-----	-----	-----	-----	-----	-----	-----	-----	-----	-----	-----	-----	-----	-----	-----	-----	-----	-----	-----	-----	-----	-----	-----	-----	-----	-----	-----	-----	-----	-----	-----	-----	-----	-----	-----	-----	-----	-----	-----	-----	-----	-----	-----	-----	-----	-----	-----	-----	-----	-----	-----	-----	-----	-----	-----	-----	-----	-----	-----	-----	-----	-----	-----	-----	-----	-----	-----	-----	-----	-----	-----	-----	-----	-----	-----	-----	-----	-----	-----	-----	-----	-----	-----	-----	-----	-----	-----	-----	-----	-----	-----	-----	-----	-----	-----	-----	-----	-----	-----	-----	-----	-----	-----	-----	-----	-----	-----	-----	-----	-----	-----	-----	-----	-----	-----	-----	-----	-----	-----	-----	-----	-----	-----	-----	-----	-----	-----	-----	-----	-----	-----	-----	-----	-----	-----	-----	-----	-----	-----	-----	-----	-----	-----	-----	-----	-----	-----	-----	-----	-----	-----	-----	-----	-----	-----	-----	-----	-----	-----	-----	-----	-----	-----	-----	-----	-----	-----	-----	-----	-----	-----	-----	-----	-----	-----	-----	-----	-----	-----	-----	-----	-----	-----	-----	-----	-----	-----	-----	-----	-----	-----	-----	-----	-----	-----	-----	-----	-----	-----	-----	-----	-----	-----	-----	-----	-----	-----	-----	-----	-----	-----	-----	-----	-----	-----	-----	-----	-----	-----	-----	-----	-----	-----	-----	-----	-----	-----	-----	-----	-----	-----	-----	-----	-----	-----	-----	-----	-----	-----	-----	-----	-----	-----	-----	-----	-----	-----	-----	-----	-----	-----	-----	-----	-----	-----	-----	-----	-----	-----	-----	-----	-----	-----	-----	-----	-----	-----	-----	-----	-----	-----	-----	-----	-----	-----	-----	-----	-----	-----	-----	-----	-----	-----	-----	-----	-----	-----	-----	-----	-----	-----	-----	-----	-----	-----	-----	-----	-----	-----	-----	-----	-----	-----	-----	-----	-----	-----	-----	-----	-----	-----	-----	-----	-----	-----	-----	-----	-----	-----	-----	-----	-----	-----	-----	-----	-----	-----	-----	-----	-----	-----	-----	-----	-----	-----	-----	-----	-----	-----	-----	-----	-----	-----	-----	-----	-----	-----	-----	-----	-----	-----	-----	-----	-----	-----	-----	-----	-----	-----	-----	-----	-----	-----	-----	-----	-----	-----	-----	-----	-----	-----	-----	-----	-----	-----	-----	-----	-----	-----	-----	-----	-----	-----	-----	-----	-----	-----	-----	-----	-----	-----	-----	-----	-----	-----	-----	-----	-----	-----	-----	-----	-----	-----	-----	-----	-----	-----	-----	-----	-----	-----	-----	-----	-----	-----	-----	-----	-----	-----	-----	-----	-----	-----	-----	-----	-----	-----	-----	-----	-----	-----	-----	-----	-----	-----	-----	-----	-----	-----	-----	-----	-----	-----	-----	-----	-----	-----	-----	-----	-----	-----	-----	-----	-----	-----	-----	-----	-----	-----	-----	-----	-----	-----	-----	-----	-----	-----	-----	-----	-----	-----	-----	-----	-----	-----	-----	-----	-----	-----	-----	-----	-----	-----	-----	-----	-----	-----	-----	-----	-----	-----	-----	-----	-----	-----	-----	-----	-----	-----	-----	-----	-----	-----	-----	-----	-----	-----	-----	-----	-----	-----	-----	-----	-----	-----	-----	-----	-----	-----	-----	-----	-----	-----	-----	-----	-----	-----	-----	-----	-----	-----	-----	-----	-----	-----	-----	-----	-----	-----	-----	-----	-----	-----	-----	-----	-----	-----	-----	-----	-----	-----	-----	-----	-----	-----	-----	-----	-----	-----	-----	-----	-----	-----	------	------	------	------	------	------	------	------	------	------	------	------	------	------	------	------	------	------	------	------	------	------	------	------	------	------	------	------	------	------	------	------	------	------	------	------	------	------	------	------	------	------	------	------	------	------	------	------	------	------	------	------	------	------	------	------	------	------	------	------	------	------	------	------	------	------	------	------	------	------	------	------	------	------	------	------	------	------	------	------	------	------	------	------	------	------	------	------	------	------	------	------	------	------	------	------	------	------	------	------	------	------	------	------	------	------	------	------	------	------	------	------	------	------	------	------	------	------	------	------	------	------	------	------	------	------	------	------	------	------	------	------	------	------	------	------	------	------	------	------	------	------	------	------	------	------	------	------	------	------	------	------	------	------	------	------	------	------	------	------	------	------	------	------	------	------	------	------	------	------	------	------	------	------	------	------	------	------	------	------	------	------	------	------	------	------	------	------	------	------	------	------	------	------	------	------	------	------	------	------	------	------	------	------	------	------	------	------	------	------	------	------	------	------	------	------	------	------	------	------	------	------	------	------	------	------	------	------	------	------	------	------	------	------	------	------	------	------	------	------	------	------	------	------	------	------	------	------	------	------	------	------	------	------	------	------	------	------	------	------	------	------	------	------	------	------	------	------	------	------	------	------	------	------	------	------	------	------	------	------	------	------	------	------	------	------	------	------	------	------	------	------	------	------	------	------	------	------	------	------	------	------	------	------	------	------	------	------	------	------	------	------	------	------	------	------	------	------	------	------	------	------	------	------	------	------	------	------	------	------	------	------	------	------	------	------	------	------	------	------	------	------	------	------	------	------	------	------	------	------	------	------	------	------	------	------	------	------	------	------	------	------	------	------	------	------	------	------	------	------	------	------	------	------	------	------	------	------	------	------	------	------	------	------	------	------	------	------	------	------	------	------	------	------	------	------	------	------	------	------	------	------	------	------	------	------	------	------	------	------	------	------	------	------	------	------	------	------	------	------	------	------	------	------	------	------	------	------	------	------	------	------	------	------	------	------	------	------	------	------	------	------	------	------	------	------	------	------	------	------	------	------	------	------	------	------	------	------	------	------	------	------	------	------

BOSE AUDIO WITH NAVIGATION

[BOSE AUDIO WITH NAVIGATION]

< WIRING DIAGRAM >

BOSE AUDIO WITH NAVIGATION

Connector No.	B204
Connector Name	WIRE TO WIRE
Connector Type	TH00MW-CS15

1	2	3	4	5	6	7	8	9	10	11	12	13	14	15
16	17	18	19	20	21	22	23	24	25	26	27	28	29	30

Connector No.	B211
Connector Name	WIRE TO WIRE
Connector Type	TK10FW-HSS

46	47	48	35	41			
1	52	2	53	154	155	158	156

Terminal No.	Color of Wire	Signal Name [Specification]
2	B/W	
3	B/W	
5	Y	
9	R	
10	P	
11	Y	
12	Y	
13	BR	
14	LG	
15	GR	
16	G	
17	P	
18	BR	
19	GR	
20	V	
21	LG	
22	W	
23	O	
24	Y	
25	BR	
26	L	
32	G	
33	R	
34	SHIELD	
35	P	
36	B/R	
37	B/R	
38	SB	
39	P	
44	SB	
45	R	
46	B	

Terminal No.	Color of Wire	Signal Name [Specification]
1	BR	
2	B	
35	G	
40	L	
41	B	
46	Y	
47	BR	
48	SHIELD	
49	L	
50	B/W	
52	SB	
53	O	
54	R	
54	R	[With Climate controlled seat]
54	R	[With heated seat]
55	Y	
56	G	
57	V	
58	B	
58	B	[With Climate controlled seat]
58	GR	[With heated seat]

Connector No.	B218
Connector Name	WIRE TO WIRE
Connector Type	NH10FW-CS10

6	5	4	3	2	1			
20	19	13	12	11	10	9	8	7

4	P	
7	B	
8	P	
9	O	
10	W	
11	O	
12	Y	
13	B	

Connector No.	B228
Connector Name	WIRE TO WIRE
Connector Type	NS12MM-CS

1	2	3	4	5		
6	7	8	9	10	11	12

Terminal No.	Color of Wire	Signal Name [Specification]
1	R	
2	GR	
3	V	
5	W	
6	B	
7	O	
8	B/R	
9	L	
10	L/W	
11	W	
11	L/R	[With NAV]
11	L/R	[Without NAV]
12	SHIELD	

Connector No.	B239
Connector Name	SATELLITE SPEAKER RH
Connector Type	TK02FBR

2	1
---	---

Terminal No.	Color of Wire	Signal Name [Specification]
1	LG	
2	GR	
3	O	

1	V	
2	P	

Connector No.	B240
Connector Name	WIRE TO WIRE
Connector Type	NS10FW-CS

7	6	5	4	3	2	1		
16	15	14	13	12	11	10	9	8

Terminal No.	Color of Wire	Signal Name [Specification]
1	GR	
2	V	
3	P	
4	Y	
5	BR	
6	SHIELD	
9	BR	
10	Y	
11	P	
12	O	
13	O	
14	B/W	
15	SHIELD	
16	LG	

Connector No.	B243
Connector Name	REAR WOOFER
Connector Type	M02FW-LC

2	1
---	---

Terminal No.	Color of Wire	Signal Name [Specification]
1	P/L	
2	R/L	

BOSE AUDIO WITH NAVIGATION

[BOSE AUDIO WITH NAVIGATION]

< WIRING DIAGRAM >

BOSE AUDIO WITH NAVIGATION

Connector No.	B245
Connector Name	WIRE TO WIRE
Connector Type	MS18MGY-CS

1	2	3	4	5	6	7
8	9	10	11	12	13	14
15	16					



Terminal No.	Color of Wire	Signal Name [Specification]
1	P	-
2	O	-
3	Y	-
8	G	-
9	V	-
10	P	-
11	R/L	-
12	P/L	-
13	L	-
14	Y	-

Connector No.	B503
Connector Name	WIRE TO WIRE
Connector Type	MS12MW-CS



57	56	55	47	46
54	53	58	52	50
49	48			

Terminal No.	Color of Wire	Signal Name [Specification]
46	R	-
47	G	-
48	R/Y	-
49	P	-
50	L	-
52	L/B	- [With Climate controlled seat]
53	R	- [With heated seat]
54	Y/W	- [With Climate controlled seat]
55	LG/R	- [With Climate controlled seat]
56	Y	- [With heated seat]
57	LG/B	- [With Climate controlled seat]
58	G/R	- [With heated seat]

56	V	-
57	B/P	-
58	B	-

Connector No.	B524
Connector Name	DRIVER SEAT SPEAKER RH
Connector Type	TK03FW



Terminal No.	Color of Wire	Signal Name [Specification]
46	R	-
47	G	-
48	R/Y	-

Connector No.	B525
Connector Name	DRIVER SEAT SPEAKER LH
Connector Type	TK03FW



48	47	46
----	----	----

Terminal No.	Color of Wire	Signal Name [Specification]
48	R/Y	-
49	P	-
50	L	-

Connector No.	B551
Connector Name	WIRE TO WIRE
Connector Type	TK10MM-NSS



34	50	49	57	40
56	58	55	54	53
2	52	1		

Terminal No.	Color of Wire	Signal Name [Specification]
1	R	-
2	B	-
35	W/Y	-
40	W/G	-
41	GR	-
46	R	-
47	G	-
48	R/Y	-
49	P	-
50	L	-
52	L/B	-
53	Y/W	- [With Climate controlled seat]
54	R/W	- [With heated seat]
55	B/W	- [With Climate controlled seat]
56	G/R	- [With heated seat]
57	LG/R	- [With heated seat]
58	V	-
59	B/P	-
60	B/W	- [With Climate controlled seat]
61	LG/B	- [With heated seat]

Connector No.	B584
Connector Name	PASSENGER SEAT SPEAKER RH
Connector Type	TK03FW



43	47	46
----	----	----

Terminal No.	Color of Wire	Signal Name [Specification]
46	R	-

47	G	-
48	R/Y	-

Connector No.	B565
Connector Name	PASSENGER SEAT SPEAKER LH
Connector Type	TK03FW



48	50	49
----	----	----

Terminal No.	Color of Wire	Signal Name [Specification]
48	R/Y	-
49	P	-
50	L	-

JCNWA3250GB

A
B
C
D
E
F
G
H
I
J
K
L
M
N
O
P

AV

BOSE AUDIO WITH NAVIGATION

< WIRING DIAGRAM >

[BOSE AUDIO WITH NAVIGATION]

BOSE AUDIO WITH NAVIGATION

Connector No.	D1
Connector Name	WIRE TO WIRE
Connector Type	TH4DFW-CS15

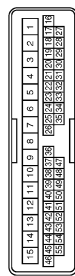
Terminal No.	Color of Wire	Signal Name [Specification]
5	B	
6	L	
7	R	
8	GR	
9	G	
10	LG	
11	P	
12	LG	
13	B/W	
14	Y	
15	O	
16	R	
17	Y	
18	BR	
19	W	
20	O	
21	GR	
22	G	
23	LG	
24	B	
27	V	
28	W	
29	GR	
30	G	
31	Y	
32	O	
33	BR	
34	L	
35	P	
36	V	
37	GR	
38	O	
39	W	
40	R	
41	SHIELD	
42	L	
43	P	
44	V	

45	LG	
46	BR	
47	L	
48	Y	
49	P	
50	B/W	
51	G	
52	Y	
53	B/W	
54	W	
55	W	

Connector No.	D2
Connector Name	TWEETER LH
Connector Type	TK02MBR-P





Terminal No.	Color of Wire	Signal Name [Specification]
1	G	
2	GR	

Connector No.	D4
Connector Name	FRONT DOOR SQUAWKER LH
Connector Type	TK02FBR





Terminal No.	Color of Wire	Signal Name [Specification]
1	G	
2	GR	

Connector No.	D11
Connector Name	FRONT DOOR WOOFER LH
Connector Type	NS02FW-CS

Terminal No.	Color of Wire	Signal Name [Specification]
1	R	
2	L	

Connector No.	D31
Connector Name	WIRE TO WIRE
Connector Type	TH4DFW-CS15



Terminal No.	Color of Wire	Signal Name [Specification]
2	B	
3	B/W	
5	GR	
9	V	
10	R	
11	L	
12	Y	
13	BR	
14	G	
15	S5	
16	G	
17	O	
18	BR	
19	GR	
20	V	
21	LG	
22	SR	
23	G	
24	Y	
25	BR	

26	L	
32	L/O	
33	W/L	
34	SHIELD	
35	W	
36	L	
37	B	
38	SB	
39	O	
44	SB	
45	R	
46	B/W	

Connector No.	D32
Connector Name	TWEETER RH
Connector Type	TK02MBR-P



Terminal No.	Color of Wire	Signal Name [Specification]
1	BR	
2	Y	

Connector No.	D34
Connector Name	FRONT DOOR SQUAWKER RH
Connector Type	TK02FBR



Terminal No.	Color of Wire	Signal Name [Specification]
1	BR	
2	Y	

JCNWA3251GB

BOSE AUDIO WITH NAVIGATION

[BOSE AUDIO WITH NAVIGATION]

< WIRING DIAGRAM >

BOSE AUDIO WITH NAVIGATION

Connector No.	D41
Connector Name	FRONT DOOR WOOFER RH
Connector Type	NS02FW-CS



Terminal No.	Color of Wire	Signal Name [Specification]
1	L	-
2	R	-

Connector No.	D51
Connector Name	WIRE TO WIRE
Connector Type	NH10MW-CS10



1	2	3	4	5	6
9	10	11	12	13	19
7	8	14	15	16	17
					18
					20

Terminal No.	Color of Wire	Signal Name [Specification]
1	BR	-
2	V	-
3	R	-
4	L	-
7	B	-
8	P	-
9	W	-
10	V	-
11	L	-
12	LG	-
13	B	-

Connector No.	D56
Connector Name	REAR DOOR SPEAKER LH
Connector Type	NS02FBR-CS



Terminal No.	Color of Wire	Signal Name [Specification]
1	L	-
2	R	-

Connector No.	D71
Connector Name	WIRE TO WIRE
Connector Type	NH10MW-CS10



1	2	3	4	5	6
9	10	11	12	13	19
7	8	14	15	16	17
					18
					20

Terminal No.	Color of Wire	Signal Name [Specification]
1	BR	-
2	V	-
3	R	-
4	L	-
7	B	-
8	P	-
9	W	-
10	V	-
11	L	-
12	LG	-
13	B	-

Connector No.	D76
Connector Name	REAR DOOR SPEAKER RH
Connector Type	NS02FBR-CS



Terminal No.	Color of Wire	Signal Name [Specification]
1	L	-
2	R	-

Connector No.	E5
Connector Name	POWER INTELLIGENT POWER DISTRIBUTION MODULE (ENGINE ROOM)
Connector Type	TH20FW-CS12-M4-1V



1	2	3	4	5	6
7	8	9	10	11	12
13	14	15	16	17	18
19	20	21	22	23	24
25	26	27	28	29	30

Terminal No.	Color of Wire	Signal Name [Specification]
4	W	-
5	P	-
6	R	-
7	Y	-
8	L	-
10	V	-
11	B	-
12	G	-
13	GR	-
16	V	-
18	Y	-
22	BR	-
23	SB	-
24	O	-
25	LG	-
30	BR	-
31	W	-
32	Y	-
34	P	-
36	GR	-

JCNWA3252GB

A
B
C
D
E
F
G
H
I
J
K
L
M
AV
O
P

BOSE AUDIO WITH NAVIGATION

[BOSE AUDIO WITH NAVIGATION]

< WIRING DIAGRAM >

BOSE AUDIO WITH NAVIGATION

Connector No.	E106
Connector Name	WIRE TO WIRE
Connector Type	TH80FW-CS16-TM4



Terminal No.	Color of Wire	Signal Name [Specification]
1	P	-
2	W	-
3	SB	-
4	LG	-
5	O	-
7	GR	-
8	G	-
9	Y	-
10	BR	-
11	SB	-
12	V	-
13	GR	-
14	GR	-
15	V	-
16	Y	-
17	GR	-
18	V	-
20	BR	-
21	P	-
22	L	-
23	P	-
27	SHIELD	-
28	L/O	-
29	W/L	-
31	BR	-
32	G	-
33	O	-
34	Y	-
40	BR	-
41	BR	-
42	L	-
43	P	-
44	W	-
45	L	-
46	GR	-
47	V	-
48	G	-
49	O	-

50	LG	-
60	W	-
61	G	-
62	Y	-
63	BR	-
64	V	-
65	Y	-
66	R	-
67	SB	-
77	O	-
78	SB	-
80	G	-
81	R	-
82	SB	-
83	GR	-
84	Y	-
85	Y	-
86	L	-
87	V	-
88	BR	-
89	LG	-
90	W	-
91	W	-
92	P	-
93	LG	-
94	BR	-
95	W	-
96	R	-
97	R	-
98	Y	-
99	V	-
100	V	-

Connector No.	E107
Connector Name	PARKING BRAKE SWITCH
Connector Type	TB01FW-LC



Terminal No.	Color of Wire	Signal Name [Specification]
1	V	-

Connector No.	F61
Connector Name	A/T ASSEMBLY
Connector Type	RK10FG-DGY

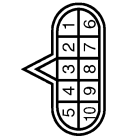

Terminal No.	Color of Wire	Signal Name [Specification]
1	Y	-
2	R	-
3	L	-
4	V	-
5	B	-
6	G	-
7	SB	-
8	P	-
9	LG	-
10	B	-

Connector No.	F103
Connector Name	WIRE TO WIRE
Connector Type	TK36FW-NS10

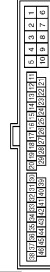

Terminal No.	Color of Wire	Signal Name [Specification]
2	L	-
3	G	-
4	B	- [With VK engine]
4	R	- [With VQ engine]
5	GR	- [With VK engine]
5	B	- [With VQ engine]
7	LG	-
8	Y	-
9	W	- [With VK engine]
9	SB	- [With VQ engine]
10	BR	- [With VK engine]
10	V	- [With VQ engine]

11	L	-
12	P	-
13	V	-
14	SB	-
15	W	-
16	R	-
17	GR	-
18	LG	-
21	LG	-
22	B	-
23	G	-
24	BR	-
25	O	-

Connector No.	F301
Connector Name	TGM (TRANSMISSION CONTROL MODULE)
Connector Type	SPT0FG

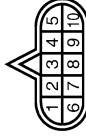

Terminal No.	Color of Wire	Signal Name [Specification]
1	W	VGN
2	B	BATT
3	R	CAN-H
4	O	K LINE
5	G	GND
6	GR	VGN
7	L	REV LAMP RLY
8	BR	CAN-L
9	Y	START RLY
10	W/B	GND

JCNWA3253GB

BOSE AUDIO WITH NAVIGATION

< WIRING DIAGRAM >

[BOSE AUDIO WITH NAVIGATION]

BOSE AUDIO WITH NAVIGATION

Connector No.	M1
Connector Name	FUSE BLOCK (U/B)
Connector Type	NS08FW-MZ



Terminal No.	Color of Wire	Signal Name [Specification]
1A	R	-
2A	W	-
3A	Y	-
4A	W	-
5A	V	-
6A	Y	-
8A	Y	-

Connector No.	M3
Connector Name	FUSE BLOCK (U/B)
Connector Type	NS12FW-CS



Terminal No.	Color of Wire	Signal Name [Specification]
6C	R	-
7C	B	-
8C	L	-
9C	LG	-
10C	LG	-
11C	LG	-
12C	BG	-

Connector No.	M5
Connector Name	WIRE TO WIRE
Connector Type	A09FW



Terminal No.	Color of Wire	Signal Name [Specification]
1	G	-
2	R	-
3	SHIELD	-

Connector No.	M6
Connector Name	WIRE TO WIRE
Connector Type	TH80MW-CS16-TM4

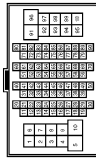

Terminal No.	Color of Wire	Signal Name [Specification]
1	W	-
2	W	-
3	SB	-
4	LG	-
5	W	-
7	BG	-
8	G	-
9	Y	-
10	W	-
11	R	-
12	V	-
13	LG	-
14	L	-
15	V	-
16	B	-
17	GR	-
18	V	-
20	SB	-
21	BR	-

22	L	-
23	P	-
27	SHIELD	-
28	V	-
29	SB	-
31	BG	-
32	P	-
33	R	-
34	EG	-
40	BR	-
41	BR	-
42	L	-
43	P	-
44	BR	-
45	Y	-
46	BG	-
47	V	-
48	G	-
49	BG	-
50	W	-
60	GR	-
61	B	-
62	LG	-
63	BR	-
64	L	-
65	R	-
66	P	-
69	L	-
77	B	-
78	V	-
80	G	-
81	L	-
82	B	-
83	BG	-
84	SB	-
85	Y	-
86	L	-
87	V	-
88	V	-
89	LG	-
90	BG	-
91	W	-
92	BG	-
93	G	-
94	Y	-
95	W	-
96	R	-
97	SB	-
98	R	-
99	W	-
100	L	-

A
B
C
D
E
F
G
H
I
J
K
L
M
AV
O
P

BOSE AUDIO WITH NAVIGATION

[BOSE AUDIO WITH NAVIGATION]

< WIRING DIAGRAM >

BOSE AUDIO WITH NAVIGATION

Connector No.	M7
Connector Name	WIRE TO WIRE
Connector Type	TH80MW-CS16-TM4



Terminal No.	Color of Wire	Signal Name [Specification]
1	G	-
2	Y	-
4	BR	-
5	P	-
6	W	-
7	G	-
8	Y	-
9	G	-
10	V	-
11	V	- [With Climate controlled seat]
12	P	- [With heated seat]
13	GR	- [With Climate controlled seat]
14	BR	- [With heated seat]
15	GR	-
16	V	-
17	BG	- [With ICC]
18	L	- [Without ICC]
19	W	-
20	R	-
21	B	-
22	LG	-
23	W	-
24	V	-
25	G	-
26	BR	-
27	SB	-
28	P	-
29	L	-
30	SHIELD	-
32	L	-
33	P	-
34	L	-
35	P	-
36	BG	-
37	SB	-

40	SHIELD	-
41	SR	-
42	V	-
45	W	-
47	L	-
48	LG	-
49	BR	-
50	V	-
51	V	-
52	P	-
53	BG	-
56	SB	-
57	P	-
58	LG	-
59	Y	-
60	GR	-
61	B	-
62	LG	-
63	BR	-
65	W	-
66	R	-
67	V	-
68	LG	-
69	SB	-
70	V	-
72	L	-
73	P	-
74	L	-
75	P	-
76	P	-
77	Y	-
78	SB	-
79	W	-
81	LG	-
82	BR	-
83	BG	-
84	B	-
85	W	-
86	G	-
87	R	-
88	G	-
91	W	-
92	G	-
96	W	-
97	BG	-
98	Y	-
99	LG	-

Connector No.	M20
Connector Name	POB HARNESS
Connector Type	TH40FB-NH

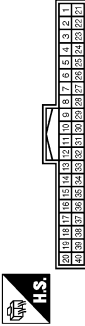

Terminal No.	Color of Wire	Signal Name [Specification]
1	B	-
11	BR	-
12	R	-
14	L	-
15	B	-
17	R	-
19	W	-
20	R	-
21	B	-
22	R	-
23	L	-
24	L	-
27	P	-
30	SHIELD	-
31	V	-
33	V	-
35	L	-
36	P	-
38	L	-
40	Y	-

Connector No.	M21
Connector Name	POB HARNESS
Connector Type	TH40FW-NH

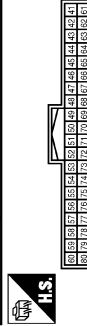

Terminal No.	Color of Wire	Signal Name [Specification]
41	LG	-
42	SHIELD	-

43	Y	- [With BOSE system]
43	V	- [Without BOSE system]
44	BR	- [With BOSE system]
44	P	- [Without BOSE system]
45	SHIELD	-
46	SB	- [With BOSE system]
46	G	- [Without BOSE system]
47	V	- [With BOSE system]
47	GR	- [Without BOSE system]
48	SHIELD	-
49	R	-
50	G	- [With BOSE system]
50	BR	- [Without BOSE system]
51	SHIELD	-
52	P	- [With BOSE system]
52	L	- [Without BOSE system]
53	L	- [With BOSE system]
53	G	- [Without BOSE system]
54	Y	-
55	BR	-
56	G	-
57	R	-
61	SB	-
62	SB	-
63	LG	-
64	B	-
65	L	-
66	R	-
68	R	-
69	V	-

JCNWA3255GB

BOSE AUDIO WITH NAVIGATION

[BOSE AUDIO WITH NAVIGATION]

< WIRING DIAGRAM >

BOSE AUDIO WITH NAVIGATION

Connector No.	M22
Connector Name	POB HARNESS
Connector Type	TH40FB-NH



Connector No.	M23
Connector Name	POB HARNESS
Connector Type	TH40FW-NH



Connector No.	M24
Connector Name	POB HARNESS
Connector Type	TH40FW-NH



Connector No.	M25
Connector Name	POB HARNESS
Connector Type	TH40FB-NH

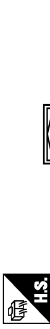

Terminal No.	Color of Wire	Signal Name [Specification]
81	L	-
82	P	-
83	B	-
84	B	-
85	B	-
86	B	-
87	B	-
88	B	-
89	Y	-
91	V	-
92	V	-
93	B	-
94	B	-
95	LG	-
96	BR	-
97	G	-
98	G	-
99	G	-
100	G	-
101	L	-
102	P	-
103	B	-
104	BR	-
105	R	-
107	Y	-
108	Y	-
109	BR	-
110	Y	-
112	B	-
113	P	-
114	L	-
116	B	-
117	B	-
117	BG	- [With VK engine] - [With YG engine]
118	B	-
119	G	-
120	V	-

Terminal No.	Color of Wire	Signal Name [Specification]
121	R	-
122	V	-
123	BG	-
124	BG	-
128	BR	-
130	B	-
131	SB	-
132	LG	-
133	L	-
135	P	-
137	Y	-
138	L	-
139	P	-
140	L	-
141	W	-
142	W	-
144	P	-
145	R	-
146	LG	-
147	B	-
148	L	-
149	B	-
150	P	-
151	L	-
152	B	-
153	W	-
154	W	-
155	W	-
157	W	-
158	R	-
159	R	-

Terminal No.	Color of Wire	Signal Name [Specification]
161	BG	-
162	BG	-
163	G	-
164	V	-
165	V	-
166	R	-
167	LG	-
168	R	-
169	R	-
170	B	-
172	B	-
174	W	-
175	B	-
176	L	-
177	P	-
178	Y	-
179	L	-
180	LG	-
182	BR	-
183	G	-
184	V	-
185	P	-
185	V	-
186	R	-
187	L	-
188	Y	-
189	B	-
190	V	-
191	G	-
192	B	-
193	SB	-
194	BR	-
198	R	-
199	B	-
200	SB	-

Terminal No.	Color of Wire	Signal Name [Specification]
201	L	-
209	G	-
209	L	- [With BOSE system] - [Without BOSE system]
210	P	- [With BOSE system] - [Without BOSE system]
210	L	- [Without BOSE system]
211	SHIELD	-
212	G	- [With BOSE system] - [Without BOSE system]
213	R	- [Without BOSE system]
214	SHIELD	-
215	V	- [With BOSE system] - [Without BOSE system]
216	CR	- [With BOSE system] - [Without BOSE system]
218	LG	- [With BOSE system] - [Without BOSE system]
218	G	-
217	SHIELD	-
218	BR	- [With BOSE system] - [Without BOSE system]
219	GR	- [With BOSE system] - [Without BOSE system]
219	V	- [Without BOSE system]
220	SHIELD	-
221	P	-
222	LG	-
223	SB	-
224	SB	-
225	LG	-
226	R	-
230	BR	-
231	SB	-
232	V	-
233	L	-
234	P	-
235	B	-
239	V	-
240	W	-

JCNWA3256GB

A
B
C
D
E
F
G
H
I
J
K
L
M
N
O
P

AV

BOSE AUDIO WITH NAVIGATION

[BOSE AUDIO WITH NAVIGATION]

< WIRING DIAGRAM >

BOSE AUDIO WITH NAVIGATION

Connector No.	M26
Connector Name	POB HARNESS
Connector Type	TH40FW-NH



Terminal No.	Color of Wire	Signal Name [Specification]
241	L	-
243	R	-
244	L	-
245	B	-
246	B	-
247	LG	- [With Climate controlled seat] - [With heated seat]
249	SHIELD	-
250	SHIELD	-
253	P	- [With Climate controlled seat]
253	B	- [With heated seat]
254	W	- [With Climate controlled seat]
254	B	- [With heated seat]
255	B	-
256	SHIELD	-
257	SHIELD	-
258	R	-
259	L	-
260	BG	-
261	P	-
269	GR	-
270	Y	-
271	BR	-
272	G	-
273	R	-
274	R	-
275	Y	-
276	B	-
277	G	-
278	R	-
279	SB	- [With Climate controlled seat]
279	R	- [With heated seat]
280	Y	-

Connector No.	M27
Connector Name	POB HARNESS
Connector Type	TH40FB-NH



Terminal No.	Color of Wire	Signal Name [Specification]
282	BG	-
283	BG	-
284	LG	-
285	W	-
287	Y	-
288	W	-
290	B	-
292	B	-
293	B	-
294	B	-
295	B	-
299	V	-
301	R	-
302	R	-
305	R	-
319	V	-
320	W	-

Connector No.	M28
Connector Name	POB HARNESS
Connector Type	TH40FW-NH



Terminal No.	Color of Wire	Signal Name [Specification]
321	V	-
322	V	-
324	B	-
325	L	-
326	L	-

327	P	-
328	P	-
330	B	-
331	V	-
332	V	-
335	B	-
337	W	-
338	W	-
343	L	-
344	B	-
345	Y	-
347	L	-
348	GR	-
349	V	-
350	LG	-
351	P	-
352	R	-
353	P	-
358	W	-
359	W	-
360	G	-

Connector No.	M29
Connector Name	POB HARNESS
Connector Type	TH40FB-NH



Terminal No.	Color of Wire	Signal Name [Specification]
361	W	-
362	W	-
363	Y	-
365	B	-
367	B	-
368	G	-
373	BR	-
374	BG	-
375	BG	-
376	V	-
377	V	-
378	B	-
379	R	-
380	R	-

381	G	-
382	V	-
383	GR	-
384	GR	-
385	P	-
386	L	-
389	R	-
397	R	-
398	L	-
400	V	-

Connector No.	M30
Connector Name	POB HARNESS
Connector Type	TH40FW-NH



Terminal No.	Color of Wire	Signal Name [Specification]
402	R	-
403	R	-
407	V	-
408	B	-
409	B	-
410	B	-
411	B	-
413	Y	-
414	BR	-
416	LG	-
417	B	-
419	SB	-
420	SHIELD	-
422	V	-
427	P	-
428	Y	-
429	P	-
430	LG	-
431	B	-
432	Y	-
435	V	-
436	BG	-
437	B	-
438	P	-
439	L	-

BOSE AUDIO WITH NAVIGATION

[BOSE AUDIO WITH NAVIGATION]

< WIRING DIAGRAM >

BOSE AUDIO WITH NAVIGATION

Connector No.	M36
Connector Name	COMBINATION SWITCH (SPIRAL CABLE)
Connector Type	TK6BFGY-IV



Terminal No.	Color of Wire	Signal Name [Specification]
24	P	-
25	SB	-
26	B	-
31	L	-
32	Y	-
33	B	-
34	LG	-

Connector No.	M37
Connector Name	STEERING ANGLE SENSOR
Connector Type	TH8BFW-NH



Terminal No.	Color of Wire	Signal Name [Specification]
1	L	CAN-H
2	P	CAN-L
7	B	GND
8	G	IGN

Connector No.	M53
Connector Name	COMBINATION METER
Connector Type	TH40FW-NH

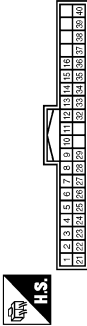

Terminal No.	Color of Wire	Signal Name [Specification]
1	W	BATTERY POWER SUPPLY
2	BG	IGNITION SIGNAL
3	GR	VEHICLE SPEED SIGNAL (2-PULSE)
4	R	VEHICLE SPEED SIGNAL (8-PULSE)
5	B	ILLUMINATION CONTROL SIGNAL
6	B	METER CONTROL SWITCH GROUND
7	SB	ENTER SWITCH SIGNAL
8	LG	SELECT SWITCH SIGNAL
9	G	ILLUMINATION CONTROL SWITCH SIGNAL (+)
10	GR	ILLUMINATION CONTROL SWITCH SIGNAL (-)
11	L	TRIP RESET SWITCH SIGNAL
12	B	GROUND
14	L	CAN-H
15	P	CAN-L
16	R	AIR BAG SIGNAL
23	B	GROUND
24	B	FUEL LEVEL SENSOR GROUND
25	W	ALTERNATOR SIGNAL
26	V	PARKING BRAKE SWITCH SIGNAL
27	V	BRAKE FLUID LEVEL SWITCH SIGNAL
28	G	SECURITY SIGNAL
29	L	WASHER LEVEL SWITCH SIGNAL
32	G	PADDLE SHIFTER SHIFT DOWN SIGNAL
33	BG	PADDLE SHIFTER SHIFT UP SIGNAL
34	G	FUEL LEVEL SENSOR SIGNAL
35	W	SEAT BELT BUCKLE SWITCH SIGNAL (DRIVER SIDE)
36	G	PASSENGER SEAT BELT WARNING SIGNAL
37	G	NON-MANUAL MODE SIGNAL
38	V	MANUAL MODE SHIFT DOWN SIGNAL
39	L	MANUAL MODE SHIFT UP SIGNAL
40	W	MANUAL MODE SIGNAL

Connector No.	M63
Connector Name	CENTER SPEAKER
Connector Type	TK20FBR



Terminal No.	Color of Wire	Signal Name [Specification]
1	V	-
2	P	-

Connector No.	M69
Connector Name	BACK-UP LAMP RELAY
Connector Type	MS32FL-M2-LC



Terminal No.	Color of Wire	Signal Name [Specification]
1	LG	-
2	R	-
3	BR	-
5	BG	-

Connector No.	M72
Connector Name	MULTIFUNCTION SWITCH
Connector Type	TH16FW-NH

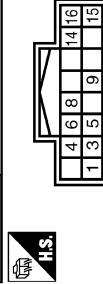

Terminal No.	Color of Wire	Signal Name [Specification]
--------------	---------------	-----------------------------

1	B	GND
3	V	ACC
4	P	ILL
5	B	ILL CONT
6	SB	AV COM1 (R)
8	LG	AV COM1 (L)
9	BR	SW GND
14	SB	DISK EJECT SIGNAL
15	R	AIR BAG CUT OFF
16	G	HAZARD ON

A
B
C
D
E
F
G
H
I
J
K
L
M
N
O
P

AV

BOSE AUDIO WITH NAVIGATION

[BOSE AUDIO WITH NAVIGATION]

< WIRING DIAGRAM >

BOSE AUDIO WITH NAVIGATION

Connector No.	M77
Connector Name	WIRE TO WIRE
Connector Type	TH10MW-NH

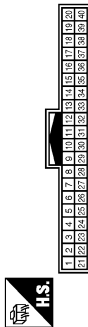

Terminal No.	Color of Wire	Signal Name [Specification]
9	LG	-
10	SB	-
11	LG	-
12	SB	-
13	B	-
14	P	- [With BOSE system] - [Without BOSE system]
15	LG	-
16	L	-
17	G	-
18	R	-
19	V	-
20	V	-
21	B	-
22	B	-
23	B	-
29	SHIELD	-
30	Y	- [With BOSE system] - [Without BOSE system]
31	BR	- [With BOSE system] - [Without BOSE system]
32	SHIELD	- [With BOSE system] - [Without BOSE system]
33	G	- [With BOSE system] - [Without BOSE system]
34	V	- [With BOSE system] - [Without BOSE system]
35	SHIELD	- [With BOSE system] - [Without BOSE system]
36	R	-
37	G	- [With BOSE system] - [Without BOSE system]
38	SHIELD	-
39	P	- [With BOSE system] - [Without BOSE system]
40	L	- [With BOSE system] - [Without BOSE system]
40	G	- [Without BOSE system]

Connector No.	M80
Connector Name	USB CONNECTOR
Connector Type	HXA0MEG



Terminal No.	Color of Wire	Signal Name [Specification]
1	W	-
2	L	-
3	G	-
4	R	-
5	SHIELD	-

Connector No.	M100
Connector Name	WIRE TO WIRE
Connector Type	TH12FW-NH

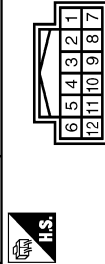

Terminal No.	Color of Wire	Signal Name [Specification]
1	SB	-
2	V	-
3	SHIELD	-
4	G	-
5	R	-
6	SHIELD	-
10	L	-
11	P	-
12	SHIELD	-

Connector No.	M105
Connector Name	WIRE TO WIRE
Connector Type	TH40FW-NH

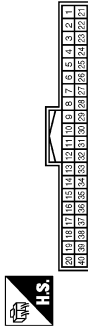

Terminal No.	Color of Wire	Signal Name [Specification]
2	R	-
3	B	-
5	LG	-
6	P	-
7	L	-
8	P	-
9	B	-
10	W	-
11	W	-
12	SB	-
14	SB	-
15	BR	-
16	V	-
18	G	-
19	B	-
20	V	-
22	BQ	-
23	B	-
25	W	-
30	R	-
31	BR	-
32	L	-
33	P	-
34	LG	-
35	W	-
36	LG	-
37	L	-
38	R	-

Connector No.	M107
Connector Name	ECM
Connector Type	RH2MEGY-R28-R-RH-Z

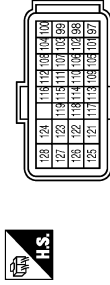

Terminal No.	Color of Wire	Signal Name [Specification]
97	R	AFS1
98	Y	AFS2
99	G	AVGC1-APSI
100	W	GND1-APSI
101	SB	ASCD SW
102	P	FTPRES
103	L	AVGC2-APSI
104	BR	GND-APSI [With ICC]
104	B	GND-APSI [Without ICC]
105	LG	PDPRES
106	P	TF
107	BG	AVGC2 PDPRES / FTPRES
108	Y	GND / ASCD SW
109	BR	NEUT-H
110	V	TAGND
112	V	GND1 PDPRES / FTPRES
113	P	VEHCAN-L1
114	L	VEHCAN-H1
117	V	K-LINE
121	G	GDCV
122	P	BRAKE
123	B	GND
124	B	GND
125	SB	VBR
126	BR	BNG SW
127	B	GND
128	B	GND

BOSE AUDIO WITH NAVIGATION

< WIRING DIAGRAM >

[BOSE AUDIO WITH NAVIGATION]

BOSE AUDIO WITH NAVIGATION

Connector No.	M110
Connector Name	WIRE TO WIRE
Connector Type	TH34MW-NH



Terminal No.	Color of Wire	Signal Name [Specification]
1	G	-
2	Y	-
3	W	-
4	R	-
7	BR	-
8	R	-
9	B	-
13	L	-
14	B	-
15	LG	-
16	Y	-
17	W	-
18	R	-
19	B	-
20	V	-
21	R	-
22	G	-
23	L	-
24	LG	-

Connector No.	M115
Connector Name	WIRE TO WIRE
Connector Type	TK38MW-NS1.0

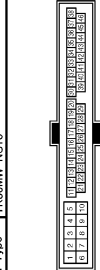

Terminal No.	Color of Wire	Signal Name [Specification]
2	SB	-
3	Y	-
4	B	- [With VK engine]

Terminal No.	Color of Wire	Signal Name [Specification]
4	SB	- [With VG engine]
5	B	-
7	W	-
8	Y	-
9	W	-
10	SB	- [With VK engine]
10	SB	- [With VG engine]
11	L	-
12	P	-
13	V	-
14	R	-
15	Y	-
16	SB	-
17	BR	-
18	LG	-
21	LG	-
22	B	-
23	W	-
24	W	-
25	BG	-

Connector No.	M120
Connector Name	BCM (BODY CONTROL MODULE)
Connector Type	TH40TB-NH

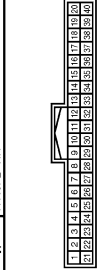

Terminal No.	Color of Wire	Signal Name [Specification]
1	G	RR WINDOW DEFEG RLY CONT
2	BG	COMBI SW INPUT 5
3	SB	COMBI SW INPUT 4
4	L	COMBI SW INPUT 3
5	G	COMBI SW INPUT 2
6	P	COMBI SW INPUT 1
8	V	POWER WINDOW SW COMM
9	P	STOP LAMP SW 1
11	R	RAIN SENSOR SERIAL LINK
14	W	OPTICAL SENSOR
16	SB	DIMMER SIGNAL
17	Y	SENSOR PWR SPLY
18	B	RECEIVER / SENSOR GND
19	R	RECEIVER PWR SPLY
20	BR	KYLS ENT RECEIVER COMM
21	P	NAVS ANT AMP

Terminal No.	Color of Wire	Signal Name [Specification]
22	GR	KYLS ENT RECEIVER RSSI
23	G	SECURITY INFO CONT
24	L	DRNGLE LINK
25	G	NAVS ANT AMP
26	GR	F-KEY IDENTIFICATION
29	G	HAZARD SW
30	EG	TR LID OPNR SW
31	W	DR DOOR UNLOCK SENSOR
32	BR	COMBI SW OUTPUT 5
33	R	COMBI SW OUTPUT 4
34	V	COMBI SW OUTPUT 3
35	Y	COMBI SW OUTPUT 2
36	LG	COMBI SW OUTPUT 1
37	R	P POSITION
39	L	CAN-H
40	P	CAN-L

Connector No.	M122
Connector Name	BCM (BODY CONTROL MODULE)
Connector Type	FEA09FW-FHA6-SA

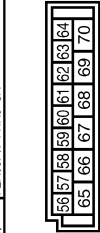

Terminal No.	Color of Wire	Signal Name [Specification]
56	R	INT ROOM LAMP PWR SPLY
57	R	BAT (FUSE)
58	L	AIR BAG
59	G	PASS DOOR UNLK OUTPUT
60	G	TURN SIG LH OUTPUT
61	V	TURN SIG RH OUTPUT
62	V	STEP LAMP CONT
63	L	ROOM LAMP TIMER CONT
65	V	ALL DOOR FL LID LOCK OUTPUT
66	LG	DR DOOR FL LID UNLK OUTPUT
67	B	GND
68	BG	PW PWR SPLY (IGN)
69	Y	PW PWR SPLY (BAT)
70	W	BAT (F/L)

A
B
C
D
E
F
G
H
I
J
K
L
M
AV
O
P

BOSE AUDIO WITH NAVIGATION

< WIRING DIAGRAM >

[BOSE AUDIO WITH NAVIGATION]

BOSE AUDIO WITH NAVIGATION

Connector No.	M160
Connector Name	ECM
Connector Type	MSB55FE-MEB10-LH

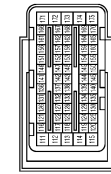

Terminal No.	Color of Wire	Signal Name [Specification]
111	W	FUEL INJECTOR DRIVER POWER SUPPLY
112	W	VINJZA
114	B	ECM GROUND
115	B	ECM GROUND
120	G	EVAP CANISTER VENT CONTROL VALVE [WITH ACTUATOR RELAY, ABS/ESP SIGNAL LEVEL CONTROLS, INJECTOR]
122	V	THROTTLE CONTROL MOTOR RELAY
123	BG	THROTTLE CONTROL MOTOR RELAY (FPOM)
125	P	FUEL PUMP CONTROL MODULE (FPOM)
126	Y	ACCELERATOR PEDAL POSITION SENSOR Z
128	SB	ASC/D STEERING SWITCH
128	SB	IGCC STEERING SWITCH
128	SB	SENSOR GROUND (WITH ICC)
128	BR	SENSOR GROUND (WITHOUT ICC)
129	B	SENSOR GROUND
130	Y	SENSOR GROUND
131	L	SENSOR POWER SUPPLY
133	BG	SENSOR POWER SUPPLY
134	P	FUEL TEMPERATURE SENSOR
136	R	ACCELERATOR PEDAL POSITION SENSOR 1
137	G	SENSOR POWER SUPPLY
138	P	BATTERY CURRENT SENSOR
139	BG	BATTERY TEMPERATURE SENSOR
140	W	SENSOR GROUND
141	G	IGNITION SWITCH
142	GR	FUEL PUMP CONTROL MODULE (FPOM) CHECK
143	P	FUEL TANK PRESSURE SENSOR
144	LG	REFRIGERANT PRESSURE SENSOR
146	L	CAN COMMUNICATION LINE
147	BR	ASC/D BRAKE SWITCH [WITHOUT ICC]
147	BR	ICC BRAKE SWITCH [WITH ICC]
150	V	SENSOR GROUND
151	P	CAN COMMUNICATION LINE
156	W	POWER SUPPLY FOR ECM (BACK-UP)
158	P	STOP LAMP SWITCH
161	Y	ECM COMMUNICATION LINE
163	W	ECM RELAY (SELF SHUT-OFF)
166	BG	ECM COMMUNICATION LINE
169	V	ENGINE SPEED SIGNAL OUTPUT
171	SB	POWER SUPPLY FOR ECM

172	SB	POWER SUPPLY FOR ECM
173	R	THROTTLE CONTROL MOTOR POWER SUPPLY
174	B	ECM GROUND
175	B	ECM GROUND

Connector No.	M181
Connector Name	WIRE TO WIRE
Connector Type	TH4JMW-NH



Terminal No.	Color of Wire	Signal Name [Specification]
2	R	
3	B	
5	R	
6	BR	
7	L	
8	P	
8	B	
10	W	
11	LG	
12	SB	
14	SB	
15	BR	
16	V	
18	G	
19	B	
20	V	
22	BG	
23	B	
25	W	
30	R	
31	BR	
32	L	
33	P	
34	LG	
35	W	
36	LG	
37	L	
38	R	

Connector No.	M182
Connector Name	DATA LINK CONNECTOR
Connector Type	BD16FW



Terminal No.	Color of Wire	Signal Name [Specification]
3	LG	
4	B	
5	B	
6	L	
7	V	
8	LG	
11	SB	
12	P	
13	L	
14	P	
16	W	

Connector No.	M200
Connector Name	WIRE TO WIRE
Connector Type	TH16FW-NH

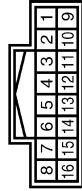

Terminal No.	Color of Wire	Signal Name [Specification]
1	P	
2	SHIELD	
3	L	
4	SHIELD	
5	G	
6	R	
7	B	
8	W	
9	SHIELD	
10	R	
10	W	

11	B	
12	W	
13	SHIELD	
14	Y	
15	O	
16	BR	

Connector No.	M206
Connector Name	WIRE TO WIRE
Connector Type	NSD8MW-CS

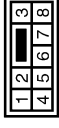

Terminal No.	Color of Wire	Signal Name [Specification]
1	Y	
2	BG	
4	SB	
5	B	
6	G	
7	R	
8	SHIELD	

Connector No.	M207
Connector Name	WIRE TO WIRE
Connector Type	NSD8FW-CS



Terminal No.	Color of Wire	Signal Name [Specification]
1	Y	
2	BG	
4	SB	
5	B	
6	G	
7	R	
8	SHIELD	

BOSE AUDIO WITH NAVIGATION

[BOSE AUDIO WITH NAVIGATION]

< WIRING DIAGRAM >

BOSE AUDIO WITH NAVIGATION

Connector No.	M208
Connector Name	AV CONTROL UNIT
Connector Type	TH18FW-GS2



Terminal No.	Color of Wire	Signal Name [Specification]
2	L	SOUND SIGNAL FRONT LH (+)
3	P	SOUND SIGNAL FRONT LH (-)
4	V	SOUND SIGNAL FRONT LH (+)
5	LG	SOUND SIGNAL REAR LH (-)
6	P	STRG SW A
7	V	ACC
10	SHIELD	SHIELD
11	G	SOUND SIGNAL FRONT RH (+)
12	BR	SOUND SIGNAL FRONT RH (-)
13	GR	SOUND SIGNAL REAR RH (+)
14	GR	SOUND SIGNAL REAR RH (-)
15	B	STRG SW GND
16	L	STRG SW B
18	Y	BATTERY
20	B	GND

Connector No.	M209
Connector Name	AV CONTROL UNIT
Connector Type	TH00PV-NH

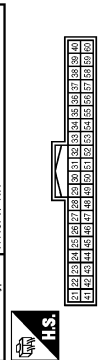

Terminal No.	Color of Wire	Signal Name [Specification]
22	W	CAMERA POWER SUPPLY
28	SB	DISK EJECT SIGNAL
42	B	CAMERA GND
48	BR	SW GND

Connector No.	M210
Connector Name	AV CONTROL UNIT
Connector Type	TH22FW-NH

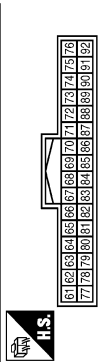

Terminal No.	Color of Wire	Signal Name [Specification]
65	V	PARKING BRAKE SIGNAL
67	R	COMPOSITE IMAGE SIGNAL GND
68	W	COMPOSITE IMAGE SIGNAL
69	G	I-KEY LINK OUTPUT
71	SHIELD	MICROPHONE SHIELD
72	G	MICROPHONE VCC
73	BR	COMM (CONT->DISP)
74	P	CAN-L
75	LG	AV COMM (L)
76	LG	AV COMM (L)
79	SB	DIMMER SIGNAL
80	W	IGNITION SIGNAL
81	EG	REVERSE SIGNAL
82	R	VEHICLE SPEED SIGNAL (PULSE)
83	SHIELD	SHIELD
84	B	COMPOSITE IMAGE SYNC SIGNAL
87	R	MICROPHONE SIGNAL
88	SHIELD	SHIELD
89	Y	COMM (DISP->CONT)
90	L	CAN-H
91	SB	AV COMM (H)
92	SB	AV COMM (H)

Connector No.	M212
Connector Name	AV CONTROL UNIT
Connector Type	HA04FL

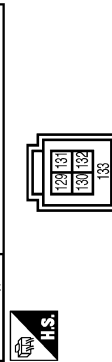

Terminal No.	Color of Wire	Signal Name [Specification]

129	G	USB GND
130	W	V BUS SIGNAL
131	R	USB D- SIGNAL
132	L	USB D+ SIGNAL
133	SHIELD	SHIELD

Connector No.	M213
Connector Name	AV CONTROL UNIT
Connector Type	TH16FW-NH

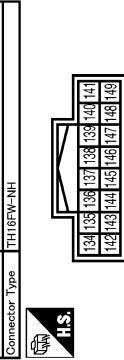

Terminal No.	Color of Wire	Signal Name [Specification]
135	G	VOICE GUIDANCE SIGNAL (+)
136	R	VOICE GUIDANCE SIGNAL (-)
137	SB	SOUND SIGNAL WOOFER +
138	L	SOUND SIGNAL CENTER SPEAKER+
139	B	SHIELD
144	SHIELD	SHIELD
145	V	SOUND SIGNAL WOOFER-
146	P	SOUND SIGNAL CENTER SPEAKER-

Connector No.	M215
Connector Name	DISPLAY UNIT
Connector Type	TH24FW-NH

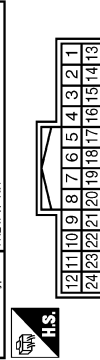

Terminal No.	Color of Wire	Signal Name [Specification]
6	SHIELD	SHIELD
7	SHIELD	SHIELD
8	R	CAMERA IMAGE SIGNAL
9	V	COMM (DISP->CONT)
10	BR	COMM (CONT->DISP)
11	Y	BATTERY
12	B	GND

18	W	COMPOSITE IMAGE SIGNAL
19	R	COMPOSITE IMAGE GND
20	B	COMPOSITE IMAGE SYNC SIGNAL
22	SHIELD	SHIELD
23	V	ACC

Connector No.	M303
Connector Name	COMBINATION SWITCH (SPIRAL CABLE)
Connector Type	TK08FY

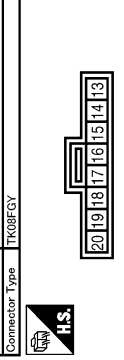

Terminal No.	Color of Wire	Signal Name [Specification]
13	-	-
14	-	-
15	-	-
16	-	-
17	-	-
18	-	-
19	-	-
20	-	-

Connector No.	M394
Connector Name	AV CONTROL UNIT
Connector Type	GT13SH-2/1S-HU

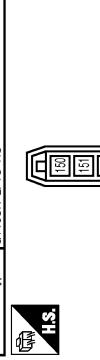

Terminal No.	Color of Wire	Signal Name [Specification]
150	-	ANTENNA AMP ON SIGNAL
151	-	AM-FM MAIN
152	-	FM SUB

JCNWA3262GB

A
B
C
D
E
F
G
H
I
J
K
L
M
N
O
P

AV

BOSE AUDIO WITH NAVIGATION

[BOSE AUDIO WITH NAVIGATION]

< WIRING DIAGRAM >

BOSE AUDIO WITH NAVIGATION

Connector No.	M395
Connector Name	AV CONTROL UNIT
Connector Type	GT15-1S-HU



Terminal No.	Color of Wire	Signal Name [Specification]
153	-	GPS ANTENNA
154	-	SHIELD

Connector No.	M396
Connector Name	AV CONTROL UNIT
Connector Type	GT17HNZ-4DS-HU



Terminal No.	Color of Wire	Signal Name [Specification]
157	-	RGB DIGITAL IMAGE SIGNAL (+)
158	-	RGB DIGITAL IMAGE SIGNAL (-)

Connector No.	M397
Connector Name	DISPLAY UNIT
Connector Type	GT17HNZ-4DS-HU



Terminal No.	Color of Wire	Signal Name [Specification]
27	-	RGB DIGITAL IMAGE SIGNAL (+)
28	-	RGB DIGITAL IMAGE SIGNAL (-)

Connector No.	M400
Connector Name	WIRE TO WIRE
Connector Type	GT13SC-2/1S-HU

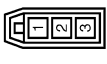

Terminal No.	Color of Wire	Signal Name [Specification]
1	-	-
2	-	-
3	-	-

Connector No.	M401
Connector Name	WIRE TO WIRE
Connector Type	GT13SQN-2/1PP-HU

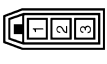

Terminal No.	Color of Wire	Signal Name [Specification]
1	-	-
2	-	-
3	-	-

Connector No.	M404
Connector Name	ANTENNA-AMP.
Connector Type	GT13SC-1/1S-HU



Terminal No.	Color of Wire	Signal Name [Specification]
1	-	-
2	-	-

1	-	AM-FM MAIN
2	-	ANTENNA AMP. ON SIGNAL

Connector No.	M406
Connector Name	WINDOW ANTENNA (MAIN)
Connector Type	PO1FB-A



Terminal No.	Color of Wire	Signal Name [Specification]
1	-	-

Connector No.	M407
Connector Name	WINDOW ANTENNA (SUB)
Connector Type	PO1FB-A



Terminal No.	Color of Wire	Signal Name [Specification]
1	-	-

Connector No.	M414
Connector Name	AV CONTROL UNIT
Connector Type	FAKPA



Terminal No.	Color of Wire	Signal Name [Specification]
1	-	-
2	-	-

159	-	SATELLITE RADIO ANTENNA
160	-	SHIELD

Connector No.	M415
Connector Name	WIRE TO WIRE
Connector Type	GT16C-1S-HU



Terminal No.	Color of Wire	Signal Name [Specification]
1	-	-
2	-	SHIELD

Connector No.	M416
Connector Name	WIRE TO WIRE
Connector Type	GT16C-1PP-HU



Terminal No.	Color of Wire	Signal Name [Specification]
1	-	-
2	-	SHIELD

JCNWA3263GB

BOSE AUDIO WITH NAVIGATION

< WIRING DIAGRAM >

[BOSE AUDIO WITH NAVIGATION]

BOSE AUDIO WITH NAVIGATION

Connector No.	M417
Connector Name	WIRE TO WIRE
Connector Type	GT18C-1S-HU



Terminal No.	Color of Wire	Signal Name [Specification]
1	SHIELD	
2	SHIELD	

Connector No.	M418
Connector Name	WIRE TO WIRE
Connector Type	GT18C-1PP-HU



Terminal No.	Color of Wire	Signal Name [Specification]
1	SHIELD	
2	SHIELD	

Connector No.	M419
Connector Name	SATELLITE RADIO ANTENNA
Connector Type	GT18C-1PP-HU



Terminal No.	Color of Wire	Signal Name [Specification]
1	SHIELD	
2	SHIELD	

Connector No.	R2
Connector Name	WIRE TO WIRE
Connector Type	TH24FW-NH

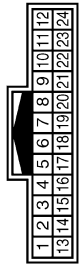

Terminal No.	Color of Wire	Signal Name [Specification]
5	SHIELD	
6	R	
7	G	
8	B	
9	B	
10	P	
11	BR	
12	R	
17	LG	
18	L	
19	G	
20	R	
21	R	
22	B	
23	GR	
24	P	

Connector No.	R5
Connector Name	WIRE TO WIRE
Connector Type	AUGMW



Terminal No.	Color of Wire	Signal Name [Specification]
1	G	
2	R	
3	SHIELD	

Connector No.	R7
Connector Name	WIRE TO WIRE
Connector Type	TH24FW-NH

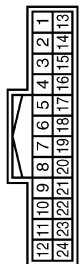

Terminal No.	Color of Wire	Signal Name [Specification]
1	G	
2	Y	
3	W	
4	R	
7	R	
8	P	
9	B	
13	L	
14	L	
15	LG	
16	Y	
17	W	
18	B	
19	B	
20	R	
21	R	
22	G	
23	L	
24	LG	

Connector No.	R11
Connector Name	WIRE TO WIRE
Connector Type	TH24FW-NH



Terminal No.	Color of Wire	Signal Name [Specification]
5	SHIELD	
6	L	
7	R	

8	B	
9	B/Y	
10	G	
11	SG	
12	V	
17	GR	
18	BR	
19	W	
20	LG	
21	P	
22	O	
23	W/R	
24	L/B	

Connector No.	R17
Connector Name	MICROPHONE
Connector Type	TK04FW



Terminal No.	Color of Wire	Signal Name [Specification]
1	L	
2	SHIELD	
4	R	

Connector No.	R19
Connector Name	FRONT MICROPHONE (ACTIVE NOISE CONTROL)
Connector Type	TK02FER



Terminal No.	Color of Wire	Signal Name [Specification]
1	W	
2	LG	

JCNWA3264GB

A
B
C
D
E
F
G
H
I
J
K
L
M
O
P

AV

BOSE AUDIO WITH NAVIGATION

< WIRING DIAGRAM >

[BOSE AUDIO WITH NAVIGATION]

BOSE AUDIO WITH NAVIGATION

Connector No.	R21
Connector Name	REAR MICROPHONE (ACTIVE NOISE CONTROL)
Connector Type	TK02BR



Terminal No.	Color of Wire	Signal Name [Specification]
1	GR	-
2	BR	-

Connector No.	T1
Connector Name	WIRE TO WIRE
Connector Type	NS12FW-OS

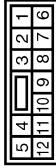

Terminal No.	Color of Wire	Signal Name [Specification]
1	R	-
2	LG	-
3	P	-
5	W	-
6	O	-
7	V	-
8	L	-
9	W	-
10	B	-
11	R	-
12	GR	-

Connector No.	T5
Connector Name	REAR VIEW CAMERA
Connector Type	TH0MMV-NH



Terminal No.	Color of Wire	Signal Name [Specification]
1	W	CAMERA POWER SUPPLY
2	B	CAMERA GND
3	R	CAMERA IMAGE SIGNAL
4	SHIELD	SHIELD

JCNWA3265GB

BASIC INSPECTION

DIAGNOSIS AND REPAIR WORKFLOW

Work Flow

INFOID:000000005912981

OVERALL SEQUENCE

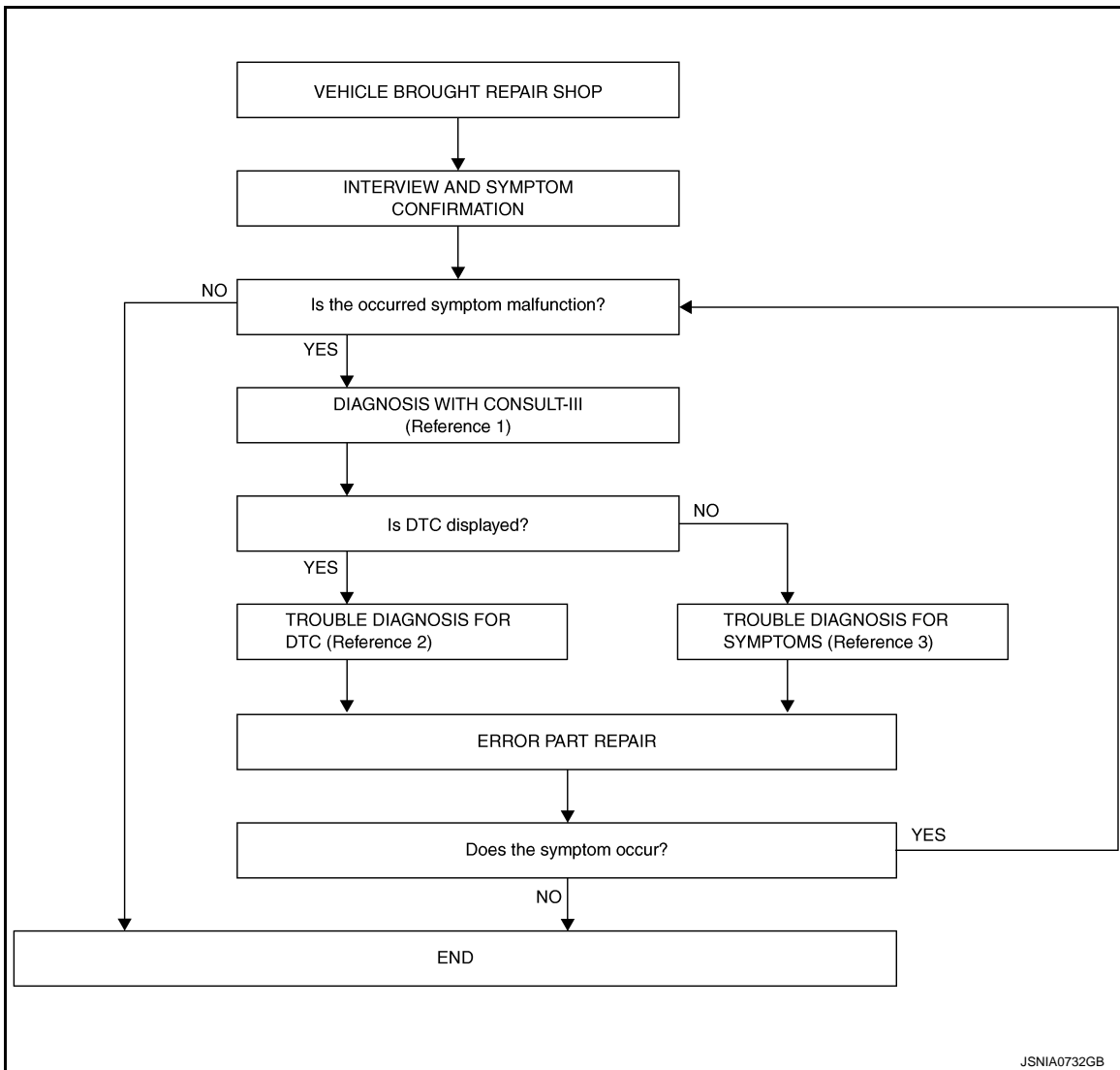

- Reference 1... Refer to [AV-172. "CONSULT - III Function"](#).
- Reference 2... Refer to [AV-185. "DTC Index"](#).
- Reference 3... Refer to [AV-288. "Symptom Table"](#).

DETAILED FLOW

1. INTERVIEW AND SYMPTOM CONFIRMATION

Check the malfunction symptoms by performing the following items.

- Interview the customer to obtain the malfunction information (conditions and environment when the malfunction occurred).
- Check the symptom.

Is the occurred symptom malfunction?

- YES >> GO TO 2.
- NO >> INSPECTION END

2. DIAGNOSIS WITH CONSULT-III

DIAGNOSIS AND REPAIR WORKFLOW

[BOSE AUDIO WITH NAVIGATION]

< BASIC INSPECTION >

1. Connect CONSULT-III and perform a self-diagnosis for "MULTI AV". Refer to [AV-172. "CONSULT - III Function"](#).

NOTE:

Skip to step 4 of the diagnosis procedure if "MULTI AV" is not displayed.

2. Check if any DTC is displayed in the "Self-Diagnosis Results".

Is DTC displayed?

YES >> GO TO 3.

NO >> GO TO 4.

3. TROUBLE DIAGNOSIS FOR DTC

1. Check the DTC indicated in the "Self-Diagnosis Results".
2. Perform the relevant diagnosis referring to the DTC Index. Refer to [AV-185. "DTC Index"](#).

>> GO TO 5.

4. TROUBLE DIAGNOSIS FOR SYMPTOMS

Perform the relevant diagnosis referring to the diagnosis chart by symptom. Refer to [AV-288. "Symptom Table"](#).

>> GO TO 5.

5. ERROR PART REPAIR

1. Repair or replace the identified malfunctioning parts.
2. Perform a self-diagnosis for "MULTI AV" with CONSULT-III.

NOTE:

Erase the stored self-diagnosis results after repairing or replacing the relevant components if any DTC has been indicated in the "Self-Diagnosis Results".

3. Check that the symptom does not occur.

Does the symptom occur?

YES >> GO TO 1.

NO >> INSPECTION END

ADDITIONAL SERVICE WHEN REPLACING (AV CONTROL UNIT)

< BASIC INSPECTION >

[BOSE AUDIO WITH NAVIGATION]

ADDITIONAL SERVICE WHEN REPLACING (AV CONTROL UNIT)

Description

INFOID:000000005912982

BEFORE REPLACEMENT

When replacing AV control unit, save or print current vehicle specification with CONSULT-III configuration before replacement.

AFTER REPLACEMENT

CAUTION:

When replacing AV control unit, you must perform "WRITE CONFIGURATION" with CONSULT-III.

- Complete the procedure of "WRITE CONFIGURATION" in order.
- If you set incorrect "WRITE CONFIGURATION", incidents might occur.
- Configuration is different for each vehicle model. Confirm configuration of each vehicle model.

Work Procedure

INFOID:000000005912983

1. SAVING VEHICLE SPECIFICATION

Ⓜ-CONSULT-III Configuration

Perform "READ CONFIGURATION" to save or print current vehicle specification. Refer to [AV-228, "Description"](#).

NOTE:

If "READ CONFIGURATION" can not be used, use the "WRITE CONFIGURATION - Manual selection".

>> GO TO 2.

2. REPLACE AV CONTROL UNIT

Replace AV control unit. Refer to [AV-298, "Removal and Installation"](#).

>> GO TO 3.

3. WRITING VEHICLE SPECIFICATION

Ⓜ-CONSULT-III Configuration

Perform "WRITE CONFIGURATION - Config file" or "WRITE CONFIGURATION - Manual selection" to write vehicle specification. Refer to [AV-228, "Work Procedure"](#).

>> GO TO 4.

4. OPERATION CHECK

Check that the operation of the AV control unit and camera images (fixed guide lines and predictive course lines) are normal.

>> WORK END

A

B

C

D

E

F

G

H

I

J

K

L

M

AV

O

P

CONFIGURATION (AV CONTROL UNIT)

< BASIC INSPECTION >

[BOSE AUDIO WITH NAVIGATION]

CONFIGURATION (AV CONTROL UNIT)

Description

INFOID:000000005912984

- Since vehicle specifications are not included in the AV control unit after replacement, it is required to write vehicle specifications with CONSULT-III.
- Configuration has three functions as follows.

Function	Description
READ CONFIGURATION	<ul style="list-style-type: none">• Reads the vehicle configuration of current AV control unit.• Saves the read vehicle configuration.
WRITE CONFIGURATION-Manual selection	Writes the vehicle configuration with manual selection.
WRITE CONFIGURATION-Config file	Writes the vehicle configuration with saved data.

Work Procedure

INFOID:000000005912985

NOTE:

If "WRITE CONFIGURATION" is unsuccessful, perform "Accessory Number Initialization". For details, refer to [AV-158, "On Board Diagnosis Function"](#).

After performing "Accessory Number Initialization", reboot the AV control unit to perform "WRITE CONFIGURATION".

1. WRITING MODE SELECTION

ⓅCONSULT-III Configuration

Select "CONFIGURATION" of "MULTI AV".

When writing saved data>>GO TO 2.

When writing manually>>GO TO 3.

2. PERFORM "WRITE CONFIGURATION-CONFIG FILE"

ⓅCONSULT-III Configuration

Perform "WRITE CONFIGURATION-Config file".

>> WORK END

3. PERFORM "WRITE CONFIGURATION-MANUAL SELECTION"

ⓅCONSULT-III Configuration

Select "WRITE CONFIGURATION-Manual selection" to write vehicle specifications into the AV control unit. For data to write, refer to [AV-228, "Configuration List"](#).

>> GO TO 4.

4. OPERATION CHECK

Check that the operation of the AV control unit and camera images (fixed guide lines and predictive course lines) are normal.

>> WORK END

Configuration List

INFOID:000000005912986

CAUTION:

Check vehicle specifications before servicing.

CONFIGURATION (AV CONTROL UNIT)

< BASIC INSPECTION >

[BOSE AUDIO WITH NAVIGATION]

MANUAL SETTING ITEM	
Items	Setting value
STEERING	LHD
	RHD
SOUND SYSTEM	BASE
	BOSE

A

B

C

D

E

F

G

H

I

J

K

L

M

AV

O

P

U1000 CAN COMM CIRCUIT

< DTC/CIRCUIT DIAGNOSIS >

[BOSE AUDIO WITH NAVIGATION]

DTC/CIRCUIT DIAGNOSIS

U1000 CAN COMM CIRCUIT

Description

INFOID:000000005912987

CAN (Controller Area Network) is a serial communication line for real-time application. It is an on-vehicle multiplex communication line with high data communication speed and excellent error detection ability. Many electronic control units are equipped onto a vehicle, and each control unit shares information and links with other control units during operation (not independently). In CAN communication, control units are connected with 2 communication lines (CAN-H, CAN-L) allowing a high rate of information transmission with less wiring. Each control unit transmits/receives data but selectively reads required data only.

CAN Communication Signal Chart. Refer to [LAN-35, "CAN COMMUNICATION SYSTEM : CAN Communication Signal Chart"](#).

DTC Logic

INFOID:000000005912988

DTC DETECTION LOGIC

DTC	Display contents of CONSULT-III	DTC detection condition	Probable malfunction location
U1000	CAN COMM CIRCUIT [U1000]	AV control unit is not transmitting or receiving CAN communication signal for 2 seconds or more.	CAN communication system.

Diagnosis Procedure

INFOID:000000005912989

1.PERFORM SELF-DIAGNOSTIC

1. Turn ignition switch ON and wait for 2 seconds or more.
2. Check "Self Diagnostic Result" of "MULTI AV".

Is "CAN COMM CIRCUIT" displayed?

- YES >> Refer to [LAN-25, "Trouble Diagnosis Flow Chart"](#).
NO >> Refer to [GI-38, "Intermittent Incident"](#).

U1010 CONTROL UNIT (CAN)

< DTC/CIRCUIT DIAGNOSIS >

[BOSE AUDIO WITH NAVIGATION]

U1010 CONTROL UNIT (CAN)

DTC Logic

INFOID:000000005912990

DTC DETECTION LOGIC

DTC	Display contents of CONSULT-III	DTC detection condition	Probable malfunction factor
U1010	CONTROL UNIT (CAN) [U1010]	CAN initial diagnosis malfunction is detected.	Replace the AV control unit if the malfunction occurs constantly. Refer to AV-298, "Removal and Installation" .

A
B
C
D
E
F
G
H
I
J
K
L
M

AV

O
P

U1200 AV CONTROL UNIT

< DTC/CIRCUIT DIAGNOSIS >

[BOSE AUDIO WITH NAVIGATION]

U1200 AV CONTROL UNIT

DTC Logic

INFOID:000000005912991

DTC	Display contents of CONSULT-III	DTC detection condition	Possible malfunction factor
U1200	Cont Unit [U1200]	AV control unit malfunction is detected.	Replace the AV control unit if the malfunction occurs constantly. Refer to AV-298, "Removal and Installation" .

U1201 AV CONTROL UNIT

< DTC/CIRCUIT DIAGNOSIS >

[BOSE AUDIO WITH NAVIGATION]

U1201 AV CONTROL UNIT

DTC Logic

INFOID:000000005912992

DTC	Display contents of CONSULT-III	DTC detection condition	Possible malfunction factor
U1201	GYRO NO CONN [U1201]	AV control unit malfunction is detected.	Replace the AV control unit if the malfunction occurs constantly. Refer to AV-298, "Removal and Installation" .

A
B
C
D
E
F
G
H
I
J
K
L
M
N
O
P

AV

U1202 AV CONTROL UNIT

< DTC/CIRCUIT DIAGNOSIS >

[BOSE AUDIO WITH NAVIGATION]

U1202 AV CONTROL UNIT

DTC Logic

INFOID:000000005912993

DTC	Display contents of CONSULT-III	DTC detection condition	Possible malfunction factor
U1202	G-SENSOR NO CONN [U1202]	AV control unit malfunction is detected.	Replace the AV control unit if the malfunction occurs constantly. Refer to AV-298, "Removal and Installation" .

U1204 AV CONTROL UNIT

< DTC/CIRCUIT DIAGNOSIS >

[BOSE AUDIO WITH NAVIGATION]

U1204 AV CONTROL UNIT

Description

INFOID:000000005912994

An intermittent error caused by strong radio interference may be detected unless any symptoms (GPS reception error, etc.) occur. Replace the AV control unit if the malfunction occurs constantly. Refer to [AV-298, "Removal and Installation"](#).

DTC Logic

INFOID:000000005912995

DTC	Display contents of CONSULT-III	DTC detection condition	Possible malfunction factor
U1204	GPS CONN [U1204]	GPS malfunction is detected.	An intermittent error caused by strong radio interference may be detected unless any symptom (GPS reception error, etc.) occurs. Replace the AV control unit if the malfunction occurs constantly. Refer to AV-298, "Removal and Installation" .

Diagnosis Procedure

INFOID:000000005912996

1. PERFORM THE SELF-DIAGNOSIS

1. Delete the "Self-Diagnosis Results" of "MULTI AV". Turn ignition switch OFF.
2. Turn ignition switch ON. Perform the self-diagnosis again.
3. Check that the DTC is detected again.

Is any DTC detected?

- YES >> Replace AV control unit. Refer to [AV-298, "Removal and Installation"](#).
- NO >> An intermittent error caused by strong radio interference may be detected unless any symptom (GPS reception error, etc.) occurs.

A
B
C
D
E
F
G
H
I
J
K
L
M
O
P

AV

U1205 AV CONTROL UNIT

< DTC/CIRCUIT DIAGNOSIS >

[BOSE AUDIO WITH NAVIGATION]

U1205 AV CONTROL UNIT

Description

INFOID:000000005912997

An intermittent error caused by strong radio interference may be detected unless any symptoms (GPS reception error, etc.) occur. Replace the AV control unit if the malfunction occurs constantly. Refer to [AV-298, "Removal and Installation"](#).

DTC Logic

INFOID:000000005912998

DTC	Display contents of CONSULT-III	DTC detection condition	Possible malfunction factor
U1205	GPS ROM [U1205]	GPS malfunction is detected.	An intermittent error caused by strong radio interference may be detected unless any symptom (GPS reception error, etc.) occurs. Replace the AV control unit if the malfunction occurs constantly. Refer to AV-298, "Removal and Installation" .

Diagnosis Procedure

INFOID:000000005912999

1. PERFORM THE SELF-DIAGNOSIS

1. Delete the "Self-Diagnosis Results" of "MULTI AV". Turn ignition switch OFF.
2. Turn ignition switch ON. Perform the self-diagnosis again.
3. Check that the DTC is detected again.

Is any DTC detected?

- YES >> Replace AV control unit. Refer to [AV-298, "Removal and Installation"](#).
- NO >> An intermittent error caused by strong radio interference may be detected unless any symptom (GPS reception error, etc.) occurs.

U1206 AV CONTROL UNIT

< DTC/CIRCUIT DIAGNOSIS >

[BOSE AUDIO WITH NAVIGATION]

U1206 AV CONTROL UNIT

Description

INFOID:000000005913000

An intermittent error caused by strong radio interference may be detected unless any symptoms (GPS reception error, etc.) occur. Replace the AV control unit if the malfunction occurs constantly. Refer to [AV-298, "Removal and Installation"](#).

DTC Logic

INFOID:000000005913001

DTC	Display contents of CONSULT-III	DTC detection condition	Possible malfunction factor
U1206	GPS RAM [U1206]	GPS malfunction is detected.	An intermittent error caused by strong radio interference may be detected unless any symptom (GPS reception error, etc.) occurs. Replace the AV control unit if the malfunction occurs constantly. Refer to AV-298, "Removal and Installation" .

Diagnosis Procedure

INFOID:000000005913002

1. PERFORM THE SELF-DIAGNOSIS

1. Delete the "Self-Diagnosis Results" of "MULTI AV". Turn ignition switch OFF.
2. Turn ignition switch ON. Perform the self-diagnosis again.
3. Check that the DTC is detected again.

Is any DTC detected?

- YES >> Replace AV control unit. Refer to [AV-298, "Removal and Installation"](#).
- NO >> An intermittent error caused by strong radio interference may be detected unless any symptom (GPS reception error, etc.) occurs.

A
B
C
D
E
F
G
H
I
J
K
L
M
O
P

AV

U1207 AV CONTROL UNIT

< DTC/CIRCUIT DIAGNOSIS >

[BOSE AUDIO WITH NAVIGATION]

U1207 AV CONTROL UNIT

Description

INFOID:000000005913003

An intermittent error caused by strong radio interference may be detected unless any symptoms (GPS reception error, etc.) occur. Replace the AV control unit if the malfunction occurs constantly. Refer to [AV-298, "Removal and Installation"](#).

DTC Logic

INFOID:000000005913004

DTC	Display contents of CONSULT-III	DTC detection condition	Possible malfunction factor
U1207	GPS RTC [U1207]	GPS malfunction is detected.	An intermittent error caused by strong radio interference may be detected unless any symptom (GPS reception error, etc.) occurs. Replace the AV control unit if the malfunction occurs constantly. Refer to AV-298, "Removal and Installation" .

Diagnosis Procedure

INFOID:000000005913005

1. PERFORM THE SELF-DIAGNOSIS

1. Delete the "Self-Diagnosis Results" of "MULTI AV". Turn ignition switch OFF.
2. Turn ignition switch ON. Perform the self-diagnosis again.
3. Check that the DTC is detected again.

Is any DTC detected?

- YES >> Replace AV control unit. Refer to [AV-298, "Removal and Installation"](#).
- NO >> An intermittent error caused by strong radio interference may be detected unless any symptom (GPS reception error, etc.) occurs.

U1216 AV CONTROL UNIT

< DTC/CIRCUIT DIAGNOSIS >

[BOSE AUDIO WITH NAVIGATION]

U1216 AV CONTROL UNIT

DTC Logic

INFOID:000000005913006

DTC	Display contents of CONSULT-III	DTC detection condition	Possible malfunction factor
U1216	CAN CONT [U1216]	AV control unit malfunction is detected.	Replace the AV control unit if the malfunction occurs constantly. Refer to AV-298, "Removal and Installation" .

A
B
C
D
E
F
G
H
I
J
K
L
M
O
P

AV

U1217 AV CONTROL UNIT

< DTC/CIRCUIT DIAGNOSIS >

[BOSE AUDIO WITH NAVIGATION]

U1217 AV CONTROL UNIT

DTC Logic

INFOID:000000005913007

DTC	Display contents of CONSULT-III	DTC detection condition	Possible malfunction factor
U1217	BLUETOOTH MODULE [U1217]	AV control unit malfunction is detected.	Replace the AV control unit if the malfunction occurs constantly. Refer to AV-298, "Removal and Installation" .

U1218 AV CONTROL UNIT

< DTC/CIRCUIT DIAGNOSIS >

[BOSE AUDIO WITH NAVIGATION]

U1218 AV CONTROL UNIT

DTC Logic

INFOID:000000005913008

DTC	Display contents of CONSULT-III	DTC detection condition	Possible malfunction factor
U1218	HDD CONN [U1218]	AV control unit malfunction is detected.	<ul style="list-style-type: none">• If the music box function has no malfunctions, then there is a possibility of the detection of a temporary malfunction.• Replace the AV control unit if the malfunction occurs constantly. Refer to AV-298, "Removal and Installation".

Diagnosis Procedure

INFOID:000000005913009

1. CHECK MUSIC BOX FUNCTION

Is music box function normal?

- YES >> Malfunction may be detected transitory.
NO >> Replace AV control unit. Refer to [AV-298, "Removal and Installation"](#).

A
B
C
D
E
F
G
H
I
J
K
L
M
O
P

AV

U1219 AV CONTROL UNIT

< DTC/CIRCUIT DIAGNOSIS >

[BOSE AUDIO WITH NAVIGATION]

U1219 AV CONTROL UNIT

DTC Logic

INFOID:000000005913010

DTC	Display contents of CONSULT-III	DTC detection condition	Possible malfunction factor
U1219	HDD READ [U1219]	AV control unit malfunction is detected.	<ul style="list-style-type: none">• If the music box function has no malfunctions, then there is a possibility of the detection of a temporary malfunction.• Replace the AV control unit if the malfunction occurs constantly. Refer to AV-298, "Removal and Installation".

Diagnosis Procedure

INFOID:000000005913011

1. CHECK MUSIC BOX FUNCTION

Is music box function normal?

YES >> Malfunction may be detected transitory.

NO >> Replace AV control unit. Refer to [AV-298, "Removal and Installation"](#).

U121A AV CONTROL UNIT

< DTC/CIRCUIT DIAGNOSIS >

[BOSE AUDIO WITH NAVIGATION]

U121A AV CONTROL UNIT

DTC Logic

INFOID:000000005913012

DTC	Display contents of CONSULT-III	DTC detection condition	Possible malfunction factor
U121A	HDD WRITE [U121A]	AV control unit malfunction is detected.	<ul style="list-style-type: none">• If the music box function has no malfunctions, then there is a possibility of the detection of a temporary malfunction.• Replace the AV control unit if the malfunction occurs constantly. Refer to AV-298, "Removal and Installation".

Diagnosis Procedure

INFOID:000000005913013

1. CHECK MUSIC BOX FUNCTION

Is music box function normal?

- YES >> Malfunction may be detected transitory.
NO >> Replace AV control unit. Refer to [AV-298, "Removal and Installation"](#).

A
B
C
D
E
F
G
H
I
J
K
L
M
O
P

AV

U121B AV CONTROL UNIT

< DTC/CIRCUIT DIAGNOSIS >

[BOSE AUDIO WITH NAVIGATION]

U121B AV CONTROL UNIT

DTC Logic

INFOID:000000005913014

DTC	Display contents of CONSULT-III	DTC detection condition	Possible malfunction factor
U121B	HDD COMM [U121B]	AV control unit malfunction is detected.	<ul style="list-style-type: none">• If the music box function has no malfunctions, then there is a possibility of the detection of a temporary malfunction.• Replace the AV control unit if the malfunction occurs constantly. Refer to AV-298, "Removal and Installation".

Diagnosis Procedure

INFOID:000000005913015

1. CHECK MUSIC BOX FUNCTION

Is music box function normal?

YES >> Malfunction may be detected transitory.

NO >> Replace AV control unit. Refer to [AV-298, "Removal and Installation"](#).

U121C AV CONTROL UNIT

< DTC/CIRCUIT DIAGNOSIS >

[BOSE AUDIO WITH NAVIGATION]

U121C AV CONTROL UNIT

DTC Logic

INFOID:000000005913016

DTC	Display contents of CONSULT-III	DTC detection condition	Possible malfunction factor
U121C	HDD ACCESS [U121C]	AV control unit malfunction is detected.	<ul style="list-style-type: none">If the music box function has no malfunctions, then there is a possibility of the detection of a temporary malfunction.Replace the AV control unit if the malfunction occurs constantly. Refer to AV-298, "Removal and Installation".

Diagnosis Procedure

INFOID:000000005913017

1. CHECK MUSIC BOX FUNCTION

Is music box function normal?

- YES >> Malfunction may be detected transitory.
NO >> Replace AV control unit. Refer to [AV-298, "Removal and Installation"](#).

A
B
C
D
E
F
G
H
I
J
K
L
M
O
P

AV

U121D AV CONTROL UNIT

< DTC/CIRCUIT DIAGNOSIS >

[BOSE AUDIO WITH NAVIGATION]

U121D AV CONTROL UNIT

DTC Logic

INFOID:000000005913018

DTC	Display contents of CONSULT-III	DTC detection condition	Possible malfunction factor
U121D	DSP CONN [U121D]	AV control unit malfunction is detected.	<ul style="list-style-type: none">• If a disc can be played, then there is a possibility of the detection of a temporary malfunction.• Replace the AV control unit if the malfunction occurs constantly. Refer to AV-298. "Removal and Installation".

Diagnosis Procedure

INFOID:000000005913019

1. CHECK PLAYBACK OF A DISK (CD)

Can a disk (CD) be played?

YES >> Malfunction may be detected transitory.

NO >> Replace AV control unit. Refer to [AV-298. "Removal and Installation"](#).

U121E AV CONTROL UNIT

< DTC/CIRCUIT DIAGNOSIS >

[BOSE AUDIO WITH NAVIGATION]

U121E AV CONTROL UNIT

DTC Logic

INFOID:000000005913020

DTC	Display contents of CONSULT-III	DTC detection condition	Possible malfunction factor
U121E	DSP COMM [U121E]	AV control unit malfunction is detected.	<ul style="list-style-type: none">• If a disc can be played, then there is a possibility of the detection of a temporary malfunction.• Replace the AV control unit if the malfunction occurs constantly. Refer to AV-298, "Removal and Installation".

Diagnosis Procedure

INFOID:000000005913021

1. CHECK PLAYBACK OF A DISK (CD)

Can a disk (CD) be played?

YES >> Malfunction may be detected transitory.

NO >> Replace AV control unit. Refer to [AV-298, "Removal and Installation"](#).

A
B
C
D
E
F
G
H
I
J
K
L
M
O
P

AV

U1225 AV CONTROL UNIT

< DTC/CIRCUIT DIAGNOSIS >

[BOSE AUDIO WITH NAVIGATION]

U1225 AV CONTROL UNIT

DTC Logic

INFOID:000000005913022

DTC DETECTION LOGIC

DTC	Display contents of CONSULT-III	DTC detection condition	Possible malfunction factor
U1225	USB CONTROLLER [U1225]	USB connection malfunction is detected.	Check that the connection to the USB connector is normal.

U1227 AV CONTROL UNIT

< DTC/CIRCUIT DIAGNOSIS >

[BOSE AUDIO WITH NAVIGATION]

U1227 AV CONTROL UNIT

DTC Logic

INFOID:000000005913023

DTC	Display contents of CONSULT-III	DTC detection condition	Possible malfunction factor
U1227	DVD COMM [U1227]	AV control unit malfunction is detected.	<ul style="list-style-type: none">• If DVD can be played, then there is a possibility of the detection of a temporary malfunction.• Replace the AV control unit if the malfunction occurs constantly. Refer to AV-298, "Removal and Installation".

Diagnosis Procedure

INFOID:000000005913024

1. CHECK PLAYBACK OF A DISK (DVD)

Can a disc (DVD) be played?

YES >> Malfunction may be detected transitory.

NO >> Replace AV control unit. Refer to [AV-298, "Removal and Installation"](#).

A
B
C
D
E
F
G
H
I
J
K
L
M
O
P

AV

U1228 AV CONTROL UNIT

< DTC/CIRCUIT DIAGNOSIS >

[BOSE AUDIO WITH NAVIGATION]

U1228 AV CONTROL UNIT

DTC Logic

INFOID:000000005913025

DTC DETECTION LOGIC

DTC	Display contents of CONSULT-III	DTC detection condition	Possible malfunction factor
U1228	SUB CPU CONN [U1228]	AV control unit malfunction is detected.	Replace the AV control unit if the malfunction occurs constantly. Refer to AV-298, "Removal and Installation" .

U1229 AV CONTROL UNIT

< DTC/CIRCUIT DIAGNOSIS >

[BOSE AUDIO WITH NAVIGATION]

U1229 AV CONTROL UNIT

DTC Logic

INFOID:000000005913026

DTC DETECTION LOGIC

DTC	Display contents of CONSULT-III	DTC detection condition	Possible malfunction factor
U1229	iPod CERTIFICATION [U1229]	AV control unit malfunction is detected.	Replace the AV control unit if the malfunction occurs constantly. Refer to AV-298, "Removal and Installation" .

A
B
C
D
E
F
G
H
I
J
K
L
M
O
P

AV

U122A AV CONTROL UNIT

< DTC/CIRCUIT DIAGNOSIS >

[BOSE AUDIO WITH NAVIGATION]

U122A AV CONTROL UNIT

DTC Logic

INFOID:000000005913027

DTC	Display contents of CONSULT-III	DTC detection condition	Action to take
U122A	CONFIG UNFINISH [U122A]	The writing of configuration data is incomplete.	Write configuration data with "MULTI AV" of CONSULT-III. Refer to AV-228. "Work Procedure" .

Diagnosis Procedure

INFOID:000000005913028

1.PERFORM THE SELF-DIAGNOSIS

When U122A is detected, write configuration data with "MULTI AV" of CONSULT-III.

>> Write configuration data with "MULTI AV" of CONSULT-III. Refer to [AV-228. "Work Procedure"](#).

U122E AV CONTROL UNIT

< DTC/CIRCUIT DIAGNOSIS >

[BOSE AUDIO WITH NAVIGATION]

U122E AV CONTROL UNIT

DTC Logic

INFOID:000000005913029

DTC DETECTION LOGIC

DTC	Display contents of CONSULT-III	DTC detection condition	Possible malfunction factor
U122E	Built-in AUDIO CONN [U122E]	AV control unit malfunction is detected.	Replace the AV control unit if the malfunction occurs constantly. Refer to AV-298, "Removal and Installation" .

A
B
C
D
E
F
G
H
I
J
K
L
M
O
P

AV

U1231 BOSE AMP.

< DTC/CIRCUIT DIAGNOSIS >

[BOSE AUDIO WITH NAVIGATION]

U1231 BOSE AMP.

DTC Logic

INFOID:000000005913030

DTC	Display contents of CONSULT-III	DTC detection condition	Possible malfunction factor
U1231	AMP TEMP [U1231]	BOSE amp. malfunction is detected.	Replace the BOSE amp. if the malfunction occurs constantly. Refer to AV-307, "Removal and Installation" .

U1232 STEERING ANGLE SENSOR

< DTC/CIRCUIT DIAGNOSIS >

[BOSE AUDIO WITH NAVIGATION]

U1232 STEERING ANGLE SENSOR

DTC Logic

INFOID:000000005913031

DTC	Display contents of CONSULT-III	DTC detection condition	Possible malfunction factor
U1232	ST ANGLE SEN CALIB [1232]	Predictive course line center position adjustment of the steering angle sensor is incomplete.	Adjust the predictive course line center position of the steering angle sensor. Refer to BRC-68. "Work Procedure" .

Diagnosis Procedure

INFOID:000000005913032

1. ADJUST THE PREDICTIVE COURSE LINE CENTER POSITION OF THE STEERING ANGLE SENSOR

When U1232 is detected, adjust the predictive course line center position of the steering angle sensor.

>> Adjusts the steering angle sensor neutral position on ABS actuator and electrical unit (control unit) side. Refer to [BRC-68. "Work Procedure"](#).

A
B
C
D
E
F
G
H
I
J
K
L
M
AV
O
P



U1243 DISPLAY UNIT

< DTC/CIRCUIT DIAGNOSIS >

[BOSE AUDIO WITH NAVIGATION]

U1243 DISPLAY UNIT

DTC Logic

INFOID:000000005913033

DTC	Display contents of CONSULT-III	DTC detection condition	Possible malfunction factor
U1243	FRONT DISP CONN [U1243]	When either one of the following items is detected: <ul style="list-style-type: none"> display unit power supply and ground circuit are malfunctioning. communication circuit between AV control unit and display unit are malfunctioning. 	<ul style="list-style-type: none"> Display unit power supply and ground circuit. Refer to AV-272, "DISPLAY UNIT : Diagnosis Procedure". Communication circuit between AV control unit and display unit.

Diagnosis Procedure

INFOID:000000005913034

1. CHECK DISPLAY UNIT POWER SUPPLY AND GROUND CIRCUIT

Check display unit power supply and ground circuit. Refer to [AV-272, "DISPLAY UNIT : Diagnosis Procedure"](#).

Is the inspection result normal?

YES >> GO TO 2.

NO >> Repair malfunctioning parts.

2. CHECK CONTINUITY COMMUNICATION CIRCUIT

- Turn ignition switch OFF.
- Disconnect display unit connector and AV control unit connector.
- Check continuity between display unit harness connector and AV control unit harness connector.

Display unit		AV control unit		Continuity
Connector	Terminals	Connector	Terminals	
M215	9	M210	89	Existed
	10		73	

- Check continuity between display unit harness connector and ground.

Display unit		Ground	Continuity
Connector	Terminals		
M215	9		Not existed
	10		

Is the inspection result normal?

YES >> GO TO 3.

NO >> Repair harness or connector.

3. CHECK COMMUNICATION SIGNAL

- Connect display unit connector and AV control unit connector.
- Turn ignition switch ON.
- Check signal between display unit harness connector and ground.

U1243 DISPLAY UNIT

< DTC/CIRCUIT DIAGNOSIS >

[BOSE AUDIO WITH NAVIGATION]

(+)		(-)	Condition	Reference value
Display unit				
Connector	Terminal			
M215	9	Ground	When adjusting display brightness.	<p>PKIB5039J</p>

Is the inspection result normal?

YES >> GO TO 4.

NO >> Replace AV control unit. Refer to [AV-298. "Removal and Installation"](#).

4. CHECK COMMUNICATION SIGNAL

Check signal between display unit harness connector and ground.

(+)		(-)	Condition	Reference value
Display unit				
Connector	Terminal			
M215	10	Ground	When adjusting display brightness.	<p>PKIB5039J</p>

Is the inspection result normal?

YES >> INSPECTION END

NO >> Replace display unit. Refer to [AV-311. "Removal and Installation"](#).

A
B
C
D
E
F
G
H
I
J
K
L
M
O
P

AV

U1244 GPS ANTENNA

< DTC/CIRCUIT DIAGNOSIS >

[BOSE AUDIO WITH NAVIGATION]

U1244 GPS ANTENNA

DTC Logic

INFOID:000000005913035

DTC	Display contents of CONSULT-III	DTC detection condition	Possible malfunction factor
U1244	GPS ANTENNA CONN [U1244]	GPS antenna connection malfunction is detected.	Check the connection of the GPS antenna connector.

Diagnosis Procedure

INFOID:000000005913036

1. GPS ANTENNA CHECK

Visually check GPS antenna and antenna feeder.

Is the inspection result normal?

YES >> GO TO 2.

NO >> Repair malfunctioning parts.

2. CHECK AV CONTROL UNIT VOLTAGE

1. Disconnect GPS antenna connector.
2. Turn ignition switch ON.
3. Check voltage between AV control unit and ground.

(+)	(-)	Voltage (Approx.)
AV control unit		
Terminal		
153	Ground	5.0 V

Is the inspection result normal?

YES >> INSPECTION END

NO >> Replace AV control unit. Refer to [AV-298. "Removal and Installation"](#).

U1258 SATELLITE RADIO ANTENNA

< DTC/CIRCUIT DIAGNOSIS >

[BOSE AUDIO WITH NAVIGATION]

U1258 SATELLITE RADIO ANTENNA

DTC Logic

INFOID:000000005913037

DTC	Display contents of CONSULT-III	DTC Detection Condition	Possible causes
U1258	XM ANTENNA CONN [U1258]	Satellite radio antenna connection malfunction is detected.	Satellite radio antenna disconnection.

Diagnosis Procedure

INFOID:000000005913038

1. SATELLITE RADIO ANTENNA CHECK

Visually check satellite radio antenna and antenna feeder.

Is the inspection result normal?

YES >> GO TO 2.

NO >> Repair malfunctioning parts.

2. CHECK AV CONTROL UNIT VOLTAGE

1. Disconnect satellite radio antenna connector.
2. Turn ignition switch ON.
3. Check voltage between AV control unit and ground.

(+)	(-)	Voltage (Approx.)
AV control unit		
Terminal		
159	Ground	5.0 V

Is the inspection result normal?

YES >> INSPECTION END

NO >> Replace AV control unit. Refer to [AV-298, "Removal and Installation"](#).

A
B
C
D
E
F
G
H
I
J
K
L
M
O
P

AV

U1263 USB

< DTC/CIRCUIT DIAGNOSIS >

[BOSE AUDIO WITH NAVIGATION]

U1263 USB

DTC Logic

INFOID:000000005913039

DTC	Display contents of CONSULT-III	DTC detection condition	Possible malfunction factor
U1263	USB OVERCURRENT [U1263]	Detection of overcurrent in USB connector.	Check USB harness between the AV control unit and USB connector.

Diagnosis Procedure

INFOID:000000005913040

1. CHECK USB HARNESS

Visually check USB harness.

Is the inspection result normal?

- YES >> Replace AV control unit. Refer to [AV-298. "Removal and Installation"](#).
- NO >> Replace USB harness. Refer to [AV-316. "Removal and Installation"](#).

U1264 ANTENNA AMP.

< DTC/CIRCUIT DIAGNOSIS >

[BOSE AUDIO WITH NAVIGATION]

U1264 ANTENNA AMP.

DTC Logic

INFOID:000000005913041

DTC	Display contents of CONSULT-III	DTC detection condition	Possible malfunction factor
U1264	ANTENNA AMP TERMINAL [OPEN or SHORT] [U1264]	Antenna amp. ON circuit is open or shorted.	Check antenna amp. ON signal circuit between the AV control unit and antenna amp.

Diagnosis Procedure

INFOID:000000005913042

1. CHECK CONTINUITY BETWEEN AV CONTROL UNIT AND ANTENNA AMP.

1. Turn ignition switch OFF.
2. Disconnect antenna amp. connector and AV control unit connector.
3. Check continuity between AV control unit harness connector and antenna amp. harness connector.

AV control unit		Antenna amp.		Continuity
Connector	Terminals	Connector	Terminals	
M394	150	M404	1	Existed

4. Check continuity between AV control unit harness connector and ground.

AV control unit		Ground	Continuity
Connector	Terminals		
M394	150		Not existed

Is the inspection result normal?

- YES >> GO TO 2.
 NO >> Repair harness or connector.

2. CHECK VOLTAGE AV CONTROL UNIT

1. Connect AV control unit connector.
2. Turn ignition switch ON.
3. Check voltage between AV control unit harness connector and ground.

AV control unit		(-)	Voltage (Approx.)
Connector	Terminals		
M394	150	Ground	12.0 V

Is the inspection result normal?

- YES >> Replace antenna amp. Refer to [AV-310, "Removal and Installation"](#).
 NO >> Replace AV control unit. Refer to [AV-298, "Removal and Installation"](#).

A
B
C
D
E
F
G
H
I
J
K
L
M
O
P

AV

U1300 AV COMM CIRCUIT

< DTC/CIRCUIT DIAGNOSIS >

[BOSE AUDIO WITH NAVIGATION]

U1300 AV COMM CIRCUIT

Description

INFOID:000000005913043

U1300 is indicated when malfunction occurs in communication signal of multi AV system. Indicated simultaneously, without fail, with the malfunction of control units connected to AV control unit with communication line. Determine the possible malfunction cause from the table below.

SELF-DIAGNOSIS RESULTS DISPLAY ITEM

DTC	Display contents of CONSULT-III	DTC detection condition	Possible malfunction factor
U1300 U1240	<ul style="list-style-type: none"> AV COMM CIRCUIT [U1300] SWITCH CONN [U1240] 	When either one of the following items are detected: <ul style="list-style-type: none"> multifunction switch power supply and ground circuits are malfunctioning. AV communication circuits between AV control unit and multifunction switch are malfunctioning. 	<ul style="list-style-type: none"> Multifunction switch power supply and ground circuits. AV communication circuits between AV control unit and multifunction switch.
U1300 U124E	<ul style="list-style-type: none"> AV COMM CIRCUIT [U1300] AMP CONN [U124E] 	When either one of the following items are detected: <ul style="list-style-type: none"> BOSE amp. power supply and ground circuits are malfunctioning. AV communication circuits between multifunction switch and BOSE amp. are malfunctioning. 	<ul style="list-style-type: none"> BOSE amp. power supply and ground circuits. Refer to AV-273. "BOSE AMP. : Diagnosis Procedure". AV communication circuits between multifunction switch and BOSE amp.
U1300 U1240 U124E	<ul style="list-style-type: none"> AV COMM CIRCUIT [U1300] SWITCH CONN [U1240] AMP CONN [U124E] 	AV communication circuits between AV control unit and multifunction switch are malfunctioning.	AV communication circuits between AV control unit and multifunction switch.

U1310 AV CONTROL UNIT

< DTC/CIRCUIT DIAGNOSIS >

[BOSE AUDIO WITH NAVIGATION]

U1310 AV CONTROL UNIT

DTC Logic

INFOID:000000005913044

DTC	Display contents of CONSULT-III	DTC detection condition	Possible malfunction factor
U1310	CONTROL UNIT (AV) [U1310]	An initial diagnosis error is detected in AV communication circuit.	Replace AV control unit. If the malfunction occurs constantly. Refer to AV-272, "AV CONTROL UNIT : Diagnosis Procedure" .

A
B
C
D
E
F
G
H
I
J
K
L
M
O
P

AV

U1601, U1609 FRONT DOOR WOOFER

< DTC/CIRCUIT DIAGNOSIS >

[BOSE AUDIO WITH NAVIGATION]

U1601, U1609 FRONT DOOR WOOFER

DTC Logic

INFOID:000000005913057

DTC DETECTION LOGIC

DTC	Display contents of CONSULT-III	DTC detection condition	Possible malfunction factor
U1601	FL-DOOR WOOFER [OPEN, SHORT, GND-SHORT or VB-SHOR] [U1601]	Malfunction is detected sound signal circuits between BOSE amp. and front door woofer LH.	Sound signal circuits between BOSE amp. and front door woofer LH.
U1609	FR-DOOR WOOFER [OPEN, SHORT, GND-SHORT or VB-SHOR] [U1609]	Malfunction is detected sound signal circuits between BOSE amp. and front door woofer RH.	Sound signal circuits between BOSE amp. and front door woofer RH.

Diagnosis Procedure

INFOID:000000005913058

1. PERFORM THE SELF-DIAGNOSIS

1. Delete the "self-diagnosis" results of "MULTI AV". Turn ignition switch OFF.
2. Turn ignition switch ON. perform the self-diagnosis again.
3. Check that the DTC is detected again.

Is any DTC detected?

- YES-1 >> U1601 Check harnesses between BOSE amp. and front door woofer LH.
YES-2 >> U1609 Check harnesses between BOSE amp. and front door woofer RH.
NO >> Refer to [GI-38, "Intermittent Incident"](#).

U1602, U160A FRONT DOOR SQUAWKER/TWEETER

< DTC/CIRCUIT DIAGNOSIS >

[BOSE AUDIO WITH NAVIGATION]

U1602, U160A FRONT DOOR SQUAWKER/TWEETER

DTC Logic

INFOID:000000005913047

DTC DETECTION LOGIC

DTC	Display contents of CONSULT-III	DTC detection condition	Possible malfunction factor
U1602	FL-DOOR SQUAWK [OPEN, SHORT, GND-SHORT or VB-SHOR] [U1602]	When either one of the following items are detected: <ul style="list-style-type: none">• sound signal circuits between BOSE amp. and front door squawker LH are malfunctioning.• sound signal circuits between BOSE amp. and tweeter LH are malfunctioning.	<ul style="list-style-type: none">• Sound signal circuits between BOSE amp. and front door squawker LH.• Sound signal circuits between BOSE amp. and tweeter LH.
U160A	FR-DOOR SQUAWK [OPEN, SHORT, GND-SHORT or VB-SHOR] [U160A]	When either one of the following items are detected: <ul style="list-style-type: none">• sound signal circuits between BOSE amp. and front door squawker RH are malfunctioning.• sound signal circuits between BOSE amp. and tweeter RH are malfunctioning.	<ul style="list-style-type: none">• Sound signal circuits between BOSE amp. and front door squawker RH.• Sound signal circuits between BOSE amp. and tweeter RH.

Diagnosis Procedure

INFOID:000000005913048

1. PERFORM THE SELF-DIAGNOSIS

1. Delete the "self-diagnosis" results of "MULTI AV". Turn ignition switch OFF.
2. Turn ignition switch ON. perform the self-diagnosis again.
3. Check that the DTC is detected again.

Is any DTC detected?

- YES-1 >> U1602: Check harnesses between BOSE amp. and front door squawker LH or between BOSE amp. and tweeter LH.
- YES-2 >> U160A: Check harnesses between BOSE amp. and front door squawker RH or between BOSE amp. and tweeter RH.
- NO >> Refer to [GI-38, "Intermittent Incident"](#).

A
B
C
D
E
F
G
H
I
J
K
L
M
O
P

AV

U162A CENTER SPEAKER

< DTC/CIRCUIT DIAGNOSIS >

[BOSE AUDIO WITH NAVIGATION]

U162A CENTER SPEAKER

DTC Logic

INFOID:000000005913045

DTC DETECTION LOGIC

DTC	Display contents of CONSULT-III	DTC detection condition	Possible malfunction factor
U162A	F-INST C-SQUAWK [OPEN, SHORT, GND-SHORT, or VB-SHORT] [U162A]	Malfunction is detected sound signal circuits between BOSE amp. and center speaker.	Sound signal circuits between BOSE amp. and center speaker.

Diagnosis Procedure

INFOID:000000005913046

1. PERFORM THE SELF-DIAGNOSIS

1. Delete the "self-diagnosis" results of "MULTI AV". Turn ignition switch OFF.
2. Turn ignition switch ON. perform the self-diagnosis again.
3. Check that the DTC is detected again.

Is any DTC detected?

- YES >> Check harnesses between BOSE amp. and center speaker.
NO >> Refer to [GI-38, "Intermittent Incident"](#)

U1632, U163A, U163E SEAT SPEAKER

< DTC/CIRCUIT DIAGNOSIS >

[BOSE AUDIO WITH NAVIGATION]

U1632, U163A, U163E SEAT SPEAKER

DTC Logic

INFOID:000000005913049

DTC DETECTION LOGIC

DTC	Display contents of CONSULT-III	DTC detection condition	Possible malfunction factor
U1632	FL-SEAT L-SQUAWK [OPEN, SHORT, GND-SHORT or VB-SHOR] [U1632]	Malfunction is detected sound signal circuits between BOSE amp. and driver seat speaker LH.	Sound signal circuits between BOSE amp. and driver seat speaker LH.
U163A	FL-SEAT R-SQUAWK [OPEN, SHORT, GND-SHORT or VB-SHOR] [U163A]	Malfunction is detected sound signal circuits between BOSE amp. and driver seat speaker RH.	Sound signal circuits between BOSE amp. and driver seat speaker RH.
U163E	FR-SEAT L-SQUAWK [OPEN, SHORT, GND-SHORT or VB-SHOR] [U163E]	Malfunction is detected sound signal circuits between BOSE amp. and passenger seat speaker LH.	Sound signal circuits between BOSE amp. and passenger seat speaker LH.

Diagnosis Procedure

INFOID:000000005913050

1. PERFORM THE SELF-DIAGNOSIS

1. Delete the "self-diagnosis" results of "MULTI AV". Turn ignition switch OFF.
2. Turn ignition switch ON. perform the self-diagnosis again.
3. Check that the DTC is detected again.

Is any DTC detected?

YES-1 >> U1632: Check harnesses between BOSE amp. and driver seat speaker LH.

YES-2 >> U163A: Check harnesses between BOSE amp. and driver seat speaker RH.

YES-3 >> U163E: Check harnesses between BOSE amp. and passenger seat speaker LH.

NO >> Refer to [GI-38. "Intermittent Incident"](#).

A
B
C
D
E
F
G
H
I
J
K
L
M
O
P

AV

U1708, U1710 REAR DOOR SPEAKER

< DTC/CIRCUIT DIAGNOSIS >

[BOSE AUDIO WITH NAVIGATION]

U1708, U1710 REAR DOOR SPEAKER

DTC Logic

INFOID:000000005989690

DTC DETECTION LOGIC

DTC	Display contents of CONSULT-III	DTC detection condition	Possible malfunction factor
U1708	RL-DOOR SPEAKER [OPEN, SHORT, GND-SHORT or VB-SHOR] [U1708]	Malfunction is detected sound signal circuits between BOSE amp. and rear door speaker LH.	Sound signal circuits between BOSE amp. and rear door speaker LH.
U1710	RR-DOOR SPEAKER [OPEN, SHORT, GND-SHORT or VB-SHOR] [U1710]	Malfunction is detected sound signal circuits between BOSE amp. and rear door speaker RH.	Sound signal circuits between BOSE amp. and rear door speaker RH.

Diagnosis Procedure

INFOID:000000005989691

1. PERFORM THE SELF-DIAGNOSIS

1. Delete the "self-diagnosis" results of "MULTI AV". Turn ignition switch OFF.
2. Turn ignition switch ON. perform the self-diagnosis again.
3. Check that the DTC is detected again.

Is any DTC detected?

- YES-1 >> U1708 Check harnesses between BOSE amp. and rear door speaker LH.
YES-2 >> U1710 Check harnesses between BOSE amp. and rear door speaker RH.
NO >> Refer to [GI-38, "Intermittent Incident"](#).

U1725 REAR WOOFER

< DTC/CIRCUIT DIAGNOSIS >

[BOSE AUDIO WITH NAVIGATION]

U1725 REAR WOOFER

DTC Logic

INFOID:000000005913051

DTC DETECTION LOGIC

DTC	Display contents of CONSULT-III	DTC detection condition	Possible malfunction factor
U1725	R-PSHELF C- WOOFER [OPEN, SHORT, GND-SHORT or VB-SHOR] [U1725]	Malfunction is detected sound signal circuits between BOSE amp. and rear woofer.	Sound signal circuits between BOSE amp. and rear woofer.

Diagnosis Procedure

INFOID:000000005913052

1. PERFORM THE SELF-DIAGNOSIS

1. Delete the "self-diagnosis" results of "MULTI AV". Turn ignition switch OFF.
2. Turn ignition switch ON. perform the self-diagnosis again.
3. Check that the DTC is detected again.

Is any DTC detected?

- YES >> Check harnesses between BOSE amp. and rear woofer.
NO >> Refer to [GI-38, "Intermittent Incident"](#).

A
B
C
D
E
F
G
H
I
J
K
L
M
O
P

AV

U190C FRONT/REAR MICROPHONE

< DTC/CIRCUIT DIAGNOSIS >

[BOSE AUDIO WITH NAVIGATION]

U190C FRONT/REAR MICROPHONE

DTC Logic

INFOID:000000005913055

DTC	Display contents of CONSULT-III	DTC detection condition	Possible malfunction factor
U190C	CORRECT MICROPHONE [OPEN, SHORT, GND-SHORT or VB-SHOR] [U190C]	Malfunction is detected sound signal circuits between BOSE amp. and front, rear or both microphone.	Sound signal circuits between BOSE amp. and front, rear or both microphone.

Diagnosis Procedure

INFOID:000000005913056

1. CHECK ON BOARD SELF-DIAGNOSIS

Perform on board self-diagnosis. Refer to [AV-177, "On Board Diagnosis Function"](#).

Is the inspection result normal?

YES >> INSPECTION END

NO >> GO TO 2.

2. CHECK CONTINUITY BETWEEN BOSE AMP. AND FRONT/REAR MICROPHONE CIRCUIT

1. Turn ignition switch OFF.
2. Disconnect BOSE amp. connector and front/rear microphone connector.
3. Check continuity between BOSE amp. harness connector and front/rear microphone harness connector.

BOSE amp.		Front microphone		Continuity
Connector	Terminals	Connector	Terminals	
B43	72	R19	2	Existed
	52		1	

BOSE amp.		Rear microphone		Continuity
Connector	Terminals	Connector	Terminals	
B43	63	R21	2	Existed
	43		1	

4. Check continuity between BOSE amp. harness connector and ground.

BOSE amp.		Ground	Continuity
Connector	Terminals		
B43	72		Not existed
	52		
	63		
	43		

Is the inspection result normal?

YES >> GO TO 3.

NO >> Repair harness or connector.

3. CHECK MICROPHONE SIGNAL

1. Connect BOSE amp. connector and front/rear microphone connector.
2. Check signal between BOSE amp. harness connector.

U190C FRONT/REAR MICROPHONE

< DTC/CIRCUIT DIAGNOSIS >

[BOSE AUDIO WITH NAVIGATION]

(+) BOSE amp.		(-) BOSE amp.		Condition	Reference value
Connector	Terminal	Connector	Terminal		
B43	72	B43	52	When inputting interior sound.	
	63		43	When inputting interior sound.	

Is the inspection result normal?

- YES >> Replace BOSE amp. Refer to [AV-307, "Removal and Installation"](#).
- NO >> Replace front/rear microphone. Refer to [AV-308, "Removal and Installation"](#)(front microphone), [AV-309, "Removal and Installation"](#)(rear microphone).

A
B
C
D
E
F
G
H
I
J
K
L
M

AV

O
P

POWER SUPPLY AND GROUND CIRCUIT

< DTC/CIRCUIT DIAGNOSIS >

[BOSE AUDIO WITH NAVIGATION]

POWER SUPPLY AND GROUND CIRCUIT

AV CONTROL UNIT

AV CONTROL UNIT : Diagnosis Procedure

INFOID:000000005913059

1.CHECK FUSE

Check for blown fuses.

Power source	Fuse No.
Battery	34
Ignition switch ACC or ON	19

Is the inspection result normal?

YES >> GO TO 2.

NO >> Be sure to eliminate cause of malfunction before installing new fuse.

2.CHECK POWER SUPPLY CIRCUIT

Check voltage between AV control unit harness connectors and ground.

Signal name	(+)		(-)	Ignition switch position	Voltage (Approx.)
	AV control unit				
	Connector	Terminal			
Battery power supply	M208	19	Ground	OFF	Battery voltage
ACC power supply		7		ACC	

Is the inspection result normal?

YES >> GO TO 3.

NO >> Check harness between AV control unit and fuse.

3.CHECK GROUND CIRCUIT

1. Turn ignition switch OFF.
2. Disconnect AV control unit connectors.
3. Check continuity between AV control unit harness connectors and ground.

AV control unit		Ground	Continuity
Connector	Terminal		
M208	20		Existed

Is the inspection result normal?

YES >> INSPECTION END

NO >> Repair harness or connector.

DISPLAY UNIT

DISPLAY UNIT : Diagnosis Procedure

INFOID:000000005913060

1.CHECK FUSE

Check for blown fuses.

Power source	Fuse No.
Battery	34
Ignition switch ACC or ON	19

Is the inspection result normal?

YES >> GO TO 2.

NO >> Be sure to eliminate cause of malfunction before installing new fuse.

POWER SUPPLY AND GROUND CIRCUIT

< DTC/CIRCUIT DIAGNOSIS >

[BOSE AUDIO WITH NAVIGATION]

2.CHECK POWER SUPPLY CIRCUIT

1. Turn ignition switch ACC.
2. Check voltage between display unit harness connector and ground.

Signal name	(+)		(-)	Ignition switch position	Voltage (Approx.)
	Display unit				
	Connector	Terminal			
Battery power supply	M215	11	Ground	OFF	Battery voltage
ACC power supply		23		ACC	

Is the inspection result normal?

YES >> GO TO 3.

NO >> Be sure to eliminate cause of malfunction before installing new fuse.

3.CHECK GROUND CIRCUIT

1. Turn ignition switch OFF.
2. Disconnect display unit connector.
3. Check continuity between display unit harness connectors and ground.

Display unit		Ground	Continuity
Connector	Terminal		
M215	12		Existed

Is the inspection result normal?

YES >> INSPECTION END

NO >> Repair harness or connector.

BOSE AMP.

BOSE AMP. : Diagnosis Procedure

INFOID:000000005913061

1.CHECK FUSE

Check for blown fuses.

Power source	Fuse No.
Battery	8, 10, 34
Ignition switch ACC or ON	19

Is the inspection result normal?

YES >> GO TO 2.

NO >> Be sure to eliminate cause of malfunction before installing new fuse.

2.CHECK POWER SUPPLY CIRCUIT

Check voltage between BOSE amp. harness connector and ground.

Signal name	(+)		(-)	Ignition switch position	Voltage (Approx.)
	BOSE amp.				
	Connector	Terminal			
Battery power supply	B41	10	Ground	OFF	Battery voltage
		11			
	B46	84			
		90			
ACC power supply	B43	56	ACC		

Is the inspection result normal?

POWER SUPPLY AND GROUND CIRCUIT

[BOSE AUDIO WITH NAVIGATION]

< DTC/CIRCUIT DIAGNOSIS >

- YES >> GO TO 3.
NO >> Check harness between BOSE amp. and fuse.

3.CHECK GROUND CIRCUIT

1. Turn ignition switch OFF.
2. Disconnect BOSE amp. connector.
3. Check continuity between BOSE amp. harness connector and ground.

AV control unit			Continuity
Connector	Terminal		
B42	7	Ground	Existed
	12		
B46	83		
	89		

Is the inspection result normal?

- YES >> INSPECTION END
NO >> Repair harness or connector.

RGB DIGITAL IMAGE SIGNAL CIRCUIT

< DTC/CIRCUIT DIAGNOSIS >

[BOSE AUDIO WITH NAVIGATION]

RGB DIGITAL IMAGE SIGNAL CIRCUIT

Description

INFOID:000000005913062

Transmit the image displayed with AV control unit with RGB digital image signal to the display unit.

Diagnosis Procedure

INFOID:000000005913063

1. CHECK CONTINUITY RGB DIGITAL IMAGE SIGNAL CIRCUIT

1. Turn ignition switch OFF.
2. Disconnect display unit connector and AV control unit connector.
3. Check continuity between display unit harness connector and AV control unit harness connector.

Display unit		AV control unit		Continuity
Connector	Terminals	Connector	Terminals	
M397	27	M396	157	Existed
	28		158	

4. Check continuity between display unit harness connector and ground.

Display unit		Ground	Continuity
Connector	Terminals		
M397	27		Not existed
	28		

Is the inspection result normal?

- YES >> GO TO 2.
 NO >> Repair harness or connector.

2. CHECK RGB DIGITAL IMAGE SIGNAL

1. Connect AV control unit connector.
2. Turn ignition switch ON.
3. Check signal between display unit harness connector and ground.

(+) Display unit		(-)	Condition	Voltage (Approx.)
Connector	Terminals			
M397	27	Ground	—	1.3 V
	28			

Is the inspection result normal?

- YES >> Replace display unit. Refer to [AV-311, "Removal and Installation"](#).
 NO >> Replace AV control unit. Refer to [AV-298, "Removal and Installation"](#).

AV

COMPOSITE IMAGE SIGNAL CIRCUIT

< DTC/CIRCUIT DIAGNOSIS >

[BOSE AUDIO WITH NAVIGATION]

COMPOSITE IMAGE SIGNAL CIRCUIT

Description

INFOID:000000005913064

AV control unit transmits the playback DVD image signal to the display unit.

Diagnosis Procedure

INFOID:000000005913065

1. CHECK CONTINUITY COMPOSITE IMAGE SIGNAL CIRCUIT

1. Turn ignition switch OFF.
2. Disconnect AV control unit connector and display unit connector.
3. Check continuity between AV control unit harness connector and display unit harness connector.

AV control unit		Display unit		Continuity
Connector	Terminal	Connector	Terminal	
M210	68	M215	18	Existed

4. Check continuity between AV control unit harness connector and ground.

AV control unit		Ground	Continuity
Connector	Terminal		
M210	68		Not existed

Is the inspection result normal?

- YES >> GO TO 2.
NO >> Repair harness or connector.

2. CHECK COMPOSITE IMAGE SIGNAL

1. Connect AV control unit connector and display unit connector.
2. Turn ignition switch ON.
3. Check signal between AV control unit harness connector and ground.

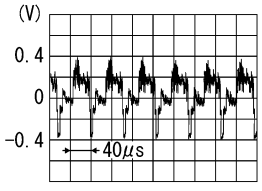
(+)		(-)	Condition	Reference value
AV control unit				
Connector	Terminal			
M210	68	Ground	At DVD image is displayed.	 <p>(V)</p> <p>0.4</p> <p>0</p> <p>-0.4</p> <p>40µs</p> <p>SKIB2251J</p>

Is the inspection result normal?

- YES >> Replace display unit. Refer to [AV-311. "Removal and Installation"](#).
NO >> Replace AV control unit. Refer to [AV-298. "Removal and Installation"](#).

DISK EJECT SIGNAL CIRCUIT

< DTC/CIRCUIT DIAGNOSIS >

[BOSE AUDIO WITH NAVIGATION]

DISK EJECT SIGNAL CIRCUIT

Description

INFOID:000000005913066

The eject signal is output to AV control unit when the eject switch of multifunction switch is pressed.

Diagnosis Procedure

INFOID:000000005913067

1. CHECK CONTINUITY DISK EJECT SIGNAL CIRCUIT

1. Turn ignition switch OFF.
2. Disconnect multifunction switch connector and AV control unit connector.
3. Check continuity between multifunction switch harness connector and AV control unit harness connector.

Multifunction switch		AV control unit		Continuity
Connector	Terminal	Connector	Terminal	
M72	14	M209	29	Existed

4. Check continuity between multifunction switch harness connector and ground.

Multifunction switch		Ground	Continuity
Connector	Terminal		
M72	14		Not existed

Is the inspection result normal?

- YES >> GO TO 2.
 NO >> Repair harness or connector.

2. CHECK AV CONTROL UNIT VOLTAGE

1. Connect multifunction switch connector and AV control unit connector.
2. Turn ignition switch ON.
3. Check voltage between AV control unit harness connector and ground.

(+)		(-)	Condition	Voltage (Approx.)
AV control unit				
Connector	Terminal			
M209	29	Ground	Pressing the eject switch	0 V
			Except for above	5.0 V

Is the inspection result normal?

- YES >> Replace preset switch. Refer to [AV-314. "Removal and Installation"](#).
 NO >> Replace AV control unit. Refer to [AV-298. "Removal and Installation"](#).

A
B
C
D
E
F
G
H
I
J
K
L
M
O
P

AV

MICROPHONE SIGNAL CIRCUIT

< DTC/CIRCUIT DIAGNOSIS >

[BOSE AUDIO WITH NAVIGATION]

MICROPHONE SIGNAL CIRCUIT

Description

INFOID:000000005913068

Supply power from AV control unit to microphone. The microphone transmits the sound/voice to the AV control unit.

Diagnosis Procedure

INFOID:000000005913069

1. CHECK CONTINUITY BETWEEN AV CONTROL UNIT AND MICROPHONE CIRCUIT

1. Turn ignition switch OFF.
2. Disconnect AV control unit connector and microphone connector.
3. Check continuity between AV control unit harness connector and microphone harness connector.

AV control unit		Microphone		Continuity
Connector	Terminals	Connector	Terminals	
M210	71	R17	2	Existed
	72		4	
	87		1	

4. Check continuity between AV control unit harness connector and ground.

AV control unit		Ground	Continuity
Connector	Terminals		
M210	72		Not existed
	87		

Is the inspection result normal?

YES >> GO TO 2.

NO >> Repair harness or connector.

2. CHECK VOLTAGE MICROPHONE VCC

1. Connect AV control unit connector.
2. Turn ignition switch ON.
3. Check voltage between AV control unit harness connector.

(+)		(-)		Voltage (Approx.)
AV control unit		AV control unit		
Connector	Terminal	Connector	Terminal	
M210	72	M210	71	5.0 V

Is the inspection result normal?

YES >> GO TO 3.

NO >> Replace AV control unit. Refer to [AV-298. "Removal and Installation"](#).

3. CHECK MICROPHONE SIGNAL

1. Connect microphone connector.
2. Check signal between AV control unit harness connector.

MICROPHONE SIGNAL CIRCUIT

< DTC/CIRCUIT DIAGNOSIS >

[BOSE AUDIO WITH NAVIGATION]

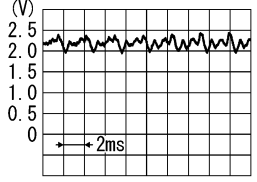
(+)		(-)		Condition	Reference value
AV control unit		AV control unit			
Connector	Terminal	Connector	Terminal		
M210	87	M210	71	Give a voice.	 <p style="text-align: right; font-size: small;">PKIB5037J</p>

Is the inspection result normal?

- YES >> Replace AV control unit. Refer to [AV-298. "Removal and Installation"](#).
- NO >> Replace microphone. Refer to [AV-319. "Removal and Installation"](#).

A
B
C
D
E
F
G
H
I
J
K
L
M

AV

O
P

CAMERA IMAGE SIGNAL CIRCUIT

< DTC/CIRCUIT DIAGNOSIS >

[BOSE AUDIO WITH NAVIGATION]

CAMERA IMAGE SIGNAL CIRCUIT

Description

INFOID:000000005913070

- The AV control unit supplies power to the rear view camera when receiving a reverse signal.
- The rear view camera transmits camera images to the display unit when power is supplied from the AV control unit.

Diagnosis Procedure

INFOID:000000005913071

1. CHECK CONTINUITY CAMERA POWER SUPPLY CIRCUIT

1. Turn ignition switch OFF.
2. Disconnect AV control unit connector and rear view camera connector.
3. Check continuity between AV control unit harness connector and rear view camera harness connector.

AV control unit		Rear view camera		Continuity
Connector	Terminal	Connector	Terminal	
M209	22	T5	1	Existed

4. Check continuity between AV control unit harness connector and ground.

AV control unit		Ground	Continuity
Connector	Terminal		
M209	22		Not existed

Is inspection result normal?

YES >> GO TO 2.

NO >> Repair harness or connector.

2. CHECK VOLTAGE CAMERA POWER SUPPLY

1. Connect AV control unit connector and rear view camera connector.
2. Turn ignition switch ON.
3. Shift the selector lever to "R".
4. Check voltage between AV control unit harness connector and ground.

(+)		(-)	Condition	Voltage (Approx.)
AV control unit				
Connector	Terminal			
M209	22	Ground	Shift position is "R".	6.0 V

Is inspection result normal?

YES >> GO TO 3.

NO >> Replace AV control unit.

3. CHECK CONTINUITY CAMERA IMAGE SIGNAL CIRCUIT

1. Turn ignition switch OFF.
2. Disconnect display unit connector and rear view camera connector.
3. Check continuity between display unit harness connector and rear view camera harness connector.

Display unit		Rear view camera		Continuity
Connector	Terminal	Connector	Terminal	
M215	8	T5	3	Existed

4. Check continuity between display unit harness connector and ground.

CAMERA IMAGE SIGNAL CIRCUIT

< DTC/CIRCUIT DIAGNOSIS >

[BOSE AUDIO WITH NAVIGATION]

Display unit		Ground	Continuity
Connector	Terminal		
M215	8		Not existed

Is inspection result normal?

- YES >> GO TO 4.
- NO >> Repair harness or connector.

4. CHECK CAMERA IMAGE SIGNAL

1. Connect display unit connector and rear view camera connector.
2. Turn ignition switch ON.
3. Shift the selector lever to "R".
4. Check signal between display unit harness connector and ground.

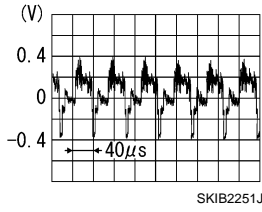
(+)		(-)	Condition	Reference value
Display unit				
Connector	Terminal			
M215	8	Ground	At rear view camera image is displayed.	

Is inspection result normal?

- YES >> Replace display unit. Refer to [AV-311, "Removal and Installation"](#).
- NO >> Replace rear view camera. Refer to [AV-320, "Removal and Installation"](#).

A
B
C
D
E
F
G
H
I
J
K
L
M
O
P

AV

STEERING SWITCH SIGNAL A CIRCUIT

< DTC/CIRCUIT DIAGNOSIS >

[BOSE AUDIO WITH NAVIGATION]

STEERING SWITCH SIGNAL A CIRCUIT

Description

INFOID:000000005913072

Transmits the steering switch signal to AV control unit.

Diagnosis Procedure

INFOID:000000005913073

1.CHECK STEERING SWITCH SIGNAL A CIRCUIT

1. Disconnect AV control unit connector and spiral cable connector.
2. Check continuity between AV control unit harness connector and spiral cable harness connector.

AV control unit		Spiral cable		Continuity
Connector	Terminal	Connector	Terminal	
M208	6	M36	24	Existed

3. Check continuity between AV control unit harness connector and ground.

AV control unit		Ground	Continuity
Connector	Terminal		
M208	6		Not existed

Is the inspection result normal?

- YES >> GO TO 2.
NO >> Repair harness or connector.

2.CHECK SPIRAL CABLE

Check spiral cable.

Is the inspection result normal?

- YES >> GO TO 3.
NO >> Replace spiral cable.

3.CHECK AV CONTROL UNIT VOLTAGE

1. Connect AV control unit connector and spiral cable connector.
2. Turn ignition switch ON.
3. Check voltage between AV control unit harness connector.

(+)		(-)		Voltage (Approx.)
AV control unit		AV control unit		
Connector	Terminal	Connector	Terminal	
M208	6	M208	15	5.0 V

Is the inspection result normal?

- YES >> GO TO 4.
NO >> Replace AV control unit. Refer to [AV-298, "Removal and Installation"](#)

4.CHECK STEERING SWITCH

1. Turn ignition switch OFF.
2. Check steering switch. Refer to [AV-282, "Component Inspection"](#).

Is the inspection result normal?

- YES >> INSPECTION END
NO >> Replace steering switch. Refer to [AV-315, "Removal and Installation"](#).

Component Inspection

INFOID:000000005913074

Measure the resistance between the steering switch connector terminals 14 to 17 and 15 to 17.

STEERING SWITCH SIGNAL A CIRCUIT

[BOSE AUDIO WITH NAVIGATION]

< DTC/CIRCUIT DIAGNOSIS >

Standard

Between terminals 14 and 17

ENTER switch ON	: 2003 – 2043 Ω
☞ switch ON	: 716 – 730 Ω
MENU DOWN switch ON	: 318 – 324 Ω
MENU UP switch ON	: 120 – 122 Ω
SOURCE switch ON	: 0 Ω

Between terminals 15 and 17

↻ switch ON	: 716 – 730 Ω
↺ switch ON	: 318 – 324 Ω
VOL UP switch ON	: 120 – 122 Ω
VOL DOWN switch ON	: 0 Ω

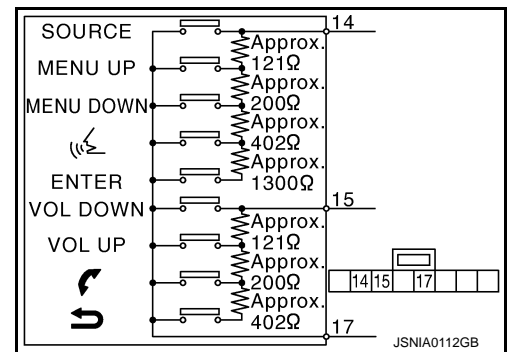

A
B
C
D
E
F
G
H
I
J
K
L
M

AV

O
P

STEERING SWITCH SIGNAL B CIRCUIT

< DTC/CIRCUIT DIAGNOSIS >

[BOSE AUDIO WITH NAVIGATION]

STEERING SWITCH SIGNAL B CIRCUIT

Description

INFOID:000000005913075

Transmits the steering switch signal to AV control unit.

Diagnosis Procedure

INFOID:000000005913076

1. CHECK STEERING SWITCH SIGNAL B CIRCUIT

1. Disconnect AV control unit connector and spiral cable connector.
2. Check continuity between AV control unit harness connector and spiral cable harness connector.

AV control unit		Spiral cable		Continuity
Connector	Terminal	Connector	Terminal	
M208	16	M36	31	Existed

3. Check continuity between AV control unit harness connector and ground.

AV control unit		Ground	Continuity
Connector	Terminal		
M208	16		Not existed

Is the inspection result normal?

- YES >> GO TO 2.
NO >> Repair harness or connector.

2. CHECK SPIRAL CABLE

Check spiral cable.

Is the inspection result normal?

- YES >> GO TO 3.
NO >> Replace spiral cable.

3. CHECK AV CONTROL UNIT VOLTAGE

1. Connect AV control unit connector and spiral cable connector.
2. Turn ignition switch ON.
3. Check voltage between AV control unit harness connector.

(+)		(-)		Voltage (Approx.)
AV control unit		AV control unit		
Connector	Terminal	Connector	Terminal	
M208	16	M208	15	5.0 V

Is the inspection result normal?

- YES >> GO TO 4.
NO >> Replace AV control unit. Refer to [AV-298, "Removal and Installation"](#).

4. CHECK STEERING SWITCH

1. Turn ignition switch OFF.
2. Check steering switch. Refer to [AV-284, "Component Inspection"](#).

Is the inspection result normal?

- YES >> INSPECTION END
NO >> Replace steering switch. Refer to [AV-315, "Removal and Installation"](#).

Component Inspection

INFOID:000000005913077

Measure the resistance between the steering switch connector terminals 14 to 17 and 15 to 17.

STEERING SWITCH SIGNAL B CIRCUIT

[BOSE AUDIO WITH NAVIGATION]

< DTC/CIRCUIT DIAGNOSIS >

Standard

Between terminals 14 and 17

ENTER switch ON	: 2003 – 2043 Ω
☞ switch ON	: 716 – 730 Ω
MENU DOWN switch ON	: 318 – 324 Ω
MENU UP switch ON	: 120 – 122 Ω
SOURCE switch ON	: 0 Ω

Between terminals 15 and 17

↻ switch ON	: 716 – 730 Ω
↺ switch ON	: 318 – 324 Ω
VOL UP switch ON	: 120 – 122 Ω
VOL DOWN switch ON	: 0 Ω

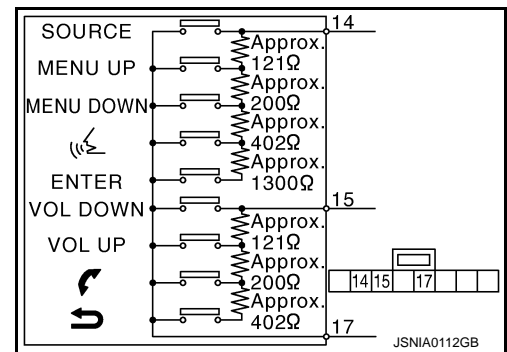

A
B
C
D
E
F
G
H
I
J
K
L
M

AV

O
P

STEERING SWITCH GROUND CIRCUIT

< DTC/CIRCUIT DIAGNOSIS >

[BOSE AUDIO WITH NAVIGATION]

STEERING SWITCH GROUND CIRCUIT

Description

INFOID:000000005913078

Transmits the steering switch signal to AV control unit.

Diagnosis Procedure

INFOID:000000005913079

1. CHECK STEERING SWITCH SIGNAL GROUND CIRCUIT

1. Disconnect AV control unit connector and spiral cable connector.
2. Check continuity between AV control unit harness connector and spiral cable harness connector.

AV control unit		Spiral cable		Continuity
Connector	Terminal	Connector	Terminal	
M208	15	M36	33	Existed

3. Connect AV control unit connector.

Is the inspection result normal?

- YES >> GO TO 2.
NO >> Repair harness or connector.

2. CHECK SPIRAL CABLE

Check spiral cable.

Is the inspection result normal?

- YES >> GO TO 3.
NO >> Replace spiral cable.

3. CHECK GROUND CIRCUIT

1. Connect AV control unit connector.
2. Check continuity between AV control unit harness connector and ground.

AV control unit		Ground	Continuity
Connector	Terminal		
M208	15		Existed

Is the inspection result normal?

- YES >> GO TO 4.
NO >> Replace AV control unit. Refer to [AV-298, "Removal and Installation"](#)

4. CHECK STEERING SWITCH

1. Turn ignition switch OFF.
2. Check steering switch. Refer to [AV-286, "Component Inspection"](#).

Is the inspection result normal?

- YES >> INSPECTION END
NO >> Replace steering switch. Refer to [AV-315, "Removal and Installation"](#).

Component Inspection

INFOID:000000005913080

Measure the resistance between the steering switch connector terminals 14 to 17 and 15 to 17.

STEERING SWITCH GROUND CIRCUIT

[BOSE AUDIO WITH NAVIGATION]

< DTC/CIRCUIT DIAGNOSIS >

Standard

Between terminals 14 and 17

ENTER switch ON	: 2003 – 2043 Ω
☞ switch ON	: 716 – 730 Ω
MENU DOWN switch ON	: 318 – 324 Ω
MENU UP switch ON	: 120 – 122 Ω
SOURCE switch ON	: 0 Ω

Between terminals 15 and 17

↻ switch ON	: 716 – 730 Ω
↺ switch ON	: 318 – 324 Ω
VOL UP switch ON	: 120 – 122 Ω
VOL DOWN switch ON	: 0 Ω

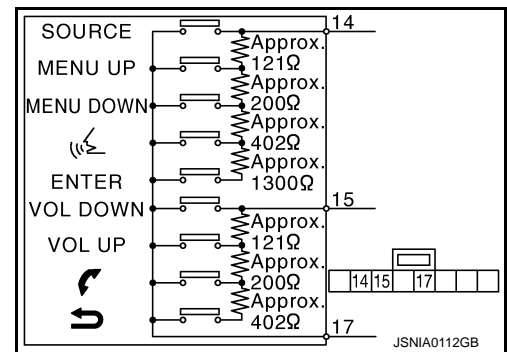

A
B
C
D
E
F
G
H
I
J
K
L
M

AV

O
P

MULTI AV SYSTEM SYMPTOMS

< SYMPTOM DIAGNOSIS >

[BOSE AUDIO WITH NAVIGATION]

SYMPTOM DIAGNOSIS

MULTI AV SYSTEM SYMPTOMS

Symptom Table

INFOID:000000005913081

RELATED TO NAVIGATION

Symptoms	Check items	Probable malfunction location
Multifunction switch and preset switch operation does not work.	<ul style="list-style-type: none"> All switches cannot be operated. "MULTI AV" is displayed on system selection screen when the CONSULT-III is started. 	<ul style="list-style-type: none"> Multifunction switch power supply and ground circuit malfunction. AV communication circuit between AV control unit and multifunction switch. Perform CONSULT-III self-diagnosis. Refer to AV-172, "CONSULT - III Function".
	<ul style="list-style-type: none"> All switches cannot be operated. "MULTI AV" is not displayed on system selection screen when the CONSULT-III is initialized. 	AV control unit power supply and ground circuit malfunction. Refer to AV-272, "AV CONTROL UNIT : Diagnosis Procedure" .
	Only specified switch cannot be operated.	Multifunction switch or preset switch malfunction. Perform multifunction switch and preset switch self-diagnosis function. Refer to AV-158, "On Board Diagnosis Function" .
Fuel economy display, vehicle setting operation is abnormal.	There is malfunction in the CONSULT-III "self-diagnosis result" of "MULTI AV". Refer to AV-172, "CONSULT - III Function" .	Perform detected DTC diagnosis. Refer to AV-185, "DTC Index" .
	There is no malfunction in the CONSULT-III "self-diagnosis results" of "MULTI AV". Refer to AV-172, "CONSULT - III Function" .	Ignition signal circuit malfunction.
Guide sound is not heard or too low.	On the setting display select "system sound (guide sound volume, etc.)," and confirm that guide sound is ON.	AV control unit malfunction. Replace AV control unit. Refer to AV-298, "Removal and Installation" .

RELATED TO HANDS-FREE PHONE

Simple Check for Bluetooth™ Communication

If cellular phone and AV control unit cannot be connected with Bluetooth™ communication, following procedure allows the technician to judge which device has malfunction.

- Turn ON cellular phone, not connecting Bluetooth™ communication.
- Start CONSULT-III, then start Windows®.
- Set CONSULT-III near a cellular phone.
- When operated Bluetooth™ registration by cellular phone, check if CONSULT-III* would be displayed on the device name.
(If other Bluetooth™ device is located near cellular phone, a name of the device would be displayed also.)

NOTE:

*.Displayed device name is "NISSAN-*****".

- If no device name is displayed, cellular phone is malfunctioning. Repair the cellular phone first, then perform diagnosis.
- If CONSULT-III is displayed on device name, cellular phone is normal. Perform diagnosis as per the following table.

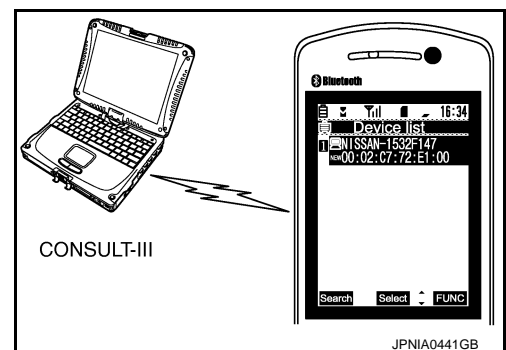

MULTI AV SYSTEM SYMPTOMS

[BOSE AUDIO WITH NAVIGATION]

< SYMPTOM DIAGNOSIS >

Symptoms	Check items	Probable malfunction location	
Does not recognize cellular phone connection. (no connection is displayed on the display at the guide.)	Repeat the registration of cellular phone.		A
Hands-free phone cannot be established.	<ul style="list-style-type: none"> Hands-free phone operation can be made, but the communication cannot be established. Hands-free phone operation can be performed, however, voice between each other cannot be heard during the conversation. 	AV control unit malfunction. Replace AV control unit. Refer to AV-298, "Removal and Installation" .	B C
The other party's voice cannot be heard by hands-free phone.	Check the "microphone speaker" in Inspection & Adjustment Mode if sound is heard.		D E
Originating sound is not heard by the other party with hands-free phone communication.	Sound operation function is normal.		
	Sound operation function does not work.	Microphone signal circuit malfunction. Refer to AV-278, "Diagnosis Procedure" .	F
The system cannot be operated.	<ul style="list-style-type: none"> The voice recognition can be controlled. Steering switch's "VOL UP", "VOL DOWN", "↶" switch works, but "↷" it does not work. 	Steering switch malfunction. Replace steering switch. Refer to AV-315, "Removal and Installation" .	G
	<ul style="list-style-type: none"> The voice recognition can be controlled. Steering switch's "↷", "VOL UP", "VOL DOWN", "↶" switches do not work. 	Steering switch signal B circuit malfunction. Refer to AV-284, "Diagnosis Procedure" .	H
	All steering switches do not work.	Steering switch ground circuit malfunction. Refer to AV-286, "Diagnosis Procedure" .	I

RELATED TO RGB IMAGE

Symptoms	Check items	Probable malfunction location	
RGB image is not shown.	—	RGB digital image signal circuit malfunction. Refer to AV-275, "Diagnosis Procedure" .	J K

RELATED TO VOICE CONTROL

Symptoms	Check items	Probable malfunction location	
The voice cannot be controlled even if the voice control screen is displayed.	Voice sounds at "Voice Microphone Test" of Confirmation/Adjustment mode.	AV control unit malfunction. Replace AV control unit. Refer to AV-298, "Removal and Installation" .	L M
	Voice does not sound at "Voice Microphone Test" of Confirmation/Adjustment mode.	Microphone circuit malfunction. Refer to AV-278, "Diagnosis Procedure" .	
The voice cannot be controlled (Voice control screen is not displayed).	<ul style="list-style-type: none"> Steering switch's "SOURCE", "MENU UP", "MENU DOWN", "ENTER" switch works, but "↶" it does not work. Hands-free phone system can be operated. 	Steering switch malfunction. Replace steering switch. Refer to AV-315, "Removal and Installation" .	N O
	Steering switch's "SOURCE", "MENU UP", "MENU DOWN", "↶", "ENTER" switches do not work.	Steering switch signal A circuit malfunction. Refer to AV-282, "Diagnosis Procedure" .	P
	All steering switches do not work.	Steering switch ground circuit malfunction. Refer to AV-286, "Diagnosis Procedure" .	

RELATED TO AUDIO

MULTI AV SYSTEM SYMPTOMS

[BOSE AUDIO WITH NAVIGATION]

< SYMPTOM DIAGNOSIS >

Symptoms	Check items	Probable malfunction location
The disk cannot be removed.	—	Disk eject signal circuit malfunction. Refer to AV-277, "Diagnosis Procedure" .
Audio sound is not heard.	There is malfunction in the CONSULT-III self-diagnosis result. Refer to AV-172, "CONSULT - III Function" .	Perform detected DTC diagnosis. Refer to AV-185, "DTC Index" .
	There is no malfunction in the CONSULT-III self-diagnosis result. Refer to AV-172, "CONSULT - III Function" .	Perform the speaker test of the on board diagnosis function. Refer to AV-158, "On Board Diagnosis Function" . When detected malfunction in satellite speaker LH, RH or passenger seat speaker RH, the following items are a possible cause. <ul style="list-style-type: none"> • Sound signal circuits between AV control unit and satellite speaker LH, RH or passenger seat speaker RH. When detected malfunction in other than satellite speaker LH, RH or passenger seat speaker RH, the following items are a possible cause. <ul style="list-style-type: none"> • Specific sound signal circuits between AV control unit and BOSE amp.
Satellite radio is not received.	There is malfunction in the CONSULT-III self-diagnosis result. Refer to AV-172, "CONSULT - III Function" .	Perform detected DTC diagnosis. Refer to AV-185, "DTC Index" .
	There is no malfunction in the CONSULT-III self-diagnosis result. Refer to AV-172, "CONSULT - III Function" .	Perform the following inspection procedure. <ol style="list-style-type: none"> 1. Check satellite radio antenna mounting nut for looseness. NOTE: Tightening torque: 6.5 N-m (0.66 kg-m, 58 in-lb) <ol style="list-style-type: none"> 2. Visually check for satellite radio antenna feeder.
AM/FM radio is not received.	Other audio sounds are normal.	<ul style="list-style-type: none"> • Antenna amp. ON signal circuit malfunction. • Antenna feeder malfunction.

RELATED TO DVD MODE

Symptoms	Check items	Probable malfunction location
The disk cannot be removed.	—	Disk eject signal circuit malfunction. Refer to AV-277, "Diagnosis Procedure" .
DVD image is not displayed.	—	Perform CONSULT-III self-diagnosis. Refer to AV-172, "CONSULT - III Function" . When detecting no malfunction in those components, the following items are a possible cause. <ul style="list-style-type: none"> • Composite image signal circuits malfunction. Refer to AV-276, "Diagnosis Procedure".
DVD sound is not heard.	No sound from all speakers.	Perform CONSULT-III self-diagnosis. Refer to AV-172, "CONSULT - III Function" .
	Sound is heard only from specific places.	Perform CONSULT-III self-diagnosis. Refer to AV-172, "CONSULT - III Function" .

RELATED TO CAMERA

Symptoms	Check items	Probable malfunction location
Camera image is not shown. (Vehicle width and predictive course line are displayed.)	—	Camera image signal circuit. Refer to AV-280, "Diagnosis Procedure" .

MULTI AV SYSTEM SYMPTOMS

[BOSE AUDIO WITH NAVIGATION]

< SYMPTOM DIAGNOSIS >

Symptoms	Check items	Probable malfunction location
Camera image does not switch.	Select "Camera Cont." of Confirmation/ Adjustment mode, Reverse Sensor is not turned ON at "Connection Confirmation".	Reverse signal circuit malfunction.
	Select "Camera Cont." of Confirmation/ Adjustment mode, Reverse Sensor is turned ON at "Connection Confirmation".	AV control unit malfunction. Replace AV control unit. Refer to AV-298, "Removal and Installation" .

RELATED TO USB

NOTE:

Check that there is no malfunction of USB equipment main body before performing a diagnosis.

Symptoms	Check items	Possible malfunction location / Action to take
iPod® or USB memory can not be recognized.	—	<ul style="list-style-type: none"> • USB harness malfunction. • USB connector malfunction.

iPod® is a trademark of Apple inc., registered in the U.S. and other countries.

RELATED TO STEERING SWITCH

Symptoms	Probable malfunction location
None of the steering switch operations work.	Steering switch ground circuit malfunction. Refer to AV-286, "Diagnosis Procedure" .
Only specified switch cannot be operated.	Steering switch malfunction. Replace steering switch. Refer to AV-315, "Removal and Installation" .
Steering switch's "SOURCE", "MENU UP", "MENU DOWN", "⏪", "ENTER" switches do not work.	Steering switch signal A circuit malfunction. Refer to AV-282, "Diagnosis Procedure" .
Steering switch's "⏩", "VOL UP", "VOL DOWN", "⏸" switches do not work.	Steering switch signal B circuit malfunction. Refer to AV-284, "Diagnosis Procedure" .

A
B
C
D
E
F
G
H
I
J
K
L
M

AV

O
P

NORMAL OPERATING CONDITION

< SYMPTOM DIAGNOSIS >

[BOSE AUDIO WITH NAVIGATION]

NORMAL OPERATING CONDITION

Description

INFOID:000000005913082

NOTE:

For Navigation system operation information, refer to Navigation system Owner's Manual.

BASIC OPERATIONS

Symptom	Possible cause	Possible solution
No image is displayed.	The brightness is at the lowest setting.	Adjust the brightness of the display.
	The systems in the video mode.	Press "DISC-AUX" to change the mode.
	The display is turned off.	Press "☀/☾" to turn on the display.
	The interior of the vehicle becomes the a little less than 80°C (176°F) or high temperature, and the protection of the display acts, and a display is turned off.	Wait until the interior of the vehicle has cooled down.
Screen not clear.	Contrast setting is not appropriate.	Adjust the contrast of the display.
No voice guidance is available. Or The volume is too high or too low.	The volume is not set correctly, or it is turned off.	Adjust the volume of voice guidance.
	Voice guidance is not provided for certain streets (roads displayed in gray).	This is not a malfunction.
No map is displayed on the screen.	A screen other than map screen is displayed.	Press "MAP".
The screen is too dim. The movement is slow.	The temperature in the interior of the vehicle is low.	Wait until the interior of the vehicle has warmed up.
Some pixels in the display are darker or brighter than others.	This condition is an inherent characteristic of liquid crystal displays.	This is not a malfunction.
Some menu items cannot be selected.	Some menu items become unavailable while the vehicle is driven.	Park the vehicle in a safe location, and then operate the navigation system.

NOTE:

Locations stored in the Address Book and other memory functions may be lost if the vehicle's battery is disconnected or becomes discharged. If this occurs, service the vehicle's battery as necessary and re-enter the information in the Address Book.

RELATED TO VOICE RECOGNITION

Related to Basic Operation

Symptom	Possible cause	Possible solution
The system does not recognize your command. or The system recognizes your command incorrectly	The interior of the vehicle is too noisy.	Close the windows or have other occupants quiet.
	The volume of your voice is too low.	Speak louder.
	The volume if your voice is too loud.	Speak softer.
	Your pronunciation is unclear.	Speak clearly.
	You are speaking before the voice recognition is ready	Press and release "☞" switch on the steering switch, and speak a command after the tone sounds.
	8 seconds or more have passed after you pressed and released "☞" switch on the steering switch.	Make sure to speak a command within 8 seconds after you press and release "☞" switch on the steering switch.
	Only a limited range of voice commands is usable for each screen.	Use a correct voice command appropriate for the current screen.
The fan of the air conditioner is too loud.	Lower the fan speed as necessary as voice command can be recognized more easily.	

Related to Item Choice

The system should respond correctly to all voice commands without difficulty. If problems are encountered, follow the solutions given in this guide for the appropriate error.

NORMAL OPERATING CONDITION

[BOSE AUDIO WITH NAVIGATION]

< SYMPTOM DIAGNOSIS >

Where the solutions are listed by number, try each solution in turn, starting with number one, until the problem is resolved.

Symptom/ error message	Solution
Displays "COMMAND NOT RECOGNIZED" or the system fails to interpret the command correctly.	1. Ensure that the command format is valid.
	2. Speak clearly without pausing between words and at a level appropriate to the ambient noise level.
	3. Ensure that the ambient noise level is not excessive, for example, windows open or defrost on. NOTE: If it is too noisy to use the phone, it is likely that voice commands will not be recognized.
	4. If optional words of the command have been omitted, then command should be tried with these in place.
The system consistently selects the wrong voicetag	1. Ensure that the voicetag requested matches what was originally stored. This can be confirmed by giving the "Addressbook" Directory or Phone Directory command.
	2. Replace one of the voicetags being confused with a different voicetag.

Related to Telephone

The system should respond correctly to all voice commands without difficulty. If problems are encountered, try the following solutions.

Where the solutions are listed by number, try each solution in turn, starting with number 1, until the problem is resolved.

Symptom	Solution
System fails to interpret the command correctly.	1. Ensure that the command is valid.
	2. Ensure that the command is spoken after the tone.
	3. Speak clearly without pausing between words and at level appropriate to the ambient noise level in the vehicle.
	4. Ensure that the ambient noise level is not excessive (for example, windows open or defroster on). NOTE: If it is too noisy to use the phone, it is likely that the voice commands will not be recognized.
	5. If more than one command was said at a time, try saying the commands separately.
	6. If the system consistently fails to recognize commands, the voice training procedure should be carried out to improve the recognition response for the speaker. See "Speaker adaptation (SA) mode" earlier in this section. Refer to "OWNER'S MANUAL".
The system consistently selects the wrong voicetag	1. Ensure that the phone book entry name requested matches what was originally stored. This can be confirmed by using the "List Names" command.
	2. Replace one of the names being confused with a new name.

RELATED TO AUDIO

- The majority of the audio malfunctions are the result of outside causes (bad CD, electromagnetic interference, etc.). Check the symptoms below to diagnose the malfunction.
- The vehicle itself can be a source of noise if noise prevention parts or electrical equipment is malfunctioning. Check if noise is caused and/or changed by engine speed, ignition switch turned to each position, and operation of each piece of electrical equipment, and then determine the cause.

NOTE:

- CD-R is not guaranteed to play because they can contain compressed audio (MP3, WMA, AAC, M4A) or could be incorrectly mastered by the customer on a computer.
- Check if the CDs carry the Compact Disc Logo. If not, the disc is not mastered to the "red book" Compact Disc Standard and may not play.

NORMAL OPERATING CONDITION

< SYMPTOM DIAGNOSIS >

[BOSE AUDIO WITH NAVIGATION]

Symptom	Cause and Counter measure
Cannot play	Check if the CD was inserted correctly.
	Check if the CD is scratched or dirty.
	Check if there is condensation inside the player, and if there is, wait until the condensation is gone (about 1 hour) before using the player.
	If there is a temperature increase error, the player will play correctly after it returns to the normal temperature.
	If there is a mixture of music CD files (CD-DA data) and MP3/WMA/AAC/M4A files on a CD, only the music CD files (CD-DA data) will be played.
	Files with extensions other than ".MP3", ".WMA", ".AAC", ".M4A", ".mp3", ".wma", ".aac" or ".m4a" cannot be played. In addition, the character codes and number of characters for folder names and file names should be in compliance with the specifications.
	Check if the disc or the file is generated in an irregular format, This may occur depending on the variation or the setting of MP3/WMA/AAC/M4A writing applications or other text editing applications.
	Check if the finalization process, such as session close and disc close, is done for the disc.
Poor sound quality	Check if the CD is scratched or dirty.
	Check if the CD is protected by copyright.
	Check if the CD is scratched or dirty.
	It takes a relatively long time before the music starts playing.
	Music cuts off or skips
	Skipping with high bit rate files
	Move immediately to the next song when playing
	The songs do not play back in the desired order.
Check if the CD is scratched or dirty.	
If there are many folder or file levels on the MP3/WMA/AAC/M4A CD, or if it is a multisession disc, some time may be required before the music starts playing.	
The writing software and hardware combination might not match, or the writing speed, writing depth, writing width might not match the specifications. Try using the slowest writing speed.	
Skipping may occur with large quantities if data such as for high bit rate data.	
When a non-MP3/WMA/AAC/M4A file has been given an extension of ".MP3", ".WMA", ".AAC", ".M4A", ".mp3", ".wma", ".aac" or ".m4a", or when play is prohibited by copyright protection, the player will skip to the next song.	
The playback order is the order in which the files were written by the software, so the files might not play in the desired order.	

Noise resulting from variations in field strength, such as fading noise and multi-path noise, or external noise from trains and other sources, is not a malfunction.

NOTE:

- Fading noise: This noise occurs because of variations in the field strength in a narrow range due to mountains or buildings blocking the signal.
- Multi-path noise: This noise results from a time difference between the broadcast waves directly from the station arriving at the antenna and the waves reflected by mountains or buildings.

RELATED TO DVD

Symptom	Possible cause	Possible solution
Not working as operated	Some operations may be rejected or may not function as intended because of the manufacturer's intent, depending on DVD.	This is not a malfunction.
Operation not accepted	If a requested operation is prohibited, then a message is displayed on the screen. (Message display depends on DVD.)	This is not a malfunction.

NORMAL OPERATING CONDITION

< SYMPTOM DIAGNOSIS >

[BOSE AUDIO WITH NAVIGATION]

Symptom	Possible cause	Possible solution
DVD can not be played	Check that the DVD is inserted in the right place.	Upturn the DVD (facing the title upward).
	Check that there is no condensation inside the player.	Wait until the condensation evaporates (approximately one hour).
	DVD menu is displayed.	Select item to touch "ENTER".
	Insertion of a DVD with a different region code.	DVDs with a different region code can not be played. Check DVD.
	Some DVD softwares may not be played because not all DVD softwares fully comply in the standard.	This is not a malfunction.
Interruption during playback or flicker in the display	Check that the DVD has no scratches and dirt.	Errors may not be corrected depending on the size of scratches.
		Wipe and clean the dirt on the disc.
Subtitles not shown	Subtitle setting is OFF.	Set subtitle.
	Subtitle is not included in the software.	Check DVD.
Not played in set language	If a language is not included in the DVD, then the DVD is played in a recommended language.	Check DVD.
Not played with set subtitle	If a set subtitle is not included in the DVD, then the DVD is played with a recommended subtitle.	Check DVD.
Angle unchangeable	Plural angles are not recorded in the software.	Check if the DVD is multi-angle capable.
Unusual screen display	Display mode to the output aspect ratio for the DVD software is inappropriate.	Switch to the appropriate display mode.
Distortion in picture	In the process of fast-forward or fast-reverse.	This is not a malfunction.
Low sound quality	Check that the DVD has no scratches and dirt.	Wipe and clean the dirt on the disc.
Subtitle and language not selectable (not played with set subtitle or in set language)	The DVD is not multilanguage-capable.	The inclusion of the number of languages depends on DVD. Languages may be selectable on the Menu screen. Check DVD.
	The DVD has a priority language or setting.	If the DVD has a priority language or settings, then settings changed with this device are not reflected.
Playback time is indicated, but no sound comes out.	Playback of Mix mode Truck 1. (Mix mode: Format including Truck 1 with data other than music and Trucks from Truck 2 with music data.)	Play music data included in trucks from Truck 2.

RELATED TO VEHICLE ICON

Symptom	Possible cause	Possible solution
Names of roads differ between Plan View and Birdview™.	This is because the quantity of the displayed information is reduced so that the screen does not become too crowded. There is also a chance that names of the roads may be displayed multiple times, and the names appearing on the screen may be different because of a processing procedure.	This is not a malfunction.
The vehicle icon is not displayed in the correct position.	The vehicle was transported after the ignition switch was pressed off, for example, by a ferry or car transporter.	Drive the vehicle for a while on a road where GPS signals can be received.
	The position and direction of the vehicle icon may be incorrect depending on the driving environments and the levels of positioning accuracy of the navigation system.	This is not a malfunction. Drive the vehicle for a while to automatically correct the position and direction of the vehicle icon.
When the vehicle is traveling on a new road, the vehicle icon is located on another road nearby.	Because the new road is not stored in the map data, the system automatically places the vehicle icon on the nearest road available.	Updated road information will be included in the next version of the map data.

NORMAL OPERATING CONDITION

< SYMPTOM DIAGNOSIS >

[BOSE AUDIO WITH NAVIGATION]

Symptom	Possible cause	Possible solution
The screen does not switch to the night screen even after turning on the headlights.	The daytime screen was set the last time the headlights were turned on.	Set the screen to the night screen mode using <Day/Night> when you turn on the headlights.
The map does not scroll even when the vehicle is moving.	The current location map screen is not displayed.	Press "MAP".
The vehicle icon is not displayed.	The current location map screen is not displayed.	Press "MAP".
The location of the vehicle icon is misaligned from the actual position.	When using tire chains or replacing the tires, speed calculations based on the speed sensor may be incorrect.	Drive the vehicle for a while [at approximately 30 km/h (19 MPH) for about 30 minutes] to automatically correct the vehicle icon position. If this does not correct the vehicle icon position, contact an INFINITI dealer.
	The map data has a mistake or is incomplete (the vehicle icon position is always misaligned in the same area).	Updated road information will be included in the next version of the map data.

RELATED TO ROUTE CALCULATION AND VISUAL GUIDANCE

Symptom	Possible cause	Possible solution
Waypoints are not included in the auto reroute calculation.	Waypoints that you have already passed are not included in the auto reroute calculation.	If you want to go to that waypoint again, you need to edit the route.
Route information is not displayed.	Route calculation has not yet been performed.	Set the destination and perform route calculation.
	You are not driving on the suggested route.	Drive on the suggested route.
	Route guidance is set to off.	Turn on route guidance.
	Route information is not provided for certain types of roads (roads displayed in gray).	This is not a malfunction.
The auto reroute calculation (or detour calculation) suggests the same route as the one previously suggested.	Route calculations took priority conditions into consideration, but the same route was calculated.	This is not a malfunction.
A waypoint cannot be added.	Five waypoints are already set on the route, including ones that you have already passed.	A maximum of 5 waypoints can be set on the route. If you want to go to 6 or more waypoints, perform route calculations multiple times as necessary.
The suggested route is not displayed.	Roads near the destination cannot be calculated.	Reset the destination to a main or ordinary road, and recalculate the route.
	The starting point and destination are too close.	Set a more distant destination.
	The starting point and destination are too far away.	Divide your trip by selecting one or two intermediate destinations, and perform route calculations multiple times.
	There are time restricted roads (by the day of the week, by time) near the current vehicle location or destination.	Set [Use Time Restricted Roads] to off.
The part of the route that you have already passed is deleted.	A route is managed by sections between waypoints. If you passed the first waypoint, the section between the starting point and the waypoint is deleted. (It may not be deleted depending on the area.)	This is not a malfunction.
An indirect route is suggested.	If there are restrictions (such as one-way streets) on roads close to the starting point or destination, the system may suggest an indirect route.	Adjust the location of the starting of the starting point or destination.
	The system may suggest an indirect route because route calculation does not take into consideration some areas such as narrow streets (gray roads.)	Reset the destination to a main or ordinary road, and recalculate the route.

NORMAL OPERATING CONDITION

< SYMPTOM DIAGNOSIS >

[BOSE AUDIO WITH NAVIGATION]

Symptom	Possible cause	Possible solution
The landmark information does not correspond to the actual information.	This may be caused by insufficient or incorrect map data.	Updated information will be included in the next version of the data.
The suggested route does not exactly connect to the starting point, waypoints, or destination.	There is no data for route calculation closes to these locations.	Set the starting point, waypoints and destination on a main road, and perform route calculation.

RELATED TO VOICE GUIDANCE

Symptom	Possible cause	Possible solution
Voice guidance is not available	Voice guidance is only available at certain intersections marked with In some case, voice guidance is not available even when the vehicle should make a turn.	This is not a malfunction.
	The vehicle has deviated from the suggested route.	Go back to the suggested route or request route calculation again
	Voice guide is set to off.	Turn on voice guidance.
	Route guidance is set to off.	Turn on voice guidance.
The guidance contact does not correspond to the actual condition.	The contact of voice guidance may vary, depending on the types of intersections at which turn are made.	Follow all traffic rules and regulations.

A
B
C
D
E
F
G
H
I
J
K
L
M

AV

O
P

REMOVAL AND INSTALLATION

AV CONTROL UNIT

Removal and Installation

INFOID:000000005913084

REMOVAL

CAUTION:

Before replacing AV control unit, perform “READ CONFIGURATION” to save or print current vehicle specification. For details, refer to [AV-227, "Work Procedure"](#).

1. Remove the preset switch. Refer to [AV-314, "Removal and Installation"](#).
2. After removing the AV control unit mounting screws to disconnect the connectors, remove the AV control unit with the bracket attached.
3. Remove the bracket screws to remove the bracket from the AV control unit.

INSTALLATION

Install in the reverse order of removal.

CAUTION:

Be sure to perform “WRITE CONFIGURATION” when replacing AV control unit. For details, refer to [AV-228, "Work Procedure"](#).

FRONT DOOR WOOFER

< REMOVAL AND INSTALLATION >

[BOSE AUDIO WITH NAVIGATION]

FRONT DOOR WOOFER

Removal and Installation

INFOID:000000005990308

REMOVAL

1. Remove the front door finisher. Refer to [INT-31, "FRONT DOOR FINISHER : Removal and Installation"](#).
2. Remove the screws and disconnect the connector to remove front door woofer.

INSTALLATION

Installation is the reverse order of removal.

A

B

C

D

E

F

G

H

I

J

K

L

M

AV

O

P

FRONT DOOR SQUAWKER

< REMOVAL AND INSTALLATION >

[BOSE AUDIO WITH NAVIGATION]

FRONT DOOR SQUAWKER

Removal and Installation

INFOID:000000005990306

REMOVAL

1. Remove the front door finisher. Refer to [INT-31, "FRONT DOOR FINISHER : Removal and Installation"](#).
2. Remove the screws to remove the front door squawker from the door finisher.

INSTALLATION

Installation is the reverse order of removal.

TWEETER

Removal and Installation

INFOID:000000005990312

REMOVAL

1. Remove the front sash inner cover. Refer to [INT-32. "FRONT DOOR SASH INNER COVER : Removal and Installation"](#).
2. Remove the screws to remove the tweeter from the front sash inner cover.

INSTALLATION

Installation is the reverse order of removal.

A
B
C
D
E
F
G
H
I
J
K
L
M

AV

O
P

REAR DOOR SPEAKER

< REMOVAL AND INSTALLATION >

[BOSE AUDIO WITH NAVIGATION]

REAR DOOR SPEAKER

Removal and Installation

INFOID:000000005990310

REMOVAL

1. Remove the rear door finisher. Refer to [INT-33. "REAR DOOR FINISHER : Removal and Installation"](#).
2. Remove the screws and disconnect the connector to remove the rear door speaker.

INSTALLATION

Installation is the reverse order of removal.

SATELLITE SPEAKER

< REMOVAL AND INSTALLATION >

[BOSE AUDIO WITH NAVIGATION]

SATELLITE SPEAKER

Removal and Installation

INFOID:000000005990429

REMOVAL

1. Remove the rear parcel shelf finisher. Refer to [INT-43, "Removal and Installation"](#).
2. Remove the screws and disconnect the connector to remove the satellite speaker.

INSTALLATION

Installation is the reverse order of removal.

A

B

C

D

E

F

G

H

I

J

K

L

M

AV

O

P

CENTER SPEAKER

< REMOVAL AND INSTALLATION >

[BOSE AUDIO WITH NAVIGATION]

CENTER SPEAKER

Removal and Installation

INFOID:000000005913094

REMOVAL

1. Remove the upper ventilator grille. Refer to [IP-13. "Removal and Installation"](#).
2. Remove the screws and disconnect the connector to remove the center speaker.

INSTALLATION

Install in the reverse order of removal.

REAR WOOFER

Removal and Installation

INFOID:000000005913096

REMOVAL

1. Remove the rear parcel shelf finisher. Refer to [INT-43, "Removal and Installation"](#).
2. Remove the screws and disconnect the connector to remove the rear woofer.

INSTALLATION

Install in the reverse order of removal.

A
B
C
D
E
F
G
H
I
J
K
L
M
O
P

AV

SEAT SPEAKER

Removal and Installation

INFOID:000000005913098

REMOVAL

1. Remove the seat speaker grille as shown in the figure.
CAUTION:
Never reuse seat speaker grille. The pawl is broken when removing.
2. Remove the front seatback trim and pad. Refer to [SE-109](#), "[SEATBACK : Disassembly and Assembly](#)".

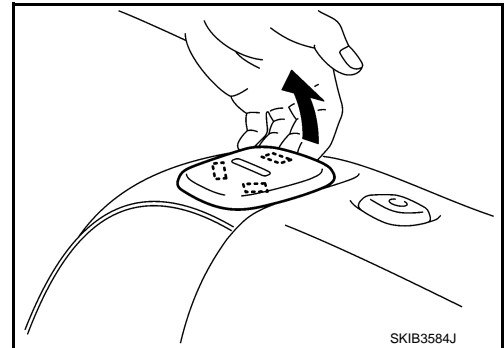

3. Remove the screws and disconnect the connector to remove the seat speaker.

INSTALLATION

Install in the reverse order of removal.

BOSE AMP.

Removal and Installation

INFOID:000000005913100

REMOVAL

1. Remove the trunk front finisher. Refer to [INT-53, "Exploded View"](#).
2. Remove the rear parcel shelf finisher. Refer to [INT-43, "Removal and Installation"](#).
3. Remove the BOSE amp. mounting bolts.
4. Disconnect the connectors to remove the BOSE amp. from the rear parcel shelf (trunk room side).

INSTALLATION

Install in the reverse order of removal.

A
B
C
D
E
F
G
H
I
J
K
L
M
O
P

AV

FRONT MICROPHONE (ACTIVE NOISE CONTROL SYSTEM/AUDIOPILOT® 2)

Removal and Installation

INFOID:000000005913102

REMOVAL

1. Remove the map lamp assembly. Refer to [INL-67, "Removal and Installation"](#).
2. Press the pawl to remove the front microphone from the map lamp assembly.

CAUTION:

Carefully handle the pawl fixing the front microphone because the pawl is fragile.

INSTALLATION

Install in the reverse order of removal.

NOTE:

Check the front microphone for looseness after the installation.

REAR MICROPHONE (ACTIVE NOISE CONTROL SYSTEM)

< REMOVAL AND INSTALLATION >

[BOSE AUDIO WITH NAVIGATION]

REAR MICROPHONE (ACTIVE NOISE CONTROL SYSTEM)

Removal and Installation

INFOID:000000005990481

REMOVAL

1. Remove the headlining. Refer to [INT-49. "Removal and Installation"](#).
2. Remove the rear microphone from the headlining.

INSTALLATION

Install in the reverse order of removal.

A

B

C

D

E

F

G

H

I

J

K

L

M

AV

O

P

ANTENNA AMP.

Removal and Installation

INFOID:000000005990476

REMOVAL

1. Remove the rear pillar finisher RH. Refer to [INT-42, "REAR PILLAR FINISHER : Removal and Installation"](#).
2. Remove the screw and disconnect the connector to remove the antenna amp.

INSTALLATION

Installation is the reverse order of removal.

DISPLAY UNIT

Removal and Installation

INFOID:000000005913086

REMOVAL

1. Remove the center ventilator assembly. Refer to [IP-13. "Removal and Installation"](#).
2. Remove the screws and disconnect the connector to remove the display unit.

INSTALLATION

Install in the reverse order of removal.

A
B
C
D
E
F
G
H
I
J
K
L
M
O
P

AV

SATELLITE RADIO ANTENNA

< REMOVAL AND INSTALLATION >

[BOSE AUDIO WITH NAVIGATION]

SATELLITE RADIO ANTENNA

Exploded View

INFOID:000000005990477

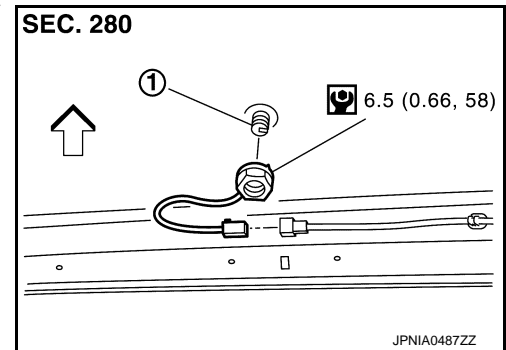

- 1. Satellite radio antenna
- ⇐: Vehicle front

Removal and Installation

INFOID:000000005990478

REMOVAL

1. Remove the head lining assembly. Refer to [INT-49. "Removal and Installation"](#).
2. Remove the nut and disconnect the connector to remove the satellite radio antenna from the roof panel.

INSTALLATION

Installation is the reverse order of removal.

CAUTION:

Be careful about tightening torque. Antenna sensitivity becomes poor, and when it is excessive, roof panel may be deformed, when satellite radio antenna mounting nut tightening torque is loose.

MULTIFUNCTION SWITCH

< REMOVAL AND INSTALLATION >

[BOSE AUDIO WITH NAVIGATION]

MULTIFUNCTION SWITCH

Removal and Installation

INFOID:000000005913106

REMOVAL

1. Remove the cluster lid D. Refer to [IP-13. "Removal and Installation"](#).
2. Remove the screws (A) to remove the multifunction switch from the cluster lid D.

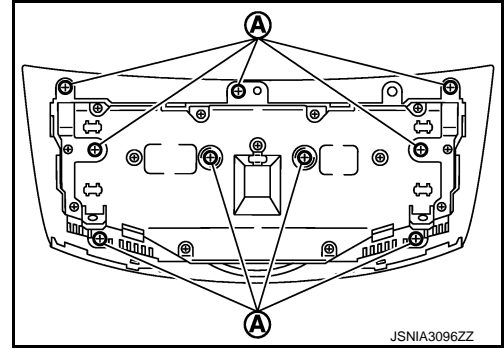

INSTALLATION

Install in the reverse order of removal.

A
B
C
D
E
F
G
H
I
J
K
L
M
AV
O
P

PRESET SWITCH

< REMOVAL AND INSTALLATION >

[BOSE AUDIO WITH NAVIGATION]

PRESET SWITCH

Removal and Installation

INFOID:000000005913108

REMOVAL

1. Remove the Instrument side panel LH and RH. Refer to [IP-24, "Removal and Installation"](#).
2. Remove the preset switch straight from the instrument panel assembly while disengaging the resin clips and pawls with a remover.

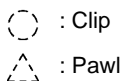
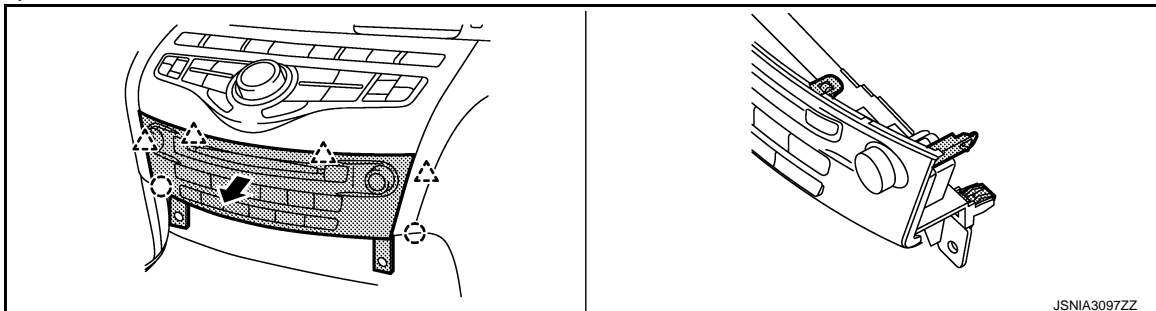

CAUTION:

- The resin clips and pawls must be disengaged slowly to avoid damage to the pawls and the preset switch.
- Place protective tape on the area of using the remover to avoid damage.

STEERING SWITCH

< REMOVAL AND INSTALLATION >

[BOSE AUDIO WITH NAVIGATION]

STEERING SWITCH

Removal and Installation

INFOID:000000005913110

REMOVAL

Refer to [ST-34. "Removal and Installation"](#).

INSTALLATION

Install in the reverse order of removal.

A

B

C

D

E

F

G

H

I

J

K

L

M

AV

O

P

USB CONNECTOR

Removal and Installation

INFOID:000000005913112

REMOVAL

1. Remove the console center finisher. Refer to [IP-24. "Removal and Installation"](#).
2. Push the pawl from the back of the console center finisher to remove the USB connector.

INSTALLATION

Install in the reverse order of removal.

GPS ANTENNA

< REMOVAL AND INSTALLATION >

[BOSE AUDIO WITH NAVIGATION]

GPS ANTENNA

Exploded View

INFOID:000000005913115

FEEDER LAYOUT

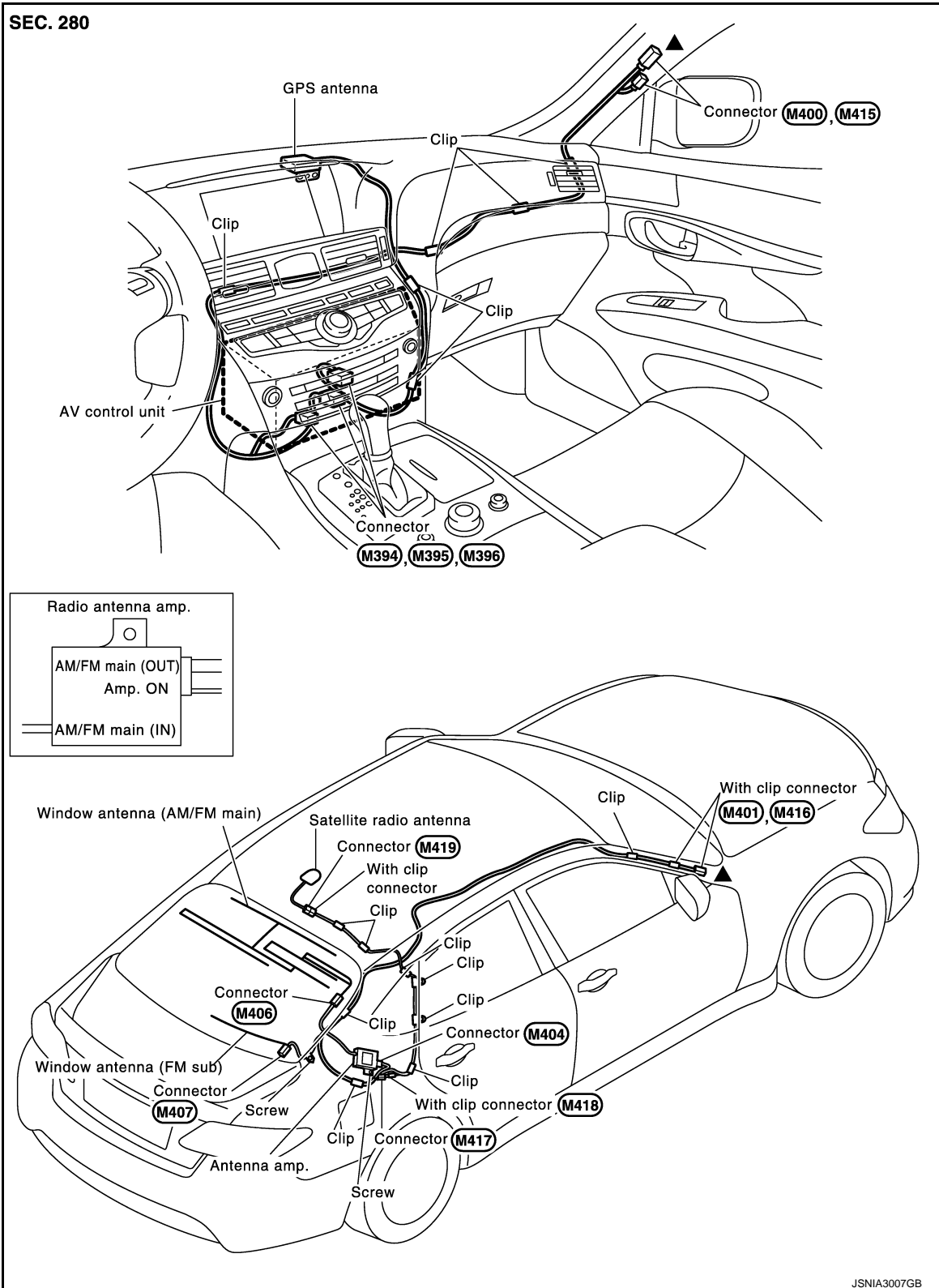

Removal and Installation

INFOID:000000005913117

REMOVAL

Revision: 2010 June

AV-317

2011 M37/M56

A
B
C
D
E
F
G
H
I
J
K
L
M
N
O
P

AV

GPS ANTENNA

< REMOVAL AND INSTALLATION >

[BOSE AUDIO WITH NAVIGATION]

1. Remove the instrument panel. Refer to [IP-13, "Removal and Installation"](#).
2. Remove the screw to remove the GPS antenna from the instrument panel.

INSTALLATION

Install in the reverse order of removal.

MICROPHONE

Removal and Installation

INFOID:000000005913114

REMOVAL

1. Remove the map lamp assembly. Refer to [INL-67, "Removal and Installation"](#).
2. Press the pawl to remove the microphone from the map lamp assembly.

CAUTION:

Carefully handle the pawl fixing the microphone because the pawl is fragile.

INSTALLATION

Install in the reverse order of removal.

NOTE:

Check the microphone for looseness after the installation.

A
B
C
D
E
F
G
H
I
J
K
L
M
O
P

AV

REAR VIEW CAMERA

Removal and Installation

INFOID:000000005913119

REMOVAL

1. Remove the trunk lid inner finisher. Refer to [INT-56, "Removal and Installation"](#).
2. Disconnect the connector.
3. Insert a tool shown in the figure in the groove and push the pawl to remove the rear view camera (2) from the inner bracket (1) of the trunk lid finisher.

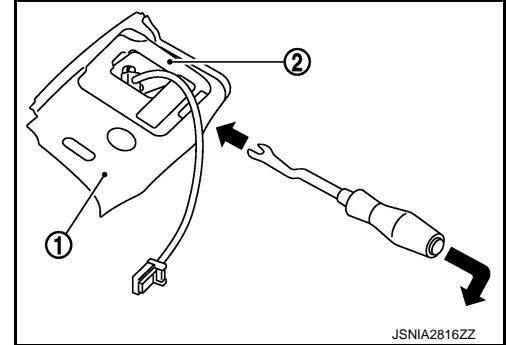

INSTALLATION

Install in the reverse order of removal.

NOTE:

Adjust the guide line position if the guide line position is shifted after installing the rear view camera. Refer to [AV-320, "Adjustment"](#).

Adjustment

INFOID:000000005913120

Adjust the guide line position if the guide line position is shifted after installing the rear view camera.

1. Draw lines on rearward area of the vehicle passing through the following points: 200 mm (7.87 in) from both sides of the vehicle, and 0.5 m (1.64 ft), 1.0 m (3.28 ft) from the rear end of the bumper.
2. Set into "Adjust offset of rear view camera" mode of Confirmation / Adjustment mode.

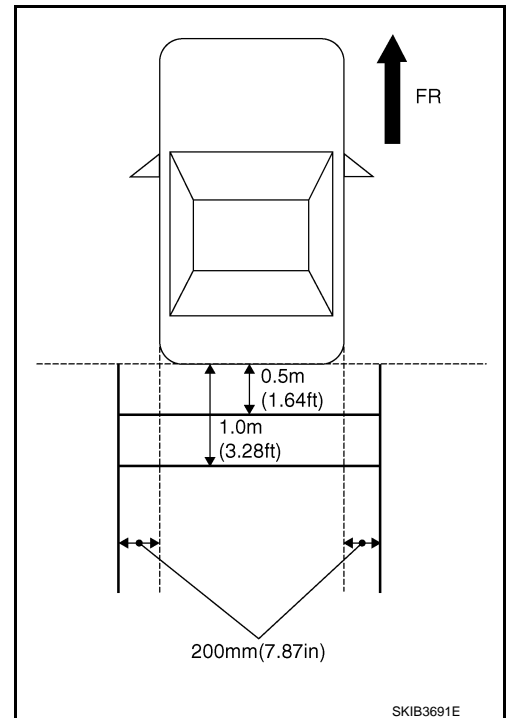

REAR VIEW CAMERA

< REMOVAL AND INSTALLATION >

[BOSE AUDIO WITH NAVIGATION]

3. Rotate the center dial, and then select the guiding line pattern so that its angle is aligned with the correction line of the rear of the vehicle.

Selected pattern : (-10°) – (10°)

4. Make fine adjustment to the correction line of the rear of the vehicle with up/down/left/right switches so that its position is aligned with the guiding line. Press "OK" switch and record the adjusted guiding line position to the camera control unit.

Up/Down adjustment range : (-10°) – (10°)

Left/Right adjustment range : (-10°) – (10°)

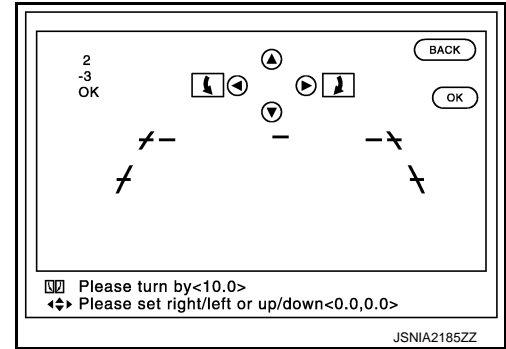

CAUTION:

Never operate other function such as pressing BACK while writing index data.

A
B
C
D
E
F
G
H
I
J
K
L
M
O
P

AV

STEERING ANGLE SENSOR

< REMOVAL AND INSTALLATION >

[BOSE AUDIO WITH NAVIGATION]

STEERING ANGLE SENSOR

Removal and Installation

INFOID:000000005913122

REMOVAL

1. Remove the spiral cable. Refer to [SR-14, "Removal and Installation"](#).
2. Remove the screws to remove the steering angle sensor from the spiral cable.

INSTALLATION

Install in the reverse order of removal.

ANTENNA FEEDER

< REMOVAL AND INSTALLATION >

[BOSE AUDIO WITH NAVIGATION]

ANTENNA FEEDER

Feeder Layout

INFOID:000000005913125

SEC. 280

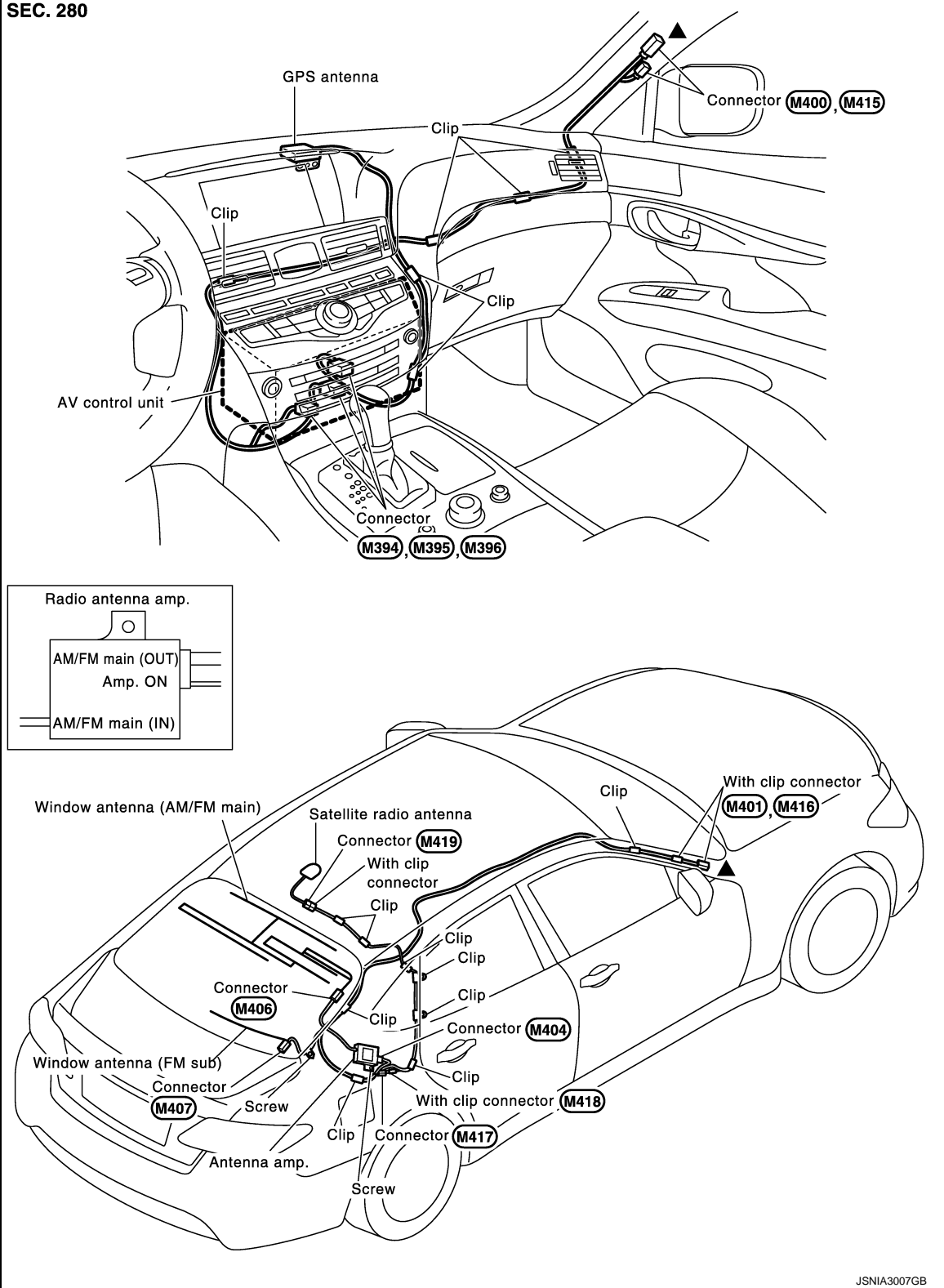

A
B
C
D
E
F
G
H
I
J
K
L
M
AV
O
P