

# SECTION **AV**

## AUDIO, VISUAL & NAVIGATION SYSTEM

A  
B  
C  
D  
E  
F  
G  
H  
I  
J  
K  
L  
M  
N  
O  
P

### CONTENTS

<p><b>BASE AUDIO WITHOUT NAVIGATION</b></p> <p><b>PRECAUTION</b> ..... 8</p> <p><b>PRECAUTIONS</b> ..... 8</p> <p style="padding-left: 20px;">Precaution for Supplemental Restraint System (SRS) "AIR BAG" and "SEAT BELT PRE-TENSIONER" .....8</p> <p style="padding-left: 20px;">Cautions in Removing Battery Terminal and AV Control Unit (Models with AV Control Unit) .....8</p> <p style="padding-left: 20px;">Precaution for Trouble Diagnosis .....8</p> <p style="padding-left: 20px;">Precaution for Harness Repair .....8</p> <p><b>PREPARATION</b> .....10</p> <p><b>PREPARATION</b> .....10</p> <p style="padding-left: 20px;">Commercial Service Tools ..... 10</p> <p><b>SYSTEM DESCRIPTION</b> .....11</p> <p><b>COMPONENT PARTS</b> .....11</p> <p style="padding-left: 20px;">Component Parts Location ..... 11</p> <p style="padding-left: 20px;">Component Description ..... 12</p> <p><b>SYSTEM</b> .....14</p> <p><b>MULTI AV SYSTEM</b> ..... 14</p> <p style="padding-left: 20px;">MULTI AV SYSTEM : System Diagram ..... 14</p> <p style="padding-left: 20px;">MULTI AV SYSTEM : System Description ..... 15</p> <p><b>DIAGNOSIS SYSTEM (AV CONTROL UNIT)....18</b></p> <p style="padding-left: 20px;">Description ..... 18</p> <p style="padding-left: 20px;">On Board Diagnosis Function ..... 18</p> <p style="padding-left: 20px;">CONSULT Function ..... 27</p> <p><b>DIAGNOSIS SYSTEM (ACTIVE NOISE CONTROL UNIT) .....30</b></p> <p style="padding-left: 20px;">On Board Diagnosis Function .....30</p> <p><b>DIAGNOSIS SYSTEM (TEL ADAPTER UNIT)....32</b></p> <p style="padding-left: 20px;">On Board Diagnosis Function ..... 32</p> <p><b>ECU DIAGNOSIS INFORMATION</b> .....34</p>	<p><b>AV CONTROL UNIT</b> .....34</p> <p style="padding-left: 20px;">Reference Value .....34</p> <p style="padding-left: 20px;">DTC Index .....40</p> <p><b>DISPLAY UNIT</b> .....42</p> <p style="padding-left: 20px;">Reference Value .....42</p> <p><b>ACTIVE NOISE CONTROL UNIT</b> .....45</p> <p style="padding-left: 20px;">Reference Value .....45</p> <p><b>SATELLITE RADIO TUNER</b> .....48</p> <p style="padding-left: 20px;">Reference Value .....48</p> <p><b>TEL ADAPTER UNIT</b> .....50</p> <p style="padding-left: 20px;">Reference Value .....50</p> <p><b>WIRING DIAGRAM</b> .....52</p> <p><b>BASE AUDIO WITHOUT NAVIGATION</b> .....52</p> <p style="padding-left: 20px;">Wiring Diagram .....52</p> <p><b>BASIC INSPECTION</b> .....57</p> <p><b>DIAGNOSIS AND REPAIR WORKFLOW</b> .....57</p> <p style="padding-left: 20px;">Work Flow .....57</p> <p><b>ADDITIONAL SERVICE WHEN REPLACING (AV CONTROL UNIT)</b> .....59</p> <p style="padding-left: 20px;">Description .....59</p> <p style="padding-left: 20px;">Work Procedure .....59</p> <p><b>CONFIGURATION (AV CONTROL UNIT)</b> .....60</p> <p style="padding-left: 20px;">Description .....60</p> <p style="padding-left: 20px;">Work Procedure .....60</p> <p style="padding-left: 20px;">Configuration List .....60</p> <p><b>DTC/CIRCUIT DIAGNOSIS</b> .....62</p> <p><b>U1000 CAN COMM CIRCUIT</b> .....62</p> <p style="padding-left: 20px;">Description .....62</p> <p style="padding-left: 20px;">DTC Logic .....62</p> <p style="padding-left: 20px;">Diagnosis Procedure .....62</p>
---	--

AV

<b>U1010 CONTROL UNIT (CAN)</b> .....	63	Diagnosis Procedure .....	82
DTC Logic .....	63		
<b>U1200 AV CONTROL UNIT</b> .....	64	<b>CAMERA IMAGE SIGNAL CIRCUIT</b> .....	83
DTC Logic .....	64	Description .....	83
		Diagnosis Procedure .....	83
<b>U1216 AV CONTROL UNIT</b> .....	65	<b>COMPOSITE IMAGE SIGNAL CIRCUIT</b> .....	85
DTC Logic .....	65	Description .....	85
		Diagnosis Procedure .....	85
<b>U1232 STEERING ANGLE SENSOR</b> .....	66	<b>HORIZONTAL SYNCHRONIZING (HP) SIGNAL CIRCUIT</b> .....	86
DTC Logic .....	66	Description .....	86
Diagnosis Procedure .....	66	Diagnosis Procedure .....	86
<b>U1243 DISPLAY UNIT</b> .....	67	<b>VERTICAL SYNCHRONIZING (VP) SIGNAL CIRCUIT</b> .....	87
DTC Logic .....	67	Description .....	87
Diagnosis Procedure .....	67	Diagnosis Procedure .....	87
<b>U1255 SATELLITE RADIO TUNER</b> .....	69	<b>DISK EJECT SIGNAL CIRCUIT</b> .....	88
DTC Logic .....	69	Description .....	88
Diagnosis Procedure .....	69	Diagnosis Procedure .....	88
<b>U1300 AV COMM CIRCUIT</b> .....	71	<b>MICROPHONE SIGNAL CIRCUIT</b> .....	89
Description .....	71	Description .....	89
		Diagnosis Procedure .....	89
<b>U1310 AV CONTROL UNIT</b> .....	72	<b>CONTROL SIGNAL CIRCUIT</b> .....	91
DTC Logic .....	72	Description .....	91
		Diagnosis Procedure .....	91
<b>POWER SUPPLY AND GROUND CIRCUIT</b> ....	73	<b>STEERING SWITCH SIGNAL A CIRCUIT</b> .....	92
<b>AV CONTROL UNIT</b> .....	73	Description .....	92
AV CONTROL UNIT : Diagnosis Procedure .....	73	Diagnosis Procedure .....	92
<b>DISPLAY UNIT</b> .....	73	Component Inspection .....	92
DISPLAY UNIT : Diagnosis Procedure .....	73	<b>STEERING SWITCH SIGNAL B CIRCUIT</b> .....	94
<b>ACTIVE NOISE CONTROL UNIT</b> .....	75	Description .....	94
ACTIVE NOISE CONTROL UNIT : Diagnosis Procedure .....	75	Diagnosis Procedure .....	94
		Component Inspection .....	94
<b>SATELLITE RADIO TUNER</b> .....	75	<b>STEERING SWITCH GROUND CIRCUIT</b> .....	96
SATELLITE RADIO TUNER : Diagnosis Procedure .....	75	Description .....	96
		Diagnosis Procedure .....	96
		Component Inspection .....	96
<b>TEL ADAPTER UNIT</b> .....	76	<b>SYMPTOM DIAGNOSIS</b> .....	98
TEL ADAPTER UNIT : Diagnosis Procedure .....	76	<b>MULTI AV SYSTEM SYMPTOMS</b> .....	98
		Symptom Table .....	98
<b>RGB (R: RED) SIGNAL CIRCUIT</b> .....	78	<b>NORMAL OPERATING CONDITION</b> .....	102
Description .....	78	Description .....	102
Diagnosis Procedure .....	78	<b>REMOVAL AND INSTALLATION</b> .....	105
<b>RGB (G: GREEN) SIGNAL CIRCUIT</b> .....	79	<b>AV CONTROL UNIT</b> .....	105
Description .....	79	Removal and Installation .....	105
Diagnosis Procedure .....	79	<b>FRONT DOOR SPEAKER</b> .....	106
<b>RGB (B: BLUE) SIGNAL CIRCUIT</b> .....	80	Removal and Installation .....	106
Description .....	80		
Diagnosis Procedure .....	80		
<b>RGB SYNCHRONIZING SIGNAL CIRCUIT</b> ....	81		
Description .....	81		
Diagnosis Procedure .....	81		
<b>RGB AREA (YS) SIGNAL CIRCUIT</b> .....	82		
Description .....	82		

<b>FRONT DOOR SQUAWKER</b> .....	<b>107</b>	Precaution for Supplemental Restraint System (SRS) "AIR BAG" and "SEAT BELT PRE-TENSIONER" .....	126	A
Removal and Installation .....	107	Cautions in Removing Battery Terminal and AV Control Unit (Models with AV Control Unit) .....	126	B
<b>REAR DOOR SPEAKER</b> .....	<b>108</b>	Precaution for Trouble Diagnosis .....	126	
Removal and Installation .....	108	Precaution for Harness Repair .....	126	
<b>ACTIVE NOISE CONTROL UNIT</b> .....	<b>109</b>	<b>PREPARATION</b> .....	<b>128</b>	C
Removal and Installation .....	109	<b>PREPARATION</b> .....	<b>128</b>	
<b>FRONT MICROPHONE (ACTIVE NOISE CONTROL SYSTEM)</b> .....	<b>110</b>	Commercial Service Tools .....	128	D
Removal and Installation .....	110	<b>SYSTEM DESCRIPTION</b> .....	<b>129</b>	
<b>REAR MICROPHONE (ACTIVE NOISE CONTROL SYSTEM)</b> .....	<b>111</b>	<b>COMPONENT PARTS</b> .....	<b>129</b>	E
Removal and Installation .....	111	Component Parts Location .....	129	
<b>ANTENNA AMP.</b> .....	<b>112</b>	Component Description .....	132	F
Removal and Installation .....	112	<b>SYSTEM</b> .....	<b>134</b>	
<b>DISPLAY UNIT</b> .....	<b>113</b>	<b>MULTI AV SYSTEM</b> .....	<b>134</b>	G
Removal and Installation .....	113	MULTI AV SYSTEM : System Diagram .....	134	
<b>SATELLITE RADIO TUNER</b> .....	<b>114</b>	MULTI AV SYSTEM : System Description .....	135	
Removal and Installation .....	114	MULTI AV SYSTEM : Fail-Safe .....	142	
<b>SATELLITE RADIO ANTENNA</b> .....	<b>115</b>	<b>DIAGNOSIS SYSTEM (AV CONTROL UNIT)</b> .	<b>143</b>	H
Exploded View .....	115	Description .....	143	
Removal and Installation .....	115	On Board Diagnosis Function .....	143	
<b>MULTIFUNCTION SWITCH</b> .....	<b>116</b>	CONSULT Function .....	157	I
Removal and Installation .....	116	<b>DIAGNOSIS SYSTEM [BOSE AMP.(ACTIVE NOISE CONTROL SYSTEM)]</b> .....	<b>162</b>	J
<b>PRESET SWITCH</b> .....	<b>117</b>	On Board Diagnosis Function .....	162	
Removal and Installation .....	117	<b>ECU DIAGNOSIS INFORMATION</b> .....	<b>164</b>	K
<b>STEERING SWITCH</b> .....	<b>118</b>	<b>AV CONTROL UNIT</b> .....	<b>164</b>	
Removal and Installation .....	118	Reference Value .....	164	L
<b>USB CONNECTOR</b> .....	<b>119</b>	Fail-Safe .....	169	
Removal and Installation .....	119	DTC Index .....	170	
<b>MICROPHONE</b> .....	<b>120</b>	<b>DISPLAY UNIT</b> .....	<b>173</b>	M
Removal and Installation .....	120	Reference Value .....	173	
<b>TEL ADAPTER UNIT</b> .....	<b>121</b>	<b>BOSE AMP.</b> .....	<b>175</b>	
Removal and Installation .....	121	Reference Value .....	175	
<b>REAR VIEW CAMERA</b> .....	<b>122</b>	<b>WIRING DIAGRAM</b> .....	<b>185</b>	AV
Removal and Installation .....	122	<b>BOSE AUDIO WITH NAVIGATION</b> .....	<b>185</b>	
Adjustment .....	122	Wiring Diagram .....	185	O
<b>STEERING ANGLE SENSOR</b> .....	<b>124</b>	<b>BASIC INSPECTION</b> .....	<b>191</b>	
Removal and Installation .....	124	<b>DIAGNOSIS AND REPAIR WORKFLOW</b> .....	<b>191</b>	P
<b>ANTENNA FEEDER</b> .....	<b>125</b>	Work Flow .....	191	
Feeder Layout .....	125	<b>ADDITIONAL SERVICE WHEN REPLACING (AV CONTROL UNIT)</b> .....	<b>193</b>	
<b>BOSE AUDIO WITH NAVIGATION</b>		Description .....	193	
<b>PRECAUTION</b> .....	<b>126</b>	Work Procedure .....	193	
<b>PRECAUTIONS</b> .....	<b>126</b>			

<b>CONFIGURATION (AV CONTROL UNIT) .....</b>	<b>194</b>	DTC Logic .....	210
Description .....	194	Diagnosis Procedure .....	210
Work Procedure .....	194		
Configuration List .....	194		
<b>DTC/CIRCUIT DIAGNOSIS .....</b>	<b>196</b>		
<b>U1000 CAN COMM CIRCUIT .....</b>	<b>196</b>	<b>U121C AV CONTROL UNIT .....</b>	<b>211</b>
Description .....	196	DTC Logic .....	211
DTC Logic .....	196	Diagnosis Procedure .....	211
Diagnosis Procedure .....	196		
<b>U1010 CONTROL UNIT (CAN) .....</b>	<b>197</b>	<b>U121D AV CONTROL UNIT .....</b>	<b>212</b>
DTC Logic .....	197	DTC Logic .....	212
		Diagnosis Procedure .....	212
<b>U1200 AV CONTROL UNIT .....</b>	<b>198</b>		
DTC Logic .....	198	<b>U121E AV CONTROL UNIT .....</b>	<b>213</b>
		DTC Logic .....	213
<b>U1201 AV CONTROL UNIT .....</b>	<b>199</b>	Diagnosis Procedure .....	213
DTC Logic .....	199		
<b>U1202 AV CONTROL UNIT .....</b>	<b>200</b>	<b>U1225 AV CONTROL UNIT .....</b>	<b>214</b>
DTC Logic .....	200	DTC Logic .....	214
<b>U1204 AV CONTROL UNIT .....</b>	<b>201</b>		
Description .....	201	<b>U1227 AV CONTROL UNIT .....</b>	<b>215</b>
DTC Logic .....	201	DTC Logic .....	215
Diagnosis Procedure .....	201	Diagnosis Procedure .....	215
<b>U1205 AV CONTROL UNIT .....</b>	<b>202</b>		
Description .....	202	<b>U1228 AV CONTROL UNIT .....</b>	<b>216</b>
DTC Logic .....	202	DTC Logic .....	216
Diagnosis Procedure .....	202		
<b>U1206 AV CONTROL UNIT .....</b>	<b>203</b>	<b>U1229 AV CONTROL UNIT .....</b>	<b>217</b>
Description .....	203	DTC Logic .....	217
DTC Logic .....	203		
Diagnosis Procedure .....	203	<b>U122A AV CONTROL UNIT .....</b>	<b>218</b>
<b>U1207 AV CONTROL UNIT .....</b>	<b>204</b>	DTC Logic .....	218
Description .....	204	Diagnosis Procedure .....	218
DTC Logic .....	204		
Diagnosis Procedure .....	204	<b>U122E AV CONTROL UNIT .....</b>	<b>219</b>
<b>U1216 AV CONTROL UNIT .....</b>	<b>205</b>	DTC Logic .....	219
DTC Logic .....	205		
<b>U1217 AV CONTROL UNIT .....</b>	<b>206</b>	<b>U1231 BOSE AMP. ....</b>	<b>220</b>
DTC Logic .....	206	DTC Logic .....	220
<b>U1218 AV CONTROL UNIT .....</b>	<b>207</b>		
DTC Logic .....	207	<b>U1232 STEERING ANGLE SENSOR .....</b>	<b>221</b>
Diagnosis Procedure .....	207	DTC Logic .....	221
<b>U1219 AV CONTROL UNIT .....</b>	<b>208</b>	Diagnosis Procedure .....	221
DTC Logic .....	208		
Diagnosis Procedure .....	208	<b>U1243 DISPLAY UNIT .....</b>	<b>222</b>
<b>U121A AV CONTROL UNIT .....</b>	<b>209</b>	DTC Logic .....	222
DTC Logic .....	209	Diagnosis Procedure .....	222
Diagnosis Procedure .....	209		
<b>U121B AV CONTROL UNIT .....</b>	<b>210</b>	<b>U1244 GPS ANTENNA .....</b>	<b>224</b>
		DTC Logic .....	224
		Diagnosis Procedure .....	224
		<b>U1258 SATELLITE RADIO ANTENNA .....</b>	<b>225</b>
		DTC Logic .....	225
		Diagnosis Procedure .....	225
		<b>U1263 USB .....</b>	<b>226</b>
		DTC Logic .....	226
		Diagnosis Procedure .....	226
		<b>U1264 ANTENNA AMP. ....</b>	<b>227</b>
		DTC Logic .....	227
		Diagnosis Procedure .....	227
		<b>U1300 AV COMM CIRCUIT .....</b>	<b>228</b>

Description .....	228	Diagnosis Procedure .....	246	
<b>U1310 AV CONTROL UNIT .....</b>	<b>229</b>	<b>STEERING SWITCH SIGNAL A CIRCUIT .....</b>	<b>248</b>	A
DTC Logic .....	229	Description .....	248	
<b>U1601, U1609 FRONT DOOR WOOFER .....</b>	<b>230</b>	Diagnosis Procedure .....	248	B
DTC Logic .....	230	Component Inspection .....	248	
Diagnosis Procedure .....	230	<b>STEERING SWITCH SIGNAL B CIRCUIT .....</b>	<b>250</b>	C
<b>U1602, U160A FRONT DOOR SQUAWKER/ TWEETER .....</b>	<b>231</b>	Description .....	250	
DTC Logic .....	231	Diagnosis Procedure .....	250	
Diagnosis Procedure .....	231	Component Inspection .....	250	D
<b>U162A CENTER SPEAKER .....</b>	<b>232</b>	<b>STEERING SWITCH GROUND CIRCUIT .....</b>	<b>252</b>	E
DTC Logic .....	232	Description .....	252	
Diagnosis Procedure .....	232	Diagnosis Procedure .....	252	
<b>U1632, U163A, U163E SEAT SPEAKER .....</b>	<b>233</b>	Component Inspection .....	252	
DTC Logic .....	233	<b>SYMPTOM DIAGNOSIS .....</b>	<b>254</b>	F
Diagnosis Procedure .....	233	<b>MULTI AV SYSTEM SYMPTOMS .....</b>	<b>254</b>	
<b>U1708, U1710 REAR DOOR SPEAKER .....</b>	<b>234</b>	Symptom Table .....	254	
DTC Logic .....	234	<b>NORMAL OPERATING CONDITION .....</b>	<b>259</b>	G
Diagnosis Procedure .....	234	Description .....	259	
<b>U1725 REAR WOOFER .....</b>	<b>235</b>	<b>REMOVAL AND INSTALLATION .....</b>	<b>265</b>	H
DTC Logic .....	235	<b>AV CONTROL UNIT .....</b>	<b>265</b>	
Diagnosis Procedure .....	235	Removal and Installation .....	265	
<b>U190C FRONT/REAR MICROPHONE .....</b>	<b>236</b>	<b>FRONT DOOR WOOFER .....</b>	<b>266</b>	I
DTC Logic .....	236	Removal and Installation .....	266	
Diagnosis Procedure .....	236	<b>FRONT DOOR SQUAWKER .....</b>	<b>267</b>	J
<b>POWER SUPPLY AND GROUND CIRCUIT ...</b>	<b>238</b>	Removal and Installation .....	267	
<b>AV CONTROL UNIT .....</b>	<b>238</b>	<b>TWEETER .....</b>	<b>268</b>	K
AV CONTROL UNIT : Diagnosis Procedure .....	238	Removal and Installation .....	268	
<b>DISPLAY UNIT .....</b>	<b>238</b>	<b>REAR DOOR SPEAKER .....</b>	<b>269</b>	L
DISPLAY UNIT : Diagnosis Procedure .....	238	Removal and Installation .....	269	
<b>BOSE AMP. ....</b>	<b>239</b>	<b>SATELLITE SPEAKER .....</b>	<b>270</b>	M
BOSE AMP. : Diagnosis Procedure .....	239	Removal and Installation .....	270	
<b>RGB DIGITAL IMAGE SIGNAL CIRCUIT .....</b>	<b>241</b>	<b>CENTER SPEAKER .....</b>	<b>271</b>	
Description .....	241	Removal and Installation .....	271	
Diagnosis Procedure .....	241	<b>REAR WOOFER .....</b>	<b>272</b>	AV
<b>COMPOSITE IMAGE SIGNAL CIRCUIT .....</b>	<b>242</b>	Removal and Installation .....	272	
Description .....	242	<b>SEAT SPEAKER .....</b>	<b>273</b>	O
Diagnosis Procedure .....	242	Removal and Installation .....	273	
<b>DISK EJECT SIGNAL CIRCUIT .....</b>	<b>243</b>	<b>BOSE AMP. ....</b>	<b>274</b>	P
Description .....	243	Removal and Installation .....	274	
Diagnosis Procedure .....	243	<b>FRONT MICROPHONE (ACTIVE NOISE CONTROL SYSTEM/AUDIOPILOT® 2) .....</b>	<b>275</b>	
<b>MICROPHONE SIGNAL CIRCUIT .....</b>	<b>244</b>	Removal and Installation .....	275	
Description .....	244	<b>REAR MICROPHONE (ACTIVE NOISE CON- TROL SYSTEM) .....</b>	<b>276</b>	
Diagnosis Procedure .....	244			
<b>CAMERA IMAGE SIGNAL CIRCUIT .....</b>	<b>246</b>			
Description .....	246			

Removal and Installation .....	276	Antenna Feeder .....	297
<b>ANTENNA AMP. ....</b>	<b>277</b>	Telematics Switch .....	298
Removal and Installation .....	277	<b>SYSTEM .....</b>	<b>299</b>
<b>DISPLAY UNIT .....</b>	<b>278</b>	<b>TELEMATICS SYSTEM .....</b>	<b>299</b>
Removal and Installation .....	278	TELEMATICS SYSTEM : System Description .....	299
<b>SATELLITE RADIO ANTENNA .....</b>	<b>279</b>	<b>HANDLING PRECAUTION .....</b>	<b>301</b>
Exploded View .....	279	Telematics .....	301
Removal and Installation .....	279	<b>DIAGNOSIS SYSTEM (TCU) .....</b>	<b>302</b>
<b>MULTIFUNCTION SWITCH .....</b>	<b>280</b>	CONSULT Function .....	302
Removal and Installation .....	280	<b>ECU DIAGNOSIS INFORMATION .....</b>	<b>304</b>
<b>PRESET SWITCH .....</b>	<b>281</b>	<b>AV CONTROL UNIT .....</b>	<b>304</b>
Removal and Installation .....	281	Reference Value .....	304
<b>STEERING SWITCH .....</b>	<b>282</b>	<b>TCU .....</b>	<b>305</b>
Removal and Installation .....	282	Reference Value .....	305
<b>USB CONNECTOR .....</b>	<b>283</b>	DTC Index .....	307
Removal and Installation .....	283	<b>WIRING DIAGRAM .....</b>	<b>309</b>
<b>GPS ANTENNA .....</b>	<b>284</b>	<b>BOSE AUDIO WITH NAVIGATION .....</b>	<b>309</b>
Exploded View .....	284	Wiring Diagram .....	309
Removal and Installation .....	285	<b>BASIC INSPECTION .....</b>	<b>315</b>
<b>MICROPHONE .....</b>	<b>286</b>	<b>DIAGNOSIS AND REPAIR WORK FLOW .....</b>	<b>315</b>
Removal and Installation .....	286	Work Flow .....	315
<b>REAR VIEW CAMERA .....</b>	<b>287</b>	<b>INSPECTION AND ADJUSTMENT .....</b>	<b>317</b>
Removal and Installation .....	287	<b>ADDITIONAL SERVICE WHEN REPLACING TCU. 317</b>	
Adjustment .....	287	ADDITIONAL SERVICE WHEN REPLACING	
<b>STEERING ANGLE SENSOR .....</b>	<b>289</b>	TCU : Description .....	317
Removal and Installation .....	289	ADDITIONAL SERVICE WHEN REPLACING	
<b>ANTENNA FEEDER .....</b>	<b>290</b>	TCU : Work Procedure .....	317
Feeder Layout .....	290	<b>DTC/CIRCUIT DIAGNOSIS .....</b>	<b>319</b>
<b>TELEMATICS SYSTEM</b>			
<b>PRECAUTION .....</b>	<b>291</b>	<b>U1000 CAN COMM CIRCUIT .....</b>	<b>319</b>
<b>PRECAUTIONS .....</b>	<b>291</b>	DESCRIPTION .....	319
Precaution for Supplemental Restraint System		DTC Logic .....	319
(SRS) "AIR BAG" and "SEAT BELT PRE-TEN-		Diagnosis Procedure .....	319
SIONER" .....	291	<b>U1010 CONTROL UNIT (CAN) .....</b>	<b>320</b>
Precaution for Trouble Diagnosis .....	291	DTC Logic .....	320
Precaution for Harness Repair .....	291	<b>U1A00 TCU .....</b>	<b>321</b>
<b>SYSTEM DESCRIPTION .....</b>	<b>293</b>	DTC Logic .....	321
<b>DESCRIPTION .....</b>	<b>293</b>	Diagnosis Procedure .....	321
Telematics system .....	293	<b>U1A01 TCU .....</b>	<b>322</b>
<b>COMPONENT PARTS .....</b>	<b>294</b>	DTC Logic .....	322
Component Parts Location .....	294	<b>U1A02 TCU .....</b>	<b>323</b>
AV CONTROL UNIT .....	295	DTC Logic .....	323
TCU .....	295	<b>U1A03 TCU .....</b>	<b>324</b>
Telematics Antenna .....	296	DTC Logic .....	324
GPS Antenna .....	296		
Microphone .....	296		

<b>U1A04 TCU</b> .....	<b>325</b>	<b>POWER SUPPLY AND GROUND CIRCUIT</b> ..	<b>334</b>	
DTC Logic .....	325	<b>TCU</b> .....	<b>334</b>	A
<b>U1A05 TCU</b> .....	<b>326</b>	TCU : Diagnosis Procedure .....	334	
DTC Logic .....	326	<b>MICROPHONE SIGNAL CIRCUIT</b> .....	<b>335</b>	B
Diagnosis Procedure .....	326	Description .....	335	
<b>U1A07 TEL ANTENNA</b> .....	<b>327</b>	Diagnosis Procedure .....	335	
DTC Logic .....	327	<b>SYMPTOM DIAGNOSIS</b> .....	<b>338</b>	C
Diagnosis Procedure .....	327	<b>TELEMATICS SYSTEM</b> .....	<b>338</b>	
<b>U1A08 TEL ANTENNA</b> .....	<b>328</b>	SYMPTOM TABLE .....	338	D
DTC Logic .....	328	<b>NORMAL OPERATING CONDITION</b> .....	<b>340</b>	
Diagnosis Procedure .....	328	Description .....	340	E
<b>U1A0B MICROPHONE</b> .....	<b>329</b>	<b>REMOVAL AND INSTALLATION</b> .....	<b>342</b>	
DTC Logic .....	329	<b>MICROPHONE</b> .....	<b>342</b>	F
Diagnosis Procedure .....	329	Removal and Installation .....	342	
<b>U1A0C MICROPHONE</b> .....	<b>331</b>	<b>TCU</b> .....	<b>343</b>	G
DTC Logic .....	331	Exploded View .....	343	
Diagnosis Procedure .....	331	Removal and Installation .....	343	
<b>U1A0E TELEMATICS SWITCH</b> .....	<b>332</b>	<b>TELEMATICS ANTENNA</b> .....	<b>344</b>	H
DTC Logic .....	332	Feeder Layout .....	344	
Diagnosis Procedure .....	332	Removal and Installation .....	345	
<b>U1A0F TELEMATICS SWITCH</b> .....	<b>333</b>	<b>TELEMATICS SWITCH</b> .....	<b>346</b>	I
DTC Logic .....	333	Removal and Installation .....	346	
Diagnosis Procedure .....	333			J
				K
				L
				M
				AV
				O
				P

## PRECAUTION

### PRECAUTIONS

#### Precaution for Supplemental Restraint System (SRS) "AIR BAG" and "SEAT BELT PRE-TENSIONER"

INFOID:000000008130715

The Supplemental Restraint System such as "AIR BAG" and "SEAT BELT PRE-TENSIONER", used along with a front seat belt, helps to reduce the risk or severity of injury to the driver and front passenger for certain types of collision. This system includes seat belt switch inputs and dual stage front air bag modules. The SRS system uses the seat belt switches to determine the front air bag deployment, and may only deploy one front air bag, depending on the severity of a collision and whether the front occupants are belted or unbelted. Information necessary to service the system safely is included in the "SRS AIR BAG" and "SEAT BELT" of this Service Manual.

**WARNING:**

Always observe the following items for preventing accidental activation.

- To avoid rendering the SRS inoperative, which could increase the risk of personal injury or death in the event of a collision that would result in air bag inflation, all maintenance must be performed by an authorized NISSAN/INFINITI dealer.
- Improper maintenance, including incorrect removal and installation of the SRS, can lead to personal injury caused by unintentional activation of the system. For removal of Spiral Cable and Air Bag Module, see "SRS AIR BAG".
- Never use electrical test equipment on any circuit related to the SRS unless instructed to in this Service Manual. SRS wiring harnesses can be identified by yellow and/or orange harnesses or harness connectors.

#### PRECAUTIONS WHEN USING POWER TOOLS (AIR OR ELECTRIC) AND HAMMERS

**WARNING:**

Always observe the following items for preventing accidental activation.

- When working near the Air Bag Diagnosis Sensor Unit or other Air Bag System sensors with the ignition ON or engine running, never use air or electric power tools or strike near the sensor(s) with a hammer. Heavy vibration could activate the sensor(s) and deploy the air bag(s), possibly causing serious injury.
- When using air or electric power tools or hammers, always switch the ignition OFF, disconnect the battery, and wait at least 3 minutes before performing any service.

#### Cautions in Removing Battery Terminal and AV Control Unit (Models with AV Control Unit)

INFOID:000000008130716

**CAUTION:**

Remove battery terminal and AV control unit after a lapse of 30 seconds or more after turning the ignition switch OFF.

**NOTE:**

After the ignition switch is turned OFF, the AV control unit continues operating for approximately 30 seconds. Therefore, data corruption may occur if battery voltage is cut off within 30 seconds.

#### Precaution for Trouble Diagnosis

INFOID:000000008130717

#### AV COMMUNICATION SYSTEM

- Do not apply voltage of 7.0 V or higher to the measurement terminals.
- Use the tester with its open terminal voltage being 7.0 V or less.
- Be sure to turn ignition switch OFF and disconnect the battery cable from the negative terminal before checking the circuit.

#### Precaution for Harness Repair

INFOID:000000008130718

#### AV COMMUNICATION SYSTEM



# PRECAUTIONS

< PRECAUTION >

[BASE AUDIO WITHOUT NAVIGATION]

- Solder the repaired parts, and wrap with tape. [Frays of twisted line must be within 110 mm (4.33 in).]

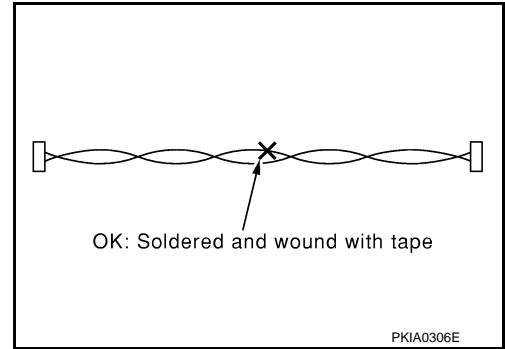

- Do not perform bypass wire connections for the repair parts. (The spliced wire will become separated and the characteristics of twisted line will be lost.)

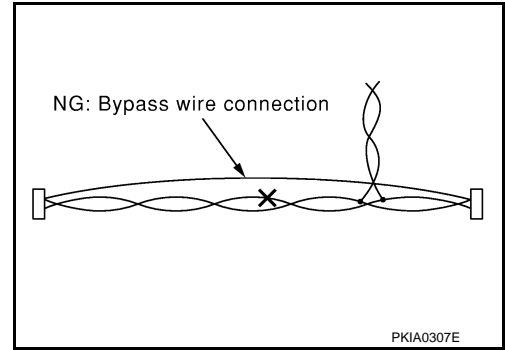

A  
B  
C  
D  
E  
F  
G  
H  
I  
J  
K  
L  
M  
O  
P

AV

# PREPARATION

< PREPARATION >

[BASE AUDIO WITHOUT NAVIGATION]

## PREPARATION

### PREPARATION

#### Commercial Service Tools

INFOID:000000008130719

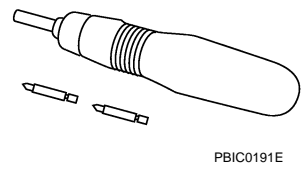
Tool	Description
<p data-bbox="162 514 267 546">Power tool</p>  <p data-bbox="820 619 901 651">PBIC0191E</p>	<p data-bbox="1006 514 1193 546">Loosening screws</p>

# COMPONENT PARTS

< SYSTEM DESCRIPTION >

[BASE AUDIO WITHOUT NAVIGATION]

## SYSTEM DESCRIPTION

### COMPONENT PARTS

#### Component Parts Location

INFOID:000000008130720

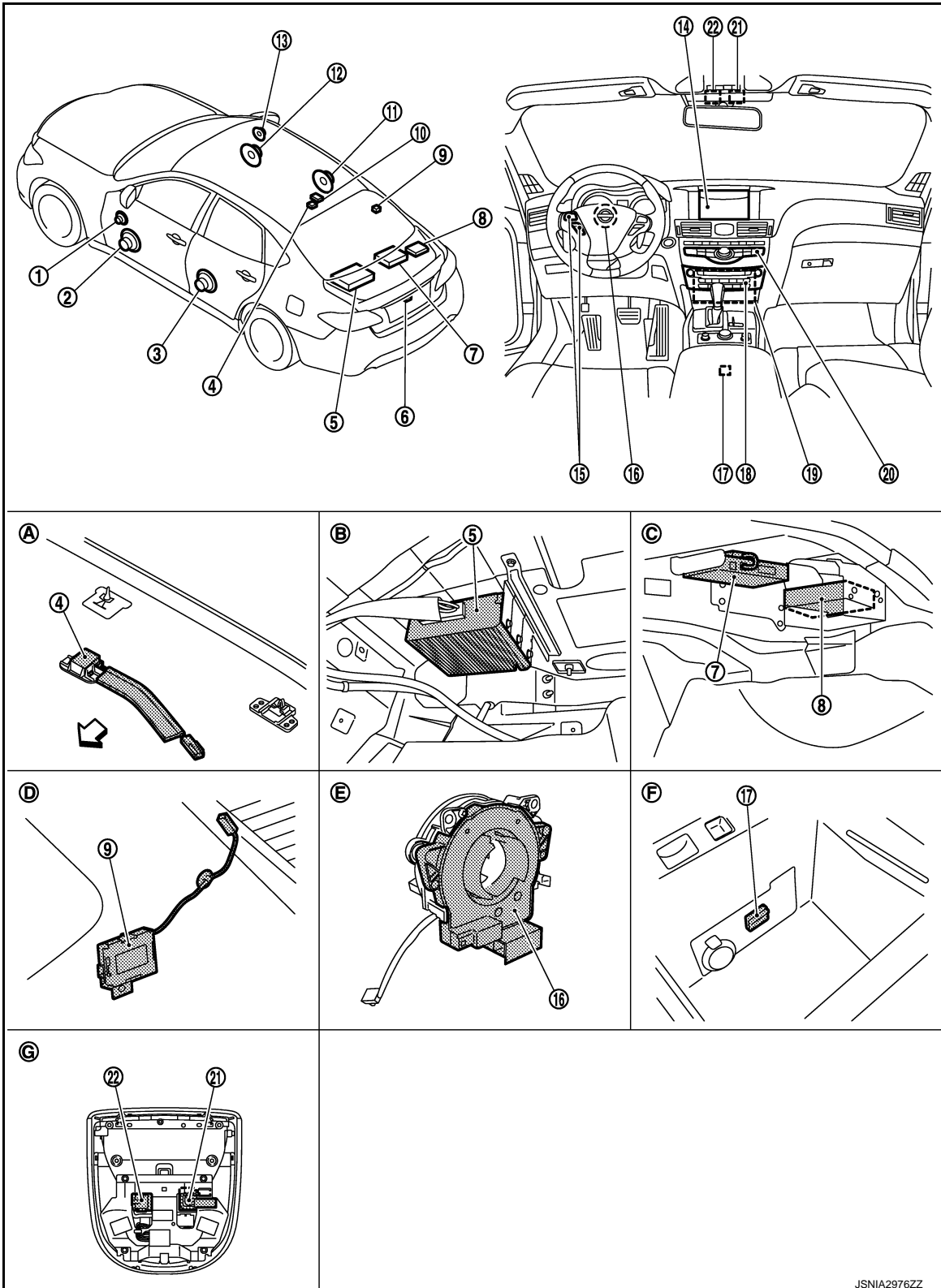

A  
B  
C  
D  
E  
F  
G  
H  
I  
J  
K  
L  
M  
N  
O  
P

AV

JSNIA2976ZZ

# COMPONENT PARTS

< SYSTEM DESCRIPTION >

[BASE AUDIO WITHOUT NAVIGATION]

- |  |   |  |
|--|---|--|
| 1. Front door squawker LH                            | 2. Front door speaker LH                    | 3. Rear door speaker LH                                |
| 4. Rear microphone (for active noise control system) | 5. Active noise control unit                | 6. Rear view camera                                    |
| 7. TEL adapter unit                                  | 8. Satellite radio tuner                    | 9. Antenna amp.  |
| 10. Satellite radio antenna                          | 11. Rear door speaker RH                    | 12. Front door speaker RH                              |
| 13. Front door squawker RH                           | 14. Display unit                            | 15. Steering switch                                    |
| 16. Steering angle sensor                            | 17. USB connector                           | 18. Preset switch                                      |
| 19. AV control unit                                  | 20. Multifunction switch                    | 21. Front microphone (for active noise control system) |
| 22. Microphone (for TEL)                             |   |  |
| A. Headlining rear center                            | B. Rear parcel shelf left side (trunk room) | C. Rear parcel shelf right side (trunk room)           |
| D. Rear pillar finisher RH removed condition         | E. Spiral cable removed condition           | F. Within center console                               |
| G. Map lamp ASSY removed condition                   |   |  |
- ⇨: Vehicle front

## Component Description

INFOID:000000008130721

Part name	Description
AV control unit	<ul style="list-style-type: none"> <li>It is the master unit of the MULTI AV system, and it is connected to each control unit by communication. It operates each system according to communication signals from the AV control unit.</li> <li>The AV control unit includes the audio, USB connection and vehicle status functions.</li> <li>It is connected to each control unit via CAN communication to obtain necessary information for the vehicle information function.</li> <li>It receives a steering angle signal from the steering angle sensor via CAN communication and controls an expected course line during rear view monitor operation.</li> <li>It inputs the illumination signals that are required for the display dimming control.</li> <li>It inputs the signals for driving status recognition (vehicle speed, reverse and parking brake).</li> <li>TEL voice signal and voice guidance signal are input from TEL adapter unit.</li> <li>Camera image signal is received and transmitted to display unit.</li> </ul>
Display unit	<ul style="list-style-type: none"> <li>Display image is controlled by the serial communication from AV control unit.</li> <li>It receives the power (signal VCC and inverter VCC) from the AV control unit and operates.</li> <li>RGB image signal is input from AV control unit (RGB image, RGB area and RGB synchronizing).</li> <li>Composite image signals are input from AV control unit.</li> <li>Synchronizing signal (HP, VP) is output to AV control unit.</li> </ul>
Active noise control unit	<ul style="list-style-type: none"> <li>Generates an antiphase sound weakening interior engine booming noise, mixes the antiphase sound with a sound signal transmitted from the AV control unit, and transmits the mixed sound signal to each speaker.</li> <li>Input microphone signal from front/rear microphone (for active noise control system).</li> </ul>
Front door speaker	<ul style="list-style-type: none"> <li>Outputs sound signal from active noise control unit.</li> <li>Outputs high, mid and low range sounds.</li> </ul>
Front door squawker	<ul style="list-style-type: none"> <li>Outputs sound signal from active noise control unit.</li> <li>Outputs high and mid range sounds.</li> </ul>
Rear door speaker	<ul style="list-style-type: none"> <li>Outputs sound signal from active noise control unit.</li> <li>Outputs high, mid and low range sounds.</li> </ul>
Front microphone (for active noise control system)	Detects interior engine booming noise and transmits a sound signal picked up by the front microphone to the active noise control unit.
Rear microphone (for active noise control system)	Detects interior engine booming noise and transmits a sound signal picked up by the rear microphone to the active noise control unit.

## COMPONENT PARTS

< SYSTEM DESCRIPTION >

[BASE AUDIO WITHOUT NAVIGATION]

Part name	Description
Multifunction switch	<ul style="list-style-type: none"> <li>• Operation panel is equipped with the centralized switch where audio and air conditioner, etc. operations are integrated.</li> <li>• Connected with preset switch via cable, and operation signal is transmitted to AV control unit via AV communication.</li> <li>• The disk ejection operating signal is performed by hardwire.</li> </ul>
Preset switch	<ul style="list-style-type: none"> <li>• Operation panel is equipped with the centralized switch where audio operations are integrated.</li> <li>• Connected with multifunction switch via cable, and operation signal is transmitted to AV control unit via AV communication.</li> </ul>
Rear view camera	<ul style="list-style-type: none"> <li>• Camera power supply is input from AV control unit.</li> <li>• The image of vehicle rear view is transmitted to display unit via AV control unit.</li> </ul>
Steering angle sensor	It is connected to the AV control unit and transmits the steering angle sensor signal via CAN communication.
Steering switch	<ul style="list-style-type: none"> <li>• Operations for audio, hands-free phone and voice recognition etc. are possible.</li> <li>• Steering switch signal (operation signal) is output to AV control unit.</li> </ul>
Microphone (for TEL)	<ul style="list-style-type: none"> <li>• Used for hands-free phone and voice recognition operation.</li> <li>• Microphone signal is transmitted to TEL adapter unit.</li> <li>• Power (Microphone VCC) is supplied from TEL adapter unit.</li> </ul>
Antenna amp.	<ul style="list-style-type: none"> <li>• Radio signal received by window antenna is amplified and transmitted to AV control unit.</li> <li>• Power (antenna amp. ON signal) is supplied from AV control unit.</li> </ul>
Satellite radio tuner	<ul style="list-style-type: none"> <li>• Inputs the satellite radio signal from satellite radio antenna and outputs the sound signal to the AV control unit.</li> <li>• It is controlled with the AV control unit and serial communication (communication signal and request signal).</li> </ul>
Satellite radio antenna	Satellite radio signal is received and transmitted to satellite radio tuner.
TEL adapter unit	<ul style="list-style-type: none"> <li>• Inputs the TEL voice signal from TEL antenna and outputs it to the AV control unit.</li> <li>• It is connected with the AV control unit via AV communication and controlled with the AV control unit.</li> </ul>
TEL antenna	Receives the TEL voice signal and outputs it to the TEL adapter unit.
USB connector	Sound signal of USB input is transmitted to AV control unit.

A  
B  
C  
D  
E  
F  
G  
H  
I  
J  
K  
L  
M  
O  
P

AV

SYSTEM

MULTI AV SYSTEM

MULTI AV SYSTEM : System Diagram

INFOID:000000008130722

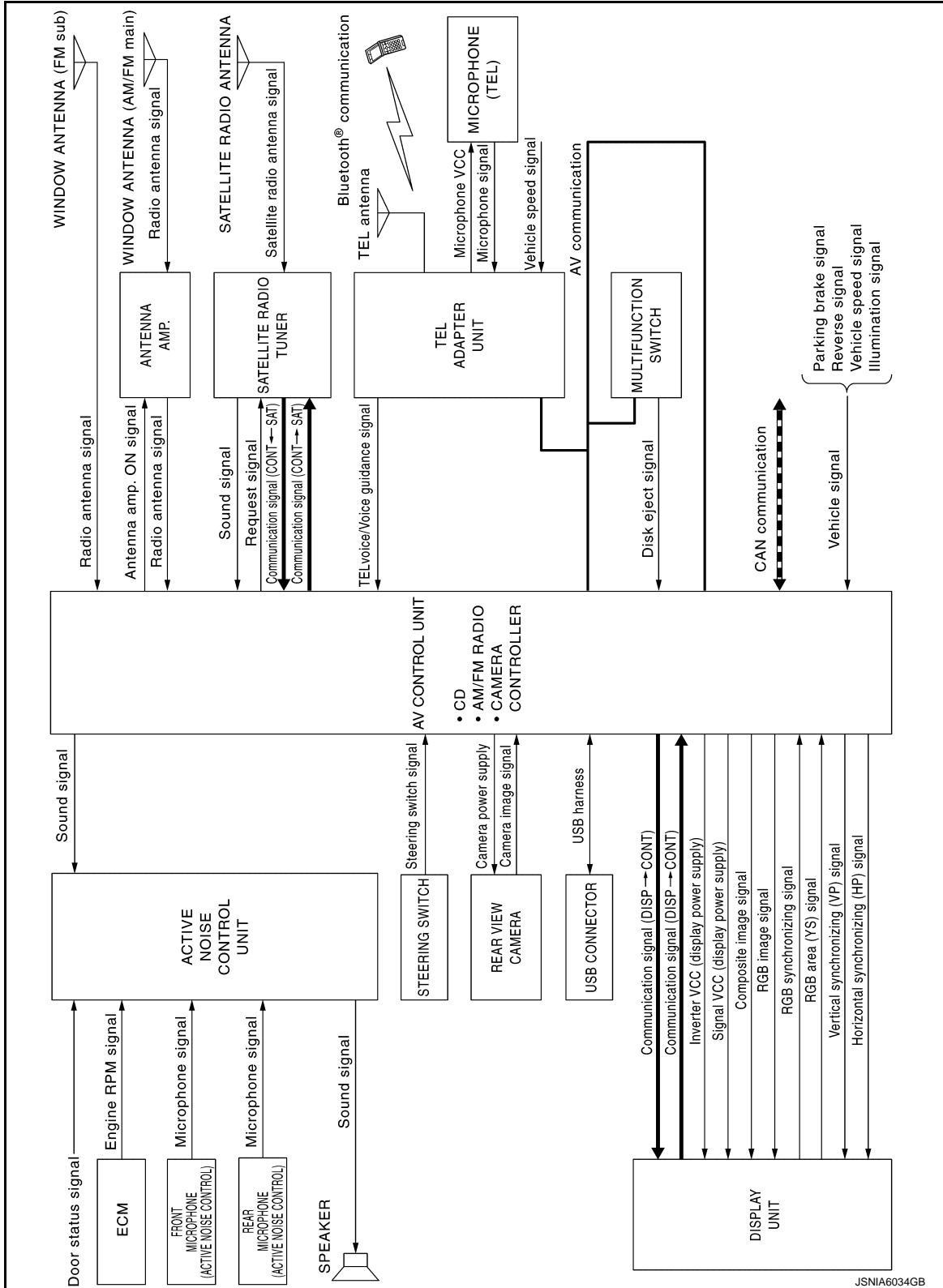

NOTE:

The name MULTIFUNCTION SWITCH indicates the integration of PRESET SWITCH and MULTIFUNCTION SWITCH virtually.

## MULTI AV SYSTEM : System Description

INFOID:000000008130723

Multi AV system means that the following systems are integrated.

FUNCTION NAME
Audio function
Hands-free phone function
Rear view monitor function
Vehicle information function

### COMMUNICATION SIGNAL

- AV control unit function by transmitting/receiving data one by one with each unit (slave unit) that configures them completely as a master unit by connecting between units that configure MULTI AV system with two AV communication lines (H, L).
- Two AV communication lines (H, L) adopt a twisted pair line that is resistant to noise.
- The AV control unit is connected by CAN communication, and it receives data signal from ECM and combination meter. It computes and displays fuel economy information value with the obtained information.
- The AV control unit is connected with display unit and serial communication, and it transmits the required signal of display and display control and receives the response signal from display unit.
- The AV control unit is receives a steering angle signal from the steering angle sensor via CAN communication and controls an expected course line during rear view monitor operation.

### AUDIO FUNCTION

The audio system is equipped with the following functions. Each function is operated with multifunction switch, preset switch or steering switch. Operation status of audio is indicated at display unit.

FUNCTION
AM/FM radio
Satellite radio
CD
USB connection function
Active noise control system

#### Operating Signal

Audio system operation can be performed with multifunction switch, preset switch or steering switch.

- Operating signal is transmitted to AV control unit with AV communication when it is operated by multifunction switch or preset switch. The disk ejection operating signal is performed by hardware.
- Operating signal is transmitted to AV control unit with steering switch signal when it is operated by steering switch.

#### Screen Display

- Switching of display is performed with serial communication between display unit and AV control unit.
- The image signal to display operating condition is performed with RGB image signal, RGB area signal and RGB image synchronizing signal.

#### AM/FM Radio Mode

- AM/FM radio tuner is built into AV control unit.
- Sound signals (AM/FM radio) are received via window antenna.
- AM/FM main antenna signal is amplified via antenna amp. and FM sub antenna signal is transmitted to AV control unit.
- AV control unit outputs sound signal is input to active noise control unit, and active noise control unit outputs to each speaker.

#### Satellite Radio Mode

- Satellite radio tuner is controlled by communication signal and request signal with AV control unit.
- Sound signal (satellite radio) is received by satellite radio antenna and transmitted to AV control unit via satellite radio tuner. AV control unit is output the sound signal (satellite radio) to active noise control unit.

#### CD Mode

A  
B  
C  
D  
E  
F  
G  
H  
I  
J  
K  
L  
M  
AV  
O  
P

# SYSTEM

## < SYSTEM DESCRIPTION >

## [BASE AUDIO WITHOUT NAVIGATION]

- CD function is built into AV control unit.
- AV control unit outputs the sound signal to active noise control unit, and active noise control unit output the signal to each speaker during playback.

### USB Connection Function

- Connecting iPod® or USB memory allows the driver to play iPod® music files or USB memory-stored music files.
- Sound signals of music files stored in iPod® or USB memory is transmitted from the USB connector to the AV control unit. The AV control unit transmits the sound signals to the each speaker via active noise control unit.
- iPod® is recharged when connected to USB connector.
- Only files that meet the following conditions will be played.

	Music file
File format	"MP3", "WMA"
File extension	".mp3", ".wma"
Maximum file size	2 GB

### NOTE:

- iPod® is a trademark of Apple inc., registered in the U.S. and other countries.
- Image signals cannot be received from iPod® or USB memory.
- Use the enclosed USB harness when connecting iPod® to USB connector.

### Active Noise Control System

- The active noise control system outputs an antiphase sound from the speakers (front door speaker and rear door speaker) against unpleasant engine booming noise (2nd and/or 3rd engine rev at 700 - 5000 rpm) and reduce sound pressure level by the interference with engine booming noise.
- The active noise control unit receives an engine speed signal from ECM and receives microphone signals from the front and rear microphone.
- The active noise control unit receives a door state signal. The active noise control system does not operate with any door open.
- Based on signals detected by the front and rear microphones, the active noise control unit generates an antiphase sound (microphone signal) weakening interior engine booming noise in real time according to a unique algorithm\*1 by a micro computer built in the active noise control unit. Then, the active noise control unit mixes the antiphase sound with a sound signal received from the AV control unit to transmit the mixed sound signal to each speaker.

### NOTE:

\*1: Algorithm means a fixed procedure to solve a question.

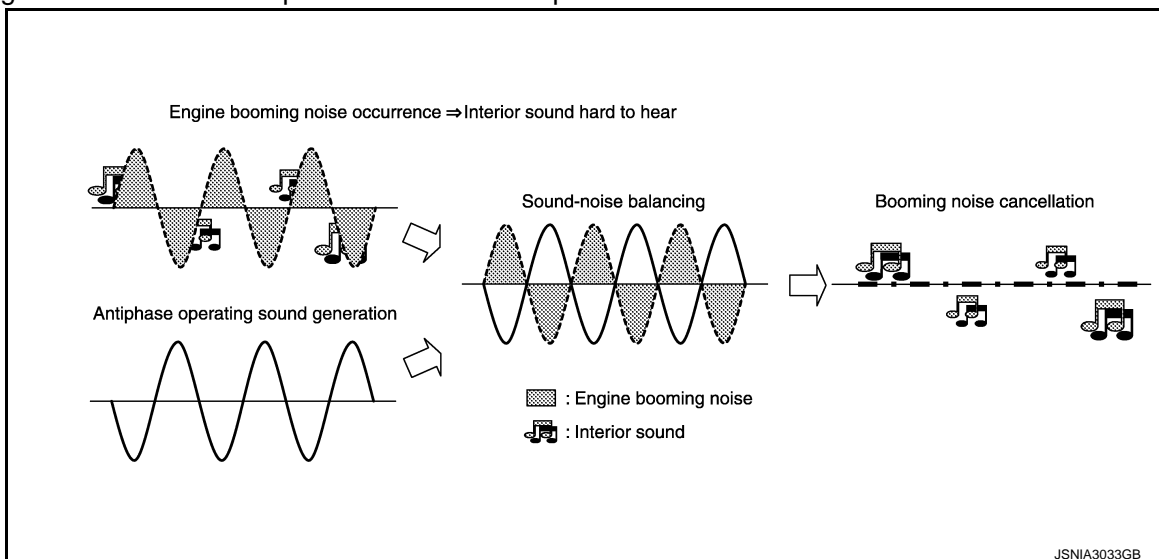

### HANDS-FREE PHONE SYSTEM

- TEL adapter unit is controlled with AV communication from AV control unit.
- The connection between cellular phone and TEL adapter unit is performed with Bluetooth® communication.



# SYSTEM

## < SYSTEM DESCRIPTION >

## [BASE AUDIO WITHOUT NAVIGATION]

- The voice guidance signal is input from the TEL adapter unit to the AV control unit and output to the front speaker when operating the cellular phone. A
- TEL adapter unit has the on board self-diagnosis function. Refer to [AV-32. "On Board Diagnosis Function"](#). B

### When A Call Is Originated

- Spoken voice sound output from the microphone (microphone signal) is input to TEL adapter unit. B
- TEL adapter unit outputs to cellular phone with Bluetooth<sup>®</sup> communication as a TEL voice signal.
- Voice sound is then heard at the other party. C

### When Receiving A Call

- Voice sound is input to own cellular phone from the other party. C
- TEL voice signal is input to TEL adapter unit by establishing Bluetooth<sup>®</sup> communication from cellular phone, and the signal is output to front speaker. D

## REAR VIEW MONITOR FUNCTION

- The AV control unit supplies power to the rear view camera when receiving a reverse signal. E
- The rear view camera transmits camera images to the AV control unit when power is supplied from the AV control unit. F
- The AV control unit transmits a warning message, fixed guide lines, and predictive course lines to the display unit by RGB image signal. Rear view monitor images are displayed by combining the RGB image signal and the camera image signals from the rear view camera. F
- Predictive course lines are controlled by a steering angle sensor signal received the AV control unit via CAN communication. G

## VEHICLE INFORMATION FUNCTION

Status of audio, climate control system, fuel economy and maintenance etc. are displayed. H

A  
B  
C  
D  
E  
F  
G  
H  
I  
J  
K  
L  
M  
O  
P

AV

# DIAGNOSIS SYSTEM (AV CONTROL UNIT)

[BASE AUDIO WITHOUT NAVIGATION]

< SYSTEM DESCRIPTION >

## DIAGNOSIS SYSTEM (AV CONTROL UNIT)

### Description

INFOID:000000008130724

- The AV control unit diagnosis function starts up with multifunction switch operation and the AV control unit performs a diagnosis for each unit in the system during the on board diagnosis.
- Perform a CONSULT diagnosis if the on board diagnosis does not start, e.g., the screen does not display anything, the multifunction switch does not function, etc.

### On Board Diagnosis Function

INFOID:000000008130725

#### MULTIFUNCTION SWITCH AND PRESET SWITCH SELF-DIAGNOSIS FUNCTION

The ON/OFF operation (continuity) of each switch in the multifunction switch and preset switch can be checked.

##### Self-diagnosis Mode

- Press the "BACK" switch and the "UP" switch of the multifunction switches within 10 seconds after turning the ignition switch from OFF to ACC and hold them for 3 seconds or more. Then the buzzer sounds, all indicators of the multifunction switch and preset switch illuminate, and the self-diagnosis mode starts.
- The continuity of each switch at the ON position can be checked by pressing the switch. The buzzer sounds if the switch is normal.

**NOTE:**

The hazard switch and disk eject switch cannot be checked.

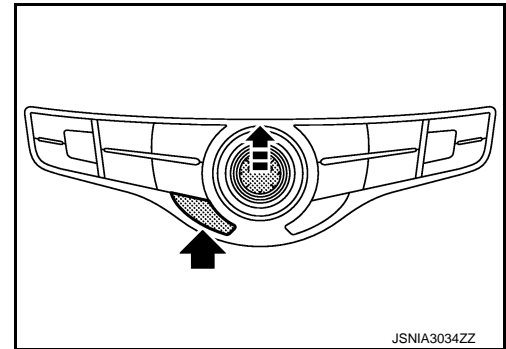

##### Finishing Self-diagnosis Mode

Self-diagnosis mode is canceled when turning the ignition switch OFF.

### ON BOARD DIAGNOSIS ITEM

#### Description

- The trouble diagnosis function has a self-diagnosis mode for conducting trouble diagnosis automatically and a confirmation/adjustment mode for operating manually.
- Self-diagnosis mode performs the AV control unit diagnosis and the connection diagnosis between each of the units that make up the system, and it indicates the results to the display unit.
- The confirmation/adjustment mode allows the technician to check, modify or adjust the vehicle signals and set values, as well as to monitor the system error records and system communication status. The checking, modifying or adjusting generally require human intervention and judgment (the system cannot make judgment automatically).

#### On Board Diagnosis Item

Mode	Description
Self Diagnosis	<ul style="list-style-type: none"><li>• AV control unit diagnosis.</li><li>• Diagnoses the connections across system components, between AV control unit and each unit.</li></ul>

# DIAGNOSIS SYSTEM (AV CONTROL UNIT)

< SYSTEM DESCRIPTION >

[BASE AUDIO WITHOUT NAVIGATION]

	Mode	Description
Confirmation/ Adjustment	Display Diagnosis	The following check functions are available: color tone check by color spectrum bar display and white display, light and shade check by gradation bar display.
	Vehicle Signals	Diagnosis of signals can be performed for vehicle speed, parking brake, lights, ignition and reverse.
	Speaker Test	The connection of a speaker can be confirmed by test tone.
	Climate Control	Start auto air conditioner system self-diagnosis.
	Error History	The system malfunction and the frequency when occurring in the past are displayed. When the malfunctioning item is selected, the time and place that the selected malfunction last occurred are displayed.
	Camera Cont.	<ul style="list-style-type: none"> <li>Guiding line position that overlaps rear view camera image can be adjusted.</li> <li>Configuration stored in the AV control unit can be checked.</li> </ul>
	Vehicle CAN Diagnosis	The transmitting/receiving of CAN communication can be monitored.
	AV COMM Diagnosis	The communication condition of each unit of Multi AV system can be monitored.
	Delete Unit Connection Log	Erase the connection history of unit and error history.
Initialize Settings	Initializes the AV control unit memory.	

## METHOD OF STARTING

1. Start the engine.
2. Turn the audio system OFF.
3. While pressing the "SETTING" button, turn the volume control dial clockwise or counterclockwise for 40 clicks or more. (When the self-diagnosis mode is started, a short beep will be heard.)
  - Shifting from current screen to previous screen is performed by pressing "BACK" button.

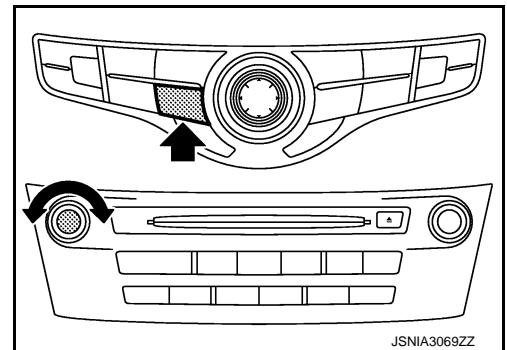

4. The trouble diagnosis initial screen is displayed, and then the items of "Self Diagnosis" and "Confirmation/Adjustment" can be selected.

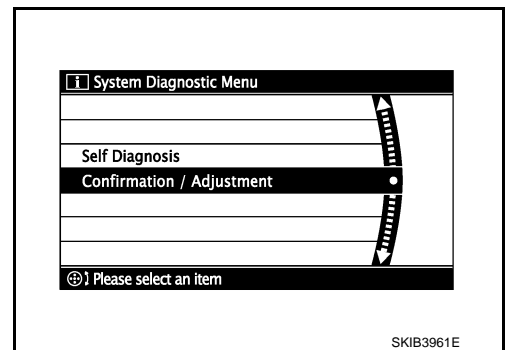

## SELF-DIAGNOSIS MODE

1. Start the self-diagnosis function and select "Self Diagnosis".
  - Self-diagnosis subdivision screen is displayed, and the self-diagnosis mode starts.
  - The bar graph visible on the center of the self-diagnosis subdivision screen indicates progress of the trouble diagnosis.

# DIAGNOSIS SYSTEM (AV CONTROL UNIT)

[BASE AUDIO WITHOUT NAVIGATION]

## < SYSTEM DESCRIPTION >

2. Diagnosis results are displayed after the self-diagnosis is completed. The unit names and the connection lines are color-coded according to the diagnostic results.

Diagnosis results	Unit	Connection line
Normal	Green	Green
Connection malfunction	Gray	Yellow
Unit malfunction <sup>Note</sup>	Red	Green

### NOTE:

Control unit (AV control unit) is displayed in red.

- Replace AV control unit if “Self-Diagnosis did not run because of a control unit malfunction” is indicated. The symptom is AV control unit internal error. Refer to [AV-105, "Removal and Installation"](#).
- If multiple errors occur at the same time for a single unit, the screen switch colors are determined according to the following order of priority: red > gray.

- The comments of the self-diagnosis results can be viewed with a component in the diagnosis result screen.

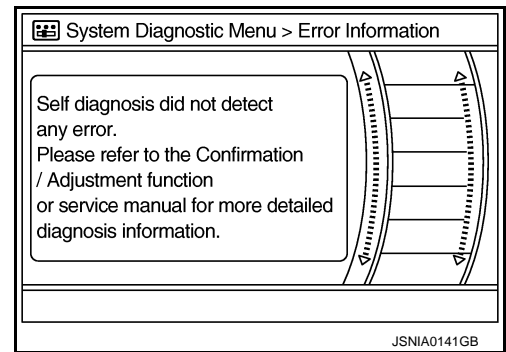
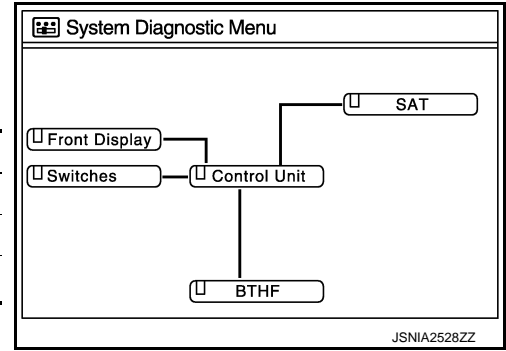

### Detection Range of Self-diagnosis Mode

- The self-diagnosis mode allows the technician to diagnose the connection in the communication line between AV control unit and each unit and the internal operation of the AV control unit.
- Because the start condition of diagnosis function is a switch operation, the on board diagnosis function cannot be started up if any malfunction is detected in the communication circuit between AV control unit and multifunction switch.

### SELF-DIAGNOSIS RESULTS

Check the applicable display at the following table, and then repair the malfunctioning parts.

Only Unit Part Is Displayed In Red.

Screen switch	Description	Possible malfunction location / Action to take
Control unit	Malfunction is detected in AV control unit power supply and ground circuits.	Check AV control unit power supply and ground circuits. Refer to <a href="#">AV-73, "AV CONTROL UNIT : Diagnosis Procedure"</a> . When detecting no malfunction in those components, replace AV control unit. Refer to <a href="#">AV-105, "Removal and Installation"</a> .

A Connecting Cable Between Units Is Displayed In Yellow.

# DIAGNOSIS SYSTEM (AV CONTROL UNIT)

< SYSTEM DESCRIPTION >

[BASE AUDIO WITHOUT NAVIGATION]

Area with yellow connection lines	Description	Possible malfunction location / Action to take
Control unit ↔ Front Display	Malfunction is detected in serial communication circuits between AV control unit and display unit.	Serial communication circuits between AV control unit and display unit.
Control unit ↔ SAT	When either one of the following items is detected: <ul style="list-style-type: none"> <li>• satellite radio tuner power supply and ground circuit are malfunctioning.</li> <li>• communication circuits between AV control unit and satellite radio tuner are malfunctioning.</li> <li>• request signal circuit between AV control unit and satellite radio tuner are malfunctioning.</li> </ul>	<ul style="list-style-type: none"> <li>• Satellite radio tuner power supply and ground circuit. Refer to <a href="#">AV-75, "SATELLITE RADIO TUNER : Diagnosis Procedure"</a>.</li> <li>• Communication circuit between AV control unit and satellite radio tuner.</li> <li>• Request signal circuit between AV control unit and satellite radio tuner.</li> </ul>
Control unit ↔ BTHF	When either one of the following items is detected: <ul style="list-style-type: none"> <li>• TEL adapter unit power supply and ground circuits are malfunctioning.</li> <li>• AV communication circuits between AV control unit and TEL adapter unit are malfunctioning.</li> </ul>	<ul style="list-style-type: none"> <li>• TEL adapter unit power supply and ground circuits. Refer to <a href="#">AV-76, "TEL ADAPTER UNIT : Diagnosis Procedure"</a>.</li> <li>• AV communication circuits between AV control unit and TEL adapter unit.</li> </ul>

## CONFIRMATION/ADJUSTMENT MODE

1. Start the diagnosis function and select "Confirmation/Adjustment". The confirmation/adjustment mode indicates where each item can be checked or adjusted.
2. Select each switch on the "Confirmation/Adjustment Mode" screen to display the relevant trouble diagnosis screen. Press the "BACK" switch to return to the initial Confirmation/Adjustment Mode screen.

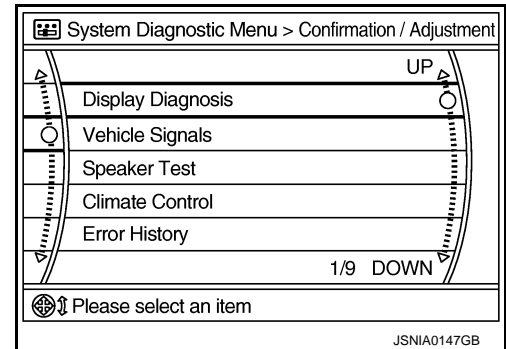

A  
B  
C  
D  
E  
F  
G  
H  
I  
J  
K  
L  
M  
N  
O  
P

AV

# DIAGNOSIS SYSTEM (AV CONTROL UNIT)

< SYSTEM DESCRIPTION >

[BASE AUDIO WITHOUT NAVIGATION]

## Display Diagnosis

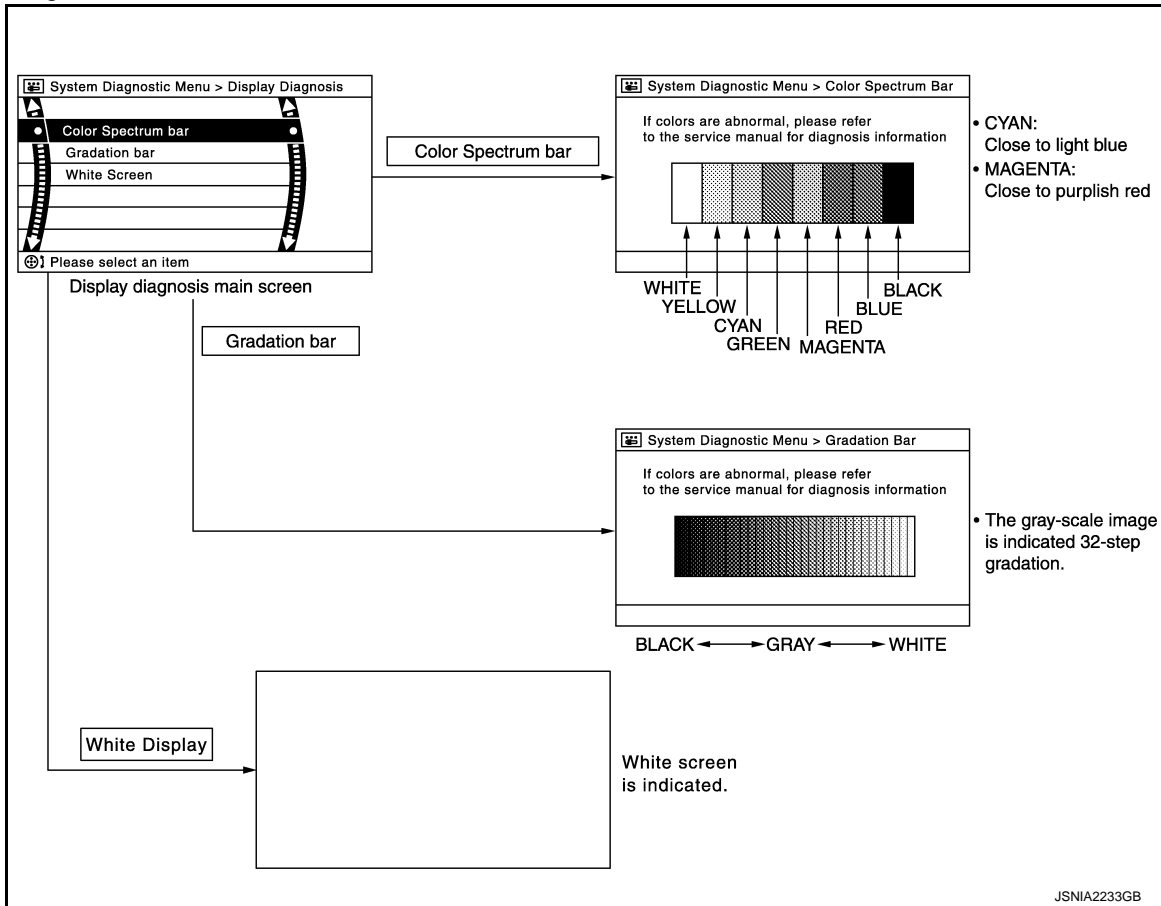

## Vehicle Signals

A comparison check can be made of each actual vehicle signal and the signals recognized by the system.

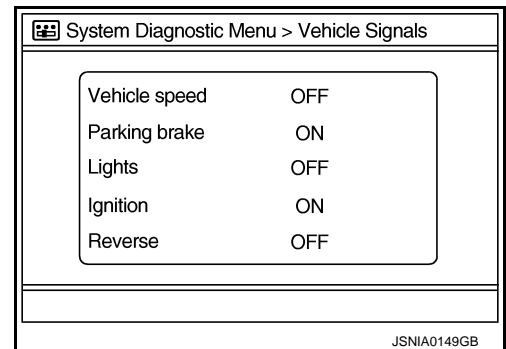

Diagnosis item	Display	Vehicle status	Remarks
Vehicle speed	ON	Vehicle speed > 0 km/h (0 MPH)	Changes in indication may be delayed. This is normal.
	OFF	Vehicle speed = 0 km/h (0 MPH)	
Parking brake	ON	Parking brake is applied.	
	OFF	Parking brake is released.	
Lights	ON	Light switch ON	—
	OFF	Light switch OFF	—
Ignition	ON	Ignition switch ON	—
	OFF	Ignition switch in ACC position	—

# DIAGNOSIS SYSTEM (AV CONTROL UNIT)

< SYSTEM DESCRIPTION >

[BASE AUDIO WITHOUT NAVIGATION]

Diagnosis item	Display	Vehicle status	Remarks
Reverse	ON	Shift the selector lever to "R" position	Changes in indication may be delayed. This is normal.
	OFF	Shift the selector lever other than "R" position	

## Speaker Test

Select "Speaker Test" to display the Speaker Diagnosis screen. Press "Start" to generate a test tone in a speaker. Press "Start" again to generate a test tone in the next speaker. Press "End" to stop the test tones.

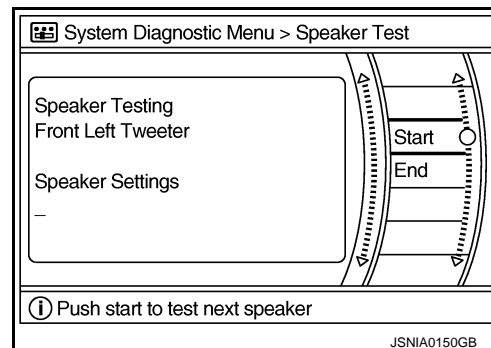

## Climate Control

Refer to "HEATER & AIR CONDITIONING CONTROL SYSTEM" for details.

## Error History

The self-diagnosis results are judged depending on whether any error occurs from when "Self-diagnosis" is selected until the self-diagnosis results are displayed.

However, the diagnosis results are judged normal if an error has occurred before the ignition switch is turned ON and then no error has occurred until the self-diagnosis start. Check the "Error Record" to detect any error that may have occurred before the self-diagnosis start because of this situation.

The frequency of occurrence is displayed in a count up manner. The actual count up method differs depending on the error item.

### Count up method A

- The counter resets to 0 if an error occurs when ignition switch is turned ON. The counter increases by 1 if the condition is normal at a next ignition ON cycle.
- The counter upper limit is 39. Any counts exceeding 39 are ignored. The counter can be reset (no error record display) with the "Delete log" switch or CONSULT.

### Count up method B

- The counter increases by 1 if an error occurs when ignition switch is ON. The counter will not decrease even if the condition is normal at the next ignition ON cycle.
- The counter upper limit is 50. Any counts exceeding 50 are ignored. The counter can be reset (no error record display) with the "Delete log" switch or CONSULT.

Display type of occurrence frequency	Error history display item
Count up method A	CAN communication line, control unit (CAN), AV communication line, control unit (AV)
Count up method B	Other than the above

# DIAGNOSIS SYSTEM (AV CONTROL UNIT)

< SYSTEM DESCRIPTION >

[BASE AUDIO WITHOUT NAVIGATION]

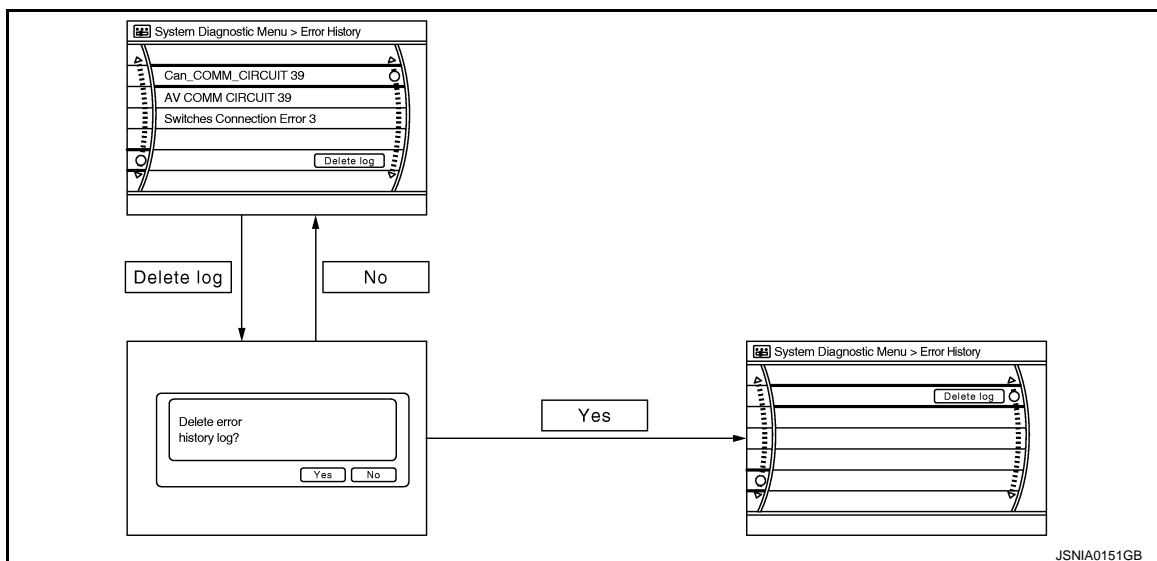

## Error item

Some error items may be displayed simultaneously according to the cause. If some error items are displayed simultaneously, the detection of the cause can be performed by the combination of display items

Error item	Description	Possible malfunction factor/Action to take
CAN COMM CIRCUIT	CAN communication malfunction is detected.	Perform diagnosis with CONSULT, and then repair the malfunctioning parts according to the diagnosis results. Refer to <a href="#">AV-27, "CONSULT Function"</a> .
CONTROL UNIT (CAN)	CAN initial diagnosis malfunction is detected.	Replace the AV control unit if the malfunction occurs constantly. Refer to <a href="#">AV-105, "Removal and Installation"</a> .
CONTROL UNIT (AV)	AV communication circuit initial diagnosis malfunction is detected.	
FLASH-ROM Error Of Control Unit CAN Controller Memory Error	AV control unit malfunction is detected.	
Steer. Angle Sensor Calibration	Predictive course line center position adjustment of the steering angle sensor is incomplete.	Adjust the predictive course line center position of the steering angle sensor. Refer to <a href="#">BRC-60, "Work Procedure"</a> .
Front Display Connection Error	When either one of the following items is detected: <ul style="list-style-type: none"> <li>display unit power supply and ground circuits are malfunctioning.</li> <li>communication circuits between AV control unit and display unit are malfunctioning.</li> </ul>	<ul style="list-style-type: none"> <li>Display unit power supply and ground circuits. Refer to <a href="#">AV-73, "DISPLAY UNIT : Diagnosis Procedure"</a>.</li> <li>Communication circuits between AV control unit and display unit.</li> </ul>
XM Connection Error	When either one of the following items is detected: <ul style="list-style-type: none"> <li>satellite radio tuner power supply and ground circuit are malfunctioning.</li> <li>communication circuits between AV control unit and satellite radio tuner are malfunctioning.</li> <li>request signal circuit between AV control unit and satellite radio tuner are malfunctioning.</li> </ul>	<ul style="list-style-type: none"> <li>Satellite radio tuner power supply and ground circuit. Refer to <a href="#">AV-75, "SATELLITE RADIO TUNER : Diagnosis Procedure"</a>.</li> <li>Communication circuit between AV control unit and satellite radio tuner.</li> <li>Request signal circuit between AV control unit and satellite radio tuner.</li> </ul>
<ul style="list-style-type: none"> <li>AV COMM CIRCUIT</li> <li>Switches Connection Error</li> </ul>	When either one of the following items is detected: <ul style="list-style-type: none"> <li>multifunction switch power supply and ground circuits are malfunctioning.</li> <li>AV communication circuits between AV control unit and multifunction switch are malfunctioning.</li> </ul>	<ul style="list-style-type: none"> <li>Multifunction switch power supply and ground circuits.</li> <li>AV communication circuits between AV control unit and multifunction switch.</li> </ul>



# DIAGNOSIS SYSTEM (AV CONTROL UNIT)

[BASE AUDIO WITHOUT NAVIGATION]

< SYSTEM DESCRIPTION >

Error item	Description	Possible malfunction factor/Action to take
<ul style="list-style-type: none"> <li>AV COMM CIRCUIT</li> <li>H/F Unit Connection Error</li> </ul>	When either one of the following items is detected: <ul style="list-style-type: none"> <li>TEL adapter unit power supply and ground circuits are malfunctioning.</li> <li>AV communication circuits between AV control unit and TEL adapter unit are malfunctioning.</li> </ul>	<ul style="list-style-type: none"> <li>TEL adapter unit power supply and ground circuits. Refer to <a href="#">AV-76, "TEL ADAPTER UNIT : Diagnosis Procedure"</a>.</li> <li>AV communication circuits between AV control unit and TEL adapter unit.</li> </ul>
<ul style="list-style-type: none"> <li>AV COMM CIRCUIT</li> <li>Switches Connection Error</li> <li>H/F Unit Connection Error</li> </ul>	Malfunction is detected in AV communication circuits between AV control unit and multifunction switch are malfunctioning.	AV communication circuits between AV control unit and multifunction switch.

## Camera Cont.

The two functions of "Correct Draw Line of Rear view Cam", "Confirm Configuration" are available.

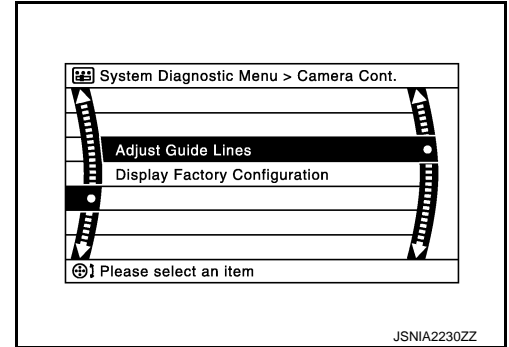

## Adjust Offset of Rear view Camera

- Use this mode to adjust the guide line display position of the rear view monitor if necessary after removing the rear view monitor camera.

### CAUTION:

After the adjustment, never perform other operations for one minute.

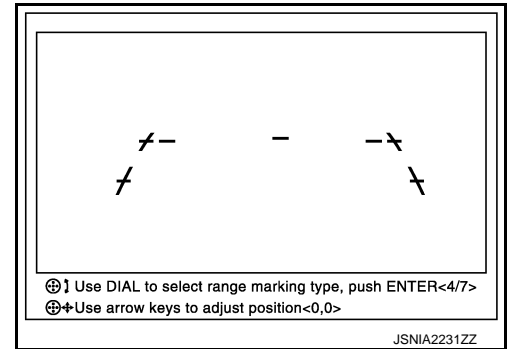

## Factory Configuration Confirmation

- Configuration stored in the AV control unit can be checked.

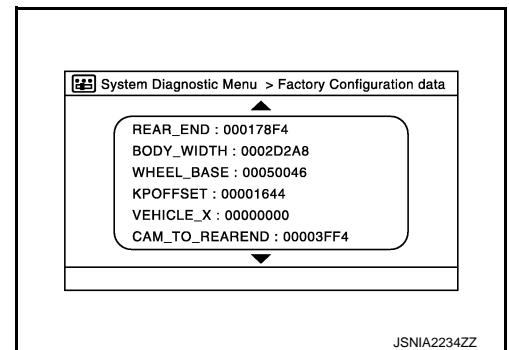

## Vehicle CAN Diagnosis

A  
B  
C  
D  
E  
F  
G  
H  
I  
J  
K  
L  
M  
AV  
O  
P

# DIAGNOSIS SYSTEM (AV CONTROL UNIT)

[BASE AUDIO WITHOUT NAVIGATION]

## < SYSTEM DESCRIPTION >

- CAN communication status and error counter is displayed.
- The error counter displays “OK” if any malfunction was not detected in the past and displays “0” if a malfunction is detected. It increases by 1 if the condition is normal at the next ignition switch ON cycle. The upper limit of the counter is 39.
- The error counter is erased if “Reset” is pressed.

Items	Display (Current)	Malfunction counter (Past)
Tx(HVAC)	OK / ???	OK / 0 – 39
Rx(ECM)	OK / ???	OK / 0 – 39
Rx(Cluster)	OK / ???	OK / 0 – 39
Rx(BCM)	OK / ???	OK / 0 – 39
Rx(HVAC)	OK / ???	OK / 0 – 39
Rx(USM)	OK / ???	OK / 0 – 39
Rx(VDC)	OK / ???	OK / 0 – 39
Rx(STRG)	OK / ???	OK / 0 – 39

### NOTE:

“???” indicates UNKWN.

### AV COMM Diagnosis

- Displays the communication status between AV control unit (master unit) and each unit.
- The error counter displays “OK” if any malfunction was not detected in the past and displays “0” if a malfunction is detected. It increases by 1 if the condition is normal at the next ignition switch ON cycle. The upper limit of the counter is 39.
- The error counter is erased if “Reset” is pressed.

Items	Status (Current)	Counter (Past)
C Tx(ITM-SW)	OK / ???	OK / 0 – 39
C Rx(PrimarySW-ITM)	OK / ???	OK / 0 – 39
C Rx(BTHF-ITM)	OK / ???	OK / 0 – 39

### NOTE:

“???” indicates UNKWN.

### Delete Unit Connection Log

Deletes any unit connection records and error records from the AV control unit memory. (Clear the records of the unit that has been removed.)

### Initialize Settings

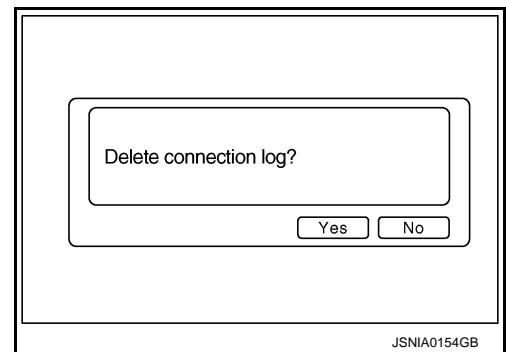
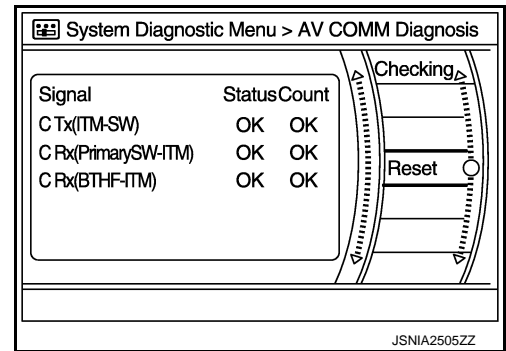
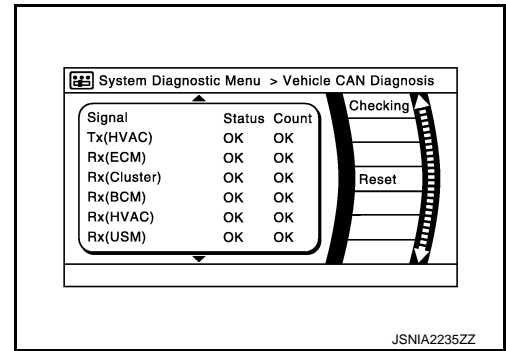

# DIAGNOSIS SYSTEM (AV CONTROL UNIT)

[BASE AUDIO WITHOUT NAVIGATION]

< SYSTEM DESCRIPTION >

“User Data Initialization” and “Accessory Number Initialization” are possible.

**CAUTION:**

- Never perform Accessory Number Initialization except when configuration is unsuccessful.
- Accessory Number Initialization requires configuration. For details, refer to [AV-60, "Description"](#).

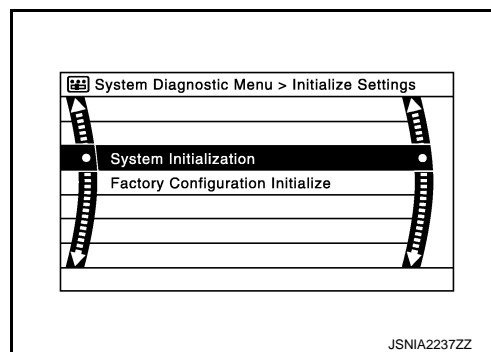

JSNIA2237ZZ

INFOID:000000008130726

## CONSULT Function

### CONSULT FUNCTIONS

CONSULT performs the following functions via the communication with the AV control unit.

Diagnosis mode	Description
Ecu Identification	The part number of AV control unit can be checked.
Self Diagnostic Result	Performs a diagnosis on the AV control unit and a connection diagnosis for the communication circuit of the Multi AV system, and displays the current and past malfunctions collectively.
Data Monitor	The diagnosis of vehicle signal that is input to the AV control unit can be performed.
Work Support	Steering angle sensor can be adjusted.
Configuration	<ul style="list-style-type: none"> <li>• Read and save the vehicle specification.</li> <li>• Write the vehicle specification when replacing AV control unit.</li> </ul>

### AV Communication

When “AV communication” of “CAN Diag Support Monitor” is selected, the following function will be performed.

AV communication	AV&NAVI C/U	Displays the communication status from AV control unit to each unit as well as the error counter.
	AUDIO	Displays the AV control unit communication status and the error counter.

### ECU IDENTIFICATION

The part number of AV control unit is displayed.

### SELF DIAGNOSIS RESULT

- In CONSULT self-diagnosis, self-diagnosis results and error history are displayed collectively.
- The current malfunction indicates “CRNT”. The past malfunction indicates “PAST”.
- The timing is displayed as “0” if any of the error codes [U1000], [U1010], [U1300] and [U1310] is detected. The counter increases by 1 if the condition is normal at the next ignition switch ON cycle.

### Self-diagnosis Results Display Item

Error item	Description	Possible malfunction factor/Action to take
CAN COMM CIRCUIT [U1000]	CAN communication malfunction is detected.	Refer to <a href="#">AV-62, "Diagnosis Procedure"</a> .
CONTROL UNIT (CAN) [U1010]	CAN initial diagnosis malfunction is detected.	Replace the AV control unit if the malfunction occurs constantly. Refer to <a href="#">AV-105, "Removal and Installation"</a> .
CONTROL UNIT (AV) [U1310]	AV communication circuit initial diagnosis malfunction is detected.	
Cont Unit [U1200] CAN CONT [U1216]	AV control unit malfunction is detected.	
ST ANGLE SEN CALIB [U1232]	Predictive course line center position adjustment of the steering angle sensor is incomplete.	Adjust the predictive course line center position of the steering angle sensor. Refer to <a href="#">BRC-60, "Work Procedure"</a> .

# DIAGNOSIS SYSTEM (AV CONTROL UNIT)

< SYSTEM DESCRIPTION >

[BASE AUDIO WITHOUT NAVIGATION]

Error item	Description	Possible malfunction factor/Action to take
FRONT DISP CONN [U1243]	When either one of the following items is detected: <ul style="list-style-type: none"> <li>• display unit power supply and ground circuits are malfunctioning.</li> <li>• communication circuits between AV control unit and display unit are malfunctioning.</li> </ul>	<ul style="list-style-type: none"> <li>• Display unit power supply and ground circuits. Refer to <a href="#">AV-73. "DISPLAY UNIT : Diagnosis Procedure"</a>.</li> <li>• Communication circuits between AV control unit and display unit.</li> </ul>
SAT CONN [U1255]	When either one of the following items is detected: <ul style="list-style-type: none"> <li>• satellite radio tuner power supply and ground circuit are malfunctioning.</li> <li>• communication circuits between AV control unit and satellite radio tuner are malfunctioning.</li> <li>• request signal circuit between AV control unit and satellite radio tuner are malfunctioning.</li> </ul>	<ul style="list-style-type: none"> <li>• Satellite radio tuner power supply and ground circuit. Refer to <a href="#">AV-75. "SATELLITE RADIO TUNER : Diagnosis Procedure"</a>.</li> <li>• Communication circuit between AV control unit and satellite radio tuner.</li> <li>• Request signal circuit between AV control unit and satellite radio tuner.</li> </ul>
<ul style="list-style-type: none"> <li>• AV COMM CIRCUIT [U1300]</li> <li>• SWITCH CONN [U1240]</li> </ul>	When either one of the following items is detected: <ul style="list-style-type: none"> <li>• multifunction switch power supply and ground circuits are malfunctioning.</li> <li>• AV communication circuits between AV control unit and multifunction switch are malfunctioning.</li> </ul>	<ul style="list-style-type: none"> <li>• Multifunction switch power supply and ground circuits.</li> <li>• AV communication circuits between AV control unit and multifunction switch.</li> </ul>
<ul style="list-style-type: none"> <li>• AV COMM CIRCUIT [U1300]</li> <li>• HAND FREE CONN [U1256]</li> </ul>	When either one of the following items is detected: <ul style="list-style-type: none"> <li>• TEL adapter unit power supply and ground circuits are malfunctioning.</li> <li>• AV communication circuits between AV control unit and TEL adapter unit are malfunctioning.</li> </ul>	<ul style="list-style-type: none"> <li>• TEL adapter unit power supply and ground circuits. Refer to <a href="#">AV-76. "TEL ADAPTER UNIT : Diagnosis Procedure"</a>.</li> <li>• AV communication circuits between AV control unit and TEL adapter unit.</li> </ul>
<ul style="list-style-type: none"> <li>• AV COMM CIRCUIT [U1300]</li> <li>• SWITCH CONN [U1240]</li> <li>• HAND FREE CONN [U1256]</li> </ul>	Malfunction is detected in AV communication circuits between AV control unit and multifunction switch.	AV communication circuits between AV control unit and multifunction switch.

## DATA MONITOR

### NOTE:

The following table includes information (items) inapplicable to this vehicle. For information (items) applicable to this vehicle, refer to CONSULT display items.

### ALL SIGNALS

- Displays the status of the following vehicle signals inputted into the AV control unit.
- For each signal, actual signal can be compared with the condition recognized on the system.

Display Item	Display	Vehicle status	Remarks
VHCL SPD SIG	On	Vehicle speed > 0 km/h (0 MPH)	Changes in indication may be delayed. This is normal.
	Off	Vehicle speed = 0 km/h (0 MPH)	
PKB SIG	On	Parking brake is applied.	
	Off	Parking brake is released.	
ILLUM SIG	On	Block the light beam from the auto light optical sensor when the light SW is ON.	—
	Off	Expose the auto light optical sensor to light when the light SW is OFF or ON.	
IGN SIG	On	Ignition switch ON	
	Off	Ignition switch in ACC position	

## DIAGNOSIS SYSTEM (AV CONTROL UNIT)

< SYSTEM DESCRIPTION >

[BASE AUDIO WITHOUT NAVIGATION]

Display Item	Display	Vehicle status	Remarks
REV SIG	On	Selector lever in R position	Changes in indication may be delayed. This is normal.
	Off	Selector lever in any position other than R	

### SELECTION FROM MENU

Allows the technician to select which vehicle signals should be displayed and displays the status of the selected vehicle signals.

Item to be selected	Description
VHCL SPD SIG	The same as when "ALL SIGNALS" is selected.
PKB SIG	
ILLUM SIG	
IGN SIG	
REV SIG	

### WORK SUPPORT

Adjusts the neutral position of the steering angle sensor.

**CAUTION:**

**For vehicles with VDC, adjust the steering angle sensor neutral position on the ABS actuator control unit side. Refer to [BRC-60, "Work Procedure"](#).**

Item	Description
ST ANGLE SENSOR ADJUSTMENT	Adjusts the neutral position of the steering angle sensor.

### CONFIGURATION

Configuration has three functions as follows.

Function	Description	
Read/Write Configuration	Before Replace ECU	Allows the reading of vehicle specification written in AV control unit to store the specification in CONSULT.
	After Replace ECU	Allows the writing of the vehicle information stored in CONSULT into the AV control unit.
Manual Configuration	Allows the writing of the vehicle specification into the AV control unit by hand.	

A  
B  
C  
D  
E  
F  
G  
H  
I  
J  
K  
L  
M

AV

O  
P

## DIAGNOSIS SYSTEM (ACTIVE NOISE CONTROL UNIT)

< SYSTEM DESCRIPTION >

[BASE AUDIO WITHOUT NAVIGATION]

---

### DIAGNOSIS SYSTEM (ACTIVE NOISE CONTROL UNIT)

#### On Board Diagnosis Function

INFOID:000000008130727

#### ON BOARD DIAGNOSIS ITEM

Starting with the operation of the door switch, the Self-diagnosis function allows the diagnoses of the active noise control unit internal circuit, the input state of each signal, and a microphone connection state. The diagnosis results are indicated by a sound.

#### METHOD OF STARTING

# DIAGNOSIS SYSTEM (ACTIVE NOISE CONTROL UNIT)

[BASE AUDIO WITHOUT NAVIGATION]

< SYSTEM DESCRIPTION >

Perform Self-diagnosis, according to the following steps:

Step	Check Item	Operation	Judgment	Output sound pattern ( : MAX :100dB. : No sound, □ : 1 cycle)	Next Step	Remarks
-	Preparation	Turn on the radio to check that the speakers are normal.	-		1	All self-diagnosis results are notified by the output sound from the speaker.
1	Self-diagnosis mode startup	Within 5 seconds after starting the engine with all doors except the one on the driver seat side closed, press the door switch 6 times or more during a time interval of 4 seconds.	-		2	* Specially, within 5 seconds after starting the engine switch to ACC. When starting self-diagnosis after turning the ignition switch to ACC, the self-diagnosis mode will not start. * Self-diagnosis can be repeatedly started by turning the ignition switch to ACC without starting the engine. In this case, the judgment performed at Step 2 becomes NG because engine speed cannot be detected.
2	Diagnoses of engine speed signal and the microphone for active noise control system	Identify a sound heard after the notification sound (Step 1).	OK	OK: After the end of the last beep of the triple short beeps heard in Step 1, silence follows for approx. 1 second and a sound is heard according to a check result (Step 3) of the number of cylinders. If not OK: (1) 1 sec./time, 10 seconds of silence	3	* If NG, a beep is heard for 30 seconds after 10-second-silence.
3	Checking the judgment result of the number of cylinders	Identify a sound (Step 2).	6-cylinder engine	x MAX 40 cycles	4	A beep sounds for 60 seconds at maximum in either case. (1 cycle for approx. 1.3 sec. x 40 cycles)
4	(Interruption of cylinder judge result notification sound)	Press the door switch 6 times or more during a time interval of 4 seconds.	8-cylinder engine	x MAX 40 cycles	5	The same sound is heard after a lapse of 60 seconds without pressing the door switch. (1 cycle only)
5	Sample sound for the active noise control system	Identify a sound heard after the notification sound (Step 3).	-	1 cycle only	6	A sample sound (heard for 20 seconds at maximum) that an ON/OFF effect of the active noise control system is initiated. (1 cycle for approx. 4 seconds x 5 cycles)
6	End of self-diagnosis	Press the door switch 6 times or more during a time interval of 4 seconds while prolonged sound is ringing. Wait for 20 seconds until the sound stops.	-	1 cycle only	End of diagnosis	After the completion of self-diagnosis, the active noise control system status normal operation. (1 cycle only)
7	Start of malfunctioning part judgment (1) or end of self-diagnosis (2)	(1) Within 30 seconds while the prolonged sound is ringing (Step 2), press the door switch 6 times or more during a time interval of 4 seconds. (2) Wait for 30 seconds until the prolonged sound stops.	-	1 cycle only	8	After the completion of self-diagnosis, the active noise control system starts normal operation. (1 cycle only)
8	Active noise control system microphone check	Identify the sound pattern.	Front microphone: OK Rear microphone: OK	x MAX 4 cycles	9	A beep sounds for 60 seconds at maximum in either case. (1 cycle for approx. 4.25 sec. x 14 cycles)
9	Start of self-diagnosis for engine speed signal (1) or end of self-diagnosis (2)	(1) Within 60 seconds while the prolonged sound is ringing, press the door switch 6 times or more during a time interval of 4 seconds. (2) Wait for 60 seconds until the prolonged sound stops.	Front microphone: NG Rear microphone: NG	x MAX 4 cycles	10	After the completion of self-diagnosis, the active noise control system starts normal operation. (1 cycle only)
10	Engine speed signal check	Identify the sound pattern.	OK	1 cycle only	11	A beep sounds for 60 seconds at maximum in either case. (1 cycle for approx. 0.75 sec. x 80 cycles)
11	End of self-diagnosis	Press the door switch 6 times or more during a time interval of 4 seconds. Wait for 60 seconds until the prolonged sound stops.	NG	x MAX 80 cycles * After only for this item: 1 sec./time, 10 seconds of silence	End of diagnosis	A beep is heard for 60 seconds after 10-second-silence. After the completion of self-diagnosis, the active noise control system starts normal operation. (1 cycle only)

J5N1A3066GB

- When a sound is not outputted from the speakers as a result of the preparation, check the AV control unit, active noise control unit, connector connections, or speakers.
- When Self-diagnosis mode does not start at Step 1, check the door state signal circuit.
- When a malfunction is detected in the microphone at Step 8, check the signal circuit of each microphone.
- When an error is detected in an engine speed signal at Step 10, check the engine speed signal circuit.

A  
B  
C  
D  
E  
F  
G  
H  
I  
J  
K  
L  
M  
N  
O  
P

AV

# DIAGNOSIS SYSTEM (TEL ADAPTER UNIT)

< SYSTEM DESCRIPTION >

[BASE AUDIO WITHOUT NAVIGATION]

## DIAGNOSIS SYSTEM (TEL ADAPTER UNIT)

### On Board Diagnosis Function

INFOID:000000008130728

#### HANDS-FREE PHONE SYSTEM ON BOARD DIAGNOSIS

During on board diagnosis the diagnosis function of TEL adapter unit starts with the operation of the steering switch and performs the diagnosis when ignition switch ACC.

#### ON BOARD DIAGNOSIS ITEM

The on board diagnosis has 3 modes: the self-diagnosis mode that performs the trouble diagnosis, the speaker adaptation data deleting mode and the hands-free phone system initialization mode.

#### CAUTION:

- Perform the diagnosis with the vehicle stopped.
- Perform STEP2 if necessary.

STEP	MODE	Description
STEP1	Self-diagnosis	The self-diagnosis mode performs the microphone test and the diagnosis of TEL adapter unit, TEL antenna and steering unit, and then reads out the results with the sound and indicates them on the display.
STEP2	Speaker adaptation data deleting	The speaker adaptation data deleting mode can delete the speaker adaptation data.
	Hands-free phone system initialization	Hands-free phone system initialization mode can perform the initialization of hands-free phone system.

#### Self-diagnosis results

Self-diagnosis mode reads out the self-diagnosis results.

#### NOTE:

- Error count is read out simultaneously when reading out the DTC name.
- The errors are read out continuously when some errors occur at the same time.

#### Self-diagnosis results

DTC	DTC name	Possible causes
DTC 10000	INTERNAL FAILURE	TEL adapter unit
DTC 01000	ANT. SHORT TO BATT OR OPEN	TEL antenna
DTC 00100	ANT. SHORT TO GROUND	
DTC 00010	STEERING REMOTE BUTTON STUCK A	Steering switch
DTC 00001	STEERING REMOTE BUTTON STUCK B	
DTC 00000	THERE ARE NO FAILURE RECORDS TO REPORT	—

#### The Details of Error Count

The error count guides "0" when the error occurs. The next time it counts up "1" if it is normal with the ignition switch ON. It continues the count up unless the initialization of hands-free phone system is performed.



# DIAGNOSIS SYSTEM (TEL ADAPTER UNIT)

< SYSTEM DESCRIPTION >

[BASE AUDIO WITHOUT NAVIGATION]

## FLOW CHART OF TROUBLE DIAGNOSIS

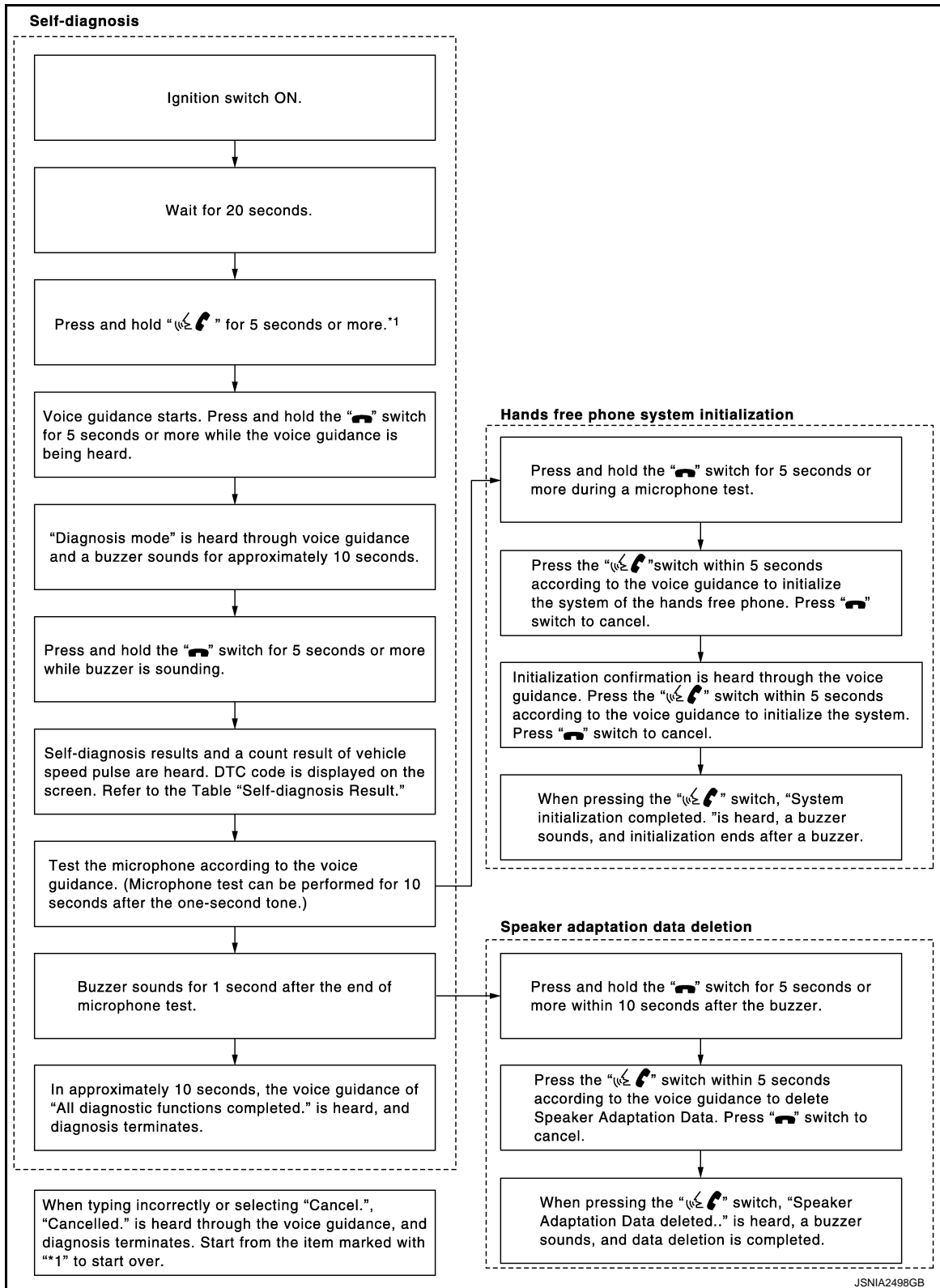

A  
B  
C  
D  
E  
F  
G  
H  
I  
J  
K  
L  
M  
AV  
O  
P

# AV CONTROL UNIT

< ECU DIAGNOSIS INFORMATION >

[BASE AUDIO WITHOUT NAVIGATION]

## ECU DIAGNOSIS INFORMATION

### AV CONTROL UNIT

#### Reference Value

INFOID:000000008130729

#### VALUES ON THE DIAGNOSIS TOOL

**NOTE:**

The following table includes information (items) inapplicable to this vehicle. For information (items) applicable to this vehicle, refer to CONSULT display items.

CONSULT MONITOR ITEM

Monitor Item	Condition		Value/Status
VHCL SPD SIG	Ignition switch ON	Vehicle speed > 0 km/h (0 MPH)	On
		Vehicle speed = 0 km/h (0 MPH)	Off
PKB SIG	Ignition switch ON	Parking brake is applied.	On
		Parking brake is released.	Off
ILLUM SIG	Ignition switch ON	Light switch ON	On
		Light switch OFF	Off
IGN SIG	Ignition switch ON	—	On
	Ignition switch ACC	—	Off
REV SIG	Ignition switch ON	Selector lever in R position	On
		Selector lever in any position other than R	Off

#### TERMINAL LAYOUT

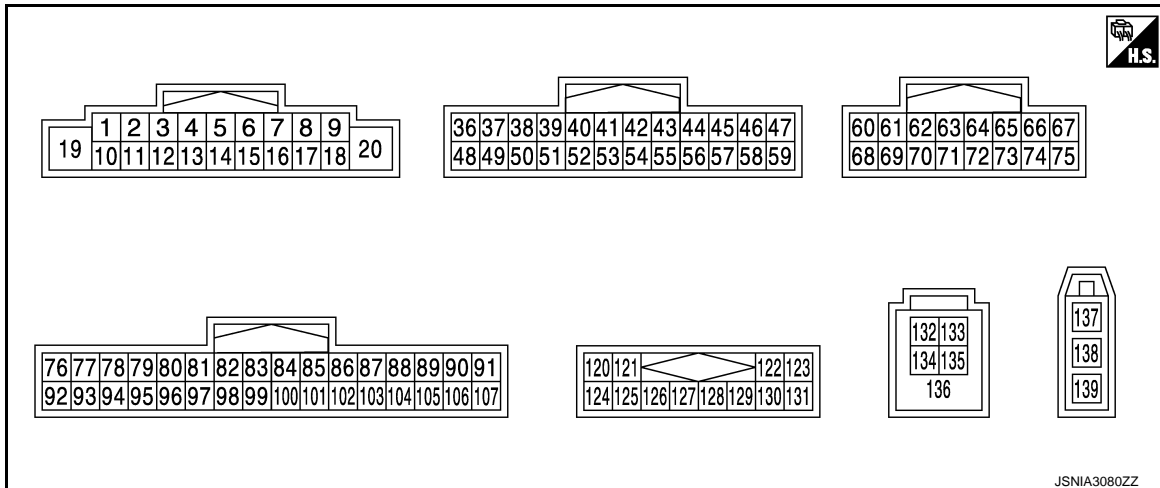



#### PHYSICAL VALUES

# AV CONTROL UNIT

< ECU DIAGNOSIS INFORMATION >

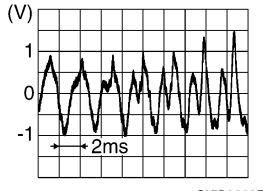
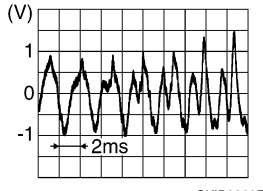
[BASE AUDIO WITHOUT NAVIGATION]

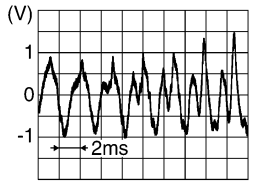
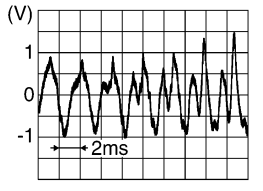
Terminal (Wire color)		Description		Condition		Reference value (Approx.)
+	-	Signal name	Input/ Output			
2 (G)	3 (L)	Sound signal front LH	Output	Ignition switch ON	Sound output	 <small>SKIB3609E</small>
4 (GR)	5 (G)	Sound signal rear LH	Output	Ignition switch ON	Sound output	 <small>SKIB3609E</small>
6 (P)	15 (B)	Steering switch signal A	Input	Ignition switch ON	Keep pressing SOURCE switch.	0 V
					Keep pressing MENU UP switch.	0.7 V
					Keep pressing MENU DOWN switch.	1.3 V
					Keep pressing  switch	2.0 V
					Except for above.	3.3 V
7 (V)	Ground	ACC power supply	Input	Ignition switch ACC	—	Battery voltage
9 (SB)	Ground	Illumination signal	Input	Ignition switch OFF	Lighting switch is OFF.	0 V
					Lighting switch is ON.	12.0 V
11 (BR)	12 (R)	Sound signal front RH	Output	Ignition switch ON	Sound output	 <small>SKIB3609E</small>
13 (P)	14 (V)	Sound signal rear RH	Output	Ignition switch ON	Sound output	 <small>SKIB3609E</small>

A  
B  
C  
D  
E  
F  
G  
H  
I  
J  
K  
L  
M  
O  
P

AV

# AV CONTROL UNIT

< ECU DIAGNOSIS INFORMATION >

[BASE AUDIO WITHOUT NAVIGATION]

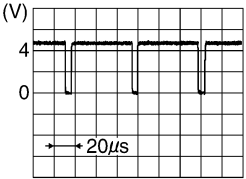
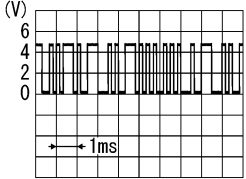
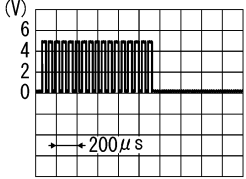
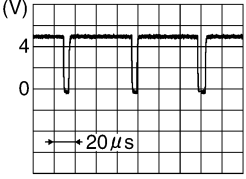
Terminal (Wire color)		Description		Condition		Reference value (Approx.)
+	-	Signal name	Input/ Output			
16 (L)	15 (B)	Steering switch signal B	Input	Ignition switch ON	Keep pressing VOL DOWN switch.	0 V
					Keep pressing VOL UP switch.	0.7 V
					Keep pressing  switch.	1.3 V
					Except for above.	3.3 V
19 (Y)	Ground	Battery power supply	Input	Ignition switch OFF	—	Battery voltage
20 (B)	Ground	Ground	—	Ignition switch ON	—	0 V
36 (BG)	Ground	Signal VCC	Output	Ignition switch ACC	—	9.0 V
37 (B)	Ground	Signal ground	—	Ignition switch OFF	—	0 V
38 (G)	Ground	Horizontal synchronizing (HP) signal	Input	Ignition switch ON	—	 <small style="display: block; text-align: right;">SKIB3601E</small>
39 (Y)	Ground	Communication signal (DISP→CONT)	Input	Ignition switch ON	When adjusting display brightness.	 <small style="display: block; text-align: right;">PKIB5039J</small>
40 (R)	Ground	RGB area (YS) signal	Output	Ignition switch ON	At RGB image is displayed.	5.0 V
					At DVD image is displayed.	 <small style="display: block; text-align: right;">PKIB4948J</small>
41	—	Shield	—	—	—	—
42 (W)	Ground	RGB synchronizing signal	Output	Ignition switch ON	—	 <small style="display: block; text-align: right;">SKIB3603E</small>

# AV CONTROL UNIT

< ECU DIAGNOSIS INFORMATION >

[BASE AUDIO WITHOUT NAVIGATION]

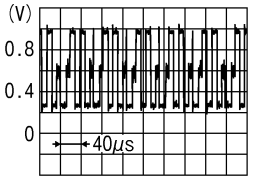
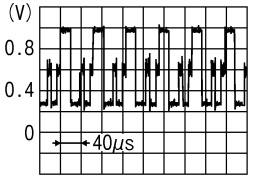
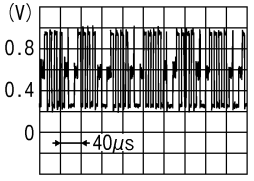
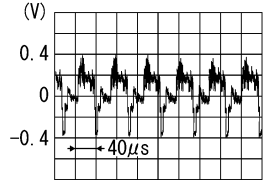
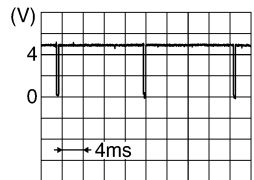
Terminal (Wire color)		Description		Condition		Reference value (Approx.)
+	-	Signal name	Input/ Output			
43 (R)	Ground	RGB signal (R: red)	Output	Ignition switch ON	Start Confirmation/Adjustment mode, and then display color bar by selecting "Color Spectrum Bar" on Display Diagnosis screen.	 <p style="text-align: right; font-size: small;">JSNIA1029ZZ</p>
44 (B)	Ground	RGB signal (G: green)	Output	Ignition switch ON	Start Confirmation/Adjustment mode, and then display color bar by selecting "Color Spectrum Bar" on Display Diagnosis screen.	 <p style="text-align: right; font-size: small;">JSNIA1030ZZ</p>
45 (W)	Ground	RGB signal (B: blue)	Output	Ignition switch ON	Start Confirmation/Adjustment mode, and then display color bar by selecting "Color Spectrum Bar" on Display Diagnosis screen.	 <p style="text-align: right; font-size: small;">JSNIA1031ZZ</p>
46 (V)	Ground	Composite image ground	—	Ignition switch ON	—	0 V
47 (SB)	Ground	Composite image signal	Output	Ignition switch ON	At rear view camera image is displayed.	 <p style="text-align: right; font-size: small;">SKIB2251J</p>
48 (L)	Ground	Inverter VCC	Output	Ignition switch ACC	—	9.0 V
49 (LG)	Ground	Inverter ground	—	Ignition switch OFF	—	0 V
50 (B)	Ground	Vertical synchronizing (VP) signal	Input	Ignition switch ON	—	 <p style="text-align: right; font-size: small;">SKIB3598E</p>



A  
B  
C  
D  
E  
F  
G  
H  
I  
J  
K  
L  
M  
O  
P

AV

# AV CONTROL UNIT

< ECU DIAGNOSIS INFORMATION >

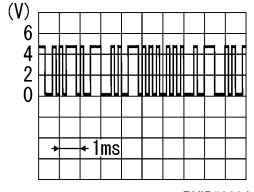
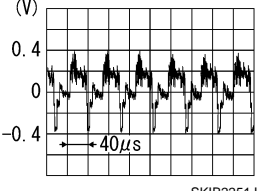
[BASE AUDIO WITHOUT NAVIGATION]

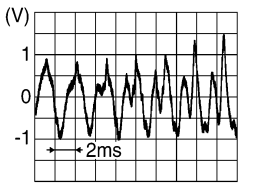
Terminal (Wire color)		Description		Condition		Reference value (Approx.)
+	-	Signal name	Input/ Output			
51 (BR)	Ground	Communication signal (CONT→DISP)	Output	Ignition switch ON	When adjusting display brightness.	 <p style="text-align: right; font-size: small;">PKIB5039J</p>
52	—	Shield	—	—	—	—
57	—	Shield	—	—	—	—
58	—	Shield	—	—	—	—
62 (W)	Ground	Camera image signal	Input	Ignition switch ON	At rear view camera image is displayed.	 <p style="text-align: right; font-size: small;">SKIB2251J</p>
71	—	Shield	—	—	—	—
72 (B)	Ground	Camera ground	—	Ignition switch ON	—	0 V
73 (W)	Ground	Camera power supply	Output	Ignition switch ON	At rear view camera image is displayed.	6.0 V
76 (LG)	—	AV communication signal (L)	Input/ Output	—	—	—
77 (SB)	—	AV communication signal (H)	Input/ Output	—	—	—
78 (SB)	—	AV communication signal (H)	Input/ Output	—	—	—
79 (LG)	—	AV communication signal (L)	Input/ Output	—	—	—
80 (P)	—	CAN-L	Input/ Output	—	—	—
81 (L)	—	CAN-H	Input/ Output	—	—	—
82 (BR)	Ground	Switch ground	—	Ignition switch ON	—	0 V
86	—	Shield	—	—	—	—
87 (P)	88 (L)	TEL voice signal	Input	Ignition switch ON	During voice guide output with the  switch pressed.	 <p style="text-align: right; font-size: small;">SKIB3609E</p>

# AV CONTROL UNIT

< ECU DIAGNOSIS INFORMATION >

[BASE AUDIO WITHOUT NAVIGATION]

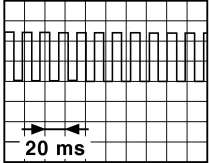
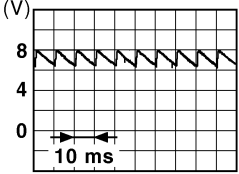
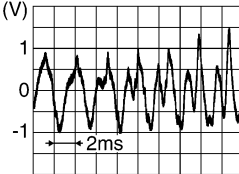
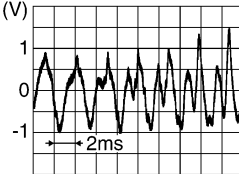
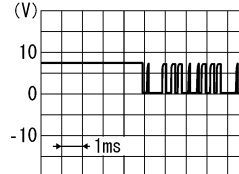
Terminal (Wire color)		Description		Condition	Reference value (Approx.)
+	-	Signal name	Input/ Output		
92 (R)	Ground	Vehicle speed signal (8-pulse)	Input	Ignition switch ON	When vehicle speed is ap- prox. 40 km/h (25 MPH)
<p><b>NOTE:</b> The maximum voltage varies de- pending on the specification (destination unit).</p>  <p style="text-align: right; font-size: small;">JSNIA0012GB</p>					
93 (V)	Ground	Parking brake signal	Input	Ignition switch ON	Parking brake is ON.
					Parking brake is OFF.
<p style="text-align: center;">0 V</p>  <p style="text-align: right; font-size: small;">JSNIA0007GB</p>					
94 (BG)	Ground	Reverse signal	Input	Ignition switch ON	R position
					Other than R position
<p style="text-align: center;">12.0 V</p> <p style="text-align: center;">0 V</p>					
95 (W)	Ground	Ignition signal	Input	Ignition switch ON	—
Battery voltage					
96 (SB)	Ground	Disk eject signal	Input	Ignition switch ON	Pressing the eject switch.
					Except for above.
<p style="text-align: center;">0 V</p> <p style="text-align: center;">3.3 V</p>					
120 (B)	124 (W)	Satellite radio sound signal LH	Input	Ignition switch ON	When satellite radio mode is selected.
 <p style="text-align: right; font-size: small;">SKIB3609E</p>					
121 (G)	125 (R)	Satellite radio sound signal RH	Input	Ignition switch ON	When satellite radio mode is selected.
 <p style="text-align: right; font-size: small;">SKIB3609E</p>					
122 (O)	Ground	Communication signal (CONT→SAT)	Output	Ignition switch ON	When satellite radio mode is selected.
 <p style="text-align: right; font-size: small;">SKIA9301J</p>					
126	—	Shield	—	—	—

A  
B  
C  
D  
E  
F  
G  
H  
I  
J  
K  
L  
M

AV

O  
P

# AV CONTROL UNIT

< ECU DIAGNOSIS INFORMATION >

[BASE AUDIO WITHOUT NAVIGATION]

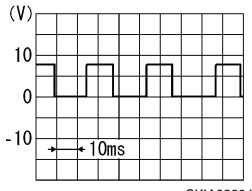
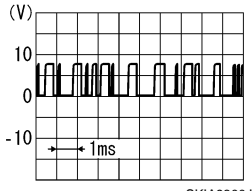
Terminal (Wire color)		Description		Condition		Reference value (Approx.)
+	-	Signal name	Input/ Output			
127	—	Shield	—	—	—	—
129 (Y)	Ground	Request signal (SAT→CONT)	Input	Ignition switch ON	When satellite radio mode is selected.	 <p style="text-align: right; font-size: small;">SKIA9299J</p>
130 (BR)	Ground	Communication signal (SAT→CONT)	Input	Ignition switch ON	When satellite radio mode is selected.	 <p style="text-align: right; font-size: small;">SKIA9300J</p>
132 (G)	—	USB ground	—	—	—	—
133 (W)	—	V BUS signal	—	—	—	—
134 (R)	—	USB D- signal	—	—	—	—
135 (L)	—	USB D+ signal	—	—	—	—
136	—	Shield	—	—	—	—
137	Ground	Antenna amp. ON signal	Output	Ignition switch ACC	—	12.0 V
138	—	AM-FM main	Input	—	—	—
139	—	FM sub	Input	—	—	—

## DTC Index

INFOID:000000008130730

## SELF-DIAGNOSIS RESULTS DISPLAY ITEM

DTC	Display item	Refer to
U1000	CAN COMM CIRCUIT [U1000]	<a href="#">AV-62. "Diagnosis Procedure"</a>
U1010	CONTROL UNIT (CAN) [1010]	<a href="#">AV-63. "DTC Logic"</a>
U1200	Cont Unit [U1200]	<a href="#">AV-64. "DTC Logic"</a>
U1216	CAN CONT [U1216]	<a href="#">AV-65. "DTC Logic"</a>
U1232	ST ANGLE SEN CALIB [1232]	<a href="#">AV-66. "Diagnosis Procedure"</a>
U1243	FRONT DISP CONN [U1243]	<a href="#">AV-67. "Diagnosis Procedure"</a>
U1255	SAT CONN [U1255]	<a href="#">AV-69. "Diagnosis Procedure"</a>
U1310	CONTROL UNIT (AV) [U1310]	<a href="#">AV-72. "DTC Logic"</a>
U1300 U1240	<ul style="list-style-type: none"> <li>• AV COMM CIRCUIT [U1300]</li> <li>• SWITCH CONN [U1240]</li> </ul>	<a href="#">AV-71. "Description"</a>



# AV CONTROL UNIT

< ECU DIAGNOSIS INFORMATION >

[BASE AUDIO WITHOUT NAVIGATION]

DTC	Display item	Refer to
U1300 U1256	<ul style="list-style-type: none"><li>• AV COMM CIRCUIT [U1300]</li><li>• HAND FREE CONN [U1256]</li></ul>	<a href="#">AV-71, "Description"</a>
U1300 U1240 U1256	<ul style="list-style-type: none"><li>• AV COMM CIRCUIT [U1300]</li><li>• SWITCH CONN [U1240]</li><li>• HAND FREE CONN [U1256]</li></ul>	<a href="#">AV-71, "Description"</a>

A

B

C

D

E

F

G

H

I

J

K

L

M

AV

O

P

# DISPLAY UNIT

< ECU DIAGNOSIS INFORMATION >

[BASE AUDIO WITHOUT NAVIGATION]

## DISPLAY UNIT

Reference Value

INFOID:000000008130731

TERMINAL LAYOUT

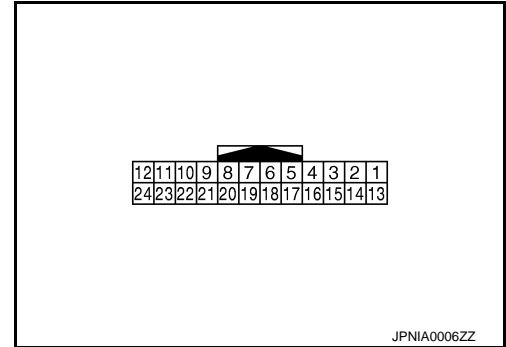

## PHYSICAL VALUES

Terminal (Wire color)		Description		Condition		Reference value (Approx.)
+	-	Signal name	Input/ Output			
1 (B)	Ground	Ground	—	Ignition switch ON	—	0 V
2 (L)	Ground	Inverter VCC	Input	Ignition switch ACC	—	9.0 V
3 (BG)	Ground	Signal VCC	Input	Ignition switch ACC	—	9.0 V
4 (V)	Ground	Composite image ground	—	Ignition switch ON	—	0 V
5	—	Shield	—	—	—	—
6 (B)	Ground	RGB signal (G: green)	Input	Ignition switch ON	Start Confirmation/Adjust- ment mode, and then dis- play color bar by selecting "Color Spectrum Bar" on Display Diagnosis screen.	<p style="text-align: right;">JSNIA1030ZZ</p>
7	—	Shield	—	—	—	—
8 (G)	Ground	Horizontal synchronizing (HP) signal	Output	Ignition switch ON	—	<p style="text-align: right;">SKIB3601E</p>

# DISPLAY UNIT

< ECU DIAGNOSIS INFORMATION >

[BASE AUDIO WITHOUT NAVIGATION]

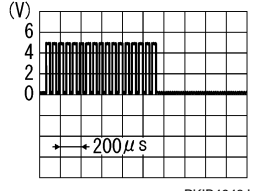
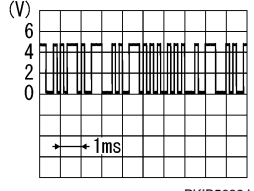
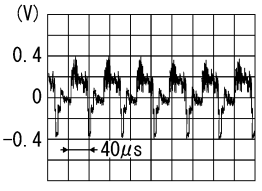
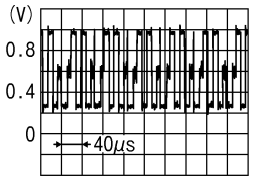
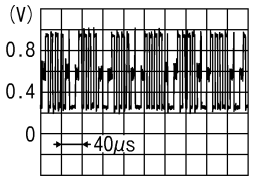
Terminal (Wire color)		Description		Condition	Reference value (Approx.)
+	-	Signal name	Input/ Output		
9 (R)	Ground	RGB area (YS) signal	Input	Ignition switch ON	At RGB image is displayed. 5.0 V
				Ignition switch ON	At DVD image is displayed. 
11 (BR)	Ground	Communication signal (CONT→DISP)	Input	Ignition switch ON	When adjusting display brightness. 
13 (LG)	Ground	Inverter ground	—	Ignition switch ON	— 0 V
14 (B)	Ground	Signal ground	—	Ignition switch ON	— 0 V
15 (SB)	Ground	Composite image signal	Input	Ignition switch ON	At rear view camera image is displayed. 
17 (R)	Ground	RGB signal (R: red)	Input	Ignition switch ON	Start Confirmation/Adjustment mode, and then display color bar by selecting "Color Spectrum Bar" on Display Diagnosis screen. 
18 (W)	Ground	RGB signal (B: blue)	Input	Ignition switch ON	Start Confirmation/Adjustment mode, and then display color bar by selecting "Color Spectrum Bar" on Display Diagnosis screen. 

A  
B  
C  
D  
E  
F  
G  
H  
I  
J  
K  
L  
M  
AV  
O  
P

# DISPLAY UNIT

< ECU DIAGNOSIS INFORMATION >

[BASE AUDIO WITHOUT NAVIGATION]

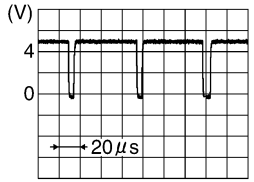
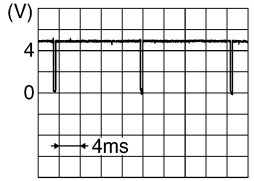
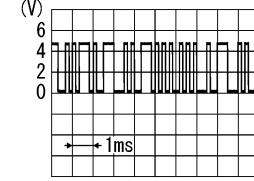
Terminal (Wire color)		Description		Condition		Reference value (Approx.)
+	-	Signal name	Input/ Output			
19 (W)	Ground	RGB synchronizing signal	Input	Ignition switch ON	—	 <p style="text-align: right;">SKIB3603E</p>
20 (B)	Ground	Vertical synchronizing (VP) signal	Output	Ignition switch On	—	 <p style="text-align: right;">SKIB3598E</p>
21	—	Shield	—	—	—	—
22 (Y)	Ground	Communication signal (DISP→CONT)	Output	Ignition switch ON	When adjusting display brightness.	 <p style="text-align: right;">PKIB5039J</p>
23	—	Shield	—	—	—	—

# ACTIVE NOISE CONTROL UNIT

< ECU DIAGNOSIS INFORMATION >

[BASE AUDIO WITHOUT NAVIGATION]

## ACTIVE NOISE CONTROL UNIT

Reference Value

INFOID:000000008130732

### TERMINAL LAYOUT

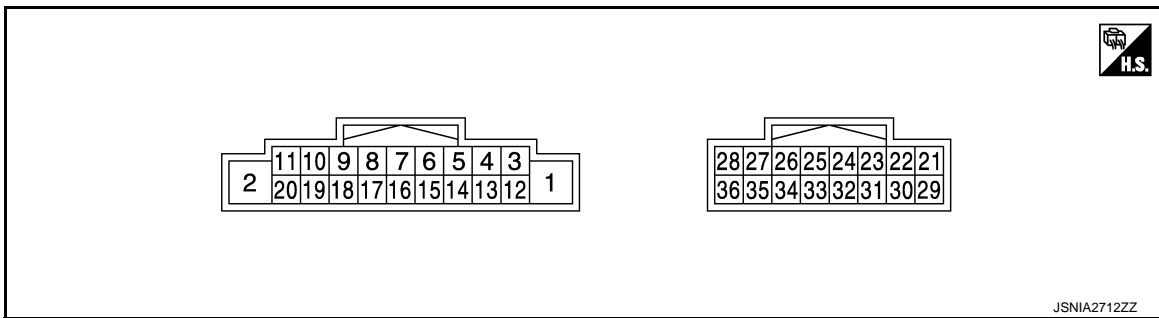

### PHYSICAL VALUES

Terminal (Wire color)		Description		Condition		Reference value (Approx.)
+	-	Signal name	Input/ Output			
1 (B/R)	Ground	Ground	—	Igni- tion switch OFF	—	0 V
2 (Y)	Ground	Battery power supply	Input	Igni- tion switch OFF	—	Battery voltage
3 (Y)	12 (L)	Sound signal front LH	Input	Igni- tion switch ON	Sound output	 SKIB3609E
4 (V)	13 (GR)	Sound signal front RH	Input	Igni- tion switch ON	Sound output	 SKIB3609E
5 (LG)	14 (W)	Sound signal rear LH	Input	Igni- tion switch ON	Sound output	 SKIB3609E

A  
B  
C  
D  
E  
F  
G  
H  
I  
J  
K  
L  
M  
AV  
O  
P

# ACTIVE NOISE CONTROL UNIT

< ECU DIAGNOSIS INFORMATION >

[BASE AUDIO WITHOUT NAVIGATION]

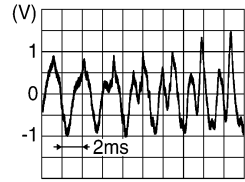
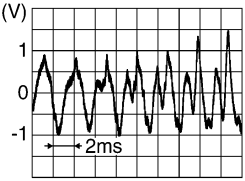
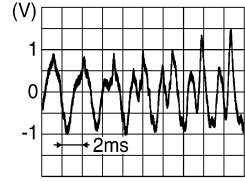
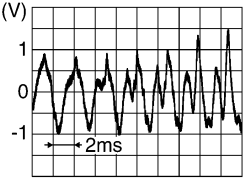
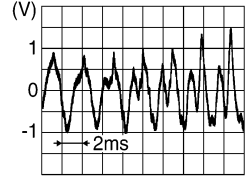
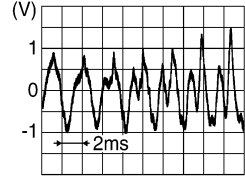
Terminal (Wire color)		Description		Condition		Reference value (Approx.)
+	-	Signal name	Input/ Output			
6 (O)	15 (SB)	Sound signal rear RH	Input	Igni- tion switch ON	Sound output	 <p style="text-align: right; font-size: small;">SKIB3609E</p>
8 (W)	17 (B)	Sound signal front door speaker LH	Output	Igni- tion switch ON	Sound output	 <p style="text-align: right; font-size: small;">SKIB3609E</p>
9 (B)	18 (W)	Sound signal front door speaker RH	Output	Igni- tion switch ON	Sound output	 <p style="text-align: right; font-size: small;">SKIB3609E</p>
10 (G)	19 (R)	Sound signal rear door speaker LH	Output	Igni- tion switch ON	Sound output	 <p style="text-align: right; font-size: small;">SKIB3609E</p>
11 (R)	20 (G)	Sound signal rear door speaker RH	Output	Igni- tion switch ON	Sound output	 <p style="text-align: right; font-size: small;">SKIB3609E</p>
23 (Y)	31 (BR)	Front microphone signal	Input	Igni- tion switch ON	When inputting interior sound	 <p style="text-align: right; font-size: small;">SKIB3609E</p>

# ACTIVE NOISE CONTROL UNIT

< ECU DIAGNOSIS INFORMATION >

[BASE AUDIO WITHOUT NAVIGATION]

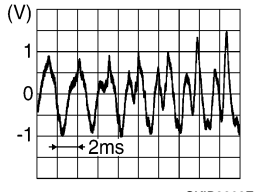
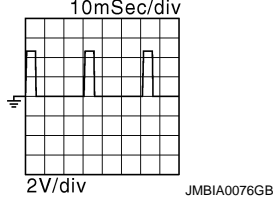
Terminal (Wire color)		Description		Condition	Reference value (Approx.)
+	-	Signal name	Input/ Output		
24 (L)	32 (LG)	Rear microphone signal	Input	Igni- tion switch ON  When inputting interior sound	
25 (P)	Ground	Step lamp signal	Input	Igni- tion switch ON  When anything door open	0 V
				Igni- tion switch ON  All doors are closed	12.0 V
27 (O)	Ground	Engine type signal	Input	Igni- tion switch ON  —	0 V
33 (SB)	Ground	Engine speed output sig- nal	Input	Igni- tion switch ON  Idle speed	
36 (V)	Ground	ACC power supply	Input	Igni- tion switch ACC  —	Battery voltage

A  
B  
C  
D  
E  
F  
G  
H  
I  
J  
K  
L  
M  
AV  
O  
P

AV

# SATELLITE RADIO TUNER

< ECU DIAGNOSIS INFORMATION >

[BASE AUDIO WITHOUT NAVIGATION]

## SATELLITE RADIO TUNER

Reference Value

INFOID:000000008130733

TERMINAL LAYOUT

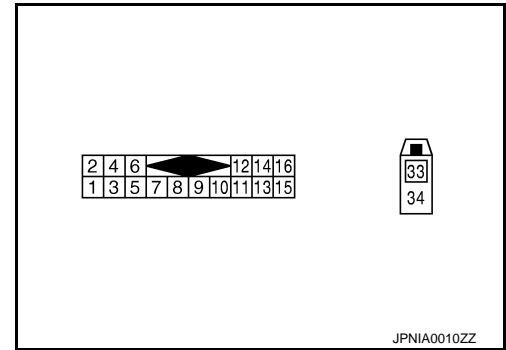

PHYSICAL VALUES

Terminal		Description		Condition		Reference value (Approx.)
+	-	Signal name	Input/Output			
2 (R)	1 (G)	Satellite radio sound signal LH	Output	Ignition switch ON	When satellite radio mode is selected.	
4 (B)	3 (W)	Satellite radio sound signal RH	Output	Ignition switch ON	When satellite radio mode is selected	
5	—	Shield	—	—	—	—
6	—	Shield	—	—	—	—
8 (R)	Ground	Request signal (SAT→CONT)	Output	Ignition switch ON	When satellite radio mode is selected	
9 (B)	Ground	Communication signal (SAT→CONT)	Output	Ignition switch ON	When satellite radio mode is selected	



# SATELLITE RADIO TUNER

< ECU DIAGNOSIS INFORMATION >

[BASE AUDIO WITHOUT NAVIGATION]

Terminal		Description		Condition		Reference value (Approx.)
+	-	Signal name	Input/Output			
10 (W)	Ground	Communication signal (CONT→SAT)	Input	Ignition switch ON	When satellite radio mode is selected	
12 (Y)	Ground	Battery power supply	Input	Ignition switch OFF	—	Battery voltage
16 (V)	Ground	ACC power supply	Input	Ignition switch ACC	—	Battery voltage
33	—	Satellite radio antenna	Input	—	—	—
34	—	Shield	—	—	—	—

A  
B  
C  
D  
E  
F  
G  
H  
I  
J  
K  
L  
M

AV

O  
P

# TEL ADAPTER UNIT

< ECU DIAGNOSIS INFORMATION >

[BASE AUDIO WITHOUT NAVIGATION]

## TEL ADAPTER UNIT

Reference Value

INFOID:000000008130734

### TERMINAL LAYOUT

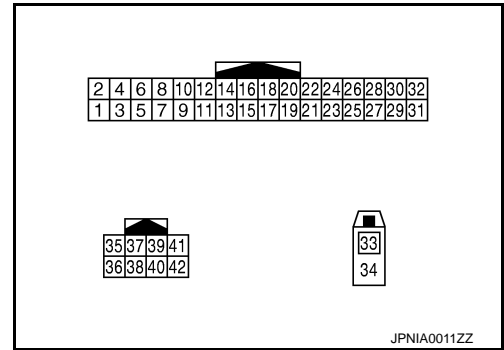

### PHYSICAL VALUES

Terminal (Wire color)		Description		Condition		Reference value (Approx.)
+	-	Signal name	Input/ Output			
1 (LG)	Ground	Battery power supply	Input	Ignition switch OFF	—	Battery voltage
2 (L)	Ground	ACC power supply	Input	Ignition switch ACC	—	Battery voltage
3 (P)	Ground	Ignition signal	Input	Ignition switch ON	—	Battery voltage
4 (B/R)	Ground	Ground	—	Ignition switch ON	—	0 V
7 (W/R)	8	Microphone signal	Input	Ignition switch ON	Give a voice	<p>PKIB5037J</p>
9 (W/L)	10 (GR/V)	TEL voice signal	Output	Ignition switch ON	During voice guide output with the  switch pressed	<p>SKIB3609E</p>
21 (B/R)	Ground	Control signal	Input	Ignition switch ON	—	0 V
23 (B/R)	Ground	Control signal	Input	Ignition switch ON	—	0 V

# TEL ADAPTER UNIT

< ECU DIAGNOSIS INFORMATION >

[BASE AUDIO WITHOUT NAVIGATION]

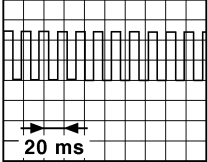
Terminal (Wire color)		Description		Condition		Reference value (Approx.)
+	-	Signal name	Input/ Output			
24 (B/R)	Ground	Control signal	Input	Ignition switch ON	—	0 V
28 (W)	Ground	Vehicle speed signal (8-pulse)	Input	Ignition switch ON	When vehicle speed is ap- prox. 40 km/h (25 MPH)	<p><b>NOTE:</b> The maximum voltage varies de- pending on the specification (destination unit).</p>  <p style="text-align: right; font-size: small;">JSNIA0012GB</p>
29 (B/R)	8	Microphone VCC	Output	Ignition switch ON	—	5.0 V
33	—	TEL antenna	Input	—	—	—
34	—	Shield	—	—	—	—
35 (GR)	—	AV communication signal (H)	Input/ Output	—	—	—
36 (SB)	—	AV communication signal (L)	Input/ Output	—	—	—

A  
B  
C  
D  
E  
F  
G  
H  
I  
J  
K  
L  
M

AV

O  
P

# BASE AUDIO WITHOUT NAVIGATION

[BASE AUDIO WITHOUT NAVIGATION]

< WIRING DIAGRAM >

## WIRING DIAGRAM

### BASE AUDIO WITHOUT NAVIGATION

#### Wiring Diagram

INFOID:000000008130735

For connector terminal arrangements, harness layouts, and alphabets in a  (option abbreviation; if not described in wiring diagram), refer to [GI-12. "Connector Information"](#).

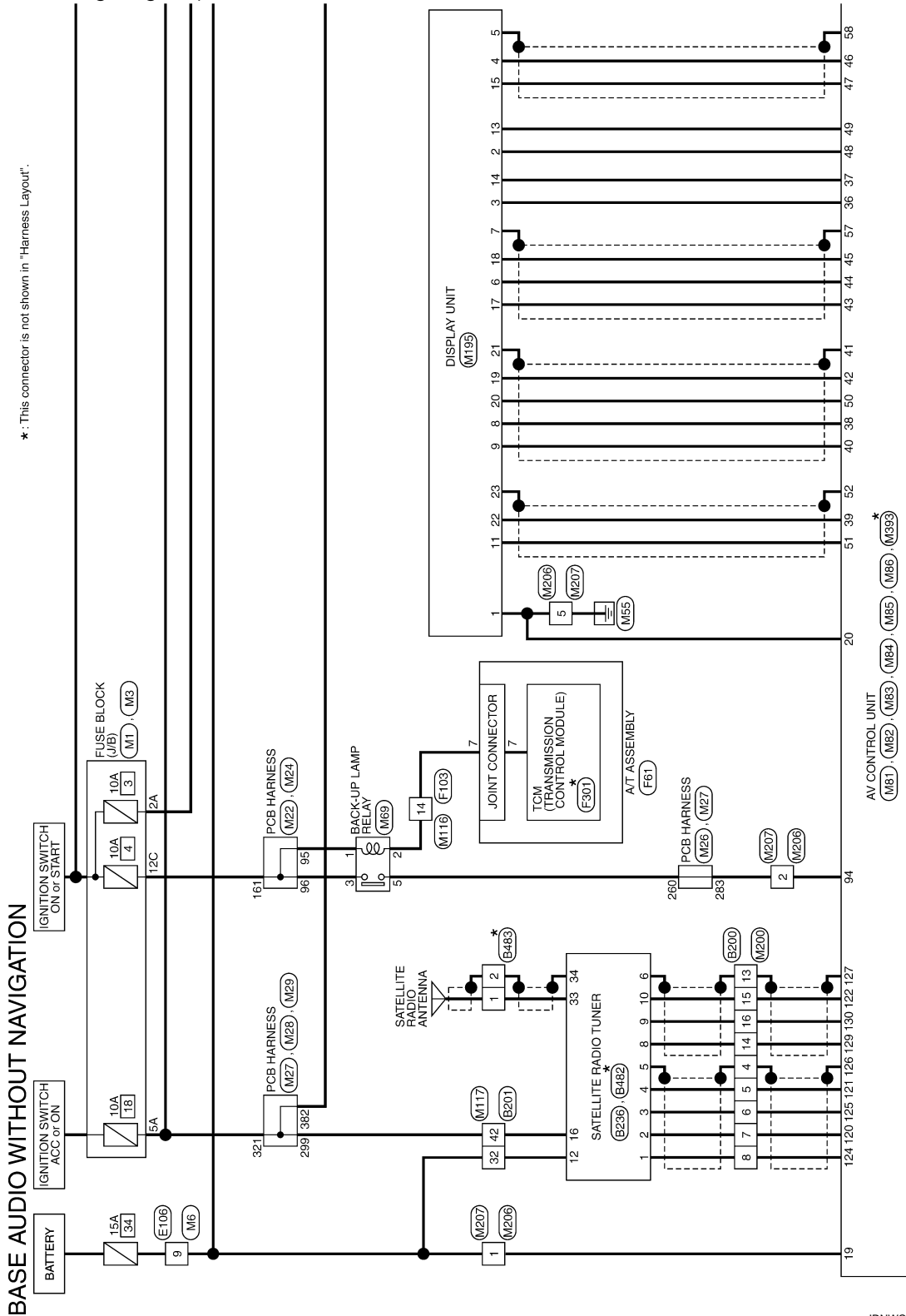

\*: This connector is not shown in "Harness Layout".

# BASE AUDIO WITHOUT NAVIGATION

## [BASE AUDIO WITHOUT NAVIGATION]

< WIRING DIAGRAM >

\*: This connector is not shown in "Harness Layout".

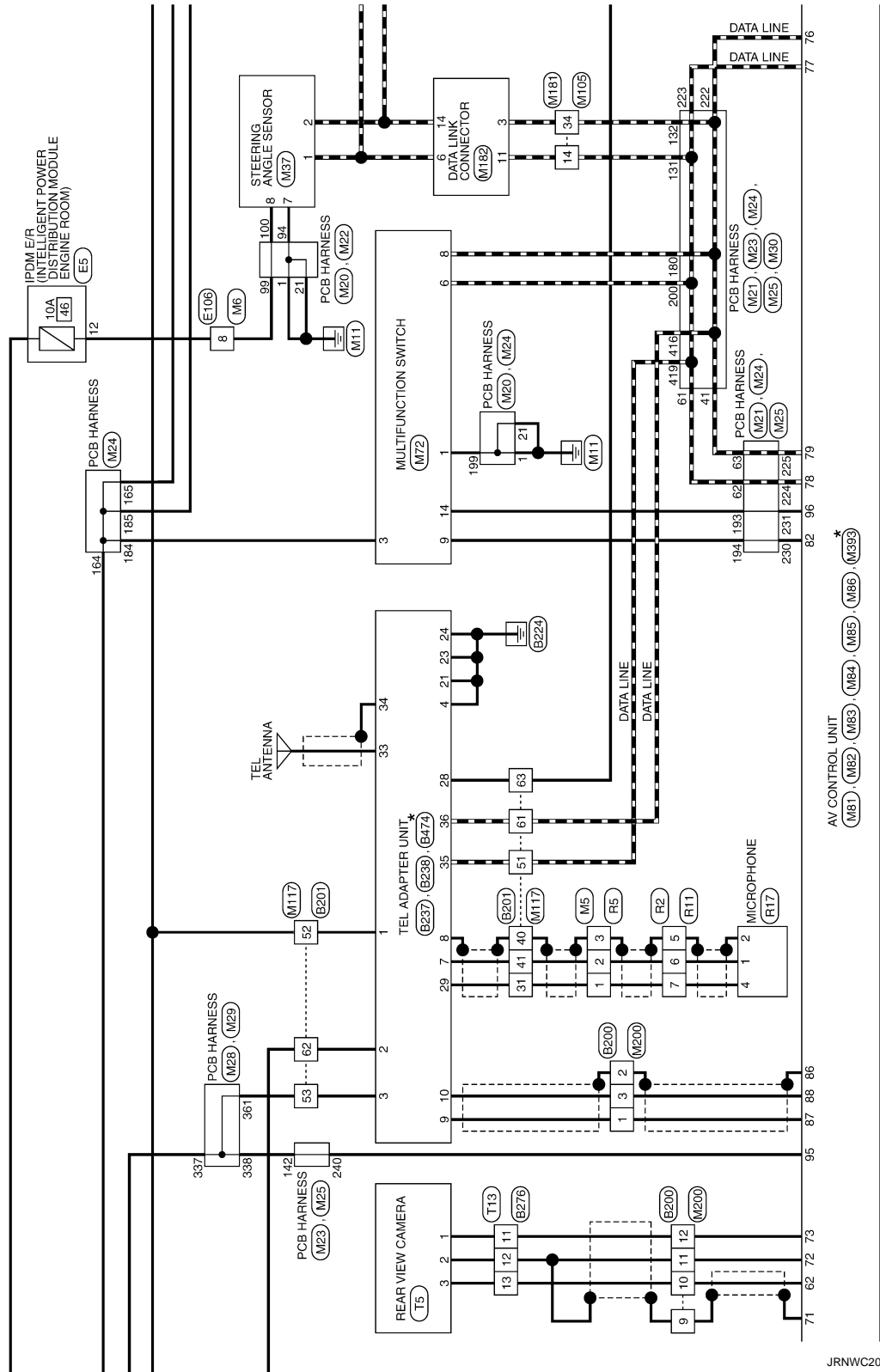

AV CONTROL UNIT  
 (M181), (M82), (M83), (M84), (M85), (M86), (M1393)\*

JRNWC2005GB

A  
B  
C  
D  
E  
F  
G  
H  
I  
J  
K  
L  
M  
N  
O  
P

AV

# BASE AUDIO WITHOUT NAVIGATION

[BASE AUDIO WITHOUT NAVIGATION]

< WIRING DIAGRAM >

\*: This connector is not shown in "Harness Layout".

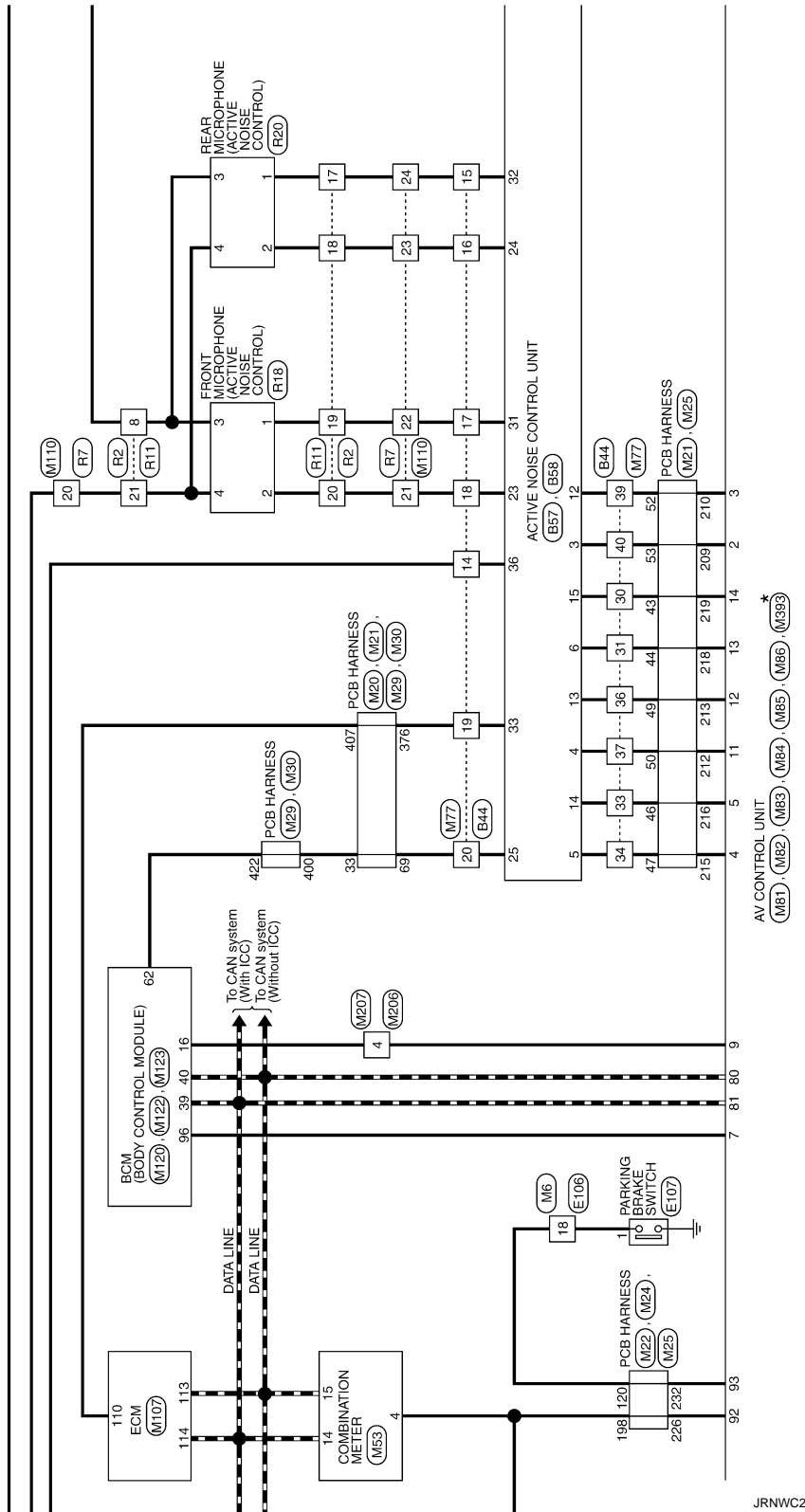

JRNWC2006GB

# BASE AUDIO WITHOUT NAVIGATION

[BASE AUDIO WITHOUT NAVIGATION]

< WIRING DIAGRAM >

\*: This connector is not shown in "Harness Layout".

⬠VK⬠ : With VK engine

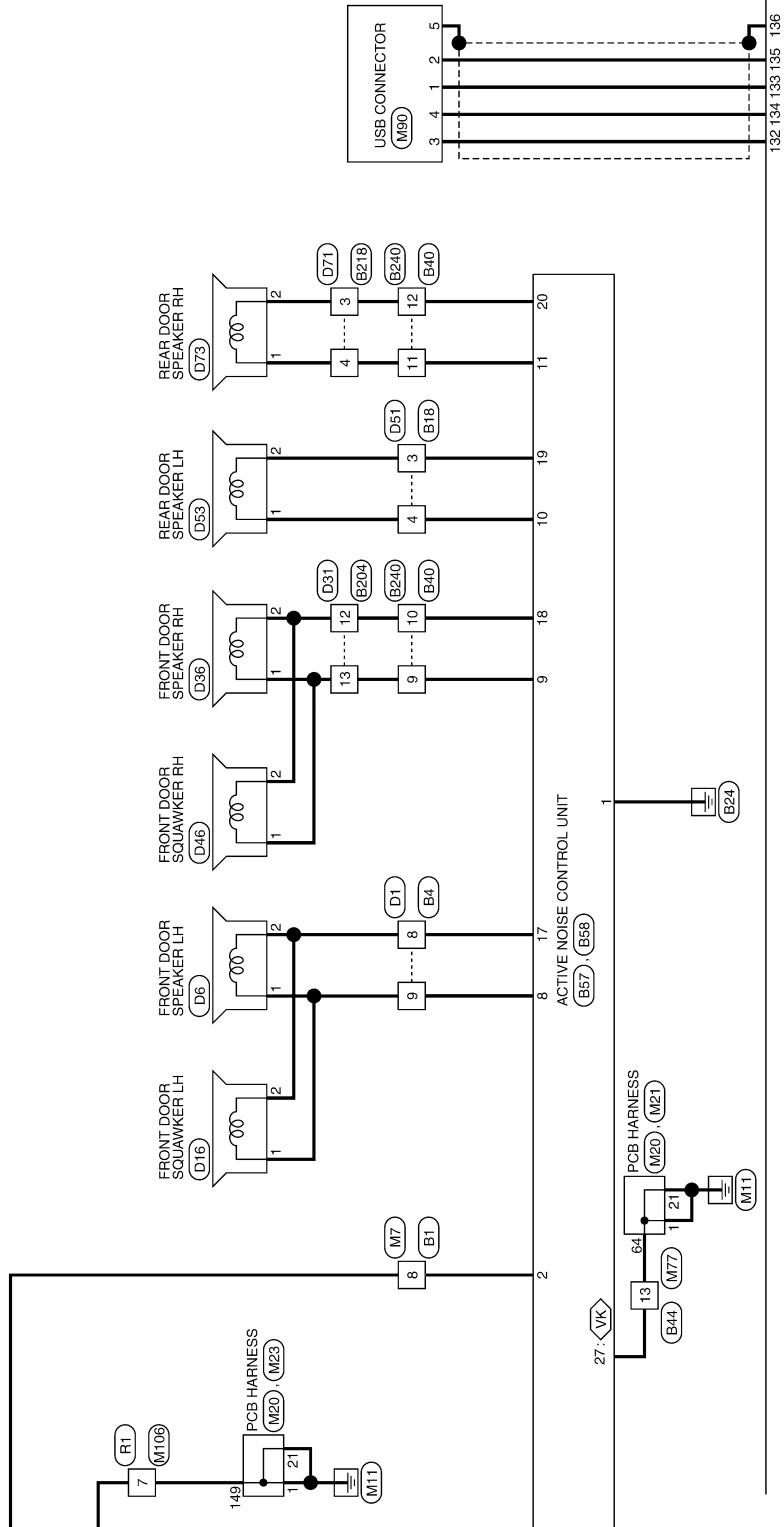

AV CONTROL UNIT  
 (M81), (M82), (M83), (M84), (M85), (M86), (M89)\*

JRNWC2007GB

A  
B  
C  
D  
E  
F  
G  
H  
I  
J  
K  
L  
M  
N  
O  
P

AV

# BASE AUDIO WITHOUT NAVIGATION

[BASE AUDIO WITHOUT NAVIGATION]

< WIRING DIAGRAM >

\* : This connector is not shown in "Harness Layout".

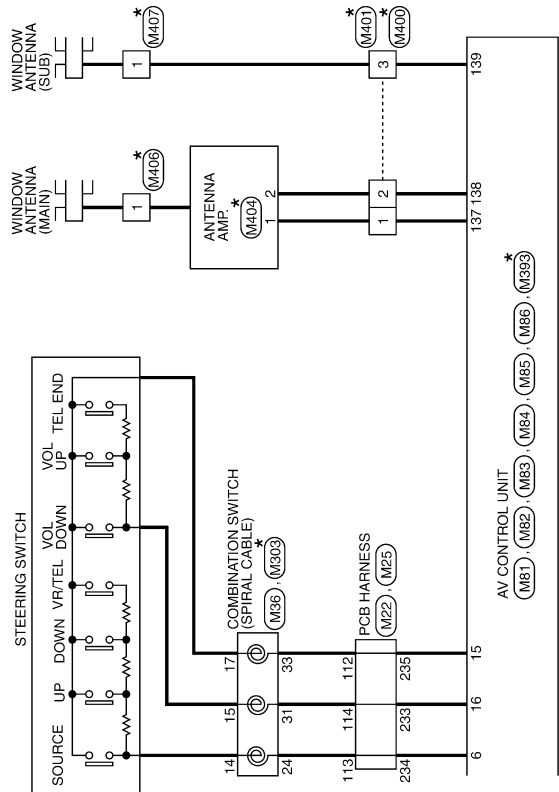

JRNWC2008GB



**BASIC INSPECTION**

DIAGNOSIS AND REPAIR WORKFLOW

Work Flow

INFOID:000000008130736

OVERALL SEQUENCE

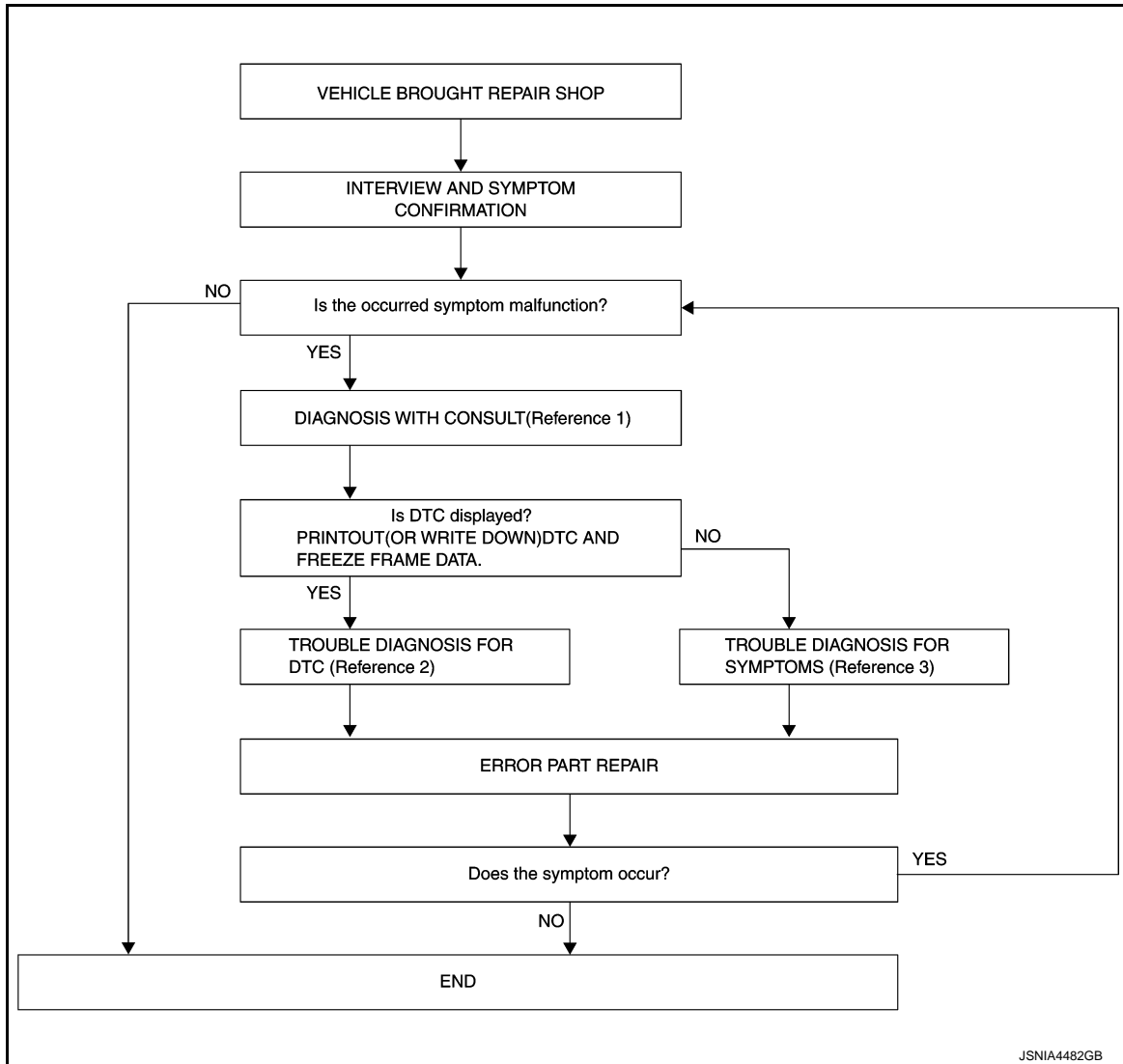

- Reference 1... Refer to [AV-27. "CONSULT Function"](#).
- Reference 2... Refer to [AV-40. "DTC Index"](#).
- Reference 3... Refer to [AV-98. "Symptom Table"](#).

DETAILED FLOW

**1. INTERVIEW AND SYMPTOM CONFIRMATION**

Check the malfunction symptoms by performing the following items.

- Interview the customer to obtain the malfunction information (conditions and environment when the malfunction occurred).
- Check the symptom.

Is the occurred symptom malfunction?

YES >> GO TO 2.

NO >> INSPECTION END

**2. DIAGNOSIS WITH CONSULT**

# DIAGNOSIS AND REPAIR WORKFLOW

[BASE AUDIO WITHOUT NAVIGATION]

< BASIC INSPECTION >

1. Connect CONSULT and perform a self-diagnosis for "MULTI AV". Refer to [AV-27. "CONSULT Function"](#).

**NOTE:**

Skip to step 4 of the diagnosis procedure if "MULTI AV" is not displayed.

2. When DTC is detected, follow the instructions below:
  - Record DTC and Freeze Frame Data.

Is DTC displayed?

YES >> GO TO 3.

NO >> GO TO 4.

## 3. TROUBLE DIAGNOSIS FOR DTC

---

1. Check the DTC indicated in the "Self-Diagnosis Results".
2. Perform the relevant diagnosis referring to the DTC Index. Refer to [AV-40. "DTC Index"](#).

>> GO TO 5.

## 4. TROUBLE DIAGNOSIS FOR SYMPTOMS

---

Perform the relevant diagnosis referring to the diagnosis chart by symptom. Refer to [AV-98. "Symptom Table"](#).

>> GO TO 5.

## 5. ERROR PART REPAIR

---

1. Repair or replace the identified malfunctioning parts.
2. Perform a self-diagnosis for "MULTI AV" with CONSULT.

**NOTE:**

Erase the stored self-diagnosis results after repairing or replacing the relevant components if any DTC has been indicated in the "Self-Diagnosis Results".

3. Check that the symptom does not occur.

Does the symptom occur?

YES >> GO TO 1.

NO >> INSPECTION END

# ADDITIONAL SERVICE WHEN REPLACING (AV CONTROL UNIT)

< BASIC INSPECTION >

[BASE AUDIO WITHOUT NAVIGATION]

## ADDITIONAL SERVICE WHEN REPLACING (AV CONTROL UNIT)

### Description

INFOID:000000008130737

#### BEFORE REPLACEMENT

When replacing AV control unit, save or print current vehicle specification with CONSULT configuration before replacement.

#### AFTER REPLACEMENT

##### **CAUTION:**

When replacing AV control unit, you must perform “After Replace ECU” or “Manual Configuration” with CONSULT.

- Complete the procedure of “After Replace ECU” or “Manual Configuration” in order.
- If you set incorrect “After Replace ECU” or “Manual Configuration”, incidents might occur.
- Configuration is different for each vehicle model. Confirm configuration of each vehicle model.

### Work Procedure

INFOID:000000008130738

#### 1. SAVING VEHICLE SPECIFICATION

##### -CONSULT Configuration

Perform “Before Replace ECU” to save or print current vehicle specification. Refer to [AV-60, "Description"](#).

##### **NOTE:**

If “Before Replace ECU” can not be used, use the “Manual Configuration”.

>> GO TO 2.

#### 2. REPLACE AV CONTROL UNIT

Replace AV control unit. Refer to [AV-105, "Removal and Installation"](#).

>> GO TO 3.

#### 3. WRITING VEHICLE SPECIFICATION

##### -CONSULT Configuration

Perform “After Replace ECU” or “Manual Configuration” to write vehicle specification. Refer to [AV-60, "Work Procedure"](#).

>> GO TO 4.

#### 4. OPERATION CHECK

Check that the operation of the AV control unit and camera images (fixed guide lines and predictive course lines) are normal.

>> WORK END

A

B

C

D

E

F

G

H

I

J

K

L

M

AV

O

P

# CONFIGURATION (AV CONTROL UNIT)

< BASIC INSPECTION >

[BASE AUDIO WITHOUT NAVIGATION]

## CONFIGURATION (AV CONTROL UNIT)

### Description

INFOID:000000008130739

- Since vehicle specifications are not included in the AV control unit after replacement, it is required to write vehicle specifications with CONSULT.
- The AV control unit configuration includes functions as follows.

Function		Description
Read/Write Configuration	Before Replace ECU	Allows the reading of vehicle specification written in AV control unit to store the specification in CONSULT.
	After Replace ECU	Allows the writing of the vehicle information stored in CONSULT into the AV control unit.
Manual Configuration		Allows the writing of the vehicle specification into the AV control unit by hand.

### Work Procedure

INFOID:000000008130740

#### 1. WRITE VEHICLE SPECIFICATION

##### ⓐCONSULT Configuration

Write vehicle specification into AV control unit.

To write vehicle specification stored in CONSULT into the AV control unit>>GO TO 2.

To write vehicle specification into the AV control unit by hand>>GO TO 3.

#### 2. WRITE STORED DATA

##### ⓐCONSULT Configuration

Select "After Replace ECU" in "Read/Write Configuration." Write data stored in CONSULT with the "Before Replace ECU" function into the AV control unit.

>> GO TO 4.

#### 3. MANUALLY WRITE VEHICLE SPECIFICATION

##### ⓐCONSULT Configuration

Perform "Manual Configuration." Refer to the Configuration List to write vehicle specification into the AV control unit. Refer to [AV-60. "Configuration List"](#).

>> GO TO 4.

#### 4. OPERATION CHECK

Check that the operation of the AV control unit and camera images (fixed guide lines and predictive course lines) are normal.

>> WORK END

### Configuration List

INFOID:000000008130741

#### CAUTION:

Grasp vehicle specifications precisely. The control of ECU may not function normally if the specifications are misread.

#### NOTE:

- The items shown in this list depend on vehicle specifications.
- The config list may not be displayed depending on vehicle specifications. This is not a malfunction.

# CONFIGURATION (AV CONTROL UNIT)

< BASIC INSPECTION >

[BASE AUDIO WITHOUT NAVIGATION]

MANUAL SETTING ITEM	
Items	Setting value
STEERING	LHD
	RHD
SOUND SYSTEM	BASE
	BOSE
ENGINE TYPE	NORMAL
	HYBRID

A

B

C

D

E

F

G

H

I

J

K

L

M

AV

O

P

# U1000 CAN COMM CIRCUIT

< DTC/CIRCUIT DIAGNOSIS >

[BASE AUDIO WITHOUT NAVIGATION]

## DTC/CIRCUIT DIAGNOSIS

### U1000 CAN COMM CIRCUIT

#### Description

INFOID:000000008130742

CAN (Controller Area Network) is a serial communication line for real-time application. It is an on-vehicle multiplex communication line with high data communication speed and excellent error detection ability. Many electronic control units are equipped onto a vehicle, and each control unit shares information and links with other control units during operation (not independently). In CAN communication, control units are connected with 2 communication lines (CAN-H, CAN-L) allowing a high rate of information transmission with less wiring. Each control unit transmits/receives data but selectively reads required data only.

CAN Communication Signal Chart. Refer to [LAN-37, "CAN COMMUNICATION SYSTEM : CAN Communication Signal Chart"](#).

#### DTC Logic

INFOID:000000008130743

#### DTC DETECTION LOGIC

DTC	Display contents of CONSULT	DTC detection condition	Probable malfunction location
U1000	CAN COMM CIRCUIT [U1000]	AV control unit is not transmitting or receiving CAN communication signal for 2 seconds or more.	CAN communication system.

#### Diagnosis Procedure

INFOID:000000008130744

#### 1. PERFORM SELF-DIAGNOSTIC

1. Turn ignition switch ON and wait for 2 seconds or more.
2. Check "Self Diagnostic Result" of "MULTI AV".

Is "CAN COMM CIRCUIT" displayed?

- YES >> Refer to [LAN-27, "Trouble Diagnosis Flow Chart"](#).  
NO >> Refer to [GI-43, "Intermittent Incident"](#).

# U1010 CONTROL UNIT (CAN)

< DTC/CIRCUIT DIAGNOSIS >

[BASE AUDIO WITHOUT NAVIGATION]

## U1010 CONTROL UNIT (CAN)

### DTC Logic

INFOID:000000008130745

### DTC DETECTION LOGIC

DTC	Display contents of CONSULT	DTC detection condition	Probable malfunction factor
U1010	CONTROL UNIT (CAN) [U1010]	CAN initial diagnosis malfunction is detected.	Replace the AV control unit if the malfunction occurs constantly. Refer to <a href="#">AV-105, "Removal and Installation"</a> .

A

B

C

D

E

F

G

H

I

J

K

L

M

AV

O

P

# U1200 AV CONTROL UNIT

< DTC/CIRCUIT DIAGNOSIS >

[BASE AUDIO WITHOUT NAVIGATION]

## U1200 AV CONTROL UNIT

### DTC Logic

INFOID:000000008130746

DTC	Display contents of CONSULT	DTC detection condition	Possible malfunction factor
U1200	Cont Unit [U1200]	AV control unit malfunction is detected.	Replace the AV control unit if the malfunction occurs constantly. Refer to <a href="#">AV-105, "Removal and Installation"</a> .



# U1216 AV CONTROL UNIT

< DTC/CIRCUIT DIAGNOSIS >

[BASE AUDIO WITHOUT NAVIGATION]

## U1216 AV CONTROL UNIT

### DTC Logic

INFOID:000000008130747

DTC	Display contents of CONSULT	DTC detection condition	Possible malfunction factor
U1216	CAN CONT [U1216]	AV control unit malfunction is detected.	Replace the AV control unit if the malfunction occurs constantly. Refer to <a href="#">AV-105, "Removal and Installation"</a> .

A  
B  
C  
D  
E  
F  
G  
H  
I  
J  
K  
L  
M  
N  
O  
P

AV

# U1232 STEERING ANGLE SENSOR

< DTC/CIRCUIT DIAGNOSIS >

[BASE AUDIO WITHOUT NAVIGATION]

## U1232 STEERING ANGLE SENSOR

### DTC Logic

INFOID:000000008130748

DTC	Display contents of CONSULT	DTC detection condition	Possible malfunction factor
U1232	ST ANGLE SEN CALIB [1232]	Predictive course line center position adjustment of the steering angle sensor is incomplete.	Adjust the predictive course line center position of the steering angle sensor. Refer to <a href="#">BRC-60. "Work Procedure"</a> .

### Diagnosis Procedure

INFOID:000000008130749

#### 1. ADJUST THE PREDICTIVE COURSE LINE CENTER POSITION OF THE STEERING ANGLE SENSOR

When U1232 is detected, adjust the predictive course line center position of the steering angle sensor.

>> Adjusts the steering angle sensor neutral position on ABS actuator and electrical unit (control unit) side. Refer to [BRC-60. "Work Procedure"](#).

# U1243 DISPLAY UNIT

< DTC/CIRCUIT DIAGNOSIS >

[BASE AUDIO WITHOUT NAVIGATION]

## U1243 DISPLAY UNIT

### DTC Logic

INFOID:000000008130750

DTC	Display contents of CONSULT	DTC detection condition	Possible malfunction factor
U1243	FRONT DISP CONN [U1243]	When either one of the following items is detected: <ul style="list-style-type: none"> <li>display unit power supply and ground circuit are malfunctioning.</li> <li>communication circuit between AV control unit and display unit are malfunctioning.</li> </ul>	<ul style="list-style-type: none"> <li>Display unit power supply and ground circuit. Refer to <a href="#">AV-73. "DISPLAY UNIT : Diagnosis Procedure"</a>.</li> <li>Communication circuit between AV control unit and display unit.</li> </ul>

### Diagnosis Procedure

INFOID:000000008130751

#### 1. CHECK DISPLAY UNIT POWER SUPPLY AND GROUND CIRCUIT

Check display unit power supply and ground circuit. Refer to [AV-73. "DISPLAY UNIT : Diagnosis Procedure"](#).

Is the inspection result normal?

YES >> GO TO 2.

NO >> Repair malfunctioning parts.

#### 2. CHECK CONTINUITY COMMUNICATION CIRCUIT

- Turn ignition switch OFF.
- Disconnect display unit connector and AV control unit connector.
- Check continuity between display unit harness connector and AV control unit harness connector.

Display unit		AV control unit		Continuity
Connector	Terminals	Connector	Terminals	
M195	11	M82	51	Existed
	22		39	

- Check continuity between display unit harness connector and ground.

Display unit		Ground	Continuity
Connector	Terminals		
M195	11		Not existed
	22		

Is the inspection result normal?

YES >> GO TO 3.

NO >> Repair harness or connector.

#### 3. CHECK COMMUNICATION SIGNAL

- Connect display unit connector and AV control unit connector.
- Turn ignition switch ON.
- Check signal between display unit harness connector and ground.

A  
B  
C  
D  
E  
F  
G  
H  
I  
J  
K  
L  
M  
O  
P

AV

# U1243 DISPLAY UNIT

< DTC/CIRCUIT DIAGNOSIS >

[BASE AUDIO WITHOUT NAVIGATION]

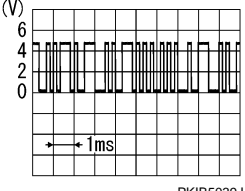
(+)		(-)	Condition	Reference value
Display unit				
Connector	Terminal			
M195	11	Ground	When adjusting display brightness.	

Is the inspection result normal?

YES >> GO TO 4.

NO >> Replace AV control unit. Refer to [AV-105. "Removal and Installation"](#).

## 4. CHECK COMMUNICATION SIGNAL

Check signal between display unit harness connector and ground.

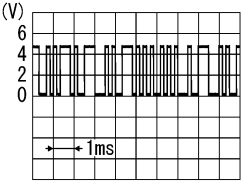
(+)		(-)	Condition	Reference value
Display unit				
Connector	Terminal			
M195	22	Ground	When adjusting display brightness.	

Is the inspection result normal?

YES >> INSPECTION END

NO >> Replace display unit. Refer to [AV-113. "Removal and Installation"](#).

# U1255 SATELLITE RADIO TUNER

< DTC/CIRCUIT DIAGNOSIS >

[BASE AUDIO WITHOUT NAVIGATION]

## U1255 SATELLITE RADIO TUNER

### DTC Logic

INFOID:000000008130752

DTC	Display contents of CONSULT	DTC Detection Condition	Possible causes
U1255	SAT CONN [U1255]	When either one of the following items is detected: <ul style="list-style-type: none"> <li>satellite radio tuner power supply and ground circuit are malfunctioning.</li> <li>communication circuits between AV control unit and satellite radio tuner are malfunctioning.</li> <li>request signal circuit between AV control unit and satellite radio tuner are malfunctioning.</li> </ul>	<ul style="list-style-type: none"> <li>Satellite radio tuner power supply and ground circuit. Refer to <a href="#">AV-75, "SATELLITE RADIO TUNER : Diagnosis Procedure"</a>.</li> <li>Communication circuit between AV control unit and satellite radio tuner.</li> <li>Request signal circuit between AV control unit and satellite radio tuner.</li> </ul>

### Diagnosis Procedure

INFOID:000000008130753

#### 1. CHECK SATELLITE RADIO TUNER POWER SUPPLY AND GROUND CIRCUIT

Check satellite radio tuner power supply and ground circuit. Refer to [AV-75, "SATELLITE RADIO TUNER : Diagnosis Procedure"](#).

Is the inspection result normal?

YES >> GO TO 2.

NO >> Repair malfunctioning parts.

#### 2. CHECK CONTINUITY COMMUNICATION CIRCUIT AND REQUEST SIGNAL CIRCUIT

- Turn ignition switch OFF.
- Disconnect AV control unit connector and satellite radio tuner connector.
- Check continuity between AV control unit harness connector and satellite radio tuner harness connector.

AV control unit		Satellite radio tuner		Continuity
Connector	Terminals	Connector	Terminals	
M85	122	B236	10	Existed
	129		8	
	130		9	

- Check continuity between AV control unit harness connector.

AV control unit		Ground	Continuity
Connector	Terminals		
M85	122	Ground	Not existed
	129		
	130		

Is the inspection result normal?

YES >> GO TO 3.

NO >> Repair harness or connector.

#### 3. CHECK AV CONTROL UNIT VOLTAGE

- Connect AV control unit connector.
- Turn ignition switch ON.
- Check signal between AV control unit harness connector and ground.

# U1255 SATELLITE RADIO TUNER

< DTC/CIRCUIT DIAGNOSIS >

[BASE AUDIO WITHOUT NAVIGATION]

(+)		(-)	Voltage (Approx.)
AV control unit			
Connector	Terminals	Ground	7.0 V 7.0 V
M85	129		
	130		

Is the inspection result normal?

YES >> GO TO 4.

NO >> Replace AV control unit. Refer to [AV-105, "Removal and Installation"](#).

## 4. CHECK SATELLITE RADIO TUNER VOLTAGE

1. Turn ignition switch OFF.
2. Disconnect AV control unit connector.
3. Connect satellite radio tuner.
4. Turn ignition switch ON.
5. Check signal between satellite radio tuner harness connector and ground.

(+)		(-)	Voltage (Approx.)
Satellite radio tuner			
Connector	Terminal	Ground	7.0 V
B236	10		

Is the inspection result normal?

YES >> INSPECTION END

NO >> Replace satellite radio tuner. Refer to [AV-114, "Removal and Installation"](#).

# U1300 AV COMM CIRCUIT

< DTC/CIRCUIT DIAGNOSIS >

[BASE AUDIO WITHOUT NAVIGATION]

## U1300 AV COMM CIRCUIT

### Description

INFOID:000000008130754

U1300 is indicated when malfunction occurs in communication signal of multi AV system. Indicated simultaneously, without fail, with the malfunction of control units connected to AV control unit with communication line. Determine the possible malfunction cause from the table below.

### SELF-DIAGNOSIS RESULTS DISPLAY ITEM

DTC	Display contents of CONSULT	DTC detection condition	Possible malfunction factor
U1300 U1240	<ul style="list-style-type: none"> <li>AV COMM CIRCUIT [U1300]</li> <li>SWITCH CONN [U1240]</li> </ul>	When either one of the following items is detected: <ul style="list-style-type: none"> <li>multifunction switch power supply and ground circuits are malfunctioning.</li> <li>AV communication circuits between AV control unit and multifunction switch are malfunctioning.</li> </ul>	<ul style="list-style-type: none"> <li>Multifunction switch power supply and ground circuits.</li> <li>AV communication circuits between AV control unit and multifunction switch.</li> </ul>
U1300 U1256	<ul style="list-style-type: none"> <li>AV COMM CIRCUIT [U1300]</li> <li>HAND FREE CONN [U1256]</li> </ul>	When either one of the following items is detected: <ul style="list-style-type: none"> <li>TEL adapter unit power supply and ground circuits are malfunctioning.</li> <li>AV communication circuits between AV control unit and TEL adapter unit are malfunctioning.</li> </ul>	<ul style="list-style-type: none"> <li>TEL adapter unit power supply and ground circuits. Refer to <a href="#">AV-76, "TEL ADAPTER UNIT : Diagnosis Procedure"</a>.</li> <li>AV communication circuits between AV control unit and TEL adapter unit.</li> </ul>
U1300 U1240 U1256	<ul style="list-style-type: none"> <li>AV COMM CIRCUIT [U1300]</li> <li>SWITCH CONN [U1240]</li> <li>HAND FREE CONN [U1256]</li> </ul>	Malfunction is detected in AV communication circuits between AV control unit and multifunction switch.	AV communication circuits between AV control unit and multifunction switch.

A  
B  
C  
D  
E  
F  
G  
H  
I  
J  
K  
L  
M

AV

O  
P

# U1310 AV CONTROL UNIT

< DTC/CIRCUIT DIAGNOSIS >

[BASE AUDIO WITHOUT NAVIGATION]

## U1310 AV CONTROL UNIT

### DTC Logic

INFOID:000000008130755

DTC	Display contents of CONSULT	DTC detection condition	Possible malfunction factor
U1310	CONTROL UNIT (AV) [U1310]	An initial diagnosis error is detected in AV communication circuit.	Replace AV control unit. If the malfunction occurs constantly. Refer to <a href="#">AV-73. "AV CONTROL UNIT : Diagnosis Procedure"</a> .



# POWER SUPPLY AND GROUND CIRCUIT

< DTC/CIRCUIT DIAGNOSIS >

[BASE AUDIO WITHOUT NAVIGATION]

## POWER SUPPLY AND GROUND CIRCUIT

### AV CONTROL UNIT

#### AV CONTROL UNIT : Diagnosis Procedure

INFOID:000000008130756

#### 1.CHECK FUSE

Check for blown fuses.

Power source	Fuse No.
Battery	34

Is the inspection result normal?

YES >> GO TO 2.

NO >> Be sure to eliminate cause of malfunction before installing new fuse.

#### 2.CHECK BATTERY POWER SUPPLY CIRCUIT

Check voltage between AV control unit harness connectors and ground.

Signal name	(+)		(-)	Ignition switch position	Voltage (Approx.)
	AV control unit				
	Connector	Terminal			
Battery power supply	M81	19	Ground	OFF	Battery voltage

Is the inspection result normal?

YES >> GO TO 3.

NO >> Check harness between AV control unit and fuse.

#### 3.CHECK ACC POWER SUPPLY CIRCUIT

Check voltage between AV control unit harness connectors and ground.

Signal name	(+)		(-)	Ignition switch position	Voltage (Approx.)
	AV control unit				
	Connector	Terminal			
ACC power supply	M81	7	Ground	ACC	Battery voltage

Is the inspection result normal?

YES >> GO TO 4.

NO >> Check harness between AV control unit and BCM.

#### 4.CHECK GROUND CIRCUIT

1. Turn ignition switch OFF.
2. Disconnect AV control unit connectors.
3. Check continuity between AV control unit harness connectors and ground.

AV control unit		Ground	Continuity
Connector	Terminal		
M81	20		

Is the inspection result normal?

YES >> INSPECTION END

NO >> Repair harness or connector.

## DISPLAY UNIT

#### DISPLAY UNIT : Diagnosis Procedure

INFOID:000000008130757

#### 1.CHECK POWER SUPPLY CIRCUIT (DISPLAY SIDE)

A  
B  
C  
D  
E  
F  
G  
H  
I  
J  
K  
L  
M  
O  
P

AV

# POWER SUPPLY AND GROUND CIRCUIT

< DTC/CIRCUIT DIAGNOSIS >

[BASE AUDIO WITHOUT NAVIGATION]

1. Turn ignition switch ACC.
2. Check voltage between display unit harness connector and ground.

Signal name	(+)		(-)	Voltage (Approx.)
	Display unit			
	Connector	Terminal		
Inverter VCC	M195	2	Ground	9.0 V
Signal VCC		3		

Is the inspection result normal?

- YES >> GO TO 4.  
NO >> GO TO 2.

## 2.CHECK POWER SUPPLY CIRCUIT (CONTINUITY)

1. Turn ignition switch OFF.
2. Disconnect the harness connector between display unit and AV control unit.
3. Check continuity between display unit harness connector and AV control unit harness connector.

Display unit		AV control unit		Continuity
Connector	Terminal	Connector	Terminal	
M195	2	M82	48	Existed
	3		36	

4. Check continuity between display unit harness connector and ground.

Display unit		Ground	Continuity
Connector	Terminal		
M195	2		Not existed
	3		

Is the inspection result normal?

- YES >> GO TO 3.  
NO >> Repair harness or connector.

## 3.CHECK POWER SUPPLY CIRCUIT (AV CONTROL UNIT SIDE)

1. Connect the AV control unit harness connector.
2. Turn ignition switch ACC.
3. Check voltage between AV control unit harness connector and ground.

Signal name	(+)		(-)	Voltage (Approx.)
	AV control unit			
	Connector	Terminal		
Inverter VCC	M82	48	Ground	9.0 V
Signal VCC		36		9.0 V

Is the inspection result normal?

- YES >> INSPECTION END  
NO >> Replace AV control unit. Refer to [AV-105. "Removal and Installation"](#).

## 4.CHECK GROUND CIRCUIT

1. Turn ignition switch OFF.
2. Disconnect display unit connector.
3. Check continuity between display unit harness connectors and ground.

# POWER SUPPLY AND GROUND CIRCUIT

< DTC/CIRCUIT DIAGNOSIS >

[BASE AUDIO WITHOUT NAVIGATION]

Display unit		Ground	Continuity
Connector	Terminal		
M195	1		Existed

Is the inspection result normal?

YES >> INSPECTION END

NO >> Repair harness or connector.

## ACTIVE NOISE CONTROL UNIT

### ACTIVE NOISE CONTROL UNIT : Diagnosis Procedure

INFOID:000000008130758

#### 1.CHECK FUSE

Check for blown fuses.

Power source	Fuse No.
Battery	34
Ignition switch ACC or ON	19

Is the inspection result normal?

YES >> GO TO 2.

NO >> Be sure to eliminate cause of malfunction before installing new fuse.

#### 2.CHECK POWER SUPPLY CIRCUIT

Check voltage between active noise control unit harness connector and ground.

Signal name	(+)		(-)	Ignition switch position	Voltage (Approx.)
	Active noise control unit				
	Connector	Terminal			
Battery power supply	B57	2	Ground	OFF	Battery voltage
ACC power supply	B58	36		ACC	

Is the inspection result normal?

YES >> GO TO 3.

NO >> Check harness between active noise control unit and fuse.

#### 3.CHECK GROUND CIRCUIT

1. Turn ignition switch OFF.
2. Disconnect active noise control unit connector.
3. Check continuity between active noise control unit harness connector and ground.

Active noise control unit		Ground	Continuity
Connector	Terminal		
B57	1		Existed

Is the inspection result normal?

YES >> INSPECTION END

NO >> Repair harness or connector.

## SATELLITE RADIO TUNER

### SATELLITE RADIO TUNER : Diagnosis Procedure

INFOID:000000008130759

#### 1.CHECK FUSE

Check for blown fuses.

A  
B  
C  
D  
E  
F  
G  
H  
I  
J  
K  
L  
M  
O  
P

# POWER SUPPLY AND GROUND CIRCUIT

< DTC/CIRCUIT DIAGNOSIS >

[BASE AUDIO WITHOUT NAVIGATION]

Power source	Fuse No.
Battery	34
Ignition switch ACC or ON	19

Is the inspection result normal?

YES >> GO TO 2.

NO >> Be sure to eliminate cause of malfunction before installing new fuse.

## 2.CHECK POWER SUPPLY CIRCUIT

Check voltage between satellite radio tuner harness connector and ground.

Signal name	(+)		(-)	Ignition switch position	Voltage (Approx.)
	Satellite radio tuner				
	Connector	Terminal			
Battery power supply	B236	12	Ground	OFF	Battery voltage
ACC power supply		16		ACC	

Is the inspection result normal?

YES >> INSPECTION END

NO >> Check harness between satellite radio tuner and fuse.

## TEL ADAPTER UNIT

### TEL ADAPTER UNIT : Diagnosis Procedure

INFOID:000000008130760

## 1.CHECK FUSE

Check for blown fuses.

Power source	Fuse No.
Battery	34
Ignition switch ACC or ON	19

Is the inspection result normal?

YES >> GO TO 2.

NO >> Be sure to eliminate cause of malfunction before installing new fuse.

## 2.CHECK POWER SUPPLY CIRCUIT

Check voltage between TEL adapter unit harness connector and ground.

Signal name	(+)		(-)	Ignition switch position	Voltage (Approx.)
	TEL adapter unit				
	Connector	Terminal			
Battery power supply	B237	1	Ground	OFF	Battery voltage
ACC power supply		2		ACC	

Is the inspection result normal?

YES >> GO TO 3.

NO >> Check harness between TEL adapter unit and fuse.

## 3.CHECK GROUND CIRCUIT

1. Turn ignition switch OFF.
2. Disconnect TEL adapter unit connector.
3. Check continuity between TEL adapter unit harness connector and ground.

# POWER SUPPLY AND GROUND CIRCUIT

< DTC/CIRCUIT DIAGNOSIS >

[BASE AUDIO WITHOUT NAVIGATION]

TEL adapter unit		Ground	Continuity
Connector	Terminal		
B237	4		Existed

Is the inspection result normal?

YES >> INSPECTION END

NO >> Repair harness or connector.

A

B

C

D

E

F

G

H

I

J

K

L

M

AV

O

P

# RGB (R: RED) SIGNAL CIRCUIT

< DTC/CIRCUIT DIAGNOSIS >

[BASE AUDIO WITHOUT NAVIGATION]

## RGB (R: RED) SIGNAL CIRCUIT

### Description

INFOID:000000008130761

Transmit the image displayed with AV control unit with RGB signal to the display unit.

### Diagnosis Procedure

INFOID:000000008130762

#### 1. CHECK CONTINUITY RGB (R: RED) SIGNAL CIRCUIT

1. Turn ignition switch OFF.
2. Disconnect display unit connector and AV control unit connector.
3. Check continuity between display unit harness connector and AV control unit harness connector.

Display unit		AV control unit		Continuity
Connector	Terminal	Connector	Terminal	
M195	17	M82	43	Existed

4. Check continuity between display unit harness connector and ground.

Display unit		Ground	Continuity
Connector	Terminal		
M195	17		Not existed

Is inspection result normal?

- YES >> GO TO 2.  
 NO >> Repair harness or connector.

#### 2. CHECK RGB (R: RED) SIGNAL

1. Connect display unit connector and AV control unit connector.
2. Turn ignition switch ON.
3. Check signal between display unit harness connector and ground.

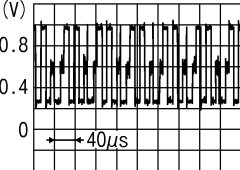
(+)		(-)	Condition	Reference value
Display unit				
Connector	Terminal			
M195	17	Ground	Start confirmation/adjustment mode, and then display color bar by selecting "Color Spectrum Bar" on DISPLAY DIAGNOSIS screen.	 <p style="text-align: right;">JSNIA1029ZZ</p>

Is inspection result normal?

- YES >> Replace display unit. Refer to [AV-113. "Removal and Installation"](#).  
 NO >> Replace AV control unit. Refer to [AV-105. "Removal and Installation"](#).

# RGB (G: GREEN) SIGNAL CIRCUIT

< DTC/CIRCUIT DIAGNOSIS >

[BASE AUDIO WITHOUT NAVIGATION]

## RGB (G: GREEN) SIGNAL CIRCUIT

### Description

INFOID:000000008130763

Transmit the image displayed with AV control unit with RGB signal to the display unit.

### Diagnosis Procedure

INFOID:000000008130764

#### 1. CHECK CONTINUITY RGB (G: GREEN) SIGNAL CIRCUIT

1. Turn ignition switch OFF.
2. Disconnect display unit connector and AV control unit connector.
3. Check continuity between display unit harness connector and AV control unit harness connector.

Display unit		AV control unit		Continuity
Connector	Terminal	Connector	Terminal	
M195	6	M82	44	Existed

4. Check continuity between display unit harness connector and ground.

Display unit		Ground	Continuity
Connector	Terminal		
M195	6		Not existed

Is inspection result normal?

- YES >> GO TO 2.  
 NO >> Repair harness or connector.

#### 2. CHECK RGB (G: GREEN) SIGNAL

1. Connect display unit connector and AV control unit connector.
2. Turn ignition switch ON.
3. Check signal between display unit harness connector and ground.

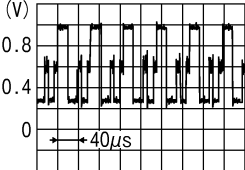
(+)		(-)	Condition	Reference value
Display unit				
Connector	Terminal			
M195	6	Ground	Start confirmation/adjustment mode, and then display color bar by selecting "Color Spectrum Bar" on DISPLAY DIAGNOSIS screen.	 <p style="text-align: right; font-size: small;">JSNIA1030ZZ</p>

Is inspection result normal?

- YES >> Replace display unit. Refer to [AV-113. "Removal and Installation"](#).  
 NO >> Replace AV control unit. Refer to [AV-105. "Removal and Installation"](#).

A  
B  
C  
D  
E  
F  
G  
H  
I  
J  
K  
L  
M  
AV  
O  
P

# RGB (B: BLUE) SIGNAL CIRCUIT

< DTC/CIRCUIT DIAGNOSIS >

[BASE AUDIO WITHOUT NAVIGATION]

## RGB (B: BLUE) SIGNAL CIRCUIT

### Description

INFOID:000000008130765

Transmit the image displayed with AV control unit with RGB signal to the display unit.

### Diagnosis Procedure

INFOID:000000008130766

#### 1. CHECK CONTINUITY RGB (B: BLUE) SIGNAL CIRCUIT

1. Turn ignition switch OFF.
2. Disconnect display unit connector and AV control unit connector.
3. Check continuity between display unit harness connector and AV control unit harness connector.

Display unit		AV control unit		Continuity
Connector	Terminal	Connector	Terminal	
M195	18	M82	45	Existed

4. Check continuity between display unit harness connector and ground.

Display unit		Ground	Continuity
Connector	Terminal		
M195	18		Not existed

Is inspection result normal?

- YES >> GO TO 2.  
NO >> Repair harness or connector.

#### 2. CHECK RGB (B: BLUE) SIGNAL

1. Connect display unit connector and AV control unit connector.
2. Turn ignition switch ON.
3. Check signal between display unit harness connector and ground.

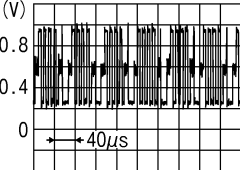
(+)		(-)	Condition	Reference value
Display unit				
Connector	Terminal			
M195	18	Ground	Start confirmation/adjustment mode, and then display color bar by selecting "Color Spectrum Bar" on DISPLAY DIAGNOSIS screen.	 <p>JSNIA1031ZZ</p>

Is inspection result normal?

- YES >> Replace display unit. Refer to [AV-113. "Removal and Installation"](#).  
NO >> Replace AV control unit. Refer to [AV-105. "Removal and Installation"](#).



# RGB SYNCHRONIZING SIGNAL CIRCUIT

< DTC/CIRCUIT DIAGNOSIS >

[BASE AUDIO WITHOUT NAVIGATION]

## RGB SYNCHRONIZING SIGNAL CIRCUIT

### Description

INFOID:000000008130767

Transmit the RGB synchronizing signal to the display unit so as to synchronize the RGB image displayed with AV control unit.

### Diagnosis Procedure

INFOID:000000008130768

#### 1. CHECK CONTINUITY RGB SYNCHRONIZING SIGNAL CIRCUIT

1. Turn ignition switch OFF.
2. Disconnect display unit connector and AV control unit connector.
3. Check continuity between display unit harness connector and AV control unit harness connector.

Display unit		AV control unit		Continuity
Connector	Terminal	Connector	Terminal	
M195	19	M82	42	Existed

4. Check continuity between display unit harness connector and ground.

Display unit		Ground	Continuity
Connector	Terminal		
M195	19		Not existed

Is the inspection result normal?

YES >> GO TO 2.

NO >> Repair harness or connector.

#### 2. CHECK RGB SYNCHRONIZING SIGNAL

1. Connect display unit connector and AV control unit connector.
2. Turn ignition switch ON.
3. Check signal between display unit harness connector and ground.

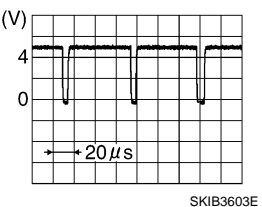
(+)		(-)	Reference value
Display unit			
Connector	Terminal		
M195	19	Ground	

Is the inspection result normal?

YES >> Replace display unit. Refer to [AV-113, "Removal and Installation"](#).

NO >> Replace AV control unit. Refer to [AV-105, "Removal and Installation"](#).

# RGB AREA (YS) SIGNAL CIRCUIT

< DTC/CIRCUIT DIAGNOSIS >

[BASE AUDIO WITHOUT NAVIGATION]

## RGB AREA (YS) SIGNAL CIRCUIT

### Description

INFOID:000000008130769

Transmits the display area of RGB image displayed by AV control unit with RGB area (YS) signal to display unit.

### Diagnosis Procedure

INFOID:000000008130770

#### 1. CHECK CONTINUITY RGB AREA (YS) SIGNAL CIRCUIT

1. Turn ignition switch OFF.
2. Disconnect display unit connector and AV control unit connector.
3. Check continuity between display unit harness connector and AV control unit harness connector.

Display unit		AV control unit		Continuity
Connector	Terminal	Connector	Terminal	
M195	9	M82	40	Existed

4. Check continuity between display unit harness connector and ground.

Display unit		Ground	Continuity
Connector	Terminal		
M195	9		Not existed

Is the inspection result normal?

- YES >> GO TO 2.  
NO >> Repair harness or connector.

#### 2. CHECK RGB AREA (YS) SIGNAL

1. Connect display unit connector and AV control unit connector.
2. Turn ignition switch ON.
3. Check signal between display unit harness connector and ground.

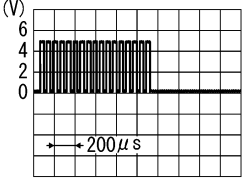
(+)		(-)	Condition	Reference value (Approx.)
Connector	Terminal			
M195	9	Ground	At RGB image is displayed.	5.0 V
			At camera image is displayed.	 PKIB4948J

Is the inspection result normal?

- YES >> Replace display unit. Refer to [AV-113. "Removal and Installation"](#).  
NO >> Replace AV control unit. Refer to [AV-105. "Removal and Installation"](#).

# CAMERA IMAGE SIGNAL CIRCUIT

< DTC/CIRCUIT DIAGNOSIS >

[BASE AUDIO WITHOUT NAVIGATION]

## CAMERA IMAGE SIGNAL CIRCUIT

### Description

INFOID:000000008130771

- AV control unit outputs camera power supply to rear view camera and inputs rear view camera image signal from rear view camera when the reverse signal is input.
- The AV control unit that inputs the camera image signal transmits the camera image signal to the display unit.

### Diagnosis Procedure

INFOID:000000008130772

#### 1. CHECK CONTINUITY CAMERA POWER SUPPLY CIRCUIT

1. Turn ignition switch OFF.
2. Disconnect AV control unit connector and rear view camera connector.
3. Check continuity between AV control unit harness connector and rear view camera harness connector.

AV control unit		Rear view camera		Continuity
Connector	Terminal	Connector	Terminal	
M83	73	T5	1	Existed

4. Check continuity between AV control unit harness connector and ground.

AV control unit		Ground	Continuity
Connector	Terminal		
M83	73		Not existed

Is inspection result normal?

- YES >> GO TO 2.  
NO >> Repair harness or connector.

#### 2. CHECK VOLTAGE CAMERA POWER SUPPLY

1. Connect AV control unit connector and rear view camera connector.
2. Turn ignition switch ON.
3. Shift the selector lever to "R".
4. Check voltage between AV control unit harness connector and ground.

(+)		(-)	Condition	Voltage (Approx.)
Connector	Terminal			
M83	73	Ground	Shift position is "R".	6.0 V

Is inspection result normal?

- YES >> GO TO 3.  
NO >> Replace AV control unit. Refer to [AV-105. "Removal and Installation"](#).

#### 3. CHECK CONTINUITY CAMERA IMAGE SIGNAL CIRCUIT

1. Turn ignition switch OFF.
2. Disconnect AV control unit connector and rear view camera connector.
3. Check continuity between AV control unit harness connector and rear view camera harness connector.

AV control unit		Rear view camera		Continuity
Connector	Terminal	Connector	Terminal	
M83	62	T5	3	Existed

4. Check continuity between AV control unit harness connector and ground.

A  
B  
C  
D  
E  
F  
G  
H  
I  
J  
K  
L  
M  
O  
P

AV

# CAMERA IMAGE SIGNAL CIRCUIT

< DTC/CIRCUIT DIAGNOSIS >

[BASE AUDIO WITHOUT NAVIGATION]

AV control unit		Ground	Continuity
Connector	Terminal		Not existed
M83	62		

Is inspection result normal?

YES >> GO TO 4.

NO >> Repair harness or connector.

## 4. CHECK CAMERA IMAGE SIGNAL

1. Connect AV control unit connector and rear view camera connector.
2. Turn ignition switch ON.
3. Shift the selector lever to "R".
4. Check signal between AV control unit harness connector and ground.

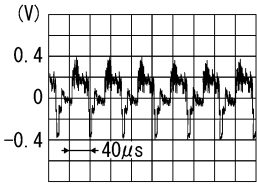
(+)		(-)	Condition	Reference value
AV control unit				
Connector	Terminal			
M83	62	Ground	At rear view camera image is displayed.	 <p style="text-align: right; font-size: small;">SKIB2251J</p>

Is inspection result normal?

YES >> Replace AV control unit. Refer to [AV-105, "Removal and Installation"](#).

NO >> Replace rear view camera. Refer to [AV-113, "Removal and Installation"](#).

# COMPOSITE IMAGE SIGNAL CIRCUIT

< DTC/CIRCUIT DIAGNOSIS >

[BASE AUDIO WITHOUT NAVIGATION]

## COMPOSITE IMAGE SIGNAL CIRCUIT

### Description

INFOID:000000008130773

AV control unit that inputs the camera image signal transmits the composite image signal to the display unit.

### Diagnosis Procedure

INFOID:000000008130774

#### 1. CHECK CONTINUITY COMPOSITE IMAGE SIGNAL CIRCUIT

1. Turn ignition switch OFF.
2. Disconnect AV control unit connector and display unit connector.
3. Check continuity between AV control unit harness connector and display unit harness connector.

AV control unit		Display unit		Continuity
Connector	Terminal	Connector	Terminal	
M82	47	M195	15	Existed

4. Check continuity between AV control unit harness connector and ground.

AV control unit		Ground	Continuity
Connector	Terminal		
M82	47		Not existed

Is the inspection result normal?

- YES >> GO TO 2.  
 NO >> Repair harness or connector.

#### 2. CHECK COMPOSITE IMAGE SIGNAL

1. Connect AV control unit connector and display unit connector.
2. Turn ignition switch ON.
3. Check signal between AV control unit harness connector and ground.

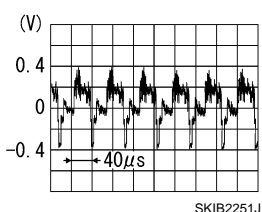
(+)		(-)	Condition	Reference value
AV control unit				
Connector	Terminal			
M82	47	Ground	At camera image is displayed.	

Is the inspection result normal?

- YES >> Replace display unit. Refer to [AV-113. "Removal and Installation"](#).  
 NO >> Replace AV control unit. Refer to [AV-105. "Removal and Installation"](#).

A  
B  
C  
D  
E  
F  
G  
H  
I  
J  
K  
L  
M  
AV  
O  
P

# HORIZONTAL SYNCHRONIZING (HP) SIGNAL CIRCUIT

< DTC/CIRCUIT DIAGNOSIS >

[BASE AUDIO WITHOUT NAVIGATION]

## HORIZONTAL SYNCHRONIZING (HP) SIGNAL CIRCUIT

### Description

INFOID:000000008130775

In composite image (camera image), transmit the vertical synchronizing (VP) signal and horizontal synchronizing (HP) signal from display unit to AV control unit so as to synchronize the RGB images displayed with AV control unit such as the image quality adjusting menu, etc.

### Diagnosis Procedure

INFOID:000000008130776

#### 1. CHECK CONTINUITY HORIZONTAL SYNCHRONIZING (HP) SIGNAL CIRCUIT

1. Turn ignition switch OFF.
2. Disconnect display unit connector and AV control unit connector.
3. Check continuity between display unit harness connector and AV control unit harness connector.

Display unit		AV control unit		Continuity
Connector	Terminal	Connector	Terminal	
M195	8	M82	38	Existed

4. Check continuity between display unit harness connector and ground.

Display unit		Ground	Continuity
Connector	Terminal		
M195	8		Not existed

Is the inspection result normal?

YES >> GO TO 2.

NO >> Repair harness or connector.

#### 2. CHECK HORIZONTAL SYNCHRONIZING (HP) SIGNAL

1. Connect display unit connector and AV control unit connector.
2. Turn ignition switch ON.
3. Check signal between display unit harness connector and ground.

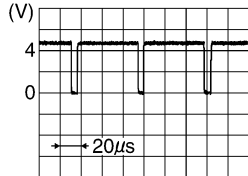
(+)		(-)	Reference value
Display unit			
Connector	Terminal		
M195	8	Ground	 SKIB3601E

Is the inspection result normal?

YES >> Replace AV control unit. Refer to [AV-105, "Removal and Installation"](#).

NO >> Replace display unit. Refer to [AV-113, "Removal and Installation"](#).

# VERTICAL SYNCHRONIZING (VP) SIGNAL CIRCUIT

< DTC/CIRCUIT DIAGNOSIS >

[BASE AUDIO WITHOUT NAVIGATION]

## VERTICAL SYNCHRONIZING (VP) SIGNAL CIRCUIT

### Description

INFOID:000000008130777

In composite image (camera image), transmit the vertical synchronizing (VP) signal and horizontal synchronizing (HP) signal from display unit to AV control unit so as to synchronize the RGB images displayed with AV control unit such as the image quality adjusting menu, etc.

### Diagnosis Procedure

INFOID:000000008130778

#### 1. CHECK CONTINUITY VERTICAL SYNCHRONIZING (VP) SIGNAL CIRCUIT

1. Turn ignition switch OFF.
2. Disconnect display unit connector and AV control unit connector.
3. Check continuity between display unit harness connector and AV control unit harness connector.

Display unit		AV control unit		Continuity
Connector	Terminal	Connector	Terminal	
M195	20	M82	50	Existed

4. Check continuity between display unit harness connector and ground.

Display unit		Ground	Continuity
Connector	Terminal		
M195	20		Not existed

Is the inspection result normal?

YES >> GO TO 2.

NO >> Repair harness or connector.

#### 2. CHECK VERTICAL SYNCHRONIZING (VP) SIGNAL

1. Connect display unit connector and AV control unit connector.
2. Turn ignition switch ON.
3. Check signal between display unit harness connector and ground.

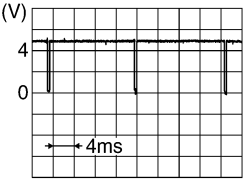
(+) Display unit		(-)	Reference value
Connector	Terminal		
M195	20	Ground	

Is the inspection result normal?

YES >> Replace AV control unit. Refer to [AV-105, "Removal and Installation"](#).

NO >> Replace display unit. Refer to [AV-113, "Removal and Installation"](#).

A  
B  
C  
D  
E  
F  
G  
H  
I  
J  
K  
L  
M  
O  
P

AV

# DISK EJECT SIGNAL CIRCUIT

< DTC/CIRCUIT DIAGNOSIS >

[BASE AUDIO WITHOUT NAVIGATION]

## DISK EJECT SIGNAL CIRCUIT

### Description

INFOID:000000008130779

The eject signal is output to AV control unit when the eject switch of multifunction switch is pressed.

### Diagnosis Procedure

INFOID:000000008130780

#### 1. CHECK CONTINUITY DISK EJECT SIGNAL CIRCUIT

1. Turn ignition switch OFF.
2. Disconnect multifunction switch connector and AV control unit connector.
3. Check continuity between multifunction switch harness connector and AV control unit harness connector.

Multifunction switch		AV control unit		Continuity
Connector	Terminal	Connector	Terminal	
M72	14	M84	96	Existed

4. Check continuity between multifunction switch harness connector and ground.

Multifunction switch		Ground	Continuity
Connector	Terminal		
M72	14		Not existed

Is the inspection result normal?

- YES >> GO TO 2.  
NO >> Repair harness or connector.

#### 2. CHECK AV CONTROL UNIT VOLTAGE

1. Connect multifunction switch connector and AV control unit connector.
2. Turn ignition switch ON.
3. Check voltage between AV control unit harness connector and ground.

(+)		(-)	Condition	Voltage (Approx.)
AV control unit				
Connector	Terminal			
M84	96	Ground	Pressing the eject switch	0 V
			Except for above	3.3 V

Is the inspection result normal?

- YES >> Replace preset switch. Refer to [AV-117, "Removal and Installation"](#).  
NO >> Replace AV control unit. Refer to [AV-105, "Removal and Installation"](#).



# MICROPHONE SIGNAL CIRCUIT

< DTC/CIRCUIT DIAGNOSIS >

[BASE AUDIO WITHOUT NAVIGATION]

## MICROPHONE SIGNAL CIRCUIT

### Description

INFOID:000000008130781

Supply power from TEL adapter unit to microphone. The microphone transmits the sound/voice to the microphone.

### Diagnosis Procedure

INFOID:000000008130782

#### 1. CHECK CONTINUITY BETWEEN TEL ADAPTER UNIT AND MICROPHONE CIRCUIT

1. Turn ignition switch OFF.
2. Disconnect TEL adapter unit connector and microphone connector.
3. Check continuity between TEL adapter unit harness connector and microphone harness connector.

TEL adapter unit		Microphone		Continuity
Connector	Terminals	Connector	Terminals	
B237	7	R17	1	Existed
	8		2	
	29		4	

4. Check continuity between TEL adapter unit harness connector and ground.

TEL adapter unit		Ground	Continuity
Connector	Terminals		
M237	7		Not existed
	29		

Is the inspection result normal?

YES >> GO TO 2.

NO >> Repair harness or connector.

#### 2. CHECK VOLTAGE MICROPHONE VCC

1. Connect TEL adapter unit connector.
2. Turn ignition switch ON.
3. Check voltage between TEL adapter unit harness connector.

(+)		(-)		Voltage (Approx.)
TEL adapter unit		TEL adapter unit		
Connector	Terminal	Connector	Terminal	
B237	29	B237	8	5.0 V

Is the inspection result normal?

YES >> GO TO 3.

NO >> Replace TEL adapter unit. Refer to [AV-121, "Removal and Installation"](#).

#### 3. CHECK MICROPHONE SIGNAL

1. Connect microphone connector.
2. Check signal between TEL adapter unit harness connector.

A  
B  
C  
D  
E  
F  
G  
H  
I  
J  
K  
L  
M  
AV  
O  
P

# MICROPHONE SIGNAL CIRCUIT

< DTC/CIRCUIT DIAGNOSIS >

[BASE AUDIO WITHOUT NAVIGATION]

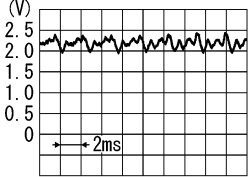
(+)		(-)		Condition	Reference value
TEL adapter unit		TEL adapter unit			
Connector	Terminal	Connector	Terminal		
B237	7	B237	8	give a voice.	 <p style="text-align: right;">PKIB5037J</p>

Is the inspection result normal?

- YES >> Replace TEL adapter unit. Refer to [AV-121, "Removal and Installation"](#).
- NO >> Replace microphone. Refer to [AV-120, "Removal and Installation"](#).

# CONTROL SIGNAL CIRCUIT

< DTC/CIRCUIT DIAGNOSIS >

[BASE AUDIO WITHOUT NAVIGATION]

## CONTROL SIGNAL CIRCUIT

### Description

INFOID:000000008130783

TEL adapter unit identifies the vehicle model according to the control signal and performs the control.

### Diagnosis Procedure

INFOID:000000008130784

#### 1. CHECK CONTINUITY CONTROL SIGNAL CIRCUIT

1. Turn ignition switch OFF.
2. Disconnect TEL adapter unit connector.
3. Check continuity between TEL adapter unit harness connector and ground.

TEL adapter unit		Ground	Continuity
Connector	Terminals		
B237	21	Ground	Existed
	23		
	24		

#### Is the inspection result normal?

- YES >> Replace TEL adapter unit. Refer to [AV-121, "Removal and Installation"](#).  
NO >> Repair harness or connector.

A  
B  
C  
D  
E  
F  
G  
H  
I  
J  
K  
L  
M

AV

O  
P

# STEERING SWITCH SIGNAL A CIRCUIT

< DTC/CIRCUIT DIAGNOSIS >

[BASE AUDIO WITHOUT NAVIGATION]

## STEERING SWITCH SIGNAL A CIRCUIT

### Description

INFOID:000000008130785

Transmits the steering switch signal to AV control unit.

### Diagnosis Procedure

INFOID:000000008130786

#### 1. CHECK STEERING SWITCH SIGNAL A CIRCUIT

1. Disconnect AV control unit connector and spiral cable connector.
2. Check continuity between AV control unit harness connector and spiral cable harness connector.

AV control unit		Spiral cable		Continuity
Connector	Terminal	Connector	Terminal	
M81	6	M36	24	Existed

3. Check continuity between AV control unit harness connector and ground.

AV control unit		Ground	Continuity
Connector	Terminal		
M81	6		Not existed

Is the inspection result normal?

- YES >> GO TO 2.  
NO >> Repair harness or connector.

#### 2. CHECK SPIRAL CABLE

Check spiral cable.

Is the inspection result normal?

- YES >> GO TO 3.  
NO >> Replace spiral cable. Refer to [SR-14, "Exploded View"](#).

#### 3. CHECK AV CONTROL UNIT VOLTAGE

1. Connect AV control unit connector and spiral cable connector.
2. Turn ignition switch ON.
3. Check voltage between AV control unit harness connector.

(+)		(-)		Voltage (Approx.)
AV control unit		AV control unit		
Connector	Terminal	Connector	Terminal	
M81	6	M81	15	3.3 V

Is the inspection result normal?

- YES >> GO TO 4.  
NO >> Replace AV control unit. Refer to [AV-105, "Removal and Installation"](#).

#### 4. CHECK STEERING SWITCH

1. Turn ignition switch OFF.
2. Check steering switch. Refer to [AV-92, "Component Inspection"](#).

Is the inspection result normal?

- YES >> INSPECTION END  
NO >> Replace steering switch. Refer to [AV-118, "Removal and Installation"](#).

### Component Inspection

INFOID:000000008130787

Measure the resistance between the steering switch connector terminals 14 to 17 and 15 to 17.

# STEERING SWITCH SIGNAL A CIRCUIT

[BASE AUDIO WITHOUT NAVIGATION]

## < DTC/CIRCUIT DIAGNOSIS >

### Standard

Between terminals 14 and 17

 switch ON	: 716 – 730 Ω
MENU DOWN switch ON	: 318 – 324 Ω
MENU UP switch ON	: 120 – 122 Ω
SOURCE switch ON	: 0 Ω

Between terminals 15 and 17

 switch ON	: 318 – 324 Ω
VOL UP switch ON	: 120 – 122 Ω
VOL DOWN switch ON	: 0 Ω

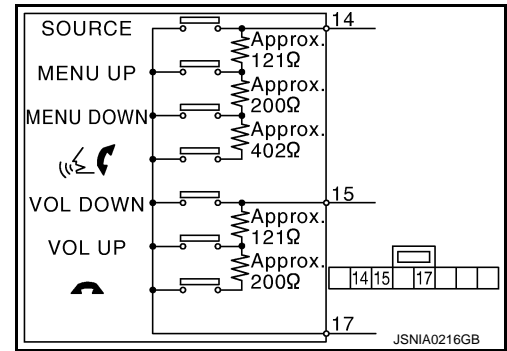

A  
B  
C  
D  
E  
F  
G  
H  
I  
J  
K  
L  
M

AV

O  
P

# STEERING SWITCH SIGNAL B CIRCUIT

< DTC/CIRCUIT DIAGNOSIS >

[BASE AUDIO WITHOUT NAVIGATION]

## STEERING SWITCH SIGNAL B CIRCUIT

### Description

INFOID:000000008130788

Transmits the steering switch signal to AV control unit.

### Diagnosis Procedure

INFOID:000000008130789

#### 1. CHECK STEERING SWITCH SIGNAL B CIRCUIT

1. Disconnect AV control unit connector and spiral cable connector.
2. Check continuity between AV control unit harness connector and spiral cable harness connector.

AV control unit		Spiral cable		Continuity
Connector	Terminal	Connector	Terminal	
M81	16	M36	31	Existed

3. Check continuity between AV control unit harness connector and ground.

AV control unit		Ground	Continuity
Connector	Terminal		
M81	16		Not existed

Is the inspection result normal?

- YES >> GO TO 2.  
NO >> Repair harness or connector.

#### 2. CHECK SPIRAL CABLE

Check spiral cable.

Is the inspection result normal?

- YES >> GO TO 3.  
NO >> Replace spiral cable. Refer to [SR-14, "Exploded View"](#).

#### 3. CHECK AV CONTROL UNIT VOLTAGE

1. Connect AV control unit connector and spiral cable connector.
2. Turn ignition switch ON.
3. Check voltage between AV control unit harness connector.

(+)		(-)		Voltage (Approx.)
AV control unit		AV control unit		
Connector	Terminal	Connector	Terminal	
M81	16	M81	15	3.3 V

Is the inspection result normal?

- YES >> GO TO 4.  
NO >> Replace AV control unit. Refer to [AV-105, "Removal and Installation"](#).

#### 4. CHECK STEERING SWITCH

1. Turn ignition switch OFF.
2. Check steering switch. Refer to [AV-94, "Component Inspection"](#).

Is the inspection result normal?

- YES >> INSPECTION END  
NO >> Replace steering switch. Refer to [AV-118, "Removal and Installation"](#).

### Component Inspection

INFOID:000000008130790

Measure the resistance between the steering switch connector terminals 14 to 17 and 15 to 17.

# STEERING SWITCH SIGNAL B CIRCUIT

[BASE AUDIO WITHOUT NAVIGATION]

## < DTC/CIRCUIT DIAGNOSIS >

### Standard

Between terminals 14 and 17

 switch ON	: 716 – 730 Ω
MENU DOWN switch ON	: 318 – 324 Ω
MENU UP switch ON	: 120 – 122 Ω
SOURCE switch ON	: 0 Ω

Between terminals 15 and 17

 switch ON	: 318 – 324 Ω
VOL UP switch ON	: 120 – 122 Ω
VOL DOWN switch ON	: 0 Ω

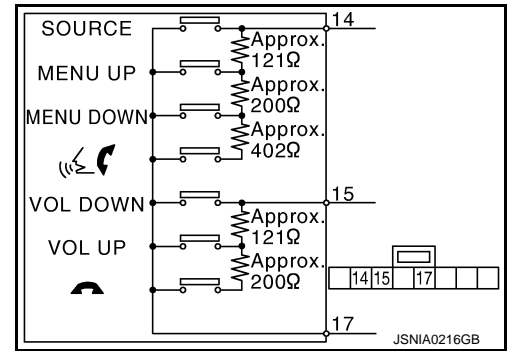

A  
B  
C  
D  
E  
F  
G  
H  
I  
J  
K  
L  
M

AV

O  
P

# STEERING SWITCH GROUND CIRCUIT

< DTC/CIRCUIT DIAGNOSIS >

[BASE AUDIO WITHOUT NAVIGATION]

## STEERING SWITCH GROUND CIRCUIT

### Description

INFOID:000000008130791

Transmits the steering switch signal to AV control unit.

### Diagnosis Procedure

INFOID:000000008130792

#### 1. CHECK STEERING SWITCH SIGNAL GROUND CIRCUIT

1. Disconnect AV control unit connector and spiral cable connector.
2. Check continuity between AV control unit harness connector and spiral cable harness connector.

AV control unit		Spiral cable		Continuity
Connector	Terminal	Connector	Terminal	
M81	15	M36	33	Existed

3. Connect AV control unit connector.

Is the inspection result normal?

- YES >> GO TO 2.  
NO >> Repair harness or connector.

#### 2. CHECK SPIRAL CABLE

Check spiral cable.

Is the inspection result normal?

- YES >> GO TO 3.  
NO >> Replace spiral cable. Refer to [SR-14, "Exploded View"](#).

#### 3. CHECK GROUND CIRCUIT

1. Connect AV control unit connector.
2. Check continuity between AV control unit harness connector and ground.

AV control unit		Ground	Continuity
Connector	Terminal		
M81	15		Existed

Is the inspection result normal?

- YES >> GO TO 4.  
NO >> Replace AV control unit. Refer to [AV-105, "Removal and Installation"](#).

#### 4. CHECK STEERING SWITCH

1. Turn ignition switch OFF.
2. Check steering switch. Refer to [AV-96, "Component Inspection"](#).

Is the inspection result normal?

- YES >> INSPECTION END  
NO >> Replace steering switch. Refer to [AV-118, "Removal and Installation"](#).

### Component Inspection

INFOID:000000008130793

Measure the resistance between the steering switch connector terminals 14 to 17 and 15 to 17.



# STEERING SWITCH GROUND CIRCUIT

[BASE AUDIO WITHOUT NAVIGATION]

< DTC/CIRCUIT DIAGNOSIS >

Standard

Between terminals 14 and 17

 switch ON	: 716 – 730 Ω
MENU DOWN switch ON	: 318 – 324 Ω
MENU UP switch ON	: 120 – 122 Ω
SOURCE switch ON	: 0 Ω

Between terminals 15 and 17

 switch ON	: 318 – 324 Ω
VOL UP switch ON	: 120 – 122 Ω
VOL DOWN switch ON	: 0 Ω

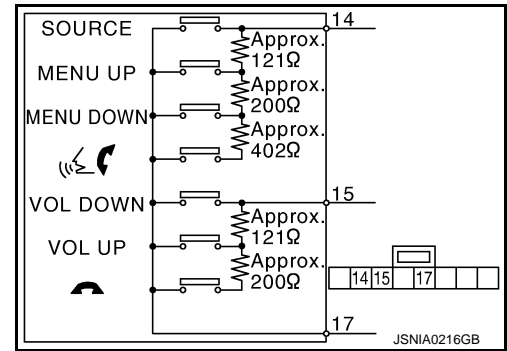

A  
B  
C  
D  
E  
F  
G  
H  
I  
J  
K  
L  
M

AV

O  
P

## SYMPTOM DIAGNOSIS

### MULTI AV SYSTEM SYMPTOMS

#### Symptom Table

INFOID:000000008130794

#### OPERATION

Symptoms	Check items	Possible malfunction location / Action to take
Multifunction switch and preset switch operation does not work.	<ul style="list-style-type: none"> <li>All switches cannot be operated.</li> <li>"MULTI AV" is displayed on system selection screen when the CONSULT is started.</li> </ul>	<ul style="list-style-type: none"> <li>Multifunction switch power supply and ground circuit.</li> <li>AV communication circuit between AV control unit and multifunction switch.</li> </ul> Perform "Self diagnosis Result" of "MULTI AV" with CONSULT. Refer to <a href="#">AV-27, "CONSULT Function"</a> .
	<ul style="list-style-type: none"> <li>All switches cannot be operated.</li> <li>"MULTI AV" is not displayed on system selection screen when the CONSULT is initialized.</li> </ul>	AV control unit power supply and ground circuit malfunction. Refer to <a href="#">AV-73, "AV CONTROL UNIT : Diagnosis Procedure"</a> .
	Only specified switch cannot be operated.	Multifunction switch or preset switch malfunction. Perform multifunction switch and preset switch self-diagnosis function. Refer to <a href="#">AV-18, "On Board Diagnosis Function"</a> .
Fuel economy display, vehicle setting operation is abnormal.	There is malfunction in the CONSULT self-diagnosis result. Refer to <a href="#">AV-27, "CONSULT Function"</a> .	Perform detected DTC diagnosis. Refer to <a href="#">AV-40, "DTC Index"</a> .
	There is no malfunction in the self-diagnosis results. Refer to <a href="#">AV-27, "CONSULT Function"</a> .	Ignition signal circuit malfunction. (AV control unit)

#### RELATED TO HANDS-FREE PHONE

- Before performing diagnosis, confirm that the cellular phone being used by the customer is compatible with the vehicle.
- It is possible that a malfunction is occurring due to a version change of the phone even though the phone is a compatible type. This can be confirmed by changing the cellular phone to another compatible type, and checking that it operates normally. It is important to determine whether the cause of the malfunction is the vehicle or the cellular phone.

#### Check Compatibility

- Make sure the customer's Bluetooth® related concern is understood.
- Verify the customer's concern.
 

**NOTE:**  
The customer's phone may be required, depending upon their concern.
- Write down the customer's phone brand, model, and service provider.
 

**NOTE:**  
It is necessary to know the service provider. On occasion, a given phone may be on the approved list with one provider, but may not be on the approved list with other providers.
- Go to "www.infiniti.com/bluetooth/".
  - Using the website's search engine, find out if the customer's phone is on the approved list.
  - If the customer's phone is NOT on the approved list:
 

Stop diagnosis here. The customer needs to obtain a Bluetooth® phone that is on the approved list before any further action.
  - If the feature related to the customer's concern shows as "N" (not compatible):
 

Stop diagnosis here. If the customer still wants the feature to function, they will need to get an approved phone showing the feature as "Y" (compatible) in the "Basic Features" list.
  - If the feature related to the customer's concern shows as "Y" (compatible):
 

Perform diagnosis as per the following table.

# MULTI AV SYSTEM SYMPTOMS

< SYMPTOM DIAGNOSIS >

[BASE AUDIO WITHOUT NAVIGATION]

Symptoms	Check items	Probable malfunction location	
Does not recognize cellular phone connection. (No connection is displayed on the display at the guide.)	Repeat the registration of cellular phone.	TEL adapter unit malfunction. Refer to <a href="#">AV-121, "Removal and Installation"</a> .	A
Hands-free phone cannot be established.	Both the reception and the speech cannot be performed	<ul style="list-style-type: none"> <li>Perform "Self diagnosis Result" of "MULTI AV" with CONSULT. Refer to <a href="#">AV-27, "CONSULT Function"</a>.</li> <li>No malfunction. TEL adapter unit malfunction. Refer to <a href="#">AV-121, "Removal and Installation"</a>.</li> <li>Malfunction is detected. Perform detected DTC diagnosis. Refer to <a href="#">AV-40, "DTC Index"</a>.</li> </ul>	B C D
The other party's voice cannot be heard by hands-free phone.	The operation of the "☞" switch can be performed.	TEL voice signal circuit malfunction between TEL adapter unit and AV control unit.	E
	The operation of the "☞" switch cannot be performed.	Control signal circuit.	F
Originating sound is not heard by the other party with hands-free phone communication.	Sound operation function is normal.	TEL adapter unit. Refer to <a href="#">AV-121, "Removal and Installation"</a> .	G
	Sound operation function does not work.	Microphone signal circuit malfunction. Refer to <a href="#">AV-120, "Removal and Installation"</a> .	H
The system cannot be operated.	"SOURCE", "MENU UP", and "MENU DOWN" switches are operated. But "☞" switch is not operated.	<ul style="list-style-type: none"> <li>Check steering switch. Refer to <a href="#">AV-92, "Component Inspection"</a>.</li> <li>Malfunction is detected. Replace steering switch. Refer to <a href="#">AV-118, "Removal and Installation"</a>.</li> </ul>	I
	"SOURCE", "MENU UP", "MENU DOWN" and "☞" switches are not operated.	Steering switch signal A circuit malfunction. Refer to <a href="#">AV-92, "Diagnosis Procedure"</a> .	J
	All steering switches do not work.	Steering switch ground circuit malfunction. Refer to <a href="#">AV-96, "Diagnosis Procedure"</a> .	J

## RELATED TO RGB IMAGE

Symptoms	Check items	Possible malfunction location / Action to take	
RGB image is not shown.	There is malfunction in the CONSULT self-diagnosis result. Refer to <a href="#">AV-27, "CONSULT Function"</a> .	Perform detected DTC diagnosis. Refer to <a href="#">AV-40, "DTC Index"</a> .	L
	There is no malfunction in CONSULT self-diagnosis results. Refer to <a href="#">AV-27, "CONSULT Function"</a> .	Vertical synchronizing (VP) signal circuit. Refer to <a href="#">AV-87, "Diagnosis Procedure"</a> .	M
Color of RGB image is not proper.	Light blue (Cyan) tint.	RGB signal (R: red) circuit. Refer to <a href="#">AV-78, "Diagnosis Procedure"</a> .	AV
	Purple (Magenta) tint.	RGB signal (G: green) circuit. Refer to <a href="#">AV-79, "Diagnosis Procedure"</a> .	
	Screen looks yellowish.	RGB signal (B: blue) circuit. Refer to <a href="#">AV-80, "Diagnosis Procedure"</a> .	O
RGB screen is rolling.	—	RGB synchronizing signal circuit. Refer to <a href="#">AV-81, "Diagnosis Procedure"</a> .	P

## RELATED TO AUDIO

# MULTI AV SYSTEM SYMPTOMS

< SYMPTOM DIAGNOSIS >

[BASE AUDIO WITHOUT NAVIGATION]

Symptoms	Check items	Probable malfunction location
The disk cannot be removed.	—	Disk eject signal circuit. Refer to <a href="#">AV-88, "Diagnosis Procedure"</a> .
No sound comes out or the level of the sound is low.	No sound from all speakers.	<ul style="list-style-type: none"> <li>Active noise control unit power supply and ground circuit malfunction. Refer to <a href="#">AV-75, "ACTIVE NOISE CONTROL UNIT : Diagnosis Procedure"</a>.</li> <li>AV control unit power supply and ground circuit malfunction. Refer to <a href="#">AV-73, "AV CONTROL UNIT : Diagnosis Procedure"</a>.</li> </ul>
	Only a certain speaker (front right, front left, rear right, or rear left, etc.) does not output sound.	<ul style="list-style-type: none"> <li>Poor connector connection of speaker.</li> <li>Sound signal circuit malfunction between AV control unit and speaker.</li> <li>Malfunction in speaker.</li> <li>Malfunction in AV control unit.</li> </ul>
Noise is mixed with audio.	Noise comes out from all speakers.	Malfunction in AV control unit.
	Noise comes out only from a certain speaker (front right, front left, rear right, or rear left, etc.).	<ul style="list-style-type: none"> <li>Poor connector connection of speaker.</li> <li>Sound signal circuit malfunction between AV control unit and speaker.</li> <li>Malfunction in speaker.</li> <li>Poor installation of speaker (e.g. backlash and looseness)</li> <li>Malfunction in AV control unit.</li> </ul>
	Noise is mixed with radio only (when the car hits a bump or while driving over bad roads).	Poor connector connection of antenna or antenna feeder.
Radio is not received or poor reception.	<ul style="list-style-type: none"> <li>Other audio sounds are normal.</li> <li>Any radio cannot be received or poor reception is caused even after moving to a service area with good reception (e.g. a place with clear view and no obstacles generating external noises).</li> </ul>	<ul style="list-style-type: none"> <li>Antenna amp. ON signal circuit malfunction.</li> <li>Poor connector connection of antenna or antenna feeder.</li> </ul>
Satellite radio is not received.	There is malfunction in the CONSULT self-diagnosis result. Refer to <a href="#">AV-27, "CONSULT Function"</a> .	<ul style="list-style-type: none"> <li>Malfunction in antenna, antenna feeder, or AV control unit. Perform DTC diagnosis. Refer to <a href="#">AV-40, "DTC Index"</a>.</li> <li>Poor continuity in antenna feeder.</li> <li>Poor connector connection of antenna or antenna feeder.</li> </ul>
	There is no malfunction in the CONSULT self-diagnosis result. Refer to <a href="#">AV-27, "CONSULT Function"</a> .	<ul style="list-style-type: none"> <li>Poor continuity in antenna feeder.</li> <li>Poor connector connection of antenna or antenna feeder.</li> <li>Loose satellite radio antenna mounting nut. Refer to <a href="#">AV-115, "Exploded View"</a>.</li> </ul>

## RELATED TO USB

### NOTE:

Check that there is no malfunction of USB equipment main body before performing a diagnosis.

Symptoms	Check items	Possible malfunction location / Action to take
iPod® or USB memory can not be recognized.	—	<ul style="list-style-type: none"> <li>USB harness malfunction.</li> <li>USB connector malfunction.</li> </ul>

iPod® is a trademark of Apple inc., registered in the U.S. and other countries.

## RELATED TO STEERING SWITCH

# MULTI AV SYSTEM SYMPTOMS

< SYMPTOM DIAGNOSIS >

[BASE AUDIO WITHOUT NAVIGATION]

Symptoms	Probable malfunction location
None of the steering switch operations work.	Steering switch ground circuit malfunction. Refer to <a href="#">AV-96, "Diagnosis Procedure"</a> .
Only specified switch cannot be operated.	<ul style="list-style-type: none"> <li>• Check steering switch. Refer to <a href="#">AV-92, "Component Inspection"</a>.</li> <li>• Malfunction is detected. Replace steering switch. Refer to <a href="#">AV-118, "Removal and Installation"</a>.</li> </ul>
"SOURCE", "MENU UP", "MENU DOWN" and "⏪ ⏩" switches are not operated.	Steering switch signal A circuit. Refer to <a href="#">AV-92, "Diagnosis Procedure"</a> .
"VOL UP", "VOL DOWN" and "⏮ ⏭" switches are not operated.	Steering switch signal B circuit. Refer to <a href="#">AV-94, "Diagnosis Procedure"</a> .

## RELATED TO CAMERA

### Trouble Diagnosis Chart by Symptom

Symptoms	Check items	Probable malfunction location
Camera image is not shown. (Vehicle width and possible route line is displayed.)	—	<ul style="list-style-type: none"> <li>• Camera image signal circuit. Refer to <a href="#">AV-83, "Diagnosis Procedure"</a>.</li> <li>• Composite image signal circuit. Refer to <a href="#">AV-85, "Diagnosis Procedure"</a>.</li> </ul>
Camera image does not switch.	"Reverse" is not turned ON on "Vehicle Signals" screen of "Confirmation/Adjustment".	Reverse signal circuit malfunction.
	"Reverse" is turned ON on "Vehicle Signals" screen of "Confirmation/Adjustment".	AV control unit malfunction. Replace AV control unit. Refer to <a href="#">AV-105, "Removal and Installation"</a> .

A  
B  
C  
D  
E  
F  
G  
H  
I  
J  
K  
L  
M

AV

O  
P

# NORMAL OPERATING CONDITION

< SYMPTOM DIAGNOSIS >

[BASE AUDIO WITHOUT NAVIGATION]

## NORMAL OPERATING CONDITION

### Description

INFOID:000000008130795

### BASIC OPERATIONS

Symptom	Possible cause	Possible solution
No image is displayed.	The brightness is at the lowest setting.	Adjust the brightness of the display.
	The systems in the video mode.	Press "DISC-AUX" to change the mode.
	The display is turned off.	Press "☀/☾ OFF" to turn on the display.
The screen is too dim. The movement is slow.	The temperature in the interior of the vehicle is low.	Wait until the interior of the vehicle has warmed up.
Some pixels in the display are darker or brighter than others.	This condition is an inherent characteristic of liquid crystal displays.	This is not a malfunction.
Some menu items cannot be selected.	Some menu items become unavailable while the vehicle is driven.	Park the vehicle in a safe location, and then operate the multi AV system.

### RELATED TO VOICE RECOGNITION

#### Related to Telephone

The system should respond correctly to all voice commands without difficulty. If problems are encountered, try the following solutions.

Where the solutions are listed by number, try each solution in turn, starting with number 1, until the problem is resolved.

Symptom	Solution
System fails to interpret the command correctly.	1. Ensure that the command is valid.
	2. Ensure that the command is spoken after the tone.
	3. Speak clearly without pausing between words and at level appropriate to the ambient noise level in the vehicle.
	4. Ensure that the ambient noise level is not excessive (for example, windows open or defroster on).
	<b>NOTE:</b> If it is too noisy to use the phone, it is likely that the voice commands will not be recognized.
	5. If more than one command was said at a time, try saying the commands separately.
The system consistently selects the wrong voicetag	6. If the system consistently fails to recognize commands, the voice training procedure should be carried out to improve the recognition response for the speaker. See "Speaker adaptation (SA) mode" earlier in this section. Refer to "OWNER'S MANUAL".
	1. Ensure that the phone book entry name requested matches what was originally stored. This can be confirmed by using the "List Names" command.
	2. Replace one of the names being confused with a new name.

### RELATED TO AUDIO

- The majority of the audio malfunctions are the result of outside causes (bad CD, electromagnetic interference, etc.). Check the symptoms below to diagnose the malfunction.
- The vehicle itself can be a source of noise if noise prevention parts or electrical equipment is malfunctioning. Check if noise is caused and/or changed by engine speed, ignition switch turned to each position, and operation of each piece of electrical equipment, and then determine the cause.

#### NOTE:

- CD-R is not guaranteed to play because they can contain compressed audio (MP3, WMA) or could be incorrectly mastered by the customer on a computer.
- Check if the CDs carry the Compact Disc Logo. If not, the disc is not mastered to the "red book" Compact Disc Standard and may not play.

# NORMAL OPERATING CONDITION

< SYMPTOM DIAGNOSIS >

[BASE AUDIO WITHOUT NAVIGATION]

Symptom	Cause and Counter measure	A
Cannot play	Check if the CD was inserted correctly.	B
	Check if the CD is scratched or dirty.	C
	Check if there is condensation inside the player, and if there is, wait until the condensation is gone (about 1 hour) before using the player.	D
	If there is a temperature increase error, the player will play correctly after it returns to the normal temperature.	E
	If there is a mixture of music CD files (CD-DA data) and MP3/WMA files on a CD, only the music CD files (CD-DA data) will be played.	F
	Files with extensions other than ".MP3", ".WMA", ".mp3" or ".wma" cannot be played. In addition, the character codes and number of characters for folder names and file names should be in compliance with the specifications.	G
	Check if the disc or the file is generated in an irregular format, This may occur depending on the variation or the setting of MP3/WMA writing applications or other text editing applications.	H
	Check if the finalization process, such as session close and disc close, is done for the disc.	I
	Check if the CD is protected by copyright.	J
Poor sound quality	Discs recorded in live file system format are not supported. (For Microsoft Windows Vista, check the settings.)	K
	Check if the CD is scratched or dirty.	L
It takes a relatively long time before the music starts playing.	Check if the CD is scratched or dirty.	M
Music cuts off or skips	If there are many folder or file levels on the MP3/WMA CD, or if it is a multisession disc, some time may be required before the music starts playing.	N
Skipping with high bit rate files	The writing software and hardware combination might not match, or the writing speed, writing depth, writing width might not match the specifications. Try using the slowest writing speed.	O
Move immediately to the next song when playing	Skipping may occur with large quantities if data such as for high bit rate data.	P
The songs do not play back in the desired order.	When a non-MP3/WMA file has been given an extension of ".MP3", ".WMA", ".mp3" or ".wma" or when play is prohibited by copyright protection, the player will skip to the next song.	Q
Poor reception only from a certain radio broadcast station.	The playback order is the order in which the files were written by the software, so the files might not play in the desired order.	R
Buzz/rattle sound from speaker	Check incoming radio wave signal strength of applicable broadcast station.	S
Buzz/rattle sound from speaker	The majority of rattle sounds are not indicative of an issue with the speaker, usually something nearby the speaker is causing the rattle.	T

Noise resulting from variations in field strength, such as fading noise and multi-path noise, or external noise from trains and other sources, is not a malfunction.

**NOTE:**

- Fading noise: This noise occurs because of variations in the field strength in a narrow range due to mountains or buildings blocking the signal.
- Multi-path noise: This noise results from a time difference between the broadcast waves directly from the station arriving at the antenna and the waves reflected by mountains or buildings.

**RELATED TO HANDS-FREE PHONE**

A  
B  
C  
D  
E  
F  
G  
H  
I  
J  
K  
L  
M  
N  
O  
P

AV

## NORMAL OPERATING CONDITION

**[BASE AUDIO WITHOUT NAVIGATION]**

< SYMPTOM DIAGNOSIS >

Symptom	Cause and Counter measure
Does not recognize cellular phone connection. (No connection is displayed on the display at the guide.)	Some Bluetooth® enabled cellular phones may not be recognized by the in-vehicle phone module. Refer to "RELATED TO HANDS-FREE PHONE (Check Compatibility)" of MULTI AV SYSTEM SYMPTOM.
Cannot use hands-free phone	Customer will not be able to use a hands-free phone under the following conditions. <ul style="list-style-type: none"> <li>• The vehicle is outside of the telephone service area.</li> <li>• The vehicle is in an area where it is difficult to receive radio waves; such as in a tunnel, in an underground parking garage, near a tall building or in a mountainous area.</li> <li>• The cellular phone is locked to prevent it from being dialed.</li> </ul> <p><b>NOTE:</b></p> <p>While a cellular phone is connected through the Bluetooth® wireless connection, the battery power of the cellular phone may discharge quicker than usual. The Bluetooth® Hands-Free Phone System cannot charge cellular phones.</p>
The other party's voice cannot be heard by hands-free phone.	When the radio wave condition is not ideal or ambient sound is too loud, it may be difficult to hear the other person's voice during a call.
Poor sound quality	Do not place the cellular phone in an area surrounded by metal or far away from the in-vehicle phone module to prevent tone quality degradation and wireless connection disruption.



## REMOVAL AND INSTALLATION

### AV CONTROL UNIT

#### Removal and Installation

INFOID:000000008130796

#### REMOVAL

**CAUTION:**

- Before replacing AV control unit, perform “Read/Write Configuration” to save or print current vehicle specification. For details, refer to [AV-59, "Work Procedure"](#).
- Remove battery terminal and AV control unit after a lapse of 30 seconds or more after turning the ignition switch OFF.

**NOTE:**

After the ignition switch is turned OFF, the AV control unit continues operating for approximately 30 seconds. Therefore, data corruption may occur if battery voltage is cut off within 30 seconds.

1. Remove the preset switch. Refer to [AV-117, "Removal and Installation"](#).
2. After removing the AV control unit mounting screws to disconnect the connectors, remove the AV control unit with the bracket attached.
3. Remove the bracket screws to remove the bracket from the AV control unit.

#### INSTALLATION

Install in the reverse order of removal.

**CAUTION:**

Be sure to perform “Read/Write Configuration” when replacing AV control unit. For details, refer to [AV-60, "Work Procedure"](#).

A  
B  
C  
D  
E  
F  
G  
H  
I  
J  
K  
L  
M  
O  
P

AV

## FRONT DOOR SPEAKER

< REMOVAL AND INSTALLATION >

[BASE AUDIO WITHOUT NAVIGATION]

---

### FRONT DOOR SPEAKER

#### Removal and Installation

INFOID:000000008130797

#### REMOVAL

1. Remove the front door finisher. Refer to [INT-25, "FRONT DOOR FINISHER : Removal and Installation"](#).
2. Remove the screws and disconnect the connector to remove the front door speaker.

#### INSTALLATION

Installation is the reverse order of removal.

# FRONT DOOR SQUAWKER

< REMOVAL AND INSTALLATION >

[BASE AUDIO WITHOUT NAVIGATION]

## FRONT DOOR SQUAWKER

### Removal and Installation

INFOID:000000008130798

#### REMOVAL

1. Remove the front door finisher. Refer to [INT-25, "FRONT DOOR FINISHER : Removal and Installation"](#).
2. Remove the screws to remove the front door squawker from the door finisher.

#### INSTALLATION

Installation is the reverse order of removal.

A  
B  
C  
D  
E  
F  
G  
H  
I  
J  
K  
L  
M  
O  
P

AV

## REAR DOOR SPEAKER

< REMOVAL AND INSTALLATION >

[BASE AUDIO WITHOUT NAVIGATION]

---

### REAR DOOR SPEAKER

#### Removal and Installation

INFOID:000000008130799

#### REMOVAL

1. Remove the rear door finisher. Refer to [INT-27, "REAR DOOR FINISHER : Removal and Installation"](#).
2. Remove the screws and disconnect the connector to remove the rear door speaker.

#### INSTALLATION

Installation is the reverse order of removal.

# ACTIVE NOISE CONTROL UNIT

< REMOVAL AND INSTALLATION >

[BASE AUDIO WITHOUT NAVIGATION]

## ACTIVE NOISE CONTROL UNIT

### Removal and Installation

INFOID:000000008130800

#### REMOVAL

1. Remove the trunk front finisher. Refer to [INT-50, "Exploded View"](#).
2. Remove the rear parcel shelf finisher. Refer to [INT-40, "Removal and Installation"](#).
3. Remove the active noise control unit mounting bolts.
4. Disconnect the connectors to remove the active noise control unit from the rear parcel shelf (trunk room side).

#### NOTE:

The active noise control unit has urethane foam as a holder to facilitate removal and installation procedure.

#### INSTALLATION

Install in the reverse order of removal.

A  
B  
C  
D  
E  
F  
G  
H  
I  
J  
K  
L  
M  
O  
P

AV

## FRONT MICROPHONE (ACTIVE NOISE CONTROL SYSTEM)

< REMOVAL AND INSTALLATION >

[BASE AUDIO WITHOUT NAVIGATION]

---

## FRONT MICROPHONE (ACTIVE NOISE CONTROL SYSTEM)

### Removal and Installation

INFOID:000000008130801

#### REMOVAL

1. Remove the map lamp of switch cover.
2. Lower the headlining front side (map lamp side) to secure work space. Refer to [INL-41, "Removal and Installation"](#).
3. Press the pawl to remove the front microphone from the map lamp assembly.

#### **CAUTION:**

**Carefully handle the pawl fixing the front microphone because the pawl is fragile.**

#### INSTALLATION

Install in the reverse order of removal.

#### **NOTE:**

Check the front microphone for looseness after the installation.

# REAR MICROPHONE (ACTIVE NOISE CONTROL SYSTEM)

< REMOVAL AND INSTALLATION >

[BASE AUDIO WITHOUT NAVIGATION]

## REAR MICROPHONE (ACTIVE NOISE CONTROL SYSTEM)

### Removal and Installation

INFOID:000000008130802

#### REMOVAL

1. Remove the headlining. Refer to [INT-46. "Removal and Installation"](#).
2. Remove the rear microphone from the headlining.

#### INSTALLATION

Install in the reverse order of removal.

A  
B  
C  
D  
E  
F  
G  
H  
I  
J  
K  
L  
M  
O  
P

AV

## ANTENNA AMP.

< REMOVAL AND INSTALLATION >

[BASE AUDIO WITHOUT NAVIGATION]

---

### ANTENNA AMP.

#### Removal and Installation

INFOID:000000008130803

#### REMOVAL

1. Remove the rear pillar finisher RH. Refer to [INT-37, "REAR PILLAR FINISHER : Removal and Installation"](#).
2. Remove the screw and disconnect the connector to remove the antenna amp.

#### INSTALLATION

Installation is the reverse order of removal.



DISPLAY UNIT

Removal and Installation

INFOID:000000008130804

REMOVAL

- 1. Remove the center ventilator assembly. Refer to [IP-13. "Removal and Installation"](#).
- 2. Remove the screws and disconnect the connector to remove the display unit.

INSTALLATION

Install in the reverse order of removal.

A  
B  
C  
D  
E  
F  
G  
H  
I  
J  
K  
L  
M  
O  
P

AV

# SATELLITE RADIO TUNER

< REMOVAL AND INSTALLATION >

[BASE AUDIO WITHOUT NAVIGATION]

---

## SATELLITE RADIO TUNER

### Removal and Installation

INFOID:000000008130805

#### REMOVAL

1. Remove the trunk front finisher. Refer to [INT-50, "Exploded View"](#).
2. Remove the rear parcel shelf finisher. Refer to [INT-39, "Exploded View"](#).
3. Remove the satellite radio tuner bracket mounting screws.
4. Disconnect the connectors to remove the satellite radio tuner with the bracket attached.
5. Remove the bracket screws to remove the bracket from the satellite radio tuner.

#### INSTALLATION

Installation is the reverse order of removal.

# SATELLITE RADIO ANTENNA

< REMOVAL AND INSTALLATION >

[BASE AUDIO WITHOUT NAVIGATION]

## SATELLITE RADIO ANTENNA

Exploded View

INFOID:000000008130806

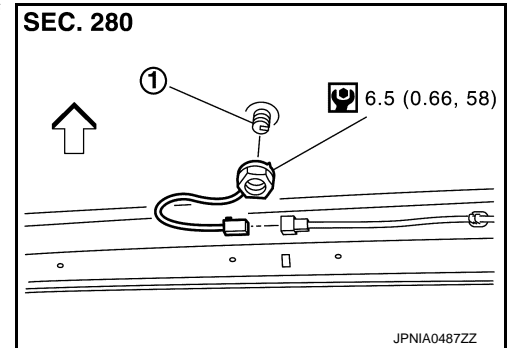

- 1. Satellite radio antenna
- ⇐: Vehicle front

## Removal and Installation

INFOID:000000008130807

### REMOVAL

1. Remove the head lining assembly. Refer to [INT-46, "Removal and Installation"](#).
2. Remove the nut and disconnect the connector to remove the satellite radio antenna from the roof panel.

### INSTALLATION

Installation is the reverse order of removal.

#### **CAUTION:**

**Be careful about tightening torque. Antenna sensitivity becomes poor, and when it is excessive, roof panel may be deformed, when satellite radio antenna mounting nut tightening torque is loose.**

A  
B  
C  
D  
E  
F  
G  
H  
I  
J  
K  
L  
M  
O  
P

AV

# MULTIFUNCTION SWITCH

< REMOVAL AND INSTALLATION >

[BASE AUDIO WITHOUT NAVIGATION]

## MULTIFUNCTION SWITCH

### Removal and Installation

INFOID:000000008130808

#### REMOVAL

1. Remove the cluster lid D. Refer to [IP-13. "Removal and Installation"](#).
2. Remove the screws (A) to remove the multifunction switch from the cluster lid D.

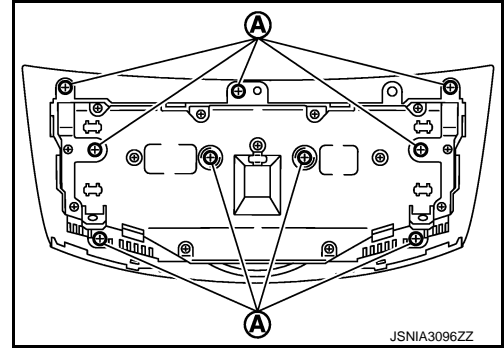

#### INSTALLATION

Install in the reverse order of removal.

# PRESET SWITCH

< REMOVAL AND INSTALLATION >

[BASE AUDIO WITHOUT NAVIGATION]

## PRESET SWITCH

### Removal and Installation

INFOID:000000008130809

#### REMOVAL

1. Remove the Instrument side panel LH and RH. Refer to [IP-24. "Removal and Installation"](#).
2. Remove the preset switch straight from the instrument panel assembly while disengaging the resin clips and pawls with a remover.

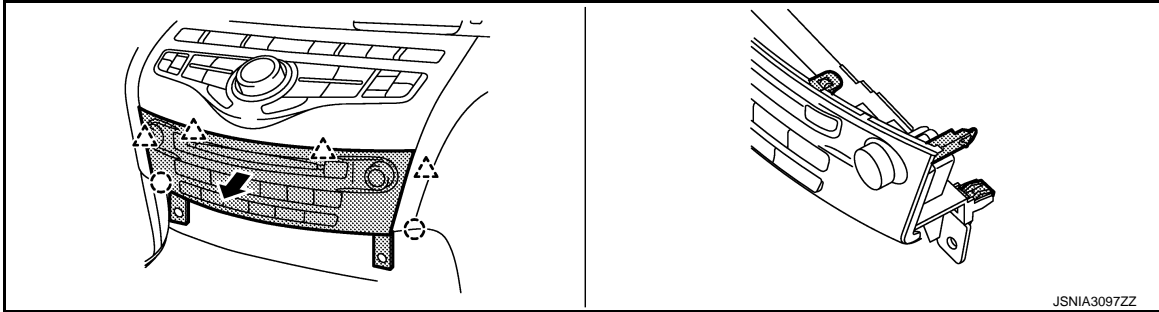

- : Clip  
△ : Pawl

#### CAUTION:

- The resin clips and pawls must be disengaged slowly to avoid damage to the pawls and the preset switch.
- Place protective tape on the area of using the remover to avoid damage.

A  
B  
C  
D  
E  
F  
G  
H  
I  
J  
K  
L  
M  
O  
P

AV

## STEERING SWITCH

< REMOVAL AND INSTALLATION >

[BASE AUDIO WITHOUT NAVIGATION]

---

### STEERING SWITCH

#### Removal and Installation

INFOID:000000008130810

#### REMOVAL

Refer to [ST-32. "Removal and Installation"](#).

#### INSTALLATION

Install in the reverse order of removal.

## USB CONNECTOR

### Removal and Installation

INFOID:000000008130811

#### REMOVAL

1. Remove the console center finisher. Refer to [IP-24, "Removal and Installation"](#).
2. Push the pawl from the back of the console center finisher to remove the USB connector.

#### INSTALLATION

Install in the reverse order of removal.

A

B

C

D

E

F

G

H

I

J

K

L

M

AV

O

P

## MICROPHONE

### Removal and Installation

INFOID:000000008130812

#### REMOVAL

1. Remove the map lamp of switch cover.
2. Lower the headlining front side (map lamp side) to secure work space. Refer to [INL-41, "Removal and Installation"](#).
3. Press the pawl to remove the microphone from the map lamp assembly.

#### **CAUTION:**

**Carefully handle the pawl fixing the microphone because the pawl is fragile.**

#### INSTALLATION

Install in the reverse order of removal.

#### **NOTE:**

Check the microphone for looseness after the installation.



# TEL ADAPTER UNIT

< REMOVAL AND INSTALLATION >

[BASE AUDIO WITHOUT NAVIGATION]

## TEL ADAPTER UNIT

### Removal and Installation

INFOID:000000008130813

#### REMOVAL

1. Remove the trunk front finisher. Refer to [INT-50. "Exploded View"](#).
2. Remove the screws and disconnect the connector to remove the TEL adapter unit.

#### INSTALLATION

Installation is the reverse order of removal.

A

B

C

D

E

F

G

H

I

J

K

L

M

AV

O

P

### REAR VIEW CAMERA

#### Removal and Installation

INFOID:000000008130814

#### REMOVAL

1. Remove the trunk lid inner finisher. Refer to [INT-53, "Removal and Installation"](#).
2. Disconnect the connector.
3. Insert a tool shown in the figure in the groove and push the pawl to remove the rear view camera (2) from the inner bracket (1) of the trunk lid finisher.

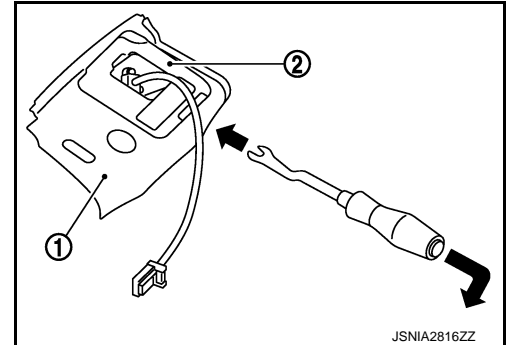

#### INSTALLATION

Install in the reverse order of removal.

#### NOTE:

Adjust the guide line position if the guide line position is shifted after installing the rear view camera. Refer to [AV-122, "Adjustment"](#).

#### Adjustment

INFOID:000000008130815

Adjust the guide line position if the guide line position is shifted after installing the rear view camera.

1. Draw lines on rearward area of the vehicle passing through the following points: 200 mm (7.87 in) from both sides of the vehicle, and 0.5 m (1.64 ft), 1.0 m (3.28 ft) from the rear end of the bumper.
2. Set into "Adjust Guide Lines" mode of "Confirmation/Adjustment" mode.

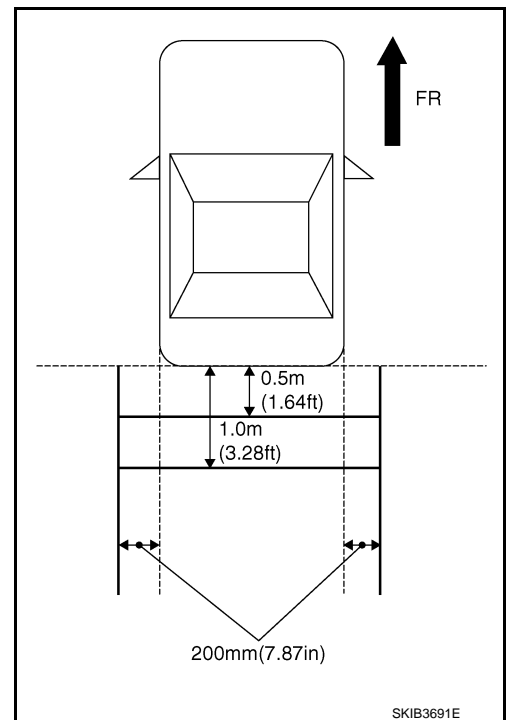

# REAR VIEW CAMERA

< REMOVAL AND INSTALLATION >

[BASE AUDIO WITHOUT NAVIGATION]

3. Rotate the center dial, and then select the guiding line pattern so that its angle is aligned with the correction line of the rear of the vehicle.

**Selected pattern : 7**

4. Make fine adjustment to the correction line of the rear of the vehicle with up/down/left/right switches so that its position is aligned with the guiding line. Press "OK" switch and record the adjusted guiding line position to the AV control unit.

**Up/Down adjustment range : (-20°) – (20°)**

**Left/Right adjustment range : (-20°) – (20°)**

**CAUTION:**

**After the adjustment, never perform other operations for one minute.**

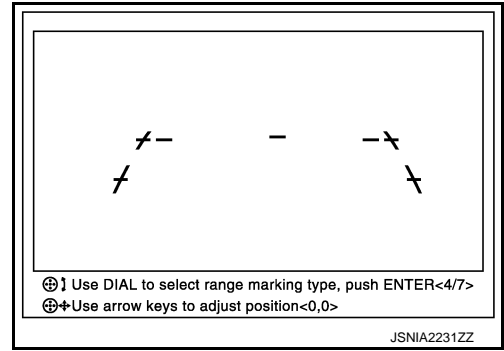

A  
B  
C  
D  
E  
F  
G  
H  
I  
J  
K  
L  
M  
O  
P

AV

# STEERING ANGLE SENSOR

< REMOVAL AND INSTALLATION >

[BASE AUDIO WITHOUT NAVIGATION]

---

## STEERING ANGLE SENSOR

### Removal and Installation

INFOID:000000008130816

#### REMOVAL

1. Remove the spiral cable. Refer to [SR-14, "Removal and Installation"](#).
2. Remove the screws to remove the steering angle sensor from the spiral cable.

#### INSTALLATION

Install in the reverse order of removal.

# ANTENNA FEEDER

< REMOVAL AND INSTALLATION >

[BASE AUDIO WITHOUT NAVIGATION]

## ANTENNA FEEDER

### Feeder Layout

INFOID:000000008130817

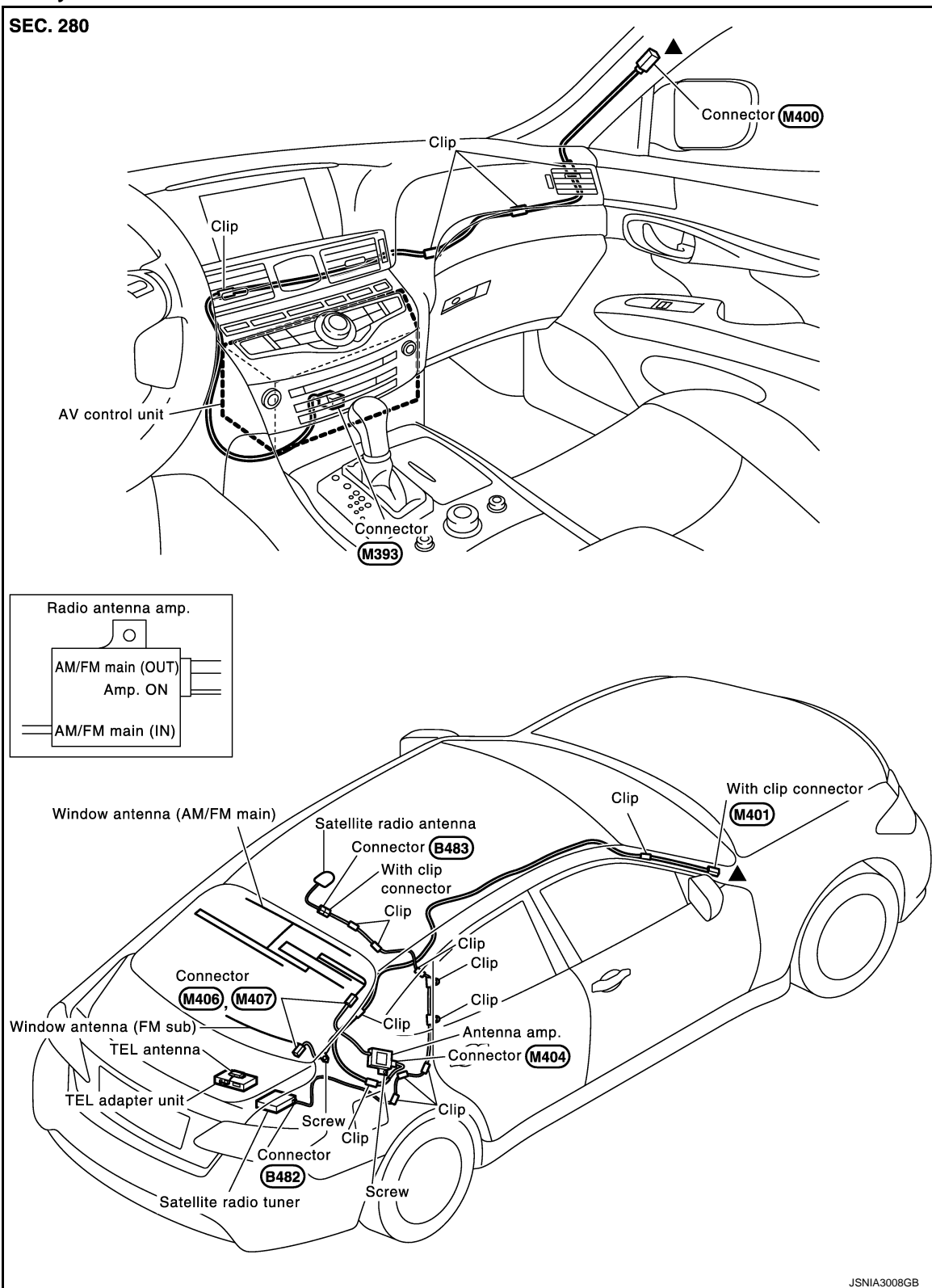

A  
B  
C  
D  
E  
F  
G  
H  
I  
J  
K  
L  
M  
N  
O  
P

AV

## PRECAUTION

### PRECAUTIONS

#### Precaution for Supplemental Restraint System (SRS) "AIR BAG" and "SEAT BELT PRE-TENSIONER"

INFOID:000000008130818

The Supplemental Restraint System such as "AIR BAG" and "SEAT BELT PRE-TENSIONER", used along with a front seat belt, helps to reduce the risk or severity of injury to the driver and front passenger for certain types of collision. This system includes seat belt switch inputs and dual stage front air bag modules. The SRS system uses the seat belt switches to determine the front air bag deployment, and may only deploy one front air bag, depending on the severity of a collision and whether the front occupants are belted or unbelted. Information necessary to service the system safely is included in the "SRS AIR BAG" and "SEAT BELT" of this Service Manual.

**WARNING:**

Always observe the following items for preventing accidental activation.

- To avoid rendering the SRS inoperative, which could increase the risk of personal injury or death in the event of a collision that would result in air bag inflation, all maintenance must be performed by an authorized NISSAN/INFINITI dealer.
- Improper maintenance, including incorrect removal and installation of the SRS, can lead to personal injury caused by unintentional activation of the system. For removal of Spiral Cable and Air Bag Module, see "SRS AIR BAG".
- Never use electrical test equipment on any circuit related to the SRS unless instructed to in this Service Manual. SRS wiring harnesses can be identified by yellow and/or orange harnesses or harness connectors.

#### PRECAUTIONS WHEN USING POWER TOOLS (AIR OR ELECTRIC) AND HAMMERS

**WARNING:**

Always observe the following items for preventing accidental activation.

- When working near the Air Bag Diagnosis Sensor Unit or other Air Bag System sensors with the ignition ON or engine running, never use air or electric power tools or strike near the sensor(s) with a hammer. Heavy vibration could activate the sensor(s) and deploy the air bag(s), possibly causing serious injury.
- When using air or electric power tools or hammers, always switch the ignition OFF, disconnect the battery, and wait at least 3 minutes before performing any service.

#### Cautions in Removing Battery Terminal and AV Control Unit (Models with AV Control Unit)

INFOID:000000008130819

**CAUTION:**

Remove battery terminal and AV control unit after a lapse of 30 seconds or more after turning the ignition switch OFF.

**NOTE:**

After the ignition switch is turned OFF, the AV control unit continues operating for approximately 30 seconds. Therefore, data corruption may occur if battery voltage is cut off within 30 seconds.

#### Precaution for Trouble Diagnosis

INFOID:000000008130820

#### AV COMMUNICATION SYSTEM

- Do not apply voltage of 7.0 V or higher to the measurement terminals.
- Use the tester with its open terminal voltage being 7.0 V or less.
- Be sure to turn ignition switch OFF and disconnect the battery cable from the negative terminal before checking the circuit.

#### Precaution for Harness Repair

INFOID:000000008130821

#### AV COMMUNICATION SYSTEM

# PRECAUTIONS

## < PRECAUTION >

## [BOSE AUDIO WITH NAVIGATION]

- Solder the repaired parts, and wrap with tape. [Frays of twisted line must be within 110 mm (4.33 in).]

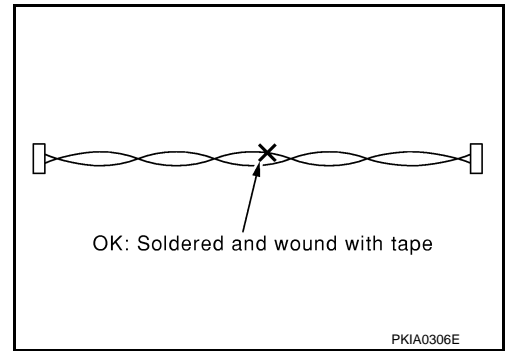

- Do not perform bypass wire connections for the repair parts. (The spliced wire will become separated and the characteristics of twisted line will be lost.)

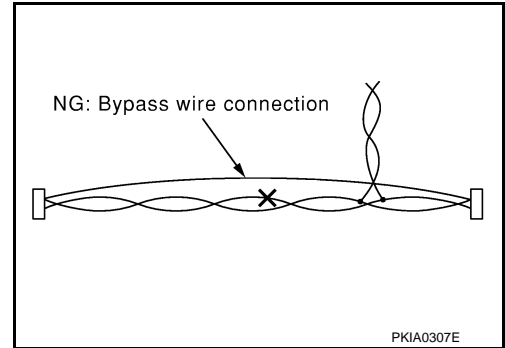

A  
B  
C  
D  
E  
F  
G  
H  
I  
J  
K  
L  
M  
O  
P

AV

PREPARATION

PREPARATION

Commercial Service Tools

INFOID:000000008130822

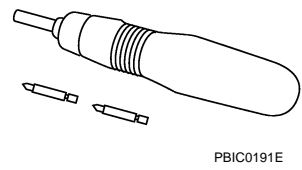
Tool	Description
<p data-bbox="162 514 276 546">Power tool</p>  <p data-bbox="820 619 901 651">PBIC0191E</p>	<p data-bbox="1006 514 1193 546">Loosening screws</p>



# COMPONENT PARTS

< SYSTEM DESCRIPTION >

[BOSE AUDIO WITH NAVIGATION]

## SYSTEM DESCRIPTION

### COMPONENT PARTS

#### Component Parts Location

INFOID:000000008130823

#### BOSE® STEREO SOUND SYSTEM

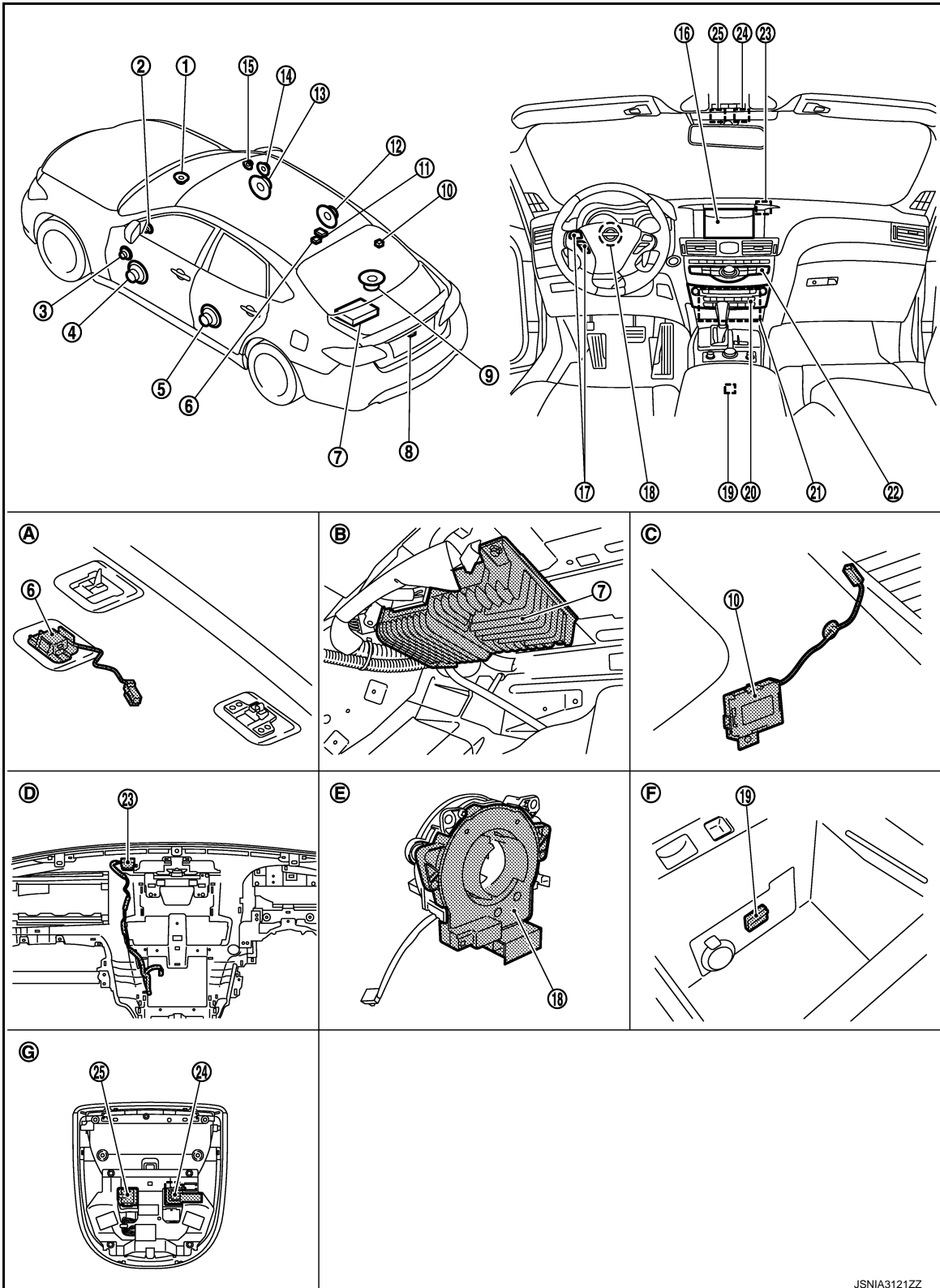

JSNIA3121ZZ

## COMPONENT PARTS

< SYSTEM DESCRIPTION >

[BOSE AUDIO WITH NAVIGATION]

- |  |   |  |
|--|---|--|
| 1. Center speaker                          | 2. Tweeter LH                               | 3. Front door squawker LH  |
| 4. Front door woofer LH                    | 5. Rear door speaker LH                     | 6. Rear microphone (for active noise control system)                 |
| 7. BOSE amp.                               | 8. Rear view camera                         | 9. Rear woofer   |
| 10. Antenna amp.                           | 11. Satellite radio antenna                 | 12. Rear door speaker RH   |
| 13. Front door woofer RH                   | 14. Front door squawker RH                  | 15. Tweeter RH   |
| 16. Display unit                           | 17. Steering switch                         | 18. Steering angle sensor  |
| 19. USB connector                          | 20. Preset switch                           | 21. AV control unit  |
| 22. Multifunction switch                   | 23. GPS antenna                             | 24. Front microphone (for active noise control system/AudioPilot® 2) |
| 25. Microphone (for TEL/voice recognition) |   |  |
| A. Headlining rear center                  | B. Rear parcel shelf left side (trunk room) | C. Rear pillar finisher RH remove condition                          |
| D. Instrument panel removed condition      | E.  | F. Within center console   |
| G. Map lamp ASSY removed condition         |   |  |

BOSE® STUDIO SURROUND® SOUND SYSTEM

# COMPONENT PARTS

< SYSTEM DESCRIPTION >

[BOSE AUDIO WITH NAVIGATION]

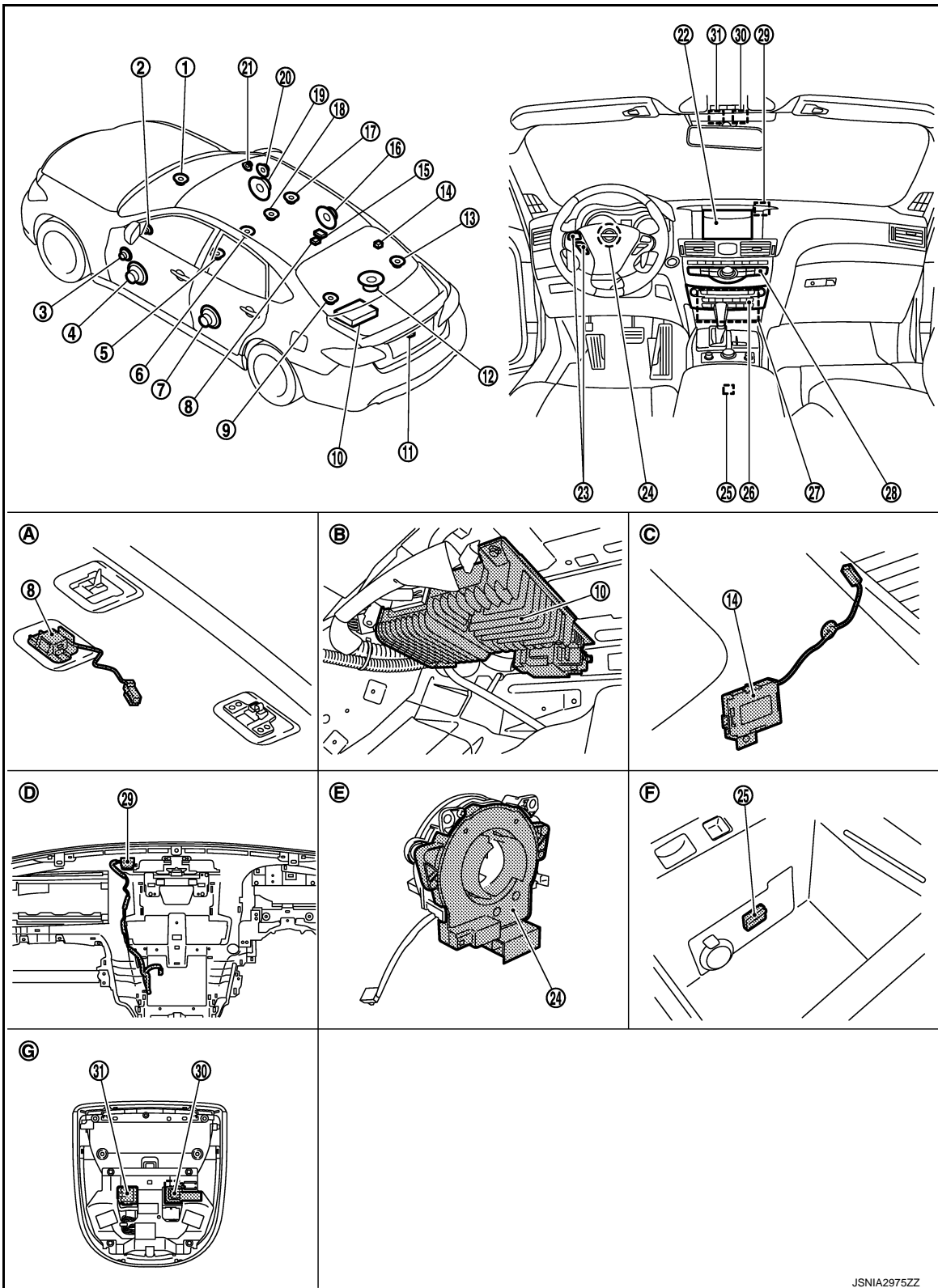

- |                          |  |                             |
|--------------------------|--|-----------------------------|
| 1. Center speaker        | 2. Tweeter LH  | 3. Front door squawker LH   |
| 4. Front door woofer LH  | 5. Driver seat speaker LH                            | 6. Driver seat speaker RH   |
| 7. Rear door speaker LH  | 8. Rear microphone (for active noise control system) | 9. Satellite speaker LH     |
| 10. BOSE amp.            | 11. Rear view camera                                 | 12. Rear woofer             |
| 13. Satellite speaker RH | 14. Antenna amp.                                     | 15. Satellite radio antenna |

# COMPONENT PARTS

< SYSTEM DESCRIPTION >

[BOSE AUDIO WITH NAVIGATION]

- |  |   |  |
|--|---|--|
| 16. Rear door speaker RH                   | 17. Passenger seat speaker RH               | 18. Passenger seat speaker LH  |
| 19. Front door woofer RH                   | 20. Front door squawker RH                  | 21. Tweeter RH   |
| 22. Display unit                           | 23. Steering switch                         | 24. Steering angle sensor  |
| 25. USB connector                          | 26. Preset switch                           | 27. AV control unit  |
| 28. Multifunction switch                   | 29. GPS antenna                             | 30. Front microphone (for active noise control system/AudioPilot® 2) |
| 31. Microphone (for TEL/voice recognition) |   |  |
| A. Headlining rear center                  | B. Rear parcel shelf left side (trunk room) | C. Rear pillar finisher RH remove condition                          |
| D. Instrument panel removed condition      | E.  | F. Within center console   |
| G. Map lamp ASSY removed condition         |   |  |

## Component Description

INFOID:000000008130824

Part name	Description
AV control unit	<ul style="list-style-type: none"> <li>Integrates hard disk drive (HDD) allowing map data to be stored. (Except for Mexico)</li> <li>Integrates hard disk drive (HDD) allowing map data and music data to be stored. (for Mexico)</li> <li>It is the master unit of the MULTI AV system, and it is connected to each control unit by communication. It operates each system according to communication signals from the AV control unit.</li> <li>The AV control unit includes the audio, hands-free phone, voice control, navigation, USB connection, DVD play, satellite radio and vehicle status functions.</li> <li>It is connected to each control unit via CAN communication to obtain necessary information for the vehicle information function.</li> <li>It receives a steering angle signal from the steering angle sensor via CAN communication and controls an expected course line during rear view monitor operation.</li> <li>It inputs the dimmer signals that are required for the display dimming control.</li> <li>It inputs the signals for driving status recognition (vehicle speed, reverse and parking brake).</li> <li>The RGB digital image signal and composite image signal are output to display unit.</li> <li>It receives an intelligent key recognition signal necessary for the intelligent key interlocking function from BCM via a hard wire</li> <li>Update of map data is performed with the DVD-ROM.</li> </ul>
Display unit	<ul style="list-style-type: none"> <li>Display image is controlled by the serial communication from AV control unit.</li> <li>The RGB digital image signal and composite image signal are input to display unit.</li> <li>Camera image signal is input from rear view camera.</li> <li>Touch panel function can be operated for each system by touching a display directly.</li> </ul>
BOSE amp.	<ul style="list-style-type: none"> <li>BOSE amp. include active noise control system and AudioPilot® 2 noise compensation technology. (BOSE stereo sound system models)</li> <li>BOSE amp. include active noise control system, AudioPilot® 2 noise compensation technology and BOSE® Centerpoint® 2 function. (BOSE® Studio Surround® sound system models)</li> <li>Generates an antiphase sound weakening interior engine booming noise, mixes the antiphase sound with a sound signal transmitted from the AV control unit, and transmits the mixed sound signal to each speaker.</li> <li>Input microphone signal transmitted from front microphone (for AudioPilot® 2 noise compensation technology).</li> <li>Input microphone signal transmitted from both front and rear microphone (for active noise control system).</li> </ul>
Front door woofer	<ul style="list-style-type: none"> <li>Outputs sound signal from BOSE amp.</li> <li>Outputs low range sound.</li> </ul>
Front door squawker	<ul style="list-style-type: none"> <li>Outputs sound signal from BOSE amp.</li> <li>Outputs mid range sound.</li> </ul>

## COMPONENT PARTS

< SYSTEM DESCRIPTION >

[BOSE AUDIO WITH NAVIGATION]

Part name	Description
Tweeter	<ul style="list-style-type: none"> <li>• Outputs sound signal from BOSE amp.</li> <li>• Outputs high range sound.</li> </ul>
Rear door speaker	<ul style="list-style-type: none"> <li>• Outputs sound signal from BOSE amp.</li> <li>• Outputs high, mid and low range sound.</li> </ul>
Satellite speaker*1	<ul style="list-style-type: none"> <li>• Outputs sound signal from BOSE amp.</li> <li>• Outputs mid and high range sound.</li> </ul>
Center speaker	<ul style="list-style-type: none"> <li>• Outputs sound signal from BOSE amp.</li> <li>• Outputs mid range sounds.</li> </ul>
Rear woofer	<ul style="list-style-type: none"> <li>• Outputs sound signal from BOSE amp.</li> <li>• Outputs low range sound.</li> </ul>
Seat speaker*1	<ul style="list-style-type: none"> <li>• Outputs sound signal from BOSE amp.</li> <li>• Outputs mid range sound.</li> </ul>
Front microphone (for active noise control system/AudioPilot® 2 noise compensation technology)	<ul style="list-style-type: none"> <li>• Used for active noise control system and AudioPilot® 2 noise compensation technology</li> <li>• Detects interior engine booming noise and transmits a sound signal to the BOSE amp.</li> </ul>
Rear microphone (for active noise control system)	<ul style="list-style-type: none"> <li>• Used for active noise control system</li> <li>• Detects interior engine booming noise and transmits a sound signal to the BOSE amp.</li> </ul>
Multifunction switch	<ul style="list-style-type: none"> <li>• Operation panel is equipped with the centralized switch where navigation and air conditioner, etc. operations are integrated.</li> <li>• Connected with preset switch via cable, and operation signal is transmitted to AV control unit via AV communication.</li> </ul>
Preset switch	<ul style="list-style-type: none"> <li>• Operation panel is equipped with the centralized switch where audio, etc. operations are integrated.</li> <li>• Connected with multifunction switch via cable, and operation signal is transmitted to AV control unit via AV communication.</li> <li>• The disk ejection operating signal is performed by hardwire.</li> </ul>
Rear view camera	<ul style="list-style-type: none"> <li>• Camera power supply is input from AV control unit.</li> <li>• The image of vehicle rear view is transmitted to display unit.</li> </ul>
Steering angle sensor	It is connected to the AV control unit and transmits the steering angle sensor signal via CAN communication.
Steering switch	<ul style="list-style-type: none"> <li>• Operations for audio, hands-free phone, voice recognition and navigation, etc. are possible.</li> <li>• Steering switch signal (operation signal) is output to AV control unit.</li> </ul>
Microphone (for TEL/voice recognition)	<ul style="list-style-type: none"> <li>• Used for hands-free phone operation and voice recognition.</li> <li>• Microphone signal is transmitted to AV control unit.</li> <li>• Power (Microphone VCC) is supplied from AV control unit.</li> </ul>
Antenna amp.	<ul style="list-style-type: none"> <li>• Radio signal received by window antenna is amplified and transmitted to AV control unit.</li> <li>• Power (antenna amp. ON signal) is supplied from AV control unit.</li> </ul>
Satellite radio antenna.	Receives the satellite radio waves and outputs it to AV control unit.
GPS antenna	GPS signal is received and transmitted to AV control unit.
USB connector	Image signal*2 and sound signal of USB input is transmitted to AV control unit.

\*1: BOSE® Studio Surround® sound system models

\*2: Image signals cannot be received from iPod®

## SYSTEM

### MULTI AV SYSTEM

### MULTI AV SYSTEM : System Diagram

INFOID:000000008130825

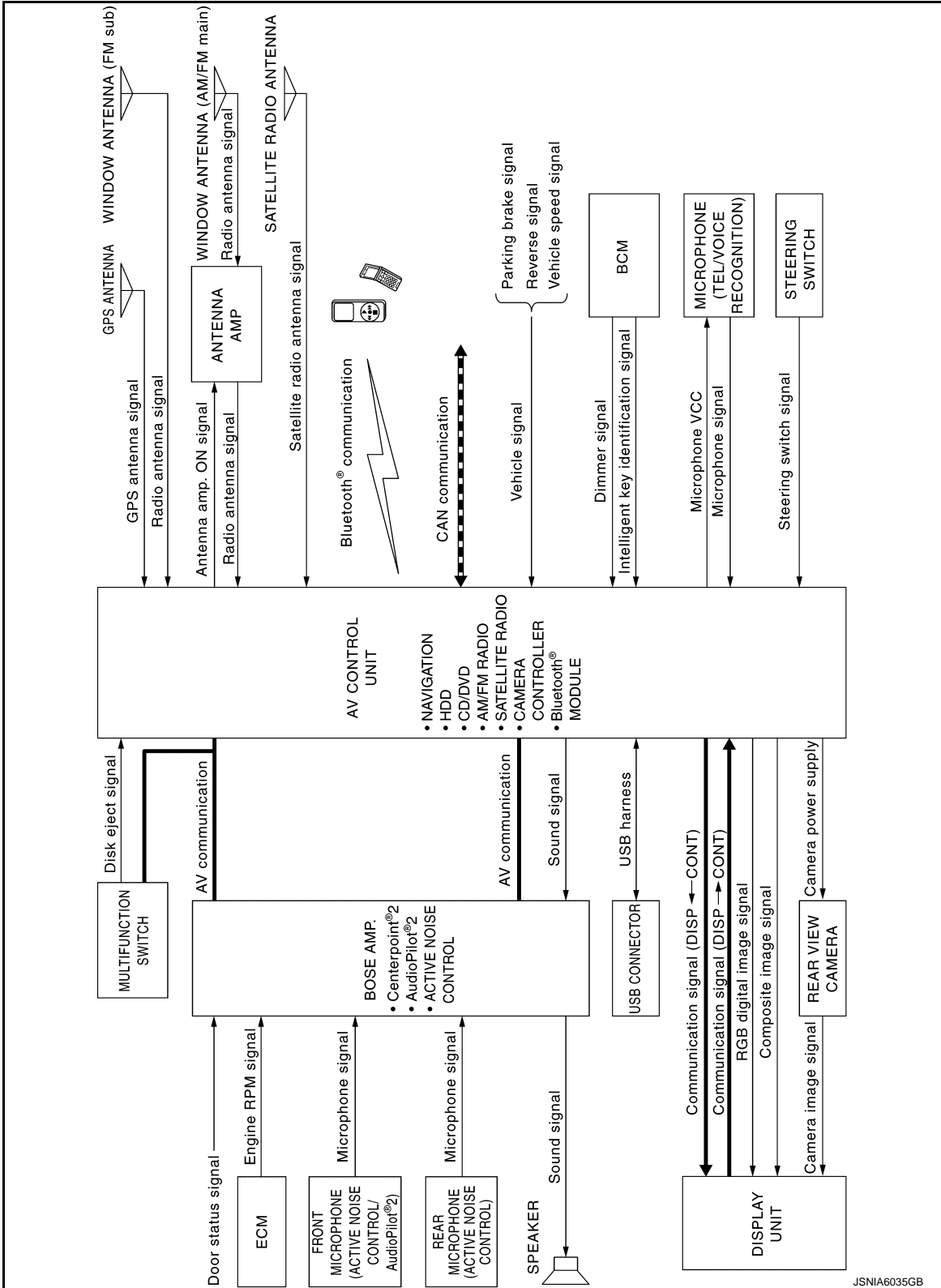

**NOTE:**

- The name MULTIFUNCTION SWITCH indicates the integration of PRESET SWITCH and MULTIFUNCTION SWITCH virtually.
- BOSE Centerpoint® 2 function has only BOSE® Studio Surround® sound system models.

MULTI AV SYSTEM : System Description

INFOID:000000008130826

Multi AV system means that the following systems are integrated.

FUNCTION NAME
Navigation system function
Audio function
DVD playback function
Hands-free phone function
USB connection function
Voice recognition function
Touch panel function
Rear view monitor function
Vehicle information function
Intelligent key interlocking function
Auto light adjustment system
Telematics system

COMMUNICATION SIGNAL

- AV control unit function by transmitting/receiving data one by one with each unit (slave unit) that configures them completely as a master unit by connecting between units that configure MULTI AV system with two AV communication lines (H, L).
- Two AV communication lines (H, L) adopt a twisted pair line that is resistant to noise.
- The AV control unit is connected by CAN communication, and it receives data signal from ECM and combination meter. It computes and displays fuel economy information value with the obtained information.
- The AV control unit is connected with display unit and serial communication, and it transmits the required signal of display and display control and receives the response signal from display unit.
- The AV control unit has a vehicle setting function and transmits/receives vehicle setting state data to/from BCM via CAN communication.
- The AV control unit receives a steering angle signal from the steering angle sensor via CAN communication and controls an expected course line during rear view monitor operation.
- The AV control unit transmits an ECO pedal reaction force setting signal (STANDARD/SOFT/OFF) to ECM that is necessary for ECO mode setting.
- The AV control unit transmits ON/OFF signals of DCA (distance control system), LDP (lane deviation prevention support system) and Blind Spot Intervention necessary for drive support system settings.

NAVIGATION SYSTEM FUNCTION

Description

- The AV control unit controls navigation function while GPS tuner has built-in map data, GYRO (angle speed sensor), on the HDD (Hard Disk Drive).
- The AV control unit inputs operation signal with communication signal, through display unit (touch panel) and multifunction switch and steering switch.
- Guide sound is output to front speaker through BOSE amp. from AV control unit when operating navigation system.
- A vehicle position is calculated with the GYRO (angle speed sensor), vehicle sensor, signal from GPS satellite and map data stored on HDD (Hard Disk Drive), and transmits the map image signal (RGB image, RGB area, RGB image synchronizing) to the display.

Position Detection Principle

A  
B  
C  
D  
E  
F  
G  
H  
I  
J  
K  
L  
M  
AV  
O  
P

# SYSTEM

## < SYSTEM DESCRIPTION >

## [BOSE AUDIO WITH NAVIGATION]

The navigation system periodically calculates the current vehicle position according to the following three types of signals.

- Travel distance of the vehicle as determined by the vehicle speed sensor
- Vehicle turning angle determined by the gyroscope (angular speed sensor)
- The travel direction of the vehicle determined by the GPS antenna (GPS information)

The current position of the vehicle is then identified by comparing the calculated vehicle position with map data, which is stored in the HDD (Hard Disk Drive) (map-matching), and indicated on the screen with a current location mark. More accurate data is used by comparing position detection results from GPS to the map-matching.

The current position is calculated by detecting the travel distance from the previous calculation point, and its direction change.

- Travel distance

The travel distance is generated from the vehicle speed sensor input signal. The automatic distance correction function is adopted for preventing a miss-detection of the travel distance because of tire wear etc.

- Travel direction

The gyroscope (angular velocity sensor) and GPS antenna (GPS information) generate the change of the travel direction. Both have advantages and disadvantages as per the following descriptions.

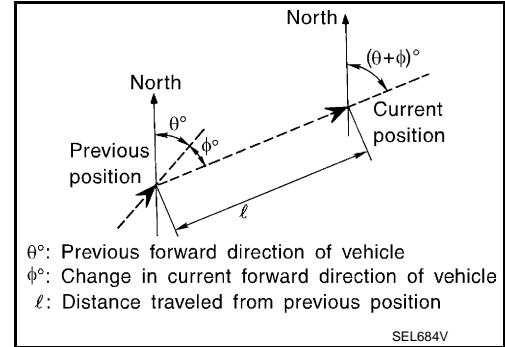
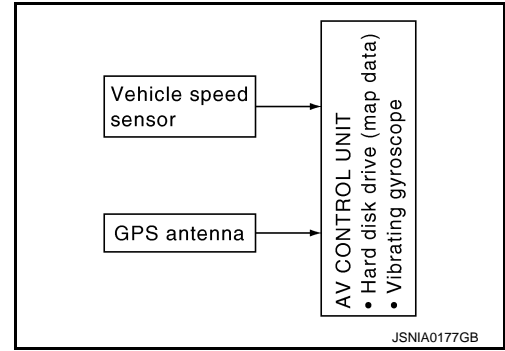

Type	Advantage	Disadvantage
Gyroscope (angular velocity sensor)	The turning angle is precisely detected.	Errors are accumulated when driving a long distance without stopping.
GPS antenna (GPS information)	The travel direction (North/South/East/West) is detected.	The travel direction is not precisely detected when driving slowly.

Input signals are prioritized in each situation. However, this order of priority may change in accordance with more detailed travel conditions so that the travel direction is detected more accurately.

### Map-matching

Map-matching repositions the vehicle on the road map when a new location is judged to be more accurate. This is done by comparing the current vehicle position (calculated by the normal position detection method) from the map data stored in the HDD (Hard Disk Drive).

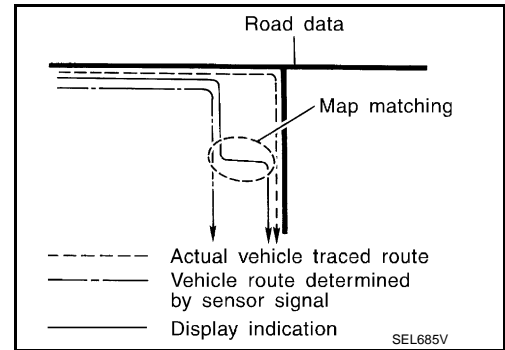

There is a possibility that the vehicle position may not be corrected in the following case, and when vehicle is driven over a certain distance or time in which GPS information is hard to receive. Correct manually the current location mark on the screen.



# SYSTEM

## < SYSTEM DESCRIPTION >

## [BOSE AUDIO WITH NAVIGATION]

- In map-matching, several alternative routes are prepared and prioritized in addition to the road judged as currently driving on. Therefore, due to errors in the distance and/or direction, an incorrect road may be prioritized, and the current location mark may be repositioned to the incorrect road.

If two roads are running in parallel, they are of the same priority. Therefore, the current location mark may appear on either of them alternately, depending on maneuvering of the steering wheel and configuration of the road, etc.

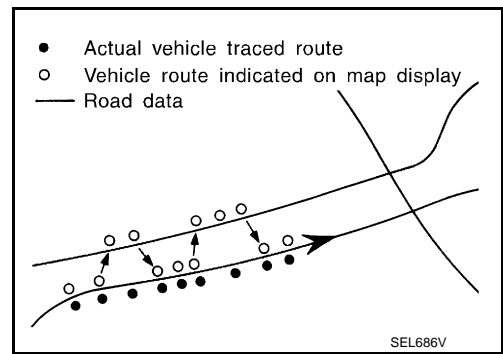

- Map-matching does not function correctly when road on which the vehicle is driving is new, etc. and not recorded in the map data. Also, map-matching does not function correctly when road pattern stored in the map data and the actual road pattern are different due to repair, etc.

Therefore, the map-matching function judges other road as a currently driving road if the road is not in the map, and displays the current location mark on it. Later, the current location mark may be repositioned to the road if the correct road is detected.

- Effective range for comparing the vehicle position and travel direction calculated by the distance and direction with the road data is limited. Therefore, correction by map-matching is not possible when there is an excessive gap between current vehicle position and the position on the map.

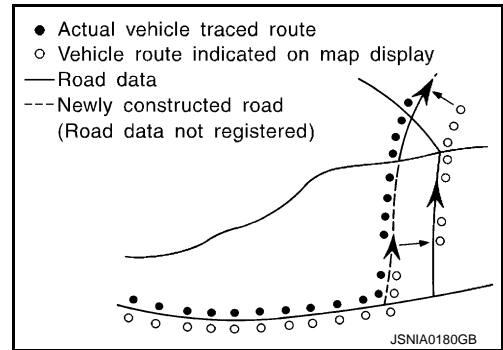

### GPS (Global Positioning System)

GPS (Global Positioning System) is developed for and is controlled by the US Department of Defense. The system utilizes GPS satellites (NAVSTAR), transmitting out radio waves while flying on an orbit around the earth at an altitude of approximately 21,000 km (13,049 mile).

The receiver calculates the travel position in three dimensions (latitude/longitude/altitude) according to the time lag of the radio waves that four or more GPS satellites transmit (three-dimensional positioning). The GPS receiver calculates the travel position in two dimensions (latitude/longitude) with the previous altitude data if the GPS receiver receives only three radio waves (two-dimensional positioning). GPS position correction is not performed while stopping the vehicle.

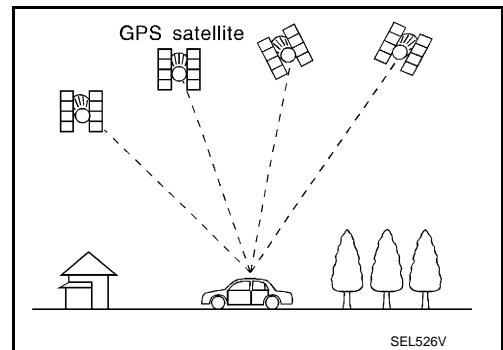

Accuracy of the GPS will deteriorate under the following conditions:

- In two-dimensional positioning, GPS accuracy will deteriorate when altitude of the vehicle position changes.
- The position of GPS satellite affects GPS detection precision. The position detection may not be precisely performed.
- The position detection is not performed if GPS receiver does not receive radio waves from GPS satellites. (Inside a tunnel, parking in a building, under an elevated highway etc.) GPS receiver may not receive radio waves from GPS satellites if any object is placed on the GPS antenna.

### NOTE:

- The detection result has an error of approximately 10 m (32.81 ft) even with a high-precision three dimensional positioning.
- There may be cases when the accuracy is lowered and radio waves are stopped intentionally because the GPS satellite signal is controlled by the US trace control center.

## AUDIO FUNCTION

### Description

- The audio function is adoption of the following system, and it is equipped with the following functions.

# SYSTEM

< SYSTEM DESCRIPTION >

[BOSE AUDIO WITH NAVIGATION]

FUNCTION	SYSTEM	
	BOSE® Studio Surround® Sound System (16 speaker models)	BOSE Stereo Sound System (10 speaker models)
AM/FM radio	X	X
Satellite radio (except for Mexico)	X	X
CD/DVD	X	X
Bluetooth® audio	X	X
Music Box (Hard Disk Drive) (for Mexico)	X	X
Active noise control system	X	X
AudioPilot® 2 Noise Compensation Technology	X	X
BOSE® Centerpoint® 2	X	

X: Applicable

- The adoption of the AudioPilot® 2 Noise Compensation Technology enables the correction of frequency bands which tend to be masked by driving noise.
- The BOSE Stereo Sound System features 8-channel amplifier and ten high-performance 3-way speakers integrated into the front doors. Furthermore, the 6x9-inch woofers mounted in the front doors provide deep bass sound.
- With the adoption of 14EQch digital amplifier and 16 speakers, BOSE® Studio Surround® Sound System provides smooth and natural sound over the range from bass to treble through the optimum placement of speakers for each seat and the control of amplifier.
- BOSE® Studio Surround® Sound System is adoption of BOSE® Centerpoint® 2 enables sound effects with a sense of realism even to playback sound of two-channel audio.
- The table below shows speakers mounted to each system.

SPEAKER	SYSTEM	
	BOSE® Studio Surround® Sound System (16 speaker models)	BOSE Stereo Sound System (10 speaker models)
Front door 3 Way speaker	Front door woofer	X
	Front door squawker	X
	Tweeter	X
Rear door speaker	X	X
Rear woofer	X	X
Center speaker	X	X
Satellite speaker	X	
Seat speaker	X	

X: Applicable

## Operating Signal

Audio system operation can be performed with multifunction switch, preset switch, steering switch, touch panel function or voice recognition function.

- Operating signal is transmitted to AV control unit with AV communication when it is operated by multifunction switch or preset switch. The disk ejection operating signal is performed by hardwire.
- Operating signal is transmitted to AV control unit with steering switch signal when it is operated by steering switch.

## Screen Display

Switching of display is performed with serial communication between display unit and AV control unit.

Operation status of audio is indicated at display unit.

## AM/FM Radio Mode

- AM/FM radio tuner is built into AV control unit.

# SYSTEM

## < SYSTEM DESCRIPTION >

## [BOSE AUDIO WITH NAVIGATION]

- Sound signals (AM/FM radio) are received via window antenna.
- AM/FM main antenna signal is amplified via antenna amp. and FM sub antenna signal is transmitted to AV control unit.
- AV control unit outputs sound signal is input to BOSE amp., and BOSE amp. outputs to each speaker.

### Satellite Radio Mode

- Satellite radio tuner is built into AV control unit.
- Sound signal (satellite radio) is received by satellite radio antenna and is transmitted to AV control unit. AV control unit outputs sound signal to BOSE amp. The signal is also outputted from BOSE amp. to each speaker.

### CD Mode

- CD function is built into AV control unit.
- AV control unit outputs sound signal to BOSE amp., and BOSE amp. outputs the signal to each speaker during playback.

### Bluetooth® Audio Mode

- Bluetooth® audio function is built into AV control unit.
- Bluetooth® audio can play music data in the portable audio by means of Bluetooth® communications between the portable audio and the AV control unit.
- AV control unit outputs sound signal to BOSE amp., and BOSE amp. outputs to each speaker.

### Music Box Mode (for Mexico)

- Music CD data is stored on HDD that is built into AV control unit, and it can be played.
- AV control unit outputs music (sound signal) that is stored on HDD to BOSE amp., and BOSE amp. outputs to each speaker.

### AudioPilot® 2 Noise Compensation Technology

- AudioPilot® 2 continuously corrects audio signals to compensate for background noise.
- AudioPilot® 2 noise compensation technology is a sound improving system that picks up by a front microphone any noises or the sound of music coming into the vehicle, and that uses the BOSE amp. to revise the frequency feature of music in real time in response to the frequency feature of the noise while driving and listening to music.

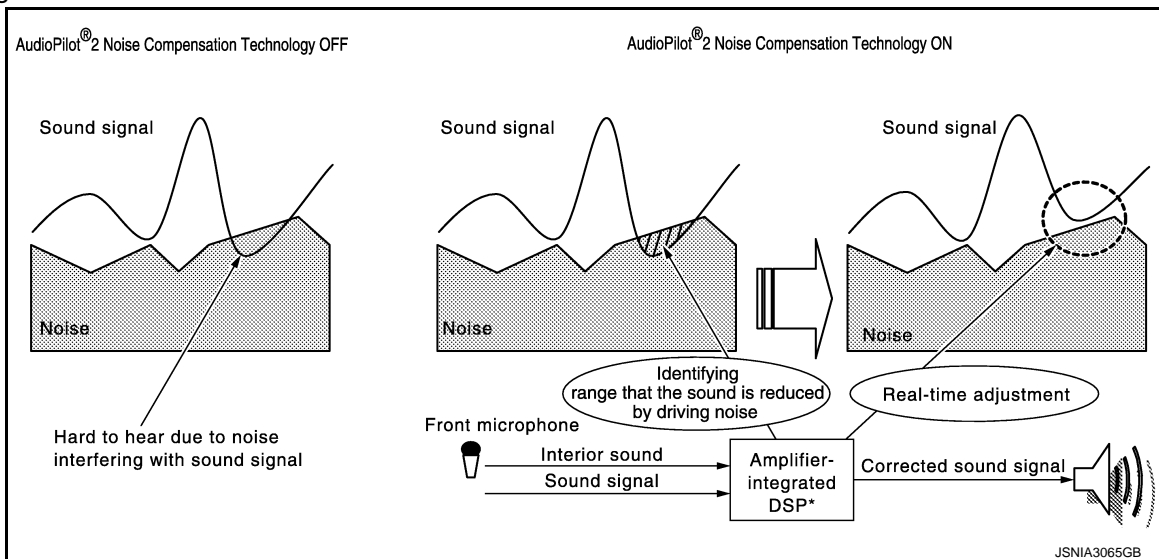

\*: DSP stands for Digital Signal Processor and enables digital processing of sound signals. DSP features precise signal processing and calculation with the digital technology on a small scale that analog methods find it difficult to process and calculate.

### BOSE® Centerpoint® 2 (BOSE® Studio Surround® Sound System)

- BOSE® Centerpoint® 2 provides a surround-sound effect, based on a stereo sound source, such as CD or MP3.
- The BOSE amp. receives a BOSE® Centerpoint® 2 ON signal during a stereophonic sound playback and divides the sound among five channels to add a sense of simulated surround playback sound.

### Active Noise Control System

# SYSTEM

## < SYSTEM DESCRIPTION >

## [BOSE AUDIO WITH NAVIGATION]

- The active noise control system incorporates the BOSE Engine Harmonic Cancellation (EHC) technology.
- The active noise control system outputs an antiphase sound from the speakers (front door speaker, rear door speaker and rear woofer) against unpleasant engine booming noise (2nd and/or 3rd engine rev at 700 - 5000 rpm) and reduces sound pressure level by the interference with engine booming noise. (VQ37VHR models)
- The active noise control system outputs an antiphase sound from the speakers (front door speaker, rear door speaker and rear woofer) against unpleasant engine booming noise (4th engine rev at Idle speed - 2500 rpm) and reduces sound pressure level by the interference with engine booming noise. (VK56VD models)
- The BOSE amp. receives an engine speed signal from ECM and receives microphone signals from the front and rear microphone.
- The BOSE amp. receives a door state signal. The active noise control system does not operate with any door open.
- Based on signals detected by the front and rear microphones, the BOSE amp. generates an antiphase sound (microphone signal) weakening interior engine booming noise in real time according to a unique algorithm<sup>\*1</sup> by a DSP<sup>\*2</sup> built in the BOSE amp. Then, the BOSE amp. mixes the antiphase sound with a sound signal received from the AV control unit to transmit the mixed sound signal to each speaker.

### NOTE:

\*1: Algorithm means a fixed procedure to solve a question.

\*2: DSP stands for Digital Signal Processor and enables digital processing of sound signals. DSP features precise signal processing and calculation with the digital technology on a small scale that analog methods find it difficult to process and calculate.

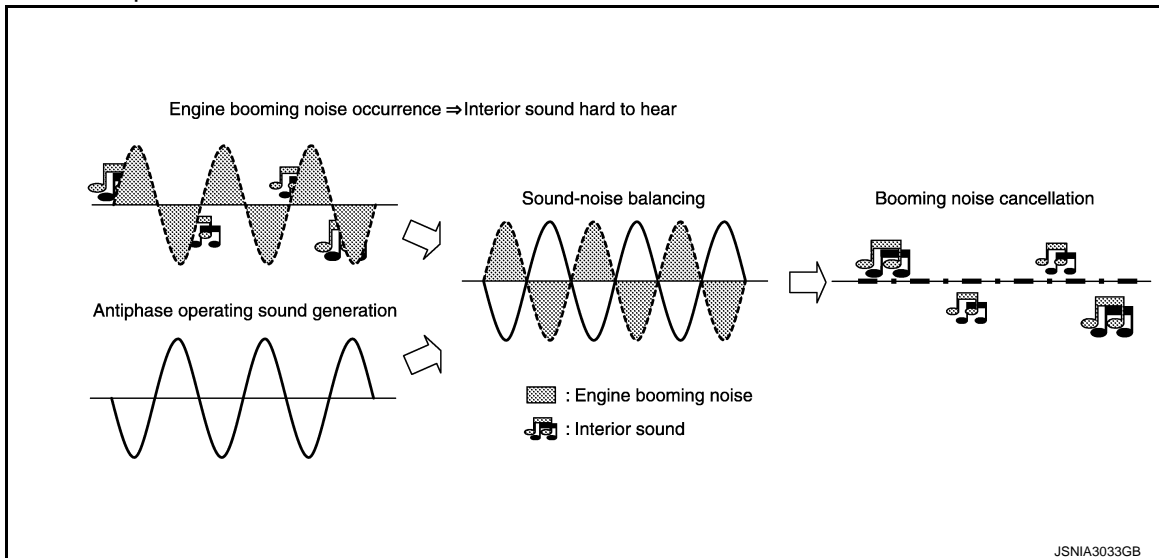

## DVD PLAYBACK FUNCTION

- DVD is played by inserting DVD into the AV control unit.
- DVD image signals are transmitted to the display unit (except for Mexico) and DVD sound signals are transmitted to each speaker via BOSE amp.

## HANDS-FREE PHONE FUNCTION

- AV control unit includes hands-free phone function.
- Hands-free communication can be operated by connecting using Bluetooth<sup>®</sup> communication with cellular phone.
- Operation is performed by steering switch, and operating condition is indicated on display unit.
- Guide sound that is heard during operation is input from AV control unit to BOSE amp., and is output from front speaker and center speaker.

### When A Call Is Originated

Spoken voice sound output from the microphone (microphone signal) is input to AV control unit. AV control unit outputs to cellular phone with Bluetooth<sup>®</sup> communication as a TEL voice signal. Voice sound is then heard at the other party.

### When Receiving A Call

# SYSTEM

## < SYSTEM DESCRIPTION >

## [BOSE AUDIO WITH NAVIGATION]

Voice sound is input to own cellular phone from the other party. TEL voice signal is output to door speaker, and the signal is input to BOSE amp. via AV control unit by establishing Bluetooth® communication from cellular phone.

### USB CONNECTION FUNCTION

- Connecting iPod® or USB memory allows the driver to play iPod® music files or USB memory-stored music files, video data, and image viewer data.
- Sound signals of music files stored in iPod® or USB memory is transmitted from the USB connector to the AV control unit. The AV control unit transmits the sound signals to the woofer and each speaker via BOSE amp.
- Video signals and image viewer file signals are transmitted from the USB connector to the AV control unit. The data and files are displayed on the front display unit screen.
- iPod® is recharged when connected to USB connector.
- Only files that meet the following conditions will be played.

	Music file	Video file	Image viewer file
File format	"MP3", "WMA", "AAC", "M4A"	"DivX", "MPEG4 (ASF)"	"JPEG"
File extension	".mp3", ".wma", ".aac", ".m4a"	".divx", ".afs", ".avi"	".jpg", ".jpeg"
Maximum file size	2 GB	2 GB	2 MB

### NOTE:

- iPod® is a trademark of Apple inc., registered in the U.S. and other countries.
- Image signals cannot be received from iPod®.
- Use the enclosed USB harness when connecting iPod® to USB connector.

### VOICE RECOGNITION FUNCTION

- Each operation of multi AV system can be performed by inputting sound to microphone.
- Start of sound recognition system can be performed by steering switch.

### TOUCH PANEL SYSTEM

Each operation of multi AV system can be performed by directly touching a display.

### REAR VIEW MONITOR FUNCTION

- The AV control unit supplies power to the rear view camera when receiving a reverse signal.
- The rear view camera transmits camera images to the display unit when power is supplied from the AV control unit.
- The AV control unit transmits a warning message, fixed guide lines, and predictive course lines to the display unit by RGB digital image signal. Rear view monitor images are displayed by combining the RGB digital image signal and the camera image signals from the rear view camera.
- Predictive course lines are controlled by a steering angle sensor signal received the AV control unit via CAN communication.

### VEHICLE INFORMATION FUNCTION

Status of audio, climate control system, fuel economy, maintenance and navigation etc. are displayed.

### INTELLIGENT KEY INTERLOCKING FUNCTION

The AV control unit recognizes a door-unlocked state of intelligent key according to an intelligent key recognition signal transmitted from BCM and saves two different types of audio settings and navigation settings.

Settings saved in the AV control unit

- Map display
- Route guidance
- Locator
- Route search
- Sound quality
- Radio preset
- Language

### AUTO LIGHT ADJUSTMENT SYSTEM

A  
B  
C  
D  
E  
F  
G  
H  
I  
J  
K  
L  
M  
O  
P

AV

# SYSTEM

< SYSTEM DESCRIPTION >

[BOSE AUDIO WITH NAVIGATION]

When the light switch is in the 1st or 2nd position, the dimming of the display is judged according to a dimming signal transmitted from BCM to the AV control unit. Display illuminance is independent of vehicle exterior illuminance detected by the auto light detecting sensor even when the light switch is in 1st or 2nd position.

## TELEMATICS SYSTEM

For further information about the telematics system, refer to [AV-299. "TELEMATICS SYSTEM : System Description"](#).

## MULTI AV SYSTEM : Fail-Safe

INFOID:000000008130827

When the ambient temperature becomes extremely low or extremely high, AV control unit displays the message and limits the AV control unit function.

### FAIL-SAFE CONDITIONS

When the ambient temperature is  $-20^{\circ}\text{C}$  ( $-4^{\circ}\text{F}$ ) or lower, or when it is  $70^{\circ}\text{C}$  ( $158^{\circ}\text{F}$ ) or higher

Display

The messages displayed on fail-safe conditions are as shown below:

Fail-safe mode	Display (display of the fail-safe condition)
When HDD temperature is low	HDD system is experiencing problems due to extreme low temperature. Normal operation will resume when temperature rises.
When HDD temperature is high	HDD system is experiencing problems due to extreme high temperature. Normal operation will resume when temperature drops.

## DESCRIPTION OF CONTROLS

Function	When Fail-safe Function is activated	
Air conditioner	Operation	Only multifunction switch (preset switch) can be operated.
	Display	<ul style="list-style-type: none"><li>• LED of multifunction switch (preset switch) illuminates.</li><li>• Aired temperature, blow angle, and flow rate are displayed in simplified mode.</li></ul>
Audio	Operation	Only ON/OFF and volume control operations by multifunction switch (preset switch) are possible.
	Display	No display ("Fail-safe mode" is displayed)
Camera	Operation	Image tone cannot be controlled.
	Display	Cannot be superimposed. (warning display, tone control display)
Hands-free phone	Operation	Cannot be operated.
Navigation	Operation	Cannot be operated.
Self diagnosis		The display in simplified mode of fail-safe condition
CONSULT diagnosis		Cannot be operated.

### Ability Operation Mode

There is an ability operation mode for Fail-safes due to low or high ambient temperature.

If HDD data can be read, fail-safe is shown, then normal displays are displayed only for functions which can be operated.

### RELEASE CONDITIONS OF FAIL-SAFE

Fail-safe is released on following conditions and normal mode is restored.

When The Temperature of HDD Is Low or High

If the ambient temperature becomes out of fail-safe condition range, normal mode is restored.

# DIAGNOSIS SYSTEM (AV CONTROL UNIT)

[BOSE AUDIO WITH NAVIGATION]

< SYSTEM DESCRIPTION >

## DIAGNOSIS SYSTEM (AV CONTROL UNIT)

### Description

INFOID:000000008130828

- The AV control unit diagnosis function starts up with multifunction switch operation and the AV control unit performs a diagnosis for each unit in the system during the on board diagnosis.
- Perform a CONSULT diagnosis if the on board diagnosis does not start, e.g., the screen does not display anything, the multifunction switch does not function, etc.

### On Board Diagnosis Function

INFOID:000000008130829

#### MULTIFUNCTION SWITCH AND PRESET SWITCH SELF-DIAGNOSIS FUNCTION

The ON/OFF operation (continuity) of each switch in the multifunction switch and preset switch can be checked.

##### Self-diagnosis Mode

- Press the "BACK" switch and the "UP" switch of the multifunction switches within 10 seconds after turning the ignition switch from OFF to ACC and hold them for 3 seconds or more. Then the buzzer sounds, all indicators of the multifunction switch and preset switch illuminate, and the self-diagnosis mode starts.
- The continuity of each switch at the ON position can be checked by pressing the switch. The buzzer sounds if the switch is normal.

**NOTE:**

The hazard switch and disk eject switch cannot be checked.

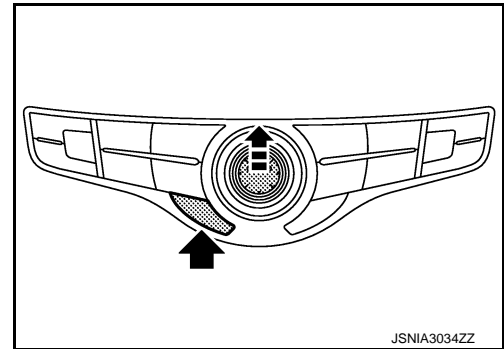

##### Finishing Self-diagnosis Mode

Self-diagnosis mode is canceled when turning the ignition switch OFF.

### ON BOARD DIAGNOSIS ITEM

#### Description

- The trouble diagnosis function has a self-diagnosis mode for conducting trouble diagnosis automatically and a confirmation/adjustment mode for operating manually.
- The self-diagnosis mode performs diagnoses on the AV control unit, connections between system components as well as connections between AV control unit and GPS antenna. Then it displays the diagnosis results on the display.
- The confirmation/adjustment mode allows the technician to check, modify or adjust the vehicle signals and set values, as well as to monitor the system error records and system communication status. The checking, modifying or adjusting generally require human intervention and judgment (the system cannot make judgment automatically).

#### On Board Diagnosis Item

Mode	Description
Self Diagnosis	<ul style="list-style-type: none"><li>• AV control unit diagnosis.</li><li>• Diagnoses the connections across system components, between AV control unit and GPS antenna.</li></ul>

A  
B  
C  
D  
E  
F  
G  
H  
I  
J  
K  
L  
M  
O  
P

AV

# DIAGNOSIS SYSTEM (AV CONTROL UNIT)

**[BOSE AUDIO WITH NAVIGATION]**

< SYSTEM DESCRIPTION >

Mode		Description	
Confirmation/ Adjustment	Display Diagnosis	The following check functions are available: color tone check by color bar display and white display, light and shade check by gray scale display and touch panel calibration response check.	
	Vehicle Signals	Diagnosis of signals can be performed for vehicle speed, parking brake, lights, ignition, reverse, side view switch and room lamp.	
	Speaker Test	The connection of a speaker can be confirmed by test tone.	
	Navigation	Steering Angle Adjustment	When there is a difference between the actual turning angle and the vehicle mark turning angle, it can be adjusted.
		Speed Calibration	When there is a difference between the current location mark and the actual location, it can be adjusted.
		XM SAT Subscription Status	The XM NavTraffic subscription status can be checked.
	Error History	The system malfunction and the frequency when occurring in the past are displayed. When the malfunctioning item is selected, the time and place that the selected malfunction last occurred are displayed.	
	Synchronizer FES Clock	-	
	Vehicle CAN Diagnosis	The transmitting/receiving of CAN communication can be monitored.	
	AV COMM Diagnosis	The communication condition of each unit of Multi AV system can be monitored.	
	Hands-free Phone	The received volume adjustment of hands-free phone and microphone speaker check can be performed.	
	Camera	The signal connected to camera control unit can be checked and the guiding line position that overlaps rear view camera image can be adjusted.	
	XM	XM NaviTraffic	Change Channel
		XM NavWeather	• Any necessary channels required to receive traffic information etc. from the satellite radio system can be set.
		XM CGS	Change Application ID
Diag		• Any application ID's required to receive traffic information etc. from the satellite radio system can be set.	
Delete Unit Connection Log	Erase the connection history of unit and error history.		
Initialize Settings	Initializes the AV control unit memory.		
Version Information	Version information of the AV control unit is displayed.		

## METHOD OF STARTING

1. Start the engine.
2. Turn the audio system OFF.
3. While pressing the "SETTING" button, turn the volume control dial clockwise or counterclockwise for 40 clicks or more. (When the self-diagnosis mode is started, a short beep will be heard.)
  - Shifting from current screen to previous screen is performed by pressing "BACK" button.

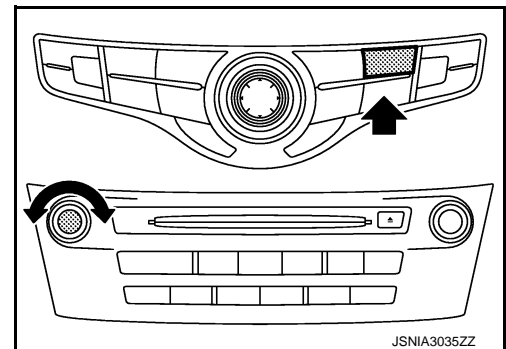



# DIAGNOSIS SYSTEM (AV CONTROL UNIT)

[BOSE AUDIO WITH NAVIGATION]

## < SYSTEM DESCRIPTION >

- The trouble diagnosis initial screen is displayed, and then the items of "Self Diagnosis" and "Confirmation/Adjustment" can be selected.

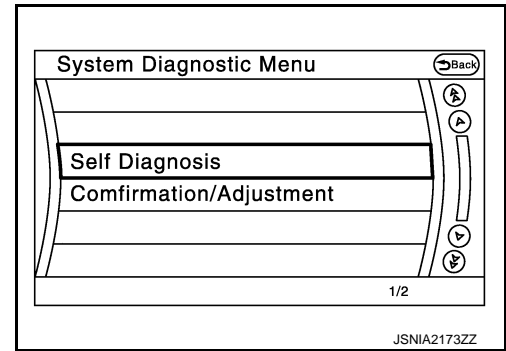

## SELF-DIAGNOSIS MODE

- Start the self-diagnosis function and select "Self Diagnosis".
  - Self-diagnosis subdivision screen is displayed, and the self-diagnosis mode starts.
  - The bar graph visible on the center of the self-diagnosis subdivision screen indicates progress of the trouble diagnosis.
- Diagnosis results are displayed after the self-diagnosis is completed. The unit names and the connection lines are color-coded according to the diagnostic results.

Diagnosis results	Unit	Connection line
Normal	Green	Green
Connection malfunction	Gray	Yellow
Unit malfunction <sup>Note</sup>	Red	Green

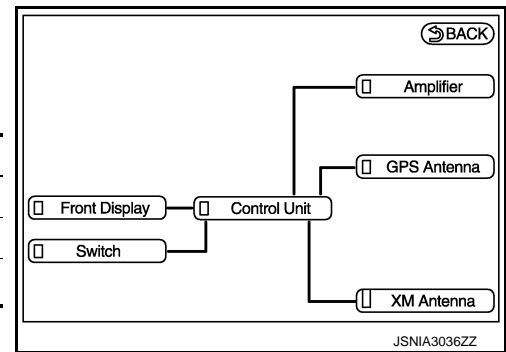

### NOTE:

Control unit (AV control unit) and amplifier (BOSE amp.) are displayed in red.

- Replace AV control unit if "Self-Diagnosis did not run because of a control unit malfunction" is indicated. The symptom is AV control unit internal error. Refer to [AV-265, "Removal and Installation"](#).
- If multiple errors occur at the same time for a single unit, the screen switch colors are determined according to the following order of priority: red > gray.

- The comments of the self-diagnosis results can be viewed with a component in the diagnosis result screen.

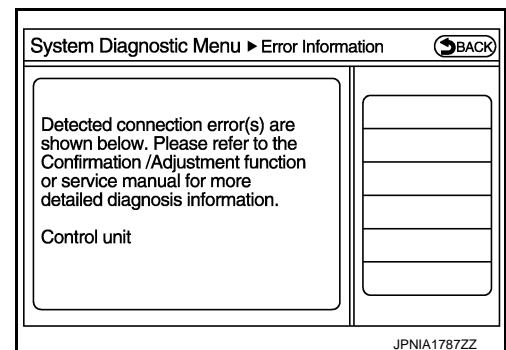

## Detection Range of Self-diagnosis Mode

- The self-diagnosis mode allows the technician to diagnose the connection in the communication line between AV control unit and each unit and the internal operation of the AV control unit.
- Because the start condition of diagnosis function is a switch operation, the on board diagnosis function cannot be started up if any malfunction is detected in the communication circuit between AV control unit and multifunction switch.

## SELF-DIAGNOSIS RESULTS

Check the applicable display at the following table, and then repair the malfunctioning parts.

Only Unit Part Is Displayed In Red.

# DIAGNOSIS SYSTEM (AV CONTROL UNIT)

< SYSTEM DESCRIPTION >

[BOSE AUDIO WITH NAVIGATION]

Screen switch	Description	Possible malfunction location / Action to take
Control Unit	Malfunction is detected in AV control unit power supply and ground circuits.	Check AV control unit power supply and ground circuits. Refer to <a href="#">AV-238, "AV CONTROL UNIT : Diagnosis Procedure"</a> . When detecting no malfunction in those components, replace AV control unit. Refer to <a href="#">AV-265, "Removal and Installation"</a> .
Amplifier	When either one of the following items are detected: <ul style="list-style-type: none"> <li>• sound signal circuits between BOSE amp. and each speaker are malfunctioning.</li> <li>• sound signal circuits between BOSE amp. and either front or rear microphone is malfunctioning.</li> <li>• BOSE amp. malfunction is detected.</li> </ul>	<ul style="list-style-type: none"> <li>• Malfunctioning speaker circuits</li> <li>• Malfunctioning front or rear microphone circuits</li> <li>• Replace BOSE amp. Refer to <a href="#">AV-274, "Removal and Installation"</a>.</li> </ul>

A Connecting Cable Between Units Is Displayed In Yellow.

Area with yellow connection lines	Description	Possible malfunction location / Action to take
Control unit ↔ Front Display	Malfunction is detected in serial communication circuits between AV control unit and display unit.	Serial communication circuits between AV control unit and display unit.
Control unit ↔ GPS Antenna	GPS antenna connection malfunctions detected.	GPS antenna
Control unit ↔ SAT Antenna	Satellite radio antenna connection malfunction is detected.	Satellite radio antenna disconnection
Control unit ↔ Amplifier	When either one of the following items are detected: <ul style="list-style-type: none"> <li>• BOSE amp. power supply and ground circuits are malfunctioning.</li> <li>• AV communication circuits between multifunction switch and BOSE amp. are malfunctioning.</li> </ul>	<ul style="list-style-type: none"> <li>• BOSE amp. power supply and ground circuits. Refer to <a href="#">AV-239, "BOSE AMP. : Diagnosis Procedure"</a>.</li> <li>• AV communication circuits between multifunction switch and BOSE amp.</li> </ul>

## CONFIRMATION/ADJUSTMENT MODE

1. Start the diagnosis function and select "Confirmation/Adjustment". The confirmation/adjustment mode indicates where each item can be checked or adjusted.
2. Select each switch on the "Confirmation/Adjustment Mode" screen to display the relevant trouble diagnosis screen. Press the "Back" switch to return to the initial Confirmation/Adjustment Mode screen.

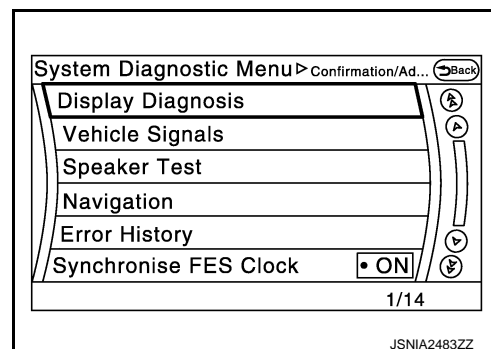

# DIAGNOSIS SYSTEM (AV CONTROL UNIT)

< SYSTEM DESCRIPTION >

[BOSE AUDIO WITH NAVIGATION]

## Display Diagnosis

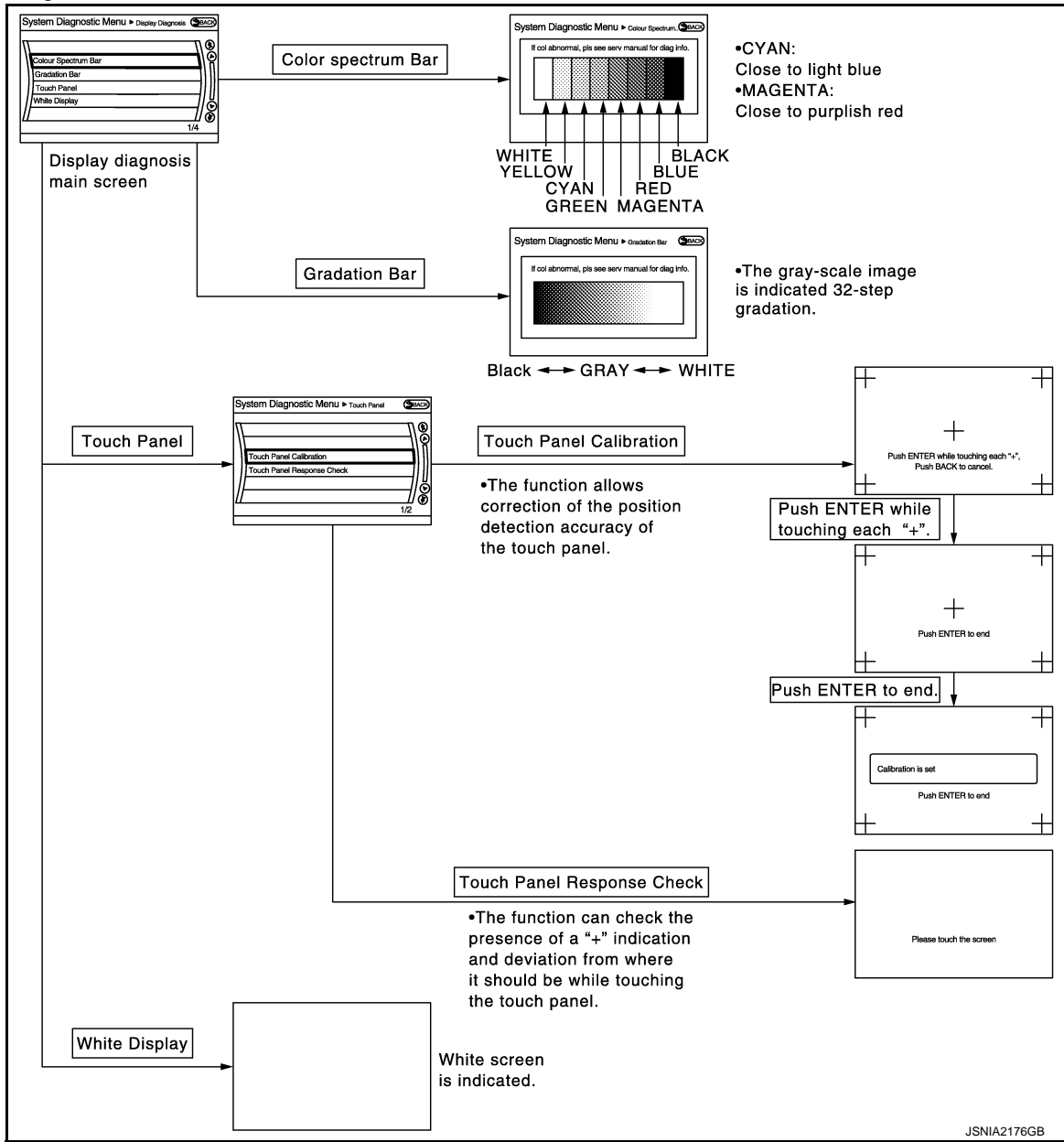

## Vehicle Signals

A comparison check can be made of each actual vehicle signal and the signals recognized by the system.

System Diagnostic Menu ▶ Vehicle Signals	
Vehicle speed	OFF
Parking brake	ON
Lights	OFF
Ignition	ON
Reverse	OFF
Side view Switch	-
Room Lamp	OFF

JSNIA2177ZZ

A  
B  
C  
D  
E  
F  
G  
H  
I  
J  
K  
L  
M  
AV  
O  
P

# DIAGNOSIS SYSTEM (AV CONTROL UNIT)

< SYSTEM DESCRIPTION >

[BOSE AUDIO WITH NAVIGATION]

Diagnosis item	Display	Vehicle status	Remarks
Vehicle speed	ON	Vehicle speed > 0 km/h (0 MPH)	Changes in indication may be delayed. This is normal.
	OFF	Vehicle speed = 0 km/h (0 MPH)	
Parking brake	ON	Parking brake is applied.	
	OFF	Parking brake is released.	
Lights	ON	Block the light beam from the auto light optical sensor when the light switch is ON.	—
	OFF	Either of the following conditions <ul style="list-style-type: none"> <li>Lighting switch OFF</li> <li>Expose the auto light optical sensor to light when the light switch is ON.</li> </ul>	
Ignition	ON	Ignition switch ON	—
	OFF	Ignition switch in ACC position	
Reverse	ON	Shift the selector lever to "R" position	Changes in indication may be delayed. This is normal.
	OFF	Shift the selector lever other than "R" position	
SIDE VIEW SW	—	—	This item is displayed, but cannot be monitored.
ROOM LAMP	OFF	—	This item is displayed, but cannot be monitored.

## Speaker Test

Select "SPEAKER DIAGNOSIS" to display the Speaker Diagnosis screen. Press "Start" to generate a test tone in a speaker. Press "Start" to generate a test tone in the next speaker. Press "Stop" to stop the test tones.

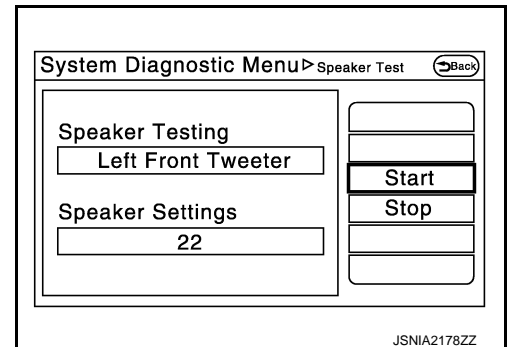

## Navigation

### STEERING ANGLE ADJUSTMENT

The steering angle output value detected with the gyroscope is adjusted.

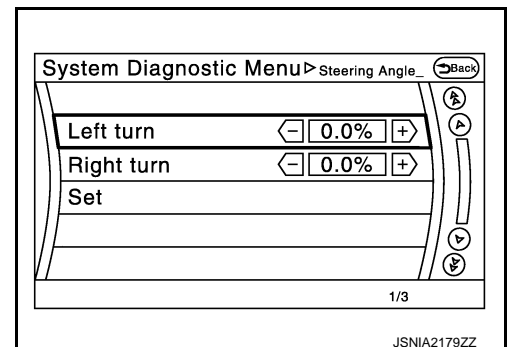

## SPEED CALIBRATION

# DIAGNOSIS SYSTEM (AV CONTROL UNIT)

[BOSE AUDIO WITH NAVIGATION]

< SYSTEM DESCRIPTION >

During normal driving, distance error caused by tire wear and tire pressure change is automatically adjusted for by the automatic distance correction function. This function, on the other hand, is for immediate adjustment, in cases such as driving with tire chain fitted on tires.

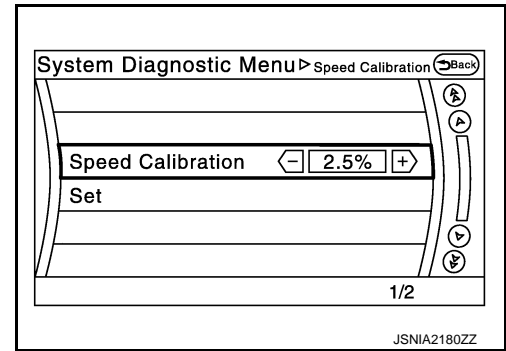

## XM SAT SUBSCRIPTION STATUS

The XM NavTraffic subscription status can be checked.

## Error History

The self-diagnosis results are judged depending on whether any error occurs from when “Self-diagnosis” is selected until the self-diagnosis results are displayed.

However, the diagnosis results are judged normal if an error has occurred before the ignition switch is turned ON and then no error has occurred until the self-diagnosis start. Check the “Error Record” to detect any error that may have occurred before the self-diagnosis start because of this situation.

The error record displays the time and place of the most recent occurrence of that error. However, take note of the following points.

- If there is a malfunction with the GPS antenna circuit board in the AV control unit, the correct date and time of occurrence may not be able to be displayed.
- Place of the error occurrence is represented by the position of the current location mark at the time an error occurred. If current location mark has deviated from the correct position, then the place of the error occurrence cannot be located correctly.
- The frequency of occurrence is displayed in a count up manner. The actual count up method differs depending on the error item.

### Count up method A

- The counter resets to 0 if an error occurs when ignition switch is turned ON. The counter increases by 1 if the condition is normal at a next ignition ON cycle.
- The counter upper limit is 39. Any counts exceeding 39 are ignored. “ The counter can be reset (no error record display) with the “Delete log” switch or CONSULT.

### Count up method B

- The counter increases by 1 if an error occurs when ignition switch is ON. The counter will not decrease even if the condition is normal at the next ignition ON cycle.
- The counter upper limit is 50. Any counts exceeding 50 are ignored. “ The counter can be reset (no error record display) with the “Delete log” switch or CONSULT.

Display type of occurrence frequency	Error history display item
Count up method A	CAN communication line, control unit (CAN), AV communication line, control unit (AV)
Count up method B	Other than the above

# DIAGNOSIS SYSTEM (AV CONTROL UNIT)

< SYSTEM DESCRIPTION >

[BOSE AUDIO WITH NAVIGATION]

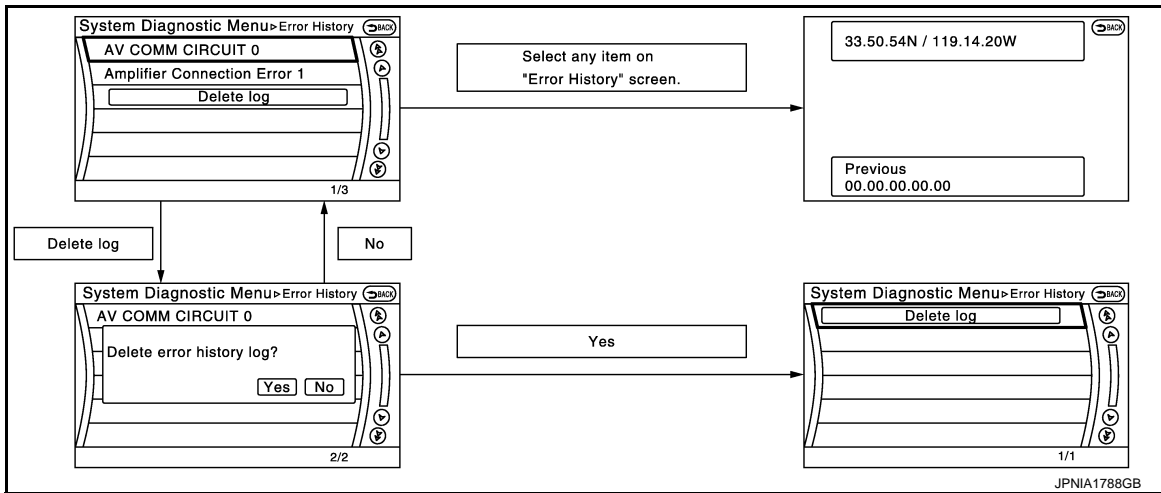

## Error item

Some error items may be displayed simultaneously according to the cause. If some error items are displayed simultaneously, the detection of the cause can be performed by the combination of display items

Error item	Description	Possible malfunction factor/Action to take
CAN COMM CIRCUIT	CAN communication malfunction is detected.	Perform diagnosis with CONSULT, and then repair the malfunctioning parts according to the diagnosis results. Refer to <a href="#">AV-157, "CONSULT Function"</a> .
CONTROL UNIT (CAN)	CAN initial diagnosis malfunction is detected.	Replace the AV control unit if the malfunction occurs constantly. Refer to <a href="#">AV-265, "Removal and Installation"</a> .
CONTROL UNIT (AV)	AV communication circuit initial diagnosis malfunction is detected.	
FLASH-ROM Error Of Control Unit	AV control unit malfunction is detected.	Replace the AV control unit if the malfunction occurs constantly. Refer to <a href="#">AV-265, "Removal and Installation"</a> .
Connection Of Gyro		
Connection of G Sensor		
CAN Controller Memory Error		
Bluetooth Module Connection Error		
Sub CPU Connection Error		
iPod authentication chip error		
Audio connection error		
DSP Connection Error		
DSP Communication Error	AV control unit malfunction is detected.	<ul style="list-style-type: none"> <li>If a disc can be played, then there is a possibility of the detection of a temporary malfunction.</li> <li>Replace the AV control unit if the malfunction occurs constantly. Refer to <a href="#">AV-265, "Removal and Installation"</a>.</li> </ul>
HDD Connection Error	AV control unit malfunction is detected.	<ul style="list-style-type: none"> <li>If the music box function has no malfunctions, then there is a possibility of the detection of a temporary malfunction.</li> <li>Replace the AV control unit if the malfunction occurs constantly. Refer to <a href="#">AV-265, "Removal and Installation"</a>.</li> </ul>
HDD Read Error		
HDD Write Error		
HDD Communication Error		
HDD Access Error		

# DIAGNOSIS SYSTEM (AV CONTROL UNIT)

< SYSTEM DESCRIPTION >

[BOSE AUDIO WITH NAVIGATION]

Error item	Description	Possible malfunction factor/Action to take
GPS Communication Error	GPS malfunction is detected.	An intermittent error caused by strong radio interference may be detected unless any symptom (GPS reception error, etc.) occurs. Replace the AV control unit if the malfunction occurs constantly. Refer to <a href="#">AV-265, "Removal and Installation"</a> .
GPS ROM Error		
GPS RAM Error		
GPS RTC Error		
Unfinished configuration	The writing of configuration data is incomplete.	Write configuration data with CONSULT. Refer to <a href="#">AV-157, "CONSULT Function"</a> .
USB Controller Communication Error	USB connection malfunction is detected.	Check that the connection to the USB connector is normal.
DVD Mechanism Communication Error	AV control unit malfunction is detected.	<ul style="list-style-type: none"> <li>If DVD can be played, then there is a possibility of the detection of a temporary malfunction.</li> <li>Replace the AV control unit if the malfunction occurs constantly. Refer to <a href="#">AV-265, "Removal and Installation"</a>.</li> </ul>
Steer. Angle Sensor Calibration	Predictive course line center position adjustment of the steering angle sensor is incomplete.	Adjust the predictive course line center position of the steering angle sensor. Refer to <a href="#">AV-157, "CONSULT Function"</a> .
Amplifier Temperature Error	BOSE amp. malfunction is detected.	Replace the BOSE amp. Refer to <a href="#">AV-274, "Removal and Installation"</a> .
Front Display Connection Error	When either one of the following items are detected: <ul style="list-style-type: none"> <li>display unit power supply and ground circuits are malfunctioning.</li> <li>communication circuits between AV control unit and display unit are malfunctioning.</li> </ul>	<ul style="list-style-type: none"> <li>Display unit power supply and ground circuits. Refer to <a href="#">AV-238, "DISPLAY UNIT : Diagnosis Procedure"</a>.</li> <li>Communication circuits between AV control unit and display unit.</li> </ul>
GPS Antenna Error	GPS antenna connection malfunction is detected.	Check the connection of the GPS antenna connector.
XM Antenna Connection Error	Satellite radio antenna connection malfunction is detected.	Satellite radio antenna disconnection.
USB electric current Error	Detection of overcurrent in USB connector.	Check USB harness between the AV control unit and USB connector.
AM/FM antenna amplifier short to ground	Antenna amp. ON signal circuit malfunction is detected.	Antenna amp. ON signal circuit between AV control unit and antenna base.
AM/FM antenna amplifier open		
FL-DOOR WOOFER OUT: open	Malfunction is detected sound signal circuits between BOSE amp. and front door woofer LH.	Sound signal circuits between BOSE amp. and front door woofer LH.
FL-DOOR WOOFER OUT: short		
FL-DOOR WOOFER OUT: short to ground		
FL-DOOR WOOFER OUT: short to battery		
FL-DOOR SQUAWKER OUT: open	When either one of the following items is detected: <ul style="list-style-type: none"> <li>sound signal circuits between BOSE amp. and front door squawker LH are malfunctioning.</li> <li>sound signal circuits between BOSE amp. and tweeter LH are malfunctioning.</li> </ul>	<ul style="list-style-type: none"> <li>Sound signal circuits between BOSE amp. and front door squawker LH.</li> <li>Sound signal circuits between BOSE amp. and tweeter LH.</li> </ul>
FL-DOOR SQUAWKER OUT: short		
FL-DOOR SQUAWKER OUT: short to ground		
FL-DOOR SQUAWKER OUT: short to battery		
FR-DOOR WOOFER OUT: open	Malfunction is detected sound signal circuits between BOSE amp. and front door woofer RH.	Sound signal circuits between BOSE amp. and front door woofer RH.
FR-DOOR WOOFER OUT: short		
FR-DOOR WOOFER OUT: short to ground		
FR-DOOR WOOFER OUT: short to battery		

A  
B  
C  
D  
E  
F  
G  
H  
I  
J  
K  
L  
M  
O  
P

AV

# DIAGNOSIS SYSTEM (AV CONTROL UNIT)

< SYSTEM DESCRIPTION >

[BOSE AUDIO WITH NAVIGATION]

Error item	Description	Possible malfunction factor/Action to take
FR-DOOR SQUAWKER OUT: open	When either one of the following items is detected: • sound signal circuits between BOSE amp. and front door squawker RH are malfunctioning. • sound signal circuits between BOSE amp. and tweeter RH are malfunctioning.	<ul style="list-style-type: none"> <li>• Sound signal circuits between BOSE amp. and front door squawker RH.</li> <li>• Sound signal circuits between BOSE amp. and tweeter RH.</li> </ul>
FR-DOOR SQUAWKER OUT: short		
FR-DOOR SQUAWKER OUT: short to ground		
FR-DOOR SQUAWKER OUT: short to battery		
FC-INST SQUAWKER OUT: open	Malfunction is detected sound signal circuits between BOSE amp. and center speaker.	Sound signal circuits between BOSE amp. and center speaker.
FC-INST SQUAWKER OUT: short		
FC-INST SQUAWKER OUT: short to ground		
FC-INST SQUAWKER OUT: short to battery		
FL-SEAT L-SQUAWKER OUT: open	Malfunction is detected sound signal circuits between BOSE amp. and driver seat speaker LH.	Sound signal circuits between BOSE amp. and driver seat speaker LH.
FL-SEAT L-SQUAWKER OUT: short		
FL-SEAT L-SQUAWKER OUT: short to ground		
FL-SEAT L-SQUAWKER OUT: short to battery		
FL-SEAT R-SQUAWKER OUT: open	Malfunction is detected sound signal circuits between BOSE amp. and driver seat speaker RH.	Sound signal circuits between BOSE amp. and driver seat speaker RH.
FL-SEAT R-SQUAWKER OUT: short		
FL-SEAT R-SQUAWKER OUT: short to ground		
FL-SEAT R-SQUAWKER OUT: short to battery		
FR-SEAT L-SQUAWKER OUT: open	Malfunction is detected sound signal circuits between BOSE amp. and passenger seat speaker LH.	Sound signal circuits between BOSE amp. and passenger seat speaker LH.
FR-SEAT L-SQUAWKER OUT: short		
FR-SEAT L-SQUAWKER OUT: short to ground		
FR-SEAT L-SQUAWKER OUT: short to battery		
FR-SEAT R-SQUAWKER OUT: open	Malfunction is detected sound signal circuits between BOSE amp. and passenger seat speaker RH.	Sound signal circuits between BOSE amp. and passenger seat speaker RH.
FR-SEAT R-SQUAWKER OUT: short		
FR-SEAT R-SQUAWKER OUT: short to ground		
FR-SEAT R-SQUAWKER OUT: short to battery		
RL-DOOR SPEAKER OUT: open	Malfunction is detected sound signal circuits between BOSE amp. and rear door speaker LH.	Sound signal circuits between BOSE amp. and rear door speaker LH.
RL-DOOR SPEAKER OUT: short		
RL-DOOR SPEAKER OUT: short to ground		
RL-DOOR SPEAKER OUT: short to battery		
RR-DOOR SPEAKER OUT: open	Malfunction is detected sound signal circuits between BOSE amp. and rear door speaker RH.	Sound signal circuits between BOSE amp. and rear door speaker RH.
RR-DOOR SPEAKER OUT: short		
RR-DOOR SPEAKER OUT: short to ground		
RR-DOOR SPEAKER OUT: short to battery		



# DIAGNOSIS SYSTEM (AV CONTROL UNIT)

## < SYSTEM DESCRIPTION >

## [BOSE AUDIO WITH NAVIGATION]

Error item	Description	Possible malfunction factor/Action to take
RL-PSHELF SQUAWKER OUT: open	Malfunction is detected sound signal circuits between BOSE amp. and satellite speaker LH.	Sound signal circuits between BOSE amp. and satellite speaker LH.
RL-PSHELF SQUAWKER OUT: short		
RL-PSHELF SQUAWKER OUT: short to ground		
RL-PSHELF SQUAWKER OUT: short to battery		
RC-PSHELF WOOFER OUT: open	Malfunction is detected sound signal circuits between BOSE amp. and rear woofer.	Sound signal circuits between BOSE amp. and rear woofer.
RC-PSHELF WOOFER OUT: short		
RC-PSHELF WOOFER OUT: short to ground		
RC-PSHELF WOOFER OUT: short to battery		
RR-PSHELF SQUAWKER OUT: open	Malfunction is detected sound signal circuits between BOSE amp. and satellite speaker RH.	Sound signal circuits between BOSE amp. and satellite speaker RH.
RR-PSHELF SQUAWKER OUT: short		
RR-PSHELF SQUAWKER OUT: short to ground		
RR-PSHELF SQUAWKER OUT: short to battery		
Compensat. mic IN: open	Malfunction is detected in sound signal circuits between BOSE amp. and either front or rear microphone.	Sound signal circuits between BOSE amp. and front or rear microphone.
Compensat. mic IN: short		
Compensat. mic IN: short to ground		
Compensat. mic IN: short to battery		
<ul style="list-style-type: none"> <li>• AV COMM CIRCUIT</li> <li>• Switches Connection Error</li> </ul>	When either one of the following items are detected: <ul style="list-style-type: none"> <li>• multifunction switch power supply and ground circuits are malfunctioning.</li> <li>• AV communication circuits between AV control unit and multifunction switch are malfunctioning.</li> </ul>	<ul style="list-style-type: none"> <li>• Multifunction switch power supply and ground circuits.</li> <li>• AV communication circuits between AV control unit and multifunction switch.</li> </ul>
<ul style="list-style-type: none"> <li>• AV COMM CIRCUIT</li> <li>• Amplifier Connection Error</li> </ul>	When either one of the following items are detected: <ul style="list-style-type: none"> <li>• BOSE amp. power supply and ground circuits are malfunctioning.</li> <li>• AV communication circuits between multifunction switch and BOSE amp. are malfunctioning.</li> </ul>	<ul style="list-style-type: none"> <li>• BOSE amp. power supply and ground circuits. Refer to <a href="#">AV-239, "BOSE AMP. : Diagnosis Procedure"</a>.</li> <li>• AV communication circuits between multifunction switch and BOSE amp.</li> </ul>
<ul style="list-style-type: none"> <li>• AV COMM CIRCUIT</li> <li>• Switches Connection Error</li> <li>• Amplifier Connection Error</li> </ul>	AV communication circuits between AV control unit and multifunction switch are malfunctioning.	AV communication circuits between AV control unit and multifunction switch.

### Vehicle CAN Diagnosis

- CAN communication status and error counter is displayed.
- The error counter displays "OK" if any malfunction was not detected in the past and displays "0" if a malfunction is detected. It increases by 1 if the condition is normal at the next ignition switch ON cycle. The upper limit of the counter is 39.
- The error counter is erased if "Reset" is pressed.

Items	Display (Current)	Malfunction counter (Past)
Tx(HVAC)	OK / ???	OK / 0 - 39
Rx(ECM)	OK / ???	OK / 0 - 39
Rx(Cluster)	OK / ???	OK / 0 - 39

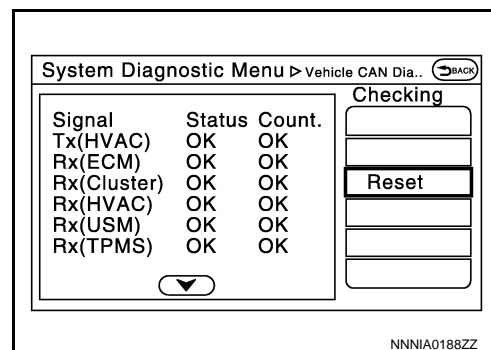

# DIAGNOSIS SYSTEM (AV CONTROL UNIT)

[BOSE AUDIO WITH NAVIGATION]

## < SYSTEM DESCRIPTION >

Items	Display (Current)	Malfunction counter (Past)
Rx(HVAC)	OK / ???	OK / 0 – 39
Rx(USM)	OK / ???	OK / 0 – 39
Rx(TPMS)	OK / ???	OK / 0 – 39
Rx(STRG)	OK / ???	OK / 0 – 39
Rx(ACC)	OK / ???	OK / 0 – 39
Rx(AT)	OK / ???	OK / 0 – 39

### NOTE:

“???” indicates UNKWN.

### AV COMM Diagnosis

- Displays the communication status between AV control unit (master unit) and each unit.
- The error counter displays “OK” if any malfunction was not detected in the past and displays “0” if a malfunction is detected. It increases by 1 if the condition is normal at the next ignition switch ON cycle. The upper limit of the counter is 39.
- The error counter is erased if “Reset” is pressed.

Items	Status (Current)	Counter (Past)
C Tx(ITM-PrimarySW)	OK / ???	OK / 0 – 39
C Rx(PrimarySW-ITM)	OK / ???	OK / 0 – 39
C Rx(Amp-ITM)	OK / ???	OK / 0 – 39
C Rx(Amp-Audio)	OK / ???	OK / 0 – 39

### NOTE:

“???” indicates UNKWN

### Hands-Free Phone

The hands-free phone reception volume adjustment and microphone and speaker test functions are also available.

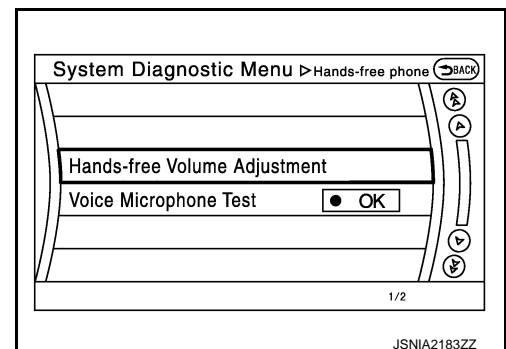
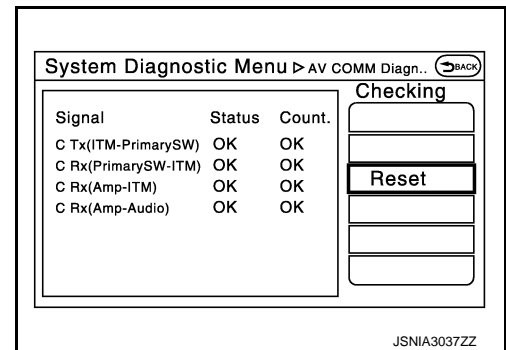

### Camera

The four functions of “Correct Draw Line of Rear view Camera”, “Alter/Confirm Configuration”, “Reset Configuration” and “Camera Syst Type” are available.

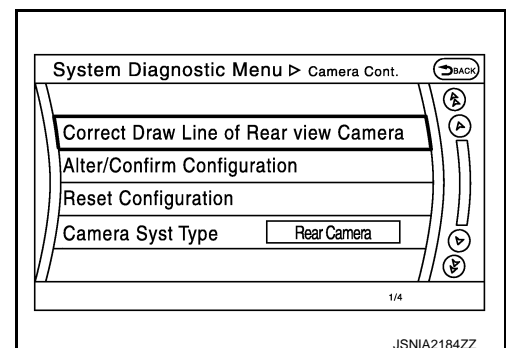

Correct Draw Line of Rear view Camera

# DIAGNOSIS SYSTEM (AV CONTROL UNIT)

[BOSE AUDIO WITH NAVIGATION]

## < SYSTEM DESCRIPTION >

- Use this mode to adjust the guide line display position of the rear view monitor if necessary after removing the rear view monitor camera.

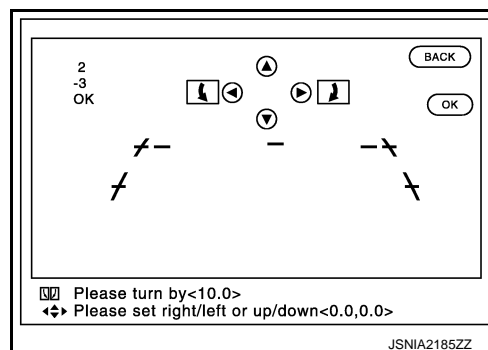

### Alter/Confirm Configuration

- Configuration stored in the AV control unit can be checked and modified.

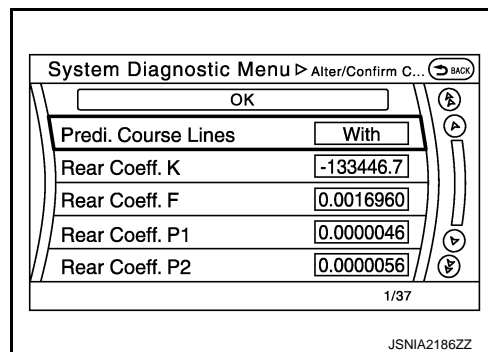

### Configuration list

Setting item	Setting		Setting item	Setting	
	Without 4WAS	With 4WAS		Without 4WAS	With 4WAS
Predi. Course Lines	With		Wheelbase	2.9000001	
Rear Coeff. K	-38009.06		Total Length	4.9489002	
Rear Coeff. F	0.0014260		Steering Gear Ratio	16.704000	13.464000
Rear Coeff. P1	0.0000062		Side Coeff. K	0.0000000	
Rear Coeff. P2	0.0000056		Side Coeff. F	0.0000000	
Rear Coeff. C1	823.00000		Side Coeff. P1	0.0000000	
Rear Coeff. C2	480.00000		Side Coeff. P2	0.0000000	
Rear Coeff. D1	800.00000		Side Coeff. C1	0.0000000	
Rear Coeff. D2	494.00000		Side Coeff. C2	0.0000000	
Car Width	1.8479000		Side Coeff. D1	0.0000000	
Rear Offset	0.0330000		Side Coeff. D2	0.0000000	
Rear Height	0.9336000		Side Offset	0.0000000	
Rear L/R Angle	0.0000000		Overall Height	0.0000000	
Rear Up/Dn Angle	48.830001		Side L/R Angle	0.0000000	
Rear Roll Angle	0.0000000		Side Up/Dn Angle	0.0000000	
Bumper Rear Dist.	0.1230000		Side Roll Angle	0.0000000	
Bumper Rear Ax Dist	1.1476001		Side Front End Dist	0.0000000	
Steer. Max Angle	524.33856	422.63496	Total Width	0.0000000	
Min. Turning Red.	5.3000002		—	—	

### Reset Configuration

# DIAGNOSIS SYSTEM (AV CONTROL UNIT)

## [BOSE AUDIO WITH NAVIGATION]

### < SYSTEM DESCRIPTION >

- Configuration stored in the AV control unit can be initialized.

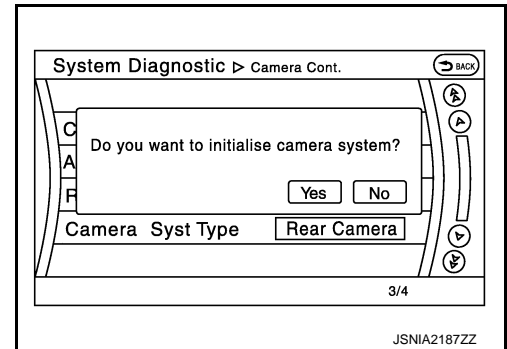

#### Camera Syst Type

- Type of camera system is selectable.

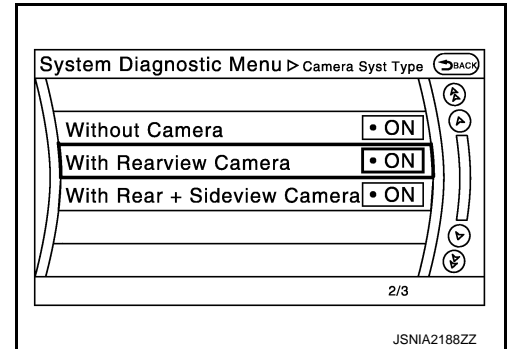

#### XM

- Change Channel
  - Any necessary channels required to receive traffic information from the satellite radio system can be set.
- Change Application ID
  - Any application ID's required to receive traffic information from the satellite radio system can be set.

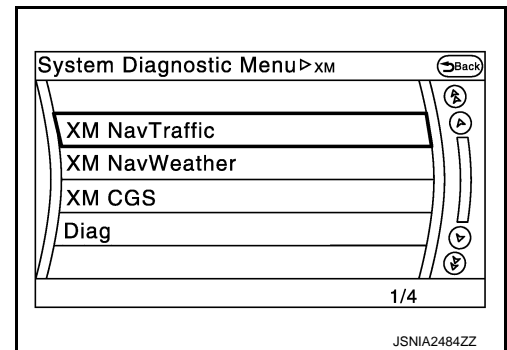

#### Delete Unit Connection Log

Deletes any unit connection records and error records from the AV control unit memory. (Clear the records of the unit that has been removed.)

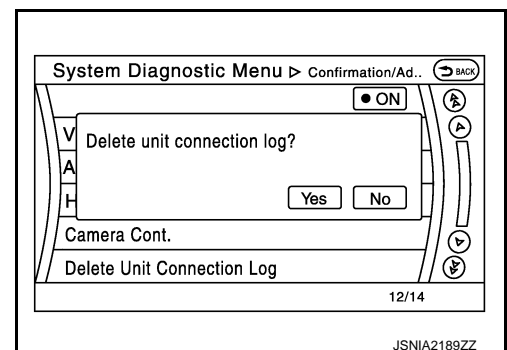

#### Initialize Settings

# DIAGNOSIS SYSTEM (AV CONTROL UNIT)

[BOSE AUDIO WITH NAVIGATION]

< SYSTEM DESCRIPTION >

“User Data Initialization” and “Accessory Number Initialization” are possible.

**CAUTION:**

- Never perform Accessory Number Initialization except when configuration is unsuccessful.
- Accessory Number Initialization requires configuration. For details, refer to [AV-194, "Description"](#).

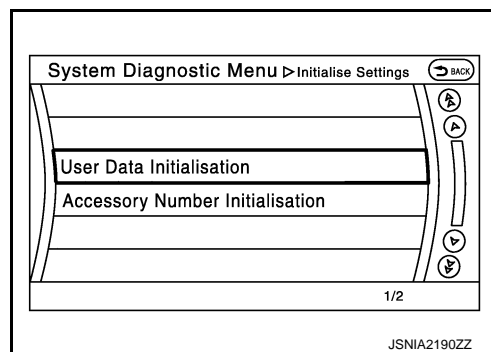

Version Information

Version information of the AV control unit is displayed.

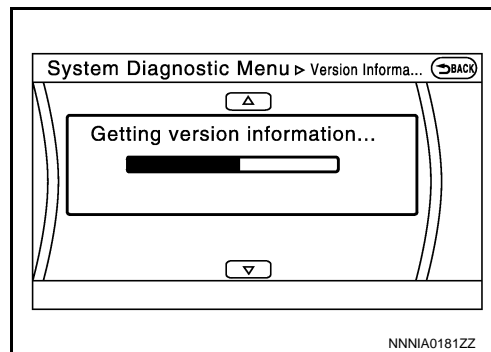

## CONSULT Function

INFOID:000000008130830

## APPLICATION ITEMS

CONSULT performs the following functions via the communication with the AV control unit.

Diagnosis mode	Description
Ecu Identification	The part number of AV control unit can be checked.
Self Diagnostic Result	Performs a diagnosis on the AV control unit and a connection diagnosis for the communication circuit of the Multi AV system, and displays the current and past malfunctions collectively.
Data Monitor	The diagnosis of vehicle signal that is input to the AV control unit can be performed.
Work Support	Steering angle sensor can be adjusted.
Configuration	<ul style="list-style-type: none"> <li>• Read and save the vehicle specification.</li> <li>• Write the vehicle specification when replacing AV control unit.</li> </ul>

AV communication

When “AV communication” of “CAN Diag Support Monitor” is selected, the following function will be performed.

AV communication	AV&NAVI C/U	Displays the communication status from AV control unit to each unit as well as the error counter.
	AUDIO	Displays the AV control unit communication status and the error counter.

## ECU IDENTIFICATION

The part number of AV control unit is displayed.

## SELF DIAGNOSIS RESULT

- In CONSULT self-diagnosis, self-diagnosis results and error history are displayed collectively.
- The current malfunction indicates “CRNT”. The past malfunction indicates “PAST”.
- The timing is displayed as “0” if any of the error codes [U1000], [U1010], [U1300] and [U1310] is detected. The counter increases by 1 if the condition is normal at the next ignition switch ON cycle.

Self-diagnosis Results Display Item

# DIAGNOSIS SYSTEM (AV CONTROL UNIT)

< SYSTEM DESCRIPTION >

[BOSE AUDIO WITH NAVIGATION]

Error item	Description	Possible malfunction factor/Action to take
CAN COMM CIRCUIT [U1000]	CAN communication malfunction is detected.	Refer to <a href="#">AV-196, "Diagnosis Procedure"</a> .
CONTROL UNIT (CAN) [U1010]	CAN initial diagnosis malfunction is detected.	Replace the AV control unit if the malfunction occurs constantly. Refer to <a href="#">AV-265, "Removal and Installation"</a> .
CONTROL UNIT (AV) [U1310]	AV communication circuit initial diagnosis malfunction is detected.	
Cont Unit [U1200]	AV control unit malfunction is detected.	
GYRO NO CONN [U1201]		
G-SENSOR NO CONN [U1202]		
CAN CONT [U1216]		
BLUETOOTH MODULE [U1217]		
SUB CPU CONN [U1228]		
iPod CERTIFICATION [U1229]		
Built-in AUDIO CONN [U122E]		
HDD CONN [U1218]	AV control unit malfunction is detected.	<ul style="list-style-type: none"> <li>• If the music box function has no malfunctions, then there is a possibility of the detection of a temporary malfunction.</li> <li>• Replace the AV control unit if the malfunction occurs constantly. Refer to <a href="#">AV-265, "Removal and Installation"</a>.</li> </ul>
HDD READ [U1219]		
HDD WRITE [U121A]		
HDD COMM [U121B]		
HDD ACCESS [U121C]		
GPS COMM [U1204]	GPS malfunction is detected.	An intermittent error caused by strong radio interference may be detected unless any symptom (GPS reception error, etc.) occurs. Replace the AV control unit if the malfunction occurs constantly. Refer to <a href="#">AV-265, "Removal and Installation"</a> .
GPS ROM [U1205]		
GPS RAM [U1206]		
GPS RTC [U1207]		
USB CONTROLLER [U1225]	USB connection malfunction is detected.	Check that the connection to the USB connector is normal.
DSP CONN [U121D]	AV control unit malfunction is detected.	<ul style="list-style-type: none"> <li>• If a disc can be played, then there is a possibility of the detection of a temporary malfunction.</li> <li>• Replace the AV control unit if the malfunction occurs constantly. Refer to <a href="#">AV-265, "Removal and Installation"</a>.</li> </ul>
DSP COMM [U121E]		
DVD COMM [U1227]	AV control unit malfunction is detected.	<ul style="list-style-type: none"> <li>• If DVD can be played, then there is a possibility of the detection of a temporary malfunction.</li> <li>• Replace the AV control unit if the malfunction occurs constantly. Refer to <a href="#">AV-265, "Removal and Installation"</a>.</li> </ul>
CONFIG UNFINISH [U122A]	The writing of configuration data is incomplete.	Write configuration data with CONSULT. Refer to <a href="#">AV-193, "Description"</a> .
AMP TEMP [U1231]	BOSE amp. malfunction is detected.	Replace the BOSE amp. if the malfunction occurs constantly. Refer to <a href="#">AV-274, "Removal and Installation"</a> .
ST ANGLE SEN CALIB [U1232]	Predictive course line center position adjustment of the steering angle sensor is incomplete.	Adjust the predictive course line center position of the steering angle sensor. Refer to <a href="#">BRC-60, "Work Procedure"</a> .

# DIAGNOSIS SYSTEM (AV CONTROL UNIT)

< SYSTEM DESCRIPTION >

[BOSE AUDIO WITH NAVIGATION]

Error item	Description	Possible malfunction factor/Action to take
FRONT DISP CONN [U1243]	When either one of the following items are detected: <ul style="list-style-type: none"> <li>• display unit power supply and ground circuits are malfunctioning.</li> <li>• communication circuits between AV control unit and display unit are malfunctioning.</li> </ul>	<ul style="list-style-type: none"> <li>• Display unit power supply and ground circuits. Refer to <a href="#">AV-238, "DISPLAY UNIT : Diagnosis Procedure"</a>.</li> <li>• Communication circuits between AV control unit and display unit.</li> </ul>
GPS ANTENNA CONN [U1244]	GPS antenna connection malfunction is detected.	Check the connection of the GPS antenna connector.
XM ANTENNA CONN [U1258]	Satellite radio antenna connection malfunction is detected.	Satellite radio antenna disconnection.
USB OVERCURRENT [U1263]	Detection of overcurrent in USB connector.	Check USB harness between the AV control unit and USB connector.
ANTENNA AMP TERMINAL [OPEN or SHORT] [U1264]	Antenna amp. ON signal circuit malfunction is detected.	Antenna amp. ON signal circuit between AV control unit and antenna base.
FL-DOOR WOOFER [OPEN, SHORT, GND-SHORT or VB-SHOR] [U1601]	Malfunction is detected sound signal circuits between BOSE amp. and front door woofer LH.	Sound signal circuits between BOSE amp. and front door woofer LH.
FL-DOOR SQUAWK [OPEN, SHORT, GND-SHORT or VB-SHOR] [U1602]	When either one of the following items are detected: <ul style="list-style-type: none"> <li>• sound signal circuits between BOSE amp. and front door squawker LH are malfunctioning.</li> <li>• sound signal circuits between BOSE amp. and tweeter LH are malfunctioning.</li> </ul>	<ul style="list-style-type: none"> <li>• Sound signal circuits between BOSE amp. and front door squawker LH.</li> <li>• Sound signal circuits between BOSE amp. and tweeter LH.</li> </ul>
FR-DOOR WOOFER [OPEN, SHORT, GND-SHORT or VB-SHOR] [U1609]	Malfunction is detected sound signal circuits between BOSE amp. and front door woofer RH.	Sound signal circuits between BOSE amp. and front door woofer RH.
FR-DOOR SQAWK [OPEN, SHORT, GND-SHORT or VB-SHOR] [U160A]	When either one of the following items are detected: <ul style="list-style-type: none"> <li>• sound signal circuits between BOSE amp. and front door squawker RH are malfunctioning.</li> <li>• sound signal circuits between BOSE amp. and tweeter RH are malfunctioning.</li> </ul>	<ul style="list-style-type: none"> <li>• Sound signal circuits between BOSE amp. and front door squawker RH.</li> <li>• Sound signal circuits between BOSE amp. and tweeter RH.</li> </ul>
F-INST C-SQAWK [OPEN, SHORT, GND-SHORT or VB-SHOR] [U162A]	Malfunction is detected sound signal circuits between BOSE amp. and center speaker.	Sound signal circuits between BOSE amp. and center speaker.
FL-SEAT L-SQAWK [OPEN, SHORT, GND-SHORT or VB-SHOR] [U1632]	Malfunction is detected sound signal circuits between BOSE amp. and driver seat speaker LH.	Sound signal circuits between BOSE amp. and driver seat speaker LH.
FL-SEAT R-SQAWK [OPEN, SHORT, GND-SHORT or VB-SHOR] [U163A]	Malfunction is detected sound signal circuits between BOSE amp. and driver seat speaker RH.	Sound signal circuits between BOSE amp. and driver seat speaker RH.
FR-SEAT L-SQAWK [OPEN, SHORT, GND-SHORT or VB-SHOR] [U163E]	Malfunction is detected sound signal circuits between BOSE amp. and passenger seat speaker LH.	Sound signal circuits between BOSE amp. and passenger seat speaker LH.
RL-DOOR SPEAKER [OPEN, SHORT, GND-SHORT or VB-SHOR] [U1708]	Malfunction is detected sound signal circuits between BOSE amp. and rear door speaker LH.	Sound signal circuits between BOSE amp. and rear door speaker LH.
RR-DOOR SPEAKER [OPEN, SHORT, GND-SHORT or VB-SHOR] [U1710]	Malfunction is detected sound signal circuits between BOSE amp. and rear door speaker RH.	Sound signal circuits between BOSE amp. and rear door speaker RH.

A  
B  
C  
D  
E  
F  
G  
H  
I  
J  
K  
L  
M  
O  
P

AV

# DIAGNOSIS SYSTEM (AV CONTROL UNIT)

< SYSTEM DESCRIPTION >

[BOSE AUDIO WITH NAVIGATION]

Error item	Description	Possible malfunction factor/Action to take
R-PSHELF C-WOOFER [OPEN, SHORT, GND-SHORT or VB-SHOR] [U1725]	Malfunction is detected sound signal circuits between BOSE amp. and rear woofer.	Sound signal circuits between BOSE amp. and rear woofer.
CORRECT MICROPHONE [OPEN, SHORT, GND-SHORT or VB-SHOR] [U190C]	Malfunction is detected in sound signal circuits between BOSE amp. and either front or rear microphone.	Sound signal circuits between BOSE amp. and front or rear microphone.
<ul style="list-style-type: none"> <li>AV COMM CIRCUIT [U1300]</li> <li>SWITCH CONN [U1240]</li> </ul>	When either one of the following items are detected: <ul style="list-style-type: none"> <li>multifunction switch power supply and ground circuits are malfunctioning.</li> <li>AV communication circuits between AV control unit and multifunction switch are malfunctioning.</li> </ul>	<ul style="list-style-type: none"> <li>Multifunction switch power supply and ground circuits.</li> <li>AV communication circuits between AV control unit and multifunction switch.</li> </ul>
<ul style="list-style-type: none"> <li>AV COMM CIRCUIT [U1300]</li> <li>AMP CONN [U124E]</li> </ul>	When either one of the following items are detected: <ul style="list-style-type: none"> <li>BOSE amp. power supply and ground circuits are malfunctioning.</li> <li>AV communication circuits between multifunction switch and BOSE amp. are malfunctioning.</li> </ul>	<ul style="list-style-type: none"> <li>BOSE amp. power supply and ground circuits. Refer to <a href="#">AV-239, "BOSE AMP. : Diagnosis Procedure"</a>.</li> <li>AV communication circuits between multifunction switch and BOSE amp.</li> </ul>
<ul style="list-style-type: none"> <li>AV COMM CIRCUIT [U1300]</li> <li>SWITCH CONN [U1240]</li> <li>AMP CONN [U124E]</li> </ul>	AV communication circuits between AV control unit and multifunction switch are malfunctioning.	AV communication circuits between AV control unit and multifunction switch.

## DATA MONITOR

### NOTE:

The following table includes information (items) inapplicable to this vehicle. For information (items) applicable to this vehicle, refer to CONSULT display items.

### ALL SIGNALS

- Displays the status of the following vehicle signals inputted into the AV control unit.
- For each signal, actual signal can be compared with the condition recognized on the system.

Display Item	Display	Vehicle status	Remarks	
VHCL SPD SIG	On	Vehicle speed > 0 km/h (0 MPH)	Changes in indication may be delayed. This is normal.	
	Off	Vehicle speed = 0 km/h (0 MPH)		
PKB SIG	On	Parking brake is applied.		
	Off	Parking brake is released.		
ILLUM SIG	On	Block the light beam from the auto light optical sensor when the light switch is ON.	—	
	Off	Either of the following conditions <ul style="list-style-type: none"> <li>Lighting switch OFF</li> <li>Expose the auto light optical sensor to light when the light switch is ON.</li> </ul>		
IGN SIG	On	Ignition switch ON		
	Off	Ignition switch in ACC position		
REV SIG	On	Selector lever in R position		Changes in indication may be delayed. This is normal.
	Off	Selector lever in any position other than R		
SIDE VIEW SW	Off	—	This item is displayed, but cannot be monitored.	
ROOM LAMP	Off	—	This item is displayed, but cannot be monitored.	

## SELECTION FROM MENU



## DIAGNOSIS SYSTEM (AV CONTROL UNIT)

[BOSE AUDIO WITH NAVIGATION]

### < SYSTEM DESCRIPTION >

Allows the technician to select which vehicle signals should be displayed and displays the status of the selected vehicle signals.

Item to be selected	Description
VHCL SPD SIG	The same as when "ALL SIGNALS" is selected.
PKB SIG	
ILLUM SIG	
IGN SIG	
REV SIG	
SIDE VIEW SW	
ROOM LAMP	

### WORK SUPPORT

Adjusts the neutral position of the steering angle sensor.

#### **CAUTION:**

**For vehicles with VDC, adjust the steering angle sensor neutral position on the ABS actuator control unit side. Refer to [BRC-60, "Work Procedure"](#).**

Item	Description
ST ANGLE SENSOR ADJUSTMENT	Adjusts the neutral position of the steering angle sensor.

### CONFIGURATION

Configuration has three functions as follows.

Function	Description
Read/Write Configuration	Before Replace ECU Allows the reading of vehicle specification written in AV control unit to store the specification in CONSULT.
	After Replace ECU Allows the writing of the vehicle information stored in CONSULT into the AV control unit.
Manual Configuration	Allows the writing of the vehicle specification into the AV control unit by hand.

A  
B  
C  
D  
E  
F  
G  
H  
I  
J  
K  
L  
M  
O  
P

AV

## **DIAGNOSIS SYSTEM [BOSE AMP.(ACTIVE NOISE CONTROL SYSTEM)]**

< SYSTEM DESCRIPTION >

**[BOSE AUDIO WITH NAVIGATION]**

---

## **DIAGNOSIS SYSTEM [BOSE AMP.(ACTIVE NOISE CONTROL SYSTEM)]**

### **On Board Diagnosis Function**

*INFOID:000000008130831*

#### **ON BOARD DIAGNOSIS ITEM**

Starting with the operation of the door switch, the Self-diagnosis function allows the diagnoses of the active noise control unit internal circuit, the input state of each signal, and a microphone connection state. The diagnosis results are indicated by a sound.

#### **METHOD OF STARTING**

# DIAGNOSIS SYSTEM [BOSE AMP.(ACTIVE NOISE CONTROL SYSTEM)]

[BOSE AUDIO WITH NAVIGATION]

## < SYSTEM DESCRIPTION >

Perform Self-diagnosis, according to the following steps:

Step	Check Item	Operation	Judgment	Output sound pattern ( : MAX :100dB. : No sound, □ : 1 cycle)	Next Step	Remarks
-	Preparation	Turn on the radio to check that the speakers are normal.	-		1	All self-diagnosis results are notified by the output sound from the speaker.
1	Self-diagnosis mode startup	Within 5 seconds after starting the engine with all doors except the one on the driver seat side closed, press the door switch 6 times or more during a time interval of 4 seconds.	-		2	* Specially, within 3 seconds after turning the ignition switch to ACC. When starting self-diagnosis after turning the ignition switch to ACC, self-diagnosis can be started by turning the ignition switch to ACC without starting the engine. In this case, the judgment performed at Step 2 becomes NG because engine pulse cannot be detected.
2	Diagnoses of engine speed signal and the microphone for active noise control system	Identify a sound heard after the notification sound (Step 1).	OK		3	* If NG, a beep is heard for 30 seconds after 10-second-silence.
3	Checking the judgment result of the number of cylinders	Identify a sound (Step 2).	6-cylinder engine 8-cylinder engine	x MAX 40 cycles x MAX 40 cycles	4	A beep sounds for 60 seconds at maximum in either case. (1 cycle for approx. 1.3 sec. x 40 cycles)
4	(Interruption of cylinder judge result notification sound)	Press the door switch 6 times or more during a time interval of 4 seconds.	-	1 cycle only	5	The same sound is heard after a lapse of 60 seconds without pressing the door switch. (1 cycle only)
5	Sample sound for the active noise control system	Identify a notification sound (Step 3).	-		6	A sample sound (heard for 20 seconds at maximum) after an ON/OFF effect of the active noise control system is initiated. (1 cycle for approx. 4 seconds x 5 cycles)
6	End of self-diagnosis	Press the door switch 6 times or more during a time interval of 4 seconds while prolonged sound is ringing. Wait for 20 seconds until the sound stops.	-	1 cycle only	End of diagnosis	After the completion of self-diagnosis, the active noise control system starts normal operation. (1 cycle only)
7	Start of malfunctioning part judgment (1) or end of self-diagnosis (2)	(1) Within 30 seconds while the prolonged sound is ringing (Step 2), press the door switch 6 times or more during a time interval of 4 seconds. (2) Wait for 30 seconds until the prolonged sound stops.	-	1 cycle only	8	After the completion of self-diagnosis, the active noise control system starts normal operation. (1 cycle only)
8	Active noise control system microphone check	Identify the sound pattern.	Front microphone: OK Rear microphone: OK Front microphone: NG Rear microphone: OK Front microphone: OK Rear microphone: NG Front microphone: NG Rear microphone: NG	x MAX 4 cycles x MAX 4 cycles x MAX 4 cycles x MAX 4 cycles	9	A beep sounds for 60 seconds at maximum in either case. (1 cycle for approx. 4.2 sec. x 14 cycles)
9	Start of self-diagnosis for engine speed signal (1) or end of self-diagnosis (2)	(1) Within 60 seconds while the prolonged sound is ringing, press the door switch 6 times or more during a time interval of 4 seconds. (2) Wait for 60 seconds until the prolonged sound stops.	-	1 cycle only	10	After the completion of self-diagnosis, the active noise control system starts normal operation. (1 cycle only)
10	Engine speed signal check	Identify the sound pattern.	OK	x MAX 80 cycles	11	A beep sounds for 60 seconds at maximum in either case. (1 cycle for approx. 0.75 sec. x 80 cycles)
11	End of self-diagnosis	Press the door switch 6 times or more during a time interval of 4 seconds. Wait for 60 seconds until the prolonged sound stops.	-	1 cycle only	End of diagnosis	A beep is heard for 60 seconds after 10-second-silence. After the completion of self-diagnosis, the active noise control system starts normal operation. (1 cycle only)

J5N1A3067GB

- When a sound is not outputted from the speakers as a result of the preparation, check the AV control unit, BOSE amp., connector connections, or speakers.
- When Self-diagnosis mode does not start at Step 1, check the door state signal circuit.
- When a malfunction is detected in the microphone at Step 8, check the signal circuit of each microphone.
- When the actual number of cylinders is different from the diagnosis sound of the cylinder identification, check the cylinder identification signal circuit.

A  
B  
C  
D  
E  
F  
G  
H  
I  
J  
K  
L  
M  
N  
O  
P

AV

# AV CONTROL UNIT

< ECU DIAGNOSIS INFORMATION >

[BOSE AUDIO WITH NAVIGATION]

## ECU DIAGNOSIS INFORMATION

### AV CONTROL UNIT

#### Reference Value

INFOID:000000008130832

#### VALUES ON THE DIAGNOSIS TOOL

##### NOTE:

The following table includes information (items) inapplicable to this vehicle. For information (items) applicable to this vehicle, refer to CONSULT display items.

##### CONSULT MONITOR ITEM

Monitor Item	Condition	Value/Status
VHCL SPD SIG	Ignition switch ON Vehicle speed > 0 km/h (0 MPH)	On
	Vehicle speed = 0 km/h (0 MPH)	Off
PKB SIG	Ignition switch ON Parking brake is applied.	On
	Parking brake is released.	Off
ILLUM SIG	Ignition switch ON Block the light beam from the auto light optical sensor when the light switch is ON.	On
	Expose the auto light optical sensor to light when the light switch is OFF or ON.	Off
IGN SIG	Ignition switch ON —	On
	Ignition switch ACC —	Off
REV SIG	Ignition switch ON Selector lever in R position	On
	Selector lever in any position other than R	Off
SIDE VIEW SW*	Ignition switch ON —	Off
ROOM LAMP*	Ignition switch ON —	Off

\*: This item is displayed, but cannot be monitored.

#### TERMINAL LAYOUT

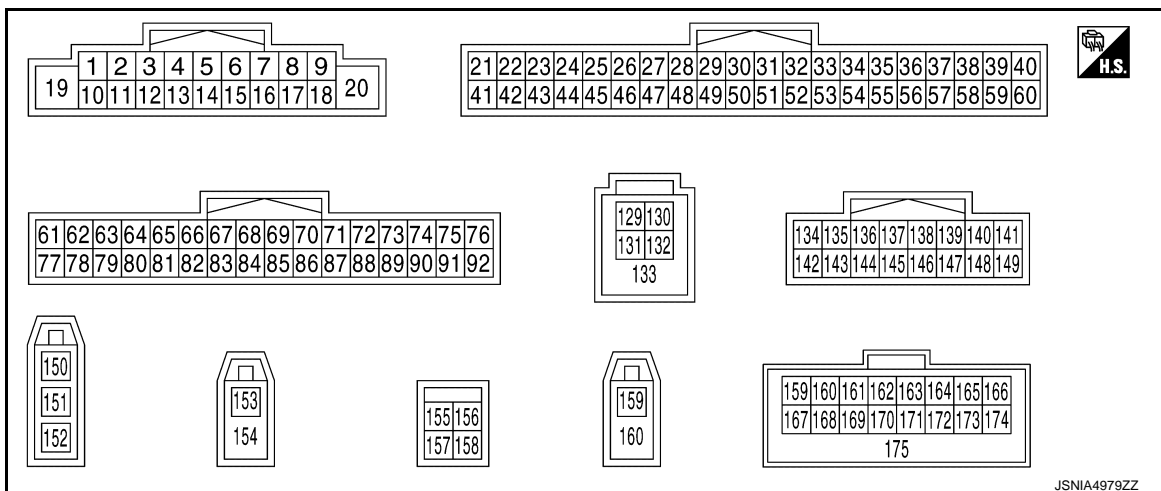



#### PHYSICAL VALUES

# AV CONTROL UNIT

< ECU DIAGNOSIS INFORMATION >

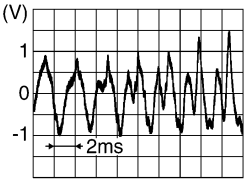
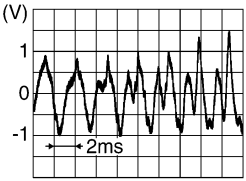
[BOSE AUDIO WITH NAVIGATION]

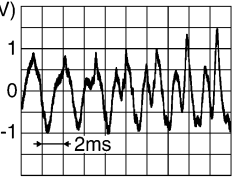
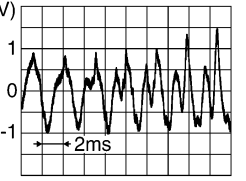

Terminal (Wire color)		Description		Condition		Reference value (Approx.)
+	-	Signal name	Input/ Output			
2 (L)	3 (P)	Sound signal front LH	Output	Ignition switch ON	Sound output	 <p style="text-align: right; font-size: small;">SKIB3609E</p>
4 (V)	5 (LG)	Sound signal rear LH	Output	Ignition switch ON	Sound output	 <p style="text-align: right; font-size: small;">SKIB3609E</p>
6 (P)	15 (B)	Steering switch signal A	Input	Ignition switch ON	Keep pressing SOURCE switch.	0 V
					Keep pressing MENU UP switch.	1.0 V
					Keep pressing MENU DOWN switch.	2.0 V
					Keep pressing  switch	3.0 V
					Keep pressing ENTER switch.	4.0 V
					Except for above.	5.0 V
7 (V)	Ground	ACC power supply	Input	Ignition switch ACC	—	Battery voltage
10	—	Shield	—	—	—	—
11 (G)	12 (R)	Sound signal front RH	Output	Ignition switch ON	Sound output	 <p style="text-align: right; font-size: small;">SKIB3609E</p>
13 (BR)	14 (GR)	Sound signal rear RH	Output	Ignition switch ON	Sound output	 <p style="text-align: right; font-size: small;">SKIB3609E</p>

A  
B  
C  
D  
E  
F  
G  
H  
I  
J  
K  
L  
M  
AV  
O  
P

# AV CONTROL UNIT

< ECU DIAGNOSIS INFORMATION >

[BOSE AUDIO WITH NAVIGATION]

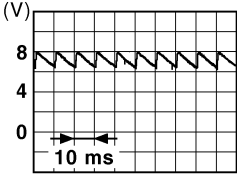
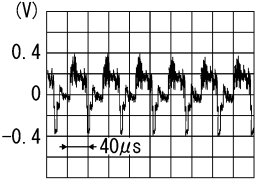
Terminal (Wire color)		Description		Condition		Reference value (Approx.)
+	-	Signal name	Input/ Output			
16 (L)	15 (B)	Steering switch signal B	Input	Ignition switch ON	Keep pressing VOL DOWN switch.	0 V
					Keep pressing VOL UP switch.	1.0 V
					Keep pressing  switch.	2.0 V
					Keep pressing  switch.	3.0 V
					Except for above.	5.0 V
19 (Y)	Ground	Battery power supply	Input	Ignition switch OFF	—	Battery voltage
20 (B)	Ground	Ground	—	Ignition switch ON	—	0 V
22 (W)	Ground	Camera power supply	Output	Ignition switch ON	At rear view camera image is displayed.	6.0 V
					Except for above.	0 V
29 (SB)	Ground	Disk eject signal	Input	Ignition switch ON	Pressing the eject switch.	0 V
					Except for above.	5.0 V
42 (B)	Ground	Camera ground	—	Ignition switch ON	—	0 V
49 (BR)	Ground	Switch ground	—	Ignition switch ON	—	0 V
65 (V)	Ground	Parking brake signal	Input	Ignition switch ON	Parking brake is ON.	0 V
					Parking brake is OFF.	 <p style="text-align: right; font-size: small;">JSNIA0007GB</p>
67 (R)	Ground	Composite image ground	—	Ignition switch ON	—	0 V
68 (W)	Ground	Composite image signal	Output	Ignition switch ON	At DVD image is displayed.	 <p style="text-align: right; font-size: small;">SKIB2251J</p>
69 (G)	Ground	Intelligent key identification signal	Input	Ignition switch ACC	At door unlock Key 1.	5.0 V
					At door unlock Key 2.	0 V
70	—	—	—	—	—	—
71	—	Shield (microphone ground)	—	—	—	—

# AV CONTROL UNIT

< ECU DIAGNOSIS INFORMATION >

[BOSE AUDIO WITH NAVIGATION]

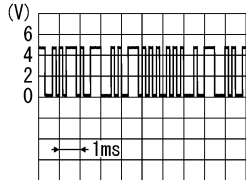
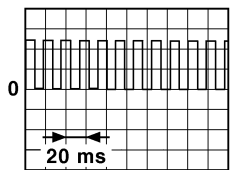
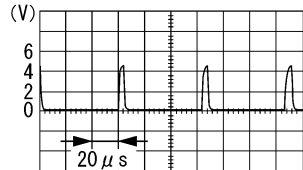
Terminal (Wire color)		Description		Condition		Reference value (Approx.)
+	-	Signal name	Input/ Output			
72 (G)	Ground	Microphone VCC	Output	Ignition switch ON	—	5.0 V
73 (BR)	Ground	Communication signal (CONT→DISP)	Output	Ignition switch ON	When adjusting display brightness.	 <p style="text-align: right; font-size: small;">PKIB5039J</p>
74 (P)	—	CAN-L	Input/ Output	—	—	—
75 (LG)	—	AV communication signal (L)	Input/ Output	—	—	—
76 (LG)	—	AV communication signal (L)	Input/ Output	—	—	—
79 (SB)	Ground	Dimmer signal	Input	Ignition switch ON	Either of the following con- ditions	0 V
					<ul style="list-style-type: none"> <li>• Lighting switch OFF</li> <li>• Expose the auto light opti- cal sensor to light when the light switch is ON.</li> </ul>	12.0 V
80 (W)	Ground	Ignition signal	Input	Ignition switch ON	—	Battery voltage
81 (BG)	Ground	Reverse signal	Input	Ignition switch ON	R position	12.0 V
					Other than R position	0 V
82 (R)	Ground	Vehicle speed signal (8-pulse)	Input	Ignition switch ON	When vehicle speed is ap- prox. 40 km/h (25 MPH)	<p><b>NOTE:</b> The maximum voltage varies de- pending on the specification (destination unit).</p>  <p style="text-align: right; font-size: small;">JSNIA0012GB</p>
83	—	Shield	—	—	—	—
84 (B)	Ground	Composite synchronizing signal	Output	Ignition switch ON	At DVD image is displayed	 <p style="text-align: right; font-size: small;">SKIA0187E</p>

A  
B  
C  
D  
E  
F  
G  
H  
I  
J  
K  
L  
M  
O  
P

AV

# AV CONTROL UNIT

< ECU DIAGNOSIS INFORMATION >

[BOSE AUDIO WITH NAVIGATION]

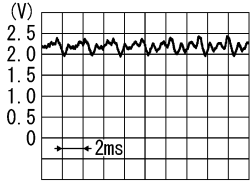
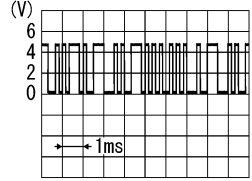
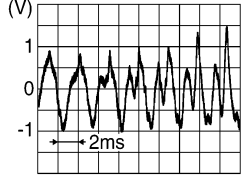
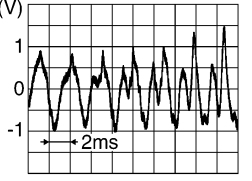
Terminal (Wire color)		Description		Condition		Reference value (Approx.)
+	-	Signal name	Input/ Output			
87 (R)	71	Microphone signal	Input	Ignition switch ON	Give a voice	 <p style="text-align: right; font-size: small;">PKIB5037J</p>
88	—	Shield	—	—	—	—
89 (Y)	Ground	Communication signal (DISP→CONT)	Input	Ignition switch ON	When adjusting display brightness.	 <p style="text-align: right; font-size: small;">PKIB5039J</p>
90 (L)	—	CAN-H	Input/ Output	—	—	—
91 (SB)	—	AV communication signal (H)	Input/ Output	—	—	—
92 (SB)	—	AV communication signal (H)	Input/ Output	—	—	—
129 (G)	—	USB ground	—	—	—	—
130 (W)	—	V BUS signal	—	—	—	—
131 (R)	—	USB D- signal	—	—	—	—
132 (L)	—	USB D+ signal	—	—	—	—
133	—	Shield	—	—	—	—
135 (G)	136 (R)	Voice guidance signal	Output	Ignition switch ON	Sound output	 <p style="text-align: right; font-size: small;">SKIB3609E</p>
137 (SB)	145 (V)	Sound signal rear woofer	Output	Ignition switch ON	Sound output	 <p style="text-align: right; font-size: small;">SKIB3609E</p>



# AV CONTROL UNIT

< ECU DIAGNOSIS INFORMATION >

[BOSE AUDIO WITH NAVIGATION]

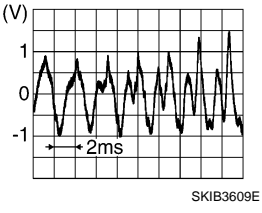
Terminal (Wire color)		Description		Condition		Reference value (Approx.)
+	-	Signal name	Input/ Output			
138 (L)	146 (P)	Sound signal center speaker	Output	Ignition switch ON	Sound output	
139 (B)	—	Shield	—	—	—	—
144	—	Shield	—	—	—	—
150	Ground	Antenna amp. ON signal	Input	Ignition switch ON	—	12.0 V
151	—	AM-FM main	Input	—	—	—
152	—	FM sub	Input	—	—	—
153	Ground	GPS antenna signal	Input	Ignition switch ON	Not connected GPS antenna connector.	5.0 V
154	—	Shield	—	—	—	—
157	Ground	RGB digital image signal (+)	Output	Ignition switch ON	Not connected connector.	1.3 V
158	Ground	RGB digital image signal (-)	Output	Ignition switch ON	Not connected connector.	1.3 V
159	—	U-voice signal	—	—	—	—
160	—	Voice ground	—	—	—	—
164	—	Manufacturer specific signal	—	—	—	—
165	—	USB V BUS signal	—	—	—	—
166	—	USB D- signal	—	—	—	—
167	—	D- voice signal	—	—	—	—
173	—	USB ground	—	—	—	—
174	—	USB D+ signal	—	—	—	—
175	—	Shield	—	—	—	—
176	Ground	Satellite radio antenna signal	Input	Ignition switch ON	Not connected satellite antenna connector.	5.0 V
177	—	Shield	—	—	—	—

## Fail-Safe

INFOID:000000008130833

When the ambient temperature becomes extremely low or extremely high, AV control unit displays the message and limits the AV control unit function.

### FAIL-SAFE CONDITIONS

When the ambient temperature is  $-20^{\circ}\text{C}$  ( $-4^{\circ}\text{F}$ ) or lower, or when it is  $70^{\circ}\text{C}$  ( $158^{\circ}\text{F}$ ) or higher

#### Display

The messages displayed on fail-safe conditions are as shown below:

# AV CONTROL UNIT

< ECU DIAGNOSIS INFORMATION >

[BOSE AUDIO WITH NAVIGATION]

Fail-safe mode	Display (display of the fail-safe condition)
When HDD temperature is low	HDD system is experiencing problems due to extreme low temperature. Normal operation will resume when temperature rises.
When HDD temperature is high	HDD system is experiencing problems due to extreme high temperature. Normal operation will resume when temperature drops.

## DESCRIPTION OF CONTROLS

Function	When Fail-safe Function is activated	
Air conditioner	Operation	Only multifunction switch (preset switch) can be operated.
	Display	<ul style="list-style-type: none"> <li>• LED of multifunction switch (preset switch) illuminates.</li> <li>• Aimed temperature, blow angle, and flow rate are displayed in simplified mode.</li> </ul>
Audio	Operation	Only ON/OFF and volume control operations by multifunction switch (preset switch) are possible.
	Display	No display ("Fail-safe mode" is displayed)
Camera	Operation	Image tone cannot be controlled.
	Display	Cannot be superimposed. (warning display, tone control display)
Hands-free phone	Operation	Cannot be operated.
Navigation	Operation	Cannot be operated.
Self diagnosis		The display in simplified mode of fail-safe condition
CONSULT diagnosis		Cannot be operated.

### Ability Operation Mode

There is an ability operation mode for Fail-saves due to low or high ambient temperature.

If HDD data can be read, fail-safe is shown, then normal displays are displayed only for functions which can be operated.

### RELEASE CONDITIONS OF FAIL-SAFE

Fail-safe is released on following conditions and normal mode is restored.

When The Temperature of HDD Is Low or High

If the ambient temperature becomes out of fail-safe condition range, normal mode is restored.

## DTC Index

INFOID:000000008130834

## SELF-DIAGNOSIS RESULTS DISPLAY ITEM

DTC	Display item	Refer to
U1000	CAN COMM CIRCUIT [U1000]	<a href="#">AV-196, "Diagnosis Procedure"</a>
U1010	CONTROL UNIT (CAN) [1010]	<a href="#">AV-197, "DTC Logic"</a>
U1200	Cont Unit [U1200]	<a href="#">AV-198, "DTC Logic"</a>
U1201	GYRO NO CONN [U1201]	<a href="#">AV-199, "DTC Logic"</a>
U1202	G-SENSOR NO CONN [U1202]	<a href="#">AV-200, "DTC Logic"</a>
U1204	GPS COMM [U1204]	<a href="#">AV-201, "Diagnosis Procedure"</a>
U1205	GPS ROM [U1205]	<a href="#">AV-202, "Diagnosis Procedure"</a>
U1206	GPS RAM [U1206]	<a href="#">AV-203, "Diagnosis Procedure"</a>
U1207	GPS RTC [U1207]	<a href="#">AV-204, "Diagnosis Procedure"</a>
U1216	CAN CONT [U1216]	<a href="#">AV-205, "DTC Logic"</a>
U1217	BLUETOOTH MODULE [U1217]	<a href="#">AV-206, "DTC Logic"</a>
U1218	HDD CONN [U1218]	<a href="#">AV-207, "Diagnosis Procedure"</a>
U1219	HDD READ [U1219]	<a href="#">AV-208, "Diagnosis Procedure"</a>
U121A	HDD WRITE [U121A]	<a href="#">AV-209, "Diagnosis Procedure"</a>
U121B	HDD COMM [U121B]	<a href="#">AV-210, "Diagnosis Procedure"</a>

# AV CONTROL UNIT

< ECU DIAGNOSIS INFORMATION >

[BOSE AUDIO WITH NAVIGATION]

DTC	Display item	Refer to	
U121C	HDD ACCESS [U121C]	<a href="#">AV-211, "Diagnosis Procedure"</a>	A
U121D	DSP CONN [U121D]	<a href="#">AV-212, "Diagnosis Procedure"</a>	
U121E	DSP COMM [U121E]	<a href="#">AV-213, "Diagnosis Procedure"</a>	B
U1225	USB CONTROLLER [U1225]	<a href="#">AV-214, "DTC Logic"</a>	
U1227	DVD COMM [U1227]	<a href="#">AV-215, "Diagnosis Procedure"</a>	
U1228	SUB CPU CONN [U1228]	<a href="#">AV-216, "DTC Logic"</a>	C
U1229	iPod CERTIFICATION [U1229]	<a href="#">AV-217, "DTC Logic"</a>	
U122A	CONFIG UNFINISH [U122A]	<a href="#">AV-218, "Diagnosis Procedure"</a>	D
U122E	Built-in AUDIO CONN [U122E]	<a href="#">AV-219, "DTC Logic"</a>	
U1231	AMP TEMP [U1231]	<a href="#">AV-220, "DTC Logic"</a>	
U1232	ST ANGLE SEN CALIB [1232]	<a href="#">AV-221, "Diagnosis Procedure"</a>	E
U1243	FRONT DISP CONN [U1243]	<a href="#">AV-222, "Diagnosis Procedure"</a>	
U1244	GPS ANTENNA CONN [U1244]	<a href="#">AV-224, "Diagnosis Procedure"</a>	F
U1258	XM ANTENNA CONN [U1258]	<a href="#">AV-225, "Diagnosis Procedure"</a>	
U1263	USB OVERCURRENT [U1263]	<a href="#">AV-226, "Diagnosis Procedure"</a>	
U1264	ANTENNA AMP TERMINAL [OPEN or SHORT] [U1264]	<a href="#">AV-227, "Diagnosis Procedure"</a>	G
U1310	CONTROL UNIT (AV) [U1310]	<a href="#">AV-229, "DTC Logic"</a>	
U1601	FL-DOOR WOOFER [OPEN, SHORT, GND-SHORT or VB-SHOR] [U1601]	<a href="#">AV-230, "Diagnosis Procedure"</a>	H
U1602	FL-DOOR SQUAWK [OPEN, SHORT, GND-SHORT or VB-SHOR] [U1602]	<a href="#">AV-231, "Diagnosis Procedure"</a>	I
U1609	FR-DOOR WOOFER [OPEN, SHORT, GND-SHORT or VB-SHOR] [U1609]	<a href="#">AV-230, "Diagnosis Procedure"</a>	J
U160A	FR-DOOR SQUAWK [OPEN, SHORT, GND-SHORT or VB-SHOR] [U160A]	<a href="#">AV-231, "Diagnosis Procedure"</a>	K
U162A	F-INST C-SQUAWK [OPEN, SHORT, GND-SHORT or VB-SHOR] [U162A]	<a href="#">AV-232, "Diagnosis Procedure"</a>	L
U1632	FL-SEAT L-SQUAWK [OPEN, SHORT, GND-SHORT or VB-SHOR] [U1632]	<a href="#">AV-233, "Diagnosis Procedure"</a>	M
U163A	FL-SEAT R-SQUAWK [OPEN, SHORT, GND-SHORT or VB-SHOR] [U163A]	<a href="#">AV-233, "Diagnosis Procedure"</a>	AV
U163E	FR-SEAT L-SQUAWK [OPEN, SHORT, GND-SHORT or VB-SHOR] [U163E]	<a href="#">AV-233, "Diagnosis Procedure"</a>	O
U1708	RL-DOOR SPEAKER [OPEN, SHORT, GND-SHORT or VB-SHOR] [U1708]	<a href="#">AV-234, "Diagnosis Procedure"</a>	
U1710	RR-DOOR SPEAKER [OPEN, SHORT, GND-SHORT or VB-SHOR] [U1710]	<a href="#">AV-234, "Diagnosis Procedure"</a>	P
U1725	R-PSHELF C-WOOFER [OPEN, SHORT, GND-SHORT or VB-SHOR] [U1725]	<a href="#">AV-235, "Diagnosis Procedure"</a>	

# AV CONTROL UNIT

< ECU DIAGNOSIS INFORMATION >

[BOSE AUDIO WITH NAVIGATION]

DTC	Display item	Refer to
U190C	CORRECT MICROPHONE [OPEN, SHORT, GND-SHORT or VB-SHOR] [U190C]	<a href="#">AV-236. "Diagnosis Procedure"</a>
U1300 U1240	<ul style="list-style-type: none"><li>• AV COMM CIRCUIT [U1300]</li><li>• SWITCH CONN [U1240]</li></ul>	<a href="#">AV-228. "Description"</a>
U1300 U124E	<ul style="list-style-type: none"><li>• AV COMM CIRCUIT [U1300]</li><li>• AMP CONN [U124E]</li></ul>	<a href="#">AV-228. "Description"</a>
U1300 U1240 U124E	<ul style="list-style-type: none"><li>• AV COMM CIRCUIT [U1300]</li><li>• SWITCH CONN [U1240]</li><li>• AMP CONN [U124E]</li></ul>	<a href="#">AV-228. "Description"</a>

# DISPLAY UNIT

< ECU DIAGNOSIS INFORMATION >

[BOSE AUDIO WITH NAVIGATION]

## DISPLAY UNIT

Reference Value

INFOID:000000008130835

TERMINAL LAYOUT

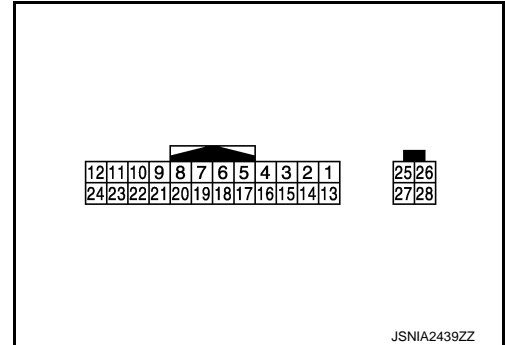

## PHYSICAL VALUES

Terminal (Wire color)		Description		Condition		Reference value (Approx.)
+	-	Signal name	Input/ Output			
6	—	Shield	—	—	—	—
7	—	Shield	—	—	—	—
8 (W)	Ground	Camera image signal	Input	Ignition switch ON	At rear view camera image is displayed.	
9 (Y)	Ground	Communication signal (DISP→CONT)	Output	Ignition switch ON	When adjusting display brightness.	
10 (BR)	Ground	Communication signal (CONT→DISP)	Input	Ignition switch ON	When adjusting display brightness.	
11 (Y)	Ground	Battery power supply	Input	Ignition switch OFF	—	Battery voltage
12 (B)	Ground	Ground	—	Ignition switch ON	—	0 V

A

B

C

D

E

F

G

H

I

J

K

L

M

AV

O

P

# DISPLAY UNIT

< ECU DIAGNOSIS INFORMATION >

[BOSE AUDIO WITH NAVIGATION]

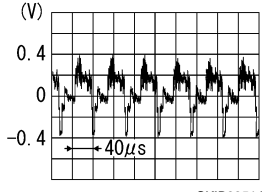
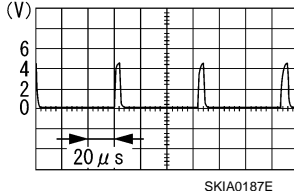
Terminal (Wire color)		Description		Condition		Reference value (Approx.)
+	-	Signal name	Input/ Output			
18 (W)	Ground	Composite image signal	Input	Ignition switch ON	At DVD image is displayed.	
19 (R)	Ground	Composite image ground	—	Ignition switch ON	—	0 V
20 (B)	Ground	Composite synchronizing signal	Input	Ignition switch ON	At DVD image is displayed	
22	—	Shield	—	—	—	—
23 (V)	Ground	ACC power supply	Input	Ignition switch ACC	—	Battery voltage
27	—	RGB digital image signal (+)	Input	—	—	—
28	—	RGB digital image signal (-)	Input	—	—	—

# BOSE AMP.

< ECU DIAGNOSIS INFORMATION >

[BOSE AUDIO WITH NAVIGATION]

## BOSE AMP.

### Reference Value

INFOID:000000008130836

### BOSE® STUDIO SURROUND® SOUND SYSTEM MODELS

#### Terminal Layout

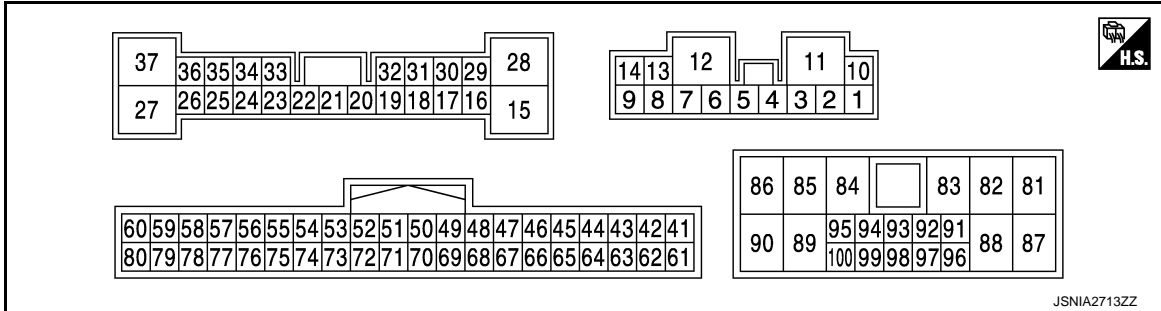

#### Physical Values

Terminal (Wire color)		Description		Condition		Reference value (Approx.)
+	-	Signal name	Input/ Output			
1 (O)	2 (LG)	Sound signal front door woofer RH	Output	Ignition switch ON	Sound output	 SKIB3609E
5 (R)	6 (L)	Sound signal front door woofer LH	Output	Ignition switch ON	Sound output	 SKIB3609E
7 (B/R)	Ground	Ground	—	Ignition switch ON	—	0 V
10 (V)	Ground	Battery power supply	Input	Ignition switch OFF	—	Battery voltage
11 (G)	Ground	Battery power supply	Input	Ignition switch OFF	—	Battery voltage
12 (B/R)	Ground	Ground	—	Ignition switch ON	—	0 V

# BOSE AMP.

< ECU DIAGNOSIS INFORMATION >

[BOSE AUDIO WITH NAVIGATION]

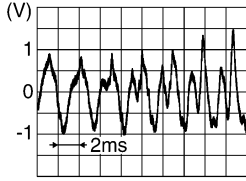
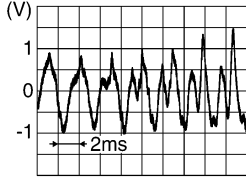
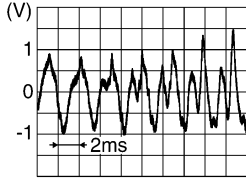
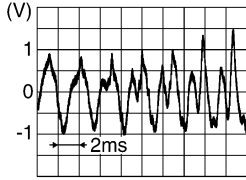
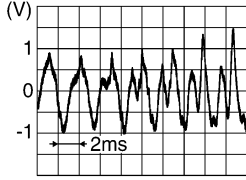
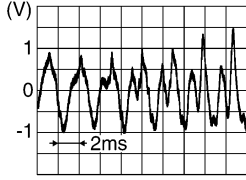
Terminal (Wire color)		Description		Condition		Reference value (Approx.)
+	-	Signal name	Input/ Output			
13 (R/L)	8 (P/L)	Sound signal rear woofer	Output	Ignition switch ON	Sound output	 <p style="text-align: right; font-size: small;">SKIB3609E</p>
14 (B)	9 (W)	Sound signal front door squawker & tweeter RH	Output	Ignition switch ON	Sound output	 <p style="text-align: right; font-size: small;">SKIB3609E</p>
15 (G)	Ground	Amp. ON signal	Output	Ignition switch ACC	—	11.0 V
16 (G)	29 (R)	Sound signal rear door speaker LH	Output	Ignition switch ON	Sound output	 <p style="text-align: right; font-size: small;">SKIB3609E</p>
17 (W)	18 (B)	Sound signal front door squawker & tweeter LH	Output	Ignition switch ON	Sound output	 <p style="text-align: right; font-size: small;">SKIB3609E</p>
19 (B/R)	32 (BR)	Sound signal driver seat speaker LH	Output	Ignition switch ON	Sound output	 <p style="text-align: right; font-size: small;">SKIB3609E</p>
22 (L)	33 (B/W)	Sound signal driver seat speaker RH	Output	Ignition switch ON	Sound output	 <p style="text-align: right; font-size: small;">SKIB3609E</p>



# BOSE AMP.

< ECU DIAGNOSIS INFORMATION >

[BOSE AUDIO WITH NAVIGATION]

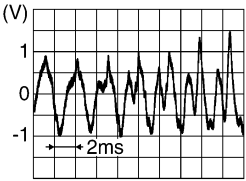
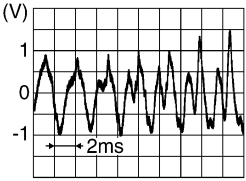
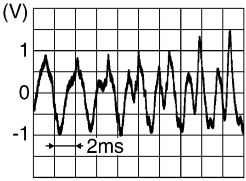
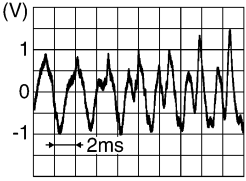
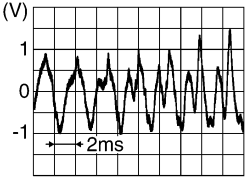
Terminal (Wire color)		Description		Condition		Reference value (Approx.)
+	-	Signal name	Input/ Output			
23 (Y)	34 (BR)	Sound signal passenger seat speaker LH	Output	Ignition switch ON	Sound output	 SKIB3609E
24 (R)	35 (G)	Sound signal rear door speaker RH	Output	Ignition switch ON	Sound output	 SKIB3609E
26 (O)	36 (W/L)	Sound signal passenger seat speaker RH	Output	Ignition switch ON	Sound output	 SKIB3609E
27 (O/L)	37 (W)	Sound signal satellite speaker LH	Output	Ignition switch ON	Sound output	 SKIB3609E
31 (V)	30 (P)	Sound signal center speak- er	Output	Ignition switch ON	Sound output	 SKIB3609E
54 (R)	—	AV communication signal (L)	Input/ Output	—	—	—
55 (R)	—	AV communication signal (L)	Input/ Output	—	—	—
56 (V)	Ground	ACC power supply	Input	Ignition switch ACC	—	12.0 V
58 (O)	Ground	Engine type signal (V8)	Input	Ignition switch ON	—	0 V

A  
B  
C  
D  
E  
F  
G  
H  
I  
J  
K  
L  
M  
P

AV

# BOSE AMP.

< ECU DIAGNOSIS INFORMATION >

[BOSE AUDIO WITH NAVIGATION]

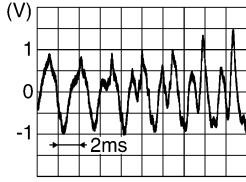
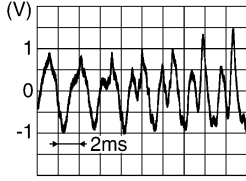
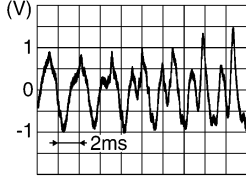
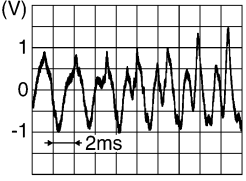
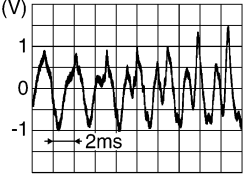
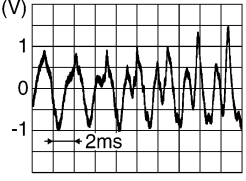
Terminal (Wire color)		Description		Condition		Reference value (Approx.)
+	-	Signal name	Input/ Output			
61 (BR)	41 (B/R)	Sound signal satellite speaker RH	Output	Ignition switch ON	Sound output	 <p style="text-align: right; font-size: small;">SKIB3609E</p>
63 (L)	43 (LG)	Rear microphone signal	Input	Ignition switch ON	When inputting interior sound	 <p style="text-align: right; font-size: small;">SKIB3609E</p>
64 (G) <sup>*1</sup> (LG) <sup>*2</sup>	44 (R) <sup>*1</sup> (B/Y) <sup>*2</sup>	Voice guidance signal	Input	Ignition switch ON	Sound output	 <p style="text-align: right; font-size: small;">SKIB3609E</p>
65 (W)	45 (B)	Sound signal front LH	Input	Ignition switch ON	Sound output	 <p style="text-align: right; font-size: small;">SKIB3609E</p>
66 (R)	46 (L)	Sound signal front RH	Input	Ignition switch ON	Sound output	 <p style="text-align: right; font-size: small;">SKIB3609E</p>
67 (BR)	47 (Y)	Sound signal rear LH	Input	Ignition switch ON	Sound output	 <p style="text-align: right; font-size: small;">SKIB3609E</p>

# BOSE AMP.

< ECU DIAGNOSIS INFORMATION >

[BOSE AUDIO WITH NAVIGATION]

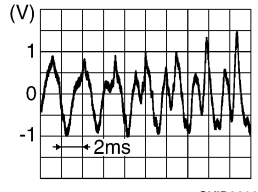
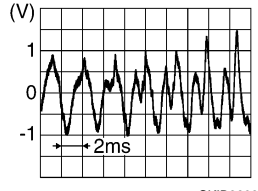
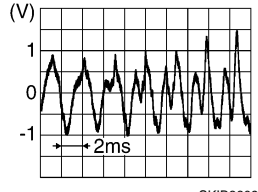
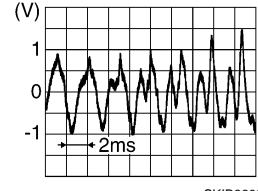
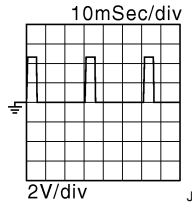
Terminal (Wire color)		Description		Condition		Reference value (Approx.)
+	-	Signal name	Input/ Output			
68 (L)	48 (P)	Sound signal rear RH	Input	Ignition switch ON	Sound output	
69 (W/L)	49 (W/R)	Sound signal center speaker	Input	Ignition switch ON	Sound output	
70 (LG)	50 (V)	Sound signal rear woofer	Input	Ignition switch ON	Sound output	
72 (Y)	52 (BR)	Front microphone signal	Input	Ignition switch ON	When inputting interior sound	
74 (G)	—	AV communication signal (H)	Input/ Output	—	—	—
75 (G)	—	AV communication signal (H)	Input/ Output	—	—	—
76 (P)	Ground	Step lamp signal	Input	Ignition switch ON	When opened any doors.	0 V
					When closed all doors.	12.0 V
78 (SB)	Ground	Engine speed signal	Input	Ignition switch ON	Idle speed	
79	—	Shield	—	—	—	—

A  
B  
C  
D  
E  
F  
G  
H  
I  
J  
K  
L  
M  
AV  
O  
P

AV

# BOSE AMP.

< ECU DIAGNOSIS INFORMATION >

[BOSE AUDIO WITH NAVIGATION]

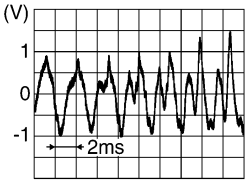
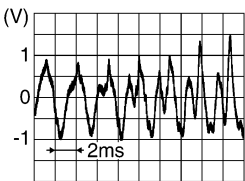
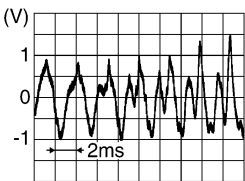
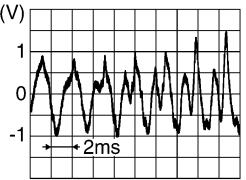
Terminal (Wire color)		Description		Condition		Reference value (Approx.)
+	-	Signal name	Input/ Output			
81 (L)	82 (B/W)	Sound signal passenger seat speaker RH	Output	Ignition switch ON	Sound output	 SKIB3609E
83 (B/R)	Ground	Ground	—	Ignition switch ON	—	0 V
84 (Y)	Ground	Battery power supply	Input	Ignition switch OFF	—	Battery voltage
85 (O)	86 (P)	Sound signal satellite speaker RH	Output	Ignition switch ON	Sound output	 SKIB3609E
87 (G)	88 (R)	Sound signal satellite speaker LH	Output	Ignition switch ON	Sound output	 SKIB3609E
89 (B/R)	Ground	Ground	—	Ignition switch ON	—	0 V
90 (Y)	Ground	Battery power supply	Input	Ignition switch OFF	—	Battery voltage
91 (G)	Ground	Amp. ON signal	Input	Ignition switch ACC	—	11.0 V
92 (G)	Ground	Amp. ON signal	Input	Ignition switch ACC	—	11.0 V
93 (BR)	94 (B/R)	Sound signal satellite speaker RH	Input	Ignition switch ON	Sound output	 SKIB3609E
95	—	Shield	—	—	—	—

# BOSE AMP.

< ECU DIAGNOSIS INFORMATION >

[BOSE AUDIO WITH NAVIGATION]

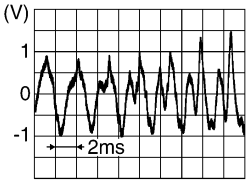
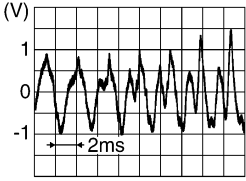
Terminal (Wire color)		Description		Condition		Reference value (Approx.)
+	-	Signal name	Input/ Output			
96 (O)	97 (W/L)	Sound signal passenger seat speaker RH	Input	Ignition switch ON	Sound output	 SKIB3609E
98	—	Shield	—	—	—	—
99 (O/L)	100 (W)	Sound signal satellite speaker LH	Input	Ignition switch ON	Sound output	 SKIB3609E

\*1: With VQ37 engine

\*2: With VK56 engine

## BOSE SOUND SYSTEM MODELS

### TERMINAL LAYOUT

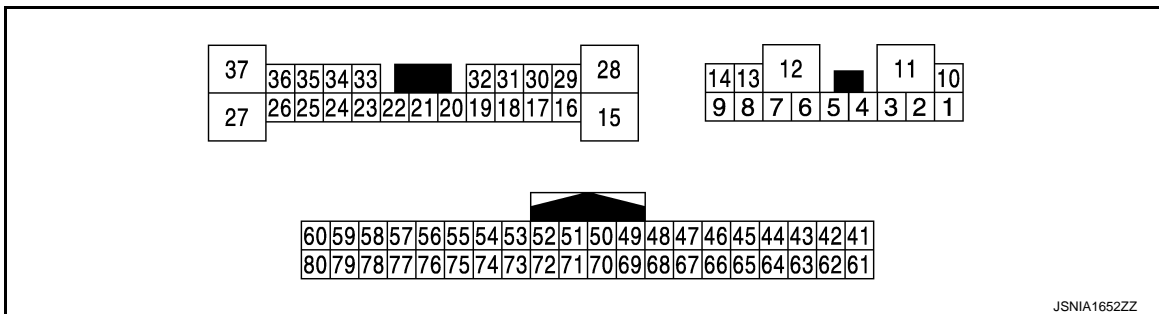

### PHYSICAL VALUES

A  
B  
C  
D  
E  
F  
G  
H  
I  
J  
K  
L  
M  
O  
P

AV

# BOSE AMP.

< ECU DIAGNOSIS INFORMATION >

[BOSE AUDIO WITH NAVIGATION]

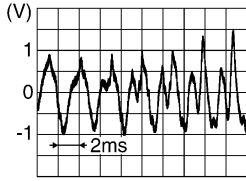
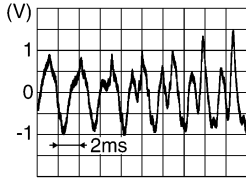
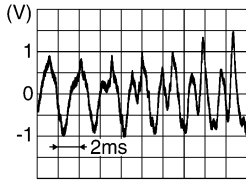
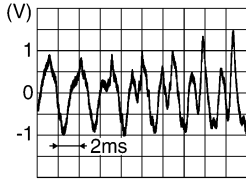
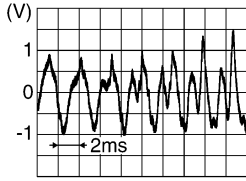
Terminal (Wire color)		Description		Condition		Reference value (Approx.)
+	-	Signal name	Input/ Output			
1 (O)	2 (LG)	Sound signal front door woofer RH	Output	Ignition switch ON	Sound output	 <p style="text-align: right; font-size: small;">SKIB3609E</p>
5 (R)	6 (L)	Sound signal front door woofer LH	Output	Ignition switch ON	Sound output	 <p style="text-align: right; font-size: small;">SKIB3609E</p>
7 (B/R)	Ground	Ground	—	Ignition switch ON	—	0 V
10 (V)	Ground	Battery power supply	Input	Ignition switch OFF	—	Battery voltage
11 (G)	Ground	Battery power supply	Input	Ignition switch OFF	—	Battery voltage
12 (B/R)	Ground	Ground	—	Ignition switch ON	—	0 V
13 (R/L)	8 (P/L)	Sound signal rear woofer	Output	Ignition switch ON	Sound output	 <p style="text-align: right; font-size: small;">SKIB3609E</p>
14 (B)	9 (W)	Sound signal front door squawker & tweeter RH	Output	Ignition switch ON	Sound output	 <p style="text-align: right; font-size: small;">SKIB3609E</p>
16 (G)	29 (R)	Sound signal rear door speaker LH	Output	Ignition switch ON	Sound output	 <p style="text-align: right; font-size: small;">SKIB3609E</p>

# BOSE AMP.

< ECU DIAGNOSIS INFORMATION >

[BOSE AUDIO WITH NAVIGATION]

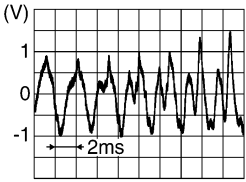
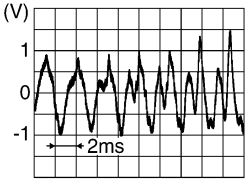
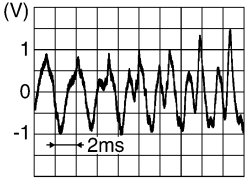
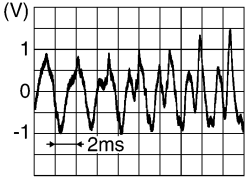
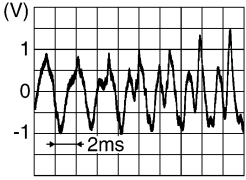
Terminal (Wire color)		Description		Condition		Reference value (Approx.)
+	-	Signal name	Input/ Output			
17 (W)	18 (B)	Sound signal front door squawker & tweeter LH	Output	Ignition switch ON	Sound output	 SKIB3609E
24 (R)	35 (G)	Sound signal rear door speaker RH	Output	Ignition switch ON	Sound output	 SKIB3609E
31 (V)	30 (P)	Sound signal center speaker	Output	Ignition switch ON	Sound output	 SKIB3609E
54 (R) <sup>*1</sup> (LG) <sup>*2</sup>	—	AV communication signal (L)	Input/ Output	—	—	—
55 (R) <sup>*1</sup> (LG) <sup>*2</sup>	—	AV communication signal (L)	Input/ Output	—	—	—
56 (V)	Ground	ACC power supply	Input	Ignition switch ACC	—	12.0 V
58 (O)	Ground	Engine type signal (V8)	Input	Ignition switch ON	—	0 V
63 (L)	43 (LG)	Rear microphone signal	Input	Ignition switch ON	When inputting interior sound	 SKIB3609E
64 (LG)	44 (B/Y)	Voice guidance signal	Input	Ignition switch ON	Sound output	 SKIB3609E

A  
B  
C  
D  
E  
F  
G  
H  
I  
J  
K  
L  
M  
P

AV

# BOSE AMP.

< ECU DIAGNOSIS INFORMATION >

[BOSE AUDIO WITH NAVIGATION]

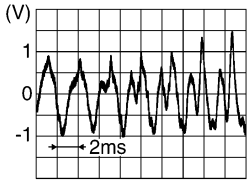
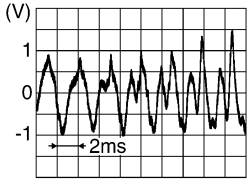
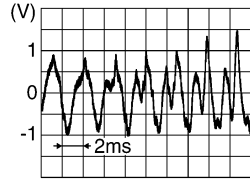
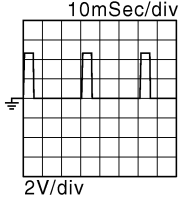
Terminal (Wire color)		Description		Condition		Reference value (Approx.)
+	-	Signal name	Input/ Output			
65 (W)	45 (B)	Sound signal front LH	Input	Ignition switch ON	Sound output	 <small>SKIB3609E</small>
66 (R)	46 (L)	Sound signal front RH	Input	Ignition switch ON	Sound output	 <small>SKIB3609E</small>
72 (Y)	52 (BR)	Front microphone signal	Input	Ignition switch ON	When inputting interior sound	 <small>SKIB3609E</small>
74 (G) <sup>*1</sup> (SB) <sup>*2</sup>	—	AV communication signal (H)	Input/ Output	—	—	—
75 (G) <sup>*1</sup> (SB) <sup>*2</sup>	—	AV communication signal (H)	Input/ Output	—	—	—
76 (P)	Ground	Step lamp signal	Input	Ignition switch ON	When opened any doors.	0 V
					When closed all doors.	12.0 V
78 (SB)	Ground	Engine speed signal	Input	Ignition switch ON	Idle speed	 <small>JMBIA0076GB</small>
79	—	Shield	—	—	—	—

\*1: With VQ37 engine

\*2: With VK56 engine



# WIRING DIAGRAM

## BOSE AUDIO WITH NAVIGATION

### Wiring Diagram

INFOID:000000008130837

For connector terminal arrangements, harness layouts, and alphabets in a  (option abbreviation; if not described in wiring diagram), refer to [GI-12. "Connector Information"](#).

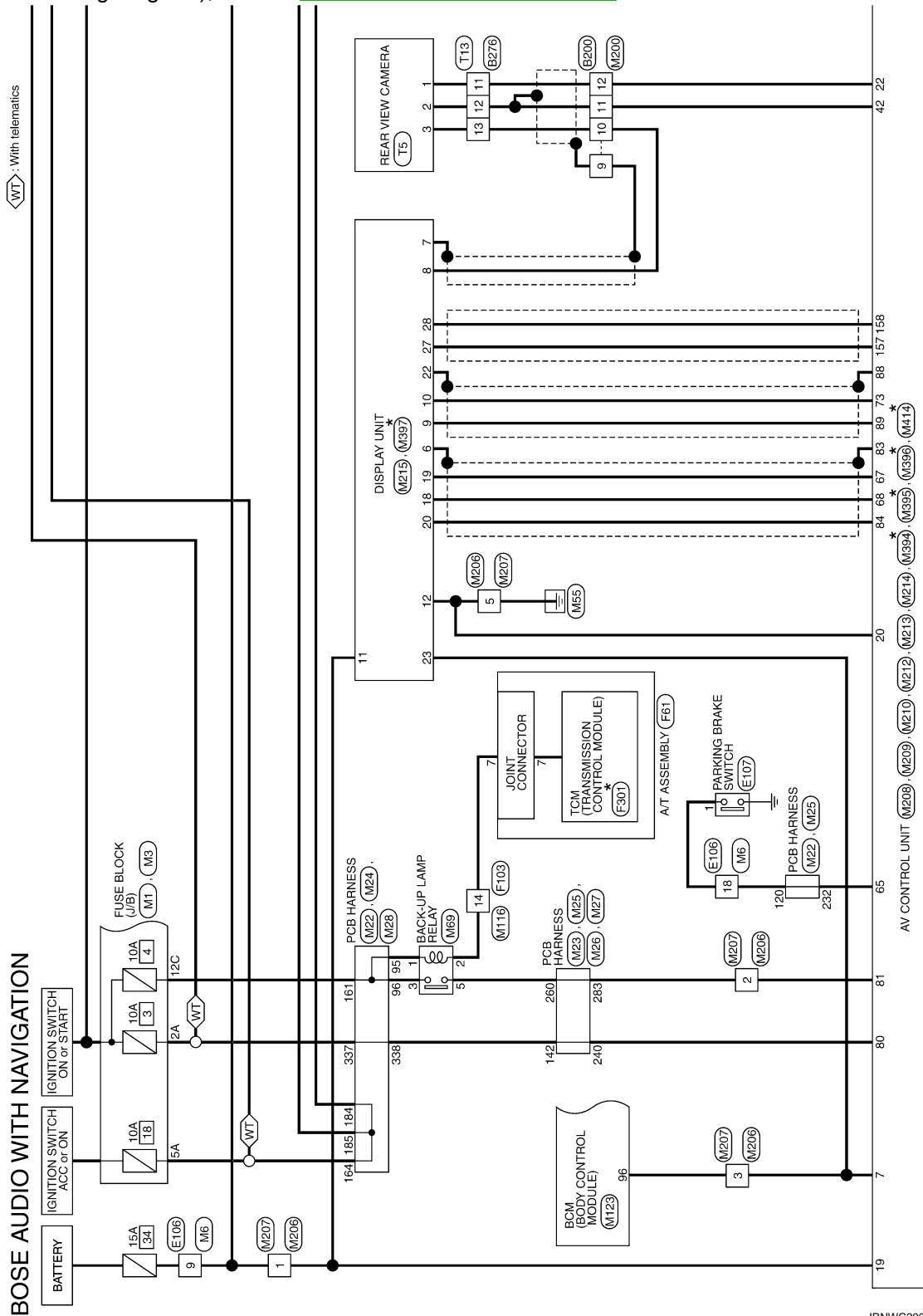

\*: This connector is not shown in "Harness Layout".

2012/02/27

JRNWC2009GB

A  
B  
C  
D  
E  
F  
G  
H  
I  
J  
K  
L  
M  
N  
O  
P

AV

# BOSE AUDIO WITH NAVIGATION

[BOSE AUDIO WITH NAVIGATION]

< WIRING DIAGRAM >

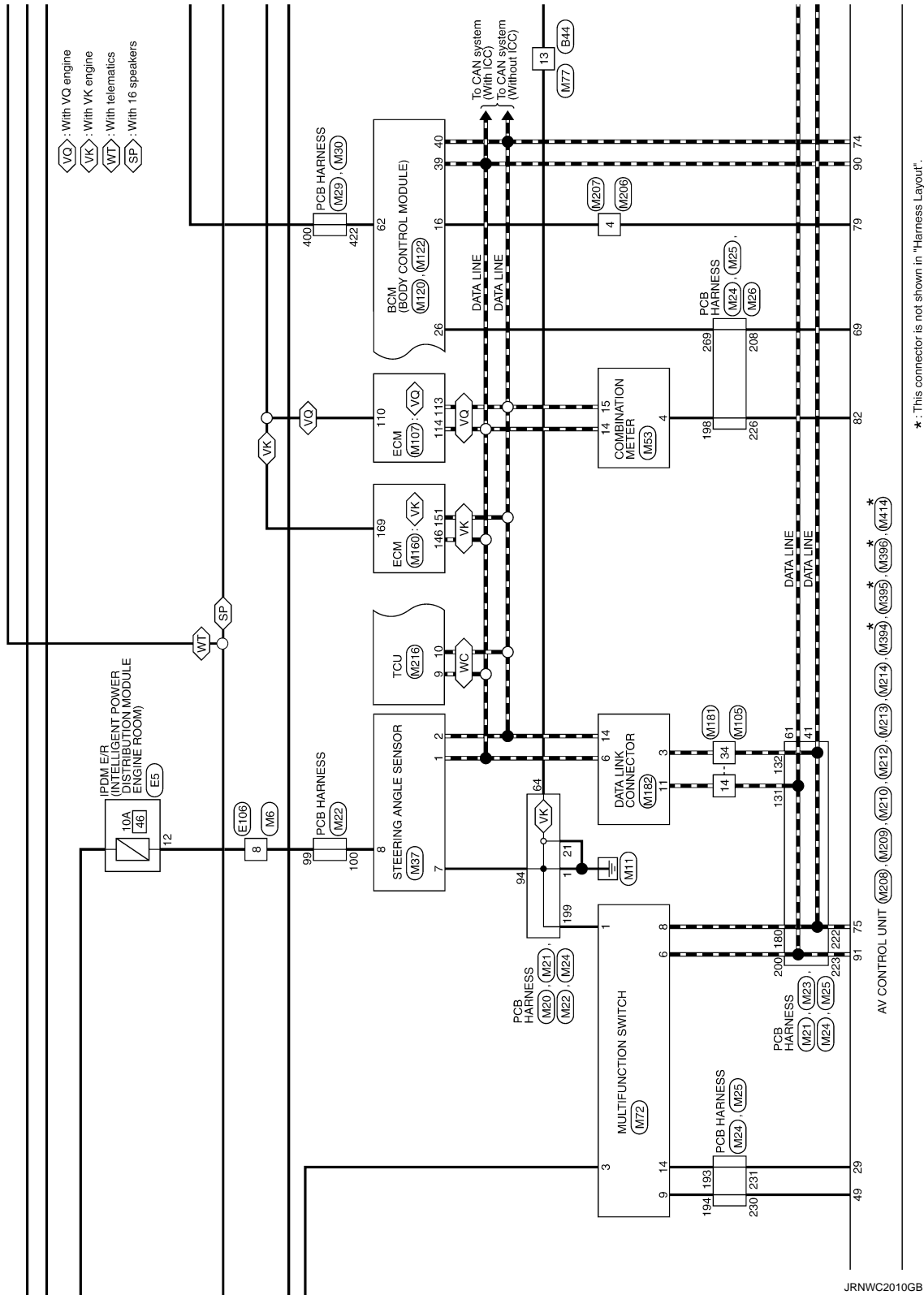

\*: This connector is not shown in "Harness Layout".

# BOSE AUDIO WITH NAVIGATION

[BOSE AUDIO WITH NAVIGATION]

< WIRING DIAGRAM >

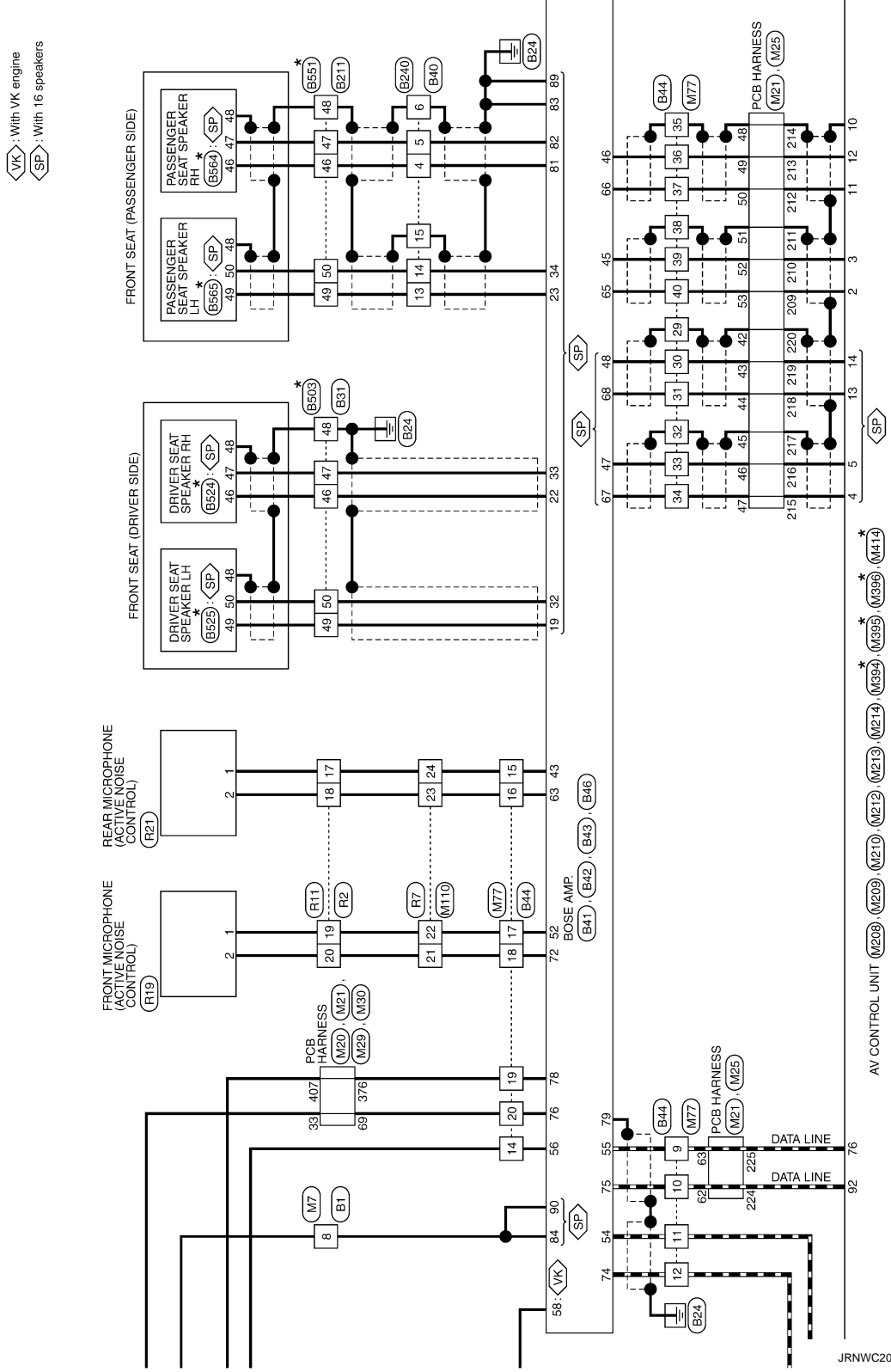

\*: This connector is not shown in "Harness Layout".

A B C D E F G H I J K L M O P

AV

# BOSE AUDIO WITH NAVIGATION

[BOSE AUDIO WITH NAVIGATION]

< WIRING DIAGRAM >

< SP > With 16 speakers

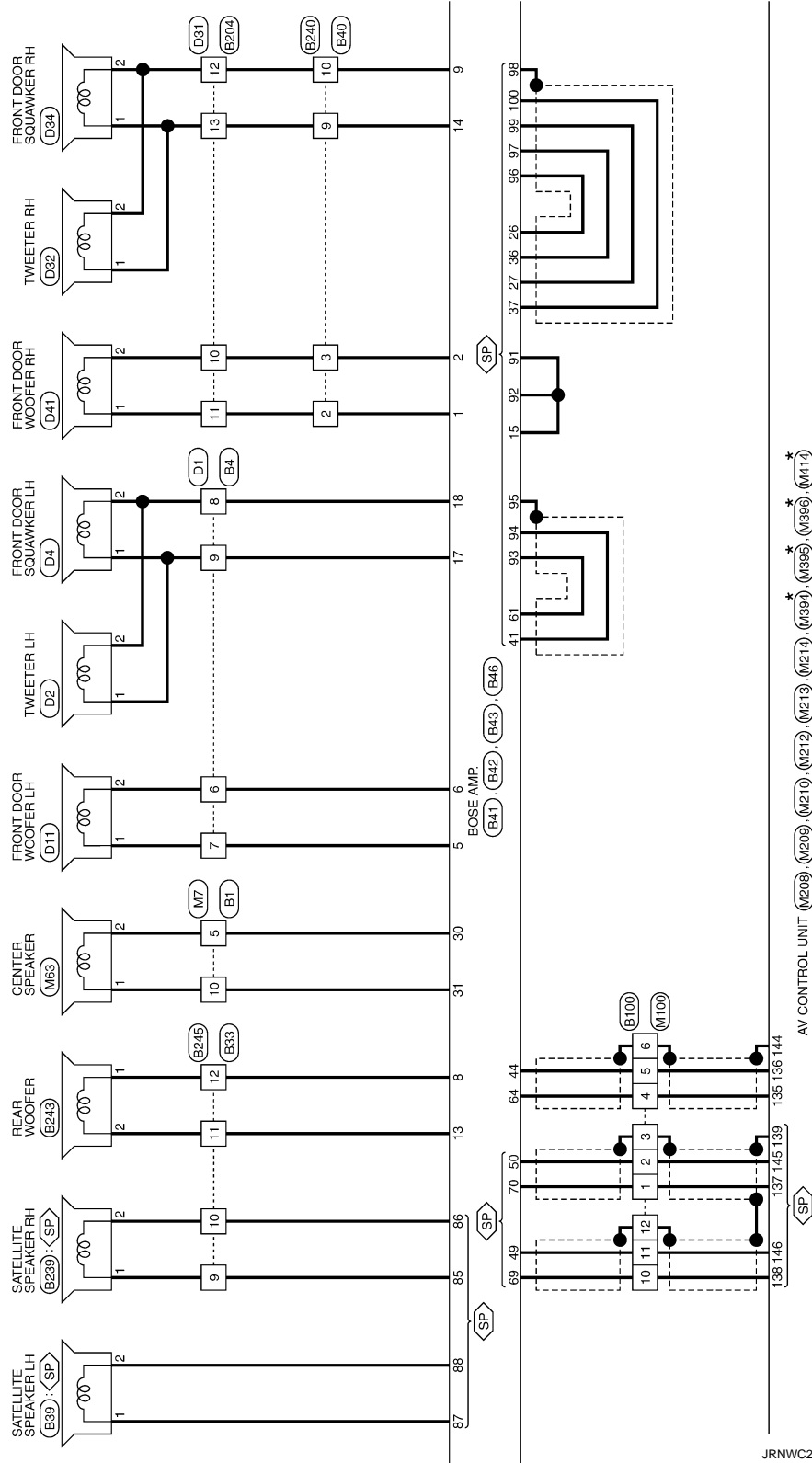

\*: This connector is not shown in "Harness Layout".

JRNWC2012GB

# BOSE AUDIO WITH NAVIGATION

## [BOSE AUDIO WITH NAVIGATION]

< WIRING DIAGRAM >

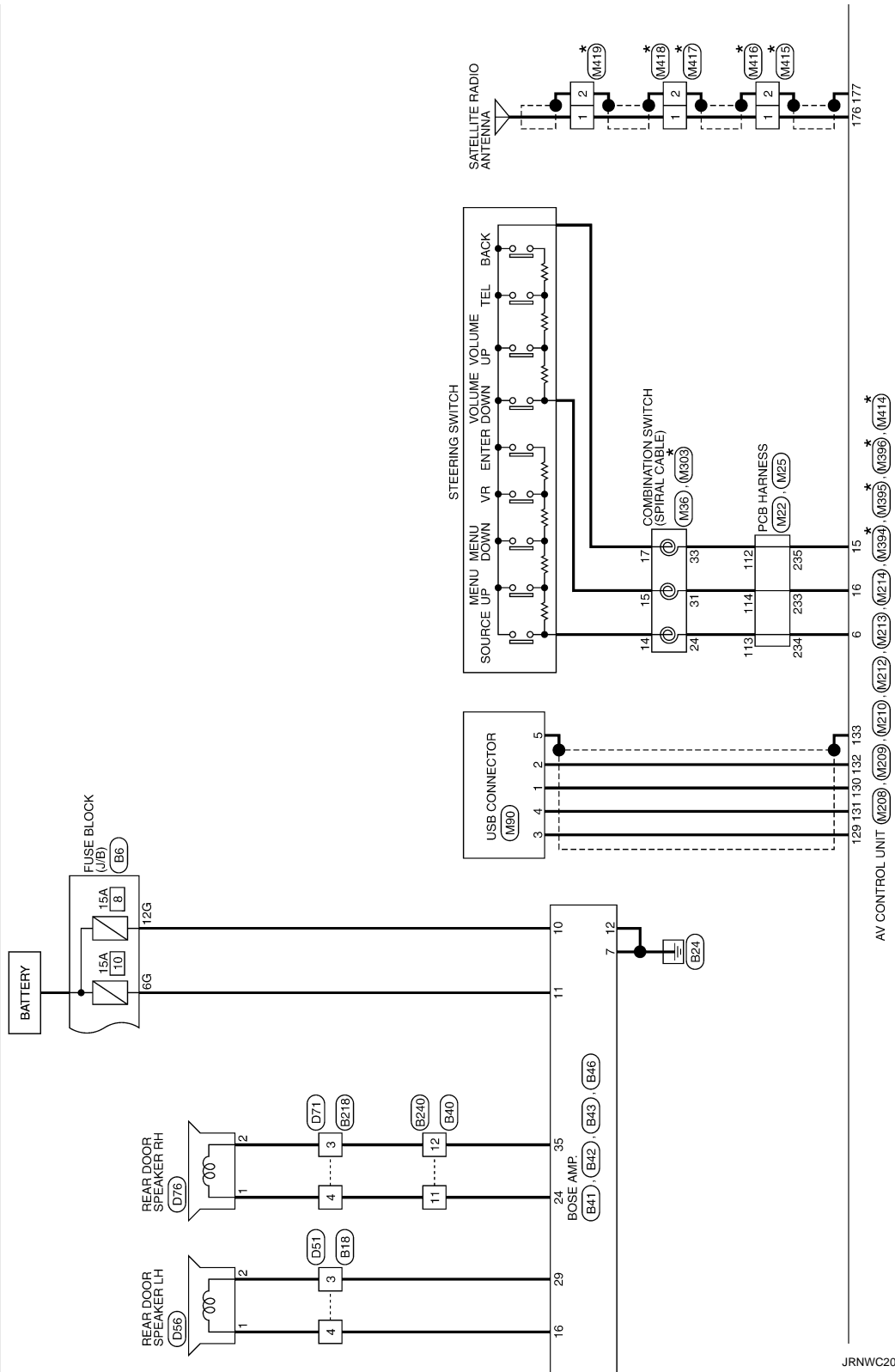

\*: This connector is not shown in "Harness Layout".

JRNWC2013GB

A  
B  
C  
D  
E  
F  
G  
H  
I  
J  
K  
L  
M  
AV  
O  
P

# BOSE AUDIO WITH NAVIGATION

[BOSE AUDIO WITH NAVIGATION]

< WIRING DIAGRAM >

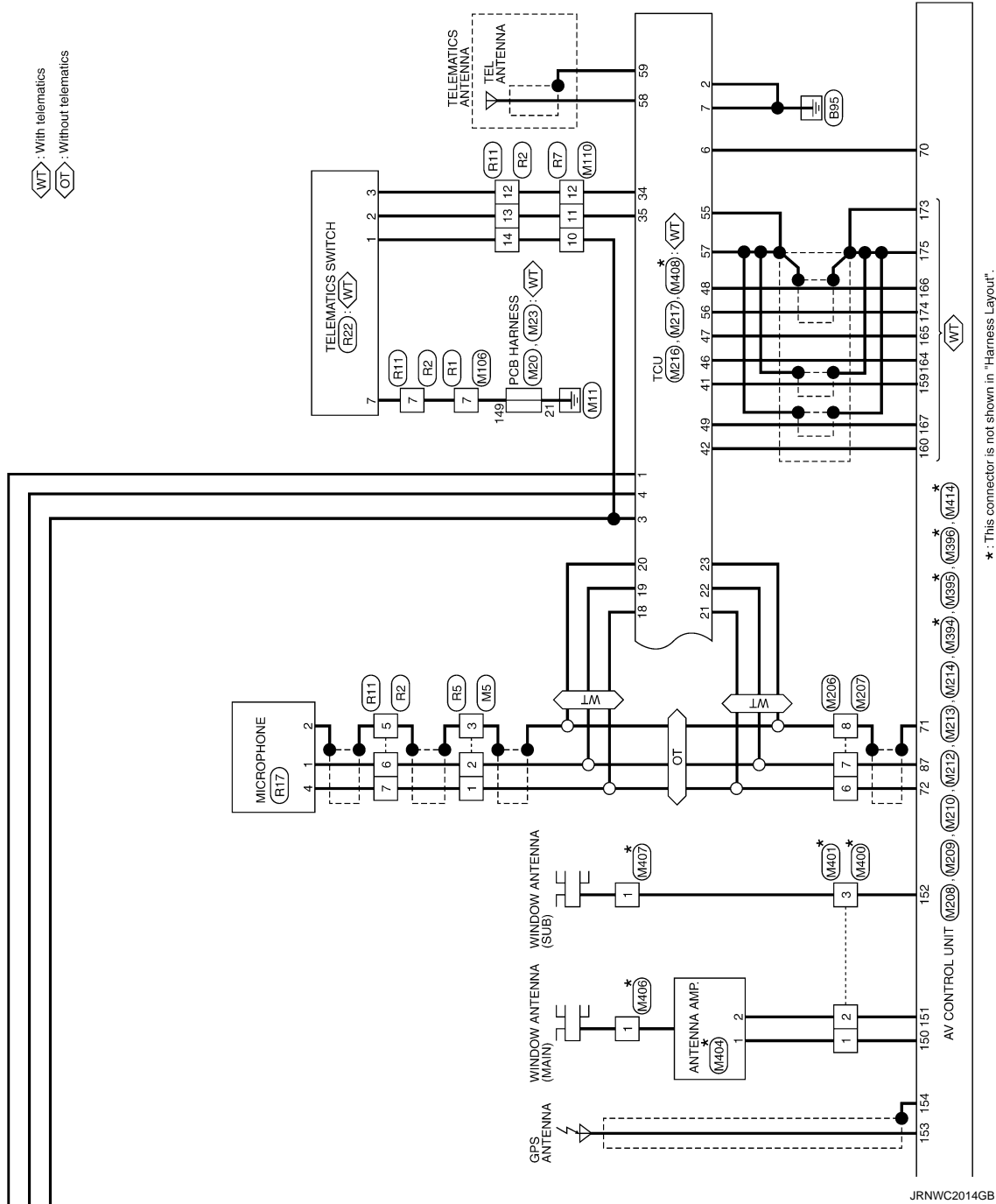

## BASIC INSPECTION

### DIAGNOSIS AND REPAIR WORKFLOW

#### Work Flow

INFOID:000000008130838

#### OVERALL SEQUENCE

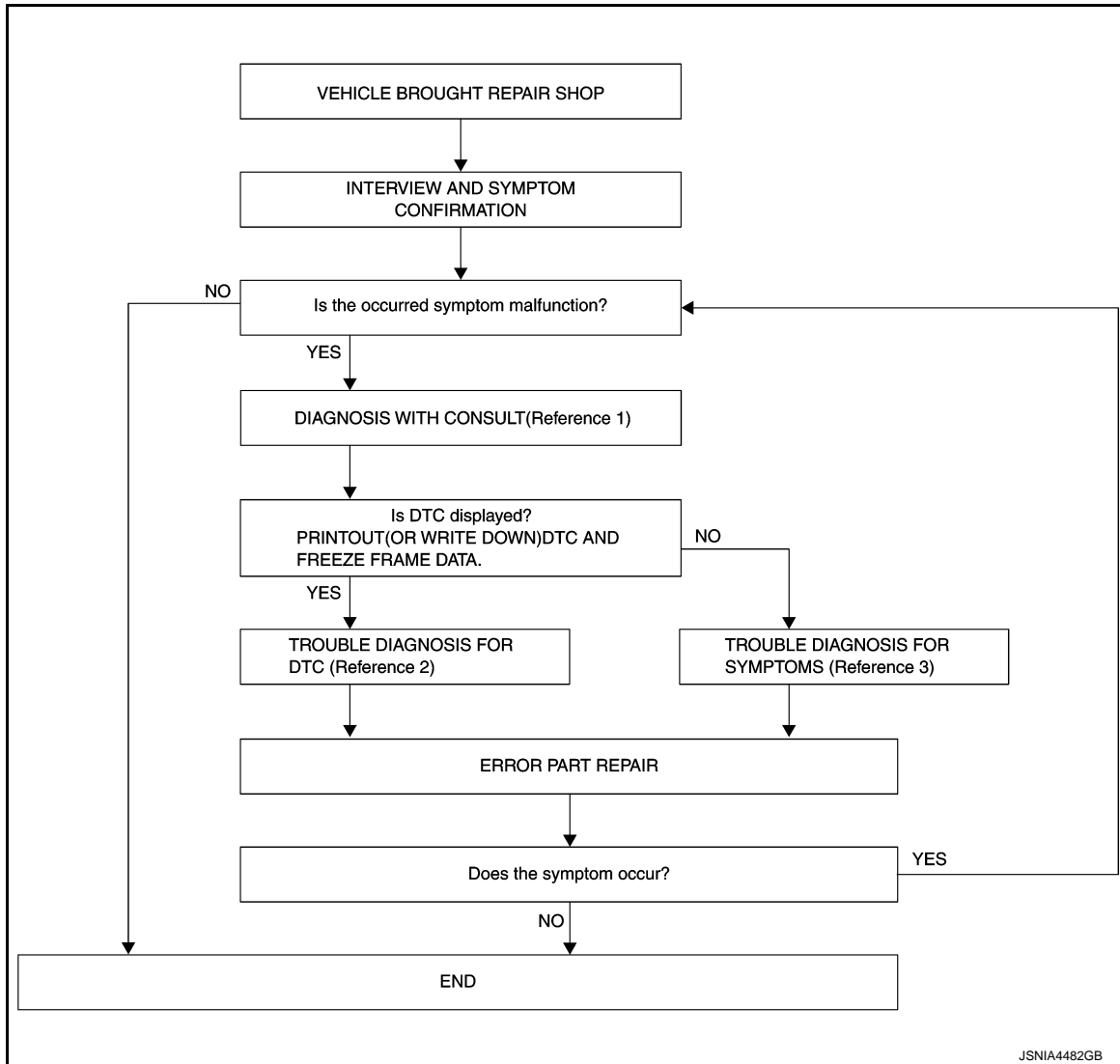

- Reference 1... Refer to [AV-157. "CONSULT Function"](#).
- Reference 2... Refer to [AV-170. "DTC Index"](#).
- Reference 3... Refer to [AV-254. "Symptom Table"](#).

#### DETAILED FLOW

##### 1. INTERVIEW AND SYMPTOM CONFIRMATION

Check the malfunction symptoms by performing the following items.

- Interview the customer to obtain the malfunction information (conditions and environment when the malfunction occurred).
- Check the symptom.

##### Is the occurred symptom malfunction?

YES >> GO TO 2.

NO >> INSPECTION END

##### 2. DIAGNOSIS WITH CONSULT

# DIAGNOSIS AND REPAIR WORKFLOW

[BOSE AUDIO WITH NAVIGATION]

< BASIC INSPECTION >

1. Connect CONSULT and perform a self-diagnosis for "MULTI AV". Refer to [AV-157. "CONSULT Function"](#).

**NOTE:**

Skip to step 4 of the diagnosis procedure if "MULTI AV" is not displayed.

2. When DTC is detected, follow the instructions below:
  - Record DTC and Freeze Frame Data.

Is DTC displayed?

YES >> GO TO 3.

NO >> GO TO 4.

## 3. TROUBLE DIAGNOSIS FOR DTC

---

1. Check the DTC indicated in the "Self-Diagnosis Results".
2. Perform the relevant diagnosis referring to the DTC Index. Refer to [AV-170. "DTC Index"](#).

>> GO TO 5.

## 4. TROUBLE DIAGNOSIS FOR SYMPTOMS

---

Perform the relevant diagnosis referring to the diagnosis chart by symptom. Refer to [AV-254. "Symptom Table"](#).

>> GO TO 5.

## 5. ERROR PART REPAIR

---

1. Repair or replace the identified malfunctioning parts.
2. Perform a self-diagnosis for "MULTI AV" with CONSULT.

**NOTE:**

Erase the stored self-diagnosis results after repairing or replacing the relevant components if any DTC has been indicated in the "Self-Diagnosis Results".

3. Check that the symptom does not occur.

Does the symptom occur?

YES >> GO TO 1.

NO >> INSPECTION END



# ADDITIONAL SERVICE WHEN REPLACING (AV CONTROL UNIT)

< BASIC INSPECTION >

[BOSE AUDIO WITH NAVIGATION]

## ADDITIONAL SERVICE WHEN REPLACING (AV CONTROL UNIT)

### Description

INFOID:000000008130839

#### BEFORE REPLACEMENT

When replacing AV control unit, save or print current vehicle specification with CONSULT configuration before replacement.

#### AFTER REPLACEMENT

##### **CAUTION:**

When replacing AV control unit, you must perform “After Replace ECU” or “Manual configuration” with CONSULT.

- Complete the procedure of “After Replace ECU” or “Manual Configuration” in order.
- If you set incorrect “After Replace ECU” or “Manual Configuration”, incidents might occur.
- Configuration is different for each vehicle model. Confirm configuration of each vehicle model.

### Work Procedure

INFOID:000000008130840

#### 1. SAVING VEHICLE SPECIFICATION

##### -CONSULT Configuration

Perform “Before Replace ECU” to save or print current vehicle specification. Refer to [AV-194, "Description"](#).

##### **NOTE:**

If “Before Replace ECU” can not be used, use the “Manual Configuration”.

>> GO TO 2.

#### 2. REPLACE AV CONTROL UNIT

Replace AV control unit. Refer to [AV-265, "Removal and Installation"](#).

>> GO TO 3.

#### 3. WRITING VEHICLE SPECIFICATION

##### -CONSULT Configuration

Perform “After Replace ECU” or “Manual Configuration” to write vehicle specification. Refer to [AV-194, "Work Procedure"](#).

>> GO TO 4.

#### 4. OPERATION CHECK

Check that the operation of the AV control unit and camera images (fixed guide lines and predictive course lines) are normal.

>> WORK END

A  
B  
C  
D  
E  
F  
G  
H  
I  
J  
K  
L  
M  
O  
P

AV

# CONFIGURATION (AV CONTROL UNIT)

< BASIC INSPECTION >

[BOSE AUDIO WITH NAVIGATION]

## CONFIGURATION (AV CONTROL UNIT)

### Description

INFOID:000000008130841

- Since vehicle specifications are not included in the AV control unit after replacement, it is required to write vehicle specifications with CONSULT.
- The AV control unit configuration includes functions as follows.

Function		Description
Read/Write Configuration	Before Replace ECU	Allows the reading of vehicle specification written in AV control unit to store the specification in CONSULT.
	After Replace ECU	Allows the writing of the vehicle information stored in CONSULT into the AV control unit.
Manual Configuration		Allows the writing of the vehicle specification into the AV control unit by hand.

### Work Procedure

INFOID:000000008130842

#### 1. WRITE VEHICLE SPECIFICATION

##### ⓐCONSULT Configuration

Write vehicle specification into AV control unit.

To write vehicle specification stored in CONSULT into the AV control unit>>GO TO 2.

To write vehicle specification into the AV control unit by hand>>GO TO 3.

#### 2. WRITE STORED DATA

##### ⓐCONSULT Configuration

Select "After Replace ECU" in "Read/Write Configuration." Write data stored in CONSULT with the "Before Replace ECU" function into the AV control unit.

>> GO TO 4.

#### 3. MANUALLY WRITE VEHICLE SPECIFICATION

##### ⓐCONSULT Configuration

Perform "Manual Configuration." Refer to the Configuration List to write vehicle specification into the AV control unit. Refer to [AV-194, "Configuration List"](#).

>> GO TO 4.

#### 4. OPERATION CHECK

Check that the operation of the AV control unit and camera images (fixed guide lines and predictive course lines) are normal.

>> WORK END

### Configuration List

INFOID:000000008130843

#### CAUTION:

Grasp vehicle specifications precisely. The control of ECU may not function normally if the specifications are misread.

#### NOTE:

- The items shown in this list depend on vehicle specifications.
- The config list may not be displayed depending on vehicle specifications. This is not malfunction.

# CONFIGURATION (AV CONTROL UNIT)

< BASIC INSPECTION >

[BOSE AUDIO WITH NAVIGATION]

MANUAL SETTING ITEM		Detail
Items	Setting value	
STEERING	LHD	LHD models
	RHD	RHD models
SOUND SYSTEM	BASE	Without BOSE system
	BOSE	With BOSE system
ENGINE TYPE	NORMAL	Except hybrid models
	HYBRID	Hybrid models
MICROPHONE	DIRECTIONAL MIC	With directional microphone*
	NON-DIRECTIONAL MIC	With non-directional microphone*

\*: In the following table, find an illustration that the (A) part matches the vehicle and select microphone type.

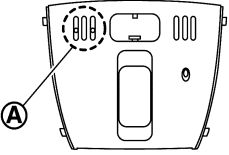
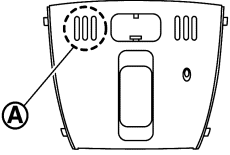
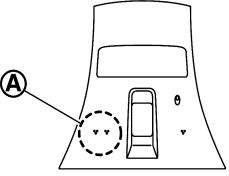
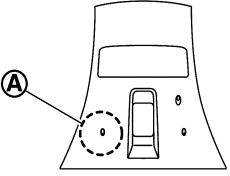
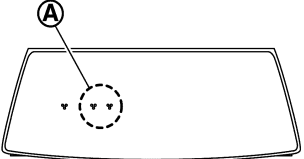
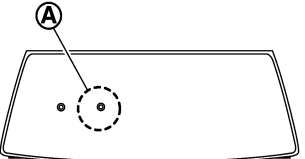
Directional microphone	Non-directional microphone
 <p style="text-align: center;">JSNIA5541ZZ</p> <p>(A): Microphone installation position</p>	 <p style="text-align: center;">JSNIA5542ZZ</p> <p>(A): Microphone installation position</p>
 <p style="text-align: center;">JSNIA5543ZZ</p> <p>(A): Microphone installation position</p>	 <p style="text-align: center;">JSNIA5544ZZ</p> <p>(A): Microphone installation position</p>
 <p style="text-align: center;">JSNIA5545ZZ</p> <p>(A): Microphone installation position</p>	 <p style="text-align: center;">JSNIA5546ZZ</p> <p>(A): Microphone installation position</p>

A  
B  
C  
D  
E  
F  
G  
H  
I  
J  
K  
L  
M  
O  
P

AV

# U1000 CAN COMM CIRCUIT

< DTC/CIRCUIT DIAGNOSIS >

[BOSE AUDIO WITH NAVIGATION]

## DTC/CIRCUIT DIAGNOSIS

### U1000 CAN COMM CIRCUIT

#### Description

INFOID:000000008130844

CAN (Controller Area Network) is a serial communication line for real-time application. It is an on-vehicle multiplex communication line with high data communication speed and excellent error detection ability. Many electronic control units are equipped onto a vehicle, and each control unit shares information and links with other control units during operation (not independently). In CAN communication, control units are connected with 2 communication lines (CAN-H, CAN-L) allowing a high rate of information transmission with less wiring. Each control unit transmits/receives data but selectively reads required data only.

CAN Communication Signal Chart. Refer to [LAN-37, "CAN COMMUNICATION SYSTEM : CAN Communication Signal Chart"](#).

#### DTC Logic

INFOID:000000008130845

#### DTC DETECTION LOGIC

DTC	Display contents of CONSULT	DTC detection condition	Probable malfunction location
U1000	CAN COMM CIRCUIT [U1000]	AV control unit is not transmitting or receiving CAN communication signal for 2 seconds or more.	CAN communication system.

#### Diagnosis Procedure

INFOID:000000008130846

#### 1. PERFORM SELF-DIAGNOSTIC

1. Turn ignition switch ON and wait for 2 seconds or more.
2. Check "Self Diagnostic Result" of "MULTI AV".

Is "CAN COMM CIRCUIT" displayed?

- YES >> Refer to [LAN-27, "Trouble Diagnosis Flow Chart"](#).  
NO >> Refer to [GI-43, "Intermittent Incident"](#).

# U1010 CONTROL UNIT (CAN)

< DTC/CIRCUIT DIAGNOSIS >

[BOSE AUDIO WITH NAVIGATION]

## U1010 CONTROL UNIT (CAN)

### DTC Logic

INFOID:000000008130847

### DTC DETECTION LOGIC

DTC	Display contents of CONSULT	DTC detection condition	Probable malfunction factor
U1010	CONTROL UNIT (CAN) [U1010]	CAN initial diagnosis malfunction is detected.	Replace the AV control unit if the malfunction occurs constantly. Refer to <a href="#">AV-265, "Removal and Installation"</a> .

A  
B  
C  
D  
E  
F  
G  
H  
I  
J  
K  
L  
M  
O  
P

AV

# U1200 AV CONTROL UNIT

< DTC/CIRCUIT DIAGNOSIS >

[BOSE AUDIO WITH NAVIGATION]

## U1200 AV CONTROL UNIT

### DTC Logic

INFOID:000000008130848

DTC	Display contents of CONSULT	DTC detection condition	Possible malfunction factor
U1200	Cont Unit [U1200]	AV control unit malfunction is detected.	Replace the AV control unit if the malfunction occurs constantly. Refer to <a href="#">AV-265, "Removal and Installation"</a> .

# U1201 AV CONTROL UNIT

< DTC/CIRCUIT DIAGNOSIS >

[BOSE AUDIO WITH NAVIGATION]

## U1201 AV CONTROL UNIT

### DTC Logic

INFOID:000000008130849

DTC	Display contents of CONSULT	DTC detection condition	Possible malfunction factor
U1201	GYRO NO CONN [U1201]	AV control unit malfunction is detected.	Replace the AV control unit if the malfunction occurs constantly. Refer to <a href="#">AV-265, "Removal and Installation"</a> .

A  
B  
C  
D  
E  
F  
G  
H  
I  
J  
K  
L  
M  
N  
O  
P

AV

# U1202 AV CONTROL UNIT

< DTC/CIRCUIT DIAGNOSIS >

[BOSE AUDIO WITH NAVIGATION]

## U1202 AV CONTROL UNIT

### DTC Logic

INFOID:000000008130850

DTC	Display contents of CONSULT	DTC detection condition	Possible malfunction factor
U1202	G-SENSOR NO CONN [U1202]	AV control unit malfunction is detected.	Replace the AV control unit if the malfunction occurs constantly. Refer to <a href="#">AV-265, "Removal and Installation"</a> .



# U1204 AV CONTROL UNIT

< DTC/CIRCUIT DIAGNOSIS >

[BOSE AUDIO WITH NAVIGATION]

## U1204 AV CONTROL UNIT

### Description

INFOID:000000008130851

An intermittent error caused by strong radio interference may be detected unless any symptoms (GPS reception error, etc.) occur. Replace the AV control unit if the malfunction occurs constantly. Refer to [AV-265, "Removal and Installation"](#).

### DTC Logic

INFOID:000000008130852

DTC	Display contents of CONSULT	DTC detection condition	Possible malfunction factor
U1204	GPS CONN [U1204]	GPS malfunction is detected.	An intermittent error caused by strong radio interference may be detected unless any symptom (GPS reception error, etc.) occurs. Replace the AV control unit if the malfunction occurs constantly. Refer to <a href="#">AV-265, "Removal and Installation"</a> .

### Diagnosis Procedure

INFOID:000000008130853

#### 1. PERFORM THE SELF-DIAGNOSIS

1. Delete the "Self-Diagnosis Results" of "MULTI AV". Turn ignition switch OFF.
2. Turn ignition switch ON. Perform the self-diagnosis again.
3. Check that the DTC is detected again.

#### Is any DTC detected?

- YES >> Replace AV control unit. Refer to [AV-265, "Removal and Installation"](#).
- NO >> An intermittent error caused by strong radio interference may be detected unless any symptom (GPS reception error, etc.) occurs.

A  
B  
C  
D  
E  
F  
G  
H  
I  
J  
K  
L  
M  
O  
P

AV

# U1205 AV CONTROL UNIT

< DTC/CIRCUIT DIAGNOSIS >

[BOSE AUDIO WITH NAVIGATION]

## U1205 AV CONTROL UNIT

### Description

INFOID:000000008130854

An intermittent error caused by strong radio interference may be detected unless any symptoms (GPS reception error, etc.) occur. Replace the AV control unit if the malfunction occurs constantly. Refer to [AV-265, "Removal and Installation"](#).

### DTC Logic

INFOID:000000008130855

DTC	Display contents of CONSULT	DTC detection condition	Possible malfunction factor
U1205	GPS ROM [U1205]	GPS malfunction is detected.	An intermittent error caused by strong radio interference may be detected unless any symptom (GPS reception error, etc.) occurs. Replace the AV control unit if the malfunction occurs constantly. Refer to <a href="#">AV-265, "Removal and Installation"</a> .

### Diagnosis Procedure

INFOID:000000008130856

#### 1. PERFORM THE SELF-DIAGNOSIS

1. Delete the "Self-Diagnosis Results" of "MULTI AV". Turn ignition switch OFF.
2. Turn ignition switch ON. Perform the self-diagnosis again.
3. Check that the DTC is detected again.

#### Is any DTC detected?

- YES >> Replace AV control unit. Refer to [AV-265, "Removal and Installation"](#).
- NO >> An intermittent error caused by strong radio interference may be detected unless any symptom (GPS reception error, etc.) occurs.

# U1206 AV CONTROL UNIT

< DTC/CIRCUIT DIAGNOSIS >

[BOSE AUDIO WITH NAVIGATION]

## U1206 AV CONTROL UNIT

### Description

INFOID:000000008130857

An intermittent error caused by strong radio interference may be detected unless any symptoms (GPS reception error, etc.) occur. Replace the AV control unit if the malfunction occurs constantly. Refer to [AV-265, "Removal and Installation"](#).

### DTC Logic

INFOID:000000008130858

DTC	Display contents of CONSULT	DTC detection condition	Possible malfunction factor
U1206	GPS RAM [U1206]	GPS malfunction is detected.	An intermittent error caused by strong radio interference may be detected unless any symptom (GPS reception error, etc.) occurs. Replace the AV control unit if the malfunction occurs constantly. Refer to <a href="#">AV-265, "Removal and Installation"</a> .

### Diagnosis Procedure

INFOID:000000008130859

#### 1. PERFORM THE SELF-DIAGNOSIS

1. Delete the "Self-Diagnosis Results" of "MULTI AV". Turn ignition switch OFF.
2. Turn ignition switch ON. Perform the self-diagnosis again.
3. Check that the DTC is detected again.

#### Is any DTC detected?

- YES >> Replace AV control unit. Refer to [AV-265, "Removal and Installation"](#).
- NO >> An intermittent error caused by strong radio interference may be detected unless any symptom (GPS reception error, etc.) occurs.

A  
B  
C  
D  
E  
F  
G  
H  
I  
J  
K  
L  
M  
O  
P

AV

# U1207 AV CONTROL UNIT

< DTC/CIRCUIT DIAGNOSIS >

[BOSE AUDIO WITH NAVIGATION]

## U1207 AV CONTROL UNIT

### Description

INFOID:000000008130860

An intermittent error caused by strong radio interference may be detected unless any symptoms (GPS reception error, etc.) occur. Replace the AV control unit if the malfunction occurs constantly. Refer to [AV-265, "Removal and Installation"](#).

### DTC Logic

INFOID:000000008130861

DTC	Display contents of CONSULT	DTC detection condition	Possible malfunction factor
U1207	GPS RTC [U1207]	GPS malfunction is detected.	An intermittent error caused by strong radio interference may be detected unless any symptom (GPS reception error, etc.) occurs. Replace the AV control unit if the malfunction occurs constantly. Refer to <a href="#">AV-265, "Removal and Installation"</a> .

### Diagnosis Procedure

INFOID:000000008130862

#### 1. PERFORM THE SELF-DIAGNOSIS

1. Delete the "Self-Diagnosis Results" of "MULTI AV". Turn ignition switch OFF.
2. Turn ignition switch ON. Perform the self-diagnosis again.
3. Check that the DTC is detected again.

#### Is any DTC detected?

- YES >> Replace AV control unit. Refer to [AV-265, "Removal and Installation"](#).
- NO >> An intermittent error caused by strong radio interference may be detected unless any symptom (GPS reception error, etc.) occurs.

# U1216 AV CONTROL UNIT

< DTC/CIRCUIT DIAGNOSIS >

[BOSE AUDIO WITH NAVIGATION]

## U1216 AV CONTROL UNIT

### DTC Logic

INFOID:000000008130863

DTC	Display contents of CONSULT	DTC detection condition	Possible malfunction factor
U1216	CAN CONT [U1216]	AV control unit malfunction is detected.	Replace the AV control unit if the malfunction occurs constantly. Refer to <a href="#">AV-265, "Removal and Installation"</a> .

A  
B  
C  
D  
E  
F  
G  
H  
I  
J  
K  
L  
M  
O  
P

AV

# U1217 AV CONTROL UNIT

< DTC/CIRCUIT DIAGNOSIS >

[BOSE AUDIO WITH NAVIGATION]

## U1217 AV CONTROL UNIT

### DTC Logic

INFOID:000000008130864

DTC	Display contents of CONSULT	DTC detection condition	Possible malfunction factor
U1217	BLUETOOTH MODULE [U1217]	AV control unit malfunction is detected.	Replace the AV control unit if the malfunction occurs constantly. Refer to <a href="#">AV-265, "Removal and Installation"</a> .

# U1218 AV CONTROL UNIT

< DTC/CIRCUIT DIAGNOSIS >

[BOSE AUDIO WITH NAVIGATION]

## U1218 AV CONTROL UNIT

### DTC Logic

INFOID:000000008130865

DTC	Display contents of CONSULT	DTC detection condition	Possible malfunction factor
U1218	HDD CONN [U1218]	AV control unit malfunction is detected.	<ul style="list-style-type: none"><li>• If the music box function has no malfunctions, then there is a possibility of the detection of a temporary malfunction.</li><li>• Replace the AV control unit if the malfunction occurs constantly. Refer to <a href="#">AV-265, "Removal and Installation"</a>.</li></ul>

### Diagnosis Procedure

INFOID:000000008130866

#### 1. CHECK MUSIC BOX FUNCTION

Is music box function normal?

- YES >> Malfunction may be detected transitory.  
NO >> Replace AV control unit. Refer to [AV-265, "Removal and Installation"](#).

A  
B  
C  
D  
E  
F  
G  
H  
I  
J  
K  
L  
M  
O  
P

AV

# U1219 AV CONTROL UNIT

< DTC/CIRCUIT DIAGNOSIS >

[BOSE AUDIO WITH NAVIGATION]

## U1219 AV CONTROL UNIT

### DTC Logic

INFOID:000000008130867

DTC	Display contents of CONSULT	DTC detection condition	Possible malfunction factor
U1219	HDD READ [U1219]	AV control unit malfunction is detected.	<ul style="list-style-type: none"><li>• If the music box function has no malfunctions, then there is a possibility of the detection of a temporary malfunction.</li><li>• Replace the AV control unit if the malfunction occurs constantly. Refer to <a href="#">AV-265, "Removal and Installation"</a>.</li></ul>

### Diagnosis Procedure

INFOID:000000008130868

#### 1. CHECK MUSIC BOX FUNCTION

Is music box function normal?

YES >> Malfunction may be detected transitory.

NO >> Replace AV control unit. Refer to [AV-265, "Removal and Installation"](#).



# U121A AV CONTROL UNIT

< DTC/CIRCUIT DIAGNOSIS >

[BOSE AUDIO WITH NAVIGATION]

## U121A AV CONTROL UNIT

### DTC Logic

INFOID:000000008130869

DTC	Display contents of CONSULT	DTC detection condition	Possible malfunction factor
U121A	HDD WRITE [U121A]	AV control unit malfunction is detected.	<ul style="list-style-type: none"><li>• If the music box function has no malfunctions, then there is a possibility of the detection of a temporary malfunction.</li><li>• Replace the AV control unit if the malfunction occurs constantly. Refer to <a href="#">AV-265, "Removal and Installation"</a>.</li></ul>

### Diagnosis Procedure

INFOID:000000008130870

#### 1. CHECK MUSIC BOX FUNCTION

Is music box function normal?

YES >> Malfunction may be detected transitory.

NO >> Replace AV control unit. Refer to [AV-265, "Removal and Installation"](#).

A  
B  
C  
D  
E  
F  
G  
H  
I  
J  
K  
L  
M  
O  
P

AV

# U121B AV CONTROL UNIT

< DTC/CIRCUIT DIAGNOSIS >

[BOSE AUDIO WITH NAVIGATION]

## U121B AV CONTROL UNIT

### DTC Logic

INFOID:000000008130871

DTC	Display contents of CONSULT	DTC detection condition	Possible malfunction factor
U121B	HDD COMM [U121B]	AV control unit malfunction is detected.	<ul style="list-style-type: none"><li>• If the music box function has no malfunctions, then there is a possibility of the detection of a temporary malfunction.</li><li>• Replace the AV control unit if the malfunction occurs constantly. Refer to <a href="#">AV-265, "Removal and Installation"</a>.</li></ul>

### Diagnosis Procedure

INFOID:000000008130872

#### 1. CHECK MUSIC BOX FUNCTION

Is music box function normal?

YES >> Malfunction may be detected transitory.

NO >> Replace AV control unit. Refer to [AV-265, "Removal and Installation"](#).

# U121C AV CONTROL UNIT

< DTC/CIRCUIT DIAGNOSIS >

[BOSE AUDIO WITH NAVIGATION]

## U121C AV CONTROL UNIT

### DTC Logic

INFOID:000000008130873

DTC	Display contents of CONSULT	DTC detection condition	Possible malfunction factor
U121C	HDD ACCESS [U121C]	AV control unit malfunction is detected.	<ul style="list-style-type: none"><li>• If the music box function has no malfunctions, then there is a possibility of the detection of a temporary malfunction.</li><li>• Replace the AV control unit if the malfunction occurs constantly. Refer to <a href="#">AV-265, "Removal and Installation"</a>.</li></ul>

### Diagnosis Procedure

INFOID:000000008130874

#### 1. CHECK MUSIC BOX FUNCTION

Is music box function normal?

YES >> Malfunction may be detected transitory.

NO >> Replace AV control unit. Refer to [AV-265, "Removal and Installation"](#).

A  
B  
C  
D  
E  
F  
G  
H  
I  
J  
K  
L  
M  
O  
P

AV

# U121D AV CONTROL UNIT

< DTC/CIRCUIT DIAGNOSIS >

[BOSE AUDIO WITH NAVIGATION]

## U121D AV CONTROL UNIT

### DTC Logic

INFOID:000000008130875

DTC	Display contents of CONSULT	DTC detection condition	Possible malfunction factor
U121D	DSP CONN [U121D]	AV control unit malfunction is detected.	<ul style="list-style-type: none"><li>• If a disc can be played, then there is a possibility of the detection of a temporary malfunction.</li><li>• Replace the AV control unit if the malfunction occurs constantly. Refer to <a href="#">AV-265. "Removal and Installation"</a>.</li></ul>

### Diagnosis Procedure

INFOID:000000008130876

#### 1. CHECK PLAYBACK OF A DISK (CD)

##### Can a disk (CD) be played?

YES >> Malfunction may be detected transitory.

NO >> Replace AV control unit. Refer to [AV-265. "Removal and Installation"](#).

# U121E AV CONTROL UNIT

< DTC/CIRCUIT DIAGNOSIS >

[BOSE AUDIO WITH NAVIGATION]

## U121E AV CONTROL UNIT

### DTC Logic

INFOID:000000008130877

DTC	Display contents of CONSULT	DTC detection condition	Possible malfunction factor
U121E	DSP COMM [U121E]	AV control unit malfunction is detected.	<ul style="list-style-type: none"><li>• If a disc can be played, then there is a possibility of the detection of a temporary malfunction.</li><li>• Replace the AV control unit if the malfunction occurs constantly. Refer to <a href="#">AV-265. "Removal and Installation"</a>.</li></ul>

### Diagnosis Procedure

INFOID:000000008130878

#### 1. CHECK PLAYBACK OF A DISK (CD)

##### Can a disk (CD) be played?

YES >> Malfunction may be detected transitory.

NO >> Replace AV control unit. Refer to [AV-265. "Removal and Installation"](#).

A  
B  
C  
D  
E  
F  
G  
H  
I  
J  
K  
L  
M  
O  
P

AV

# U1225 AV CONTROL UNIT

< DTC/CIRCUIT DIAGNOSIS >

[BOSE AUDIO WITH NAVIGATION]

## U1225 AV CONTROL UNIT

### DTC Logic

INFOID:000000008130879

### DTC DETECTION LOGIC

DTC	Display contents of CONSULT	DTC detection condition	Possible malfunction factor
U1225	USB CONTROLLER [U1225]	USB connection malfunction is detected.	Check that the connection to the USB connector is normal.

# U1227 AV CONTROL UNIT

< DTC/CIRCUIT DIAGNOSIS >

[BOSE AUDIO WITH NAVIGATION]

## U1227 AV CONTROL UNIT

### DTC Logic

INFOID:000000008130880

DTC	Display contents of CONSULT	DTC detection condition	Possible malfunction factor
U1227	DVD COMM [U1227]	AV control unit malfunction is detected.	<ul style="list-style-type: none"><li>• If DVD can be played, then there is a possibility of the detection of a temporary malfunction.</li><li>• Replace the AV control unit if the malfunction occurs constantly. Refer to <a href="#">AV-265. "Removal and Installation"</a>.</li></ul>

### Diagnosis Procedure

INFOID:000000008130881

#### 1. CHECK PLAYBACK OF A DISK (DVD)

##### Can a disc (DVD) be played?

YES >> Malfunction may be detected transitory.

NO >> Replace AV control unit. Refer to [AV-265. "Removal and Installation"](#).

A  
B  
C  
D  
E  
F  
G  
H  
I  
J  
K  
L  
M  
O  
P

AV

# U1228 AV CONTROL UNIT

< DTC/CIRCUIT DIAGNOSIS >

[BOSE AUDIO WITH NAVIGATION]

## U1228 AV CONTROL UNIT

### DTC Logic

INFOID:000000008130882

### DTC DETECTION LOGIC

DTC	Display contents of CONSULT	DTC detection condition	Possible malfunction factor
U1228	SUB CPU CONN [U1228]	AV control unit malfunction is detected.	Replace the AV control unit if the malfunction occurs constantly. Refer to <a href="#">AV-265, "Removal and Installation"</a> .



# U1229 AV CONTROL UNIT

< DTC/CIRCUIT DIAGNOSIS >

[BOSE AUDIO WITH NAVIGATION]

## U1229 AV CONTROL UNIT

### DTC Logic

INFOID:000000008130883

### DTC DETECTION LOGIC

DTC	Display contents of CONSULT	DTC detection condition	Possible malfunction factor
U1229	iPod CERTIFICATION [U1229]	AV control unit malfunction is detected.	Replace the AV control unit if the malfunction occurs constantly. Refer to <a href="#">AV-265, "Removal and Installation"</a> .

A  
B  
C  
D  
E  
F  
G  
H  
I  
J  
K  
L  
M  
N  
O  
P

AV

# U122A AV CONTROL UNIT

< DTC/CIRCUIT DIAGNOSIS >

[BOSE AUDIO WITH NAVIGATION]

## U122A AV CONTROL UNIT

### DTC Logic

INFOID:000000008130884

DTC	Display contents of CONSULT	DTC detection condition	Action to take
U122A	CONFIG UNFINISH [U122A]	The writing of configuration data is incomplete.	Write configuration data with "MULTI AV" of CONSULT. Refer to <a href="#">AV-194, "Work Procedure"</a> .

### Diagnosis Procedure

INFOID:000000008130885

#### 1.PERFORM THE SELF-DIAGNOSIS

When U122A is detected, write configuration data with "MULTI AV" of CONSULT.

>> Write configuration data with "MULTI AV" of CONSULT. Refer to [AV-194, "Work Procedure"](#).

# U122E AV CONTROL UNIT

< DTC/CIRCUIT DIAGNOSIS >

[BOSE AUDIO WITH NAVIGATION]

## U122E AV CONTROL UNIT

### DTC Logic

INFOID:000000008130886

### DTC DETECTION LOGIC

DTC	Display contents of CONSULT	DTC detection condition	Possible malfunction factor
U122E	Built-in AUDIO CONN [U122E]	AV control unit malfunction is detected.	Replace the AV control unit if the malfunction occurs constantly. Refer to <a href="#">AV-265, "Removal and Installation"</a> .

A

B

C

D

E

F

G

H

I

J

K

L

M

AV

O

P

# U1231 BOSE AMP.

< DTC/CIRCUIT DIAGNOSIS >

[BOSE AUDIO WITH NAVIGATION]

## U1231 BOSE AMP.

### DTC Logic

INFOID:000000008130887

DTC	Display contents of CONSULT	DTC detection condition	Possible malfunction factor
U1231	AMP TEMP [U1231]	BOSE amp. malfunction is detected.	Replace the BOSE amp. if the malfunction occurs constantly. Refer to <a href="#">AV-274, "Removal and Installation"</a> .

# U1232 STEERING ANGLE SENSOR

< DTC/CIRCUIT DIAGNOSIS >

[BOSE AUDIO WITH NAVIGATION]

## U1232 STEERING ANGLE SENSOR

### DTC Logic

INFOID:000000008130888

DTC	Display contents of CONSULT	DTC detection condition	Possible malfunction factor
U1232	ST ANGLE SEN CALIB [1232]	Predictive course line center position adjustment of the steering angle sensor is incomplete.	Adjust the predictive course line center position of the steering angle sensor. Refer to <a href="#">BRC-60, "Work Procedure"</a> .

### Diagnosis Procedure

INFOID:000000008130889

#### 1. ADJUST THE PREDICTIVE COURSE LINE CENTER POSITION OF THE STEERING ANGLE SENSOR

When U1232 is detected, adjust the predictive course line center position of the steering angle sensor.

>> Adjusts the steering angle sensor neutral position on ABS actuator and electrical unit (control unit) side. Refer to [BRC-60, "Work Procedure"](#).

A  
B  
C  
D  
E  
F  
G  
H  
I  
J  
K  
L  
M  
AV  
O  
P



# U1243 DISPLAY UNIT

< DTC/CIRCUIT DIAGNOSIS >

[BOSE AUDIO WITH NAVIGATION]

## U1243 DISPLAY UNIT

### DTC Logic

INFOID:000000008130890

DTC	Display contents of CONSULT	DTC detection condition	Possible malfunction factor
U1243	FRONT DISP CONN [U1243]	When either one of the following items is detected: <ul style="list-style-type: none"><li>display unit power supply and ground circuit are malfunctioning.</li><li>communication circuit between AV control unit and display unit are malfunctioning.</li></ul>	<ul style="list-style-type: none"><li>Display unit power supply and ground circuit. Refer to <a href="#">AV-238. "DISPLAY UNIT : Diagnosis Procedure"</a>.</li><li>Communication circuit between AV control unit and display unit.</li></ul>

### Diagnosis Procedure

INFOID:000000008130891

#### 1. CHECK DISPLAY UNIT POWER SUPPLY AND GROUND CIRCUIT

Check display unit power supply and ground circuit. Refer to [AV-238. "DISPLAY UNIT : Diagnosis Procedure"](#).

Is the inspection result normal?

YES >> GO TO 2.

NO >> Repair malfunctioning parts.

#### 2. CHECK CONTINUITY COMMUNICATION CIRCUIT

- Turn ignition switch OFF.
- Disconnect display unit connector and AV control unit connector.
- Check continuity between display unit harness connector and AV control unit harness connector.

Display unit		AV control unit		Continuity
Connector	Terminals	Connector	Terminals	
M215	9	M210	89	Existed
	10		73	

- Check continuity between display unit harness connector and ground.

Display unit		Ground	Continuity
Connector	Terminals		
M215	9		Not existed
	10		

Is the inspection result normal?

YES >> GO TO 3.

NO >> Repair harness or connector.

#### 3. CHECK COMMUNICATION SIGNAL

- Connect display unit connector and AV control unit connector.
- Turn ignition switch ON.
- Check signal between display unit harness connector and ground.

# U1243 DISPLAY UNIT

< DTC/CIRCUIT DIAGNOSIS >

[BOSE AUDIO WITH NAVIGATION]

(+)		(-)	Condition	Reference value
Display unit				
Connector	Terminal			
M215	9	Ground	When adjusting display brightness.	

Is the inspection result normal?

YES >> GO TO 4.

NO >> Replace AV control unit. Refer to [AV-265. "Removal and Installation"](#).

## 4. CHECK COMMUNICATION SIGNAL

Check signal between display unit harness connector and ground.

(+)		(-)	Condition	Reference value
Display unit				
Connector	Terminal			
M215	10	Ground	When adjusting display brightness.	

Is the inspection result normal?

YES >> INSPECTION END

NO >> Replace display unit. Refer to [AV-278. "Removal and Installation"](#).

A  
B  
C  
D  
E  
F  
G  
H  
I  
J  
K  
L  
M  
O  
P

AV

# U1244 GPS ANTENNA

< DTC/CIRCUIT DIAGNOSIS >

[BOSE AUDIO WITH NAVIGATION]

## U1244 GPS ANTENNA

### DTC Logic

INFOID:000000008130892

DTC	Display contents of CONSULT	DTC detection condition	Possible malfunction factor
U1244	GPS ANTENNA CONN [U1244]	GPS antenna connection malfunction is detected.	Check the connection of the GPS antenna connector.

### Diagnosis Procedure

INFOID:000000008130893

#### 1. GPS ANTENNA CHECK

Visually check GPS antenna and antenna feeder.

Is the inspection result normal?

YES >> GO TO 2.

NO >> Repair malfunctioning parts.

#### 2. CHECK AV CONTROL UNIT VOLTAGE

1. Disconnect GPS antenna connector.
2. Turn ignition switch ON.
3. Check voltage between AV control unit and ground.

(+)	(-)	Voltage (Approx.)
AV control unit		
Terminal		
153	Ground	5.0 V

Is the inspection result normal?

YES >> INSPECTION END

NO >> Replace AV control unit. Refer to [AV-265. "Removal and Installation"](#).



# U1258 SATELLITE RADIO ANTENNA

< DTC/CIRCUIT DIAGNOSIS >

[BOSE AUDIO WITH NAVIGATION]

## U1258 SATELLITE RADIO ANTENNA

### DTC Logic

INFOID:000000008130894

DTC	Display contents of CONSULT	DTC Detection Condition	Possible causes
U1258	XM ANTENNA CONN [U1258]	Satellite radio antenna connection malfunction is detected.	Satellite radio antenna disconnection.

### Diagnosis Procedure

INFOID:000000008130895

#### 1. SATELLITE RADIO ANTENNA CHECK

Visually check satellite radio antenna and antenna feeder.

Is the inspection result normal?

YES >> GO TO 2.

NO >> Repair malfunctioning parts.

#### 2. CHECK AV CONTROL UNIT VOLTAGE

1. Disconnect satellite radio antenna connector.
2. Turn ignition switch ON.
3. Check voltage between AV control unit and ground.

(+)	(-)	Voltage (Approx.)
AV control unit		
Terminal		
159	Ground	5.0 V

Is the inspection result normal?

YES >> INSPECTION END

NO >> Replace AV control unit. Refer to [AV-265, "Removal and Installation"](#).

A  
B  
C  
D  
E  
F  
G  
H  
I  
J  
K  
L  
M  
O  
P

AV

**U1263 USB**

**DTC Logic**

INFOID:000000008130896

DTC	Display contents of CONSULT	DTC detection condition	Possible malfunction factor
U1263	USB OVERCURRENT [U1263]	Detection of overcurrent in USB connector.	Check USB harness between the AV control unit and USB connector.

**Diagnosis Procedure**

INFOID:000000008130897

**1.CHECK USB HARNESS**

Visually check USB harness.

Is the inspection result normal?

- YES >> Replace AV control unit. Refer to [AV-265. "Removal and Installation"](#).
- NO >> Replace USB harness. Refer to [AV-283. "Removal and Installation"](#).

# U1264 ANTENNA AMP.

< DTC/CIRCUIT DIAGNOSIS >

[BOSE AUDIO WITH NAVIGATION]

## U1264 ANTENNA AMP.

### DTC Logic

INFOID:000000008130898

DTC	Display contents of CONSULT	DTC detection condition	Possible malfunction factor
U1264	ANTENNA AMP TERMINAL [OPEN or SHORT] [U1264]	Antenna amp. ON circuit is open or shorted.	Check antenna amp. ON signal circuit between the AV control unit and antenna amp.

### Diagnosis Procedure

INFOID:000000008130899

#### 1. CHECK CONTINUITY BETWEEN AV CONTROL UNIT AND ANTENNA AMP.

1. Turn ignition switch OFF.
2. Disconnect antenna amp. connector and AV control unit connector.
3. Check continuity between AV control unit harness connector and antenna amp. harness connector.

AV control unit		Antenna amp.		Continuity
Connector	Terminals	Connector	Terminals	
M394	150	M404	1	Existed

4. Check continuity between AV control unit harness connector and ground.

AV control unit		Ground	Continuity
Connector	Terminals		
M394	150		Not existed

Is the inspection result normal?

- YES >> GO TO 2.  
 NO >> Repair harness or connector.

#### 2. CHECK VOLTAGE AV CONTROL UNIT

1. Connect AV control unit connector.
2. Turn ignition switch ON.
3. Check voltage between AV control unit harness connector and ground.

AV control unit		(-)	Voltage (Approx.)
Connector	Terminals		
M394	150	Ground	12.0 V

Is the inspection result normal?

- YES >> Replace antenna amp. Refer to [AV-277, "Removal and Installation"](#).  
 NO >> Replace AV control unit. Refer to [AV-265, "Removal and Installation"](#).

A  
B  
C  
D  
E  
F  
G  
H  
I  
J  
K  
L  
M  
O  
P

AV

# U1300 AV COMM CIRCUIT

< DTC/CIRCUIT DIAGNOSIS >

[BOSE AUDIO WITH NAVIGATION]

## U1300 AV COMM CIRCUIT

### Description

INFOID:000000008130900

U1300 is indicated when malfunction occurs in communication signal of multi AV system. Indicated simultaneously, without fail, with the malfunction of control units connected to AV control unit with communication line. Determine the possible malfunction cause from the table below.

### SELF-DIAGNOSIS RESULTS DISPLAY ITEM

DTC	Display contents of CONSULT	DTC detection condition	Possible malfunction factor
U1300 U1240	<ul style="list-style-type: none"> <li>AV COMM CIRCUIT [U1300]</li> <li>SWITCH CONN [U1240]</li> </ul>	When either one of the following items are detected: <ul style="list-style-type: none"> <li>multifunction switch power supply and ground circuits are malfunctioning.</li> <li>AV communication circuits between AV control unit and multifunction switch are malfunctioning.</li> </ul>	<ul style="list-style-type: none"> <li>Multifunction switch power supply and ground circuits.</li> <li>AV communication circuits between AV control unit and multifunction switch.</li> </ul>
U1300 U124E	<ul style="list-style-type: none"> <li>AV COMM CIRCUIT [U1300]</li> <li>AMP CONN [U124E]</li> </ul>	When either one of the following items are detected: <ul style="list-style-type: none"> <li>BOSE amp. power supply and ground circuits are malfunctioning.</li> <li>AV communication circuits between multifunction switch and BOSE amp. are malfunctioning.</li> </ul>	<ul style="list-style-type: none"> <li>BOSE amp. power supply and ground circuits. Refer to <a href="#">AV-239. "BOSE AMP. : Diagnosis Procedure"</a>.</li> <li>AV communication circuits between multifunction switch and BOSE amp.</li> </ul>
U1300 U1240 U124E	<ul style="list-style-type: none"> <li>AV COMM CIRCUIT [U1300]</li> <li>SWITCH CONN [U1240]</li> <li>AMP CONN [U124E]</li> </ul>	AV communication circuits between AV control unit and multifunction switch are malfunctioning.	AV communication circuits between AV control unit and multifunction switch.

# U1310 AV CONTROL UNIT

< DTC/CIRCUIT DIAGNOSIS >

[BOSE AUDIO WITH NAVIGATION]

## U1310 AV CONTROL UNIT

### DTC Logic

INFOID:000000008130901

DTC	Display contents of CONSULT	DTC detection condition	Possible malfunction factor
U1310	CONTROL UNIT (AV) [U1310]	An initial diagnosis error is detected in AV communication circuit.	Replace AV control unit. If the malfunction occurs constantly. Refer to <a href="#">AV-238, "AV CONTROL UNIT : Diagnosis Procedure"</a> .

A  
B  
C  
D  
E  
F  
G  
H  
I  
J  
K  
L  
M  
O  
P

AV

# U1601, U1609 FRONT DOOR WOOFER

< DTC/CIRCUIT DIAGNOSIS >

[BOSE AUDIO WITH NAVIGATION]

## U1601, U1609 FRONT DOOR WOOFER

### DTC Logic

INFOID:000000008130902

### DTC DETECTION LOGIC

DTC	Display contents of CONSULT	DTC detection condition	Possible malfunction factor
U1601	FL-DOOR WOOFER [OPEN, SHORT, GND-SHORT or VB-SHOR] [U1601]	Malfunction is detected sound signal circuits between BOSE amp. and front door woofer LH.	Sound signal circuits between BOSE amp. and front door woofer LH.
U1609	FR-DOOR WOOFER [OPEN, SHORT, GND-SHORT or VB-SHOR] [U1609]	Malfunction is detected sound signal circuits between BOSE amp. and front door woofer RH.	Sound signal circuits between BOSE amp. and front door woofer RH.

### Diagnosis Procedure

INFOID:000000008130903

#### 1. PERFORM THE SELF-DIAGNOSIS

1. Delete the "self-diagnosis" results of "MULTI AV". Turn ignition switch OFF.
2. Turn ignition switch ON. perform the self-diagnosis again.
3. Check that the DTC is detected again.

#### Is any DTC detected?

- YES-1 >> U1601 Check harnesses between BOSE amp. and front door woofer LH.  
YES-2 >> U1609 Check harnesses between BOSE amp. and front door woofer RH.  
NO >> Refer to [GI-43, "Intermittent Incident"](#).

# U1602, U160A FRONT DOOR SQUAWKER/TWEETER

< DTC/CIRCUIT DIAGNOSIS >

[BOSE AUDIO WITH NAVIGATION]

## U1602, U160A FRONT DOOR SQUAWKER/TWEETER

### DTC Logic

INFOID:000000008130904

### DTC DETECTION LOGIC

DTC	Display contents of CONSULT	DTC detection condition	Possible malfunction factor
U1602	FL-DOOR SQUAWK [OPEN, SHORT, GND-SHORT or VB-SHOR] [U1602]	When either one of the following items are detected: <ul style="list-style-type: none"><li>• sound signal circuits between BOSE amp. and front door squawker LH are malfunctioning.</li><li>• sound signal circuits between BOSE amp. and tweeter LH are malfunctioning.</li></ul>	<ul style="list-style-type: none"><li>• Sound signal circuits between BOSE amp. and front door squawker LH.</li><li>• Sound signal circuits between BOSE amp. and tweeter LH.</li></ul>
U160A	FR-DOOR SQUAWK [OPEN, SHORT, GND-SHORT or VB-SHOR] [U160A]	When either one of the following items are detected: <ul style="list-style-type: none"><li>• sound signal circuits between BOSE amp. and front door squawker RH are malfunctioning.</li><li>• sound signal circuits between BOSE amp. and tweeter RH are malfunctioning.</li></ul>	<ul style="list-style-type: none"><li>• Sound signal circuits between BOSE amp. and front door squawker RH.</li><li>• Sound signal circuits between BOSE amp. and tweeter RH.</li></ul>

### Diagnosis Procedure

INFOID:000000008130905

#### 1. PERFORM THE SELF-DIAGNOSIS

1. Delete the "self-diagnosis" results of "MULTI AV". Turn ignition switch OFF.
2. Turn ignition switch ON. perform the self-diagnosis again.
3. Check that the DTC is detected again.

#### Is any DTC detected?

- YES-1 >> U1602: Check harnesses between BOSE amp. and front door squawker LH or between BOSE amp. and tweeter LH.
- YES-2 >> U160A: Check harnesses between BOSE amp. and front door squawker RH or between BOSE amp. and tweeter RH.
- NO >> Refer to [GI-43, "Intermittent Incident"](#).

A  
B  
C  
D  
E  
F  
G  
H  
I  
J  
K  
L  
M  
O  
P

AV

# U162A CENTER SPEAKER

< DTC/CIRCUIT DIAGNOSIS >

[BOSE AUDIO WITH NAVIGATION]

## U162A CENTER SPEAKER

### DTC Logic

INFOID:000000008130906

### DTC DETECTION LOGIC

DTC	Display contents of CONSULT	DTC detection condition	Possible malfunction factor
U162A	F-INST C-SQUAWK [OPEN, SHORT, GND-SHORT, or VB-SHORT] [U162A]	Malfunction is detected sound signal circuits between BOSE amp. and center speaker.	Sound signal circuits between BOSE amp. and center speaker.

### Diagnosis Procedure

INFOID:000000008130907

#### 1. PERFORM THE SELF-DIAGNOSIS

1. Delete the "self-diagnosis" results of "MULTI AV". Turn ignition switch OFF.
2. Turn ignition switch ON. perform the self-diagnosis again.
3. Check that the DTC is detected again.

#### Is any DTC detected?

- YES >> Check harnesses between BOSE amp. and center speaker.  
NO >> Refer to [GI-43, "Intermittent Incident"](#)



# U1632, U163A, U163E SEAT SPEAKER

< DTC/CIRCUIT DIAGNOSIS >

[BOSE AUDIO WITH NAVIGATION]

## U1632, U163A, U163E SEAT SPEAKER

### DTC Logic

INFOID:000000008130908

### DTC DETECTION LOGIC

DTC	Display contents of CONSULT	DTC detection condition	Possible malfunction factor
U1632	FL-SEAT L-SQUAWK [OPEN, SHORT, GND-SHORT or VB-SHOR] [U1632]	Malfunction is detected sound signal circuits between BOSE amp. and driver seat speaker LH.	Sound signal circuits between BOSE amp. and driver seat speaker LH.
U163A	FL-SEAT R-SQUAWK [OPEN, SHORT, GND-SHORT or VB-SHOR] [U163A]	Malfunction is detected sound signal circuits between BOSE amp. and driver seat speaker RH.	Sound signal circuits between BOSE amp. and driver seat speaker RH.
U163E	FR-SEAT L-SQUAWK [OPEN, SHORT, GND-SHORT or VB-SHOR] [U163E]	Malfunction is detected sound signal circuits between BOSE amp. and passenger seat speaker LH.	Sound signal circuits between BOSE amp. and passenger seat speaker LH.

### Diagnosis Procedure

INFOID:000000008130909

#### 1. PERFORM THE SELF-DIAGNOSIS

1. Delete the "self-diagnosis" results of "MULTI AV". Turn ignition switch OFF.
2. Turn ignition switch ON. perform the self-diagnosis again.
3. Check that the DTC is detected again.

#### Is any DTC detected?

YES-1 >> U1632: Check harnesses between BOSE amp. and driver seat speaker LH.

YES-2 >> U163A: Check harnesses between BOSE amp. and driver seat speaker RH.

YES-3 >> U163E: Check harnesses between BOSE amp. and passenger seat speaker LH.

NO >> Refer to [GI-43, "Intermittent Incident"](#).

A  
B  
C  
D  
E  
F  
G  
H  
I  
J  
K  
L  
M  
O  
P

AV

# U1708, U1710 REAR DOOR SPEAKER

< DTC/CIRCUIT DIAGNOSIS >

[BOSE AUDIO WITH NAVIGATION]

## U1708, U1710 REAR DOOR SPEAKER

### DTC Logic

INFOID:000000008130910

### DTC DETECTION LOGIC

DTC	Display contents of CONSULT	DTC detection condition	Possible malfunction factor
U1708	RL-DOOR SPEAKER [OPEN, SHORT, GND-SHORT or VB-SHOR] [U1708]	Malfunction is detected sound signal circuits between BOSE amp. and rear door speaker LH.	Sound signal circuits between BOSE amp. and rear door speaker LH.
U1710	RR-DOOR SPEAKER [OPEN, SHORT, GND-SHORT or VB-SHOR] [U1710]	Malfunction is detected sound signal circuits between BOSE amp. and rear door speaker RH.	Sound signal circuits between BOSE amp. and rear door speaker RH.

### Diagnosis Procedure

INFOID:000000008130911

#### 1. PERFORM THE SELF-DIAGNOSIS

1. Delete the "self-diagnosis" results of "MULTI AV". Turn ignition switch OFF.
2. Turn ignition switch ON. perform the self-diagnosis again.
3. Check that the DTC is detected again.

#### Is any DTC detected?

- YES-1 >> U1708 Check harnesses between BOSE amp. and rear door speaker LH.  
YES-2 >> U1710 Check harnesses between BOSE amp. and rear door speaker RH.  
NO >> Refer to [GI-43, "Intermittent Incident"](#).

# U1725 REAR WOOFER

< DTC/CIRCUIT DIAGNOSIS >

[BOSE AUDIO WITH NAVIGATION]

## U1725 REAR WOOFER

### DTC Logic

INFOID:000000008130912

### DTC DETECTION LOGIC

DTC	Display contents of CONSULT	DTC detection condition	Possible malfunction factor
U1725	R-PSHELF C- WOOFER [OPEN, SHORT, GND-SHORT or VB-SHOR] [U1725]	Malfunction is detected sound signal circuits between BOSE amp. and rear woofer.	Sound signal circuits between BOSE amp. and rear woofer.

### Diagnosis Procedure

INFOID:000000008130913

#### 1. PERFORM THE SELF-DIAGNOSIS

1. Delete the "self-diagnosis" results of "MULTI AV". Turn ignition switch OFF.
2. Turn ignition switch ON. perform the self-diagnosis again.
3. Check that the DTC is detected again.

#### Is any DTC detected?

- YES >> Check harnesses between BOSE amp. and rear woofer.  
NO >> Refer to [GI-43, "Intermittent Incident"](#).

A  
B  
C  
D  
E  
F  
G  
H  
I  
J  
K  
L  
M  
O  
P

AV

# U190C FRONT/REAR MICROPHONE

< DTC/CIRCUIT DIAGNOSIS >

[BOSE AUDIO WITH NAVIGATION]

## U190C FRONT/REAR MICROPHONE

### DTC Logic

INFOID:000000008130914

DTC	Display contents of CONSULT	DTC detection condition	Possible malfunction factor
U190C	CORRECT MICROPHONE [OPEN, SHORT, GND-SHORT or VB-SHOR] [U190C]	Malfunction is detected sound signal circuits between BOSE amp. and front, rear or both microphone.	Sound signal circuits between BOSE amp. and front, rear or both microphone.

### Diagnosis Procedure

INFOID:000000008130915

#### 1. CHECK ON BOARD SELF-DIAGNOSIS

Perform on board self-diagnosis. Refer to [AV-162, "On Board Diagnosis Function"](#).

Is the inspection result normal?

YES >> INSPECTION END

NO >> GO TO 2.

#### 2. CHECK CONTINUITY BETWEEN BOSE AMP. AND FRONT/REAR MICROPHONE CIRCUIT

1. Turn ignition switch OFF.
2. Disconnect BOSE amp. connector and front/rear microphone connector.
3. Check continuity between BOSE amp. harness connector and front/rear microphone harness connector.

BOSE amp.		Front microphone		Continuity
Connector	Terminals	Connector	Terminals	
B43	72	R19	2	Existed
	52		1	

BOSE amp.		Rear microphone		Continuity
Connector	Terminals	Connector	Terminals	
B43	63	R21	2	Existed
	43		1	

4. Check continuity between BOSE amp. harness connector and ground.

BOSE amp.		Ground	Continuity
Connector	Terminals		
B43	72		Not existed
	52		
	63		
	43		

Is the inspection result normal?

YES >> GO TO 3.

NO >> Repair harness or connector.

#### 3. CHECK MICROPHONE SIGNAL

1. Connect BOSE amp. connector and front/rear microphone connector.
2. Check signal between BOSE amp. harness connector.

# U190C FRONT/REAR MICROPHONE

< DTC/CIRCUIT DIAGNOSIS >

[BOSE AUDIO WITH NAVIGATION]

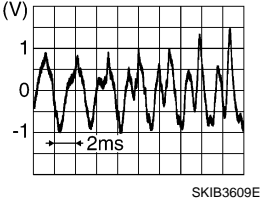
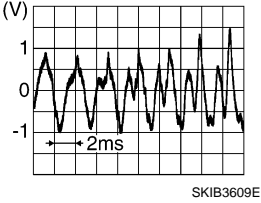
(+)		(-)		Condition	Reference value
BOSE amp.		BOSE amp.			
Connector	Terminal	Connector	Terminal		
B43	72	B43	52	When inputting interior sound.	
	63		43	When inputting interior sound.	

Is the inspection result normal?

- YES >> Replace BOSE amp. Refer to [AV-274, "Removal and Installation"](#).
- NO >> Replace front/rear microphone. Refer to [AV-275, "Removal and Installation"](#)(front microphone), [AV-276, "Removal and Installation"](#)(rear microphone).

A  
B  
C  
D  
E  
F  
G  
H  
I  
J  
K  
L  
M  
N  
O  
P

AV

# POWER SUPPLY AND GROUND CIRCUIT

< DTC/CIRCUIT DIAGNOSIS >

[BOSE AUDIO WITH NAVIGATION]

## POWER SUPPLY AND GROUND CIRCUIT

### AV CONTROL UNIT

#### AV CONTROL UNIT : Diagnosis Procedure

INFOID:000000008130916

#### 1.CHECK FUSE

Check for blown fuses.

Power source	Fuse No.
Battery	34

Is the inspection result normal?

YES >> GO TO 2.

NO >> Be sure to eliminate cause of malfunction before installing new fuse.

#### 2.CHECK BATTERY POWER SUPPLY CIRCUIT

Check voltage between AV control unit harness connectors and ground.

Signal name	(+)		(-)	Ignition switch position	Voltage (Approx.)
	AV control unit				
	Connector	Terminal			
Battery power supply	M208	19	Ground	OFF	Battery voltage

Is the inspection result normal?

YES >> GO TO 3.

NO >> Check harness between AV control unit and fuse.

#### 3.CHECK ACC POWER SUPPLY CIRCUIT

Check voltage between AV control unit harness connectors and ground.

Signal name	(+)		(-)	Ignition switch position	Voltage (Approx.)
	AV control unit				
	Connector	Terminal			
ACC power supply	M208	7	Ground	ACC	Battery voltage

Is the inspection result normal?

YES >> GO TO 4.

NO >> Check harness between AV control unit and BCM.

#### 4.CHECK GROUND CIRCUIT

1. Turn ignition switch OFF.
2. Disconnect AV control unit connectors.
3. Check continuity between AV control unit harness connectors and ground.

AV control unit		Ground	Continuity
Connector	Terminal		
M208	20		Existed

Is the inspection result normal?

YES >> INSPECTION END

NO >> Repair harness or connector.

## DISPLAY UNIT

#### DISPLAY UNIT : Diagnosis Procedure

INFOID:000000008130917

#### 1.CHECK FUSE

# POWER SUPPLY AND GROUND CIRCUIT

< DTC/CIRCUIT DIAGNOSIS >

[BOSE AUDIO WITH NAVIGATION]

Check for blown fuses.

Power source	Fuse No.
Battery	34

Is the inspection result normal?

YES >> GO TO 2.

NO >> Be sure to eliminate cause of malfunction before installing new fuse.

## 2.CHECK BATTERY POWER SUPPLY CIRCUIT

1. Turn ignition switch OFF.
2. Check voltage between display unit harness connector and ground.

Signal name	(+)		(-)	Ignition switch position	Voltage (Approx.)
	Display unit				
	Connector	Terminal			
Battery power supply	M215	11	Ground	OFF	Battery voltage

Is the inspection result normal?

YES >> GO TO 3.

NO >> Check harness between display unit and fuse.

## 3.CHECK ACC POWER SUPPLY CIRCUIT

1. Turn ignition switch ACC.
2. Check voltage between display unit harness connector and ground.

Signal name	(+)		(-)	Ignition switch position	Voltage (Approx.)
	Display unit				
	Connector	Terminal			
ACC power supply	M215	23	Ground	ACC	Battery voltage

Is the inspection result normal?

YES >> GO TO 4.

NO >> Check harness between display unit and BCM.

## 4.CHECK GROUND CIRCUIT

1. Turn ignition switch OFF.
2. Disconnect display unit connector.
3. Check continuity between display unit harness connectors and ground.

Display unit		Ground	Continuity
Connector	Terminal		
M215	12		

Is the inspection result normal?

YES >> INSPECTION END

NO >> Repair harness or connector.

## BOSE AMP.

### BOSE AMP. : Diagnosis Procedure

INFOID:000000008130918

#### 1.CHECK FUSE

Check for blown fuses.

# POWER SUPPLY AND GROUND CIRCUIT

< DTC/CIRCUIT DIAGNOSIS >

[BOSE AUDIO WITH NAVIGATION]

Power source	Fuse No.
Battery	8, 10, 34*
Ignition switch ACC or ON	18

\*: With 16 speaker models

Is the inspection result normal?

YES >> GO TO 2.

NO >> Be sure to eliminate cause of malfunction before installing new fuse.

## 2. CHECK POWER SUPPLY CIRCUIT

Check voltage between BOSE amp. harness connector and ground.

Signal name	(+)		(-)	Ignition switch position	Voltage (Approx.)
	BOSE amp.				
	Connector	Terminal			
Battery power supply	B41	10	Ground	OFF	Battery voltage
		11			
	B46	84			
		90			
ACC power supply	B43	56		ACC	

Is the inspection result normal?

YES >> GO TO 3.

NO >> Check harness between BOSE amp. and fuse.

## 3. CHECK GROUND CIRCUIT

1. Turn ignition switch OFF.
2. Disconnect BOSE amp. connector.
3. Check continuity between BOSE amp. harness connector and ground.

AV control unit			Continuity
Connector	Terminal		
B42	7	Ground	Existed
	12		
B46	83		
	89		

Is the inspection result normal?

YES >> INSPECTION END

NO >> Repair harness or connector.



# RGB DIGITAL IMAGE SIGNAL CIRCUIT

< DTC/CIRCUIT DIAGNOSIS >

[BOSE AUDIO WITH NAVIGATION]

## RGB DIGITAL IMAGE SIGNAL CIRCUIT

### Description

INFOID:000000008130919

Transmit the image displayed with AV control unit with RGB digital image signal to the display unit.

### Diagnosis Procedure

INFOID:000000008130920

#### 1. CHECK CONTINUITY RGB DIGITAL IMAGE SIGNAL CIRCUIT

1. Turn ignition switch OFF.
2. Disconnect display unit connector and AV control unit connector.
3. Check continuity between display unit harness connector and AV control unit harness connector.

Display unit		AV control unit		Continuity
Connector	Terminals	Connector	Terminals	
M397	27	M396	157	Existed
	28		158	

4. Check continuity between display unit harness connector and ground.

Display unit		Ground	Continuity
Connector	Terminals		
M397	27		Not existed
	28		

Is the inspection result normal?

- YES >> GO TO 2.  
 NO >> Repair harness or connector.

#### 2. CHECK RGB DIGITAL IMAGE SIGNAL

1. Connect AV control unit connector.
2. Turn ignition switch ON.
3. Check signal between display unit harness connector and ground.

(+)		(-)	Condition	Voltage (Approx.)
Display unit				
Connector	Terminals			
M397	27	Ground	—	1.3 V
	28			

Is the inspection result normal?

- YES >> Replace display unit. Refer to [AV-278, "Removal and Installation"](#).  
 NO >> Replace AV control unit. Refer to [AV-265, "Removal and Installation"](#).

AV

# COMPOSITE IMAGE SIGNAL CIRCUIT

< DTC/CIRCUIT DIAGNOSIS >

[BOSE AUDIO WITH NAVIGATION]

## COMPOSITE IMAGE SIGNAL CIRCUIT

### Description

INFOID:000000008130921

AV control unit transmits the playback DVD image signal to the display unit.

### Diagnosis Procedure

INFOID:000000008130922

#### 1. CHECK CONTINUITY COMPOSITE IMAGE SIGNAL CIRCUIT

1. Turn ignition switch OFF.
2. Disconnect AV control unit connector and display unit connector.
3. Check continuity between AV control unit harness connector and display unit harness connector.

AV control unit		Display unit		Continuity
Connector	Terminal	Connector	Terminal	
M210	68	M215	18	Existed

4. Check continuity between AV control unit harness connector and ground.

AV control unit		Ground	Continuity
Connector	Terminal		
M210	68		Not existed

Is the inspection result normal?

- YES >> GO TO 2.  
NO >> Repair harness or connector.

#### 2. CHECK COMPOSITE IMAGE SIGNAL

1. Connect AV control unit connector and display unit connector.
2. Turn ignition switch ON.
3. Check signal between AV control unit harness connector and ground.

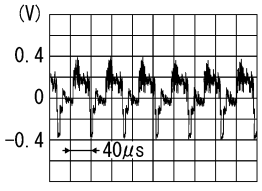
(+)		(-)	Condition	Reference value
AV control unit				
Connector	Terminal			
M210	68	Ground	At DVD image is displayed.	 <p>(V)</p> <p>0.4</p> <p>0</p> <p>-0.4</p> <p>40µs</p> <p>SKIB2251J</p>

Is the inspection result normal?

- YES >> Replace display unit. Refer to [AV-278. "Removal and Installation"](#).  
NO >> Replace AV control unit. Refer to [AV-265. "Removal and Installation"](#).

# DISK EJECT SIGNAL CIRCUIT

< DTC/CIRCUIT DIAGNOSIS >

[BOSE AUDIO WITH NAVIGATION]

## DISK EJECT SIGNAL CIRCUIT

### Description

INFOID:000000008130923

The eject signal is output to AV control unit when the eject switch of multifunction switch is pressed.

### Diagnosis Procedure

INFOID:000000008130924

#### 1. CHECK CONTINUITY DISK EJECT SIGNAL CIRCUIT

1. Turn ignition switch OFF.
2. Disconnect multifunction switch connector and AV control unit connector.
3. Check continuity between multifunction switch harness connector and AV control unit harness connector.

Multifunction switch		AV control unit		Continuity
Connector	Terminal	Connector	Terminal	
M72	14	M209	29	Existed

4. Check continuity between multifunction switch harness connector and ground.

Multifunction switch		Ground	Continuity
Connector	Terminal		
M72	14		Not existed

Is the inspection result normal?

- YES >> GO TO 2.  
NO >> Repair harness or connector.

#### 2. CHECK AV CONTROL UNIT VOLTAGE

1. Connect multifunction switch connector and AV control unit connector.
2. Turn ignition switch ON.
3. Check voltage between AV control unit harness connector and ground.

(+)		(-)	Condition	Voltage (Approx.)
AV control unit				
Connector	Terminal			
M209	29	Ground	Pressing the eject switch	0 V
			Except for above	5.0 V

Is the inspection result normal?

- YES >> Replace preset switch. Refer to [AV-281, "Removal and Installation"](#).  
NO >> Replace AV control unit. Refer to [AV-265, "Removal and Installation"](#).

A  
B  
C  
D  
E  
F  
G  
H  
I  
J  
K  
L  
M  
O  
P

AV

# MICROPHONE SIGNAL CIRCUIT

< DTC/CIRCUIT DIAGNOSIS >

[BOSE AUDIO WITH NAVIGATION]

## MICROPHONE SIGNAL CIRCUIT

### Description

INFOID:000000008130925

Supply power from AV control unit to microphone. The microphone transmits the sound/voice to the AV control unit.

### Diagnosis Procedure

INFOID:000000008130926

#### 1.CHECK CONTINUITY BETWEEN AV CONTROL UNIT AND MICROPHONE CIRCUIT

1. Turn ignition switch OFF.
2. Disconnect AV control unit connector and microphone connector.
3. Check continuity between AV control unit harness connector and microphone harness connector.

AV control unit		Microphone		Continuity
Connector	Terminals	Connector	Terminals	
M210	71	R17	2	Existed
	72		4	
	87		1	

4. Check continuity between AV control unit harness connector and ground.

AV control unit		Ground	Continuity
Connector	Terminals		
M210	72		Not existed
	87		

Is the inspection result normal?

YES >> GO TO 2.

NO >> Repair harness or connector.

#### 2.CHECK VOLTAGE MICROPHONE VCC

1. Connect AV control unit connector.
2. Turn ignition switch ON.
3. Check voltage between AV control unit harness connector.

(+)		(-)		Voltage (Approx.)
AV control unit		AV control unit		
Connector	Terminal	Connector	Terminal	
M210	72	M210	71	5.0 V

Is the inspection result normal?

YES >> GO TO 3.

NO >> Replace AV control unit. Refer to [AV-265. "Removal and Installation"](#).

#### 3.CHECK MICROPHONE SIGNAL

1. Connect microphone connector.
2. Check signal between AV control unit harness connector.

# MICROPHONE SIGNAL CIRCUIT

< DTC/CIRCUIT DIAGNOSIS >

[BOSE AUDIO WITH NAVIGATION]

(+)		(-)		Condition	Reference value
AV control unit		AV control unit			
Connector	Terminal	Connector	Terminal		
M210	87	M210	71	Give a voice.	<p style="text-align: right; font-size: small;">PKIB5037J</p>

Is the inspection result normal?

- YES >> Replace AV control unit. Refer to [AV-265. "Removal and Installation"](#).
- NO >> Replace microphone. Refer to [AV-286. "Removal and Installation"](#).

A  
B  
C  
D  
E  
F  
G  
H  
I  
J  
K  
L  
M

AV

O  
P

# CAMERA IMAGE SIGNAL CIRCUIT

< DTC/CIRCUIT DIAGNOSIS >

[BOSE AUDIO WITH NAVIGATION]

## CAMERA IMAGE SIGNAL CIRCUIT

### Description

INFOID:000000008130927

- The AV control unit supplies power to the rear view camera when receiving a reverse signal.
- The rear view camera transmits camera images to the display unit when power is supplied from the AV control unit.

### Diagnosis Procedure

INFOID:000000008130928

#### 1. CHECK CONTINUITY CAMERA POWER SUPPLY CIRCUIT

1. Turn ignition switch OFF.
2. Disconnect AV control unit connector and rear view camera connector.
3. Check continuity between AV control unit harness connector and rear view camera harness connector.

AV control unit		Rear view camera		Continuity
Connector	Terminal	Connector	Terminal	
M209	22	T5	1	Existed

4. Check continuity between AV control unit harness connector and ground.

AV control unit		Ground	Continuity
Connector	Terminal		
M209	22		Not existed

Is inspection result normal?

YES >> GO TO 2.

NO >> Repair harness or connector.

#### 2. CHECK VOLTAGE CAMERA POWER SUPPLY

1. Connect AV control unit connector and rear view camera connector.
2. Turn ignition switch ON.
3. Shift the selector lever to "R".
4. Check voltage between AV control unit harness connector and ground.

(+)		(-)	Condition	Voltage (Approx.)
AV control unit				
Connector	Terminal			
M209	22	Ground	Shift position is "R".	6.0 V

Is inspection result normal?

YES >> GO TO 3.

NO >> Replace AV control unit.

#### 3. CHECK CONTINUITY CAMERA IMAGE SIGNAL CIRCUIT

1. Turn ignition switch OFF.
2. Disconnect display unit connector and rear view camera connector.
3. Check continuity between display unit harness connector and rear view camera harness connector.

Display unit		Rear view camera		Continuity
Connector	Terminal	Connector	Terminal	
M215	8	T5	3	Existed

4. Check continuity between display unit harness connector and ground.

# CAMERA IMAGE SIGNAL CIRCUIT

< DTC/CIRCUIT DIAGNOSIS >

[BOSE AUDIO WITH NAVIGATION]

Display unit		Ground	Continuity
Connector	Terminal		
M215	8		Not existed

Is inspection result normal?

- YES >> GO TO 4.
- NO >> Repair harness or connector.

## 4. CHECK CAMERA IMAGE SIGNAL

1. Connect display unit connector and rear view camera connector.
2. Turn ignition switch ON.
3. Shift the selector lever to "R".
4. Check signal between display unit harness connector and ground.

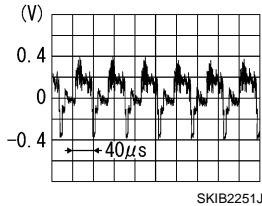
(+)		(-)	Condition	Reference value
Display unit				
Connector	Terminal			
M215	8	Ground	At rear view camera image is displayed.	

Is inspection result normal?

- YES >> Replace display unit. Refer to [AV-278, "Removal and Installation"](#).
- NO >> Replace rear view camera. Refer to [AV-287, "Removal and Installation"](#).

AV

# STEERING SWITCH SIGNAL A CIRCUIT

< DTC/CIRCUIT DIAGNOSIS >

[BOSE AUDIO WITH NAVIGATION]

## STEERING SWITCH SIGNAL A CIRCUIT

### Description

INFOID:000000008130929

Transmits the steering switch signal to AV control unit.

### Diagnosis Procedure

INFOID:000000008130930

#### 1. CHECK STEERING SWITCH SIGNAL A CIRCUIT

1. Disconnect AV control unit connector and spiral cable connector.
2. Check continuity between AV control unit harness connector and spiral cable harness connector.

AV control unit		Spiral cable		Continuity
Connector	Terminal	Connector	Terminal	
M208	6	M36	24	Existed

3. Check continuity between AV control unit harness connector and ground.

AV control unit		Ground	Continuity
Connector	Terminal		
M208	6		Not existed

Is the inspection result normal?

- YES >> GO TO 2.  
NO >> Repair harness or connector.

#### 2. CHECK SPIRAL CABLE

Check spiral cable.

Is the inspection result normal?

- YES >> GO TO 3.  
NO >> Replace spiral cable.

#### 3. CHECK AV CONTROL UNIT VOLTAGE

1. Connect AV control unit connector and spiral cable connector.
2. Turn ignition switch ON.
3. Check voltage between AV control unit harness connector.

(+)		(-)		Voltage (Approx.)
AV control unit		AV control unit		
Connector	Terminal	Connector	Terminal	
M208	6	M208	15	5.0 V

Is the inspection result normal?

- YES >> GO TO 4.  
NO >> Replace AV control unit. Refer to [AV-265, "Removal and Installation"](#)

#### 4. CHECK STEERING SWITCH

1. Turn ignition switch OFF.
2. Check steering switch. Refer to [AV-248, "Component Inspection"](#).

Is the inspection result normal?

- YES >> INSPECTION END  
NO >> Replace steering switch. Refer to [AV-282, "Removal and Installation"](#).

### Component Inspection

INFOID:000000008130931

Measure the resistance between the steering switch connector terminals 14 to 17 and 15 to 17.



# STEERING SWITCH SIGNAL A CIRCUIT

[BOSE AUDIO WITH NAVIGATION]

## < DTC/CIRCUIT DIAGNOSIS >

### Standard

Between terminals 14 and 17

ENTER switch ON	: 2003 – 2043 Ω
☞ switch ON	: 716 – 730 Ω
MENU DOWN switch ON	: 318 – 324 Ω
MENU UP switch ON	: 120 – 122 Ω
SOURCE switch ON	: 0 Ω

Between terminals 15 and 17

↻ switch ON	: 716 – 730 Ω
↺ switch ON	: 318 – 324 Ω
VOL UP switch ON	: 120 – 122 Ω
VOL DOWN switch ON	: 0 Ω

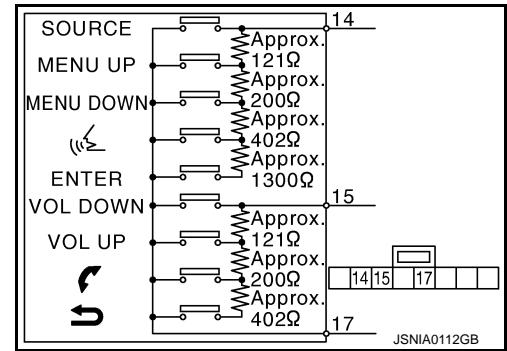

A  
B  
C  
D  
E  
F  
G  
H  
I  
J  
K  
L  
M

AV

O  
P

# STEERING SWITCH SIGNAL B CIRCUIT

< DTC/CIRCUIT DIAGNOSIS >

[BOSE AUDIO WITH NAVIGATION]

## STEERING SWITCH SIGNAL B CIRCUIT

### Description

INFOID:000000008130932

Transmits the steering switch signal to AV control unit.

### Diagnosis Procedure

INFOID:000000008130933

#### 1. CHECK STEERING SWITCH SIGNAL B CIRCUIT

1. Disconnect AV control unit connector and spiral cable connector.
2. Check continuity between AV control unit harness connector and spiral cable harness connector.

AV control unit		Spiral cable		Continuity
Connector	Terminal	Connector	Terminal	
M208	16	M36	31	Existed

3. Check continuity between AV control unit harness connector and ground.

AV control unit		Ground	Continuity
Connector	Terminal		
M208	16		Not existed

Is the inspection result normal?

- YES >> GO TO 2.  
NO >> Repair harness or connector.

#### 2. CHECK SPIRAL CABLE

Check spiral cable.

Is the inspection result normal?

- YES >> GO TO 3.  
NO >> Replace spiral cable.

#### 3. CHECK AV CONTROL UNIT VOLTAGE

1. Connect AV control unit connector and spiral cable connector.
2. Turn ignition switch ON.
3. Check voltage between AV control unit harness connector.

(+)		(-)		Voltage (Approx.)
AV control unit		AV control unit		
Connector	Terminal	Connector	Terminal	
M208	16	M208	15	5.0 V

Is the inspection result normal?

- YES >> GO TO 4.  
NO >> Replace AV control unit. Refer to [AV-265, "Removal and Installation"](#).

#### 4. CHECK STEERING SWITCH

1. Turn ignition switch OFF.
2. Check steering switch. Refer to [AV-250, "Component Inspection"](#).

Is the inspection result normal?

- YES >> INSPECTION END  
NO >> Replace steering switch. Refer to [AV-282, "Removal and Installation"](#).

### Component Inspection

INFOID:000000008130934

Measure the resistance between the steering switch connector terminals 14 to 17 and 15 to 17.

# STEERING SWITCH SIGNAL B CIRCUIT

[BOSE AUDIO WITH NAVIGATION]

## < DTC/CIRCUIT DIAGNOSIS >

### Standard

Between terminals 14 and 17

ENTER switch ON	: 2003 – 2043 Ω
⏏ switch ON	: 716 – 730 Ω
MENU DOWN switch ON	: 318 – 324 Ω
MENU UP switch ON	: 120 – 122 Ω
SOURCE switch ON	: 0 Ω

Between terminals 15 and 17

↶ switch ON	: 716 – 730 Ω
↷ switch ON	: 318 – 324 Ω
VOL UP switch ON	: 120 – 122 Ω
VOL DOWN switch ON	: 0 Ω

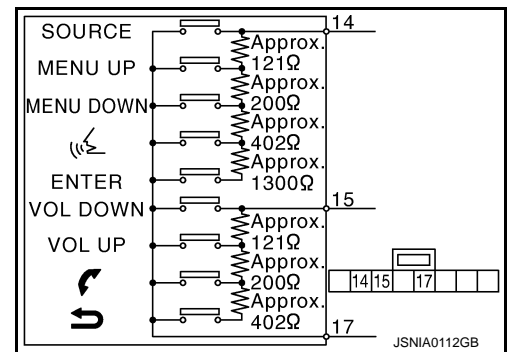

A  
B  
C  
D  
E  
F  
G  
H  
I  
J  
K  
L  
M

AV

O  
P

# STEERING SWITCH GROUND CIRCUIT

< DTC/CIRCUIT DIAGNOSIS >

[BOSE AUDIO WITH NAVIGATION]

## STEERING SWITCH GROUND CIRCUIT

### Description

INFOID:000000008130935

Transmits the steering switch signal to AV control unit.

### Diagnosis Procedure

INFOID:000000008130936

#### 1. CHECK STEERING SWITCH SIGNAL GROUND CIRCUIT

1. Disconnect AV control unit connector and spiral cable connector.
2. Check continuity between AV control unit harness connector and spiral cable harness connector.

AV control unit		Spiral cable		Continuity
Connector	Terminal	Connector	Terminal	
M208	15	M36	33	Existed

3. Connect AV control unit connector.

Is the inspection result normal?

- YES >> GO TO 2.  
NO >> Repair harness or connector.

#### 2. CHECK SPIRAL CABLE

Check spiral cable.

Is the inspection result normal?

- YES >> GO TO 3.  
NO >> Replace spiral cable.

#### 3. CHECK GROUND CIRCUIT

1. Connect AV control unit connector.
2. Check continuity between AV control unit harness connector and ground.

AV control unit		Ground	Continuity
Connector	Terminal		
M208	15		Existed

Is the inspection result normal?

- YES >> GO TO 4.  
NO >> Replace AV control unit. Refer to [AV-265, "Removal and Installation"](#)

#### 4. CHECK STEERING SWITCH

1. Turn ignition switch OFF.
2. Check steering switch. Refer to [AV-252, "Component Inspection"](#).

Is the inspection result normal?

- YES >> INSPECTION END  
NO >> Replace steering switch. Refer to [AV-282, "Removal and Installation"](#).

### Component Inspection

INFOID:000000008130937

Measure the resistance between the steering switch connector terminals 14 to 17 and 15 to 17.

# STEERING SWITCH GROUND CIRCUIT

[BOSE AUDIO WITH NAVIGATION]

## < DTC/CIRCUIT DIAGNOSIS >

### Standard

Between terminals 14 and 17

ENTER switch ON	: 2003 – 2043 Ω
⏏ switch ON	: 716 – 730 Ω
MENU DOWN switch ON	: 318 – 324 Ω
MENU UP switch ON	: 120 – 122 Ω
SOURCE switch ON	: 0 Ω

Between terminals 15 and 17

↶ switch ON	: 716 – 730 Ω
↷ switch ON	: 318 – 324 Ω
VOL UP switch ON	: 120 – 122 Ω
VOL DOWN switch ON	: 0 Ω

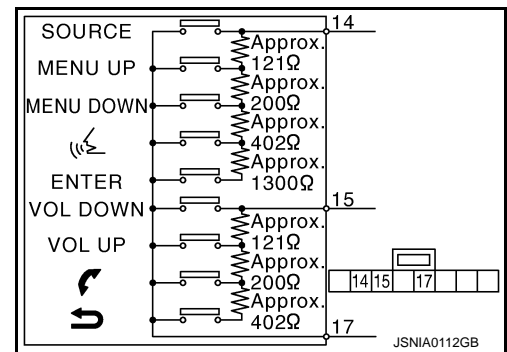

A  
B  
C  
D  
E  
F  
G  
H  
I  
J  
K  
L  
M

AV

O  
P

## SYMPTOM DIAGNOSIS

### MULTI AV SYSTEM SYMPTOMS

#### Symptom Table

INFOID:000000008130938

#### RELATED TO NAVIGATION

Symptoms	Check items	Probable malfunction location
Multifunction switch and preset switch operation does not work.	<ul style="list-style-type: none"> <li>All switches cannot be operated.</li> <li>"MULTI AV" is displayed on system selection screen when the CONSULT is started.</li> </ul>	<ul style="list-style-type: none"> <li>Multifunction switch power supply and ground circuit malfunction.</li> <li>AV communication circuit between AV control unit and multifunction switch. Perform CONSULT self-diagnosis. Refer to <a href="#">AV-157, "CONSULT Function"</a>.</li> </ul>
	<ul style="list-style-type: none"> <li>All switches cannot be operated.</li> <li>"MULTI AV" is not displayed on system selection screen when the CONSULT is initialized.</li> </ul>	AV control unit power supply and ground circuit malfunction. Refer to <a href="#">AV-238, "AV CONTROL UNIT : Diagnosis Procedure"</a> .
	Only specified switch cannot be operated.	Multifunction switch or preset switch malfunction. Perform multifunction switch and preset switch self-diagnosis function. Refer to <a href="#">AV-143, "On Board Diagnosis Function"</a> .
Fuel economy display, vehicle setting operation is abnormal.	There is malfunction in the CONSULT "self-diagnosis result" of "MULTI AV". Refer to <a href="#">AV-157, "CONSULT Function"</a> .	Perform detected DTC diagnosis. Refer to <a href="#">AV-170, "DTC Index"</a> .
	There is no malfunction in the CONSULT "self-diagnosis results" of "MULTI AV". Refer to <a href="#">AV-157, "CONSULT Function"</a> .	Ignition signal circuit malfunction.
Guide sound is not heard or too low.	On the setting display select "system sound (guide sound volume, etc.)," and confirm that guide sound is ON.	AV control unit malfunction. Replace AV control unit. Refer to <a href="#">AV-265, "Removal and Installation"</a> .

#### RELATED TO HANDS-FREE PHONE

- Before performing diagnosis, confirm that the cellular phone being used by the customer is compatible with the vehicle.
- It is possible that a malfunction is occurring due to a version change of the phone even though the phone is a compatible type. This can be confirmed by changing the cellular phone to another compatible type, and checking that it operates normally. It is important to determine whether the cause of the malfunction is the vehicle or the cellular phone.

#### Check Compatibility

- Make sure the customer's Bluetooth® related concern is understood.
- Verify the customer's concern.
 

**NOTE:**  
The customer's phone may be required, depending upon their concern.
- Write down the customer's phone brand, model, and service provider.
 

**NOTE:**  
It is necessary to know the service provider. On occasion, a given phone may be on the approved list with one provider, but may not be on the approved list with other providers.
- Go to "www.infiniti.com/bluetooth/".
  - Using the website's search engine, find out if the customer's phone is on the approved list.
  - If the customer's phone is NOT on the approved list:
 

Stop diagnosis here. The customer needs to obtain a Bluetooth® phone that is on the approved list before any further action.
  - If the feature related to the customer's concern shows as "N" (not compatible):

# MULTI AV SYSTEM SYMPTOMS

[BOSE AUDIO WITH NAVIGATION]

## < SYMPTOM DIAGNOSIS >

Stop diagnosis here. If the customer still wants the feature to function, they will need to get an approved phone showing the feature as “Y” (compatible) in the “Basic Features” list.

- d. If the feature related to the customer's concern shows as “Y” (compatible):  
Perform diagnosis as per the following table.

Symptoms	Check items	Probable malfunction location
Does not recognize cellular phone connection. (no connection is displayed on the display at the guide.)	Repeat the registration of cellular phone.	
Hands-free phone cannot be established.	<ul style="list-style-type: none"> <li>Hands-free phone operation can be made, but the communication cannot be established.</li> <li>Hands-free phone operation can be performed, however, voice between each other cannot be heard during the conversation.</li> </ul>	AV control unit malfunction. Replace AV control unit. Refer to <a href="#">AV-265, "Removal and Installation"</a> .
The other party's voice cannot be heard by hands-free phone.	Check the “microphone speaker” in Inspection & Adjustment Mode if sound is heard.	
Originating sound is not heard by the other party with hands-free phone communication.	Sound operation function is normal.	
	Sound operation function does not work.	Microphone signal circuit malfunction. Refer to <a href="#">AV-244, "Diagnosis Procedure"</a> .
The system cannot be operated.	<ul style="list-style-type: none"> <li>The voice recognition can be controlled.</li> <li>Steering switch's "VOL UP", "VOL DOWN", "↶" switch works, but "↷" it does not work.</li> </ul>	Steering switch malfunction. Replace steering switch. Refer to <a href="#">AV-282, "Removal and Installation"</a> .
	<ul style="list-style-type: none"> <li>The voice recognition can be controlled.</li> <li>Steering switch's "↷", "VOL UP", "VOL DOWN", "↶" switches do not work.</li> </ul>	Steering switch signal B circuit malfunction. Refer to <a href="#">AV-250, "Diagnosis Procedure"</a> .
	All steering switches do not work.	Steering switch ground circuit malfunction. Refer to <a href="#">AV-252, "Diagnosis Procedure"</a> .

## RELATED TO RGB IMAGE

Symptoms	Check items	Probable malfunction location
RGB image is not shown.	—	RGB digital image signal circuit malfunction. Refer to <a href="#">AV-241, "Diagnosis Procedure"</a> .

## RELATED TO VOICE CONTROL

Symptoms	Check items	Probable malfunction location
The voice cannot be controlled even if the voice control screen is displayed.	Voice sounds at “Voice Microphone Test” of Confirmation/Adjustment mode.	AV control unit malfunction. Replace AV control unit. Refer to <a href="#">AV-265, "Removal and Installation"</a> .
	Voice does not sound at “Voice Microphone Test” of Confirmation/Adjustment mode.	Microphone circuit malfunction. Refer to <a href="#">AV-244, "Diagnosis Procedure"</a> .

## MULTI AV SYSTEM SYMPTOMS

**[BOSE AUDIO WITH NAVIGATION]**

< SYMPTOM DIAGNOSIS >

Symptoms	Check items	Probable malfunction location
The voice cannot be controlled (Voice control screen is not displayed).	<ul style="list-style-type: none"> <li>Steering switch's "SOURCE", "MENU UP", "MENU DOWN", "ENTER" switch works, but "↖" it does not work.</li> <li>Hands-free phone system can be operated.</li> </ul>	Steering switch malfunction. Replace steering switch. Refer to <a href="#">AV-282, "Removal and Installation"</a> .
	Steering switch's "SOURCE", "MENU UP", "MENU DOWN", "↖", "ENTER" switches do not work.	Steering switch signal A circuit malfunction. Refer to <a href="#">AV-248, "Diagnosis Procedure"</a> .
	All steering switches do not work.	Steering switch ground circuit malfunction. Refer to <a href="#">AV-252, "Diagnosis Procedure"</a> .

### RELATED TO AUDIO

Symptoms	Check items	Probable malfunction location
The disk cannot be removed.	—	Disk eject signal circuit malfunction. Refer to <a href="#">AV-243, "Diagnosis Procedure"</a> .
No sound comes out or the level of the sound is low.	No sound from all speakers.	<ul style="list-style-type: none"> <li>BOSE amp. ON signal circuit malfunction.</li> <li>BOSE amp. power supply and ground circuits malfunction.</li> </ul> Refer to <a href="#">AV-239, "BOSE AMP. : Diagnosis Procedure"</a> .
	Sound is not heard from woofer.	<ul style="list-style-type: none"> <li>Woofer power supply and ground circuit malfunction.</li> <li>Sound signal (woofer) circuit malfunction.</li> <li>Woofer amp. ON signal circuit malfunction.</li> </ul>
	Only a certain speaker (front right, front left, rear right, or rear left, etc.) does not output sound.	<ul style="list-style-type: none"> <li>Poor connector connection of speaker.</li> <li>Sound signal circuit malfunction between AV control unit and BOSE amp.</li> <li>Sound signal circuit malfunction between BOSE amp. and speaker.</li> <li>Malfunction in speaker.</li> <li>Malfunction in AV control unit.</li> <li>Malfunction in BOSE amp.</li> </ul>
Noise is mixed with audio.	Noise comes out from all speakers.	<ul style="list-style-type: none"> <li>Malfunction in AV control unit.</li> <li>Malfunction in BOSE amp.</li> </ul>
	Noise comes out only from a certain speaker (front right, front left, rear right, or rear left, etc.).	<ul style="list-style-type: none"> <li>Poor connector connection of speaker.</li> <li>Sound signal circuit malfunction between AV control unit and BOSE amp.</li> <li>Sound signal circuit malfunction between BOSE amp. and speaker.</li> <li>Malfunction in speaker.</li> <li>Poor installation of speaker (e.g. backlash and looseness)</li> <li>Malfunction in AV control unit.</li> <li>Malfunction in BOSE amp.</li> </ul>
	Noise is mixed with radio only (when the car hits a bump or while driving over bad roads).	Poor connector connection of antenna or antenna feeder.
Radio is not received or poor reception.	<ul style="list-style-type: none"> <li>Other audio sounds are normal.</li> <li>Any radio cannot be received or poor reception is caused even after moving to a service area with good reception (e.g. a place with clear view and no obstacles generating external noises).</li> </ul>	<ul style="list-style-type: none"> <li>Antenna amp. ON signal circuit malfunction.</li> <li>Poor connector connection of antenna or antenna feeder.</li> </ul>



# MULTI AV SYSTEM SYMPTOMS

[BOSE AUDIO WITH NAVIGATION]

## < SYMPTOM DIAGNOSIS >

Symptoms	Check items	Probable malfunction location
Satellite radio is not received.	There is malfunction in the CONSULT self-diagnosis result. Refer to <a href="#">AV-157, "CONSULT Function"</a> .	<ul style="list-style-type: none"> <li>Malfunction in antenna, antenna feeder, or AV control unit. Perform DTC diagnosis. Refer to <a href="#">AV-170, "DTC Index"</a>.</li> <li>Poor continuity in antenna feeder.</li> <li>Poor connector connection of antenna or antenna feeder.</li> </ul>
	There is no malfunction in the CONSULT self-diagnosis result. Refer to <a href="#">AV-157, "CONSULT Function"</a> .	<ul style="list-style-type: none"> <li>Poor continuity in antenna feeder.</li> <li>Poor connector connection of antenna or antenna feeder.</li> <li>Loose satellite radio antenna mounting nut. Refer to <a href="#">AV-279, "Exploded View"</a>.</li> </ul>

## RELATED TO DVD MODE

Symptoms	Check items	Probable malfunction location
The disk cannot be removed.	—	Disk eject signal circuit malfunction. Refer to <a href="#">AV-243, "Diagnosis Procedure"</a> .
DVD image is not displayed.	—	Perform CONSULT self-diagnosis. Refer to <a href="#">AV-157, "CONSULT Function"</a> . When detecting no malfunction in those components, the following items are a possible cause. <ul style="list-style-type: none"> <li>Composite image signal circuits malfunction. Refer to <a href="#">AV-242, "Diagnosis Procedure"</a>.</li> </ul>
DVD sound is not heard.	No sound from all speakers.	Perform CONSULT self-diagnosis. Refer to <a href="#">AV-157, "CONSULT Function"</a> .
	Sound is heard only from specific places.	Perform CONSULT self-diagnosis. Refer to <a href="#">AV-157, "CONSULT Function"</a> .

## RELATED TO CAMERA

Symptoms	Check items	Probable malfunction location
Camera image is not shown. (Vehicle width and predictive course line are displayed.)	—	Camera image signal circuit. Refer to <a href="#">AV-246, "Diagnosis Procedure"</a> .
Camera image does not switch.	Select "Camera Cont." of Confirmation/Adjustment mode, Reverse Sensor is not turned ON at "Connection Confirmation".	Reverse signal circuit malfunction.
	Select "Camera Cont." of Confirmation/Adjustment mode, Reverse Sensor is turned ON at "Connection Confirmation".	AV control unit malfunction. Replace AV control unit. Refer to <a href="#">AV-265, "Removal and Installation"</a> .

## RELATED TO USB

### NOTE:

Check that there is no malfunction of USB equipment main body before performing a diagnosis.

Symptoms	Check items	Possible malfunction location / Action to take
iPod® or USB memory can not be recognized.	—	<ul style="list-style-type: none"> <li>USB harness malfunction.</li> <li>USB connector malfunction.</li> </ul>

iPod® is a trademark of Apple inc., registered in the U.S. and other countries.

## RELATED TO STEERING SWITCH

Symptoms	Probable malfunction location
None of the steering switch operations work.	Steering switch ground circuit malfunction. Refer to <a href="#">AV-252, "Diagnosis Procedure"</a> .
Only specified switch cannot be operated.	Steering switch malfunction. Replace steering switch. Refer to <a href="#">AV-282, "Removal and Installation"</a> .

# MULTI AV SYSTEM SYMPTOMS

[BOSE AUDIO WITH NAVIGATION]

< SYMPTOM DIAGNOSIS >

Symptoms	Probable malfunction location
Steering switch's "SOURCE", "MENU UP", "MENU DOWN", "↙", "ENTER" switches do not work.	Steering switch signal A circuit malfunction. Refer to <a href="#">AV-248. "Diagnosis Procedure"</a> .
Steering switch's "→", "VOL UP", "VOL DOWN", "↻" switches do not work.	Steering switch signal B circuit malfunction. Refer to <a href="#">AV-250. "Diagnosis Procedure"</a> .

# NORMAL OPERATING CONDITION

< SYMPTOM DIAGNOSIS >

[BOSE AUDIO WITH NAVIGATION]

## NORMAL OPERATING CONDITION

### Description

INFOID:000000008130939

**NOTE:**

For Navigation system operation information, refer to Navigation system Owner's Manual.

### BASIC OPERATIONS

Symptom	Possible cause	Possible solution
No image is displayed.	The brightness is at the lowest setting.	Adjust the brightness of the display.
	The systems in the video mode.	Press "DISC-AUX" to change the mode.
	The display is turned off.	Press "☀/☾" to turn on the display.
	The interior of the vehicle becomes the a little less than 80°C (176°F) or high temperature, and the protection of the display acts, and a display is turned off.	Wait until the interior of the vehicle has cooled down.
Screen not clear.	Contrast setting is not appropriate.	Adjust the contrast of the display.
No voice guidance is available. Or The volume is too high or too low.	The volume is not set correctly, or it is turned off.	Adjust the volume of voice guidance.
	Voice guidance is not provided for certain streets (roads displayed in gray).	This is not a malfunction.
No map is displayed on the screen.	A screen other than map screen is displayed.	Press "MAP".
The screen is too dim. The movement is slow.	The temperature in the interior of the vehicle is low.	Wait until the interior of the vehicle has warmed up.
Some pixels in the display are darker or brighter than others.	This condition is an inherent characteristic of liquid crystal displays.	This is not a malfunction.
Some menu items cannot be selected.	Some menu items become unavailable while the vehicle is driven.	Park the vehicle in a safe location, and then operate the navigation system.

**NOTE:**

Locations stored in the Address Book and other memory functions may be lost if the vehicle's battery is disconnected or becomes discharged. If this occurs, service the vehicle's battery as necessary and re-enter the information in the Address Book.

### RELATED TO VOICE RECOGNITION

#### Related to Basic Operation

Symptom	Possible cause	Possible solution
The system does not recognize your command. or The system recognizes your command incorrectly	The interior of the vehicle is too noisy.	Close the windows or have other occupants quiet.
	The volume of your voice is too low.	Speak louder.
	The volume if your voice is too loud.	Speak softer.
	Your pronunciation is unclear.	Speak clearly.
	You are speaking before the voice recognition is ready	Press and release "☞" switch on the steering switch, and speak a command after the tone sounds.
	8 seconds or more have passed after you pressed and released "☞" switch on the steering switch.	Make sure to speak a command within 8 seconds after you press and release "☞" switch on the steering switch.
	Only a limited range of voice commands is usable for each screen.	Use a correct voice command appropriate for the current screen.
The fan of the air conditioner is too loud.	Lower the fan speed as necessary as voice command can be recognized more easily.	

#### Related to Item Choice

The system should respond correctly to all voice commands without difficulty. If problems are encountered, follow the solutions given in this guide for the appropriate error.

## NORMAL OPERATING CONDITION

< SYMPTOM DIAGNOSIS >

[BOSE AUDIO WITH NAVIGATION]

Where the solutions are listed by number, try each solution in turn, starting with number one, until the problem is resolved.

Symptom/ error message	Solution
Displays "COMMAND NOT RECOGNIZED" or the system fails to interpret the command correctly.	1. Ensure that the command format is valid.
	2. Speak clearly without pausing between words and at a level appropriate to the ambient noise level.
	3. Ensure that the ambient noise level is not excessive, for example, windows open or defrost on. <b>NOTE:</b> If it is too noisy to use the phone, it is likely that voice commands will not be recognized.
	4. If optional words of the command have been omitted, then command should be tried with these in place.
The system consistently selects the wrong voicetag	1. Ensure that the voicetag requested matches what was originally stored. This can be confirmed by giving the "Addressbook" Directory or Phone Directory command.
	2. Replace one of the voicetags being confused with a different voicetag.

Related to Telephone

The system should respond correctly to all voice commands without difficulty. If problems are encountered, try the following solutions.

Where the solutions are listed by number, try each solution in turn, starting with number 1, until the problem is resolved.

Symptom	Solution
System fails to interpret the command correctly.	1. Ensure that the command is valid.
	2. Ensure that the command is spoken after the tone.
	3. Speak clearly without pausing between words and at level appropriate to the ambient noise level in the vehicle.
	4. Ensure that the ambient noise level is not excessive (for example, windows open or defroster on). <b>NOTE:</b> If it is too noisy to use the phone, it is likely that the voice commands will not be recognized.
	5. If more than one command was said at a time, try saying the commands separately.
	6. If the system consistently fails to recognize commands, the voice training procedure should be carried out to improve the recognition response for the speaker. See "Speaker adaptation (SA) mode" earlier in this section. Refer to "OWNER'S MANUAL".
The system consistently selects the wrong voicetag	1. Ensure that the phone book entry name requested matches what was originally stored. This can be confirmed by using the "List Names" command.
	2. Replace one of the names being confused with a new name.

### RELATED TO AUDIO

- The majority of the audio malfunctions are the result of outside causes (bad CD, electromagnetic interference, etc.). Check the symptoms below to diagnose the malfunction.
- The vehicle itself can be a source of noise if noise prevention parts or electrical equipment is malfunctioning. Check if noise is caused and/or changed by engine speed, ignition switch turned to each position, and operation of each piece of electrical equipment, and then determine the cause.

**NOTE:**

- CD-R is not guaranteed to play because they can contain compressed audio (MP3, WMA, AAC, M4A) or could be incorrectly mastered by the customer on a computer.
- Check if the CDs carry the Compact Disc Logo. If not, the disc is not mastered to the "red book" Compact Disc Standard and may not play.

# NORMAL OPERATING CONDITION

< SYMPTOM DIAGNOSIS >

[BOSE AUDIO WITH NAVIGATION]

Symptom	Cause and Counter measure	
Cannot play	Check if the CD was inserted correctly.	A
	Check if the CD is scratched or dirty.	B
	Check if there is condensation inside the player, and if there is, wait until the condensation is gone (about 1 hour) before using the player.	C
	If there is a temperature increase error, the player will play correctly after it returns to the normal temperature.	D
	If there is a mixture of music CD files (CD-DA data) and MP3/WMA/AAC/M4A files on a CD, only the music CD files (CD-DA data) will be played.	E
	Files with extensions other than ".MP3", ".WMA", ".AAC", ".M4A", ".mp3", ".wma", ".aac" or ".m4a" cannot be played. In addition, the character codes and number of characters for folder names and file names should be in compliance with the specifications.	F
	Check if the disc or the file is generated in an irregular format, This may occur depending on the variation or the setting of MP3/WMA/AAC/M4A writing applications or other text editing applications.	G
	Check if the finalization process, such as session close and disc close, is done for the disc.	H
Poor sound quality	Check if the CD is scratched or dirty.	I
It takes a relatively long time before the music starts playing.	If there are many folder or file levels on the MP3/WMA/AAC/M4A CD, or if it is a multisession disc, some time may be required before the music starts playing.	J
Music cuts off or skips	The writing software and hardware combination might not match, or the writing speed, writing depth, writing width might not match the specifications. Try using the slowest writing speed.	K
Skipping with high bit rate files	Skipping may occur with large quantities if data such as for high bit rate data.	L
Move immediately to the next song when playing	When a non-MP3/WMA/AAC/M4A file has been given an extension of ".MP3", ".WMA", ".AAC", ".M4A", ".mp3", ".wma", ".aac" or ".m4a", or when play is prohibited by copyright protection, the player will skip to the next song.	M
The songs do not play back in the desired order.	The playback order is the order in which the files were written by the software, so the files might not play in the desired order.	AV
Poor reception only from a certain radio broadcast station.	Check incoming radio wave signal strength of applicable broadcast station.	
Buzz/rattle sound from speaker	The majority of rattle sounds are not indicative of an issue with the speaker, usually something nearby the speaker is causing the rattle.	

Noise resulting from variations in field strength, such as fading noise and multi-path noise, or external noise from trains and other sources, is not a malfunction.

**NOTE:**

- Fading noise: This noise occurs because of variations in the field strength in a narrow range due to mountains or buildings blocking the signal.
- Multi-path noise: This noise results from a time difference between the broadcast waves directly from the station arriving at the antenna and the waves reflected by mountains or buildings.

**RELATED TO DVD**

Symptom	Possible cause	Possible solution
Not working as operated	Some operations may be rejected or may not function as intended because of the manufacturer's intent, depending on DVD.	This is not a malfunction.
Operation not accepted	If a requested operation is prohibited, then a message is displayed on the screen. (Message display depends on DVD.)	This is not a malfunction.

## NORMAL OPERATING CONDITION

< SYMPTOM DIAGNOSIS >

[BOSE AUDIO WITH NAVIGATION]

Symptom	Possible cause	Possible solution
DVD can not be played	Check that the DVD is inserted in the right place.	Upturn the DVD (facing the title upward).
	Check that there is no condensation inside the player.	Wait until the condensation evaporates (approximately one hour).
	DVD menu is displayed.	Select item to touch "ENTER".
	Insertion of a DVD with a different region code.	DVDs with a different region code can not be played. Check DVD.
	Some DVD softwares may not be played because not all DVD softwares fully comply in the standard.	This is not a malfunction.
Interruption during playback or flicker in the display	Check that the DVD has no scratches and dirt.	Errors may not be corrected depending on the size of scratches.
		Wipe and clean the dirt on the disc.
Subtitles not shown	Subtitle setting is OFF.	Set subtitle.
	Subtitle is not included in the software.	Check DVD.
Not played in set language	If a language is not included in the DVD, then the DVD is played in a recommended language.	Check DVD.
Not played with set subtitle	If a set subtitle is not included in the DVD, then the DVD is played with a recommended subtitle.	Check DVD.
Angle unchangeable	Plural angles are not recorded in the software.	Check if the DVD is multi-angle capable.
Unusual screen display	Display mode to the output aspect ratio for the DVD software is inappropriate.	Switch to the appropriate display mode.
Distortion in picture	In the process of fast-forward or fast-reverse.	This is not a malfunction.
Low sound quality	Check that the DVD has no scratches and dirt.	Wipe and clean the dirt on the disc.
Subtitle and language not selectable (not played with set subtitle or in set language)	The DVD is not multilanguage-capable.	The inclusion of the number of languages depends on DVD. Languages may be selectable on the Menu screen. Check DVD.
	The DVD has a priority language or setting.	If the DVD has a priority language or settings, then settings changed with this device are not reflected.
Playback time is indicated, but no sound comes out.	Playback of Mix mode Truck 1. (Mix mode: Format including Truck 1 with data other than music and Trucks from Truck 2 with music data.)	Play music data included in trucks from Truck 2.

### RELATED TO VEHICLE ICON

Symptom	Possible cause	Possible solution
Names of roads differ between Plan View and Birdview®.	This is because the quantity of the displayed information is reduced so that the screen does not become too crowded. There is also a chance that names of the roads may be displayed multiple times, and the names appearing on the screen may be different because of a processing procedure.	This is not a malfunction.
The vehicle icon is not displayed in the correct position.	The vehicle was transported after the ignition switch was pressed off, for example, by a ferry or car transporter.	Drive the vehicle for a while on a road where GPS signals can be received.
	The position and direction of the vehicle icon may be incorrect depending on the driving environments and the levels of positioning accuracy of the navigation system.	This is not a malfunction. Drive the vehicle for a while to automatically correct the position and direction of the vehicle icon.
When the vehicle is traveling on a new road, the vehicle icon is located on another road nearby.	Because the new road is not stored in the map data, the system automatically places the vehicle icon on the nearest road available.	Updated road information will be included in the next version of the map data.

## NORMAL OPERATING CONDITION

< SYMPTOM DIAGNOSIS >

[BOSE AUDIO WITH NAVIGATION]

Symptom	Possible cause	Possible solution
The screen does not switch to the night screen even after turning on the headlights.	The daytime screen was set the last time the headlights were turned on.	Set the screen to the night screen mode using <Day/Night> when you turn on the headlights.
The map does not scroll even when the vehicle is moving.	The current location map screen is not displayed.	Press "MAP".
The vehicle icon is not displayed.	The current location map screen is not displayed.	Press "MAP".
The location of the vehicle icon is misaligned from the actual position.	When using tire chains or replacing the tires, speed calculations based on the speed sensor may be incorrect.	Drive the vehicle for a while [at approximately 30 km/h (19 MPH) for about 30 minutes] to automatically correct the vehicle icon position. If this does not correct the vehicle icon position, contact an INFINITI dealer.
	The map data has a mistake or is incomplete (the vehicle icon position is always misaligned in the same area).	Updated road information will be included in the next version of the map data.

### RELATED TO ROUTE CALCULATION AND VISUAL GUIDANCE

Symptom	Possible cause	Possible solution
Waypoints are not included in the auto reroute calculation.	Waypoints that you have already passed are not included in the auto reroute calculation.	If you want to go to that waypoint again, you need to edit the route.
Route information is not displayed.	Route calculation has not yet been performed.	Set the destination and perform route calculation.
	You are not driving on the suggested route.	Drive on the suggested route.
	Route guidance is set to off.	Turn on route guidance.
	Route information is not provided for certain types of roads (roads displayed in gray).	This is not a malfunction.
The auto reroute calculation (or detour calculation) suggests the same route as the one previously suggested.	Route calculations took priority conditions into consideration, but the same route was calculated.	This is not a malfunction.
A waypoint cannot be added.	Five waypoints are already set on the route, including ones that you have already passed.	A maximum of 5 waypoints can be set on the route. If you want to go to 6 or more waypoints, perform route calculations multiple times as necessary.
The suggested route is not displayed.	Roads near the destination cannot be calculated.	Reset the destination to a main or ordinary road, and recalculate the route.
	The starting point and destination are too close.	Set a more distant destination.
	The starting point and destination are too far away.	Divide your trip by selecting one or two intermediate destinations, and perform route calculations multiple times.
	There are time restricted roads (by the day of the week, by time) near the current vehicle location or destination.	Set [Use Time Restricted Roads] to off.
The part of the route that you have already passed is deleted.	A route is managed by sections between waypoints. If you passed the first waypoint, the section between the starting point and the waypoint is deleted. (It may not be deleted depending on the area.)	This is not a malfunction.
An indirect route is suggested.	If there are restrictions (such as one-way streets) on roads close to the starting point or destination, the system may suggest an indirect route.	Adjust the location of the starting of the starting point or destination.
	The system may suggest an indirect route because route calculation does not take into consideration some areas such as narrow streets (gray roads.)	Reset the destination to a main or ordinary road, and recalculate the route.

## NORMAL OPERATING CONDITION

< SYMPTOM DIAGNOSIS >

[BOSE AUDIO WITH NAVIGATION]

Symptom	Possible cause	Possible solution
The landmark information does not correspond to the actual information.	This may be caused by insufficient or incorrect map data.	Updated information will be included in the next version of the data.
The suggested route does not exactly connect to the starting point, waypoints, or destination.	There is no data for route calculation closes to these locations.	Set the starting point, waypoints and destination on a main road, and perform route calculation.

### RELATED TO VOICE GUIDANCE

Symptom	Possible cause	Possible solution
Voice guidance is not available	Voice guidance is only available at certain intersections marked with In some case, voice guidance is not available even when the vehicle should make a turn.	This is not a malfunction.
	The vehicle has deviated from the suggested route.	Go back to the suggested route or request route calculation again
	Voice guide is set to off.	Turn on voice guidance.
	Route guidance is set to off.	Turn on voice guidance.
The guidance contact does not correspond to the actual condition.	The contact of voice guidance may vary, depending on the types of intersections at which turn are made.	Follow all traffic rules and regulations.

### RELATED TO HANDS-FREE PHONE

Symptom	Cause and Counter measure
Does not recognize cellular phone connection. (No connection is displayed on the display at the guide.)	Some Bluetooth® enabled cellular phones may not be recognized by the in-vehicle phone module. Refer to "RELATED TO HANDS-FREE PHONE (Check Compatibility)" of MULTI AV SYSTEM SYMPTOM.
Cannot use hands-free phone	Customer will not be able to use a hands-free phone under the following conditions. <ul style="list-style-type: none"> <li>• The vehicle is outside of the telephone service area.</li> <li>• The vehicle is in an area where it is difficult to receive radio waves; such as in a tunnel, in an underground parking garage, near a tall building or in a mountainous area.</li> <li>• The cellular phone is locked to prevent it from being dialed.</li> </ul> <p><b>NOTE:</b></p> While a cellular phone is connected through the Bluetooth® wireless connection, the battery power of the cellular phone may discharge quicker than usual. The Bluetooth® Hands-Free Phone System cannot charge cellular phones.
The other party's voice cannot be heard by hands-free phone.	When the radio wave condition is not ideal or ambient sound is too loud, it may be difficult to hear the other person's voice during a call.
Poor sound quality	Do not place the cellular phone in an area surrounded by metal or far away from the in-vehicle phone module to prevent tone quality degradation and wireless connection disruption.



# REMOVAL AND INSTALLATION

## AV CONTROL UNIT

### Removal and Installation

INFOID:000000008130940

#### REMOVAL

**CAUTION:**

- Before replacing AV control unit, perform “Read/Write Configuration” to save or print current vehicle specification. For details, refer to [AV-193, "Work Procedure"](#).
- Remove battery terminal and AV control unit after a lapse of 30 seconds or more after turning the ignition switch OFF.

**NOTE:**

After the ignition switch is turned OFF, the AV control unit continues operating for approximately 30 seconds. Therefore, data corruption may occur if battery voltage is cut off within 30 seconds.

1. Remove the preset switch. Refer to [AV-281, "Removal and Installation"](#).
2. After removing the AV control unit mounting screws to disconnect the connectors, remove the AV control unit with the bracket attached.
3. Remove the bracket screws to remove the bracket from the AV control unit.

#### INSTALLATION

Install in the reverse order of removal.

**CAUTION:**

Be sure to perform “Read/Write Configuration” when replacing AV control unit. For details, refer to [AV-194, "Work Procedure"](#).

A  
B  
C  
D  
E  
F  
G  
H  
I  
J  
K  
L  
M  
O  
P

AV

## FRONT DOOR WOOFER

< REMOVAL AND INSTALLATION >

[BOSE AUDIO WITH NAVIGATION]

---

### FRONT DOOR WOOFER

#### Removal and Installation

INFOID:000000008130941

#### REMOVAL

1. Remove the front door finisher. Refer to [INT-25, "FRONT DOOR FINISHER : Removal and Installation"](#).
2. Remove the screws and disconnect the connector to remove front door woofer.

#### INSTALLATION

Installation is the reverse order of removal.

# FRONT DOOR SQUAWKER

< REMOVAL AND INSTALLATION >

[BOSE AUDIO WITH NAVIGATION]

## FRONT DOOR SQUAWKER

### Removal and Installation

INFOID:000000008130942

#### REMOVAL

1. Remove the front door finisher. Refer to [INT-25, "FRONT DOOR FINISHER : Removal and Installation"](#).
2. Remove the screws to remove the front door squawker from the door finisher.

#### INSTALLATION

Installation is the reverse order of removal.

A  
B  
C  
D  
E  
F  
G  
H  
I  
J  
K  
L  
M  
O  
P

AV

## TWEETER

### Removal and Installation

INFOID:000000008130943

#### REMOVAL

1. Remove the front sash inner cover. Refer to [INT-26. "FRONT DOOR SASH INNER COVER : Removal and Installation"](#).
2. Remove the screws to remove the tweeter from the front sash inner cover.

#### INSTALLATION

Installation is the reverse order of removal.

# REAR DOOR SPEAKER

< REMOVAL AND INSTALLATION >

[BOSE AUDIO WITH NAVIGATION]

## REAR DOOR SPEAKER

### Removal and Installation

INFOID:000000008130944

#### REMOVAL

1. Remove the rear door finisher. Refer to [INT-27. "REAR DOOR FINISHER : Removal and Installation"](#).
2. Remove the screws and disconnect the connector to remove the rear door speaker.

#### INSTALLATION

Installation is the reverse order of removal.

A

B

C

D

E

F

G

H

I

J

K

L

M

AV

O

P

# SATELLITE SPEAKER

< REMOVAL AND INSTALLATION >

[BOSE AUDIO WITH NAVIGATION]

---

## SATELLITE SPEAKER

### Removal and Installation

INFOID:000000008130945

#### REMOVAL

1. Remove the rear parcel shelf finisher. Refer to [INT-40, "Removal and Installation"](#).
2. Remove the screws and disconnect the connector to remove the satellite speaker.

#### INSTALLATION

Installation is the reverse order of removal.

# CENTER SPEAKER

< REMOVAL AND INSTALLATION >

[BOSE AUDIO WITH NAVIGATION]

## CENTER SPEAKER

### Removal and Installation

INFOID:000000008130946

#### REMOVAL

1. Remove the upper ventilator grille. Refer to [IP-13. "Removal and Installation"](#).
2. Remove the screws and disconnect the connector to remove the center speaker.

#### INSTALLATION

Install in the reverse order of removal.

A

B

C

D

E

F

G

H

I

J

K

L

M

AV

O

P

## REAR WOOFER

### Removal and Installation

INFOID:000000008130947

#### REMOVAL

1. Remove the rear parcel shelf finisher. Refer to [INT-40, "Removal and Installation"](#).
2. Remove the screws and disconnect the connector to remove the rear woofer.

#### INSTALLATION

Install in the reverse order of removal.



# SEAT SPEAKER

< REMOVAL AND INSTALLATION >

[BOSE AUDIO WITH NAVIGATION]

## SEAT SPEAKER

### Removal and Installation

INFOID:000000008130948

#### REMOVAL

1. Remove the seat speaker grille as shown in the figure.  
**CAUTION:**  
**Never reuse seat speaker grille. The pawl is broken when removing.**
2. Remove the front seatback trim and pad. Refer to [SE-85, "SEATBACK : Disassembly and Assembly"](#).

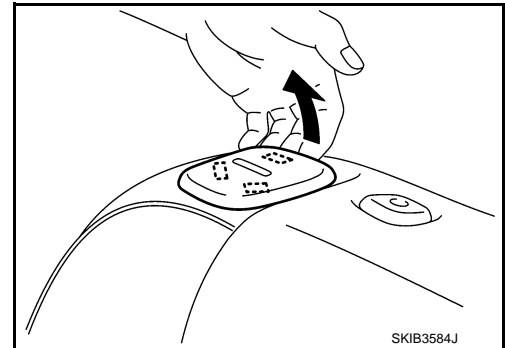

3. Remove the screws and disconnect the connector to remove the seat speaker.

#### INSTALLATION

Install in the reverse order of removal.

A  
B  
C  
D  
E  
F  
G  
H  
I  
J  
K  
L  
M

AV

O  
P

**BOSE AMP.****Removal and Installation**

INFOID:000000008130949

**REMOVAL**

1. Remove the trunk front finisher. Refer to [INT-50, "Exploded View"](#).
2. Remove the rear parcel shelf finisher. Refer to [INT-40, "Removal and Installation"](#).
3. Remove the BOSE amp. mounting bolts.
4. Disconnect the connectors to remove the BOSE amp. from the rear parcel shelf (trunk room side).

**INSTALLATION**

Install in the reverse order of removal.

**FRONT MICROPHONE (ACTIVE NOISE CONTROL SYSTEM/AUDIOPILOT® 2)**

**Removal and Installation**

INFOID:000000008130950

**REMOVAL**

1. Remove the map lamp of switch cover.
2. Lower the headlining front side (map lamp side) to secure work space. Refer to [INL-41, "Removal and Installation"](#).
3. Press the pawl to remove the front microphone from the map lamp assembly.

**CAUTION:**

**Carefully handle the pawl fixing the front microphone because the pawl is fragile.**

**INSTALLATION**

Install in the reverse order of removal.

**NOTE:**

Check the front microphone for looseness after the installation.

A  
B  
C  
D  
E  
F  
G  
H  
I  
J  
K  
L  
M

AV

O  
P

## REAR MICROPHONE (ACTIVE NOISE CONTROL SYSTEM)

< REMOVAL AND INSTALLATION >

[BOSE AUDIO WITH NAVIGATION]

---

## REAR MICROPHONE (ACTIVE NOISE CONTROL SYSTEM)

### Removal and Installation

INFOID:000000008130951

#### REMOVAL

1. Remove the headlining. Refer to [INT-46. "Removal and Installation"](#).
2. Remove the rear microphone from the headlining.

#### INSTALLATION

Install in the reverse order of removal.

## ANTENNA AMP.

### Removal and Installation

INFOID:000000008130952

#### REMOVAL

1. Remove the rear pillar finisher RH. Refer to [INT-37, "REAR PILLAR FINISHER : Removal and Installation"](#).
2. Remove the screw and disconnect the connector to remove the antenna amp.

#### INSTALLATION

Installation is the reverse order of removal.

A  
B  
C  
D  
E  
F  
G  
H  
I  
J  
K  
L  
M  
N  
O  
P

AV

## DISPLAY UNIT

### Removal and Installation

INFOID:000000008130953

#### REMOVAL

1. Remove the center ventilator assembly. Refer to [IP-13. "Removal and Installation"](#).
2. Remove the screws and disconnect the connector to remove the display unit.

#### INSTALLATION

Install in the reverse order of removal.

# SATELLITE RADIO ANTENNA

< REMOVAL AND INSTALLATION >

[BOSE AUDIO WITH NAVIGATION]

## SATELLITE RADIO ANTENNA

Exploded View

INFOID:000000008130954

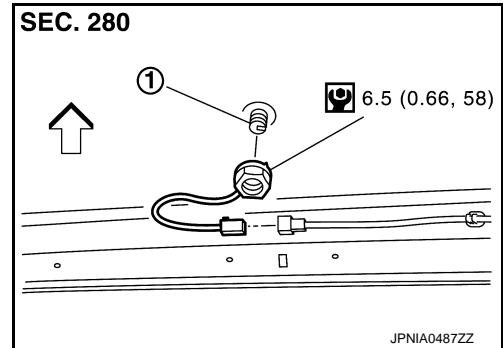

- 1. Satellite radio antenna
- ⇐: Vehicle front

## Removal and Installation

INFOID:000000008130955

### REMOVAL

1. Remove the head lining assembly. Refer to [INT-46, "Removal and Installation"](#).
2. Remove the nut and disconnect the connector to remove the satellite radio antenna from the roof panel.

### INSTALLATION

Installation is the reverse order of removal.

#### **CAUTION:**

**Be careful about tightening torque. Antenna sensitivity becomes poor, and when it is excessive, roof panel may be deformed, when satellite radio antenna mounting nut tightening torque is loose.**

A  
B  
C  
D  
E  
F  
G  
H  
I  
J  
K  
L  
M  
O  
P

AV

# MULTIFUNCTION SWITCH

< REMOVAL AND INSTALLATION >

[BOSE AUDIO WITH NAVIGATION]

## MULTIFUNCTION SWITCH

### Removal and Installation

INFOID:000000008130956

#### REMOVAL

1. Remove the cluster lid D. Refer to [IP-13. "Removal and Installation"](#).
2. Remove the screws (A) to remove the multifunction switch from the cluster lid D.

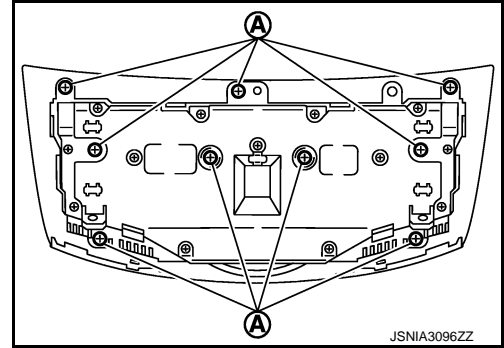

#### INSTALLATION

Install in the reverse order of removal.



## PRESET SWITCH

### Removal and Installation

INFOID:000000008130957

#### REMOVAL

1. Remove the Instrument side panel LH and RH. Refer to [IP-24, "Removal and Installation"](#).
2. Remove the preset switch straight from the instrument panel assembly while disengaging the resin clips and pawls with a remover.

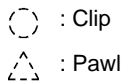
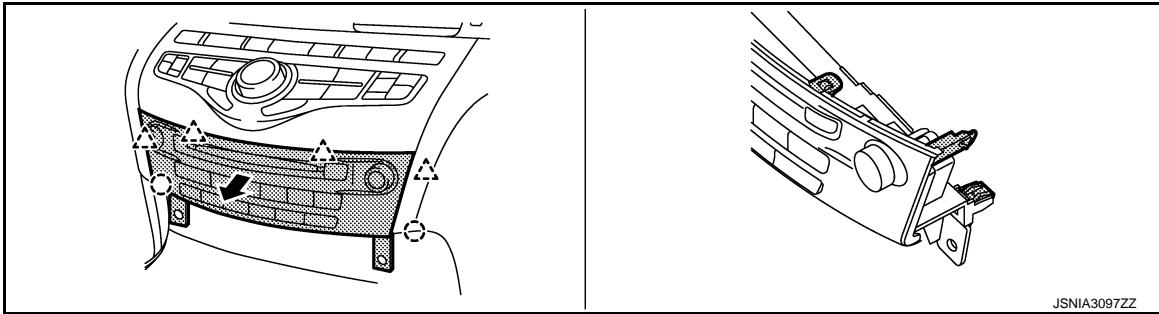

#### CAUTION:

- The resin clips and pawls must be disengaged slowly to avoid damage to the pawls and the preset switch.
- Place protective tape on the area of using the remover to avoid damage.

A  
B  
C  
D  
E  
F  
G  
H  
I  
J  
K  
L  
M  
O  
P

AV

## STEERING SWITCH

< REMOVAL AND INSTALLATION >

[BOSE AUDIO WITH NAVIGATION]

---

### STEERING SWITCH

#### Removal and Installation

INFOID:000000008130958

#### REMOVAL

Refer to [ST-32. "Removal and Installation"](#).

#### INSTALLATION

Install in the reverse order of removal.

## USB CONNECTOR

### Removal and Installation

INFOID:000000008130959

#### REMOVAL

1. Remove the console center finisher. Refer to [IP-24, "Removal and Installation"](#).
2. Push the pawl from the back of the console center finisher to remove the USB connector.

#### INSTALLATION

Install in the reverse order of removal.

A  
B  
C  
D  
E  
F  
G  
H  
I  
J  
K  
L  
M  
N  
O  
P

AV

# GPS ANTENNA

< REMOVAL AND INSTALLATION >

[BOSE AUDIO WITH NAVIGATION]

## GPS ANTENNA

Exploded View

INFOID:000000008130960

FEEDER LAYOUT

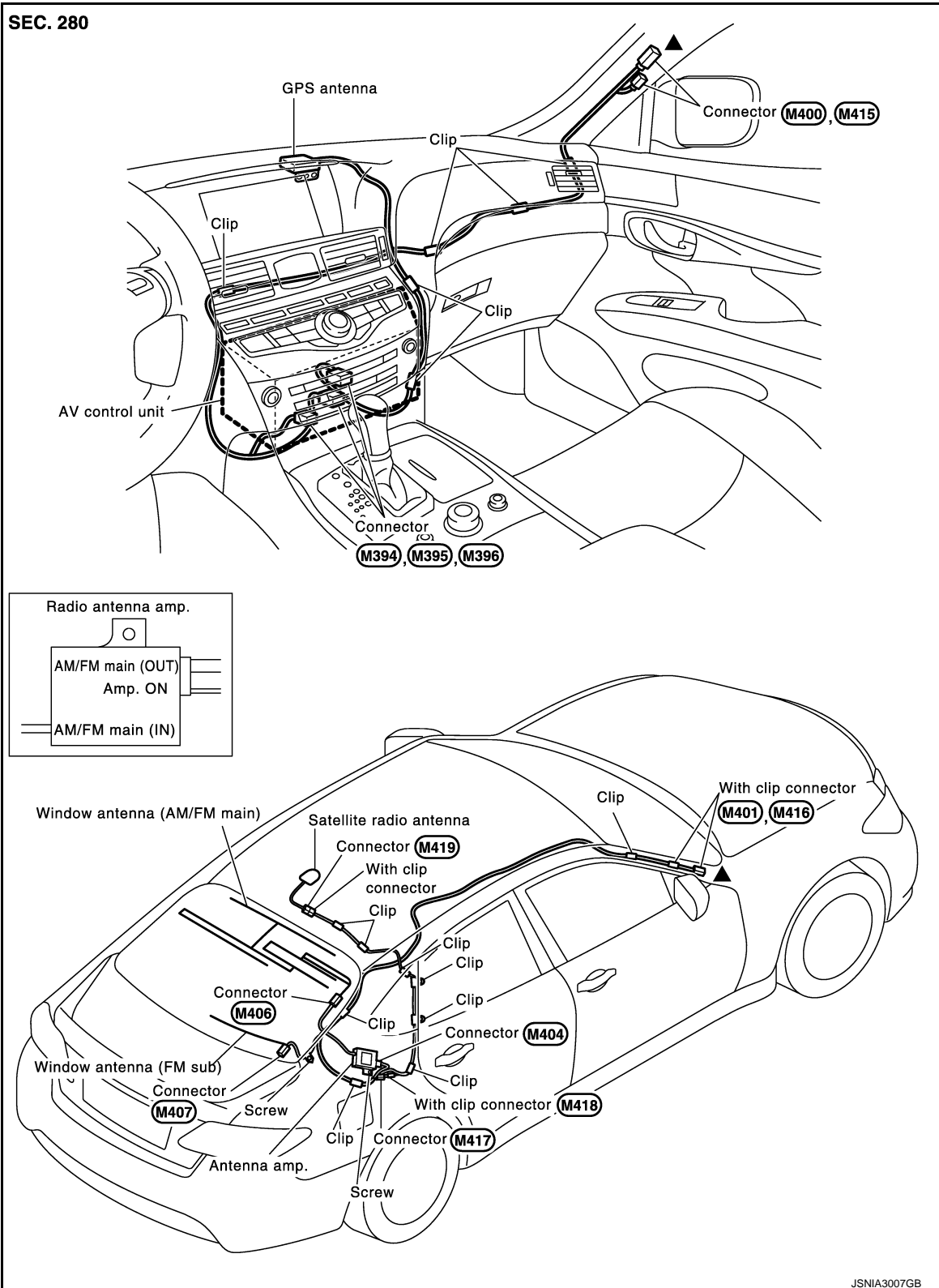

## Removal and Installation

INFOID:000000008130961

### REMOVAL

1. Remove the instrument panel. Refer to [IP-13. "Removal and Installation"](#).
2. Remove the screw to remove the GPS antenna from the instrument panel.

### INSTALLATION

Install in the reverse order of removal.

A

B

C

D

E

F

G

H

I

J

K

L

M

AV

O

P

## MICROPHONE

### Removal and Installation

INFOID:000000008130962

#### REMOVAL

1. Remove the map lamp of switch cover.
2. Lower the headlining front side (map lamp side) to secure work space. Refer to [INL-41, "Removal and Installation"](#).
3. Press the pawl to remove the microphone from the map lamp assembly.

**CAUTION:**

**Carefully handle the pawl fixing the microphone because the pawl is fragile.**

#### INSTALLATION

Install in the reverse order of removal.

**NOTE:**

Check the microphone for looseness after the installation.

## REAR VIEW CAMERA

### Removal and Installation

INFOID:000000008130963

#### REMOVAL

1. Remove the trunk lid inner finisher. Refer to [INT-53, "Removal and Installation"](#).
2. Disconnect the connector.
3. Insert a tool shown in the figure in the groove and push the pawl to remove the rear view camera (2) from the inner bracket (1) of the trunk lid finisher.

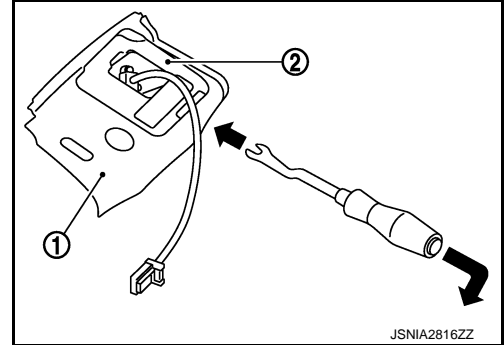

#### INSTALLATION

Install in the reverse order of removal.

#### NOTE:

Adjust the guide line position if the guide line position is shifted after installing the rear view camera. Refer to [AV-287, "Adjustment"](#).

#### Adjustment

INFOID:000000008130964

Adjust the guide line position if the guide line position is shifted after installing the rear view camera.

1. Draw lines on rearward area of the vehicle passing through the following points: 200 mm (7.87 in) from both sides of the vehicle, and 0.5 m (1.64 ft), 1.0 m (3.28 ft) from the rear end of the bumper.
2. Set into "Adjust offset of rear view camera" mode of Confirmation / Adjustment mode.

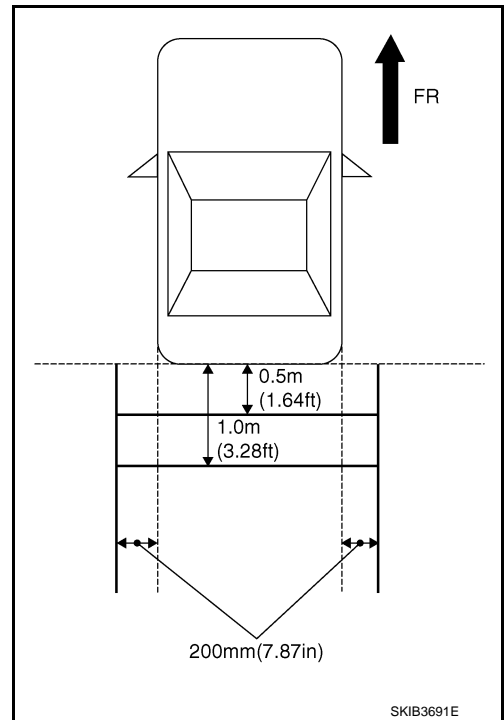

A  
B  
C  
D  
E  
F  
G  
H  
I  
J  
K  
L  
M  
AV  
O  
P

# REAR VIEW CAMERA

## < REMOVAL AND INSTALLATION >

[BOSE AUDIO WITH NAVIGATION]

3. Rotate the center dial, and then select the guiding line pattern so that its angle is aligned with the correction line of the rear of the vehicle.

Selected pattern : (-10°) – (10°)

4. Make fine adjustment to the correction line of the rear of the vehicle with up/down/left/right switches so that its position is aligned with the guiding line. Press "OK" switch and record the adjusted guiding line position to the camera control unit.

Up/Down adjustment range : (-10°) – (10°)

Left/Right adjustment range : (-10°) – (10°)

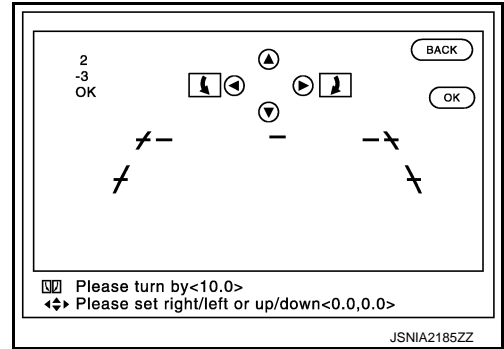

### CAUTION:

Never operate other function such as pressing BACK while writing index data.



# STEERING ANGLE SENSOR

< REMOVAL AND INSTALLATION >

[BOSE AUDIO WITH NAVIGATION]

## STEERING ANGLE SENSOR

### Removal and Installation

INFOID:000000008130965

#### REMOVAL

1. Remove the spiral cable. Refer to [SR-14, "Removal and Installation"](#).
2. Remove the screws to remove the steering angle sensor from the spiral cable.

#### INSTALLATION

Install in the reverse order of removal.

A

B

C

D

E

F

G

H

I

J

K

L

M

AV

O

P

# ANTENNA FEEDER

< REMOVAL AND INSTALLATION >

[BOSE AUDIO WITH NAVIGATION]

## ANTENNA FEEDER

### Feeder Layout

INFOID:000000008130966

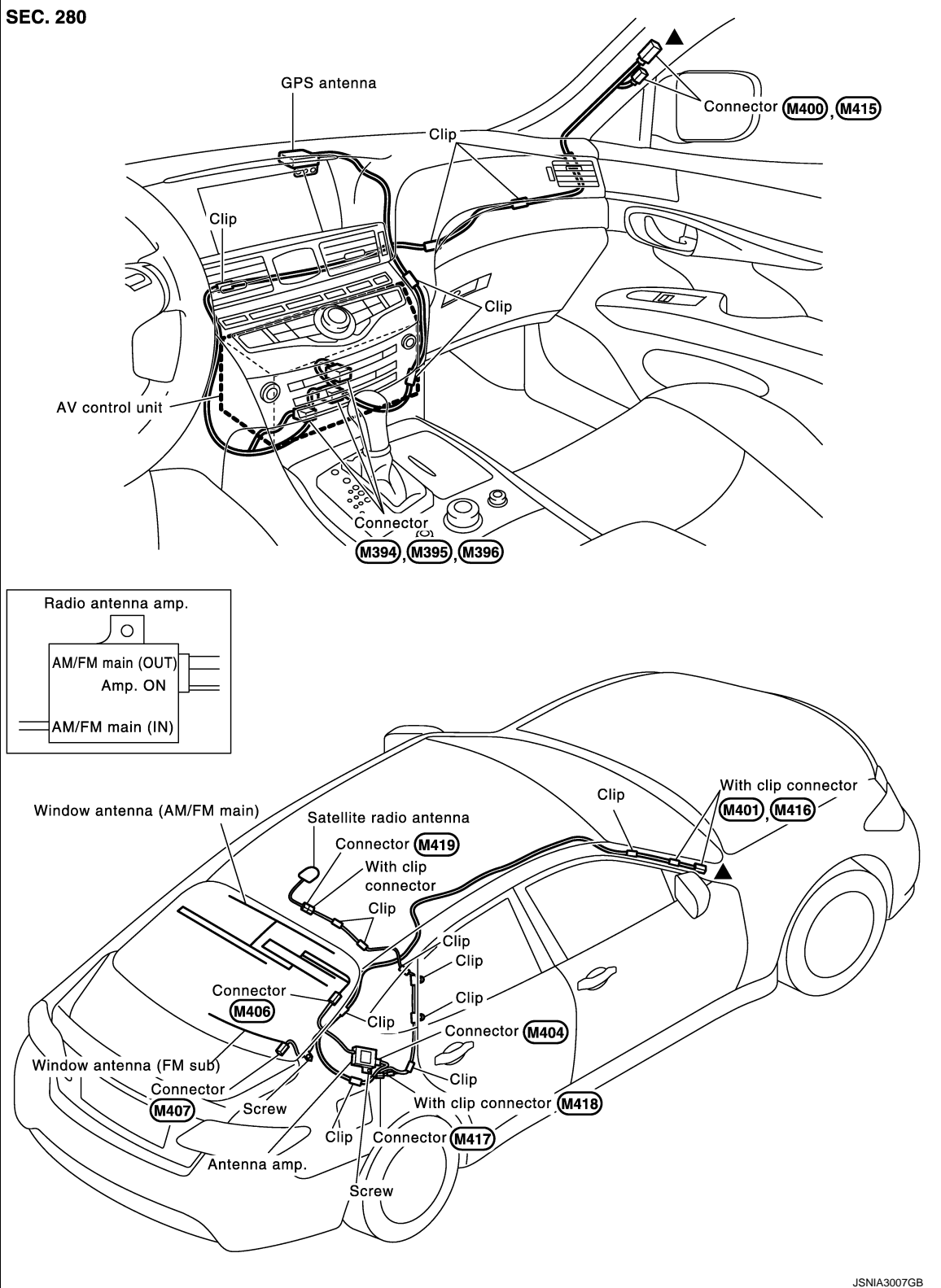

PRECAUTION

PRECAUTIONS

Precaution for Supplemental Restraint System (SRS) "AIR BAG" and "SEAT BELT PRE-TENSIONER"

INFOID:000000008220838

The Supplemental Restraint System such as "AIR BAG" and "SEAT BELT PRE-TENSIONER", used along with a front seat belt, helps to reduce the risk or severity of injury to the driver and front passenger for certain types of collision. This system includes seat belt switch inputs and dual stage front air bag modules. The SRS system uses the seat belt switches to determine the front air bag deployment, and may only deploy one front air bag, depending on the severity of a collision and whether the front occupants are belted or unbelted. Information necessary to service the system safely is included in the "SRS AIR BAG" and "SEAT BELT" of this Service Manual.

**WARNING:**

Always observe the following items for preventing accidental activation.

- To avoid rendering the SRS inoperative, which could increase the risk of personal injury or death in the event of a collision that would result in air bag inflation, all maintenance must be performed by an authorized NISSAN/INFINITI dealer.
- Improper maintenance, including incorrect removal and installation of the SRS, can lead to personal injury caused by unintentional activation of the system. For removal of Spiral Cable and Air Bag Module, see "SRS AIR BAG".
- Never use electrical test equipment on any circuit related to the SRS unless instructed to in this Service Manual. SRS wiring harnesses can be identified by yellow and/or orange harnesses or harness connectors.

PRECAUTIONS WHEN USING POWER TOOLS (AIR OR ELECTRIC) AND HAMMERS

**WARNING:**

Always observe the following items for preventing accidental activation.

- When working near the Air Bag Diagnosis Sensor Unit or other Air Bag System sensors with the ignition ON or engine running, never use air or electric power tools or strike near the sensor(s) with a hammer. Heavy vibration could activate the sensor(s) and deploy the air bag(s), possibly causing serious injury.
- When using air or electric power tools or hammers, always switch the ignition OFF, disconnect the battery, and wait at least 3 minutes before performing any service.

Precaution for Trouble Diagnosis

INFOID:000000008220839

AV COMMUNICATION SYSTEM

- Do not apply voltage of 7.0 V or higher to the measurement terminals.
- Use the tester with its open terminal voltage being 7.0 V or less.
- Be sure to turn ignition switch OFF and disconnect the battery cable from the negative terminal before checking the circuit.

Precaution for Harness Repair

INFOID:000000008220840

AV COMMUNICATION SYSTEM

- Solder the repaired parts, and wrap with tape. [Frays of twisted line must be within 110 mm (4.33 in).]

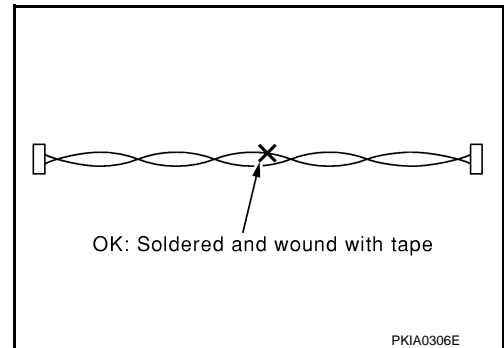

## PRECAUTIONS

[TELEMATICS SYSTEM]

### < PRECAUTION >

- Do not perform bypass wire connections for the repair parts. (The spliced wire will become separated and the characteristics of twisted line will be lost.)

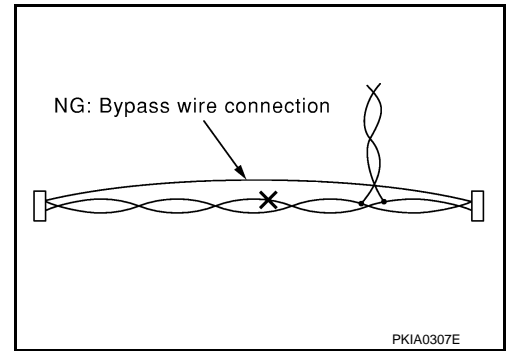

# SYSTEM DESCRIPTION

## DESCRIPTION

### Telematics system

INFOID:000000008220841

The adoption of the Telematics system allows the provision of information and services in real time for safe and pleasant driving.

- TCU (Telematics Communication Unit) equipped with a radio communication terminal communicates with the information center (Infiniti Connection™ Data Center) via radio waves for receiving Infiniti Connection™ services.
- In addition to the services received while driving, various kinds of vehicle information can be obtained via Infiniti Connection™ Data Center by using cell phone or personal computer.

### Infiniti Connection™ SERVICE

The user can transmit/receive various kinds of information via the information centers (Infiniti Connection™ Data Center).

- The available services are: Information service, Infiniti Connection™ Response service, shortest route search, safety & security service, etc.
- The user can access Infiniti Connection™ user's homepage and check eco drive information by using cell phone or personal computer.

A  
B  
C  
D  
E  
F  
G  
H  
I  
J  
K  
L  
M  
O  
P



# COMPONENT PARTS

< SYSTEM DESCRIPTION >

[TELEMATICS SYSTEM]

## COMPONENT PARTS

### Component Parts Location

INFOID:000000008220842

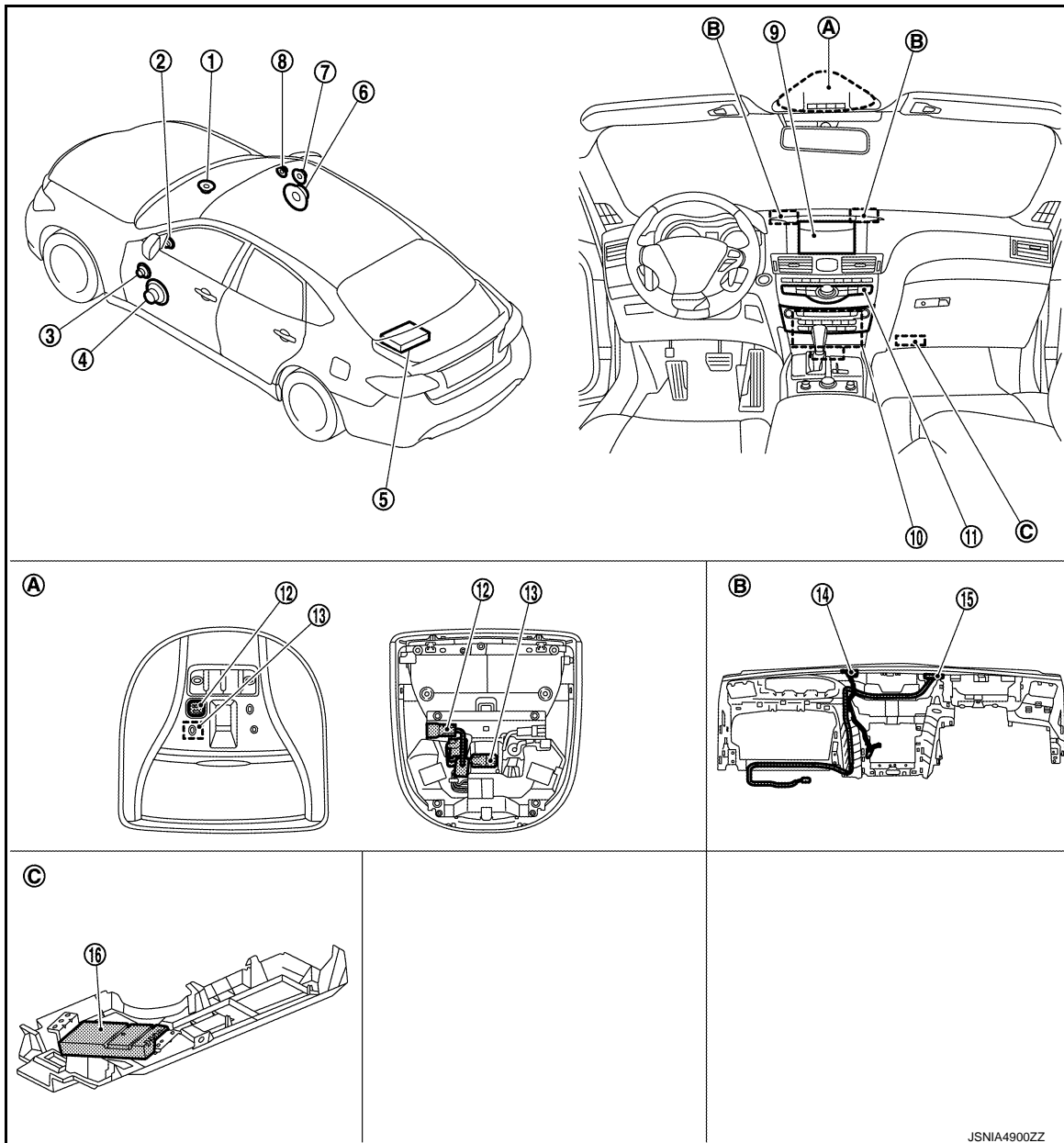

A. Map lamp assembly part

B. Instrument panel removed condition

C. Instrument lower cover removed condition

No.	Part name	Description
1.	Center speaker	Outputs sound signal.
2.	Tweeter LH	
3.	Front door squawker LH	
4.	Front door woofer LH	
5.	BOSE amp.	Inputs sound signal from AV control unit, and outputs sound signal to each speaker.

# COMPONENT PARTS

< SYSTEM DESCRIPTION >

[TELEMATICS SYSTEM]

No.	Part name	Description
6.	Front door woofer RH	Outputs sound signal.
7.	Front door squawker RH	
8.	Tweeter RH	
9.	Display unit	<ul style="list-style-type: none"> <li>• Display image is controlled by the serial communication from AV control unit.</li> <li>• The RGB digital image signal and composite image signal are input to display unit.</li> <li>• Touch panel function can be operated for each system by touching a display directly.</li> </ul>
10.	AV control unit	Refer to <a href="#">AV-295, "AV CONTROL UNIT"</a> .
11.	Multifunction switch	<ul style="list-style-type: none"> <li>• Operation panel is equipped with the centralized switch where navigation and CARWINGS, etc. operations are integrated.</li> <li>• Connected with preset switch via cable, and operation signal is transmitted to AV control unit via AV communication.</li> </ul>
12.	Telematics switch	Refer to <a href="#">AV-298, "Telematics Switch"</a> .
13.	Microphone	Refer to <a href="#">AV-296, "Microphone"</a> .
14.	GPS antenna	Refer to <a href="#">AV-296, "GPS Antenna"</a> .
15.	Telematics antenna	Refer to <a href="#">AV-296, "Telematics Antenna"</a> .
16.	TCU	Refer to <a href="#">AV-295, "TCU"</a> .

## AV CONTROL UNIT

INFOID:000000008220843

- AV control unit is installed at the center of the instrument panel.
- It is connected to TCU with the USB harness and signals necessary for Telematics function is sent and received.
- Switch operation signals used for the Telematics system are transmitted to TCU via USB communication from the AV control unit.

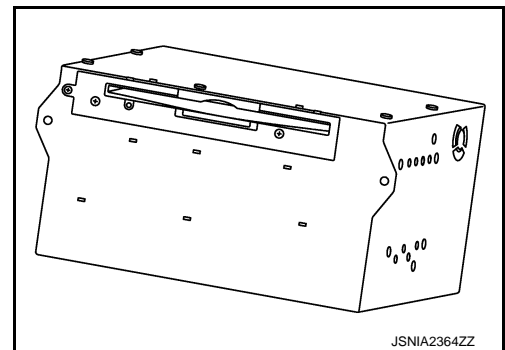

JSNIA2364ZZ

## TCU

INFOID:000000008220844

- TCU is abbreviation of Telematics Communication Unit.
- It is installed on the instrument lower cover.
- A radio communication terminal and SIM card are built into the unit and data is sent and received in SMS<sup>\*1</sup>, DTMF tone signal and packet communication<sup>\*2</sup> with the Infiniti Connection™ Data Center through the TEL antenna.

### NOTE:

\*1: SMS stands for Short Message Service. It is also referred to as Text Messaging, Short Mail, etc. It is the service that performs text based message communication.

\*2: Packet communication means a communication method that data are broken down into smaller chunks for communication. The split data is called a packet and this method improves the efficiency of the communication circuit.

- It is connected to the AV control unit with the USB harness for sound signal input/output and USB communication.
- VIN information necessary for the Telematics service is memorized.
- It is connected to the air bag diagnosis sensor unit via CAN communication. TCU performs an emergency report when the air bag is inflated.
- Audio signals received during SOS/Infiniti Connection™ Response Specialists call are transmitted from TCU to each speaker via the AV control unit.

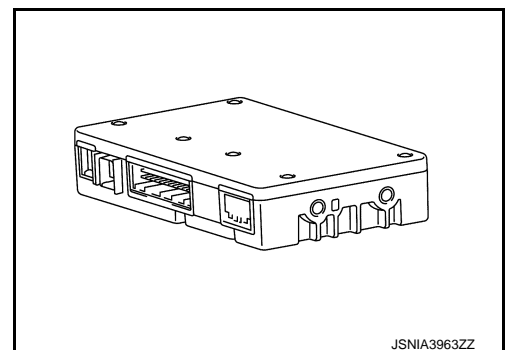

JSNIA3963ZZ

A  
B  
C  
D  
E  
F  
G  
H  
I  
J  
K  
L  
M  
AV  
O  
P

# COMPONENT PARTS

## [TELEMATICS SYSTEM]

### < SYSTEM DESCRIPTION >

- During the communication with Infiniti Connection™ Data Center and Infiniti Connection™ Response Center, TCU prohibit the use of Bluetooth® hands-free phone.

### Telematics Antenna

INFOID:000000008220845

- The telematics antenna consists of TEL antenna and GPS antenna.
- It is installed in the instrument panel.

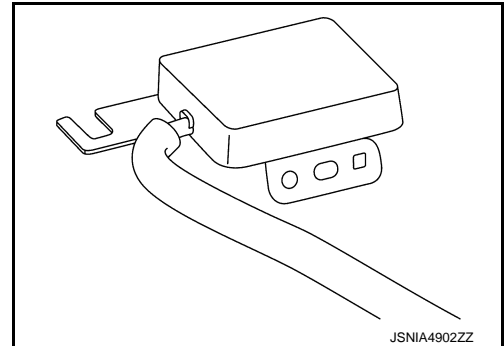

### TEL ANTENNA

- Data communications signals and voice signals are transmitted/received.
- Power is supplied with TCU activated.

### GPS ANTENNA

- GPS signal is received and transmitted to TCU.

#### **NOTE:**

The placement of an object on the instrument panel may cause desensitization in the receiver sensitivity.

### GPS Antenna

INFOID:000000008235764

- GPS antenna is installed in the instrument panel.
- Power is supplied from the AV control unit.
- This antenna amplifies radio waves received from the GPS satellite and transmits the GPS signal to the AV control unit.

#### **NOTE:**

An object on the instrument panel may cause the reception sensitivity to be decreased.

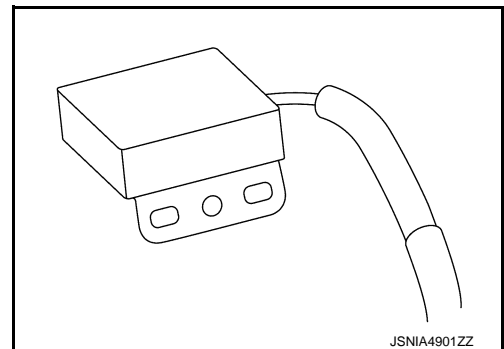

### Microphone

INFOID:000000008220846

Microphone is installed on the map lamp assembly.

- The microphone is used for hands-free phone and voice recognition function in addition to the Infiniti Connection™ Response service of Infiniti Connection™.
- TCU supplies power to the microphone.
- An audio signal during speech is transmitted to TCU.

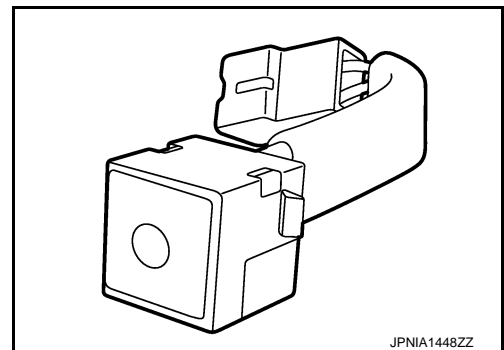



# COMPONENT PARTS

< SYSTEM DESCRIPTION >

[TELEMATICS SYSTEM]

## Antenna Feeder

INFOID:000000008220847

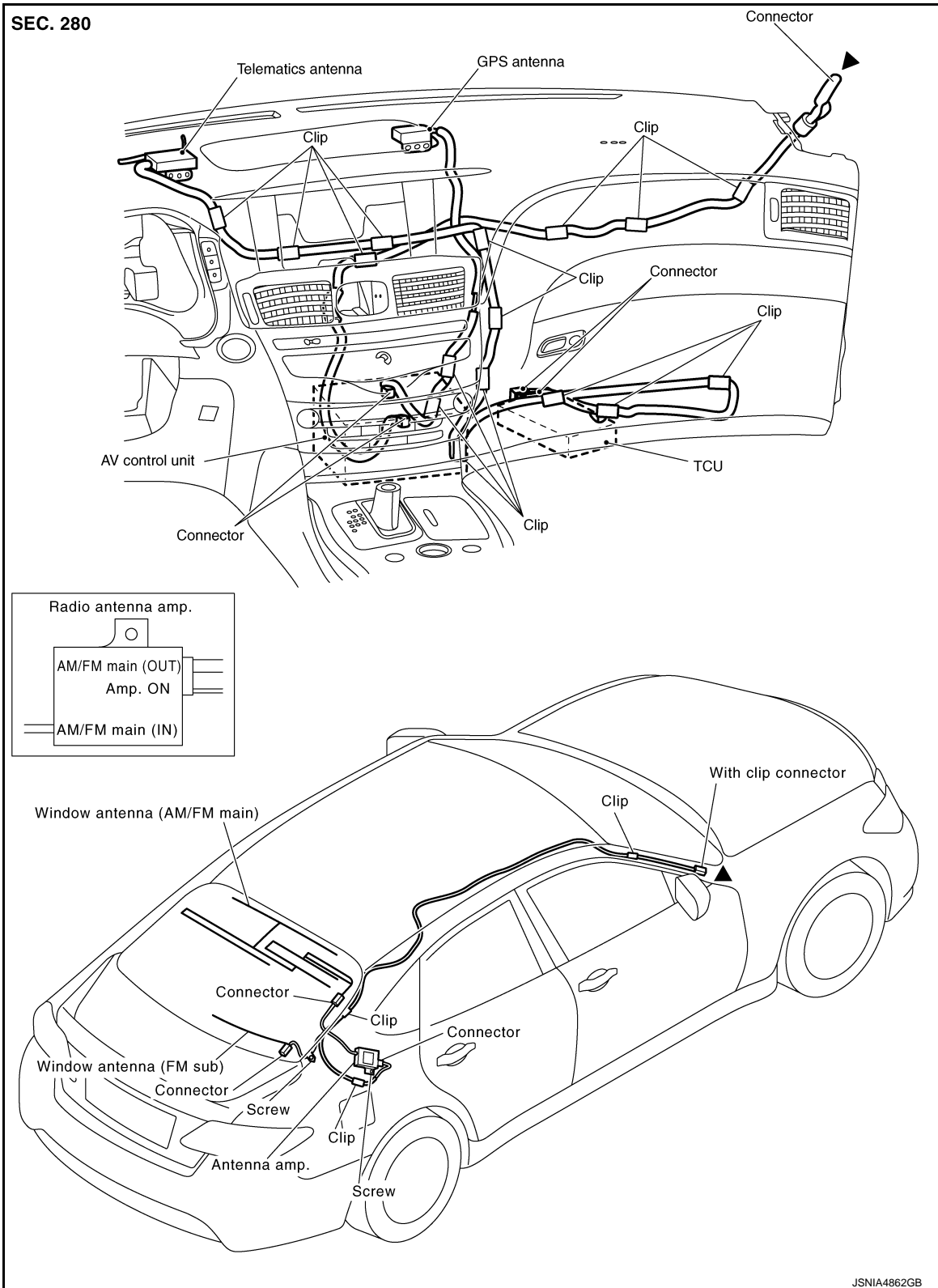

▲: Indicates that the parts is connected at points with same symbol in actual vehicle.

A  
B  
C  
D  
E  
F  
G  
H  
I  
J  
K  
L  
M  
N  
O  
P

AV

## Telematics Switch

- The Telematics switch is located on the map lamp assembly.
- The Telematics switch is connected to TCU and transmits an operation signal.
- The state of LED (ON/Blink/OFF) shows the status of SOS call.

LED ON :SOS Call available  
LED Blink :SOS Call in communication  
LED OFF :Out of service area or system error

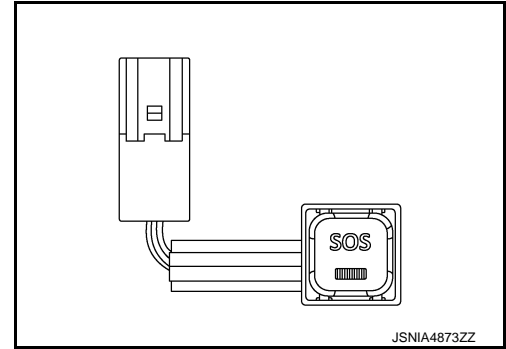

SYSTEM  
TELEMATICS SYSTEM

TELEMATICS SYSTEM : System Description

INFOID:000000008220850

SYSTEM DIAGRAM

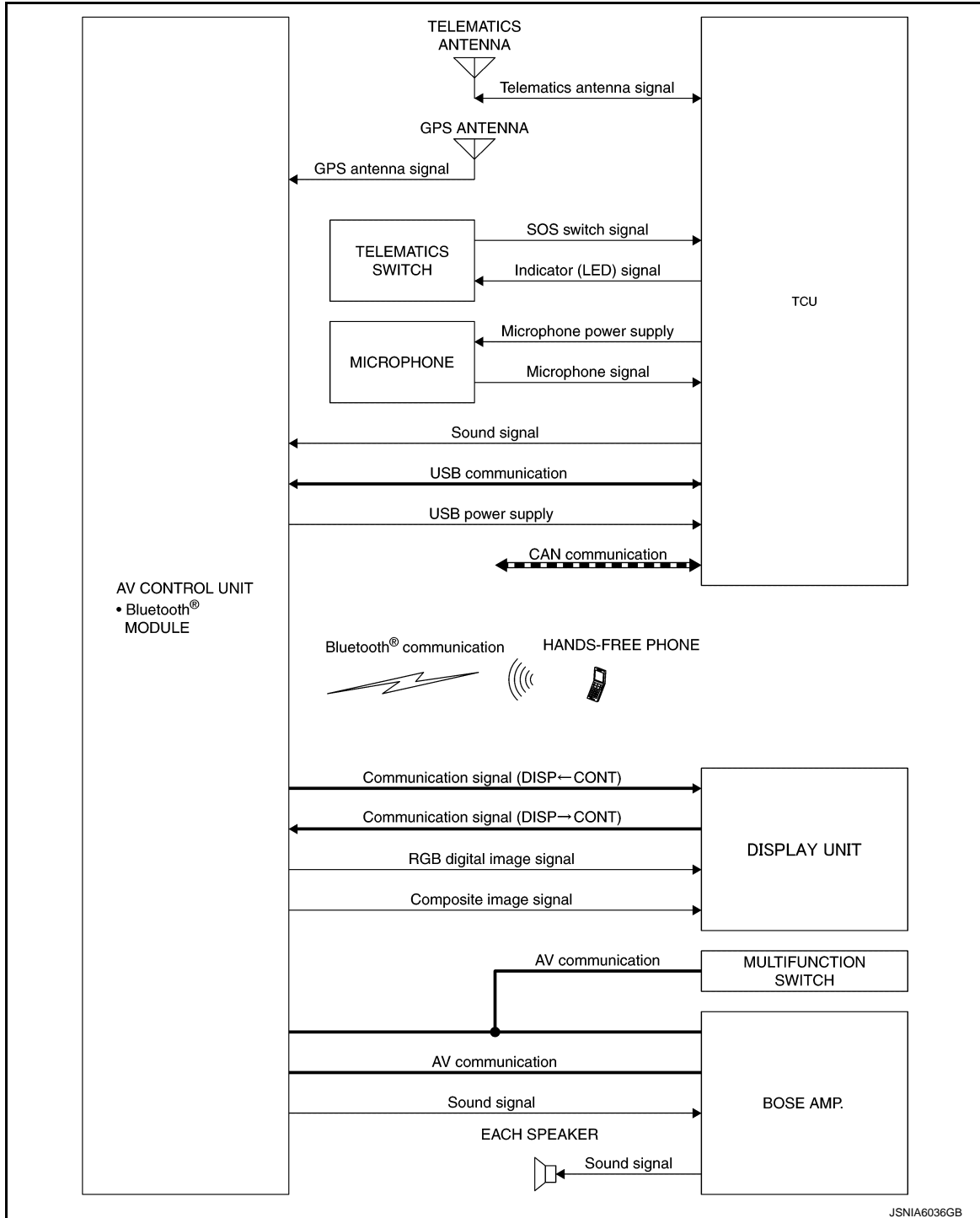

DESCRIPTION

The telematics system interacts with the INFINITI CONNECTION data center using GPS and GSM/GPRS technologies. The telematics control unit (TCU) can send messages to and receive commands from the INFINITI CONNECTION data center. This allows the INFINITI CONNECTION data center to monitor the vehicle and obtain actual position coordinates and automatically detected events, as well as initiate certain services from outside the vehicle. In addition, the vehicle operator can initiate services from inside the vehicle.

A  
B  
C  
D  
E  
F  
G  
H  
I  
J  
K  
L  
M  
AV  
O  
P

# SYSTEM

< SYSTEM DESCRIPTION >

[TELEMATICS SYSTEM]

---

**NOTE:**

For additional information on the Telematics system, refer to the NAVIGATION SYSTEM OWNER'S MANUAL.

## HANDLING PRECAUTION

### Telematics

INFOID:000000008220851

- In the following cases, no Infiniti Connection™ services are available.
  - When the user has not subscribed to the service.
  - When the vehicle moves out of the radio receiving zone
  - When the radio wave reception environment is not suitable to data communication.
  - When the vehicle is in a location that may block radio waves such as in an underground parking lot, behind a building, and in mountainous areas.
- Because the voice exchange with the Infiniti Connection™ data center uses the data communication mode, the service area may be narrower and the connection availability may be worse than the normal telephone system.
- Communication and calls to the Infiniti Connection™ data center require additional charges.
- If the vehicle is outside the communication area of TCU or the radio wave reception condition is poor, the connection to the Infiniti Connection™ data center may not be available or interrupted.
- If the communication is interrupted during a data download through any of the available services, the data must be downloaded again from the beginning.
- When transferring your vehicle, always resign from your membership. For details about the cancellation procedure, contact the Infiniti Connection™ customer center.

A  
B  
C  
D  
E  
F  
G  
H  
I  
J  
K  
L  
M  
O  
P

AV

< SYSTEM DESCRIPTION >

## DIAGNOSIS SYSTEM (TCU)

### CONSULT Function

INFOID:000000008220852

#### APPLICABLE ITEM

CONSULT performs the following items by communication with TCU:

Diagnosis mode	Description
ECU identification information	Checks TCU part number and various ID numbers.
Self-diagnosis results	Performs the diagnosis of TCU and displays the current and past malfunctions collectively.
Data Monitor	The diagnosis of the vehicle signal that is input to TCU can be performed.
Work Support	Performs TCU activation setting and center connection setting.

#### ECU IDENTIFICATION INFORMATION

Displays TCU part number and various ID numbers.

Display items	Description
CONTROL UNIT NUMBER	Displays TCU part number.
UNIT ID	Displays AV control unit ID number.
TCU ID	Displays TCU ID number.
SIM ID	Displays ICC ID of SIM card.
TCU PHONE NUMBER	Displays the phone number of TCU.
VIN	Displays the vehicle identification number stored in TCU.

#### SELF-DIAGNOSIS RESULTS

Refer to [AV-307, "DTC Index"](#).

#### DATA MONITOR

##### NOTE:

The following table includes information (items) inapplicable to this vehicle. For information (items) applicable to this vehicle, refer to CONSULT display items.

All Items

- Displays the status of the following vehicle signals inputted into TCU.
- For each signal, the actual signal can be compared with the condition recognized on the system.

Display item	Dis-play	Condition	Note
ECHO CANCEL	type1	—	This item is displayed, but cannot be monitored.
	type2		
	type3		
	type4		
NOISE CANCEL	type1	—	This item is displayed, but cannot be monitored.
	type2		
	type3		
	type4		
TCU STANDBY TIME	14DAY YS	Set at 14 days (default)	Set value for continued operation time to control battery consumption
	2DAY S	Set at 2 days	
	30DAY YS	Set at 30 days	
	NON	No setting	

# DIAGNOSIS SYSTEM (TCU)

< SYSTEM DESCRIPTION >

[TELEMATICS SYSTEM]

Display item	Display	Condition	Note
NAD OUTPUT STATUS	On	When TCU activation is ON	NAD: Abbreviation of Network Access Device. ON/OFF setting of radio wave
	Off	When TCU activation is OFF	
ACN COMM SEQUENCE LOG	—	—	—
SOS COMM SEQUENCE LOG	—	—	—

## SELECTION FROM MENU

Allows the technician to select which vehicle signals should be displayed and displays the status of the selected vehicle signals.

Item to be selected	Description
ECHO CANCEL	"The same as when ALL SIGNALS" is selected
NOISE CANCEL	
TCU STANDBY TIME	
NAD OUTPUT STATUS	
ACN COMM SEQUENCE LOG	
SOS COMM SEQUENCE LOG	

## Work Support

Performs TCU activation setting and center connection setting.

Item name	DESCRIPTION
SAVE VIN DATA	The VIN data saved in TCU is stored in CONSULT.
CHANGE TCU ACTIVATE SETTING	TCU ON/OFF setting is available.
CENTER CONNECTION SETTING	Connection of the Infiniti Connection™ Data Center can be set.
WRITE VIN DATA	Write VIN data stored by "SAVE VIN DATA" in work support mode to TCU.
WRITE VIN DATA (MANUAL)	Write VIN data in TCU.

A  
B  
C  
D  
E  
F  
G  
H  
I  
J  
K  
L  
M

AV

O  
P

# ECU DIAGNOSIS INFORMATION

## AV CONTROL UNIT

### Reference Value

INFOID:000000008220853

ECU	System	Reference
AV control unit	BOSE audio with navigation	<a href="#">AV-164. "Reference Value"</a>
		<a href="#">AV-169. "Fail-Safe"</a>
		<a href="#">AV-170. "DTC Index"</a>



# TCU

< ECU DIAGNOSIS INFORMATION >

[TELEMATICS SYSTEM]

## TCU

### Reference Value

INFOID:000000008220854

### VALUES ON THE DIAGNOSIS TOOL

**NOTE:**

The following table includes information (items) inapplicable to this vehicle. For information (items) applicable to this vehicle, refer to CONSULT display items.

Monitor Item	Condition	Value/Status
ECHO CANCEL	This item is displayed, but cannot be monitored.	type1
		type2
		type3
		type4
NOISE CANCEL	This item is displayed, but cannot be monitored.	type1
		type2
		type3
		type4
TCU STANDBY TIME	Set at 14 days (default)	14DAYS
	Set at 2 days	2DAYS
	Set at 30 days	30DAYS
	No setting	NON
NAD OUTPUT STATUS	When TCU activation is ON	On
	When TCU activation is OFF	Off
ACN COMM SEQUENCE LOG	—	—
SOS COMM SEQUENCE LOG	—	—

### TERMINAL LAYOUT

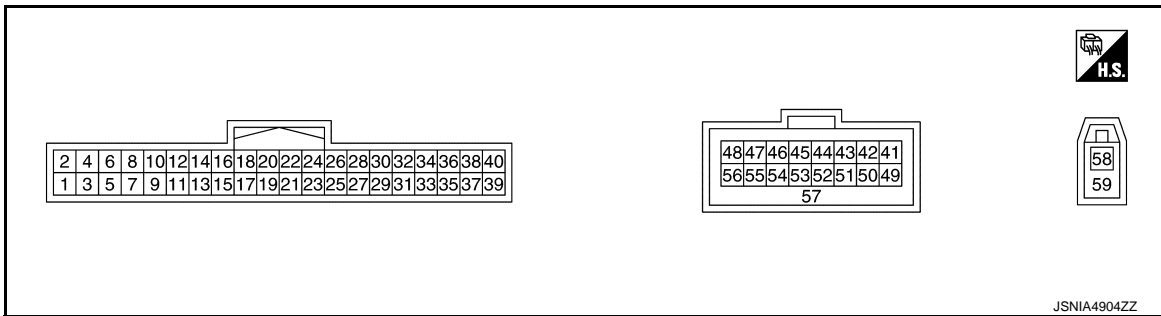

### PHYSICAL VALUES

AV

Terminal (Wire color)		Description		Condition	Threshold value	Reference value (Approx.)
+	-	Signal name	Input/Output			
1 (Y)	2 (B)	Battery power supply	Input	Ignition switch OFF	—	9 - 16 V
2 (B)	—	Ground	—	Ignition switch ON	—	Less than 1 V

# TCU

## < ECU DIAGNOSIS INFORMATION >

## [TELEMATICS SYSTEM]

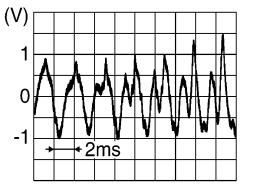
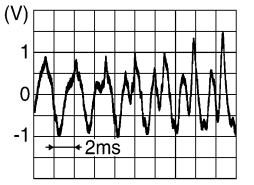
Terminal (Wire color)		Description		Condition		Threshold value	Reference value (Approx.)
+	-	Signal name	Input/ Out- put				
3 (SB)	2 (B)	ACC power supply	Input	Igni- tion switch ACC	—	9 - 16 V	12 V
4 (W)	2 (B)	Ignition signal	Input	Igni- tion switch ON	—	9 - 16 V	12 V
5 (V)	2 (B)	ACC output	Out- put	Igni- tion switch ACC	—	9 - 16 V	12 V
6 (P)	—	—	—	—	—	—	—
7 (B)	—	Ground	—	Igni- tion switch ON	—	Less than 1 V	0 V
9 (L)	—	CAN-H	Input/ Out- put	—	—	—	—
10 (P)	—	CAN-L	Input/ Out- put	—	—	—	—
18 (G)	Grou nd	Microphone VCC	Out- put	Igni- tion switch ACC	—	4.0 - 5.3 V	5 V
19 (R)	20	Microphone signal	Input	Igni- tion switch ACC	When input- ting interior sound	—	 <small>SKIB3609E</small>
21 (G)	23	Microphone VCC	Input	Igni- tion switch ACC	—	4.0 - 5.3 V	5 V
22 (R)	23	Sound signal	Out- put	Igni- tion switch ACC	When input- ting interior sound	—	 <small>SKIB3609E</small>
34 (G)	2 (B)	SOS call switch signal	Input	Igni- tion switch ACC	When press- ing SOS switch	Less than 1 V	0 V
					Except for above	—	5 V

# TCU

< ECU DIAGNOSIS INFORMATION >

[TELEMATICS SYSTEM]

Terminal (Wire color)		Description		Condition	Threshold value	Reference value (Approx.)
+	-	Signal name	Input/ Out- put			
35 (BR)	2 (B)	SOS switch LED signal	Input	Igni- tion switch ACC	When not illu- minated LED lamp of SOS switch	12 V
					When illumi- nated LED lamp of SOS switch	Less than 1 V
41	42	U-VOICE signal	Input	Igni- tion switch ON	—	—
46	—	Manufacturer Specific signal	—	—	Not used.	—
47	55	USB V BUS signal	Input	Igni- tion switch ON	—	—
48	55	USB D- signal	Input/ Out- put	Igni- tion switch ON	—	—
49	42	D-VOICE signal	Out- put	Igni- tion switch ON	—	—
56	55	USB D+ signal	Input/ Out- put	Igni- tion switch ON	—	—
57	—	Shield	—	—	—	—
58	Grou- nd	TEL antenna sig- nal	Input	—	Not connected TEL antenna connector.	2.8 V
59	—	Shield	—	—	—	—

## DTC Index

INFOID:000000008220855

DTC	Display contents of CONSULT	Refer to
U1000	CAN COMM CIRC [U1000]	<a href="#">AV-319, "Diagnosis Procedure"</a>
U1010	CONTROL UNIT (CAN) [U1010]	<a href="#">AV-320, "DTC Logic"</a>
U1A00	ACC NO CONN [U1A00]	<a href="#">AV-321, "Diagnosis Procedure"</a>
U1A01	INTERNAL ERROR (TCU) [U1A01]	<a href="#">AV-322, "DTC Logic"</a>
U1A02	TEL COMMUNICATION MODULE [U1A02]	<a href="#">AV-323, "DTC Logic"</a>
U1A03	SIM CARD [U1A03]	<a href="#">AV-324, "DTC Logic"</a>
U1A04	VIN UNFINISHED [U1A04]	<a href="#">AV-325, "DTC Logic"</a>
U1A05	USB COMM [U1A05]	<a href="#">AV-326, "Diagnosis Procedure"</a>
U1A07	TEL ANTENNA SHORT [U1A07]	<a href="#">AV-327, "Diagnosis Procedure"</a>
U1A08	TEL ANTENNA NO CONN [U1A08]	<a href="#">AV-328, "Diagnosis Procedure"</a>

# TCU

< ECU DIAGNOSIS INFORMATION >

[TELEMATICS SYSTEM]

DTC	Display contents of CONSULT	Refer to
U1A0B	MIC IN CONN [U1A0B]	<a href="#">AV-329. "Diagnosis Procedure"</a>
U1A0C	MIC OUT CONN [U1A0C]	<a href="#">AV-331. "Diagnosis Procedure"</a>
U1A0E	SOS SWITCH ON STUCK [U1A0E]	<a href="#">AV-332. "Diagnosis Procedure"</a>
U1A0F	SOS SWITCH NO CONN [U1A0F]	<a href="#">AV-333. "Diagnosis Procedure"</a>

< WIRING DIAGRAM >

# WIRING DIAGRAM

## BOSE AUDIO WITH NAVIGATION

### Wiring Diagram

INFOID:000000008220856

For connector terminal arrangements, harness layouts, and alphabets in a  (option abbreviation; if not described in wiring diagram), refer to [GI-12. "Connector Information"](#).

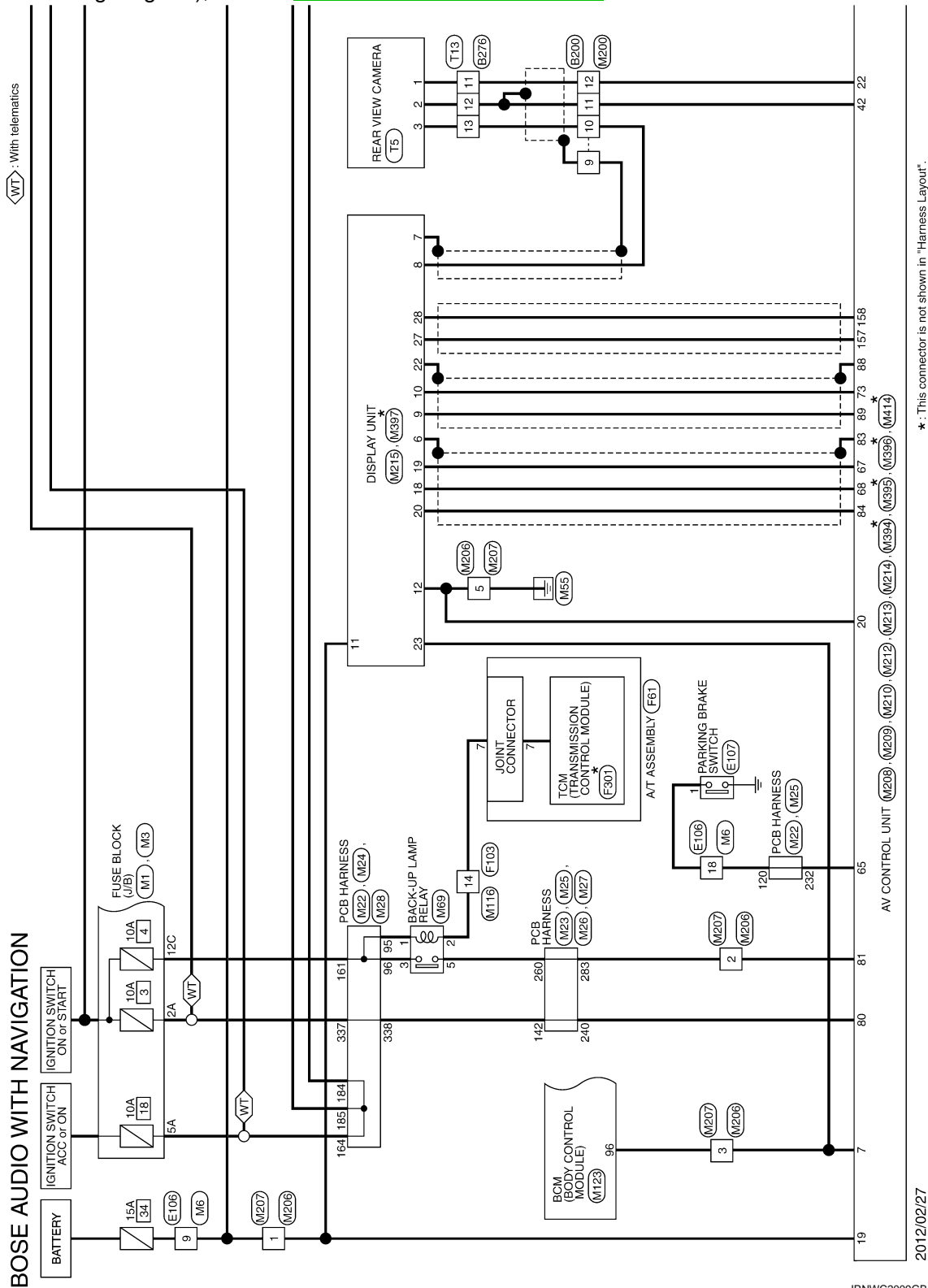

\*: This connector is not shown in "Harness Layout".

2012/02/27

JRNWC2009GB

A  
B  
C  
D  
E  
F  
G  
H  
I  
J  
K  
L  
M  
N  
O  
P

AV

# BOSE AUDIO WITH NAVIGATION

< WIRING DIAGRAM >

[TELEMATICS SYSTEM]

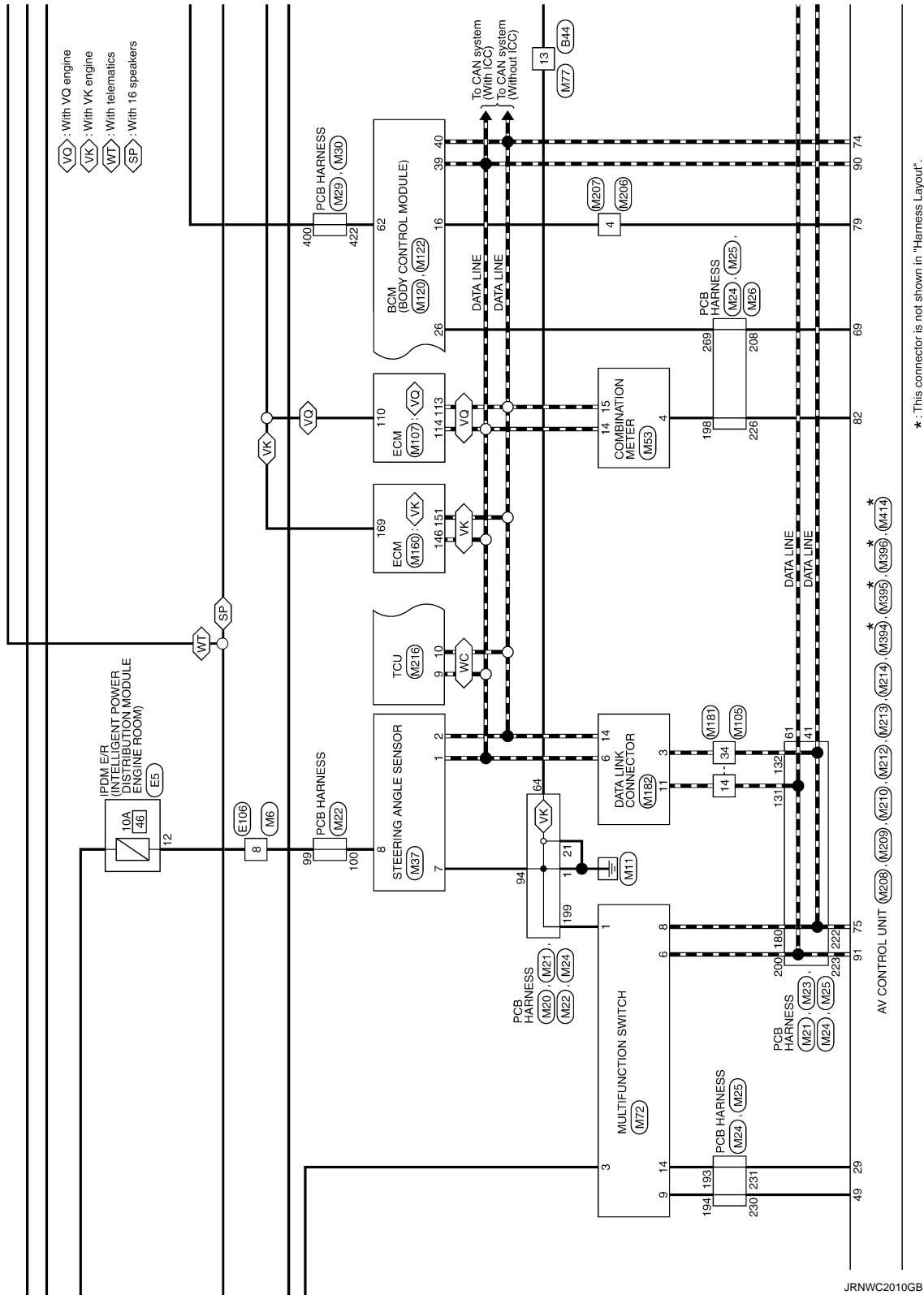

\*: This connector is not shown in "Harness Layout".

# BOSE AUDIO WITH NAVIGATION

< WIRING DIAGRAM >

[TELEMATICS SYSTEM]

VK : With VK engine  
SP : With 16 speakers

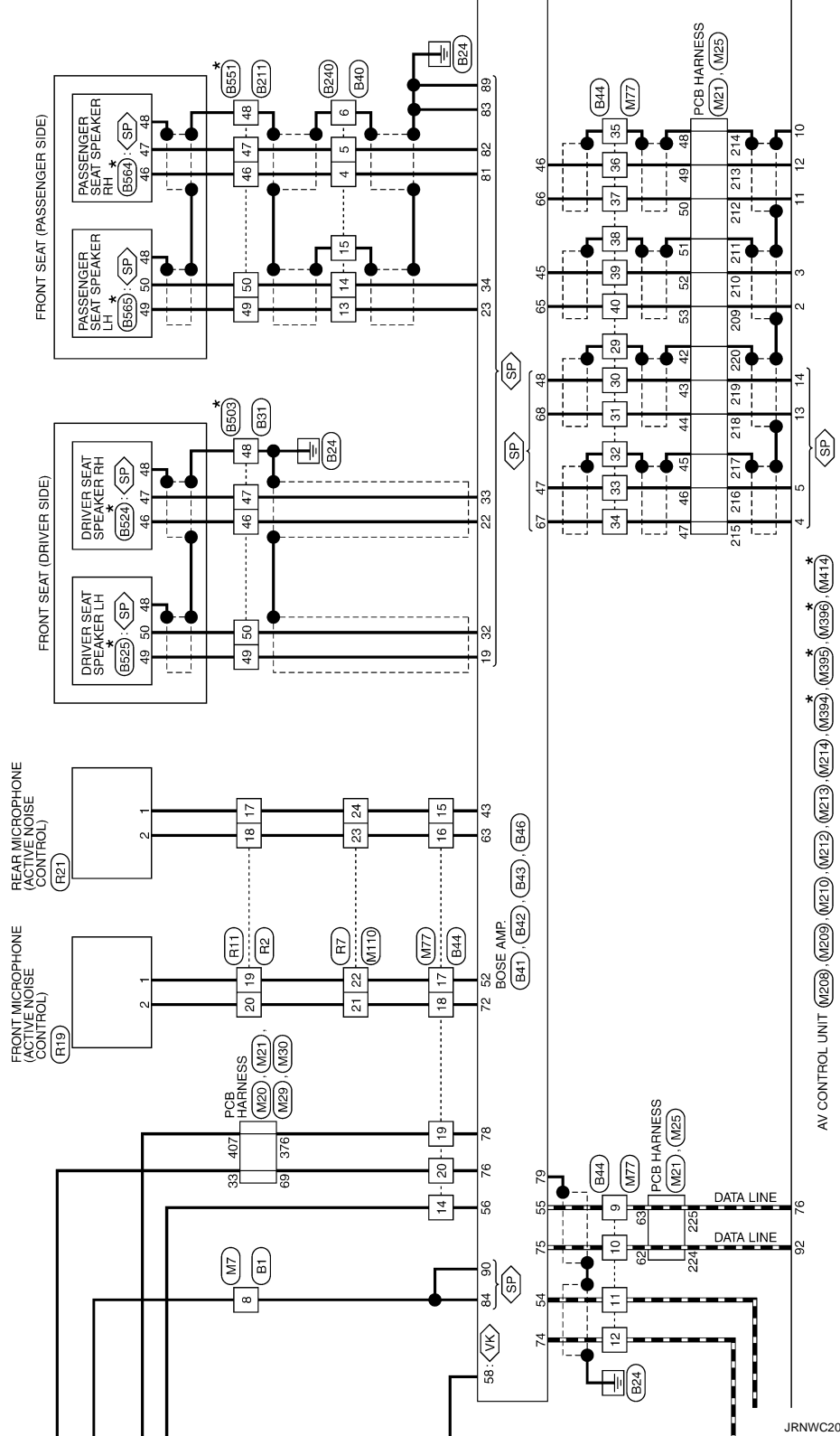

JRNWC2011GB

\*: This connector is not shown in "Harness Layout".

A  
B  
C  
D  
E  
F  
G  
H  
I  
J  
K  
L  
M  
N  
O  
P

AV

# BOSE AUDIO WITH NAVIGATION

< WIRING DIAGRAM >

[TELEMATICS SYSTEM]

< SP > With 16 speakers

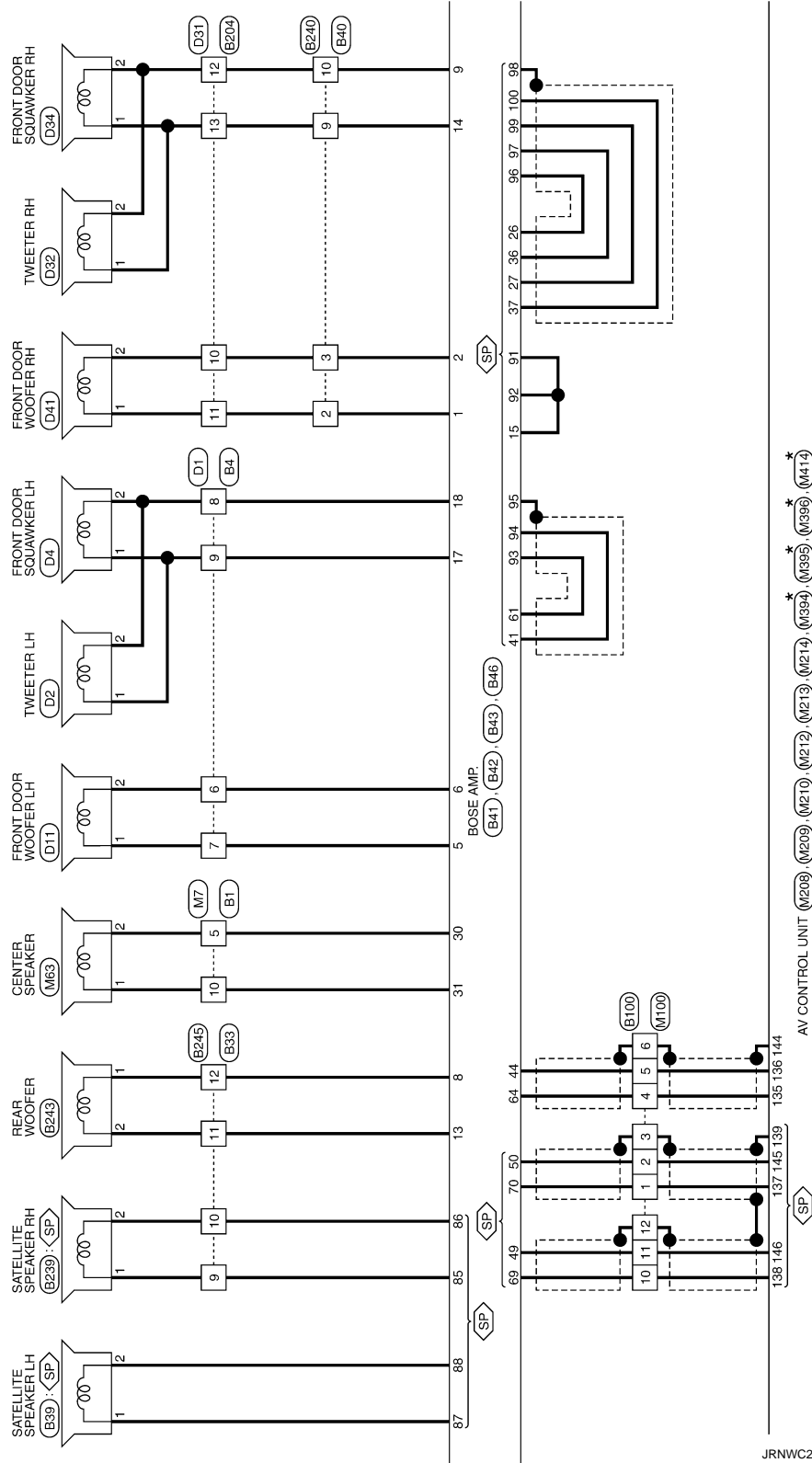

\*: This connector is not shown in "Harness Layout".

JRNWC2012GB



# BOSE AUDIO WITH NAVIGATION

< WIRING DIAGRAM >

[TELEMATICS SYSTEM]

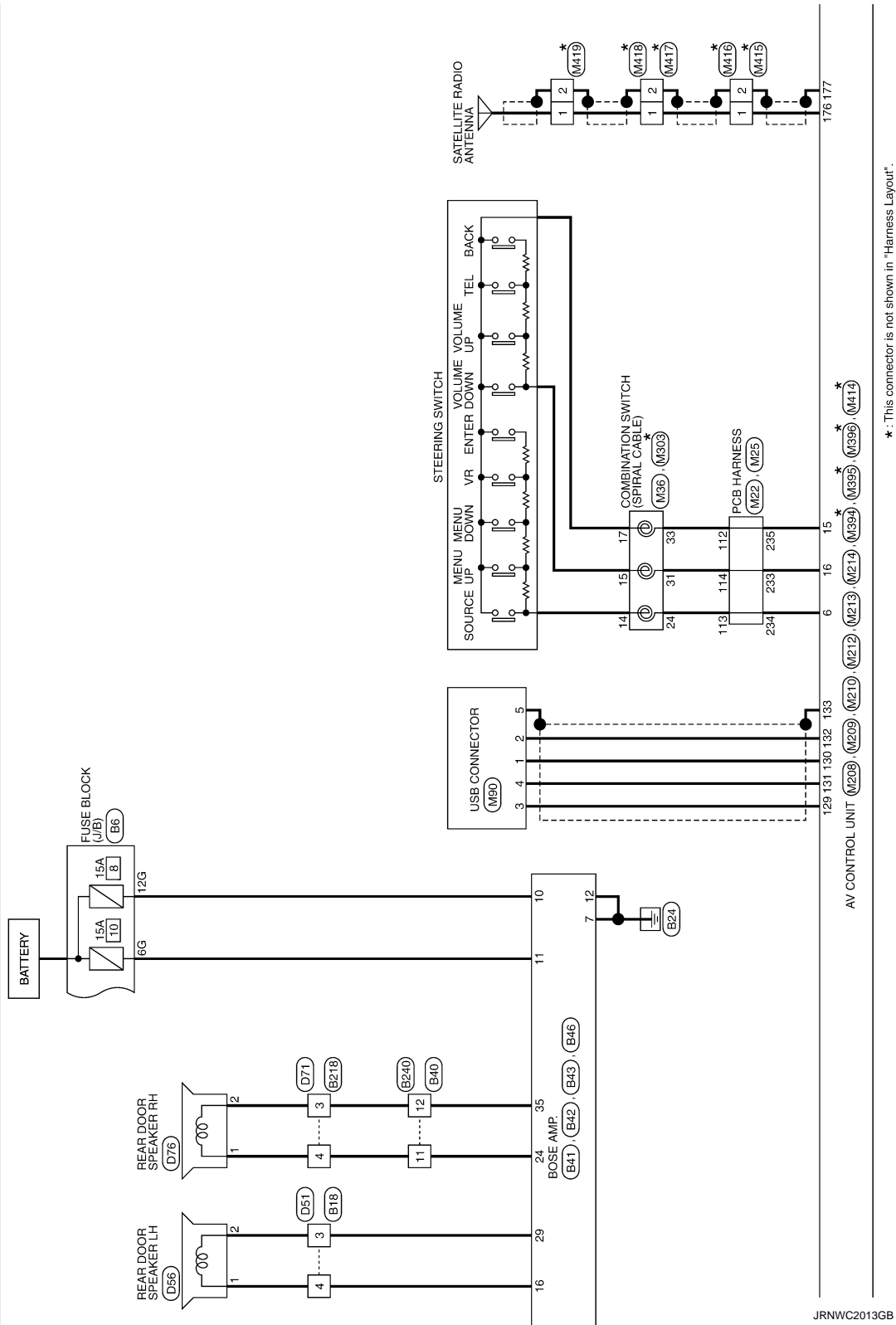

\*: This connector is not shown in "Harness Layout".

JRNWC2013GB

A  
B  
C  
D  
E  
F  
G  
H  
I  
J  
K  
L  
M  
N  
O  
P

AV

# BOSE AUDIO WITH NAVIGATION

< WIRING DIAGRAM >

[TELEMATICS SYSTEM]

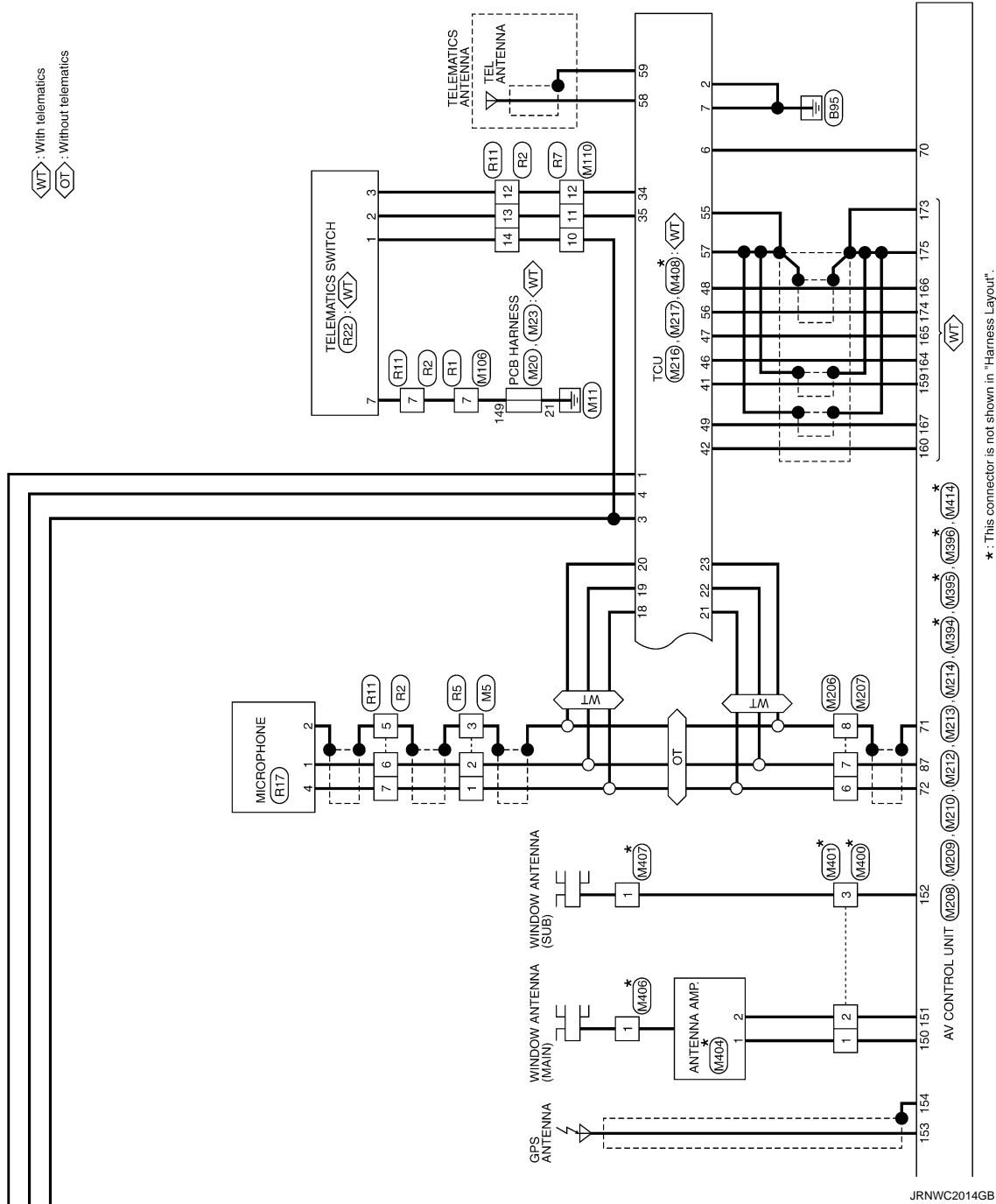

## BASIC INSPECTION

### DIAGNOSIS AND REPAIR WORK FLOW

#### Work Flow

INFOID:000000008220857

#### OVERALL SEQUENCE

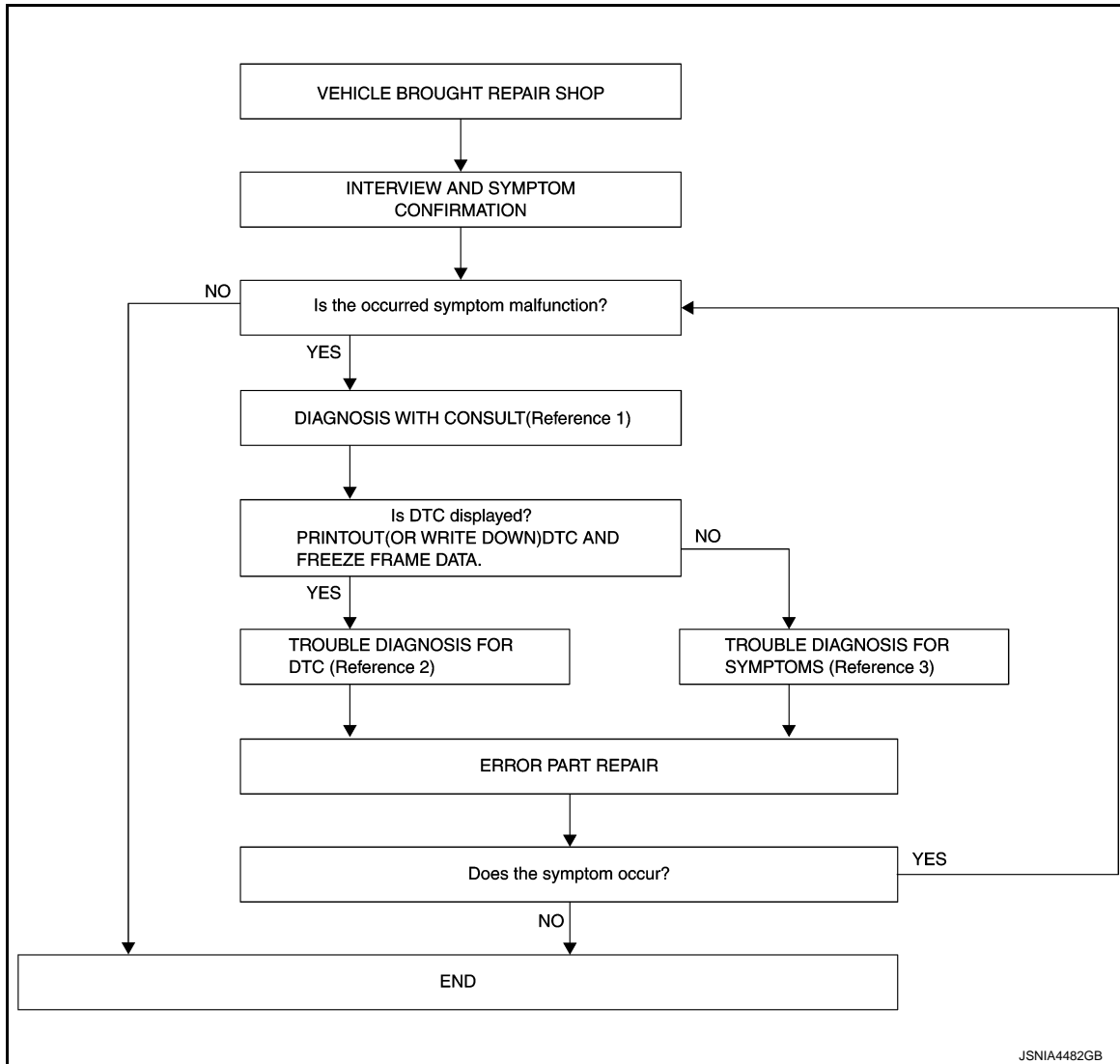

- Reference 1... Refer to [AV-302. "CONSULT Function"](#).
- Reference 2... Refer to [AV-307. "DTC Index"](#).
- Reference 3... Refer to [AV-338. "SYMPTOM TABLE"](#).

#### DETAILED FLOW

##### 1. INTERVIEW AND SYMPTOM CONFIRMATION

Check the malfunction symptoms by performing the following items.

- Interview the customer to obtain the malfunction information (conditions and environment when the malfunction occurred).
- Check the symptom.

##### Is the occurred symptom malfunction?

YES >> GO TO 2.

NO >> INSPECTION END

##### 2. DIAGNOSIS WITH CONSULT

# DIAGNOSIS AND REPAIR WORK FLOW

[TELEMATICS SYSTEM]

< BASIC INSPECTION >

1. Connect CONSULT and perform a self-diagnosis for "TCU". Refer to [AV-302, "CONSULT Function"](#).
2. When DTC is detected, follow the instructions below:
  - Record DTC and Freeze Frame Data.

Is DTC displayed?

- YES >> GO TO 3.  
NO >> GO TO 4.

## 3. TROUBLE DIAGNOSIS FOR DTC

---

1. Check the DTC indicated in the self-diagnosis results.
2. Perform the relevant diagnosis referring to the DTC Index. Refer to [AV-307, "DTC Index"](#).

>> GO TO 5.

## 4. TROUBLE DIAGNOSIS FOR SYMPTOMS

---

Perform the relevant diagnosis referring to the diagnosis chart by symptom. Refer to [AV-338, "SYMPTOM TABLE"](#).

>> GO TO 5.

## 5. ERROR PART REPAIR

---

1. Repair or replace the identified malfunctioning parts.
2. Perform a self-diagnosis for "TCU" with CONSULT.
3. Check that the symptom does not occur.

Does the symptom occur?

- YES >> GO TO 1.  
NO >> INSPECTION END

**INSPECTION AND ADJUSTMENT****ADDITIONAL SERVICE WHEN REPLACING TCU****ADDITIONAL SERVICE WHEN REPLACING TCU : Description**

INFOID:000000008242275

When TCU is replaced, TCU activation operation is required.

Preparation before activation operation

- Subscribe to telematics service
- Preregister user ID and password (can be performed from owner homepage)

**ADDITIONAL SERVICE WHEN REPLACING TCU : Work Procedure**

INFOID:000000008242276

**1. READING OF VIN DATA**

 CONSULT work support

Select SAVE VIN DATA, then START on SAVE VIN DATA screen to save the VIN data stored in replaced TCU in CONSULT. If it cannot be saved, writing operation must be performed manually.

>> GO TO 2.

**2. TCU REPLACEMENT**

Replace TCU. Refer to [AV-343, "Removal and Installation"](#).

>> GO TO 3.

**3. NOTICE TO CARRIER ATX HELP DESK**

Contact ATX help desk to notice the termination of replaced TCU and connection of new TCU. (VIN is required)

Can ID data be saved to CONSULT at 1st step?

- YES >> GO TO 4.  
NO >> GO TO 5.

**4. AUTOMATIC WRITING OF VIN DATA TO TCU**

 CONSULT work support

Select WRITE VIN DATA, then START at WRITE SAVED VIN DATA screen to write the VIN data saved in CONSULT into new TCU.

>> GO TO 6.

**5. MANUAL WRITING OF VIN DATA TO TCU**

 CONSULT work support

Select VIN REGISTRATION, WRITE VIN DATA then START on changing screen to write the VIN data saved into new TCU.

>> GO TO 6.

**6. TCU ACTIVATION**

 CONSULT work support

1. Wait for 5 seconds or more after turning the power switch ON.
2. Touch TELEMATICS on the CONSULT screen.
3. After performing System Call of CONSULT, touch the Work support tab.
4. On the work support screen of CONSULT, select TCU ACTIVATE SETTING and touch Start.
5. On the TCU ACTIVATE SETTING screen, touch Start to set to ON. Touch End.
6. Exit from CONSULT.
7. Turn the power switch OFF.
8. Wait (at least 10 seconds) until the power switch indicator turns OFF to shut down TCU.

A

B

C

D

E

F

G

H

I

J

K

L

M

AV

O

P

# INSPECTION AND ADJUSTMENT

< BASIC INSPECTION >

[TELEMATICS SYSTEM]

---

>> WORK END.

**DTC/CIRCUIT DIAGNOSIS**

**U1000 CAN COMM CIRCUIT**

**DESCRIPTION**

INFOID:000000008220865

CAN (Controller Area Network) is a serial communication line for real time applications. It is an on-board multiplex communication line with high data communication speed and excellent error detection ability. A modern vehicle is equipped with many ECMs, and each control unit shares information and links with other control units during operation (not independent). --In CAN communication, 2 control units are connected with 2 communication lines (CAN H-line, CAN L-line) allowing a high rate of information transmission with less wiring. Each control unit transmits/receives data but selectively reads required data only.

Refer to [LAN-37, "CAN COMMUNICATION SYSTEM : CAN Communication Signal Chart"](#) for details of the communication signal.

**DTC Logic**

INFOID:000000008220866

**DTC DETECTION LOGIC**

DTC	Display contents of CONSULT	DTC Detection condition	Probable malfunction location
U1000	CAN COMM CIRC [U1000]	When TCU did not transmit and receive CAN communication signal continuously for 2 seconds or more	CAN communication system

**Diagnosis Procedure**

INFOID:000000008220867

**1. PERFORM SELF-DIAGNOSIS**

1. Turn the power switch ON and hold it for 2 seconds or more.
2. "Check the self-diagnosis result of "TCU".

Is CAN communication system displayed?

- YES >> Refer to [LAN-27, "Trouble Diagnosis Flow Chart"](#).
- NO >> Refer to [GI-43, "Intermittent Incident"](#).

AV

# U1010 CONTROL UNIT (CAN)

< DTC/CIRCUIT DIAGNOSIS >

[TELEMATICS SYSTEM]

## U1010 CONTROL UNIT (CAN)

### DTC Logic

INFOID:000000008220868

### DTC DETECTION LOGIC

DTC	Display contents of CONSULT	DTC Detection condition	Action to take
U1010	CONTROL UNIT (CAN) [U1010]	A malfunction is detected in CAN controller initial diagnosis of TCU.	<ul style="list-style-type: none"><li>• Check the harness connection and erase DTC.</li><li>• Replace TCU if malfunction constantly occurs. <a href="#">AV-343</a>, "<a href="#">Removal and Installation</a>".</li></ul>



U1A00 TCU

DTC Logic

INFOID:000000008220869

DTC	Display contents of CONSULT	DTC Detection condition	Action to take
U1A00	ACC NO CONN [U1A00]	No input of ACC signal	<ul style="list-style-type: none"> <li>Check the ACC power circuit. <a href="#">AV-334, "TCU : Diagnosis Procedure"</a>.</li> <li>If the ACC circuit is normal, replace TCU. Refer to <a href="#">AV-343, "Removal and Installation"</a>.</li> </ul>

Diagnosis Procedure

INFOID:000000008220870

1. CHECK ACC POWER CIRCUIT

1. Check the ACC power circuit. Refer to [AV-334, "TCU : Diagnosis Procedure"](#).

Is the check result normal?

- YES >> Replace TCU. Refer to [AV-343, "Removal and Installation"](#).
- NO >> Repair the harnesses or connectors.

A  
B  
C  
D  
E  
F  
G  
H  
I  
J  
K  
L  
M



O  
P

# U1A01 TCU

< DTC/CIRCUIT DIAGNOSIS >

[TELEMATICS SYSTEM]

## U1A01 TCU

### DTC Logic

INFOID:000000008220871

DTC	Display contents of CONSULT	DTC Detection condition	Action to take
U1A01	INTERNAL ERROR (TCU) [U1A01]	Malfunction in TCU is detected.	<ul style="list-style-type: none"><li>• Check the connector wiring and erase DTC.</li><li>• Replace TCU if malfunction constantly occurs. Refer to <a href="#">AV-343. "Removal and Installation"</a>.</li></ul>

# U1A02 TCU

< DTC/CIRCUIT DIAGNOSIS >

[TELEMATICS SYSTEM]

## U1A02 TCU

### DTC Logic

INFOID:000000008220872

DTC	Display contents of CONSULT	DTC Detection condition	Action to take
U1A02	TEL COMMUNICATION MODULE [U1A02]	Malfunction on the communication module in TCU is detected.	<ul style="list-style-type: none"><li>• Check the harness connection and erase DTC.</li><li>• Replace TCU if malfunction constantly occurs. Refer to <a href="#">AV-343. "Removal and Installation"</a>.</li></ul>

A  
B  
C  
D  
E  
F  
G  
H  
I  
J  
K  
L  
M  
O  
P

AV

# U1A03 TCU

< DTC/CIRCUIT DIAGNOSIS >

[TELEMATICS SYSTEM]

## U1A03 TCU

### DTC Logic

INFOID:000000008220873

DTC	Display contents of CONSULT	DTC Detection condition	Action to take
U1A03	SIM CARD [U1A03]	SIM card malfunction is detected.	<ul style="list-style-type: none"><li>• Check the harness connection and erase DTC.</li><li>• Replace TCU if malfunction constantly occurs. Refer to <a href="#">AV-343</a>. "Removal and Installation".</li></ul>

# U1A04 TCU

< DTC/CIRCUIT DIAGNOSIS >

[TELEMATICS SYSTEM]

## U1A04 TCU

### DTC Logic

INFOID:000000008220874

DTC	Display contents of CONSULT	DTC Detection condition	Action to take
U1A04	VIN UNFINISHED [U1A04]	No write of VIN number is detected.	<ul style="list-style-type: none"><li>• Write VIN number using CONSULT.</li><li>• Replace TCU if malfunction is detected after VIN number is written and ignition switch turned OFF and ON. When ignition switch is turned OFF, ignition switch shall be turned ON after keep the off position more than 5 sec. Refer to <a href="#">AV-343, "Removal and Installation"</a>.</li></ul>

A  
B  
C  
D  
E  
F  
G  
H  
I  
J  
K  
L  
M

AV

O  
P

## U1A05 TCU

### DTC Logic

INFOID:000000008220875

DTC	Display contents of CONSULT	DTC Detection condition	Action to take
U1A05	USB COMM [U1A05]	TCU It is detected for malfunction of the USB communication module (communication disabled) between TCU and AV control unit.	<ul style="list-style-type: none"> <li>Check the USB harness connection and erase DTC.</li> <li>Replace TCU if malfunction constantly occurs.</li> </ul> Refer to <a href="#">AV-343. "Removal and Installation"</a> .

### Diagnosis Procedure

INFOID:000000008220876

#### 1. CHECK USB HARNESS CONTINUITY

1. Turn ignition switch OFF.
2. Disconnect TCU and AV control unit connectors.
3. Check the continuity between TCU vehicle-side harness connector and TCU vehicle-side harness connector.

TCU		AV control unit		Continuity
Connector	Terminal	Connector	Terminal	
M217	47	M214	165	Existed
	48		166	
	56		174	

4. Check the continuity between TCU vehicle-side harness connector and ground.

TCU		Ground	Continuity
Connector	Terminal		
M217	47	Ground	Not existed
	48		
	56		

#### Is the check result normal?

- YES >> Replace TCU. Refer to [AV-343. "Removal and Installation"](#).  
 NO >> Repair or replace the harnesses or connectors.

# U1A07 TEL ANTENNA

< DTC/CIRCUIT DIAGNOSIS >

[TELEMATICS SYSTEM]

## U1A07 TEL ANTENNA

### DTC Logic

INFOID:000000008220877

DTC	Display contents of CONSULT	DTC Detection condition	Action to take
U1A07	TEL ANTENNA SHORT [U1A07]	TEL antenna was short-circuited.	<ul style="list-style-type: none"> <li>Check the TEL antenna harness connection and the harness condition, and erase DTC.</li> <li>If poor harness condition or malfunction constantly occurs, replace the TEL antenna. Refer to <a href="#">AV-345, "Removal and Installation"</a>.</li> </ul>

### Diagnosis Procedure

INFOID:000000008220878

#### 1. HARNESS INSPECTION

- Turn the power switch OFF.
- Disconnect the TEL antenna feeder connector of TCU.
- Check the continuity between TCU vehicle-side harness connector.

TEL antenna		TEL antenna		Continuity
Connector	Terminal	Connector	Terminal	
M408	58	M408	59	Not existed

Is the check result normal?

- YES >> Replace TCU. Refer to [AV-343, "Removal and Installation"](#).  
 NO >> Replace the TEL antenna. [AV-345, "Removal and Installation"](#).

A  
B  
C  
D  
E  
F  
G  
H  
I  
J  
K  
L  
M

AV

O  
P

## U1A08 TEL ANTENNA

### DTC Logic

INFOID:000000008220879

DTC	Display contents of CONSULT	DTC Detection condition	Action to take
U1A08	TEL ANTENNA NO CONN [U1A08]	No input of TEL antenna signal.	<ul style="list-style-type: none"> <li>Check the harness connection and erase DTC.</li> <li>Replace TCU if malfunction constantly occurs. Refer to <a href="#">AV-343. "Removal and Installation"</a>.</li> </ul>

### Diagnosis Procedure

INFOID:000000008220880

#### 1. CHECK OF TEL ANTENNA

1. Turn the ignition switch OFF.
2. Disconnect the TEL antenna feeder connector.
3. Visually check TEL antenna and antenna feeder.

Is the inspection result normal?

- YES >> GO TO 2.  
 NO >> Repair malfunctioning parts.

#### 2. CHECK TCU VOLTAGE

1. Disconnect TEL antenna connector.
2. Turn ignition switch ON.
3. Check voltage between TCU and ground.

(+)		Voltage (Approx.)
TCU	(-)	
Connector		
58	Ground	2.8 V

Is the inspection result normal?

- YES >> Replace the TEL antenna. Refer to [AV-345. "Removal and Installation"](#).  
 NO >> Replace TCU. Refer to [AV-343. "Removal and Installation"](#).



## U1A0B MICROPHONE

### DTC Logic

INFOID:000000008220884

DTC	Display contents of CONSULT	DTC detection condition	Possible malfunction factor
U1A0B	MIC IN CONN [U1A0B]	When either one of the following items is detected: <ul style="list-style-type: none"> <li>• sound signal circuits between TCU and microphone.</li> <li>• microphone VCC signal circuits between TCU and microphone.</li> </ul>	<ul style="list-style-type: none"> <li>• Sound signal circuits between TCU and microphone.</li> <li>• Microphone VCC signal circuits between TCU and microphone.</li> </ul>

### Diagnosis Procedure

INFOID:000000008220885

#### 1. CHECK CONTINUITY BETWEEN TCU AND MICROPHONE CIRCUIT

1. Turn ignition switch OFF.
2. Disconnect TCU connector and microphone connector.
3. Check continuity between TCU harness connector and microphone harness connector.

TCU		Microphone		Continuity
Connector	Terminals	Connector	Terminals	
M216	18	R17	4	Existed
	19		1	
	20		2	

4. Check continuity between TCU harness connector and ground.

TCU		Ground	Continuity
Connector	Terminals		
M216	18		Not existed
	19		

Is the inspection result normal?

- YES >> GO TO 2.  
 NO >> Repair harness or connector.

#### 2. CHECK VOLTAGE MICROPHONE POWER SUPPLY

1. Connect TCU connector.
2. Turn ignition switch ON.
3. Check voltage between TCU harness connector.

TCU		Ground	Voltage (Approx.)
Connector	Terminal		
M216	18		5.0 V

Is the inspection result normal?

- YES >> GO TO 3.  
 NO >> Replace TCU. Refer to [AV-343, "Removal and Installation"](#).

#### 3. CHECK MICROPHONE SIGNAL

1. Connect microphone connector.
2. Check signal between TCU harness connector.

# U1A0B MICROPHONE

< DTC/CIRCUIT DIAGNOSIS >

[TELEMATICS SYSTEM]

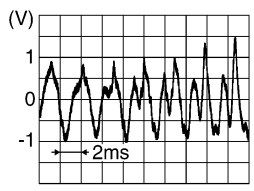
(+)		(-)		Condition	Reference value
TCU		TCU			
Connector	Terminal	Connector	Terminal		
M216	19	M216	20	When inputting interior sound.	 <p style="text-align: right; font-size: small;">SKIB3609E</p>

Is the inspection result normal?

- YES >> Replace TCU. Refer to [AV-343. "Removal and Installation"](#).
- NO >> Replace microphone. Refer to [AV-342. "Removal and Installation"](#).

## U1A0C MICROPHONE

### DTC Logic

INFOID:000000008220886

DTC	Display contents of CONSULT	DTC detection condition	Possible malfunction factor
U1A0C	MIC OUT CONN [U1A0C]	Malfunction is detected sound signal circuits between TCU and AV control unit.	Sound signal circuits between TCU and AV control unit.

### Diagnosis Procedure

INFOID:000000008220887

#### 1. CHECK CONTINUITY BETWEEN TCU AND AV CONTROL UNIT CIRCUIT

1. Turn ignition switch OFF.
2. Disconnect TCU connector and AV control unit connector.
3. Check continuity between TCU harness connector and AV control unit harness connector.

TCU		AV control unit		Continuity
Connector	Terminals	Connector	Terminals	
M216	22	M210	87	Existed
	23		71	

4. Check continuity between TCU harness connector and ground.

TCU		Ground	Continuity
Connector	Terminals		
M216	22		Not existed
	23		

Is the inspection result normal?

- YES >> GO TO 2.  
 NO >> Repair harness or connector.

#### 2. CHECK MICROPHONE SIGNAL

1. Connect TCU connector and AV control unit connector.
2. Check signal between TCU harness connector.

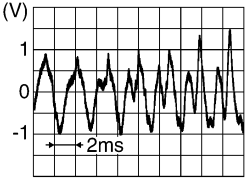
(+)		(-)		Condition	Reference value
TCU		TCU			
Connector	Terminal	Connector	Terminal		
M216	22	M216	23	When inputting interior sound.	 <p style="text-align: right; font-size: small;">SKIB3609E</p>

Is the inspection result normal?

- YES >> Replace AV control unit. Refer to [AV-265, "Removal and Installation"](#).  
 NO >> Replace TCU. Refer to [AV-343, "Removal and Installation"](#).

A  
B  
C  
D  
E  
F  
G  
H  
I  
J  
K  
L  
M  
N  
O  
P

AV

# U1A0E TELEMATICS SWITCH

< DTC/CIRCUIT DIAGNOSIS >

[TELEMATICS SYSTEM]

## U1A0E TELEMATICS SWITCH

### DTC Logic

INFOID:000000008220888

DTC	Display contents of CONSULT	DTC detection condition	Possible malfunction factor
U1A0E	SOS SWITCH ON STUCK [U1A0E]	SOS call switch is ON 10 second or more	SOS call switch signal circuits between TCU and telematics switch.

### Diagnosis Procedure

INFOID:000000008220889

#### 1. CHECK TCU AND TELEMATICS SWITCH SIGNAL CIRCUIT

1. Disconnect TCU connector and telematics switch connector.
2. Check continuity between TCU connector and telematics switch connector.

TCU		Telematics switch		Continuity
Connector	Terminal	Connector	Terminal	
M216	34	R22	3	Existed

3. Check continuity between TCU harness connector and ground.

TCU		Ground	Continuity
Connector	Terminal		
M216	34		Not existed

Is the inspection result normal?

- YES >> GO TO 2.  
 NO >> Repair harness or connector.

#### 2. CHECK TCU VOLTAGE

1. Connect TCU switch connector.
2. Turn ignition switch ON.
3. Check voltage TCU harness connector.

TCU (+)		(-)	Voltage (Approx.)
Connector	Terminal		
M216	34	Ground	5.0 V

Is the inspection result normal?

- YES >> Replace TCU. Refer to [AV-343, "Removal and Installation"](#).  
 NO >> Replace telematics switch. Refer to [AV-346, "Removal and Installation"](#).

# U1A0F TELEMATICS SWITCH

< DTC/CIRCUIT DIAGNOSIS >

[TELEMATICS SYSTEM]

## U1A0F TELEMATICS SWITCH

### DTC Logic

INFOID:000000008220890

DTC	Display contents of CONSULT	DTC detection condition	Possible malfunction factor
U1A0F	SOS SWITCH NO CONN [U1A0F]	Malfunction detected is SOS call switch signal circuit between TCU and telematics switch.	SOS call switch signal circuits between TCU and telematics switch.

### Diagnosis Procedure

INFOID:000000008220891

#### 1. CHECK TCU AND TELEMATICS SWITCH SIGNAL CIRCUIT

1. Disconnect TCU connector and telematics switch connector.
2. Check continuity between TCU connector and telematics switch connector.

TCU		Telematics switch		Continuity
Connector	Terminal	Connector	Terminal	
M216	34	R22	3	Existed

3. Check continuity between TCU harness connector and ground.

TCU		Ground	Continuity
Connector	Terminal		
M216	34		Not existed

Is the inspection result normal?

- YES >> GO TO 2.  
 NO >> Repair harness or connector.

#### 2. CHECK TCU VOLTAGE

1. Connect TCU connector.
2. Turn ignition switch ON.
3. Check voltage TCU harness connector.

TCU (+)		(-)	Voltage (Approx.)
Connector	Terminal		
M216	34	Ground	12.0 V

Is the inspection result normal?

- YES >> Replace TCU. Refer to [AV-343, "Removal and Installation"](#).  
 NO >> Replace telematics switch. Refer to [AV-346, "Removal and Installation"](#).

A  
B  
C  
D  
E  
F  
G  
H  
I  
J  
K  
L  
M  
O  
P

AV

# POWER SUPPLY AND GROUND CIRCUIT

< DTC/CIRCUIT DIAGNOSIS >

[TELEMATICS SYSTEM]

## POWER SUPPLY AND GROUND CIRCUIT

### TCU

#### TCU : Diagnosis Procedure

INFOID:000000008220892

#### 1.CHECK FUSE

Check if the fuse is burned out.

Power source	Fuse No.
Battery	34
Power switch ACC or ON	18

Is the check result normal?

YES >> GO TO 2.

NO >> Replace the fuse after repairing the applicable circuit.

#### 2.CHECK BATTERY VOLTAGE

Check the voltage between the TCU harness connector and ground.

Signal	TCU Connector	Probe Terminal		Test condition	Standard	Reference value (Approx.)
		(+)	(-)			
Battery power supply	M216	1	2, 7	OFF	9 – 16 V	Battery Voltage
ACC power supply		3		ACC	9 – 16 V	12 V

Is the check result normal?

YES >> GO TO 3.

NO >> Repair harness between TCU and fuse.

#### 3.GROUND CIRCUIT INSPECTION

1. Turn ignition switch OFF.
2. Disconnect TCU connector.
3. Check the continuity between TCU vehicle-side harness connector and ground.

Signal	Connector	Terminal	Continuity
Ground	M216	2, 7	Exists

Is the check result normal?

YES >> INSPECTION END

NO >> Repair the harnesses or connectors.

# MICROPHONE SIGNAL CIRCUIT

< DTC/CIRCUIT DIAGNOSIS >

[TELEMATICS SYSTEM]

## MICROPHONE SIGNAL CIRCUIT

### Description

INFOID:000000008220893

- TCU supplies power to the microphone when receiving a microphone ON signal from the AV control unit.
- The microphone transmits an audio signal to TCU.
- TCU transmits a received sound signal to the AV control unit.

### Diagnosis Procedure

INFOID:000000008220894

#### 1. CHECK CONTINUITY BETWEEN AV CONTROL UNIT AND TCU CIRCUIT

1. Turn ignition switch OFF.
2. Disconnect AV control unit connector and TCU connector.
3. Check continuity between AV control unit harness connector and TCU harness connector.

AV control unit		TCU		Continuity
Connector	Terminals	Connector	Terminals	
M210	72	M216	21	Existed
	71		23	
	87		22	

4. Check continuity between AV control unit harness connector and ground.

AV control unit		Ground	Continuity
Connector	Terminals		
M210	72		Not existed
	87		

Is the inspection result normal?

- YES >> GO TO 2.  
NO >> Repair harness or connector.

#### 2. CHECK VOLTAGE TEL ON SIGNAL

1. Connect AV control unit connector.
2. Turn ignition switch ON.
3. Check voltage between AV control unit harness connector.

(+)		(-)		Voltage (Approx.)
AV control unit		Ground		
Connector	Terminal			
M131	72			5.0 V

Is the inspection result normal?

- YES >> GO TO 3.  
NO >> Replace AV control unit. Refer to [AV-265, "Removal and Installation"](#).

#### 3. CHECK MICROPHONE SIGNAL (AV CONTROL UNIT TO TCU)

1. Turn ignition switch OFF.
2. Connect TCU connector.
3. Turn ignition switch ON.
4. Check signal between AV control unit harness connector.

A  
B  
C  
D  
E  
F  
G  
H  
I  
J  
K  
L  
M  
O  
P

AV

# MICROPHONE SIGNAL CIRCUIT

< DTC/CIRCUIT DIAGNOSIS >

[TELEMATICS SYSTEM]

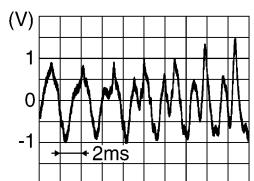
(+)		(-)		Condition	Reference value
AV control unit		AV control unit			
Connector	Terminal	Connector	Terminal		
M210	87	M210	71	Give a voice.	 <p style="text-align: right; font-size: small;">SKIB3609E</p>

Is the inspection result normal?

- YES >> Replace AV control unit. Refer to [AV-265. "Removal and Installation"](#).  
 NO >> GO TO 4.

## 4. CHECK CONTINUITY BETWEEN TCU AND MICROPHONE CIRCUIT

- Turn ignition switch OFF.
- Disconnect TCU connector and microphone connector.
- Check continuity between TCU harness connector and microphone harness connector.

TCU		Microphone		Continuity
Connector	Terminals	Connector	Terminals	
M216	18	R17	4	Existed
	19		1	
	20		2	

- Check continuity between TCU harness connector and ground.

TCU		Ground	Continuity
Connector	Terminals		
M216	18		Not existed
	19		

Is the inspection result normal?

- YES >> GO TO 5.  
 NO >> Repair harness or connector.

## 5. CHECK VOLTAGE MICROPHONE POWER SUPPLY

- Connect TCU connector.
- Turn ignition switch ON.
- Check voltage between TCU harness connector.

(+)		(-)		Voltage (Approx.)
TCU		Ground		
Connector	Terminal			
M216	18			5.0 V

Is the inspection result normal?

- YES >> GO TO 6.  
 NO >> Replace TCU. Refer to [AV-343. "Removal and Installation"](#).

## 6. CHECK MICROPHONE SIGNAL (TCU TO MICROPHONE)

- Turn ignition switch OFF.
- Connect microphone connector.
- Turn ignition switch ON.



# MICROPHONE SIGNAL CIRCUIT

< DTC/CIRCUIT DIAGNOSIS >

[TELEMATICS SYSTEM]

4. Check signal between TCU harness connector.

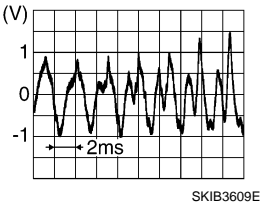
(+)		(-)		Condition	Reference value
TCU		TCU			
Connector	Terminal	Connector	Terminal		
M216	19	M216	20	When inputting interior sound.	

Is the inspection result normal?

YES >> Replace TCU. Refer to [AV-343. "Removal and Installation"](#).

NO >> Replace microphone. Refer to [AV-342. "Removal and Installation"](#).

A  
B  
C  
D  
E  
F  
G  
H  
I  
J  
K  
L  
M  
O  
P

AV

# SYMPTOM DIAGNOSIS

## TELEMATICS SYSTEM

### SYMPTOM TABLE

INFOID:000000008220895

#### AV SYSTEM

Symptoms	Check items	Possible malfunction location/Action to take
AV control unit does not start (Display is not indicated).	—	Refer to <a href="#">AV-254, "Symptom Table"</a> .

#### TELEMATICS SYSTEM

# TELEMATICS SYSTEM

< SYMPTOM DIAGNOSIS >

[TELEMATICS SYSTEM]

Symptoms	Check items	Indicator on SOS switch	Pop-up message	Possible malfunction location/Action to take
Telematics operation is not available.	Check the display when Telematics is operated.	OFF	No service.	Check ON/OFF status of TCU using the data monitor of CONSULT. <ul style="list-style-type: none"> <li>• Replace TCU if it is ON. Refer to <a href="#">AV-343, "Removal and Installation"</a>.</li> <li>• Turn it ON again if it is OFF. Replace TCU if ON is switched to OFF. Refer to <a href="#">AV-343, "Removal and Installation"</a>.</li> </ul>
				Use other cellular phone to check radio wave condition. <ul style="list-style-type: none"> <li>• If the service is available, replace TCU or TEL antenna.                             <ul style="list-style-type: none"> <li>- For TCU replacement, refer to <a href="#">AV-343, "Removal and Installation"</a>.</li> <li>- For TEL antenna replacement, refer to <a href="#">AV-345, "Removal and Installation"</a>.</li> </ul> </li> <li>• If the service is not available, move the vehicle to the position where service is available and perform the operation again. If guidance of "out of service area" appears when SOS switch is pressed even in the service area of cellular phone, confirm the SIM line contract status.</li> </ul>
		ON	Telematics communication is currently busy. Please try again later.	Use other cellular phone to check radio wave condition. <ul style="list-style-type: none"> <li>• If it is OK, there may be a cause at the Infiniti Connection™ Data Center. Check connection after certain time. If there is no problem at the Infiniti Connection™ Data Center, replace TCU or TEL antenna.                             <ul style="list-style-type: none"> <li>- For TCU replacement, refer to <a href="#">AV-343, "Removal and Installation"</a>.</li> <li>- For TEL antenna replacement, refer to <a href="#">AV-345, "Removal and Installation"</a>.</li> </ul> </li> <li>• If it is NG, check connection again after certain time.</li> </ul>
				TCU line is using. <p>Check connection after certain time. Replace TCU if it is frequently displayed. Refer to <a href="#">AV-343, "Removal and Installation"</a>.</p>
				The connection to the call center failed. <p>There may be a cause at the Infiniti Connection™ Data Center. Check connection after certain time. If there is no problem at the Infiniti Connection™ Data Center, replace TCU or TEL antenna.</p> <ul style="list-style-type: none"> <li>• For TCU replacement, refer to <a href="#">AV-343, "Removal and Installation"</a>.</li> <li>• For TEL antenna replacement, refer to <a href="#">AV-345, "Removal and Installation"</a>.</li> <li>• Perform CONSULT self-diagnosis. Refer to <a href="#">AV-302, "CONSULT Function"</a>.</li> </ul>
			"Please ask for initiation of service at your dealer"	Check the infiniti connection™ data base.
	<ul style="list-style-type: none"> <li>• No communication with Infiniti Connection™ Response service is available in Infiniti Connection™ service.</li> <li>• Other services are normal.</li> </ul>			Check the microphone voice signal circuit. Refer to <a href="#">AV-335, "Diagnosis Procedure"</a> .

A  
B  
C  
D  
E  
F  
G  
H  
I  
J  
K  
L  
M  
AV  
O  
P

# NORMAL OPERATING CONDITION

< SYMPTOM DIAGNOSIS >

[TELEMATICS SYSTEM]

## NORMAL OPERATING CONDITION

### Description

INFOID:000000008220896

**NOTE:**

For Telematics system operation detail information, refer to Navigation system Owner's Manual.

### BASIC OPERATIONS

Symptom	Possible cause	Possible solution
No image is displayed.	The brightness is at the lowest setting.	Adjust the brightness of the display.
	The system in the video mode.	Press ""AUX" to change the mode.
	The display is turned off.	Press "☀/☾" to turn on the display.
	The interior of the vehicle becomes the a little less than 80°C (176°F) or high temperature, and the protection of the display acts, and a display is turned off.	Wait until the interior of the vehicle has cooled down.
The screen is darker.	The cabin temperature is too low.	Wait until the interior of the vehicle temperature becomes moderate.
	The adjustment of display brightness is set to the maximum of darkness.	Adjust the brightness setting of the display.
The screen is brighter.	The adjustment of display brightness is set to the maximum of brightness.	
When looking at the screen from an angle, the screen lightens or darkens.	This is a typical phenomenon for liquid crystal displays.	
The screen is too dim. The movement is slow.	The temperature in the interior of the vehicle is less than 50°F (0°C).	Wait until the interior of the vehicle temperature becomes within 50°F(0°C) to 122°F (50°C).
The screen is too dim. The movement is slow.	The temperature in the interior of the vehicle is low.	Wait until the interior of the vehicle has warmed up.
No voice guidance is available. Or The volume is too high or too low.	The volume is not set correctly, or it is turned off.	Adjust the volume of voice guidance.
	Voice guidance is not provided for certain streets (roads displayed in gray).	This is not a malfunction.
No map is displayed on the screen.	A screen other than map screen is displayed.	Press "MAP".
Some pixels in the display are darker or brighter than others.	This condition is an inherent characteristic of liquid crystal displays.	This is not a malfunction.
Some menu items cannot be selected.	Some menu items become unavailable while the vehicle is driven.	Park the vehicle in a safe location, and then operate the navigation system.
A small black spot or a small bright spot appears on the screen.	This is a typical phenomenon for liquid crystal displays.	This is not a malfunction.
A dot or stripe pattern appears on the screen.	Electromagnetic wave that is generated from neon billboards, high voltage electric power cables, ham radios or other radio devices equipped to other vehicles may adversely affect the screen.	
Image lag appears on the screen.	This is a typical phenomenon for liquid crystal displays.	

**NOTE:**

Locations stored in the Address Book and other memory functions may be lost if the vehicle's battery is disconnected or becomes discharged. If this occurs, service the vehicle's battery as necessary and re-enter the information in the Address Book.

### RELATED TO CARWINGS™

## NORMAL OPERATING CONDITION

< SYMPTOM DIAGNOSIS >

[TELEMATICS SYSTEM]

Symptom	Possible cause	Possible solution
The system cannot connect to the Infiniti Connection™ Data Center.	A subscription for the CARWINGS™ service has not been established.	Sign up for a subscription to the Infiniti Connection™ service. For details about subscriptions, contact a Infiniti dealer or visit the Infiniti Connection™ website.
	The communication line is busy.	Try again after a short period of time.
	The vehicle is in a location where it is difficult to receive radio waves.	When the vehicle moves to an area where radio waves can be transmitted sufficiently, communication will be restored. When the icon on the display shows that the vehicle is inside the communication area, the system can be used.
	Radio wave reception for TCU is insufficient.	When the vehicle moves to an area where radio waves can be transmitted sufficiently, communication will be restored. When the icon on the display shows that the vehicle is inside the communication area, the system can be used.
Some of the items that are displayed on the menu screen cannot be selected.	The vehicle is being driven and some menu items are disabled.	The vehicle is being driven. Stop the vehicle in a safe location and apply the parking brake before operating the functions.
Some parts of the screen are not displayed	The vehicle is being driven and some menu items are disabled.	Operate the system after stopping the vehicle in a safe location and applying the parking brake.
The system does not announce information.	The volume level is set to the minimum.	Adjust the volume level by operating the VOL switches located on the control panel or on the steering wheel switch while the system is announcing information.

A  
B  
C  
D  
E  
F  
G  
H  
I  
J  
K  
L  
M  
N  
O  
P

AV

## REMOVAL AND INSTALLATION

### MICROPHONE

#### Removal and Installation

INFOID:000000008220897

#### REMOVAL

1. Remove map lamp assembly. Refer to [INL-41, "Removal and Installation"](#).
2. Remove microphone, stretching pawls of map lamp assembly.

#### INSTALLATION

Installation is the reverse order of removal.

## TCU

## Exploded View

INFOID:000000008235769

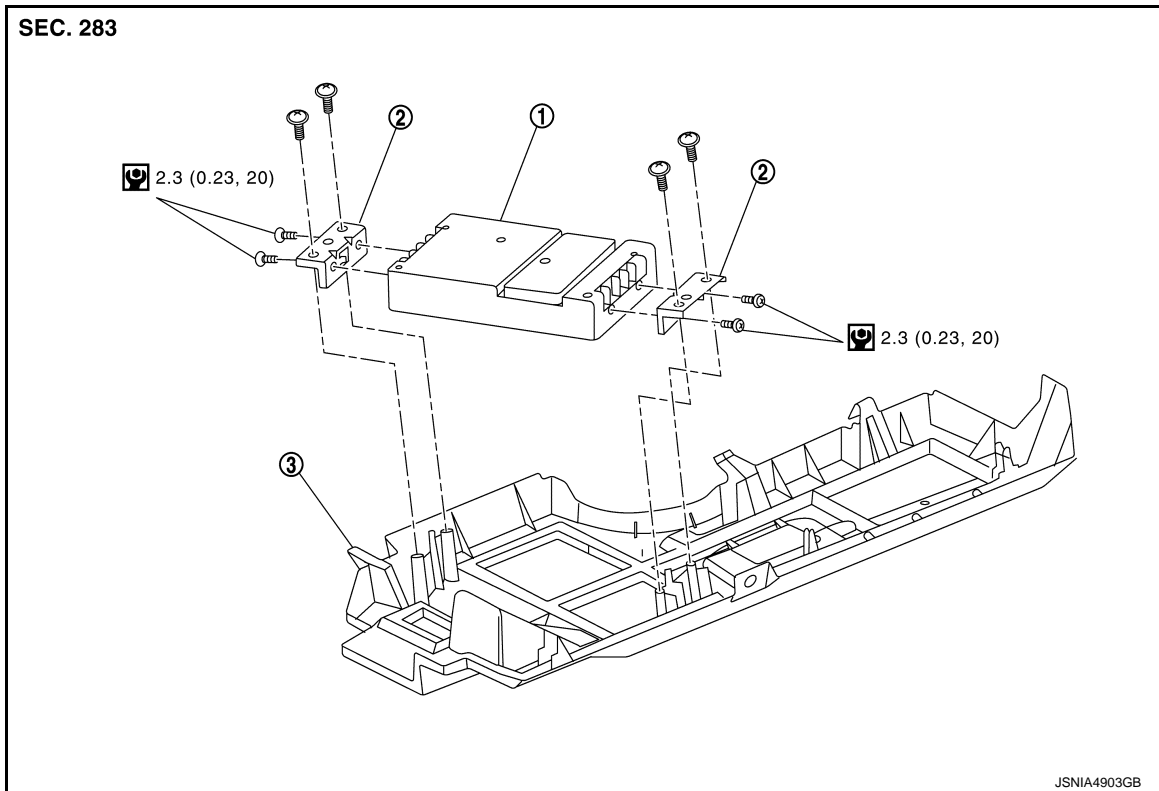

1. TCU

2. Bracket

3. Instrument lower cover

 : N·m (kg·m, in·lb)

## Removal and Installation

INFOID:000000008220898

## REMOVAL

**NOTE:**

Before replacing TCU, perform "WRITE VIN DATA" to save current vehicle specification. For details, refer to [AV-317. "ADDITIONAL SERVICE WHEN REPLACING TCU : Work Procedure"](#).

1. Remove the instrument lower cover. Refer to [IP-12. "Exploded View"](#).
2. Remove the mounting screw and disconnect the connector, and then remove them together with the bracket from instrument lower cover.
3. Remove the bracket mounting screw and remove the bracket from TCU.

## INSTALLATION

1. Install in the reverse order of removal.
2. After installation, perform activation. Refer to [AV-317. "ADDITIONAL SERVICE WHEN REPLACING TCU : Work Procedure"](#).

# TELEMATICS ANTENNA

< REMOVAL AND INSTALLATION >

[TELEMATICS SYSTEM]

## TELEMATICS ANTENNA

### Feeder Layout

INFOID:000000008220899

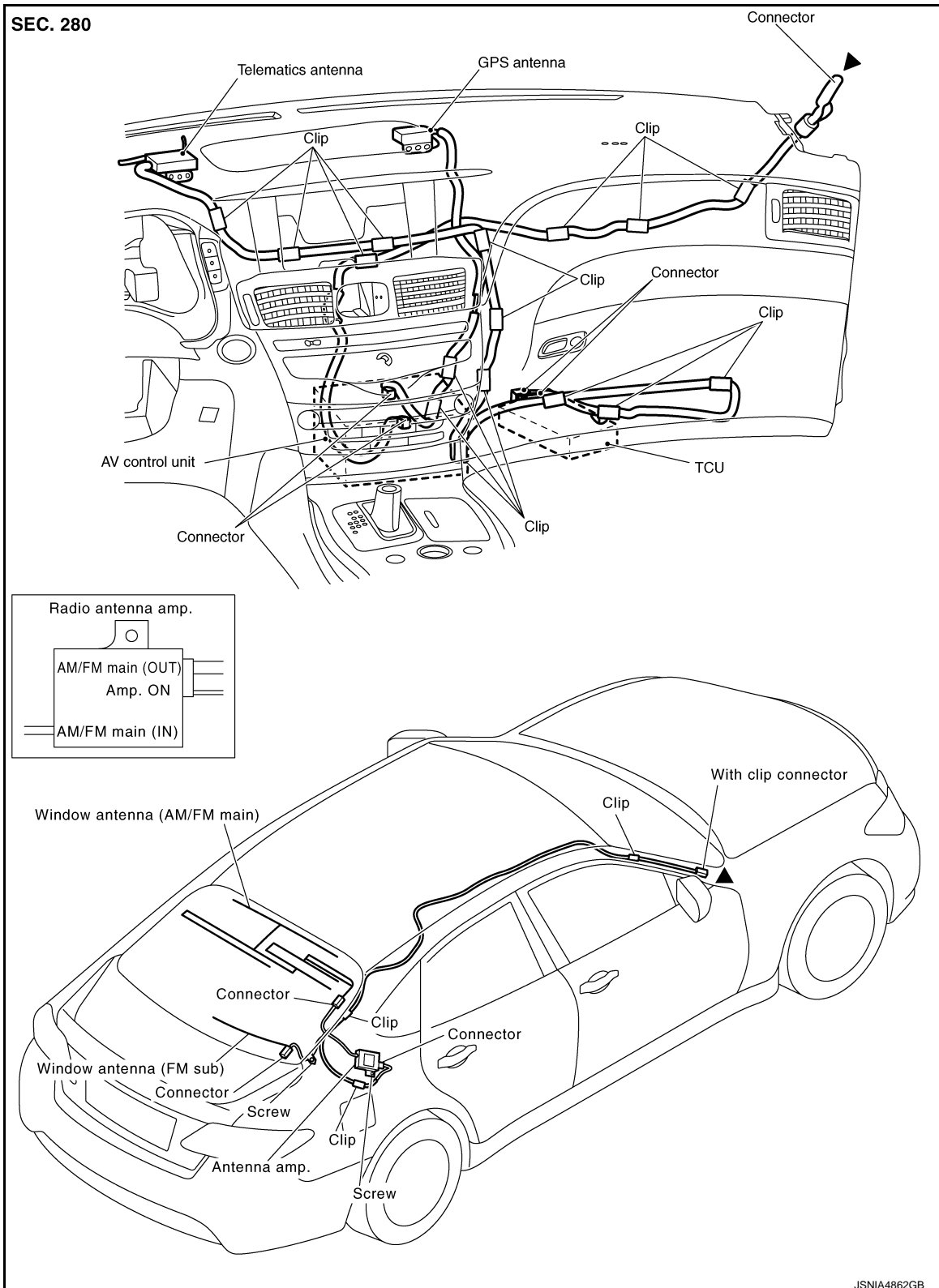

▲: Indicates that the parts is connected at points with same symbol in actual vehicle.



## Removal and Installation

INFOID:000000008220900

### REMOVAL

1. Remove instrument panel assembly. Refer to [IP-13. "Removal and Installation"](#).
2. Remove telematics antenna from instrument panel assembly.

### INSTALLATION

Install in the reverse order of removal.

A

B

C

D

E

F

G

H

I

J

K

L

M

AV

O

P

## TELEMATICS SWITCH

### Removal and Installation

INFOID:000000008220901

#### REMOVAL

1. Pull down headlining (front side) and obtain space for work between vehicle and headlining. Refer to [INT-46, "Removal and Installation"](#).
2. Disconnect connector, then remove telematics switch with the telematics switch finisher.
3. Remove the telematics switch, stretching pawls of telematics switch finisher.

#### INSTALLATION

Installation is the reverse order of removal.