

A
B
C

SECTION INL

INTERIOR LIGHTING SYSTEM

CONTENTS

<p>BASIC INSPECTION 3</p> <p>DIAGNOSIS AND REPAIR WORKFLOW 3</p> <p style="padding-left: 20px;">Work Flow3</p> <p>FUNCTION DIAGNOSIS 6</p> <p>INTERIOR ROOM LAMP CONTROL SYSTEM 6</p> <p style="padding-left: 20px;">System Diagram6</p> <p style="padding-left: 20px;">System Description6</p> <p style="padding-left: 20px;">Component Parts Location7</p> <p style="padding-left: 20px;">Component Description7</p> <p>ILLUMINATION CONTROL SYSTEM 9</p> <p style="padding-left: 20px;">System Diagram9</p> <p style="padding-left: 20px;">System Description9</p> <p style="padding-left: 20px;">Component Parts Location9</p> <p style="padding-left: 20px;">Component Description 10</p> <p>DIAGNOSIS SYSTEM (BCM)11</p> <p>COMMON ITEM 11</p> <p style="padding-left: 20px;">COMMON ITEM : Diagnosis Description 11</p> <p style="padding-left: 20px;">COMMON ITEM : CONSULT-III Function 11</p> <p>INT LAMP11</p> <p style="padding-left: 20px;">INT LAMP : CONSULT-III Function (BCM-INT LAMP) 12</p> <p>BATTERY SAVER13</p> <p style="padding-left: 20px;">BATTERY SAVER : CONSULT-III Function (BCM-BATTERY SAVER) 13</p> <p>INTELLIGENT KEY 15</p> <p style="padding-left: 20px;">INTELLIGENT KEY : CONSULT-III Function (BCM - INTELLIGENT KEY) 15</p> <p>COMPONENT DIAGNOSIS19</p> <p>POWER SUPPLY AND GROUND CIRCUIT19</p> <p>BCM 19</p>	<p style="padding-left: 20px;">BCM : Diagnosis Procedure19</p> <p style="padding-left: 20px;">BCM : Special Repair Requirement20</p> <p>BATTERY SAVER OUTPUT/POWER SUPPLY CIRCUIT21</p> <p style="padding-left: 20px;">Description21</p> <p style="padding-left: 20px;">Component Function Check21</p> <p style="padding-left: 20px;">Diagnosis Procedure21</p> <p>INTERIOR ROOM LAMP CONTROL CIRCUIT23</p> <p style="padding-left: 20px;">Description23</p> <p style="padding-left: 20px;">Component Function Check23</p> <p style="padding-left: 20px;">Diagnosis Procedure23</p> <p>STEP LAMP CIRCUIT25</p> <p style="padding-left: 20px;">Description25</p> <p style="padding-left: 20px;">Component Function Check25</p> <p style="padding-left: 20px;">Diagnosis Procedure25</p> <p>TRUNK ROOM LAMP CIRCUIT27</p> <p style="padding-left: 20px;">Description27</p> <p style="padding-left: 20px;">Component Function Check27</p> <p style="padding-left: 20px;">Diagnosis Procedure27</p> <p>PUSH-BUTTON IGNITION SWITCH ILLUMINATION CIRCUIT29</p> <p style="padding-left: 20px;">Description29</p> <p style="padding-left: 20px;">Component Function Check29</p> <p style="padding-left: 20px;">Diagnosis Procedure29</p> <p>INTERIOR ROOM LAMP CONTROL SYSTEM31</p> <p style="padding-left: 20px;">Wiring Diagram31</p> <p>ILLUMINATION42</p> <p style="padding-left: 20px;">Wiring Diagram42</p> <p>ECU DIAGNOSIS57</p> <p>BCM (BODY CONTROL MODULE)57</p> <p style="padding-left: 20px;">Reference Value57</p>
--	--

A
B
C
D
E
F
G
H
I
J
K
INL

Terminal Layout	62	Precautions Necessary for Steering Wheel Rotation after Battery Disconnect (Early Production, With Electronic Steering Column Lock)	95
Physical Values	62		
Wiring Diagram	80		
Fail Safe	88		
DTC Inspection Priority Chart	90		
DTC Index	92		
SYMPTOM DIAGNOSIS	94	ON-VEHICLE REPAIR	97
INTERIOR LIGHTING SYSTEM SYMPTOMS...	94	INTERIOR ROOM LAMP	97
Symptom Table	94	Removal and Installation	97
PRECAUTION	95	ILLUMINATION	100
PRECAUTIONS	95	Removal and Installation	100
Precaution for Supplemental Restraint System (SRS) "AIR BAG" and "SEAT BELT PRE-TENSIONER"	95	SERVICE DATA AND SPECIFICATIONS (SDS)	101
General precautions for service operations	95	SERVICE DATA AND SPECIFICATIONS (SDS)	101
		Bulb Specifications	101

DIAGNOSIS AND REPAIR WORKFLOW

< BASIC INSPECTION >

BASIC INSPECTION

DIAGNOSIS AND REPAIR WORKFLOW

Work Flow

INFOID:000000005461039

OVERALL SEQUENCE

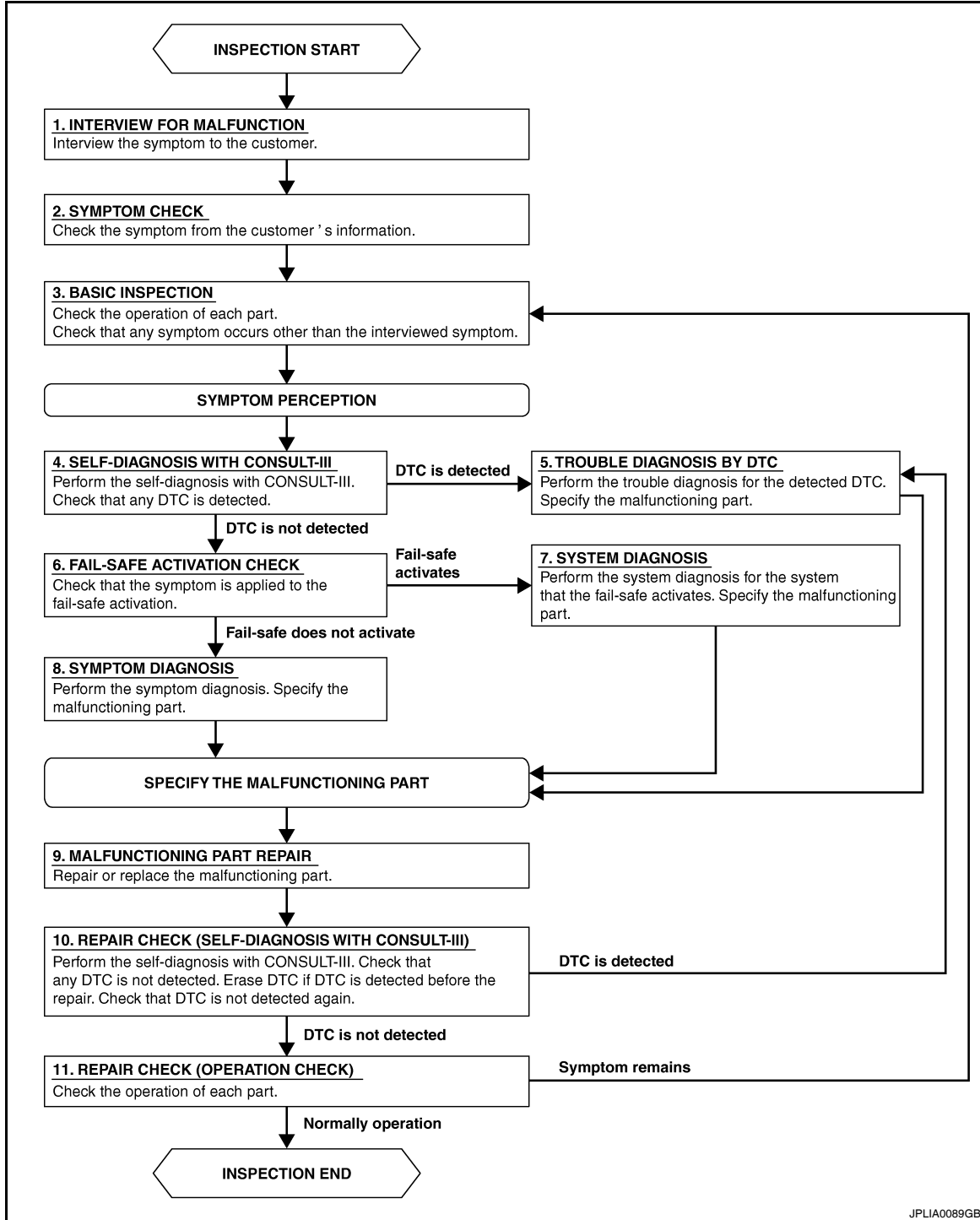

A
B
C
D
E
F
G
H
I
J
K
INL
M
N
O
P

DIAGNOSIS AND REPAIR WORKFLOW

< BASIC INSPECTION >

DETAILED FLOW

1. INTERVIEW FOR MALFUNCTION

Find out what the customer's concerns are.

>> GO TO 2

2. SYMPTOM CHECK

Verify the symptom from the customer's information.

>> GO TO 3

3. BASIC INSPECTION

Check the operation of each part. Check that any concerns occur other than those mentioned in the customer interview.

>> GO TO 4

4. SELF-DIAGNOSIS WITH CONSULT-III

Perform the self-diagnosis with CONSULT-III. Check that any DTC is detected.

Is any DTC detected?

YES >> GO TO 5

NO >> GO TO 6

5. TROUBLE DIAGNOSIS BY DTC

Perform the trouble diagnosis for the detected DTC. Specify the malfunctioning part.

>> GO TO 9

6. FAIL-SAFE ACTIVATION CHECK

Determine if the customer's concern is related to fail-safe activation.

Does the fail-safe activate?

YES >> GO TO 7

NO >> GO TO 8

7. SYSTEM DIAGNOSIS

Perform the system diagnosis for the system in which the fail-safe activates. Specify the malfunctioning part.

>> GO TO 9

8. SYMPTOM DIAGNOSIS

Perform the symptom diagnosis. Specify the malfunctioning part.

>> GO TO 9

9. MALFUNCTION PART REPAIR

Repair or replace the malfunctioning part.

>> GO TO 10

10. REPAIR CHECK (SELF-DIAGNOSIS WITH CONSULT-III)

Perform the self-diagnosis with CONSULT-III. Verified that no DTCs are detected. Erase all DTCs detected prior to the repair. Verify that DTC is not detected again.

Is any DTC detected?

DIAGNOSIS AND REPAIR WORKFLOW

< BASIC INSPECTION >

YES >> GO TO 5

NO >> GO TO 11

11. REPAIR CHECK (OPERATION CHECK)

Check the operation of each part.

Does it operate normally?

YES >> Inspection End

NO >> GO TO 3

A

B

C

D

E

F

G

H

I

J

K

INL

M

N

O

P

INTERIOR ROOM LAMP CONTROL SYSTEM

< FUNCTION DIAGNOSIS >

FUNCTION DIAGNOSIS

INTERIOR ROOM LAMP CONTROL SYSTEM

System Diagram

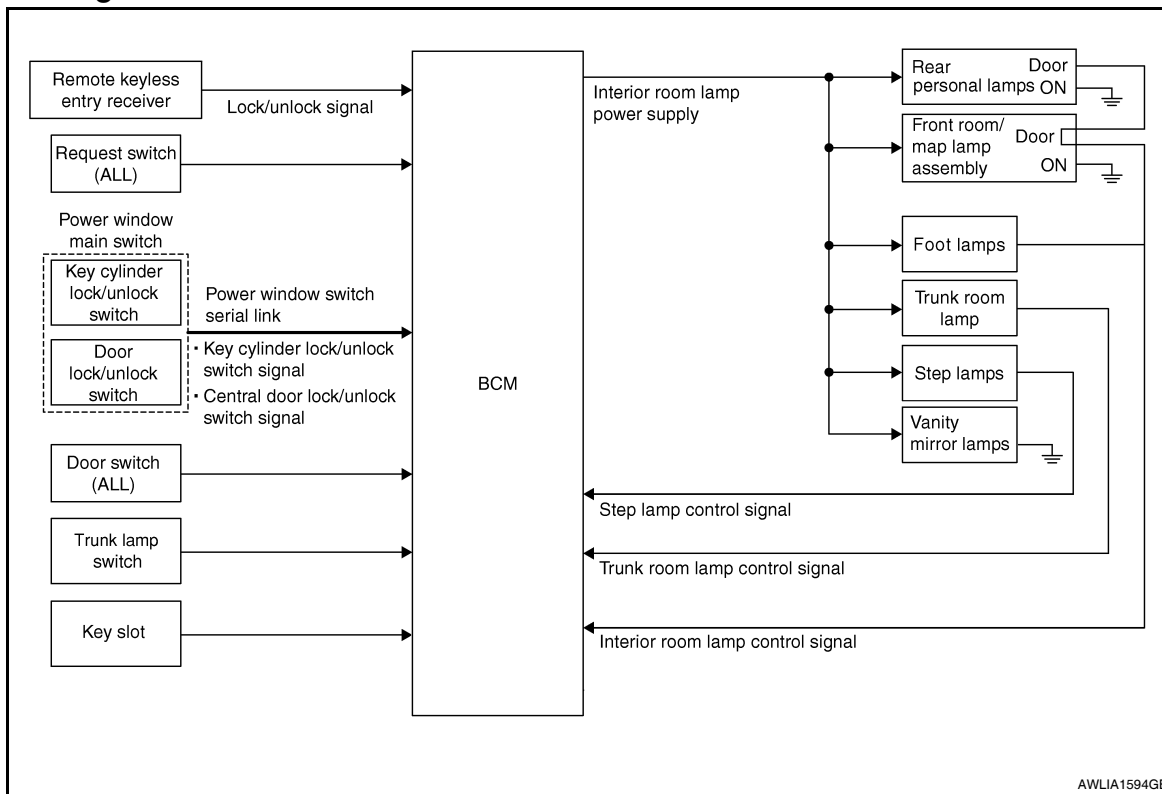

System Description

INFOID:000000005461041

OUTLINE

- Interior room lamps* are controlled by interior room lamp timer control function of BCM.
*:Front room/map lamp assembly, foot lamps and rear personal lamps (when front room/map lamp assembly switch is in DOOR position).
- Trunk room lamp is controlled by trunk room lamp control function of BCM.
- Step lamps are controlled by step lamp control function of BCM.

INTERIOR ROOM LAMP CONTROL SYSTEM

< FUNCTION DIAGNOSIS >

Component Parts Location

INFOID:000000005461042

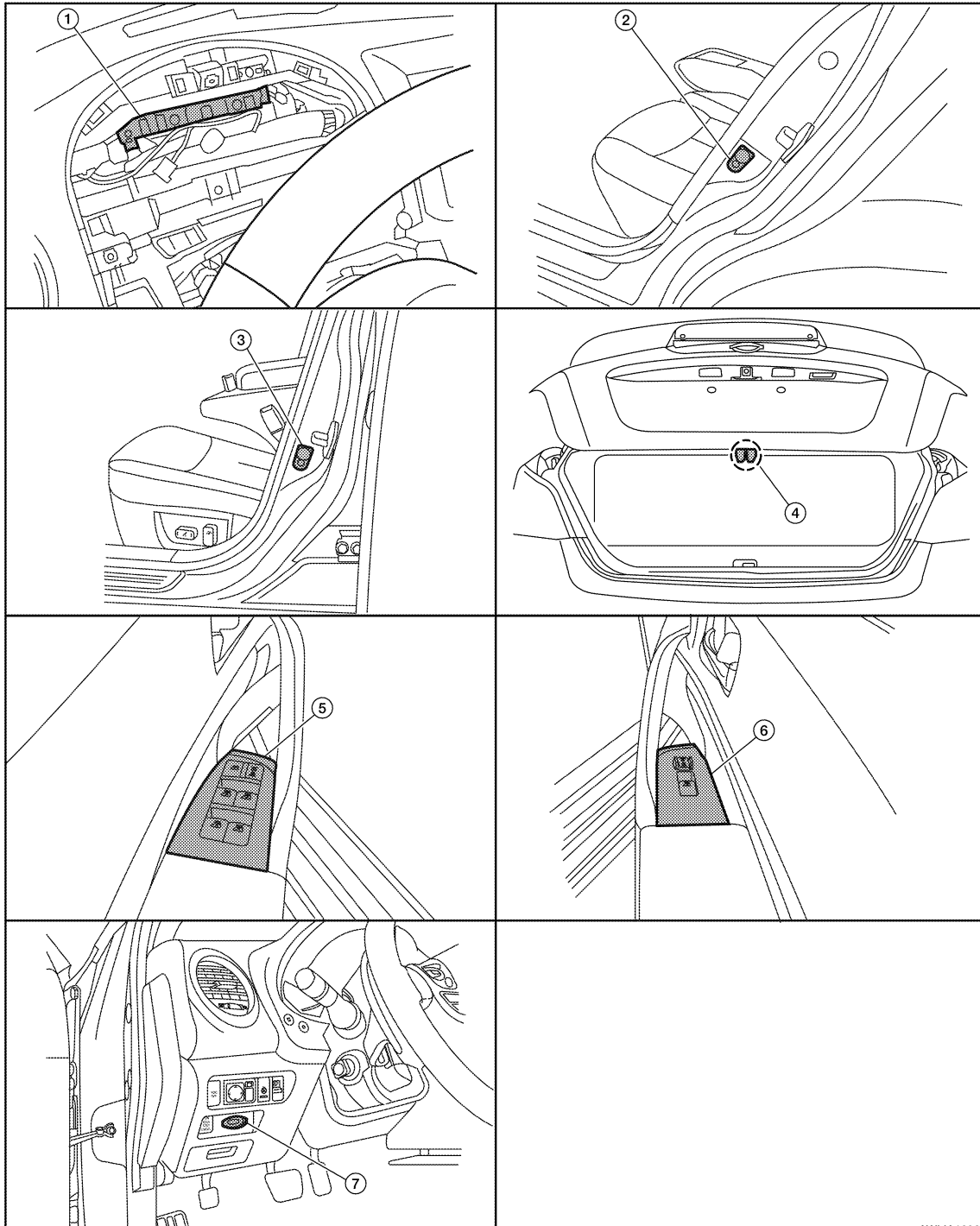

- | | | |
|--|---|---|
| 1. BCM M17, M18, M19, M20, M21 (view with combination meter removed) | 2. Rear door switch LH B18, RH B116 | 3. Front door switch LH B8, RH B108 |
| 4. Trunk lamp switch and trunk release solenoid T7 | 5. Main power window and door lock/unlock switch D7, D8 | 6. Power window and door lock/unlock switch RH D105 |
| 7. Key slot M40 | | |

AWLIA1606ZZ

Component Description

INFOID:000000005461043

SWITCH OPERATION

INTERIOR ROOM LAMP CONTROL SYSTEM

< FUNCTION DIAGNOSIS >

When a door is opened, the door switch closes to send a ground signal to the BCM. When the trunk is opened, the trunk lamp switch and trunk release solenoid closes sending a ground signal to the BCM.

ROOM LAMP TIMER OPERATION

When the front room/map lamp assembly switch is in DOOR position and when all conditions below are met, BCM begins timer control (maximum 30 seconds) for interior room lamp ON/OFF.

- When the front door LH is unlocked [with Intelligent Key, main power window and door lock/unlock switch, power window and door lock/unlock switch RH, or front door lock assembly (key cylinder switch)].
- When a door opens → closes and the Intelligent Key is not inserted in the key slot.

Timer control is cancelled under the following conditions.

- When the front door LH is locked [with Intelligent Key, main power window and door lock/unlock switch, power window and door lock/unlock switch RH, or front door lock assembly (key cylinder switch)].
- A door is opened (door switch turns ON).
- Intelligent Key is inserted into the key slot.

Interior lamp operational settings can be changed with the function setting of CONSULT-III.

INTERIOR LAMP BATTERY SAVER CONTROL

If an interior lamp is left ON and does not turn OFF even when the doors are closed, the BCM turns off power to the interior lamps automatically to save the battery 30 minutes after the ignition switch is turned OFF.

The BCM controls the interior lamps listed below

- Front step lamp LH and RH
- Rear step lamp LH and RH
- Front room/map lamp assembly
- Foot lamp LH and RH
- Personal lamp rear LH and RH
- Vanity mirror lamp LH and RH
- Trunk room lamp

After the battery saver system turns the lamps OFF, the lamps will illuminate again when

- a signal is received from an Intelligent Key, main power window and door lock/unlock switch or power window and door lock/unlock switch RH, or when the front door LH lock assembly (key cylinder switch) is locked or unlocked
- a door is opened or closed
- the Intelligent Key is removed from or inserted into the key slot.

The interior lamp battery saver control time period can be changed with the function setting of CONSULT-III.

ILLUMINATION CONTROL SYSTEM

< FUNCTION DIAGNOSIS >

ILLUMINATION CONTROL SYSTEM

System Diagram

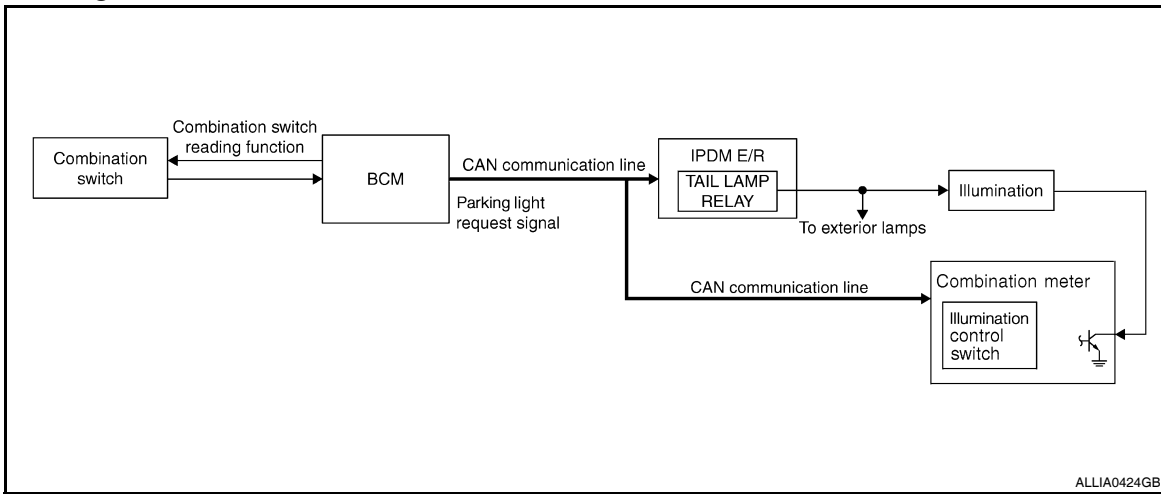

System Description

INFOID:000000005461045

The illumination lamps operation is dependent upon the position of the lighting switch (combination switch). When the lighting switch is placed in the 1ST or 2ND position (or if the auto light system is activated) the BCM (body control module) receives input requesting the illumination lamps to illuminate. This input is communicated to the IPDM E/R (intelligent power distribution module engine room) across the CAN communication lines. The CPU (central processing unit) of the IPDM E/R controls the tail lamp relay coil. When energized, this relay directs power to the illumination lamps, which then illuminate.

Component Parts Location

INFOID:000000005461046

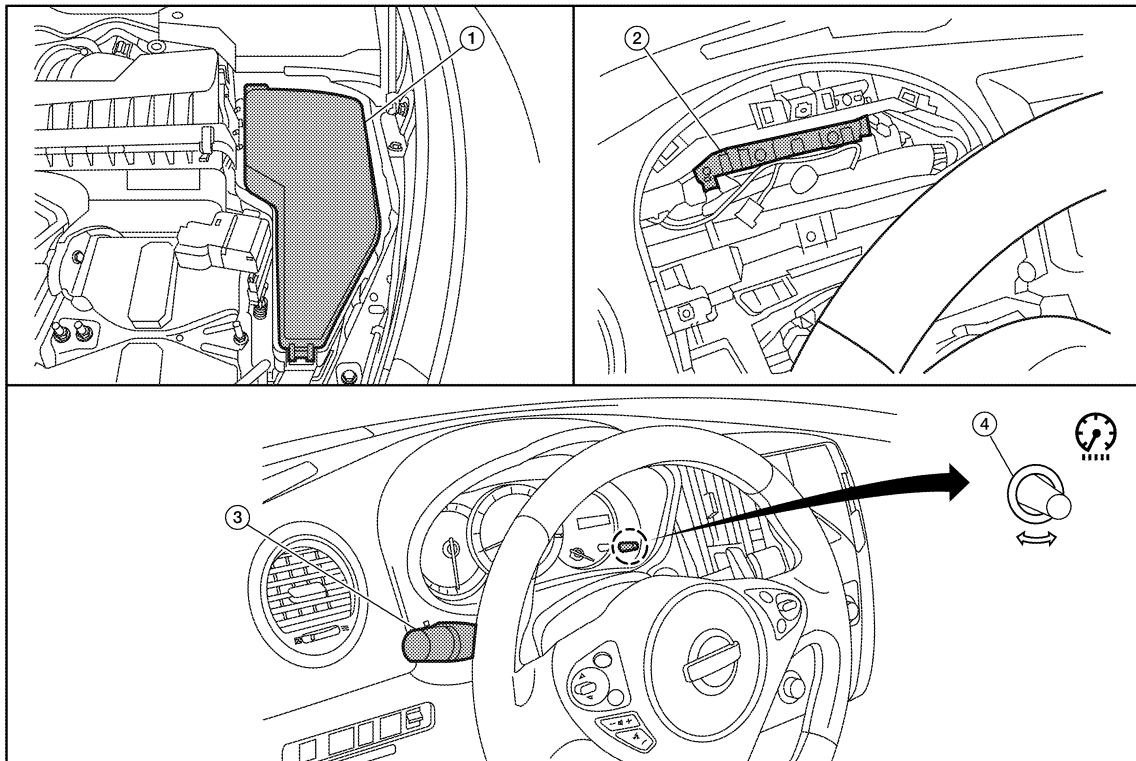

ILLUMINATION CONTROL SYSTEM

< FUNCTION DIAGNOSIS >

1. IPDM E/R E17, E18
2. BCM M16, M17, M18, M19 (view with combination meter removed)
3. Combination switch M28
4. Illumination control switch (built into combination meter)

Component Description

INFOID:000000005461047

ILLUMINATION OPERATION BY LIGHTING SWITCH

With the lighting switch in the 1ST or 2ND position (or if the auto light system is activated), the BCM receives input requesting the illumination lamps to illuminate. This input is communicated to the IPDM E/R across the CAN communication lines. The CPU of the IPDM E/R controls the tail lamp relay coil which, when energized, directs power

BATTERY SAVER CONTROL

When the lighting switch (combination switch) is in the 1ST or 2ND position and the ignition switch is turned from ON or ACC to OFF, the battery saver control feature is activated. Under this condition, the illumination lamps remain illuminated for 30 minutes unless the lighting switch position is changed. If the lighting switch position is changed, then the illumination lamps are turned off after a 30 second delay. When the lighting switch is turned from OFF to 1ST or 2ND position (or if auto light system is activated) after illumination lamps have been turned off by the battery saver control, the illumination lamps illuminate again.

DIAGNOSIS SYSTEM (BCM)

< FUNCTION DIAGNOSIS >

DIAGNOSIS SYSTEM (BCM)

COMMON ITEM

COMMON ITEM : Diagnosis Description

INFOID:000000005530117

BCM CONSULT-III FUNCTION

CONSULT-III performs the following functions via CAN communication with BCM.

Diagnosis mode	Function Description
WORK SUPPORT	Changes the setting for each system function.
SELF DIAGNOSTIC RESULT	Displays the diagnosis results judged by BCM.
CAN DIAG SUPPORT MNTR	Monitors the reception status of CAN communication viewed from BCM.
DATA MONITOR	The BCM input/output signals are displayed.
ACTIVE TEST	The signals used to activate each device are forcibly supplied from BCM.
ECU IDENTIFICATION	The BCM part number is displayed.
CONFIGURATION	<ul style="list-style-type: none"> Enables to read and save the vehicle specification. Enables to write the vehicle specification when replacing BCM.

SYSTEM APPLICATION

BCM can perform the following functions for each system.

NOTE:

It can perform the diagnosis modes except the following for all sub system selection items.

System	Sub system selection item	Diagnosis mode		
		WORK SUPPORT	DATA MONITOR	ACTIVE TEST
Door lock	DOOR LOCK	×	×	×
Rear window defogger	REAR DEFOGGER		×	×
Warning chime	BUZZER		×	×
Interior room lamp timer	INT LAMP	×	×	×
Exterior lamp	HEADLAMP	×	×	×
Wiper and washer	WIPER	×	×	×
Turn signal and hazard warning lamps	FLASHER	×	×	×
Intelligent Key system	INTELLIGENT KEY	×	×	×
Combination switch	COMB SW		×	
BCM	BCM	×		
Immobilizer	IMMU		×	×
Interior room lamp battery saver	BATTERY SAVER	×	×	×
Trunk open	TRUNK		×	×
Vehicle security system	THEFT ALM	×	×	×
RAP system	RETAINED PWR		×	
Signal buffer system	SIGNAL BUFFER		×	×
TPMS	AIR PRESSURE MONITOR	×	×	×

COMMON ITEM : CONSULT-III Function

INFOID:000000005530118

ECU IDENTIFICATION

Displays the BCM part No.

SELF-DIAG RESULT

Refer to [INL-92. "DTC Index"](#).

INT LAMP

DIAGNOSIS SYSTEM (BCM)

< FUNCTION DIAGNOSIS >

INT LAMP : CONSULT-III Function (BCM-INT LAMP)

INFOID:000000005530119

WORK SUPPORT

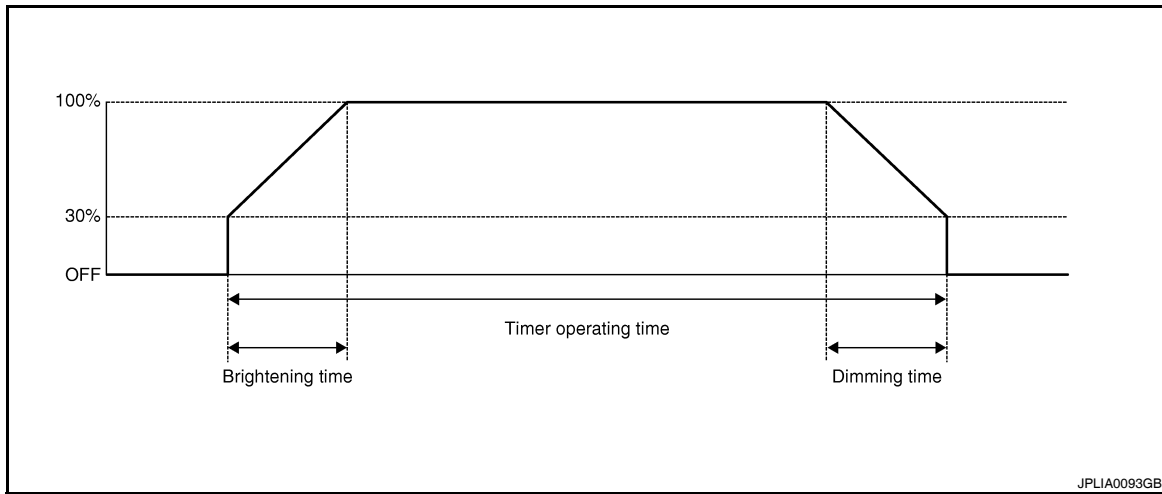

Service item	Setting item	Setting	
SET I/L D-UNLCK INTCON	ON*	With the interior room lamp timer function	
	OFF	Without the interior room lamp timer function	
ROOM LAMP TIMER SET	MODE 2	7.5 sec.	Sets the interior room lamp ON time. (Timer operating time)
	MODE 3*	15 sec.	
	MODE 4	30 sec.	
ROOM LAMP ON TIME SET	MODE 1	0.5 sec.	Sets the interior room lamp gradual brightening time.
	MODE 2*	1 sec.	
	MODE 3	2 sec.	
	MODE 4	3 sec.	
	MODE 5	0 sec.	
ROOM LAMP OFF TIME SET	MODE 1	0.5 sec.	Sets the interior room lamp gradual dimming time.
	MODE 2	1 sec.	
	MODE 3	2 sec.	
	MODE 4*	3 sec.	
	MODE 5	0 sec.	
R LAMP TIMER LOGIC SET	ON* (MODE 1)	Interior room lamp timer activates with synchronizing all doors.	
	OFF (MODE 2)	Interior room lamp timer activates with synchronizing the driver door only.	

* : Initial setting

DATA MONITOR

Monitor item [Unit]	Description
REQ SW-DR [ON/OFF]	The switch status input from request switch (driver side)
REQ SW-AS [ON/OFF]	The switch status input from front request switch (passenger side)
REQ SW-RL [ON/OFF]	The switch status input from rear request switch (driver side)
REQ SW-RR [ON/OFF]	The switch status input from rear request switch (passenger side)

DIAGNOSIS SYSTEM (BCM)

< FUNCTION DIAGNOSIS >

Monitor item [Unit]	Description
PUSH SW [ON/OFF]	The switch status input from push-button ignition switch
ACC RLY-F/B [ON/OFF]	Indicates status of accessory relay
UNLK SEN-DR [ON/OFF]	Driver door unlock status input from unlock sensor
KEY SW-SLOT [ON/OFF]	Key switch status input from key slot
DOOR SW-DR [ON/OFF]	The switch status input from front door switch LH
DOOR SW-AS [ON/OFF]	The switch status input from front door switch RH
DOOR SW-RR [ON/OFF]	The switch status input from rear door switch RH
DOOR SW-RL [ON/OFF]	The switch status input from rear door switch LH
CDL LOCK SW [ON/OFF]	Lock switch status received from central door lock switch by power window switch serial link
CDL UNLOCK SW [ON/OFF]	Unlock switch status received from central door lock switch by power window switch serial link
KEY CYL LK-SW [ON/OFF]	Lock switch status received from key cylinder switch by power window switch serial link
KEY CYL UN-SW [ON/OFF]	Unlock switch status received from key cylinder switch by power window switch serial link
TRNK/HAT MNTR [ON/OFF]	The switch status input from trunk room lamp switch
RKE-LOCK [ON/OFF]	Lock signal status received from remote keyless entry receiver
RKE-UNLOCK [ON/OFF]	Unlock signal status received from remote keyless entry receiver

ACTIVE TEST

Test item	Operation	Description
INT LAMP	ON	Outputs the interior room lamp control signal to turn map lamp and personal lamp ON (Map lamp switch is in DOOR position).
	OFF	Stops the interior room lamp control signal to turn map lamp and personal lamp OFF.
STEP LAMP TEST	ON	Outputs the step lamp control signal to turn step lamp ON.
	OFF	Stops the step lamp control signal to turn step lamp OFF.
LUGGAGE LAMP TEST	ON	Outputs the luggage room lamp control signal to turn step lamp ON.
	OFF	Stops the luggage room lamp control signal to turn step lamp ON.

BATTERY SAVER

BATTERY SAVER : CONSULT-III Function (BCM-BATTERY SAVER)

INFOID:000000005530120

WORK SUPPORT

Service item	Setting item	Setting
ROOM LAMP BAT SAV SET	ON*	With the interior room lamp battery saver function
	OFF	Without the interior room lamp battery saver function

DIAGNOSIS SYSTEM (BCM)

< FUNCTION DIAGNOSIS >

Service item	Setting item	Setting	
ROOM LAMP TIMER SET	MODE 1*	30 min.	Sets the interior room lamp battery saver timer operating time.
	MODE 2	60 min.	
BATTERY SAVER SET	ON*	With the exterior lamp battery saver function	
	OFF	Without the exterior lamp battery saver function	

* : Initial setting

DATA MONITOR

Monitor item [Unit]	Description
REQ SW-DR [ON/OFF]	The switch status input from front request switch (driver side)
REQ SW-AS [ON/OFF]	The switch status input from front request switch (passenger side)
REQ SW-RL [ON/OFF]	The switch status input from rear request switch (driver side)
REQ SW-RR [ON/OFF]	The switch status input from rear request switch (passenger side)
PUSH SW [ON/OFF]	The switch status input from push-button ignition switch
ACC RLY-F/B [ON/OFF]	Indicates accessory relay status
UNLK SEN-DR [ON/OFF]	The unlock status input from front door unlock sensor LH
KEY SW-SLOT [ON/OFF]	Key switch status input from key slot
DOOR SW-DR [ON/OFF]	The switch status input from front door switch LH
DOOR SW-AS [ON/OFF]	The switch status input from front door switch RH
DOOR SW-RR [ON/OFF]	The switch status input from rear door switch RH
DOOR SW-RL [ON/OFF]	The switch status input from rear door switch LH
CDL LOCK SW [ON/OFF]	Lock switch status received from central door lock switch by power window switch serial link
CDL UNLOCK SW [ON/OFF]	Unlock switch status received from central door lock switch by power window switch serial link
KEY CYL LK-SW [ON/OFF]	Lock switch status received from key cylinder switch by power window switch serial link
KEY CYL UN-SW [ON/OFF]	Unlock switch status received from key cylinder switch by power window switch serial link
TRNK/HAT MNTR [ON/OFF]	The switch status input from trunk room lamp switch
RKE-LOCK [ON/OFF]	Lock signal status received from remote keyless entry receiver
RKE-UNLOCK [ON/OFF]	Unlock signal status received from remote keyless entry receiver

ACTIVE TEST

DIAGNOSIS SYSTEM (BCM)

< FUNCTION DIAGNOSIS >

Test item	Operation	Description
BATTERY SAVER	OFF	Cuts the interior room lamp power supply to turn interior room lamp OFF.
	ON	Outputs the interior room lamp power supply to turn interior room lamp ON.*

* : Each lamp switch is in ON position.

INTELLIGENT KEY

INTELLIGENT KEY : CONSULT-III Function (BCM - INTELLIGENT KEY) INFOID:000000005548825

WORK SUPPORT

Monitor item	Description
CONFIRM KEY FOB ID	It can be checked whether Intelligent Key ID code is registered or not in this mode.
AUTO LOCK SET	Auto door lock time can be changed in this mode. <ul style="list-style-type: none"> • MODE 1: 1 minute • MODE 2: 5 minutes • MODE 3: 30 seconds • MODE 4: 2 minutes
LOCK/UNLOCK BY I-KEY	Door lock/unlock function by door request switch (driver side, passenger side and trunk) mode can be changed to operate (ON) or not operate (OFF) with this mode.
ENGINE START BY I-KEY	Engine start function mode can be changed to operate (ON) or not operate (OFF) with this mode.
TRUNK/GLASS HATCH OPEN	Buzzer reminder function mode by trunk opener request switch can be changed to operate (ON) or not operate (OFF) with this mode.
PANIC ALARM SET	Panic alarm button pressing time on Intelligent Key remote control button can be selected from the following with this mode. <ul style="list-style-type: none"> • MODE 1: 0.5 sec. • MODE 2: OFF: Non-operation • MODE 3: 1.5 sec.
PW DOWN SET	Unlock button pressing time on Intelligent Key button to lower front windows can be selected from the following with this mode. <ul style="list-style-type: none"> • MODE 1: 3 sec. • MODE 2: OFF: Non-operation • MODE 3: 5 sec.
TRUNK OPEN DELAY	Trunk button pressing time on Intelligent Key button can be selected from the following with this mode. <ul style="list-style-type: none"> • MODE 1: 0.5 sec. • MODE 2: OFF: No delay • MODE 3: 1.5 sec.
LO- BATT OF KEY FOB WARN	Intelligent Key low battery warning mode can be changed to operate (ON) or not operate (OFF) with this mode.
ANTI KEY LOCK IN FUNCTI	Key reminder function mode can be changed to operate (ON) or not operate (OFF) with this mode.
HAZARD ANSWER BACK	Hazard reminder function mode can be selected from the following with this mode. <ul style="list-style-type: none"> • LOCK ONLY: Door lock operation only • UNLOCK ONLY: Door unlock operation only • LOCK AND UNLOCK: Lock/unlock operation • OFF: Non operation
ANS BACK I-KEY LOCK	Buzzer reminder function (lock operation) mode by door request switch (driver side and passenger side) can be selected from the following with this mode. <ul style="list-style-type: none"> • HORN CHIRP: Sound horn • BUZZER: Sound Intelligent Key warning buzzer • OFF: Non-operation
ANS BACK I-KEY UNLOCK	Buzzer reminder function (unlock operation) mode by door request switch can be changed to operate (ON) or not operate (OFF) with this mode.
SHORT CRANKING OUTPUT	Starter motor can operate during the times below. <ul style="list-style-type: none"> • 70 msec • 100 msec • 200 msec

DIAGNOSIS SYSTEM (BCM)

< FUNCTION DIAGNOSIS >

Monitor item	Description
INSIDE ANT DIAGNOSIS	This function allows inside key antenna self-diagnosis.
HORN WITH KEYLESS LOCK	Horn reminder function mode by Intelligent Key button can be changed to operate (ON) or not operate (OFF) with this mode.

SELF-DIAG RESULT

Refer to [BCS-81, "DTC Index"](#).

DATA MONITOR

Monitor Item	Condition
REQ SW-DR	Indicates [ON/OFF] condition of door request switch (driver side).
REQ SW-AS	Indicates [ON/OFF] condition of door request switch (passenger side).
REQ SW-BD/TR	Indicates [ON/OFF] condition of trunk opener request switch.
PUSH SW	Indicates [ON/OFF] condition of push button ignition switch.
IGN RLY2-F/B	Indicates [ON/OFF] condition of ignition relay 2.
ACC RLY-F/B	Indicates [ON/OFF] condition of accessory relay.
BRAKE SW 1	Indicates [ON/OFF] condition of brake switch.
BRAKE SW 2	Indicates [ON/OFF] condition of brake switch.
DETE/CANCL SW	Indicates [ON/OFF] condition of P position.
SFT PN/N SW	Indicates [ON/OFF] condition of P or N position.
S/L -LOCK*	Indicates [ON/OFF] condition of steering lock (LOCK).
S/L -UNLOCK*	Indicates [ON/OFF] condition of steering lock (UNLOCK).
S/L RELAY-F/B*	Indicates [ON/OFF] condition of ignition switch.
UNLK SEN-DR	Indicates [ON/OFF] condition of driver door UNLOCK status.
PUSH SW -IPDM	Indicates [ON/OFF] condition of push button ignition switch from IPDM E/R via CAN.
IGN RLY1-F/B	Indicates [ON/OFF] condition of ignition relay 1 from IPDM E/R via CAN.
DETE SW -IPDM	Indicates [ON/OFF] condition of P position from TCM via CAN.
SFT PN -IPDM	Indicates [ON/OFF] condition of P or N position from TCM via CAN.
SFT P -MET	Indicates [ON/OFF] condition of P position from TCM via CAN.
SFT N -MET	Indicates [ON/OFF] condition of N position from IPDM E/R via CAN.
ENGINE STATE	Indicates [STOP/START/CRANK/RUN] condition of engine states from ECM via CAN.
S/L LOCK-IPDM*	Indicates [ON/OFF] condition of steering lock (LOCK) request from IPDM E/R via CAN.
S/L UNLK-IPDM*	Indicates [ON/OFF] condition of steering lock (UNLOCK) request from IPDM E/R via CAN.
S/L RELAY-REQ*	Indicates [ON/OFF] condition of steering lock relay from IPDM E/R via CAN.
VEH SPEED 1	Display the vehicle speed signal received from combination meter by numerical value [km/h].
VEH SPEED 2	Display the vehicle speed signal received from ABS or VDC or CVT by numerical value [km/h].
DOOR STAT-DR	Indicates [LOCK/READY/UNLK] condition of driver side door status.
DOOR STAT-AS	Indicates [LOCK/READY/UNLK] condition of passenger side door status.
ID OK FLAG	Indicates [SET/RESET] condition of key ID.
PRMT ENG STRT	Indicates [SET/RESET] condition of engine start possibility.
KEY SW -SLOT	Indicates [ON/OFF] condition of key slot.
TRNK/HAT MNTR	Indicates [ON/OFF] condition of trunk lid.
RKE-LOCK	Indicates [ON/OFF] condition of LOCK signal from Intelligent Key.
RKE-UNLOCK	Indicates [ON/OFF] condition of UNLOCK signal from Intelligent Key.
RKE-TR/BD	Indicates [ON/OFF] condition of TRUNK OPEN signal from Intelligent Key.
RKE-PANIC	Indicates [ON/OFF] condition of PANIC button of Intelligent Key.

DIAGNOSIS SYSTEM (BCM)

< FUNCTION DIAGNOSIS >

Monitor Item	Condition
RKE-P/W OPEN	Indicates [ON/OFF] condition of P/W DOWN signal from Intelligent Key.
RKE-MODE CHG	Indicates [ON/OFF] condition of MODE CHANGE signal from Intelligent Key.
RKE OPE COUN1	When remote keyless entry receiver receives the signal transmitted while operating on Intelligent Key, the numerical value start changing.
REVERSE SW	Indicates [ON/OFF] condition of reverse switch status.

* : With electronic steering column lock

ACTIVE TEST

Test item	Description
BATTERY SAVER	This test is able to check interior room lamp operation. The interior room lamp will be activated after "ON" on CONSULT-III screen is touched.
PW REMOTO DOWN SET	This test is able to check power window down operation. The power window down will be activated after "ON" on CONSULT-III screen is touched.
OUTSIDE BUZZER	This test is able to check Intelligent Key warning buzzer operation. Intelligent Key warning buzzer sounds when "ON" on CONSULT-III screen is touched.
INSIDE BUZZER	This test is able to check warning chime by combination meter operation. <ul style="list-style-type: none"> Take out warning chime sounds when "TAKE OUT" on CONSULT-III screen is touched. Key warning chime sounds when "KEY WARN" on CONSULT-III screen is touched. P position warning chime sounds when "P RNG WARN" on CONSULT-III screen is touched. ACC warning chime sounds when "ACC WARN" on CONSULT-III screen is touched.
INDICATOR	This test is able to check warning lamp operation. <ul style="list-style-type: none"> "KEY" Warning lamp illuminates when "KEY IND ON" on CONSULT-III screen is touched. "KEY" Warning lamp flashes when "KEY IND FSH" on CONSULT-III screen is touched.
INT LAMP	This test is able to check interior room lamp operation. The interior room lamp will be activated after "ON" on CONSULT-III screen is touched.
LCD	This test is able to check meter display information <ul style="list-style-type: none"> Engine start information displays when "BRAKE/P" on CONSULT-III screen is touched. Engine start information displays when "BRAKE/P/ON" on CONSULT-III screen is touched. Key ID warning displays when "KEY ID NG" on CONSULT-III screen is touched. Steering lock information displays when "STLCK RELES" on CONSULT-III screen is touched.* P position warning displays when "P RNG IND" on CONSULT-III screen is touched. Intelligent Key insert information displays when "INSERT KEY" on CONSULT-III screen is touched. Intelligent Key low battery warning displays when "KEY BAT LOW" on CONSULT-III screen is touched. Take away window warning displays when "TK AWAY WDW" on CONSULT-III screen is touched. Take away warning display when "TAKE AWAY" on CONSULT-III screen is touched. OFF position warning display when "IGN OFF WARN" on CONSULT-III screen is touched.
TRUNK/GLASS HATCH	This test is able to check trunk lid opener actuator open operation. This actuator opens when "ON" on CONSULT-III screen is touched.
FLASHER	This test is able to check security hazard lamp operation. The hazard lamps will be activated after "ON" on CONSULT-III screen is touched.
HORN	This test is able to check horn operation. The horn will be activated after "ON" on CONSULT-III screen is touched.
P RANGE	This test is able to check CVT shift selector power supply CVT shift selector power is supplied when "ON" on CONSULT-III screen is touched.
ENGINE SW ILLUMI	This test is able to check push-ignition switch illumination operation. Push-ignition switch illumination illuminates when "ON" on CONSULT-III screen is touched.
LOCK INDICATOR	This test is able to check LOCK indicator in push-ignition switch operation. LOCK indicator in push-ignition switch illuminates when "ON" on CONSULT-III screen is touched.
ACC INDICATOR	This test is able to check ACC indicator in push-ignition switch operation. LOCK indicator in push-ignition switch illuminates when "ON" on CONSULT-III screen is touched.
IGNITION ON IND	This test is able to check INGITION ON indicator in push-ignition switch operation. LOCK indicator in push-ignition switch illuminates when "ON" on CONSULT-III screen is touched.

DIAGNOSIS SYSTEM (BCM)

< FUNCTION DIAGNOSIS >

Test item	Description
KEY SLOT ILLUMI	This test is able to check key slot illumination operation. Key slot illumination flash when "ON" on CONSULT-III screen is touched.
TRUNK/BACK DOOR	This test is able to check trunk lid opener actuator open operation. This actuator opens when "ON" on CONSULT-III screen is touched.

* : With electronic steering column lock

POWER SUPPLY AND GROUND CIRCUIT

< COMPONENT DIAGNOSIS >

COMPONENT DIAGNOSIS

POWER SUPPLY AND GROUND CIRCUIT

BCM

BCM : Diagnosis Procedure

INFOID:000000005530128

Regarding Wiring Diagram information, refer to [BCS-69, "Wiring Diagram"](#).

1. CHECK FUSE AND FUSIBLE LINK

Check if the following BCM fuses or fusible link are blown.

Terminal No.	Signal name	Fuse and fusible link No.
1	Battery power supply	H
11		10
24		7

Is the fuse or fusible link blown?

- YES >> Replace the blown fuse or fusible link after repairing the affected circuit.
 NO >> GO TO 2

2. CHECK POWER SUPPLY CIRCUIT

- Turn ignition switch OFF.
- Disconnect BCM.
- Check voltage between BCM harness connector and ground.

Terminals		Voltage (Approx.)
(+)	(-)	
BCM		Ground Battery voltage
Connector	Terminal	
M16 (A)	1	
M17 (B)	11	
M18 (C)	24	

Is the measurement normal?

- YES >> GO TO 3
 NO >> Repair or replace harness.

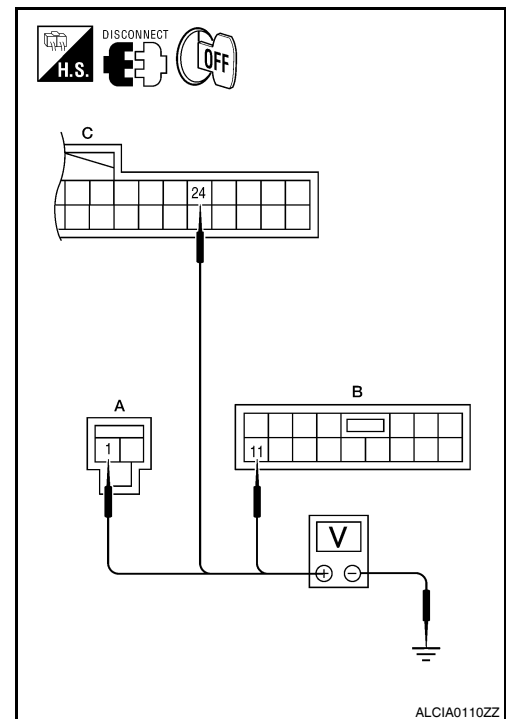

3. CHECK GROUND CIRCUIT

A
B
C
D
E
F
G
H
I
J
K
INL
M
N
O
P

POWER SUPPLY AND GROUND CIRCUIT

< COMPONENT DIAGNOSIS >

Check continuity between BCM harness connector and ground.

BCM		Ground	Continuity
Connector	Terminal		
M17	13		Yes

Does continuity exist?

- YES >> Inspection End.
- NO >> Repair or replace harness.

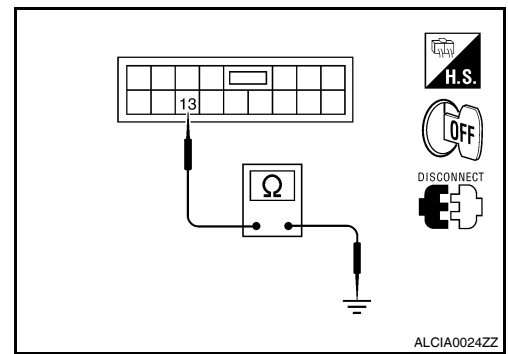

INFOID:000000005530129

BCM : Special Repair Requirement

1. REQUIRED WORK WHEN REPLACING BCM

Initialize control unit. Refer to [BCS-6. "CONFIGURATION \(BCM\) : Special Repair Requirement"](#).

>> Work End.

BATTERY SAVER OUTPUT/POWER SUPPLY CIRCUIT

< COMPONENT DIAGNOSIS >

BATTERY SAVER OUTPUT/POWER SUPPLY CIRCUIT

Description

INFOID:000000005461054

Provides the interior room lamp power supply. Also cuts the power supply when the interior room lamp battery saver is activated.

Component Function Check

INFOID:000000005461055

1. CHECK BATTERY SAVER OUTPUT/POWER SUPPLY FUNCTION

CONSULT-III

1. Turn ignition switch ON.
2. Turn each interior room lamp ON.
 - Front room/map lamp assembly
 - Personal lamps rear
 - Foot lamps
 - Front step lamps
 - Rear step lamps
 - Trunk room lamp
 - Vanity mirror lamps
3. Select "BATTERY SAVER" of BCM (BATTERY SAVER) active test item.
4. While operating the test item, check that each interior room lamp turns ON/OFF.

OFF : Interior room lamp OFF

ON : Interior room lamp ON

Is the inspection result normal?

YES >> Battery saver output/power supply circuit is normal.

NO >> Refer to [INL-21, "Diagnosis Procedure"](#).

Diagnosis Procedure

INFOID:000000005461056

Regarding Wiring Diagram information, refer to [INL-31, "Wiring Diagram"](#).

1. CHECK BATTERY SAVER OUTPUT/POWER SUPPLY OUTPUT

CONSULT-III

1. Turn ignition switch ON.
2. Select "BATTERY SAVER" of BCM (BATTERY SAVER) active test item.
3. While operating the test item, check voltage between BCM connector M17 terminal 4 and ground.

(+)		(-)	Test item	Voltage
BCM		Ground	BATTERY SAVER	
Connector	Terminal		OFF	0V
M17	4		ON	Battery voltage

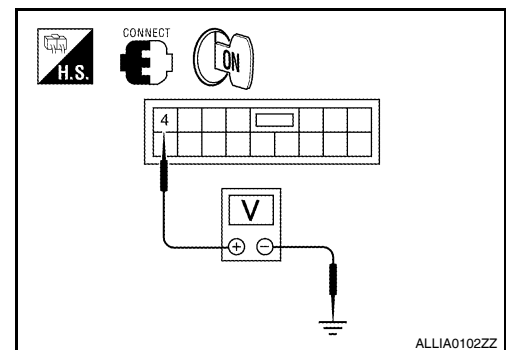

Is the inspection result normal?

YES >> GO TO 2

NO >> Replace BCM. Refer to [BCS-87, "Removal and Installation"](#).

2. CHECK BATTERY SAVER OUTPUT/POWER SUPPLY OPEN CIRCUIT

1. Turn ignition switch OFF.
2. Disconnect the following connectors.
 - BCM M17

BATTERY SAVER OUTPUT/POWER SUPPLY CIRCUIT

< COMPONENT DIAGNOSIS >

- Front room/map lamp assembly
 - Vanity mirror lamp LH
 - Vanity mirror lamp RH
 - Foot lamp LH
 - Foot lamp RH
 - Front step lamp LH
 - Front step lamp RH
 - Rear step lamp LH
 - Rear step lamp RH
 - Trunk room lamp
3. Check continuity between BCM connector M17 terminal 4 and each interior room lamp connector.

BCM		Each interior room lamp			Continuity
Connector	Terminal	Connector		Terminal	
M17	4	Front room/map lamp assembly	R8	1	Yes
		Vanity mirror lamp LH	R3	2	
		Vanity mirror lamp RH	R9	2	
		Foot lamp LH	M99	1	
		Foot lamp RH	M100	1	
		Front step lamp LH	D11	1	
		Front step lamp RH	D109	1	
		Rear step lamp LH	D206	1	
		Rear step lamp RH	D301	1	
		Trunk room lamp	B36	1	

Is the inspection result normal?

- YES >> GO TO 3
 NO >> Repair the harness or connectors.

3. CHECK BATTERY SAVER OUTPUT/POWER SUPPLY SHORT CIRCUIT

Check continuity between BCM connector M17 terminal 4 and ground.

BCM		Ground	Continuity
Connector	Terminal		
M17	4		No

Is the inspection result normal?

- YES >> Replace the interior room lamp. Refer to [INL-97](#), "[Removal and Installation](#)".
 NO >> Repair the harness or connectors.

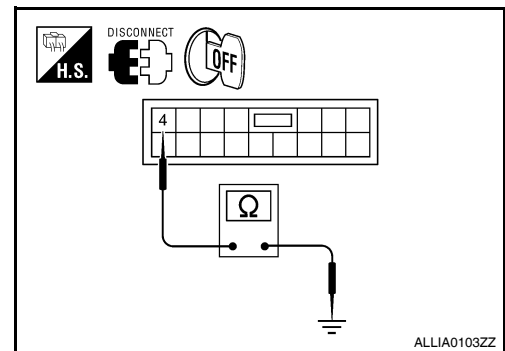

INTERIOR ROOM LAMP CONTROL CIRCUIT

< COMPONENT DIAGNOSIS >

INTERIOR ROOM LAMP CONTROL CIRCUIT

Description

INFOID:000000005461057

Controls each interior room lamp (ground side) by PWM signal.

NOTE:

PWM signal control period is approximately 250 Hz (in the gradual brightening/dimming).

Component Function Check

INFOID:000000005461058

CAUTION:

Before performing the diagnosis, check that the following is normal.

- Battery saver output/power supply
- Front room/map lamp assembly bulbs
- Personal lamp rear bulbs
- Foot lamp bulbs

1. CHECK INTERIOR ROOM LAMP CONTROL FUNCTION

CONSULT-III

1. Switch the front room/map lamp assembly to DOOR.
2. Turn ignition switch ON.
3. Select "INT LAMP" of BCM (INT LAMP) active test item.
4. While operating the test item, check that each interior room lamp turns ON/OFF (gradual brightening/dimming).

ON : Interior room lamp gradual brightening

OFF : Interior room lamp gradual dimming

Is the inspection result normal?

YES >> Interior room lamp control circuit is normal.

NO >> Refer to [INL-23, "Diagnosis Procedure"](#).

Diagnosis Procedure

INFOID:000000005461059

Regarding Wiring Diagram information, refer to [INL-31, "Wiring Diagram"](#).

1. CHECK INTERIOR ROOM LAMP CONTROL OUTPUT

CONSULT-III

1. Turn ignition switch OFF.
2. Select "INT LAMP" of BCM (INT LAMP) active test item.
3. While operating the test item, check voltage between BCM connector M17 terminal 19 and ground.

BCM		Ground	Test item	Voltage
Connector	Terminal		INT LAMP	
M17	19		ON	0V
			OFF	Battery voltage

Is the inspection result normal?

YES >> Interior room lamp control circuit is operating normally.

Fixed ON>>GO TO 3

Fixed OFF>>GO TO 2

2. CHECK INTERIOR ROOM LAMP CONTROL OPEN CIRCUIT

1. Turn ignition switch OFF.
2. Disconnect BCM connector M17, front room/map lamp assembly and foot lamp connectors.
3. Check continuity between BCM connector M17 terminal 19 and each interior room lamp connector.

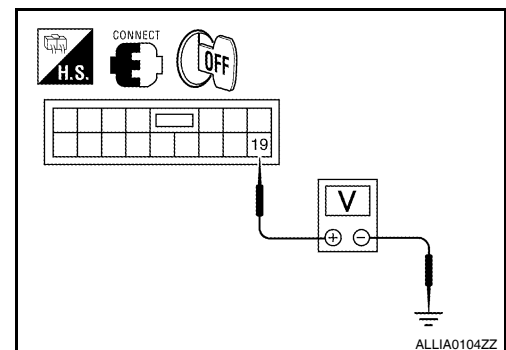

INTERIOR ROOM LAMP CONTROL CIRCUIT

< COMPONENT DIAGNOSIS >

BCM		Interior room lamp			Continuity
Connector	Terminal	Connector		Terminal	
M17	19	Front room/map lamp assembly	R8	2	Yes
		Foot lamp LH	M99	2	
		Foot lamp RH	M100	2	

Is the inspection result normal?

YES >> Check interior room lamps for an open. If OK, replace BCM. Refer to [BCS-87, "Removal and Installation"](#). If NG, replace the interior room lamp. Refer to [INL-97, "Removal and Installation"](#).

NO >> Repair the harness or connectors.

3. CHECK INTERIOR ROOM LAMP CONTROL SHORT CIRCUIT

1. Turn ignition switch OFF.
2. Disconnect BCM connector M17, front room/map lamp assembly and foot lamp connectors.
3. Check continuity between BCM connector M17 terminal 19 and ground.

BCM		Ground	Continuity
Connector	Terminal		
M17	19		No

Is the inspection result normal?

YES >> Check interior room lamps for a short circuit. If OK, replace BCM. Refer to [BCS-87, "Removal and Installation"](#). If NG, replace the interior room lamp. Refer to [INL-97, "Removal and Installation"](#).

NO >> Repair the harness or connectors.

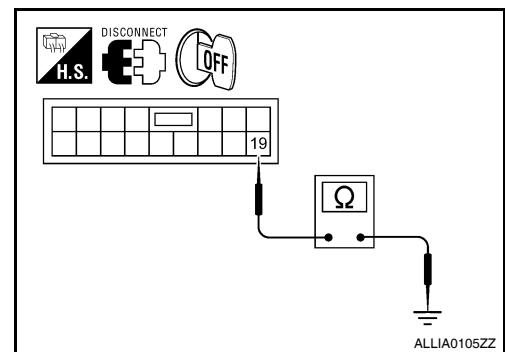

STEP LAMP CIRCUIT

< COMPONENT DIAGNOSIS >

STEP LAMP CIRCUIT

Description

INFOID:000000005461060

Controls the step lamp (ground side) to turn the step lamp ON and OFF.

Component Function Check

INFOID:000000005461061

CAUTION:

Before performing the diagnosis, check that the following is normal.

- Battery saver output/power supply
- Step lamp bulbs

1.CHECK STEP LAMP OPERATION

CONSULT-III

1. Turn ignition switch ON.
2. Select "STEP LAMP TEST" of BCM (INT LAMP) active test item.
3. While operating the test item, check that step lamps turn ON/OFF.

ON : Step lamp ON

OFF : Step lamp OFF

Is the inspection result normal?

- YES >> Step lamp control circuit is normal.
NO >> Refer to [INL-25, "Diagnosis Procedure"](#).

Diagnosis Procedure

INFOID:000000005461062

Regarding Wiring Diagram information, refer to [INL-31, "Wiring Diagram"](#).

1.CHECK STEP LAMP OUTPUT

CONSULT-III

1. Turn ignition switch ON.
2. Select "STEP LAMP TEST" of BCM (INT LAMP) active test item.
3. While operating the test item, check voltage between BCM connector M17 terminal 7 and ground.

BCM		Ground	Test item	Voltage
Connector	Terminal		STEP LAMP TEST	
M17	7	ON	0V	
		OFF	Battery voltage	

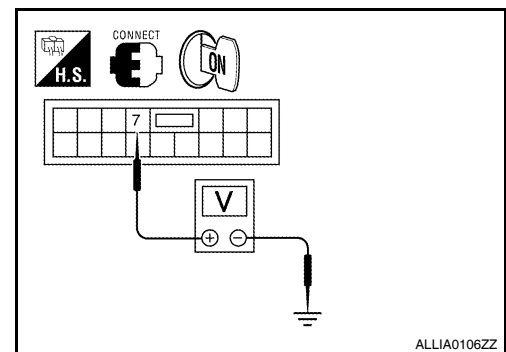

Is the inspection result normal?

- YES >> Step lamp control circuit is operating normally.
Fixed ON>>GO TO 3
Fixed OFF>>GO TO 2

2.CHECK STEP LAMP OPEN CIRCUIT

STEP LAMP CIRCUIT

< COMPONENT DIAGNOSIS >

1. Turn ignition switch OFF.
2. Disconnect BCM connector M17 and step lamp connectors.
3. Check continuity between BCM connector M17 (A) terminal 7 and step lamp connectors (B) terminal 2.

BCM		Step lamp			Continuity
Connector	Terminal	Connector	Terminal	Terminal	
M17 (A)	7	Front LH	D11 (B)	2	Yes
		Front RH	D109 (B)	2	
		Rear LH	D206 (B)	2	
		Rear RH	D301 (B)	2	

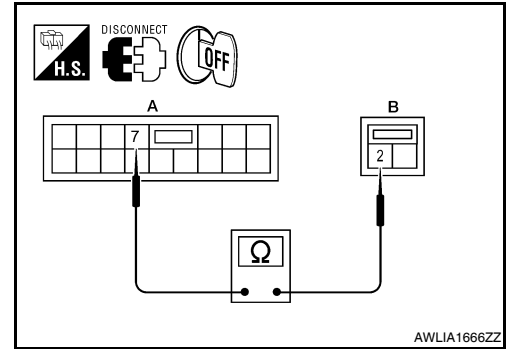

Is the inspection result normal?

YES >> Check step lamp for an open. If OK, replace BCM. Refer to [BCS-87, "Removal and Installation"](#). If NG, replace step lamp. Refer to [INL-97, "Removal and Installation"](#).

NO >> Repair harness or connectors.

3. CHECK STEP LAMP SHORT CIRCUIT

1. Turn ignition switch OFF.
2. Disconnect BCM connector M17 and step lamp connectors.
3. Check continuity between BCM connector M17 terminal 7 and ground.

BCM		Ground	Continuity
Connector	Terminal		
M17	7		No

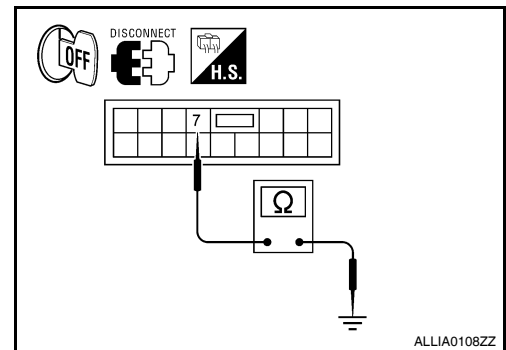

Is the inspection result normal?

YES >> Check step lamp for a short circuit. If OK, replace BCM. Refer to [BCS-87, "Removal and Installation"](#). If NG, replace step lamp. Refer to [INL-97, "Removal and Installation"](#).

NO >> Repair the harness or connectors.

TRUNK ROOM LAMP CIRCUIT

< COMPONENT DIAGNOSIS >

TRUNK ROOM LAMP CIRCUIT

Description

INFOID:000000005461063

Controls the trunk room lamp (ground side) to turn the trunk room lamp ON and OFF.

Component Function Check

INFOID:000000005461064

CAUTION:

Before performing the diagnosis, check that the following is normal.

- Battery saver output/power supply
- Trunk room lamp bulb

1.CHECK TRUNK ROOM LAMP OPERATION

CONSULT-III

1. Turn ignition switch ON.
2. Select "LUGGAGE LAMP TEST" of BCM (INT LAMP) active test item.
3. While operating the test item, check that trunk room lamp turns ON/OFF.

ON : Trunk room lamp ON

OFF : Trunk room lamp OFF

Is the inspection result normal?

- YES >> Trunk room lamp control circuit is normal.
NO >> Refer to [INL-27, "Diagnosis Procedure"](#).

Diagnosis Procedure

INFOID:000000005461065

Regarding Wiring Diagram information, refer to [INL-31, "Wiring Diagram"](#).

1.CHECK TRUNK ROOM LAMP OUTPUT

CONSULT-III

1. Turn ignition switch ON.
2. Select "LUGGAGE LAMP TEST" of BCM (INT LAMP) active test item.
3. While operating the test item, check voltage between BCM connector M20 terminal 110 and ground.

BCM		Ground	Test item	Voltage
Connector	Terminal		LUGGAGE LAMP TEST	
M20	110		ON	0V
			OFF	Battery voltage

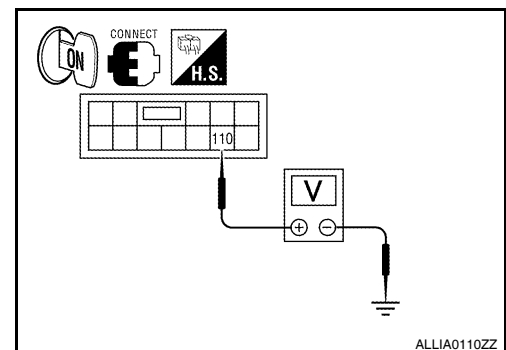

Is the inspection result normal?

- YES >> Trunk room lamp control circuit is operating normally.
Fixed ON>>GO TO 3
Fixed OFF>>GO TO 2

2.CHECK TRUNK ROOM LAMP OPEN CIRCUIT

TRUNK ROOM LAMP CIRCUIT

< COMPONENT DIAGNOSIS >

1. Turn ignition switch OFF.
2. Disconnect BCM connector M20 and trunk room lamp connector.
3. Check continuity between BCM connector M20 (A) terminal 110 and trunk room lamp connector B36 (B) terminal 2.

BCM		Trunk room lamp		Continuity
Connector	Terminal	Connector	Terminal	
M20	110	B36	2	Yes

Is the inspection result normal?

YES >> Check trunk room lamp for an open. If OK, replace BCM. Refer to [BCS-87, "Removal and Installation"](#). If NG, replace trunk room lamp. Refer to [INL-97, "Removal and Installation"](#).

NO >> Repair harness or connectors.

3. CHECK TRUNK ROOM LAMP SHORT CIRCUIT

1. Turn ignition switch OFF.
2. Disconnect BCM connector M20 and trunk room lamp connector.
3. Check continuity between BCM connector M20 terminal 110 and ground.

BCM		Ground	Continuity
Connector	Terminal		
M20	110		No

Is the inspection result normal?

YES >> Check trunk room lamp for a short circuit. If OK, replace BCM. Refer to [BCS-87, "Removal and Installation"](#). If NG, replace trunk room lamp. Refer to [INL-97, "Removal and Installation"](#).

NO >> Repair harnesses or connectors.

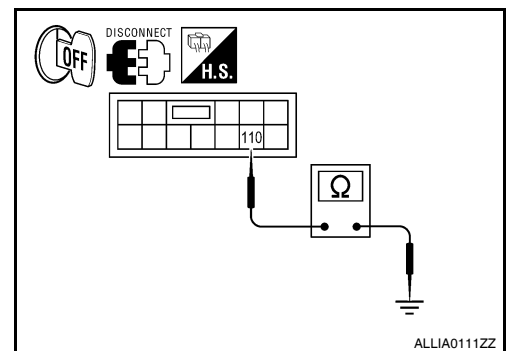
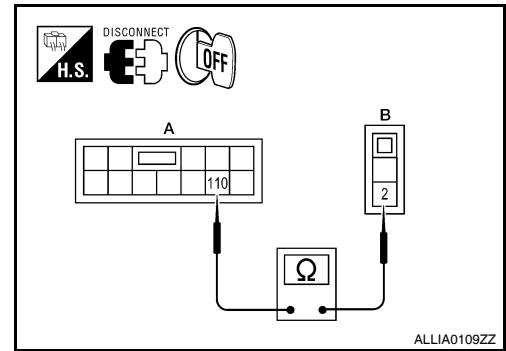

PUSH-BUTTON IGNITION SWITCH ILLUMINATION CIRCUIT

< COMPONENT DIAGNOSIS >

PUSH-BUTTON IGNITION SWITCH ILLUMINATION CIRCUIT

Description

INFOID:000000005461066

Provides the power supply and the ground to control the push-button ignition switch illumination.

Component Function Check

INFOID:000000005461067

1. CHECK PUSH-BUTTON IGNITION SWITCH ILLUMINATION OPERATION

CONSULT-III

1. Turn the ignition switch ON.
2. Select "ENGINE SW ILLUMI" of BCM (INTELLGENT KEY) active test item.
3. While operating the test item, check that the push-button ignition switch illumination turns ON/OFF

ON : Push-button ignition switch illumination ON

OFF : Push-button ignition switch illumination OFF

Is the inspection result normal?

- YES >> Push-button ignition switch illumination circuit is normal.
 NO >> Refer to [INL-29, "Diagnosis Procedure"](#).

Diagnosis Procedure

INFOID:000000005461068

Regarding Wiring Diagram information, refer to [INL-42, "Wiring Diagram"](#).

1. CHECK PUSH-BUTTON IGNITION SWITCH ILLUMINATION OPERATION

CONSULT-III

1. Turn the ignition switch ON.
2. Select "ENGINE SW ILLUMI" of BCM (INTELLGENT KEY) active test item.
3. While operating the test item, check voltage between push-button ignition switch connector M38 terminal 3 and ground.

Terminals		Test item	Voltage
(+)	(-)		
Push-button ignition switch		ENGINE SW ILLUMI	
Connector	Terminal		
M38	3		
		ON	5V
		OFF	0V

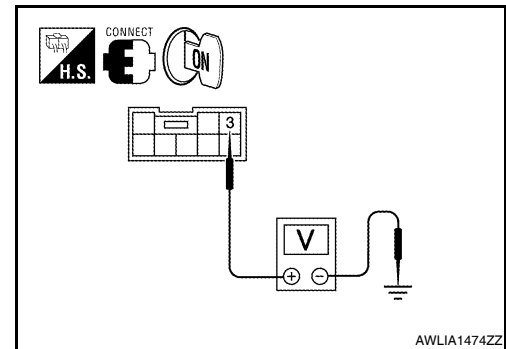

Is the inspection result normal?

- YES >> GO TO 4
 NO >> GO TO 2

2. CHECK PUSH-BUTTON IGNITION SWITCH ILLUMINATION POWER SUPPLY OPEN CIRCUIT

PUSH-BUTTON IGNITION SWITCH ILLUMINATION CIRCUIT

< COMPONENT DIAGNOSIS >

1. Turn the ignition switch OFF.
2. Disconnect BCM connector M18 and push-button ignition switch connector.
3. Check continuity between BCM connector M18 (A) terminal 41 and push-button ignition switch connector M38 (B) terminal 3.

BCM		Push-button ignition switch		Continuity
Connector	Terminal	Connector	Terminal	
M18 (A)	41	M38 (B)	3	Yes

Is the inspection result normal?

- YES >> GO TO 3
 NO >> Repair the harness or connectors.

3.CHECK PUSH-BUTTON IGNITION SWITCH ILLUMINATION POWER SUPPLY SHORT CIRCUIT

Check continuity between BCM connector M18 terminal 41 and ground.

BCM		Ground	Continuity
Connector	Terminal		
M18	41		No

Is the inspection result normal?

- YES >> Replace BCM. Refer to [BCS-87. "Removal and Installation"](#).
 NO >> Repair the harness or connectors.

4.CHECK PUSH-BUTTON IGNITION SWITCH ILLUMINATION GROUND CIRCUIT

1. Turn the ignition switch OFF.
2. Disconnect push-button ignition switch connector.
3. Check continuity between push-button ignition switch connector M38 terminal 2 and ground.

Push-button ignition switch		Ground	Continuity
Connector	Terminal		
M38	2		No

Is the inspection result normal?

- YES >> Replace push-button ignition switch.
 NO >> GO TO 5

5.CHECK PUSH-BUTTON IGNITION SWITCH ILLUMINATION GROUND OPEN CIRCUIT

1. Disconnect BCM connector M17.
2. Check continuity between BCM connector M17 (A) terminal 14 and push-button ignition switch connector M38 (B) terminal 2.

BCM		Push-button ignition switch		Continuity
Connector	Terminal	Connector	Terminal	
M17 (A)	14	M38 (B)	2	Yes

Is the inspection result normal?

- YES >> Replace BCM. Refer to [BCS-87. "Removal and Installation"](#).
 NO >> Repair the harness or connectors.

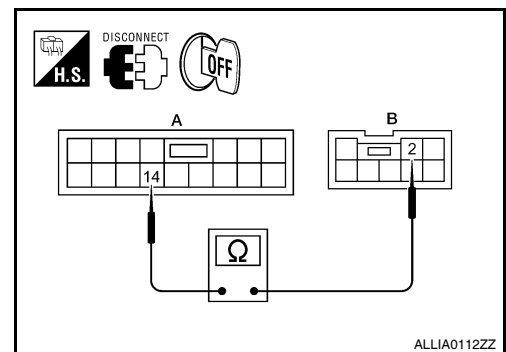
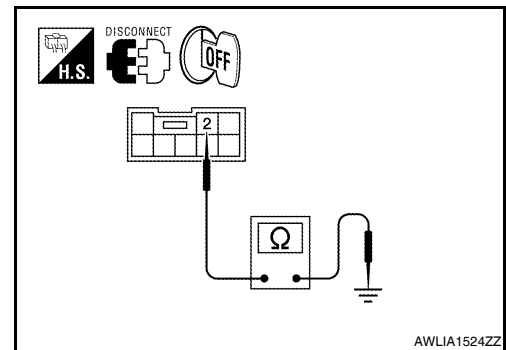
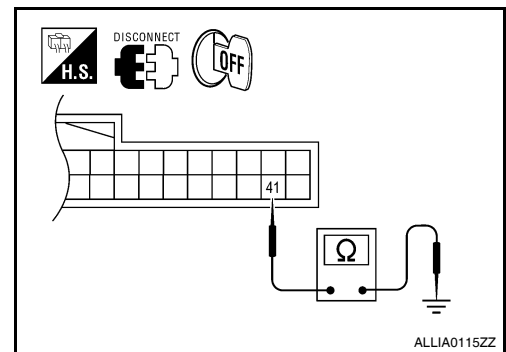
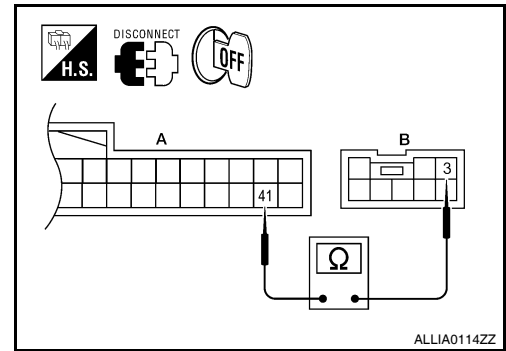

INTERIOR ROOM LAMP CONTROL SYSTEM

< COMPONENT DIAGNOSIS >

INTERIOR ROOM LAMP CONTROL SYSTEM

Wiring Diagram

INFOID:000000005461069

(NV) : WITH NAVI

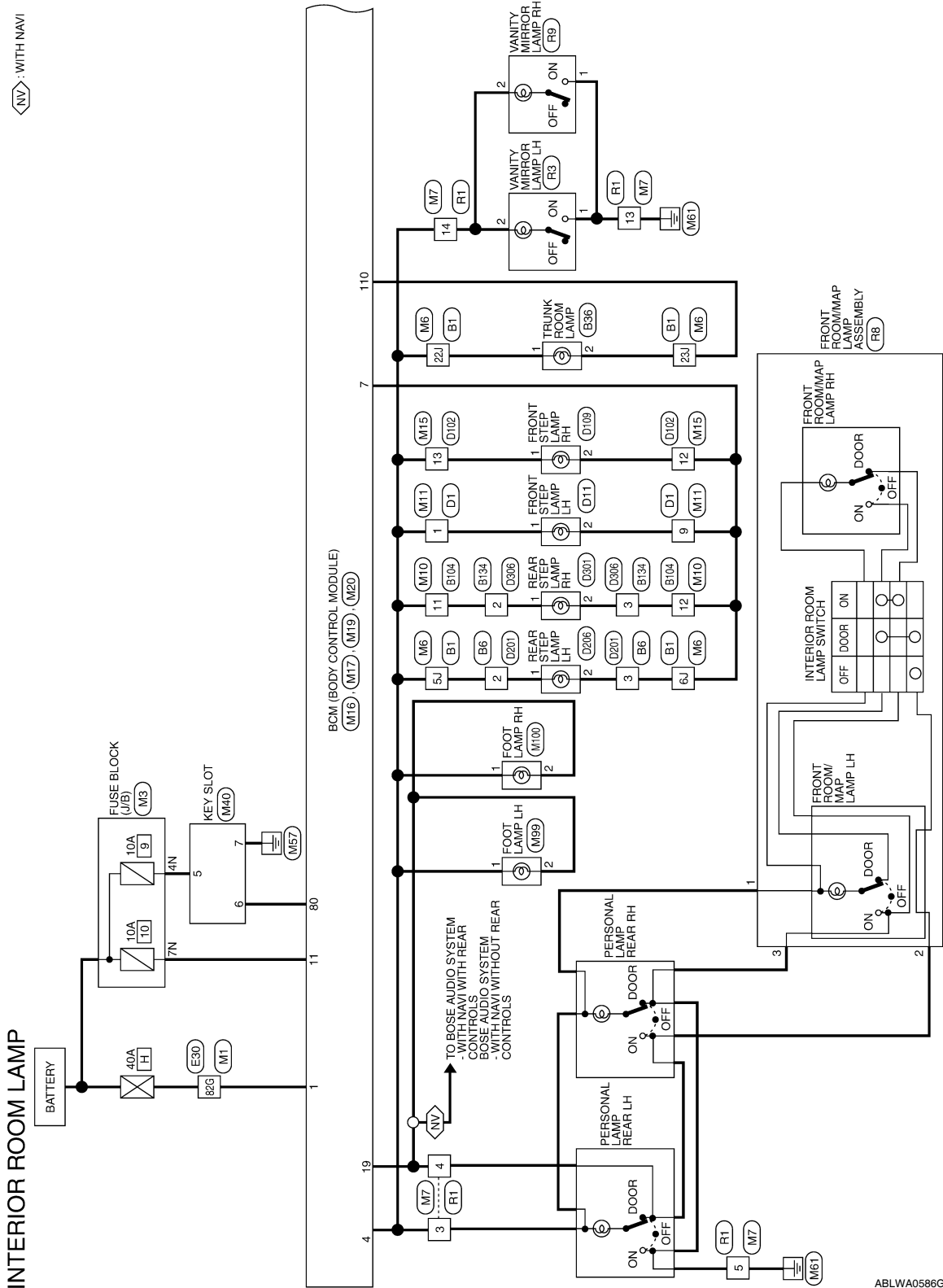

ABLWA0586GE

A
B
C
D
E
F
G
H
I
J
K
L
M
N
O
P

INL

INTERIOR ROOM LAMP CONTROL SYSTEM

< COMPONENT DIAGNOSIS >

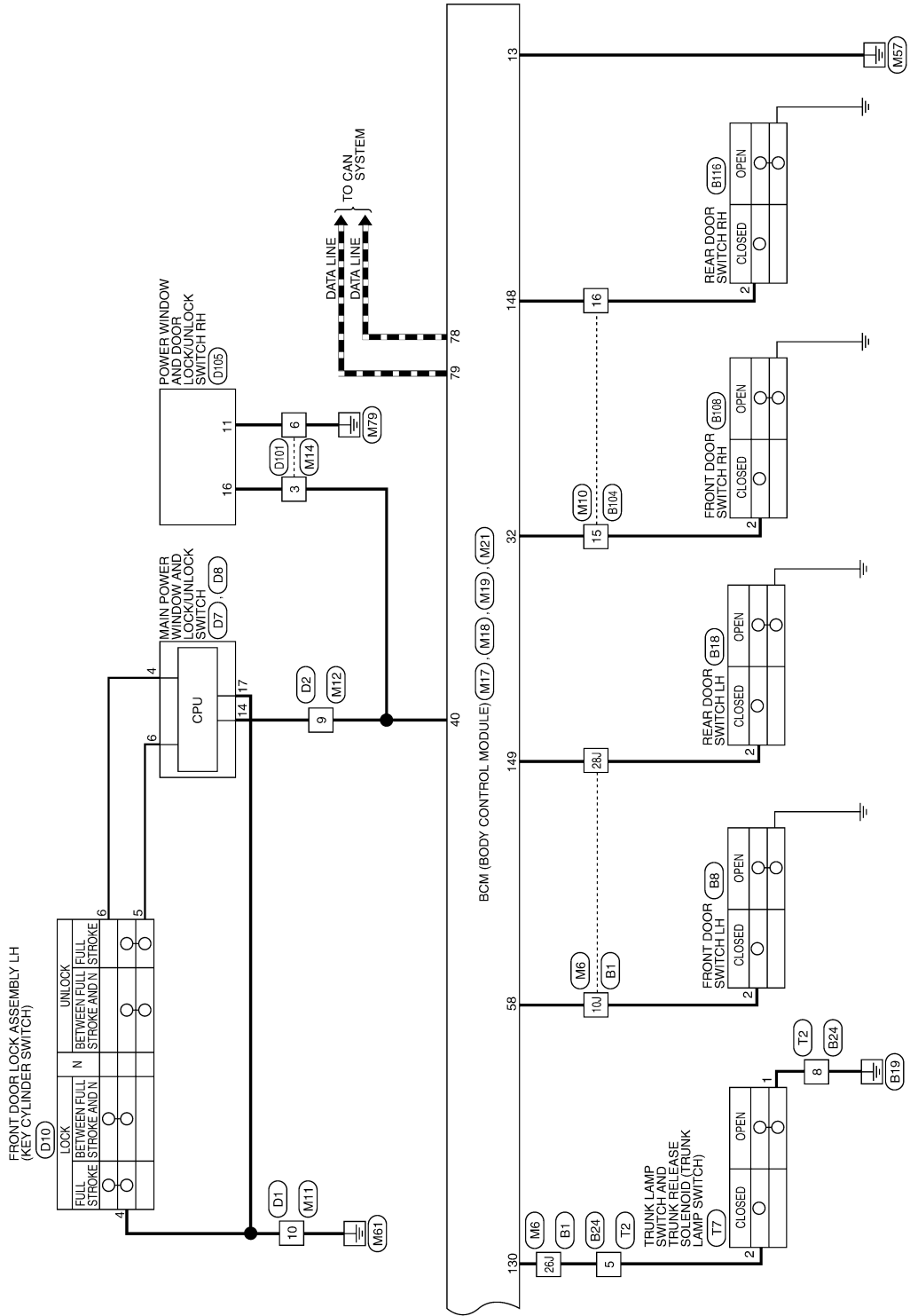

ABLWA0587GE

INTERIOR ROOM LAMP CONTROL SYSTEM

< COMPONENT DIAGNOSIS >

INTERIOR ROOM LAMP CONNECTORS

Connector No.	M1
Connector Name	WIRE TO WIRE
Connector Color	WHITE

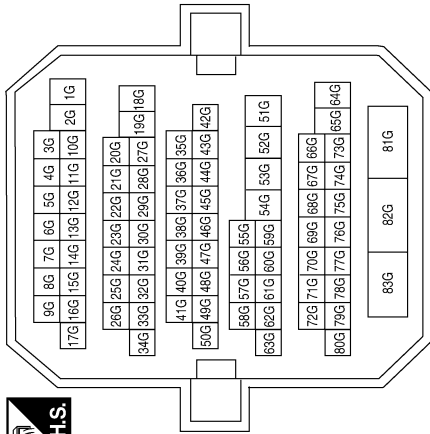

Terminal No.	Color of Wire	Signal Name
82G	W/B	-

Connector No.	M3
Connector Name	FUSE BLOCK (J/B)
Connector Color	WHITE

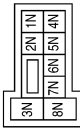

Terminal No.	Color of Wire	Signal Name
4N	G/Y	-
7N	Y/R	-

Connector No.	M6
Connector Name	WIRE TO WIRE
Connector Color	WHITE

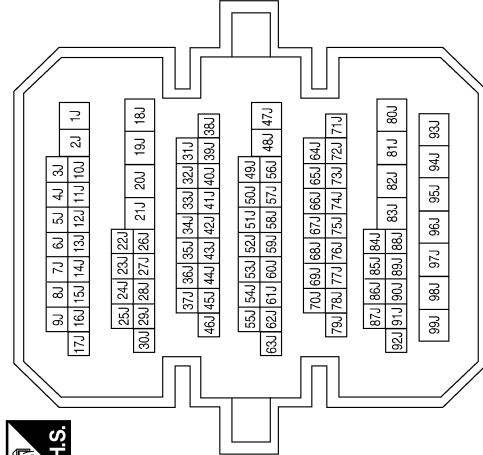

Terminal No.	Color of Wire	Signal Name
5J	P/W	-
6J	R/W	-
10J	SB	-
22J	P/W	-
23J	V/W	-
26J	W	-
28J	R/B	-

A
B
C
D
E
F
G
H
I
J
K
L
M
N
O
P

INL

INTERIOR ROOM LAMP CONTROL SYSTEM

< COMPONENT DIAGNOSIS >

Connector No.	M11
Connector Name	WIRE TO WIRE
Connector Color	WHITE



1	2	3	4	5	6	7
8	9	10	11	12	13	14
15	16					

Terminal No.	Color of Wire	Signal Name
1	P/W	-
9	R/W	-
10	B	-

Connector No.	M10
Connector Name	WIRE TO WIRE
Connector Color	WHITE



7	6	5	4	3	2	1
16	15	14	13	12	11	10
9	8					

Terminal No.	Color of Wire	Signal Name
11	P/W	-
12	R/W	-
15	R/B	-
16	R/W	-

Connector No.	M7
Connector Name	WIRE TO WIRE
Connector Color	WHITE



1	2	3	4	5	6	7	8
9	10	11	12	13	14	15	16

Terminal No.	Color of Wire	Signal Name
3	P/W	-
4	Y	-
5	B	-
13	B	-
14	P/W	-

Connector No.	M15
Connector Name	WIRE TO WIRE
Connector Color	WHITE



1	2	3	4	5	6	7	8
9	10	11	12	13	14	15	16

Terminal No.	Color of Wire	Signal Name
12	R/W	-
13	P/W	-

Connector No.	M14
Connector Name	WIRE TO WIRE
Connector Color	WHITE



1	2	3	4
5	6	7	8
9	10		

Terminal No.	Color of Wire	Signal Name
3	Y/G	-
6	B	-

Connector No.	M12
Connector Name	WIRE TO WIRE
Connector Color	WHITE



1	2	3	4	5	6	7	8	9	10	11	12
13	14	15	16	17	18	19	20	21	22	23	24

Terminal No.	Color of Wire	Signal Name
9	Y/G	-

ABLIA0542GB

INTERIOR ROOM LAMP CONTROL SYSTEM

< COMPONENT DIAGNOSIS >

Connector No.	M18
Connector Name	BCM (BODY CONTROL MODULE)
Connector Color	GREEN



39	38	37	36	35	34	33	32	31	30	29	28	27	26	25	24	23	22	21	20
59	58	57	56	55	54	53	52	51	50	49	48	47	46	45	44	43	42	41	40

Terminal No.	Color of Wire	Signal Name
32	R/B	AS DOOR SW 1
40	Y/G	PW K-LINE
58	SB	DR DOOR SW

Connector No.	M17
Connector Name	BCM (BODY CONTROL MODULE)
Connector Color	WHITE



4	5	6	7	8	9	10		
11	12	13	14	15	16	17	18	19

Terminal No.	Color of Wire	Signal Name
4	P/W	R/L POWER SUPPLY
7	R/W	STEP LAMP CONT
11	Y/R	BAT BCM FUSE
13	B	GND1
19	Y	ROOM LAMP CONT

Connector No.	M16
Connector Name	BCM (BODY CONTROL MODULE)
Connector Color	BLACK



1	2	3
---	---	---

Terminal No.	Color of Wire	Signal Name
1	W/B	BATT (F/L)

Connector No.	M21
Connector Name	BCM (BODY CONTROL MODULE)
Connector Color	GRAY



131	130	129	128	127	126	125	124	123	122	121	120	119	118	117	116	115	114	113	112
151	150	149	148	147	146	145	144	143	142	141	140	139	138	137	136	135	134	133	132

Terminal No.	Color of Wire	Signal Name
130	W	TRUNK SW
148	R/W	RR DOOR SW
149	R/B	RL DOOR SW

Connector No.	M20
Connector Name	BCM (BODY CONTROL MODULE)
Connector Color	WHITE



100	101	102	103	104		
105	106	107	108	109	110	111

Terminal No.	Color of Wire	Signal Name
110	V/W	TRUNK LAMP CONT

Connector No.	M19
Connector Name	BCM (BODY CONTROL MODULE)
Connector Color	BLACK



79	78	77	76	75	74	73	72	71	70	69	68	67	66	65	64	63	62	61	60
99	98	97	96	95	94	93	92	91	90	89	88	87	86	85	84	83	82	81	80

Terminal No.	Color of Wire	Signal Name
78	P	CAN-L
79	L	CAN-H
80	R/L	FOB SLOT ILLUMINATION

ABLIA1739GB

INTERIOR ROOM LAMP CONTROL SYSTEM

< COMPONENT DIAGNOSIS >

Connector No.	M100
Connector Name	FOOT LAMP RH
Connector Color	BROWN



Terminal No.	Color of Wire	Signal Name
1	P/W	-
2	Y	-

Connector No.	M99
Connector Name	FOOT LAMP LH
Connector Color	BROWN



Terminal No.	Color of Wire	Signal Name
1	P/W	-
2	Y	-

Connector No.	M40
Connector Name	KEY SLOT
Connector Color	WHITE

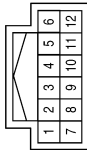

Terminal No.	Color of Wire	Signal Name
5	G/Y	+LIGHT BAT
6	R/L	LIGHT A
7	B	GND

Terminal No.	Color of Wire	Signal Name
5J	W	-
6J	Y	-
10J	SB	-
22J	L	-
23J	Y	-
26J	W	-
28J	BR	-

Connector No.	B1
Connector Name	WIRE TO WIRE
Connector Color	WHITE

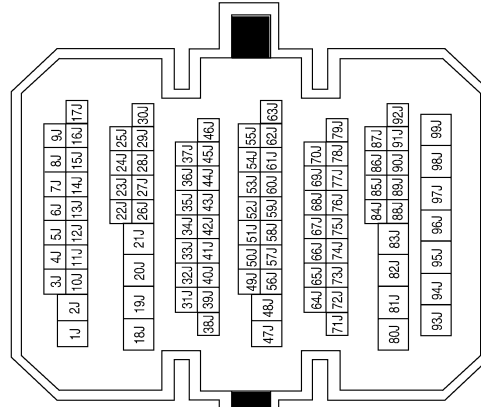

Connector No.	E30
Connector Name	WIRE TO WIRE
Connector Color	WHITE

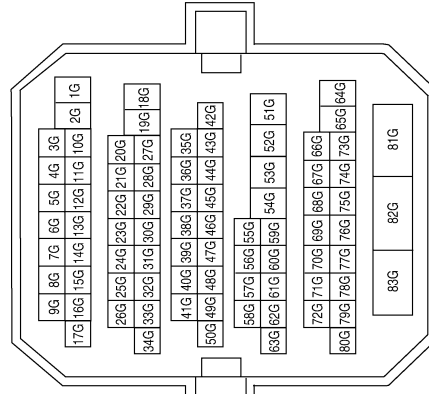

Terminal No.	Color of Wire	Signal Name
82G	LG	-

ABLIA1807GB

INTERIOR ROOM LAMP CONTROL SYSTEM

< COMPONENT DIAGNOSIS >

Connector No.	B18
Connector Name	REAR DOOR SWITCH LH
Connector Color	WHITE

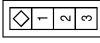
Terminal No.	Color of Wire	Signal Name
2	BR	-

Connector No.	B8
Connector Name	FRONT DOOR SWITCH LH
Connector Color	WHITE

Terminal No.	Color of Wire	Signal Name
2	SB	-

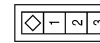
Connector No.	B6
Connector Name	WIRE TO WIRE
Connector Color	WHITE

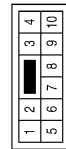

Terminal No.	Color of Wire	Signal Name
2	W	-
3	Y	-

Connector No.	B104
Connector Name	WIRE TO WIRE
Connector Color	WHITE

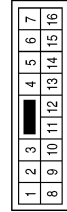
Terminal No.	Color of Wire	Signal Name
11	W	-
12	Y	-
15	GR	-
16	B	-

Connector No.	B36
Connector Name	TRUNK ROOM LAMP
Connector Color	WHITE

Terminal No.	Color of Wire	Signal Name
1	L	-
2	Y	-

Connector No.	B24
Connector Name	WIRE TO WIRE
Connector Color	WHITE

Terminal No.	Color of Wire	Signal Name
5	W	-
8	B	-

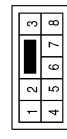
ABLIA1808GB



INTERIOR ROOM LAMP CONTROL SYSTEM

< COMPONENT DIAGNOSIS >

Connector No.	B108
Connector Name	FRONT DOOR SWITCH RH
Connector Color	WHITE

Terminal No.	Color of Wire	Signal Name
2	GR	-

Connector No.	B116
Connector Name	REAR DOOR SWITCH RH
Connector Color	WHITE

Terminal No.	Color of Wire	Signal Name
2	B	-

Connector No.	B134
Connector Name	WIRE TO WIRE
Connector Color	WHITE

Terminal No.	Color of Wire	Signal Name
2	W	-
3	Y	-

Connector No.	T2
Connector Name	WIRE TO WIRE
Connector Color	WHITE

Terminal No.	Color of Wire	Signal Name
5	W	-
8	B	-

Connector No.	T7
Connector Name	TRUNK LAMP SWITCH AND TRUNK RELEASE SOLENOID
Connector Color	WHITE

Terminal No.	Color of Wire	Signal Name
1	B	-
2	W	-

Connector No.	R1
Connector Name	WIRE TO WIRE
Connector Color	WHITE

Terminal No.	Color of Wire	Signal Name
3	W	-
4	W	-
5	W	-
13	B	-
14	P	-

ABLIA1809GB

INTERIOR ROOM LAMP CONTROL SYSTEM

< COMPONENT DIAGNOSIS >

Connector No.	R9
Connector Name	VANITY MIRROR LAMP RH
Connector Color	WHITE



Terminal No.	Color of Wire	Signal Name
1	B	-
2	P	-

Connector No.	R8
Connector Name	FRONT ROOM/MAP LAMP ASSEMBLY
Connector Color	GRAY

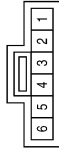

Terminal No.	Color of Wire	Signal Name
1	W	-
2	W	-
3	W	-

Connector No.	R3
Connector Name	VANITY MIRROR LAMP LH
Connector Color	WHITE



Terminal No.	Color of Wire	Signal Name
1	B	-
2	P	-

Connector No.	D7
Connector Name	MAIN POWER WINDOW AND DOOR LOCK/UNLOCK SWITCH
Connector Color	WHITE

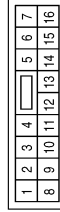

Terminal No.	Color of Wire	Signal Name
4	L	LOCK
6	R	UNLOCK
14	O	COM

Connector No.	D2
Connector Name	WIRE TO WIRE
Connector Color	WHITE

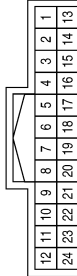

Terminal No.	Color of Wire	Signal Name
9	O	-

Connector No.	D1
Connector Name	WIRE TO WIRE
Connector Color	WHITE

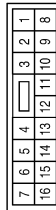

Terminal No.	Color of Wire	Signal Name
1	W	-
9	Y	-
10	B	-

A
B
C
D
E
F
G
H
I
J
K
INL
M
N
O
P

INTERIOR ROOM LAMP CONTROL SYSTEM

< COMPONENT DIAGNOSIS >

Connector No.	D11
Connector Name	FRONT STEP LAMP LH
Connector Color	WHITE



Terminal No.	Color of Wire	Signal Name
1	W	-
2	Y	-

Connector No.	D10
Connector Name	FRONT DOOR LOCK ASSEMBLY LH
Connector Color	GRAY

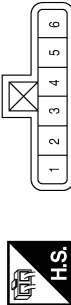

Terminal No.	Color of Wire	Signal Name
4	B	-
5	R	-
6	L	-

Connector No.	D8
Connector Name	MAIN POWER WINDOW AND DOOR LOCK/UNLOCK SWITCH
Connector Color	WHITE

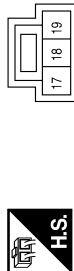

Terminal No.	Color of Wire	Signal Name
17	B	GND

Connector No.	D105
Connector Name	POWER WINDOW AND DOOR LOCK/UNLOCK SWITCH RH
Connector Color	WHITE

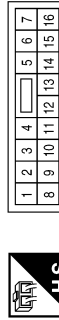

Terminal No.	Color of Wire	Signal Name
11	B	GND
16	R	COM

Connector No.	D102
Connector Name	WIRE TO WIRE
Connector Color	WHITE

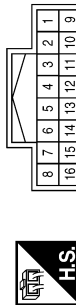

Terminal No.	Color of Wire	Signal Name
12	Y	-
13	W	-

Connector No.	D101
Connector Name	WIRE TO WIRE
Connector Color	WHITE



Terminal No.	Color of Wire	Signal Name
3	R	-
6	B	-

ABLIA0548GB

INTERIOR ROOM LAMP CONTROL SYSTEM

< COMPONENT DIAGNOSIS >

Connector No.	D206
Connector Name	REAR STEP LAMP LH
Connector Color	WHITE



Terminal No.	Color of Wire	Signal Name
1	W	-
2	Y	-

Connector No.	D201
Connector Name	WIRE TO WIRE
Connector Color	WHITE

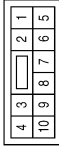

Terminal No.	Color of Wire	Signal Name
2	W	-
3	Y	-

Connector No.	D109
Connector Name	FRONT STEP LAMP RH
Connector Color	WHITE



Terminal No.	Color of Wire	Signal Name
1	W	-
2	Y	-

Connector No.	D306
Connector Name	WIRE TO WIRE
Connector Color	WHITE

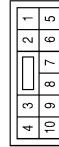

Terminal No.	Color of Wire	Signal Name
2	W	-
3	Y	-

Connector No.	D301
Connector Name	REAR STEP LAMP RH
Connector Color	WHITE



Terminal No.	Color of Wire	Signal Name
1	W	-
2	Y	-

ABLIA0549GB

A
B
C
D
E
F
G
H
I
J
K
INL
M
N
O
P

ILLUMINATION

< COMPONENT DIAGNOSIS >

ILLUMINATION

Wiring Diagram

INFOID:000000005461070

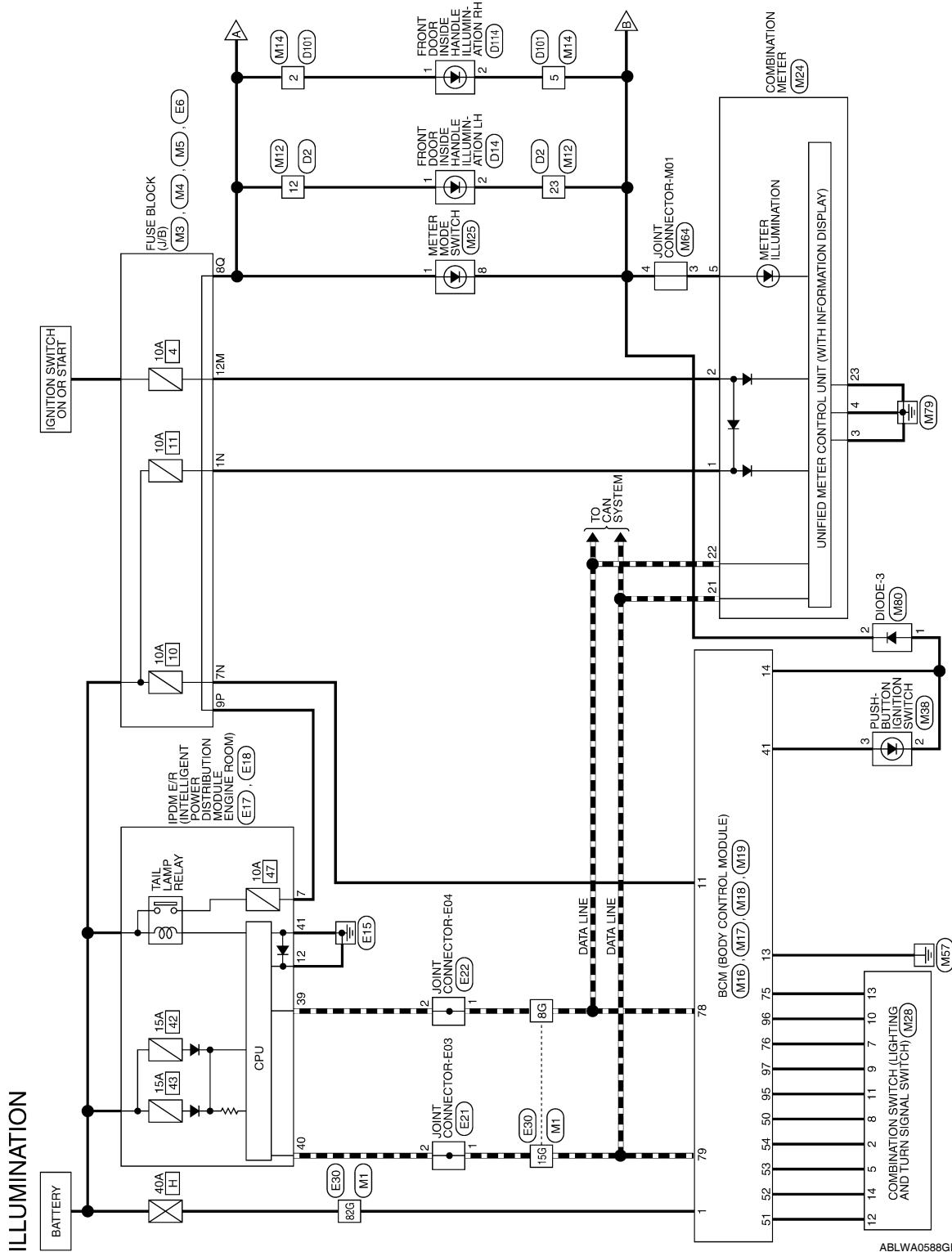

ABLWA0588GE

ILLUMINATION

< COMPONENT DIAGNOSIS >

- <AD> : WITH AUTOMATIC DRIVE POSITIONER
- <BA> : WITH BASE AUDIO SYSTEM
- <MC> : WITH MONOCHROME DISPLAY
- <N> : FOR CANADA
- <RN> : WITH REAR CONTROLS
- <SW> : WITH HEATED STEERING WHEEL
- <WB> : WITH BOSE AUDIO SYSTEM
- <XA> : WITHOUT AUTOMATIC DRIVE POSITIONER

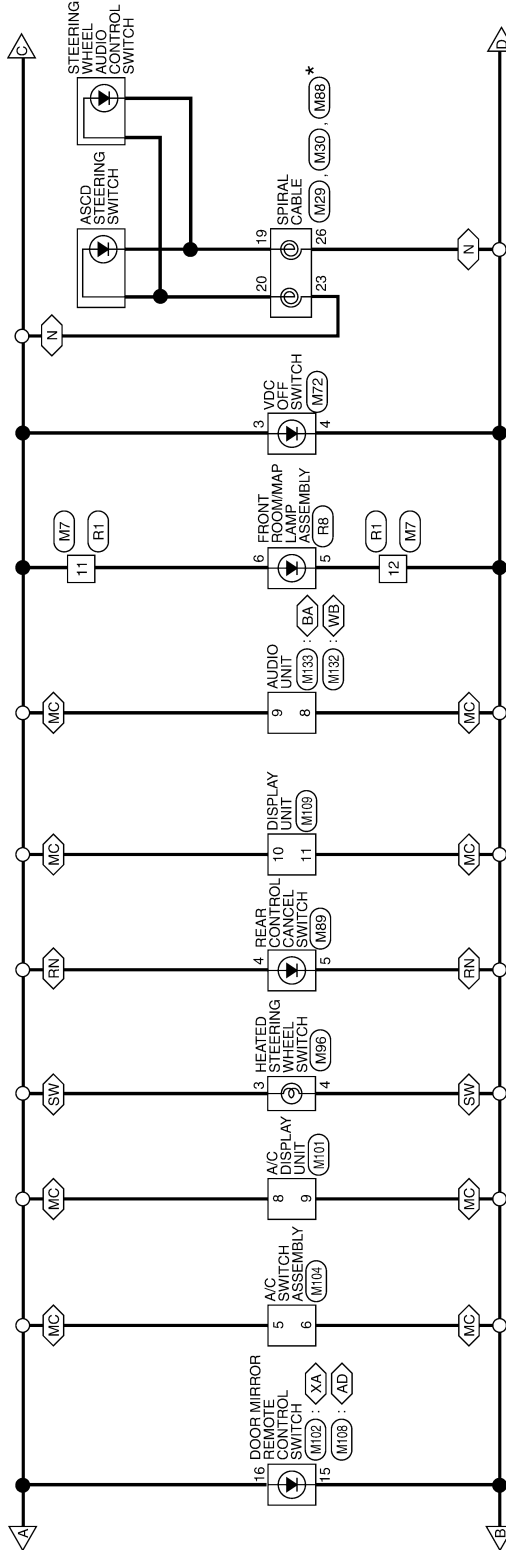

* : THIS CONNECTOR IS NOT SHOWN IN "HARNES LAYOUT" OF PG SECTION.

ABLWA0589GE

A
B
C
D
E
F
G
H
I
J
K
INL
M
N
O
P

ILLUMINATION

< COMPONENT DIAGNOSIS >

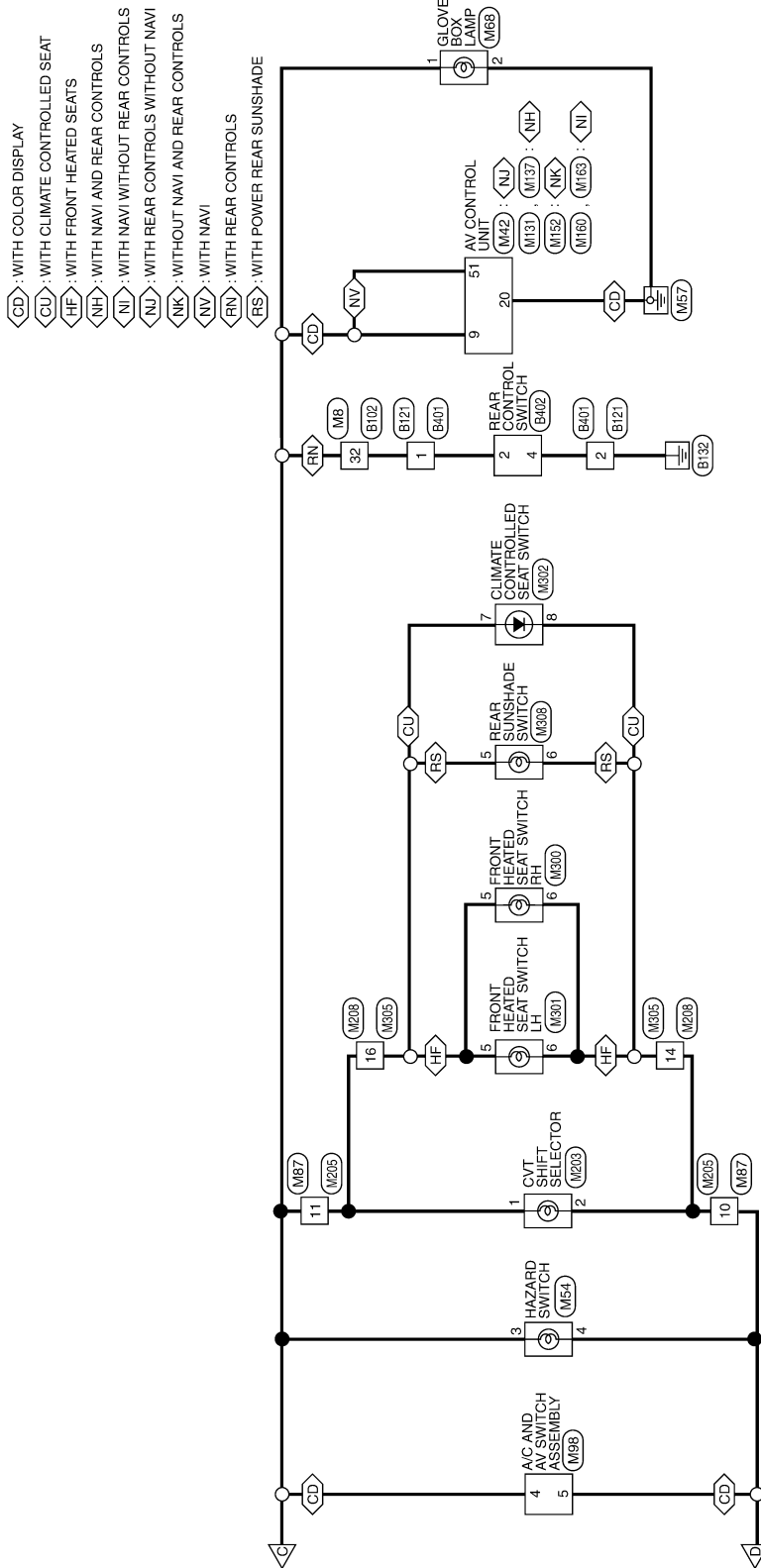

* : THIS CONNECTOR IS NOT SHOWN IN "HARNES LAYOUT" OF PG SECTION.

ABLWA0590GE

ILLUMINATION CONNECTORS

Connector No.	M1
Connector Name	WIRE TO WIRE
Connector Color	WHITE

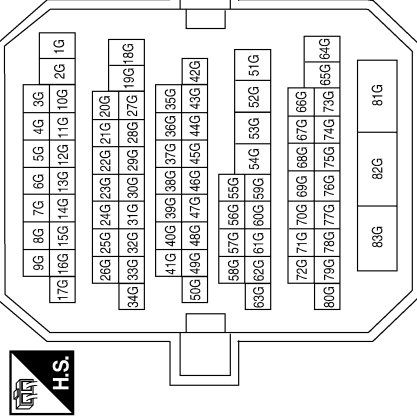

Terminal No.	Color of Wire	Signal Name
8G	P	-
15G	L	-
82G	W/B	-

Connector No.	M3
Connector Name	FUSE BLOCK (J/B)
Connector Color	WHITE

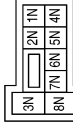

Terminal No.	Color of Wire	Signal Name
1N	W/L	-
7N	Y/R	-

Connector No.	M4
Connector Name	FUSE BLOCK (J/B)
Connector Color	WHITE

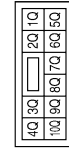

Terminal No.	Color of Wire	Signal Name
8Q	R/L	-

Connector No.	M5
Connector Name	FUSE BLOCK (J/B)
Connector Color	WHITE

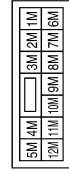

Terminal No.	Color of Wire	Signal Name
12M	O	-



ILLUMINATION

< COMPONENT DIAGNOSIS >

Connector No.	M12
Connector Name	WIRE TO WIRE
Connector Color	WHITE

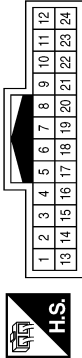

Terminal No.	Color of Wire	Signal Name
12	R/L	-
23	R/Y	-

Connector No.	M8
Connector Name	WIRE TO WIRE
Connector Color	WHITE



Terminal No.	Color of Wire	Signal Name
32	R/L	-

Connector No.	M7
Connector Name	WIRE TO WIRE
Connector Color	WHITE

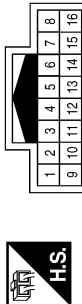

Terminal No.	Color of Wire	Signal Name
11	R/L	-
12	R/Y	-

Connector No.	M17
Connector Name	BCM (BODY CONTROL MODULE)
Connector Color	WHITE

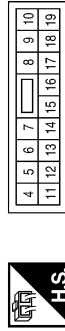

Terminal No.	Color of Wire	Signal Name
11	Y/R	BAT BCM FUSE
13	B	GND1
14	GR/W	LOW SIDE PUSH LED

Connector No.	M16
Connector Name	BCM (BODY CONTROL MODULE)
Connector Color	BLACK



Terminal No.	Color of Wire	Signal Name
1	W/B	BATT (F/L)

Connector No.	M14
Connector Name	WIRE TO WIRE
Connector Color	WHITE

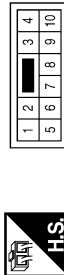

Terminal No.	Color of Wire	Signal Name
2	R/L	-
5	R/Y	-

ABLIA1740GB

ILLUMINATION

< COMPONENT DIAGNOSIS >

Connector No.	M24
Connector Name	COMBINATION METER
Connector Color	WHITE

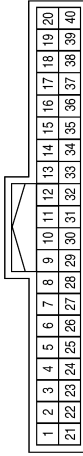
1	2	3	4	5	6	7	8	9	10	11	12	13	14	15	16	17	18	19	20
21	22	23	24	25	26	27	28	29	30	31	32	33	34	35	36	37	38	39	40

Connector No.	M19
Connector Name	BCM (BODY CONTROL MODULE)
Connector Color	BLACK

79	78	77	76	75	74	73	72	71	70	69	68	67	66	65	64	63	62	61	60
59	58	97	96	95	94	93	92	91	90	89	88	87	86	85	84	83	82	81	80

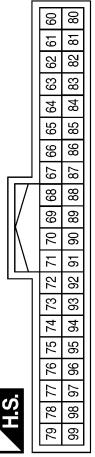
Connector No.	M18
Connector Name	BCM (BODY CONTROL MODULE)
Connector Color	GREEN

39	38	37	36	35	34	33	32	31	30	29	28	27	26	25	24	23	22	21	20
59	58	57	56	55	54	53	52	51	50	49	48	47	46	45	44	43	42	41	40

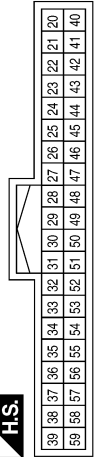
Terminal No.	Color of Wire	Signal Name
1	W/L	BAT
2	O	IGN
3	B	GND (POWER)
4	B	GND(ILL)
5	B	ILL CONT OUT
21	L	CAN H
22	P	CAN L
23	B	GND (CIRCUIT)

Terminal No.	Color of Wire	Signal Name
75	R/Y	INPUT 5
76	R/G	INPUT 3
78	P	CAN-L
79	L	CAN-H
95	R/W	INPUT 1
96	P/B	INPUT 4
97	R/B	INPUT 2

Terminal No.	Color of Wire	Signal Name
41	W	RING LED
50	LG/B	OUTPUT 5
51	L/W	OUTPUT 1
52	G/B	OUTPUT 2
53	LG/R	OUTPUT 3
54	G/Y	OUTPUT 4

Terminal No.	Color of Wire	Signal Name
2	G/Y	OUTPUT 4
5	LG/R	OUTPUT 3
7	R/G	INPUT 3
8	LG/B	OUTPUT 5
9	R/B	INPUT 2
10	P/B	INPUT 4
11	R/W	INPUT 1
12	L/W	OUTPUT 1
13	R/Y	INPUT 5
14	G/B	OUTPUT 2

Connector No.	M28
Connector Name	COMBINATION SWITCH
Connector Color	WHITE



1	2	3	4	5	6		
7	8	9	10	11	12	13	14

Connector No.	M25
Connector Name	METER MODE SWITCH
Connector Color	WHITE



1	2	3	4
5	6	7	8

Terminal No.	Color of Wire	Signal Name
1	R/L	SW ILL POWER
8	R/Y	SW ILL GND

ABLIA1741GB

A
B
C
D
E
F
G
H
I
J
K
L
M
N
O
P

INL

ILLUMINATION

< COMPONENT DIAGNOSIS >

Connector No.	M38
Connector Name	PUSH-BUTTON IGNITION SWITCH
Connector Color	BROWN

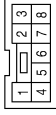

Terminal No.	Color of Wire	Signal Name
2	GR/W	-
3	W	-

Connector No.	M30
Connector Name	SPIRAL CABLE
Connector Color	GRAY

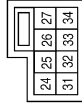

Terminal No.	Color of Wire	Signal Name
26	R/Y	ILL-

Connector No.	M29
Connector Name	SPIRAL CABLE
Connector Color	YELLOW



Terminal No.	Color of Wire	Signal Name
23	R/L	ILL+

Connector No.	M64
Connector Name	JOINT CONNECTOR-M01
Connector Color	WHITE



Terminal No.	Color of Wire	Signal Name
3	B	-
4	R/Y	-

Connector No.	M54
Connector Name	HAZARD SWITCH
Connector Color	WHITE



Terminal No.	Color of Wire	Signal Name
3	R/L	TAIL/ILL RLY
4	R/Y	ILL CONT OUT

Connector No.	M42
Connector Name	AV CONTROL UNIT (WITH REAR CONTROLS WITHOUT NAVI)
Connector Color	WHITE

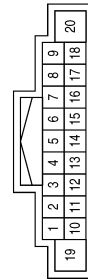

Terminal No.	Color of Wire	Signal Name
9	R/L	ILL
20	B	GND

ABLIA1742GB

ILLUMINATION

< COMPONENT DIAGNOSIS >

Connector No.	M80
Connector Name	DIODE-3
Connector Color	-



Terminal No.	Color of Wire	Signal Name
1	GR/W	-
2	R/Y	-

Connector No.	M72
Connector Name	VDC OFF SWITCH
Connector Color	GRAY

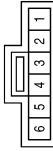

Terminal No.	Color of Wire	Signal Name
3	R/L	-
4	R/Y	-

Connector No.	M68
Connector Name	GLOVE BOX LAMP
Connector Color	BROWN



Terminal No.	Color of Wire	Signal Name
1	R/L	-
2	B	-

Connector No.	M89
Connector Name	REAR CONTROL CANCEL SWITCH
Connector Color	WHITE

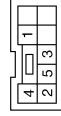

Terminal No.	Color of Wire	Signal Name
4	R/L	-
5	R/Y	-

Connector No.	M88
Connector Name	SPIRAL CABLE
Connector Color	GRAY

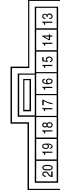

Terminal No.	Color of Wire	Signal Name
19	P	ILL -
20	Y	ILL +

Connector No.	M87
Connector Name	WIRE TO WIRE
Connector Color	BROWN

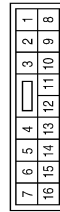

Terminal No.	Color of Wire	Signal Name
10	R/Y	-
11	R/L	-

ABLIA1743GB

A
B
C
D
E
F
G
H
I
J
K
INL
M
N
O
P

ILLUMINATION

< COMPONENT DIAGNOSIS >

Connector No.	M101
Connector Name	A/C DISPLAY UNIT
Connector Color	BLACK

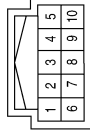

Terminal No.	Color of Wire	Signal Name
8	R/L	ILL+
9	R/Y	ILL-

Connector No.	M98
Connector Name	A/C AND AV SWITCH ASSEMBLY
Connector Color	WHITE

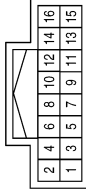

Terminal No.	Color of Wire	Signal Name
4	R/L	ILL+
5	R/Y	ILL CONT GND

Connector No.	M96
Connector Name	HEATED STEERING WHEEL SWITCH
Connector Color	WHITE



Terminal No.	Color of Wire	Signal Name
3	R/L	-
4	R/Y	-

Connector No.	M108
Connector Name	DOOR MIRROR REMOTE CONTROL SWITCH (WITH AUTOMATIC DRIVER POSITIONER)
Connector Color	BROWN

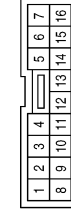

Terminal No.	Color of Wire	Signal Name
15	R/Y	-
16	R/L	-

Connector No.	M104
Connector Name	A/C SWITCH ASSEMBLY
Connector Color	WHITE

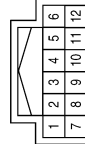

Terminal No.	Color of Wire	Signal Name
5	R/L	ILL+
6	R/Y	ILL-

Connector No.	M102
Connector Name	DOOR MIRROR REMOTE CONTROL SWITCH (WITHOUT AUTOMATIC DRIVER POSITIONER)
Connector Color	WHITE

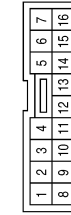

Terminal No.	Color of Wire	Signal Name
15	R/Y	-
16	R/L	-

ABLIA1744GB

ILLUMINATION

< COMPONENT DIAGNOSIS >

Connector No.	M132
Connector Name	AUDIO UNIT (WITH BOSE AUDIO SYSTEM)
Connector Color	WHITE

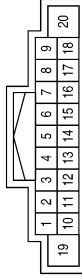

Terminal No.	Color of Wire	Signal Name
8	R/Y	ILL (-)
9	R/L	ILL (+), LIGHT SW

Connector No.	M131
Connector Name	AV CONTROL UNIT (WITH NAVI AND REAR CONTROLS)
Connector Color	WHITE

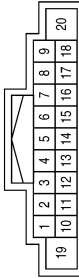

Terminal No.	Color of Wire	Signal Name
9	R/L	ILL

Connector No.	M109
Connector Name	DISPLAY UNIT (WITH MONOCHROME DISPLAY)
Connector Color	WHITE

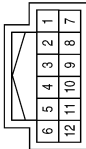

Terminal No.	Color of Wire	Signal Name
10	R/L	ILL+
11	R/Y	ILL-

Connector No.	M152
Connector Name	AV CONTROL UNIT (WITHOUT NAVI AND REAR CONTROLS)
Connector Color	WHITE

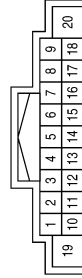

Terminal No.	Color of Wire	Signal Name
9	R/L	ILL
20	B	GND

Connector No.	M137
Connector Name	AV CONTROL UNIT (WITH NAVI AND REAR CONTROLS)
Connector Color	WHITE

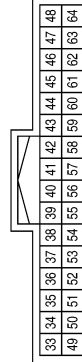

Terminal No.	Color of Wire	Signal Name
8	R/Y	MR OUTPUT

Connector No.	M133
Connector Name	AUDIO UNIT (WITH BASE AUDIO SYSTEM)
Connector Color	WHITE

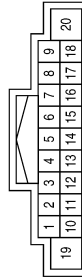

Terminal No.	Color of Wire	Signal Name
8	R/Y	ILL (-)
9	R/L	ILL (+), LIGHT SW

ABLIA1745GB

ILLUMINATION

< COMPONENT DIAGNOSIS >

Connector No.	M203
Connector Name	CVT SHIFT SELECTOR
Connector Color	BROWN



Terminal No.	Color of Wire	Signal Name
1	R/L	-
2	R/Y	-

Connector No.	M163
Connector Name	AV CONTROL UNIT (WITH NAVI WITHOUT REAR CONTROLS)
Connector Color	WHITE

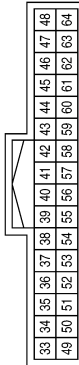

Terminal No.	Color of Wire	Signal Name
51	R/L	MR OUTPUT

Connector No.	M160
Connector Name	AV CONTROL UNIT (WITH NAVI WITHOUT REAR CONTROLS)
Connector Color	WHITE

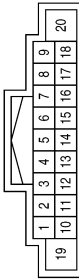

Terminal No.	Color of Wire	Signal Name
9	R/L	ILL
20	B	GND

Connector No.	M300
Connector Name	FRONT HEATED SEAT SWITCH RH
Connector Color	BROWN



Terminal No.	Color of Wire	Signal Name
5	L	-
6	Y	-

Connector No.	M208
Connector Name	WIRE TO WIRE
Connector Color	WHITE



Terminal No.	Color of Wire	Signal Name
14	R/Y	-
16	R/L	-

Connector No.	M205
Connector Name	WIRE TO WIRE
Connector Color	BROWN

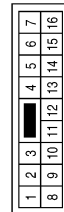

Terminal No.	Color of Wire	Signal Name
10	R/Y	-
11	R/L	-

ABLIA1746GB

ILLUMINATION

< COMPONENT DIAGNOSIS >

Connector No.	M305
Connector Name	WIRE TO WIRE
Connector Color	WHITE

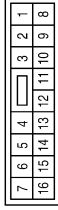

Terminal No.	Color of Wire	Signal Name
14	Y	-
16	L	-

Connector No.	M302
Connector Name	CLIMATE CONTROLLED SEAT SWITCH
Connector Color	WHITE

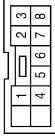

Terminal No.	Color of Wire	Signal Name
7	L	-
8	Y	-

Connector No.	M301
Connector Name	FRONT HEATED SEAT SWITCH LH
Connector Color	WHITE



Terminal No.	Color of Wire	Signal Name
5	L	-
6	Y	-

Connector No.	E17
Connector Name	IPDM E/R (INTELLIGENT POWER DISTRIBUTION MODULE ENGINE ROOM)
Connector Color	WHITE

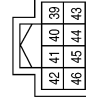

Terminal No.	Color of Wire	Signal Name
39	P	CAN-L
40	L	CAN-H
41	B	GND (SIGNAL)

Connector No.	E6
Connector Name	FUSE BLOCK (J/B)
Connector Color	WHITE



Terminal No.	Color of Wire	Signal Name
9P	GR	-

Connector No.	M308
Connector Name	REAR SUNSHADE SWITCH
Connector Color	WHITE



Terminal No.	Color of Wire	Signal Name
5	L	-
6	Y	-

ABLIA1747GB

A
B
C
D
E
F
G
H
I
J
K
L
M
N
O
P

INL

ILLUMINATION

< COMPONENT DIAGNOSIS >

Connector No.	E18
Connector Name	IPDM E/R (INTELLIGENT POWER DISTRIBUTION MODULE ENGINE ROOM)
Connector Color	WHITE

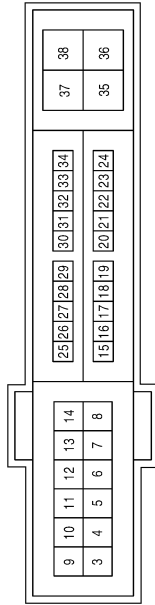

Terminal No.	Color of Wire	Signal Name
7	GR	TAIL/ILLUMI
12	B	GND (POWER)

Connector No.	E21
Connector Name	JOINT CONNECTOR-E03
Connector Color	WHITE



Terminal No.	Color of Wire	Signal Name
1	L	-
2	L	-

Connector No.	E22
Connector Name	JOINT CONNECTOR-E04
Connector Color	WHITE



Connector No.	E30
Connector Name	WIRE TO WIRE
Connector Color	WHITE

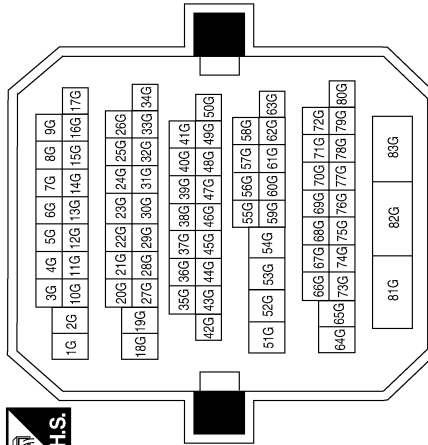

Terminal No.	Color of Wire	Signal Name
1	P	-
2	P	-

Terminal No.	Color of Wire	Signal Name
8G	P	-
15G	L	-
82G	LG	-

ILLUMINATION

< COMPONENT DIAGNOSIS >

Connector No.	B401
Connector Name	WIRE TO WIRE
Connector Color	WHITE

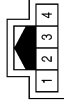

Terminal No.	Color of Wire	Signal Name
1	R/L	-
2	B	-

Connector No.	B121
Connector Name	WIRE TO WIRE
Connector Color	WHITE

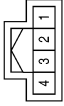

Terminal No.	Color of Wire	Signal Name
1	P	-
2	B	-

Connector No.	B102
Connector Name	WIRE TO WIRE
Connector Color	WHITE



Terminal No.	Color of Wire	Signal Name
32	P	-

Connector No.	R8
Connector Name	FRONT ROOM/MAP LAMP ASSEMBLY
Connector Color	GRAY

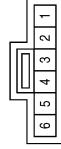

Terminal No.	Color of Wire	Signal Name
5	R/Y	-
6	R/L	-

Connector No.	R1
Connector Name	WIRE TO WIRE
Connector Color	WHITE

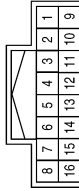

Terminal No.	Color of Wire	Signal Name
11	R/L	-
12	R/Y	-

Connector No.	B402
Connector Name	REAR CONTROL SWITCH
Connector Color	WHITE

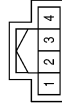

Terminal No.	Color of Wire	Signal Name
2	R/L	-
4	B	-

A
B
C
D
E
F
G
H
I
J
K
INL
M
N
O
P

ILLUMINATION

< COMPONENT DIAGNOSIS >

Connector No.	D2
Connector Name	WIRE TO WIRE
Connector Color	WHITE

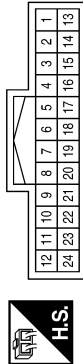

Terminal No.	Color of Wire	Signal Name
12	L	-
23	Y	-

Connector No.	D14
Connector Name	FRONT DOOR INSIDE HANDLE ILLUMINATION LH
Connector Color	GRAY



Terminal No.	Color of Wire	Signal Name
1	L	-
2	Y	-

Connector No.	D101
Connector Name	WIRE TO WIRE
Connector Color	WHITE



Terminal No.	Color of Wire	Signal Name
2	L	-
5	Y	-

Connector No.	D114
Connector Name	FRONT DOOR INSIDE HANDLE ILLUMINATION RH
Connector Color	GRAY



Terminal No.	Color of Wire	Signal Name
1	L	-
2	Y	-

ABLIA1750GB

BCM (BODY CONTROL MODULE)

< ECU DIAGNOSIS >

ECU DIAGNOSIS

BCM (BODY CONTROL MODULE)

Reference Value

INFOID:000000005530121

VALUES ON THE DIAGNOSIS TOOL

Monitor Item	Condition	Value/Status
FR WIPER HI	Other than front wiper switch HI	OFF
	Front wiper switch HI	ON
FR WIPER LOW	Other than front wiper switch LO	OFF
	Front wiper switch LO	ON
FR WASHER SW	Front washer switch OFF	OFF
	Front washer switch ON	ON
FR WIPER INT	Other than front wiper switch INT	OFF
	Front wiper switch INT	ON
FR WIPER STOP	Front wiper is not in STOP position	OFF
	Front wiper is in STOP position	ON
INT VOLUME	Wiper intermittent dial is in a dial position 1 - 7	Wiper intermittent dial position
TURN SIGNAL R	Other than turn signal switch RH	OFF
	Turn signal switch RH	ON
TURN SIGNAL L	Other than turn signal switch LH	OFF
	Turn signal switch LH	ON
TAIL LAMP SW	Other than lighting switch 1ST and 2ND	OFF
	Lighting switch 1ST or 2ND	ON
HI BEAM SW	Other than lighting switch HI	OFF
	Lighting switch HI	ON
HEAD LAMP SW 1	Other than lighting switch 2ND	OFF
	Lighting switch 2ND	ON
HEAD LAMP SW 2	Other than lighting switch 2ND	OFF
	Lighting switch 2ND	ON
PASSING SW	Other than lighting switch PASS	OFF
	Lighting switch PASS	ON
AUTO LIGHT SW	Other than lighting switch AUTO	OFF
	Lighting switch AUTO	ON
FR FOG SW	Front fog lamp switch OFF	OFF
	Front fog lamp switch ON	ON
DOOR SW-DR	Driver door closed	OFF
	Driver door opened	ON
DOOR SW-AS	Passenger door closed	OFF
	Passenger door opened	ON
DOOR SW-RR	Rear door RH closed	OFF
	Rear door RH opened	ON
DOOR SW-RL	Rear door LH closed	OFF
	Rear door LH opened	ON

BCM (BODY CONTROL MODULE)

< ECU DIAGNOSIS >

Monitor Item	Condition	Value/Status
CDL LOCK SW	Other than power door lock switch LOCK	OFF
	Power door lock switch LOCK	ON
CDL UNLOCK SW	Other than power door lock switch UNLOCK	OFF
	Power door lock switch UNLOCK	ON
KEY CYL LK-SW	Other than driver door key cylinder LOCK position	OFF
	Driver door key cylinder LOCK position	ON
KEY CYL UN-SW	Other than driver door key cylinder UNLOCK position	OFF
	Driver door key cylinder UNLOCK position	ON
HAZARD SW	When hazard switch is not pressed	OFF
	When hazard switch is pressed	ON
REAR DEF SW	When rear window defogger switch is pressed	ON
TR CANCEL SW	Trunk lid opener cancel switch OFF	OFF
	Trunk lid opener cancel switch ON	ON
TR/BD OPEN SW	Trunk lid opener switch OFF	OFF
	While the trunk lid opener switch is turned ON	ON
TRNK/HAT MNTR	Trunk lid closed	OFF
	Trunk lid opened	ON
RKE-LOCK	When LOCK button of Intelligent Key is not pressed	OFF
	When LOCK button of Intelligent Key is pressed	ON
RKE-UNLOCK	When UNLOCK button of Intelligent Key is not pressed	OFF
	When UNLOCK button of Intelligent Key is pressed	ON
RKE-TR/BD	When TRUNK OPEN button of Intelligent Key is not pressed	OFF
	When TRUNK OPEN button of Intelligent Key is pressed	ON
RKE-PANIC	When PANIC button of Intelligent Key is not pressed	OFF
	When PANIC button of Intelligent Key is pressed	ON
RKE-P/W OPEN	When UNLOCK button of Intelligent Key is not pressed and held	OFF
	When UNLOCK button of Intelligent Key is pressed and held	ON
RKE-MODE CHG	When LOCK/UNLOCK button of Intelligent Key is not pressed and held simultaneously	OFF
	When LOCK/UNLOCK button of Intelligent Key is pressed and held simultaneously	ON
OPTICAL SENSOR	When outside of the vehicle is bright	Close to 5 V
	When outside of the vehicle is dark	Close to 0 V
REQ SW-DR	When front door request switch is not pressed (driver side)	OFF
	When front door request switch is pressed (driver side)	ON
REQ SW-AS	When front door request switch is not pressed (passenger side)	OFF
	When front door request switch is pressed (passenger side)	ON
REQ SW-RL	When rear door request switch is not pressed (driver side)	OFF
	When rear door request switch is pressed (driver side)	ON
REQ SW-RR	When rear door request switch is not pressed (passenger side)	OFF
	When rear door request switch is pressed (passenger side)	ON
REQ SW-BD/TR	When trunk request switch is not pressed	OFF
	When trunk request switch is pressed	ON
PUSH SW	When engine switch (push switch) is not pressed	OFF
	When engine switch (push switch) is pressed	ON

BCM (BODY CONTROL MODULE)

< ECU DIAGNOSIS >

Monitor Item	Condition	Value/Status	
IGN RLY 2-F/B	Ignition switch OFF or ACC	OFF	A
	Ignition switch ON	ON	
ACC RLY-F/B	Ignition switch OFF	OFF	B
	Ignition switch ACC or ON	ON	
BRAKE SW 1	When the brake pedal is not depressed	ON	C
	When the brake pedal is depressed	OFF	
DETE/CANCL SW	When selector lever is in P position	OFF	D
	When selector lever is in any position other than P	ON	
SFT PN/N SW	When selector lever is in any position other than P or N	OFF	E
	When selector lever is in P or N position	ON	
S/L-LOCK*	Electronic steering column lock LOCK status	OFF	F
	Electronic steering column lock UNLOCK status	ON	
S/L-UNLOCK*	Electronic steering column lock UNLOCK status	OFF	G
	Electronic steering column lock LOCK status	ON	
S/L RELAY-F/B*	Ignition switch OFF or ACC	OFF	H
	Ignition switch ON	ON	
UNLK SEN-DR	Driver door UNLOCK status	OFF	I
	Driver door LOCK status	ON	
PUSH SW-IPDM	When engine switch (push switch) is not pressed	OFF	J
	When engine switch (push switch) is pressed	ON	
IGN RLY1 F/B	Ignition switch OFF or ACC	OFF	K
	Ignition switch ON	ON	
DETE SW -IPDM	When selector lever is in P position	OFF	
	When selector lever is in any position other than P	ON	
SFT PN -IPDM	When selector lever is in any position other than P or N	OFF	
	When selector lever is in P or N position	ON	
SFT P-MET	When selector lever is in any position other than P	OFF	
	When selector lever is in P position	ON	
SFT N-MET	When selector lever is in any position other than N	OFF	INL
	When selector lever is in N position	ON	
ENGINE STATE	Engine stopped	STOP	M
	While the engine stalls	STALL	
	At engine cranking	CRANK	
	Engine running	RUN	N
S/L LOCK-IPDM*	Electronic steering column lock LOCK status	OFF	O
	Electronic steering column lock UNLOCK status	ON	
S/L UNLK-IPDM*	Electronic steering column lock UNLOCK status	OFF	P
	Electronic steering column lock LOCK status	ON	
S/L RELAY-REQ*	Ignition switch OFF or ACC	OFF	
	Ignition switch ON	ON	
VEH SPEED 1	While driving	Equivalent to speedometer reading	
VEH SPEED 2	While driving	Equivalent to speedometer reading	

BCM (BODY CONTROL MODULE)

< ECU DIAGNOSIS >

Monitor Item	Condition	Value/Status
DOOR STAT-DR	Driver door LOCK status	LOCK
	Wait with selective UNLOCK operation (5 seconds)	READY
	Driver door UNLOCK status	UNLK
DOOR STAT-AS	Passenger door LOCK status	LOCK
	Wait with selective UNLOCK operation (5 seconds)	READY
	Passenger door UNLOCK status	UNLK
ID OK FLAG	Ignition switch ACC or ON	RESET
	Ignition switch OFF	SET
PRMT ENG STRT	When the engine start is prohibited	RESET
	When the engine start is permitted	SET
KEY SW -SLOT	When Intelligent Key is not inserted into key slot	OFF
	When Intelligent Key is inserted into key slot	ON
RKE OPE COUN1	During the operation of Intelligent Key	Operation frequency of Intelligent Key
CONFIRM ID ALL	The key ID that the key slot receives does not accord with any key ID registered to BCM.	YET
	The key ID that the key slot receives accords with any key ID registered to BCM.	DONE
CONFIRM ID4	The key ID that the key slot receives does not accord with the fourth key ID registered to BCM.	YET
	The key ID that the key slot receives accords with the fourth key ID registered to BCM.	DONE
CONFIRM ID3	The key ID that the key slot receives does not accord with the third key ID registered to BCM.	YET
	The key ID that the key slot receives accords with the third key ID registered to BCM.	DONE
CONFIRM ID2	The key ID that the key slot receives does not accord with the second key ID registered to BCM.	YET
	The key ID that the key slot receives accords with the second key ID registered to BCM.	DONE
CONFIRM ID1	The key ID that the key slot receives does not accord with the first key ID registered to BCM.	YET
	The key ID that the key slot receives accords with the first key ID registered to BCM.	DONE
TP 4	The ID of fourth key is not registered to BCM	YET
	The ID of fourth key is registered to BCM	DONE
TP 3	The ID of third key is not registered to BCM	YET
	The ID of third key is registered to BCM	DONE
TP 2	The ID of second key is not registered to BCM	YET
	The ID of second key is registered to BCM	DONE
TP 1	The ID of first key is not registered to BCM	YET
	The ID of first key is registered to BCM	DONE
AIR PRESS FL	Ignition switch ON (only when the signal from the transmitter is received)	Air pressure of front LH tire
AIR PRESS FR	Ignition switch ON (only when the signal from the transmitter is received)	Air pressure of front RH tire
AIR PRESS RR	Ignition switch ON (only when the signal from the transmitter is received)	Air pressure of rear RH tire
AIR PRESS RL	Ignition switch ON (only when the signal from the transmitter is received)	Air pressure of rear LH tire

BCM (BODY CONTROL MODULE)

< ECU DIAGNOSIS >

Monitor Item	Condition	Value/Status	
ID REGST FL1	When ID of front LH tire transmitter is registered	DONE	A
	When ID of front LH tire transmitter is not registered	YET	
ID REGST FR1	When ID of front RH tire transmitter is registered	DONE	B
	When ID of front RH tire transmitter is not registered	YET	
ID REGST RR1	When ID of rear RH tire transmitter is registered	DONE	C
	When ID of rear RH tire transmitter is not registered	YET	
ID REGST RL1	When ID of rear LH tire transmitter is registered	DONE	D
	When ID of rear LH tire transmitter is not registered	YET	
WARNING LAMP	Tire pressure indicator OFF	OFF	E
	Tire pressure indicator ON	ON	
BUZZER	Tire pressure warning alarm is not sounding	OFF	F
	Tire pressure warning alarm is sounding	ON	

* : With electronic steering column lock

A
B
C
D
E
F
G
H
I
J
K
L
M
N
O
P

INL

BCM (BODY CONTROL MODULE)

< ECU DIAGNOSIS >

Terminal Layout

INFOID:000000005530122

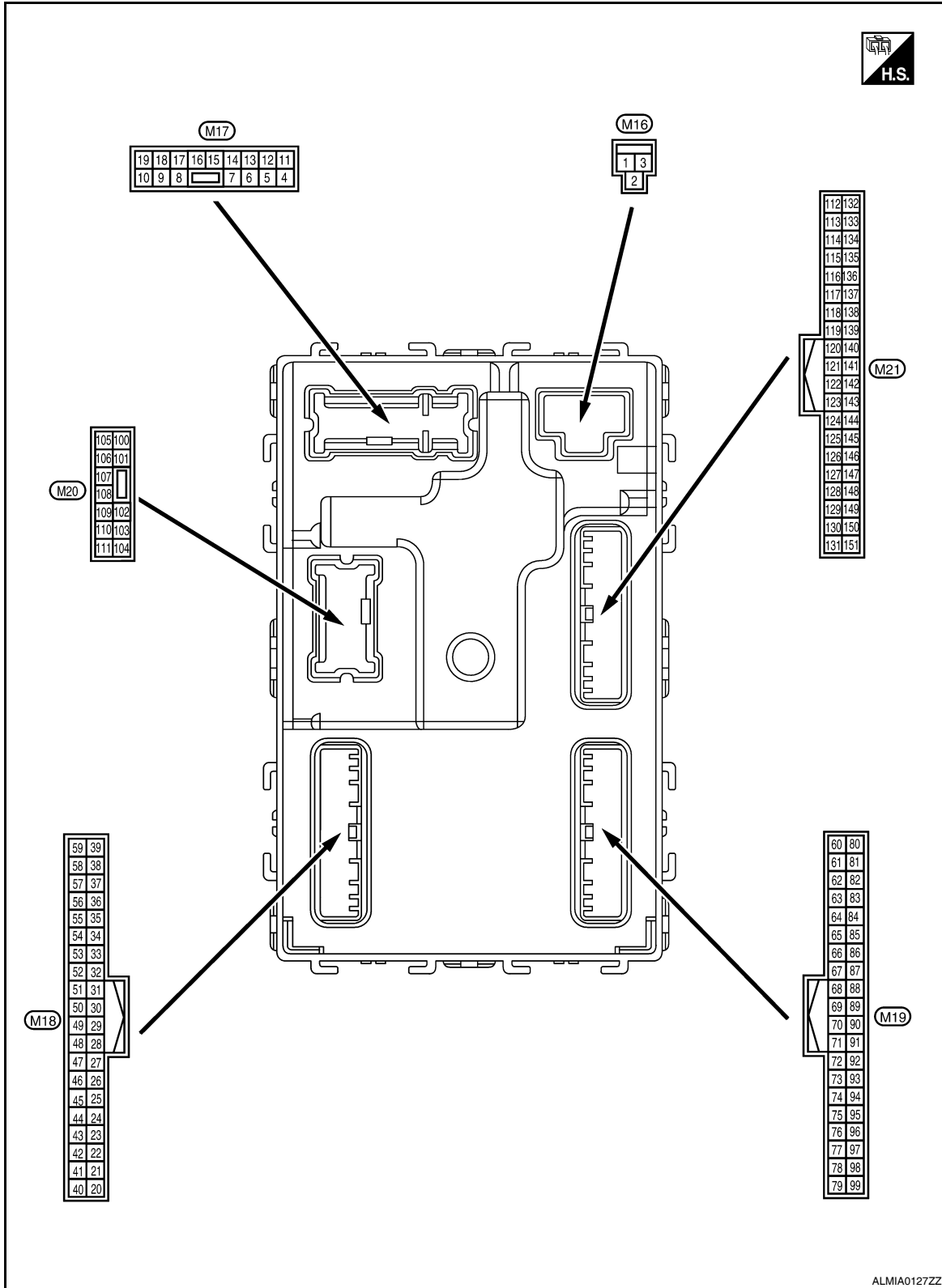

Physical Values

INFOID:000000005530123

BCM (BODY CONTROL MODULE)

< ECU DIAGNOSIS >

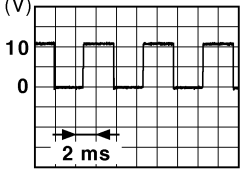
Terminal No. (Wire color)		Description		Condition		Value (Approx.)
(+)	(-)	Signal name	Input/ Output			
1 (W/B)	Ground	Battery power supply	Input	Ignition switch OFF		Battery voltage
2 (R/Y)	Ground	Battery power supply output	Output	Ignition switch OFF		Battery voltage
3 (L/W)	Ground	Ignition power supply output	Output	Ignition switch ON		Battery voltage
4 (P/W)	Ground	Interior room lamp power supply	Output	After passing the interior room lamp battery saver operation time		0V
				Any other time after passing the interior room lamp battery saver operation time		Battery voltage
5 (G)	Ground	Front door RH UNLOCK	Output	Front door RH	UNLOCK (actuator is activated)	Battery voltage
					Other than UNLOCK (actuator is not activated)	0V
7 (R/W)	Ground	Step lamp	Output	Step lamp	ON	0V
					OFF	Battery voltage
8 (V)	Ground	All doors LOCK	Output	All doors	LOCK (actuator is activated)	Battery voltage
					Other than LOCK (actuator is not activated)	0V
9 (L)	Ground	Front door LH UNLOCK	Output	Front door LH	UNLOCK (actuator is activated)	Battery voltage
					Other than UNLOCK (actuator is not activated)	0V
10 (G)	Ground	Rear door RH and rear door LH UNLOCK	Output	Rear door RH and rear door LH	UNLOCK (actuator is activated)	Battery voltage
					Other than UNLOCK (actuator is not activated)	0V
11 (Y/R)	Ground	Battery power supply	Input	Ignition switch OFF		Battery voltage
13 (B)	Ground	Ground	—	Ignition switch ON		0V
14 (GR/W)	Ground	Engine switch (push switch) illumination ground	Input	Tail lamp	OFF	0V
					ON	<p>NOTE: When the illumination brightening/dimming level is in the neutral position</p>  <p style="text-align: right;"><small>JSNIA0010GB</small></p>
15 (Y/L)	Ground	ACC indicator lamp	Output	Ignition switch	OFF	Battery voltage
					ACC or ON	0V

A
B
C
D
E
F
G
H
I
J
K
INL
M
N
O
P

BCM (BODY CONTROL MODULE)

< ECU DIAGNOSIS >

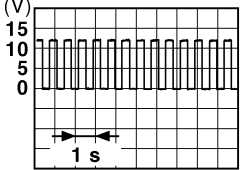
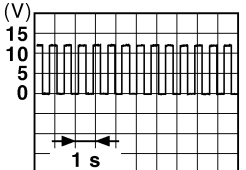
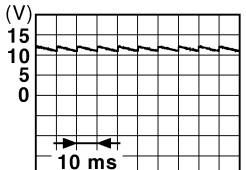
Terminal No. (Wire color)		Description		Condition	Value (Approx.)
(+)	(-)	Signal name	Input/ Output		
17 (G/B)	Ground	Turn signal (RH)	Output	Ignition switch ON	Turn signal switch OFF 0V
				Turn signal switch RH	 6.5 V PKID0926E
18 (G/Y)	Ground	Turn signal (LH)	Output	Ignition switch ON	Turn signal switch OFF 0V
				Turn signal switch LH	 6.5 V PKID0926E
19 (Y)	Ground	Room lamp timer control	Output	Interior room lamp	OFF Battery voltage
				ON	0V
21 (P/B)	Ground	Optical sensor signal	Input	Ignition switch ON	When outside of the vehicle is bright Close to 5V
				When outside of the vehicle is dark Close to 0V	
24 (R/W)	Ground	Stop lamp switch 1	Input	—	Battery voltage
26 (O/L)	Ground	Stop lamp switch 2	Input	Stop lamp switch	OFF (brake pedal is released) 0V
				ON (brake pedal is depressed) Battery voltage	
27 (O)	Ground	Front door lock assembly LH (unlock sensor)	Input	Front door LH	LOCK status  11.8V JPMIA0011GB
				UNLOCK status 0V	
29 (Y)	Ground	Key slot switch	Input	When Intelligent Key is inserted into key slot Battery voltage	
				When Intelligent Key is not inserted into key slot 0V	
30 (V/Y)	Ground	ACC feedback signal	Input	Ignition switch	OFF 0
				ACC or ON Battery voltage	
31 (G)	Ground	Rear window defogger feedback signal	Input	Rear window defogger switch	OFF 0V
				ON Battery voltage	

BCM (BODY CONTROL MODULE)

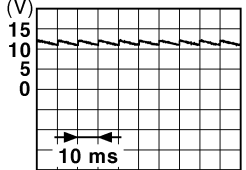
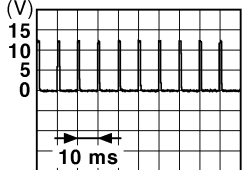
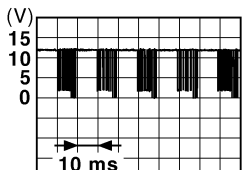

< ECU DIAGNOSIS >

Terminal No. (Wire color)		Description		Condition		Value (Approx.)
(+)	(-)	Signal name	Input/ Output			
32 (R/B)	Ground	Front door RH switch	Input	Front door RH switch	OFF (when front door RH closes)	 <p style="text-align: right; font-size: small;">JPMIA0011GB</p> <p style="text-align: center;">11.8 V</p>
					ON (when front door RH opens)	0V
37 (O)	Ground	Trunk lid opener cancel switch	Input	Trunk lid opener cancel switch	CANCEL	 <p style="text-align: right; font-size: small;">JPMIA0012GB</p> <p style="text-align: center;">1.1V</p>
					ON	0V
38 (GR/W)	Ground	Rear window defogger ON signal	Input	Rear window defogger switch	OFF	5V
					ON	0V
40 (Y/G)	Ground	Power window serial link	Input/ Output	Ignition switch ON	 <p style="text-align: right; font-size: small;">JPMIA0013GB</p> <p style="text-align: center;">10.2V</p>	
				Ignition switch OFF or ACC	0V	
41 (W)	Ground	Engine switch (push switch) illumination	Output	Engine switch (push switch) illumination	ON	5.5V
				OFF	0V	
42 (R)	Ground	LOCK indicator lamp	Output	LOCK indicator lamp	ON	0V
				OFF	Battery voltage	
45 (P)	Ground	Receiver & sensor ground	Input	Ignition switch ON	0V	
46 (V/W)	Ground	Receiver & sensor power supply output	Output	Ignition switch	OFF	0V
				ACC or ON	5.0V	

A
B
C
D
E
F
G
H
I
J
K
INL
M
N
O
P

BCM (BODY CONTROL MODULE)

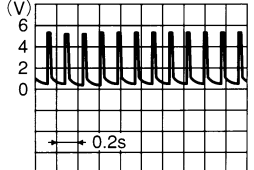
< ECU DIAGNOSIS >

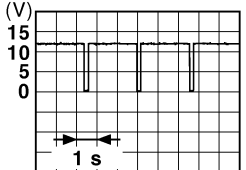
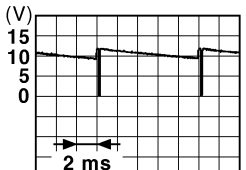
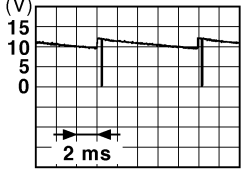
Terminal No. (Wire color)		Description		Condition	Value (Approx.)
(+)	(-)	Signal name	Input/ Output		
47 ¹ (G/O)	Ground	Tire pressure receiver signal	Input/ Output	Ignition switch ON	Standby state  OCC3881D
				When receiving the signal from the transmitter  OCC3880D	
48 (R/G)	Ground	Selector lever transmission range switch signal	Input	Selector lever	P or N position: 12.0V Except P and N positions: 0V
					ON: 0V
49 (L/O)	Ground	Security indicator signal	Output	Security indicator	Blinking  JPMIA0014GB 11.3V
					OFF: Battery voltage
50 (LG/B)	Ground	Combination switch OUTPUT 5	Output	Combination switch (Wiper intermittent dial 4)	All switch OFF: 0V Lighting switch 1ST Lighting switch high-beam Lighting switch 2ND Turn signal switch RH  JPMIA0031GB 10.7V
51 (L/W)	Ground	Combination switch OUTPUT 1	Output	Combination switch	All switch OFF (Wiper intermittent dial 4): 0V Front wiper switch HI (Wiper intermittent dial 4) Any of the conditions below with all switch OFF: • Wiper intermittent dial 1 • Wiper intermittent dial 2 • Wiper intermittent dial 3 • Wiper intermittent dial 6 • Wiper intermittent dial 7  JPMIA0032GB 10.7V

BCM (BODY CONTROL MODULE)

< ECU DIAGNOSIS >

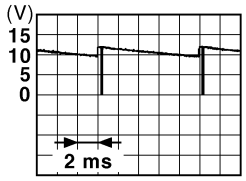
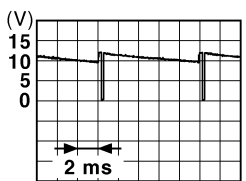
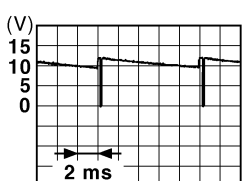
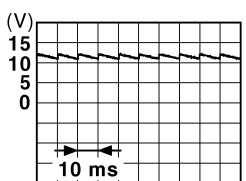
Terminal No. (Wire color)		Description		Condition	Value (Approx.)		
		Signal name	Input/ Output				
(+)	(-)						
52 (G/B)	Ground	Combination switch OUTPUT 2	Output	Combination switch	All switch OFF (Wiper intermittent dial 4)	0V	
					Front washer switch ON (Wiper intermittent dial 4)		
					Any of the conditions below with all switch OFF		
					<ul style="list-style-type: none"> • Wiper intermittent dial 1 • Wiper intermittent dial 5 • Wiper intermittent dial 6 		
					10.7V		
53 (LG/ R)	Ground	Combination switch OUTPUT 3	Output	Combination switch (Wiper intermit- tent dial 4)	All switch OFF	0V	
					Front wiper switch INT		
					Front wiper switch LO		
					Lighting switch AUTO		
					10.7V		
54 (G/Y)	Ground	Combination switch OUTPUT 4	Output	Combination switch (Wiper intermit- tent dial 4)	All switch OFF	0V	
					Front fog lamp switch ON		
					Lighting switch 2ND		
					Lighting switch flash-to- pass		
					10.7V		
57 ¹ (W)	Ground	Tire pressure warn- ing check switch	Input	—	5V		
58 (SB)	Ground	Front door LH switch	Input	Front door LH switch	OFF (front door LH CLOSE)		
					ON (front door LH OPEN)		0V
					11.8V		
59 (G/R)	Ground	Rear window defog- ger relay	Output	Rear window de- fogger	Active	Battery voltage	
					Not activated	0V	

A
B
C
D
E
F
G
H
I
J
K
L
M
N
O
P

INL

BCM (BODY CONTROL MODULE)

< ECU DIAGNOSIS >

Terminal No. (Wire color)		Description		Condition	Value (Approx.)
(+)	(-)	Signal name	Input/ Output		
60 (B/R)	Ground	Front console antenna 2 (-)	Output	Ignition switch OFF	<p style="text-align: right; font-size: small;">JMKIA0062GB</p>
				When Intelligent Key is not in the passenger compartment	<p style="text-align: right; font-size: small;">JMKIA0063GB</p>
61 (W/R)	Ground	Center console antenna 2 (+)	Output	Ignition switch OFF	<p style="text-align: right; font-size: small;">JMKIA0062GB</p>
				When Intelligent Key is not in the passenger compartment	<p style="text-align: right; font-size: small;">JMKIA0063GB</p>
62 (V)	Ground	Front outside handle RH antenna (-)	Output	When the front door RH request switch is operated with ignition switch OFF	<p style="text-align: right; font-size: small;">JMKIA0062GB</p>
				When Intelligent Key is not in the antenna detection area	<p style="text-align: right; font-size: small;">JMKIA0063GB</p>

BCM (BODY CONTROL MODULE)

< ECU DIAGNOSIS >





Terminal No. (Wire color)		Description		Condition	Value (Approx.)
(+)	(-)	Signal name	Input/ Output		
63 (P)	Ground	Front outside handle RH antenna (+)	Output	When the front door RH request switch is operated with ignition switch OFF	<p style="text-align: right; font-size: small;">JMKIA0062GB</p>
				When Intelligent Key is not in the antenna detection area	<p style="text-align: right; font-size: small;">JMKIA0063GB</p>
64 (V)	Ground	Front outside handle LH antenna (-)	Output	When the front door LH request switch is operated with ignition switch OFF	<p style="text-align: right; font-size: small;">JMKIA0062GB</p>
				When Intelligent Key is not in the antenna detection area	<p style="text-align: right; font-size: small;">JMKIA0063GB</p>
65 (P)	Ground	Front outside handle LH antenna (+)	Output	When the front door LH request switch is operated with ignition switch OFF	<p style="text-align: right; font-size: small;">JMKIA0062GB</p>
				When Intelligent Key is not in the antenna detection area	<p style="text-align: right; font-size: small;">JMKIA0063GB</p>

A
B
C
D
E
F
G
H
I
J
K
M
N
O
P

INL

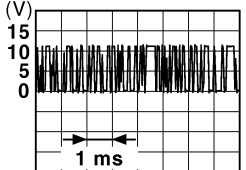
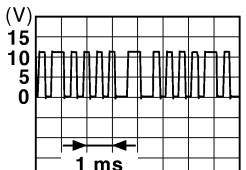

BCM (BODY CONTROL MODULE)

< ECU DIAGNOSIS >

Terminal No. (Wire color)		Description		Condition		Value (Approx.)
		Signal name	Input/ Output			
(+)	(-)					
68 (G/O)	Ground	NATS antenna amp (built in key slot)	Input/ Output	During waiting	Ignition switch is pressed while inserting the Intelli- gent Key into the key slot.	Just after pressing ignition switch. Pointer of tester should move.
69 (O)	Ground	NATS antenna amp (built in key slot)	Input/ Output	During waiting	Ignition switch is pressed while inserting the Intelli- gent Key into the key slot.	Just after pressing ignition switch. Pointer of tester should move.
70 (R/B)	Ground	Ignition relay-2 con- trol	Output	Ignition switch	OFF or ACC	0V
					ON	Battery voltage
71 (L/O)	Ground	Remote keyless entry receiver signal	Input/ Output	During waiting		 <p style="text-align: right; font-size: small;">JMKIA0064GB</p>
				When operating either button on Intelligent Key		 <p style="text-align: right; font-size: small;">JMKIA0065GB</p>
75 (R/Y)	Ground	Combination switch INPUT 5	Input	Combination switch	All switch OFF (Wiper intermittent dial 4)	 <p style="text-align: right; font-size: small;">JPMIA0041GB</p> <p style="text-align: center;">1.4V</p>
					Front fog lamp switch ON (Wiper intermittent dial 4)	 <p style="text-align: right; font-size: small;">JPMIA0037GB</p> <p style="text-align: center;">1.3V</p>
					Any of the conditions below with all switch OFF • Wiper intermittent dial 1 • Wiper intermittent dial 2 • Wiper intermittent dial 6 • Wiper intermittent dial 7	 <p style="text-align: right; font-size: small;">JPMIA0040GB</p> <p style="text-align: center;">1.3V</p>

BCM (BODY CONTROL MODULE)

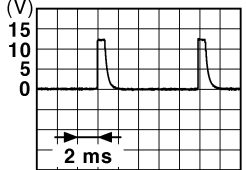
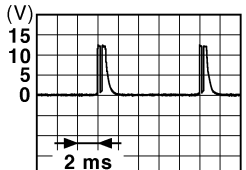
< ECU DIAGNOSIS >

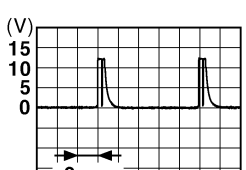
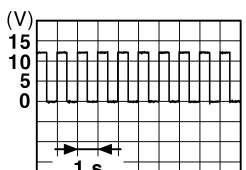
Terminal No. (Wire color)		Description		Condition	Value (Approx.)	
(+)	(-)	Signal name	Input/ Output			
76 (R/G)	Ground	Combination switch INPUT 3	Input	Combination switch	All switch OFF (Wiper intermittent dial 4)	 <small>JPMIA0041GB</small> 1.4V
					Lighting switch high-beam (Wiper intermittent dial 4)	 <small>JPMIA0036GB</small> 1.3V
					Lighting switch 2ND (Wiper intermittent dial 4)	 <small>JPMIA0037GB</small> 1.3V
					Any of the conditions below with all switch OFF • Wiper intermittent dial 1 • Wiper intermittent dial 2 • Wiper intermittent dial 3	 <small>JPMIA0040GB</small> 1.3V
77 ² (BR)	Ground	Engine switch (push switch)	Input	Engine switch (push switch)	Pressed Not pressed	0V Battery voltage
78 (P)	Ground	CAN-L	Input/ Output	—	—	
79 (L)	Ground	CAN-H	Input/ Output	—	—	
80 (R/L)	Ground	Key slot illumination	Output	Key slot illumina- tion	OFF	0V
					Blinking	 <small>JPMIA0015GB</small> 6.5V
					ON	Battery voltage

A
B
C
D
E
F
G
H
I
J
K

INL

M
N
O
P



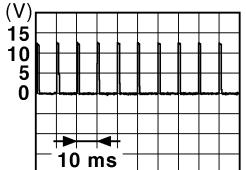
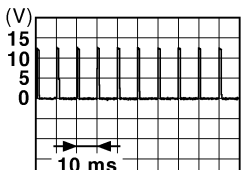

BCM (BODY CONTROL MODULE)

< ECU DIAGNOSIS >

Terminal No. (Wire color)		Description		Condition		Value (Approx.)
(+)	(-)	Signal name	Input/ Output			
81 (LG)	Ground	ON indicator lamp	Output	Ignition switch	OFF or ACC	0V
					ON	Battery voltage
83 (L)	Ground	ACC relay control	Output	Ignition switch	OFF	0V
					ACC or ON	Battery voltage
84 (Y/R)	Ground	CVT shift selector	Output	—		Battery voltage
85 ³ (L/O)	Ground	Electronic steering column lock condition No. 1	Input	Electronic steer- ing column lock	Lock status	0V
					Unlock status	Battery voltage
86 ³ (G/R)	Ground	Electronic steering column lock condition No. 2	Input	Electronic steer- ing column lock	Lock status	Battery voltage
					Unlock status	0V
87 (G/B)	Ground	Selector lever P posi- tion switch	Input	Selector lever	P position	0V
					Any position other than P	Battery voltage
88 (R)	Ground	Front door RH re- quest switch	Input	Front door RH re- quest switch	ON (pressed)	0V
					OFF (not pressed)	 <p style="text-align: center;">1.0V</p>
89 (R)	Ground	Front door LH re- quest switch	Input	Front door LH re- quest switch	ON (pressed)	0V
					OFF (not pressed)	 <p style="text-align: center;">1.0V</p>
90 (Y)	Ground	Blower fan motor re- lay control	Output	Ignition switch	OFF or ACC	0V
					ON	Battery voltage
91 (L/R)	Ground	Remote keyless entry receiver power sup- ply	Output	Ignition switch OFF		Battery voltage
94 ³ (G/Y)	Ground	Steering wheel lock unit power supply	Output	Ignition switch	OFF or ACC	Battery voltage
					ON	0V

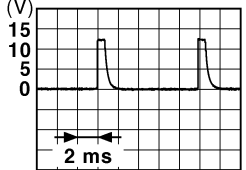
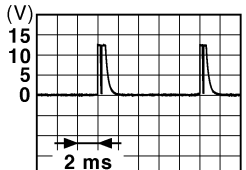
BCM (BODY CONTROL MODULE)

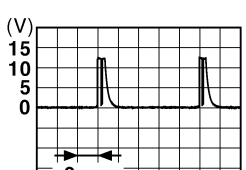
< ECU DIAGNOSIS >

Terminal No. (Wire color)		Description		Condition	Value (Approx.)
(+)	(-)	Signal name	Input/ Output		
95 (R/W)	Ground	Combination switch INPUT 1	Input	Combination switch (Wiper intermittent dial 4)	All switch OFF  1.4V
					Turn signal switch LH  1.3V
					Turn signal switch RH  1.3V
					Front wiper switch LO  1.3V
					Front washer switch ON  1.3V

A
B
C
D
E
F
G
H
I
J
K
INL
M
N
O
P



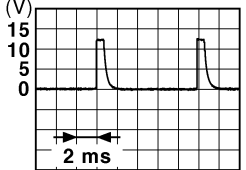
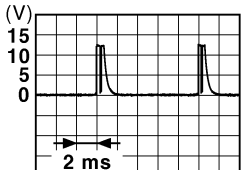
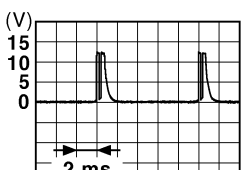
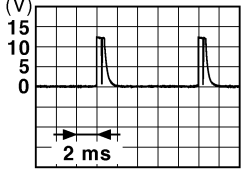

BCM (BODY CONTROL MODULE)

< ECU DIAGNOSIS >

Terminal No. (Wire color)		Description		Condition	Value (Approx.)
(+)	(-)	Signal name	Input/ Output		
96 (P/B)	Ground	Combination switch INPUT 4	Input	Combination switch	All switch OFF (Wiper intermittent dial 4) <div style="text-align: right;">  <p>JPMIA0041GB 1.4V</p> </div>
					Lighting switch AUTO (Wiper intermittent dial 4) <div style="text-align: right;">  <p>JPMIA0038GB 1.3V</p> </div>
					Lighting switch 1ST (Wiper intermittent dial 4) <div style="text-align: right;">  <p>JPMIA0036GB 1.3V</p> </div>
					Any of the conditions below with all switch OFF <ul style="list-style-type: none"> • Wiper intermittent dial 1 • Wiper intermittent dial 5 • Wiper intermittent dial 6 <div style="text-align: right;">  <p>JPMIA0039GB 1.3V</p> </div>

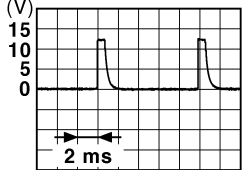
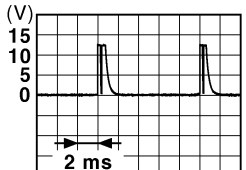
BCM (BODY CONTROL MODULE)

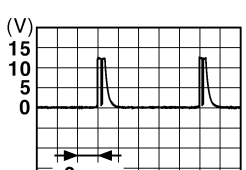
< ECU DIAGNOSIS >

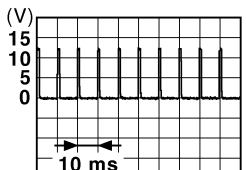
Terminal No. (Wire color)		Description		Condition	Value (Approx.)	
(+)	(-)	Signal name	Input/ Output			
97 (R/B)	Ground	Combination switch INPUT 2	Input	Combination switch (Wiper intermittent dial 4)	All switch OFF	 <p style="text-align: center;">1.4V</p>
					Lighting switch flash-to-pass	 <p style="text-align: center;">1.3V</p>
					Lighting switch 2ND	 <p style="text-align: center;">1.3V</p>
					Front wiper switch INT	 <p style="text-align: center;">1.3V</p>
					Front wiper switch HI	 <p style="text-align: center;">1.3V</p>
					Pressed	0 V
98 (G/O)	Ground	Hazard switch	Input	Hazard switch	Not pressed	 <p style="text-align: center;">1.1V</p>

A
B
C
D
E
F
G
H
I
J
K
L
M
N
O
P

INL

BCM (BODY CONTROL MODULE)

< ECU DIAGNOSIS >

Terminal No. (Wire color)		Description		Condition	Value (Approx.)	
(+)	(-)	Signal name	Input/ Output			
99 ³ (L/Y)	Ground	Electronic steering column lock unit com- munication	Input/ Output	Electronic steer- ing column lock	LOCK status	Battery voltage
					LOCK or UNLOCK	<p style="text-align: right; font-size: small;">JMKIA0066GB</p>
					For 15 seconds after UN- LOCK	Battery voltage
					15 seconds or later after UNLOCK	0V
103 (V)	Ground	Trunk lid opening.	Output	Trunk lid	Open (trunk lid opener ac- tuator is activated)	Battery voltage
					Close (trunk lid opener ac- tuator is not activated)	0V
110 (V/W)	Ground	Trunk room lamp	Output	Trunk room lamp	ON	0V
					OFF	Battery voltage
114 (B)	Ground	Trunk room antenna 1 (-)	Output	Ignition switch OFF	When Intelligent Key is in the passenger compart- ment	<p style="text-align: right; font-size: small;">JMKIA0062GB</p>
					When Intelligent Key is not in the passenger compart- ment	<p style="text-align: right; font-size: small;">JMKIA0063GB</p>

BCM (BODY CONTROL MODULE)

< ECU DIAGNOSIS >

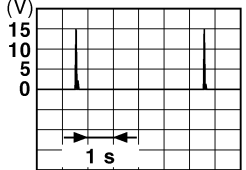
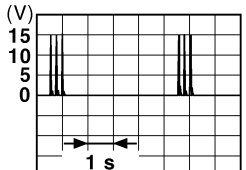
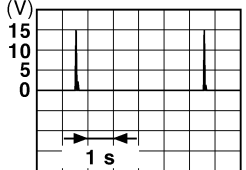
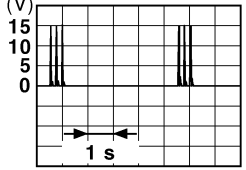
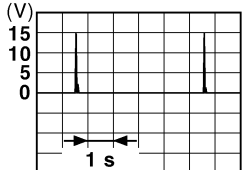
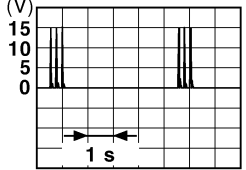
Terminal No. (Wire color)		Description		Condition	Value (Approx.)
(+)	(-)	Signal name	Input/ Output		
115 (W)	Ground	Trunk room antenna 1 (+)	Output	Ignition switch OFF	 <p style="text-align: right; font-size: small;">JMKIA0062GB</p>
				When Intelligent Key is not in the passenger compart- ment	 <p style="text-align: right; font-size: small;">JMKIA0063GB</p>
118 (L/O)	Ground	Rear bumper anten- na (-)	Output	When the trunk lid request switch is operated with ignition switch OFF	 <p style="text-align: right; font-size: small;">JMKIA0062GB</p>
				When Intelligent Key is not in the antenna detection area	 <p style="text-align: right; font-size: small;">JMKIA0063GB</p>
119 (BR/ W)	Ground	Rear bumper anten- na (+)	Output	When the trunk lid request switch is operated with ignition switch OFF	 <p style="text-align: right; font-size: small;">JMKIA0062GB</p>
				When Intelligent Key is not in the antenna detection area	 <p style="text-align: right; font-size: small;">JMKIA0063GB</p>

A
B
C
D
E
F
G
H
I
J
K
M
N
O
P

INL

BCM (BODY CONTROL MODULE)

< ECU DIAGNOSIS >

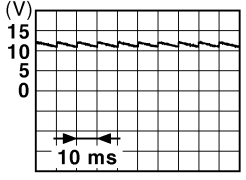
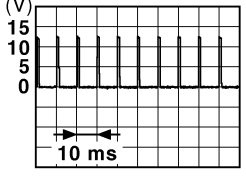
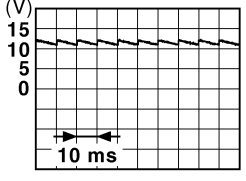
Terminal No. (Wire color)		Description		Condition		Value (Approx.)
(+)	(-)	Signal name	Input/ Output			
127 (BR/ W)	Ground	Ignition relay (IPDM E/R) control	Output	Ignition switch	OFF or ACC	Battery voltage
					ON	0V
130 (W)	Ground	Trunk room lamp switch	Input	Trunk room lamp switch	OFF (trunk is closed)	 <p style="text-align: right; margin-right: 50px;">JPMIA0011GB</p> <p style="text-align: center;">11.8V</p>
					ON (trunk is open)	0V
132 (R)	Ground	Starter motor relay control	Output	Ignition switch ON	When selector lever is in P or N position and the brake is depressed	Battery voltage
					When selector lever is in P or N position and the brake is not depressed	0V
140 ⁴ (L/R)	Ground	Engine switch (push switch)	Input	Engine switch (push switch)	Pressed	0V
					Not pressed	Battery voltage
141 (BR)	Ground	Trunk request switch	Input	Trunk request switch	ON (pressed)	0V
					OFF (not pressed)	 <p style="text-align: right; margin-right: 50px;">JPMIA0016GB</p> <p style="text-align: center;">1.0V</p>
144 (GR)	Ground	Request switch buzz- er	Output	Request switch buzzer	Sounding	0V
					Not sounding	Battery voltage
147 (L/R)	Ground	Trunk lid opener switch	Input	Trunk lid opener switch	Pressed	0V
					Not pressed	Battery voltage
148 (R/W)	Ground	Rear door RH switch	Input	Rear door RH switch	OFF (when rear door RH closes)	 <p style="text-align: right; margin-right: 50px;">JPMIA0011GB</p> <p style="text-align: center;">11.8V</p>
					ON (when rear door RH opens)	0V

BCM (BODY CONTROL MODULE)

< ECU DIAGNOSIS >

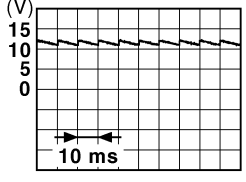
Terminal No. (Wire color)		Description		Condition	Value (Approx.)	
		Signal name	Input/ Output			
(+)	(-)					
149 (R/B)	Ground	Rear door LH switch	Input	Rear door LH switch	OFF (when rear door LH closes)	
				ON (when rear door LH opens)	0V	

- 1 : With low tire pressure monitoring system
- 2 : With electronic steering column lock
- 3 : Early production
- 4 : Without electronic steering column lock

A
B
C
D
E
F
G
H
I
J
K
L
M
N
O
P

INL

BCM (BODY CONTROL MODULE)

< ECU DIAGNOSIS >

Wiring Diagram

INFOID:000000005530124

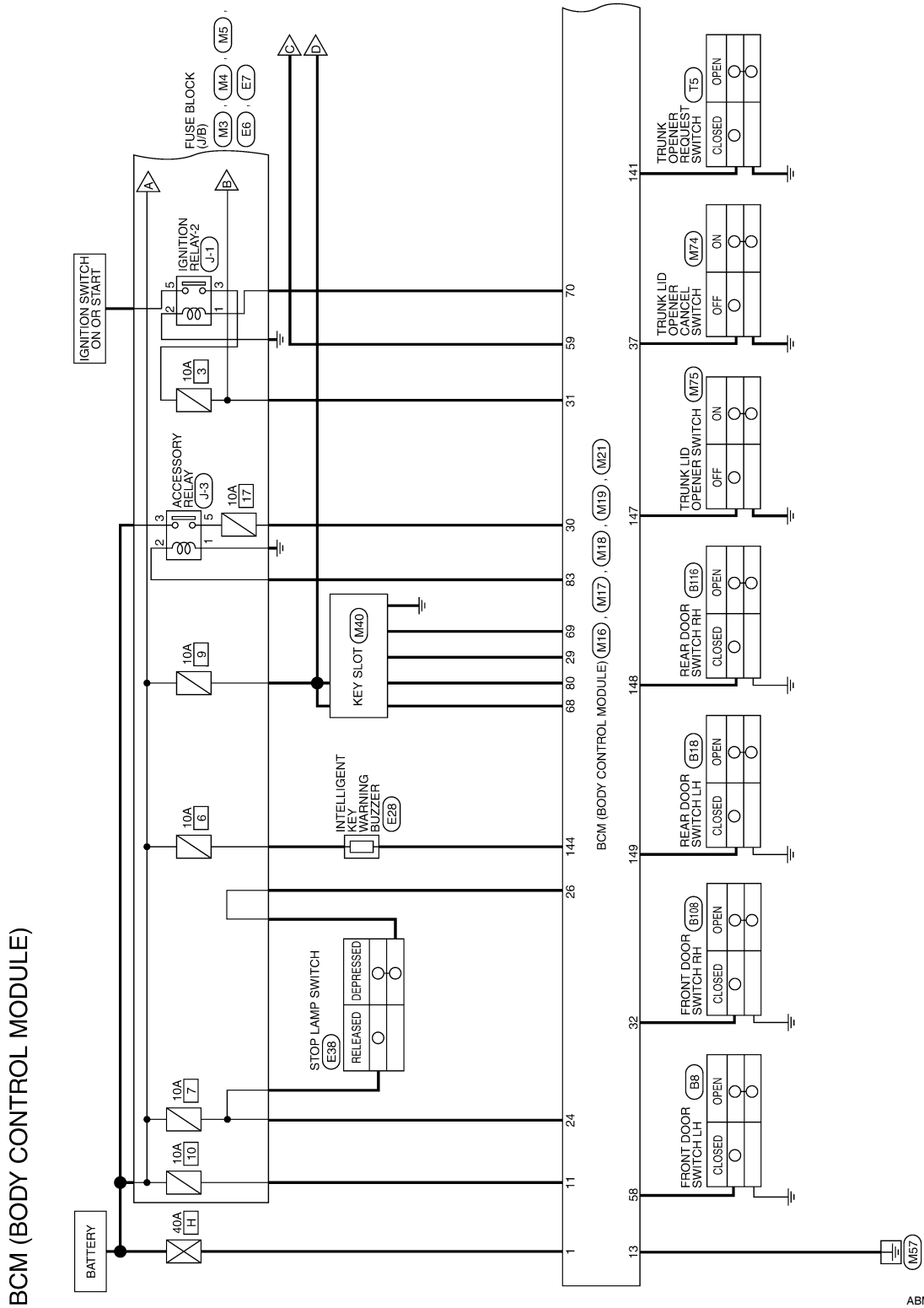

ABMWA0498G

BCM (BODY CONTROL MODULE)

< ECU DIAGNOSIS >

- ◊TP◊ : WITH LOW TIRE PRESSURE MONITORING SYSTEM
- ◊EH◊ : WITH ELECTRONIC STEERING COLUMN LOCK
- ◊EJ◊ : WITHOUT ELECTRONIC STEERING COLUMN LOCK

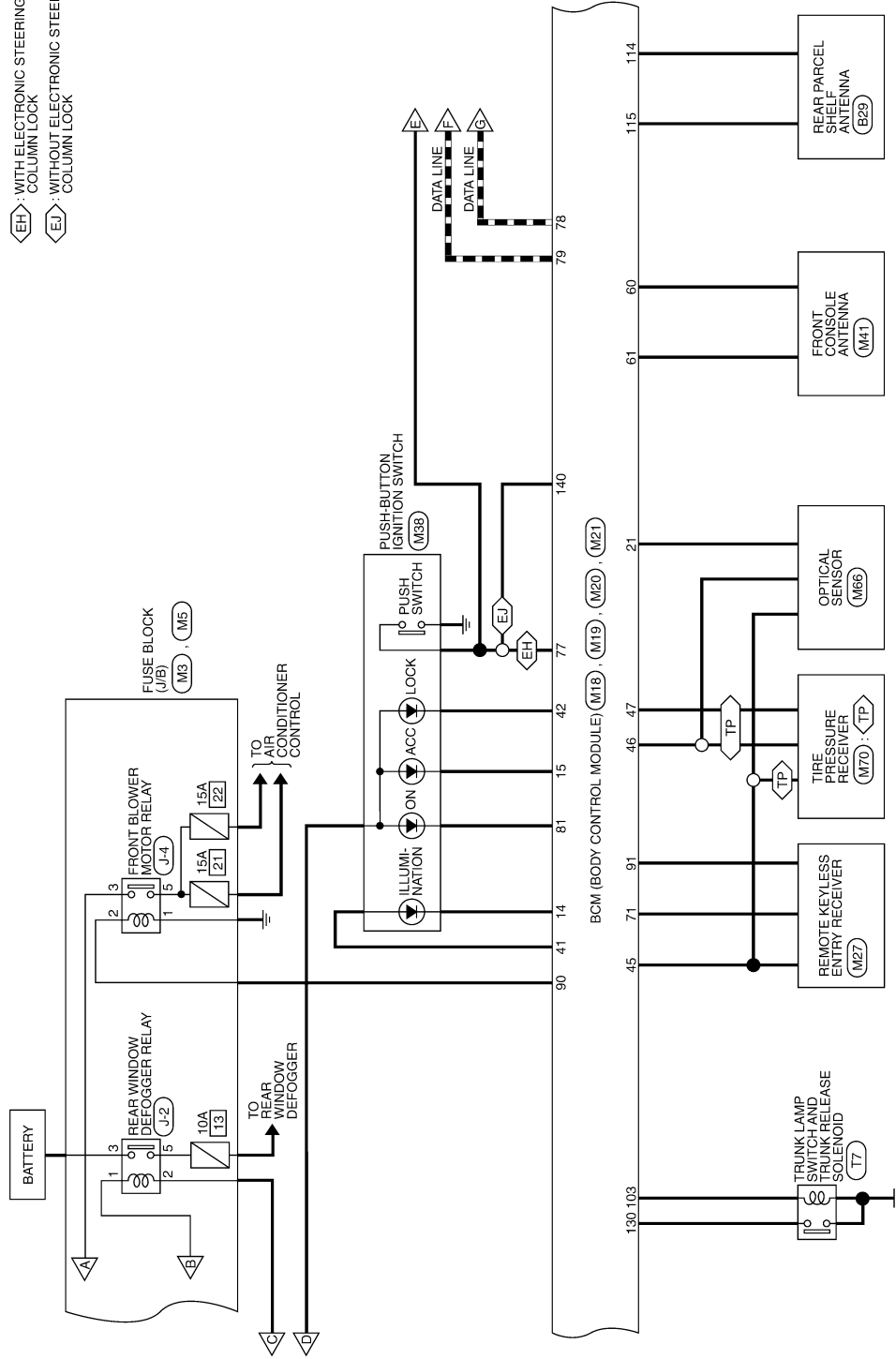

A
B
C
D
E
F
G
H
I
J
K
L
M
N
O
P

INL

ABMWA0817GI

BCM (BODY CONTROL MODULE)

< ECU DIAGNOSIS >

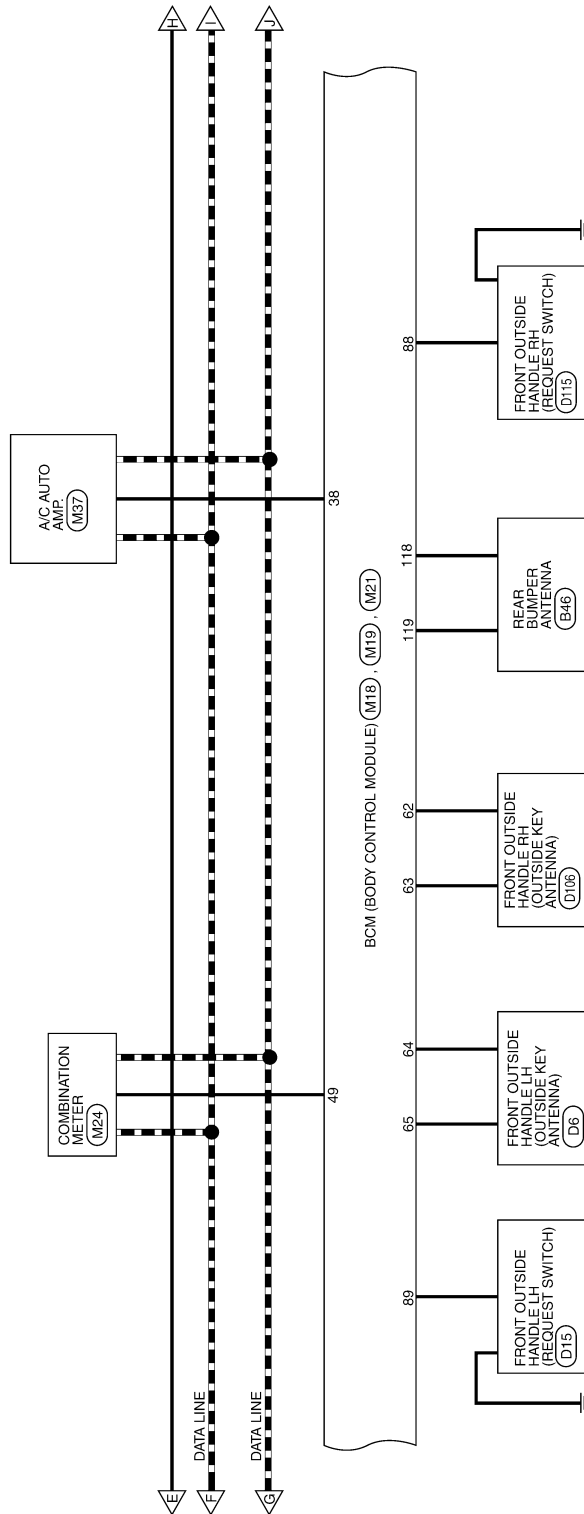

ABMWA0818GI

BCM (BODY CONTROL MODULE)

< ECU DIAGNOSIS >

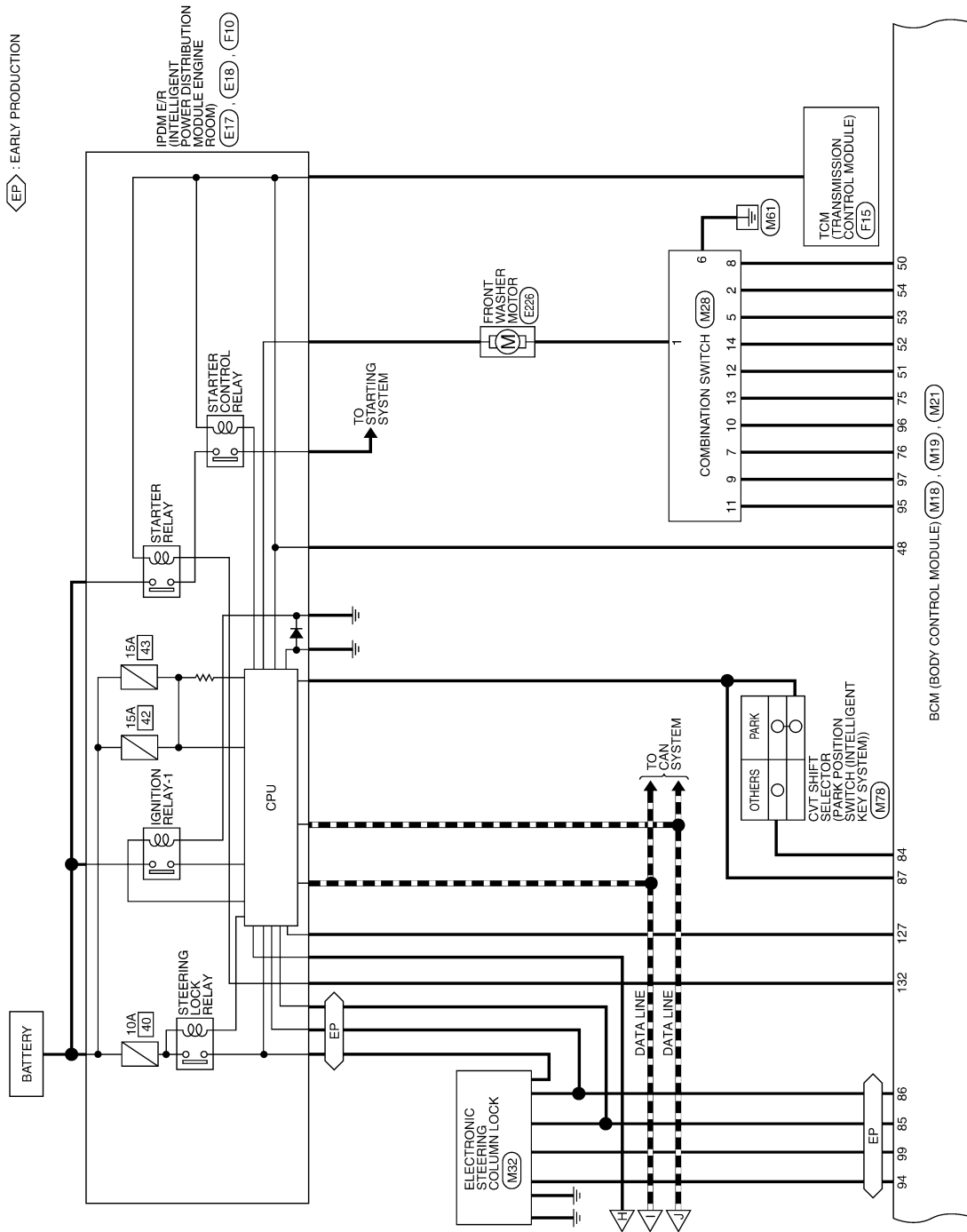

ABMWA0819GI

A
B
C
D
E
F
G
H
I
J
K
L
M
N
O
P

INL

BCM (BODY CONTROL MODULE)

< ECU DIAGNOSIS >

- $\langle A2 \rangle$: WITH LEFT AND RIGHT FRONT POWER WINDOW ANTI-PINCH SYSTEM
- $\langle A3 \rangle$: WITH FRONT AND REAR POWER WINDOW ANTI-PINCH SYSTEM
- $\langle DP \rangle$: WITH DUAL PANEL SUNROOF
- $\langle DW \rangle$: WITHOUT DUAL PANEL SUNROOF

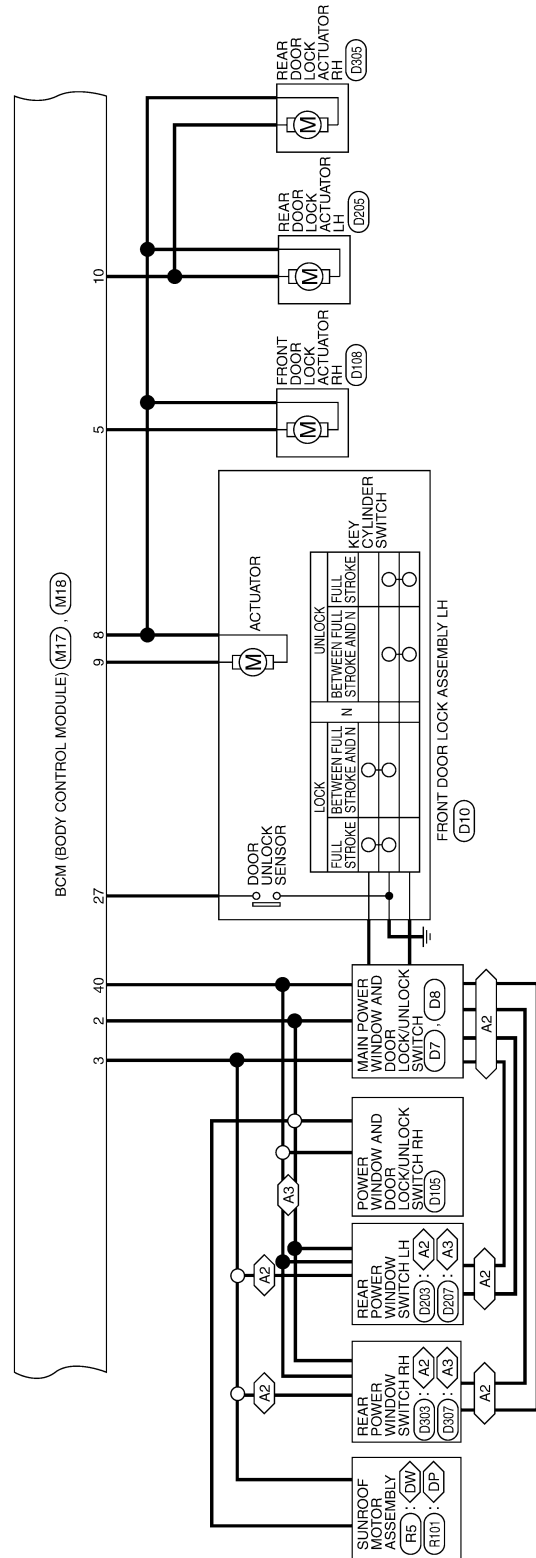

ABMWA0081GI

BCM (BODY CONTROL MODULE)

< ECU DIAGNOSIS >

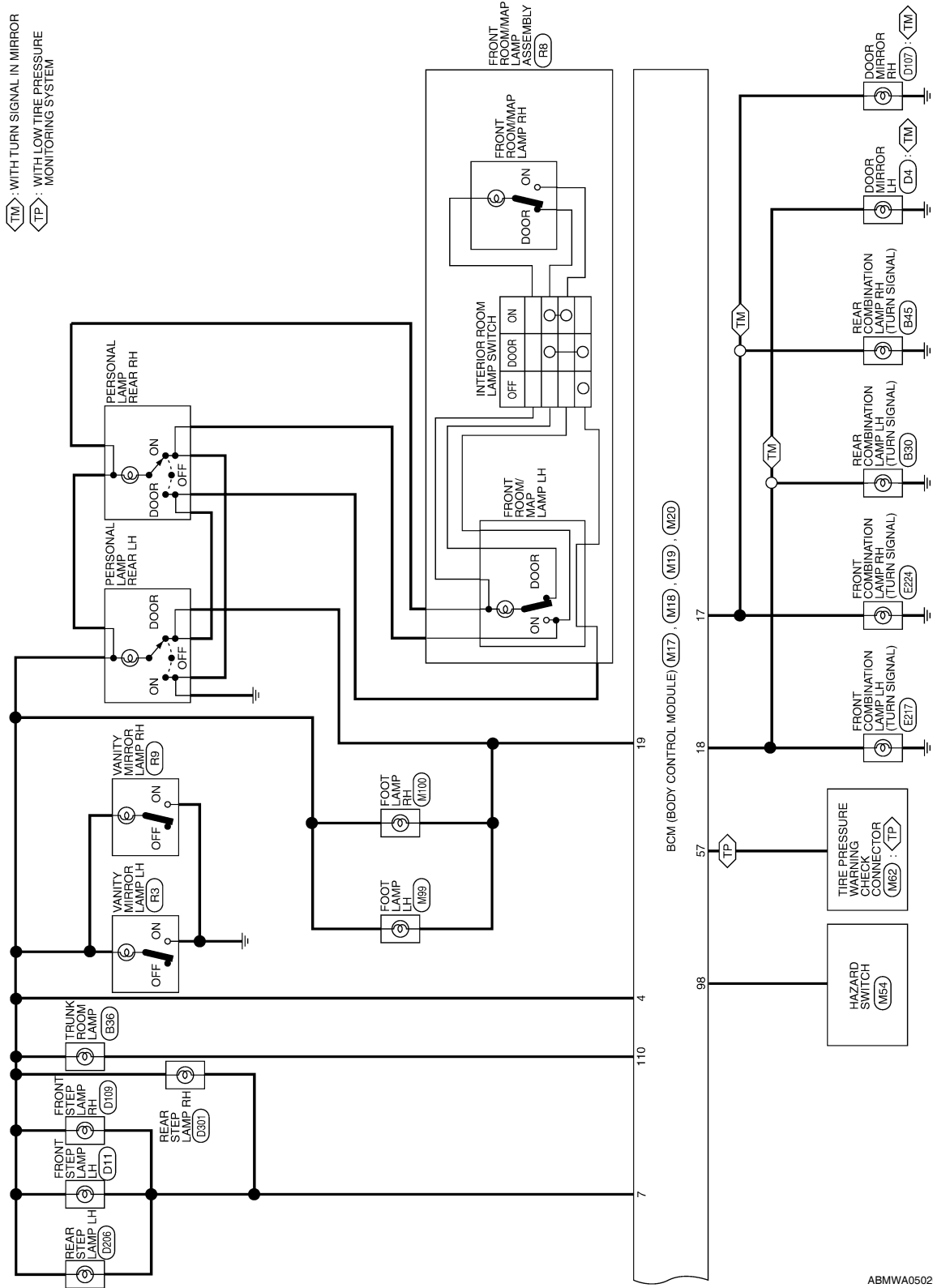

ABMWA0502GI

A
B
C
D
E
F
G
H
I
J
K
INL
M
N
O
P

BCM (BODY CONTROL MODULE)

< ECU DIAGNOSIS >

BCM (BODY CONTROL MODULE) CONNECTORS

Connector No.	M16
Connector Name	BCM (BODY CONTROL MODULE)
Connector Color	BLACK



Terminal No.	Color of Wire	Signal Name
1	W/B	BATT (F/L)
2	R/Y	P/W POWER SUPPLY PERM
3	L/W	P/W POWER SUPPLY IGN

Connector No.	M17
Connector Name	BCM (BODY CONTROL MODULE)
Connector Color	WHITE

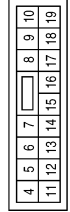

Terminal No.	Color of Wire	Signal Name
4	P/W	R/L POWER SUPPLY
5	G	DOOR UNLOCK OUTPUT AS
6	-	-
7	R/W	STEP LAMP CONT
8	V	DOOR LOCK OUTPUT ALL
9	L	DOOR UNLOCK OUTPUT (DR/FL)

Terminal No.	Color of Wire	Signal Name
10	G	DOOR UNLOCK OUTPUT (RR/RL)
11	Y/R	BAT BCM FUSE
12	-	-
13	B	GND1
14	GR/W	LOW SIDE PUSH LED
15	Y/L	ACC LED
16	-	-
17	G/B	FR FLASHER
18	G/Y	FL FLASHER
19	Y	ROOM LAMP CONT

Connector No.	M18
Connector Name	BCM (BODY CONTROL MODULE)
Connector Color	GREEN

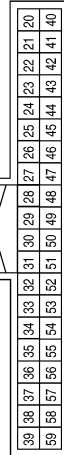

Terminal No.	Color of Wire	Signal Name
20	-	-
21	P/B	A/L SIGNAL TYPE 1
22	-	-
23	-	-
24	R/W	BRAKE SW1
25	-	-
26	O/L	BRAKE SW2

Terminal No.	Color of Wire	Signal Name
27	O	DOOR LOCK STATUS DR
28	-	-
29	Y	FOB IN SW 1
30	V/Y	ACC F/B
31	G	IGN F/B
32	R/B	AS DOOR SW 1
33	-	-
34	-	-
35	-	-
36	-	-
37	O	TRUNK CANCEL SW
38	GR/W	REAR DEFOGGER SW
39	-	-
40	Y/G	PW K-LINE
41	W	RING LED
42	R	S/L LOCK LED
43	-	-
44	-	-

Terminal No.	Color of Wire	Signal Name
45	P	GND RF2 A/L
46	V/W	A/L POWER SUPPLY 5V
47	G/O	RF2 TUNER SIGNAL
48	R/G	SHIFT N/P/ NEUTRAL SW
49	L/O	IMMO LED (SECURITY INDICATOR)
50	LG/B	OUTPUT 5
51	L/W	OUTPUT 1
52	G/B	OUTPUT 2
53	LG/R	OUTPUT 3
54	G/Y	OUTPUT 4
55	-	-
56	-	-
57	W	TPMS MODE
58	SB	DR DOOR SW
59	G/R	REAR DEFOGGER

ABMIA1331GB

BCM (BODY CONTROL MODULE)

< ECU DIAGNOSIS >

Connector No.	M19
Connector Name	BCM (BODY CONTROL MODULE)
Connector Color	BLACK



79	78	77	76	75	74	73	72	71	70	69	68	67	66	65	64	63	62	61	60
59	58	57	56	55	54	53	52	51	50	49	48	47	46	45	44	43	42	41	40

Terminal No.	Color of Wire	Signal Name
60	B/R	ROOM ANT 2 B
61	W/R	ROOM ANT 2 A
62	V	AS DOOR ANT B
63	P	AS DOOR ANT A
64	V	DR DOOR ANT B
65	P	DR DOOR ANT A
66	-	-

Terminal No.	Color of Wire	Signal Name
67	-	-
68	G/O	FOB READER CLOCK
69	O	FOB READER DATA
70	R/B	IGN REL OUTPUT 2
71	L/O	RF1 TUNER SIGNAL
72	-	-
73	-	-
74	-	-
75	R/Y	INPUT 5
76	R/G	INPUT 3
77	BR	ENG START SW
78	P	CAN-L
79	L	CAN-H
80	R/L	FOB SLOT ILLUMINATION
81	LG	IGN ON LED
82	-	-
83	L	ACC CONT

Terminal No.	Color of Wire	Signal Name
84	Y/R	AT DEVICE OUT
85	L/O	S/L CONDITION 1
86	G/R	S/L CONDITION 2
87	G/B	SHIFT P/ASCD CANCEL SW
88	R	AS REQUEST SW
89	R	DR REQUEST SW
90	Y	BLOWER FAN RELAY
91	L/R	RF POWER SUPPLY 12V
92	-	-
93	-	-
94	G/Y	S/L POWER SUPPLY 12V
95	R/W	INPUT 1
96	P/B	INPUT 4
97	R/B	INPUT 2
98	G/O	HAZARD SW
99	L/Y	S/L K-LINE

Connector No.	M20
Connector Name	BCM (BODY CONTROL MODULE)
Connector Color	WHITE



100	101	102	103	104		
105	106	107	108	109	110	111

Terminal No.	Color of Wire	Signal Name
100	-	-
101	-	-
102	-	-
103	V	CDL BACK TRUNK

Terminal No.	Color of Wire	Signal Name
104	-	-
105	-	-
106	-	-
107	-	-
108	-	-
109	-	-
110	V/W	TRUNK LAMP CONT
111	-	-

ABMIA1332GB

A
B
C
D
E
F
G
H
I
J
K
L
M
N
O
P



BCM (BODY CONTROL MODULE)

< ECU DIAGNOSIS >

Terminal No.	Color of Wire	Signal Name
136	-	-
137	-	-
138	-	-
139	-	-
140	BR	ENG START SW W/O ESCL
141	BR	TRUNK REQUEST SW
142	-	-
143	-	-
144	GR	BUZZER
145	-	-
146	-	-
147	L/R	BACK TRUNK OPENER
148	R/W	RR DOOR SW
149	R/B	RL DOOR SW
150	-	-
151	-	-

Terminal No.	Color of Wire	Signal Name
119	BR/W	BACK DOOR ANT A
120	-	-
121	-	-
122	-	-
123	-	-
124	-	-
125	-	-
126	-	-
127	BR/W	IGN RELAY OUTPUT
128	-	-
129	-	-
130	W	TRUNK SW
131	-	-
132	R	ST RELAY OUTPUT
133	-	-
134	-	-
135	-	-

Terminal No.	Color of Wire	Signal Name
10	P/B	INPUT 4
11	R/W	INPUT 1
12	L/W	OUTPUT 1
13	R/Y	INPUT 5
14	G/B	OUTPUT 2

Connector No.	M21
Connector Name	BCM (BODY CONTROL MODULE)
Connector Color	GRAY

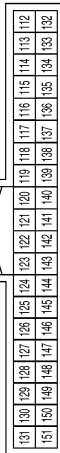

Terminal No.	Color of Wire	Signal Name
112	-	-
113	-	-
114	B	TRUNK ANT 1 B
115	W	TRUNK ANT 1 A
116	-	-
117	-	-
118	L/O	BACK DOOR ANT B

Connector No.	M28
Connector Name	COMBINATION SWITCH
Connector Color	WHITE

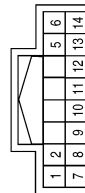

Terminal No.	Color of Wire	Signal Name
1	R/L	-
2	G/Y	OUTPUT 4
5	LG/R	OUTPUT 3
6	B	-
7	R/G	INPUT 3
8	LG/B	OUTPUT 5
9	R/B	INPUT 2

ABMIA2102GB

INFOID:000000005530125

Fail Safe

Display contents of CONSULT	Fail-safe	Cancellation
B2013: ID DISCORD BCM-S/L*	Inhibit engine cranking	Erase DTC
B2014: CHAIN OF S/L-BCM*	Inhibit engine cranking	Erase DTC
B2190: NATS ANTENNA AMP	Inhibit engine cranking	Erase DTC

BCM (BODY CONTROL MODULE)

< ECU DIAGNOSIS >

Display contents of CONSULT	Fail-safe	Cancellation	
B2191: DIFFERENCE OF KEY	Inhibit engine cranking	Erase DTC	A
B2192: ID DISCORD BCM-ECM	Inhibit engine cranking	Erase DTC	
B2193: CHAIN OF BCM-ECM	Inhibit engine cranking	Erase DTC	B
B2195: ANTI-SCANNING	Inhibit engine cranking	Erase DTC	
B2557: VEHICLE SPEED*	Inhibit electronic steering column lock	When normal vehicle speed signals have been received from ABS actuator and electric unit (control unit) for 500 ms	C
B2560: STARTER CONT RELAY	Inhibit engine cranking	500 ms after the following CAN signal communication status has become consistent <ul style="list-style-type: none"> • Starter control relay signal • Starter relay status signal 	D
B2562: LO VOLTAGE	<ul style="list-style-type: none"> • Inhibit engine cranking • Inhibit electronic steering column lock* 	100 ms after the power supply voltage increases to more than 8.8 V	E
B2601: SHIFT POSITION*	Inhibit electronic steering column lock	500 ms after the following signal reception status becomes consistent <ul style="list-style-type: none"> • Selector lever P position switch signal • P range signal (CAN) 	F
B2602: SHIFT POSITION*	Inhibit electronic steering column lock	5 seconds after the following BCM recognition conditions are fulfilled <ul style="list-style-type: none"> • Ignition switch is in the ON position • Selector lever P position switch signal: Except P position (battery voltage) • Vehicle speed: 4 km/h or more 	G
B2603: SHIFT POSI STATUS*	Inhibit electronic steering column lock	500 ms after the following BCM recognition conditions are fulfilled <ul style="list-style-type: none"> • Ignition switch is in the ON position • Selector lever P position switch signal: Except P position (battery voltage) • Selector lever transmission range switch signal: Except P and N positions (0 V) 	H
B2604: TRANSMISSION RANGE SWITCH*	Inhibit electronic steering column lock	500 ms after any of the following BCM recognition conditions is fulfilled <ul style="list-style-type: none"> • Status 1 <ul style="list-style-type: none"> - Ignition switch is in the ON position - Selector lever transmission range switch signal: P and N position (battery voltage) - P range signal or N range signal (CAN): ON • Status 2 <ul style="list-style-type: none"> - Ignition switch is in the ON position - Selector lever transmission range switch signal: Except P and N positions (0 V) - P range signal and N range signal (CAN): OFF 	I J K INL
B2605: TRANSMISSION RANGE SWITCH*	Inhibit electronic steering column lock	500 ms after any of the following BCM recognition conditions is fulfilled <ul style="list-style-type: none"> • Ignition switch is in the ON position - Power position: IGN - Selector lever transmission range switch signal: Except P and N positions (0 V) - Transmission range switch signal (CAN): OFF • Status 2 <ul style="list-style-type: none"> - Ignition switch is in the ON position - Selector lever transmission range switch signal: P or N position (battery voltage) - Transmission range switch signal (CAN): ON 	L M N O P
B2606: S/L RELAY*	Inhibit engine cranking	500 ms after the following CAN signal communication status has become consistent <ul style="list-style-type: none"> • Electronic steering column lock relay signal (Request signal) • Electronic steering column lock relay signal (Condition signal) 	

BCM (BODY CONTROL MODULE)

< ECU DIAGNOSIS >

Display contents of CONSULT	Fail-safe	Cancellation
B2607: S/L RELAY*	Inhibit engine cranking	500 ms after the following CAN signal communication status has become consistent <ul style="list-style-type: none"> Electronic steering column lock relay signal (Request signal) Electronic steering column lock relay signal (Condition signal)
B2608: STARTER RELAY	Inhibit engine cranking	500 ms after the following signal communication status becomes consistent <ul style="list-style-type: none"> Starter motor relay control signal Starter relay status signal (CAN)
B2609: S/L STATUS*	<ul style="list-style-type: none"> Inhibit engine cranking Inhibit electronic steering column lock 	When the following electronic steering column lock conditions agree <ul style="list-style-type: none"> BCM electronic steering column lock control status Electronic steering column lock condition No. 1 signal status Electronic steering column lock condition No. 2 signal status
B260A: IGNITION RELAY	Inhibit engine cranking	500 ms after the following conditions are fulfilled <ul style="list-style-type: none"> IGN relay (IPDM E/R) control signal: OFF (Battery voltage) Ignition ON signal (CAN to IPDM E/R): OFF (Request signal) Ignition ON signal (CAN from IPDM E/R): OFF (Condition signal)
B260F: ENG STATE SIG LOST	Maintains the power supply position attained at the time of DTC detection	When any of the following conditions is fulfilled <ul style="list-style-type: none"> Power position changes to ACC Receives engine status signal (CAN)
B2612: S/L STATUS*	<ul style="list-style-type: none"> Inhibit engine cranking Inhibit electronic steering column lock 	When any of the following conditions is fulfilled <ul style="list-style-type: none"> Electronic steering column lock unit status signal (CAN) is received normally The BCM electronic steering column lock control status matches the electronic steering column lock status recognized by the electronic steering column lock unit status signal (CAN from IPDM E/R)
B2617: STARTER RELAY CIRC	Inhibit engine cranking	1 second after the starter motor relay control inside BCM becomes normal
B2618: BCM	Inhibit engine cranking	1 second after the ignition relay (IPDM E/R) control inside BCM becomes normal
B2619: BCM*	Inhibit engine cranking	1 second after the electronic steering column lock unit power supply output control inside BCM becomes normal
B26E1: ENG STATE NO RECIV	Inhibit engine cranking	When any of the following conditions are fulfilled <ul style="list-style-type: none"> Power position changes to ACC Receives engine status signal (CAN)

* : With electronic steering column lock

DTC Inspection Priority Chart

INFOID:000000005530126

If some DTCs are displayed at the same time, perform inspections one by one based on the following priority chart.

Priority	DTC
1	<ul style="list-style-type: none"> B2562: LO VOLTAGE
2	<ul style="list-style-type: none"> U1000: CAN COMM CIRCUIT U1010: CONTROL UNIT (CAN)
3	<ul style="list-style-type: none"> B2190: NATS ANTENNA AMP B2191: DIFFERENCE OF KEY B2192: ID DISCORD BCM-ECM B2193: CHAIN OF BCM-ECM

BCM (BODY CONTROL MODULE)

< ECU DIAGNOSIS >

Priority	DTC	A	
4	<ul style="list-style-type: none"> • B2013: ID DISCORD BCM-S/L* • B2014: CHAIN OF S/L-BCM* • B2553: IGNITION RELAY • B2555: STOP LAMP • B2556: PUSH-BTN IGN SW • B2557: VEHICLE SPEED • B2560: STARTER CONT RELAY • B2601: SHIFT POSITION • B2602: SHIFT POSITION • B2603: SHIFT POSI STATUS • B2604: TRANSMISSION RANGE SWITCH • B2605: TRANSMISSION RANGE SWITCH • B2606: S/L RELAY* • B2607: S/L RELAY* • B2608: STARTER RELAY • B2609: S/L STATUS* • B260A: IGNITION RELAY • B260B: STEERING LOCK UNIT* • B260C: STEERING LOCK UNIT* • B260D: STEERING LOCK UNIT* • B260F: ENG STATE SIG LOST • B2612: S/L STATUS* • B2614: ACC RELAY CIRC • B2615: BLOWER RELAY CIRC • B2616: IGN RELAY CIRC • B2617: STARTER RELAY CIRC • B2618: BCM • B2619: BCM* • B261A: PUSH-BTN IGN SW • B26E1: ENG STATE NO RECIV • C1729: VHCL SPEED SIG ERR • U0415: VEHICLE SPEED SIG 	<p>A</p> <p>B</p> <p>C</p> <p>D</p> <p>E</p> <p>F</p> <p>G</p> <p>H</p> <p>I</p> <p>J</p>	
	<ul style="list-style-type: none"> • C1704: LOW PRESSURE FL • C1705: LOW PRESSURE FR • C1706: LOW PRESSURE RR • C1707: LOW PRESSURE RL • C1708: [NO DATA] FL • C1709: [NO DATA] FR • C1710: [NO DATA] RR • C1711: [NO DATA] RL • C1712: [CHECKSUM ERR] FL • C1713: [CHECKSUM ERR] FR • C1714: [CHECKSUM ERR] RR • C1715: [CHECKSUM ERR] RL • C1716: [PRESSDATA ERR] FL • C1717: [PRESSDATA ERR] FR • C1718: [PRESSDATA ERR] RR • C1719: [PRESSDATA ERR] RL • C1720: [CODE ERR] FL • C1721: [CODE ERR] FR • C1722: [CODE ERR] RR • C1723: [CODE ERR] RL • C1724: [BATT VOLT LOW] FL • C1725: [BATT VOLT LOW] FR • C1726: [BATT VOLT LOW] RR • C1727: [BATT VOLT LOW] RL • C1734: CONTROL UNIT 	<p>K</p> <p>INL</p> <p>M</p> <p>N</p> <p>O</p> <p>P</p>	
	6	<ul style="list-style-type: none"> • B2622: INSIDE ANTENNA • B2623: INSIDE ANTENNA 	

* : With electronic steering column lock

BCM (BODY CONTROL MODULE)

< ECU DIAGNOSIS >

DTC Index

INFOID:000000005530127

NOTE:

- Details of time display
- CRNT: Displays when there is a malfunction now or after returning to the normal condition until turning ignition switch OFF → ON again.
- 1 - 39: Displayed if any previous malfunction is present when current condition is normal. It increases 1 → 2 → 3...38 → 39 after returning to the normal condition whenever ignition switch OFF → ON. The counter remains at 39 even if the number of cycles exceeds it. It is counted from 1 again when turning ignition switch OFF → ON after returning to the normal condition if the malfunction is detected again.

CONSULT display	Fail-safe	Intelligent Key warning lamp ON	Tire pressure monitor warning lamp ON	Reference page
No DTC is detected. further testing may be required.	—	—	—	—
U1000: CAN COMM CIRCUIT	—	—	—	BCS-36
U1010: CONTROL UNIT (CAN)	—	—	—	BCS-37
U0415: VEHICLE SPEED SIG	—	—	—	BCS-38
B2013: ID DISCORD BCM-S/L*	×	—	—	SEC-39
B2014: CHAIN OF S/L-BCM*	×	—	—	SEC-40
B2190: NATS ANTENNA AMP	×	—	—	SEC-43
B2191: DIFFERENCE OF KEY	×	—	—	SEC-46
B2192: ID DISCORD BCM-ECM	×	—	—	SEC-47
B2193: CHAIN OF BCM-ECM	×	—	—	SEC-48
B2553: IGNITION RELAY	—	—	—	PCS-55
B2555: STOP LAMP	—	—	—	SEC-49
B2556: PUSH-BTN IGN SW	—	×	—	SEC-52
B2557: VEHICLE SPEED	×	×	—	SEC-54
B2560: STARTER CONT RELAY	×	×	—	SEC-55
B2562: LOW VOLTAGE	—	—	—	BCS-39
B2601: SHIFT POSITION	×	×	—	SEC-56
B2602: SHIFT POSITION	×	×	—	SEC-59
B2603: SHIFT POSI STATUS	×	×	—	SEC-62
B2604: TRANSMISSION RANGE SWITCH	×	×	—	SEC-65
B2605: TRANSMISSION RANGE SWITCH	×	×	—	SEC-67
B2606: S/L RELAY*	×	×	—	SEC-69
B2607: S/L RELAY*	×	×	—	SEC-70
B2608: STARTER RELAY	×	×	—	SEC-72
B2609: S/L STATUS*	×	×	—	SEC-74
B260A: IGNITION RELAY	×	×	—	PCS-57
B260B: STEERING LOCK UNIT*	—	×	—	SEC-78
B260C: STEERING LOCK UNIT*	—	×	—	SEC-79
B260D: STEERING LOCK UNIT*	—	×	—	SEC-80
B260F: ENG STATE SIG LOST	×	×	—	SEC-81
B2612: S/L STATUS*	×	×	—	SEC-83
B2614: ACC RELAY CIRC	—	×	—	PCS-59

BCM (BODY CONTROL MODULE)

< ECU DIAGNOSIS >

CONSULT display	Fail-safe	Intelligent Key warning lamp ON	Tire pressure monitor warning lamp ON	Reference page	
B2615: BLOWER RELAY CIRC	—	×	—	PCS-62	A
B2616: IGN RELAY CIRC	—	×	—	PCS-65	B
B2617: STARTER RELAY CIRC	×	×	—	PCS-65	
B2618: BCM	×	×	—	PCS-68	C
B2619: BCM*	×	×	—	SEC-89	
B261A: PUSH-BTN IGN SW	—	×	—	SEC-90	
B2622: INSIDE ANTENNA	—	—	—	DLK-60	D
B2623: INSIDE ANTENNA	—	—	—	DLK-63	
B26E1: ENG STATE NO RES	×	×	—	SEC-82	E
C1704: LOW PRESSURE FL	—	—	×	WT-48	
C1705: LOW PRESSURE FR	—	—	×	WT-48	
C1706: LOW PRESSURE RR	—	—	×	WT-48	F
C1707: LOW PRESSURE RL	—	—	×	WT-48	
C1708: [NO DATA] FL	—	—	×	WT-14	G
C1709: [NO DATA] FR	—	—	×	WT-14	
C1710: [NO DATA] RR	—	—	×	WT-14	
C1711: [NO DATA] RL	—	—	×	WT-14	H
C1712: [CHECKSUM ERR] FL	—	—	×	WT-16	
C1713: [CHECKSUM ERR] FR	—	—	×	WT-16	I
C1714: [CHECKSUM ERR] RR	—	—	×	WT-16	
C1715: [CHECKSUM ERR] RL	—	—	×	WT-16	
C1716: [PRESSDATA ERR] FL	—	—	×	WT-18	J
C1717: [PRESSDATA ERR] FR	—	—	×	WT-18	
C1718: [PRESSDATA ERR] RR	—	—	×	WT-18	
C1719: [PRESSDATA ERR] RL	—	—	×	WT-18	K
C1720: [CODE ERR] FL	—	—	×	WT-16	
C1721: [CODE ERR] FR	—	—	×	WT-16	INL
C1722: [CODE ERR] RR	—	—	×	WT-16	
C1723: [CODE ERR] RL	—	—	×	WT-16	
C1724: [BATT VOLT LOW] FL	—	—	×	WT-16	M
C1725: [BATT VOLT LOW] FR	—	—	×	WT-16	
C1726: [BATT VOLT LOW] RR	—	—	×	WT-16	N
C1727: [BATT VOLT LOW] RL	—	—	×	WT-16	
C1729: VHCL SPEED SIG ERR	—	—	×	WT-20	
C1734: CONTROL UNIT	—	—	×	WT-21	O

* : With electronic steering column lock

INTERIOR LIGHTING SYSTEM SYMPTOMS

< SYMPTOM DIAGNOSIS >

SYMPTOM DIAGNOSIS

INTERIOR LIGHTING SYSTEM SYMPTOMS

Symptom Table

INFOID:000000005461078

CAUTION:

Perform the self-diagnosis with CONSULT-III before the symptom diagnosis. Perform the trouble diagnosis if any DTC is detected.

Symptom	Possible cause	Inspection item
All the following lamps do not turn ON. <ul style="list-style-type: none"> • Front room/map lamp assembly • Personal lamp rear LH and RH • Trunk room lamp • Foot lamp LH and RH • Front step lamp LH and RH • Rear step lamp LH and RH • Vanity mirror lamp LH and RH 	<ul style="list-style-type: none"> • Harness between BCM and each interior room lamp • BCM 	Battery saver output/power supply circuit Refer to INL-21 .
<ul style="list-style-type: none"> • Interior room lamp does not turn ON even though the door is open. (It turns ON when turning the interior room lamp ON.) • Interior room lamp does not turn OFF even though the door is closed. 	<ul style="list-style-type: none"> • Harness between BCM and each door switch • Harness between BCM and each interior room lamp • BCM 	Door switch circuit Refer to DLK-68 . Interior room lamp control circuit Refer to DLK-68 .
Interior room lamp timer does not activate. (It turns ON/ OFF when the door opens/closes.)	—	Check the interior room lamp setting. Refer to INL-12 .
Step lamps do not turn ON. (The front room/map lamps and the personal lamps turn ON.) Step lamps do not turn OFF. (The room/map lamps and the personal lamps turn OFF.)	<ul style="list-style-type: none"> • Harness between BCM and each step lamp • BCM 	Step lamp circuit Refer to INL-25 .
<ul style="list-style-type: none"> • Trunk room lamp does not turn ON. (The bulb is normal.) • Trunk room lamp does not turn OFF. 	<ul style="list-style-type: none"> • Harness between BCM and trunk room lamp switch • Harness between BCM and trunk room lamp • BCM 	Trunk room lamp switch circuit Refer to INL-27 . Trunk room lamp circuit Refer to INL-27 .
<ul style="list-style-type: none"> • Push-button ignition switch illumination does not turn ON. • Push-button ignition switch illumination does not turn OFF. 	<ul style="list-style-type: none"> • Harness between BCM and combination switch • Harness between BCM and push-button ignition switch • BCM 	Combination switch input circuit Refer to BCS-42 . Push-button ignition switch illumination circuit Refer to INL-29 .
Interior room lamp battery saver does not activate.	—	Check the interior room lamp battery saver setting. Refer to INL-13 .

PRECAUTIONS

< PRECAUTION >

PRECAUTION

PRECAUTIONS

Precaution for Supplemental Restraint System (SRS) "AIR BAG" and "SEAT BELT PRE-TENSIONER"

INFOID:000000005461079

The Supplemental Restraint System such as "AIR BAG" and "SEAT BELT PRE-TENSIONER", used along with a front seat belt, helps to reduce the risk or severity of injury to the driver and front passenger for certain types of collision. This system includes seat belt switch inputs and dual stage front air bag modules. The SRS system uses the seat belt switches to determine the front air bag deployment, and may only deploy one front air bag, depending on the severity of a collision and whether the front occupants are belted or unbelted. Information necessary to service the system safely is included in the SR and SB section of this Service Manual.

WARNING:

- To avoid rendering the SRS inoperative, which could increase the risk of personal injury or death in the event of a collision which would result in air bag inflation, all maintenance must be performed by an authorized NISSAN/INFINITI dealer.
- Improper maintenance, including incorrect removal and installation of the SRS, can lead to personal injury caused by unintentional activation of the system. For removal of Spiral Cable and Air Bag Module, see the SR section.
- Do not use electrical test equipment on any circuit related to the SRS unless instructed to in this Service Manual. SRS wiring harnesses can be identified by yellow and/or orange harnesses or harness connectors.

PRECAUTIONS WHEN USING POWER TOOLS (AIR OR ELECTRIC) AND HAMMERS

WARNING:

- When working near the Airbag Diagnosis Sensor Unit or other Airbag System sensors with the Ignition ON or engine running, DO NOT use air or electric power tools or strike near the sensor(s) with a hammer. Heavy vibration could activate the sensor(s) and deploy the air bag(s), possibly causing serious injury.
- When using air or electric power tools or hammers, always switch the Ignition OFF, disconnect the battery, and wait at least 3 minutes before performing any service.

General precautions for service operations

INFOID:000000005461080

- When removing or disassembling any part, be careful not to damage or deform it. Protect parts which may get in the way with cloth.
- When removing parts with a screw driver or other tool, protect parts by wrapping them with vinyl or tape.
- Keep removed parts protected with cloth.
- If a non-reuseable part is removed, replace it with a new one.
- After re-assembly has been completed, make sure each part functions correctly.
- Never work with wet hands.
- Turn the lighting switch OFF before disconnecting and connecting the connector.
- Do not use organic solvent (paint thinner or gasoline) to clean lamps or remove sealant residue.

Precautions Necessary for Steering Wheel Rotation after Battery Disconnect (Early Production, With Electronic Steering Column Lock)

INFOID:000000005885956

NOTE:

- Before removing and installing any control units, first turn the push-button ignition switch to the LOCK position, then disconnect both battery cables.
- After finishing work, confirm that all control unit connectors are connected properly, then re-connect both battery cables.
- Always use CONSULT-III to perform self-diagnosis as a part of each function inspection after finishing work. If a DTC is detected, perform trouble diagnosis according to self-diagnosis results.

This vehicle is equipped with a push-button ignition switch and a steering lock unit.

If the battery is disconnected or discharged, the steering wheel will lock and cannot be turned.

If turning the steering wheel is required with the battery disconnected or discharged, follow the procedure below before starting the repair operation.

A
B
C
D
E
F
G
H
I
J
K
INL
M
N
O
P

PRECAUTIONS

< PRECAUTION >

OPERATION PROCEDURE

1. Connect both battery cables.

NOTE:

Supply power using jumper cables if battery is discharged.

2. Carry the Intelligent Key or insert it to the key slot and turn the push-button ignition switch to ACC position. (At this time, the steering lock will be released.)
3. Disconnect both battery cables. The steering lock will remain released with both battery cables disconnected and the steering wheel can be turned.
4. Perform the necessary repair operation.
5. When the repair work is completed, re-connect both battery cables. With the brake pedal released, turn the push-button ignition switch from ACC position to ON position, then to LOCK position. (The steering wheel will lock when the push-button ignition switch is turned to LOCK position.)
6. Perform self-diagnosis check of all control units using CONSULT-III.

INTERIOR ROOM LAMP

< ON-VEHICLE REPAIR >

ON-VEHICLE REPAIR

INTERIOR ROOM LAMP

Removal and Installation

INFOID:000000005461082

FRONT ROOM/MAP LAMP

Removal

1. Release the metal clips and drop front edge of front room/map lamp (1) away from headlining. Slide front room/map lamp forward in vehicle to clear pawls at rear.

←: Vehicle front

○: Pawl

□: Metal clip

2. Disconnect the connectors, then remove map lamp.

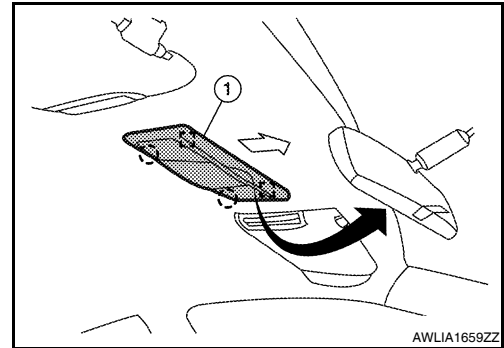

Installation

Installation is in the reverse order of removal.

Bulb Replacement

1. Using a suitable tool (3), remove front room/map lamp lens (2) RH/LH.
2. Pull bulb (1) straight out to remove.

**Front room/
map lamp bulb : 12V - 8W**

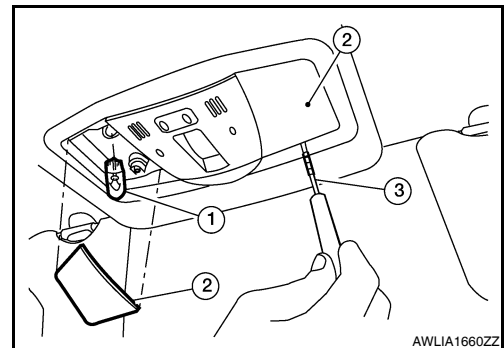

VANITY MIRROR LAMP

Removal

The vanity mirror lamp is replaced as part of the sunvisor assembly. Refer to [INT-32. "Removal and Installation"](#).

Installation

Installation is in the reverse order of removal.

Bulb Replacement

1. Using a suitable tool (1), remove the vanity mirror lamp lens (2) RH/LH.
2. Pull bulb (3) straight out to remove.

Vanity mirror lamp bulb : 12V - 1.4W

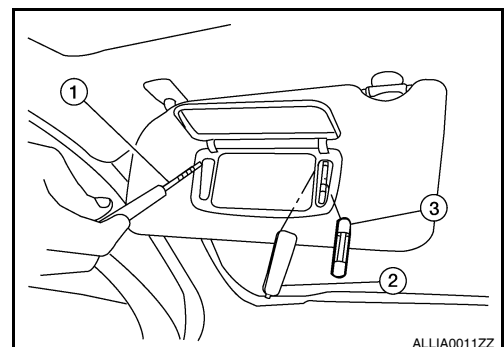

GLOVE BOX LAMP

Removal

A
B
C
D
E
F
G
H
I
J
K
INL
M
N
O
P

INTERIOR ROOM LAMP

< ON-VEHICLE REPAIR >

1. Remove the lower instrument glove box assembly (1). Refer to [IP-12, "Removal and Installation"](#).
2. Rotate glove box lamp socket (3) counterclockwise to remove.

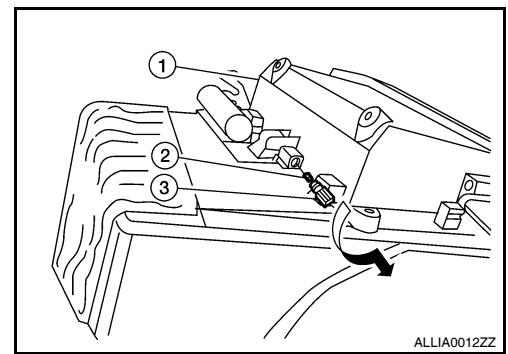

Installation

Installation is in the reverse order of removal.

Bulb Replacement

1. Remove glove box lamp socket (3).
2. Pull bulb (2) straight out to remove.

Glove box lamp bulb : 12V - 3.4W

STEP LAMP

Removal

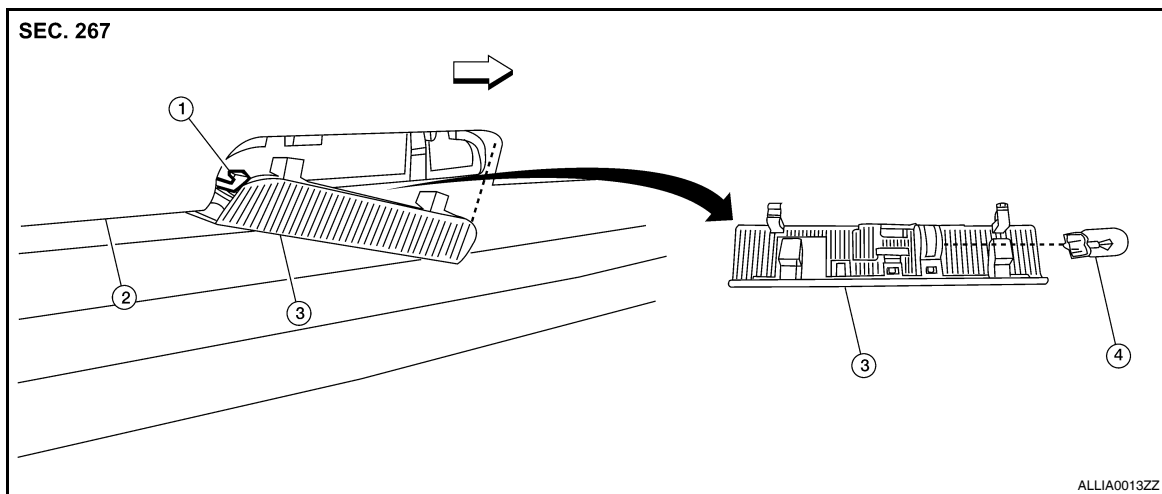

- | | | |
|------------------------|------------------|--------------------------|
| 1. Step lamp connector | 2. Door finisher | 3. Step lamp lens/socket |
| 4. Step lamp bulb | ← Vehicle front | |

1. Insert a suitable tool between door finisher (2) and step lamp lens/socket (1) to release the pawls.
2. Disconnect the step lamp connector, then remove step lamp.

Installation

Installation is in the reverse order of removal.

Bulb Replacement

1. Remove the step lamp lens/socket.
2. Pull the bulb straight out to remove.

Step lamp bulb : 12V - 3.8W

FOOT LAMP

Removal

INTERIOR ROOM LAMP

< ON-VEHICLE REPAIR >

1. Remove instrument lower cover LH if accessing driver side foot lamp socket, refer to [IP-11, "Exploded View"](#). Grasp foot lamp socket, then rotate counterclockwise to release from substrate (1).

NOTE:

Lamp socket is shown from passenger compartment side.

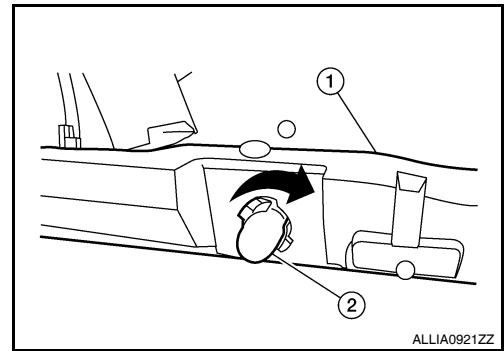

Installation

Installation is in the reverse order of removal.

Bulb Replacement

1. Remove foot lamp socket from substrate.
2. Pull bulb (2) straight out to remove.

Foot lamp bulb : 12V - 3.4W

PERSONAL LAMP

Removal

The personal lamp is replaced as part of the headlining assembly. Refer to [INT-32, "Removal and Installation"](#).

Installation

Installation is in the reverse order of removal.

Bulb Replacement

1. Using a suitable tool, release the pawls and remove personal lamp lens (3) from the personal lamp (1).
⇐: Vehicle front
2. Pull bulb (2) straight out to remove.

Personal lamp bulb : 12V - 8W

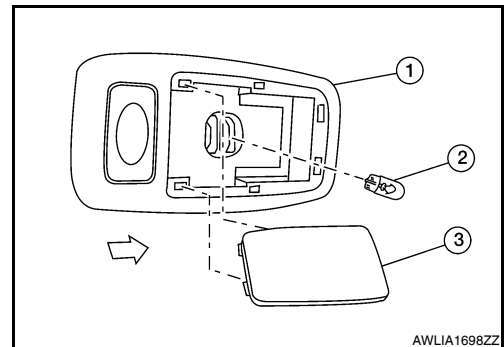

A
B
C
D
E
F
G
H
I
J
K
INL
M
N
O
P

ILLUMINATION

< ON-VEHICLE REPAIR >

ILLUMINATION

Removal and Installation

INFOID:000000005461083

TRUNK ROOM LAMP

Removal

1. Release the tab (A), then swing open the lens.
↳ Vehicle front
2. Remove the bulb (3).
3. Release the tab (B), then pull trunk room lamp (2) away from body opening.
4. Disconnect the connector (1) and remove trunk room lamp.

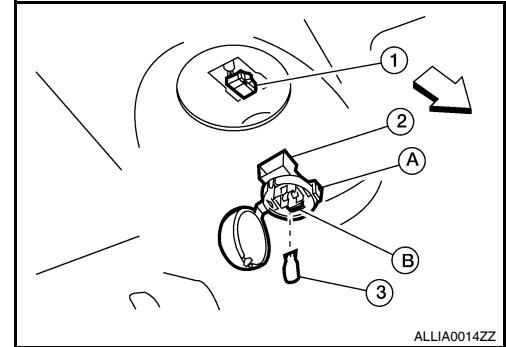

Installation

Installation is in the reverse order of removal.

Bulb Replacement

1. Release the tab (A), then swing open the lens.
2. Pull bulb (3) straight out to remove.

Trunk room lamp bulb : 12V - 3.4W

SERVICE DATA AND SPECIFICATIONS (SDS)

< SERVICE DATA AND SPECIFICATIONS (SDS)

SERVICE DATA AND SPECIFICATIONS (SDS)

SERVICE DATA AND SPECIFICATIONS (SDS)

Bulb Specifications

INFOID:000000005461084

Item	Type	Wattage (W)	Bulb No.*
Front room/map lamp	Wedge	8	-
Vanity mirror lamp	Cylinder	1.4	-
Glove box lamp	Wedge	3.4	158
Step lamp	Wedge	3.8	194
Foot lamp	Wedge	3.4	158
Personal lamp	Wedge	8	-
Trunk room lamp	Wedge	3.4	158
Front door switch illumination	LED	-	-
Push-button ignition switch illumination	LED	-	-

* Always check with the Parts Department for the latest parts information.

A
B
C
D
E
F
G
H
I
J
K
L
M
N
O
P

INL