

SECTION **LAN**
LAN SYSTEM

A
B
C

CONTENTS

CAN FUNDAMENTAL		
HOW TO USE THIS MANUAL	4	
HOW TO USE THIS SECTION	4	
Information	4	
PRECAUTION	5	
PRECAUTIONS	5	
Precautions for Trouble Diagnosis	5	
Precautions for Harness Repair	5	
SYSTEM DESCRIPTION	6	
SYSTEM	6	
CAN COMMUNICATION SYSTEM	6	
CAN COMMUNICATION SYSTEM : System De- scription	6	
DIAG ON CAN	6	
DIAG ON CAN : System Description	6	
TROUBLE DIAGNOSIS	8	
Component Description	8	
Condition of Error Detection	8	
Symptom When Error Occurs in CAN Communi- cation System	9	
CAN Diagnosis with CONSULT	11	
Self-Diagnosis	12	
CAN Diagnostic Support Monitor	12	
How to Use CAN Communication Signal Chart	14	
BASIC INSPECTION	15	
DIAGNOSIS AND REPAIR WORKFLOW	15	
Trouble Diagnosis Flow Chart	15	
Trouble Diagnosis Procedure	15	
CAN		
HOW TO USE THIS MANUAL	20	
HOW TO USE THIS SECTION	20	
Information	20	
Abbreviation List	20	
PRECAUTION	21	
PRECAUTIONS	21	
Precaution for Supplemental Restraint System (SRS) "AIR BAG" and "SEAT BELT PRE-TEN- SIONER"	21	
Service Procedure Precautions for Models with a Pop-up Roll Bar	21	
Precaution for Battery Service	21	
Precautions for Trouble Diagnosis	21	
Precautions for Harness Repair	22	
SYSTEM DESCRIPTION	23	
COMPONENT PARTS	23	
Component Parts Location	23	
SYSTEM	24	
CAN COMMUNICATION SYSTEM	24	
CAN COMMUNICATION SYSTEM : System De- scription	24	
CAN COMMUNICATION SYSTEM : CAN Com- munication Control Circuit	27	
CAN COMMUNICATION SYSTEM : CAN System Specification Chart	28	
CAN COMMUNICATION SYSTEM : CAN Com- munication Signal Chart	28	
WIRING DIAGRAM	32	
CAN SYSTEM	32	
Wiring Diagram	32	
BASIC INSPECTION	34	
DIAGNOSIS AND REPAIR WORKFLOW	34	
Interview Sheet	34	

D
E
F
G
H
I
J
K
L

LAN

N
O

P

DTC/CIRCUIT DIAGNOSIS	35	Diagnosis Procedure	53
MALFUNCTION AREA CHART	35	CAN COMMUNICATION CIRCUIT	54
Main Line	35	Diagnosis Procedure	54
Branch Line	35	CAN SYSTEM (TYPE 1)	
Short Circuit	35	DTC/CIRCUIT DIAGNOSIS	56
MAIN LINE BETWEEN ADP AND C/ROOF CIRCUIT	36	MAIN LINE BETWEEN ADP AND C/ROOF CIRCUIT	56
Diagnosis Procedure	36	Diagnosis Procedure	56
MAIN LINE BETWEEN C/ROOF AND M&A CIRCUIT	37	MAIN LINE BETWEEN C/ROOF AND M&A CIRCUIT	57
Diagnosis Procedure	37	Diagnosis Procedure	57
MAIN LINE BETWEEN M&A AND DLC CIRCUIT	38	MAIN LINE BETWEEN M&A AND DLC CIRCUIT	58
Diagnosis Procedure	38	Diagnosis Procedure	58
MAIN LINE BETWEEN DLC AND TCM CIRCUIT	39	MAIN LINE BETWEEN DLC AND TCM CIRCUIT	59
Diagnosis Procedure	39	Diagnosis Procedure	59
ECM BRANCH LINE CIRCUIT	40	ECM BRANCH LINE CIRCUIT	60
Diagnosis Procedure	40	Diagnosis Procedure	60
ADP BRANCH LINE CIRCUIT	41	ADP BRANCH LINE CIRCUIT	61
Diagnosis Procedure	41	Diagnosis Procedure	61
C/ROOF BRANCH LINE CIRCUIT	42	C/ROOF BRANCH LINE CIRCUIT	62
Diagnosis Procedure	42	Diagnosis Procedure	62
4WD BRANCH LINE CIRCUIT	43	4WD BRANCH LINE CIRCUIT	63
Diagnosis Procedure	43	Diagnosis Procedure	63
AV BRANCH LINE CIRCUIT	44	AV BRANCH LINE CIRCUIT	64
Diagnosis Procedure	44	Diagnosis Procedure	64
HVAC BRANCH LINE CIRCUIT	45	HVAC BRANCH LINE CIRCUIT	65
Diagnosis Procedure	45	Diagnosis Procedure	65
M&A BRANCH LINE CIRCUIT	46	M&A BRANCH LINE CIRCUIT	66
Diagnosis Procedure	46	Diagnosis Procedure	66
A-BAG BRANCH LINE CIRCUIT	47	A-BAG BRANCH LINE CIRCUIT	67
Diagnosis Procedure	47	Diagnosis Procedure	67
BCM BRANCH LINE CIRCUIT	48	BCM BRANCH LINE CIRCUIT	68
Diagnosis Procedure	48	Diagnosis Procedure	68
DLC BRANCH LINE CIRCUIT	49	DLC BRANCH LINE CIRCUIT	69
Diagnosis Procedure	49	Diagnosis Procedure	69
STRG BRANCH LINE CIRCUIT	50	STRG BRANCH LINE CIRCUIT	70
Diagnosis Procedure	50	Diagnosis Procedure	70
ABS BRANCH LINE CIRCUIT	51	ABS BRANCH LINE CIRCUIT	71
Diagnosis Procedure	51	Diagnosis Procedure	71
TCM BRANCH LINE CIRCUIT	52	TCM BRANCH LINE CIRCUIT	72
Diagnosis Procedure	52	Diagnosis Procedure	72
IPDM-E BRANCH LINE CIRCUIT	53		

IPDM-E BRANCH LINE CIRCUIT	73	CAN COMMUNICATION CIRCUIT	74
Diagnosis Procedure	73	Diagnosis Procedure	74

A

B

C

D

E

F

G

H

I

J

K

L

LAN

N

O

P

HOW TO USE THIS MANUAL

HOW TO USE THIS SECTION

Information

INFOID:000000008462754

- “CAN FUNDAMENTAL” of LAN Section describes the basic knowledge of the CAN communication system and the method of trouble diagnosis.
- For information peculiar to a vehicle and inspection procedure, refer to “CAN”.

PRECAUTION

PRECAUTIONS

Precautions for Trouble Diagnosis

INFOID:000000008462755

CAUTION:

Follow the instructions listed below. Failure to do this may cause damage to parts:

- Never apply 7.0 V or more to the measurement terminal.
- Use a tester with open terminal voltage of 7.0 V or less.
- Turn the ignition switch OFF and disconnect the battery cable from the negative terminal when checking the harness.

Precautions for Harness Repair

INFOID:000000008462756

- Solder the repaired area and wrap tape around the soldered area.

NOTE:

A fray of twisted lines must be within 110 mm (4.33 in).

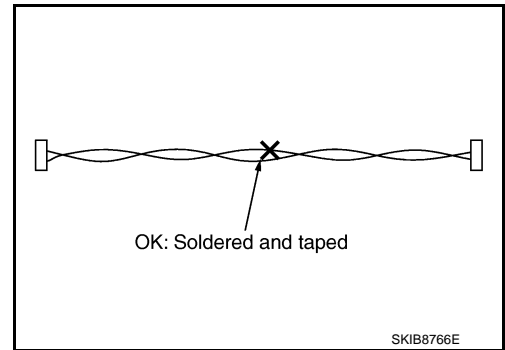

- Bypass connection is never allowed at the repaired area.

NOTE:

Bypass connection may cause CAN communication error. The spliced wire becomes separated and the characteristics of twisted line are lost.

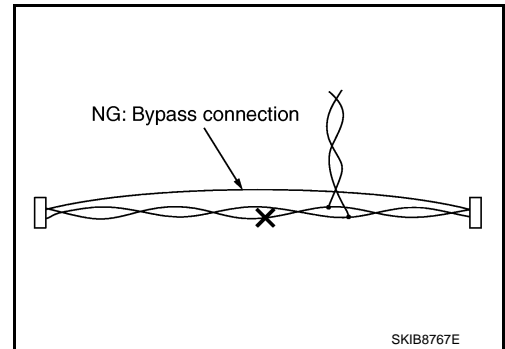

- Replace the applicable harness as an assembly if error is detected on the shield lines of CAN communication line.

A
B
C
D
E
F
G
H
I
J
K
L
L
N
O
P

LAN

SYSTEM DESCRIPTION

SYSTEM

CAN COMMUNICATION SYSTEM

CAN COMMUNICATION SYSTEM : System Description

INFOID:000000008462757

CAN (Controller Area Network) is a serial communication line for real time application. It is an on-vehicle multiplex communication line with high data communication speed and excellent error detection ability. Many electronic control units are equipped onto a vehicle, and each control unit shares information and links with other control units during operation (not independent). In CAN communication, control units are connected with 2 communication lines (CAN-H line, CAN-L line) allowing a high rate of information transmission with less wiring. Each control unit transmits/receives data but selectively reads required data only.

DIAG ON CAN

DIAG ON CAN : System Description

INFOID:000000008462758

SYSTEM DIAGRAM

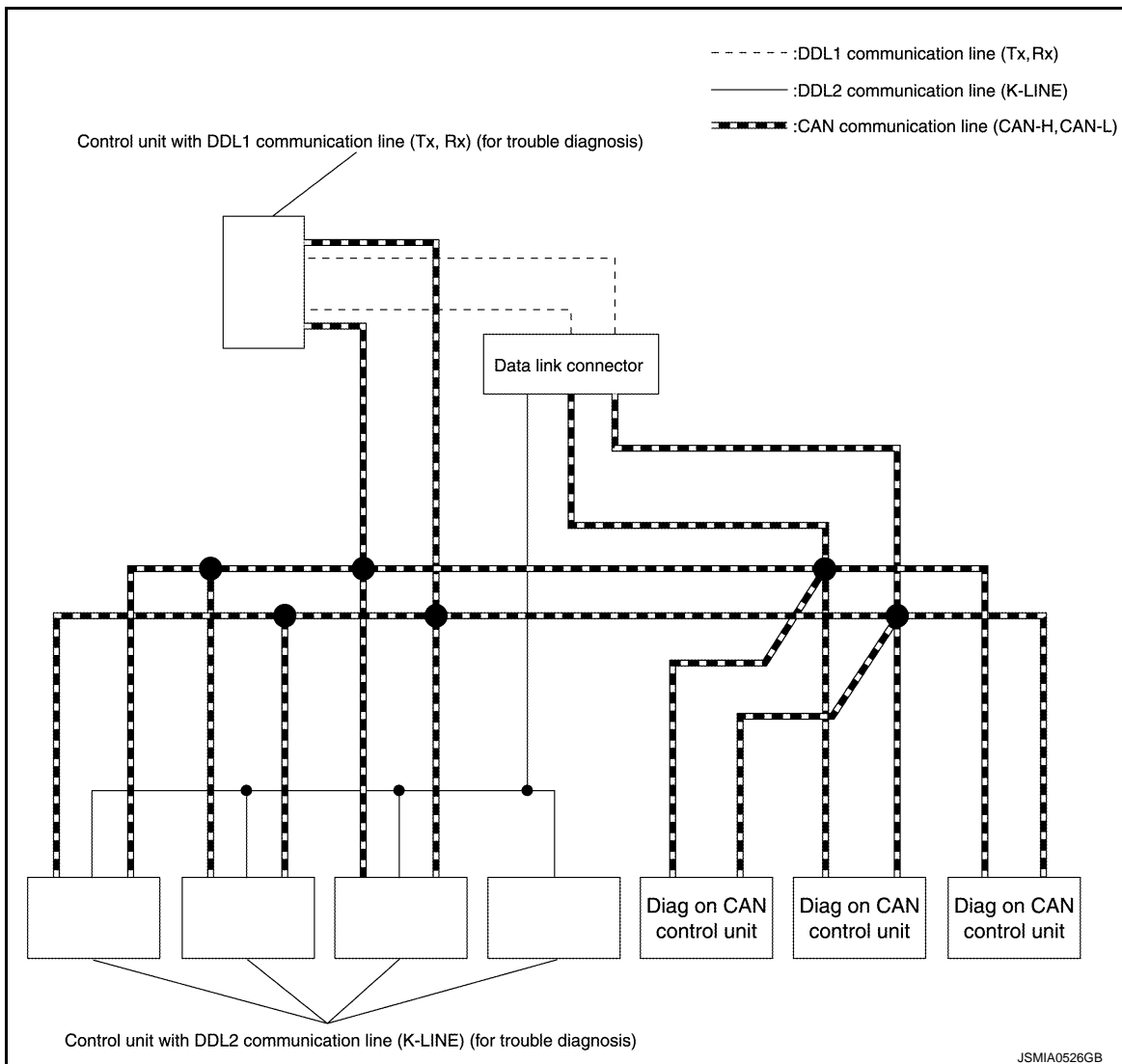

SYSTEM

< SYSTEM DESCRIPTION >

[CAN FUNDAMENTAL]

Name	Harness	Description
DDL1	Tx Rx	For communications with the diagnostic tool. (CAN-H and CAN-L are used for controlling)
DDL2	K-LINE	For communications with the diagnostic tool. (CAN-H and CAN-L are used for controlling)
Diag on CAN	CAN-H CAN-L	For communications with the diagnostic tool. (CAN-H and CAN-L are also used for control and diagnoses.)

DESCRIPTION

“Diag on CAN” is a diagnosis method which uses the CAN communication line for the communication between the control unit and the diagnostic tool.

A
B
C
D
E
F
G
H
I
J
K
L

LAN

N
O
P

TROUBLE DIAGNOSIS

Component Description

INFOID:000000008462759

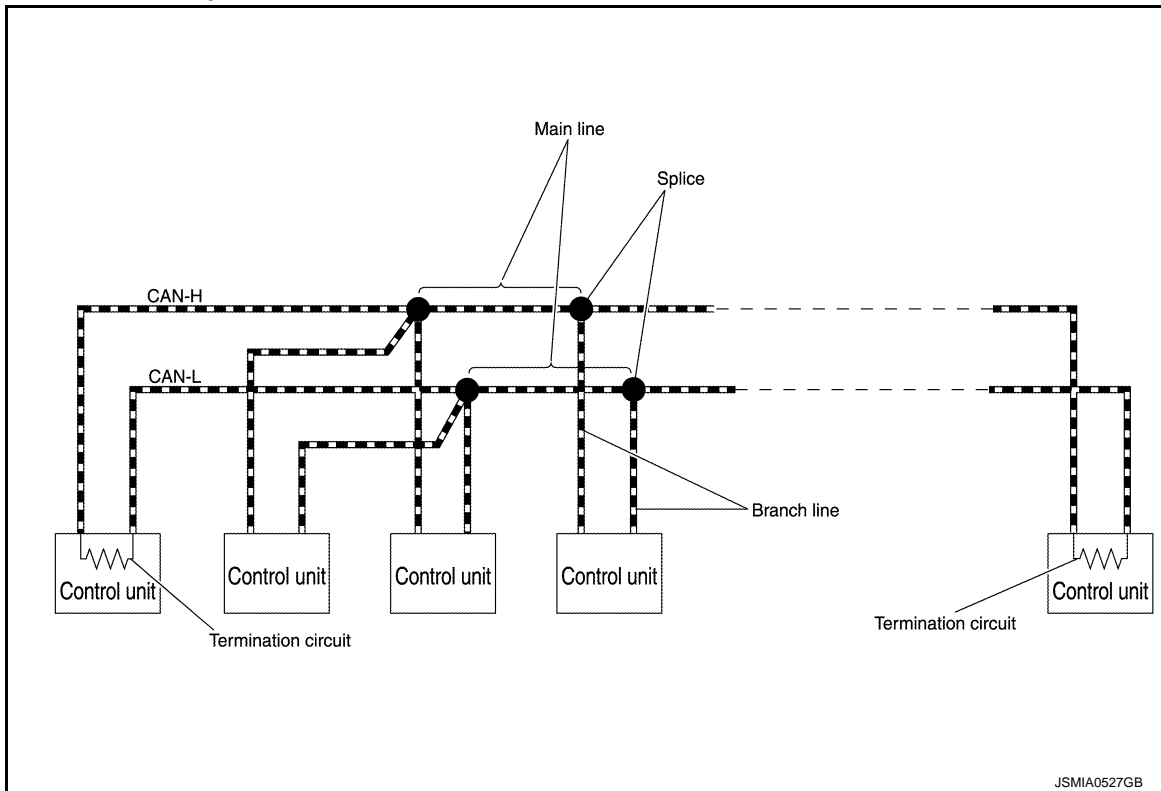

Component	Description
Main line	CAN communication line between splices
Branch line	CAN communication line between splice and a control unit
Splice	A point connecting a branch line with a main line
Termination circuit	Circuit connected across the CAN communication system. (Resistor)

Condition of Error Detection

INFOID:000000008462760

DTC (e.g. U1000 and U1001) of CAN communication is indicated on SELF-DIAG RESULTS on CONSULT if a CAN communication signal is not transmitted or received between units for 2 seconds or more.

CAN COMMUNICATION SYSTEM ERROR

- CAN communication line open (CAN-H, CAN-L, or both)
- CAN communication line short (ground, between CAN communication lines, other harnesses)
- Error of CAN communication control circuit of the unit connected to CAN communication line

WHEN DTC OF CAN COMMUNICATION IS INDICATED EVEN THOUGH CAN COMMUNICATION SYSTEM IS NORMAL

- Removal/installation of parts: Error may be detected when removing and installing CAN communication unit and related parts while turning the ignition switch ON. (A DTC except for CAN communication may be detected.)
- Fuse blown out (removed): CAN communication of the unit may cease.
- Voltage drop: Error may be detected if voltage drops due to discharged battery when turning the ignition switch ON (Depending on the control unit which carries out CAN communication).
- Error may be detected if the power supply circuit of the control unit, which carries out CAN communication, malfunctions (Depending on the control unit which carries out CAN communication).
- Error may be detected if reprogramming is not completed normally.

NOTE:

CAN communication system is normal if DTC of CAN communication is indicated on SELF-DIAG RESULTS of CONSULT under the above conditions. Erase the memory of the self-diagnosis of each control unit.

TROUBLE DIAGNOSIS

< SYSTEM DESCRIPTION >

[CAN FUNDAMENTAL]

Symptom When Error Occurs in CAN Communication System

INFOID:000000008462761

In CAN communication system, multiple control units mutually transmit and receive signals. Each control unit cannot transmit and receive signals if any error occurs on CAN communication line. Under this condition, multiple control units related to the root cause malfunction or go into fail-safe mode.

ERROR EXAMPLE

NOTE:

Each vehicle differs in symptom of each control unit under fail-safe mode and CAN communication line wiring.

Example: Main Line Between Data Link Connector and ABS Actuator and Electric Unit (Control Unit) Open Circuit

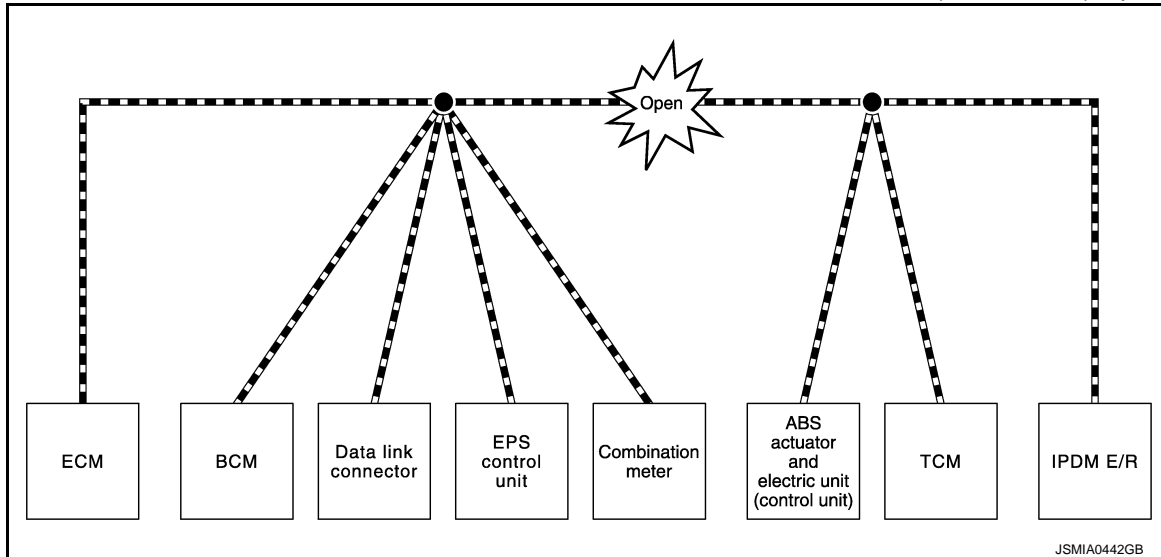

Unit name	Major symptom
ECM	Engine torque limiting is affected, and shift harshness increases.
BCM	<ul style="list-style-type: none"> Reverse warning buzzer does not sound. The front wiper moves under continuous operation mode even though the front wiper switch being in the intermittent position.
EPS control unit	The steering effort increases.
Combination meter	<ul style="list-style-type: none"> The shift position indicator and OD OFF indicator turn OFF. The speedometer is inoperative. The odo/trip meter stops.
ABS actuator and electric unit (control unit)	Normal operation.
TCM	No impact on operation.
IPDM E/R	When the ignition switch is ON, <ul style="list-style-type: none"> The headlamps (Lo) turn ON. The cooling fan continues to rotate.

A
B
C
D
E
F
G
H
I
J
K
L
LAN
N
O
P

TROUBLE DIAGNOSIS

[CAN FUNDAMENTAL]

< SYSTEM DESCRIPTION >

Example: TCM Branch Line Open Circuit

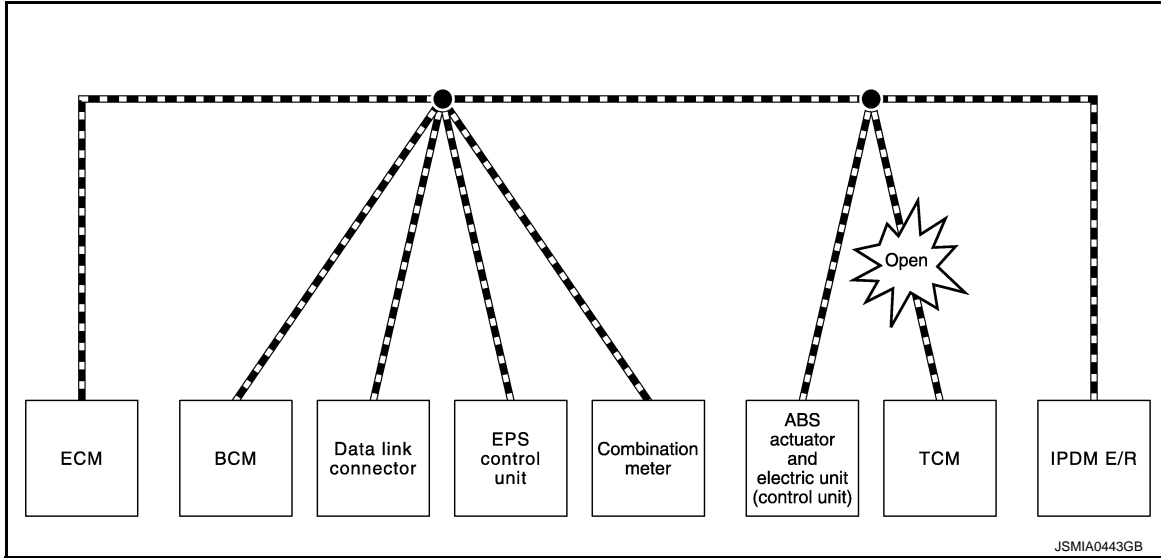

Unit name	Major symptom
ECM	Engine torque limiting is affected, and shift harshness increases.
BCM	Reverse warning buzzer does not sound.
EPS control unit	Normal operation.
Combination meter	<ul style="list-style-type: none"> Shift position indicator and O/D OFF indicator turn OFF. Warning lamps turn ON.
ABS actuator and electric unit (control unit)	Normal operation.
TCM	No impact on operation.
IPDM E/R	Normal operation.

NOTE:

The model (all control units on CAN communication system are Diag on CAN) cannot perform CAN diagnosis with CONSULT if the following error occurs. The error is judged by the symptom.

Error	Difference of symptom
Data link connector branch line open circuit	Normal operation.
CAN-H, CAN-L harness short-circuit	Most of the control units which are connected to the CAN communication system enter fail-safe mode or are deactivated.

Example: Data Link Connector Branch Line Open Circuit

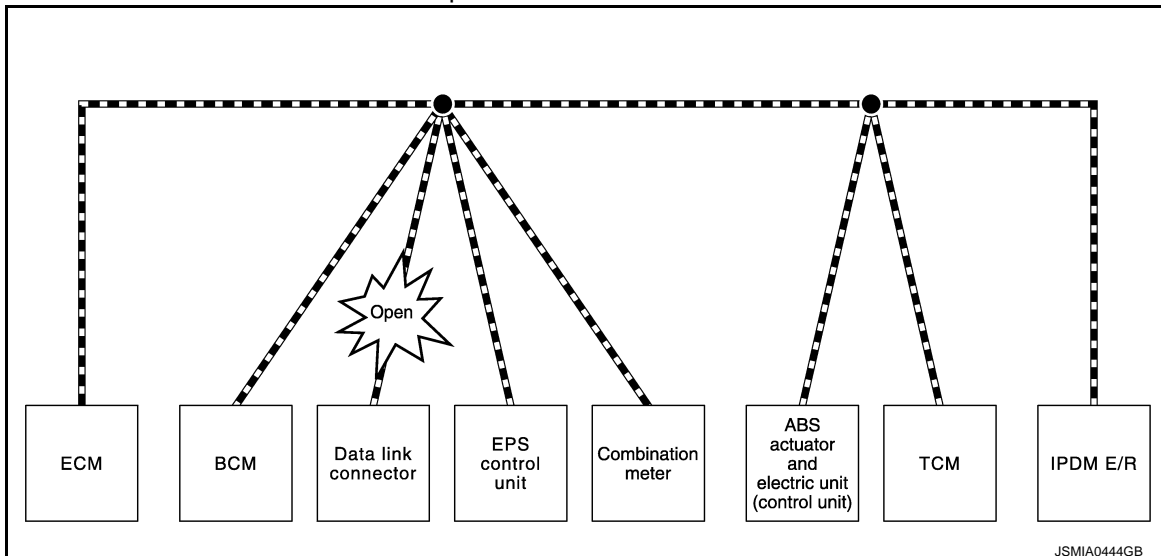

TROUBLE DIAGNOSIS

< SYSTEM DESCRIPTION >

[CAN FUNDAMENTAL]

Unit name	Major symptom
ECM	Normal operation.
BCM	
EPS control unit	
Combination meter	
ABS actuator and electric unit (control unit)	
TCM	
IPDM E/R	

NOTE:

When data link connector branch line is open, transmission and reception of CAN communication signals are not affected. Therefore, no symptoms occur. However, be sure to repair malfunctioning circuit.

Example: CAN-H, CAN-L Harness Short Circuit

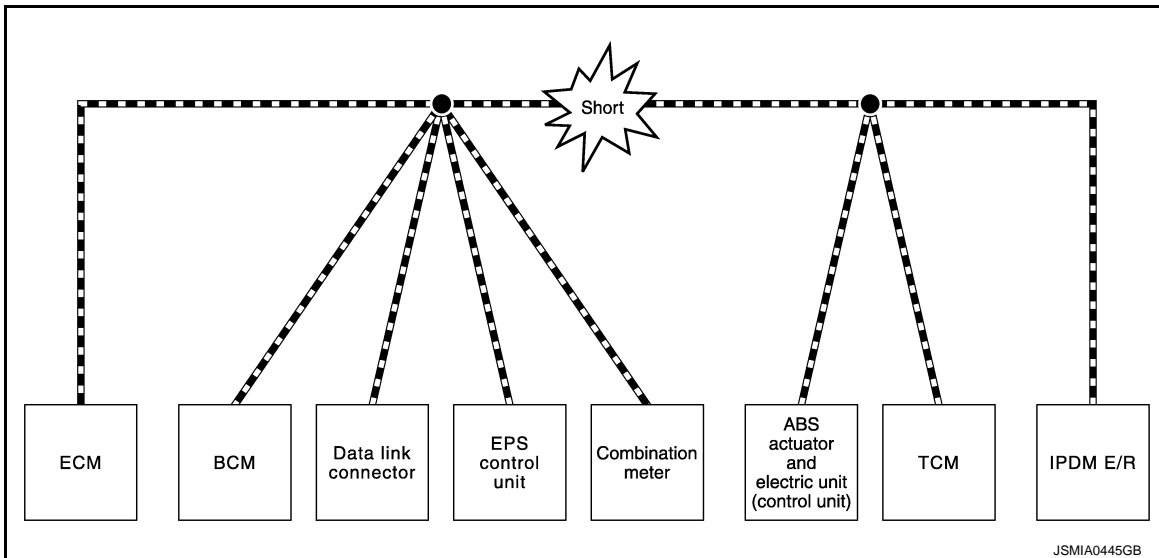

Unit name	Major symptom
ECM	<ul style="list-style-type: none"> • Engine torque limiting is affected, and shift harshness increases. • Engine speed drops.
BCM	<ul style="list-style-type: none"> • Reverse warning buzzer does not sound. • The front wiper moves under continuous operation mode even though the front wiper switch being in the intermittent position. • The room lamp does not turn ON. • The engine does not start (if an error or malfunction occurs while turning the ignition switch OFF.) • The steering lock does not release (if an error or malfunction occurs while turning the ignition switch OFF.)
EPS control unit	The steering effort increases.
Combination meter	<ul style="list-style-type: none"> • The tachometer and the speedometer do not move. • Warning lamps turn ON. • Indicator lamps do not turn ON.
ABS actuator and electric unit (control unit)	Normal operation.
TCM	No impact on operation.
IPDM E/R	When the ignition switch is ON, <ul style="list-style-type: none"> • The headlamps (Lo) turn ON. • The cooling fan continues to rotate.

CAN Diagnosis with CONSULT

INFOID:000000008462762

CAN diagnosis on CONSULT extracts the root cause by receiving the following information.

A
B
C
D
E
F
G
H
I
J
K
L
N
O
P

LAN

TROUBLE DIAGNOSIS

[CAN FUNDAMENTAL]

< SYSTEM DESCRIPTION >

- Response to the system call
- Control unit diagnosis information
- Self-diagnosis
- CAN diagnostic support monitor

Self-Diagnosis

INFOID:000000008462763

If communication signals cannot be transmitted or received among control units communicating via CAN communication line, CAN communication-related DTC is displayed on the CONSULT "Self Diagnostic Result" screen.

NOTE:

The following table shows examples of CAN communication-related DTC. For other DTC, refer to the applicable sections.

DTC	Self-diagnosis item (CONSULT indication)	DTC detection condition		Inspection/Action
U1000	CAN COMM CIRCUIT	ECM	When ECM is not transmitting or receiving CAN communication signal of OBD (emission-related diagnosis) for 2 seconds or more.	Start the inspection. Refer to the applicable section of the indicated control unit.
		Except for ECM	When a control unit (except for ECM) is not transmitting or receiving CAN communication signal for 2 seconds or more.	
U1001	CAN COMM CIRCUIT	When ECM is not transmitting or receiving CAN communication signal other than OBD (emission-related diagnosis) for 2 seconds or more.		
U1002	SYSTEM COMM	When a control unit is not transmitting or receiving CAN communication signal for 2 seconds or less.		
U1010	CONTROL UNIT(CAN)	When an error is detected during the initial diagnosis for CAN controller of each control unit.		

CAN Diagnostic Support Monitor

INFOID:000000008462764

MONITOR ITEM (CONSULT)

Example: CAN DIAG SUPPORT MNTR indication

Without PAST				With PAST			
BCM				ENGINE			
MONITOR ITEM	PRESENT	PAST		MONITOR ITEM	PRESENT	PAST	
INITIAL DIAG	OK	-		TRANSMIT DIAG	OK	OK	
TRANSMIT DIAG	OK	-		VDC/TCS/ABS	OK	5	
ECM	OK	-		METER/M&A	Not diagnosed	-	
METER/M&A	OK	-		BCM/SEC	OK	OK	
TCM	OK	-		ICC	Not diagnosed	-	
IPDM E/R	OK	-		HVAC	Not diagnosed	-	
I-KEY	OK	-		TCM	OK	OK	
				EPS	OK	OK	
				IPDM E/R	OK	5	
				e4WD	Not diagnosed	-	
				AWD/4WD	Not diagnosed	-	

JSMIA0964GB

Without PAST

Item	PRESENT	Description
Initial diagnosis	OK	Normal at present
	NG	Control unit error (Except for some control units)

TROUBLE DIAGNOSIS

< SYSTEM DESCRIPTION >

[CAN FUNDAMENTAL]

Item	PRESENT	Description
Transmission diagnosis	OK	Normal at present
	UNKWN	Unable to transmit signals for 2 seconds or more.
		Diagnosis not performed
Control unit name (Reception diagnosis)	OK	Normal at present
	UNKWN	Unable to receive signals for 2 seconds or more.
		Diagnosis not performed
	No control unit for receiving signals. (No applicable optional parts)	

With PAST

Item	PRESENT	PAST	Description
Transmission diagnosis	OK	OK	Normal at present and in the past
		1 – 39	Normal at present, but unable to transmit signals for 2 seconds or more in the past. (The number indicates the number of ignition switch cycles from OFF to ON.)
	UNKWN	0	Unable to transmit signals for 2 seconds or more at present.
Control unit name (Reception diagnosis)	OK	OK	Normal at present and in the past
		1 – 39	Normal at present, but unable to receive signals for 2 seconds or more in the past. (The number indicates the number of ignition switch cycles from OFF to ON.)
	UNKWN	0	Unable to receive signals for 2 seconds or more at present.
	Not diagnosed	-	Diagnosis not performed.
No control unit for receiving signals. (No applicable optional parts)			

A
B
C
D
E
F
G
H
I
J
K
L
N
O
P

LAN

TROUBLE DIAGNOSIS

< SYSTEM DESCRIPTION >

[CAN FUNDAMENTAL]

How to Use CAN Communication Signal Chart

INFOID:00000008462765

The CAN communication signal chart lists the signals transmitted/received among control units. It is useful for detecting the root cause by finding a signal related to the symptom, and by checking transmission and reception unit.

Example: Tachometer does not move even though the engine rotates.

T: Transmit R: Receive

Signal name/Connecting unit	ECM	BCM	M&A	STRG	ABS	IPDM-E
A/C compressor feedback signal	T		R			
A/C compressor request signal	T					R
Accelerator pedal position signal	T				R	
Cooling fan motor operation signal	T					R
Engine coolant temperature signal	T		R			
Engine speed signal	T		R		R	
Fuel consumption monitor signal	T		R			
Malfunction indicator lamp signal	T		R			
A/C switch signal	R	T				
Ignition switch signal		T				R
Sleep/wake up signal		T	R			R

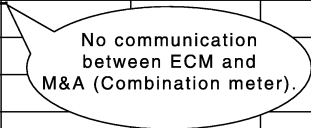

No communication between ECM and M&A (Combination meter).

↓

It indicates that an error occurs between ECM and Combination meter (Shaded area).

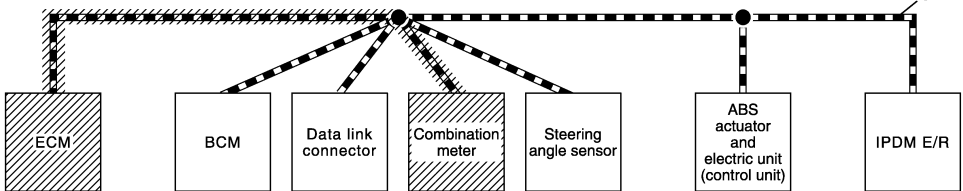

JSMIA0446GB

BASIC INSPECTION

DIAGNOSIS AND REPAIR WORKFLOW

Trouble Diagnosis Flow Chart

INFOID:000000008462766

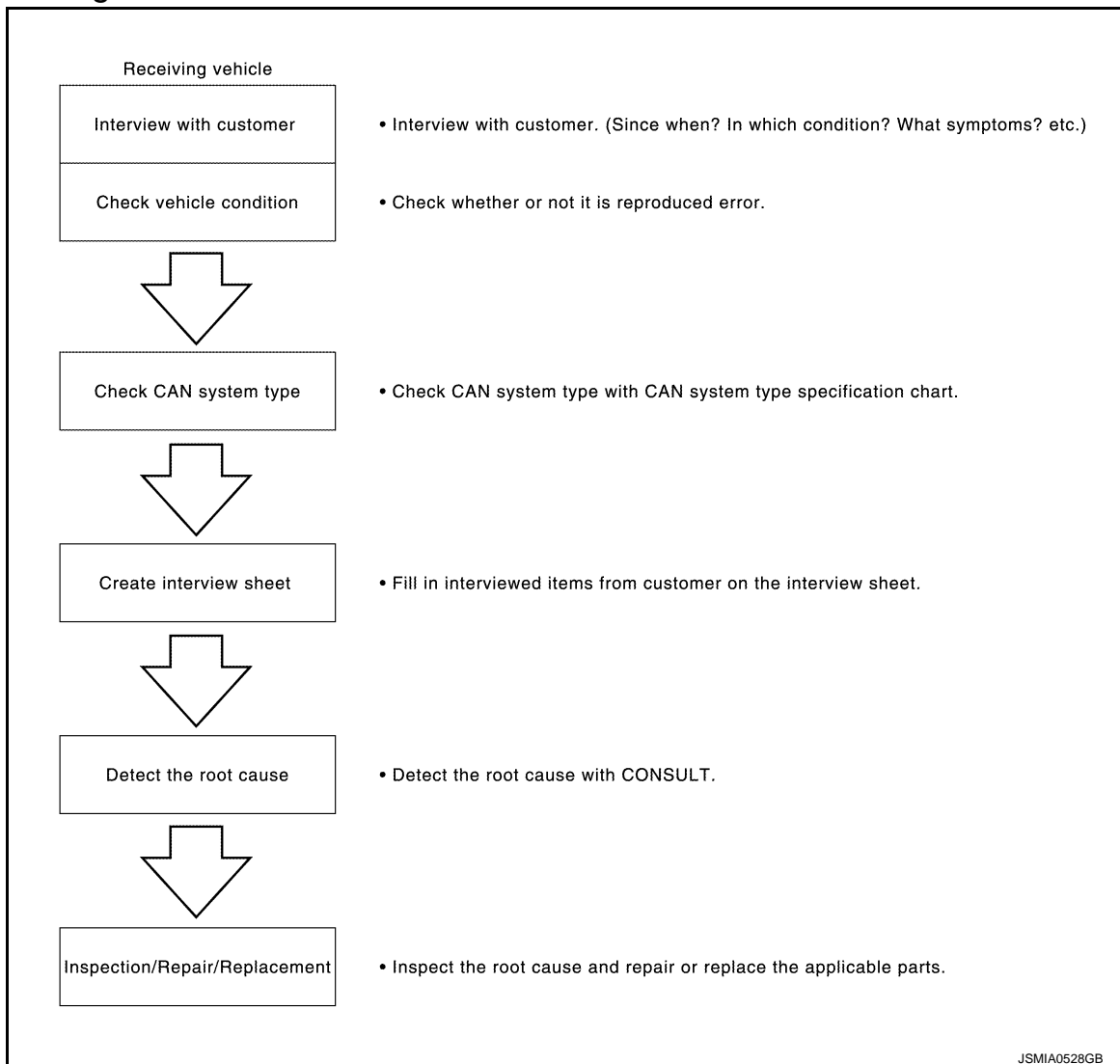

Trouble Diagnosis Procedure

INFOID:000000008462767

INTERVIEW WITH CUSTOMER

Interview with the customer is important to detect the root cause of CAN communication system errors and to understand vehicle condition and symptoms for proper trouble diagnosis.

Points in interview

- What: Parts name, system name
- When: Date, Frequency
- Where: Road condition, Place
- In what condition: Driving condition/environment
- Result: Symptom

Notes for checking error symptoms:

- Check normal units as well as error symptoms.
- Example: Circuit between ECM and the combination meter is judged normal if the customer indicates tachometer functions normally.
- When a CAN communication system error is present, multiple control units may malfunction or go into fail-safe mode.

A
B
C
D
E
F
G
H
I
J
K
L

LAN

N
O
P

DIAGNOSIS AND REPAIR WORKFLOW

< BASIC INSPECTION >

[CAN FUNDAMENTAL]

- Indication of the combination meter is important to detect the root cause because it is the most obvious to the customer, and it performs CAN communication with many units.

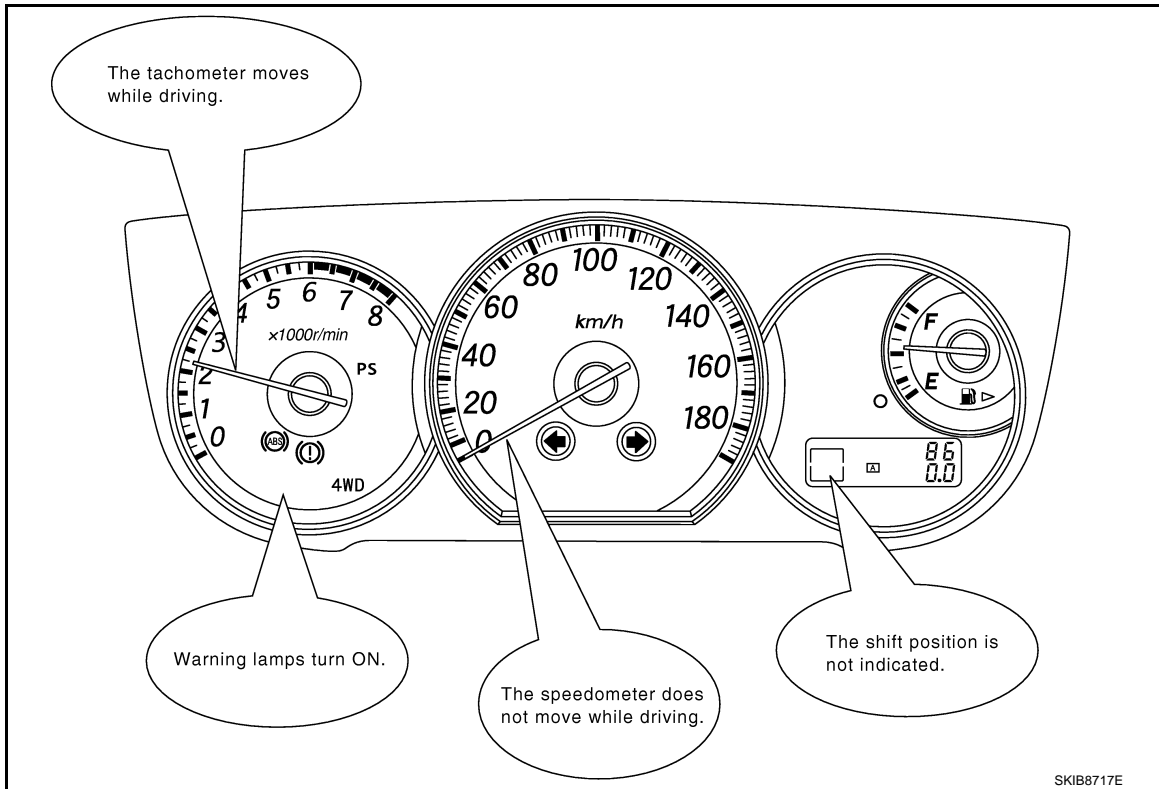

INSPECTION OF VEHICLE CONDITION

Check whether the symptom is reproduced or not.

NOTE:

Do not turn the ignition switch OFF or disconnect the battery cable while reproducing the error. The error may temporarily correct itself, making it difficult to determine the root cause.

CHECK OF CAN SYSTEM TYPE (HOW TO USE CAN SYSTEM TYPE SPECIFICATION CHART)

Determine CAN system type based on vehicle equipment.

NOTE:

- This chart is used if CONSULT does not automatically recognize CAN system type.
- There are two styles for CAN system type specification charts. Depending on the number of available system types, either style A or style B may be used.

CAN System Type Specification Chart (Style A)

NOTE:

DIAGNOSIS AND REPAIR WORKFLOW

< BASIC INSPECTION >

[CAN FUNDAMENTAL]

CAN system type is easily checked with the vehicle equipment identification information shown in the chart.

Example:
Vehicle is equipped as follows: Wagon, AWD, VQ35DE, CVT, VDC, and Intelligent Key system. (○ shows an example of CAN system type.)

CAN System Specification Chart
Determine CAN system type from the following specification chart.

Body type	Wagon					
Axle	2WD			AWD		
Engine	QR25DE			VQ35DE		
Transmission	A/T			CVT		
Brake control	ABS			VDC		
Intelligent Key system		×		×		×
CAN system type	1	2	3	4	5	6
CAN communication control unit						
ECM	×	×	×	×	×	×
AWD control unit					×	×
Air bag diagnosis sensor unit	×	×	×	×	×	×
BCM	×	×	×	×	×	×
Intelligent Key unit		×		×		×
Steering angle sensor					×	×
EPS control unit	×	×	×	×	×	×
Combination meter	×	×	×	×	×	×
ABS actuator and electric unit (control unit)	×	×	×	×	×	×
TCM	×	×	×	×	×	×
IPDM E/R	×	×	×	×	×	×

× : Applicable

VEHICLE EQUIPMENT IDENTIFICATION INFORMATION
NOTE:
Check CAN system type from the vehicle shape and equipment.

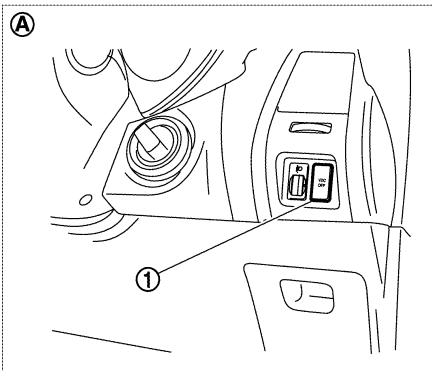

1. VDC OFF switch
A. With VDC

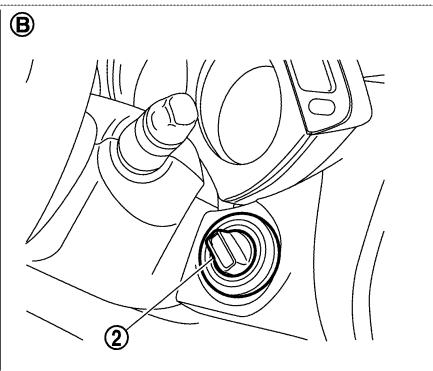

2. Ignition knob
B. With Intelligent Key system

For the above case, CAN system type is "6".

JSMIA0529GB

A
B
C
D
E
F
G
H
I
J
K
L
N
O
P

LAN

CAN System Type Specification Chart (Style B)

NOTE:

DIAGNOSIS AND REPAIR WORKFLOW

< BASIC INSPECTION >

[CAN FUNDAMENTAL]

CAN system type is easily checked with the vehicle equipment identification information shown in the chart.

Example:
Vehicle is equipped as follows: Sedan, 2WD, MR20DE, CVT, ABS, Active AFS, Intelligent Key system, Navigation system and Automatic drive positioner. (○ shows an example of CAN system type.)

CAN System Specification Chart
Refer to the specification as shown in the chart.

Body type	Sedan		
Axle	2WD		AWD
Engine	HR15DE	MR20DE	HR15DE
Transmission	A/T	CVT	A/T
Brake control	ABS		
Specification chart	XX.XX. SPECIFICATION CHART A.	XX.XX. SPECIFICATION CHART B.	XX.XX. SPECIFICATION CHART C.

×: Applicable

Check the vehicle equipment with the vehicle identification number plate.
Check the vehicle equipment.
Select the applicable vehicle equipment. Refer to the specification chart.

SPECIFICATION CHART B
Determine CAN system type from the following specification chart.

Body type	Sedan											
Axle	2WD											
Engine	MR20DE											
Transmission	CVT											
Brake control	ABS											
Active AFS		×			×	×		×	×	×		
Intelligent Key system			×		×		×	×	×	×		
Navigation system				×		×		×		×		
Automatic drive positioner								×	×	×		
CAN system type	9	10	11	12	13	14	15	16	17	18	19	20
CAN communication control unit												
ECM	×	×	×	×	×	×	×	×	×	×	×	×
AFS control unit		×			×	×			×	×		×
BCM	×	×	×	×	×	×	×	×	×	×	×	×
IPDM E/R	×	×	×	×	×	×	×	×	×	×	×	×

×: Applicable

Check the vehicle equipment.
The number indicates the CAN system type of the vehicle.

VEHICLE EQUIPMENT IDENTIFICATION INFORMATION
NOTE:
Check CAN system type from the vehicle shape and equipment.

In the above example,

- Checking Xenon bulb and bending lamp lead to judge whether or not Active AFS is equipped.
- Checking the ignition knob leads to judge whether or not Intelligent Key system is equipped.
- Checking display and multifunction switch lead to judge whether or not Navigation system is equipped.
- Checking seat memory switch leads to judge whether or not Automatic drive positioner is equipped.

1. Bending lamp 2. Xenon bulb 3. Ignition knob
4. Display 5. Multifunction switch 6. Seat memory switch
A. With active AFS B. With Intelligent Key system C. With navigation system
D. With automatic drive positioner

For the above case, CAN system type is "20".

JSMIA0530GB

CREATE INTERVIEW SHEET

Fill out the symptom described by the customer, vehicle condition, and CAN system type on the interview sheet.

DIAGNOSIS AND REPAIR WORKFLOW

< BASIC INSPECTION >

[CAN FUNDAMENTAL]

Interview Sheet (Example)

CAN Communication System Diagnosis Interview Sheet	
Date received:	3, Feb. 2006
Type: DBA-KG11	VIN No.: KG11-005040
Model: BDRARGZG11EDA-E-J-	
First registration: 10, Jan. 2001	Mileage: 62,140
CAN system type:	Type 19
Symptom (Results from interview with customer)	
<ul style="list-style-type: none">· Headlamps suddenly turn ON while driving the vehicle.· The engine does not restart after stopping the vehicle and turning the ignition switch OFF.· The cooling fan continues rotating while turning the ignition switch ON.	
Condition at inspection	
Error Symptom: <u>Present</u> / Past	
<p>The engine does not start.</p> <p>While turning the ignition switch ON,</p> <ul style="list-style-type: none">· The headlamps (Lo) turn ON, and the cooling fan continues rotating.· The interior lamp does not turn ON.	

JSMIA0531GB

A
B
C
D
E
F
G
H
I
J
K
L

DETECT THE ROOT CAUSE

CAN diagnosis function of CONSULT detects the root cause.

LAN

N
O
P

HOW TO USE THIS SECTION

< HOW TO USE THIS MANUAL >

[CAN]

HOW TO USE THIS MANUAL

HOW TO USE THIS SECTION

Information

INFOID:000000008462768

- “CAN” of LAN Section describes information peculiar to a vehicle and inspection procedures.
- For trouble diagnosis procedure, refer to [LAN-15, "Trouble Diagnosis Flow Chart"](#) of “CAN FUNDAMENTAL”.

Abbreviation List

INFOID:000000008462769

Unit name abbreviations in CONSULT CAN diagnosis and in this section are as per the following list.

Abbreviation	Unit name
4WD	AWD control unit
A-BAG	Air bag diagnosis sensor unit
ABS	ABS actuator and electric unit (control unit)
ADP	Driver seat control unit
AV	AV control unit
BCM	BCM
C/ROOF	Soft top control unit
DLC	Data link connector
ECM	ECM
HVAC	A/C auto amp.
IPDM-E	IPDM E/R
M&A	Combination meter
STRG	Steering angle sensor
TCM	TCM

PRECAUTION

PRECAUTIONS

Precaution for Supplemental Restraint System (SRS) "AIR BAG" and "SEAT BELT PRE-TENSIONER"

INFOID:000000008462770

The Supplemental Restraint System such as "AIR BAG" and "SEAT BELT PRE-TENSIONER", used along with a front seat belt, helps to reduce the risk or severity of injury to the driver and front passenger for certain types of collision. This system includes seat belt switch inputs and dual stage front air bag modules. The SRS system uses the seat belt switches to determine the front air bag deployment, and may only deploy one front air bag, depending on the severity of a collision and whether the front occupants are belted or unbelted. Information necessary to service the system safely is included in the "SRS AIR BAG" and "SEAT BELT" of this Service Manual.

WARNING:

Always observe the following items for preventing accidental activation.

- To avoid rendering the SRS inoperative, which could increase the risk of personal injury or death in the event of a collision that would result in air bag inflation, all maintenance must be performed by an authorized NISSAN/INFINITI dealer.
- Improper maintenance, including incorrect removal and installation of the SRS, can lead to personal injury caused by unintentional activation of the system. For removal of Spiral Cable and Air Bag Module, see "SRS AIR BAG".
- Never use electrical test equipment on any circuit related to the SRS unless instructed to in this Service Manual. SRS wiring harnesses can be identified by yellow and/or orange harnesses or harness connectors.

PRECAUTIONS WHEN USING POWER TOOLS (AIR OR ELECTRIC) AND HAMMERS

WARNING:

Always observe the following items for preventing accidental activation.

- When working near the Air Bag Diagnosis Sensor Unit or other Air Bag System sensors with the ignition ON or engine running, never use air or electric power tools or strike near the sensor(s) with a hammer. Heavy vibration could activate the sensor(s) and deploy the air bag(s), possibly causing serious injury.
- When using air or electric power tools or hammers, always switch the ignition OFF, disconnect the battery, and wait at least 3 minutes before performing any service.

Service Procedure Precautions for Models with a Pop-up Roll Bar

INFOID:000000008462771

WARNING:

Always observe the following items for preventing accidental activation.

- Risk of passenger injury or death may increase if the pop-up roll bar does not deploy during a roll over collision. In order to reduce the chance of an incident where the pop-up roll bar is inoperative, all maintenance must be performed by a NISSAN or INFINITI dealer.
- Before removing and installing the pop-up roll bar component parts and harness, always turn the ignition switch OFF, disconnect the battery negative terminal, and wait for 3 minutes or more. (The purpose of this operation is to discharge electricity that is accumulated in the auxiliary power supply circuit in the air bag diagnosis sensor unit.)
- When repairing, removing, and installing a pop-up roll bar, always refer to SRS AIR BAG and SRS AIR BAG CONTROL warnings in the Service Manual.

Precaution for Battery Service

INFOID:000000008462772

Before disconnecting the battery, lower both the driver and passenger windows. This will prevent any interference between the window edge and the vehicle when the door is opened/closed. During normal operation, the window slightly raises and lowers automatically to prevent any window to vehicle interference. The automatic window function will not work with the battery disconnected.

Precautions for Trouble Diagnosis

INFOID:000000008462773

CAUTION:

Follow the instructions listed below. Failure to do this may cause damage to parts:

A
B
C
D
E
F
G
H
I
J
K
L
N
O
P



PRECAUTIONS

[CAN]

< PRECAUTION >

- Never apply 7.0 V or more to the measurement terminal.
- Use a tester with open terminal voltage of 7.0 V or less.
- Turn the ignition switch OFF and disconnect the battery cable from the negative terminal when checking the harness.

Precautions for Harness Repair

INFOID:000000008462774

- Solder the repaired area and wrap tape around the soldered area.

NOTE:

A fray of twisted lines must be within 110 mm (4.33 in).

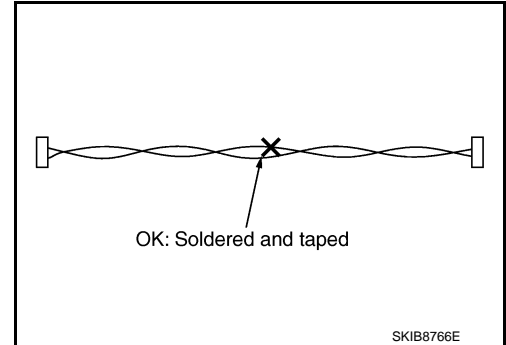

- Bypass connection is never allowed at the repaired area.

NOTE:

Bypass connection may cause CAN communication error. The spliced wire becomes separated and the characteristics of twisted line are lost.

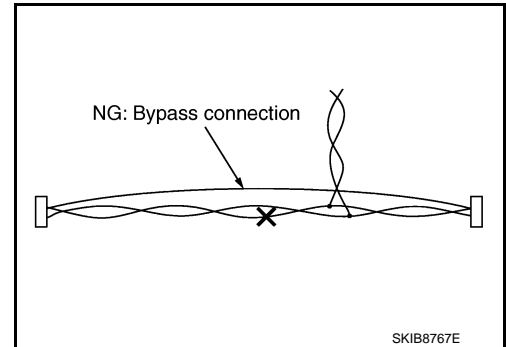

- Replace the applicable harness as an assembly if error is detected on the shield lines of CAN communication line.

SYSTEM DESCRIPTION

COMPONENT PARTS

Component Parts Location

INFOID:000000008462775

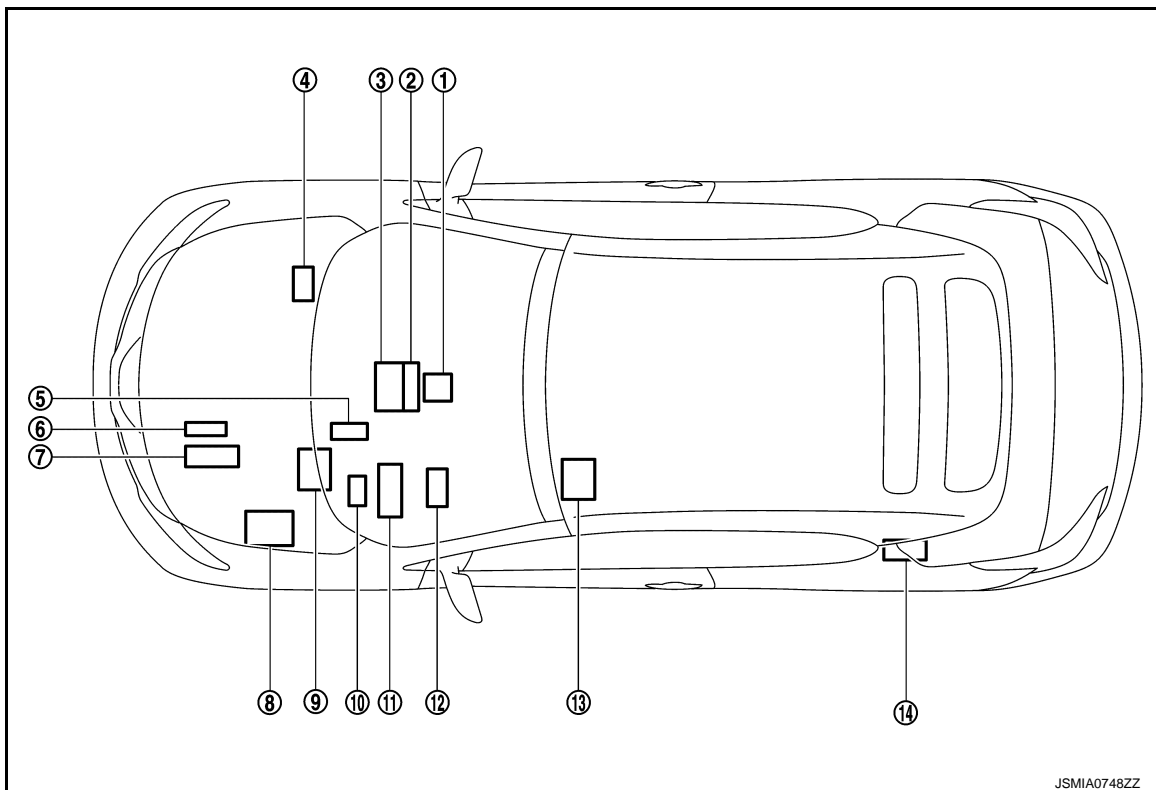

- | | | |
|--|---------------------------|---------------------------|
| 1. Air bag diagnosis sensor unit | 2. A/C auto amp. | 3. AV control unit |
| 4. ABS actuator and electric unit (control unit) | 5. AWD control unit | 6. TCM |
| 7. ECM | 8. IPDM E/R | 9. BCM |
| 10. Data link connector | 11. Combination meter | 12. Steering angle sensor |
| 13. Driver seat control unit | 14. Soft top control unit | |

A
B
C
D
E
F
G
H
I
J
K
L
LAN
N
O
P

LAN

SYSTEM

CAN COMMUNICATION SYSTEM

CAN COMMUNICATION SYSTEM : System Description

INFOID:000000008462776

SYSTEM DIAGRAM

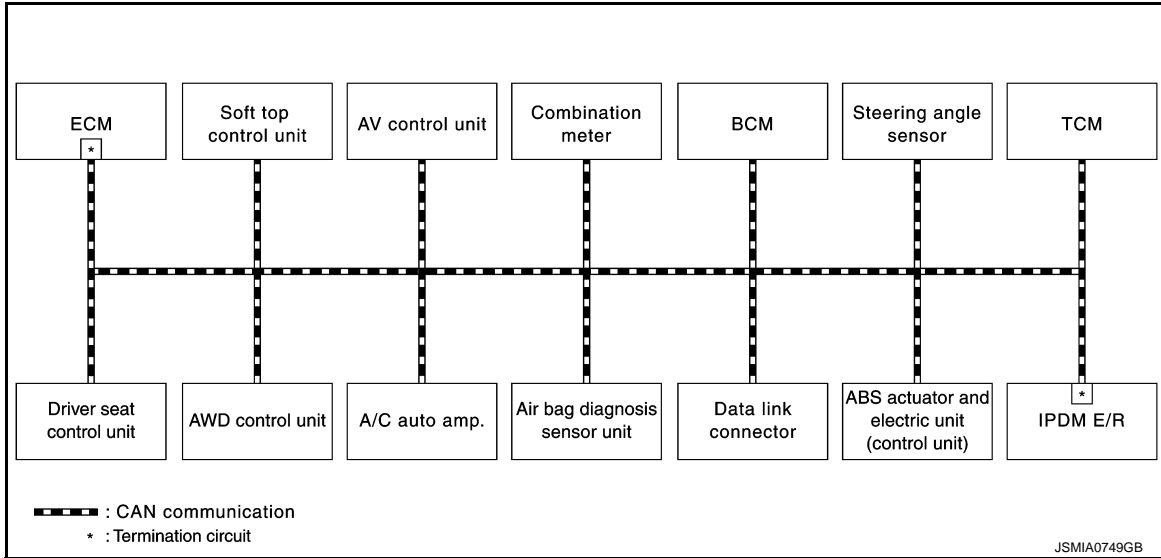

DESCRIPTION

CAN (Controller Area Network) is a serial communication line for real time application. It is an on-vehicle multiplex communication line with high data communication speed and excellent error detection ability. Many electronic control units are equipped onto a vehicle, and each control unit shares information and links with other control units during operation (not independent). In CAN communication, control units are connected with 2 communication lines (CAN-H line, CAN-L line) allowing a high rate of information transmission with less wiring. Each control unit transmits/receives data but selectively reads required data only.

Can Communication Signal Generation

- Termination circuits (resistors) are connected across the CAN communication system. When transmitting a CAN communication signal, each control unit passes a current to the CAN-H line and the current returns to the CAN-L line.

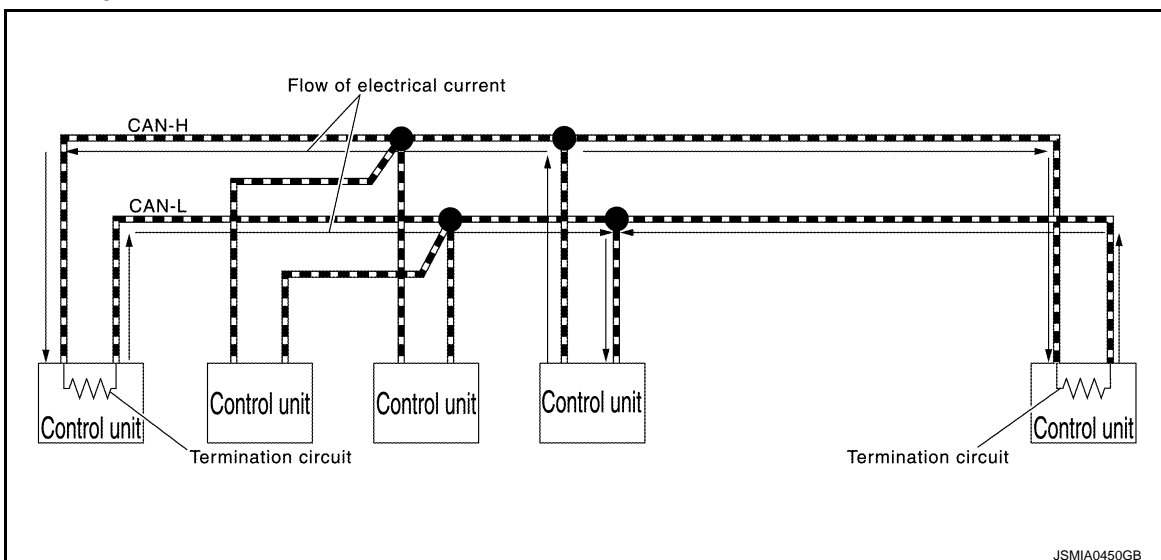

SYSTEM

[CAN]

< SYSTEM DESCRIPTION >

- The current flows separately into the termination circuits connected across the CAN communication system and the termination circuits drop voltage to generate a potential difference between the CAN-H line and the CAN-L line.

NOTE:

A signal with no current passage is called "Recessive" and one with current passage is called "Dominant".

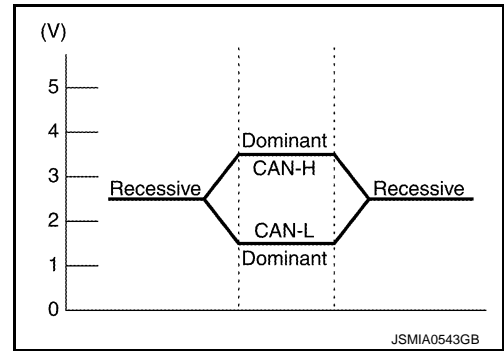

- The system produces digital signals for signal communications, by using the potential difference.

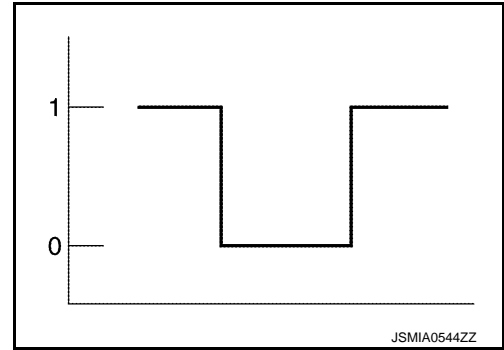

The Construction Of Can Communication Signal (Message)

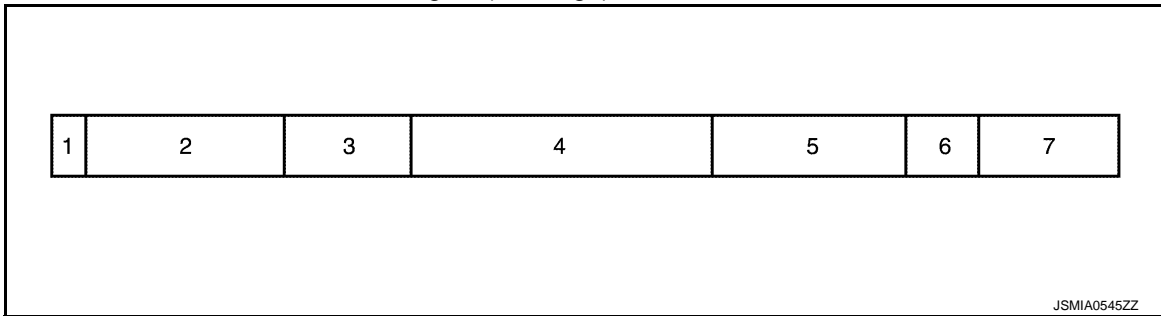

No.	Message name	Description
1	Start of frame (1 bit)	Start of message.
2	Arbitration of field (11 bit)	Priorities of message-sending are shown when there is a possibility that multiple messages are sent at the same time.
3	Control field (6 bit)	Signal quantity in data field is shown.
4	Data field (0-64 bit)	Actual signal is shown.
5	CRC field (16 bit)	<ul style="list-style-type: none"> The transmitting control unit calculates sending data in advance and writes the calculated value in a message. The receiving control unit calculates received data and judges that the data reception is normal when the calculated value is the same as the value written in the sent data.
6	ACK field (2 bit)	The completion of normal reception is sent to the transmitting unit.
7	End of frame (7 bit)	End of message.

CAN COMMUNICATION LINE

A
B
C
D
E
F
G
H
I
J
K
L
N
O
P

LAN

SYSTEM

[CAN]

< SYSTEM DESCRIPTION >

The CAN communication line is a twisted pair wire consisting of strands of CAN-L (1) and CAN-H (2) and has noise immunity.

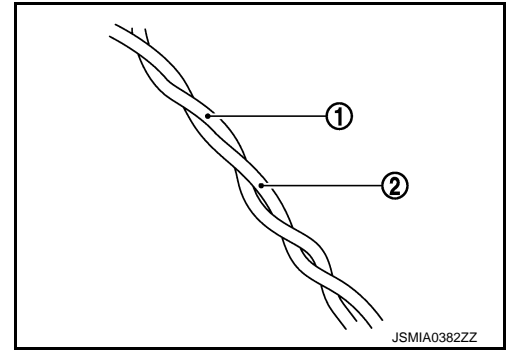

NOTE:

The CAN communication system has the characteristics of noise-resistant because this system produces digital signals by using the potential difference between the CAN-H line and the CAN-L line and has the twisted pair wire structure.

Since the CAN-H line and the CAN-L line are always adjacent to each other, the same degree of noise occurs, respectively, when a noise (1) occurs. Although the noise changes the voltage, the potential difference (2) between the CAN-H line and the CAN-L line is insensitive to noise. Therefore, noise-resistant signals can be obtained.

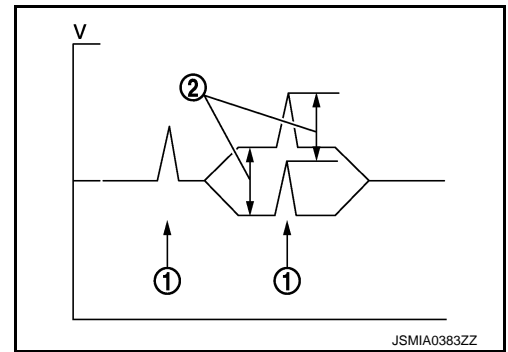

CAN SIGNAL COMMUNICATIONS

Each control unit of the CAN communication system transmits signals through the CAN communication control circuit included in the control unit and receives only necessary signals from each control unit to perform various kinds of control.

- Example: Transmitted signals

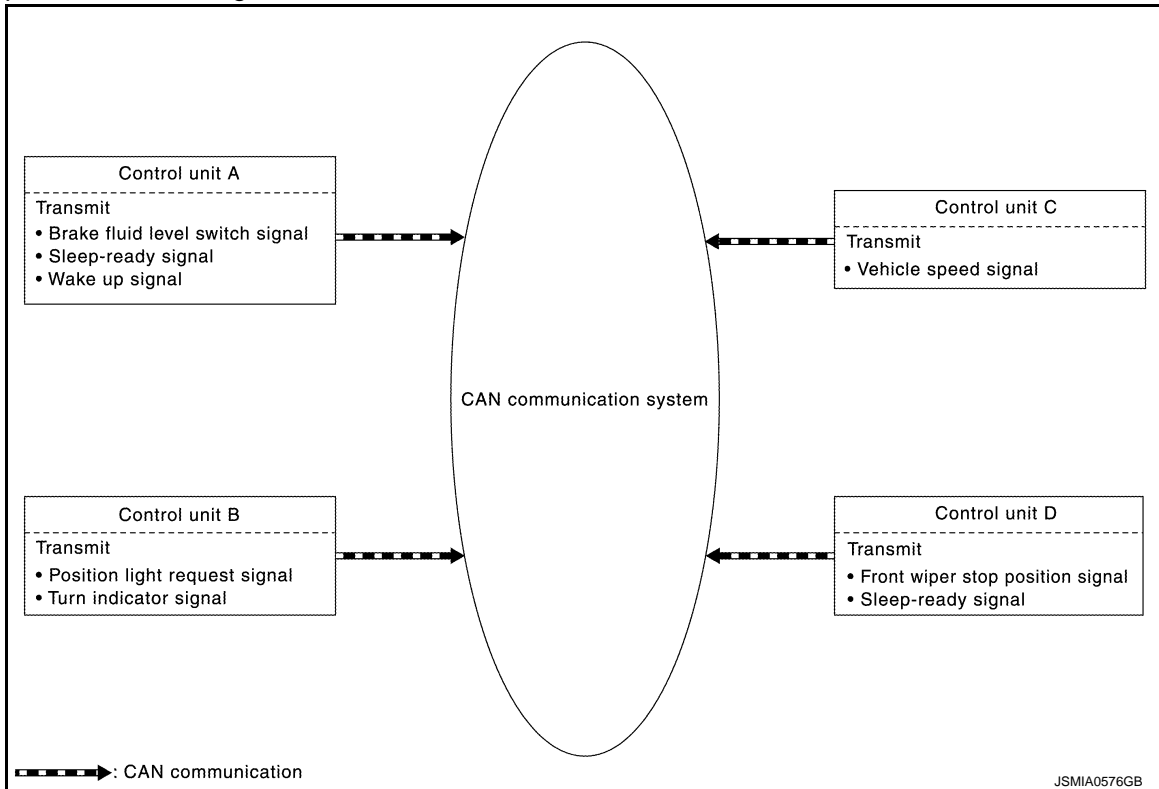

SYSTEM

[CAN]

< SYSTEM DESCRIPTION >

- Example: Received signals

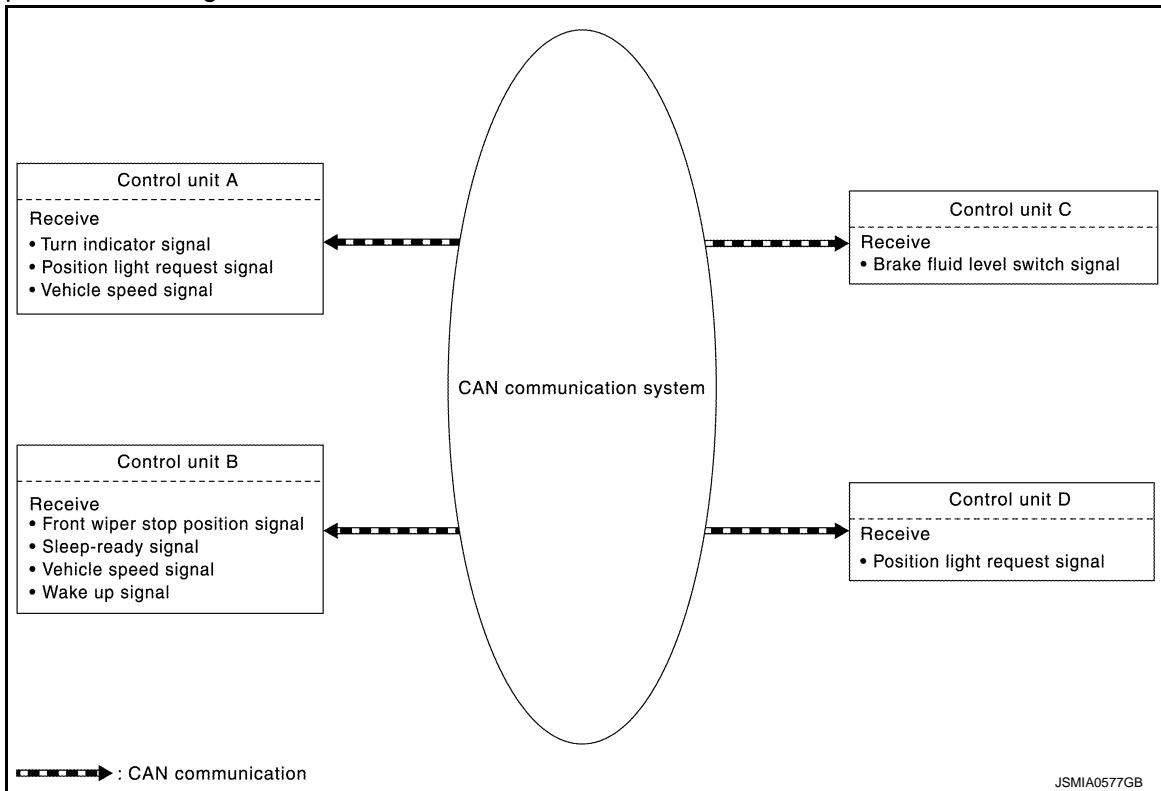

NOTE:

The above signal names and signal communications are provided for reference purposes. For CAN communications signals of this vehicle, refer to [LAN-28, "CAN COMMUNICATION SYSTEM : CAN Communication Signal Chart"](#).

CAN COMMUNICATION SYSTEM : CAN Communication Control Circuit

INFOID:000000008462777

CAN communication control circuit is incorporated into the control unit and transmits/receives CAN communication signals.

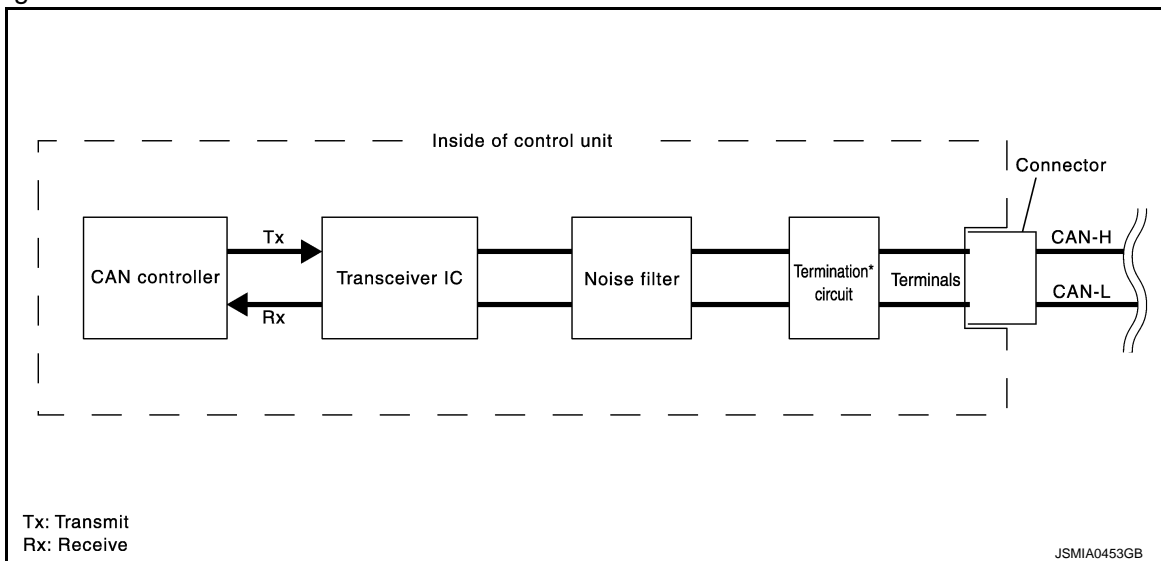

Component	System description
CAN controller	It controls CAN communication signal transmission and reception, error detection, etc.
Transceiver IC	It converts digital signal into CAN communication signal, and CAN communication signal into digital signal.

SYSTEM

[CAN]

< SYSTEM DESCRIPTION >

Component	System description
Noise filter	It eliminates noise of CAN communication signal.
Termination circuit* (Resistance of approx. 120 Ω)	Generates a potential difference between CAN-H and CAN-L.

*: These are the only control units wired with both ends of CAN communication system.

CAN COMMUNICATION SYSTEM : CAN System Specification Chart

INFOID:000000008462778

Determine CAN system type from the following specification chart.

NOTE:

Refer to [LAN-15. "Trouble Diagnosis Procedure"](#) for how to use CAN system specification chart.

Body type	Convertible
Axle	AWD
Engine	VQ35DE
Transmission	CVT
Brake control	VDC
CAN system type	1

CAN COMMUNICATION SYSTEM : CAN Communication Signal Chart

INFOID:000000008462779

Refer to [LAN-14. "How to Use CAN Communication Signal Chart"](#) for how to use CAN communication signal chart.

NOTE:

Refer to [LAN-20. "Abbreviation List"](#) for the abbreviations of the connecting units.

T: Transmit R: Receive

Signal name	ECM	ADP	C/ROOF	4WD	AV	HVAC	M&A	A-BAG	BCM	STRG	ABS	TCM	IPDM-E
A/C compressor request signal	T												R
Accelerator pedal position signal	T			R							R	R	
ASCD CRUISE indicator signal	T						R						
ASCD operation signal	T											R	
ASCD SET indicator signal	T						R						
Closed throttle position signal	T											R	
Cooling fan speed request signal	T												R
Engine and CVT integrated control signal	T											R	
	R											T	
Engine coolant temperature signal	T					R	R					R	
Engine speed signal	T			R			R				R	R	
Engine status signal	T				R				R				
Fuel consumption monitor signal	T				R		R						
Fuel filler cap warning display signal	T						R						
Malfunctioning indicator lamp signal	T						R						
Power generation command value signal	T												R
System setting signal		T			R								
		R			T				R				
					R				T				
Meter display signal			T				R						
							R		T				

SYSTEM

< SYSTEM DESCRIPTION >

[CAN]

Signal name	ECM	ADP	C/ROOF	4WD	AV	HVAC	M&A	A-BAG	BCM	STRG	ABS	TCM	IPDM-E	
Roof operation signal			T				R							A
Roof status signal			T				R							B
Tonneau board status signal			T				R							
AWD LOCK indicator lamp signal				T			R							C
AWD malfunction signal				T							R			
AWD signal				T							R			D
AWD warning lamp signal				T			R							
A/C switch/indicator signal					T	R								E
A/C switch operation signal					R	T								
Rear window defogger switch signal					T				R					
Voice recognition signal					T	R								F
A/C switch signal	R					T			T					
Blower fan motor switch signal	R					T			T					G
Brake fluid level switch signal							T				R			
Distance to empty signal					R		T							
Fuel filler cap warning reset signal	R						T							H
Fuel level low warning signal					R		T							
Fuel level sensor signal	R						T							I
Odometer signal							T		R					
Overdrive control switch signal							T					R		J
Parking brake switch signal				R			T							
Seat belt buckle switch signal							T		R					
Sleep-ready signal							T		R					K
									R				T	
Vehicle speed signal	R	R	R		R		T		R			R	R	L
		R	R	R			R		R		T			
Wake up signal							T		R					
Pop-up roll bar malfunction signal			R					T						
Pop-up roll bar operation signal			R					T						LAN
Buzzer output signal							R		T					
Door switch signal		R			R		R		T				R	N
Door unlock signal		R							T					
Front fog light request signal									T				R	
Front wiper request signal									T				R	O
High beam request signal							R		T				R	
Horn reminder signal									T				R	P
Ignition switch ACC signal		R	R						T					
Ignition switch ON signal		R	R						T				R	
									R				T	
Interlock/PNP switch signal									T				R	
									R				T	
Key ID signal		R							T					

SYSTEM

< SYSTEM DESCRIPTION >

[CAN]

Signal name	ECM	ADP	C/ROOF	4WD	AV	HVAC	M&A	A-BAG	BCM	STRG	ABS	TCM	IPDM-E
Key switch signal		R							T				
Key warning lamp signal							R		T				
Low beam request signal									T				R
Low tire pressure warning lamp signal							R		T				
Oil pressure switch signal							R		T				T
Position light request signal							R		T				R
Rear window defogger control signal									T				R
Shipping mode status signal							R		T				
Sleep wake up signal		R	R				R		T				R
Starter control relay signal									T				R
Starter relay status signal									T				R
Starting mode signal		R	R						T				
Stop lamp switch signal									T			R	
Theft warning horn request signal									T				R
TPMS malfunction warning lamp signal							R		T				
Trunk switch signal							R		T				
Turn indicator signal							R		T				
Steering angle sensor signal				R	R					T	R		
ABS operation signal											T	R	
ABS warning lamp signal							R				T		
Brake warning lamp signal							R				T		
Decel G sensor signal				R							T		
Side G sensor signal				R							T		
VDC OFF indicator lamp signal							R				T		
VDC warning lamp signal							R				T		
Yaw rate sensor signal				R							T		
Current gear position signal											R	T	
CVT position indicator signal							R		R		R	T	
CVT self-diagnosis signal	R											T	
Input shaft revolution signal	R											T	
N range signal									R		R	T	
OD OFF indicator signal							R					T	
Output shaft revolution signal	R											T	
P range signal		R							R		R	T	
R range signal											R	T	
Shift position signal							R				R	T	
A/C compressor feedback signal	R					R							T
Detention switch signal									R				T
Front wiper stop position signal									R				T

SYSTEM

< SYSTEM DESCRIPTION >

[CAN]

Signal name	ECM	ADP	C/ROOF	4WD	AV	HVAC	M&A	A-BAG	BCM	STRG	ABS	TCM	IPDM-E
High beam status signal	R												T
Low beam status signal	R												T
Push-button ignition switch status signal									R				T

A

B

C

D

E

F

G

H

I

J

K

L

LAN

N

O

P

WIRING DIAGRAM

CAN SYSTEM

Wiring Diagram

INFOID:000000008462780

For connector terminal arrangements, harness layouts, and alphabets in a  (option abbreviation; if not described in wiring diagram), refer to [GI-12. "Connector Information"](#).

CAN SYSTEM

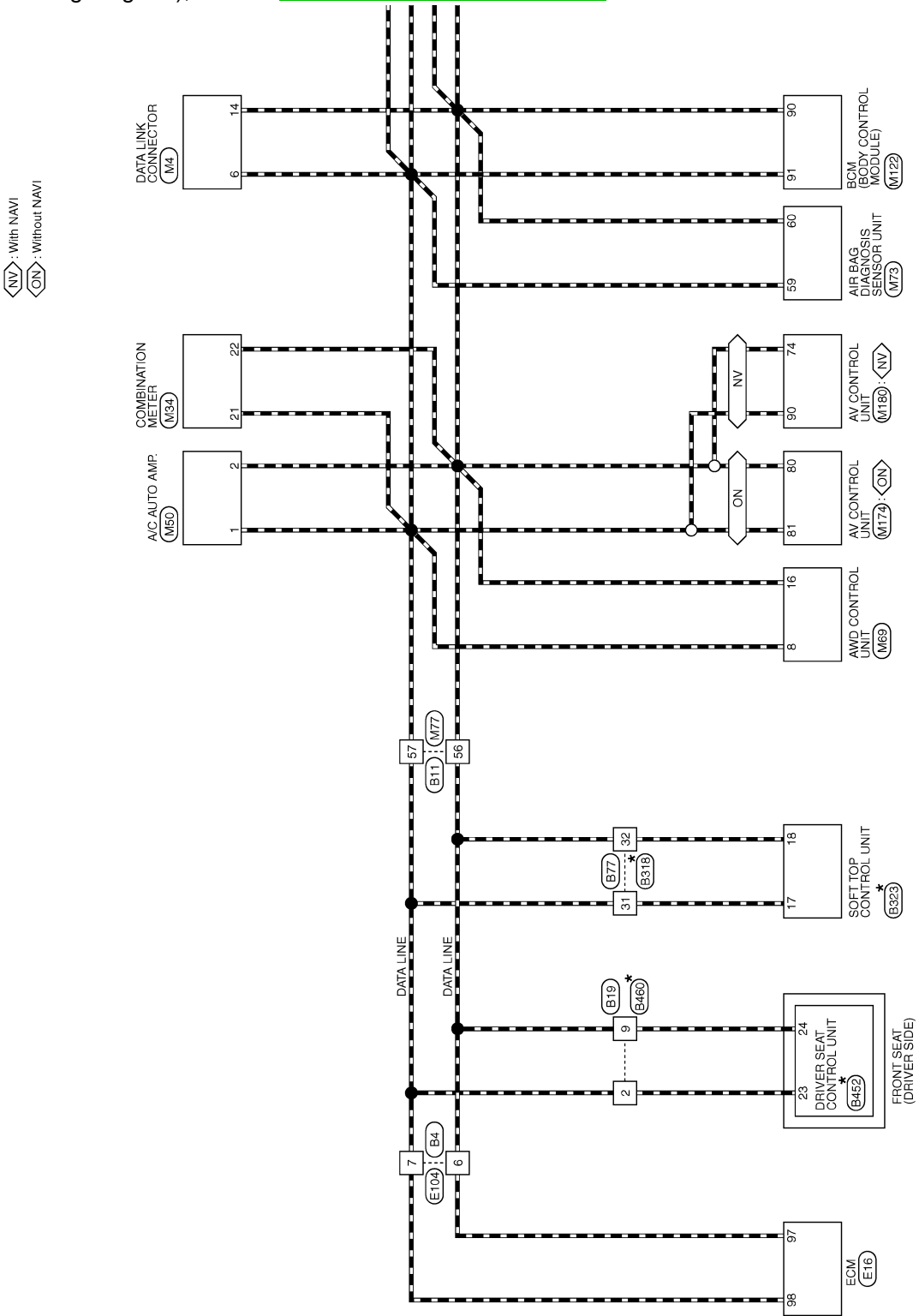

*: This connector is not shown in "Harness Layout".

2012/09/18

JRMWD5069GB

CAN SYSTEM

< WIRING DIAGRAM >

[CAN]

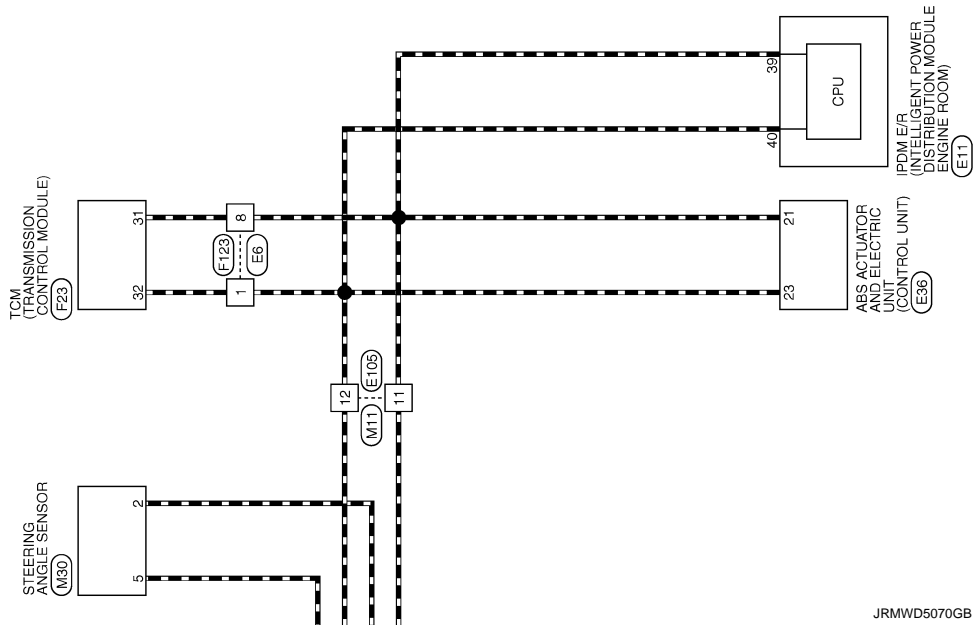

JRMWD5070GB

A
B
C
D
E
F
G
H
I
J
K
L
LAN
N
O
P

BASIC INSPECTION

DIAGNOSIS AND REPAIR WORKFLOW

Interview Sheet

INFOID:000000008462781

NOTE:

Refer to [LAN-15, "Trouble Diagnosis Procedure"](#) for how to use interview sheet.

CAN Communication System Diagnosis Interview Sheet	
	Date received: <input style="width: 100px;" type="text"/>
Type: <input style="width: 150px;" type="text"/>	VIN No.: <input style="width: 150px;" type="text"/>
Model: <input style="width: 500px;" type="text"/>	
First registration: <input style="width: 150px;" type="text"/>	Mileage: <input style="width: 150px;" type="text"/>
CAN system type: <input style="width: 100px;" type="text"/>	
Symptom (Results from interview with customer)	
Condition at inspection	
Error symptom : Present / Past	

SKIB8898E

MALFUNCTION AREA CHART

< DTC/CIRCUIT DIAGNOSIS >

[CAN]

DTC/CIRCUIT DIAGNOSIS

MALFUNCTION AREA CHART

Main Line

INFOID:0000000008462782

Malfunction area	Reference
Main line between driver seat control unit and soft top control unit	LAN-36. "Diagnosis Procedure"
Main line between soft top control unit and combination meter	LAN-37. "Diagnosis Procedure"
Main line between combination meter and data link connector	LAN-38. "Diagnosis Procedure"
Main line between data link connector and TCM	LAN-39. "Diagnosis Procedure"

Branch Line

INFOID:0000000008462783

Malfunction area	Reference
ECM branch line circuit	LAN-40. "Diagnosis Procedure"
Driver seat control unit branch line circuit	LAN-41. "Diagnosis Procedure"
Soft top control unit branch line circuit	LAN-42. "Diagnosis Procedure"
AWD control unit branch line circuit	LAN-43. "Diagnosis Procedure"
AV control unit branch line circuit	LAN-44. "Diagnosis Procedure"
A/C auto amp. branch line circuit	LAN-45. "Diagnosis Procedure"
Combination meter branch line circuit	LAN-46. "Diagnosis Procedure"
Air bag diagnosis sensor unit branch line circuit	LAN-47. "Diagnosis Procedure"
BCM branch line circuit	LAN-48. "Diagnosis Procedure"
Data link connector branch line circuit	LAN-49. "Diagnosis Procedure"
Steering angle sensor branch line circuit	LAN-50. "Diagnosis Procedure"
ABS actuator and electric unit (control unit) branch line circuit	LAN-51. "Diagnosis Procedure"
TCM branch line circuit	LAN-52. "Diagnosis Procedure"
IPDM E/R branch line circuit	LAN-53. "Diagnosis Procedure"

Short Circuit

INFOID:0000000008462784

Malfunction area	Reference
CAN communication circuit	LAN-54. "Diagnosis Procedure"

LAN

MAIN LINE BETWEEN ADP AND C/ROOF CIRCUIT

< DTC/CIRCUIT DIAGNOSIS >

[CAN]

MAIN LINE BETWEEN ADP AND C/ROOF CIRCUIT

Diagnosis Procedure

INFOID:000000008462785

1. CHECK HARNESS CONTINUITY (OPEN CIRCUIT)

1. Turn the ignition switch OFF.
2. Disconnect the battery cable from the negative terminal.
3. Disconnect the following harness connectors.
 - ECM
 - Harness connectors B460 and B19
 - Harness connectors B77 and B318
4. Check the continuity between the harness connectors.

Harness connector		Harness connector		Continuity
Connector No.	Terminal No.	Connector No.	Terminal No.	
B19	2	B77	31	Existed
	9		32	Existed

Is the inspection result normal?

- YES (Present error)>>Connect all the connectors and diagnose again. Refer to [LAN-15, "Trouble Diagnosis Flow Chart"](#).
- YES (Past error)>>Error was detected in the main line between the driver seat control unit and the soft top control unit.
- NO >> Repair the main line between the harness connectors B19 and B77.

MAIN LINE BETWEEN C/ROOF AND M&A CIRCUIT

< DTC/CIRCUIT DIAGNOSIS >

[CAN]

MAIN LINE BETWEEN C/ROOF AND M&A CIRCUIT

Diagnosis Procedure

INFOID:000000008462786

1.CHECK CONNECTOR

1. Turn the ignition switch OFF.
2. Disconnect the battery cable from the negative terminal.
3. Check the following terminals and connectors for damage, bend and loose connection (connector side and harness side).
 - Harness connector B11
 - Harness connector M77

Is the inspection result normal?

YES >> GO TO 2.

NO >> Repair the terminal and connector.

2.CHECK HARNESS CONTINUITY (OPEN CIRCUIT)

1. Disconnect the following harness connectors.
 - Harness connectors B318 and B77
 - Harness connectors B11 and M77
2. Check the continuity between the harness connectors.

Harness connector		Harness connector		Continuity
Connector No.	Terminal No.	Connector No.	Terminal No.	
B77	31	B11	57	Existed
	32		56	Existed

Is the inspection result normal?

YES >> GO TO 3.

NO >> Repair the main line between the harness connectors B77 and B11.

3.CHECK HARNESS CONTINUITY (OPEN CIRCUIT)

1. Disconnect the connector of combination meter.
2. Check the continuity between the harness connector and the combination meter harness connector.

Harness connector		Combination meter harness connector		Continuity
Connector No.	Terminal No.	Connector No.	Terminal No.	
M77	57	M34	21	Existed
	56		22	Existed

Is the inspection result normal?

YES (Present error)>>Connect all the connectors and diagnose again. Refer to [LAN-15. "Trouble Diagnosis Flow Chart"](#).

YES (Past error)>>Error was detected in the main line between the soft top control unit and the combination meter.

NO >> Repair the main line between the harness connector M77 and the combination meter.

A
B
C
D
E
F
G
H
I
J
K
L
LAN
N
O
P

MAIN LINE BETWEEN M&A AND DLC CIRCUIT

< DTC/CIRCUIT DIAGNOSIS >

[CAN]

MAIN LINE BETWEEN M&A AND DLC CIRCUIT

Diagnosis Procedure

INFOID:000000008462787

1. CHECK HARNESS CONTINUITY (OPEN CIRCUIT)

1. Turn the ignition switch OFF.
2. Disconnect the battery cable from the negative terminal.
3. Disconnect the following harness connectors.
 - ECM
 - Combination meter
4. Check the continuity between the combination meter harness connector and the data link connector.

Combination meter harness connector		Data link connector		Continuity
Connector No.	Terminal No.	Connector No.	Terminal No.	
M34	21	M4	6	Existed
	22		14	Existed

Is the inspection result normal?

YES (Present error)>>Connect all the connectors and diagnose again. Refer to [LAN-15. "Trouble Diagnosis Flow Chart"](#).

YES (Past error)>>Error was detected in the main line between the combination meter and the data link connector.

NO >> Repair the main line between the combination meter and the data link connector.

MAIN LINE BETWEEN DLC AND TCM CIRCUIT

< DTC/CIRCUIT DIAGNOSIS >

[CAN]

MAIN LINE BETWEEN DLC AND TCM CIRCUIT

Diagnosis Procedure

INFOID:000000008462788

1. CHECK CONNECTOR

1. Turn the ignition switch OFF.
2. Disconnect the battery cable from the negative terminal.
3. Check the following terminals and connectors for damage, bend and loose connection (connector side and harness side).
 - Harness connector M11
 - Harness connector E105

Is the inspection result normal?

YES >> GO TO 2.

NO >> Repair the terminal and connector.

2. CHECK HARNESS CONTINUITY (OPEN CIRCUIT)

1. Disconnect the harness connectors M11 and E105.
2. Check the continuity between the data link connector and the harness connector.

Data link connector		Harness connector		Continuity
Connector No.	Terminal No.	Connector No.	Terminal No.	
M4	6	M11	12	Existed
	14		11	Existed

Is the inspection result normal?

YES >> GO TO 3.

NO >> Repair the main line between the data link connector and the harness connector M11.

3. CHECK HARNESS CONTINUITY (OPEN CIRCUIT)

1. Disconnect the harness connectors E6 and F123.
2. Check the continuity between the harness connectors.

Harness connector		Harness connector		Continuity
Connector No.	Terminal No.	Connector No.	Terminal No.	
E105	12	E6	1	Existed
	11		8	Existed

Is the inspection result normal?

YES (Present error)>>Connect all the connectors and diagnose again. Refer to [LAN-15, "Trouble Diagnosis Flow Chart"](#).

YES (Past error)>>Error was detected in the main line between the data link connector and the TCM.

NO >> Repair the main line between the harness connectors E105 and E6.

A
B
C
D
E
F
G
H
I
J
K
L
N
O
P

LAN

ECM BRANCH LINE CIRCUIT

< DTC/CIRCUIT DIAGNOSIS >

[CAN]

ECM BRANCH LINE CIRCUIT

Diagnosis Procedure

INFOID:000000008462789

1. CHECK CONNECTOR

1. Turn the ignition switch OFF.
2. Disconnect the battery cable from the negative terminal.
3. Check the following terminals and connectors for damage, bend and loose connection (unit side and connector side).
 - ECM
 - Harness connector E104
 - Harness connector B4

Is the inspection result normal?

YES >> GO TO 2.

NO >> Repair the terminal and connector.

2. CHECK HARNESS FOR OPEN CIRCUIT

1. Disconnect the connector of ECM.
2. Check the resistance between the ECM harness connector terminals.

ECM harness connector		Resistance (Ω)
Connector No.	Terminal No.	
E16	98	Approx. 108 – 132
	97	

Is the measurement value within the specification?

YES >> GO TO 3.

NO >> Repair the ECM branch line.

3. CHECK POWER SUPPLY AND GROUND CIRCUIT

Check the power supply and the ground circuit of the ECM. Refer to [EC-147, "Diagnosis Procedure"](#).

Is the inspection result normal?

YES (Present error)>>Replace the ECM. Refer to [EC-433, "Removal and Installation"](#).

YES (Past error)>>Error was detected in the ECM branch line.

NO >> Repair the power supply and the ground circuit.

ADP BRANCH LINE CIRCUIT

< DTC/CIRCUIT DIAGNOSIS >

[CAN]

ADP BRANCH LINE CIRCUIT

Diagnosis Procedure

INFOID:000000008462790

1. CHECK CONNECTOR

1. Turn the ignition switch OFF.
2. Disconnect the battery cable from the negative terminal.
3. Check the following terminals and connectors for damage, bend and loose connection (unit side and connector side).
 - Driver seat control unit
 - Harness connector B460
 - Harness connector B19

Is the inspection result normal?

YES >> GO TO 2.

NO >> Repair the terminal and connector.

2. CHECK HARNESS FOR OPEN CIRCUIT

1. Disconnect the connector of driver seat control unit.
2. Check the resistance between the driver seat control unit harness connector terminals.

Driver seat control unit harness connector			Resistance (Ω)
Connector No.	Terminal No.		
B452	23	24	Approx. 54 – 66

Is the measurement value within the specification?

YES >> GO TO 3.

NO >> Repair the driver seat control unit branch line.

3. CHECK POWER SUPPLY AND GROUND CIRCUIT

Check the power supply and the ground circuit of the driver seat control unit. Refer to [ADP-50, "DRIVER SEAT CONTROL UNIT : Diagnosis Procedure"](#).

Is the inspection result normal?

YES (Present error)>>Replace the driver seat control unit. Refer to [ADP-121, "Removal and Installation"](#).

YES (Past error)>>Error was detected in the driver seat control unit branch line.

NO >> Repair the power supply and the ground circuit.

LAN

C/ROOF BRANCH LINE CIRCUIT

< DTC/CIRCUIT DIAGNOSIS >

[CAN]

C/ROOF BRANCH LINE CIRCUIT

Diagnosis Procedure

INFOID:000000008462791

1. CHECK CONNECTOR

1. Turn the ignition switch OFF.
2. Disconnect the battery cable from the negative terminal.
3. Check the following terminals and connectors for damage, bend and loose connection (unit side and connector side).
 - Soft top control unit
 - Harness connector B318
 - Harness connector B77

Is the inspection result normal?

YES >> GO TO 2.

NO >> Repair the terminal and connector.

2. CHECK HARNESS FOR OPEN CIRCUIT

1. Disconnect the connector of soft top control unit.
2. Check the resistance between the soft top control unit harness connector terminals.

Soft top control unit harness connector			Resistance (Ω)
Connector No.	Terminal No.		
B323	17	18	Approx. 54 – 66

Is the measurement value within the specification?

YES >> GO TO 3.

NO >> Repair the soft top control unit branch line.

3. CHECK POWER SUPPLY AND GROUND CIRCUIT

Check the power supply and the ground circuit of the soft top control unit. Refer to [RF-165, "Diagnosis Procedure"](#).

Is the inspection result normal?

YES (Present error)>>Replace the soft top control unit. Refer to [RF-229, "Removal and Installation"](#).

YES (Past error)>>Error was detected in the soft top control unit branch line.

NO >> Repair the power supply and the ground circuit.

4WD BRANCH LINE CIRCUIT

< DTC/CIRCUIT DIAGNOSIS >

[CAN]

4WD BRANCH LINE CIRCUIT

Diagnosis Procedure

INFOID:000000008462792

1. CHECK CONNECTOR

1. Turn the ignition switch OFF.
2. Disconnect the battery cable from the negative terminal.
3. Check the terminals and connectors of the AWD control unit for damage, bend and loose connection (unit side and connector side).

Is the inspection result normal?

- YES >> GO TO 2.
NO >> Repair the terminal and connector.

2. CHECK HARNESS FOR OPEN CIRCUIT

1. Disconnect the connector of AWD control unit.
2. Check the resistance between the AWD control unit harness connector terminals.

AWD control unit harness connector			Resistance (Ω)
Connector No.	Terminal No.		
M69	8	16	Approx. 54 – 66

Is the measurement value within the specification?

- YES >> GO TO 3.
NO >> Repair the AWD control unit branch line.

3. CHECK POWER SUPPLY AND GROUND CIRCUIT

Check the power supply and the ground circuit of the AWD control unit. Refer to [DLN-34, "Diagnosis Procedure"](#).

Is the inspection result normal?

- YES (Present error)>>Replace the AWD control unit. Refer to [DLN-48, "Removal and Installation"](#).
YES (Past error)>>Error was detected in the AWD control unit branch line.
NO >> Repair the power supply and the ground circuit.

A
B
C
D
E
F
G
H
I
J
K
L

LAN

N
O
P

AV BRANCH LINE CIRCUIT

< DTC/CIRCUIT DIAGNOSIS >

[CAN]

AV BRANCH LINE CIRCUIT

Diagnosis Procedure

INFOID:000000008462793

1. CHECK CONNECTOR

1. Turn the ignition switch OFF.
2. Disconnect the battery cable from the negative terminal.
3. Check the terminals and connectors of the AV control unit for damage, bend and loose connection (unit side and connector side).

Is the inspection result normal?

- YES >> GO TO 2.
NO >> Repair the terminal and connector.

2. CHECK HARNESS FOR OPEN CIRCUIT

1. Disconnect the connector of AV control unit.
 2. Check the resistance between the AV control unit harness connector terminals.
- Models with navigation system

AV control unit harness connector			Resistance (Ω)
Connector No.	Terminal No.		
M180	90	74	Approx. 54 – 66

- Models without navigation system

AV control unit harness connector			Resistance (Ω)
Connector No.	Terminal No.		
M174	81	80	Approx. 54 – 66

Is the measurement value within the specification?

- YES >> GO TO 3.
NO >> Repair the AV control unit branch line.

3. CHECK POWER SUPPLY AND GROUND CIRCUIT

Check the power supply and the ground circuit of the AV control unit. Refer to the following.

- BOSE audio without navigation: [AV-70, "AV CONTROL UNIT : Diagnosis Procedure"](#)
- BOSE audio with navigation: [AV-208, "AV CONTROL UNIT : Diagnosis Procedure"](#)

Is the inspection result normal?

- YES (Present error)>>Replace the AV control unit. Refer to the following.
- BOSE audio without navigation: [AV-102, "Removal and Installation"](#)
 - BOSE audio with navigation: [AV-236, "Removal and Installation"](#)

YES (Past error)>>Error was detected in the AV control unit branch line.

NO >> Repair the power supply and the ground circuit.

HVAC BRANCH LINE CIRCUIT

< DTC/CIRCUIT DIAGNOSIS >

[CAN]

HVAC BRANCH LINE CIRCUIT

Diagnosis Procedure

INFOID:000000008462794

1. CHECK CONNECTOR

1. Turn the ignition switch OFF.
2. Disconnect the battery cable from the negative terminal.
3. Check the terminals and connectors of the A/C auto amp. for damage, bend and loose connection (unit side and connector side).

Is the inspection result normal?

- YES >> GO TO 2.
NO >> Repair the terminal and connector.

2. CHECK HARNESS FOR OPEN CIRCUIT

1. Disconnect the connector of A/C auto amp.
2. Check the resistance between the A/C auto amp. harness connector terminals.

A/C auto amp. harness connector			Resistance (Ω)
Connector No.	Terminal No.		
M50	1	2	Approx. 54 – 66

Is the measurement value within the specification?

- YES >> GO TO 3.
NO >> Repair the A/C auto amp. branch line.

3. CHECK POWER SUPPLY AND GROUND CIRCUIT

Check the power supply and the ground circuit of the A/C auto amp. Refer to [HAC-63, "A/C AUTO AMP. : Diagnosis Procedure"](#).

Is the inspection result normal?

- YES (Present error)>>Replace the A/C auto amp. Refer to [HAC-79, "Removal and Installation"](#).
YES (Past error)>>Error was detected in the A/C auto amp. branch line.
NO >> Repair the power supply and the ground circuit.

A
B
C
D
E
F
G
H
I
J
K
L

LAN

N
O
P

M&A BRANCH LINE CIRCUIT

< DTC/CIRCUIT DIAGNOSIS >

[CAN]

M&A BRANCH LINE CIRCUIT

Diagnosis Procedure

INFOID:000000008462795

1. CHECK CONNECTOR

1. Turn the ignition switch OFF.
2. Disconnect the battery cable from the negative terminal.
3. Check the terminals and connectors of the combination meter for damage, bend and loose connection (unit side and connector side).

Is the inspection result normal?

- YES >> GO TO 2.
NO >> Repair the terminal and connector.

2. CHECK HARNESS FOR OPEN CIRCUIT

1. Disconnect the connector of combination meter.
2. Check the resistance between the combination meter harness connector terminals.

Combination meter harness connector			Resistance (Ω)
Connector No.	Terminal No.		
M34	21	22	Approx. 54 – 66

Is the measurement value within the specification?

- YES >> GO TO 3.
NO >> Repair the combination meter branch line.

3. CHECK POWER SUPPLY AND GROUND CIRCUIT

Check the power supply and the ground circuit of the combination meter. Refer to [MWI-47, "COMBINATION METER : Diagnosis Procedure"](#).

Is the inspection result normal?

- YES (Present error)>>Replace the combination meter. Refer to [MWI-70, "Removal and Installation"](#).
YES (Past error)>>Error was detected in the combination meter branch line.
NO >> Repair the power supply and the ground circuit.

A-BAG BRANCH LINE CIRCUIT

< DTC/CIRCUIT DIAGNOSIS >

[CAN]

A-BAG BRANCH LINE CIRCUIT

Diagnosis Procedure

INFOID:000000008462796

WARNING:

Always observe the following items for preventing accidental activation.

- Before servicing, turn ignition switch OFF, disconnect battery negative terminal, and wait 3 minutes or more. (To discharge backup capacitor.)
- Never use unspecified tester or other measuring device.

1. CHECK CONNECTOR

1. Turn the ignition switch OFF.
2. Disconnect the battery cable from the negative terminal.
3. Check the terminals and connectors of the air bag diagnosis sensor unit for damage, bend and loose connection (unit side and connector side).

Is the inspection result normal?

YES >> GO TO 2.

NO >> Replace the main harness.

2. CHECK AIR BAG DIAGNOSIS SENSOR UNIT

Check the air bag diagnosis sensor unit. Refer to [SRC-26. "Work Flow"](#).

Is the inspection result normal?

YES >> Replace the main harness.

NO >> Replace parts whose air bag system has a malfunction.

A
B
C
D
E
F
G
H
I
J
K
L
N
O
P

LAN

BCM BRANCH LINE CIRCUIT

< DTC/CIRCUIT DIAGNOSIS >

[CAN]

BCM BRANCH LINE CIRCUIT

Diagnosis Procedure

INFOID:000000008462797

1. CHECK CONNECTOR

1. Turn the ignition switch OFF.
2. Disconnect the battery cable from the negative terminal.
3. Check the terminals and connectors of the BCM for damage, bend and loose connection (unit side and connector side).

Is the inspection result normal?

- YES >> GO TO 2.
NO >> Repair the terminal and connector.

2. CHECK HARNESS FOR OPEN CIRCUIT

1. Disconnect the connector of BCM.
2. Check the resistance between the BCM harness connector terminals.

BCM harness connector			Resistance (Ω)
Connector No.	Terminal No.		
M122	91	90	Approx. 54 – 66

Is the measurement value within the specification?

- YES >> GO TO 3.
NO >> Repair the BCM branch line.

3. CHECK POWER SUPPLY AND GROUND CIRCUIT

Check the power supply and the ground circuit of the BCM. Refer to [BCS-70, "Diagnosis Procedure"](#).

Is the inspection result normal?

- YES (Present error)>>Replace the BCM. Refer to [BCS-77, "Removal and Installation"](#).
YES (Past error)>>Error was detected in the BCM branch line.
NO >> Repair the power supply and the ground circuit.

DLC BRANCH LINE CIRCUIT

< DTC/CIRCUIT DIAGNOSIS >

[CAN]

DLC BRANCH LINE CIRCUIT

Diagnosis Procedure

INFOID:000000008462798

1. CHECK CONNECTOR

1. Turn the ignition switch OFF.
2. Disconnect the battery cable from the negative terminal.
3. Check the terminals and connectors of the data link connector for damage, bend and loose connection (connector side and harness side).

Is the inspection result normal?

- YES >> GO TO 2.
NO >> Repair the terminal and connector.

2. CHECK HARNESS FOR OPEN CIRCUIT

Check the resistance between the data link connector terminals.

Data link connector			Resistance (Ω)
Connector No.	Terminal No.		
M4	6	14	Approx. 54 – 66

Is the measurement value within the specification?

- YES (Present error)>>Diagnose again. Refer to [LAN-15. "Trouble Diagnosis Flow Chart"](#).
YES (Past error)>>Error was detected in the data link connector branch line circuit.
NO >> Repair the data link connector branch line.

LAN

STRG BRANCH LINE CIRCUIT

< DTC/CIRCUIT DIAGNOSIS >

[CAN]

STRG BRANCH LINE CIRCUIT

Diagnosis Procedure

INFOID:000000008462799

1. CHECK CONNECTOR

1. Turn the ignition switch OFF.
2. Disconnect the battery cable from the negative terminal.
3. Check the terminals and connectors of the steering angle sensor for damage, bend and loose connection (unit side and connector side).

Is the inspection result normal?

- YES >> GO TO 2.
NO >> Repair the terminal and connector.

2. CHECK HARNESS FOR OPEN CIRCUIT

1. Disconnect the connector of steering angle sensor.
2. Check the resistance between the steering angle sensor harness connector terminals.

Steering angle sensor harness connector			Resistance (Ω)
Connector No.	Terminal No.		
M30	5	2	Approx. 54 – 66

Is the measurement value within the specification?

- YES >> GO TO 3.
NO >> Repair the steering angle sensor branch line.

3. CHECK POWER SUPPLY AND GROUND CIRCUIT

Check the power supply and the ground circuit of the steering angle sensor. Refer to [BRC-25, "Wiring Diagram"](#).

Is the inspection result normal?

- YES (Present error)>>Replace the steering angle sensor. Refer to [BRC-105, "Removal and Installation"](#).
YES (Past error)>>Error was detected in the steering angle sensor branch line.
NO >> Repair the power supply and the ground circuit.

ABS BRANCH LINE CIRCUIT

< DTC/CIRCUIT DIAGNOSIS >

[CAN]

ABS BRANCH LINE CIRCUIT

Diagnosis Procedure

INFOID:000000008462800

1. CHECK CONNECTOR

1. Turn the ignition switch OFF.
2. Disconnect the battery cable from the negative terminal.
3. Check the terminals and connectors of the ABS actuator and electric unit (control unit) for damage, bend and loose connection (unit side and connector side).

Is the inspection result normal?

- YES >> GO TO 2.
NO >> Repair the terminal and connector.

2. CHECK HARNESS FOR OPEN CIRCUIT

1. Disconnect the connector of ABS actuator and electric unit (control unit).
2. Check the resistance between the ABS actuator and electric unit (control unit) harness connector terminals.

ABS actuator and electric unit (control unit) harness connector			Resistance (Ω)
Connector No.	Terminal No.		
E36	23	21	Approx. 54 – 66

Is the measurement value within the specification?

- YES >> GO TO 3.
NO >> Repair the ABS actuator and electric unit (control unit) branch line.

3. CHECK POWER SUPPLY AND GROUND CIRCUIT

Check the power supply and the ground circuit of the ABS actuator and electric unit (control unit). Refer to [BRC-43, "Diagnosis Procedure"](#).

Is the inspection result normal?

- YES (Present error)>>Replace the ABS actuator and electric unit (control unit). Refer to [BRC-102, "Removal and Installation"](#).
YES (Past error)>>Error was detected in the ABS actuator and electric unit (control unit) branch line.
NO >> Repair the power supply and the ground circuit.

LAN

TCM BRANCH LINE CIRCUIT

< DTC/CIRCUIT DIAGNOSIS >

[CAN]

TCM BRANCH LINE CIRCUIT

Diagnosis Procedure

INFOID:000000008462801

1. CHECK CONNECTOR

1. Turn the ignition switch OFF.
2. Disconnect the battery cable from the negative terminal.
3. Check the following terminals and connectors for damage, bend and loose connection (unit side and connector side).
 - TCM
 - Harness connector F123
 - Harness connector E6

Is the inspection result normal?

- YES >> GO TO 2.
NO >> Repair the terminal and connector.

2. CHECK HARNESS FOR OPEN CIRCUIT

1. Disconnect the connector of TCM.
2. Check the resistance between the TCM harness connector terminals.

TCM harness connector			Resistance (Ω)
Connector No.	Terminal No.		
F23	32	31	Approx. 54 – 66

Is the measurement value within the specification?

- YES >> GO TO 3.
NO >> Repair the TCM branch line.

3. CHECK POWER SUPPLY AND GROUND CIRCUIT

Check the power supply and the ground circuit of the TCM. Refer to [TM-103, "Diagnosis Procedure"](#).

Is the inspection result normal?

- YES (Present error)>>Replace the TCM. Refer to [TM-143, "Removal and Installation"](#).
YES (Past error)>>Error was detected in the TCM branch line.
NO >> Repair the power supply and the ground circuit.

IPDM-E BRANCH LINE CIRCUIT

< DTC/CIRCUIT DIAGNOSIS >

[CAN]

IPDM-E BRANCH LINE CIRCUIT

Diagnosis Procedure

INFOID:000000008462802

1. CHECK CONNECTOR

1. Turn the ignition switch OFF.
2. Disconnect the battery cable from the negative terminal.
3. Check the terminals and connectors of the IPDM E/R for damage, bend and loose connection (unit side and connector side).

Is the inspection result normal?

- YES >> GO TO 2.
NO >> Repair the terminal and connector.

2. CHECK HARNESS FOR OPEN CIRCUIT

1. Disconnect the connector of IPDM E/R.
2. Check the resistance between the IPDM E/R harness connector terminals.

IPDM E/R harness connector			Resistance (Ω)
Connector No.	Terminal No.		
E11	40	39	Approx. 108 – 132

Is the measurement value within the specification?

- YES >> GO TO 3.
NO >> Repair the IPDM E/R branch line.

3. CHECK POWER SUPPLY AND GROUND CIRCUIT

Check the power supply and the ground circuit of the IPDM E/R. Refer to [PCS-30, "Diagnosis Procedure"](#).

Is the inspection result normal?

- YES (Present error)>>Replace the IPDM E/R. Refer to [PCS-31, "Removal and Installation"](#).
YES (Past error)>>Error was detected in the IPDM E/R branch line.
NO >> Repair the power supply and the ground circuit.

A
B
C
D
E
F
G
H
I
J
K
L

LAN

N
O
P

CAN COMMUNICATION CIRCUIT

< DTC/CIRCUIT DIAGNOSIS >

[CAN]

CAN COMMUNICATION CIRCUIT

Diagnosis Procedure

INFOID:000000008462803

1.CONNECTOR INSPECTION

1. Turn the ignition switch OFF.
2. Disconnect the battery cable from the negative terminal.
3. Disconnect all the unit connectors on CAN communication system.
4. Check terminals and connectors for damage, bend and loose connection.

Is the inspection result normal?

- YES >> GO TO 2.
NO >> Repair the terminal and connector.

2.CHECK HARNESS CONTINUITY (SHORT CIRCUIT)

Check the continuity between the data link connector terminals.

Data link connector		Continuity
Connector No.	Terminal No.	
M4	6 14	Not existed

Is the inspection result normal?

- YES >> GO TO 3.
NO >> Check the harness and repair the root cause.

3.CHECK HARNESS CONTINUITY (SHORT CIRCUIT)

Check the continuity between the data link connector and the ground.

Data link connector		Ground	Continuity
Connector No.	Terminal No.		
M4	6		Not existed
	14		Not existed

Is the inspection result normal?

- YES >> GO TO 4.
NO >> Check the harness and repair the root cause.

4.CHECK ECM AND IPDM E/R TERMINATION CIRCUIT

1. Remove the ECM and the IPDM E/R.
2. Check the resistance between the ECM terminals.

ECM		Resistance (Ω)
Terminal No.		
98	97	Approx. 108 – 132

3. Check the resistance between the IPDM E/R terminals.

IPDM E/R		Resistance (Ω)
Terminal No.		
40	39	Approx. 108 – 132

Is the measurement value within the specification?

- YES >> GO TO 5.
NO >> Replace the ECM and/or the IPDM E/R.

5.CHECK SYMPTOM

Connect all the connectors. Check if the symptoms described in the “Symptom (Results from interview with customer)” are reproduced.

CAN COMMUNICATION CIRCUIT

[CAN]

< DTC/CIRCUIT DIAGNOSIS >

Inspection result

Reproduced>>GO TO 6.

Non-reproduced>>Start the diagnosis again. Follow the trouble diagnosis procedure when past error is detected.

6.CHECK UNIT REPRODUCTION

Perform the reproduction test as per the following procedure for each unit.

1. Turn the ignition switch OFF.
2. Disconnect the battery cable from the negative terminal.
3. Disconnect one of the control unit connectors of CAN communication system.

NOTE:

ECM and IPDM E/R have a termination circuit. Check other units first.

4. Connect the battery cable to the negative terminal. Check if the symptoms described in the “Symptom (Results from interview with customer)” are reproduced.

NOTE:

Although unit-related error symptoms occur, do not confuse them with other symptoms.

Inspection result

Reproduced>>Connect the connector. Check other units as per the above procedure.

Non-reproduced>>Replace the unit whose connector was disconnected.

A
B
C
D
E
F
G
H
I
J
K
L

LAN

N
O
P

MAIN LINE BETWEEN ADP AND C/ROOF CIRCUIT

< DTC/CIRCUIT DIAGNOSIS >

[CAN SYSTEM (TYPE 1)]

DTC/CIRCUIT DIAGNOSIS

MAIN LINE BETWEEN ADP AND C/ROOF CIRCUIT

Diagnosis Procedure

INFOID:000000008462804

1. CHECK HARNESS CONTINUITY (OPEN CIRCUIT)

1. Turn the ignition switch OFF.
2. Disconnect the battery cable from the negative terminal.
3. Disconnect the following harness connectors.
 - ECM
 - Harness connectors B460 and B19
 - Harness connectors B77 and B318
4. Check the continuity between the harness connectors.

Harness connector		Harness connector		Continuity
Connector No.	Terminal No.	Connector No.	Terminal No.	
B19	2	B77	31	Existed
	9		32	Existed

Is the inspection result normal?

- YES (Present error)>>Connect all the connectors and diagnose again. Refer to [LAN-15. "Trouble Diagnosis Flow Chart"](#).
- YES (Past error)>>Error was detected in the main line between the driver seat control unit and the soft top control unit.
- NO >> Repair the main line between the harness connectors B19 and B77.

MAIN LINE BETWEEN C/ROOF AND M&A CIRCUIT

< DTC/CIRCUIT DIAGNOSIS >

[CAN SYSTEM (TYPE 1)]

MAIN LINE BETWEEN C/ROOF AND M&A CIRCUIT

Diagnosis Procedure

INFOID:000000008462805

1.CHECK CONNECTOR

1. Turn the ignition switch OFF.
2. Disconnect the battery cable from the negative terminal.
3. Check the following terminals and connectors for damage, bend and loose connection (connector side and harness side).
 - Harness connector B11
 - Harness connector M77

Is the inspection result normal?

YES >> GO TO 2.

NO >> Repair the terminal and connector.

2.CHECK HARNESS CONTINUITY (OPEN CIRCUIT)

1. Disconnect the following harness connectors.
 - Harness connectors B318 and B77
 - Harness connectors B11 and M77
2. Check the continuity between the harness connectors.

Harness connector		Harness connector		Continuity
Connector No.	Terminal No.	Connector No.	Terminal No.	
B77	31	B11	57	Existed
	32		56	Existed

Is the inspection result normal?

YES >> GO TO 3.

NO >> Repair the main line between the harness connectors B77 and B11.

3.CHECK HARNESS CONTINUITY (OPEN CIRCUIT)

1. Disconnect the connector of combination meter.
2. Check the continuity between the harness connector and the combination meter harness connector.

Harness connector		Combination meter harness connector		Continuity
Connector No.	Terminal No.	Connector No.	Terminal No.	
M77	57	M34	21	Existed
	56		22	Existed

Is the inspection result normal?

YES (Present error)>>Connect all the connectors and diagnose again. Refer to [LAN-15. "Trouble Diagnosis Flow Chart"](#).

YES (Past error)>>Error was detected in the main line between the soft top control unit and the combination meter.

NO >> Repair the main line between the harness connector M77 and the combination meter.

A
B
C
D
E
F
G
H
I
J
K
L
LAN
N
O
P

MAIN LINE BETWEEN M&A AND DLC CIRCUIT

< DTC/CIRCUIT DIAGNOSIS >

[CAN SYSTEM (TYPE 1)]

MAIN LINE BETWEEN M&A AND DLC CIRCUIT

Diagnosis Procedure

INFOID:000000008462806

1. CHECK HARNESS CONTINUITY (OPEN CIRCUIT)

1. Turn the ignition switch OFF.
2. Disconnect the battery cable from the negative terminal.
3. Disconnect the following harness connectors.
 - ECM
 - Combination meter
4. Check the continuity between the combination meter harness connector and the data link connector.

Combination meter harness connector		Data link connector		Continuity
Connector No.	Terminal No.	Connector No.	Terminal No.	
M34	21	M4	6	Existed
	22		14	Existed

Is the inspection result normal?

YES (Present error)>>Connect all the connectors and diagnose again. Refer to [LAN-15. "Trouble Diagnosis Flow Chart"](#).

YES (Past error)>>Error was detected in the main line between the combination meter and the data link connector.

NO >> Repair the main line between the combination meter and the data link connector.

MAIN LINE BETWEEN DLC AND TCM CIRCUIT

< DTC/CIRCUIT DIAGNOSIS >

[CAN SYSTEM (TYPE 1)]

MAIN LINE BETWEEN DLC AND TCM CIRCUIT

Diagnosis Procedure

INFOID:000000008462807

1. CHECK CONNECTOR

1. Turn the ignition switch OFF.
2. Disconnect the battery cable from the negative terminal.
3. Check the following terminals and connectors for damage, bend and loose connection (connector side and harness side).
 - Harness connector M11
 - Harness connector E105

Is the inspection result normal?

YES >> GO TO 2.

NO >> Repair the terminal and connector.

2. CHECK HARNESS CONTINUITY (OPEN CIRCUIT)

1. Disconnect the harness connectors M11 and E105.
2. Check the continuity between the data link connector and the harness connector.

Data link connector		Harness connector		Continuity
Connector No.	Terminal No.	Connector No.	Terminal No.	
M4	6	M11	12	Existed
	14		11	Existed

Is the inspection result normal?

YES >> GO TO 3.

NO >> Repair the main line between the data link connector and the harness connector M11.

3. CHECK HARNESS CONTINUITY (OPEN CIRCUIT)

1. Disconnect the harness connectors E6 and F123.
2. Check the continuity between the harness connectors.

Harness connector		Harness connector		Continuity
Connector No.	Terminal No.	Connector No.	Terminal No.	
E105	12	E6	1	Existed
	11		8	Existed

Is the inspection result normal?

YES (Present error)>>Connect all the connectors and diagnose again. Refer to [LAN-15, "Trouble Diagnosis Flow Chart"](#).

YES (Past error)>>Error was detected in the main line between the data link connector and the TCM.

NO >> Repair the main line between the harness connectors E105 and E6.

ECM BRANCH LINE CIRCUIT

< DTC/CIRCUIT DIAGNOSIS >

[CAN SYSTEM (TYPE 1)]

ECM BRANCH LINE CIRCUIT

Diagnosis Procedure

INFOID:000000008462808

1. CHECK CONNECTOR

1. Turn the ignition switch OFF.
2. Disconnect the battery cable from the negative terminal.
3. Check the following terminals and connectors for damage, bend and loose connection (unit side and connector side).
 - ECM
 - Harness connector E104
 - Harness connector B4

Is the inspection result normal?

YES >> GO TO 2.

NO >> Repair the terminal and connector.

2. CHECK HARNESS FOR OPEN CIRCUIT

1. Disconnect the connector of ECM.
2. Check the resistance between the ECM harness connector terminals.

ECM harness connector		Resistance (Ω)
Connector No.	Terminal No.	
E16	98	Approx. 108 – 132
	97	

Is the measurement value within the specification?

YES >> GO TO 3.

NO >> Repair the ECM branch line.

3. CHECK POWER SUPPLY AND GROUND CIRCUIT

Check the power supply and the ground circuit of the ECM. Refer to [EC-147, "Diagnosis Procedure"](#).

Is the inspection result normal?

YES (Present error)>>Replace the ECM. Refer to [EC-433, "Removal and Installation"](#).

YES (Past error)>>Error was detected in the ECM branch line.

NO >> Repair the power supply and the ground circuit.

ADP BRANCH LINE CIRCUIT

< DTC/CIRCUIT DIAGNOSIS >

[CAN SYSTEM (TYPE 1)]

ADP BRANCH LINE CIRCUIT

Diagnosis Procedure

INFOID:000000008462809

1. CHECK CONNECTOR

1. Turn the ignition switch OFF.
2. Disconnect the battery cable from the negative terminal.
3. Check the following terminals and connectors for damage, bend and loose connection (unit side and connector side).
 - Driver seat control unit
 - Harness connector B460
 - Harness connector B19

Is the inspection result normal?

YES >> GO TO 2.

NO >> Repair the terminal and connector.

2. CHECK HARNESS FOR OPEN CIRCUIT

1. Disconnect the connector of driver seat control unit.
2. Check the resistance between the driver seat control unit harness connector terminals.

Driver seat control unit harness connector			Resistance (Ω)
Connector No.	Terminal No.		
B452	23	24	Approx. 54 – 66

Is the measurement value within the specification?

YES >> GO TO 3.

NO >> Repair the driver seat control unit branch line.

3. CHECK POWER SUPPLY AND GROUND CIRCUIT

Check the power supply and the ground circuit of the driver seat control unit. Refer to [ADP-50, "DRIVER SEAT CONTROL UNIT : Diagnosis Procedure"](#).

Is the inspection result normal?

YES (Present error)>>Replace the driver seat control unit. Refer to [ADP-121, "Removal and Installation"](#).

YES (Past error)>>Error was detected in the driver seat control unit branch line.

NO >> Repair the power supply and the ground circuit.

A
B
C
D
E
F
G
H
I
J
K
L

LAN

N
O
P

C/ROOF BRANCH LINE CIRCUIT

< DTC/CIRCUIT DIAGNOSIS >

[CAN SYSTEM (TYPE 1)]

C/ROOF BRANCH LINE CIRCUIT

Diagnosis Procedure

INFOID:000000008462810

1. CHECK CONNECTOR

1. Turn the ignition switch OFF.
2. Disconnect the battery cable from the negative terminal.
3. Check the following terminals and connectors for damage, bend and loose connection (unit side and connector side).
 - Soft top control unit
 - Harness connector B318
 - Harness connector B77

Is the inspection result normal?

YES >> GO TO 2.

NO >> Repair the terminal and connector.

2. CHECK HARNESS FOR OPEN CIRCUIT

1. Disconnect the connector of soft top control unit.
2. Check the resistance between the soft top control unit harness connector terminals.

Soft top control unit harness connector		Resistance (Ω)
Connector No.	Terminal No.	
B323	17	Approx. 54 – 66
	18	

Is the measurement value within the specification?

YES >> GO TO 3.

NO >> Repair the soft top control unit branch line.

3. CHECK POWER SUPPLY AND GROUND CIRCUIT

Check the power supply and the ground circuit of the soft top control unit. Refer to [RF-165, "Diagnosis Procedure"](#).

Is the inspection result normal?

YES (Present error)>>Replace the soft top control unit. Refer to [RF-229, "Removal and Installation"](#).

YES (Past error)>>Error was detected in the soft top control unit branch line.

NO >> Repair the power supply and the ground circuit.

4WD BRANCH LINE CIRCUIT

< DTC/CIRCUIT DIAGNOSIS >

[CAN SYSTEM (TYPE 1)]

4WD BRANCH LINE CIRCUIT

Diagnosis Procedure

INFOID:000000008462811

1. CHECK CONNECTOR

1. Turn the ignition switch OFF.
2. Disconnect the battery cable from the negative terminal.
3. Check the terminals and connectors of the AWD control unit for damage, bend and loose connection (unit side and connector side).

Is the inspection result normal?

- YES >> GO TO 2.
NO >> Repair the terminal and connector.

2. CHECK HARNESS FOR OPEN CIRCUIT

1. Disconnect the connector of AWD control unit.
2. Check the resistance between the AWD control unit harness connector terminals.

AWD control unit harness connector			Resistance (Ω)
Connector No.	Terminal No.		
M69	8	16	Approx. 54 – 66

Is the measurement value within the specification?

- YES >> GO TO 3.
NO >> Repair the AWD control unit branch line.

3. CHECK POWER SUPPLY AND GROUND CIRCUIT

Check the power supply and the ground circuit of the AWD control unit. Refer to [DLN-34, "Diagnosis Procedure"](#).

Is the inspection result normal?

- YES (Present error)>>Replace the AWD control unit. Refer to [DLN-48, "Removal and Installation"](#).
YES (Past error)>>Error was detected in the AWD control unit branch line.
NO >> Repair the power supply and the ground circuit.

A
B
C
D
E
F
G
H
I
J
K
L

LAN

N
O
P

AV BRANCH LINE CIRCUIT

Diagnosis Procedure

INFOID:000000008462812

1. CHECK CONNECTOR

1. Turn the ignition switch OFF.
2. Disconnect the battery cable from the negative terminal.
3. Check the terminals and connectors of the AV control unit for damage, bend and loose connection (unit side and connector side).

Is the inspection result normal?

- YES >> GO TO 2.
 NO >> Repair the terminal and connector.

2. CHECK HARNESS FOR OPEN CIRCUIT

1. Disconnect the connector of AV control unit.
 2. Check the resistance between the AV control unit harness connector terminals.
- Models with navigation system

AV control unit harness connector			Resistance (Ω)
Connector No.	Terminal No.		
M180	90	74	Approx. 54 – 66

- Models without navigation system

AV control unit harness connector			Resistance (Ω)
Connector No.	Terminal No.		
M174	81	80	Approx. 54 – 66

Is the measurement value within the specification?

- YES >> GO TO 3.
 NO >> Repair the AV control unit branch line.

3. CHECK POWER SUPPLY AND GROUND CIRCUIT

Check the power supply and the ground circuit of the AV control unit. Refer to the following.

- BOSE audio without navigation: [AV-70, "AV CONTROL UNIT : Diagnosis Procedure"](#)
- BOSE audio with navigation: [AV-208, "AV CONTROL UNIT : Diagnosis Procedure"](#)

Is the inspection result normal?

- YES (Present error)>>Replace the AV control unit. Refer to the following.
- BOSE audio without navigation: [AV-102, "Removal and Installation"](#)
 - BOSE audio with navigation: [AV-236, "Removal and Installation"](#)

YES (Past error)>>Error was detected in the AV control unit branch line.

NO >> Repair the power supply and the ground circuit.

HVAC BRANCH LINE CIRCUIT

< DTC/CIRCUIT DIAGNOSIS >

[CAN SYSTEM (TYPE 1)]

HVAC BRANCH LINE CIRCUIT

Diagnosis Procedure

INFOID:000000008462813

1. CHECK CONNECTOR

1. Turn the ignition switch OFF.
2. Disconnect the battery cable from the negative terminal.
3. Check the terminals and connectors of the A/C auto amp. for damage, bend and loose connection (unit side and connector side).

Is the inspection result normal?

- YES >> GO TO 2.
NO >> Repair the terminal and connector.

2. CHECK HARNESS FOR OPEN CIRCUIT

1. Disconnect the connector of A/C auto amp.
2. Check the resistance between the A/C auto amp. harness connector terminals.

A/C auto amp. harness connector			Resistance (Ω)
Connector No.	Terminal No.		
M50	1	2	Approx. 54 – 66

Is the measurement value within the specification?

- YES >> GO TO 3.
NO >> Repair the A/C auto amp. branch line.

3. CHECK POWER SUPPLY AND GROUND CIRCUIT

Check the power supply and the ground circuit of the A/C auto amp. Refer to [HAC-63, "A/C AUTO AMP. : Diagnosis Procedure"](#).

Is the inspection result normal?

- YES (Present error)>>Replace the A/C auto amp. Refer to [HAC-79, "Removal and Installation"](#).
YES (Past error)>>Error was detected in the A/C auto amp. branch line.
NO >> Repair the power supply and the ground circuit.

A
B
C
D
E
F
G
H
I
J
K
L

LAN

N
O
P

M&A BRANCH LINE CIRCUIT

< DTC/CIRCUIT DIAGNOSIS >

[CAN SYSTEM (TYPE 1)]

M&A BRANCH LINE CIRCUIT

Diagnosis Procedure

INFOID:000000008462814

1. CHECK CONNECTOR

1. Turn the ignition switch OFF.
2. Disconnect the battery cable from the negative terminal.
3. Check the terminals and connectors of the combination meter for damage, bend and loose connection (unit side and connector side).

Is the inspection result normal?

- YES >> GO TO 2.
NO >> Repair the terminal and connector.

2. CHECK HARNESS FOR OPEN CIRCUIT

1. Disconnect the connector of combination meter.
2. Check the resistance between the combination meter harness connector terminals.

Combination meter harness connector			Resistance (Ω)
Connector No.	Terminal No.		
M34	21	22	Approx. 54 – 66

Is the measurement value within the specification?

- YES >> GO TO 3.
NO >> Repair the combination meter branch line.

3. CHECK POWER SUPPLY AND GROUND CIRCUIT

Check the power supply and the ground circuit of the combination meter. Refer to [MWI-47, "COMBINATION METER : Diagnosis Procedure"](#).

Is the inspection result normal?

- YES (Present error)>>Replace the combination meter. Refer to [MWI-70, "Removal and Installation"](#).
YES (Past error)>>Error was detected in the combination meter branch line.
NO >> Repair the power supply and the ground circuit.

A-BAG BRANCH LINE CIRCUIT

< DTC/CIRCUIT DIAGNOSIS >

[CAN SYSTEM (TYPE 1)]

A-BAG BRANCH LINE CIRCUIT

Diagnosis Procedure

INFOID:000000008462815

WARNING:

Always observe the following items for preventing accidental activation.

- Before servicing, turn ignition switch OFF, disconnect battery negative terminal, and wait 3 minutes or more. (To discharge backup capacitor.)
- Never use unspecified tester or other measuring device.

1.CHECK CONNECTOR

1. Turn the ignition switch OFF.
2. Disconnect the battery cable from the negative terminal.
3. Check the terminals and connectors of the air bag diagnosis sensor unit for damage, bend and loose connection (unit side and connector side).

Is the inspection result normal?

YES >> GO TO 2.

NO >> Replace the main harness.

2.CHECK AIR BAG DIAGNOSIS SENSOR UNIT

Check the air bag diagnosis sensor unit. Refer to [SRC-26. "Work Flow"](#).

Is the inspection result normal?

YES >> Replace the main harness.

NO >> Replace parts whose air bag system has a malfunction.

A
B
C
D
E
F
G
H
I
J
K
L
N
O
P

LAN

BCM BRANCH LINE CIRCUIT

< DTC/CIRCUIT DIAGNOSIS >

[CAN SYSTEM (TYPE 1)]

BCM BRANCH LINE CIRCUIT

Diagnosis Procedure

INFOID:000000008462816

1. CHECK CONNECTOR

1. Turn the ignition switch OFF.
2. Disconnect the battery cable from the negative terminal.
3. Check the terminals and connectors of the BCM for damage, bend and loose connection (unit side and connector side).

Is the inspection result normal?

- YES >> GO TO 2.
NO >> Repair the terminal and connector.

2. CHECK HARNESS FOR OPEN CIRCUIT

1. Disconnect the connector of BCM.
2. Check the resistance between the BCM harness connector terminals.

BCM harness connector			Resistance (Ω)
Connector No.	Terminal No.		
M122	91	90	Approx. 54 – 66

Is the measurement value within the specification?

- YES >> GO TO 3.
NO >> Repair the BCM branch line.

3. CHECK POWER SUPPLY AND GROUND CIRCUIT

Check the power supply and the ground circuit of the BCM. Refer to [BCS-70, "Diagnosis Procedure"](#).

Is the inspection result normal?

- YES (Present error)>>Replace the BCM. Refer to [BCS-77, "Removal and Installation"](#).
YES (Past error)>>Error was detected in the BCM branch line.
NO >> Repair the power supply and the ground circuit.

DLC BRANCH LINE CIRCUIT

< DTC/CIRCUIT DIAGNOSIS >

[CAN SYSTEM (TYPE 1)]

DLC BRANCH LINE CIRCUIT

Diagnosis Procedure

INFOID:000000008462817

1. CHECK CONNECTOR

1. Turn the ignition switch OFF.
2. Disconnect the battery cable from the negative terminal.
3. Check the terminals and connectors of the data link connector for damage, bend and loose connection (connector side and harness side).

Is the inspection result normal?

- YES >> GO TO 2.
NO >> Repair the terminal and connector.

2. CHECK HARNESS FOR OPEN CIRCUIT

Check the resistance between the data link connector terminals.

Data link connector			Resistance (Ω)
Connector No.	Terminal No.		
M4	6	14	Approx. 54 – 66

Is the measurement value within the specification?

- YES (Present error)>>Diagnose again. Refer to [LAN-15. "Trouble Diagnosis Flow Chart"](#).
YES (Past error)>>Error was detected in the data link connector branch line circuit.
NO >> Repair the data link connector branch line.

A
B
C
D
E
F
G
H
I
J
K
L

LAN

N
O
P

STRG BRANCH LINE CIRCUIT

< DTC/CIRCUIT DIAGNOSIS >

[CAN SYSTEM (TYPE 1)]

STRG BRANCH LINE CIRCUIT

Diagnosis Procedure

INFOID:000000008462818

1. CHECK CONNECTOR

1. Turn the ignition switch OFF.
2. Disconnect the battery cable from the negative terminal.
3. Check the terminals and connectors of the steering angle sensor for damage, bend and loose connection (unit side and connector side).

Is the inspection result normal?

- YES >> GO TO 2.
NO >> Repair the terminal and connector.

2. CHECK HARNESS FOR OPEN CIRCUIT

1. Disconnect the connector of steering angle sensor.
2. Check the resistance between the steering angle sensor harness connector terminals.

Steering angle sensor harness connector			Resistance (Ω)
Connector No.	Terminal No.		
M30	5	2	Approx. 54 – 66

Is the measurement value within the specification?

- YES >> GO TO 3.
NO >> Repair the steering angle sensor branch line.

3. CHECK POWER SUPPLY AND GROUND CIRCUIT

Check the power supply and the ground circuit of the steering angle sensor. Refer to [BRC-25, "Wiring Diagram"](#).

Is the inspection result normal?

- YES (Present error)>>Replace the steering angle sensor. Refer to [BRC-105, "Removal and Installation"](#).
YES (Past error)>>Error was detected in the steering angle sensor branch line.
NO >> Repair the power supply and the ground circuit.

ABS BRANCH LINE CIRCUIT

< DTC/CIRCUIT DIAGNOSIS >

[CAN SYSTEM (TYPE 1)]

ABS BRANCH LINE CIRCUIT

Diagnosis Procedure

INFOID:000000008462819

1. CHECK CONNECTOR

1. Turn the ignition switch OFF.
2. Disconnect the battery cable from the negative terminal.
3. Check the terminals and connectors of the ABS actuator and electric unit (control unit) for damage, bend and loose connection (unit side and connector side).

Is the inspection result normal?

- YES >> GO TO 2.
NO >> Repair the terminal and connector.

2. CHECK HARNESS FOR OPEN CIRCUIT

1. Disconnect the connector of ABS actuator and electric unit (control unit).
2. Check the resistance between the ABS actuator and electric unit (control unit) harness connector terminals.

ABS actuator and electric unit (control unit) harness connector			Resistance (Ω)
Connector No.	Terminal No.		
E36	23	21	Approx. 54 – 66

Is the measurement value within the specification?

- YES >> GO TO 3.
NO >> Repair the ABS actuator and electric unit (control unit) branch line.

3. CHECK POWER SUPPLY AND GROUND CIRCUIT

Check the power supply and the ground circuit of the ABS actuator and electric unit (control unit). Refer to [BRC-43, "Diagnosis Procedure"](#).

Is the inspection result normal?

- YES (Present error)>>Replace the ABS actuator and electric unit (control unit). Refer to [BRC-102, "Removal and Installation"](#).
YES (Past error)>>Error was detected in the ABS actuator and electric unit (control unit) branch line.
NO >> Repair the power supply and the ground circuit.

A
B
C
D
E
F
G
H
I
J
K
L

LAN

TCM BRANCH LINE CIRCUIT

< DTC/CIRCUIT DIAGNOSIS >

[CAN SYSTEM (TYPE 1)]

TCM BRANCH LINE CIRCUIT

Diagnosis Procedure

INFOID:000000008462820

1. CHECK CONNECTOR

1. Turn the ignition switch OFF.
2. Disconnect the battery cable from the negative terminal.
3. Check the following terminals and connectors for damage, bend and loose connection (unit side and connector side).
 - TCM
 - Harness connector F123
 - Harness connector E6

Is the inspection result normal?

YES >> GO TO 2.

NO >> Repair the terminal and connector.

2. CHECK HARNESS FOR OPEN CIRCUIT

1. Disconnect the connector of TCM.
2. Check the resistance between the TCM harness connector terminals.

TCM harness connector			Resistance (Ω)
Connector No.	Terminal No.		
F23	32	31	Approx. 54 – 66

Is the measurement value within the specification?

YES >> GO TO 3.

NO >> Repair the TCM branch line.

3. CHECK POWER SUPPLY AND GROUND CIRCUIT

Check the power supply and the ground circuit of the TCM. Refer to [TM-103, "Diagnosis Procedure"](#).

Is the inspection result normal?

YES (Present error)>>Replace the TCM. Refer to [TM-143, "Removal and Installation"](#).

YES (Past error)>>Error was detected in the TCM branch line.

NO >> Repair the power supply and the ground circuit.

IPDM-E BRANCH LINE CIRCUIT

< DTC/CIRCUIT DIAGNOSIS >

[CAN SYSTEM (TYPE 1)]

IPDM-E BRANCH LINE CIRCUIT

Diagnosis Procedure

INFOID:000000008462821

1. CHECK CONNECTOR

1. Turn the ignition switch OFF.
2. Disconnect the battery cable from the negative terminal.
3. Check the terminals and connectors of the IPDM E/R for damage, bend and loose connection (unit side and connector side).

Is the inspection result normal?

- YES >> GO TO 2.
NO >> Repair the terminal and connector.

2. CHECK HARNESS FOR OPEN CIRCUIT

1. Disconnect the connector of IPDM E/R.
2. Check the resistance between the IPDM E/R harness connector terminals.

IPDM E/R harness connector			Resistance (Ω)
Connector No.	Terminal No.		
E11	40	39	Approx. 108 – 132

Is the measurement value within the specification?

- YES >> GO TO 3.
NO >> Repair the IPDM E/R branch line.

3. CHECK POWER SUPPLY AND GROUND CIRCUIT

Check the power supply and the ground circuit of the IPDM E/R. Refer to [PCS-30, "Diagnosis Procedure"](#).

Is the inspection result normal?

- YES (Present error)>>Replace the IPDM E/R. Refer to [PCS-31, "Removal and Installation"](#).
YES (Past error)>>Error was detected in the IPDM E/R branch line.
NO >> Repair the power supply and the ground circuit.

A
B
C
D
E
F
G
H
I
J
K
L

LAN

N
O
P

CAN COMMUNICATION CIRCUIT

< DTC/CIRCUIT DIAGNOSIS >

[CAN SYSTEM (TYPE 1)]

CAN COMMUNICATION CIRCUIT

Diagnosis Procedure

INFOID:000000008462822

1. CONNECTOR INSPECTION

1. Turn the ignition switch OFF.
2. Disconnect the battery cable from the negative terminal.
3. Disconnect all the unit connectors on CAN communication system.
4. Check terminals and connectors for damage, bend and loose connection.

Is the inspection result normal?

- YES >> GO TO 2.
NO >> Repair the terminal and connector.

2. CHECK HARNESS CONTINUITY (SHORT CIRCUIT)

Check the continuity between the data link connector terminals.

Data link connector			Continuity
Connector No.	Terminal No.		
M4	6	14	Not existed

Is the inspection result normal?

- YES >> GO TO 3.
NO >> Check the harness and repair the root cause.

3. CHECK HARNESS CONTINUITY (SHORT CIRCUIT)

Check the continuity between the data link connector and the ground.

Data link connector		Ground	Continuity
Connector No.	Terminal No.		
M4	6		Not existed
	14		Not existed

Is the inspection result normal?

- YES >> GO TO 4.
NO >> Check the harness and repair the root cause.

4. CHECK ECM AND IPDM E/R TERMINATION CIRCUIT

1. Remove the ECM and the IPDM E/R.
2. Check the resistance between the ECM terminals.

ECM		Resistance (Ω)
Terminal No.		
98	97	Approx. 108 – 132

3. Check the resistance between the IPDM E/R terminals.

IPDM E/R		Resistance (Ω)
Terminal No.		
40	39	Approx. 108 – 132

Is the measurement value within the specification?

- YES >> GO TO 5.
NO >> Replace the ECM and/or the IPDM E/R.

5. CHECK SYMPTOM

Connect all the connectors. Check if the symptoms described in the "Symptom (Results from interview with customer)" are reproduced.

CAN COMMUNICATION CIRCUIT

< DTC/CIRCUIT DIAGNOSIS >

[CAN SYSTEM (TYPE 1)]

Inspection result

Reproduced>>GO TO 6.

Non-reproduced>>Start the diagnosis again. Follow the trouble diagnosis procedure when past error is detected.

6.CHECK UNIT REPRODUCTION

Perform the reproduction test as per the following procedure for each unit.

1. Turn the ignition switch OFF.
2. Disconnect the battery cable from the negative terminal.
3. Disconnect one of the control unit connectors of CAN communication system.

NOTE:

ECM and IPDM E/R have a termination circuit. Check other units first.

4. Connect the battery cable to the negative terminal. Check if the symptoms described in the "Symptom (Results from interview with customer)" are reproduced.

NOTE:

Although unit-related error symptoms occur, do not confuse them with other symptoms.

Inspection result

Reproduced>>Connect the connector. Check other units as per the above procedure.

Non-reproduced>>Replace the unit whose connector was disconnected.

A
B
C
D
E
F
G
H
I
J
K
L
N
O
P

LAN