

SECTION **STC**

STEERING CONTROL SYSTEM

A
B
C
D
E
F
G
H
I
J
K
L
M
N
O
P

CONTENTS

PRECAUTION	BASIC INSPECTION	
2	10	F
PRECAUTIONS	DIAGNOSIS AND REPAIR WORK FLOW	
2	10	
Precaution for Supplemental Restraint System (SRS) "AIR BAG" and "SEAT BELT PRE-TEN- SIONER"	Work Flow	STC
2	10	
Precaution for Battery Service	DTC/CIRCUIT DIAGNOSIS	
2	11	
Service Procedure Precautions for Models with a Pop-up Roll Bar	POWER SUPPLY AND GROUND CIRCUIT	H
2	11	
SYSTEM DESCRIPTION	Description	
3	11	
COMPONENT PARTS	Diagnosis Procedure	
3	11	
Component Parts Location	POWER STEERING SOLENOID VALVE	I
3	12	
Component Description	Diagnosis Procedure	
3	12	
Power Steering Control Unit	Component Inspection	J
3	13	
Power Steering Solenoid Valve	ENGINE SPEED SIGNAL CIRCUIT	
3	14	
SYSTEM	Description	K
4	14	
EPS SYSTEM	Diagnosis Procedure	
4	14	
EPS SYSTEM : System Diagram	VEHICLE SPEED SIGNAL CIRCUIT	L
4	16	
EPS SYSTEM : System Description	Description	
4	16	
EPS SYSTEM : Fail-Safe	Diagnosis Procedure	
5	16	
ECU DIAGNOSIS INFORMATION	SYMPTOM DIAGNOSIS	M
7	18	
POWER STEERING CONTROL UNIT	UNBALANCE STEERING WHEEL TURNING FORCE (TORQUE VARIATION)	
7	18	
Reference Value	Description	
7	18	
Fail-Safe	Diagnosis Procedure	N
8	18	
WIRING DIAGRAM	REMOVAL AND INSTALLATION	O
9	19	
POWER STEERING CONTROL SYSTEM	POWER STEERING CONTROL UNIT	
9	19	
Wiring Diagram - ELECTRONICALLY CON- TROLLED POWER STEERING SYSTEM -	Removal and Installation	P
9	19	

PRECAUTIONS

< PRECAUTION >

PRECAUTION

PRECAUTIONS

Precaution for Supplemental Restraint System (SRS) "AIR BAG" and "SEAT BELT PRE-TENSIONER"

INFOID:000000008461618

The Supplemental Restraint System such as "AIR BAG" and "SEAT BELT PRE-TENSIONER", used along with a front seat belt, helps to reduce the risk or severity of injury to the driver and front passenger for certain types of collision. This system includes seat belt switch inputs and dual stage front air bag modules. The SRS system uses the seat belt switches to determine the front air bag deployment, and may only deploy one front air bag, depending on the severity of a collision and whether the front occupants are belted or unbelted. Information necessary to service the system safely is included in the "SRS AIR BAG" and "SEAT BELT" of this Service Manual.

WARNING:

Always observe the following items for preventing accidental activation.

- To avoid rendering the SRS inoperative, which could increase the risk of personal injury or death in the event of a collision that would result in air bag inflation, all maintenance must be performed by an authorized NISSAN/INFINITI dealer.
- Improper maintenance, including incorrect removal and installation of the SRS, can lead to personal injury caused by unintentional activation of the system. For removal of Spiral Cable and Air Bag Module, see "SRS AIR BAG".
- Never use electrical test equipment on any circuit related to the SRS unless instructed to in this Service Manual. SRS wiring harnesses can be identified by yellow and/or orange harnesses or harness connectors.

PRECAUTIONS WHEN USING POWER TOOLS (AIR OR ELECTRIC) AND HAMMERS

WARNING:

Always observe the following items for preventing accidental activation.

- When working near the Air Bag Diagnosis Sensor Unit or other Air Bag System sensors with the ignition ON or engine running, never use air or electric power tools or strike near the sensor(s) with a hammer. Heavy vibration could activate the sensor(s) and deploy the air bag(s), possibly causing serious injury.
- When using air or electric power tools or hammers, always switch the ignition OFF, disconnect the battery, and wait at least 3 minutes before performing any service.

Precaution for Battery Service

INFOID:000000008461619

Before disconnecting the battery, lower both the driver and passenger windows. This will prevent any interference between the window edge and the vehicle when the door is opened/closed. During normal operation, the window slightly raises and lowers automatically to prevent any window to vehicle interference. The automatic window function will not work with the battery disconnected.

Service Procedure Precautions for Models with a Pop-up Roll Bar

INFOID:000000008461620

WARNING:

Always observe the following items for preventing accidental activation.

- Risk of passenger injury or death may increase if the pop-up roll bar does not deploy during a roll over collision. In order to reduce the chance of an incident where the pop-up roll bar is inoperative, all maintenance must be performed by a NISSAN or INFINITI dealer.
- Before removing and installing the pop-up roll bar component parts and harness, always turn the ignition switch OFF, disconnect the battery negative terminal, and wait for 3 minutes or more. (The purpose of this operation is to discharge electricity that is accumulated in the auxiliary power supply circuit in the air bag diagnosis sensor unit.)
- When repairing, removing, and installing a pop-up roll bar, always refer to SRS AIR BAG and SRS AIR BAG CONTROL warnings in the Service Manual.

COMPONENT PARTS

< SYSTEM DESCRIPTION >

SYSTEM DESCRIPTION

COMPONENT PARTS

Component Parts Location

INFOID:000000008461621

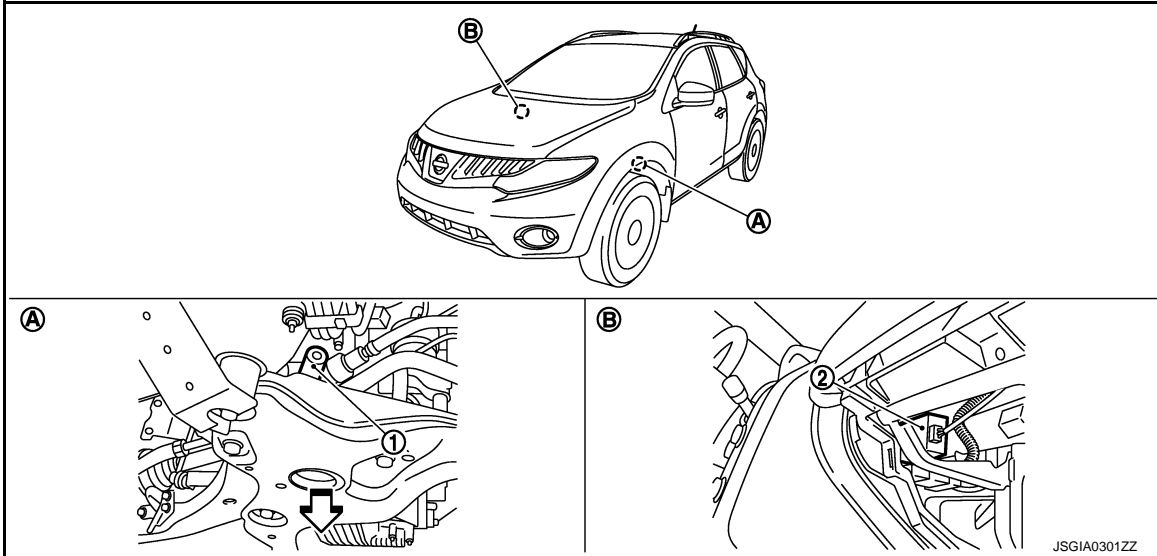

- 1. Power steering solenoid valve
- 2. Power steering control unit
- A. Steering gear assembly
- B. Glove box assembly removed

↔: Vehicle front

Component Description

INFOID:000000008461622

Component parts	Reference/Function
Power steering control unit	STC-3, "Power Steering Control Unit"
Combination meter	STC-16, "Description"
ECM	STC-14, "Description"
Power steering solenoid valve	STC-3, "Power Steering Solenoid Valve"

Power Steering Control Unit

INFOID:000000008461623

- Signals from various sensors control the driving voltage to power steering solenoid valve.
- Power steering control unit controls the driving voltage to power steering solenoid valve for maintaining the power steering assist force when the fail-safe function is activated. (The engine speed signals control EPS system if any vehicle speed signal error is detected.)

Power Steering Solenoid Valve

INFOID:000000008461624

Power steering solenoid valve controls the power steering oil pressure in the gear housing assembly.

SYSTEM

< SYSTEM DESCRIPTION >

SYSTEM

EPS SYSTEM

EPS SYSTEM : System Diagram

INFOID:000000008461625

CONTROL DIAGRAM

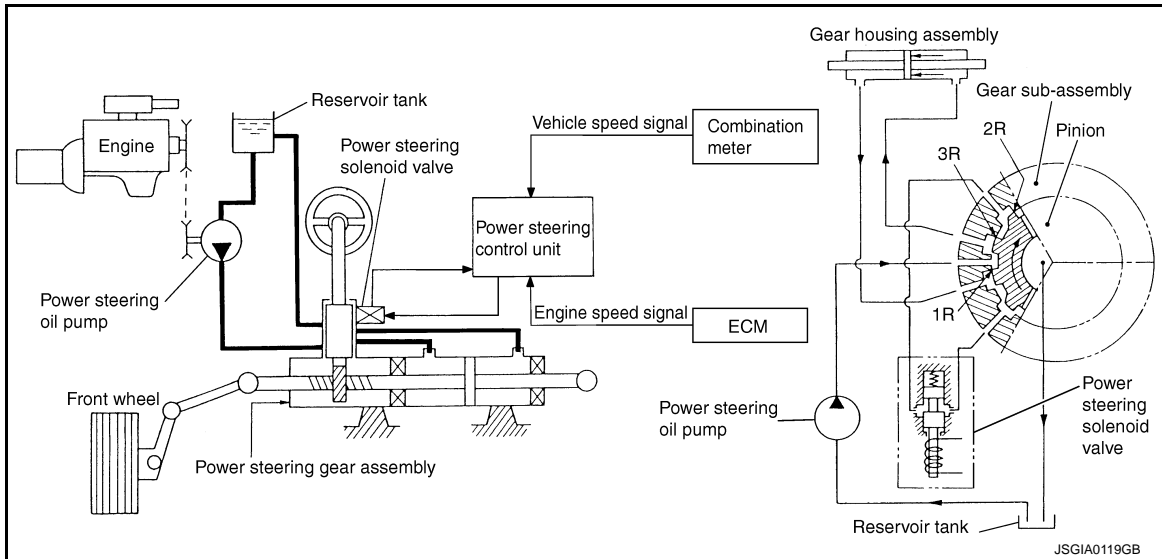

CROSS-SECTIONAL VIEW

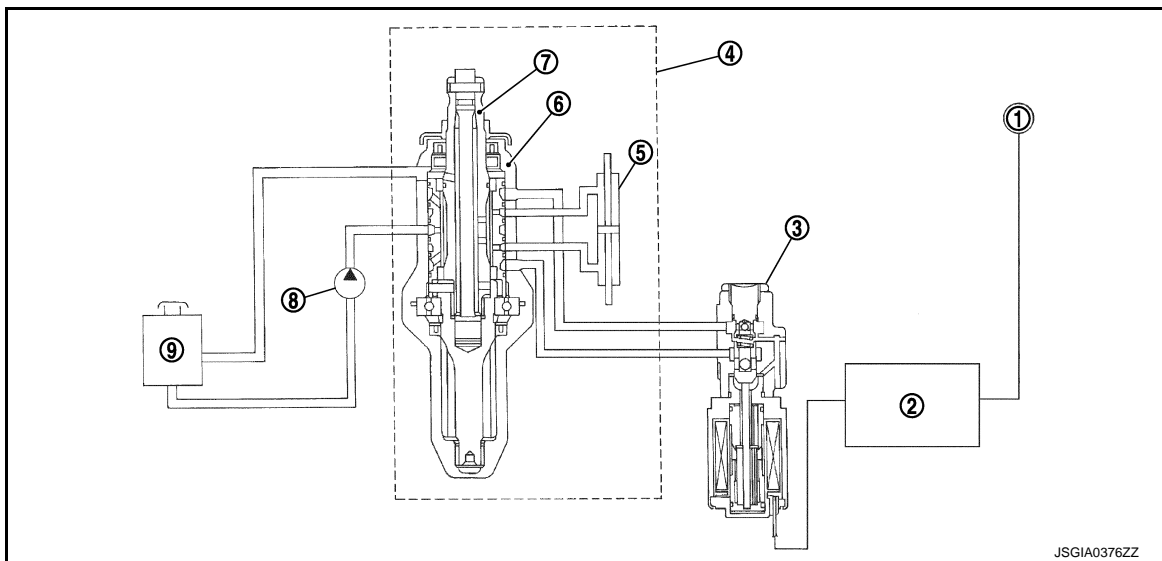

- | | | |
|---------------------------|--------------------------------|----------------------------------|
| 1. Combination meter | 2. Power steering control unit | 3. Power steering solenoid valve |
| 4. Steering gear assembly | 5. Gear housing assembly | 6. Gear sub-assembly |
| 7. Pinion | 8. Power steering oil pump | 9. Reservoir tank |

EPS SYSTEM : System Description

INFOID:000000008461626

- The EPS system controls the power steering solenoid valve through the power steering control unit.

SYSTEM

< SYSTEM DESCRIPTION >

- The valve driving voltage to control the power steering solenoid valve varies according to the vehicle speed.

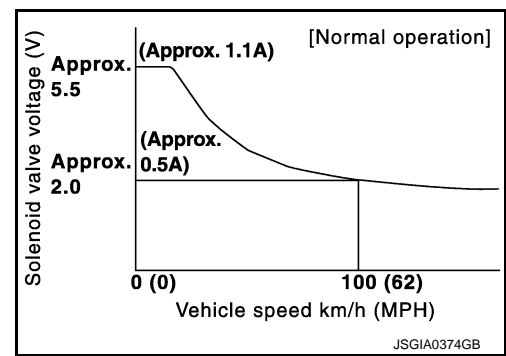

OPERATION PRINCIPLE

During Parking (When Turning The Steering Wheel To The Right.)

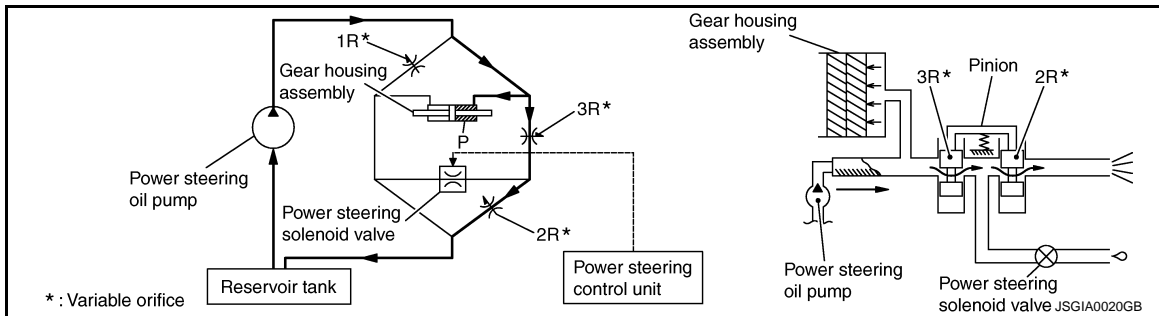

- Power steering solenoid valve is closed while a vehicle is stopped.
- Pinion "1R", "2R" and "3R" are closed depending on steering torque of steering wheel.
- Oil pressure "P" in the gear housing assembly is the sum of oil pressures occurred in "2R" and "3R". This results in a light steering force because of high pressure.

During High-speed Operation

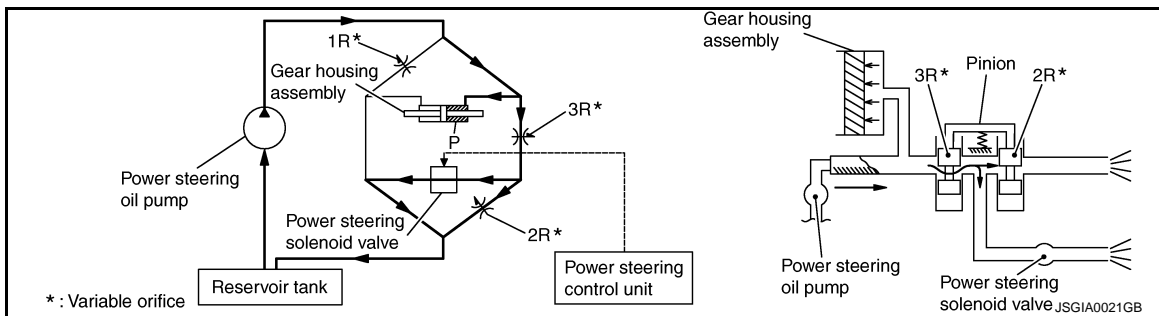

- Power steering solenoid valve is opened during high-speed operation.
- Pinion "1R", "2R" and "3R" are closed depending on steering torque of steering wheel.
- Oil pressure "2R" does not occur because the power steering solenoid valve is on full throttle.
- Oil pressure "P" in the gear housing assembly includes only oil pressure occurred in "3R" and results in a heavy steering force.

EPS SYSTEM : Fail-Safe

INFOID:000000008461627

EPS system

SYSTEM

< SYSTEM DESCRIPTION >

- EPS system enters the fail-safe mode (that allows the steering force to be controlled without impairing the drivability) if any of the input/output values to/from EPS system (power steering control unit) deviate from the standard range.

NOTE:

The system enters the fail-safe mode if the engine speed remains at 1,500 rpm or more for over 10 seconds while the vehicle is stopped. This is normal.

- The fail-safe function is canceled when a vehicle speed signal of 2 km/h (1.2 MPH) or more is inputted or the ignition switch is turned OFF→ON. EPS system restores the normal operation at that time.

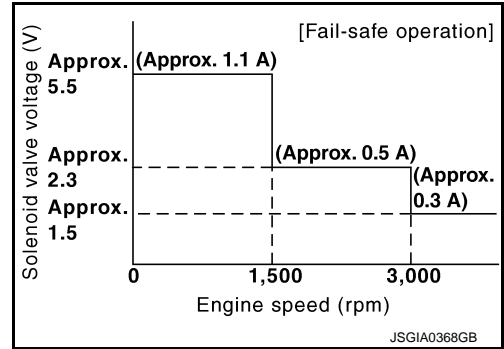

Mode	Warning lamp	DTC	Detection point (malfunction part)	Error area and root cause
Fail-safe function	—	—	Vehicle speed signal input	<ul style="list-style-type: none"> • Engine speed is 1,500 rpm or more and there is no vehicle speed signal input for over 10 seconds during vehicle travel. • Vehicle speed signal has abruptly dropped from 30 km/h (19 MPH) or more to 2 km/h (1.2 MPH) or less within 1.4 seconds.

POWER STEERING CONTROL UNIT

< ECU DIAGNOSIS INFORMATION >

ECU DIAGNOSIS INFORMATION

POWER STEERING CONTROL UNIT

Reference Value

INFOID:000000008461628

TERMINAL LAYOUT

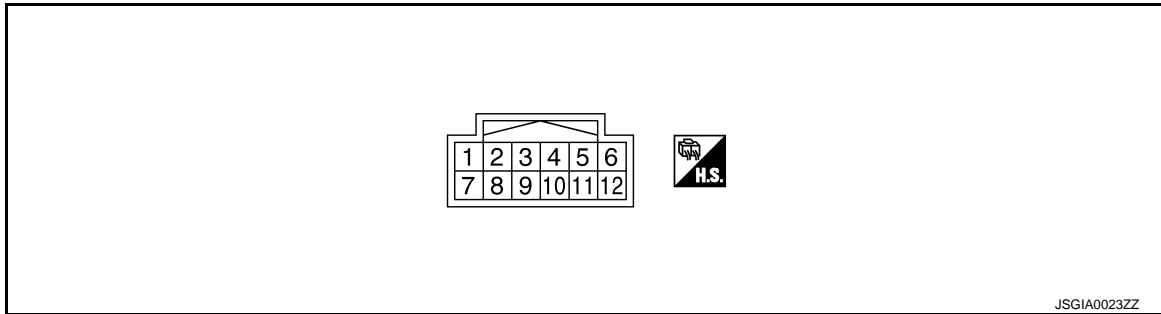

PHYSICAL VALUES

Terminal No. (Wire color)		Description		Condition	Value (Approx.)
+	-	Signal name	Input/ Output		
1 (Y)	Ground	Power steering solenoid valve voltage	Output	Vehicle speed: 0 km/h (0 MPH) (Engine is running)	4.4 – 6.6 V
				Vehicle speed: 100 km/h (62 MPH)	2.4 – 3.6 V
3 (G)	Ground	Ignition switch power supply	Input	Ignition switch: ON	Battery voltage
				Ignition switch: OFF	0 V
5 (LG)	Ground	Power steering solenoid valve ground	—	Always	0 V
6 (B)	Ground	Ground	—	Always	0 V
8 (P)	Ground	Vehicle speed signal	Input	Vehicle speed: 40 km/h (25 MPH) CAUTION: Check air pressure of tire under standard condition.	<p>NOTE: The maximum voltage varies depending on the specification (destination unit).</p> <p>JSNIA0015GB</p>

A
B
C
D
E
F

STC

H
I
J
K
L
M
N
O
P

POWER STEERING CONTROL UNIT

< ECU DIAGNOSIS INFORMATION >

Terminal No. (Wire color)		Description		Condition	Value (Approx.)
+	-	Signal name	Input/ Output		
10 (V)	Ground	Engine speed signal	Input	Engine is running <ul style="list-style-type: none"> • Warm-up condition • Idle speed 	
				Engine is running <ul style="list-style-type: none"> • Warm-up condition • Engine speed: Approx. 2,000 rpm 	

CAUTION:

When using circuit tester or oscilloscope to measure voltage for inspection, be sure not to forcibly extend any connector terminals.

Fail-Safe

INFOID:000000008461629

EPS system

- EPS system enters the fail-safe mode (that allows the steering force to be controlled without impairing the drivability) if any of the input/output values to/from EPS system (power steering control unit) deviate from the standard range.

NOTE:

The system enters the fail-safe mode if the engine speed remains at 1,500 rpm or more for over 10 seconds while the vehicle is stopped. This is normal.

- The fail-safe function is canceled when a vehicle speed signal of 2 km/h (1.2 MPH) or more is inputted or the ignition switch is turned OFF→ON. EPS system restores the normal operation at that time.

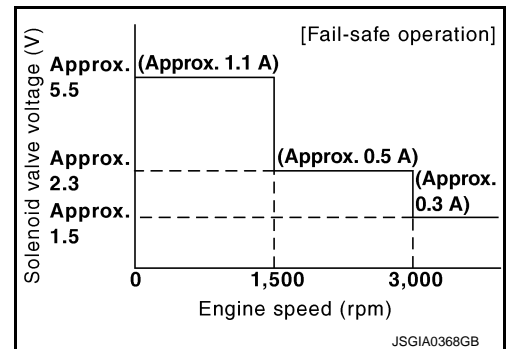

Mode	Warning lamp	DTC	Detection point (malfunction part)	Error area and root cause
Fail-safe function	—	—	Vehicle speed signal input	<ul style="list-style-type: none"> • Engine speed is 1,500 rpm or more and there is no vehicle speed signal input for over 10 seconds during vehicle travel. • Vehicle speed signal has abruptly dropped from 30 km/h (19 MPH) or more to 2 km/h (1.2 MPH) or less within 1.4 seconds.

POWER STEERING CONTROL SYSTEM

< WIRING DIAGRAM >

WIRING DIAGRAM

POWER STEERING CONTROL SYSTEM

Wiring Diagram - ELECTRONICALLY CONTROLLED POWER STEERING SYSTEM -

INFOID:000000008461630

For connector terminal arrangements, harness layouts, and alphabets in a ◊ (option abbreviation; if not described in wiring diagram), refer to [GI-12. "Connector Information"](#).

POWER STEERING CONTROL SYSTEM

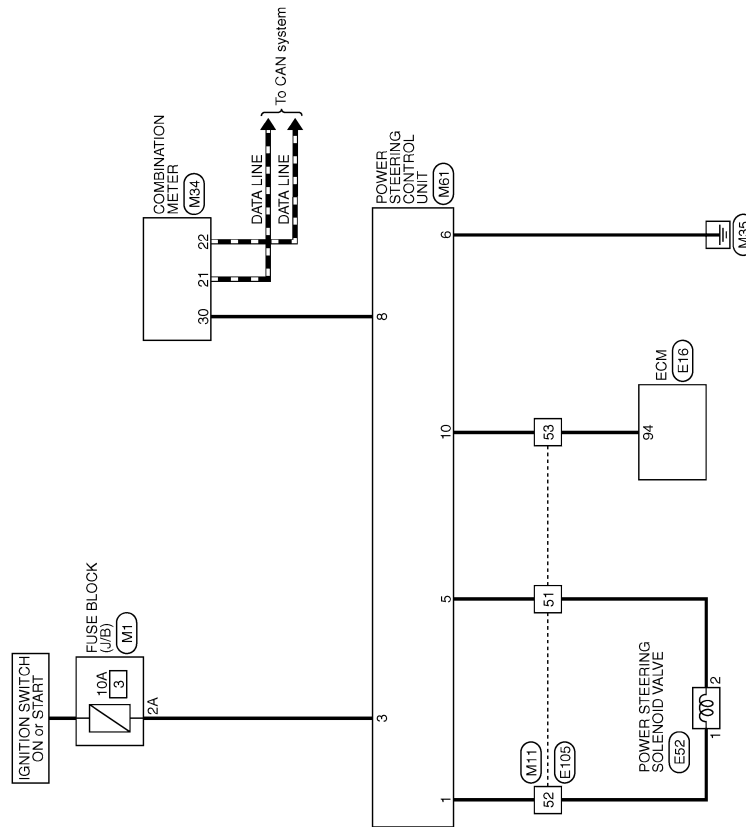

2011/02/02

JCGWA0351GB

A
B
C
D
E
F
STC
H
I
J
K
L
M
N
O
P

DIAGNOSIS AND REPAIR WORK FLOW

< BASIC INSPECTION >

BASIC INSPECTION

DIAGNOSIS AND REPAIR WORK FLOW

Work Flow

INFOID:000000008461631

DETAILED FLOW

1. COLLECT THE INFORMATION FROM THE CUSTOMER

It is also important to clarify customer complaints before inspection. First of all, reproduce symptoms and understand them fully. Ask customer about his/her complaints carefully. In some cases, it is necessary to check symptoms by driving vehicle with customer.

CAUTION:

Customers are not professional. It is dangerous to make an easy guess like “maybe the customer means that...,” or “maybe the customer mentions this symptom”.

>> GO TO 2.

2. CHECK THE STATUS

1. Power steering fluid leakage and check the power steering fluid level. Refer to [ST-27, "Inspection"](#).
2. Check the drive belt tension. Refer to [EM-14, "Checking"](#).
3. Check the power steering gear for damages, cracks and fluid leakage. Refer to [ST-45, "Inspection"](#).
4. Check the relief oil pressure. Refer to [ST-51, "Inspection"](#).

>> GO TO 3.

3. DIAGNOSIS CHART BY SYMPTOM

Perform the diagnosis by symptom. Refer to [STC-18, "Diagnosis Procedure"](#).

>> GO TO 4.

4. FINAL CHECK

Check the input/output standard values for the power steering control unit.

Are the power steering control unit input/output values within standard ranges respectively?

- YES >> INSPECTION END
NO >> GO TO 2.

POWER SUPPLY AND GROUND CIRCUIT

< DTC/CIRCUIT DIAGNOSIS >

DTC/CIRCUIT DIAGNOSIS

POWER SUPPLY AND GROUND CIRCUIT

Description

INFOID:0000000008461632

Power supply to EPS system

Diagnosis Procedure

INFOID:0000000008461633

1. CHECK POWER SUPPLY

1. Turn the ignition switch OFF.
2. Disconnect power steering control unit harness connector.
3. Check voltage between power steering control unit harness connector and ground.

Power steering control unit		—	Voltage (Approx.)
Connector	Terminal		
M61	3	Ground	0 V

4. Turn the ignition switch ON.
CAUTION:
Never start the engine.
5. Check voltage between power steering control unit harness connector and ground.

Power steering control unit		—	Voltage (Approx.)
Connector	Terminal		
M61	3	Ground	Battery voltage

Is the inspection result normal?

YES >> GO TO 2.

NO >> Check the following. If any items are damaged, repair or replace damaged parts.

- 10A fuses (#3) open
- Harness for short or open between ignition switch and power steering control unit harness connector No. 3 terminal.
- Ignition switch. Refer to [PCS-66. "Component Inspection"](#).

2. CHECK GROUND CIRCUIT

1. Turn the ignition switch OFF.
2. Check continuity between power steering control unit harness connector and ground.

Power steering control unit		—	Continuity
Connector	Terminal		
M61	6	Ground	Existed

Is the inspection result normal?

YES >> GO TO 3.

NO >> Repair open circuit or short to power in harness or connectors.

3. CHECK TERMINALS AND HARNESS CONNECTORS

Check power steering control unit pin terminals for damage or loose connection with harness connector.

Is the inspection result normal?

YES >> INSPECTION END

NO >> Repair or replace damaged parts.

POWER STEERING SOLENOID VALVE

< DTC/CIRCUIT DIAGNOSIS >

POWER STEERING SOLENOID VALVE

Diagnosis Procedure

INFOID:000000008461634

1. CHECK POWER STEERING SOLENOID VALVE SIGNAL

Check voltage between power steering control unit harness connector and ground.

Power steering control unit		—	Condition	Voltage (Approx.)
Connector	Terminal			
M61	1	Ground	Vehicle speed: 0 km/h (0 MPH) (Engine is running)	4.4 – 6.6 V
			Vehicle speed: 100 km/h (62 MPH)	2.4 – 3.6 V

Is the inspection result normal?

YES >> GO TO 4.

NO >> GO TO 2.

2. CHECK HARNESS BETWEEN POWER STEERING SOLENOID VALVE AND POWER STEERING CONTROL UNIT

1. Turn the ignition switch OFF.
2. Disconnect power steering solenoid valve harness connector.
3. Disconnect power steering control unit harness connector.
4. Check the continuity between power steering solenoid valve harness connector and the power steering control unit harness connector.

Power steering solenoid valve		Power steering control unit		Continuity
Connector	Terminal	Connector	Terminal	
E52	1	M61	1	Existed
E52	2	M61	5	Existed

5. Check continuity between power steering control unit harness connector and ground.

Power steering control unit		—	Continuity
Connector	Terminal		
M61	1	Ground	Not existed
M61	5		

Is the inspection result normal?

YES >> GO TO 3.

NO >> Repair or replace damaged parts.

3. CHECK POWER STEERING SOLENOID VALVE

Check power steering solenoid valve. Refer to [STC-13, "Component Inspection"](#).

Is the inspection result normal?

YES >> GO TO 4.

NO >> Replace gear-sub assembly. Refer to [ST-37, "Exploded View"](#).

4. CHECK TERMINALS AND HARNESS CONNECTORS

- Check power steering control unit pin terminals for damage or loose connection with harness connector.
- Check power steering solenoid valve pin terminals for damage or loose connection with harness connector.

Is the inspection result normal?

YES >> INSPECTION END

NO >> Repair or replace damaged parts.

POWER STEERING SOLENOID VALVE

< DTC/CIRCUIT DIAGNOSIS >

Component Inspection

INFOID:000000008461635

1. CHECK POWER STEERING SOLENOID VALVE

1. Turn the ignition switch OFF.
2. Disconnect power steering solenoid valve harness connector.
3. Check resistance between power steering solenoid valve connector terminals.

Power steering solenoid valve		Resistance (Approx.)
Terminal		
1	2	4 – 6 Ω

4. Check power steering solenoid valve by listening for its operation sound while applying battery voltage to power steering solenoid valve connector E52 terminals 1 (positive) and 2 (negative).

Is the inspection result normal?

YES >> INSPECTION END

NO >> Replace gear-sub assembly. Refer to [ST-37, "Exploded View"](#).

A
B
C
D
E
F
H
I
J
K
L
M
N
O
P

STC

ENGINE SPEED SIGNAL CIRCUIT

< DTC/CIRCUIT DIAGNOSIS >

ENGINE SPEED SIGNAL CIRCUIT

Description

INFOID:000000008461636

ECM sends engine speed signal to power steering control unit.

Diagnosis Procedure

INFOID:000000008461637

1. PERFORM ECM SELF-DIAGNOSIS

With CONSULT

1. Turn the ignition switch ON.

CAUTION:

Never start the engine

2. Perform "ENGINE" self-diagnosis. Refer to [EC-63, "CONSULT Function"](#).

Is any DTC detected?

YES >> Check the DTC.

NO >> GO TO 2.

2. CHECK HARNESS BETWEEN ECM AND POWER STEERING CONTROL UNIT

1. Turn the ignition switch OFF.
2. Disconnect ECM harness connectors.
3. Disconnect power steering control unit harness connector.
4. Check continuity between ECM harness connector and power steering control unit harness connector.

ECM		Power steering control unit		Continuity
Connector	Terminal	Connector	Terminal	
E16	94	M61	10	Existed

5. Check continuity between power steering control unit harness connector and ground.

Power steering control unit		—	Continuity
Connector	Terminal		
M61	10	Ground	Not existed

Is the inspection result normal?

YES >> GO TO 3.

NO >> Repair or replace damaged parts.

3. CHECK ENGINE SPEED SIGNAL (1)

1. Connect ECM harness connectors.
2. Check signal between ECM harness connector and ground with oscilloscope.

ENGINE SPEED SIGNAL CIRCUIT

< DTC/CIRCUIT DIAGNOSIS >

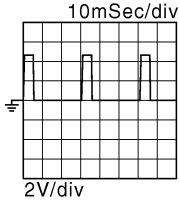
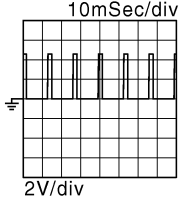
ECM		Ground	Condition	Voltage (Approx.)
Connector	Terminal			
E16	94	Ground	Engine is running • Warm-up condition • Idle speed	
			Engine is running • Warm-up condition • Engine speed: Approx. 2,000 rpm	

Is the inspection result normal?

YES >> GO TO 4.

NO >> Replace ECM. Refer to [EC-118, "Description"](#).

4. CHECK ENGINE SPEED SIGNAL (2)

- Turn the ignition switch OFF.
- Connect power steering control unit harness connector.
- Check signal between power steering control unit harness connector and ground with oscilloscope.

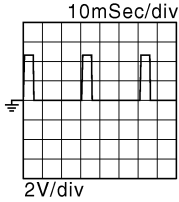
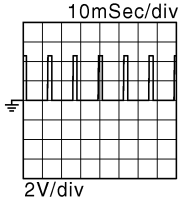
Power steering control unit		—	Condition	Voltage (Approx.)
Connector	Terminal			
M61	10	Ground	Engine is running • Warm-up condition • Idle speed	
			Engine is running • Warm-up condition • Engine speed: Approx. 2,000 rpm	

Is the inspection result normal?

YES >> GO TO 5.

NO >> Replace power steering control unit. Refer to [STC-19, "Removal and Installation"](#).

5. CHECK TERMINALS AND HARNESS CONNECTORS

- Check power steering control unit pin terminals for damage or loose connection with harness connector.
- Check ECM pin terminals for damage or loose connection with harness connector.

Is the inspection result normal?

YES >> INSPECTION END

NO >> Repair or replace damaged parts.

VEHICLE SPEED SIGNAL CIRCUIT

< DTC/CIRCUIT DIAGNOSIS >

VEHICLE SPEED SIGNAL CIRCUIT

Description

INFOID:000000008461638

Combination meter sends vehicle speed signal to power steering control unit.

Diagnosis Procedure

INFOID:000000008461639

1. PERFORM COMBINATION METER SELF-DIAGNOSIS

With CONSULT

1. Turn the ignition switch ON.

CAUTION:

Never start the engine

2. Perform "METER/M&A" self-diagnosis. Refer to [MWI-21, "CONSULT Function"](#).

Is any DTC detected?

- YES >> Check the DTC.
NO >> GO TO 2.

2. CHECK HARNESS BETWEEN COMBINATION METER AND POWER STEERING CONTROL UNIT

1. Turn the ignition switch OFF.
2. Disconnect combination meter harness connector.
3. Disconnect power steering control unit harness connector.
4. Check continuity between combination meter harness connector and power steering control unit harness connector.

Combination meter		Power steering control unit		Continuity
Connector	Terminal	Connector	Terminal	
M34	30	M61	8	Existed

5. Check continuity between power steering control unit harness connector and ground.

Power steering control unit		—	Continuity
Connector	Terminal		
M61	8	Ground	Not existed

Is the inspection result normal?

- YES >> GO TO 3.
NO >> Repair or replace damaged parts.

3. CHECK VEHICLE SPEED SIGNAL (1)

1. Turn the ignition switch OFF.
2. Connect combination meter harness connector.
3. Check combination meter input/output standard values. Refer to [MWI-25, "Reference Value"](#).

Is the inspection result normal?

- YES >> GO TO 4.
NO >> Replace combination meter Refer to [MWI-70, "Exploded View"](#).

4. CHECK VEHICLE SPEED SIGNAL (2)

1. Turn the ignition switch OFF.
2. Connect power steering control unit harness connector.
3. Check signal between power steering control unit harness connector and ground with oscilloscope.

VEHICLE SPEED SIGNAL CIRCUIT

< DTC/CIRCUIT DIAGNOSIS >

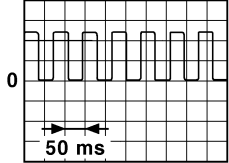
Power steering control unit		—	Condition	Voltage (Approx.)
Connector	Terminal			
M61	8	Ground	Vehicle speed: 40 km/h (25 MPH) CAUTION: Check air pressure of tire under standard condition.	NOTE: The maximum voltage varies depending on the specification (destination unit).  <p style="text-align: right; font-size: small;">JSNIA0015GB</p>

Is the inspection result normal?

YES >> GO TO 5.

NO >> Replace power steering control unit. Refer to [STC-19, "Removal and Installation"](#).

5. CHECK TERMINALS AND HARNESS CONNECTORS

- Check power steering control unit pin terminals for damage or loose connection with harness connector.
- Check combination meter pin terminals for damage or loose connection with harness connector.

Is the inspection result normal?

YES >> INSPECTION END

NO >> Repair or replace damaged parts.

A
B
C
D
E
F
H
I
J
K
L
M
N
O
P

STC

UNBALANCE STEERING WHEEL TURNING FORCE (TORQUE VARIATION)

< SYMPTOM DIAGNOSIS >

SYMPTOM DIAGNOSIS

UNBALANCE STEERING WHEEL TURNING FORCE (TORQUE VARIATION)

Description

INFOID:000000008461640

- Hard steering when fully turning the steering wheel.
- Light steering when driving at a high speed.

Diagnosis Procedure

INFOID:000000008461641

1. CHECK SYSTEM FOR POWER SUPPLY AND GROUND

Perform trouble diagnosis for power supply and ground. Refer to [STC-11, "Diagnosis Procedure"](#).

Is the inspection result normal?

- YES >> GO TO 2.
- NO >> Repair or replace damaged parts.

2. CHECK SYSTEM FOR VEHICLE SPEED SIGNAL

Perform trouble diagnosis for vehicle speed signal. Refer to [STC-16, "Diagnosis Procedure"](#).

Is the inspection result normal?

- YES >> GO TO 3.
- NO >> Repair or replace damaged parts.

3. CHECK SYSTEM FOR ENGINE SPEED SIGNAL

Perform trouble diagnosis for engine speed signal. Refer to [STC-14, "Diagnosis Procedure"](#).

Is the inspection result normal?

- YES >> GO TO 4.
- NO >> Repair or replace damaged parts.

4. CHECK SYSTEM FOR POWER STEERING SOLENOID VALVE

Perform trouble diagnosis for power steering solenoid valve. Refer to [STC-12, "Diagnosis Procedure"](#).

Is the inspection result normal?

- YES >> Perform the symptom diagnosis for the steering system. Refer to [ST-26, "NVH Troubleshooting Chart"](#).
- NO >> Repair or replace damaged parts.

POWER STEERING CONTROL UNIT

< REMOVAL AND INSTALLATION >

REMOVAL AND INSTALLATION

POWER STEERING CONTROL UNIT

Removal and Installation

INFOID:000000008461642

REMOVAL

1. Remove instrument lower panel RH. Refer to [IP-12. "Exploded View"](#).
2. Disconnect power steering control unit connector.
3. Remove power steering control unit.

INSTALLATION

Install in the reverse order of removal.

A
B
C
D
E
F
H
I
J
K
L
M
N
O
P

STC