

SECTION **DEF**
DEFOGGER

A
B
C
D
E
F
G
H
I
J
K
DEF
M
N
O
P

CONTENTS

BASIC INSPECTION	3	REAR WINDOW DEFOGGER RELAY	12
DIAGNOSIS AND REPAIR WORKFLOW	3	Description	12
Work Flow	3	Component Function Check	12
SYSTEM DESCRIPTION	4	Diagnosis Procedure	12
REAR WINDOW DEFOGGER SYSTEM	4	Component Inspection	13
WITH BOSE SYSTEM	4	REAR WINDOW DEFOGGER	14
WITH BOSE SYSTEM : System Diagram	4	Description	14
WITH BOSE SYSTEM : System Description	4	Component Function Check	14
WITH BOSE SYSTEM : Component Parts Location	5	Diagnosis Procedure	14
WITH BOSE SYSTEM : Component Description.....	5	Component Inspection	16
WITHOUT BOSE SYSTEM	6	DOOR MIRROR DEFOGGER	17
WITHOUT BOSE SYSTEM : System Diagram	6	Description	17
WITHOUT BOSE SYSTEM : System Description.....	6	Component Function Check	17
WITHOUT BOSE SYSTEM : Component Parts Location	7	Diagnosis Procedure	17
WITHOUT BOSE SYSTEM : Component Description	7	DRIVER SIDE DOOR MIRROR DEFOGGER ...	18
DIAGNOSIS SYSTEM (BCM)	8	Description	18
COMMON ITEM	8	Component Function Check	18
COMMON ITEM : CONSULT-III Function (BCM - COMMON ITEM)	8	Diagnosis Procedure	18
REAR WINDOW DEFOGGER	9	Component Inspection	19
REAR WINDOW DEFOGGER : CONSULT-III Function (BCM - REAR DEFOGGER)	9	PASSENGER SIDE DOOR MIRROR DEFOGGER	20
DTC/CIRCUIT DIAGNOSIS	10	Description	20
POWER SUPPLY AND GROUND CIRCUIT	10	Component Function Check	20
Diagnosis Procedure	10	Diagnosis Procedure	20
REAR WINDOW DEFOGGER SWITCH	11	Component Inspection	21
Description	11	REAR WINDOW DEFOGGER SYSTEM	22
Component Function Check	11	Wiring Diagram - DEFOGGER SYSTEM -	22
Diagnosis Procedure	11	ECU DIAGNOSIS INFORMATION	29
BCM (BODY CONTROL MODULE)	29	Reference Value	29
Reference Value	29	Wiring Diagram - BCM -	53
Wiring Diagram - BCM -	53	Fail-safe	68
Fail-safe	68	DTC Inspection Priority Chart	71
DTC Inspection Priority Chart	71	DTC Index	72
DTC Index	72		

SYMPTOM DIAGNOSIS	74	ON IS NOT DISPLAYED WHEN PRESSING REAR WINDOW DEFOGGER SWITCH BUT IT IS OPERATED	78
REAR WINDOW DEFOGGER DOES NOT OPERATE	74	Diagnosis Procedure	78
Diagnosis Procedure	74	REAR WINDOW DEFOGGER INDICATOR DOES NOT ILLUMINATE	79
REAR WINDOW DEFOGGER AND DOOR MIRROR DEFOGGER DO NOT OPERATE.	75	Diagnosis Procedure	79
Diagnosis Procedure	75	PRECAUTION	80
REAR WINDOW DEFOGGER DOES NOT OPERATE BUT BOTH DOOR MIRROR DEFOGGERS OPERATE.	76	PRECAUTIONS	80
Diagnosis Procedure	76	FOR USA AND CANADA	80
DOOR MIRROR DEFOGGER DOES NOT OPERATE	77	FOR USA AND CANADA : Precaution for Supplemental Restraint System (SRS) "AIR BAG" and "SEAT BELT PRE-TENSIONER"	80
BOTH SIDES	77	FOR MEXICO	80
BOTH SIDES : Diagnosis Procedure	77	FOR MEXICO : Precaution for Supplemental Restraint System (SRS) "AIR BAG" and "SEAT BELT PRE-TENSIONER"	80
DRIVER SIDE	77	REMOVAL AND INSTALLATION	82
DRIVER SIDE : Diagnosis Procedure	77	FILAMENT	82
PASSENGER SIDE	77	Inspection and Repair	82
PASSENGER SIDE : Diagnosis Procedure	77		

DIAGNOSIS AND REPAIR WORKFLOW

< BASIC INSPECTION >

BASIC INSPECTION

DIAGNOSIS AND REPAIR WORKFLOW

Work Flow

INFOID:000000005513185

DETAILED FLOW

1.OBTAIN INFORMATION ABOUT SYMPTOM

Interview the customer to obtain the malfunction information (conditions and environment when the malfunction occurred) as much as possible when the customer brings the vehicle in.

>> GO TO 2.

2.CHECK DTC

Perform self diagnosis with CONSULT-III

Is any DTC detected?

YES >> Refer to [DEF-72, "DTC Index"](#).

NO >> GO TO 3.

3.REPRODUCE THE MALFUNCTION INFORMATION

Check the malfunction on the vehicle that the customer describes.

Inspect the relation of the symptoms and the condition when the symptoms occur.

>> GO TO 4.

4.IDENTIFY THE MALFUNCTIONING SYSTEM WITH "SYMPTOM DIAGNOSIS"

Use "Symptom diagnosis" from the symptom inspection result in step 3. Then identify where to start performing the diagnosis based on possible causes and symptoms.

>> GO TO 5.

5.IDENTIFY MALFUNCTIONING PARTS WITH "COMPONENT DIAGNOSIS"

Perform the diagnosis with "Component diagnosis" of the applicable system.

>> GO TO 6.

6.REPAIR OR REPLACE THE MALFUNCTIONING PARTS

Repair or replace the specified malfunctioning parts.

>> GO TO 7.

7.FINAL CHECK

Check that malfunctions are not reproduced when obtaining the malfunction information from the customer, referring to the symptom inspection result in step 3.

Are all malfunctions corrected?

YES >> INSPECTION END

NO >> GO TO 4.

A
B
C
D
E
F
G
H
I
J
K
DEF
M
N
O
P

REAR WINDOW DEFOGGER SYSTEM

< SYSTEM DESCRIPTION >

SYSTEM DESCRIPTION

REAR WINDOW DEFOGGER SYSTEM WITH BOSE SYSTEM

WITH BOSE SYSTEM : System Diagram

INFOID:000000005513186

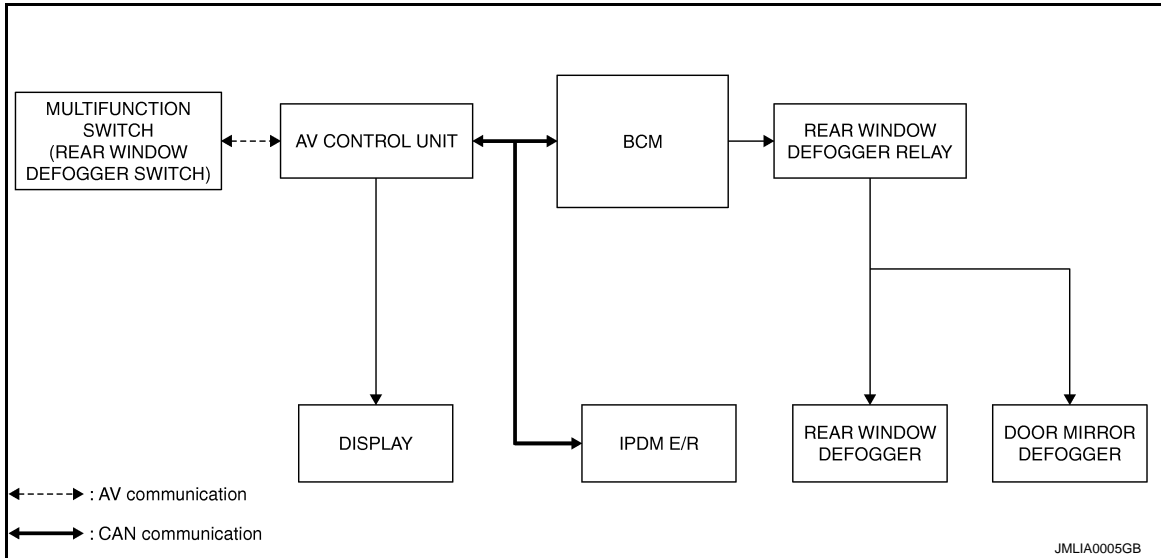

WITH BOSE SYSTEM : System Description

INFOID:000000005513187

Operation Description

- Turn rear window defogger switch ON when the ignition switch is turned ON. Then multifunction switch (rear window defogger switch) transmits rear window defogger switch signal to AV control unit via AV communication. AV control unit transmits rear window defogger switch signal to BCM via CAN communication.
- BCM turns rear window defogger relay ON and transmits rear window defogger control signal to IPDM E/R via CAN communication when rear window defogger switch signal is received.
- Rear window defogger and door mirror defogger (with door mirror defogger) are supplied with power and operate when rear window defogger relay turns ON.
- IPDM E/R transmits rear window defogger control signal to AV control unit via CAN communication.
- AV control unit transmits rear defogger indicator signal to multifunction switch (rear window defogger switch) via AV communication. then rear window defogger indicator is illuminated.

Timer function

- BCM turns rear window defogger relay ON for approximately 15 minutes when rear window defogger switch is turned ON. It makes rear window defogger and door mirror defogger (with door mirror defogger) operate.
- Timer is canceled after pressing rear window defogger switch again during timer operation. Then BCM turns rear window defogger relay OFF. The same reaction also occurs during timer operation, if the ignition switch is turned OFF.

INPUT/OUTPUT SIGNAL CHART

Switch	Input signal to BCM	BCM function	Actuator
Rear window defogger switch	Defogger switch signal	Rear window defogger & Door mirror defogger* control	Rear window defogger
Push button ignition switch	Ignition signal		Door mirror defogger*

*: With door mirror defogger

REAR WINDOW DEFOGGER SYSTEM

< SYSTEM DESCRIPTION >

WITH BOSE SYSTEM : Component Parts Location

INFOID:000000005513188

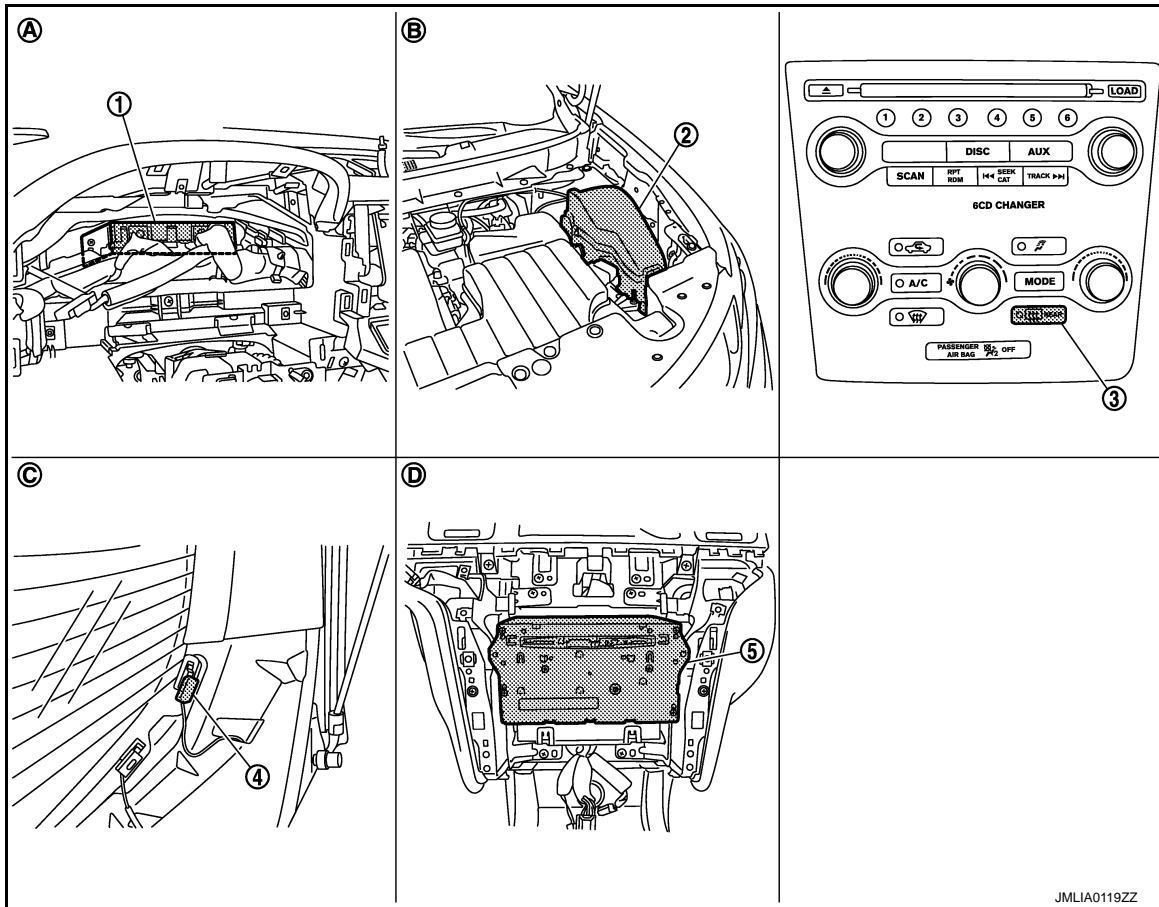

- | | | |
|--|---|---|
| 1. BCM M118, M119, M122, M123 | 2. IPDM E/R E6, E11 | 3. Rear window defogger switch (built-in multifunction switch M125) |
| 4. Rear window defogger connector D184 | 5. AV control unit
With NAVI M145, M146
Without NAVI M129, M131 | |
| A. Dash side lower (passenger side) | B. Engine room dash panel (LH) | C. Behind rear pillar finisher (LH) |
| D. Behind cluster lid C | | |

WITH BOSE SYSTEM : Component Description

INFOID:000000005513189

BCM	<ul style="list-style-type: none"> Operates the rear window defogger with the operation of rear window defogger switch. Performs the timer control of rear window defogger.
Rear window defogger relay	<ul style="list-style-type: none"> Operates the rear window defogger and the door mirror defogger with the control signal from BCM.
IPDM E/R	<ul style="list-style-type: none"> Transmit rear window defogger control signal to AV control unit via CAN communication.
Multifunction switch (Rear window defogger switch)	<ul style="list-style-type: none"> The rear window defogger switch is installed. Turns the indicator lamp ON when detecting the operation of rear window defogger.
AV control unit	<ul style="list-style-type: none"> Displays the rear window defogger ON to the display when detecting the operation of rear window defogger.
Rear window defogger	<ul style="list-style-type: none"> Heats the heating wire with the power supply from the rear window defogger relay to prevent the rear window from fogging up.
Door mirror defogger*	<ul style="list-style-type: none"> Heats the heating wire with the power supply from the rear window defogger relay to prevent the door mirror from fogging up.

REAR WINDOW DEFOGGER SYSTEM

< SYSTEM DESCRIPTION >

*: With mirror defogger

WITHOUT BOSE SYSTEM

WITHOUT BOSE SYSTEM : System Diagram

INFOID:000000005513190

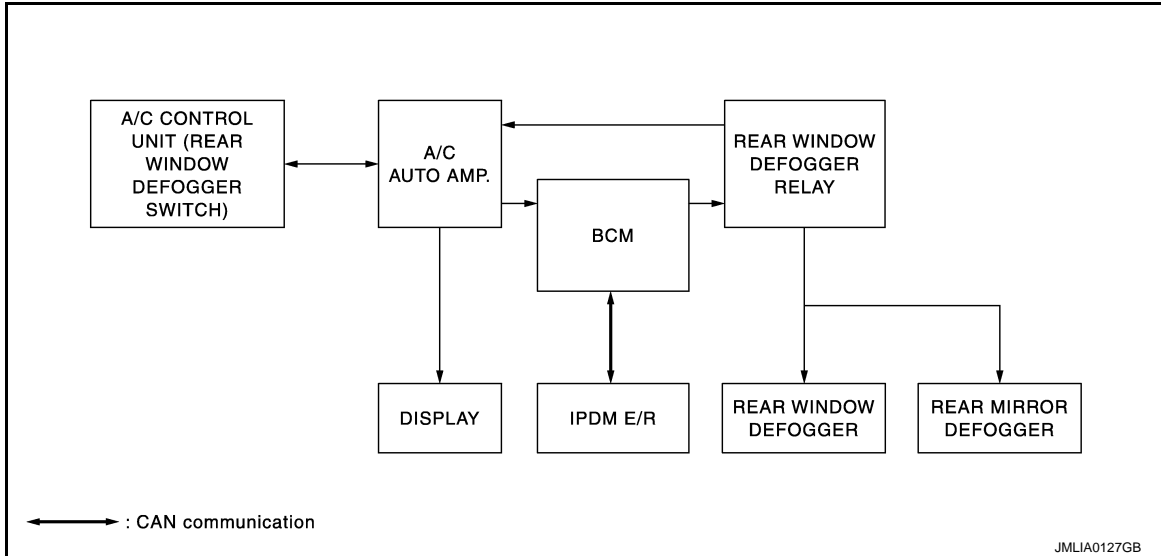

WITHOUT BOSE SYSTEM : System Description

INFOID:000000005513191

Operation Description

- Turn rear window defogger switch ON when the ignition switch is turned ON. Then A/C control unit (rear window defogger switch) transmits rear window defogger switch signal to A/C auto amp.. transmits rear window defogger switch signal to BCM.
- BCM turns rear window defogger relay ON and transmits rear window defogger control signal to IPDM E/R via CAN communication when rear window defogger switch signal is received.
- Rear window defogger and door mirror defogger (with door mirror defogger) are supplied with power and operate when rear window defogger relay turns ON.
- Rear window defogger relay transmits rear window defogger control signal to A/C auto amp. when rear window defogger operates.
- A/C auto amp. transmit rear window defogger indicator signal to A/C control unit (rear window defogger switch). Then rear window defogger indicator is illuminated.

Timer function

- BCM turns rear window defogger relay ON for approximately 15 minutes when rear window defogger switch is turned ON. It makes rear window defogger and door mirror defogger (with door mirror defogger) operate.
- Timer is canceled after pressing rear window defogger switch again during timer operation. Then BCM turns rear window defogger relay OFF. The same reaction also occurs during timer operation, if the ignition switch is turned OFF.

INPUT/OUTPUT SIGNAL CHART

Switch	Input signal to BCM	BCM function	Actuator
Rear window defogger switch	Defogger switch signal	Rear window defogger & Door mirror defogger* control	Rear window defogger
Push button ignition switch	Ignition signal		Door mirror defogger*

*: With door mirror defogger

REAR WINDOW DEFOGGER SYSTEM

< SYSTEM DESCRIPTION >

WITHOUT BOSE SYSTEM : Component Parts Location

INFOID:000000005513192

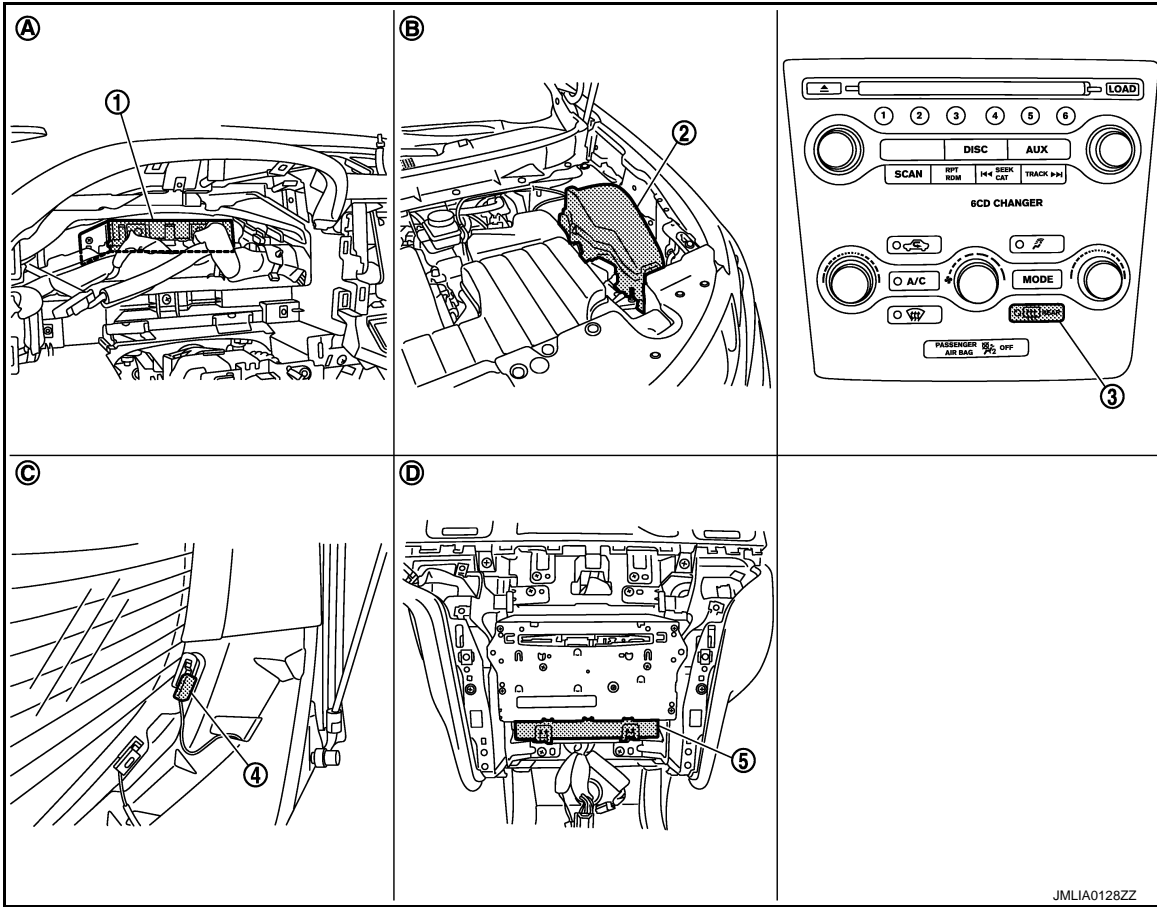

- | | | |
|--|--------------------------------|--|
| 1. BCM M118, M119, M122, M123 | 2. IPDM E/R E6, E11 | 3. Rear window defogger switch (built-in A/C control unit M95) |
| 4. Rear window defogger connector D184 | 5. A/C auto amp. M50 | |
| A. Dash side lower (passenger side) | B. Engine room dash panel (LH) | C. Behind rear pillar finisher (LH) |
| D. Behind cluster lid C | | |

WITHOUT BOSE SYSTEM : Component Description

INFOID:000000005513193

BCM	<ul style="list-style-type: none"> Operates the rear window defogger with the operation of rear window defogger switch. Performs the timer control of rear window defogger.
Rear window defogger relay	<ul style="list-style-type: none"> Operates the rear window defogger and the door mirror defogger with the control signal from BCM.
IPDM E/R	<ul style="list-style-type: none"> Transmit rear window defogger control signal to ECM via CAN communication.
A/C control unit (Rear window defogger switch)	<ul style="list-style-type: none"> The rear window defogger switch is installed. Turns the indicator lamp ON when detecting the operation of rear window defogger.
A/C auto amp.	<ul style="list-style-type: none"> Displays the rear window defogger ON to the display when detecting the operation of rear window defogger.
Rear window defogger	<ul style="list-style-type: none"> Heats the heating wire with the power supply from the rear window defogger relay to prevent the rear window from fogging up.
Door mirror defogger*	<ul style="list-style-type: none"> Heats the heating wire with the power supply from the rear window defogger relay to prevent the door mirror from fogging up.

*: With door mirror defogger

DIAGNOSIS SYSTEM (BCM)

< SYSTEM DESCRIPTION >

DIAGNOSIS SYSTEM (BCM)

COMMON ITEM

COMMON ITEM : CONSULT-III Function (BCM - COMMON ITEM)

INFOID:000000005513194

APPLICATION ITEM

CONSULT-III performs the following functions via CAN communication with BCM.

Diagnosis mode	Function Description
Work Support	Changes the setting for each system function.
Self Diagnostic Result	Displays the diagnosis results judged by BCM.
CAN Diag Support Monitor	Monitors the reception status of CAN communication viewed from BCM. Refer to CONSULT-III operation manual.
Data Monitor	The BCM input/output signals are displayed.
Active Test	The signals used to activate each device are forcibly supplied from BCM.
Ecu Identification	The BCM part number is displayed.
Configuration	This function is not used even though it is displayed.

SYSTEM APPLICATION

BCM can perform the following functions for each system.

NOTE:

It can perform the diagnosis modes except the following for all sub system selection items.

×: Applicable item

System	Sub system selection item	Diagnosis mode		
		Work Support	Data Monitor	Active Test
Door lock	DOOR LOCK	×	×	×
Rear window defogger	REAR DEFOGGER		×	×
Warning chime	BUZZER		×	×
Interior room lamp timer	INT LAMP	×	×	×
Exterior lamp	HEAD LAMP	×	×	×
Wiper and washer	WIPER	×	×	×
Turn signal and hazard warning lamps	FLASHER	×	×	×
—	AIR CONDITONER*		×	
Intelligent Key system	INTELLIGENT KEY	×	×	×
Combination switch	COMB SW		×	
Body control system	BCM	×		
IVIS - NATS	IMMU		×	×
Interior room lamp battery saver	BATTERY SAVER	×	×	×
Trunk open	TRUNK		×	
Vehicle security system	THEFT ALM	×	×	×
RAP system	RETAINED PWR		×	
Signal buffer system	SIGNAL BUFFER		×	×
TPMS	TPMS (AIR PRESSURE MONITOR)	×	×	×

*: This item is displayed, but is not used.

FREEZE FRAME DATA (FFD) AND IGN COUNTER

Freeze Frame Data

The BCM records the following condition at the moment a particular DTC is detected.

- Vehicle Speed
- Odo/Trip Meter

DIAGNOSIS SYSTEM (BCM)

< SYSTEM DESCRIPTION >

- Vehicle Condition (BCM detected condition)

CONSULT screen terms	Description
SLEEP>LOCK	While turning BCM status from low power consumption mode to normal mode (Power supply position is "LOCK")
SLEEP>OFF	While turning BCM status from low power consumption mode to normal mode (Power supply position is "OFF".)
LOCK>ACC	While turning power supply position from "LOCK" to "ACC"
ACC>ON	While turning power supply position from "ACC" to "IGN"
RUN>ACC	While turning power supply position from "RUN" to "ACC" (Vehicle is stopping and selector lever is except P position.)
CRANK>RUN	While turning power supply position from "CRANKING" to "RUN" (From cranking up the engine to run it)
RUN>URGENT	While turning power supply position from "RUN" to "ACC" (Emergency stop operation)
ACC>OFF	While turning power supply position from "ACC" to "OFF"
OFF>LOCK	While turning power supply position from "OFF" to "LOCK"
OFF>ACC	While turning power supply position from "OFF" to "ACC"
ON>CRANK	While turning power supply position from "IGN" to "CRANKING"
OFF>SLEEP	While turning BCM status from normal mode (Power supply position is "OFF".) to low power consumption mode
LOCK>SLEEP	While turning BCM status from normal mode (Power supply position is "LOCK".) to low power consumption mode
LOCK	Power supply position is "LOCK" (Ignition switch OFF with steering is locked.)
OFF	Power supply position is "OFF" (Ignition switch OFF with steering is unlocked.)
ACC	Power supply position is "ACC" (Ignition switch ACC)
ON	Power supply position is "IGN" (Ignition switch ON with engine stopped)
ENGINE RUN	Power supply position is "RUN" (Ignition switch ON with engine running)
CRANKING	Power supply position is "CRANKING" (At engine cranking)

IGN Counter

IGN counter indicates the number of times that ignition switch is turned ON after DTC is detected.

- The number is 0 when a malfunction is detected now.
- The number increases like 1 → 2 → 3...38 → 39 after returning to the normal condition whenever ignition switch OFF → ON.
- The number is fixed to 39 until the self-diagnosis results are erased if it is over 39.

REAR WINDOW DEFOGGER

REAR WINDOW DEFOGGER : CONSULT-III Function (BCM - REAR DEFOGGER)

INFOID:000000005513195

Data monitor

Monitor Item	Description
REAR DEF SW	This is displayed even when it is not equipped.
PUSH SW	Indicates [ON/OFF] condition of push switch.

ACTIVE TEST

Test Item	Description
REAR DEFOGGER	This test is able to check rear window defogger operation. Rear window defogger operates when "ON" on CONSULT-III screen is touched.

POWER SUPPLY AND GROUND CIRCUIT

< DTC/CIRCUIT DIAGNOSIS >

DTC/CIRCUIT DIAGNOSIS

POWER SUPPLY AND GROUND CIRCUIT

Diagnosis Procedure

INFOID:000000005513196

1. CHECK FUSE AND FUSIBLE LINK

Check that the following fuse and fusible link are not blown.

Terminal No.	Signal name	Fuse and fusible link No.
1	Battery power supply	L
11		10

Is the fuse blown?

YES >> Replace the blown fuse or fusible link after repairing the affected circuit if a fuse or fusible link is blown.

NO >> GO TO 2.

2. CHECK POWER SUPPLY CIRCUIT

1. Turn ignition switch OFF.
2. Disconnect BCM connectors.
3. Check voltage between BCM harness connector and ground.

Terminals		Voltage (Approx.)
(+)	(-)	
BCM		Ground
Connector	Terminal	
M118	1	
M119	11	Battery voltage

Is the measurement value normal?

YES >> GO TO 3.

NO >> Repair or replace harness or connector.

3. CHECK GROUND CIRCUIT

Check continuity between BCM harness connector and ground.

BCM		Ground	Continuity
Connector	Terminal		
M119	13		Existed

Does continuity exist?

YES >> INSPECTION END

NO >> Repair or replace harness or connector.

REAR WINDOW DEFOGGER SWITCH

< DTC/CIRCUIT DIAGNOSIS >

REAR WINDOW DEFOGGER SWITCH

Description

INFOID:000000005513197

- The rear window defogger is operated by turning the rear window defogger switch ON.
- The indicator lamp in the rear window defogger illuminates when the rear window defogger is operating.

Component Function Check

INFOID:000000005513198

1.CHECK REAR WINDOW DEFOGGER SWITCH FUNCTION

Check that the indicator lamp of rear window defogger illuminates when rear window defogger switch ON.

Is the inspection result normal?

- YES >> Rear window defogger switch function is OK.
- NO >> Refer to [DEF-11. "Diagnosis Procedure"](#)

Diagnosis Procedure

INFOID:000000005513199

WITH BOSE AUDIO SYSTEM

1.CHECK PRESET SWITCH (REAR WINDOW DEFOGGER SWITCH)

Does preset switch operate normally?

- Without navigation system. Refer to [AV-74. "Diagnosis Description"](#).
- With navigation system. Refer to [AV-587. "Diagnosis Description"](#).

Is the inspection result normal?

- YES >> INSPECTION END
- NO >> Replace preset switch (rear window defogger switch). Refer to [AV-547. "Removal and Installation"](#).
(without navigation system) or [AV-797. "Removal and Installation"](#) (with navigation system).

WITHOUT BOSE AUDIO SYSTEM

1.CHECK A/C CONTROL (REAR WINDOW DEFOGGER SWITCH)

Check A/C control. Refer to [HAC-75. "Diagnosis Procedure"](#).

Is the inspection result normal?

- YES >> INSPECTION END
- NO >> Replace A/C control. Refer to [VTL-22. "Removal and Installation"](#).

A
B
C
D
E
F
G
H
I
J
K
M
N
O
P

DEF

REAR WINDOW DEFOGGER RELAY

< DTC/CIRCUIT DIAGNOSIS >

REAR WINDOW DEFOGGER RELAY

Description

INFOID:000000005513200

Power is supplied to the rear window defogger with BCM control.

Component Function Check

INFOID:000000005513201

1.CHECK REAR WINDOW DEFOGGER RELAY POWER SUPPLY CIRCUIT

1. Perform Active Test ("REAR DEFOGGER") with CONSULT-III.
2. Touch "ON".
3. Check that the rear window heating wire is getting warmer.

Is the inspection result normal?

- YES >> Rear window defogger relay power supply circuit is OK.
NO >> Refer to [DEF-12, "Diagnosis Procedure"](#)

Diagnosis Procedure

INFOID:000000005513202

1.CHECK FUSE

1. Turn ignition switch OFF.
2. Check 10A fuse (No.3, located in fuse block (J/B)).

Is the inspection result normal?

- YES >> GO TO 2.
NO >> Replace the blown fuse after repairing the affected circuit if a fuse is blown.

2.CHECK REAR WINDOW DEFOGGER RELAY CIRCUIT

1. Turn ignition switch ON.
2. Check voltage between BCM harness connector and ground.

(+)		(-)	Condition of rear window defogger switch	Voltage (V) (Approx.)
BCM				
Connector	Terminal			
M123	151	Ground	ON	0
			OFF	Battery voltage

Is the inspection result normal?

- YES >> GO TO 5.
NO >> GO TO 3.

3.CHECK FUSE BLOCK (J/B)

Check voltage between fuse block (J/B) connector and ground.

Fuse block (J/B)		Ground	Voltage (V) (Approx.)
Connector	Terminal		
M2	4B		Battery voltage

Is the inspection result normal?

- YES >> Repair or replace harness or connector between BCM and fuse block (J/B).
NO >> GO TO 4.

4.CHECK REAR WINDOW DEFOGGER RELAY

Check rear window defogger relay.

Refer to [DEF-13, "Component Inspection"](#)

Is the inspection result normal?

- YES >> Replace fuse block (J/B).
NO >> Replace rear window defogger relay.

REAR WINDOW DEFOGGER RELAY

< DTC/CIRCUIT DIAGNOSIS >

5. CHECK INTERMITTENT INCIDENT

Check intermittent incident.
Refer to [GI-39, "Intermittent Incident"](#)

>> INSPECTION END

Component Inspection

INFOID:000000005513203

1. CHECK REAR WINDOW DEFOGGER RELAY

1. Turn ignition switch OFF.
2. Disconnect rear window defogger relay.
3. Check rear window defogger relay.

Terminal		Condition	Continuity
Rear window defogger relay			
3	5	12 V direct current supply between terminals 1 and 2.	Existed
		No current supply	Not existed

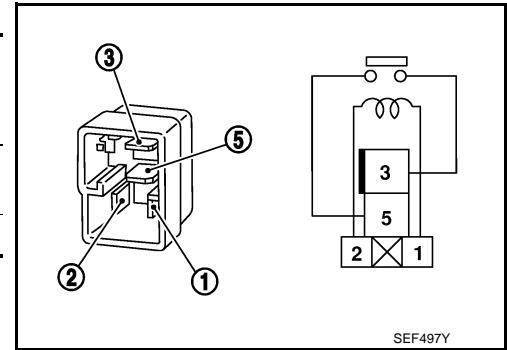

Is the inspection result normal?

- YES >> INSPECTION END
NO >> Replace rear window defogger relay.

A
B
C
D
E
F
G
H
I
J
K
DEF
M
N
O
P

REAR WINDOW DEFOGGER

< DTC/CIRCUIT DIAGNOSIS >

REAR WINDOW DEFOGGER

Description

INFOID:000000005513204

Heats the heating wire with the power supply from the rear window defogger relay to prevent the rear window from fogging up.

Component Function Check

INFOID:000000005513205

1.CHECK REAR WINDOW DEFOGGER

1. Perform Active Test ("REAR DEFOGGER") with CONSULT-III.
2. Touch "ON".
3. Check that the rear window heating wire is getting warmer.

Is the inspection result normal?

- YES >> Rear window defogger is OK.
NO >> Refer to [DEF-14, "Diagnosis Procedure"](#)

Diagnosis Procedure

INFOID:000000005513206

1.CHECK FUSE

1. Turn ignition switch OFF.
2. Check the following.
 - 20A fuse (No.14, located in fuse block (J/B))
 - 20A fuse (No.15, located in fuse block (J/B))

Is the inspection result normal?

- YES >> GO TO 2.
NO >> Replace the blown fuse after repairing the affected circuit if a fuse is blown.

2.CHECK POWER SUPPLY CIRCUIT

1. Disconnect rear window defogger harness connector.
2. Turn ignition switch ON.
3. Check voltage between rear window defogger connector and ground.

(+)		(-)	Condition of rear window defogger switch	Voltage (V) (Approx.)
Rear window defogger				
Connector	Terminal			
D184	1	Ground	ON	Battery voltage
			OFF	0

Is the inspection result normal?

- YES >> GO TO 3.
NO >> GO TO 4.

3.CHECK GROUND CIRCUIT

1. Turn ignition switch OFF.
2. Check continuity between rear window defogger harness connector and ground.

Rear window defogger		Ground	Continuity
Connector	Terminal		
D185	2		Existed

Is the inspection result normal?

- YES >> GO TO 9.
NO >> Repair or replace harness or connector between rear window defogger and ground.

4.CHECK REAR WINDOW DEFOGGER CIRCUIT 1

REAR WINDOW DEFOGGER

< DTC/CIRCUIT DIAGNOSIS >

1. Turn ignition switch OFF.
2. Disconnect condenser connector.
3. Check continuity between condenser harness connector and rear window defogger harness connector.

Condenser		Rear window defogger		Continuity
Connector	Terminal	Connector	Terminal	
B75	2	B184	1	Existed

Is the inspection result normal?

- YES >> GO TO 5.
 NO >> Repair or replace harness or connector.

5.CHECK REAR WINDOW DEFOGGER CIRCUIT 2

1. Check continuity between fuse block (J/B) harness connector and condenser harness connector.

Fuse block (J/B)		Condenser		Continuity
Connector	Terminal	Connector	Terminal	
B6	10G	B74	1	Existed
	11G			

Is the inspection result normal?

- YES >> GO TO 6.
 NO >> Repair or replace harness or connector between fuse block (J/B) and condenser.

6.CHECK FUSE BLOCK (J/B)

1. Turn ignition switch ON.
2. Check voltage between fuse block (J/B) connector (fuse block side) and ground.

(+)		(-)	Condition of rear window defogger switch	Voltage (V) (Approx.)
Fuse block (J/B)				
Connector	Terminal			
B6	10G	Ground	ON	Battery voltage
			OFF	0
	11G		ON	Battery voltage
			OFF	0

Is the inspection result normal?

- YES >> GO TO 7.
 NO >> GO TO 8.

7.CHECK CONDENSER

Check condenser. Refer to [DEF-16, "Component Inspection"](#)

Is the inspection result normal?

- YES >> GO TO 10.
 NO >> Replace condenser.

8.CHECK REAR WINDOW DEFOGGER RELAY

Check rear window defogger relay. Refer to [DEF-13, "Component Inspection"](#)

Is the inspection result normal?

- YES >> Replace fuse block (J/B).
 NO >> Replace rear window defogger relay.

9.CHECK FILAMENT

Check the filament for damage or blown.
 Refer to [DEF-82, "Inspection and Repair"](#)

Is the inspection result normal?

A
B
C
D
E
F
G
H
I
J
K

DEF

M
N
O
P

REAR WINDOW DEFOGGER

< DTC/CIRCUIT DIAGNOSIS >

YES >> GO TO 10.
NO >> Repair filament.

10.CHECK INTERMITTENT INCIDENT

Check intermittent incident.
Refer to [GI-39. "Intermittent Incident"](#)

>> INSPECTION END

Component Inspection

INFOID:000000005513207

1.CHECK CONDENSER

1. Check continuity between condenser connector and ground part of condenser.

Condensor		Ground part of condenser	Continuity
Connector	Terminal		
B74	1		Not existed
B75	2		

2. Check condenser.

Condensor				Continuity
Connector	Terminal	Connector	Terminal	
B74	1	B75	2	Existed

Is the inspection result normal?

YES >> INSPECTION END
NO >> Repair condenser.

DOOR MIRROR DEFOGGER

< DTC/CIRCUIT DIAGNOSIS >

DOOR MIRROR DEFOGGER

Description

INFOID:000000005513208

Power is supplied to the door mirror defogger with BCM control.

Component Function Check

INFOID:000000005513209

1.CHECK DOOR MIRROR DEFOGGER

1. Perform Active Test ("REAR DEFOGGER") with CONSULT-III.
2. Touch "ON".
3. Check that both side door mirror glass is getting warmer.

Is the inspection result normal?

- YES >> Door mirror defogger is OK.
NO >> Refer to [DEF-17. "Diagnosis Procedure"](#)

Diagnosis Procedure

INFOID:000000005513210

1.CHECK FUSE

1. Turn ignition switch OFF.
2. Check 10A fuse (No.13, located in fuse block (J/B)).

Is the inspection result normal?

- YES >> GO TO 2.
NO >> Replace the blown fuse after repairing the affected circuit if a fuse is blown.

2.CHECK FUSE BLOCK (J/B)

1. Turn ignition switch ON.
2. Check voltage between fuse block (J/B) connector (fuse block side) and ground.

(+)		(-)	Condition of rear window defogger switch	Voltage (V) (Approx.)
Fuse block (J/B)				
Connector	Terminal			
M3	10C	Ground	ON	Battery voltage
			OFF	0

Is the inspection result normal?

- YES >> GO TO 3.
NO >> Replace fuse block (J/B).

3.CHECK DOOR MIRROR DEFOGGER CIRCUIT

Check voltage between door mirror defogger (driver side) connector and ground.

Door mirror defogger (driver side)		Ground	Condition of rear window defogger switch	Voltage (V) (Approx.)
Connector	Terminal			
D3	7	Ground	ON	Battery voltage
			OFF	0

Is the inspection result normal?

- YES >> GO TO 4.
NO >> Repair or replace the harness or connector.

4.CHECK INTERMITTENT INCIDENT

Check intermittent incident. Refer to [GI-39. "Intermittent Incident"](#)

Is the inspection result normal?

>> INSPECTION END

A
B
C
D
E
F
G
H
I
J
K
DEF
M
N
O
P

DRIVER SIDE DOOR MIRROR DEFOGGER

< DTC/CIRCUIT DIAGNOSIS >

DRIVER SIDE DOOR MIRROR DEFOGGER

Description

INFOID:000000005513211

Heats the heating wire with the power supply from the rear window defogger relay to prevent the door mirror from fogging up.

Component Function Check

INFOID:000000005513212

1.CHECK DRIVER SIDE DOOR MIRROR DEFOGGER

1. Perform Active Test ("REAR DEFOGGER") with CONSULT-III.
2. Touch "ON".
3. Check that the driver side door mirror glass is getting warmer.

Is the inspection result normal?

- YES >> Driver side door mirror defogger is OK.
NO >> Refer to [DEF-18, "Diagnosis Procedure"](#)

Diagnosis Procedure

INFOID:000000005513213

1.CHECK POWER SUPPLY CIRCUIT

1. Turn ignition switch OFF.
2. Disconnect door mirror (driver side) connector.
3. Turn ignition switch ON.
4. Check voltage between door mirror (driver side) harness connector and ground.

(+)		(-)	Condition of rear window defogger switch	Voltage (V) (Approx.)
Connector	Terminal			
D3	7	Ground	ON	Battery voltage
			OFF	0

Is the inspection result normal?

- YES >> GO TO 2.
NO >> Repair or replace harness or connector between fuse block (J/B) and door mirror (driver side).

2.CHECK GROUND CIRCUIT

1. Turn ignition switch OFF.
2. Check continuity between door mirror (driver side) harness connector and ground.

Door mirror (driver side)		Ground	Continuity
Connector	Terminal		
D3	19		Existed

Is the inspection result normal?

- YES >> GO TO 3.
NO >> Repair or replace harness or connector between door mirror (driver side) and ground.

3.CHECK DRIVER SIDE DOOR MIRROR DEFOGGER

Check driver side door mirror defogger.
Refer to [DEF-19, "Component Inspection"](#)

Is the inspection result normal?

- YES >> GO TO 4.
NO >> Replace door mirror (driver side). Refer to [MIR-72, "DOOR MIRROR ASSEMBLY : Removal and Installation"](#)

4.CHECK INTERMITTENT INCIDENT

Check intermittent incident.

DRIVER SIDE DOOR MIRROR DEFOGGER

< DTC/CIRCUIT DIAGNOSIS >

Refer to [GI-39. "Intermittent Incident"](#)

Is the inspection result normal?

>> INSPECTION END

Component Inspection

INFOID:000000005513214

1. CHECK DRIVER SIDE DOOR MIRROR DEFOGGER

1. Turn ignition switch OFF.
2. Disconnect door mirror (driver side) connector.
3. Check continuity between door mirror terminals.

Door mirror (driver side)		Continuity
Connector	Terminal	
D3	7 19	Existed

Is the inspection result normal?

YES >> INSPECTION END

NO >> Replace door mirror glass (driver side). Refer to [MIR-72. "DOOR MIRROR ASSEMBLY : Removal and Installation"](#)

A
B
C
D
E
F
G
H
I
J
K
DEF
M
N
O
P

DEF

PASSENGER SIDE DOOR MIRROR DEFOGGER

< DTC/CIRCUIT DIAGNOSIS >

PASSENGER SIDE DOOR MIRROR DEFOGGER

Description

INFOID:000000005513215

Heats the heating wire with the power supply from the rear window defogger relay to prevent the door mirror from fogging up.

Component Function Check

INFOID:000000005513216

1.CHECK PASSENGER SIDE DOOR MIRROR DEFOGGER

1. Perform Active Test ("REAR DEFOGGER") with CONSULT-III.
2. Touch "ON".
3. Check that the passenger side door mirror glass is getting warmer.

Is the inspection result normal?

- YES >> Passenger side door mirror defogger is OK.
NO >> Refer to [DEF-20, "Diagnosis Procedure"](#)

Diagnosis Procedure

INFOID:000000005513217

1.CHECK POWER SUPPLY CIRCUIT

1. Turn ignition switch OFF.
2. Disconnect door mirror (passenger side) connector.
3. Turn ignition switch ON.
4. Check voltage between door mirror (passenger side) harness connector and ground.

(+)		(-)	Condition of rear window defogger switch	Voltage (V) (Approx.)
Connector	Terminal			
D43	7	Ground	ON	Battery voltage
			OFF	0

Is the inspection result normal?

- YES >> GO TO 2.
NO >> Repair or replace harness or connector between fuse block (J/B) and door mirror (passenger side).

2.CHECK GROUND CIRCUIT

1. Turn ignition switch OFF.
2. Check continuity between door mirror (passenger side) harness connector and ground.

Door mirror (passenger side)		Ground	Continuity
Connector	Terminal		
D43	19		Existed

Is the inspection result normal?

- YES >> GO TO 3.
NO >> Repair or replace harness or connector between door mirror (passenger side) and ground.

3.CHECK PASSENGER SIDE DOOR MIRROR DEFOGGER

Check passenger side door mirror defogger.
Refer to [DEF-21, "Component Inspection"](#)

Is the inspection result normal?

- YES >> GO TO 4.
NO >> Replace door mirror (passenger side). Refer to [MIR-72, "DOOR MIRROR ASSEMBLY : Removal and Installation"](#)

4.CHECK INTERMITTENT INCIDENT

PASSENGER SIDE DOOR MIRROR DEFOGGER

< DTC/CIRCUIT DIAGNOSIS >

Check intermittent incident.
Refer to [GI-39. "Intermittent Incident"](#)

>> INSPECTION END

Component Inspection

INFOID:000000005513218

1. CHECK PASSENGER DOOR MIRROR DEFOGGER

1. Turn ignition switch OFF.
2. Disconnect door mirror (passenger side) connector.
3. Check continuity between door mirror terminals.

Door mirror (passenger side)		Continuity
Connector	Terminal	
D43	7 19	Existed

Is the inspection result normal?

YES >> INSPECTION END

NO >> Replace door mirror glass (passenger side). Refer to [MIR-72. "DOOR MIRROR ASSEMBLY : Removal and Installation"](#)

A
B
C
D
E
F
G
H
I
J
K
DEF
M
N
O
P

DEF

REAR WINDOW DEFOGGER SYSTEM

< DTC/CIRCUIT DIAGNOSIS >

DEFOGGER

Connector No.	B6
Connector Name	FUSE BLOCK (J/B)
Connector Type	HS12FBR-CS



Terminal No.	Color of Wire	Signal Name [Specification]
2G	GR	-
4G	L	-
5G	P	-
10G	Y	-
11G	Y	-

Connector No.	B74
Connector Name	CONDENSER
Connector Type	P01FE-A



Terminal No.	Color of Wire	Signal Name [Specification]
1	Y	-

Connector No.	B75
Connector Name	CONDENSER
Connector Type	P01FE-A



Terminal No.	Color of Wire	Signal Name [Specification]
1	Y	-

Connector No.	G
Connector Name	-
Connector Type	-

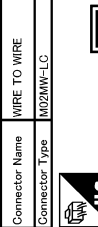

Terminal No.	Color of Wire	Signal Name [Specification]
1	G	-
2	B	-

Connector No.	D3
Connector Name	DOOR MIRROR (DRIVER SIDE)
Connector Type	TH2MMW-NH

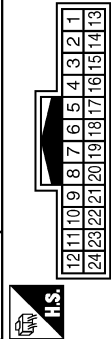

Terminal No.	Color of Wire	Signal Name [Specification]
7	LG	-
10	BR	-
11	BR	-
12	SB	-
19	B	-
21	BR	-
22	G	-
23	GR	-
24	Y	-

Connector No.	B21
Connector Name	WIRE TO WIRE
Connector Type	TH4DFW-CS15

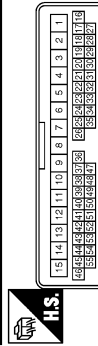

Terminal No.	Color of Wire	Signal Name [Specification]
1	V	-
2	G	-
3	P	-
4	B	-
5	W	-
8	SB	-
7	P	-
8	BR	-
9	GR	-
10	V	-
11	O	-
14	O	-
15	LG	-
16	G	-
17	Y	-
18	GR	-
20	LG	-
24	P	-
25	V	-
26	W	-
28	W	-
30	SB	-
31	BR	-
32	R	-
33	G	-
34	Y	-
35	L	-
42	GR	-
43	L	-
44	W	-
45	SB	-
46	R	-
50	V	-
51	O	-
52	P	-
53	L	-

Connector No.	D41
Connector Name	WIRE TO WIRE
Connector Type	TH4DFW-CS15

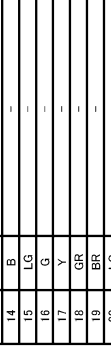

Terminal No.	Color of Wire	Signal Name [Specification]
1	G	-
2	V	-
4	B	-
5	W	-
6	P	-
7	O	-
8	B	-
16	G	-
17	Y	-
18	GR	-
19	BR	-
20	LG	-
24	LG	-
25	W	-
26	W	-
28	O	-
29	V	-
30	SB	-
31	BR	-
32	R	-
33	G	-
34	Y	-
35	L	-
42	GR	-
43	L	-
44	W	-
45	SB	-
46	R	-
50	V	-
51	O	-
52	P	-
53	L	-

53	L	-	[Without automatic drive positioner]
53	P	-	[Without automatic drive positioner]
54	SB	-	[Without automatic drive positioner]
34	LG	-	[Without automatic drive positioner]
35	LG	-	[Without automatic drive positioner]
35	O	-	[Without automatic drive positioner]

Connector No.	D41
Connector Name	WIRE TO WIRE
Connector Type	TH4DFW-CS15

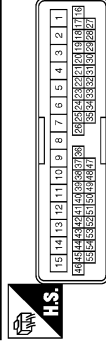

Terminal No.	Color of Wire	Signal Name [Specification]
1	G	-
2	V	-
4	B	-
5	W	-
6	P	-
7	O	-
8	B	-
16	G	-
17	Y	-
18	GR	-
19	BR	-
20	LG	-
24	LG	-
25	W	-
26	W	-
28	O	-
29	V	-
30	SB	-
31	BR	-
32	R	-
33	G	-
34	Y	-
35	L	-

JCLWM4218GB

A
B
C
D
E
F
G
H
I
J
K
DEF
M
N
O
P

REAR WINDOW DEFOGGER SYSTEM

< DTC/CIRCUIT DIAGNOSIS >

DEFOGGER

Connector No.	D43
Connector Name	DOOR MIRROR (PASSENGER SIDE)
Connector Type	TH24MW-NH



Terminal No.	Color of Wire	Signal Name [Specification]
7	LG	-
10	BR	-
11	SB	-
12	V	-
18	B	-
21	BR	-
22	G	-
23	GR	-
24	Y	-

Connector No.	D183
Connector Name	WIRE TO WIRE
Connector Type	M02PW-LC



Terminal No.	Color of Wire	Signal Name [Specification]
1	G	-
2	B	-

Connector No.	D184
Connector Name	REAR WINDOW DEFOGGER
Connector Type	PRO1FB-A



Terminal No.	Color of Wire	Signal Name [Specification]
1	G	-

Connector No.	D185
Connector Name	REAR WINDOW DEFOGGER
Connector Type	PRO1FB-A



Terminal No.	Color of Wire	Signal Name [Specification]
2	B	-

Connector No.	E11
Connector Name	FUSE IN INTELLIGENT POWER DISTRIBUTION MODULE (ENGINE ROOM)
Connector Type	TH03FW-NH

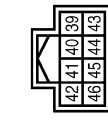

Terminal No.	Color of Wire	Signal Name [Specification]
39	P	-
40	L	-
41	B	-
42	SB	-

43	Y	-
44	W	-
45	O	-
46	BR	-

Connector No.	E105
Connector Name	WIRE TO WIRE
Connector Type	TH10MW-CS10-M3

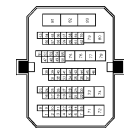

Terminal No.	Color of Wire	Signal Name [Specification]
2	BR	-
3	Y	-
4	W	-
5	LG	-
6	GR	-
8	G	-
11	P	-
12	L	-
13	Y	-
14	O	-
15	BR	-
20	Y	-
21	BR	-
22	P	-
23	P	-
24	L	-
25	O	-
26	G	-
28	SB	-
29	W	-
30	Y	-
47	P	-
48	L	-
49	SB	-
50	GR	-
51	LG	-
52	V	-
53	GR	-
54	BR	-
55	Y	-
56	W/L	-

60	V	-
61	BR	-
62	O	-
63	L/O	-
64	SHIELD	-
66	W	-
67	BR	-
68	Y	-
69	SB	-
70	GR	-
71	SB	-
72	Y	-
73	L	-
74	W	-
75	BR	-
76	GR	-
77	O	-
78	V	-
79	Y	-
80	R	-
81	W	-
82	LG	-
83	O	-

Connector No.	M1
Connector Name	FUSE BLOCK (J/B)
Connector Type	NS03FW-M2

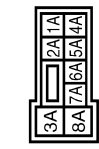

Terminal No.	Color of Wire	Signal Name [Specification]
1A	Y	-
2A	G	-
3A	Y	-
4A	GR	-
5A	R	-
6A	W	-
7A	LG	-
8A	Y	-

REAR WINDOW DEFOGGER SYSTEM

< DTC/CIRCUIT DIAGNOSIS >

DEFOGGER

Connector No.	M2
Connector Name	FUSE BLOCK (J/B)
Connector Type	NS10FW-CS



Terminal No.	Color of Wire	Signal Name [Specification]
1B	W	-
3B	L	-
4B	G	-
5B	L	-
6B	Y	-
7B	R	-
8B	R	-
9B	GR	-

Connector No.	M3
Connector Name	FUSE BLOCK (J/B)
Connector Type	NS12FW-CS

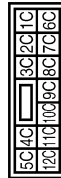

Terminal No.	Color of Wire	Signal Name [Specification]
6C	BR	-
7C	B	-
8C	G	-
9C	GR	-
10C	SB	-
11C	R	-
12C	O	-

Connector No.	M4
Connector Name	DATA LINK CONNECTOR
Connector Type	BD10FW

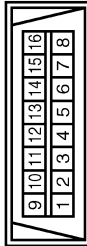

Terminal No.	Color of Wire	Signal Name [Specification]
4	B	-
5	B	-
6	L	-
7	O	-
8	G	-
14	P	-
16	Y	-

Connector No.	M11
Connector Name	WIRE TO WIRE
Connector Type	TH70FW-CS10-M3



Terminal No.	Color of Wire	Signal Name [Specification]
2	L	-
3	P	-
4	O	-
5	O	-
6	G	-
8	R	-
11	P	-
12	L	-
13	V	-
14	Y	-
15	R	-
20	Y	-
21	BR	-
22	G	-
23	P	-

Connector No.	M18
Connector Name	WIRE TO WIRE
Connector Type	TH40MP-CS15

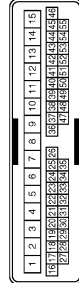

Terminal No.	Color of Wire	Signal Name [Specification]
1	G	-
2	V	-
4	W	-
5	B	- [With BOSE system]
6	BR	- [Without BOSE system]
8	GR	-
7	G	-
8	B	-
16	W	-
17	Y	-
18	W	-
19	R	-
20	SB	-
24	LG	-
25	Y	-
26	P	-
29	O	-
30	G	-
31	V	-
32	Y	-
33	P	-
34	SB	-
35	R	-

24	Y	-
25	L	-
26	L	-
27	O	-
28	BR	-
29	L	-
30	R	-
47	P	-
48	L	-
49	W	-
50	GR	-
51	LG	-
52	Y	-
53	V	-
54	SB	-
55	P	-
56	SB	-
60	V	-
61	GR	-
62	O	-
63	V	-
64	SHIELD	-
66	W	-
67	R	-
68	W	-
69	P	-
70	G	-
71	G	-
72	BR	-
73	L	-
74	W	-
75	BR	-
76	R	-
77	G	-
78	Y	-
79	G	-
80	R	-
81	W	-
82	W	-
83	O	-

JCLWM4220GB

A
B
C
D
E
F
G
H
I
J
K
DEF
M
N
O
P

REAR WINDOW DEFOGGER SYSTEM

< DTC/CIRCUIT DIAGNOSIS >

DEFOGGER

Connector No.	M20
Connector Name	WIRE TO WIRE
Connector Type	TH40MW-CS15

1	2	3	4	5	6	7	8	9	10	11	12	13	14	15
16	17	18	19	20	21	22	23	24	25	26	27	28	29	30
31	32	33	34	35	36	37	38	39	40	41	42	43	44	45



Terminal No.	Color of Wire	Signal Name [Specification]
1	V	-
2	G	-
3	W	-
4	B	-
5	L	-
6	V	-
7	BR	-
8	O	-
9	SB	-
10	L	-
11	G	-
14	B	-
15	GR	-
16	L	-
17	Y	-
18	W	-
19	Y	-
20	SB	-
24	P	-
25	V	-
26	W	-
28	R	-
30	L	-
31	SB	-
32	W	-
33	P	-
34	SB	-
35	R	-
41	LG	-
42	LG	-
43	O	-
44	Y	-
45	P	-
46	P	-
50	V	-
51	O	-
52	GR	- [With automatic drive positioner]
52	R	- [Without automatic drive positioner]

53	L	- [With automatic drive positioner]
53	V	- [Without automatic drive positioner]
54	LG	- [With automatic drive positioner]
54	G	- [Without automatic drive positioner]
55	SB	- [With automatic drive positioner]
55	O	- [Without automatic drive positioner]

Connector No.	M50
Connector Name	A/C AUTO AMP
Connector Type	SAB10FW

1	2	3	4	5	6	7	8	9	10	11	12	13	14	15	16	17	18	19	20
21	22	23	24	25	26	27	28	29	30	31	32	33	34	35	36	37	38	39	40



Terminal No.	Color of Wire	Signal Name [Specification]
1	L	CAN-H
2	P	CAN-L
6	L	TX(AMP)/SW(DISP)
7	P	RX(SW)/AMP
10	L	LAN SIG
11	R	VACTR
15	O	SUN SENS
16	G	INTAKE SENS
17	R	ACC
19	B	GND
20	G	IGN
26	GR	RR DEF F/B
27	BR	RR DEF ON
32	L	FAN PWM
34	P	AMB POWER
35	L	AMB SENS
36	LG	INCAR SENS
37	Y	SENS GND
38	B	GND(POWER)
40	Y	BAT

Connector No.	M95
Connector Name	A/C CONTROL
Connector Type	TH12FW-NH

1	2	3	4	5	6
7	8	9	10	11	12



Terminal No.	Color of Wire	Signal Name [Specification]
1	G	IGN
2	B	GND
3	L	RX(AMP)/SW
4	P	TX(SW)/AMP
5	R	ILL+
6	BR	ILL-

Connector No.	M18
Connector Name	BCM (BODY CONTROL MODULE)
Connector Type	M03FE-LG

1	3
2	



Terminal No.	Color of Wire	Signal Name [Specification]
1	W	BAT (E/L)
2	GR	POWER WINDOW POWER SUPPLY (BAT)
3	L	POWER WINDOW POWER SUPPLY (PAD)

Connector No.	M119
Connector Name	BCM (BODY CONTROL MODULE)
Connector Type	NS16FW-CS



4	5	6	7	8	9	10		
11	12	13	14	15	16	17	18	19

Terminal No.	Color of Wire	Signal Name [Specification]
4	P	INTERIOR ROOM LAMP POWER SUPPLY
5	G	PASSENGER DOOR UNLOCK OUTPUT
7	W	STEP LAMP OUTPUT
8	V	ALL DOOR FUEL LID LOCK OUTPUT
9	G	DRIVER DOOR FUEL LID LOCK OUTPUT
10	P	REAR DOOR UNLOCK OUTPUT
11	LG	BAT (FUSE)
13	B	GND
14	O	PUSH-BUTTON IGNITION SW ILL GND
15	L	ACC IND
17	G	TURN SIGNAL RH
18	BR	TURN SIGNAL LH
19	Y	ROOM LAMP TIMER CONTROL

REAR WINDOW DEFOGGER SYSTEM

< DTC/CIRCUIT DIAGNOSIS >

DEFOGGER

Connector No.	M122
Connector Name	BCM (BODY CONTROL MODULE)
Connector Type	TH40FB-NH

Terminal No.	Color of Wire	Signal Name [Specification]
72	B	ROOM ANT2-
73	W	ROOM ANT2+
74	Y	PASSENGER DOOR ANT-
75	LG	PASSENGER DOOR ANT+
76	V	DRIVER DOOR ANT-
77	P	DRIVER DOOR ANT+
80	SB	IMMOBI ANTENNA CONTROL
81	O	IMMOBI ANTENNA SIGNAL
82	BR	IGN RELAY (F/B) CONT
83	P	KEYLESS ENTRY RECEIVER SIGNAL
87	R	COMBI SW INPUT 5
88	GR	COMBI SW INPUT 3
89	BR	PUSH SW
90	P	CAN-L
91	L	CAN-H
92	R	KEY SLOT ILL
93	P	ON IND
95	L	ACC RELAY CONT
96	Y	CVT SHIFT SELECTOR POWER SUPPLY
97	O	S/L CONDITION 1
98	L	S/L CONDITION 2
99	V	SHIFT P
100	P	PASSENGER DOOR REQUEST SW
101	W	DRIVER DOOR REQUEST SW
102	Y	BLOWER FAN MOTOR RELAY CONT
103	L	KEYLESS ENTRY RECEIVER POWER SUPPLY
106	Y	S/L POWER SUPPLY
107	O	COMBI SW INPUT 1
108	P	COMBI SW INPUT 4
109	SB	COMBI SW INPUT 2
110	G	HAZARD SW
111	LG	S/L COMM

Connector No.	M123
Connector Name	BCM (BODY CONTROL MODULE)
Connector Type	TH40FC-NH

Terminal No.	Color of Wire	Signal Name [Specification]
112	R	RAIN SENSOR SERIAL LINK
113	O	OPTICAL SENSOR
116	GR	FUSE CHECK
118	L	STOP LAMP SW
119	W	DR DOOR UNLOCK SENSOR
121	Y	KEY SLOT SW
123	G	IGN F/B
124	R	PASSENGER DOOR SW
130	BR	REAR DEFOGGER SW
132	G	POWER WINDOW SW COMM
133	W	PUSH-BUTTON IGNITION SW ILL POWER
134	R	LOCK IND
137	P	RECEIVER/SENSOR GND
138	V	RECEIVER/SENSOR POWER SUPPLY
139	O	TIRE PRESS RECEIVER SIGNAL
140	GR	SHIFT N/P
141	O	SECURITY INDICATOR OUTPUT
142	L	COMBI SW OUTPUT 5
143	W	COMBI SW OUTPUT 1
144	P	COMBI SW OUTPUT 2
145	V	COMBI SW OUTPUT 3
146	Y	COMBI SW OUTPUT 4
149	W	TIRE PRESS WARNING CHECK SW
150	SB	DRIVER DOOR SW
151	G	REAR WINDOW DEFOGGER RELAY

Connector No.	M125
Connector Name	MULTIFUNCTION SWITCH
Connector Type	TH18FN-NH

Terminal No.	Color of Wire	Signal Name [Specification]
1	B	GND
3	R	ACC
4	R	ILL
5	SB	ILL CONT
6	R	AV COMM (H)
8	L	AV COMM (L)
9	V	SW GND
14	W	EJECT SIGNAL

Connector No.	M129
Connector Name	AV CONTROL UNIT WITH BOSE SYSTEM WITHOUT NAVIGATION SYSTEM
Connector Type	TH44FW-NH

Terminal No.	Color of Wire	Signal Name [Specification]
36	L	COMPOSITE IMAGE SIGNAL
37	P	COMPOSITE IMAGE GND
38	Y	RGB (B/BLUE) SIGNAL
39	L	RGB (G/GREEN) SIGNAL
40	G	RGB (R/RED) SIGNAL
41	B	RGB SYNC
42	SHIELD	SHIELD
43	W	RGB AREA (YS) SIGNAL
44	G	COMM (DISP->CONT)
45	G	HP
46	LG	SIGNAL GND
47	O	SIGNAL VCC
48	SHIELD	SHIELD
50	SHIELD	SHIELD

55	SHIELD	SHIELD
56	R	COMM (CONT->DISP)
57	R	V.P
58	BR	INVERTER GND
59	Y	INVERTER VCC

Connector No.	M131
Connector Name	AV CONTROL UNIT WITH BOSE SYSTEM WITHOUT NAVIGATION SYSTEM
Connector Type	TH42FW-NH

Terminal No.	Color of Wire	Signal Name [Specification]
79	L	TEL VOICE SIGNAL (-)
80	R	TEL VOICE SIGNAL (+)
81	SHIELD	SHIELD
82	W	SOUND SIGNAL RH (-) [With DVD player]
82	W	IPod SOUND SIGNAL RH (-) [Without DVD player]
83	R	SOUND SIGNAL RH (+) [With DVD player]
83	R	IPod SOUND SIGNAL RH (+) [Without DVD player]
85	B	GND
86	L	CAN-L
87	P	CAN-H
88	R	AV COMM (H)
89	L	AV COMM (L)
90	G	AV COMM (H)
91	L	AV COMM (L)
95	R	AUX SOUND SIGNAL RH (+)
86	B	AUX SOUND SIGNAL LH (+)
97	W	AUX SOUND SIGNAL GND
98	G	SOUND SIGNAL LH (-) [With DVD player]
98	L	IPod SOUND SIGNAL LH (-) [Without DVD player]
99	B	SOUND SIGNAL LH (+) [With DVD player]
99	B	IPod SOUND SIGNAL LH (+) [Without DVD player]
100	SHIELD	SHIELD [With DVD player]
100	SHIELD	SHIELD [Without DVD player]
101	V	SW GND
103	W	EJECT SIGNAL
104	G	IGNITION
105	SB	REVERSE
106	G	PARKING BRAKE
107	V	VEHICLE SPEED (8-PULSE)

A B C D E F G H I J K M N O P DEF

JCLWM4222GB

REAR WINDOW DEFOGGER SYSTEM

< DTC/CIRCUIT DIAGNOSIS >

DEFOGGER	
Connector No.	M145
Connector Name	AV CONTROL UNIT (WITH NAVIGATION SYSTEM)
Connector Type	TH145V-NH

62	63	64	65	66	67	68	69	70	71	72
R	W	SHIELD	B	SHIELD	W	B	R	R	G	SHIELD
RGB (GREEN) SIGNAL	RGB (BLUE) SIGNAL	SHIELD	RGB S/VCC	SHIELD	RGB AREA (TS) SIGNAL	HP	VP	COMM (CONT->DISP)	COMM (DISP->CONT)	SHIELD

62	64	66	68	70	72
61	63	65	67	69	71

Terminal No.	Color of Wire	Signal Name [Specification]
21	B	GND
22	Y	BATTERY
23	B	GND
24	Y	BATTERY
25	R	ACC
26	B	MICROPHONE VCC
27	SHIELD	MICROPHONE GND
28	W	MICROPHONE SIGNAL
35	G	IGNITION
36	G	PARKING BRAKE
37	SB	REVERSE
38	V	VEHICLE SPEED (B-PULSE)
40	P	CONNECTION RECOGNITION
42	B	CONTROL SIGNAL
43	B	CONTROL SIGNAL
46	G	AV COMM (H)
49	L	AV COMM (L)
50	R	AV COMM (H)
51	L	AV COMM (L)
52	L	CAN-H
53	P	CAN-L

DEFOGGER	
Connector No.	M146
Connector Name	AV CONTROL UNIT (WITH NAVIGATION SYSTEM)
Connector Type	TH12FW-NH

62	64	66	68	70	72
61	63	65	67	69	71

DEFOGGER	
Terminal No.	61
Color of Wire	G
Signal Name [Specification]	RGB (RED) SIGNAL

JCLWM4223GB

BCM (BODY CONTROL MODULE)

< ECU DIAGNOSIS INFORMATION >

ECU DIAGNOSIS INFORMATION

BCM (BODY CONTROL MODULE)

Reference Value

INFOID:000000005683244

VALUES ON THE DIAGNOSIS TOOL

CONSULT-III MONITOR ITEM

Monitor Item	Condition	Value/Status
FR WIPER HI	Other than front wiper switch HI	Off
	Front wiper switch HI	On
FR WIPER LOW	Other than front wiper switch LO	Off
	Front wiper switch LO	On
FR WASHER SW	Front washer switch OFF	Off
	Front washer switch ON	On
FR WIPER INT	Other than front wiper switch INT/AUTO	Off
	Front wiper switch INT/AUTO	On
FR WIPER STOP	Front wiper is not in STOP position	Off
	Front wiper is in STOP position	On
INT VOLUME	Wiper intermittent dial is in a dial position 1 - 7	Wiper intermittent dial position
RR WIPER ON	Other than rear wiper switch ON	Off
	Rear wiper switch ON	On
RR WIPER INT	Other than rear wiper switch INT	Off
	Rear wiper switch INT	On
RR WASHER SW	Rear washer switch OFF	Off
	Rear washer switch ON	On
RR WIPER STOP	Rear wiper is in STOP position	Off
	Rear wiper is not in STOP position	On
TURN SIGNAL R	Other than turn signal switch RH	Off
	Turn signal switch RH	On
TURN SIGNAL L	Other than turn signal switch LH	Off
	Turn signal switch LH	On
TAIL LAMP SW	Other than lighting switch 1ST and 2ND	Off
	Lighting switch 1ST or 2ND	On
HI BEAM SW	Other than lighting switch HI	Off
	Lighting switch HI	On
HEAD LAMP SW 1	Other than lighting switch 2ND	Off
	Lighting switch 2ND	On
HEAD LAMP SW 2	Other than lighting switch 2ND	Off
	Lighting switch 2ND	On
PASSING SW	Other than lighting switch PASS	Off
	Lighting switch PASS	On
AUTO LIGHT SW	Other than lighting switch AUTO	Off
	Lighting switch AUTO	On
FR FOG SW	Front fog lamp switch OFF	Off
	Front fog lamp switch ON	On

BCM (BODY CONTROL MODULE)

< ECU DIAGNOSIS INFORMATION >

Monitor Item	Condition	Value/Status
RR FOG SW	NOTE: The item is indicated, but not monitored.	Off
DOOR SW-DR	Driver door closed	Off
	Driver door opened	On
DOOR SW-AS	Passenger door closed	Off
	Passenger door opened	On
DOOR SW-RR	Rear RH door closed	Off
	Rear RH door opened	On
DOOR SW-RL	Rear LH door closed	Off
	Rear LH door opened	On
DOOR SW-BK	Back door closed	Off
	Back door opened	On
CDL LOCK SW	Other than power door lock switch LOCK	Off
	Power door lock switch LOCK	On
CDL UNLOCK SW	Other than power door lock switch UNLOCK	Off
	Power door lock switch UNLOCK	On
KEY CYL LK-SW	Other than driver door key cylinder LOCK position	Off
	Driver door key cylinder LOCK position	On
KEY CYL UN-SW	Other than driver door key cylinder UNLOCK position	Off
	Driver door key cylinder UNLOCK position	On
KEY CYL SW-TR	NOTE: The item is indicated, but not monitored.	Off
HAZARD SW	Hazard switch is OFF	Off
	Hazard switch is ON	On
REAR DEF SW NOTE: For models with BOSE audio system this item is not monitored.	Rear window defogger switch OFF	Off
	Rear window defogger switch ON	On
TR CANCEL SW	NOTE: The item is indicated, but not monitored.	Off
TR/BD OPEN SW	Back door opener switch OFF	Off
	While the back door opener switch is turned ON	On
TRNK/HAT MNTR	NOTE: The item is indicated, but not monitored.	Off
RKE-LOCK	LOCK button of Intelligent Key is not pressed	Off
	LOCK button of Intelligent Key is pressed	On
RKE-UNLOCK	UNLOCK button of Intelligent Key is not pressed	Off
	UNLOCK button of Intelligent Key is pressed	On
RKE-TR/BD	BACK DOOR OPEN button of Intelligent Key is not pressed	Off
	BACK DOOR OPEN button of Intelligent Key is pressed	On
RKE-PANIC	PANIC button of Intelligent Key is not pressed	Off
	PANIC button of Intelligent Key is pressed	On
RKE-P/W OPEN	UNLOCK button of Intelligent Key is not pressed	Off
	UNLOCK button of Intelligent Key is pressed and held	On

BCM (BODY CONTROL MODULE)

< ECU DIAGNOSIS INFORMATION >

Monitor Item	Condition	Value/Status	
RKE-MODE CHG	LOCK/UNLOCK button of Intelligent Key is not pressed and held simultaneously	Off	A
	LOCK/UNLOCK button of Intelligent Key is pressed and held simultaneously	On	B
OPTICAL SENSOR	Bright outside of the vehicle	Close to 5 V	C
	Dark outside of the vehicle	Close to 0 V	
REQ SW -DR	Driver door request switch is not pressed	Off	D
	Driver door request switch is pressed	On	
REQ SW -AS	Passenger door request switch is not pressed	Off	E
	Passenger door request switch is pressed	On	
REQ SW -RR	NOTE: The item is indicated, but not monitored.	Off	F
REQ SW -RR	NOTE: The item is indicated, but not monitored.	Off	G
REQ SW -BD/TR	Back door request switch is not pressed	Off	H
	Back door request switch is pressed	On	
PUSH SW	Push-button ignition switch (push switch) is not pressed	Off	I
	Push-button ignition switch (push switch) is pressed	On	
IGN RLY2 -F/B	Ignition switch in OFF or ACC position	Off	J
	Ignition switch in ON position	On	
ACC RLY -F/B	NOTE: The item is indicated, but not monitored.	Off	K
CLUCH SW	NOTE: The item is indicated, but not monitored.	Off	L
BRAKE SW 1	The brake pedal is depressed when No. 7 fuse is blown	Off	M
	The brake pedal is not depressed when No. 7 fuse is blown, or No. 7 fuse is normal	On	
BRAKE SW 2	The brake pedal is not depressed	Off	N
	Stop lamp switch 1 signal circuit is normal	On	
DETE/CANCL SW	Selector lever in P position	Off	O
	Selector lever in any position other than P	On	
SFT PN/N SW	Selector lever in any position other than P and N	Off	P
	Selector lever in P or N position	On	
S/L -LOCK NOTE: For models without steering lock unit this item is not displayed.	Steering is unlocked	Off	Q
	Steering is locked	On	
S/L -UNLOCK NOTE: For models without steering lock unit this item is not displayed.	Steering is locked	Off	R
	Steering is unlocked	On	
S/L RELAY-F/B NOTE: For models without steering lock unit this item is not displayed.	Ignition switch in OFF or ACC position	Off	S
	Ignition switch in ON position	On	
UNLK SEN -DR	Driver door is unlocked	Off	T
	Driver door is locked	On	
PUSH SW -IPDM	Push-button ignition switch (push-switch) is not pressed	Off	U
	Push-button ignition switch (push-switch) is pressed	On	

BCM (BODY CONTROL MODULE)

< ECU DIAGNOSIS INFORMATION >

Monitor Item	Condition	Value/Status
IGN RLY1 -F/B	Ignition switch in OFF or ACC position	Off
	Ignition switch in ON position	On
DETE SW -IPDM	Selector lever in any position other than P	Off
	Selector lever in P position	On
SFT PN -IPDM	Selector lever in any position other than P and N	Off
	Selector lever in P or N position	On
SFT P -MET	Selector lever in any position other than P	Off
	Selector lever in P position	On
SFT N -MET	Selector lever in any position other than N	Off
	Selector lever in N position	On
ENGINE STATE	Engine stopped	Stop
	While the engine stalls	Stall
	At engine cranking	Crank
	Engine running	Run
S/L LOCK-IPDM NOTE: For models without steering lock unit this item is not displayed.	Steering is unlocked	Off
	Steering is locked	On
S/L UNLK-IPDM NOTE: For models without steering lock unit this item is not displayed.	Steering is locked	Off
	Steering is unlocked	On
S/L RELAY-REQ NOTE: For models without steering lock unit this item is not displayed.	Steering lock system is not the LOCK condition and the changing condition from LOCK to UNLOCK.	Off
	Steering lock system is the LOCK condition or the changing condition from LOCK to UNLOCK.	On
VEH SPEED 1	While driving	Equivalent to speedometer reading
VEH SPEED 2	While driving	Equivalent to speedometer reading
DOOR STAT-DR	Driver door is locked	LOCK
	Wait with selective UNLOCK operation (5 seconds)	READY
	Driver door is unlocked	UNLOCK
DOOR STAT-AS	Passenger door is locked	LOCK
	Wait with selective UNLOCK operation (5 seconds)	READY
	Passenger door is unlocked	UNLOCK
ID OK FLAG	Power supply position in LOCK position	Reset
	Power supply position in any position other than LOCK	Set
PRMT ENG STRT	The engine start is prohibited	Reset
	The engine start is permitted	Set
PRMT RKE STRT	NOTE: The item is indicated, but not monitored.	Reset
KEY SW -SLOT	Intelligent Key is not inserted into key slot	Off
	Intelligent Key is inserted into key slot	On
RKE OPE COUN1	During the operation of Intelligent Key	Operation frequency of Intelligent Key
RKE OPE COUN2	NOTE: The item is indicated, but not monitored.	—

BCM (BODY CONTROL MODULE)

< ECU DIAGNOSIS INFORMATION >

Monitor Item	Condition	Value/Status	
CONFIRM ID ALL	The Intelligent Key ID that the key slot receives is not recognized by any Intelligent Key ID registered to BCM.	Yet	A
	The Intelligent Key ID that the key slot receives is recognized by any Intelligent Key ID registered to BCM.	Done	B
CONFIRM ID4	The Intelligent Key ID that the key slot receives is not recognized by the fourth Intelligent Key ID registered to BCM.	Yet	C
	The Intelligent Key ID that the key slot receives is recognized by the fourth Intelligent Key ID registered to BCM.	Done	
CONFIRM ID3	The Intelligent Key ID that the key slot receives is not recognized by the third Intelligent Key ID registered to BCM.	Yet	D
	The Intelligent Key ID that the key slot receives is recognized by the third Intelligent Key ID registered to BCM.	Done	
CONFIRM ID2	The Intelligent Key ID that the key slot receives is not recognized by the second Intelligent Key ID registered to BCM.	Yet	E
	The Intelligent Key ID that the key slot receives is recognized by the second Intelligent Key ID registered to BCM.	Done	
CONFIRM ID1	The Intelligent Key ID that the key slot receives is not recognized by the first Intelligent Key ID registered to BCM.	Yet	F
	The Intelligent Key ID that the key slot receives is recognized by the first Intelligent Key ID registered to BCM.	Done	
TP 4	The ID of fourth Intelligent Key is not registered to BCM	Yet	H
	The ID of fourth Intelligent Key is registered to BCM	Done	
TP 3	The ID of third Intelligent Key is not registered to BCM	Yet	I
	The ID of third Intelligent Key is registered to BCM	Done	
TP 2	The ID of second Intelligent Key is not registered to BCM	Yet	J
	The ID of second Intelligent Key is registered to BCM	Done	
TP 1	The ID of first Intelligent Key is not registered to BCM	Yet	K
	The ID of first Intelligent Key is registered to BCM	Done	
AIR PRESS FL	Ignition switch ON (Only when the signal from the transmitter is received)	Air pressure of front LH tire	
AIR PRESS FR	Ignition switch ON (Only when the signal from the transmitter is received)	Air pressure of front RH tire	
AIR PRESS RR	Ignition switch ON (Only when the signal from the transmitter is received)	Air pressure of rear RH tire	DEF
AIR PRESS RL	Ignition switch ON (Only when the signal from the transmitter is received)	Air pressure of rear LH tire	M
ID REGST FL1	ID of front LH tire transmitter is registered	Done	N
	ID of front LH tire transmitter is not registered	Yet	
ID REGST FR1	ID of front RH tire transmitter is registered	Done	O
	ID of front RH tire transmitter is not registered	Yet	
ID REGST RR1	ID of rear RH tire transmitter is registered	Done	P
	ID of rear RH tire transmitter is not registered	Yet	
ID REGST RL1	ID of rear LH tire transmitter is registered	Done	
	ID of rear LH tire transmitter is not registered	Yet	
WARNING LAMP	Tire pressure indicator OFF	Off	
	Tire pressure indicator ON	On	
BUZZER	Tire pressure warning alarm is not sounding	Off	
	Tire pressure warning alarm is sounding	On	

BCM (BODY CONTROL MODULE)

< ECU DIAGNOSIS INFORMATION >

TERMINAL LAYOUT

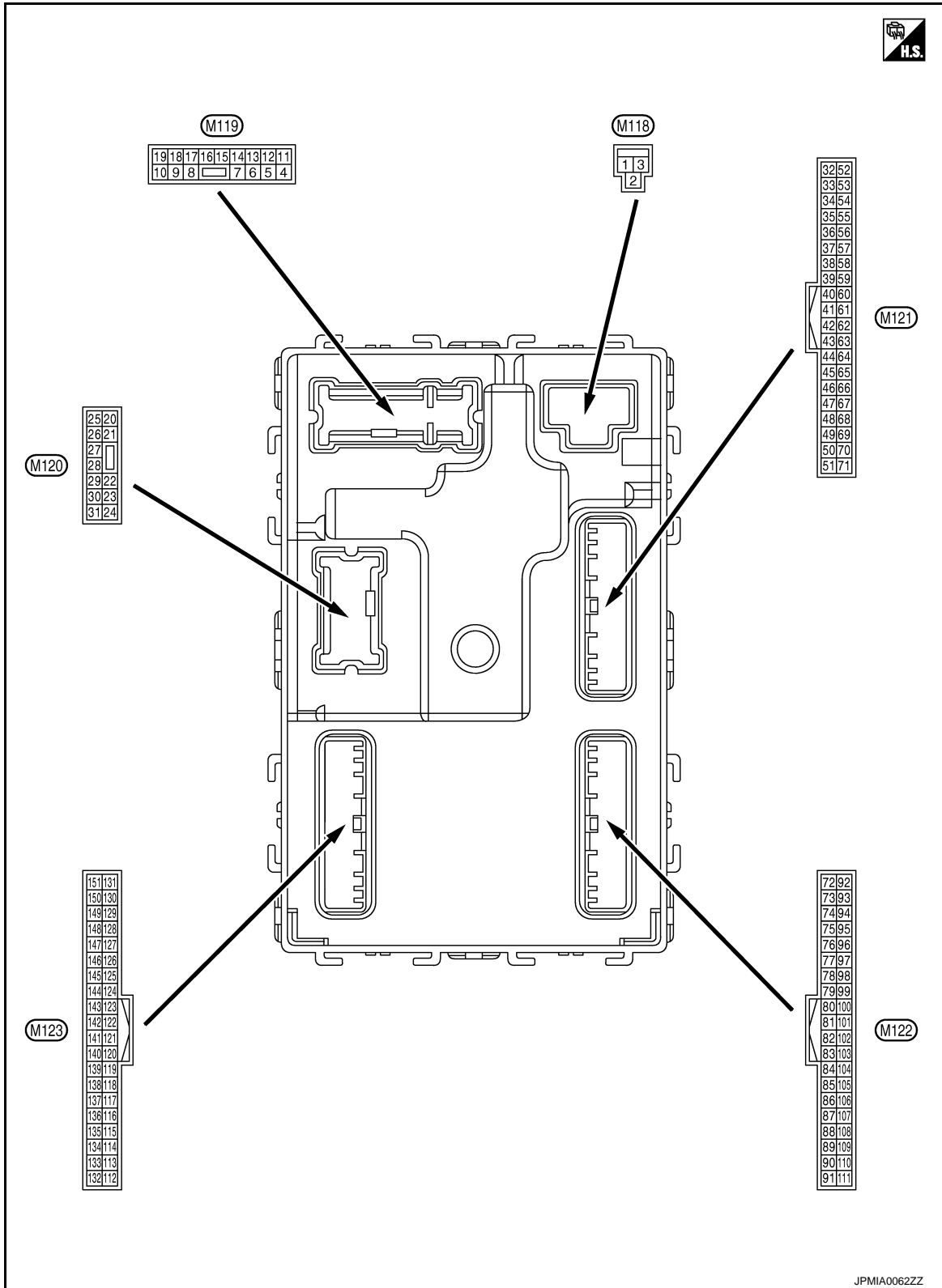

PHYSICAL VALUES

BCM (BODY CONTROL MODULE)

< ECU DIAGNOSIS INFORMATION >

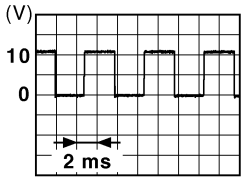
Terminal No. (Wire color)		Description		Condition		Value (Approx.)
+	-					
1 (W)	Ground	Battery power supply	Input	Ignition switch OFF		Battery voltage
2 (GR)	Ground	P/W power supply (BAT)	Output	Ignition switch OFF		Battery voltage
3 (L)	Ground	P/W power supply (RAP)	Output	Ignition switch ON		Battery voltage
4 (P)	Ground	Interior room lamp power supply	Output	Interior room lamp battery saver is activated. (Cuts the interior room lamp power supply)		0 V
				Interior room lamp battery saver is not activated. (Outputs the interior room lamp power supply)		Battery voltage
5 (G)	Ground	Passenger door UN- LOCK	Output	Passenger door	UNLOCK (Actuator is activated)	Battery voltage
					Other than UNLOCK (Actuator is not activated)	0 V
7 (W)	Ground	Step lamp	Output	Step lamp	ON	0 V
					OFF	Battery voltage
8 (V)	Ground	All doors LOCK	Output	All doors	LOCK (Actuator is activated)	Battery voltage
					Other than LOCK (Actuator is not activated)	0 V
9 (G)	Ground	Driver door UNLOCK	Output	Driver door	UNLOCK (Actuator is activated)	Battery voltage
					Other than UNLOCK (Actuator is not activated)	0 V
10 (P)	Ground	Rear RH door and rear LH door UN- LOCK	Output	Rear RH door and rear LH door	UNLOCK (Actuator is activated)	Battery voltage
					Other than UNLOCK (Actuator is not activated)	0 V
11 (LG)	Ground	Battery power supply	Input	Ignition switch OFF		Battery voltage
13 (B)	Ground	Ground	—	Ignition switch ON		0 V
14 (O)	Ground	Push-button ignition switch illumination ground	Output	Tail lamp	OFF	0 V
					ON	<p>NOTE: When the illumination brightening/dimming level is in the neutral position</p>  <p style="text-align: right; font-size: small;">JSNIA0010GB</p>
15 (L)	Ground	ACC indicator lamp	Output	Ignition switch	OFF (LOCK and ON indicator lamps are not illuminated.)	Battery voltage
					ACC	0 V

BCM (BODY CONTROL MODULE)

< ECU DIAGNOSIS INFORMATION >

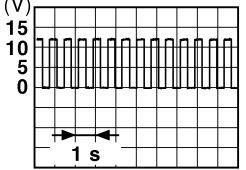
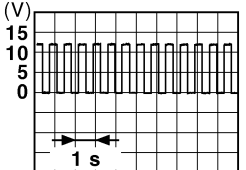
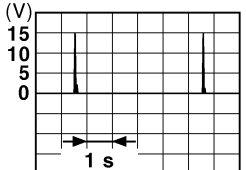
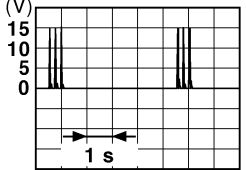
Terminal No. (Wire color)		Description		Condition	Value (Approx.)
+	-	Signal name	Input/ Output		
17 (G)	Ground	Turn signal RH	Output	Ignition switch ON	Turn signal switch OFF Turn signal switch RH
				Turn signal switch RH	 <p style="text-align: right; font-size: small;">PKID0926E</p>
18 (BR)	Ground	Turn signal LH	Output	Ignition switch ON	Turn signal switch OFF Turn signal switch LH
				Turn signal switch LH	 <p style="text-align: right; font-size: small;">PKID0926E</p>
19 (Y)	Ground	Room lamp timer control	Output	Interior room lamp	Turn signal switch OFF OFF
				OFF	ON
23 (BR)	Ground	Back door open	Output	Back door	Battery voltage OPEN (Back door opener actuator is activated)
				Battery voltage	Other than OPEN (Back door opener actuator is not activated)
26 (G)	Ground	Rear wiper	Output	Rear wiper	OFF (Stopped) ON (Operated)
				OFF (Stopped)	ON (Operated)
34 (B)	Ground	Luggage room anten- na (-)	Output	Ignition switch OFF	When Intelligent Key is in the passenger compart- ment
				When Intelligent Key is in the passenger compart- ment	 <p style="text-align: right; font-size: small;">JMKIA0062GB</p>
				When Intelligent Key is not in the passenger compart- ment	 <p style="text-align: right; font-size: small;">JMKIA0063GB</p>

BCM (BODY CONTROL MODULE)

< ECU DIAGNOSIS INFORMATION >

Terminal No. (Wire color)		Description		Condition	Value (Approx.)	
		Signal name	Input/ Output			
+	-					
35 (W)	Ground	Luggage room antenna (+)	Output	Ignition switch OFF	<p style="text-align: right; font-size: small;">JMKIA0062GB</p>	
				When Intelligent Key is not in the passenger compartment	<p style="text-align: right; font-size: small;">JMKIA0063GB</p>	
38 (L)	Ground	Rear bumper antenna (-)	Output	When the back door request switch is operated with ignition switch OFF	<p style="text-align: right; font-size: small;">JMKIA0062GB</p>	
				When Intelligent Key is not in the antenna detection area	<p style="text-align: right; font-size: small;">JMKIA0063GB</p>	
39 (BR)	Ground	Rear bumper antenna (+)	Output	When the back door request switch is operated with ignition switch OFF	<p style="text-align: right; font-size: small;">JMKIA0062GB</p>	
				When Intelligent Key is not in the antenna detection area	<p style="text-align: right; font-size: small;">JMKIA0063GB</p>	
47 (L)	Ground	Ignition relay (IPDM E/R) control	Output	Ignition switch	OFF or ACC	Battery voltage
				ON	0 V	

A
B
C
D
E
F
G
H
I
J
K
DEF
M
N
O
P

BCM (BODY CONTROL MODULE)

< ECU DIAGNOSIS INFORMATION >

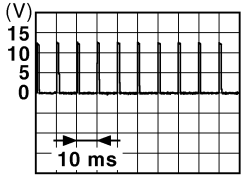
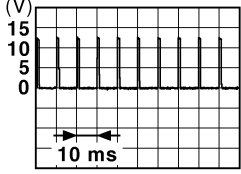
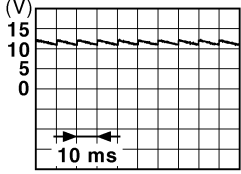
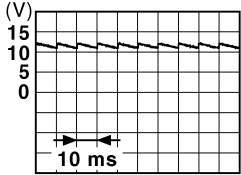
Terminal No. (Wire color)		Description		Condition		Value (Approx.)
		Signal name	Input/ Output			
+	-					
52 (R)	Ground	Starter relay control	Output	Ignition switch ON	When selector lever is in P or N position	Battery voltage
					When selector lever is not in P or N position	0.3 V
				Ignition switch OFF	0 V	
61 (R)	Ground	Back door request switch	Input	Back door re- quest switch	ON (Pressed)	0 V
					OFF (Not pressed)	 1.0 V
64 (GR)	Ground	Warning buzzer	Output	Warning buzzer	Sounding	0 V
					Not sounding	Battery voltage
65 (O)	Ground	Rear wiper stop posi- tion	Input	Rear wiper	In stop position	 1.0 V
					Not in stop position	0 V
66 (Y)	Ground	Back door switch	Input	Back door switch	OFF (When back door closes)	 11.8 V
					ON (When back door opens)	0 V
67 (LG)	Ground	Back door opener switch	Input	Back door opener switch	Pressed	0 V
					Not pressed	 11.8 V

BCM (BODY CONTROL MODULE)

< ECU DIAGNOSIS INFORMATION >

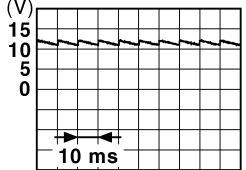
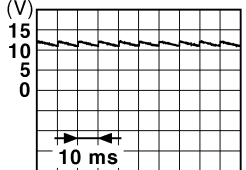
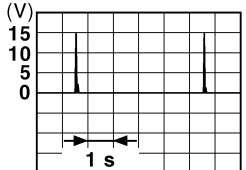
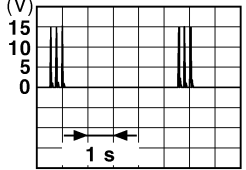
Terminal No. (Wire color)		Description		Condition	Value (Approx.)
+	-	Signal name	Input/ Output		
68 (W)	Ground	Rear RH door switch	Input	Rear RH door switch	 <p style="text-align: center;">11.8 V</p>
				OFF (When rear RH door closes)	0 V
69 (R)	Ground	Rear LH door switch	Input	Rear LH door switch	 <p style="text-align: center;">11.8 V</p>
				OFF (When rear LH door closes)	0 V
72 (B)	Ground	Room antenna (-) (Center console)	Output	Ignition switch OFF	 <p style="text-align: center;">1 s</p>
				When Intelligent Key is in the passenger compartment	 <p style="text-align: center;">1 s</p>

A
B
C
D
E
F
G
H
I
J
K
M
N
O
P

DEF

BCM (BODY CONTROL MODULE)

< ECU DIAGNOSIS INFORMATION >

Terminal No. (Wire color)		Description		Condition	Value (Approx.)
+	-	Signal name	Input/ Output		
73 (W)	Ground	Room antenna (+) (Center console)	Output	Ignition switch OFF	<p style="text-align: right; font-size: small;">JMKIA0062GB</p>
				When Intelligent Key is not in the passenger compart- ment	<p style="text-align: right; font-size: small;">JMKIA0063GB</p>
74 (Y)	Ground	Passenger door an- tenna (-)	Output	When the pas- senger door re- quest switch is operated with ig- nition switch OFF	<p style="text-align: right; font-size: small;">JMKIA0062GB</p>
				When Intelligent Key is not in the antenna detection area	<p style="text-align: right; font-size: small;">JMKIA0063GB</p>
75 (LG)	Ground	Passenger door an- tenna (+)	Output	When the pas- senger door re- quest switch is operated with ig- nition switch OFF	<p style="text-align: right; font-size: small;">JMKIA0062GB</p>
				When Intelligent Key is not in the antenna detection area	<p style="text-align: right; font-size: small;">JMKIA0063GB</p>

BCM (BODY CONTROL MODULE)

< ECU DIAGNOSIS INFORMATION >





Terminal No. (Wire color)		Description		Condition	Value (Approx.)	
+	-	Signal name	Input/ Output			
76 (V)	Ground	Driver door antenna (-)	Output	When the driver door request switch is operated with ignition switch OFF	<p style="text-align: right; font-size: small;">JMKIA0062GB</p>	
				When Intelligent Key is not in the antenna detection area	<p style="text-align: right; font-size: small;">JMKIA0063GB</p>	
77 (P)	Ground	Driver door antenna (+)	Output	When the driver door request switch is operated with ignition switch OFF	<p style="text-align: right; font-size: small;">JMKIA0062GB</p>	
				When Intelligent Key is not in the antenna detection area	<p style="text-align: right; font-size: small;">JMKIA0063GB</p>	
80 (SB)	Ground	NATS antenna amp.	Input/ Output	During waiting	Ignition switch is pressed while inserting Intelligent Key into the key slot.	Just after pressing ignition switch. Pointer of tester should move.
81 (O)	Ground	NATS antenna amp.	Input/ Output	During waiting	Ignition switch is pressed while inserting Intelligent Key into the key slot.	Just after pressing ignition switch. Pointer of tester should move.
82 (BR)	Ground	Ignition relay [fuse block (J/B)] control	Output	Ignition switch	OFF or ACC	0 V
					ON	Battery voltage

A
B
C
D
E
F
G
H
I
J
K
DEF
M
N
O
P

DEF

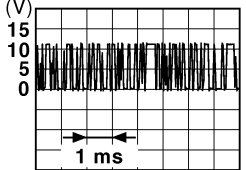
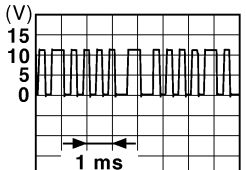
BCM (BODY CONTROL MODULE)

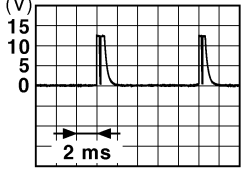
< ECU DIAGNOSIS INFORMATION >

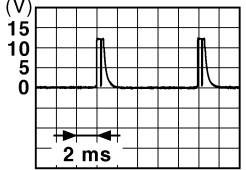
Terminal No. (Wire color)		Description		Condition	Value (Approx.)	
+	-	Signal name	Input/ Output			
83 (P)	Ground	Remote keyless entry receiver communication	Input/ Output	During waiting	 <small>JMKIA0064GB</small>	
				When operating either button on Intelligent Key	 <small>JMKIA0065GB</small>	
87 (R)	Ground	Combination switch INPUT 5	Input	Combination switch	All switches OFF (Wiper intermittent dial 4)	 <small>JPMIA0041GB</small> 1.4 V
					Front fog lamp switch ON (Wiper intermittent dial 4)	 <small>JPMIA0037GB</small> 1.3 V
					Rear wiper switch ON (Wiper intermittent dial 4)	 <small>JPMIA0039GB</small> 1.3 V
					Any of the conditions below with all switches OFF <ul style="list-style-type: none"> • Wiper intermittent dial 1 • Wiper intermittent dial 2 • Wiper intermittent dial 6 • Wiper intermittent dial 7 	 <small>JPMIA0040GB</small> 1.3 V

BCM (BODY CONTROL MODULE)

< ECU DIAGNOSIS INFORMATION >

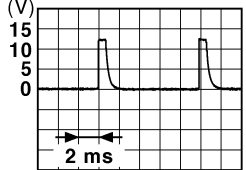
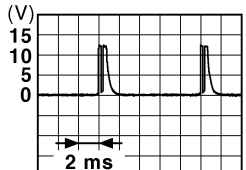
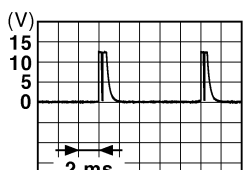
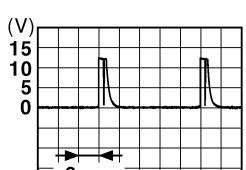
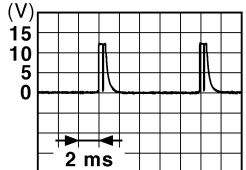
Terminal No. (Wire color)		Description		Condition	Value (Approx.)	
+	-	Signal name	Input/ Output			
88 (GR)	Ground	Combination switch INPUT 3	Input	Combination switch	All switches OFF (Wiper intermittent dial 4)	 <p style="text-align: center;">1.4 V</p>
					Lighting switch HI (Wiper intermittent dial 4)	 <p style="text-align: center;">1.3 V</p>
					Lighting switch 2ND (Wiper intermittent dial 4)	 <p style="text-align: center;">1.3 V</p>
					Rear washer switch ON (Wiper intermittent dial 4)	 <p style="text-align: center;">1.3 V</p>
					Any of the conditions below with all switches OFF	 <p style="text-align: center;">1.3 V</p>
89 (BR)	Ground	Push-button ignition switch (push switch)	Input	Push-button ignition switch (push switch)	Pressed	0 V
				Not pressed	Battery voltage	
90 (P)	Ground	CAN - L	Input/ Output	—	—	
91 (L)	Ground	CAN - H	Input/ Output	—	—	

A
B
C
D
E
F
G
H
I
J
K
DEF
M
N
O
P



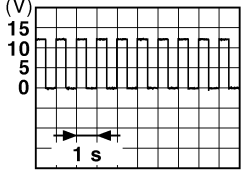
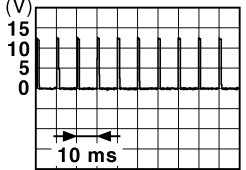
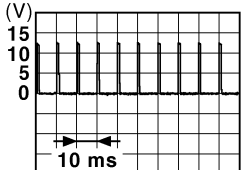

BCM (BODY CONTROL MODULE)

< ECU DIAGNOSIS INFORMATION >

Terminal No. (Wire color)		Description		Condition	Value (Approx.)	
+	-	Signal name	Input/ Output			
92 (R)	Ground	Key slot illumination	Output	Key slot illumination	OFF	0 V
					Blinking	 <p style="text-align: right; font-size: small;">JPMA0015GB</p>
93 (P)	Ground	ON indicator lamp	Output	Ignition switch	OFF (LOCK and ACC indicator lamps are not illuminated.)	Battery voltage
					ON	0 V
95 (L)	Ground	ACC relay control	Output	Ignition switch	OFF	0 V
					ACC or ON	Battery voltage
96 (Y)	Ground	CVT shift selector (detention switch) power supply	Output	—	Battery voltage	
97*1 (O)	Ground	Steering lock condition No. 1	Input	Steering lock	LOCK status	0 V
					UNLOCK status	Battery voltage
98*1 (L)	Ground	Steering lock condition No. 2	Input	Steering lock	LOCK status	Battery voltage
					UNLOCK status	0 V
99 (V)	Ground	Selector lever P position switch	Input	Selector lever	P position	0 V
					Any position other than P	Battery voltage
100 (P)	Ground	Passenger door request switch	Input	Passenger door request switch	ON (Pressed)	0 V
					OFF (Not pressed)	 <p style="text-align: right; font-size: small;">JPMA0016GB</p>
101 (W)	Ground	Driver door request switch	Input	Driver door request switch	ON (Pressed)	0 V
					OFF (Not pressed)	 <p style="text-align: right; font-size: small;">JPMA0016GB</p>
102 (Y)	Ground	Blower fan motor relay control	Output	Ignition switch	OFF or ACC	0 V
					ON	Battery voltage
103 (L)	Ground	Remote keyless entry receiver power supply	Output	Ignition switch OFF	Battery voltage	

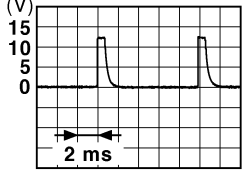
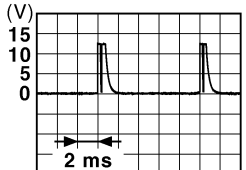
BCM (BODY CONTROL MODULE)

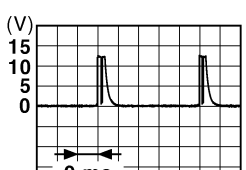
< ECU DIAGNOSIS INFORMATION >

Terminal No. (Wire color)		Description		Condition	Value (Approx.)	
		Signal name	Input/ Output			
+	-					
106*1 (Y)	Ground	Steering lock unit power supply	Output	Ignition switch	OFF or ACC	Battery voltage
					ON	0 V
107 (O)	Ground	Combination switch INPUT 1	Input	Combination switch (Wiper intermittent dial 4)	All switches OFF	 <p style="text-align: center;">1.4 V</p>
					Turn signal switch LH	 <p style="text-align: center;">1.3 V</p>
					Turn signal switch RH	 <p style="text-align: center;">1.3 V</p>
					Front wiper switch LO	 <p style="text-align: center;">1.3 V</p>
					Front washer switch ON	 <p style="text-align: center;">1.3 V</p>

A
B
C
D
E
F
G
H
I
J
K
DEF
M
N
O
P



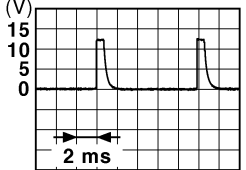
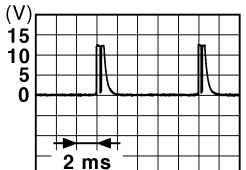
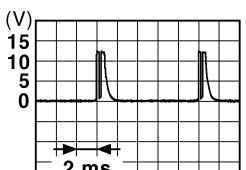
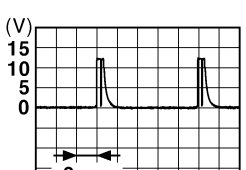
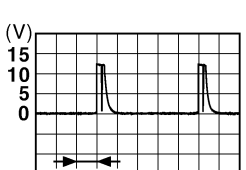

BCM (BODY CONTROL MODULE)

< ECU DIAGNOSIS INFORMATION >

Terminal No. (Wire color)		Description		Condition	Value (Approx.)	
		Signal name	Input/ Output			
+	-					
108 (P)	Ground	Combination switch INPUT 4	Input	Combination switch	All switches OFF (Wiper intermittent dial 4)	 <small>JPMIA0041GB</small> 1.4 V
					Lighting switch AUTO (Wiper intermittent dial 4)	 <small>JPMIA0038GB</small> 1.3 V
					Lighting switch 1ST (Wiper intermittent dial 4)	 <small>JPMIA0036GB</small> 1.3 V
					Rear wiper switch INT (Wiper intermittent dial 4)	 <small>JPMIA0040GB</small> 1.3 V
					Any of the conditions below with all switches OFF	 <small>JPMIA0039GB</small> 1.3 V

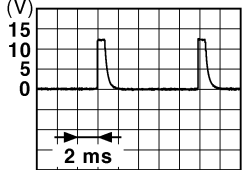
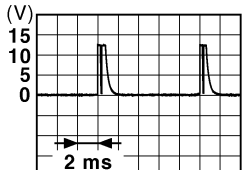
BCM (BODY CONTROL MODULE)

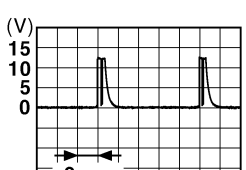
< ECU DIAGNOSIS INFORMATION >

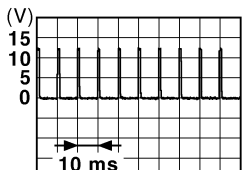
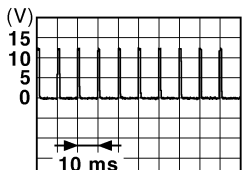
Terminal No. (Wire color)		Description		Condition	Value (Approx.)	
+	-	Signal name	Input/ Output			
109 (SB)	Ground	Combination switch INPUT 2	Input	Combination switch (Wiper intermittent dial 4)	All switches OFF	 1.4 V
					Lighting switch PASS	 1.3 V
					Lighting switch 2ND	 1.3 V
					Front wiper switch INT/ AUTO	 1.3 V
					Front wiper switch HI	 1.3 V
					ON	0 V
110 (G)	Ground	Hazard switch	Input	Hazard switch	 1.1 V	
				OFF	 1.1 V	

A
B
C
D
E
F
G
H
I
J
K
DEF
M
N
O
P

BCM (BODY CONTROL MODULE)

< ECU DIAGNOSIS INFORMATION >

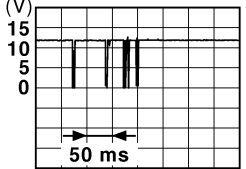
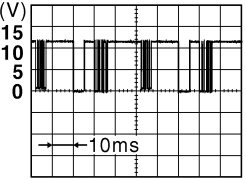
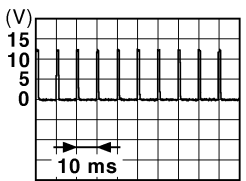
Terminal No. (Wire color)		Description		Condition	Value (Approx.)	
+	-	Signal name	Input/ Output			
111*1 (LG)	Ground	Steering lock unit communication	Input/ Output	Steering lock	LOCK status	Battery voltage
					LOCK or UNLOCK	 <p style="text-align: right; font-size: small;">JMKIA0066GB</p>
					For 15 seconds after UN- LOCK	Battery voltage
				15 seconds or later after UNLOCK	0 V	
112 (R)	Ground	Rain sensor serial link	Input/ Output	Ignition switch ON	 <p style="text-align: right; font-size: small;">JPMIA0156GB</p>	
					8.7 V	
113 (O)	Ground	Optical sensor	Input	Ignition switch ON	When bright outside of the vehicle	Close to 5 V
				When dark outside of the vehicle	Close to 0 V	
116 (GR)	Ground	Stop lamp switch 1	Input	—	Battery voltage	
118 (L)	Ground	Stop lamp switch 2	Input	Stop lamp switch	OFF (Brake pedal is not depressed)	0 V
					ON (Brake pedal is de- pressed)	Battery voltage
119 (W)	Ground	Front door lock as- sembly driver side (Unlock sensor)	Input	Driver door	LOCK status (unlock sen- sor switch OFF)	 <p style="text-align: right; font-size: small;">JPMIA0012GB</p>
					UNLOCK status (unlock sensor switch ON)	1.1 V
					0 V	
121 (Y)	Ground	Key slot switch	Input	When Intelligent Key is inserted into key slot	Battery voltage	
				When Intelligent Key is not inserted into key slot	0 V	
123 (G)	Ground	IGN feedback	Input	Ignition switch	OFF or ACC	0 V
				ON	Battery voltage	

BCM (BODY CONTROL MODULE)

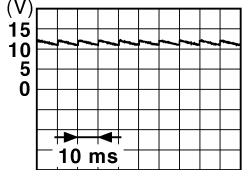
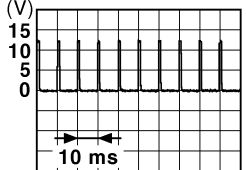
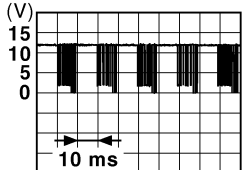
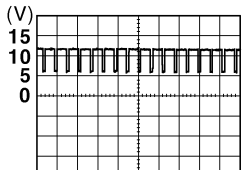

< ECU DIAGNOSIS INFORMATION >

Terminal No. (Wire color)		Description		Condition	Value (Approx.)
+	-	Signal name	Input/ Output		
124 (R)	Ground	Passenger door switch	Input	Passenger door switch	 <p style="text-align: center;">11.8 V</p>
				OFF (When passenger door closes)	0 V
130*2 (BR)	Ground	Rear window defog- ger switch	Input	Ignition switch ON	 <p style="text-align: center;">1.1 V</p>
				Rear window defogger switch ON	0 V
132 (G)	Ground	Power window switch communication	Input/ Output	Ignition switch ON	 <p style="text-align: center;">10.2 V</p>
				Ignition switch OFF or ACC	Battery voltage
133 (W)	Ground	Push-button ignition switch illumination	Output	Push-button igni- tion switch illumi- nation	<p style="text-align: center;">NOTE: The pulse width of this wave is varied by the illumination bright- ening/dimming level.</p>  <p style="text-align: center;">9.5 V</p>
				ON (When tail lamps OFF)	0 V
				ON (When tail lamps ON)	0 V
134 (R)	Ground	LOCK indicator lamp	Output	LOCK indicator lamp	Battery voltage
				OFF (ACC and ON indica- tor lamps are not illuminat- ed.)	0 V
137 (P)	Ground	Receiver and sensor ground	Input	Ignition switch ON	0 V
138 (V)	Ground	Receiver and sensor power supply	Output	Ignition switch	0 V
				ACC or ON	5.0 V

A
B
C
D
E
F
G
H
I
J
K
DEF
M
N
O
P

BCM (BODY CONTROL MODULE)

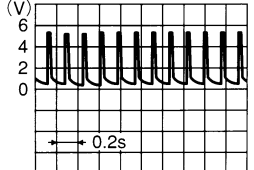
< ECU DIAGNOSIS INFORMATION >

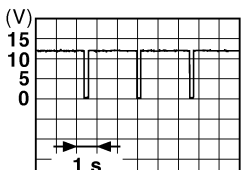
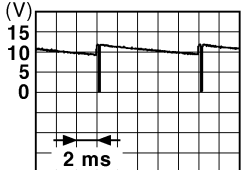
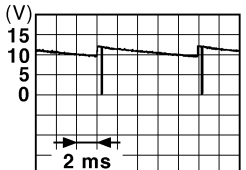
Terminal No. (Wire color)		Description		Condition	Value (Approx.)
+	-	Signal name	Input/ Output		
139 (O)	Ground	Tire pressure receiver communication	Input/ Output	Ignition switch ON	Standby state  OCC3881D
				When receiving the signal from the transmitter  OCC3880D	
140 (GR)	Ground	Selector lever P/N position	Input	Selector lever	P or N position Battery voltage
				Except P and N positions	0 V
141 (O)	Ground	Security indicator	Output	Security indicator	ON 0 V
				Blinking  JPMA0014GB 11.3 V	
				OFF Battery voltage	
142 (L)	Ground	Combination switch OUTPUT 5	Output	Combination switch (Wiper intermittent dial 4)	All switches OFF 0 V
				Lighting switch 1ST	 JPMA0031GB 10.7 V
				Lighting switch HI	
				Lighting switch 2ND	
Turn signal switch RH					
143 (W)	Ground	Combination switch OUTPUT 1	Output	Combination switch	All switches OFF (Wiper intermittent dial 4) 0 V
				Front wiper switch HI (Wiper intermittent dial 4)	 JPMA0032GB 10.7 V
				Rear wiper switch INT (Wiper intermittent dial 4)	
				Any of the conditions below with all switches OFF • Wiper intermittent dial 1 • Wiper intermittent dial 2 • Wiper intermittent dial 3 • Wiper intermittent dial 6 • Wiper intermittent dial 7	

BCM (BODY CONTROL MODULE)

< ECU DIAGNOSIS INFORMATION >

Terminal No. (Wire color)		Description		Condition	Value (Approx.)	
+	-	Signal name	Input/ Output			
144 (P)	Ground	Combination switch OUTPUT 2	Output	Combination switch	All switches OFF (Wiper intermittent dial 4)	0 V
					Front washer switch ON (Wiper intermittent dial 4)	
					Rear wiper switch ON (Wiper intermittent dial 4)	
					Rear washer switch ON (Wiper intermittent dial 4)	
					Any of the conditions below with all switches OFF <ul style="list-style-type: none"> • Wiper intermittent dial 1 • Wiper intermittent dial 5 • Wiper intermittent dial 6 	
145 (V)	Ground	Combination switch OUTPUT 3	Output	Combination switch (Wiper intermit- tent dial 4)	All switches OFF	0 V
					Front wiper switch INT/ AUTO	
					Front wiper switch LO	
					Lighting switch AUTO	
146 (Y)	Ground	Combination switch OUTPUT 4	Output	Combination switch (Wiper intermit- tent dial 4)	All switches OFF	0 V
					Front fog lamp switch ON	
					Lighting switch 2ND	
					Lighting switch PASS	
					Turn signal switch LH	
149 (W)	Ground	Tire pressure warn- ing check switch	Input	Ignition switch ON		11.8 V
						11.8 V
150 (SB)	Ground	Driver door switch	Input	Driver door switch	OFF (When driver door closes)	11.8 V
					ON (When driver door opens)	0 V

A
B
C
D
E
F
G
H
I
J
K
DEF
M
N
O
P

BCM (BODY CONTROL MODULE)

< ECU DIAGNOSIS INFORMATION >

Terminal No. (Wire color)		Description		Condition		Value (Approx.)
+	-	Signal name	Input/ Output			
151 (G)	Ground	Rear window defogger relay control	Output	Rear window defogger	Active	0 V
					Not activated	Battery voltage

NOTE:

- *1: With steering lock unit
- *2: Without BOSE audio system

BCM (BODY CONTROL MODULE)

< ECU DIAGNOSIS INFORMATION >

Wiring Diagram - BCM -

INFOID:000000005683245

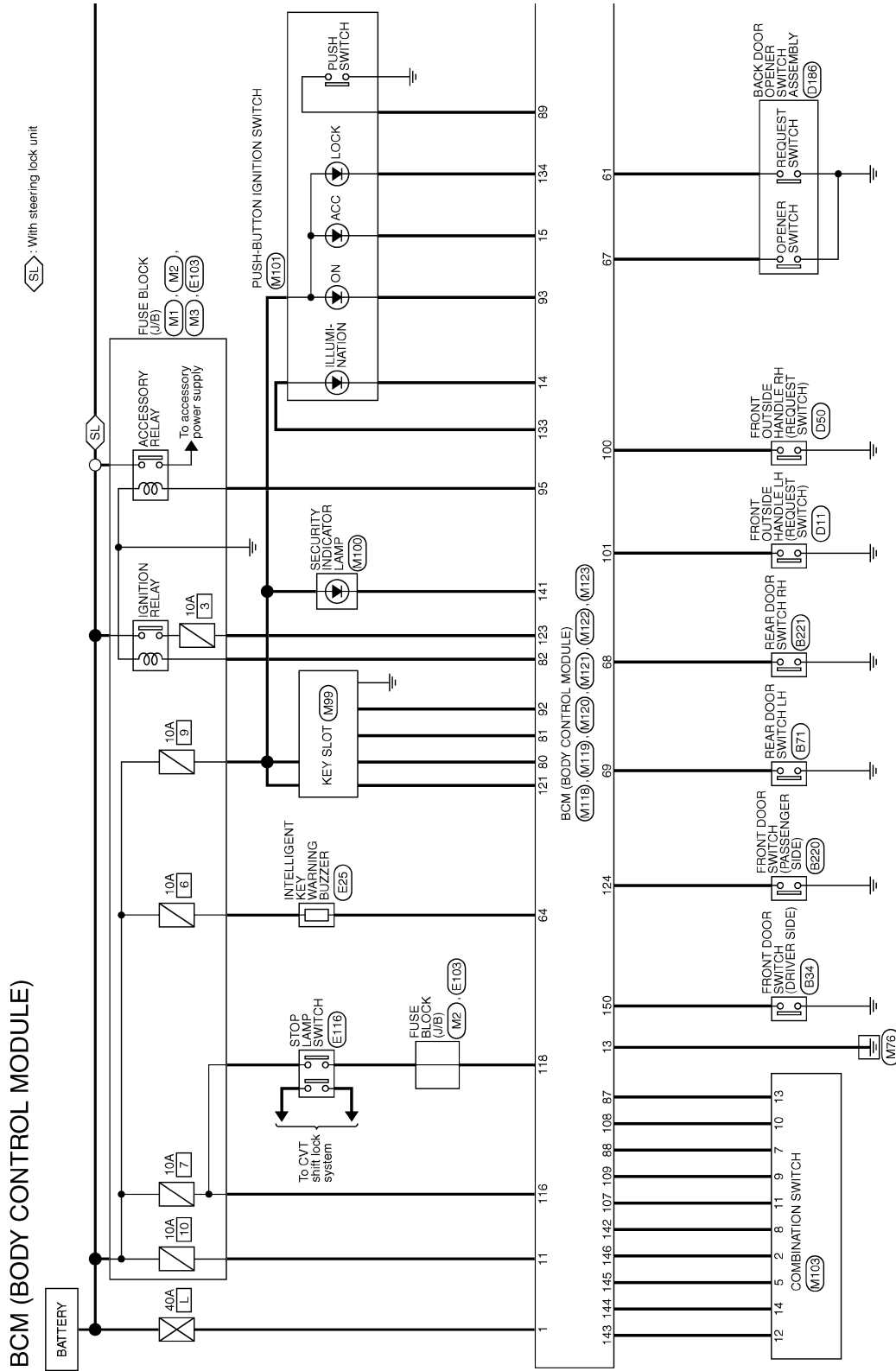

SL: With steering lock unit

A
B
C
D
E
F
G
H
I
J
K
DEF
M
N
O
P

2009/08/07

JCMWM4865GB

BCM (BODY CONTROL MODULE)

< ECU DIAGNOSIS INFORMATION >

- : Except for Mexico
- : With power seat without automatic drive positioner
- : With steering lock unit

* : This connector is not shown in "Harness Layout".

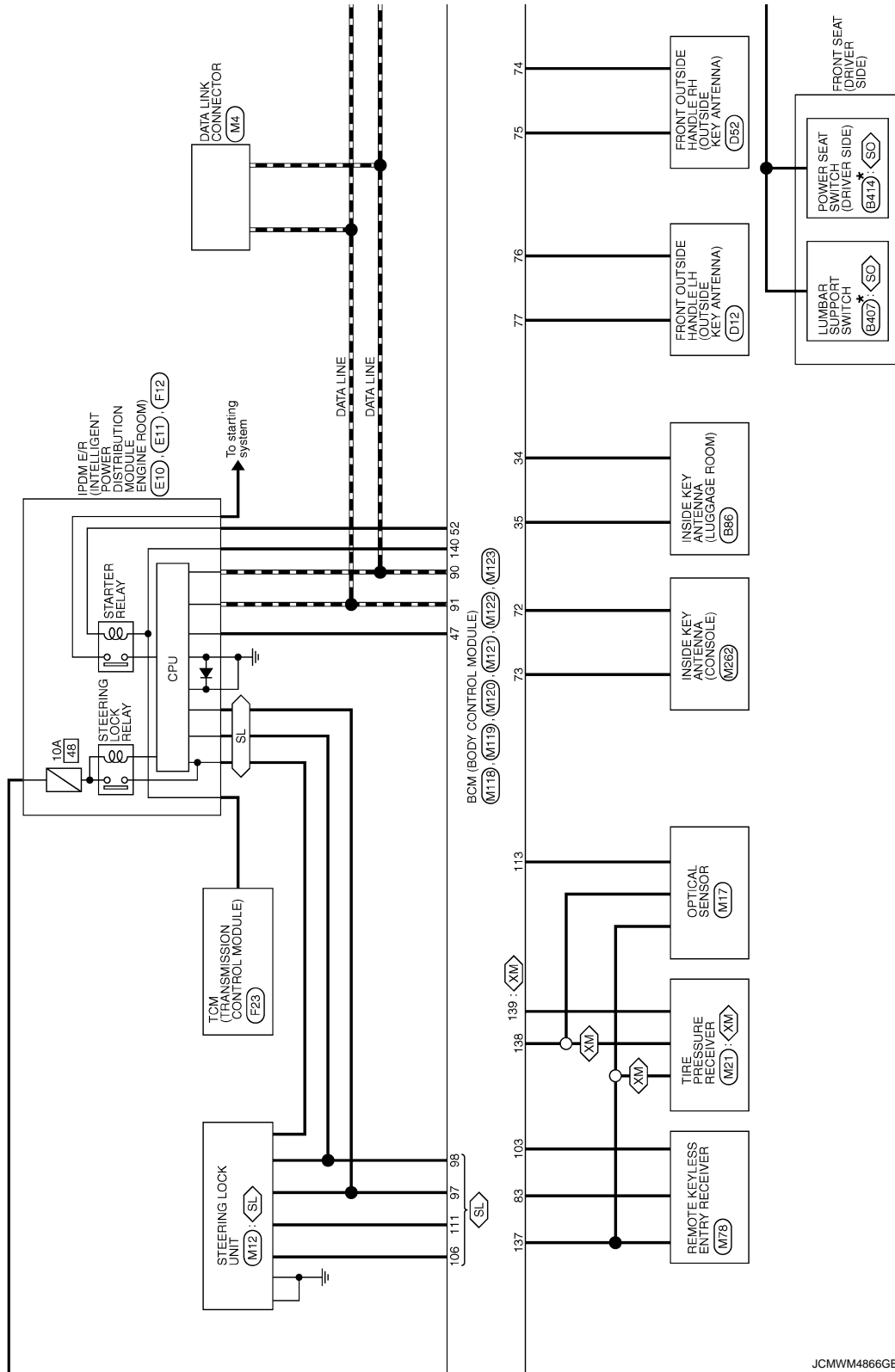

JCMWM4866GB

BCM (BODY CONTROL MODULE)

< ECU DIAGNOSIS INFORMATION >

- ◊NV◊ : With navigation system
- ◊BO◊ : With BOSE system without navigation system
- ◊RF◊ : With sunroof
- ◊PM◊ : With automatic drive positioner
- ◊SO◊ : With power seat without automatic drive positioner
- ◊AB◊ : With automatic back door

* : This connector is not shown in "Harness Layout".

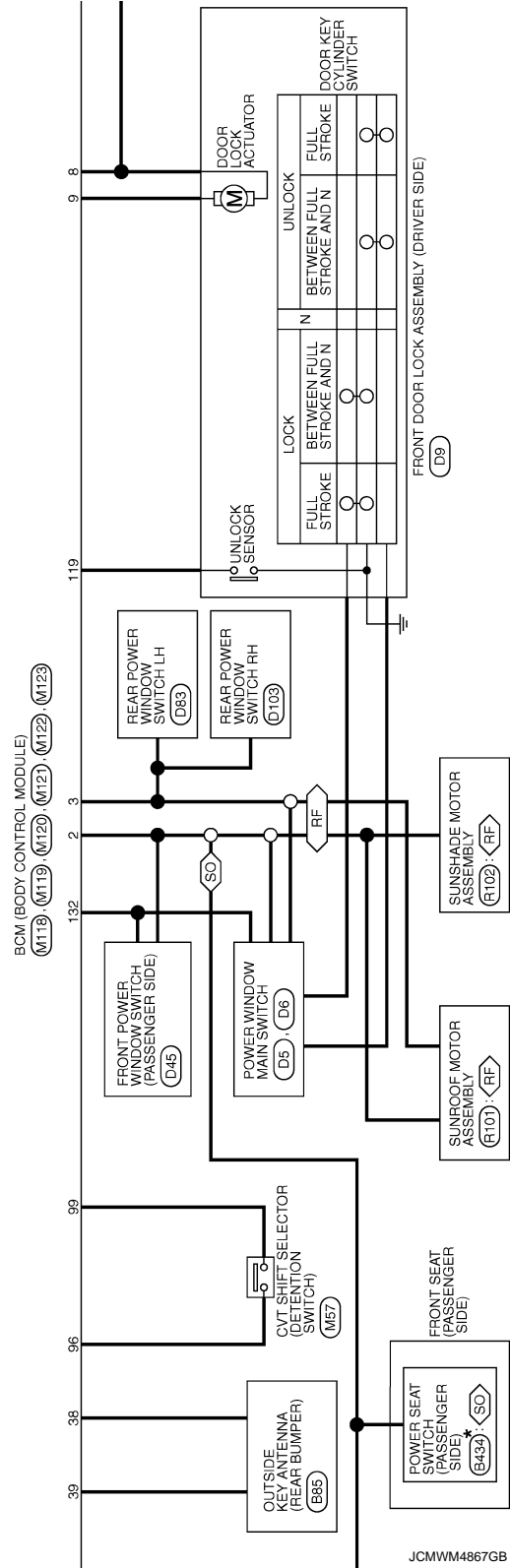
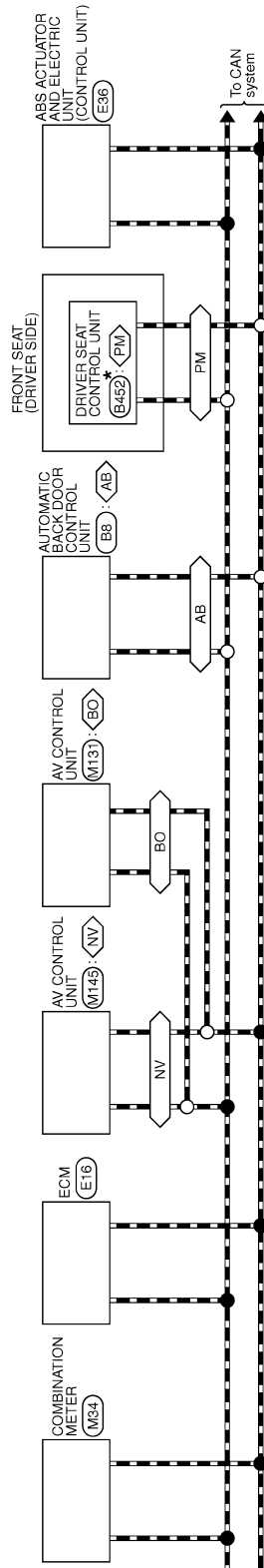

A
B
C
D
E
F
G
H
I
J
K
DEF
M
N
O
P

BCM (BODY CONTROL MODULE)

< ECU DIAGNOSIS INFORMATION >

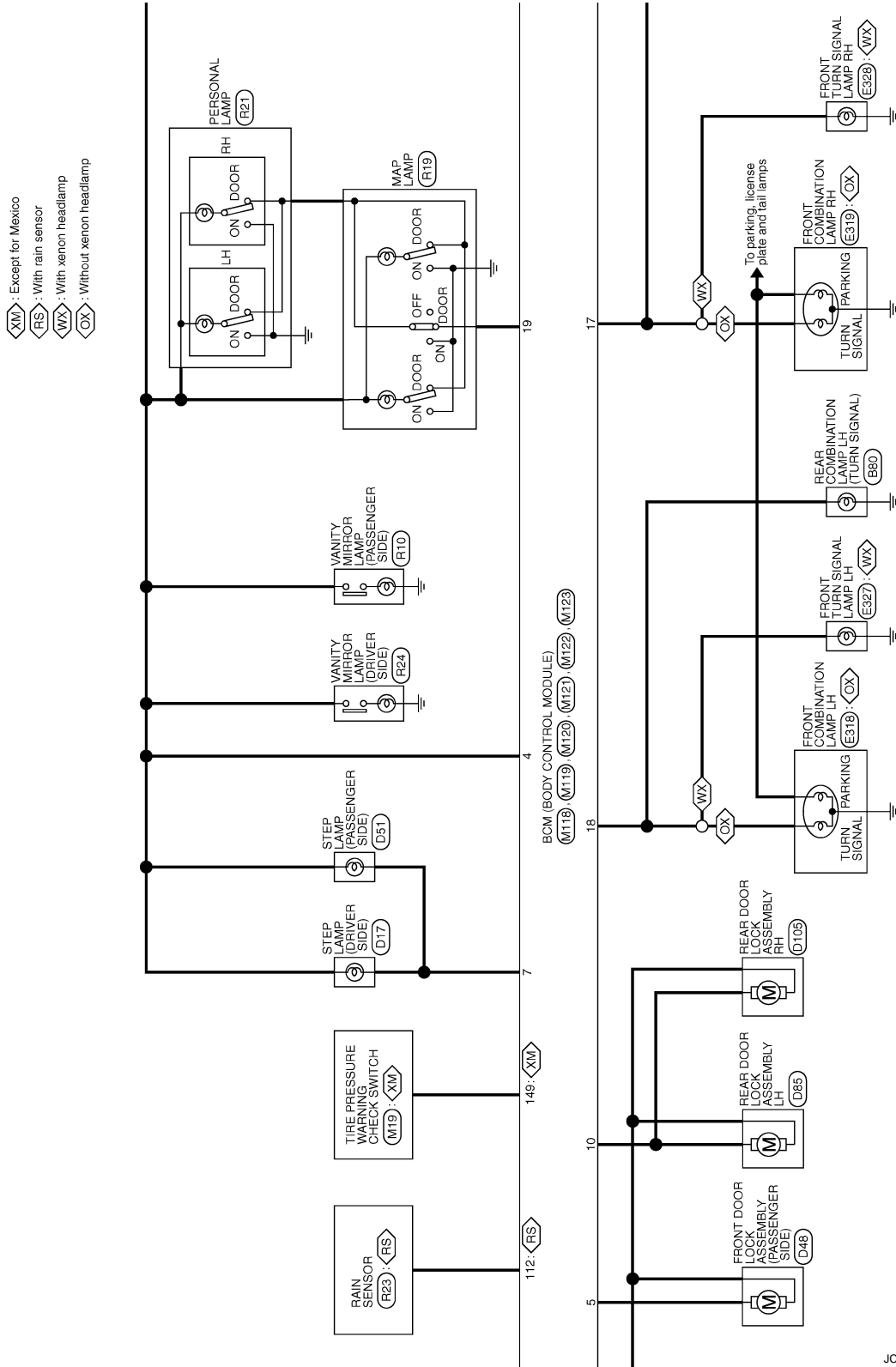

JCMWM4868GB

BCM (BODY CONTROL MODULE)

< ECU DIAGNOSIS INFORMATION >

◊AB◊ : With automatic back door
 ◊OA◊ : Without automatic back door

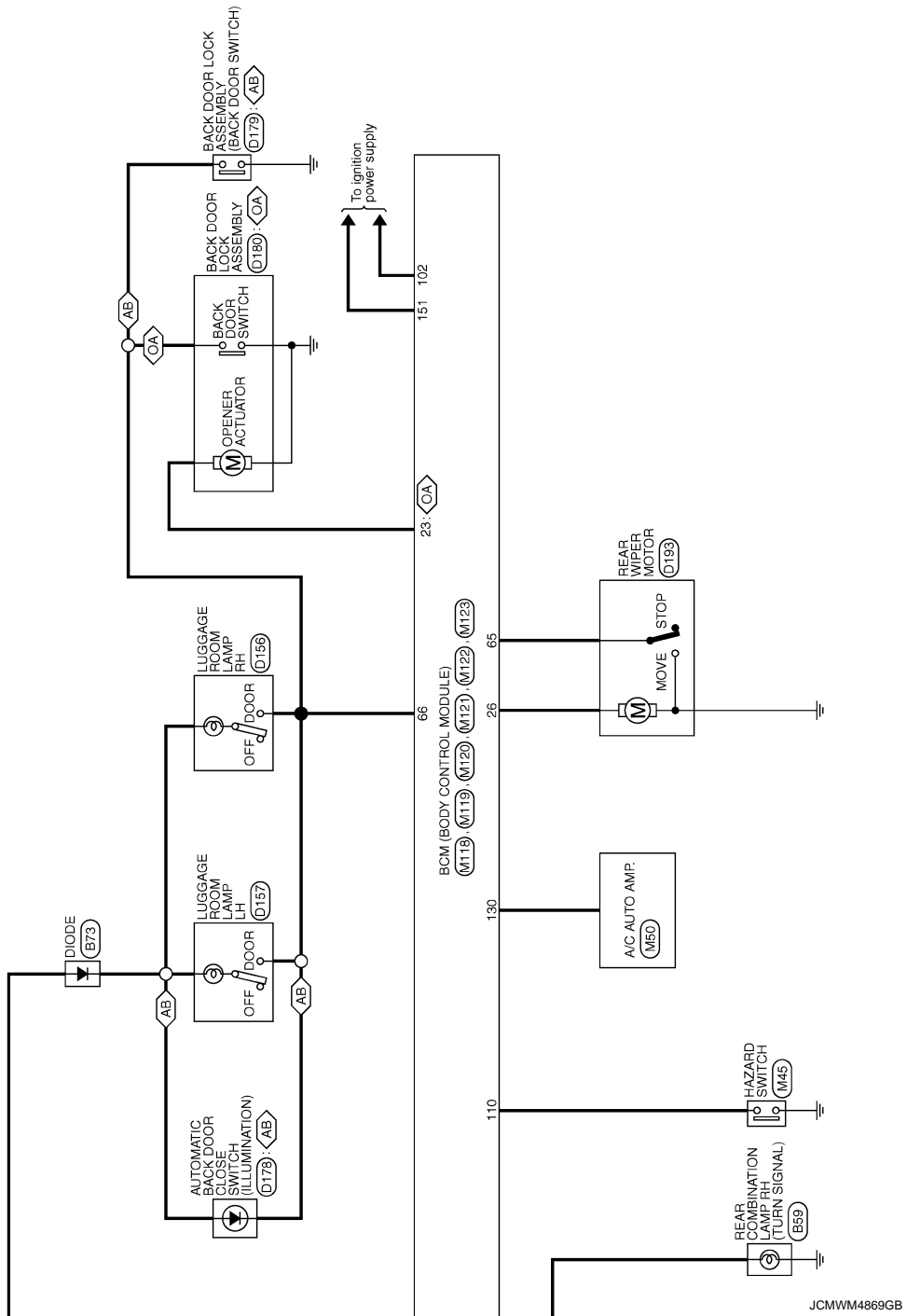

A
B
C
D
E
F
G
H
I
J
K
DEF
M
N
O
P

BCM (BODY CONTROL MODULE)

< ECU DIAGNOSIS INFORMATION >

BCM (BODY CONTROL MODULE)

Connector No.	B8
Connector Name	AUTOMATIC BACK DOOR CONTROL UNIT
Connector Type	THE2FW-TB6

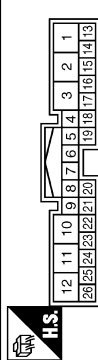

Terminal No.	Color of Wire	Signal Name [Specification]
1	BR	BUZZER
2	Y	ABD SW
4	Y	ABD CLOSE SW
6	L	CAN HI
7	P	CAN LOW
8	LG	HALF LATCH SW
9	GR	IGN
10	SB	BAT
11	V	CLOSURE MTR (CLOSE)
12	R	CLOSURE MTR (OPEN)
14	V	TOUCH SENS LH
15	O	TOUCH SENS GND
16	W	TOUCH SENS RH
17	LG	MAIN SW
19	P	CLOSE SW
20	L	OPEN SW
21	B	GND
22	B	GND
23	GR	GND
24	BR	ENCODER B
25	Y	ENCODER A
26	G	ENCODER PWR

Connector No.	B84
Connector Name	FRONT DOOR SWITCH (DRIVER SIDE)
Connector Type	A03FW

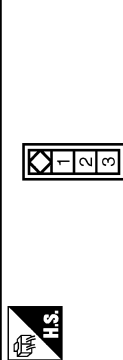

Terminal No.	Color of Wire	Signal Name [Specification]
1		
2		
3		

2	SB
---	----

Connector No.	B59
Connector Name	REAR COMBINATION LAMP RH
Connector Type	NS0AMW-CS

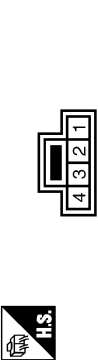

Terminal No.	Color of Wire	Signal Name [Specification]
1	LG	[With rear view camera]
2	BR	[Without rear view camera]
3	P	
4	L	

Connector No.	B71
Connector Name	REAR DOOR SWITCH LH
Connector Type	A03FW

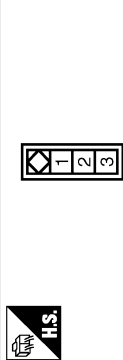

Terminal No.	Color of Wire	Signal Name [Specification]
2	BR	

Connector No.	B73
Connector Name	DIODE
Connector Type	24335-C902

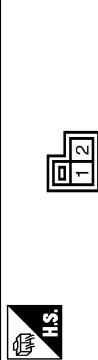

Terminal No.	Color of Wire	Signal Name [Specification]
1	W	
2	L	

Connector No.	B80
Connector Name	REAR COMBINATION LAMP LH
Connector Type	NS0AMW-CS

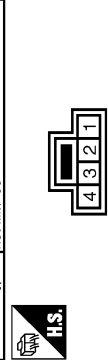

Terminal No.	Color of Wire	Signal Name [Specification]
1	B	
2	Y	
3	P	
4	L	

Connector No.	B85
Connector Name	OUTSIDE KEY ANTENNA (REAR BUMPER)
Connector Type	RK02FGY



Terminal No.	Color of Wire	Signal Name [Specification]
1		
2		

1	R
2	G

Connector No.	B86
Connector Name	INSIDE KEY ANTENNA (LUGGAGE ROOM)
Connector Type	RK02FGY



Terminal No.	Color of Wire	Signal Name [Specification]
1	W	
2	B	

Connector No.	BZ20
Connector Name	FRONT DOOR SWITCH (PASSENGER SIDE)
Connector Type	A03FW

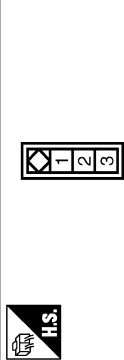

Terminal No.	Color of Wire	Signal Name [Specification]
2	R	

JCMWM4870GB

BCM (BODY CONTROL MODULE)

< ECU DIAGNOSIS INFORMATION >

BCM (BODY CONTROL MODULE)

Connector No.	B221
Connector Name	REAR DOOR SWITCH RH
Connector Type	AS3FW

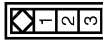

Terminal No.	Color of Wire	Signal Name [Specification]
2	W	-

Connector No.	B407
Connector Name	LUMBAR SUPPORT SWITCH
Connector Type	NS4AFBR-CS



Terminal No.	Color of Wire	Signal Name [Specification]
11	O	-
12	LG	-
13	Y/W	-
14	Y	-

Connector No.	B414
Connector Name	POWER SEAT SWITCH (DRIVER SIDE)
Connector Type	NS10FW-CS



Terminal No.	Color of Wire	Signal Name [Specification]
1	R	-

2	B	-
3	LG	-
4	G/R	-
5	V	-
6	R/L	-
7	L	-
8	L/W	-
9	L/R	-
10	L/B	-

Connector No.	B434
Connector Name	POWER SEAT SWITCH (PASSENGER SIDE)
Connector Type	NS10FW-CS



Terminal No.	Color of Wire	Signal Name [Specification]
1	R	-
2	B	-
3	G	-
4	G/R	-
5	V	-
6	R/L	-

Connector No.	B452
Connector Name	DRIVER SEAT CONTROL UNIT
Connector Type	TR432FW

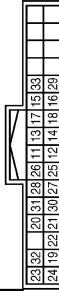

Terminal No.	Color of Wire	Signal Name [Specification]
11	G/B	-
12	G/W	-
13	R/G	-
14	R/W	-
15	Y/B	-

16	Y/R	-
17	LG/B	-
18	LC/R	-
19	G/Y	-
20	R/Y	-
21	L/Y	-
22	BR/Y	-
23	P	-
24	P/L	-
25	G/O	-
26	L/O	-
27	V	-
28	V/W	-
29	O/L	-
30	BR	-
31	BR/W	-
32	W/L	-
33	W	-

Connector No.	D5
Connector Name	POWER WINDOW MAIN SWITCH
Connector Type	NS16FW-CS



Terminal No.	Color of Wire	Signal Name [Specification]
1	GR	-
2	W	-
3	BR	-
4	L	-
5	SB	-
6	R	-
7	P	-
8	L	-
9	G	-
10	V	-
11	LG	-
13	Y	-
14	O	-
15	R	-

Connector No.	D6
Connector Name	POWER WINDOW MAIN SWITCH
Connector Type	NS33FW-CS



Terminal No.	Color of Wire	Signal Name [Specification]
17	B	-
19	LG	-

Connector No.	D9
Connector Name	FRONT DOOR LOCK ASSEMBLY (DRIVER SIDE)
Connector Type	EB6FGY-RS

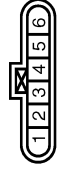

Terminal No.	Color of Wire	Signal Name [Specification]
1	V	-
2	G	-
3	P	-
4	B	-
5	R	-
6	L	-

JCMWM4871GB

A
B
C
D
E
F
G
H
I
J
K
DEF
M
N
O
P

BCM (BODY CONTROL MODULE)

< ECU DIAGNOSIS INFORMATION >

BCM (BODY CONTROL MODULE)

Connector No.	D11
Connector Name	FRONT OUTSIDE HANDLE LH (REQUEST SWITCH)
Connector Type	RK02FB



Terminal No.	Color of Wire	Signal Name [Specification]
1	W	-
2	B	-

Connector No.	D12
Connector Name	FRONT OUTSIDE HANDLE LH (OUTSIDE KEY ANTENNA)
Connector Type	RK02MGY



Terminal No.	Color of Wire	Signal Name [Specification]
1	P	-
2	V	-

Connector No.	D17
Connector Name	STEP LAMP (DRIVER SIDE)
Connector Type	G02FW



Terminal No.	Color of Wire	Signal Name [Specification]
1	G	-
2	R	-

Connector No.	D45
Connector Name	FRONT POWER WINDOW SWITCH (PASSENGER SIDE)
Connector Type	NS10FW-CS



Terminal No.	Color of Wire	Signal Name [Specification]
3	W	-
4	R	-
8	L	-
9	LG	-
10	P	-
11	B	-
12	Y	-
13	G	-
16	O	-

Connector No.	D48
Connector Name	FRONT DOOR LOCK ASSEMBLY (PASSENGER SIDE)
Connector Type	E06FGY-RS



Terminal No.	Color of Wire	Signal Name [Specification]
5	V	-
6	G	-

Connector No.	D50
Connector Name	FRONT OUTSIDE HANDLE RH (REQUEST SWITCH)
Connector Type	RK02FB



Terminal No.	Color of Wire	Signal Name [Specification]
1	O	-
2	B	-

Connector No.	D51
Connector Name	STEP LAMP (PASSENGER SIDE)
Connector Type	G02FW



Terminal No.	Color of Wire	Signal Name [Specification]
1	G	-
2	R	-

Connector No.	D52
Connector Name	FRONT OUTSIDE HANDLE RH (OUTSIDE KEY ANTENNA)
Connector Type	RK02MGY



Terminal No.	Color of Wire	Signal Name [Specification]
1	LG	-
2	W	-

Connector No.	D83
Connector Name	REAR POWER WINDOW SWITCH LH
Connector Type	NS08FW-CS

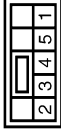

Terminal No.	Color of Wire	Signal Name [Specification]
1	R	-
2	P	-
3	SB	-
4	LG	-
5	L	-

Connector No.	D85
Connector Name	REAR DOOR LOCK ASSEMBLY LH
Connector Type	E06FGY-RS



Terminal No.	Color of Wire	Signal Name [Specification]
1	V	-
2	G	-

JCMWM4872GB

BCM (BODY CONTROL MODULE)

< ECU DIAGNOSIS INFORMATION >

BCM (BODY CONTROL MODULE)

Connector No.	D103
Connector Name	REAR POWER WINDOW SWITCH RH
Connector Type	NS8FW-CS

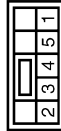

Terminal No.	Color of Wire	Signal Name [Specification]
1	R	-
2	P	-
3	SB	-
4	LG	-
5	L	-

Connector No.	D105
Connector Name	REAR DOOR LOCK ASSEMBLY RH
Connector Type	ED8FG-RS



Terminal No.	Color of Wire	Signal Name [Specification]
5	V	-
6	G	-

Connector No.	D156
Connector Name	LUGGAGE ROOM LAMP RH
Connector Type	CJ04FW



Terminal No.	Color of Wire	Signal Name [Specification]
2	W	-
4	LG	-

Connector No.	D157
Connector Name	LUGGAGE ROOM LAMP LH
Connector Type	CJ04FW



Terminal No.	Color of Wire	Signal Name [Specification]
2	W	-
4	LG	-

Connector No.	D178
Connector Name	AUTOMATIC BACK DOOR CLOSE SWITCH
Connector Type	TK08FGY



Terminal No.	Color of Wire	Signal Name [Specification]
1	O	-
2	B	-
3	W	-
4	LG	-

Connector No.	D179
Connector Name	BACK DOOR LOCK ASSEMBLY WITH AUTOMATE BACK DOOR
Connector Type	NS8FW-CS

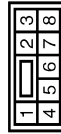

Terminal No.	Color of Wire	Signal Name [Specification]
1	R	-
2	V	-
4	G	-
5	L	-
6	W	-
7	LG	-
8	B	-

Connector No.	D180
Connector Name	BACK DOOR LOCK ASSEMBLY WITHOUT AUTOMATE BACK DOOR
Connector Type	NS8FW-CS



Terminal No.	Color of Wire	Signal Name [Specification]
1	BR	-
2	B	-
3	LG	-
4	B	-

Connector No.	D186
Connector Name	BACK DOOR OPENER SWITCH ASSEMBLY
Connector Type	TR06MF-NH



Terminal No.	Color of Wire	Signal Name [Specification]
1	W	-
2	B	-
3	B	-
4	V	-

Connector No.	D193
Connector Name	REAR WIPER MOTOR
Connector Type	CJ04FW-1V



Terminal No.	Color of Wire	Signal Name [Specification]
1	G	-
3	GR	-
4	O	-

A
B
C
D
E
F
G
H
I
J
K
DEF
M
N
O
P

BCM (BODY CONTROL MODULE)

< ECU DIAGNOSIS INFORMATION >

BCM (BODY CONTROL MODULE)

Connector No.	E10
Connector Name	ENGINE INTELLIGENT POWER DISTRIBUTION MODULE (ENGINE I/PD/M)
Connector Type	TH20FW-CS12-M4-TV

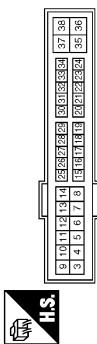

Terminal No.	Color of Wire	Signal Name [Specification]
4	LG	-
5	Y	-
7	GR	-
10	BR	-
11	P	-
12	B	-
13	SB	-
15	W	-
16	L/Y	-
18	Y	-
20	L	-
21	O	-
22	SB	-
23	GR	-
24	G	-
25	GR	-
26	Y	-
27	W	-
28	SB	-
30	BR	-
32	V	-
33	G	-
34	O	-
35	P	-
36	G	-
38	GR	-

Connector No.	E11
Connector Name	ENGINE INTELLIGENT POWER DISTRIBUTION MODULE (ENGINE I/PD/M)
Connector Type	TH40FW-NH



Terminal No.	Color of Wire	Signal Name [Specification]
39	P	-
40	L	-
41	B	-
42	SB	-
43	Y	-
44	W	-
45	O	-
46	BR	-

Connector No.	E16
Connector Name	ECM
Connector Type	RH42FB-RZ8-L-LH

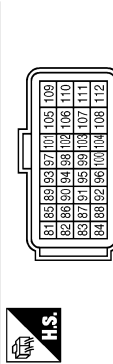

Terminal No.	Color of Wire	Signal Name [Specification]
81	W	APSI
82	O	APSZ
83	BR	AVCC1-APSI
84	B	GND-APSI
85	Y	ASCD SW
86	SB	FTPRES
87	GR	AVCC2-APSZ
88	O	KLINE
91	L	AVCC2-FTPRES
92	BR	GND-ASQDSW
93	BR	IGN SW
94	GR	TACHO(GABIN)
95	Y	TF
96	GR	GND-FTPRES

97	P	VEHCAN-L
98	L	VEHCAN-H
100	G	GND-APSZ
102	B	NEUT-T
104	SB	GND-TF
105	V	NBR
106	SB	BRAKE
107	B	GND
108	B	GND
109	W	ODCV
110	G	ENCSW
111	B	GND
112	B	GND

Connector No.	E25
Connector Name	INTELLIGENT KEY WARNING BUZZER
Connector Type	RK03FB



Terminal No.	Color of Wire	Signal Name [Specification]
1	G	-
3	GR	-

Connector No.	E36
Connector Name	ABS ACTUATOR AND ELECTRIC UNIT (CONTROL UNIT)
Connector Type	AE22FB-AJZ4-LH

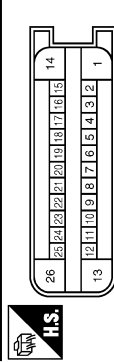

Terminal No.	Color of Wire	Signal Name [Specification]
1	R	VALVE/ECU SUPPLY
2	Y	WSS RL SIG(-)
3	L	WSS RL PWRC(-)
4	GR	CLUSTER SUPPLY
5	B	WSS FR PWRC(-)

6	W	WSS FR SIG(-)
7	LG	LIS
8	V	WSS FL SIG(-)
9	W	WSS FL PWRC(-)
10	SB	CLUSTER GND
11	P	WSS RR PWRC(-)
12	V	WSS RR SIG(-)
13	B/W	MOTOR GND
14	G	MOTOR SUPPLY
15	SB	BLS
16	O	DIAG K
18	O	DIAG H
19	BR	IGN
20	GR	GAMI L
21	P	VDC OFF SW
22	Y	GAMI L
23	L	GAMI H
25	W	VALVE/ECU GND
26	B/W	VALVE/ECU GND

Connector No.	E03
Connector Name	FUSE BLOCK (J/B)
Connector Type	NS15FW-CS

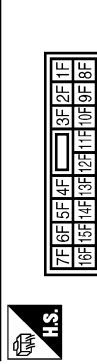

Terminal No.	Color of Wire	Signal Name [Specification]
1F	L	-
2F	LG	-
4F	BR	-
6F	Y	-
8F	R	-
11F	GR	-
12F	V	-

BCM (BODY CONTROL MODULE)

< ECU DIAGNOSIS INFORMATION >

BCM (BODY CONTROL MODULE)

Connector No.	E116
Connector Name	STOP LAMP SWITCH
Connector Type	MD4FW-LC



3	4
1	2

Terminal No.	Color of Wire	Signal Name [Specification]
1	R	-
2	LG	-
3	G	-
4	Y	-

Connector No.	E318
Connector Name	FRONT COMBINATION LAMP LH
Connector Type	Z08FER



3	2	1
---	---	---

Terminal No.	Color of Wire	Signal Name [Specification]
1	LG	-
2	B	-
3	Y	-

Connector No.	E319
Connector Name	FRONT COMBINATION LAMP RH
Connector Type	Z08FER



3	2	1
---	---	---

Terminal No.	Color of Wire	Signal Name [Specification]
1	R	-
2	B	-
3	G	-

Connector No.	E527
Connector Name	FRONT TURN SIGNAL LAMP LH
Connector Type	RS0ZFGY



2	1
---	---

Terminal No.	Color of Wire	Signal Name [Specification]
1	Y	-
2	B	-

Connector No.	E528
Connector Name	FRONT TURN SIGNAL LAMP RH
Connector Type	RS0ZFGY



2	1
---	---

Terminal No.	Color of Wire	Signal Name [Specification]
1	G	-
2	B	-

Connector No.	F12
Connector Name	INTEGRATED LIGHT POWER DISTRIBUTION MODULE ENGINE ROOM
Connector Type	TH20FW-CS12-M4



53	54	55	56	57	58	59	60	61	62	63	64	65	66	67	68	69	70	71	72	73	74	75	76	77	78	79	80
----	----	----	----	----	----	----	----	----	----	----	----	----	----	----	----	----	----	----	----	----	----	----	----	----	----	----	----

Terminal No.	Color of Wire	Signal Name [Specification]
48	W	-
49	R/B	-
51	LG	-
52	Y/G	-
53	R/W	-
54	G/W	-
55	W/L	-
56	R/Y	-
57	O	-
58	Y	-
69	W/B	-
70	O	-
72	R/B	-
75	LG	-
76	SB	-
77	GR	-
80	B	-

Connector No.	F23
Connector Name	TCM (TRANSMISSION CONTROL MODULE)
Connector Type	RM40FB-R2B-L-RH



31	32	33	34	35	36	37	38	39	40	47	48
21	22	23	24	25	26	27	28	29	30	45	46
11	12	13	14	15	16	17	18	19	20	43	44
1	2	3	4	5	6	7	8	9	10	41	42

Terminal No.	Color of Wire	Signal Name [Specification]
1	P/B	INH SW 2
2	P/L	INH SW 3
3	G/O	INH SW 4
4	GR	INH SW 3, MON
5	B	GND

Terminal No.	Color of Wire	Signal Name [Specification]
6	O	K-LINE
7	W	SENSOR GND
8	C/W	CLOCK (SEL2)
9	L/R	CHP-SELECT (SEL1)
10	BR/R	DATA I/O (SEL3)
11	BR/W	INH SW 1
13	V	ATF TEMP SENSOR
14	R/W	PRI PRESS SENSOR
15	V/W	SEC PRESS SENSOR
19	G/B	REV LAMP RELAY
20	R/B	STARTER RELAY
25	W/R	SENSOR GND
26	L/O	SENSOR POWER SOURCE(SV)
27	R/G	S/M-D
28	R	S/M-C
29	O/B	S/M-B
30	G/R	S/M-A
31	P	CAN-L
32	L	CAN-H
33	LG	PRI SPEED SENSOR
34	LG/R	SEC SPEED SENSOR
37	V/R	L/OASEL-ON/OFF SOL
38	L/W	L/OASEL LINEAR SOL
39	W/B	SEC- LINEAR SOL
40	R/Y	PL LINEAR SOL
42	B	GND
46	Y	VIGN
47	L/R	BAIT
48	Y	VIGN

A
B
C
D
E
F
G
H
I
J
K
DEF
M
N
O
P

BCM (BODY CONTROL MODULE)

< ECU DIAGNOSIS INFORMATION >

BCM (BODY CONTROL MODULE)

Connector No.	M1
Connector Name	FUSE BLOCK (J/B)
Connector Type	NS08FW-MZ



Terminal No.	Color of Wire	Signal Name [Specification]
1A	Y	-
2A	G	-
3A	Y	-
4A	GR	-
5A	R	-
6A	W	-
7A	LG	-
8A	Y	-

Connector No.	M2
Connector Name	FUSE BLOCK (J/B)
Connector Type	NS10FW-CS



Terminal No.	Color of Wire	Signal Name [Specification]
1B	W	-
2B	L	-
3B	G	-
4B	L	-
5B	L	-
6B	Y	-
7B	R	-
8B	R	-
9B	GR	-

Connector No.	M3
Connector Name	FUSE BLOCK (J/B)
Connector Type	NS12FW-CS



Terminal No.	Color of Wire	Signal Name [Specification]
6C	BR	-
7C	B	-
8C	G	-
9C	GR	-
10C	SR	-
11C	R	-
12C	O	-

Connector No.	M4
Connector Name	DATA LINK CONNECTOR
Connector Type	BD16FW

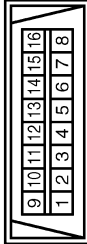

Terminal No.	Color of Wire	Signal Name [Specification]
4	B	-
5	B	-
6	L	-
7	O	-
8	G	-
14	P	-
16	Y	-

Connector No.	M12
Connector Name	STEERING LOCK UNIT
Connector Type	TK08FW-NH



Terminal No.	Color of Wire	Signal Name [Specification]
1	P	S/L 12V MECHANICAL(V1)
2	LG	S/L COM
3	O	S/L CONDITION 1
5	B	GND 1
6	B	GND 2
7	Y	S/L 12V CP(V2)
8	L	S/L CONDITION 2

Connector No.	M17
Connector Name	OPTICAL SENSOR
Connector Type	TK03FW



Terminal No.	Color of Wire	Signal Name [Specification]
1	V	-
2	O	-
3	P	-

Connector No.	M19
Connector Name	TIRE PRESSURE WARNING CHECK SWITCH
Connector Type	TK02FW



Terminal No.	Color of Wire	Signal Name [Specification]
1	W	-

Connector No.	M21
Connector Name	TIRE PRESSURE RECEIVER
Connector Type	TK04FW



Terminal No.	Color of Wire	Signal Name [Specification]
1	P	GND
2	O	SIGNAL
4	V	POWER

BCM (BODY CONTROL MODULE)

< ECU DIAGNOSIS INFORMATION >

BCM (BODY CONTROL MODULE)

Connector No.	M34
Connector Name	COMBINATION METER
Connector Type	TH4CFV-NH

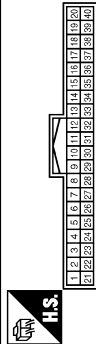

Terminal No.	Color of Wire	Signal Name [Specification]
1	Y	BAT
2	O	IGN
3	B	GROUND
4	B	GROUND
5	SB	ILLUMINATION CONTROL
8	SB	TRIP RESET SWITCH
9	W	SW ILL POWER
10	O	METER CONTROL SW GND
11	L	ENTER SWITCH
12	R	SELECT SWITCH
13	V	ILLUMINATION CONTROL SWITCH (OFF/ON automatic drive position)
15	Y	ILLUMINATION CONTROL SWITCH (OFF/ON automatic drive position)
14	GR	ILLUMINATION CONTROL SWITCH (-)
15	GR	AIR BAG
18	L	AMBIENT SENSOR
19	P	AMBIENT SENSOR POWER
20	Y	AMBIENT SENSOR GROUND
21	L	CAN-H
22	P	CAN-L
23	B	GROUND
24	W	FUEL LEVEL SENSOR GROUND
25	ER	CHG
26	G	FUEL LEVEL SENSOR GROUND
27	V	PARKING BRAKE SWITCH
28	R	WASHER LEVEL SWITCH
29	R	WASHER LEVEL SWITCH
30	P	VEHICLE SPEED (2-PULSE)
31	V	VEHICLE SPEED (8-PULSE)
32	LG	OD OFF/SPORTS
34	G	FUEL LEVEL SENSOR
35	SB	SEAT BELT BUCKLE SWITCH (DRIVER SIDE)
36	R	SEAT BELT BUCKLE SWITCH (PASSENGER SIDE)

Connector No.	M45
Connector Name	HAZARD SWITCH
Connector Type	TK03FW

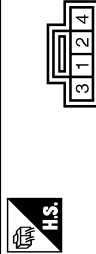

Terminal No.	Color of Wire	Signal Name [Specification]
1	B	-
2	G	-
3	R	-
4	SB	-

Connector No.	M60
Connector Name	A/C AUTO AMP.
Connector Type	ISAB0FW

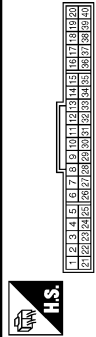

Terminal No.	Color of Wire	Signal Name [Specification]
1	L	CAN-H
2	P	CAN-L
6	L	TX (AMP)/SW (DISP)
7	P	RX (SW/AMP)
10	L	LANT SIG
11	R	VACTR
15	O	SUN SENS
16	G	INTAKE SENS
17	R	ACC
19	B	IGN
20	G	IGN
26	GR	RR DEF F/B
27	BR	RR DEF ON
32	L	FAN PWM
34	P	AMB POWER
35	L	AMB SENS
36	LG	INCAR SENS
37	Y	SENS GND

39	B	GND(POWER)
40	Y	BAT

Connector No.	M57
Connector Name	CVT SHFT SELECTOR
Connector Type	TK10FW



Terminal No.	Color of Wire	Signal Name [Specification]
1	LG	-
4	B	-
6	P	-
7	B	-
8	Y	-
9	V	-

Connector No.	M78
Connector Name	REMOTE KEYLESS ENTRY RECEIVER
Connector Type	JAB04FB

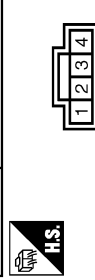

Terminal No.	Color of Wire	Signal Name [Specification]
1	P	GND
2	P	SIGNAL
4	L	+12V

Connector No.	M89
Connector Name	KEY SLOT
Connector Type	TH12FW-NH

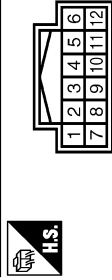

Terminal No.	Color of Wire	Signal Name [Specification]
1	GR	BAT
2	SB	GLOCK
3	O	DATA
5	GR	ILL BAT
6	B	ILL
7	B	GND
11	Y	KEY SWITCH SIGNAL

Connector No.	MT00
Connector Name	SECURITY INDICATOR LAMP
Connector Type	TK02FBR



Terminal No.	Color of Wire	Signal Name [Specification]
1	GR	-
2	O	-

A B C D E F G H I J K DEF M N O P

BCM (BODY CONTROL MODULE)

< ECU DIAGNOSIS INFORMATION >

BCM (BODY CONTROL MODULE)

Connector No.	M101
Connector Name	PUSH-BUTTON IGNITION SWITCH
Connector Type	TK08FR



Terminal No.	Color of Wire	Signal Name [Specification]
1	B	-
2	O	-
3	W	-
4	BR	-
5	R	-
6	L	-
7	B	-
8	GR	-

Connector No.	M103
Connector Name	COMBINATION SWITCH
Connector Type	TH16FW-NH



Terminal No.	Color of Wire	Signal Name [Specification]
1	G	RR
2	Y	OUTPUT 4
3	O	FR
4	W	IGN
5	V	OUTPUT 3
6	B	GND
7	GR	INPUT 3
8	L	OUTPUT 5
9	SB	INPUT 2
10	P	INPUT 4
11	O	INPUT 1
12	W	OUTPUT 1
13	R	INPUT 5
14	P	OUTPUT 2

Connector No.	M118
Connector Name	BCM (BODY CONTROL MODULE)
Connector Type	MS03FB-LC



Terminal No.	Color of Wire	Signal Name [Specification]
1	W	BAT (F/L)
2	GR	POWER WINDOW POWER SUPPLY (BAT)
3	L	POWER WINDOW POWER SUPPLY (RAP)

Connector No.	M119
Connector Name	BCM (BODY CONTROL MODULE)
Connector Type	NS16FW-CS



Terminal No.	Color of Wire	Signal Name [Specification]
4	P	INTERIOR ROOM LAMP POWER SUPPLY
5	G	PASSENGER DOOR UNLOCK OUTPUT
7	W	STEP LAMP OUTPUT
8	V	ALL DOOR FUEL LID LOCK OUTPUT
9	G	DRIVER DOOR FUEL LID UNLOCK OUTPUT
10	P	REAR DOOR UNLOCK OUTPUT
11	LG	BAT FUSE
13	B	GND
14	O	PUSH-BUTTON IGNITION SW ILL GND
15	L	ACC IND
17	G	TURN SIGNAL RH
18	BR	TURN SIGNAL LH
19	Y	ROOM LAMP TIMER CONTROL

Connector No.	M120
Connector Name	BCM (BODY CONTROL MODULE)
Connector Type	NS12FW-CS



Terminal No.	Color of Wire	Signal Name [Specification]
23	BR	BACK DOOR OPEN OUTPUT
28	G	REAR WIPER OUTPUT

Connector No.	M121
Connector Name	BCM (BODY CONTROL MODULE)
Connector Type	TH06FY-NH



Terminal No.	Color of Wire	Signal Name [Specification]
34	B	LUGGAGE ROOM ANT1-
35	W	LUGGAGE ROOM ANT1+
38	L	REAR BUMPER ANT+
39	BR	REAR BUMPER ANT-
47	L	IGN RELAY EDM L/R CONT
52	R	STARTER RELAY CONT
61	R	BACK DOOR OPENER REQUEST SW
64	GR	REQUEST SW BUZZER
65	O	REAR WIPER STOP POSITION
66	Y	BACK DOOR SW
67	LG	BACK DOOR OPENER SW
68	W	REAR RH DOOR SW
69	R	REAR LH DOOR SW

Connector No.	M122
Connector Name	BCM (BODY CONTROL MODULE)
Connector Type	TH40FB-NH



Terminal No.	Color of Wire	Signal Name [Specification]
72	B	ROOM ANT2-
73	W	ROOM ANT2+
74	Y	PASSENGER DOOR ANT-
75	LG	PASSENGER DOOR ANT+
76	V	DRIVER DOOR ANT-
77	P	DRIVER DOOR ANT+
80	SB	IMMOBILIZER ANTENNA CONTROL
81	O	IMMOBILIZER ANTENNA SIGNAL
82	BR	IGN RELAY (F/B) CONT
83	P	KEYLESS ENTRY RECEIVER SIGNAL
87	R	COMBI SW INPUT 5
88	GR	COMBI SW INPUT 3
89	BR	PUSH SW
90	P	CAN-L
91	L	CAN-H
92	R	KEY SLOT ILL
93	P	ON IND
95	L	ACC RELAY CONT
96	Y	CVT SHIFT SELECTOR POWER SUPPLY
97	O	S/L CONDITION 1
98	L	S/L CONDITION 2
99	V	SHIFT P
100	P	PASSENGER DOOR REQUEST SW
101	W	DRIVER DOOR REQUEST SW
102	Y	BLOWER FAN MOTOR RELAY CONT
103	L	KEYLESS ENTRY RECEIVER POWER SUPPLY
106	Y	S/L POWER SUPPLY
107	O	COMBI SW INPUT 1
108	P	COMBI SW INPUT 4
109	SB	COMBI SW INPUT 2
110	G	HAZARD SW
111	LG	S/L COMM

JCMWM4878GB

BCM (BODY CONTROL MODULE)

< ECU DIAGNOSIS INFORMATION >

BCM (BODY CONTROL MODULE)

Connector No.	M123
Connector Name	BCM (BODY CONTROL MODULE)
Connector Type	TH40FG-NH

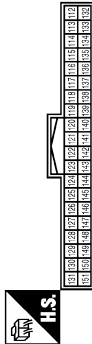

Terminal No.	Color of Wire	Signal Name [Specification]
112	R	RAIN SENSOR SERIAL LINK
113	O	OPTICAL SENSOR
116	GR	FUSE CHECK
118	L	STOP LAMP SW
119	W	DR DOOR UNLOCK SENSOR
121	Y	KEY SLOT SW
123	G	IGN P/B
124	R	PASSENGER DOOR SW
130	BR	REAR DEFOGGER SW
132	G	POWER WINDOW SW COMM
133	W	PUSH-BUTTON IGNITION SW ILL POWER
134	R	LOCK IND
137	P	RECEIVER/SENSOR GND
138	V	RECEIVER/SENSOR POWER SUPPLY
139	O	TIRE PRESS. RECEIVER SIGNAL
140	GR	SHIFT N/P
141	O	SECURITY INDICATOR OUTPUT
142	L	COMBI SW OUTPUT 5
143	W	COMBI SW OUTPUT 1
144	P	COMBI SW OUTPUT 2
145	V	COMBI SW OUTPUT 3
146	Y	COMBI SW OUTPUT 4
149	W	TIRE PRESS WARNING CHECK SW
150	SB	DRIVER DOOR SW
151	G	REAR WINDOW DEFOGGER RELAY

Connector No.	M131
Connector Name	AV CONTROL UNIT (WITH BOSE SYSTEM WITHOUT NAVIGATION SYSTEM)
Connector Type	TH32FP-NH

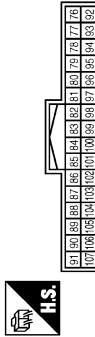

Terminal No.	Color of Wire	Signal Name [Specification]
79	L	TEL VOICE SIGNAL (-)
80	R	TEL VOICE SIGNAL (+)
81	SHIELD	SHIELD
82	W	SOUND SIGNAL RH (-) [With DVD player]
82	W	#Red SOUND SIGNAL RH (-) [Without DVD player]
83	R	SOUND SIGNAL RH (+) [With DVD player]
83	R	#Red SOUND SIGNAL RH (+) [Without DVD player]
85	B	GND
86	L	CAN-H
87	P	CAN-L
88	R	AV COMM (H)
88	R	AV COMM (L)
89	L	AV COMM (L)
90	G	AV COMM (H)
91	L	AV COMM (L)
95	R	AUX SOUND SIGNAL RH (+)
96	B	AUX SOUND SIGNAL LH (+)
97	W	AUX SOUND SIGNAL GND
98	G	SOUND SIGNAL LH (-) [With DVD player]
98	L	#Red SOUND SIGNAL LH (-) [Without DVD player]
99	B	SOUND SIGNAL LH (+) [With DVD player]
99	BR	#Red SOUND SIGNAL LH (+) [Without DVD player]
100	SHIELD	SHIELD [With DVD player]
100	SHIELD	SHIELD [Without DVD player]
101	V	SW GND
103	W	EJECT SIGNAL
104	G	IGNITION
105	SB	REVERSE
106	G	PARKING BRAKE
107	V	VEHICLE SPEED (8-PULSE)

Connector No.	M145
Connector Name	AV CONTROL UNIT (WITH NAVIGATION SYSTEM)
Connector Type	TH40FW-NH

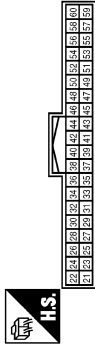

Terminal No.	Color of Wire	Signal Name [Specification]
21	B	GND
22	Y	BATTERY
23	B	GND
24	Y	BATTERY
25	R	ACC
26	B	MICROPHONE VCC
21	SHIELD	MICROPHONE GND
21	W	MICROPHONE SIGNAL
35	G	IGNITION
36	G	PARKING BRAKE
37	SB	REVERSE
38	V	VEHICLE SPEED (8-PULSE)
40	P	CONNECTION RECOGNITION
42	B	CONTROL SIGNAL
43	B	CONTROL SIGNAL
48	G	AV COMM (H)
49	L	AV COMM (L)
50	R	AV COMM (H)
51	L	AV COMM (L)
52	L	CAN-H
53	P	CAN-L

Connector No.	M202
Connector Name	INSIDE KEY ANTENNA (CONSOLE)
Connector Type	RK02FGY

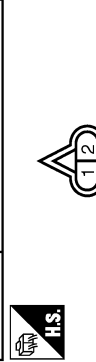

Terminal No.	Color of Wire	Signal Name [Specification]
1	W	-

Connector No.	B
Connector Name	-
Connector Type	-



Terminal No.	Color of Wire	Signal Name [Specification]
1	B	-
2	P/W	-

Connector No.	RI9
Connector Name	MAP LAMP
Connector Type	TK00BFGY



Terminal No.	Color of Wire	Signal Name [Specification]
1	P/W	-
2	Y	-
3	B	-
4	SB	-
5	R/Y	-
6	R/L	-

A
B
C
D
E
F
G
H
I
J
K
DEF
M
N
O
P

BCM (BODY CONTROL MODULE)

< ECU DIAGNOSIS INFORMATION >

BCM (BODY CONTROL MODULE)

Connector No.	R21
Connector Name	PERSONAL LAMP
Connector Type	THRMFV-NH



Terminal No.	Color of Wire	Signal Name [Specification]
1	P/W	-
2	B	-
3	SB	-

Connector No.	R22
Connector Name	RAIN SENSOR
Connector Type	AA8D9FB



Terminal No.	Color of Wire	Signal Name [Specification]
1	Y/R	-
2	R	-
3	B	-

Connector No.	R24
Connector Name	VANITY MIRROR LAMP (DRIVER SIDE)
Connector Type	MCADZFW



Terminal No.	Color of Wire	Signal Name [Specification]
1	-	-
2	-	-

1	B
2	P/W

Connector No.	R101
Connector Name	SUNROOF MOTOR ASSEMBLY
Connector Type	YEA10FGY

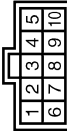

Terminal No.	Color of Wire	Signal Name [Specification]
1	B	GND
2	O	GND
3	U	IGN
4	Y	PUSH SW
5	LG	OPEN SW
6	R	BAT
7	P	COMM
8	BR	SPEED(SP)
9	W	2ND SW
10	V	CLOSE SW

Connector No.	R102
Connector Name	SUNSHADE MOTOR ASSEMBLY
Connector Type	YEA10FGY



Terminal No.	Color of Wire	Signal Name [Specification]
1	B	GND
6	G	BAT
7	P	COMM
8	BR	SPEED(SP)

Fail-safe

FAIL-SAFE CONTROL BY DTC

BCM performs fail-safe control when any DTC are detected.

JCMWM4880GB

INFOID:000000005683246

BCM (BODY CONTROL MODULE)

< ECU DIAGNOSIS INFORMATION >

Display contents of CONSULT	Fail-safe	Cancellation	A
B2013: ID DISCORD BCM-S/L	Inhibit engine cranking	Erase DTC	A
B2014: CHAIN OF S/L-BCM	Inhibit engine cranking	Erase DTC	B
B2190: NATS ANTENNA AMP	Inhibit engine cranking	Erase DTC	B
B2191: DIFFERENCE OF KEY	Inhibit engine cranking	Erase DTC	C
B2192: ID DISCORD BCM-ECM	Inhibit engine cranking	Erase DTC	C
B2193: CHAIN OF BCM-ECM	Inhibit engine cranking	Erase DTC	D
B2195: ANTI SCANNING	Inhibit engine cranking	Ignition switch ON → OFF	D
B2557: VEHICLE SPEED	Inhibit steering lock	When normal vehicle speed signals are received from ABS actuator and electric unit (control unit) for 500 ms	E
B2560: STARTER CONT RELAY	Inhibit engine cranking	500 ms after the following CAN signal communication status becomes consistent <ul style="list-style-type: none"> • Starter control relay signal • Starter relay status signal 	E
B2601: SHIFT POSITION	Inhibit steering lock	500 ms after the following signal reception status becomes consistent <ul style="list-style-type: none"> • Selector lever P position switch signal • P range signal (CAN) 	F
B2602: SHIFT POSITION	Inhibit steering lock	5 seconds after the following BCM recognition conditions are fulfilled <ul style="list-style-type: none"> • Ignition switch is in the ON position • Selector lever P position switch signal: Except P position (battery voltage) • Vehicle speed: 4 km/h (2.5 MPH) or more 	G
B2603: SHIFT POSI STATUS	Inhibit steering lock	500 ms after the following BCM recognition conditions are fulfilled <ul style="list-style-type: none"> • Ignition switch is in the ON position • Selector lever P position switch signal: Except P position (battery voltage) • Selector lever P/N position signal: Except P and N positions (0 V) 	H
B2604: PNP SW	Inhibit steering lock	500 ms after any of the following BCM recognition conditions are fulfilled <ul style="list-style-type: none"> • Status 1 <ul style="list-style-type: none"> - Ignition switch is in the ON position - Selector lever P/N position signal: P and N position (battery voltage) - P range signal or N range signal (CAN): ON • Status 2 <ul style="list-style-type: none"> - Ignition switch is in the ON position - Selector lever P/N position signal: Except P and N positions (0 V) - P range signal and N range signal (CAN): OFF 	I
B2605: PNP SW	Inhibit steering lock	500 ms after any of the following BCM recognition conditions are fulfilled <ul style="list-style-type: none"> • Ignition switch is in the ON position <ul style="list-style-type: none"> - Power position: IGN - Selector lever P/N position signal: Except P and N positions (0 V) - Interlock/PNP switch signal (CAN): OFF • Status 2 <ul style="list-style-type: none"> - Ignition switch is in the ON position - Selector lever P/N position signal: P or N position (battery voltage) - PNP switch signal (CAN): ON 	J
B2606: S/L RELAY	Inhibit engine cranking	500 ms after the following CAN signal communication status becomes consistent <ul style="list-style-type: none"> • Steering lock relay signal (Request signal) • Steering lock relay signal (Condition signal) 	K

DEF

BCM (BODY CONTROL MODULE)

< ECU DIAGNOSIS INFORMATION >

Display contents of CONSULT	Fail-safe	Cancellation
B2607: S/L RELAY	Inhibit engine cranking	500 ms after the following CAN signal communication status becomes consistent <ul style="list-style-type: none"> • Steering lock relay signal (Request signal) • Steering lock relay signal (Condition signal)
B2608: STARTER RELAY	Inhibit engine cranking	500 ms after the following signal communication status becomes consistent <ul style="list-style-type: none"> • Starter motor relay control signal • Starter relay status signal (CAN)
B2609: S/L STATUS	<ul style="list-style-type: none"> • Inhibit engine cranking • Inhibit steering lock 	When the following steering lock conditions agree <ul style="list-style-type: none"> • BCM steering lock control status • Steering lock condition No. 1 signal status • Steering lock condition No. 2 signal status
B260A: IGNITION RELAY	Inhibit engine cranking	500 ms after the following conditions are fulfilled <ul style="list-style-type: none"> • IGN relay (IPDM E/R) control signal: OFF (Battery voltage) • Ignition ON signal (CAN to IPDM E/R): OFF (Request signal) • Ignition ON signal (CAN from IPDM E/R): OFF (Condition signal)
B260F: ENG STATE SIG LOST	Maintains the power supply position attained at the time of DTC detection	When any of the following conditions are fulfilled <ul style="list-style-type: none"> • Power position changes to ACC • Receives engine status signal (CAN)
B2612: S/L STATUS	<ul style="list-style-type: none"> • Inhibit engine cranking • Inhibit steering lock 	When any of the following conditions are fulfilled <ul style="list-style-type: none"> • Steering lock unit status signal (CAN) is received normally • The BCM steering lock control status matches the steering lock status recognized by the steering lock unit status signal (CAN from IPDM E/R)
B2617: STARTER RELAY CIRC	Inhibit engine cranking	1 second after the starter motor relay control inside BCM becomes normal
B2618: BCM	Inhibit engine cranking	1 second after the ignition relay (IPDM E/R) control inside BCM becomes normal
B2619: BCM	Inhibit engine cranking	1 second after the steering lock unit power supply output control inside BCM becomes normal
B261E: VEHICLE TYPE	Inhibit engine cranking	BCM initialization
B26E9: S/L STATUS	<ul style="list-style-type: none"> • Inhibit engine cranking • Inhibit steering lock 	When BCM transmits the LOCK request signal to steering lock unit, and receives LOCK response signal from steering lock unit, the following conditions are fulfilled <ul style="list-style-type: none"> • Steering condition No. 1 signal: LOCK (0V) • Steering condition No. 2 signal: LOCK (Battery voltage)

HIGH FLASHER OPERATION

BCM detects the turn signal lamp circuit status by the current value.

BCM increases the turn signal lamp blinking speed if the bulb or harness open is detected with the turn signal lamp operating.

NOTE:

The blinking speed is normal while activating the hazard warning lamp.

FAIL-SAFE CONTROL BY RAIN SENSOR MALFUNCTION

- BCM judges the rain sensor serial link error by the rain sensor serial link condition and detects the rain sensor malfunction by rain sensor malfunction signal.
- When BCM detects the rain sensor serial link error or the rain sensor malfunction while front wiper AUTO operation, BCM operates a fail-safe control.

NOTE:

If rain sensor malfunction is detected when ignition switch is turned OFF ⇒ ON and front wiper switch is INT/AUTO position, BCM operates a fail-safe control.

REAR WIPER MOTOR PROTECTION

BCM detects the rear wiper stopping position according to the rear wiper stop position signal.

When the rear wiper stop position signal does not change for more than 5 seconds while driving the rear wiper, BCM stops power supply to protect the rear wiper motor.

Condition of cancellation

1. More than 1 minute is passed after the rear wiper stop.

BCM (BODY CONTROL MODULE)

< ECU DIAGNOSIS INFORMATION >

2. Turn rear wiper switch OFF.
3. Operate the rear wiper switch or rear washer switch.

A

DTC Inspection Priority Chart

INFOID:000000005683247

If some DTCs are displayed at the same time, perform inspections one by one based on the following priority chart.

B

Priority	DTC
1	B2562: LOW VOLTAGE
2	<ul style="list-style-type: none"> • U1000: CAN COMM • U1010: CONTROL UNIT(CAN)
3	<ul style="list-style-type: none"> • B2190: NATS ANTENNA AMP • B2191: DIFFERENCE OF KEY • B2192: ID DISCORD BCM-ECM • B2193: CHAIN OF BCM-ECM • B2195: ANTI SCANNING
4	<ul style="list-style-type: none"> • B2013: ID DISCORD BCM-S/L • B2014: CHAIN OF S/L-BCM • B2553: IGNITION RELAY • B2555: STOP LAMP • B2556: PUSH-BTN IGN SW • B2557: VEHICLE SPEED • B2560: STARTER CONT RELAY • B2601: SHIFT POSITION • B2602: SHIFT POSITION • B2603: SHIFT POSI STATUS • B2604: PNP SW • B2605: PNP SW • B2606: S/L RELAY • B2607: S/L RELAY • B2608: STARTER RELAY • B2609: S/L STATUS • B260A: IGNITION RELAY • B260B: STEERING LOCK UNIT • B260C: STEERING LOCK UNIT • B260D: STEERING LOCK UNIT • B260F: ENG STATE SIG LOST • B2612: S/L STATUS • B2614: ACC RELAY CIRC • B2615: BLOWER RELAY CIRC • B2616: IGN RELAY CIRC • B2617: STARTER RELAY CIRC • B2618: BCM • B2619: BCM • B261A: PUSH-BTN IGN SW • B261E: VEHICLE TYPE • B26E9: S/L STATUS • B26EA: KEY REGISTRATION • C1729: VHCL SPEED SIG ERR • U0415: VEHICLE SPEED SIG

C

D

E

F

G

H

I

J

K

DEF

M

N

O

P

BCM (BODY CONTROL MODULE)

< ECU DIAGNOSIS INFORMATION >

Priority	DTC
5	<ul style="list-style-type: none"> • C1704: LOW PRESSURE FL • C1705: LOW PRESSURE FR • C1706: LOW PRESSURE RR • C1707: LOW PRESSURE RL • C1708: [NO DATA] FL • C1709: [NO DATA] FR • C1710: [NO DATA] RR • C1711: [NO DATA] RL • C1716: [PRESSDATA ERR] FL • C1717: [PRESSDATA ERR] FR • C1718: [PRESSDATA ERR] RR • C1719: [PRESSDATA ERR] RL • C1734: CONTROL UNIT
6	<ul style="list-style-type: none"> • B2622: INSIDE ANTENNA • B2623: INSIDE ANTENNA

DTC Index

INFOID:000000005683248

NOTE:

The details of time display are as follows.

- CRNT: A malfunction is detected now.
- PAST: A malfunction was detected in the past.

IGN counter is displayed on Freeze Frame Data. For details of Freeze Frame Data, refer to [BCS-17. "COMMON ITEM : CONSULT-III Function \(BCM - COMMON ITEM\)"](#).

CONSULT display	Fail-safe	Freeze Frame Data •Vehicle Speed •Odo/Trip Meter •Vehicle Condition	Intelligent Key warning lamp ON	Tire pressure monitor warning lamp ON	Reference page
No DTC is detected. further testing may be required.	—	—	—	—	—
U1000: CAN COMM	—	—	—	—	BCS-38
U1010: CONTROL UNIT(CAN)	—	—	—	—	BCS-39
U0415: VEHICLE SPEED SIG	—	—	—	—	BCS-40
B2013: ID DISCORD BCM-S/L*	×	×	—	—	SEC-51
B2014: CHAIN OF S/L-BCM*	×	×	—	—	SEC-52
B2190: NATS ANTENNA AMP	×	—	—	—	SEC-43
B2191: DIFFERENCE OF KEY	×	—	—	—	SEC-46
B2192: ID DISCORD BCM-ECM	×	—	—	—	SEC-47
B2193: CHAIN OF BCM-ECM	×	—	—	—	SEC-49
B2195: ANTI SCANNING	×	—	—	—	SEC-50
B2553: IGNITION RELAY	—	×	—	—	PCS-48
B2555: STOP LAMP	—	×	—	—	SEC-55
B2556: PUSH-BTN IGN SW	—	×	×	—	SEC-57
B2557: VEHICLE SPEED	×	×	×	—	SEC-59
B2560: STARTER CONT RELAY	×	×	×	—	SEC-60
B2562: LOW VOLTAGE	—	×	—	—	BCS-41
B2601: SHIFT POSITION	×	×	×	—	SEC-61
B2602: SHIFT POSITION	×	×	×	—	SEC-64
B2603: SHIFT POSI STATUS	×	×	×	—	SEC-66
B2604: PNP SW	×	×	×	—	SEC-69

BCM (BODY CONTROL MODULE)

< ECU DIAGNOSIS INFORMATION >

CONSULT display	Fail-safe	Freeze Frame Data •Vehicle Speed •Odo/Trip Meter •Vehicle Condition	Intelligent Key warning lamp ON	Tire pressure monitor warning lamp ON	Reference page
B2605: PNP SW	×	×	×	—	SEC-71
B2606: S/L RELAY*	×	×	×	—	SEC-73
B2607: S/L RELAY*	×	×	×	—	SEC-74
B2608: STARTER RELAY	×	×	×	—	SEC-76
B2609: S/L STATUS*	×	×	×	—	SEC-78
B260A: IGNITION RELAY	×	×	×	—	PCS-50
B260B: STEERING LOCK UNIT*	—	×	×	—	SEC-82
B260C: STEERING LOCK UNIT*	—	×	×	—	SEC-83
B260D: STEERING LOCK UNIT*	—	×	×	—	SEC-84
B260F: ENG STATE SIG LOST	×	×	×	—	SEC-85
B2612: S/L STATUS*	×	×	×	—	SEC-88
B2614: ACC RELAY CIRC	—	×	×	—	PCS-52
B2615: BLOWER RELAY CIRC	—	×	×	—	PCS-55
B2616: IGN RELAY CIRC	—	×	×	—	PCS-58
B2617: STARTER RELAY CIRC	×	×	×	—	SEC-92
B2618: BCM	×	×	×	—	PCS-61
B2619: BCM*	×	×	×	—	SEC-94
B261A: PUSH-BTN IGN SW	—	×	×	—	SEC-95
B261E: VEHICLE TYPE	×	×	× (Turn ON for 15 seconds)	—	SEC-98
B2622: INSIDE ANTENNA	—	×	—	—	DLK-91
B2623: INSIDE ANTENNA	—	×	—	—	DLK-93
B26E9: S/L STATUS*	×	×	× (Turn ON for 15 seconds)	—	SEC-86
B26EA: KEY REGISTRATION	—	×	× (Turn ON for 15 seconds)	—	SEC-87
C1704: LOW PRESSURE FL	—	—	—	×	WT-25
C1705: LOW PRESSURE FR	—	—	—	×	
C1706: LOW PRESSURE RR	—	—	—	×	
C1707: LOW PRESSURE RL	—	—	—	×	
C1708: [NO DATA] FL	—	—	—	×	WT-27
C1709: [NO DATA] FR	—	—	—	×	
C1710: [NO DATA] RR	—	—	—	×	
C1711: [NO DATA] RL	—	—	—	×	
C1716: [PRESSDATA ERR] FL	—	—	—	×	WT-30
C1717: [PRESSDATA ERR] FR	—	—	—	×	
C1718: [PRESSDATA ERR] RR	—	—	—	×	
C1719: [PRESSDATA ERR] RL	—	—	—	×	
C1729: VHCL SPEED SIG ERR	—	—	—	×	WT-32
C1734: CONTROL UNIT	—	—	—	×	WT-34

NOTE:

*: For models without steering lock unit this DTC is not applied.

REAR WINDOW DEFOGGER DOES NOT OPERATE

< SYMPTOM DIAGNOSIS >

SYMPTOM DIAGNOSIS

REAR WINDOW DEFOGGER DOES NOT OPERATE

Diagnosis Procedure

INFOID:000000005513225

1. CHECK POWER SUPPLY AND GROUND CIRCUIT

Check power supply and ground circuit.

Refer to [DEF-10, "Diagnosis Procedure"](#).

Is the inspection result normal?

YES >> GO TO 2.

NO >> Repair or replace the malfunctioning parts.

2. CHECK REAR WINDOW DEFOGGER SWITCH

Check rear window defogger switch.

Refer to [DEF-11, "Component Function Check"](#).

Is the inspection result normal?

YES >> GO TO 3.

NO >> Repair or replace the malfunctioning parts.

3. CHECK REAR WINDOW DEFOGGER RELAY

Check rear window defogger relay.

Refer to [DEF-12, "Component Function Check"](#).

Is the inspection result normal?

YES >> GO TO 4.

NO >> Repair or replace the malfunctioning parts.

4. CHECK REAR WINDOW DEFOGGER

Check rear window defogger.

Refer to [DEF-14, "Component Function Check"](#).

Is the inspection result normal?

YES >> GO TO 5.

NO >> Repair or replace the malfunctioning parts.

5. CONFIRM THE OPERATION

Confirm the operation again.

Is the inspection result normal?

YES >> Check intermittent incident. Refer to [GI-39, "Intermittent Incident"](#).

NO >> GO TO 1.

REAR WINDOW DEFOGGER AND DOOR MIRROR DEFOGGER DO NOT OPERATE.

< SYMPTOM DIAGNOSIS >

REAR WINDOW DEFOGGER AND DOOR MIRROR DEFOGGER DO NOT OPERATE.

Diagnosis Procedure

INFOID:000000005513226

1. CHECK POWER SUPPLY AND GROUND CIRCUIT

Check power supply and ground circuit.
Refer to [DEF-10, "Diagnosis Procedure"](#).

Is the inspection result normal?

- YES >> GO TO 2.
- NO >> Repair or replace the malfunctioning parts.

2. CHECK REAR WINDOW DEFOGGER SWITCH

Check rear window defogger switch.
Refer to [DEF-11, "Component Function Check"](#).

Is the inspection result normal?

- YES >> GO TO 3.
- NO >> Repair or replace the malfunctioning parts.

3. CHECK REAR WINDOW DEFOGGER RELAY

Check rear window defogger relay.
Refer to [DEF-12, "Component Function Check"](#).

Is the inspection result normal?

- YES >> GO TO 4.
- NO >> Repair or replace the malfunctioning parts.

4. CONFIRM THE OPERATION

Confirm the operation again.

Is the inspection result normal?

- YES >> Check intermittent incident. Refer to [GI-39, "Intermittent Incident"](#).
- NO >> GO TO 1.

A
B
C
D
E
F
G
H
I
J
K
M
N
O
P

DEF

REAR WINDOW DEFOGGER DOES NOT OPERATE BUT BOTH DOOR MIRROR DEFOGGER OPERATE.

< SYMPTOM DIAGNOSIS >

REAR WINDOW DEFOGGER DOES NOT OPERATE BUT BOTH DOOR MIRROR DEFOGGER OPERATE.

Diagnosis Procedure

INFOID:00000000513227

1. CHECK REAR WINDOW DEFOGGER

Check rear window defogger.

Refer to [DEF-14, "Component Function Check"](#).

Is the inspection result normal?

YES >> GO TO 2.

NO >> Repair or replace the malfunctioning parts.

2. CONFIRM THE OPERATION

Confirm the operation again

Is the inspection result normal?

YES >> Check intermittent incident. Refer to [GI-39, "Intermittent Incident"](#).

NO >> GO TO 1.

DOOR MIRROR DEFOGGER DOES NOT OPERATE

< SYMPTOM DIAGNOSIS >

DOOR MIRROR DEFOGGER DOES NOT OPERATE BOTH SIDES

BOTH SIDES : Diagnosis Procedure

INFOID:000000005513228

1.CHECK DOOR MIRROR DEFOGGER

Check door mirror defogger.

Refer to [DEF-17, "Component Function Check"](#).

Is the inspection result normal?

YES >> GO TO 2.

NO >> Repair or replace the malfunctioning parts.

2.CONFIRM THE OPERATION

Confirm the operation again.

Is the inspection result normal?

YES >> Check intermittent incident. Refer to [GI-39, "Intermittent Incident"](#).

NO >> GO TO 1.

DRIVER SIDE

DRIVER SIDE : Diagnosis Procedure

INFOID:000000005513229

1.CHECK DRIVER SIDE DOOR MIRROR DEFOGGER

Check driver side door mirror defogger.

Refer to [DEF-18, "Component Function Check"](#).

Is the inspection result normal?

YES >> GO TO 2.

NO >> Repair or replace the malfunctioning parts.

2.CONFIRM THE OPERATION

Confirm the operation again.

Is the inspection result normal?

YES >> Check intermittent incident. Refer to [GI-39, "Intermittent Incident"](#).

NO >> GO TO 1.

PASSENGER SIDE

PASSENGER SIDE : Diagnosis Procedure

INFOID:000000005513230

1.CHECK PASSENGER SIDE DOOR MIRROR DEFOGGER.

Check passenger side door mirror defogger.

Refer to [DEF-20, "Component Function Check"](#).

Is the inspection result normal?

YES >> GO TO 2.

NO >> Repair or replace the malfunctioning parts.

2.CONFIRM THE OPERATION

Confirm the operation again.

Is the inspection result normal?

YES >> Check intermittent incident. Refer to [GI-39, "Intermittent Incident"](#).

NO >> GO TO 1.

A
B
C
D
E
F
G
H
I
J
K
M
N
O
P

DEF

ON IS NOT DISPLAYED WHEN PRESSING REAR WINDOW DEFOGGER SWITCH BUT IT IS OPERATED

< SYMPTOM DIAGNOSIS >

ON IS NOT DISPLAYED WHEN PRESSING REAR WINDOW DEFOGGER SWITCH BUT IT IS OPERATED

Diagnosis Procedure

INFOID:000000005513231

WITH BOSE AUDIO SYSTEM

1. CHECK AV CONTROL UNIT FUNCTION

Check that the AV control unit is operating normally.

- Without navigation refer to [AV-49, "Work Flow"](#).
- With navigation refer to [AV-563, "Work Flow"](#).

Is the inspection result normal?

- YES >> GO TO 2.
NO >> Repair or replace the malfunctioning parts.

2. CONFIRM THE OPERATION

Confirm the operation again.

Is the inspection result normal?

- YES >> Check intermittent incident. Refer to [GI-39, "Intermittent Incident"](#).
NO >> GO TO 1.

WITHOUT BOSE AUDIO SYSTEM

1. CHECK A/C CONTROL UNIT FUNCTION

Check that A/C the control unit is operating normally. Refer to [HAC-5, "Work Flow"](#).

Is the inspection result normal?

- YES >> GO TO 2.
NO >> Repair or replace the malfunctioning parts.

2. CONFIRM THE OPERATION

Confirm the operation again.

Is the inspection result normal?

- YES >> Check intermittent incident. Refer to [GI-39, "Intermittent Incident"](#).
NO >> GO TO 1.

REAR WINDOW DEFOGGER INDICATOR DOES NOT ILLUMINATE

< SYMPTOM DIAGNOSIS >

REAR WINDOW DEFOGGER INDICATOR DOES NOT ILLUMINATE

Diagnosis Procedure

INFOID:000000005513232

WITH BOSE AUDIO SYSTEM

1.CHECK PRESET SWITCH (REAR WINDOW DEFOGGER SWITCH)

Check rear window defogger operate.

YES >> Replace preset switch (rear window defogger switch). Refer to [AV-547. "Removal and Installation"](#) (without navigation system) or [AV-797. "Removal and Installation"](#) (with navigation system).

NO >> Check rear window defogger system. Refer to [DEF-3. "Work Flow"](#).

WITHOUT BOSE AUDIO SYSTEM

1.CHECK A/C CONTROL (REAR WINDOW DEFOGGER SWITCH)

Check rear window defogger operate.

YES >> Replace A/C control (rear window defogger switch). Refer to [VTL-22. "Removal and Installation"](#).

NO >> Check rear window defogger system. Refer to [DEF-3. "Work Flow"](#).

A
B
C
D
E
F
G
H
I
J
K
DEF
M
N
O
P

PRECAUTIONS

< PRECAUTION >

PRECAUTION

PRECAUTIONS

FOR USA AND CANADA

FOR USA AND CANADA : Precaution for Supplemental Restraint System (SRS) "AIR BAG" and "SEAT BELT PRE-TENSIONER"

INFOID:000000005683249

The Supplemental Restraint System such as "AIR BAG" and "SEAT BELT PRE-TENSIONER", used along with a front seat belt, helps to reduce the risk or severity of injury to the driver and front passenger for certain types of collision. This system includes seat belt switch inputs and dual stage front air bag modules. The SRS system uses the seat belt switches to determine the front air bag deployment, and may only deploy one front air bag, depending on the severity of a collision and whether the front occupants are belted or unbelted.

Information necessary to service the system safely is included in the "SRS AIR BAG" and "SEAT BELT" of this Service Manual.

WARNING:

- To avoid rendering the SRS inoperative, which could increase the risk of personal injury or death in the event of a collision which would result in air bag inflation, all maintenance must be performed by an authorized NISSAN/INFINITI dealer.
- Improper maintenance, including incorrect removal and installation of the SRS, can lead to personal injury caused by unintentional activation of the system. For removal of Spiral Cable and Air Bag Module, see the "SRS AIR BAG".
- Do not use electrical test equipment on any circuit related to the SRS unless instructed to in this Service Manual. SRS wiring harnesses can be identified by yellow and/or orange harnesses or harness connectors.

PRECAUTIONS WHEN USING POWER TOOLS (AIR OR ELECTRIC) AND HAMMERS

WARNING:

- When working near the Air Bag Diagnosis Sensor Unit or other Air Bag System sensors with the ignition ON or engine running, DO NOT use air or electric power tools or strike near the sensor(s) with a hammer. Heavy vibration could activate the sensor(s) and deploy the air bag(s), possibly causing serious injury.
- When using air or electric power tools or hammers, always switch the ignition OFF, disconnect the battery, and wait at least 3 minutes before performing any service.

FOR MEXICO

FOR MEXICO : Precaution for Supplemental Restraint System (SRS) "AIR BAG" and "SEAT BELT PRE-TENSIONER"

INFOID:000000005683250

The Supplemental Restraint System such as "AIR BAG" and "SEAT BELT PRE-TENSIONER", used along with a front seat belt, helps to reduce the risk or severity of injury to the driver and front passenger for certain types of collision. Information necessary to service the system safely is included in the "SRS AIR BAG" and "SEAT BELT" of this Service Manual.

WARNING:

- To avoid rendering the SRS inoperative, which could increase the risk of personal injury or death in the event of a collision which would result in air bag inflation, all maintenance must be performed by an authorized NISSAN/INFINITI dealer.
- Improper maintenance, including incorrect removal and installation of the SRS, can lead to personal injury caused by unintentional activation of the system. For removal of Spiral Cable and Air Bag Module, see the "SRS AIR BAG".
- Do not use electrical test equipment on any circuit related to the SRS unless instructed to in this Service Manual. SRS wiring harnesses can be identified by yellow and/or orange harnesses or harness connectors.

PRECAUTIONS WHEN USING POWER TOOLS (AIR OR ELECTRIC) AND HAMMERS

WARNING:

- When working near the Air Bag Diagnosis Sensor Unit or other Air Bag System sensors with the ignition ON or engine running, DO NOT use air or electric power tools or strike near the sensor(s)

PRECAUTIONS

< PRECAUTION >

- with a hammer. Heavy vibration could activate the sensor(s) and deploy the air bag(s), possibly causing serious injury.
- When using air or electric power tools or hammers, always switch the ignition OFF, disconnect the battery, and wait at least 3 minutes before performing any service.

A

B

C

D

E

F

G

H

I

J

K

DEF

M

N

O

P

FILAMENT

< REMOVAL AND INSTALLATION >

REMOVAL AND INSTALLATION

FILAMENT

Inspection and Repair

INFOID:000000005513234

INSPECTION

1. When measuring voltage, wrap tin foil around the top of the negative probe. Then press the foil against the wire with your finger.

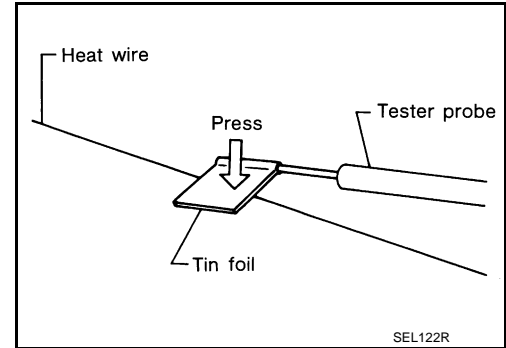

2. Attach probe circuit tester (in Volt range) to middle portion of each filament.

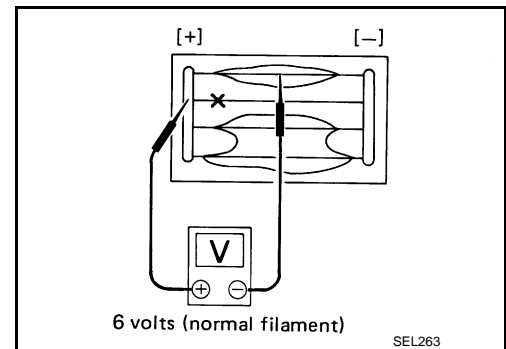

3. If a filament is burned out, circuit tester registers 0 or battery voltage.
4. To locate burned out point, move probe to left and right along filament. Test needle will swing abruptly when probe passes the point.

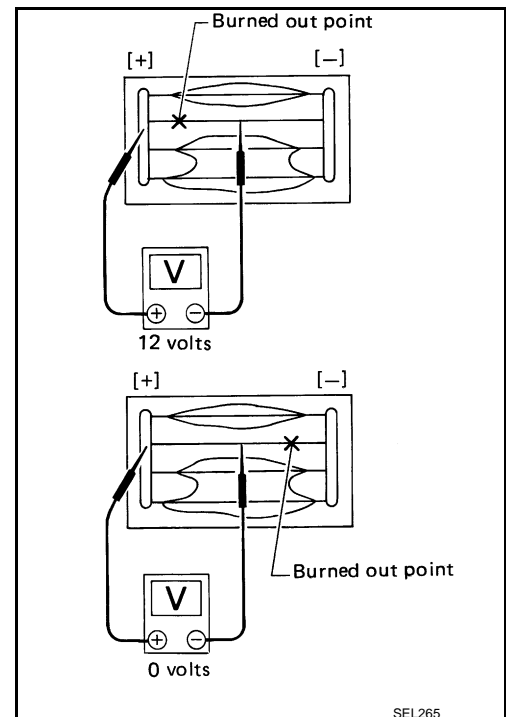

REPAIR

REPAIR EQUIPMENT

- Conductive silver composition (Dupont No. 4817 or equivalent)

FILAMENT

< REMOVAL AND INSTALLATION >

- Ruler 30 cm (11.8 in) long
- Drawing pen
- Heat gun
- Alcohol
- Cloth

REPAIRING PROCEDURE

1. Wipe broken heat wire and its surrounding area clean with a cloth dampened in alcohol.
2. Apply a small amount of conductive silver composition to tip of drawing pen. Shake silver composition container before use.
3. Place ruler on glass along broken line. Deposit conductive silver composition on break with drawing pen. Slightly overlap existing heat wire on both sides [preferably 5 mm (0.20 in)] of the break.

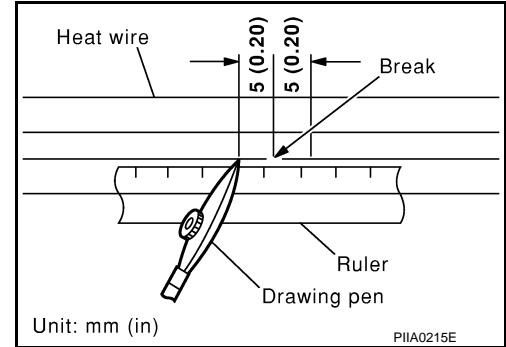

4. After repair has been completed, check repaired wire for continuity. This check should be conducted 10 minutes after silver composition is deposited. Do not touch repaired area while test is being conducted.

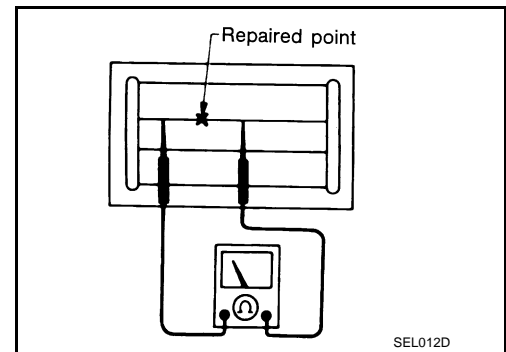

5. Apply a constant stream of hot air directly to the repaired area for approximately 20 minutes with a heat gun. A minimum distance of 3 cm (1.2 in) should be kept between repaired area and hot air outlet. If a heat gun is not available, let the repaired area dry for 24 hours.

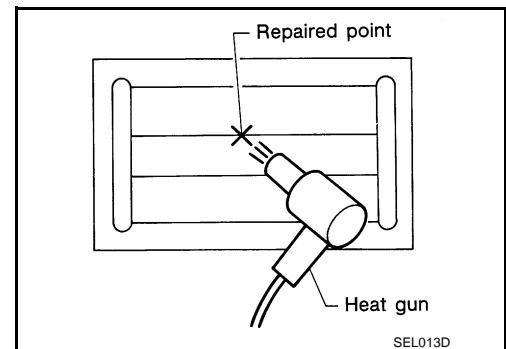

A
B
C
D
E
F
G
H
I
J
K
DEF
M
N
O
P