

SECTION **PWC**

POWER WINDOW CONTROL SYSTEM

A
B
C
D
E
F
G
H
I
J
L
M
N
O
P

CONTENTS

<p>BASIC INSPECTION 4</p> <p>DIAGNOSIS AND REPAIR WORK FLOW 4</p> <p style="padding-left: 20px;">Work Flow4</p> <p>INSPECTION AND ADJUSTMENT 5</p> <p>ADDITIONAL SERVICE WHEN REMOVING BATTERY NEGATIVE TERMINAL5</p> <p style="padding-left: 20px;">ADDITIONAL SERVICE WHEN REMOVING BATTERY NEGATIVE TERMINAL : Description5</p> <p style="padding-left: 20px;">ADDITIONAL SERVICE WHEN REMOVING BATTERY NEGATIVE TERMINAL : Special Repair Requirement5</p> <p>ADDITIONAL SERVICE WHEN REPLACING CONTROL UNIT5</p> <p style="padding-left: 20px;">ADDITIONAL SERVICE WHEN REPLACING CONTROL UNIT : Description5</p> <p style="padding-left: 20px;">ADDITIONAL SERVICE WHEN REPLACING CONTROL UNIT : Special Repair Requirement6</p> <p>SYSTEM DESCRIPTION 7</p> <p>POWER WINDOW SYSTEM 7</p> <p style="padding-left: 20px;">System Diagram7</p> <p style="padding-left: 20px;">System Description7</p> <p style="padding-left: 20px;">Component Parts Location9</p> <p style="padding-left: 20px;">Component Description9</p> <p>DIAGNOSIS SYSTEM (BCM)11</p> <p>COMMON ITEM11</p> <p style="padding-left: 20px;">COMMON ITEM : CONSULT Function (BCM - COMMON ITEM) 11</p> <p>RETAINED PWR12</p> <p style="padding-left: 20px;">RETAINED PWR : CONSULT Function (BCM - RETAINED PWR) 12</p> <p>DTC/CIRCUIT DIAGNOSIS14</p> <p>POWER SUPPLY AND GROUND CIRCUIT14</p>	<p>BCM14</p> <p style="padding-left: 20px;">BCM : Diagnosis Procedure14</p> <p>POWER WINDOW MAIN SWITCH14</p> <p style="padding-left: 20px;">POWER WINDOW MAIN SWITCH : Diagnosis Procedure 14</p> <p>FRONT POWER WINDOW SWITCH (PASSENGER SIDE)15</p> <p style="padding-left: 20px;">FRONT POWER WINDOW SWITCH (PASSENGER SIDE) : Diagnosis Procedure15</p> <p>REAR POWER WINDOW SWITCH16</p> <p style="padding-left: 20px;">REAR POWER WINDOW SWITCH : Diagnosis Procedure16</p> <p>REAR POWER WINDOW SWITCH18</p> <p style="padding-left: 20px;">Description18</p> <p style="padding-left: 20px;">Component Function Check18</p> <p style="padding-left: 20px;">Diagnosis Procedure18</p> <p style="padding-left: 20px;">Component Inspection19</p> <p>POWER WINDOW MOTOR20</p> <p>DRIVER SIDE20</p> <p style="padding-left: 20px;">DRIVER SIDE : Description20</p> <p style="padding-left: 20px;">DRIVER SIDE : Component Function Check20</p> <p style="padding-left: 20px;">DRIVER SIDE : Diagnosis Procedure20</p> <p style="padding-left: 20px;">DRIVER SIDE : Component Inspection21</p> <p>PASSENGER SIDE21</p> <p style="padding-left: 20px;">PASSENGER SIDE : Description21</p> <p style="padding-left: 20px;">PASSENGER SIDE : Component Function Check21</p> <p style="padding-left: 20px;">PASSENGER SIDE : Diagnosis Procedure21</p> <p style="padding-left: 20px;">PASSENGER SIDE : Component Inspection22</p> <p>REAR LH23</p> <p style="padding-left: 20px;">REAR LH : Description23</p> <p style="padding-left: 20px;">REAR LH : Component Function Check23</p> <p style="padding-left: 20px;">REAR LH : Diagnosis Procedure23</p> <p style="padding-left: 20px;">REAR LH : Component Inspection24</p>
---	---



REAR RH	24	DRIVER SIDE POWER WINDOW DOES NOT OPERATE	79
REAR RH : Description	24	Diagnosis Procedure	79
REAR RH : Component Function Check	24	FRONT PASSENGER SIDE POWER WINDOW DOES NOT OPERATE	80
REAR RH : Diagnosis Procedure	25	WHEN POWER WINDOW MAIN SWITCH IS OPERATED	80
REAR RH : Component Inspection	26	WHEN POWER WINDOW MAIN SWITCH IS OPERATED : Diagnosis Procedure	80
ENCODER CIRCUIT	27	WHEN FRONT POWER WINDOW SWITCH (PASSENGER SIDE) IS OPERATED	80
DRIVER SIDE	27	WHEN FRONT POWER WINDOW SWITCH (PASSENGER SIDE) IS OPERATED : Diagnosis Procedure	80
DRIVER SIDE : Description	27	WHEN BOTH POWER WINDOW MAIN SWITCH AND FRONT POWER WINDOW SWITCH ARE OPERATED	80
DRIVER SIDE : Component Function Check	27	WHEN BOTH POWER WINDOW MAIN SWITCH AND FRONT POWER WINDOW SWITCH ARE OPERATED : Diagnosis Procedure	80
DRIVER SIDE : Diagnosis Procedure	27	REAR LH SIDE POWER WINDOW ALONE DOES NOT OPERATE	81
PASSENGER SIDE	29	WHEN POWER WINDOW MAIN SWITCH IS OPERATED	81
PASSENGER SIDE : Description	29	WHEN POWER WINDOW MAIN SWITCH IS OPERATED : Diagnosis Procedure	81
PASSENGER SIDE : Component Function Check	29	WHEN REAR POWER WINDOW SWITCH LH IS OPERATED	81
PASSENGER SIDE : Diagnosis Procedure	29	WHEN REAR POWER WINDOW SWITCH LH IS OPERATED : Diagnosis Procedure	81
POWER WINDOW SERIAL LINK	32	WHEN BOTH POWER WINDOW MAIN SWITCH AND REAR POWER WINDOW SWITCH LH ARE OPERATED	81
POWER WINDOW MAIN SWITCH	32	WHEN BOTH POWER WINDOW MAIN SWITCH AND REAR POWER WINDOW SWITCH LH ARE OPERATED : Diagnosis Procedure	81
POWER WINDOW MAIN SWITCH : Description ...	32	REAR RH SIDE POWER WINDOW ALONE DOES NOT OPERATE	82
POWER WINDOW MAIN SWITCH : Component Function Check	32	WHEN POWER WINDOW MAIN SWITCH IS OPERATED	82
POWER WINDOW MAIN SWITCH : Diagnosis Procedure	32	WHEN POWER WINDOW MAIN SWITCH IS OPERATED : Diagnosis Procedure	82
FRONT POWER WINDOW SWITCH (PASSENGER SIDE)	33	WHEN REAR POWER WINDOW SWITCH RH IS OPERATED	82
FRONT POWER WINDOW SWITCH (PASSENGER SIDE) : Description	33	WHEN REAR POWER WINDOW SWITCH RH IS OPERATED : Diagnosis Procedure	82
FRONT POWER WINDOW SWITCH (PASSENGER SIDE) : Component Function Check	33	WHEN BOTH POWER WINDOW MAIN SWITCH AND REAR POWER WINDOW SWITCH RH ARE OPERATED	82
FRONT POWER WINDOW SWITCH (PASSENGER SIDE) : Diagnosis Procedure	34	WHEN BOTH POWER WINDOW MAIN SWITCH AND REAR POWER WINDOW SWITCH RH ARE OPERATED : Diagnosis Procedure	82
ECU DIAGNOSIS INFORMATION	36	POWER WINDOWS DO NOT OPERATE WITH ANY POWER WINDOW SWITCHES	78
BCM	36	Diagnosis Procedure	78
Reference Value	36	SYMPTOM DIAGNOSIS	78
Wiring Diagram - BCM -	59	POWER WINDOWS DO NOT OPERATE WITH ANY POWER WINDOW SWITCHES	78
Fail-safe	63	Diagnosis Procedure	78
DTC Inspection Priority Chart	64	DRIVER SIDE POWER WINDOW DOES NOT OPERATE	79
DTC Index	65	Diagnosis Procedure	79
POWER WINDOW MAIN SWITCH	68	FRONT PASSENGER SIDE POWER WINDOW DOES NOT OPERATE	80
Reference Value	68	WHEN POWER WINDOW MAIN SWITCH IS OPERATED	80
Wiring Diagram - POWER WINDOW SYSTEM - ...	69	WHEN POWER WINDOW MAIN SWITCH IS OPERATED : Diagnosis Procedure	80
Fail Safe	71	WHEN FRONT POWER WINDOW SWITCH (PASSENGER SIDE) IS OPERATED	80
FRONT POWER WINDOW SWITCH (PASSENGER SIDE)	73	WHEN FRONT POWER WINDOW SWITCH (PASSENGER SIDE) IS OPERATED : Diagnosis Procedure	80
Reference Value	73	WHEN BOTH POWER WINDOW MAIN SWITCH AND FRONT POWER WINDOW SWITCH ARE OPERATED	80
Wiring Diagram - POWER WINDOW SYSTEM - ...	74	WHEN BOTH POWER WINDOW MAIN SWITCH AND FRONT POWER WINDOW SWITCH ARE OPERATED : Diagnosis Procedure	80
Fail Safe	76	REAR LH SIDE POWER WINDOW ALONE DOES NOT OPERATE	81
SYMPTOM DIAGNOSIS	78	WHEN POWER WINDOW MAIN SWITCH IS OPERATED	81
POWER WINDOWS DO NOT OPERATE WITH ANY POWER WINDOW SWITCHES	78	WHEN POWER WINDOW MAIN SWITCH IS OPERATED : Diagnosis Procedure	81
Diagnosis Procedure	78	WHEN REAR POWER WINDOW SWITCH LH IS OPERATED	81
		WHEN REAR POWER WINDOW SWITCH LH IS OPERATED : Diagnosis Procedure	81
		WHEN BOTH POWER WINDOW MAIN SWITCH AND REAR POWER WINDOW SWITCH LH ARE OPERATED	81
		WHEN BOTH POWER WINDOW MAIN SWITCH AND REAR POWER WINDOW SWITCH LH ARE OPERATED : Diagnosis Procedure	81
		REAR RH SIDE POWER WINDOW ALONE DOES NOT OPERATE	82
		WHEN POWER WINDOW MAIN SWITCH IS OPERATED	82
		WHEN POWER WINDOW MAIN SWITCH IS OPERATED : Diagnosis Procedure	82
		WHEN REAR POWER WINDOW SWITCH RH IS OPERATED	82
		WHEN REAR POWER WINDOW SWITCH RH IS OPERATED : Diagnosis Procedure	82
		WHEN BOTH POWER WINDOW MAIN SWITCH AND REAR POWER WINDOW SWITCH RH ARE OPERATED	82
		WHEN BOTH POWER WINDOW MAIN SWITCH AND REAR POWER WINDOW SWITCH RH ARE OPERATED : Diagnosis Procedure	82

WHEN BOTH POWER WINDOW MAIN SWITCH AND REAR POWER WINDOW SWITCH RH ARE OPERATED : Diagnosis Procedure82	POWER WINDOW LOCK SWITCH DOES NOT FUNCTION88	A
	Diagnosis Procedure88	
AUTO OPERATION DOES NOT OPERATE BUT MANUAL OPERATES NORMALLY83	POWER WINDOW SWITCH ILLUMINATION DOES NOT ILLUMINATE89	B
	Diagnosis Procedure89	
DRIVER SIDE83	PRECAUTION90	C
DRIVER SIDE : Diagnosis Procedure83	PRECAUTIONS90	
PASSENGER SIDE83	FOR USA AND CANADA90	D
PASSENGER SIDE : Diagnosis Procedure83	FOR USA AND CANADA : Precaution for Supplemental Restraint System (SRS) "AIR BAG" and "SEAT BELT PRE-TENSIONER"90	E
ANTI-PINCH FUNCTION DOES NOT OPERATE NORMALLY84	FOR USA AND CANADA : Precaution for Procedure without Cowl Top Cover90	
	FOR MEXICO90	F
DRIVER SIDE84	FOR MEXICO : Precaution for Supplemental Restraint System (SRS) "AIR BAG" and "SEAT BELT PRE-TENSIONER"90	G
DRIVER SIDE : Diagnosis Procedure84	FOR MEXICO : Precaution for Procedure without Cowl Top Cover91	
PASSENGER SIDE84	REMOVAL AND INSTALLATION92	H
PASSENGER SIDE : Diagnosis Procedure84	POWER WINDOW MAIN SWITCH92	I
POWER WINDOW RETAINED POWER OPERATION DOES NOT OPERATE PROPERLY85	Exploded View92	
Diagnosis Procedure85	Removal and Installation92	J
DOOR KEY CYLINDER SWITCH DOES NOT OPERATE POWER WINDOWS86		
Diagnosis Procedure86		
KEYLESS POWER WINDOW DOWN DOES NOT OPERATE87		
Diagnosis Procedure87		

PWC

L
M
N
O
P

DIAGNOSIS AND REPAIR WORK FLOW

< BASIC INSPECTION >

BASIC INSPECTION

DIAGNOSIS AND REPAIR WORK FLOW

Work Flow

INFOID:000000008458000

DETAILED FLOW

1.OBTAIN INFORMATION ABOUT SYMPTOM

Interview the customer to obtain the malfunction information (conditions and environment when the malfunction occurred) as much as possible when the customer brings the vehicle in.

>> GO TO 2.

2.REPRODUCE THE MALFUNCTION INFORMATION

Check the malfunction on the vehicle that the customer describes.
Inspect the relation of the symptoms and the condition when the symptoms occur.

>> GO TO 3.

3.IDENTIFY THE MALFUNCTIONING SYSTEM WITH "SYMPTOM DIAGNOSIS"

Use "Symptom diagnosis" from the symptom inspection result in step 2 and then identify where to start performing the diagnosis based on possible causes and symptoms.

>> GO TO 4.

4.IDENTIFY THE MALFUNCTIONING PARTS WITH "COMPONENT DIAGNOSIS"

Perform the diagnosis with "Component diagnosis" of the applicable system.

>> GO TO 5.

5.REPAIR OR REPLACE THE MALFUNCTIONING PARTS

Repair or replace the specified malfunctioning parts.

>> GO TO 6.

6.FINAL CHECK

Check that malfunctions are not reproduced when obtaining the malfunction information from the customer, referring to the symptom inspection result in step 2.

Are the malfunctions corrected?

YES >> INSPECTION END

NO >> GO TO 3.

INSPECTION AND ADJUSTMENT

< BASIC INSPECTION >

INSPECTION AND ADJUSTMENT

ADDITIONAL SERVICE WHEN REMOVING BATTERY NEGATIVE TERMINAL

ADDITIONAL SERVICE WHEN REMOVING BATTERY NEGATIVE TERMINAL : Description

INFOID:000000008458001

When battery negative terminal is disconnected, initialization is necessary.

If any of the following operations are performed, initialization is necessary as well as when battery negative terminal is disconnected.

- Power supply to the power window control unit is cut off by the removal of battery terminal or the battery fuse is blown.
- Disconnection and connection of power window control unit harness connector.
- Removal and installation of motor from regulator assembly.
- Operation of regulator assembly as an independent unit.
- Removal and installation of rear power window control unit.
- Removal and installation of door glass.
- Removal and installation of door glass run.

The operations as per the following cannot be performed while initialization is not complete.

- AUTO-UP operation
- Anti-pinch function
- Door key cylinder switch power window function

ADDITIONAL SERVICE WHEN REMOVING BATTERY NEGATIVE TERMINAL : Special Repair Requirement

INFOID:000000008458002

INITIALIZATION PROCEDURE

1. Disconnect battery negative terminal or power window control unit connector. Reconnect it after a minute or more.
2. Turn ignition switch ON.
3. Operate power window switch to fully open door glass. (This operation is unnecessary if door glass is already fully open.)
4. Pull and hold power window switch UP (AUTO-UP operation). Even after door glass stops at the fully closed position, pull the switch for 2 seconds or more.
5. Initialization procedure is complete.
6. Inspect anti-pinch function.

CHECK ANTI-PINCH FUNCTION

1. Fully open door glass.
 2. Place a piece of wood near the fully closed position.
 3. Close door glass completely using AUTO-UP.
- Check that door glass lowers approximately 150 mm (5.9 in) without pinching piece of wood and stops.
 - Check that door glass does not rise when operating power window main switch while lowering.

CAUTION:

- Perform initialization when AUTO-UP operation or anti-pinch function does not operate normally.
- Check that AUTO-UP operates before inspection when initialization is performed.
- Never check with hands or other body parts because they may be pinched. Never get pinched.
- It may switch to the fail-safe mode if open/close operation is performed continuously without fully closing door glass. Perform initialization in the above situation. Refer to [PWC-71, "Fail Safe"](#).
- Finish initialization. Otherwise, the next operation cannot be done.

1. AUTO-UP operation
2. Anti-pinch function
3. Door key cylinder switch power window function

ADDITIONAL SERVICE WHEN REPLACING CONTROL UNIT

ADDITIONAL SERVICE WHEN REPLACING CONTROL UNIT : Description

INFOID:000000008458003

When the control unit is replaced, initialization is necessary.

If any of the following operations are performed, initialization is necessary as well as when the control unit is disconnected.

A
B
C
D
E
F
G
H
I
J
L
M
N
O
P

PWC

INSPECTION AND ADJUSTMENT

< BASIC INSPECTION >

- Power supply to the power window control unit is cut off by the removal of battery terminal or the battery fuse is blown.
- Disconnection and connection of power window control unit harness connector.
- Removal and installation of motor from regulator assembly.
- Disconnection and connection of battery negative terminal.
- Removal and installation of rear power window control unit.
- Removal and installation of door glass.
- Removal and installation of door glass run.

The following specified operations cannot be performed while initialization is not complete.

- AUTO-UP operation
- Anti-pinch function
- Door key cylinder switch power window function

ADDITIONAL SERVICE WHEN REPLACING CONTROL UNIT : Special Repair Requirement

INFOID:000000008458004

INITIALIZATION PROCEDURE

1. Disconnect battery negative terminal or power window control unit connector. Reconnect it after a minute or more.
2. Turn ignition switch ON.
3. Operate power window switch to fully open door glass. (This operation is unnecessary if door glass is already fully open.)
4. Pull and hold power window switch UP (AUTO-UP operation). Even after door glass stops at the fully closed position, pull the switch for 2 seconds or more.
5. Initialization procedure is complete.
6. Inspect anti-pinch function.

CHECK ANTI-PINCH FUNCTION

1. Fully open door glass.
 2. Place a piece of wood near the fully closed position.
 3. Close door glass completely using AUTO-UP.
- Check that door glass lowers approximately 150 mm (5.9 in) without pinching piece of wood and stops.
 - Check that door glass does not rise when operating power window main switch while lowering.

CAUTION:

- **Perform initialization when AUTO-UP operation or anti-pinch function does not operate normally.**
 - **Check that AUTO-UP operates before inspection when initialization is performed.**
 - **Never check with hands or other body parts because they may be pinched. Never get pinched.**
 - **It may switch to the fail-safe mode if open/close operation is performed continuously without fully closing. Perform initialization in the above situation. Refer to [PWC-71, "Fail Safe"](#).**
 - **Finish initialization. Otherwise, the next operation cannot be done.**
1. **AUTO-UP operation**
 2. **Anti-pinch function**
 3. **Door key cylinder switch power window function**

POWER WINDOW SYSTEM

< SYSTEM DESCRIPTION >

SYSTEM DESCRIPTION

POWER WINDOW SYSTEM

System Diagram

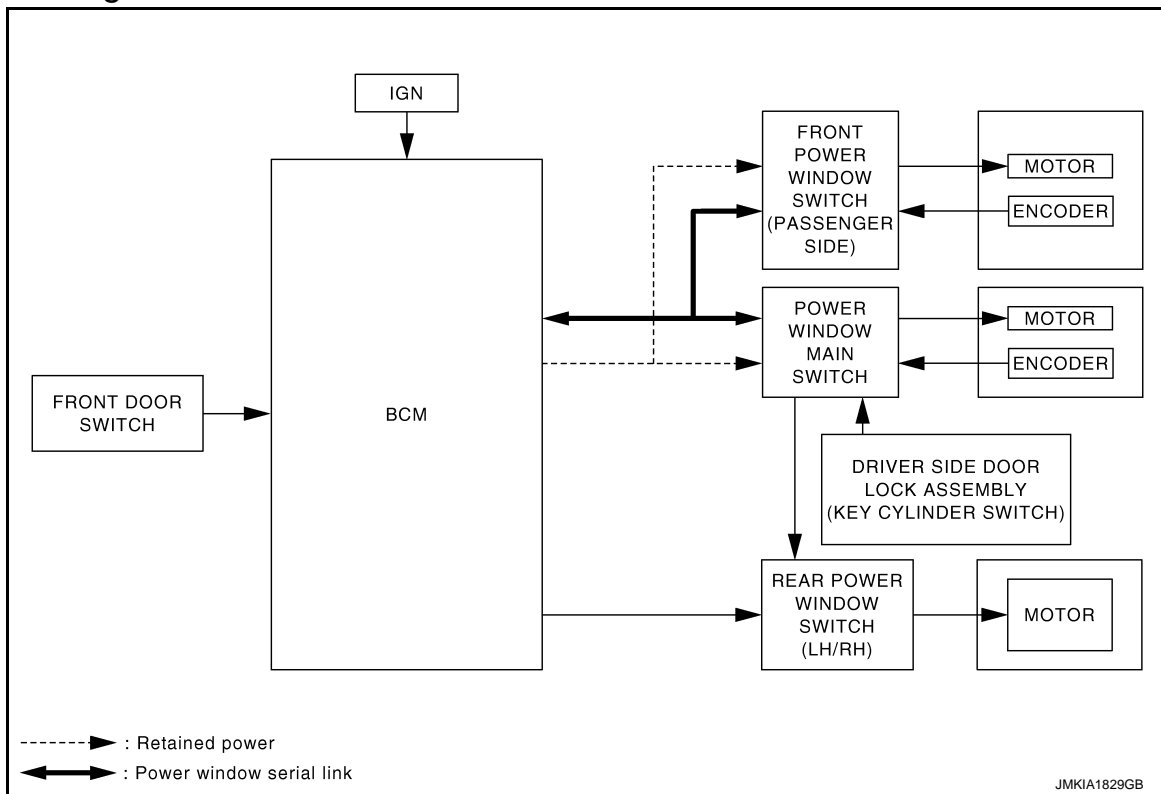

System Description

INFOID:000000008458006

POWER WINDOW SYSTEM

- Power window system is operable during the retained power operation timer after turning ignition switch OFF.
- Power window main switch can open/close door glass.
- Front and rear power window switch can open/close the corresponding door glass.
- AUTO UP/DOWN operation can be performed when front power window switch turns to AUTO.
- Power window lock switch can lock all power windows other than driver seat.
- Power window serial link transmits the signals from power window main switch to front power window switch (passenger side).
- If door glass receives resistance that is the specified value or more while power window of front seat is in AUTO-UP operation, power window of front seat operates in the reverse direction.
- Hold the door key cylinder to the LOCK or UNLOCK direction for 1.5seconds or more to OPEN or CLOSE from power window when ignition switch OFF.
- Front power windows open when pressing Intelligent Key unlock button for 3 seconds.

POWER WINDOW AUTO-OPERATION

- AUTO UP/DOWN operation can be performed when front power window motor turns to AUTO.
- Encoder continues detecting the movement of power window motor and transmits to power window switch as the encoder pulse signal while power window motor is operating.
- Power window switch reads the changes of encoder signal and stops AUTO operation when door glass is at fully opened/closed position.
- Power window motor is operable in case encoder is malfunctioning.

RETAINED POWER OPERATION

Retained power operation is an additional power supply function that enables power window system to operate for 45 seconds after ignition switch turns OFF.

A

B

C

D

E

F

G

H

I

J

PWC

L

M

N

O

P

POWER WINDOW SYSTEM

< SYSTEM DESCRIPTION >

RETAINED POWER FUNCTION CANCEL CONDITIONS

- Front door CLOSE (door switch OFF) → OPEN (door switch ON).
- When ignition switch turns ON again.
- When timer times out. (45 seconds)

POWER WINDOW LOCK FUNCTION

Ground circuit inside power window main switch shuts off when power window lock switch is ON. This inhibits power window switch operation except with the power window main switch.

POWER WINDOW SERIAL LINK

- Front power window switches and BCM transmit and receive the power window serial link.
- Power window serial link transmits the power window main switch operation signals and IGN signal to power window main switch module, front power window switch (passenger side) module.

ANTI-PINCH OPERATION

- Pinch the foreign matter in the door glass during AUTO-UP operation is the anti-pinch function that lowers the door glass 150 mm (5.9 in) when detected.
- Encoder continues detecting the movement of power window motor and transmits to power window switch as the encoder pulse signal while power window motor is operating.
- Resistance is applied to the power window motor rotation that changes the frequency of encoder pulse signal if foreign material is trapped in the door glass.
- Power window switch controls to lower the door glass for 150 mm (5.9 in) after it detects encoder pulse signal frequency change.

OPERATION CONDITION

- When front door glass AUTO-UP operation is performed (anti-pinch function does not operate just before the door glass closes and is fully closed)

NOTE:

Depending on environment and driving conditions, if a similar impact or load is applied to the door glass, it may lower.

DOOR KEY CYLINDER SWITCH POWER WINDOW FUNCTION

Hold the door key cylinder to the LOCK or UNLOCK direction for 1.5 seconds or more to OPEN or CLOSE front power windows when ignition switch is OFF. In addition, it stops when key position is moved to NEUTRAL when operating.

OPERATION CONDITION

- Ignition switch OFF.
- Hold door key cylinder to LOCK position for 1.5 seconds or more to perform CLOSE operation of the door glass.
- Hold door key cylinder to UNLOCK position for 1.5 seconds or more to perform OPEN operation of the door glass.

KEYLESS POWER WINDOW DOWN FUNCTION

Front power windows open when the unlock button on Intelligent Key is activated and kept pressed for more than 3* seconds with the ignition switch OFF. The windows keep opening if the unlock button is continuously pressed.

The power window opening stops when the following operations are performed.

- When the unlock button is kept pressed more than 15 seconds.
- When the ignition switch is turned ON while the power window opening is operated.
- When the unlock button is released.

While retained power operation activate, keyless power window down function cannot be operated.

Keyless power window down operation mode can be changed by "PW DOWN SET" mode in "WORK SUPPORT". Refer to [DLK-57, "INTELLIGENT KEY : CONSULT Function \(BCM - INTELLIGENT KEY\)".](#)

NOTE:

Use CONSULT to change settings.

MODE 1 (3 sec) / MODE 2 (OFF) / MODE 3 (5 sec)

POWER WINDOW SYSTEM

< SYSTEM DESCRIPTION >

Component Parts Location

INFOID:000000008458007

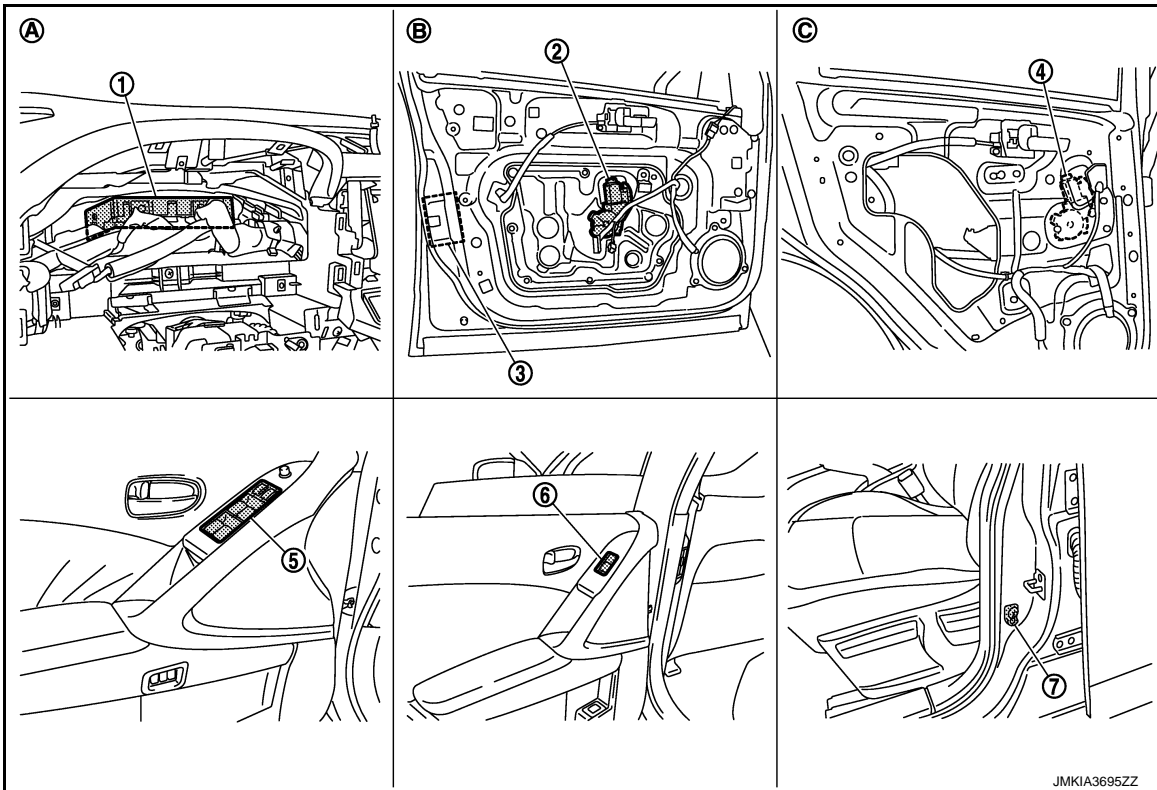

- | | | |
|---|---|--|
| 1. BCM
M118, M119, M122, M123 | 2. Front power window motor (driver side)
D7 | 3. Front door lock assembly (driver side)
Door key cylinder switch D9 |
| 4. Rear power window motor LH
D82 | 5. Power window main switch
D5, D6 | 6. Rear power window switch LH
D83 |
| 7. Front door switch (driver side)
B34 | | |
| A. Behind the combination meter | B. View with front door finisher removed. | C. View with rear door finisher removed. |

Component Description

INFOID:000000008458008

Component	Function
BCM	<ul style="list-style-type: none"> Supplies power to power window switch Controls retained power function
Power window main switch	<ul style="list-style-type: none"> Directly controls all power window motor of all doors Controls anti-pinch operation of power window
Front power window switch (passenger side)	<ul style="list-style-type: none"> Controls power window motor of front passenger side door Controls anti-pinch operation of power window
Rear power window switch (LH & RH)	Controls power window motor of rear right and left doors
Front power window motor (driver side)	<ul style="list-style-type: none"> Integrates the encoder and power window motor Starts operating with signals from power window main switch Outputs front power window motor (driver side) rotation as a pulse signal to power window main switch
Front power window motor (passenger side)	<ul style="list-style-type: none"> Integrates the encoder and power window motor Starts operating with signals from power window main switch & front power window switch (passenger side) Outputs front power window motor (passenger side) rotation as a pulse signal to front power window switch (passenger side)

A
B
C
D
E
F
G
H
I
J
PWC

L
M
N
O
P

POWER WINDOW SYSTEM

< SYSTEM DESCRIPTION >

Component	Function
Rear power window motor (LH & RH)	Starts operating with signals from power window main switch & rear power window switch (LH & RH)
Front door lock assembly (driver side) Door Key cylinder switch	Transmits operation condition of Key cylinder switch to power window
Front door switch	Door open/close condition and transmits to BCM

DIAGNOSIS SYSTEM (BCM)

< SYSTEM DESCRIPTION >

DIAGNOSIS SYSTEM (BCM)

COMMON ITEM

COMMON ITEM : CONSULT Function (BCM - COMMON ITEM)

INFOID:000000008946145

APPLICATION ITEM

CONSULT performs the following functions via CAN communication with BCM.

Diagnosis mode	Function Description
Work Support	Changes the setting for each system function.
Self Diagnostic Result	Displays the diagnosis results judged by BCM.
CAN Diag Support Monitor	Monitors the reception status of CAN communication viewed from BCM.
Data Monitor	The BCM input/output signals are displayed.
Active Test	The signals used to activate each device are forcibly supplied from BCM.
Ecu Identification	The BCM part number is displayed.
Configuration	<ul style="list-style-type: none"> • Read and save the vehicle specification. • Write the vehicle specification when replacing BCM.

SYSTEM APPLICATION

BCM can perform the following functions for each system.

NOTE:

It can perform the diagnosis modes except the following for all sub system selection items.

×: Applicable item

System	Sub system selection item	Diagnosis mode		
		Work Support	Data Monitor	Active Test
Door lock	DOOR LOCK	×	×	×
Rear window defogger	REAR DEFOGGER		×	×
Warning chime	BUZZER		×	×
Interior room lamp timer	INT LAMP	×	×	×
Exterior lamp	HEAD LAMP	×	×	×
Wiper and washer	WIPER	×*1	×	×
Turn signal and hazard warning lamps	FLASHER	×	×	×
—	AIR CONDITONER*2			
<ul style="list-style-type: none"> • Intelligent Key system • Engine start system 	INTELLIGENT KEY	×	×	×
Combination switch	COMB SW		×	
Body control system	BCM	×		
NVIS - NATS	IMMU		×	×
Interior room lamp battery saver	BATTERY SAVER	×	×	×
Back door opener system	TRUNK		×	×
Vehicle security system	THEFT ALM	×	×	×
RAP system	RETAINED PWR		×	
Signal buffer system	SIGNAL BUFFER		×	×
TPMS	TPMS (AIR PRESSURE MONITOR)	×	×	×

NOTE:

- *1: For models with rain sensor this mode is displayed, but is not used.
- *2: This item is displayed, but is not used.

FREEZE FRAME DATA (FFD)

DIAGNOSIS SYSTEM (BCM)

< SYSTEM DESCRIPTION >

The BCM records the following vehicle condition at the time a particular DTC is detected, and displays on CONSULT.

CONSULT screen item	Indication/Unit	Description	
Vehicle Speed	km/h	Vehicle speed of the moment a particular DTC is detected	
Odo/Trip Meter	km	Total mileage (Odometer value) of the moment a particular DTC is detected	
Vehicle Condition	SLEEP>LOCK	Power position status of the moment a particular DTC is detected	While turning BCM status from low power consumption mode to normal mode (Power supply position is "LOCK"*)
	SLEEP>OFF		While turning BCM status from low power consumption mode to normal mode (Power supply position is "OFF".)
	LOCK>ACC		While turning power supply position from "LOCK" to "ACC"
	ACC>ON		While turning power supply position from "ACC" to "IGN"
	RUN>ACC		While turning power supply position from "RUN" to "ACC" (Vehicle is stopping and selector lever is except P position.)
	CRANK>RUN		While turning power supply position from "CRANKING" to "RUN" (From cranking up the engine to run it)
	RUN>URGENT		While turning power supply position from "RUN" to "ACC" (Emergency stop operation)
	ACC>OFF		While turning power supply position from "ACC" to "OFF"
	OFF>LOCK		While turning power supply position from "OFF" to "LOCK"*
	OFF>ACC		While turning power supply position from "OFF" to "ACC"
	ON>CRANK		While turning power supply position from "IGN" to "CRANKING"
	OFF>SLEEP		While turning BCM status from normal mode (Power supply position is "OFF".) to low power consumption mode
	LOCK>SLEEP		While turning BCM status from normal mode (Power supply position is "LOCK"*) to low power consumption mode
	LOCK		Power supply position is "LOCK"*
	OFF		Power supply position is "OFF" (Ignition switch OFF)
	ACC		Power supply position is "ACC" (Ignition switch ACC)
	ON		Power supply position is "IGN" (Ignition switch ON with engine stopped)
	ENGINE RUN		Power supply position is "RUN" (Ignition switch ON with engine running)
	CRANKING		Power supply position is "CRANKING" (At engine cranking)
IGN Counter	0 - 39	The number of times that ignition switch is turned ON after DTC is detected <ul style="list-style-type: none"> • The number is 0 when a malfunction is detected now. • The number increases like 1 → 2 → 3...38 → 39 after returning to the normal condition whenever ignition switch OFF → ON. • The number is fixed to 39 until the self-diagnosis results are erased if it is over 39. 	

NOTE:

*: Power supply position shifts to "LOCK" from "OFF", when ignition switch is in the OFF position, selector lever is in the P position, and any of the following conditions are met.

- Closing door
- Opening door
- Door is locked using door request switch
- Door is locked using Intelligent Key

The power supply position shifts to "ACC" when the push-button ignition switch (push switch) is pushed at "LOCK".

RETAINED PWR

RETAINED PWR : CONSULT Function (BCM - RETAINED PWR)

INFOID:000000008458010

Data monitor

NOTE:

DIAGNOSIS SYSTEM (BCM)

< SYSTEM DESCRIPTION >

The following table includes information (items) inapplicable to this vehicle. For information (items) applicable to this vehicle, refer to CONSULT display items.

Monitor Item	Description
DOOR SW-DR	Indicates [ON/OFF] condition of driver side door switch.
DOOR SW-AS	Indicates [ON/OFF] condition of passenger side door switch.

A

B

C

D

E

F

G

H

I

J

PWC

L

M

N

O

P

POWER SUPPLY AND GROUND CIRCUIT

< DTC/CIRCUIT DIAGNOSIS >

DTC/CIRCUIT DIAGNOSIS

POWER SUPPLY AND GROUND CIRCUIT

BCM

BCM : Diagnosis Procedure

INFOID:000000008458011

1.CHECK FUSE AND FUSIBLE LINK

Check that the following fuse and fusible link are not blown.

Signal name	Fuse and fusible link No.
Battery power supply	L
	10

Is the fuse fusing?

YES >> Replace the blown fuse or fusible link after repairing the affected circuit if a fuse or fusible link is blown.

NO >> GO TO 2.

2.CHECK POWER SUPPLY CIRCUIT

1. Turn ignition switch OFF.
2. Disconnect BCM connectors.
3. Check voltage between BCM harness connector and ground.

Terminals		Voltage (Approx.)
(+)	(-)	
BCM		Ground Battery voltage
Connector	Terminal	
M118	1	
M119	11	

Is the measurement value normal?

YES >> GO TO 3.

NO >> Repair harness or connector.

3.CHECK GROUND CIRCUIT

Check continuity between BCM harness connector and ground.

BCM		Ground	Continuity
Connector	Terminal		
M119	13		Existed

Does continuity exist?

YES >> INSPECTION END

NO >> Repair harness or connector.

POWER WINDOW MAIN SWITCH

POWER WINDOW MAIN SWITCH : Diagnosis Procedure

INFOID:000000008458012

1.CHECK POWER SUPPLY

1. Turn ignition OFF.
2. Disconnect power window main switch connector.
3. Turn ignition switch ON.
4. Check voltage between power window main switch harness connector and ground.

POWER SUPPLY AND GROUND CIRCUIT

< DTC/CIRCUIT DIAGNOSIS >

(+)		(-)	Voltage (V) (Approx.)
Power window main switch			
Connector	Terminal	Ground	Battery voltage
D5	10		
D6	19		

Is the inspection result normal?

YES >> GO TO 3.

NO >> GO TO 2.

2. CHECK POWER SUPPLY CIRCUIT

- Turn ignition switch OFF.
- Disconnect BCM connector.
- Check continuity between BCM harness connector and power window main switch harness connector.

BCM		Power window main switch		Continuity
Connector	Terminal	Connector	Terminal	
M118	2	D6	19	Existed
	3	D5	10	

- Check continuity between BCM harness connector and ground.

BCM		Ground	Continuity
Connector	Terminal		
M118	2		Ground
	3		

Is the inspection result normal?

YES >> Replace BCM. Refer to [BCS-84, "Exploded View"](#).

NO >> Repair or replace harness.

3. CHECK GROUND CIRCUIT

- Turn ignition switch OFF.
- Check continuity between power window main switch harness connector and ground.

Power window main switch		Ground	Continuity
Connector	Terminal		
D6	17		Ground

Is the inspection result normal?

YES >> INSPECTION END

NO >> Repair or replace harness.

FRONT POWER WINDOW SWITCH (PASSENGER SIDE)

FRONT POWER WINDOW SWITCH (PASSENGER SIDE) : Diagnosis Procedure

INFOID:000000008458013

1. CHECK POWER SUPPLY

- Turn ignition switch OFF.
- Disconnect front power window switch (passenger side) connector.
- Turn ignition switch ON.
- Check voltage between front power window switch (passenger side) harness connector and ground.

POWER SUPPLY AND GROUND CIRCUIT

< DTC/CIRCUIT DIAGNOSIS >

(+)		(-)	Voltage (V) (Approx.)
Front power window switch (passenger side)			
Connector	Terminal	Ground	Battery voltage
D45	10		

Is the inspection result normal?

YES >> GO TO 3.

NO >> GO TO 2.

2.CHECK POWER SUPPLY CIRCUIT

1. Turn ignition switch OFF.
2. Disconnect BCM connector.
3. Check continuity between BCM harness connector and front power window switch (passenger side) harness connector.

BCM		Front power window switch (passenger side)		Continuity
Connector	Terminal	Connector	Terminal	
M118	2	D45	10	Existed

4. Check continuity between BCM harness connector and ground.

BCM		Ground	Continuity
Connector	Terminal		
M118	2		Not existed

Is the inspection result normal?

YES >> Replace BCM. Refer to [BCS-84, "Exploded View"](#).

NO >> Repair or replace harness.

3.CHECK GROUND CIRCUIT

1. Turn ignition switch OFF.
2. Check continuity between front power window switch (passenger side) harness connector and ground.

Front power window switch (passenger side)		Ground	Continuity
Connector	Terminal		
D45	11		Existed

Is the inspection result normal?

YES >> INSPECTION END

NO >> Repair or replace harness.

REAR POWER WINDOW SWITCH

REAR POWER WINDOW SWITCH : Diagnosis Procedure

INFOID:000000008458014

1.CHECK POWER SUPPLY

1. Turn ignition switch OFF.
2. Disconnect rear power window switch connector.
3. Turn ignition switch ON.
4. Check voltage between rear power window switch harness connector and ground.

(+)		(-)	Voltage (V) (Approx.)
Rear power window switch			
Connector	Terminal	Ground	Battery voltage
LH	D83		
RH	D103		

POWER SUPPLY AND GROUND CIRCUIT

< DTC/CIRCUIT DIAGNOSIS >

Is the inspection result normal?

- YES >> INSPECTION END
- NO >> GO TO 2.

2. CHECK POWER SUPPLY CIRCUIT

1. Turn ignition switch OFF.
2. Disconnect BCM connector.
3. Check continuity between BCM harness connector and rear power window switch harness connector.

BCM		Rear power window switch		Continuity
Connector	Terminal	Connector	Terminal	
M118	3	LH	D83	Existed
		RH	D103	

4. Check continuity between BCM harness connector and ground.

BCM		Ground	Continuity
Connector	Terminal		
M118	3		Not existed

Is the inspection result normal?

- YES >> Replace BCM. Refer to [BCS-84, "Exploded View"](#).
- NO >> Repair or replace harness.

A
B
C
D
E
F
G
H
I
J
L
M
N
O
P

PWC

REAR POWER WINDOW SWITCH

< DTC/CIRCUIT DIAGNOSIS >

REAR POWER WINDOW SWITCH

Description

INFOID:000000008458015

Rear power window motor will be operated if rear power window switch is operated.

Component Function Check

INFOID:000000008458016

1. CHECK REAR POWER WINDOW SWITCH FUNCTION

Check rear power window motor operation with rear power window switch.

Is the inspection result normal?

- YES >> Rear power window switch is OK.
 NO >> Refer to [PWC-18, "Diagnosis Procedure"](#).

Diagnosis Procedure

INFOID:000000008458017

1. CHECK REAR POWER WINDOW SWITCH INPUT SIGNAL

1. Turn ignition switch OFF.
2. Disconnect rear power window switch connector.
3. Turn ignition switch ON.
4. Check voltage between rear power window switch harness connector and ground.

(+)			(-)	Condition	Voltage (V) (Approx.)	
Rear power window switch						
Connector	Terminal		Ground	Power window main switch: LH	UP	Battery voltage
LH	D83	2			DOWN	0
		3			UP	0
RH	D103				2	DOWN
		3		UP		Battery voltage
				2	DOWN	0
		3			UP	0
3	2			DOWN	Battery voltage	
		2	UP	Battery voltage		

Is the inspection result normal?

- YES >> GO TO 3.
 NO >> GO TO 2.

2. CHECK REAR POWER WINDOW SWITCH CIRCUIT

1. Turn ignition switch OFF.
2. Disconnect power window main switch connector.
3. Check continuity between power window main switch harness connector and rear power window switch harness connector.

Power window main switch		Rear power window switch			Continuity
Connector	Terminal	Connector	Terminal		
D5	1	LH	D83	2	Existed
	3			3	
	5	RH	D103	3	
	7			2	

4. Check continuity between power window main switch harness connector and ground.

REAR POWER WINDOW SWITCH

< DTC/CIRCUIT DIAGNOSIS >

Power window main switch		Ground	Continuity
Connector	Terminal		
D5	1	Ground	Not existed
	3		
	5		
	7		

Is the inspection result normal?

YES >> Replace power window main switch. Refer to [PWC-92. "Removal and Installation"](#).

NO >> Repair or replace harness.

3.CHECK REAR POWER WINDOW SWITCH

Check rear power window switch.

Refer to [PWC-19. "Component Inspection"](#).

Is the inspection result normal?

YES >> GO TO 4.

NO >> Replace rear power window switch. Refer to [PWC-92. "Removal and Installation"](#).

4.CHECK INTERMITTENT INCIDENT

Refer to [GI-45. "Intermittent Incident"](#).

>> INSPECTION END

Component Inspection

INFOID:000000008458018

1.CHECK REAR POWER WINDOW SWITCH

1. Turn ignition switch OFF.
2. Disconnect rear power window switch connector.
3. Check rear power window switch terminals.

Rear power window switch	Terminal		Rear power window switch condition	Continuity
D83 (LH) D103 (RH)	1	5	UP	Existed
	3	4		
	3	4	NEUTRAL	
	2	5		
	1	4	DOWN	
	2	5		

Is the inspection result normal?

YES >> INSPECTION END

NO >> Replace rear power window switch. Refer to [PWC-92. "Removal and Installation"](#).

PWC

POWER WINDOW MOTOR

< DTC/CIRCUIT DIAGNOSIS >

POWER WINDOW MOTOR DRIVER SIDE

DRIVER SIDE : Description

INFOID:000000008458019

Door glass moves UP/DOWN by receiving the signal from power window main switch.

DRIVER SIDE : Component Function Check

INFOID:000000008458020

1. CHECK FRONT POWER WINDOW MOTOR (DRIVER SIDE) OPERATION

Check front power window motor (driver side) operation with power window main switch.

Is the inspection result normal?

- YES >> Front power window motor (driver side) is OK.
 NO >> Refer to [PWC-20, "DRIVER SIDE : Diagnosis Procedure"](#).

DRIVER SIDE : Diagnosis Procedure

INFOID:000000008458021

1. CHECK POWER WINDOW MOTOR (DRIVER SIDE) INPUT SIGNAL

1. Turn ignition switch OFF.
2. Disconnect front power window motor (driver side) connector.
3. Turn ignition switch ON.
4. Check voltage between power window motor (driver side) harness connector and ground.

(+)		(-)	Condition	Voltage (V) (Approx.)
Connector	Terminal			
D7	1	Ground	UP	0
			DOWN	Battery voltage
	2		UP	Battery voltage
			DOWN	0

Is the inspection result normal?

- YES >> GO TO 3.
 NO >> GO TO 2.

2. CHECK POWER WINDOW MOTOR CIRCUIT

1. Turn ignition switch OFF.
2. Disconnect power window main switch connector.
3. Check continuity between power window main switch harness connector and front power window motor (driver side) harness connector.

Power window main switch		Front power window motor (driver side)		Continuity
Connector	Terminal	Connector	Terminal	
D5	8	D7	2	Existed
	11		1	

4. Check continuity between power window main switch harness connector and ground.

Power window main switch		Ground	Continuity
Connector	Terminal		
D5	8		Not existed
	11		

Is the inspection result normal?

- YES >> Replace power window main switch. Refer to [PWC-92, "Removal and Installation"](#).
 NO >> Repair or replace harness.

POWER WINDOW MOTOR

< DTC/CIRCUIT DIAGNOSIS >

3.CHECK FRONT POWER WINDOW MOTOR (DRIVER SIDE)

Check front power window motor (driver side).

Refer to [PWC-21, "DRIVER SIDE : Component Inspection"](#).

Is the inspection result normal?

YES >> GO TO 4.

NO >> Replace power window motor (driver side). Refer to [GW-21, "Removal and Installation"](#).

4.CHECK INTERMITTENT INCIDENT

Refer to [GI-45, "Intermittent Incident"](#).

>> INSPECTION END

DRIVER SIDE : Component Inspection

INFOID:000000008458022

1.CHECK FRONT POWER WINDOW MOTOR (DRIVER SIDE)

1. Turn ignition switch OFF.
2. Disconnect front power window motor (driver side) connector.
3. Check motor operate by connecting the battery voltage directly to front power window motor (driver side) terminals.

Front power window motor (driver side)			Motor condition
Connector	Terminal		
	(+)	(-)	
D7	1	2	DOWN
	2	1	UP

Is the inspection result normal?

YES >> INSPECTION END

NO >> Replace front power window motor (driver side). Refer to [GW-21, "Removal and Installation"](#).

PASSENGER SIDE

PASSENGER SIDE : Description

INFOID:000000008458023

PWC

Door glass moves UP/DOWN by receiving the signal from power window main switch or front power window switch (passenger side).

PASSENGER SIDE : Component Function Check

INFOID:000000008458024

1. CHECK FRONT POWER WINDOW MOTOR (PASSENGER SIDE) OPERATION

Check front power window motor (passenger side) operation with power window main switch or front power window switch (passenger side).

Is the inspection result normal?

YES >> Power window motor (passenger side) is OK.

NO >> Refer to [PWC-21, "PASSENGER SIDE : Diagnosis Procedure"](#).

PASSENGER SIDE : Diagnosis Procedure

INFOID:000000008458025

1.CHECK FRONT POWER WINDOW MOTOR (PASSENGER SIDE) INPUT SIGNAL

1. Turn ignition switch OFF.
2. Disconnect front power window motor (passenger side) connector.
3. Turn ignition switch ON.
4. Check voltage between front power window motor (passenger side) harness connector and ground.

POWER WINDOW MOTOR

< DTC/CIRCUIT DIAGNOSIS >

(+)		(-)	Condition	Voltage (V) (Approx.)
Front power window motor (passenger side)				
Connector	Terminal			
D46	1	Ground	UP	Battery voltage
			DOWN	0
	2		UP	0
			DOWN	Battery voltage

Is the inspection result normal?

YES >> GO TO 3.

NO >> GO TO 2.

2. CHECK FRONT POWER WINDOW MOTOR (PASSENGER SIDE) CIRCUIT

1. Turn ignition switch OFF.
2. Disconnect front power window switch (passenger side) connector.
3. Check continuity between front power window switch (passenger side) harness connector and front power window motor (passenger side) harness connector.

Front power window switch (passenger side)		Front power window motor (passenger side)		Continuity
Connector	Terminal	Connector	Terminal	
D45	9	D46	1	Existed
	8		2	

4. Check continuity between front power window switch (passenger side) harness connector and ground.

Front power window switch (passenger side)		Ground	Continuity
Connector	Terminal		
D45	9		Not existed
	8		

Is the inspection result normal?

YES >> Replace front power window switch (passenger side). [PWC-92. "Removal and Installation"](#).

NO >> Repair or replace harness.

3. CHECK FRONT POWER WINDOW MOTOR (PASSENGER SIDE)

Check front power window motor (passenger side).

Refer to [PWC-22. "PASSENGER SIDE : Component Inspection"](#).

Is the inspection result normal?

YES >> GO TO 4.

NO >> Replace front power window motor (passenger side). Refer to [GW-21. "Removal and Installation"](#).

4. CHECK INTERMITTENT INCIDENT

Refer to [GI-45. "Intermittent Incident"](#).

>> INSPECTION END

PASSENGER SIDE : Component Inspection

INFOID:000000008458026

1. CHECK FRONT POWER WINDOW MOTOR (PASSENGER SIDE)

1. Turn ignition switch OFF.
2. Disconnect front power window motor (passenger side) connector.
3. Check motor operate by connecting the battery voltage directly to front power window motor (passenger side) terminals.

POWER WINDOW MOTOR

< DTC/CIRCUIT DIAGNOSIS >

Front power window motor (passenger side)			Motor condition
Connector	Terminal		
	(+)	(-)	
D46	2	1	DOWN
	1	2	UP

Is the inspection result normal?

YES >> INSPECTION END

NO >> Replace front power window motor (passenger side). Refer to [GW-21. "Removal and Installation"](#).

REAR LH

REAR LH : Description

INFOID:000000008458027

Door glass moves UP/DOWN by receiving the signal from power window main switch or rear power window switch LH.

REAR LH : Component Function Check

INFOID:000000008458028

1.CHECK REAR POWER WINDOW MOTOR LH OPERATION

Check rear power window motor LH operation with power window main switch or rear power window switch LH.

Is the inspection result normal?

YES >> Rear power window motor LH is OK.

NO >> Refer to [PWC-23. "REAR LH : Diagnosis Procedure"](#)

REAR LH : Diagnosis Procedure

INFOID:000000008458029

1.CHECK REAR POWER WINDOW MOTOR LH INPUT SIGNAL

1. Turn ignition switch OFF.
2. Disconnect rear power window motor LH connector.
3. Turn ignition switch ON.
4. Check voltage between rear power window motor LH harness connector and ground.

(+) Rear power window motor LH		(-)	Condition	Voltage (V) (Approx.)
Connector	Terminal			
D82	1	Ground	UP	Battery voltage
			DOWN	0
	3		UP	0
			DOWN	Battery voltage

Is the inspection result normal?

YES >> GO TO 3.

NO >> GO TO 2.

2.CHECK REAR POWER WINDOW MOTOR LH CIRCUIT

1. Turn ignition switch OFF.
2. Disconnect rear power window switch LH connector.
3. Check continuity between rear power window switch LH harness connector and rear power window motor LH harness connector.

Rear power window switch LH		Rear power window motor LH		Continuity
Connector	Terminal	Connector	Terminal	
D83	4	D82	3	Existed
	5		1	

A
B
C
D
E
F
G
H
I
J
L
M
N
O
P

PWC

POWER WINDOW MOTOR

< DTC/CIRCUIT DIAGNOSIS >

4. Check continuity between rear power window switch LH harness connector and ground.

Rear power window switch LH		Ground	Continuity
Connector	Terminal		
D83	4		Not existed
	5		

Is the inspection result normal?

YES >> Replace rear power window switch. Refer to [PWC-92. "Removal and Installation"](#).

NO >> Repair or replace harness.

3.CHECK REAR POWER WINDOW MOTOR LH

Check rear power window motor LH.

Refer to [PWC-24. "REAR LH : Component Inspection"](#).

Is the inspection result normal?

YES >> GO TO 4.

NO >> Replace rear power window motor LH. Refer to [GW-26. "Removal and Installation"](#).

4.CHECK INTERMITTENT INCIDENT

Refer to [GI-45. "Intermittent Incident"](#).

>> INSPECTION END

REAR LH : Component Inspection

INFOID:000000008458030

COMPONENT INSPECTION

1.CHECK REAR POWER WINDOW MOTOR LH

1. Turn ignition switch OFF.
2. Disconnect rear power window motor LH connector.
3. Check motor operate by connecting the battery voltage directly to rear power window motor LH terminals.

Rear power window motor LH			Motor condition
Connector	Terminal		
	(+)	(-)	
D82	3	1	DOWN
	1	3	UP

Is the inspection result normal?

YES >> INSPECTION END

NO >> Replace rear power window motor LH. Refer to [GW-26. "Removal and Installation"](#).

REAR RH

REAR RH : Description

INFOID:000000008458031

Door glass moves UP/DOWN by receiving the signal from power window main switch or rear power window switch RH.

REAR RH : Component Function Check

INFOID:000000008458032

1. CHECK REAR POWER WINDOW MOTOR RH OPERATION

Check rear power window motor RH operation with power window main switch or rear power window switch RH.

Is the inspection result normal?

YES >> Rear power window motor RH is OK.

NO >> Refer to [PWC-25. "REAR RH : Diagnosis Procedure"](#).

POWER WINDOW MOTOR

< DTC/CIRCUIT DIAGNOSIS >

REAR RH : Diagnosis Procedure

INFOID:000000008458033

1. CHECK REAR POWER WINDOW MOTOR RH INPUT SIGNAL

1. Turn ignition switch OFF.
2. Disconnect rear power window motor RH connector.
3. Turn ignition switch ON.
4. Check voltage between rear power window motor RH harness connector and ground.

(+)		(-)	Condition	Voltage (V) (Approx.)
Connector	Terminal			
D102	1	Ground	UP	Battery voltage
			DOWN	0
	3		UP	0
			DOWN	Battery voltage

Is the inspection result normal?

- YES >> GO TO 3.
NO >> GO TO 2.

2. CHECK REAR POWER WINDOW MOTOR RH CIRCUIT

1. Turn ignition switch OFF.
2. Disconnect rear power window switch RH connector.
3. Check continuity between rear power window switch RH harness connector and rear power window motor RH harness connector.

Rear power window switch RH		Rear power window motor RH		Continuity
Connector	Terminal	Connector	Terminal	
D103	4	D102	3	Existed
	5		1	

4. Check continuity between rear power window switch RH harness connector and ground.

Rear power window switch RH		Ground	Continuity
Connector	Terminal		
D103	4		Not existed
	5		

Is the inspection result normal?

- YES >> Replace rear power window switch RH. Refer to [PWC-92, "Removal and Installation"](#).
NO >> Repair or replace harness.

3. CHECK REAR POWER WINDOW MOTOR RH

Check rear power window motor RH.
Refer to [PWC-26, "REAR RH : Component Inspection"](#).

Is the inspection result normal?

- YES >> GO TO 4.
NO >> Replace rear power window motor RH. Refer to [GW-26, "Removal and Installation"](#).

4. CHECK INTERMITTENT INCIDENT

Refer to [GI-45, "Intermittent Incident"](#).

>> INSPECTION END

A
B
C
D
E
F
G
H
I
J

PWC

L
M
N
O
P

POWER WINDOW MOTOR

< DTC/CIRCUIT DIAGNOSIS >

REAR RH : Component Inspection

INFOID:000000008458034

COMPONENT INSPECTION

1. CHECK REAR POWER WINDOW MOTOR RH

1. Turn ignition switch OFF.
2. Disconnect rear power window motor RH connector.
3. Check motor operation by connecting the battery voltage directly to rear power window motor RH terminals.

Rear power window motor RH			Motor condition
Connector	Terminal		
	(+)	(-)	
D102	3	1	DOWN
	1	3	UP

Is the inspection result normal?

YES >> INSPECTION END

NO >> Replace rear power window motor RH. Refer to [GW-26, "Removal and Installation"](#).

ENCODER CIRCUIT

< DTC/CIRCUIT DIAGNOSIS >

ENCODER CIRCUIT

DRIVER SIDE

DRIVER SIDE : Description

INFOID:000000008458035

Detects condition of the front power window motor (driver side) operation and transmits to power window main switch as the pulse signal.

DRIVER SIDE : Component Function Check

INFOID:000000008458036

1.CHECK ENCODER OPERATION

Check driver side door glass perform AUTO open/close operation normally by power window main switch.

Is the inspection result normal?

YES >> Encoder is OK.

NO >> Refer to [PWC-27, "DRIVER SIDE : Diagnosis Procedure"](#).

DRIVER SIDE : Diagnosis Procedure

INFOID:000000008458037

1.CHECK ENCODER SIGNAL

1. Turn ignition switch ON.
2. Check signal between power window main switch harness connector and ground using oscilloscope.

(+)		(-)	Signal (Reference value)
Power window main switch			
Connector	Terminal	Ground	Refer to following signal
D5	9		
	13		

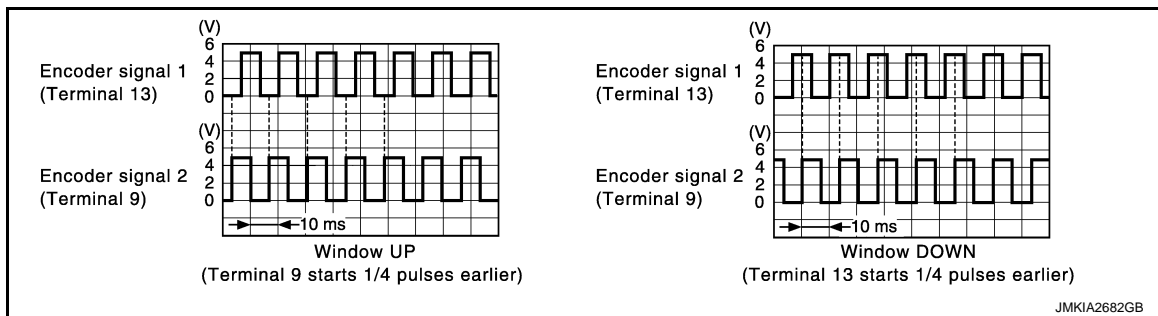

Is the inspection result normal?

YES >> Replace power window main switch. Refer to [PWC-92, "Removal and Installation"](#).

NO >> GO TO 2.

2.CHECK ENCODER SIGNAL CIRCUIT

1. Turn ignition switch OFF.
2. Disconnect power window main switch connector and front power window motor (driver side) connector.
3. Check continuity between power window main switch harness connector and front power window motor (driver side) harness connector.

Power window main switch		Front power window motor (driver side)		Continuity
Connector	Terminal	Connector	Terminal	
D5	9	D7	3	Existed
	13		5	

4. Check continuity between power window main switch harness connector and ground.

ENCODER CIRCUIT

< DTC/CIRCUIT DIAGNOSIS >

Power window main switch		Ground	Continuity
Connector	Terminal		
D5	9		
	13		

Is the inspection result normal?

YES >> GO TO 3.

NO >> Repair or replace harness.

3.CHECK ENCORDER POWER SUPPLY

1. Connect power window main switch connector.
2. Turn ignition switch ON.
3. Check voltage between front power window motor (driver side) harness connector and ground.

(+)		(-)	Voltage (V) (Approx.)
Front power window motor (driver side)			
Connector	Terminal		
D7	4	Ground	Battery voltage

Is the inspection result normal?

YES >> GO TO 5.

NO >> GO TO 4.

4.CHECK ENCORDER POWER SUPPLY CIRCUIT

1. Turn ignition switch OFF.
2. Disconnect power window main switch connector.
3. Check continuity between power window main switch harness connector and front power window motor (driver side) harness connector.

Power window main switch		Front power window motor (driver side)		Continuity
Connector	Terminal	Connector	Terminal	
D5	15	D7	4	Existed

4. Check continuity between power window main switch harness connector and ground.

Power window main switch		Ground	Continuity
Connector	Terminal		
D5	15		

Is the inspection result normal?

YES >> Replace power window main switch. Refer to [PWC-92. "Removal and Installation"](#).

NO >> Repair or replace harness.

5.CHECK GROUND CIRCUIT 1

1. Turn ignition switch OFF.
2. Disconnect power window main switch connector.
3. Check continuity between power window main switch harness connector and front power window motor (driver side) harness connector.

Power window main switch		Front power window motor (driver side)		Continuity
Connector	Terminal	Connector	Terminal	
D5	2	D7	6	Existed

Is the inspection result normal?

YES >> GO TO 6.

NO >> Repair or replace harness.

6.CHECK GROUND CIRCUIT 2

ENCODER CIRCUIT

< DTC/CIRCUIT DIAGNOSIS >

1. Connect power window main switch connector.
2. Check continuity between power window main switch harness connector and ground.

Power window main switch		Ground	Continuity
Connector	Terminal		
D5	2		Existed

Is the inspection result normal?

- YES >> Replace front power window motor (driver side). Refer to [GW-21, "Removal and Installation"](#).
 NO >> Replace power window main switch. Refer to [PWC-92, "Removal and Installation"](#).

PASSENGER SIDE

PASSENGER SIDE : Description

INFOID:000000008458038

Detects condition of the front power window motor (passenger side) operation and transmits to front power window switch (passenger side) as the pulse signal.

PASSENGER SIDE : Component Function Check

INFOID:000000008458039

1.CHECK ENCODER OPERATION

Check passenger side door glass perform AUTO open/close operation normally by power window main switch or front power window switch (passenger side).

Is the inspection result normal?

- YES >> Encoder is OK.
 NO >> Refer to [PWC-29, "PASSENGER SIDE : Diagnosis Procedure"](#).

PASSENGER SIDE : Diagnosis Procedure

INFOID:000000008458040

1.CHECK ENCODER SIGNAL

1. Turn ignition switch ON.
2. Check signal between front power window switch (passenger side) harness connector and ground using oscilloscope.

(+)		(-)	Signal (Reference value)
Front power window switch (passenger side)			
Connector	Terminal		
D45	12	Ground	Refer to following signal
	15		

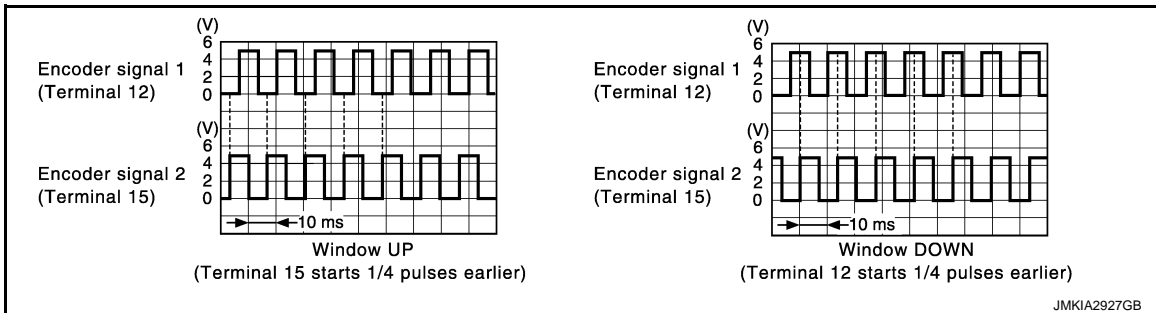

Is the inspection result normal?

- YES >> Replace front power window switch (passenger side). Refer to [PWC-92, "Removal and Installation"](#).
 NO >> GO TO 2.

2.CHECK ENCODER SIGNAL CIRCUIT

1. Turn ignition switch OFF.

ENCODER CIRCUIT

< DTC/CIRCUIT DIAGNOSIS >

2. Disconnect front power window switch (passenger side) connector and front power window motor (passenger side) connector.
3. Check continuity between front power window switch (passenger side) harness connector and front power window motor (passenger side) harness connector.

Front power window switch (passenger side)		Front power window motor (passenger side)		Continuity
Connector	Terminal	Connector	Terminal	
D45	12	D46	5	Existed
	15		3	

4. Check continuity between front power window switch (passenger side) harness connector and ground.

Front power window switch (passenger side)		Ground	Continuity
Connector	Terminal		
D45	12		Not existed
	15		

Is the inspection result normal?

YES >> GO TO 3.

NO >> Repair or replace harness.

3.CHECK ENCODER POWER SUPPLY

1. Connect front power window switch (passenger side) connector.
2. Turn ignition switch ON.
3. Check voltage between front power window motor (passenger side) harness connector and ground.

(+)		(-)	Voltage (V) (Approx.)
Front power window motor (passenger side)			
Connector	Terminal	Ground	Battery voltage
D46	4		

Is the inspection result normal?

YES >> GO TO 5.

NO >> GO TO 4.

4.CHECK ENCODER POWER SUPPLY CIRCUIT

1. Turn ignition switch OFF.
2. Disconnect front power window switch (passenger side) connector.
3. Check continuity between front power window switch (passenger side) harness connector and front power window motor (passenger side) harness connector.

Front power window switch (passenger side)		Front power window motor (passenger side)		Continuity
Connector	Terminal	Connector	Terminal	
D45	4	D46	4	Existed

4. Check continuity between front power window switch (passenger side) harness connector and ground.

Front power window switch (passenger side)		Ground	Continuity
Connector	Terminal		
D45	4		Not existed

Is the inspection result normal?

YES >> Replace front power window switch (passenger side). Refer to [PWC-92, "Removal and Installation"](#).

NO >> Repair or replace harness.

5.CHECK GROUND CIRCUIT 1

1. Turn ignition switch OFF.

ENCODER CIRCUIT

< DTC/CIRCUIT DIAGNOSIS >

2. Disconnect front power window switch (passenger side) connector.
3. Check continuity between front power window switch (passenger side) harness connector and front power window motor (passenger side) harness connector.

Front power window switch (passenger side)		Front power window motor (passenger side)		Continuity
Connector	Terminal	Connector	Terminal	
D45	3	D46	6	Existed

Is the inspection result normal?

- YES >> GO TO 6.
 NO >> Repair or replace harness.

6. CHECK GROUND CIRCUIT 2

1. Connect front power window switch (passenger side) connector.
2. Check continuity between front power window switch (passenger side) harness connector and ground.

Front power window switch (passenger side)		Ground	Continuity
Connector	Terminal		
D45	3		Existed

Is the inspection result normal?

- YES >> Replace front power window motor (passenger side). Refer to [GW-21, "Removal and Installation"](#).
 NO >> Replace front power window switch (passenger side). Refer to [PWC-92, "Removal and Installation"](#).

A
B
C
D
E
F
G
H
I
J
L
M
N
O
P

PWC

POWER WINDOW SERIAL LINK

< DTC/CIRCUIT DIAGNOSIS >

POWER WINDOW SERIAL LINK

POWER WINDOW MAIN SWITCH

POWER WINDOW MAIN SWITCH : Description

INFOID:000000008458041

Power window main switch, front power window switch (passenger side) and BCM transmit and receive the signal by power window serial link.

The signal mentioned below is transmitted from BCM to power window main switch, front power window switch (passenger side).

- Keyless power window down signal

The signal mentioned below is transmitted from power window main switch to front power window switch (passenger side).

- Front passenger side door window operation signal
- Power window control by key cylinder switch signal
- Power window lock switch signal
- Retained power operation signal

POWER WINDOW MAIN SWITCH : Component Function Check

INFOID:000000008458042

1.CHECK POWER WINDOW SWITCH OUTPUT SIGNAL

With CONSULT

Check ("CDL LOCK SW ", "CDL UNLOCK SW") in "DATA MONITOR" mode for "POWER DOOR LOCK SYSTEM" with CONSULT. Refer to [DLK-55. "DOOR LOCK : CONSULT Function \(BCM - DOOR LOCK\)"](#).

Monitor item	Condition
CDL LOCK SW	LOCK : ON
	UNLOCK : OFF
CDL UNLOCK SW	LOCK : OFF
	UNLOCK : ON

Is the inspection result normal?

YES >> Power window serial link is OK.

NO >> Refer to [PWC-32. "POWER WINDOW MAIN SWITCH : Diagnosis Procedure"](#).

POWER WINDOW MAIN SWITCH : Diagnosis Procedure

INFOID:000000008458043

1.CHECK POWER WINDOW SWITCH OUTPUT SIGNAL

1. Turn ignition switch ON.
2. Check signal between power window main switch harness connector and ground.

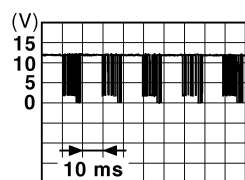
(+)		(-)	Signal (Reference value)
Connector	Terminal		
D5	14	Ground	 <p style="text-align: right;">JPMIA0013GB</p>

Is the inspection result normal?

YES >> GO TO 4.

NO >> GO TO 2.

2.CHECK POWER WINDOW SERIAL LINK SIGNAL

POWER WINDOW SERIAL LINK

< DTC/CIRCUIT DIAGNOSIS >

1. Turn ignition switch OFF.
2. Disconnect power window main switch connector.
3. Turn ignition switch ON.
4. Check voltage between power window main switch harness connector and ground.

(+)		(-)	Voltage (V) (Approx.)
Power window main switch			
Connector	Terminal	Ground	Battery voltage
D5	14		

Is the measurement value within the specification?

- YES >> Replace power window main switch. Refer to [PWC-92, "Removal and Installation"](#).
 NO >> GO TO 3.

3.CHECK POWER WINDOW SERIAL LINK CIRCUIT

1. Turn ignition switch OFF.
2. Disconnect BCM connector.
3. Check continuity between BCM connector and power window main switch connector.

BCM		Power window main switch		Continuity
Connector	Terminal	Connector	Terminal	
M123	132	D5	14	Existed

4. Check continuity between BCM connector and ground.

BCM		Ground	Continuity
Connector	Terminal		
M123	132		Not existed

Is the inspection result normal?

- YES >> Replace BCM. Refer to [BCS-84, "Exploded View"](#).
 NO >> Repair or replace harness.

4.CHECK INTERMITTENT INCIDENT

Refer to [GI-45, "Intermittent Incident"](#).

>> INSPECTION END

FRONT POWER WINDOW SWITCH (PASSENGER SIDE)

FRONT POWER WINDOW SWITCH (PASSENGER SIDE) : Description

INFOID:000000008458044

Power window main switch, front power window switch (passenger side) and BCM transmit and receive the signal by power window serial link.

The signal mentioned below is transmitted from BCM to power window main switch, front power window switch (passenger side).

- Keyless power window down signal

The signal mentioned below is transmitted from power window main switch to front power window switch (passenger side).

- Front passenger side door window operation signal
- Power window control by key cylinder switch signal
- Power window lock switch signal
- Retained power operation signal

FRONT POWER WINDOW SWITCH (PASSENGER SIDE) : Component Function

Check

INFOID:000000008458045

1.CHECK POWER WINDOW SWITCH OUTPUT SIGNAL

POWER WINDOW SERIAL LINK

< DTC/CIRCUIT DIAGNOSIS >

Ⓟ With CONSULT

Check ("CDL LOCK SW", "CDL UNLOCK SW") in "DATA MONITOR" mode for "POWER DOOR LOCK SYSTEM" with CONSULT. Refer to [DLK-55, "DOOR LOCK : CONSULT Function \(BCM - DOOR LOCK\)"](#).

Monitor item	Condition	
CDL LOCK SW	LOCK	: ON
	UNLOCK	: OFF
CDL UNLOCK SW	LOCK	: OFF
	UNLOCK	: ON

Is the inspection result normal?

YES >> Power window serial link is OK.

NO >> Refer to [PWC-34, "FRONT POWER WINDOW SWITCH \(PASSENGER SIDE\) : Diagnosis Procedure"](#).

FRONT POWER WINDOW SWITCH (PASSENGER SIDE) : Diagnosis Procedure

INFOID:000000008458046

1. CHECK POWER WINDOW SWITCH OUTPUT SIGNAL

1. Turn ignition switch ON.
2. Check signal between front power window switch (passenger side) harness connector and ground.

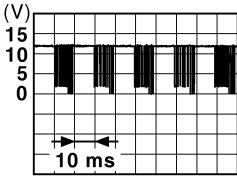
(+)		(-)	Signal (Reference value)
Connector	Terminal		
D45	16	Ground	 <p>JPMAA0013GB</p>

Is the inspection result normal?

YES >> Replace front power window switch (passenger side). Refer to [PWC-92, "Removal and Installation"](#).

NO >> GO TO 2.

2. CHECK POWER WINDOW SERIAL LINK SIGNAL

1. Turn ignition switch OFF.
2. Disconnect front power window switch (passenger side) connector.
3. Turn ignition switch ON.
4. Check voltage between front power window switch (passenger side) harness connector and ground.

(+)		(-)	Voltage (V) (Approx.)
Connector	Terminal		
D45	16	Ground	Battery voltage

Is the inspection result normal?

YES >> Replace power window main switch. Refer to [PWC-92, "Removal and Installation"](#).

NO >> GO TO 3.

3. CHECK POWER WINDOW SERIAL LINK CIRCUIT

1. Turn ignition switch OFF.
2. Disconnect BCM connector.
3. Check continuity between BCM connector and front power window switch (passenger side) connector.

POWER WINDOW SERIAL LINK

< DTC/CIRCUIT DIAGNOSIS >

BCM		Front power window switch (passenger side)		Continuity
Connector	Terminal	Connector	Terminal	
M123	132	D45	16	Existed

4. Check continuity between BCM connector and ground.

BCM		Ground	Continuity
Connector	Terminal		
M123	132		Not existed

Is the inspection result normal?

- YES >> Replace BCM. Refer to [BCS-84. "Exploded View"](#).
- NO >> Repair or replace harness.

PWC

BCM

< ECU DIAGNOSIS INFORMATION >

ECU DIAGNOSIS INFORMATION

BCM

Reference Value

INFOID:000000008946146

VALUES ON THE DIAGNOSIS TOOL

NOTE:

The following table includes information (items) inapplicable to this vehicle. For information (items) applicable to this vehicle, refer to CONSULT display items.

CONSULT MONITOR ITEM

Monitor Item	Condition	Value/Status
FR WIPER HI	Other than front wiper switch HI	Off
	Front wiper switch HI	On
FR WIPER LOW	Other than front wiper switch LO	Off
	Front wiper switch LO	On
FR WASHER SW	Front washer switch OFF	Off
	Front washer switch ON	On
FR WIPER INT	Other than front wiper switch INT/AUTO	Off
	Front wiper switch INT/AUTO	On
FR WIPER STOP	Front wiper is not in STOP position	Off
	Front wiper is in STOP position	On
INT VOLUME	Wiper intermittent dial is in a dial position 1 - 7	Wiper intermittent dial position
RR WIPER ON	Other than rear wiper switch ON	Off
	Rear wiper switch ON	On
RR WIPER INT	Other than rear wiper switch INT	Off
	Rear wiper switch INT	On
RR WASHER SW	Rear washer switch OFF	Off
	Rear washer switch ON	On
RR WIPER STOP	Rear wiper is in STOP position	Off
	Rear wiper is not in STOP position	On
TURN SIGNAL R	Other than turn signal switch RH	Off
	Turn signal switch RH	On
TURN SIGNAL L	Other than turn signal switch LH	Off
	Turn signal switch LH	On
TAIL LAMP SW	Other than lighting switch 1ST and 2ND	Off
	Lighting switch 1ST or 2ND	On
HI BEAM SW	Other than lighting switch HI	Off
	Lighting switch HI	On
HEAD LAMP SW 1	Other than lighting switch 2ND	Off
	Lighting switch 2ND	On
HEAD LAMP SW 2	Other than lighting switch 2ND	Off
	Lighting switch 2ND	On
PASSING SW	Other than lighting switch PASS	Off
	Lighting switch PASS	On
AUTO LIGHT SW	Other than lighting switch AUTO	Off
	Lighting switch AUTO	On

BCM

< ECU DIAGNOSIS INFORMATION >

Monitor Item	Condition	Value/Status	
FR FOG SW	Front fog lamp switch OFF	Off	A
	Front fog lamp switch ON	On	
RR FOG SW	NOTE: The item is indicated, but not monitored.	Off	B
DOOR SW-DR	Driver door closed	Off	C
	Driver door opened	On	
DOOR SW-AS	Passenger door closed	Off	D
	Passenger door opened	On	
DOOR SW-RR	Rear RH door closed	Off	E
	Rear RH door opened	On	
DOOR SW-RL	Rear LH door closed	Off	F
	Rear LH door opened	On	
DOOR SW-BK	Back door closed	Off	G
	Back door opened	On	
CDL LOCK SW	Other than power door lock switch LOCK	Off	H
	Power door lock switch LOCK	On	
CDL UNLOCK SW	Other than power door lock switch UNLOCK	Off	I
	Power door lock switch UNLOCK	On	
KEY CYL LK-SW	Other than driver door key cylinder LOCK position	Off	J
	Driver door key cylinder LOCK position	On	
KEY CYL UN-SW	Other than driver door key cylinder UNLOCK position	Off	K
	Driver door key cylinder UNLOCK position	On	
KEY CYL SW-TR	NOTE: The item is indicated, but not monitored.	Off	L
HAZARD SW	Hazard switch is OFF	Off	M
	Hazard switch is ON	On	
REAR DEF SW NOTE: For models with BOSE audio system this item is not monitored.	Rear window defogger switch OFF	Off	N
	Rear window defogger switch ON	On	
TR CANCEL SW	NOTE: The item is indicated, but not monitored.	Off	O
TR/BD OPEN SW	Back door opener switch OFF	Off	P
	While the back door opener switch is turned ON	On	
TRNK/HAT MNTR	NOTE: The item is indicated, but not monitored.	Off	
RKE-LOCK	LOCK button of Intelligent Key is not pressed	Off	O
	LOCK button of Intelligent Key is pressed	On	
RKE-UNLOCK	UNLOCK button of Intelligent Key is not pressed	Off	P
	UNLOCK button of Intelligent Key is pressed	On	
RKE-TR/BD	BACK DOOR OPEN button of Intelligent Key is not pressed	Off	
	BACK DOOR OPEN button of Intelligent Key is pressed	On	
RKE-PANIC	PANIC button of Intelligent Key is not pressed	Off	
	PANIC button of Intelligent Key is pressed	On	
RKE-P/W OPEN	UNLOCK button of Intelligent Key is not pressed	Off	
	UNLOCK button of Intelligent Key is pressed and held	On	

PWC

BCM

< ECU DIAGNOSIS INFORMATION >

Monitor Item	Condition	Value/Status
RKE-MODE CHG	LOCK/UNLOCK button of Intelligent Key is not pressed and held simultaneously	Off
	LOCK/UNLOCK button of Intelligent Key is pressed and held simultaneously	On
OPTICAL SENSOR	Bright outside of the vehicle	Close to 5 V
	Dark outside of the vehicle	Close to 0 V
REQ SW -DR	Driver door request switch is not pressed	Off
	Driver door request switch is pressed	On
REQ SW -AS	Passenger door request switch is not pressed	Off
	Passenger door request switch is pressed	On
REQ SW -RR	NOTE: The item is indicated, but not monitored.	Off
REQ SW -RR	NOTE: The item is indicated, but not monitored.	Off
REQ SW -BD/TR	Back door request switch is not pressed	Off
	Back door request switch is pressed	On
PUSH SW	Push-button ignition switch (push switch) is not pressed	Off
	Push-button ignition switch (push switch) is pressed	On
IGN RLY2 -F/B	Ignition switch in OFF or ACC position	Off
	Ignition switch in ON position	On
ACC RLY -F/B	NOTE: The item is indicated, but not monitored.	Off
CLUCH SW	NOTE: The item is indicated, but not monitored.	Off
BRAKE SW 1	The brake pedal is depressed when No. 7 fuse is blown	Off
	The brake pedal is not depressed when No. 7 fuse is blown, or No. 7 fuse is normal	On
BRAKE SW 2	The brake pedal is not depressed	Off
	Stop lamp switch 1 signal circuit is normal	On
DETE/CANCL SW	Selector lever in P position	Off
	Selector lever in any position other than P	On
SFT PN/N SW	Selector lever in any position other than P and N	Off
	Selector lever in P or N position	On
S/L -LOCK	NOTE: The item is indicated, but not monitored.	Off
S/L -UNLOCK	NOTE: The item is indicated, but not monitored.	Off
S/L RELAY-F/B	NOTE: The item is indicated, but not monitored.	Off
UNLK SEN -DR	Driver door is unlocked	Off
	Driver door is locked	On
PUSH SW -IPDM	Push-button ignition switch (push-switch) is not pressed	Off
	Push-button ignition switch (push-switch) is pressed	On
IGN RLY1 -F/B	Ignition switch in OFF or ACC position	Off
	Ignition switch in ON position	On
DETE SW -IPDM	Selector lever in any position other than P	Off
	Selector lever in P position	On

BCM

< ECU DIAGNOSIS INFORMATION >

Monitor Item	Condition	Value/Status	
SFT PN -IPDM	Selector lever in any position other than P and N	Off	A
	Selector lever in P or N position	On	
SFT P -MET	Selector lever in any position other than P	Off	B
	Selector lever in P position	On	
SFT N -MET	Selector lever in any position other than N	Off	C
	Selector lever in N position	On	
ENGINE STATE	Engine stopped	Stop	
	While the engine stalls	Stall	D
	At engine cranking	Crank	
	Engine running	Run	
S/L LOCK-IPDM	NOTE: The item is indicated, but not monitored.	Off	E
S/L UNLK-IPDM	NOTE: The item is indicated, but not monitored.	Off	F
S/L RELAY-REQ	NOTE: The item is indicated, but not monitored.	Off	
VEH SPEED 1	While driving	Equivalent to speedometer reading	G
VEH SPEED 2	While driving	Equivalent to speedometer reading	H
DOOR STAT-DR	Driver door is locked	LOCK	
	Wait with selective UNLOCK operation (5 seconds)	READY	I
	Driver door is unlocked	UNLOCK	
DOOR STAT-AS	Passenger door is locked	LOCK	
	Wait with selective UNLOCK operation (5 seconds)	READY	J
	Passenger door is unlocked	UNLOCK	
ID OK FLAG	Power supply position in LOCK position	Reset	
	Power supply position in any position other than LOCK	Set	PWC
PRMT ENG STRT	The engine start is prohibited	Reset	
	The engine start is permitted	Set	L
PRMT RKE STRT	NOTE: The item is indicated, but not monitored.	Reset	
KEY SW -SLOT	Intelligent Key is not inserted into key slot	Off	M
	Intelligent Key is inserted into key slot	On	
RKE OPE COUN1	During the operation of Intelligent Key	Operation frequency of Intelligent Key	N
RKE OPE COUN2	NOTE: The item is indicated, but not monitored.	—	
CONFIRM ID ALL	The Intelligent Key ID that the key slot receives is not recognized by any Intelligent Key ID registered to BCM.	Yet	O
	The Intelligent Key ID that the key slot receives is recognized by any Intelligent Key ID registered to BCM.	Done	P
CONFIRM ID4	The Intelligent Key ID that the key slot receives is not recognized by the fourth Intelligent Key ID registered to BCM.	Yet	
	The Intelligent Key ID that the key slot receives is recognized by the fourth Intelligent Key ID registered to BCM.	Done	

BCM

< ECU DIAGNOSIS INFORMATION >

Monitor Item	Condition	Value/Status
CONFIRM ID3	The Intelligent Key ID that the key slot receives is not recognized by the third Intelligent Key ID registered to BCM.	Yet
	The Intelligent Key ID that the key slot receives is recognized by the third Intelligent Key ID registered to BCM.	Done
CONFIRM ID2	The Intelligent Key ID that the key slot receives is not recognized by the second Intelligent Key ID registered to BCM.	Yet
	The Intelligent Key ID that the key slot receives is recognized by the second Intelligent Key ID registered to BCM.	Done
CONFIRM ID1	The Intelligent Key ID that the key slot receives is not recognized by the first Intelligent Key ID registered to BCM.	Yet
	The Intelligent Key ID that the key slot receives is recognized by the first Intelligent Key ID registered to BCM.	Done
TP 4	The ID of fourth Intelligent Key is not registered to BCM	Yet
	The ID of fourth Intelligent Key is registered to BCM	Done
TP 3	The ID of third Intelligent Key is not registered to BCM	Yet
	The ID of third Intelligent Key is registered to BCM	Done
TP 2	The ID of second Intelligent Key is not registered to BCM	Yet
	The ID of second Intelligent Key is registered to BCM	Done
TP 1	The ID of first Intelligent Key is not registered to BCM	Yet
	The ID of first Intelligent Key is registered to BCM	Done
AIR PRESS FL	Ignition switch ON (Only when the signal from the transmitter is received)	Air pressure of front LH tire
AIR PRESS FR	Ignition switch ON (Only when the signal from the transmitter is received)	Air pressure of front RH tire
AIR PRESS RR	Ignition switch ON (Only when the signal from the transmitter is received)	Air pressure of rear RH tire
AIR PRESS RL	Ignition switch ON (Only when the signal from the transmitter is received)	Air pressure of rear LH tire
ID REGST FL1	ID of front LH tire transmitter is registered	Done
	ID of front LH tire transmitter is not registered	Yet
ID REGST FR1	ID of front RH tire transmitter is registered	Done
	ID of front RH tire transmitter is not registered	Yet
ID REGST RR1	ID of rear RH tire transmitter is registered	Done
	ID of rear RH tire transmitter is not registered	Yet
ID REGST RL1	ID of rear LH tire transmitter is registered	Done
	ID of rear LH tire transmitter is not registered	Yet
WARNING LAMP	Tire pressure indicator OFF	Off
	Tire pressure indicator ON	On
BUZZER	Tire pressure warning alarm is not sounding	Off
	Tire pressure warning alarm is sounding	On

BCM

< ECU DIAGNOSIS INFORMATION >

TERMINAL LAYOUT

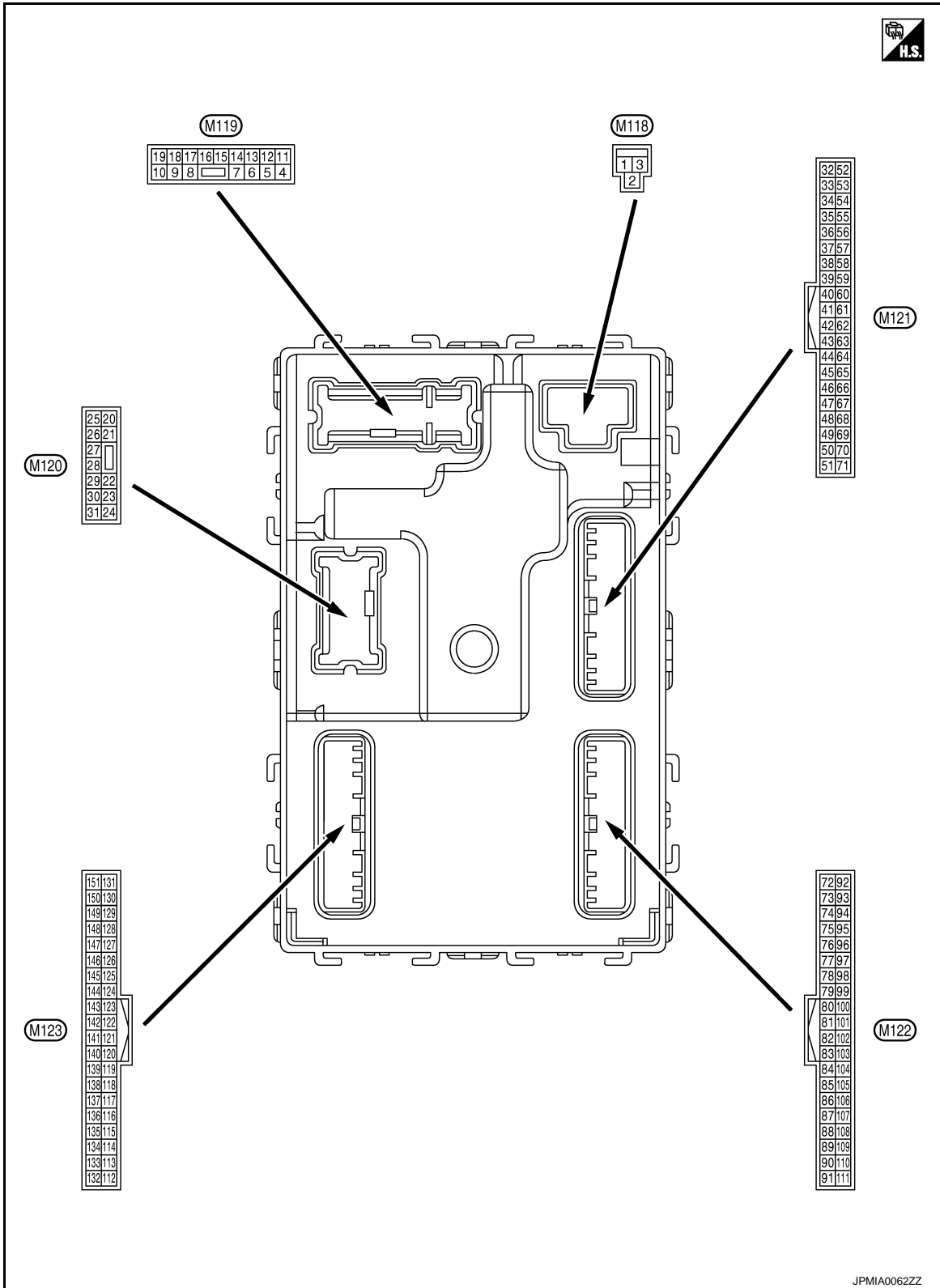

PHYSICAL VALUES

A
B
C
D
E
F
G
H
I
J
K
L
M
N
O
P

PWC

BCM

< ECU DIAGNOSIS INFORMATION >

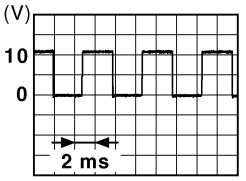
Terminal No. (Wire color)		Description		Condition		Value (Approx.)
+	-	Signal name	Input/ Output			
1 (W)	Ground	Battery power supply	Input	Ignition switch OFF		Battery voltage
2 (GR)	Ground	P/W power supply (BAT)	Output	Ignition switch OFF		Battery voltage
3 (L)	Ground	P/W power supply (IGN)	Output	Ignition switch ON		Battery voltage
4 (P/W)	Ground	Interior room lamp power supply	Output	Interior room lamp battery saver is activated. (Cuts the interior room lamp power supply)		0 V
				Interior room lamp battery saver is not activated. (Outputs the interior room lamp power supply)		Battery voltage
5 (G)	Ground	Passenger door UN- LOCK	Output	Passenger door	UNLOCK (Actuator is activated)	Battery voltage
					Other than UNLOCK (Actuator is not activated)	0 V
7 (W)	Ground	Step lamp control	Output	Step lamp	ON	0 V
					OFF	Battery voltage
8 (V)	Ground	All doors LOCK	Output	All doors	LOCK (Actuator is activated)	Battery voltage
					Other than LOCK (Actuator is not activated)	0 V
9 (G)	Ground	Driver door UNLOCK	Output	Driver door	UNLOCK (Actuator is activated)	Battery voltage
					Other than UNLOCK (Actuator is not activated)	0 V
10 (P)	Ground	Rear RH door and rear LH door UN- LOCK	Output	Rear RH door and rear LH door	UNLOCK (Actuator is activated)	Battery voltage
					Other than UNLOCK (Actuator is not activated)	0 V
11 (LG)	Ground	Battery power supply	Input	Ignition switch OFF		Battery voltage
13 (B)	Ground	Ground	—	Ignition switch ON		0 V
14 (O)	Ground	Push-button ignition switch illumination ground	Output	Tail lamp	OFF	0 V
					ON	<p>NOTE: When the illumination brightening/dimming level is in the neutral position</p>  <p style="text-align: right; font-size: small;">JSNIA0010GB</p>
15 (L)	Ground	ACC indicator lamp	Output	Ignition switch	OFF (LOCK and ON indicator lamps are not illuminated.)	Battery voltage
					ACC	0 V

BCM

< ECU DIAGNOSIS INFORMATION >

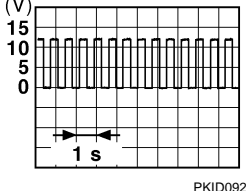
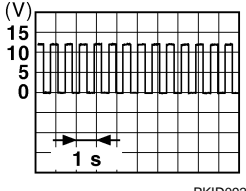
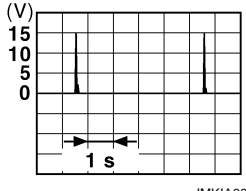
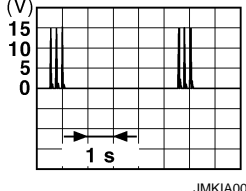
Terminal No. (Wire color)		Description		Condition	Value (Approx.)
+	-	Signal name	Input/ Output		
17 (G)	Ground	Turn signal RH	Output	Turn signal switch OFF	0 V
				Ignition switch ON Turn signal switch RH	 6.5 V
18 (BR)	Ground	Turn signal LH	Output	Turn signal switch OFF	0 V
				Ignition switch ON Turn signal switch LH	 6.5 V
19 (Y)	Ground	Interior room lamp control	Output	Interior room lamp	OFF
				ON	Battery voltage
23 (BR)	Ground	Back door open	Output	Back door	OPEN (Back door opener actuator is activated)
				Other than OPEN (Back door opener actuator is not activated)	Battery voltage
26 (G)	Ground	Rear wiper	Output	Rear wiper	OFF (Stopped)
				ON (Operated)	0 V
34 (B)	Ground	Luggage room antenna (-)	Output	Ignition switch OFF	 6.5 V
				When Intelligent Key is not in the passenger compartment	 6.5 V

A
B
C
D
E
F
G
H
I
J
L
M
N
O
P

PWC

BCM

< ECU DIAGNOSIS INFORMATION >

Terminal No. (Wire color)		Description		Condition	Value (Approx.)
+	-	Signal name	Input/ Output		
35 (W)	Ground	Luggage room antenna (+)	Output	Ignition switch OFF	<p style="text-align: right; font-size: small;">JMKIA0062GB</p>
				When Intelligent Key is not in the passenger compartment	<p style="text-align: right; font-size: small;">JMKIA0063GB</p>
38 (L)	Ground	Rear bumper antenna (-)	Output	When the back door request switch is operated with ignition switch OFF	<p style="text-align: right; font-size: small;">JMKIA0062GB</p>
				When Intelligent Key is not in the antenna detection area	<p style="text-align: right; font-size: small;">JMKIA0063GB</p>
39 (BR)	Ground	Rear bumper antenna (+)	Output	When the back door request switch is operated with ignition switch OFF	<p style="text-align: right; font-size: small;">JMKIA0062GB</p>
				When Intelligent Key is not in the antenna detection area	<p style="text-align: right; font-size: small;">JMKIA0063GB</p>
47 (L)	Ground	Ignition relay (IPDM E/R) control	Output	Ignition switch	Battery voltage
				OFF or ACC	0 V

BCM

< ECU DIAGNOSIS INFORMATION >

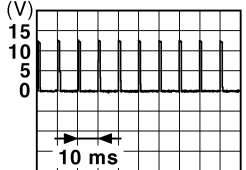
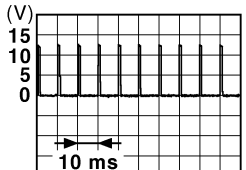
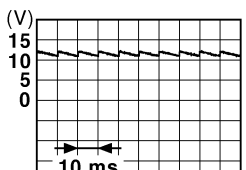
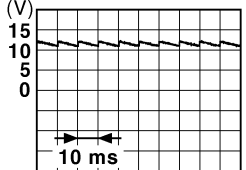
Terminal No. (Wire color)		Description		Condition		Value (Approx.)
		Signal name	Input/ Output			
+	-					
52 (R)	Ground	Starter relay control	Output	Ignition switch ON	When selector lever is in P or N position	Battery voltage
					When selector lever is not in P or N position	0.3 V
				Ignition switch OFF	0 V	
60 (BR)	Ground	Push-button ignition switch (push switch)	Input	Push-button igni- tion switch (push switch)	Pressed	0 V
					Not pressed	Battery voltage
61 (R)	Ground	Back door request switch	Input	Back door re- quest switch	ON (Pressed)	0 V
					OFF (Not pressed)	 <p style="text-align: right; font-size: small;">JPMIA0016GB</p> <p style="text-align: center;">1.0 V</p>
64 (GR)	Ground	Intelligent key warn- ing buzzer control	Output	Warning buzzer	Sounding	0 V
					Not sounding	Battery voltage
65 (O)	Ground	Rear wiper stop posi- tion	Input	Rear wiper	In stop position	 <p style="text-align: right; font-size: small;">JPMIA0016GB</p> <p style="text-align: center;">1.0 V</p>
					Not in stop position	0 V
66 (Y)	Ground	Back door switch	Input	Back door switch	OFF (When back door closes)	 <p style="text-align: right; font-size: small;">JPMIA0011GB</p> <p style="text-align: center;">11.8 V</p>
					ON (When back door opens)	0 V
67 (LG)	Ground	Back door opener switch	Input	Back door opener switch	Pressed	0 V
					Not pressed	 <p style="text-align: right; font-size: small;">JPMIA0011GB</p> <p style="text-align: center;">11.8 V</p>

A
B
C
D
E
F
G
H
I
J
L
M
N
O
P

PWC

BCM

< ECU DIAGNOSIS INFORMATION >

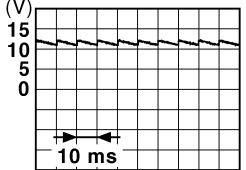
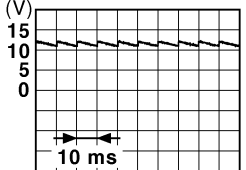
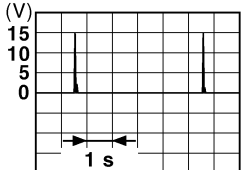
Terminal No. (Wire color)		Description		Condition	Value (Approx.)
+	-	Signal name	Input/ Output		
68 (W)	Ground	Rear RH door switch	Input	Rear RH door switch	 <p style="text-align: right; font-size: small;">JPMIA0011GB</p> <p style="text-align: center;">11.8 V</p>
					ON (When rear RH door opens)
69 (R)	Ground	Rear LH door switch	Input	Rear LH door switch	 <p style="text-align: right; font-size: small;">JPMIA0011GB</p> <p style="text-align: center;">11.8 V</p>
					ON (When rear LH door opens)
72 (B)	Ground	Room antenna (-) (Center console)	Output	Ignition switch OFF	 <p style="text-align: right; font-size: small;">JMKIA0062GB</p>
					When Intelligent Key is not in the passenger compart- ment

BCM

< ECU DIAGNOSIS INFORMATION >

Terminal No. (Wire color)		Description		Condition	Value (Approx.)
+	-	Signal name	Input/ Output		
73 (W)	Ground	Room antenna (+) (Center console)	Output	Ignition switch OFF	<p style="text-align: right; font-size: small;">JMKIA0062GB</p>
				When Intelligent Key is not in the passenger compart- ment	<p style="text-align: right; font-size: small;">JMKIA0063GB</p>
74 (Y)	Ground	Passenger door an- tenna (-)	Output	When the pas- senger door re- quest switch is operated with ig- nition switch OFF	<p style="text-align: right; font-size: small;">JMKIA0062GB</p>
				When Intelligent Key is not in the antenna detection area	<p style="text-align: right; font-size: small;">JMKIA0063GB</p>
75 (LG)	Ground	Passenger door an- tenna (+)	Output	When Intelligent Key is in the antenna detection area	<p style="text-align: right; font-size: small;">JMKIA0062GB</p>
				When the pas- senger door re- quest switch is operated with ig- nition switch OFF	<p style="text-align: right; font-size: small;">JMKIA0063GB</p>

A
B
C
D
E
F
G
H
I
J
L
M
N
O
P

PWC

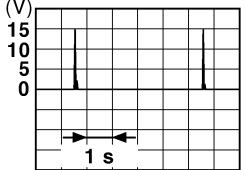
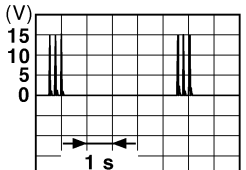
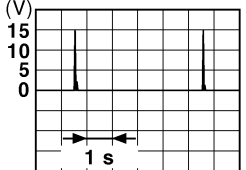
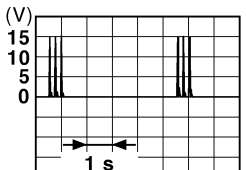

BCM

< ECU DIAGNOSIS INFORMATION >

Terminal No. (Wire color)		Description		Condition	Value (Approx.)	
+	-	Signal name	Input/ Output			
76 (V)	Ground	Driver door antenna (-)	Output	When Intelligent Key is in the antenna detection area	 <p style="text-align: right; font-size: small;">JMKIA0062GB</p>	
				When Intelligent Key is not in the antenna detection area	 <p style="text-align: right; font-size: small;">JMKIA0063GB</p>	
77 (P)	Ground	Driver door antenna (+)	Output	When Intelligent Key is in the antenna detection area	 <p style="text-align: right; font-size: small;">JMKIA0062GB</p>	
				When Intelligent Key is not in the antenna detection area	 <p style="text-align: right; font-size: small;">JMKIA0063GB</p>	
80 (SB)	Ground	NATS antenna amp.	Input/ Output	During waiting	Ignition switch is pressed while inserting Intelligent Key into the key slot.	Just after pressing ignition switch. Pointer of tester should move.
81 (O)	Ground	NATS antenna amp.	Input/ Output	During waiting	Ignition switch is pressed while inserting Intelligent Key into the key slot.	Just after pressing ignition switch. Pointer of tester should move.
82 (BR)	Ground	Ignition relay [fuse block (J/B)] control	Output	Ignition switch	OFF or ACC	0 V
					ON	Battery voltage

BCM

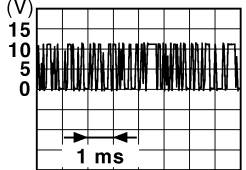
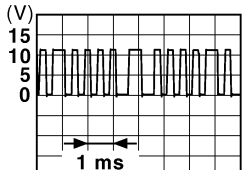
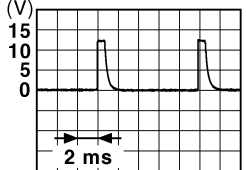
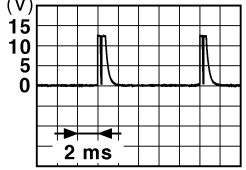
< ECU DIAGNOSIS INFORMATION >

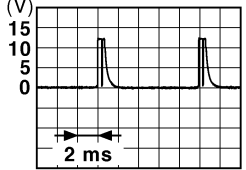

Terminal No. (Wire color)		Description		Condition	Value (Approx.)
		Signal name	Input/ Output		
+	-				
83 (P)	Ground	Remote keyless entry receiver communication	Input/ Output	During waiting	 <p style="text-align: right; font-size: small;">JMKIA0064GB</p>
				When operating either button on Intelligent Key	 <p style="text-align: right; font-size: small;">JMKIA0065GB</p>
87 (R)	Ground	Combination switch INPUT 5	Input	Combination switch	All switches OFF (Wiper intermittent dial 4)  <p style="text-align: right; font-size: small;">JPMIA0041GB</p> <p style="text-align: center;">1.4 V</p>
					Front fog lamp switch ON (Wiper intermittent dial 4)  <p style="text-align: right; font-size: small;">JPMIA0037GB</p> <p style="text-align: center;">1.3 V</p>
					Rear wiper switch ON (Wiper intermittent dial 4)  <p style="text-align: right; font-size: small;">JPMIA0039GB</p> <p style="text-align: center;">1.3 V</p>
					Any of the conditions below with all switches OFF <ul style="list-style-type: none"> • Wiper intermittent dial 1 • Wiper intermittent dial 2 • Wiper intermittent dial 6 • Wiper intermittent dial 7  <p style="text-align: right; font-size: small;">JPMIA0040GB</p> <p style="text-align: center;">1.3 V</p>

A
B
C
D
E
F
G
H
I
J
L
M
N
O
P

PWC

BCM

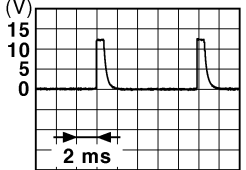
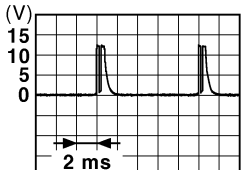
< ECU DIAGNOSIS INFORMATION >

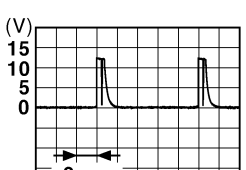
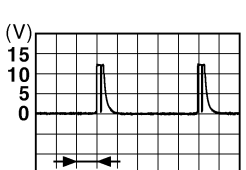
Terminal No. (Wire color)		Description		Condition	Value (Approx.)	
+	-	Signal name	Input/ Output			
88 (GR)	Ground	Combination switch INPUT 3	Input	Combination switch	All switches OFF (Wiper intermittent dial 4)	 <p style="text-align: right; font-size: small;">JPMIA0041GB</p> <p style="text-align: center;">1.4 V</p>
					Lighting switch HI (Wiper intermittent dial 4)	 <p style="text-align: right; font-size: small;">JPMIA0036GB</p> <p style="text-align: center;">1.3 V</p>
					Lighting switch 2ND (Wiper intermittent dial 4)	 <p style="text-align: right; font-size: small;">JPMIA0037GB</p> <p style="text-align: center;">1.3 V</p>
					Rear washer switch ON (Wiper intermittent dial 4)	 <p style="text-align: right; font-size: small;">JPMIA0039GB</p> <p style="text-align: center;">1.3 V</p>
					Any of the conditions below with all switches OFF	 <p style="text-align: right; font-size: small;">JPMIA0040GB</p> <p style="text-align: center;">1.3 V</p>
90 (P)	Ground	CAN-L	Input/ Output	—	—	
91 (L)	Ground	CAN-H	Input/ Output	—	—	

BCM

< ECU DIAGNOSIS INFORMATION >

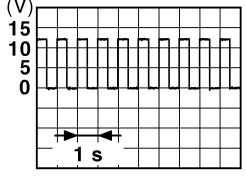
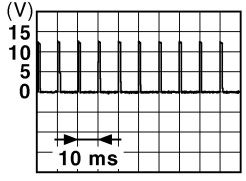
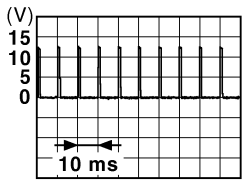

Terminal No. (Wire color)		Description		Condition	Value (Approx.)	
+	-	Signal name	Input/ Output			
92 (R)	Ground	Key slot illumination	Output	OFF	0 V	
				Blinking	 6.5 V	
				ON	Battery voltage	
93 (P)	Ground	ON indicator lamp	Output	Ignition switch	OFF (LOCK and ACC indicator lamps are not illuminated.)	Battery voltage
				ON	0 V	
95 (L)	Ground	ACC relay control	Output	Ignition switch	OFF	0 V
				ACC or ON	Battery voltage	
96 (Y)	Ground	CVT shift selector (detention switch) power supply	Output	—	Battery voltage	
99 (V)	Ground	Selector lever P position switch	Input	Selector lever	P position	0 V
				Any position other than P	Battery voltage	
100 (P)	Ground	Passenger door request switch	Input	Passenger door request switch	ON (Pressed)	0 V
				OFF (Not pressed)	 1.0 V	
101 (W)	Ground	Driver door request switch	Input	Driver door request switch	ON (Pressed)	0 V
				OFF (Not pressed)	 1.0 V	
102 (Y)	Ground	Blower fan motor relay control	Output	Ignition switch	OFF or ACC	0 V
				ON	Battery voltage	
103 (L)	Ground	Remote keyless entry receiver power supply	Output	Ignition switch OFF	Battery voltage	

A
B
C
D
E
F
G
H
I
J
L
M
N
O
P

PWC



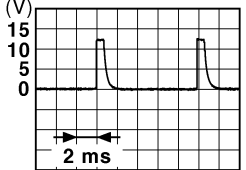

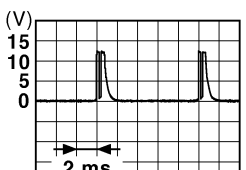
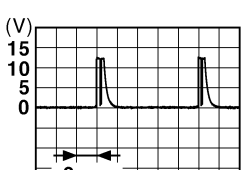
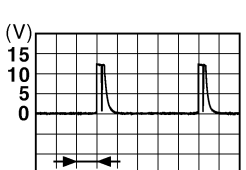
BCM

< ECU DIAGNOSIS INFORMATION >

Terminal No. (Wire color)		Description		Condition	Value (Approx.)	
+	-	Signal name	Input/ Output			
107 (O)	Ground	Combination switch INPUT 1	Input	Combination switch (Wiper intermittent dial 4)	All switches OFF	 <p style="text-align: right;">JPMIA0041GB 1.4 V</p>
					Turn signal switch LH	 <p style="text-align: right;">JPMIA0037GB 1.3 V</p>
					Turn signal switch RH	 <p style="text-align: right;">JPMIA0036GB 1.3 V</p>
					Front wiper switch LO	 <p style="text-align: right;">JPMIA0038GB 1.3 V</p>
					Front washer switch ON	 <p style="text-align: right;">JPMIA0039GB 1.3 V</p>

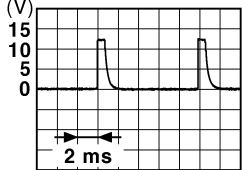
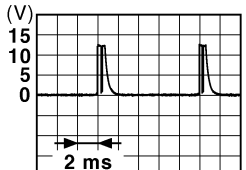
BCM

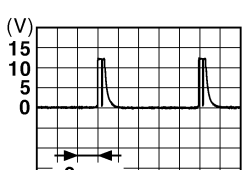
< ECU DIAGNOSIS INFORMATION >



Terminal No. (Wire color)		Description		Condition	Value (Approx.)	
		Signal name	Input/ Output			
+	-					
108 (P)	Ground	Combination switch INPUT 4	Input	Combination switch	All switches OFF (Wiper intermittent dial 4)	 <p style="text-align: right;">1.4 V</p>
					Lighting switch AUTO (Wiper intermittent dial 4)	 <p style="text-align: right;">1.3 V</p>
					Lighting switch 1ST (Wiper intermittent dial 4)	 <p style="text-align: right;">1.3 V</p>
					Rear wiper switch INT (Wiper intermittent dial 4)	 <p style="text-align: right;">1.3 V</p>
					Any of the conditions below with all switches OFF	 <p style="text-align: right;">1.3 V</p>

A
B
C
D
E
F
G
H
I
J
L
M
N
O
P

PWC

BCM

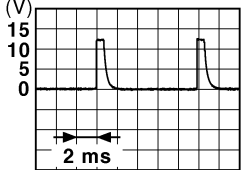
< ECU DIAGNOSIS INFORMATION >

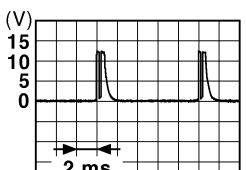
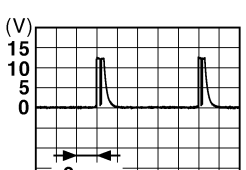
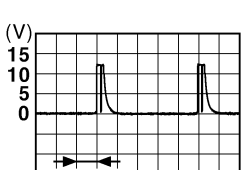
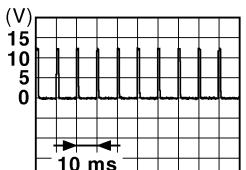
Terminal No. (Wire color)		Description		Condition	Value (Approx.)	
+	-	Signal name	Input/ Output			
109 (SB)	Ground	Combination switch INPUT 2	Input	Combination switch (Wiper intermittent dial 4)	All switches OFF	 <p style="text-align: right;">JPMIA0041GB</p> <p style="text-align: center;">1.4 V</p>
					Lighting switch PASS	 <p style="text-align: right;">JPMIA0037GB</p> <p style="text-align: center;">1.3 V</p>
					Lighting switch 2ND	 <p style="text-align: right;">JPMIA0036GB</p> <p style="text-align: center;">1.3 V</p>
					Front wiper switch INT/ AUTO	 <p style="text-align: right;">JPMIA0038GB</p> <p style="text-align: center;">1.3 V</p>
					Front wiper switch HI	 <p style="text-align: right;">JPMIA0040GB</p> <p style="text-align: center;">1.3 V</p>
					ON	0 V
110 (G)	Ground	Hazard switch	Input	Hazard switch	<p style="text-align: center;">OFF</p>  <p style="text-align: right;">JPMIA0012GB</p> <p style="text-align: center;">1.1 V</p>	

BCM

< ECU DIAGNOSIS INFORMATION >

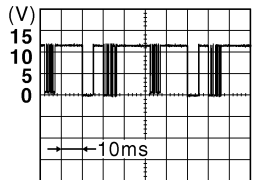
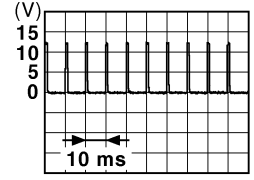
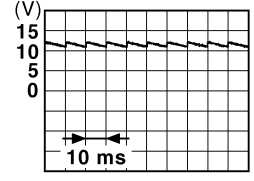
Terminal No. (Wire color)		Description		Condition	Value (Approx.)
+	-	Signal name	Input/ Output		
112 (R)	Ground	Rain sensor serial link	Input/ Output	Ignition switch ON	 8.7 V
113 (P/B)	Ground	Optical sensor	Input	Ignition switch ON	When bright outside of the vehicle Close to 5 V
				When dark outside of the vehicle Close to 0 V	
116 (GR)	Ground	Stop lamp switch 1	Input	—	Battery voltage
118 (L)	Ground	Stop lamp switch 2	Input	Stop lamp switch	OFF (Brake pedal is not depressed) 0 V
				ON (Brake pedal is depressed) Battery voltage	
119 (W)	Ground	Front door lock assembly driver side (Unlock sensor)	Input	Driver door	 1.1 V
				UNLOCK status (unlock sensor switch ON) 0 V	
121 (Y)	Ground	Key slot switch	Input	When Intelligent Key is inserted into key slot Battery voltage	
				When Intelligent Key is not inserted into key slot 0 V	
123 (G)	Ground	IGN feedback	Input	Ignition switch	OFF or ACC 0 V
				ON Battery voltage	
124 (R)	Ground	Passenger door switch	Input	Passenger door switch	 11.8 V
				ON (When passenger door opens) 0 V	

A
B
C
D
E
F
G
H
I
J
L
M
N
O
P

PWC

BCM

< ECU DIAGNOSIS INFORMATION >

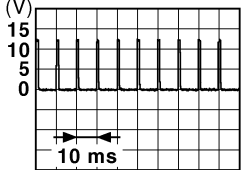
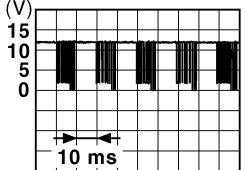
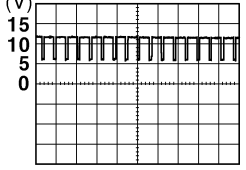
Terminal No. (Wire color)		Description		Condition		Value (Approx.)
+	-	Signal name	Input/ Output			
130 (BR)	Ground	Rear window defogger switch	Input	Ignition switch ON	Rear window defogger switch OFF	 1.1 V
				Ignition switch ON	Rear window defogger switch ON	0 V
132 (G)	Ground	Power window switch communication	Input/ Output	Ignition switch ON		 10.2 V
				Ignition switch OFF or ACC		Battery voltage
133 (W)	Ground	Push-button ignition switch illumination	Output	Push-button ignition switch illumination	ON (When tail lamps OFF)	9.5 V
					ON (When tail lamps ON)	<p>NOTE: The pulse width of this wave is varied by the illumination brightening/dimming level.</p>  Reference: JPMIA0159GB
134 (R)	Ground	LOCK indicator lamp	Output	LOCK indicator lamp	OFF (ACC and ON indicator lamps are not illuminated.)	Battery voltage
					ON	0 V
137 (P)	Ground	Receiver and sensor ground	Input	Ignition switch ON		0 V
138 (V)	Ground	Receiver and sensor power supply	Output	Ignition switch	OFF	0 V
					ACC or ON	5.0 V

BCM

< ECU DIAGNOSIS INFORMATION >

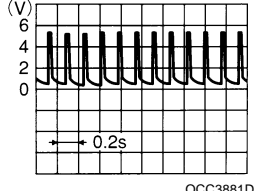
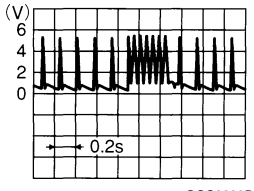
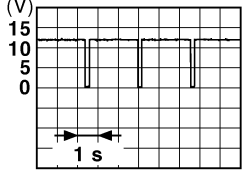
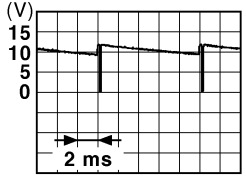
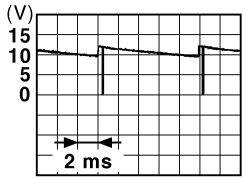
Terminal No. (Wire color)		Description		Condition	Value (Approx.)
+	-	Signal name	Input/ Output		
139 (O)	Ground	Tire pressure receiver communication	Input/ Output	Ignition switch ON	Standby state  OCC3881D
				When receiving the signal from the transmitter  OCC3880D	
140 (GR)	Ground	Selector lever P/N position	Input	Selector lever	P or N position Battery voltage
				Except P and N positions	0 V
141 (O)	Ground	Security indicator	Output	Security indicator	ON 0 V
				Blinking  JPMA0014GB 11.3 V	
				OFF Battery voltage	
142 (L)	Ground	Combination switch OUTPUT 5	Output	Combination switch (Wiper intermittent dial 4)	All switches OFF 0 V
				Lighting switch 1ST	 JPMA0031GB 10.7 V
				Lighting switch HI	
				Lighting switch 2ND	
Turn signal switch RH					
143 (W)	Ground	Combination switch OUTPUT 1	Output	Combination switch	All switches OFF (Wiper intermittent dial 4) 0 V
				Front wiper switch HI (Wiper intermittent dial 4)	 JPMA0032GB 10.7 V
				Rear wiper switch INT (Wiper intermittent dial 4)	
				Any of the conditions below with all switches OFF • Wiper intermittent dial 1 • Wiper intermittent dial 2 • Wiper intermittent dial 3 • Wiper intermittent dial 6 • Wiper intermittent dial 7	

A
B
C
D
E
F
G
H
I
J
L
M
N
O
P

PWC

BCM

< ECU DIAGNOSIS INFORMATION >

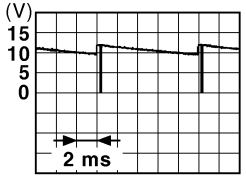
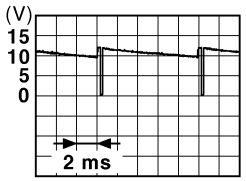
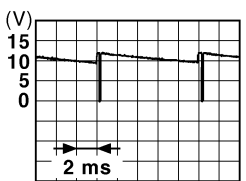
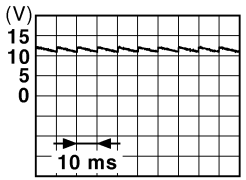
Terminal No. (Wire color)		Description		Condition	Value (Approx.)	
+	-	Signal name	Input/ Output			
144 (P)	Ground	Combination switch OUTPUT 2	Output	Combination switch	All switches OFF (Wiper intermittent dial 4)	0 V
					Front washer switch ON (Wiper intermittent dial 4)	
					Rear wiper switch ON (Wiper intermittent dial 4)	
					Rear washer switch ON (Wiper intermittent dial 4)	
					Any of the conditions below with all switches OFF <ul style="list-style-type: none"> • Wiper intermittent dial 1 • Wiper intermittent dial 5 • Wiper intermittent dial 6 	
145 (V)	Ground	Combination switch OUTPUT 3	Output	Combination switch (Wiper intermit- tent dial 4)	All switches OFF	0 V
					Front wiper switch INT/ AUTO	
					Front wiper switch LO	
					Lighting switch AUTO	
146 (Y)	Ground	Combination switch OUTPUT 4	Output	Combination switch (Wiper intermit- tent dial 4)	All switches OFF	0 V
					Front fog lamp switch ON	
					Lighting switch 2ND	
					Lighting switch PASS	
					Turn signal switch LH	
150 (SB)	Ground	Driver door switch	Input	Driver door switch	OFF (When driver door closes)	 11.8 V
					ON (When driver door opens)	0 V
151 (G)	Ground	Rear window defog- ger relay control	Output	Rear window de- fogger	Active	0 V
					Not activated	Battery voltage

Wiring Diagram - BCM -

For connector terminal arrangements, harness layouts, and alphabets in a  (option abbreviation; if not described in wiring diagram), refer to [GI-12, "Connector Information"](#).

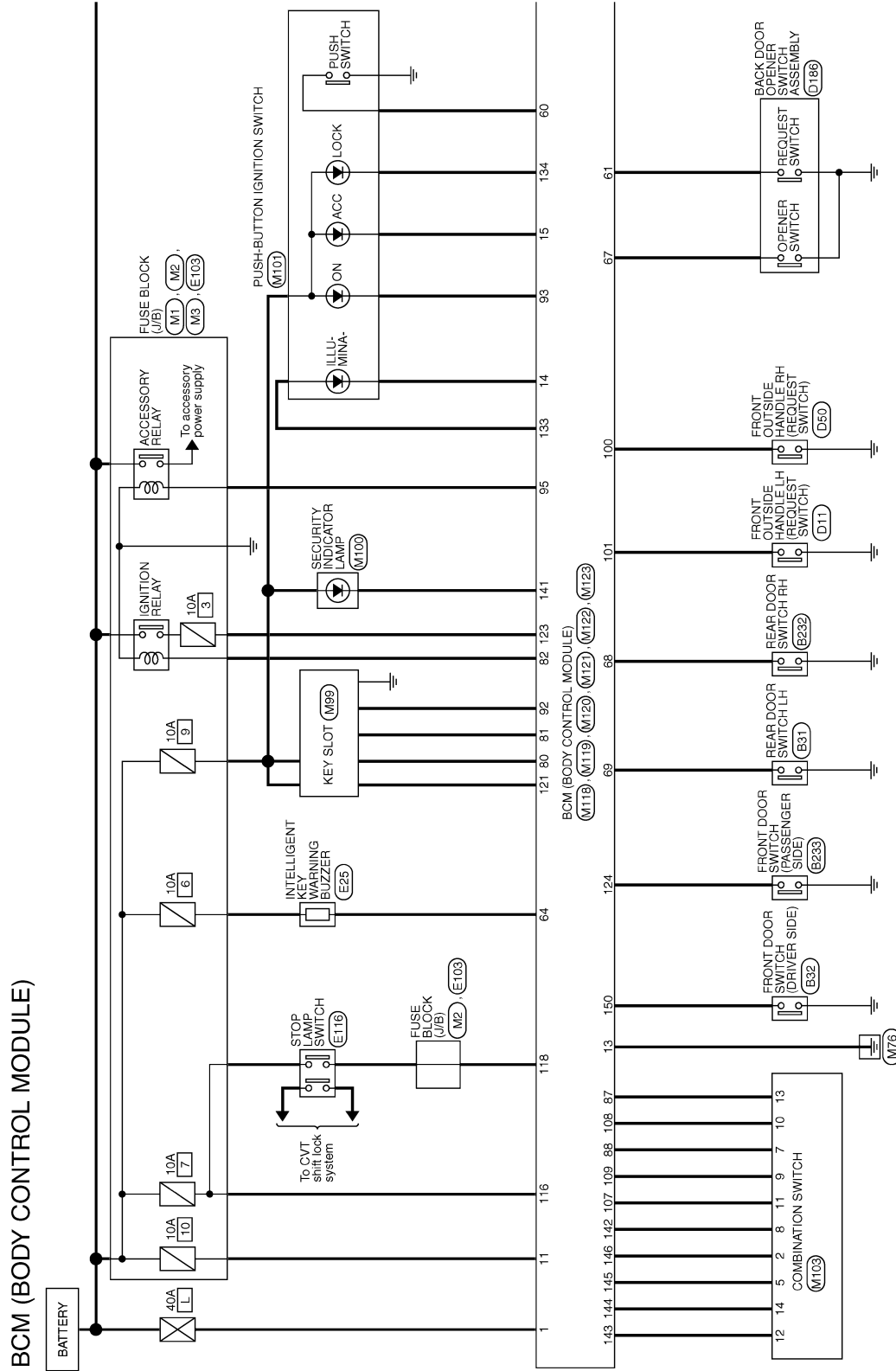

A
B
C
D
E
F
G
H
I
J
L
M
N
O
P

PWC

2011/07/28

JRMWC5024GB

XM : Except for Mexico
 SO : With power seat without automatic drive positioner

* : This connector is not shown in "Harness Layout".

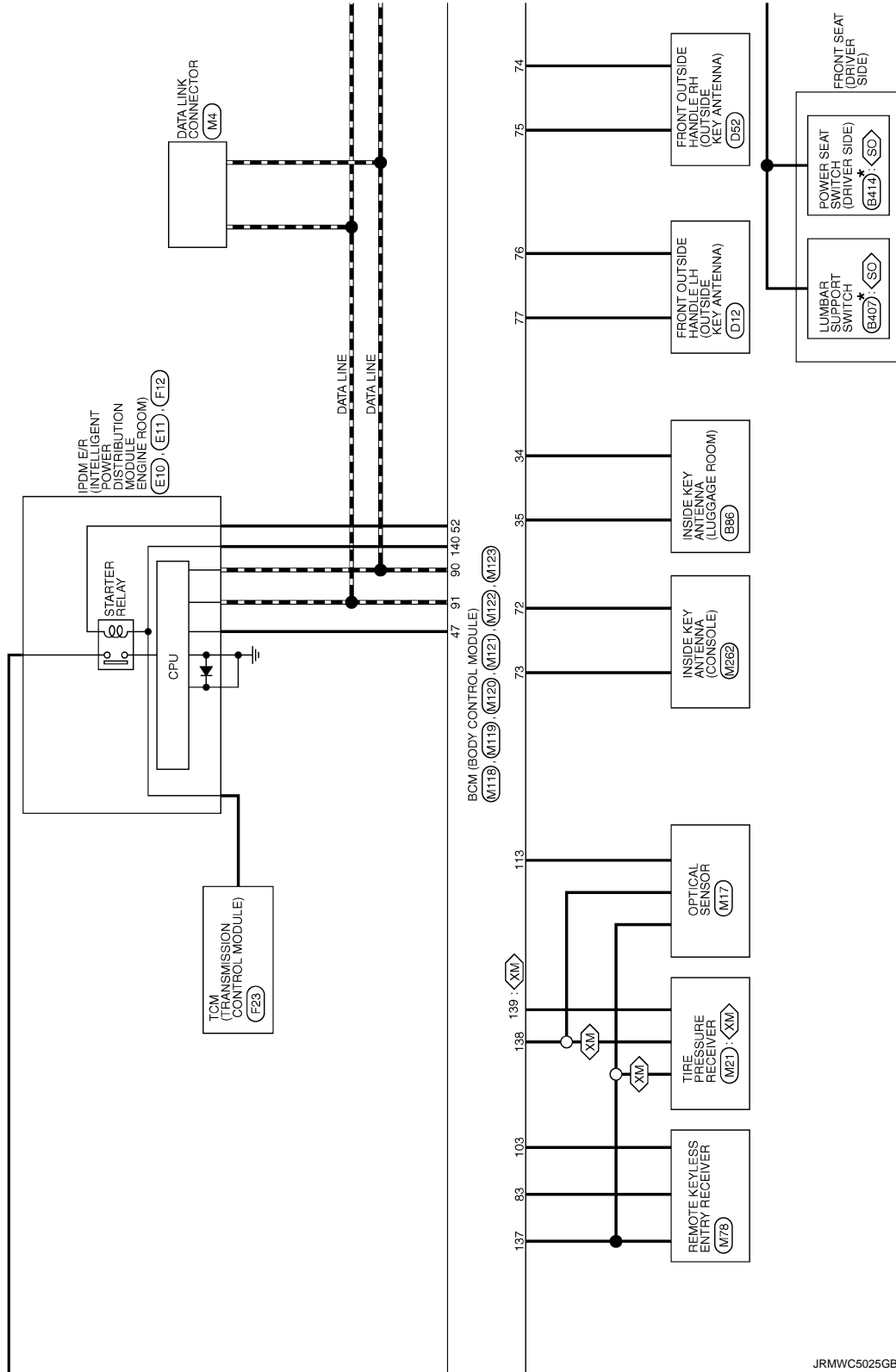

JRMWC5025GB

< ECU DIAGNOSIS INFORMATION >

- ◊NV◊ : With navigation system
- ◊ON◊ : Without navigation system
- ◊RF◊ : With sunroof
- ◊PM◊ : With automatic drive positioner
- ◊SO◊ : With power seat without automatic drive positioner
- ◊AB◊ : With automatic back door
- ◊WD◊ : With color display

* : This connector is not shown in "Harness Layout".

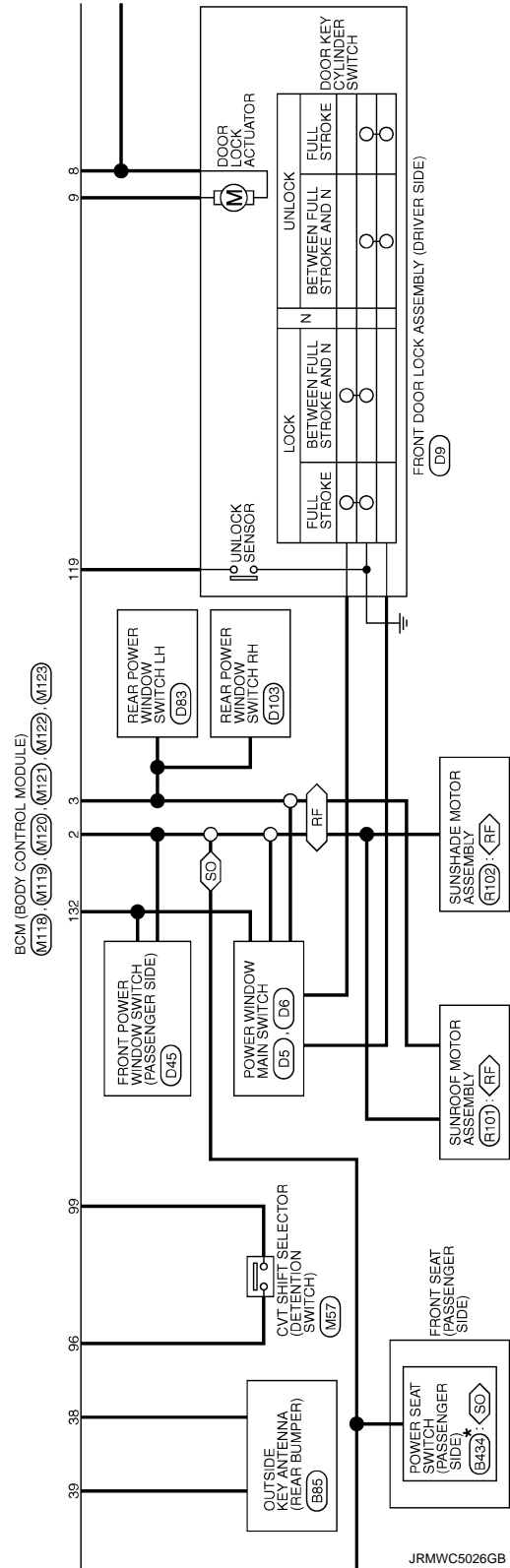
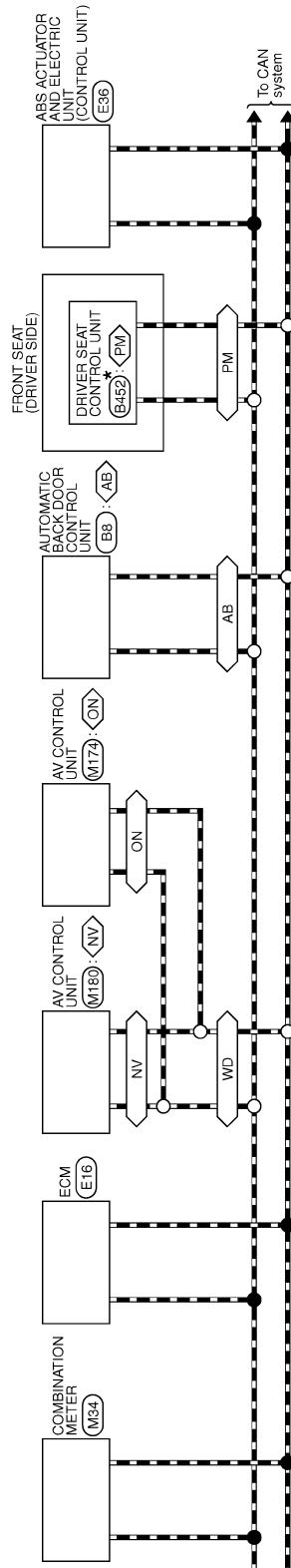

A
B
C
D
E
F
G
H
I
J
K
L
M
N
O
P

PWC

BCM

< ECU DIAGNOSIS INFORMATION >

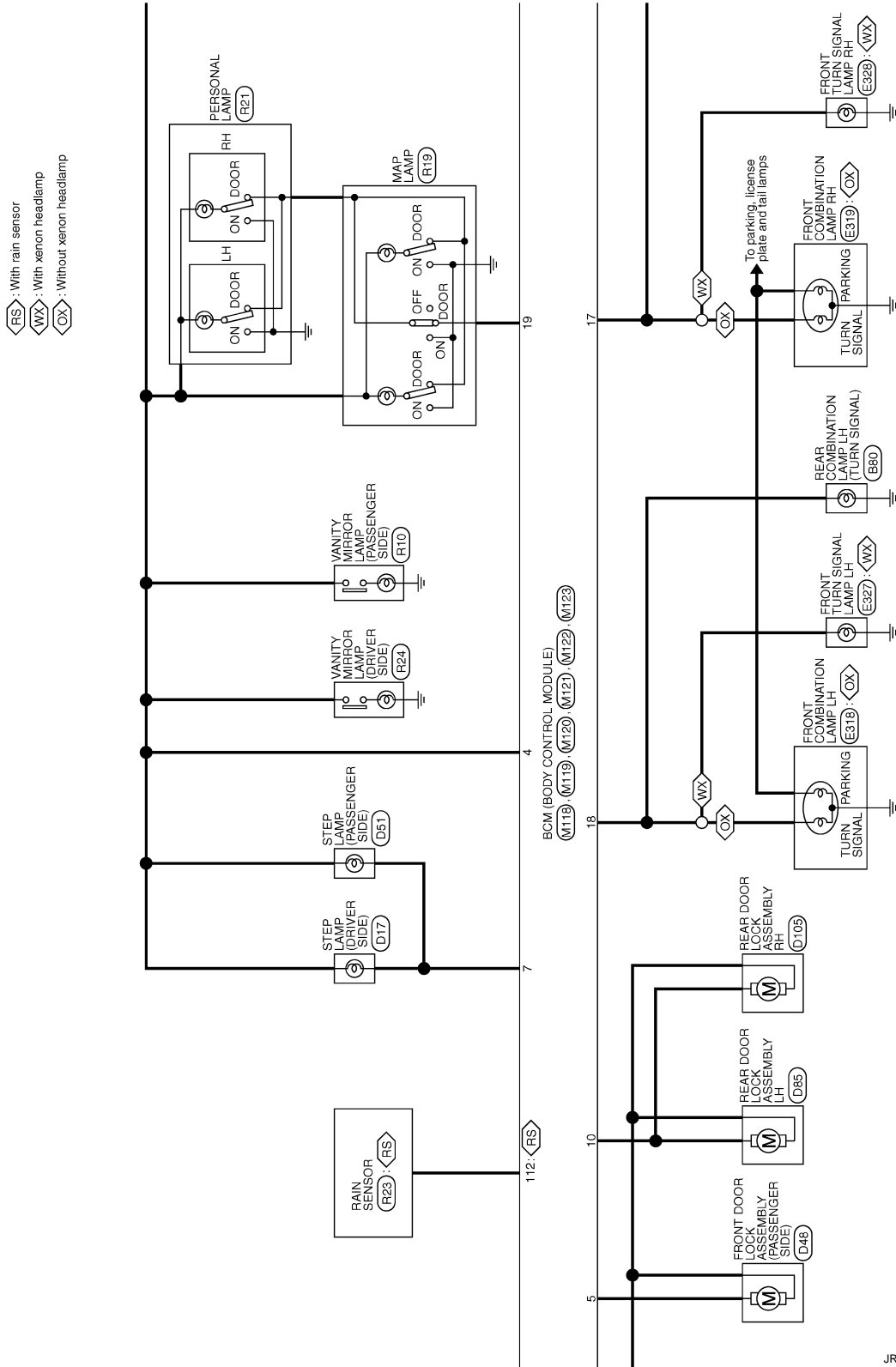

JRMWC5027GB

◊AB◊ : With automatic back door
 ◊OA◊ : Without automatic back door

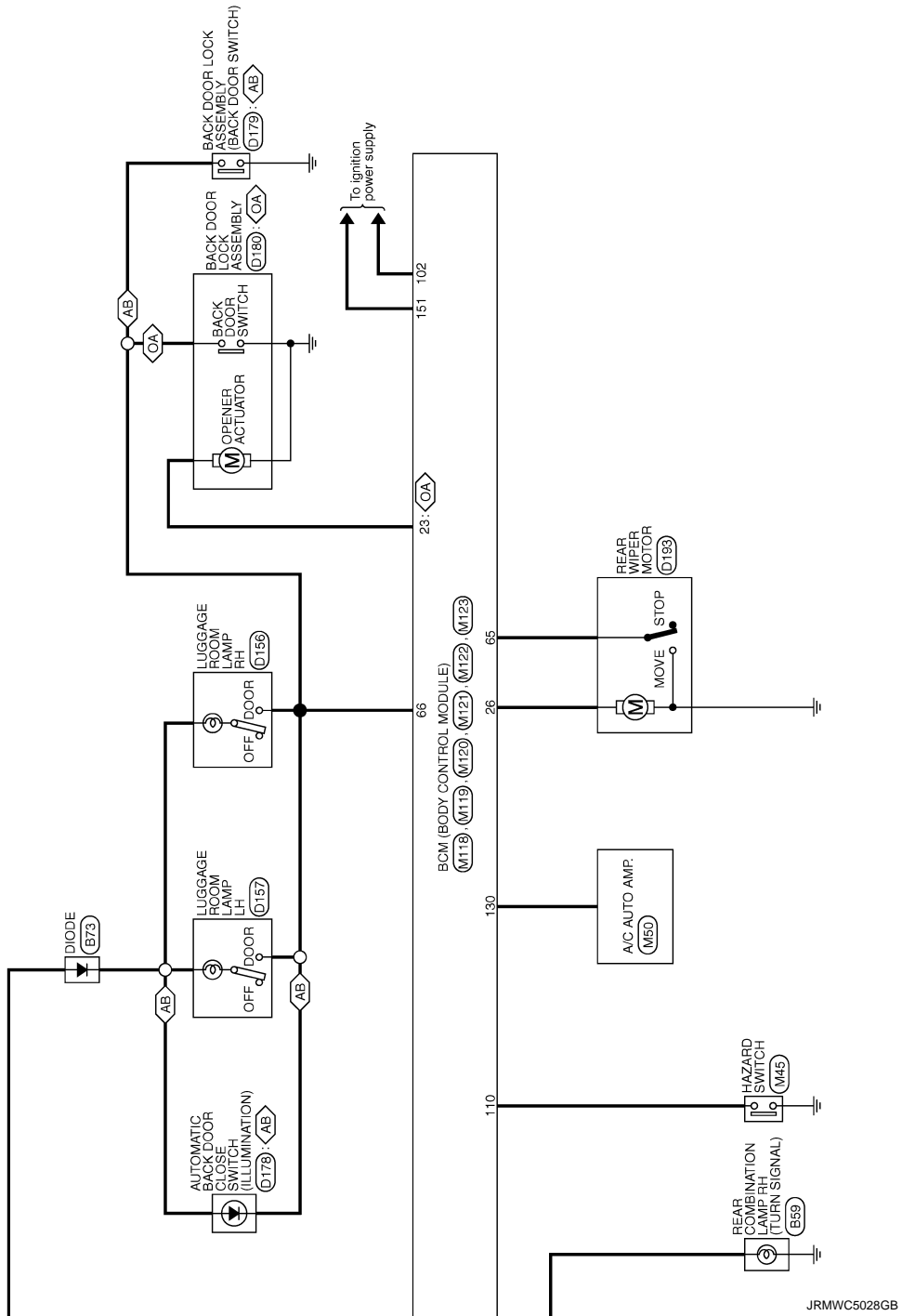

Fail-safe

FAIL-SAFE CONTROL BY DTC

BCM performs fail-safe control when any DTC are detected.

INFOID:000000008946148

A
B
C
D
E
F
G
H
I
J
L
M
N
O
P



BCM

< ECU DIAGNOSIS INFORMATION >

Display contents of CONSULT	Fail-safe	Cancellation
B2190: NATS ANTENNA AMP	Inhibit engine cranking	Erase DTC
B2191: DIFFERENCE OF KEY	Inhibit engine cranking	Erase DTC
B2192: ID DISCORD BCM-ECM	Inhibit engine cranking	Erase DTC
B2193: CHAIN OF BCM-ECM	Inhibit engine cranking	Erase DTC
B2195: ANTI SCANNING	Inhibit engine cranking	Ignition switch ON → OFF
B2560: STARTER CONT RELAY	Inhibit engine cranking	500 ms after the following CAN signal communication status becomes consistent <ul style="list-style-type: none"> • Starter control relay signal • Starter relay status signal
B2608: STARTER RELAY	Inhibit engine cranking	500 ms after the following signal communication status becomes consistent <ul style="list-style-type: none"> • Starter motor relay control signal • Starter relay status signal (CAN)
B260A: IGNITION RELAY	Inhibit engine cranking	500 ms after the following conditions are fulfilled <ul style="list-style-type: none"> • IGN relay (IPDM E/R) control signal: OFF (Battery voltage) • Ignition ON signal (CAN to IPDM E/R): OFF (Request signal) • Ignition ON signal (CAN from IPDM E/R): OFF (Condition signal)
B260F: ENG STATE SIG LOST	Maintains the power supply position attained at the time of DTC detection	When any of the following conditions are fulfilled <ul style="list-style-type: none"> • Power position changes to ACC • Receives engine status signal (CAN)
B2617: STARTER RELAY CIRC	Inhibit engine cranking	1 second after the starter motor relay control inside BCM becomes normal
B2618: BCM	Inhibit engine cranking	1 second after the ignition relay (IPDM E/R) control inside BCM becomes normal
B261E: VEHICLE TYPE	Inhibit engine cranking	BCM initialization

HIGH FLASHER OPERATION

BCM detects the turn signal lamp circuit status by the current value.

BCM increases the turn signal lamp blinking speed if the bulb or harness open is detected with the turn signal lamp operating.

NOTE:

The blinking speed is normal while activating the hazard warning lamp.

FAIL-SAFE CONTROL BY RAIN SENSOR MALFUNCTION

- BCM judges the rain sensor serial link error by the rain sensor serial link condition and detects the rain sensor malfunction by rain sensor malfunction signal.
- When BCM detects the rain sensor serial link error or the rain sensor malfunction while front wiper AUTO operation, BCM operates a fail-safe control.

NOTE:

If rain sensor malfunction is detected when ignition switch is turned OFF ⇒ ON and front wiper switch is INT/AUTO position, BCM operates a fail-safe control.

REAR WIPER MOTOR PROTECTION

BCM detects the rear wiper stopping position according to the rear wiper stop position signal.

When the rear wiper stop position signal does not change for more than 5 seconds while driving the rear wiper, BCM stops power supply to protect the rear wiper motor.

Condition of cancellation

1. More than 1 minute is passed after the rear wiper stop.
2. Turn rear wiper switch OFF.
3. Operate the rear wiper switch or rear washer switch.

DTC Inspection Priority Chart

INFOID:000000008946149

If some DTCs are displayed at the same time, perform inspections one by one based on the following priority chart.

BCM

< ECU DIAGNOSIS INFORMATION >

Priority	DTC	A
1	B2562: LOW VOLTAGE	A
2	<ul style="list-style-type: none"> • U1000: CAN COMM • U1010: CONTROL UNIT(CAN) 	B
3	<ul style="list-style-type: none"> • B2190: NATS ANTENNA AMP • B2191: DIFFERENCE OF KEY • B2192: ID DISCORD BCM-ECM • B2193: CHAIN OF BCM-ECM • B2195: ANTI SCANNING 	C
4	<ul style="list-style-type: none"> • B2553: IGNITION RELAY • B2555: STOP LAMP • B2556: PUSH-BTN IGN SW • B2557: VEHICLE SPEED • B2560: STARTER CONT RELAY • B2601: SHIFT POSITION • B2602: SHIFT POSITION • B2603: SHIFT POSI STATUS • B2604: PNP SW • B2605: PNP SW • B2608: STARTER RELAY • B260A: IGNITION RELAY • B260F: ENG STATE SIG LOST • B2614: ACC RELAY CIRC • B2615: BLOWER RELAY CIRC • B2616: IGN RELAY CIRC • B2617: STARTER RELAY CIRC • B2618: BCM • B261A: PUSH-BTN IGN SW • B261E: VEHICLE TYPE • B26EA: KEY REGISTRATION • C1729: VHCL SPEED SIG ERR • U0415: VEHICLE SPEED SIG 	D E F G H I
5	<ul style="list-style-type: none"> • C1704: LOW PRESSURE FL • C1705: LOW PRESSURE FR • C1706: LOW PRESSURE RR • C1707: LOW PRESSURE RL • C1708: [NO DATA] FL • C1709: [NO DATA] FR • C1710: [NO DATA] RR • C1711: [NO DATA] RL • C1716: [PRESSDATA ERR] FL • C1717: [PRESSDATA ERR] FR • C1718: [PRESSDATA ERR] RR • C1719: [PRESSDATA ERR] RL • C1734: CONTROL UNIT 	J PWC L M
6	<ul style="list-style-type: none"> • B2622: INSIDE ANTENNA • B2623: INSIDE ANTENNA 	N

DTC Index

INFOID:000000008946150

NOTE:

The details of time display are as follows.

- CRNT: A malfunction is detected now.
- PAST: A malfunction was detected in the past.

IGN counter is displayed on Freeze Frame Data. For details of Freeze Frame Data, refer to [BCS-18. "COMMON ITEM : CONSULT Function \(BCM - COMMON ITEM\)"](#).

BCM

< ECU DIAGNOSIS INFORMATION >

CONSULT display	Fail-safe	Freeze Frame Data •Vehicle Speed •Odo/Trip Meter •Vehicle Condition	Intelligent Key warning lamp ON	Tire pressure monitor warning lamp ON	Reference
No DTC is detected. further testing may be required.	—	—	—	—	—
U1000: CAN COMM	—	—	—	—	BCS-39
U1010: CONTROL UNIT(CAN)	—	—	—	—	BCS-40
U0415: VEHICLE SPEED SIG	—	—	—	—	BCS-41
B2190: NATS ANTENNA AMP	×	—	—	—	SEC-42
B2191: DIFFERENCE OF KEY	×	—	—	—	SEC-45
B2192: ID DISCORD BCM-ECM	×	—	—	—	SEC-46
B2193: CHAIN OF BCM-ECM	×	—	—	—	SEC-48
B2195: ANTI SCANNING	×	—	—	—	SEC-49
B2553: IGNITION RELAY	—	×	—	—	PCS-47
B2555: STOP LAMP	—	×	—	—	SEC-50
B2556: PUSH-BTN IGN SW	—	×	×	—	SEC-52
B2557: VEHICLE SPEED	×	×	×	—	SEC-54
B2560: STARTER CONT RELAY	×	×	×	—	SEC-55
B2562: LOW VOLTAGE	—	×	—	—	BCS-42
B2601: SHIFT POSITION	×	×	×	—	SEC-56
B2602: SHIFT POSITION	×	×	×	—	SEC-59
B2603: SHIFT POSI STATUS	×	×	×	—	SEC-61
B2604: PNP SW	×	×	×	—	SEC-64
B2605: PNP SW	×	×	×	—	SEC-66
B2608: STARTER RELAY	×	×	×	—	SEC-68
B260A: IGNITION RELAY	×	×	×	—	PCS-49
B260F: ENG STATE SIG LOST	×	×	×	—	SEC-70
B2614: ACC RELAY CIRC	—	×	×	—	PCS-51
B2615: BLOWER RELAY CIRC	—	×	×	—	PCS-54
B2616: IGN RELAY CIRC	—	×	×	—	PCS-57
B2617: STARTER RELAY CIRC	×	×	×	—	SEC-72
B2618: BCM	×	×	×	—	PCS-60
B261A: PUSH-BTN IGN SW	—	×	×	—	SEC-75
B261E: VEHICLE TYPE	×	×	× (Turn ON for 15 seconds)	—	SEC-78
B2622: INSIDE ANTENNA	—	×	—	—	DLK-91
B2623: INSIDE ANTENNA	—	×	—	—	DLK-93
B26EA: KEY REGISTRATION	—	×	× (Turn ON for 15 seconds)	—	SEC-71
C1704: LOW PRESSURE FL	—	—	—	×	WT-20
C1705: LOW PRESSURE FR	—	—	—	×	
C1706: LOW PRESSURE RR	—	—	—	×	
C1707: LOW PRESSURE RL	—	—	—	×	

BCM

< ECU DIAGNOSIS INFORMATION >

CONSULT display	Fail-safe	Freeze Frame Data •Vehicle Speed •Odo/Trip Meter •Vehicle Condition	Intelligent Key warning lamp ON	Tire pressure monitor warning lamp ON	Reference
C1708: [NO DATA] FL	—	—	—	×	WT-22
C1709: [NO DATA] FR	—	—	—	×	
C1710: [NO DATA] RR	—	—	—	×	
C1711: [NO DATA] RL	—	—	—	×	
C1716: [PRESSDATA ERR] FL	—	—	—	×	WT-25
C1717: [PRESSDATA ERR] FR	—	—	—	×	
C1718: [PRESSDATA ERR] RR	—	—	—	×	
C1719: [PRESSDATA ERR] RL	—	—	—	×	
C1729: VHCL SPEED SIG ERR	—	—	—	×	WT-26
C1734: CONTROL UNIT	—	—	—	×	WT-27

A
B
C
D
E
F
G
H
I
J
L
M
N
O
P

PWC

POWER WINDOW MAIN SWITCH

< ECU DIAGNOSIS INFORMATION >

POWER WINDOW MAIN SWITCH

Reference Value

INFOID:000000008458052

TERMINAL LAYOUT

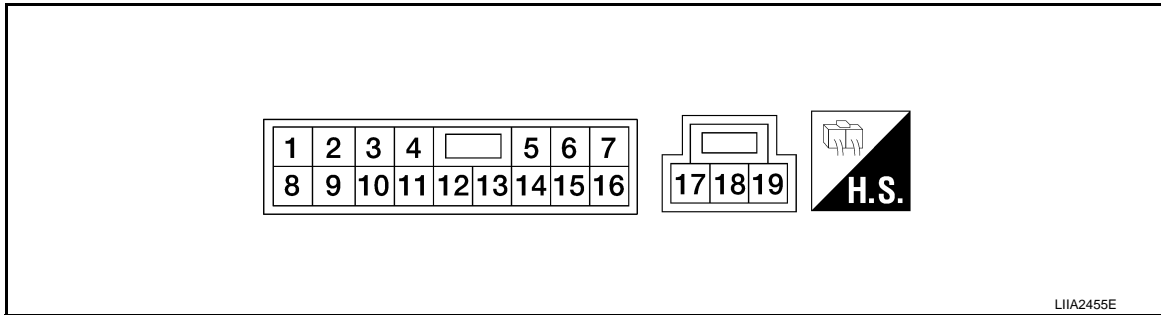

PHYSICAL VALUES

POWER WINDOW MAIN SWITCH

Terminal No. (Wire color)		Description		Condition	Voltage (V) (Approx.)
+	-	Signal name	Input/ Output		
1 (GR)	Ground	Rear power window motor LH UP signal	Output	When rear LH switch in power window main switch is UP at operated	Battery voltage
2 (W)	Ground	Encoder ground	—	—	0
3 (BR)	Ground	Rear power window motor LH DOWN signal	Output	When rear LH switch in power window main switch is DOWN at operated	Battery voltage
4 (L)	Ground	Door key cylinder switch LH LOCK signal	Input	Key position (Neutral → Locked)	5 → 0
5 (SB)	Ground	Rear power window motor RH DOWN signal	Output	When rear RH switch in power window main switch is DOWN at operated	Battery voltage
6 (R)	Ground	Door key cylinder switch LH UNLOCK signal	Input	Key position (Neutral → Unlocked)	5 → 0
7 (P)	Ground	Rear power window motor RH UP signal	Output	When rear RH switch in power window main switch is UP at operated	Battery voltage
8 (L)	Ground	Front power window motor (driver side) UP signal	Output	When front LH switch in power window main switch is UP at operated	Battery voltage
9 (G)	Ground	Encoder pulse signal 2	Input	When front power window motor (driver side) operates	

JMKIA0070GB

POWER WINDOW MAIN SWITCH

< ECU DIAGNOSIS INFORMATION >

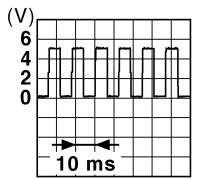
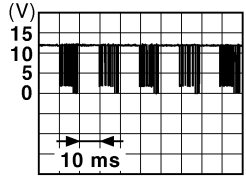
Terminal No. (Wire color)		Description		Condition	Voltage (V) (Approx.)
+	-	Signal name	Input/ Output		
10 (V)	Ground	Retained power signal	Input	Ignition switch ON	Battery voltage
				Within 45 seconds after ignition switch is turned to OFF	Battery voltage
				When driver side or passenger side door is opened during retained power operation	0
11 (LG)	Ground	Front power window motor (driver side) DOWN signal	Output	When front LH switch in power window main switch is DOWN at operated	Battery voltage
13 (Y)	Ground	Encoder pulse signal 1	Input	When front power window motor (driver side) operates.	 <small>JMKIA0070GB</small>
14 (O)	Ground	Power window serial link	Input/ Output	Ignition switch ON or power window timer operating	 <small>JPMIA0013GB</small>
15 (R)	Ground	Encoder power supply	Output	Ignition switch ON	Battery voltage
17 (B)	Ground	Ground	—	—	0
19 (LG)	Ground	Battery power supply	Input	Ignition switch OFF	Battery voltage

A
B
C
D
E
F
G
H
I
J
L
M
N
O
P

PWC

Wiring Diagram - POWER WINDOW SYSTEM -

INFOID:000000008458053

POWER WINDOW MAIN SWITCH

< ECU DIAGNOSIS INFORMATION >

For connector terminal arrangements, harness layouts, and alphabets in a ◊ (option abbreviation; if not described in wiring diagram), refer to [GI-12, "Connector Information"](#).

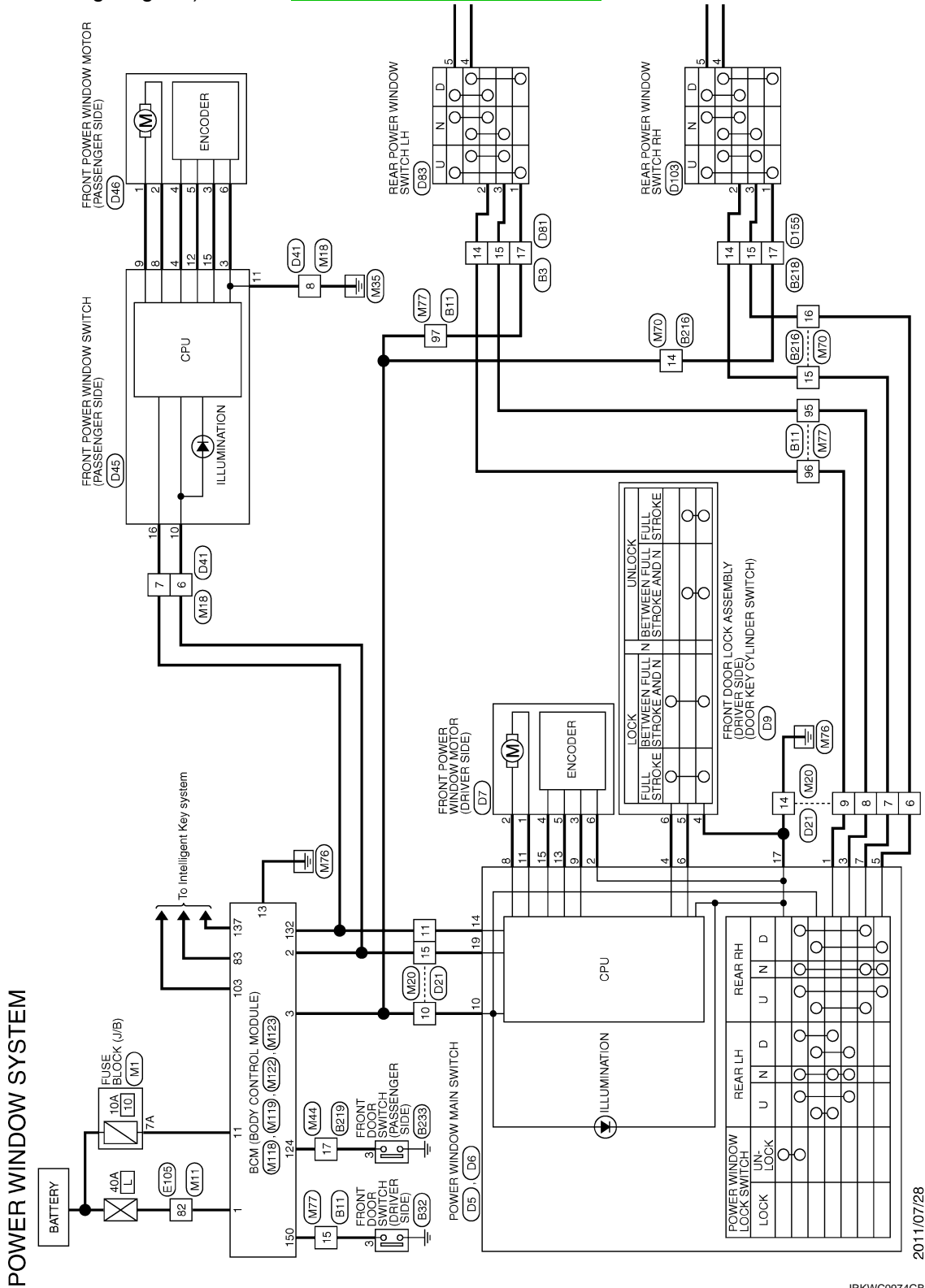

2011/07/28

JRWKC0974GB

POWER WINDOW MAIN SWITCH

< ECU DIAGNOSIS INFORMATION >

A
B
C
D
E
F
G
H
I
J
L
M
N
O
P

PWC

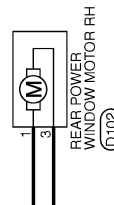
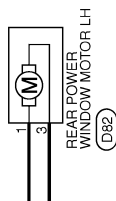

JRKWC0975GB

INFOID:000000008458054

Fail Safe

FAIL-SAFE CONTROL

Switches to fail-safe control when malfunction is detected in encoder signal that detects up/down speed and direction of door glass. Switches to fail-safe control when error beyond regulation value is detected between the fully closed position and the actual position of the glass.

POWER WINDOW MAIN SWITCH

< ECU DIAGNOSIS INFORMATION >

Error	Error condition
Pulse sensor malfunction	When only one side of pulse signal is being detected for more than the specified value.
Both pulse sensors malfunction	When both pulse signals have not been detected for more than the specified value during glass open/close operation.
Pulse direction malfunction	When the pulse signal that is detected during glass open/close operation detects the opposite condition of power window motor operating direction.
Glass recognition position malfunction 1	When it detects the error between glass fully closed position in power window switch memory and actual fully closed position during glass open/close operation is more than the specified value.
Glass recognition position malfunction 2	When it detects pulse count more than the value of glass full stroke during glass open/close operation.
Malfunction of not yet updated closed position of glass	When glass open/close operation is continuously performed without fully closing more than the specified value (approximately 10 strokes).

It changes to condition before initialization and the following functions do not operate when switched to fail-safe control.

- Auto-up operation
- Anti-pinch function
- Retained power function

Perform initial operation to recover when switched to fail-safe mode. However, it switches back to fail-safe control when malfunction is found in power window switch or front power window motor.

FRONT POWER WINDOW SWITCH (PASSENGER SIDE)

< ECU DIAGNOSIS INFORMATION >

FRONT POWER WINDOW SWITCH (PASSENGER SIDE)

Reference Value

INFOID:000000008458055

TERMINAL LAYOUT

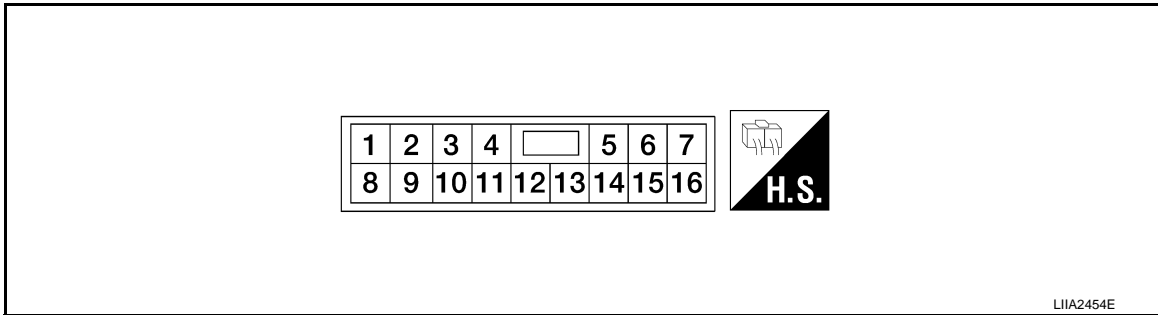

PHYSICAL VALUES

FRONT POWER WINDOW SWITCH (PASSENGER SIDE)

Terminal No.		Description		Condition	Voltage [V] (Approx.)
+	-	Signal name	Input/ Output		
3 (W)	Ground	Encoder ground	—	—	0
4 (R)	Ground	Encoder power supply	Output	When ignition switch ON or power window timer operates	Battery voltage
8 (L)	Ground	Power window motor DOWN signal	Output	When power window motor is DOWN at operated.	Battery voltage
9 (LG)	Ground	Power window motor UP signal	Output	When power window motor is UP at operated.	Battery voltage
10 (P)	Ground	Battery power supply	Input	—	Battery voltage
11 (B)	Ground	Ground	—	—	0
12 (Y)	Ground	Encoder pulse signal 1	Input	When power window motor operates.	

JMKIA0070GB

A
B
C
D
E
F
G
H
I
J
L
M
N
O
P

PWC

FRONT POWER WINDOW SWITCH (PASSENGER SIDE)

< ECU DIAGNOSIS INFORMATION >

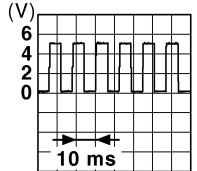
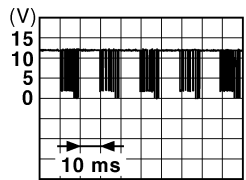
Terminal No.		Description		Condition	Voltage [V] (Approx.)
+	-	Signal name	Input/ Output		
15 (G)	Ground	Encoder pulse signal 2	Input	When power window motor operates.	 <p style="text-align: right; font-size: small;">JMkia0070GB</p>
16 (O)	Ground	Power window serial link	Input/ Output	Ignition switch ON or power window timer operating.	 <p style="text-align: right; font-size: small;">JPMIA0013GB</p>

Wiring Diagram - POWER WINDOW SYSTEM -

INFOID:000000008946151

FRONT POWER WINDOW SWITCH (PASSENGER SIDE)

< ECU DIAGNOSIS INFORMATION >

For connector terminal arrangements, harness layouts, and alphabets in a  (option abbreviation; if not described in wiring diagram), refer to [GI-12, "Connector Information"](#).

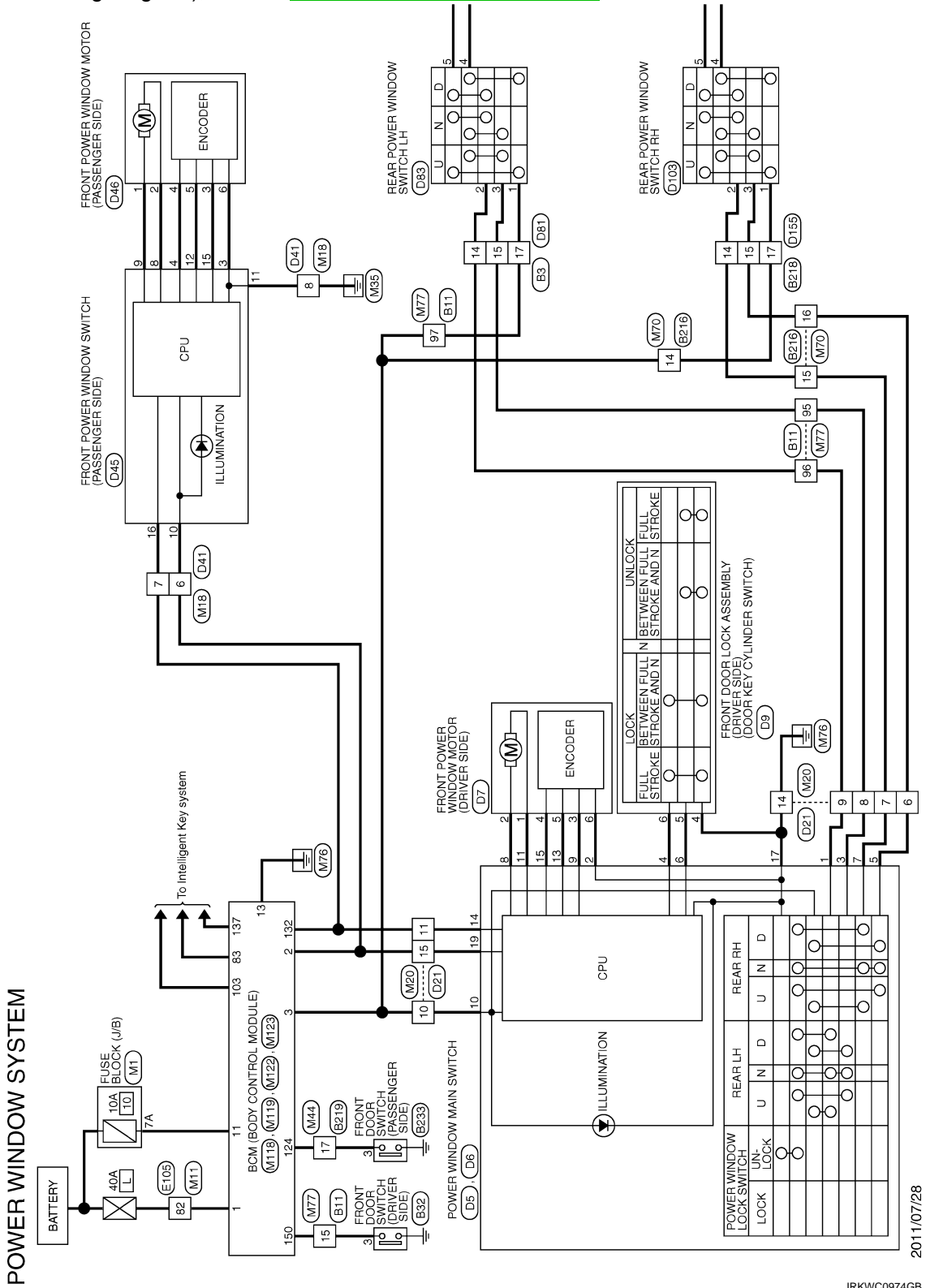

2011/07/28

JRWKC0974GB

A
B
C
D
E
F
G
H
I
J
K
L
M
N
O
P

PWC

FRONT POWER WINDOW SWITCH (PASSENGER SIDE)

< ECU DIAGNOSIS INFORMATION >

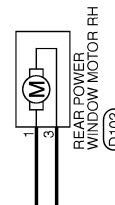
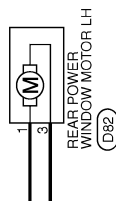

JRKWC0975GB

INFOID:000000008458057

Fail Safe

FAIL-SAFE CONTROL

Switches to fail-safe control when malfunction is detected in encoder signal that detects up/down speed and direction of door glass. Switches to fail-safe control when error beyond regulation value is detected between the fully closed position and the actual position of the glass.

FRONT POWER WINDOW SWITCH (PASSENGER SIDE)

< ECU DIAGNOSIS INFORMATION >

Error	Error condition
Pulse sensor malfunction	When only one side of pulse signal is being detected for more than the specified value.
Both pulse sensors malfunction	When both pulse signals have not been detected for more than the specified value during glass open/close operation.
Pulse direction malfunction	When the pulse signal that is detected during glass open/close operation detects the opposite condition of power window motor operating direction.
Glass recognition position malfunction 1	When it detects the error between glass fully closed position in power window switch memory and actual fully closed position during glass open/close operation is more than the specified value.
Glass recognition position malfunction 2	When it detects pulse count more than the value of glass full stroke during glass open/close operation.
Malfunction of not yet updated closed position of glass	When glass open/close operation is continuously performed without fully closing more than the specified value (approximately 10 strokes).

It changes to condition before initialization and the following functions do not operate when switched to fail-safe control.

- Auto-up operation
- Anti-pinch function
- Retained power function

Perform initial operation to recover when switched to fail-safe mode. However, it switches back to fail-safe control when malfunction is found in power window switch or in front power window motor.

A
B
C
D
E
F
G
H
I
J
L
M
N
O
P

PWC

POWER WINDOWS DO NOT OPERATE WITH ANY POWER WINDOW SWITCHES

< SYMPTOM DIAGNOSIS >

SYMPTOM DIAGNOSIS

POWER WINDOWS DO NOT OPERATE WITH ANY POWER WINDOW SWITCHES

Diagnosis Procedure

INFOID:000000008458058

1. CHECK BCM POWER SUPPLY AND GROUND CIRCUIT

Check BCM power supply and ground circuit.
Refer to [PWC-14, "BCM : Diagnosis Procedure"](#).

Is the inspection result normal?

- YES >> GO TO 2.
- NO >> Repair or replace the malfunctioning parts.

2. CHECK POWER WINDOW MAIN SWITCH POWER SUPPLY AND GROUND CIRCUIT

Check power window main switch power supply and ground circuit.
Refer to [PWC-14, "POWER WINDOW MAIN SWITCH : Diagnosis Procedure"](#).

Is the inspection result normal?

- YES >> GO TO 3.
- NO >> Repair or replace the malfunctioning parts.

3. CONFIRM THE OPERATION

Confirm the operation again.

Is the result normal?

- YES >> Check intermittent incident. Refer to [GI-45, "Intermittent Incident"](#).
- NO >> GO TO 1.

DRIVER SIDE POWER WINDOW DOES NOT OPERATE

< SYMPTOM DIAGNOSIS >

DRIVER SIDE POWER WINDOW DOES NOT OPERATE

Diagnosis Procedure

INFOID:000000008458059

1.CHECK FRONT POWER WINDOW MOTOR (DRIVER SIDE)

Check power window motor.

Refer to [PWC-20, "DRIVER SIDE : Component Function Check"](#).

Is the inspection result normal?

YES >> GO TO 2.

NO >> Repair or replace the malfunctioning parts.

2.CONFIRM THE OPERATION

Confirm the operation again.

Is the result normal?

YES >> Check intermittent incident. Refer to [GI-45, "Intermittent Incident"](#).

NO >> GO TO 1.

A
B
C
D
E
F
G
H
I
J
L
M
N
O
P

PWC

FRONT PASSENGER SIDE POWER WINDOW DOES NOT OPERATE

< SYMPTOM DIAGNOSIS >

FRONT PASSENGER SIDE POWER WINDOW DOES NOT OPERATE WHEN POWER WINDOW MAIN SWITCH IS OPERATED

WHEN POWER WINDOW MAIN SWITCH IS OPERATED : Diagnosis Procedure

INFOID:000000008458060

1. CHECK FRONT POWER WINDOW SWITCH (PASSENGER SIDE) SERIAL LINK CIRCUIT

Check front power window switch (passenger side) serial link circuit.

Refer to [PWC-33. "FRONT POWER WINDOW SWITCH \(PASSENGER SIDE\) : Component Function Check"](#).

Is the inspection result normal?

YES >> GO TO 2.

NO >> Repair or replace the malfunctioning parts.

2. CONFIRM THE OPERATION

Confirm the operation again.

Is the result normal?

YES >> Check intermittent incident. Refer to [GI-45. "Intermittent Incident"](#).

NO >> GO TO 1.

WHEN FRONT POWER WINDOW SWITCH (PASSENGER SIDE) IS OPERATED

WHEN FRONT POWER WINDOW SWITCH (PASSENGER SIDE) IS OPERATED :
Diagnosis Procedure

INFOID:000000008458061

1. REPLACE FRONT POWER WINDOW SWITCH (PASSENGER SIDE)

Replace front power window switch (passenger side).

Refer to [PWC-92. "Removal and Installation"](#)

>> INSPECTION END

WHEN BOTH POWER WINDOW MAIN SWITCH AND FRONT POWER WINDOW SWITCH ARE OPERATED

WHEN BOTH POWER WINDOW MAIN SWITCH AND FRONT POWER WINDOW
SWITCH ARE OPERATED : Diagnosis Procedure

INFOID:000000008458062

1. CHECK FRONT POWER WINDOW SWITCH (PASSENGER SIDE) POWER SUPPLY AND GROUND CIR- CUIT

Check front power window switch (passenger side) power supply and ground circuit.

Refer to [PWC-14. "POWER WINDOW MAIN SWITCH : Diagnosis Procedure"](#).

Is the inspection result normal?

YES >> GO TO 2.

NO >> Repair or replace the malfunctioning parts.

2. CHECK PASSENGER SIDE POWER WINDOW MOTOR CIRCUIT

Check passenger side power window motor circuit.

Refer to [PWC-21. "PASSENGER SIDE : Component Function Check"](#).

Is the inspection result normal?

YES >> GO TO 3.

NO >> Repair or replace the malfunctioning parts.

3. CONFIRM THE OPERATION

Confirm the operation again.

Is the result normal?

YES >> Check intermittent incident. Refer to [GI-45. "Intermittent Incident"](#).

NO >> GO TO 1.

REAR LH SIDE POWER WINDOW ALONE DOES NOT OPERATE

< SYMPTOM DIAGNOSIS >

REAR LH SIDE POWER WINDOW ALONE DOES NOT OPERATE WHEN POWER WINDOW MAIN SWITCH IS OPERATED

WHEN POWER WINDOW MAIN SWITCH IS OPERATED : Diagnosis Procedure

INFOID:000000008458063

1. CHECK REAR POWER WINDOW SWITCH

Check rear power window switch.

Refer to [PWC-18, "Component Function Check"](#).

Is the inspection result normal?

YES >> GO TO 2.

NO >> Repair or replace the malfunctioning parts.

2. CONFIRM THE OPERATION

Confirm the operation again.

Is the result normal?

YES >> Check intermittent incident. Refer to [GI-45, "Intermittent Incident"](#).

NO >> GO TO 1.

WHEN REAR POWER WINDOW SWITCH LH IS OPERATED

WHEN REAR POWER WINDOW SWITCH LH IS OPERATED : Diagnosis Procedure

INFOID:000000008458064

1. CHECK REAR POWER WINDOW SWITCH POWER SUPPLY AND GROUND CIRCUIT

Check rear power window switch power supply and ground circuit.

Refer to [PWC-16, "REAR POWER WINDOW SWITCH : Diagnosis Procedure"](#).

Is the inspection result normal?

YES >> GO TO 2.

NO >> Repair or replace the malfunctioning parts.

2. REPLACE REAR POWER WINDOW SWITCH LH

Replace rear power window switch LH.

Refer to [PWC-92, "Removal and Installation"](#).

>> INSPECTION END

WHEN BOTH POWER WINDOW MAIN SWITCH AND REAR POWER WINDOW SWITCH LH ARE OPERATED

WHEN BOTH POWER WINDOW MAIN SWITCH AND REAR POWER WINDOW
SWITCH LH ARE OPERATED : Diagnosis Procedure

INFOID:000000008458065

1. CHECK REAR POWER WINDOW MOTOR LH

Check rear power window motor LH.

Refer to [PWC-23, "REAR LH : Component Function Check"](#).

Is the inspection result normal?

YES >> GO TO 2.

NO >> Repair or replace the malfunctioning parts.

2. CONFIRM THE OPERATION

Confirm the operation again.

Is the result normal?

YES >> Check intermittent incident. Refer to [GI-45, "Intermittent Incident"](#).

NO >> GO TO 1.

A
B
C
D
E
F
G
H
I
J
L
M
N
O
P

PWC

REAR RH SIDE POWER WINDOW ALONE DOES NOT OPERATE

< SYMPTOM DIAGNOSIS >

REAR RH SIDE POWER WINDOW ALONE DOES NOT OPERATE WHEN POWER WINDOW MAIN SWITCH IS OPERATED

WHEN POWER WINDOW MAIN SWITCH IS OPERATED : Diagnosis Procedure

INFOID:000000008458066

1.CHECK REAR POWER WINDOW SWITCH

Check rear power window switch.

Refer to [PWC-18. "Component Function Check"](#).

Is the inspection result normal?

YES >> GO TO 2.

NO >> Repair or replace the malfunctioning parts.

2.CONFIRM THE OPERATION

Confirm the operation again.

Is the result normal?

YES >> Check intermittent incident. Refer to [GI-45. "Intermittent Incident"](#).

NO >> GO TO 1.

WHEN REAR POWER WINDOW SWITCH RH IS OPERATED

WHEN REAR POWER WINDOW SWITCH RH IS OPERATED : Diagnosis Procedure

INFOID:000000008458067

1.CHECK REAR POWER WINDOW SWITCH POWER SUPPLY AND GROUND CIRCUIT

Check rear power window switch power supply and ground circuit.

Refer to [PWC-16. "REAR POWER WINDOW SWITCH : Diagnosis Procedure"](#).

Is the inspection result normal?

YES >> GO TO 2.

NO >> Repair or replace the malfunctioning parts.

2.REPLACE REAR POWER WINDOW SWITCH RH

Replace rear power window switch RH.

Refer to [PWC-92. "Removal and Installation"](#).

>> INSPECTION END

WHEN BOTH POWER WINDOW MAIN SWITCH AND REAR POWER WINDOW SWITCH RH ARE OPERATED

WHEN BOTH POWER WINDOW MAIN SWITCH AND REAR POWER WINDOW
SWITCH RH ARE OPERATED : Diagnosis Procedure

INFOID:000000008458068

1.CHECK REAR POWER WINDOW MOTOR RH

Check rear power window motor RH.

Refer to [PWC-24. "REAR RH : Component Function Check"](#).

Is the inspection result normal?

YES >> GO TO 2.

NO >> Repair or replace the malfunctioning parts.

2.CONFIRM THE OPERATION

Confirm the operation again.

Is the result normal?

YES >> Check intermittent incident. Refer to [GI-45. "Intermittent Incident"](#).

NO >> GO TO 1.

AUTO OPERATION DOES NOT OPERATE BUT MANUAL OPERATES NORMALLY

< SYMPTOM DIAGNOSIS >

AUTO OPERATION DOES NOT OPERATE BUT MANUAL OPERATES NORMALLY

DRIVER SIDE

DRIVER SIDE : Diagnosis Procedure

INFOID:000000008458069

1.PERFORM INITIALIZATION PROCEDURE

Initialization procedure is executed and operation is confirmed.

Refer to [PWC-5, "ADDITIONAL SERVICE WHEN REMOVING BATTERY NEGATIVE TERMINAL : Special Repair Requirement"](#).

Is the inspection result normal?

YES >> INSPECTION END

NO >> GO TO 2.

2.CHECK ENCODER (DRIVER SIDE) CIRCUIT

Check encoder (driver side) circuit.

Refer to [PWC-27, "DRIVER SIDE : Component Function Check"](#).

Is the inspection result normal?

YES >> GO TO 3.

NO >> Repair or replace the malfunctioning parts.

3.CONFIRM THE OPERATION

Confirm the operation again.

Is the result normal?

YES >> Check intermittent incident. Refer to [GI-45, "Intermittent Incident"](#).

NO >> GO TO 1.

PASSENGER SIDE

PASSENGER SIDE : Diagnosis Procedure

INFOID:000000008458070

1.PERFORM INITIALIZAITON PROCEDURE

Initialization procedure is executed and operation is confirmed.

Refer to [PWC-5, "ADDITIONAL SERVICE WHEN REMOVING BATTERY NEGATIVE TERMINAL : Special Repair Requirement"](#).

Is the inspection result normal?

YES >> INSPECTION END

NO >> GO TO 2.

2.CHECK ENCODER (PASSENGER SIDE) CIRCUIT

Check encoder (passenger side) circuit.

Refer to [PWC-29, "PASSENGER SIDE : Component Function Check"](#).

Is the inspection result normal?

YES >> GO TO 3.

NO >> Repair or replace the malfunctioning parts.

3.CONFIRM THE OPERATION

Confirm the operation again.

Is the result normal?

YES >> Check intermittent incident. Refer to [GI-45, "Intermittent Incident"](#).

NO >> GO TO 1.

A
B
C
D
E
F
G
H
I
J
L
M
N
O
P

PWC

ANTI-PINCH FUNCTION DOES NOT OPERATE NORMALLY

< SYMPTOM DIAGNOSIS >

ANTI-PINCH FUNCTION DOES NOT OPERATE NORMALLY

DRIVER SIDE

DRIVER SIDE : Diagnosis Procedure

INFOID:000000008458071

1.CHECK POWER WINDOW AUTO OPERATION

Check power window auto operation.

Is the inspection result normal?

YES >> GO TO 2.

NO >> Refer to [PWC-83. "DRIVER SIDE : Diagnosis Procedure"](#).

2.CONFIRM THE OPERATION

Confirm the operation again.

Is the result normal?

YES >> Check intermittent incident. Refer to [GI-45. "Intermittent Incident"](#).

NO >> GO TO 1.

PASSENGER SIDE

PASSENGER SIDE : Diagnosis Procedure

INFOID:000000008458072

1.CHECK POWER WINDOW AUTO OPERATION

Check power window auto operation.

Is the inspection result normal?

YES >> GO TO 2.

NO >> Refer to [PWC-83. "PASSENGER SIDE : Diagnosis Procedure"](#).

2.CONFIRM THE OPERATION

Confirm the operation again.

Is the result normal?

YES >> Check intermittent incident. Refer to [GI-45. "Intermittent Incident"](#).

NO >> GO TO 1.

POWER WINDOW RETAINED POWER OPERATION DOES NOT OPERATE PROPERLY

< SYMPTOM DIAGNOSIS >

POWER WINDOW RETAINED POWER OPERATION DOES NOT OPERATE PROPERLY

Diagnosis Procedure

INFOID:000000008458073

1.CHECK DOOR SWITCH

Check door switch.

Refer to [DLK-97, "WITH AUTOMATIC BACK DOOR : Component Function Check"](#).

Is the inspection result normal?

YES >> GO TO 2.

NO >> Repair or replace the malfunctioning parts.

2.CONFIRM THE OPERATION

Confirm the operation again.

Is the result normal?

YES >> Check intermittent incident. Refer to [GI-45, "Intermittent Incident"](#).

NO >> GO TO 1.

A
B
C
D
E
F
G
H
I
J
L
M
N
O
P

PWC

DOOR KEY CYLINDER SWITCH DOES NOT OPERATE POWER WINDOWS

< SYMPTOM DIAGNOSIS >

DOOR KEY CYLINDER SWITCH DOES NOT OPERATE POWER WINDOWS

Diagnosis Procedure

INFOID:000000008458074

1.PERFORM INITIALIZATION PROCEDURE

Initialization procedure is executed and operation is confirmed.

Refer to [PWC-5, "ADDITIONAL SERVICE WHEN REMOVING BATTERY NEGATIVE TERMINAL : Special Repair Requirement"](#).

Is the inspection result normal?

YES >> INSPECTION END
NO >> GO TO 2.

2.CHECK DRIVER SIDE DOOR LOCK ASSEMBLY (DOOR KEY CYLINDER SWITCH)

Check driver side door lock assembly (door key cylinder switch).

Refer to [DLK-110, "Component Function Check"](#).

Is the inspection result normal?

YES >> GO TO 3.
NO >> Repair or replace the malfunctioning parts.

3.CONFIRM THE OPERATION

Confirm the operation again.

Is the result normal?

YES >> Check intermittent incident. Refer to [GI-45, "Intermittent Incident"](#).
NO >> GO TO 1.

KEYLESS POWER WINDOW DOWN DOES NOT OPERATE

< SYMPTOM DIAGNOSIS >

KEYLESS POWER WINDOW DOWN DOES NOT OPERATE

Diagnosis Procedure

INFOID:000000008458075

1. CHECK INTELLIGENT KEY FUNCTION

Check Intelligent Key function.

Refer to [DLK-127, "Component Function Check"](#).

Is the inspection result normal?

YES >> GO TO 2.

NO >> Replace BCM. Refer to [BCS-84, "Exploded View"](#).

2. CONFIRM THE OPERATION

Confirm the operation again.

Is the inspection result normal?

YES >> Check intermittent incident. Refer to [GI-45, "Intermittent Incident"](#).

NO >> GO TO 1.

A
B
C
D
E
F
G
H
I
J
L
M
N
O
P

PWC

POWER WINDOW LOCK SWITCH DOES NOT FUNCTION

< SYMPTOM DIAGNOSIS >

POWER WINDOW LOCK SWITCH DOES NOT FUNCTION

Diagnosis Procedure

INFOID:000000008458076

1. REPLACE POWER WINDOW MAIN SWITCH

Replace power window main switch.

>> Refer to [PWC-92. "Removal and Installation"](#).

POWER WINDOW SWITCH ILLUMINATION DOES NOT ILLUMINATE

< SYMPTOM DIAGNOSIS >

POWER WINDOW SWITCH ILLUMINATION DOES NOT ILLUMINATE

Diagnosis Procedure

INFOID:000000008458077

1. REPLACE POWER WINDOW MAIN SWITCH

Replace power window main switch.

>> Refer to [PWC-92. "Removal and Installation"](#).

A
B
C
D
E
F
G
H
I
J
L
M
N
O
P

PWC

PRECAUTIONS

< PRECAUTION >

PRECAUTION

PRECAUTIONS

FOR USA AND CANADA

FOR USA AND CANADA : Precaution for Supplemental Restraint System (SRS) "AIR BAG" and "SEAT BELT PRE-TENSIONER"

INFOID:000000008458078

The Supplemental Restraint System such as "AIR BAG" and "SEAT BELT PRE-TENSIONER", used along with a front seat belt, helps to reduce the risk or severity of injury to the driver and front passenger for certain types of collision. This system includes seat belt switch inputs and dual stage front air bag modules. The SRS system uses the seat belt switches to determine the front air bag deployment, and may only deploy one front air bag, depending on the severity of a collision and whether the front occupants are belted or unbelted. Information necessary to service the system safely is included in the "SRS AIR BAG" and "SEAT BELT" of this Service Manual.

WARNING:

Always observe the following items for preventing accidental activation.

- To avoid rendering the SRS inoperative, which could increase the risk of personal injury or death in the event of a collision that would result in air bag inflation, all maintenance must be performed by an authorized NISSAN/INFINITI dealer.
- Improper maintenance, including incorrect removal and installation of the SRS, can lead to personal injury caused by unintentional activation of the system. For removal of Spiral Cable and Air Bag Module, see "SRS AIR BAG".
- Never use electrical test equipment on any circuit related to the SRS unless instructed to in this Service Manual. SRS wiring harnesses can be identified by yellow and/or orange harnesses or harness connectors.

PRECAUTIONS WHEN USING POWER TOOLS (AIR OR ELECTRIC) AND HAMMERS

WARNING:

Always observe the following items for preventing accidental activation.

- When working near the Air Bag Diagnosis Sensor Unit or other Air Bag System sensors with the ignition ON or engine running, never use air or electric power tools or strike near the sensor(s) with a hammer. Heavy vibration could activate the sensor(s) and deploy the air bag(s), possibly causing serious injury.
- When using air or electric power tools or hammers, always switch the ignition OFF, disconnect the battery, and wait at least 3 minutes before performing any service.

FOR USA AND CANADA : Precaution for Procedure without Cowl Top Cover

INFOID:000000008458079

When performing the procedure after removing cowl top cover, cover the lower end of windshield with urethane, etc to prevent damage to windshield.

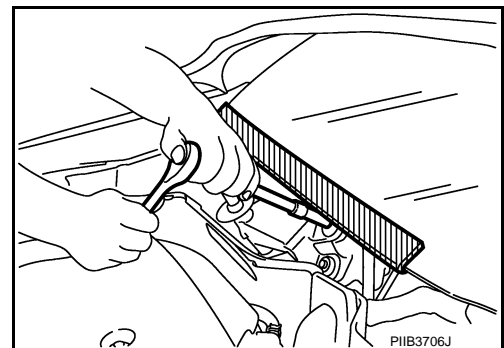

FOR MEXICO

FOR MEXICO : Precaution for Supplemental Restraint System (SRS) "AIR BAG" and "SEAT BELT PRE-TENSIONER"

INFOID:000000008458080

The Supplemental Restraint System such as "AIR BAG" and "SEAT BELT PRE-TENSIONER", used along with a front seat belt, helps to reduce the risk or severity of injury to the driver and front passenger for certain types of collision. Information necessary to service the system safely is included in the "SRS AIR BAG" and "SEAT BELT" of this Service Manual.

PRECAUTIONS

< PRECAUTION >

WARNING:

Always observe the following items for preventing accidental activation.

- To avoid rendering the SRS inoperative, which could increase the risk of personal injury or death in the event of a collision that would result in air bag inflation, all maintenance must be performed by an authorized NISSAN/INFINITI dealer.
- Improper maintenance, including incorrect removal and installation of the SRS, can lead to personal injury caused by unintentional activation of the system. For removal of Spiral Cable and Air Bag Module, see "SRS AIR BAG".
- Never use electrical test equipment on any circuit related to the SRS unless instructed to in this Service Manual. SRS wiring harnesses can be identified by yellow and/or orange harnesses or harness connectors.

PRECAUTIONS WHEN USING POWER TOOLS (AIR OR ELECTRIC) AND HAMMERS

WARNING:

Always observe the following items for preventing accidental activation.

- When working near the Air Bag Diagnosis Sensor Unit or other Air Bag System sensors with the ignition ON or engine running, never use air or electric power tools or strike near the sensor(s) with a hammer. Heavy vibration could activate the sensor(s) and deploy the air bag(s), possibly causing serious injury.
- When using air or electric power tools or hammers, always switch the ignition OFF, disconnect the battery, and wait at least 3 minutes before performing any service.

FOR MEXICO : Precaution for Procedure without Cowl Top Cover

INFOID:000000008458081

When performing the procedure after removing cowl top cover, cover the lower end of windshield with urethane, etc to prevent damage to windshield.

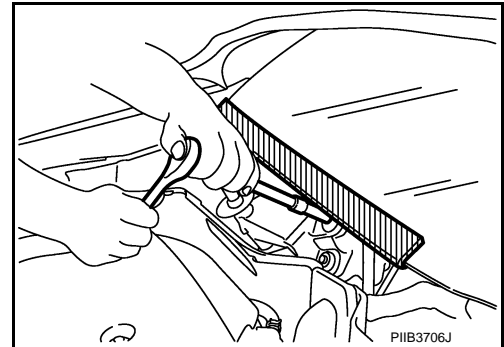

A
B
C
D
E
F
G
H
I
J
L
M
N
O
P

PWC

POWER WINDOW MAIN SWITCH

< REMOVAL AND INSTALLATION >

REMOVAL AND INSTALLATION

POWER WINDOW MAIN SWITCH

Exploded View

INFOID:000000008458082

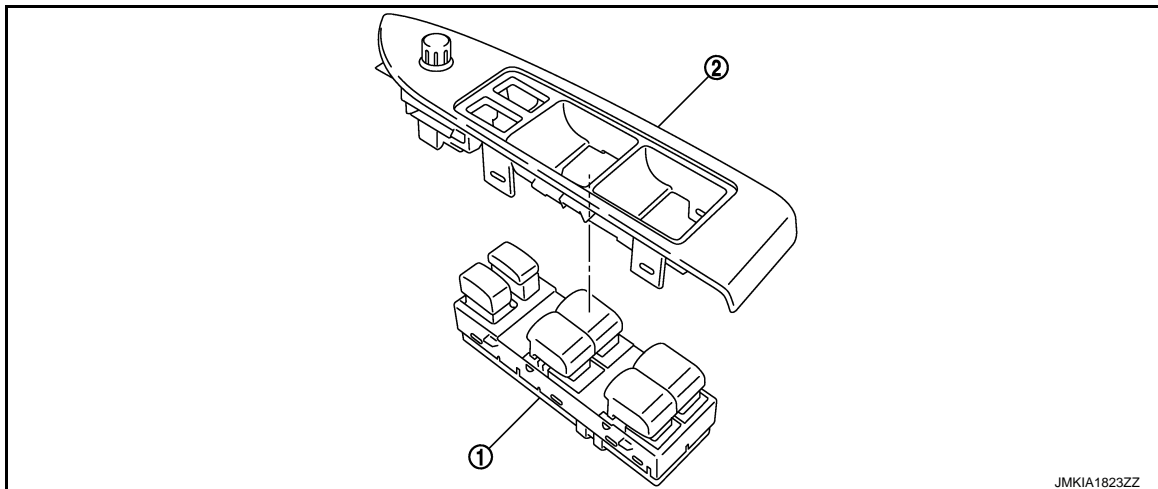

1. Power window main switch
2. Power window main switch finisher

NOTE:

The same procedure is also performed for front power window switch (passenger side) and rear power switch (LH & RH).

Refer to removal and installation procedure. Refer to [PWC-92. "Removal and Installation"](#).

Removal and Installation

INFOID:000000008458083

REMOVAL

1. Remove the power window main switch finisher (2).
Refer to [INT-12. "FRONT DOOR FINISHER : Exploded View"](#) and [INT-12. "FRONT DOOR FINISHER : Removal and Installation"](#).
2. Power window main switch (1) is removed from power window main switch finisher (2) using remover tool (A).

CAUTION:

Do not fold the pawl of power window main switch finisher.

NOTE:

The same procedure is also performed for front power window switch (passenger side) and rear power window switch (LH & RH).

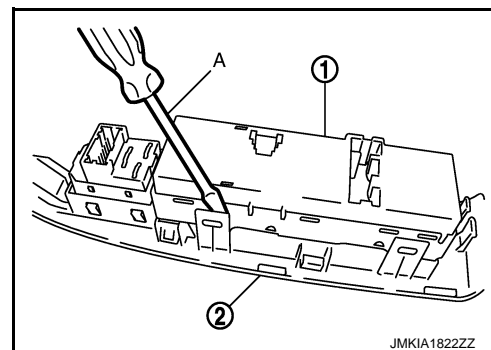

INSTALLATION

Install in the reverse order of removal.

NOTE:

Power window main switch is exchanged or is detached it is necessary to do the initialization procedure.

Refer to [PWC-6. "ADDITIONAL SERVICE WHEN REPLACING CONTROL UNIT : Special Repair Requirement"](#).