

SECTION **HRN**
HORN

A
B
C
D
E
F
G
H
I
J
K
M
N
O
P

CONTENTS

PRECAUTION	2	HORN	3
PRECAUTIONS	2	Wiring Diagram	3
Precaution for Supplemental Restraint System (SRS) "AIR BAG" and "SEAT BELT PRE-TEN- SIONER"	2	REMOVAL AND INSTALLATION	6
WIRING DIAGRAM	3	HORN	6
		Removal and Installation	6

HRN

PRECAUTIONS

< PRECAUTION >

PRECAUTION

PRECAUTIONS

Precaution for Supplemental Restraint System (SRS) "AIR BAG" and "SEAT BELT PRE-TENSIONER"

INFOID:000000006738326

The Supplemental Restraint System such as "AIR BAG" and "SEAT BELT PRE-TENSIONER", used along with a front seat belt, helps to reduce the risk or severity of injury to the driver and front passenger for certain types of collision. This system includes seat belt switch inputs and dual stage front air bag modules. The SRS system uses the seat belt switches to determine the front air bag deployment, and may only deploy one front air bag, depending on the severity of a collision and whether the front occupants are belted or unbelted. Information necessary to service the system safely is included in the SR and SB section of this Service Manual.

WARNING:

- To avoid rendering the SRS inoperative, which could increase the risk of personal injury or death in the event of a collision which would result in air bag inflation, all maintenance must be performed by an authorized NISSAN/INFINITI dealer.
- Improper maintenance, including incorrect removal and installation of the SRS, can lead to personal injury caused by unintentional activation of the system. For removal of Spiral Cable and Air Bag Module, see the SR section.
- Do not use electrical test equipment on any circuit related to the SRS unless instructed to in this Service Manual. SRS wiring harnesses can be identified by yellow and/or orange harnesses or harness connectors.

PRECAUTIONS WHEN USING POWER TOOLS (AIR OR ELECTRIC) AND HAMMERS

WARNING:

- When working near the Airbag Diagnosis Sensor Unit or other Airbag System sensors with the Ignition ON or engine running, DO NOT use air or electric power tools or strike near the sensor(s) with a hammer. Heavy vibration could activate the sensor(s) and deploy the air bag(s), possibly causing serious injury.
- When using air or electric power tools or hammers, always switch the Ignition OFF, disconnect the battery, and wait at least 3 minutes before performing any service.

HORN

< WIRING DIAGRAM >

WIRING DIAGRAM

HORN

Wiring Diagram

INFOID:000000006738328

◊RK◊ : WITH REMOTE KEYLESS ENTRY SYSTEM
◊VS◊ : WITH VEHICLE SECURITY SYSTEM

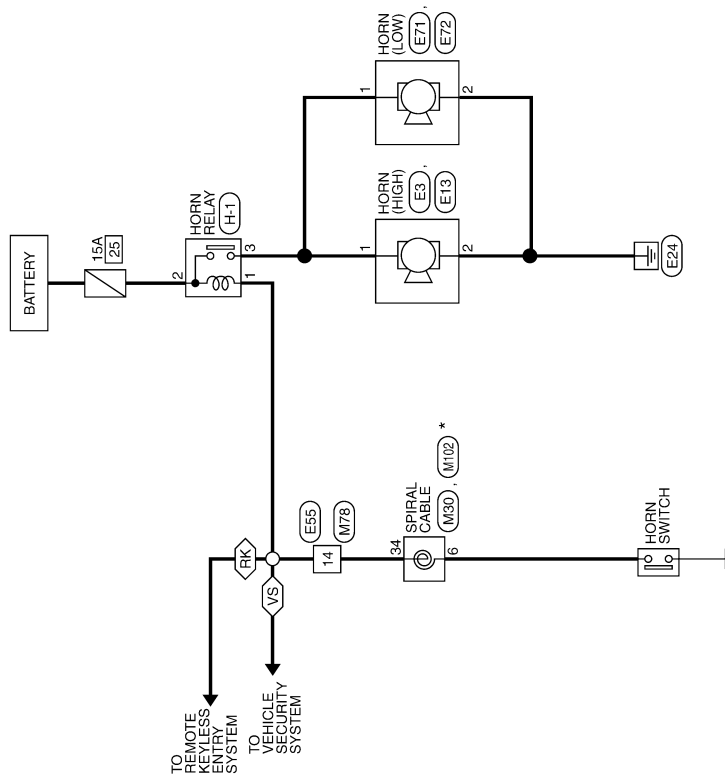

*: THIS CONNECTOR IS NOT SHOWN IN "HARNES LAYOUT" OF PG SECTION.

HORN

ABLWA1275GB

A
B
C
D
E
F
G
H
I
J
K
L
M
N
O
P

HRN

HORN CONNECTORS

Connector No.	M30
Connector Name	SPIRAL CABLE
Connector Color	GRAY

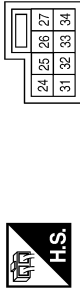

Terminal No.	34	Color of Wire	W	Signal Name	-
--------------	----	---------------	---	-------------	---

Connector No.	M78
Connector Name	WIRE TO WIRE
Connector Color	WHITE

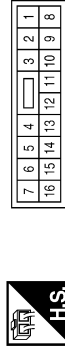

Terminal No.	14	Color of Wire	W	Signal Name	-
--------------	----	---------------	---	-------------	---

Connector No.	M102
Connector Name	SPIRAL CABLE
Connector Color	GRAY



Terminal No.	6	Color of Wire	G	Signal Name	-
--------------	---	---------------	---	-------------	---

Connector No.	E3
Connector Name	HORN (HIGH)
Connector Color	BLACK



Terminal No.	1	Color of Wire	G	Signal Name	-
--------------	---	---------------	---	-------------	---

Connector No.	E13
Connector Name	HORN (HIGH)
Connector Color	BLACK



Terminal No.	2	Color of Wire	B	Signal Name	-
--------------	---	---------------	---	-------------	---

Connector No.	E55
Connector Name	WIRE TO WIRE
Connector Color	WHITE

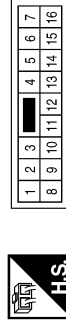

Terminal No.	14	Color of Wire	W	Signal Name	-
--------------	----	---------------	---	-------------	---

HORN

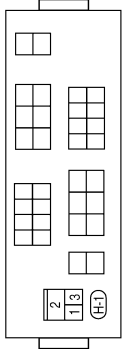

< WIRING DIAGRAM >

Connector No.	H-1
Connector Name	FUSE AND FUSIBLE LINK BOX (HORN RELAY)
Connector Color	-



Terminal No.	Color of Wire	Signal Name
1	W	-
2	R	-
3	G	-

Connector No.	E72
Connector Name	HORN (LOW)
Connector Color	BLACK

Terminal No.	Color of Wire	Signal Name
2	B	-

Connector No.	E71
Connector Name	HORN (LOW)
Connector Color	BLACK

Terminal No.	Color of Wire	Signal Name
1	G	-

A
B
C
D
E
F
G
H
I
J
K
HRN
M
N
O
P

ABLIA2955GB

HORN

< REMOVAL AND INSTALLATION >

REMOVAL AND INSTALLATION

HORN

Removal and Installation

INFOID:000000006738329

REMOVAL

1. Remove the front grille. Refer to [EXT-28. "Removal and Installation"](#).
2. Disconnect the harness connectors (A) from the horns (Low, High).
⇐: Front
3. Release the horn (Low, High) harness clips from the horn (Low, High) brackets.
4. Remove the horn (Low) bolt (B) and remove the horn (Low) (1).
5. Remove the horn (High) bolt (C) and remove the horn (High) (2).

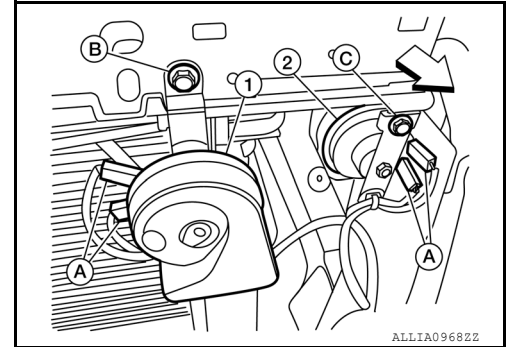

INSTALLATION

Installation is in the reverse order of removal.