

SECTION **EX**
EXHAUST SYSTEM



CONTENTS

PRECAUTION	2	Commercial Service Tool	3	F
PRECAUTIONS	2	ON-VEHICLE MAINTENANCE	4	
Precaution for Supplemental Restraint System (SRS) "AIR BAG" and "SEAT BELT PRE-TEN- SIONER"	2	EXHAUST SYSTEM	4	G
		Checking Exhaust System	4	
PREPARATION	3	ON-VEHICLE REPAIR	5	H
PREPARATION	3	EXHAUST SYSTEM	5	
Special Service Tool	3	Removal and Installation	5	I

A
C
D
E
F
G
H
I
J
K
L
M
N
O
P

PRECAUTIONS

< PRECAUTION >

PRECAUTION

PRECAUTIONS

Precaution for Supplemental Restraint System (SRS) "AIR BAG" and "SEAT BELT PRE-TENSIONER"

INFOID:000000001303546

The Supplemental Restraint System such as "AIR BAG" and "SEAT BELT PRE-TENSIONER", used along with a front seat belt, helps to reduce the risk or severity of injury to the driver and front passenger for certain types of collision. This system includes seat belt switch inputs and dual stage front air bag modules. The SRS system uses the seat belt switches to determine the front air bag deployment, and may only deploy one front air bag, depending on the severity of a collision and whether the front occupants are belted or unbelted. Information necessary to service the system safely is included in the SR and SB section of this Service Manual.

WARNING:

- To avoid rendering the SRS inoperative, which could increase the risk of personal injury or death in the event of a collision which would result in air bag inflation, all maintenance must be performed by an authorized NISSAN/INFINITI dealer.
- Improper maintenance, including incorrect removal and installation of the SRS, can lead to personal injury caused by unintentional activation of the system. For removal of Spiral Cable and Air Bag Module, see the SR section.
- Do not use electrical test equipment on any circuit related to the SRS unless instructed to in this Service Manual. SRS wiring harnesses can be identified by yellow and/or orange harnesses or harness connectors.

PREPARATION

< PREPARATION >

PREPARATION

PREPARATION

Special Service Tool

INFOID:000000001282200

A

EX

The actual shapes of Kent-Moore tools may differ from those of special service tools illustrated here.

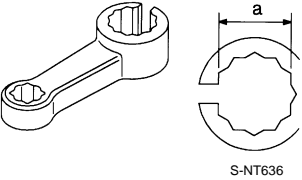
Tool number (Kent-Moore No.) Tool name	Description
KV10114400 (J-38365) Heated oxygen sensor wrench 	Loosening or tightening heated oxygen sensors: a: 22 mm (0.87 in)



C

D

E

Commercial Service Tool

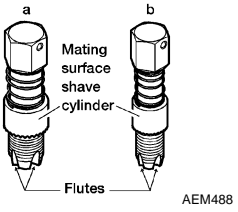
INFOID:000000001282201

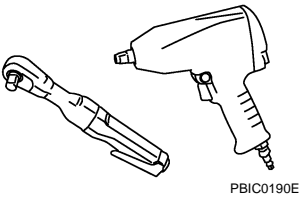
(Kent-Moore No.) Tool name	Description
(J-43897-18) (J-43897-12) Oxygen sensor thread cleaner 	Reconditioning the exhaust system threads before installing a new heated oxygen sensor (Use with anti-seize lubricant shown below): a: J-43897-18 (18 mm, 0.71 in) dia. for zirconia oxygen sensor b: J-43897-12 (12 mm, 0.47 in) dia. for titania oxygen sensor
Anti-seize lubricant (Permatex 133AR or equivalent meeting MIL specification MIL-A-907) 	Lubricating oxygen sensor thread cleaning tool when reconditioning exhaust system threads
Power tool 	Loosening nuts and bolts

F

G

H

I

J

K

L

M

N

O

P

EXHAUST SYSTEM

< ON-VEHICLE MAINTENANCE >

ON-VEHICLE MAINTENANCE

EXHAUST SYSTEM

Checking Exhaust System

INFOID:000000001282202

Check exhaust pipes, muffler and mounting for improper attachment, leaks, cracks, damage or deterioration.

- If anything is found, repair or replace damaged parts.

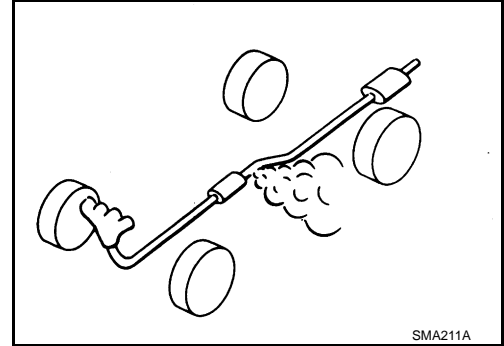

EXHAUST SYSTEM

< ON-VEHICLE REPAIR >

ON-VEHICLE REPAIR

EXHAUST SYSTEM

Removal and Installation

INFOID:000000001282203

A

EX

VQ40DE Exhaust System

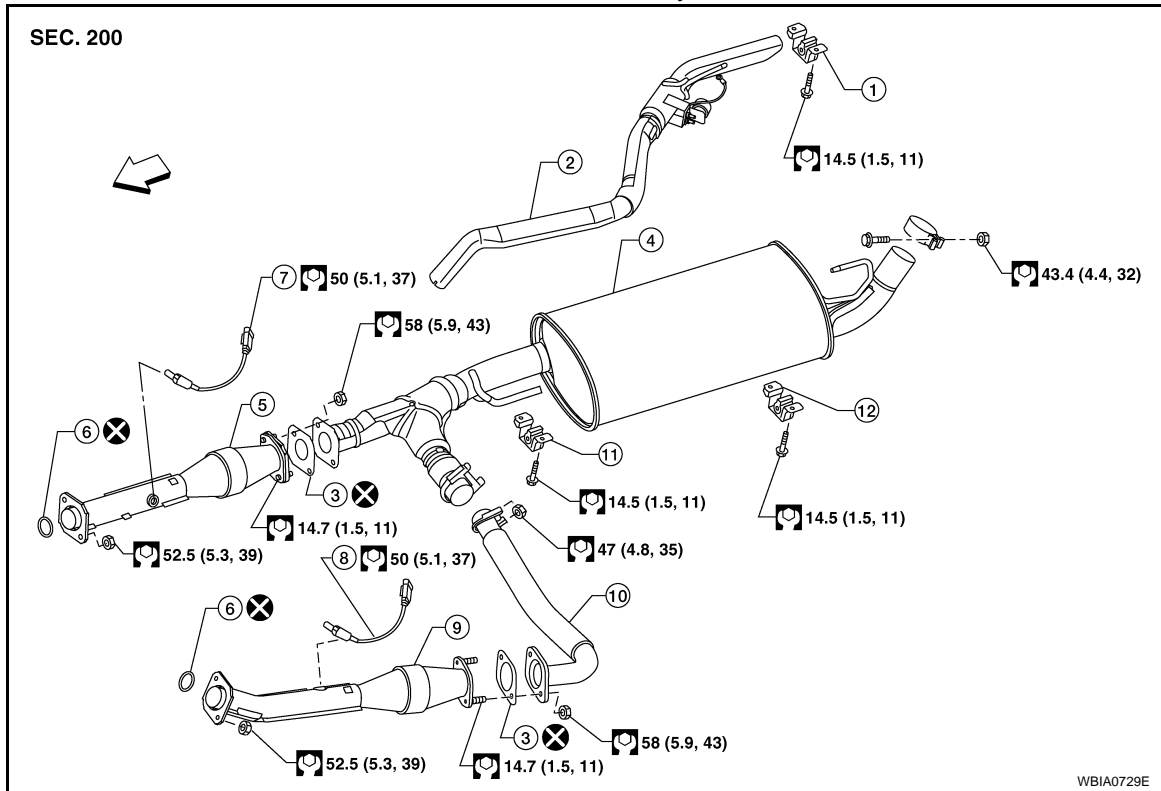

- | | | |
|------------------------------------|------------------------------------|---------------------------------|
| 1. Tailpipe hanger bracket | 2. Tailpipe | 3. Gasket |
| 4. Main muffler | 5. Right front exhaust tube | 6. Ring gasket |
| 7. Heated oxygen sensor 2 (bank 2) | 8. Heated oxygen sensor 2 (bank 1) | 9. Left front exhaust tube |
| 10. Center exhaust tube | 11. Muffler hanger bracket front | 12. Muffler hanger bracket rear |
- ⇐ Front

C

D

E

F

G

H

I

J

K

L

M

N

O

P

EXHAUST SYSTEM

< ON-VEHICLE REPAIR >

VK56DE Exhaust System

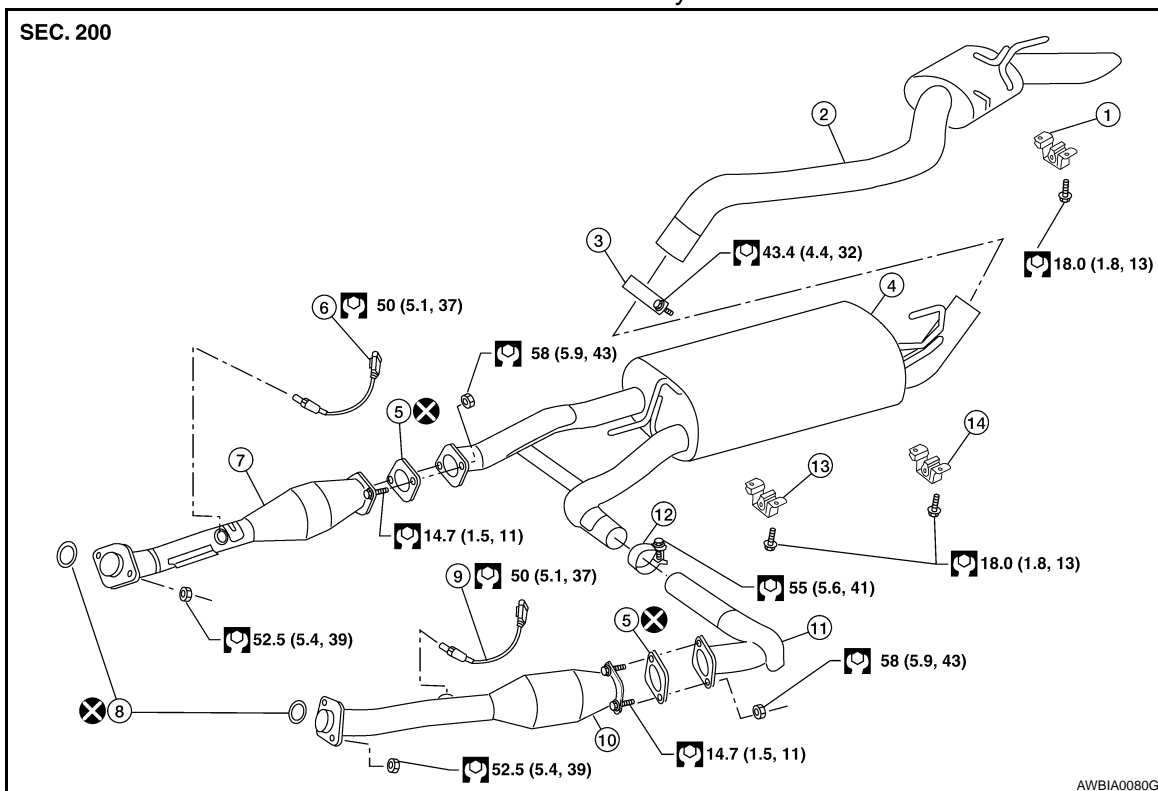

- | | | |
|----------------------------------|---------------------------------|------------------------------------|
| 1. Tailpipe hanger bracket | 2. Tailpipe | 3. Clamp |
| 4. Main muffler | 5. Gasket | 6. Heated oxygen sensor 2 (bank 2) |
| 7. Right front exhaust tube | 8. Ring gasket | 9. Heated oxygen sensor 2 (bank 1) |
| 10. Left front exhaust tube | 11. Center exhaust tube | 12. Clamp |
| 13. Muffler hanger bracket front | 14. Muffler hanger bracket rear | |

CAUTION:

- Be sure to use genuine exhaust system parts or equivalents which are specially designed for heat resistance, corrosion resistance, and shape.
- Perform the operation with the exhaust system fully cooled. The system will be hot just after the engine stops.
- Be careful not to cut your hand on the heat insulator edge.

REMOVAL

Remove exhaust system components using power tool.

INSTALLATION

Installation is in the reverse order of removal.

CAUTION:

- Always replace exhaust gaskets with new ones when reassembling.
- Before installing a new heated oxygen sensor, clean and lube the exhaust tube threads using suitable tool.

Oxygen sensor thread cleaner : — (J-43897-18)

Oxygen sensor thread cleaner : — (J-43897-12)

- Discard any heated oxygen sensor which has been dropped from a height of more than 0.5 m (19.7 in) onto a hard surface such as a concrete floor; install a new one.
- Do not over-torque the heated oxygen sensor. Doing so may damage the heated oxygen sensor, resulting in the MIL coming on.
- If any mounting insulator is badly deformed, repair or replace it. If deposits such as mud pile up on the mounting insulators, clean and inspect them.

EXHAUST SYSTEM

< ON-VEHICLE REPAIR >

- **Temporarily tighten the mounting nuts on the exhaust manifold side and the mounting bolts on the vehicle side. Check each part for interference with other components, and then tighten the nuts and bolts to specification.**

A

INSPECTION AFTER INSTALLATION

- With the engine running, check exhaust tube joints for gas leakage and unusual noises.
- Check to ensure that mounting brackets and mounting rubbers are installed properly and free from undue stress. Improper installation could result in excessive noise and vibration.

EX

C

D

E

F

G

H

I

J

K

L

M

N

O

P