

SECTION **AV**

**AUDIO, VISUAL & NAVIGATION SYSTEM**

**CONTENTS**

<b>BASE AUDIO</b>		
<b>BASIC INSPECTION</b> .....	10	
<b>DIAGNOSIS AND REPAIR WORKFLOW</b> .....	10	
Work Flow .....	10	
<b>FUNCTION DIAGNOSIS</b> .....	12	
<b>AUDIO SYSTEM</b> .....	12	
System Diagram .....	12	
System Description .....	12	
Component Parts Location .....	12	
Component Description .....	13	
<b>COMPONENT DIAGNOSIS</b> .....	14	
<b>POWER SUPPLY AND GROUND CIRCUIT</b> .....	14	
<b>AUDIO UNIT</b> .....	14	
AUDIO UNIT : Diagnosis Procedure .....	14	
<b>FRONT DOOR SPEAKER</b> .....	15	
Description .....	15	
Diagnosis Procedure .....	15	
<b>FRONT TWEETER</b> .....	17	
Description .....	17	
Diagnosis Procedure .....	17	
<b>REAR DOOR SPEAKER</b> .....	19	
Description .....	19	
Diagnosis Procedure .....	19	
<b>ECU DIAGNOSIS</b> .....	21	
<b>AUDIO UNIT</b> .....	21	
Reference Value .....	21	
Wiring Diagram .....	23	
<b>SYMPTOM DIAGNOSIS</b> .....	29	
<b>AUDIO SYSTEM</b> .....	29	
<b>AUDIO UNIT</b> .....	29	
AUDIO UNIT : Symptom Table .....	29	
<b>NORMAL OPERATING CONDITION</b> .....	30	
Description .....	30	
<b>PRECAUTION</b> .....	31	
<b>PRECAUTIONS</b> .....	31	
Precaution for Supplemental Restraint System (SRS) "AIR BAG" and "SEAT BELT PRE-TENSIONER" .....	31	
Precaution Necessary for Steering Wheel Rotation After Battery Disconnect .....	31	
<b>PREPARATION</b> .....	33	
<b>PREPARATION</b> .....	33	
Commercial Service Tools .....	33	
<b>ON-VEHICLE REPAIR</b> .....	34	
<b>AUDIO UNIT</b> .....	34	
Removal and Installation .....	34	
<b>FRONT TWEETER</b> .....	36	
Removal and Installation .....	36	
<b>FRONT DOOR SPEAKER</b> .....	37	
Removal and Installation .....	37	
<b>REAR DOOR SPEAKER</b> .....	38	
Removal and Installation .....	38	
<b>AUDIO ANTENNA</b> .....	39	
Location of Antenna .....	39	
Window Antenna Repair .....	39	
<b>AUXILIARY INPUT JACK</b> .....	41	
Removal and Installation .....	41	
<b>ANTENNA AMP.</b> .....	42	
Removal and Installation .....	42	

A  
B  
C  
D  
E  
F  
G  
H  
I  
J  
K  
L  
M  
AV

<b>MID AUDIO</b>	
<b>BASIC INSPECTION .....</b>	<b>43</b>
<b>DIAGNOSIS AND REPAIR WORKFLOW .....</b>	<b>43</b>
Work Flow .....	43
<b>FUNCTION DIAGNOSIS .....</b>	<b>45</b>
<b>AUDIO SYSTEM .....</b>	<b>45</b>
System Diagram .....	45
System Description .....	45
Component Parts Location .....	47
Component Description .....	47
<b>REAR VIEW MONITOR SYSTEM .....</b>	<b>49</b>
System Diagram .....	49
System Description .....	49
Component Parts Location .....	50
Component Description .....	50
<b>DVD PLAYER .....</b>	<b>52</b>
System Diagram .....	52
System Description .....	52
Component Parts Location .....	53
Component Description .....	53
<b>DIAGNOSIS SYSTEM (AV CONTROL UNIT) ...</b>	<b>54</b>
<b>AV CONTROL UNIT .....</b>	<b>54</b>
AV CONTROL UNIT : Diagnosis Description .....	54
AV CONTROL UNIT : CONSULT-III Function .....	60
<b>A/C AND AV SWITCH ASSEMBLY .....</b>	<b>60</b>
A/C AND AV SWITCH ASSEMBLY : Component Function Check .....	60
<b>COMPONENT DIAGNOSIS .....</b>	<b>62</b>
<b>U1000 CAN COMM CIRCUIT .....</b>	<b>62</b>
Description .....	62
DTC Logic .....	62
Diagnosis Procedure .....	62
<b>U1010 CONTROL UNIT (CAN) .....</b>	<b>63</b>
Description .....	63
DTC Logic .....	63
Diagnosis Procedure .....	63
<b>U1200 AV CONTROL UNIT .....</b>	<b>64</b>
Description .....	64
DTC Logic .....	64
<b>U1216 AV CONTROL UNIT .....</b>	<b>65</b>
Description .....	65
DTC Logic .....	65
<b>U1240 SWITCH CONN .....</b>	<b>66</b>
Description .....	66
<b>U1243 DISPLAY UNIT .....</b>	<b>67</b>
Description .....	67
DTC Logic .....	67
Diagnosis Procedure .....	67
<b>U1248 DVD DECK CONN .....</b>	<b>69</b>
Description .....	69
DTC Logic .....	69
Diagnosis Procedure .....	69
<b>U1255 SATELLITE RADIO TUNER .....</b>	<b>70</b>
Description .....	70
DTC Logic .....	70
Diagnosis Procedure .....	70
<b>U1300 AV COMM CIRCUIT .....</b>	<b>71</b>
Description .....	71
<b>U1310 AV CONTROL UNIT .....</b>	<b>72</b>
Description .....	72
DTC Logic .....	72
<b>POWER SUPPLY AND GROUND CIRCUIT ....</b>	<b>73</b>
<b>AV CONTROL UNIT .....</b>	<b>73</b>
AV CONTROL UNIT : Diagnosis Procedure .....	73
<b>DISPLAY UNIT .....</b>	<b>74</b>
DISPLAY UNIT : Diagnosis Procedure .....	74
<b>A/C AND AV SWITCH ASSEMBLY .....</b>	<b>75</b>
A/C AND AV SWITCH ASSEMBLY : Diagnosis Procedure .....	75
<b>SATELLITE RADIO TUNER .....</b>	<b>76</b>
SATELLITE RADIO TUNER : Diagnosis Proce- dure .....	76
<b>REAR VIEW CAMERA CONTROL UNIT .....</b>	<b>77</b>
REAR VIEW CAMERA CONTROL UNIT : Diagno- sis Procedure .....	77
<b>REAR VIEW CAMERA .....</b>	<b>78</b>
REAR VIEW CAMERA : Diagnosis Procedure .....	78
<b>DVD PLAYER .....</b>	<b>79</b>
DVD PLAYER : Diagnosis Procedure .....	79
<b>VIDEO MONITOR .....</b>	<b>80</b>
VIDEO MONITOR : Diagnosis Procedure .....	80
<b>RGB (R: RED) SIGNAL CIRCUIT .....</b>	<b>82</b>
Description .....	82
Diagnosis Procedure .....	82
<b>RGB (G: GREEN) SIGNAL CIRCUIT .....</b>	<b>83</b>
Description .....	83
Diagnosis Procedure .....	83
<b>RGB (B: BLUE) SIGNAL CIRCUIT .....</b>	<b>84</b>
Description .....	84
Diagnosis Procedure .....	84
<b>RGB SYNCHRONIZING SIGNAL CIRCUIT ....</b>	<b>85</b>
Description .....	85
Diagnosis Procedure .....	85

<b>RGB AREA (YS) SIGNAL CIRCUIT</b> .....	<b>86</b>	<b>SYMPTOM DIAGNOSIS</b> .....	<b>136</b>	A
Description .....	86	<b>AUDIO SYSTEM</b> .....	<b>136</b>	B
Diagnosis Procedure .....	86	Symptom Table .....	136	C
<b>HORIZONTAL SYNCHRONIZING (HP) SIGNAL CIRCUIT</b> .....	<b>87</b>	<b>NORMAL OPERATING CONDITION</b> .....	<b>137</b>	D
Description .....	87	Description .....	137	E
Diagnosis Procedure .....	87	<b>PRECAUTION</b> .....	<b>138</b>	F
<b>VERTICAL SYNCHRONIZING (VP) SIGNAL CIRCUIT</b> .....	<b>88</b>	<b>PRECAUTIONS</b> .....	<b>138</b>	G
Description .....	88	Precaution for Supplemental Restraint System (SRS) "AIR BAG" and "SEAT BELT PRE-TENSIONER" .....	138	H
Diagnosis Procedure .....	88	Precaution Necessary for Steering Wheel Rotation After Battery Disconnect .....	138	I
<b>FRONT DOOR SPEAKER</b> .....	<b>89</b>	<b>PREPARATION</b> .....	<b>140</b>	J
Description .....	89	Commercial Service Tools .....	140	K
Diagnosis Procedure .....	89	<b>ON-VEHICLE REPAIR</b> .....	<b>141</b>	L
<b>FRONT TWEETER</b> .....	<b>91</b>	<b>AV CONTROL UNIT</b> .....	<b>141</b>	M
Description .....	91	Removal and Installation .....	141	AV
Diagnosis Procedure .....	91	<b>DISPLAY UNIT</b> .....	<b>143</b>	O
<b>REAR DOOR SPEAKER</b> .....	<b>93</b>	Removal and Installation .....	143	P
Description .....	93	<b>FRONT TWEETER</b> .....	<b>144</b>	
Diagnosis Procedure .....	93	Removal and Installation .....	144	
<b>STEERING SWITCH</b> .....	<b>95</b>	<b>FRONT DOOR SPEAKER</b> .....	<b>145</b>	
Description .....	95	Removal and Installation .....	145	
Diagnosis Procedure .....	95	<b>REAR DOOR SPEAKER</b> .....	<b>146</b>	
<b>COMMUNICATION SIGNAL CIRCUIT</b> .....	<b>97</b>	Removal and Installation .....	146	
<b>SATELLITE RADIO TUNER</b> .....	<b>97</b>	<b>STEERING SWITCH</b> .....	<b>147</b>	
SATELLITE RADIO TUNER : Description .....	97	Removal and Installation .....	147	
SATELLITE RADIO TUNER : Diagnosis Procedure .....	97	<b>DVD ENTERTAINMENT SYSTEM</b> .....	<b>148</b>	
<b>SOUND SIGNAL CIRCUIT</b> .....	<b>100</b>	Removal and Installation of DVD Player .....	148	
<b>SATELLITE RADIO TUNER</b> .....	<b>100</b>	Removal and Installation of Video Monitor .....	148	
SATELLITE RADIO TUNER : Description .....	100	<b>AUDIO ANTENNA</b> .....	<b>149</b>	
SATELLITE RADIO TUNER : Diagnosis Procedure .....	100	Location of Antenna .....	149	
<b>ECU DIAGNOSIS</b> .....	<b>102</b>	Window Antenna Repair .....	149	
<b>AV CONTROL UNIT</b> .....	<b>102</b>	<b>AUXILIARY INPUT JACK</b> .....	<b>151</b>	
Reference Value .....	102	Removal and Installation .....	151	
Wiring Diagram .....	110	<b>ANTENNA AMP.</b> .....	<b>152</b>	
DTC Index .....	125	Removal and Installation .....	152	
<b>DISPLAY UNIT</b> .....	<b>127</b>	<b>SATELLITE RADIO ANTENNA</b> .....	<b>153</b>	
Reference Value .....	127	Removal and Installation .....	153	
<b>SATELLITE RADIO TUNER</b> .....	<b>130</b>	<b>SATELLITE RADIO TUNER</b> .....	<b>154</b>	
Reference Value .....	130	Removal and Installation .....	154	
<b>REAR VIEW CAMERA CONTROL UNIT</b> .....	<b>132</b>	<b>REAR VIEW CAMERA</b> .....	<b>155</b>	
Reference Value .....	132			
<b>DVD PLAYER</b> .....	<b>134</b>			
Reference Value .....	134			

Removal and Installation .....	155	Diagnosis Procedure .....	182
<b>REAR VIEW CAMERA CONTROL UNIT .....</b>	<b>156</b>	<b>U1200 AV CONTROL UNIT .....</b>	<b>183</b>
Removal and Installation .....	156	Description .....	183
<b>BOSE AUDIO WITHOUT NAVIGATION</b>		DTC Logic .....	183
<b>BASIC INSPECTION .....</b>	<b>157</b>	<b>U1216 AV CONTROL UNIT .....</b>	<b>184</b>
<b>DIAGNOSIS AND REPAIR WORKFLOW .....</b>	<b>157</b>	Description .....	184
Work Flow .....	157	DTC Logic .....	184
<b>FUNCTION DIAGNOSIS .....</b>	<b>159</b>	<b>U1240 SWITCH CONN .....</b>	<b>185</b>
<b>AUDIO SYSTEM .....</b>	<b>159</b>	Description .....	185
System Diagram .....	159	<b>U1243 DISPLAY UNIT .....</b>	<b>186</b>
System Description .....	159	Description .....	186
Component Parts Location .....	161	DTC Logic .....	186
Component Description .....	162	Diagnosis Procedure .....	186
<b>REAR VIEW MONITOR SYSTEM .....</b>	<b>163</b>	<b>U1248 DVD DECK CONN .....</b>	<b>188</b>
System Diagram .....	163	Description .....	188
System Description .....	163	DTC Logic .....	188
Component Parts Location .....	164	Diagnosis Procedure .....	188
Component Description .....	165	<b>U1255 SATELLITE RADIO TUNER .....</b>	<b>189</b>
<b>DVD PLAYER .....</b>	<b>166</b>	Description .....	189
System Diagram .....	166	DTC Logic .....	189
System Description .....	166	Diagnosis Procedure .....	189
Component Parts Location .....	167	<b>U1256 HAND FREE CONN .....</b>	<b>190</b>
Component Description .....	167	Description .....	190
<b>HANDS-FREE PHONE SYSTEM .....</b>	<b>169</b>	<b>U1300 AV COMM CIRCUIT .....</b>	<b>191</b>
System Diagram .....	169	Description .....	191
System Description .....	169	<b>U1310 AV CONTROL UNIT .....</b>	<b>192</b>
Component Parts Location .....	170	Description .....	192
Component Description .....	171	DTC Logic .....	192
<b>DIAGNOSIS SYSTEM (AV CONTROL UNIT) .</b>	<b>172</b>	<b>POWER SUPPLY AND GROUND CIRCUIT ...</b>	<b>193</b>
<b>AV CONTROL UNIT .....</b>	<b>172</b>	<b>AV CONTROL UNIT .....</b>	<b>193</b>
AV CONTROL UNIT : Diagnosis Description .....	172	AV CONTROL UNIT : Diagnosis Procedure .....	193
AV CONTROL UNIT : CONSULT-III Function .....	178	<b>DISPLAY UNIT .....</b>	<b>194</b>
<b>A/C AND AV SWITCH ASSEMBLY .....</b>	<b>178</b>	DISPLAY UNIT : Diagnosis Procedure .....	194
A/C AND AV SWITCH ASSEMBLY : Component		<b>A/C AND AV SWITCH ASSEMBLY .....</b>	<b>195</b>
Function Check .....	178	A/C AND AV SWITCH ASSEMBLY : Diagnosis	
<b>DIAGNOSIS SYSTEM (BLUETOOTH CON-</b>		Procedure .....	195
<b>TROL UNIT) .....</b>	<b>180</b>	<b>BOSE SPEAKER AMP .....</b>	<b>196</b>
Diagnosis Description .....	180	BOSE SPEAKER AMP : Diagnosis Procedure ....	196
Work Flow .....	180	<b>SUBWOOFER .....</b>	<b>197</b>
<b>COMPONENT DIAGNOSIS .....</b>	<b>181</b>	SUBWOOFER : Diagnosis Procedure .....	197
<b>U1000 CAN COMM CIRCUIT .....</b>	<b>181</b>	<b>SATELLITE RADIO TUNER .....</b>	<b>198</b>
Description .....	181	SATELLITE RADIO TUNER : Diagnosis Proce-	
DTC Logic .....	181	dure .....	198
Diagnosis Procedure .....	181	<b>REAR VIEW CAMERA CONTROL UNIT .....</b>	<b>198</b>
<b>U1010 CONTROL UNIT (CAN) .....</b>	<b>182</b>	REAR VIEW CAMERA CONTROL UNIT : Diagno-	
Description .....	182	sis Procedure .....	198
DTC Logic .....	182		

<b>REAR VIEW CAMERA</b> .....	<b>199</b>	Description .....	225	
REAR VIEW CAMERA : Diagnosis Procedure .....	199	Diagnosis Procedure .....	225	A
<b>DVD PLAYER</b> .....	<b>200</b>	<b>AMP ON SIGNAL CIRCUIT</b> .....	<b>228</b>	
DVD PLAYER : Diagnosis Procedure .....	200	Description .....	228	B
<b>VIDEO MONITOR</b> .....	<b>201</b>	Diagnosis Procedure .....	228	
VIDEO MONITOR : Diagnosis Procedure .....	201	<b>STEERING SWITCH</b> .....	<b>229</b>	
<b>BLUETOOTH CONTROL UNIT</b> .....	<b>202</b>	Description .....	229	C
BLUETOOTH CONTROL UNIT : Diagnosis Procedure .....	202	Diagnosis Procedure .....	229	
<b>MICROPHONE</b> .....	<b>203</b>	<b>COMMUNICATION SIGNAL CIRCUIT</b> .....	<b>231</b>	
MICROPHONE : Diagnosis Procedure .....	203	<b>SATELLITE RADIO TUNER</b> .....	<b>231</b>	D
<b>RGB (R: RED) SIGNAL CIRCUIT</b> .....	<b>206</b>	SATELLITE RADIO TUNER : Description .....	231	
Description .....	206	SATELLITE RADIO TUNER : Diagnosis Procedure .....	231	E
Diagnosis Procedure .....	206	<b>SOUND SIGNAL CIRCUIT</b> .....	<b>234</b>	
<b>RGB (G: GREEN) SIGNAL CIRCUIT</b> .....	<b>207</b>	<b>SATELLITE RADIO TUNER</b> .....	<b>234</b>	F
Description .....	207	SATELLITE RADIO TUNER : Description .....	234	
Diagnosis Procedure .....	207	SATELLITE RADIO TUNER : Diagnosis Procedure .....	234	G
<b>RGB (B: BLUE) SIGNAL CIRCUIT</b> .....	<b>208</b>	<b>MICROPHONE SIGNAL CIRCUIT</b> .....	<b>236</b>	
Description .....	208	Description .....	236	H
Diagnosis Procedure .....	208	Diagnosis Procedure .....	236	
<b>RGB SYNCHRONIZING SIGNAL CIRCUIT</b> .....	<b>209</b>	<b>ECU DIAGNOSIS</b> .....	<b>238</b>	
Description .....	209	<b>AV CONTROL UNIT</b> .....	<b>238</b>	
Diagnosis Procedure .....	209	Reference Value .....	238	I
<b>RGB AREA (YS) SIGNAL CIRCUIT</b> .....	<b>210</b>	Wiring Diagram .....	245	J
Description .....	210	DTC Index .....	268	
Diagnosis Procedure .....	210	<b>DISPLAY UNIT</b> .....	<b>270</b>	
<b>HORIZONTAL SYNCHRONIZING (HP) SIGNAL CIRCUIT</b> .....	<b>211</b>	Reference Value .....	270	K
Description .....	211	<b>BOSE SPEAKER AMP</b> .....	<b>273</b>	
Diagnosis Procedure .....	211	Reference Value .....	273	L
<b>VERTICAL SYNCHRONIZING (VP) SIGNAL CIRCUIT</b> .....	<b>212</b>	<b>SATELLITE RADIO TUNER</b> .....	<b>275</b>	
Description .....	212	Reference Value .....	275	M
Diagnosis Procedure .....	212	<b>REAR VIEW CAMERA CONTROL UNIT</b> .....	<b>277</b>	
<b>FRONT DOOR SPEAKER</b> .....	<b>213</b>	Reference Value .....	277	
Description .....	213	<b>DVD PLAYER</b> .....	<b>279</b>	AV
Diagnosis Procedure .....	213	Reference Value .....	279	
<b>FRONT TWEETER</b> .....	<b>216</b>	<b>BLUETOOTH CONTROL UNIT</b> .....	<b>281</b>	
Description .....	216	Reference Value .....	281	O
Diagnosis Procedure .....	216	<b>SYMPTOM DIAGNOSIS</b> .....	<b>283</b>	
<b>REAR DOOR SPEAKER</b> .....	<b>219</b>	<b>AUDIO SYSTEM</b> .....	<b>283</b>	
Description .....	219	Symptom Table .....	283	P
Diagnosis Procedure .....	219	<b>NORMAL OPERATING CONDITION</b> .....	<b>285</b>	
<b>REAR TWEETER</b> .....	<b>222</b>	Description .....	285	
Description .....	222	<b>PRECAUTION</b> .....	<b>286</b>	
Diagnosis Procedure .....	222			
<b>SUBWOOFER</b> .....	<b>225</b>			

<b>PRECAUTIONS</b> .....	286	Removal and Installation .....	306
Precaution for Supplemental Restraint System (SRS) "AIR BAG" and "SEAT BELT PRE-TENSIONER" .....	286	<b>SATELLITE RADIO TUNER</b> .....	307
Precaution Necessary for Steering Wheel Rotation After Battery Disconnect .....	286	Removal and Installation .....	307
<b>PREPARATION</b> .....	288	<b>REAR VIEW CAMERA</b> .....	308
<b>PREPARATION</b> .....	288	Removal and Installation .....	308
Commercial Service Tools .....	288	<b>REAR VIEW CAMERA CONTROL UNIT</b> .....	309
<b>ON-VEHICLE REPAIR</b> .....	289	Removal and Installation .....	309
<b>AV CONTROL UNIT</b> .....	289	<b>BOSE AUDIO WITH NAVIGATION</b>	
Removal and Installation .....	289	<b>BASIC INSPECTION</b> .....	310
<b>DISPLAY UNIT</b> .....	291	<b>DIAGNOSIS AND REPAIR WORKFLOW</b> .....	310
Removal and Installation .....	291	Work Flow .....	310
<b>FRONT TWEETER</b> .....	292	<b>FUNCTION DIAGNOSIS</b> .....	312
Removal and Installation .....	292	<b>AUDIO SYSTEM</b> .....	312
<b>FRONT DOOR SPEAKER</b> .....	293	System Diagram .....	312
Removal and Installation .....	293	System Description .....	312
<b>REAR DOOR SPEAKER</b> .....	294	Component Parts Location .....	314
Removal and Installation .....	294	Component Description .....	315
Removal and Installation .....	294	<b>NAVIGATION SYSTEM</b> .....	316
<b>STEERING SWITCH</b> .....	295	System Diagram .....	316
Removal and Installation .....	295	System Description .....	316
<b>MICROPHONE</b> .....	296	Component Parts Location .....	319
Removal and Installation .....	296	Component Description .....	320
<b>TEL ANTENNA</b> .....	297	<b>REAR VIEW MONITOR SYSTEM</b> .....	321
Removal and Installation .....	297	System Diagram .....	321
<b>BLUETOOTH CONTROL UNIT</b> .....	298	System Description .....	321
Removal and Installation .....	298	Component Parts Location .....	322
<b>BOSE SPEAKER AMP</b> .....	299	Component Description .....	323
Removal and Installation .....	299	<b>DVD PLAYER</b> .....	324
<b>SUBWOOFER</b> .....	300	System Diagram .....	324
Removal and Installation .....	300	System Description .....	324
<b>DVD ENTERTAINMENT SYSTEM</b> .....	301	Component Parts Location .....	325
Removal and Installation of DVD Player .....	301	Component Description .....	325
Removal and Installation of Video Monitor .....	301	<b>HANDS-FREE PHONE SYSTEM</b> .....	327
<b>AUDIO ANTENNA</b> .....	302	System Diagram .....	327
Location of Antenna .....	302	System Description .....	327
Window Antenna Repair .....	302	Component Parts Location .....	328
<b>AUXILIARY INPUT JACK</b> .....	304	Component Description .....	329
Removal and Installation .....	304	<b>DIAGNOSIS SYSTEM (AV CONTROL UNIT)..</b>	330
<b>ANTENNA AMP.</b> .....	305	<b>AV CONTROL UNIT</b> .....	330
Removal and Installation .....	305	AV CONTROL UNIT : Diagnosis Description .....	330
<b>SATELLITE RADIO ANTENNA</b> .....	306	AV CONTROL UNIT : CONSULT-III Function .....	341
		<b>A/C AND AV SWITCH ASSEMBLY</b> .....	343
		A/C AND AV SWITCH ASSEMBLY : Component	
		Function Check .....	343
		<b>COMPONENT DIAGNOSIS</b> .....	344
		<b>U1000 CAN COMM CIRCUIT</b> .....	344

Description .....	344	Description .....	359	
DTC Logic .....	344	DTC Logic .....	359	A
Diagnosis Procedure .....	344			
<b>U1010 CONTROL UNIT (CAN) .....</b>	<b>345</b>	<b>U121D AV CONTROL UNIT .....</b>	<b>360</b>	
Description .....	345	Description .....	360	B
DTC Logic .....	345	DTC Logic .....	360	
Diagnosis Procedure .....	345			
<b>U1200 AV CONTROL UNIT .....</b>	<b>346</b>	<b>U121E AV CONTROL UNIT .....</b>	<b>361</b>	C
Description .....	346	Description .....	361	
DTC Logic .....	346	DTC Logic .....	361	
<b>U1201 AV CONTROL UNIT .....</b>	<b>347</b>	<b>U121F AV CONTROL UNIT .....</b>	<b>362</b>	D
Description .....	347	Description .....	362	
DTC Logic .....	347	DTC Logic .....	362	
		Diagnosis Procedure .....	362	E
<b>U1204 GPS COMM .....</b>	<b>348</b>	<b>U1243 DISPLAY UNIT .....</b>	<b>363</b>	F
Description .....	348	Description .....	363	
DTC Logic .....	348	DTC Logic .....	363	
		Diagnosis Procedure .....	363	
<b>U1205 GPS ROM .....</b>	<b>349</b>	<b>U1244 GPS ANTENNA .....</b>	<b>365</b>	G
Description .....	349	Description .....	365	
DTC Logic .....	349	DTC Logic .....	365	
		Diagnosis Procedure .....	365	
<b>U1206 GPS RAM .....</b>	<b>350</b>	<b>U1250 CAMERA CONTROL UNIT .....</b>	<b>366</b>	H
Description .....	350	Description .....	366	
DTC Logic .....	350	DTC Logic .....	366	
		Diagnosis Procedure .....	366	I
<b>U1207 GPS RTC .....</b>	<b>351</b>	<b>U1258 SATELLITE RADIO ANTENNA .....</b>	<b>368</b>	J
Description .....	351	Description .....	368	
DTC Logic .....	351	DTC Logic .....	368	
		Diagnosis Procedure .....	368	
<b>U1216 AV CONTROL UNIT .....</b>	<b>352</b>	<b>U1300 AV COMM CIRCUIT .....</b>	<b>369</b>	K
Description .....	352	Description .....	369	
DTC Logic .....	352			
<b>U1217 AV CONTROL UNIT .....</b>	<b>353</b>	<b>U1310 AV CONTROL UNIT .....</b>	<b>370</b>	L
Description .....	353	Description .....	370	
DTC Logic .....	353	DTC Logic .....	370	
<b>U1218 AV CONTROL UNIT .....</b>	<b>354</b>	<b>POWER SUPPLY AND GROUND CIRCUIT ..</b>	<b>371</b>	M
Description .....	354	<b>AV CONTROL UNIT .....</b>	<b>371</b>	
DTC Logic .....	354	AV CONTROL UNIT : Diagnosis Procedure .....	371	
<b>U1219 AV CONTROL UNIT .....</b>	<b>355</b>	<b>DISPLAY UNIT .....</b>	<b>372</b>	AV
Description .....	355	DISPLAY UNIT : Diagnosis Procedure .....	372	
DTC Logic .....	355			
<b>U1220 AV CONTROL UNIT .....</b>	<b>356</b>	<b>A/C AND AV SWITCH ASSEMBLY .....</b>	<b>373</b>	O
Description .....	356	A/C AND AV SWITCH ASSEMBLY : Diagnosis		
DTC Logic .....	356	Procedure .....	373	
<b>U121A AV CONTROL UNIT .....</b>	<b>357</b>	<b>BOSE SPEAKER AMP .....</b>	<b>374</b>	P
Description .....	357	BOSE SPEAKER AMP : Diagnosis Procedure .....	374	
DTC Logic .....	357			
<b>U121B AV CONTROL UNIT .....</b>	<b>358</b>	<b>SUBWOOFER .....</b>	<b>374</b>	
Description .....	358	SUBWOOFER : Diagnosis Procedure .....	375	
DTC Logic .....	358			
<b>U121C AV CONTROL UNIT .....</b>	<b>359</b>	<b>REAR VIEW CAMERA CONTROL UNIT .....</b>	<b>375</b>	

REAR VIEW CAMERA CONTROL UNIT : Diagnosis Procedure .....	375	Diagnosis Procedure .....	400
<b>REAR VIEW CAMERA .....</b>	<b>376</b>	<b>AMP ON SIGNAL CIRCUIT .....</b>	<b>403</b>
REAR VIEW CAMERA : Diagnosis Procedure .....	376	Description .....	403
<b>DVD PLAYER .....</b>	<b>377</b>	Diagnosis Procedure .....	403
DVD PLAYER : Diagnosis Procedure .....	377	<b>STEERING SWITCH .....</b>	<b>404</b>
<b>VIDEO MONITOR .....</b>	<b>378</b>	Description .....	404
VIDEO MONITOR : Diagnosis Procedure .....	378	Diagnosis Procedure .....	404
<b>MICROPHONE .....</b>	<b>379</b>	<b>MICROPHONE SIGNAL CIRCUIT .....</b>	<b>406</b>
MICROPHONE : Diagnosis Procedure .....	379	Description .....	406
<b>RGB (R: RED) SIGNAL CIRCUIT .....</b>	<b>381</b>	Diagnosis Procedure .....	406
Description .....	381	<b>ECU DIAGNOSIS .....</b>	<b>408</b>
Diagnosis Procedure .....	381	<b>AV CONTROL UNIT .....</b>	<b>408</b>
<b>RGB (G: GREEN) SIGNAL CIRCUIT .....</b>	<b>382</b>	Reference Value .....	408
Description .....	382	Wiring Diagram .....	414
Diagnosis Procedure .....	382	DTC Index .....	436
<b>RGB (B: BLUE) SIGNAL CIRCUIT .....</b>	<b>383</b>	<b>DISPLAY UNIT .....</b>	<b>438</b>
Description .....	383	Reference Value .....	438
Diagnosis Procedure .....	383	<b>BOSE SPEAKER AMP .....</b>	<b>441</b>
<b>RGB SYNCHRONIZING SIGNAL CIRCUIT ...</b>	<b>384</b>	Reference Value .....	441
Description .....	384	<b>REAR VIEW CAMERA CONTROL UNIT .....</b>	<b>443</b>
Diagnosis Procedure .....	384	Reference Value .....	443
<b>RGB AREA (YS) SIGNAL CIRCUIT .....</b>	<b>385</b>	<b>DVD PLAYER .....</b>	<b>445</b>
Description .....	385	Reference Value .....	445
Diagnosis Procedure .....	385	<b>SYMPTOM DIAGNOSIS .....</b>	<b>447</b>
<b>HORIZONTAL SYNCHRONIZING (HP) SIGNAL CIRCUIT .....</b>	<b>386</b>	<b>MULTI AV SYSTEM .....</b>	<b>447</b>
Description .....	386	Symptom Table .....	447
Diagnosis Procedure .....	386	<b>NORMAL OPERATING CONDITION .....</b>	<b>449</b>
<b>VERTICAL SYNCHRONIZING (VP) SIGNAL CIRCUIT .....</b>	<b>387</b>	Description .....	449
Description .....	387	<b>PRECAUTION .....</b>	<b>457</b>
Diagnosis Procedure .....	387	<b>PRECAUTIONS .....</b>	<b>457</b>
<b>FRONT DOOR SPEAKER .....</b>	<b>388</b>	Precaution for Supplemental Restraint System (SRS) "AIR BAG" and "SEAT BELT PRE-TENSIONER" .....	457
Description .....	388	Precaution Necessary for Steering Wheel Rotation After Battery Disconnect .....	457
Diagnosis Procedure .....	388	Precaution for Trouble Diagnosis .....	458
<b>FRONT TWEETER .....</b>	<b>391</b>	Precaution for Harness Repair .....	458
Description .....	391	<b>PREPARATION .....</b>	<b>459</b>
Diagnosis Procedure .....	391	<b>PREPARATION .....</b>	<b>459</b>
<b>REAR DOOR SPEAKER .....</b>	<b>394</b>	Commercial Service Tools .....	459
Description .....	394	<b>ON-VEHICLE REPAIR .....</b>	<b>460</b>
Diagnosis Procedure .....	394	<b>AV CONTROL UNIT .....</b>	<b>460</b>
<b>REAR TWEETER .....</b>	<b>397</b>	Removal and Installation .....	460
Description .....	397	<b>DISPLAY UNIT .....</b>	<b>462</b>
Diagnosis Procedure .....	397		
<b>SUBWOOFER .....</b>	<b>400</b>		
Description .....	400		



Removal and Installation .....	462	<b>AUXILIARY INPUT JACK .....</b>	<b>471</b>	
		Removal and Installation .....	471	A
<b>FRONT TWEETER .....</b>	<b>463</b>	<b>ANTENNA AMP. ....</b>	<b>472</b>	
Removal and Installation .....	463	Removal and Installation .....	472	B
<b>FRONT DOOR SPEAKER .....</b>	<b>464</b>	<b>GPS ANTENNA .....</b>	<b>473</b>	
Removal and Installation .....	464	Removal and Installation .....	473	C
<b>REAR DOOR SPEAKER .....</b>	<b>465</b>	<b>SATELLITE RADIO ANTENNA .....</b>	<b>474</b>	
Removal and Installation .....	465	Removal and Installation .....	474	D
Removal and Installation .....	465	<b>STEERING SWITCH .....</b>	<b>475</b>	
<b>BOSE SPEAKER AMP .....</b>	<b>466</b>	Removal and Installation .....	475	E
Removal and Installation .....	466	<b>MICROPHONE .....</b>	<b>476</b>	
<b>SUBWOOFER .....</b>	<b>467</b>	Removal and Installation .....	476	F
Removal and Installation .....	467	<b>REAR VIEW CAMERA .....</b>	<b>477</b>	
<b>DVD ENTERTAINMENT SYSTEM .....</b>	<b>468</b>	Removal and Installation .....	477	G
Removal and Installation of DVD Player .....	468	<b>REAR VIEW CAMERA CONTROL UNIT .....</b>	<b>478</b>	
Removal and Installation of Video Monitor .....	468	Removal and Installation .....	478	H
<b>AUDIO ANTENNA .....</b>	<b>469</b>			I
Location of Antenna .....	469			J
Window Antenna Repair .....	469			K
				L
				M
				AV
				O
				P

## BASIC INSPECTION

### DIAGNOSIS AND REPAIR WORKFLOW

#### Work Flow

INFOID:000000005259245

#### OVERALL SEQUENCE

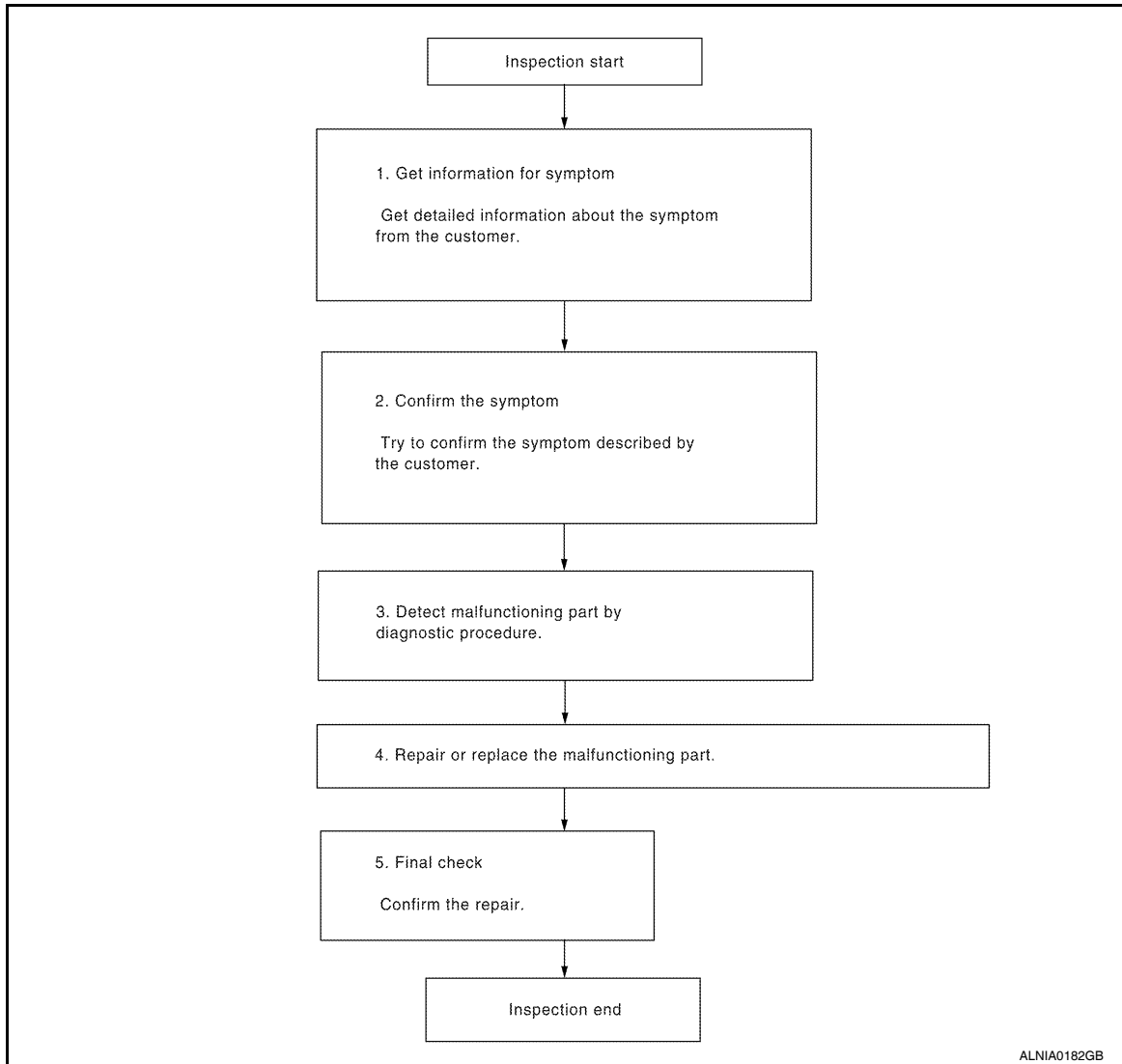

#### DETAILED FLOW

##### 1.GET INFORMATION FOR SYMPTOM

Get detailed information from the customer about the symptom (the condition and the environment when the incident/malfunction occurred).

>> GO TO 2

##### 2.CONFIRM THE SYMPTOM

Try to confirm the symptom described by the customer. Verify relation between the symptom and the condition when the symptom is detected.

>> GO TO 3

##### 3.DETECT MALFUNCTIONING PART BY DIAGNOSTIC PROCEDURE

Inspect according to Diagnostic Procedure of the system.

# DIAGNOSIS AND REPAIR WORKFLOW

< BASIC INSPECTION >

[BASE AUDIO]

---

Is malfunctioning part detected?

YES >> GO TO 4

NO >> GO TO 2

## 4.REPAIR OR REPLACE THE MALFUNCTIONING PART

---

1. Repair or replace the malfunctioning part.
2. Reconnect parts or connectors disconnected during Diagnostic Procedure.

>> GO TO 5

## 5.FINAL CHECK

---

Refer to confirmed symptom in step 2, and make sure that the symptom is not detected.

Has the symptom been repaired?

YES >> Inspection End.

NO >> GO TO 2

A

B

C

D

E

F

G

H

I

J

K

L

M

AV

O

P

## FUNCTION DIAGNOSIS

### AUDIO SYSTEM

#### System Diagram

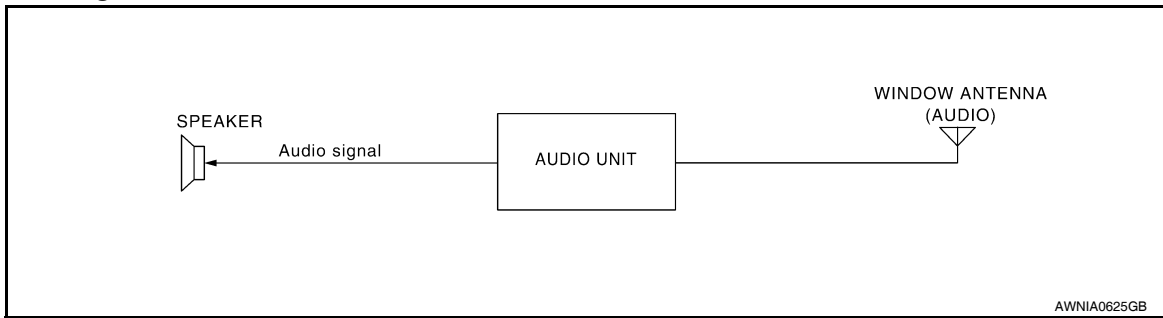

#### System Description

INFOID:000000005259247

#### AUDIO SYSTEM

The audio system consists of the following components

- Audio unit
- Window antenna (audio)
- Front door speakers
- Front tweeters
- Rear door speakers

When the audio system is on, radio signals are received by the window antenna. The audio unit then sends audio signals to the front door speakers, front tweeters and rear speakers.

Refer to Owner's Manual for audio system operating instructions.

#### Component Parts Location

INFOID:000000005259248

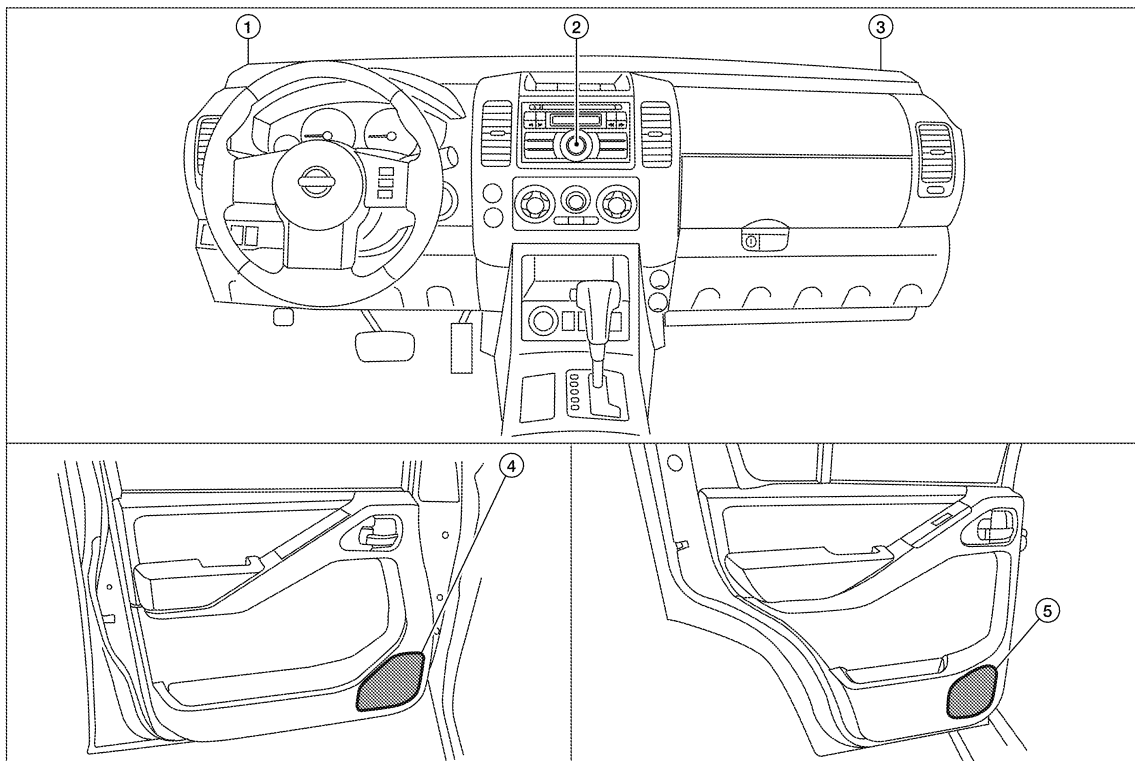

# AUDIO SYSTEM

< FUNCTION DIAGNOSIS >

[BASE AUDIO]

- |  |  |                          |
|--|--|--------------------------|
| 1. Front tweeter LH M109                   | 2. Audio unit M38                          | 3. Front tweeter RH M111 |
| 4. Front door speaker<br>LH D12<br>RH D112 | 5. Rear door speaker<br>LH D209<br>RH D309 |                          |

A

B

## Component Description

INFOID:000000005259249

Part name	Description
Audio unit	Controls audio system functions
Front door speakers	<ul style="list-style-type: none"><li>• Outputs audio signal from audio unit</li><li>• Outputs high, mid and low range sounds</li></ul>
Front tweeters	<ul style="list-style-type: none"><li>• Outputs audio signal from audio unit</li><li>• Outputs high range sounds</li></ul>
Rear door speakers	<ul style="list-style-type: none"><li>• Outputs audio signal from audio unit</li><li>• Outputs high, mid and low range sounds</li></ul>

C

D

E

F

G

H

I

J

K

L

M

AV

O

P

# POWER SUPPLY AND GROUND CIRCUIT

< COMPONENT DIAGNOSIS >

[BASE AUDIO]

## COMPONENT DIAGNOSIS

### POWER SUPPLY AND GROUND CIRCUIT AUDIO UNIT

#### AUDIO UNIT : Diagnosis Procedure

INFOID:000000005259250

Regarding Wiring Diagram information, refer to [AV-23, "Wiring Diagram"](#).

### 1. CHECK FUSES

Check that the following fuses are not blown.

Unit	Terminals	Signal name	Fuse No.
Audio unit	19	Battery power	29
	7	Ignition switch ACC or ON	4

Are the fuses OK?

YES >> GO TO 2

NO >> If fuse is blown, be sure to eliminate cause of malfunction before installing new fuse.

### 2. POWER SUPPLY CIRCUIT CHECK

1. Disconnect audio unit connector M38.
2. Check voltage between the audio unit connector M38 and ground.

(+)		(-)	OFF	ACC	ON
Connector	Terminal				
M38	19	Ground	Battery voltage	Battery voltage	Battery voltage
	7	Ground	0V	Battery voltage	Battery voltage

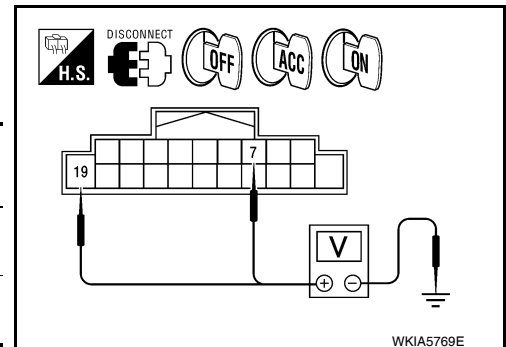

Are the voltage results as specified?

YES >> GO TO 3

NO >> • Check connector housings for disconnected or loose terminals.  
• Repair harness or connector.

### 3. GROUND CIRCUIT CHECK

Inspect audio unit case ground.

Does case ground pass inspection?

YES >> Inspection End.

NO >> Repair audio unit case ground.

# FRONT DOOR SPEAKER

< COMPONENT DIAGNOSIS >

[BASE AUDIO]

## FRONT DOOR SPEAKER

### Description

INFOID:000000005259251

The audio unit sends audio signals to the front door speakers using the front door speaker circuits.

### Diagnosis Procedure

INFOID:000000005259252

Regarding Wiring Diagram information, refer to [AV-23, "Wiring Diagram"](#).

## 1. HARNESS CHECK

1. Disconnect audio unit connector M38 (A) and suspect speaker connector (B).
2. Check continuity between audio unit harness connector M38 (A) terminal and suspect speaker harness connector (B) terminal.

A		B		Continuity
Connector	Terminal	Connector	Terminal	
M38	2	D12	1	Yes
	3		2	
	11	D112	1	
	12		2	

3. Check continuity between audio unit harness connector M38 (A) terminal and ground.

A		—	Continuity
Connector	Terminal		
M38	2	Ground	No
	3		
	11		
	12		

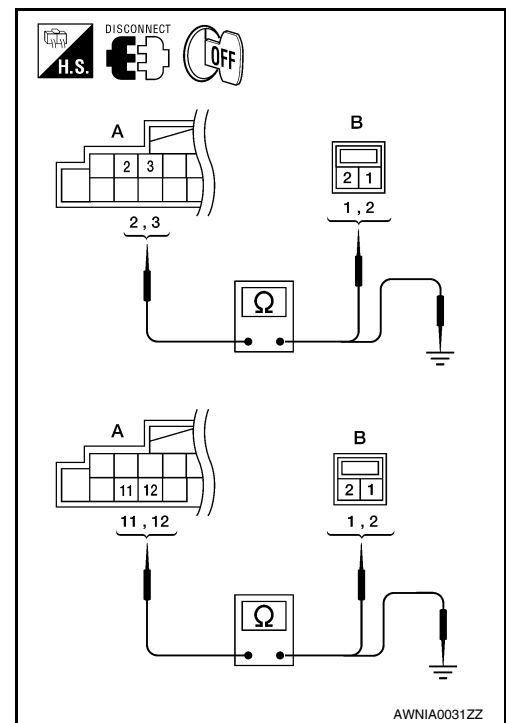

Are continuity results as specified?

YES >> GO TO 2

- NO >> • Check connector housings for disconnected or loose terminals.  
• Repair harness or connector.

## 2. FRONT SPEAKER SIGNAL CHECK

AV

# FRONT DOOR SPEAKER

[BASE AUDIO]

## < COMPONENT DIAGNOSIS >

1. Connect audio unit connector and front speaker connector.
2. Turn ignition switch to ACC.
3. Push "POWER" switch.
4. Check the signal between audio unit harness connector terminals with CONSULT-III or oscilloscope.

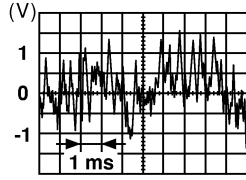
Connector	Terminal		Condition	Reference signal
	(+)	(-)		
M38	2	3	Receive audio signal	 SKIA0177E
	11	12		

Is the audio signal voltage as specified?

- YES >> Replace speaker. Refer to [AV-37. "Removal and Installation"](#).
- NO >> Replace audio unit. Refer to [AV-34. "Removal and Installation"](#).

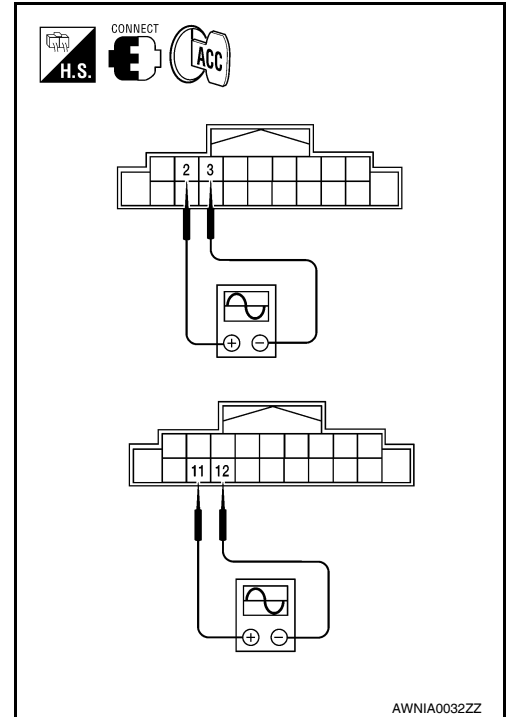



# FRONT TWEETER

< COMPONENT DIAGNOSIS >

[BASE AUDIO]

## FRONT TWEETER

### Description

INFOID:000000005259253

The audio unit sends audio signals to the front tweeters using the front tweeter circuits.

### Diagnosis Procedure

INFOID:000000005259254

Regarding Wiring Diagram information, refer to [AV-23, "Wiring Diagram"](#).

## 1. HARNESS CHECK

1. Disconnect audio unit connector M38 (A) and suspect front tweeter connector (B).
2. Check continuity between audio unit harness connector M38 (A) and suspect front tweeter harness connector (B).

A		B		Continuity
Connector	Terminal	Connector	Terminal	
M38	2	M109	1	Yes
	3		2	
	11	M111	1	
	12		2	

3. Check continuity between audio unit harness connector M38 (A) and ground.

A		—	Continuity
Connector	Terminal		
M38	2	Ground	No
	3		
	11		
	12		

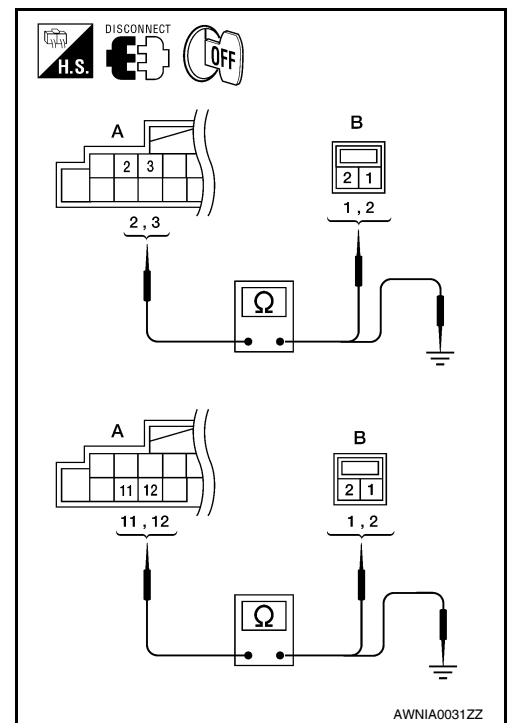

Are the continuity results as specified?

YES >> GO TO 2

- NO >> • Check connector housings for disconnected or loose terminals.  
• Repair harness or connector.

## 2. TWEETER SIGNAL CHECK

A  
B  
C  
D  
E  
F  
G  
H  
I  
J  
K  
L  
M  
AV  
O  
P

# FRONT TWEETER

[BASE AUDIO]

## < COMPONENT DIAGNOSIS >

1. Connect audio unit connector and front tweeter connector.
2. Turn ignition switch to ACC.
3. Push "POWER" switch.
4. Check the signal between audio unit harness connector terminals with CONSULT-III or oscilloscope.

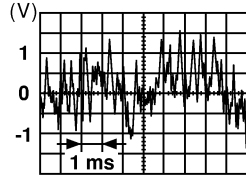
Connector	Terminals		Condition	Reference signal
	(+)	(-)		
M38	2	3	Receive audio signal	 <small>SKIA0177E</small>
	11	12		

Is the audio signal voltage as specified?

- YES >> Replace tweeter. Refer to [AV-36. "Removal and Installation"](#).
- NO >> Replace audio unit. Refer to [AV-34. "Removal and Installation"](#).

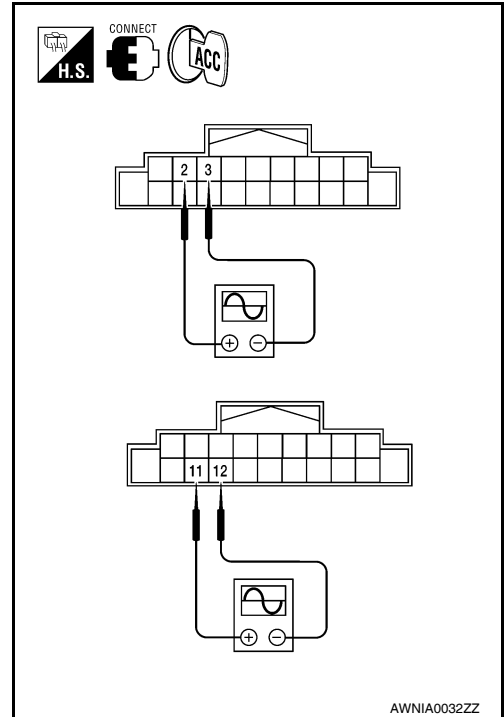

# REAR DOOR SPEAKER

< COMPONENT DIAGNOSIS >

[BASE AUDIO]

## REAR DOOR SPEAKER

### Description

INFOID:000000005259255

The audio unit sends audio signals to the rear door speakers using the rear door speaker circuits.

### Diagnosis Procedure

INFOID:000000005259256

Regarding Wiring Diagram information, refer to [AV-23, "Wiring Diagram"](#).

## 1. HARNESS CHECK

1. Disconnect audio unit connector M38 (A) and suspect speaker connector.
2. Check continuity between audio unit harness connector M38 (A) and suspect speaker harness connector (B).

A		B		Continuity
Connector	Terminal	Connector	Terminal	
M38	4	D207	1	Yes
	5		2	
	13	D307	1	
	14		2	

3. Check continuity between audio unit harness connector M38 (A) and ground.

A		—	Continuity
Connector	Terminal		
M38	4	Ground	No
	5		
	13		
	14		

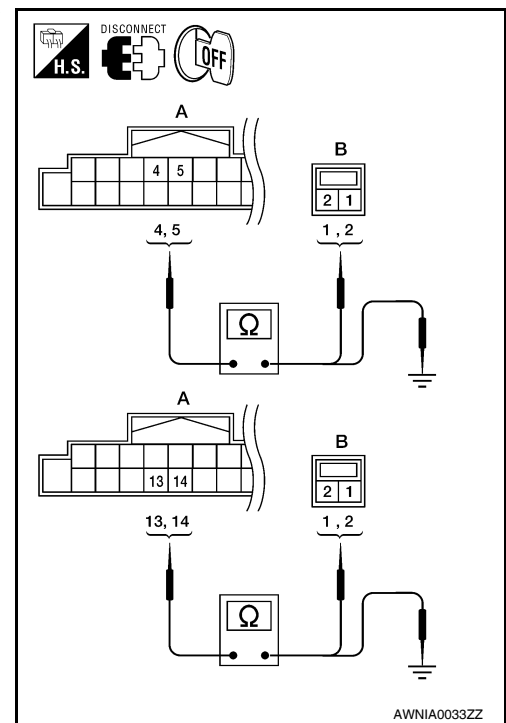

Are the continuity results as specified?

YES >> GO TO 2

NO >> • Check connector housings for disconnected or loose terminals.

• Repair harness or connector.

## 2. REAR SPEAKER SIGNAL CHECK

A  
B  
C  
D  
E  
F  
G  
H  
I  
J  
K  
L  
M  
AV  
O  
P

# REAR DOOR SPEAKER

[BASE AUDIO]

## < COMPONENT DIAGNOSIS >

1. Connect audio unit connector and rear door speaker connector.
2. Turn ignition switch to ACC.
3. Push "POWER" switch.
4. Check the signal between audio unit harness connector terminals with CONSULT-III or oscilloscope.

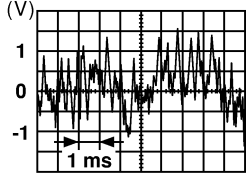
Connector	Terminal		Condition	Reference signal
	(+)	(-)		
M38	4	5	Receive audio signal	
	13	14		

SKIA0177E

Is the audio signal voltage as specified?

- YES >> Replace rear speaker. Refer to [AV-38, "Removal and Installation"](#).
- NO >> Replace audio unit. Refer to [AV-34, "Removal and Installation"](#).

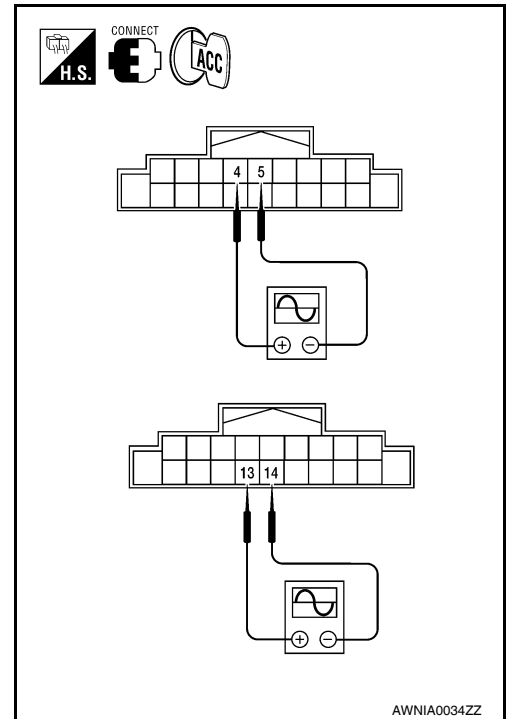

AWNIA0034ZZ

# AUDIO UNIT

< ECU DIAGNOSIS >

[BASE AUDIO]

## ECU DIAGNOSIS

### AUDIO UNIT

Reference Value

INFOID:000000005259257

### TERMINAL LAYOUT

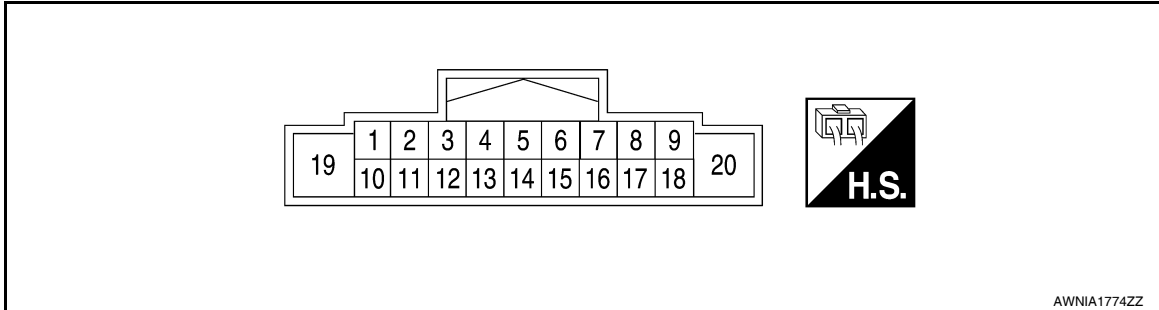

### PHYSICAL VALUES

Terminal (Wire color)		Item	Signal input/ output	Condition		Reference value
+	-					
2 (BR)	3 (L)	Audio signal front LH	Output	Ignition switch ON	Audio output	<p>SKIA0177E</p>
4 (G)	5 (B)	Audio signal rear LH	Output	Ignition switch ON	Audio output	<p>SKIA0177E</p>
7 (G/B)	Ground	ACC signal	Input	Ignition switch ON	Ignition switch ACC or ON	Battery voltage
8 (GR)	—	Illumination control	—	—	—	—
9 (R)	Ground	Illumination power	Input	Ignition switch ON	Lighting switch ON	Battery voltage
11 (LG)	12 (R)	Audio signal front RH	Output	Ignition switch ON	Audio output	<p>SKIA0177E</p>

# AUDIO UNIT

< ECU DIAGNOSIS >

[BASE AUDIO]

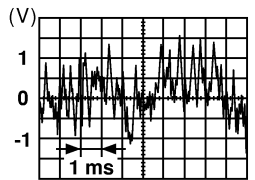
Terminal (Wire color)		Item	Signal input/ output	Condition		Reference value
+	-					
13 (GR)	14 (O)	Audio signal rear RH	Output	Ignition switch ON	Audio output	 <p style="text-align: right; font-size: small;">SKIA0177E</p>
19 (Y)	Ground	Battery power	Input	-	-	Battery voltage

Wiring Diagram

INFOID:000000005259258

BASE AUDIO SYSTEM

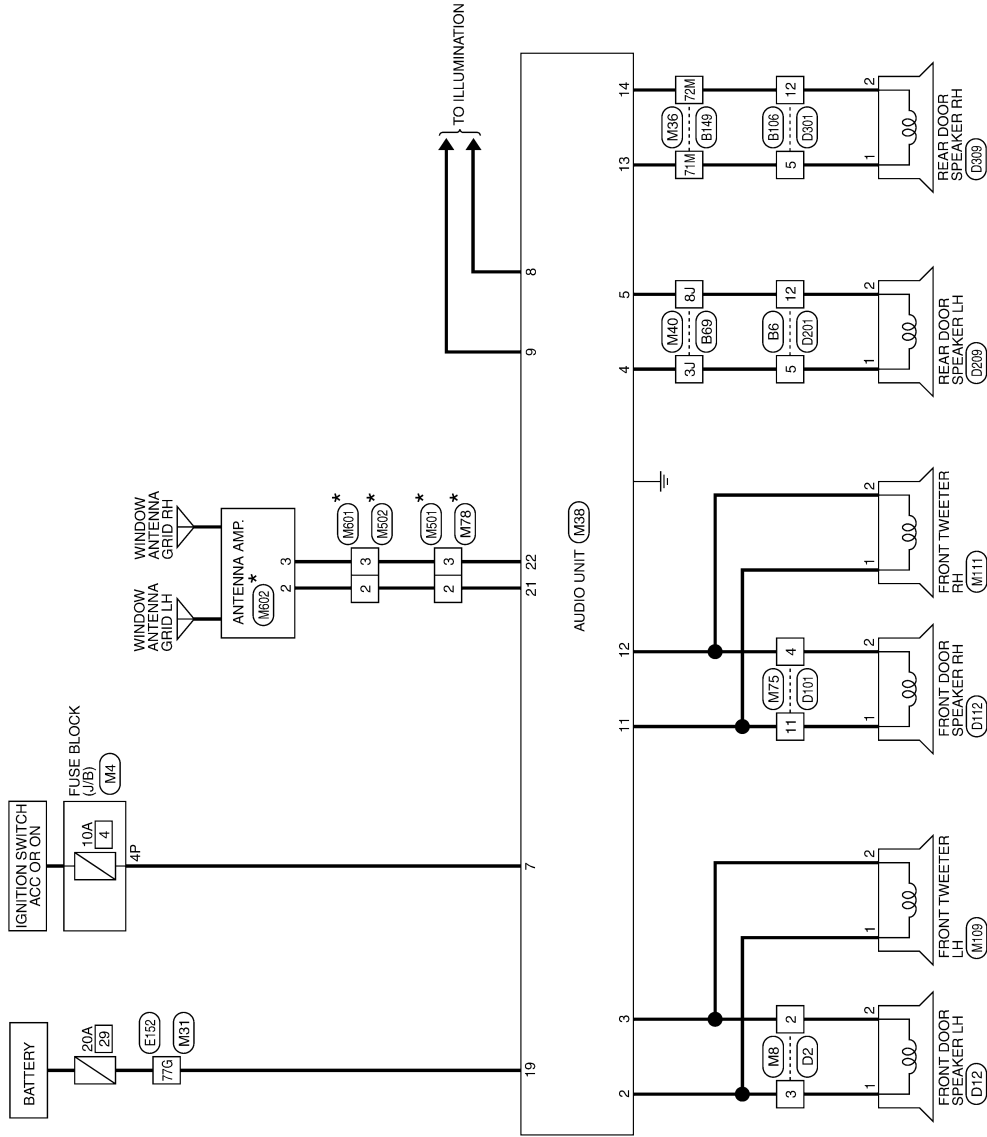

\*: THIS CONNECTOR IS NOT SHOWN IN "HARNES LAYOUT" OF PG SECTION.

ABNWA0589GB

A  
B  
C  
D  
E  
F  
G  
H  
I  
J  
K  
L  
M  
N  
O  
P

AV





# AUDIO UNIT

< ECU DIAGNOSIS >

[BASE AUDIO]

Connector No.	M38
Connector Name	AUDIO UNIT
Connector Color	WHITE

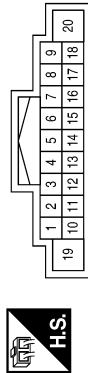

Terminal No.	Color of Wire	Signal Name
1	-	-
2	BR	FR SP LH (+)
3	L	FR SP LH (-)
4	G	RR SP LH (+)
5	B	RR SP LH (-)
6	-	-
7	G/B	ACC
8	GR	ILL CONT OUT

Terminal No.	Color of Wire	Signal Name
9	R	TAIL/ILL RLY
10	-	-
11	LG	FR SP RH (+)
12	R	FR SP RH (-)
13	GR	RR SP RH (+)
14	O	RR SP RH (-)
15	-	-
16	-	-
17	-	-
18	-	-
19	Y	BAT
20	-	-

Connector No.	M75
Connector Name	WIRE TO WIRE
Connector Color	WHITE

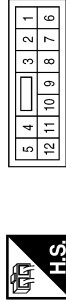

Terminal No.	Color of Wire	Signal Name
4	R	-
11	LG	-

Connector No.	M78
Connector Name	WIRE TO WIRE
Connector Color	GRAY

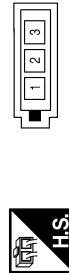

Terminal No.	Color of Wire	Signal Name
1	-	-
2	-	-
3	-	-

Connector No.	M109
Connector Name	FRONT TWEETER LH
Connector Color	BROWN



Terminal No.	Color of Wire	Signal Name
1	G	-
2	L	-

Connector No.	M111
Connector Name	FRONT TWEETER RH
Connector Color	BROWN



Terminal No.	Color of Wire	Signal Name
1	W	-
2	L	-

ABN1A1497GB

A  
B  
C  
D  
E  
F  
G  
H  
I  
J  
K  
L  
M  
N  
O  
P



# AUDIO UNIT

< ECU DIAGNOSIS >

[BASE AUDIO]

Connector No.	M601
Connector Name	WIRE TO WIRE
Connector Color	GRAY



Terminal No.	Color of Wire	Signal Name
1	-	-
2	-	-
3	-	-

Connector No.	M502
Connector Name	WIRE TO WIRE
Connector Color	GRAY



Terminal No.	Color of Wire	Signal Name
1	-	-
2	-	-
3	-	-

Connector No.	M501
Connector Name	WIRE TO WIRE
Connector Color	GRAY

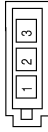

Terminal No.	Color of Wire	Signal Name
1	-	-
2	-	-
3	-	-

Connector No.	B6
Connector Name	WIRE TO WIRE
Connector Color	WHITE

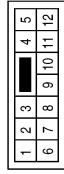

Terminal No.	Color of Wire	Signal Name
5	G	-
12	B	-

Connector No.	E152
Connector Name	WIRE TO WIRE
Connector Color	WHITE

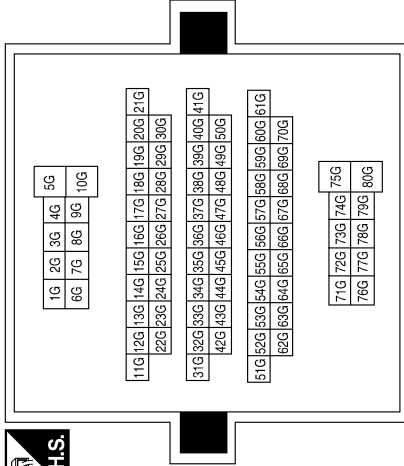

Terminal No.	Color of Wire	Signal Name
77G	Y	-

# AUDIO UNIT

< ECU DIAGNOSIS >

[BASE AUDIO]

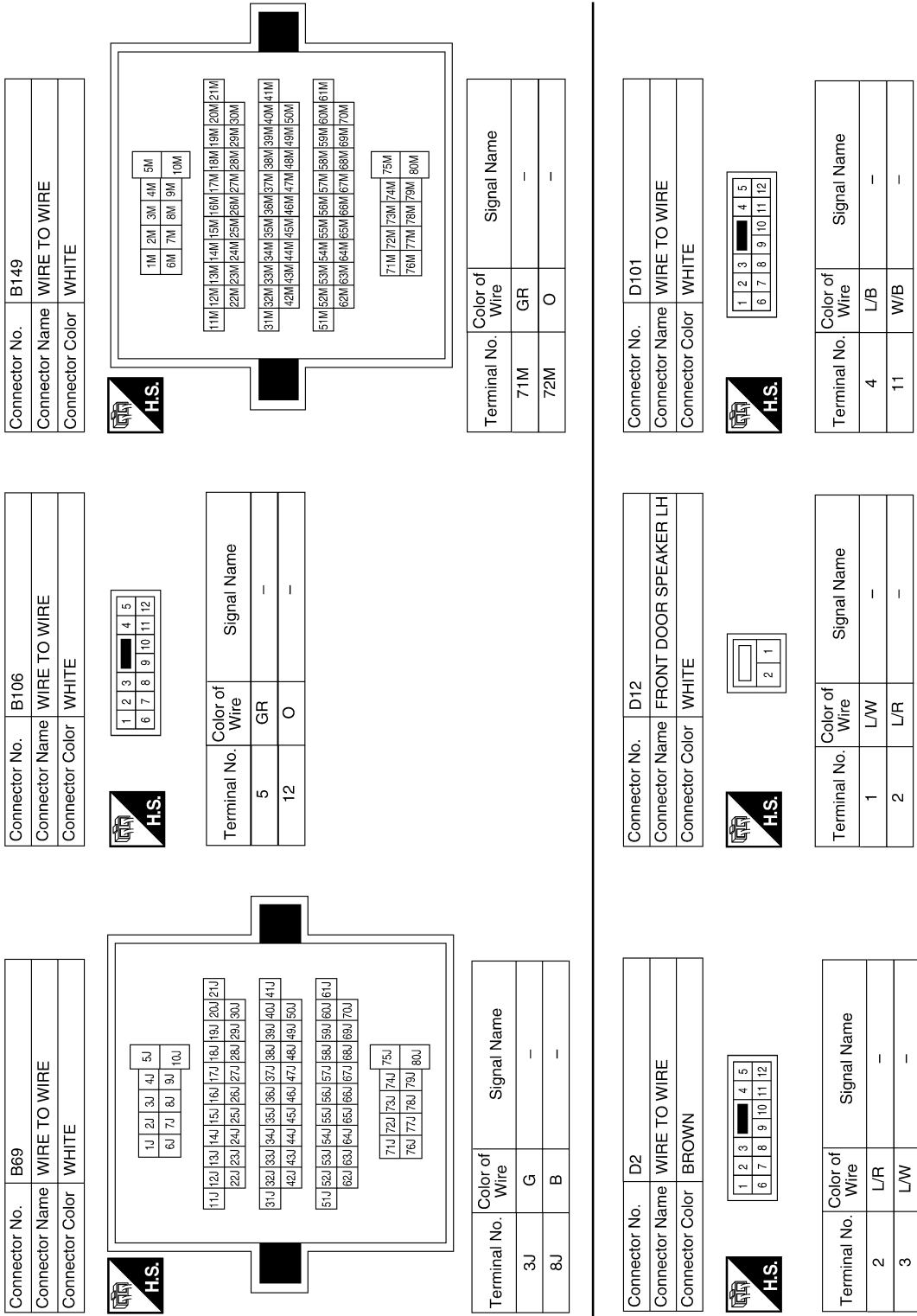

A  
B  
C  
D  
E  
F  
G  
H  
I  
J  
K  
L  
M  
N  
O  
P

AV

# AUDIO UNIT

< ECU DIAGNOSIS >

[BASE AUDIO]

Connector No.	D209
Connector Name	REAR DOOR SPEAKER LH (WITH BASE AND MID AUDIO SYSTEMS)
Connector Color	WHITE



Terminal No.	Color of Wire	Signal Name
1	GR	-
2	O	-

Connector No.	D201
Connector Name	WIRE TO WIRE
Connector Color	WHITE

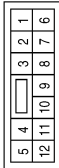

Terminal No.	Color of Wire	Signal Name
5	GR	-
12	O	-

Connector No.	D112
Connector Name	FRONT DOOR SPEAKER RH
Connector Color	WHITE



Terminal No.	Color of Wire	Signal Name
1	W/B	-
2	L/B	-

Connector No.	D309
Connector Name	REAR DOOR SPEAKER RH (WITH BASE AND MID AUDIO SYSTEMS)
Connector Color	WHITE



Terminal No.	Color of Wire	Signal Name
1	GR	-
2	O	-

Connector No.	D301
Connector Name	WIRE TO WIRE
Connector Color	WHITE



Terminal No.	Color of Wire	Signal Name
5	GR	-
12	O	-

ABNIA1624GB

**SYMPTOM DIAGNOSIS**

AUDIO SYSTEM

AUDIO UNIT

AUDIO UNIT : Symptom Table

INFOID:000000005259259

Symptom	Possible cause	Reference page
Inoperative	<ul style="list-style-type: none"> <li>• Audio unit power circuit</li> <li>• Audio unit</li> </ul>	<ul style="list-style-type: none"> <li>• <a href="#">AV-14</a></li> <li>• <a href="#">AV-34</a></li> </ul>
All speakers do not sound	<ul style="list-style-type: none"> <li>• Audio unit power circuit</li> <li>• Audio unit</li> </ul>	<ul style="list-style-type: none"> <li>• <a href="#">AV-14</a></li> <li>• <a href="#">AV-34</a></li> </ul>
One or several speakers do not sound	<ul style="list-style-type: none"> <li>• Front door speaker</li> <li>• Front tweeter</li> <li>• Rear door speaker</li> </ul>	<ul style="list-style-type: none"> <li>• <a href="#">AV-15</a></li> <li>• <a href="#">AV-17</a></li> <li>• <a href="#">AV-19</a></li> </ul>

A  
B  
C  
D  
E  
F  
G  
H  
I  
J  
K  
L  
M

AV

O  
P

# NORMAL OPERATING CONDITION

< SYMPTOM DIAGNOSIS >

[BASE AUDIO]

## NORMAL OPERATING CONDITION

### Description

INFOID:000000005259260

The majority of the audio concerns are the result of outside causes (bad CD, electromagnetic interference, etc.).

### NOISE

The following noise results from variations in field strength, such as fading noise and multi-path noise, or external noise from trains and other sources. It is not a malfunction.

- Fading noise: This noise occurs because of variations in the field strength in a narrow range due to mountains or buildings blocking the signal.
- Multi-path noise: This noise results from the waves sent directly from the broadcast station arriving at the antenna at a different time from the waves which reflect off mountains or buildings.

The vehicle itself can be a source of noise if noise prevention parts or electrical equipment is malfunctioning. Check if noise is caused and/or changed by engine speed, ignition switch turned to each position, and operation of each piece of electrical equipment, and determine the cause.

#### NOTE:

The source of the noise can be found easily by listening to the noise while removing the fuses of electrical components, one by one.

#### Type of Noise and Possible Cause

Occurrence condition		Possible cause
Occurs only when engine is ON.	A continuous growling noise occurs. The speed of the noise varies with changes in the engine speed.	<ul style="list-style-type: none"> <li>• Ignition components</li> </ul>
The occurrence of the noise is linked with the operation of the fuel pump.		<ul style="list-style-type: none"> <li>• Fuel pump condenser</li> </ul>
Noise only occurs when various electrical components are operating.	A cracking or snapping sound occurs with the operation of various switches.	<ul style="list-style-type: none"> <li>• Relay malfunction, audio unit malfunction</li> </ul>
	The noise occurs when various motors are operating.	<ul style="list-style-type: none"> <li>• Motor case ground</li> <li>• Motor</li> </ul>
The noise occurs constantly, not just under certain conditions.		<ul style="list-style-type: none"> <li>• Rear defogger coil malfunction</li> <li>• Open circuit in printed heater</li> <li>• Poor ground of antenna feeder line</li> </ul>
A cracking or snapping sound occurs while the vehicle is being driven, especially when it is vibrating excessively.		<ul style="list-style-type: none"> <li>• Ground wire of body parts</li> <li>• Ground due to improper part installation</li> <li>• Wiring connections or a short circuit</li> </ul>

PRECAUTION

PRECAUTIONS

Precaution for Supplemental Restraint System (SRS) "AIR BAG" and "SEAT BELT PRE-TENSIONER"

INFOID:000000005259261

The Supplemental Restraint System such as "AIR BAG" and "SEAT BELT PRE-TENSIONER", used along with a front seat belt, helps to reduce the risk or severity of injury to the driver and front passenger for certain types of collision. This system includes seat belt switch inputs and dual stage front air bag modules. The SRS system uses the seat belt switches to determine the front air bag deployment, and may only deploy one front air bag, depending on the severity of a collision and whether the front occupants are belted or unbelted. Information necessary to service the system safely is included in the SR and SB section of this Service Manual.

**WARNING:**

- To avoid rendering the SRS inoperative, which could increase the risk of personal injury or death in the event of a collision which would result in air bag inflation, all maintenance must be performed by an authorized NISSAN/INFINITI dealer.
- Improper maintenance, including incorrect removal and installation of the SRS, can lead to personal injury caused by unintentional activation of the system. For removal of Spiral Cable and Air Bag Module, see the SR section.
- Do not use electrical test equipment on any circuit related to the SRS unless instructed to in this Service Manual. SRS wiring harnesses can be identified by yellow and/or orange harnesses or harness connectors.

PRECAUTIONS WHEN USING POWER TOOLS (AIR OR ELECTRIC) AND HAMMERS

**WARNING:**

- When working near the Airbag Diagnosis Sensor Unit or other Airbag System sensors with the Ignition ON or engine running, DO NOT use air or electric power tools or strike near the sensor(s) with a hammer. Heavy vibration could activate the sensor(s) and deploy the air bag(s), possibly causing serious injury.
- When using air or electric power tools or hammers, always switch the Ignition OFF, disconnect the battery, and wait at least 3 minutes before performing any service.

Precaution Necessary for Steering Wheel Rotation After Battery Disconnect

INFOID:000000005259262

**NOTE:**

- This Procedure is applied only to models with Intelligent Key system and NATS (NISSAN ANTI-THEFT SYSTEM).
- Remove and install all control units after disconnecting both battery cables with the ignition knob in the "LOCK" position.
- Always use CONSULT-III to perform self-diagnosis as a part of each function inspection after finishing work. If DTC is detected, perform trouble diagnosis according to self-diagnostic results.

For models equipped with the Intelligent Key system and NATS, an electrically controlled steering lock mechanism is adopted on the key cylinder.

For this reason, if the battery is disconnected or if the battery is discharged, the steering wheel will lock and steering wheel rotation will become impossible.

If steering wheel rotation is required when battery power is interrupted, follow the procedure below before starting the repair operation.

OPERATION PROCEDURE

1. Connect both battery cables.

**NOTE:**

Supply power using jumper cables if battery is discharged.

2. Use the Intelligent Key or mechanical key to turn the ignition switch to the "ACC" position. At this time, the steering lock will be released.
3. Disconnect both battery cables. The steering lock will remain released and the steering wheel can be rotated.
4. Perform the necessary repair operation.

A  
B  
C  
D  
E  
F  
G  
H  
I  
J  
K  
L  
M  
AV  
O  
P

## PRECAUTIONS

< PRECAUTION >

[BASE AUDIO]

- 
5. When the repair work is completed, return the ignition switch to the "LOCK" position before connecting the battery cables. (At this time, the steering lock mechanism will engage.)
  6. Perform a self-diagnosis check of all control units using CONSULT-III.



PREPARATION

PREPARATION

Commercial Service Tools

INFOID:000000005259263

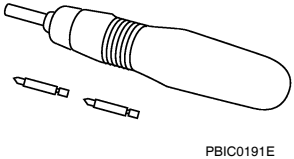
Tool name	Description
<p>Power tool</p>  <p>PBIC0191E</p>	<p>Loosening bolts and nuts</p>

A  
B  
C  
D  
E  
F  
G  
H  
I  
J  
K  
L  
M  
AV  
O  
P

AV

## ON-VEHICLE REPAIR

### AUDIO UNIT

#### Removal and Installation

INFOID:000000005259264

#### Removal and Installation

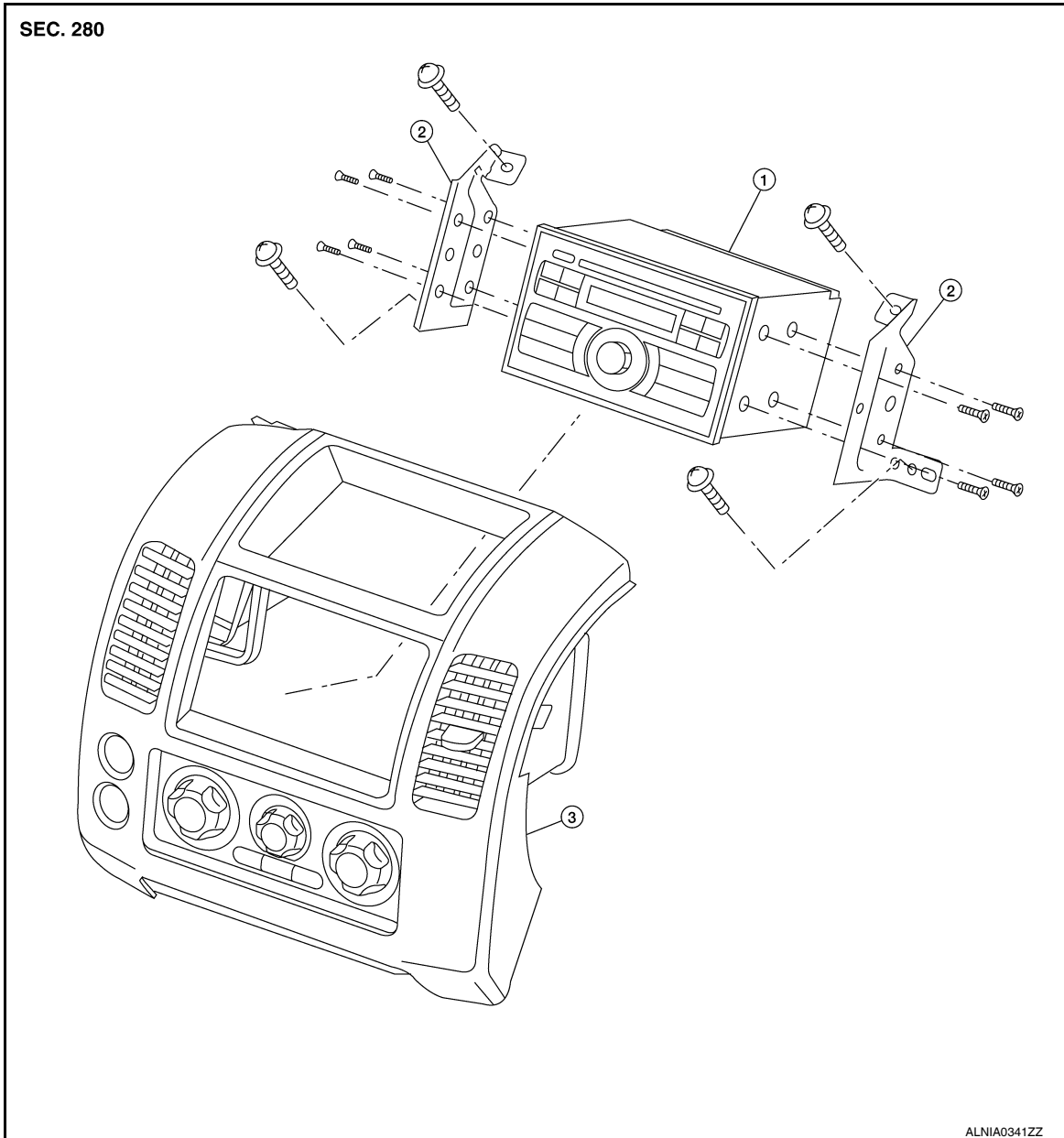

1. Audio unit                      2. Audio unit brackets (LH) and (RH)      3. Cluster lid C

#### REMOVAL

1. Disconnect the battery negative terminal.
2. Remove the cluster lid C. Refer to [IP-12. "Removal and Installation"](#).
3. Remove the audio unit screws, using power tool.
4. Remove the audio unit and disconnect audio unit connectors.
5. Remove the audio unit brackets screws and remove the audio unit brackets.

#### INSTALLATION

# AUDIO UNIT

< ON-VEHICLE REPAIR >

[BASE AUDIO]

Installation is in the reverse order of removal.

- A
- B
- C
- D
- E
- F
- G
- H
- I
- J
- K
- L
- M
- AV**
- O
- P

## FRONT TWEETER

## Removal and Installation

INFOID:000000005259265

## REMOVAL

**CAUTION:****Use a suitable tool to prevent damage to the front tweeter speaker grille trim and the instrument panel.**

1. Remove the front tweeter grille.
2. Remove the front tweeter screws (A).
3. Pull out the front tweeter speaker (1) and disconnect front tweeter connector, then remove the front tweeter speaker (1).

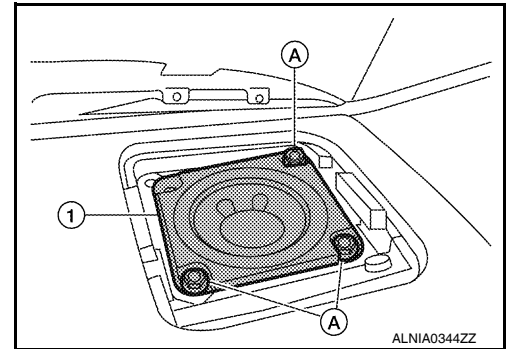

## INSTALLATION

Installation is in the reverse order of removal.

# FRONT DOOR SPEAKER

< ON-VEHICLE REPAIR >

[BASE AUDIO]

## FRONT DOOR SPEAKER

### Removal and Installation

INFOID:000000005259266

#### REMOVAL

1. Remove the front door finisher. Refer to [INT-14, "Removal and Installation"](#).
2. Remove the front door speaker screws (A).
3. Pull out the front door speaker (1), and disconnect the front door speaker connector and remove the front door speaker (1).

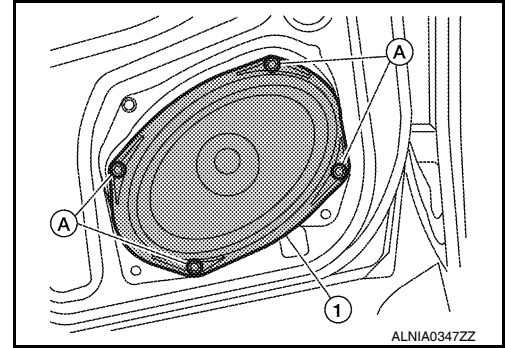

#### INSTALLATION

Installation is in the reverse order of removal.

A  
B  
C  
D  
E  
F  
G  
H  
I  
J  
K  
L  
M

AV

O  
P

## REAR DOOR SPEAKER

### Removal and Installation

INFOID:000000005259267

#### REMOVAL

1. Remove the rear door finisher. Refer to [INT-14. "Removal and Installation"](#).
2. Remove the rear door speaker screws (A).
3. Disconnect the rear door speaker connector (B) and remove rear door speaker (1).

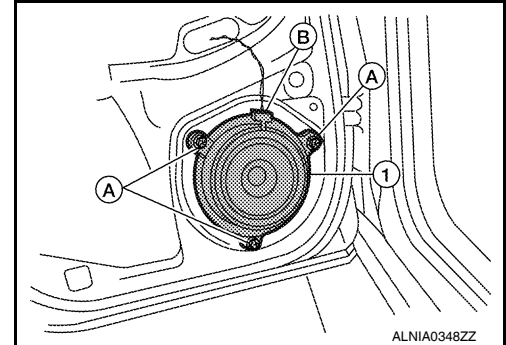

#### INSTALLATION

Installation is in the reverse order of removal.

## AUDIO ANTENNA

### Location of Antenna

INFOID:000000005259268

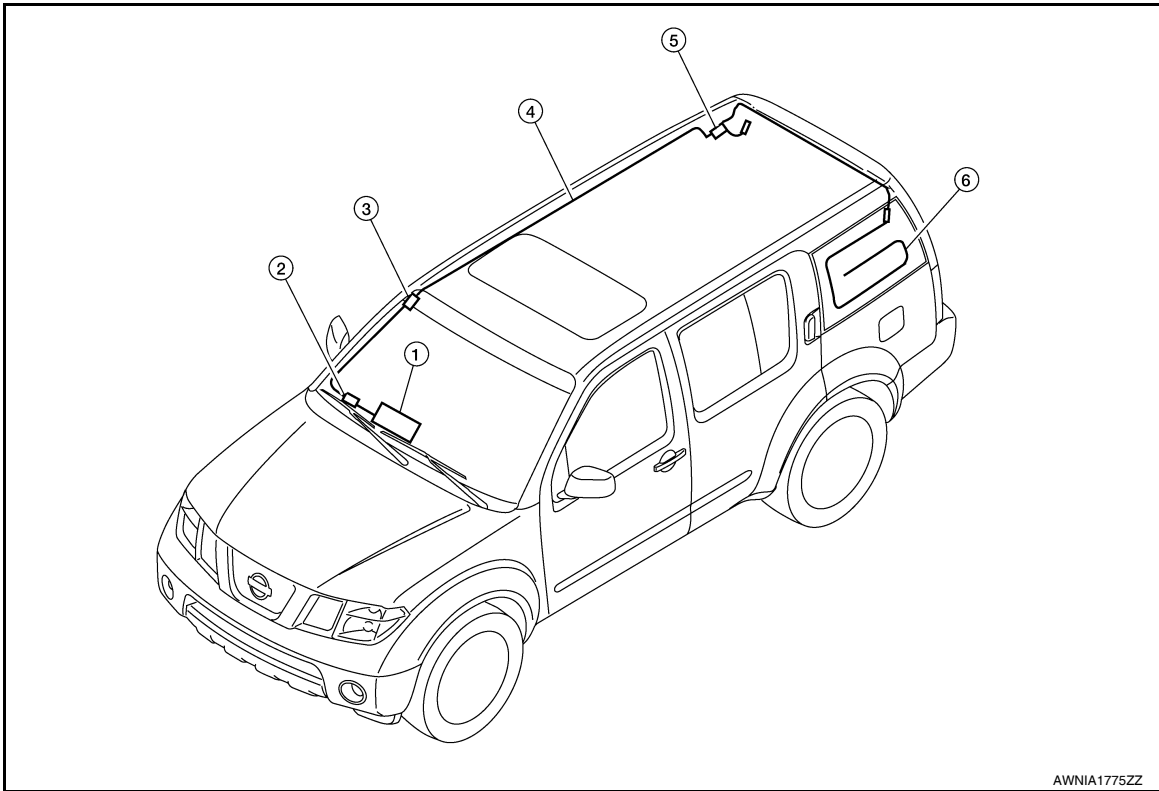

AWNIA1775ZZ

- |                   |                                |                                 |
|-------------------|--------------------------------|---------------------------------|
| 1. Audio unit M38 | 2. Harness connector M78, M501 | 3. Harness connector M502, M601 |
| 4. Antenna feeder | 5. Antenna amp. M602           | 6. Window antenna grid          |

### Window Antenna Repair

INFOID:000000005259269

#### ELEMENT CHECK

1. Attach probe circuit tester (ohm setting) to antenna terminal on each side.

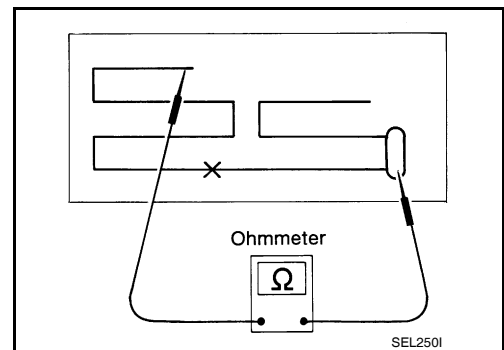

A  
B  
C  
D  
E  
F  
G  
H  
I  
J  
K  
L  
M  
AV  
O  
P

# AUDIO ANTENNA

< ON-VEHICLE REPAIR >

[BASE AUDIO]

- When measuring continuity, wrap tin foil around the top of probe. Then, press the foil against the wire with your finger.

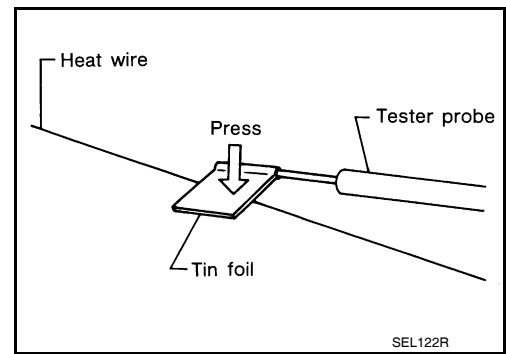

2. If an element is broken, no continuity will exist.

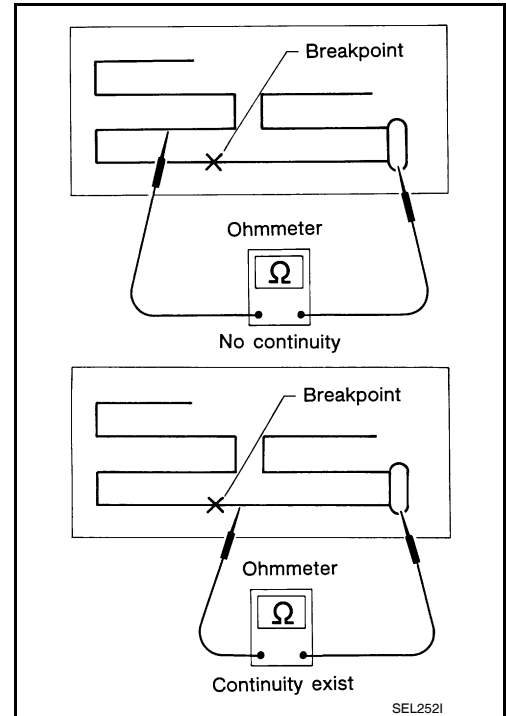

3. To locate a break, move probe along element. Tester indication will change abruptly when probe passes the broken point.

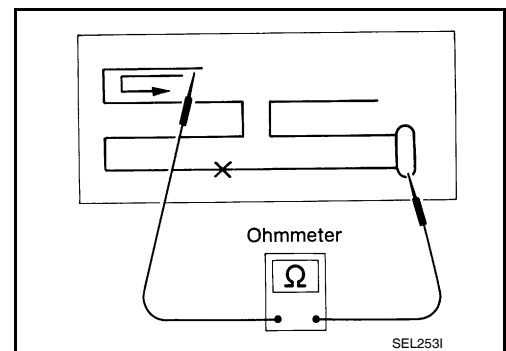

## ELEMENT REPAIR

Refer to [DEF-43, "Filament Repair"](#).



# AUXILIARY INPUT JACK

< ON-VEHICLE REPAIR >

[BASE AUDIO]

## AUXILIARY INPUT JACK

### Removal and Installation

INFOID:000000005570793

#### Removal

1. Remove the A/T finisher. Refer to [JP-12. "Removal and Installation"](#).
2. Remove the auxiliary input jack.

#### Installation

Installation is in the reverse order of removal.

A

B

C

D

E

F

G

H

I

J

K

L

M

AV

O

P

## ANTENNA AMP.

< ON-VEHICLE REPAIR >

[BASE AUDIO]

### ANTENNA AMP.

#### Removal and Installation

INFOID:000000005550725

#### REMOVAL

1. Remove the luggage side upper and lower RH finishers. Refer to [INT-22. "Removal and Installation"](#).
2. Detach the antenna amp. harness clip (D), disconnect the antenna amp. connector (A), harness connector (B), then remove the antenna amp. screw (C) and remove the antenna amp. (1).

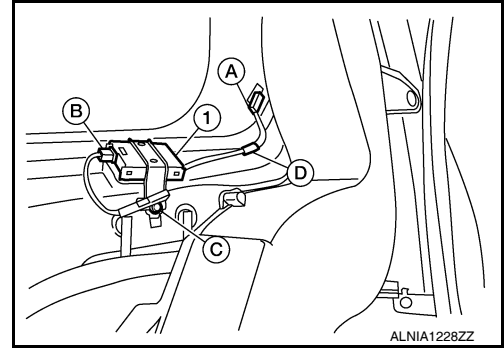

#### INSTALLATION

Installation is in the reverse order of removal.

## BASIC INSPECTION

### DIAGNOSIS AND REPAIR WORKFLOW

#### Work Flow

INFOID:000000005259270

#### OVERALL SEQUENCE

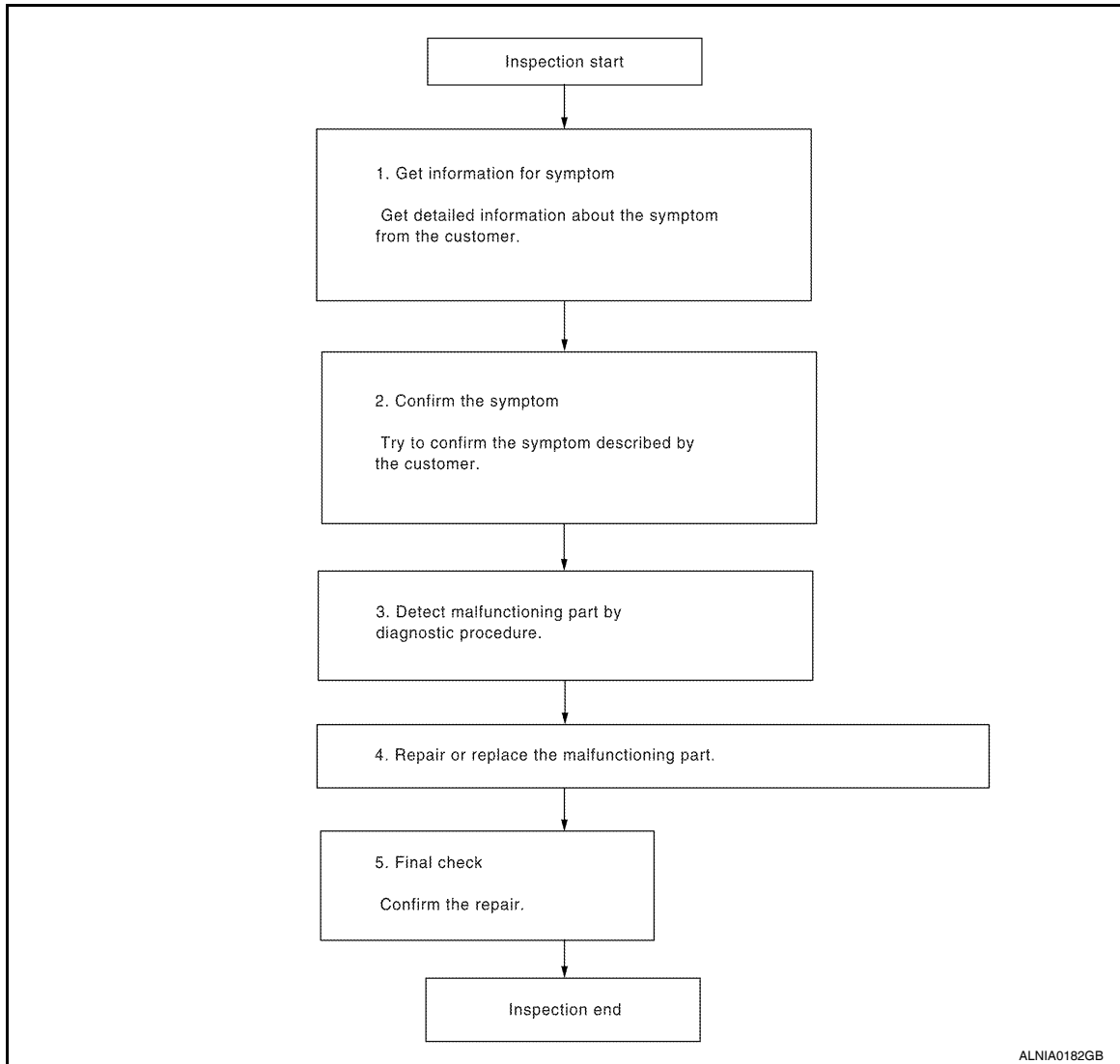

#### DETAILED FLOW

##### 1.GET INFORMATION FOR SYMPTOM

Get detailed information from the customer about the symptom (the condition and the environment when the incident/malfunction occurred).

>> GO TO 2

##### 2.CONFIRM THE SYMPTOM

Try to confirm the symptom described by the customer. Verify relation between the symptom and the condition when the symptom is detected.

>> GO TO 3

##### 3.DETECT MALFUNCTIONING PART BY DIAGNOSTIC PROCEDURE

Inspect according to Diagnostic Procedure of the system.

A  
B  
C  
D  
E  
F  
G  
H  
I  
J  
K  
L  
M

AV

O  
P

## DIAGNOSIS AND REPAIR WORKFLOW

[MID AUDIO]

< BASIC INSPECTION >

---

Is malfunctioning part detected?

- YES >> GO TO 4
- NO >> GO TO 2

### 4. REPAIR OR REPLACE THE MALFUNCTIONING PART

---

1. Repair or replace the malfunctioning part.
2. Reconnect parts or connectors disconnected during Diagnostic Procedure.

>> GO TO 5

### 5. FINAL CHECK

---

Refer to confirmed symptom in step 2, and make sure that the symptom is not detected.

Has the symptom been repaired?

- YES >> Inspection End.
- NO >> GO TO 2

FUNCTION DIAGNOSIS

AUDIO SYSTEM

System Diagram

INFOID:000000005259271

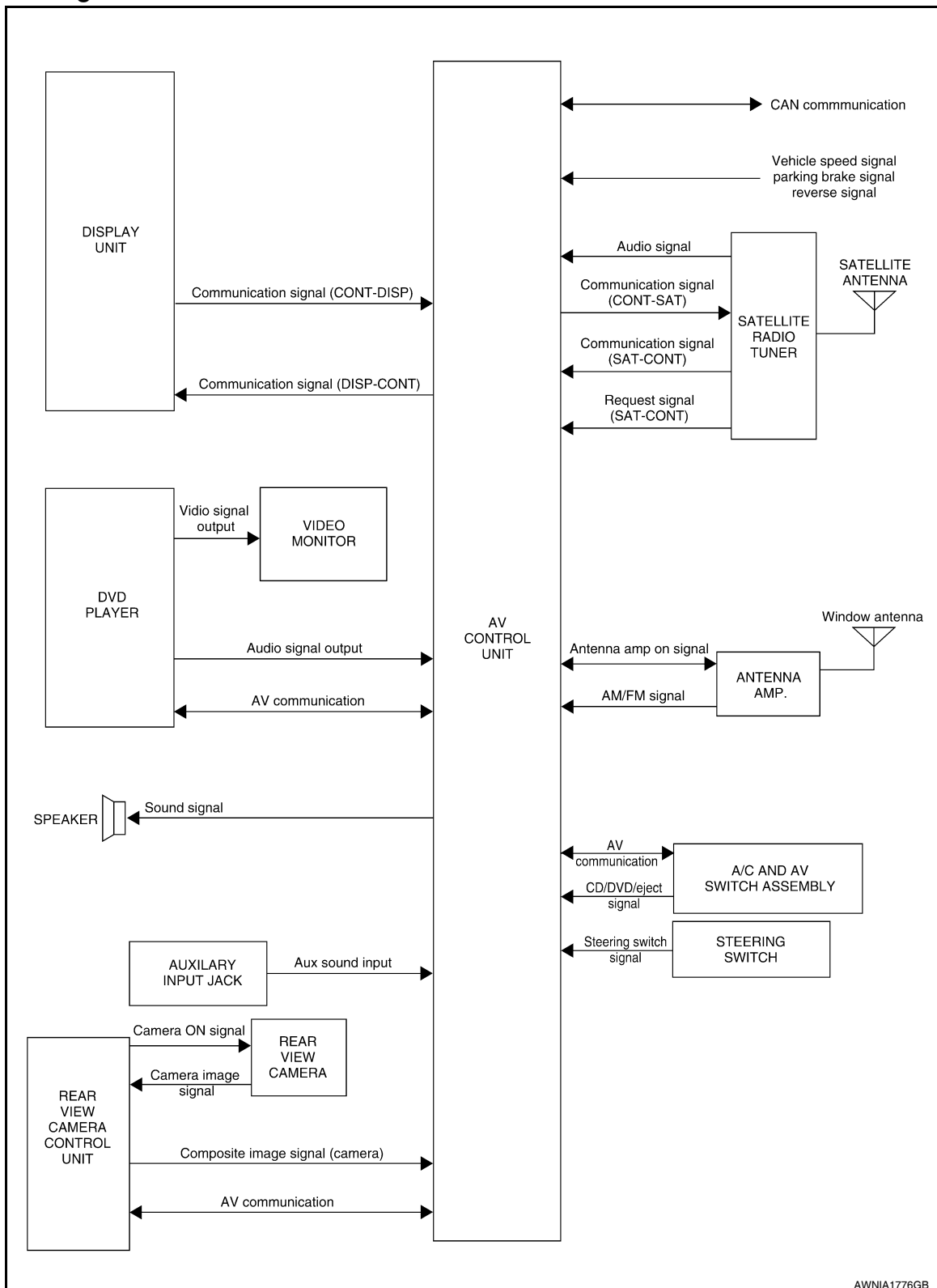

A  
B  
C  
D  
E  
F  
G  
H  
I  
J  
K  
L  
M  
N  
O  
P

AV

AWNIA1776GB

System Description

INFOID:000000005259272

AUDIO SYSTEM

## < FUNCTION DIAGNOSIS >

---

The audio system consists of the following components

- AV control unit
- Display unit
- Window antenna
- Steering wheel audio control switches
- A/C and AV switch assembly
- Front door speakers
- Front tweeters
- Rear door speakers

When the audio system is on, radio signals are received by the window antenna. The AV control unit then sends audio signals to the front door speakers, front tweeters and rear door speakers.

Refer to Owner's Manual for audio system operating instructions.

## SATELLITE RADIO SYSTEM

The satellite radio system consists of the following components

- Satellite antenna
- Satellite radio tuner

When the satellite radio system is on, radio signals are supplied to the satellite radio tuner from the satellite antenna. The satellite radio tuner then sends audio signals to the AV control unit.

Refer to Owner's Manual for satellite radio system operating instructions.

## SPEED SENSITIVE VOLUME SYSTEM

The volume level of this system goes up and down automatically in proportion to vehicle speed. The control level can be set by the customer. Refer to the Owner's Manual for operating instructions.

# AUDIO SYSTEM

< FUNCTION DIAGNOSIS >

[MID AUDIO]

## Component Parts Location

INFOID:000000005259273

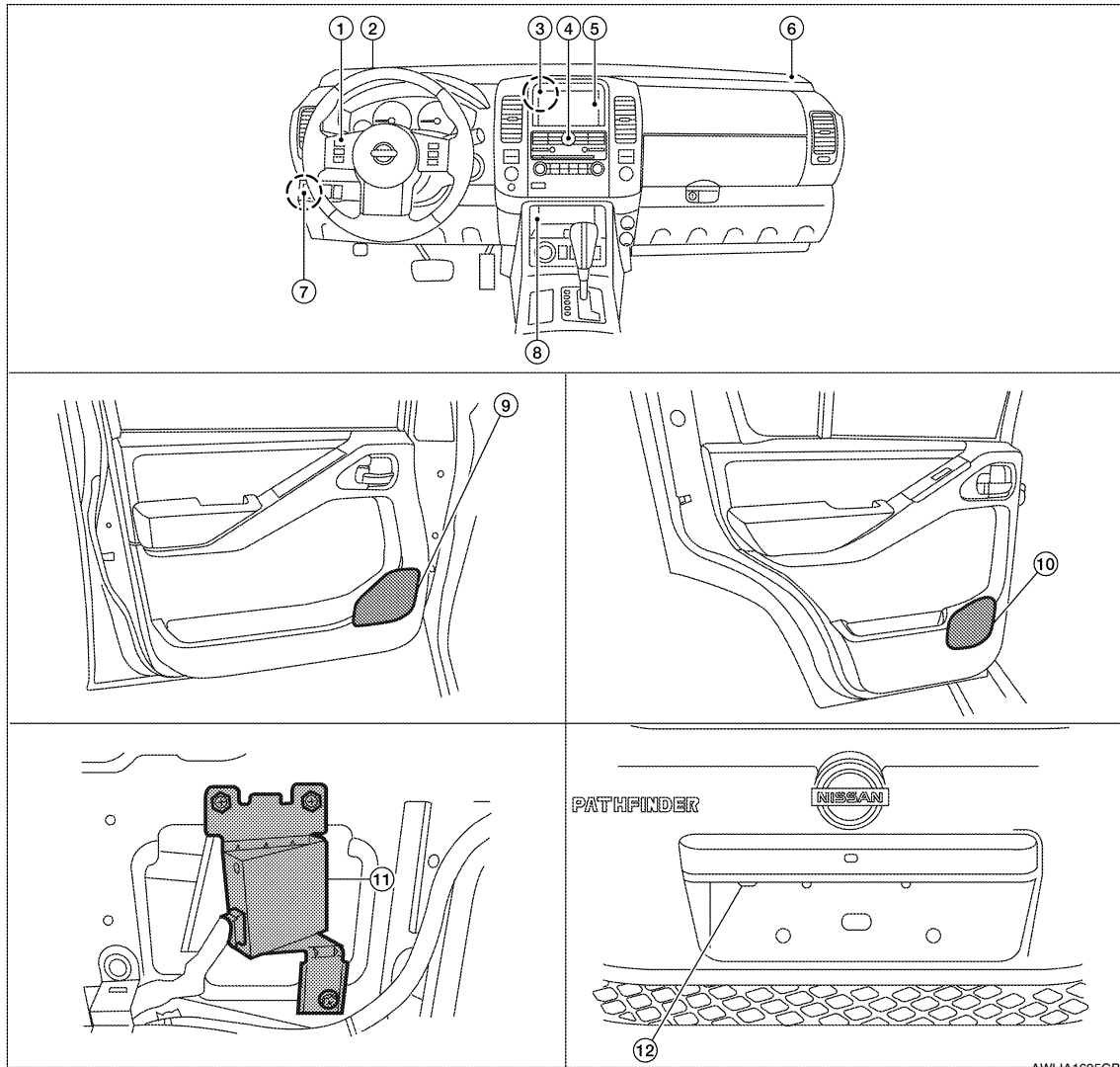

- |  |  |  |
|--|--|--|
| 1. Steering wheel audio control switches               | 2. Front tweeter LH M109   | 3. AV control unit M42, M43, M45, M46, M70 |
| 4. A/C and AV switch assembly M98                      | 5. Display unit M93  | 6. Front tweeter RH M111                   |
| 7. Satellite radio tuner (factory installed) M41, M129 | 8. Aux. jack M85   | 9. Front door speaker LH D12, RH D112      |
| 10. Rear door speaker LH D209, RH D309                 | 11. Rear view camera control unit B176 (located behind luggage side finisher RH) | 12. Rear view camera D551                  |

## Component Description

INFOID:000000005259274

Part name	Description
AV control unit	Controls audio system and satellite radio system functions
Display unit	Displays audio and climate control related information
A/C and AV switch assembly	<ul style="list-style-type: none"> <li>All audio and A/C operations can be operated</li> <li>switch signal is output to the AV control unit and A/C auto amp</li> </ul>
Steering wheel audio control switches	<ul style="list-style-type: none"> <li>Audio operation can be operated</li> <li>Steering switch signal (operation signal) is output to AV control unit</li> </ul>

A  
B  
C  
D  
E  
F  
G  
H  
I  
J  
K  
L  
M  
N  
O  
P

AV

## AUDIO SYSTEM

< FUNCTION DIAGNOSIS >

[MID AUDIO]

Part name	Description
Front door speakers	<ul style="list-style-type: none"><li>• Outputs audio signal from AV control unit</li><li>• Outputs high, mid and low range sounds</li></ul>
Front tweeters	<ul style="list-style-type: none"><li>• Outputs audio signal from AV control unit</li><li>• Outputs high range sounds</li></ul>
Rear door speakers	<ul style="list-style-type: none"><li>• Outputs audio signal from AV control unit</li><li>• Outputs high, mid and low range sounds</li></ul>
Antenna amp.	<ul style="list-style-type: none"><li>• Radio signal received by window antenna is amplified and sent to AV control unit</li><li>• Power (antenna amp. ON signal) is supplied from AV control unit</li></ul>
Satellite radio tuner	<ul style="list-style-type: none"><li>• Receives radio signals from satellite antenna</li><li>• Sends audio signals to AV control unit</li></ul>
Satellite antenna	Audio signal (satellite radio) is received and output to AV control unit.



# REAR VIEW MONITOR SYSTEM

< FUNCTION DIAGNOSIS >

[MID AUDIO]

## REAR VIEW MONITOR SYSTEM

### System Diagram

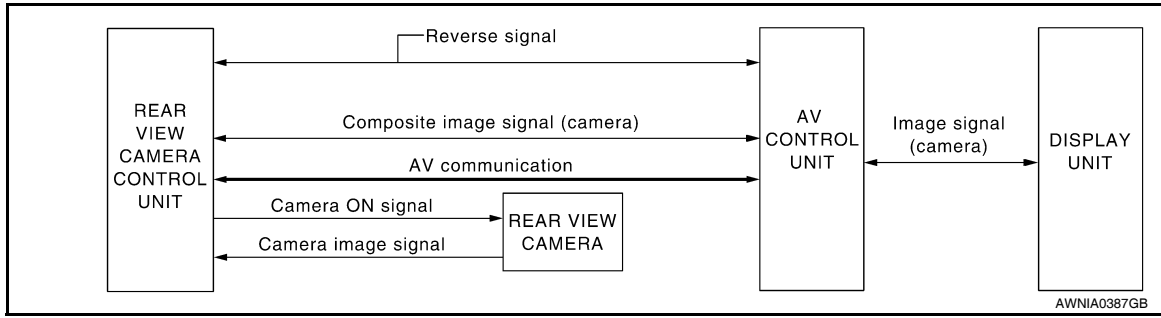

### System Description

INFOID:000000005259276

When the selector is in the R position, the display shows a view to the rear of the vehicle. Lines which indicate the vehicle clearance and distances are also displayed.

#### AV COMMUNICATION LINE

The rear view camera unit is connected to the AV control unit using an AV communication line. This line is used to transmit and receive data.

A  
B  
C  
D  
E  
F  
G  
H  
I  
J  
K  
L  
M  
O  
P

AV

# REAR VIEW MONITOR SYSTEM

< FUNCTION DIAGNOSIS >

[MID AUDIO]

## Component Parts Location

INFOID:000000005259277

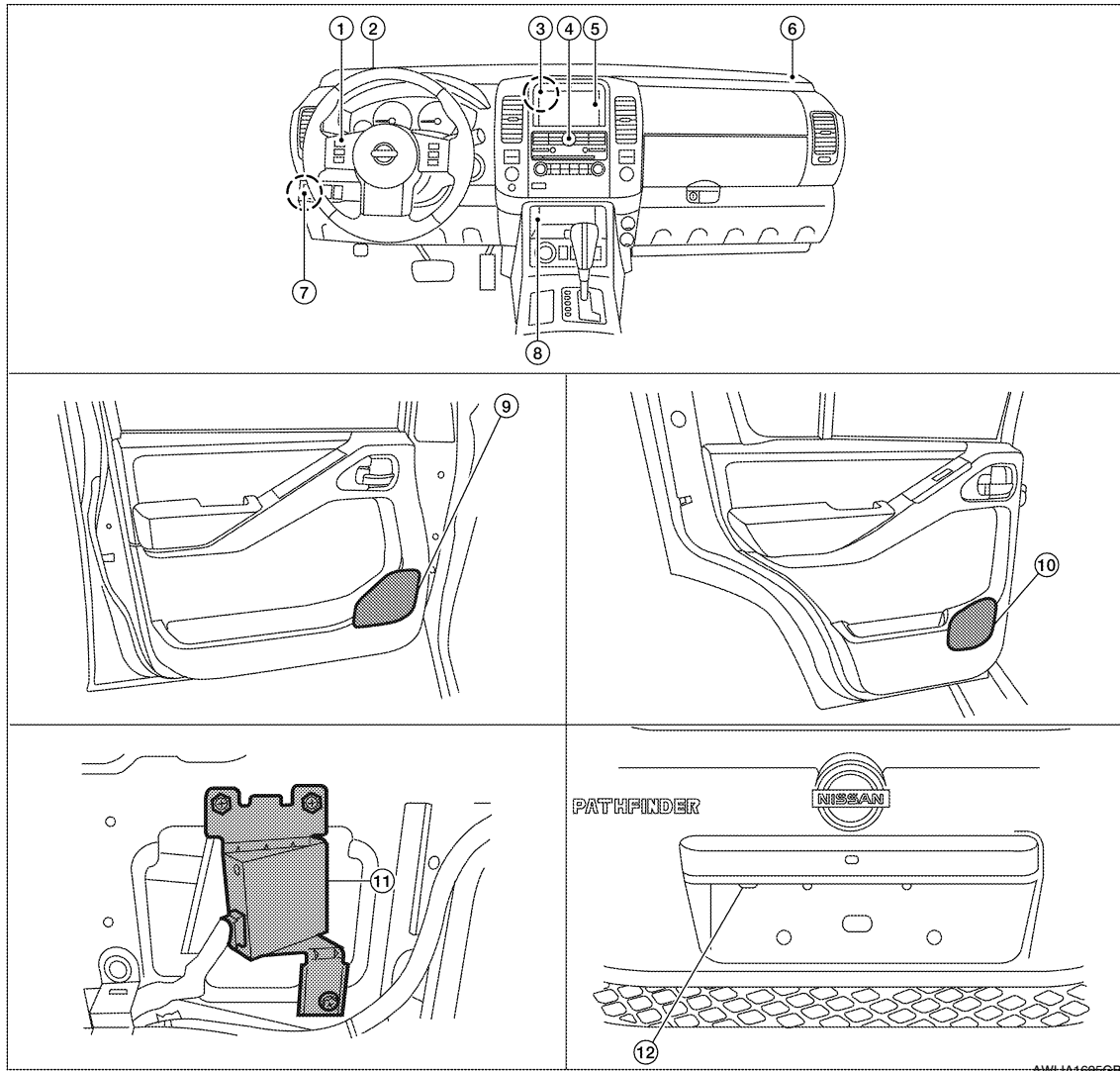

AWLIA1695GB

- |  |  |  |
|--|--|--|
| 1. Steering wheel audio control switches               | 2. Front tweeter LH M109   | 3. AV control unit M42, M43, M45, M46, M70 |
| 4. A/C and AV switch assembly M98                      | 5. Display unit M93  | 6. Front tweeter RH M111                   |
| 7. Satellite radio tuner (factory installed) M41, M129 | 8. Aux. jack M85   | 9. Front door speaker LH D12, RH D112      |
| 10. Rear door speaker LH D209, RH D309                 | 11. Rear view camera control unit B176 (located behind luggage side finisher RH) | 12. Rear view camera D551                  |

## Component Description

INFOID:000000005259278

Part name	Description
AV control unit	Camera image signal is sent from rear view camera control unit

# REAR VIEW MONITOR SYSTEM

< FUNCTION DIAGNOSIS >

[MID AUDIO]

Part name	Description
Rear view camera control unit	<ul style="list-style-type: none"><li>• Receives reverse signal from back-up lamp relay</li><li>• Receives rear view camera image signal</li><li>• Sends camera ON signal to rear view camera</li><li>• Sends image signal to AV control unit</li></ul>
Rear view camera	<ul style="list-style-type: none"><li>• Receives camera ON signal from rear view camera control unit</li><li>• Sends image signal to rear view camera control unit</li></ul>

A

B

C

D

E

F

G

H

I

J

K

L

M

AV

O

P

## DVD PLAYER

### System Diagram

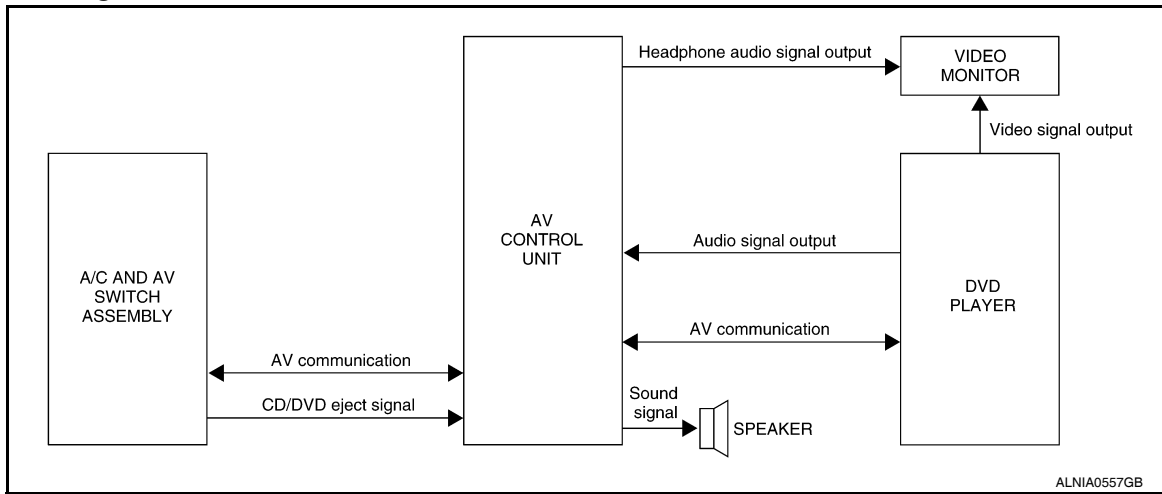

### System Description

INFOID:000000005259280

The DVD entertainment system consists of the following components

- AV control unit
- Display unit
- DVD player
- Video monitor
- A/C and AV switch assembly
- Steering wheel audio control switches
- Front tweeters
- Front door speakers
- Rear door speakers

When the DVD entertainment system is on, video signals are sent from the DVD player to the video monitor. Audio signals are sent to the AV control unit. Audio signals can be directed through the vehicle speakers or through wireless infrared headphones. Refer to the Owner's Manual for complete DVD entertainment system operating instructions.

# DVD PLAYER

< FUNCTION DIAGNOSIS >

[MID AUDIO]

## Component Parts Location

INFOID:000000005259281

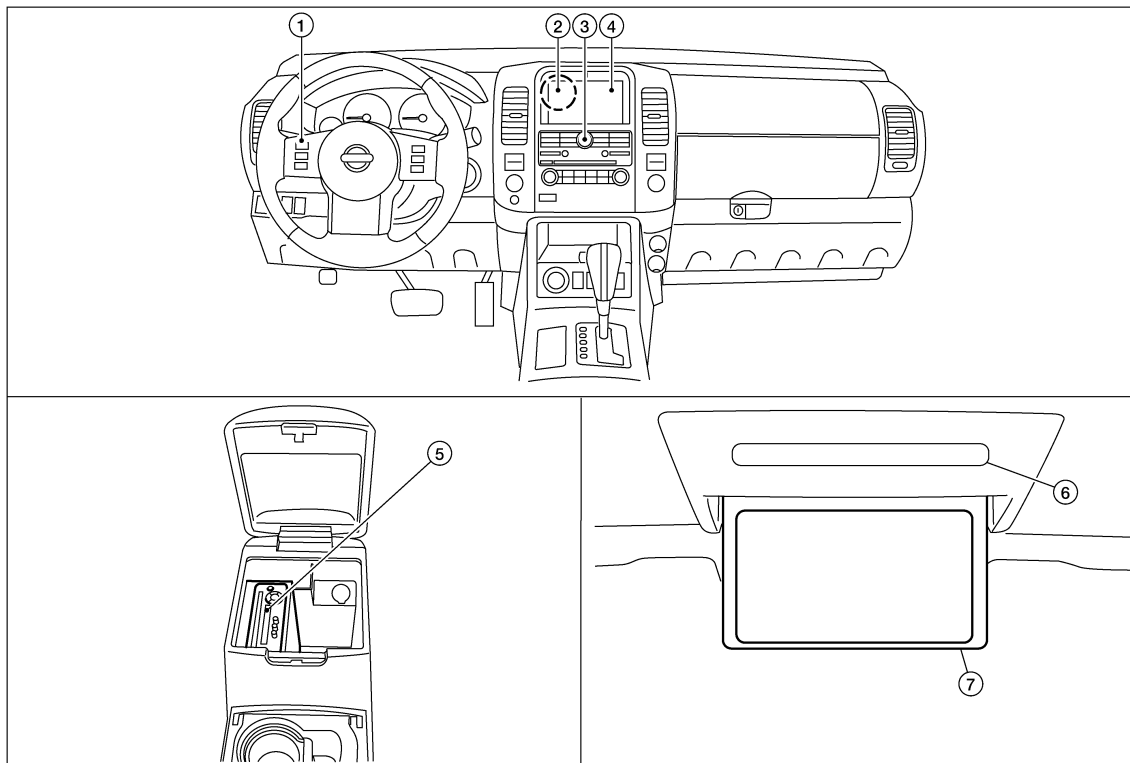

ALNIA0558GB

- |  |  |  |
|--|--|--|
| 1. Steering wheel audio control switches | 2. AV control unit M42, M43, M45, M46, M70     | 3. A/C and AV switch assembly M98  |
| 4. Display unit M93                      | 5. DVD player M205 (located in center console) | 6. Infrared headphone and remote receiver/transmitter (part of video monitor assembly) |
| 7. Video monitor B76                     |  |  |

## Component Description

INFOID:000000005259282

Part name	Description
DVD player	<ul style="list-style-type: none"> <li>• Outputs DVD video to video monitor</li> <li>• Outputs DVD audio to the AV control unit</li> </ul>
Video monitor	<ul style="list-style-type: none"> <li>• Receives and displays the DVD video signal</li> </ul>
AV control unit	<ul style="list-style-type: none"> <li>• Controls audio system and DVD entertainment system functions</li> </ul>
A/C and AV switch assembly	<ul style="list-style-type: none"> <li>• All audio and A/C operations can be operated</li> <li>• Switch signal is output to the AV control unit and A/C auto amp</li> </ul>
Steering wheel audio control switches	<ul style="list-style-type: none"> <li>• Audio operation can be operated</li> <li>• Steering switch signal (operation signal) is output to AV control unit</li> </ul>
Front door speakers	<ul style="list-style-type: none"> <li>• Outputs audio signal from AV control unit</li> <li>• Outputs high, mid and low range sounds</li> </ul>
Front tweeters	<ul style="list-style-type: none"> <li>• Outputs audio signal from AV control unit</li> <li>• Outputs high range sounds</li> </ul>
Rear door speakers	<ul style="list-style-type: none"> <li>• Outputs audio signal from AV control unit</li> <li>• Outputs high, mid and low range sounds</li> </ul>

# DIAGNOSIS SYSTEM (AV CONTROL UNIT)

< FUNCTION DIAGNOSIS >

[MID AUDIO]

## DIAGNOSIS SYSTEM (AV CONTROL UNIT)

### AV CONTROL UNIT

#### AV CONTROL UNIT : Diagnosis Description

INFOID:000000005259283

#### DESCRIPTION

- Diagnosis function consists of the "Self-Diagnosis" mode performed automatically and the "Confirmation/Adjustment" mode operated manually.
- "Self-Diagnosis" mode checks for connections between the units constituting this system, analyzes each individual unit at the same time, and displays the results on the LCD screen.
- "Confirmation/Adjustment" mode is used to perform trouble diagnosis that requires operation and judgment by an operator (trouble that cannot be automatically judged by the system), to check/change the set value, and to display the error history of the AV control unit.

#### DIAGNOSIS ITEM

Mode		Description	
Self-diagnosis		<ul style="list-style-type: none"> <li>• AV control unit diagnosis</li> <li>• Analyzes connection between the AV control unit, front display, Bluetooth, DVD deck, satellite tuner, switches and rear view camera control unit.</li> </ul>	
CONFIRMATION/ ADJUSTMENT	Display diagnosis	Color spectrum bar	Color tone of the screen can be checked by the display of a color bar.
		Gradation bar	Shading of the screen can be checked by the display of a gray scale.
	Vehicle signals		The following vehicle signals are analyzed: Vehicle speed signal, parking brake signal, light signal, ignition switch signal, and reverse signal.
	Speaker test		Connection can be checked by sending a test tone to each speaker.
	Climate control		Start automatic air conditioner self-diagnosis
	Error history		Diagnosis results previously stored in the memory are displayed in this mode.
	Vehicle CAN diagnosis		The transmitting/receiving of CAN communication can be monitored.
	AV COMM diagnosis		The transmitting/receiving of AV communication can be monitored.
	Delete connection log		Erase the error history and connection history of the unit.
	Initialize settings		All audio settings are reset to default levels.

#### OPERATION PROCEDURE

1. Start the engine.
2. Turn the audio system off.
3. While pressing the "SETTING" button, turn the volume control dial counterclockwise 30 clicks or more.

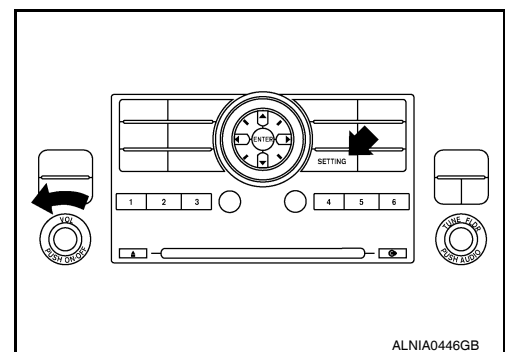

ALNIA0446GB

# DIAGNOSIS SYSTEM (AV CONTROL UNIT)

< FUNCTION DIAGNOSIS >

[MID AUDIO]

- The initial trouble diagnosis screen will be displayed, and items “Self-Diagnosis” and “Confirmation/Adjustment” can be selected.

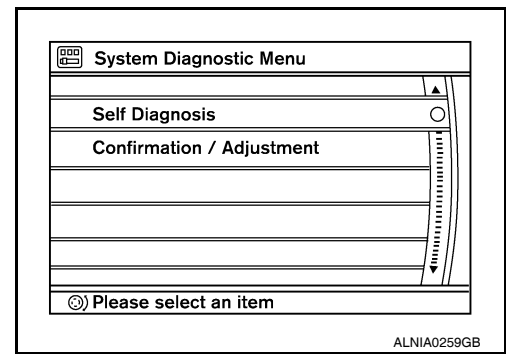

## SELF-DIAGNOSIS

- Perform self-diagnosis by selecting “Self-Diagnosis”.
  - Self-diagnosis subdivision screen is displayed, and the self-diagnosis mode starts.
  - A bar graph visible on the center of the self-diagnosis subdivision screen indicates progress of the trouble diagnosis.

**NOTE:**

Self-diagnosis requires approximately 10 seconds to complete.

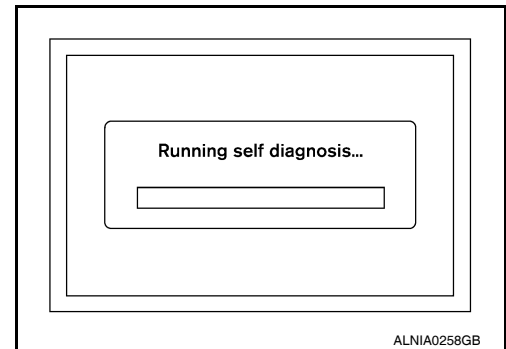

- Diagnosis results are displayed after the self-diagnosis is completed. The unit names and the connection lines are color-coded according to the diagnostic results.

Diagnosis results	Unit	Connection line
Normal	Green	Green
Connection malfunction	Gray	Yellow
Unit malfunction <sup>Note</sup>	Red	Green

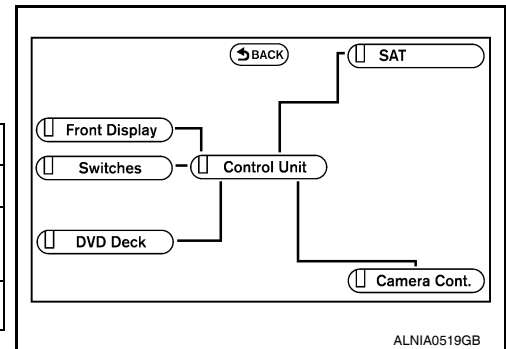

Note:

- Only the AV control unit is displayed in red.
- If multiple malfunctions occur at the same time for a single unit, the screen switch colors are determined according to the following order of priority: red > yellow > gray.

- Select a component on the “Self Diagnosis” screen and comments for the diagnosis results will be shown.

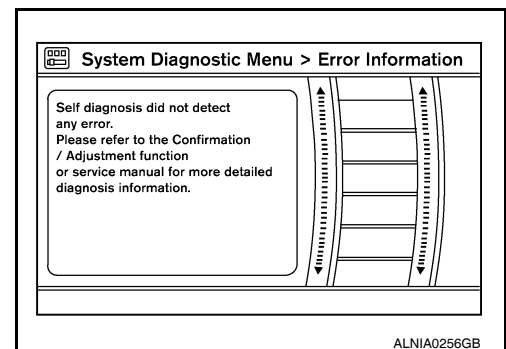

## Self-Diagnosis Results

A  
B  
C  
D  
E  
F  
G  
H  
I  
J  
K  
L  
M  
AV  
O  
P

# DIAGNOSIS SYSTEM (AV CONTROL UNIT)

< FUNCTION DIAGNOSIS >

[MID AUDIO]

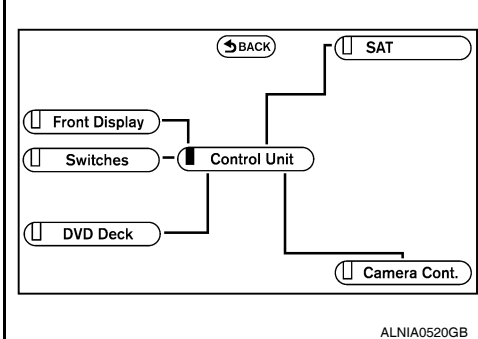
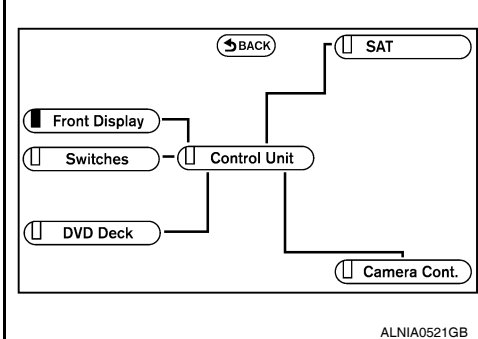
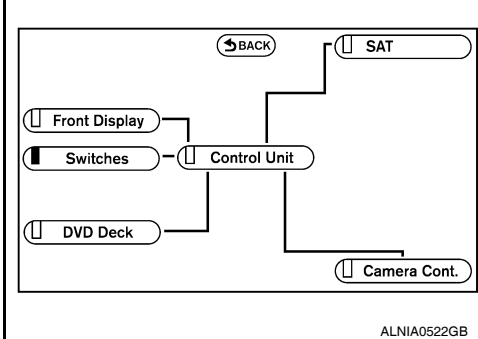
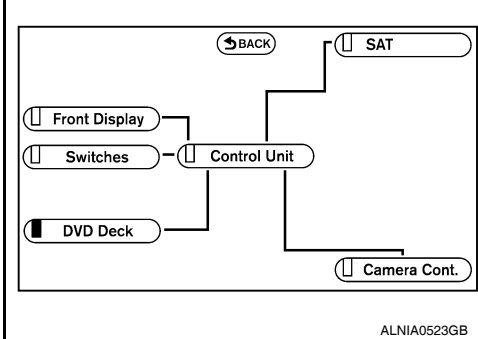
Area with yellow connection lines	Description	Possible malfunction location / Action to take
 <p>ALNIA0520GB</p>	<p>AV control unit malfunction is detected</p>	<p>Replace the AV control unit. Refer to <a href="#">AV-141. "Removal and Installation"</a>.</p>
 <p>ALNIA0521GB</p>	<p>Poor connection is detected for the display unit</p>	<ul style="list-style-type: none"> <li>• Harness or connector</li> <li>• AV control unit</li> <li>• Display unit</li> </ul>
 <p>ALNIA0522GB</p>	<p>Switch malfunction is detected</p>	<p>Perform A/C and AV switch assembly diagnostics. Refer to <a href="#">AV-60. "A/C AND AV SWITCH ASSEMBLY : Component Function Check"</a></p>
 <p>ALNIA0523GB</p>	<p>Poor connection is detected for the DVD player.</p>	<ul style="list-style-type: none"> <li>• Harness or connector</li> <li>• AV control unit</li> <li>• DVD player</li> </ul>



# DIAGNOSIS SYSTEM (AV CONTROL UNIT)

< FUNCTION DIAGNOSIS >

[MID AUDIO]

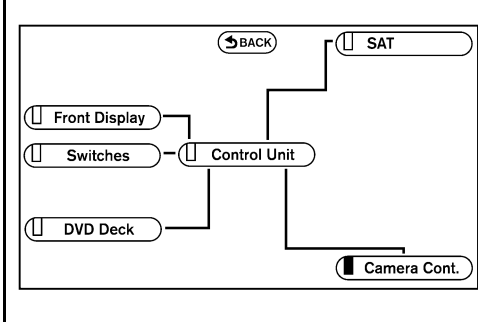
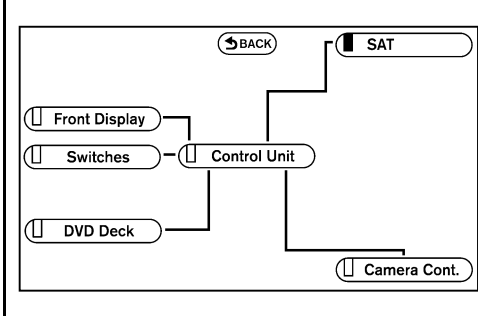
Area with yellow connection lines	Description	Possible malfunction location / Action to take
 <p>ALNIA0524GB</p>	<p>Poor connection is detected for the rear view camera control unit.</p>	<ul style="list-style-type: none"> <li>• Harness or connector</li> <li>• AV control unit</li> <li>• Rear view camera control unit</li> </ul>
 <p>ALNIA0525GB</p>	<p>Poor connection is detected for the satellite radio tuner.</p>	<ul style="list-style-type: none"> <li>• Harness or connector</li> <li>• AV control unit</li> <li>• Satellite radio tuner</li> </ul>

## CONFIRMATION/ADJUSTMENT MODE

1. Start the diagnosis function and select "Confirmation/Adjustment". The confirmation/adjustment mode indicates where each item can be checked or adjusted.
2. Select each item on the "Confirmation/Adjustment" mode screen to display the relevant trouble diagnosis screen. Press the "BACK" button or touch "BACK" on the touch screen to return to the initial Confirmation/Adjustment Mode screen.

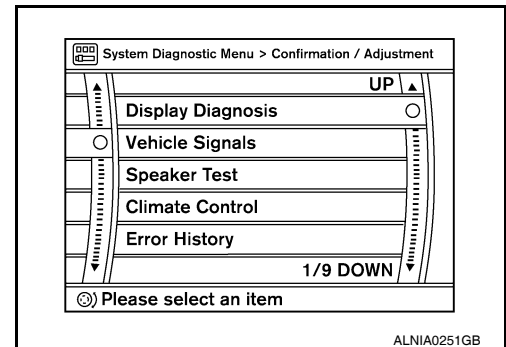

## Display Diagnosis

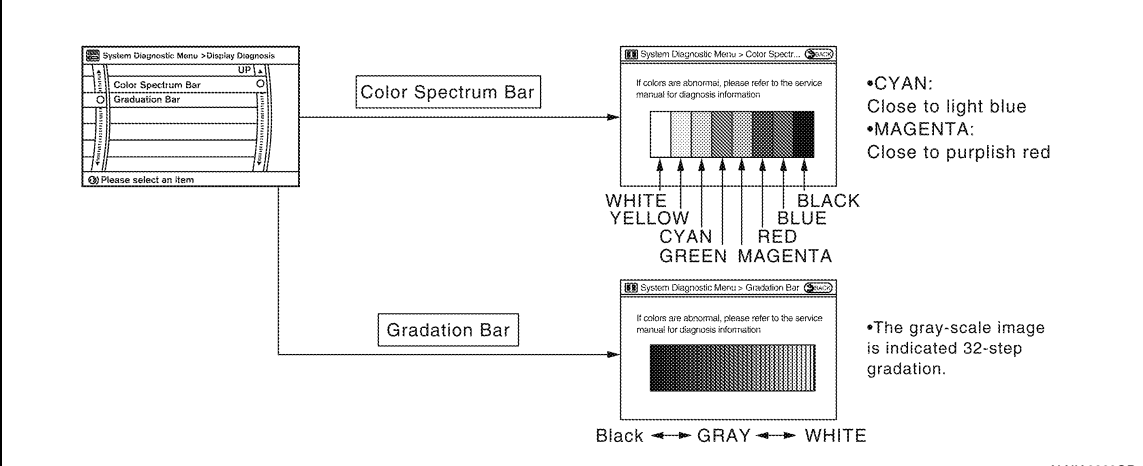

**Color Spectrum Bar**

If colors are abnormal, please refer to the service manual for diagnosis information.

- CYAN: Close to light blue
- MAGENTA: Close to purplish red

**Gradation Bar**

If colors are abnormal, please refer to the service manual for diagnosis information.

- The gray-scale image is indicated 32-step gradation.

Black ← GRAY → WHITE

ALNIA0260GB

## Vehicle Signals

A  
B  
C  
D  
E  
F  
G  
H  
I  
J  
K  
L  
M  
N  
O  
P

AV

# DIAGNOSIS SYSTEM (AV CONTROL UNIT)

## < FUNCTION DIAGNOSIS >

[MID AUDIO]

A comparison check can be made of each actual vehicle signal and the signals recognized by the system.

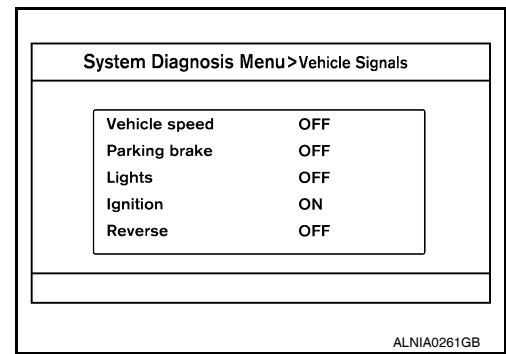

Diagnosis item	Display	Vehicle status	Remarks
Vehicle speed	ON	Vehicle speed > 0 km/h	Changes in indication may be delayed by approximately 1.5 seconds. This is normal.
	OFF	Vehicle speed = 0 km/h	
	-	Ignition switch in ACC position	
Parking brake	ON	Parking brake is applied.	
	OFF	Parking brake is released.	
Lights	ON	Light switch ON	
	OFF	Light switch OFF	
Ignition	ON	Ignition switch ON	-
	OFF	Ignition switch in ACC position	
Reverse	ON	Selector lever in R position	Changes in indication may be delayed by approximately 1.5 seconds. This is normal.
	OFF	Selector lever in any position other than R	
	-	Ignition switch in ACC position	

### Speaker Test

Select "Speaker Test" to display the speaker diagnosis screen. Press "Start" to generate a test tone in speakers. Touch "End" to stop the test tones.

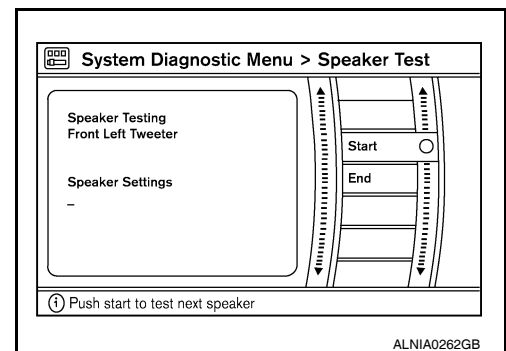

### Error History

The self-diagnosis results are judged depending on whether any error occurs from when "Self-diagnosis" is selected until the self-diagnosis results are displayed.

However, the diagnosis results are judged normal if an error has occurred before the ignition SW is turned ON and then no error has occurred until the self-diagnosis start. Check the "Error History" to detect any error that may have occurred before the self-diagnosis start because of this situation.

#### Count up method A

- The counter resets to 0 if an error occurs when IGN switch is turned ON. The counter increases by 1 if the condition is normal at a next IGN ON cycle.

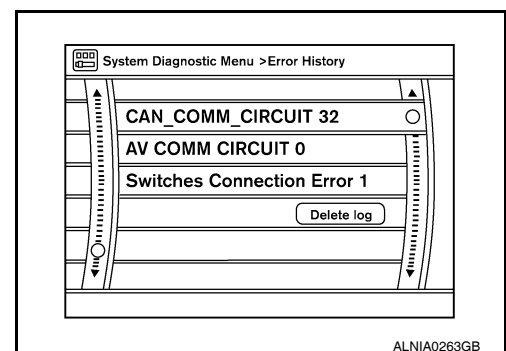

# DIAGNOSIS SYSTEM (AV CONTROL UNIT)

[MID AUDIO]

## < FUNCTION DIAGNOSIS >

- The counter upper limit is 39. Any counts exceeding 39 are ignored. The counter can be reset (no error-record display) with the "Delete log" switch or CONSULT-III.
- Count up method B
- The counter increases by 1 if an error occurs when IGN switch is ON. The counter will not decrease even if the condition is normal at the next IGN ON cycle.
- The counter upper limit is 50. Any counts exceeding 50 are ignored. The counter can be reset (no error-record display) with the "Delete log" switch or CONSULT-III.

Display method of occurrence frequency	Error history display item
Count up method A	CAN communication line, control unit (CAN), AV communication line, control unit (AV communication)
Count up method B	Other than above

### Vehicle CAN Diagnosis

- CAN communication status and error counter is displayed.
- The error counter displays "OK" if any malfunction was not detected in the past and displays "0" if a malfunction is detected. It increases by 1 if the condition is normal at the next ignition switch ON cycle. The upper limit of the counter is 39.
- The error counter is erased if reset.

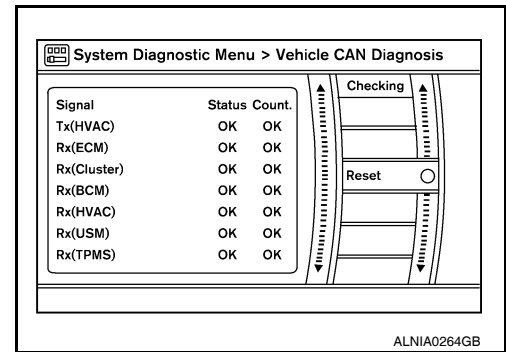

### AV COMM Diagnosis

- AV communication status and error counter is displayed.
- The error counter displays "OK" if any malfunction was not detected in the past and displays "0" if a malfunction is detected. It increases by 1 if the condition is normal at the next ignition switch ON cycle. The upper limit of the counter is 39.
- The error counter is erased if reset.

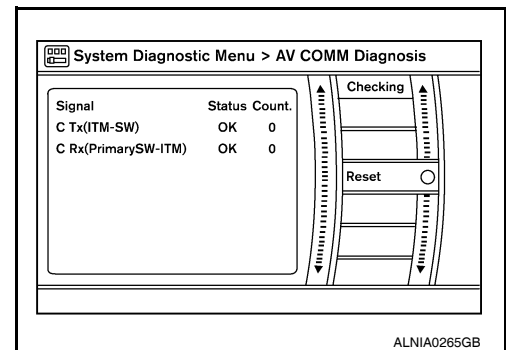

### Delete Unit Connection Log

Deletes any unit connection records and error records from the AV control unit memory. (Clear the records of the unit that has been removed)

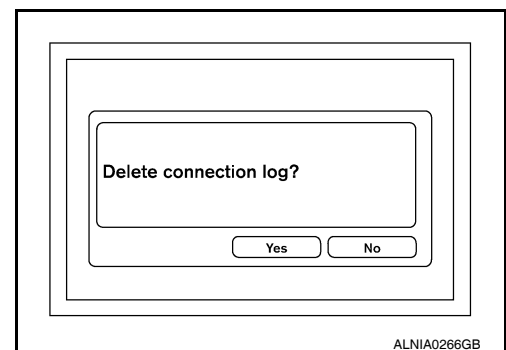

### Initialize Settings

# DIAGNOSIS SYSTEM (AV CONTROL UNIT)

< FUNCTION DIAGNOSIS >

[MID AUDIO]

Initializes the AV control unit memory.

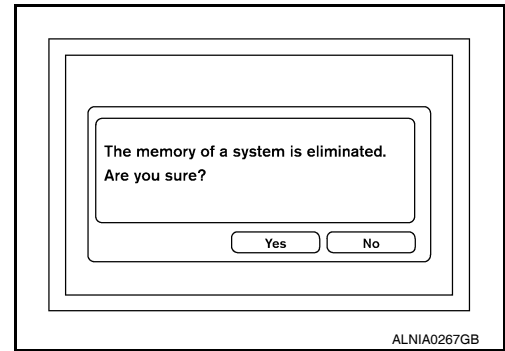

## AV CONTROL UNIT : CONSULT-III Function

INFOID:000000005259284

CONSULT-III can display each diagnostic item using the diagnostic test modes shown following.

MULTI AV diagnosis mode	Description
SELF-DIAG RESULTS	Displays AV control unit self-diagnosis results.
DATA MONITOR	Displays AV control unit input/output data in real time.
CAN DIAG SUPPORT MNTR	The result of transmit/receive diagnosis of CAN communication can be read.
AV COMM MONITOR	Allows the technician to monitor the status of the Multi AV system communication signals.
ECU PART NUMBER	The part number of AV control unit can be checked.

## DATA MONITOR

### Display Item List

Display item [unit]	ALL SIGNALS	SELECTION FROM MENU	Description
VHCL SPD SIG [ON/OFF]	X	X	Displays "ON" when vehicle speed > 0 km/h. Displays "OFF" when vehicle speed = 0 km/h.
PKB SIG [ON/OFF]	X	X	Displays [ON/OFF] condition of parking brake switch.
ILLUM SIG [ON/OFF]	X	X	Displays [ON/OFF] condition of lighting switch.
IGN SIG [ON/OFF]	X	X	Displays [ON/OFF] condition of ignition switch.
REV SIG [ON/OFF]	X	X	Displays [ON/OFF] condition of back-up lamp switch.

## A/C AND AV SWITCH ASSEMBLY

### A/C AND AV SWITCH ASSEMBLY : Component Function Check

INFOID:000000005259285

#### A/C and AV switch assembly self-diagnosis function

##### Description

The ON/OFF operation (continuity) of each switch in the A/C and AV switch assembly can be checked.

##### Self-diagnosis mode

- Press the "BACK" button and the "UP" button within 10 seconds after turning the ignition switch from OFF to ACC and hold them for 3 seconds or more. When the self-diagnosis mode starts, a beep will sound and all LED indicators of the switch will illuminate.
- The continuity of each switch and control dial of the A/C and AV switch assembly can be checked. If the switch is operating normally, the system will beep and the LED's will illuminate when each switch is operated.

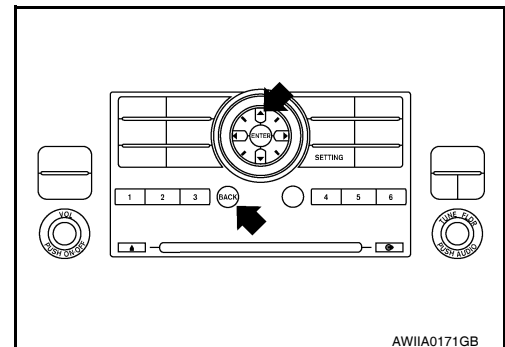

Finishing self-diagnosis mode

# DIAGNOSIS SYSTEM (AV CONTROL UNIT)

< FUNCTION DIAGNOSIS >

[MID AUDIO]

Self-diagnosis mode is canceled when the ignition switch is turned OFF.

A

B

C

D

E

F

G

H

I

J

K

L

M

**AV**

O

P

## COMPONENT DIAGNOSIS

### U1000 CAN COMM CIRCUIT

#### Description

INFOID:000000005259286

CAN (Controller Area Network) is a serial communication line for real time application. It is an on-vehicle multiplex communication line with high data communication speed and excellent error detection ability. Many electronic control units are equipped onto a vehicle and each control unit shares information and links with other control units during operation (not independent). In CAN communication, control units are connected with 2 communication lines (CAN-H, CAN-L) allowing a high rate of information transmission with less wiring. Each control unit transmits/receives data but selectively reads required data only.

CAN Communication Signal Chart. Refer to [LAN-53, "CAN Communication Signal Chart"](#).

#### DTC Logic

INFOID:000000005259287

#### DTC DETECTION LOGIC

DTC	Display contents of CONSULT-III	Diagnostic item is detected when ...	Probable malfunction location
U1000	CAN COMM CIRCUIT	When AV control unit is not transmitting or receiving CAN communication signal for 2 seconds or more.	CAN communication system

#### Diagnosis Procedure

INFOID:000000005259288

#### 1. PERFORM SELF DIAGNOSTIC

1. Turn ignition switch ON and wait for 2 seconds or more.
2. Check "Self Diagnostic Result" of "MULTI AV".

#### Is "CAN COMM CIRCUIT" displayed?

- YES >> Refer to "LAN system". Refer to [LAN-14, "Trouble Diagnosis Flow Chart"](#).
- NO >> Refer to GI section. Refer to [GI-37, "Intermittent Incident"](#).

# U1010 CONTROL UNIT (CAN)

< COMPONENT DIAGNOSIS >

[MID AUDIO]

## U1010 CONTROL UNIT (CAN)

### Description

INFOID:000000005259289

Initial diagnosis of AV control unit.

### DTC Logic

INFOID:000000005259290

### DTC DETECTION LOGIC

DTC	Display contents of CONSULT-III	Diagnostic item is detected when ...	Probable malfunction location
U1010	CONTROL UNIT (CAN)	CAN initial diagnosis malfunction is detected	AV control unit

### Diagnosis Procedure

INFOID:000000005259291

#### 1. REPLACE AV CONTROL UNIT

When DTC U1010 is detected, replace AV control unit. Refer to [AV-141, "Removal and Installation"](#).

>> Inspection End.

A  
B  
C  
D  
E  
F  
G  
H  
I  
J  
K  
L  
M

AV

O  
P

# U1200 AV CONTROL UNIT

< COMPONENT DIAGNOSIS >

[MID AUDIO]

## U1200 AV CONTROL UNIT

### Description

INFOID:000000005259292

Replace the AV control unit if this DTC is displayed. Refer to [AV-141, "Removal and Installation"](#).

Part name	Description
AV CONTROL UNIT	<ul style="list-style-type: none"><li>• It is the master unit of the MULTI AV system and it is connected to each control unit by means of communication. It operates each system according to communication signals from the AV control unit.</li><li>• AV control unit includes audio function and vehicle information function.</li><li>• It is connected to ECM and combination meter via CAN communication to obtain necessary information for the vehicle information function.</li><li>• It inputs the automatic brightness ON/OFF signals that are required for the display dimming control.</li><li>• It inputs the signals for driving status recognition (vehicle speed, reverse and parking brake).</li></ul>

### DTC Logic

INFOID:000000005259293

DTC	Display contents of CONSULT-III	DTC Detection Condition	Action to take
U1200	Control Unit FLASH- ROM [U1200]	An internal malfunction is detected in AV control unit (FLASH-ROM).	Replace AV control unit. Refer to <a href="#">AV-141, "Removal and Installation"</a> .



# U1216 AV CONTROL UNIT

< COMPONENT DIAGNOSIS >

[MID AUDIO]

## U1216 AV CONTROL UNIT

### Description

INFOID:000000005259294

Replace the AV control unit if this DTC is displayed. Refer to [AV-141, "Removal and Installation"](#).

Part name	Description
AV CONTROL UNIT	<ul style="list-style-type: none"><li>• It is the master unit of the MULTI AV system and it is connected to each control unit by means of communication. It operates each system according to communication signals from the AV control unit.</li><li>• AV control unit includes audio function and vehicle information function.</li><li>• It is connected to ECM and combination meter via CAN communication to obtain necessary information for the vehicle information function.</li><li>• It inputs the automatic brightness ON/OFF signals that are required for the display dimming control.</li><li>• It inputs the signals for driving status recognition (vehicle speed, reverse and parking brake).</li></ul>

### DTC Logic

INFOID:000000005259295

DTC	Display contents of CONSULT-III	DTC Detection Condition	Action to take
U1216	CAN CONT [U1216]	Internal malfunction of AV control unit (CAN controller) is detected.	Replace AV control unit. Refer to <a href="#">AV-141, "Removal and Installation"</a> .

A  
B  
C  
D  
E  
F  
G  
H  
I  
J  
K  
L  
M  
O  
P

AV

# U1240 SWITCH CONN

< COMPONENT DIAGNOSIS >

[MID AUDIO]

## U1240 SWITCH CONN

### Description

INFOID:000000005259296

U1240 is indicated when malfunction occurs in communication signal of multi AV system. Indicated simultaneously, without fail, with the malfunction of control units connected to AV control unit with communication line. Determine the possible malfunction cause from the table below.

### Self-diagnosis results display item

DTC	Display contents of CONSULT-III	DTC Detection Condition	Possible causes
U1240	<ul style="list-style-type: none"><li>SWITCH CONN [U1240]</li></ul>	<ul style="list-style-type: none"><li>A/C and AV switch assembly power supply and ground circuit malfunction is detected</li><li>A malfunction is detected in communication circuit between AV control unit and A/C and AV switch assembly</li><li>A malfunction is detected in communication signal between AV control unit and A/C and AV switch assembly</li></ul>	<ul style="list-style-type: none"><li>A/C and AV switch assembly power supply and ground circuits</li><li>Communication circuit between AV control unit and A/C and AV switch assembly</li></ul>

# U1243 DISPLAY UNIT

< COMPONENT DIAGNOSIS >

[MID AUDIO]

## U1243 DISPLAY UNIT

### Description

INFOID:000000005259297

Part name	Description
DISPLAY UNIT	<ul style="list-style-type: none"> <li>• Display image is controlled by the serial communication from AV control unit.</li> <li>• Inputs the RGB image signal (RGB, RGB area and RGB synchronizing) from AV control unit and the auxiliary image signal from the auxiliary input jacks.</li> <li>• Outputs the synchronizing signals (HP and VP) to the AV control unit.</li> </ul>

### DTC Logic

INFOID:000000005259298

DTC	Display contents of CONSULT-III	DTC Detection Condition	Possible causes
U1243	FRONT DISP CONN [U1243]	<ul style="list-style-type: none"> <li>• Display unit power supply and ground circuit malfunction is detected</li> <li>• Malfunction is detected on communication circuit between display unit and AV control unit</li> <li>• Malfunction is detected on communication signal between display unit and AV control unit</li> </ul>	<ul style="list-style-type: none"> <li>• Display unit power supply and ground circuit</li> <li>• Communication circuit between display unit and AV control unit</li> </ul>

### Diagnosis Procedure

INFOID:000000005259299

Regarding Wiring Diagram information, refer to [AV-110. "Wiring Diagram"](#).

#### 1. CHECK DISPLAY UNIT POWER SUPPLY AND GROUND CIRCUIT

Check display unit power supply and ground circuit. Refer to [AV-74. "DISPLAY UNIT : Diagnosis Procedure"](#).

Is inspection result OK?

YES >> GO TO 2

NO >> Repair malfunctioning parts.

#### 2. CHECK CONTINUITY OF COMMUNICATION CIRCUIT

1. Turn ignition switch OFF.
2. Disconnect display unit connector and AV control unit connector.
3. Check continuity between display unit harness connector M93 (A) terminals 11, 22 and AV control unit harness connector M133 (B) terminals 56, 44.

A		B		Continuity
Connector	Terminal	Connector	Terminal	
M93	11	M133	56	Yes
	22		44	

4. Check continuity between display unit harness connector M93 (A) terminals 11, 22 and ground.

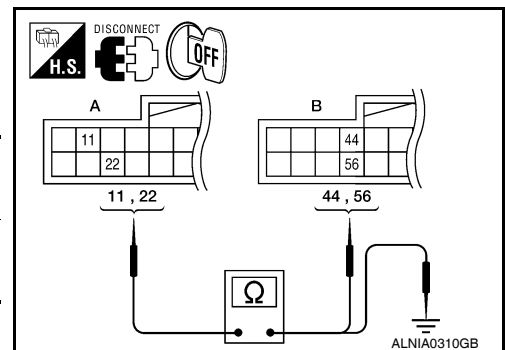

A		—	Continuity
Connector	Terminal		
M93	11	Ground	No
	22		

Are continuity results as specified?

YES >> GO TO 3

# U1243 DISPLAY UNIT

[MID AUDIO]

## < COMPONENT DIAGNOSIS >

NO >> Repair harness or connector.

### 3. CHECK COMMUNICATION SIGNAL

1. Connect display unit connector and AV control unit connector.
2. Turn ignition switch ON.
3. Check signal between display unit harness connector M93 terminal 11 and ground with an oscilloscope or CONSULT-III.

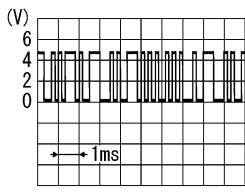
(+)		(-)	Reference signal
Connector	Terminal		
M93	11	Ground	 <p>PKIB5039J</p>

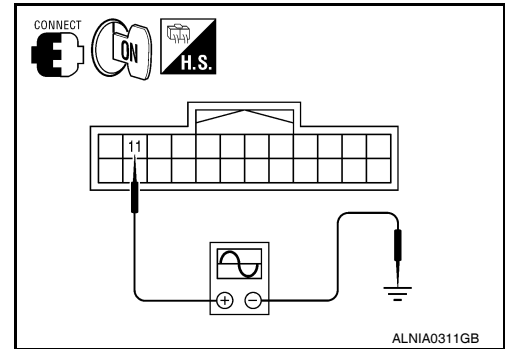

Are voltage readings as specified?

YES >> GO TO 4

NO >> Replace AV control unit. Refer to [AV-141, "Removal and Installation"](#).

### 4. CHECK COMMUNICATION SIGNAL

Check signal between display unit harness connector M93 terminal 22 and ground with an oscilloscope or CONSULT-III.

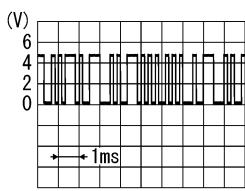
(+)		(-)	Reference signal
Connector	Terminal		
M93	22	Ground	 <p>PKIB5039J</p>

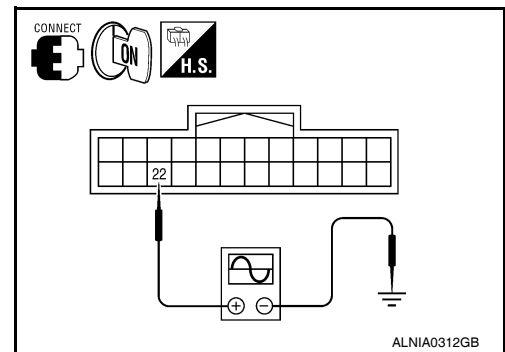

Are voltage readings as specified?

YES >> Inspection End.

NO >> Replace display unit. Refer to [AV-143, "Removal and Installation"](#).

# U1248 DVD DECK CONN

< COMPONENT DIAGNOSIS >

[MID AUDIO]

## U1248 DVD DECK CONN

### Description

INFOID:000000005259300

U1248 is indicated when a malfunction occurs in the communication signal of the DVD player. Indicated simultaneously, without fail, with the malfunction of control units connected to AV control unit with communication line. Determine the possible malfunction cause from the table below.

### DTC Logic

INFOID:000000005259301

DTC	Display contents of CONSULT-III	DTC Detection Condition	Possible causes
U1248	DVD DECK CONN [U1248]	<ul style="list-style-type: none"><li>DVD player power supply and ground circuit malfunction is detected</li><li>Malfunction is detected on communication circuit between DVD player and AV control unit</li><li>Malfunction is detected on communication signal between DVD player and AV control unit</li></ul>	<ul style="list-style-type: none"><li>DVD player power supply and ground circuit</li><li>Communication circuit between DVD player and AV control unit</li></ul>

### Diagnosis Procedure

INFOID:000000005259302

#### 1. CHECK DVD PLAYER POWER SUPPLY AND GROUND CIRCUIT

Check DVD player power supply and ground circuit. Refer to [AV-79. "DVD PLAYER : Diagnosis Procedure"](#).

Is inspection result OK?

- YES >> Inspection End.
- NO >> Repair malfunctioning parts.

A  
B  
C  
D  
E  
F  
G  
H  
I  
J  
K  
L  
M  
O  
P



# U1255 SATELLITE RADIO TUNER

< COMPONENT DIAGNOSIS >

[MID AUDIO]

## U1255 SATELLITE RADIO TUNER

### Description

INFOID:000000005259303

Part name	Description
SATELLITE RADIO TUNER	<ul style="list-style-type: none"><li>Inputs the satellite radio signal from satellite radio antenna and outputs it to the AV control unit.</li><li>It is controlled with the communication (communication signal, request signal) from AV control unit.</li></ul>

### DTC Logic

INFOID:000000005259304

DTC	Display contents of CONSULT-III	DTC Detection Condition	Possible causes
U1255	SAT CONN [U1255]	The satellite radio tuner power supply and ground circuit malfunction is detected	Satellite radio tuner power supply and ground circuit

### Diagnosis Procedure

INFOID:000000005259305

#### 1. CHECK SATELLITE RADIO TUNER POWER SUPPLY AND GROUND CIRCUIT

Check satellite radio tuner power supply and ground circuit. Refer to [AV-76. "SATELLITE RADIO TUNER : Diagnosis Procedure"](#).

Is inspection result OK?

- YES >> Inspection End.
- NO >> Repair malfunctioning parts.

# U1300 AV COMM CIRCUIT

< COMPONENT DIAGNOSIS >

[MID AUDIO]

## U1300 AV COMM CIRCUIT

### Description

INFOID:000000005259306

U1300 is indicated when malfunction occurs in communication signal of multi AV system. Indicated simultaneously, without fail, with the malfunction of control units connected to AV control unit with communication line. Determine the possible malfunction cause from the table below.

### Self-diagnosis results display item

DTC	Display contents of CONSULT-III	DTC Detection Condition	Possible causes
U1300 U1240	<ul style="list-style-type: none"><li>AV COMM CIRCUIT [U1300]</li><li>SWITCH CONN [U1240]</li></ul>	<ul style="list-style-type: none"><li>A/C and AV switch assembly power supply and ground circuit malfunction is detected</li><li>A malfunction is detected in communication circuit between AV control unit and A/C and AV switch assembly</li><li>A malfunction is detected in communication signal between AV control unit and A/C and AV switch assembly</li></ul>	<ul style="list-style-type: none"><li>A/C and AV switch assembly power supply and ground circuits</li><li>Communication circuit between AV control unit and A/C and AV switch assembly</li></ul>

A  
B  
C  
D  
E  
F  
G  
H  
I  
J  
K  
L  
M  
O  
P

AV

# U1310 AV CONTROL UNIT

< COMPONENT DIAGNOSIS >

[MID AUDIO]

## U1310 AV CONTROL UNIT

### Description

INFOID:000000005259307

Replace the AV control unit if this DTC is displayed. Refer to [AV-141, "Removal and Installation"](#).

Part name	Description
AV CONTROL UNIT	<ul style="list-style-type: none"><li>• It is the master unit of the MULTI AV system and it is connected to each control unit by means of communication. It operates each system according to communication signals from the AV control unit.</li><li>• AV control unit includes audio function and vehicle information function.</li><li>• It is connected to ECM and combination meter via CAN communication to obtain necessary information for the vehicle information function.</li><li>• It inputs the automatic brightness ON/OFF signals that are required for the display dimming control.</li><li>• It inputs the signals for driving status recognition (vehicle speed, reverse and parking brake).</li></ul>

### DTC Logic

INFOID:000000005259308

DTC	Display contents of CONSULT-III	DTC Detection Condition	Action to take
U1310	CONTROL UNIT (AV) [U1310]	An initial diagnosis error is detected in AV communication circuit.	Replace AV control unit. Refer to <a href="#">AV-141, "Removal and Installation"</a> .



# POWER SUPPLY AND GROUND CIRCUIT

< COMPONENT DIAGNOSIS >

[MID AUDIO]

## POWER SUPPLY AND GROUND CIRCUIT

### AV CONTROL UNIT

#### AV CONTROL UNIT : Diagnosis Procedure

INFOID:000000005259309

Regarding Wiring Diagram information, refer to [AV-110. "Wiring Diagram"](#).

### 1. CHECK FUSES

Check that the following fuses of the AV control unit are not are not blown.

Unit	Terminals	Signal name	Fuse No.
AV control unit	19	Battery power	29
	7	Ignition switch ACC or ON	4
	104	Ignition switch ON or START	12

Are the fuses OK?

YES >> GO TO 2

NO >> If fuse is blown, be sure to eliminate cause of malfunction before installing new fuse.

### 2. POWER SUPPLY CIRCUIT CHECK

- Disconnect AV control unit connectors M131 and M135.
- Check voltage between the AV control unit connectors M131 and M135 and ground.

Connector	(+)		(-)	OFF	ACC	ON
	Terminal					
M131	7	Ground	0V	Battery voltage	Battery voltage	
	19	Ground	Battery voltage	Battery voltage	Battery voltage	
M135	104	Ground	0V	0V	Battery voltage	

Are the voltage results as specified?

YES >> GO TO 3

- NO >>
- Check connector housings for disconnected or loose terminals.
  - Repair harness or connector.

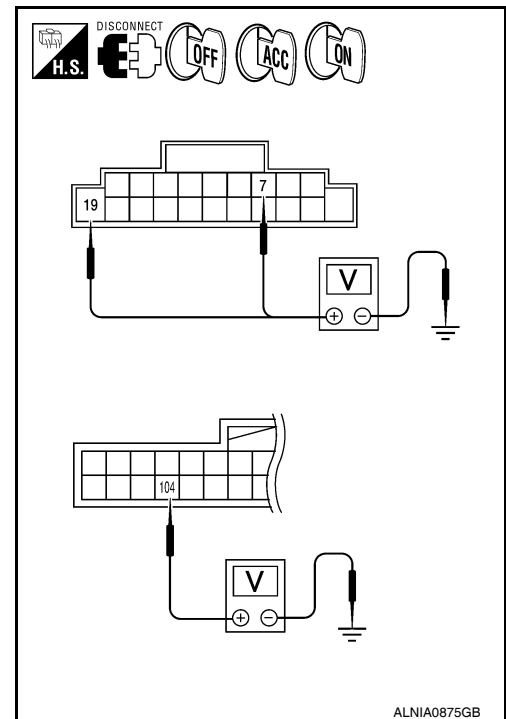

### 3. GROUND CIRCUIT CHECK

A  
B  
C  
D  
E  
F  
G  
H  
I  
J  
K  
L  
M  
N  
O  
P

AV

# POWER SUPPLY AND GROUND CIRCUIT

[MID AUDIO]

## < COMPONENT DIAGNOSIS >

1. Turn ignition switch OFF.
2. Check continuity between AV control unit harness connectors M131, M133 and M135 and ground.

(+)		(-)	Continuity
Connector	Terminal		
M131	20	Ground	Yes
M133	54		
M135	85		

Are the continuity results as specified?

- YES >> Inspection End.  
 NO >> Repair AV control unit ground.

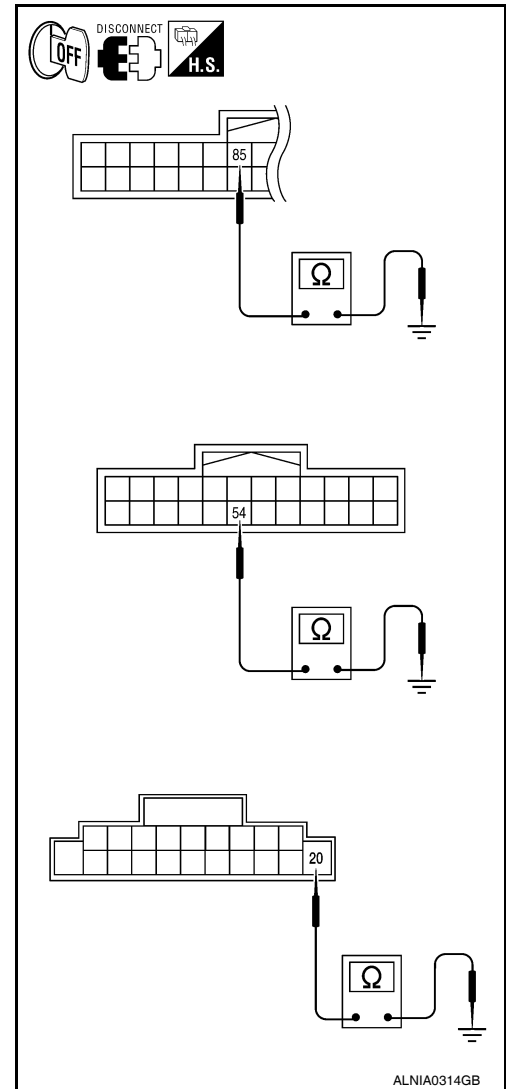

## DISPLAY UNIT

### DISPLAY UNIT : Diagnosis Procedure

INFOID:000000005259310

Regarding Wiring Diagram information, refer to [AV-110. "Wiring Diagram"](#).

## 1. CHECK POWER SUPPLY CIRCUIT

1. Turn ignition switch to ACC.
2. Check voltage between display unit harness connector M93 and ground.

Signal name	Connector	Terminal	Ignition switch position	Value (Approx.)
Inverter VCC	M93	2	ACC	9V
Signal VCC		3		

Does specified voltage exist?

- YES >> GO TO 3  
 NO >> GO TO 2

## 2. CHECK POWER SUPPLY CIRCUIT

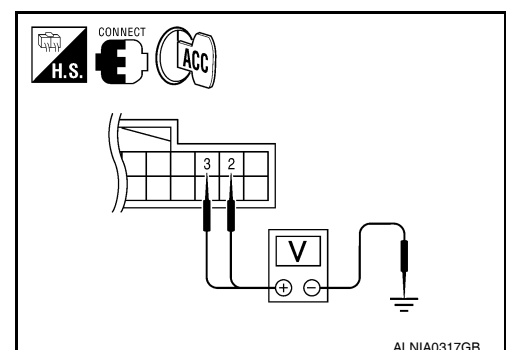

# POWER SUPPLY AND GROUND CIRCUIT

[MID AUDIO]

## < COMPONENT DIAGNOSIS >

1. Turn ignition switch OFF.
2. Disconnect the display unit connector M93 and the AV control unit connector M133.
3. Check continuity between the display unit harness connector M93 (A) and the AV control unit connector M133 (B).

A		B		Continuity
Connector	Terminal	Connector	Terminal	
M93	2	M133	59	Yes
	3		47	

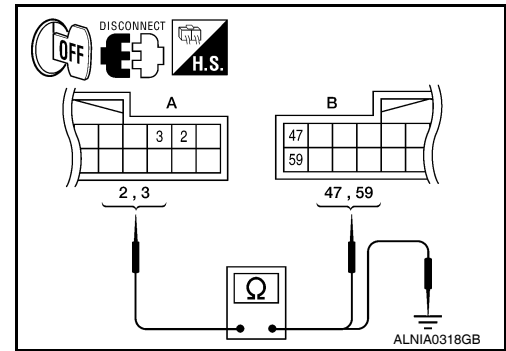

4. Check continuity between the display unit harness connector M93 (A) and ground.

A		—	Continuity
Connector	Terminal		
M93	2	Ground	No
	3		

### Are continuity results as specified?

YES >> Check AV control unit power and ground supply. Refer to [AV-73. "AV CONTROL UNIT : Diagnosis Procedure"](#).

NO >> Repair harness or connector.

## 3.CHECK GROUND CIRCUIT

1. Turn ignition switch OFF.
2. Disconnect display unit connector.
3. Check continuity between display unit harness connector and ground.

Connector	Terminal	—	Continuity
M93	1	Ground	Yes

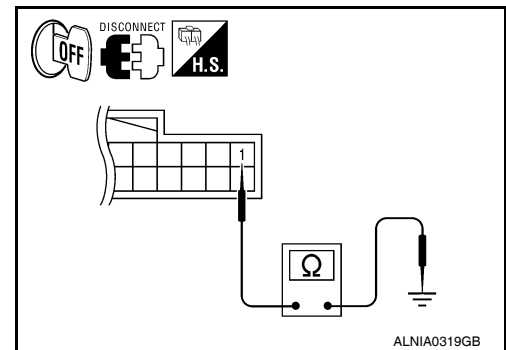

### Does continuity exist?

YES >> Inspection End.

NO >> Repair harness or connector.

## A/C AND AV SWITCH ASSEMBLY

### A/C AND AV SWITCH ASSEMBLY : Diagnosis Procedure

INFOID:000000005259311

Regarding Wiring Diagram information, refer to [AV-110. "Wiring Diagram"](#).

## 1.CHECK FUSE

Check that the fuse of the AC and AV switch assembly is not blown.

Unit	Terminal	Signal name	Fuse No.
A/C and AV switch assembly	2	Ignition switch ACC or ON	4

### Is the fuse OK?

YES >> GO TO 2

NO >> If fuse is blown, be sure to eliminate cause of malfunction before installing new fuse.

## 2.POWER SUPPLY CIRCUIT CHECK

A  
B  
C  
D  
E  
F  
G  
H  
I  
J  
K  
L  
M  
N  
O  
P

AV

# POWER SUPPLY AND GROUND CIRCUIT

[MID AUDIO]

## < COMPONENT DIAGNOSIS >

1. Disconnect A/C and AV switch assembly connector M98.
2. Check voltage between the A/C and AV switch assembly connector M98 and ground.

(+) Connector		Terminal	(-)	OFF	ACC	ON
Terminal						
M98		2	Ground	0V	Battery voltage	Battery voltage

Are the voltage results as specified?

- YES >> GO TO 3  
 NO >> • Check connector housings for disconnected or loose terminals.  
 • Repair harness or connector.

### 3. GROUND CIRCUIT CHECK

1. Turn ignition switch OFF.
2. Check continuity between A/C and AV switch assembly harness connector M98 and ground.

Connector	Terminal	—	Continuity
M98	1	Ground	Yes

Are the continuity results as specified?

- YES >> Inspection End.  
 NO >> Repair harness or ground.

## SATELLITE RADIO TUNER

### SATELLITE RADIO TUNER : Diagnosis Procedure

INFOID:000000005259312

Regarding Wiring Diagram information, refer to [AV-110, "Wiring Diagram"](#).

### 1. CHECK FUSES

Check that the following fuses of the satellite radio tuner (factory installed) are not blown.

Unit	Terminals	Signal name	Fuse No.
Satellite radio tuner (factory installed)	32	Ignition switch ON or START	17
	36	Ignition switch ACC or ON	4

Are the fuses OK?

- YES >> GO TO 2  
 NO >> If fuse is blown, be sure to eliminate cause of malfunction before installing new fuse.

### 2. POWER SUPPLY CIRCUIT CHECK

1. Turn ignition switch OFF.
2. Disconnect satellite radio tuner (factory installed) connector M41.
3. Check voltage between the satellite radio tuner (factory installed) and ground.

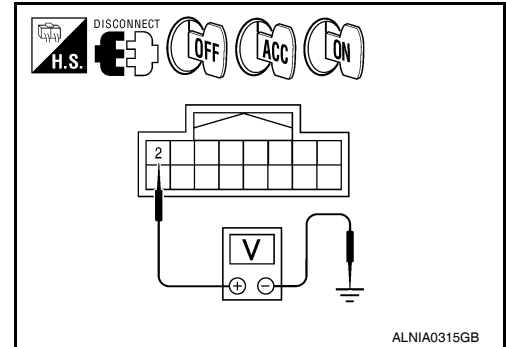

ALNIA0315GB

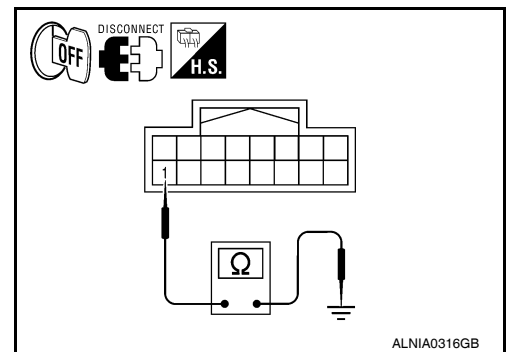

ALNIA0316GB

# POWER SUPPLY AND GROUND CIRCUIT

< COMPONENT DIAGNOSIS >

[MID AUDIO]

(+)		(-)	OFF	ACC	ON
Connector	Terminal				
M41	32	Ground	0V	0V	Battery voltage
	36		0V	Battery voltage	Battery voltage

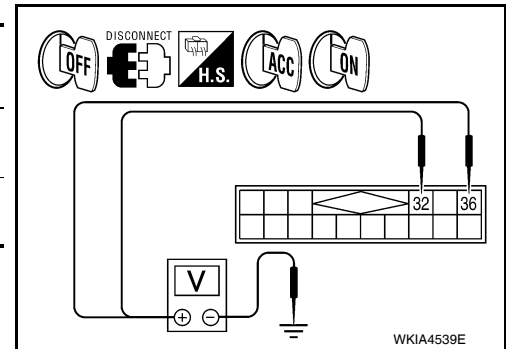

Are the voltage readings as specified?

- YES >> GO TO 3  
 NO >> • Check connector housings for disconnected or loose terminals.  
 • Repair harness or connector.

## 3. GROUND CIRCUIT CHECK

Inspect satellite radio tuner (factory installed) case ground.

Does case ground pass inspection?

- YES >> Inspection End.  
 NO >> Repair satellite radio tuner (factory installed) case ground.

## REAR VIEW CAMERA CONTROL UNIT

### REAR VIEW CAMERA CONTROL UNIT : Diagnosis Procedure

INFOID:000000005259313

Regarding Wiring Diagram information, refer to [AV-110. "Wiring Diagram"](#).

## 1. CHECK FUSE

Check that the following fuses of the rear view camera control unit are not blown.

Unit	Terminals	Signal name	Fuse No.
Rear view camera control unit	1	Battery power	29
	2	Ignition switch ACC or ON	4

Are the fuses OK?

- YES >> GO TO 2  
 NO >> Be sure to eliminate cause of malfunction before installing new fuse.

## 2. CHECK POWER SUPPLY CIRCUIT

Check voltage between rear view camera control unit harness connector B176 and ground.

(+)		(-)	OFF	ACC	ON
Connector	Terminal				
B176	1	Ground	Battery voltage	Battery voltage	Battery voltage
	2		0V	Battery voltage	Battery voltage

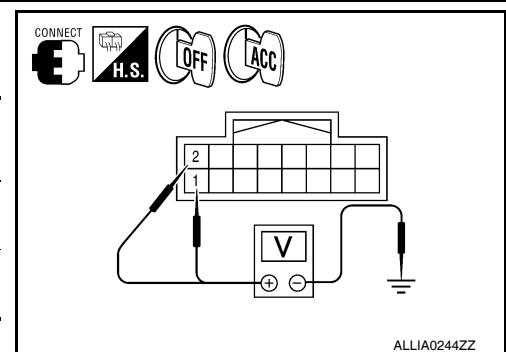

Is battery voltage present?

- YES >> GO TO 3  
 NO >> Repair harness or connector.

## 3. CHECK GROUND CIRCUIT

1. Turn ignition switch OFF.
2. Disconnect rear view camera control unit connector.

# POWER SUPPLY AND GROUND CIRCUIT

[MID AUDIO]

## < COMPONENT DIAGNOSIS >

- Check continuity between rear view camera control unit harness connector B176 terminal 3 and ground.

Connector	Terminal	—	Continuity
B176	3	Ground	Yes

### Does continuity exist?

- YES >> Inspection End.  
NO >> Repair harness or connector.

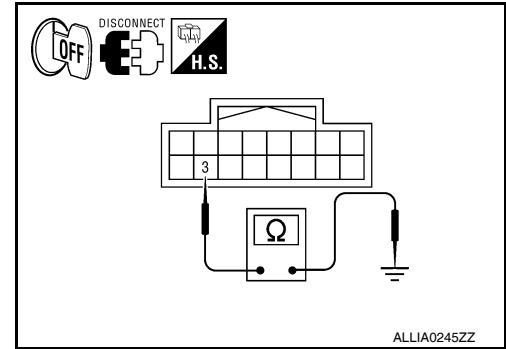

## REAR VIEW CAMERA

### REAR VIEW CAMERA : Diagnosis Procedure

INFOID:000000005259314

Regarding Wiring Diagram information, refer to [AV-110, "Wiring Diagram"](#).

## 1. CHECK POWER SUPPLY CIRCUIT (REAR VIEW CAMERA SIDE)

- Turn ignition switch ON.
- Shift transmission into reverse.
- Check voltage between rear view camera harness connector D551 and ground.

Signal name	Connector	Terminal	Transmission position	Value (Approx.)
Camera ON signal	D551	1	Reverse	6V

### Is voltage reading approximately 6 volts?

- YES >> GO TO 4  
NO >> GO TO 2

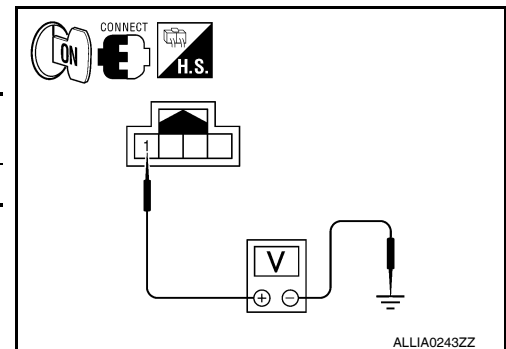

## 2. CHECK POWER SUPPLY CIRCUIT (CONTINUITY)

- Turn ignition switch OFF.
- Disconnect rear view camera and rear view camera control unit connectors.
- Check continuity between rear view camera harness connector D551 (A) terminal 1 and rear view camera control unit harness connector B176 (B) terminal 8.

A		B		Continuity
Connector	Terminal	Connector	Terminal	
D551	1	B176	8	Yes

- Check continuity between rear view camera harness connector D551 (A) terminal 1 and ground.

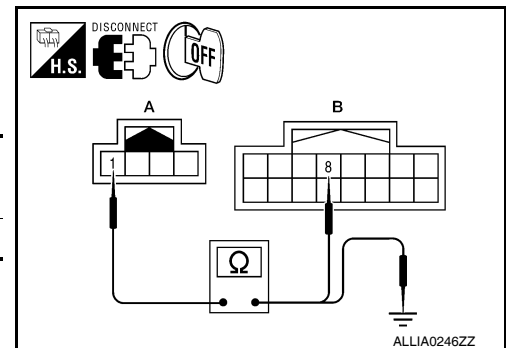

A		—	Continuity
Connector	Terminal		
D551	1	Ground	No

### Are continuity results as specified?

- YES >> GO TO 3  
NO >> Repair harness or connector.

## 3. CHECK POWER SUPPLY CIRCUIT (REAR VIEW CAMERA CONTROL UNIT SIDE)

- Connect rear view camera control unit harness connector.

# POWER SUPPLY AND GROUND CIRCUIT

[MID AUDIO]

## < COMPONENT DIAGNOSIS >

- Turn ignition switch ON.
- Check voltage between rear view camera control unit harness connector B176 and ground.

Signal name	Connector	Terminal	Transmission position	Value (Approx.)
Camera ON signal	B176	8	Reverse	6V

Is voltage reading approximately 6 volts?

- YES >> Inspection End.  
 NO >> Replace rear view camera control unit. Refer to [AV-156](#).  
["Removal and Installation"](#).

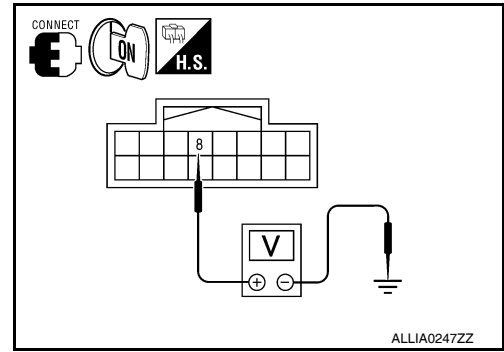

## 4.CHECK GROUND CIRCUIT

- Turn ignition switch OFF.
- Disconnect rear view camera harness connector.
- Check continuity between rear view camera harness connector D551 terminal 2 and ground.

Connector	Terminal	—	Continuity
D551	2	Ground	Yes

Does continuity exist?

- YES >> Inspection End.  
 NO >> Repair harness or connector.

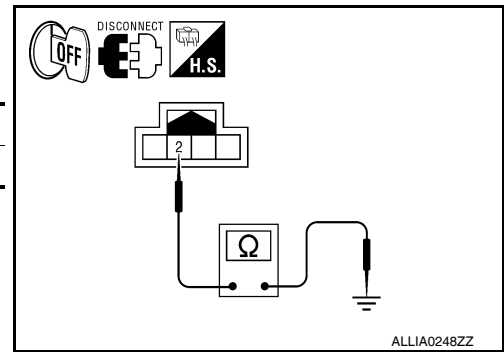

## DVD PLAYER

### DVD PLAYER : Diagnosis Procedure

INFOID:000000005259315

Regarding Wiring Diagram information, refer to [AV-110](#). "Wiring Diagram".

## 1.CHECK FUSE

Check that the following fuses of the DVD player are not blown.

Unit	Terminal	Signal name	Fuse No.
DVD player	21	Battery power	29
	24	Ignition switch ACC or ON	4

Is the fuse OK?

- YES >> GO TO 2  
 NO >> If fuse is blown, be sure to eliminate cause of malfunction before installing new fuse.

## 2.POWER SUPPLY CIRCUIT CHECK

- Disconnect DVD player connector M205.
- Check voltage between the DVD player connector M205 and ground.

(+)		(-)	OFF	ACC	ON
Connector	Terminal				
M205	21	Ground	Battery voltage	Battery voltage	Battery voltage
	24		0V	Battery voltage	Battery voltage

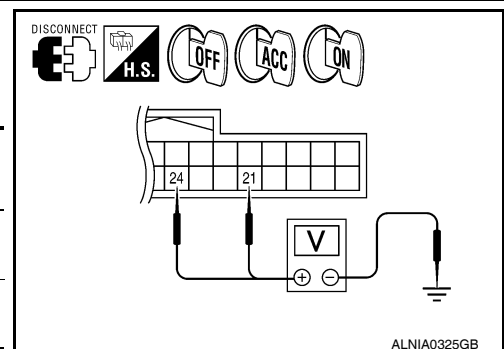

A  
B  
C  
D  
E  
F  
G  
H  
I  
J  
K  
L  
M  
N  
O  
P

AV

# POWER SUPPLY AND GROUND CIRCUIT

[MID AUDIO]

## < COMPONENT DIAGNOSIS >

### Are the voltage results as specified?

- YES >> GO TO 3  
 NO >> • Check connector housings for disconnected or loose terminals.  
 • Repair harness or connector.

### 3. GROUND CIRCUIT CHECK

- Turn ignition switch OFF.
- Check continuity between DVD player harness connector M205 terminal 5 and ground.

Connector	Terminal	—	Continuity
M205	5	Ground	Yes

### Is continuity present?

- YES >> Inspection End.  
 NO >> Repair DVD player ground.

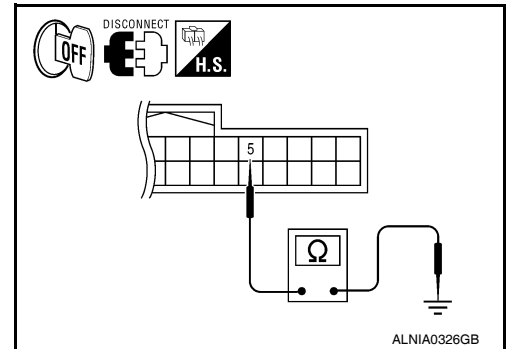

## VIDEO MONITOR

### VIDEO MONITOR : Diagnosis Procedure

INFOID:000000005259316

Regarding Wiring Diagram information, refer to [AV-110. "Wiring Diagram"](#).

### 1. CHECK POWER SUPPLY CIRCUIT

- Turn ignition switch to ACC.
- Check voltage between video monitor harness connector B76 and ground.

Connector	Terminal	Ignition switch position	Value (Approx.)
B76	16	ACC	Battery voltage

### Does battery voltage exist?

- YES >> GO TO 3  
 NO >> GO TO 2

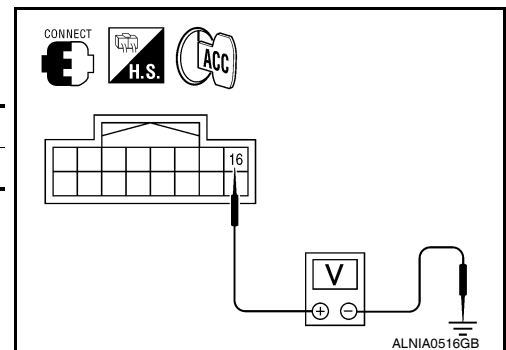

### 2. CHECK POWER SUPPLY CIRCUIT

- Turn ignition switch OFF.
- Disconnect the video monitor connector B76 and the DVD player connector M205.
- Check continuity between the video monitor harness connector B76 (A) and the DVD player connector M205 (B).

A		B		Continuity
Connector	Terminal	Connector	Terminal	
B76	16	M205	9	Yes

- Check continuity between video monitor harness connector B76 (A) and ground.

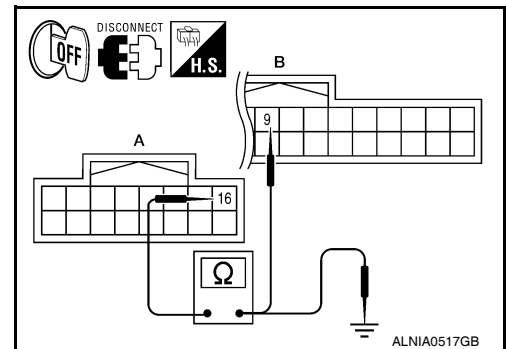

A		—	Continuity
Connector	Terminal		
B76	16	Ground	No

### Are continuity results as specified?



# POWER SUPPLY AND GROUND CIRCUIT

[MID AUDIO]

## < COMPONENT DIAGNOSIS >

- YES >> Check DVD player power and ground supply. Refer to [AV-73. "AV CONTROL UNIT : Diagnosis Procedure"](#).
- NO >> Repair harness or connector.

### 3. CHECK GROUND CIRCUIT

1. Turn ignition switch OFF.
2. Disconnect video monitor connector.
3. Check continuity between video monitor harness connector B76 and ground.

Connector	Terminal	—	Continuity
B76	12	Ground	Yes
	15		

#### Does continuity exist?

- YES >> Inspection End.
- NO >> Repair harness or connector.

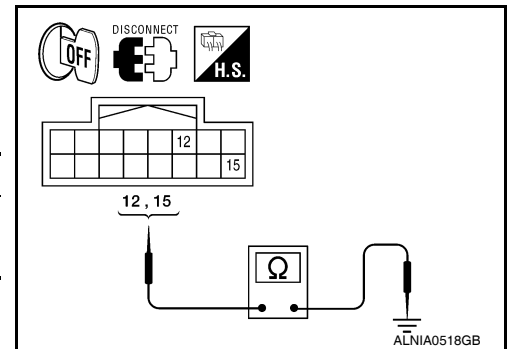

A  
B  
C  
D  
E  
F  
G  
H  
I  
J  
K  
L  
M

AV

O  
P

# RGB (R: RED) SIGNAL CIRCUIT

< COMPONENT DIAGNOSIS >

[MID AUDIO]

## RGB (R: RED) SIGNAL CIRCUIT

### Description

INFOID:000000005259317

Transmit the image displayed with AV control unit with RGB signal to the display unit.

### Diagnosis Procedure

INFOID:000000005259318

Regarding Wiring Diagram information, refer to [AV-110, "Wiring Diagram"](#).

## 1. CHECK CONTINUITY RGB (R: RED) SIGNAL CIRCUIT

1. Turn ignition switch OFF.
2. Disconnect display unit connector M93 and AV control unit connector M133.
3. Check continuity between display unit harness connector M93 (A) terminal 17 and AV control unit harness connector M133 (B) terminal 40.

A		B		Continuity
Connector	Terminal	Connector	Terminal	
M93	17	M133	40	Yes

4. Check continuity between display unit harness connector M93 (A) terminal 17 and ground.

A		—	Continuity
Connector	Terminal		
M93	17	Ground	No

Are the continuity results as specified?

- YES >> GO TO 2  
 NO >> Repair harness or connector.

## 2. CHECK RGB (R: RED) SIGNAL

1. Connect display unit connector M93 and AV control unit connector M133.
2. Turn ignition switch ON.
3. Check signal between display unit harness connector M93 terminal 17 and ground.

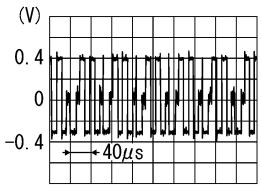
(+)		(-)	Condition	Reference signal
Connector	Terminal			
M93	17	Ground	Receive audio signal	 <p>SKIB2236J</p>

Are the voltage readings as specified?

- YES >> Replace display unit. Refer to [AV-143, "Removal and Installation"](#).  
 NO >> Replace AV control unit. Refer to [AV-141, "Removal and Installation"](#).

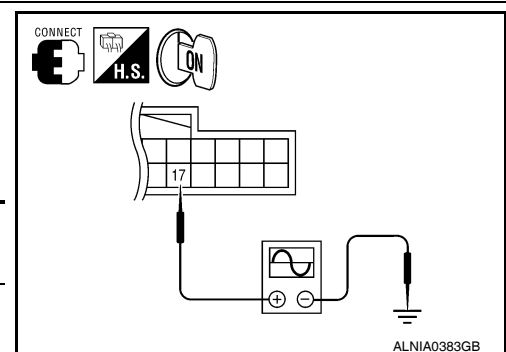
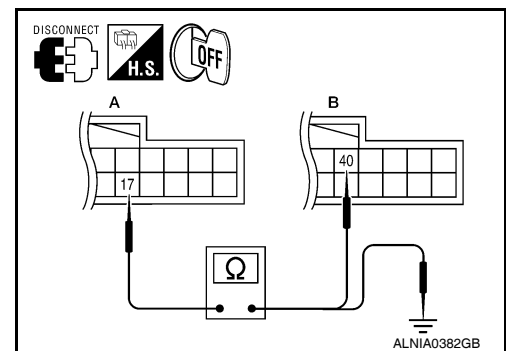

# RGB (G: GREEN) SIGNAL CIRCUIT

< COMPONENT DIAGNOSIS >

[MID AUDIO]

## RGB (G: GREEN) SIGNAL CIRCUIT

### Description

INFOID:000000005259319

Transmit the image displayed with AV control unit with RGB signal to the display unit.

### Diagnosis Procedure

INFOID:000000005259320

Regarding Wiring Diagram information, refer to [AV-110, "Wiring Diagram"](#).

### 1. CHECK CONTINUITY RGB (G: GREEN) SIGNAL CIRCUIT

1. Turn ignition switch OFF.
2. Disconnect display unit connector M93 and AV control unit connector M133.
3. Check continuity between display unit harness connector M93 (A) terminal 6 and AV control unit harness connector M133 (B) terminal 39.

A		B		Continuity
Connector	Terminal	Connector	Terminal	
M93	6	M133	39	Yes

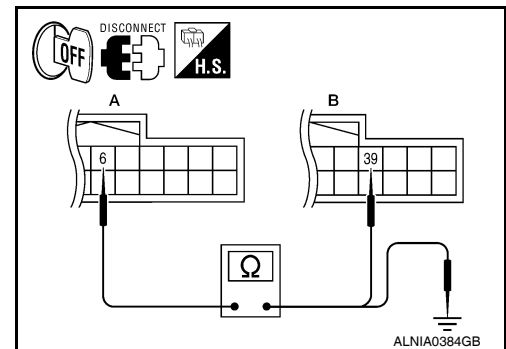

4. Check continuity between display unit harness connector M93 (A) terminal 6 and ground.

A		—	Continuity
Connector	Terminal		
M93	6	Ground	No

Are the continuity results as specified?

YES >> GO TO 2

NO >> Repair harness or connector.

### 2. CHECK RGB (G: GREEN) SIGNAL

1. Connect display unit connector M93 and AV control unit connector M133.
2. Turn ignition switch ON.
3. Check signal between display unit harness connector M93 terminal 6 and ground.

(+)		(-)	Condition	Reference signal
Connector	Terminal			
M93	6	Ground	Receive audio signal	<p>The graph shows a square wave signal oscillating between approximately 0.4V and -0.4V. The time scale is marked as 40µs. The part number SKIB2236J is noted at the bottom right.</p>

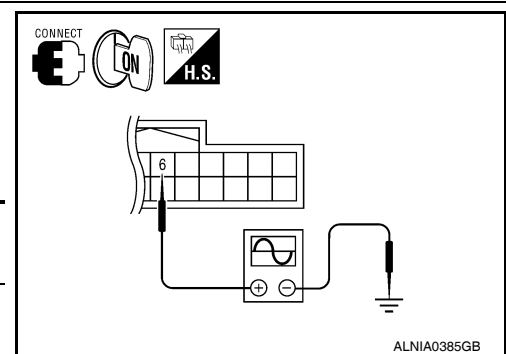

Are voltage readings as specified?

YES >> Replace display unit. Refer to [AV-143, "Removal and Installation"](#).

NO >> Replace AV control unit. Refer to [AV-141, "Removal and Installation"](#).

# RGB (B: BLUE) SIGNAL CIRCUIT

< COMPONENT DIAGNOSIS >

[MID AUDIO]

## RGB (B: BLUE) SIGNAL CIRCUIT

### Description

INFOID:000000005259321

Transmit the image displayed with AV control unit with RGB signal to the display unit.

### Diagnosis Procedure

INFOID:000000005259322

Regarding Wiring Diagram information, refer to [AV-110, "Wiring Diagram"](#).

### 1. CHECK CONTINUITY RGB (B: BLUE) SIGNAL CIRCUIT

1. Turn ignition switch OFF.
2. Disconnect display unit connector M93 and AV control unit connector M133.
3. Check continuity between display unit harness connector M93 (A) terminal 18 and AV control unit harness connector M133 (B) terminal 38.

A		B		Continuity
Connector	Terminal	Connector	Terminal	
M93	18	M133	38	Yes

4. Check continuity between display unit harness connector M93 (A) terminal 18 and ground.

A		—	Continuity
Connector	Terminal		
M93	18	Ground	No

Are continuity results as specified?

- YES >> GO TO 2  
 NO >> Repair harness or connector.

### 2. CHECK RGB (B: BLUE) SIGNAL

1. Connect display unit connector M93 and AV control unit connector M133.
2. Turn ignition switch ON.
3. Check signal between display unit harness connector M93 terminal 18 and ground.

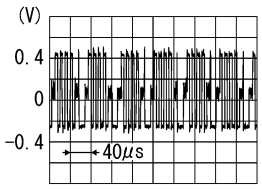
(+)		(-)	Condition	Reference signal
Connector	Terminal			
M93	18	Ground	Receive audio signal	 <p>SKIB2237J</p>

Are voltage readings as specified?

- YES >> Replace display unit. Refer to [AV-143, "Removal and Installation"](#).  
 NO >> Replace AV control unit. Refer to [AV-141, "Removal and Installation"](#).

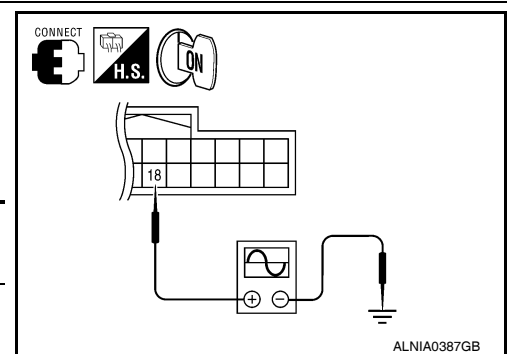
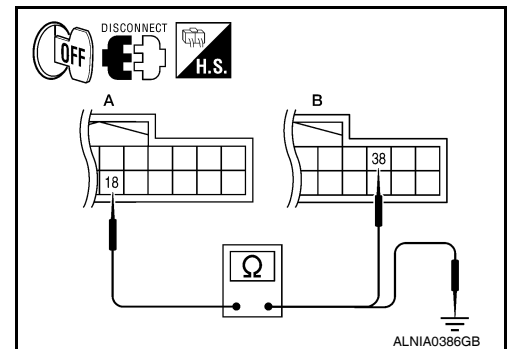

# RGB SYNCHRONIZING SIGNAL CIRCUIT

< COMPONENT DIAGNOSIS >

[MID AUDIO]

## RGB SYNCHRONIZING SIGNAL CIRCUIT

### Description

INFOID:000000005259323

Transmit the RGB synchronizing signal to the display unit so as to synchronize the RGB image displayed with AV control unit.

### Diagnosis Procedure

INFOID:000000005259324

Regarding Wiring Diagram information, refer to [AV-110, "Wiring Diagram"](#).

### 1. CHECK CONTINUITY RGB SYNCHRONIZING SIGNAL CIRCUIT

1. Turn ignition switch OFF.
2. Disconnect display unit connector M93 and AV control unit connector M133.
3. Check continuity between display unit harness connector M93 (A) terminal 19 and AV control unit harness connector M133 (B) terminal 41.

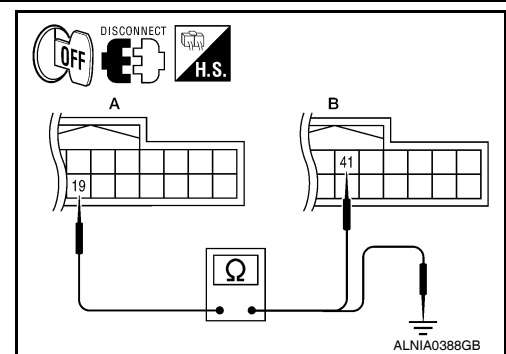

A		B		Continuity
Connector	Terminal	Connector	Terminal	
M93	19	M133	41	Yes

4. Check continuity between display unit harness connector M93 (A) terminal 19 and ground.

A		—	Continuity
Connector	Terminal		
M93	19	Ground	No

Are continuity results as specified?

YES >> GO TO 2

NO >> Repair harness or connector.

### 2. CHECK RGB SYNCHRONIZING SIGNAL

1. Connect display unit connector M93 and AV control unit connector M133.
2. Turn ignition switch ON.
3. Check signal between display unit harness connector M93 terminal 19 and ground.

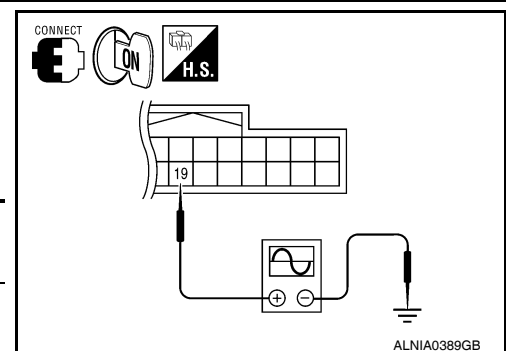

(+) Connector		(-)	Condition	Reference signal
Connector	Terminal			
M93	19	Ground	Receive audio signal	

Are voltage readings as specified?

YES >> Replace display unit. Refer to [AV-143, "Removal and Installation"](#).

NO >> Replace AV control unit. Refer to [AV-141, "Removal and Installation"](#).

# RGB AREA (YS) SIGNAL CIRCUIT

< COMPONENT DIAGNOSIS >

[MID AUDIO]

## RGB AREA (YS) SIGNAL CIRCUIT

### Description

INFOID:000000005259325

Transmits the display area of RGB image displayed by AV control unit with RGB area (YS) signal to display unit.

### Diagnosis Procedure

INFOID:000000005259326

Regarding Wiring Diagram information, refer to [AV-110, "Wiring Diagram"](#).

### 1. CHECK CONTINUITY RGB AREA (YS) SIGNAL CIRCUIT

1. Turn ignition switch OFF.
2. Disconnect display unit connector M93 and AV control unit connector M133.
3. Check continuity between display unit harness connector M93 (A) terminal 9 and AV control unit harness connector M133 (B) terminal 43.

A		B		Continuity
Connector	Terminal	Connector	Terminal	
M93	9	M133	43	Yes

4. Check continuity between display unit harness connector M93 (A) terminal 9 and ground.

A		—	Continuity
Connector	Terminal		
M93	9	Ground	No

Are continuity results as specified?

- YES >> GO TO 2  
 NO >> Repair harness or connector.

### 2. CHECK RGB SYNCHRONIZING SIGNAL

1. Connect display unit connector M93 and AV control unit connector M133.
2. Turn ignition switch ON.
3. Check signal between display unit harness connector M93 terminal 9 and ground.

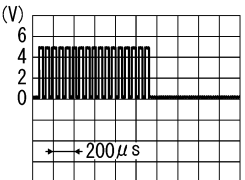
(+)		(-)	Condition	Reference signal
Connector	Terminal			
M93	9	Ground	Receive audio signal	 <p>PK1B4948J</p>

Are voltage readings as specified?

- YES >> Replace display unit. Refer to [AV-143, "Removal and Installation"](#).  
 NO >> Replace AV control unit. Refer to [AV-141, "Removal and Installation"](#).

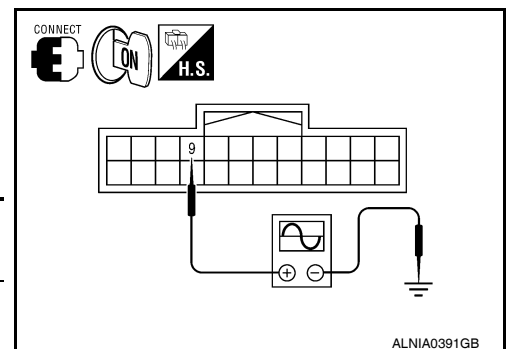
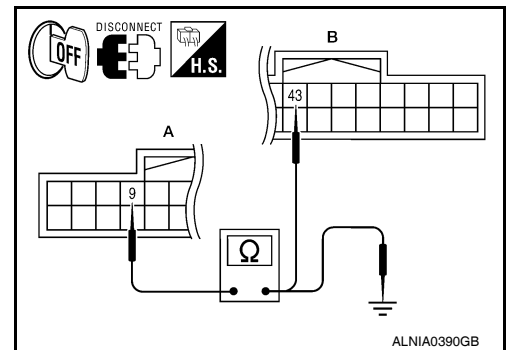

# HORIZONTAL SYNCHRONIZING (HP) SIGNAL CIRCUIT

< COMPONENT DIAGNOSIS >

[MID AUDIO]

## HORIZONTAL SYNCHRONIZING (HP) SIGNAL CIRCUIT

### Description

INFOID:000000005259327

In composite image (AUX image, camera image), transmit the vertical synchronizing (VP) signal and horizontal synchronizing (HP) signal from display unit to AV control unit so as to synchronize the RGB images displayed with AV control unit such as the image quality adjusting menu, etc.

### Diagnosis Procedure

INFOID:000000005259328

Regarding Wiring Diagram information, refer to [AV-110, "Wiring Diagram"](#).

### 1. CHECK CONTINUITY HORIZONTAL SYNCHRONIZING (HP) SIGNAL CIRCUIT

1. Turn ignition switch OFF.
2. Disconnect display unit connector M93 and AV control unit connector M133.
3. Check continuity between display unit harness connector M93 (A) terminal 8 and AV control unit harness connector M133 (B) terminal 45.

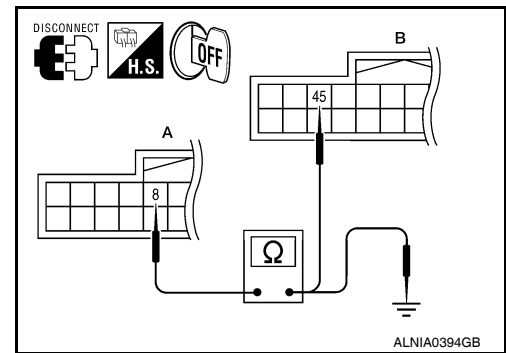

A		B		Continuity
Connector	Terminal	Connector	Terminal	
M93	8	M133	45	Yes

4. Check continuity between display unit harness connector M93 (A) terminal 8 and ground.

A		—	Continuity
Connector	Terminal		
M93	8	Ground	No

Are continuity results as specified?

YES >> GO TO 2

NO >> Repair harness or connector.

### 2. CHECK HORIZONTAL SYNCHRONIZING (HP) SIGNAL

1. Connect display unit connector M93 and AV control unit connector M133.
2. Turn ignition switch ON.
3. Check signal between display unit harness connector M93 terminal 8 and ground.

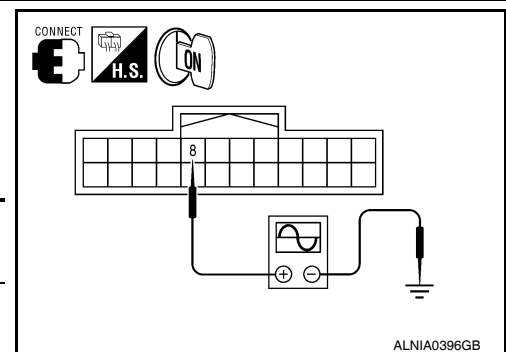

(+) Connector		(-)	Condition	Reference signal
Connector	Terminal			
M93	8	Ground	Receive audio signal	

Are voltage readings as specified?

YES >> Replace AV control unit. Refer to [AV-141, "Removal and Installation"](#).

NO >> Replace display unit. Refer to [AV-143, "Removal and Installation"](#).

# VERTICAL SYNCHRONIZING (VP) SIGNAL CIRCUIT

< COMPONENT DIAGNOSIS >

[MID AUDIO]

## VERTICAL SYNCHRONIZING (VP) SIGNAL CIRCUIT

### Description

INFOID:000000005259329

In composite image (AUX image, camera image), transmit the vertical synchronizing (VP) signal and horizontal synchronizing (HP) signal from display unit to AV control unit so as to synchronize the RGB images displayed with AV control unit such as the image quality adjusting menu, etc.

### Diagnosis Procedure

INFOID:000000005259330

Regarding Wiring Diagram information, refer to [AV-110, "Wiring Diagram"](#).

## 1. CHECK CONTINUITY VERTICAL SYNCHRONIZING (VP) SIGNAL CIRCUIT

1. Turn ignition switch OFF.
2. Disconnect display unit connector M93 and AV control unit connector M133.
3. Check continuity between display unit harness connector M93 (A) terminal 20 and AV control unit harness connector M133 (B) terminal 57.

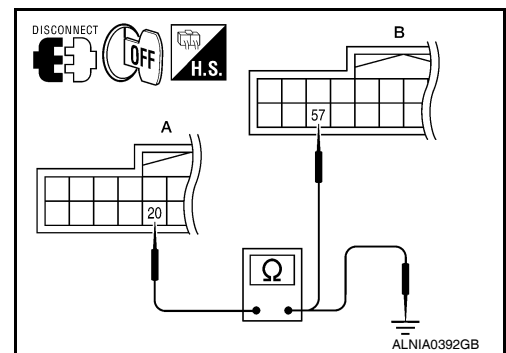

A		B		Continuity
Connector	Terminal	Connector	Terminal	
M93	20	M133	57	Yes

4. Check continuity between display unit harness connector M93 (A) terminal 20 and ground.

A		—	Continuity
Connector	Terminal		
M93	20	Ground	No

Are continuity results as specified?

- YES >> GO TO 2  
 NO >> Repair harness or connector.

## 2. CHECK VERTICAL SYNCHRONIZING (VP) SIGNAL

1. Connect display unit connector M93 and AV control unit connector M133.
2. Turn ignition switch ON.
3. Check signal between display unit harness connector M93 terminal 20 and ground.

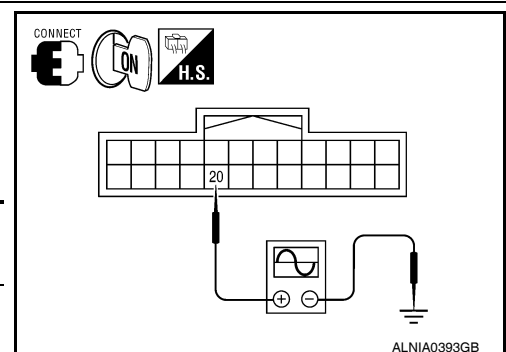

(+)		(-)	Condition	Reference signal
Connector	Terminal			
M93	20	Ground	Receive audio signal	

Are voltage readings as specified?

- YES >> Replace AV control unit. Refer to [AV-141, "Removal and Installation"](#).  
 NO >> Replace display unit. Refer to [AV-143, "Removal and Installation"](#).



# FRONT DOOR SPEAKER

< COMPONENT DIAGNOSIS >

[MID AUDIO]

## FRONT DOOR SPEAKER

### Description

INFOID:000000005259331

The AV control unit sends audio signals to the front door speakers using the front door speaker circuits.

### Diagnosis Procedure

INFOID:000000005259332

Regarding Wiring Diagram information, refer to [AV-110, "Wiring Diagram"](#).

## 1. HARNESS CHECK

1. Disconnect AV control unit connector M131 and suspect speaker connector.
2. Check continuity between AV control unit harness connector M131 (A) terminal and suspect speaker harness connector (B) terminal.

A		B		Continuity
Connector	Terminal	Connector	Terminal	
M131	2	D12	1	Yes
	3		2	
	11	D112	1	
	12		2	

3. Check continuity between AV control unit harness connector M131 (A) terminal and ground.

A		—	Continuity
Connector	Terminal		
M131	2	Ground	No
	3		
	11		
	12		

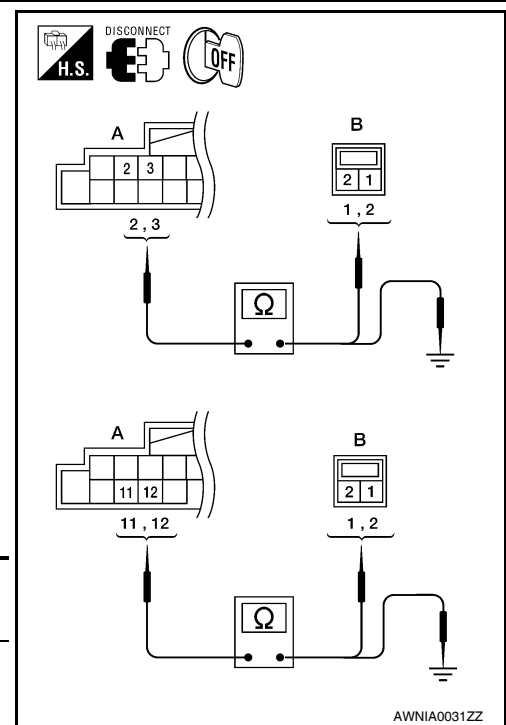

### Are continuity results as specified?

YES >> GO TO 2

- NO >> • Check connector housings for disconnected or loose terminals.  
• Repair harness or connector.

## 2. FRONT SPEAKER SIGNAL CHECK

A  
B  
C  
D  
E  
F  
G  
H  
I  
J  
K  
L  
M  
O  
P

AV

# FRONT DOOR SPEAKER

[MID AUDIO]

## < COMPONENT DIAGNOSIS >

1. Connect AV control unit connector M131 and front speaker connector.
2. Turn ignition switch to ACC.
3. Push "POWER" switch.
4. Check the signal between AV control unit harness connector M131 terminals with CONSULT-III or oscilloscope.

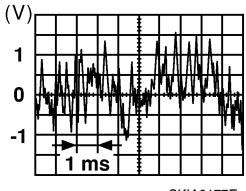
Con- nec- tor	(+) (-)		Condi- tion	Reference signal
	Termi- nal	Termi- nal		
M131	2	3	Receive audio signal	
	11	12		

Is the audio signal voltage as specified?

- YES >> Replace speaker. Refer to [AV-145, "Removal and Installation"](#).
- NO >> Replace AV control unit. Refer to [AV-141, "Removal and Installation"](#).

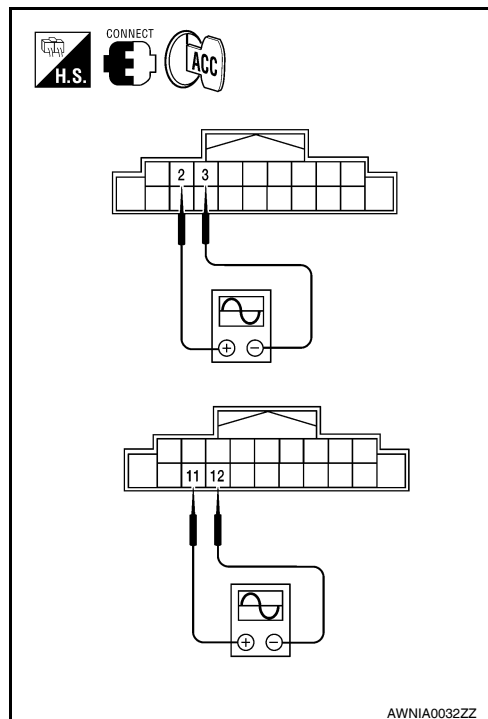

# FRONT TWEETER

< COMPONENT DIAGNOSIS >

[MID AUDIO]

## FRONT TWEETER

### Description

INFOID:000000005259333

The AV control unit sends audio signals to the front tweeters using the front tweeter circuits.

### Diagnosis Procedure

INFOID:000000005259334

Regarding Wiring Diagram information, refer to [AV-110, "Wiring Diagram"](#).

## 1. HARNESS CHECK

1. Disconnect AV control unit connector M131 and suspect front tweeter connector.
2. Check continuity between AV control unit harness connector M131 (A) and suspect front tweeter harness connector (B).

A		B		Continuity
Connector	Terminal	Connector	Terminal	
M131	2	M109	1	Yes
	3		2	
	11	M111	1	
	12		2	

3. Check continuity between AV control unit harness connector M131 (A) and ground.

A		—	Continuity
Connector	Terminal		
M131	2	Ground	No
	3		
	11		
	12		

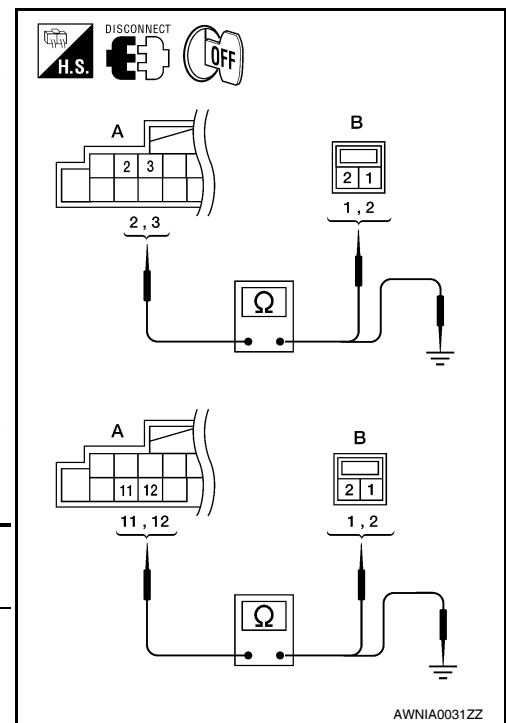

Are the continuity results as specified?

YES >> GO TO 2

- NO >> • Check connector housings for disconnected or loose terminals.  
• Repair harness or connector.

## 2. FRONT TWEETER SIGNAL CHECK

A  
B  
C  
D  
E  
F  
G  
H  
I  
J  
K  
L  
M  
O  
P

AV

# FRONT TWEETER

[MID AUDIO]

## < COMPONENT DIAGNOSIS >

1. Connect AV control unit connector M131 and front tweeter connector.
2. Turn ignition switch to ACC.
3. Push "POWER" switch.
4. Check the signal between AV control unit harness connector M131 terminals with CONSULT-III or oscilloscope.

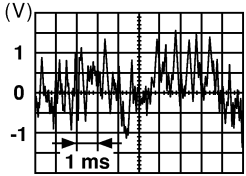
(+)		(-)		Condi- tion	Reference signal
Connector	Terminal	Terminal	Terminal		
M131	2	3	11	12	 <p style="text-align: center;">SKIA0177E</p>
	11	12			

Is the audio signal voltage as specified?

- YES >> Replace the suspect front tweeter. Refer to [AV-144, "Removal and Installation"](#).
- NO >> Replace AV control unit. Refer to [AV-141, "Removal and Installation"](#).

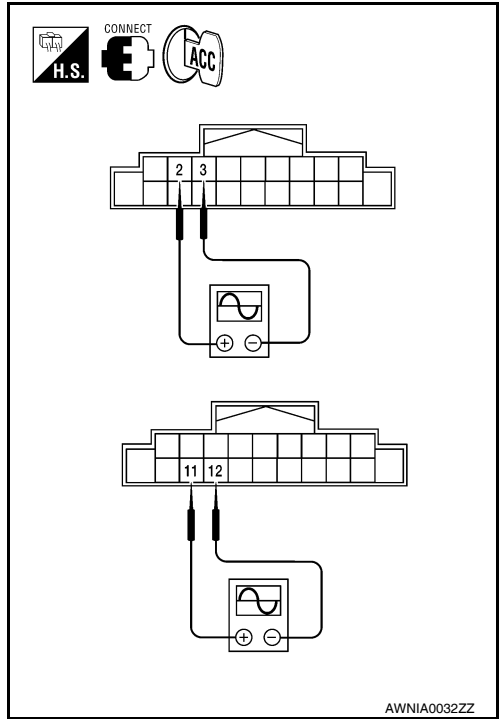

# REAR DOOR SPEAKER

< COMPONENT DIAGNOSIS >

[MID AUDIO]

## REAR DOOR SPEAKER

### Description

INFOID:000000005259335

The AV control unit sends audio signals to the rear speakers using the rear speaker circuits.

### Diagnosis Procedure

INFOID:000000005259336

Regarding Wiring Diagram information, refer to [AV-110, "Wiring Diagram"](#).

## 1. HARNESS CHECK

1. Disconnect AV control unit connector M131 and suspect rear speaker connector.
2. Check continuity between AV control unit harness connector M131 (A) and suspect rear speaker harness connector (B).

A		B		Continuity
Connector	Terminal	Connector	Terminal	
M131	4	D209	1	Yes
	5		2	
	13	D309	1	
	14		2	

3. Check continuity between AV control unit harness connector M131 (A) and ground.

A		—	Continuity
Connector	Terminal		
M131	4	Ground	No
	5		
	13		
	14		

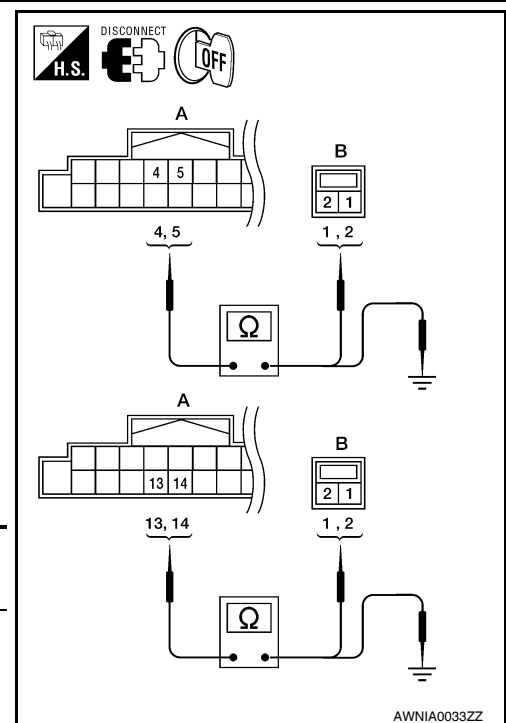

Are the continuity results as specified?

YES >> GO TO 2

NO >> • Check connector housings for disconnected or loose terminals.  
• Repair harness or connector.

## 2. REAR SPEAKER SIGNAL CHECK

AV

# REAR DOOR SPEAKER

[MID AUDIO]

## < COMPONENT DIAGNOSIS >

1. Connect AV control unit connector and rear speaker connector.
2. Turn ignition switch to ACC.
3. Push "POWER" switch.
4. Check the signal between AV control unit harness connector M131 terminals with CONSULT-III or oscilloscope.

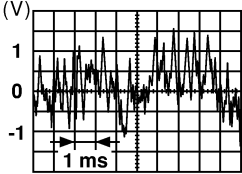
(+)		(-)		Condition	Reference signal
Connector	Terminal	Terminal	Terminal		
M131	4	5	14	Receive audio signal	 <p>(V)</p> <p>1</p> <p>0</p> <p>-1</p> <p>1 ms</p> <p>SKIA0177E</p>
		13			

Is the audio signal voltage as specified?

YES >> Replace the suspect rear door speaker. Refer to [AV-146. "Removal and Installation"](#).

NO >> Replace AV control unit. Refer to [AV-141. "Removal and Installation"](#).

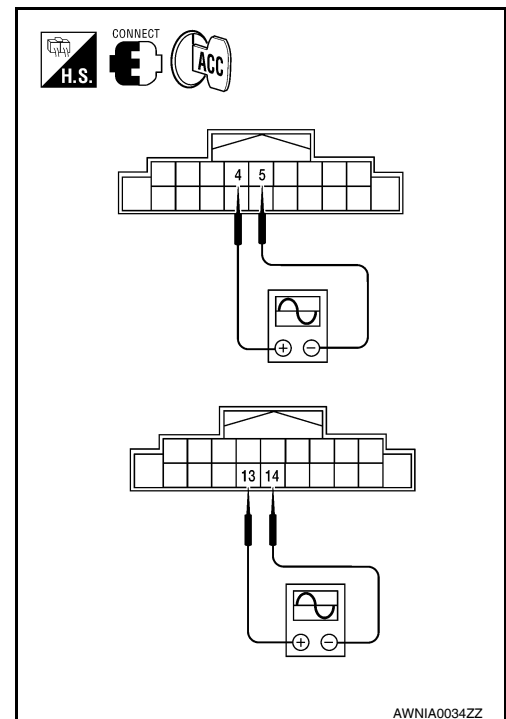

# STEERING SWITCH

< COMPONENT DIAGNOSIS >

[MID AUDIO]

## STEERING SWITCH

### Description

INFOID:000000005259337

When one of the steering wheel AV control switches is pushed, the resistance in the steering wheel AV control switch circuit changes depending on which button is pushed.

### Diagnosis Procedure

INFOID:000000005259338

Regarding Wiring Diagram information, refer to [AV-110, "Wiring Diagram"](#).

### 1. CHECK STEERING WHEEL AUDIO CONTROL SWITCH RESISTANCE

1. Disconnect steering wheel audio control switch connector M102.
2. Check resistance between steering switch connector terminals.

Terminal	Signal name	Condition	Resistance (Ω) (Approx.)	
16	17	Seek (down)	Depress ▽ switch.	165
		Volume (down)	Depress VOL down switch.	487
		Power	Depress PWR switch.	0
20	17	Seek (up)	Depress △ switch.	165
		Volume (up)	Depress VOL up switch.	487
		Mode	Depress MODE switch.	0

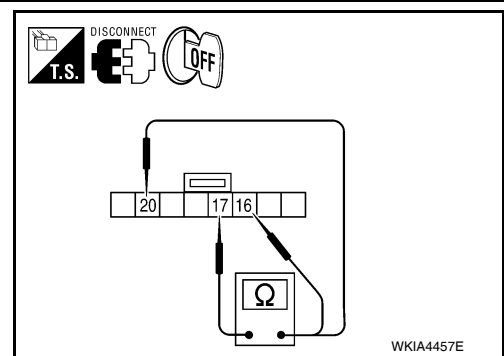

Do the steering wheel audio control switches check OK?

YES >> GO TO 2

NO >> Replace steering wheel audio control switch. Refer to [AV-147, "Removal and Installation"](#).

### 2. CHECK HARNESS

1. Turn ignition switch OFF.
2. Disconnect AV control unit connector M131 and spiral cable connector M30.
3. Check continuity between AV control unit harness connector M131 (A) and spiral cable harness connector M30 (B).

A		B		Continuity
Connector	Terminal	Connector	Terminal	
M131	6	M30	24	Yes
	15		31	
	16		32	

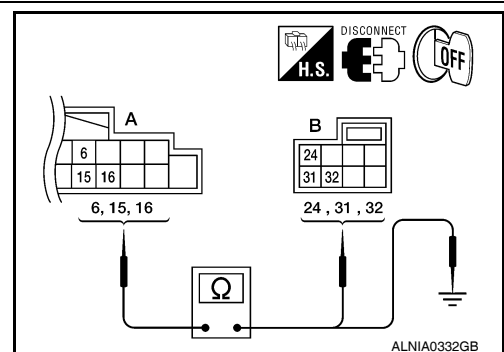

4. Check continuity between AV control unit connector 1312 (A) and ground.

A		—	Continuity
Connector	Terminal		
M131	6	Ground	No
	15		
	16		

Are the continuity results as specified?

YES >> GO TO 3

A  
B  
C  
D  
E  
F  
G  
H  
I  
J  
K  
L  
M  
N  
O  
P

AV

# STEERING SWITCH

[MID AUDIO]

## < COMPONENT DIAGNOSIS >

NO >> Repair harness.

### 3. SPIRAL CABLE CHECK

1. Disconnect spiral cable connector M102.
2. Check continuity between spiral cable harness connector M30 (A) and M102 (B).

A		B		Continuity
Connector	Terminal	Connector	Terminal	
M30	24	M102	20	Yes
	31		17	
	32		16	

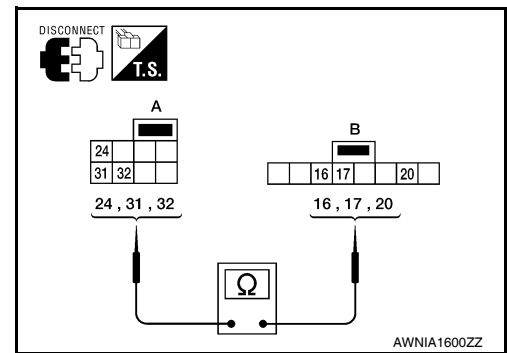

Is continuity present?

YES >> Inspection End.

NO >> Replace spiral cable. Refer to [SR-7, "Removal and Installation"](#).



# COMMUNICATION SIGNAL CIRCUIT

[MID AUDIO]

< COMPONENT DIAGNOSIS >

## COMMUNICATION SIGNAL CIRCUIT SATELLITE RADIO TUNER

### SATELLITE RADIO TUNER : Description

INFOID:000000005259339

Communication signals are exchanged between the AV control unit and satellite radio tuner using the communication circuits.

### SATELLITE RADIO TUNER : Diagnosis Procedure

INFOID:000000005259340

Regarding Wiring Diagram information, refer to [AV-110, "Wiring Diagram"](#).

#### 1.CHECK HARNESS - 1

1. Turn ignition switch OFF.
2. Disconnect satellite radio tuner (factory installed) connector M41 and AV control unit connector M43.
3. Check continuity between satellite radio tuner (factory installed) harness connector M41 (A) terminal 28 and AV control unit harness connector M43 (B) terminal 28.

A		B		Continuity
Connector	Terminal	Connector	Terminal	
M41	28	M43	28	Yes

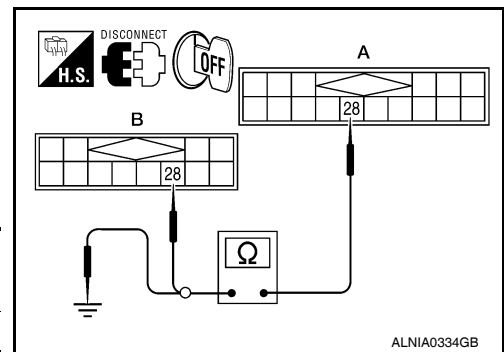

4. Check continuity between satellite radio tuner (factory installed) harness connector M41 (A) terminal 28 and ground.

A		—	Continuity
Connector	Terminal		
M41	28	Ground	No

Are continuity results as specified?

YES >> GO TO 2

NO >> Repair harness or connector.

#### 2.CHECK HARNESS - 2

1. Check continuity between satellite radio tuner (factory installed) harness connector M41 (A) terminal 29 and AV control unit harness connector M43 (B) terminal 29.

A		B		Continuity
Connector	Terminal	Connector	Terminal	
M41	29	M43	29	Yes

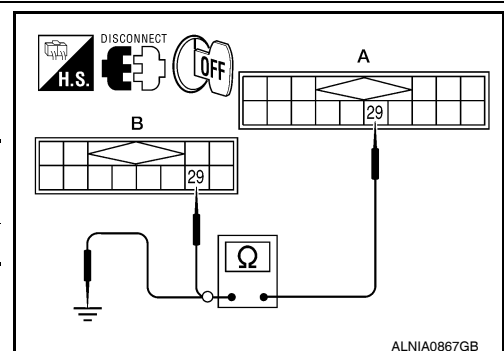

2. Check continuity between satellite radio tuner (factory installed) harness connector M41 (A) terminal 29 and ground.

A		—	Continuity
Connector	Terminal		
M41	29	Ground	No

Are continuity results as specified?

YES >> GO TO 3

NO >> Repair harness or connector.

A  
B  
C  
D  
E  
F  
G  
H  
I  
J  
K  
L  
M  
N  
O  
P

AV

# COMMUNICATION SIGNAL CIRCUIT

< COMPONENT DIAGNOSIS >

[MID AUDIO]

## 3. CHECK HARNESS - 3

1. Check continuity between satellite radio tuner (factory installed) harness connector M41 (A) terminal 30 and AV control unit harness connector M43 (B) terminal 30.

A		B		Continuity
Connector	Terminal	Connector	Terminal	
M41	30	M43	30	Yes

2. Check continuity between satellite radio tuner (factory installed) harness connector M41 (A) terminal 30 and ground.

A		—	Continuity
Connector	Terminal		
M41	30	Ground	No

Are continuity results as specified?

- YES >> GO TO 4  
 NO >> Repair harness or connector.

## 4. CHECK REQ1 SIGNAL

1. Connect satellite radio tuner (factory installed) connector and AV control unit connector.
2. Turn ignition switch to ACC
3. Check signal between satellite radio tuner (factory installed) harness connector M41 terminal 28 and ground with CONSULT-III or oscilloscope.

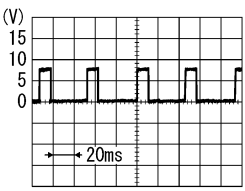
(+)		(-)	Reference signal
Connector	Terminal		
M41	28	Ground	 <p>SKIB3825E</p>

Are voltage readings as specified?

- YES >> GO TO 5  
 NO >> Replace AV control unit. Refer to [AV-141, "Removal and Installation"](#).

## 5. CHECK TXD SIGNAL

Check signal between satellite radio tuner (factory installed) harness connector M41 terminal 29 and ground with CONSULT-III or oscilloscope.

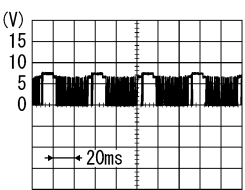
(+)		(-)	Reference signal
Connector	Terminal		
M41	29	Ground	 <p>SKIB3824E</p>

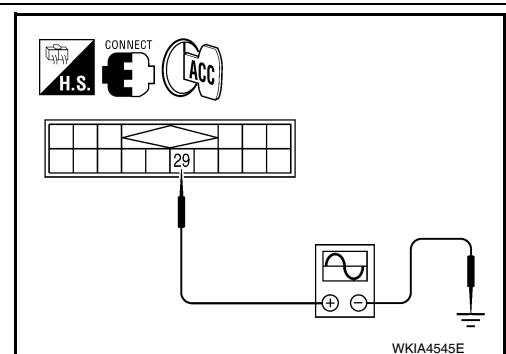
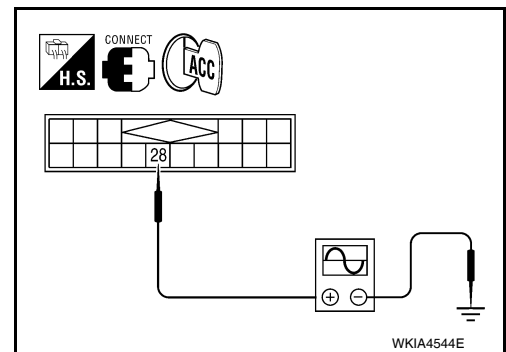
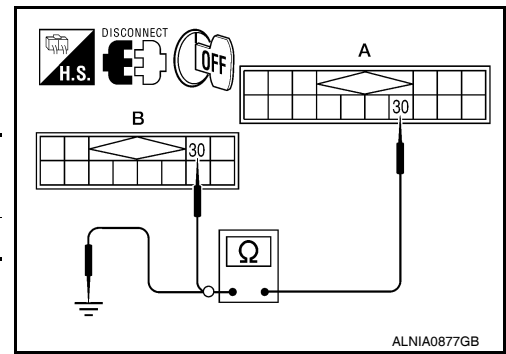

# COMMUNICATION SIGNAL CIRCUIT

[MID AUDIO]

< COMPONENT DIAGNOSIS >

Are the voltage readings as specified?

YES >> GO TO 6

NO >> Replace satellite radio tuner. Refer to [AV-154. "Removal and Installation"](#).

## 6. CHECK RXD SIGNAL

Check signal between satellite radio tuner (factory installed) harness connector M41 terminal 30 and ground with CONSULT-III or oscilloscope.

(+)		(-)	Reference signal
Connector	Terminal		
M41	30	Ground	

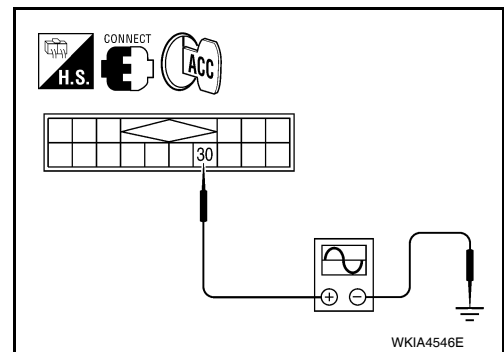

Are the voltage readings as specified?

YES >> Replace satellite radio tuner. Refer to [AV-154. "Removal and Installation"](#).

NO >> Replace AV control unit. Refer to [AV-141. "Removal and Installation"](#).

A  
B  
C  
D  
E  
F  
G  
H  
I  
J  
K  
L  
M  
O  
P

AV

# SOUND SIGNAL CIRCUIT

< COMPONENT DIAGNOSIS >

[MID AUDIO]

## SOUND SIGNAL CIRCUIT SATELLITE RADIO TUNER

### SATELLITE RADIO TUNER : Description

INFOID:000000005259341

Left and right channel audio signals are supplied from the satellite radio tuner to the AV control unit through the sound signal circuits.

### SATELLITE RADIO TUNER : Diagnosis Procedure

INFOID:000000005259342

Regarding Wiring Diagram information, refer to [AV-110, "Wiring Diagram"](#).

#### LEFT CHANNEL

##### 1. CHECK HARNESS

1. Turn ignition switch OFF.
2. Disconnect satellite radio tuner (factory installed) connector M41 and AV control unit connector M43.
3. Check continuity between satellite radio tuner (factory installed) connector M41 (A) and AV control unit connector M43 (B).

A		B		Continuity
Connector	Terminal	Connector	Terminal	
M41	21	M43	21	Yes
	22		22	

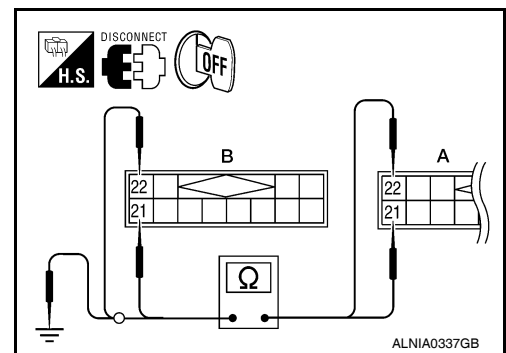

4. Check continuity between satellite radio tuner (factory installed) connector M41 (A) and ground.

A		—	Continuity
Connector	Terminal		
M41	21	Ground	No
	22		

Are continuity results as specified?

YES >> GO TO 2

NO >> Repair harness or connector.

##### 2. CHECK LEFT CHANNEL AUDIO SIGNAL

1. Connect satellite radio tuner (factory installed) and AV control unit.
2. Turn ignition switch ON.
3. Check signal between satellite radio tuner (factory installed) connector M41 terminals 21 and 22 with CONSULT-III or oscilloscope.

(+)		(-)	Reference signal
Connector	Terminal		
M41	22	21	<p>SKIB3609E</p>

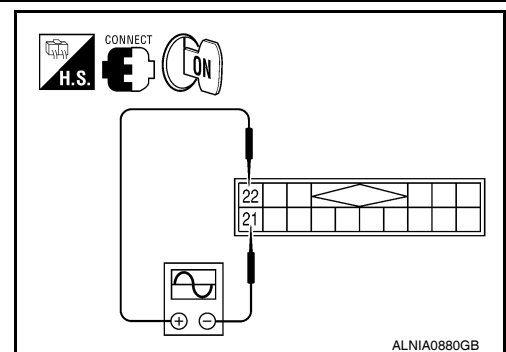

# SOUND SIGNAL CIRCUIT

[MID AUDIO]

## < COMPONENT DIAGNOSIS >

### Are voltage readings as specified?

- YES >> Replace AV control unit. Refer to [AV-141, "Removal and Installation"](#).  
 NO >> Replace satellite radio tuner. Refer to [AV-154, "Removal and Installation"](#).

### RIGHT CHANNEL

#### 1. CHECK HARNESS

- Turn ignition switch OFF.
- Disconnect satellite radio tuner (factory installed) connector M41 and AV control unit connector M43.
- Check continuity between satellite radio tuner (factory installed) M41 (A) and AV control unit M43 (B).

A		B		Continuity
Connector	Terminal	Connector	Terminal	
M41	23	M43	23	Yes
	24		24	

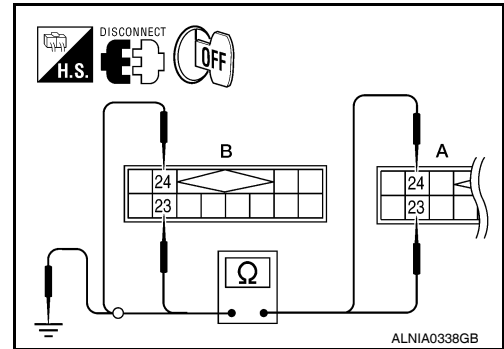

- Check continuity between satellite radio tuner (factory installed) connector M41 (A) and ground.

A		—	Continuity
Connector	Terminal		
M41	23	Ground	No
	24		

### Are continuity results as specified?

- YES >> GO TO 2  
 NO >> Repair harness or connector.

#### 2. CHECK RIGHT CHANNEL AUDIO SIGNAL

- Connect satellite radio tuner (factory installed) and AV control unit.
- Turn ignition switch ON.
- Check signal between satellite radio tuner (factory installed) connector M41 terminals 23 and 24 with CONSULT-III or oscilloscope.

(+) Connector		Terminal	(-)	Reference signal
Connector	Terminal			
M41	24	23		

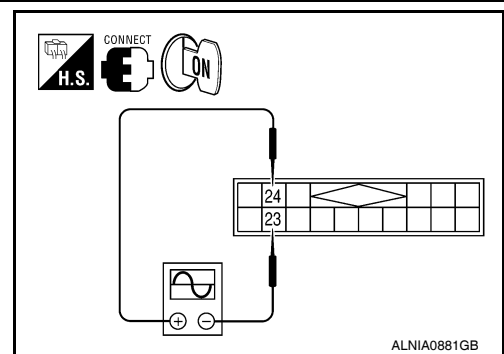

### Are voltage readings as specified?

- YES >> Replace AV control unit. Refer to [AV-141, "Removal and Installation"](#).  
 NO >> Replace satellite radio tuner. Refer to [AV-154, "Removal and Installation"](#).

A  
B  
C  
D  
E  
F  
G  
H  
I  
J  
K  
L  
M  
O  
P

AV

# AV CONTROL UNIT

< ECU DIAGNOSIS >

[MID AUDIO]

## ECU DIAGNOSIS

### AV CONTROL UNIT

#### Reference Value

INFOID:000000005259343

#### VALUES ON THE DIAGNOSIS TOOL

CONSULT-III data monitor item

Display Item	Dis-play	Vehicle status	Remarks
VHCL SPD SIG	ON	Vehicle speed >0 km/h (0 MPH)	Changes in indication may be delayed. This is normal.
	OFF	Vehicle speed =0 km/h (0 MPH)	
PKB SIG	ON	Parking brake is applied.	Changes in indication may be delayed. This is normal.
	OFF	Parking brake is released.	
ILLUM SIG	ON	Block the light beam from the auto light optical sensor when the light SW is ON .	—
	OFF	Expose the auto light optical sensor to light when the light SW is OFF or ON.	
IGN SIG	ON	Ignition switch ON	—
	OFF	Ignition switch in ACC position	
REV SIG	ON	Selector lever in R position	Changes in indication may be delayed. This is normal.
	OFF	Selector lever in any position other than R	

#### TERMINAL LAYOUT

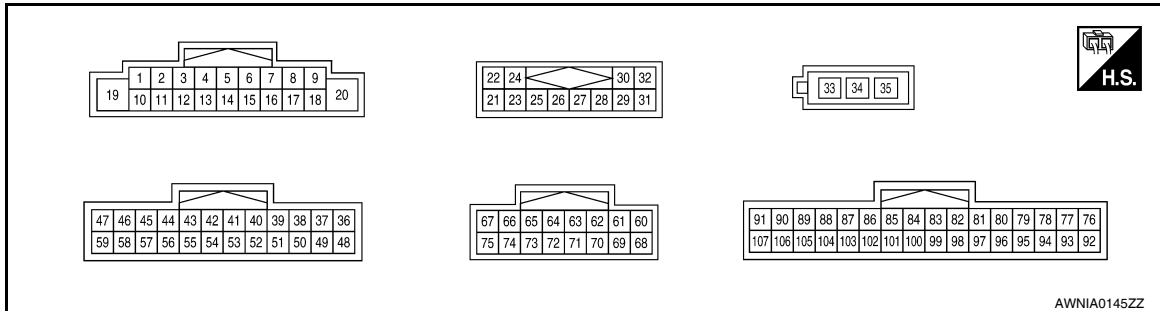

#### PHYSICAL VALUES

# AV CONTROL UNIT

< ECU DIAGNOSIS >

[MID AUDIO]

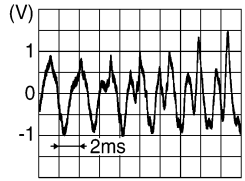
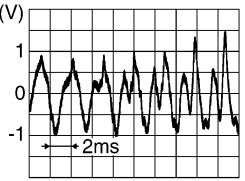
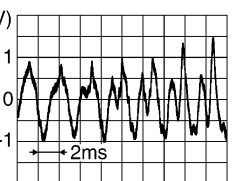
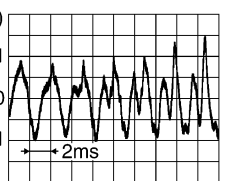
Terminal (Wire color)		Description		Condition		Reference value (Approx.)
+	-	Signal name	Input/ Output			
2 (BR)	3 (L)	Sound signal front door speaker and front tweeter LH	Output	Ignition switch ON	Audio output	 SKIB3609E
4 (G)	5 (B)	Sound signal rear door speaker and rear tweeter LH	Output	Ignition switch ON	Audio output	 SKIB3609E
6 (Y)	15 (L)	Steering switch signal A	Input	Ignition switch ON	Press and hold MODE switch.	0V
					Press and hold Δ switch.	0.75V
					Press and hold VOL up switch	2V
					Except for above.	5V
7 (G/Y)	Ground	ACC power supply	Input	Ignition switch ACC	—	Battery voltage
9 (V)	Ground	Illumination signal	Input	OFF	Lighting switch is OFF.	0V
					Lighting switch is ON.	Battery voltage
11 (LG)	12 (R)	Sound signal front door speaker and front tweeter RH	Output	Ignition switch ON	Voice output	 SKIB3609E
13 (GR)	14 (O)	Sound signal rear door speaker and rear tweeter RH	Output	Ignition switch ON	Voice output	 SKIB3609E
15 (L)	Ground	Steering switch signal GND	—	Ignition switch ON	—	0V

A  
B  
C  
D  
E  
F  
G  
H  
I  
J  
K  
L  
M  
O  
P

AV

# AV CONTROL UNIT

< ECU DIAGNOSIS >

[MID AUDIO]

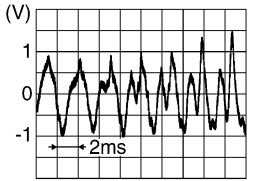
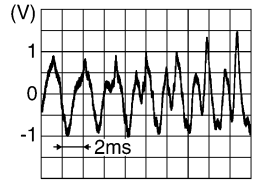
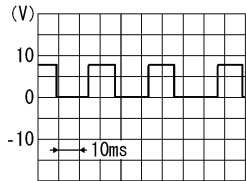
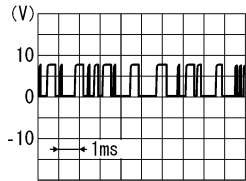
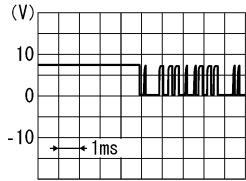
Terminal (Wire color)		Description		Condition		Reference value (Approx.)
+	-	Signal name	Input/ Output			
16 (G)	15 (L)	Steering switch signal B	Input	Ignition switch ON	Press and hold POWER switch	0V
					Press and hold ∇ switch	0.75V
					Press and hold VOL down switch	2V
					Except for above	5V
19 (Y)	Ground	Battery power supply	Input	Ignition switch OFF	—	Battery voltage
20 (B)	Ground	Ground	—	Ignition switch ON	—	0V
22 (R)	21 (G)	Satellite radio sound signal LH	Input	Ignition switch ON	When satellite radio mode is selected	 <p style="text-align: right; font-size: small;">SKIB3609E</p>
24 (B)	23 (W)	Satellite radio sound signal RH	Input	Ignition switch ON	When satellite radio mode is selected	 <p style="text-align: right; font-size: small;">SKIB3609E</p>
28 (O)	Ground	Request signal (SAT→CONT)	Input	Ignition switch ON	When satellite radio mode is selected	 <p style="text-align: right; font-size: small;">SKIA9299J</p>
29 (P)	Ground	Communication signal (SAT→CONT)	Input	Ignition switch ON	When satellite radio mode is selected	 <p style="text-align: right; font-size: small;">SKIA9300J</p>
30 (L)	Ground	Communication signal (CONT→SAT)	Output	Ignition switch ON	When satellite radio mode is selected	 <p style="text-align: right; font-size: small;">SKIA9301J</p>
34	—	Antenna main	—	—	—	—



# AV CONTROL UNIT

< ECU DIAGNOSIS >

[MID AUDIO]

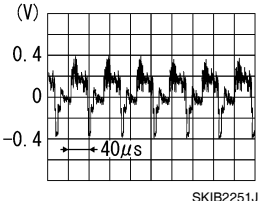
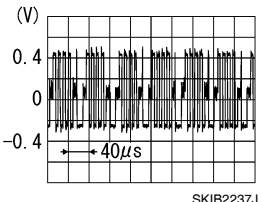
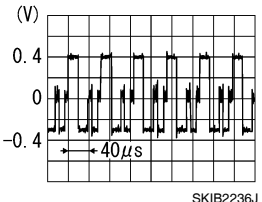
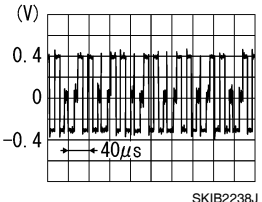
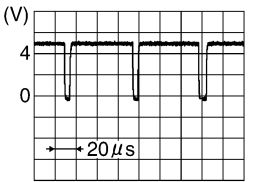
Terminal (Wire color)		Description		Condition		Reference value (Approx.)
+	-	Signal name	Input/ Output			
35	—	Antenna power	Output	Ignition switch ON	With AM/FM radio selected	12V
36 (G)	Ground	AUX image signal	Output	Ignition switch ON	When AUX mode is select- ed	 <p style="text-align: right; font-size: small;">SKIB2251J</p>
37 (R)	Ground	AUX image ground	—	Ignition switch ON	—	0V
38 (R)	Ground	RGB signal (B: blue)	Output	Ignition switch ON	Start confirmation/adjust- ment mode, and then dis- play color bar by selecting "Color Spectrum Bar" on DISPLAY DIAGNOSIS screen.	 <p style="text-align: right; font-size: small;">SKIB2237J</p>
39 (B)	Ground	RGB signal (G: green)	Output	Ignition switch ON	Start confirmation/adjust- ment mode, and then dis- play color bar by selecting "Color Spectrum Bar" on DISPLAY DIAGNOSIS screen.	 <p style="text-align: right; font-size: small;">SKIB2236J</p>
40 (W)	Ground	RGB signal (R: red)	Output	Ignition switch ON	Start confirmation/adjust- ment mode, and then dis- play color bar by selecting "Color Spectrum Bar" on DISPLAY DIAGNOSIS screen.	 <p style="text-align: right; font-size: small;">SKIB2238J</p>
41 (R)	Ground	RGB synchronizing signal	Output	Ignition switch ON	—	 <p style="text-align: right; font-size: small;">SKIB3603E</p>
42	—	RGB synchronizing ground	—	Ignition switch ON	—	0V

A  
B  
C  
D  
E  
F  
G  
H  
I  
J  
K  
L  
M  
P

AV

# AV CONTROL UNIT

< ECU DIAGNOSIS >

[MID AUDIO]

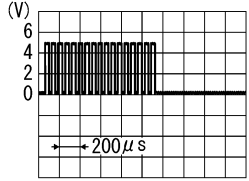
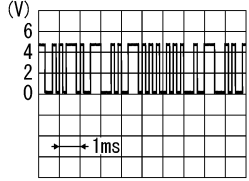
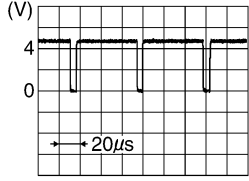
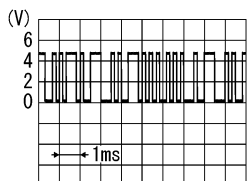
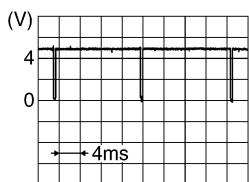
Terminal (Wire color)		Description		Condition	Reference value (Approx.)	
+	-	Signal name	Input/ Output			
43 (G)	Ground	RGB area (YS) signal	Output	Ignition switch ON	5V	
				RGB image	AUX image	 <p style="text-align: right; font-size: small;">PKIB4948J</p>
44 (LG)	Ground	Communication signal (DISP→CONT)	Input	Ignition switch ON	When adjusting display-brightness	 <p style="text-align: right; font-size: small;">PKIB5039J</p>
45 (B)	Ground	Horizontal synchronizing (HP) signal	Input	Ignition switch ON	—	 <p style="text-align: right; font-size: small;">SKIB3601E</p>
46 (BR)	Ground	Signal ground	—	Ignition switch	—	0V
47 (R)	Ground	Signal VCC	Output	Ignition switch ACC	—	9V
54 (B)	Ground	Ground	—	Ignition switch ON	—	0V
56 (V)	Ground	Communication signal (CONT→DISP)	Output	Ignition switch ON	When adjusting display-brightness	 <p style="text-align: right; font-size: small;">PKIB5039J</p>
57 (W)	Ground	Vertical synchronizing (VP) signal	Input	Ignition switch On	—	 <p style="text-align: right; font-size: small;">SKIB3598E</p>
58 (SB)	Ground	Inverter ground	—	Ignition switch ON	—	0V

# AV CONTROL UNIT

< ECU DIAGNOSIS >

[MID AUDIO]

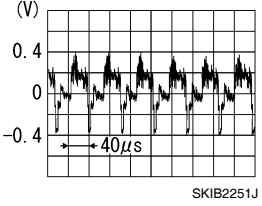
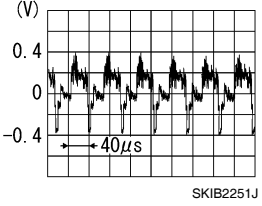
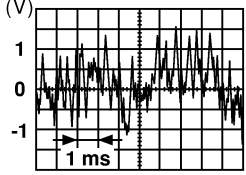
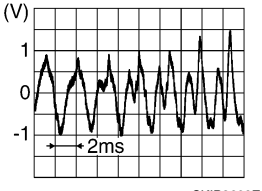
Terminal (Wire color)		Description		Condition		Reference value (Approx.)
+	-	Signal name	Input/ Output			
59 (O)	Ground	Inverter VCC	Output	Ignition switch ACC	—	9V
64 (W)	Ground	Rear view camera video signal ground	—	Ignition switch ON	—	0V
65 (B)	Ground	Rear view camera video in (+)	Input	Ignition switch ON	With rear view camera ON	 <p style="text-align: right; font-size: small;">SKIB2251J</p>
66 (G)	Ground	DVD player video signal (+)	Input	Ignition switch ON	With DVD player operating	 <p style="text-align: right; font-size: small;">SKIB2251J</p>
68 (BR)	—	Rear view camera signal	Output	—	—	—
72	—	Shield	—	—	—	—
74 (R)	Ground	DVD player video ground	—	Ignition switch ON	—	0V
77 (B)	76 (R)	Headphone RH audio sig- nal	Output	Ignition switch ON	With DVD player operating	 <p style="text-align: right; font-size: small;">SKIA0177E</p>
83 (R)	82 (G)	DVD player audio signal RH	Input	Ignition switch ON	With DVD player operating	 <p style="text-align: right; font-size: small;">SKIB3609E</p>
85 (B)	Ground	Ground	—	Ignition switch ON	—	0V
86 (L)	—	CAN-H	Input/ Output	—	—	—
87 (P)	—	CAN-L	Input/ Output	—	—	—
88 (L)	—	AV communication signal 1 (H)	Input/ Output	—	—	—

A  
B  
C  
D  
E  
F  
G  
H  
I  
J  
K  
L  
M  
P

AV

# AV CONTROL UNIT

< ECU DIAGNOSIS >

[MID AUDIO]

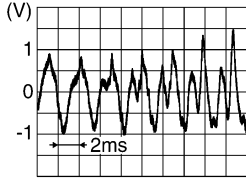
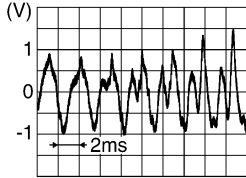
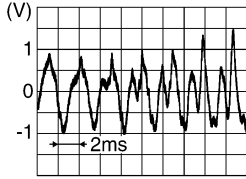
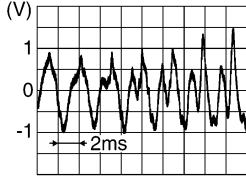
Terminal (Wire color)		Description		Condition		Reference value (Approx.)
+	-	Signal name	Input/ Output			
89 (P)	—	AV communication signal 1 (L)	Input/ Output	—	—	—
90 (L)	—	AV communication signal 2 (H)	Input/ Output	—	—	—
91 (P)	—	AV communication signal 2 (L)	Input/ Output	—	—	—
93 (G)	92 (W)	Headphone LH audio signal	Output	Ignition switch ON	With DVD player operating	 <p style="text-align: right; font-size: small;">SKIB3609E</p>
95 (B)	97 (R)	AUX audio signal RH	Input	Ignition switch ON	When AUX mode is selected	 <p style="text-align: right; font-size: small;">SKIB3609E</p>
96 (W)	97 (R)	AUX audio signal LH	Input	Ignition switch ON	When AUX mode is selected	 <p style="text-align: right; font-size: small;">SKIB3609E</p>
98 (B)	99 (W)	DVD player audio signal LH	Input	Ignition switch ON	With DVD player operating	 <p style="text-align: right; font-size: small;">SKIB3609E</p>
101 (GR)	Ground	A/C and AV switch assembly ground	—	Ignition switch ON	—	0V
103 (SB)	Ground	CD eject signal	Input	—	Pressing the eject switch	0V
					Except for above	3.3V
104 (W/G)	Ground	Ignition signal	Input	Ignition switch ON	—	Battery voltage
105 (W)	Ground	Reverse signal	Input	Ignition switch ON	R position	Battery voltage
					Other than R position	0V

# AV CONTROL UNIT

< ECU DIAGNOSIS >

[MID AUDIO]

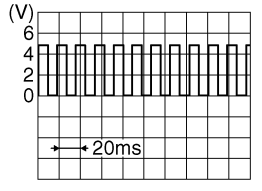
Terminal (Wire color)		Description		Condition		Reference value (Approx.)
+	-	Signal name	Input/ Output			
106 (G)	Ground	Parking brake signal	Input	Ignition switch ON	Parking brake ON	0V
				Ignition switch OFF	Parking brake OFF	Battery voltage
107 (LG)	Ground	Vehicle speed signal (8-pulse)	Input	Ignition switch ON	When vehicle speed is ap- prox. 40 km/h (25MPH)	

A  
B  
C  
D  
E  
F  
G  
H  
I  
J  
K  
L  
M

AV

O  
P

# AV CONTROL UNIT

< ECU DIAGNOSIS >

[MID AUDIO]

## Wiring Diagram

INFOID:000000005259344

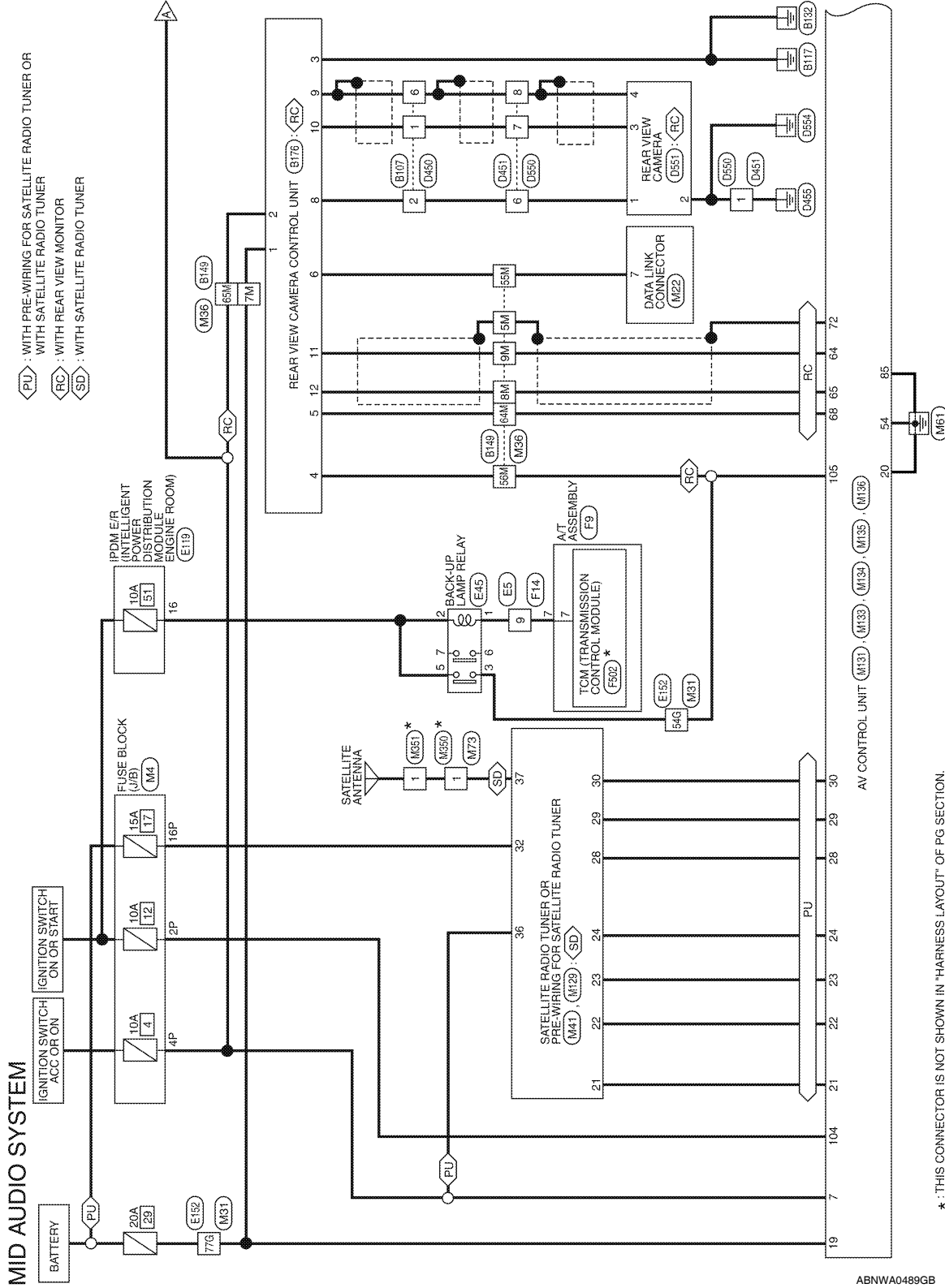

\* THIS CONNECTOR IS NOT SHOWN IN "HARNESS LAYOUT" OF PG SECTION.

ABNWA0489GB

# AV CONTROL UNIT

< ECU DIAGNOSIS >

[MID AUDIO]

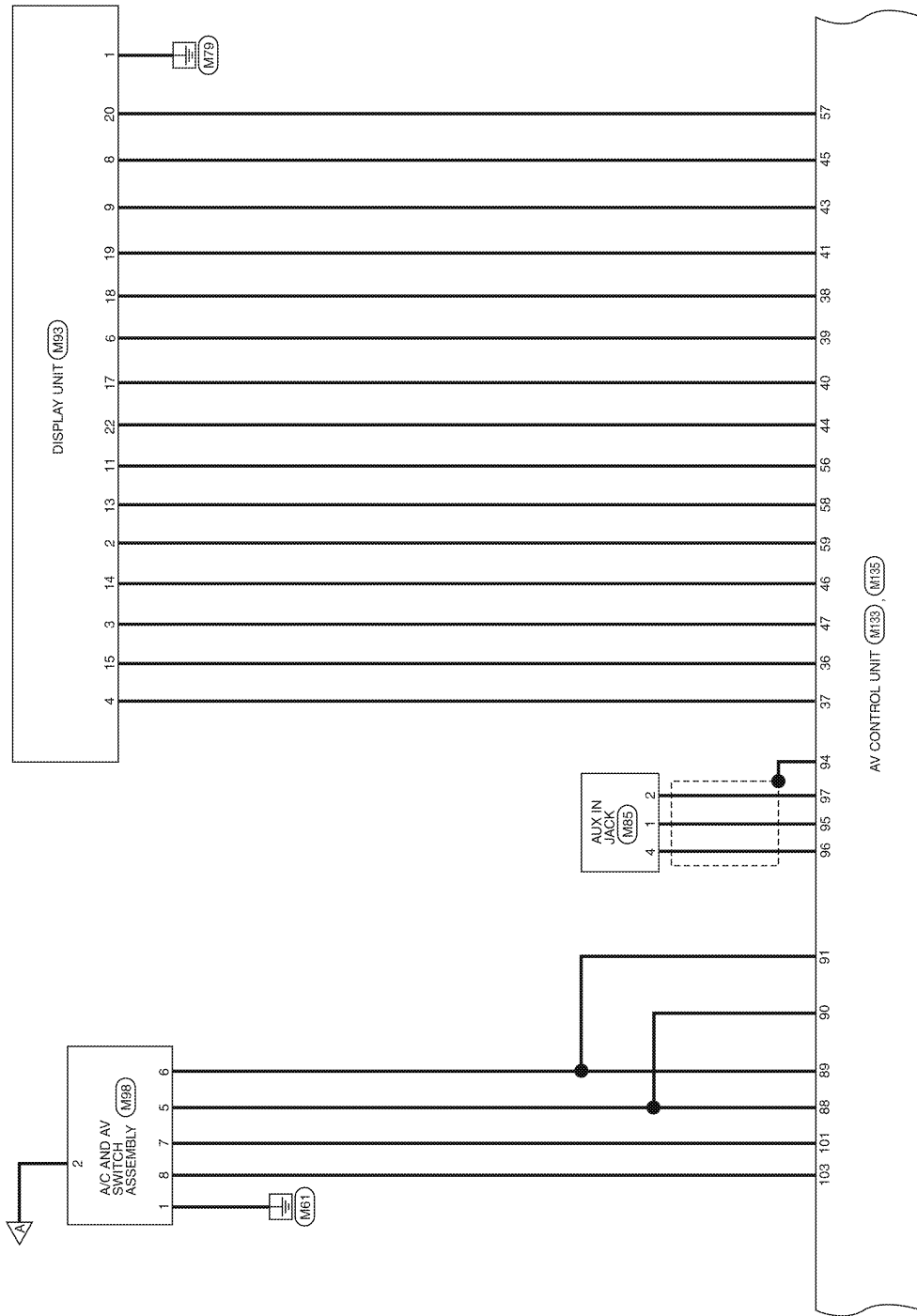

ABNWA0491GB

A  
B  
C  
D  
E  
F  
G  
H  
I  
J  
K  
L  
M  
O  
P

AV

# AV CONTROL UNIT

< ECU DIAGNOSIS >

[MID AUDIO]

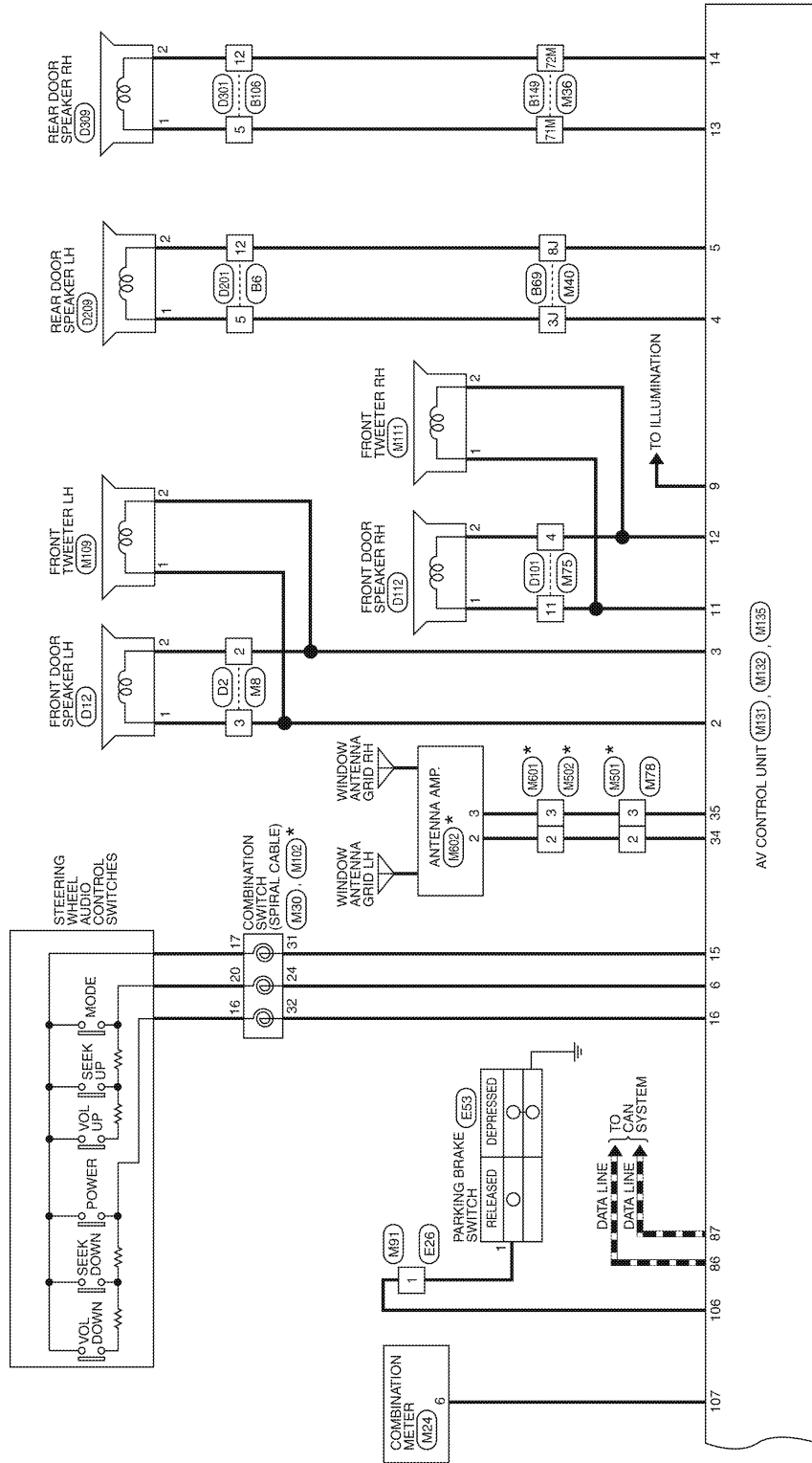

ABNWA0492GB

\*: THIS CONNECTOR IS NOT SHOWN IN "HARNES LAYOUT" OF PG SECTION.



## MID AUDIO SYSTEM CONNECTORS

Connector No.	M4
Connector Name	FUSE BLOCK (J/B)
Connector Color	WHITE



Terminal No.	Color of Wire	Signal Name
2P	W/G	--
4P	G/B	--

Connector No.	M8
Connector Name	WIRE TO WIRE
Connector Color	BROWN

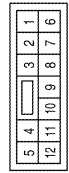

Terminal No.	Color of Wire	Signal Name
2	L	--
3	BR	--

Connector No.	M22
Connector Name	DATA LINK CONNECTOR
Connector Color	WHITE

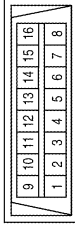

Terminal No.	Color of Wire	Signal Name
7	W	--

Connector No.	M24
Connector Name	COMBINATION METER
Connector Color	WHITE

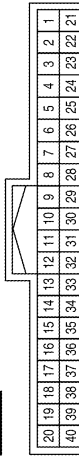

Terminal No.	Color of Wire	Signal Name
6	LG	SPEED OUT 8

Connector No.	M30
Connector Name	COMBINATION SWITCH
Connector Color	GRAY

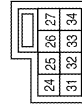

Terminal No.	Color of Wire	Signal Name
24	Y	STRG SW A (UP)
31	L	GND
32	G	STRG SW B (DOWN)

Connector No.	M31
Connector Name	WIRE TO WIRE
Connector Color	WHITE

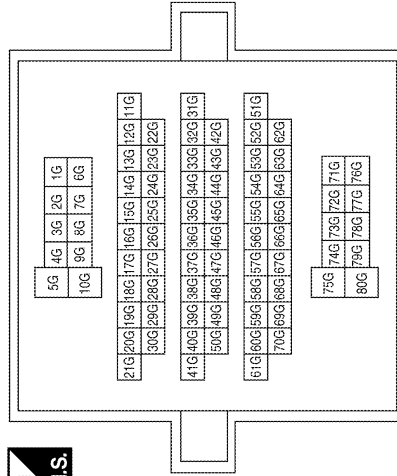

Terminal No.	Color of Wire	Signal Name
54G	SB	--
77G	Y	--

ABN1A1499GB

A  
B  
C  
D  
E  
F  
G  
H  
I  
J  
K  
L  
M  
N  
O  
P

AV

# AV CONTROL UNIT

< ECU DIAGNOSIS >

[MID AUDIO]

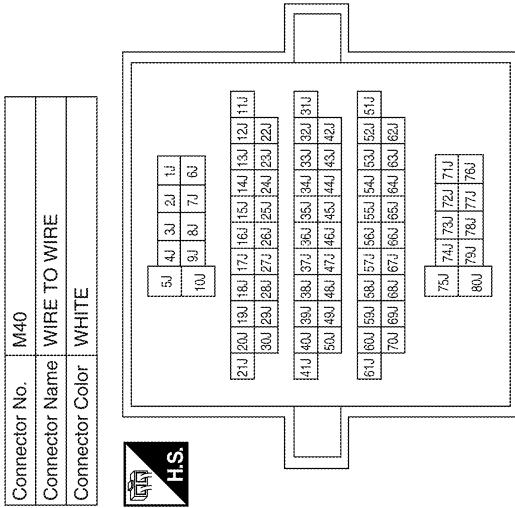

Terminal No.	Color of Wire	Signal Name
3J	G	-
8J	B	-



Terminal No.	Color of Wire	Signal Name
1	-	-

Terminal No.	Color of Wire	Signal Name
5M	SHIELD	-
7M	R/B	-
8M	B	-
9M	W	-
55M	W	-
56M	BR	-
64M	BR	-
65M	G/Y	-
71M	GR	-
72M	O	-

Terminal No.	Color of Wire	Signal Name
28	O	REQ (TO HU)
29	P	TX (FROM HU)
30	L	RX (TO HU)
32	R/B	BACKUP
36	G/B	ACC

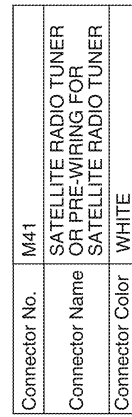
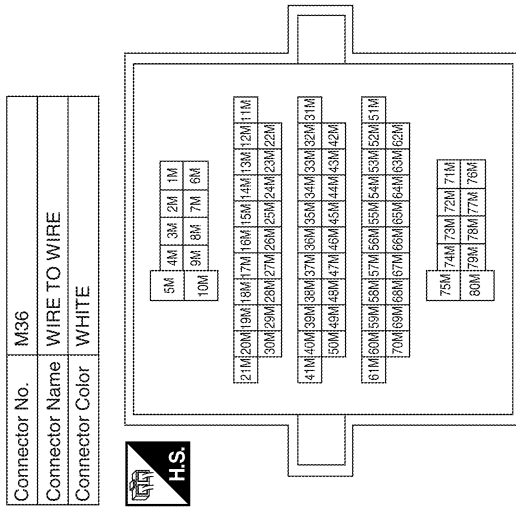

Terminal No.	Color of Wire	Signal Name
21	G	SAT LCH (-)
22	R	SAT LCH (+)
23	W	SAT RCH (-)
24	B	SAT RCH (+)

ABNIA1500GB

# AV CONTROL UNIT

< ECU DIAGNOSIS >

[MID AUDIO]

Connector No.	M85
Connector Name	AUX IN JACK
Connector Color	WHITE

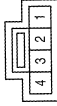

Terminal No.	Color of Wire	Signal Name
1	B	AUX AUDIO RH+
2	R	AUX GND
4	W	AUX AUDIO LH+

Connector No.	M78
Connector Name	WIRE TO WIRE
Connector Color	GRAY

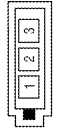

Terminal No.	Color of Wire	Signal Name
2	--	--
3	--	--

Connector No.	M75
Connector Name	WIRE TO WIRE
Connector Color	WHITE



Terminal No.	Color of Wire	Signal Name
4	R	--
11	LG	--

Terminal No.	Color of Wire	Signal Name
6	B	G
7	--	--
8	B	HP
9	G	YS
10	--	--
11	V	IT DISP
12	--	--
13	SB	INV GND
14	BR	SIG GND
15	G	COMP IN SYNC
16	--	--
17	W	R
18	R	B
19	R	RGB SYNC
20	W	VP
21	--	--
22	LG	DISP IT
23	--	--
24	--	--

Connector No.	M93
Connector Name	DISPLAY UNIT (WITHOUT NAVI)
Connector Color	WHITE

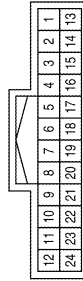

Terminal No.	Color of Wire	Signal Name
1	B	GND
2	O	INV VCC
3	R	SIG VCC
4	R	COMP IN-
5	--	--

Connector No.	M91
Connector Name	WIRE TO WIRE
Connector Color	WHITE

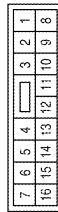

Terminal No.	Color of Wire	Signal Name
1	G	--

ABNIA1501GB

A  
B  
C  
D  
E  
F  
G  
H  
I  
J  
K  
L  
M  
N  
O  
P

AV

# AV CONTROL UNIT

< ECU DIAGNOSIS >

[MID AUDIO]

Connector No.	M109
Connector Name	FRONT TWEETER LH
Connector Color	BROWN



Terminal No.	Color of Wire	Signal Name
1	G	-
2	L	-

Connector No.	M102
Connector Name	COMBINATION SWITCH
Connector Color	GRAY



Terminal No.	Color of Wire	Signal Name
16	L	-
17	BR	-
20	W	-

Connector No.	M98
Connector Name	A/C AND AV SWITCH ASSEMBLY
Connector Color	WHITE

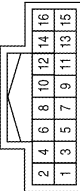

Terminal No.	Color of Wire	Signal Name
1	B	GND
2	G/Y	ACC
5	L	M CAN1-H
6	P	M CAN1-L
7	GR	SW GND
8	SB	CD DVD EJECT

Connector No.	M129
Connector Name	SATELLITE RADIO TUNER OR PRE-WIRING FOR SATELLITE RADIO TUNER
Connector Color	WHITE



Terminal No.	Color of Wire	Signal Name
37	-	-

Connector No.	M111
Connector Name	FRONT TWEETER RH
Connector Color	BROWN



Terminal No.	Color of Wire	Signal Name
1	W	-
2	L	-

ABNIA1502GB

# AV CONTROL UNIT

< ECU DIAGNOSIS >

[MID AUDIO]

Connector No.	M132
Connector Name	AV CONTROL UNIT (WITH MID AUDIO SYSTEM)
Connector Color	GRAY



Terminal No.	Color of Wire	Signal Name
33	--	--
34	--	ANT MAIN
35	--	ANT +B

Terminal No.	Color of Wire	Signal Name
9	--	--
10	--	--
11	LG	FR SPRH (+)
12	R	FR SPRH (-)
13	GR	RR SPRH (+)
14	O	RR SPRH (-)
15	L	STRG SW GND
16	G	STRG SW B
17	--	--
18	--	--
19	Y	+B
20	B	GND

Connector No.	M131
Connector Name	AV CONTROL UNIT (WITH MID AUDIO SYSTEM)
Connector Color	WHITE

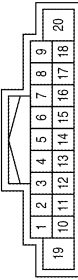

Terminal No.	Color of Wire	Signal Name
1	--	--
2	BR	FR SP LH (+)
3	L	FR SP LH (-)
4	G	RR SP LH (+)
5	B	RR SP LH (-)
6	Y	STRG SW A
7	G/Y	ACC
8	--	--

Connector No.	M133
Connector Name	AV CONTROL UNIT (WITH MID AUDIO SYSTEM)
Connector Color	WHITE

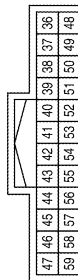

Terminal No.	Color of Wire	Signal Name
45	B	HP
46	BR	SIG GND
47	R	SIG VCC
48	--	--
49	--	--
50	--	--
51	--	--
52	--	--
53	--	--
54	B	GND
55	--	--
56	V	IT DISP
57	W	VP
58	SB	INV GND
59	O	INV VCC

Terminal No.	Color of Wire	Signal Name
36	G	COMP OUT+
37	R	COMP OUT-
38	R	B
39	B	G
40	W	R
41	R	RGB SYNC
42	--	--
43	G	YS
44	LG	DISP IT

ABN1A1503GB

A  
B  
C  
D  
E  
F  
G  
H  
I  
J  
K  
L  
M  
N  
O  
P

AV

# AV CONTROL UNIT

< ECU DIAGNOSIS >

[MID AUDIO]

Connector No.	M134
Connector Name	AV CONTROL UNIT (WITH MID AUDIO SYSTEM)
Connector Color	WHITE

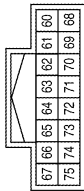

Terminal No.	Color of Wire	Signal Name
60	--	--
61	--	--
62	--	--
63	--	--
64	W	VTR -
65	B	VTR +

Terminal No.	Color of Wire	Signal Name
66	--	--
67	--	--
68	BR	RV CAM SIG
69	--	--
70	--	--
71	--	--
72	SHIELD	COMP IN SHIELD
73	--	--
74	--	--
75	--	--

Connector No.	M135
Connector Name	AV CONTROL UNIT (WITH MID AUDIO SYSTEM)
Connector Color	WHITE

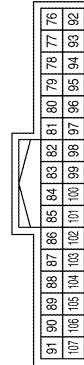

Terminal No.	Color of Wire	Signal Name
76	--	--
77	--	--
78	--	--
79	--	--
80	--	--
81	--	--
82	--	--
83	--	--
84	--	--

Terminal No.	Color of Wire	Signal Name
85	B	GND
86	L	CAN-H
87	P	CAN-L
88	L	M CAN1 H
89	P	M CAN1 L
90	L	M CAN2 H
91	P	M CAN2 L
92	--	--
93	--	--
94	SHIELD	HP SHIELD
95	B	AUX AUDIO RH+
96	W	AUX AUDIO LH+
97	R	AUX GND
98	--	--
99	--	--
100	--	--

Terminal No.	Color of Wire	Signal Name
101	GR	SW GND
102	--	--
103	SB	CD EJECT
104	W/G	IGN
105	W	REVERSE SIG
106	G	PKB SIG
107	LG	SPEED 8P

# AV CONTROL UNIT

< ECU DIAGNOSIS >

[MID AUDIO]

Connector No.	M350
Connector Name	WIRE TO WIRE
Connector Color	BROWN



Terminal No.	Color of Wire	Signal Name
1	--	--

Terminal No.	Color of Wire	Signal Name
29	P	RX (TO HU)
30	L	TX (FROM HU)
31	--	--
32	--	--

Connector No.	M136
Connector Name	AV CONTROL UNIT (WITH MID AUDIO SYSTEM)
Connector Color	WHITE

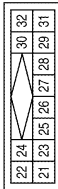

Terminal No.	Color of Wire	Signal Name
21	G	N BUS LH-
22	R	N BUS LH+
23	W	N BUS RH-
24	B	N BUS RH+
25	--	--
26	--	--
27	--	--
28	O	REQ1 (TO HU)

Connector No.	M502
Connector Name	WIRE TO WIRE
Connector Color	GRAY

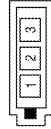

Terminal No.	Color of Wire	Signal Name
2	--	--
3	--	--

Connector No.	M501
Connector Name	WIRE TO WIRE
Connector Color	GRAY

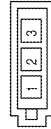

Terminal No.	Color of Wire	Signal Name
2	--	--
3	--	--

Connector No.	M351
Connector Name	SATELLITE ANTENNA
Connector Color	BROWN



Terminal No.	Color of Wire	Signal Name
1	--	--

ABNIA1505GB

A  
B  
C  
D  
E  
F  
G  
H  
I  
J  
K  
L  
M  
N  
O  
P

AV

# AV CONTROL UNIT

< ECU DIAGNOSIS >

[MID AUDIO]

Connector No.	E5
Connector Name	WIRE TO WIRE
Connector Color	WHITE



Terminal No.	9	Color of Wire	LG	Signal Name	--
--------------	---	---------------	----	-------------	----

Connector No.	M602
Connector Name	ANTENNA AMP.
Connector Color	GRAY

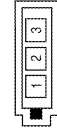

Terminal No.	2	Color of Wire	--	Signal Name	--
3	--	--	--	--	--

Connector No.	M601
Connector Name	WIRE TO WIRE
Connector Color	GRAY

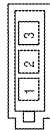

Terminal No.	2	Color of Wire	--	Signal Name	--
3	--	--	--	--	--

Connector No.	E53
Connector Name	PARKING BRAKE SWITCH
Connector Color	BLACK



Terminal No.	1	Color of Wire	G	Signal Name	--
--------------	---	---------------	---	-------------	----

Connector No.	E45
Connector Name	BACK-UP LAMP RELAY
Connector Color	BROWN



Terminal No.	1	Color of Wire	LG	Signal Name	--
2	W/G	--	--	--	--
3	SB	--	--	--	--
5	W/G	--	--	--	--

Connector No.	E26
Connector Name	WIRE TO WIRE
Connector Color	WHITE

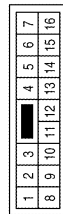

Terminal No.	1	Color of Wire	G	Signal Name	--
--------------	---	---------------	---	-------------	----

ABNIA1506GB



# AV CONTROL UNIT

< ECU DIAGNOSIS >

[MID AUDIO]

Connector No.	F9
Connector Name	A/T ASSEMBLY
Connector Color	GREEN

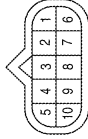

Terminal No.	Color of Wire	Signal Name
7	LG	-

Connector No.	E152
Connector Name	WIRE TO WIRE
Connector Color	WHITE

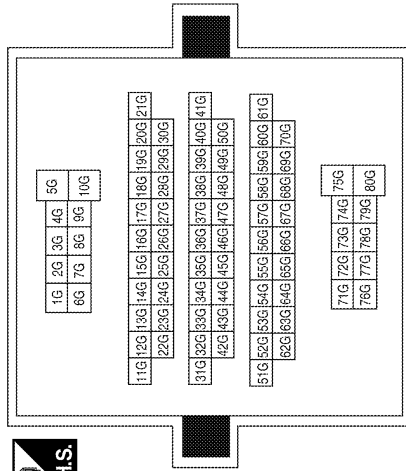

Terminal No.	Color of Wire	Signal Name
54G	SB	-
77G	Y	-

Connector No.	E119
Connector Name	IPDM E/R (INTELLIGENT POWER DISTRIBUTION MODULE ENGINE ROOM)
Connector Color	WHITE

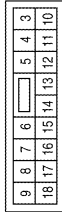

Terminal No.	Color of Wire	Signal Name
16	W/G	REVERSE LAMP

Connector No.	B6
Connector Name	WIRE TO WIRE
Connector Color	WHITE

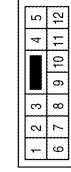

Terminal No.	Color of Wire	Signal Name
5	G	-
12	B	-

Connector No.	F502
Connector Name	TCM (TRANSMISSION CONTROL MODULE)
Connector Color	GRAY

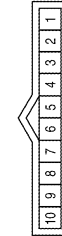

Terminal No.	Color of Wire	Signal Name
7	O	REV LAMP RLY

Connector No.	F14
Connector Name	WIRE TO WIRE
Connector Color	WHITE

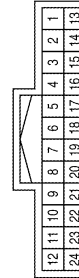

Terminal No.	Color of Wire	Signal Name
9	V	-

ABNIA1507GB

A  
B  
C  
D  
E  
F  
G  
H  
I  
J  
K  
L  
M  
N  
O  
P

AV

# AV CONTROL UNIT

< ECU DIAGNOSIS >

[MID AUDIO]

Connector No.	B106
Connector Name	WIRE TO WIRE
Connector Color	WHITE

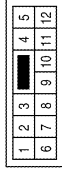

Terminal No.	Color of Wire	Signal Name
5	GR	-
12	O	-

Terminal No.	Color of Wire	Signal Name
3J	G	-
8J	B	-

Connector No.	B69
Connector Name	WIRE TO WIRE
Connector Color	WHITE

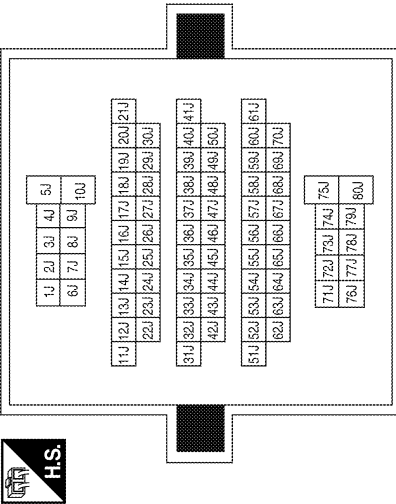

Terminal No.	Color of Wire	Signal Name
5M	SHEILD	-
7M	R/B	-
8M	B	-
9M	W	-
55M	W	-
56M	BR	-
64M	BR	-
65M	G/Y	-
71M	GR	-
72M	O	-

Connector No.	B149
Connector Name	WIRE TO WIRE
Connector Color	WHITE

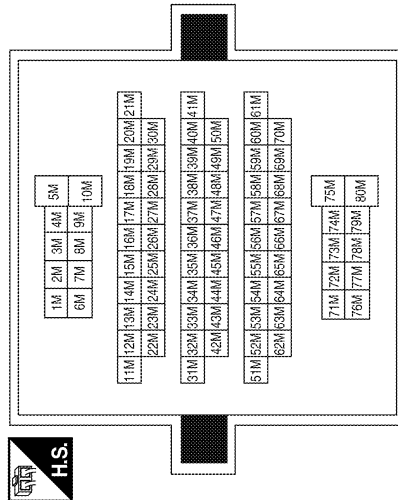

Connector No.	B107
Connector Name	WIRE TO WIRE
Connector Color	WHITE

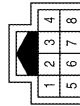

Terminal No.	Color of Wire	Signal Name
1	G	-
2	Y	-
6	SHEILD	-

ABNIA1508GB

# AV CONTROL UNIT

< ECU DIAGNOSIS >

[MID AUDIO]

Connector No.	B176
Connector Name	REAR VIEW CAMERA CONTROL UNIT
Connector Color	WHITE

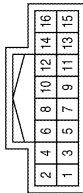

Terminal No.	Color of Wire	Signal Name
1	R/B	BAT+
2	G/Y	ACC
3	B	GND
4	LG	REVERSE
5	BR	AV CONT
6	W	CHECK CONN KLINE
7	-	-
8	Y	CAMERA 6V
9	SHIELD	CAMERA -
10	G	CAMERA +
11	W	VIDEO GND
12	B	VIDEO +
13	-	-
14	-	-
15	-	-
16	-	-

Connector No.	D2
Connector Name	WIRE TO WIRE
Connector Color	BROWN

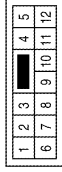

Terminal No.	Color of Wire	Signal Name
2	L/R	-
3	L/W	-

Connector No.	D12
Connector Name	FRONT DOOR SPEAKER LH
Connector Color	WHITE



Terminal No.	Color of Wire	Signal Name
1	L/W	-
2	L/R	-

Connector No.	D101
Connector Name	WIRE TO WIRE
Connector Color	WHITE



Terminal No.	Color of Wire	Signal Name
4	L/B	-
11	W/B	-

Connector No.	D112
Connector Name	FRONT DOOR SPEAKER RH
Connector Color	WHITE



Terminal No.	Color of Wire	Signal Name
1	W/B	-
2	L/B	-

ABNIA1509GB

A  
B  
C  
D  
E  
F  
G  
H  
I  
J  
K  
L  
M  
N  
O  
P

AV

# AV CONTROL UNIT

< ECU DIAGNOSIS >

[MID AUDIO]

Connector No.	D301
Connector Name	WIRE TO WIRE
Connector Color	WHITE

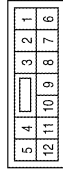

Terminal No.	Color of Wire	Signal Name
5	GR	--
12	O	--

Connector No.	D209
Connector Name	REAR DOOR SPEAKER LH (WITH BASE AND MID AUDIO SYSTEMS)
Connector Color	WHITE



Terminal No.	Color of Wire	Signal Name
1	GR	--
2	O	--

Connector No.	D201
Connector Name	WIRE TO WIRE
Connector Color	WHITE

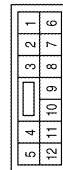

Terminal No.	Color of Wire	Signal Name
5	GR	--
12	O	--

Connector No.	D451
Connector Name	WIRE TO WIRE
Connector Color	WHITE

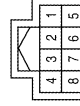

Terminal No.	Color of Wire	Signal Name
1	B	--
6	Y	--
7	G	--
8	SHIELD	--

Connector No.	D450
Connector Name	WIRE TO WIRE
Connector Color	WHITE



Terminal No.	Color of Wire	Signal Name
1	G	--
2	Y	--
6	SHIELD	--

Connector No.	D309
Connector Name	REAR DOOR SPEAKER LH (WITH BASE AND MID AUDIO SYSTEMS)
Connector Color	WHITE



Terminal No.	Color of Wire	Signal Name
1	GR	--
2	O	--

ABN1A1510GB

A  
B  
C  
D  
E  
F  
G  
H  
I  
J  
K  
L  
M  
N  
O  
P

Connector No.	D551
Connector Name	REAR VIEW CAMERA
Connector Color	WHITE

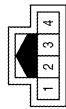

Terminal No.	Color of Wire	Signal Name
1	Y	CAMERA 6V
2	B	GND
3	G	CAMERA +
4	SHIELD	CAMERA -

Connector No.	D550
Connector Name	WIRE TO WIRE
Connector Color	WHITE

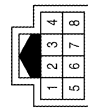

Terminal No.	Color of Wire	Signal Name
1	B	-
6	Y	-
7	G	-
8	SHIELD	-

AV

ABNIA1780GB

INFOID:000000005259345

## DTC Index

Self-diagnosis results display item

# AV CONTROL UNIT

< ECU DIAGNOSIS >

[MID AUDIO]

Error item	Refer to
CAN COMM CIRCUIT [U1000]	<a href="#">AV-62. "DTC Logic"</a>
CONTROL UNIT (CAN) [U1010]	<a href="#">AV-63. "DTC Logic"</a>
Control Unit FLASH-ROM [U1200]	<a href="#">AV-64. "DTC Logic"</a>
CAN CONT [U1216]	<a href="#">AV-65. "DTC Logic"</a>
SWITCH CONN [U1240]	<a href="#">AV-66. "Description"</a>
FRONT DISP CONN [U1243]	<a href="#">AV-67. "DTC Logic"</a>
DVD DECK CONN [U1248]	<a href="#">AV-69. "DTC Logic"</a>
SAT CONN [U1255]	<a href="#">AV-70. "DTC Logic"</a>
AV COMM CIRCUIT [U1300]	<a href="#">AV-71. "Description"</a>
CONTROL UNIT (AV) [U1310]	<a href="#">AV-72. "DTC Logic"</a>

# DISPLAY UNIT

< ECU DIAGNOSIS >

[MID AUDIO]

## DISPLAY UNIT

Reference Value

INFOID:000000005259346

### TERMINAL LAYOUT

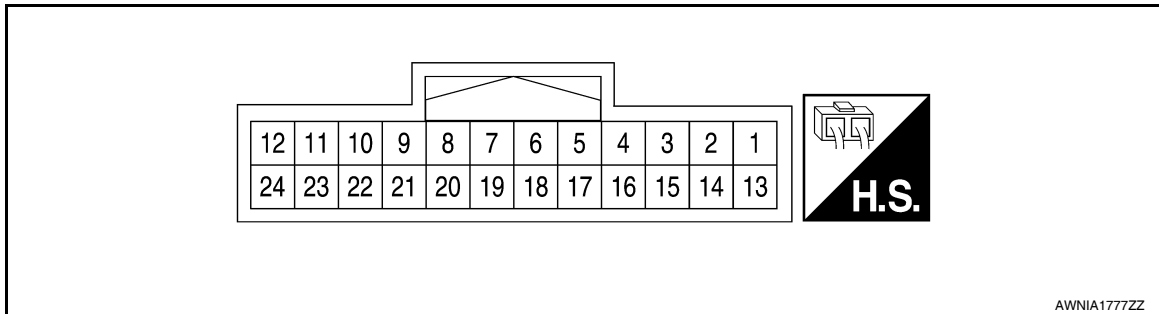

### PHYSICAL VALUES

Terminal (Wire color)		Description		Condition		Reference value (Approx.)
+	-	Signal name	Input/Output			
1 (B)	Ground	Ground	—	Ignition switch ON	—	0V
2 (O)	Ground	Inverter VCC	Input	Ignition switch ACC	—	9V
3 (R)	Ground	Signal VCC	Input	Ignition switch ACC	—	9V
4 (R)	Ground	AUX image ground	—	Ignition switch ON	—	0V
6 (B)	Ground	RGB signal (G: green)	Input	Ignition switch ON	Start confirmation/adjustment mode, and then display color bar by selecting "Color Spectrum Bar" on DISPLAY DIAGNOSIS screen.	
8 (B)	Ground	Horizontal synchronizing (HP) signal	Output	Ignition switch ON	—	

# DISPLAY UNIT

< ECU DIAGNOSIS >

[MID AUDIO]

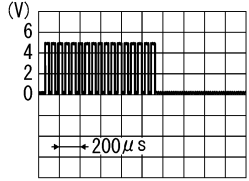
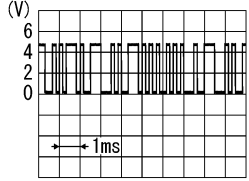
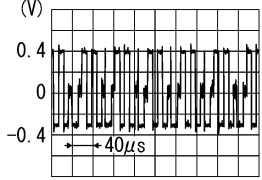
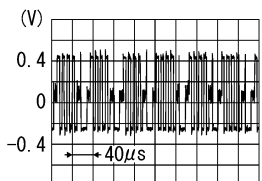
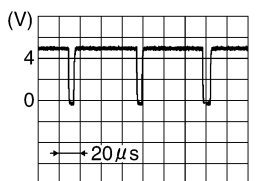
Terminal (Wire color)		Description		Condition	Reference value (Approx.)
+	-	Signal name	Input/ Output		
9 (G)	Ground	RGB area (YS) signal	Input	Ignition switch ON	At RGB image displayed 5V
				At rear view camera image displayed	 PKIB4948J
11 (V)	Ground	Communication signal (CONT→DISP)	Input	Ignition switch ON	When adjusting display-brightness  PKIB5039J
13 (SB)	Ground	Inverter ground	—	Ignition switch ON	— 0V
14 (BR)	Ground	Signal ground	—	Ignition switch ON	— 0V
15 (G)	—	AUX image synchronizing signal	Input	—	—
17 (W)	Ground	RGB signal (R: red)	Input	Ignition switch ON	Start confirmation/adjustment mode, and then display color bar by selecting "Color Spectrum Bar" on DISPLAY DIAGNOSIS screen.  SKIB2238J
18 (R)	Ground	RGB signal (B: blue)	Input	Ignition switch ON	Start confirmation/adjustment mode, and then display color bar by selecting "Color Spectrum Bar" on DISPLAY DIAGNOSIS screen.  SKIB2237J
19 (R)	Ground	RGB synchronizing signal	Input	Ignition switch ON	—  SKIB3603E



# DISPLAY UNIT

< ECU DIAGNOSIS >

[MID AUDIO]

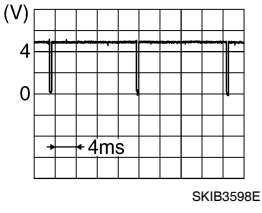
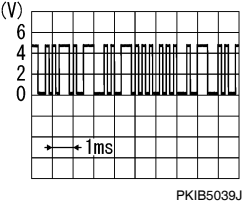
Terminal (Wire color)		Description		Condition	Reference value (Approx.)
+	-	Signal name	Input/ Output		
20 (W)	Ground	Vertical synchronizing (VP) signal	Output	Ignition switch On	—
					
22 (LG)	Ground	Communication signal (DISP→CONT)	Output	Ignition switch ON	When adjusting display- brightness
					

A  
B  
C  
D  
E  
F  
G  
H  
I  
J  
K  
L  
M

AV

O  
P

# SATELLITE RADIO TUNER

< ECU DIAGNOSIS >

[MID AUDIO]

## SATELLITE RADIO TUNER

Reference Value

INFOID:000000005259347

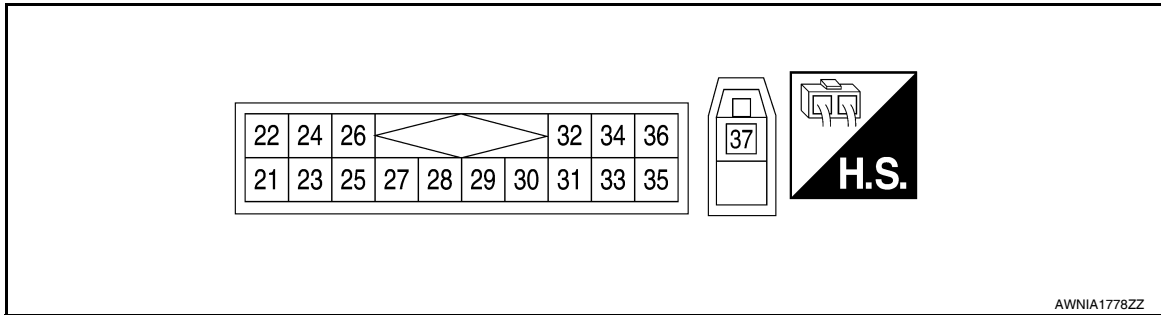

### PHYSICAL VALUES

Terminal		Description		Condition		Reference value (Approx.)
+	-	Signal name	Input/Output			
22 (R)	21 (G)	Satellite radio sound signal LH	Output	Ignition switch ON	When satellite radio mode is selected	<p>SKIB3609E</p>
24 (B)	23 (W)	Satellite radio sound signal RH	Output	Ignition switch ON	When satellite radio mode is selected	<p>SKIB3609E</p>
28 (O)	Ground	Request signal (SAT→CONT)	Output	Ignition switch ON	When satellite radio mode is selected	<p>SKIA9299J</p>
29 (P)	Ground	Communication signal (SAT→CONT)	Output	Ignition switch ON	When satellite radio mode is selected	<p>SKIA9300J</p>

# SATELLITE RADIO TUNER

< ECU DIAGNOSIS >

[MID AUDIO]

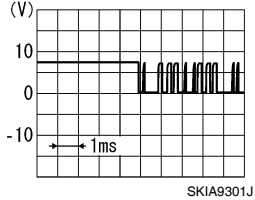
Terminal		Description		Condition		Reference value (Approx.)
+	-	Signal name	Input/Output			
30 (L)	Ground	Communication signal (CONT→SAT)	Input	Ignition switch ON	When satellite radio mode is selected	
32 (R/B)	Ground	Battery power supply	Input	Ignition switch OFF	—	Battery voltage
36 (G/B)	Ground	ACC power supply	Input	Ignition switch ACC	—	Battery voltage
37	—	Satellite antenna	Input	—	—	—

A  
B  
C  
D  
E  
F  
G  
H  
I  
J  
K  
L  
M

AV

O  
P

# REAR VIEW CAMERA CONTROL UNIT

< ECU DIAGNOSIS >

[MID AUDIO]

## REAR VIEW CAMERA CONTROL UNIT

Reference Value

INFOID:000000005259348

### TERMINAL LAYOUT

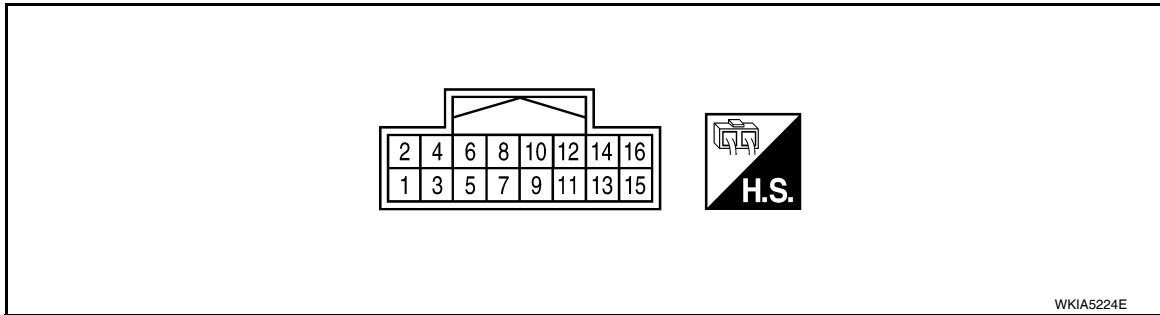

### PHYSICAL VALUES

Terminal	Description		Condition	Reference value (Approx.)		
	+	-			Signal name	Input/Output
1 (R/B)	Ground	Battery power	Input	Ignition switch OFF —	Battery voltage	
2 (G/Y)	Ground	ACC power	Input	Ignition switch ACC —	Battery voltage	
3 (B)	Ground	Ground	—	Ignition switch ON —	0V	
4 (LG)	Ground	Reverse signal input	Input	Ignition switch ON	A/T selector lever R position Battery voltage	
				A/T selector lever in other than R position	0V	
5 (BR)	Ground	AV Control	Output	Ignition switch ON —	0V	
6 (W)	Ground	DDL	Output	— —	—	
8 (Y)	Ground	Camera power output	Output	Ignition switch ON	A/T selector lever R position 6V	
9	Ground	Camera image input (-)	Input	Ignition switch ON —	0V	
10 (G)	Ground	Camera image input (+)	Input	Ignition switch ON	A/T selector lever R position	<p style="text-align: right;">SKIA4894E</p>

# REAR VIEW CAMERA CONTROL UNIT

< ECU DIAGNOSIS >

[MID AUDIO]

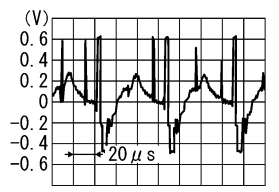
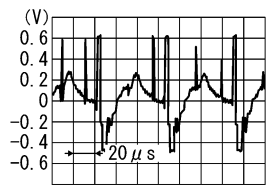
Terminal		Description		Condition		Reference value (Approx.)
+	-	Signal name	Input/Output			
11 (W)	Ground	Composite image output (-)	Output	Ignition switch ON	A/T selector lever R position	 <p style="text-align: right; font-size: small;">SKIA4896E</p>
12 (B)	Ground	Composite image output (+)	Output	Ignition switch ON	A/T selector lever R position	 <p style="text-align: right; font-size: small;">SKIA4896E</p>

A  
B  
C  
D  
E  
F  
G  
H  
I  
J  
K  
L  
M

AV

O  
P

# DVD PLAYER

< ECU DIAGNOSIS >

[MID AUDIO]

## DVD PLAYER

### Reference Value

INFOID:000000005259349

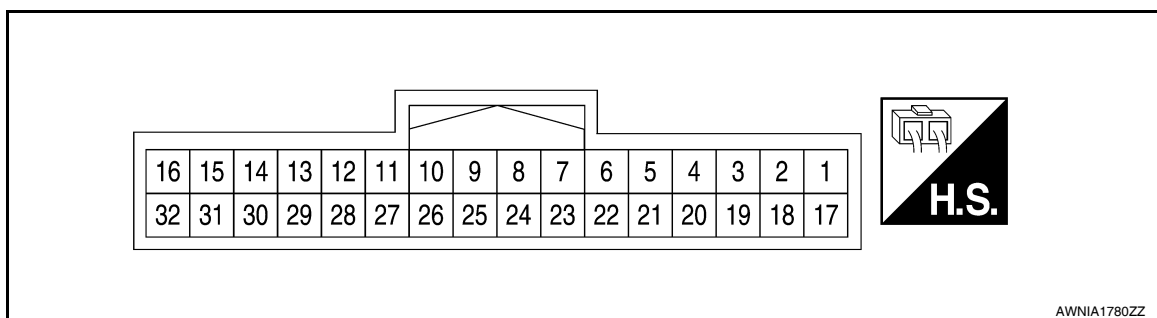

### PHYSICAL VALUES

Terminal		Description		Condition		Reference value (Approx.)
+	-	Signal name	Input/ Output			
1 (B)	2 (W)	DVD audio signal LH	Output	Ignition switch ON	With operation of the DVD player	<p>SKIB3609E</p>
5 (B)	Ground	Ground	—	Ignition switch ON	—	0V
6 (BR)	Ground	Illumination control (pulse width modulated)	—	—	With lighting switch ON	—
7 (L)	Ground	CAN communication	Input/ Output	Ignition switch ON	—	—
9 (BR)	Ground	Video monitor power supply	Output	Ignition switch ON	With DVD player operation	12V
10 (GR)	Ground	Switch power	Output	Ignition switch ON	With DVD player operation	5V
12 (W/L)	Ground	VTR (+)	Output	Ignition switch ON	With DVD player operation	—
13 (O/L)	Ground	VTR (-)	Output	Ignition switch ON	With DVD player operation	—
14 (Y)	Ground	Display ground	—	Ignition switch ON	With DVD player operation	0V
16 (V)	—	Data receive	Input	—	—	—

# DVD PLAYER

< ECU DIAGNOSIS >

[MID AUDIO]

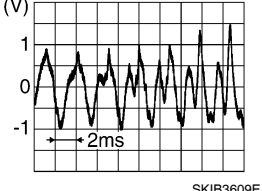
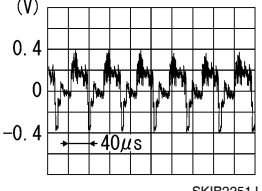
Terminal		Description		Condition		Reference value (Approx.)
+	-	Signal name	Input/Output			
17 (R)	18 (G)	DVD audio signal RH	Output	Ignition switch ON	With DVD player operation	
21 (Y)	Ground	Battery power	Input	—	—	12V
22 (SB)	Ground	Illumination power	Input	—	With instrument illumination ON	12V
23 (P)	Ground	CAN communication	Input/Output	Ignition switch ON	—	0V
24 (G/B)	Ground	ACC power	Input	Ignition switch ACC or ON	—	12V
26 (P)	Ground	Ground	Input	Ignition switch ON	—	0V
28 (G)	Ground	Video out	Input	Ignition switch ACC or ON	—	
32 (LG)	—	Data transmit	Output	—	—	—

A  
B  
C  
D  
E  
F  
G  
H  
I  
J  
K  
L  
M  
N  
O  
P

AV

# AUDIO SYSTEM

< SYMPTOM DIAGNOSIS >

[MID AUDIO]

## SYMPTOM DIAGNOSIS

### AUDIO SYSTEM

#### Symptom Table

INFOID:000000005259350

#### AUDIO SYSTEM

Symptom	Possible cause	Reference page
Inoperative	<ul style="list-style-type: none"> <li>AV control unit power circuit</li> <li>AV control unit</li> </ul>	<ul style="list-style-type: none"> <li><a href="#">AV-73</a></li> <li><a href="#">AV-54</a></li> </ul>
Steering wheel audio control switch does not operate	<ul style="list-style-type: none"> <li>Steering wheel audio control switch</li> <li>AV control unit</li> </ul>	<ul style="list-style-type: none"> <li><a href="#">AV-95</a></li> <li><a href="#">AV-54</a></li> </ul>
All speakers do not sound	<ul style="list-style-type: none"> <li>AV control unit</li> <li>AV control unit power circuit</li> </ul>	<ul style="list-style-type: none"> <li><a href="#">AV-54</a></li> <li><a href="#">AV-73</a></li> </ul>
One or several speakers do not sound	<ul style="list-style-type: none"> <li>Front door speaker</li> <li>Front tweeter</li> <li>Rear door speaker</li> </ul>	<ul style="list-style-type: none"> <li><a href="#">AV-89</a></li> <li><a href="#">AV-91</a></li> <li><a href="#">AV-93</a></li> </ul>

#### CD

Symptom	Possible cause	Reference page
CD cannot be inserted.	AV control unit	<a href="#">AV-54</a>
CD cannot be ejected.		
The CD cannot be played.		
The sound skips, stops suddenly, or is distorted.		

#### SATELLITE RADIO

Symptom	Possible cause	Reference page
Inoperative	<ul style="list-style-type: none"> <li>Satellite radio tuner power or ground circuit</li> <li>Satellite radio tuner communication circuit</li> <li>Satellite radio tuner</li> </ul>	<ul style="list-style-type: none"> <li><a href="#">AV-76</a></li> <li><a href="#">AV-97</a></li> <li><a href="#">AV-76</a></li> </ul>
Right or left channel does not sound	<ul style="list-style-type: none"> <li>Satellite radio tuner right channel audio signal circuit</li> <li>Satellite radio tuner left channel audio signal circuit</li> <li>Satellite radio tuner</li> </ul>	<ul style="list-style-type: none"> <li><a href="#">AV-100</a></li> <li><a href="#">AV-100</a></li> <li><a href="#">AV-76</a></li> </ul>

#### DVD PLAYER

Symptom	Possible cause	Reference page
DVD player inoperative	<ul style="list-style-type: none"> <li>Power supply and ground circuits</li> <li>DVD player</li> </ul>	<ul style="list-style-type: none"> <li><a href="#">AV-79</a></li> <li><a href="#">AV-134</a></li> </ul>
No sound when playing a DVD	<ul style="list-style-type: none"> <li>Audio signal circuits</li> <li>AV control unit</li> <li>DVD player</li> </ul>	<ul style="list-style-type: none"> <li><a href="#">AV-102</a></li> <li><a href="#">AV-54</a></li> <li><a href="#">AV-134</a></li> </ul>
Video monitor is inoperative/does not display properly	<ul style="list-style-type: none"> <li>Power supply and ground circuits</li> <li>Video out circuit</li> <li>DVD player</li> <li>Video monitor</li> </ul>	<ul style="list-style-type: none"> <li><a href="#">AV-80</a></li> <li><a href="#">AV-134</a></li> <li><a href="#">AV-134</a></li> <li><a href="#">AV-143</a></li> </ul>
DVD remote control is inoperative/does not operate properly	<ul style="list-style-type: none"> <li>DVD player</li> <li>Video monitor</li> </ul>	<ul style="list-style-type: none"> <li><a href="#">AV-79</a></li> <li><a href="#">AV-80</a></li> </ul>
Headphones inoperative	<ul style="list-style-type: none"> <li>Headphone batteries</li> <li>Headphone audio signal circuits from AV control unit</li> <li>AV control unit</li> <li>Video monitor</li> </ul>	<ul style="list-style-type: none"> <li><a href="#">AV-134</a></li> <li><a href="#">AV-102</a></li> <li><a href="#">AV-102</a></li> </ul>



# NORMAL OPERATING CONDITION

< SYMPTOM DIAGNOSIS >

[MID AUDIO]

## NORMAL OPERATING CONDITION

### Description

INFOID:000000005259351

The majority of the audio concerns are the result of outside causes (bad CD, electromagnetic interference, etc.).

### NOISE

The following noise results from variations in field strength, such as fading noise and multi-path noise, or external noise from trains and other sources. It is not a malfunction.

- Fading noise: This noise occurs because of variations in the field strength in a narrow range due to mountains or buildings blocking the signal.
- Multi-path noise: This noise results from the waves sent directly from the broadcast station arriving at the antenna at a different time from the waves which reflect off mountains or buildings.

The vehicle itself can be a source of noise if noise prevention parts or electrical equipment is malfunctioning. Check if noise is caused and/or changed by engine speed, ignition switch turned to each position, and operation of each piece of electrical equipment, and determine the cause.

### NOTE:

The source of the noise can be found easily by listening to the noise while removing the fuses of electrical components, one by one.

### Type of Noise and Possible Cause

Occurrence condition		Possible cause
Occurs only when engine is ON.	A continuous growling noise occurs. The speed of the noise varies with changes in the engine speed.	• Ignition components
The occurrence of the noise is linked with the operation of the fuel pump.		• Fuel pump condenser
Noise only occurs when various electrical components are operating.	A cracking or snapping sound occurs with the operation of various switches.	• Relay malfunction, audio unit malfunction
	The noise occurs when various motors are operating.	• Motor case ground • Motor
The noise occurs constantly, not just under certain conditions.		• Rear defogger coil malfunction • Open circuit in printed heater • Poor ground of antenna feeder line
A cracking or snapping sound occurs while the vehicle is being driven, especially when it is vibrating excessively.		• Ground wire of body parts • Ground due to improper part installation • Wiring connections or a short circuit

A  
B  
C  
D  
E  
F  
G  
H  
I  
J  
K  
L  
M  
O  
P

AV

## PRECAUTION

### PRECAUTIONS

#### Precaution for Supplemental Restraint System (SRS) "AIR BAG" and "SEAT BELT PRE-TENSIONER"

INFOID:000000005259352

The Supplemental Restraint System such as "AIR BAG" and "SEAT BELT PRE-TENSIONER", used along with a front seat belt, helps to reduce the risk or severity of injury to the driver and front passenger for certain types of collision. This system includes seat belt switch inputs and dual stage front air bag modules. The SRS system uses the seat belt switches to determine the front air bag deployment, and may only deploy one front air bag, depending on the severity of a collision and whether the front occupants are belted or unbelted. Information necessary to service the system safely is included in the SR and SB section of this Service Manual.

**WARNING:**

- To avoid rendering the SRS inoperative, which could increase the risk of personal injury or death in the event of a collision which would result in air bag inflation, all maintenance must be performed by an authorized NISSAN/INFINITI dealer.
- Improper maintenance, including incorrect removal and installation of the SRS, can lead to personal injury caused by unintentional activation of the system. For removal of Spiral Cable and Air Bag Module, see the SR section.
- Do not use electrical test equipment on any circuit related to the SRS unless instructed to in this Service Manual. SRS wiring harnesses can be identified by yellow and/or orange harnesses or harness connectors.

#### PRECAUTIONS WHEN USING POWER TOOLS (AIR OR ELECTRIC) AND HAMMERS

**WARNING:**

- When working near the Airbag Diagnosis Sensor Unit or other Airbag System sensors with the Ignition ON or engine running, DO NOT use air or electric power tools or strike near the sensor(s) with a hammer. Heavy vibration could activate the sensor(s) and deploy the air bag(s), possibly causing serious injury.
- When using air or electric power tools or hammers, always switch the Ignition OFF, disconnect the battery, and wait at least 3 minutes before performing any service.

#### Precaution Necessary for Steering Wheel Rotation After Battery Disconnect

INFOID:000000005259353

**NOTE:**

- This Procedure is applied only to models with Intelligent Key system and NATS (NISSAN ANTI-THEFT SYSTEM).
- Remove and install all control units after disconnecting both battery cables with the ignition knob in the "LOCK" position.
- Always use CONSULT-III to perform self-diagnosis as a part of each function inspection after finishing work. If DTC is detected, perform trouble diagnosis according to self-diagnostic results.

For models equipped with the Intelligent Key system and NATS, an electrically controlled steering lock mechanism is adopted on the key cylinder.

For this reason, if the battery is disconnected or if the battery is discharged, the steering wheel will lock and steering wheel rotation will become impossible.

If steering wheel rotation is required when battery power is interrupted, follow the procedure below before starting the repair operation.

#### OPERATION PROCEDURE

1. Connect both battery cables.

**NOTE:**

Supply power using jumper cables if battery is discharged.

2. Use the Intelligent Key or mechanical key to turn the ignition switch to the "ACC" position. At this time, the steering lock will be released.
3. Disconnect both battery cables. The steering lock will remain released and the steering wheel can be rotated.
4. Perform the necessary repair operation.

## PRECAUTIONS

< PRECAUTION >

[MID AUDIO]

5. When the repair work is completed, return the ignition switch to the "LOCK" position before connecting the battery cables. (At this time, the steering lock mechanism will engage.)
6. Perform a self-diagnosis check of all control units using CONSULT-III.

A

B

C

D

E

F

G

H

I

J

K

L

M

AV

O

P

# PREPARATION

## PREPARATION

### Commercial Service Tools

INFOID:000000005259354

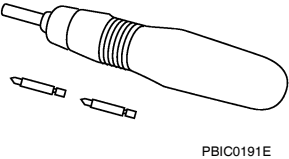
Tool name	Description
<p>Power tool</p>  <p>PBIC0191E</p>	<p>Loosening bolts and nuts</p>

# AV CONTROL UNIT

< ON-VEHICLE REPAIR >

[MID AUDIO]

## ON-VEHICLE REPAIR

### AV CONTROL UNIT

#### Removal and Installation

INFOID:000000005259355

#### AUDIO UNIT - WITHOUT NAVI

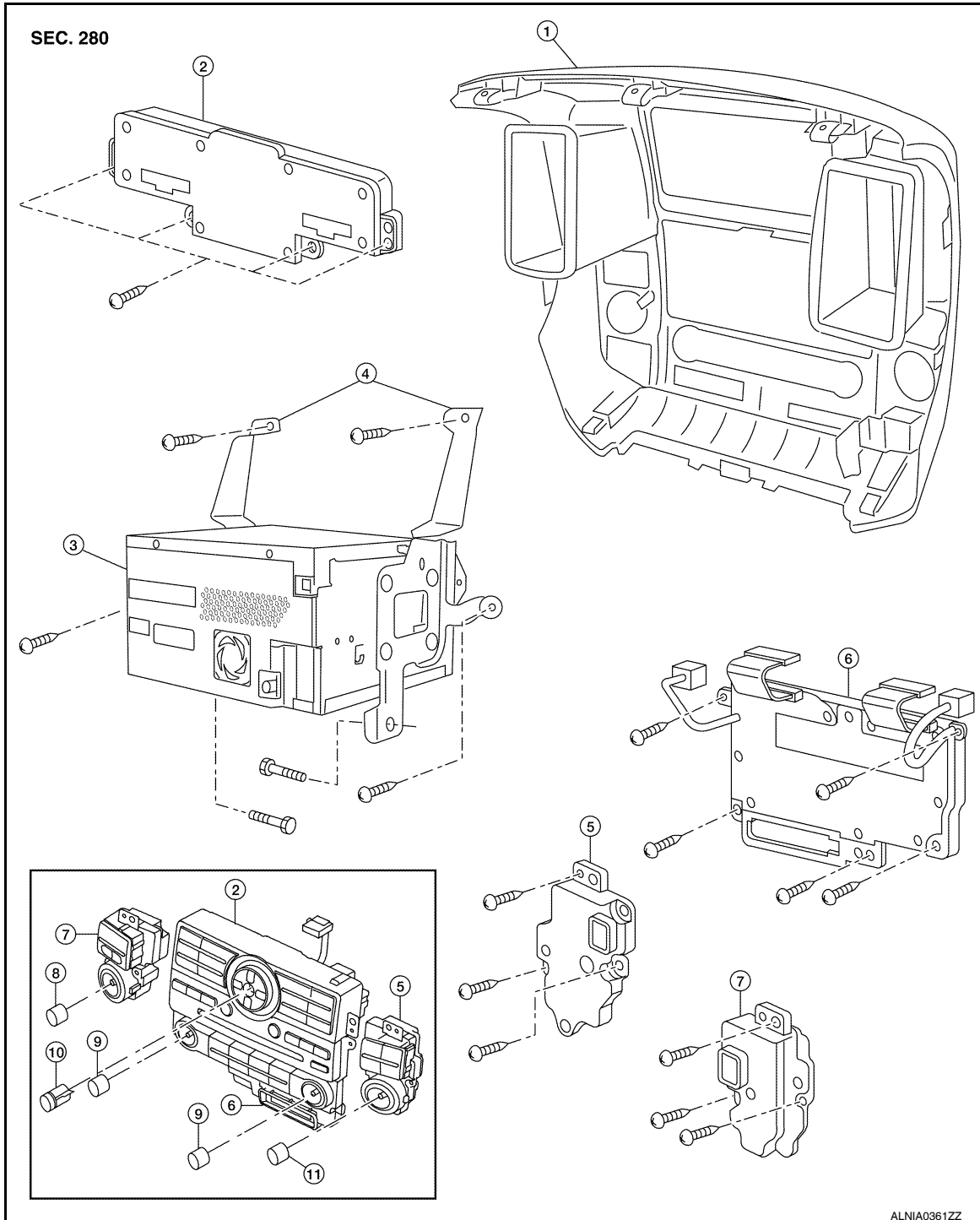

- |                             |                       |                               |
|-----------------------------|-----------------------|-------------------------------|
| 1. Cluster lid C            | 2. AV switch assembly | 3. AV control unit            |
| 4. AV control unit brackets | 5. Tuner knob switch  | 6. A/C and AV switch assembly |
| 7. Volume knob switch       | 8. Volume knob        | 9. Temp knobs RH and LH       |
| 10. Enter button            | 11. Tuner knob        |                               |

A  
B  
C  
D  
E  
F  
G  
H  
I  
J  
K  
L  
M  
AV  
O  
P

## AV CONTROL UNIT

< ON-VEHICLE REPAIR >

[MID AUDIO]

### **CAUTION:**

Only remove and replace the A/C or AV switch assembly knobs if damaged or missing. The knobs must not be removed from switches when removing and installing the A/C or AV switch assembly to prevent damage to the switch assembly.

### REMOVAL

1. Disconnect the battery negative terminal.
2. Remove the cluster lid C. Refer to [IP-12. "Removal and Installation"](#).
3. Remove the AV control unit screws, using a power tool.
4. Remove the AV control unit.
5. Remove the A/C and AV switch assembly screws, then remove the A/C and AV switch assemblies as necessary.

### INSTALLATION

Installation is in the reverse order of removal.

## DISPLAY UNIT

### Removal and Installation

INFOID:000000005259356

#### REMOVAL

1. Remove Cluster lid C. Refer to [IP-12. "Removal and Installation"](#).
2. Remove the display unit screws (A).
3. Pull out the display unit (1), then disconnect the display unit connectors and remove the display unit (1).

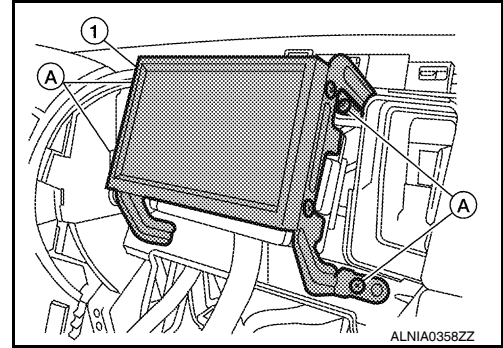

4. Remove the A/C auto amp screws (A), remove the (C103) fasteners (B) from the display unit assembly brackets and remove the A/C auto amp. (1).
5. Remove the display unit bracket unit screws (C) and remove the display unit brackets (2).

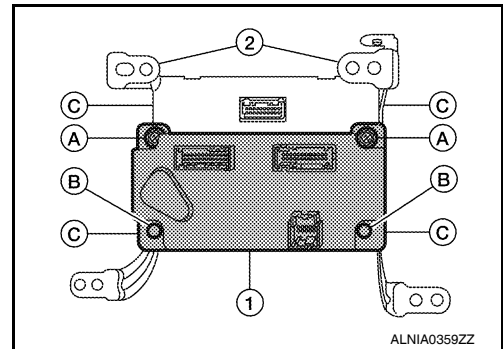

#### INSTALLATION

Installation is in reverse order of removal.

A  
B  
C  
D  
E  
F  
G  
H  
I  
J  
K  
L  
M

AV

O  
P

## FRONT TWEETER

## Removal and Installation

INFOID:000000005259357

## REMOVAL

**CAUTION:****Use a suitable tool to prevent damage to the front tweeter speaker grille trim and the instrument panel.**

1. Remove the front tweeter grille.
2. Remove the front tweeter screws (A).
3. Pull out the front tweeter speaker (1) and disconnect front tweeter connector, then remove the front tweeter speaker (1).

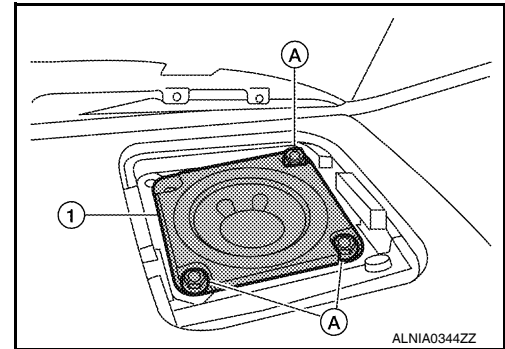

## INSTALLATION

Installation is in the reverse order of removal.



# FRONT DOOR SPEAKER

< ON-VEHICLE REPAIR >

[MID AUDIO]

## FRONT DOOR SPEAKER

### Removal and Installation

INFOID:000000005259358

#### REMOVAL

1. Remove the front door finisher. Refer to [INT-14, "Removal and Installation"](#).
2. Remove the front door speaker screws (A).
3. Pull out the front door speaker (1), and disconnect the front door speaker connector and remove the front door speaker (1).

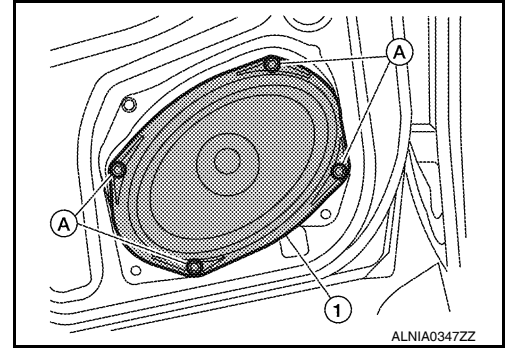

#### INSTALLATION

Installation is in the reverse order of removal.

A  
B  
C  
D  
E  
F  
G  
H  
I  
J  
K  
L  
M  
N  
O  
P

AV

## REAR DOOR SPEAKER

### Removal and Installation

INFOID:000000005259359

#### REMOVAL

1. Remove the rear door finisher. Refer to [INT-14. "Removal and Installation"](#).
2. Remove the rear door speaker screws (A).
3. Disconnect the rear door speaker connector (B) and remove rear door speaker (1).

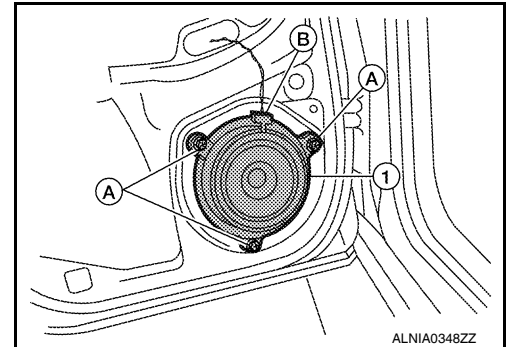

#### INSTALLATION

Installation is in the reverse order of removal.

# STEERING SWITCH

< ON-VEHICLE REPAIR >

[MID AUDIO]

## STEERING SWITCH

### Removal and Installation

INFOID:000000005259360

### Removal and Installation

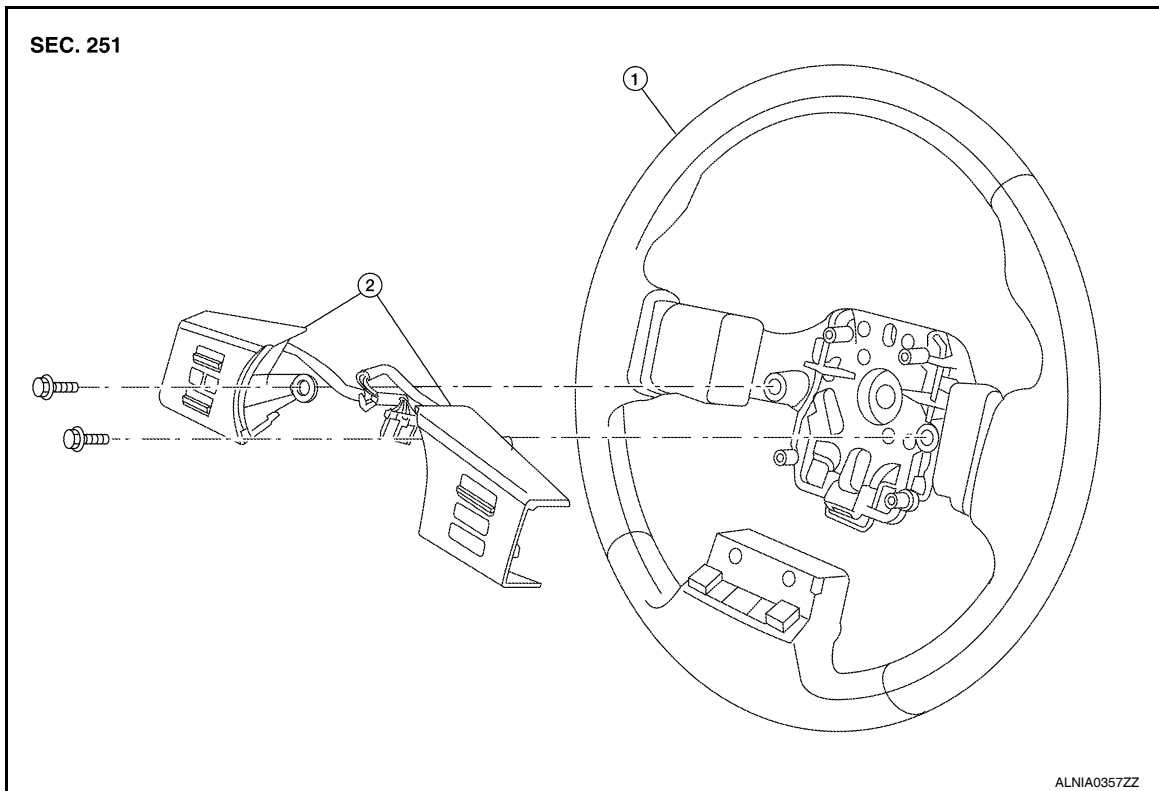

1. Steering wheel

2. Steering wheel audio control switches

### REMOVAL

1. Remove the driver air bag module. Refer to [SR-5, "Removal and Installation"](#).
2. Remove the steering wheel audio control switch assembly screws.
3. Disconnect the steering wheel audio control switches connector.
4. Remove the steering wheel audio control switches by pulling on steering wheel audio control switches to release the pawls.

#### CAUTION:

Do not tilt steering wheel audio control switches during removal or damage may occur to the pawls.

- ○:Pawl

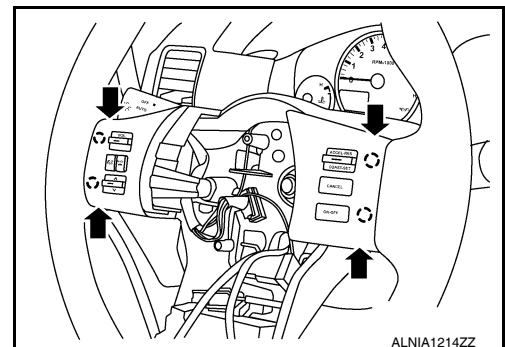

### INSTALLATION

Installation is in the reverse order of removal.

A  
B  
C  
D  
E  
F  
G  
H  
I  
J  
K  
L  
M  
AV  
O  
P

# DVD ENTERTAINMENT SYSTEM

< ON-VEHICLE REPAIR >

[MID AUDIO]

## DVD ENTERTAINMENT SYSTEM

### Removal and Installation of DVD Player

INFOID:000000005259361

#### REMOVAL

1. Remove the center console assembly. Refer to [IP-12. "Removal and Installation"](#).
2. Disconnect the DVD player connector (A).
3. Remove the DVD player screws (B), then remove the DVD player (1).
4. Remove the DVD player bracket screws and then remove DVD player brackets.

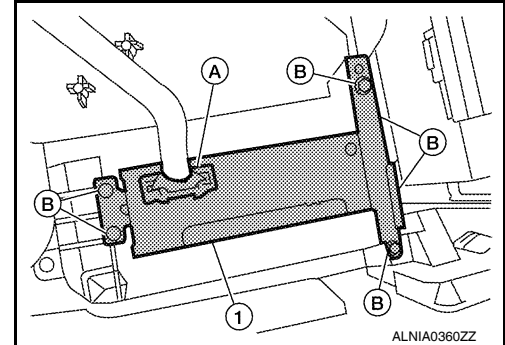

#### INSTALLATION

Installation is in reverse order of removal.

### Removal and Installation of Video Monitor

INFOID:000000005259362

#### REMOVAL

1. Release the clips and remove the video monitor finisher from headlining.
2. Press the release tabs and remove the cover.
3. Remove the video monitor screws.
4. Gently lower the assembly and disconnect the connector, then remove the video monitor from the headlining.

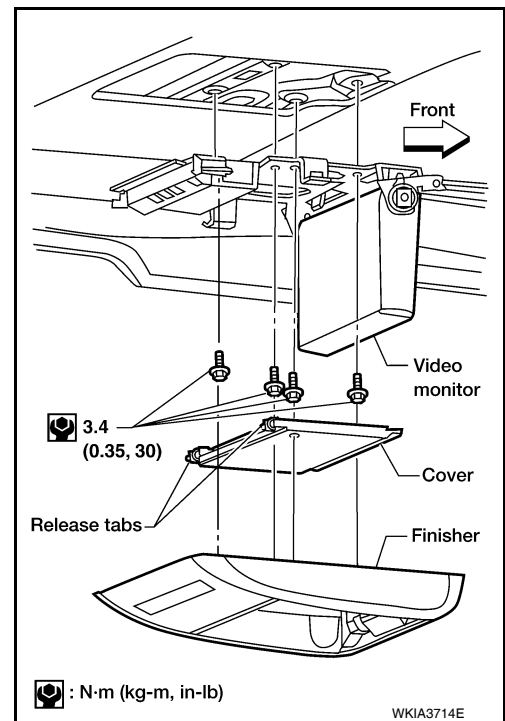

#### INSTALLATION

Installation is in reverse order of removal.

# AUDIO ANTENNA

< ON-VEHICLE REPAIR >

[MID AUDIO]

## AUDIO ANTENNA

### Location of Antenna

INFOID:000000005259363

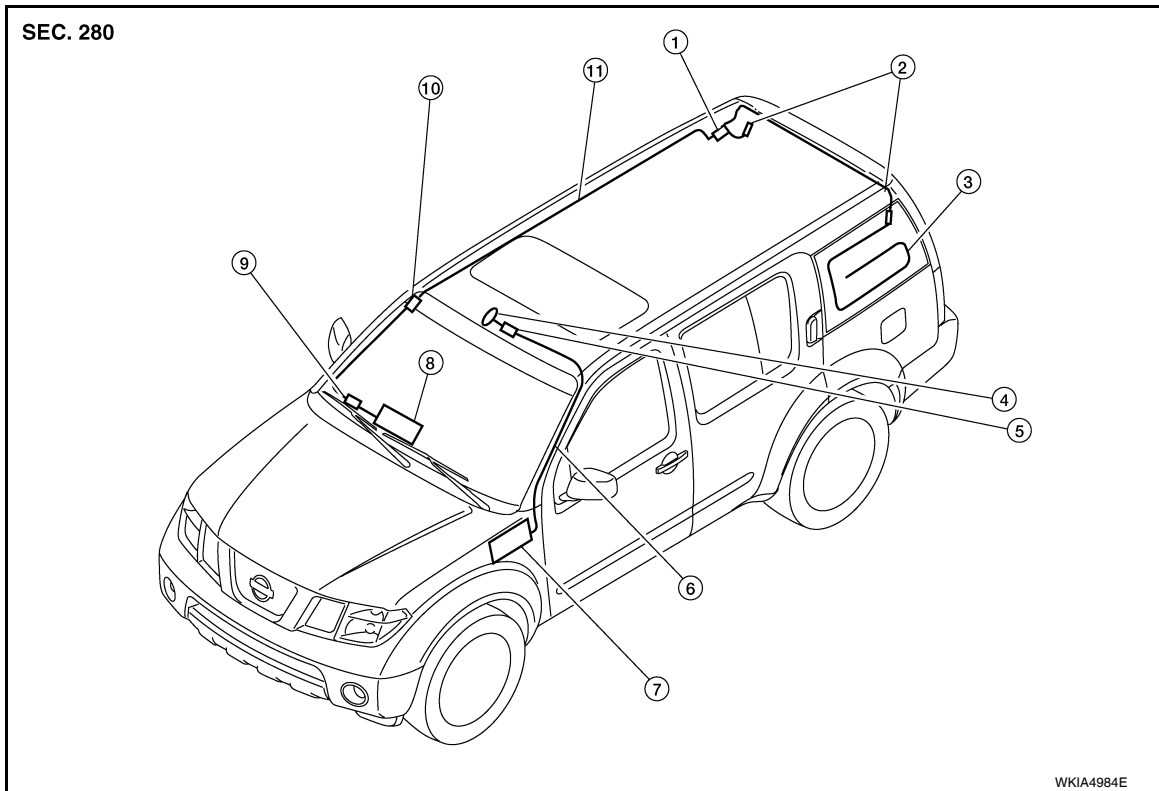

- |                                       |  |                                   |
|---------------------------------------|--|-----------------------------------|
| 1. Antenna amp.<br>M602               | 2. Window antenna grid connector bracket | 3. Window antenna grid            |
| 4. Satellite antenna<br>M351          | 5. Harness connector<br>M73, M350        | 6. Satellite antenna feeder       |
| 7. Satellite radio tuner<br>M41, M129 | 8. AV control unit M132                  | 9. Harness connector<br>M78, M501 |
| 10. Harness connector<br>M502, M601   | 11. Antenna feeder                       |                                   |

### Window Antenna Repair

INFOID:000000005259364

#### ELEMENT CHECK

1. Attach probe circuit tester (ohm setting) to antenna terminal on each side.

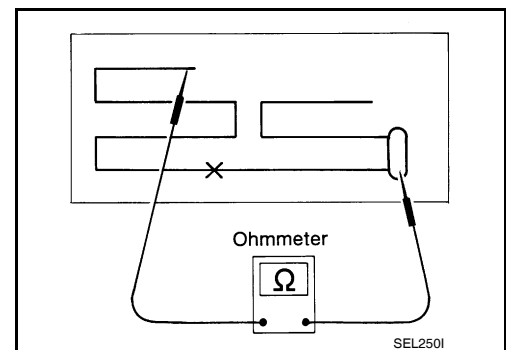

A  
B  
C  
D  
E  
F  
G  
H  
I  
J  
K  
L  
M  
N  
O  
P

AV

# AUDIO ANTENNA

< ON-VEHICLE REPAIR >

[MID AUDIO]

- When measuring continuity, wrap tin foil around the top of probe. Then, press the foil against the wire with your finger.

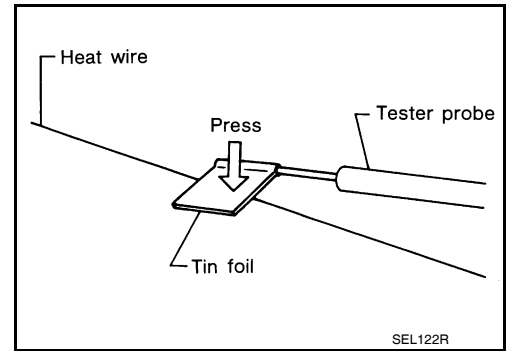

2. If an element is broken, no continuity will exist.

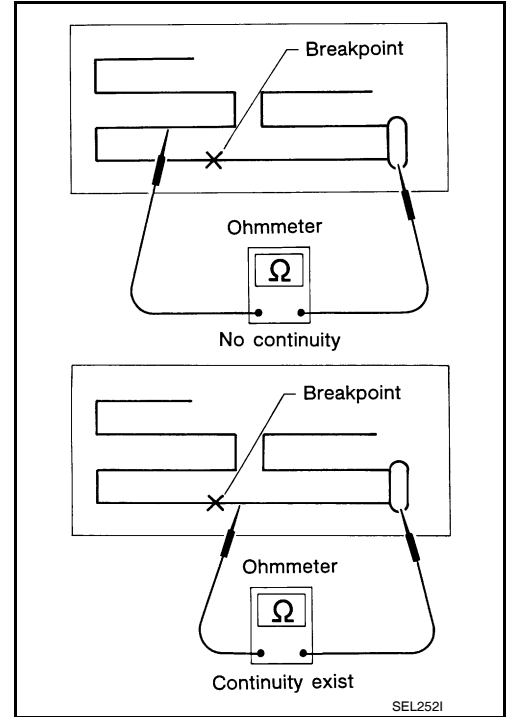

3. To locate a break, move probe along element. Tester indication will change abruptly when probe passes the broken point.

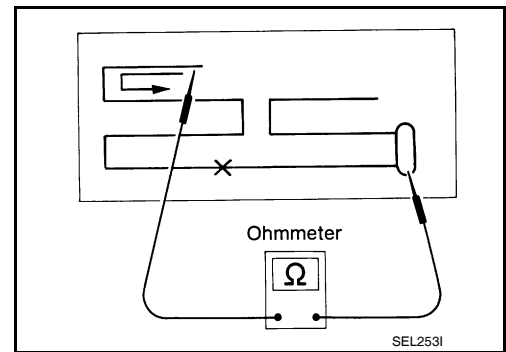

## ELEMENT REPAIR

Refer to [DEF-43, "Filament Repair"](#).

# AUXILIARY INPUT JACK

< ON-VEHICLE REPAIR >

[MID AUDIO]

## AUXILIARY INPUT JACK

### Removal and Installation

INFOID:000000005570797

#### Removal

1. Remove the A/T finisher. Refer to [JP-12. "Removal and Installation"](#).
2. Remove the auxiliary input jack.

#### Installation

Installation is in the reverse order of removal.

A

B

C

D

E

F

G

H

I

J

K

L

M

AV

O

P

## ANTENNA AMP.

< ON-VEHICLE REPAIR >

[MID AUDIO]

### ANTENNA AMP.

#### Removal and Installation

INFOID:000000005550740

#### REMOVAL

1. Remove the luggage side upper and lower RH finishers. Refer to [INT-22. "Removal and Installation"](#).
2. Detach the antenna amp. harness clip (D), disconnect the antenna amp. connector (A), harness connector (B), then remove the antenna amp. screw (C) and remove the antenna amp. (1).

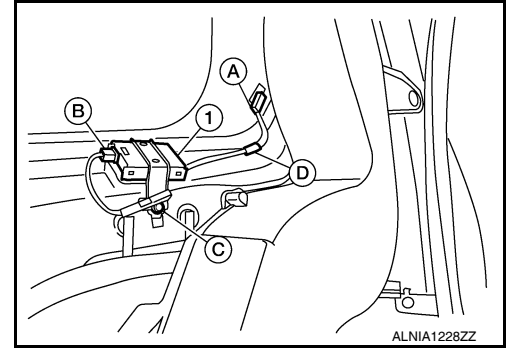

#### INSTALLATION

Installation is in the reverse order of removal.



## SATELLITE RADIO ANTENNA

### Removal and Installation

INFOID:000000005259365

#### REMOVAL

1. Remove the front roof console finisher. Refer to [INT-19. "Removal and Installation"](#).
2. Disconnect the satellite antenna connector.
3. Remove the satellite antenna nut.
4. Remove the satellite antenna.

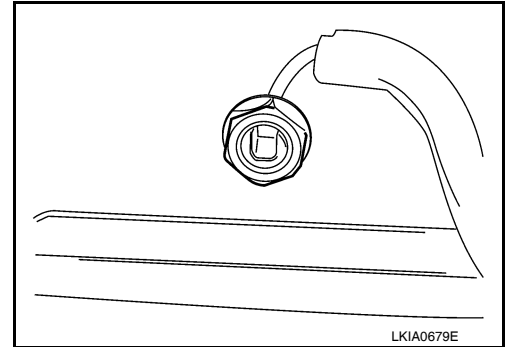

#### INSTALLATION

Installation is in the reverse order of removal.

A  
B  
C  
D  
E  
F  
G  
H  
I  
J  
K  
L  
M  
O  
P

AV

## SATELLITE RADIO TUNER

### Removal and Installation

INFOID:000000005259366

#### REMOVAL

1. Disconnect the battery negative terminal.
2. Disconnect the satellite radio tuner connectors.
3. Remove satellite radio tuner screws (A), and remove satellite radio tuner from above the parking brake pedal.

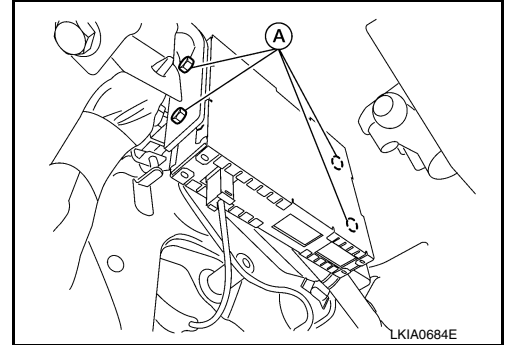

#### INSTALLATION

Installation is in the reverse order of removal.

# REAR VIEW CAMERA

< ON-VEHICLE REPAIR >

[MID AUDIO]

## REAR VIEW CAMERA

### Removal and Installation

INFOID:000000005259367

#### Rear View Camera

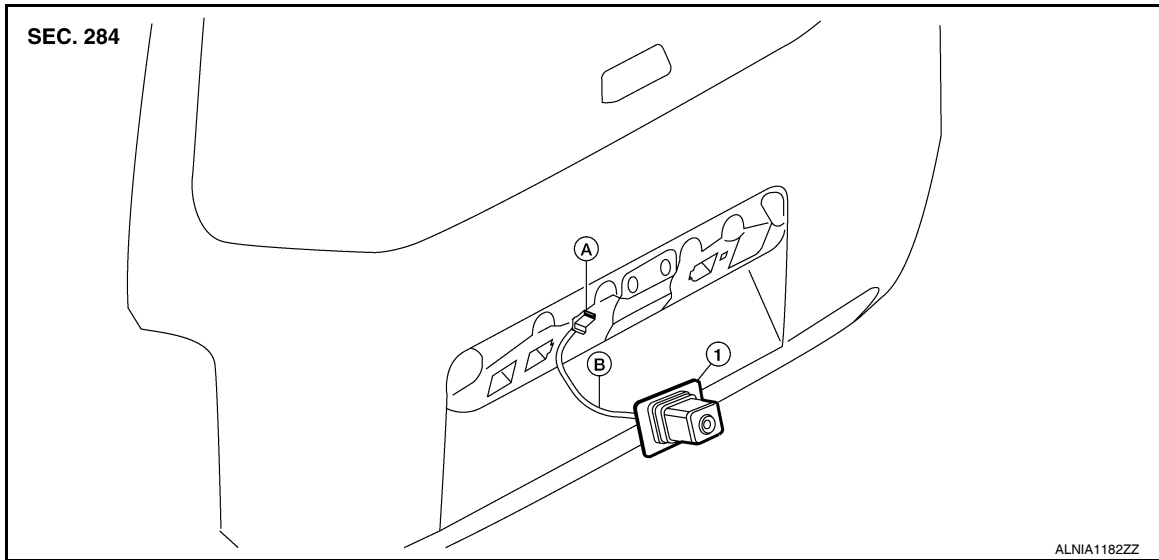

1. Rear view camera                      A. Rear view camera connector                      B. Rear view camera harness clip

#### REMOVAL

1. Remove the license lamp finisher. Refer to [EXT-21, "Removal and Installation"](#).
2. Disconnect the rear view camera connector.
3. Detach the rear view camera harness clip.
4. Detach the rear view camera to release, then pull out to remove the rear view camera while feeding the rear view camera harness and connector through the back door.

#### INSTALLATION

Installation is in the reverse order of removal.

A  
B  
C  
D  
E  
F  
G  
H  
I  
J  
K  
L  
M

AV

O  
P

# REAR VIEW CAMERA CONTROL UNIT

< ON-VEHICLE REPAIR >

[MID AUDIO]

## REAR VIEW CAMERA CONTROL UNIT

### Removal and Installation

INFOID:000000005259368

#### REMOVAL

1. Remove the luggage side lower finisher RH. Refer to [INT-22. "Removal and Installation"](#).
2. Remove the rear HVAC duct tube (C103) fastener and remove the HVAC duct tube.
3. Remove the rear view camera control unit screws (A), disconnect the rear view camera control unit connector (B) and remove the rear view camera control unit (1).

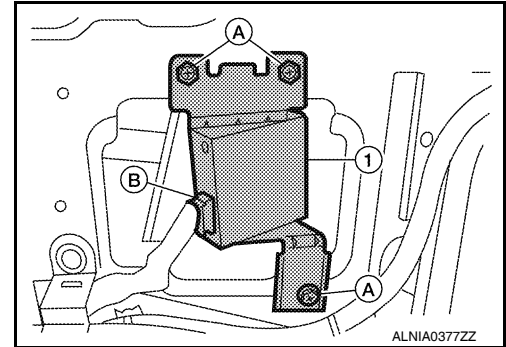

#### INSTALLATION

Installation is in the reverse order of removal.

**BASIC INSPECTION**

DIAGNOSIS AND REPAIR WORKFLOW

Work Flow

INFOID:000000005259369

OVERALL SEQUENCE

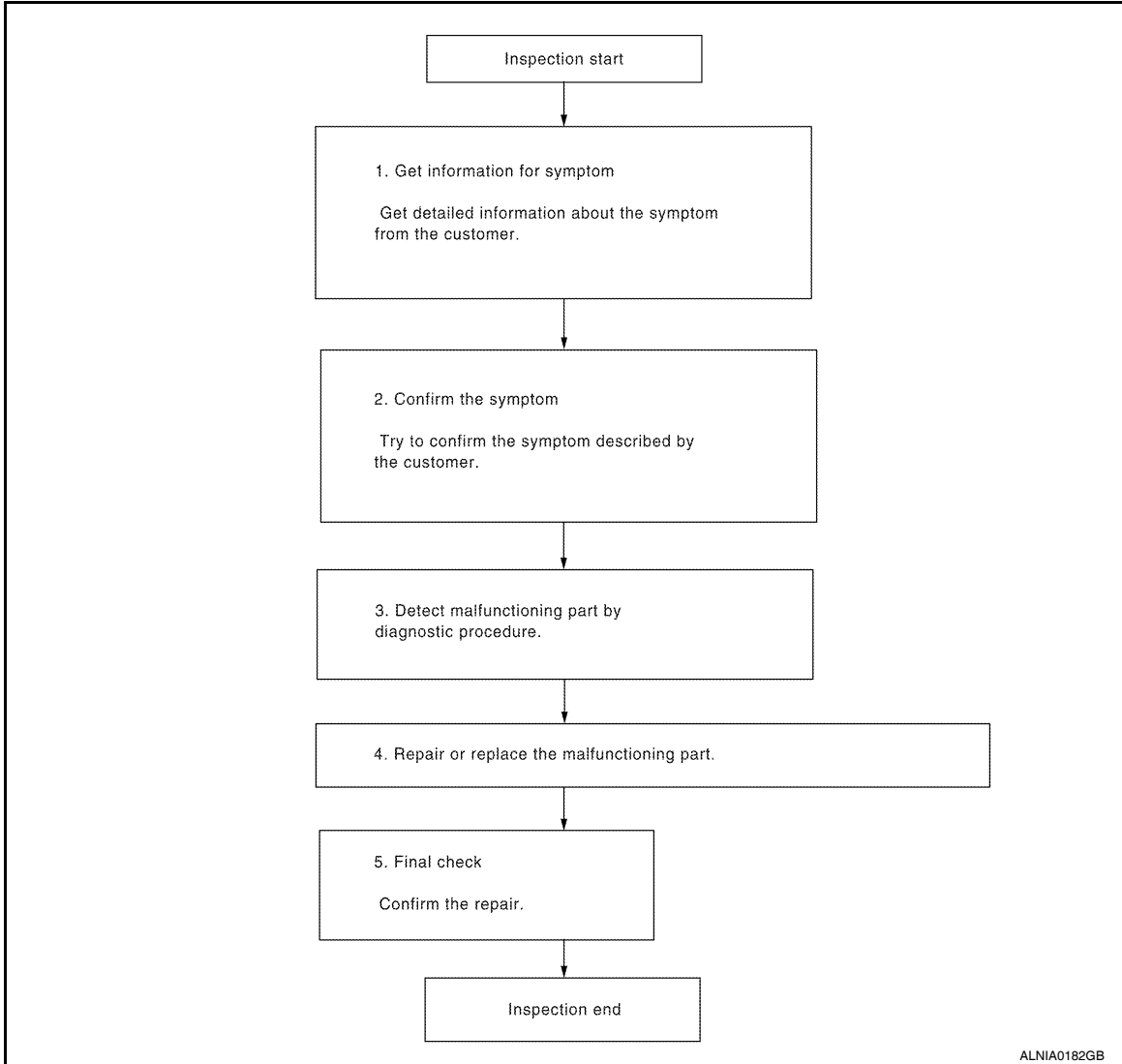

DETAILED FLOW

**1.GET INFORMATION FOR SYMPTOM**

Get detailed information from the customer about the symptom (the condition and the environment when the incident/malfunction occurred).

>> GO TO 2

**2.CONFIRM THE SYMPTOM**

Try to confirm the symptom described by the customer. Verify relation between the symptom and the condition when the symptom is detected.

>> GO TO 3

**3.DETECT MALFUNCTIONING PART BY DIAGNOSTIC PROCEDURE**

Inspect according to Diagnostic Procedure of the system.

A  
B  
C  
D  
E  
F  
G  
H  
I  
J  
K  
L  
M

AV

O  
P

## DIAGNOSIS AND REPAIR WORKFLOW

[BOSE AUDIO WITHOUT NAVIGATION]

< BASIC INSPECTION >

---

Is malfunctioning part detected?

YES >> GO TO 4

NO >> GO TO 2

### 4. REPAIR OR REPLACE THE MALFUNCTIONING PART

---

1. Repair or replace the malfunctioning part.
2. Reconnect parts or connectors disconnected during Diagnostic Procedure.

>> GO TO 5

### 5. FINAL CHECK

---

Refer to confirmed symptom in step 2, and make sure that the symptom is not detected.

Was the repair confirmed?

YES >> Inspection End.

NO >> GO TO 2

# AUDIO SYSTEM

< FUNCTION DIAGNOSIS >

[BOSE AUDIO WITHOUT NAVIGATION]

## FUNCTION DIAGNOSIS

### AUDIO SYSTEM

#### System Diagram

INFOID:000000005259370

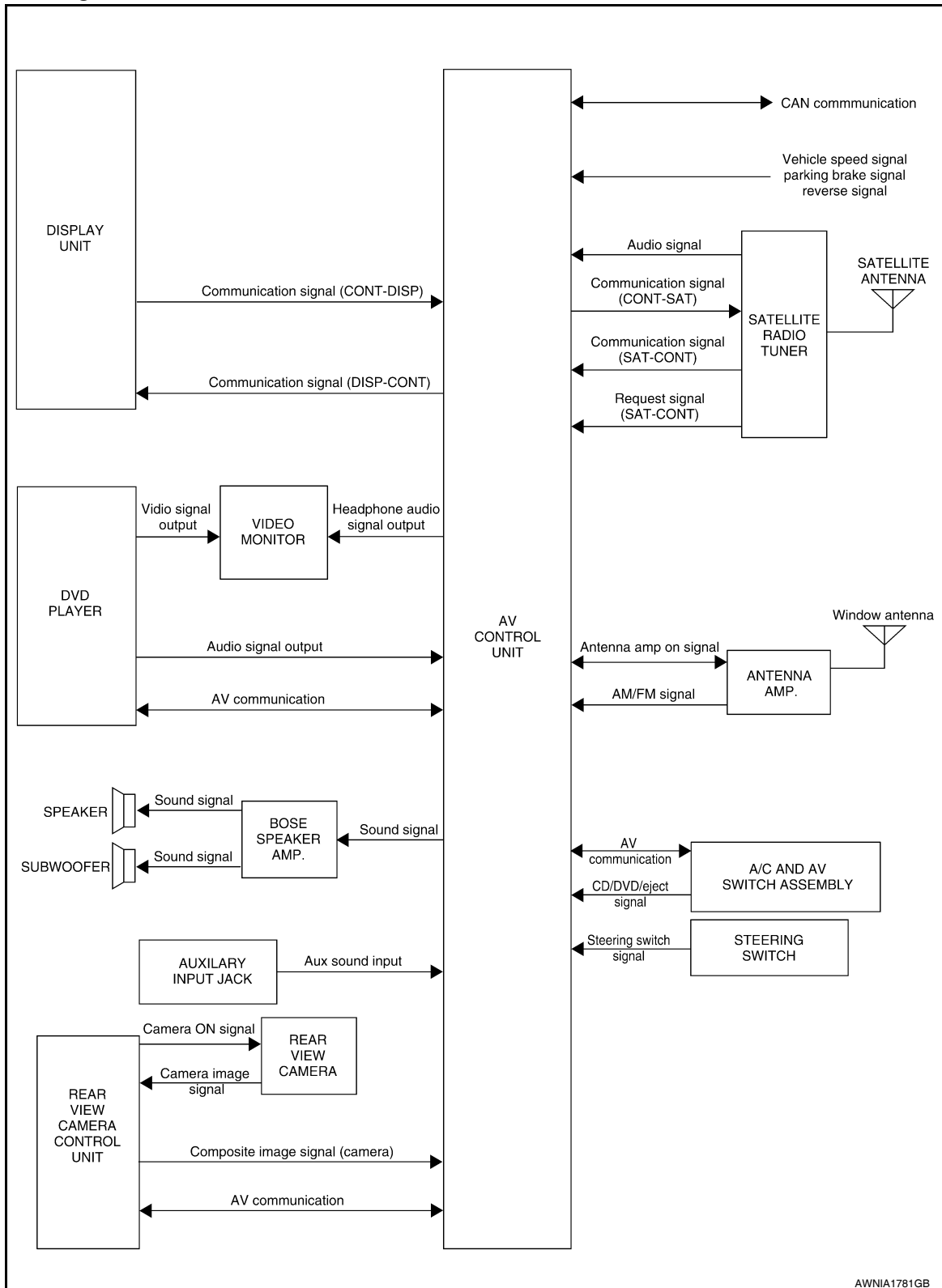

AWNIA1781GB

#### System Description

INFOID:000000005259371

### AUDIO SYSTEM

Revision: July 2009

AV-159

2010 Pathfinder

A  
B  
C  
D  
E  
F  
G  
H  
I  
J  
K  
L  
M  
N  
O  
P

AV

## AUDIO SYSTEM

< FUNCTION DIAGNOSIS >

[BOSE AUDIO WITHOUT NAVIGATION]

---

The audio system consists of the following components

- AV control unit
- Display unit
- BOSE speaker amp.
- Window antenna
- Steering wheel audio control switches
- A/C and AV switch assembly
- Front door speakers
- Front tweeters
- Rear door speakers
- Rear tweeters
- Subwoofer

When the audio system is on, radio signals are received by the window antenna. The AV control unit then sends audio signals to the BOSE speaker amp. The BOSE speaker amp. amplifies the audio signals before sending them to the front door speakers, front tweeters, rear door speakers, rear tweeters and the subwoofer. Refer to Owner's Manual for audio system operating instructions.

### SATELLITE RADIO SYSTEM

The satellite radio system consists of the following components

- Satellite antenna
- Satellite radio tuner

When the satellite radio system is on, radio signals are supplied to the satellite radio tuner from the satellite antenna. The satellite radio tuner then sends audio signals to the AV control unit. Refer to Owner's Manual for satellite radio system operating instructions.

### SPEED SENSITIVE VOLUME SYSTEM

Volume level of this system goes up and down automatically in proportion to the vehicle speed. The control level can be selected by the customer. Refer to Owner's Manual for operating instructions.



# AUDIO SYSTEM

< FUNCTION DIAGNOSIS >

[BOSE AUDIO WITHOUT NAVIGATION]

## Component Parts Location

INFOID:000000005259372

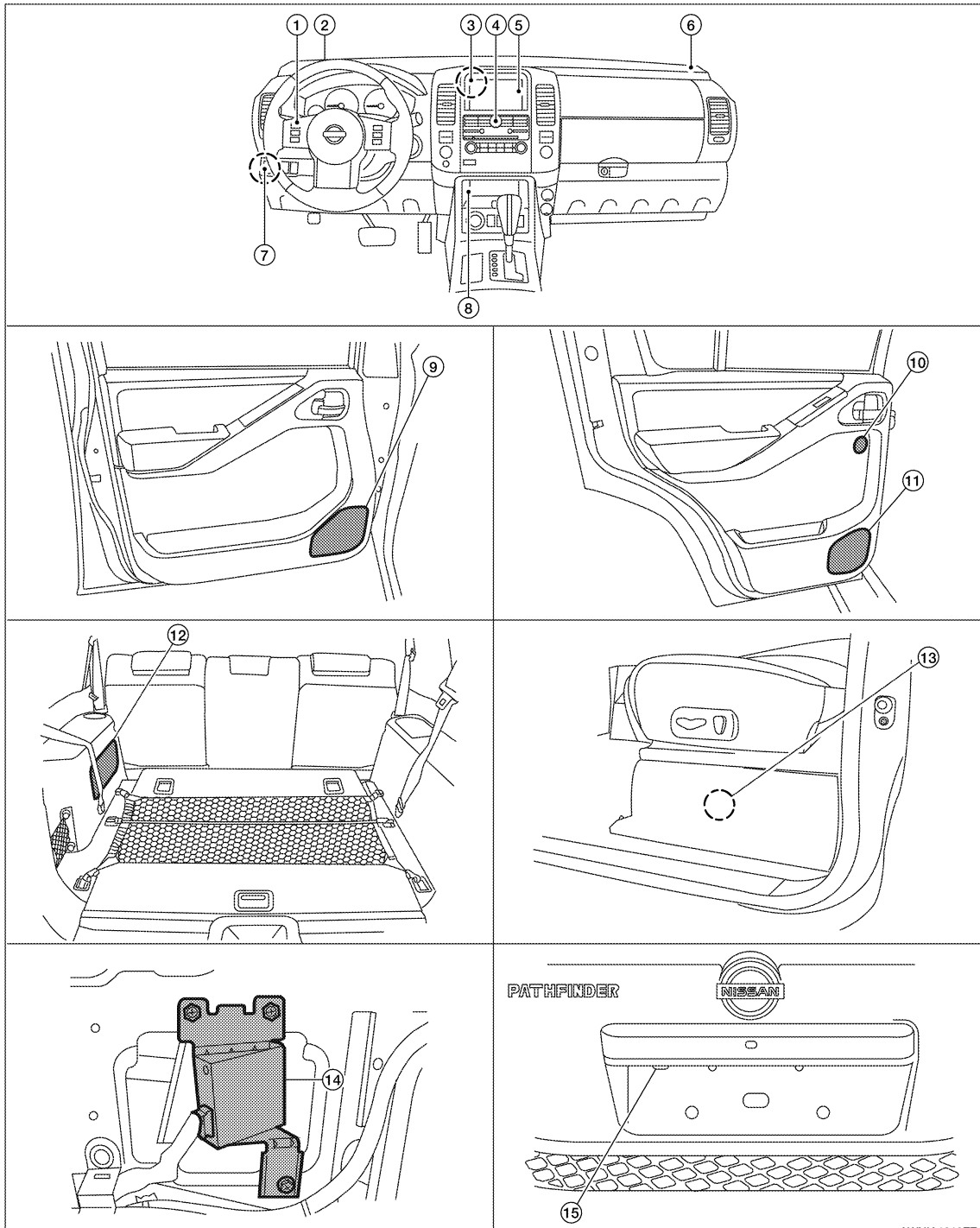

- |  |                          |   |
|--|--------------------------|---|
| 1. Steering wheel audio control switches | 2. Front tweeter LH M109 | 3. AV control unit M131, M133, M134, M135, M136 |
| 4. A/C and AV switch assembly M98        | 5. Display unit M93      | 6. Front tweeter RH M111                        |
| 7. Satellite radio tuner M41, M129       | 8. Aux jack M85          | 9. Front door speaker LH D12<br>RH D112         |

A  
B  
C  
D  
E  
F  
G  
H  
I  
J  
K  
L  
M  
O  
P

AV

# AUDIO SYSTEM

< FUNCTION DIAGNOSIS >

[BOSE AUDIO WITHOUT NAVIGATION]

- |  |   |                           |
|--|---|---------------------------|
| 10. Rear tweeter<br>LH D208<br>RH D308                     | 11. Rear door speaker<br>LH D207<br>RH D307                                 | 12. Subwoofer B72         |
| 13. BOSE speaker amp B74 & B75 (located under driver seat) | 14. Rear camera control unit B176 (located behind luggage side finisher RH) | 15. Rear view camera D551 |

## Component Description

INFOID:000000005259373

Part name	Description
AV control unit	Controls audio system and satellite radio system functions
Display unit	Displays all audio and climate control related information
BOSE speaker amp.	Receives power (amp ON) and audio signals from audio unit and outputs audio signals to each speaker.
Steering wheel audio control switches	<ul style="list-style-type: none"><li>• Audio operation can be operated</li><li>• Steering wheel audio control switch signal is output to audio unit</li></ul>
Front door speakers	<ul style="list-style-type: none"><li>• Outputs audio signal from BOSE speaker amp.</li><li>• Outputs high, mid and low range sounds</li></ul>
Front tweeters	<ul style="list-style-type: none"><li>• Outputs audio signal from BOSE speaker amp.</li><li>• Outputs high range sounds</li></ul>
Rear door speakers	<ul style="list-style-type: none"><li>• Outputs audio signal from BOSE speaker amp.</li><li>• Outputs high, mid and low range sounds</li></ul>
Rear tweeters	<ul style="list-style-type: none"><li>• Outputs audio signal from BOSE speaker amp.</li><li>• Outputs high range sounds</li></ul>
Subwoofer	<ul style="list-style-type: none"><li>• Outputs audio signal from BOSE speaker amp.</li><li>• Outputs low range sounds</li></ul>
Satellite radio tuner	<ul style="list-style-type: none"><li>• Receives radio signals from satellite antenna</li><li>• Sends audio signals to AV control unit</li></ul>
Satellite antenna	Audio signal (satellite radio) is received and output to AV control unit.

# REAR VIEW MONITOR SYSTEM

< FUNCTION DIAGNOSIS >

[BOSE AUDIO WITHOUT NAVIGATION]

## REAR VIEW MONITOR SYSTEM

### System Diagram

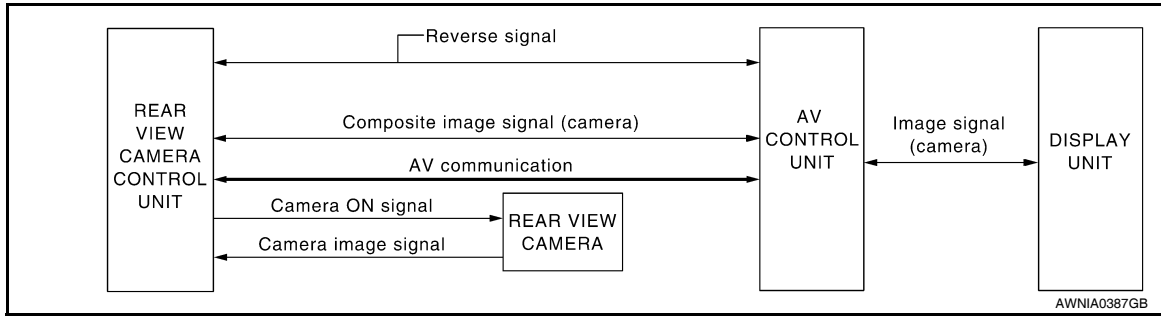

### System Description

INFOID:000000005259375

When the selector is in the R position, the display shows a view to the rear of the vehicle. Lines which indicate the vehicle clearance and distances are also displayed.

#### AV COMMUNICATION LINE

The rear view camera unit is connected to the AV control unit using an AV communication line. This line is used to transmit and receive data.

A  
B  
C  
D  
E  
F  
G  
H  
I  
J  
K  
L  
M  
O  
P

AV

# REAR VIEW MONITOR SYSTEM

[BOSE AUDIO WITHOUT NAVIGATION]

< FUNCTION DIAGNOSIS >

## Component Parts Location

INFOID:000000005259376

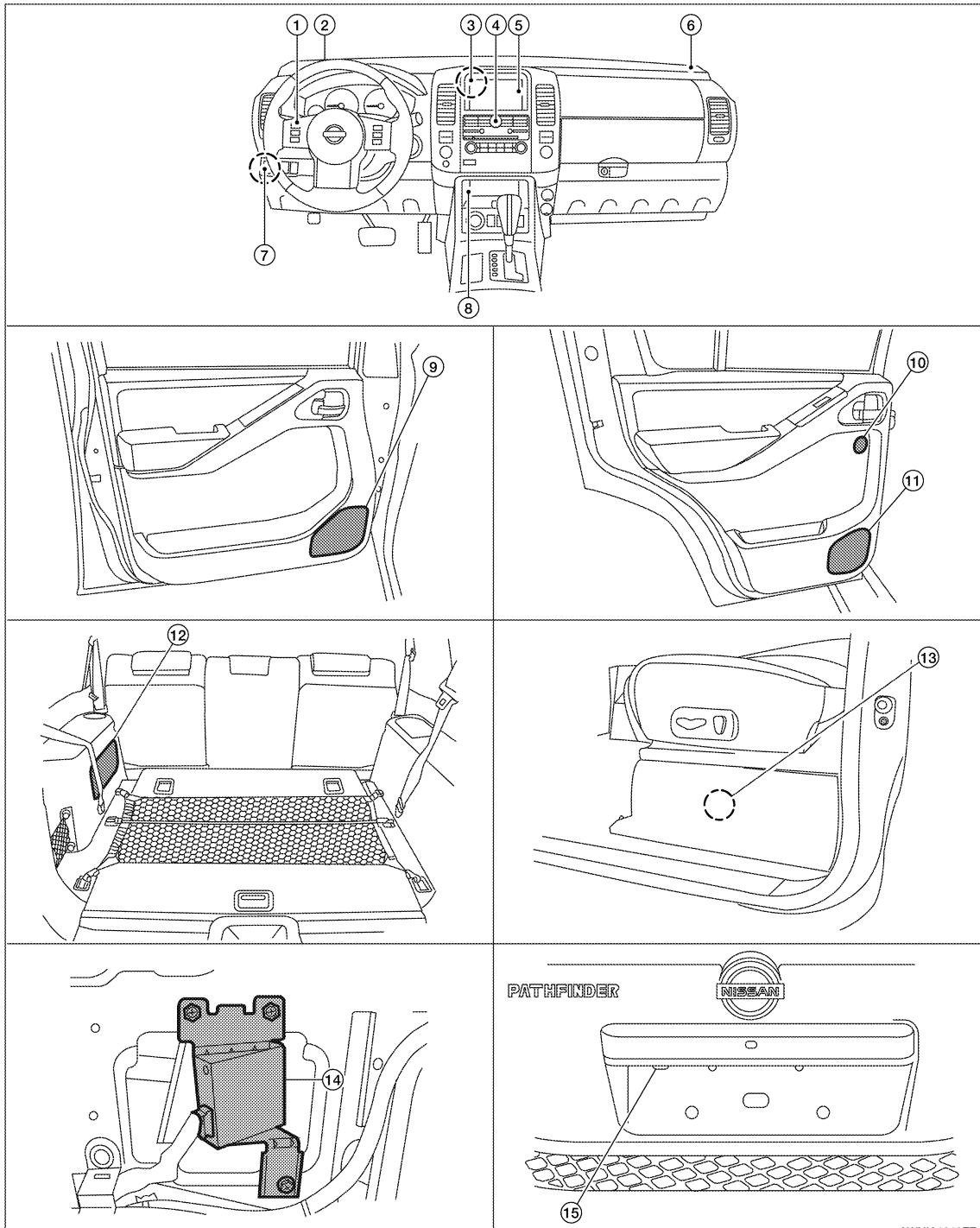

AWNIA1613ZZ

- |  |                          |   |
|--|--------------------------|---|
| 1. Steering wheel audio control switches | 2. Front tweeter LH M109 | 3. AV control unit M131, M133, M134, M135, M136 |
| 4. A/C and AV switch assembly M98        | 5. Display unit M93      | 6. Front tweeter RH M111                        |
| 7. Satellite radio tuner M41, M129       | 8. Aux jack M85          | 9. Front door speaker LH D12<br>RH D112         |

# REAR VIEW MONITOR SYSTEM

[BOSE AUDIO WITHOUT NAVIGATION]

< FUNCTION DIAGNOSIS >

- |  |   |                           |
|--|---|---------------------------|
| 10. Rear tweeter<br>LH D208<br>RH D308                     | 11. Rear door speaker<br>LH D207<br>RH D307                                 | 12. Subwoofer B72         |
| 13. BOSE speaker amp B74 & B75 (located under driver seat) | 14. Rear camera control unit B176 (located behind luggage side finisher RH) | 15. Rear view camera D551 |

## Component Description

INFOID:000000005259377

Part name	Description
AV control unit	Camera image signal is sent from rear view camera control unit
Rear view camera control unit	<ul style="list-style-type: none"> <li>Receives reverse signal from back-up lamp relay</li> <li>Receives rear view camera image signal</li> <li>Sends camera ON signal to rear view camera</li> <li>Sends image signal to AV control unit</li> </ul>
Rear view camera	<ul style="list-style-type: none"> <li>Receives camera ON signal from rear view camera control unit</li> <li>Sends image signal to rear view camera control unit</li> </ul>

A  
B  
C  
D  
E  
F  
G  
H  
I  
J  
K  
L  
M

AV

O  
P

# DVD PLAYER

< FUNCTION DIAGNOSIS >

[BOSE AUDIO WITHOUT NAVIGATION]

## DVD PLAYER

### System Diagram

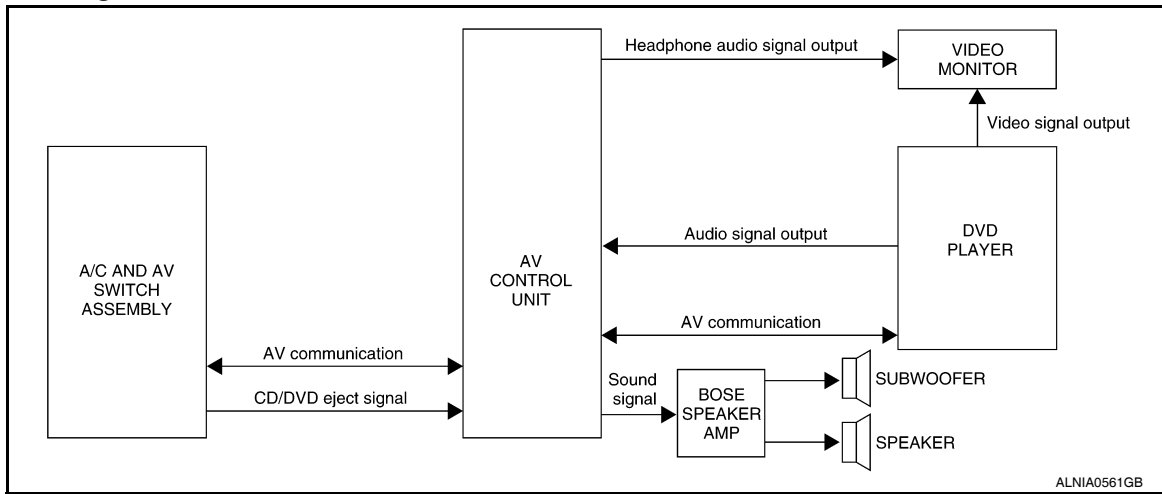

### System Description

INFOID:000000005259379

The DVD entertainment system consists of the following components

- AV control unit
- Display unit
- DVD player
- Video monitor
- A/C and AV switch assembly
- Steering wheel audio control switches
- BOSE speaker amp.
- Front tweeters
- Front door speakers
- Rear tweeters
- Rear door speakers
- Subwoofer

When the DVD entertainment system is on, video signals are sent from the DVD player to the video monitor. Audio signals are sent to the AV control unit. Audio signals can be directed through wired or wireless infrared headphones or through the BOSE speaker amp. to the vehicle speakers. Refer to the Owner's Manual for complete DVD entertainment system operating instructions.

# DVD PLAYER

< FUNCTION DIAGNOSIS >

[BOSE AUDIO WITHOUT NAVIGATION]

## Component Parts Location

INFOID:000000005259380

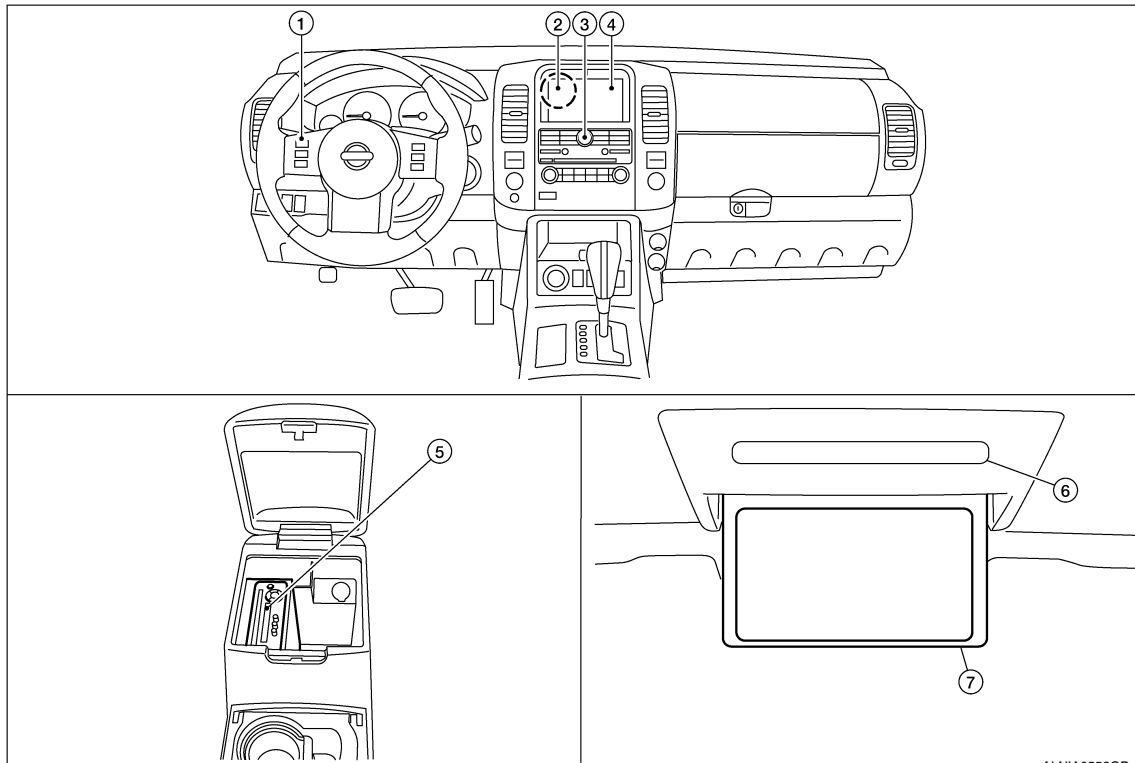

ALNIA0558GB

- |  |   |  |
|--|---|--|
| 1. Steering wheel audio control switches | 2. AV control unit M131, M133, M134, M135, M136 | 3. A/C and AV switch assembly M98  |
| 4. Display unit M93                      | 5. DVD player M205 (located in center console)  | 6. Infrared headphone and remote receiver/transmitter (part of video monitor assembly) |
| 7. Video monitor B76                     |   |  |

## Component Description

INFOID:000000005259381

Part name	Description
DVD player	<ul style="list-style-type: none"> <li>Outputs DVD video to video monitor</li> <li>Outputs DVD audio to the AV control unit</li> </ul>
Video monitor	<ul style="list-style-type: none"> <li>Receives and displays the DVD video signal</li> </ul>
AV control unit	<ul style="list-style-type: none"> <li>Controls audio system and DVD entertainment system functions</li> </ul>
BOSE speaker amp.	<ul style="list-style-type: none"> <li>Receives audio signals from the AV control unit</li> <li>Outputs amplified audio signals to the speakers</li> </ul>
A/C and AV switch assembly	<ul style="list-style-type: none"> <li>All audio and A/C operations can be operated</li> <li>Switch signal is output to the AV control unit and A/C auto amp</li> </ul>
Steering wheel audio control switches	<ul style="list-style-type: none"> <li>Audio operation can be operated</li> <li>Steering switch signal (operation signal) is output to AV control unit</li> </ul>
Front door speakers	<ul style="list-style-type: none"> <li>Outputs audio signal from BOSE speaker amp.</li> <li>Outputs high, mid and low range sounds</li> </ul>
Front and rear tweeters	<ul style="list-style-type: none"> <li>Outputs audio signal from BOSE speaker amp.</li> <li>Outputs high range sounds</li> </ul>

## DVD PLAYER

< FUNCTION DIAGNOSIS >

[BOSE AUDIO WITHOUT NAVIGATION]

Part name	Description
Rear door speakers	<ul style="list-style-type: none"><li>• Outputs audio signal from BOSE speaker amp.</li><li>• Outputs high, mid and low range sounds</li></ul>
Subwoofer	<ul style="list-style-type: none"><li>• Outputs audio signal from BOSE speaker amp.</li><li>• Outputs low range sounds</li></ul>



# HANDS-FREE PHONE SYSTEM

< FUNCTION DIAGNOSIS >

[BOSE AUDIO WITHOUT NAVIGATION]

## HANDS-FREE PHONE SYSTEM

### System Diagram

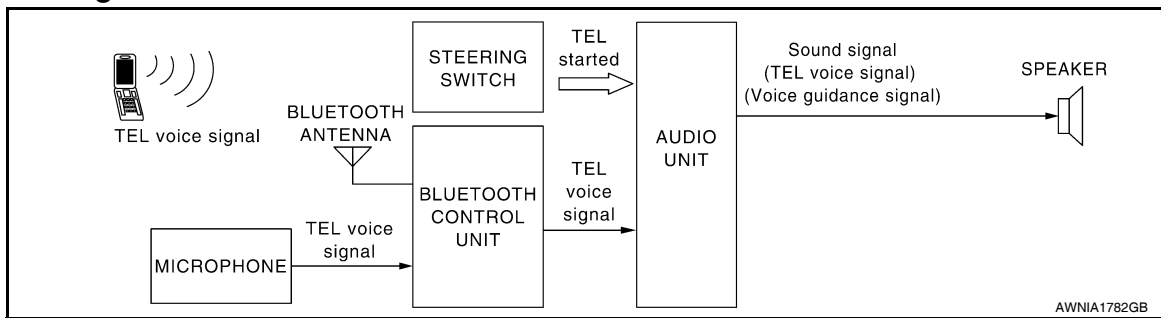

### System Description

Refer to the owner's manual for Bluetooth telephone system operating instructions.

#### NOTE:

Cellular telephones must have their wireless connection set up (paired) before using the Bluetooth telephone system.

Bluetooth telephone system allows users who have a Bluetooth cellular telephone to make a wireless connection between their cellular telephone and the Bluetooth control unit. Hands-free cellular telephone calls can be sent and received. Personal memos can be created using the Nissan Voice Recognition system. Some Bluetooth cellular telephones may not be recognized by the Bluetooth control unit. When a cellular telephone or the Bluetooth control unit is replaced, the telephone must be paired with the Bluetooth control unit. Different cellular telephones may have different pairing procedures. Refer to the cellular telephone operating manual.

#### BLUETOOTH CONTROL UNIT

When the ignition switch is turned to ACC or ON, the Bluetooth control unit will power up. During power up, the Bluetooth control unit is initialized and performs various self checks. Initialization may take up to 10 seconds. If a phone is present in the vehicle and paired with the Bluetooth control unit, Nissan Voice Recognition will then become active. Bluetooth telephone functions can be turned off using the Nissan Voice Recognition system.

#### STEERING WHEEL AUDIO CONTROL SWITCHES

When buttons on the steering wheel audio control switch are pushed, the resistance in steering wheel audio control switch circuit changes depending on which button is pushed. The Bluetooth control unit uses this signal to perform various functions while navigating through the voice recognition system.

The following functions can be performed using the steering wheel audio control switch:

- Initiate Self Diagnosis of the Bluetooth telephone system
- Start a voice recognition session
- Answer and end telephone calls
- Adjust the volume of calls
- Record memos

#### MICROPHONE

The microphone is located in the roof console assembly. The microphone sends a signal to the Bluetooth control unit. The microphone can be actively tested during self-diagnosis.

#### AV CONTROL UNIT

The AV control unit receives signals from the Bluetooth control unit and sends audio signals to the speakers.

A  
B  
C  
D  
E  
F  
G  
H  
I  
J  
K  
L  
M  
AV  
O  
P

# HANDS-FREE PHONE SYSTEM

[BOSE AUDIO WITHOUT NAVIGATION]

< FUNCTION DIAGNOSIS >

## Component Parts Location

INFOID:000000005259384

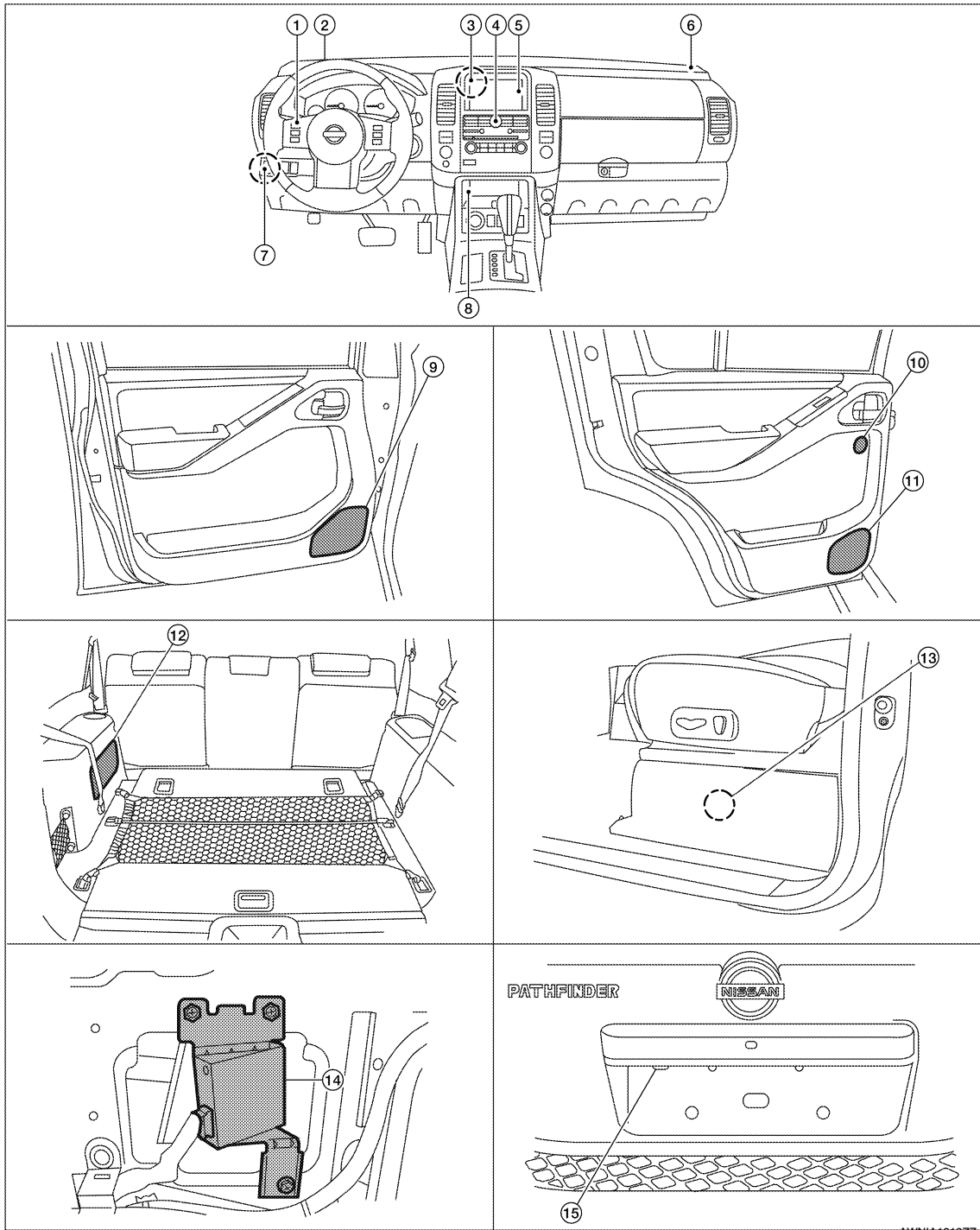

AWNIA1613ZZ

- |  |                          |   |
|--|--------------------------|---|
| 1. Steering wheel audio control switches | 2. Front tweeter LH M109 | 3. AV control unit M42, M43, M45, M46, M69, M70 |
| 4. A/C and AV switch assembly M98        | 5. Display unit M93      | 6. Front tweeter RH M111                        |
| 7. Satellite radio tuner M41, M129       | 8. Aux jack M85          | 9. Front door speaker LH D12 RH D112            |

# HANDS-FREE PHONE SYSTEM

[BOSE AUDIO WITHOUT NAVIGATION]

< FUNCTION DIAGNOSIS >

- |  |   |                           |
|--|---|---------------------------|
| 10. Rear tweeter<br>LH D208<br>RH D308                     | 11. Rear door speaker<br>LH D207<br>RH D307                                 | 12. Subwoofer B72         |
| 13. BOSE speaker amp B74 & B75 (located under driver seat) | 14. Rear camera control unit B176 (located behind luggage side finisher RH) | 15. Rear view camera D551 |

## Component Description

INFOID:000000005259385

Part name	Description
AV control unit	<ul style="list-style-type: none"> <li>Receives telephone voice signal from Bluetooth control unit.</li> <li>Sends telephone voice and voice guidance signals to the speakers.</li> </ul>
Door speaker	Receives telephone voice and voice guidance signals from the AV control unit.
Front tweeter	
Center speaker	
Steering wheel audio control switches	<ul style="list-style-type: none"> <li>Start a voice recognition session</li> <li>Answer and end telephone calls</li> <li>Adjust the volume level</li> </ul>
Microphone	Sends voice signals to Bluetooth control unit
Bluetooth control unit	Controls hands-free phone functions
Bluetooth antenna	Sends telephone voice signal to bluetooth control unit

A  
B  
C  
D  
E  
F  
G  
H  
I  
J  
K  
L  
M

AV

O  
P

# DIAGNOSIS SYSTEM (AV CONTROL UNIT)

< FUNCTION DIAGNOSIS >

[BOSE AUDIO WITHOUT NAVIGATION]

## DIAGNOSIS SYSTEM (AV CONTROL UNIT)

### AV CONTROL UNIT

#### AV CONTROL UNIT : Diagnosis Description

INFOID:000000005259386

#### DESCRIPTION

- Diagnosis function consists of the "Self-Diagnosis" mode performed automatically and the "Confirmation/Adjustment" mode operated manually.
- "Self-Diagnosis" mode checks for connections between the units constituting this system, analyzes each individual unit at the same time, and displays the results on the LCD screen.
- "Confirmation/Adjustment" mode is used to perform trouble diagnosis that requires operation and judgment by an operator (trouble that cannot be automatically judged by the system), to check/change the set value, and to display the error history of the AV control unit.

#### DIAGNOSIS ITEM

Mode		Description	
Self-diagnosis		<ul style="list-style-type: none"> <li>• AV control unit diagnosis</li> <li>• Analyzes connection between the AV control unit, front display, Bluetooth, DVD deck, satellite tuner, switches and rear view camera control unit.</li> </ul>	
CONFIRMATION/ ADJUSTMENT	Display diagnosis	Color spectrum bar	Color tone of the screen can be checked by the display of a color bar.
		Gradation bar	Shading of the screen can be checked by the display of a gray scale.
	Vehicle signals		The following vehicle signals are analyzed: Vehicle speed signal, parking brake signal, light signal, ignition switch signal, and reverse signal.
	Speaker test		Connection can be checked by sending a test tone to each speaker.
	Climate control		Start automatic air conditioner self-diagnosis
	Error history		Diagnosis results previously stored in the memory are displayed in this mode.
	Vehicle CAN diagnosis		The transmitting/receiving of CAN communication can be monitored.
	AV COMM diagnosis		The transmitting/receiving of AV communication can be monitored.
	Delete connection log		Erase the error history and connection history of the unit.
	Initialize settings		All audio settings are reset to default levels.

#### OPERATION PROCEDURE

1. Start the engine.
2. Turn the audio system off.
3. While pressing the "SETTING" button, turn the volume control dial counterclockwise 30 clicks or more.

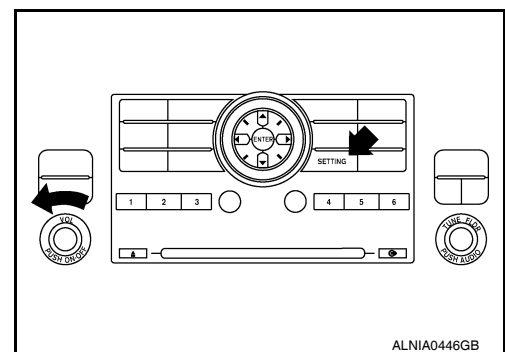

# DIAGNOSIS SYSTEM (AV CONTROL UNIT)

[BOSE AUDIO WITHOUT NAVIGATION]

< FUNCTION DIAGNOSIS >

- The initial trouble diagnosis screen will be displayed, and items “Self-Diagnosis” and “Confirmation/Adjustment” can be selected.

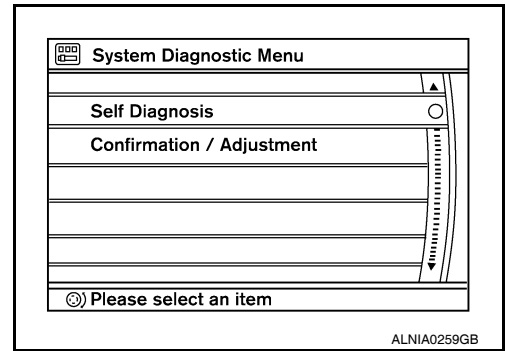

## SELF-DIAGNOSIS

- Perform self-diagnosis by selecting “Self-Diagnosis”.
  - Self-diagnosis subdivision screen is displayed, and the self-diagnosis mode starts.
  - A bar graph visible on the center of the self-diagnosis subdivision screen indicates progress of the trouble diagnosis.

**NOTE:**

Self-diagnosis requires approximately 10 seconds to complete.

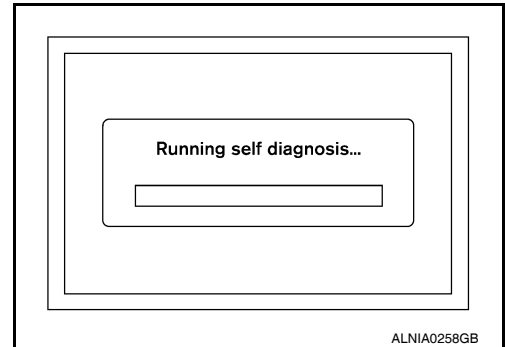

- Diagnosis results are displayed after the self-diagnosis is completed. The unit names and the connection lines are color-coded according to the diagnostic results.

Diagnosis results	Unit	Connection line
Normal	Green	Green
Connection malfunction	Gray	Yellow
Unit malfunction <sup>Note</sup>	Red	Green

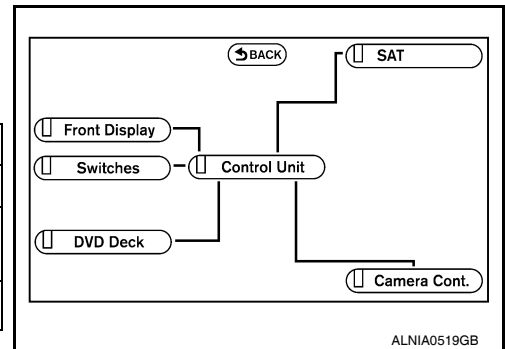

Note:

- Only the AV control unit is displayed in red.
- If multiple malfunctions occur at the same time for a single unit, the screen switch colors are determined according to the following order of priority: red > yellow > gray.

- Select a component on the “Self Diagnosis” screen and comments for the diagnosis results will be shown.

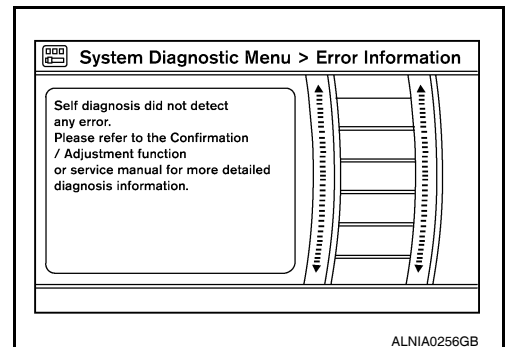

## Self-Diagnosis Results

A  
B  
C  
D  
E  
F  
G  
H  
I  
J  
K  
L  
M  
AV  
O  
P

# DIAGNOSIS SYSTEM (AV CONTROL UNIT)

< FUNCTION DIAGNOSIS >

[BOSE AUDIO WITHOUT NAVIGATION]

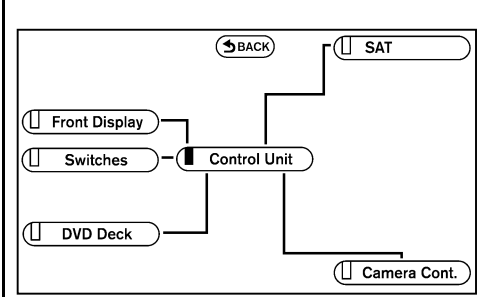
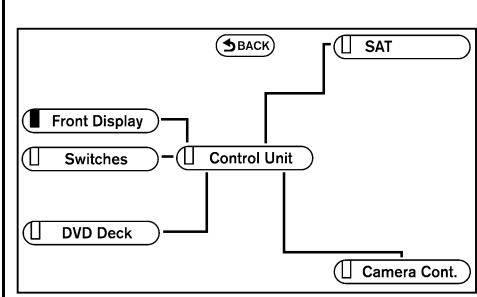
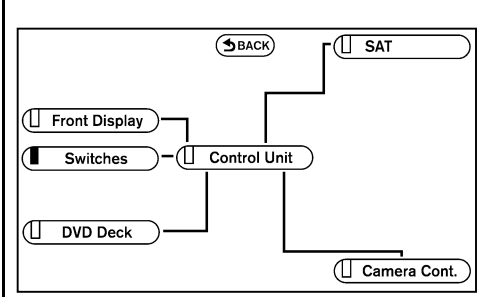
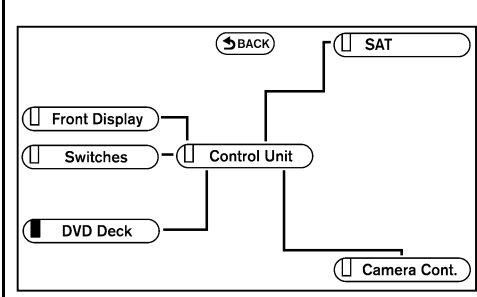
Area with yellow connection lines	Description	Possible malfunction location / Action to take
 <p>ALNIA0520GB</p>	<p>AV control unit malfunction is detected</p>	<p>Replace the AV control unit. Refer to <a href="#">AV-141, "Removal and Installation"</a>.</p>
 <p>ALNIA0521GB</p>	<p>Poor connection is detected for the display unit</p>	<ul style="list-style-type: none"> <li>• Harness or connector</li> <li>• AV control unit</li> <li>• Display unit</li> </ul>
 <p>ALNIA0522GB</p>	<p>Switch malfunction is detected</p>	<p>Perform A/C and AV switch assembly diagnostics. Refer to <a href="#">AV-178, "A/C AND AV SWITCH ASSEMBLY : Component Function Check"</a></p>
 <p>ALNIA0523GB</p>	<p>Poor connection is detected for the DVD player.</p>	<ul style="list-style-type: none"> <li>• Harness or connector</li> <li>• AV control unit</li> <li>• DVD player</li> </ul>

# DIAGNOSIS SYSTEM (AV CONTROL UNIT)

< FUNCTION DIAGNOSIS >

[BOSE AUDIO WITHOUT NAVIGATION]

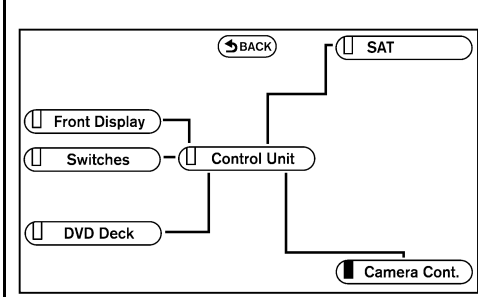
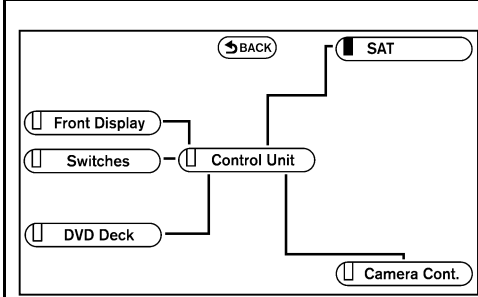
Area with yellow connection lines	Description	Possible malfunction location / Action to take
 <p>ALNIA0524GB</p>	<p>Poor connection is detected for the rear view camera control unit.</p>	<ul style="list-style-type: none"> <li>• Harness or connector</li> <li>• AV control unit</li> <li>• Rear view camera control unit</li> </ul>
 <p>ALNIA0525GB</p>	<p>Poor connection is detected for the satellite radio tuner.</p>	<ul style="list-style-type: none"> <li>• Harness or connector</li> <li>• AV control unit</li> <li>• Satellite radio tuner</li> </ul>

## CONFIRMATION/ADJUSTMENT MODE

1. Start the diagnosis function and select "Confirmation/Adjustment". The confirmation/adjustment mode indicates where each item can be checked or adjusted.
2. Select each item on the "Confirmation/Adjustment" mode screen to display the relevant trouble diagnosis screen. Press the "BACK" button or touch "BACK" on the touch screen to return to the initial Confirmation/Adjustment Mode screen.

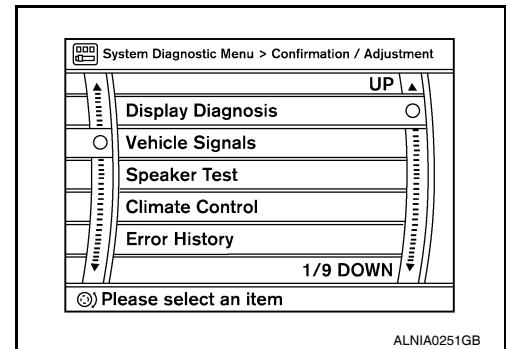

## Display Diagnosis

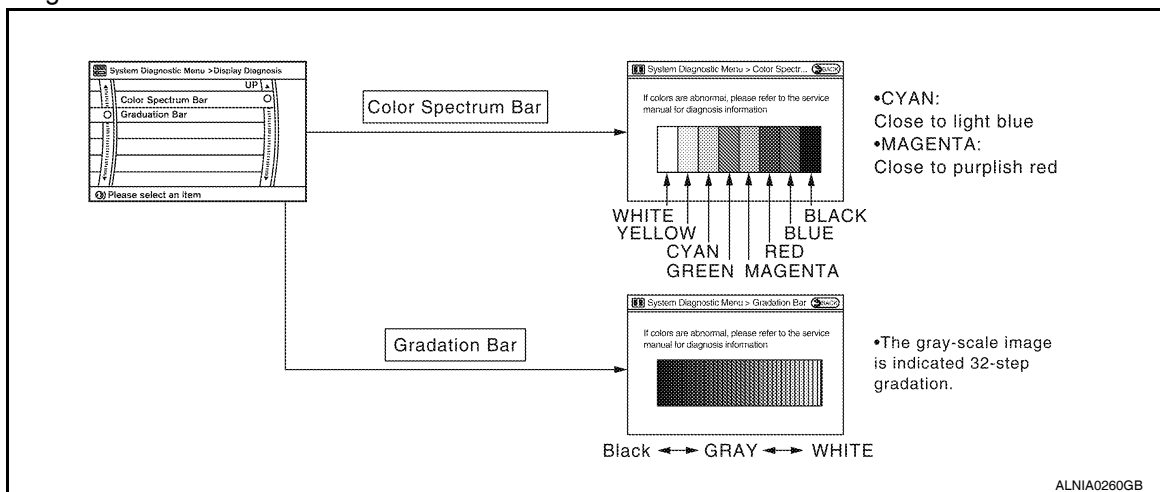

**Color Spectrum Bar**

•CYAN:  
Close to light blue

•MAGENTA:  
Close to purplish red

**Gradation Bar**

•The gray-scale image is indicated 32-step gradation.

Black ← GRAY → WHITE

## Vehicle Signals

A  
B  
C  
D  
E  
F  
G  
H  
I  
J  
K  
L  
M  
O  
P

AV

# DIAGNOSIS SYSTEM (AV CONTROL UNIT)

## < FUNCTION DIAGNOSIS >

## [BOSE AUDIO WITHOUT NAVIGATION]

A comparison check can be made of each actual vehicle signal and the signals recognized by the system.

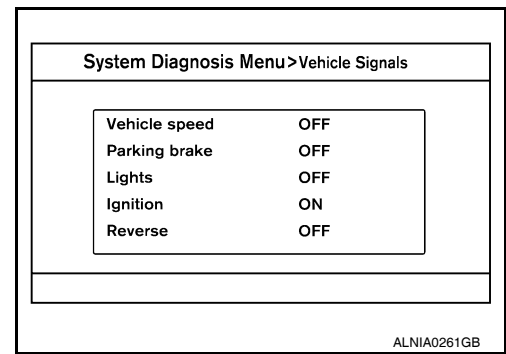

Diagnosis item	Display	Vehicle status	Remarks
Vehicle speed	ON	Vehicle speed > 0 km/h	Changes in indication may be delayed by approximately 1.5 seconds. This is normal.
	OFF	Vehicle speed = 0 km/h	
	-	Ignition switch in ACC position	
Parking brake	ON	Parking brake is applied.	
	OFF	Parking brake is released.	
Lights	ON	Light switch ON	
	OFF	Light switch OFF	
Ignition	ON	Ignition switch ON	-
	OFF	Ignition switch in ACC position	
Reverse	ON	Selector lever in R position	Changes in indication may be delayed by approximately 1.5 seconds. This is normal.
	OFF	Selector lever in any position other than R	
	-	Ignition switch in ACC position	

### Speaker Test

Select "Speaker Test" to display the speaker diagnosis screen. Press "Start" to generate a test tone in speakers. Touch "End" to stop the test tones.

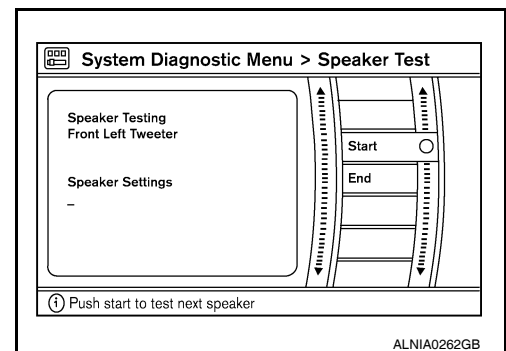

### Error History

The self-diagnosis results are judged depending on whether any error occurs from when "Self-diagnosis" is selected until the self-diagnosis results are displayed.

However, the diagnosis results are judged normal if an error has occurred before the ignition SW is turned ON and then no error has occurred until the self-diagnosis start. Check the "Error History" to detect any error that may have occurred before the self-diagnosis start because of this situation.

#### Count up method A

- The counter resets to 0 if an error occurs when IGN switch is turned ON. The counter increases by 1 if the condition is normal at a next IGN ON cycle.

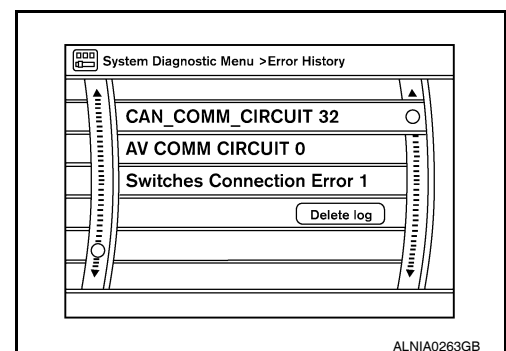



# DIAGNOSIS SYSTEM (AV CONTROL UNIT)

[BOSE AUDIO WITHOUT NAVIGATION]

## < FUNCTION DIAGNOSIS >

- The counter upper limit is 39. Any counts exceeding 39 are ignored. The counter can be reset (no error-record display) with the "Delete log" switch or CONSULT-III.
- Count up method B
- The counter increases by 1 if an error occurs when IGN switch is ON. The counter will not decrease even if the condition is normal at the next IGN ON cycle.
- The counter upper limit is 50. Any counts exceeding 50 are ignored. The counter can be reset (no error-record display) with the "Delete log" switch or CONSULT-III.

Display method of occurrence frequency	Error history display item
Count up method A	CAN communication line, control unit (CAN), AV communication line, control unit (AV communication)
Count up method B	Other than above

### Vehicle CAN Diagnosis

- CAN communication status and error counter is displayed.
- The error counter displays "OK" if any malfunction was not detected in the past and displays "0" if a malfunction is detected. It increases by 1 if the condition is normal at the next ignition switch ON cycle. The upper limit of the counter is 39.
- The error counter is erased if reset.

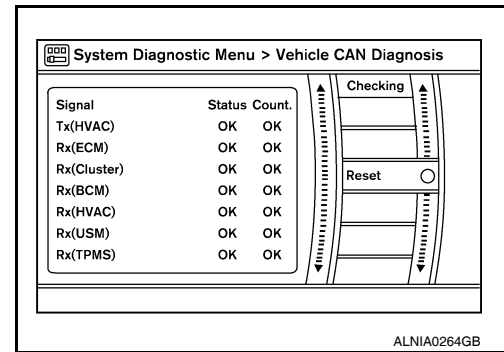

### AV COMM Diagnosis

- AV communication status and error counter is displayed.
- The error counter displays "OK" if any malfunction was not detected in the past and displays "0" if a malfunction is detected. It increases by 1 if the condition is normal at the next ignition switch ON cycle. The upper limit of the counter is 39.
- The error counter is erased if reset.

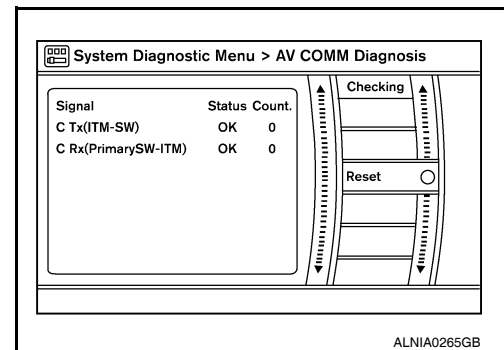

### Delete Unit Connection Log

Deletes any unit connection records and error records from the AV control unit memory. (Clear the records of the unit that has been removed)

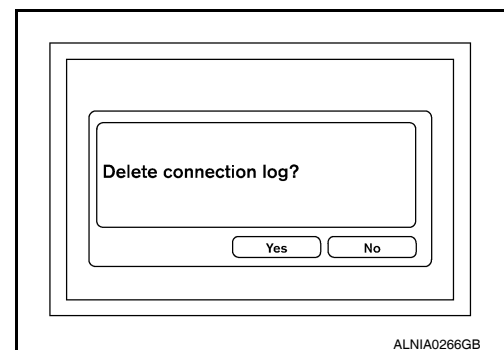

### Initialize Settings

# DIAGNOSIS SYSTEM (AV CONTROL UNIT)

< FUNCTION DIAGNOSIS >

[BOSE AUDIO WITHOUT NAVIGATION]

Initializes the AV control unit memory.

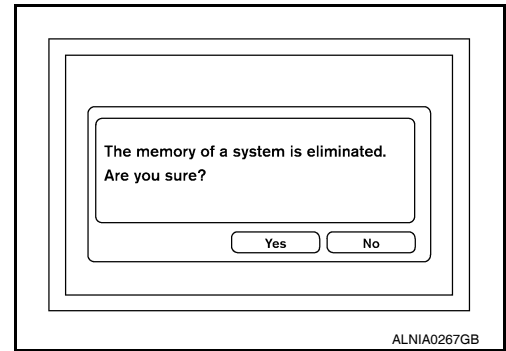

## AV CONTROL UNIT : CONSULT-III Function

INFOID:000000005259387

CONSULT-III can display each diagnostic item using the diagnostic test modes shown following.

MULTI AV diagnosis mode	Description
SELF-DIAG RESULTS	Displays AV control unit self-diagnosis results.
DATA MONITOR	Displays AV control unit input/output data in real time.
CAN DIAG SUPPORT MNTR	The result of transmit/receive diagnosis of CAN communication can be read.
AV COMM MONITOR	Allows the technician to monitor the status of the Multi AV system communication signals.
ECU PART NUMBER	The part number of AV control unit can be checked.

## DATA MONITOR

### Display Item List

Display item [unit]	ALL SIGNALS	SELECTION FROM MENU	Description
VHCL SPD SIG [ON/OFF]	X	X	Displays "ON" when vehicle speed > 0 km/h. Displays "OFF" when vehicle speed = 0 km/h.
PKB SIG [ON/OFF]	X	X	Displays [ON/OFF] condition of parking brake switch.
ILLUM SIG [ON/OFF]	X	X	Displays [ON/OFF] condition of lighting switch.
IGN SIG [ON/OFF]	X	X	Displays [ON/OFF] condition of ignition switch.
REV SIG [ON/OFF]	X	X	Displays [ON/OFF] condition of back-up lamp switch.

## A/C AND AV SWITCH ASSEMBLY

### A/C AND AV SWITCH ASSEMBLY : Component Function Check

INFOID:000000005259388

#### A/C and AV switch assembly self-diagnosis function

##### Description

The ON/OFF operation (continuity) of each switch in the A/C and AV switch assembly can be checked.

##### Self-diagnosis mode

- Press the "BACK" button and the "UP" button within 10 seconds after turning the ignition switch from OFF to ACC and hold them for 3 seconds or more. When the self-diagnosis mode starts, a beep will sound and all LED indicators of the switch will illuminate.
- The continuity of each switch and control dial of the A/C and AV switch assembly can be checked. If the switch is operating normally, the system will beep and the LED's will illuminate when each switch is operated.

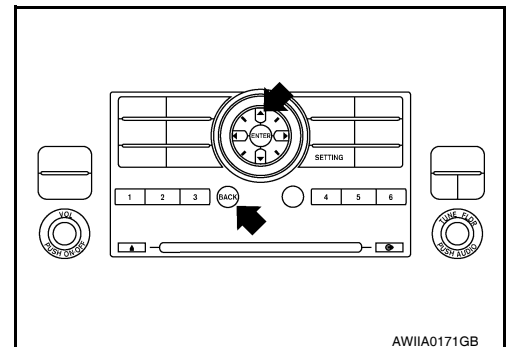

Finishing self-diagnosis mode

# DIAGNOSIS SYSTEM (AV CONTROL UNIT)

< FUNCTION DIAGNOSIS >

[BOSE AUDIO WITHOUT NAVIGATION]

Self-diagnosis mode is canceled when the ignition switch is turned OFF.

A

B

C

D

E

F

G

H

I

J

K

L

M

**AV**

O

P

# DIAGNOSIS SYSTEM (BLUETOOTH CONTROL UNIT)

< FUNCTION DIAGNOSIS >

[BOSE AUDIO WITHOUT NAVIGATION]

## DIAGNOSIS SYSTEM (BLUETOOTH CONTROL UNIT)

### Diagnosis Description

INFOID:000000005259389

The Bluetooth control unit has two diagnostic checks. The first diagnostic check is performed automatically every ignition cycle during control unit initialization. The second diagnostic check is performed by the technician using the steering wheel audio control switches prior to trouble diagnosis.

### BLUETOOTH CONTROL UNIT INITIALIZATION CHECKS

- Internal control unit failure
- Bluetooth antenna connection open or shorted
- Steering wheel audio control switches (SEND/END) stuck closed
- Vehicle speed pulse count
- Microphone connection test (with playback to operator)
- Bluetooth inquiry check

### OPERATION PROCEDURE

1. Turn ignition switch to ACC or ON.
2. Wait for the Bluetooth system to complete initialization. This may take up to 10 seconds.
3. Press and hold the steering wheel audio control switch  button for at least 5 seconds. The Bluetooth system will begin to play a verbal prompt.

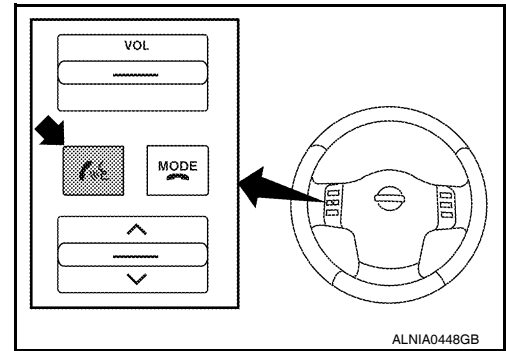

4. While the prompt is playing, press and hold the steering wheel audio control switch  button until you hear the “Diagnostics mode” prompt. The Bluetooth system will sound a 5 second beep.
5. While the beep is sounding, press and hold the steering wheel audio control switch END button again until you hear prompts.
6. The Bluetooth system has now entered into the diagnostic mode. Results of the diagnostic checks will be verbalized to the technician. Refer to [AV-180. "Work Flow"](#).
7. After the failure records are reported, an interactive microphone test will be performed. Follow the voice prompt. If the microphone test fails refer to [AV-180. "Work Flow"](#).
8. Self-diagnosis mode is complete when the voice prompt says “All diagnostic functions completed”.

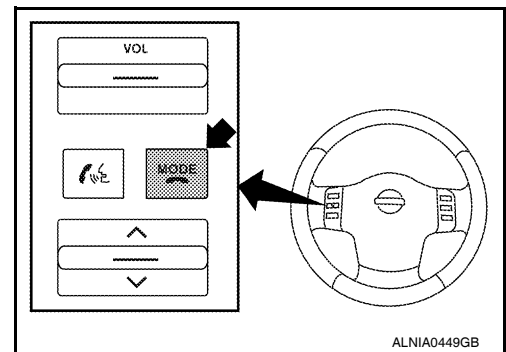

### Work Flow

INFOID:000000005259390

Failure Message	Action
“Internal failure”	Replace Bluetooth control unit. Refer to <a href="#">AV-298. "Removal and Installation"</a> .
“Bluetooth antenna open”	1. Inspect harness connection.
“Bluetooth antenna shorted”	2. Replace Bluetooth antenna. Refer to <a href="#">AV-297. "Removal and Installation"</a> .
“Phone/Send for Hands Free System is stuck”	Check steering wheel audio control switches. Refer to <a href="#">AV-229. "Description"</a> .
“Phone/End for the Hands Free System is stuck”	
“Microphone test” (failed interactive test)	1. Inspect harness between Bluetooth control unit and microphone. 2. Replace microphone. Refer to <a href="#">AV-296. "Removal and Installation"</a> .

# U1000 CAN COMM CIRCUIT

< COMPONENT DIAGNOSIS >

[BOSE AUDIO WITHOUT NAVIGATION]

## COMPONENT DIAGNOSIS

### U1000 CAN COMM CIRCUIT

#### Description

INFOID:000000005259391

CAN (Controller Area Network) is a serial communication line for real time application. It is an on-vehicle multiplex communication line with high data communication speed and excellent error detection ability. Many electronic control units are equipped onto a vehicle and each control unit shares information and links with other control units during operation (not independent). In CAN communication, control units are connected with 2 communication lines (CAN-H, CAN-L) allowing a high rate of information transmission with less wiring. Each control unit transmits/receives data but selectively reads required data only.

CAN Communication Signal Chart. Refer to [LAN-13, "How to Use CAN Communication Signal Chart"](#).

#### DTC Logic

INFOID:000000005259392

#### DTC DETECTION LOGIC

DTC	Display contents of CONSULT-III	Diagnostic item is detected when ...	Probable malfunction location
U1000	CAN COMM CIRCUIT	When AV control unit is not transmitting or receiving CAN communication signal for 2 seconds or more.	CAN communication system

#### Diagnosis Procedure

INFOID:000000005259393

#### 1.PERFORM SELF DIAGNOSTIC

1. Turn ignition switch ON and wait for 2 seconds or more.
2. Check "Self Diagnostic Result" of "MULTI AV".

Is "CAN COMM CIRCUIT" displayed?

- YES >> Refer to "LAN system". Refer to [LAN-14, "Trouble Diagnosis Flow Chart"](#).  
NO >> Refer to GI section. Refer to [GI-37, "Intermittent Incident"](#).

A  
B  
C  
D  
E  
F  
G  
H  
I  
J  
K  
L  
M

AV

O  
P

# U1010 CONTROL UNIT (CAN)

< COMPONENT DIAGNOSIS >

[BOSE AUDIO WITHOUT NAVIGATION]

## U1010 CONTROL UNIT (CAN)

### Description

INFOID:000000005259394

Initial diagnosis of AV control unit.

### DTC Logic

INFOID:000000005259395

### DTC DETECTION LOGIC

DTC	Display contents of CONSULT-III	Diagnostic item is detected when ...	Probable malfunction location
U1010	CONTROL UNIT (CAN)	CAN initial diagnosis malfunction is detected	AV control unit

### Diagnosis Procedure

INFOID:000000005259396

#### 1. REPLACE AV CONTROL UNIT

When DTC U1010 is detected, replace AV control unit. Refer to [AV-289. "Removal and Installation"](#).

>> Inspection End.

# U1200 AV CONTROL UNIT

< COMPONENT DIAGNOSIS >

[BOSE AUDIO WITHOUT NAVIGATION]

## U1200 AV CONTROL UNIT

### Description

INFOID:000000005259397

Replace the AV control unit if this DTC is displayed. Refer to [AV-289, "Removal and Installation"](#).

Part name	Description
AV CONTROL UNIT	<ul style="list-style-type: none"><li>• It is the master unit of the MULTI AV system and it is connected to each control unit by means of communication. It operates each system according to communication signals from the AV control unit.</li><li>• AV control unit includes audio function and vehicle information function.</li><li>• It is connected to ECM and combination meter via CAN communication to obtain necessary information for the vehicle information function.</li><li>• It inputs the automatic brightness ON/OFF signals that are required for the display dimming control.</li><li>• It inputs the signals for driving status recognition (vehicle speed, reverse and parking brake).</li></ul>

### DTC Logic

INFOID:000000005259398

DTC	Display contents of CONSULT-III	DTC Detection Condition	Action to take
U1200	Control Unit FLASH- ROM [U1200]	An internal malfunction is detected in AV control unit (FLASH-ROM).	Replace AV control unit. Refer to <a href="#">AV-289, "Removal and Installation"</a> .

A  
B  
C  
D  
E  
F  
G  
H  
I  
J  
K  
L  
M  
O  
P

AV

# U1216 AV CONTROL UNIT

< COMPONENT DIAGNOSIS >

[BOSE AUDIO WITHOUT NAVIGATION]

## U1216 AV CONTROL UNIT

### Description

INFOID:000000005259399

Replace the AV control unit if this DTC is displayed. Refer to [AV-289, "Removal and Installation"](#).

Part name	Description
AV CONTROL UNIT	<ul style="list-style-type: none"><li>• It is the master unit of the MULTI AV system and it is connected to each control unit by means of communication. It operates each system according to communication signals from the AV control unit.</li><li>• AV control unit includes audio function and vehicle information function.</li><li>• It is connected to ECM and combination meter via CAN communication to obtain necessary information for the vehicle information function.</li><li>• It inputs the automatic brightness ON/OFF signals that are required for the display dimming control.</li><li>• It inputs the signals for driving status recognition (vehicle speed, reverse and parking brake).</li></ul>

### DTC Logic

INFOID:000000005259400

DTC	Display contents of CONSULT-III	DTC Detection Condition	Action to take
U1216	CAN CONT [U1216]	Internal malfunction of AV control unit (CAN controller) is detected.	Replace AV control unit. Refer to <a href="#">AV-289, "Removal and Installation"</a> .



# U1240 SWITCH CONN

< COMPONENT DIAGNOSIS >

[BOSE AUDIO WITHOUT NAVIGATION]

## U1240 SWITCH CONN

### Description

INFOID:000000005259401

U1240 is indicated when malfunction occurs in communication signal of multi AV system. Indicated simultaneously, without fail, with the malfunction of control units connected to AV control unit with communication line. Determine the possible malfunction cause from the table below.

### Self-diagnosis results display item

DTC	Display contents of CONSULT-III	DTC Detection Condition	Possible causes
U1240	<ul style="list-style-type: none"><li>SWITCH CONN [U1240]</li></ul>	<ul style="list-style-type: none"><li>A/C and AV switch assembly power supply and ground circuit malfunction is detected</li><li>A malfunction is detected in communication circuit between AV control unit and A/C and AV switch assembly</li><li>A malfunction is detected in communication signal between AV control unit and A/C and AV switch assembly</li></ul>	<ul style="list-style-type: none"><li>A/C and AV switch assembly power supply and ground circuits</li><li>Communication circuit between AV control unit and A/C and AV switch assembly</li></ul>

A  
B  
C  
D  
E  
F  
G  
H  
I  
J  
K  
L  
M  
O  
P

AV

# U1243 DISPLAY UNIT

< COMPONENT DIAGNOSIS >

[BOSE AUDIO WITHOUT NAVIGATION]

## U1243 DISPLAY UNIT

### Description

INFOID:000000005259402

Part name	Description
DISPLAY UNIT	<ul style="list-style-type: none"> <li>• Display image is controlled by the serial communication from AV control unit.</li> <li>• Inputs the RGB image signal (RGB, RGB area and RGB synchronizing) from AV control unit and the auxiliary image signal from the auxiliary input jacks.</li> <li>• Outputs the synchronizing signals (HP and VP) to the AV control unit.</li> </ul>

### DTC Logic

INFOID:000000005259403

DTC	Display contents of CONSULT-III	DTC Detection Condition	Possible causes
U1243	FRONT DISP CONN [U1243]	<ul style="list-style-type: none"> <li>• Display unit power supply and ground circuit malfunction is detected</li> <li>• Malfunction is detected on communication circuit between display unit and AV control unit</li> <li>• Malfunction is detected on communication signal between display unit and AV control unit</li> </ul>	<ul style="list-style-type: none"> <li>• Display unit power supply and ground circuit</li> <li>• Communication circuit between display unit and AV control unit</li> </ul>

### Diagnosis Procedure

INFOID:000000005259404

Regarding Wiring Diagram information, refer to [AV-245. "Wiring Diagram"](#).

#### 1. CHECK DISPLAY UNIT POWER SUPPLY AND GROUND CIRCUIT

Check display unit power supply and ground circuit. Refer to [AV-194. "DISPLAY UNIT : Diagnosis Procedure"](#).

Is inspection result OK?

YES >> GO TO 2

NO >> Repair malfunctioning parts.

#### 2. CHECK CONTINUITY OF COMMUNICATION CIRCUIT

1. Turn ignition switch OFF.
2. Disconnect display unit connector and AV control unit connector.
3. Check continuity between display unit harness connector M93 (A) terminals 11, 22 and AV control unit harness connector M45 (B) terminals 56, 44.

A		B		Continuity
Connector	Terminal	Connector	Terminal	
M93	11	M45	56	Yes
	22		44	

4. Check continuity between display unit harness connector M93 (A) terminals 11, 22 and ground.

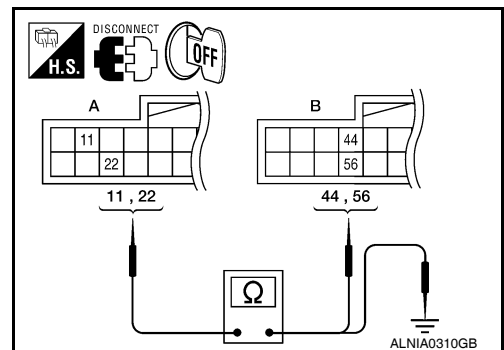

A		—	Continuity
Connector	Terminal		
M93	11	Ground	No
	22		

Are continuity results as specified?

YES >> GO TO 3

# U1243 DISPLAY UNIT

[BOSE AUDIO WITHOUT NAVIGATION]

## < COMPONENT DIAGNOSIS >

NO >> Repair harness or connector.

### 3. CHECK COMMUNICATION SIGNAL

1. Connect display unit connector and AV control unit connector.
2. Turn ignition switch ON.
3. Check signal between display unit harness connector M93 terminal 11 and ground with an oscilloscope or CONSULT-III.

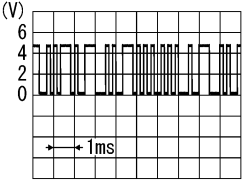
(+)		(-)	Reference signal
Connector	Terminal		
M93	11	Ground	 <p>PKIB5039J</p>

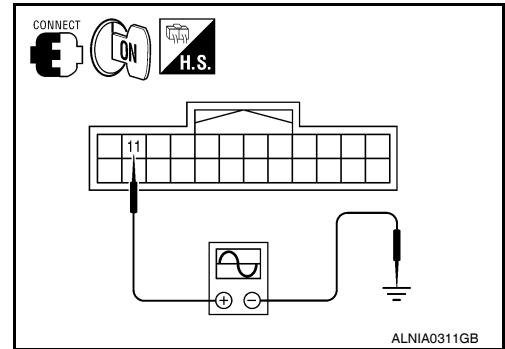

Are voltage readings as specified?

YES >> GO TO 4

NO >> Replace AV control unit. Refer to [AV-289, "Removal and Installation"](#).

### 4. CHECK COMMUNICATION SIGNAL

Check signal between display unit harness connector M93 terminal 22 and ground with an oscilloscope or CONSULT-III.

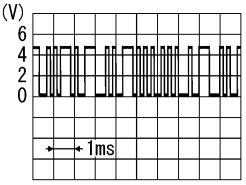
(+)		(-)	Reference signal
Connector	Terminal		
M93	22	Ground	 <p>PKIB5039J</p>

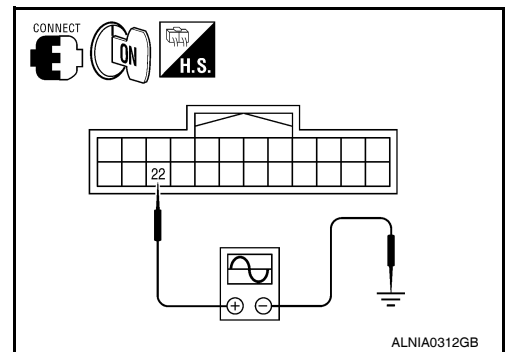

Are voltage readings as specified?

YES >> Inspection End.

NO >> Replace display unit. Refer to [AV-289, "Removal and Installation"](#).

A  
B  
C  
D  
E  
F  
G  
H  
I  
J  
K  
L  
M

AV

# U1248 DVD DECK CONN

< COMPONENT DIAGNOSIS >

[BOSE AUDIO WITHOUT NAVIGATION]

## U1248 DVD DECK CONN

### Description

INFOID:000000005259405

U1248 is indicated when a malfunction occurs in the communication signal of the DVD player. Indicated simultaneously, without fail, with the malfunction of control units connected to AV control unit with communication line. Determine the possible malfunction cause from the table below.

### DTC Logic

INFOID:000000005259406

DTC	Display contents of CONSULT-III	DTC Detection Condition	Possible causes
U1248	DVD DECK CONN [U1248]	<ul style="list-style-type: none"><li>DVD player power supply and ground circuit malfunction is detected</li><li>Malfunction is detected on communication circuit between DVD player and AV control unit</li><li>Malfunction is detected on communication signal between DVD player and AV control unit</li></ul>	<ul style="list-style-type: none"><li>DVD player power supply and ground circuit</li><li>Communication circuit between DVD player and AV control unit</li></ul>

### Diagnosis Procedure

INFOID:000000005259407

#### 1. CHECK DVD PLAYER POWER SUPPLY AND GROUND CIRCUIT

Check DVD player power supply and ground circuit. Refer to [AV-200, "DVD PLAYER : Diagnosis Procedure"](#).

Is inspection result OK?

YES >> Inspection End.

NO >> Repair malfunctioning parts.

# U1255 SATELLITE RADIO TUNER

< COMPONENT DIAGNOSIS >

[BOSE AUDIO WITHOUT NAVIGATION]

## U1255 SATELLITE RADIO TUNER

### Description

INFOID:000000005259408

Part name	Description
SATELLITE RADIO TUNER	<ul style="list-style-type: none"><li>Inputs the satellite radio signal from satellite radio antenna and outputs it to the AV control unit.</li><li>It is controlled with the communication (communication signal, request signal) from AV control unit.</li></ul>

### DTC Logic

INFOID:000000005259409

DTC	Display contents of CONSULT-III	DTC Detection Condition	Possible causes
U1255	SAT CONN [U1255]	The satellite radio tuner power supply and ground circuit malfunction is detected	Satellite radio tuner power supply and ground circuit

### Diagnosis Procedure

INFOID:000000005259410

#### 1. CHECK SATELLITE RADIO TUNER POWER SUPPLY AND GROUND CIRCUIT

Check satellite radio tuner power supply and ground circuit. Refer to [AV-198, "SATELLITE RADIO TUNER : Diagnosis Procedure"](#).

Is inspection result OK?

- YES >> Inspection End.
- NO >> Repair malfunctioning parts.

A  
B  
C  
D  
E  
F  
G  
H  
I  
J  
K  
L  
M  
O  
P

AV

# U1256 HAND FREE CONN

< COMPONENT DIAGNOSIS >

[BOSE AUDIO WITHOUT NAVIGATION]

## U1256 HAND FREE CONN

### Description

INFOID:000000005259411

U1256 is indicated when malfunction occurs in communication signal of multi AV system. Indicated simultaneously, without fail, with the malfunction of control units connected to AV control unit with communication line. Determine the possible malfunction cause from the table below.

### Self-diagnosis results display item

DTC	Display contents of CONSULT-III	DTC Detection Condition	Possible causes
U1256	<ul style="list-style-type: none"><li>HAND FREE CONN [U1256]</li></ul>	<ul style="list-style-type: none"><li>Bluetooth control unit power supply and ground circuit malfunction is detected</li><li>A malfunction is detected in communication circuit between AV control unit and Bluetooth control unit</li><li>A malfunction is detected in communication signal between AV control unit and Bluetooth control unit</li></ul>	<ul style="list-style-type: none"><li>Bluetooth control unit power supply and ground circuits</li><li>Communication circuit between AV control unit and Bluetooth control unit</li></ul>

# U1300 AV COMM CIRCUIT

< COMPONENT DIAGNOSIS >

[BOSE AUDIO WITHOUT NAVIGATION]

## U1300 AV COMM CIRCUIT

### Description

INFOID:000000005259412

U1300 is indicated when malfunction occurs in communication signal of multi AV system. Indicated simultaneously, without fail, with the malfunction of control units connected to AV control unit with communication line. Determine the possible malfunction cause from the table below.

### Self-diagnosis results display item

DTC	Display contents of CONSULT-III	DTC Detection Condition	Possible causes
U1300 U1240	<ul style="list-style-type: none"><li>AV COMM CIRCUIT [U1300]</li><li>SWITCH CONN [U1240]</li></ul>	<ul style="list-style-type: none"><li>A/C and AV switch assembly power supply and ground circuit malfunction is detected</li><li>A malfunction is detected in communication circuit between AV control unit and A/C and AV switch assembly</li><li>A malfunction is detected in communication signal between AV control unit and A/C and AV switch assembly</li></ul>	<ul style="list-style-type: none"><li>A/C and AV switch assembly power supply and ground circuits</li><li>Communication circuit between AV control unit and A/C and AV switch assembly</li></ul>

A  
B  
C  
D  
E  
F  
G  
H  
I  
J  
K  
L  
M

AV

O  
P

# U1310 AV CONTROL UNIT

< COMPONENT DIAGNOSIS >

[BOSE AUDIO WITHOUT NAVIGATION]

## U1310 AV CONTROL UNIT

### Description

INFOID:000000005259413

Replace the AV control unit if this DTC is displayed. Refer to [AV-289, "Removal and Installation"](#).

Part name	Description
AV CONTROL UNIT	<ul style="list-style-type: none"><li>• It is the master unit of the MULTI AV system and it is connected to each control unit by means of communication. It operates each system according to communication signals from the AV control unit.</li><li>• AV control unit includes audio function and vehicle information function.</li><li>• It is connected to ECM and combination meter via CAN communication to obtain necessary information for the vehicle information function.</li><li>• It inputs the automatic brightness ON/OFF signals that are required for the display dimming control.</li><li>• It inputs the signals for driving status recognition (vehicle speed, reverse and parking brake).</li></ul>

### DTC Logic

INFOID:000000005259414

DTC	Display contents of CONSULT-III	DTC Detection Condition	Action to take
U1310	CONTROL UNIT (AV) [U1310]	An initial diagnosis error is detected in AV communication circuit.	Replace AV control unit. Refer to <a href="#">AV-289, "Removal and Installation"</a>



# POWER SUPPLY AND GROUND CIRCUIT

< COMPONENT DIAGNOSIS >

[BOSE AUDIO WITHOUT NAVIGATION]

## POWER SUPPLY AND GROUND CIRCUIT

### AV CONTROL UNIT

#### AV CONTROL UNIT : Diagnosis Procedure

INFOID:000000005259415

Regarding Wiring Diagram information, refer to [AV-245. "Wiring Diagram"](#).

### 1. CHECK FUSES

Check that the following fuses of the AV control unit are not are not blown.

Unit	Terminals	Signal name	Fuse No.
AV control unit	19	Battery power	29
	7	Ignition switch ACC or ON	4
	104	Ignition switch ON or START	12

Are the fuses OK?

YES >> GO TO 2

NO >> If fuse is blown, be sure to eliminate cause of malfunction before installing new fuse.

### 2. POWER SUPPLY CIRCUIT CHECK

1. Disconnect AV control unit connectors M42 and M70.
2. Check voltage between the AV control unit connectors M42 and M70 and ground.

Connector	(+)		(-)	OFF	ACC	ON
	Terminal					
M42	7	Ground	0V	Battery voltage	Battery voltage	
	19	Ground	Battery voltage	Battery voltage	Battery voltage	
M70	104	Ground	0V	0V	Battery voltage	

Are the voltage results as specified?

YES >> GO TO 3

- NO >>
- Check connector housings for disconnected or loose terminals.
  - Repair harness or connector.

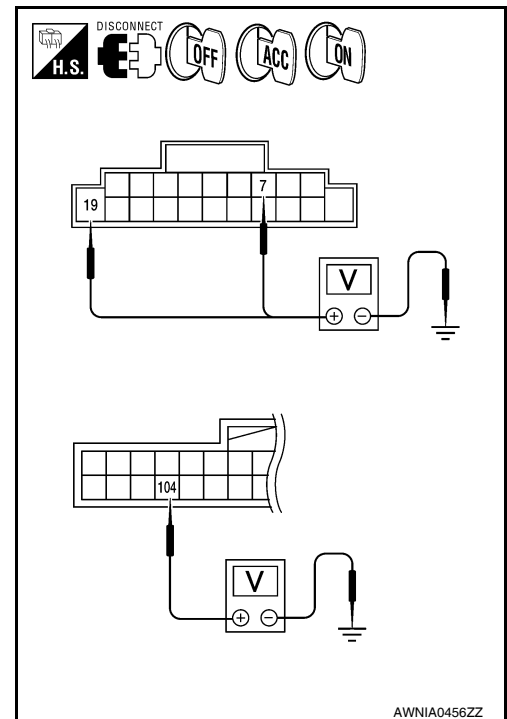

### 3. GROUND CIRCUIT CHECK

# POWER SUPPLY AND GROUND CIRCUIT

[BOSE AUDIO WITHOUT NAVIGATION]

## < COMPONENT DIAGNOSIS >

1. Turn ignition switch OFF.
2. Check continuity between AV control unit harness connectors M42, M45 and M70 and ground.

(+)		(-)	Continuity
Connector	Terminal		
M42	20	Ground	Yes
M45	54		
M70	85		

Are the continuity results as specified?

- YES >> Inspection End.  
 NO >> Repair AV control unit ground.

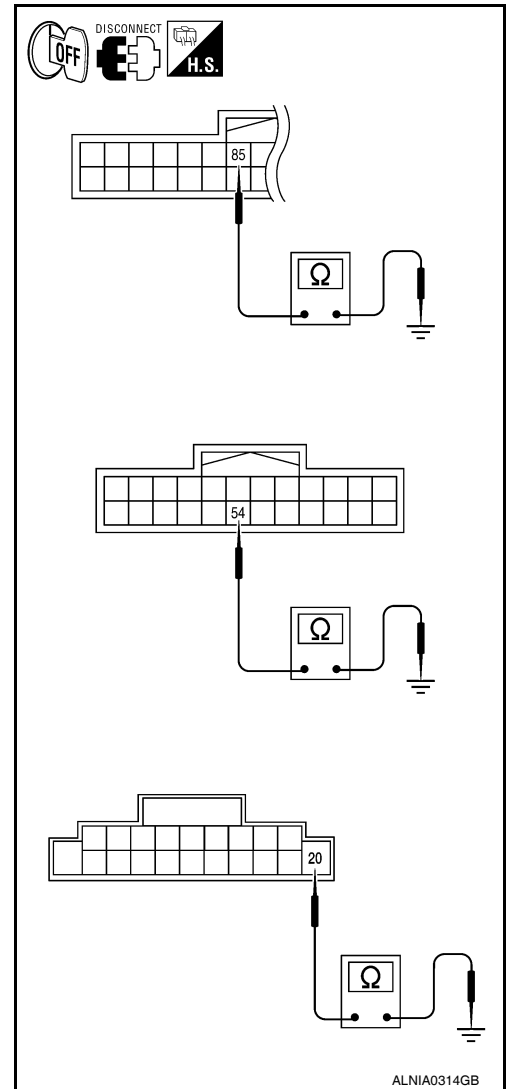

ALNIA0314GB

## DISPLAY UNIT

### DISPLAY UNIT : Diagnosis Procedure

INFOID:000000005259416

Regarding Wiring Diagram information, refer to [AV-245. "Wiring Diagram"](#).

## 1. CHECK POWER SUPPLY CIRCUIT

1. Turn ignition switch to ACC.
2. Check voltage between display unit harness connector M93 and ground.

Connector	Terminal	Ignition switch position	Value (Approx.)
M93	2	ACC	9V
	3		

Does specified voltage exist?

- YES >> GO TO 3  
 NO >> GO TO 2

## 2. CHECK POWER SUPPLY CIRCUIT

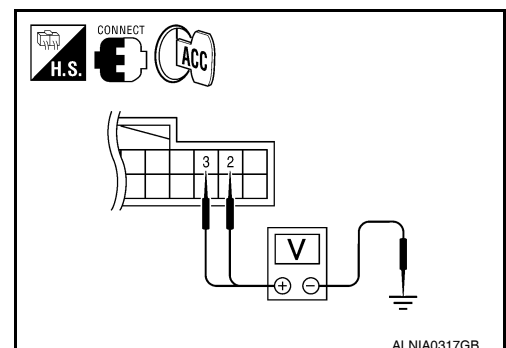

ALNIA0317GB

# POWER SUPPLY AND GROUND CIRCUIT

[BOSE AUDIO WITHOUT NAVIGATION]

## < COMPONENT DIAGNOSIS >

1. Turn ignition switch OFF.
2. Disconnect the display unit connector M93 and the AV control unit connector M45.
3. Check continuity between the display unit harness connector M93 (A) and the AV control unit connector M45 (B).

A		B		Continuity
Connector	Terminal	Connector	Terminal	
M93	2	M45	59	Yes
	3		47	

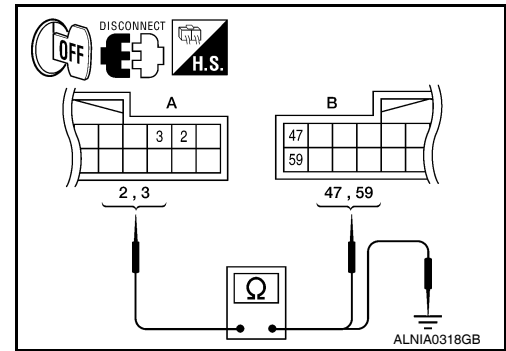

4. Check continuity between the display unit harness connector M93 (A) and ground.

A		—	Continuity
Connector	Terminal		
M93	2	Ground	No
	3		

### Are continuity results as specified?

YES >> Check AV control unit power and ground supply. Refer to [AV-193. "AV CONTROL UNIT : Diagnosis Procedure"](#).

NO >> Repair harness or connector.

## 3.CHECK GROUND CIRCUIT

1. Turn ignition switch OFF.
2. Disconnect display unit connector.
3. Check continuity between display unit harness connector and ground.

Connector	Terminal	—	Continuity
M93	1	Ground	Yes

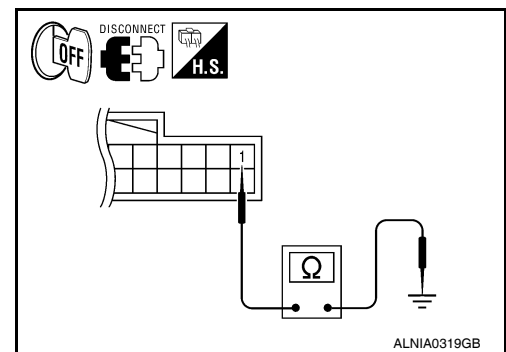

### Does continuity exist?

YES >> Inspection End.

NO >> Repair harness or connector.

## A/C AND AV SWITCH ASSEMBLY

### A/C AND AV SWITCH ASSEMBLY : Diagnosis Procedure

INFOID:000000005259417

Regarding Wiring Diagram information, refer to [AV-245. "Wiring Diagram"](#).

## 1.CHECK FUSE

Check that the fuse of the AC and AV switch assembly is not blown.

Unit	Terminal	Signal name	Fuse No.
A/C and AV switch assembly	2	Ignition switch ACC or ON	4

### Is the fuse OK?

YES >> GO TO 2

NO >> If fuse is blown, be sure to eliminate cause of malfunction before installing new fuse.

## 2.POWER SUPPLY CIRCUIT CHECK

A  
B  
C  
D  
E  
F  
G  
H  
I  
J  
K  
L  
M  
O  
P

AV

# POWER SUPPLY AND GROUND CIRCUIT

[BOSE AUDIO WITHOUT NAVIGATION]

## < COMPONENT DIAGNOSIS >

1. Disconnect A/C and AV switch assembly connector M98.
2. Check voltage between the A/C and AV switch assembly connector M98 and ground.

(+)		(-)	OFF	ACC	ON
Connector	Terminal				
M98	2	Ground	0V	Battery voltage	Battery voltage

Are the voltage results as specified?

- YES >> GO TO 3  
 NO >> • Check connector housings for disconnected or loose terminals.  
 • Repair harness or connector.

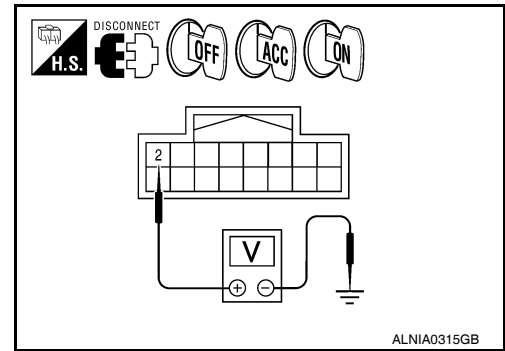

ALNIA0316GB

## 3. GROUND CIRCUIT CHECK

1. Turn ignition switch OFF.
2. Check continuity between A/C and AV switch assembly harness connector M98 and ground.

Connector	Terminal	—	Continuity
M98	1	Ground	Yes

Does continuity exist?

- YES >> Inspection End.  
 NO >> Repair harness or ground.

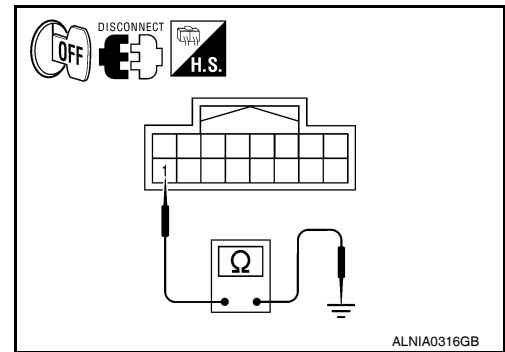

ALNIA0316GB

## BOSE SPEAKER AMP

### BOSE SPEAKER AMP : Diagnosis Procedure

INFOID:000000005259418

Regarding Wiring Diagram information, refer to [AV-245. "Wiring Diagram"](#).

## 1. CHECK FUSE

Check that the BOSE speaker amp. fuse is not blown.

Unit	Terminal	Signal name	Fuse No.
BOSE speaker amp.	1	Battery power	29

Are the fuses OK?

- YES >> GO TO 2  
 NO >> Be sure to eliminate cause of malfunction before installing new fuse.

## 2. CHECK POWER SUPPLY CIRCUIT

1. Turn ignition switch OFF.
2. Disconnect BOSE speaker amp. connector.
3. Check voltage between BOSE speaker amp. harness connector B74 terminal 1 and ground.

(+)		(-)	Voltage (approx.)
Connector	Terminal		
B74	1	Ground	Battery voltage

Is battery voltage present?

- YES >> GO TO 3  
 NO >> Check harness between BOSE speaker amp. and fuse.

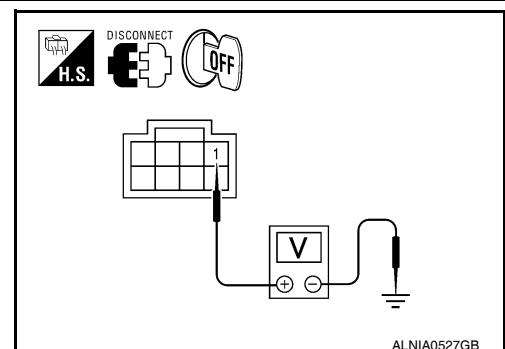

ALNIA0527GB

# POWER SUPPLY AND GROUND CIRCUIT

[BOSE AUDIO WITHOUT NAVIGATION]

< COMPONENT DIAGNOSIS >

## 3. CHECK GROUND CIRCUIT

1. Turn ignition switch OFF.
2. Disconnect BOSE speaker amp. connector.
3. Check continuity between BOSE speaker amp. harness connector B74 terminal 17 and ground.

(+)		(-)	Continuity
Connector	Terminal		
B74	17	Ground	Yes

Does continuity exist?

- YES >> Inspection End.  
 NO >> Repair harness or connector.

## SUBWOOFER

### SUBWOOFER : Diagnosis Procedure

INFOID:000000005259419

Regarding Wiring Diagram information, refer to [AV-245, "Wiring Diagram"](#).

## 1. CHECK FUSE

Check that the subwoofer fuse is not blown.

Unit	Terminal	Signal name	Fuse No.
Subwoofer	6	Battery power	17

Is the fuse OK?

- YES >> GO TO 2  
 NO >> Be sure to eliminate cause of malfunction before installing new fuse.

## 2. CHECK POWER SUPPLY CIRCUIT

1. Turn ignition switch OFF.
2. Disconnect subwoofer connector.
3. Check voltage between subwoofer harness connector B72 terminal 6 and ground.

(+)		(-)	Voltage (approx.)
Connector	Terminal		
B72	6	Ground	Battery voltage

Is battery voltage present?

- YES >> GO TO 3  
 NO >> Check harness between subwoofer and fuse.

## 3. CHECK GROUND CIRCUIT

1. Turn ignition switch OFF.
2. Check continuity between subwoofer harness connector B72 terminal 5 and ground.

(+)		(-)	Continuity
Connector	Terminal		
B72	5	Ground	Yes

Does continuity exist?

- YES >> Inspection End.  
 NO >> Repair harness or connector.

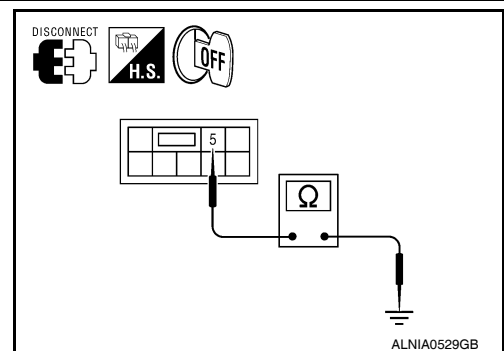
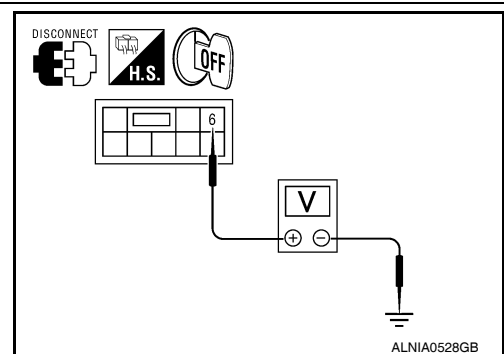
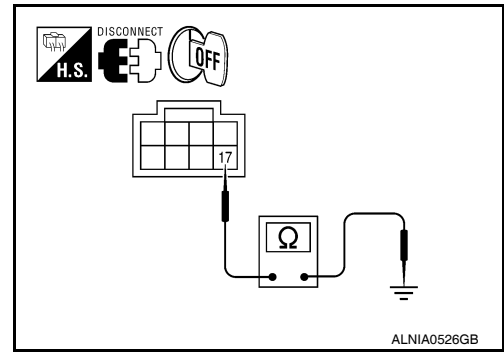

A  
B  
C  
D  
E  
F  
G  
H  
I  
J  
K  
L  
M  
N  
O  
P

AV

# POWER SUPPLY AND GROUND CIRCUIT

< COMPONENT DIAGNOSIS >

[BOSE AUDIO WITHOUT NAVIGATION]

## SATELLITE RADIO TUNER

### SATELLITE RADIO TUNER : Diagnosis Procedure

INFOID:000000005259420

Regarding Wiring Diagram information, refer to [AV-245, "Wiring Diagram"](#).

#### 1.CHECK FUSES

Check that the following fuses of the satellite radio tuner (factory installed) are not blown.

Unit	Terminals	Signal name	Fuse No.
Satellite radio tuner (factory installed)	32	Battery power	17
	36	Ignition switch ACC or ON	4

Are the fuses OK?

YES >> GO TO 2

NO >> If fuse is blown, be sure to eliminate cause of malfunction before installing new fuse.

#### 2.POWER SUPPLY CIRCUIT CHECK

1. Turn ignition switch OFF.
2. Disconnect satellite radio tuner (factory installed) connector M41.
3. Check voltage between the satellite radio tuner (factory installed) and ground.

(+)		(-)	OFF	ACC	ON
Connector	Terminal				
M41	32	Ground	Battery voltage	Battery voltage	Battery voltage
	36		0V	Battery voltage	Battery voltage

Are the voltage readings as specified?

YES >> GO TO 3

NO >> • Check connector housings for disconnected or loose terminals.  
• Repair harness or connector.

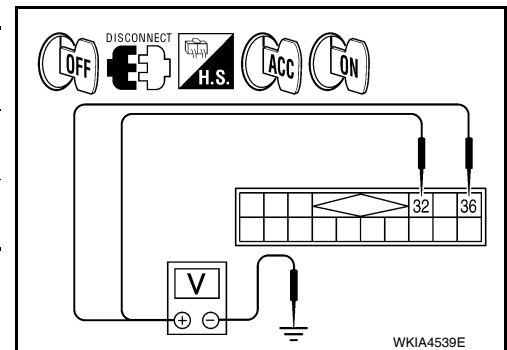

#### 3.GROUND CIRCUIT CHECK

Inspect satellite radio tuner (factory installed) case ground.

Does case ground pass inspection?

YES >> Inspection End.

NO >> Repair satellite radio tuner (factory installed) case ground.

## REAR VIEW CAMERA CONTROL UNIT

### REAR VIEW CAMERA CONTROL UNIT : Diagnosis Procedure

INFOID:000000005259421

Regarding Wiring Diagram information, refer to [AV-245, "Wiring Diagram"](#).

#### 1.CHECK FUSE

Check that the following fuses of the rear view camera control unit are not blown.

# POWER SUPPLY AND GROUND CIRCUIT

< COMPONENT DIAGNOSIS >

[BOSE AUDIO WITHOUT NAVIGATION]

Unit	Terminals	Signal name	Fuse No.
Rear view camera control unit	1	Battery power	29
	2	Ignition switch ACC or ON	4

**Are the fuses OK?**

YES >> GO TO 2

NO >> Be sure to eliminate cause of malfunction before installing new fuse.

**2.CHECK POWER SUPPLY CIRCUIT**

Check voltage between rear view camera control unit harness connector B176 and ground.

(+)		(-)	Ignition switch position	Value (Approx.)
Connector	Terminal			
B176	1	Ground	OFF	Battery voltage
	2		ACC	

**Are the voltage readings as specified?**

YES >> GO TO 3

NO >> Repair harness or connector.

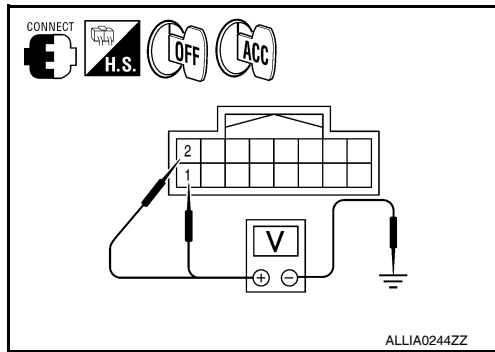

**3.CHECK GROUND CIRCUIT**

1. Turn ignition switch OFF.
2. Disconnect rear view camera control unit connector.
3. Check continuity between rear view camera control unit harness connector B176 terminal 3 and ground.

Connector	Terminal	—	Continuity
B176	3	Ground	Yes

**Does continuity exist?**

YES >> Inspection End.

NO >> Repair harness or connector.

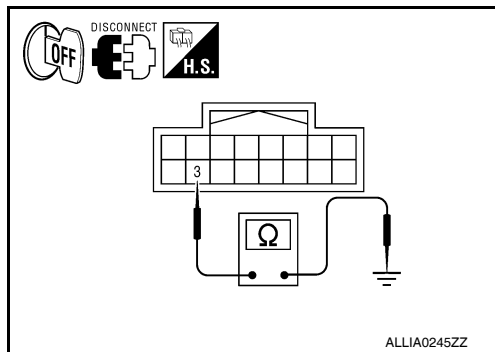

**REAR VIEW CAMERA**

**REAR VIEW CAMERA : Diagnosis Procedure**

INFOID:000000005259422

Regarding Wiring Diagram information, refer to [AV-245. "Wiring Diagram"](#).

**1.CHECK POWER SUPPLY CIRCUIT (REAR VIEW CAMERA SIDE)**

1. Turn ignition switch ON.
2. Shift transmission into reverse.
3. Check voltage between rear view camera harness connector D551 and ground.

(+)		(-)	Transmission position	Value (Approx.)
Connector	Terminal			
D551	1	Ground	Reverse	6V

**Is voltage reading approximately 6 volts?**

YES >> GO TO 4

NO >> GO TO 2

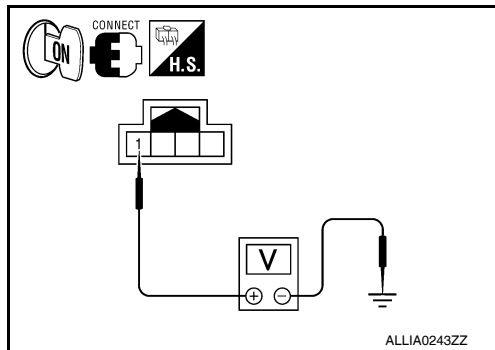

A  
B  
C  
D  
E  
F  
G  
H  
I  
J  
K  
L  
M  
AV

# POWER SUPPLY AND GROUND CIRCUIT

[BOSE AUDIO WITHOUT NAVIGATION]

< COMPONENT DIAGNOSIS >

## 2. CHECK POWER SUPPLY CIRCUIT (CONTINUITY)

1. Turn ignition switch OFF.
2. Disconnect rear view camera and rear view camera control unit connectors.
3. Check continuity between rear view camera harness connector D551 (A) terminal 1 and rear view camera control unit harness connector B176 (B) terminal 8.

A		B		Continuity
Connector	Terminal	Connector	Terminal	
D551	1	B176	8	Yes

4. Check continuity between rear view camera harness connector D551 (A) terminal 1 and ground.

A		—	Continuity
Connector	Terminal		
D551	1	Ground	No

Are continuity results as specified?

- YES >> GO TO 3  
 NO >> Repair harness or connector.

## 3. CHECK POWER SUPPLY CIRCUIT (REAR VIEW CAMERA CONTROL UNIT SIDE)

1. Connect rear view camera control unit harness connector.
2. Turn ignition switch ON.
3. Check voltage between rear view camera control unit harness connector B176 and ground.

(+)		(-)	Transmission position	Value (Approx.)
Connector	Terminal			
B176	8	Ground	Reverse	6V

Is voltage reading approximately 6 volts?

- YES >> GO TO 4.  
 NO >> Replace rear view camera control unit. Refer to [AV-309](#), "Removal and Installation".

## 4. CHECK GROUND CIRCUIT

1. Turn ignition switch OFF.
2. Disconnect rear view camera harness connector.
3. Check continuity between rear view camera harness connector D551 terminal 2 and ground.

Connector	Terminal	—	Continuity
D551	2	Ground	Yes

Does continuity exist?

- YES >> Inspection End.  
 NO >> Repair harness or connector.

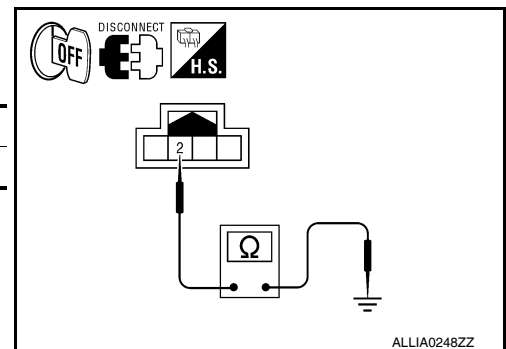
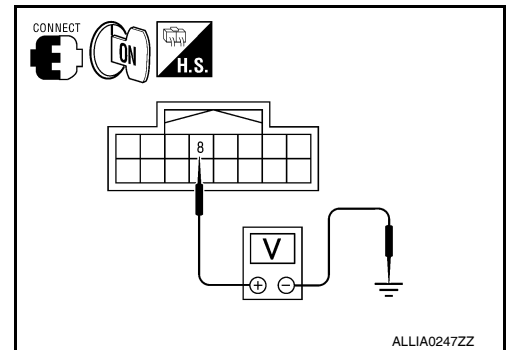
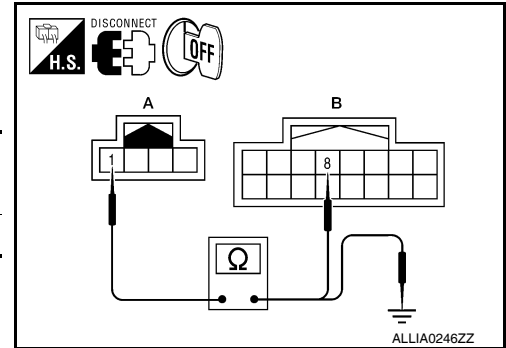

## DVD PLAYER

### DVD PLAYER : Diagnosis Procedure

INFOID:000000005259423

Regarding Wiring Diagram information, refer to [AV-245](#), "Wiring Diagram".



# POWER SUPPLY AND GROUND CIRCUIT

< COMPONENT DIAGNOSIS >

[BOSE AUDIO WITHOUT NAVIGATION]

## 1. CHECK FUSE

Check that the following fuses of the DVD player are not blown.

Unit	Terminal	Signal name	Fuse No.
DVD player	21	Battery power	29
	24	Ignition switch ACC or ON	4

Is the fuse OK?

YES >> GO TO 2

NO >> If fuse is blown, be sure to eliminate cause of malfunction before installing new fuse.

## 2. POWER SUPPLY CIRCUIT CHECK

1. Disconnect DVD player connector M205.
2. Check voltage between the DVD player connector M205 and ground.

(+)		(-)	OFF	ACC	ON
Connector	Terminal				
M205	21	Ground	Battery voltage	Battery voltage	Battery voltage
	24		0V	Battery voltage	Battery voltage

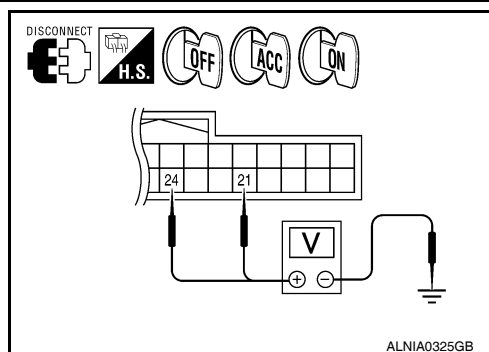

Are the voltage results as specified?

YES >> GO TO 3

NO >> • Check connector housings for disconnected or loose terminals.  
• Repair harness or connector.

## 3. GROUND CIRCUIT CHECK

1. Turn ignition switch OFF.
2. Check continuity between DVD player harness connector M205 terminal 5 and ground.

Connector	Terminal	—	Continuity
M205	5	Ground	Yes

Does continuity exist?

YES >> Inspection End.

NO >> Repair DVD player ground.

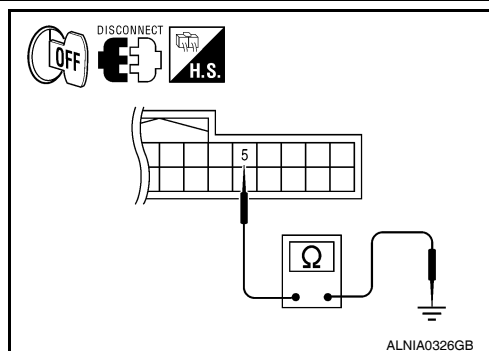

## VIDEO MONITOR

### VIDEO MONITOR : Diagnosis Procedure

INFOID:000000005259424

Regarding Wiring Diagram information, refer to [AV-245, "Wiring Diagram"](#).

## 1. CHECK POWER SUPPLY CIRCUIT

1. Turn ignition switch to ACC.

# POWER SUPPLY AND GROUND CIRCUIT

[BOSE AUDIO WITHOUT NAVIGATION]

< COMPONENT DIAGNOSIS >

- Check voltage between video monitor harness connector B76 and ground.

(+)		(-)	Ignition switch position	Value (Approx.)
Connector	Terminal			
B76	16	Ground	ACC	Battery voltage

Does battery voltage exist?

- YES >> GO TO 3  
NO >> GO TO 2

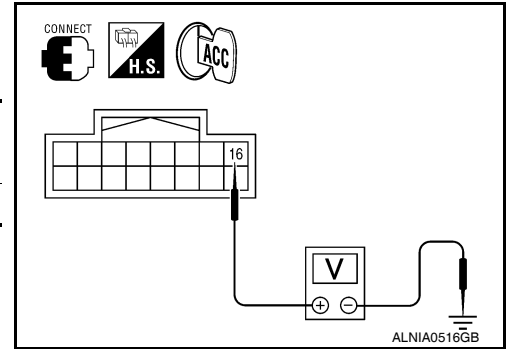

## 2.CHECK POWER SUPPLY CIRCUIT

- Turn ignition switch OFF.
- Disconnect the video monitor connector B76 and the DVD player connector M205.
- Check continuity between the video monitor harness connector B76 (A) and the DVD player connector M205 (B).

A		B		Continuity
Connector	Terminal	Connector	Terminal	
B76	16	M205	9	Yes

- Check continuity between video monitor harness connector B76 (A) and ground.

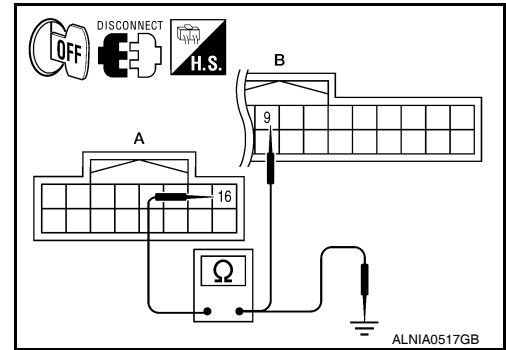

A		—	Continuity
Connector	Terminal		
B76	16	Ground	No

Are continuity results as specified?

- YES >> Check DVD player power and ground supply. Refer to [AV-193, "AV CONTROL UNIT : Diagnosis Procedure"](#).  
NO >> Repair harness or connector.

## 3.CHECK GROUND CIRCUIT

- Turn ignition switch OFF.
- Disconnect video monitor connector.
- Check continuity between video monitor harness connector B76 and ground.

Connector	Terminal	—	Continuity
B76	12	Ground	Yes
	15		

Does continuity exist?

- YES >> Inspection End.  
NO >> Repair harness or connector.

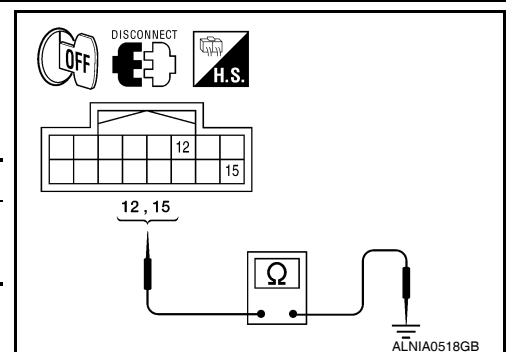

## BLUETOOTH CONTROL UNIT

### BLUETOOTH CONTROL UNIT : Diagnosis Procedure

INFOID:000000005259425

Regarding Wiring Diagram information, refer to [AV-245, "Wiring Diagram"](#).

## 1.CHECK FUSE

Check that the following fuses of the Bluetooth control unit are not blown.

# POWER SUPPLY AND GROUND CIRCUIT

< COMPONENT DIAGNOSIS >

[BOSE AUDIO WITHOUT NAVIGATION]

Power source	Fuse No.
Battery	29
Ignition switch ACC or ON	4
Ignition switch ON or START	12

Are the fuses OK?

YES >> GO TO 2

NO >> Be sure to eliminate cause of malfunction before installing new fuse.

## 2.CHECK POWER SUPPLY CIRCUIT

Check voltage between Bluetooth control unit harness connector and ground.

(+) Connector		Terminal	(-)	OFF	ACC	ON
B124	1			Ground	Battery voltage	Battery voltage
	2	0V	Battery voltage		Battery voltage	
	3	0V	0V		Battery voltage	

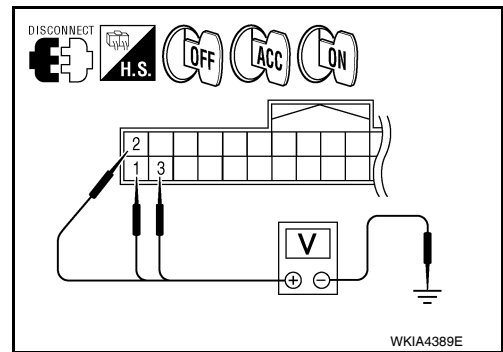

Are the voltage results as specified?

YES >> GO TO 3

NO >> Check harness between Bluetooth control unit and fuse.

## 3.CHECK GROUND CIRCUIT

1. Turn ignition switch OFF.
2. Disconnect Bluetooth control unit connector B124.
3. Check continuity between Bluetooth control unit harness connector and ground.

Connector	Terminal	—	Continuity
B124	4	Ground	Yes
	21		
	22		
	24		

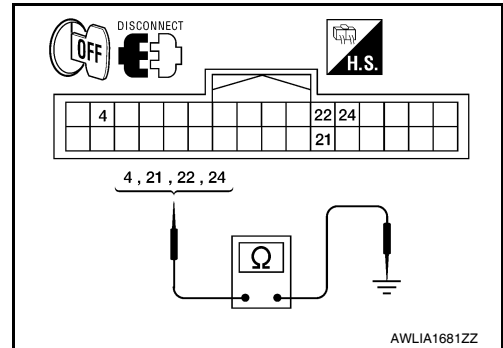

Does continuity exist?

YES >> Inspection End.

NO >> Repair harness or connector.

## MICROPHONE

### MICROPHONE : Diagnosis Procedure

INFOID:000000005259426

Regarding Wiring Diagram information, refer to [AV-245, "Wiring Diagram"](#).

## 1.CHECK POWER SUPPLY CIRCUIT (MICROPHONE SIDE)

# POWER SUPPLY AND GROUND CIRCUIT

[BOSE AUDIO WITHOUT NAVIGATION]

## < COMPONENT DIAGNOSIS >

Check voltage between microphone harness connector and ground.

(+)		(-)	Value (Approx.)
Connector	Terminal		
R8	4	Ground	5V

Is proper voltage present?

- YES >> GO TO 4
- NO >> GO TO 2

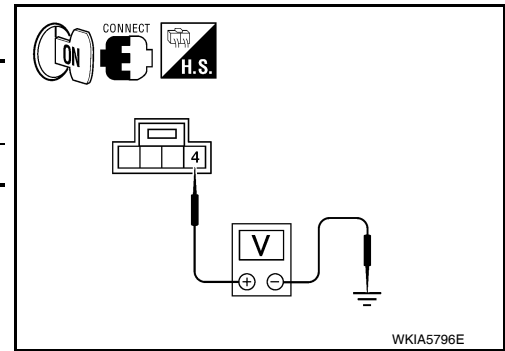

## 2. CHECK POWER SUPPLY CIRCUIT (CONTINUITY)

- Turn ignition switch OFF.
- Disconnect Bluetooth control unit and microphone connectors.
- Check continuity between microphone harness connector R8 (A) terminal 4 and Bluetooth control unit harness connector B124 (B) terminal 29.

A		B		Continuity
Connector	Terminal	Connector	Terminal	
R8	4	B124	29	Yes

- Check continuity between microphone harness connector R8 (A) terminal 4 and ground.

A		—	Continuity
Connector	Terminal		
R8	4	Ground	No

Are continuity results as specified?

- YES >> GO TO 3
- NO >> Repair harness or connector.

## 3. CHECK POWER SUPPLY CIRCUIT (BLUETOOTH CONTROL UNIT SIDE)

- Connect Bluetooth control unit connector.
- Turn ignition switch ON.
- Check voltage between Bluetooth control unit harness connector and ground.

(+)		(-)	Value (Approx.)
Connector	Terminal		
B124	29	Ground	5V

Is proper voltage present?

- YES >> Inspection End.
- NO >> Replace Bluetooth control unit. Refer to [AV-298](#), "[Removal and Installation](#)".

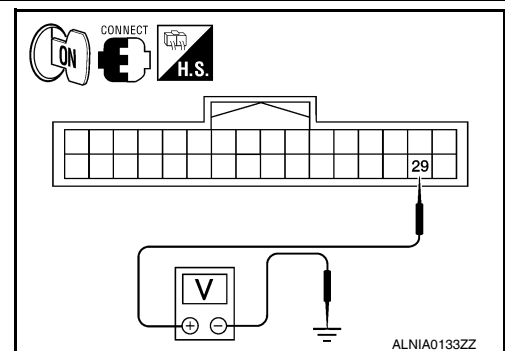
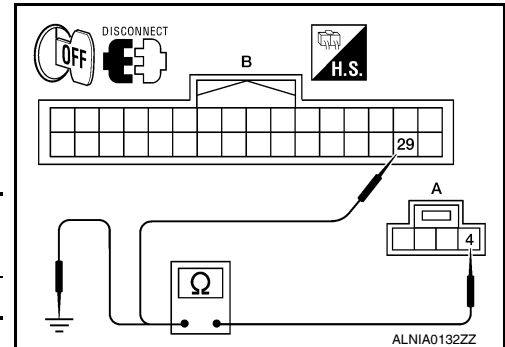

## 4. CHECK GROUND CIRCUIT

# POWER SUPPLY AND GROUND CIRCUIT

< COMPONENT DIAGNOSIS >

[BOSE AUDIO WITHOUT NAVIGATION]

1. Turn ignition switch OFF.
2. Disconnect Bluetooth control unit and microphone connectors.
3. Check continuity between microphone harness connector R8 terminal 2 and Bluetooth control unit harness connector B124 terminal 8.

Connector	Terminal	Connector	Terminal	Continuity
R8	2	B124	8	Yes

Is continuity present?

- YES >> Inspection End.  
NO >> Repair harness or connector.

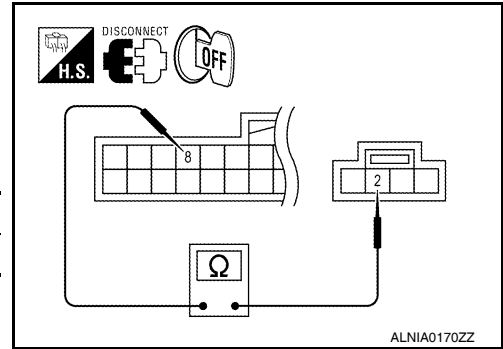

A  
B  
C  
D  
E  
F  
G  
H  
I  
J  
K  
L  
M  
AV  
O  
P

# RGB (R: RED) SIGNAL CIRCUIT

< COMPONENT DIAGNOSIS >

[BOSE AUDIO WITHOUT NAVIGATION]

## RGB (R: RED) SIGNAL CIRCUIT

### Description

INFOID:000000005259427

Transmit the image displayed with AV control unit with RGB signal to the display unit.

### Diagnosis Procedure

INFOID:000000005259428

Regarding Wiring Diagram information, refer to [AV-245, "Wiring Diagram"](#).

### 1. CHECK CONTINUITY RGB (R: RED) SIGNAL CIRCUIT

1. Turn ignition switch OFF.
2. Disconnect display unit connector M93 and AV control unit connector M45.
3. Check continuity between display unit harness connector M93 (A) terminal 17 and AV control unit harness connector M45 (B) terminal 40.

A		B		Continuity
Connector	Terminal	Connector	Terminal	
M93	17	M45	40	Yes

4. Check continuity between display unit harness connector M93 (A) terminal 17 and ground.

A		—	Continuity
Connector	Terminal		
M93	17	Ground	No

Are the continuity results as specified?

- YES >> GO TO 2  
 NO >> Repair harness or connector.

### 2. CHECK RGB (R: RED) SIGNAL

1. Connect display unit connector M93 and AV control unit connector M45.
2. Turn ignition switch ON.
3. Check signal between display unit harness connector M93 terminal 17 and ground.

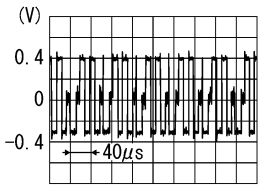
(+)		(-)	Condition	Reference signal
Connector	Terminal			
M93	17	Ground	Receive audio signal	 <p>SKIB2238J</p>

Are the voltage readings as specified?

- YES >> Replace display unit. Refer to [AV-291, "Removal and Installation"](#).  
 NO >> Replace AV control unit. Refer to [AV-289, "Removal and Installation"](#).

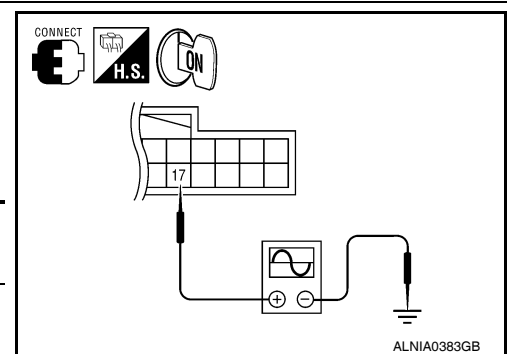
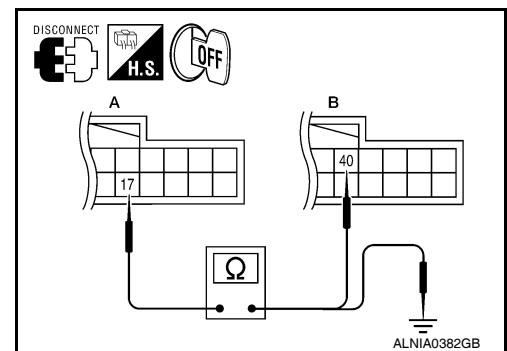

# RGB (G: GREEN) SIGNAL CIRCUIT

< COMPONENT DIAGNOSIS >

[BOSE AUDIO WITHOUT NAVIGATION]

## RGB (G: GREEN) SIGNAL CIRCUIT

### Description

INFOID:000000005259429

Transmit the image displayed with AV control unit with RGB signal to the display unit.

### Diagnosis Procedure

INFOID:000000005259430

Regarding Wiring Diagram information, refer to [AV-245, "Wiring Diagram"](#).

### 1. CHECK CONTINUITY RGB (G: GREEN) SIGNAL CIRCUIT

1. Turn ignition switch OFF.
2. Disconnect display unit connector M93 and AV control unit connector M45.
3. Check continuity between display unit harness connector M93 (A) terminal 6 and AV control unit harness connector M45 (B) terminal 39.

A		B		Continuity
Connector	Terminal	Connector	Terminal	
M93	6	M45	39	Yes

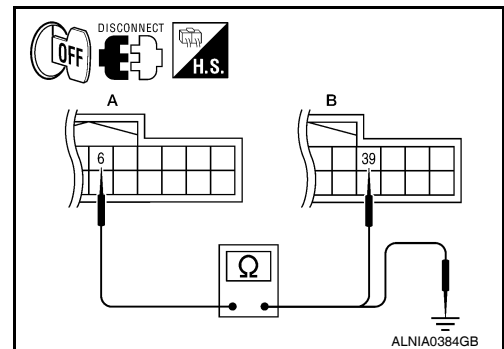

4. Check continuity between display unit harness connector M93 (A) terminal 6 and ground.

A		—	Continuity
Connector	Terminal		
M93	6	Ground	No

Are the continuity results as specified?

YES >> GO TO 2

NO >> Repair harness or connector.

### 2. CHECK RGB (G: GREEN) SIGNAL

1. Connect display unit connector M93 and AV control unit connector M45.
2. Turn ignition switch ON.
3. Check signal between display unit harness connector M93 terminal 6 and ground.

(+)		(-)	Condition	Reference signal
Connector	Terminal			
M93	6	Ground	Receive audio signal	<p>Reference signal waveform showing a square wave between 0.4V and -0.4V with a 40µs scale bar. The waveform is labeled SKIB2236J.</p>

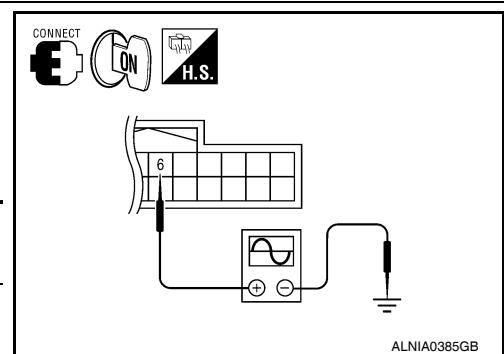

Are voltage readings as specified?

YES >> Replace display unit. Refer to [AV-291, "Removal and Installation"](#).

NO >> Replace AV control unit. Refer to [AV-289, "Removal and Installation"](#).

# RGB (B: BLUE) SIGNAL CIRCUIT

< COMPONENT DIAGNOSIS >

[BOSE AUDIO WITHOUT NAVIGATION]

## RGB (B: BLUE) SIGNAL CIRCUIT

### Description

INFOID:000000005259431

Transmit the image displayed with AV control unit with RGB signal to the display unit.

### Diagnosis Procedure

INFOID:000000005259432

Regarding Wiring Diagram information, refer to [AV-245, "Wiring Diagram"](#).

### 1. CHECK CONTINUITY RGB (B: BLUE) SIGNAL CIRCUIT

1. Turn ignition switch OFF.
2. Disconnect display unit connector M93 and AV control unit connector M45.
3. Check continuity between display unit harness connector M93 (A) terminal 18 and AV control unit harness connector M45 (B) terminal 38.

A		B		Continuity
Connector	Terminal	Connector	Terminal	
M93	18	M45	38	Yes

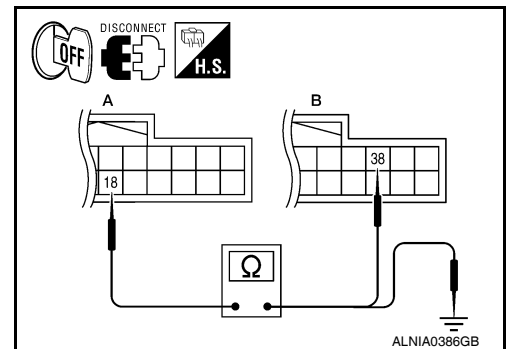

4. Check continuity between display unit harness connector M93 (A) terminal 18 and ground.

A		—	Continuity
Connector	Terminal		
M93	18	Ground	No

Are continuity results as specified?

- YES >> GO TO 2  
 NO >> Repair harness or connector.

### 2. CHECK RGB (B: BLUE) SIGNAL

1. Connect display unit connector M93 and AV control unit connector M45.
2. Turn ignition switch ON.
3. Check signal between display unit harness connector M93 terminal 18 and ground.

(+)		(-)	Condition	Reference signal
Connector	Terminal			
M93	18	Ground	Receive audio signal	<p>SKIB2237J</p>

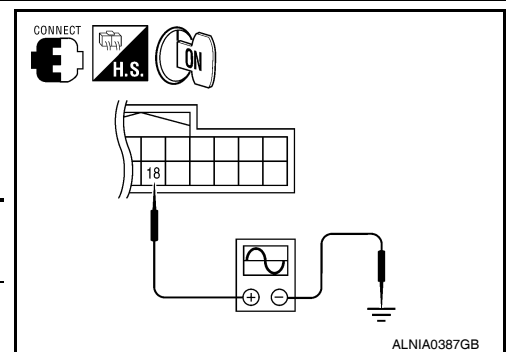

Are voltage readings as specified?

- YES >> Replace display unit. Refer to [AV-291, "Removal and Installation"](#).  
 NO >> Replace AV control unit. Refer to [AV-289, "Removal and Installation"](#).



# RGB SYNCHRONIZING SIGNAL CIRCUIT

< COMPONENT DIAGNOSIS >

[BOSE AUDIO WITHOUT NAVIGATION]

## RGB SYNCHRONIZING SIGNAL CIRCUIT

### Description

INFOID:000000005259433

Transmit the RGB synchronizing signal to the display unit so as to synchronize the RGB image displayed with AV control unit.

### Diagnosis Procedure

INFOID:000000005259434

Regarding Wiring Diagram information, refer to [AV-245, "Wiring Diagram"](#).

### 1. CHECK CONTINUITY RGB SYNCHRONIZING SIGNAL CIRCUIT

- Turn ignition switch OFF.
- Disconnect display unit connector M93 and AV control unit connector M45.
- Check continuity between display unit harness connector M93 (A) terminal 19 and AV control unit harness connector M45 (B) terminal 41.

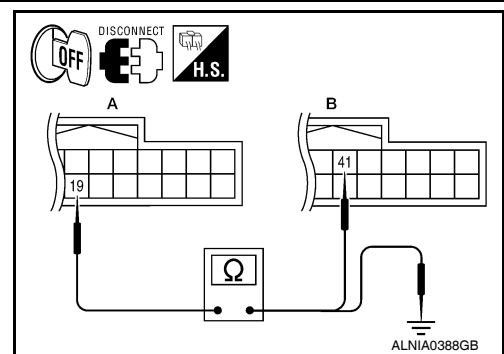

A		B		Continuity
Connector	Terminal	Connector	Terminal	
M93	19	M45	41	Yes

- Check continuity between display unit harness connector M93 (A) terminal 19 and ground.

A		—	Continuity
Connector	Terminal		
M93	19	Ground	No

Are continuity results as specified?

YES >> GO TO 2

NO >> Repair harness or connector.

### 2. CHECK RGB SYNCHRONIZING SIGNAL

- Connect display unit connector M93 and AV control unit connector M45.
- Turn ignition switch ON.
- Check signal between display unit harness connector M93 terminal 19 and ground.

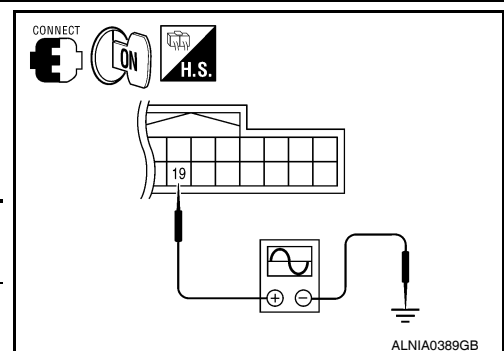

(+) Connector		(-)	Condition	Reference signal
Connector	Terminal			
M93	19	Ground	Receive audio signal	

Are voltage readings as specified?

YES >> Replace display unit. Refer to [AV-291, "Removal and Installation"](#).

NO >> Replace AV control unit. Refer to [AV-289, "Removal and Installation"](#).

A  
B  
C  
D  
E  
F  
G  
H  
I  
J  
K  
L  
M  
N  
O  
P

AV

# RGB AREA (YS) SIGNAL CIRCUIT

< COMPONENT DIAGNOSIS >

[BOSE AUDIO WITHOUT NAVIGATION]

## RGB AREA (YS) SIGNAL CIRCUIT

### Description

INFOID:000000005259435

Transmits the display area of RGB image displayed by AV control unit with RGB area (YS) signal to display unit.

### Diagnosis Procedure

INFOID:000000005259436

Regarding Wiring Diagram information, refer to [AV-245, "Wiring Diagram"](#).

### 1. CHECK CONTINUITY RGB AREA (YS) SIGNAL CIRCUIT

1. Turn ignition switch OFF.
2. Disconnect display unit connector M93 and AV control unit connector M45.
3. Check continuity between display unit harness connector M93 (A) terminal 9 and AV control unit harness connector M45 (B) terminal 43.

A		B		Continuity
Connector	Terminal	Connector	Terminal	
M93	9	M45	43	Yes

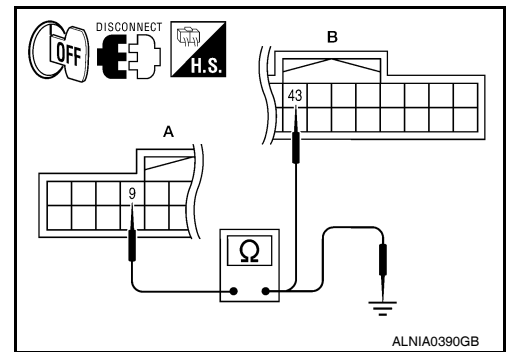

4. Check continuity between display unit harness connector M93 (A) terminal 9 and ground.

A		—	Continuity
Connector	Terminal		
M93	9	Ground	No

Are continuity results as specified?

- YES >> GO TO 2  
 NO >> Repair harness or connector.

### 2. CHECK RGB SYNCHRONIZING SIGNAL

1. Connect display unit connector M93 and AV control unit connector M45.
2. Turn ignition switch ON.
3. Check signal between display unit harness connector M93 terminal 9 and ground.

(+)		(-)	Condition	Reference signal
Connector	Terminal			
M93	9	Ground	Receive audio signal	<p>PK1B4948J</p>

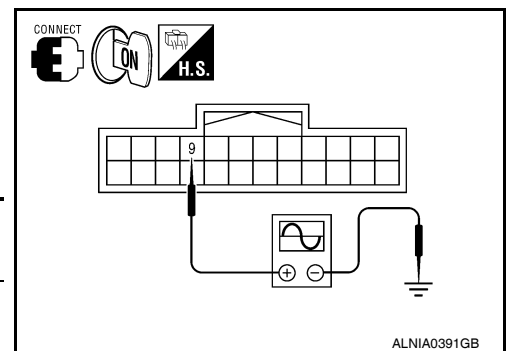

Are voltage readings as specified?

- YES >> Replace display unit. Refer to [AV-291, "Removal and Installation"](#).  
 NO >> Replace AV control unit. Refer to [AV-289, "Removal and Installation"](#).

# HORIZONTAL SYNCHRONIZING (HP) SIGNAL CIRCUIT

< COMPONENT DIAGNOSIS >

[BOSE AUDIO WITHOUT NAVIGATION]

## HORIZONTAL SYNCHRONIZING (HP) SIGNAL CIRCUIT

### Description

INFOID:000000005259437

In composite image (AUX image, camera image), transmit the vertical synchronizing (VP) signal and horizontal synchronizing (HP) signal from display unit to AV control unit so as to synchronize the RGB images displayed with AV control unit such as the image quality adjusting menu, etc.

### Diagnosis Procedure

INFOID:000000005259438

Regarding Wiring Diagram information, refer to [AV-245. "Wiring Diagram"](#).

### 1. CHECK CONTINUITY HORIZONTAL SYNCHRONIZING (HP) SIGNAL CIRCUIT

1. Turn ignition switch OFF.
2. Disconnect display unit connector M93 and AV control unit connector M45.
3. Check continuity between display unit harness connector M93 (A) terminal 8 and AV control unit harness connector M45 (B) terminal 45.

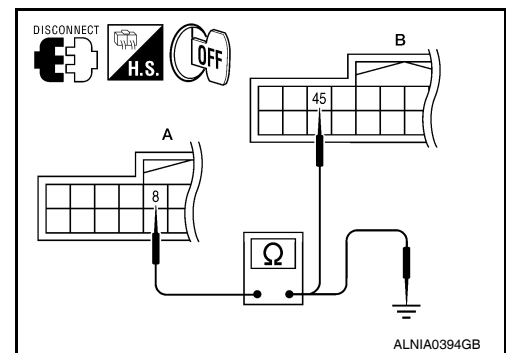

A		B		Continuity
Connector	Terminal	Connector	Terminal	
M93	8	M45	45	Yes

4. Check continuity between display unit harness connector M93 (A) terminal 8 and ground.

A		—	Continuity
Connector	Terminal		
M93	8	Ground	No

Are continuity results as specified?

YES >> GO TO 2

NO >> Repair harness or connector.

### 2. CHECK HORIZONTAL SYNCHRONIZING (HP) SIGNAL

1. Connect display unit connector M93 and AV control unit connector M45.
2. Turn ignition switch ON.
3. Check signal between display unit harness connector M93 terminal 8 and ground.

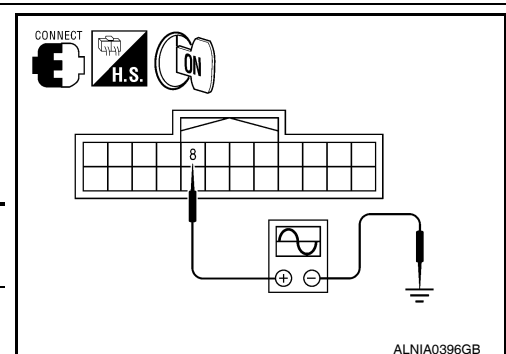

(+)		(-)	Condition	Reference signal
Connector	Terminal			
M93	8	Ground	Receive audio signal	<p>SKIB3601E</p>

Are voltage readings as specified?

YES >> Replace AV control unit. Refer to [AV-289. "Removal and Installation"](#).

NO >> Replace display unit. Refer to [AV-291. "Removal and Installation"](#).

A  
B  
C  
D  
E  
F  
G  
H  
I  
J  
K  
L  
M  
N  
O  
P

AV

# VERTICAL SYNCHRONIZING (VP) SIGNAL CIRCUIT

< COMPONENT DIAGNOSIS >

[BOSE AUDIO WITHOUT NAVIGATION]

## VERTICAL SYNCHRONIZING (VP) SIGNAL CIRCUIT

### Description

INFOID:000000005259439

In composite image (AUX image, camera image), transmit the vertical synchronizing (VP) signal and horizontal synchronizing (HP) signal from display unit to AV control unit so as to synchronize the RGB images displayed with AV control unit such as the image quality adjusting menu, etc.

### Diagnosis Procedure

INFOID:000000005259440

Regarding Wiring Diagram information, refer to [AV-245. "Wiring Diagram"](#).

### 1. CHECK CONTINUITY VERTICAL SYNCHRONIZING (VP) SIGNAL CIRCUIT

1. Turn ignition switch OFF.
2. Disconnect display unit connector M93 and AV control unit connector M45.
3. Check continuity between display unit harness connector M93 (A) terminal 20 and AV control unit harness connector M45 (B) terminal 57.

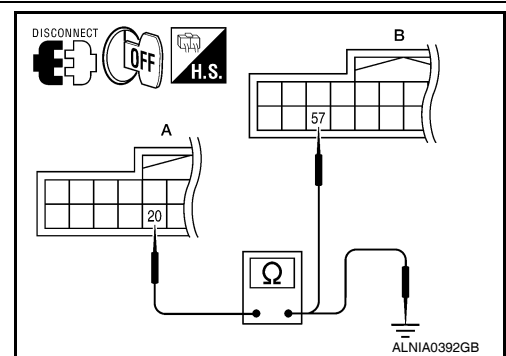

A		B		Continuity
Connector	Terminal	Connector	Terminal	
M93	20	M45	57	Yes

4. Check continuity between display unit harness connector M93 (A) terminal 20 and ground.

A		—	Continuity
Connector	Terminal		
M93	20	Ground	No

Are continuity results as specified?

- YES >> GO TO 2  
 NO >> Repair harness or connector.

### 2. CHECK VERTICAL SYNCHRONIZING (VP) SIGNAL

1. Connect display unit connector M93 and AV control unit connector M45.
2. Turn ignition switch ON.
3. Check signal between display unit harness connector M93 terminal 20 and ground.

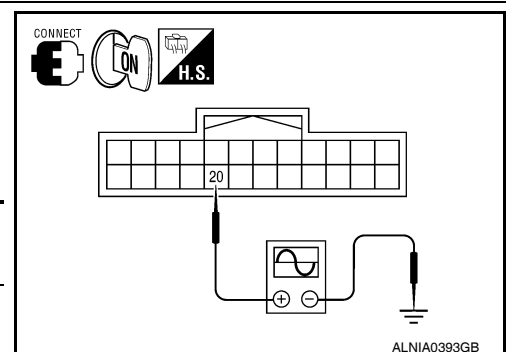

(+) Connector		(-) Terminal	Condition	Reference signal
M93	20	Ground	Receive audio signal	

Are voltage readings as specified?

- YES >> Replace AV control unit. Refer to [AV-289. "Removal and Installation"](#).  
 NO >> Replace display unit. Refer to [AV-291. "Removal and Installation"](#).

# FRONT DOOR SPEAKER

[BOSE AUDIO WITHOUT NAVIGATION]

< COMPONENT DIAGNOSIS >

## FRONT DOOR SPEAKER

### Description

INFOID:000000005259441

The AV control unit sends audio signals to the BOSE speaker amp. The BOSE speaker amp. amplifies the audio signals before sending them to the front door speakers using the audio signal circuits.

### Diagnosis Procedure

INFOID:000000005259442

Regarding Wiring Diagram information, refer to [AV-245, "Wiring Diagram"](#).

### 1. HARNESS CHECK

1. Disconnect BOSE speaker amp. connector B75 and suspect speaker connector.
2. Check continuity between BOSE speaker amp. harness connector B75 (A) and suspect speaker harness connector (B).

A		B		Continuity
Connector	Terminal	Connector	Terminal	
B75	13	D12	1	Yes
	14		2	
	15	D112	1	
	16		2	

3. Check continuity between BOSE speaker amp. harness connector B75 (A) and ground.

A		—	Continuity
Connector	Terminal		
B75	13	Ground	No
	14		
	15		
	16		

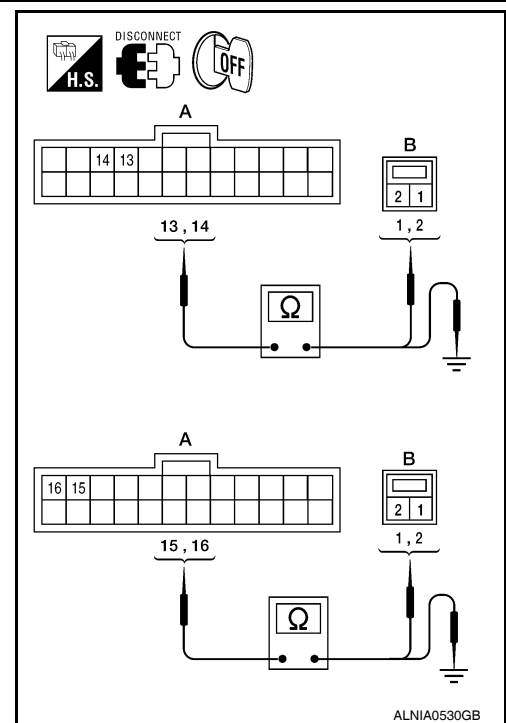

Are continuity test results as specified?

YES >> GO TO 2

- NO >> • Check connector housings for disconnected or loose terminals.  
• Repair harness or connector.

### 2. FRONT SPEAKER SIGNAL CHECK

A  
B  
C  
D  
E  
F  
G  
H  
I  
J  
K  
L  
M  
O  
P

AV

# FRONT DOOR SPEAKER

[BOSE AUDIO WITHOUT NAVIGATION]

## < COMPONENT DIAGNOSIS >

1. Connect BOSE speaker amp. connector B75 and suspect speaker connector.
2. Turn ignition switch to ACC.
3. Push "POWER" switch.
4. Check the signal between BOSE speaker amp. harness connector B75 terminals with CONSULT-III or oscilloscope.

Connector	Terminal		Condition	Reference signal
	(+)	(-)		
B75	13	14	Receive audio signal	
	15	16		

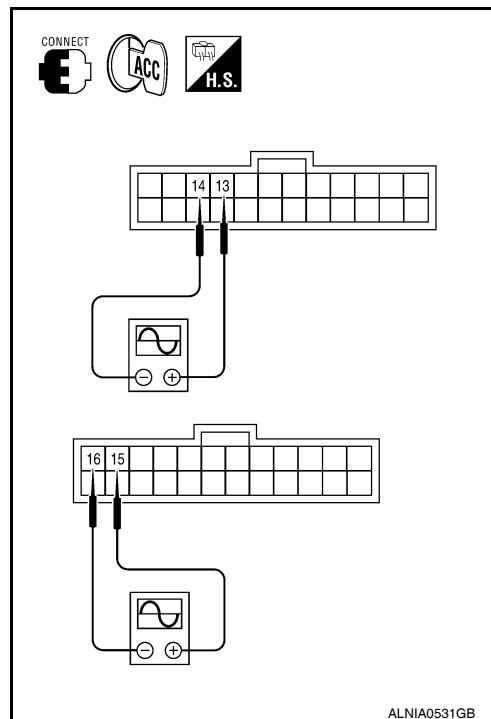

Is audio signal voltage as specified?

YES >> Replace suspect speaker. Refer to [AV-293, "Removal and Installation"](#).

NO >> GO TO 3

### 3. HARNESS CHECK

1. Disconnect AV control unit connector M69 and BOSE speaker amp. connector B75.
2. Check continuity between AV control unit harness connector M69 (A) and BOSE speaker amp. harness connector B75 (B).

A		B		Continuity
Connector	Terminal	Connector	Terminal	
M69	113	B75	30	Yes
	119		29	
	109		28	
	115		27	

3. Check continuity between AV control unit harness connector M69 (A) and ground.

A		—	Continuity
Connector	Terminal		
M69	113	Ground	No
	119		
	109		
	115		

Are continuity test results as specified?

YES >> GO TO 4

NO >> • Check connector housings for disconnected or loose terminals.  
• Repair harness or connector.

### 4. FRONT SPEAKER SIGNAL CHECK

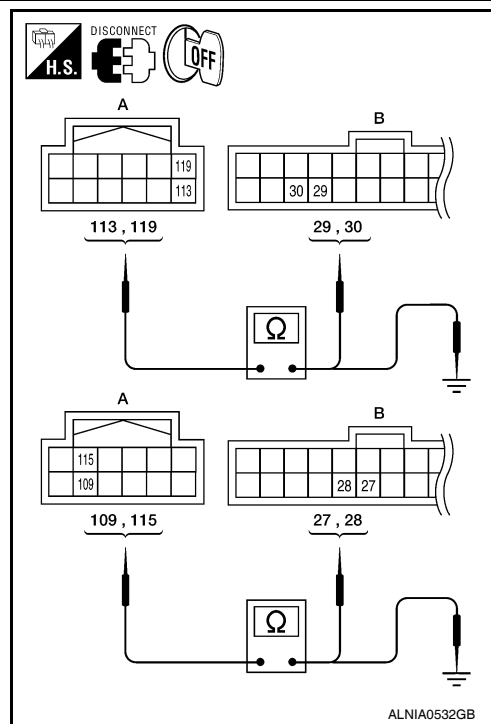

# FRONT DOOR SPEAKER

[BOSE AUDIO WITHOUT NAVIGATION]

< COMPONENT DIAGNOSIS >

1. Connect AV control unit connector and BOSE speaker amp. connector.
2. Turn ignition switch ACC.
3. Push "POWER" switch.
4. Check the signal between AV control unit harness connector M69 terminals with CONSULT-III or oscilloscope.

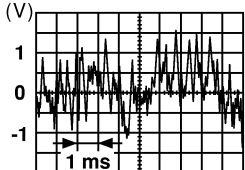
Connector	Terminals		Condition	Reference signal
	(+)	(-)		
M69	113	119	Receive audio signal	
	109	115		

SKIA0177E

Are the audio signal voltage readings as specified?

- YES >> Replace BOSE speaker amp. Refer to [AV-299, "Removal and Installation"](#).
- NO >> Replace AV control unit. Refer to [AV-289, "Removal and Installation"](#).

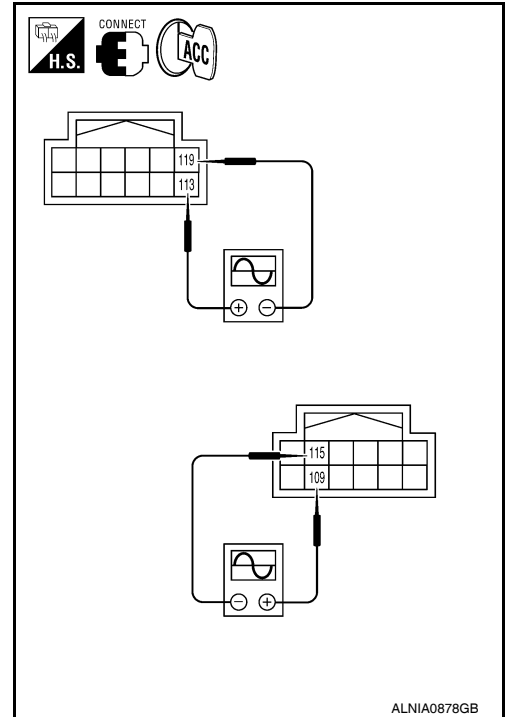

A  
B  
C  
D  
E  
F  
G  
H  
I  
J  
K  
L  
M

AV

O  
P

# FRONT TWEETER

[BOSE AUDIO WITHOUT NAVIGATION]

< COMPONENT DIAGNOSIS >

## FRONT TWEETER

### Description

INFOID:000000005259443

The AV control unit sends audio signals to the BOSE speaker amp. The BOSE speaker amp. amplifies the audio signals before sending them to the tweeters using the audio signal circuits.

### Diagnosis Procedure

INFOID:000000005259444

Regarding Wiring Diagram information, refer to [AV-245, "Wiring Diagram"](#).

## 1. HARNESS CHECK

1. Disconnect BOSE speaker amp. connector B75 and suspect tweeter connector.
2. Check continuity between BOSE speaker amp. harness connector B75 (A) and suspect tweeter harness connector (B).

A		B		Continuity
Connector	Terminal	Connector	Terminal	
B75	13	M109	1	Yes
	14		2	
	15	M111	1	
	16		2	

3. Check continuity between BOSE speaker amp. harness connector B75 (A) and ground.

A		—	Continuity
Connector	Terminal		
B75	13	Ground	No
	14		
	15		
	16		

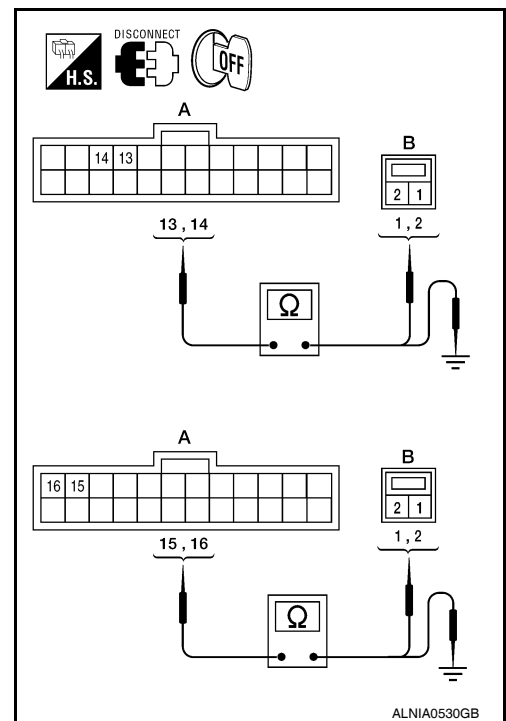

Are continuity results as specified?

YES >> GO TO 2

NO >> • Check connector housings for disconnected or loose terminals.  
• Repair harness or connector.

## 2. FRONT TWEETER SIGNAL CHECK



# FRONT TWEETER

[BOSE AUDIO WITHOUT NAVIGATION]

## < COMPONENT DIAGNOSIS >

1. Connect BOSE speaker amp. connector B75 and suspect tweeter connector.
2. Turn ignition switch to ACC.
3. Push "POWER" switch.
4. Check the signal between BOSE speaker amp. harness connector B75 terminals with CONSULT-III or oscilloscope.

Connector	Terminal		Condition	Reference signal
	(+)	(-)		
B75	13	14	Receive audio signal	
	15	16		

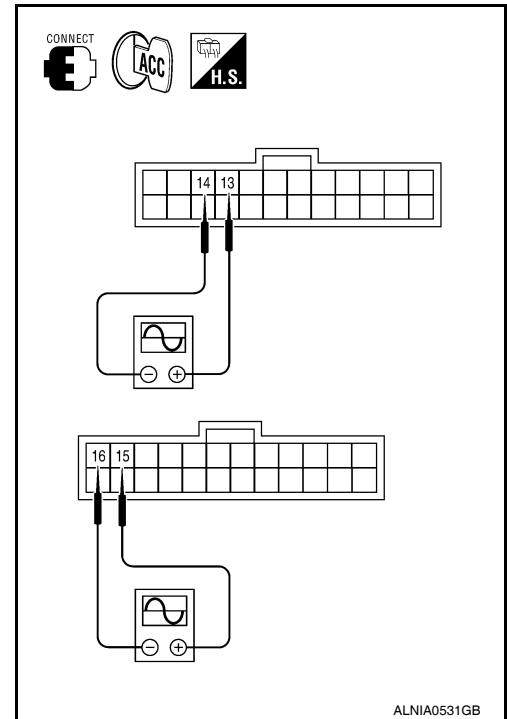

Is audio signal voltage as specified?

- YES >> Replace suspect tweeter. Refer to [AV-292. "Removal and Installation"](#).
- NO >> GO TO 3

### 3. HARNESS CHECK

1. Disconnect AV control unit connector M69 and BOSE speaker amp. connector B75.
2. Check continuity between AV control unit harness connector M69 (A) and BOSE speaker amp. harness connector B75 (B).

A		B		Continuity
Connector	Terminal	Connector	Terminal	
M69	113	B75	30	Yes
	119		29	
	109		28	
	115		27	

3. Check continuity between AV control unit harness connector M69 (A) and ground.

A		—	Continuity
Connector	Terminal		
M69	113	Ground	No
	119		
	109		
	115		

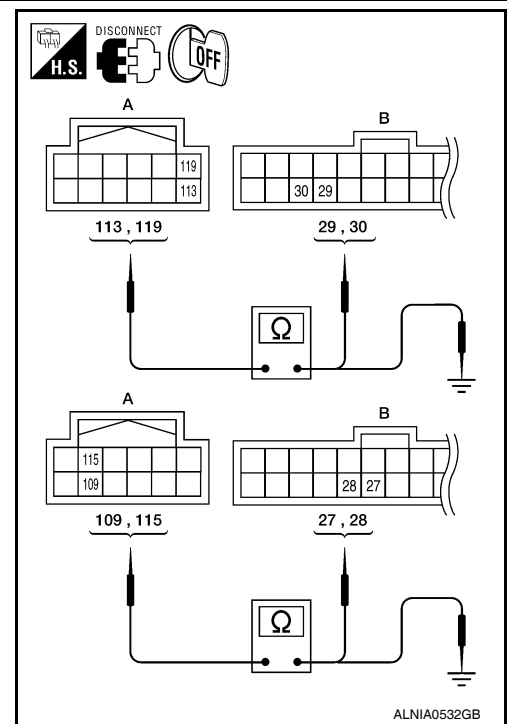

Are continuity results as specified?

- YES >> GO TO 4
- NO >> • Check connector housings for disconnected or loose terminals.  
• Repair harness or connector.

### 4. FRONT TWEETER SIGNAL CHECK

A  
B  
C  
D  
E  
F  
G  
H  
I  
J  
K  
L  
M  
O  
P

AV

# FRONT TWEETER

[BOSE AUDIO WITHOUT NAVIGATION]

< COMPONENT DIAGNOSIS >

1. Connect AV control unit connector and BOSE speaker amp. connector.
2. Turn ignition switch ACC.
3. Push "POWER" switch.
4. Check the signal between AV control unit harness connector M69 terminals with CONSULT-III or oscilloscope.

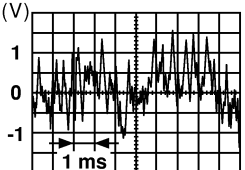
Connector	Terminals		Condition	Reference signal
	(+)	(-)		
M69	113	119	Receive audio signal	
	109	115		

SKIA0177E

Are the audio signal voltage readings as specified?

- YES >> Replace BOSE speaker amp. Refer to [AV-299, "Removal and Installation"](#).
- NO >> Replace AV control unit. Refer to [AV-289, "Removal and Installation"](#).

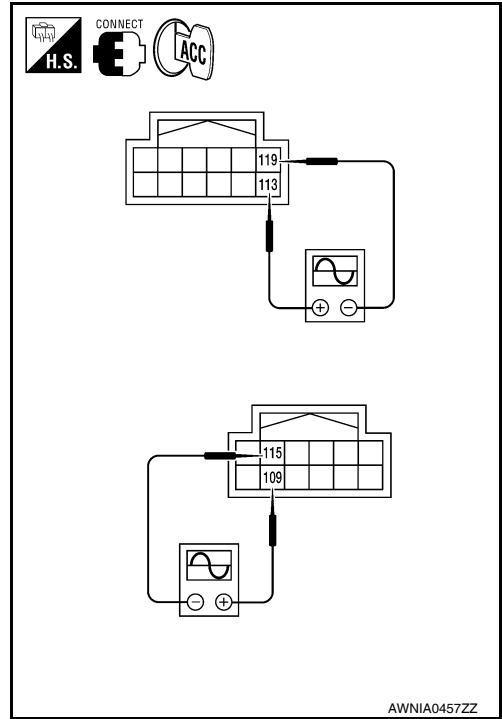

# REAR DOOR SPEAKER

[BOSE AUDIO WITHOUT NAVIGATION]

< COMPONENT DIAGNOSIS >

## REAR DOOR SPEAKER

### Description

INFOID:000000005259445

The AV control unit sends audio signals to the BOSE speaker amp. The BOSE speaker amp. amplifies the audio signals before sending them to the rear door speakers using the audio signal circuits.

### Diagnosis Procedure

INFOID:000000005259446

Regarding Wiring Diagram information, refer to [AV-245, "Wiring Diagram"](#).

### 1. HARNESS CHECK

1. Disconnect BOSE speaker amp. connectors B75 and suspect speaker connector.
2. Check continuity between BOSE speaker amp. harness connectors B75 (A) and suspect speaker harness connector (B).

A		B		Continuity
Connector	Terminal	Connector	Terminal	
B75	9	D207	1	Yes
	10		2	
	11	D307	1	
	12		2	

3. Check continuity between BOSE speaker amp. harness connectors B75 (A) and ground.

Connector	Terminal	-	Continuity
B75	9	Ground	No
	10		
	11		
	12		

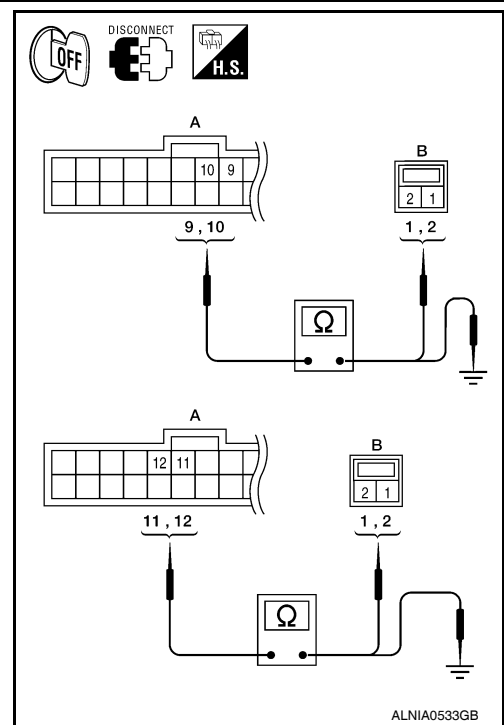

Are the continuity results as specified?

YES >> GO TO 2

- NO >> • Check connector housings for disconnected or loose terminals.  
• Repair harness or connector.

### 2. REAR DOOR SPEAKER SIGNAL CHECK

A  
B  
C  
D  
E  
F  
G  
H  
I  
J  
K  
L  
M  
O  
P

AV

# REAR DOOR SPEAKER

[BOSE AUDIO WITHOUT NAVIGATION]

## < COMPONENT DIAGNOSIS >

1. Connect BOSE speaker amp. connectors and suspect speaker connector.
2. Turn ignition switch to ACC.
3. Push "POWER" switch.
4. Check the signal between BOSE speaker amp. harness connectors B75 terminals with CONSULT-III or oscilloscope.

Connector	Terminals		Condition	Reference signal
	(+)	(-)		
B75	9	10	Receive audio signal	
	11	12		

SKIA0177E

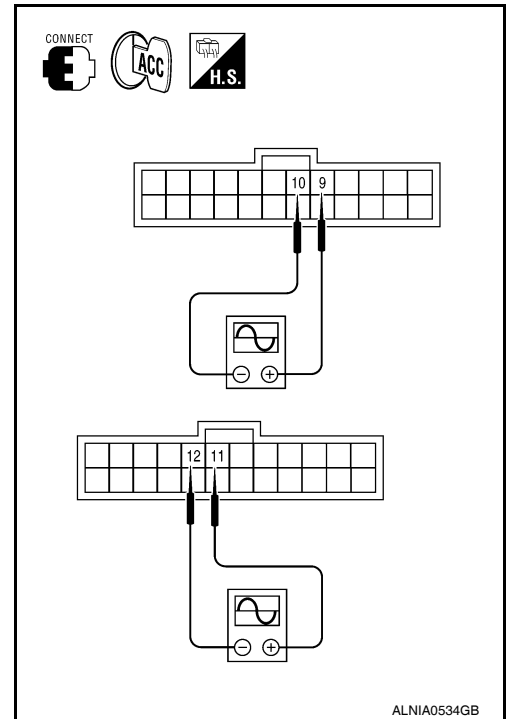

Are audio signal voltage readings as specified?

YES >> Replace suspect speaker. Refer to [AV-294, "Removal and Installation"](#).

NO >> GO TO 3

## 3. HARNESS CHECK

1. Disconnect AV control unit connector M69 and BOSE speaker amp. connector B75.
2. Check continuity between AV control unit harness connector M69 (A) and BOSE speaker amp. harness connector B75 (B).

A		B		Continuity
Connector	Terminal	Connector	Terminal	
M69	112	B75	26	Yes
	118		25	
	108		24	
	114		23	

3. Check continuity between AV control unit harness connector M69 (A) and ground.

A		—	Continuity
Connector	Terminal		
M69	112	Ground	No
	118		
	108		
	114		

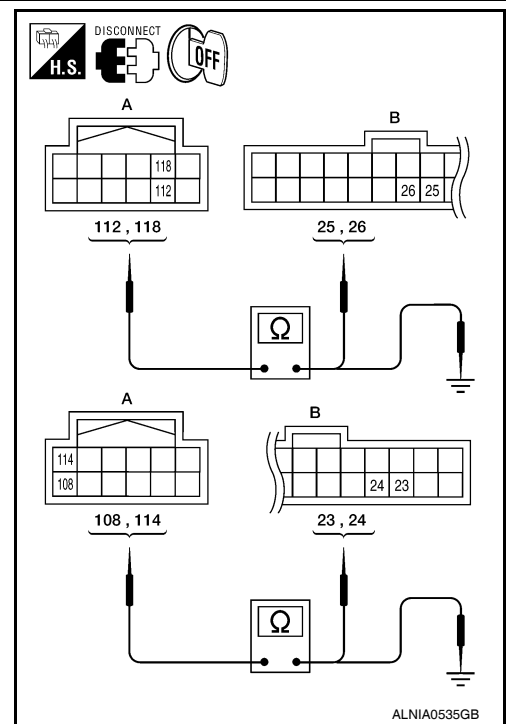

Are the continuity results as specified?

YES >> GO TO 4

NO >> • Check connector housings for disconnected or loose terminals.  
• Repair harness or connector.

## 4. REAR DOOR SPEAKER SIGNAL CHECK

# REAR DOOR SPEAKER

[BOSE AUDIO WITHOUT NAVIGATION]

< COMPONENT DIAGNOSIS >

1. Connect AV control unit connector M69 and BOSE speaker amp. connector B75.
2. Turn ignition switch to ACC.
3. Push "POWER" switch.
4. Check the signal between AV control unit harness connector M69 terminals with CONSULT-III or oscilloscope.

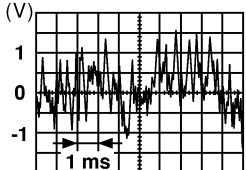
Connector	Terminals		Condition	Reference signal
	(+)	(-)		
M69	112	118	Receive audio signal	 <p style="text-align: right; font-size: small;">SKIA0177E</p>
	108	114		

Is the audio signal voltage reading as specified?

- YES >> Replace BOSE speaker amp. Refer to [AV-299, "Removal and Installation"](#).
- NO >> Replace AV control unit. Refer to [AV-289, "Removal and Installation"](#).

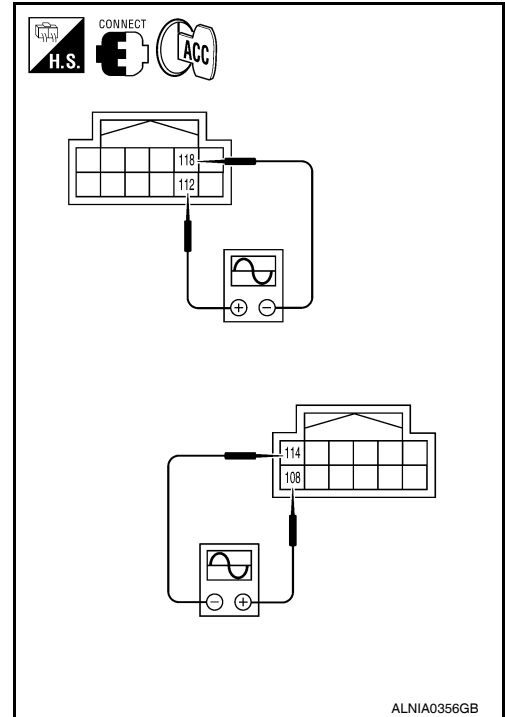

A  
B  
C  
D  
E  
F  
G  
H  
I  
J  
K  
L  
M

AV

O  
P

# REAR TWEETER

[BOSE AUDIO WITHOUT NAVIGATION]

< COMPONENT DIAGNOSIS >

## REAR TWEETER

### Description

INFOID:000000005259447

The AV control unit sends audio signals to the BOSE speaker amp. The BOSE speaker amp. amplifies the audio signals before sending them to the rear tweeters using the audio signal circuits.

### Diagnosis Procedure

INFOID:000000005259448

Regarding Wiring Diagram information, refer to [AV-245, "Wiring Diagram"](#).

### 1. HARNESS CHECK

1. Disconnect BOSE speaker amp. connectors B75 and suspect tweeter connector.
2. Check continuity between BOSE speaker amp. harness connectors B75 (A) and suspect tweeter harness connector (B).

A		B		Continuity
Connector	Terminal	Connector	Terminal	
B75	9	D208	1	Yes
	10		2	
	11	D308	1	
	12		2	

3. Check continuity between BOSE speaker amp. harness connectors B75 (A) and ground.

Connector	Terminal	-	Continuity
B75	9	Ground	No
	10		
	11		
	12		

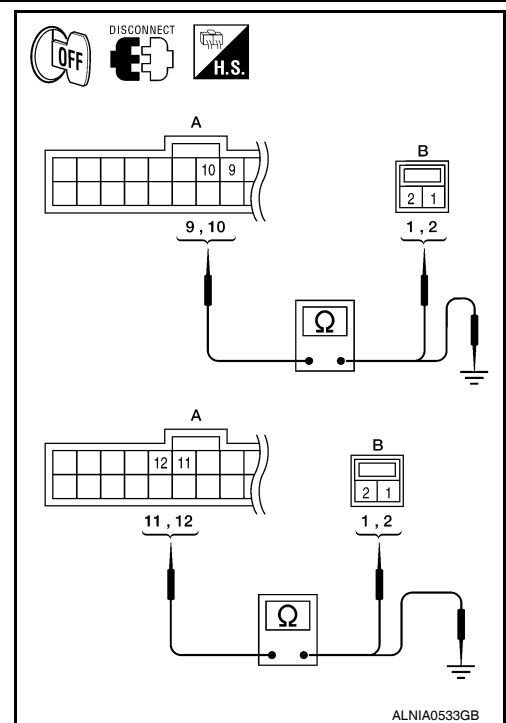

Are the continuity results as specified?

- YES >> GO TO 2  
 NO >> • Check connector housings for disconnected or loose terminals.  
 • Repair harness or connector.

### 2. REAR TWEETER SIGNAL CHECK

# REAR TWEETER

[BOSE AUDIO WITHOUT NAVIGATION]

## < COMPONENT DIAGNOSIS >

1. Connect BOSE speaker amp. connectors and suspect tweeter connector.
2. Turn ignition switch to ACC.
3. Push "POWER" switch.
4. Check the signal between BOSE speaker amp. harness connectors B75 terminals with CONSULT-III or oscilloscope.

Connector	Terminals		Condition	Reference signal
	(+)	(-)		
B75	9	10	Receive audio signal	
	11	12		

SKIA0177E

Are audio signal voltage readings as specified?

YES >> Replace suspect tweeter. Refer to [AV-294, "Removal and Installation"](#).

NO >> GO TO 3

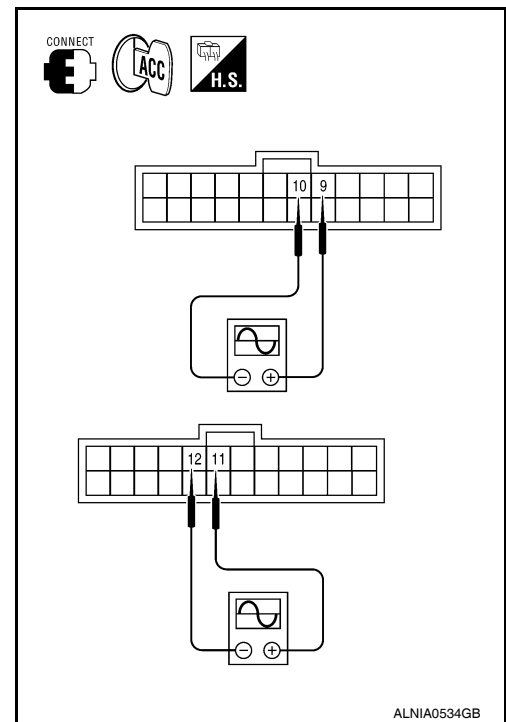

## 3. HARNESS CHECK

1. Disconnect AV control unit connector M69 and BOSE speaker amp. connector B75.
2. Check continuity between AV control unit harness connector M69 (A) and BOSE speaker amp. harness connector B75 (B).

A		B		Continuity
Connector	Terminal	Connector	Terminal	
M69	112	B75	26	Yes
	118		25	
	108		24	
	114		23	

3. Check continuity between AV control unit harness connector M69 (A) and ground.

A		—	Continuity
Connector	Terminal		
M69	112	Ground	No
	118		
	108		
	114		

Are the continuity results as specified?

YES >> GO TO 4

NO >> • Check connector housings for disconnected or loose terminals.  
• Repair harness or connector.

## 4. REAR TWEETER SIGNAL CHECK

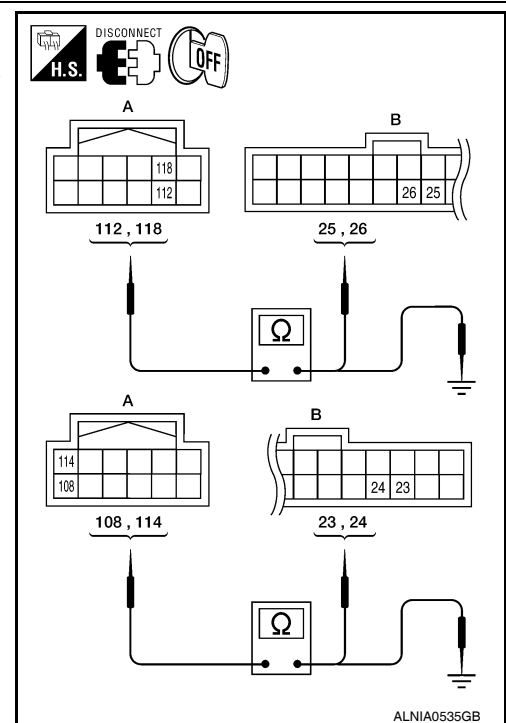

A  
B  
C  
D  
E  
F  
G  
H  
I  
J  
K  
L  
M  
N  
O  
P

AV

# REAR TWEETER

[BOSE AUDIO WITHOUT NAVIGATION]

## < COMPONENT DIAGNOSIS >

1. Connect AV control unit connector M69 and BOSE speaker amp. connector B75.
2. Turn ignition switch to ACC.
3. Push "POWER" switch.
4. Check the signal between AV control unit harness connector M69 terminals with CONSULT-III or oscilloscope.

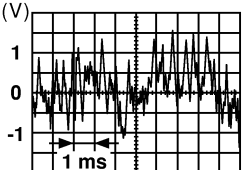
Connector	Terminals		Condition	Reference signal
	(+)	(-)		
M69	112	118	Receive audio signal	 <p style="text-align: center;">SKIA0177E</p>
	108	114		

Is the audio signal voltage reading as specified?

- YES >> Replace BOSE speaker amp. Refer to [AV-299, "Removal and Installation"](#).
- NO >> Replace AV control unit. Refer to [AV-289, "Removal and Installation"](#).

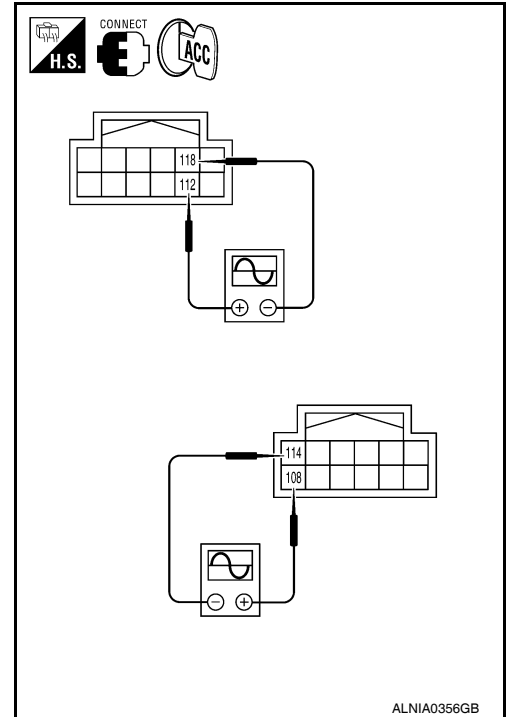



# SUBWOOFER

< COMPONENT DIAGNOSIS >

[BOSE AUDIO WITHOUT NAVIGATION]

## SUBWOOFER

### Description

INFOID:000000005259449

The AV control unit sends audio signals to the BOSE speaker amp. The BOSE speaker amp. amplifies the audio signals before sending them to the subwoofer using the audio signal circuits.

### Diagnosis Procedure

INFOID:000000005259450

Regarding Wiring Diagram information, refer to [AV-245, "Wiring Diagram"](#).

### 1. VERIFY SUBWOOFER POWER AND GROUND SUPPLY

Check power and ground supply to the subwoofer. Refer to [AV-197, "SUBWOOFER : Diagnosis Procedure"](#)

Did the power and ground supply check OK?

YES >> GO TO 2

- NO >> • Check connector housings for disconnected or loose terminals.  
 • Repair harness or connector.

### 2. HARNESS CHECK

1. Disconnect BOSE speaker amp. connectors and subwoofer connector.
2. Check continuity between BOSE speaker amp. harness connectors B74 (A) and B75 (B) and subwoofer harness connector B72 (C).

Connector	Terminal	Connector	Terminal	Continuity
A: B74	3	C: B72	1	Yes
	19		2	
B: B75	22		4	

3. Check continuity between BOSE speaker amp. harness connector B74 (A) and B75 (B) and ground.

Connector	Terminal	-	Continuity
A: B74	3	Ground	No
	19		
B: B75	22		

Are the continuity results as specified?

YES >> GO TO 3

- NO >> • Check connector housings for disconnected or loose terminals.  
 • Repair harness or connector.

### 3. SUBWOOFER AMP ON SIGNAL CHECK

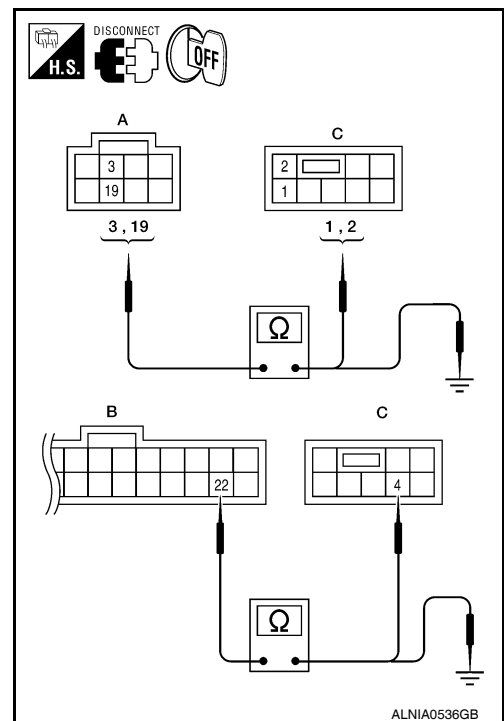

# SUBWOOFER

[BOSE AUDIO WITHOUT NAVIGATION]

## < COMPONENT DIAGNOSIS >

1. Connect BOSE speaker amp. connector B74.
2. Turn ignition switch to ACC.
3. Push "POWER" switch.
4. Check voltage between subwoofer connector B72 terminal 4 and ground.

(+)		(-)	Voltage
Connector	Terminal		
B72	4	Ground	Battery voltage

Are the voltage readings as specified?

YES >> GO TO 4

NO >> Replace BOSE speaker amp. Refer to [AV-299, "Removal and Installation"](#).

## 4.SUBWOOFER AUDIO SIGNAL CHECK

1. Connect BOSE speaker amp. connectors and subwoofer connector.
2. Turn ignition switch to ACC.
3. Push "POWER" switch.
4. Check the signal between BOSE speaker amp. harness connector B74 terminals with CONSULT-III or oscilloscope.

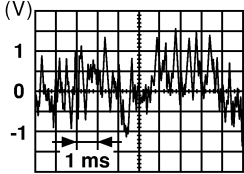
Connector	Terminals		Condition	Reference signal
	(+)	(-)		
B74	19	3	Receive audio signal	 <p style="text-align: right; font-size: small;">SKIA0177E</p>

Is the audio signal voltage as specified?

YES >> Replace subwoofer. Refer to [AV-300, "Removal and Installation"](#).

NO >> GO TO 5

## 5.HARNESS CHECK

1. Turn ignition switch OFF.

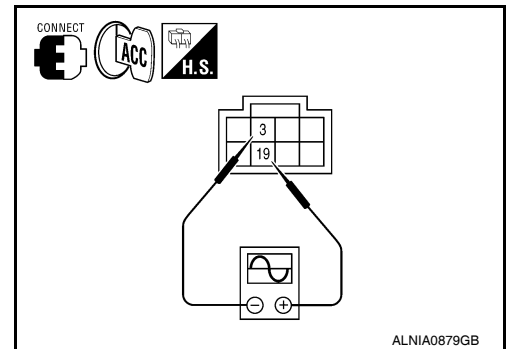
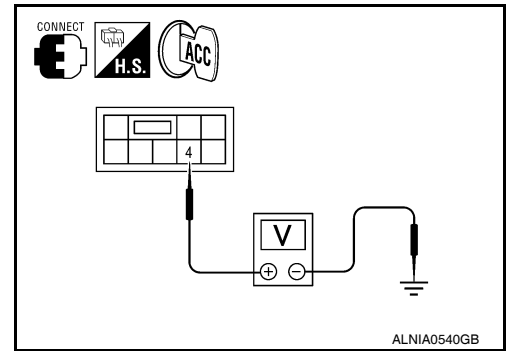

# SUBWOOFER

[BOSE AUDIO WITHOUT NAVIGATION]

## < COMPONENT DIAGNOSIS >

- Disconnect AV control unit connector M69 and BOSE speaker amp. connector B75.
- Check continuity between AV control unit harness connector M69 (A) and BOSE speaker amp. harness connector B75 (B).

A		B		Continuity
Connector	Terminal	Connector	Terminal	
M69	112	B75	26	Yes
	118		25	
	108		24	
	114		23	

- Check continuity between AV control unit harness connector M69 (A) and ground.

A		—	Continuity
Connector	Terminal		
M69	112	Ground	No
	118		
	108		
	114		

Are the continuity results as specified?

YES >> GO TO 6

NO >> • Check connector housings for disconnected or loose terminals.

- Repair harness or connector.

## 6. BACK DOOR SPEAKER SIGNAL CHECK

- Connect AV control unit connector M69 and BOSE speaker amp. connector B75.
- Turn ignition switch to ACC.
- Push "POWER" switch.
- Check the signal between AV control unit harness connector M69 terminals with CONSULT-III or oscilloscope.

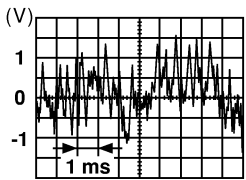
Connector	Terminals		Condition	Reference signal
	(+)	(-)		
M69	112	118	Receive audio signal	
	108	114		

Is the audio signal voltage reading as specified?

YES >> Replace BOSE speaker amp. Refer to [AV-299, "Removal and Installation"](#).

NO >> Replace AV control unit. Refer to [AV-289, "Removal and Installation"](#).

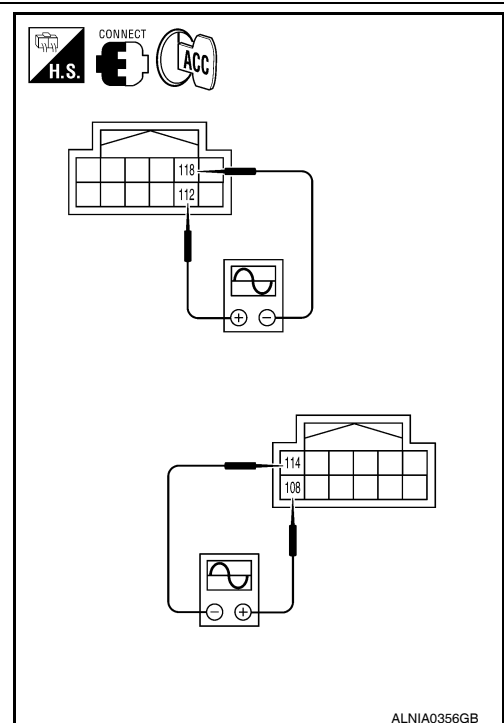
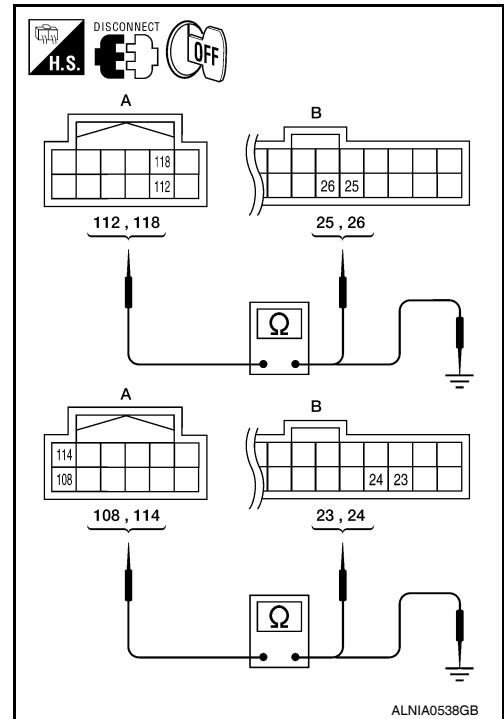

# AMP ON SIGNAL CIRCUIT

< COMPONENT DIAGNOSIS >

[BOSE AUDIO WITHOUT NAVIGATION]

## AMP ON SIGNAL CIRCUIT

### Description

INFOID:000000005259451

When the audio system is turned on, a voltage signal is supplied from the AV control unit to the BOSE speaker amp. When this signal is received, the BOSE speaker amp. will turn on.

### Diagnosis Procedure

INFOID:000000005259452

Regarding Wiring Diagram information, refer to [AV-245, "Wiring Diagram"](#).

### 1. CHECK AMP ON SIGNAL (BOSE SPEAKER AMP)

1. Turn audio system ON.
2. Check voltage between BOSE speaker amp. harness connector B75 terminal 31 and ground.

(+)		(-)	Value (Approx.)
Connector	Terminal		
B75	31	Ground	Battery Voltage

Is battery voltage present?

- YES >> Inspection End.  
NO >> GO TO 2

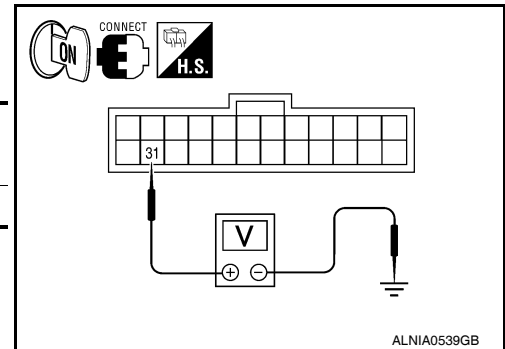

### 2. CHECK AMP ON SIGNAL (AV CONTROL UNIT)

Check voltage between AV control unit harness connector M69 terminal 110 and ground.

(+)		(-)	Value (Approx.)
Connector	Terminal		
M69	110	Ground	Battery Voltage

Is battery voltage present?

- YES >> Repair harness or connector.  
NO >> Replace AV control unit. Refer to [AV-289, "Removal and Installation"](#).

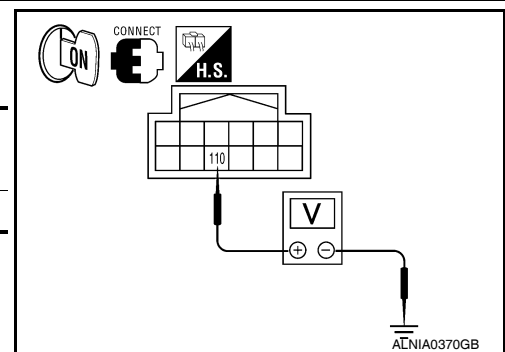

# STEERING SWITCH

< COMPONENT DIAGNOSIS >

[BOSE AUDIO WITHOUT NAVIGATION]

## STEERING SWITCH

### Description

INFOID:000000005259453

When one of the steering wheel AV control switches is pushed, the resistance in the steering wheel AV control switch circuit changes depending on which button is pushed.

### Diagnosis Procedure

INFOID:000000005259454

Regarding Wiring Diagram information, refer to [AV-245, "Wiring Diagram"](#).

### 1. CHECK STEERING WHEEL AUDIO CONTROL SWITCH RESISTANCE

1. Turn ignition switch OFF.
2. Disconnect steering wheel audio control switch connector M102.
3. Check resistance between steering switch connector terminals.

Terminal	Signal name	Condition	Resistance (Ω) (Approx.)	
16	17	Seek (down)	Depress ▽ switch.	165
		Volume (down)	Depress VOL down switch.	487
		Mode	Depress MODE switch.	0
20	17	Seek (up)	Depress △ switch.	165
		Volume (up)	Depress VOL up switch.	487
		Power	Depress PWR switch.	0

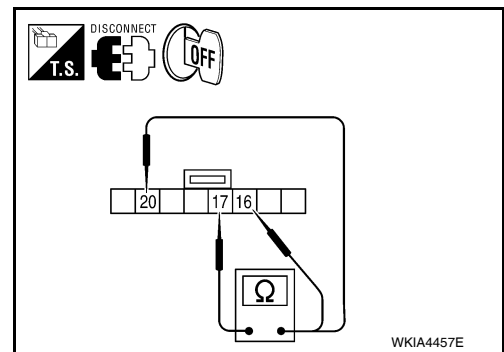

Do the steering wheel audio control switches check OK?

YES >> GO TO 2

NO >> Replace steering wheel audio control switch. Refer to [AV-295, "Removal and Installation"](#).

### 2. CHECK HARNESS

1. Disconnect AV control unit connector M42 and spiral cable connector M30.
2. Check continuity between AV control unit harness connector M42 (A) and spiral cable harness connector M30 (B).

A		B		Continuity
Connector	Terminal	Connector	Terminal	
M42	6	M30	24	Yes
	15		31	
	16		32	

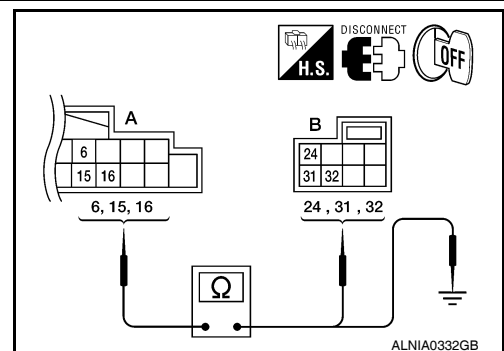

3. Check continuity between AV control unit connector M42 (A) and ground.

A		—	Continuity
Connector	Terminal		
M42	6	Ground	No
	15		
	16		

Are the continuity results as specified?

YES >> GO TO 3

A  
B  
C  
D  
E  
F  
G  
H  
I  
J  
K  
L  
M  
N  
O  
P

AV

# STEERING SWITCH

[BOSE AUDIO WITHOUT NAVIGATION]

< COMPONENT DIAGNOSIS >

NO >> Repair harness.

## 3. SPIRAL CABLE CHECK

1. Disconnect spiral cable connector M102.
2. Check continuity between spiral cable harness connector M30 (A) and M102 (B).

A		B		Continuity
Connector	Terminal	Connector	Terminal	
M30	24	M102	20	Yes
	31		17	
	32		16	

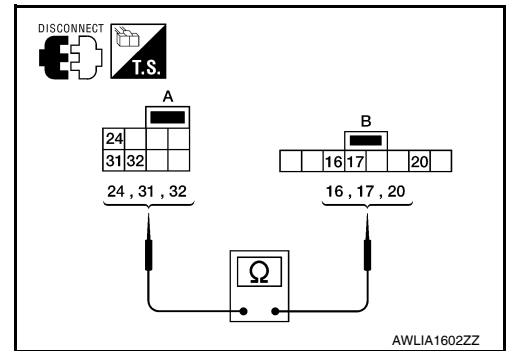

Is continuity present?

YES >> Inspection End.

NO >> Replace spiral cable. Refer to [SR-7, "Removal and Installation"](#).

# COMMUNICATION SIGNAL CIRCUIT

[BOSE AUDIO WITHOUT NAVIGATION]

< COMPONENT DIAGNOSIS >

## COMMUNICATION SIGNAL CIRCUIT SATELLITE RADIO TUNER

### SATELLITE RADIO TUNER : Description

INFOID:000000005259455

Communication signals are exchanged between the AV control unit and satellite radio tuner using the communication circuits.

### SATELLITE RADIO TUNER : Diagnosis Procedure

INFOID:000000005259456

Regarding Wiring Diagram information, refer to [AV-245, "Wiring Diagram"](#).

#### 1.CHECK HARNESS - 1

1. Turn ignition switch OFF.
2. Disconnect satellite radio tuner (factory installed) connector M41 and AV control unit connector M136.
3. Check continuity between satellite radio tuner (factory installed) harness connector M41 (A) terminal 28 and AV control unit harness connector M136 (B) terminal 28.

A		B		Continuity
Connector	Terminal	Connector	Terminal	
M41	28	M136	28	Yes

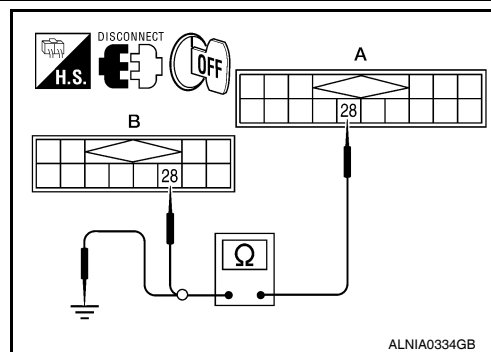

4. Check continuity between satellite radio tuner (factory installed) harness connector M41 (A) terminal 28 and ground.

A		—	Continuity
Connector	Terminal		
M41	28	Ground	No

Are continuity results as specified?

YES >> GO TO 2

NO >> Repair harness or connector.

#### 2.CHECK HARNESS - 2

1. Check continuity between satellite radio tuner (factory installed) harness connector M41 (A) terminal 29 and AV control unit harness connector M136 (B) terminal 29.

A		B		Continuity
Connector	Terminal	Connector	Terminal	
M41	29	M136	29	Yes

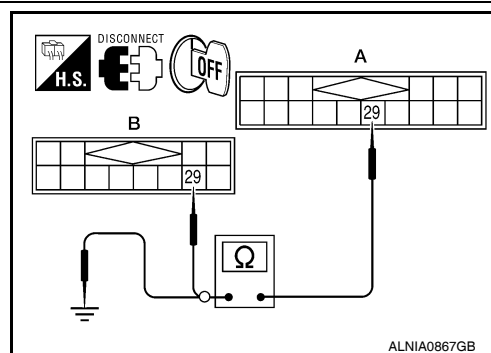

2. Check continuity between satellite radio tuner (factory installed) harness connector M41 (A) terminal 29 and ground.

A		—	Continuity
Connector	Terminal		
M41	29	Ground	No

Are continuity results as specified?

YES >> GO TO 3

NO >> Repair harness or connector.

A  
B  
C  
D  
E  
F  
G  
H  
I  
J  
K  
L  
M  
O  
P

AV

# COMMUNICATION SIGNAL CIRCUIT

[BOSE AUDIO WITHOUT NAVIGATION]

< COMPONENT DIAGNOSIS >

## 3. CHECK HARNESS - 3

1. Check continuity between satellite radio tuner (factory installed) harness connector M41 (A) terminal 30 and AV control unit harness connector M136 (B) terminal 30.

A		B		Continuity
Connector	Terminal	Connector	Terminal	
M41	30	M136	30	Yes

2. Check continuity between satellite radio tuner (factory installed) harness connector M41 (A) terminal 30 and ground.

A		—	Continuity
Connector	Terminal		
M41	30	Ground	No

Are continuity results as specified?

- YES >> GO TO 4  
 NO >> Repair harness or connector.

## 4. CHECK REQ1 SIGNAL

1. Connect satellite radio tuner (factory installed) connector and AV control unit connector.
2. Turn ignition switch to ACC
3. Check signal between satellite radio tuner (factory installed) harness connector M41 terminal 28 and ground with CONSULT-III or oscilloscope.

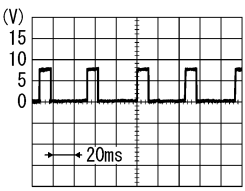
(+)		(-)	Reference signal
Connector	Terminal		
M41	28	Ground	 <p>SKIB3825E</p>

Are voltage readings as specified?

- YES >> GO TO 5  
 NO >> Replace AV control unit. Refer to [AV-141, "Removal and Installation"](#).

## 5. CHECK TXD SIGNAL

Check signal between satellite radio tuner (factory installed) harness connector M41 terminal 29 and ground with CONSULT-III or oscilloscope.

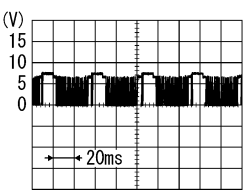
(+)		(-)	Reference signal
Connector	Terminal		
M41	29	Ground	 <p>SKIB3824E</p>

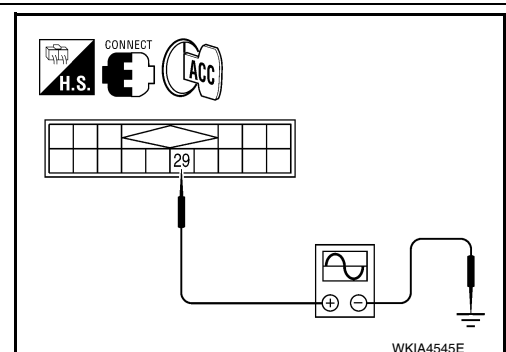
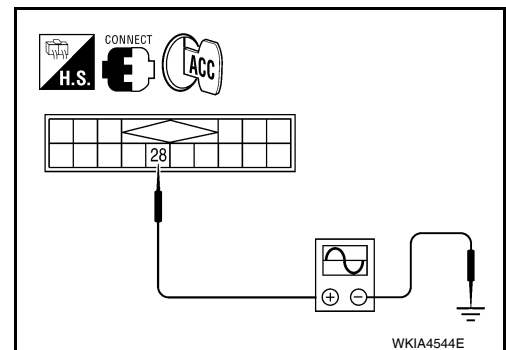
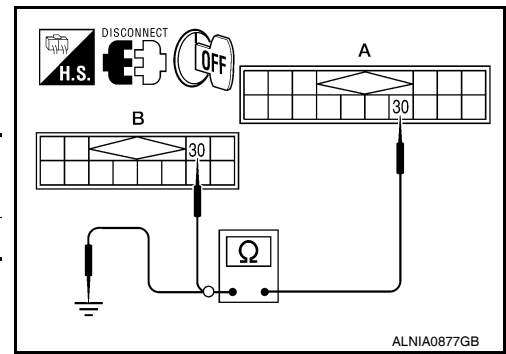



# COMMUNICATION SIGNAL CIRCUIT

[BOSE AUDIO WITHOUT NAVIGATION]

< COMPONENT DIAGNOSIS >

Are the voltage readings as specified?

YES >> GO TO 6

NO >> Replace satellite radio tuner. Refer to [AV-154. "Removal and Installation"](#).

## 6. CHECK RXD SIGNAL

Check signal between satellite radio tuner (factory installed) harness connector M41 terminal 30 and ground with CONSULT-III or oscilloscope.

(+)		(-)	Reference signal
Connector	Terminal		
M41	30	Ground	

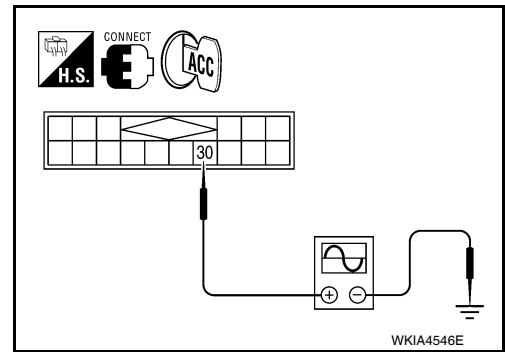

Are the voltage readings as specified?

YES >> Replace satellite radio tuner. Refer to [AV-154. "Removal and Installation"](#).

NO >> Replace AV control unit. Refer to [AV-141. "Removal and Installation"](#).

A  
B  
C  
D  
E  
F  
G  
H  
I  
J  
K  
L  
M  
O  
P

AV

# SOUND SIGNAL CIRCUIT

[BOSE AUDIO WITHOUT NAVIGATION]

< COMPONENT DIAGNOSIS >

## SOUND SIGNAL CIRCUIT SATELLITE RADIO TUNER

### SATELLITE RADIO TUNER : Description

INFOID:000000005259457

Left and right channel audio signals are supplied from the satellite radio tuner to the AV control unit through the sound signal circuits.

### SATELLITE RADIO TUNER : Diagnosis Procedure

INFOID:000000005259458

Regarding Wiring Diagram information, refer to [AV-245, "Wiring Diagram"](#).

#### LEFT CHANNEL

##### 1. CHECK HARNESS

1. Turn ignition switch OFF.
2. Disconnect satellite radio tuner (factory installed) connector M41 and AV control unit connector M136.
3. Check continuity between satellite radio tuner (factory installed) connector M41 (A) and AV control unit connector M136 (B).

A		B		Continuity
Connector	Terminal	Connector	Terminal	
M41	21	M43	21	Yes
	22		22	

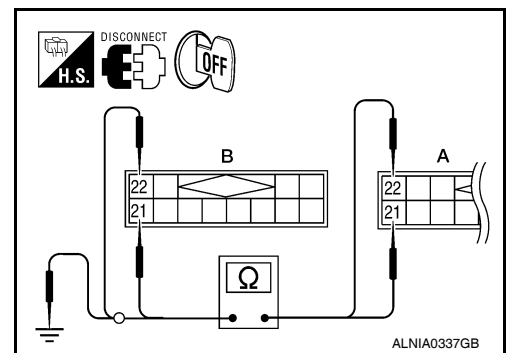

4. Check continuity between satellite radio tuner (factory installed) connector M41 (A) and ground.

A		—	Continuity
Connector	Terminal		
M41	21	Ground	No
	22		

Are continuity results as specified?

YES >> GO TO 2

NO >> Repair harness or connector.

##### 2. CHECK LEFT CHANNEL AUDIO SIGNAL

1. Connect satellite radio tuner (factory installed) and AV control unit.
2. Turn ignition switch ON.
3. Check signal between satellite radio tuner (factory installed) connector M41 terminals 21 and 22 with CONSULT-III or oscilloscope.

(+) Connector		Terminal	(-)	Reference signal
Connector	Terminal			
M41	22	21		

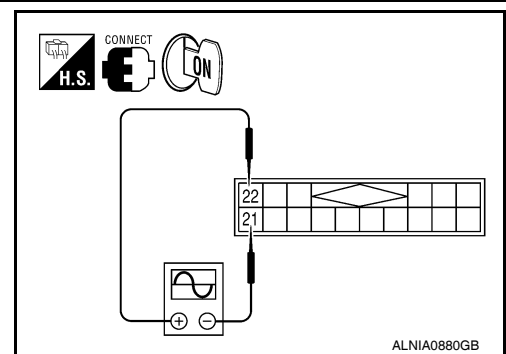

# SOUND SIGNAL CIRCUIT

[BOSE AUDIO WITHOUT NAVIGATION]

## < COMPONENT DIAGNOSIS >

### Are voltage readings as specified?

- YES >> Replace AV control unit. Refer to [AV-141, "Removal and Installation"](#).  
 NO >> Replace satellite radio tuner. Refer to [AV-154, "Removal and Installation"](#).

### RIGHT CHANNEL

#### 1. CHECK HARNESS

- Turn ignition switch OFF.
- Disconnect satellite radio tuner (factory installed) connector M41 and AV control unit connector M136.
- Check continuity between satellite radio tuner (factory installed) M41 (A) and AV control unit M136 (B).

A		B		Continuity
Connector	Terminal	Connector	Terminal	
M41	23	M136	23	Yes
	24		24	

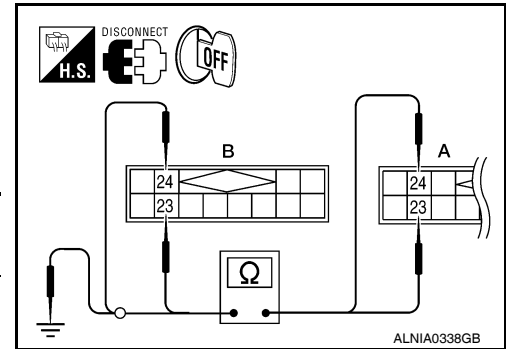

- Check continuity between satellite radio tuner (factory installed) connector M41 (A) and ground.

A		—	Continuity
Connector	Terminal		
M41	23	Ground	No
	24		

### Are continuity results as specified?

- YES >> GO TO 2  
 NO >> Repair harness or connector.

#### 2. CHECK RIGHT CHANNEL AUDIO SIGNAL

- Connect satellite radio tuner (factory installed) and AV control unit.
- Turn ignition switch ON.
- Check signal between satellite radio tuner (factory installed) connector M41 terminals 23 and 24 with CONSULT-III or oscilloscope.

(+) Connector		Terminal	(-)	Reference signal
Connector	Terminal			
M41	24	23	<p>The oscilloscope shows a complex waveform between terminals 23 and 24 of connector M41. The vertical axis is labeled (V) and ranges from -1 to 1. The horizontal axis is labeled 2ms. The waveform oscillates between approximately 0.5V and -0.5V. The reference code SKIB3609E is at the bottom right.</p>	

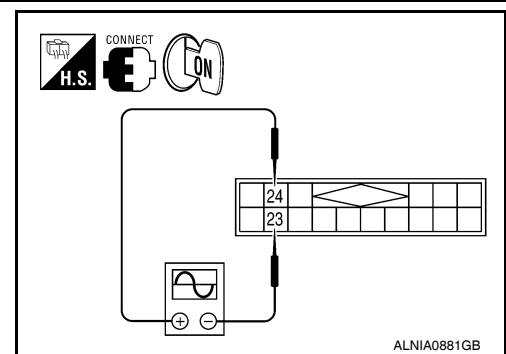

### Are voltage readings as specified?

- YES >> Replace AV control unit. Refer to [AV-141, "Removal and Installation"](#).  
 NO >> Replace satellite radio tuner. Refer to [AV-154, "Removal and Installation"](#).

A  
B  
C  
D  
E  
F  
G  
H  
I  
J  
K  
L  
M  
O  
P

AV

# MICROPHONE SIGNAL CIRCUIT

< COMPONENT DIAGNOSIS >

[BOSE AUDIO WITHOUT NAVIGATION]

## MICROPHONE SIGNAL CIRCUIT

### Description

INFOID:000000005259459

Voice signals are transmitted from the microphone to the Bluetooth control unit using the microphone signal circuits.

### Diagnosis Procedure

INFOID:000000005259460

Regarding Wiring Diagram information, refer to [AV-245, "Wiring Diagram"](#).

### 1. CHECK HARNESS BETWEEN BLUETOOTH CONTROL UNIT AND MICROPHONE

1. Turn ignition switch OFF.
2. Disconnect Bluetooth control unit connector and microphone connector.
3. Check continuity between Bluetooth control unit harness connector B124 (A) and microphone harness connector R8 (B).

A		B		Continuity
Connector	Terminal	Connector	Terminal	
B124	7	R8	1	Yes
	8		2	
	29		4	

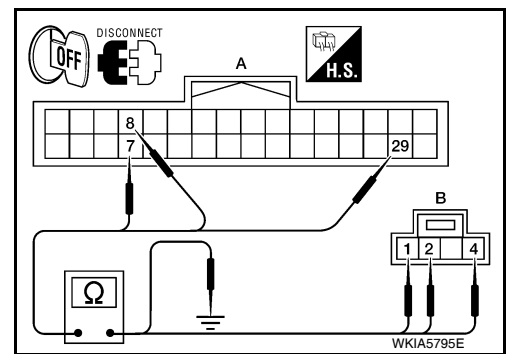

4. Check continuity between Bluetooth control unit harness connector B124 (A) and ground.

A		—	Continuity
Connector	Terminal		
B124	7	Ground	No
	8		
	29		

Are the continuity test results as specified?

- YES >> GO TO 2  
 NO >> Repair harness or connector.

### 2. CHECK MICROPHONE POWER SUPPLY

1. Connect Bluetooth control unit connector and microphone connector.
2. Turn ignition switch ON.
3. Check voltage between microphone harness connector R8 terminal 4 and ground.

**4 - Ground : Approx. 5V**

Is voltage reading approx. 5 volts?

- YES >> GO TO 3  
 NO >> Replace Bluetooth control unit. Refer to [AV-298, "Removal and Installation"](#).

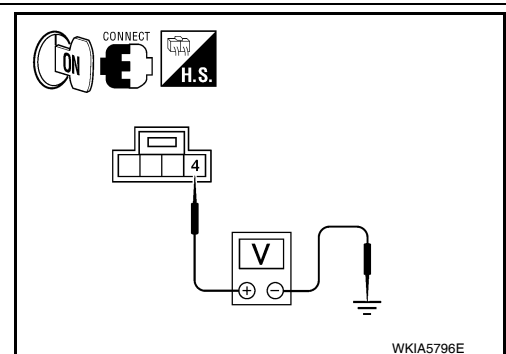

### 3. CHECK MICROPHONE SIGNAL

# MICROPHONE SIGNAL CIRCUIT

[BOSE AUDIO WITHOUT NAVIGATION]

< COMPONENT DIAGNOSIS >

Check signal between Bluetooth control unit harness connector B124 terminals 7 and 8.

7 - 8:

When giving a voice

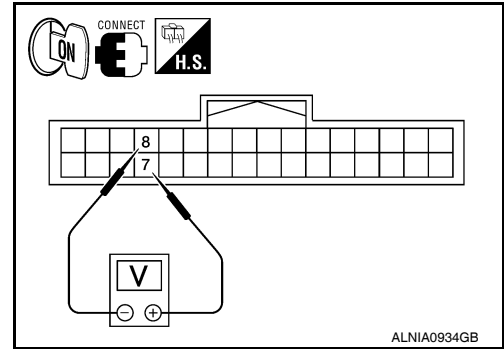
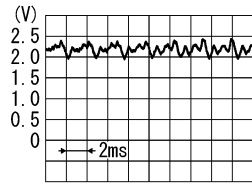

Are voltage readings as specified?

- YES >> Replace Bluetooth control unit. Refer to [AV-298. "Removal and Installation"](#).
- NO >> Replace microphone. Refer to [AV-296. "Removal and Installation"](#).

A  
B  
C  
D  
E  
F  
G  
H  
I  
J  
K  
L  
M  
O  
P

AV

# AV CONTROL UNIT

[BOSE AUDIO WITHOUT NAVIGATION]

< ECU DIAGNOSIS >

## ECU DIAGNOSIS

### AV CONTROL UNIT

#### Reference Value

INFOID:000000005259461

#### VALUES ON THE DIAGNOSIS TOOL

CONSULT-III data monitor item

Display Item	Dis-play	Vehicle status	Remarks
VHCL SPD SIG	ON	Vehicle speed >0 km/h (0 MPH)	Changes in indication may be delayed. This is normal.
	OFF	Vehicle speed =0 km/h (0 MPH)	
PKB SIG	ON	Parking brake is applied.	Changes in indication may be delayed. This is normal.
	OFF	Parking brake is released.	
ILLUM SIG	ON	Block the light beam from the auto light optical sensor when the light SW is ON .	—
	OFF	Expose the auto light optical sensor to light when the light SW is OFF or ON.	
IGN SIG	ON	Ignition switch ON	—
	OFF	Ignition switch in ACC position	
REV SIG	ON	Selector lever in R position	Changes in indication may be delayed. This is normal.
	OFF	Selector lever in any position other than R	

#### TERMINAL LAYOUT

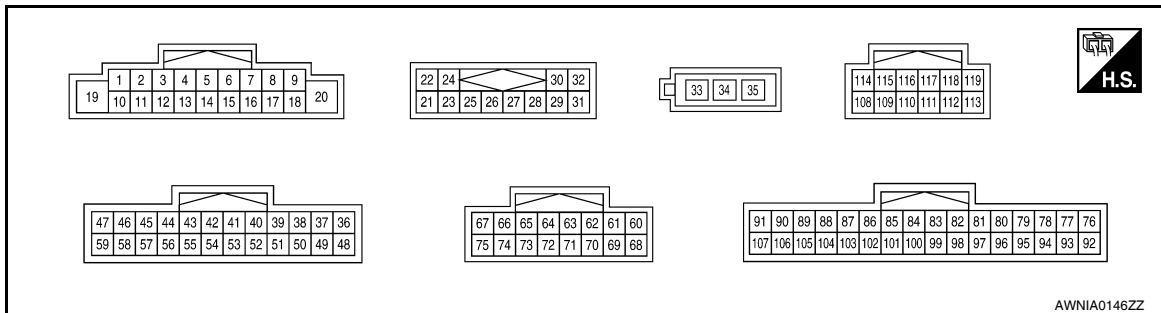

#### PHYSICAL VALUES

Terminal (Wire color)		Description		Condition		Reference value (Approx.)
+	-	Signal name	Input/ Output			
6 (Y)	15 (L)	Steering switch signal A	Input	Ignition switch ON	Pressing  switch	0V
					Pressing  switch	0.75V
					Pressing VOL up switch	2V
					Except for above	5V
7 (G/Y)	Ground	ACC power supply	Input	Ignition switch ACC	—	Battery voltage
9 (V)	Ground	Illumination signal	Input	OFF	Lighting switch is OFF.	0V
					Lighting switch is ON.	Battery voltage

# AV CONTROL UNIT

**[BOSE AUDIO WITHOUT NAVIGATION]**

< ECU DIAGNOSIS >

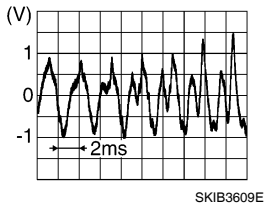
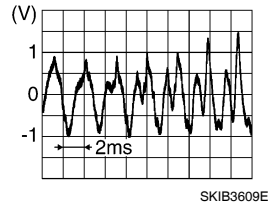
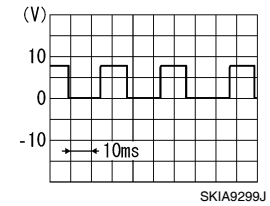
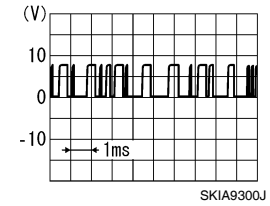
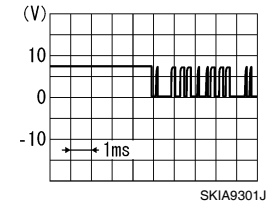
Terminal (Wire color)		Description		Condition	Reference value (Approx.)	
+	-	Signal name	Input/ Output			
15 (L)	Ground	Steering switch signal ground	—	Ignition switch ON	—  0V	
16 (G)	15 (L)	Steering switch signal B	Input	Ignition switch ON	Pressing  MODE switch	0V
					Pressing  VOL down switch	0.75V
					Pressing VOL down switch	2V
					Except for above	5V
19 (Y)	Ground	Battery power supply	Input	Ignition switch OFF	—  Battery voltage	
20 (B)	Ground	Ground	—	Ignition switch ON	—  0V	
22 (R)	21 (G)	Satellite radio sound signal LH	Input	Ignition switch ON	When satellite radio mode is selected	
24 (B)	23 (W)	Satellite radio sound signal RH	Input	Ignition switch ON	When satellite radio mode is selected	
28 (O)	Ground	Request signal (SAT→CONT)	Input	Ignition switch ON	When satellite radio mode is selected	
29 (P)	Ground	Communication signal (SAT→CONT)	Input	Ignition switch ON	When satellite radio mode is selected	
30 (L)	Ground	Communication signal (CONT→SAT)	Output	Ignition switch ON	When satellite radio mode is selected	

A  
B  
C  
D  
E  
F  
G  
H  
I  
J  
K  
L  
M  
AV  
O  
P

# AV CONTROL UNIT

**[BOSE AUDIO WITHOUT NAVIGATION]**

< ECU DIAGNOSIS >

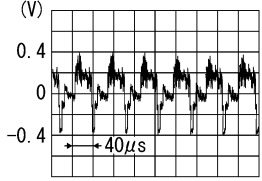
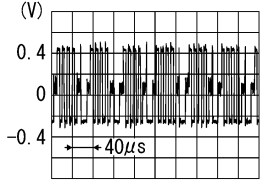
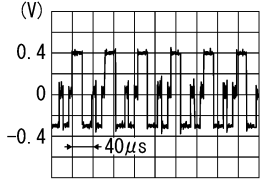
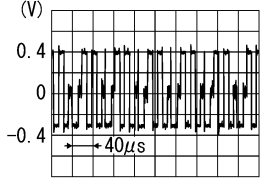
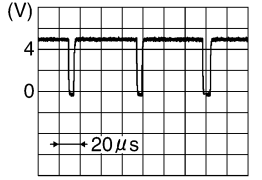
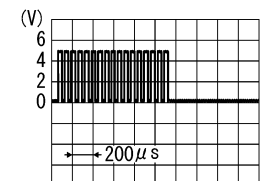
Terminal (Wire color)		Description		Condition		Reference value (Approx.)
+	-	Signal name	Input/ Output			
34	—	Antenna main	—	—	—	—
35	—	Antenna B+	—	—	—	—
36 (G)	Ground	AUX image signal	Output	Ignition switch ON	When AUX mode is selected	 <p style="text-align: right; font-size: small;">SKIB2251J</p>
37 (R)	Ground	AUX image ground	—	Ignition switch ON	—	0V
38 (R)	Ground	RGB signal (B: blue)	Output	Ignition switch ON	Start confirmation/adjustment mode, and then display color bar by selecting "Color Spectrum Bar" on DISPLAY DIAGNOSIS screen.	 <p style="text-align: right; font-size: small;">SKIB2237J</p>
39 (B)	Ground	RGB signal (G: green)	Output	Ignition switch ON	Start confirmation/adjustment mode, and then display color bar by selecting "Color Spectrum Bar" on DISPLAY DIAGNOSIS screen.	 <p style="text-align: right; font-size: small;">SKIB2236J</p>
40 (W)	Ground	RGB signal (R: red)	Output	Ignition switch ON	Start confirmation/adjustment mode, and then display color bar by selecting "Color Spectrum Bar" on DISPLAY DIAGNOSIS screen.	 <p style="text-align: right; font-size: small;">SKIB2238J</p>
41 (R)	Ground	RGB synchronizing signal	Output	Ignition switch ON	—	 <p style="text-align: right; font-size: small;">SKIB3603E</p>
43 (G)	Ground	RGB area (YS) signal	Output	Ignition switch ON	RGB image	5V
					AUX image	 <p style="text-align: right; font-size: small;">PKIB4948J</p>



# AV CONTROL UNIT

< ECU DIAGNOSIS >

[BOSE AUDIO WITHOUT NAVIGATION]

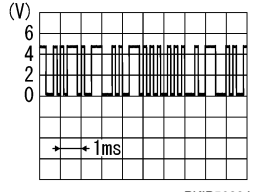
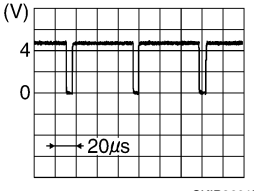
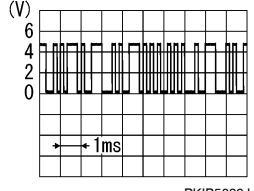
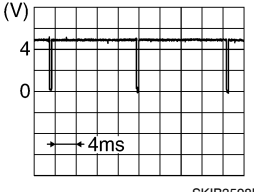
Terminal (Wire color)		Description		Condition		Reference value (Approx.)
+	-	Signal name	Input/ Output			
44 (LG)	Ground	Communication signal (DISP→CONT)	Input	Ignition switch ON	When adjusting display- brightness	 <p style="text-align: right; font-size: small;">PKIB5039J</p>
45 (B)	Ground	Horizontal synchronizing (HP) signal	Input	Ignition switch ON	—	 <p style="text-align: right; font-size: small;">SKIB3601E</p>
46 (BR)	Ground	Signal ground	—	Ignition switch	—	0V
47 (R)	Ground	Signal VCC	Output	Ignition switch ACC	—	9V
54 (B)	Ground	Ground	—	Ignition switch ON	—	0V
56 (V)	Ground	Communication signal (CONT→DISP)	Output	Ignition switch ON	When adjusting display- brightness	 <p style="text-align: right; font-size: small;">PKIB5039J</p>
57 (W)	Ground	Vertical synchronizing (VP) signal	Input	Ignition switch On	—	 <p style="text-align: right; font-size: small;">SKIB3598E</p>
58 (SB)	Ground	Inverter ground	—	Ignition switch ON	—	0V
59 (O)	Ground	Inverter VCC	Output	Ignition switch ACC	—	9V
64 (W)	Ground	Rear view camera video signal ground	—	Ignition switch ON	—	0V

A  
B  
C  
D  
E  
F  
G  
H  
I  
J  
K  
L  
M  
AV  
O  
P

AV

# AV CONTROL UNIT

**[BOSE AUDIO WITHOUT NAVIGATION]**

< ECU DIAGNOSIS >

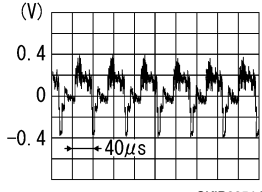
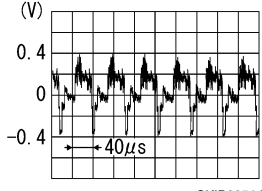
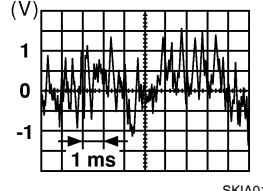
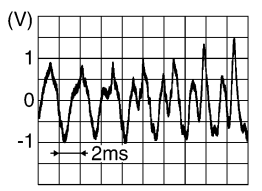
Terminal (Wire color)		Description		Condition		Reference value (Approx.)
+	-	Signal name	Input/ Output			
65 (B)	Ground	Rear view camera video in (+)	Input	Ignition switch ON	With rear view camera ON	 <p style="text-align: right; font-size: small;">SKIB2251J</p>
66 (G)	Ground	DVD player video signal (+)	Input	Ignition switch ON	With DVD player operating	 <p style="text-align: right; font-size: small;">SKIB2251J</p>
68 (BR)	—	AV control	Output	—	—	—
72	—	Shield	—	—	—	—
74 (R)	Ground	DVD player video ground	—	Ignition switch ON	—	0V
77 (B)	76 (R)	Headphone RH audio signal	Output	Ignition switch ON	With DVD player operating	 <p style="text-align: right; font-size: small;">SKIA0177E</p>
80 (GR)	79 (SB)	Microphone signal	Input	Ignition switch ON	—	—
83 (R)	82 (G)	DVD player audio signal RH	Input	Ignition switch ON	With DVD player operating	 <p style="text-align: right; font-size: small;">SKIB3609E</p>
85 (B)	Ground	Ground	—	Ignition switch ON	—	0V
86 (L)	—	CAN-H	Input/ Output	—	—	—
87 (P)	—	CAN-L	Input/ Output	—	—	—
88 (L)	—	AV communication signal 1 (H)	Input/ Output	—	—	—
89 (P)	—	AV communication signal 1 (L)	Input/ Output	—	—	—

# AV CONTROL UNIT

< ECU DIAGNOSIS >

[BOSE AUDIO WITHOUT NAVIGATION]

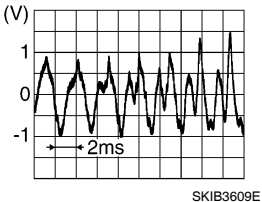
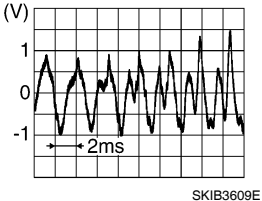
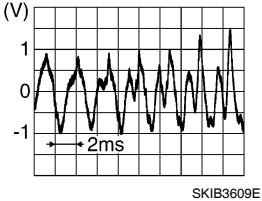
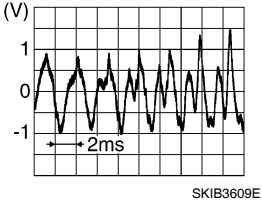
Terminal (Wire color)		Description		Condition		Reference value (Approx.)
+	-	Signal name	Input/ Output			
90 (L)	—	AV communication signal 2 (H)	Input/ Output	—	—	—
91 (P)	—	AV communication signal 2 (L)	Input/ Output	—	—	—
93 (G)	92 (W)	Headphone LH audio sig- nal	Output	Ignition switch ON	With DVD player operating	
94	—	Shield	—	—	—	—
95 (B)	97 (R)	AUX audio signal RH	Input	Ignition switch ON	When AUX mode is select- ed	
96 (W)	97 (R)	AUX audio signal LH	Input	Ignition switch ON	When AUX mode is select- ed	
98 (B)	99 (W)	DVD player audio signal LH	Input	Ignition switch ON	With DVD player operating	
101 (GR)	Ground	A/C and AV switch assem- bly ground	—	Ignition switch ON	—	0V
103 (SB)	Ground	CD eject signal	Input	—	Pressing the eject switch	0V
					Except for above	3.3V
104 (W/G)	Ground	Ignition signal	Input	Ignition switch ON	—	Battery voltage
105 (W)	Ground	Reverse signal	Input	Ignition switch ON	R position	Battery voltage
					Other than R position	0V
106 (G)	Ground	Parking brake signal	Input	Ignition switch ON	Parking brake ON	0V
					Parking brake OFF	Battery voltage

A  
B  
C  
D  
E  
F  
G  
H  
I  
J  
K  
L  
M

AV

# AV CONTROL UNIT

< ECU DIAGNOSIS >

[BOSE AUDIO WITHOUT NAVIGATION]

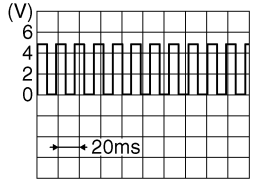
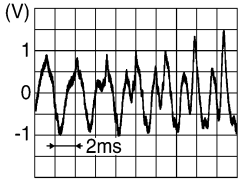
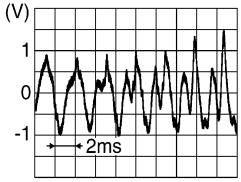
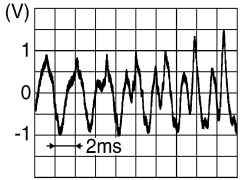
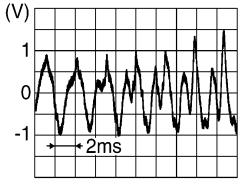
Terminal (Wire color)		Description		Condition		Reference value (Approx.)
+	-	Signal name	Input/ Output			
107 (LG)	Ground	Vehicle speed signal (8-pulse)	Input	Ignition switch ON	When vehicle speed is ap- prox. 40 km/h (25MPH)	 <p style="text-align: right; font-size: small;">SKIA6649J</p>
108 (G/R)	114 (B)	Rear RH pre-amp. audio signal	Output	Ignition switch ON	Audio output	 <p style="text-align: right; font-size: small;">SKIB3609E</p>
109 (G/Y)	115 (G/O)	Front RH pre-amp. audio signal	Output	Ignition switch ON	Audio output	 <p style="text-align: right; font-size: small;">SKIB3609E</p>
110 (SB)	Ground	Amp. ON signal	Output	Ignition switch ON	Audio output	Battery voltage
112 (BR/W)	118 (BR/Y)	Rear LH pre-amp. audio signal	Output	Ignition switch ON	Audio output	 <p style="text-align: right; font-size: small;">SKIB3609E</p>
113 (BR)	119 (B)	Front LH pre-amp. audio signal	Output	Ignition switch ON	Audio output	 <p style="text-align: right; font-size: small;">SKIB3609E</p>

# AV CONTROL UNIT

[BOSE AUDIO WITHOUT NAVIGATION]

< ECU DIAGNOSIS >

## Wiring Diagram

INFOID:000000005259462

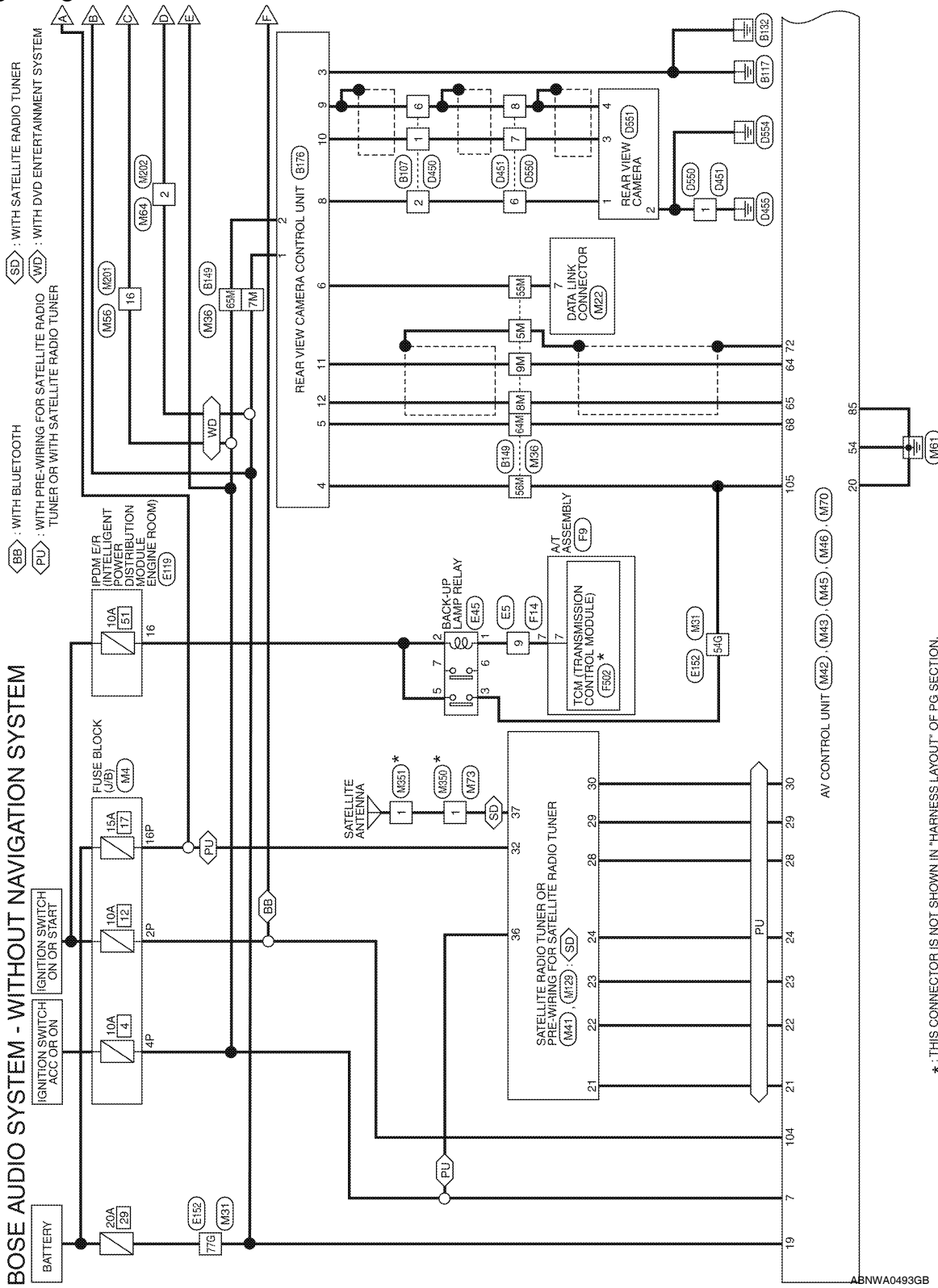

\*: THIS CONNECTOR IS NOT SHOWN IN "HARNES LAYOUT" OF PG SECTION.

A  
B  
C  
D  
E  
F  
G  
H  
I  
J  
K  
L  
M  
N  
O  
P

AV

# AV CONTROL UNIT

[BOSE AUDIO WITHOUT NAVIGATION]

< ECU DIAGNOSIS >

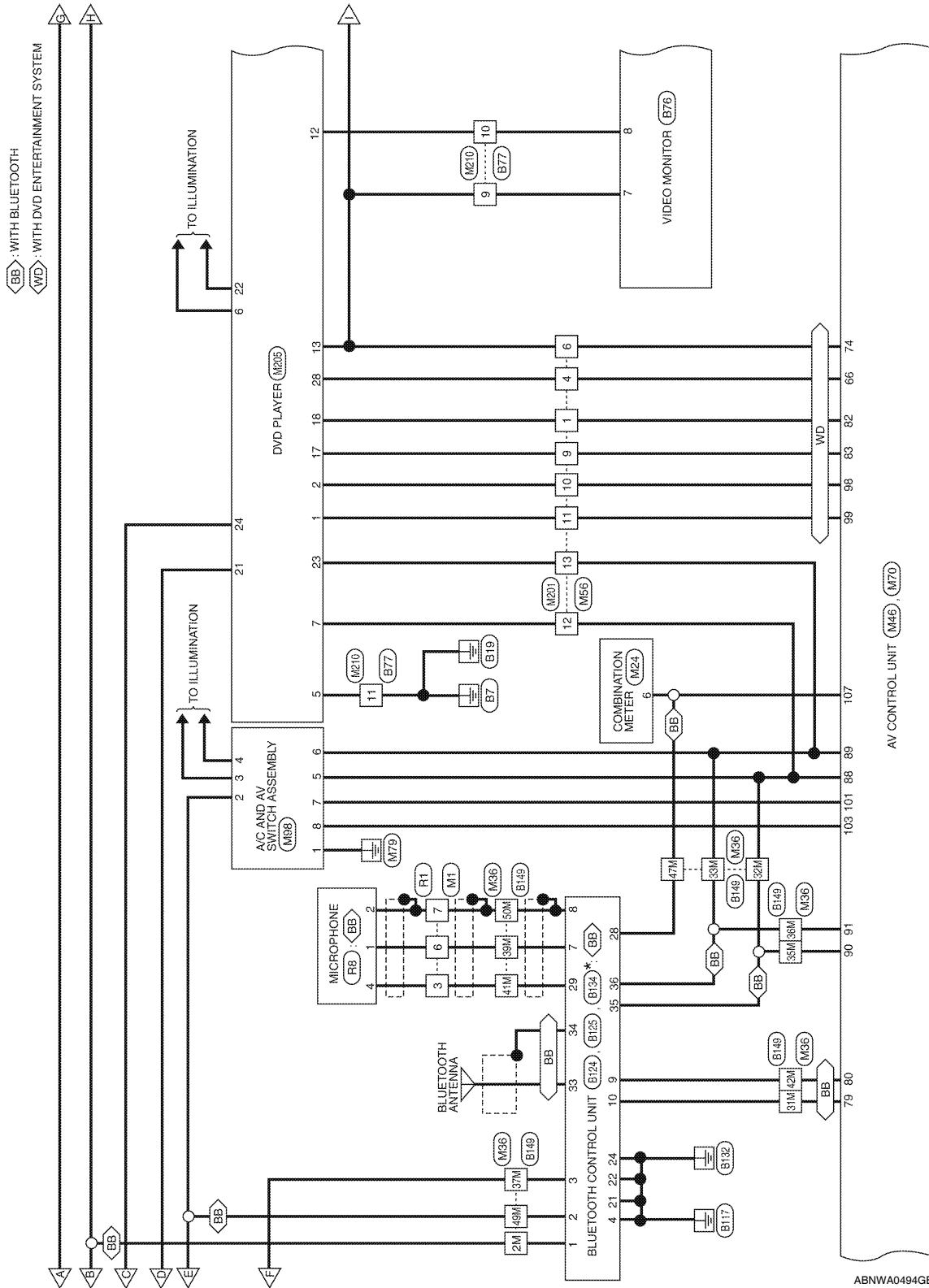

\* : THIS CONNECTOR IS NOT SHOWN IN "HARNESS LAYOUT" OF PG SECTION.

# AV CONTROL UNIT

[BOSE AUDIO WITHOUT NAVIGATION]

< ECU DIAGNOSIS >

WD: WITH DVD ENTERTAINMENT SYSTEM

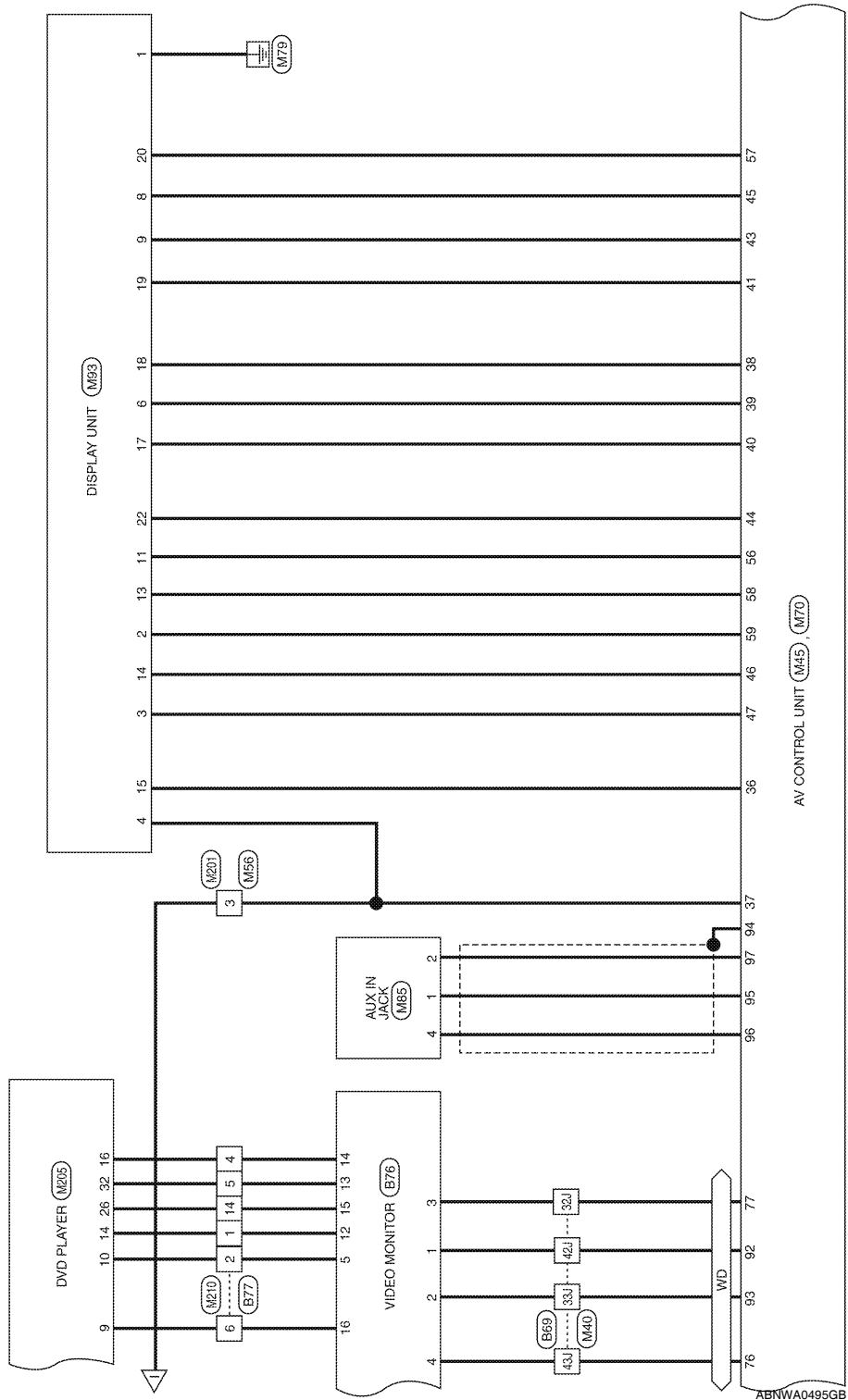

A  
B  
C  
D  
E  
F  
G  
H  
I  
J  
K  
L  
M  
AV  
O  
P

# AV CONTROL UNIT

[BOSE AUDIO WITHOUT NAVIGATION]

< ECU DIAGNOSIS >

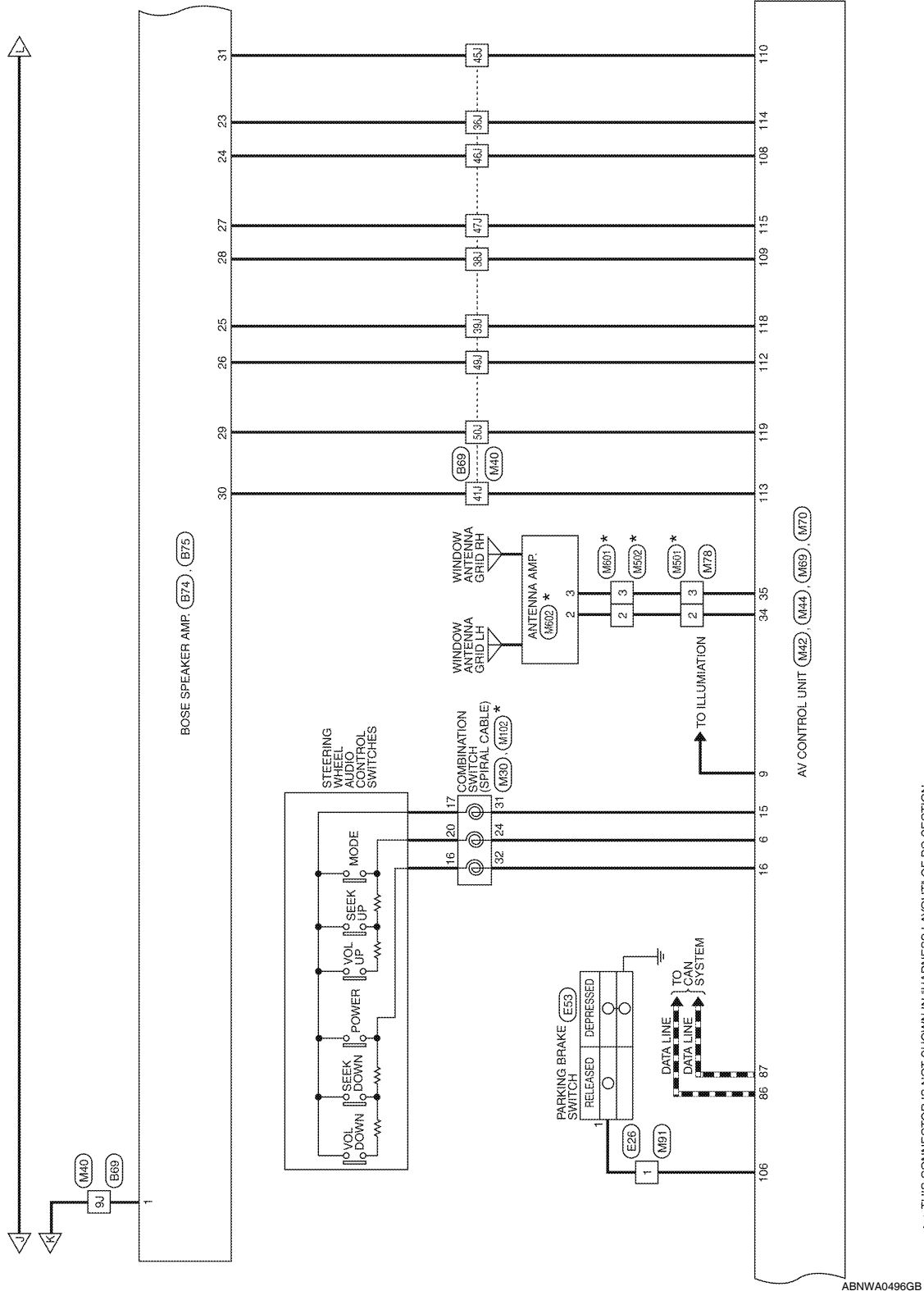

\* : THIS CONNECTOR IS NOT SHOWN IN "HARNES LAYOUT" OF PG SECTION





# AV CONTROL UNIT

[BOSE AUDIO WITHOUT NAVIGATION]

< ECU DIAGNOSIS >

## BOSE AUDIO SYSTEM CONNECTORS - WITHOUT NAVIGATION SYSTEM

Connector No.	M1
Connector Name	WIRE TO WIRE
Connector Color	WHITE

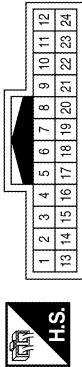

Terminal No.	Color of Wire	Signal Name
3	G	-
6	R	-
7	SHIELD	-

Connector No.	M4
Connector Name	FUSE BLOCK (J/B)
Connector Color	WHITE

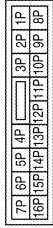

Terminal No.	Color of Wire	Signal Name
2P	W/G	-
4P	G/B	-
16P	R/B	-

Connector No.	M8
Connector Name	WIRE TO WIRE
Connector Color	BROWN

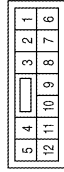

Terminal No.	Color of Wire	Signal Name
2	L	-
3	G	-

Connector No.	M22
Connector Name	DATA LINK CONNECTOR
Connector Color	WHITE

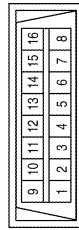

Terminal No.	Color of Wire	Signal Name
7	W	-

Connector No.	M24
Connector Name	COMBINATION METER
Connector Color	WHITE

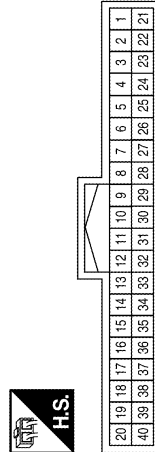

Terminal No.	Color of Wire	Signal Name
6	LG	SPEED OUT 8

Connector No.	M30
Connector Name	COMBINATION SWITCH
Connector Color	GRAY



Terminal No.	Color of Wire	Signal Name
24	Y	STRG SW A (UP)
31	L	GND
32	G	STRG SW B (DOWN)

# AV CONTROL UNIT

[BOSE AUDIO WITHOUT NAVIGATION]

< ECU DIAGNOSIS >

Terminal No.	Color of Wire	Signal Name
54G	SB	-
77G	Y	-

Connector No.	M31
Connector Name	WIRE TO WIRE
Connector Color	WHITE

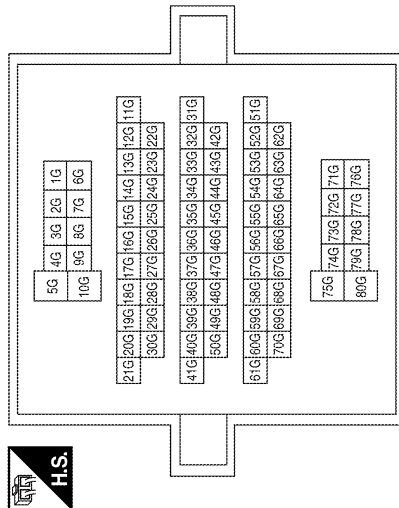

Terminal No.	Color of Wire	Signal Name
2M	R/Y	-
5M	SHIELD	-
7M	R/B	-
8M	B	-
9M	W	-
31M	B	-
32M	L	-
33M	P	-
35M	L	-
36M	P	-
37M	W/G	-
39M	SHIELD	-

Connector No.	M36
Connector Name	WIRE TO WIRE
Connector Color	WHITE

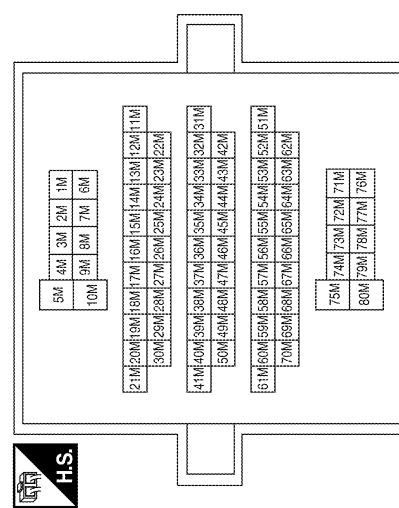

Terminal No.	Color of Wire	Signal Name
41M	G	-
42M	GR	-
49M	G/Y	-
50M	P	-
55M	W	-
56M	BR	-
64M	BR	-
65M	G/Y	-
71M	GR	-
72M	O	-

ABNIA1516GB

A  
B  
C  
D  
E  
F  
G  
H  
I  
J  
K  
L  
M  
N  
O  
P

AV

# AV CONTROL UNIT

[BOSE AUDIO WITHOUT NAVIGATION]

< ECU DIAGNOSIS >

Terminal No.	Color of Wire	Signal Name
39J	BR/Y	-
41J	BR	-
42J	W	-
43J	R	-
45J	SB	-
46J	G/R	-
47J	G/O	-
49J	BR/W	-
50J	B	-
79J	R/B	-

Terminal No.	Color of Wire	Signal Name
1J	R	-
2J	L	-
3J	GR	-
6J	W	-
7J	LG	-
8J	O	-
9J	Y	-
32J	B	-
33J	G	-
36J	B	-
38J	G/Y	-

Connector No.	M40
Connector Name	WIRE TO WIRE
Connector Color	WHITE

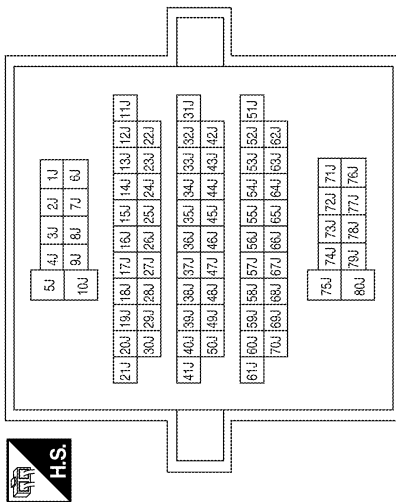

Terminal No.	Color of Wire	Signal Name
27	-	-
28	O	REQ (TO HU)
29	P	TX (FROM HU)
30	L	RX (TO HU)
31	-	-
32	R/B	BACKUP
36	G/B	ACC

Connector No.	M41
Connector Name	SATELLITE RADIO TUNER OR PRE-WIRING FOR SATELLITE RADIO TUNER
Connector Color	WHITE

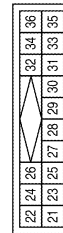

Terminal No.	Color of Wire	Signal Name
21	G	SAT LCH (-)
22	R	SAT LCH (+)
23	W	SAT RCH (-)
24	B	SAT RCH (+)

ABNIA1517GB

# AV CONTROL UNIT

[BOSE AUDIO WITHOUT NAVIGATION]

< ECU DIAGNOSIS >

Connector No.	M42
Connector Name	AV CONTROL UNIT (WITH BOSE AUDIO SYSTEM WITHOUT NAVI)
Connector Color	WHITE

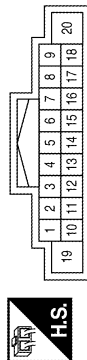

Terminal No.	Color of Wire	Signal Name
1	--	--
2	--	--
3	--	--
4	--	--
5	--	--
6	Y	STRG SW A

Terminal No.	Color of Wire	Signal Name
7	G/Y	ACC
8	--	--
9	V	ILL+
10	--	--
11	--	--
12	--	--
13	--	--
14	--	--
15	L	STRG SW GND
16	G	STRG SW B
17	--	--
18	--	--
19	Y	+B
20	B	GND

Connector No.	M43
Connector Name	AV CONTROL UNIT (WITH BOSE AUDIO SYSTEM WITHOUT NAVI)
Connector Color	WHITE

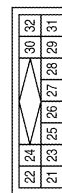

Terminal No.	Color of Wire	Signal Name
21	G	N BUS LH-
22	R	N BUS LH+
23	W	N BUS RH-
24	B	N BUS RH+
25	--	--

Terminal No.	Color of Wire	Signal Name
26	--	--
27	--	--
28	O	REQ1 (TO HU)
29	P	RX (TO HU)
30	L	TX (FROM HU)
31	--	--
32	--	--

Connector No.	M44
Connector Name	AV CONTROL UNIT (WITH BOSE AUDIO SYSTEM WITHOUT NAVI)
Connector Color	GRAY

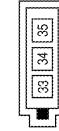

Terminal No.	Color of Wire	Signal Name
33	--	--
34	--	ANT MAIN
35	--	ANT +B

ABNIA1518GB

A  
B  
C  
D  
E  
F  
G  
H  
I  
J  
K  
L  
M  
N  
O  
P

AV

# AV CONTROL UNIT

[BOSE AUDIO WITHOUT NAVIGATION]

< ECU DIAGNOSIS >

Terminal No.	Color of Wire	Signal Name
55	-	-
56	V	IT DISP
57	W	VP
58	SB	INV GND
59	O	INV VCC

Terminal No.	Color of Wire	Signal Name
42	-	-
43	G	YS
44	LG	DISP IT
45	B	HP
46	BR	SIG GND
47	R	SIG VCC
48	-	-
49	-	-
50	-	-
51	-	-
52	-	-
53	-	-
54	B	GND

Connector No.	M45
Connector Name	AV CONTROL UNIT (WITH BOSE AUDIO SYSTEM WITHOUT NAVI)
Connector Color	WHITE

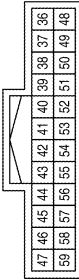

Terminal No.	Color of Wire	Signal Name
36	G	COMP OUT+
37	R	COMP OUT-
38	R	B
39	B	G
40	W	R
41	R	RGB SYNC

Connector No.	M56
Connector Name	WIRE TO WIRE
Connector Color	WHITE

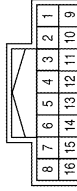

Terminal No.	Color of Wire	Signal Name
1	G	-
3	L	-
4	G	-
6	R	-
9	R	-
10	W	-
11	B	-
12	L	-
13	P	-
16	G/B	-

Terminal No.	Color of Wire	Signal Name
66	G	COMP1 IN+
67	-	-
68	BR	RV CAM SIG
69	-	-
70	-	-
71	-	-
72	SHIELD	COMP IN SHIELD
73	-	-
74	R	COMP1 IN-
75	-	-

Connector No.	M46
Connector Name	AV CONTROL UNIT (WITH BOSE AUDIO SYSTEM WITHOUT NAVI)
Connector Color	WHITE

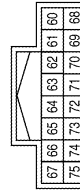

Terminal No.	Color of Wire	Signal Name
60	-	-
61	-	-
62	-	-
63	-	-
64	W	VTR -
65	B	VTR +

ABNIA1519GB

# AV CONTROL UNIT

[BOSE AUDIO WITHOUT NAVIGATION]

< ECU DIAGNOSIS >

Terminal No.	Color of Wire	Signal Name
114	B	RR RH PRE-
115	G/O	FR RH PRE-
116	--	--
117	--	--
118	BR/Y	RR LH PRE-
119	B	FR LH PRE-

Connector No.	M69
Connector Name	AV CONTROL UNIT (WITH BOSE AUDIO SYSTEM WITHOUT NAVI)
Connector Color	WHITE

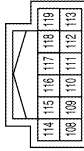

Terminal No.	Color of Wire	Signal Name
108	G/R	RR RH PRE+
109	G/Y	FR RH PRE+
110	SB	AMP ON
111	--	--
112	BR/W	RR LH PRE+
113	BR	FR LH PRE+

Connector No.	M64
Connector Name	WIRE TO WIRE
Connector Color	WHITE



Terminal No.	Color of Wire	Signal Name
2	Y	--

Connector No.	M70
Connector Name	AV CONTROL UNIT (WITH BOSE AUDIO SYSTEM WITHOUT NAVI)
Connector Color	WHITE

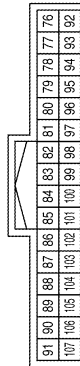

Terminal No.	Color of Wire	Signal Name
76	R	HP RH-
77	B	HP RH+
78	--	--
79	SB	TEL VOICE (TO IT)-
80	GR	TEL VOICE (TO IT)+
81	--	--
82	G	AUDIO BUS RH-
83	R	AUDIO BUS RH+
84	--	--

Terminal No.	Color of Wire	Signal Name
101	GR	SW GND
102	--	--
103	SB	CD EJECT
104	W/G	IGN
105	W	REVERSE SIG
106	G	PKB SIG
107	LG	SPEED 8P

Terminal No.	Color of Wire	Signal Name
85	B	GND
86	L	CAN-H
87	P	CAN-L
88	L	M CAN1 H
89	P	M CAN1 L
90	L	M CAN2 H
91	P	M CAN2 L
92	W	HP LH-
93	G	HP LH+
94	SHIELD	HP SHIELD
95	B	AUX AUDIO RH+
96	W	AUX AUDIO LH+
97	R	AUX GND
98	B	AUDIO BUS LH-
99	W	AUDIO BUS LH+
100	--	--

ABNIA1520GB

A  
B  
C  
D  
E  
F  
G  
H  
I  
J  
K  
L  
M  
N  
O  
P

AV

# AV CONTROL UNIT

[BOSE AUDIO WITHOUT NAVIGATION]

< ECU DIAGNOSIS >

Connector No.	M78
Connector Name	WIRE TO WIRE
Connector Color	GRAY

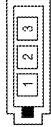

Terminal No.	Color of Wire	Signal Name
2	--	--
3	--	--

Connector No.	M75
Connector Name	WIRE TO WIRE
Connector Color	WHITE

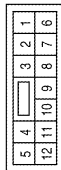

Terminal No.	Color of Wire	Signal Name
4	R	--
11	W	--

Connector No.	M73
Connector Name	WIRE TO WIRE
Connector Color	BROWN



Terminal No.	Color of Wire	Signal Name
1	--	--

Connector No.	M91
Connector Name	WIRE TO WIRE
Connector Color	WHITE

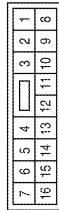

Terminal No.	Color of Wire	Signal Name
1	G	--

Connector No.	M85
Connector Name	AUX IN JACK
Connector Color	WHITE

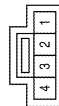

Terminal No.	Color of Wire	Signal Name
1	B	AUX AUDIO RH+
2	R	AUX GND
4	W	AUX AUDIO LH+

ABNIA1521GB



# AV CONTROL UNIT

[BOSE AUDIO WITHOUT NAVIGATION]

< ECU DIAGNOSIS >

Connector No.	M98
Connector Name	A/C AND AV SWITCH ASSEMBLY
Connector Color	WHITE

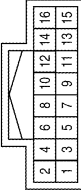

Terminal No.	Color of Wire	Signal Name
1	B	GND
2	G/Y	ACC
3	LG	ILL
4	BR	ILL CONT GND
5	L	M CAN1-H
6	P	M CAN1-L
7	GR	SW GND
8	SB	CD DVD EJECT

Terminal No.	Color of Wire	Signal Name
6	B	G
7	--	--
8	B	HP
9	G	YS
10	--	--
11	V	IT DISP
12	--	--
13	SB	INV GND
14	BR	SIG GND
15	G	COMP IN SYNC
16	--	--
17	W	R
18	R	B
19	R	RGB SYNC
20	W	VP
21	--	--
22	LG	DISP IT
23	--	--
24	--	--

Connector No.	M93
Connector Name	DISPLAY UNIT (WITHOUT NAVI)
Connector Color	WHITE

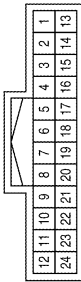

Terminal No.	Color of Wire	Signal Name
1	B	GND
2	O	INV VCC
3	R	SIG VCC
4	R	COMP IN-
5	--	--

Connector No.	M111
Connector Name	FRONT TWEETER RH
Connector Color	BROWN



Terminal No.	Color of Wire	Signal Name
1	W	--
2	L	--

Connector No.	M109
Connector Name	FRONT TWEETER LH
Connector Color	BROWN



Terminal No.	Color of Wire	Signal Name
1	G	--
2	L	--

Connector No.	M102
Connector Name	COMBINATION SWITCH
Connector Color	GRAY

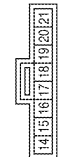

Terminal No.	Color of Wire	Signal Name
16	L	--
17	BR	--
20	W	--

ABNIA1522GB

A  
B  
C  
D  
E  
F  
G  
H  
I  
J  
K  
L  
M  
N  
O  
P

AV

# AV CONTROL UNIT

[BOSE AUDIO WITHOUT NAVIGATION]

< ECU DIAGNOSIS >

Connector No.	M129
Connector Name	SATELLITE RADIO TUNER OR PRE-WIRING FOR SATELLITE RADIO TUNER
Connector Color	WHITE



Terminal No.	Color of Wire	Signal Name
37	-	-

Connector No.	M201
Connector Name	WIRE TO WIRE
Connector Color	WHITE



Terminal No.	Color of Wire	Signal Name
1	G	-
3	L	-
4	G	-
6	R	-
9	R	-
10	W	-
11	B	-
12	L	-
13	P	-
16	G/B	-

Connector No.	M202
Connector Name	WIRE TO WIRE
Connector Color	WHITE

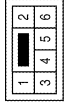

Terminal No.	Color of Wire	Signal Name
2	Y	-

Connector No.	M205
Connector Name	DVD PLAYER
Connector Color	WHITE

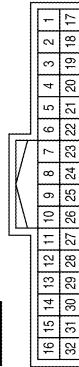

Terminal No.	Color of Wire	Signal Name
1	B	FES L+ OUTPUT
2	W	FES L- OUTPUT
3	-	-
4	-	-

Terminal No.	Color of Wire	Signal Name
5	B	GND
6	BR	ILL-
7	L	M CAN2 H
8	-	-
9	BR	+B
10	GR	SW POWER +5
11	-	-
12	W/L	VTR+
13	O/L	VTR-
14	Y	GND
15	-	-
16	V	DATA RX1 (LCD->DVD)
17	R	FES R+ OUTPUT
18	G	FES R- OUTPUT

Terminal No.	Color of Wire	Signal Name
19	-	-
20	-	-
21	Y	+B
22	SB	ILL+
23	P	M CAN2 L
24	G/B	ACC
25	-	-
26	P	GND
27	-	-
28	G	VIDEO OUT
29	-	-
30	-	-
31	-	-
32	LG	DATA TX1 (DVD->LCD)

ABNIA1523GB

# AV CONTROL UNIT

[BOSE AUDIO WITHOUT NAVIGATION]

< ECU DIAGNOSIS >

Connector No.	M350
Connector Name	WIRE TO WIRE
Connector Color	BROWN



Terminal No.	Color of Wire	Signal Name
1	--	--

Terminal No.	Color of Wire	Signal Name
1	Y	--
2	GR	--
4	V	--
5	LG	--
6	BR	--
9	O/L	--
10	W/L	--
11	B	--
14	P	--

Connector No.	M210
Connector Name	WIRE TO WIRE
Connector Color	WHITE

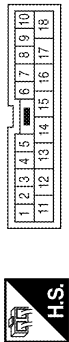

Connector No.	M502
Connector Name	WIRE TO WIRE
Connector Color	GRAY



Terminal No.	Color of Wire	Signal Name
2	--	--
3	--	--

Connector No.	M501
Connector Name	WIRE TO WIRE
Connector Color	GRAY

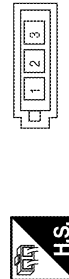

Terminal No.	Color of Wire	Signal Name
2	--	--
3	--	--

Connector No.	M351
Connector Name	SATELLITE ANTENNA
Connector Color	BROWN



Terminal No.	Color of Wire	Signal Name
1	--	--

ABNIA1524GB

A  
B  
C  
D  
E  
F  
G  
H  
I  
J  
K  
L  
M  
N  
O  
P

AV

# AV CONTROL UNIT

[BOSE AUDIO WITHOUT NAVIGATION]

< ECU DIAGNOSIS >

Connector No.	E5
Connector Name	WIRE TO WIRE
Connector Color	WHITE

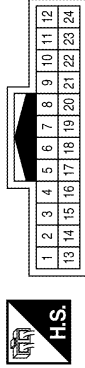

Terminal No.	9	Color of Wire	LG	Signal Name	--
--------------	---	---------------	----	-------------	----

Connector No.	M602
Connector Name	ANTENNA AMP.
Connector Color	GRAY

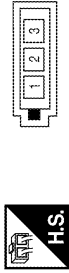

Terminal No.	2	Color of Wire	--	Signal Name	--
3	--	--	--	--	--

Connector No.	M601
Connector Name	WIRE TO WIRE
Connector Color	GRAY



Terminal No.	2	Color of Wire	--	Signal Name	--
3	--	--	--	--	--

Connector No.	E53
Connector Name	PARKING BRAKE SWITCH
Connector Color	BLACK



Terminal No.	1	Color of Wire	G	Signal Name	--
--------------	---	---------------	---	-------------	----

Connector No.	E45
Connector Name	BACK-UP LAMP RELAY
Connector Color	BROWN



Terminal No.	1	Color of Wire	LG	Signal Name	--
2	W/G	W/G	--	--	--
3	SB	SB	--	--	--
5	W/G	W/G	--	--	--

Connector No.	E26
Connector Name	WIRE TO WIRE
Connector Color	WHITE

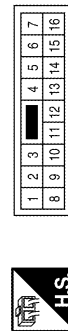

Terminal No.	1	Color of Wire	G	Signal Name	--
--------------	---	---------------	---	-------------	----

ABNIA1525GB

# AV CONTROL UNIT

[BOSE AUDIO WITHOUT NAVIGATION]

< ECU DIAGNOSIS >

Connector No.	F9
Connector Name	A/T ASSEMBLY
Connector Color	GREEN

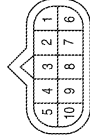

Terminal No.	7	Color of Wire	LG	Signal Name	-
--------------	---	---------------	----	-------------	---

Connector No.	E152
Connector Name	WIRE TO WIRE
Connector Color	WHITE

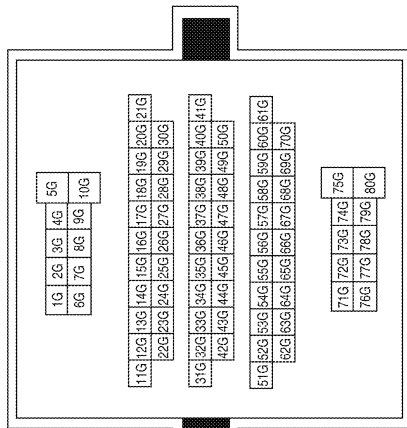

Terminal No.	Color of Wire	Signal Name
54G	SB	-
77G	Y	-

Connector No.	E119
Connector Name	IPDM E/R (INTELLIGENT POWER DISTRIBUTION MODULE ENGINE ROOM)
Connector Color	WHITE

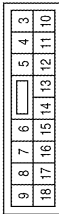

Terminal No.	Color of Wire	Signal Name
16	W/G	REVERSE LAMP

Connector No.	B6
Connector Name	WIRE TO WIRE
Connector Color	WHITE

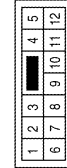

Terminal No.	Color of Wire	Signal Name
5	B	-
12	G	-

Connector No.	F502
Connector Name	TCM (TRANSMISSION CONTROL MODULE)
Connector Color	GRAY

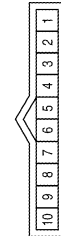

Terminal No.	Color of Wire	Signal Name
7	O	REV LAMP RLY

Connector No.	F14
Connector Name	WIRE TO WIRE
Connector Color	WHITE

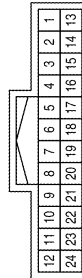

Terminal No.	Color of Wire	Signal Name
9	V	-

ABNIA1526GB

A  
B  
C  
D  
E  
F  
G  
H  
I  
J  
K  
L  
M  
N  
O  
P

AV

# AV CONTROL UNIT

[BOSE AUDIO WITHOUT NAVIGATION]

< ECU DIAGNOSIS >

Terminal No.	Color of Wire	Signal Name
38J	G/Y	--
39J	BR/Y	--
41J	BR	--
42J	W	--
43J	R	--
45J	SB	--
46J	G/R	--
47J	G/O	--
49J	BR/W	--
50J	B	--
79J	R/B	--

Terminal No.	Color of Wire	Signal Name
1J	R	--
2J	L	--
3J	GR	--
6J	W	--
7J	LG	--
8J	O	--
9J	Y	--
32J	B	--
33J	G	--
36J	B	--

Connector No.	B69
Connector Name	WIRE TO WIRE
Connector Color	WHITE

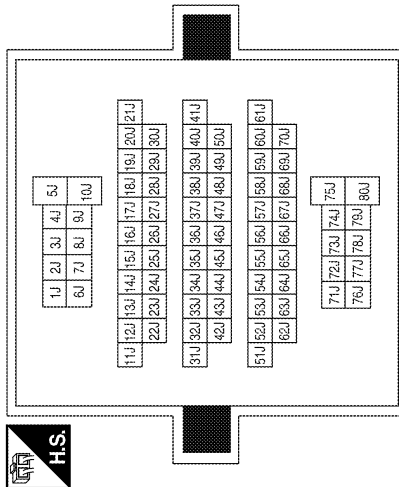

Connector No.	B74
Connector Name	BOSE SPEAKER AMP.
Connector Color	GRAY

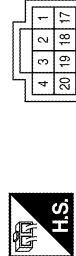

Connector No.	B72
Connector Name	SUBWOOFER
Connector Color	WHITE

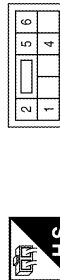

Terminal No.	Color of Wire	Signal Name
1	Y	BATT
2	--	--
3	B	WOOFER-
4	--	--
17	B	GND
18	--	--
19	SB	WOOFER+
20	--	--

Terminal No.	Color of Wire	Signal Name
1	B	WOOFER-
2	SB	WOOFER+
4	Y	AMP ON
5	B	GND
6	R/B	BATT

ABNIA1527GB

# AV CONTROL UNIT

[BOSE AUDIO WITHOUT NAVIGATION]

< ECU DIAGNOSIS >

Connector No.	B77
Connector Name	WIRE TO WIRE
Connector Color	WHITE

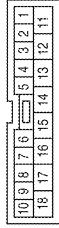

Terminal No.	Color of Wire	Signal Name
1	Y	--
2	GR	--
4	V	--
5	LG	--
6	BR	--
9	O/L	--
10	W/L	--
11	B	--
14	P	--

Connector No.	B76
Connector Name	VIDEO MONITOR
Connector Color	WHITE

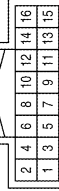

Terminal No.	Color of Wire	Signal Name
1	W	FES L CH INPUT-
2	G	FES L CH INPUT+
3	B	FES R CH INPUT-
4	R	FES R CH INPUT+
5	GR	SW POWER +5
6	--	--
7	O/L	VIDEO IN-
8	W/L	VIDEO IN+
9	--	--
10	--	--
11	--	--
12	Y	GND
13	LG	DATA RX (DVD->LCD)
14	V	DATA TX (DVD->DVD)
15	P	GND
16	BR	FILTERED BATT

Connector No.	B75
Connector Name	BOSE SPEAKER AMP.
Connector Color	BLACK

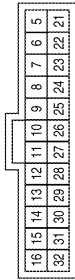

Terminal No.	Color of Wire	Signal Name
5	--	--
6	--	--
7	--	--
8	--	--
9	B	RR DR LH+ OUT
10	G	RR DR LH- OUT
11	GR	RR DR RH+ OUT
12	O	RR DR RH- OUT
13	LG	FR DR LH+ OUT
14	L	FR DR LH- OUT
15	W	FR DR RH+ OUT
16	R	FR DR RH- OUT
21	--	--
22	Y	WOOFER CTRL
23	B	RR RH-(IN)
24	G/R	RR RH+(IN)
25	BR/Y	RR LH-(IN)
26	BR/W	RR LH+(IN)
27	G/O	FR RH-(IN)
28	G/Y	FR RH+(IN)
29	B	FR LH-(IN)
30	BR	FR LH+(IN)
31	SB	AMP ON
32	--	--

ABNIA1528GB

A  
B  
C  
D  
E  
F  
G  
H  
I  
J  
K  
L  
M  
N  
O  
P

AV

# AV CONTROL UNIT

[BOSE AUDIO WITHOUT NAVIGATION]

< ECU DIAGNOSIS >

Connector No.	B107
Connector Name	WIRE TO WIRE
Connector Color	WHITE

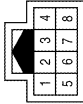

Terminal No.	Color of Wire	Signal Name
1	G	--
2	Y	--
6	SHIELD	--

Connector No.	B106
Connector Name	WIRE TO WIRE
Connector Color	WHITE

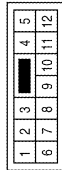

Terminal No.	Color of Wire	Signal Name
5	GR	--
12	O	--

Connector No.	B125
Connector Name	BLUETOOTH CONTROL UNIT
Connector Color	WHITE

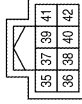

Terminal No.	Color of Wire	Signal Name
35	L	M CAN1 H
36	P	M CAN1 L

Terminal No.	Color of Wire	Signal Name
4	B	GND
7	R	MIC IN+
8	SHIELD	MIC IN-
9	W	AUDIO OUT+
10	B	AUDIO OUT-
21	B	CONT 2
22	B	CONT 3
24	B	CONT 5
28	SB	SPEED SIGNAL
29	W	MIC POWER

Connector No.	B124
Connector Name	BLUETOOTH CONTROL UNIT
Connector Color	WHITE



Terminal No.	Color of Wire	Signal Name
1	R/Y	BATT
2	G/Y	ACC
3	W/G	IGN

ABNIA1529GB



# AV CONTROL UNIT

[BOSE AUDIO WITHOUT NAVIGATION]

< ECU DIAGNOSIS >

Connector No.	B134
Connector Name	BLUETOOTH CONTROL UNIT
Connector Color	BLACK



Terminal No.	Color of Wire	Signal Name
33	B	-
34	B	-

Connector No.	B149
Connector Name	WIRE TO WIRE
Connector Color	WHITE

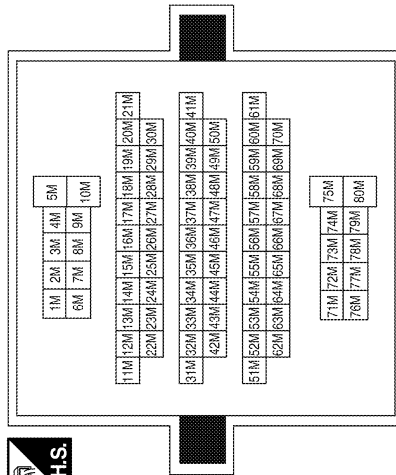

ABNIA1530GB

Terminal No.	Color of Wire	Signal Name
41M	G	-
42M	GR	-
49M	G/Y	-
50M	R	-
55M	W	-
56M	BR	-
64M	BR	-
65M	G/Y	-
71M	GR	-
72M	O	-

Terminal No.	Color of Wire	Signal Name
2M	R/Y	-
5M	SHIELD	-
7M	R/B	-
8M	B	-
9M	W	-
31M	SB	-
32M	L	-
33M	P	-
35M	L	-
36M	P	-
37M	W/G	-
39M	SHIELD	-

A  
B  
C  
D  
E  
F  
G  
H  
I  
J  
K  
L  
M  
N  
O  
P

AV

# AV CONTROL UNIT

[BOSE AUDIO WITHOUT NAVIGATION]

< ECU DIAGNOSIS >

Connector No.	R1
Connector Name	WIRE TO WIRE
Connector Color	WHITE

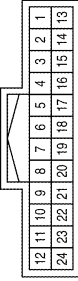

Terminal No.	Color of Wire	Signal Name
3	G	--
6	R	--
7	SHIELD	--

Terminal No.	Color of Wire	Signal Name
1	R/B	BAT+
2	Gr/Y	ACC
3	B	GND
4	LG	REVERSE
5	BR	AV CONT
6	W	CHECK CONN KLINE
7	--	--
8	Y	CAMERA 6V
9	SHIELD	CAMERA -
10	G	CAMERA +
11	W	VIDEO GND
12	B	VIDEO +
13	--	--
14	--	--
15	--	--
16	--	--

Connector No.	B176
Connector Name	REAR VIEW CAMERA CONTROL UNIT
Connector Color	WHITE

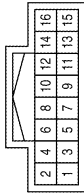

Connector No.	D12
Connector Name	FRONT DOOR SPEAKER LH
Connector Color	WHITE



Terminal No.	Color of Wire	Signal Name
1	L/W	--
2	L/R	--

Connector No.	D2
Connector Name	WIRE TO WIRE
Connector Color	BROWN

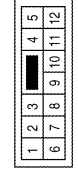

Terminal No.	Color of Wire	Signal Name
2	L/R	--
3	L/W	--

Connector No.	R8
Connector Name	MICROPHONE
Connector Color	WHITE

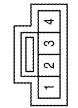

Terminal No.	Color of Wire	Signal Name
1	R	MIC OUT +
2	SHIELD	MIC OUT -
3	--	--
4	G	MIC POWER

ABNIA1531GB

# AV CONTROL UNIT

[BOSE AUDIO WITHOUT NAVIGATION]

< ECU DIAGNOSIS >

Connector No.	D201
Connector Name	WIRE TO WIRE
Connector Color	WHITE

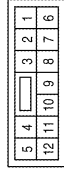

Terminal No.	Color of Wire	Signal Name
5	GR	-
12	O	-

Connector No.	D112
Connector Name	FRONT DOOR SPEAKER RH
Connector Color	WHITE



Terminal No.	Color of Wire	Signal Name
1	W/B	-
2	L/B	-

Connector No.	D101
Connector Name	WIRE TO WIRE
Connector Color	WHITE

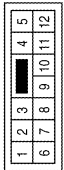

Terminal No.	Color of Wire	Signal Name
4	L/B	-
11	W/B	-

Connector No.	D301
Connector Name	WIRE TO WIRE
Connector Color	WHITE

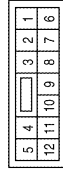

Terminal No.	Color of Wire	Signal Name
5	GR	-
12	O	-

Connector No.	D208
Connector Name	REAR TWEETER LH
Connector Color	BROWN



Terminal No.	Color of Wire	Signal Name
1	GR	-
2	O	-

Connector No.	D207
Connector Name	REAR DOOR SPEAKER LH (WITH BOSE AUDIO SYSTEM)
Connector Color	BROWN



Terminal No.	Color of Wire	Signal Name
1	GR	-
2	O	-

ABNIA1532GB

A  
B  
C  
D  
E  
F  
G  
H  
I  
J  
K  
L  
M  
N  
O  
P

AV

# AV CONTROL UNIT

[BOSE AUDIO WITHOUT NAVIGATION]

< ECU DIAGNOSIS >

Connector No.	D450
Connector Name	WIRE TO WIRE
Connector Color	WHITE

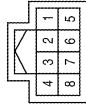

Terminal No.	Color of Wire	Signal Name
1	G	--
2	Y	--
6	SHIELD	--

Connector No.	D308
Connector Name	REAR TWEETER RH
Connector Color	BROWN



Terminal No.	Color of Wire	Signal Name
1	GR	--
2	O	--

Connector No.	D307
Connector Name	REAR DOOR SPEAKER RH (WITH BOSE AUDIO SYSTEM)
Connector Color	BROWN



Terminal No.	Color of Wire	Signal Name
1	GR	--
2	O	--

Connector No.	D551
Connector Name	REAR VIEW CAMERA
Connector Color	WHITE



Terminal No.	Color of Wire	Signal Name
1	Y	CAMERA_6V
2	B	GND
3	G	CAMERA +
4	SHIELD	CAMERA -

Connector No.	D550
Connector Name	WIRE TO WIRE
Connector Color	WHITE

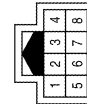

Terminal No.	Color of Wire	Signal Name
1	B	--
6	Y	--
7	G	--
8	SHIELD	--

Connector No.	D451
Connector Name	WIRE TO WIRE
Connector Color	WHITE

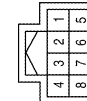

Terminal No.	Color of Wire	Signal Name
1	B	--
6	Y	--
7	G	--
8	SHIELD	--

ABN1A1533GB

INFOID:000000005259463

DTC Index

Self-diagnosis results display item

# AV CONTROL UNIT

< ECU DIAGNOSIS >

[BOSE AUDIO WITHOUT NAVIGATION]

Error item	Refer to
CAN COMM CIRCUIT [U1000]	<a href="#">AV-181, "DTC Logic"</a>
CONTROL UNIT (CAN) [U1010]	<a href="#">AV-182, "DTC Logic"</a>
Control Unit FLASH-ROM [U1200]	<a href="#">AV-183, "DTC Logic"</a>
CAN CONT [U1216]	<a href="#">AV-184, "DTC Logic"</a>
SWITCHE CONN [U1240]	<a href="#">AV-185, "Description"</a>
FRONT DISP CONN [U1243]	<a href="#">AV-186, "DTC Logic"</a>
DVD DECK [U1248]	<a href="#">AV-188, "DTC Logic"</a>
SAT CONN [U1255]	<a href="#">AV-189, "DTC Logic"</a>
HAND FREE CONN [U1256]	<a href="#">AV-190, "Description"</a>
AV COMM CIRCUIT [U1300]	<a href="#">AV-191, "Description"</a>
CONTROL UNIT (AV) [U1310]	<a href="#">AV-192, "DTC Logic"</a>

A

B

C

D

E

F

G

H

I

J

K

L

M

AV

O

P

# DISPLAY UNIT

< ECU DIAGNOSIS >

[BOSE AUDIO WITHOUT NAVIGATION]

## DISPLAY UNIT

Reference Value

INFOID:000000005259464

### TERMINAL LAYOUT

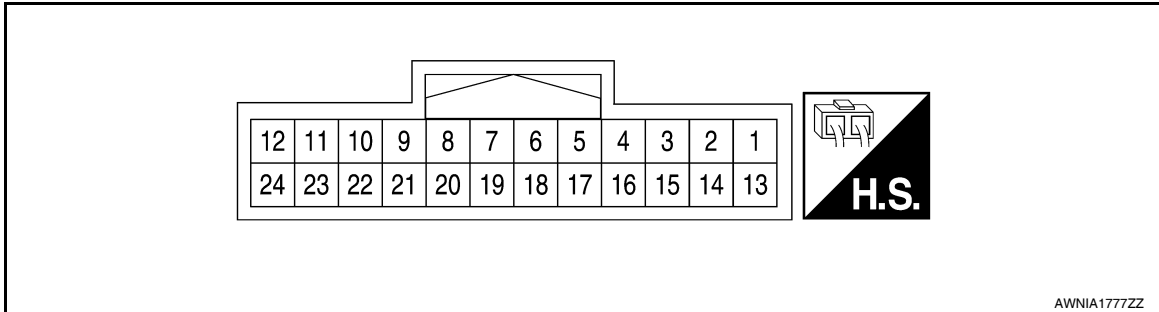

### PHYSICAL VALUES

Terminal (Wire color)		Description		Condition		Reference value (Approx.)
+	-	Signal name	Input/ Output			
1 (B)	Ground	Ground	—	Ignition switch ON	—	0V
2 (O)	Ground	Inverter VCC	Input	Ignition switch ACC	—	9V
3 (R)	Ground	Signal VCC	Input	Ignition switch ACC	—	9V
4 (R)	Ground	AUX image ground	—	Ignition switch ON	—	0V
6 (B)	Ground	RGB signal (G: green)	Input	Ignition switch ON	Start confirmation/adjust- ment mode, and then dis- play color bar by selecting "Color Spectrum Bar" on DISPLAY DIAGNO- SIS screen.	<p>SKIB2236J</p>
8 (B)	Ground	Horizontal synchronizing (HP) signal	Output	Ignition switch ON	—	<p>SKIB3601E</p>

# DISPLAY UNIT

[BOSE AUDIO WITHOUT NAVIGATION]

< ECU DIAGNOSIS >

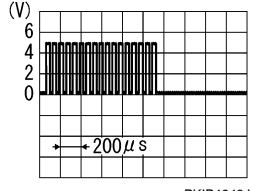
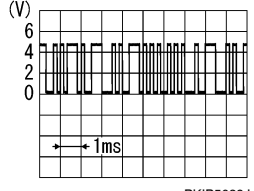
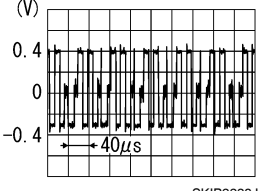
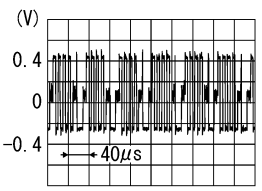
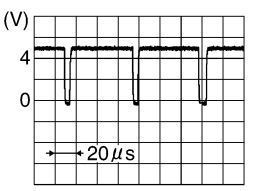
Terminal (Wire color)		Description		Condition	Reference value (Approx.)
+	-	Signal name	Input/ Output		
9 (G)	Ground	RGB area (YS) signal	Input	Ignition switch ON	At RGB image displayed 5V
				Ignition switch ON	At rear view camera image displayed  PKIB4948J
11 (V)	Ground	Communication signal (CONT→DISP)	Input	Ignition switch ON	When adjusting display-brightness  PKIB5039J
13 (SB)	Ground	Inverter ground	—	Ignition switch ON	— 0V
14 (BR)	Ground	Signal ground	—	Ignition switch ON	— 0V
15 (G)	—	AUX image synchronizing signal	Input	—	—
17 (W)	Ground	RGB signal (R: red)	Input	Ignition switch ON	Start confirmation/adjustment mode, and then display color bar by selecting "Color Spectrum Bar" on DISPLAY DIAGNOSIS screen.  SKIB2238J
18 (R)	Ground	RGB signal (B: blue)	Input	Ignition switch ON	Start confirmation/adjustment mode, and then display color bar by selecting "Color Spectrum Bar" on DISPLAY DIAGNOSIS screen.  SKIB2237J
19 (R)	Ground	RGB synchronizing signal	Input	Ignition switch ON	—  SKIB3603E

A  
B  
C  
D  
E  
F  
G  
H  
I  
J  
K  
L  
M  
AV  
O  
P

# DISPLAY UNIT

[BOSE AUDIO WITHOUT NAVIGATION]

< ECU DIAGNOSIS >

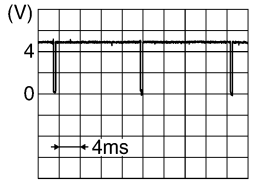
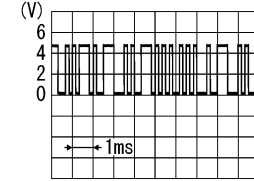
Terminal (Wire color)		Description		Condition		Reference value (Approx.)
+	-	Signal name	Input/ Output			
20 (W)	Ground	Vertical synchronizing (VP) signal	Output	Ignition switch On	—	 <p>SKIB3598E</p>
22 (LG)	Ground	Communication signal (DISP→CONT)	Output	Ignition switch ON	When adjusting display- brightness	 <p>PKIB5039J</p>



# BOSE SPEAKER AMP

[BOSE AUDIO WITHOUT NAVIGATION]

< ECU DIAGNOSIS >

## BOSE SPEAKER AMP

Reference Value

INFOID:000000005259465

### TERMINAL LAYOUT

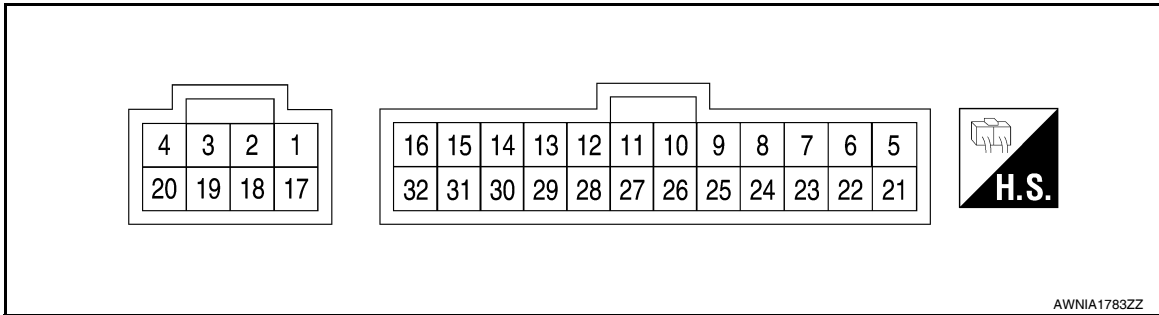

### PHYSICAL VALUES

Terminal (Wire color)		Description		Condition		Reference value (Approx.)
+	-	Signal name	Input/ Output			
1 (Y)	Ground	Battery power	Input	—	—	Battery voltage
9 (B)	10 (G)	Audio signal rear door speaker and tweeter LH	Output	Ignition switch ON	Audio output	 SKIB3609E
11 (GR)	12 (O)	Audio signal rear door speaker and tweeter RH	Output	Ignition switch ON	Audio output	 SKIB3609E
13 (LG)	14 (L)	Audio signal front door speaker and tweeter LH	Output	Ignition switch ON	Audio output	 SKIB3609E
15 (W)	16 (R)	Audio signal front door speaker and tweeter RH	Output	Ignition switch ON	Audio output	 SKIB3609E

A  
B  
C  
D  
E  
F  
G  
H  
I  
J  
K  
L  
M  
O  
P

AV

# BOSE SPEAKER AMP

**[BOSE AUDIO WITHOUT NAVIGATION]**

< ECU DIAGNOSIS >

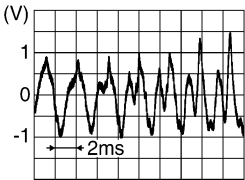
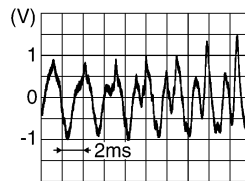
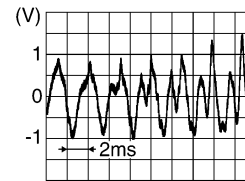
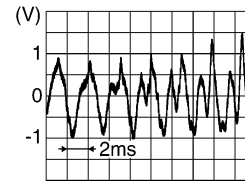
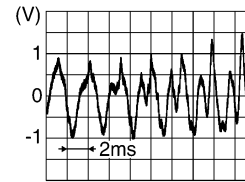
Terminal (Wire color)		Description		Condition		Reference value (Approx.)
+	-	Signal name	Input/ Output			
17 (B)	Ground	Ground	—	Ignition switch ON	—	0V
19 (SB)	3 (B)	Audio signal subwoofer	Output	Ignition switch ON	Audio output	 <p style="text-align: right; font-size: small;">SKIB3609E</p>
22 (Y)	Ground	Subwoofer amp. ON signal	Output	Ignition switch ACC	Audio output	Battery voltage
24 (G/R)	23 (B)	Audio signal rear RH	Input	Ignition switch ON	Audio input	 <p style="text-align: right; font-size: small;">SKIB3609E</p>
26 (BR/W)	25 (BR/Y)	Audio signal rear LH	Input	Ignition switch ON	Audio input	 <p style="text-align: right; font-size: small;">SKIB3609E</p>
28 (G/Y)	27 (G/O)	Audio signal front RH	Input	Ignition switch ON	Audio input	 <p style="text-align: right; font-size: small;">SKIB3609E</p>
30 (BR)	29 (B)	Audio signal front LH	Input	Ignition switch ON	Audio input	 <p style="text-align: right; font-size: small;">SKIB3609E</p>
31 (SB)	Ground	Amp. ON signal	Input	Ignition switch ON	Audio output	Battery voltage

# SATELLITE RADIO TUNER

[BOSE AUDIO WITHOUT NAVIGATION]

< ECU DIAGNOSIS >

## SATELLITE RADIO TUNER

Reference Value

INFOID:000000005259466

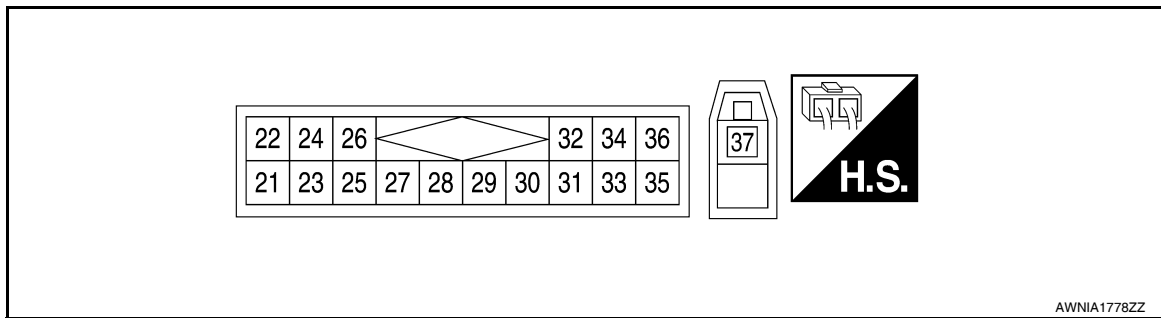

### PHYSICAL VALUES

Terminal		Description		Condition		Reference value (Approx.)
+	-	Signal name	Input/Output			
22 (R)	21 (G)	Satellite radio sound signal LH	Output	Ignition switch ON	When satellite radio mode is selected	
24 (B)	23 (W)	Satellite radio sound signal RH	Output	Ignition switch ON	When satellite radio mode is selected	
28 (O)	Ground	Request signal (SAT→CONT)	Output	Ignition switch ON	When satellite radio mode is selected	
29 (P)	Ground	Communication signal (SAT→CONT)	Output	Ignition switch ON	When satellite radio mode is selected	

A  
B  
C  
D  
E  
F  
G  
H  
I  
J  
K  
L  
M  
AV  
O  
P

# SATELLITE RADIO TUNER

[BOSE AUDIO WITHOUT NAVIGATION]

< ECU DIAGNOSIS >

Terminal		Description		Condition		Reference value (Approx.)
+	-	Signal name	Input/ Output			
30 (L)	Ground	Communication signal (CONT→SAT)	Input	Ignition switch ON	When satellite radio mode is selected	<p style="text-align: right; font-size: small;">SKIA9301J</p>
32 (R/B)	Ground	Battery power supply	Input	Ignition switch OFF	—	Battery voltage
36 (G/B)	Ground	ACC power supply	Input	Ignition switch ACC	—	Battery voltage
37	—	Satellite antenna	Input	—	—	—

# REAR VIEW CAMERA CONTROL UNIT

< ECU DIAGNOSIS >

[BOSE AUDIO WITHOUT NAVIGATION]

## REAR VIEW CAMERA CONTROL UNIT

Reference Value

INFOID:000000005259467

### TERMINAL LAYOUT

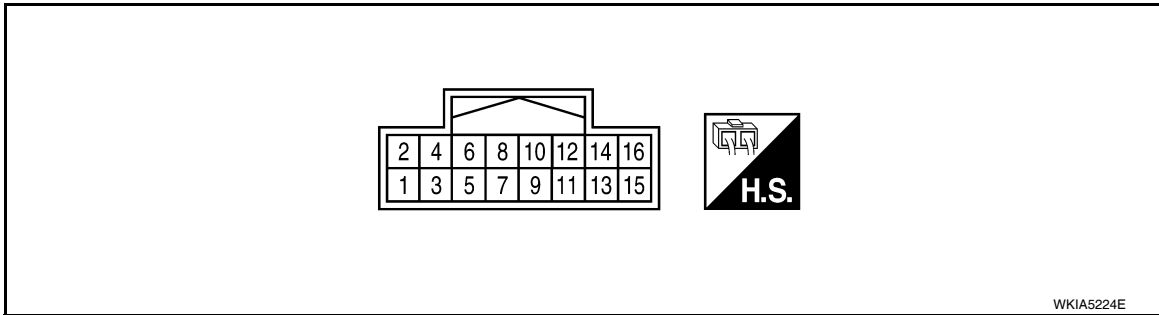

### PHYSICAL VALUES

Terminal			Description		Condition	Reference value (Approx.)
	+	-	Signal name	Input/Output		
1 (R/B)	Ground	Battery power	Input	Ignition switch OFF	—	Battery voltage
2 (G/R)	Ground	ACC power	Input	Ignition switch ACC	—	Battery voltage
3 (B)	Ground	Ground	—	Ignition switch ON	—	0V
4 (LG)	Ground	Reverse signal input	Input	Ignition switch ON	A/T selector lever R position	Battery voltage
					A/T selector lever in other than R position	0V
5 (BR)	Ground	AV Control	Output	Ignition switch ON	—	0V
6 (W)	Ground	DDL	Output	—	—	—
8 (Y)	Ground	Camera power output	Output	Ignition switch ON	A/T selector lever R position	6V
9	Ground	Camera image input (-)	Input	Ignition switch ON	—	0V
10 (G)	Ground	Camera image input (+)	Input	Ignition switch ON	A/T selector lever R position	<p>SKIA4894E</p>

# REAR VIEW CAMERA CONTROL UNIT

**[BOSE AUDIO WITHOUT NAVIGATION]**

< ECU DIAGNOSIS >

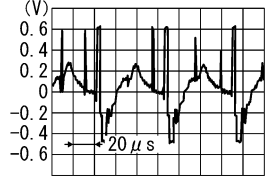
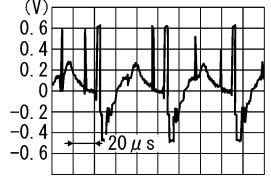
Terminal		Description		Condition		Reference value (Approx.)
+	-	Signal name	Input/Output			
11 (W)	Ground	Composite image output (-)	Output	Ignition switch ON	A/T selector lever R position	 <p style="text-align: right; font-size: small;">SKIA4896E</p>
12 (B)	Ground	Composite image output (+)	Output	Ignition switch ON	A/T selector lever R position	 <p style="text-align: right; font-size: small;">SKIA4896E</p>

# DVD PLAYER

< ECU DIAGNOSIS >

[BOSE AUDIO WITHOUT NAVIGATION]

## DVD PLAYER

### Reference Value

INFOID:000000005259468

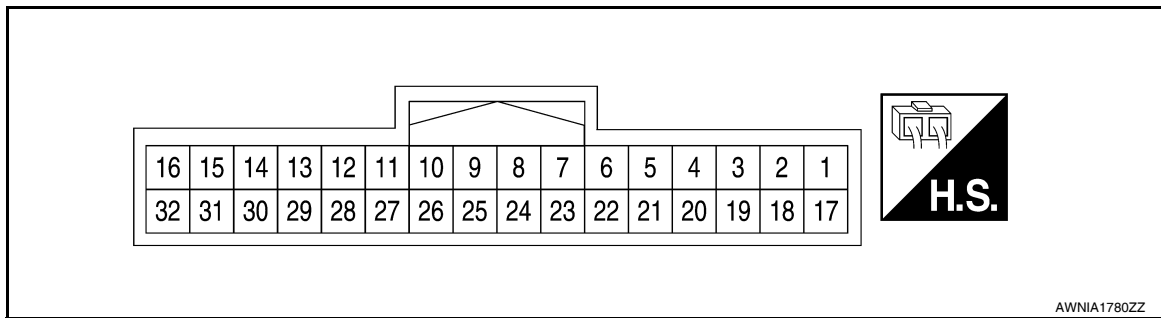

### PHYSICAL VALUES

Terminal		Description		Condition		Reference value (Approx.)
+	-	Signal name	Input/ Output			
1 (B)	2 (W)	DVD audio signal LH	Output	Ignition switch ON	With operation of the DVD player	<p>SKIB3609E</p>
5 (B)	Ground	Ground	—	Ignition switch ON	—	0V
6 (BR)	Ground	Illumination control (pulse width modulated)	—	—	With lighting switch ON	—
7 (L)	Ground	CAN communication	Input/ Output	Ignition switch ON	—	—
9 (BR)	Ground	Video monitor power supply	Output	Ignition switch ON	With DVD player operation	12V
10 (GR)	Ground	Switch power	Output	Ignition switch ON	With DVD player operation	5V
12 (W/L)	Ground	VTR (+)	Output	Ignition switch ON	With DVD player operation	—
13 (O/L)	Ground	VTR (-)	Output	Ignition switch ON	With DVD player operation	—
14 (Y)	Ground	Display ground	—	Ignition switch ON	With DVD player operation	0V
16 (V)	—	Data receive	Input	—	—	—

# DVD PLAYER

< ECU DIAGNOSIS >

[BOSE AUDIO WITHOUT NAVIGATION]

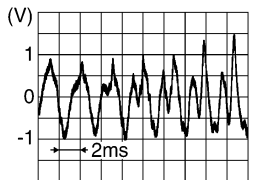
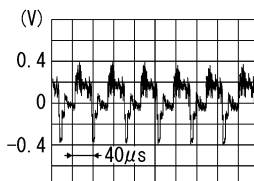
Terminal		Description		Condition		Reference value (Approx.)
+	-	Signal name	Input/ Output			
17 (R)	18 (G)	DVD audio signal RH	Output	Ignition switch ON	With DVD player operation	 <p style="text-align: right; font-size: small;">SKIB3609E</p>
21 (Y)	Ground	Battery power	Input	—	—	12V
22 (SB)	Ground	Illumination power	Input	—	With instrument illumination ON	12V
23 (P)	Ground	CAN communication	Input/ Output	Ignition switch ON	—	0V
24 (G/B)	Ground	ACC power	Input	Ignition switch ACC or ON	—	12V
26 (P)	Ground	Ground	Input	Ignition switch ON	—	0V
28 (G)	Ground	Video out	Input	Ignition switch ACC or ON	—	 <p style="text-align: right; font-size: small;">SKIB2251J</p>
32 (LG)	—	Data transmit	Output	—	—	—



# BLUETOOTH CONTROL UNIT

< ECU DIAGNOSIS >

[BOSE AUDIO WITHOUT NAVIGATION]

## BLUETOOTH CONTROL UNIT

Reference Value

INFOID:000000005259469

### TERMINAL LAYOUT

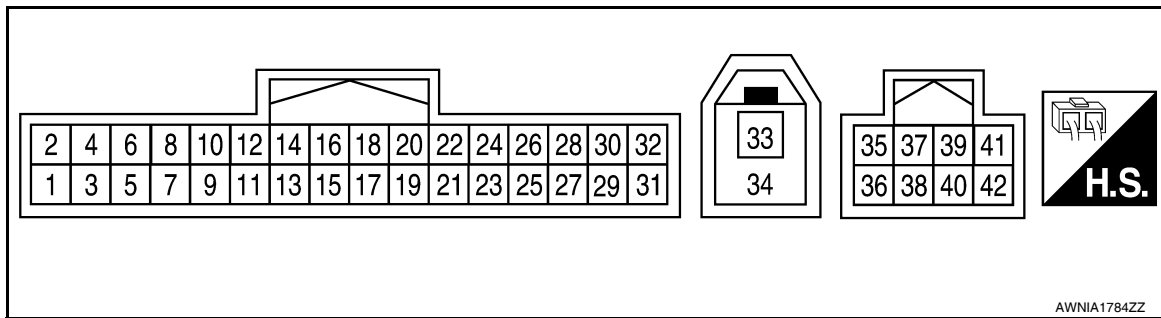

AWNIA1784ZZ

### PHYSICAL VALUES

Terminal (Wire color)		Item	Signal input/ output	Condition		Reference value (Approx.)
+	-			Ignition switch	Operation	
1 (R/Y)	Ground	Battery power	Input	-	-	Battery voltage
2 (G/Y)	Ground	ACC power	Input	ACC/ON	-	Battery voltage
3 (W/G)	Ground	IGN power	Input	ON/ START	-	Battery voltage
4 (B)	-	Ground	-	-	-	-
7 (R)	-	Mic-in signal	Input	-	-	-
8	-	Shield	-	-	-	-
9 (W)	10 (B)	Audio out	Output	ACC/ON	Bluetooth control unit sends audio signal	
21 (B)	-	Ground	-	-	-	-
22 (B)	-	Ground	-	-	-	-
24 (B)	-	Ground	-	-	-	-
28 (SB)	Ground	Vehicle speed input signal (8- pulse)	Input	ON	When vehicle speed is approx. 40 km/h (25 mph)	
29 (W)	Ground	Microphone power	Output	ON	With Bluetooth ON	5V

# BLUETOOTH CONTROL UNIT

[BOSE AUDIO WITHOUT NAVIGATION]

< ECU DIAGNOSIS >

Terminal (Wire color)		Item	Signal input/ output	Condition		Reference value (Approx.)
+	-			Ignition switch	Operation	
33 (B)	-	Bluetooth an- tenna	-	-	-	-
34 (B)	-	Bluetooth an- tenna	-	-	-	-
35 (L)	-	M-CAN H	-	-	-	-
36 (P)	-	M-CAN L	-	-	-	-

# AUDIO SYSTEM

[BOSE AUDIO WITHOUT NAVIGATION]

< SYMPTOM DIAGNOSIS >

## SYMPTOM DIAGNOSIS

### AUDIO SYSTEM

#### Symptom Table

INFOID:000000005259470

#### AUDIO SYSTEM

Symptom	Possible cause	Reference page
Inoperative	<ul style="list-style-type: none"> <li>AV control unit power circuit</li> <li>AV control unit</li> </ul>	<ul style="list-style-type: none"> <li><a href="#">AV-193</a></li> <li><a href="#">AV-172</a></li> </ul>
Steering wheel audio control switch does not operate	<ul style="list-style-type: none"> <li>Steering wheel audio control switch</li> <li>AV control unit</li> </ul>	<ul style="list-style-type: none"> <li><a href="#">AV-229</a></li> <li><a href="#">AV-172</a></li> </ul>
All speakers do not sound	<ul style="list-style-type: none"> <li>AV control unit</li> <li>AV control unit power circuit</li> <li>BOSE speaker amp. ON signal</li> <li>BOSE speaker amp. power/ground circuit</li> <li>BOSE speaker amp.</li> </ul>	<ul style="list-style-type: none"> <li><a href="#">AV-172</a></li> <li><a href="#">AV-193</a></li> <li><a href="#">AV-228</a></li> <li><a href="#">AV-196</a></li> <li><a href="#">AV-273</a></li> </ul>
One or several speakers do not sound	<ul style="list-style-type: none"> <li>Front door speaker</li> <li>Front tweeter</li> <li>Rear door speaker</li> <li>Rear tweeter</li> <li>Subwoofer</li> </ul>	<ul style="list-style-type: none"> <li><a href="#">AV-213</a></li> <li><a href="#">AV-216</a></li> <li><a href="#">AV-219</a></li> <li><a href="#">AV-222</a></li> <li><a href="#">AV-225</a></li> </ul>

#### CD

Symptom	Possible cause	Reference page
CD cannot be inserted.	AV control unit	<a href="#">AV-172</a>
CD cannot be ejected.		
The CD cannot be played.		
The sound skips, stops suddenly, or is distorted.		

#### SATELLITE RADIO

Symptom	Possible cause	Reference page
Inoperative	<ul style="list-style-type: none"> <li>Satellite radio tuner power or ground circuit</li> <li>Satellite radio tuner communication circuit</li> <li>Satellite radio tuner</li> </ul>	<ul style="list-style-type: none"> <li><a href="#">AV-198</a></li> <li><a href="#">AV-231</a></li> <li><a href="#">AV-307</a></li> </ul>
Right or left channel does not sound	<ul style="list-style-type: none"> <li>Satellite radio tuner audio signal circuit</li> <li>Satellite radio tuner</li> </ul>	<ul style="list-style-type: none"> <li><a href="#">AV-234</a></li> <li><a href="#">AV-307</a></li> </ul>

#### DVD PLAYER

Symptom	Possible cause	Reference page
DVD player inoperative	<ul style="list-style-type: none"> <li>Power supply and ground circuits</li> <li>DVD player</li> </ul>	<ul style="list-style-type: none"> <li><a href="#">AV-200</a></li> <li><a href="#">AV-301</a></li> </ul>
No sound when playing a DVD	<ul style="list-style-type: none"> <li>Audio signal circuits</li> <li>AV control unit</li> <li>DVD player</li> </ul>	<ul style="list-style-type: none"> <li><a href="#">AV-279</a></li> <li><a href="#">AV-172</a></li> <li><a href="#">AV-301</a></li> </ul>
Video monitor is inoperative/does not display properly	<ul style="list-style-type: none"> <li>Power supply and ground circuits</li> <li>Video out circuit</li> <li>DVD player</li> <li>Display monitor</li> </ul>	<ul style="list-style-type: none"> <li><a href="#">AV-201</a></li> <li><a href="#">AV-279</a></li> <li><a href="#">AV-301</a></li> <li><a href="#">AV-301</a></li> </ul>

## AUDIO SYSTEM

< SYMPTOM DIAGNOSIS >

[BOSE AUDIO WITHOUT NAVIGATION]

Symptom	Possible cause	Reference page
DVD remote control is inoperative/does not operate properly	<ul style="list-style-type: none"><li>• DVD player</li><li>• Video monitor</li></ul>	<ul style="list-style-type: none"><li>• <a href="#">AV-301</a></li><li>• <a href="#">AV-301</a></li></ul>
Headphones inoperative	<ul style="list-style-type: none"><li>• Headphone batteries</li><li>• Headphone audio signal circuits from AV control unit</li><li>• AV control unit</li><li>• Video monitor</li></ul>	<ul style="list-style-type: none"><li>• <a href="#">AV-238</a></li><li>• <a href="#">AV-238</a></li></ul>

# NORMAL OPERATING CONDITION

< SYMPTOM DIAGNOSIS >

[BOSE AUDIO WITHOUT NAVIGATION]

## NORMAL OPERATING CONDITION

### Description

INFOID:000000005259471

The majority of the audio concerns are the result of outside causes (bad CD, electromagnetic interference, etc.).

### NOISE

The following noise results from variations in field strength, such as fading noise and multi-path noise, or external noise from trains and other sources. It is not a malfunction.

- Fading noise: This noise occurs because of variations in the field strength in a narrow range due to mountains or buildings blocking the signal.
- Multi-path noise: This noise results from the waves sent directly from the broadcast station arriving at the antenna at a different time from the waves which reflect off mountains or buildings.

The vehicle itself can be a source of noise if noise prevention parts or electrical equipment is malfunctioning. Check if noise is caused and/or changed by engine speed, ignition switch turned to each position, and operation of each piece of electrical equipment, and determine the cause.

### NOTE:

The source of the noise can be found easily by listening to the noise while removing the fuses of electrical components, one by one.

### Type of Noise and Possible Cause

Occurrence condition		Possible cause
Occurs only when engine is ON.	A continuous growling noise occurs. The speed of the noise varies with changes in the engine speed.	• Ignition components
The occurrence of the noise is linked with the operation of the fuel pump.		• Fuel pump condenser
Noise only occurs when various electrical components are operating.	A cracking or snapping sound occurs with the operation of various switches.	• Relay malfunction, AV control unit malfunction
	The noise occurs when various motors are operating.	• Motor case ground • Motor
The noise occurs constantly, not just under certain conditions.		• Rear defogger coil malfunction • Open circuit in printed heater • Poor ground of antenna feeder line
A cracking or snapping sound occurs while the vehicle is being driven, especially when it is vibrating excessively.		• Ground wire of body parts • Ground due to improper part installation • Wiring connections or a short circuit

A  
B  
C  
D  
E  
F  
G  
H  
I  
J  
K  
L  
M  
O  
P

AV

&lt; PRECAUTION &gt;

## PRECAUTION

### PRECAUTIONS

#### Precaution for Supplemental Restraint System (SRS) "AIR BAG" and "SEAT BELT PRE-TENSIONER"

INFOID:000000005259472

The Supplemental Restraint System such as "AIR BAG" and "SEAT BELT PRE-TENSIONER", used along with a front seat belt, helps to reduce the risk or severity of injury to the driver and front passenger for certain types of collision. This system includes seat belt switch inputs and dual stage front air bag modules. The SRS system uses the seat belt switches to determine the front air bag deployment, and may only deploy one front air bag, depending on the severity of a collision and whether the front occupants are belted or unbelted. Information necessary to service the system safely is included in the SR and SB section of this Service Manual.

**WARNING:**

- To avoid rendering the SRS inoperative, which could increase the risk of personal injury or death in the event of a collision which would result in air bag inflation, all maintenance must be performed by an authorized NISSAN/INFINITI dealer.
- Improper maintenance, including incorrect removal and installation of the SRS, can lead to personal injury caused by unintentional activation of the system. For removal of Spiral Cable and Air Bag Module, see the SR section.
- Do not use electrical test equipment on any circuit related to the SRS unless instructed to in this Service Manual. SRS wiring harnesses can be identified by yellow and/or orange harnesses or harness connectors.

#### PRECAUTIONS WHEN USING POWER TOOLS (AIR OR ELECTRIC) AND HAMMERS

**WARNING:**

- When working near the Airbag Diagnosis Sensor Unit or other Airbag System sensors with the Ignition ON or engine running, DO NOT use air or electric power tools or strike near the sensor(s) with a hammer. Heavy vibration could activate the sensor(s) and deploy the air bag(s), possibly causing serious injury.
- When using air or electric power tools or hammers, always switch the Ignition OFF, disconnect the battery, and wait at least 3 minutes before performing any service.

#### Precaution Necessary for Steering Wheel Rotation After Battery Disconnect

INFOID:000000005259473

**NOTE:**

- This Procedure is applied only to models with Intelligent Key system and NATS (NISSAN ANTI-THEFT SYSTEM).
- Remove and install all control units after disconnecting both battery cables with the ignition knob in the "LOCK" position.
- Always use CONSULT-III to perform self-diagnosis as a part of each function inspection after finishing work. If DTC is detected, perform trouble diagnosis according to self-diagnostic results.

For models equipped with the Intelligent Key system and NATS, an electrically controlled steering lock mechanism is adopted on the key cylinder.

For this reason, if the battery is disconnected or if the battery is discharged, the steering wheel will lock and steering wheel rotation will become impossible.

If steering wheel rotation is required when battery power is interrupted, follow the procedure below before starting the repair operation.

#### OPERATION PROCEDURE

1. Connect both battery cables.

**NOTE:**

Supply power using jumper cables if battery is discharged.

2. Use the Intelligent Key or mechanical key to turn the ignition switch to the "ACC" position. At this time, the steering lock will be released.
3. Disconnect both battery cables. The steering lock will remain released and the steering wheel can be rotated.
4. Perform the necessary repair operation.

## PRECAUTIONS

< PRECAUTION >

[BOSE AUDIO WITHOUT NAVIGATION]

5. When the repair work is completed, return the ignition switch to the "LOCK" position before connecting the battery cables. (At this time, the steering lock mechanism will engage.)
6. Perform a self-diagnosis check of all control units using CONSULT-III.

A

B

C

D

E

F

G

H

I

J

K

L

M

AV

O

P

# PREPARATION

< PREPARATION >

[BOSE AUDIO WITHOUT NAVIGATION]

## PREPARATION

### PREPARATION

#### Commercial Service Tools

INFOID:000000005259474

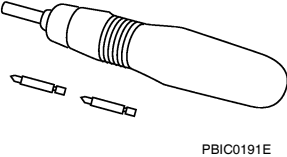
Tool name	Description
<p data-bbox="175 520 285 541">Power tool</p>  <p data-bbox="829 632 899 646">PBIC0191E</p>	<p data-bbox="1003 415 1256 436">Loosening bolts and nuts</p>



# AV CONTROL UNIT

< ON-VEHICLE REPAIR >

[BOSE AUDIO WITHOUT NAVIGATION]

## ON-VEHICLE REPAIR

### AV CONTROL UNIT

#### Removal and Installation

INFOID:000000005259475

#### AUDIO UNIT - WITHOUT NAVI

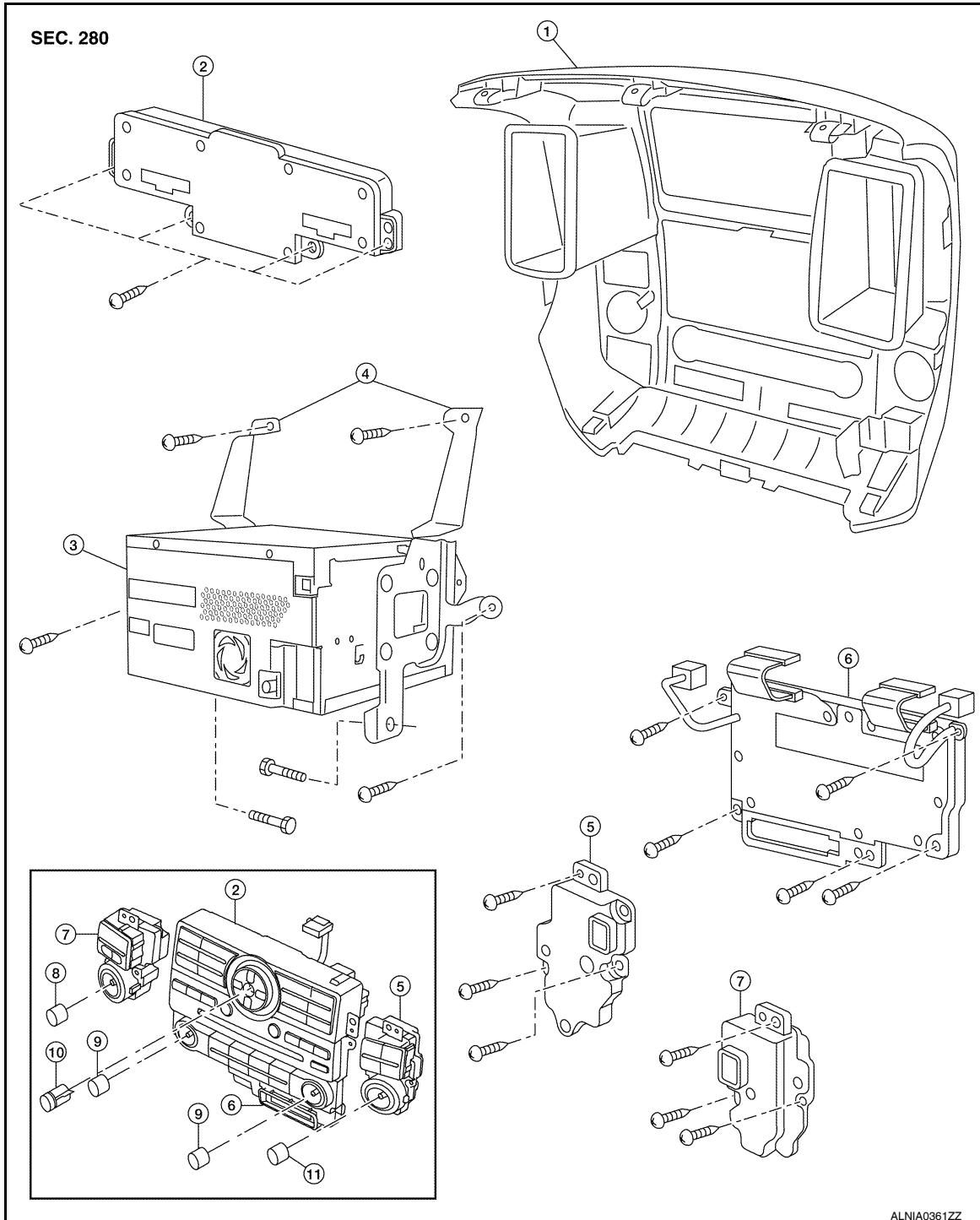

- |                             |                       |                               |
|-----------------------------|-----------------------|-------------------------------|
| 1. Cluster lid C            | 2. AV switch assembly | 3. AV control unit            |
| 4. AV control unit brackets | 5. Tuner knob switch  | 6. A/C and AV switch assembly |
| 7. Volume knob switch       | 8. Volume knob        | 9. Temp knobs RH and LH       |
| 10. Enter button            | 11. Tuner knob        |                               |

A  
B  
C  
D  
E  
F  
G  
H  
I  
J  
K  
L  
M  
AV  
O  
P

## AV CONTROL UNIT

< ON-VEHICLE REPAIR >

[BOSE AUDIO WITHOUT NAVIGATION]

---

### **CAUTION:**

Only remove and replace the A/C or AV switch assembly knobs if damaged or missing. The knobs must not be removed from switches when removing and installing the A/C or AV switch assembly to prevent damage to the switch assembly.

### REMOVAL

1. Disconnect the battery negative terminal.
2. Remove the cluster lid C. Refer to [IP-12. "Removal and Installation"](#).
3. Remove the AV control unit screws, using a power tool.
4. Remove the AV control unit.
5. Remove the A/C and AV switch assembly screws, then remove the A/C and AV switch assemblies as necessary.

### INSTALLATION

Installation is in the reverse order of removal.

# DISPLAY UNIT

< ON-VEHICLE REPAIR >

[BOSE AUDIO WITHOUT NAVIGATION]

## DISPLAY UNIT

### Removal and Installation

INFOID:000000005259476

#### REMOVAL

1. Remove Cluster lid C. Refer to [IP-12. "Removal and Installation"](#).
2. Remove the display unit screws (A).
3. Pull out the display unit (1), then disconnect the display unit connectors and remove the display unit (1).

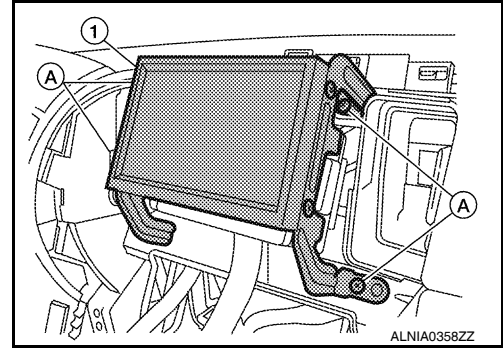

4. Remove the A/C auto amp screws (A), remove the (C103) fasteners (B) from the display unit assembly brackets and remove the A/C auto amp. (1).
5. Remove the display unit bracket unit screws (C) and remove the display unit brackets (2).

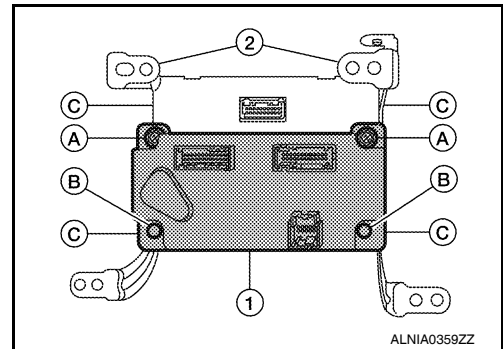

#### INSTALLATION

Installation is in reverse order of removal.

A  
B  
C  
D  
E  
F  
G  
H  
I  
J  
K  
L  
M  
O  
P

AV

# FRONT TWEETER

[BOSE AUDIO WITHOUT NAVIGATION]

< ON-VEHICLE REPAIR >

## FRONT TWEETER

### Removal and Installation

INFOID:000000005259477

#### REMOVAL

**CAUTION:**

Use a suitable tool to prevent damage to the front tweeter speaker grille trim and the instrument panel.

1. Remove the front tweeter grille.
2. Remove the front tweeter screws (A).
3. Pull out the front tweeter speaker (1) and disconnect front tweeter connector, then remove the front tweeter speaker (1).

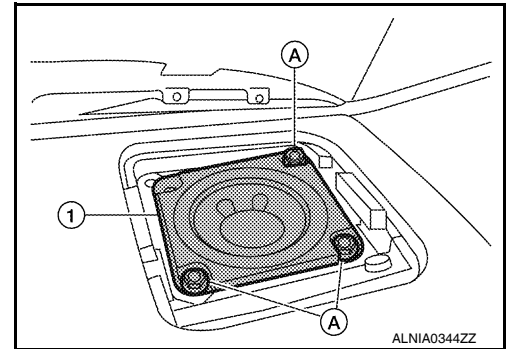

#### INSTALLATION

Installation is in the reverse order of removal.

# FRONT DOOR SPEAKER

< ON-VEHICLE REPAIR >

[BOSE AUDIO WITHOUT NAVIGATION]

## FRONT DOOR SPEAKER

### Removal and Installation

INFOID:000000005259478

#### REMOVAL

1. Remove the front door finisher. Refer to [INT-14, "Removal and Installation"](#).
2. Remove the front door speaker screws (A).
3. Pull out the front door speaker (1), and disconnect the front door speaker connector and remove the front door speaker (1).

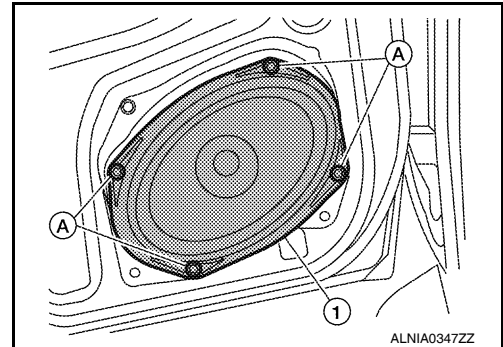

#### INSTALLATION

Installation is in the reverse order of removal.

A  
B  
C  
D  
E  
F  
G  
H  
I  
J  
K  
L  
M  
N  
O  
P

AV

## REAR DOOR SPEAKER

< ON-VEHICLE REPAIR >

[BOSE AUDIO WITHOUT NAVIGATION]

### REAR DOOR SPEAKER

#### Removal and Installation

INFOID:000000005259479

#### REMOVAL

1. Remove the rear door finisher. Refer to [INT-14. "Removal and Installation"](#).
2. Remove the rear door speaker screws (A).
3. Disconnect the rear door speaker connector (B) and remove rear door speaker (1).

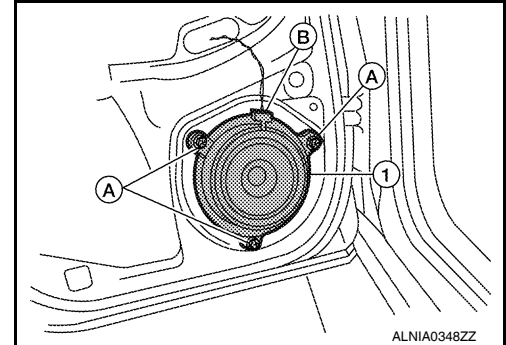

#### INSTALLATION

Installation is in the reverse order of removal.

#### Removal and Installation

INFOID:000000005259480

#### REAR TWEETER

##### Removal

1. Remove rear door finisher. Refer to [INT-14. "Removal and Installation"](#).
2. Remove the rear tweeter screws (A) and remove the rear tweeter (1).

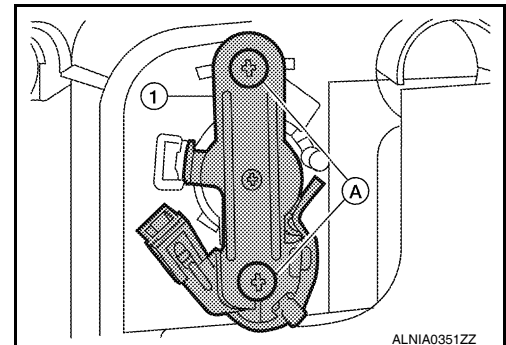

##### Installation

Installation is in the reverse order of removal.

# STEERING SWITCH

< ON-VEHICLE REPAIR >

[BOSE AUDIO WITHOUT NAVIGATION]

## STEERING SWITCH

### Removal and Installation

INFOID:000000005520631

### Removal and Installation

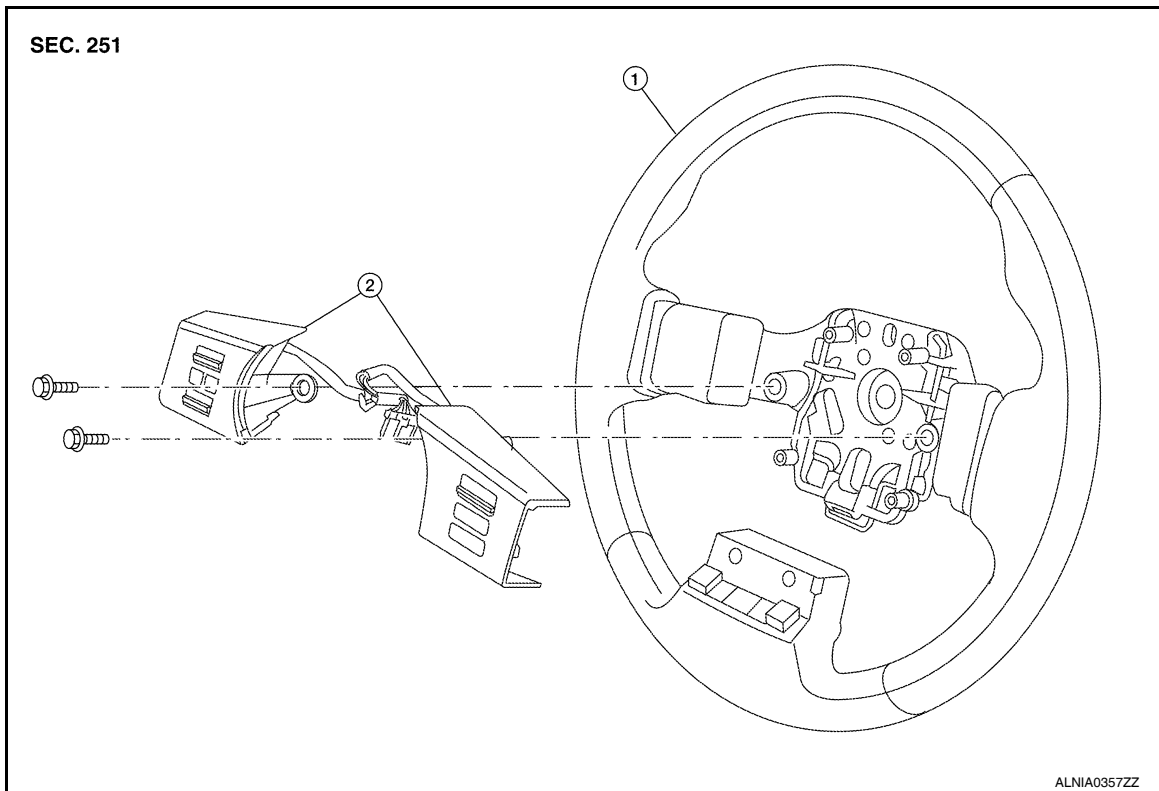

1. Steering wheel

2. Steering wheel audio control switches

### REMOVAL

1. Remove the driver air bag module. Refer to [SR-5, "Removal and Installation"](#).
2. Remove the steering wheel audio control switch assembly screws.
3. Disconnect the steering wheel audio control switches connector.
4. Remove the steering wheel audio control switches by pulling on steering wheel audio control switches to release the pawls.

#### CAUTION:

Do not tilt steering wheel audio control switches during removal or damage may occur to the pawls.

- ○:Pawl

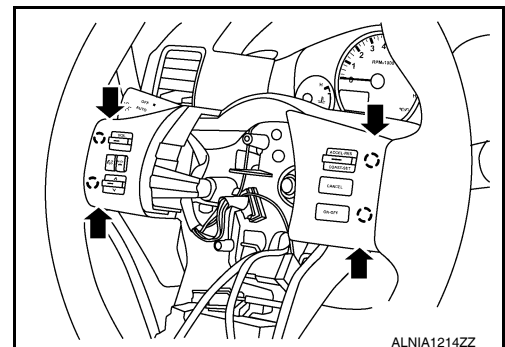

### INSTALLATION

Installation is in the reverse order of removal.

A  
B  
C  
D  
E  
F  
G  
H  
I  
J  
K  
L  
M  
AV  
O  
P

# MICROPHONE

< ON-VEHICLE REPAIR >

[BOSE AUDIO WITHOUT NAVIGATION]

## MICROPHONE

### Removal and Installation

INFOID:000000005259482

#### REMOVAL

1. Remove the front roof console finisher. Refer to [INT-19, "Removal and Installation"](#).
2. Detach the microphone (1) from the front console finisher tabs (A).
3. Detach the microphone connector (B) and remove the microphone (1).

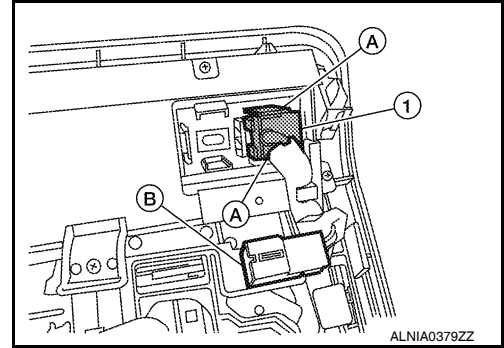

#### INSTALLATION

Installation is in the reverse order of removal.



# TEL ANTENNA

< ON-VEHICLE REPAIR >

[BOSE AUDIO WITHOUT NAVIGATION]

## TEL ANTENNA

### Removal and Installation

INFOID:000000005259483

### BLUETOOTH ANTENNA

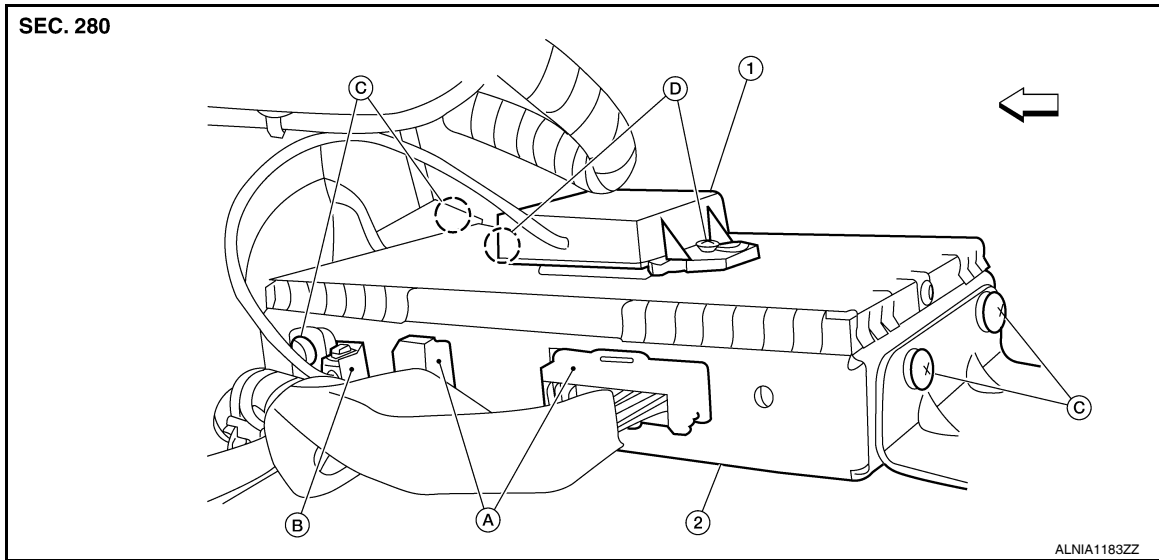

- |                                |                                  |                                      |
|--------------------------------|----------------------------------|--------------------------------------|
| 1. Bluetooth antenna           | 2. Bluetooth control unit        | A. Bluetooth control unit connectors |
| B. Bluetooth antenna connector | C. Bluetooth control unit screws | D. Bluetooth antenna screws          |
- ← Vehicle front

### REMOVAL

1. Remove the RH front seat. Refer to [SE-30. "Removal and Installation"](#).
2. Disconnect the Bluetooth antenna connector.
3. Remove the Bluetooth antenna screws and remove the Bluetooth antenna.

### INSTALLATION

Installation is in the reverse order of removal.

A  
B  
C  
D  
E  
F  
G  
H  
I  
J  
K  
L  
M  
O  
P

AV

# BLUETOOTH CONTROL UNIT

< ON-VEHICLE REPAIR >

[BOSE AUDIO WITHOUT NAVIGATION]

## BLUETOOTH CONTROL UNIT

### Removal and Installation

INFOID:000000005259484

### BLUETOOTH CONTROL UNIT

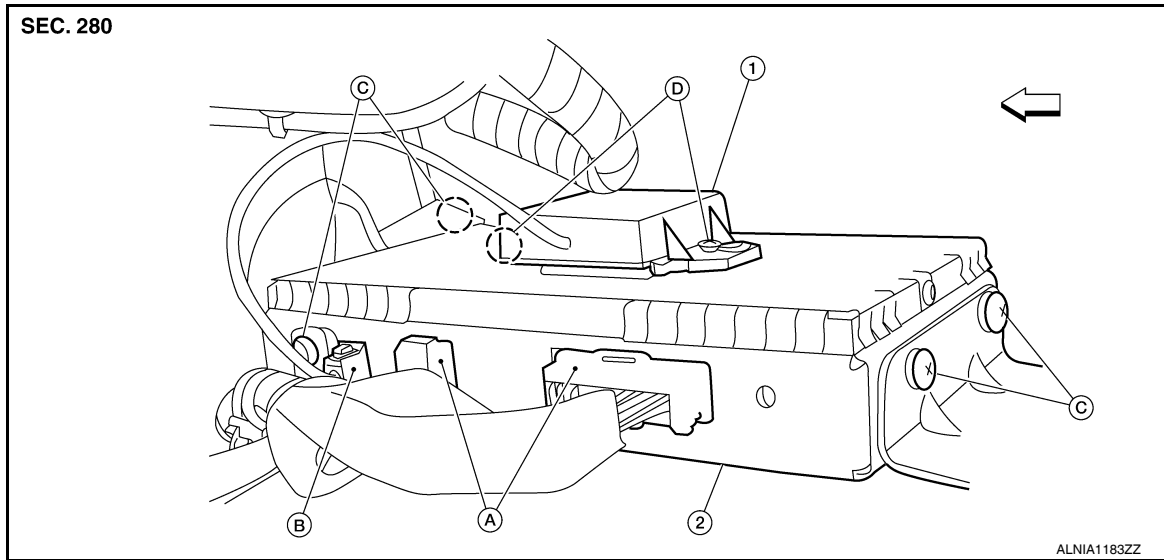

- |                                |                                  |                                      |
|--------------------------------|----------------------------------|--------------------------------------|
| 1. Bluetooth antenna           | 2. Bluetooth control unit        | A. Bluetooth control unit connectors |
| B. Bluetooth antenna connector | C. Bluetooth control unit screws | D. Bluetooth antenna screws          |

← Vehicle front

### REMOVAL

1. Remove the RH front seat. Refer to [SE-30. "Removal and Installation"](#).
2. Disconnect the Bluetooth control unit connectors.
3. Remove the Bluetooth control unit bracket screws and remove the Bluetooth control unit assembly.
4. Remove the Bluetooth control unit screws.
5. Transfer the Bluetooth antenna to the new Bluetooth control unit.

### INSTALLATION

Installation is in the reverse order of removal.

## BOSE SPEAKER AMP

## Removal and Installation

INFOID:000000005259485

## BOSE SPEAKER AMP.

## Removal

**NOTE:**

Do not remove the LH front seat from the vehicle.

1. Remove LH front seat bolts, disconnect the LH front seat electrical harness connector. Refer to [SE-30. "Removal and Installation"](#).
2. Tilt the LH front seat back to access the BOSE speaker amp. (1), then remove the BOSE speaker amp. screws (B).
  - ⇒: Vehicle front
3. Disconnect the Bose speaker amp. connectors (A) and remove Bose speaker amp. (1) from the bracket (2).
4. Then remove the BOSE speaker amp. bracket screws (C) and remove bracket (2).

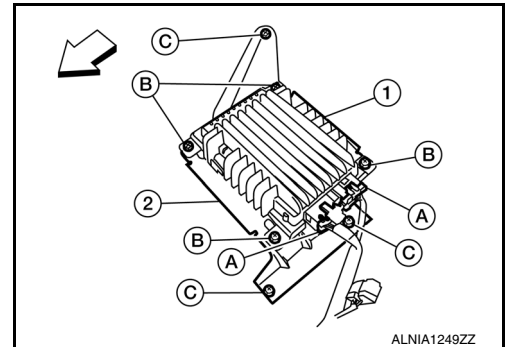

## Installation

Installation is in the reverse order of removal.

A  
B  
C  
D  
E  
F  
G  
H  
I  
J  
K  
L  
M  
N  
O  
P

AV

# SUBWOOFER

< ON-VEHICLE REPAIR >

[BOSE AUDIO WITHOUT NAVIGATION]

## SUBWOOFER

### Removal and Installation

INFOID:000000005259486

### SUBWOOFER (BOSE SYSTEM)

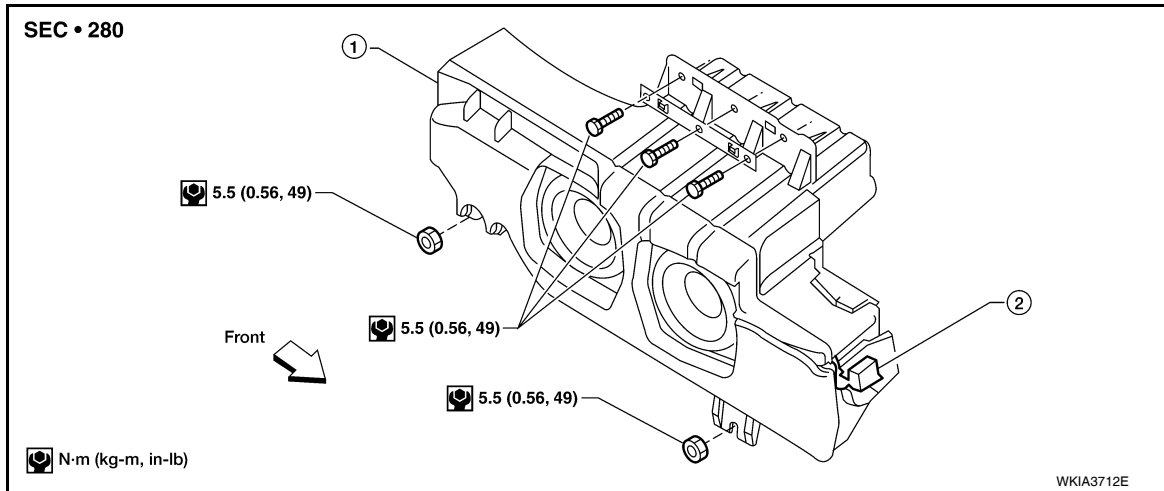

1. Subwoofer (BOSE system)

2. Subwoofer (BOSE system) connector

#### Removal

1. Remove the luggage side lower finisher LH. Refer to [INT-22. "Removal and Installation"](#).
2. Remove subwoofer bolts and nuts.
3. Disconnect the subwoofer connector and remove the subwoofer.

#### Installation

Installation is in the reverse order of removal.

# DVD ENTERTAINMENT SYSTEM

[BOSE AUDIO WITHOUT NAVIGATION]

< ON-VEHICLE REPAIR >

## DVD ENTERTAINMENT SYSTEM

### Removal and Installation of DVD Player

INFOID:000000005259487

#### REMOVAL

1. Remove the center console assembly. Refer to [IP-12. "Removal and Installation"](#).
2. Disconnect the DVD player connector (A).
3. Remove the DVD player screws (B), then remove the DVD player (1).
4. Remove the DVD player bracket screws and then remove DVD player brackets.

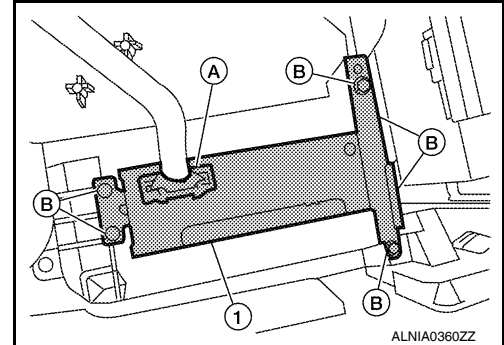

#### INSTALLATION

Installation is in reverse order of removal.

### Removal and Installation of Video Monitor

INFOID:000000005259488

#### REMOVAL

1. Release the clips and remove the video monitor finisher from headlining.
2. Press the release tabs and remove the cover.
3. Remove the video monitor screws.
4. Gently lower the assembly and disconnect the connector, then remove the video monitor from the headlining.

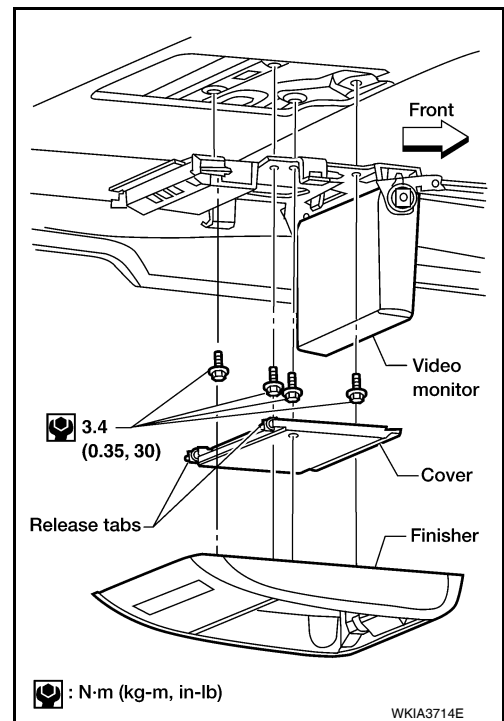

#### INSTALLATION

Installation is in reverse order of removal.

A  
B  
C  
D  
E  
F  
G  
H  
I  
J  
K  
L  
M  
AV  
O  
P

# AUDIO ANTENNA

< ON-VEHICLE REPAIR >

[BOSE AUDIO WITHOUT NAVIGATION]

## AUDIO ANTENNA

### Location of Antenna

INFOID:000000005259489

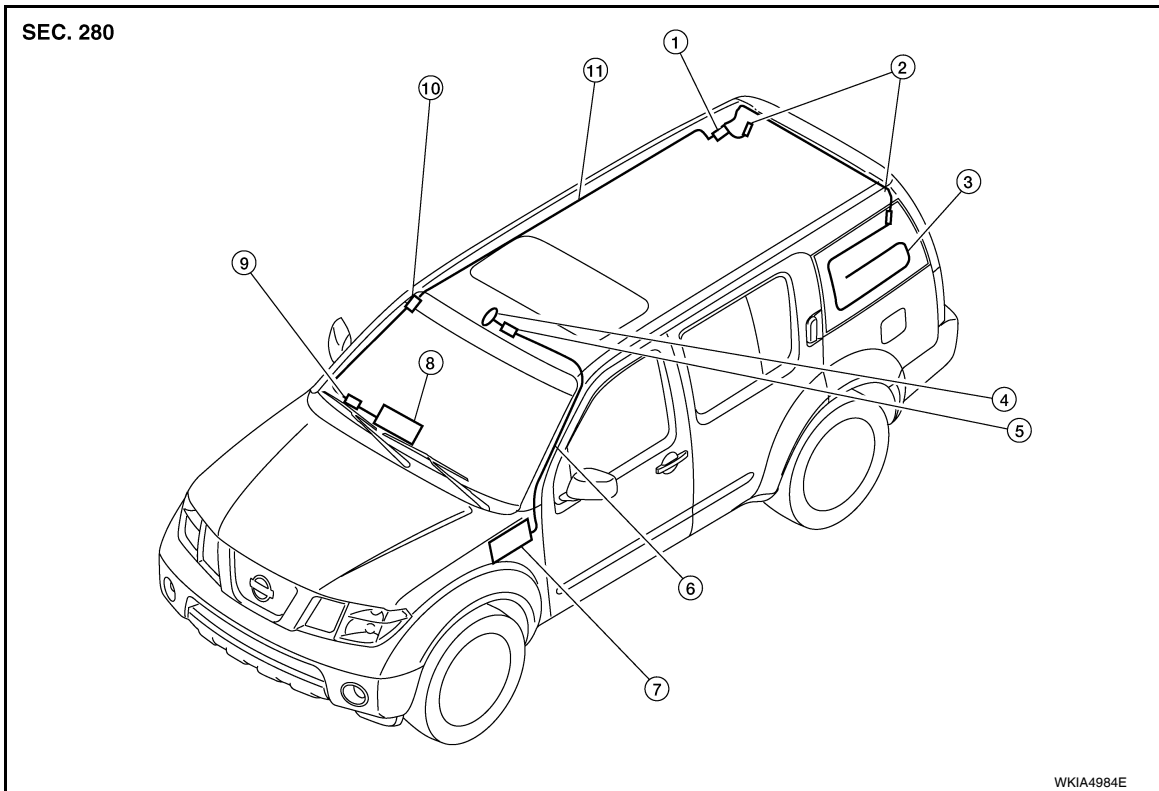

- |                                       |  |                                   |
|---------------------------------------|--|-----------------------------------|
| 1. Antenna amp.<br>M602               | 2. Window antenna grid connector bracket | 3. Window antenna grid            |
| 4. Satellite antenna<br>M351          | 5. Harness connector<br>M73, M350        | 6. Satellite antenna feeder       |
| 7. Satellite radio tuner<br>M41, M129 | 8. AV control unit M43, M44              | 9. Harness connector<br>M78, M501 |
| 10. Harness connector<br>M502, M601   | 11. Antenna feeder                       |                                   |

### Window Antenna Repair

INFOID:000000005259490

#### ELEMENT CHECK

1. Attach probe circuit tester (ohm setting) to antenna terminal on each side.

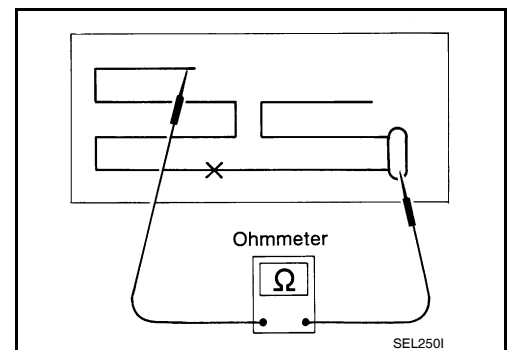

# AUDIO ANTENNA

< ON-VEHICLE REPAIR >

[BOSE AUDIO WITHOUT NAVIGATION]

- When measuring continuity, wrap tin foil around the top of probe. Then, press the foil against the wire with your finger.

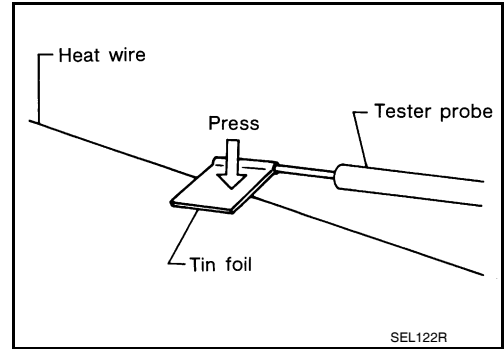

2. If an element is broken, no continuity will exist.

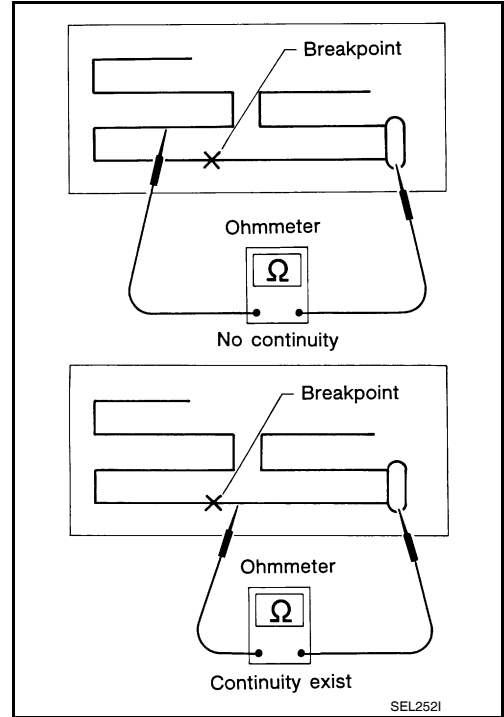

3. To locate a break, move probe along element. Tester indication will change abruptly when probe passes the broken point.

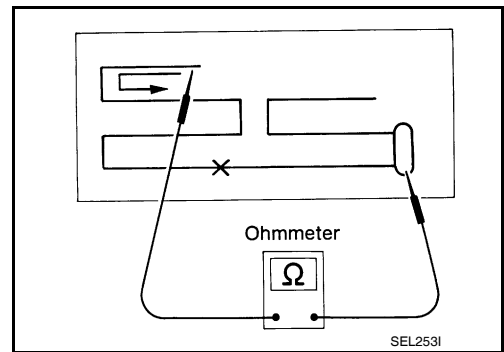

## ELEMENT REPAIR

Refer to [DEF-43, "Filament Repair"](#).

A  
B  
C  
D  
E  
F  
G  
H  
I  
J  
K  
L  
M  
AV  
O  
P

## AUXILIARY INPUT JACK

< ON-VEHICLE REPAIR >

[BOSE AUDIO WITHOUT NAVIGATION]

---

### AUXILIARY INPUT JACK

#### Removal and Installation

INFOID:000000005570798

#### Removal

1. Remove the A/T finisher. Refer to [IP-12. "Removal and Installation"](#).
2. Remove the auxiliary input jack.

#### Installation

Installation is in the reverse order of removal.



# ANTENNA AMP.

< ON-VEHICLE REPAIR >

[BOSE AUDIO WITHOUT NAVIGATION]

## ANTENNA AMP.

### Removal and Installation

INFOID:000000005550743

#### REMOVAL

1. Remove the luggage side upper and lower RH finishers. Refer to [INT-22. "Removal and Installation"](#).
2. Detach the antenna amp. harness clip (D), disconnect the antenna amp. connector (A), harness connector (B), then remove the antenna amp. screw (C) and remove the antenna amp. (1).

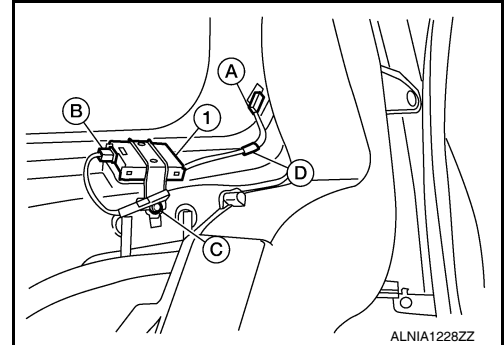

#### INSTALLATION

Installation is in the reverse order of removal.

A  
B  
C  
D  
E  
F  
G  
H  
I  
J  
K  
L  
M

AV

O  
P

# SATELLITE RADIO ANTENNA

[BOSE AUDIO WITHOUT NAVIGATION]

< ON-VEHICLE REPAIR >

## SATELLITE RADIO ANTENNA

### Removal and Installation

INFOID:000000005259492

#### REMOVAL

1. Remove the front roof console finisher. Refer to [INT-19, "Removal and Installation"](#).
2. Disconnect the satellite antenna connector.
3. Remove the satellite antenna nut.
4. Remove the satellite antenna.

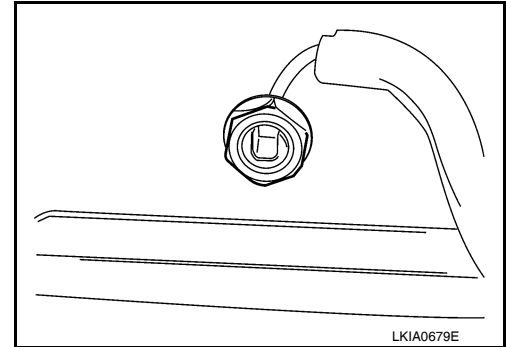

#### INSTALLATION

Installation is in the reverse order of removal.

# SATELLITE RADIO TUNER

< ON-VEHICLE REPAIR >

[BOSE AUDIO WITHOUT NAVIGATION]

## SATELLITE RADIO TUNER

### Removal and Installation

INFOID:000000005259491

#### REMOVAL

1. Disconnect the battery negative terminal.
2. Disconnect the satellite radio tuner connectors.
3. Remove satellite radio tuner screws (A), and remove satellite radio tuner from above the parking brake pedal.

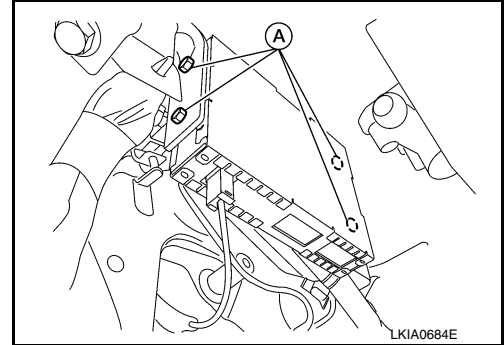

#### INSTALLATION

Installation is in the reverse order of removal.

A  
B  
C  
D  
E  
F  
G  
H  
I  
J  
K  
L  
M  
O  
P

AV

## REAR VIEW CAMERA

< ON-VEHICLE REPAIR >

[BOSE AUDIO WITHOUT NAVIGATION]

### REAR VIEW CAMERA

#### Removal and Installation

INFOID:000000005259493

#### Rear View Camera

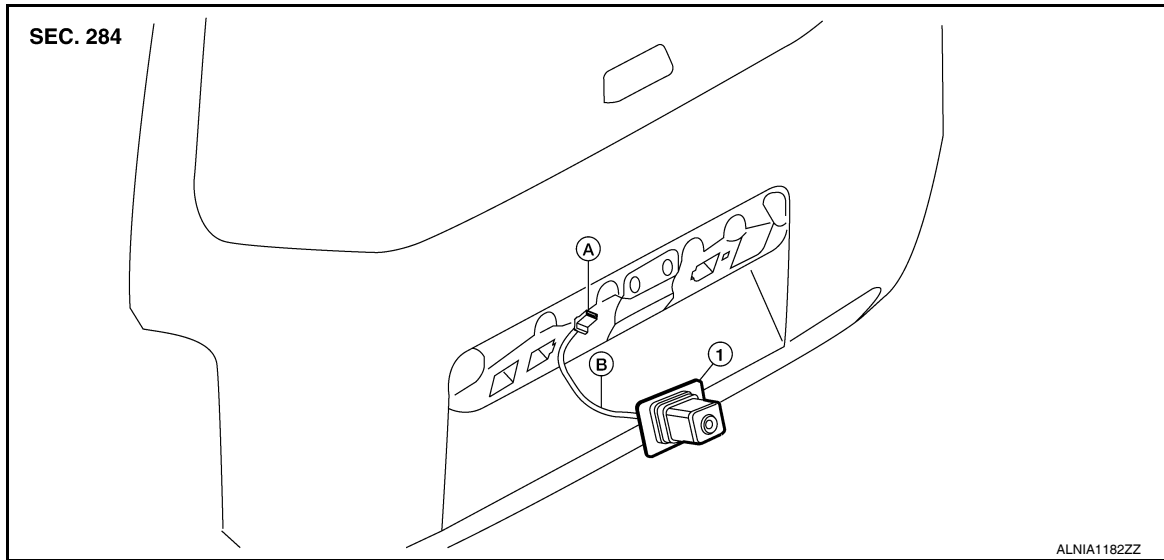

1. Rear view camera                      A. Rear view camera connector                      B. Rear view camera harness clip

#### REMOVAL

1. Remove the license lamp finisher. Refer to [EXT-21, "Removal and Installation"](#).
2. Disconnect the rear view camera connector.
3. Detach the rear view camera harness clip.
4. Detach the rear view camera to release, then pull out to remove the rear view camera while feeding the rear view camera harness and connector through the back door.

#### INSTALLATION

Installation is in the reverse order of removal.

# REAR VIEW CAMERA CONTROL UNIT

< ON-VEHICLE REPAIR >

[BOSE AUDIO WITHOUT NAVIGATION]

## REAR VIEW CAMERA CONTROL UNIT

### Removal and Installation

INFOID:000000005259494

#### REMOVAL

1. Remove the luggage side lower finisher RH. Refer to [INT-22. "Removal and Installation"](#).
2. Remove the rear HVAC duct tube (C103) fastener and remove the HVAC duct tube.
3. Remove the rear view camera control unit screws (A), disconnect the rear view camera control unit connector (B) and remove the rear view camera control unit (1).

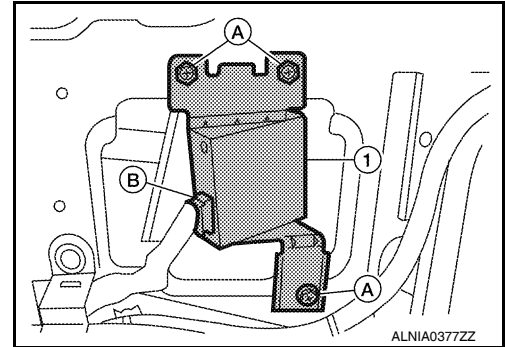

#### INSTALLATION

Installation is in the reverse order of removal.

A  
B  
C  
D  
E  
F  
G  
H  
I  
J  
K  
L  
M  
O  
P

AV

## BASIC INSPECTION

### DIAGNOSIS AND REPAIR WORKFLOW

#### Work Flow

INFOID:000000005259495

#### OVERALL SEQUENCE

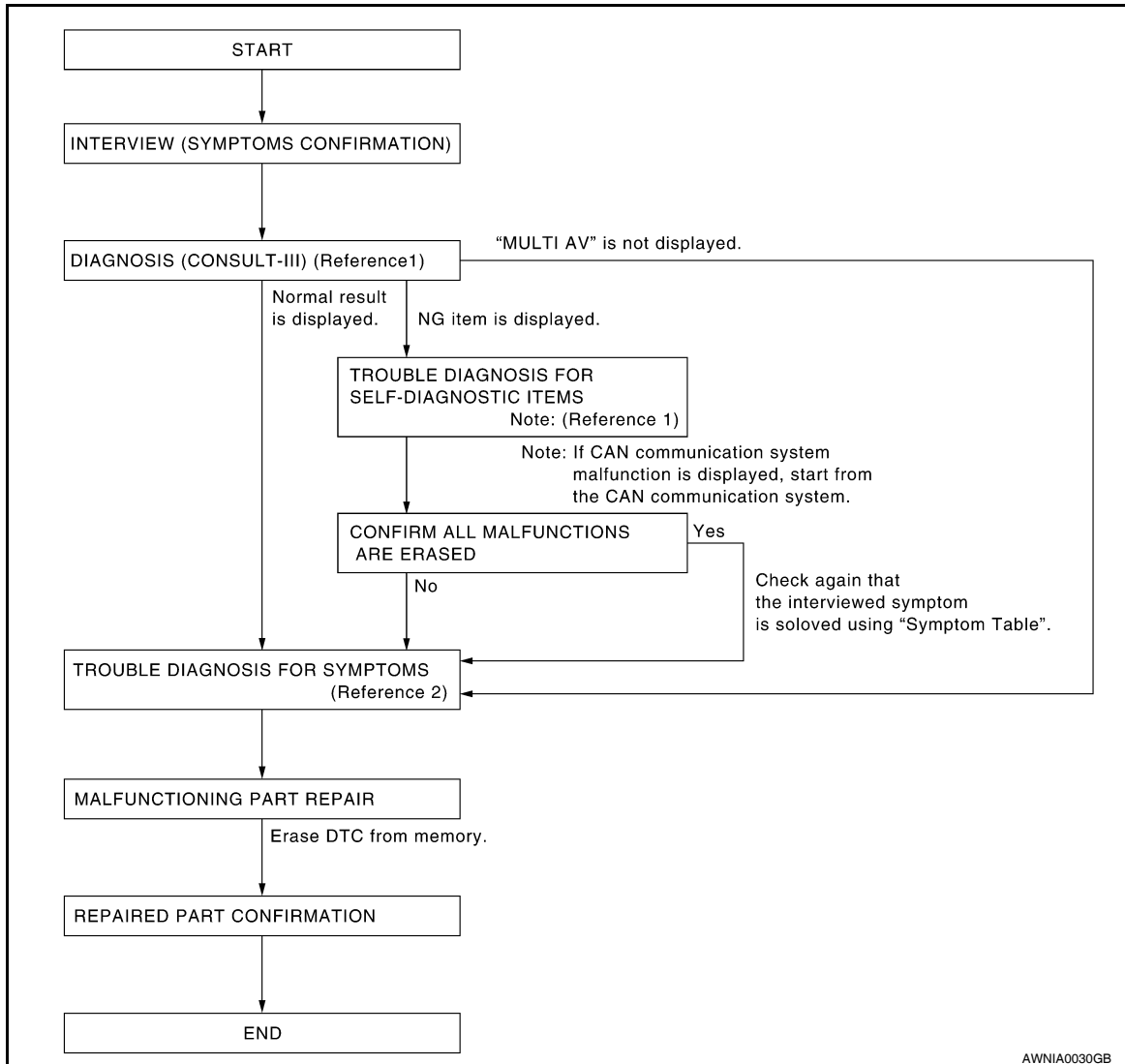

- Reference 1... Refer to [AV-341, "AV CONTROL UNIT : CONSULT-III Function"](#).
- Reference 2... Refer to [AV-447, "Symptom Table"](#).

#### DETAILED FLOW

##### 1. CHECK SYMPTOM

Check the malfunction symptoms by performing the following items.

- Interview the customer to obtain the malfunction information (conditions and environment when the malfunction occurred).
- Check the symptom.

>> GO TO 2

##### 2. SELF-DIAGNOSIS (CONSULT-III)

1. Connect CONSULT-III and perform "SELF-DIAGNOSIS" for "MULTI AV".  
**NOTE:**  
Skip to step 4 of the diagnosis procedure if "MULTI AV" is not displayed.
2. Check if any DTC No. is displayed in the self-diagnosis results.

# DIAGNOSIS AND REPAIR WORKFLOW

[BOSE AUDIO WITH NAVIGATION]

< BASIC INSPECTION >

Is any DTC displayed?

- YES >> GO TO 3
- NO >> GO TO 4

## 3. CHECK SELF-DIAGNOSIS RESULTS (CONSULT-III)

1. Check the DTC No. indicated in the self-diagnosis results.
2. Perform the relevant diagnosis referring to the DTC No. list. Refer to [AV-436, "DTC Index"](#).

### NOTE:

Start with the diagnosis for the CAN communication system if "CAN COMM CIRCUIT [U1000] or CONTROL UNIT (CAN) [U1010]" is displayed.

>> GO TO 5

## 4. PERFORM DIAGNOSIS BY SYMPTOM

Perform the relevant diagnosis referring to the diagnosis chart by symptom. Refer to [AV-447, "Symptom Table"](#).

>> GO TO 5

## 5. REPAIR OR REPLACE MALFUNCTIONING PARTS

Repair or replace the identified malfunctioning parts.

### NOTE:

Erase the stored self-diagnosis results after repairing or replacing the relevant components if any DTC No. has been indicated in the self-diagnosis results.

>> GO TO 6

## 6. CHECK AFTER REPAIR

1. Perform self-diagnosis for "MULTI AV" with CONSULT-III after repairing or replacing the malfunctioning parts.
2. Check if any DTC No. is displayed in the self-diagnosis results.

Is any DTC displayed?

- YES >> GO TO 3
- NO >> GO TO 7

## 7. FINAL CHECK

Perform the operation check to confirm that the malfunction symptom is solved or that any other symptoms are present.

Are any symptoms present?

- YES >> GO TO 4
- NO >> Inspection End.

A  
B  
C  
D  
E  
F  
G  
H  
I  
J  
K  
L  
M  
O  
P

AV

## FUNCTION DIAGNOSIS

### AUDIO SYSTEM

#### System Diagram

INFOID:000000005259496

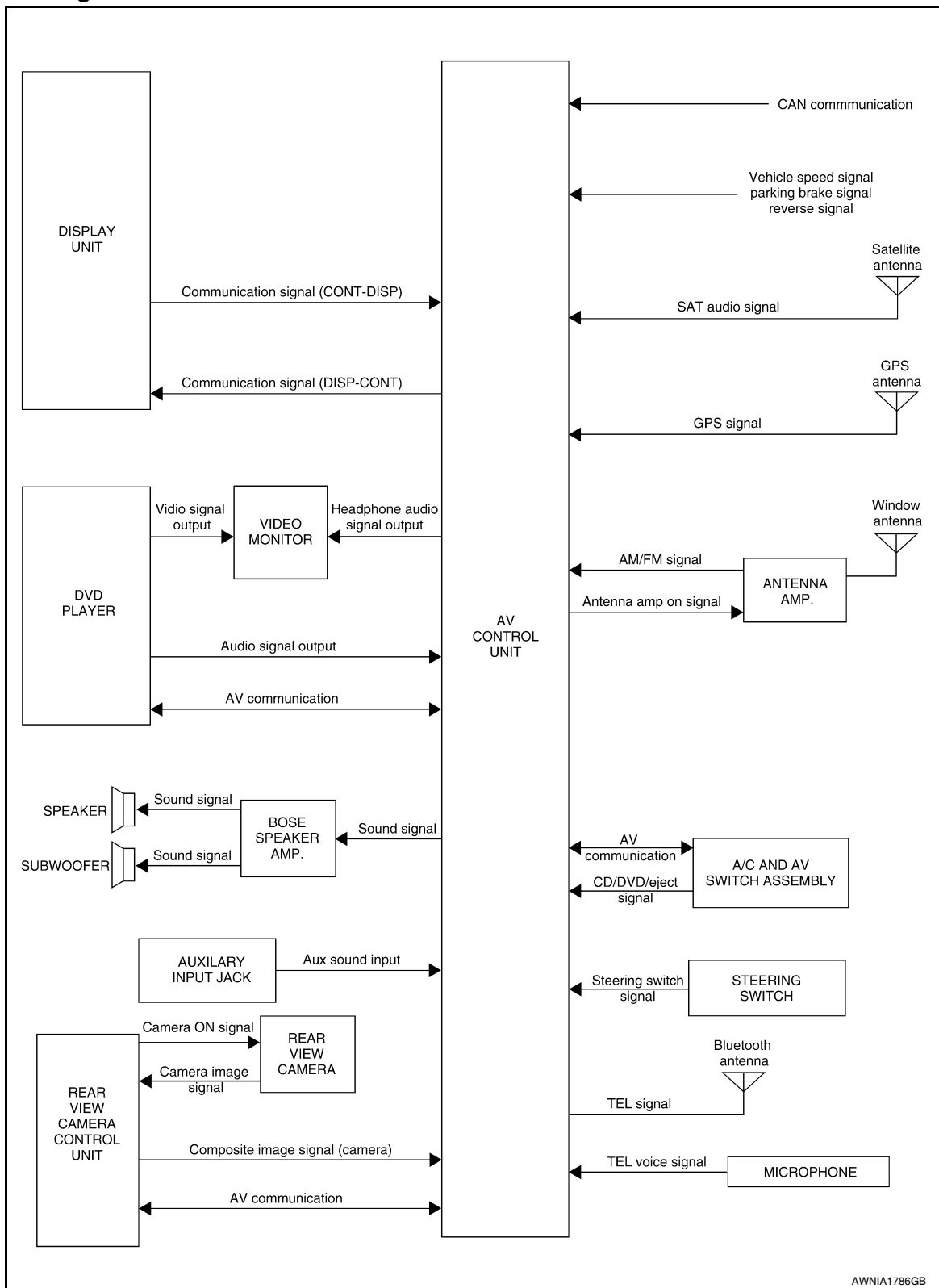

AWNIA1786GB

#### System Description

INFOID:000000005259497

### AUDIO SYSTEM



# AUDIO SYSTEM

[BOSE AUDIO WITH NAVIGATION]

## < FUNCTION DIAGNOSIS >

The audio system consists of the following components

- AV control unit
- Display unit
- BOSE speaker amp.
- Window antenna
- Steering wheel audio control switches
- A/C and AV switch assembly
- Front door speakers
- Front tweeters
- Rear door speakers
- Rear tweeters
- Subwoofer

When the audio system is on, radio signals are received by the window antenna. The AV control unit then sends audio signals to the BOSE speaker amp. The BOSE speaker amp. amplifies the audio signals before sending them to the front door speakers, front tweeters, rear door speakers, rear tweeters and the subwoofer. Refer to Owner's Manual for audio system operating instructions.

### SATELLITE RADIO SYSTEM

The satellite radio system consists of the following components

- Satellite antenna
- AV control unit

When the satellite radio system is on, radio signals are supplied to the AV control unit from the satellite antenna. The AV control unit then sends audio signals to the BOSE speaker amp. Refer to Owner's Manual for satellite radio system operating instructions.

### SPEED SENSITIVE VOLUME SYSTEM

Volume level of this system goes up and down automatically in proportion to the vehicle speed. The control level can be selected by the customer. Refer to Owner's Manual for operating instructions.

A  
B  
C  
D  
E  
F  
G  
H  
I  
J  
K  
L  
M  
O  
P

AV

# AUDIO SYSTEM

< FUNCTION DIAGNOSIS >

[BOSE AUDIO WITH NAVIGATION]

## Component Parts Location

INFOID:000000005259498

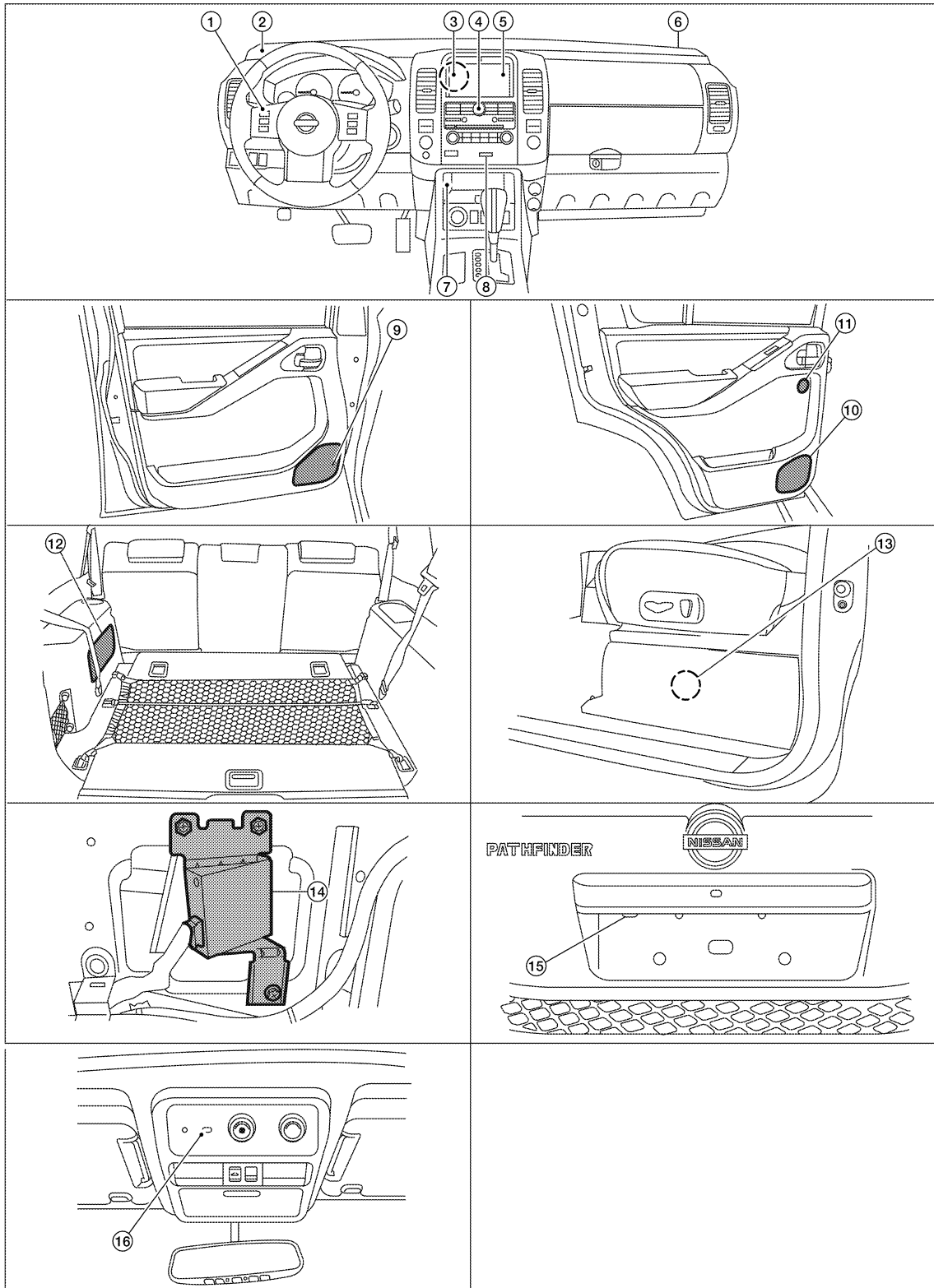

AWNIA1814ZZ

- |  |                          |  |
|--|--------------------------|--|
| 1. Steering wheel audio control switches | 2. Front tweeter LH M109 | 3. AV control unit M23, M37, M39, M44, M48, M71, M72 |
| 4. A/C and AV switch assembly M98        | 5. Display unit M92      | 6. Front tweeter RH M111                             |

# AUDIO SYSTEM

< FUNCTION DIAGNOSIS >

[BOSE AUDIO WITH NAVIGATION]

- |   |   |  |
|---|---|--|
| 7. Aux. jack M85  | 8. Compact Flash insert slot  | 9. Front door speaker<br>LH D12<br>RH D112 |
| 10. Rear door speaker<br>LH D207<br>RH D307               | 11. Rear tweeter<br>LH D208<br>RH D308                                  | 12. Subwoofer B72                          |
| 13. BOSE speaker amp B74, B75 (located under driver seat) | 14. Rear camera control unit B176 (located behind luggage finisher RHL) | 15. Rear view camera D551                  |
| 16. Microphone R8   |   |  |

A  
B  
C

## Component Description

INFOID:000000005259499

Part name	Description
AV control unit	Controls audio system and satellite radio system functions
Display unit	<ul style="list-style-type: none"> <li>• Touch screen controls all audio and A/C operations</li> <li>• Displays all audio and climate control related information</li> </ul>
BOSE speaker amp.	Receives power (amp ON) and audio signals from AV control unit and outputs audio signals to each speaker.
Steering wheel audio control switches	<ul style="list-style-type: none"> <li>• Audio operation can be operated</li> <li>• Steering wheel audio control switch signal is output to AV control unit</li> </ul>
Front door speakers	<ul style="list-style-type: none"> <li>• Outputs audio signal from BOSE speaker amp.</li> <li>• Outputs high, mid and low range sounds</li> </ul>
Front tweeters	<ul style="list-style-type: none"> <li>• Outputs audio signal from BOSE speaker amp.</li> <li>• Outputs high range sounds</li> </ul>
Rear door speakers	<ul style="list-style-type: none"> <li>• Outputs audio signal from BOSE speaker amp.</li> <li>• Outputs high, mid and low range sounds</li> </ul>
Rear tweeters	<ul style="list-style-type: none"> <li>• Outputs audio signal from BOSE speaker amp.</li> <li>• Outputs high range sounds</li> </ul>
Subwoofer	<ul style="list-style-type: none"> <li>• Outputs audio signal from BOSE speaker amp.</li> <li>• Outputs low range sounds</li> </ul>
Satellite antenna	Audio signal (satellite radio) is received and output to AV control unit.

D  
E  
F  
G  
H  
I  
J  
K

L  
M

AV

O  
P

## NAVIGATION SYSTEM

### System Diagram

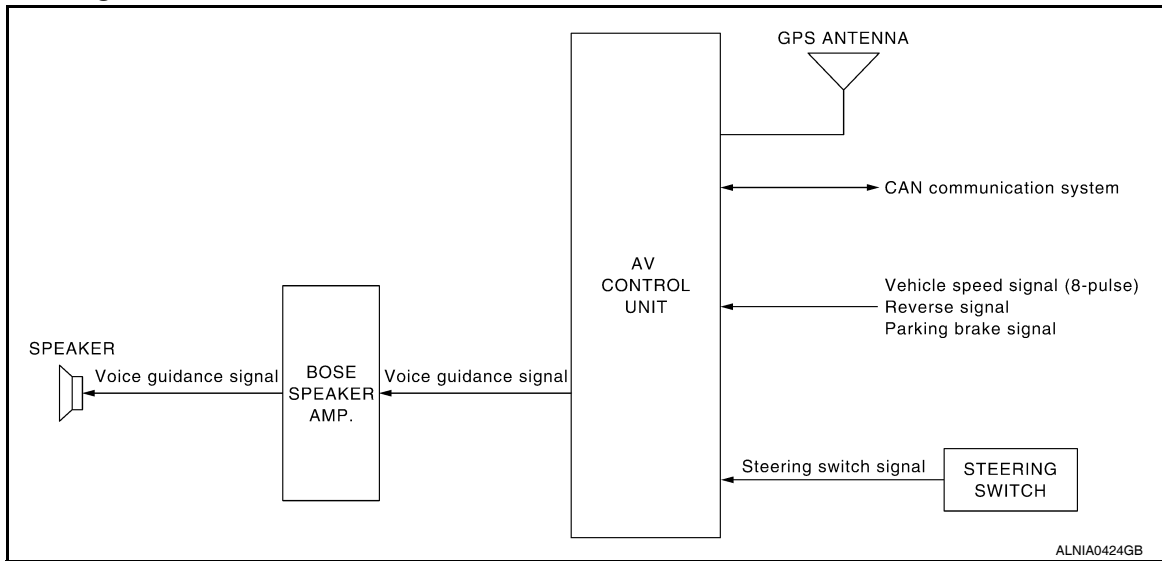

### System Description

INFOID:000000005259501

**NOTE:**

Refer to NAVI System Owner's Manual for system operation.

The navigation system periodically calculates the vehicle's current position according to the following three signals: Travel distance of the vehicle as determined by the vehicle speed sensor, turning angle of the vehicle as determined by the gyroscope (angular velocity sensor), and the direction of vehicle travel as determined by the GPS antenna (GPS information).

The current position of the vehicle is then identified by comparing the calculated vehicle position with map data read from the map data, which is stored in the hard disk drive (HDD)(map-matching), and indicated on the screen with a current-location mark.

By comparing the vehicle position detection results found by the GPS and by map-matching, more accurate vehicle position data can be used.

The current vehicle position will be calculated by detecting the distance the vehicle moved from the previous calculation point and its direction.

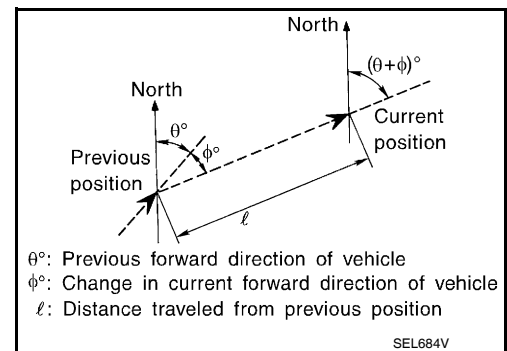

### TRAVEL DISTANCE

Travel distance calculations are based on the vehicle speed input signal. Therefore, the calculation may become incorrect as the tires wear down. To prevent this, an automatic distance fine adjustment function has been adopted.

### TRAVEL DIRECTION

Change in the travel direction of the vehicle is calculated by a gyroscope (angular velocity sensor) and a GPS antenna (GPS information). As the gyroscope and GPS antenna have both merit and demerit, input signals from them are prioritized in each situation. However, this order of priority may change in accordance with more detailed travel conditions so that the travel direction is detected more accurately.

# NAVIGATION SYSTEM

< FUNCTION DIAGNOSIS >

[BOSE AUDIO WITH NAVIGATION]

Type	Advantage	Disadvantage
Gyroscope (angular velocity sensor)	<ul style="list-style-type: none"> <li>Can detect the vehicle's turning angle quite accurately.</li> </ul>	<ul style="list-style-type: none"> <li>Direction errors may accumulate when the vehicle is driven for long distances without stopping.</li> </ul>
GPS antenna (GPS information)	<ul style="list-style-type: none"> <li>Can detect the vehicle's travel direction (North/South/East/West).</li> </ul>	<ul style="list-style-type: none"> <li>Correct direction cannot be detected when the vehicle speed is low.</li> </ul>

## MAP-MATCHING

Map-matching is a function that repositions the vehicle on the road map when a new location is judged to be the most accurate. This is done by comparing the current vehicle position, calculated by the method described in the position detection principle, with the road map data around the vehicle, read from the map data stored on the HDD.

Therefore, the vehicle position may not be corrected after the vehicle is driven over a certain distance or time in which GPS information is hard to receive. In this case, the current-location mark on the display must be corrected manually.

### CAUTION:

**The road map data is based on data stored on the HDD.**

- In map-matching, alternative routes to reach the destination will be shown and prioritized, after the road on which the vehicle is currently driven has been judged and the current-location mark has been repositioned.

If there is an error in distance and/or direction, the alternative routes will be shown in different order of priority, and the wrong road can be avoided.

If two roads are running in parallel, they are of the same priority. Therefore, the current-location mark may appear on either of them alternately, depending on maneuvering of the steering wheel and configuration of the road.

- Map-matching does not function correctly when the road on which the vehicle is driving is new and not recorded on the HDD, or when the road pattern stored in the map data and the actual road pattern are different due to repair.

When driving on a road not present in the map, the map-matching function may find another road and position the current-location mark on it. Then, when the correct road is detected, the current-location mark may leap to it.

- Effective range for comparing the vehicle position and travel direction calculated by the distance and direction with the road data read from the HDD is limited. Therefore, when there is an excessive gap between the current vehicle position and the position on the map, correction by map-matching is not possible.

## GPS (GLOBAL POSITIONING SYSTEM)

GPS (Global Positioning System) has been developed and controlled by the US Department of Defense. The system utilizes GPS satellite (NAVSTAR), sending out radio waves while flying on an orbit around the earth at the height of approx. 21,000 km (13,000 miles). The GPS receiver calculates the vehicle's position in three dimensions (latitude/longitude/altitude) according to the time lag of the radio waves received from four or more GPS satellites (three-dimensional positioning). If radio waves were received only from three GPS satellites, the GPS receiver calculates the vehicle's position in two dimensions (latitude/longitude), utilizing the altitude data calculated previously by using radio waves from four or more GPS satellites (two-dimensional positioning).

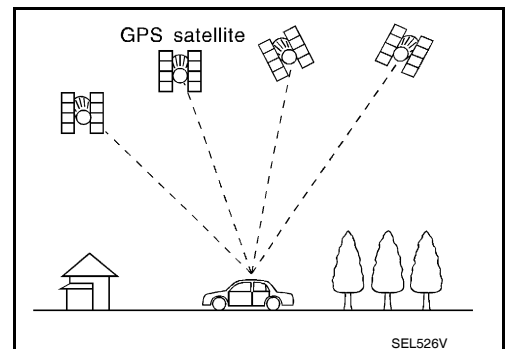
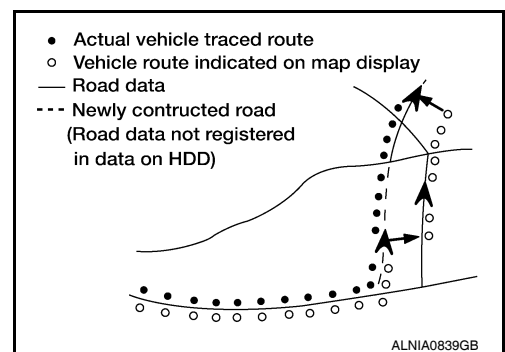
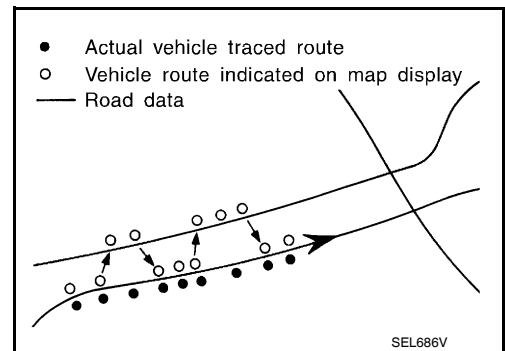
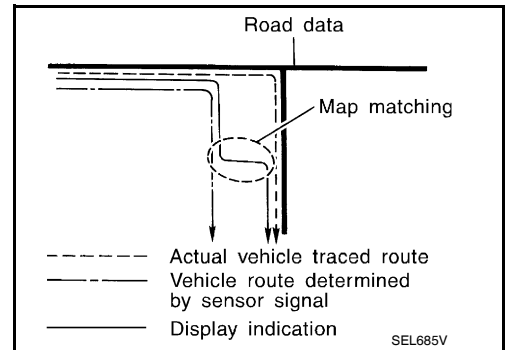

## NAVIGATION SYSTEM

< FUNCTION DIAGNOSIS >

[BOSE AUDIO WITH NAVIGATION]

---

Accuracy of the GPS will deteriorate under the following conditions.

- In two-dimensional positioning, the GPS accuracy will deteriorate when the altitude of the vehicle position changes.
- There may be an error of approximately 10 m (30 ft.) in position detected by three-dimensional positioning, which is more accurate than two-dimensional positioning. The accuracy can be even lower depending on the arrangement of the GPS satellites utilized for the positioning.
- Position detection is not possible when the vehicle is in an area where radio waves from the GPS satellite do not reach, such as in a tunnel, parking lot in a building, and under an elevated highway. Radio waves from the GPS satellites may not be received when some object is located over the GPS antenna.
- Position correction by GPS is not available while the vehicle is stopped.

# NAVIGATION SYSTEM

< FUNCTION DIAGNOSIS >

[BOSE AUDIO WITH NAVIGATION]

## Component Parts Location

INFOID:000000005259502

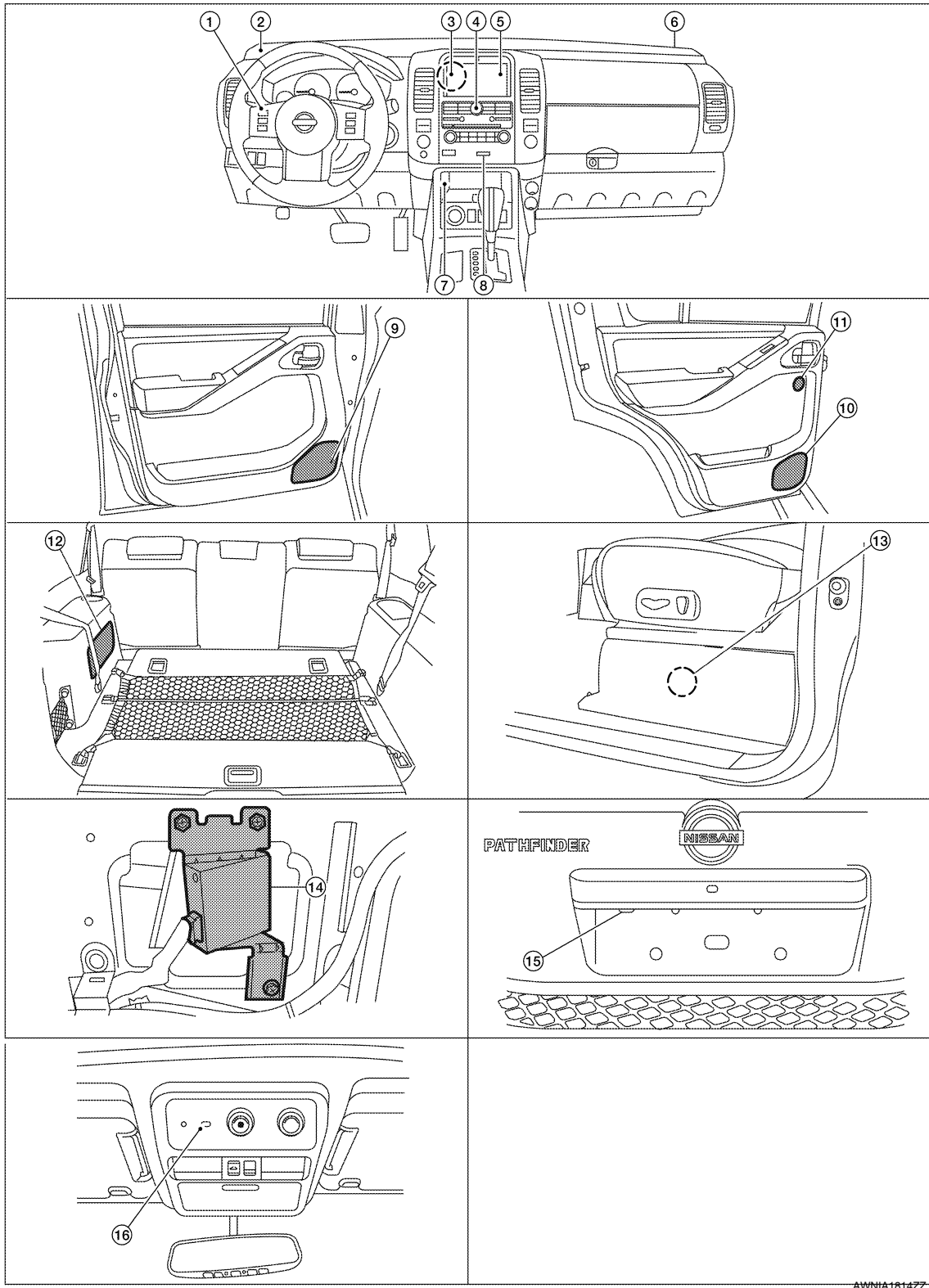

A  
B  
C  
D  
E  
F  
G  
H  
I  
J  
K  
L  
M  
AV  
O  
P

- |  |                          |  |
|--|--------------------------|--|
| 1. Steering wheel audio control switches | 2. Front tweeter LH M109 | 3. AV control unit M23, M37, M39, M44, M48, M71, M72 |
| 4. A/C and AV switch assembly M98        | 5. Display unit M92      | 6. Front tweeter RH M111                             |

AWNIA1814ZZ

# NAVIGATION SYSTEM

< FUNCTION DIAGNOSIS >

[BOSE AUDIO WITH NAVIGATION]

- |   |   |  |
|---|---|--|
| 7. Aux. jack M85  | 8. Compact Flash insert slot  | 9. Front door speaker<br>LH D12<br>RH D112 |
| 10. Rear door speaker<br>LH D207<br>RH D307               | 11. Rear tweeter<br>LH D208<br>RH D308                                  | 12. Subwoofer B72                          |
| 13. BOSE speaker amp B74, B75 (located under driver seat) | 14. Rear camera control unit B176 (located behind luggage finisher RHI) | 15. Rear view camera D551                  |
| 16. Microphone R8   |   |  |

## Component Description

INFOID:000000005259503

Part name	Description
AV control unit	<ul style="list-style-type: none"><li>Controls each operation of the navigation system</li><li>DVD-ROM drive is built in</li><li>Voice guidance signal is output to BOSE speaker amp.</li></ul>
BOSE speaker amp.	Voice guidance signal is input from AV control unit, and it is output to speakers.
Tweeter	Voice guidance signal from BOSE speaker amp. is output.
Steering wheel audio control switches	<ul style="list-style-type: none"><li>Each operation of navigation system can be performed</li><li>Switch operating signal is output to AV control unit</li></ul>
Microphone	Sends voice signals to AV control unit
GPS antenna	GPS signal is received and is output to AV control unit.



# REAR VIEW MONITOR SYSTEM

< FUNCTION DIAGNOSIS >

[BOSE AUDIO WITH NAVIGATION]

## REAR VIEW MONITOR SYSTEM

### System Diagram

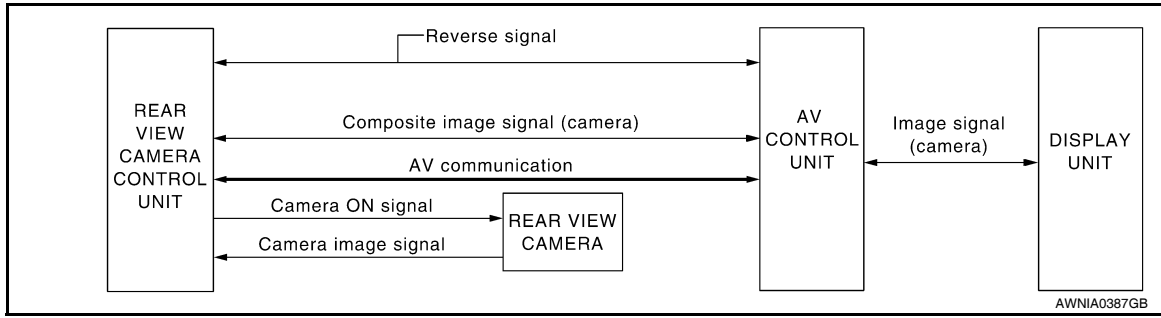

### System Description

INFOID:000000005259505

When the selector is in the R position, the display shows a view to the rear of the vehicle. Lines which indicate the vehicle clearance and distances are also displayed.

#### AV COMMUNICATION LINE

The rear view camera control unit is connected to the audio control unit using an AV communication line. This line is used to transmit and receive data.

A  
B  
C  
D  
E  
F  
G  
H  
I  
J  
K  
L  
M  
O  
P

AV

# REAR VIEW MONITOR SYSTEM

< FUNCTION DIAGNOSIS >

[BOSE AUDIO WITH NAVIGATION]

## Component Parts Location

INFOID:000000005259506

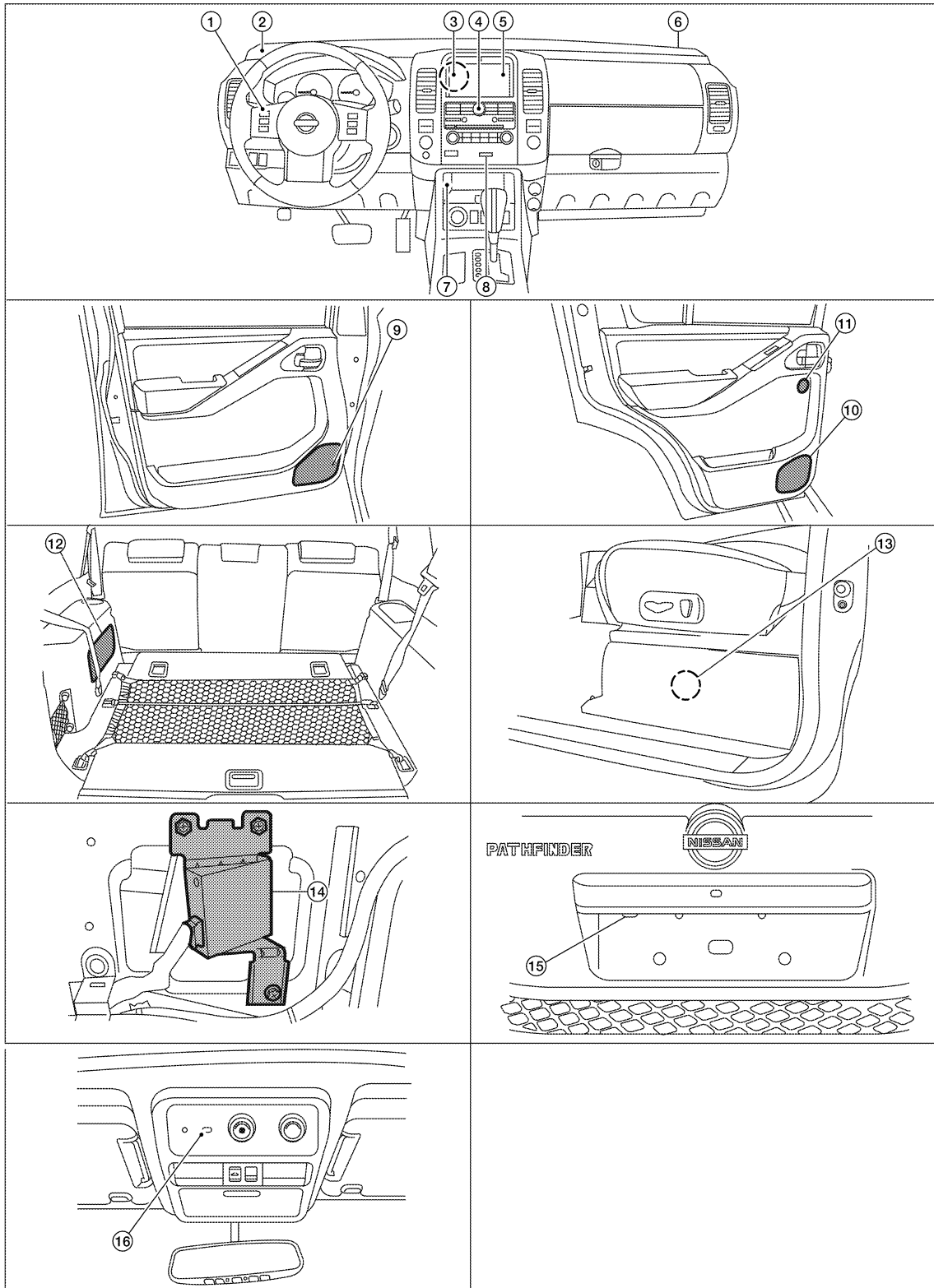

AWNIA1814ZZ

- |  |                          |  |
|--|--------------------------|--|
| 1. Steering wheel audio control switches | 2. Front tweeter LH M109 | 3. AV control unit M23, M37, M39, M44, M48, M71, M72 |
| 4. A/C and AV switch assembly M98        | 5. Display unit M92      | 6. Front tweeter RH M111                             |

# REAR VIEW MONITOR SYSTEM

< FUNCTION DIAGNOSIS >

[BOSE AUDIO WITH NAVIGATION]

- |   |   |  |
|---|---|--|
| 7. Aux. jack M85  | 8. Compact Flash insert slot  | 9. Front door speaker<br>LH D12<br>RH D112 |
| 10. Rear door speaker<br>LH D207<br>RH D307               | 11. Rear tweeter<br>LH D208<br>RH D308                                  | 12. Subwoofer B72                          |
| 13. BOSE speaker amp B74, B75 (located under driver seat) | 14. Rear camera control unit B176 (located behind luggage finisher RHL) | 15. Rear view camera D551                  |
| 16. Microphone R8   |   |  |

A  
B  
C

## Component Description

INFOID:000000005259507

D

Part name	Description
AV control unit	Camera image signal is sent from rear view camera control unit
Rear view camera control unit	<ul style="list-style-type: none"> <li>Receives reverse signal from back-up lamp relay</li> <li>Receives rear view camera image signal</li> <li>Sends camera ON signal to rear view camera</li> <li>Sends image signal to AV control unit</li> </ul>
Rear view camera	<ul style="list-style-type: none"> <li>Receives camera ON signal from rear view camera control unit</li> <li>Sends image signal to rear view camera control unit</li> </ul>

E

F

G

H

I

J

K

L

M

AV

O

P

## DVD PLAYER

### System Diagram

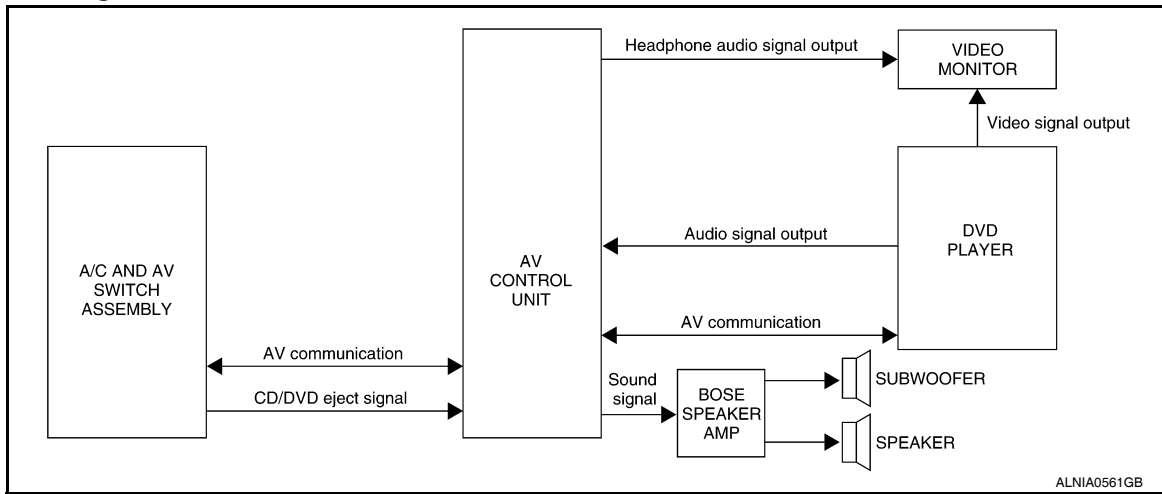

### System Description

INFOID:000000005259509

The DVD entertainment system consists of the following components

- AV control unit
- Display unit
- DVD player
- Video monitor
- A/C and AV switch assembly
- Steering wheel audio control switches
- BOSE speaker amp.
- Front tweeters
- Front door speakers
- Rear tweeters
- Rear door speakers
- Subwoofer

When the DVD entertainment system is on, video signals are sent from the DVD player to the video monitor. Audio signals are sent to the AV control unit. Audio signals can be directed through wireless infrared headphones or through the BOSE speaker amp. to the vehicle speakers. Refer to the Owner's Manual for complete DVD entertainment system operating instructions.

# DVD PLAYER

< FUNCTION DIAGNOSIS >

[BOSE AUDIO WITH NAVIGATION]

## Component Parts Location

INFOID:000000005259510

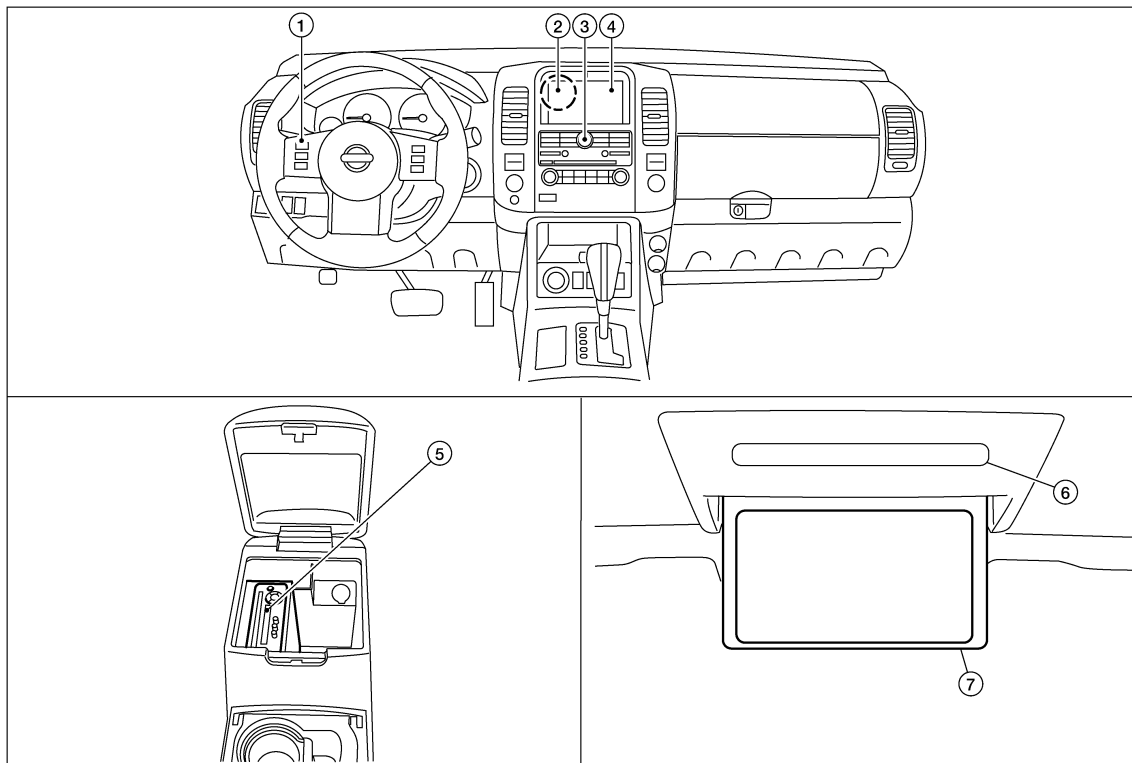

ALNIA0558GB

- |  |  |  |
|--|--|--|
| 1. Steering wheel audio control switches | 2. AV control unit M23, M37, M39, M44, M48, M71, M72 | 3. A/C and AV switch assembly M98  |
| 4. Display unit M92                      | 5. DVD player M205 (located in center console)       | 6. Infrared headphone and remote receiver/transmitter (part of video monitor assembly) |
| 7. Video monitor B76                     |  |  |

## Component Description

INFOID:000000005259511

Part name	Description
DVD player	<ul style="list-style-type: none"> <li>Outputs DVD video to video monitor</li> <li>Outputs DVD audio to the AV control unit</li> </ul>
Video monitor	<ul style="list-style-type: none"> <li>Receives and displays the DVD video signal</li> </ul>
AV control unit	<ul style="list-style-type: none"> <li>Controls audio system and DVD entertainment system functions</li> </ul>
BOSE speaker amp.	<ul style="list-style-type: none"> <li>Receives audio signals from the AV control unit</li> <li>Outputs amplified audio signals to the speakers</li> </ul>
A/C and AV switch assembly	<ul style="list-style-type: none"> <li>All audio and A/C operations can be operated</li> <li>Switch signal is output to the AV control unit and A/C auto amp</li> </ul>
Steering wheel audio control switches	<ul style="list-style-type: none"> <li>Audio operation can be operated</li> <li>Steering switch signal (operation signal) is output to AV control unit</li> </ul>
Front door speakers	<ul style="list-style-type: none"> <li>Outputs audio signal from BOSE speaker amp.</li> <li>Outputs high, mid and low range sounds</li> </ul>
Front and rear tweeters	<ul style="list-style-type: none"> <li>Outputs audio signal from BOSE speaker amp.</li> <li>Outputs high range sounds</li> </ul>

## DVD PLAYER

< FUNCTION DIAGNOSIS >

[BOSE AUDIO WITH NAVIGATION]

Part name	Description
Rear door speakers	<ul style="list-style-type: none"><li>• Outputs audio signal from BOSE speaker amp.</li><li>• Outputs high, mid and low range sounds</li></ul>
Subwoofer	<ul style="list-style-type: none"><li>• Outputs audio signal from BOSE speaker amp.</li><li>• Outputs low range sounds</li></ul>

# HANDS-FREE PHONE SYSTEM

< FUNCTION DIAGNOSIS >

[BOSE AUDIO WITH NAVIGATION]

## HANDS-FREE PHONE SYSTEM

### System Diagram

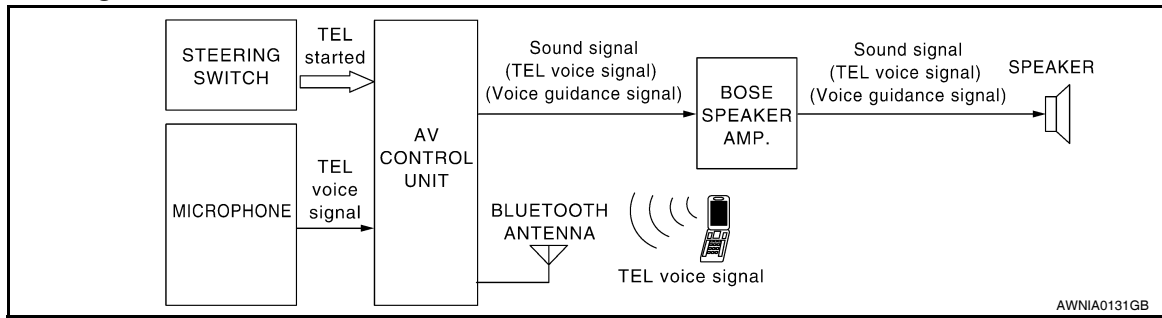

### System Description

Refer to the Owner's Manual for Bluetooth telephone system operating instructions.

#### NOTE:

Cellular telephones must have their wireless connection set up (paired) before using the Bluetooth telephone system.

Bluetooth telephone system allows users who have a Bluetooth equipped cellular telephone to make a wireless connection between their cellular telephone and the AV control unit. Hands-free cellular telephone calls can be sent and received. Personal memos can be created using the Nissan Voice Recognition system. Some Bluetooth cellular telephones may not be recognized by the AV control unit. When a cellular telephone or the AV control unit is replaced, the telephone must be paired with the AV control unit. Different cellular telephones may have different pairing procedures. Refer to the cellular telephone operating manual and the vehicle Owner's Manual for more information.

#### AV CONTROL UNIT

When the ignition switch is turned to ACC or ON, the AV control unit will power up. During power up, the Bluetooth feature is initialized and performs various self checks. Initialization may take up to 10 seconds. If a phone is present in the vehicle and paired with the AV control unit, Nissan Voice Recognition will then become active. Bluetooth telephone functions can be turned off using the Nissan Voice Recognition system.

#### STEERING WHEEL AUDIO CONTROL SWITCHES

When buttons on the steering wheel audio control switch are pushed, the resistance in steering wheel audio control switch circuit changes depending on which button is pushed. The AV control unit uses this signal to perform various functions while navigating through the voice recognition system.

The following functions can be performed using the steering wheel audio control switch:

- Initiate Self Diagnosis of the Bluetooth telephone system
- Start a voice recognition session
- Answer and end telephone calls
- Adjust the volume of calls
- Record memos

#### MICROPHONE

The microphone is located in the roof console assembly. The microphone sends a signal to the AV control unit. The microphone can be actively tested during self-diagnosis.

# HANDS-FREE PHONE SYSTEM

< FUNCTION DIAGNOSIS >

[BOSE AUDIO WITH NAVIGATION]

## Component Parts Location

INFOID:000000005259514

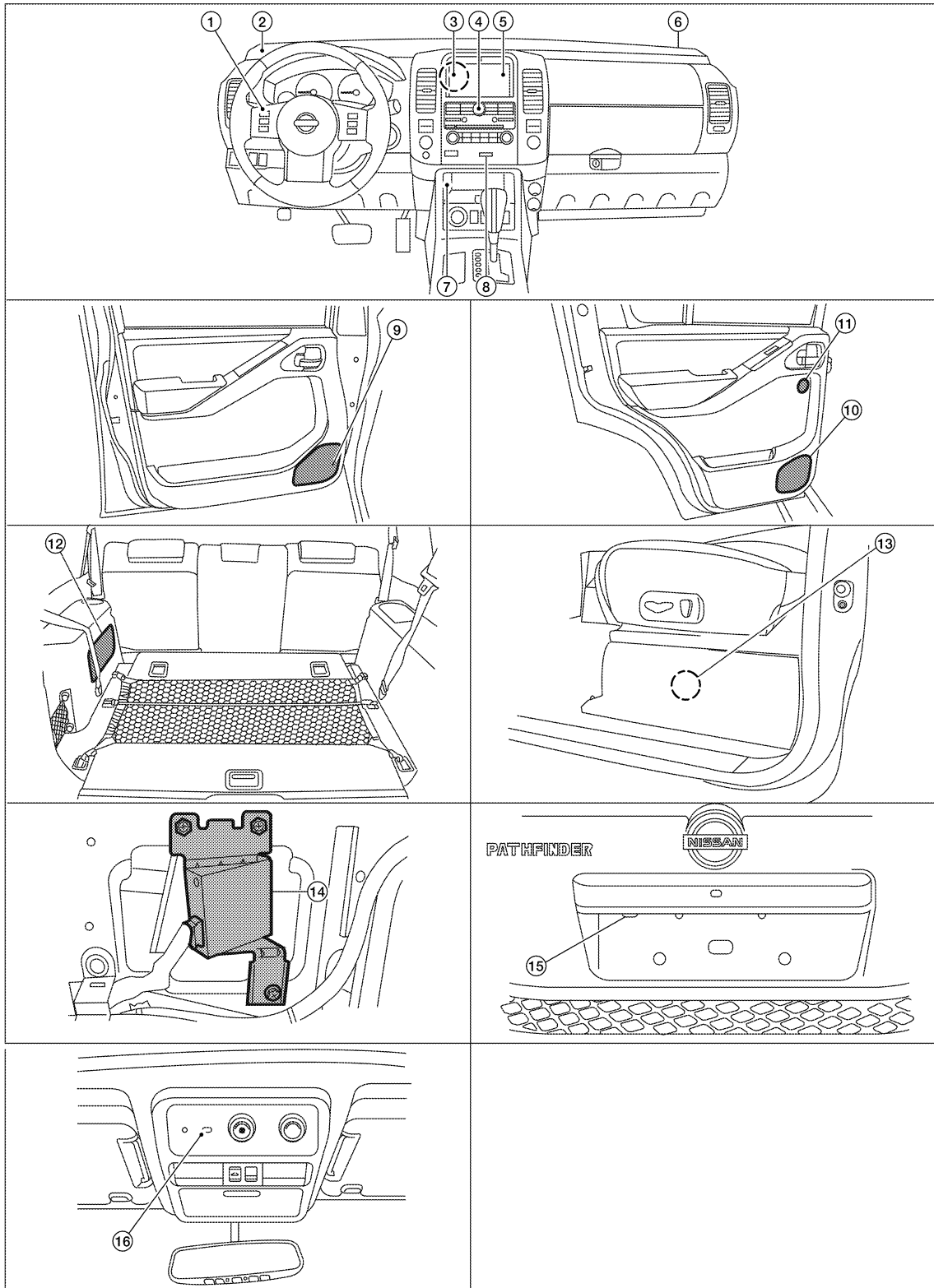

AWNIA1814ZZ

- |  |                          |  |
|--|--------------------------|--|
| 1. Steering wheel audio control switches | 2. Front tweeter LH M109 | 3. AV control unit M23, M37, M39, M44, M48, M71, M72 |
| 4. A/C and AV switch assembly M98        | 5. Display unit M92      | 6. Front tweeter RH M111                             |



# HANDS-FREE PHONE SYSTEM

< FUNCTION DIAGNOSIS >

[BOSE AUDIO WITH NAVIGATION]

- |   |   |  |
|---|---|--|
| 7. Aux. jack M85  | 8. Compact Flash insert slot  | 9. Front door speaker<br>LH D12<br>RH D112 |
| 10. Rear door speaker<br>LH D207<br>RH D307               | 11. Rear tweeter<br>LH D208<br>RH D308                                  | 12. Subwoofer B72                          |
| 13. BOSE speaker amp B74, B75 (located under driver seat) | 14. Rear camera control unit B176 (located behind luggage finisher RHL) | 15. Rear view camera D551                  |
| 16. Microphone R8   |   |  |

A  
B  
C

## Component Description

INFOID:000000005259515

D

Part name	Description
AV control unit	<ul style="list-style-type: none"> <li>Receives telephone voice signal from Antenna and Microphone</li> <li>Sends telephone voice and voice guidance signals to the speakers</li> </ul>
BOSE speaker amp.	<ul style="list-style-type: none"> <li>Receives audio signals from the AV control unit</li> <li>Outputs amplified audio signals to the speakers.</li> </ul>
Front door speaker	Receives telephone voice and voice guidance signals from the AV control unit through the BOSE speaker amp.
Front tweeter	
Steering wheel audio control switches	<ul style="list-style-type: none"> <li>Start a voice recognition session</li> <li>Answer and end telephone calls</li> <li>Adjust the volume level</li> </ul>
Microphone	Sends voice signals to Bluetooth control unit
Bluetooth antenna	Sends telephone voice signal to Bluetooth control unit

E  
F  
G  
H

I

J

K

L

M

AV

O

P

# DIAGNOSIS SYSTEM (AV CONTROL UNIT)

< FUNCTION DIAGNOSIS >

[BOSE AUDIO WITH NAVIGATION]

## DIAGNOSIS SYSTEM (AV CONTROL UNIT)

### AV CONTROL UNIT

#### AV CONTROL UNIT : Diagnosis Description

INFOID:000000005259516

#### DESCRIPTION

- Diagnosis function consists of the "Self-Diagnosis" mode performed automatically and the "Confirmation/Adjustment" mode operated manually.
- "Self-Diagnosis" mode checks for connections between the units constituting this system, analyzes each individual unit at the same time, and displays the results on the LCD screen.
- "Confirmation/Adjustment" mode is used to perform trouble diagnosis that requires operation and judgment by an operator (trouble that cannot be automatically judged by the system), to check/change the set value, and to display the error history of the AV control unit.

#### DIAGNOSIS ITEM

Mode	Description
Self-diagnosis	<ul style="list-style-type: none"><li>• AV control unit diagnosis</li><li>• Analyzes connection between the AV control unit, front display, switches, DVD deck, GPS antenna, rear view camera control unit and SAT antenna.</li></ul>

# DIAGNOSIS SYSTEM (AV CONTROL UNIT)

< FUNCTION DIAGNOSIS >

[BOSE AUDIO WITH NAVIGATION]

Mode		Description	
CONFIRMATION/ ADJUSTMENT	Display diagnosis	Color spectrum bar	Color tone of the screen can be checked by the display of a color bar.
		Gradation bar	Shading of the screen can be checked by the display of a gray scale.
		Touch panel	<ul style="list-style-type: none"> <li>• Touch panel calibration</li> <li>• Touch panel response check</li> </ul>
	Vehicle signals		The following vehicle signals are analyzed: Vehicle speed signal, parking brake signal, light signal, ignition switch signal, and reverse signal.
	Speaker test		Connection can be checked by sending a test tone to each speaker.
	Navigation	Steering angle adjustment	Confirm/adjust the steering angle when there is a difference between the displayed vehicle mark turning angle and actual.
		Speed calibration	Confirm/adjust the speed calibration when there is a difference between the displayed vehicle mark location and actual.
		XM SAT subscription status	Check the subscription status of the XM NAV Traffic subscription.
	Error history		Diagnosis results previously stored in the memory are displayed in this mode.
	Synchronize FES clock		Turns FES (Family Entertainment System) clock synchronization function ON/OFF.
	Vehicle CAN diagnosis		The transmitting/receiving of CAN communication can be monitored.
	AV COMM diagnosis		The transmitting/receiving of AV communication can be monitored.
	Handsfree phone	Handsfree volume adjustment	Adjust handsfree volume (low, medium, high).
		Voice microphone test	Test microphone operation.
		Delete handsfree memory	Erase handsfree system memory.
	Bluetooth	Confirm/Change passkey	Confirm and change the Bluetooth passkey
		Confirm/Change device name	Confirm and change a device name stored in Bluetooth.
	SAT	Change channel	Any necessary channels required to receive traffic information from the satellite radio system can be set.
		Change application ID	Any application ID's required to receive traffic information from the satellite radio system can be set.
		Diag	Not used.
Delete connection log		Erase the error history and connection history of the unit.	
Initialize settings		All audio settings are reset to default levels.	

## OPERATION PROCEDURE

1. Start the engine.
2. Turn the audio system off.
3. While pressing the "SETTING" button, turn the volume control dial counterclockwise 30 clicks or more.

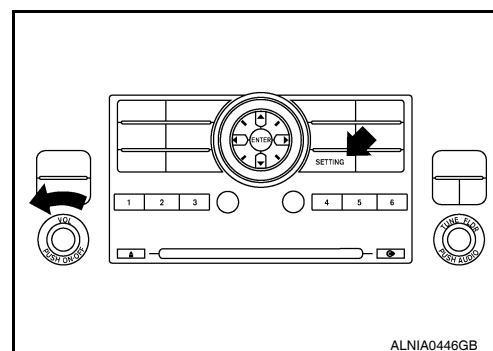

# DIAGNOSIS SYSTEM (AV CONTROL UNIT)

[BOSE AUDIO WITH NAVIGATION]

< FUNCTION DIAGNOSIS >

- The initial trouble diagnosis screen will be displayed, and items “Self-Diagnosis” and “Confirmation/Adjustment” can be selected.

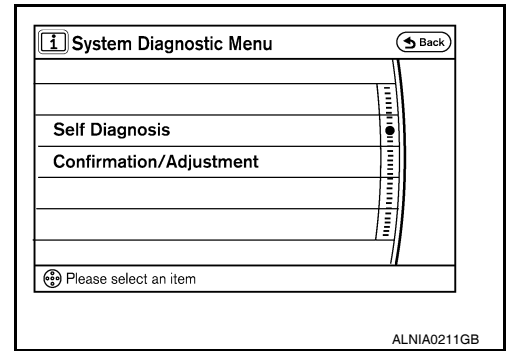

## SELF-DIAGNOSIS

- Perform self-diagnosis by selecting “Self-Diagnosis”.
  - Self-diagnosis subdivision screen is displayed, and the self-diagnosis mode starts.
  - A bar graph visible on the center of the self-diagnosis subdivision screen indicates progress of the trouble diagnosis.

**NOTE:**

Self-diagnosis requires approximately 10 seconds to complete.

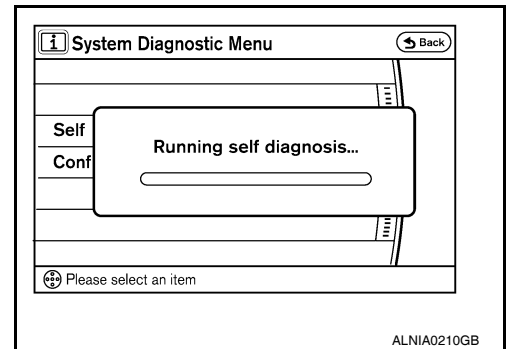

- Diagnosis results are displayed after the self-diagnosis is completed. The unit names and the connection lines are color-coded according to the diagnostic results.

Diagnosis results	Unit	Connection line
Normal	Green	Green
Connection malfunction	Gray	Yellow
Unit malfunction <sup>Note</sup>	Red	Green

Note:

- Only the AV control unit is displayed in red.
- If multiple malfunctions occur at the same time for a single unit, the screen switch colors are determined according to the following order of priority: red > yellow > gray.

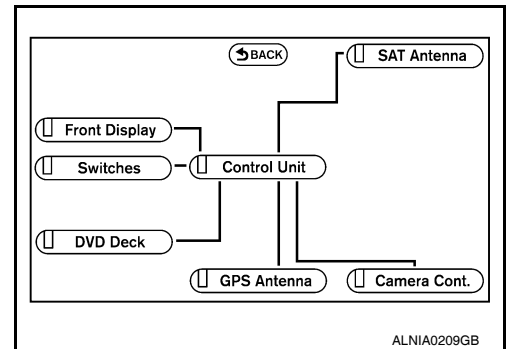

- Select a component on the “Self-Diagnosis” screen and comments for the diagnosis results will be shown.

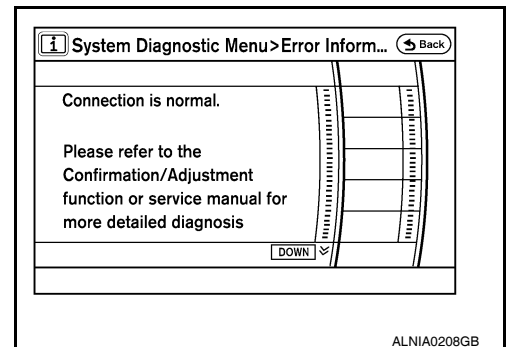

## Self-Diagnosis Results

# DIAGNOSIS SYSTEM (AV CONTROL UNIT)

< FUNCTION DIAGNOSIS >

[BOSE AUDIO WITH NAVIGATION]

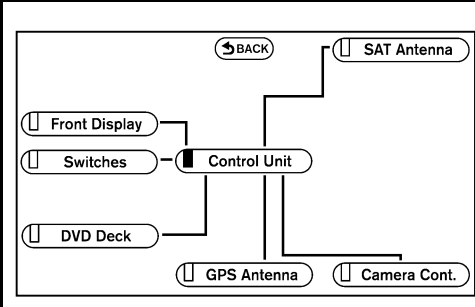
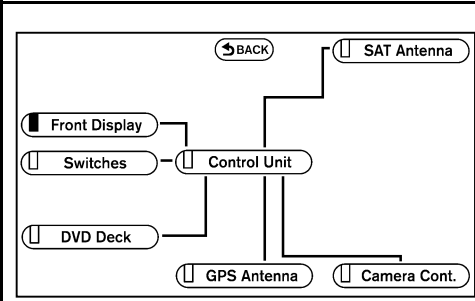
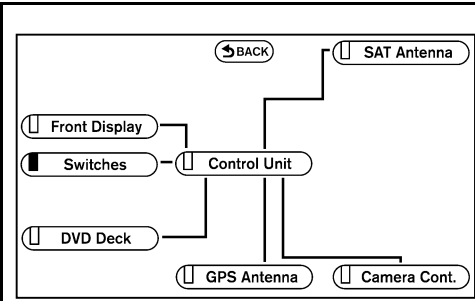
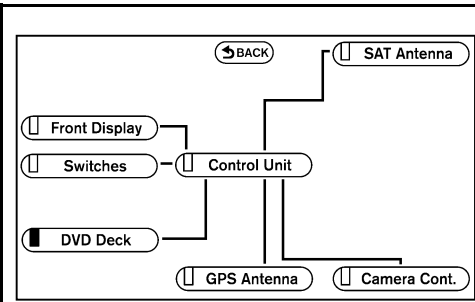
Area with yellow connection lines	Description	Possible malfunction location / Action to take
 <p>ALNIA0214GB</p>	<p>AV control unit malfunction is detected</p>	<p>Replace the AV control unit. Refer to <a href="#">AV-289. "Removal and Installation"</a>.</p>
 <p>ALNIA0207GB</p>	<p>Poor connection is detected for the display unit</p>	<ul style="list-style-type: none"> <li>• Harness or connector</li> <li>• AV control unit</li> <li>• Display unit</li> </ul>
 <p>ALNIA0212GB</p>	<p>Switch malfunction is detected</p>	<p>Perform A/C and AV switch assembly diagnostics. Refer to <a href="#">AV-343. "A/C AND AV SWITCH ASSEMBLY : Component Function Check"</a></p>
 <p>ALNIA0213GB</p>	<p>Poor connection is detected for the DVD player.</p>	<ul style="list-style-type: none"> <li>• Harness or connector</li> <li>• AV control unit</li> <li>• DVD player</li> </ul>

A  
B  
C  
D  
E  
F  
G  
H  
I  
J  
K  
L  
M  
O  
P

AV

# DIAGNOSIS SYSTEM (AV CONTROL UNIT)

< FUNCTION DIAGNOSIS >

[BOSE AUDIO WITH NAVIGATION]

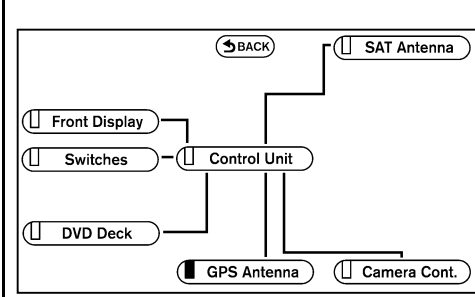
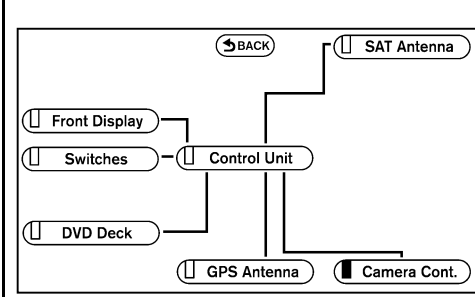
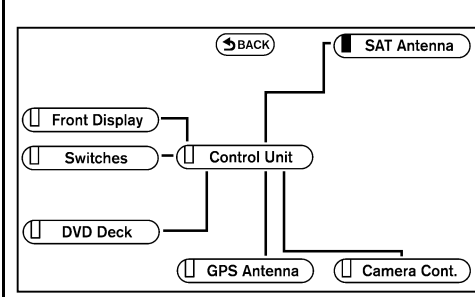
Area with yellow connection lines	Description	Possible malfunction location / Action to take
 <p>ALNIA0215GB</p>	<p>Poor connection is detected for the GPS antenna</p>	<ul style="list-style-type: none"> <li>• Harness or connector</li> <li>• AV control unit</li> <li>• GPS antenna</li> </ul>
 <p>ALNIA0217GB</p>	<p>Poor connection is detected for the rear camera control unit.</p>	<ul style="list-style-type: none"> <li>• Harness or connector</li> <li>• AV control unit</li> <li>• Rear camera control unit</li> </ul>
 <p>ALNIA0216GB</p>	<p>Poor connection is detected for the satellite radio antenna.</p>	<ul style="list-style-type: none"> <li>• Harness or connector</li> <li>• AV control unit</li> <li>• Satellite radio antenna</li> </ul>

## CONFIRMATION/ADJUSTMENT MODE

1. Start the diagnosis function and select "Confirmation/Adjustment". The confirmation/adjustment mode indicates where each item can be checked or adjusted.
2. Select each item on the "Confirmation/Adjustment" mode screen to display the relevant trouble diagnosis screen. Touch "BACK" on the display or press the "BACK" button to return to the initial Confirmation/Adjustment Mode screen.

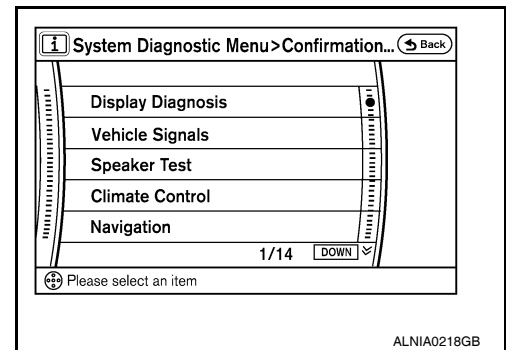

# DIAGNOSIS SYSTEM (AV CONTROL UNIT)

< FUNCTION DIAGNOSIS >

[BOSE AUDIO WITH NAVIGATION]

## Display Diagnosis

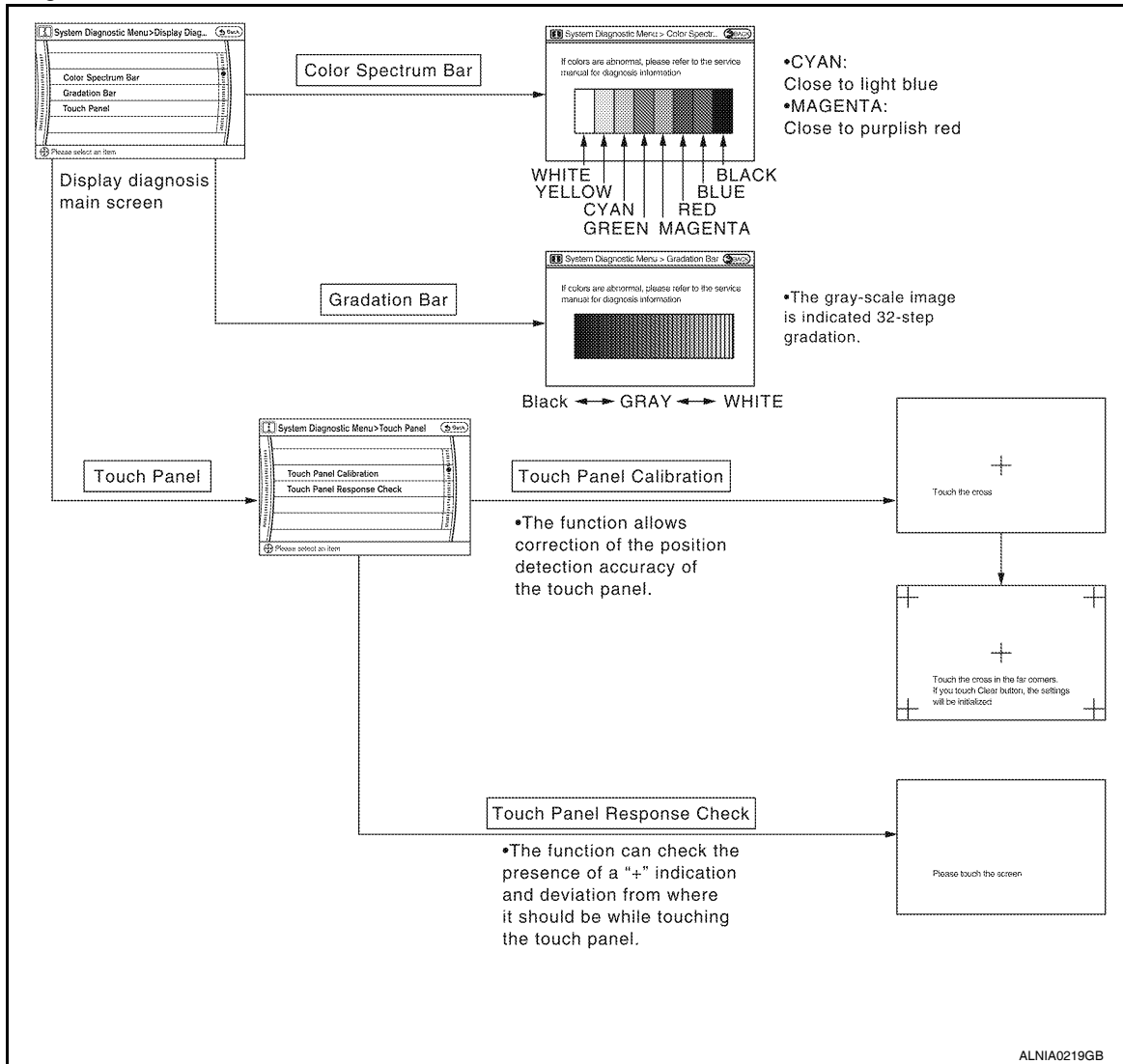

The tint of the color bar indication is as per the following list if RGB signal error is detected.

- R (red) signal error** : Light blue (Cyan) tint
- G (green) signal error** : Purple (Magenta) tint
- B (blue) signal error** : Yellow tint

### Vehicle Signals

A comparison check can be made of each actual vehicle signal and the signals recognized by the system.

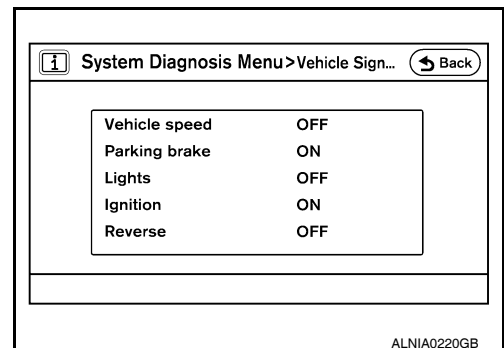

# DIAGNOSIS SYSTEM (AV CONTROL UNIT)

< FUNCTION DIAGNOSIS >

[BOSE AUDIO WITH NAVIGATION]

Diagnosis item	Display	Vehicle status	Remarks
Vehicle speed	ON	Vehicle speed > 0 km/h	Changes in indication may be delayed by approximately 1.5 seconds. This is normal.
	OFF	Vehicle speed = 0 km/h	
	—	Ignition switch in ACC position	
Parking brake	ON	Parking brake is applied.	
	OFF	Parking brake is released.	
Lights	ON	Light switch ON	Block the light beam from the auto light optical sensor.
	OFF	Light switch OFF	
Ignition	ON	Ignition switch ON	—
	OFF	Ignition switch in ACC position	
Reverse	ON	Selector lever in R position	Changes in indication may be delayed by approximately 1.5 seconds. This is normal.
	OFF	Selector lever in any position other than R	
	—	Ignition switch in ACC position	

## Speaker Test

Select "Speaker Test" to display the speaker diagnosis screen. Press "Start" to generate a test tone in speakers. Touch "End" to stop the test tones.

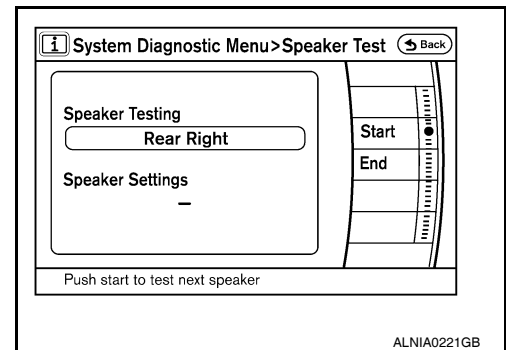

## Navigation

### STEERING ANGLE ADJUSTMENT

The steering angle output value detected with the gyroscope is adjusted.

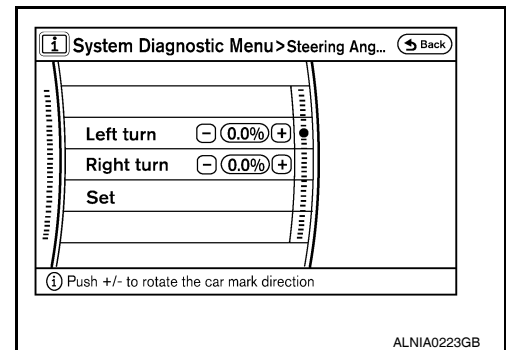

### SPEED CALIBRATION

During normal driving, distance error caused by tire wear and tire pressure change is automatically adjusted for by the automatic distance correction function. This function, on the other hand, is for immediate adjustment, in cases such as driving with tire chain fitted on tires.

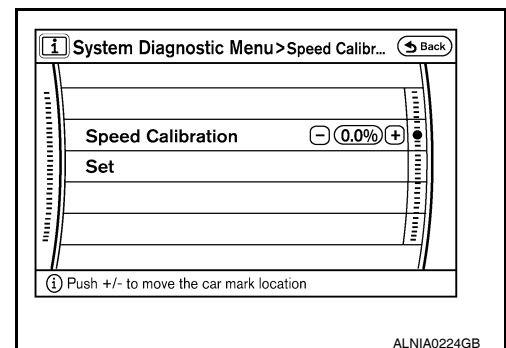



# DIAGNOSIS SYSTEM (AV CONTROL UNIT)

< FUNCTION DIAGNOSIS >

[BOSE AUDIO WITH NAVIGATION]

## XM SAT SUBSCRIPTION STATUS

The XM NavTraffic subscription status can be checked.

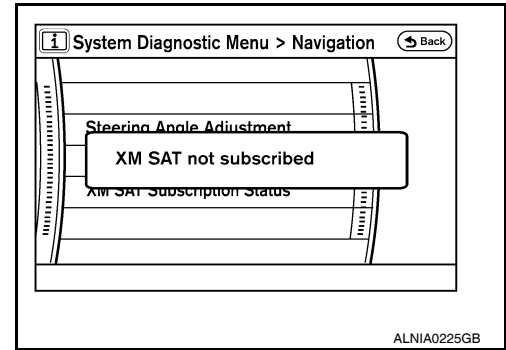

## Error History

The self-diagnosis results are judged depending on whether any error occurs from when "Self-diagnosis" is selected until the self-diagnosis results are displayed.

However, the diagnosis results are judged normal if an error has occurred before the ignition SW is turned ON and then no error has occurred until the self-diagnosis start. Check the "Error History" to detect any error that may have occurred before the self-diagnosis start because of this situation.

### Count up method A

- The counter resets to 0 if an error occurs when IGN switch is turned ON. The counter increases by 1 if the condition is normal at a next IGN ON cycle.
- The counter upper limit is 39. Any counts exceeding 39 are ignored. The counter can be reset (no error-record display) with the "Delete log" switch or CONSULT-III.

### Count up method B

- The counter increases by 1 if an error occurs when IGN switch is ON. The counter will not decrease even if the condition is normal at the next IGN ON cycle.
- The counter upper limit is 50. Any counts exceeding 50 are ignored. The counter can be reset (no error-record display) with the "Delete log" switch or CONSULT-III.

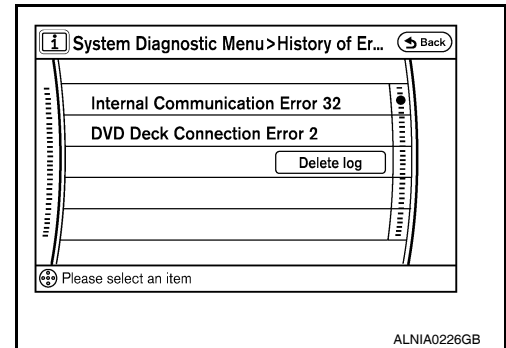

Display method of occurrence frequency	Error history display item
Count up method A	CAN communication line, control unit (CAN), AV communication line, control unit (AV communication)
Count up method B	Other than above

## Error item

Some error items may be displayed simultaneously according to the cause. If some error items are displayed simultaneously, the detection of the cause can be performed by the combination of display items

Error item	Description	Possible malfunction factor/Action to take
CAN COMM CIRCUIT	CAN communication malfunction is detected	Perform diagnosis with CONSULT-III, and then repair the malfunctioning parts according to the diagnosis results. Refer to <a href="#">AV-341, "AV CONTROL UNIT : CONSULT-III Function"</a> .

A  
B  
C  
D  
E  
F  
G  
H  
I  
J  
K  
L  
M  
AV  
O  
P

# DIAGNOSIS SYSTEM (AV CONTROL UNIT)

< FUNCTION DIAGNOSIS >

[BOSE AUDIO WITH NAVIGATION]

Error item	Description	Possible malfunction factor/Action to take		
CONTROL UNIT (CAN)	CAN initial diagnosis malfunction is detected	Replace the AV control unit. Refer to <a href="#">AV-289, "Removal and Installation"</a>		
CONTROL UNIT (AV)	AV communication circuit initial diagnosis malfunction is detected			
FLASH-ROM Error Of Control Unit	AV control unit malfunction is detected			
Connection Of Gyro				
XM SERIAL COMM Error				
CAN Controller Memory Error				
Bluetooth Module Connection Error				
HDD CONN Error				
HDD READ Error				
HDD WRITE Error				
HDD COMM Error				
HDD ACCESS Error				
DSP CONN Error	AV control unit power supply and ground circuit. Refer to <a href="#">AV-371, "AV CONTROL UNIT : Diagnosis Procedure"</a>			
DSP COMM Error				
Internal Communication Error	GPS malfunction is detected	An intermittent error caused by strong radio interference may be detected unless any symptoms (GPS reception error, etc.) occur. Replace the AV control unit ff the malfunction occurs constantly. Refer to <a href="#">AV-289, "Removal and Installation"</a>		
GPS Communication Error				
GPS ROM Error				
GPS RAM Error				
GPS RTC Error	<ul style="list-style-type: none"> <li>• Display unit power supply and ground circuit malfunction is detected</li> <li>• Malfunction is detected on communication circuit between display unit and AV control unit</li> <li>• Malfunction is detected on communication signal between display unit and AV control unit</li> </ul>	<ul style="list-style-type: none"> <li>• Display unit power supply and ground circuit. Refer to <a href="#">AV-372, "DISPLAY UNIT : Diagnosis Procedure"</a></li> <li>• Communication circuit between display unit and AV control unit</li> </ul>		
Front Display Connection Error				
GPS Antenna Error			GPS antenna connection malfunction is detected	GPS antenna
XM Antenna Connection Error			Poor connection is detected in satellite radio antenna	Satellite radio antenna
Camera Control Unit Connection Error	A malfunction is detected in the rear view camera-connection recognition signal circuit	Rear view camera-connection recognition signal circuit		
<ul style="list-style-type: none"> <li>• AV COMM CIRCUIT</li> <li>• Switches Connection Error</li> </ul>	<ul style="list-style-type: none"> <li>• A/C and AV switch assembly power supply and ground circuit malfunction is detected</li> <li>• A malfunction is detected in AV communication circuit between AV control unit and A/C and AV switch assembly</li> <li>• A malfunction is detected in AV communication signal between AV control unit and A/C and AV switch assembly</li> </ul>	<ul style="list-style-type: none"> <li>• A/C and AV switch assembly power supply and ground circuits. Refer to <a href="#">AV-373, "A/C AND AV SWITCH ASSEMBLY : Diagnosis Procedure"</a></li> <li>• AV communication circuit between AV control unit and A/C and AV switch assembly</li> </ul>		

# DIAGNOSIS SYSTEM (AV CONTROL UNIT)

[BOSE AUDIO WITH NAVIGATION]

## < FUNCTION DIAGNOSIS >

Error item	Description	Possible malfunction factor/Action to take
<ul style="list-style-type: none"> <li>AV COMM CIRCUIT</li> <li>Rear View Camera Connection Error</li> </ul>	<ul style="list-style-type: none"> <li>A malfunction is detected in camera control unit power supply and ground circuits</li> <li>Malfunction is detected on AV communication signal between camera control unit and AV control unit</li> </ul>	Rear view camera control unit power supply and ground circuits. Refer to <a href="#">AV-375</a> , " <a href="#">REAR VIEW CAMERA CONTROL UNIT : Diagnosis Procedure</a> "
<ul style="list-style-type: none"> <li>AV COMM CIRCUIT</li> <li>Rear View Camera Connection Error</li> <li>Rear View Camera Control Unit Connection Error</li> </ul>	<ul style="list-style-type: none"> <li>Malfunction is detected in AV communication circuit between camera control unit and AV control unit</li> <li>Malfunction is detected on AV communication signal between camera control unit and AV control unit</li> </ul>	AV communication circuit between Camera control unit and AV control unit

### Vehicle CAN Diagnosis

- CAN communication status and error counter is displayed.
- The error counter displays "OK" if any malfunction was not detected in the past and displays "0" if a malfunction is detected. It increases by 1 if the condition is normal at the next ignition switch ON cycle. The upper limit of the counter is 39.
- The error counter is erased if reset.

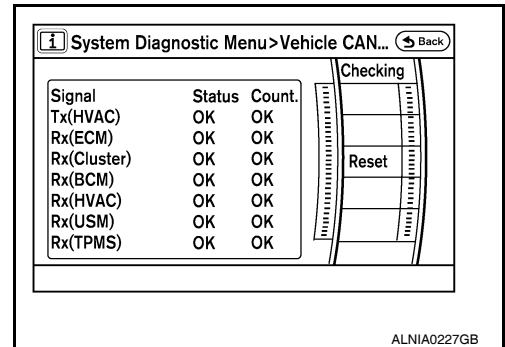

### AV COMM Diagnosis

- AV communication status and error counter is displayed.
- The error counter displays "OK" if any malfunction was not detected in the past and displays "0" if a malfunction is detected. It increases by 1 if the condition is normal at the next ignition switch ON cycle. The upper limit of the counter is 39.
- The error counter is erased if reset.

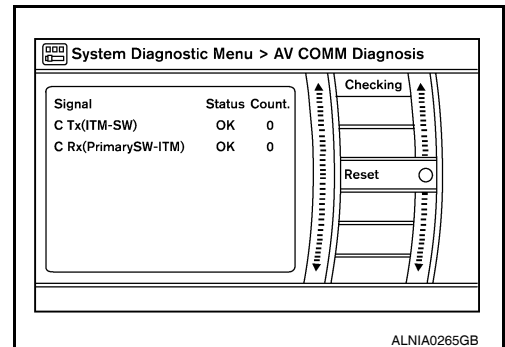

### Handsfree Phone

The hands-free phone reception volume adjustment, microphone and speaker test, and memory erase functions are also available.

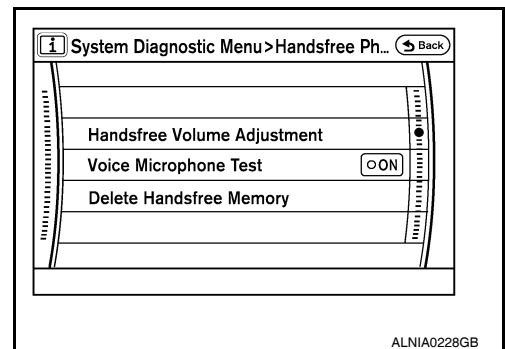

### Bluetooth

Passkey confirmation/change

# DIAGNOSIS SYSTEM (AV CONTROL UNIT)

[BOSE AUDIO WITH NAVIGATION]

## < FUNCTION DIAGNOSIS >

- The passkey of Bluetooth can be confirmed and changed.
- The passkey can be changed by four digits within 0 to 9.

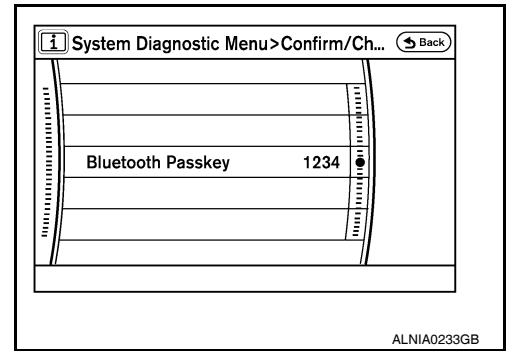

## Device name check/change

- The device name of Bluetooth can be confirmed and changed.
- The device name can be changed by sixteen digits within A to Z (small character can be used) and - (hyphen).

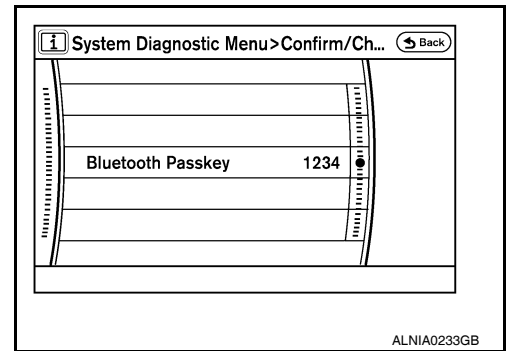

## SAT

- Change Channel
- Any necessary channels required to receive traffic information from the satellite radio system can be set.

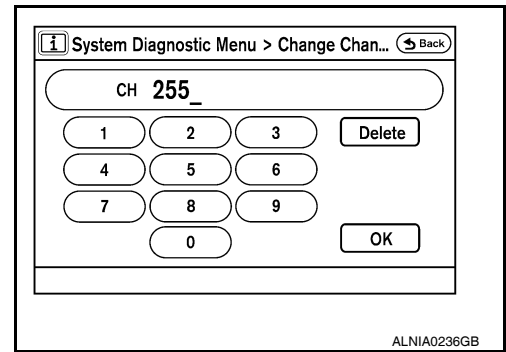

- Change Application ID
- Any application ID's required to receive traffic information from the satellite radio system can be set.

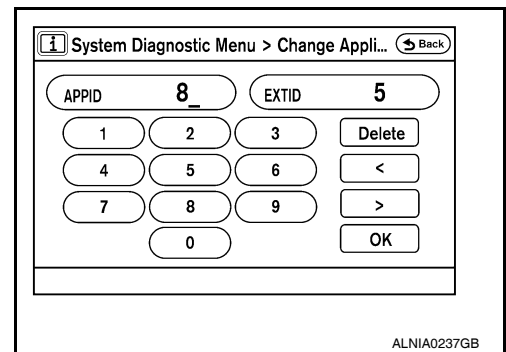

## Delete Unit Connection Log

# DIAGNOSIS SYSTEM (AV CONTROL UNIT)

## < FUNCTION DIAGNOSIS >

## [BOSE AUDIO WITH NAVIGATION]

Deletes any unit connection records and error records from the AV control unit memory. (Clear the records of the unit that has been removed)

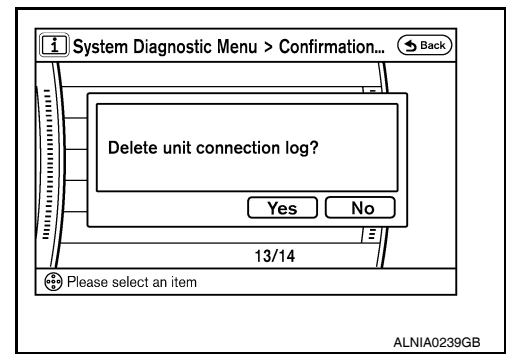

### Initialize Settings

Initializes the AV control unit memory.

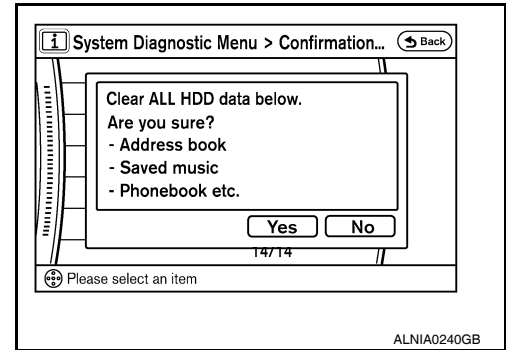

## AV CONTROL UNIT : CONSULT-III Function

INFOID:000000005259517

CONSULT-III can display each diagnostic item using the diagnostic test modes shown following.

MULTI AV diagnosis mode	Description
SELF-DIAG RESULTS	Displays AV control unit self-diagnosis results.
DATA MONITOR	Displays AV control unit input/output data in real time.
CAN DIAG SUPPORT MNTR	The result of transmit/receive diagnosis of CAN communication can be read.
AV COMM MONITOR	Allows the technician to monitor the status of the Multi AV system communication signals.
ECU PART NUMBER	The part number of AV control unit can be checked.

### Self-diagnosis results

- In CONSULT-III self-diagnosis, self-diagnosis results and error history are displayed collectively.
- The current malfunction indicates “CRNT”. The past malfunction indicates “PAST”.
- The timing is displayed as “0” if any of the error codes [U1000], [U1010], [U1300] and [U1310] is detected. The counter increases by 1 if the condition is normal at the next ignition switch ON cycle.

Self-diagnosis results display item

Error item	Description	Possible malfunction factor/Action to take
CAN COMM CIRCUIT[U1000]	CAN communication malfunction is detected	Perform diagnosis with CONSULT-III, and then repair the malfunctioning parts according to the diagnosis results. Refer to <a href="#">AV-341. "AV CONTROL UNIT : CONSULT-III Function"</a> .

## DIAGNOSIS SYSTEM (AV CONTROL UNIT)

< FUNCTION DIAGNOSIS >

[BOSE AUDIO WITH NAVIGATION]

Error item	Description	Possible malfunction factor/Action to take
CONTROL UNIT (CAN) [U1010]	CAN initial diagnosis malfunction is detected	Replace the AV control unit
CONTROL UNIT (AV) [U1310]	AV communication circuit initial diagnosis malfunction is detected	
Control Unit FLASH-ROM [U1200]	AV control unit malfunction is detected	
Gyro NO CONN [U1201]		
CAN CONT [U1216]		
BLUETOOTH CONN [U1217]		
HDD CONN [U1218]		
HDD READ [U1219]		
XM SERIAL COMM [U1220]		
HDD WRITE [U121A]		
HDD COMM [U121B]		
HDD ACCESS [U121C]		
DSP CONN [U121D]		
DSP COMM [U121E]		
INTERNAL COMM [U121F]	AV control unit power supply and ground circuit	
GPS COMM [U1204]	GPS malfunction is detected	An intermittent error caused by strong radio interference may be detected unless any symptoms (GPS reception error, etc.) occur. Replace the AV control unit if the malfunction occurs constantly.
GPS ROM [U1205]		
GPS RAM [U1206]		
GPS RTC [U1207]		
FRONT DISP CONN [U1243]	<ul style="list-style-type: none"> <li>• Display unit power supply and ground circuit malfunction is detected</li> <li>• Malfunction is detected on communication circuit between display unit and AV control unit</li> <li>• Malfunction is detected on communication signal between display unit and AV control unit</li> </ul>	<ul style="list-style-type: none"> <li>• Display unit power supply and ground circuit</li> <li>• Communication circuit between display unit and AV control unit</li> </ul>
GPS ANTENNA CONN [U1244]	GPS antenna connection malfunction is detected	GPS antenna
XM ANTENNA CONN [U1258]	Poor connection is detected in satellite radio antenna	Satellite radio antenna
CAMERA CONT. CONN [U1250]	A malfunction is detected in Camera-connection recognition signal circuit	Camera-connection recognition signal circuit
<ul style="list-style-type: none"> <li>• AV COMM CIRCUIT [U1300]</li> <li>• SWITCHE CONN [U1240]</li> </ul>	<ul style="list-style-type: none"> <li>• Multifunction switch power supply and ground circuit malfunction is detected</li> <li>• A malfunction is detected in AV communication circuit between AV control unit and multifunction switch</li> <li>• A malfunction is detected in AV communication signal between AV control unit and multifunction switch</li> </ul>	<ul style="list-style-type: none"> <li>• Multifunction switch power supply and ground circuits</li> <li>• AV communication circuit between AV control unit and multifunction switch</li> </ul>

# DIAGNOSIS SYSTEM (AV CONTROL UNIT)

< FUNCTION DIAGNOSIS >

[BOSE AUDIO WITH NAVIGATION]

Error item	Description	Possible malfunction factor/Action to take
<ul style="list-style-type: none"> <li>AV COMM CIRCUIT [U1300]</li> <li>REAR CAMERA LAN CONN [U1252]</li> </ul>	<ul style="list-style-type: none"> <li>A malfunction is detected in camera control unit power supply and ground circuits</li> <li>Malfunction is detected on AV communication signal between Camera control unit and AV control unit</li> </ul>	Camera control unit power supply and ground circuits
<ul style="list-style-type: none"> <li>AV COMM CIRCUIT [U1300]</li> <li>CAMERA CONT. CONN [U1250]</li> <li>REAR CAMERA LAN CONN [U1252]</li> </ul>	<ul style="list-style-type: none"> <li>Malfunction is detected on AV communication circuit between camera control unit and AV control unit</li> <li>Malfunction is detected on AV communication signal between camera control unit and AV control unit</li> </ul>	AV communication circuit between camera control unit and AV control unit

## DATA MONITOR

Display Item List

Display item [unit]	ALL SIGNALS	SELECTION FROM MENU	Description
VHCL SPD SIG [ON/OFF]	X	X	Displays "ON" when vehicle speed > 0 km/h. Displays "OFF" when vehicle speed = 0 km/h.
PKB SIG [ON/OFF]	X	X	Displays [ON/OFF] condition of parking brake switch.
ILLUM SIG [ON/OFF]	X	X	Displays [ON/OFF] condition of lighting switch.
IGN SIG [ON/OFF]	X	X	Displays [ON/OFF] condition of ignition switch.
REV SIG [ON/OFF]	X	X	Displays [ON/OFF] condition of back-up lamp switch.

## A/C AND AV SWITCH ASSEMBLY

### A/C AND AV SWITCH ASSEMBLY : Component Function Check

INFOID:000000005259518

A/C and AV switch assembly self-diagnosis function

Description

The ON/OFF operation (continuity) of each switch in the A/C and AV switch assembly can be checked.

Self-diagnosis mode

- Press the "BACK" button and the "UP" button within 10 seconds after turning the ignition switch from OFF to ACC and hold them for 3 seconds or more. When the self-diagnosis mode starts, a beep will sound and all LED indicators of the switch will illuminate.
- The continuity of each switch and control dial of the A/C and AV switch assembly can be checked. If the switch is operating normally, the system will beep and the LED's will illuminate when each switch is operated.

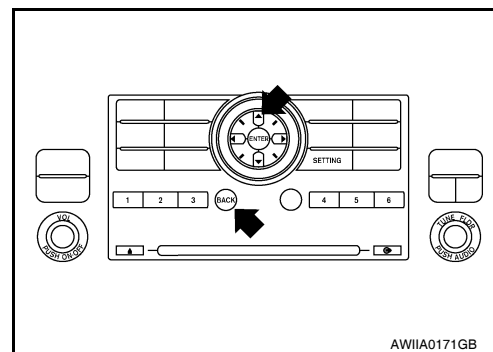

Finishing self-diagnosis mode

Self-diagnosis mode is canceled when the ignition switch is turned OFF.

## COMPONENT DIAGNOSIS

### U1000 CAN COMM CIRCUIT

#### Description

INFOID:000000005259519

CAN (Controller Area Network) is a serial communication line for real time application. It is an on-vehicle multiplex communication line with high data communication speed and excellent error detection ability. Many electronic control units are equipped onto a vehicle and each control unit shares information and links with other control units during operation (not independent). In CAN communication, control units are connected with 2 communication lines (CAN-H, CAN-L) allowing a high rate of information transmission with less wiring. Each control unit transmits/receives data but selectively reads required data only.

CAN Communication Signal Chart. Refer to [LAN-13, "How to Use CAN Communication Signal Chart"](#).

#### DTC Logic

INFOID:000000005259520

#### DTC DETECTION LOGIC

DTC	Display contents of CONSULT-III	Diagnostic item is detected when ...	Probable malfunction location
U1000	CAN COMM CIRCUIT	When AV control unit is not transmitting or receiving CAN communication signal for 2 seconds or more.	CAN communication system

#### Diagnosis Procedure

INFOID:000000005259521

#### 1. PERFORM SELF DIAGNOSTIC

1. Turn ignition switch ON and wait for 2 seconds or more.
2. Check "Self Diagnostic Result" of "MULTI AV".

#### Is "CAN COMM CIRCUIT" displayed?

- YES >> Refer to "LAN system". Refer to [LAN-14, "Trouble Diagnosis Flow Chart"](#).
- NO >> Refer to GI section. Refer to [GI-37, "Intermittent Incident"](#).



# U1010 CONTROL UNIT (CAN)

< COMPONENT DIAGNOSIS >

[BOSE AUDIO WITH NAVIGATION]

## U1010 CONTROL UNIT (CAN)

### Description

INFOID:000000005259522

Initial diagnosis of AV control unit.

### DTC Logic

INFOID:000000005259523

### DTC DETECTION LOGIC

DTC	Display contents of CONSULT-III	Diagnostic item is detected when ...	Probable malfunction location
U1010	CONTROL UNIT (CAN)	CAN initial diagnosis malfunction is detected	AV control unit

### Diagnosis Procedure

INFOID:000000005259524

#### 1. REPLACE AV CONTROL UNIT

When DTC U1010 is detected, replace AV control unit. Refer to [AV-289. "Removal and Installation"](#).

>> Inspection End.

A  
B  
C  
D  
E  
F  
G  
H  
I  
J  
K  
L  
M  
O  
P

AV

# U1200 AV CONTROL UNIT

< COMPONENT DIAGNOSIS >

[BOSE AUDIO WITH NAVIGATION]

## U1200 AV CONTROL UNIT

### Description

INFOID:000000005259525

Replace the AV control unit if this DTC is displayed. Refer to [AV-289. "Removal and Installation"](#).

Part name	Description
AV CONTROL UNIT	<ul style="list-style-type: none"><li>• It is the master unit of the MULTI AV system and it is connected to each control unit by means of communication. It operates each system according to communication signals from the AV control unit.</li><li>• AV control unit includes audio function and vehicle information function.</li><li>• It is connected to ECM and combination meter via CAN communication to obtain necessary information for the vehicle information function.</li><li>• It inputs the automatic brightness ON/OFF signals that are required for the display dimming control.</li><li>• It inputs the signals for driving status recognition (vehicle speed, reverse and parking brake).</li></ul>

### DTC Logic

INFOID:000000005259526

DTC	Display contents of CONSULT-III	DTC Detection Condition	Action to take
U1200	Control Unit FLASH- ROM [U1200]	An internal malfunction is detected in AV control unit (FLASH-ROM).	Replace AV control unit. Refer to <a href="#">AV-289. "Removal and Installation"</a>

# U1201 AV CONTROL UNIT

< COMPONENT DIAGNOSIS >

[BOSE AUDIO WITH NAVIGATION]

## U1201 AV CONTROL UNIT

### Description

INFOID:000000005259527

Replace the AV control unit if this DTC is displayed. Refer to [AV-289, "Removal and Installation"](#).

Part name	Description
AV CONTROL UNIT	<ul style="list-style-type: none"><li>• It is the master unit of the MULTI AV system and it is connected to each control unit by means of communication. It operates each system according to communication signals from the AV control unit.</li><li>• AV control unit includes audio function and vehicle information function.</li><li>• It is connected to ECM and combination meter via CAN communication to obtain necessary information for the vehicle information function.</li><li>• It inputs the automatic brightness ON/OFF signals that are required for the display dimming control.</li><li>• It inputs the signals for driving status recognition (vehicle speed, reverse and parking brake).</li></ul>

### DTC Logic

INFOID:000000005259528

#### DTC DETECTION LOGIC

DTC	CONSULT-III display	Detection condition	Action to take
U1201	GYRO NO CONN [U1201]	An internal malfunction is detected in AV control unit (gyrocompass disconnection).	Replace AV control unit. Refer to <a href="#">AV-289, "Removal and Installation"</a> .

A  
B  
C  
D  
E  
F  
G  
H  
I  
J  
K  
L  
M  
O  
P

AV

# U1204 GPS COMM

< COMPONENT DIAGNOSIS >

[BOSE AUDIO WITH NAVIGATION]

## U1204 GPS COMM

### Description

INFOID:000000005259529

Replace the AV control unit if this DTC is displayed. Refer to [AV-289. "Removal and Installation"](#).

Part name	Description
AV CONTROL UNIT	<ul style="list-style-type: none"><li>• It is the master unit of the MULTI AV system and it is connected to each control unit by means of communication. It operates each system according to communication signals from the AV control unit.</li><li>• AV control unit includes audio function and vehicle information function.</li><li>• It is connected to ECM and combination meter via CAN communication to obtain necessary information for the vehicle information function.</li><li>• It inputs the automatic brightness ON/OFF signals that are required for the display dimming control.</li><li>• It inputs the signals for driving status recognition (vehicle speed, reverse and parking brake).</li></ul>

### DTC Logic

INFOID:000000005259530

#### DTC DETECTION LOGIC

DTC	CONSULT-III display	Detection condition	Action to take
U1204	GPS COMM [U1204]	An internal malfunction is detected in AV control unit (GPS malfunction).	Replace AV control unit. Refer to <a href="#">AV-460. "Removal and Installation"</a> .

# U1205 GPS ROM

< COMPONENT DIAGNOSIS >

[BOSE AUDIO WITH NAVIGATION]

## U1205 GPS ROM

### Description

INFOID:000000005259531

Replace the AV control unit if this DTC is displayed. Refer to [AV-289. "Removal and Installation"](#).

Part name	Description
AV CONTROL UNIT	<ul style="list-style-type: none"><li>• It is the master unit of the MULTI AV system and it is connected to each control unit by means of communication. It operates each system according to communication signals from the AV control unit.</li><li>• AV control unit includes audio function and vehicle information function.</li><li>• It is connected to ECM and combination meter via CAN communication to obtain necessary information for the vehicle information function.</li><li>• It inputs the automatic brightness ON/OFF signals that are required for the display dimming control.</li><li>• It inputs the signals for driving status recognition (vehicle speed, reverse and parking brake).</li></ul>

### DTC Logic

INFOID:000000005259532

#### DTC DETECTION LOGIC

DTC	CONSULT-III display	Detection condition	Action to take
U1205	GPS ROM [U1205]	An internal malfunction is detected in AV control unit (GPS malfunction).	Replace AV control unit. Refer to <a href="#">AV-460. "Removal and Installation"</a> .

A  
B  
C  
D  
E  
F  
G  
H  
I  
J  
K  
L  
M  
O  
P

AV

# U1206 GPS RAM

< COMPONENT DIAGNOSIS >

[BOSE AUDIO WITH NAVIGATION]

## U1206 GPS RAM

### Description

INFOID:000000005259533

Replace the AV control unit if this DTC is displayed. Refer to [AV-289. "Removal and Installation"](#).

Part name	Description
AV CONTROL UNIT	<ul style="list-style-type: none"><li>• It is the master unit of the MULTI AV system and it is connected to each control unit by means of communication. It operates each system according to communication signals from the AV control unit.</li><li>• AV control unit includes audio function and vehicle information function.</li><li>• It is connected to ECM and combination meter via CAN communication to obtain necessary information for the vehicle information function.</li><li>• It inputs the automatic brightness ON/OFF signals that are required for the display dimming control.</li><li>• It inputs the signals for driving status recognition (vehicle speed, reverse and parking brake).</li></ul>

### DTC Logic

INFOID:000000005259534

#### DTC DETECTION LOGIC

DTC	CONSULT-III display	Detection condition	Action to take
U1206	GPS RAM [U1206]	An internal malfunction is detected in AV control unit (GPS malfunction).	Replace AV control unit. Refer to <a href="#">AV-460. "Removal and Installation"</a> .

# U1207 GPS RTC

< COMPONENT DIAGNOSIS >

[BOSE AUDIO WITH NAVIGATION]

## U1207 GPS RTC

### Description

INFOID:000000005259535

Replace the AV control unit if this DTC is displayed. Refer to [AV-289. "Removal and Installation"](#).

Part name	Description
AV CONTROL UNIT	<ul style="list-style-type: none"><li>• It is the master unit of the MULTI AV system and it is connected to each control unit by means of communication. It operates each system according to communication signals from the AV control unit.</li><li>• AV control unit includes audio function and vehicle information function.</li><li>• It is connected to ECM and combination meter via CAN communication to obtain necessary information for the vehicle information function.</li><li>• It inputs the automatic brightness ON/OFF signals that are required for the display dimming control.</li><li>• It inputs the signals for driving status recognition (vehicle speed, reverse and parking brake).</li></ul>

### DTC Logic

INFOID:000000005259536

#### DTC DETECTION LOGIC

DTC	CONSULT-III display	Detection condition	Action to take
U1207	GPS RTC [U1207]	An internal malfunction is detected in AV control unit (GPS malfunction).	Replace AV control unit. Refer to <a href="#">AV-460. "Removal and Installation"</a> .

A  
B  
C  
D  
E  
F  
G  
H  
I  
J  
K  
L  
M  
O  
P

AV

# U1216 AV CONTROL UNIT

< COMPONENT DIAGNOSIS >

[BOSE AUDIO WITH NAVIGATION]

## U1216 AV CONTROL UNIT

### Description

INFOID:000000005259537

Replace the AV control unit if this DTC is displayed. Refer to [AV-460. "Removal and Installation"](#).

Part name	Description
AV CONTROL UNIT	<ul style="list-style-type: none"><li>• It is the master unit of the MULTI AV system and it is connected to each control unit by means of communication. It operates each system according to communication signals from the AV control unit.</li><li>• AV control unit includes audio function and vehicle information function.</li><li>• It is connected to ECM and combination meter via CAN communication to obtain necessary information for the vehicle information function.</li><li>• It inputs the automatic brightness ON/OFF signals that are required for the display dimming control.</li><li>• It inputs the signals for driving status recognition (vehicle speed, reverse and parking brake).</li></ul>

### DTC Logic

INFOID:000000005259538

DTC	Display contents of CONSULT-III	DTC Detection Condition	Action to take
U1216	CAN CONT [U1216]	Internal malfunction of AV control unit (CAN controller) is detected.	Replace AV control unit. Refer to <a href="#">AV-460. "Removal and Installation"</a> .



# U1217 AV CONTROL UNIT

< COMPONENT DIAGNOSIS >

[BOSE AUDIO WITH NAVIGATION]

## U1217 AV CONTROL UNIT

### Description

INFOID:000000005259539

Replace the AV control unit if this DTC is displayed. Refer to [AV-289. "Removal and Installation"](#).

Part name	Description
AV CONTROL UNIT	<ul style="list-style-type: none"><li>• It is the master unit of the MULTI AV system and it is connected to each control unit by means of communication. It operates each system according to communication signals from the AV control unit.</li><li>• AV control unit includes audio function and vehicle information function.</li><li>• It is connected to ECM and combination meter via CAN communication to obtain necessary information for the vehicle information function.</li><li>• It inputs the automatic brightness ON/OFF signals that are required for the display dimming control.</li><li>• It inputs the signals for driving status recognition (vehicle speed, reverse and parking brake).</li></ul>

### DTC Logic

INFOID:000000005259540

#### DTC DETECTION LOGIC

DTC	CONSULT-III display	Detection condition	Action to take
U1217	BLUETOOTH CONN [U1217]	An internal malfunction is detected in AV control unit (Bluetooth module connection malfunction).	Replace AV control unit. Refer to <a href="#">AV-460. "Removal and Installation"</a> .

A  
B  
C  
D  
E  
F  
G  
H  
I  
J  
K  
L  
M  
O  
P

AV

# U1218 AV CONTROL UNIT

< COMPONENT DIAGNOSIS >

[BOSE AUDIO WITH NAVIGATION]

## U1218 AV CONTROL UNIT

### Description

INFOID:000000005259541

Replace the AV control unit if this DTC is displayed. Refer to [AV-460, "Removal and Installation"](#).

Part name	Description
AV CONTROL UNIT	<ul style="list-style-type: none"><li>• Integrates HDD (hard disk drive) allowing map data and music data to be stored.</li><li>• It is the master unit of the MULTI AV system, and it is connected to each control unit by means of communication. It operates each system according to communication signals from the AV control unit.</li><li>• The AV control unit includes the audio, hands-free phone, voice control, navigation, and vehicle information functions.</li><li>• It is connected to ECM and combination meter via CAN communication to obtain necessary information for the vehicle information function.</li><li>• It inputs the automatic brightness ON/OFF signals that are required for the display dimming control.</li><li>• It inputs the signals for driving status recognition (vehicle speed, reverse and parking brake).</li></ul>

### DTC Logic

INFOID:000000005259542

DTC	Display contents of CONSULT-III	DTC Detection Condition	Action to take
U1218	HDD-CONN [U1218]	Internal malfunction of AV control unit (HDD connection malfunction) is detected.	Replace AV control unit. Refer to <a href="#">AV-460, "Removal and Installation"</a> .

# U1219 AV CONTROL UNIT

< COMPONENT DIAGNOSIS >

[BOSE AUDIO WITH NAVIGATION]

## U1219 AV CONTROL UNIT

### Description

INFOID:000000005259543

Replace the AV control unit if this DTC is displayed. Refer to [AV-460, "Removal and Installation"](#).

Part name	Description
AV CONTROL UNIT	<ul style="list-style-type: none"><li>• Integrates HDD (hard disk drive) allowing map data and music data to be stored.</li><li>• It is the master unit of the MULTI AV system, and it is connected to each control unit by means of communication. It operates each system according to communication signals from the AV control unit.</li><li>• The AV control unit includes the audio, hands-free phone, voice control, navigation, and vehicle information functions.</li><li>• It is connected to ECM and combination meter via CAN communication to obtain necessary information for the vehicle information function.</li><li>• It inputs the automatic brightness ON/OFF signals that are required for the display dimming control.</li><li>• It inputs the signals for driving status recognition (vehicle speed, reverse and parking brake).</li></ul>

### DTC Logic

INFOID:000000005259544

DTC	Display contents of CONSULT-III	DTC Detection Condition	Action to take
U1219	HDD-READ [U1219]	Internal malfunction of AV control unit (HDD read malfunction) is detected.	Replace AV control unit. Refer to <a href="#">AV-460, "Removal and Installation"</a> .

A  
B  
C  
D  
E  
F  
G  
H  
I  
J  
K  
L  
M  
O  
P

AV

# U1220 AV CONTROL UNIT

< COMPONENT DIAGNOSIS >

[BOSE AUDIO WITH NAVIGATION]

## U1220 AV CONTROL UNIT

### Description

INFOID:000000005259545

Replace the AV control unit if this DTC is displayed. Refer to [AV-289. "Removal and Installation"](#).

Part name	Description
AV CONTROL UNIT	<ul style="list-style-type: none"><li>• It is the master unit of the MULTI AV system and it is connected to each control unit by means of communication. It operates each system according to communication signals from the AV control unit.</li><li>• AV control unit includes audio function and vehicle information function.</li><li>• It is connected to ECM and combination meter via CAN communication to obtain necessary information for the vehicle information function.</li><li>• It inputs the automatic brightness ON/OFF signals that are required for the display dimming control.</li><li>• It inputs the signals for driving status recognition (vehicle speed, reverse and parking brake).</li></ul>

### DTC Logic

INFOID:000000005259546

#### DTC DETECTION LOGIC

DTC	CONSULT-III display	Detection condition	Action to take
U1220	XM SERIAL COMM [U1220]	An internal malfunction is detected in AV control unit (satellite radio tuner communication malfunction).	Replace AV control unit. Refer to <a href="#">AV-460. "Removal and Installation"</a> .

# U121A AV CONTROL UNIT

< COMPONENT DIAGNOSIS >

[BOSE AUDIO WITH NAVIGATION]

## U121A AV CONTROL UNIT

### Description

INFOID:000000005259547

Replace the AV control unit if this DTC is displayed. Refer to [AV-460, "Removal and Installation"](#).

Part name	Description
AV CONTROL UNIT	<ul style="list-style-type: none"><li>Integrates HDD (hard disk drive) allowing map data and music data to be stored.</li><li>It is the master unit of the MULTI AV system, and it is connected to each control unit by means of communication. It operates each system according to communication signals from the AV control unit.</li><li>The AV control unit includes the audio, hands-free phone, voice control, navigation, and vehicle information functions.</li><li>It is connected to ECM and combination meter via CAN communication to obtain necessary information for the vehicle information function.</li><li>It inputs the automatic brightness ON/OFF signals that are required for the display dimming control.</li><li>It inputs the signals for driving status recognition (vehicle speed, reverse and parking brake).</li></ul>

### DTC Logic

INFOID:000000005259548

DTC	Display contents of CONSULT-III	DTC Detection Condition	Action to take
U121A	HDD-WRITE [U121A]	Internal malfunction of AV control unit (HDD write malfunction) is detected.	Replace AV control unit. Refer to <a href="#">AV-460, "Removal and Installation"</a> .

A  
B  
C  
D  
E  
F  
G  
H  
I  
J  
K  
L  
M  
O  
P

AV

# U121B AV CONTROL UNIT

< COMPONENT DIAGNOSIS >

[BOSE AUDIO WITH NAVIGATION]

## U121B AV CONTROL UNIT

### Description

INFOID:000000005259549

Replace the AV control unit if this DTC is displayed. Refer to [AV-460, "Removal and Installation"](#).

Part name	Description
AV CONTROL UNIT	<ul style="list-style-type: none"><li>• Integrates HDD (hard disk drive) allowing map data and music data to be stored.</li><li>• It is the master unit of the MULTI AV system, and it is connected to each control unit by means of communication. It operates each system according to communication signals from the AV control unit.</li><li>• The AV control unit includes the audio, hands-free phone, voice control, navigation, and vehicle information functions.</li><li>• It is connected to ECM and combination meter via CAN communication to obtain necessary information for the vehicle information function.</li><li>• It inputs the automatic brightness ON/OFF signals that are required for the display dimming control.</li><li>• It inputs the signals for driving status recognition (vehicle speed, reverse and parking brake).</li></ul>

### DTC Logic

INFOID:000000005259550

DTC	Display contents of CONSULT-III	DTC Detection Condition	Action to take
U121B	HDD-COMM [U121B]	Internal malfunction of AV control unit (HDD communication error) is detected.	Replace AV control unit. Refer to <a href="#">AV-460, "Removal and Installation"</a> .

# U121C AV CONTROL UNIT

< COMPONENT DIAGNOSIS >

[BOSE AUDIO WITH NAVIGATION]

## U121C AV CONTROL UNIT

### Description

INFOID:000000005259551

Replace the AV control unit if this DTC is displayed. Refer to [AV-460, "Removal and Installation"](#).

Part name	Description
AV CONTROL UNIT	<ul style="list-style-type: none"><li>• Integrates HDD (hard disk drive) allowing map data and music data to be stored.</li><li>• It is the master unit of the MULTI AV system, and it is connected to each control unit by means of communication. It operates each system according to communication signals from the AV control unit.</li><li>• The AV control unit includes the audio, hands-free phone, voice control, navigation, and vehicle information functions.</li><li>• It is connected to ECM and combination meter via CAN communication to obtain necessary information for the vehicle information function.</li><li>• It inputs the automatic brightness ON/OFF signals that are required for the display dimming control.</li><li>• It inputs the signals for driving status recognition (vehicle speed, reverse and parking brake).</li></ul>

### DTC Logic

INFOID:000000005259552

DTC	Display contents of CONSULT-III	DTC Detection Condition	Action to take
U121C	HDD-ACCESS [U121C]	Internal malfunction of AV control unit (HDD access error) is detected.	Replace AV control unit. Refer to <a href="#">AV-460, "Removal and Installation"</a> .

A  
B  
C  
D  
E  
F  
G  
H  
I  
J  
K  
L  
M  
O  
P

AV

# U121D AV CONTROL UNIT

< COMPONENT DIAGNOSIS >

[BOSE AUDIO WITH NAVIGATION]

## U121D AV CONTROL UNIT

### Description

INFOID:000000005259553

Replace the AV control unit if this DTC is displayed. Refer to [AV-460, "Removal and Installation"](#).

Part name	Description
AV CONTROL UNIT	<ul style="list-style-type: none"><li>• Integrates HDD (hard disk drive) allowing map data and music data to be stored.</li><li>• It is the master unit of the MULTI AV system, and it is connected to each control unit by means of communication. It operates each system according to communication signals from the AV control unit.</li><li>• The AV control unit includes the audio, hands-free phone, voice control, navigation, and vehicle information functions.</li><li>• It is connected to ECM and combination meter via CAN communication to obtain necessary information for the vehicle information function.</li><li>• It inputs the automatic brightness ON/OFF signals that are required for the display dimming control.</li><li>• It inputs the signals for driving status recognition (vehicle speed, reverse and parking brake).</li></ul>

### DTC Logic

INFOID:000000005259554

DTC	Display contents of CONSULT-III	DTC Detection Condition	Action to take
U121D	DSP CONN [U121D]	Internal malfunction of AV control unit (DSP connection error) is detected.	Replace AV control unit. Refer to <a href="#">AV-460, "Removal and Installation"</a> .



# U121E AV CONTROL UNIT

< COMPONENT DIAGNOSIS >

[BOSE AUDIO WITH NAVIGATION]

## U121E AV CONTROL UNIT

### Description

INFOID:000000005259555

Replace the AV control unit if this DTC is displayed. Refer to [AV-460, "Removal and Installation"](#).

Part name	Description
AV CONTROL UNIT	<ul style="list-style-type: none"><li>Integrates HDD (hard disk drive) allowing map data and music data to be stored.</li><li>It is the master unit of the MULTI AV system, and it is connected to each control unit by means of communication. It operates each system according to communication signals from the AV control unit.</li><li>The AV control unit includes the audio, hands-free phone, voice control, navigation, and vehicle information functions.</li><li>It is connected to ECM and combination meter via CAN communication to obtain necessary information for the vehicle information function.</li><li>It inputs the automatic brightness ON/OFF signals that are required for the display dimming control.</li><li>It inputs the signals for driving status recognition (vehicle speed, reverse and parking brake).</li></ul>

### DTC Logic

INFOID:000000005259556

DTC	Display contents of CONSULT-III	DTC Detection Condition	Action to take
U121E	DSP COMM [U121E]	Internal malfunction of AV control unit (DSP communication error) is detected.	Replace AV control unit. Refer to <a href="#">AV-460, "Removal and Installation"</a> .

A  
B  
C  
D  
E  
F  
G  
H  
I  
J  
K  
L  
M  
O  
P

AV

# U121F AV CONTROL UNIT

< COMPONENT DIAGNOSIS >

[BOSE AUDIO WITH NAVIGATION]

## U121F AV CONTROL UNIT

### Description

INFOID:000000005259557

Part name	Description
AV CONTROL UNIT	<ul style="list-style-type: none"><li>• Integrates HDD (hard disk drive) allowing map data and music data to be stored.</li><li>• It is the master unit of the MULTI AV system, and it is connected to each control unit by means of communication. It operates each system according to communication signals from the AV control unit.</li><li>• The AV control unit includes the audio, hands-free phone, voice control, navigation, and vehicle information functions.</li><li>• It is connected to ECM and combination meter via CAN communication to obtain necessary information for the vehicle information function.</li><li>• It inputs the automatic brightness ON/OFF signals that are required for the display dimming control.</li><li>• It inputs the signals for driving status recognition (vehicle speed, reverse and parking brake).</li></ul>

### DTC Logic

INFOID:000000005259558

DTC	Display contents of CONSULT-III	DTC Detection Condition	Action to take
U121F	INTERNAL COMM [U121F]	Internal malfunction of AV control unit (internal communication error) is detected.	AV control unit power supply and ground circuit

### Diagnosis Procedure

INFOID:000000005259559

#### 1. CHECK AV CONTROL UNIT POWER SUPPLY AND GROUND CIRCUIT

Check audio control unit power supply and ground circuit. Refer to [AV-371, "AV CONTROL UNIT : Diagnosis Procedure"](#).

Is inspection result OK?

- YES >> Inspection End.
- NO >> Repair malfunctioning parts.

# U1243 DISPLAY UNIT

< COMPONENT DIAGNOSIS >

[BOSE AUDIO WITH NAVIGATION]

## U1243 DISPLAY UNIT

### Description

INFOID:000000005259560

Part name	Description
DISPLAY UNIT	<ul style="list-style-type: none"> <li>• Display image is controlled by the serial communication from AV control unit.</li> <li>• RGB image signal is input from AV control unit (RGB, RGB area and RGB synchronizing). Auxiliary image signal is input from the auxiliary input jack. Camera image signal is input from the camera control unit.</li> <li>• Synchronize signal (HP, VP) is output to AV control unit.</li> <li>• Touch panel function can be operated for each system by touching a display directly.</li> </ul>

### DTC Logic

INFOID:000000005259561

DTC	Display contents of CONSULT-III	DTC Detection Condition	Possible causes
U1243	FRONT DISP CONN [U1243]	<ul style="list-style-type: none"> <li>• Display unit power supply and ground circuit malfunction is detected</li> <li>• Malfunction is detected on communication circuit between display unit and AV control unit</li> <li>• Malfunction is detected on communication signal between display unit and AV control unit</li> </ul>	<ul style="list-style-type: none"> <li>• Display unit power supply and ground circuit</li> <li>• Communication circuit between display unit and AV control unit</li> </ul>

### Diagnosis Procedure

INFOID:000000005259562

Regarding Wiring Diagram information, refer to [AV-414, "Wiring Diagram"](#).

#### 1. CHECK DISPLAY UNIT POWER SUPPLY AND GROUND CIRCUIT

Check display unit power supply and ground circuit. Refer to [AV-372, "DISPLAY UNIT : Diagnosis Procedure"](#).

Is inspection result OK?

YES >> GO TO 2

NO >> Repair malfunctioning parts.

#### 2. CHECK CONTINUITY COMMUNICATION CIRCUIT

1. Turn ignition switch OFF.
2. Disconnect display unit connector M92 and AV control unit connector M37.
3. Check continuity between display unit harness connector M92 (A) terminals 11, 22 and AV control unit harness connector M37 (B) terminals 30, 31.

A		B		Continuity
Connector	Terminal	Connector	Terminal	
M92	11	M37	30	Yes
	22		31	

4. Check continuity between display unit harness connector M92 (A) terminals 11, 22 and ground.

A		—	Continuity
Connector	Terminal		
M92	11	Ground	No
	22		

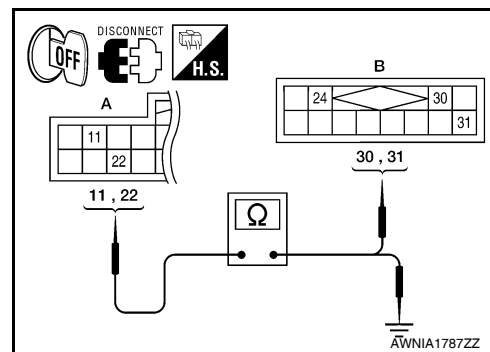

# U1243 DISPLAY UNIT

[BOSE AUDIO WITH NAVIGATION]

## < COMPONENT DIAGNOSIS >

### Are continuity results as specified?

- YES >> GO TO 3
- NO >> Repair harness or connector.

### 3. CHECK COMMUNICATION SIGNAL

1. Connect display unit connector M92 and AV control unit connector M37.
2. Turn ignition switch ON.
3. Check signal between display unit harness connector M92 terminal 11 and ground.

Connector	Terminals		Reference Signal
	(+)	(-)	
M92	11	Ground	

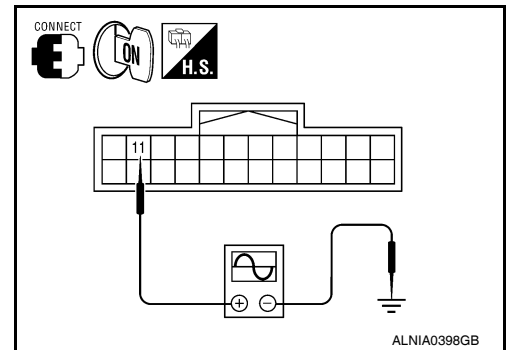

### Are voltage readings as specified?

- YES >> GO TO 4
- NO >> Replace AV control unit. Refer to [AV-460. "Removal and Installation"](#).

### 4. CHECK COMMUNICATION SIGNAL

Check signal between display unit harness connector M92 terminal 22 and ground.

Connector	Terminals		Reference Signal
	(+)	(-)	
M92	22	Ground	

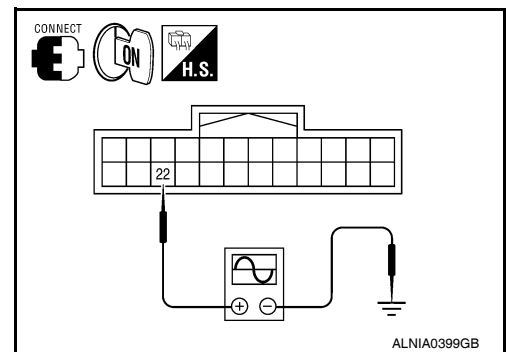

### Are voltage readings as specified?

- YES >> Inspection End.
- NO >> Replace display unit. Refer to [AV-462. "Removal and Installation"](#).

# U1244 GPS ANTENNA

< COMPONENT DIAGNOSIS >

[BOSE AUDIO WITH NAVIGATION]

## U1244 GPS ANTENNA

### Description

INFOID:000000005259563

The GPS antenna receives satellite GPS signals.

### DTC Logic

INFOID:000000005259564

### DTC DETECTION LOGIC

DTC	CONSULT-III display	Detection condition
U1244	GPS ANTENNA CONN [U1244]	GPS antenna connection malfunction is detected.

### Diagnosis Procedure

INFOID:000000005259565

Regarding Wiring Diagram information, refer to [AV-414. "Wiring Diagram"](#).

## 1. GPS ANTENNA CHECK

Inspect GPS antenna and antenna feeder for damage or poor connection.

Is the GPS antenna and feeder clean and undamaged?

YES >> GO TO 2

NO >> Repair or replace malfunctioning parts.

## 2. CHECK AV CONTROL UNIT VOLTAGE

- Turn ignition switch ON.
- Check voltage between AV control unit connector M72 terminal 109 and ground.

**109 - Ground : Approx. 5V**

Is the voltage reading as specified?

YES >> Replace GPS antenna. Refer to [AV-473. "Removal and Installation"](#).

NO >> Replace AV control unit. Refer to [AV-460. "Removal and Installation"](#).

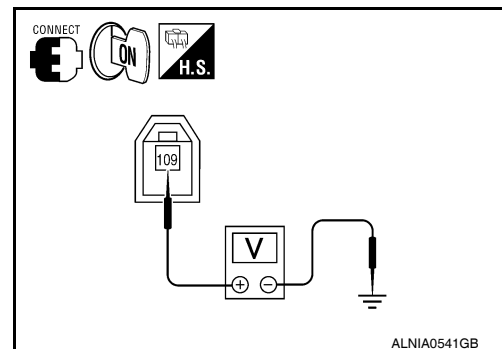

A  
B  
C  
D  
E  
F  
G  
H  
I  
J  
K  
L  
M  
O  
P

AV

# U1250 CAMERA CONTROL UNIT

< COMPONENT DIAGNOSIS >

[BOSE AUDIO WITH NAVIGATION]

## U1250 CAMERA CONTROL UNIT

### Description

INFOID:000000005259566

Part name	Description
CAMERA CONTROL UNIT	<ul style="list-style-type: none"> <li>Camera image signal is input from rear view camera, and camera image is indicated on the display.</li> <li>Power (camera ON signal) is sent to rear view camera.</li> <li>Controlled by audio communication sent from AV control unit.</li> <li>AV control unit recognizes the presence of camera system with camera connection recognition signal.</li> </ul>

### DTC Logic

INFOID:000000005259567

DTC	Display contents of CONSULT-III	DTC Detection Condition	Possible causes
U1250	CAMERA CONT. CONN [U1250]	A malfunction is detected in camera-connection recognition signal circuit	Camera-connection recognition signal circuit

### Diagnosis Procedure

INFOID:000000005259568

Regarding Wiring Diagram information, refer to [AV-414. "Wiring Diagram"](#).

## 1. CHECK CAMERA-CONNECTION RECOGNITION SIGNAL CIRCUIT

- Disconnect AV control unit connector and camera control unit connector.
- Check continuity between AV control unit harness connector M48 (A) terminal 87 and camera control unit harness connector B176 (B) terminal 5.

A		B		Continuity
Connector	Terminal	Connector	Terminal	
M48	87	B176	5	Yes

- Check continuity between AV control unit harness connector M48 (A) terminal 87 and ground.

A		—	Continuity
Connector	Terminal		
M48	87	Ground	No

Are the continuity results as specified?

- YES >> GO TO 2  
 NO >> Repair harness or connector.

## 2. CHECK AV CONTROL UNIT VOLTAGE

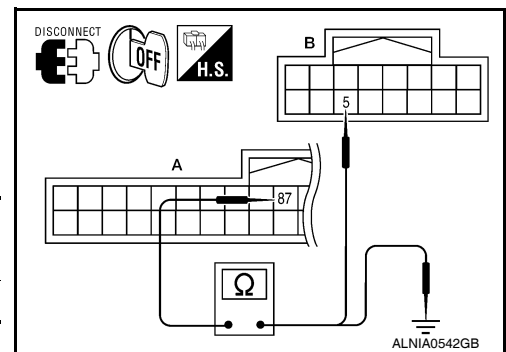

# U1250 CAMERA CONTROL UNIT

[BOSE AUDIO WITH NAVIGATION]

## < COMPONENT DIAGNOSIS >

1. Connect AV control unit connector.
2. Turn ignition switch ON.
3. Check voltage between AV control unit harness connector M48 terminal 87 and ground.

Connector	Terminals		Voltage
	(+)	(-)	
M48	87	Ground	Approx. 5V

Is voltage approximately 5 volts?

- YES >> Replace camera control unit. Refer to [AV-477, "Removal and Installation"](#).
- NO >> Replace AV control unit. Refer to [AV-460, "Removal and Installation"](#).

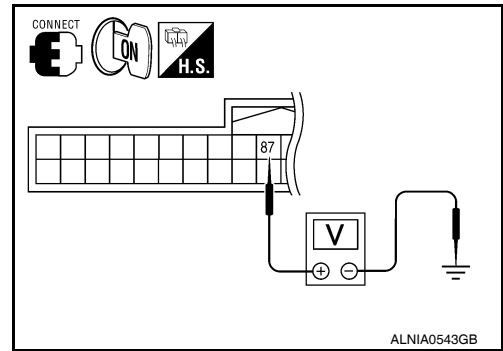

A

B

C

D

E

F

G

H

I

J

K

L

M

AV

O

P

# U1258 SATELLITE RADIO ANTENNA

< COMPONENT DIAGNOSIS >

[BOSE AUDIO WITH NAVIGATION]

## U1258 SATELLITE RADIO ANTENNA

### Description

INFOID:000000005259569

Part name	Description
SATELLITE RADIO ANTENNA	Satellite radio signal is received and sent to audio control unit.

### DTC Logic

INFOID:000000005259570

DTC	Display contents of CONSULT-III	DTC Detection Condition	Possible causes
U1258	XM ANETNNA CONN [U1258]	Satellite radio antenna connection malfunction is detected	Satellite radio antenna disconnection

### Diagnosis Procedure

INFOID:000000005259571

Regarding Wiring Diagram information, refer to [AV-414, "Wiring Diagram"](#).

## 1. SATELLITE RADIO ANTENNA CHECK

Visually check satellite radio antenna and antenna feeder.

Is inspection result OK?

- YES >> GO TO 2
- NO >> Repair malfunctioning parts.

## 2. CHECK AV CONTROL UNIT VOLTAGE

1. Disconnect AV control unit connector M71.
2. Turn ignition switch ON.
3. Check voltage between AV control unit connector M71 terminal 108 and ground.

**108 - Ground : Approx. 5 V**

Is voltage approximately 5 volts?

- YES >> Inspection End.
- NO >> Replace AV control unit. Refer to [AV-460, "Removal and Installation"](#).

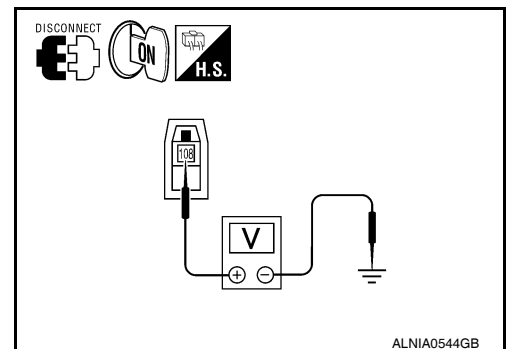



# U1300 AV COMM CIRCUIT

< COMPONENT DIAGNOSIS >

[BOSE AUDIO WITH NAVIGATION]

## U1300 AV COMM CIRCUIT

### Description

INFOID:000000005259572

U1300 is indicated when malfunction occurs in communication signal of multi AV system. Indicated simultaneously, without fail, with the malfunction of control units connected to AV control unit with communication line. Determine the possible malfunction cause from the table below.

### Self-diagnosis results display item

DTC	Display contents of CONSULT-III	DTC Detection Condition	Possible causes
U1300 U1240	<ul style="list-style-type: none"><li>AV COMM CIRCUIT [U1300]</li><li>SWITCH CONN [U1240]</li></ul>	<ul style="list-style-type: none"><li>A/C and AV switch assembly power supply and ground circuit malfunction is detected</li><li>A malfunction is detected in communication circuit between AV control unit and A/C and AV switch assembly</li><li>A malfunction is detected in communication signal between AV control unit and A/C and AV switch assembly</li></ul>	<ul style="list-style-type: none"><li>A/C and AV switch assembly power supply and ground circuits</li><li>Communication circuit between AV control unit and A/C and AV switch assembly</li></ul>

A  
B  
C  
D  
E  
F  
G  
H  
I  
J  
K  
L  
M

AV

O  
P

# U1310 AV CONTROL UNIT

< COMPONENT DIAGNOSIS >

[BOSE AUDIO WITH NAVIGATION]

## U1310 AV CONTROL UNIT

### Description

INFOID:000000005259573

Replace the AV control unit if this DTC is displayed. Refer to [AV-460, "Removal and Installation"](#).

Part name	Description
AV CONTROL UNIT	<ul style="list-style-type: none"><li>• It is the master unit of the MULTI AV system and it is connected to each control unit by means of communication. It operates each system according to communication signals from the AV control unit.</li><li>• AV control unit includes audio function and vehicle information function.</li><li>• It is connected to ECM and combination meter via CAN communication to obtain necessary information for the vehicle information function.</li><li>• It inputs the automatic brightness ON/OFF signals that are required for the display dimming control.</li><li>• It inputs the signals for driving status recognition (vehicle speed, reverse and parking brake).</li></ul>

### DTC Logic

INFOID:000000005259574

DTC	Display contents of CONSULT-III	DTC Detection Condition	Action to take
U1310	CONTROL UNIT (AV) [U1310]	An initial diagnosis error is detected in AV communication circuit.	Replace AV control unit. Refer to <a href="#">AV-460, "Removal and Installation"</a> .

# POWER SUPPLY AND GROUND CIRCUIT

< COMPONENT DIAGNOSIS >

[BOSE AUDIO WITH NAVIGATION]

## POWER SUPPLY AND GROUND CIRCUIT

### AV CONTROL UNIT

#### AV CONTROL UNIT : Diagnosis Procedure

INFOID:000000005259575

Regarding Wiring Diagram information, refer to [AV-414. "Wiring Diagram"](#).

### 1. CHECK FUSES

Check that the following AV control unit fuses are not blown.

Unit	Terminals	Signal name	Fuse No.
AV control unit	19, 69, 71	Battery power	29
	7, 72	Ignition switch ACC or ON	4
	82	Ignition switch ON or START	12

Are the fuses OK?

YES >> GO TO 2

NO >> If fuse is blown, be sure to eliminate cause of malfunction before installing new fuse.

### 2. POWER SUPPLY CIRCUIT CHECK

- Disconnect AV control unit connectors M39 and M48.
- Check voltage between the AV control unit connectors M39 and M48 and ground.

Connector	(+)		(-)	OFF	ACC	ON
	Terminal					
M39	7	Ground	0V	Battery voltage	Battery voltage	
	19	Ground	Battery voltage	Battery voltage	Battery voltage	
M48	69	Ground	Battery voltage	Battery voltage	Battery voltage	
	71	Ground	Battery voltage	Battery voltage	Battery voltage	
	72	Ground	0V	Battery voltage	Battery voltage	
	82	Ground	0V	0V	Battery voltage	

Are the voltage results as specified?

YES >> GO TO 3

- NO >>
- Check connector housings for disconnected or loose terminals.
  - Repair harness or connector.

### 3. GROUND CIRCUIT CHECK

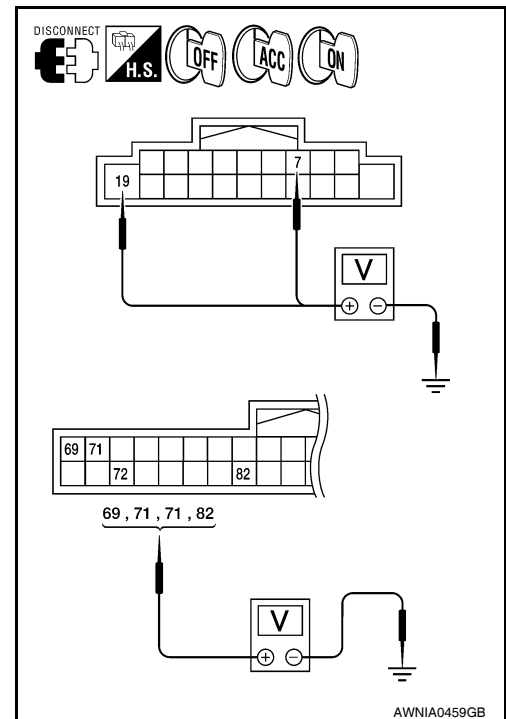

A  
B  
C  
D  
E  
F  
G  
H  
I  
J  
K  
L  
M  
N  
O  
P

AV

# POWER SUPPLY AND GROUND CIRCUIT

[BOSE AUDIO WITH NAVIGATION]

## < COMPONENT DIAGNOSIS >

1. Ignition OFF.
2. Check continuity between AV control unit harness connector M48 and ground.

(+)		(-)	Continuity
Connector	Terminal		
M48	68	Ground	Yes
	70		
	89		
	90		

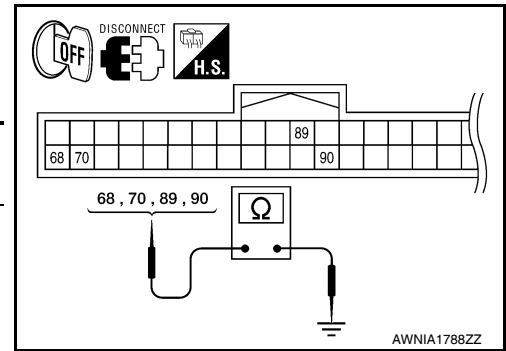

Are the continuity results as specified?

- YES >> Inspection End.  
 NO >> Repair AV control unit ground.

## DISPLAY UNIT

### DISPLAY UNIT : Diagnosis Procedure

INFOID:000000005259576

Regarding Wiring Diagram information, refer to [AV-414. "Wiring Diagram"](#).

## 1.CHECK FUSES

Check that the following display unit fuses are not blown.

Unit	Terminals	Signal name	Fuse No.
Display unit	2	Battery power	29
	3	Ignition switch ACC or ON	4

Are the fuses OK?

- YES >> GO TO 2  
 NO >> If fuse is blown, be sure to eliminate cause of malfunction before installing new fuse.

## 2.CHECK POWER SUPPLY CIRCUIT

1. Turn ignition switch to ACC
2. Check voltage between display unit harness connector M92 and ground.

Connector	Terminal	Ignition switch position	Value (Approx.)
M92	2	ACC	Battery voltage
	3		

Does specified voltage exist?

- YES >> GO TO 3.  
 NO >> • Check connector housings for disconnected or loose terminals.  
 • Repair harness or connector.

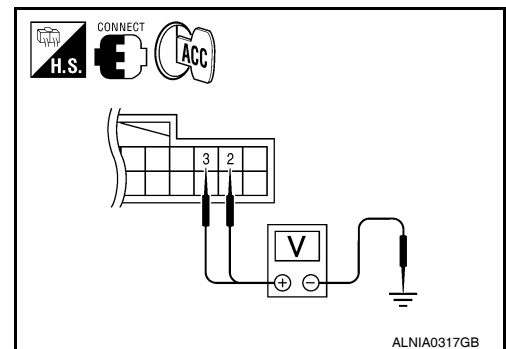

## 3.CHECK GROUND CIRCUIT

# POWER SUPPLY AND GROUND CIRCUIT

[BOSE AUDIO WITH NAVIGATION]

## < COMPONENT DIAGNOSIS >

1. Turn ignition switch OFF.
2. Disconnect display unit connector.
3. Check continuity between display unit harness connector M92 and ground.

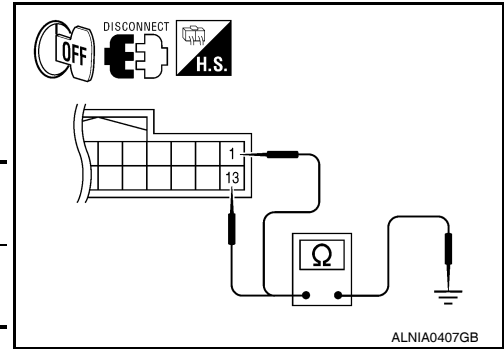

(+)		(-)	Continuity
Connector	Terminal		
M92	1	Ground	Yes
	13		

### Does continuity exist?

- YES >> Inspection End.  
 NO >> Repair harness or connector.

## A/C AND AV SWITCH ASSEMBLY

### A/C AND AV SWITCH ASSEMBLY : Diagnosis Procedure

INFOID:000000005259577

Regarding Wiring Diagram information, refer to [AV-414. "Wiring Diagram"](#).

## 1.CHECK FUSE

Check that the A/C and AV switch assembly fuse is not blown.

Unit	Terminal	Signal name	Fuse No.
A/C and AV switch assembly	2	Ignition switch ACC or ON	4

### Is the fuse OK?

- YES >> GO TO 2  
 NO >> If fuse is blown, be sure to eliminate cause of malfunction before installing new fuse.

## 2.POWER SUPPLY CIRCUIT CHECK

1. Disconnect A/C and AV switch assembly connector M98.
2. Check voltage between the A/C and AV switch assembly connector M98 and ground.

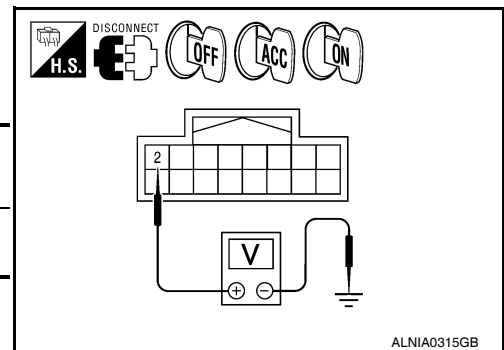

(+)		(-)	OFF	ACC	ON
Connector	Terminal				
M98	2	Ground	0V	Battery voltage	Battery voltage

### Are the voltage results as specified?

- YES >> GO TO 3  
 NO >> • Check connector housings for disconnected or loose terminals.  
 • Repair harness or connector.

## 3.GROUND CIRCUIT CHECK

A  
B  
C  
D  
E  
F  
G  
H  
I  
J  
K  
L  
M  
AV  
O  
P

# POWER SUPPLY AND GROUND CIRCUIT

[BOSE AUDIO WITH NAVIGATION]

## < COMPONENT DIAGNOSIS >

1. Ignition OFF.
2. Check continuity between A/C and AV switch assembly harness connector M98 and ground.

(+)		(-)	Continuity
Connector	Terminal		
M98	1	Ground	Yes

Are the continuity results as specified?

- YES >> Inspection End.  
 NO >> Repair A/C and AV switch assembly ground.

## BOSE SPEAKER AMP

### BOSE SPEAKER AMP : Diagnosis Procedure

INFOID:000000005259578

Regarding Wiring Diagram information, refer to [AV-414. "Wiring Diagram"](#).

## 1.CHECK FUSE

Check that the BOSE speaker amp. fuse is not blown.

Unit	Terminal	Signal name	Fuse No.
BOSE speaker amp.	1	Battery power	29

Are the fuses OK?

- YES >> GO TO 2  
 NO >> Be sure to eliminate cause of malfunction before installing new fuse.

## 2.CHECK POWER SUPPLY CIRCUIT

1. Turn ignition switch OFF.
2. Disconnect BOSE speaker amp. connector.
3. Check voltage between BOSE speaker amp. harness connector B74 terminal 1 and ground.

(+)		(-)	Voltage (approx.)
Connector	Terminal		
B74	1	Ground	Battery voltage

Is battery voltage present?

- YES >> GO TO 3  
 NO >> Check harness between BOSE speaker amp. and fuse.

## 3.CHECK GROUND CIRCUIT

1. Turn ignition switch OFF.
2. Disconnect BOSE speaker amp. connector.
3. Check continuity between BOSE speaker amp. harness connector B74 terminal 17 and ground.

(+)		(-)	Continuity
Connector	Terminal		
B74	17	Ground	Yes

Does continuity exist?

- YES >> Inspection End.  
 NO >> Repair harness or connector.

## SUBWOOFER

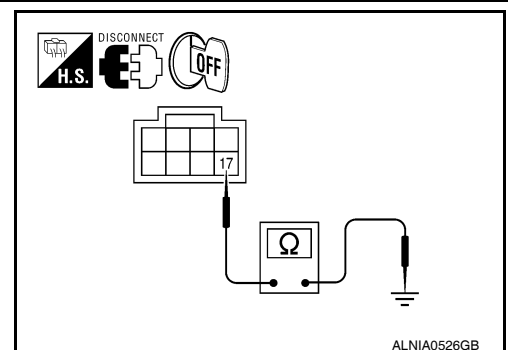
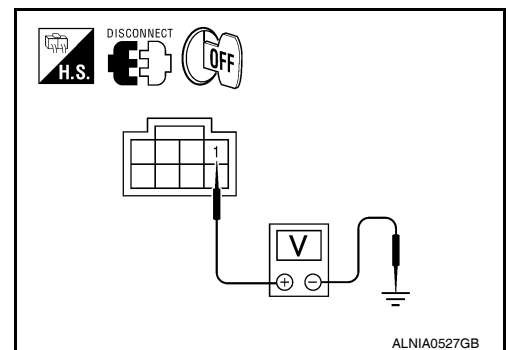
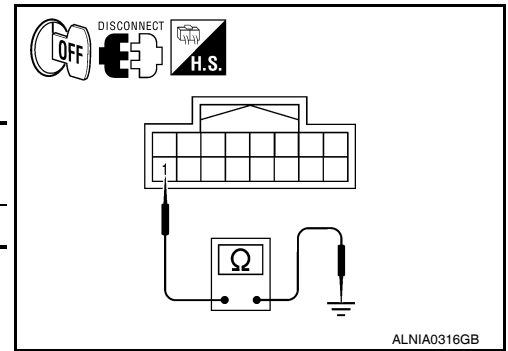

# POWER SUPPLY AND GROUND CIRCUIT

< COMPONENT DIAGNOSIS >

[BOSE AUDIO WITH NAVIGATION]

## SUBWOOFER : Diagnosis Procedure

INFOID:000000005259579

Regarding Wiring Diagram information, refer to [AV-414, "Wiring Diagram"](#).

### 1.CHECK FUSE

Check that the subwoofer fuse is not blown.

Unit	Terminal	Signal name	Fuse No.
Subwoofer	6	Battery power	17

Is the fuse OK?

YES >> GO TO 2

NO >> Be sure to eliminate cause of malfunction before installing new fuse.

### 2.CHECK POWER SUPPLY CIRCUIT

1. Turn ignition switch OFF.
2. Disconnect subwoofer connector.
3. Check voltage between subwoofer harness connector B72 terminal 6 and ground.

(+)		(-)	Voltage (approx.)
Connector	Terminal		
B72	6	Ground	Battery voltage

Is battery voltage present?

YES >> GO TO 3

NO >> Check harness between subwoofer and fuse.

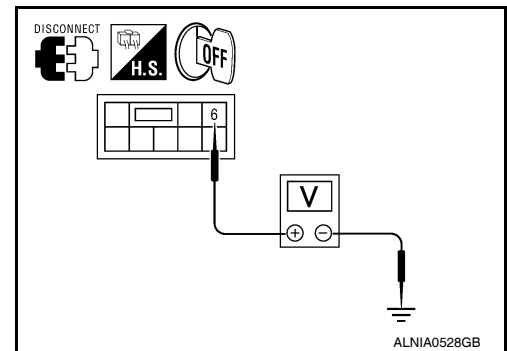

### 3.CHECK GROUND CIRCUIT

1. Turn ignition switch OFF.
2. Check continuity between subwoofer harness connector B72 terminal 5 and ground.

(+)		(-)	Continuity
Connector	Terminal		
B72	5	Ground	Yes

Does continuity exist?

YES >> Inspection End.

NO >> Repair harness or connector.

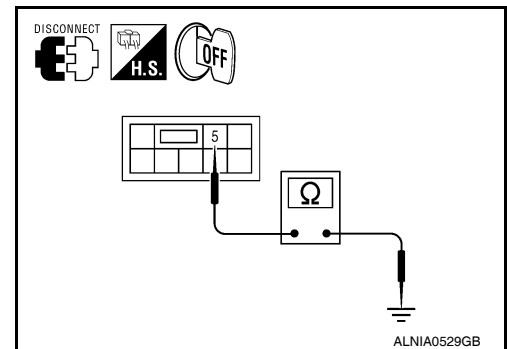

## REAR VIEW CAMERA CONTROL UNIT

### REAR VIEW CAMERA CONTROL UNIT : Diagnosis Procedure

INFOID:000000005259580

Regarding Wiring Diagram information, refer to [AV-414, "Wiring Diagram"](#).

### 1.CHECK FUSE

Check that the following fuses of the rear view camera control unit are not blown.

Unit	Terminals	Signal name	Fuse No.
Rear view camera control unit	1	Battery power	29
	2	Ignition switch ACC or ON	4

A  
B  
C  
D  
E  
F  
G  
H  
I  
J  
K  
L  
M  
N  
O  
P

AV

# POWER SUPPLY AND GROUND CIRCUIT

[BOSE AUDIO WITH NAVIGATION]

## < COMPONENT DIAGNOSIS >

### Are the fuses OK?

- YES >> GO TO 2
- NO >> Be sure to eliminate cause of malfunction before installing new fuse.

## 2.CHECK POWER SUPPLY CIRCUIT

Check voltage between rear view camera control unit harness connector B176 and ground.

(+)		(-)	Ignition switch position	Value (Approx.)
Connector	Terminal			
B176	1	Ground	OFF	Battery voltage
	2		ACC	

### Are the voltage readings as specified?

- YES >> GO TO 3
- NO >> Repair harness or connector.

## 3.CHECK GROUND CIRCUIT

1. Turn ignition switch OFF.
2. Disconnect rear view camera control unit connector.
3. Check continuity between rear view camera control unit harness connector B176 terminal 3 and ground.

Connector	Terminal	—	Continuity
B176	3	Ground	Yes

### Does continuity exist?

- YES >> Inspection End.
- NO >> Repair harness or connector.

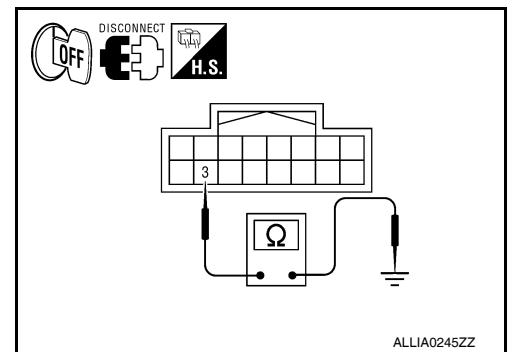
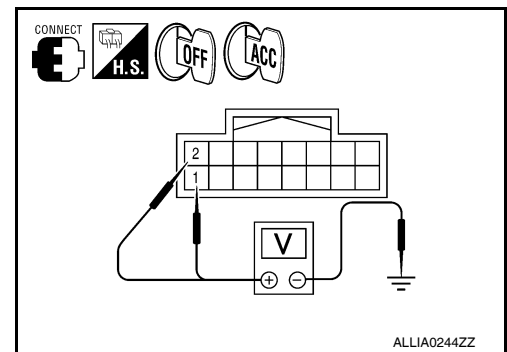

## REAR VIEW CAMERA

### REAR VIEW CAMERA : Diagnosis Procedure

INFOID:000000005259581

Regarding Wiring Diagram information, refer to [AV-414, "Wiring Diagram"](#).

## 1.CHECK POWER SUPPLY CIRCUIT (REAR VIEW CAMERA SIDE)

1. Turn ignition switch ON.
2. Shift transmission into reverse.
3. Check voltage between rear view camera harness connector D551 and ground.

(+)		(-)	Transmission position	Value (Approx.)
Connector	Terminal			
D551	1	Ground	Reverse	6V

### Is voltage reading approximately 6 volts?

- YES >> GO TO 4
- NO >> GO TO 2

## 2.CHECK POWER SUPPLY CIRCUIT (CONTINUITY)

1. Turn ignition switch OFF.
2. Disconnect rear view camera and rear view camera control unit connectors.

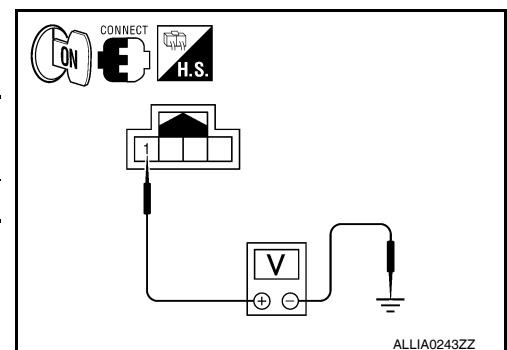



# POWER SUPPLY AND GROUND CIRCUIT

[BOSE AUDIO WITH NAVIGATION]

## < COMPONENT DIAGNOSIS >

- Check continuity between rear view camera harness connector D551 (A) terminal 1 and rear view camera control unit harness connector B176 (B) terminal 8.

A		B		Continuity
Connector	Terminal	Connector	Terminal	
D551	1	B176	8	Yes

- Check continuity between rear view camera harness connector D551 (A) terminal 1 and ground.

A		—	Continuity
Connector	Terminal		
D551	1	Ground	No

### Are continuity results as specified?

YES >> GO TO 3

NO >> Repair harness or connector.

## 3.CHECK POWER SUPPLY CIRCUIT (REAR VIEW CAMERA CONTROL UNIT SIDE)

- Connect rear view camera control unit harness connector.
- Turn ignition switch ON.
- Check voltage between rear view camera control unit harness connector B176 and ground.

(+)		(-)	Transmission position	Value (Approx.)
Connector	Terminal			
B176	8	Ground	Reverse	6V

### Is voltage reading approximately 6 volts?

YES >> GO TO 4.

NO >> Replace rear view camera control unit. Refer to [AV-309](#).  
"Removal and Installation".

## 4.CHECK GROUND CIRCUIT

- Turn ignition switch OFF.
- Disconnect rear view camera harness connector.
- Check continuity between rear view camera harness connector D551 terminal 2 and ground.

Connector	Terminal	—	Continuity
D551	2	Ground	Yes

### Does continuity exist?

YES >> Inspection End.

NO >> Repair harness or connector.

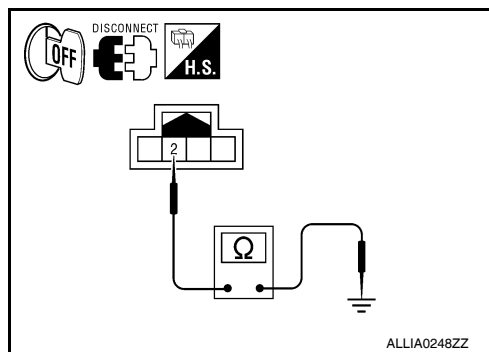
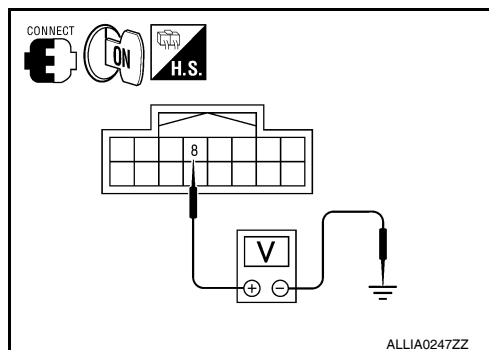
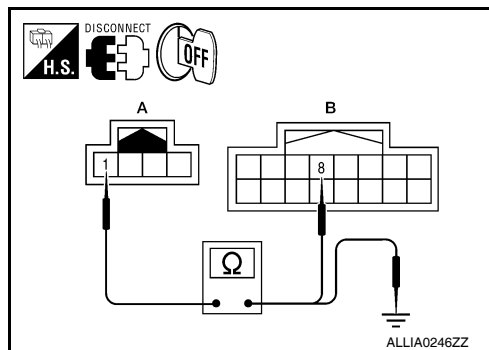

## DVD PLAYER

### DVD PLAYER : Diagnosis Procedure

INFOID:000000005259582

Regarding Wiring Diagram information, refer to [AV-414](#). "Wiring Diagram".

## 1.CHECK FUSE

Check that the following fuses of the DVD player are not blown.

# POWER SUPPLY AND GROUND CIRCUIT

< COMPONENT DIAGNOSIS >

[BOSE AUDIO WITH NAVIGATION]

Unit	Terminal	Signal name	Fuse No.
DVD player	21	Battery power	29
	24	Ignition switch ACC or ON	4

## Is the fuse OK?

YES >> GO TO 2

NO >> If fuse is blown, be sure to eliminate cause of malfunction before installing new fuse.

## 2. POWER SUPPLY CIRCUIT CHECK

1. Disconnect DVD player connector M205.
2. Check voltage between the DVD player connector M205 and ground.

(+)		(-)	OFF	ACC	ON
Connector	Terminal				
M205	21	Ground	Battery voltage	Battery voltage	Battery voltage
	24		0V	Battery voltage	Battery voltage

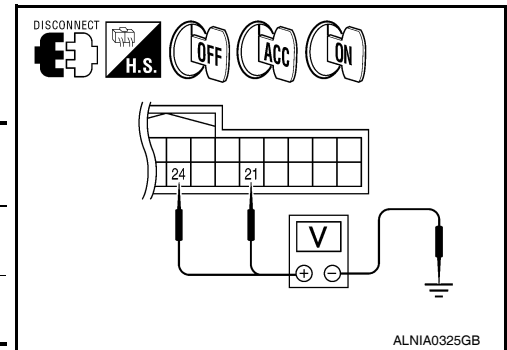

## Are the voltage results as specified?

YES >> GO TO 3

NO >> • Check connector housings for disconnected or loose terminals.  
• Repair harness or connector.

## 3. GROUND CIRCUIT CHECK

1. Turn ignition switch OFF.
2. Check continuity between DVD player harness connector M205 terminal 5 and ground.

Connector	Terminal	—	Continuity
M205	5	Ground	Yes

## Does continuity exist?

YES >> Inspection End.

NO >> Repair DVD player ground.

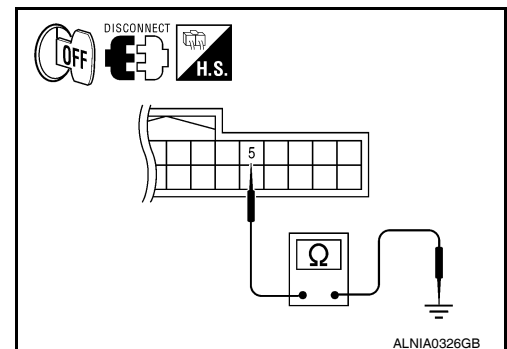

## VIDEO MONITOR

### VIDEO MONITOR : Diagnosis Procedure

INFOID:000000005259583

Regarding Wiring Diagram information, refer to [AV-414. "Wiring Diagram"](#).

## 1. CHECK POWER SUPPLY CIRCUIT

1. Turn ignition switch to ACC.

# POWER SUPPLY AND GROUND CIRCUIT

[BOSE AUDIO WITH NAVIGATION]

## < COMPONENT DIAGNOSIS >

- Check voltage between video monitor harness connector B76 and ground.

(+)		(-)	Ignition switch position	Value (Approx.)
Connector	Terminal			
B76	16	Ground	ACC	Battery voltage

Does battery voltage exist?

- YES >> GO TO 3  
NO >> GO TO 2

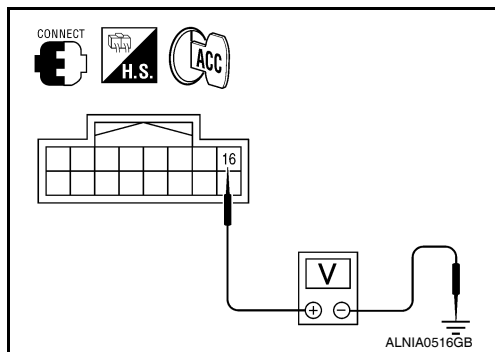

## 2.CHECK POWER SUPPLY CIRCUIT

- Turn ignition switch OFF.
- Disconnect the video monitor connector B76 and the DVD player connector M205.
- Check continuity between the video monitor harness connector B76 (A) and the DVD player connector M205 (B).

A		B		Continuity
Connector	Terminal	Connector	Terminal	
B76	16	M205	9	Yes

- Check continuity between video monitor harness connector B76 (A) and ground.

A		—	Continuity
Connector	Terminal		
B76	16	Ground	No

Are continuity results as specified?

- YES >> Check DVD player power and ground supply. Refer to [AV-193, "AV CONTROL UNIT : Diagnosis Procedure"](#).  
NO >> Repair harness or connector.

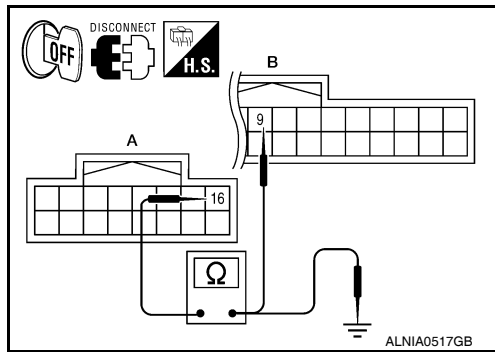

## 3.CHECK GROUND CIRCUIT

- Turn ignition switch OFF.
- Disconnect video monitor connector.
- Check continuity between video monitor harness connector B76 and ground.

Connector	Terminal	—	Continuity
B76	12	Ground	Yes
	15		

Does continuity exist?

- YES >> Inspection End.  
NO >> Repair harness or connector.

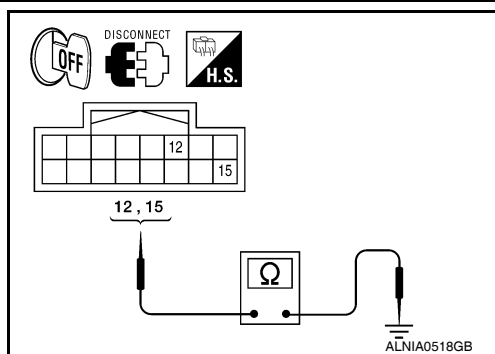

## MICROPHONE

### MICROPHONE : Diagnosis Procedure

INFOID:000000005259584

Regarding Wiring Diagram information, refer to [AV-414, "Wiring Diagram"](#).

## 1.CHECK POWER SUPPLY CIRCUIT

# POWER SUPPLY AND GROUND CIRCUIT

[BOSE AUDIO WITH NAVIGATION]

## < COMPONENT DIAGNOSIS >

Check voltage between microphone harness connector R8 terminal 4 and ground.

(+)		(-)	Ignition switch position	Value (Approx.)
Connector	Terminal			
R8	4	Ground	ON	5V

Is approximately 5V present?

- YES >> GO TO 3  
NO >> GO TO 2

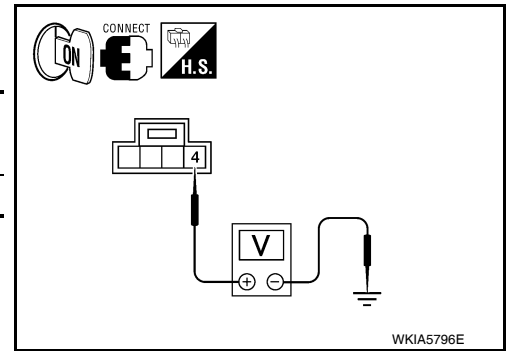

## 2. CHECK POWER SUPPLY CIRCUIT (CONTINUITY)

- Turn ignition switch OFF.
- Disconnect microphone and AV control unit harness connectors.
- Check continuity between microphone harness connector R8 (A) terminal 4 and AV control unit harness connector M48 (B) terminal 73.

A		B		Continuity
Connector	Terminal	Connector	Terminal	
R8	4	M48	73	Yes

- Check continuity between microphone harness connector R8 (A) terminal 4 and ground.

A		—	Continuity
Connector	Terminal		
R8	4	Ground	No

Are the continuity test results as specified?

- YES >> Replace the AV control unit. Refer to [AV-460, "Removal and Installation"](#).  
NO >> Repair harness or connector.

## 3. CHECK GROUND CIRCUIT

- Turn ignition switch OFF.
- Disconnect microphone harness connector R8 and AV control unit harness connector M48.
- Check continuity between microphone harness connector R8 (A) terminal 2 and AV control unit harness connector M48 (B) terminal 74.

A		B		Continuity
Connector	Terminal	Connector	Terminal	
R8	2	M48	74	Yes

Does continuity exist?

- YES >> Inspection End.  
NO >> Repair harness or connector.

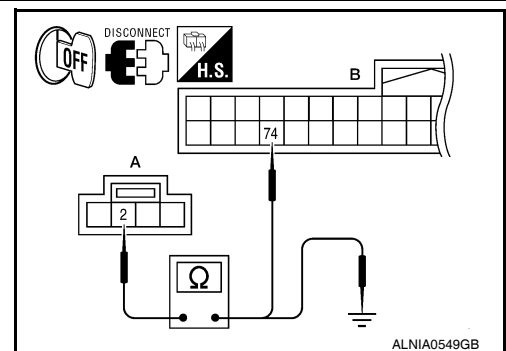
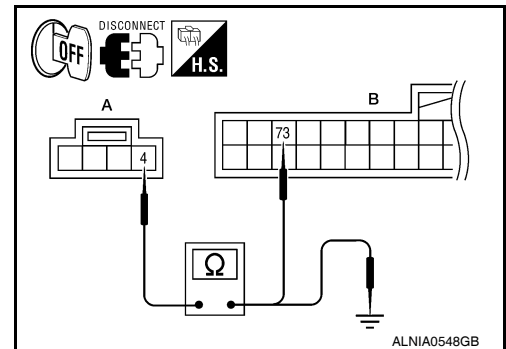

# RGB (R: RED) SIGNAL CIRCUIT

< COMPONENT DIAGNOSIS >

[BOSE AUDIO WITH NAVIGATION]

## RGB (R: RED) SIGNAL CIRCUIT

### Description

INFOID:000000005259585

Transmit the image displayed with audio control unit with RGB signal to the display unit.

### Diagnosis Procedure

INFOID:000000005259586

Regarding Wiring Diagram information, refer to [AV-414, "Wiring Diagram"](#).

### 1. CHECK CONTINUITY RGB (R: RED) SIGNAL CIRCUIT

1. Turn ignition switch OFF.
2. Disconnect display unit connector M92 and AV control unit connector M37.
3. Check continuity between display unit harness connector M92 (A) terminal 17 and AV control unit harness connector M37 (B) terminal 21.

A		B		Continuity
Connector	Terminal	Connector	Terminal	
M92	17	M37	21	Yes

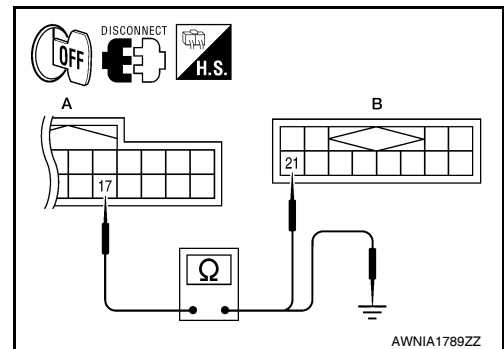

4. Check continuity between display unit harness connector M92 (A) terminal 17 and ground.

A		—	Continuity
Connector	Terminal		
M92	17	Ground	No

Are the continuity results as specified?

YES >> GO TO 2

NO >> Repair harness or connector.

### 2. CHECK RGB (R: RED) SIGNAL

1. Connect display unit connector M92 and AV control unit connector M37.
2. Turn ignition switch ON.
3. Check signal between display unit harness connector M92 terminal 17 and ground.

(+)		(-)	Condition	Reference signal
Connector	Terminal			
M92	17	Ground	Receive audio signal	

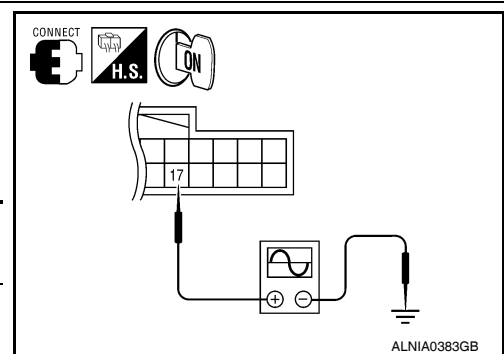

Are the voltage readings as specified?

YES >> Replace display unit. Refer to [AV-462, "Removal and Installation"](#).

NO >> Replace AV control unit. Refer to [AV-460, "Removal and Installation"](#).

A  
B  
C  
D  
E  
F  
G  
H  
I  
J  
K  
L  
M  
AV  
O  
P

# RGB (G: GREEN) SIGNAL CIRCUIT

< COMPONENT DIAGNOSIS >

[BOSE AUDIO WITH NAVIGATION]

## RGB (G: GREEN) SIGNAL CIRCUIT

### Description

INFOID:000000005259587

Transmit the image displayed with AV control unit with RGB signal to the display unit.

### Diagnosis Procedure

INFOID:000000005259588

Regarding Wiring Diagram information, refer to [AV-414, "Wiring Diagram"](#).

### 1. CHECK CONTINUITY RGB (G: GREEN) SIGNAL CIRCUIT

1. Turn ignition switch OFF.
2. Disconnect display unit connector M92 and AV control unit connector M37.
3. Check continuity between display unit harness connector M92 (A) terminal 6 and AV control unit harness connector M37 (B) terminal 22.

A		B		Continuity
Connector	Terminal	Connector	Terminal	
M92	6	M37	22	Yes

4. Check continuity between display unit harness connector M92 (A) terminal 6 and ground.

A		—	Continuity
Connector	Terminal		
M92	6	Ground	No

Are the continuity results as specified?

- YES >> GO TO 2  
 NO >> Repair harness or connector.

### 2. CHECK RGB (G: GREEN) SIGNAL

1. Connect display unit connector M92 and AV control unit connector M37.
2. Turn ignition switch ON.
3. Check signal between display unit harness connector M92 terminal 6 and ground.

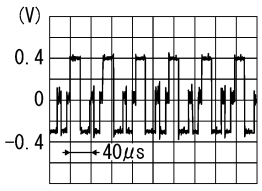
(+)		(-)	Condition	Reference signal
Connector	Terminal			
M92	6	Ground	Receive audio signal	 <p>SKIB2236J</p>

Are voltage readings as specified?

- YES >> Replace display unit. Refer to [AV-462, "Removal and Installation"](#).  
 NO >> Replace AV control unit. Refer to [AV-460, "Removal and Installation"](#).

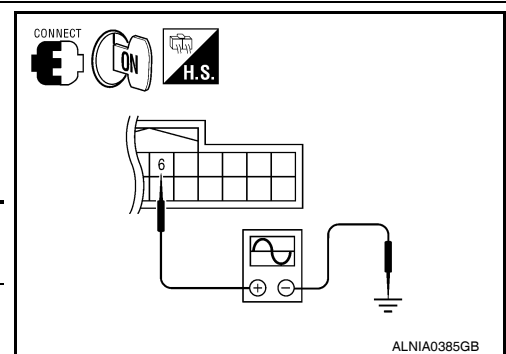
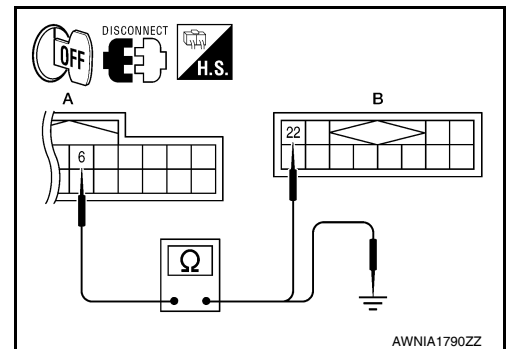

# RGB (B: BLUE) SIGNAL CIRCUIT

< COMPONENT DIAGNOSIS >

[BOSE AUDIO WITH NAVIGATION]

## RGB (B: BLUE) SIGNAL CIRCUIT

### Description

INFOID:000000005259589

Transmit the image displayed with AV control unit with RGB signal to the display unit.

### Diagnosis Procedure

INFOID:000000005259590

Regarding Wiring Diagram information, refer to [AV-414, "Wiring Diagram"](#).

### 1. CHECK CONTINUITY RGB (B: BLUE) SIGNAL CIRCUIT

1. Turn ignition switch OFF.
2. Disconnect display unit connector M92 and AV control unit connector M37.
3. Check continuity between display unit harness connector M92 (A) terminal 18 and AV control unit harness connector M37 (B) terminal 23.

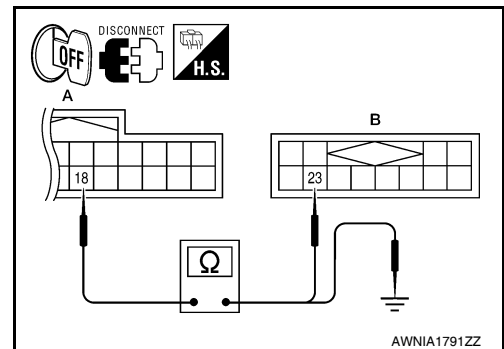

A		B		Continuity
Connector	Terminal	Connector	Terminal	
M92	18	M37	23	Yes

4. Check continuity between display unit harness connector M92 (A) terminal 18 and ground.

A		—	Continuity
Connector	Terminal		
M92	18	Ground	No

Are continuity results as specified?

YES >> GO TO 2

NO >> Repair harness or connector.

### 2. CHECK RGB (B: BLUE) SIGNAL

1. Connect display unit connector M92 and AV control unit connector M37.
2. Turn ignition switch ON.
3. Check signal between display unit harness connector M92 terminal 18 and ground.

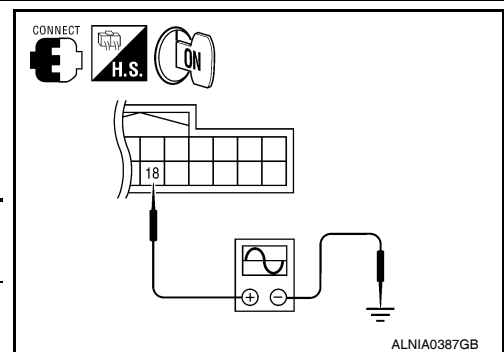

(+)		(-)	Condition	Reference signal
Connector	Terminal			
M92	18	Ground	Receive audio signal	<p>SKIB2237J</p>

Are voltage readings as specified?

YES >> Replace display unit. Refer to [AV-462, "Removal and Installation"](#).

NO >> Replace AV control unit. Refer to [AV-460, "Removal and Installation"](#).

A  
B  
C  
D  
E  
F  
G  
H  
I  
J  
K  
L  
M  
AV  
O  
P

# RGB SYNCHRONIZING SIGNAL CIRCUIT

< COMPONENT DIAGNOSIS >

[BOSE AUDIO WITH NAVIGATION]

## RGB SYNCHRONIZING SIGNAL CIRCUIT

### Description

INFOID:000000005259591

Transmit the RGB synchronizing signal to the display unit so as to synchronize the RGB image displayed with AV control unit.

### Diagnosis Procedure

INFOID:000000005259592

Regarding Wiring Diagram information, refer to [AV-414, "Wiring Diagram"](#).

### 1. CHECK CONTINUITY RGB SYNCHRONIZING SIGNAL CIRCUIT

1. Turn ignition switch OFF.
2. Disconnect display unit connector M92 and AV control unit connector M37.
3. Check continuity between display unit harness connector M92 (A) terminal 19 and AV control unit harness connector M37 (B) terminal 25.

A		B		Continuity
Connector	Terminal	Connector	Terminal	
M92	19	M37	25	Yes

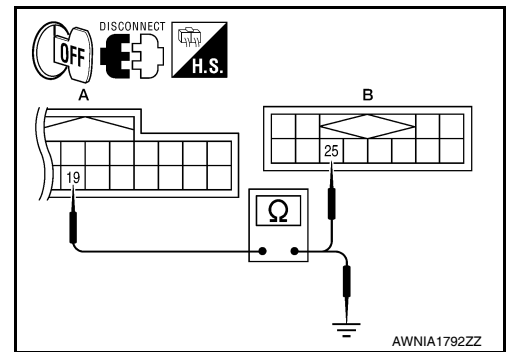

4. Check continuity between display unit harness connector M92 (A) terminal 19 and ground.

A		—	Continuity
Connector	Terminal		
M92	19	Ground	No

Are continuity results as specified?

- YES >> GO TO 2  
 NO >> Repair harness or connector.

### 2. CHECK RGB SYNCHRONIZING SIGNAL

1. Connect display unit connector M92 and AV control unit connector M37.
2. Turn ignition switch ON.
3. Check signal between display unit harness connector M92 terminal 19 and ground.

(+)		(-)	Condition	Reference signal
Connector	Terminal			
M92	19	Ground	Receive audio signal	<p>SKIB3603E</p>

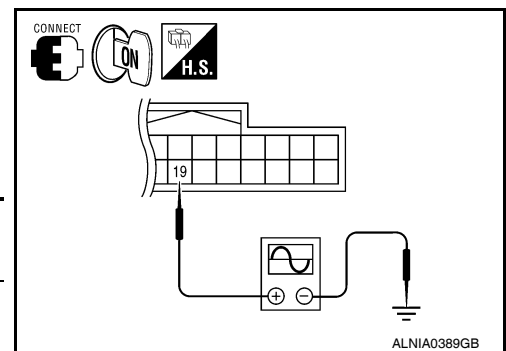

Are voltage readings as specified?

- YES >> Replace display unit. Refer to [AV-462, "Removal and Installation"](#).  
 NO >> Replace AV control unit. Refer to [AV-460, "Removal and Installation"](#).



# RGB AREA (YS) SIGNAL CIRCUIT

< COMPONENT DIAGNOSIS >

[BOSE AUDIO WITH NAVIGATION]

## RGB AREA (YS) SIGNAL CIRCUIT

### Description

INFOID:000000005259593

Transmits the display area of RGB image displayed by AV control unit with RGB area (YS) signal to display unit.

### Diagnosis Procedure

INFOID:000000005259594

Regarding Wiring Diagram information, refer to [AV-414, "Wiring Diagram"](#).

### 1. CHECK CONTINUITY RGB AREA (YS) SIGNAL CIRCUIT

1. Turn ignition switch OFF.
2. Disconnect display unit connector M92 and AV control unit connector M37.
3. Check continuity between display unit harness connector M92 (A) terminal 9 and AV control unit harness connector M37 (B) terminal 27.

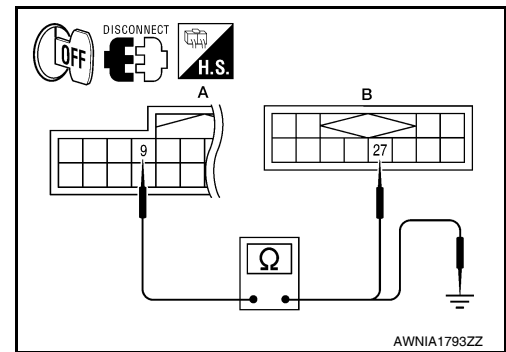

A		B		Continuity
Connector	Terminal	Connector	Terminal	
M92	9	M37	27	Yes

4. Check continuity between display unit harness connector M92 (A) terminal 9 and ground.

A		—	Continuity
Connector	Terminal		
M92	9	Ground	No

Are continuity results as specified?

YES >> GO TO 2

NO >> Repair harness or connector.

### 2. CHECK RGB SYNCHRONIZING SIGNAL

1. Connect display unit connector M92 and AV control unit connector M37.
2. Turn ignition switch ON.
3. Check signal between display unit harness connector M92 terminal 9 and ground.

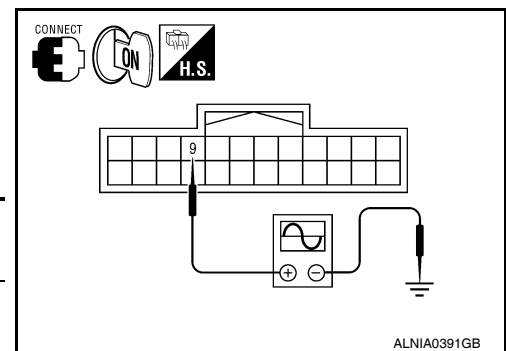

(+)		(-)	Condition	Reference signal
Connector	Terminal			
M92	9	Ground	Receive audio signal	

Are voltage readings as specified?

YES >> Replace display unit. Refer to [AV-462, "Removal and Installation"](#).

NO >> Replace AV control unit. Refer to [AV-460, "Removal and Installation"](#).

A  
B  
C  
D  
E  
F  
G  
H  
I  
J  
K  
L  
M  
N  
O  
P

AV

# HORIZONTAL SYNCHRONIZING (HP) SIGNAL CIRCUIT

< COMPONENT DIAGNOSIS >

[BOSE AUDIO WITH NAVIGATION]

## HORIZONTAL SYNCHRONIZING (HP) SIGNAL CIRCUIT

### Description

INFOID:000000005259595

In composite image (AUX image, camera image), transmit the vertical synchronizing (VP) signal and horizontal synchronizing (HP) signal from display unit to AV control unit so as to synchronize the RGB images displayed with AV control unit such as the image quality adjusting menu, etc.

### Diagnosis Procedure

INFOID:000000005259596

Regarding Wiring Diagram information, refer to [AV-414, "Wiring Diagram"](#).

### 1. CHECK CONTINUITY HORIZONTAL SYNCHRONIZING (HP) SIGNAL CIRCUIT

1. Turn ignition switch OFF.
2. Disconnect display unit connector M92 and AV control unit connector M37.
3. Check continuity between display unit harness connector M92 (A) terminal 8 and AV control unit harness connector M37 (B) terminal 28.

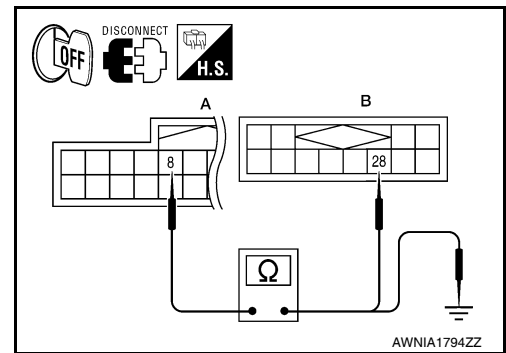

A		B		Continuity
Connector	Terminal	Connector	Terminal	
M92	8	M37	28	Yes

4. Check continuity between display unit harness connector M92 (A) terminal 8 and ground.

A		—	Continuity
Connector	Terminal		
M92	8	Ground	No

Are continuity results as specified?

- YES >> GO TO 2  
 NO >> Repair harness or connector.

### 2. CHECK HORIZONTAL SYNCHRONIZING (HP) SIGNAL

1. Connect display unit connector M92 and AV control unit connector M37.
2. Turn ignition switch ON.
3. Check signal between display unit harness connector M92 terminal 8 and ground.

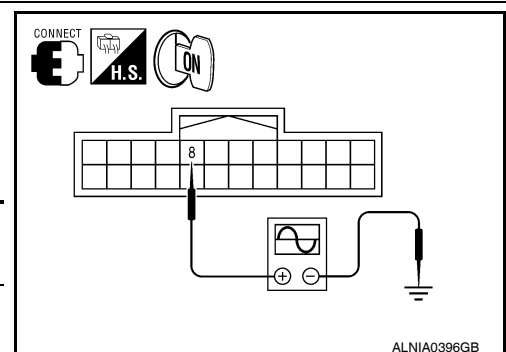

(+) Connector		(-) Terminal	Condition	Reference signal
M92	8	Ground	Receive audio signal	<p>SKIB3601E</p>

Are voltage readings as specified?

- YES >> Replace AV control unit. Refer to [AV-460, "Removal and Installation"](#).  
 NO >> Replace display unit. Refer to [AV-462, "Removal and Installation"](#).

# VERTICAL SYNCHRONIZING (VP) SIGNAL CIRCUIT

< COMPONENT DIAGNOSIS >

[BOSE AUDIO WITH NAVIGATION]

## VERTICAL SYNCHRONIZING (VP) SIGNAL CIRCUIT

### Description

INFOID:000000005259597

In composite image (AUX image, camera image), transmit the vertical synchronizing (VP) signal and horizontal synchronizing (HP) signal from display unit to AV control unit so as to synchronize the RGB images displayed with AV control unit such as the image quality adjusting menu, etc.

### Diagnosis Procedure

INFOID:000000005259598

Regarding Wiring Diagram information, refer to [AV-414. "Wiring Diagram"](#).

### 1. CHECK CONTINUITY VERTICAL SYNCHRONIZING (VP) SIGNAL CIRCUIT

1. Turn ignition switch OFF.
2. Disconnect display unit connector M92 and AV control unit connector M37.
3. Check continuity between display unit harness connector M92 (A) terminal 20 and AV control unit harness connector M37 (B) terminal 29.

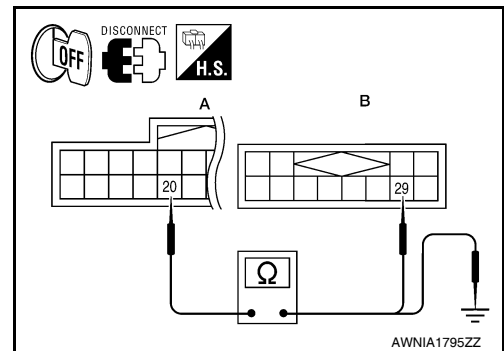

A		B		Continuity
Connector	Terminal	Connector	Terminal	
M92	20	M37	29	Yes

4. Check continuity between display unit harness connector M92 (A) terminal 20 and ground.

A		—	Continuity
Connector	Terminal		
M92	20	Ground	No

Are continuity results as specified?

YES >> GO TO 2

NO >> Repair harness or connector.

### 2. CHECK VERTICAL SYNCHRONIZING (VP) SIGNAL

1. Connect display unit connector M92 and AV control unit connector M37.
2. Turn ignition switch ON.
3. Check signal between display unit harness connector M92 terminal 20 and ground.

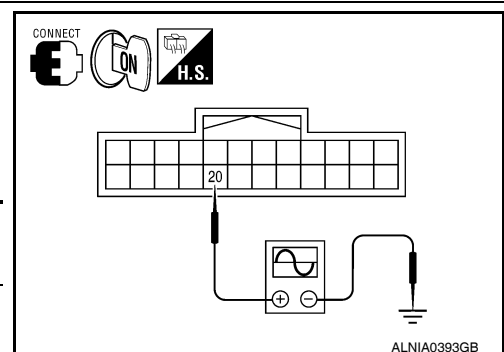

(+)		(-)	Condition	Reference signal
Connector	Terminal			
M92	20	Ground	Receive audio signal	

Are voltage readings as specified?

YES >> Replace AV control unit. Refer to [AV-460. "Removal and Installation"](#).

NO >> Replace display unit. Refer to [AV-462. "Removal and Installation"](#).

# FRONT DOOR SPEAKER

< COMPONENT DIAGNOSIS >

[BOSE AUDIO WITH NAVIGATION]

## FRONT DOOR SPEAKER

### Description

INFOID:000000005259599

The AV control unit sends audio signals to the BOSE speaker amp. The BOSE speaker amp. amplifies the audio signals before sending them to the front door speakers using the audio signal circuits.

### Diagnosis Procedure

INFOID:000000005259600

Regarding Wiring Diagram information, refer to [AV-414, "Wiring Diagram"](#).

## 1. HARNESS CHECK

1. Disconnect BOSE speaker amp. connector B75 and suspect speaker connector.
2. Check continuity between BOSE speaker amp. harness connector B75 (A) and suspect speaker harness connector (B).

A		B		Continuity
Connector	Terminal	Connector	Terminal	
B75	13	D12	1	Yes
	14		2	
	15	D112	1	
	16		2	

3. Check continuity between BOSE speaker amp. harness connector B75 (A) and ground.

A		—	Continuity
Connector	Terminal		
B75	13	Ground	No
	14		
	15		
	15		

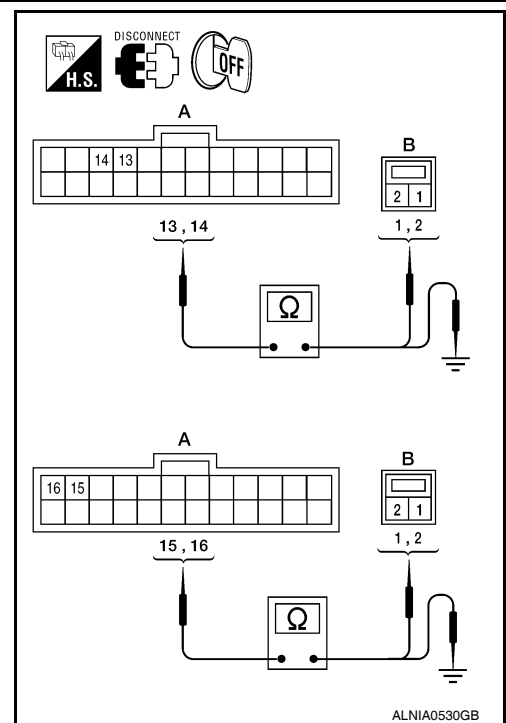

Are continuity test results as specified?

- YES >> GO TO 2  
 NO >> • Check connector housings for disconnected or loose terminals.  
 • Repair harness or connector.

## 2. FRONT SPEAKER SIGNAL CHECK

# FRONT DOOR SPEAKER

[BOSE AUDIO WITH NAVIGATION]

## < COMPONENT DIAGNOSIS >

1. Connect BOSE speaker amp. connector B75 and suspect speaker connector.
2. Turn ignition switch to ACC.
3. Push "POWER" switch.
4. Check the signal between BOSE speaker amp. harness connector B75 terminals with CONSULT-III or oscilloscope.

Connector	Terminal		Condition	Reference signal
	(+)	(-)		
B75	13	14	Receive audio signal	
	15	16		

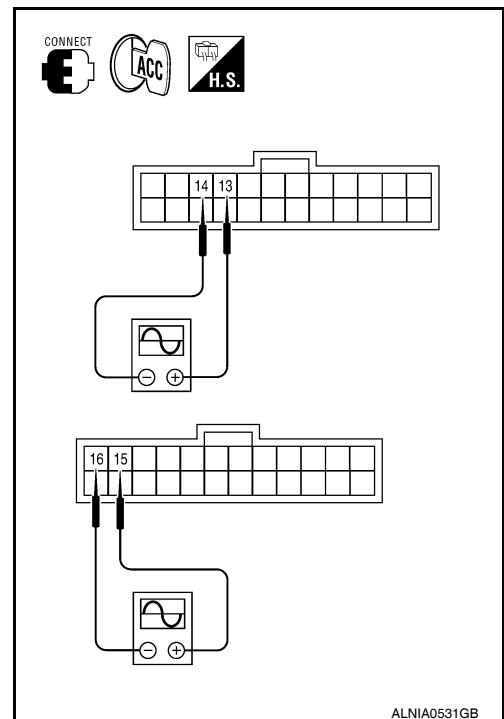

Is audio signal voltage as specified?

YES >> Replace suspect speaker. Refer to [AV-464, "Removal and Installation"](#).

NO >> GO TO 3

## 3. HARNESS CHECK

1. Disconnect AV control unit connector M39 and BOSE speaker amp. connector B75.
2. Check continuity between AV control unit harness connector M39 (A) and BOSE speaker amp. harness connector B75 (B).

A		B		Continuity
Connector	Terminal	Connector	Terminal	
M39	2	B75	30	Yes
	3		29	
	11		28	
	12		27	

3. Check continuity between AV control unit harness connector M39 (A) and ground.

A		—	Continuity
Connector	Terminal		
M39	2	Ground	No
	3		
	11		
	12		

Are continuity test results as specified?

YES >> GO TO 4

NO >> • Check connector housings for disconnected or loose terminals.  
• Repair harness or connector.

## 4. FRONT SPEAKER SIGNAL CHECK

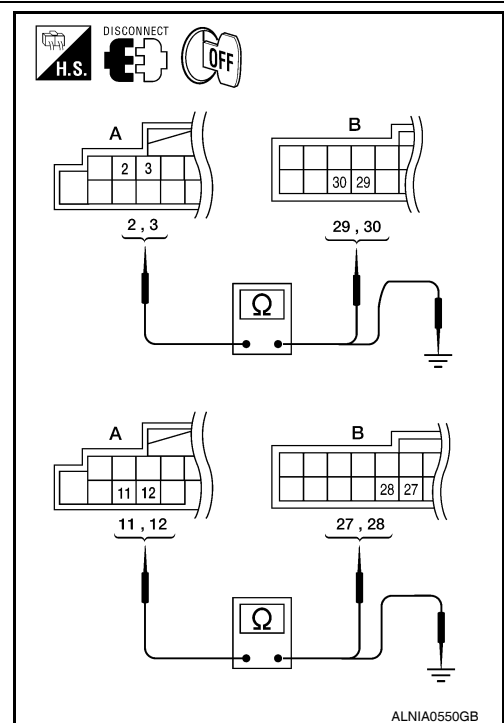

# FRONT DOOR SPEAKER

[BOSE AUDIO WITH NAVIGATION]

< COMPONENT DIAGNOSIS >

1. Connect AV control unit connector and BOSE speaker amp. connector.
2. Turn ignition switch ACC.
3. Push "POWER" switch.
4. Check the signal between AV control unit harness connector M39 terminals with CONSULT-III or oscilloscope.

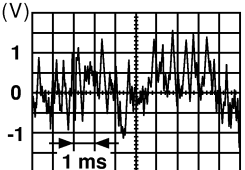
Connector	Terminals		Condition	Reference signal
	(+)	(-)		
M39	2	3	Receive audio signal	
	11	12		

SKIA0177E

Are the audio signal voltage readings as specified?

- YES >> Replace BOSE speaker amp. Refer to [AV-466, "Removal and Installation"](#).
- NO >> Replace AV control unit. Refer to [AV-460, "Removal and Installation"](#).

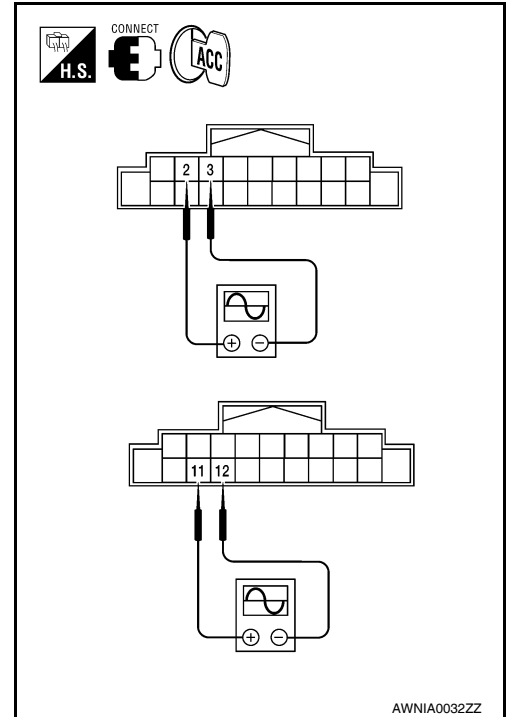

# FRONT TWEETER

< COMPONENT DIAGNOSIS >

[BOSE AUDIO WITH NAVIGATION]

## FRONT TWEETER

### Description

INFOID:000000005259601

The AV control unit sends audio signals to the BOSE speaker amp. The BOSE speaker amp. amplifies the audio signals before sending them to the tweeters using the audio signal circuits.

### Diagnosis Procedure

INFOID:000000005259602

Regarding Wiring Diagram information, refer to [AV-414, "Wiring Diagram"](#).

### 1. HARNESS CHECK

1. Disconnect BOSE speaker amp. connector B75 and suspect tweeter connector.
2. Check continuity between BOSE speaker amp. harness connector B75 (A) and suspect tweeter harness connector (B).

A		B		Continuity
Connector	Terminal	Connector	Terminal	
B75	13	M109	1	Yes
	14		2	
	15	M111	1	
	16		2	

3. Check continuity between BOSE speaker amp. harness connector B75 (A) and ground.

A		—	Continuity
Connector	Terminal		
B75	13	Ground	No
	14		
	15		
	16		

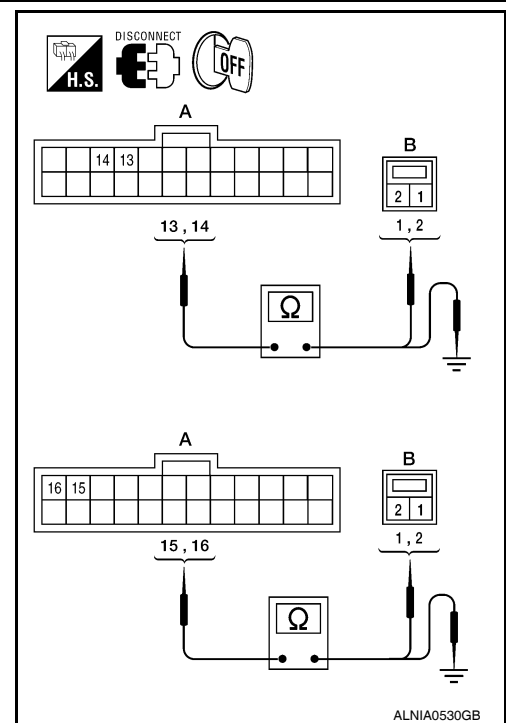

Are continuity test results as specified?

YES >> GO TO 2

- NO >> • Check connector housings for disconnected or loose terminals.  
• Repair harness or connector.

### 2. FRONT TWEETER SIGNAL CHECK

A  
B  
C  
D  
E  
F  
G  
H  
I  
J  
K  
L  
M  
O  
P

AV

# FRONT TWEETER

[BOSE AUDIO WITH NAVIGATION]

## < COMPONENT DIAGNOSIS >

1. Connect BOSE speaker amp. connector B75 and suspect tweeter connector.
2. Turn ignition switch to ACC.
3. Push "POWER" switch.
4. Check the signal between BOSE speaker amp. harness connector B75 terminals with CONSULT-III or oscilloscope.

Connector	Terminal		Condition	Reference signal
	(+)	(-)		
B75	13	14	Receive audio signal	
	15	16		

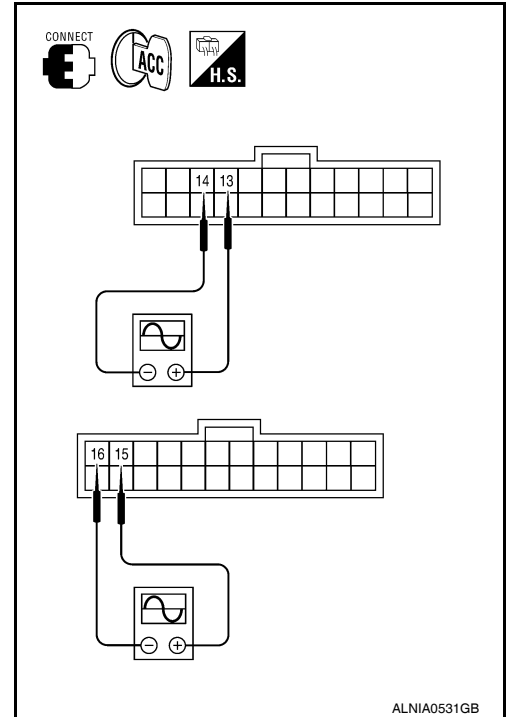

Is audio signal voltage as specified?

YES >> Replace suspect tweeter. Refer to [AV-463. "Removal and Installation"](#).

NO >> GO TO 3

## 3. HARNESS CHECK

1. Disconnect AV control unit connector M39 and BOSE speaker amp. connector B75.
2. Check continuity between AV control unit harness connector M39 (A) and BOSE speaker amp. harness connector B75 (B).

A		B		Continuity
Connector	Terminal	Connector	Terminal	
M39	2	B75	30	Yes
	3		29	
	11		28	
	12		27	

3. Check continuity between AV control unit harness connector M39 (A) and ground.

A		—	Continuity
Connector	Terminal		
M39	2	Ground	No
	3		
	11		
	12		

Are continuity test results as specified?

YES >> GO TO 4

NO >> • Check connector housings for disconnected or loose terminals.  
• Repair harness or connector.

## 4. FRONT TWEETER SIGNAL CHECK

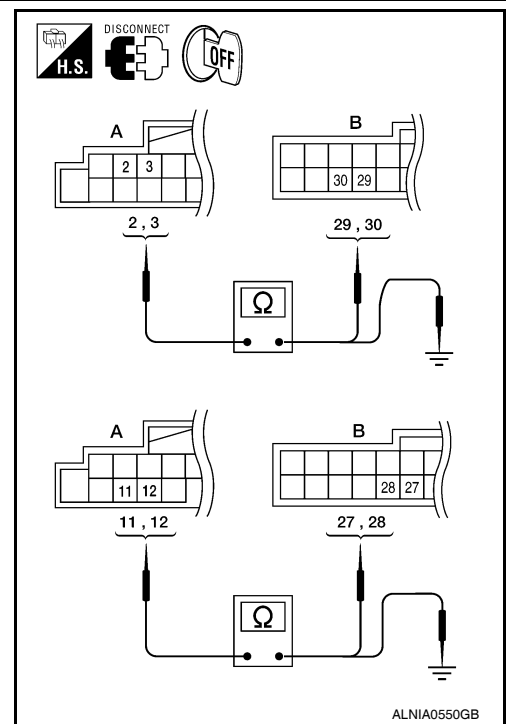



# FRONT TWEETER

## < COMPONENT DIAGNOSIS >

## [BOSE AUDIO WITH NAVIGATION]

1. Connect AV control unit connector and BOSE speaker amp. connector.
2. Turn ignition switch ACC.
3. Push "POWER" switch.
4. Check the signal between AV control unit harness connector M39 terminals with CONSULT-III or oscilloscope.

Connector	Terminals		Condition	Reference signal
	(+)	(-)		
M39	2	3	Receive audio signal	
	11	12		

SKIA0177E

Are the audio signal voltage readings as specified?

- YES >> Replace BOSE speaker amp. Refer to [AV-466, "Removal and Installation"](#).
- NO >> Replace AV control unit. Refer to [AV-460, "Removal and Installation"](#).

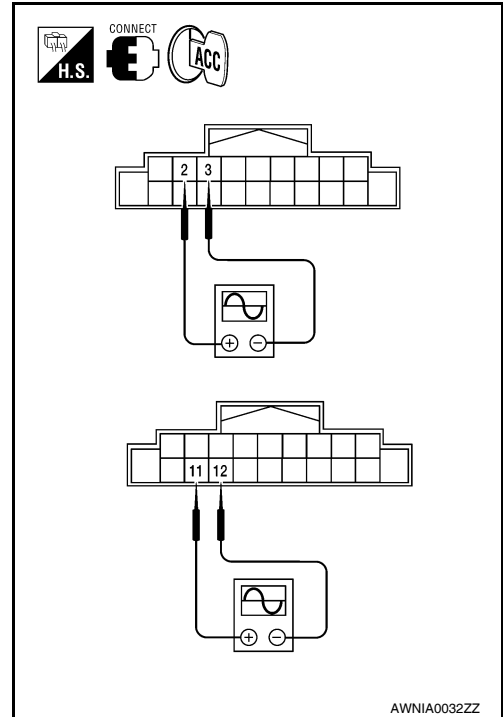

A  
B  
C  
D  
E  
F  
G  
H  
I  
J  
K  
L  
M  
O  
P

AV

# REAR DOOR SPEAKER

< COMPONENT DIAGNOSIS >

[BOSE AUDIO WITH NAVIGATION]

## REAR DOOR SPEAKER

### Description

INFOID:000000005259603

The AV control unit sends audio signals to the BOSE speaker amp. The BOSE speaker amp. amplifies the audio signals before sending them to the rear door speakers using the audio signal circuits.

### Diagnosis Procedure

INFOID:000000005259604

Regarding Wiring Diagram information, refer to [AV-414, "Wiring Diagram"](#).

## 1. HARNESS CHECK

1. Disconnect BOSE speaker amp. connectors B75 and suspect speaker connector.
2. Check continuity between BOSE speaker amp. harness connectors B75 (A) and suspect speaker harness connector (B).

A		B		Continuity
Connector	Terminal	Connector	Terminal	
B75	9	D207	1	Yes
	10		2	
	11	D307	1	
	12		2	

3. Check continuity between BOSE speaker amp. harness connectors B75 (A) and ground.

Connector	Terminal	-	Continuity
B75	9	Ground	No
	10		
	11		
	12		

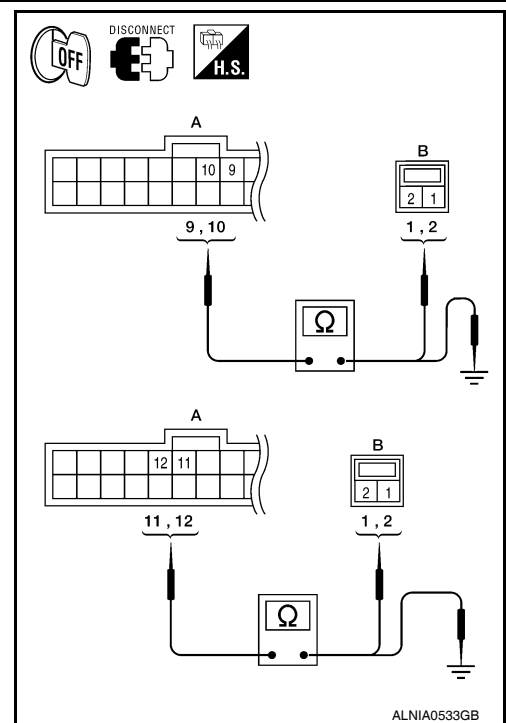

Are the continuity test results as specified?

YES >> GO TO 2

NO >> • Check connector housings for disconnected or loose terminals.  
• Repair harness or connector.

## 2. REAR DOOR SPEAKER SIGNAL CHECK

# REAR DOOR SPEAKER

[BOSE AUDIO WITH NAVIGATION]

## < COMPONENT DIAGNOSIS >

1. Connect BOSE speaker amp. connectors and suspect speaker connector.
2. Turn ignition switch to ACC.
3. Push "POWER" switch.
4. Check the signal between BOSE speaker amp. harness connectors B75 terminals with CONSULT-III or oscilloscope.

Connector	Terminals		Condition	Reference signal
	(+)	(-)		
B75	9	10	Receive audio signal	
	11	12		

SKIA0177E

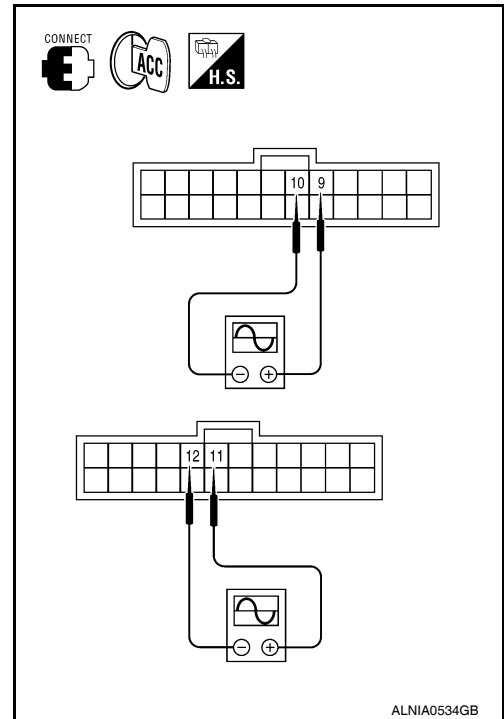

Are audio signal voltage readings as specified?

YES >> Replace suspect speaker. Refer to [AV-464, "Removal and Installation"](#).

NO >> GO TO 3

## 3. HARNESS CHECK

1. Disconnect AV control unit connector M39 and BOSE speaker amp. connector B75.
2. Check continuity between AV control unit harness connector M39 (A) and BOSE speaker amp. harness connector B75 (B).

A		B		Continuity
Connector	Terminal	Connector	Terminal	
M39	4	B75	26	Yes
	5		25	
	13		24	
	14		23	

3. Check continuity between AV control unit harness connector M39 (A) and ground.

A		—	Continuity
Connector	Terminal		
M39	4	Ground	No
	5		
	13		
	14		

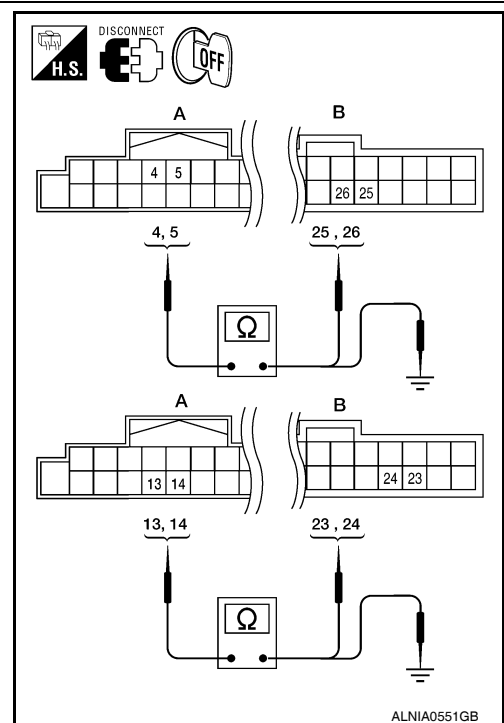

Are the continuity test results as specified?

YES >> GO TO 4

NO >> • Check connector housings for disconnected or loose terminals.  
• Repair harness or connector.

## 4. REAR DOOR SPEAKER SIGNAL CHECK

## REAR DOOR SPEAKER

### < COMPONENT DIAGNOSIS >

**[BOSE AUDIO WITH NAVIGATION]**

1. Connect AV control unit connector M39 and BOSE speaker amp. connector B75.
2. Turn ignition switch to ACC.
3. Push "POWER" switch.
4. Check the signal between AV control unit harness connector M39 terminals with CONSULT-III or oscilloscope.

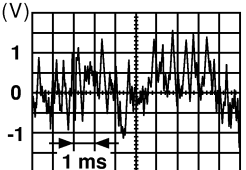
Connector	Terminals		Condition	Reference signal
	(+)	(-)		
M39	4	5	Receive audio signal	 <p style="text-align: right; font-size: small;">SKIA0177E</p>
	13	14		

**Is the audio signal voltage reading as specified?**

- YES >> Replace BOSE speaker amp. Refer to [AV-466, "Removal and Installation"](#).
- NO >> Replace AV control unit. Refer to [AV-460, "Removal and Installation"](#).

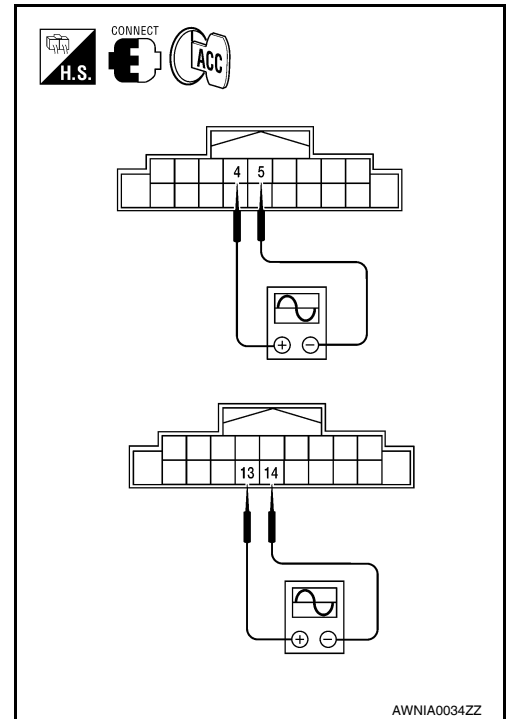

# REAR TWEETER

< COMPONENT DIAGNOSIS >

[BOSE AUDIO WITH NAVIGATION]

## REAR TWEETER

### Description

INFOID:000000005259605

The AV control unit sends audio signals to the BOSE speaker amp. The BOSE speaker amp. amplifies the audio signals before sending them to the rear tweeters using the audio signal circuits.

### Diagnosis Procedure

INFOID:000000005259606

Regarding Wiring Diagram information, refer to [AV-414, "Wiring Diagram"](#).

### 1. HARNESS CHECK

1. Disconnect BOSE speaker amp. connectors B75 and suspect tweeter connector.
2. Check continuity between BOSE speaker amp. harness connectors B75 (A) and suspect tweeter harness connector (B).

A		B		Continuity
Connector	Terminal	Connector	Terminal	
B75	9	D208	1	Yes
	10		2	
	11	D308	1	
	12		2	

3. Check continuity between BOSE speaker amp. harness connectors B75 (A) and ground.

Connector	Terminal	-	Continuity
B75	9	Ground	No
	10		
	11		
	12		

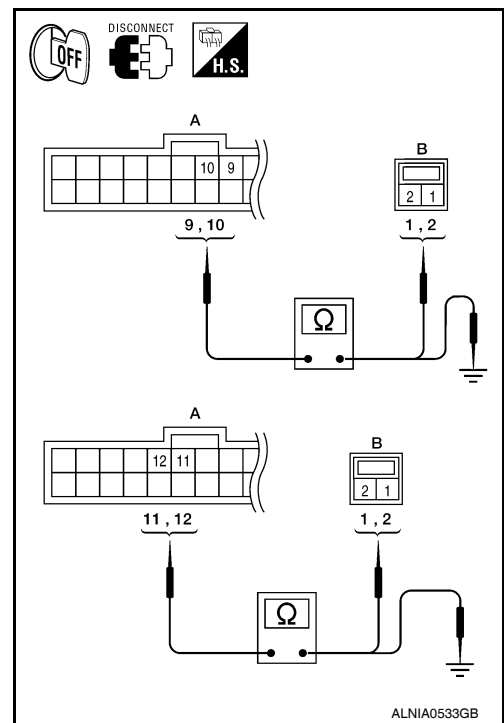

Are the continuity test results as specified?

YES >> GO TO 2

- NO >> • Check connector housings for disconnected or loose terminals.  
• Repair harness or connector.

### 2. REAR TWEETER SIGNAL CHECK

A  
B  
C  
D  
E  
F  
G  
H  
I  
J  
K  
L  
M  
O  
P

AV

# REAR TWEETER

[BOSE AUDIO WITH NAVIGATION]

## < COMPONENT DIAGNOSIS >

1. Connect BOSE speaker amp. connectors and suspect tweeter connector.
2. Turn ignition switch to ACC.
3. Push "POWER" switch.
4. Check the signal between BOSE speaker amp. harness connectors B75 terminals with CONSULT-III or oscilloscope.

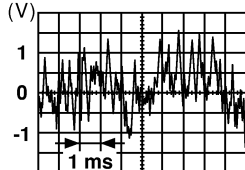
Connector	Terminals		Condition	Reference signal
	(+)	(-)		
B75	9	10	Receive audio signal	
	11	12		

SKIA0177E

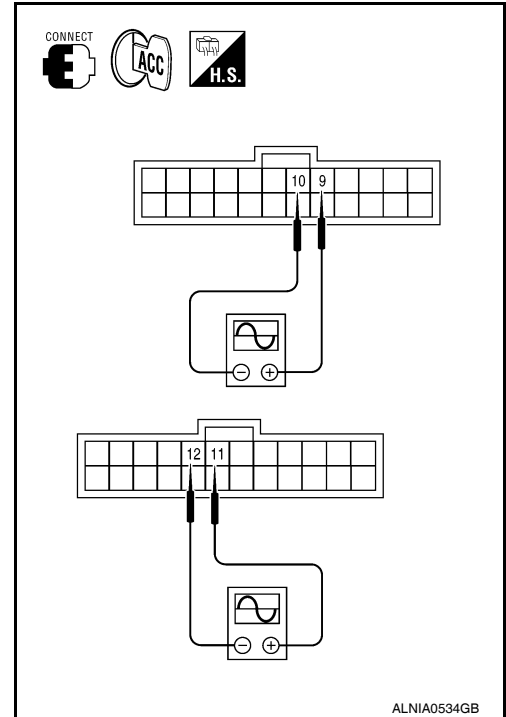

Are audio signal voltage readings as specified?

YES >> Replace suspect tweeter. Refer to [AV-465. "Removal and Installation"](#).

NO >> GO TO 3

## 3. HARNESS CHECK

1. Disconnect AV control unit connector M39 and BOSE speaker amp. connector B75.
2. Check continuity between AV control unit harness connector M39 (A) and BOSE speaker amp. harness connector B75 (B).

A		B		Continuity
Connector	Terminal	Connector	Terminal	
M39	4	B75	26	Yes
	5		25	
	13		24	
	14		23	

3. Check continuity between AV control unit harness connector M39 (A) and ground.

A		—	Continuity
Connector	Terminal		
M39	4	Ground	No
	5		
	13		
	14		

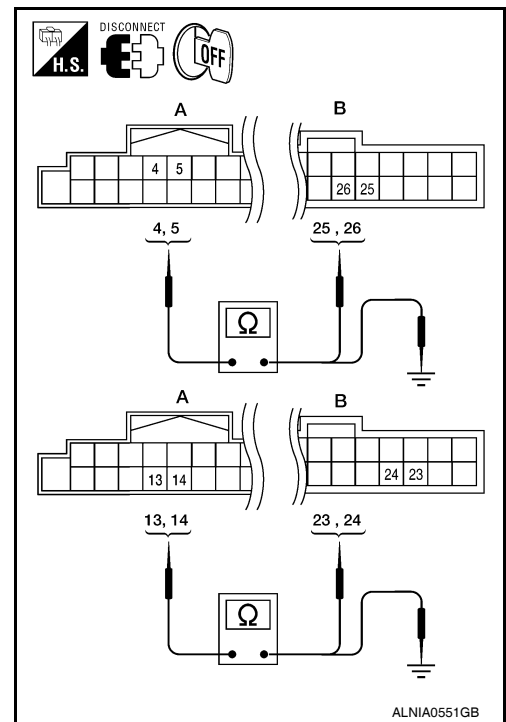

Are the continuity test results as specified?

YES >> GO TO 4

NO >> • Check connector housings for disconnected or loose terminals.  
• Repair harness or connector.

## 4. REAR TWEETER SIGNAL CHECK

# REAR TWEETER

## < COMPONENT DIAGNOSIS >

## [BOSE AUDIO WITH NAVIGATION]

1. Connect AV control unit connector M39 and BOSE speaker amp. connector B75.
2. Turn ignition switch to ACC.
3. Push "POWER" switch.
4. Check the signal between AV control unit harness connector M39 terminals with CONSULT-III or oscilloscope.

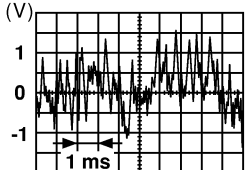
Connector	Terminals		Condition	Reference signal
	(+)	(-)		
M39	4	5	Receive audio signal	 <small>SKIA0177E</small>
	13	14		

Is the audio signal voltage reading as specified?

- YES >> Replace BOSE speaker amp. Refer to [AV-466, "Removal and Installation"](#).
- NO >> Replace AV control unit. Refer to [AV-460, "Removal and Installation"](#).

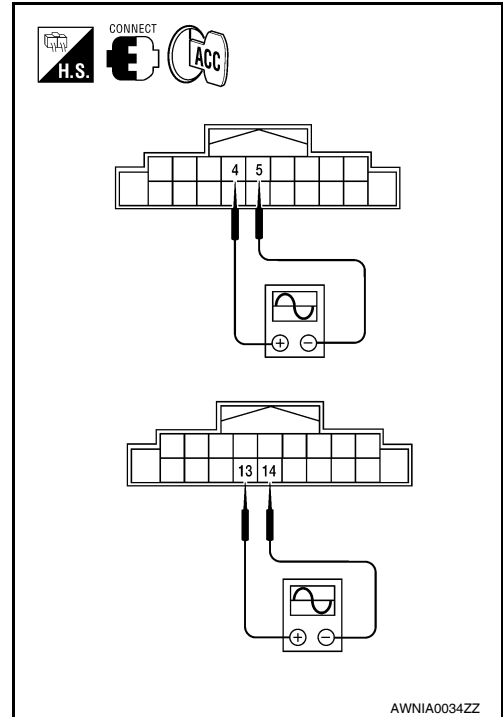

A  
B  
C  
D  
E  
F  
G  
H  
I  
J  
K  
L  
M  
N  
O  
P

AV

# SUBWOOFER

< COMPONENT DIAGNOSIS >

[BOSE AUDIO WITH NAVIGATION]

## SUBWOOFER

### Description

INFOID:000000005259607

The AV control unit sends audio signals to the BOSE speaker amp. The BOSE speaker amp. amplifies the audio signals before sending them to the subwoofer using the audio signal circuits.

### Diagnosis Procedure

INFOID:000000005259608

Regarding Wiring Diagram information, refer to [AV-414, "Wiring Diagram"](#).

### 1. VERIFY SUBWOOFER POWER AND GROUND SUPPLY

Check power and ground supply to the subwoofer. Refer to [AV-197, "SUBWOOFER : Diagnosis Procedure"](#)

Did the power and ground supply check OK?

YES >> GO TO 2

NO >> • Check connector housings for disconnected or loose terminals.  
• Repair harness or connector.

### 2. HARNESS CHECK

1. Disconnect BOSE speaker amp. connectors and subwoofer connector.
2. Check continuity between BOSE speaker amp. harness connectors B74 (A) and B75 (B) and subwoofer harness connector B72 (C).

Connector	Terminal	Connector	Terminal	Continuity
A: B74	3	C: B72	1	Yes
	19		2	
B: B75	22		4	

3. Check continuity between BOSE speaker amp. harness connector B74 (A) and B75 (B) and ground.

Connector	Terminal	-	Continuity
A: B74	3	Ground	No
	19		
B: B75	22		

Are the continuity test results as specified?

YES >> GO TO 3

NO >> • Check connector housings for disconnected or loose terminals.  
• Repair harness or connector.

### 3. SUBWOOFER AMP ON SIGNAL CHECK

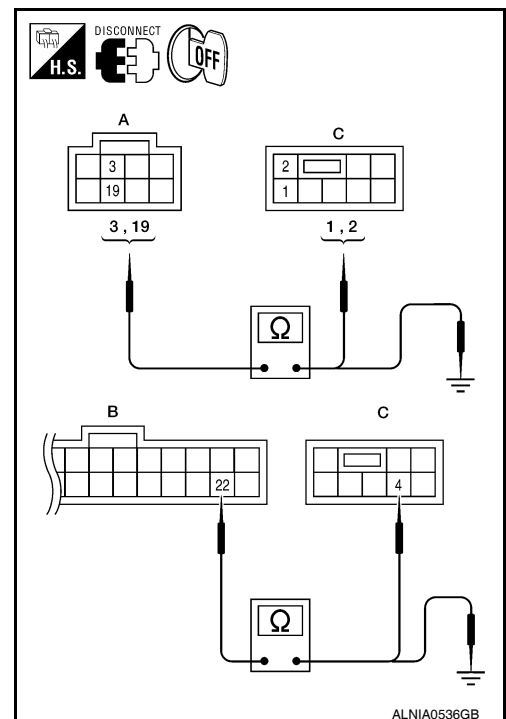

ALNIA0536GB



# SUBWOOFER

## < COMPONENT DIAGNOSIS >

## [BOSE AUDIO WITH NAVIGATION]

1. Connect BOSE speaker amp. connector B74.
2. Turn ignition switch to ACC.
3. Push "POWER" switch.
4. Check voltage between subwoofer connector B72 terminal 4 and ground.

(+)		(-)	Voltage
Connector	Terminal		
B72	4	Ground	Battery voltage

Are the voltage readings as specified?

YES >> GO TO 4

NO >> Replace BOSE speaker amp. Refer to [AV-466, "Removal and Installation"](#)

### 4. SUBWOOFER AUDIO SIGNAL CHECK

1. Connect BOSE speaker amp. connectors and subwoofer connector.
2. Turn ignition switch to ACC.
3. Push "POWER" switch.
4. Check the signal between BOSE speaker amp. harness connector B74 terminals with CONSULT-III or oscilloscope.

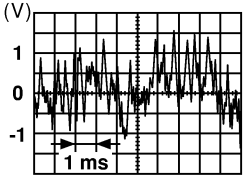
Connector	Terminals		Condition	Reference signal
	(+)	(-)		
B74	19	3	Receive audio signal	 <p style="text-align: right; font-size: small;">SKIA0177E</p>

Is the audio signal voltage as specified?

YES >> Replace subwoofer. Refer to [AV-467, "Removal and Installation"](#).

NO >> GO TO 5

### 5. HARNESS CHECK

1. Turn ignition switch OFF.

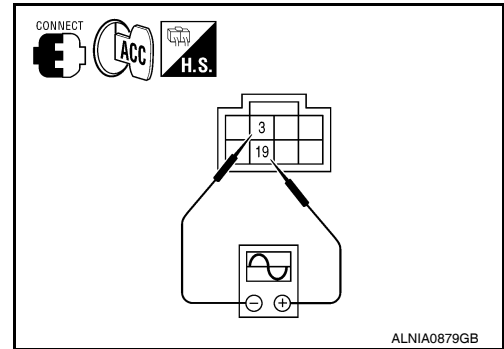
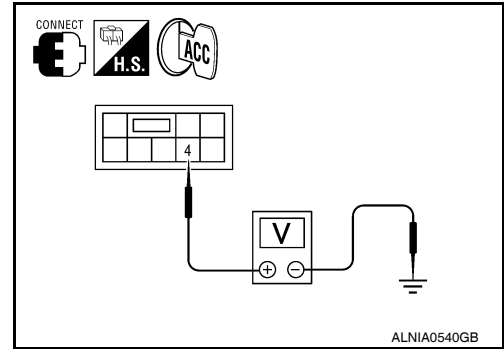

A  
B  
C  
D  
E  
F  
G  
H  
I  
J  
K  
L  
M  
O  
P

AV

# SUBWOOFER

## < COMPONENT DIAGNOSIS >

## [BOSE AUDIO WITH NAVIGATION]

2. Disconnect AV control unit connector M39 and BOSE speaker amp. connector B75.
3. Check continuity between AV control unit harness connector M39 (A) and BOSE speaker amp. harness connector B75 (B).

A		B		Continuity
Connector	Terminal	Connector	Terminal	
M39	4	B75	26	Yes
	5		25	
	13		24	
	14		23	

4. Check continuity between AV control unit harness connector M39 (A) and ground.

A		—	Continuity
Connector	Terminal		
M39	4	Ground	No
	5		
	13		
	14		

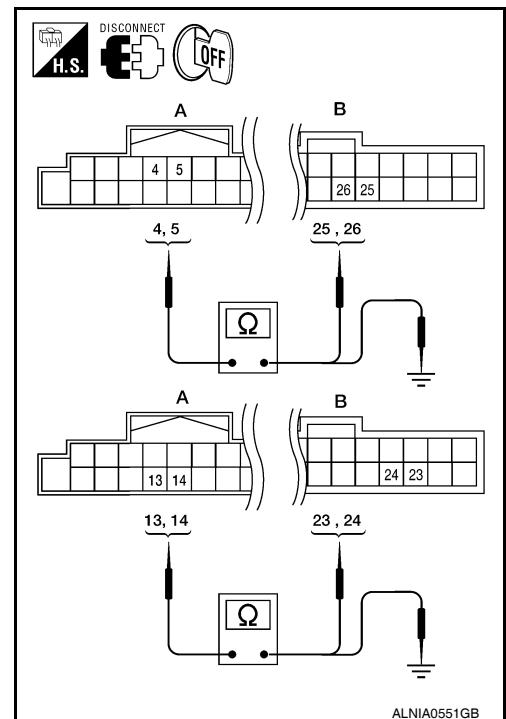

Are the continuity test results as specified?

- YES >> GO TO 6  
 NO >> • Check connector housings for disconnected or loose terminals.  
 • Repair harness or connector.

## 6. BACK DOOR SPEAKER SIGNAL CHECK

1. Connect AV control unit connector M39 and BOSE speaker amp. connector B75.
2. Turn ignition switch to ACC.
3. Push "POWER" switch.
4. Check the signal between AV control unit harness connector M39 terminals with CONSULT-III or oscilloscope.

Connector	Terminals		Condition	Reference signal
	(+)	(-)		
M39	4	5	Receive audio signal	<p style="font-size: x-small; text-align: right;">SKIA0177E</p>
	13	14		

Is the audio signal voltage reading as specified?

- YES >> Replace BOSE speaker amp. Refer to [AV-466, "Removal and Installation"](#).  
 NO >> Replace AV control unit. Refer to [AV-460, "Removal and Installation"](#).

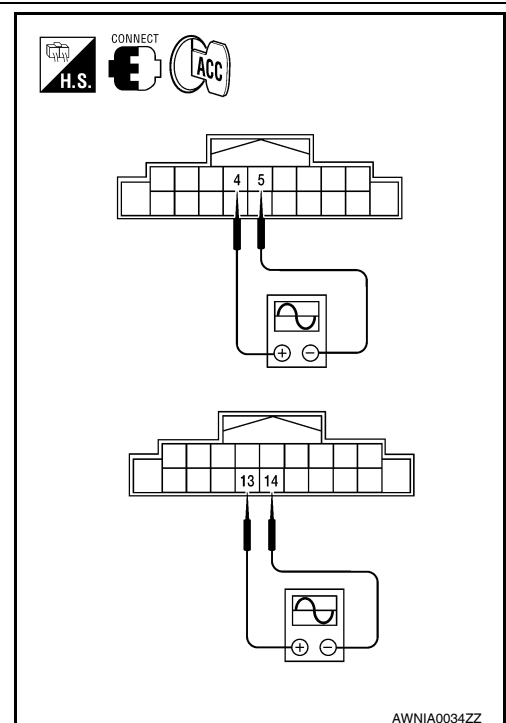

# AMP ON SIGNAL CIRCUIT

< COMPONENT DIAGNOSIS >

[BOSE AUDIO WITH NAVIGATION]

## AMP ON SIGNAL CIRCUIT

### Description

INFOID:000000005259609

When the audio system is turned on, a voltage signal is supplied from the AV control unit to the BOSE speaker amp. When this signal is received, the BOSE speaker amp. will turn on.

### Diagnosis Procedure

INFOID:000000005259610

Regarding Wiring Diagram information, refer to [AV-414, "Wiring Diagram"](#).

#### 1. CHECK AMP ON SIGNAL (BOSE SPEAKER AMP)

1. Turn audio system ON.
2. Check voltage between BOSE speaker amp. harness connector B75 terminal 31 and ground.

(+)		(-)	Value (Approx.)
Connector	Terminal		
B75	31	Ground	Battery Voltage

##### Is battery voltage present?

- YES >> Inspection End.  
NO >> GO TO 2

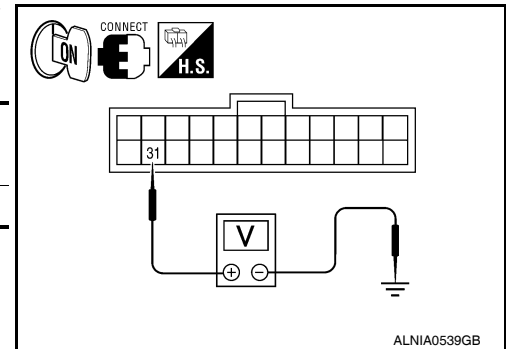

#### 2. CHECK AMP ON SIGNAL (AV CONTROL UNIT)

Check voltage between AV control unit harness connector M39 terminal 1 and ground.

(+)		(-)	Value (Approx.)
Connector	Terminal		
M39	1	Ground	Battery Voltage

##### Is battery voltage present?

- YES >> Repair harness or connector.  
NO >> Replace AV control unit. Refer to [AV-460, "Removal and Installation"](#).

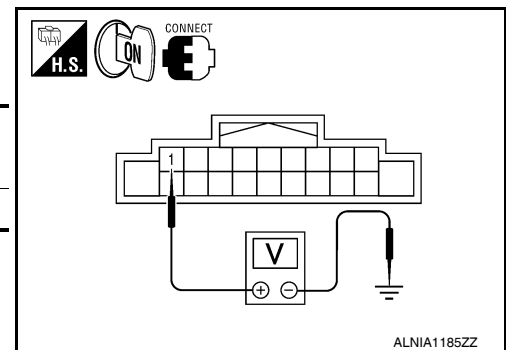

A  
B  
C  
D  
E  
F  
G  
H  
I  
J  
K  
L  
M  
O  
P

AV

# STEERING SWITCH

< COMPONENT DIAGNOSIS >

[BOSE AUDIO WITH NAVIGATION]

## STEERING SWITCH

### Description

INFOID:000000005259611

When one of the steering wheel audio control switches is pushed, the resistance in the steering wheel audio control switch circuit changes depending on which button is pushed.

### Diagnosis Procedure

INFOID:000000005259612

Regarding Wiring Diagram information, refer to [AV-414, "Wiring Diagram"](#).

### 1. CHECK STEERING WHEEL AUDIO CONTROL SWITCH RESISTANCE

1. Turn ignition switch OFF.
2. Disconnect steering wheel audio control switch connector M102.
3. Check resistance between steering switch connector terminals.

Terminal	Signal name	Condition	Resistance (Ω) (Approx.)	
16	17	Seek (down)	Depress ▽ switch.	165
		Volume (down)	Depress VOL down switch.	487
		Phone/Send	Depress MODE switch.	0
20	17	Seek (up)	Depress △ switch.	165
		Volume (up)	Depress VOL up switch.	487
		Mode/End	Depress ↻ switch.	0

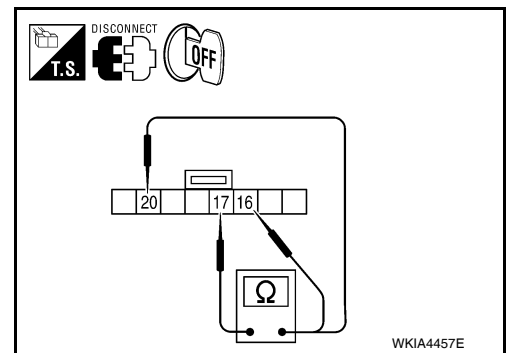

Do the steering wheel audio control switches check OK?

YES >> GO TO 2

NO >> Replace steering wheel audio control switch. Refer to [AV-475, "Removal and Installation"](#).

### 2. CHECK HARNESS

1. Turn ignition switch OFF.
2. Disconnect AV control unit connector M39 and spiral cable connector M30.
3. Check continuity between AV control unit harness connector M39 (A) and spiral cable harness connector M30 (B).

A		B		Continuity
Connector	Terminal	Connector	Terminal	
M39	6	M30	24	Yes
	15		31	
	16		32	

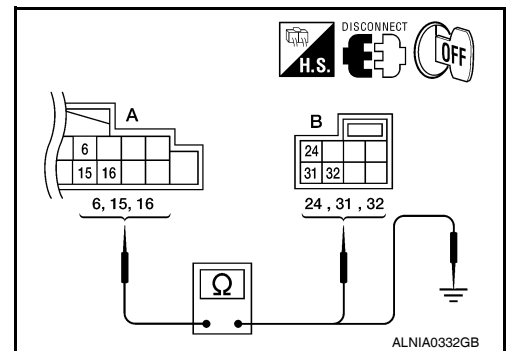

4. Check continuity between AV control unit connector M39 (A) and ground.

A		—	Continuity
Connector	Terminal		
M39	6	Ground	No
	15		
	16		

# STEERING SWITCH

[BOSE AUDIO WITH NAVIGATION]

< COMPONENT DIAGNOSIS >

Are the continuity results as specified?

- YES >> GO TO 3
- NO >> Repair harness.

## 3. SPIRAL CABLE CHECK

1. Disconnect spiral cable connector M102.
2. Check continuity between spiral cable harness connector M30 (A) and M102 (B).

A		B		Continuity
Connector	Terminal	Connector	Terminal	
M30	24	M102	20	Yes
	31		17	
	32		16	

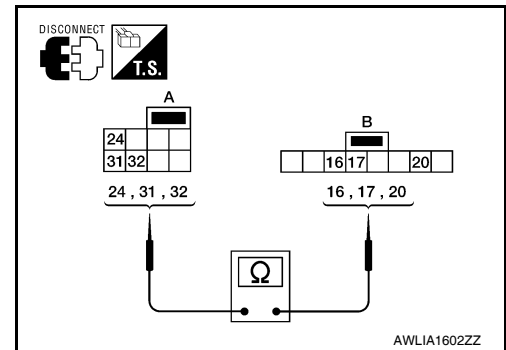

Does continuity exist?

- YES >> Inspection End.
- NO >> Replace spiral cable. Refer to [SR-7, "Removal and Installation"](#).

A  
B  
C  
D  
E  
F  
G  
H  
I  
J  
K  
L  
M  
AV  
O  
P

# MICROPHONE SIGNAL CIRCUIT

< COMPONENT DIAGNOSIS >

[BOSE AUDIO WITH NAVIGATION]

## MICROPHONE SIGNAL CIRCUIT

### Description

INFOID:000000005259613

Voice signals are transmitted from the microphone to the AV control unit using the microphone signal circuits.

### Diagnosis Procedure

INFOID:000000005259614

Regarding Wiring Diagram information, refer to [AV-414, "Wiring Diagram"](#).

### 1. VERIFY MICROPHONE POWER AND GROUND SUPPLY

Check power and ground supply to the microphone. Refer to [AV-379, "MICROPHONE : Diagnosis Procedure"](#).

Did the power and ground supply check OK?

YES >> GO TO 2

NO >> • Check connector housings for disconnected or loose terminals.  
• Repair harness or connector.

### 2. CHECK HARNESS BETWEEN AV CONTROL UNIT AND MICROPHONE

1. Turn ignition switch OFF.
2. Disconnect AV control unit connector and microphone connector.
3. Check continuity between AV control unit harness connector M48 (A) and microphone harness connector R8 (B).

A		B		Continuity
Connector	Terminal	Connector	Terminal	
M48	75	R8	1	Yes
	74		2	
	73		4	

4. Check continuity between AV control unit harness connector M48 (A) and ground.

A		—	Continuity
Connector	Terminal		
M48	75	Ground	No
	74		
	73		

Are the continuity results as specified?

YES >> GO TO 3

NO >> Repair harness or connector.

### 3. CHECK MICROPHONE SIGNAL

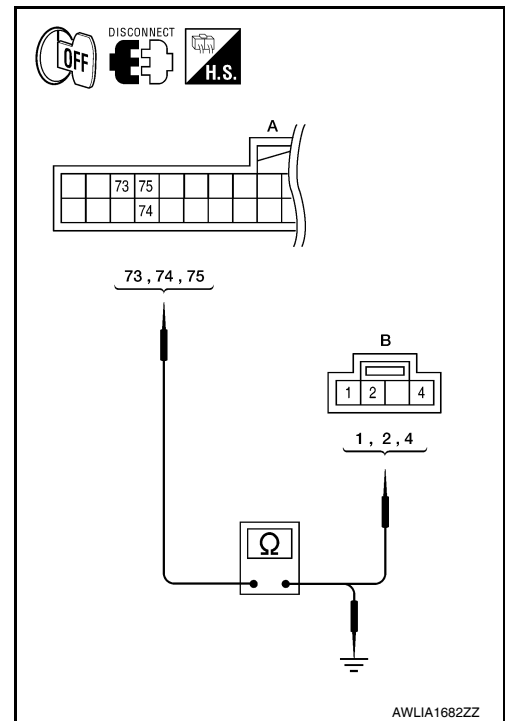

# MICROPHONE SIGNAL CIRCUIT

< COMPONENT DIAGNOSIS >

[BOSE AUDIO WITH NAVIGATION]

Check signal between AV control unit harness connector M48 terminals 74 and 75 with CONSULT-III or oscilloscope.

Connector	(+)	(-)	Reference signal
	Terminal	Terminal	
M48	75	74	<p>While speaking into MIC</p> <p>PKIB5037J</p>

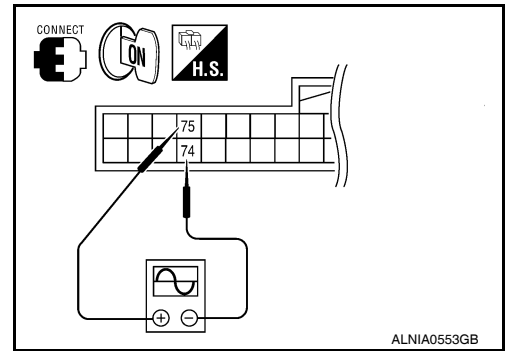

Are voltage readings as specified?

- YES >> Replace AV control unit. Refer to [AV-460, "Removal and Installation"](#).
- NO >> Replace microphone. Refer to [AV-476, "Removal and Installation"](#).

A  
B  
C  
D  
E  
F  
G  
H  
I  
J  
K  
L  
M  
O  
P

AV

# AV CONTROL UNIT

< ECU DIAGNOSIS >

[BOSE AUDIO WITH NAVIGATION]

## ECU DIAGNOSIS

### AV CONTROL UNIT

#### Reference Value

INFOID:000000005259615

#### VALUES ON THE DIAGNOSIS TOOL

CONSULT-III data monitor item

Display Item	Display	Vehicle status	Remarks
VHCL SPD SIG	ON	Vehicle speed >0 km/h (0 MPH)	Changes in indication may be delayed. This is normal.
	OFF	Vehicle speed =0 km/h (0 MPH)	
PKB SIG	ON	Parking brake is applied.	Changes in indication may be delayed. This is normal.
	OFF	Parking brake is released.	
ILLUM SIG	ON	Block the light beam from the auto light optical sensor when the light SW is ON.	—
	OFF	Expose the auto light optical sensor to light when the light SW is OFF or ON.	
IGN SIG	ON	Ignition switch ON	—
	OFF	Ignition switch in ACC position	
REV SIG	ON	Selector lever in R position	Changes in indication may be delayed. This is normal.
	OFF	Selector lever in any position other than R	

#### TERMINAL LAYOUT

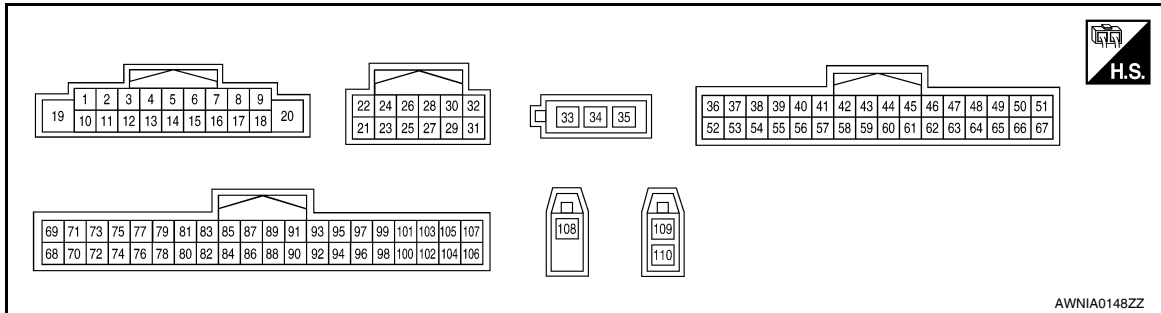

#### PHYSICAL VALUES

Terminal (Wire color)		Description		Condition		Reference value (Approx.)
+	-	Signal name	Input/Output			
1 (SB)	Ground	Amp. ON signal	Output	Ignition switch ON	—	Battery voltage
2 (BR)	3 (B)	Pre-amp. audio signal front LH	Output	Ignition switch ON	Audio output	





SKIB3609E

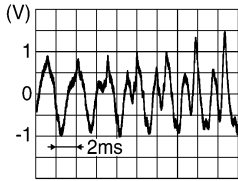

# AV CONTROL UNIT

< ECU DIAGNOSIS >

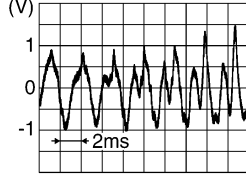
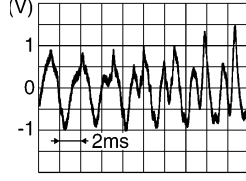
[BOSE AUDIO WITH NAVIGATION]

Terminal (Wire color)		Description		Condition		Reference value (Approx.)
+	-	Signal name	Input/ Output			
4 (BR/W)	5 (BR/Y)	Pre-amp. audio signal rear LH	Output	Ignition switch ON	Audio output	 SKIB3609E
6 (Y)	15 (L)	Steering switch signal A	Input	Ignition switch ON	Pressing  switch	0V
					Pressing  switch	0.75V
					Pressing VOL up switch	2V
					Except for above	5V
7 (G/Y)	Ground	ACC power supply	Input	Ignition switch ACC	-	Battery voltage
9 (V)	Ground	Illumination signal	Input	Ignition switch OFF	Lighting switch is OFF.	0V
					Lighting switch is ON.	Battery voltage
11 (G/Y)	12 (G/O)	Pre-amp. audio signal front RH	Output	Ignition switch ON	Audio output	 SKIB3609E
13 (G/R)	14 (B)	Audio signal rear RH	Output	Ignition switch ON	Audio output	 SKIB3609E
15 (L)	Ground	Steering switch signal ground	—	Ignition switch ON	—	0V
16 (G)	15 (L)	Steering switch signal B	Input	Ignition switch ON	Pressing  switch	0V
					Pressing  switch	0.75V
					Pressing VOL down switch	2V
					Except for above	5V
19 (Y)	Ground	Battery power supply	Input	Ignition switch OFF	—	Battery voltage
20 (B)	Ground	Ground	—	Ignition switch ON	—	0V

A  
B  
C  
D  
E  
F  
G  
H  
I  
J  
K  
L  
M  
AV  
O  
P

# AV CONTROL UNIT

< ECU DIAGNOSIS >

[BOSE AUDIO WITH NAVIGATION]

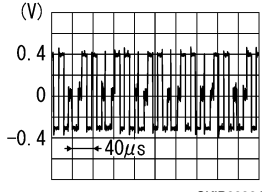
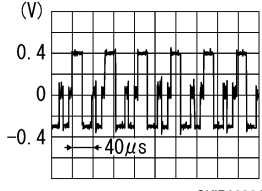
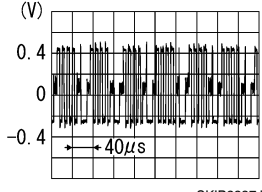
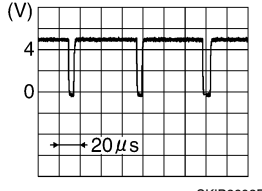
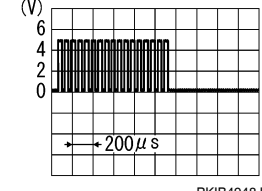
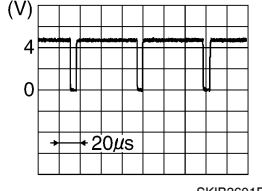
Terminal (Wire color)		Description		Condition		Reference value (Approx.)
+	-	Signal name	Input/ Output			
21 (L)	Ground	RGB signal (R: red)	Output	Ignition switch ON	Start confirmation/adjustment mode, and then display color bar by selecting "Color Spectrum Bar" on DISPLAY DIAGNOSIS screen.	 <p style="text-align: right; font-size: small;">SKIB2238J</p>
22 (G)	Ground	RGB signal (G: green)	Output	Ignition switch ON	Start confirmation/adjustment mode, and then display color bar by selecting "Color Spectrum Bar" on DISPLAY DIAGNOSIS screen.	 <p style="text-align: right; font-size: small;">SKIB2236J</p>
23 (Y)	Ground	RGB signal (B: blue)	Output	Ignition switch ON	Start confirmation/adjustment mode, and then display color bar by selecting "Color Spectrum Bar" on DISPLAY DIAGNOSIS screen.	 <p style="text-align: right; font-size: small;">SKIB2237J</p>
25 (R)	Ground	RGB synchronizing signal	Output	Ignition switch ON	—	 <p style="text-align: right; font-size: small;">SKIB3603E</p>
27 (G)	Ground	RGB area (YS) signal	Output	Ignition switch ON	At RGB image displayed	5V
					At rear view camera image displayed	 <p style="text-align: right; font-size: small;">PKIB4948J</p>
28 (B)	Ground	Horizontal synchronizing (HP) signal	Input	Ignition switch ON	—	 <p style="text-align: right; font-size: small;">SKIB3601E</p>

# AV CONTROL UNIT

< ECU DIAGNOSIS >

[BOSE AUDIO WITH NAVIGATION]

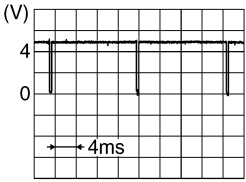
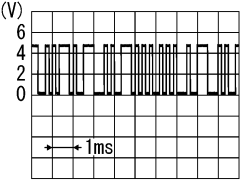
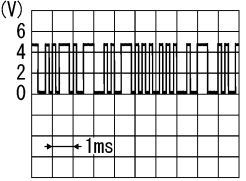
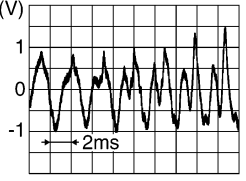
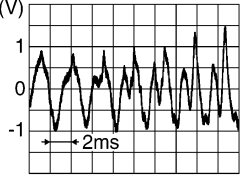
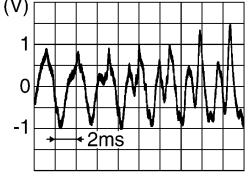
Terminal (Wire color)		Description		Condition		Reference value (Approx.)
+	-	Signal name	Input/ Output			
29 (W)	Ground	Vertical synchronizing (VP) signal	Input	Ignition switch ON	—	 <p style="text-align: right; font-size: small;">SKIB3598E</p>
30 (V)	Ground	Communication signal (CONT→DISP)	Output	Ignition switch ON	When adjusting display-brightness	 <p style="text-align: right; font-size: small;">PKIB5039J</p>
31 (LG)	Ground	Communication signal (DISP→CONT)	Input	Ignition switch ON	When adjusting display-brightness	 <p style="text-align: right; font-size: small;">PKIB5039J</p>
34	—	Antenna main	—	—	—	—
35	—	Antenna B+	—	—	—	—
42 (W)	58 (B)	DVD audio signal LH	Input	Ignition switch ON	When DVD player is operating	 <p style="text-align: right; font-size: small;">SKIB3609E</p>
43 (R)	59 (G)	DVD audio signal RH	Input	Ignition switch ON	When DVD player is operating	 <p style="text-align: right; font-size: small;">SKIB3609E</p>
48 (SB)	Ground	CD/DVD eject signal	Input	—	Pressing the eject switch	0V
					Except for above	3.3V
50 (W)	51 (R)	AUX jack audio signal LH	Input	Ignition switch ON	When AUX mode is selected	 <p style="text-align: right; font-size: small;">SKIB3609E</p>

A  
B  
C  
D  
E  
F  
G  
H  
I  
J  
K  
L  
M  
O  
P

AV

# AV CONTROL UNIT

< ECU DIAGNOSIS >

[BOSE AUDIO WITH NAVIGATION]

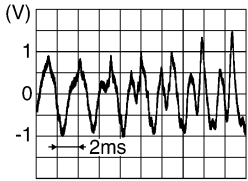
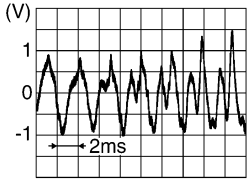
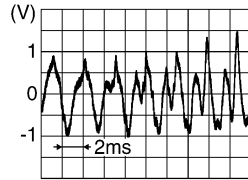
Terminal (Wire color)		Description		Condition		Reference value (Approx.)
+	-	Signal name	Input/ Output			
61 (G)	45 (W)	Headphone LH audio signal	Output	Ignition switch ON	When DVD player is operating	 <small>SKIB3609E</small>
62 (R)	46 (B)	Headphone RH audio signal	Output	Ignition switch ON	When DVD player is operating	 <small>SKIB3609E</small>
65 (GR)	Ground	A/C and AV switch assembly ground	—	Ignition switch ON	—	0V
66 (B)	51 (R)	AUX jack audio signal RH	Input	Ignition switch ON	When AUX mode is selected	 <small>SKIB3609E</small>
68 (B)	Ground	Ground	—	Ignition switch ON	—	0V
69 (R/B)	Ground	Battery power supply	Input	Ignition switch OFF	—	Battery voltage
70 (B)	Ground	Ground	—	Ignition switch ON	—	0V
71 (R/B)	Ground	Battery power supply	Input	Ignition switch OFF	—	Battery voltage
72 (G/Y)	Ground	ACC power supply	Input	Ignition switch ACC	—	Battery voltage
73 (W)	Ground	MIC power	Output	Ignition switch ON	—	5V
74	—	Shield	—	—	—	—
75 (R)	—	MIC signal	Input	Ignition switch ON	—	—
76	—	Shield	—	—	—	—
82 (W/G)	Ground	IGN ON or START power supply	Input	Ignition switch ON or START	—	Battery voltage

# AV CONTROL UNIT

< ECU DIAGNOSIS >

[BOSE AUDIO WITH NAVIGATION]

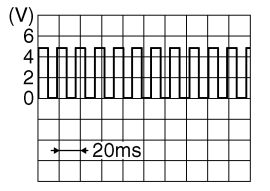
Terminal (Wire color)		Description		Condition		Reference value (Approx.)
+	-	Signal name	Input/ Output			
83 (G)	Ground	Parking brake signal	Input	Ignition switch ON	Parking brake ON	0V
				Ignition switch ON	Parking brake OFF	Battery voltage
84 (W)	Ground	Reverse signal	Input	Ignition switch ON	R position	Battery voltage
				Ignition switch ON	Other than R position	0V
85 (LG)	Ground	Vehicle speed signal (8- pulse)	Input	Ignition switch ON	When vehicle speed is ap- prox. 40 km/h (25MPH)	 <p style="text-align: right; font-size: small;">SKIA6649J</p>
89 (B)	—	Ground	Input	—	—	0V
90 (B)	—	Ground	Input	—	—	0V
95 (L)	—	AV communication signal 2 (H)	Input/ Output	—	—	—
96 (P)	—	AV communication signal 2 (L)	Input/ Output	—	—	—
97 (L)	—	AV communication signal 1 (H)	Input/ Output	—	—	—
98 (P)	—	AV communication signal 1 (L)	Input/ Output	—	—	—
99 (L)	—	CAN-H	Input/ Output	—	—	—
100 (P)	—	CAN-L	Input/ Output	—	—	—
108	—	Satellite antenna signal	Input	—	—	—
109	—	GPS antenna	Input	—	—	—
110	—	GPS antenna	Input	—	—	—

A  
B  
C  
D  
E  
F  
G  
H  
I  
J  
K  
L  
M

AV



# AV CONTROL UNIT

[BOSE AUDIO WITH NAVIGATION]

< ECU DIAGNOSIS >

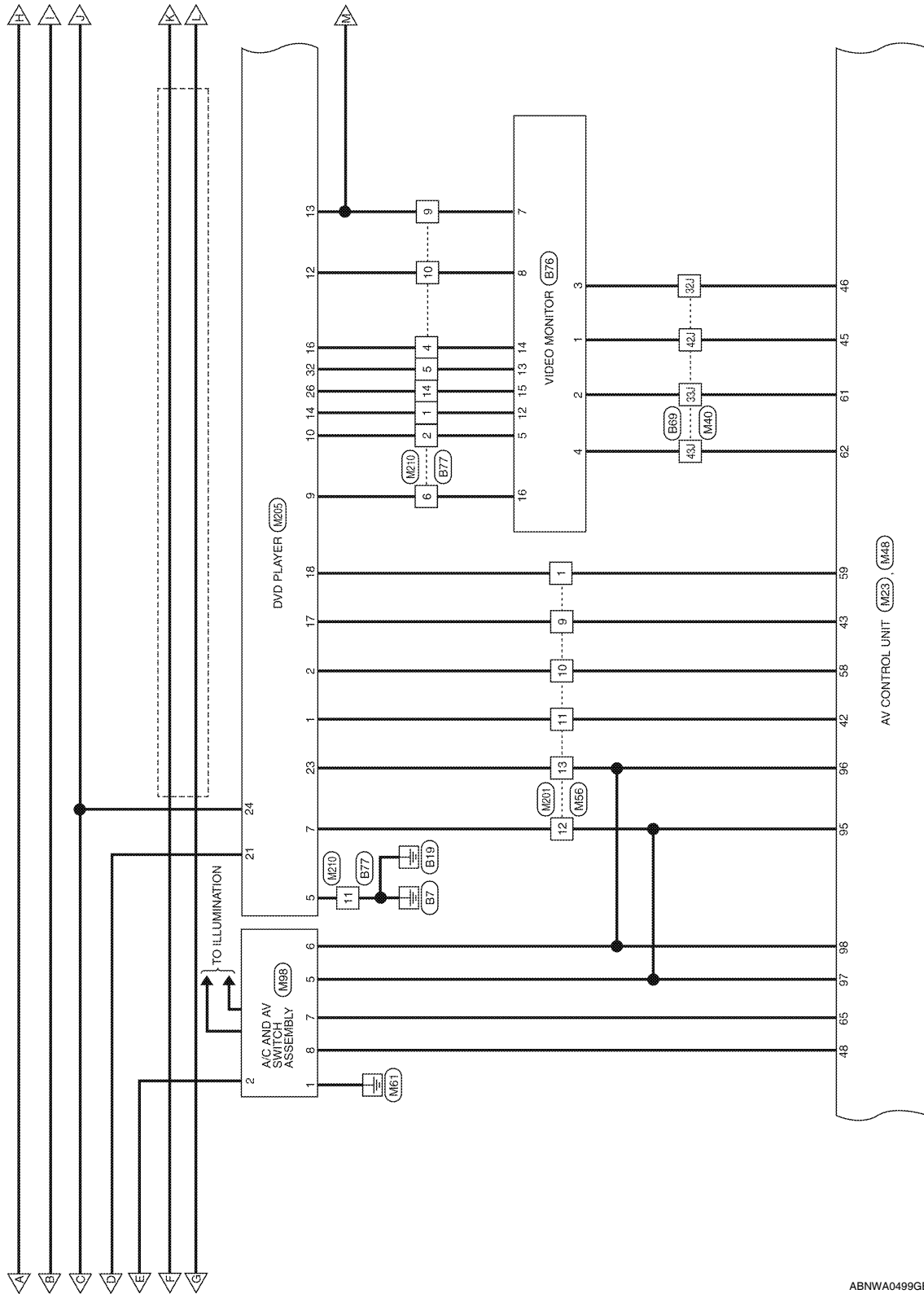

ABNWA0499GB

A  
B  
C  
D  
E  
F  
G  
H  
I  
J  
K  
L  
M  
N  
O  
P

AV

# AV CONTROL UNIT

< ECU DIAGNOSIS >

[BOSE AUDIO WITH NAVIGATION]

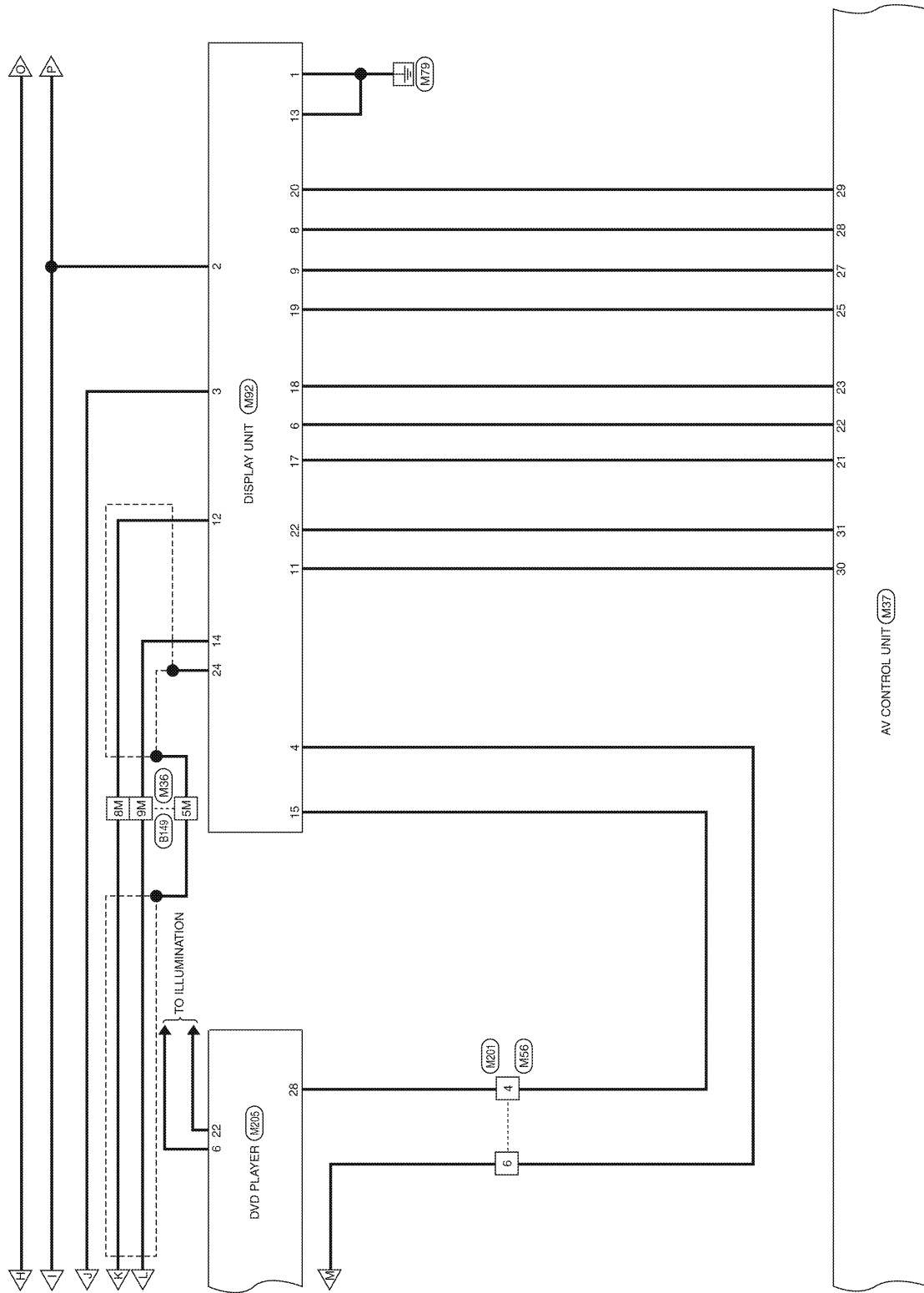

ABNWA0500GB





# AV CONTROL UNIT

< ECU DIAGNOSIS >

[BOSE AUDIO WITH NAVIGATION]

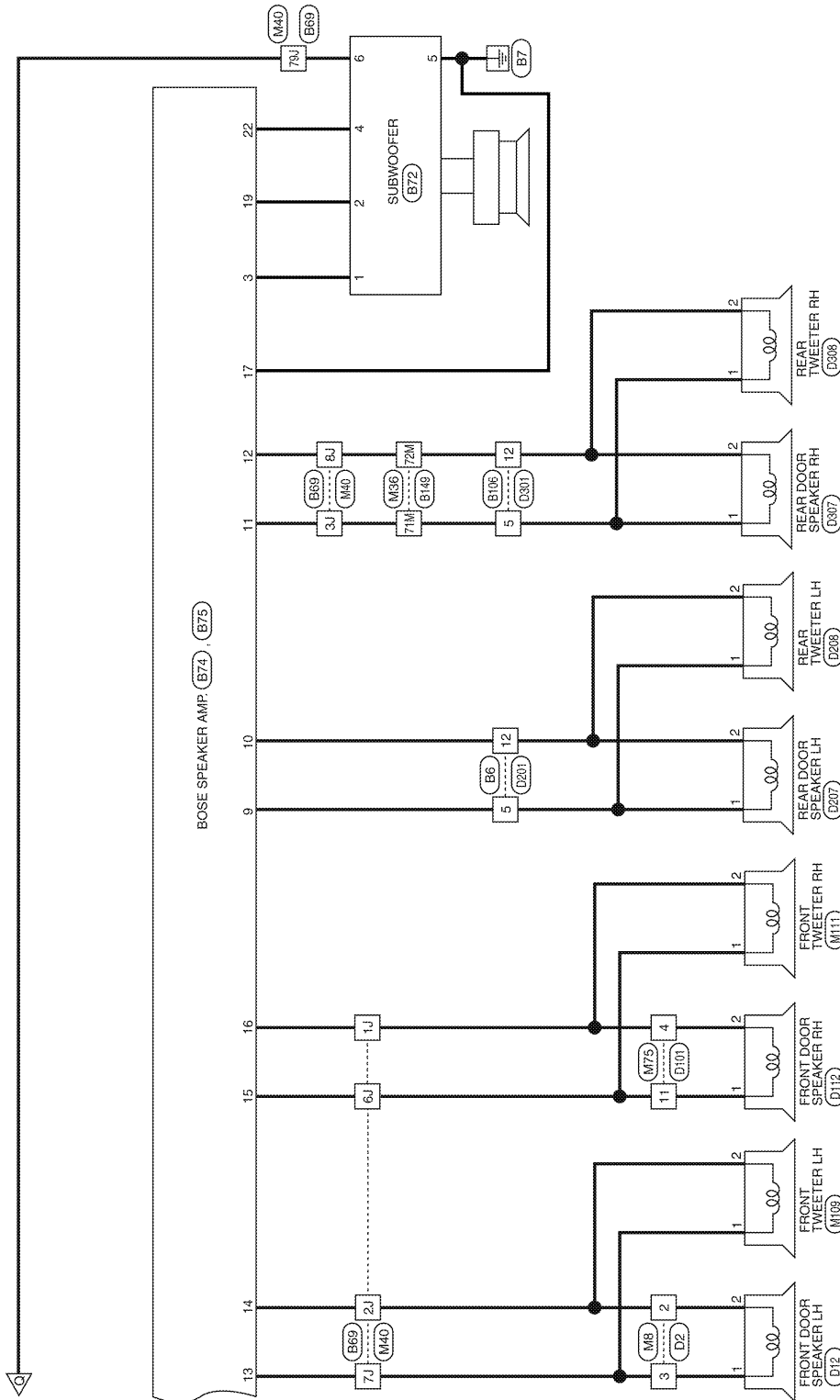

ABNWA0502GB

# AV CONTROL UNIT

< ECU DIAGNOSIS >

[BOSE AUDIO WITH NAVIGATION]

## BOSE AUDIO SYSTEM CONNECTORS - WITH NAVIGATION SYSTEM

Connector No.	M1
Connector Name	WIRE TO WIRE
Connector Color	WHITE

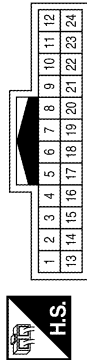

Terminal No.	Color of Wire	Signal Name
3	G	-
6	R	-
7	SHIELD	-

Connector No.	M22
Connector Name	DATA LINK CONNECTOR
Connector Color	WHITE

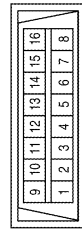

Terminal No.	Color of Wire	Signal Name
7	W	-

Connector No.	M4
Connector Name	FUSE BLOCK (J/B)
Connector Color	WHITE

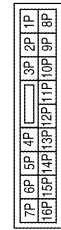

Terminal No.	Color of Wire	Signal Name
2P	W/G	-
4P	G/B	-
16P	R/B	-

Connector No.	M23
Connector Name	AV CONTROL UNIT (WITH BOSE AUDIO SYSTEM WITH NAVI)
Connector Color	WHITE

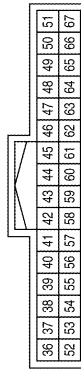

Terminal No.	Color of Wire	Signal Name
36	-	-
37	-	-
38	-	-
39	-	-
40	-	-
41	-	-
42	W	AUDIO BUS LH +
43	R	AUDIO BUS RH +
44	-	-
45	W	HP LH -
46	B	HP LH -
47	-	-
48	SB	CD-DVD-EJECT

Connector No.	M8
Connector Name	WIRE TO WIRE
Connector Color	BROWN

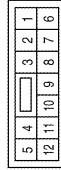

Terminal No.	Color of Wire	Signal Name
2	L	-
3	G	-

Terminal No.	Color of Wire	Signal Name
49	SHIELD	-
50	W	AUX AUDIO LH +
51	R	AUX GND
52	-	-
53	-	-
54	-	-
55	-	-
56	-	-
57	-	-
58	B	AUDIO BUS LH -
59	G	AUDIO BUS RH -
60	-	-
61	G	HP LH +
62	R	HP RH +
63	-	-
64	-	-
65	GR	SW GND
66	B	AUX AUDIO RH +
67	-	-

A  
B  
C  
D  
E  
F  
G  
H  
I  
J  
K  
L  
M  
N  
O  
P

AV

# AV CONTROL UNIT

< ECU DIAGNOSIS >

[BOSE AUDIO WITH NAVIGATION]

Connector No.	M30
Connector Name	COMBINATION SWITCH
Connector Color	GRAY

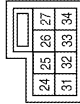

Terminal No.	Color of Wire	Signal Name
24	Y	STRG SW A (UP)
31	L	GND
32	G	STRG SW B (DOWN)

Connector No.	M24
Connector Name	COMBINATION METER
Connector Color	WHITE

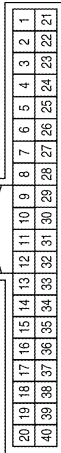

Terminal No.	Color of Wire	Signal Name
6	LG	SPEED OUT 8

Connector No.	M36
Connector Name	WIRE TO WIRE
Connector Color	WHITE

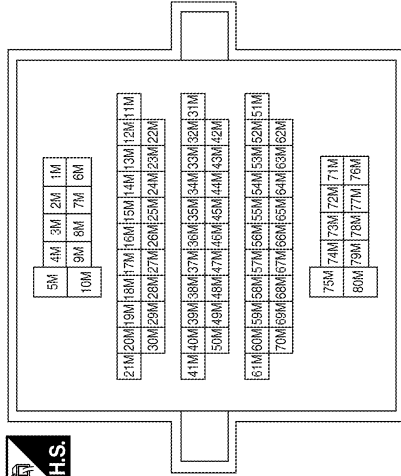

Connector No.	M31
Connector Name	WIRE TO WIRE
Connector Color	WHITE

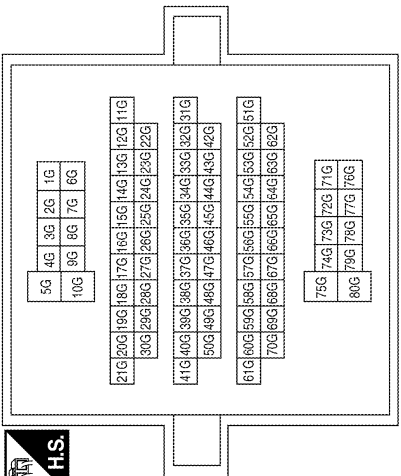

Terminal No.	Color of Wire	Signal Name
54G	SB	--
77G	Y	--

Terminal No.	Color of Wire	Signal Name
5M	SHIELD	--
7M	R/B	--
8M	B	--
9M	W	--
55M	W	--
56M	BR	--
64M	BR	--
65M	G/Y	--
71M	GR	--
72M	O	--

ABN1A1535GB

# AV CONTROL UNIT

< ECU DIAGNOSIS >

[BOSE AUDIO WITH NAVIGATION]

Connector No.	M39
Connector Name	AV CONTROL UNIT (WITH BOSE AUDIO SYSTEM WITH NAVI)
Connector Color	WHITE

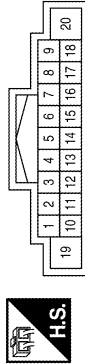

Terminal No.	Color of Wire	Signal Name
1	SB	AMP ON
2	BR	FR LH PRE+
3	B	FR LH PRE-
4	BR/W	RR LH PRE+
5	BR/Y	RR LH PRE-
6	Y	STRG SW A
7	G/Y	ACC
8	--	--
9	V	ILL+
10	--	--
11	G/Y	FR_RH_PRE+
12	G/O	FR_RH_PRE-
13	G/R	RR_RH_PRE+
14	B	RR_RH_PRE-
15	L	STRG_SW_GND
16	G	STRG_SW_B
17	--	--
18	--	--
19	Y	+B
20	B	GND

Connector No.	M37
Connector Name	AV CONTROL UNIT (WITH BOSE AUDIO SYSTEM WITH NAVI)
Connector Color	WHITE

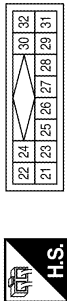

Terminal No.	Color of Wire	Signal Name
21	L	R
22	G	G
23	Y	B
24	--	--
25	R	RGB SYNC
26	--	--
27	G	YS
28	B	HP
29	W	VP
30	V	IT DISP
31	LG	DISP IT
32	--	--

A  
B  
C  
D  
E  
F  
G  
H  
I  
J  
K  
L  
M  
N  
O  
P

AV

ABNIA1536GB

# AV CONTROL UNIT

< ECU DIAGNOSIS >

[BOSE AUDIO WITH NAVIGATION]

Terminal No.	Color of Wire	Signal Name
38J	G/Y	-
39J	BR/Y	-
41J	BR	-
42J	W	-
43J	R	-
45J	SB	-
46J	G/R	-
47J	G/O	-
49J	BR/W	-
50J	B	-
79J	R/B	-

Terminal No.	Color of Wire	Signal Name
1J	R	-
2J	L	-
3J	GR	-
6J	W	-
7J	LG	-
8J	O	-
9J	Y	-
32J	B	-
33J	G	-
36J	B	-

Connector No.	M40
Connector Name	WIRE TO WIRE
Connector Color	WHITE

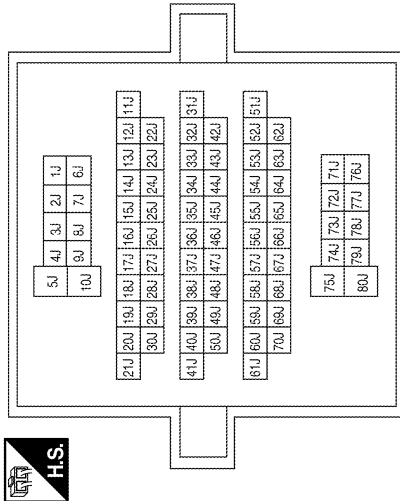

Connector No.	M44
Connector Name	AV CONTROL UNIT (WITH BOSE AUDIO SYSTEM WITH NAVI)
Connector Color	GRAY

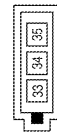

Terminal No.	Color of Wire	Signal Name
33	-	-
34	-	ANT MAIN
35	-	ANT +B

ABNIA1537GB

# AV CONTROL UNIT

< ECU DIAGNOSIS >

[BOSE AUDIO WITH NAVIGATION]

Connector No.	M56
Connector Name	WIRE TO WIRE
Connector Color	WHITE

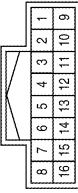

Terminal No.	Color of Wire	Signal Name
1	G	-
3	L	-
4	G	-
6	R	-
9	R	-
10	W	-
11	B	-
12	L	-
13	P	-
16	G/B	-

Terminal No.	Color of Wire	Signal Name
88	-	-
89	B	RESERVE 2
90	B	RESERVE 3
91	-	-
92	-	-
93	-	-
94	-	-
95	L	M-CAN2-H
96	P	M-CAN2-L
97	L	M-CAN1-H
98	P	M-CAN1-L
99	L	CAN-H
100	P	CAN-L
101	-	-
102	-	-
103	-	-
104	-	-
105	-	-
106	-	-
107	-	-

Connector No.	M48
Connector Name	AV CONTROL UNIT (WITH BOSE AUDIO SYSTEM WITH NAVI)
Connector Color	WHITE

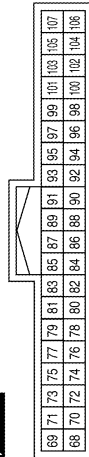

Terminal No.	Color of Wire	Signal Name
68	B	GND
69	R/B	+B
70	B	GND
71	R/B	+B
72	G/Y	ACC
73	W	MIC VCC (PWR)
74	SHIELD	MIC GND (IN -)
75	R	MIC SIG. (IN +)
77	-	-
78	-	-
79	-	-
80	-	-
81	-	-
82	W/G	IGN
83	G	PKB SIG
84	W	REVERSE SIG
85	LG	SPEED 8P
86	-	-
87	BR	RV CAM SIG

ABNIA1538GB

A  
B  
C  
D  
E  
F  
G  
H  
I  
J  
K  
L  
M  
N  
O  
P



# AV CONTROL UNIT

< ECU DIAGNOSIS >

[BOSE AUDIO WITH NAVIGATION]

Connector No.	M72
Connector Name	AV CONTROL UNIT (WITH BOSE AUDIO SYSTEM WITH NAVI)
Connector Color	GRAY



Terminal No.	Color of Wire	Signal Name
109	—	GPS ANT
110	—	GPS ANT

Connector No.	M71
Connector Name	AV CONTROL UNIT (WITH BOSE AUDIO SYSTEM WITH NAVI)
Connector Color	VIOLET



Terminal No.	Color of Wire	Signal Name
108	—	SAT ANT

Connector No.	M64
Connector Name	WIRE TO WIRE
Connector Color	WHITE



Terminal No.	Color of Wire	Signal Name
2	Y	—

Connector No.	M78
Connector Name	WIRE TO WIRE
Connector Color	GRAY



Terminal No.	Color of Wire	Signal Name
2	—	—
3	—	—

Connector No.	M75
Connector Name	WIRE TO WIRE
Connector Color	WHITE

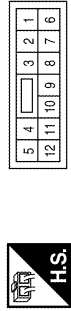

Terminal No.	Color of Wire	Signal Name
4	R	—
11	W	—

Connector No.	M73
Connector Name	WIRE TO WIRE
Connector Color	BROWN



Terminal No.	Color of Wire	Signal Name
1	—	—

ABNIA1539GB



# AV CONTROL UNIT

< ECU DIAGNOSIS >

[BOSE AUDIO WITH NAVIGATION]

Connector No.	M91
Connector Name	WIRE TO WIRE
Connector Color	WHITE

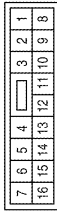

Terminal No.	Color of Wire	Signal Name
1	G	-

Connector No.	M85
Connector Name	AUX IN JACK
Connector Color	WHITE

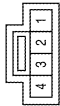

Terminal No.	Color of Wire	Signal Name
1	B	AUX AUDIO RH+
2	R	AUX GND
4	W	AUX AUDIO LH+

Connector No.	M98
Connector Name	A/C AND AV SWITCH ASSEMBLY
Connector Color	WHITE

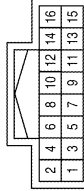

Terminal No.	Color of Wire	Signal Name
1	B	GND
2	G/Y	ACC
3	LG	ILL
4	BR	ILL_CONT GND
5	L	M CAN1-L
6	P	M CAN1-H
7	GR	SW GND
8	SB	CD DVD EJECT

Terminal No.	Color of Wire	Signal Name
15	G	COMP1 IN+
16	-	-
17	L	R
18	Y	B
19	R	RGB SYNC
20	W	VP
21	-	-
22	LG	DISP IT
23	-	-
24	SHIELD	COMP2 IN SHIELD

Connector No.	M92
Connector Name	DISPLAY UNIT (WITH NAVI)
Connector Color	WHITE

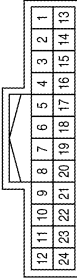

Terminal No.	Color of Wire	Signal Name
1	B	GND
2	Y	+B
3	V	ACC
4	R	COMP1 IN-
5	-	-
6	G	G
7	-	-
8	B	HP
9	G	YS
10	-	-
11	V	IT DISP
12	B	COMP2 IN+
13	B	GND
14	W	COMP2 IN-

ABNIA1540GB

A  
B  
C  
D  
E  
F  
G  
H  
I  
J  
K  
L  
M  
N  
O  
P

AV

# AV CONTROL UNIT

< ECU DIAGNOSIS >

[BOSE AUDIO WITH NAVIGATION]

Connector No.	M111
Connector Name	FRONT TWEETER RH
Connector Color	BROWN



Terminal No.	Color of Wire	Signal Name
1	W	--
2	L	--

Connector No.	M109
Connector Name	FRONT TWEETER LH
Connector Color	BROWN



Terminal No.	Color of Wire	Signal Name
1	G	--
2	L	--

Connector No.	M102
Connector Name	COMBINATION SWITCH
Connector Color	GRAY



Terminal No.	Color of Wire	Signal Name
16	L	--
17	BR	--
20	W	--

Connector No.	M202
Connector Name	WIRE TO WIRE
Connector Color	WHITE

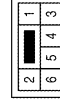

Terminal No.	Color of Wire	Signal Name
2	Y	--

Terminal No.	Color of Wire	Signal Name
10	W	--
11	B	--
12	L	--
13	P	--
16	G/B	--

Connector No.	M201
Connector Name	WIRE TO WIRE
Connector Color	WHITE

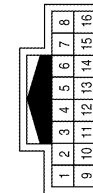

Terminal No.	Color of Wire	Signal Name
1	G	--
3	L	--
4	G	--
6	R	--
9	R	--

ABNIA1541GB

# AV CONTROL UNIT

< ECU DIAGNOSIS >

[BOSE AUDIO WITH NAVIGATION]

Terminal No.	Color of Wire	Signal Name
24	G/B	ACC
25	-	-
26	P	GND
27	-	-
28	G	VIDEO OUT
29	-	-
30	-	-
31	-	-
32	LG	DATA TX1 (DVD->LCD)

Terminal No.	Color of Wire	Signal Name
7	L	M CAN2 H
8	-	-
9	BR	+B
10	GR	SW POWER +5
11	-	-
12	W/L	VTR+
13	O/L	VTR-
14	Y	GND
15	-	-
16	V	DATA RX1 (LCD->DVD)
17	R	FES R+ OUTPUT
18	G	FES R- OUTPUT
19	-	-
20	-	-
21	Y	+B
22	SB	ILL+
23	P	M CAN2 L

Connector No.	M205
Connector Name	DVD PLAYER
Connector Color	WHITE

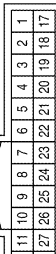

Terminal No.	Color of Wire	Signal Name
1	B	FES L+ OUTPUT
2	W	FES L- OUTPUT
3	-	-
4	-	-
5	B	GND
6	BR	ILL-

Connector No.	M351
Connector Name	SATELLITE ANTENNA
Connector Color	BROWN



Terminal No.	Color of Wire	Signal Name
1	-	-

Connector No.	M350
Connector Name	WIRE TO WIRE
Connector Color	BROWN



Terminal No.	Color of Wire	Signal Name
1	-	-

Connector No.	M210
Connector Name	WIRE TO WIRE
Connector Color	WHITE

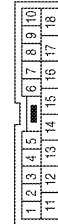

Terminal No.	Color of Wire	Signal Name
1	Y	-
2	GR	-
4	V	-
5	LG	-
6	BR	-
9	O/L	-
10	W/L	-
11	B	-
14	P	-

ABNIA1542GB

A  
B  
C  
D  
E  
F  
G  
H  
I  
J  
K  
L  
M  
N  
O  
P

AV

# AV CONTROL UNIT

< ECU DIAGNOSIS >

[BOSE AUDIO WITH NAVIGATION]

Connector No.	M601
Connector Name	WIRE TO WIRE
Connector Color	GRAY

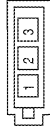

Terminal No.	Color of Wire	Signal Name
2	-	-
3	-	-

Connector No.	M502
Connector Name	WIRE TO WIRE
Connector Color	GRAY

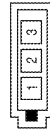

Terminal No.	Color of Wire	Signal Name
2	-	-
3	-	-

Connector No.	M501
Connector Name	WIRE TO WIRE
Connector Color	GRAY

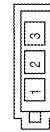

Terminal No.	Color of Wire	Signal Name
2	-	-
3	-	-

Connector No.	E26
Connector Name	WIRE TO WIRE
Connector Color	WHITE

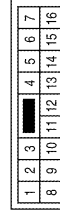

Terminal No.	Color of Wire	Signal Name
1	G	-

Connector No.	E5
Connector Name	WIRE TO WIRE
Connector Color	WHITE

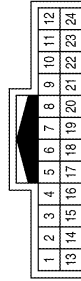

Terminal No.	Color of Wire	Signal Name
9	LG	-

Connector No.	M602
Connector Name	ANTENNA AMP.
Connector Color	GRAY

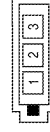

Terminal No.	Color of Wire	Signal Name
1	-	-
2	-	-
3	-	-

ABNIA1543GB

# AV CONTROL UNIT

< ECU DIAGNOSIS >

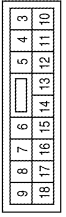

[BOSE AUDIO WITH NAVIGATION]

Connector No.	E119
Connector Name	IPDM E/R (INTELLIGENT POWER DISTRIBUTION MODULE ENGINE ROOM)
Connector Color	WHITE



Terminal No.	Color of Wire	Signal Name
16	W/G	REVERSE_LAMP

Connector No.	E53
Connector Name	PARKING BRAKE SWITCH
Connector Color	BLACK

Terminal No.	Color of Wire	Signal Name
1	G	-

Connector No.	E45
Connector Name	BACK-UP LAMP RELAY
Connector Color	BROWN

Terminal No.	Color of Wire	Signal Name
1	LG	-
2	W/G	-
3	SB	-
5	W/G	-

Connector No.	F14
Connector Name	WIRE TO WIRE
Connector Color	WHITE

Terminal No.	Color of Wire	Signal Name
9	LG	-

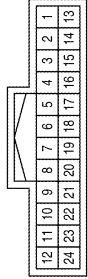
Connector No.	F9
Connector Name	A/T ASSEMBLY
Connector Color	GREEN

Terminal No.	Color of Wire	Signal Name
7	LG	-

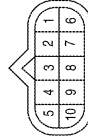
Connector No.	E152
Connector Name	WIRE TO WIRE
Connector Color	WHITE

Terminal No.	Color of Wire	Signal Name
54G	SB	-
77G	Y	-

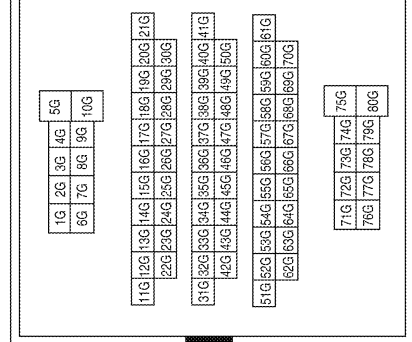
ABN1A1544GB

A  
B  
C  
D  
E  
F  
G  
H  
I  
J  
K  
L  
M  
N  
O  
P

AV

# AV CONTROL UNIT

< ECU DIAGNOSIS >

[BOSE AUDIO WITH NAVIGATION]

Connector No.	B6
Connector Name	WIRE TO WIRE
Connector Color	WHITE

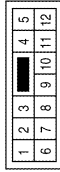

Terminal No.	Color of Wire	Signal Name
5	B	-
12	G	-

Connector No.	F502
Connector Name	TCM (TRANSMISSION CONTROL MODULE)
Connector Color	GRAY

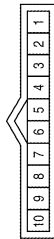

Terminal No.	Color of Wire	Signal Name
7	O	REV LAMP RLY

Terminal No.	Color of Wire	Signal Name
38J	G/Y	-
39J	BR/Y	-
41J	BR	-
42J	W	-
43J	R	-
45J	SB	-
46J	G/R	-
47J	G/O	-
49J	BR/W	-
50J	B	-
79J	R/B	-

Terminal No.	Color of Wire	Signal Name
1J	R	-
2J	L	-
3J	GR	-
6J	W	-
7J	LG	-
8J	O	-
9J	Y	-
32J	B	-
33J	G	-
36J	B	-

Connector No.	B69
Connector Name	WIRE TO WIRE
Connector Color	WHITE

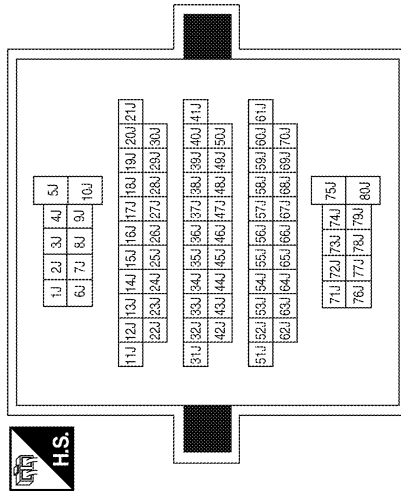

ABNIA1545GB

# AV CONTROL UNIT

< ECU DIAGNOSIS >

[BOSE AUDIO WITH NAVIGATION]

Connector No.	B75
Connector Name	BOSE SPEAKER AMP.
Connector Color	BLACK

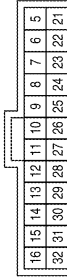

Terminal No.	Color of Wire	Signal Name
5	--	--
6	--	--
7	--	--
8	--	--
9	B	RR DR LH+ OUT
10	G	RR DR LH- OUT
11	GR	RR DR RH+ OUT
12	O	RR DR RH- OUT
13	LG	FR DR LH+ OUT
14	L	FR DR LH- OUT
15	W	FR DR RH+ OUT
16	R	FR DR RH- OUT
21	--	--
22	Y	WOOFER CTRL
23	B	RR RH- IN
24	G/R	RR RH+ IN
25	BR/Y	RR LH- IN
26	BR/W	RR LH+ IN
27	G/O	FR RH- IN
28	G/Y	FR RH+ IN
29	B	FR LH- IN
30	BR	FR LH+ IN
31	SB	AMP ON
32	--	--

Connector No.	B74
Connector Name	BOSE SPEAKER AMP.
Connector Color	GRAY

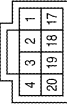

Terminal No.	Color of Wire	Signal Name
1	Y	BATT
2	--	--
3	B	WOOFER- OUT
4	--	--
17	B	GND
18	--	--
19	SB	WOOFER+ OUT
20	--	--

Connector No.	B72
Connector Name	SUBWOOFER
Connector Color	WHITE

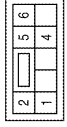

Terminal No.	Color of Wire	Signal Name
1	B	WOOFER-
2	SB	WOOFER+
4	Y	AMP ON
5	B	GND
6	R/B	BATT

ABNIA1546GB

A  
B  
C  
D  
E  
F  
G  
H  
I  
J  
K  
L  
M  
N  
O  
P

AV

# AV CONTROL UNIT

< ECU DIAGNOSIS >

[BOSE AUDIO WITH NAVIGATION]

Connector No.	B77
Connector Name	WIRE TO WIRE
Connector Color	WHITE

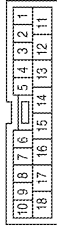

Terminal No.	Color of Wire	Signal Name
1	Y	--
2	GR	--
4	V	--
5	LG	--
6	BR	--
9	O/L	--
10	W/L	--
11	B	--
14	P	--

Terminal No.	Color of Wire	Signal Name
8	W/L	VIDEO IN+
9	--	--
10	--	--
11	--	--
12	Y	GND
13	LG	DATA RX (DVD->LCD)
14	V	DATA TX (LCD->DVD)
15	P	GND
16	BR	FILTERED BATT

Connector No.	B76
Connector Name	VIDEO MONITOR
Connector Color	WHITE

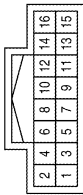

Terminal No.	Color of Wire	Signal Name
1	W	FES L CH INPUT-
2	G	FES L CH INPUT+
3	B	FES R CH INPUT-
4	R	FES R CH INPUT+
5	GR	SW POWER +5
6	--	--
7	O/L	VIDEO IN-

Connector No.	B107
Connector Name	WIRE TO WIRE
Connector Color	WHITE

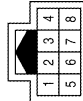

Terminal No.	Color of Wire	Signal Name
1	G	--
2	Y	--
6	SHIELD	--

Connector No.	B106
Connector Name	WIRE TO WIRE
Connector Color	WHITE

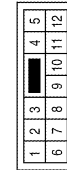

Terminal No.	Color of Wire	Signal Name
5	GR	--
12	O	--

ABNIA1547GB



# AV CONTROL UNIT

< ECU DIAGNOSIS >

[BOSE AUDIO WITH NAVIGATION]

Connector No.	R1
Connector Name	WIRE TO WIRE
Connector Color	WHITE

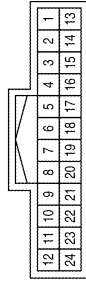

Terminal No.	Color of Wire	Signal Name
3	G	-
6	R	-
7	SHIELD	-

Connector No.	B176
Connector Name	REAR VIEW CAMERA CONTROL UNIT
Connector Color	WHITE

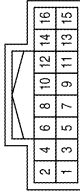

Terminal No.	Color of Wire	Signal Name
1	R/B	BAT+
2	G/Y	ACC
3	LG	GND
4	BR	REVERSE
5	W	AV CONT
6	-	CHECK CONN KLINE
7	-	-
8	Y	CAMERA 6V
9	SHIELD	CAMERA -
10	G	CAMERA +
11	W	VIDEO GND
12	B	VIDEO +
13	-	-
14	-	-
15	-	-
16	-	-

Connector No.	B149
Connector Name	WIRE TO WIRE
Connector Color	WHITE

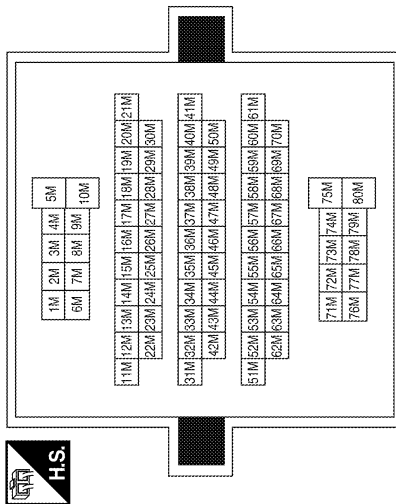

Terminal No.	Color of Wire	Signal Name
5M	SHIELD	-
7M	R/B	-
8M	B	-
9M	W	-
55M	W	-
56M	BR	-
64M	BR	-
65M	G/Y	-
71M	GR	-
72M	O	-

ABNIA1548GB

A  
B  
C  
D  
E  
F  
G  
H  
I  
J  
K  
L  
M  
N  
O  
P

AV

# AV CONTROL UNIT

< ECU DIAGNOSIS >

[BOSE AUDIO WITH NAVIGATION]

Connector No.	D12
Connector Name	FRONT DOOR SPEAKER LH
Connector Color	WHITE



Terminal No.	Color of Wire	Signal Name
1	L/W	--
2	L/R	--

Connector No.	D2
Connector Name	WIRE TO WIRE
Connector Color	BROWN

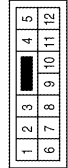

Terminal No.	Color of Wire	Signal Name
2	L/R	--
3	L/W	--

Connector No.	R8
Connector Name	MICROPHONE
Connector Color	WHITE

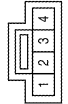

Terminal No.	Color of Wire	Signal Name
1	R	MIC OUT +
2	SHIELD	MIC OUT -
4	G	MIC POWER

Connector No.	D201
Connector Name	WIRE TO WIRE
Connector Color	WHITE

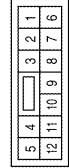

Terminal No.	Color of Wire	Signal Name
5	GR	--
12	O	--

Connector No.	D112
Connector Name	FRONT DOOR SPEAKER RH
Connector Color	WHITE



Terminal No.	Color of Wire	Signal Name
1	W/B	--
2	L/B	--

Connector No.	D101
Connector Name	WIRE TO WIRE
Connector Color	WHITE

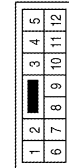

Terminal No.	Color of Wire	Signal Name
4	L/B	--
11	W/B	--

ABNIA1549GB

# AV CONTROL UNIT

< ECU DIAGNOSIS >

[BOSE AUDIO WITH NAVIGATION]

Connector No.	D301
Connector Name	WIRE TO WIRE
Connector Color	WHITE

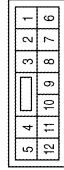

Terminal No.	Color of Wire	Signal Name
5	GR	-
12	O	-

Connector No.	D208
Connector Name	REAR TWEETER LH
Connector Color	BROWN



Terminal No.	Color of Wire	Signal Name
1	GR	-
2	O	-

Connector No.	D207
Connector Name	REAR DOOR SPEAKER LH (WITH BOSE AUDIO SYSTEM)
Connector Color	BROWN



Terminal No.	Color of Wire	Signal Name
1	GR	-
2	O	-

Connector No.	D450
Connector Name	WIRE TO WIRE
Connector Color	WHITE

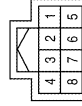

Terminal No.	Color of Wire	Signal Name
1	G	-
2	Y	-
6	SHIELD	-

Connector No.	D308
Connector Name	REAR TWEETER RH
Connector Color	BROWN



Terminal No.	Color of Wire	Signal Name
1	GR	-
2	O	-

Connector No.	D307
Connector Name	REAR DOOR SPEAKER RH (WITH BOSE AUDIO SYSTEM)
Connector Color	BROWN



Terminal No.	Color of Wire	Signal Name
1	GR	-
2	O	-

ABNIA1550GB

A  
B  
C  
D  
E  
F  
G  
H  
I  
J  
K  
L  
M  
N  
O  
P

AV

# AV CONTROL UNIT

< ECU DIAGNOSIS >

[BOSE AUDIO WITH NAVIGATION]

Connector No.	D551
Connector Name	REAR VIEW CAMERA
Connector Color	WHITE

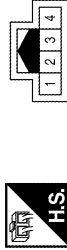

Terminal No.	Color of Wire	Signal Name
1	Y	CAMERA 6V
2	B	GND
3	G	CAMERA +
4	SHIELD	CAMERA -

Connector No.	D550
Connector Name	WIRE TO WIRE
Connector Color	WHITE

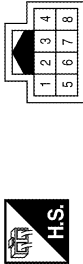

Terminal No.	Color of Wire	Signal Name
1	B	-
6	Y	-
7	G	-
8	SHIELD	-

Connector No.	D451
Connector Name	WIRE TO WIRE
Connector Color	WHITE

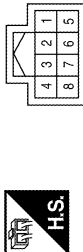

Terminal No.	Color of Wire	Signal Name
1	B	-
6	Y	-
7	G	-
8	SHIELD	-

ABNIA1551GB

INFOID:000000005259617

DTC Index

Self-diagnosis results display item

# AV CONTROL UNIT

< ECU DIAGNOSIS >

[BOSE AUDIO WITH NAVIGATION]

Error item	Refer to
CAN COMM CIRCUIT [U1000]	<a href="#">AV-344, "DTC Logic"</a>
CONTROL UNIT (CAN) [U1010]	<a href="#">AV-345, "DTC Logic"</a>
Control Unit FLASH-ROM [U1200]	<a href="#">AV-346, "DTC Logic"</a>
Gyro NO CONN [U1201]	<a href="#">AV-347, "DTC Logic"</a>
CAN CONT [U1216]	<a href="#">AV-352, "DTC Logic"</a>
BLUETOOTH CONN [U1217]	<a href="#">AV-353, "DTC Logic"</a>
HDD CONN [U1218]	<a href="#">AV-354, "DTC Logic"</a>
HDD READ [U1219]	<a href="#">AV-355, "DTC Logic"</a>
XM SERIAL COMM [U1220]	<a href="#">AV-356, "DTC Logic"</a>
HDD WRITE [U121A]	<a href="#">AV-357, "DTC Logic"</a>
HDD COMM [U121B]	<a href="#">AV-358, "DTC Logic"</a>
HDD ACCESS [U121C]	<a href="#">AV-359, "DTC Logic"</a>
DSP CONN [U121D]	<a href="#">AV-360, "DTC Logic"</a>
DSP COMM [U121E]	<a href="#">AV-361, "DTC Logic"</a>
INTERNAL COMM [U121F]	<a href="#">AV-362, "DTC Logic"</a>
GPS COMM [U1204]	<a href="#">AV-348, "DTC Logic"</a>
GPS ROM [U1205]	<a href="#">AV-349, "DTC Logic"</a>
GPS RAM [U1206]	<a href="#">AV-350, "DTC Logic"</a>
GPS RTC [U1207]	<a href="#">AV-351, "DTC Logic"</a>
FRONT DISP CONN [U1243]	<a href="#">AV-363, "DTC Logic"</a>
GPS ANTENNA CONN [U1244]	<a href="#">AV-365, "DTC Logic"</a>
CAMERA CONT. CONN [U1250]	<a href="#">AV-366, "DTC Logic"</a>
XM ANTENNA CONN [U1258]	<a href="#">AV-368, "DTC Logic"</a>
AV COMM CIRUICT [U1300]	<a href="#">AV-369, "Description"</a>
CONTROL UNIT (AV) [U1310]	<a href="#">AV-370, "DTC Logic"</a>

A  
B  
C  
D  
E  
F  
G  
H  
I  
J  
K  
L  
M  
O  
P

AV

# DISPLAY UNIT

< ECU DIAGNOSIS >

[BOSE AUDIO WITH NAVIGATION]

## DISPLAY UNIT

Reference Value

INFOID:000000005259618

### TERMINAL LAYOUT

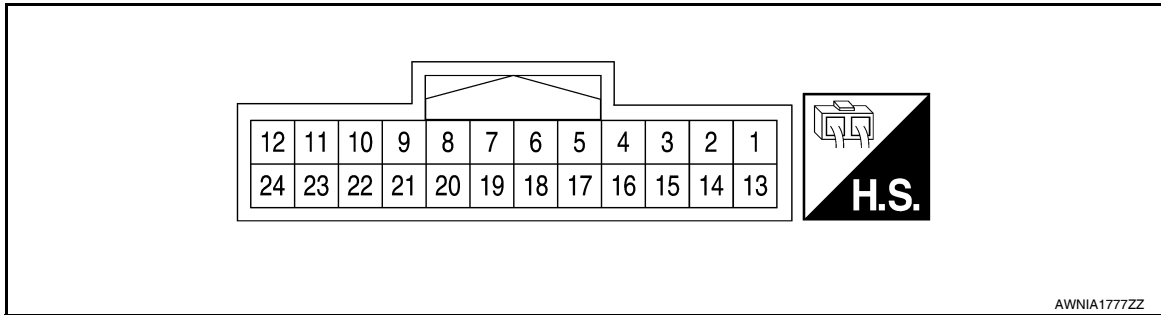

### PHYSICAL VALUES

Terminal (Wire color)		Description		Condition		Reference value (Approx.)
+	-	Signal name	Input/ Output			
1 (B)	Ground	Ground	—	Ignition switch ON	—	0V
2 (Y)	Ground	Battery power	Input	—	—	Battery voltage
3 (V)	Ground	ACC power	Input	Ignition switch ACC	—	Battery voltage
4 (R)	Ground	DVD video (-)	—	Ignition switch ON	When DVD mode is select- ed	0V
6 (G)	Ground	RGB signal (G: green)	Input	Ignition switch ON	Start confirmation/adjust- ment mode, and then dis- play color bar by selecting "Color Spectrum Bar" on DISPLAY DIAGNO- SIS screen.	 SKIB2236J
8 (B)	Ground	Horizontal synchronizing (HP) signal	Output	Ignition switch ON	—	 SKIB3601E
9 (G)	Ground	RGB area (YS) signal	Input	Ignition switch ON	At RGB image displayed	5V
					At rear view camera image displayed	 PKIB4948J

# DISPLAY UNIT

< ECU DIAGNOSIS >

[BOSE AUDIO WITH NAVIGATION]

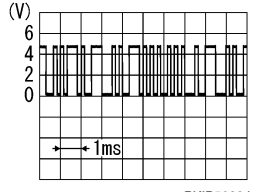
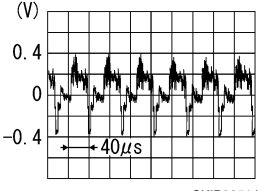
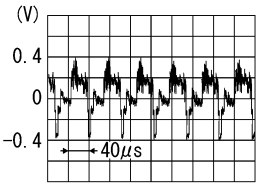
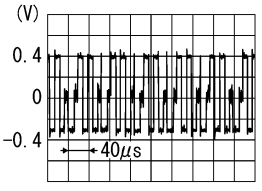
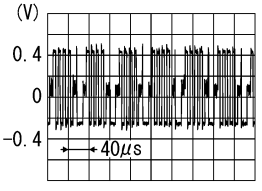
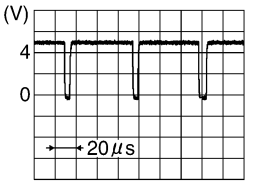
Terminal (Wire color)		Description		Condition		Reference value (Approx.)
+	-	Signal name	Input/ Output			
11 (V)	Ground	Communication signal (CONT→DISP)	Input	Ignition switch ON	When adjusting display- brightness	 <p>PKIB5039J</p>
12 (B)	14 (W)	Rear view camera video (+)	Input	Ignition switch ON	Transmission in reverse	 <p>SKIB2251J</p>
13 (B)	Ground	Ground	—	Ignition switch ON	—	0V
14 (W)	Ground	Rear view camera video (-)	—	Ignition switch ON	Transmission in reverse	0V
15 (G)	4 (R)	DVD video (+)	Input	Ignition switch ON	When DVD mode is select- ed	 <p>SKIB2251J</p>
17 (L)	Ground	RGB signal (R: red)	Input	Ignition switch ON	Start confirmation/adjust- ment mode, and then dis- play color bar by select- ing "Color Spectrum Bar" on DISPLAY DIAGNOSIS screen.	 <p>SKIB2238J</p>
18 (Y)	Ground	RGB signal (B: blue)	Input	Ignition switch ON	Start confirmation/adjust- ment mode, and then dis- play color bar by selecting "Color Spectrum Bar" on DISPLAY DIAGNO- SIS screen.	 <p>SKIB2237J</p>
19 (R)	Ground	RGB synchronizing signal	Input	Ignition switch ON	—	 <p>SKIB3603E</p>

A  
B  
C  
D  
E  
F  
G  
H  
I  
J  
K  
L  
M

AV

O  
P

# DISPLAY UNIT

< ECU DIAGNOSIS >

[BOSE AUDIO WITH NAVIGATION]

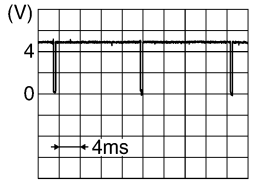
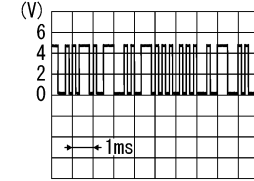
Terminal (Wire color)		Description		Condition		Reference value (Approx.)
+	-	Signal name	Input/ Output			
20 (W)	Ground	Vertical synchronizing (VP) signal	Output	Ignition switch On	—	 <p style="text-align: right; font-size: small;">SKIB3598E</p>
22 (LG)	Ground	Communication signal (DISP→CONT)	Output	Ignition switch ON	When adjusting display-brightness	 <p style="text-align: right; font-size: small;">PKIB5039J</p>
24	—	Shield	—	—	—	—



# BOSE SPEAKER AMP

< ECU DIAGNOSIS >

[BOSE AUDIO WITH NAVIGATION]

## BOSE SPEAKER AMP

Reference Value

INFOID:000000005259619

### TERMINAL LAYOUT

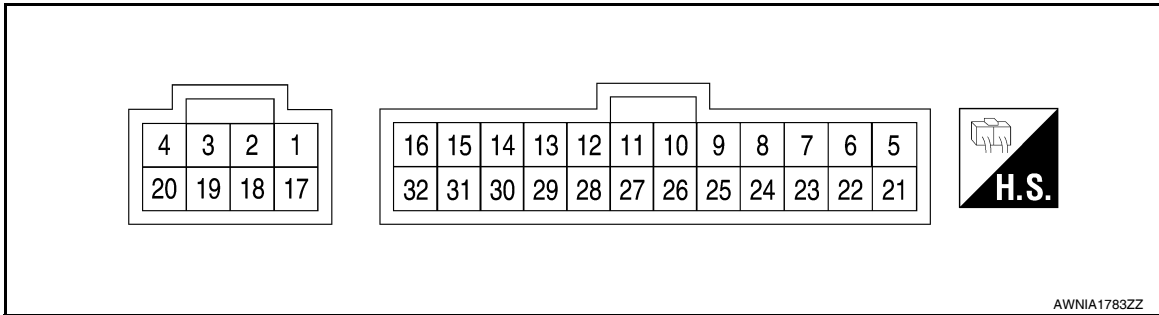

### PHYSICAL VALUES

Terminal (Wire color)		Description		Condition		Reference value (Approx.)
+	-	Signal name	Input/ Output			
1 (Y)	Ground	Battery power	Input	—	—	Battery voltage
9 (B)	10 (G)	Audio signal rear door speaker and tweeter LH	Output	Ignition switch ON	Audio output	 SKIB3609E
11 (GR)	12 (O)	Audio signal rear door speaker and tweeter RH	Output	Ignition switch ON	Audio output	 SKIB3609E
13 (LG)	14 (L)	Audio signal front door speaker and tweeter LH	Output	Ignition switch ON	Audio output	 SKIB3609E
15 (W)	16 (R)	Audio signal front door speaker and tweeter RH	Output	Ignition switch ON	Audio output	 SKIB3609E

A  
B  
C  
D  
E  
F  
G  
H  
I  
J  
K  
L  
M  
O  
P

AV

# BOSE SPEAKER AMP

< ECU DIAGNOSIS >

[BOSE AUDIO WITH NAVIGATION]

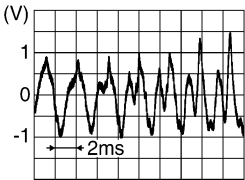
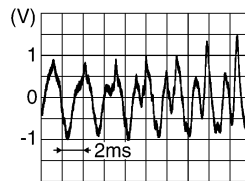
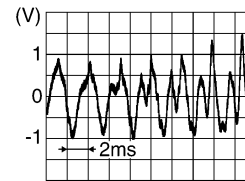
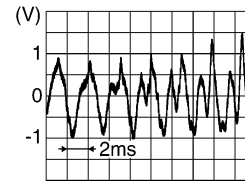
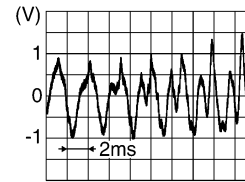
Terminal (Wire color)		Description		Condition		Reference value (Approx.)
+	-	Signal name	Input/ Output			
17 (B)	Ground	Ground	—	Ignition switch ON	—	0V
19 (SB)	3 (B)	Audio signal subwoofer	Output	Ignition switch ON	Audio output	 <p style="text-align: right; font-size: small;">SKIB3609E</p>
22 (Y)	Ground	Subwoofer amp. ON signal	Output	Ignition switch ACC	Audio output	Battery voltage
24 (G/R)	23 (B)	Audio signal rear RH	Input	Ignition switch ON	Audio input	 <p style="text-align: right; font-size: small;">SKIB3609E</p>
26 (BR/W)	25 (BR/Y)	Audio signal rear LH	Input	Ignition switch ON	Audio input	 <p style="text-align: right; font-size: small;">SKIB3609E</p>
28 (G/Y)	27 (G/O)	Audio signal front RH	Input	Ignition switch ON	Audio input	 <p style="text-align: right; font-size: small;">SKIB3609E</p>
30 (BR)	29 (B)	Audio signal front LH	Input	Ignition switch ON	Audio input	 <p style="text-align: right; font-size: small;">SKIB3609E</p>
31 (SB)	Ground	Amp. ON signal	Input	Ignition switch ON	Audio output	Battery voltage

# REAR VIEW CAMERA CONTROL UNIT

< ECU DIAGNOSIS >

[BOSE AUDIO WITH NAVIGATION]

## REAR VIEW CAMERA CONTROL UNIT

Reference Value

INFOID:000000005259620

### TERMINAL LAYOUT

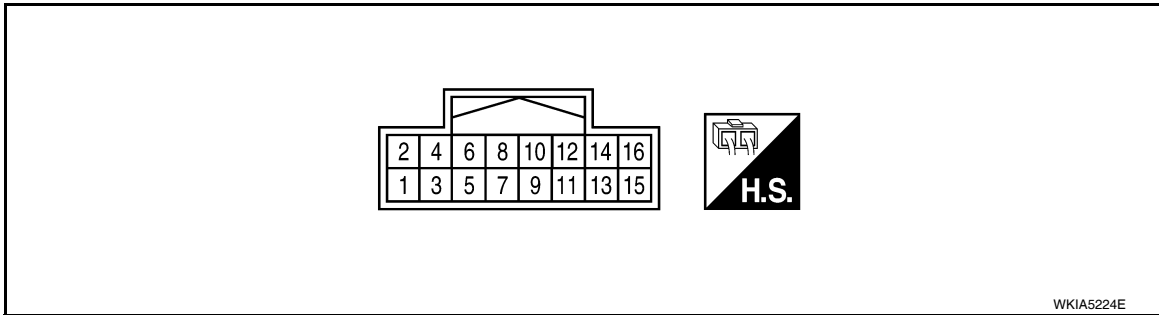

### PHYSICAL VALUES

Terminal			Description		Condition	Reference value (Approx.)
	+	-	Signal name	Input/Output		
1 (R/B)	Ground	Battery power	Input	Ignition switch OFF	—	Battery voltage
2 (G/Y)	Ground	ACC power	Input	Ignition switch ACC	—	Battery voltage
3 (B)	Ground	Ground	—	Ignition switch ON	—	0V
4 (LG)	Ground	Reverse signal input	Input	Ignition switch ON	A/T selector lever R position	Battery voltage
					A/T selector lever in other than R position	0V
5 (BR)	Ground	AV Control	Output	Ignition switch ON	—	0V
6 (W)	Ground	DDL	Output	—	—	—
8 (Y)	Ground	Camera power output	Output	Ignition switch ON	A/T selector lever R position	6V
9	Ground	Camera image input (-)	Input	Ignition switch ON	—	0V
10 (G)	Ground	Camera image input (+)	Input	Ignition switch ON	A/T selector lever R position	<p>SKIA4894E</p>

# REAR VIEW CAMERA CONTROL UNIT

**[BOSE AUDIO WITH NAVIGATION]**

< ECU DIAGNOSIS >

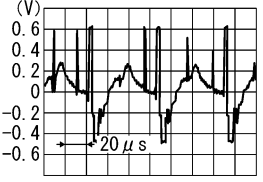
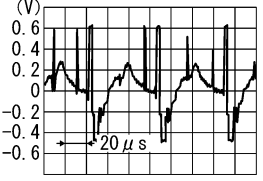
Terminal		Description		Condition		Reference value (Approx.)
+	-	Signal name	Input/Output			
11 (W)	Ground	Composite image output (-)	Output	Ignition switch ON	A/T selector lever R position	 <p style="text-align: right; font-size: small;">SKIA4896E</p>
12 (B)	Ground	Composite image output (+)	Output	Ignition switch ON	A/T selector lever R position	 <p style="text-align: right; font-size: small;">SKIA4896E</p>

# DVD PLAYER

< ECU DIAGNOSIS >

[BOSE AUDIO WITH NAVIGATION]

## DVD PLAYER

### Reference Value

INFOID:000000005259621

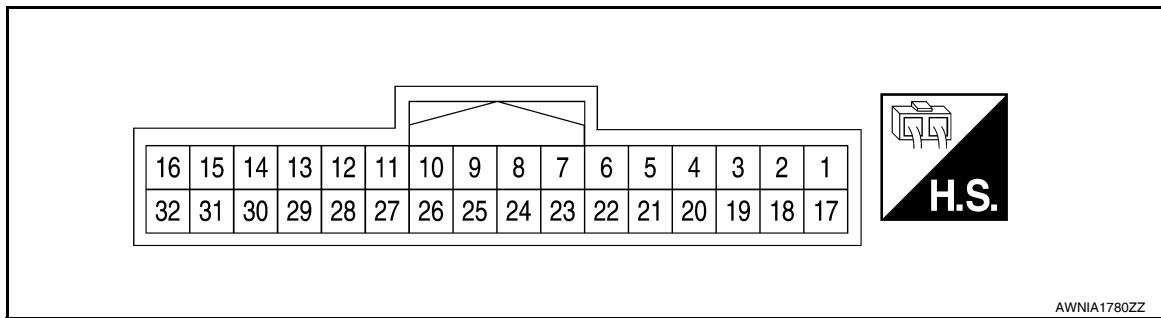

### PHYSICAL VALUES

Terminal		Description		Condition		Reference value (Approx.)
+	-	Signal name	Input/Output			
1 (B)	2 (W)	DVD audio signal LH	Output	Ignition switch ON	With operation of the DVD player	<p>SKIB3609E</p>
5 (B)	Ground	Ground	—	Ignition switch ON	—	0V
6 (BR)	Ground	Illumination control (pulse width modulated)	—	—	With lighting switch ON	—
7 (L)	Ground	CAN communication	Input/Output	Ignition switch ON	—	—
9 (BR)	Ground	Video monitor power supply	Output	Ignition switch ON	With DVD player operation	12V
10 (GR)	Ground	Switch power	Output	Ignition switch ON	With DVD player operation	5V
12 (W/L)	Ground	VTR (+)	Output	Ignition switch ON	With DVD player operation	—
13 (O/L)	Ground	VTR (-)	Output	Ignition switch ON	With DVD player operation	—
14 (Y)	Ground	Display ground	—	Ignition switch ON	With DVD player operation	0V
16 (V)	—	Data receive	Input	—	—	—

# DVD PLAYER

< ECU DIAGNOSIS >

[BOSE AUDIO WITH NAVIGATION]

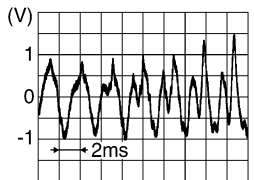
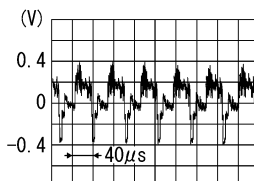
Terminal		Description		Condition		Reference value (Approx.)
+	-	Signal name	Input/ Output			
17 (R)	18 (G)	DVD audio signal RH	Output	Ignition switch ON	With DVD player operation	 <p style="text-align: right; font-size: small;">SKIB3609E</p>
21 (Y)	Ground	Battery power	Input	—	—	12V
22 (SB)	Ground	Illumination power	Input	—	With instrument illumination ON	12V
23 (P)	Ground	CAN communication	Input/ Output	Ignition switch ON	—	0V
24 (G/B)	Ground	ACC power	Input	Ignition switch ACC or ON	—	12V
26 (P)	Ground	Ground	Input	Ignition switch ON	—	0V
28 (G)	Ground	Video out	Input	Ignition switch ACC or ON	—	 <p style="text-align: right; font-size: small;">SKIB2251J</p>
32 (LG)	—	Data transmit	Output	—	—	—

# MULTI AV SYSTEM

< SYMPTOM DIAGNOSIS >

[BOSE AUDIO WITH NAVIGATION]

## SYMPTOM DIAGNOSIS

### MULTI AV SYSTEM

#### Symptom Table

INFOID:000000005259622

#### AUDIO SYSTEM

Symptom	Possible cause	Reference page
Inoperative	<ul style="list-style-type: none"><li>• AV control unit power and ground circuit</li><li>• AV control unit</li></ul>	<ul style="list-style-type: none"><li>• <a href="#">AV-371</a></li><li>• <a href="#">AV-330</a></li></ul>
Steering wheel audio control switch does not operate	<ul style="list-style-type: none"><li>• Steering wheel audio control switch</li><li>• AV control unit</li></ul>	<ul style="list-style-type: none"><li>• <a href="#">AV-404</a></li><li>• <a href="#">AV-330</a></li></ul>
All speakers do not sound	<ul style="list-style-type: none"><li>• AV control unit power and ground circuit</li><li>• BOSE speaker amp. ON signal</li><li>• BOSE speaker amp. power and ground circuit</li><li>• BOSE speaker amp.</li><li>• AV control unit</li></ul>	<ul style="list-style-type: none"><li>• <a href="#">AV-371</a></li><li>• <a href="#">AV-403</a></li><li>• <a href="#">AV-374</a></li><li>• <a href="#">AV-466</a></li><li>• <a href="#">AV-330</a></li></ul>
One or several speakers do not sound	<ul style="list-style-type: none"><li>• Front door speaker</li><li>• Front tweeter</li><li>• Rear tweeter</li><li>• Rear door speaker</li><li>• Subwoofer</li></ul>	<ul style="list-style-type: none"><li>• <a href="#">AV-388</a></li><li>• <a href="#">AV-391</a></li><li>• <a href="#">AV-397</a></li><li>• <a href="#">AV-394</a></li><li>• <a href="#">AV-400</a></li></ul>

#### NAVIGATION SYSTEM

Symptom	Possible cause	Reference page
Inoperative	<ul style="list-style-type: none"><li>• AV control unit power and ground circuit</li><li>• AV control unit</li></ul>	<ul style="list-style-type: none"><li>• <a href="#">AV-371</a></li><li>• <a href="#">AV-330</a></li></ul>
Steering wheel audio control switch does not operate	<ul style="list-style-type: none"><li>• Steering wheel audio control switch</li><li>• AV control unit</li></ul>	<ul style="list-style-type: none"><li>• <a href="#">AV-404</a></li><li>• <a href="#">AV-330</a></li></ul>
Voice activated control does not operate	<ul style="list-style-type: none"><li>• Microphone</li><li>• Steering switch</li><li>• AV control unit</li></ul>	<ul style="list-style-type: none"><li>• <a href="#">AV-406</a></li><li>• <a href="#">AV-404</a></li><li>• <a href="#">AV-460</a></li></ul>

#### HANDS-FREE PHONE SYSTEM

Symptom	Possible cause	Reference page
Inoperative	<ul style="list-style-type: none"><li>• AV control unit power and ground circuit</li><li>• AV control unit</li></ul>	<ul style="list-style-type: none"><li>• <a href="#">AV-371</a></li><li>• <a href="#">AV-330</a></li></ul>
Steering wheel audio control switch does not operate	<ul style="list-style-type: none"><li>• Steering wheel audio control switch</li><li>• AV control unit</li></ul>	<ul style="list-style-type: none"><li>• <a href="#">AV-404</a></li><li>• <a href="#">AV-330</a></li></ul>
Voice activated control does not operate	<ul style="list-style-type: none"><li>• Microphone</li><li>• Steering switch</li><li>• AV control unit</li></ul>	<ul style="list-style-type: none"><li>• <a href="#">AV-406</a></li><li>• <a href="#">AV-404</a></li><li>• <a href="#">AV-460</a></li></ul>

#### REAR VIEW MONITOR

Symptom	Possible cause	Reference page
Inoperative	<ul style="list-style-type: none"><li>• Rear view camera control unit power and ground circuit</li><li>• Reverse signal circuit</li><li>• Camera ON signal circuit</li><li>• Camera image signal circuit (rear view camera to rear view camera control unit)</li><li>• Camera image signal circuit (rear view camera control unit to AV control unit)</li><li>• Rear view camera control unit</li></ul>	<ul style="list-style-type: none"><li>• <a href="#">AV-375</a></li><li>• <a href="#">AV-443</a></li><li>• <a href="#">AV-443</a></li><li>• <a href="#">AV-443</a></li><li>• <a href="#">AV-443</a></li><li>• <a href="#">AV-443</a></li></ul>

#### DVD PLAYER

# MULTI AV SYSTEM

< SYMPTOM DIAGNOSIS >

[BOSE AUDIO WITH NAVIGATION]

Symptom	Possible cause	Reference page
DVD player inoperative	<ul style="list-style-type: none"><li>• Power supply and ground circuits</li><li>• DVD player</li></ul>	<ul style="list-style-type: none"><li>• <a href="#">AV-371</a></li><li>• <a href="#">AV-377</a></li></ul>
No sound when playing a DVD	<ul style="list-style-type: none"><li>• Audio signal circuits</li><li>• AV control unit</li><li>• DVD player</li></ul>	<ul style="list-style-type: none"><li>• <a href="#">AV-445</a></li><li>• <a href="#">AV-330</a></li><li>• <a href="#">AV-377</a></li></ul>
Video monitor is inoperative/does not display properly	<ul style="list-style-type: none"><li>• Power supply and ground circuits</li><li>• Video out circuit</li><li>• DVD player</li><li>• Video monitor</li></ul>	<ul style="list-style-type: none"><li>• <a href="#">AV-371</a></li><li>• <a href="#">AV-134</a></li><li>• <a href="#">AV-377</a></li><li>• <a href="#">AV-378</a></li></ul>
DVD remote control is inoperative/does not operate properly	<ul style="list-style-type: none"><li>• DVD player</li><li>• Video monitor</li></ul>	<ul style="list-style-type: none"><li>• <a href="#">AV-408</a></li><li>• <a href="#">AV-408</a></li></ul>
Headphones inoperative	<ul style="list-style-type: none"><li>• Headphone batteries</li><li>• Headphone audio signal circuits from AV control unit</li><li>• AV control unit</li><li>• Video monitor</li></ul>	<ul style="list-style-type: none"><li>• <a href="#">AV-408</a></li><li>• <a href="#">AV-408</a></li><li>• <a href="#">AV-408</a></li></ul>



# NORMAL OPERATING CONDITION

< SYMPTOM DIAGNOSIS >

[BOSE AUDIO WITH NAVIGATION]

## NORMAL OPERATING CONDITION

### Description

INFOID:000000005259623

#### AUDIO SYSTEM

The majority of the audio troubles are the result of outside causes (bad CD, electromagnetic interference, etc.).

#### Noise

The following noise results from variations in field strength, such as fading noise and multi-path noise, or external noise from trains and other sources. It is not a malfunction.

- Fading noise: This noise occurs because of variations in the field strength in a narrow range due to mountains or buildings blocking the signal.
- Multi-path noise: This noise results from the waves sent directly from the broadcast station arriving at the antenna at a different time from the waves which reflect off mountains or buildings.

The vehicle itself can be a source of noise if noise prevention parts or electrical equipment is malfunctioning. Check if noise is caused and/or changed by engine speed, ignition switch turned to each position, and operation of each piece of electrical equipment, and determine the cause.

#### NOTE:

The source of the noise can be found easily by listening to the noise while removing the fuses of electrical components, one by one.

#### Type of Noise and Possible Cause

Occurrence condition		Possible cause
Occurs only when engine is ON.	A continuous growling noise occurs. The speed of the noise varies with changes in the engine speed.	<ul style="list-style-type: none"> <li>• Ignition components</li> </ul>
The occurrence of the noise is linked with the operation of the fuel pump.		<ul style="list-style-type: none"> <li>• Fuel pump condenser</li> </ul>
Noise only occurs when various electrical components are operating.	A cracking or snapping sound occurs with the operation of various switches.	<ul style="list-style-type: none"> <li>• Relay malfunction, audio unit malfunction</li> </ul>
	The noise occurs when various motors are operating.	<ul style="list-style-type: none"> <li>• Motor case ground</li> <li>• Motor</li> </ul>
The noise occurs constantly, not just under certain conditions.		<ul style="list-style-type: none"> <li>• Rear defogger coil malfunction</li> <li>• Open circuit in printed heater</li> <li>• Poor ground of antenna feeder line</li> </ul>
A cracking or snapping sound occurs while the vehicle is being driven, especially when it is vibrating excessively.		<ul style="list-style-type: none"> <li>• Ground wire of body parts</li> <li>• Ground due to improper part installation</li> <li>• Wiring connections or a short circuit</li> </ul>

#### NAVIGATION SYSTEM

#### Basic Operation

Symptom	Cause	Remedy
No image is shown.	Display brightness adjustment is set fully to DARK side.	Adjust the display brightness.
No guide sound is heard. Audio guide volume is too low or too high.	Volume control is set to OFF, MIN or MAX.	Adjust the audio guide volume.
	Audio guidance is not available while the vehicle is driving on a dark pink route.	System is not malfunctioning.
Screen is too dark. Motion of the image is too slow.	Temperature inside the vehicle is low.	Wait until the temperature inside the vehicle reaches the proper temperature.
Small black or bright spots appear on the screen.	Symptom peculiar to a liquid crystal display (display unit).	System is not malfunctioning.

#### Vehicle Mark

## NORMAL OPERATING CONDITION

< SYMPTOM DIAGNOSIS >

[BOSE AUDIO WITH NAVIGATION]

Symptom	Cause	Remedy
Map screen and BIRDVIEW™ Name of the place vary with the screen.	Some thinning of the character data is done to prevent the display becoming to complex. In some cases and in some locations, the display contents may differ. The same place name, street name, etc. may not be displayed every time on account of the data processing.	System is not malfunctioning.
Vehicle mark is not positioned correctly.	Vehicle is transferred by ferry or by towing after its ignition switch is turned to OFF.	Drive the vehicle for a while in the GPS satellite signal receiving condition.
Screen will not switch to nighttime mode after the lighting switch is turned ON.	The daytime screen is selected by the "SWITCH SCREENS" when the last time the screen dimming setting is done. Switching between daytime/nighttime screen may be inhibited by the automatic illumination adjustment function.	Perform screen dimming and select the nighttime screen by "SWITCH SCREENS".
Map screen will not scroll in accordance with the vehicle travel.	Current location is not displayed.	Press "MAP" button to display the current location.
Vehicle mark will not be shown.	Current location is not displayed.	Press "MAP" button to display the current location.
Accuracy indicator (GPS satellite mark) on the map screen stays gray.	GPS satellite signal is intercepted because the vehicle is in or behind a building.	Move the vehicle out to an open space.
	GPS satellite signal cannot be received because an obstacle is placed on top of the instrument panel.	Do not place anything on top of the meter display (instrument panel).
	GPS satellites are not visible from current location.	Wait until GPS satellites are visible by moving the vehicle.
Vehicle location accuracy is low.	Accuracy indicator (GPS satellite mark) on the map screen stays gray.	Current location is not determined.
	Vehicle speed setting by the vehicle speed pulse has been deviated (advanced or retarded) from the actual vehicle speed because tire chain is fitted or the system has been used on another vehicle.	Drive the vehicle for a while [for approx. 30 minutes at approx. 30 km/h (19 MPH)] and the deviation will be automatically adjusted. If advancement or retard still occur, perform the distance adjustment by CONFIRMATION/ADJUSTMENT mode of diagnosis function.
	Map data has error or omission. (Vehicle mark is always deviated to the same position.)	As a rule, an updated map DVD-ROM will be released once a year.

### Destination, Passing Points and Menu Items Cannot be Selected/Set

Symptom	Cause	Remedy
Destination cannot be set.	Destination to be set is on an expressway.	Set the destination on an ordinary road.
Passing point is not searched when re-searching the route.	The vehicle has already passed the passing point, or the system judged so.	To include the passing points that have been passed into the route again, set the route again.
Route information will not be displayed.	Route searching has not been done.	Set the destination and perform route searching.
	Vehicle mark is not on the recommended route.	Drive on the recommended route.
	Route guide is turned OFF.	Turn route guide ON.
	Route information is not available on the dark pink route.	System is not malfunctioning.
After the route searching, no guide sign will appear as the vehicle goes near the entrance/exit to the toll road.	Vehicle mark is not on the recommended route. (On the display, only guide signs related to the recommended route will be shown.)	Drive on the recommended route.

## NORMAL OPERATING CONDITION

< SYMPTOM DIAGNOSIS >

[BOSE AUDIO WITH NAVIGATION]

Symptom	Cause	Remedy
Automatic route searching is not possible.	Vehicle is driving on a highway (gray route), or no recommended route is available.	Drive on a road to be searched. Or re-search the route manually. In this case, however, the whole route will be searched.
Performed automatic detour search (or detour search). However, the result is the same as that of the previous search.	Performed search with every conditions considered. However, the result is the same as that of the previous search.	System is not malfunctioning.
Passing points cannot be set.	More than five passing points were set.	Passing points can be set up to five. To stop at more than five points, perform sharing in several steps.
When setting the route, the starting point cannot be selected.	The current vehicle location is always set as the starting point of a route.	System is not malfunctioning.
Some menu items cannot be selected.	The vehicle is being driven.	Stop the vehicle at a safe place and then operate the system.

### Voice Guide

Symptom	Cause	Remedy
Voice guide will not operate.	Note: Voice guide is only available at intersections that satisfy certain conditions (indicated by ● on the map). Therefore, guidance may not be given even when the route on the map changes direction.	System is not malfunctioning.
	The vehicle is not on the recommended route.	Return to the recommended route or re-search the route.
	Voice guide is turned OFF.	Turn voice guide ON.
	Route guide is turned OFF.	Turn route guide ON.
Voice guide does not match the actual road pattern.	Voice guide may vary with the direction to which the vehicle is turn and the connection of the road to other roads.	Drive in conformity to the actual traffic rules.

### Route Search

Symptom	Cause	Remedy
No route is shown.	No road to be searched is found around the destination.	Find wider road (orange road or wider) nearby and reset the destination and passing points onto it. Take care of the traveling direction when there are separate up and down roads.
	Starting point and the destination are too close.	Set the destination at more distant point.
	Conditional traffic regulation (day of the week/ time of the day) is set at the area around the current location or the destination.	Turn the time-regulating search conditions OFF. Turn "Avoid regulation time" in the search conditions OFF.
Indicated route is intermittent.	In some areas, highways (gray routes) are not used for the search <sup>(Note)</sup> Therefore, the route to the current location or the passing points may be intermittent.	System is not malfunctioning.
When the vehicle has passed the recommended route, it is deleted from the screen.	A recommended route is controlled by each section. When the vehicle has passed the passing point 1, then the map data from the starting point up to the passing point 1 will be deleted. (The data may remain undeleted in some area.)	System is not malfunctioning.

# NORMAL OPERATING CONDITION

< SYMPTOM DIAGNOSIS >

[BOSE AUDIO WITH NAVIGATION]

Symptom	Cause	Remedy
Detouring route is recommended.	In some areas, highways (gray routes) are not used for the search. (Note). Therefore, detour route may be recommended.	Set the route closer to the basic route (gray route).
	A detour route may be shown when some traffic regulation (one-way traffic, etc.) is set at the area around the starting point or the destination.	Slightly move the starting point or the destination, or set the passing point on the route of your choice.
	In the area where highways (gray routes) are used for the search, left turn has priority around the current location and the destination (passing points). For this reason, the recommended route may be detouring.	System is not malfunctioning.
Landmarks on the map do not match the actual ones.	This can be happen due to omission or error in the map data.	As a rule, an updated map DVD-ROM will be released once a year. Wait until the latest map has become available.
Recommended route is far from the starting point, passing points, and destination.	Starting point, passing points, and destination of the route guide were set far from the desired points because route searching data around these area were not stored.	Reset the destination onto the road nearby. If this road is one of the highways (gray routes), an ordinary road nearby may be displayed as the recommended route.

**NOTE:**

Except for the ordinance-designated cities. (Malfunctioning areas may be changed in the updated map disc.)

**Examples of Current-Location Mark Displacement**

Vehicle's travel amount is calculated by reading its travel distance and turning angle. Therefore, if the vehicle is driven in the following manner, an error will occur in the vehicle's current location display. If correct location has not been restored after driving the vehicle for a while, perform location correction.

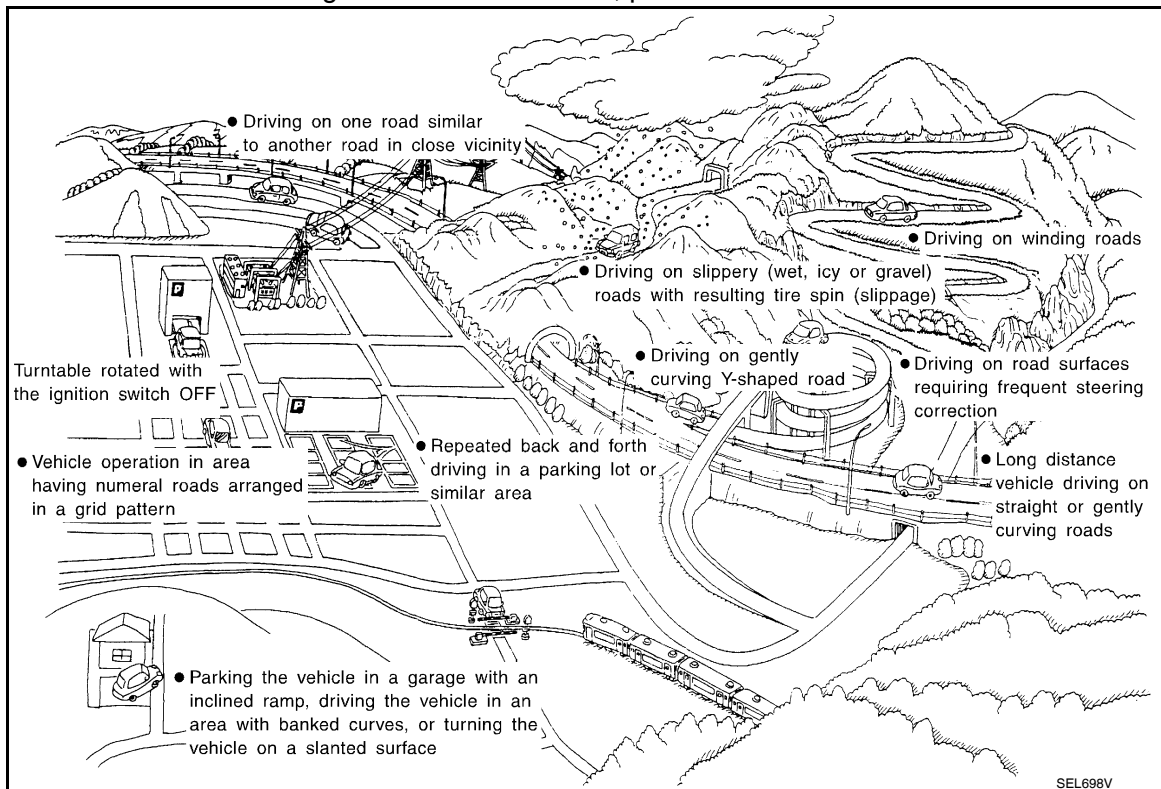

# NORMAL OPERATING CONDITION

< SYMPTOM DIAGNOSIS >

[BOSE AUDIO WITH NAVIGATION]

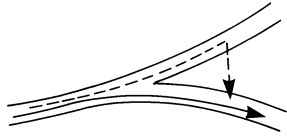
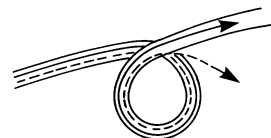
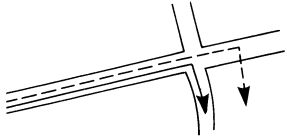
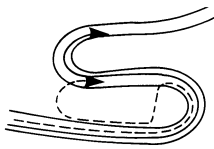
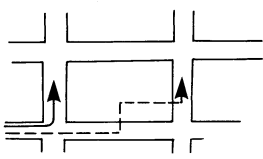
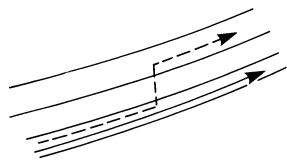
Cause (condition)	-: While driving    ooo: Display	Driving condition	Remarks (correction, etc.)
Road configuration	Y-intersections	 <p style="text-align: center; font-size: small;">ELK0192D</p>	At a Y intersection or similar gradual division of roads, an error in the direction of travel deduced by the sensor may result in the current-location mark appearing on the wrong road.
	Spiral roads	 <p style="text-align: center; font-size: small;">ELK0193D</p>	When driving on a large, continuous spiral road (such as loop bridge), turning angle error is accumulated and the vehicle mark may deviate from the correct location.
	Straight roads	 <p style="text-align: center; font-size: small;">ELK0194D</p>	When driving on a long, straight road and slow curve without stopping, map-matching does not work effectively enough and distance errors may accumulate. As a result, the vehicle mark may deviate from the correct location when the vehicle is turned at a corner.
	Zigzag roads	 <p style="text-align: center; font-size: small;">ELK0195D</p>	When driving on a zigzag road, the map may be matched to other roads in the similar direction nearby at every turn, and the vehicle mark may deviate from the correct location.
	Roads laid out in a grid pattern	 <p style="text-align: center; font-size: small;">ELK0196D</p>	When driving where roads are laid out in a grid pattern, or where many roads are running in the similar direction nearby, the map may be matched to them by mistake and the vehicle mark may deviate from the correct location.
	Parallel roads	 <p style="text-align: center; font-size: small;">ELK0197D</p>	When two roads are running in parallel (such as highway and sideway), the map may be matched to the other road by mistake and the vehicle mark may deviate from the correct location.

A  
B  
C  
D  
E  
F  
G  
H  
I  
J  
K  
L  
M  
AV  
O  
P

# NORMAL OPERATING CONDITION

< SYMPTOM DIAGNOSIS >

[BOSE AUDIO WITH NAVIGATION]

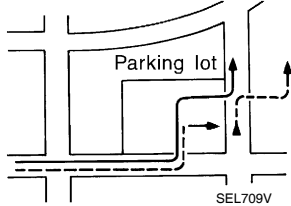
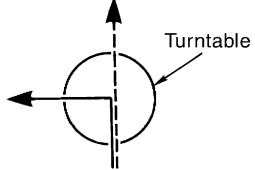
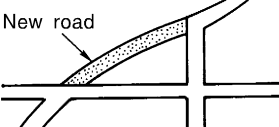
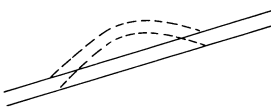
	Cause (condition)    -: While driving    ooo: Display	Driving condition	Remarks (correction, etc.)
Place	In a parking lot  SEL709V	When driving in a parking lot, or other location where there are no roads on the map, matching may place the vehicle mark on a nearby road. When the vehicle returns to the road, the vehicle mark may have deviated from the correct location. When driving in circle or turning the steering wheel repeatedly, direction errors accumulate, and the vehicle mark may deviate from the correct location.	If after travelling about 10 km (6 miles) the correct location has not been restored, perform location correction and, if necessary, direction correction.
	Turntable  SEL710V	When the ignition switch is OFF, the navigation system cannot get the signal from the gyroscope (angular speed sensor). Therefore, the displayed direction may be wrong and the correct road may not be easily returned to after rotating the vehicle on a turntable with the ignition OFF.	
	Slippery roads	On snow, wet roads, gravel, or other roads where tires may slip easily, accumulated mileage errors may cause the vehicle mark to deviate from the correct road.	
	Slopes	When parking in sloped garages, when travelling on banked roads, or in other cases where the vehicle turns when tilted, an error in the turning angle will occur, and the vehicle mark may deviate from the road.	
Map data	Road not displayed on the map screen  SEL699V	When driving on new roads or other roads not displayed on the map screen, map matching does not function correctly and matches the location to a nearby road. When the vehicle returns to a road which is on the map, the vehicle mark may deviate from the correct road.	
	Different road pattern (Changed due to repair)  ELK0201D	If the road pattern stored in the map data and the actual road pattern are different, map matching does not function correctly and matches the location to a nearby road. The vehicle mark may deviate from the correct road.	
Vehicle	Use of tire chains	When tire chains are used, the mileage is not correctly detected, and the vehicle mark may deviate from the correct road.	Drive the vehicle for a while. If the distance still deviates, adjust it by using the distance adjustment function. (If the tire chain is removed, recover the original value.)

# NORMAL OPERATING CONDITION

< SYMPTOM DIAGNOSIS >

[BOSE AUDIO WITH NAVIGATION]

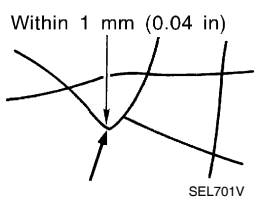
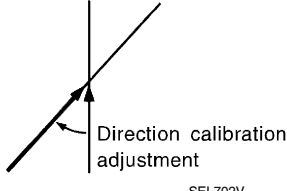
Cause (condition)	-: While driving    ooo: Display	Driving condition	Remarks (correction, etc.)
Precautions for driving	Just after the engine is started	If the vehicle is driven just after the engine is started when the gyroscope (angular speed sensor) correction is not completed, the vehicle can lose its direction and may have deviated from the correct location.	Wait for a short while before driving after starting the engine.
	Continuous driving without stopping	When driving long distances without stopping, direction errors may accumulate, and the current-location mark may deviate from the correct road.	Stop and adjust the orientation.
	Abusive driving	Spinning the wheels or engaging in other kinds of abusive driving may result in the system being unable to perform correct detection, and may cause the vehicle mark to deviate from the correct road.	If after travelling about 10 km (6 miles) the correct location has not been restored, perform location correction and, if necessary, direction correction.
How to correct location	Position correction accuracy 	If the accuracy of location settings is poor, accuracy may be reduced when the correct road cannot be found, particularly in places where there are many roads.	Enter in the road displayed on the screen with an accuracy of approx. 1mm. Caution: Whenever possible, use detailed map for the correction.
	Direction when location is corrected 	If the accuracy of location settings during correction is poor, accuracy may be reduced afterwards.	Perform direction correction.

### Location Correction by Map-Matching is Slow

- The map-matching function needs to refer to the data of the surrounding area. It is necessary to drive some distance for the function to work.
- Because map-matching operates on this principle, when there are many roads running in similar directions in the surrounding area, no matching determination may be made. The location may not be corrected until some special feature is found.

### Name of Road is Not Displayed

The current road name may not be displayed if there are no road names displayed on the map screen.

### Contents of Display Differ for Birdview™ and the (Flat) Map Screen

Difference of the BIRDVIEW™ screen from the flat map screen are as follows.

- The current place name displays names which are primarily in the direction of vehicle travel.
- The amount of time before the vehicle travel or turn angle is updated on the screen is longer than for the (flat) map display.
- The conditions for display of place names, roads, and other data are different for nearby areas and for more distant areas.
- Some thinning of the character data is done to prevent the display becoming too complex. In some cases and in some locations, the display contents may differ.
- The same place name, street name, etc. may be displayed multiple times.

### Vehicle Mark Shows a Position Which is Completely Wrong

In the following cases, the vehicle mark may appear on completely different position in the map depending on the GPS satellite signal receiving conditions. In this case, perform location correction and direction correction.

- When location correction has not been done
- If the receiving conditions of the GPS satellite signal is poor, if the vehicle mark becomes out of place, it may move to a completely different location and not come back if location correction is not done. The position will be corrected if the GPS signal can be received.
- When the vehicle has traveled by ferry, or when the vehicle has been being towed

## NORMAL OPERATING CONDITION

< SYMPTOM DIAGNOSIS >

[BOSE AUDIO WITH NAVIGATION]

- Because calculation of the current location cannot be done when traveling with the ignition off, for example when traveling by ferry or when being towed, the location before travel is displayed. If the precise location can be detected with GPS, the location will be corrected.

### Vehicle Mark Jumps

In the following cases, the vehicle mark may appear to jump as a result of automatic correction of the current location.

- When map matching has been done
  - If the current location and the vehicle mark are different when map matching is done, the vehicle mark may seem to jump. At this time, the location may be “corrected” to the wrong road or to a location which is not on a road.
- When GPS location correction has been done
  - If the current location and the vehicle mark are different when the location is corrected using GPS measurements, the vehicle mark may seem to jump. At this time, the location may be “corrected” to a location which is not on a road.

### Vehicle Mark is in a River or Sea

The navigation system moves the vehicle mark with no distinction between land and rivers or sea. If the vehicle mark is somehow out of place, it may appear that the vehicle is driving in a river or the sea.

### Vehicle Mark Automatically Rotates

The system wrongly memorizes the rotating status as stopping when the ignition switch is turned ON with the turntable rotating. That causes the vehicle mark to rotate when the vehicle is stopped.

### When Driving on Same Road, Sometimes Vehicle Mark is in Right Place and Sometimes it is in Wrong Place

The conditions of the GPS antenna (GPS data) and gyroscope (angular speed sensor) change gradually. Depending on the road traveled and the operation of the steering wheel, the location detection results will be different. Therefore, even on a road on which the location has never been wrong, conditions may cause the vehicle mark to deviate.



PRECAUTION

PRECAUTIONS

Precaution for Supplemental Restraint System (SRS) "AIR BAG" and "SEAT BELT PRE-TENSIONER"

INFOID:000000005259624

The Supplemental Restraint System such as "AIR BAG" and "SEAT BELT PRE-TENSIONER", used along with a front seat belt, helps to reduce the risk or severity of injury to the driver and front passenger for certain types of collision. This system includes seat belt switch inputs and dual stage front air bag modules. The SRS system uses the seat belt switches to determine the front air bag deployment, and may only deploy one front air bag, depending on the severity of a collision and whether the front occupants are belted or unbelted. Information necessary to service the system safely is included in the SR and SB section of this Service Manual.

**WARNING:**

- To avoid rendering the SRS inoperative, which could increase the risk of personal injury or death in the event of a collision which would result in air bag inflation, all maintenance must be performed by an authorized NISSAN/INFINITI dealer.
- Improper maintenance, including incorrect removal and installation of the SRS, can lead to personal injury caused by unintentional activation of the system. For removal of Spiral Cable and Air Bag Module, see the SR section.
- Do not use electrical test equipment on any circuit related to the SRS unless instructed to in this Service Manual. SRS wiring harnesses can be identified by yellow and/or orange harnesses or harness connectors.

PRECAUTIONS WHEN USING POWER TOOLS (AIR OR ELECTRIC) AND HAMMERS

**WARNING:**

- When working near the Airbag Diagnosis Sensor Unit or other Airbag System sensors with the Ignition ON or engine running, DO NOT use air or electric power tools or strike near the sensor(s) with a hammer. Heavy vibration could activate the sensor(s) and deploy the air bag(s), possibly causing serious injury.
- When using air or electric power tools or hammers, always switch the Ignition OFF, disconnect the battery, and wait at least 3 minutes before performing any service.

Precaution Necessary for Steering Wheel Rotation After Battery Disconnect

INFOID:000000005259625

**NOTE:**

- This Procedure is applied only to models with Intelligent Key system and NATS (NISSAN ANTI-THEFT SYSTEM).
- Remove and install all control units after disconnecting both battery cables with the ignition knob in the "LOCK" position.
- Always use CONSULT-III to perform self-diagnosis as a part of each function inspection after finishing work. If DTC is detected, perform trouble diagnosis according to self-diagnostic results.

For models equipped with the Intelligent Key system and NATS, an electrically controlled steering lock mechanism is adopted on the key cylinder.

For this reason, if the battery is disconnected or if the battery is discharged, the steering wheel will lock and steering wheel rotation will become impossible.

If steering wheel rotation is required when battery power is interrupted, follow the procedure below before starting the repair operation.

OPERATION PROCEDURE

1. Connect both battery cables.

**NOTE:**

Supply power using jumper cables if battery is discharged.

2. Use the Intelligent Key or mechanical key to turn the ignition switch to the "ACC" position. At this time, the steering lock will be released.
3. Disconnect both battery cables. The steering lock will remain released and the steering wheel can be rotated.
4. Perform the necessary repair operation.

A  
B  
C  
D  
E  
F  
G  
H  
I  
J  
K  
L  
M  
AV  
O  
P

# PRECAUTIONS

[BOSE AUDIO WITH NAVIGATION]

< PRECAUTION >

- When the repair work is completed, return the ignition switch to the "LOCK" position before connecting the battery cables. (At this time, the steering lock mechanism will engage.)
- Perform a self-diagnosis check of all control units using CONSULT-III.

## Precaution for Trouble Diagnosis

INFOID:000000005259626

### AV COMMUNICATION SYSTEM

- Do not apply voltage of 7.0 V or higher to the measurement terminals.
- Use the tester with its open terminal voltage being 7.0 V or less.
- Be sure to turn ignition switch OFF and disconnect the battery cable from the negative terminal before checking the circuit.

## Precaution for Harness Repair

INFOID:000000005259627

### AV COMMUNICATION SYSTEM

- Solder the repaired parts, and wrap with tape. [Frays of twisted line must be within 110 mm (4.33 in).]

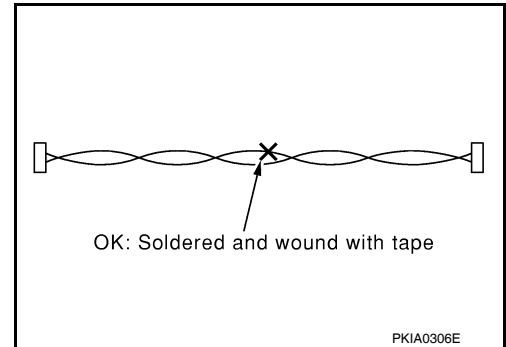

- Do not perform bypass wire connections for the repair parts. (The spliced wire will become separated and the characteristics of twisted line will be lost.)

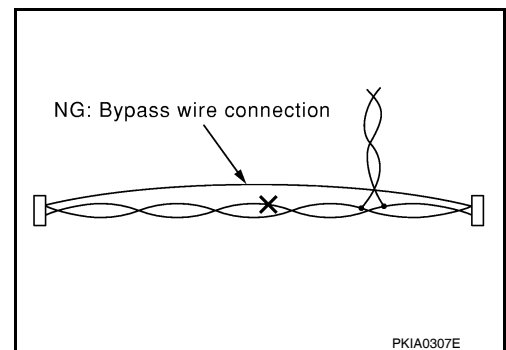

PREPARATION

PREPARATION

Commercial Service Tools

INFOID:000000005259628

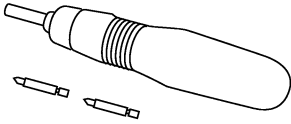
Tool name	Description
<p>Power tool</p>  <p>PBIC0191E</p>	<p>Loosening bolts and nuts</p>

A  
B  
C  
D  
E  
F  
G  
H  
I  
J  
K  
L  
M  
AV  
O  
P

AV

# AV CONTROL UNIT

< ON-VEHICLE REPAIR >

[BOSE AUDIO WITH NAVIGATION]

## ON-VEHICLE REPAIR

### AV CONTROL UNIT

#### Removal and Installation

INFOID:000000005259629

#### AUDIO UNIT

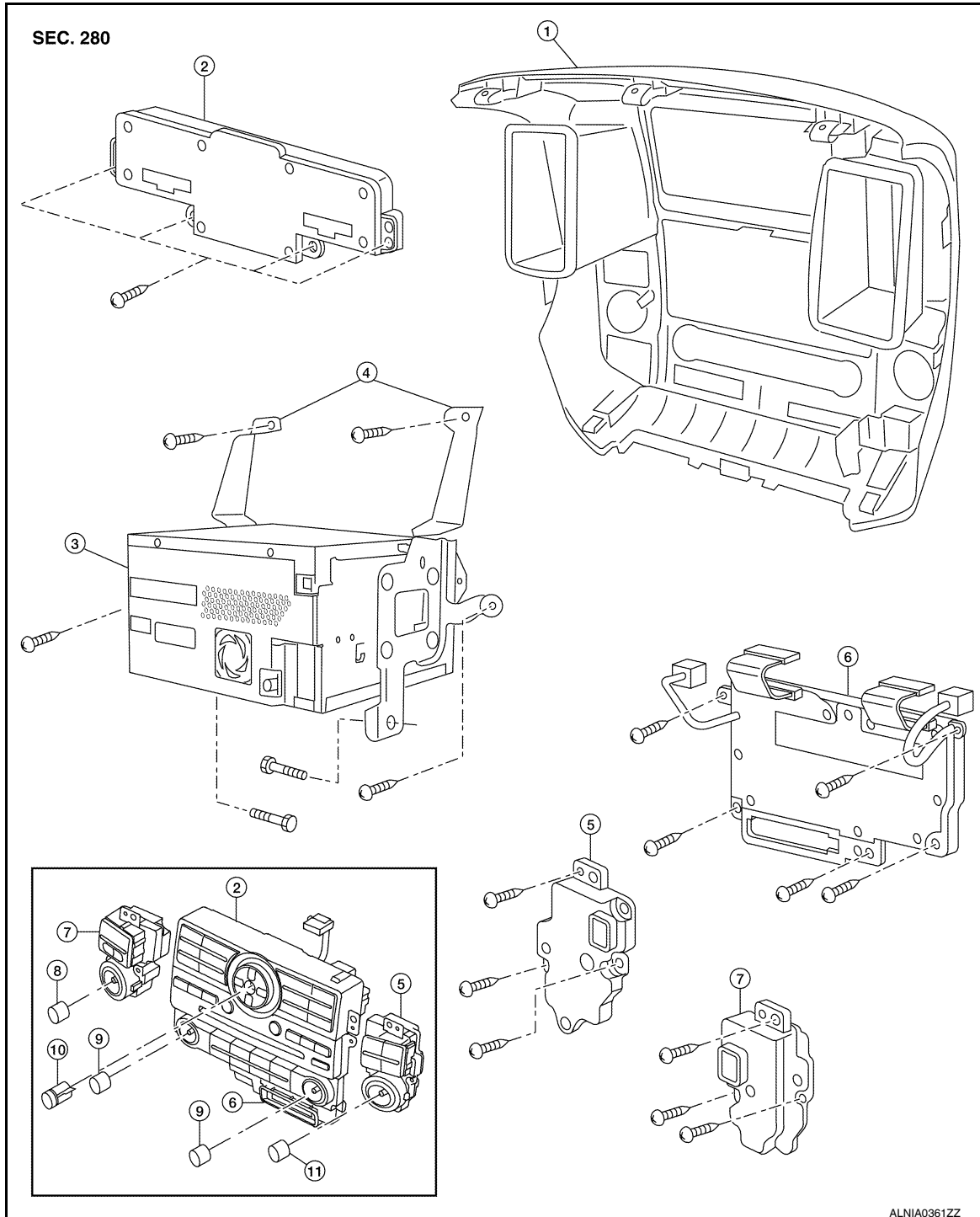

- |                             |                       |                               |
|-----------------------------|-----------------------|-------------------------------|
| 1. Cluster lid C            | 2. AV switch assembly | 3. AV control unit            |
| 4. AV control unit brackets | 5. Tuner knob switch  | 6. A/C and AV switch assembly |
| 7. Volume knob switch       | 8. Volume knob        | 9. Temp knobs RH and LH       |
| 10. Enter button            | 11. Tuner knob        |                               |

# AV CONTROL UNIT

< ON-VEHICLE REPAIR >

[BOSE AUDIO WITH NAVIGATION]

## CAUTION:

Only remove and replace the A/C or AV switch assembly knobs if damaged or missing. The knobs must not be removed from switches when removing and installing the A/C or AV switch assembly to prevent damage to the switch assembly.

## REMOVAL

1. Disconnect the battery negative terminal.
2. Remove the cluster lid C. Refer to [JP-12, "Removal and Installation"](#).
3. Remove the AV control unit screws, using a power tool.
4. Remove the AV control unit.
5. Remove the A/C and AV switch assembly screws, then remove the A/C and AV switch assemblies as necessary.

## INSTALLATION

Installation is in the reverse order of removal.

A  
B  
C  
D  
E  
F  
G  
H  
I  
J  
K  
L  
M  
N  
O  
P

AV

# DISPLAY UNIT

< ON-VEHICLE REPAIR >

[BOSE AUDIO WITH NAVIGATION]

## DISPLAY UNIT

### Removal and Installation

INFOID:000000005259630

#### REMOVAL

1. Remove Cluster lid C. Refer to [IP-12, "Removal and Installation"](#).
2. Remove the display unit screws (A).
3. Pull out the display unit (1), then disconnect the display unit connectors and remove the display unit (1).

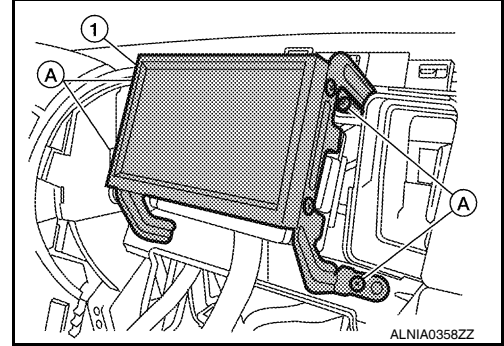

4. Remove the A/C auto amp.screws (A), remove the (C103) fasteners (B) from the display unit assembly brackets and remove the A/C auto amp. (1).
5. Remove the display unit bracket unit screws (C) and remove the display unit brackets (2).

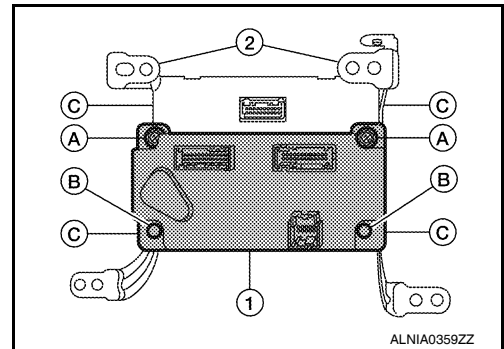

#### INSTALLATION

Installation is in reverse order of removal.

## FRONT TWEETER

### Removal and Installation

INFOID:000000005259631

#### REMOVAL

**CAUTION:**

Use a suitable tool to prevent damage to the front tweeter speaker grille trim and the instrument panel.

1. Remove the front tweeter grille.
2. Remove the front tweeter screws (A).
3. Pull out the front tweeter speaker (1) and disconnect front tweeter connector, then remove the front tweeter speaker (1).

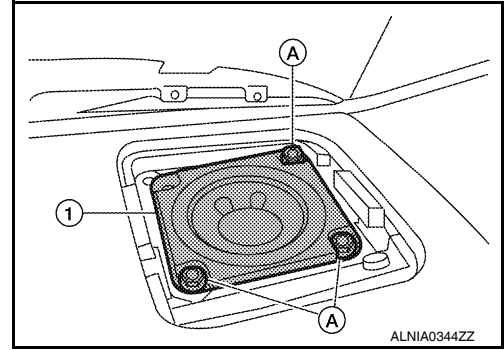

#### INSTALLATION

Installation is in the reverse order of removal.

A  
B  
C  
D  
E  
F  
G  
H  
I  
J  
K  
L  
M  
O  
P

AV

# FRONT DOOR SPEAKER

< ON-VEHICLE REPAIR >

[BOSE AUDIO WITH NAVIGATION]

## FRONT DOOR SPEAKER

### Removal and Installation

INFOID:000000005259632

#### REMOVAL

1. Remove the front door finisher. Refer to [INT-14, "Removal and Installation"](#).
2. Remove the front door speaker screws (A).
3. Pull out the front door speaker (1), and disconnect the front door speaker connector and remove the front door speaker (1).

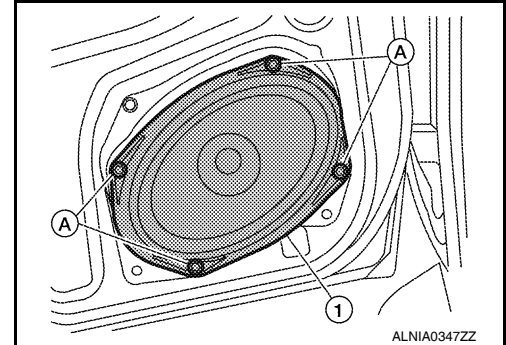

#### INSTALLATION

Installation is in the reverse order of removal.



# REAR DOOR SPEAKER

< ON-VEHICLE REPAIR >

[BOSE AUDIO WITH NAVIGATION]

## REAR DOOR SPEAKER

### Removal and Installation

INFOID:000000005259633

#### REMOVAL

1. Remove the rear door finisher. Refer to [INT-14. "Removal and Installation"](#).
2. Remove the rear door speaker screws (A).
3. Disconnect the rear door speaker connector (B) and remove rear door speaker (1).

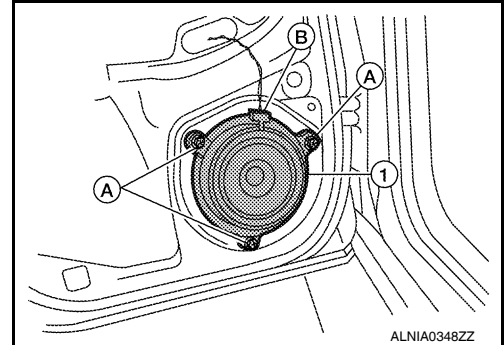

#### INSTALLATION

Installation is in the reverse order of removal.

### Removal and Installation

INFOID:000000005259634

#### REAR TWEETER

##### Removal

1. Remove rear door finisher. Refer to [INT-14. "Removal and Installation"](#).
2. Remove the rear tweeter screws (A) and remove the rear tweeter (1).

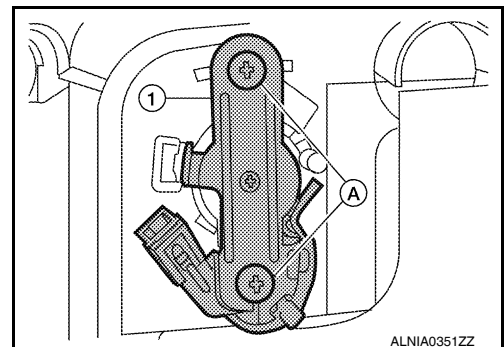

##### Installation

Installation is in the reverse order of removal.

A  
B  
C  
D  
E  
F  
G  
H  
I  
J  
K  
L  
M

AV

## BOSE SPEAKER AMP

### Removal and Installation

INFOID:000000005259635

#### BOSE SPEAKER AMP.

##### Removal

##### NOTE:

Do not remove the LH front seat from the vehicle.

1. Remove LH front seat bolts, disconnect the LH front seat electrical harness connector. Refer to [SE-30. "Removal and Installation"](#).
2. Tilt the LH front seat back to access the BOSE speaker amp. (1), then remove the BOSE speaker amp. screws (B).
  - ⇒: Vehicle front
3. Disconnect the Bose speaker amp. connectors (A) and remove Bose speaker amp. (1) from the bracket (2).
4. Then remove the BOSE speaker amp. bracket screws (C) and remove bracket (2).

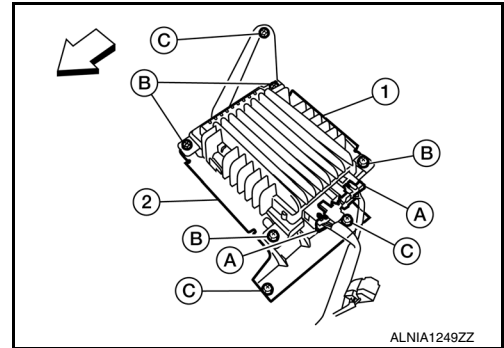

ALNIA1249ZZ

##### Installation

Installation is in the reverse order of removal.

# SUBWOOFER

< ON-VEHICLE REPAIR >

[BOSE AUDIO WITH NAVIGATION]

## SUBWOOFER

### Removal and Installation

INFOID:000000005259636

### SUBWOOFER (BOSE)

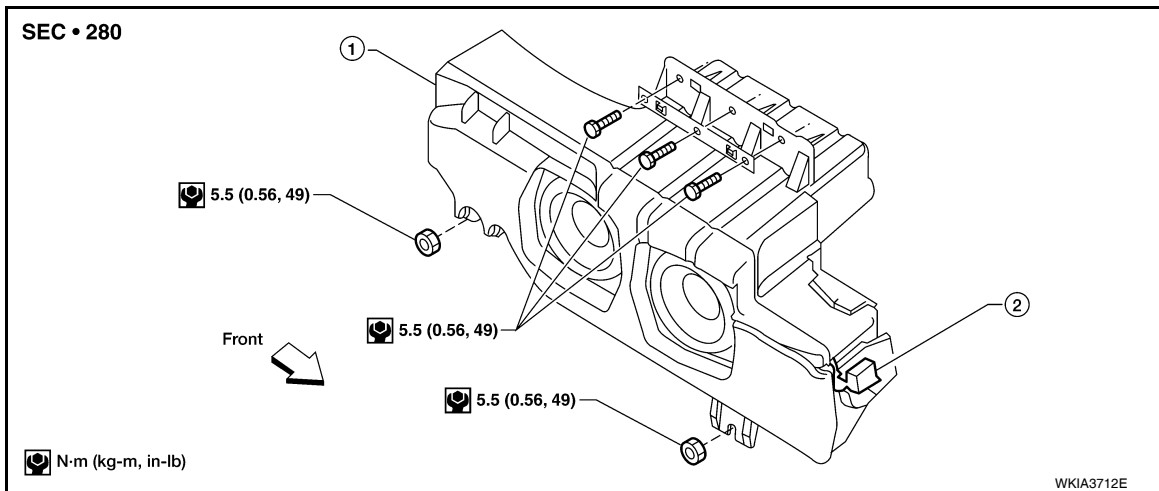

1. Subwoofer (BOSE system)
2. Subwoofer (BOSE system) connector

#### Removal

1. Remove the luggage side lower finisher LH. Refer to [INT-22. "Removal and Installation"](#).
2. Remove subwoofer bolts and nuts.
3. Disconnect the subwoofer connector and remove the subwoofer.

#### Installation

Installation is in the reverse order of removal.

A  
B  
C  
D  
E  
F  
G  
H  
I  
J  
K  
L  
M

AV

O  
P

# DVD ENTERTAINMENT SYSTEM

< ON-VEHICLE REPAIR >

[BOSE AUDIO WITH NAVIGATION]

## DVD ENTERTAINMENT SYSTEM

### Removal and Installation of DVD Player

INFOID:000000005259637

#### REMOVAL

1. Remove the center console assembly. Refer to [IP-12. "Removal and Installation"](#).
2. Disconnect the DVD player connector (A).
3. Remove the DVD player screws (B), then remove the DVD player (1).
4. Remove the DVD player bracket screws and then remove DVD player brackets.

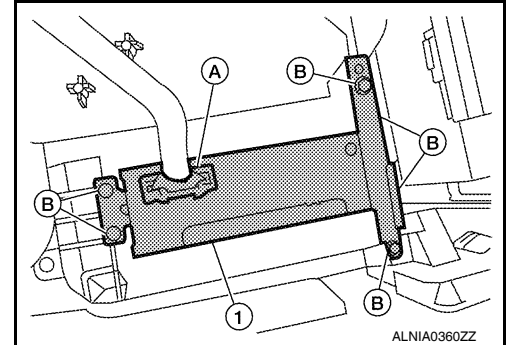

#### INSTALLATION

Installation is in reverse order of removal.

### Removal and Installation of Video Monitor

INFOID:000000005259638

#### REMOVAL

1. Release the clips and remove the video monitor finisher from headlining.
2. Press the release tabs and remove the cover.
3. Remove the video monitor screws.
4. Gently lower the assembly and disconnect the connector, then remove the video monitor from the headlining.

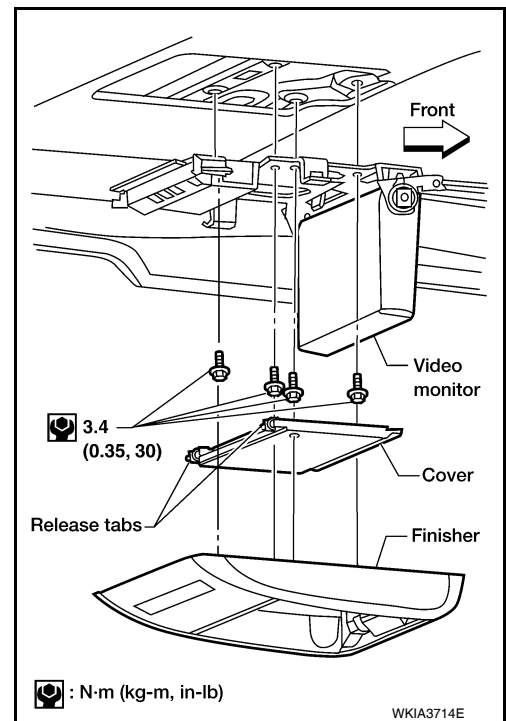

#### INSTALLATION

Installation is in reverse order of removal.

# AUDIO ANTENNA

< ON-VEHICLE REPAIR >

[BOSE AUDIO WITH NAVIGATION]

## AUDIO ANTENNA

### Location of Antenna

INFOID:000000005259639

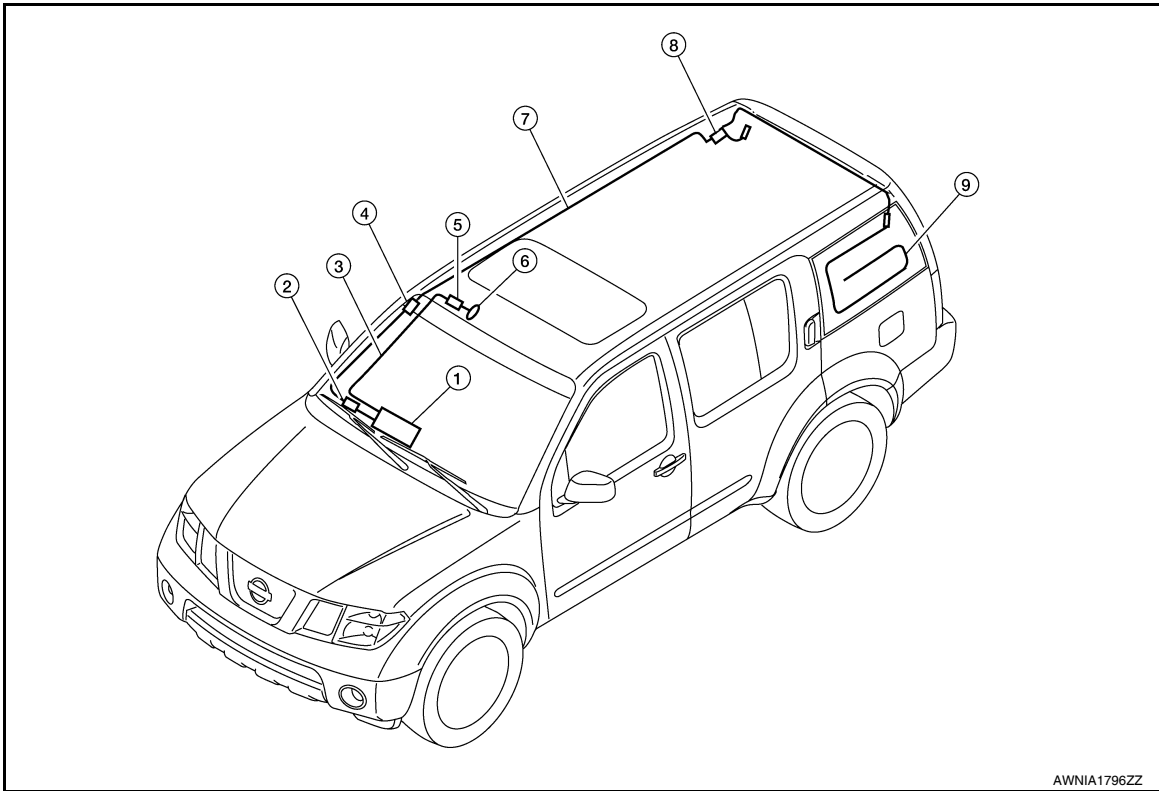

AWNIA1796ZZ

- |                                 |                                |                             |
|---------------------------------|--------------------------------|-----------------------------|
| 1. AV control unit M44, M71     | 2. Harness connector M78, M501 | 3. Satellite antenna feeder |
| 4. Harness connector M502, M601 | 5. Harness connector M73, M350 | 6. Satellite antenna M351   |
| 7. Antenna feeder               | 8. Antenna amp. M602           | 9. Window antenna grid      |

### Window Antenna Repair

INFOID:000000005259640

#### ELEMENT CHECK

1. Attach probe circuit tester (ohm setting) to antenna terminal on each side.

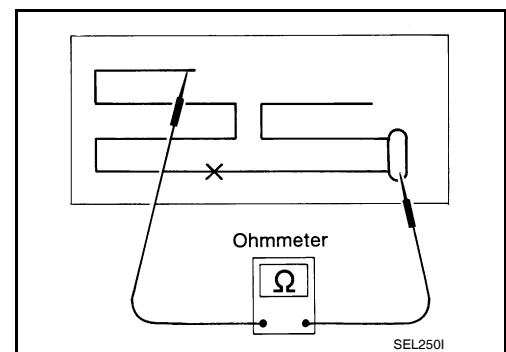

A  
B  
C  
D  
E  
F  
G  
H  
I  
J  
K  
L  
M  
AV  
O  
P

# AUDIO ANTENNA

## < ON-VEHICLE REPAIR >

## [BOSE AUDIO WITH NAVIGATION]

- When measuring continuity, wrap tin foil around the top of probe. Then, press the foil against the wire with your finger.

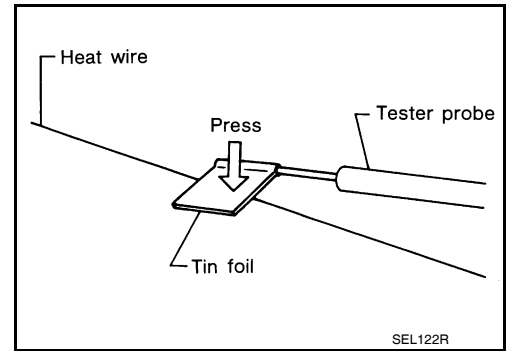

2. If an element is broken, no continuity will exist.

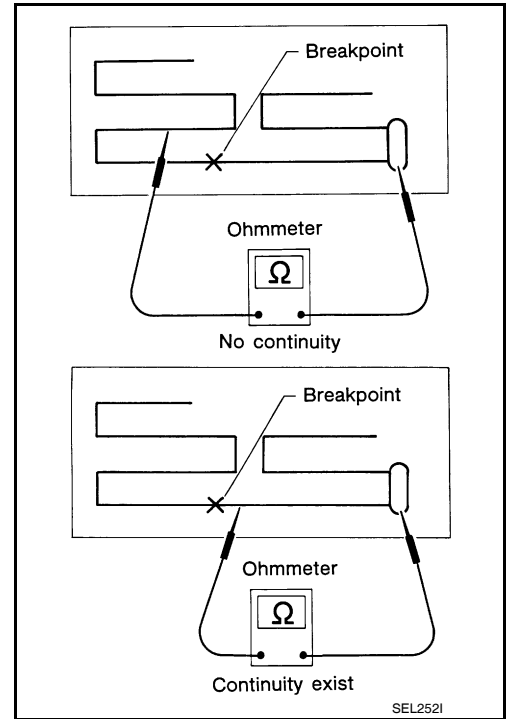

3. To locate a break, move probe along element. Tester indication will change abruptly when probe passes the broken point.

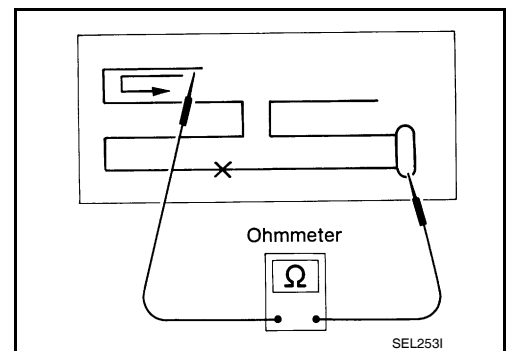

## ELEMENT REPAIR

Refer to [DEF-43, "Filament Repair"](#).

# AUXILIARY INPUT JACK

< ON-VEHICLE REPAIR >

[BOSE AUDIO WITH NAVIGATION]

## AUXILIARY INPUT JACK

### Removal and Installation

INFOID:000000005570799

#### Removal

1. Remove the A/T finisher. Refer to [JP-12. "Removal and Installation"](#).
2. Remove the auxiliary input jack.

#### Installation

Installation is in the reverse order of removal.

A

B

C

D

E

F

G

H

I

J

K

L

M

AV

O

P

## ANTENNA AMP.

< ON-VEHICLE REPAIR >

[BOSE AUDIO WITH NAVIGATION]

### ANTENNA AMP.

#### Removal and Installation

INFOID:000000005550747

#### REMOVAL

1. Remove the luggage side upper and lower RH finishers. Refer to [INT-22. "Removal and Installation"](#).
2. Detach the antenna amp. harness clip (D), disconnect the antenna amp. connector (A), harness connector (B), then remove the antenna amp. screw (C) and remove the antenna amp. (1).

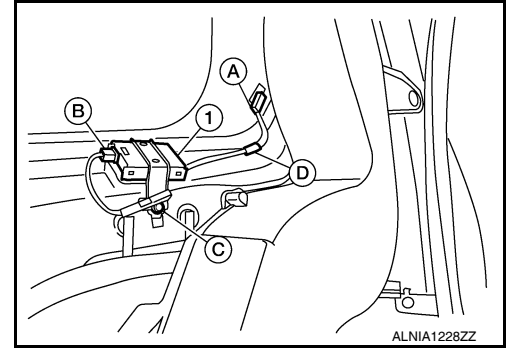

#### INSTALLATION

Installation is in the reverse order of removal.



## GPS ANTENNA

### Removal and Installation

INFOID:000000005259641

#### REMOVAL

1. Remove the cluster lid C. Refer to [IP-12. "Removal and Installation"](#).
2. Remove the GPS antenna screws (A), detach the GPS antenna harness clip (B).
3. Remove GPS antenna and feeder assembly (1) out of the instrument panel.

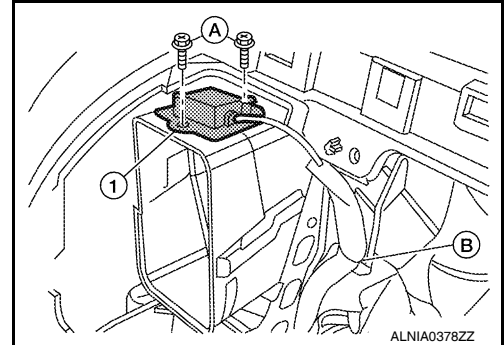

#### INSTALLATION

Installation is in the reverse order of removal.

A  
B  
C  
D  
E  
F  
G  
H  
I  
J  
K  
L  
M

AV

O  
P

# SATELLITE RADIO ANTENNA

< ON-VEHICLE REPAIR >

[BOSE AUDIO WITH NAVIGATION]

## SATELLITE RADIO ANTENNA

### Removal and Installation

INFOID:000000005259642

#### REMOVAL

1. Remove the front roof console finisher. Refer to [INT-19, "Removal and Installation"](#).
2. Disconnect the satellite antenna connector.
3. Remove the satellite antenna nut.
4. Remove the satellite antenna.

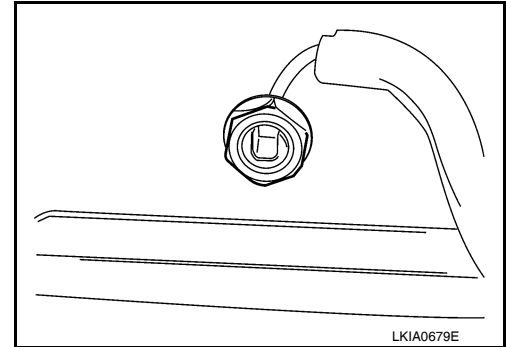

#### INSTALLATION

Installation is in the reverse order of removal.

# STEERING SWITCH

< ON-VEHICLE REPAIR >

[BOSE AUDIO WITH NAVIGATION]

## STEERING SWITCH

### Removal and Installation

INFOID:000000005520632

### Removal and Installation

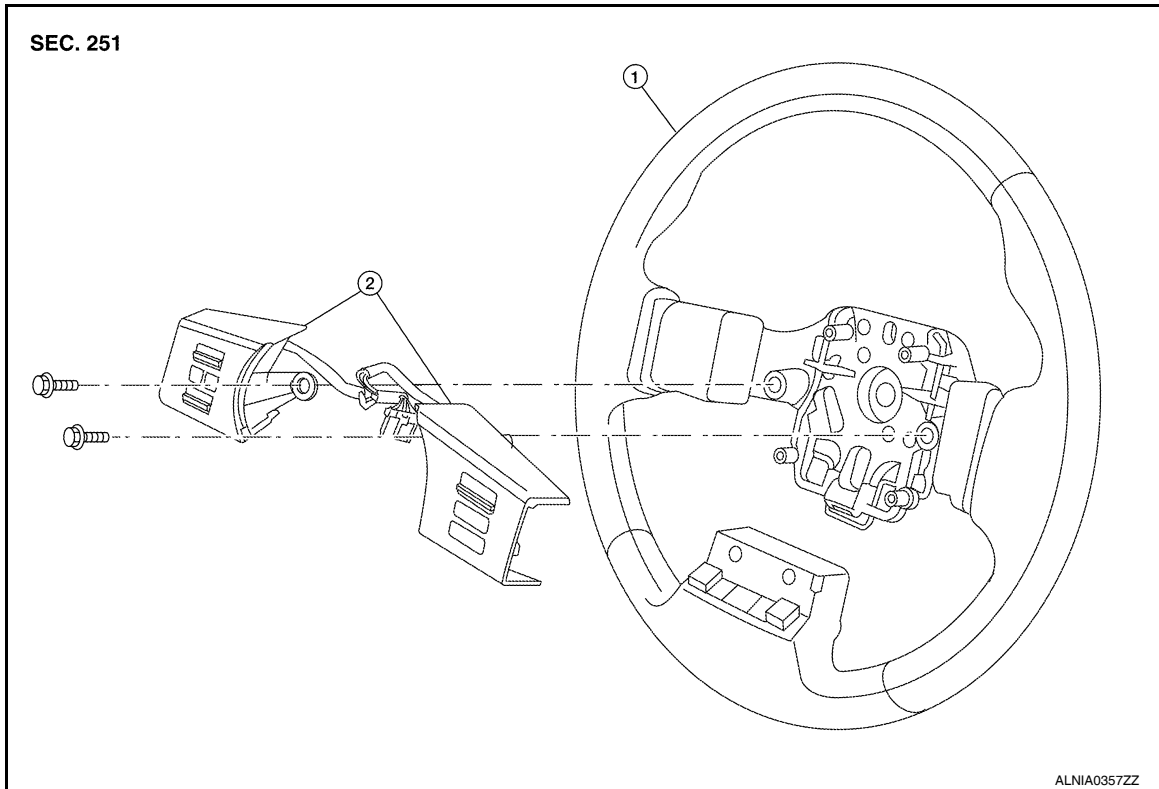

1. Steering wheel

2. Steering wheel audio control switches

### REMOVAL

1. Remove the driver air bag module. Refer to [SR-5, "Removal and Installation"](#).
2. Remove the steering wheel audio control switch assembly screws.
3. Disconnect the steering wheel audio control switches connector.
4. Remove the steering wheel audio control switches by pulling on steering wheel audio control switches to release the pawls.

**CAUTION:**

**Do not tilt steering wheel audio control switches during removal or damage may occur to the pawls.**

- ○:Pawl

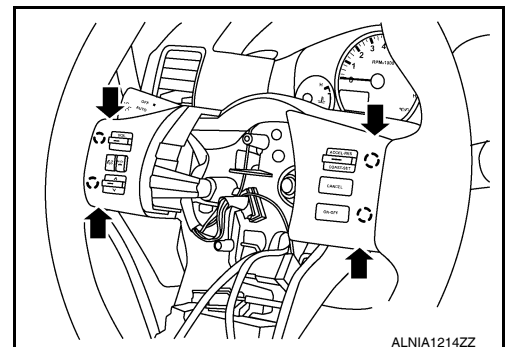

### INSTALLATION

Installation is in the reverse order of removal.

A  
B  
C  
D  
E  
F  
G  
H  
I  
J  
K  
L  
M  
AV  
O  
P

# MICROPHONE

< ON-VEHICLE REPAIR >

[BOSE AUDIO WITH NAVIGATION]

## MICROPHONE

### Removal and Installation

INFOID:000000005259644

#### REMOVAL

1. Remove the front roof console finisher. Refer to [INT-19, "Removal and Installation"](#).
2. Detach the microphone (1) from the front console finisher tabs (A).
3. Detach the microphone connector (B) and remove the microphone (1).

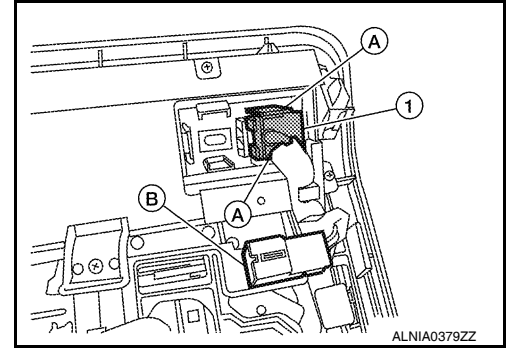

#### INSTALLATION

Installation is in the reverse order of removal.

# REAR VIEW CAMERA

< ON-VEHICLE REPAIR >

[BOSE AUDIO WITH NAVIGATION]

## REAR VIEW CAMERA

### Removal and Installation

INFOID:000000005259645

#### Rear View Camera

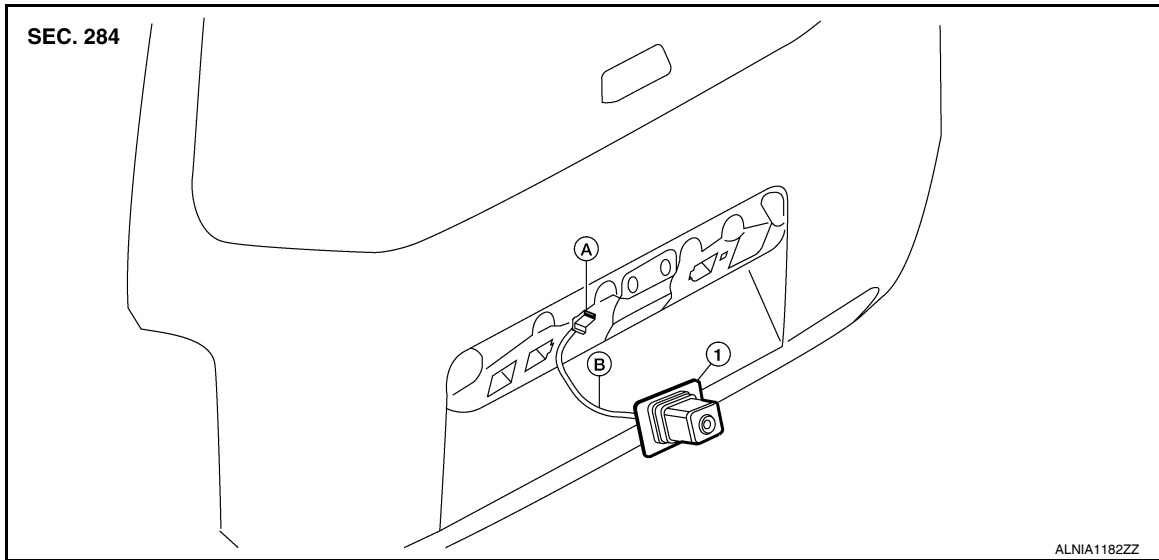

1. Rear view camera                      A. Rear view camera connector                      B. Rear view camera harness clip

#### REMOVAL

1. Remove the license lamp finisher. Refer to [EXT-21, "Removal and Installation"](#).
2. Disconnect the rear view camera connector.
3. Detach the rear view camera harness clip.
4. Detach the rear view camera to release, then pull out to remove the rear view camera while feeding the rear view camera harness and connector through the back door.

#### INSTALLATION

Installation is in the reverse order of removal.

A  
B  
C  
D  
E  
F  
G  
H  
I  
J  
K  
L  
M

AV

O  
P

## REAR VIEW CAMERA CONTROL UNIT

< ON-VEHICLE REPAIR >

[BOSE AUDIO WITH NAVIGATION]

### REAR VIEW CAMERA CONTROL UNIT

#### Removal and Installation

INFOID:000000005259646

#### REMOVAL

1. Remove the luggage side lower finisher RH. Refer to [INT-22. "Removal and Installation"](#).
2. Remove the rear HVAC duct tube (C103) fastener and remove the HVAC duct tube.
3. Remove the rear view camera control unit screws (A), disconnect the rear view camera control unit connector (B) and remove the rear view camera control unit (1).

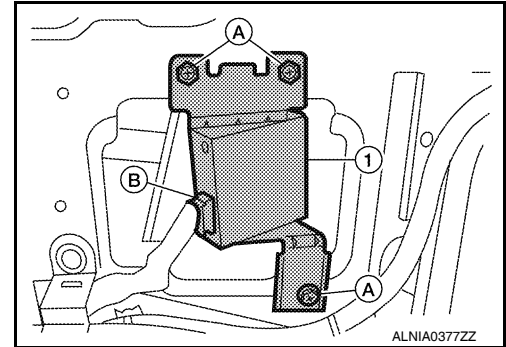

#### INSTALLATION

Installation is in the reverse order of removal.