

SECTION LAN
LAN SYSTEM

A
B
C

CONTENTS

CAN FUNDAMENTAL		PRECAUTIONS	37	
PRECAUTION	3	Precaution for Supplemental Restraint System (SRS) "AIR BAG" and "SEAT BELT PRE-TENSIONER"	37	
PRECAUTIONS	3	Precaution Necessary for Steering Wheel Rotation After Battery Disconnect	37	
Precaution for Trouble Diagnosis	3	Precautions for Trouble Diagnosis	38	
Precaution for Harness Repair	3	Precautions for Harness Repair	38	
SYSTEM DESCRIPTION	4	BASIC INSPECTION	39	
CAN COMMUNICATION SYSTEM	4	DIAGNOSIS AND REPAIR WORKFLOW	39	
System Description	4	Interview Sheet	39	
System Diagram	4	Diagnosis Sheet (CAN Type 1)	40	
CAN Communication Control Circuit	5	Diagnosis Sheet (CAN Type 2)	41	
DIAG ON CAN	6	Diagnosis Sheet (CAN Type 3)	42	
Description	6	Diagnosis Sheet (CAN Type 4)	43	
System Diagram	6	Diagnosis Sheet (CAN Type 5)	44	
TROUBLE DIAGNOSIS	7	Diagnosis Sheet (CAN Type 6)	45	
Condition of Error Detection	7	Diagnosis Sheet (CAN Type 7)	46	
Symptom When Error Occurs in CAN Communication System	7	Diagnosis Sheet (CAN Type 8)	47	
Self-Diagnosis	10	Diagnosis Sheet (CAN Type 9)	48	
CAN Diagnostic Support Monitor	10	Diagnosis Sheet (CAN Type 10)	49	
BASIC INSPECTION	13	Diagnosis Sheet (CAN Type 11)	50	
DIAGNOSIS AND REPAIR WORKFLOW	13	Diagnosis Sheet (CAN Type 12)	51	
Information Needed for Trouble Diagnosis	13	SYSTEM DESCRIPTION	52	
How to Use CAN Communication Signal Chart	13	CAN COMMUNICATION SYSTEM	52	
Trouble Diagnosis Flow Chart	14	CAN System Specification Chart	52	
Trouble Diagnosis Procedure	14	CAN Communication Signal Chart	53	
CAN		TROUBLE DIAGNOSIS	56	
HOW TO USE THIS MANUAL	36	CAN Diagnostic Support Monitor	56	
HOW TO USE THIS SECTION	36	DTC Index	60	
Caution	36	WIRING DIAGRAM	61	
Abbreviation List	36	CAN SYSTEM	61	
PRECAUTION	37	Wiring Diagram	61	
		DTC/CIRCUIT DIAGNOSIS	69	

D
E
F
G
H
I
J
K
L

LAN

N
O
P

CAN COMMUNICATION SYSTEM	69	Diagnosis Procedure	78
Component Parts Location	69		
MALFUNCTION AREA CHART	70	4WD BRANCH LINE CIRCUIT	79
Main Line	70	Diagnosis Procedure	79
Branch Line	70	ADP BRANCH LINE CIRCUIT	80
Short Circuit	70	Diagnosis Procedure	80
MAIN LINE BETWEEN TCM AND A-BAG		BCM BRANCH LINE CIRCUIT	81
CIRCUIT	71	Diagnosis Procedure	81
Diagnosis Procedure	71	DLC BRANCH LINE CIRCUIT	82
MAIN LINE BETWEEN A-BAG AND DLC CIR-		Diagnosis Procedure	82
CUIT	73	HVAC BRANCH LINE CIRCUIT	83
Diagnosis Procedure	73	Diagnosis Procedure	83
MAIN LINE BETWEEN DLC AND ABS CIR-		M&A BRANCH LINE CIRCUIT	84
CUIT	74	Diagnosis Procedure	84
Diagnosis Procedure	74	STRG BRANCH LINE CIRCUIT	85
ECM BRANCH LINE CIRCUIT	75	Diagnosis Procedure	85
Diagnosis Procedure	75	ABS BRANCH LINE CIRCUIT	86
TCM BRANCH LINE CIRCUIT	76	Diagnosis Procedure	86
Diagnosis Procedure	76	IPDM-E BRANCH LINE CIRCUIT	87
AV BRANCH LINE CIRCUIT	77	Diagnosis Procedure	87
Diagnosis Procedure	77	CAN COMMUNICATION CIRCUIT	88
I-KEY BRANCH LINE CIRCUIT	78	Diagnosis Procedure	

PRECAUTION

PRECAUTIONS

Precaution for Trouble Diagnosis

INFOID:000000006247751

CAUTION:

- Never apply 7.0 V or more to the measurement terminal.
- Use a tester with open terminal voltage of 7.0 V or less.
- Turn the ignition switch OFF and disconnect the battery cable from the negative terminal when checking the harness.

Precaution for Harness Repair

INFOID:000000006247752

- Solder the repaired area and wrap tape around the soldered area.

NOTE:

A fray of twisted lines must be within 110 mm (4.33 in).

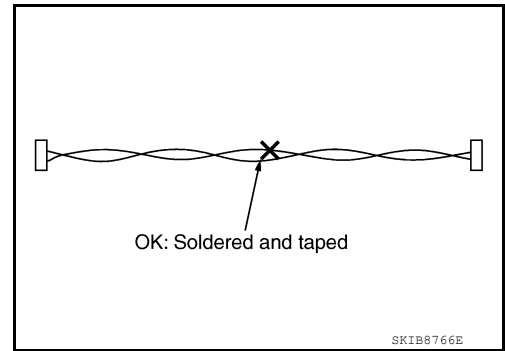

- Bypass connection is never allowed at the repaired area.

NOTE:

Bypass connection may cause CAN communication error. The spliced wire becomes separated and the characteristics of twisted line are lost.

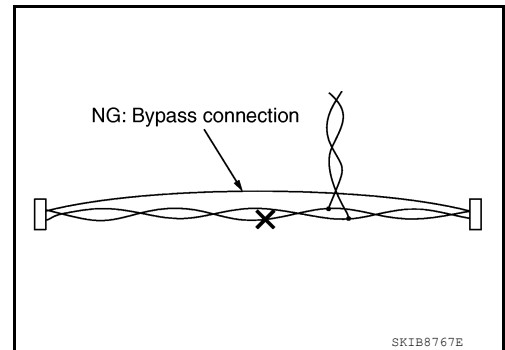

- Replace the applicable harness as an assembly if error is detected on the shield lines of CAN communication line.

A
B
C
D
E
F
G
H
I
J
K
L

LAN

SYSTEM DESCRIPTION

CAN COMMUNICATION SYSTEM

System Description

INFOID:000000006247753

- CAN communication is a multiplex communication system. This enables the system to transmit and receive large quantities of data at high speed by connecting control units with two communication lines (CAN-H and CAN-L).
- Control units on the CAN network transmit signals using the CAN communication control circuit. They receive only necessary signals from other control units to operate various functions.
- CAN communication lines adopt twisted-pair line style (two lines twisted) for noise immunity.

System Diagram

INFOID:000000006247754

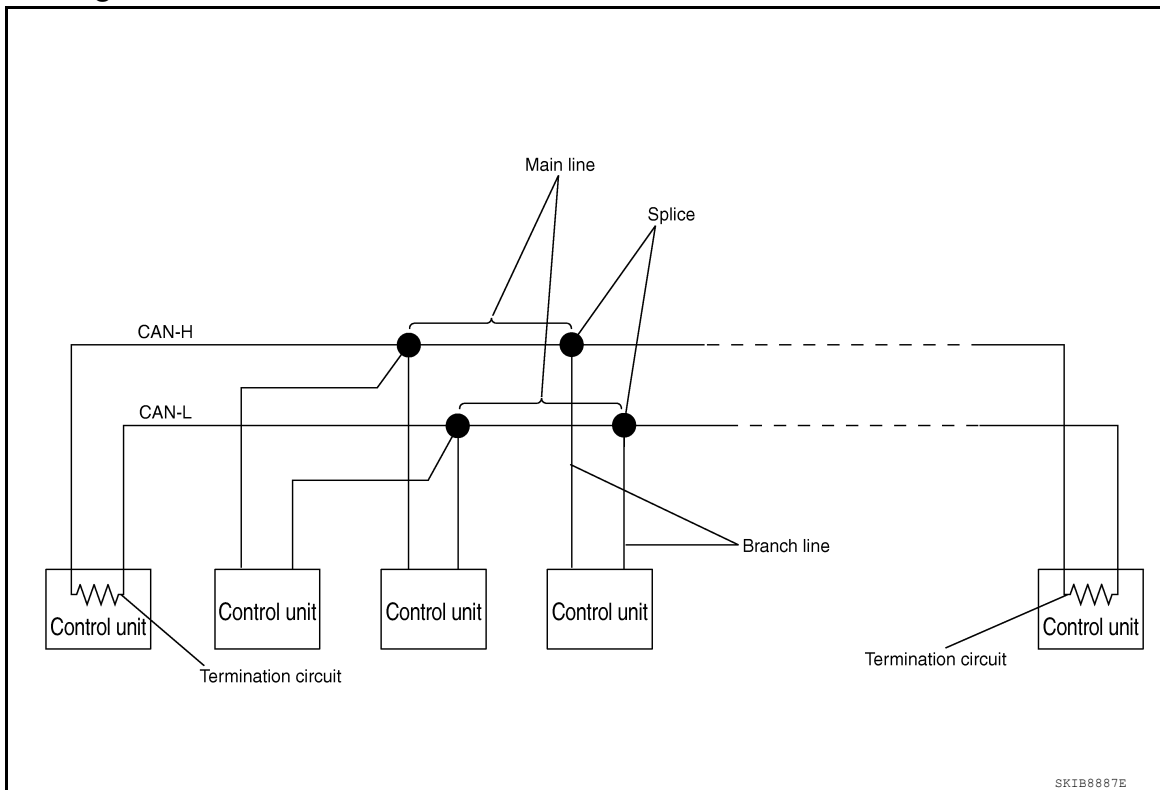

Each control unit passes an electric current to the termination circuits when transmitting CAN communication signal. The termination circuits produce an electrical potential difference between CAN-H and CAN-L. CAN communication system transmits and receives CAN communication signals by the potential difference.

Component	Description
Main line	CAN communication line between splices
Branch line	CAN communication line between splice and a control unit
Splice	A point connecting a branch line with a main line
Termination circuit	Refer to LAN-5, "CAN Communication Control Circuit" .

CAN COMMUNICATION SYSTEM

< SYSTEM DESCRIPTION >

[CAN FUNDAMENTAL]

CAN Communication Control Circuit

INFOID:000000006247755

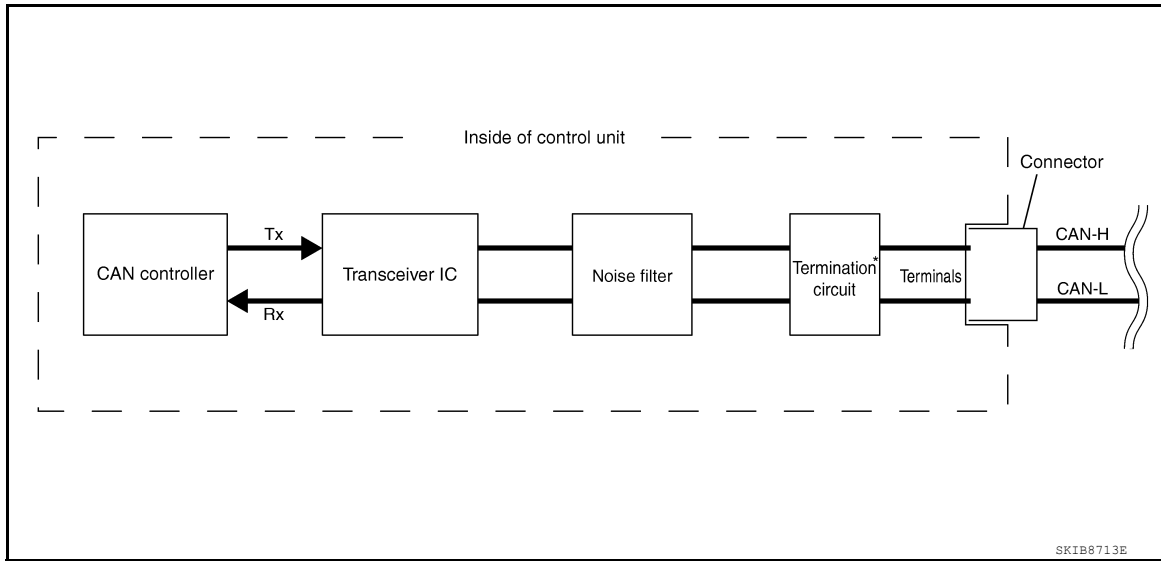

Component	System description
CAN controller	It controls CAN communication signal transmission and reception, error detection, etc.
Transceiver IC	It converts digital signal into CAN communication signal, and CAN communication signal into digital signal.
Noise filter	It eliminates noise of CAN communication signal.
Termination circuit* (Resistance of approx. 120 Ω)	It produces potential difference.

*: These are the only control units wired with both ends of CAN communication system.

A
B
C
D
E
F
G
H
I
J
K
L

LAN

DIAG ON CAN

Description

INFOID:000000006247756

“Diag on CAN” is a diagnosis using CAN communication instead of previous DDL1 and DDL2 communication lines, between control units and diagnosis unit.

System Diagram

INFOID:000000006247757

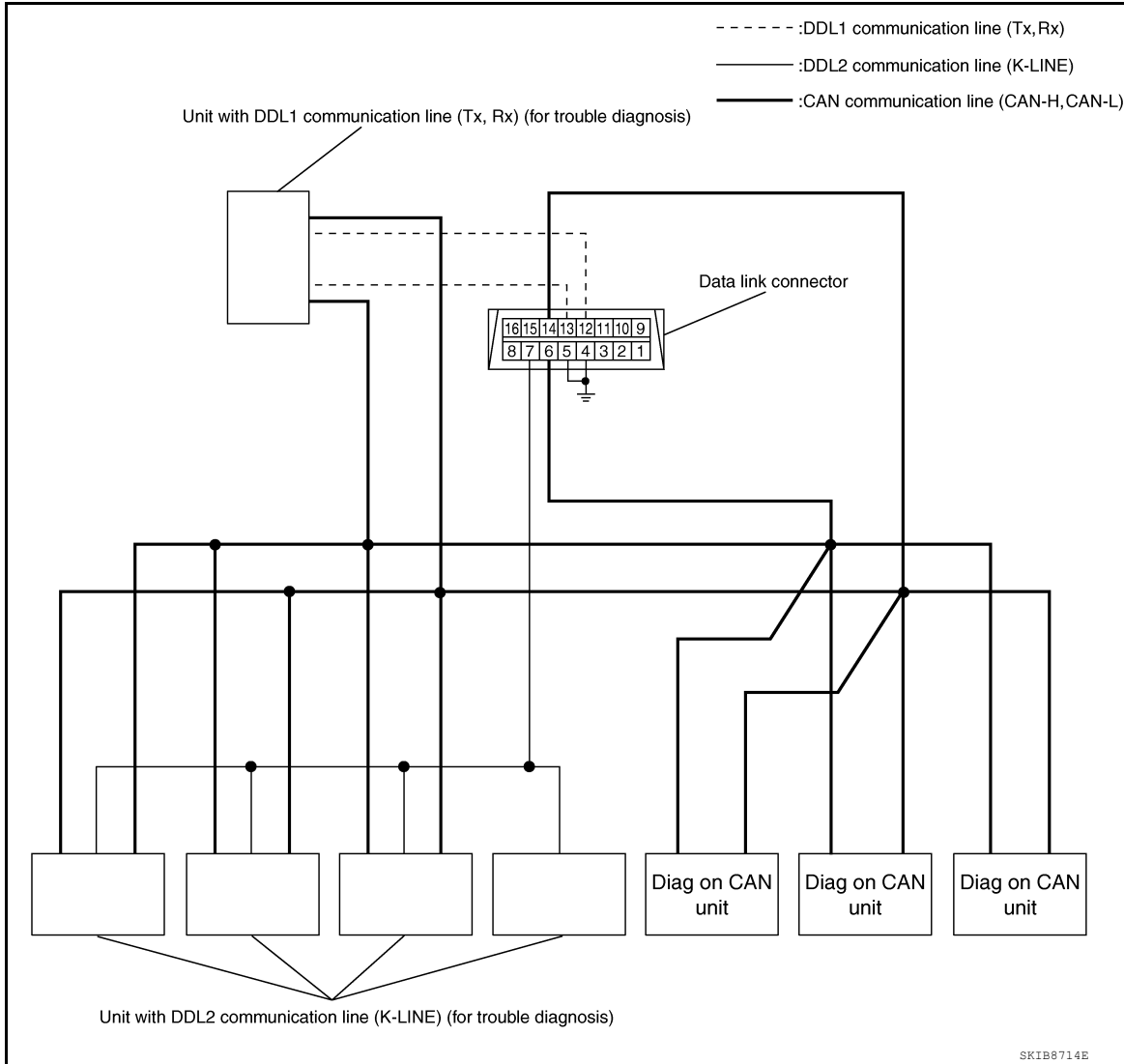

Name	Harness	Description
DDL1	Tx Rx	It is used for trouble diagnosis. (CAN-H and CAN-L are used for controlling)
DDL2	K-LINE	It is used for trouble diagnosis. (CAN-H and CAN-L are used for controlling)
Diag on CAN	CAN-H CAN-L	It is used for trouble diagnosis and control.

TROUBLE DIAGNOSIS

Condition of Error Detection

INFOID:000000006625213

DTC (e.g. U1000 and U1001) of CAN communication is indicated on SELF-DIAG RESULTS on CONSULT-III if a CAN communication signal is not transmitted or received between units for 2 seconds or more.

CAN COMMUNICATION SYSTEM ERROR

- CAN communication line open (CAN-H, CAN-L, or both)
- CAN communication line short (ground, between CAN communication lines, other harnesses)
- Error of CAN communication control circuit of the unit connected to CAN communication line

WHEN DTC OF CAN COMMUNICATION IS INDICATED EVEN THOUGH CAN COMMUNICATION SYSTEM IS NORMAL

- Removal/installation of parts: Error may be detected when removing and installing CAN communication unit and related parts while turning the ignition switch ON. (A DTC except for CAN communication may be detected.)
- Fuse blown out (removed): CAN communication of the unit may cease.
- Voltage drop: Error may be detected if voltage drops due to discharged battery when turning the ignition switch ON (Depending on the control unit which carries out CAN communication).
- Error may be detected if the power supply circuit of the control unit, which carries out CAN communication, malfunctions (Depending on the control unit which carries out CAN communication).
- Error may be detected if reprogramming is not completed normally.

CAUTION:

CAN communication system is normal if DTC of CAN communication is indicated on SELF-DIAG RESULTS of CONSULT-III under the above conditions. Erase the memory of the self-diagnosis of each unit.

Symptom When Error Occurs in CAN Communication System

INFOID:000000006247759

In CAN communication system, multiple units mutually transmit and receive signals. Each unit cannot transmit and receive signals if any error occurs on CAN communication line. Under this condition, multiple control units related to the root cause malfunction or go into fail-safe mode.

ERROR EXAMPLE

NOTE:

- Each vehicle differs in symptom of each unit under fail-safe mode and CAN communication line wiring.
- Refer to [LAN-36, "Abbreviation List"](#) for the unit abbreviation.

Example: TCM branch line open circuit

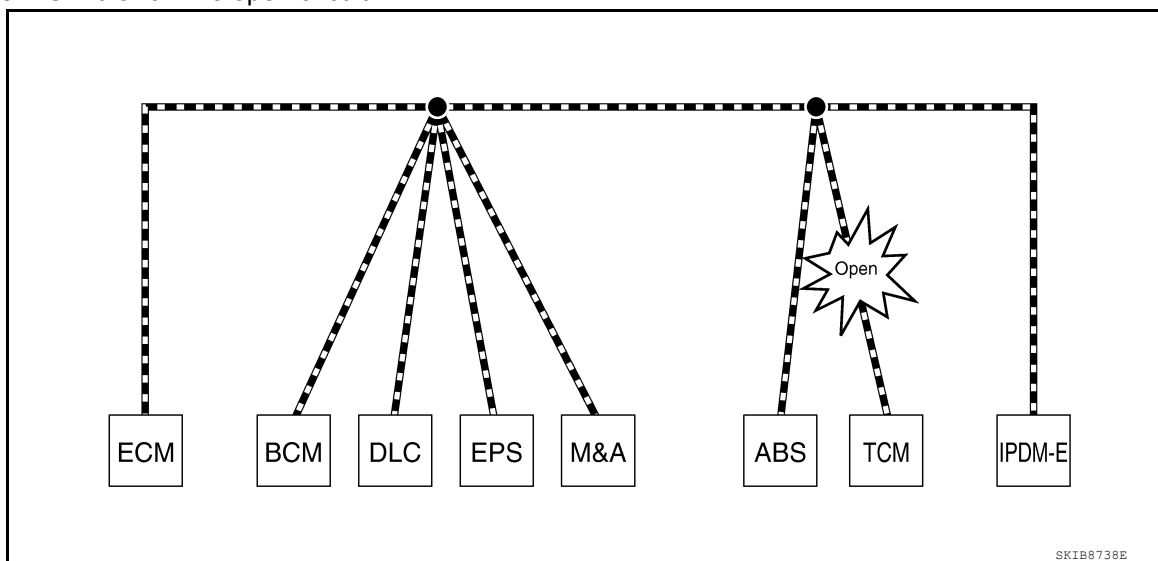

Unit name	Symptom
ECM	Engine torque limiting is affected, and shift harshness increases.
BCM	Reverse warning chime does not sound.

A
B
C
D
E
F
G
H
I
J
K
L

LAN

N
O
P

TROUBLE DIAGNOSIS

< SYSTEM DESCRIPTION >

[CAN FUNDAMENTAL]

Unit name	Symptom
EPS control unit	Normal operation.
Combination meter	<ul style="list-style-type: none"> Shift position indicator and OD OFF indicator turn OFF. Warning lamps turn ON.
ABS actuator and electric unit (control unit)	Normal operation.
TCM	No impact on operation.
IPDM E/R	Normal operation.

Example: Data link connector branch line open circuit

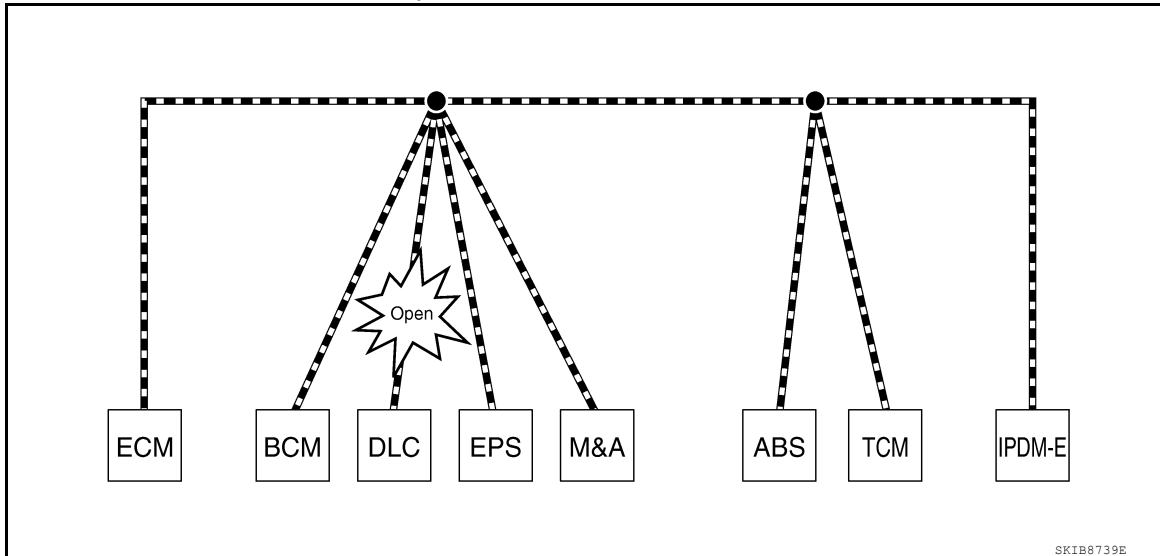

Unit name	Symptom
ECM	Normal operation.
BCM	
EPS control unit	
Combination meter	
ABS actuator and electric unit (control unit)	
TCM	
IPDM E/R	

NOTE:

- When data link connector branch line is open, transmission and reception of CAN communication signals are not affected. Therefore, no symptoms occur. However, be sure to repair malfunctioning circuit.
- When data link connector branch line is open, "ECU list" displayed on the CONSULT-III "CAN DIAG SUPPORT MNTR" may be the same as when the CAN communication line has short-circuit. However, symptoms differ depending on the case. See below chart for the differences.

	"ECU list" on the "CAN DIAG SUPPORT MNTR" (CONSULT-III)	Difference of symptom
Data link connector branch line open circuit		Normal operation.
CAN-H, CAN-L harness short-circuit	All Diag on CAN units are not indicated.	Most of the units which are connected to the CAN communication system enter fail-safe mode or are deactivated.

TROUBLE DIAGNOSIS

< SYSTEM DESCRIPTION >

[CAN FUNDAMENTAL]

Example: Main Line Between Data Link Connector and ABS Actuator and Electric Unit (Control Unit) Open Circuit

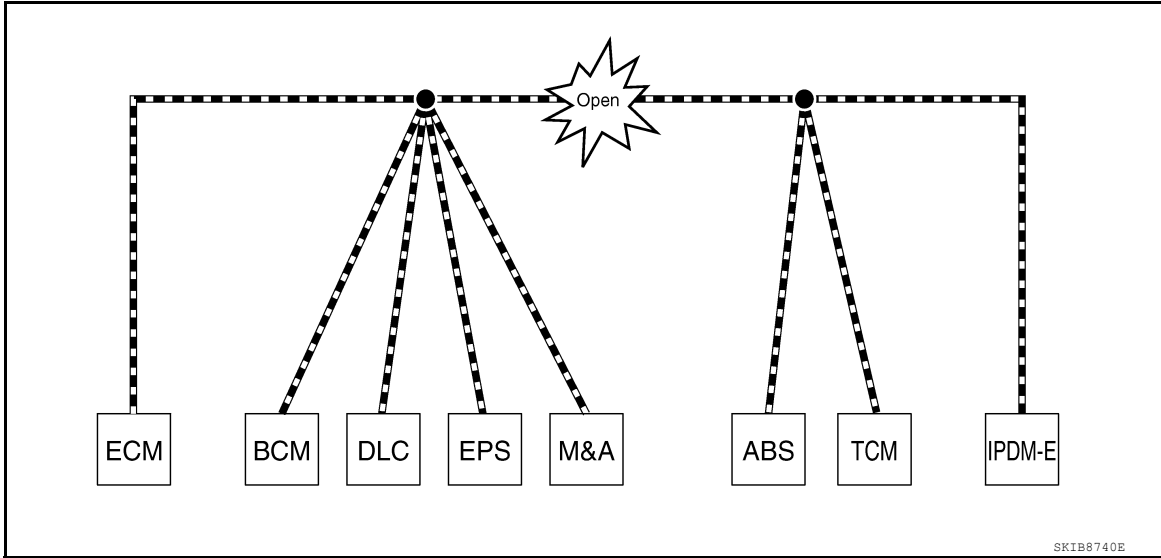

Unit name	Symptom
ECM	Engine torque limiting is affected, and shift harshness increases.
BCM	<ul style="list-style-type: none"> Reverse warning chime does not sound. The front wiper moves under continuous operation mode even though the front wiper switch being in the intermittent position.
EPS control unit	The steering effort increases.
Combination meter	<ul style="list-style-type: none"> The shift position indicator and OD OFF indicator turn OFF. The speedometer is inoperative. The odo/trip meter stops.
ABS actuator and electric unit (control unit)	Normal operation.
TCM	No impact on operation.
IPDM E/R	When the ignition switch is ON, <ul style="list-style-type: none"> The headlamps (Lo) turn ON. The cooling fan continues to rotate.

Example: CAN-H, CAN-L Harness Short Circuit

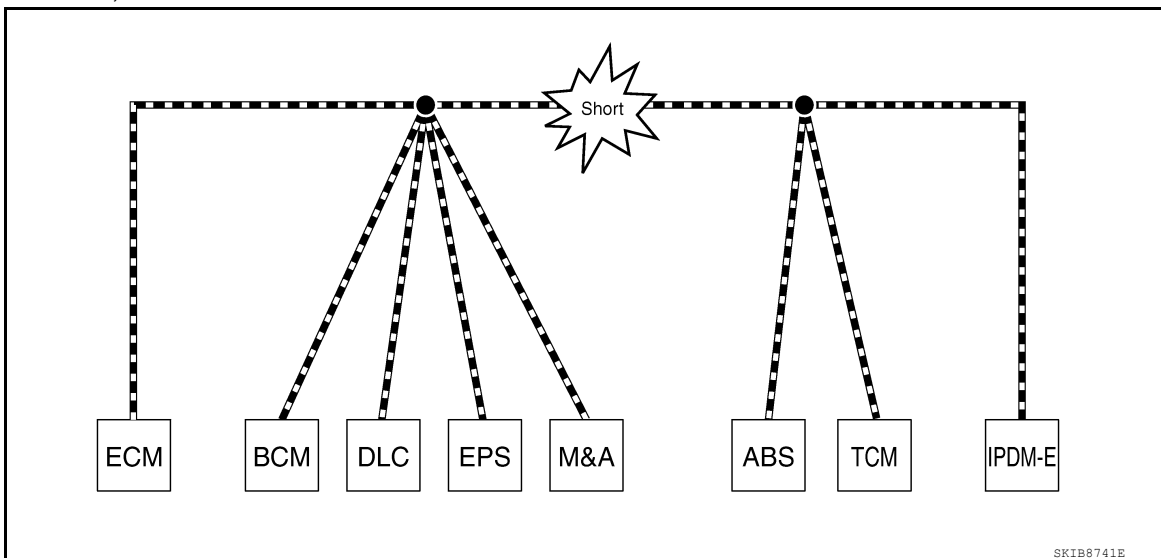

A
B
C
D
E
F
G
H
I
J
K
L
N
O
P

LAN

TROUBLE DIAGNOSIS

< SYSTEM DESCRIPTION >

[CAN FUNDAMENTAL]

Unit name	Symptom
ECM	<ul style="list-style-type: none"> • Engine torque limiting is affected, and shift harshness increases. • Engine speed drops.
BCM	<ul style="list-style-type: none"> • Reverse warning chime does not sound. • The front wiper moves under continuous operation mode even though the front wiper switch being in the intermittent position. • The room lamp does not turn ON. • The engine does not start (if an error or malfunction occurs while turning the ignition switch OFF.) • The steering lock does not release (if an error or malfunction occurs while turning the ignition switch OFF.)
EPS control unit	The steering effort increases.
Combination meter	<ul style="list-style-type: none"> • The tachometer and the speedometer do not move. • Warning lamps turn ON. • Indicator lamps do not turn ON.
ABS actuator and electric unit (control unit)	Normal operation.
TCM	No impact on operation.
IPDM E/R	When the ignition switch is ON, <ul style="list-style-type: none"> • The headlamps (Lo) turn ON. • The cooling fan continues to rotate.

Self-Diagnosis

INFOID:000000006625212

If communication signals cannot be transmitted or received among units communicating via CAN communication line, CAN communication-related DTC is displayed on the CONSULT-III "Self Diagnostic Result" screen.

NOTE:

The following table shows examples of CAN communication-related DTC. For other DTC, refer to the applicable sections.

DTC	Self-diagnosis item (CONSULT-III indication)	DTC detection condition		Inspection/Action
U1000	CAN COMM CIRCUIT	ECM	When ECM is not transmitting or receiving CAN communication signal of OBD (emission-related diagnosis) for 2 seconds or more.	Start the inspection. Refer to the applicable section of the indicated control unit.
		Except for ECM	When a control unit (except for ECM) is not transmitting or receiving CAN communication signal for 2 seconds or more.	
U1001	CAN COMM CIRCUIT	When ECM is not transmitting or receiving CAN communication signal other than OBD (emission-related diagnosis) for 2 seconds or more.		
U1002	SYSTEM COMM	When a control unit is not transmitting or receiving CAN communication signal for 2 seconds or less.		
U1010	CONTROL UNIT(CAN)	When an error is detected during the initial diagnosis for CAN controller of each control unit.		

CAN Diagnostic Support Monitor

INFOID:000000006247761

CONSULT-III and CAN diagnostic support monitor (on-board diagnosis function) are used for detecting root cause.

MONITOR ITEM (CONSULT-III)

TROUBLE DIAGNOSIS

< SYSTEM DESCRIPTION >

[CAN FUNDAMENTAL]

Example: CAN DIAG SUPPORT MNTR indication

Without PAST			With PAST		
ECM			ECM		
	PRSNT	PAST		PRSNT	PAST
INITIAL DIAG	OK		TRANSMIT DIAG	OK	OK
TRANSMIT DIAG	OK		VDC/TCS/ABS	-	-
TCM	OK		METER/M&A	OK	OK
VDC/TCS/ABS	UNKWN		BCM/SEC	OK	OK
METER/M&A	OK		ICC	-	-
ICC	UNKWN		HVAC	-	-
BCM/SEC	OK		TCM	OK	OK
IPDM E/R	OK		EPS	-	-
			IPDM E/R	OK	OK
			e4WD	-	-
			AWD/4WD	OK	OK

PKID1075E

Without PAST

Item	PRSNT	Description
Initial diagnosis	OK	Normal at present
	NG	Control unit error (Except for some control units)
Transmission diagnosis	OK	Normal at present
	UNKWN	Unable to transmit signals for 2 seconds or more. Diagnosis not performed
Control unit name (Reception diagnosis)	OK	Normal at present
	UNKWN	Unable to receive signals for 2 seconds or more. Diagnosis not performed
	UNKWN	No control unit for receiving signals. (No applicable optional parts)

With PAST

Item	PRSNT	PAST	Description
Transmission diagnosis	OK	OK	Normal at present and in the past
		1 – 39	Normal at present, but unable to transmit signals for 2 seconds or more in the past. (The number indicates the number of ignition switch cycles from OFF to ON.)
	UNKWN	0	Unable to transmit signals for 2 seconds or more at present.
Control unit name (Reception diagnosis)	OK	OK	Normal at present and in the past
		1 – 39	Normal at present, but unable to receive signals for 2 seconds or more in the past. (The number indicates the number of ignition switch cycles from OFF to ON.)
	UNKWN	0	Unable to receive signals for 2 seconds or more at present.
	-	-	Diagnosis not performed. No control unit for receiving signals. (No applicable optional parts)

MONITOR ITEM (ON-BOARD DIAGNOSIS)

NOTE:

For some models, CAN communication diagnosis result is received from the vehicle monitor. (CONSULT-III is not available.)

A
B
C
D
E
F
G
H
I
J
K
L
N
O
P

LAN

TROUBLE DIAGNOSIS

< SYSTEM DESCRIPTION >

[CAN FUNDAMENTAL]

Example: Vehicle Display

Item	Result indicated	Error counter	Description
CAN_COMM (Initial diagnosis)	OK	0	Normal at present
	NG	1 – 50	Control unit error (The number indicates how many times diagnosis has been run.)
CAN_CIRC_1 (Transmission diagnosis)	OK	0	Normal at present
	UNKWN	1 – 50	Unable to transmit for 2 seconds or more at present. (The number indicates how many times diagnosis has been run.)
CAN_CIRC_2 – 9 (Reception diagnosis of each unit)	OK	0	Normal at present
	UNKWN	1 – 50	Unable to transmit for 2 seconds or more at present. (The number indicates how many times diagnosis has been run.)
			Diagnosis not performed.
			No control unit for receiving signals. (No applicable optional parts)

BASIC INSPECTION

DIAGNOSIS AND REPAIR WORKFLOW

Information Needed for Trouble Diagnosis

INFOID:000000006247762

CAN communication system performs trouble diagnosis with the following tools.

Tool	Usage
Interview sheet	For filling in vehicle information and interview with customer.
Data sheet	For copying on-board diagnosis data.
Diagnosis sheet	For detecting the root cause. (Diagnosis sheet includes system diagram for every CAN system type)
ECU list (On the "CAN DIAG SUPPORT MNTR")	For checking the condition of control units and the status of CAN communication.
SELF-DIAG RESULTS (CONSULT-III)	
CAN DIAG SUPPORT MNTR (CONSULT-III)	
CAN communication signal chart	For converting information received from a customer into CAN communication signal transmission and reception. This information can be used to judge whether a circuit between control units is normal or abnormal.
Abbreviation list	For checking abbreviations in CAN communication signal chart and diagnosis sheet.

How to Use CAN Communication Signal Chart

INFOID:000000006247763

The CAN communication signal chart lists the signals needed for trouble diagnosis. It is useful for detecting the root cause by finding a signal related to the symptom, and by checking transmission and reception unit.

Example: Tachometer does not move even though the engine rotates.

T: Transmit R: Receive

Signal name/Connecting unit	ECM	BCM	M&A	STRG	ABS	IPDM-E
A/C compressor feedback signal	T		R			
A/C compressor request signal	T					R
Accelerator pedal position signal	T				R	
Cooling fan motor operation signal	T					R
Engine coolant temperature signal	T		R			
Engine speed signal	T		R		R	
Fuel consumption monitor signal	T		R			
Malfunction indicator lamp signal	T		R			
A/C switch signal	R	T				
Ignition switch signal		T				R
Sleep/wake up signal		T	R			R

No communication between ECM and M&A.

It indicates that an error occurs between ECM and M&A (Shaded area).

CAN-H, CAN-L

SKIB8715E

DIAGNOSIS AND REPAIR WORKFLOW

< BASIC INSPECTION >

[CAN FUNDAMENTAL]

Trouble Diagnosis Flow Chart

INFOID:000000006247764

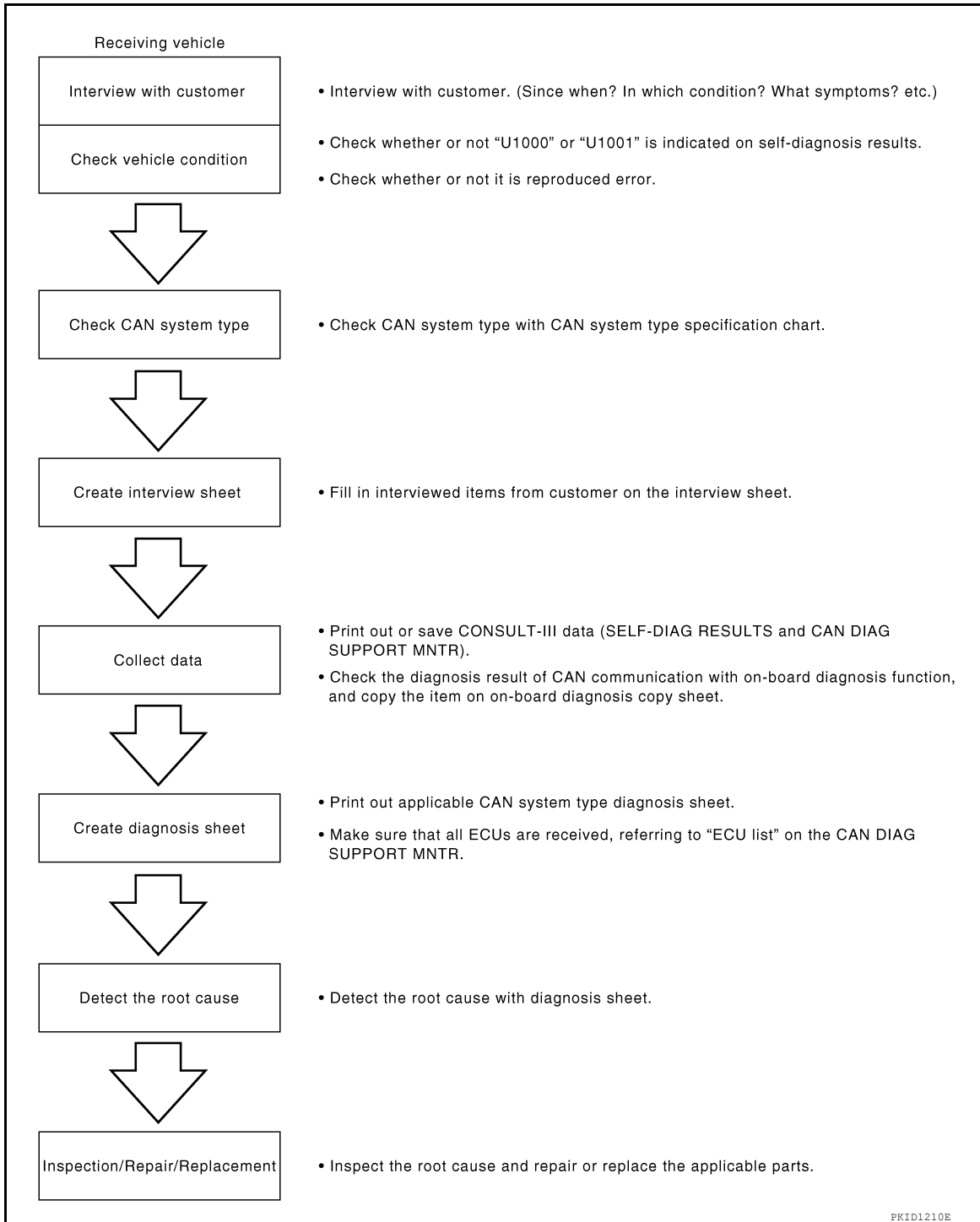

Trouble Diagnosis Procedure

INFOID:000000006247765

INTERVIEW WITH CUSTOMER

Interview with the customer is important to detect the root cause of CAN communication system errors and to understand vehicle condition and symptoms for proper trouble diagnosis.

Points in interview

- What: Parts name, system name
- When: Date, Frequency
- Where: Road condition, Place
- In what condition: Driving condition/environment

DIAGNOSIS AND REPAIR WORKFLOW

< BASIC INSPECTION >

[CAN FUNDAMENTAL]

- Result: Symptom

NOTE:

- Check normal units as well as error symptoms.
- Example: Circuit between ECM and the combination meter is judged normal if the customer indicates tachometer functions normally.
- When a CAN communication system error is present, multiple control units may malfunction or go into fail-safe mode.
- Indication of the combination meter is important to detect the root cause because it is the most obvious to the customer, and it performs CAN communication with many units.

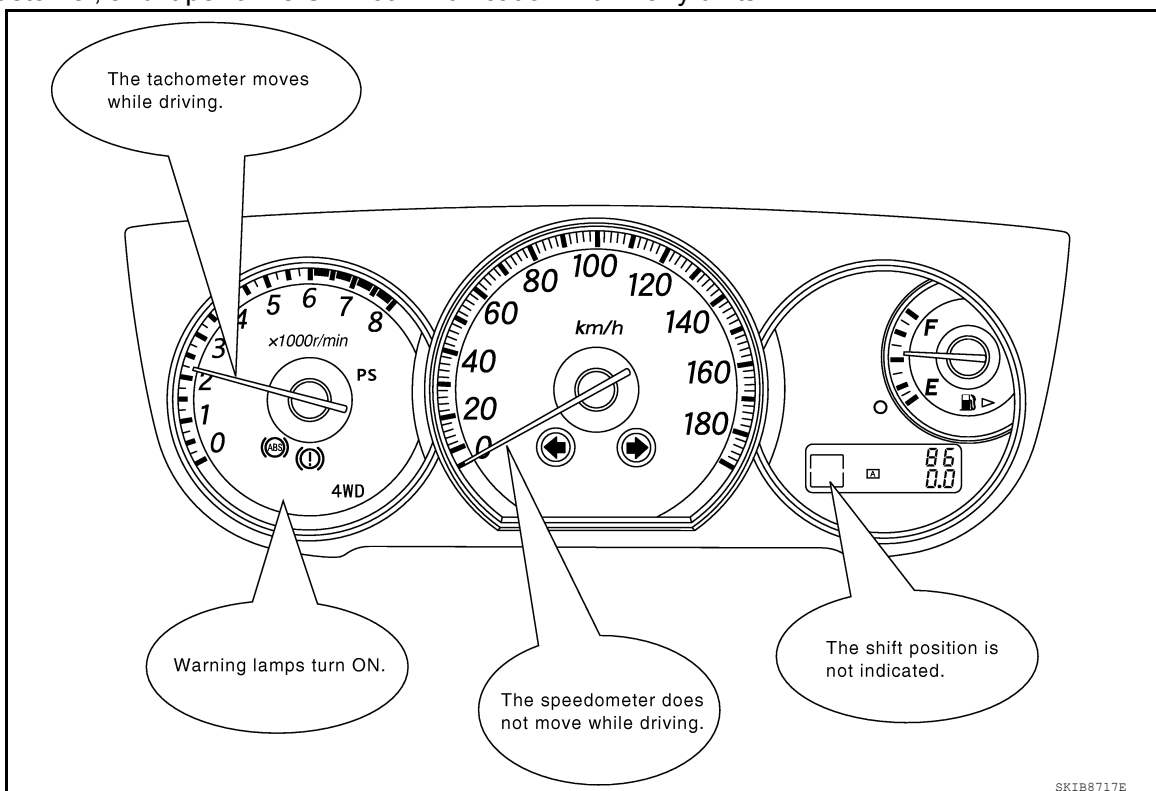

INSPECTION OF VEHICLE CONDITION

- Check whether or not “U1000” or “U1001” is indicated on “SELF-DIAG RESULTS” by CONSULT-III.

NOTE:

Root cause cannot be detected using the procedure in this section if “U1000” or “U1001” is not indicated.

- Check whether the symptom is reproduced or not.

NOTE:

- Do not turn the ignition switch OFF or disconnect the battery cable while reproducing the error. The error may temporarily correct itself, making it difficult to determine the root cause.
- The procedures for present errors differ from the procedures for past errors. Refer to “DETECT THE ROOT CAUSE”.

CHECK OF CAN SYSTEM TYPE (HOW TO USE CAN SYSTEM TYPE SPECIFICATION CHART)

Determine CAN system type based on vehicle equipment. Then choose the correct diagnosis sheet.

NOTE:

There are two styles for CAN system type specification charts. Depending on the number of available system types, either style A or style B may be used.

CAN System Type Specification Chart (Style A)

NOTE:

A
B
C
D
E
F
G
H
I
J
K
L
LAN
N
O
P

DIAGNOSIS AND REPAIR WORKFLOW

< BASIC INSPECTION >

[CAN FUNDAMENTAL]

CAN system type is easily checked with the vehicle equipment identification information shown in the chart.

Example:
Vehicle is equipped as follows: Wagon, AWD, VQ35DE, CVT, VDC, and Intelligent Key system. (○ shows an example of CAN system type.)

CAN System Specification Chart
Determine CAN system type from the following specification chart. Then choose the correct diagnosis sheet.

Body type	Wagon					
Axle	2WD			AWD		
Engine	QR25DE		VQ35DE			
Transmission	A/T		CVT			
Brake control	ABS			VDC		
Intelligent Key system		X		X		X
CAN system type	1	2	3	4	5	6
Diagnosis sheet	(XX-XX)	(XX-XX)	(XX-XX)	(XX-XX)	(XX-XX)	(XX-XX)
CAN communication signal chart	XX-XX. "TYPE 1/TYPE 2"		XX-XX. "TYPE 3/TYPE 4"		XX-XX. "TYPE 5/TYPE 6"	

X : Applicable

VEHICLE EQUIPMENT IDENTIFICATION INFORMATION
NOTE:
Check CAN system type from the vehicle shape and equipment.

With VDC

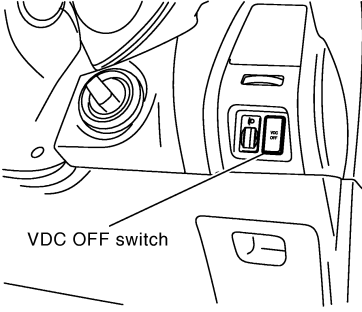

VDC OFF switch

With Intelligent Key system

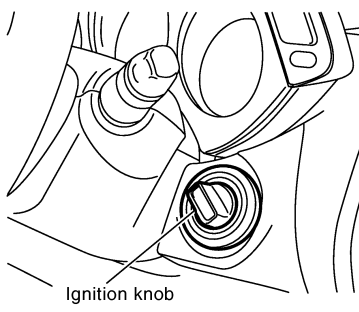

Ignition knob

In the above example,
• Checking VDC OFF switch leads to judge whether or not VDC is equipped.
• Checking the ignition knob leads to judge whether or not Intelligent Key system is equipped.

For the above case, CAN system type is "6".

SK1B8888E

CAN System Type Specification Chart (Style B)

NOTE:

DIAGNOSIS AND REPAIR WORKFLOW

< BASIC INSPECTION >

[CAN FUNDAMENTAL]

Interview Sheet (Example)

CAN Communication System Diagnosis Interview Sheet	
Date received:	3, Feb. 2005
Type: DBA-KG11	VIN No.: KG11-005040
Model: BDRARGZ397EDA-E-J-	
First registration: 10, Jan. 2005	Mileage: 621
CAN system type: Type 19	
Symptom (Results from interview with customer)	
<ul style="list-style-type: none">• Headlamps suddenly turn ON while driving the vehicle.• The engine does not restart after stopping the vehicle and turning the ignition switch OFF.• The cooling fan continues rotating while turning the ignition switch ON.	
Condition at inspection	
Error Symptom: Present / Past	
The engine does not start. While turning the ignition switch ON, <ul style="list-style-type: none">• The headlamps (Lo) turn ON, and the cooling fan continues rotating.• The interior lamp does not turn ON. On CONSULT-III screen, <ul style="list-style-type: none">• IPDM E/R is not indicated on SELECT SYSTEM.• ENGINE: U1001• BCM, ADAPTIVE LIGHT: U1000	

PKID1211E

COLLECT DATA

Collect CONSULT-III Data

Print out or save the following CONSULT-III data.

- SELF-DIAG RESULTS
- CAN DIAG SUPPORT MNTR ("ECU list" included)

NOTE:

DIAGNOSIS AND REPAIR WORKFLOW

< BASIC INSPECTION >

[CAN FUNDAMENTAL]

Some items may not be needed depending on CAN system type of vehicle.

(Example)

ECU list

CAN DIAG SUPPORT MNTR

SELF-DIAG RESULTS

PKID1212E

Create On-board Diagnosis Copy Sheet

Display the trouble diagnosis result of CAN communication with the on-board diagnosis function on the vehicle monitor, etc. Copy them on the on-board diagnosis copy sheet.

NOTE:

A
B
C
D
E
F
G
H
I
J
K
L
N
O
P

LAN

DIAGNOSIS AND REPAIR WORKFLOW

< BASIC INSPECTION >

[CAN FUNDAMENTAL]

For some models, CAN communication diagnosis result is received from the vehicle monitor. (CONSULT-III is not available.)

Example: Copy the diagnosis result of CAN communication from the vehicle monitor.

Vehicle monitor indication

CAN DIAG SUPPORT MONITOR			Delete
CAN_COMM	OK	0	
CAN_CIRC_1	OK	0	
CAN_CIRC_2	UNKWN	12	
CAN_CIRC_3	UNKWN	12	
CAN_CIRC_4	UNKWN	0	
CAN_CIRC_5	OK	0	
CAN_CIRC_6	UNKWN	0	
CAN_CIRC_7	OK	0	
CAN_CIRC_8	UNKWN	0	
CAN_CIRC_9	UNKWN	50	



Copy

Vehicle monitor (Display control unit) CAN DIAG SUPPORT MONITOR copy sheet

Indication item (Diagnosis item)	Vehicle monitor		Indication item (Diagnosis item)	Vehicle monitor	
	Result indicated	Error counter		Result indicated	Error counter
CAN_COMM (Initial diagnosis)	OK	0	CAN_CIRC_5 (Receive diagnosis of Unified meter and A/C amp.)	OK	0
CAN_CIRC_1 (Transmit diagnosis)	OK	0	CAN_CIRC_6	Not available	
CAN_CIRC_2 (Receive diagnosis of BCM)	UNKWN	12	CAN_CIRC_7 (Receive diagnosis of IPDM E/R)	OK	0
CAN_CIRC_3 (Receive diagnosis of ECM)	UNKWN	12	CAN_CIRC_8	Not available	
CAN_CIRC_4	Not available		CAN_CIRC_9	Not available	

Result indicated: Fill in the indication (OK, NG or UNKWN).
Error counter: Fill in the indicated number.

SKIB8722E

CREATE DIAGNOSIS SHEET

NOTE:

Be sure to use the diagnosis sheet for the correct CAN system type.

Print Diagnosis Sheet

Print the diagnosis sheet for the applicable CAN system type.

Check Collected Data

Make sure that all ECUs are received, referring to "ECU list".

DIAGNOSIS AND REPAIR WORKFLOW

< BASIC INSPECTION >

[CAN FUNDAMENTAL]

- For abbreviations, refer to [LAN-36, "Abbreviation List"](#).

Unit names are indicated by abbreviations.

CAN-H and CAN-L are described with one line.

Used for detecting root cause.

▲ indicates Diag on CAN unit.

▲ indicates Diag on CAN unit.

Fill out possible root cause and inspection result.

Make sure that all ECUs are received, referring to "ECU list".

CAN DIAG SUPPORT MNTR

CAN1		CAN2		IPDM-E		
CAN_H max=4.4V						
CAN_H min=2.3V				PRSNLT	PAST	
CAN_L max=3.1V				TRANSMIT DIAG	OK	OK
CAN_L min=1.0V				ECM	OK	OK
Battery(V)11.7V				BCM/SEC	OK	OK
		CAN		AV		
ECU list				TRANSMIT DIAG	PRSNLT	PAST
ABS, IPDM-E, AV, BCM, TCM, M&A, ECM, EPS, AFS, I-KEY, ADP				ECM	OK	OK
				METER/M&A	OK	OK
				BCM/SEC	-	-
				HVAC	-	-
				IPDM E/R	-	-
				TIRE-P	-	-
				PRSNLT	PAST	
INITIAL DIAG				OK		
TRANSMIT DIAG				OK		
ECM				OK		

PKID1213E

DETECT THE ROOT CAUSE

Identify the root cause using the created diagnosis sheet.

Identifying the root cause

- Draw a line on the diagnosis sheet to indicate the possible cause. Narrow the search.

NOTE:

- Color-code when drawing lines.
- Do not draw a line onto a existing line.
- Drawing a line is not necessary if the circuit is shorted. Refer to "Present Error — Short Circuit —", "Past Error — Short Circuit —".

Refer to the following for details of the trouble diagnosis procedure.

- "Present Error — Open Circuit —"
- "Present Error — Short Circuit —"
- "Past Error — Open Circuit —"
- "Past Error — Short Circuit —"

NOTE:

When the root cause appears to be a branch line or short circuit, be sure to check the control unit as well as the communication line.

Present Error — Open Circuit —

A
B
C
D
E
F
G
H
I
J
K
L

LAN

N
O
P

DIAGNOSIS AND REPAIR WORKFLOW

< BASIC INSPECTION >

[CAN FUNDAMENTAL]

Identify the error circuit using information from the “CAN DIAG SUPPORT MNTR” (“ECU list” included).

1. ECU list: Check the items indicated in “ECU list”. Draw a line on the diagnosis sheet to indicate the error circuit.

NOTE:

CAN communication line has no error if units other than Diag on CAN units are not indicated. An error may be on the power supply of the control unit, DDL1 line or DDL2 line.

- a. “TCM” which is Diag on CAN unit, is not indicated on “ECU list”. This indicates that DLC is not receiving a signal from TCM. Draw a line to indicate an error between DLC and TCM (line 1-a in the figure below).

NOTE:

- Diag on CAN units are not indicated on the “ECU list” when the CAN line between Diag on CAN unit and the data link connector is open.
- For a description of Diag on CAN, refer to [LAN-6, "Description"](#).

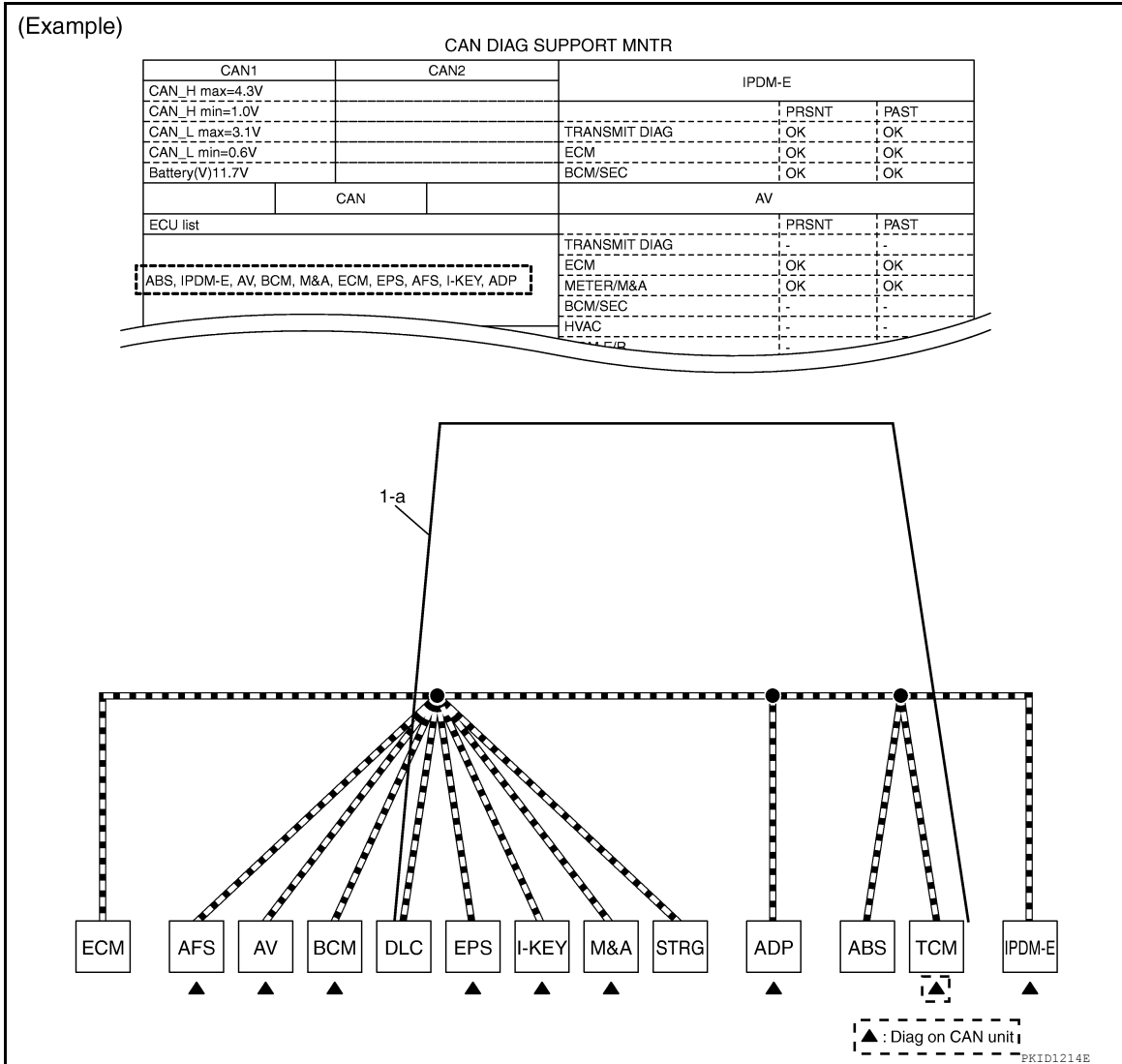

2. CAN DIAG SUPPORT MNTR: Check each item on “CAN DIAG SUPPORT MNTR”. Draw a line on the diagnosis sheet to indicate the error circuit.

- a. Reception item of “ECM”: On “TCM”, “UNKWN” is indicated. This means ECM cannot receive the signal from TCM. Draw a line to indicate an error between ECM and TCM (line 2-a in the figure below).

NOTE:

If “UNKWN” is indicated on “TRANSMIT DIAG”, then the control unit cannot transmit CAN communication signal to each unit. Draw a line between the control unit and the splice.

- b. Reception item of “AFS”: On “TCM”, “UNKWN” is indicated. This means AFS cannot receive the signal from TCM. Draw a line to indicate an error between AFS and TCM (line 2-b in the figure below).

DIAGNOSIS AND REPAIR WORKFLOW

< BASIC INSPECTION >

[CAN FUNDAMENTAL]

- c. Reception item of "AV": "UNKWN" is not indicated. This indicates normal communication between AV and its receiving units. Do not draw any line.

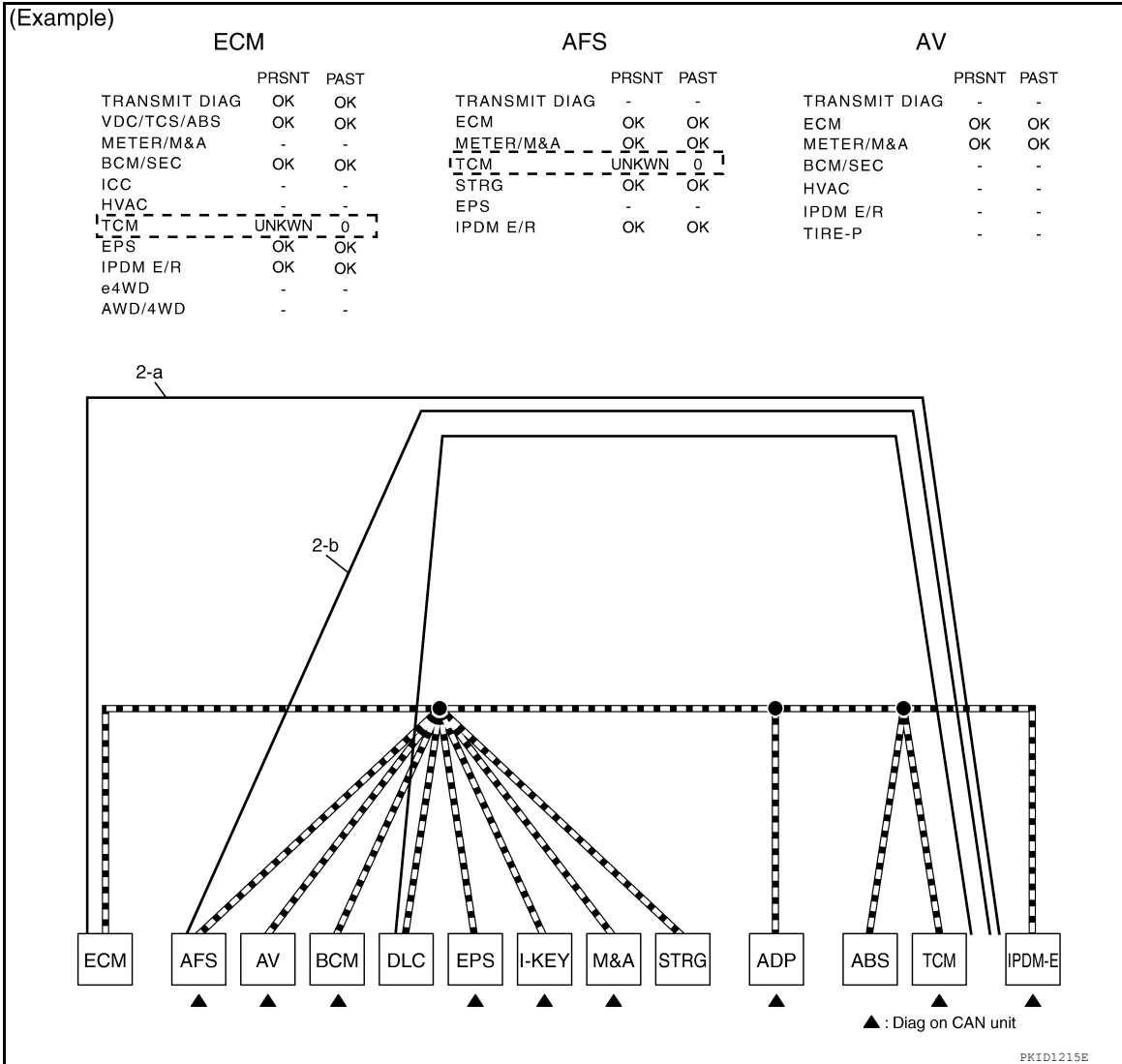

- d. Reception item of "BCM": On "TCM", "UNKWN" is indicated. This means BCM cannot receive the signal from TCM. Draw a line to indicate an error between BCM and TCM (line 2-d in the figure below).
- e. Reception item of "EPS" and "I-KEY": "UNKWN" is not indicated. This indicates normal communication between EPS and I-KEY and their receiving units. Do not draw any line.

NOTE:

A
B
C
D
E
F
G
H
I
J
K
L
N
O
P

LAN

DIAGNOSIS AND REPAIR WORKFLOW

< BASIC INSPECTION >

[CAN FUNDAMENTAL]

On CAN DIAG SUPPORT MNTR (without PAST), “UNKWN” is indicated even though the item is not used in the trouble diagnosis. For the details of each item on CAN diagnostic support monitor, refer to [LAN-56, "CAN Diagnostic Support Monitor"](#).

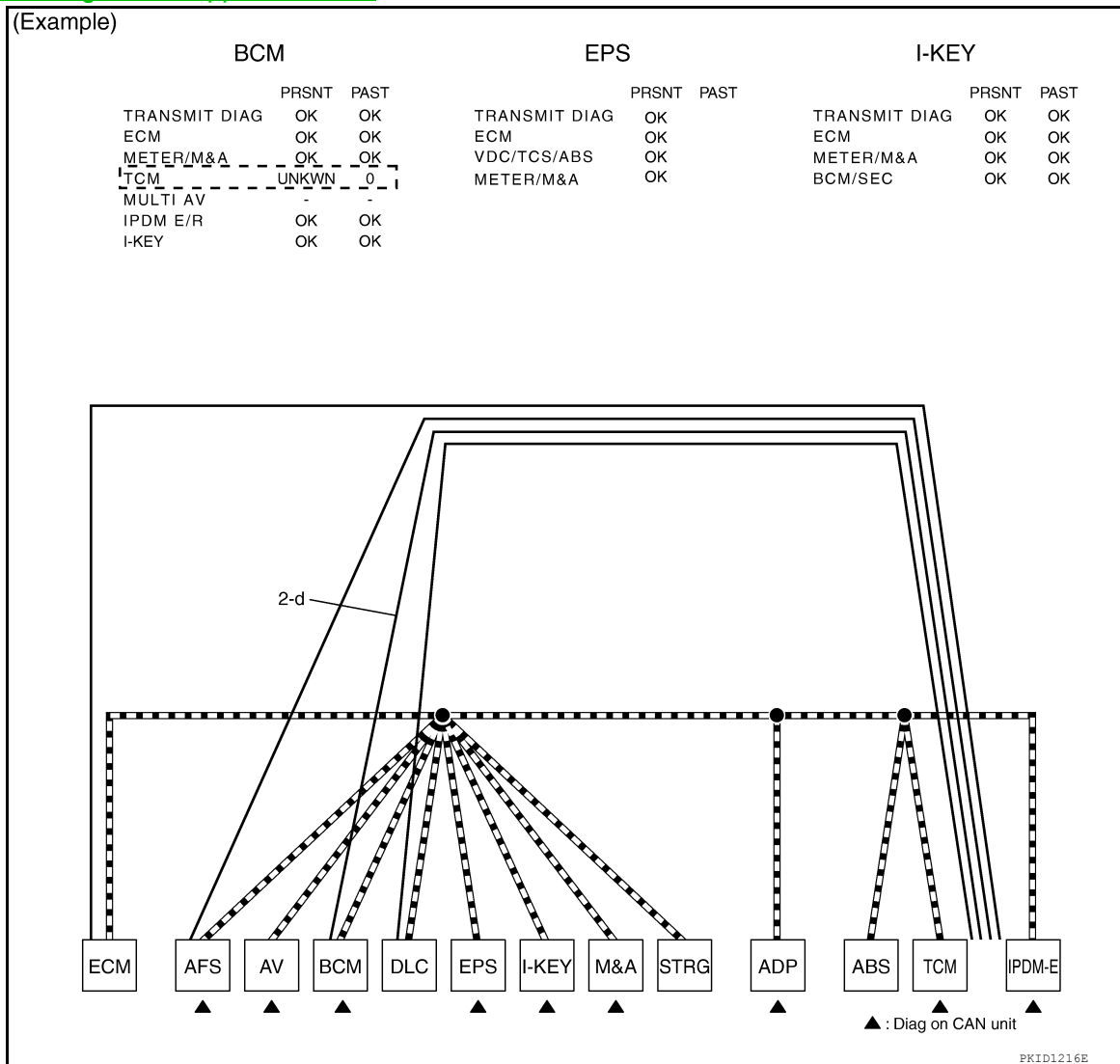

- f. Reception item of “M&A”: On “TCM”, “UNKWN” is indicated. This means M&A cannot receive the signal from TCM. Draw a line to indicate an error between M&A and TCM (line 2-f in the figure below).
- g. Reception item of “ADP”: On “TCM”, “UNKWN” is indicated. This means ADP cannot receive the signal from TCM. Draw a line to indicate an error between ADP and TCM (line 2-g in the figure below).

DIAGNOSIS AND REPAIR WORKFLOW

< BASIC INSPECTION >

[CAN FUNDAMENTAL]

- h. Reception item of "ABS": "UNKWN" is not indicated. This indicates normal communication between ABS and its receiving units. Do not draw any line.

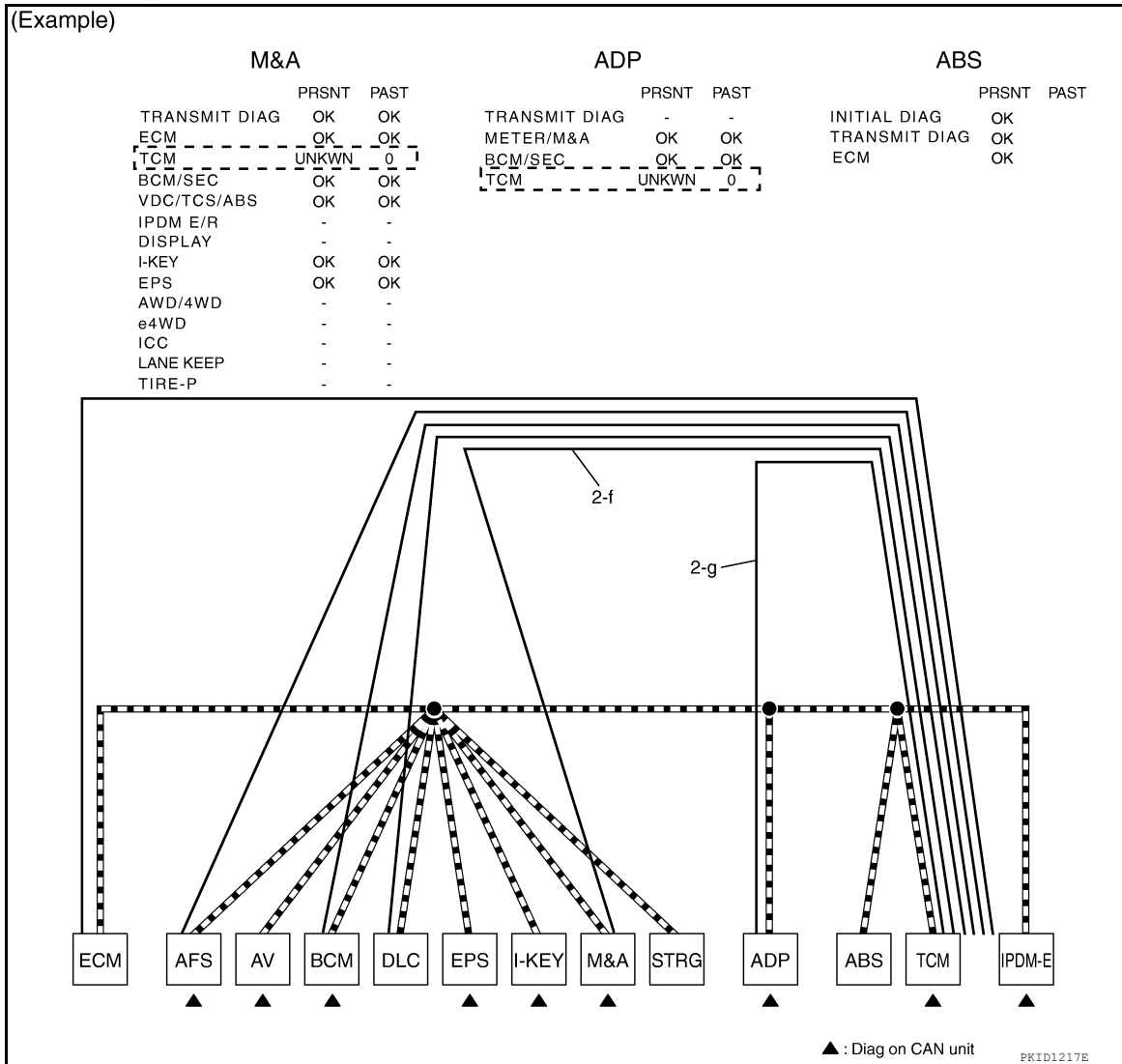

- i. Reception item of "IPDM-E": "UNKWN" is not indicated. This indicates normal communication between IPDM-E and its receiving units. Do not draw any line.
3. Based on information received from "CAN DIAG SUPPORT MNTR", place a check mark on the known good CAN communication line between ECM and IPDM-E.
- Through the previous procedure, the circuit between ADP splice and TCM has the most amount of lines (shade 3-a in the figure below).
 - Place a check mark on the known good lines to establish the error circuit.

A
B
C
D
E
F
G
H
I
J
K
L
N
O
P

LAN

DIAGNOSIS AND REPAIR WORKFLOW

< BASIC INSPECTION >

[CAN FUNDAMENTAL]

Reception item of "IPDM-E": On "ECM", "OK" is indicated. IPDM-E communicates normally with ECM. Put a check mark on the normal circuit between ECM and IPDM-E (check mark 3-b in the figure below).

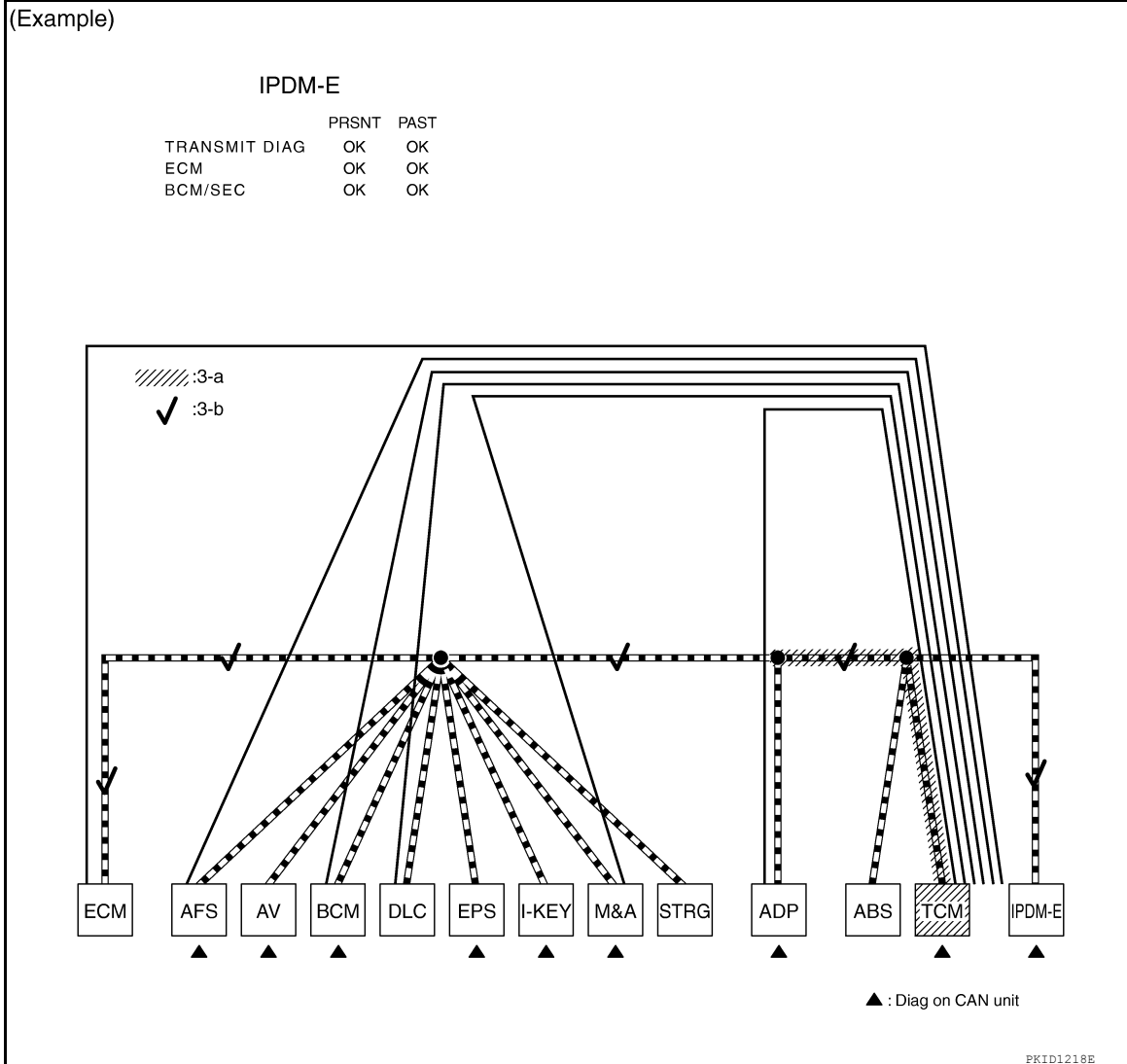

- Through the above procedure, the error is detected in the TCM branch line (shaded in the figure below).

NOTE:

For abbreviations, refer to [LAN-36. "Abbreviation List"](#).

DIAGNOSIS AND REPAIR WORKFLOW

< BASIC INSPECTION >

[CAN FUNDAMENTAL]

- Perform the inspection for the detected error circuit. For the inspection procedure, refer to "MALFUNCTION AREA CHART".

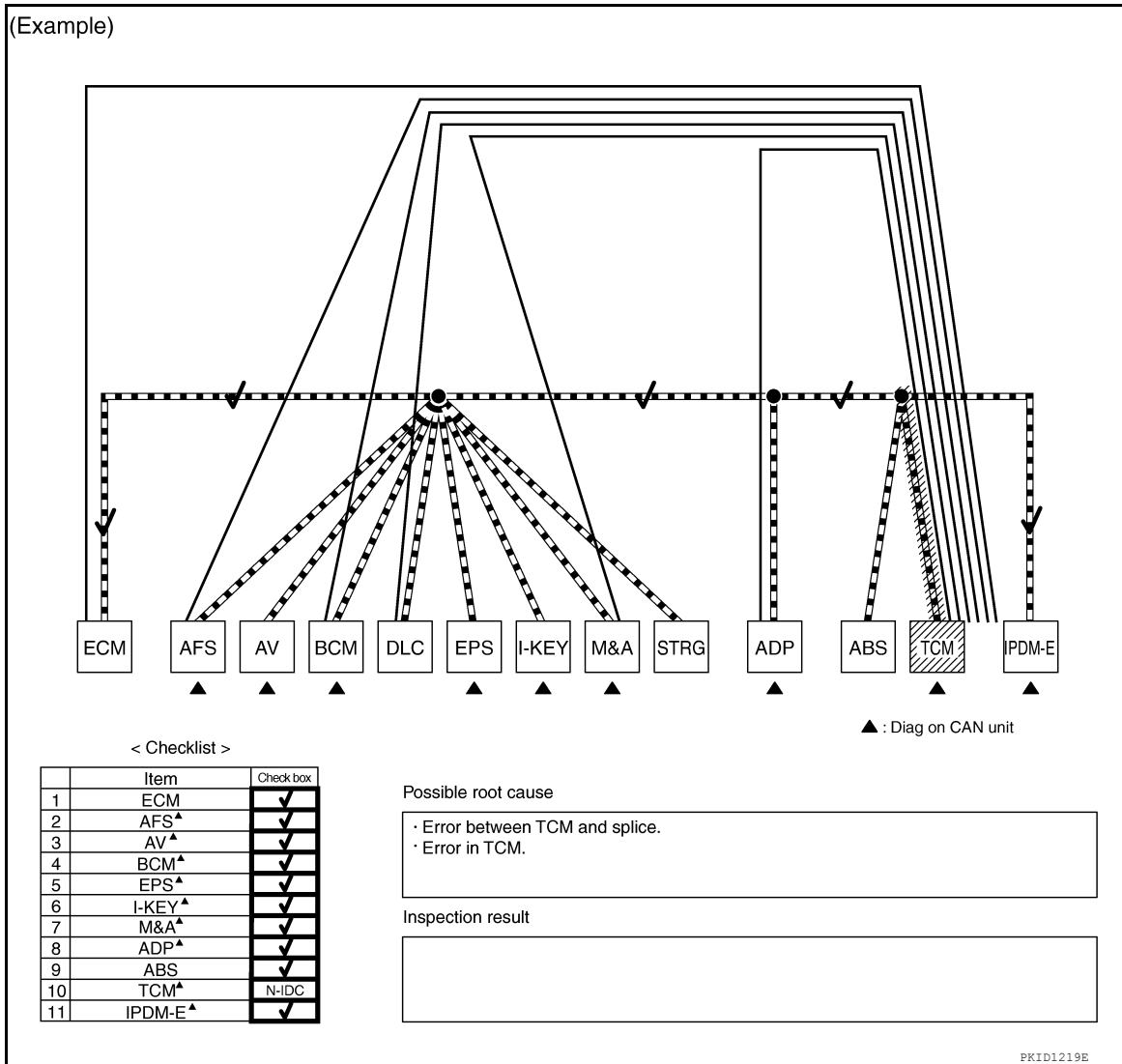

Present Error — Short Circuit —

When the symptoms listed below exist, a short circuit of the CAN communication line is a possible cause.

Received data

Item (CONSULT-III)	Indication
ECU list (on the CAN DIAG SUPPORT MNTR)	All Diag on CAN units are not indicated.
CAN DIAG SUPPORT MNTR	"UNKWVN" is indicated under "TRANSMIT DIAG" and most reception items.

Error symptom

- Most the units connected to the CAN communication system go into fail-safe mode or are deactivated.

Inspection procedure

A
B
C
D
E
F
G
H
I
J
K
L
LAN
N
O
P

DIAGNOSIS AND REPAIR WORKFLOW

< BASIC INSPECTION >

[CAN FUNDAMENTAL]

- Refer to "MALFUNCTION AREA CHART".

(Example)

CAN DIAG SUPPORT MNTR

CAN1		CAN2		ECM		
CAN_H max=4.3V					PRSENT	PAST
CAN_H min=1.0V					UNKWN	0
CAN_L max=3.1V				TRANSMIT DIAG	UNKWN	0
CAN_L min=0.6V				VDC/TCS/ABS	UNKWN	0
Battery(V)11.7V				METER/M&A	-	-
		CAN		BCM/SEC	UNKWN	0
ECU list				ICC	-	-
				HVAC	-	-
All Diag on CAN units are not indicated.		ABS, ECM		TCM	UNKWN	0
				EPS	UNKWN	0
				IPDM E/R	UNKWN	0
				e4WD	-	-
				AWD/4WD	-	-
		ABS			PRSENT	PAST
				INITIAL DIAG	NG	
				TRANSMIT DIAG	UNKWN	
				ECM	UNKWN	

"UNKWN" is indicated under most reception items of CAN DIAG SUPPORT MNTR.

PKID1220E

Past Error — Open Circuit —

Review CAN communication signal chart based on information received from the interview with the customer and on past error information from SELF-DIAG RESULTS and CAN DIAG SUPPORT MNTR.

DIAGNOSIS AND REPAIR WORKFLOW

< BASIC INSPECTION >

[CAN FUNDAMENTAL]

1. SELF-DIAG RESULTS: Inspect the control units indicating “U1000” or “U1001” on SELF-DIAG RESULTS.

ALL DTC READING			
DTC RESULTS	TIME	DTC RESULTS	TIME
ABS		BCM	
U1000 : CAN COMM CIRCUIT	3	No DTC is detected. Further testing may be required.	
IPDM E/R		TRANSMISSION	
No DTC is detected. Further testing may be required.		U1000 : CAN COMM CIRCUIT	3
MULTI AV		METER	
No DTC is detected. Further testing may be required.		U1000 : CAN COMM CIRCUIT	3

DTC RESULTS	TIME	DTC RESULTS	TIME
EPS		AUTO DRIVE POS.	
U1000 : CAN COMM CIRCUIT	PAST	No DTC is detected. Further testing may be required.	
ENGINE			
U1001 : CAN COMM CIRCUIT	1t		
ADAPTIVE LIGHT			
No DTC is detected. Further testing may be required.			
INTELLIGENT KEY			
No DTC is detected. Further testing may be required.			

PKID1221E

2. CAN DIAG SUPPORT MNTR (with PAST): Check the CAN DIAG SUPPORT MNTR (with PAST) of units indicating “U1000” or “U1001” on SELF-DIAG RESULTS. Draw a line on the diagnosis sheet to indicate the possible error circuit.

NOTE:

For the details of each indication on CAN DIAG SUPPORT MNTR, refer to [LAN-56, "CAN Diagnostic Support Monitor"](#).

- a. Reception item of “ECM”: “VDC/TCS/ABS”, “3” is indicated in the “PAST”. This means ECM could not receive the signal from ABS in the past. Draw a line between ECM and ABS (line 2-a in the figure below).
- b. Reception item of “M&A”: “VDC/TCS/ABS”, “3” is indicated in the “PAST”. This means M&A could not receive the signal from ABS in the past. Draw a line between M&A and ABS (line 2-b in the figure below).

A
B
C
D
E
F
G
H
I
J
K
L

LAN

N
O
P

DIAGNOSIS AND REPAIR WORKFLOW

< BASIC INSPECTION >

[CAN FUNDAMENTAL]

- c. Reception item of "TCM": "VDC/TCS/ABS", "3" is indicated in the "PAST". This means TCM could not receive the signal from ABS in the past. Draw a line between TCM and ABS (line 2-c in the figure below).

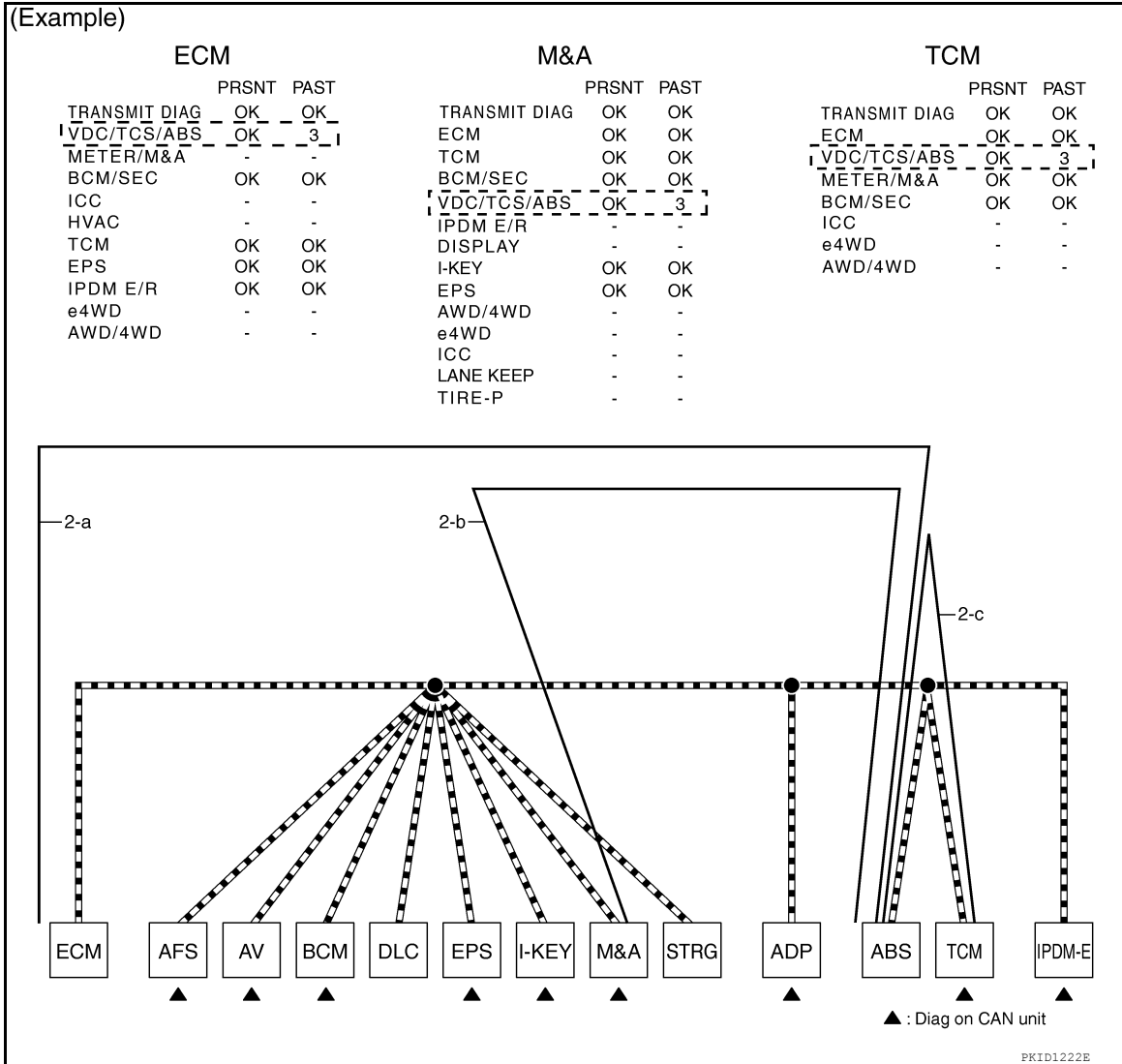

3. CAN DIAG SUPPORT MNTR (without PAST): Check the CAN DIAG SUPPORT MNTR (without PAST) of units indicating "U1000" or "U1001" on SELF-DIAG RESULTS. Draw a line on the diagnosis sheet to indicate the possible error circuit.

NOTE:

- While an error occurred in the past according to SELF-DIAG RESULTS, it is unclear which signal is not received. Assume that errors were detected from all reception items.
- Draw a single line among the unit and all reception items. (Work flow differs from CAN DIAG SUPPORT MNTR (with PAST).)

- a. Reception item of "EPS": Assume that the unit could not receive the signals from ECM, ABS, and M&A. Draw a line among EPS, ECM, ABS, and M&A (line 3-a in the figure below).

DIAGNOSIS AND REPAIR WORKFLOW

< BASIC INSPECTION >

[CAN FUNDAMENTAL]

- b. Reception item of "ABS": Assume that the unit could not receive the signal from ECM. Draw a line between ABS and ECM (line 3-b in the figure below).

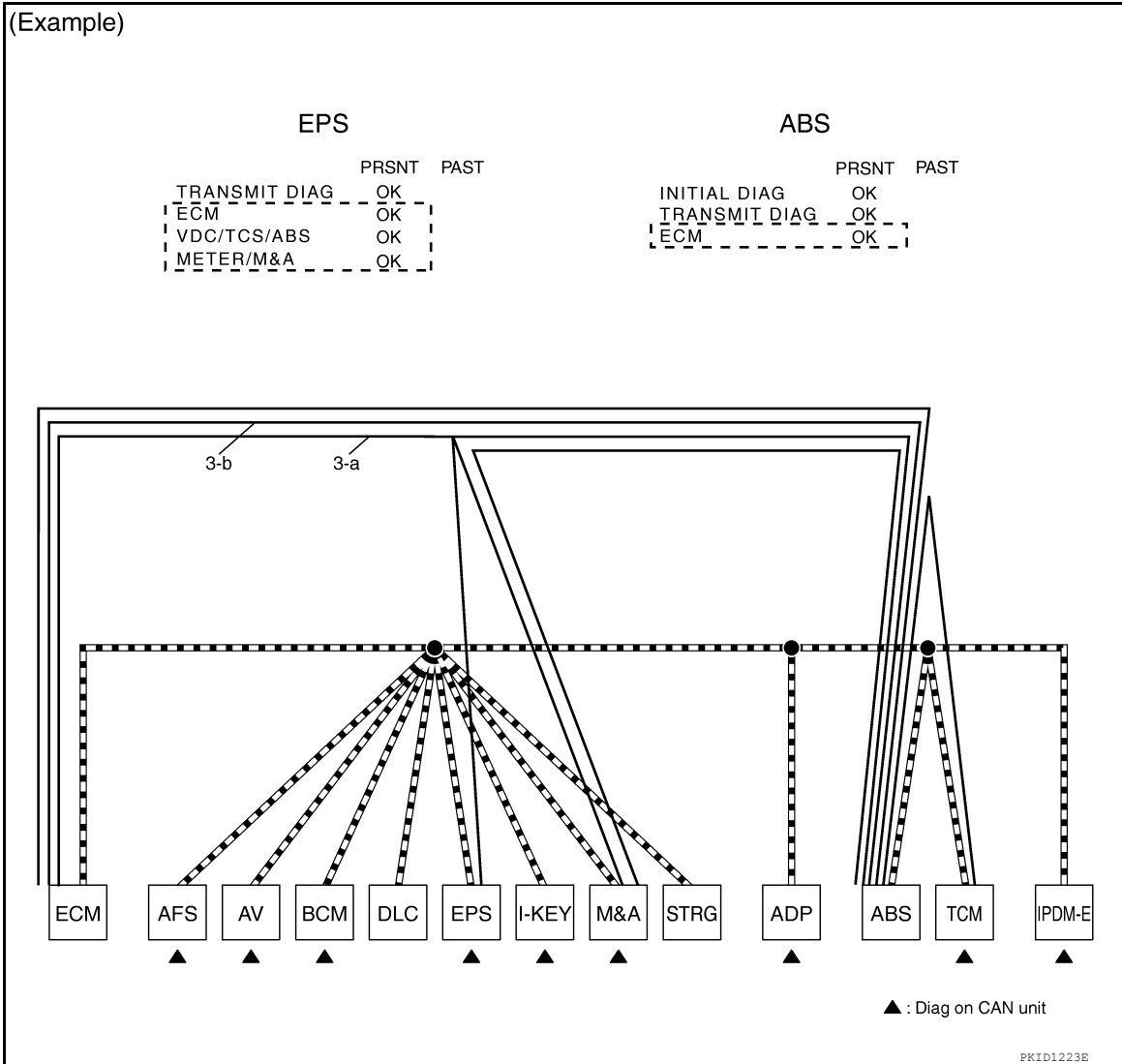

4. Search for the possible cause using CAN communication signal chart using information from the interview with the customer.

NOTE:

For the details of CAN communication signal, refer to [LAN-53, "CAN Communication Signal Chart"](#).

- a. ABS warning lamp turned ON and speedometer did not move: This means that "ABS warning lamp signal" and "Vehicle speed signal" could not communicate between M&A and ABS (4-a in the figure below).

A
B
C
D
E
F
G
H
I
J
K
L
N
O
P

LAN

DIAGNOSIS AND REPAIR WORKFLOW

< BASIC INSPECTION >

[CAN FUNDAMENTAL]

- b. The tachometer moved normally: This means that “Engine speed signal” could communicate normally between ECM and M&A (4-b in the figure below).

(Example)

First registration:

CAN system type:

Symptom (Results from interview with customer)

While driving,

- ABS warning lamp turned ON.
- Speedometer did not move.
- Tachometer moved normally.

CAN Communication Signal Chart

Signal name/Connecting unit	T: Transmit R: Receive											
	ECM	AFS ¹	AV ²	BCM	EPS	I-KEY ³	M&A	STRG ¹	ADP ⁴	ABS	TCM	IPDM/E
A/C compressor request signal	T											R
Accelerator pedal position signal	T										R	
Closed throttle position signal	T										R	
Cooling fan speed request signal	T											R
Engine and CVT integrated control signal	T										R	
	R										T	
Engine coolant temperature signal	T						R				R	
4-b Engine speed signal	T						R				R	
Engine status signal	T		R		R							
Fuel consumption monitor signal	T		R				R					
MI signal	T						R					
Wide open throttle position signal	T										R	
4-a ABS warning lamp signal							R			T		
Brake warning lamp signal							R			T		
Steering angle sensor signal		R						T				
Vehicle speed signal	R	R		R	R	R	T		R	T	R	
Input shaft revolution signal	R											T
Output shaft revolution signal	R											T
Shift position indicator signal	R	R	R	R ⁵			R		R ⁶		T	
Second position indicator signal							R				T	
Front wiper stop position signal				R								T
High beam status signal	R	R										T
Low beam status signal	R	R										T

SKIB8895E

5. Fill out the diagnosis sheet based on information from step 4.
- a. The ABS warning lamp turned ON and speedometer did not move: Assume that a possible cause is no communication between M&A and ABS. Draw a line between M&A and ABS. (Line 5-a in the figure below).

DIAGNOSIS AND REPAIR WORKFLOW

< BASIC INSPECTION >

[CAN FUNDAMENTAL]

- b. The tachometer moved normally: Put check marks between ECM and M&A. The circuit between ECM and M&A is functioning properly (check marks 5-b in the figure below).

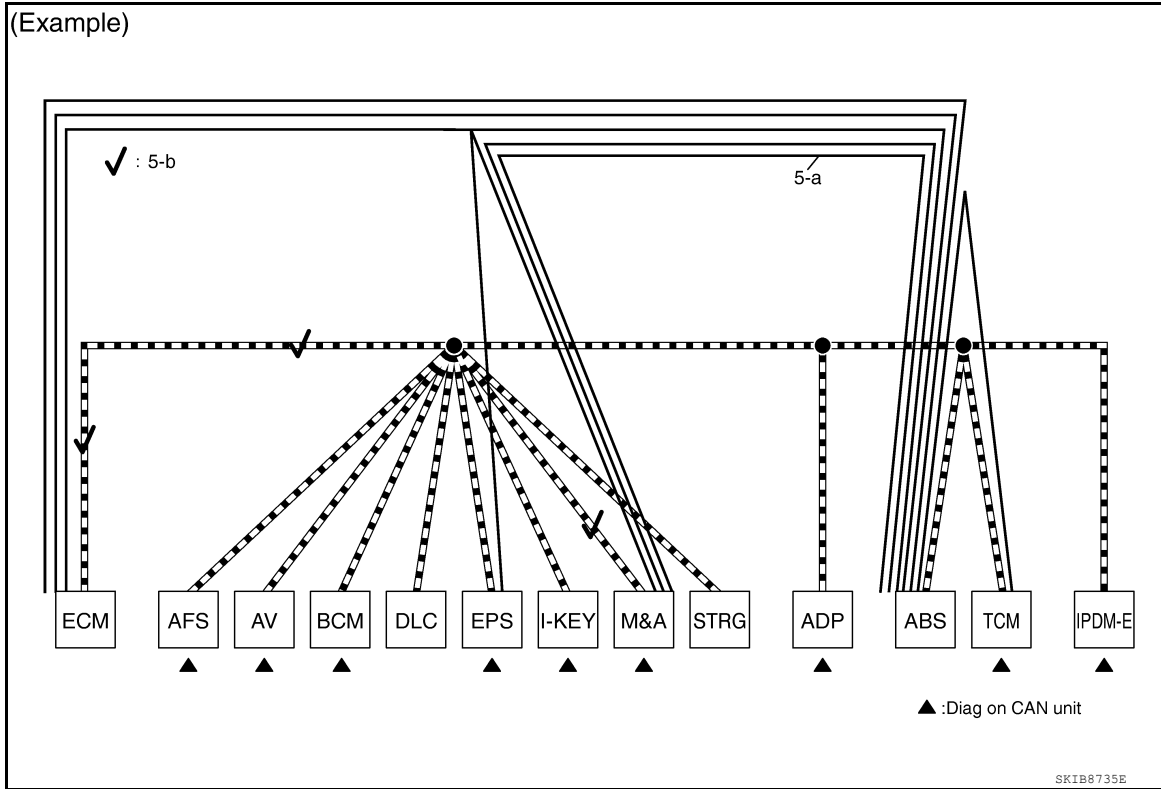

6. The circuit which has the most amount of lines are the possible cause. Error is detected from ABS actuator and electric unit (control unit) branch line (shaded in the figure below).

NOTE:

For abbreviations, refer to [LAN-36, "Abbreviation List"](#).

A
B
C
D
E
F
G
H
I
J
K
L

LAN

DIAGNOSIS AND REPAIR WORKFLOW

< BASIC INSPECTION >

[CAN FUNDAMENTAL]

7. Perform the inspection procedure for the possible cause. Refer to "MALFUNCTION AREA CHART".

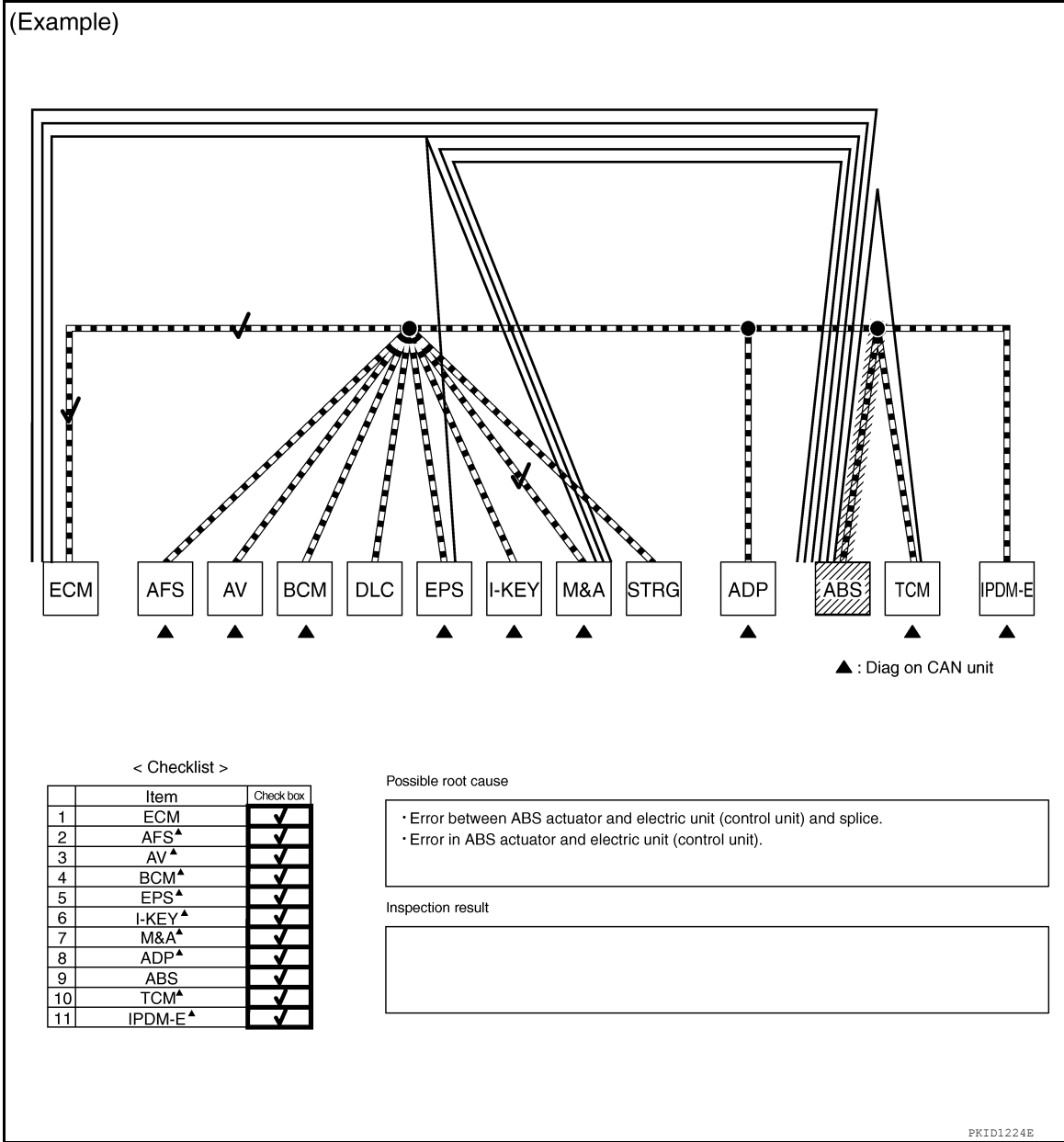

Past Error — Short Circuit —

When the symptoms listed below exist, a short circuit of the CAN communication line is a possible cause.

Item (CONSULT-III)	Indication	Inspection procedure
SELF-DIAG RESULTS	"U1000" and "U1001" is indicated in the past for most units.	Refer to "MALFUNCTION AREA CHART".
CAN DIAG SUPPORT MNTR	Only on CAN DIAG SUPPORT MNTR (with PAST), "1 - 39" is indicated on "PAST" of "TRANSMIT DIAG" and the reception item.	

DIAGNOSIS AND REPAIR WORKFLOW

< BASIC INSPECTION >

[CAN FUNDAMENTAL]

(Example)

DTC RESULTS	TIME	DTC RESULTS	TIME	DTC RESULTS	TIME	DTC RESULTS	TIME
ENGINE		ADAPTIVE LIGHT		MULTI AV		BCM	
U1000 : CAN COMM CIRCUIT	1t	U1000 : CAN COMM CIRCUIT	5	U1000 : CAN COMM CIRCUIT	5	U1000 : CAN COMM CIRCUIT	5
U1001 : CAN COMM CIRCUIT	1t						
EPS		INTELLIGENT KEY		METER		AUTO DRIVE POS.	
U1000 : CAN COMM CIRCUIT	5	U1000 : CAN COMM CIRCUIT	5	U1000 : CAN COMM CIRCUIT	5	U1000 : CAN COMM CIRCUIT	PAST

“U1000” and “U1001” is indicated in the past for most units.

ECM			AFS			AV			BCM		
	PRSNT	PAST		PRSNT	PAST		PRSNT	PAST		PRSNT	PAST
TRANSMIT DIAG	OK	5	TRANSMIT DIAG	-	-	TRANSMIT DIAG	-	-	TRANSMIT DIAG	OK	5
VDC/TCS/ABS	OK	5	ECM	OK	5	ECM	OK	5	ECM	OK	5
METER/M&A	-	-	METER/M&A	OK	5	METER/M&A	OK	5	METER/M&A	OK	5
BCM/SEC	OK	5	TCM	OK	5	BCM/SEC	-	-	TCM	OK	5
ICC	-	-	STRG	OK	5	HVAC	-	-	MULTI AV	-	-
HVAC	-	-	EPS	-	-	IPDM E/R	-	-	IPDM E/R	OK	5
TCM	OK	5	IPDM E/R	OK	5	TIRE-P	-	-	I-KEY	OK	5
EPS	OK	5									
IPDM E/R	OK	5									
e4WD	-	-									
AWD/4WD	-	-									

EPS			I-KEY			M&A			ADP		
	PRSNT	PAST		PRSNT	PAST		PRSNT	PAST		PRSNT	PAST
TRANSMIT DIAG	OK		TRANSMIT DIAG	OK	5	TRANSMIT DIAG	OK	5	TRANSMIT DIAG	-	-
ECM	OK		ECM	OK	5	ECM	OK	5	METER/M&A	OK	5
VDC/TCS/ABS	OK		METER/M&A	OK	5	TCM	OK	5	BCM/SEC	OK	5
METER/M&A				OK	5	BCM/SEC	OK	5	TCM	OK	5
						VDC/TCS/ABS	OK	5			
						IPDM E/R	-	-			
							OK	5			
								5			

Only on CAN DIAG SUPPORT MNTR (with PAST), “1-39” is indicated on “PAST” of “TRANSMIT DIAG” and the reception item.

A
B
C
D
E
F
G
H
I
J
K
L
N
O
P

LAN

PKID1225E

HOW TO USE THIS SECTION

< HOW TO USE THIS MANUAL >

[CAN]

HOW TO USE THIS MANUAL

HOW TO USE THIS SECTION

Caution

INFOID:000000006247766

- This section describes information peculiar to a vehicle, sheets for trouble diagnosis, and inspection procedures.
- For trouble diagnosis procedure, refer to [LAN-14, "Trouble Diagnosis Procedure"](#).

Abbreviation List

INFOID:000000006247767

Abbreviation in CAN communication signal chart, and the diagnosis sheet are as per the following list.

Abbreviation	Unit name	SELECT SYSTEM (CONSULT-III)	CAN DIAG SUPPORT MNTR (CONSULT-III)
4WD	Transfer control unit	ALL MODE AWD/4WD	AWD/4WD
A-BAG	Air bag diagnosis sensor unit	AIR BAG	—
ABS	ABS actuator and electric unit (control unit)	ABS	VDC/TCS/ABS
ADP	Driver seat control unit	AUTO DRIVE POS.	—
AV	AV control unit	MULTI AV	DISPLAY
BCM	BCM	BCM	BCM/SEC
DLC	Data link connector	—	—
ECM	ECM	ENGINE	ECM
HVAC	A/C auto amp.	HVAC	HVAC
I-KEY	Intelligent Key unit	INTELLIGENT KEY	I-KEY
IPDM-E	IPDM E/R	IPDM E/R	IPDM E/R
M&A	Combination meter	METER/M&A	METER/M&A
STRG	Steering angle sensor	—	STRG
TCM	TCM	TRANSMISSION	TCM

PRECAUTION

PRECAUTIONS

Precaution for Supplemental Restraint System (SRS) "AIR BAG" and "SEAT BELT PRE-TENSIONER"

INFOID:000000006247768

The Supplemental Restraint System such as "AIR BAG" and "SEAT BELT PRE-TENSIONER", used along with a front seat belt, helps to reduce the risk or severity of injury to the driver and front passenger for certain types of collision. This system includes seat belt switch inputs and dual stage front air bag modules. The SRS system uses the seat belt switches to determine the front air bag deployment, and may only deploy one front air bag, depending on the severity of a collision and whether the front occupants are belted or unbelted. Information necessary to service the system safely is included in the "SRS AIR BAG" and "SEAT BELT" of this Service Manual.

WARNING:

Always observe the following items for preventing accidental activation.

- To avoid rendering the SRS inoperative, which could increase the risk of personal injury or death in the event of a collision that would result in air bag inflation, all maintenance must be performed by an authorized NISSAN/INFINITI dealer.
- Improper maintenance, including incorrect removal and installation of the SRS, can lead to personal injury caused by unintentional activation of the system. For removal of Spiral Cable and Air Bag Module, see "SRS AIR BAG".
- Never use electrical test equipment on any circuit related to the SRS unless instructed to in this Service Manual. SRS wiring harnesses can be identified by yellow and/or orange harnesses or harness connectors.

PRECAUTIONS WHEN USING POWER TOOLS (AIR OR ELECTRIC) AND HAMMERS

WARNING:

Always observe the following items for preventing accidental activation.

- When working near the Air Bag Diagnosis Sensor Unit or other Air Bag System sensors with the ignition ON or engine running, never use air or electric power tools or strike near the sensor(s) with a hammer. Heavy vibration could activate the sensor(s) and deploy the air bag(s), possibly causing serious injury.
- When using air or electric power tools or hammers, always switch the ignition OFF, disconnect the battery, and wait at least 3 minutes before performing any service.

Precaution Necessary for Steering Wheel Rotation After Battery Disconnect

INFOID:000000008191796

NOTE:

- This Procedure is applied only to models with Intelligent Key system and NATS (NISSAN ANTI-THEFT SYSTEM).
- Remove and install all control units after disconnecting both battery cables with the ignition knob in the "LOCK" position.
- Always use CONSULT-III to perform self-diagnosis as a part of each function inspection after finishing work. If DTC is detected, perform trouble diagnosis according to self-diagnostic results.

For models equipped with the Intelligent Key system and NATS, an electrically controlled steering lock mechanism is adopted on the key cylinder.

For this reason, if the battery is disconnected or if the battery is discharged, the steering wheel will lock and steering wheel rotation will become impossible.

If steering wheel rotation is required when battery power is interrupted, follow the procedure below before starting the repair operation.

OPERATION PROCEDURE

1. Connect both battery cables.

NOTE:

Supply power using jumper cables if battery is discharged.

2. Use the Intelligent Key or mechanical key to turn the ignition switch to the "ACC" position. At this time, the steering lock will be released.
3. Disconnect both battery cables. The steering lock will remain released and the steering wheel can be rotated.

A
B
C
D
E
F
G
H
I
J
K
L
N
O
P

LAN

PRECAUTIONS

[CAN]

< PRECAUTION >

4. Perform the necessary repair operation.
5. When the repair work is completed, return the ignition switch to the "LOCK" position before connecting the battery cables. (At this time, the steering lock mechanism will engage.)
6. Perform a self-diagnosis check of all control units using CONSULT-III.

Precautions for Trouble Diagnosis

INFOID:000000006247769

CAUTION:

- Never apply 7.0 V or more to the measurement terminal.
- Use a tester with open terminal voltage of 7.0 V or less.
- Turn the ignition switch OFF and disconnect the battery cable from the negative terminal when checking the harness.

Precautions for Harness Repair

INFOID:000000006247770

- Solder the repaired area and wrap tape around the soldered area.

NOTE:

A fray of twisted lines must be within 110 mm (4.33 in).

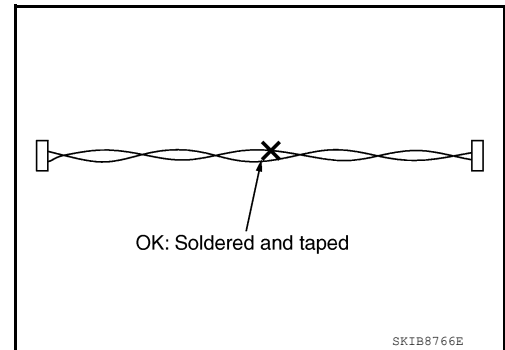

- Bypass connection is never allowed at the repaired area.

NOTE:

Bypass connection may cause CAN communication error. The spliced wire becomes separated and the characteristics of twisted line are lost.

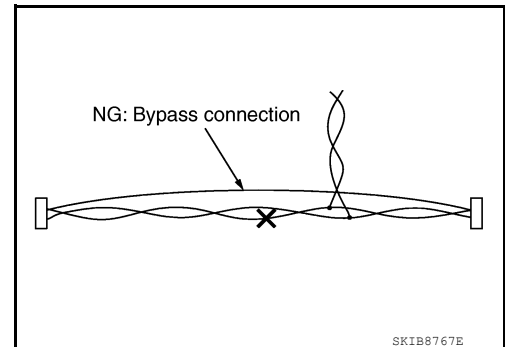

- Replace the applicable harness as an assembly if error is detected on the shield lines of CAN communication line.

DIAGNOSIS AND REPAIR WORKFLOW

< BASIC INSPECTION >

[CAN]

Diagnosis Sheet (CAN Type 1)

INFOID:000000006247772

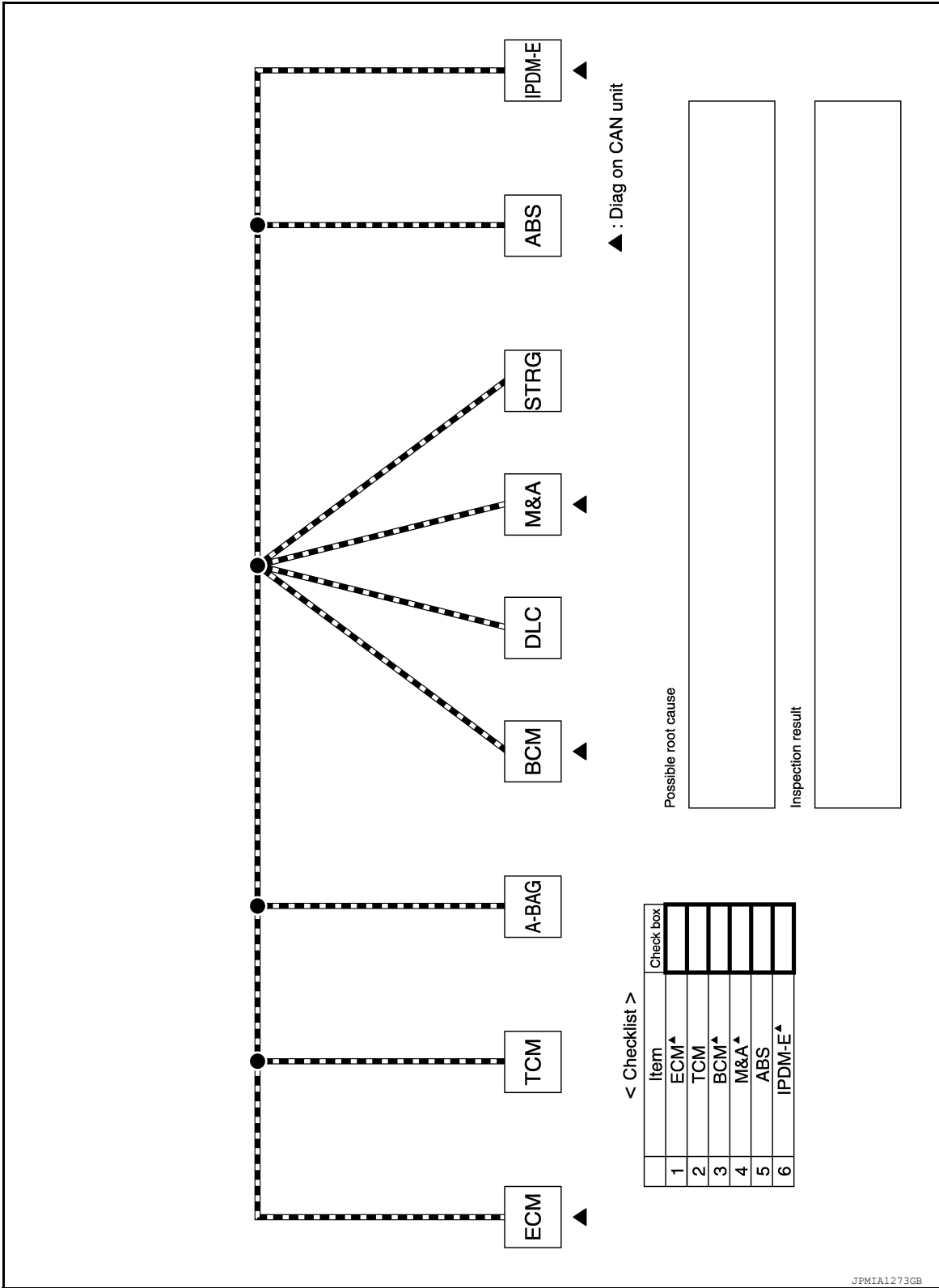

JPMIA1273GB

DIAGNOSIS AND REPAIR WORKFLOW

< BASIC INSPECTION >

[CAN]

Diagnosis Sheet (CAN Type 2)

INFOID:000000006247773

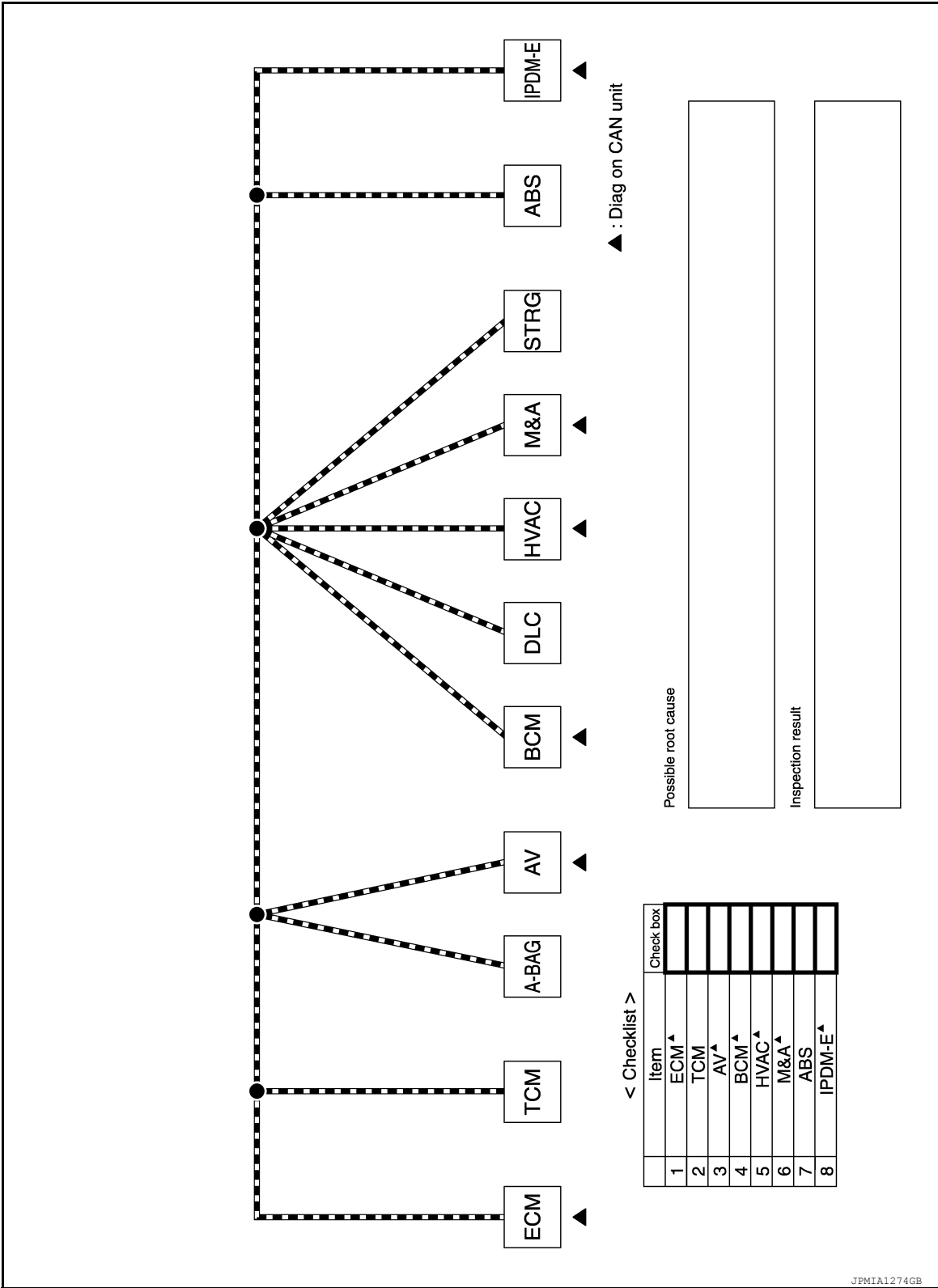

A
B
C
D
E
F
G
H
I
J
K
L
LAN
N
O
P

DIAGNOSIS AND REPAIR WORKFLOW

< BASIC INSPECTION >

[CAN]

Diagnosis Sheet (CAN Type 3)

INFOID:000000006247774

▲ : Diag on CAN unit

< Checklist >		Check box
1	ECM▲	<input type="checkbox"/>
2	TCM	<input type="checkbox"/>
3	AV▲	<input type="checkbox"/>
4	I-KEY▲	<input type="checkbox"/>
5	BCM▲	<input type="checkbox"/>
6	HVAC▲	<input type="checkbox"/>
7	M&A▲	<input type="checkbox"/>
8	ABS	<input type="checkbox"/>
9	IPDM-E▲	<input type="checkbox"/>

Possible root cause

Inspection result

JPMIA1275GB

DIAGNOSIS AND REPAIR WORKFLOW

< BASIC INSPECTION >

[CAN]

Diagnosis Sheet (CAN Type 4)

INFOID:000000006247775

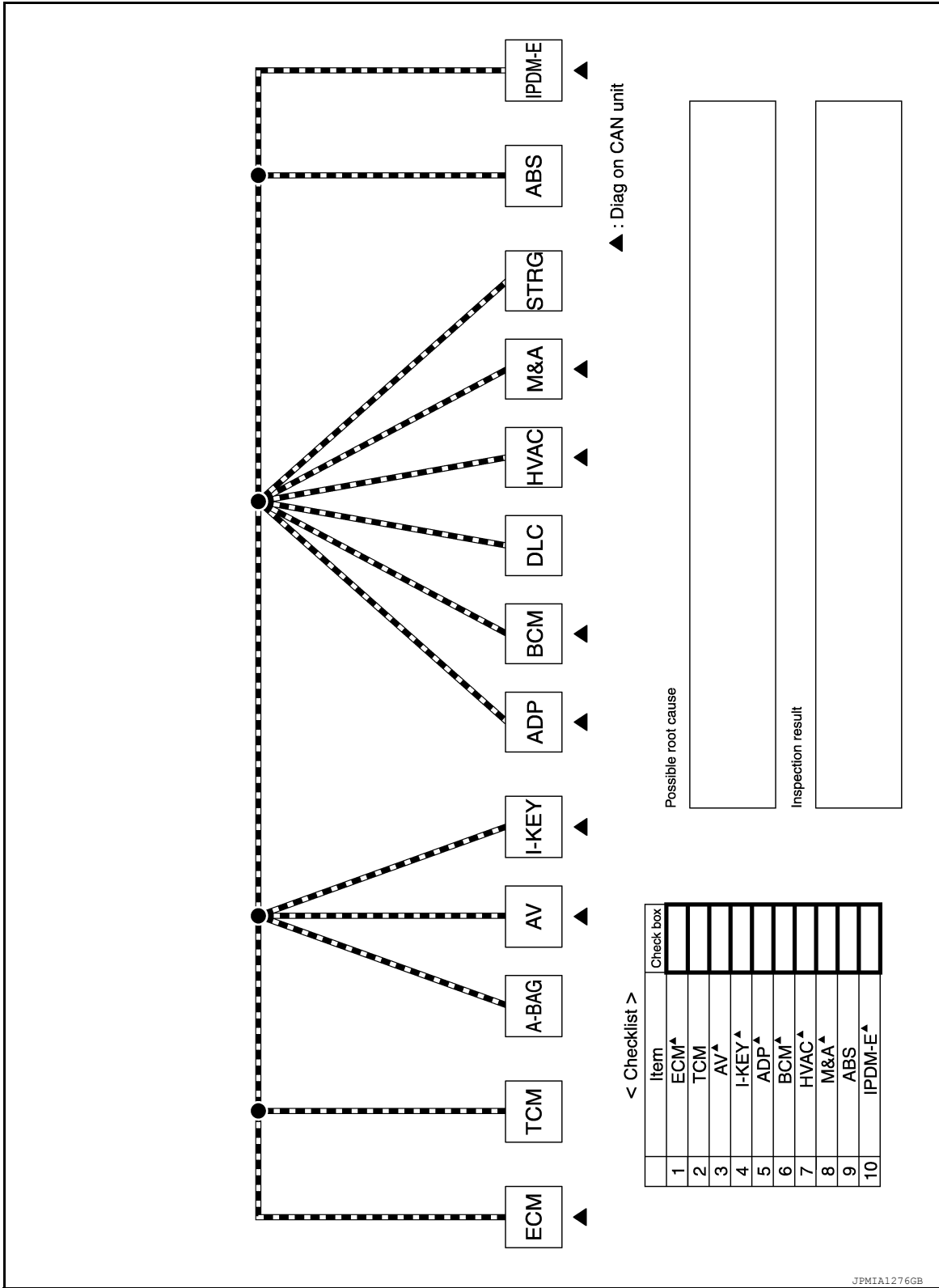

A
B
C
D
E
F
G
H
I
J
K
L
LAN
N
O
P

DIAGNOSIS AND REPAIR WORKFLOW

< BASIC INSPECTION >

[CAN]

Diagnosis Sheet (CAN Type 5)

INFOID:000000006247776

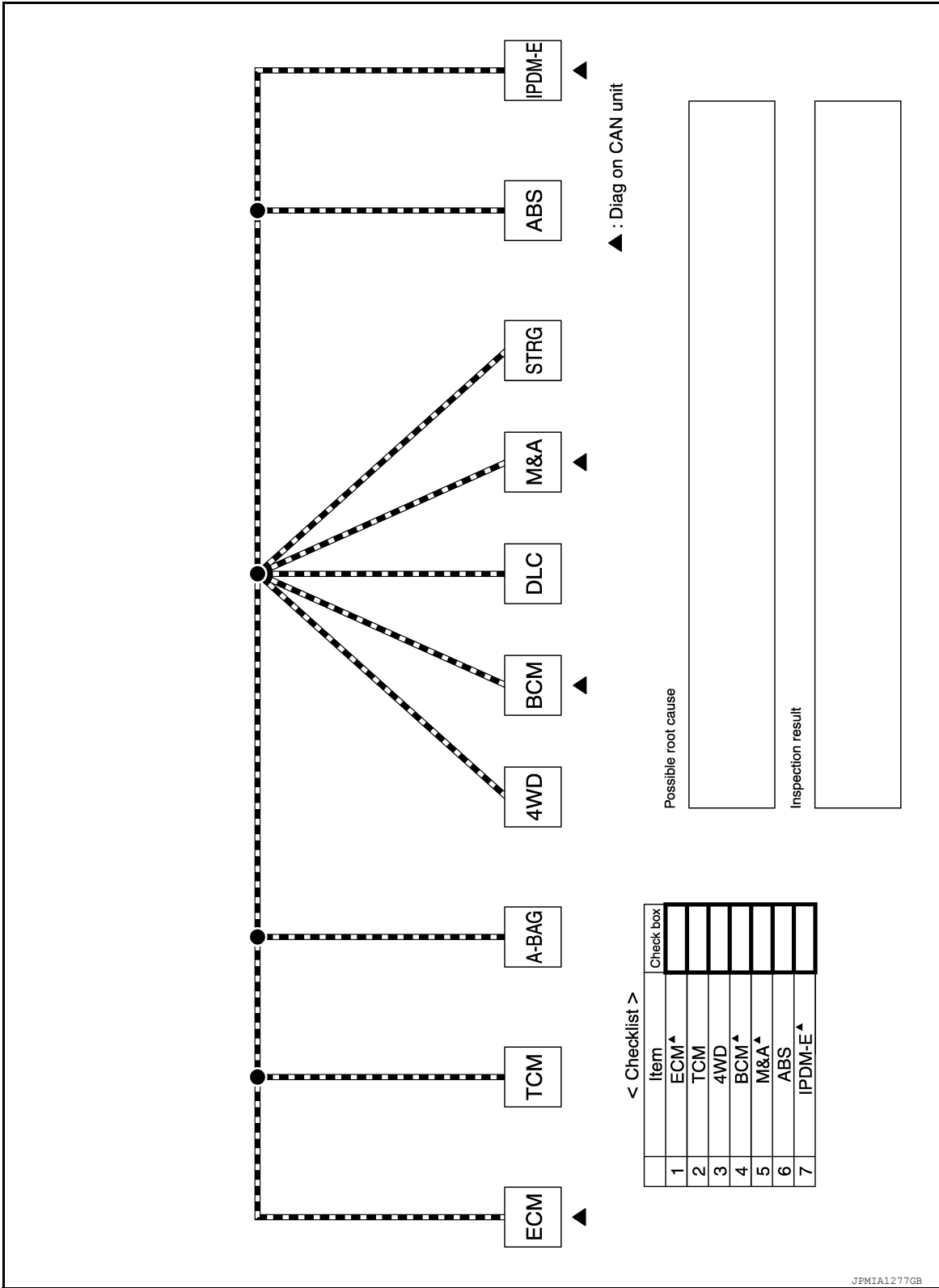

JPMIA1277GB

DIAGNOSIS AND REPAIR WORKFLOW

< BASIC INSPECTION >

[CAN]

Diagnosis Sheet (CAN Type 6)

INFOID:000000006247777

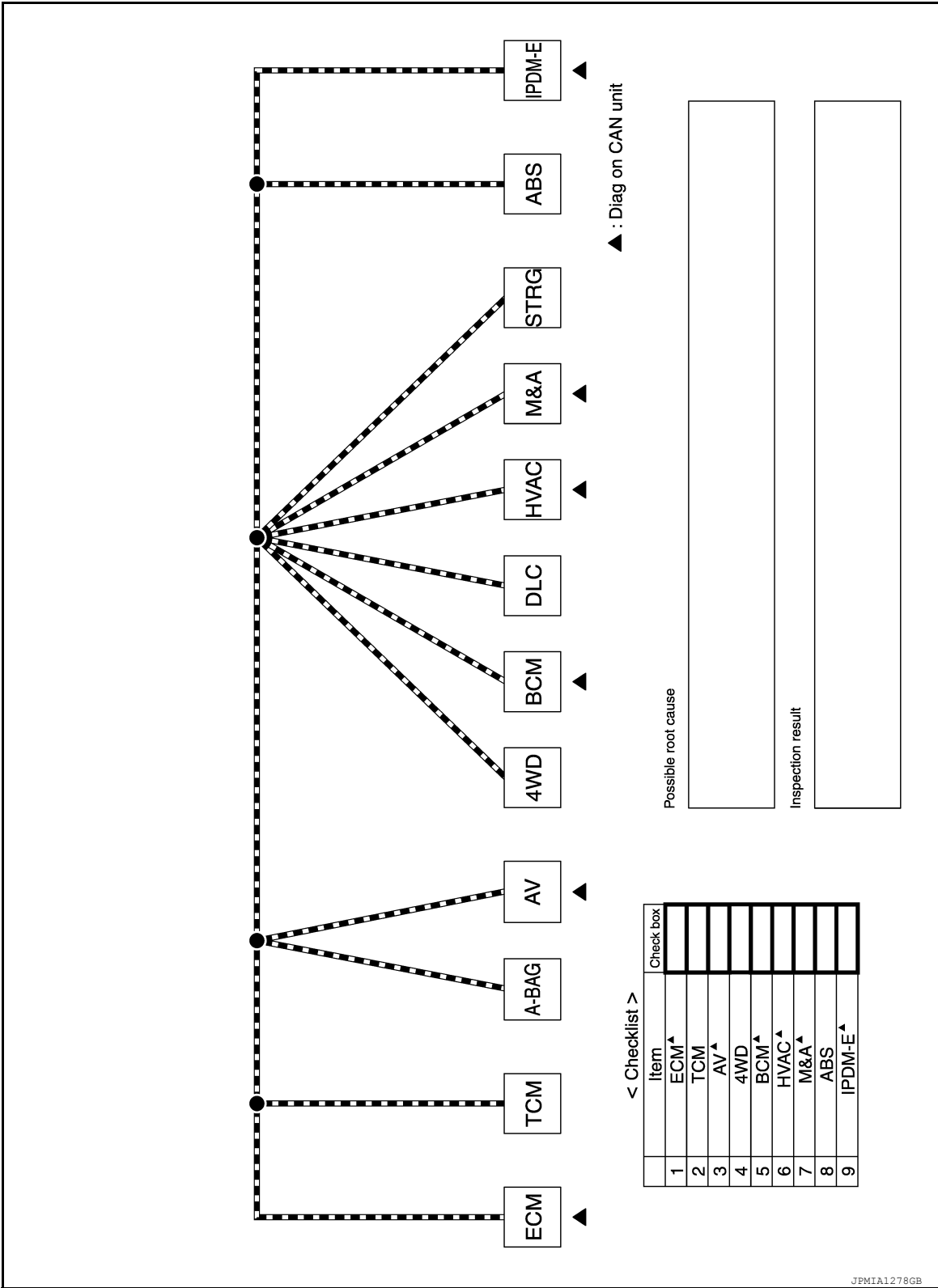

< Checklist >

Item	Check box
1 ECM▲	<input type="checkbox"/>
2 TCM	<input type="checkbox"/>
3 AV▲	<input type="checkbox"/>
4 4WD	<input type="checkbox"/>
5 BCM▲	<input type="checkbox"/>
6 HVAC▲	<input type="checkbox"/>
7 M&A▲	<input type="checkbox"/>
8 ABS	<input type="checkbox"/>
9 IPDM-E▲	<input type="checkbox"/>

A
B
C
D
E
F
G
H
I
J
K
L
LAN
N
O
P

DIAGNOSIS AND REPAIR WORKFLOW

< BASIC INSPECTION >

[CAN]

Diagnosis Sheet (CAN Type 7)

INFOID:000000006247778

▲ : Diag on CAN unit

< Checklist >

Item	Check box
1	ECM▲
2	TCM
3	AV▲
4	I-KEY▲
5	4WD
6	BCM▲
7	HVAC▲
8	M&A▲
9	ABS
10	IPDM-E▲

Possible root cause

Inspection result

JPMIA1279GB

DIAGNOSIS AND REPAIR WORKFLOW

< BASIC INSPECTION >

[CAN]

Diagnosis Sheet (CAN Type 8)

INFOID:000000006247779

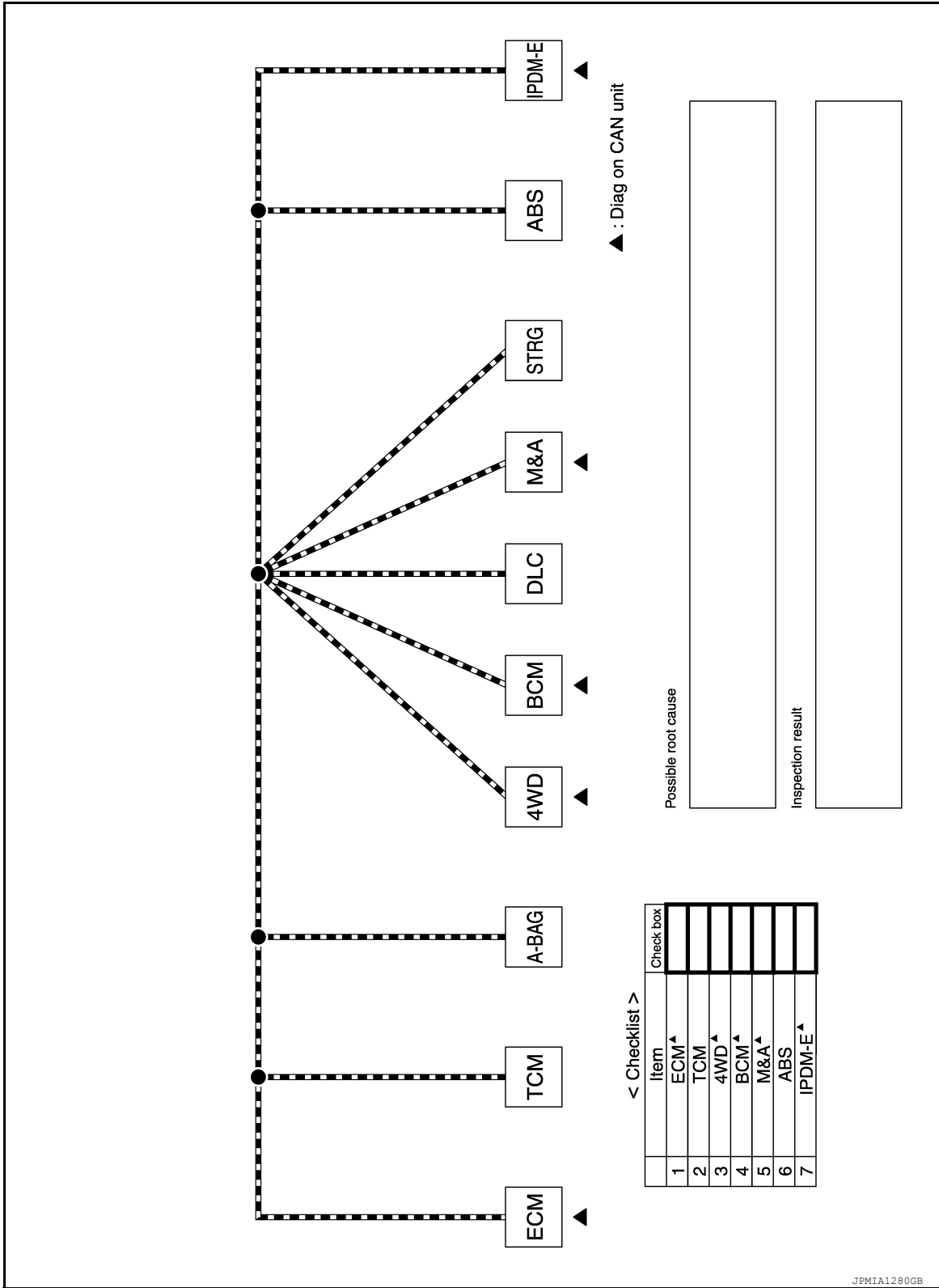

A
B
C
D
E
F
G
H
I
J
K
L
LAN
N
O
P

DIAGNOSIS AND REPAIR WORKFLOW

< BASIC INSPECTION >

[CAN]

Diagnosis Sheet (CAN Type 9)

INFOID:000000006247780

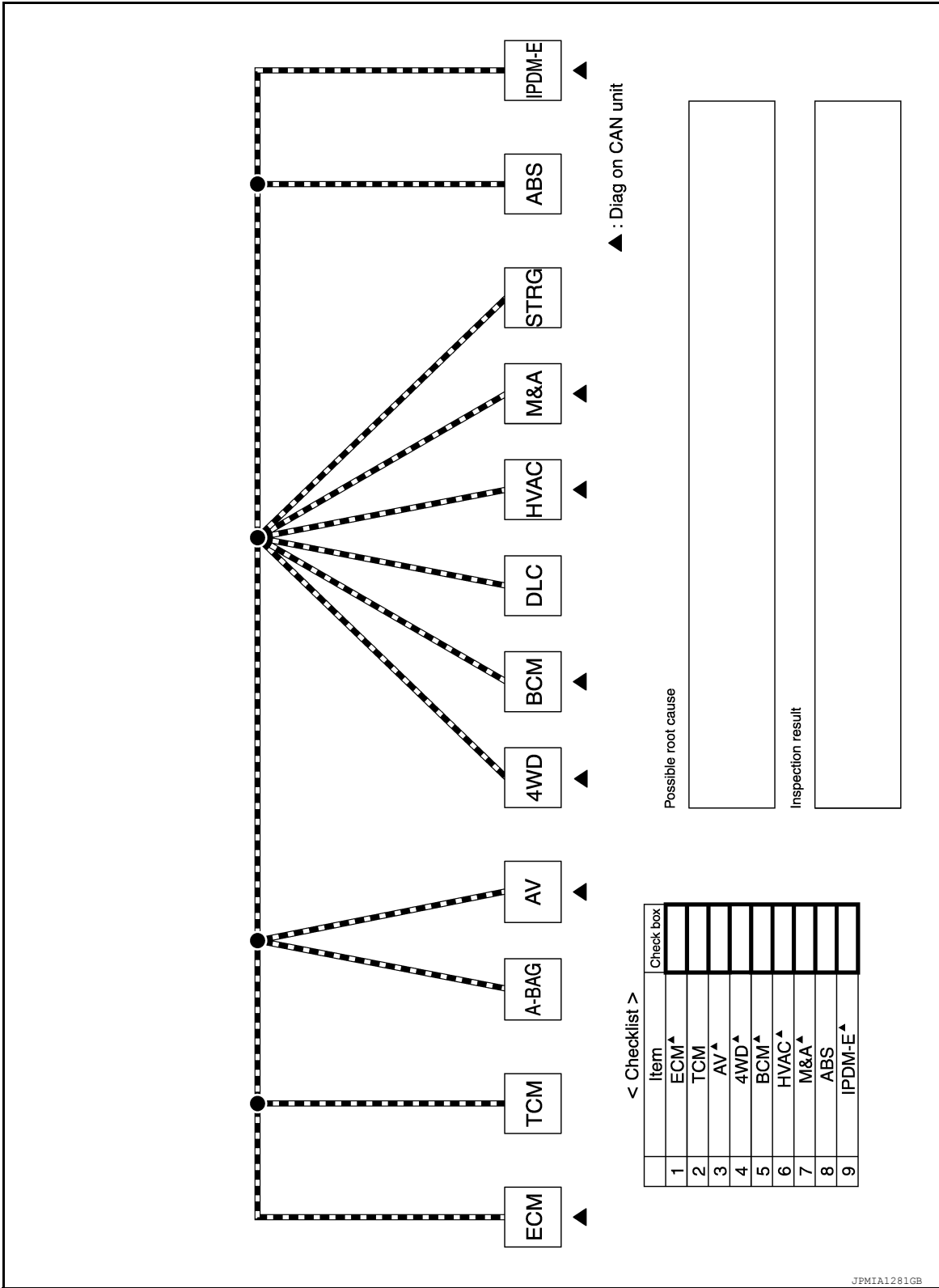

JPMIA1281GB

DIAGNOSIS AND REPAIR WORKFLOW

< BASIC INSPECTION >

[CAN]

Diagnosis Sheet (CAN Type 10)

INFOID:000000006247781

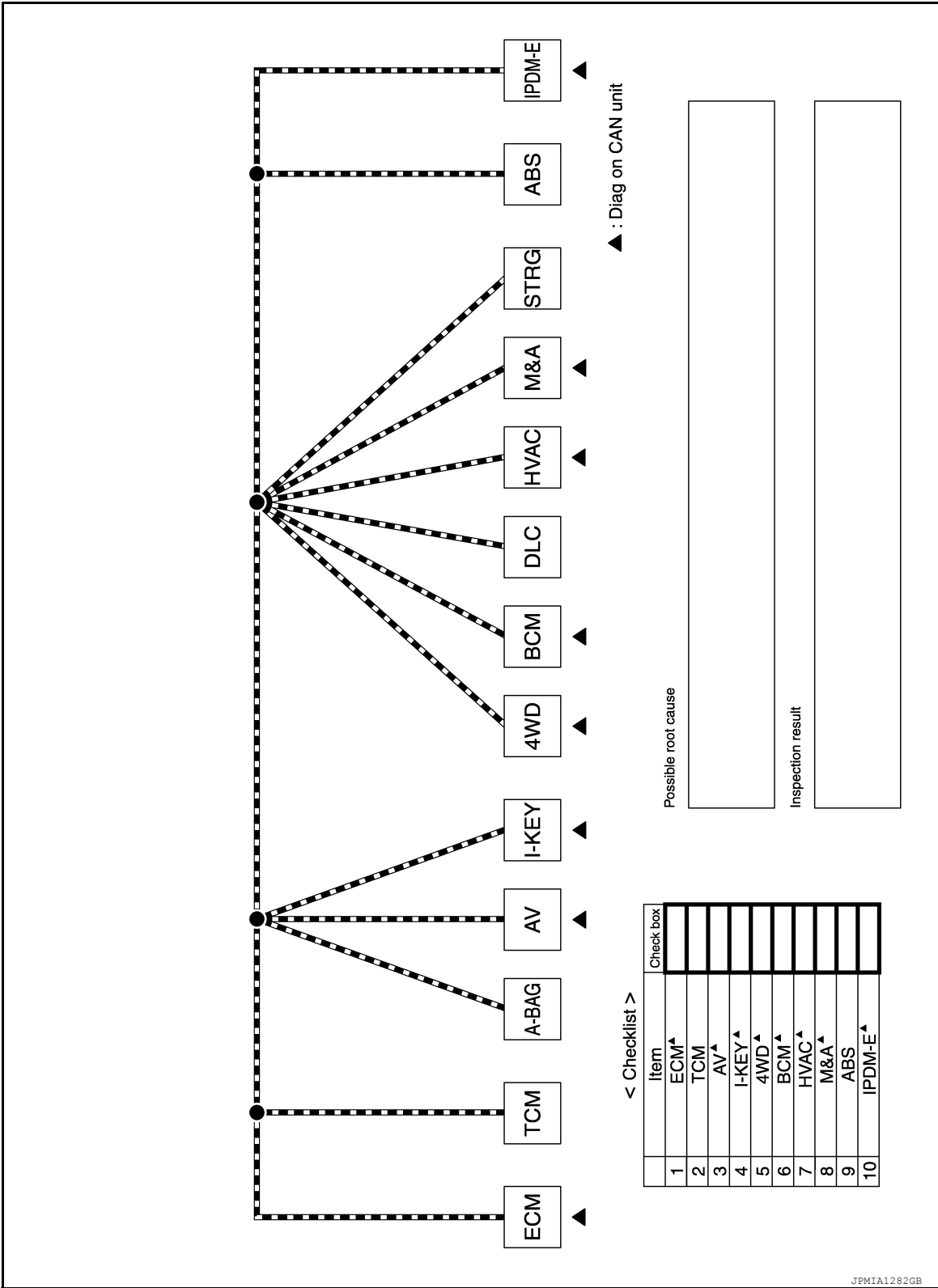

JPMIA1282GB

A
B
C
D
E
F
G
H
I
J
K
L
LAN
N
O
P

DIAGNOSIS AND REPAIR WORKFLOW

< BASIC INSPECTION >

[CAN]

Diagnosis Sheet (CAN Type 11)

INFOID:000000006247782

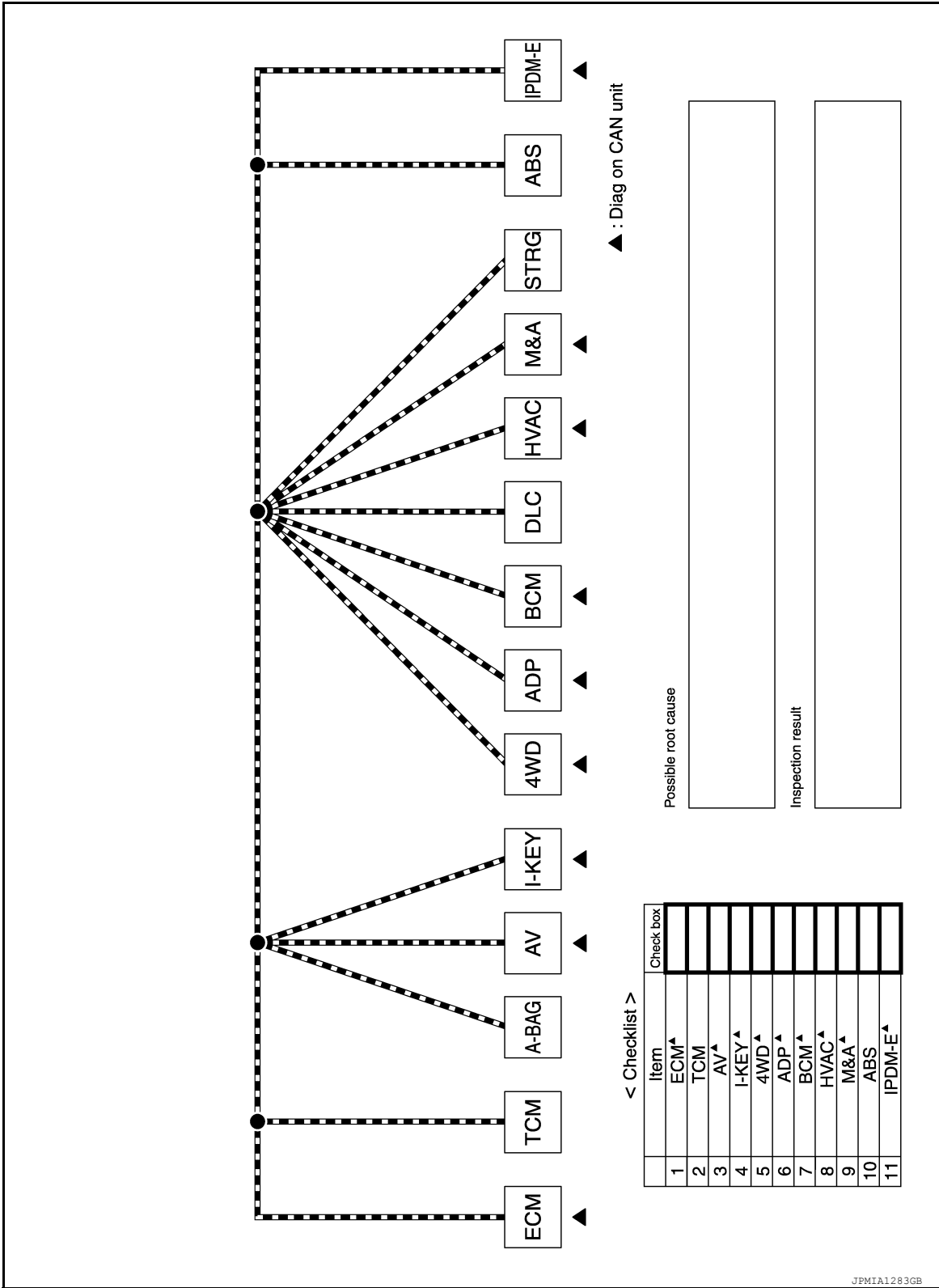

DIAGNOSIS AND REPAIR WORKFLOW

< BASIC INSPECTION >

[CAN]

Diagnosis Sheet (CAN Type 12)

INFOID:000000006247783

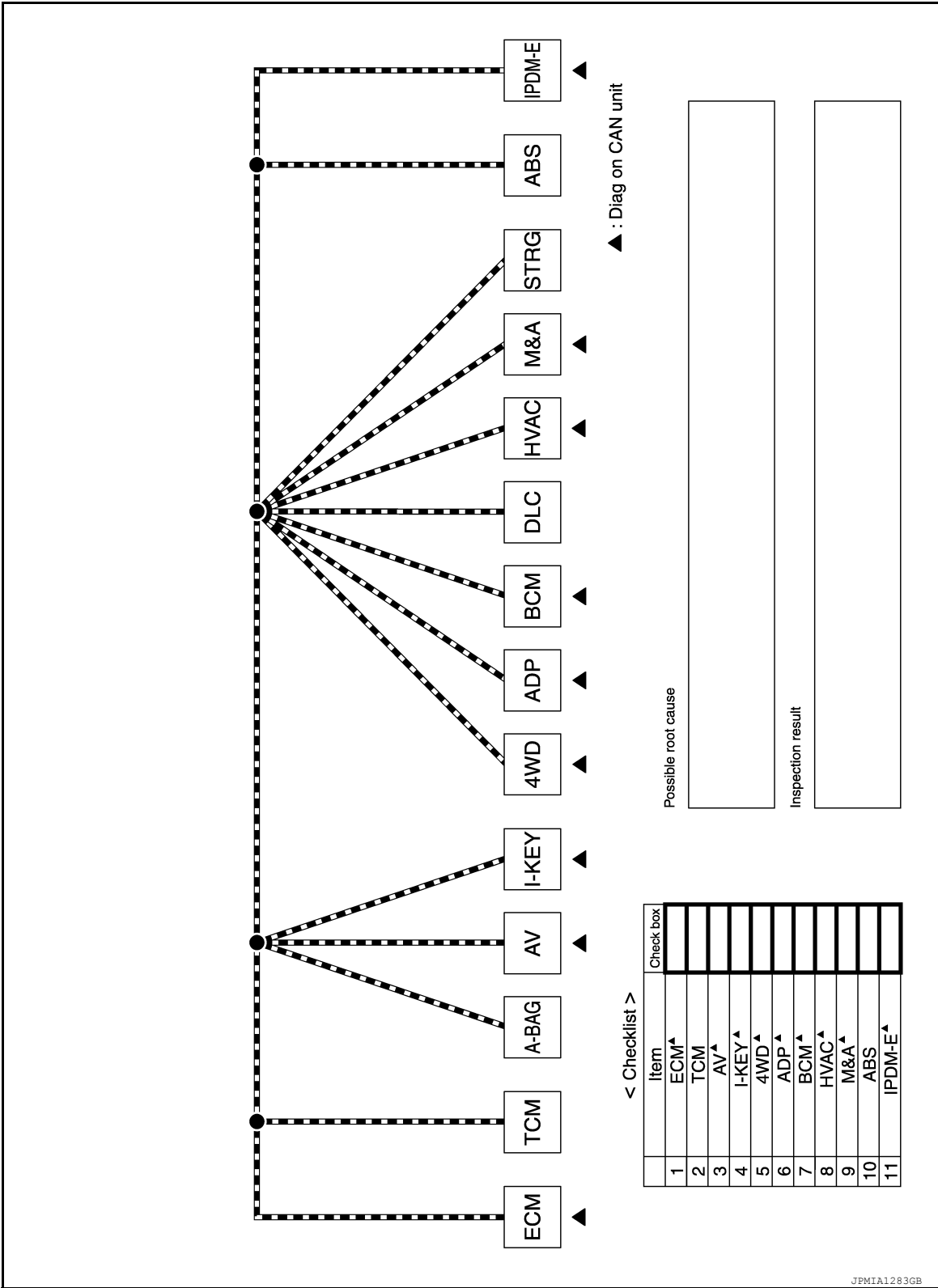

JPMIA1283GB

A
B
C
D
E
F
G
H
I
J
K
L
LAN
N
O
P

CAN COMMUNICATION SYSTEM

< SYSTEM DESCRIPTION >

[CAN]

SYSTEM DESCRIPTION

CAN COMMUNICATION SYSTEM

CAN System Specification Chart

INFOID:000000006247784

Determine CAN system type from the following specification chart. Then choose the correct diagnosis sheet.

NOTE:

Refer to [LAN-14, "Trouble Diagnosis Procedure"](#) for how to use CAN system specification chart.

Body type	Wagon											
Axle	2WD			4WD (Part time)				4WD (All-mode)				
Engine	VQ40DE										VK56 DE	
Transmission	A/T											
Brake control	VDC											
Color display		×	×	×		×	×		×	×	×	×
Intelligent Key system			×	×			×			×	×	×
Automatic drive positioner				×							×	×
Automatic air conditioner		×	×	×		×	×		×	×	×	×
CAN system type	1	2	3	4	5	6	7	8	9	10	11	12
Diagnosis sheet	LAN-40	LAN-41	LAN-42	LAN-43	LAN-44	LAN-45	LAN-46	LAN-47	LAN-48	LAN-49	LAN-50	LAN-51

×: Applicable

VEHICLE EQUIPMENT IDENTIFICATION INFORMATION

NOTE:

CAN COMMUNICATION SYSTEM

[CAN]

< SYSTEM DESCRIPTION >

Check CAN system type from the vehicle shape and equipment.

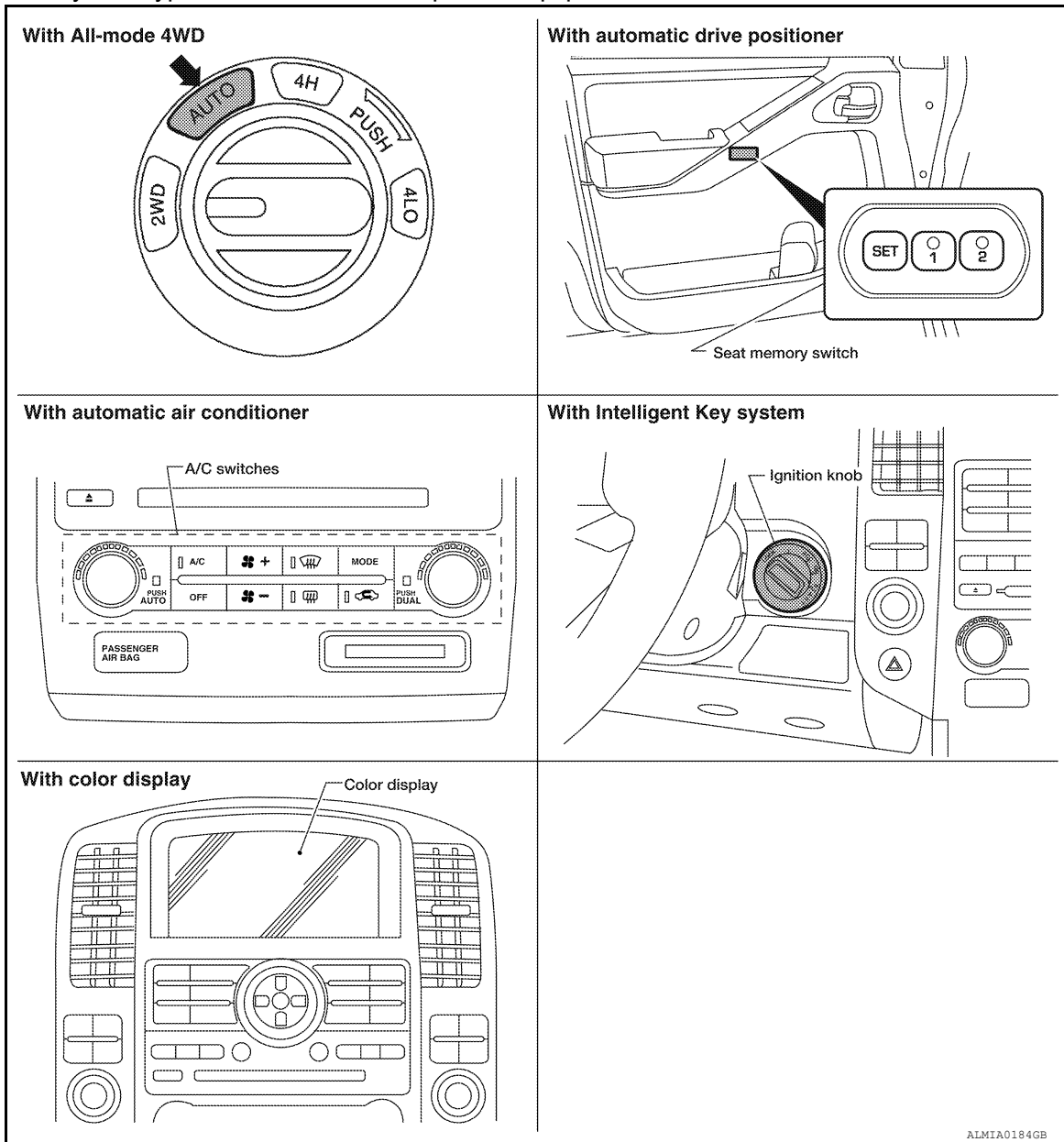

A
B
C
D
E
F
G
H
I
J
K
L

CAN Communication Signal Chart

INFOID:000000006247785

LAN

Refer to [LAN-13, "How to Use CAN Communication Signal Chart"](#) for how to use CAN communication signal chart.

NOTE:

Refer to [LAN-36, "Abbreviation List"](#) for the abbreviations of the connecting units.

T: Transmit R: Receive

Signal name/Connecting unit	ECM	TCM	AV	I-KEY	4WD*1	4WD*2	ADP	BCM	HVAC*3	M&A	STRG	ABS	IPDM-E
A/C compressor request signal	T												R
Accelerator pedal position signal	T	R				R						R	
ASCD CRUISE lamp signal	T									R			
ASCD OD cancel request signal	T	R											
ASCD operation signal	T	R											
ASCD SET lamp signal	T									R			

N
O
P

CAN COMMUNICATION SYSTEM

< SYSTEM DESCRIPTION >

[CAN]

Signal name/Connecting unit	ECM	TCM	AV	I-KEY	4WD*1	4WD*2	ADP	BCM	HVAC*3	M&A	STRG	ABS	IPDM-E
Battery voltage signal	T	R											
Closed throttle position signal	T	R											
Cooling fan speed request signal	T												R
Engine coolant temperature signal	T								R	R			
Engine speed signal	T	R	R	R	R	R			R	R		R	
Engine status signal	T							R					
Fuel consumption monitor signal	T									R			
			R							T			
Malfunction indicator lamp signal	T									R			
Power generation command value signal	T												R
Wide open throttle position signal	T	R											
A/T fluid temperature sensor signal		T								R			
A/T position indicator lamp signal		T			R	R	R			R		R	
A/T self-diagnosis signal	R	T											
Input speed signal	R	T											
O/D OFF indicator signal		T								R			
Output shaft revolution signal	R	T			R	R							
P range signal		T					R			R		R	
System setting signal			T	R			R	R					
			R	T			T	T					
A/C switch/indicator signal			T						R				
			R						T				
Buzzer output signal				T						R			
								T		R			
Door lock/unlock request signal				T				R					
Hazard request signal				T				R					
Hazard warning lamp request signal				T				R					
Ignition knob switch signal				T				R					
Key fob ID signal				T				R					
				R			R	T					
KEY warning signal				T						R			
LOCK warning signal				T						R			
Panic alarm request signal				T				R					
Power window open request signal				T				R					
A/C switch signal	R							T	R				
Blower fan motor switch signal	R							T					
Day time running light request signal								T		R			R
Door lock/unlock status signal				R				T					
Door switch signal			R	R			R	T		R			R
Front fog light request signal								T		R			R
Front wiper request signal								T					R
High beam request signal								T		R			R
Horn chirp signal								T					R

CAN COMMUNICATION SYSTEM

< SYSTEM DESCRIPTION >

[CAN]

Signal name/Connecting unit	ECM	TCM	AV	I-KEY	4WD*1	4WD*2	ADP	BCM	HVAC*3	M&A	STRG	ABS	IPDM-E
Ignition switch signal				R			R	T					R
Key fob door unlock signal							R	T					
Key switch signal							R	T					
Low beam request signal								T					R
Position light request signal								T		R			R
Rear window defogger switch signal								T					R
Sleep wake up signal							R	T		R			R
Theft warning horn request signal								T					R
Tire pressure data signal			R					T					
Tire pressure signal			R					T		R			
Turn indicator signal								T		R			
1st position switch signal*4		R								T			
Distance to empty signal			R							T			
Fuel level low warning signal			R							T			
Fuel level sensor signal	R									T			
Manual mode shift down signal*5		R								T			
Manual mode shift up signal*5		R								T			
Manual mode signal*5		R								T			
Non-manual mode signal*5		R								T			
Overdrive control switch signal*4		R								T			
Seat belt buckle switch signal								R		T			
Stop lamp switch signal		R		R				R		T			
					R							T	
Vehicle speed signal	R	R	R	R			R	R	R	T			
	R				R	R			R	R		T	
Steering angle sensor signal											T	R	
ABS warning lamp signal										R		T	
Brake warning lamp signal										R		T	
Hill descent control indicator lamp signal*6										R		T	
SLIP indicator lamp signal										R		T	
VDC OFF indicator lamp signal										R		T	
Front wiper stop position signal								R					T
High beam status signal	R												T
Low beam status signal	R												T
Rear window defogger control signal	R		R										T

- *1: Part time 4WD models
- *2: All-mode 4WD models
- *3: Models with automatic air conditioner
- *4: Models without manual mode
- *5: Models with manual mode
- *6: Models with hill descent control

NOTE:

CAN data of the air bag diagnosis sensor unit is not used by usual service work, thus it is omitted.

A
B
C
D
E
F
G
H
I
J
K
L
LAN
N
O
P

TROUBLE DIAGNOSIS

[CAN]

< SYSTEM DESCRIPTION >

TROUBLE DIAGNOSIS

CAN Diagnostic Support Monitor

INFOID:000000006247786

Use "CAN DIAG SUPPORT MNTR" for detecting the root cause.

MONITOR ITEM LIST (CONSULT-III)

ECM

0: Error at present, 1 – 39: Error in the past (Number means the number of times the ignition switch is turned OFF→ON)

ITEM	CAN DIAG SUP-PORT MNTR	Description	Normal		Error	
			PRSNT	PAST	PRSNT	PAST
ECM	TRANSMIT DIAG	Signal transmission status	OK	OK or 1 – 39*	UNKWN	0
	VDC/TCS/ABS	Signal receiving status from the ABS actuator and electric unit (control unit)				
	METER/M&A	Signal receiving status from the combination meter				
	BCM/SEC	Signal receiving status from the BCM				
	ICC/ADAS	Not used even though indicated				
	HVAC					
	TCM	Signal receiving status from the TCM	OK	OK or 1 – 39*	UNKWN	0
	MULTI AV	Not used even though indicated				
	EPS					
	IPDM E/R	Signal receiving status from the IPDM E/R	OK	OK or 1 – 39*	UNKWN	0
	e4WD	Not used even though indicated				
	AWD/4WD	Signal receiving status from the transfer control unit	OK	OK or 1 – 39*	UNKWN	0

*: 39 or higher number is fixed at 39 until the self-diagnosis result is erased.

TCM

NOTE:

Replace the unit when "NG" is indicated on the "INITIAL DIAG".

ITEM	CAN DIAG SUP-PORT MNTR	Description	Normal	Error
			PRSNT	
TCM	INITIAL DIAG	Status of CAN controller	OK	NG
	TRANSMIT DIAG	Signal transmission status		
	ECM	Signal receiving status from the ECM		
	VDC/TCS/ABS	Signal receiving status from the ABS actuator and electric unit (control unit)		
	METER/M&A	Signal receiving status from the combination meter		
	ICC/e4WD	Not used even though indicated		
	AWD/4WD	Signal receiving status from the transfer control unit	OK	UNKWN

AV Control Unit

TROUBLE DIAGNOSIS

[CAN]

< SYSTEM DESCRIPTION >

0: Error at present, 1 – 39: Error in the past (Number means the number of times the ignition switch is turned OFF→ON)

ITEM	CAN DIAG SUP-PORT MNTR	Description	Normal		Error					
			PRSNT	PAST	PRSNT	PAST				
AV	TRANSMIT DIAG	Signal transmission status	OK	OK or 1 – 39*	UNKWN	0				
	ECM	Signal receiving status from the ECM								
	METER/M&A	Signal receiving status from the combination meter								
	BCM/SEC	Signal receiving status from the BCM								
	HVAC	Signal receiving status from the A/C auto amp.								
	STRG	Not used even though indicated								
	IPDM E/R	Signal receiving status from the IPDM E/R					OK	OK or 1 – 39*	UNKWN	0
	TIRE-P	Not used even though indicated								

*: 39 or higher number is fixed at 39 until the self-diagnosis result is erased.

Intelligent Key Unit

0: Error at present, 1 – 39: Error in the past (Number means the number of times the ignition switch is turned OFF→ON)

ITEM	CAN DIAG SUP-PORT MNTR	Description	Normal		Error	
			PRSNT	PAST	PRSNT	PAST
I-KEY	TRANSMIT DIAG	Signal transmission status	OK	OK or 1 – 39*	UNKWN	0
	ECM	Signal receiving status from the ECM				
	METER/M&A	Signal receiving status from the combination meter				
	BCM/SEC	Signal receiving status from the BCM				

*: 39 or higher number is fixed at 39 until the self-diagnosis result is erased.

Transfer Control Unit (All-mode 4WD)

0: Error at present, 1 – 39: Error in the past (Number means the number of times the ignition switch is turned OFF→ON)

ITEM	CAN DIAG SUP-PORT MNTR	Description	Normal		Error	
			PRSNT	PAST	PRSNT	PAST
4WD	TRANSMIT DIAG	Signal transmission status	OK	OK or 1 – 39*	UNKWN	0
	ECM	Signal receiving status from the ECM				
	VDC/TCS/ABS	Signal receiving status from the ABS actuator and electric unit (control unit)				
	TCM	Signal receiving status from the TCM				
	STRG	Signal receiving status from the steering angle sensor				

*: 39 or higher number is fixed at 39 until the self-diagnosis result is erased.

Transfer Control Unit (Part Time 4WD)

NOTE:

Replace the unit when “NG” is indicated on the “INITIAL DIAG”.

A
B
C
D
E
F
G
H
I
J
K
L
N
O
P

LAN

TROUBLE DIAGNOSIS

< SYSTEM DESCRIPTION >

[CAN]

ITEM	CAN DIAG SUP-PORT MNTR	Description	Normal	Error
			PRSNT	
4WD	INITIAL DIAG	Status of CAN controller	OK	NG
	TRANSMIT DIAG	Signal transmission status		UNKWN
	ECM	Signal receiving status from the ECM		
	VDC/TCS/ABS	Signal receiving status from the ABS actuator and electric unit (control unit)		
	TCM	Signal receiving status from the TCM		
	METER/M&A	Signal receiving status from the combination meter		

Driver Seat Control Unit

0: Error at present, 1 – 39: Error in the past (Number means the number of times the ignition switch is turned OFF→ON)

ITEM	CAN DIAG SUP-PORT MNTR	Description	Normal		Error	
			PRSNT	PAST	PRSNT	PAST
ADP	TRANSMIT DIAG	Not used even though indicated				
	METER/M&A	Signal receiving status from the combination meter	OK	OK or 1 – 39*	UNKWN	0
	BCM/SEC	Signal receiving status from the BCM				
	TCM	Signal receiving status from the TCM				

*: 39 or higher number is fixed at 39 until the self-diagnosis result is erased.

BCM

NOTE:

Replace the unit when “NG” is indicated on the “INITIAL DIAG”.

ITEM	CAN DIAG SUP-PORT MNTR	Description	Normal	Error
			PRSNT	
BCM	INITIAL DIAG	Status of CAN controller	OK	NG
	TRANSMIT DIAG	Signal transmission status		UNKWN
	ECM	Signal receiving status from the ECM		
	IPDM E/R	Signal receiving status from the IPDM E/R		
	METER/M&A	Signal receiving status from the combination meter		
	I-KEY	Not used even though indicated		

A/C Auto Amp.

TROUBLE DIAGNOSIS

< SYSTEM DESCRIPTION >

[CAN]

0: Error at present, 1 – 39: Error in the past (Number means the number of times the ignition switch is turned OFF→ON)

ITEM	CAN DIAG SUP-PORT MNTR	Description	Normal		Error	
			PRSNT	PAST	PRSNT	PAST
HVAC	TRANSMIT DIAG	Signal transmission status	OK	OK or 1 – 39*	UNKWN	0
	ECM	Signal receiving status from the ECM				
	TCM	Not used even though indicated				
	BCM/SEC	Signal receiving status from the BCM	OK	OK or 1 – 39*	UNKWN	0
	VDC/TCS/ABS	Signal receiving status from the ABS actuator and electric unit (control unit)				
	IPDM E/R	Not used even though indicated				
	DISPLAY	Signal receiving status from the AV control unit	OK	OK or 1 – 39*	UNKWN	0
	I-KEY	Not used even though indicated				
	EPS					
	AWD/4WD					
	e4WD					
	ICC/ADAS					
	LANE CAMERA					
TIRE-P						

*: 39 or higher number is fixed at 39 until the self-diagnosis result is erased.

Combination Meter

0: Error at present, 1 – 39: Error in the past (Number means the number of times the ignition switch is turned OFF→ON)

ITEM	CAN DIAG SUP-PORT MNTR	Description	Normal		Error	
			PRSNT	PAST	PRSNT	PAST
M&A	TRANSMIT DIAG	Signal transmission status	OK	OK or 1 – 39*	UNKWN	0
	ECM	Signal receiving status from the ECM				
	TCM	Signal receiving status from the TCM				
	BCM/SEC	Signal receiving status from the BCM				
	VDC/TCS/ABS	Signal receiving status from the ABS actuator and electric unit (control unit)				
	IPDM E/R	Signal receiving status from the IPDM E/R				
	DISPLAY	Not used even though indicated				
	I-KEY	Signal receiving status from the Intelligent Key unit	OK	OK or 1 – 39*	UNKWN	0
	EPS	Not used even though indicated				
	AWD/4WD					
	e4WD					
	ICC/ADAS					
	LANE CAMERA					
TIRE-P						

*: 39 or higher number is fixed at 39 until the self-diagnosis result is erased.

ABS Actuator and Electric Unit (Control Unit)

TROUBLE DIAGNOSIS

< SYSTEM DESCRIPTION >

[CAN]

ITEM	CAN DIAG SUP-PORT MNTR	Description	Normal	Error	
			PRSNT		
ABS	INITIAL DIAG	Status of CAN controller	OK	NG ^{Caution}	
	TRANSMIT DIAG	Signal transmission status		OK	UNKWN
	ECM	Signal receiving status from the ECM			
	TCM	Signal receiving status from the TCM			
	METER/M&A	Not used even though indicated			
	STRG	Signal receiving status from the steering angle sensor	OK	UNKWN	
	ICC/ADAS	Not used even though indicated			
	AWD/4WD	Signal receiving status from the transfer control unit	OK	UNKWN	

CAUTION:

Never replace the unit even when “NG” is indicated on the “INITIAL DIAG” at this stage. Follow the trouble diagnosis procedures.

IPDM E/R

0: Error at present, 1 – 39: Error in the past (Number means the number of times the ignition switch is turned OFF→ON)

ITEM	CAN DIAG SUP-PORT MNTR	Description	Normal		Error	
			PRSNT	PAST	PRSNT	PAST
IPDM-E	TRANSMIT DIAG	Signal transmission status	OK	OK	UNKWN	0
	ECM	Signal receiving status from the ECM		or		
	BCM/SEC	Signal receiving status from the BCM		1 – 39*		

*: 39 or higher number is fixed at 39 until the self-diagnosis result is erased.

DTC Index

INFOID:000000006247787

DTC	Self-diagnosis item (CONSULT-III indication)	DTC detection condition		Inspection/Action
U0101	LOST COMM (TCM)	When ECM is not transmitting or receiving CAN communication signal of OBD (emission-related diagnosis) from TCM for 2 seconds or more.		Refer to LAN-36 .
U0140	LOST COMM (BCM)	When ECM is not transmitting or receiving CAN communication signal of OBD (emission-related diagnosis) from BCM for 2 seconds or more.		
U0164	LOST COMM (HVAC)	When ECM is not transmitting or receiving CAN communication signal of OBD (emission-related diagnosis) from A/C auto amp. or unified meter and A/C amp. for 2 seconds or more.		
U1000	CAN COMM CIRCUIT	ECM	When ECM is not transmitting or receiving CAN communication signal of OBD (emission-related diagnosis) for 2 seconds or more.	
		Except for ECM	When a control unit (except for ECM) is not transmitting or receiving CAN communication signal for 2 seconds or more.	
U1001	CAN COMM CIRCUIT	When ECM is not transmitting or receiving CAN communication signal other than OBD (emission-related diagnosis) for 2 seconds or more.		
U1002	SYSTEM COMM	When a control unit is not transmitting or receiving CAN communication signal for 2 seconds or less.		
U1010	CONTROL UNIT(CAN)	When an error is detected during the initial diagnosis for CAN controller of each control unit.		Replace the control unit indicating “U1010” or “P0607”.
P0607	ECM			

WIRING DIAGRAM

CAN SYSTEM

Wiring Diagram

INFOID:000000006247789

- ◊ : WITH BOSE AUDIO SYSTEM - WITHOUT NAVI
- ◊ : WITH BOSE AUDIO SYSTEM - WITH NAVI
- ◊ : WITH COLOR DISPLAY
- ◊ : WITH INTELLIGENT KEY SYSTEM
- ◊ : WITH MID AUDIO SYSTEM
- ◊ : WITH VK56DE
- ◊ : WITH VQ40DE
- ◊ : 86
- ◊ : 99 *2 ◊ : 100
- ◊ : 86
- ◊ : 87

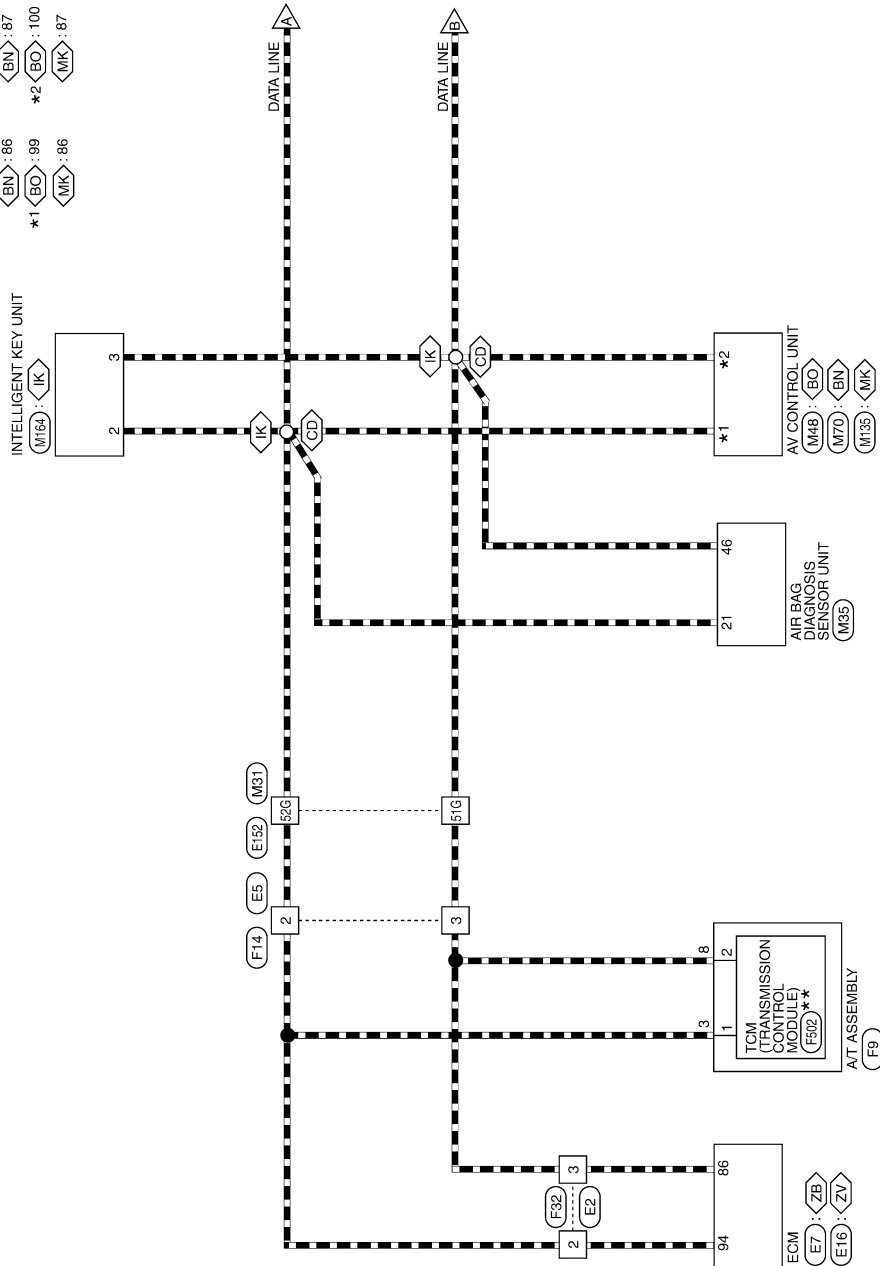

** : THIS CONNECTOR IS NOT SHOWN IN "HARNES LAYOUT" OF PG SECTION.

ABMWA0495GB

A
B
C
D
E
F
G
H
I
J
K
L
N
O
P

LAN

CAN SYSTEM

< WIRING DIAGRAM >

[CAN]

- <AM> : 7
- *3 <PT> : 1
- *4 <AM> : 8
- <PT> : 2
- *5 <ZV> : 11
- *6 <ZV> : 13
- <ZB> : 15

- <4W> : WITH 4-WHEEL DRIVE
- <AD> : WITH AUTOMATIC DRIVE POSITIONER
- <AM> : ALL-MODE 4WD SYSTEM
- <CD> : WITH COLOR DISPLAY
- <PT> : PART TIME 4WD SYSTEM
- <ZV> : WITH VK56DE
- <ZB> : WITH VQ40DE

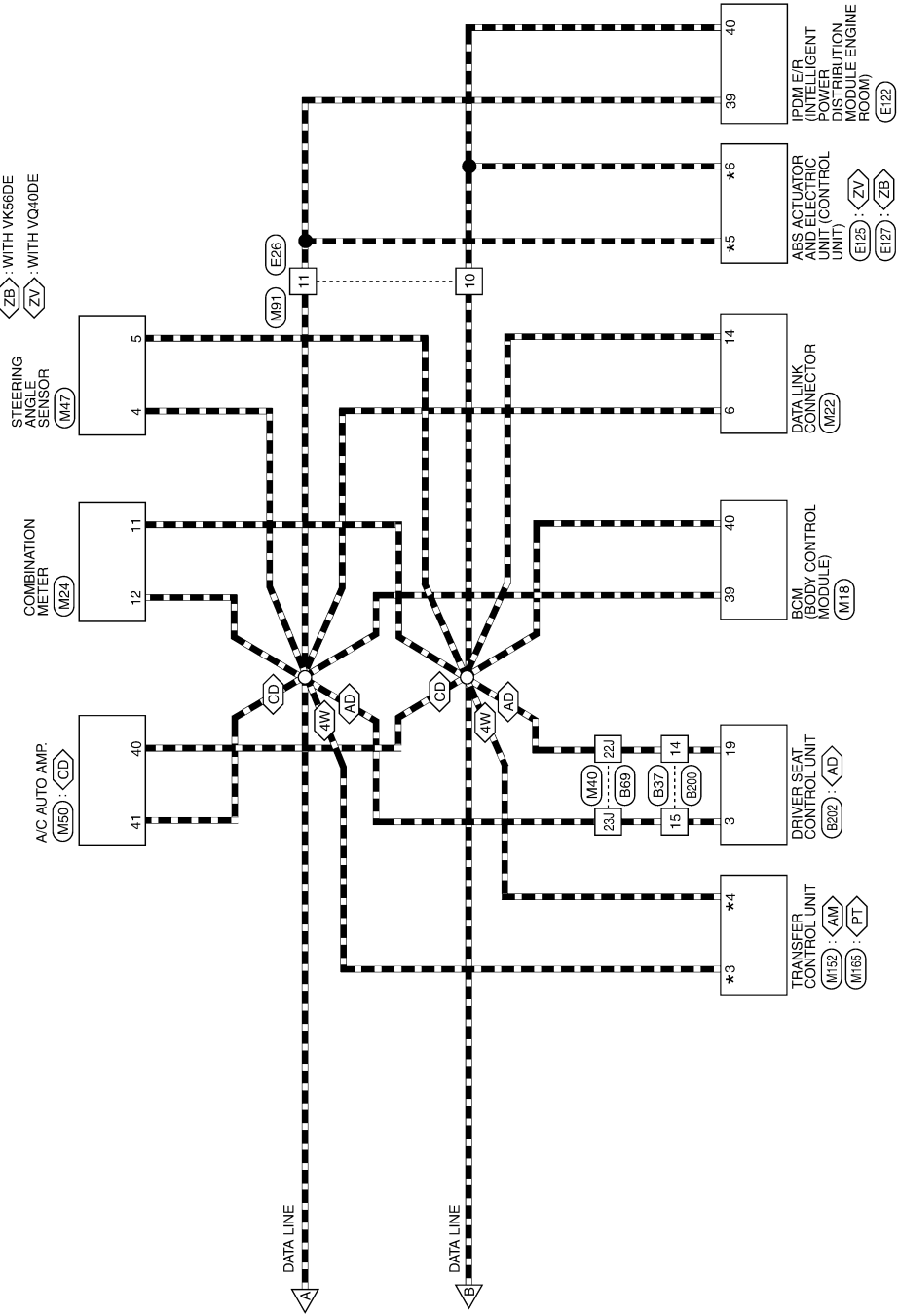

ABMWA0496GB

CAN SYSTEM CONNECTORS

Connector No.	M18
Connector Name	BCM (BODY CONTROL MODULE)
Connector Color	WHITE

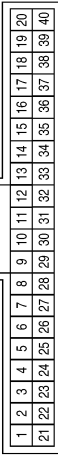

Terminal No.	Color of Wire	Signal Name
39	L	CAN-H
40	P	CAN-L

Connector No.	M31
Connector Name	WIRE TO WIRE
Connector Color	WHITE

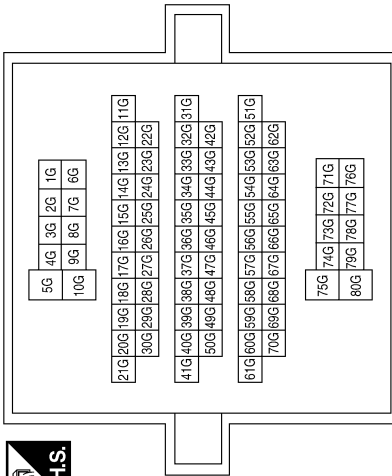

Terminal No.	Color of Wire	Signal Name
51G	P	-
52G	L	-

Connector No.	M22
Connector Name	DATA LINK CONNECTOR
Connector Color	WHITE

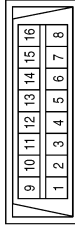

Terminal No.	Color of Wire	Signal Name
6	L	-
14	P	-

Connector No.	M35
Connector Name	AIR BAG DIAGNOSIS SENSOR UNIT
Connector Color	YELLOW

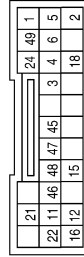

Terminal No.	Color of Wire	Signal Name
21	L	CAN-H
46	P	CAN-L

Connector No.	M24
Connector Name	COMBINATION METER
Connector Color	WHITE

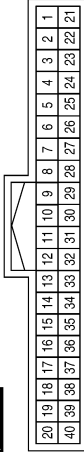

Terminal No.	Color of Wire	Signal Name
11	P	CAN-L
12	L	CAN-H

Connector No.	M40
Connector Name	WIRE TO WIRE
Connector Color	WHITE

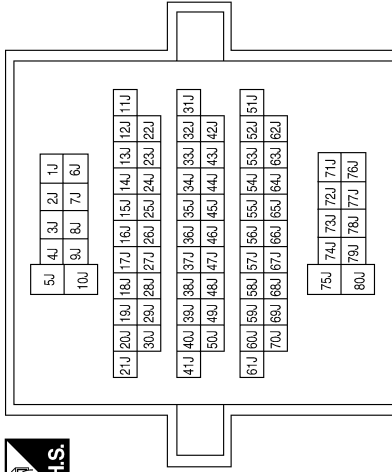

Terminal No.	Color of Wire	Signal Name
22J	P	-
23J	L	-

A
B
C
D
E
F
G
H
I
J
K
L
N
O
P

LAN

ABM1A1323GB

CAN SYSTEM

< WIRING DIAGRAM >

[CAN]

Connector No.	M50
Connector Name	A/C AUTO AMP.
Connector Color	BLUE



29	38	37	36	35	34	33	32	31	30	29	28	27
52	51	50	49	48	47	46	45	44	43	42	41	40

Terminal No.	Color of Wire	Signal Name
40	P	CAN-L
41	L	CAN-H

Connector No.	M48
Connector Name	AV CONTROL UNIT (WITH BOSE AUDIO SYSTEM - WITH NAVI)
Connector Color	WHITE



69	71	73	77	79	81	83	85	87	89	91	93	95	97	99	101	103	105	107	
68	70	72	74	76	78	80	82	84	86	88	90	92	94	96	98	100	102	104	106

Terminal No.	Color of Wire	Signal Name
99	L	CAN-H
100	P	CAN-L

Connector No.	M47
Connector Name	STEERING ANGLE SENSOR
Connector Color	WHITE



1	2	3		
4	5	6	7	8

Terminal No.	Color of Wire	Signal Name
4	L	CAN-H
5	P	CAN-L

Connector No.	M135
Connector Name	AV CONTROL UNIT (WITH MID AUDIO SYSTEM)
Connector Color	WHITE



91	90	89	88	87	86	85	84	83	82	81	80	79	78	77	76
107	106	105	104	103	102	101	100	99	98	97	96	95	94	93	92

Terminal No.	Color of Wire	Signal Name
86	L	CAN-H
87	P	CAN-L

Connector No.	M91
Connector Name	WIRE TO WIRE
Connector Color	WHITE



7	6	5	4	3	2	1		
16	15	14	13	12	11	10	9	8

Terminal No.	Color of Wire	Signal Name
10	P	-
11	L	-

Connector No.	M70
Connector Name	AV CONTROL UNIT (WITH BOSE AUDIO SYSTEM - WITHOUT NAVI)
Connector Color	WHITE



91	90	89	88	87	86	85	84	83	82	81	80	79	78	77	76
107	106	105	104	103	102	101	100	99	98	97	96	95	94	93	92

Terminal No.	Color of Wire	Signal Name
86	L	CAN-H
87	P	CAN-L

ABM1A1324GB

CAN SYSTEM

< WIRING DIAGRAM >

[CAN]

Connector No.	M165
Connector Name	TRANSFER CONTROL UNIT (PART TIME 4WD SYSTEM)
Connector Color	WHITE

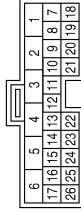

Terminal No.	Color of Wire	Signal Name
1	L	CAN-H
2	P	CAN-L

Connector No.	M164
Connector Name	INTELLIGENT KEY UNIT
Connector Color	WHITE

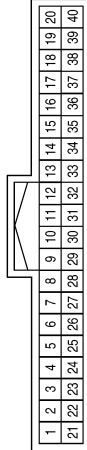

Terminal No.	Color of Wire	Signal Name
2	L	CAN-H
3	P	CAN-L

Connector No.	M152
Connector Name	TRANSFER CONTROL UNIT (ALL-MODE 4WD SYSTEM)
Connector Color	WHITE

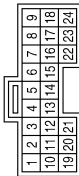

Terminal No.	Color of Wire	Signal Name
7	L	CAN-H
8	P	CAN-L

Connector No.	E7
Connector Name	ECM (WITH VK56DE)
Connector Color	BLACK

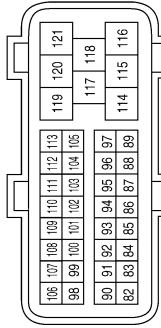

Terminal No.	Color of Wire	Signal Name
86	P	CAN-L
94	L	CAN-H

Connector No.	E5
Connector Name	WIRE TO WIRE
Connector Color	WHITE



Terminal No.	Color of Wire	Signal Name
2	L	-
3	P	-

Connector No.	E2
Connector Name	WIRE TO WIRE
Connector Color	WHITE

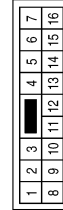

Terminal No.	Color of Wire	Signal Name
2	L	-
3	P	-

A
B
C
D
E
F
G
H
I
J
K
L
N
O
P

LAN

CAN SYSTEM

< WIRING DIAGRAM >

[CAN]

Connector No.	E16
Connector Name	ECM (WITH VQ40DE)
Connector Color	BLACK

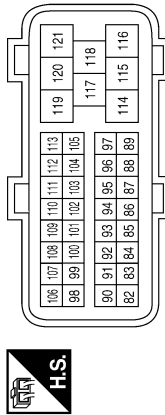

Terminal No.	Color of Wire	Signal Name
86	P	CAN-L
94	L	CAN-H

Connector No.	E26
Connector Name	WIRE TO WIRE
Connector Color	WHITE

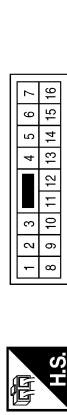

Terminal No.	Color of Wire	Signal Name
10	P	-
11	L	-

Connector No.	E122
Connector Name	IPDM E/R (INTELLIGENT POWER DISTRIBUTION MODULE ENGINE ROOM)
Connector Color	WHITE

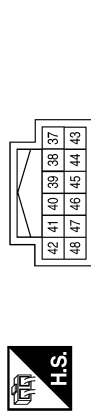

Terminal No.	Color of Wire	Signal Name
39	L	CAN-H
40	P	CAN-L

Connector No.	E125
Connector Name	ABS ACTUATOR AND ELECTRIC UNIT (CONTROL UNIT) (WITH VQ40DE)
Connector Color	BLACK

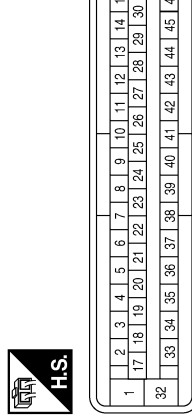

Terminal No.	Color of Wire	Signal Name
12	L	CAN-H
13	P	CAN-L

Connector No.	E127
Connector Name	ABS ACTUATOR AND ELECTRIC UNIT (CONTROL UNIT) (WITH VK56DE)
Connector Color	BLACK

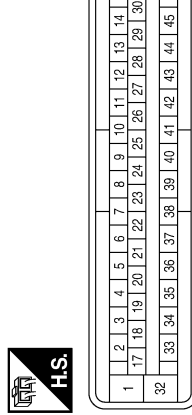

Terminal No.	Color of Wire	Signal Name
11	L	CAN-H
15	P	CAN-L

Connector No.	E152
Connector Name	WIRE TO WIRE
Connector Color	WHITE

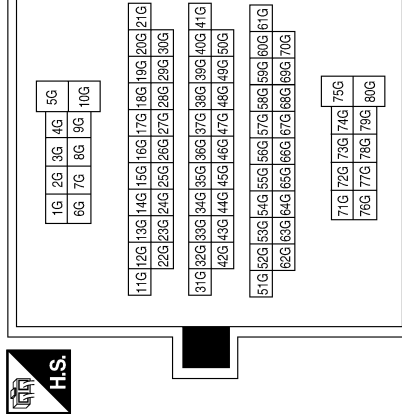

Terminal No.	Color of Wire	Signal Name
51G	P	-
52G	L	-

ABM1A1326GB

CAN SYSTEM

< WIRING DIAGRAM >

[CAN]

Connector No.	F9
Connector Name	A/T ASSEMBLY
Connector Color	GREEN



Terminal No.	Color of Wire	Signal Name
3	L	-
8	P	-

Connector No.	F14
Connector Name	WIRE TO WIRE
Connector Color	WHITE

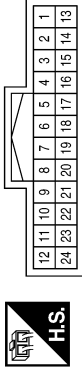

Terminal No.	Color of Wire	Signal Name
2	L	-
3	P	-

Connector No.	F32
Connector Name	WIRE TO WIRE
Connector Color	WHITE



Terminal No.	Color of Wire	Signal Name
2	L	-
3	P	-

Connector No.	F502
Connector Name	TCM (TRANSMISSION CONTROL MODULE)
Connector Color	GRAY

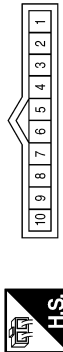

Terminal No.	Color of Wire	Signal Name
1	BR	CAN-H
2	LY	CAN-L

Connector No.	B37
Connector Name	WIRE TO WIRE
Connector Color	WHITE

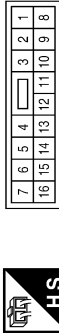

Terminal No.	Color of Wire	Signal Name
14	P	-
15	L	-

Connector No.	B69
Connector Name	WIRE TO WIRE
Connector Color	WHITE

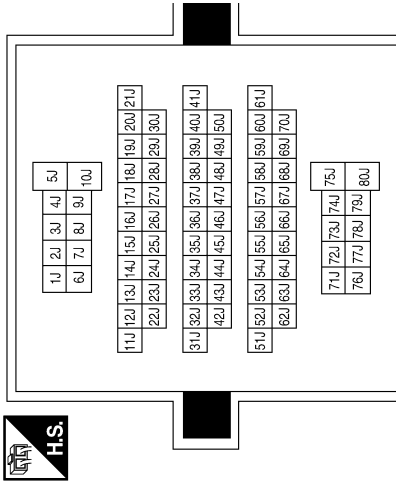

Terminal No.	Color of Wire	Signal Name
22J	P	-
23J	L	-

A
B
C
D
E
F
G
H
I
J
K
L
LAN
N
O
P

ABM1A1327GB

CAN SYSTEM

< WIRING DIAGRAM >

[CAN]

Connector No.	B202
Connector Name	DRIVER SEAT CONTROL UNIT
Connector Color	WHITE



1	2	3	4	5	6	7	8	9	10	11	12	13	14	15	16
17	18	19	20	21	22	23	24	25	26	27	28	29	30	31	32

Terminal No.	Color of Wire	Signal Name
3	L	CAN-H
19	P	CAN-L

Connector No.	B200
Connector Name	WIRE TO WIRE
Connector Color	WHITE



1	2	3	4	5	6	7		
8	9	10	11	12	13	14	15	16

Terminal No.	Color of Wire	Signal Name
14	P	-
15	L	-

ABMIA1328GB

CAN COMMUNICATION SYSTEM

< DTC/CIRCUIT DIAGNOSIS >

[CAN]

DTC/CIRCUIT DIAGNOSIS

CAN COMMUNICATION SYSTEM

Component Parts Location

INFOID:000000006247788

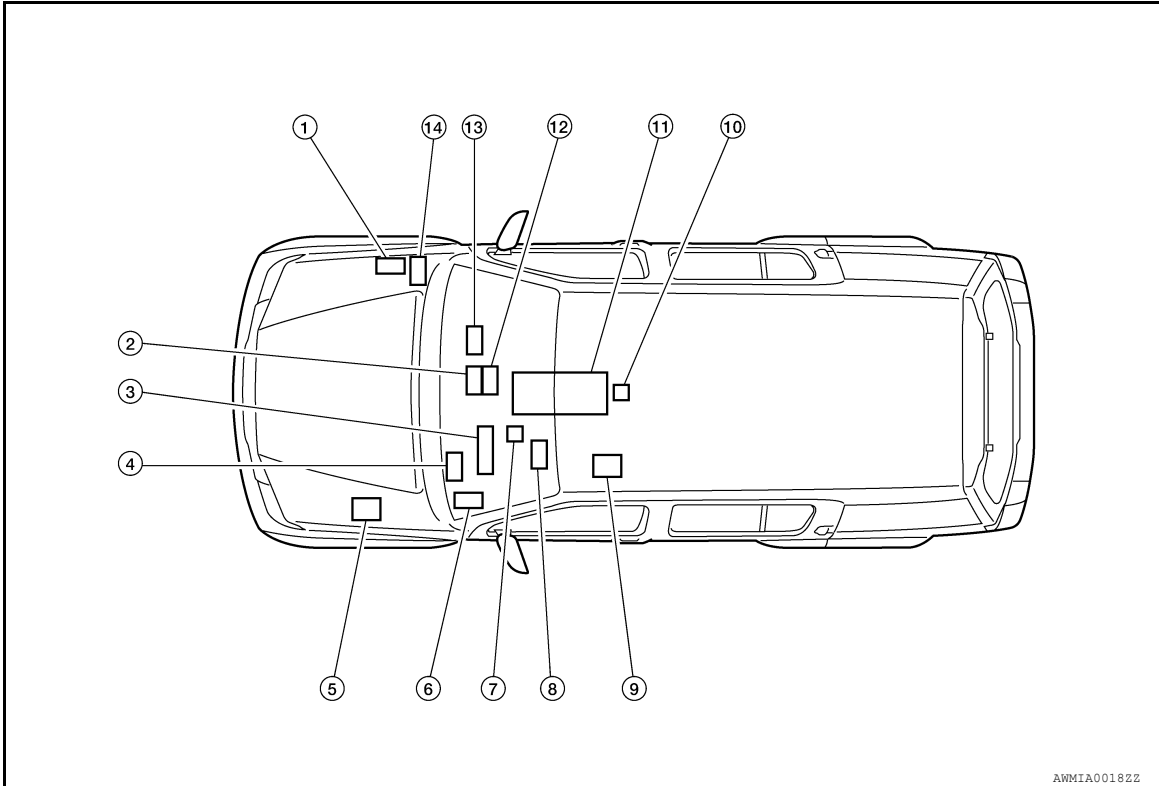

- | | | |
|---|---|---|
| 1. ECM
E7: VK engine models
E16: VQ engine models | 2. AV control unit
M48: With BOSE audio system with navigation system
M70: Without BOSE audio system without navigation system
M135: With mid audio system | 3. Combination meter M24 |
| 4. BCM M18 | 5. ABS actuator and electric unit (control unit)
E125: VQ engine models
E127: VK engine models | 6. Transfer control unit
M152: All-mode 4WD models
M165: Part time 4WD models |
| 7. Data link connector M22 | 8. Steering angle sensor M47 | 9. Driver seat control unit B202 |
| 10. Air bag diagnosis sensor unit M35 | 11. A/T assembly F9 | 12. A/C auto amp. M50 |
| 13. Intelligent Key unit M164 | 14. IPDM E/R E122 | |

A
B
C
D
E
F
G
H
I
J
K
L
LAN
N
O
P

MALFUNCTION AREA CHART

< DTC/CIRCUIT DIAGNOSIS >

[CAN]

MALFUNCTION AREA CHART

Main Line

INFOID:000000006247790

Malfunction area	Reference
Main line between TCM and air bag diagnosis sensor unit	LAN-71, "Diagnosis Procedure"
Main line between air bag diagnosis sensor unit and data link connector	LAN-73, "Diagnosis Procedure"
Main line between data link connector and ABS actuator and electric unit (control unit)	LAN-74, "Diagnosis Procedure"

Branch Line

INFOID:000000006247791

Malfunction area	Reference
ECM branch line circuit	LAN-75, "Diagnosis Procedure"
TCM branch line circuit	LAN-76, "Diagnosis Procedure"
AV control unit branch line circuit	LAN-77, "Diagnosis Procedure"
Intelligent Key unit branch line circuit	LAN-78, "Diagnosis Procedure"
Transfer control unit branch line circuit	LAN-79, "Diagnosis Procedure"
Driver seat control unit branch line circuit	LAN-80, "Diagnosis Procedure"
BCM branch line circuit	LAN-81, "Diagnosis Procedure"
Data link connector branch line circuit	LAN-82, "Diagnosis Procedure"
A/C auto amp. branch line circuit	LAN-83, "Diagnosis Procedure"
Combination meter branch line circuit	LAN-84, "Diagnosis Procedure"
Steering angle sensor branch line circuit	LAN-85, "Diagnosis Procedure"
ABS actuator and electric unit (control unit) branch line circuit	LAN-86, "Diagnosis Procedure"
IPDM E/R branch line circuit	LAN-87, "Diagnosis Procedure"

Short Circuit

INFOID:000000006247792

Malfunction area	Reference
CAN communication circuit	LAN-88, "Diagnosis Procedure"

MAIN LINE BETWEEN TCM AND A-BAG CIRCUIT

< DTC/CIRCUIT DIAGNOSIS >

[CAN]

MAIN LINE BETWEEN TCM AND A-BAG CIRCUIT

Diagnosis Procedure

INFOID:000000006247793

1.CHECK CONNECTOR

1. Turn the ignition switch OFF.
2. Disconnect the battery cable from the negative terminal.
3. Check the following terminals and connectors for damage, bend and loose connection (connector side and harness side).
 - Harness connector F14
 - Harness connector E5
 - Harness connector E152
 - Harness connector M31

Is the inspection result normal?

YES >> GO TO 2.

NO >> Repair the terminal and connector.

2.CHECK HARNESS CONTINUITY (OPEN CIRCUIT)

1. Disconnect the following harness connectors.
 - A/T assembly
 - Harness connectors F14 and E5
2. Check the continuity between the A/T assembly harness connector and the harness connector.

A/T assembly harness connector		Harness connector		Continuity
Connector No.	Terminal No.	Connector No.	Terminal No.	
F9	3	F14	2	Existed
	8		3	Existed

Is the inspection result normal?

YES >> GO TO 3.

NO >> Repair the main line between the A/T assembly and the harness connector F14.

3.CHECK HARNESS CONTINUITY (OPEN CIRCUIT)

1. Disconnect the harness connectors E152 and M31.
2. Check the continuity between the harness connectors.

Harness connector		Harness connector		Continuity
Connector No.	Terminal No.	Connector No.	Terminal No.	
E5	2	E152	52G	Existed
	3		51G	Existed

Is the inspection result normal?

YES >> GO TO 4.

NO >> Repair the main line between the harness connectors E5 and E152.

4.CHECK HARNESS CONTINUITY (OPEN CIRCUIT)

Check the continuity between the harness connector and the data link connector.

Harness connector		Data link connector		Continuity
Connector No.	Terminal No.	Connector No.	Terminal No.	
M31	52G	M22	6	Existed
	51G		14	Existed

Is the inspection result normal?

YES (Present error)>>Check the following items again.

- Decision of CAN system type.

MAIN LINE BETWEEN TCM AND A-BAG CIRCUIT

< DTC/CIRCUIT DIAGNOSIS >

[CAN]

- Not received CONSULT-III data [SELF-DIAG RESULTS, CAN DIAG SUPPORT MNTR ("ECU list" included)].
- Procedure for detecting root cause.

YES (Past error)>>Error was detected in the main line between the TCM and the air bag diagnosis sensor unit.

NO >> Repair the main line between the harness connector M31 and the air bag diagnosis sensor unit.

MAIN LINE BETWEEN A-BAG AND DLC CIRCUIT

< DTC/CIRCUIT DIAGNOSIS >

[CAN]

MAIN LINE BETWEEN A-BAG AND DLC CIRCUIT

Diagnosis Procedure

INFOID:000000006247794

1. CHECK HARNESS CONTINUITY (OPEN CIRCUIT)

1. Turn the ignition switch OFF.
2. Disconnect the battery cable from the negative terminal.
3. Disconnect the harness connectors E152 and M31.
4. Check the continuity between the harness connector and the data link connector.

Harness connector		Data link connector		Continuity
Connector No.	Terminal No.	Connector No.	Terminal No.	
M31	52G	M22	6	Existed
	51G		14	Existed

Is the inspection result normal?

YES (Present error)>>Check the following items again.

- Decision of CAN system type.
- Not received CONSULT-III data [SELF-DIAG RESULTS, CAN DIAG SUPPORT MNTR (“ECU list” included)].
- Procedure for detecting root cause.

YES (Past error)>>Error was detected in the main line between the air bag diagnosis sensor unit and the data link connector.

NO >> Repair the main line between the air bag diagnosis sensor unit and the data link connector.

A
B
C
D
E
F
G
H
I
J
K
L

LAN

N
O
P

MAIN LINE BETWEEN DLC AND ABS CIRCUIT

< DTC/CIRCUIT DIAGNOSIS >

[CAN]

MAIN LINE BETWEEN DLC AND ABS CIRCUIT

Diagnosis Procedure

INFOID:000000006247795

1. CHECK CONNECTOR

1. Turn the ignition switch OFF.
2. Disconnect the battery cable from the negative terminal.
3. Check the following terminals and connectors for damage, bend and loose connection (connector side and harness side).
 - Harness connector M91
 - Harness connector E26

Is the inspection result normal?

YES >> GO TO 2.

NO >> Repair the terminal and connector.

2. CHECK HARNESS CONTINUITY (OPEN CIRCUIT)

1. Disconnect the harness connectors M91 and E26.
2. Check the continuity between the data link connector and the harness connector.

Data link connector		Harness connector		Continuity
Connector No.	Terminal No.	Connector No.	Terminal No.	
M22	6	M91	11	Existed
	14		10	Existed

Is the inspection result normal?

YES >> GO TO 3.

NO >> Repair the main line between the data link connector and the harness connector M91.

3. CHECK HARNESS CONTINUITY (OPEN CIRCUIT)

1. Disconnect the connector of ABS actuator and electric unit (control unit).
2. Check the continuity between the harness connector and the ABS actuator and electric unit (control unit) harness connector.
 - VQ engine models

Harness connector		ABS actuator and electric unit (control unit) harness connector		Continuity
Connector No.	Terminal No.	Connector No.	Terminal No.	
E26	11	E125	12	Existed
	10		13	Existed

- VK engine models

Harness connector		ABS actuator and electric unit (control unit) harness connector		Continuity
Connector No.	Terminal No.	Connector No.	Terminal No.	
E26	11	E127	11	Existed
	10		15	Existed

Is the inspection result normal?

YES (Present error)>>Check the following items again.

- Decision of CAN system type.
- Not received CONSULT-III data [SELF-DIAG RESULTS, CAN DIAG SUPPORT MNTR ("ECU list" included)].
- Procedure for detecting root cause.

YES (Past error)>>Error was detected in the main line between the data link connector and the ABS actuator and electric unit (control unit).

NO >> Repair the main line between the harness connector E26 and the ABS actuator and electric unit (control unit).

ECM BRANCH LINE CIRCUIT

< DTC/CIRCUIT DIAGNOSIS >

[CAN]

ECM BRANCH LINE CIRCUIT

Diagnosis Procedure

INFOID:000000006247796

1. CHECK CONNECTOR

1. Turn the ignition switch OFF.
2. Disconnect the battery cable from the negative terminal.
3. Check the following terminals and connectors for damage, bend and loose connection (unit side and connector side).
 - ECM
 - Harness connector E2
 - Harness connector F32

Is the inspection result normal?

YES >> GO TO 2.

NO >> Repair the terminal and connector.

2. CHECK HARNESS FOR OPEN CIRCUIT

1. Disconnect the connector of ECM.
2. Check the resistance between the ECM harness connector terminals.
 - VQ engine models

ECM harness connector			Resistance (Ω)
Connector No.	Terminal No.		
E16	94	86	Approx. 108 – 132

- VK engine models

ECM harness connector			Resistance (Ω)
Connector No.	Terminal No.		
E7	94	86	Approx. 108 – 132

Is the measurement value within the specification?

YES >> GO TO 3.

NO >> Repair the ECM branch line.

3. CHECK POWER SUPPLY AND GROUND CIRCUIT

Check the power supply and the ground circuit of the ECM. Refer to the following.

- VQ40DE: [EC-94, "Diagnosis Procedure"](#)
- VK56DE: [EC-609, "Diagnosis Procedure"](#)

Is the inspection result normal?

YES (Present error)>>Replace the ECM. Refer to the following.

- VQ40DE: [EC-24, "Procedure After Replacing ECM"](#)
- VK56DE: [EC-592, "Procedure After Replacing ECM"](#)

YES (Past error)>>Error was detected in the ECM branch line.

NO >> Repair the power supply and the ground circuit.

A
B
C
D
E
F
G
H
I
J
K
L
N
O
P

LAN

TCM BRANCH LINE CIRCUIT

< DTC/CIRCUIT DIAGNOSIS >

[CAN]

TCM BRANCH LINE CIRCUIT

Diagnosis Procedure

INFOID:000000006247797

1. CHECK CONNECTOR

1. Turn the ignition switch OFF.
2. Disconnect the battery cable from the negative terminal.
3. Check the terminals and connectors of the A/T assembly for damage, bend and loose connection (unit side and connector side).

Is the inspection result normal?

- YES >> GO TO 2.
NO >> Repair the terminal and connector.

2. CHECK HARNESS FOR OPEN CIRCUIT

1. Disconnect the connector of A/T assembly.
2. Check the resistance between the A/T assembly harness connector terminals.

A/T assembly harness connector			Resistance (Ω)
Connector No.	Terminal No.		
F9	3	8	Approx. 54 – 66

Is the measurement value within the specification?

- YES >> GO TO 3.
NO >> Repair the TCM branch line.

3. CHECK HARNESS FOR OPEN CIRCUIT

1. Remove the control valve with TCM. Refer to [TM-174, "Removal and Installation"](#).
2. Disconnect the connector of TCM.
3. Check the continuity between the A/T assembly harness connector and TCM harness connector.

A/T assembly harness connector	TCM harness connector		Continuity
Terminal No.	Connector No.	Terminal No.	
3	F502	1	Existed
8		2	Existed

Is the inspection result normal?

- YES >> GO TO 4.
NO >> Repair the harness between the A/T assembly harness connector and the TCM harness connector.

4. CHECK POWER SUPPLY AND GROUND CIRCUIT

Check the power supply and the ground circuit of the TCM. Refer to [TM-100, "Diagnosis Procedure"](#).

Is the inspection result normal?

- YES (Present error)>>Replace the control valve with TCM. Refer to [TM-174, "Removal and Installation"](#).
YES (Past error)>>Error was detected in the TCM branch line.
NO >> Repair the power supply and the ground circuit.

AV BRANCH LINE CIRCUIT

< DTC/CIRCUIT DIAGNOSIS >

[CAN]

AV BRANCH LINE CIRCUIT

Diagnosis Procedure

INFOID:000000006247798

1. CHECK CONNECTOR

1. Turn the ignition switch OFF.
2. Disconnect the battery cable from the negative terminal.
3. Check the terminals and connectors of the AV control unit for damage, bend and loose connection (unit side and connector side).

Is the inspection result normal?

- YES >> GO TO 2.
NO >> Repair the terminal and connector.

2. CHECK HARNESS FOR OPEN CIRCUIT

1. Disconnect the connector of AV control unit.
 2. Check the resistance between the AV control unit harness connector terminals.
- With BOSE audio system with navigation system

AV control unit harness connector			Resistance (Ω)
Connector No.	Terminal No.		
M48	99	100	Approx. 54 – 66

- With BOSE audio system without navigation system

AV control unit harness connector			Resistance (Ω)
Connector No.	Terminal No.		
M70	86	87	Approx. 54 – 66

- With mid audio system

AV control unit harness connector			Resistance (Ω)
Connector No.	Terminal No.		
M135	86	87	Approx. 54 – 66

Is the measurement value within the specification?

- YES >> GO TO 3.
NO >> Repair the AV control unit branch line.

3. CHECK POWER SUPPLY AND GROUND CIRCUIT

Check the power supply and the ground circuit of the AV control unit. Refer to the following.

- With BOSE audio system with navigation system: [AV-334. "AV CONTROL UNIT : Diagnosis Procedure"](#)
- With BOSE audio system without navigation system: [AV-163. "AV CONTROL UNIT : Diagnosis Procedure"](#)
- With mid audio system: [AV-64. "AV CONTROL UNIT : Diagnosis Procedure"](#)

Is the inspection result normal?

- YES (Present error)>>Replace the AV control unit. Refer to the following.
- With BOSE audio system with navigation system: [AV-420. "Removal and Installation"](#)
 - With BOSE audio system without navigation system: [AV-256. "Removal and Installation"](#)
 - With mid audio system: [AV-113. "Removal and Installation"](#)

YES (Past error)>>Error was detected in the AV control unit branch line.

- NO >> Repair the power supply and the ground circuit.

I-KEY BRANCH LINE CIRCUIT

< DTC/CIRCUIT DIAGNOSIS >

[CAN]

I-KEY BRANCH LINE CIRCUIT

Diagnosis Procedure

INFOID:000000006247799

1. CHECK CONNECTOR

1. Turn the ignition switch OFF.
2. Disconnect the battery cable from the negative terminal.
3. Check the terminals and connectors of the Intelligent Key unit for damage, bend and loose connection (unit side and connector side).

Is the inspection result normal?

- YES >> GO TO 2.
NO >> Repair the terminal and connector.

2. CHECK HARNESS FOR OPEN CIRCUIT

1. Disconnect the connector of Intelligent Key unit.
2. Check the resistance between the Intelligent Key unit harness connector terminals.

Intelligent Key unit harness connector			Resistance (Ω)
Connector No.	Terminal No.		
M164	2	3	Approx. 54 – 66

Is the measurement value within the specification?

- YES >> GO TO 3.
NO >> Repair the Intelligent Key unit branch line.

3. CHECK POWER SUPPLY AND GROUND CIRCUIT

Check the power supply and the ground circuit of the Intelligent Key unit. Refer to [DLK-54, "INTELLIGENT KEY UNIT : Diagnosis Procedure"](#).

Is the inspection result normal?

- YES (Present error)>>Replace the Intelligent Key unit.
YES (Past error)>>Error was detected in the Intelligent Key unit branch line.
NO >> Repair the power supply and the ground circuit.

4WD BRANCH LINE CIRCUIT

< DTC/CIRCUIT DIAGNOSIS >

[CAN]

4WD BRANCH LINE CIRCUIT

Diagnosis Procedure

INFOID:000000006247800

1. CHECK CONNECTOR

1. Turn the ignition switch OFF.
2. Disconnect the battery cable from the negative terminal.
3. Check the terminals and connectors of the transfer control unit connector for damage, bend and loose connection (unit side and connector side).

Is the inspection result normal?

- YES >> GO TO 2.
NO >> Repair the terminal and connector.

2. CHECK HARNESS FOR OPEN CIRCUIT

1. Disconnect the connector of transfer control unit.
 2. Check the resistance between the transfer control unit harness connector terminals.
- All-mode 4WD models

Transfer control unit harness connector			Resistance (Ω)
Connector No.	Terminal No.		
M152	7	8	Approx. 54 – 66

- Part time 4WD models

Transfer control unit harness connector			Resistance (Ω)
Connector No.	Terminal No.		
M165	1	2	Approx. 54 – 66

Is the measurement value within the specification?

- YES >> GO TO 3.
NO >> Repair the transfer control unit branch line.

3. CHECK POWER SUPPLY AND GROUND CIRCUIT

Check the power supply and the ground circuit of the transfer control unit. Refer to the following.

- All-mode 4WD models: [DLN-28. "Diagnosis Procedure"](#)
- Part time 4WD models: [DLN-206. "Diagnosis Procedure"](#)

Is the inspection result normal?

- YES (Present error)>>Replace the transfer control unit. Refer to the following.
- All-mode 4WD models: [DLN-140. "Removal and Installation"](#)
 - Part time 4WD models: [DLN-277. "Removal and Installation"](#)

YES (Past error)>>Error was detected in the transfer control unit branch line.

- NO >> Repair the power supply and the ground circuit.

A
B
C
D
E
F
G
H
I
J
K
L
N
O
P

LAN

ADP BRANCH LINE CIRCUIT

< DTC/CIRCUIT DIAGNOSIS >

[CAN]

ADP BRANCH LINE CIRCUIT

Diagnosis Procedure

INFOID:000000006247801

1. CHECK CONNECTOR

1. Turn the ignition switch OFF.
2. Disconnect the battery cable from the negative terminal.
3. Check the following terminals and connectors for damage, bend and loose connection (unit side and connector side).
 - Driver seat control unit
 - Harness connector B200
 - Harness connector B37
 - Harness connector B69
 - Harness connector M40

Is the inspection result normal?

YES >> GO TO 2.

NO >> Repair the terminal and connector.

2. CHECK HARNESS FOR OPEN CIRCUIT

1. Disconnect the connector of driver seat control unit.
2. Check the resistance between the driver seat control unit harness connector terminals.

Driver seat control unit harness connector			Resistance (Ω)
Connector No.	Terminal No.		
B202	3	19	Approx. 54 – 66

Is the measurement value within the specification?

YES >> GO TO 3.

NO >> Repair the driver seat control unit branch line.

3. CHECK POWER SUPPLY AND GROUND CIRCUIT

Check the power supply and the ground circuit of the driver seat control unit. Refer to [ADP-48. "DRIVER SEAT CONTROL UNIT : Diagnosis Procedure"](#).

Is the inspection result normal?

YES (Present error)>>Replace the driver seat control unit. Refer to [ADP-148. "Removal and Installation"](#).

YES (Past error)>>Error was detected in the driver seat control unit branch line.

NO >> Repair the power supply and the ground circuit.

BCM BRANCH LINE CIRCUIT

< DTC/CIRCUIT DIAGNOSIS >

[CAN]

BCM BRANCH LINE CIRCUIT

Diagnosis Procedure

INFOID:000000006247802

1. CHECK CONNECTOR

1. Turn the ignition switch OFF.
2. Disconnect the battery cable from the negative terminal.
3. Check the terminals and connectors of the BCM for damage, bend and loose connection (unit side and connector side).

Is the inspection result normal?

- YES >> GO TO 2.
NO >> Repair the terminal and connector.

2. CHECK HARNESS FOR OPEN CIRCUIT

1. Disconnect the connector of BCM.
2. Check the resistance between the BCM harness connector terminals.

BCM harness connector			Resistance (Ω)
Connector No.	Terminal No.		
M18	39	40	Approx. 54 – 66

Is the measurement value within the specification?

- YES >> GO TO 3.
NO >> Repair the BCM branch line.

3. CHECK POWER SUPPLY AND GROUND CIRCUIT

Check the power supply and the ground circuit of the BCM. Refer to [BCS-30, "Diagnosis Procedure"](#).

Is the inspection result normal?

- YES (Present error)>>Replace the BCM. Refer to [BCS-55, "Removal and Installation"](#).
YES (Past error)>>Error was detected in the BCM branch line.
NO >> Repair the power supply and the ground circuit.

A
B
C
D
E
F
G
H
I
J
K
L

LAN

N
O
P

DLC BRANCH LINE CIRCUIT

< DTC/CIRCUIT DIAGNOSIS >

[CAN]

DLC BRANCH LINE CIRCUIT

Diagnosis Procedure

INFOID:000000006247803

1. CHECK CONNECTOR

1. Turn the ignition switch OFF.
2. Disconnect the battery cable from the negative terminal.
3. Check the terminals and connectors of the data link connector for damage, bend and loose connection (connector side and harness side).

Is the inspection result normal?

- YES >> GO TO 2.
NO >> Repair the terminal and connector.

2. CHECK HARNESS FOR OPEN CIRCUIT

Check the resistance between the data link connector terminals.

Data link connector			Resistance (Ω)
Connector No.	Terminal No.		
M22	6	14	Approx. 54 – 66

Is the measurement value within the specification?

- YES (Present error)>>Check the following items again.
- Decision of CAN system type.
 - Not received CONSULT-III data [SELF-DIAG RESULTS, CAN DIAG SUPPORT MNTR (“ECU list” included)].
 - Procedure for detecting root cause.
- YES (Past error)>>Error was detected in the data link connector branch line circuit.
NO >> Repair the data link connector branch line.

HVAC BRANCH LINE CIRCUIT

< DTC/CIRCUIT DIAGNOSIS >

[CAN]

HVAC BRANCH LINE CIRCUIT

Diagnosis Procedure

INFOID:000000006247804

1. CHECK CONNECTOR

1. Turn the ignition switch OFF.
2. Disconnect the battery cable from the negative terminal.
3. Check the terminals and connectors of the A/C auto amp. for damage, bend and loose connection (unit side and connector side).

Is the inspection result normal?

- YES >> GO TO 2.
NO >> Repair the terminal and connector.

2. CHECK HARNESS FOR OPEN CIRCUIT

1. Disconnect the connector of A/C auto amp.
2. Check the resistance between the A/C auto amp. harness connector terminals.

A/C auto amp. harness connector			Resistance (Ω)
Connector No.	Terminal No.		
M50	41	40	Approx. 54 – 66

Is the measurement value within the specification?

- YES >> GO TO 3.
NO >> Repair the A/C auto amp. branch line.

3. CHECK POWER SUPPLY AND GROUND CIRCUIT

Check the power supply and the ground circuit of the A/C auto amp. Refer to [HAC-91, "A/C Auto Amp Power and Ground Diagnosis Procedure"](#).

Is the inspection result normal?

- YES (Present error)>>Replace the front air control. Refer to [VTL-7, "Removal and Installation"](#).
YES (Past error)>>Error was detected in the A/C auto amp. branch line.
NO >> Repair the power supply and the ground circuit.

A
B
C
D
E
F
G
H
I
J
K
L

LAN

N
O
P

M&A BRANCH LINE CIRCUIT

< DTC/CIRCUIT DIAGNOSIS >

[CAN]

M&A BRANCH LINE CIRCUIT

Diagnosis Procedure

INFOID:000000006247805

1. CHECK CONNECTOR

1. Turn the ignition switch OFF.
2. Disconnect the battery cable from the negative terminal.
3. Check the terminals and connectors of the combination meter for damage, bend and loose connection (unit side and connector side).

Is the inspection result normal?

- YES >> GO TO 2.
NO >> Repair the terminal and connector.

2. CHECK HARNESS FOR OPEN CIRCUIT

1. Disconnect the connector of combination meter.
2. Check the resistance between the combination meter harness connector terminals.

Combination meter harness connector			Resistance (Ω)
Connector No.	Terminal No.		
M24	12	11	Approx. 54 – 66

Is the measurement value within the specification?

- YES >> GO TO 3.
NO >> Repair the combination meter branch line.

3. CHECK POWER SUPPLY AND GROUND CIRCUIT

Check the power supply and the ground circuit of the combination meter. Refer to [MWI-31, "COMBINATION METER : Diagnosis Procedure"](#).

Is the inspection result normal?

- YES (Present error)>>Replace the combination meter. Refer to [MWI-88, "Removal and Installation"](#).
YES (Past error)>>Error was detected in the combination meter branch line.
NO >> Repair the power supply and the ground circuit.

STRG BRANCH LINE CIRCUIT

< DTC/CIRCUIT DIAGNOSIS >

[CAN]

STRG BRANCH LINE CIRCUIT

Diagnosis Procedure

INFOID:000000006247806

1.CHECK CONNECTOR

1. Turn the ignition switch OFF.
2. Disconnect the battery cable from the negative terminal.
3. Check the terminals and connectors of the steering angle sensor for damage, bend and loose connection (unit side and connector side).

Is the inspection result normal?

- YES >> GO TO 2.
NO >> Repair the terminal and connector.

2.CHECK HARNESS FOR OPEN CIRCUIT

1. Disconnect the connector of steering angle sensor.
2. Check the resistance between the steering angle sensor harness connector terminals.

Steering angle sensor harness connector			Resistance (Ω)
Connector No.	Terminal No.		
M47	4	5	Approx. 54 – 66

Is the measurement value within the specification?

- YES >> GO TO 3.
NO >> Repair the steering angle sensor branch line.

3.CHECK POWER SUPPLY AND GROUND CIRCUIT

Check the power supply and the ground circuit of the steering angle sensor. Refer to the following.

- VQ40DE: [BRC-88, "Wiring Diagram - With VQ40DE"](#)
- VK56DE: [BRC-207, "Wiring Diagram - With VK56DE"](#)

Is the inspection result normal?

- YES (Present error)>>Replace the steering angle sensor. Refer to [BRC-233, "Removal and Installation"](#).
YES (Past error)>>Error was detected in the steering angle sensor branch line.
NO >> Repair the power supply and the ground circuit.

A
B
C
D
E
F
G
H
I
J
K
L

LAN

N
O
P

ABS BRANCH LINE CIRCUIT

< DTC/CIRCUIT DIAGNOSIS >

[CAN]

ABS BRANCH LINE CIRCUIT

Diagnosis Procedure

INFOID:000000006247807

1. CHECK CONNECTOR

1. Turn the ignition switch OFF.
2. Disconnect the battery cable from the negative terminal.
3. Check the terminals and connectors of the ABS actuator and electric unit (control unit) for damage, bend and loose connection (unit side and connector side).

Is the inspection result normal?

- YES >> GO TO 2.
NO >> Repair the terminal and connector.

2. CHECK HARNESS FOR OPEN CIRCUIT

1. Disconnect the connector of ABS actuator and electric unit (control unit).
 2. Check the resistance between the ABS actuator and electric unit (control unit) harness connector terminals.
- VQ engine models

ABS actuator and electric unit (control unit) harness connector			Resistance (Ω)
Connector No.	Terminal No.		
E125	12	13	Approx. 54 – 66

- VK engine models

ABS actuator and electric unit (control unit) harness connector			Resistance (Ω)
Connector No.	Terminal No.		
E127	11	15	Approx. 54 – 66

Is the measurement value within the specification?

- YES >> GO TO 3.
NO >> Repair the ABS actuator and electric unit (control unit) branch line.

3. CHECK POWER SUPPLY AND GROUND CIRCUIT

Check the power supply and the ground circuit of the ABS actuator and electric unit (control unit). Refer to the following.

- VQ40DE: [BRC-40. "Diagnosis Procedure"](#)
- VK56DE: [BRC-150. "Diagnosis Procedure"](#)

Is the inspection result normal?

- YES (Present error)>>Replace the ABS actuator and electric unit (control unit). Refer to [BRC-231. "Removal and Installation"](#).
YES (Past error)>>Error was detected in the ABS actuator and electric unit (control unit) branch line.
NO >> Repair the power supply and the ground circuit.

IPDM-E BRANCH LINE CIRCUIT

< DTC/CIRCUIT DIAGNOSIS >

[CAN]

IPDM-E BRANCH LINE CIRCUIT

Diagnosis Procedure

INFOID:000000006247808

1. CHECK CONNECTOR

1. Turn the ignition switch OFF.
2. Disconnect the battery cable from the negative terminal.
3. Check the terminals and connectors of the IPDM E/R for damage, bend and loose connection (unit side and connector side).

Is the inspection result normal?

- YES >> GO TO 2.
NO >> Repair the terminal and connector.

2. CHECK HARNESS FOR OPEN CIRCUIT

1. Disconnect the connector of IPDM E/R.
2. Check the resistance between the IPDM E/R harness connector terminals.

IPDM E/R harness connector			Resistance (Ω)
Connector No.	Terminal No.		
E122	39	40	Approx. 108 – 132

Is the measurement value within the specification?

- YES >> GO TO 3.
NO >> Repair the IPDM E/R branch line.

3. CHECK POWER SUPPLY AND GROUND CIRCUIT

Check the power supply and the ground circuit of the IPDM E/R. Refer to [PCS-14, "Diagnosis Procedure"](#).

Is the inspection result normal?

- YES (Present error)>>Replace the IPDM E/R. Refer to [PCS-29, "Removal and Installation of IPDM E/R"](#).
YES (Past error)>>Error was detected in the IPDM E/R branch line.
NO >> Repair the power supply and the ground circuit.

A
B
C
D
E
F
G
H
I
J
K
L

LAN

CAN COMMUNICATION CIRCUIT

[CAN]

< DTC/CIRCUIT DIAGNOSIS >

CAN COMMUNICATION CIRCUIT

Diagnosis Procedure

INFOID:000000006247809

1. CONNECTOR INSPECTION

1. Turn the ignition switch OFF.
2. Disconnect the battery cable from the negative terminal.
3. Disconnect all the unit connectors on CAN communication system.
4. Check terminals and connectors for damage, bend and loose connection.

Is the inspection result normal?

- YES >> GO TO 2.
NO >> Repair the terminal and connector.

2. CHECK HARNESS CONTINUITY (SHORT CIRCUIT)

Check the continuity between the data link connector terminals.

Data link connector			Continuity
Connector No.	Terminal No.		
M22	6	14	Not existed

Is the inspection result normal?

- YES >> GO TO 3.
NO >> Check the harness and repair the root cause.

3. CHECK HARNESS CONTINUITY (SHORT CIRCUIT)

Check the continuity between the data link connector and the ground.

Data link connector		Ground	Continuity
Connector No.	Terminal No.		
M22	6		Not existed
	14		Not existed

Is the inspection result normal?

- YES >> GO TO 4.
NO >> Check the harness and repair the root cause.

4. CHECK ECM AND IPDM E/R TERMINATION CIRCUIT

1. Remove the ECM and the IPDM E/R.
2. Check the resistance between the ECM terminals.

ECM		Resistance (Ω)
Terminal No.		
94	86	Approx. 108 – 132

3. Check the resistance between the IPDM E/R terminals.

IPDM E/R		Resistance (Ω)
Terminal No.		
39	40	Approx. 108 – 132

Is the measurement value within the specification?

- YES >> GO TO 5.
NO >> Replace the ECM and/or the IPDM E/R.

5. CHECK SYMPTOM

Connect all the connectors. Check if the symptoms described in the "Symptom (Results from interview with customer)" are reproduced.

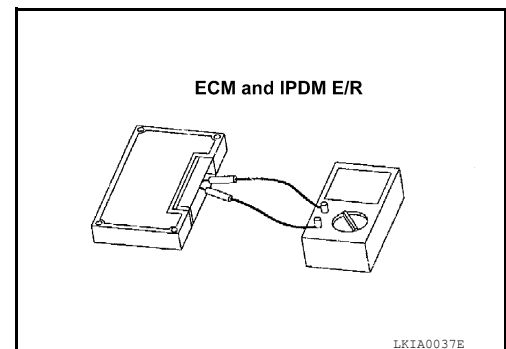

LKIA0037E

CAN COMMUNICATION CIRCUIT

[CAN]

< DTC/CIRCUIT DIAGNOSIS >

Inspection result

Reproduced>>GO TO 6.

Non-reproduced>>Start the diagnosis again. Follow the trouble diagnosis procedure when past error is detected.

6.CHECK UNIT REPRODUCTION

Perform the reproduction test as per the following procedure for each unit.

1. Turn the ignition switch OFF.
2. Disconnect the battery cable from the negative terminal.
3. Disconnect one of the unit connectors of CAN communication system.

NOTE:

ECM and IPDM E/R have a termination circuit. Check other units first.

4. Connect the battery cable to the negative terminal. Check if the symptoms described in the "Symptom (Results from interview with customer)" are reproduced.

NOTE:

Although unit-related error symptoms occur, do not confuse them with other symptoms.

Inspection result

Reproduced>>Connect the connector. Check other units as per the above procedure.

Non-reproduced>>Replace the unit whose connector was disconnected.

A
B
C
D
E
F
G
H
I
J
K
L

LAN

N
O
P