

SECTION **PWO**
POWER OUTLET

A
B
C
D
E
F
G
H
I
J
K
L
N
O
P

CONTENTS

PRECAUTION	2	Wiring Diagram - Early Production	4
		Wiring Diagram - Late Production	7
PRECAUTIONS	2	PREPARATION	11
Precaution for Supplemental Restraint System (SRS) "AIR BAG" and "SEAT BELT PRE-TEN- SIONER"	2	PREPARATION	11
Precaution Necessary for Steering Wheel Rota- tion After Battery Disconnect	2	Special Service Tool	11
WIRING DIAGRAM	4	REMOVAL AND INSTALLATION	12
POWER SOCKET	4	POWER SOCKET	12
		Removal and Installation	12

PWO

PRECAUTIONS

< PRECAUTION >

PRECAUTION

PRECAUTIONS

Precaution for Supplemental Restraint System (SRS) "AIR BAG" and "SEAT BELT PRE-TENSIONER"

INFOID:000000007354893

The Supplemental Restraint System such as "AIR BAG" and "SEAT BELT PRE-TENSIONER", used along with a front seat belt, helps to reduce the risk or severity of injury to the driver and front passenger for certain types of collision. This system includes seat belt switch inputs and dual stage front air bag modules. The SRS system uses the seat belt switches to determine the front air bag deployment, and may only deploy one front air bag, depending on the severity of a collision and whether the front occupants are belted or unbelted. Information necessary to service the system safely is included in the SR and SB section of this Service Manual.

WARNING:

- To avoid rendering the SRS inoperative, which could increase the risk of personal injury or death in the event of a collision which would result in air bag inflation, all maintenance must be performed by an authorized NISSAN/INFINITI dealer.
- Improper maintenance, including incorrect removal and installation of the SRS, can lead to personal injury caused by unintentional activation of the system. For removal of Spiral Cable and Air Bag Module, see the SR section.
- Do not use electrical test equipment on any circuit related to the SRS unless instructed to in this Service Manual. SRS wiring harnesses can be identified by yellow and/or orange harnesses or harness connectors.

PRECAUTIONS WHEN USING POWER TOOLS (AIR OR ELECTRIC) AND HAMMERS

WARNING:

- When working near the Airbag Diagnosis Sensor Unit or other Airbag System sensors with the Ignition ON or engine running, DO NOT use air or electric power tools or strike near the sensor(s) with a hammer. Heavy vibration could activate the sensor(s) and deploy the air bag(s), possibly causing serious injury.
- When using air or electric power tools or hammers, always switch the Ignition OFF, disconnect the battery, and wait at least 3 minutes before performing any service.

Precaution Necessary for Steering Wheel Rotation After Battery Disconnect

INFOID:000000007354894

NOTE:

- This Procedure is applied only to models with Intelligent Key system and NATS (NISSAN ANTI-THEFT SYSTEM).
- Remove and install all control units after disconnecting both battery cables with the ignition knob in the "LOCK" position.
- Always use CONSULT to perform self-diagnosis as a part of each function inspection after finishing work. If DTC is detected, perform trouble diagnosis according to self-diagnostic results.

For models equipped with the Intelligent Key system and NATS, an electrically controlled steering lock mechanism is adopted on the key cylinder.

For this reason, if the battery is disconnected or if the battery is discharged, the steering wheel will lock and steering wheel rotation will become impossible.

If steering wheel rotation is required when battery power is interrupted, follow the procedure below before starting the repair operation.

OPERATION PROCEDURE

1. Connect both battery cables.

NOTE:

Supply power using jumper cables if battery is discharged.

2. Use the Intelligent Key or mechanical key to turn the ignition switch to the "ACC" position. At this time, the steering lock will be released.
3. Disconnect both battery cables. The steering lock will remain released and the steering wheel can be rotated.
4. Perform the necessary repair operation.

PRECAUTIONS

< PRECAUTION >

5. When the repair work is completed, return the ignition switch to the "LOCK" position before connecting the battery cables. (At this time, the steering lock mechanism will engage.)
6. Perform a self-diagnosis check of all control units using CONSULT.

A

B

C

D

E

F

G

H

I

J

K

L

PWO

N

O

P

POWER SOCKET

< WIRING DIAGRAM >

WIRING DIAGRAM

POWER SOCKET

Wiring Diagram - Early Production

INFOID:000000008166408

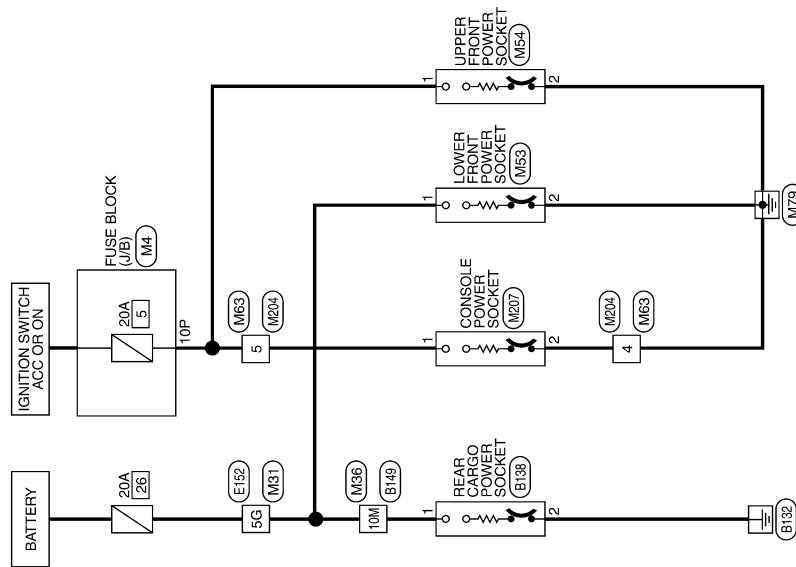

POWER SOCKET - EARLY PRODUCTION

ABMWA1707GB

POWER SOCKET

< WIRING DIAGRAM >

POWER SOCKET CONNECTORS - EARLY PRODUCTION

Connector No.	M4
Connector Name	FUSE BLOCK (J/B)
Connector Color	WHITE



Terminal No.	Color of Wire	Signal Name
10P	G/Y	-

Connector No.	M31
Connector Name	WIRE TO WIRE
Connector Color	WHITE

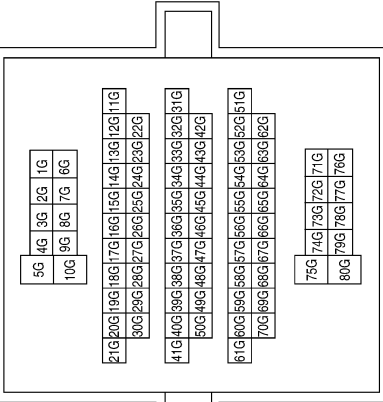

Terminal No.	Color of Wire	Signal Name
5G	R	-

Connector No.	M36
Connector Name	WIRE TO WIRE
Connector Color	WHITE

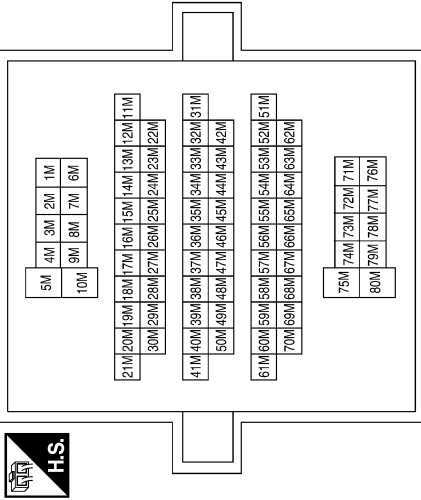

Terminal No.	Color of Wire	Signal Name
10M	R	-

Connector No.	M53
Connector Name	LOWER FRONT POWER SOCKET
Connector Color	BLACK



Terminal No.	Color of Wire	Signal Name
1	R	-
2	B	-

Connector No.	M54
Connector Name	UPPER FRONT POWER SOCKET
Connector Color	GRAY



Terminal No.	Color of Wire	Signal Name
1	G/B	-
2	B	-

Connector No.	M63
Connector Name	WIRE TO WIRE
Connector Color	WHITE



Terminal No.	Color of Wire	Signal Name
4	B	-
5	G/Y	-

ABMIA3955GB

A
B
C
D
E
F
G
H
I
J
K
L
N
O
P

PWO

POWER SOCKET

< WIRING DIAGRAM >

Connector No.	M207
Connector Name	CONSOLE POWER SOCKET
Connector Color	BLACK



Terminal No.	Color of Wire	Signal Name
1	G/Y	-
2	B	-

Connector No.	M204
Connector Name	WIRE TO WIRE
Connector Color	WHITE



Terminal No.	Color of Wire	Signal Name
4	B	-
5	G/Y	-

Connector No.	B149
Connector Name	WIRE TO WIRE
Connector Color	WHITE

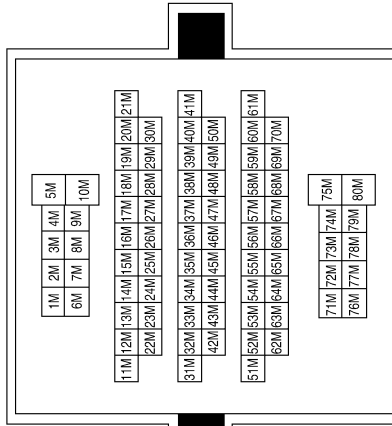

Connector No.	B138
Connector Name	REAR CARGO POWER SOCKET
Connector Color	BLACK



Terminal No.	Color of Wire	Signal Name
1	R	-
2	B	-

Connector No.	E152
Connector Name	WIRE TO WIRE
Connector Color	WHITE

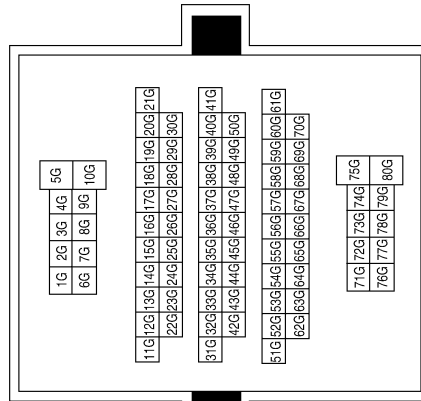

Terminal No.	Color of Wire	Signal Name
10M	R	-

Terminal No.	Color of Wire	Signal Name
5G	R	-

ABMIA0059GB

POWER SOCKET

< WIRING DIAGRAM >

Wiring Diagram - Late Production

INFOID:000000007354895

POWER SOCKET - LATE PRODUCTION

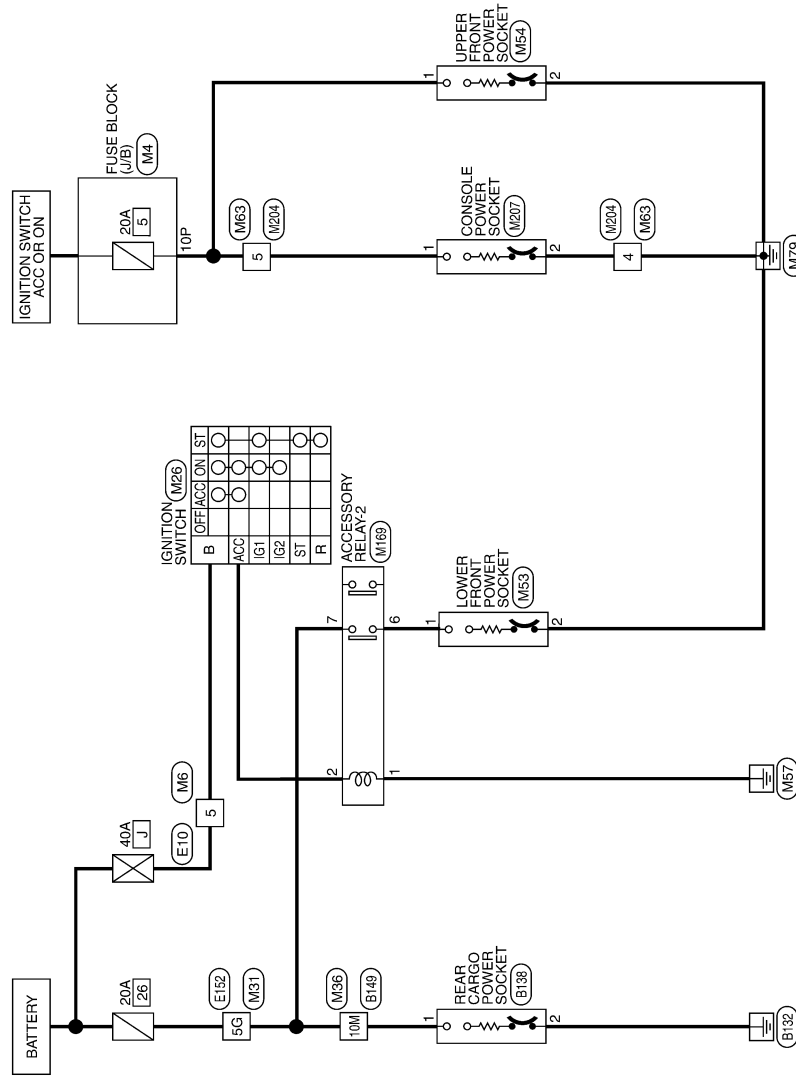

A
B
C
D
E
F
G
H
I
J
K
L
N
O
P

PWO

ABMWA1708GB

POWER SOCKET

< WIRING DIAGRAM >

POWER SOCKET CONNECTORS - LATE PRODUCTION

Connector No.	M4
Connector Name	FUSE BLOCK (J/B)
Connector Color	WHITE



Terminal No.	10P	Color of Wire	G/Y	Signal Name	-
--------------	-----	---------------	-----	-------------	---

Connector No.	M6
Connector Name	WIRE TO WIRE
Connector Color	WHITE

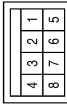

Terminal No.	5	Color of Wire	G	Signal Name	-
--------------	---	---------------	---	-------------	---

Connector No.	M26
Connector Name	IGNITION SWITCH
Connector Color	WHITE



Terminal No.	B	Color of Wire	G	Signal Name	-
	ACC		G/Y		-

Connector No.	M31
Connector Name	WIRE TO WIRE
Connector Color	WHITE

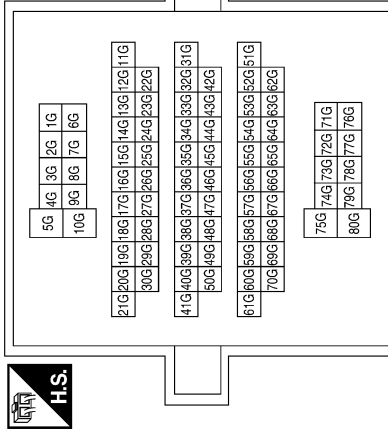

Terminal No.	5G	Color of Wire	R	Signal Name	-
--------------	----	---------------	---	-------------	---

Connector No.	M36
Connector Name	WIRE TO WIRE
Connector Color	WHITE

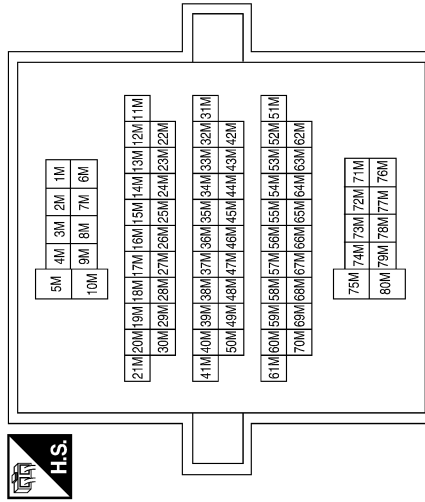

Terminal No.	10M	Color of Wire	R	Signal Name	-
--------------	-----	---------------	---	-------------	---

Connector No.	M53
Connector Name	LOWER FRONT POWER SOCKET
Connector Color	BLACK



Terminal No.	1	Color of Wire	W	Signal Name	-
	2		B		-

ABMIA3956GB

POWER SOCKET

< WIRING DIAGRAM >

Connector No.	M169
Connector Name	ACCESSORY RELAY-2
Connector Color	BROWN



Terminal No.	Color of Wire	Signal Name
1	B	-
2	G/Y	-
6	W	-
7	R	-

Connector No.	M63
Connector Name	WIRE TO WIRE
Connector Color	WHITE



Terminal No.	Color of Wire	Signal Name
4	B	-
5	G/Y	-

Connector No.	M54
Connector Name	UPPER FRONT POWER SOCKET
Connector Color	GRAY



Terminal No.	Color of Wire	Signal Name
1	G/B	-
2	B	-

Connector No.	E10
Connector Name	WIRE TO WIRE
Connector Color	WHITE



Terminal No.	Color of Wire	Signal Name
5	G	-

Connector No.	M207
Connector Name	CONSOLE POWER SOCKET
Connector Color	BLACK



Terminal No.	Color of Wire	Signal Name
1	G/Y	-
2	B	-

Connector No.	M204
Connector Name	WIRE TO WIRE
Connector Color	WHITE



Terminal No.	Color of Wire	Signal Name
4	B	-
5	G/Y	-

AAMIA0870GB

A
B
C
D
E
F
G
H
I
J
K
L
N
O
P

PWO

POWER SOCKET

< WIRING DIAGRAM >

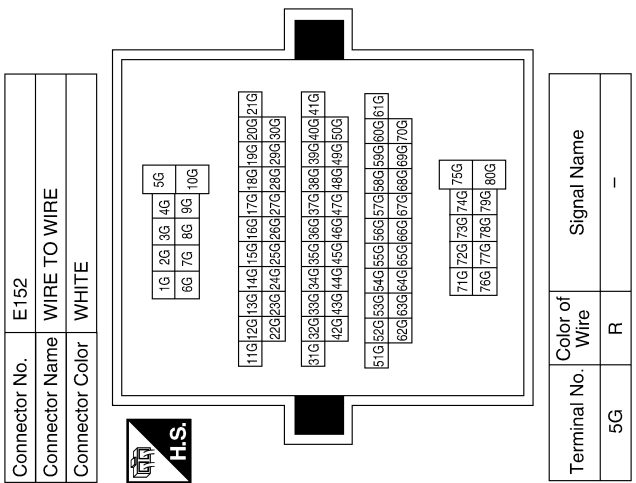
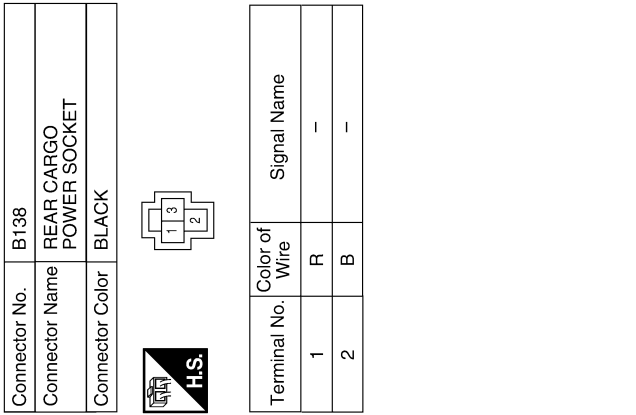
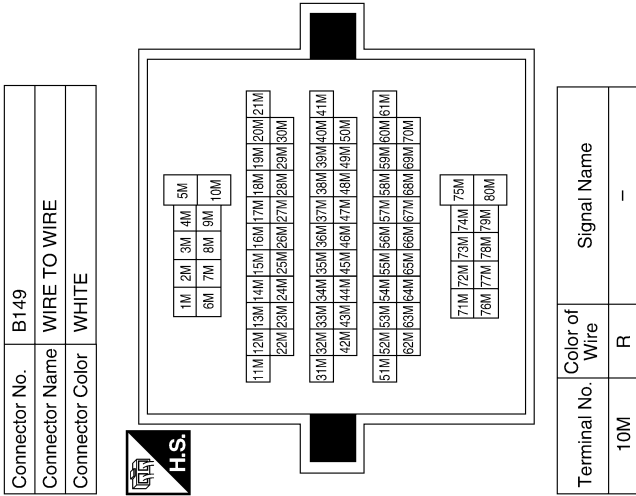

AAMIA0871GB

PREPARATION

< PREPARATION >

PREPARATION

PREPARATION

Special Service Tool

INFOID:000000007354896

The actual shapes of Kent-Moore tools may differ from those of special service tools illustrated here.

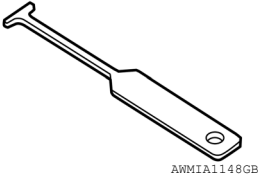
Tool number (Kent-Moore No.) Tool name	Description
— (J-42059) Power socket removal tool 	For removing power sockets

A
B
C
D
E
F
G
H
I
J
K
L

PWO

POWER SOCKET

< REMOVAL AND INSTALLATION >

REMOVAL AND INSTALLATION

POWER SOCKET

Removal and Installation

INFOID:000000007354897

UPPER AND LOWER FRONT POWER SOCKET, CONSOLE POWER SOCKET, AND REAR CAR-GO POWER SOCKET

NOTE:

If the tool does not fit because of the location of the power socket, further disassembly may be required. Refer to [IP-11, "Exploded View"](#) (Instrument Panel), [IP-23, "Disassembly and Assembly"](#) (Center Console), or [INT-25, "Removal and Installation"](#) (Luggage Floor Trim).

Removal

1. Remove the fuse for the power socket.
2. Insert one end of the Tool (A) into one of the square holes inside the power socket.

Tool number: — (J-42059)

3. Lift up the handle of the Tool until the other end of the Tool is inside the socket and snaps into the other square hole in the power socket.
4. Pull the power socket straight out with the Tool.

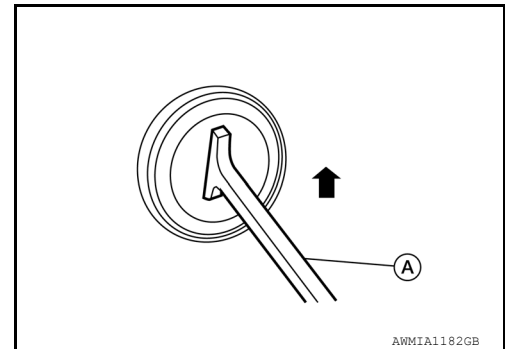

5. Disconnect power socket connector.
6. Remove ring from power socket finisher while pressing pawls.

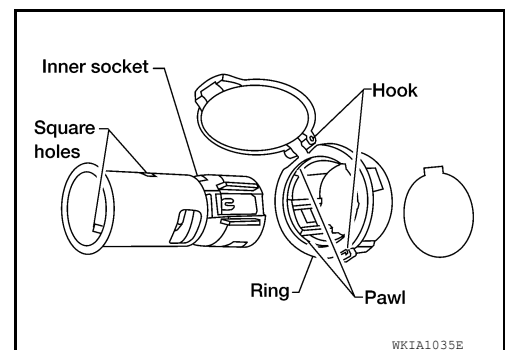

Installation

Installation is in the reverse order of removal.

NOTE:

Make sure to align the tab with the square notched area during installation.

