

# WCS

SECTION

## WARNING CHIME SYSTEM

A  
B  
C  
D  
E  
F  
G  
H  
I  
J  
K  
L  
M  
N  
O  
P

### CONTENTS

<p><b>PRECAUTION</b> ..... 3</p> <p><b>PRECAUTIONS</b> ..... 3</p> <p style="padding-left: 20px;">Precaution for Supplemental Restraint System (SRS) "AIR BAG" and "SEAT BELT PRE-TENSIONER" .....3</p> <p><b>SYSTEM DESCRIPTION</b> ..... 4</p> <p><b>COMPONENT PARTS</b> ..... 4</p> <p style="padding-left: 20px;">Component Parts Location .....4</p> <p style="padding-left: 20px;">Component Description .....5</p> <p><b>SYSTEM</b> ..... 6</p> <p><b>WARNING CHIME SYSTEM</b> .....6</p> <p style="padding-left: 20px;">WARNING CHIME SYSTEM : System Diagram .....6</p> <p style="padding-left: 20px;">WARNING CHIME SYSTEM : System Description .....6</p> <p><b>LIGHT REMINDER WARNING CHIME</b> .....6</p> <p style="padding-left: 20px;">LIGHT REMINDER WARNING CHIME : System Diagram .....6</p> <p style="padding-left: 20px;">LIGHT REMINDER WARNING CHIME : System Description .....6</p> <p><b>SEAT BELT WARNING CHIME</b> .....7</p> <p style="padding-left: 20px;">SEAT BELT WARNING CHIME : System Diagram .....7</p> <p style="padding-left: 20px;">SEAT BELT WARNING CHIME : System Description .....7</p> <p><b>PARKING BRAKE RELEASE WARNING CHIME</b>.....7</p> <p style="padding-left: 20px;">PARKING BRAKE RELEASE WARNING CHIME : System Diagram .....7</p> <p style="padding-left: 20px;">PARKING BRAKE RELEASE WARNING CHIME : System Description .....7</p> <p><b>DIAGNOSIS SYSTEM (COMBINATION METER)</b> ..... 9</p> <p style="padding-left: 20px;">Description .....9</p> <p style="padding-left: 20px;">CONSULT Function (METER/M&amp;A) .....9</p>	<p><b>DIAGNOSIS SYSTEM (BCM)</b> .....14</p> <p><b>COMMON ITEM</b> .....14</p> <p style="padding-left: 20px;">COMMON ITEM : CONSULT Function (BCM - COMMON ITEM) .....14</p> <p><b>BUZZER</b> .....14</p> <p style="padding-left: 20px;">BUZZER : CONSULT Function (BCM - BUZZER)...15</p> <p><b>ECU DIAGNOSIS INFORMATION</b> .....16</p> <p><b>BCM, COMBINATION METER</b> .....16</p> <p style="padding-left: 20px;">List of ECU Reference .....16</p> <p><b>WIRING DIAGRAM</b> .....17</p> <p><b>WARNING CHIME SYSTEM</b> .....17</p> <p style="padding-left: 20px;">Wiring Diagram .....17</p> <p><b>BASIC INSPECTION</b> .....25</p> <p><b>DIAGNOSIS AND REPAIR WORKFLOW</b> .....25</p> <p style="padding-left: 20px;">Work Flow .....25</p> <p><b>DTC/CIRCUIT DIAGNOSIS</b> .....27</p> <p><b>POWER SUPPLY AND GROUND CIRCUIT</b> ....27</p> <p><b>COMBINATION METER</b> .....27</p> <p style="padding-left: 20px;">COMBINATION METER : Diagnosis Procedure ....27</p> <p><b>BCM (BODY CONTROL MODULE)</b> .....27</p> <p style="padding-left: 20px;">BCM (BODY CONTROL MODULE) : Diagnosis Procedure .....28</p> <p><b>METER BUZZER CIRCUIT</b> .....29</p> <p style="padding-left: 20px;">Description .....29</p> <p style="padding-left: 20px;">Component Function Check .....29</p> <p style="padding-left: 20px;">Diagnosis Procedure .....29</p> <p><b>SEAT BELT BUCKLE SWITCH SIGNAL CIRCUIT</b> .....30</p> <p style="padding-left: 20px;">Description .....30</p> <p style="padding-left: 20px;">Component Function Check .....30</p>
---	---

WCS

Diagnosis Procedure .....	30
Component Inspection .....	31
<b>SYMPTOM DIAGNOSIS .....</b>	<b>32</b>
<b>WARNING CHIME SYSTEM SYMPTOMS .....</b>	<b>32</b>
Symptom Table .....	32
<b>THE LIGHT REMINDER WARNING DOES NOT SOUND .....</b>	<b>33</b>
Description .....	33
Diagnosis Procedure .....	33

<b>THE SEAT BELT WARNING CONTINUES SOUNDING, OR DOES NOT SOUND .....</b>	<b>34</b>
Description .....	34
Diagnosis Procedure .....	34
<b>THE PARKING BRAKE RELEASE WARNING CONTINUES SOUNDING, OR DOES NOT SOUND .....</b>	<b>35</b>
Description .....	35
Diagnosis Procedure .....	35

# PRECAUTIONS

< PRECAUTION >

## PRECAUTION

### PRECAUTIONS

#### Precaution for Supplemental Restraint System (SRS) "AIR BAG" and "SEAT BELT PRE-TENSIONER"

INFOID:000000008945485

The Supplemental Restraint System such as "AIR BAG" and "SEAT BELT PRE-TENSIONER", used along with a front seat belt, helps to reduce the risk or severity of injury to the driver and front passenger for certain types of collision. Information necessary to service the system safely is included in the SR and SB section of this Service Manual.

**WARNING:**

- To avoid rendering the SRS inoperative, which could increase the risk of personal injury or death in the event of a collision which would result in air bag inflation, all maintenance must be performed by an authorized NISSAN/INFINITI dealer.
- Improper maintenance, including incorrect removal and installation of the SRS, can lead to personal injury caused by unintentional activation of the system. For removal of Spiral Cable and Air Bag Module, see the SR section.
- Do not use electrical test equipment on any circuit related to the SRS unless instructed to in this Service Manual. SRS wiring harnesses can be identified by yellow and/or orange harnesses or harness connectors.

#### PRECAUTIONS WHEN USING POWER TOOLS (AIR OR ELECTRIC) AND HAMMERS

**WARNING:**

- When working near the Airbag Diagnosis Sensor Unit or other Airbag System sensors with the Ignition ON or engine running, DO NOT use air or electric power tools or strike near the sensor(s) with a hammer. Heavy vibration could activate the sensor(s) and deploy the air bag(s), possibly causing serious injury.
- When using air or electric power tools or hammers, always switch the Ignition OFF, disconnect the battery and wait at least 3 minutes before performing any service.

A  
B  
C  
D  
E  
F  
G  
H  
I  
J  
K  
L  
M  
O  
P

WCS

# COMPONENT PARTS

< SYSTEM DESCRIPTION >

## SYSTEM DESCRIPTION

### COMPONENT PARTS

#### Component Parts Location

INFOID:000000008509979

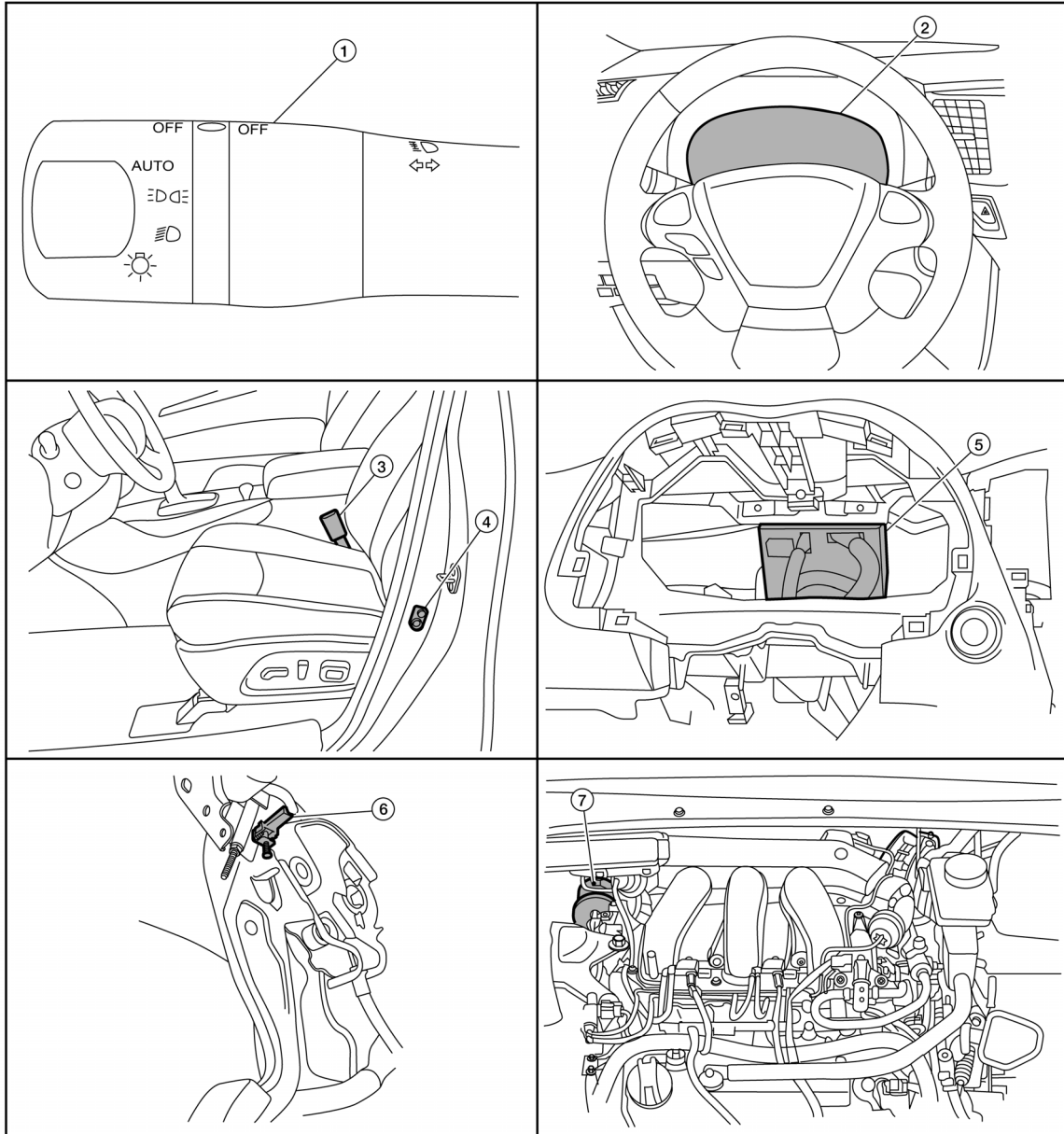

AWN1A2728ZZ

- |   |  |  |
|---|--|--|
| 1. Combination switch (lighting and turn signal switch) | 2. Combination meter                         | 3. Seat belt buckle switch (driver seat) |
| 4. Front door switch LH                                 | 5. BCM (view with combination meter removed) | 6. Parking brake switch                  |
| 7. ABS actuator and electric unit (control unit)        |  |  |

# COMPONENT PARTS

< SYSTEM DESCRIPTION >

## Component Description

INFOID:000000008509980

A  
B  
C  
D  
E  
F  
G  
H  
I  
J  
K  
L  
M  
O  
P

WCS

Unit	Description
Combination switch (lighting and turn signal switch)	Transmits the lighting switch signal to the BCM.
Combination meter	<ul style="list-style-type: none"> <li>Receives a buzzer output signal from the BCM with CAN communication line and sounds the buzzer.</li> <li>Receives the seat belt buckle switch signal from the seat belt buckle switch (driver seat) and transmits it to the BCM via CAN communication.</li> <li>Judges whether the parking brake is released using the vehicle speed signal and the parking brake switch signal, and sounds the buzzer if necessary.</li> </ul>
BCM	Based on the signals received from various units and switches, transmits the buzzer output signal to the combination meter via CAN communication.
Front door switch LH	Transmits the front door switch LH signal to the BCM.
Seat belt buckle switch (driver seat)	Transmits the seat belt buckle switch (driver seat) signal to the combination meter.
Parking brake switch	Transmits the parking brake switch signal to the combination meter.
ABS actuator and electric unit (control unit)	Transmits the vehicle speed signal to the combination meter via CAN communication.

# SYSTEM

< SYSTEM DESCRIPTION >

## SYSTEM

### WARNING CHIME SYSTEM

#### WARNING CHIME SYSTEM : System Diagram

INFOID:000000008509981

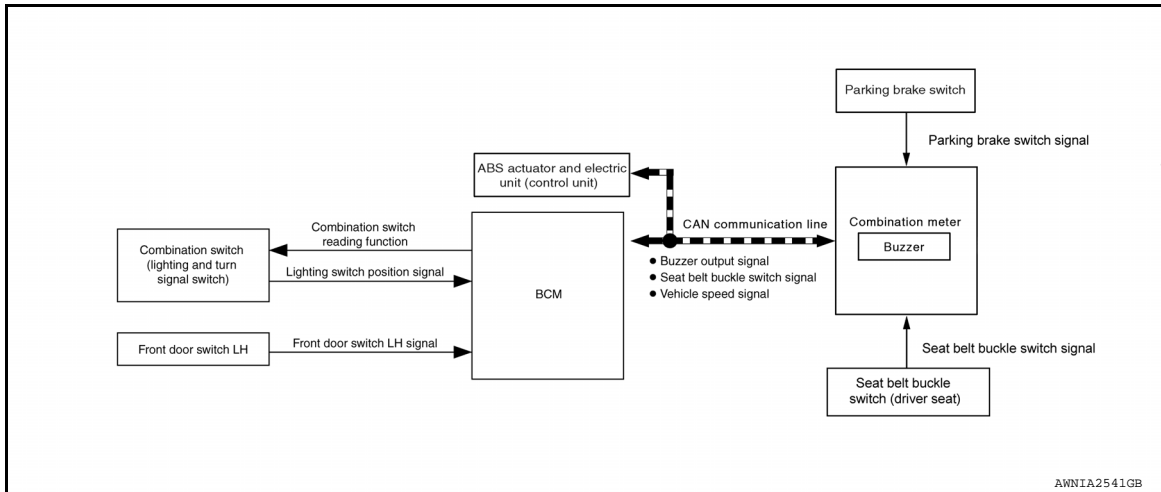

#### WARNING CHIME SYSTEM : System Description

INFOID:000000008509982

##### DESCRIPTION

- The buzzer for the warning chime system is installed in the combination meter.
- The buzzer sounds when the combination meter receives a buzzer output signal from the BCM.
- The BCM receives signals from various units and transmits a buzzer output signal to the combination meter with CAN communication line if it judges that the warning buzzer should be activated.

### LIGHT REMINDER WARNING CHIME

#### LIGHT REMINDER WARNING CHIME : System Diagram

INFOID:000000008509983

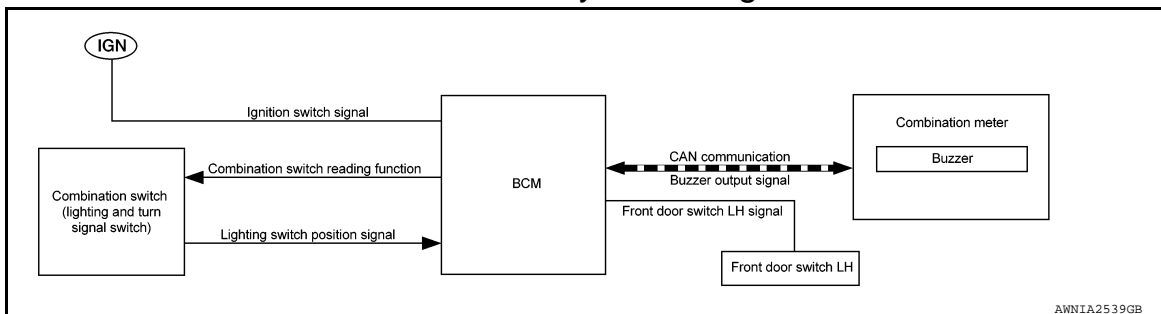

#### LIGHT REMINDER WARNING CHIME : System Description

INFOID:000000008509984

##### DESCRIPTION

With the ignition switch in the OFF or ACC position, driver door open, and lighting switch in parking or headlamp position, the light warning chime will sound.

- BCM detects the ignition switch in the OFF or ACC position, the front door switch LH ON, and the lighting switch in parking or headlamp position, and then transmits the buzzer output signal (light reminder warning chime) to the combination meter with CAN communication line.
- When the combination meter receives the buzzer output signal (light reminder warning chime), it sounds the buzzer.

##### WARNING OPERATION CONDITIONS

If all of the following conditions are fulfilled:

- Lighting switch is in parking or headlamp position
- Ignition switch is in OFF or ACC
- Front door switch LH is ON

# SYSTEM

## < SYSTEM DESCRIPTION >

### WARNING CANCEL CONDITIONS

Warning is canceled if any of the following conditions is fulfilled:

- Lighting switch OFF
- Ignition switch ON
- Front door switch LH is OFF

### SEAT BELT WARNING CHIME

#### SEAT BELT WARNING CHIME : System Diagram

INFOID:000000008509985

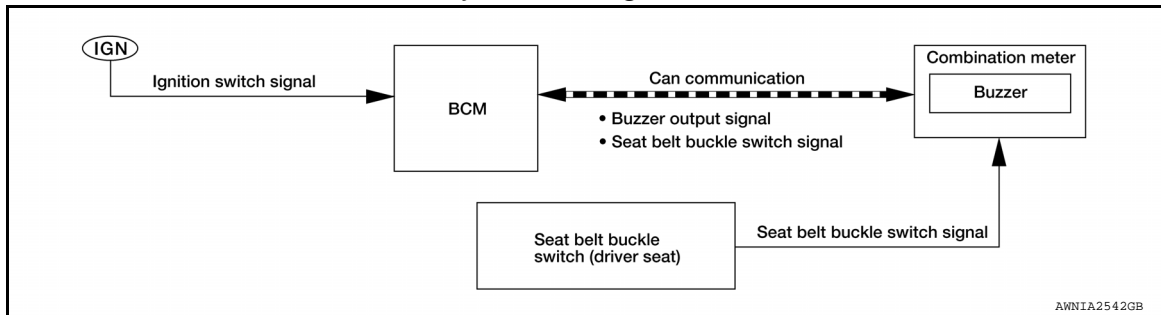

#### SEAT BELT WARNING CHIME : System Description

INFOID:000000008509986

##### DESCRIPTION

With the ignition switch turned ON and driver seat belt unfastened, the seat belt warning chime will sound for approximately 6 seconds.

- BCM receives seat belt buckle switch (driver seat) signal from combination meter with CAN communication line.
- BCM detects the ignition switch turned ON and the seat belt buckle switch (driver seat) is ON, and then transmits buzzer output signal (seat belt warning chime) to combination meter with CAN communication line.
- When the combination meter receives the buzzer output signal (seat belt warning chime), it sounds the buzzer.

##### WARNING OPERATION CONDITIONS

If all of the following conditions are fulfilled:

- Ignition switch OFF→ON
- Seat belt buckle switch (driver seat) is ON (seat belt not fastened).

##### WARNING CANCEL CONDITIONS

Cancels the warning if any of the following conditions is fulfilled:

- Ignition switch OFF
- Seat belt buckle switch (driver seat) is OFF (seat belt fastened).

### PARKING BRAKE RELEASE WARNING CHIME

#### PARKING BRAKE RELEASE WARNING CHIME : System Diagram

INFOID:000000008509987

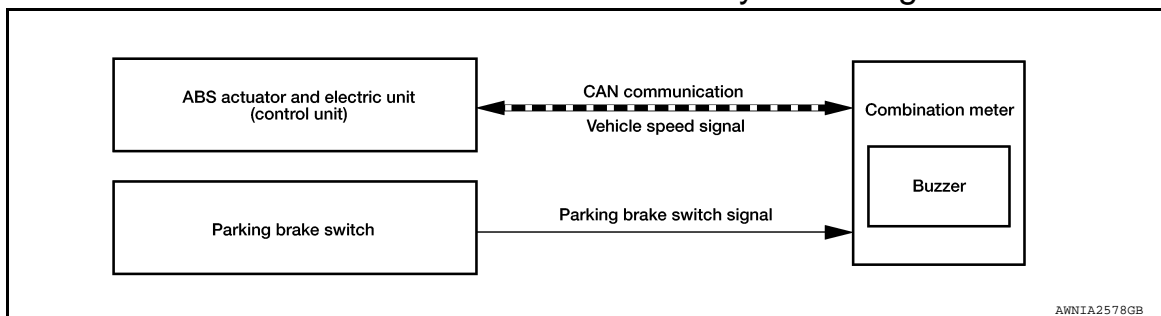

WCS

#### PARKING BRAKE RELEASE WARNING CHIME : System Description

INFOID:000000008509988

##### DESCRIPTION

# SYSTEM

## < SYSTEM DESCRIPTION >

---

- The combination meter receives the vehicle speed signal from the ABS actuator and electric unit (control unit) via CAN communication line.
- The combination meter judges whether the parking brake is released using the parking brake switch signal from the parking brake switch, and sounds the warning buzzer if necessary.

### WARNING OPERATION CONDITIONS

If all of the following conditions are fulfilled:

- Vehicle speed is approximately 4 MPH (7 km/h) or higher.
- Parking brake switch ON

### WARNING CANCEL CONDITIONS

Warning is canceled if any of the following conditions are fulfilled:

- Vehicle speed is approximately 2 MPH (3 km/h) or less.
- Parking brake switch OFF



# DIAGNOSIS SYSTEM (COMBINATION METER)

< SYSTEM DESCRIPTION >

## DIAGNOSIS SYSTEM (COMBINATION METER)

### Description

INFOID:000000008945479

#### COMBINATION METER SELF-DIAGNOSIS MODE

The following meter functions can be checked during Combination Meter Self-Diagnosis Mode:

- Pointer sweep of speedometer, tachometer and gauges.
- Illumination of all LCD segments and color patterns for meter displays.
- Illumination of all lamps/LEDs that are controlled by the combination meter (regardless of switch status).

#### STARTING COMBINATION METER SELF-DIAGNOSIS MODE

##### NOTE:

- Check combination meter power supply and ground circuits if self-diagnosis mode does not start. Refer to [MWI-59, "COMBINATION METER : Diagnosis Procedure"](#). Replace combination meter if power supply and ground circuits are found to be normal and self-diagnosis mode does not start. Refer to [MWI-82, "Removal and Installation"](#).
- Combination meter self-diagnosis mode will function with the ignition switch in ON. Combination meter self-diagnosis mode will exit upon turning the ignition switch to OFF.

#### How to Initiate Self-Diagnosis Mode

1. Press and hold the trip reset switch while turning the ignition switch ON. After 2 seconds release trip reset switch, then press the trip reset switch 3 times within 7 seconds after the ignition switch is turned ON.
2. When the diagnosis function is activated, the meter illuminates all of the following:
  - Warning lights/indicators.
  - Meter assembly.
  - Information display color bars red, green, blue and white (1).
  - Odometer, trip A/B odometers and CVT indicator LCD display segments (2).
3. Pressing and holding the trip reset switch performs the pointer sweep test.

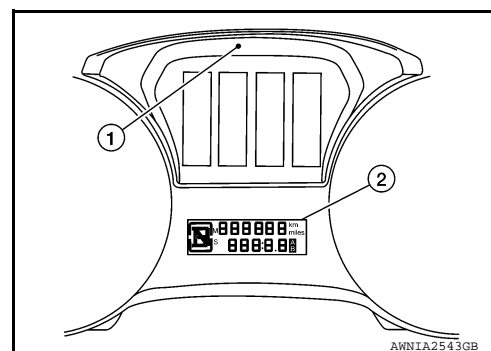

### CONSULT Function (METER/M&A)

INFOID:000000008945480

#### APPLICATION ITEMS

CONSULT can display each diagnostic item using the diagnostic test modes shown.

METER/M&A Diagnosis mode	Description
SELF DIAGNOSTIC RESULT	Displays combination meter self-diagnosis results.
DATA MONITOR	Displays combination meter input/output data in real time.
WARNING HISTORY	Lighting history of the warning lamp and indicator lamp can be checked.
CAN DIAG SUPPORT MNTR	The result of transmit/receive diagnosis of CAN communication can be read.

#### SELF DIAG RESULT

Refer to [MWI-29, "DTC Index"](#).

#### DATA MONITOR

Display Item List

A  
B  
C  
D  
E  
F  
G  
H  
I  
J  
K  
L  
M  
O  
P

## DIAGNOSIS SYSTEM (COMBINATION METER)

### < SYSTEM DESCRIPTION >

X: Applicable

Display item [Unit]	MAIN SIGNALS	Description
SPEED METER	X	Displays the value of vehicle speed signal.
SPEED OUTPUT [mph or km/h]	X	Vehicle speed signal value transmitted to other units via CAN communication.
ODO OUTPUT [mph or km/h]		Odometer signal value transmitted to other units via CAN communication.
TACHO METER [rpm]	X	Value of the engine speed signal received from ECM via CAN communication.
FUEL METER [L]	X	Fuel level indicated on combination meter.
W TEMP METER [°F] or [°C]	X	Displays the value of engine coolant temperature signal, which is input from ECM.
ABS W/L [On/Off]		Displays [ON/OFF] condition of ABS warning indicator.
VDC/TCS IND [On/Off]		Displays [ON/OFF] condition of VDC OFF warning lamp.
SLIP IND [On/Off]		Displays [ON/OFF] condition of SLIP indicator lamp.
BRAKE W/L [On/Off]		Displays [ON/OFF] condition of brake warning indicator.
FR FOG IND [Off]		Displays [ON/OFF] condition of front fog lamp indicator.
DOOR W/L [ON/OFF]		Displays [ON/OFF] condition of door warning message.
TRUNK/GLAS-H [ON/OFF]		Displays [ON/OFF] condition of glass hatch warning message.
HI-BEAM IND [ON/OFF]		Displays [ON/OFF] condition of high beam indicator.
TURN IND [On/Off]		Displays [ON/OFF] condition of turn indicator.
LIGHT IND [On/Off]		Displays [ON/OFF] condition of light indicator.
OIL W/L [ON/OFF]		Displays [ON/OFF] condition of low oil pressure warning message.
MIL [ON/OFF]		Displays [ON/OFF] condition of malfunction indicator.
CRUISE IND [Off]		Displays [ON/OFF] condition of CRUISE indicator in the information display.
SET IND [On/Off]		Displays [ON/OFF] condition of SET indicator in the information display.
O/D OFF IND [On/Off]		Displays [ON/OFF] condition of O/D OFF indicator.
CVT IND [On/Off]		Displays [ON/OFF] condition of CVT indicator in the information display.
4WD W/L [On/Off]		Displays [ON/OFF] condition of 4WD warning message in the information display.
FUEL W/L [On/Off]		Displays [ON/OFF] condition of low-fuel warning message.
WASHER W/L [On/Off]		Displays [ON/OFF] condition of low washer fluid warning message.

## DIAGNOSIS SYSTEM (COMBINATION METER)

### < SYSTEM DESCRIPTION >

Display item [Unit]	MAIN SIGNALS	Description	A
KEY G/Y W/L [On/Off]		Displays [ON/OFF] condition of key green warning lamp.	A
EPS W/L [On/Off]		Displays [ON/OFF] condition of EPS warning indicator.	B
LCD		Displays the value of Intelligent Key system message indication.	C
SHIFT IND		Displays shift selector position.	C
4WD IND [AUTO, LOCK, 2W]		Displays [ON/OFF] condition of 4WD modes in the information display.	D
TOW MODE IND [On/Off]		Displays [ON/OFF] condition of tow mode indicator.	D
FUEL CAP W/L [On/Off]		Displays [ON/OFF] condition of loose fuel cap warning message.	E
O/D OFF SW [On/Off]		Displays [ON/OFF] condition of O/D OFF switch.	F
COMP F/B SIG [On/Off]		A/C compressor activation condition that ECM judges according to the water temperature and the acceleration degree.	F
PKB SW [On/Off]		Displays [ON/OFF] condition of parking brake switch.	G
BRAKE OIL SW [On/Off]		Displays [ON/OFF] condition of brake fluid level switch.	H
BUCKLE SW [On/Off]		Displays [ON/OFF] condition of seat belt buckle switch (driver seat).	H
PASS BUCKLE SW [On/Off]		Displays [ON/OFF] condition of seat belt buckle switch (passenger seat).	I
TOW MODE SW [On/Off]		Displays [ON/OFF] condition of tow mode switch.	J
DISTANCE [km] or [Mi]		Displays distance to empty.	J
OUTSIDE TEMP [°C or °F]		Displays the ambient temperature which is input from ambient sensor.	K
FUEL LOW SIG [On/Off]		Displays the [ON/OFF] condition the fuel level low warning signal.	L
BUZZER [On/Off]	X	Buzzer status (in the combination meter) is detected from the buzzer output signal received from each unit via CAN communication and the warning output condition of the combination meter.	L
BATTERY CIRCUIT STATUS [NORMAL/OPEN]		Displays [NORMAL/OPEN] condition of battery circuit status.	M
PARKING AIDS DSP [On/Off]		Displays [On/Off] condition of parking aids display setting.	WCS
PARKING AIDS SENSOR [On/Off]		Displays [On/Off] condition of parking aids sensor setting.	WCS
PARKING AIDS VOLUME [Low/Medium/High]		Displays [Low/Medium/High] condition of parking aids volume.	O
PARKING AIDS RANGE [Near/Medium/Far]		Displays [Near/Medium/Far] condition of parking aids range.	P
TPMS DISP [ON/OFF]		Displays [ON/OFF] condition of TPMS display.	P
TIRE STATUS FR [ON/OFF]		Displays [ON/OFF] condition of tire status.	
TIRE STATUS FL [ON/OFF]		Displays [ON/OFF] condition of tire status.	

## DIAGNOSIS SYSTEM (COMBINATION METER)

### < SYSTEM DESCRIPTION >

Display item [Unit]	MAIN SIGNALS	Description
TIRE STATUS RR [ON/OFF]		Displays [ON/OFF] condition of tire status.
TIRE STATUS RL [ON/OFF]		Displays [ON/OFF] condition of tire status.
SONER SET AVA [Available/Unavailable]		Displays [AVAILABLE/UNAVAILABLE] condition of meter setting.
STRG SW INPUT [SW1,SW2,SW3,SW4,SW5,SW6,SW7,SW8,SW9,SW10]		Displays [SW1,SW2,SW3,SW4,SW5,SW6,SW7,SW8,SW9,SW10] condition of steering switch.
ITS SONER SET OUTPUT		Displays status of soner.
SONAR DET STA [ON/OFF]		Displays [ON/OFF] condition of sonar detection area.
SONAR WARN [OFF/SENSOR DEACTIVE/SENSOR ERROR]		Displays [OFF/SENSOR DEACTIVE/SENSOR ERROR] condition of sonar warning.
SONAR DET DSP RC [ON/OFF]		Displays [ON/OFF] condition of RC sonar detection display.
SONAR DSP AREA RC [ON/OFF]		Displays [ON/OFF] condition of RC sonar detection area image.
SONAR DET DSP RL [ON/OFF]		Displays [ON/OFF] condition of RL sonar detection display.
SONAR DSP AREA RL [ON/OFF]		Displays [ON/OFF] condition of RL sonar detection area image.
SONAR DET DSP RR [ON/OFF]		Displays [ON/OFF] condition of RR sonar detection display.
SONAR DSP AREA RR [ON/OFF]		Displays [ON/OFF] condition of RR sonar detection area image.
SONAR DET DSP FC [ON/OFF]		Displays [ON/OFF] condition of FC sonar detection area.
SONAR DSP AREA FC [ON/OFF]		Displays [ON/OFF] condition of FC sonar detection area image.
SONAR DET DSP FL [ON/OFF]		Displays [ON/OFF] condition of FL sonar detection display.
SONAR DSP AREA FL [ON/OFF]		Displays [ON/OFF] condition of FL sonar detection area image.
SONAR DET DSP FR [ON/OFF]		Displays [ON/OFF] condition of FR sonar detection display.
SONAR DSP AREA FR [ON/OFF]		Displays [ON/OFF] condition of FR sonar detection area image.
SONAR DIST DSP [ON/OFF]		Displays sonar distance status.
TPMS PRESS L [ON/OFF]		Displays [ON/OFF] condition of low tire pressure message in the information display.
TPMS MALF [ON/OFF]		Displays [ON/OFF] condition of TPMS warning indicator.
4WD CL TMP H [ON/OFF]		Displays [ON/OFF] condition of 4WD clutch high temperature message in the information display.
4WD TIRE CHCK [ON/OFF]		Displays [ON/OFF] condition of 4WD tire check message in the information display.
4WD SYS MALF [ON/OFF]		Displays [ON/OFF] condition of 4WD system malfunction message in the information display.

# DIAGNOSIS SYSTEM (COMBINATION METER)

## < SYSTEM DESCRIPTION >

Display item [Unit]	MAIN SIGNALS	Description
TIRE PRESS FR [kPa, kg/cm2 or Psi]		Displays air pressure of front right tire.
TIRE PRESS FL [kPa, kg/cm2 or Psi]		Displays air pressure of front left tire.
TIRE PRESS RR [kPa, kg/cm2 or Psi]		Displays air pressure of rear right tire.
TIRE PRESS RL [kPa, kg/cm2 or Psi]		Displays air pressure of rear left tire.

## SPECIAL FUNCTION

Special menu

Display item	Description
W/L ON HISTORY	Lighting history of warning lamp and indicator lamp can be checked.

### W/L ON HISTORY

- “W/L ON HISTORY” indicates the “TIME” when the warning/ indicator lamp is turned on.
- The “TIME” above is:
  - 0: The condition that the warning/indicator lamp has been turned on 1 or more times after starting the engine and waiting for 30 seconds.
  - 1 - 39: The number of times the engine was restarted after the 0 condition.
  - NO W/L ON HISTORY: No warning/indicator lamp history is stored.

### NOTE:

- W/L ON HISTORY is not stored for approximately 30 seconds after the engine starts.
- Brake warning lamp does not store any history when the parking brake is applied or the brake fluid level gets low.

WCS

# DIAGNOSIS SYSTEM (BCM)

< SYSTEM DESCRIPTION >

## DIAGNOSIS SYSTEM (BCM) COMMON ITEM

COMMON ITEM : CONSULT Function (BCM - COMMON ITEM)

INFOID:000000008945482

### APPLICATION ITEM

CONSULT performs the following functions via CAN communication with BCM.

Direct Diagnostic Mode	Description
Ecu Identification	The BCM part number is displayed.
Self Diagnostic Result	The BCM self diagnostic results are displayed.
Data Monitor	The BCM input/output data is displayed in real time.
Active Test	The BCM activates outputs to test components.
Work support	The settings for BCM functions can be changed.
Configuration	<ul style="list-style-type: none"> <li>The vehicle specification can be read and saved.</li> <li>The vehicle specification can be written when replacing BCM.</li> </ul>
CAN Diag Support Mntr	The result of transmit/receive diagnosis of CAN communication is displayed.

### SYSTEM APPLICATION

BCM can perform the following functions.

System	Sub System	Direct Diagnostic Mode						
		Ecu Identification	Self Diagnostic Result	Data Monitor	Active Test	Work support	Configuration	CAN Diag Support Mntr
Door lock	DOOR LOCK		×	×	×	×		
Rear window defogger	REAR DEFOGGER			×	×	×		
Warning chime	BUZZER			×	×			
Interior room lamp timer	INT LAMP			×	×	×		
Exterior lamp	HEADLAMP			×	×	×		
Wiper and washer	WIPER			×	×	×		
Turn signal and hazard warning lamps	FLASHER			×	×			
Air conditioner	AIR CONDITIONER			×				
Intelligent Key system	INTELLIGENT KEY		×	×	×	×		
Combination switch	COMB SW			×				
BCM	BCM	×	×			×	×	×
Immobilizer	IMMU		×	×	×			
Interior room lamp battery saver	BATTERY SAVER			×	×			
Back door open	TRUNK			×				
Vehicle security system	THEFT ALM			×	×	×		
RAP system	RETAINED PWR			×				
Signal buffer system	SIGNAL BUFFER			×				
TPMS	AIR PRESSURE MONITOR		×	×	×	×		

## BUZZER

# DIAGNOSIS SYSTEM (BCM)

< SYSTEM DESCRIPTION >

## BUZZER : CONSULT Function (BCM - BUZZER)

INFOID:000000008945483

### DATA MONITOR

Monitor Item [Unit]	Description
PUSH -SW [On/Off]	Indicates condition of push-button ignition switch.
UNLK SEN -DR [On/Off]	Indicates condition of door unlock sensor.
VEH SPEED 1 [km/h]	Indicates vehicle speed signal received from ABS on CAN communication line.
TAIL LAMP SW [On/Off]	Indicates condition of combination switch.
FR FOG SW [On/Off]	Indicates condition of front fog lamp switch.
DOOR SW-DR [On/Off]	Indicates condition of front door switch LH.
CDL LOCK SW [On/Off]	Indicates condition of lock signal from door lock and unlock switch.

### ACTIVE TEST

Test Item	Description
SEAT BELT WARN TEST	This test is able to check seat belt warning chime operation [On/Off].
LIGHT WARN ALM	This test is able to check light warning chime operation [On/Off].
REVERSE WARNING	This test is able to check reverse warning chime operation [On/Off].
ID REGIST WARNING	This test is able to check TPMS transmitter ID regist warning chime operation [On/Off].

A  
B  
C  
D  
E  
F  
G  
H  
I  
J  
K  
L  
M  
O  
P

WCS

# BCM, COMBINATION METER

< ECU DIAGNOSIS INFORMATION >

## ECU DIAGNOSIS INFORMATION

### BCM, COMBINATION METER

#### List of ECU Reference

INFOID:000000008509993

ECU	Reference
BCM	<a href="#">BCS-28, "Reference Value"</a>
	<a href="#">BCS-48, "Fail Safe"</a>
	<a href="#">BCS-48, "DTC Inspection Priority Chart"</a>
	<a href="#">BCS-50, "DTC Index"</a>
COMBINATION METER	<a href="#">MWI-24, "Reference Value"</a>
	<a href="#">MWI-28, "Fail-Safe"</a>
	<a href="#">MWI-29, "DTC Index"</a>





# WARNING CHIME SYSTEM

< WIRING DIAGRAM >

## WARNING CHIME SYSTEM CONNECTORS

Connector No.	M3
Connector Name	FUSE BLOCK (J/B)
Connector Color	WHITE

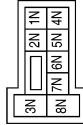

Connector No.	M4
Connector Name	FUSE BLOCK (J/B)
Connector Color	WHITE



Connector No.	M18
Connector Name	BCM (BODY CONTROL MODULE)
Connector Color	GREEN

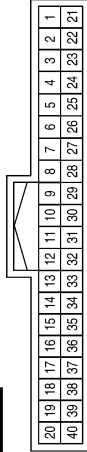

Terminal No.	Color of Wire	Signal Name
6N	W	-

Terminal No.	Color of Wire	Signal Name
8P	BG	-
13P	W	-

Terminal No.	Color of Wire	Signal Name
10	W	COMBI SW IN 5
11	BG	COMBI SW IN 4
12	R	COMBI SW IN 3
13	G	COMBI SW IN 2
14	P	COMBI SW IN 1
25	W	BRAKE SW FUSE

Connector No.	M19
Connector Name	BCM (BODY CONTROL MODULE)
Connector Color	BLACK

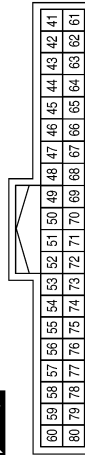

Terminal No.	Color of Wire	Signal Name
59	P	CAN-L
60	L	CAN-H
75	BG	COMBI SW OUT 5
76	P	COMBI SW OUT 4
77	R	COMBI SW OUT 3
78	G	COMBI SW OUT 2
79	W	COMBI SW OUT 1

Connector No.	M20
Connector Name	BCM (BODY CONTROL MODULE)
Connector Color	GRAY

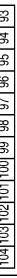

Terminal No.	Color of Wire	Signal Name
96	BG	DR DOOR SW

# WARNING CHIME SYSTEM

< WIRING DIAGRAM >

Connector No.	M31
Connector Name	WIRE TO WIRE
Connector Color	WHITE

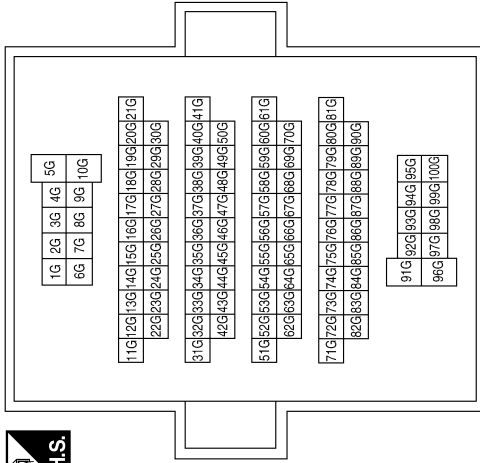

Terminal No.	Color of Wire	Signal Name
10G	W	-
33G	G	-
35G	P	-
36G	L	-

Connector No.	M28
Connector Name	COMBINATION SWITCH
Connector Color	WHITE

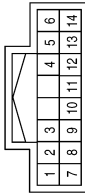

Terminal No.	Color of Wire	Signal Name
2	BG	-
5	R	-
7	R	-
8	W	-
9	G	-
10	P	-
11	W	-
12	P	-
13	BG	-
14	G	-

Connector No.	M24
Connector Name	COMBINATION METER
Connector Color	WHITE

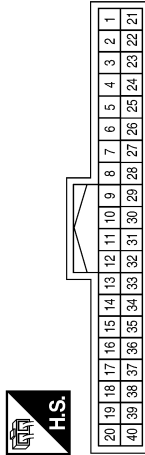

Terminal No.	Color of Wire	Signal Name
1	B	GND1
2	B	GND2
9	Y	DR BUCKLE SW
12	G	PKB
21	BG	IGN
22	W	BAT
38	P	CAN-L
39	L	CAN-H

A  
B  
C  
D  
E  
F  
G  
H  
I  
J  
K  
L  
M  
O  
P

WCS

AANIA1155GB

# WARNING CHIME SYSTEM

< WIRING DIAGRAM >

Connector No.	M41
Connector Name	JOINT CONNECTOR-M18
Connector Color	WHITE



Terminal No.	Color of Wire	Signal Name
1	P	-
2	P	-

Terminal No.	Color of Wire	Signal Name
66A	BG	-
67A	Y	-
89A	L	-
90A	P	-

Connector No.	M40
Connector Name	WIRE TO WIRE
Connector Color	BROWN

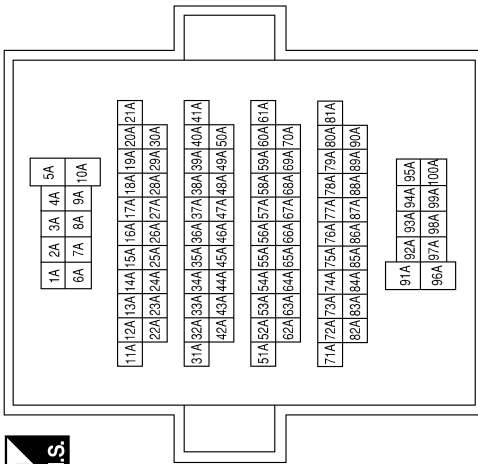
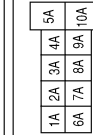

Connector No.	M81
Connector Name	BCM (BODY CONTROL MODULE)
Connector Color	WHITE

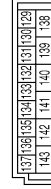

Terminal No.	Color of Wire	Signal Name
131	W	BAT BCM FUSE
134	B	GND 2
139	W	BAT-POWER F/L
143	B	GND 1

Connector No.	M68
Connector Name	FUSE BLOCK (J/B)
Connector Color	BROWN



Terminal No.	Color of Wire	Signal Name
10R	W	-

Connector No.	M43
Connector Name	JOINT CONNECTOR-M17
Connector Color	WHITE



Terminal No.	Color of Wire	Signal Name
1	L	-
2	L	-

AANIA1156GB

# WARNING CHIME SYSTEM

< WIRING DIAGRAM >

Connector No.	E52
Connector Name	PARKING BRAKE SWITCH
Connector Color	BLACK



Terminal No.	Color of Wire	Signal Name
1	LG	-

Connector No.	M181
Connector Name	JOINT CONNECTOR-M36
Connector Color	WHITE

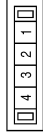

Terminal No.	Color of Wire	Signal Name
1	W	-
2	W	-

Connector No.	M84
Connector Name	WIRE TO WIRE
Connector Color	WHITE

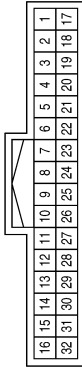

Terminal No.	Color of Wire	Signal Name
17	L	-
18	P	-

Connector No.	E125
Connector Name	ABS ACTUATOR AND ELECTRIC UNIT (CONTROL UNIT)
Connector Color	BLACK

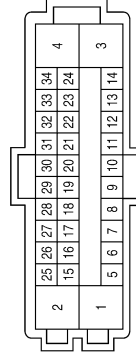

Terminal No.	Color of Wire	Signal Name
15	P	CAN-L
25	L	CAN-H

Connector No.	E71
Connector Name	JOINT CONNECTOR-E15
Connector Color	BLACK



Terminal No.	Color of Wire	Signal Name
1	L	-
3	L	-

Connector No.	E70
Connector Name	JOINT CONNECTOR-E14
Connector Color	BLACK



Terminal No.	Color of Wire	Signal Name
1	P	-
3	P	-

AANIA1157GB

A  
B  
C  
D  
E  
F  
G  
H  
I  
J  
K  
L  
M  
N  
O  
P

WCS

# WARNING CHIME SYSTEM

< WIRING DIAGRAM >

Connector No.	B8
Connector Name	FRONT DOOR SWITCH LH
Connector Color	WHITE

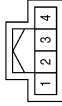

Terminal No.	Color of Wire	Signal Name
3	L	-

Terminal No.	Color of Wire	Signal Name
10G	P	-
33G	LG	-
35G	P	-
36G	L	-

Connector No.	E152
Connector Name	WIRE TO WIRE
Connector Color	WHITE

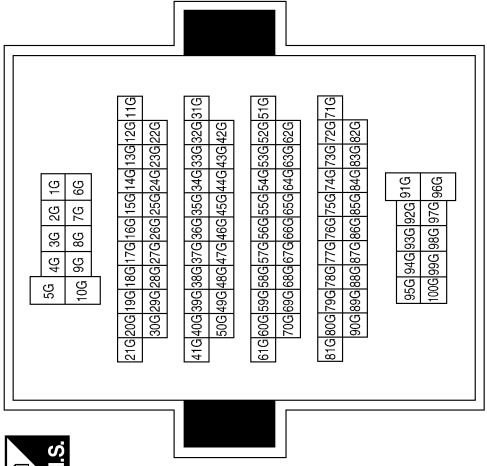

Connector No.	B16
Connector Name	JOINT CONNECTOR-B11
Connector Color	WHITE

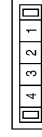

Terminal No.	Color of Wire	Signal Name
1	P	-
2	P	-

Connector No.	B12
Connector Name	JOINT CONNECTOR-B10
Connector Color	WHITE



Terminal No.	Color of Wire	Signal Name
1	L	-
2	L	-

Connector No.	B11
Connector Name	JOINT CONNECTOR-B09
Connector Color	WHITE



Terminal No.	Color of Wire	Signal Name
1	P	-
2	P	-

AANIA1158GB

# WARNING CHIME SYSTEM

< WIRING DIAGRAM >

Connector No.	B17
Connector Name	JOINT CONNECTOR-B12
Connector Color	WHITE



Terminal No.	Color of Wire	Signal Name
1	L	-
2	L	-

Connector No.	B32
Connector Name	WIRE TO WIRE
Connector Color	WHITE

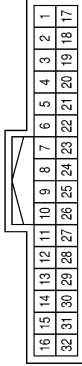

Terminal No.	Color of Wire	Signal Name
18	L	-
19	P	-

Connector No.	B69
Connector Name	WIRE TO WIRE
Connector Color	GRAY

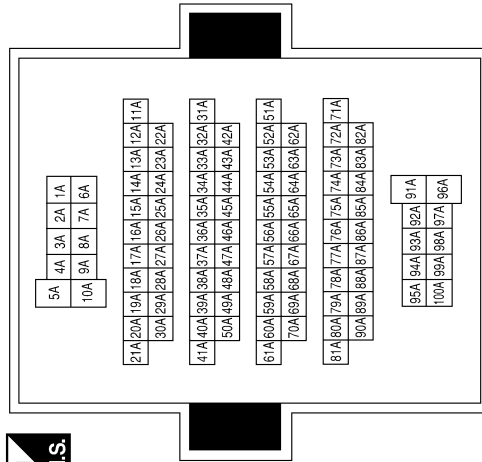

Terminal No.	Color of Wire	Signal Name
66A	L	-
67A	LG	-
89A	L	-
90A	P	-

Connector No.	B74
Connector Name	WIRE TO WIRE
Connector Color	WHITE

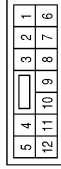

Terminal No.	Color of Wire	Signal Name
3	LG	-
4	B	-

AANIA1159GB

A  
B  
C  
D  
E  
F  
G  
H  
I  
J  
K  
L  
M  
O  
P

WCS

# WARNING CHIME SYSTEM

< WIRING DIAGRAM >

Connector No.	B124
Connector Name	WIRE TO WIRE
Connector Color	WHITE



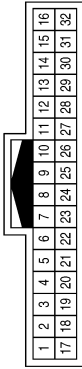

Terminal No.	Color of Wire	Signal Name
18	L	-
19	P	-

Connector No.	B101
Connector Name	WIRE TO WIRE
Connector Color	WHITE



Terminal No.	Color of Wire	Signal Name
17	L	-
18	P	-

Connector No.	B80
Connector Name	JOINT CONNECTOR-B17
Connector Color	WHITE

Terminal No.	Color of Wire	Signal Name
1	LG	-
2	LG	-

Connector No.	B221
Connector Name	SEAT BELT BUCKLE SWITCH (DRIVER SEAT)
Connector Color	WHITE

Terminal No.	Color of Wire	Signal Name
3	GR	-
4	BG	-

Connector No.	B220
Connector Name	WIRE TO WIRE
Connector Color	WHITE

Terminal No.	Color of Wire	Signal Name
3	BG	-
4	GR	-

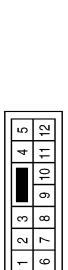
AANIA1160GB



# DIAGNOSIS AND REPAIR WORKFLOW

< BASIC INSPECTION >

## BASIC INSPECTION

### DIAGNOSIS AND REPAIR WORKFLOW

Work Flow

INFOID:000000008509995

#### OVERALL SEQUENCE

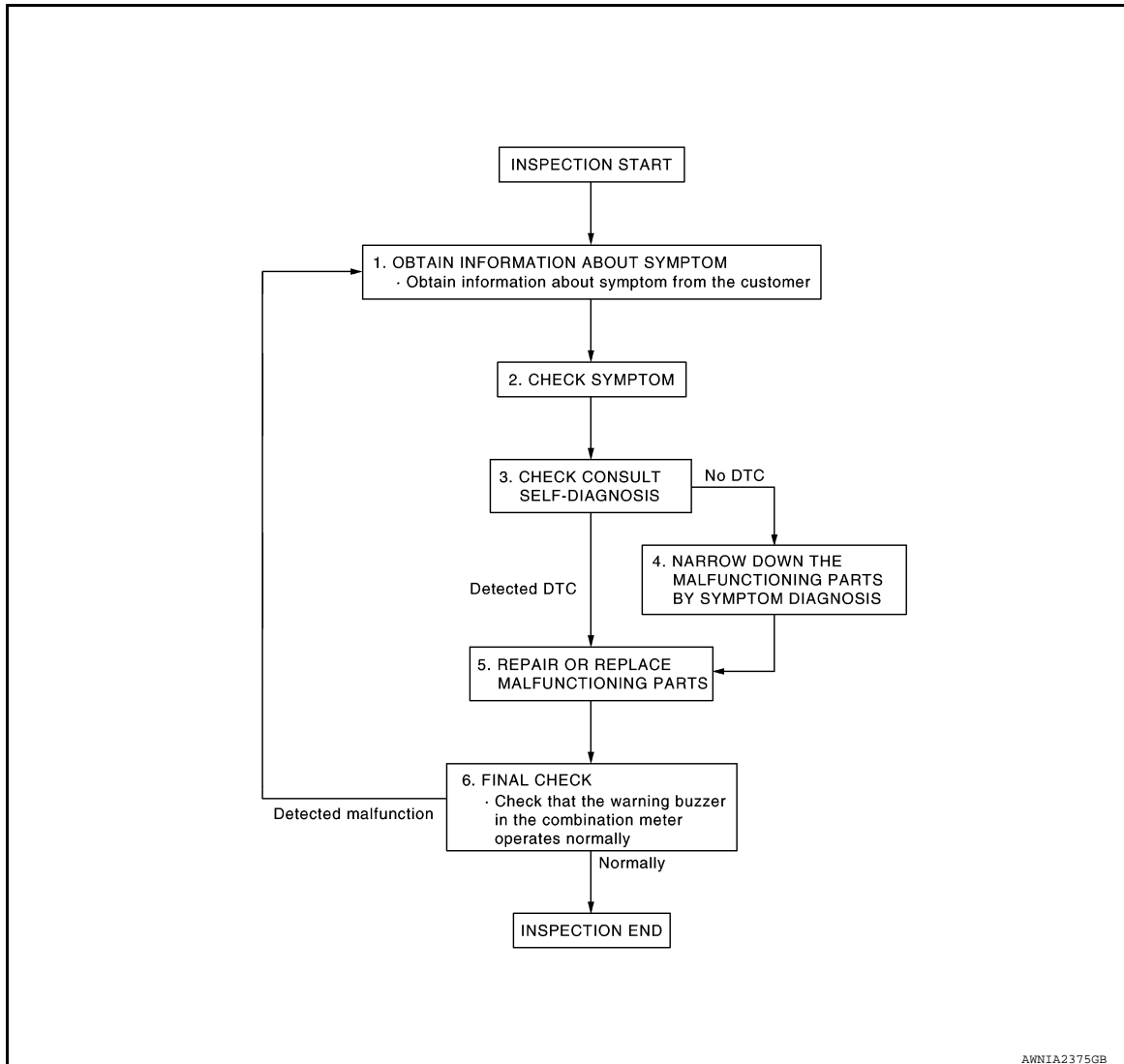

#### DETAILED FLOW

##### 1. OBTAIN INFORMATION ABOUT SYMPTOM

Interview the customer to obtain as much information as possible about the conditions and environment under which the malfunction occurred.

>> GO TO 2.

##### 2. CHECK SYMPTOM

- Check the symptom based on the information obtained from the customer.
- Check if any other malfunctions are present.

>> GO TO 3.

##### 3. CHECK CONSULT SELF-DIAGNOSIS RESULTS

Connect CONSULT and perform Self Diagnosis. Refer to [MWI-29, "DTC Index"](#).

## DIAGNOSIS AND REPAIR WORKFLOW

< BASIC INSPECTION >

---

Are self-diagnosis results normal?

YES >> GO TO 4.

NO >> GO TO 5.

### 4. NARROW DOWN MALFUNCTIONING PARTS BY SYMPTOM DIAGNOSIS

---

Perform symptom diagnosis. Refer to [WCS-32. "Symptom Table"](#).

>> GO TO 5.

### 5. REPAIR OR REPLACE MALFUNCTIONING PARTS

---

Repair or replace malfunctioning parts.

**NOTE:**

If DTC is displayed, erase DTC after repairing or replacing malfunctioning parts.

>> GO TO 6.

### 6. FINAL CHECK

---

Check that the warning buzzer in the combination meter operates normally.

Does it operate normally?

YES >> Inspection End.

NO >> GO TO 1.

# POWER SUPPLY AND GROUND CIRCUIT

< DTC/CIRCUIT DIAGNOSIS >

## DTC/CIRCUIT DIAGNOSIS

### POWER SUPPLY AND GROUND CIRCUIT COMBINATION METER

#### COMBINATION METER : Diagnosis Procedure

INFOID:000000008945481

Regarding Wiring Diagram information, refer to [MWI-31, "Wiring Diagram"](#).

#### 1. CHECK FUSES

Check that the following fuses are not blown.

Unit	Power source	Fuse No.
Combination meter	Battery	13
		65
	Ignition switch ON or START	31

Is the fuse blown?

YES >> GO TO 2.

NO >> Replace the blown fuse after repairing the affected circuit.

#### 2. POWER SUPPLY CIRCUIT CHECK

1. Disconnect combination meter connector.
2. Check voltage between combination meter harness connector M24 terminals 5, 21, 22 and ground.

Terminals		Ignition switch position				
(+)		(-)	OFF	ACC	ON	START
Connector	Terminal					
M24	22	Ground	Battery voltage	Battery voltage	Battery voltage	Battery voltage
	21		0V	0V	Battery voltage	Battery voltage
	5		0V	Battery voltage	Battery voltage	0V

Is the inspection result normal?

YES >> GO TO 3.

NO >> Repair or replace harness or connectors.

#### 3. GROUND CIRCUIT CHECK

1. Turn ignition switch OFF.
2. Check continuity between combination meter harness connector M24 terminals 1, 2 and ground.

Terminals		Continuity	
(+)			(-)
Connector	Terminal		
M24	1	Ground	Yes
	2		

Is the inspection result normal?

YES >> Inspection End.

NO >> Repair or replace harness or connectors.

#### BCM (BODY CONTROL MODULE)

A  
B  
C  
D  
E  
F  
G  
H  
I  
J  
K  
L  
M  
O  
P

# POWER SUPPLY AND GROUND CIRCUIT

< DTC/CIRCUIT DIAGNOSIS >

## BCM (BODY CONTROL MODULE) : Diagnosis Procedure

INFOID:000000008945484

Regarding Wiring Diagram information, refer to [BCS-53. "Wiring Diagram"](#).

### 1. CHECK FUSE AND FUSIBLE LINK

Check that the following fuse and fusible link are not blown.

Terminal No.	Signal name	Fuse and fusible link No.
139	Fusible link battery power	O (40A)
131	BCM battery fuse	1 (10A)

Is the fuse or fusible link blown?

YES >> Replace the blown fuse or fusible link after repairing the affected circuit.

NO >> GO TO 2

### 2. CHECK POWER SUPPLY CIRCUIT

1. Disconnect BCM connector M81.

2. Check voltage between BCM connector M81 terminals 131, 139 and ground.

BCM		Ground	Voltage (Approx.)
Connector	Terminal		
M81	131	—	Battery voltage
	139		

Is the inspection result normal?

YES >> GO TO 3

NO >> Repair or replace harness or connectors.

### 3. CHECK GROUND CIRCUIT

Check continuity between BCM connector M81 terminals 134, 143 and ground.

BCM		Ground	Continuity
Connector	Terminal		
M81	134	—	Yes
	143		

Is the inspection result normal?

YES >> Inspection End.

NO >> Repair or replace harness or connectors.

# METER BUZZER CIRCUIT

< DTC/CIRCUIT DIAGNOSIS >

## METER BUZZER CIRCUIT

### Description

INFOID:000000008509998

- The buzzer for the warning chime system is installed in the combination meter.
- The combination meter sounds the buzzer based on the signals transmitted from various units.

### Component Function Check

INFOID:000000008509999

#### 1. CHECK OPERATION OF METER BUZZER

1. Select BUZZER of BCM on CONSULT.
2. Perform LIGHT WARN ALM or SEAT BELT WARN TEST of ACTIVE TEST.

#### Does meter buzzer activate?

- YES >> Inspection End.  
NO >> Refer to [WCS-29, "Diagnosis Procedure"](#).

### Diagnosis Procedure

INFOID:000000008510000

#### 1. CHECK COMBINATION METER INPUT SIGNAL

Select the Data Monitor for the METER/M&A and check the BUZZER monitor value.

BUZZER

Under the condition of buzzer input : On

Except above : Off

#### Is the inspection result normal?

- YES >> Replace combination meter. Refer to [MWI-82, "Removal and Installation"](#).  
NO >> Replace BCM. Refer to [BCS-78, "Removal and Installation"](#).

A  
B  
C  
D  
E  
F  
G  
H  
I  
J  
K  
L  
M  
O  
P

WCS

# SEAT BELT BUCKLE SWITCH SIGNAL CIRCUIT

< DTC/CIRCUIT DIAGNOSIS >

## SEAT BELT BUCKLE SWITCH SIGNAL CIRCUIT

### Description

INFOID:000000008510001

Transmits a seat belt buckle switch signal to the combination meter.

### Component Function Check

INFOID:000000008510002

#### 1. CHECK COMBINATION METER INPUT SIGNAL

1. Ignition ON.
2. Monitor seat belt warning lamp while fastening and unfastening the driver seat belt buckle.

Condition	Warning lamp status
When driver seat belt buckle is unfastened	ON
When driver seat belt buckle is fastened	OFF

#### Is the inspection result normal?

- YES >> Inspection End.  
NO >> Refer to [WCS-30, "Diagnosis Procedure"](#).

### Diagnosis Procedure

INFOID:000000008510003

Regarding Wiring Diagram information, refer to [WCS-17, "Wiring Diagram"](#).

#### 1. CHECK COMBINATION METER INPUT SIGNAL

1. Turn ignition switch ON.
2. Check voltage between combination meter harness connector M24 terminal 9 and ground.

Combination meter		Condition	Voltage (Approx.)
Connector	Terminals		
	(+)	(-)	
M24	9	Ground	When driver seat belt is fastened 12 V
			When driver seat belt is unfastened 0 V

#### Is the inspection result normal?

- YES >> Replace combination meter. Refer to [MWI-82, "Removal and Installation"](#).  
NO >> GO TO 2.

#### 2. CHECK SEAT BELT BUCKLE SWITCH CIRCUIT

1. Turn ignition switch OFF.
2. Disconnect combination meter harness connector M24 and seat belt buckle switch (driver seat) harness connector B221.
3. Check continuity between combination meter harness connector M24 terminal 9 and seat belt buckle switch (driver seat) harness connector B221 terminal 4.

Combination meter		Seat belt buckle switch (driver seat)		Continuity
Connector	Terminal	Connector	Terminal	
M24	9	B221	4	Yes

4. Check continuity between combination meter harness connector M24 terminal 9 and ground.

# SEAT BELT BUCKLE SWITCH SIGNAL CIRCUIT

## < DTC/CIRCUIT DIAGNOSIS >

Combination meter		Ground	Continuity
Connector	Terminal		
M24	9		No

Is the inspection result normal?

YES >> GO TO 3.

NO >> Repair or replace harness or connector.

### 3. CHECK SEAT BELT BUCKLE SWITCH GROUND CIRCUIT

Check continuity between seat belt buckle switch (driver seat) harness connector B221 terminal 3 and ground.

Seat belt buckle switch (driver seat)		Ground	Continuity
Connector	Terminal		
B221	3		Yes

Is the inspection result normal?

YES >> Inspection End.

NO >> Repair or replace harness or connector.

### Component Inspection

INFOID:000000008510004

#### 1. CHECK SEAT BELT BUCKLE SWITCH

1. Turn ignition switch OFF.
2. Disconnect the seat belt buckle switch (driver seat) connector.
3. Check continuity between the seat belt buckle switch (driver seat) terminals 3 and 4.

Condition	Terminal	Continuity
When seat belt buckle is fastened	3- 4	No
When seat belt buckle is unfastened		Yes

Is the inspection result normal?

YES >> Inspection End.

NO >> Replace the seat belt buckle switch (driver seat). Refer to [SR-30. "Removal and Installation"](#).

WCS

## WARNING CHIME SYSTEM SYMPTOMS

< SYMPTOM DIAGNOSIS >

### SYMPTOM DIAGNOSIS

#### WARNING CHIME SYSTEM SYMPTOMS

##### Symptom Table

INFOID:000000008510005

**CAUTION:**

Perform the self-diagnosis with CONSULT before the symptom diagnosis. Perform the trouble diagnosis if any DTC is detected.

Symptom	Possible cause	Inspection item
The light reminder warning does not sound.	<ul style="list-style-type: none"><li>• Harness between BCM and front door switch LH</li><li>• Front door switch LH</li><li>• BCM</li><li>• Combination meter</li></ul>	Refer to <a href="#">WCS-33</a> .
The parking brake release warning continues sounding or does not sound.	<ul style="list-style-type: none"><li>• Harness between combination meter and parking brake switch</li><li>• Parking brake switch</li><li>• BCM</li><li>• Combination meter</li></ul>	Refer to <a href="#">WCS-35</a> .
The seat belt warning continues sounding or does not sound.	<ul style="list-style-type: none"><li>• Harness between combination meter and seat belt buckle switch (driver seat)</li><li>• Seat belt buckle switch (driver seat)</li><li>• BCM</li><li>• Combination meter</li></ul>	Refer to <a href="#">WCS-34</a> .
Warning chime does not sound at all.	<ul style="list-style-type: none"><li>• BCM</li><li>• Combination meter</li></ul>	Refer to <a href="#">WCS-29</a> .



# THE LIGHT REMINDER WARNING DOES NOT SOUND

< SYMPTOM DIAGNOSIS >

## THE LIGHT REMINDER WARNING DOES NOT SOUND

### Description

INFOID:000000008510006

Light reminder warning does not sound even though headlamp is illuminated.

### Diagnosis Procedure

INFOID:000000008510007

#### 1.CHECK COMBINATION METER INPUT SIGNAL

Select the Data Monitor for the METER/M&A and check the BUZZER monitor value.

##### BUZZER

Under the condition of buzzer input : On

Except above : Off

Is the inspection result normal?

YES >> Replace combination meter. Refer to [MWI-82, "Removal and Installation"](#).

NO >> GO TO 2.

#### 2.CHECK FRONT DOOR SWITCH LH SIGNAL CIRCUIT

Perform inspection of the front door switch LH signal circuit. Refer to [DLK-168, "Diagnosis Procedure"](#).

Is the inspection result normal?

YES >> GO TO 3.

NO >> Repair or replace harness or connector.

#### 3.CHECK FRONT DOOR SWITCH LH

Perform a unit inspection for the front door switch LH. Refer to [DLK-169, "Component Inspection"](#).

Is the inspection result normal?

YES >> Replace the BCM. Refer to [BCS-78, "Removal and Installation"](#).

NO >> Replace the front door switch LH. Refer to [DLK-310, "Removal and Installation"](#).

A  
B  
C  
D  
E  
F  
G  
H  
I  
J  
K  
L  
M  
O  
P

WCS

# THE SEAT BELT WARNING CONTINUES SOUNDING, OR DOES NOT SOUND

< SYMPTOM DIAGNOSIS >

## THE SEAT BELT WARNING CONTINUES SOUNDING, OR DOES NOT SOUND

### Description

INFOID:000000008510008

- Seat belt warning does not sound even though driver seat belt is not fastened.
- Seat belt warning sounds even though driver seat belt is fastened.

### Diagnosis Procedure

INFOID:000000008510009

#### 1. CHECK WARNING CHIME OPERATION

1. Select BUZZER of BCM on CONSULT.
2. Perform SEAT BELT WARN TEST of ACTIVE TEST.

Component	CONSULT	Condition
Buzzer	SEAT BELT WARN TEST	ON
		OFF

Is the inspection result normal?

- YES >> GO TO 2.  
NO >> Replace combination meter. Refer to [MWI-82, "Removal and Installation"](#).

#### 2. CHECK COMBINATION METER INPUT SIGNAL

Perform a component function test of the combination meter input signal. Refer to [WCS-30, "Component Function Check"](#).

Is the inspection result normal?

- YES >> Replace BCM. Refer to [BCS-78, "Removal and Installation"](#).  
NO >> GO TO 3.

#### 3. CHECK SEAT BELT BUCKLE SWITCH CIRCUIT

Perform an inspection of the seat belt buckle switch (driver seat) circuit. Refer to [WCS-30, "Diagnosis Procedure"](#).

Is the inspection result normal?

- YES >> GO TO 4.  
NO >> Repair or replace harness or connector.

#### 4. CHECK SEAT BELT BUCKLE SWITCH

Perform a unit inspection for the seat belt buckle switch (driver seat). Refer to [WCS-31, "Component Inspection"](#).

Is the inspection result normal?

- YES >> Replace the combination meter. Refer to [MWI-82, "Removal and Installation"](#).  
NO >> Replace the seat belt buckle switch (driver seat). Refer to [SB-7, "Front Seat Belt"](#).

# THE PARKING BRAKE RELEASE WARNING CONTINUES SOUNDING, OR DOES NOT SOUND

< SYMPTOM DIAGNOSIS >

## THE PARKING BRAKE RELEASE WARNING CONTINUES SOUNDING, OR DOES NOT SOUND

### Description

INFOID:000000008510010

- The parking brake warning buzzer sounds continuously during vehicle travel though the parking brake is released.
- The parking brake warning buzzer does not sound at all even though driving the vehicle with the parking brake applied.

### Diagnosis Procedure

INFOID:000000008510011

#### 1. CHECK PARKING BRAKE WARNING LAMP

1. Start the engine.
2. Check the operation of the brake warning lamp by operating the parking brake.

Condition	Warning lamp status
Parking brake applied	ON
Parking brake released	OFF

Is the inspection result normal?

- YES >> Replace the combination meter. Refer to [MWI-82, "Removal and Installation"](#).  
NO >> GO TO 2.

#### 2. CHECK PARKING BRAKE SWITCH SIGNAL CIRCUIT

Perform inspection of the parking brake switch signal circuit. Refer to [MWI-69, "Diagnosis Procedure"](#).

Is the inspection result normal?

- YES >> GO TO 3.  
NO >> Repair or replace harness or connector.

#### 3. CHECK PARKING BRAKE SWITCH UNIT

Perform a unit inspection for the parking brake switch. Refer to [MWI-69, "Component Inspection"](#).

Is the inspection result normal?

- YES >> Replace the combination meter. Refer to [MWI-82, "Removal and Installation"](#).  
NO >> Replace the parking brake switch. Refer to [PB-7, "Exploded View"](#).

WCS