

MWI

SECTION

METER, WARNING LAMP & INDICATOR

A
B
C
D
E
F
G
H
I
J
K
L
M
O
P

CONTENTS

BASIC INSPECTION	3	FUEL GAUGE : Component Description	12
DIAGNOSIS AND REPAIR WORKFLOW	3	ENGINE OIL PRESSURE GAUGE	12
Work Flow	3	ENGINE OIL PRESSURE GAUGE : System Dia-	12
FUNCTION DIAGNOSIS	4	gram	12
METER SYSTEM	4	ENGINE OIL PRESSURE GAUGE : System De-	12
METER SYSTEM	4	scription	12
METER SYSTEM : System Diagram	4	ENGINE OIL PRESSURE GAUGE : Component	13
METER SYSTEM : System Description	4	Parts Location	13
METER SYSTEM : Arrangement of Combination		ENGINE OIL PRESSURE GAUGE : Component	13
Meter	5	Description	13
METER SYSTEM : Component Parts Location	6	VOLTAGE GAUGE	13
METER SYSTEM : Component Description	6	VOLTAGE GAUGE : System Diagram	14
SPEEDOMETER	7	VOLTAGE GAUGE : System Description	14
SPEEDOMETER : System Diagram	7	VOLTAGE GAUGE : Component Parts Location	14
SPEEDOMETER : System Description	7	VOLTAGE GAUGE : Component Description	15
SPEEDOMETER : Component Parts Location	7	ODO/TRIP METER	15
SPEEDOMETER : Component Description	8	ODO/TRIP METER : System Diagram	15
TACHOMETER	8	ODO/TRIP METER : System Description	15
TACHOMETER : System Diagram	8	ODO/TRIP METER : Component Parts Location	15
TACHOMETER : System Description	8	ODO/TRIP METER : Component Description	16
TACHOMETER : Component Parts Location	9	SHIFT POSITION INDICATOR	16
TACHOMETER : Component Description	9	SHIFT POSITION INDICATOR : System Diagram	16
ENGINE COOLANT TEMPERATURE GAUGE	9	SHIFT POSITION INDICATOR : System Descrip-	16
ENGINE COOLANT TEMPERATURE GAUGE :		tion	16
System Diagram	10	SHIFT POSITION INDICATOR : Component	17
ENGINE COOLANT TEMPERATURE GAUGE :		Parts Location	17
System Description	10	SHIFT POSITION INDICATOR : Component De-	17
ENGINE COOLANT TEMPERATURE GAUGE :		scription	17
Component Parts Location	10	WARNING LAMPS/INDICATOR LAMPS	17
ENGINE COOLANT TEMPERATURE GAUGE :		WARNING LAMPS/INDICATOR LAMPS : System	17
Component Description	11	Diagram	17
FUEL GAUGE	11	WARNING LAMPS/INDICATOR LAMPS : System	18
FUEL GAUGE : System Diagram	11	Description	18
FUEL GAUGE : System Description	11	WARNING LAMPS/INDICATOR LAMPS : Com-	18
FUEL GAUGE : Component Parts Location	11	ponent Parts Location	18
		WARNING LAMPS/INDICATOR LAMPS : Com-	18
		ponent Description	18

MWI

TRIP COMPUTER	19	Fail Safe	57
TRIP COMPUTER : System Diagram	19	DTC Index	59
TRIP COMPUTER : System Description	19		
TRIP COMPUTER : Component Parts Location ...	20	BCM (BODY CONTROL MODULE)	60
TRIP COMPUTER : Component Description	20	Reference Value	60
COMPASS	21	Terminal Layout	63
Description	21	Physical Values	63
DIAGNOSIS SYSTEM (METER)	23	Wiring Diagram	69
Diagnosis Description	23	Fail Safe	72
CONSULT-III Function (METER/M&A)	24	DTC Inspection Priority Chart	73
COMPONENT DIAGNOSIS	27	DTC Index	73
DTC U1000 CAN COMMUNICATION	27	IPDM E/R (INTELLIGENT POWER DISTRI- BUTION MODULE ENGINE ROOM)	75
DTC Logic	27	Reference Value	75
Diagnosis Procedure	27	Terminal Layout	77
DTC B2205 VEHICLE SPEED CIRCUIT	28	Physical Values	77
Description	28	Wiring Diagram	81
DTC Logic	28	Fail Safe	85
Diagnosis Procedure	28	DTC Index	87
POWER SUPPLY AND GROUND CIRCUIT	29	SYMPTOM DIAGNOSIS	88
COMBINATION METER	29	THE FUEL GAUGE POINTER DOES NOT MOVE	88
COMBINATION METER : Diagnosis Procedure ...	29	Description	88
BCM (BODY CONTROL MODULE)	29	Diagnosis Procedure	88
BCM (BODY CONTROL MODULE) : Diagnosis Procedure	29	THE FUEL GAUGE POINTER DOES NOT MOVE TO "F" WHEN REFUELING	89
IPDM E/R (INTELLIGENT POWER DISTRI- BUTION MODULE ENGINE ROOM)	30	Description	89
IPDM E/R (INTELLIGENT POWER DISTRI- BUTION MODULE ENGINE ROOM) : Diagnosis Pro- cedure	30	Diagnosis Procedure	89
FUEL LEVEL SENSOR SIGNAL CIRCUIT	32	THE OIL PRESSURE WARNING LAMP DOES NOT TURN ON	90
Description	32	Description	90
Component Function Check	32	Diagnosis Procedure	90
Diagnosis Procedure	32	THE OIL PRESSURE WARNING LAMP DOES NOT TURN OFF	91
Component Inspection	33	Description	91
OIL PRESSURE SWITCH SIGNAL CIRCUIT ...	34	Diagnosis Procedure	91
Description	34	NORMAL OPERATING CONDITION	92
Component Function Check	34	COMPASS	92
Diagnosis Procedure	34	COMPASS : Description	92
Component Inspection	34	PRECAUTION	93
COMPASS	35	PRECAUTIONS	93
Wiring Diagram — With HomeLink® Universal Transceiver	35	Supplemental Restraint System (SRS) "AIR BAG" and "SEAT BELT PRE-TENSIONER"	93
Wiring Diagram — Without HomeLink® Universal Transceiver	37	Precaution Necessary for Steering Wheel Rota- tion After Battery Disconnect	93
ECU DIAGNOSIS	39	ON-VEHICLE REPAIR	94
COMBINATION METER	39	COMBINATION METER	94
Reference Value	39	Removal and Installation	94
Wiring Diagram	41		

DIAGNOSIS AND REPAIR WORKFLOW

< BASIC INSPECTION >

BASIC INSPECTION

DIAGNOSIS AND REPAIR WORKFLOW

Work Flow

INFOID:000000003935298

DETAILED FLOW

1.CONFIRM SYMPTOM

Confirm symptom or customer complaint.

>> GO TO 2

2.CHECK SELF-DIAGNOSIS OPERATION OF COMBINATION METER

Perform self-diagnosis of combination meter. Refer to [MWI-23, "Diagnosis Description"](#).

Does self-diagnosis mode operate?

YES >> GO TO 3

NO >> Check power supply and ground circuit of combination meter. Refer to [MWI-29, "COMBINATION METER : Diagnosis Procedure"](#). Then, GO TO 4

3.CHECK COMBINATION METER (CONSULT-III)

Select "METER/M&A" on CONSULT-III and perform "SELF-DIAGNOSIS" of combination meter. Refer to [MWI-24, "CONSULT-III Function \(METER/M&A\)"](#).

Self-diagnostic results content

No malfunction detected>>Repair or replace the cause of symptom. Then, GO TO 4

Malfunction detected>>Refer to [MWI-59, "DTC Index"](#). Then, GO TO 4

4.CONFIRM OPERATION

Does the combination meter operate normally?

YES or NO

YES >> Inspection End.

NO >> GO TO 1

A
B
C
D
E
F
G
H
I
J
K
L
M
O
P

MWI

METER SYSTEM

< FUNCTION DIAGNOSIS >

FUNCTION DIAGNOSIS

METER SYSTEM

METER SYSTEM

METER SYSTEM : System Diagram

INFOID:000000003935299

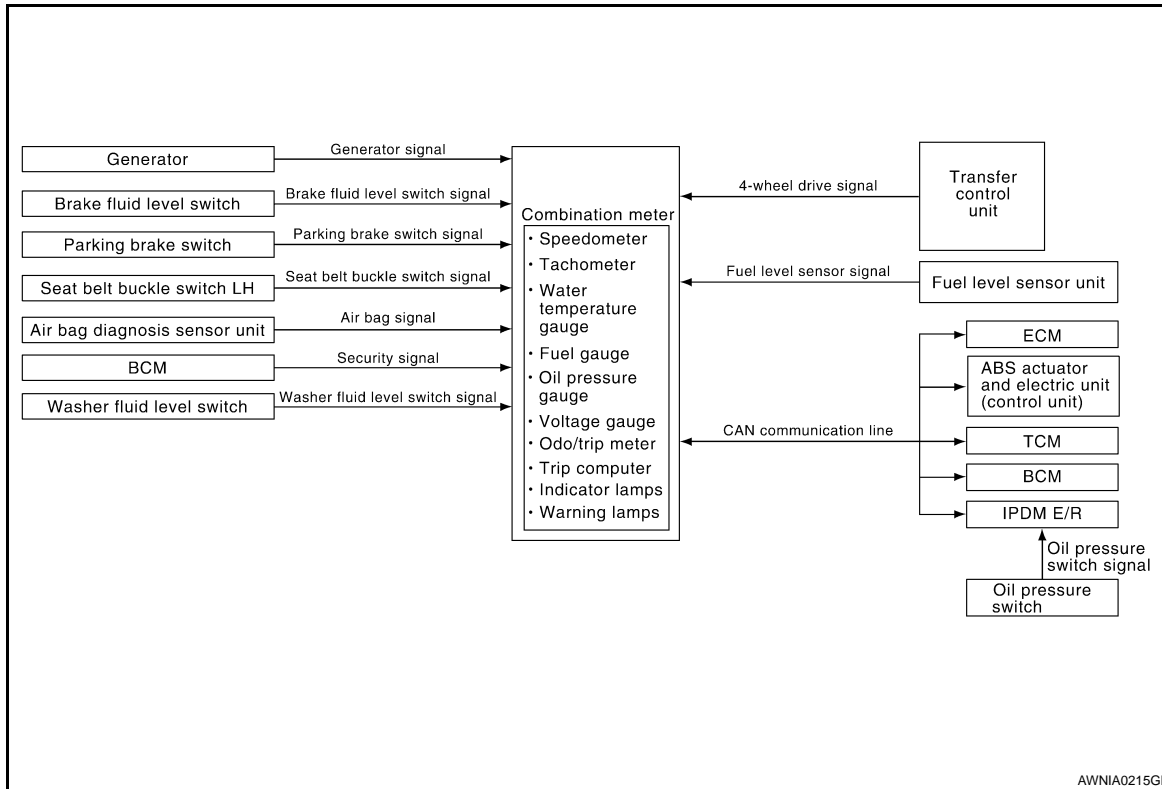

METER SYSTEM : System Description

INFOID:000000003935300

COMBINATION METER

- Speedometer, odo/trip meter, tachometer, fuel gauge, engine coolant temperature gauge, engine oil pressure gauge, voltage gauge and trip computer are controlled by the unified meter control unit, which is built into the combination meter.
- Warning and indicator lamps are controlled by the unified meter control unit and by components connected directly to the combination meter.
- Digital meter is adopted for odo/trip meter*, as well as the A/T position indicator display.
*The record of the odometer is kept even if the battery cable is disconnected. The record of the trip meter is erased when the battery cable is disconnected.
- Odo/trip meter and A/T indicator segments can be checked in diagnosis mode.
- Meter/gauge can be checked in diagnosis mode.

NOTE:

Under the following conditions, the meters will perform a homing function. The meter pointers will move down slightly and then move back to the resting position. This is a normal design condition.

- Approximately 60 seconds after turning the ignition switch from the ON to the OFF position
- If the battery is disconnected and then reconnected

METER SYSTEM

< FUNCTION DIAGNOSIS >

METER SYSTEM : Arrangement of Combination Meter

INFOID:000000003935301

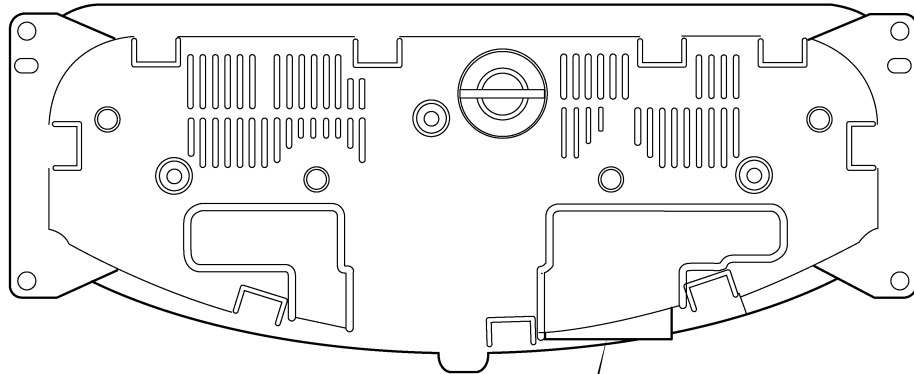
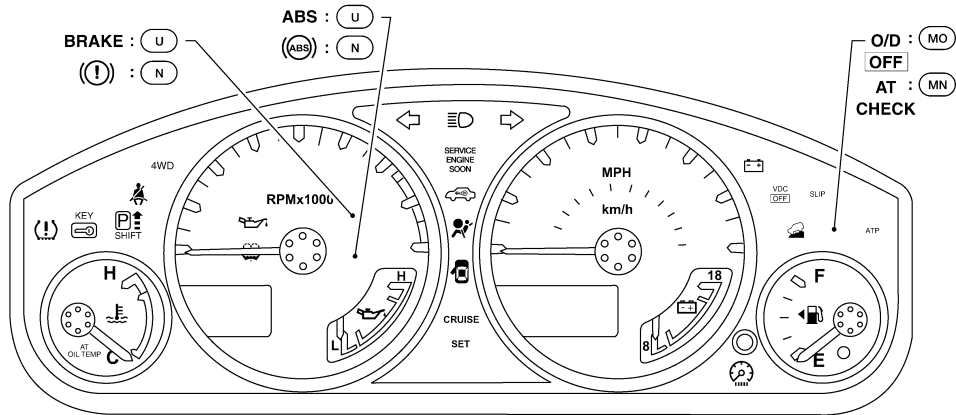

- (MN) : WITH MANUAL MODE
- (MO) : WITHOUT MANUAL MODE
- (N) : CANADA
- (U) : USA

20	19	18	17	16	15	14	13	12	11	10	9	8	7	6	5	4	3	2	1	(M24)
40	39	38	37	36	35	34	33	32	31	30	29	28	27	26	25	24	23	22	21	

A
B
C
D
E
F
G
H
I
J
K
L
M
N
O
P

MWI

AWNIA0216GB

METER SYSTEM

< FUNCTION DIAGNOSIS >

METER SYSTEM : Component Parts Location

INFOID:000000003935302

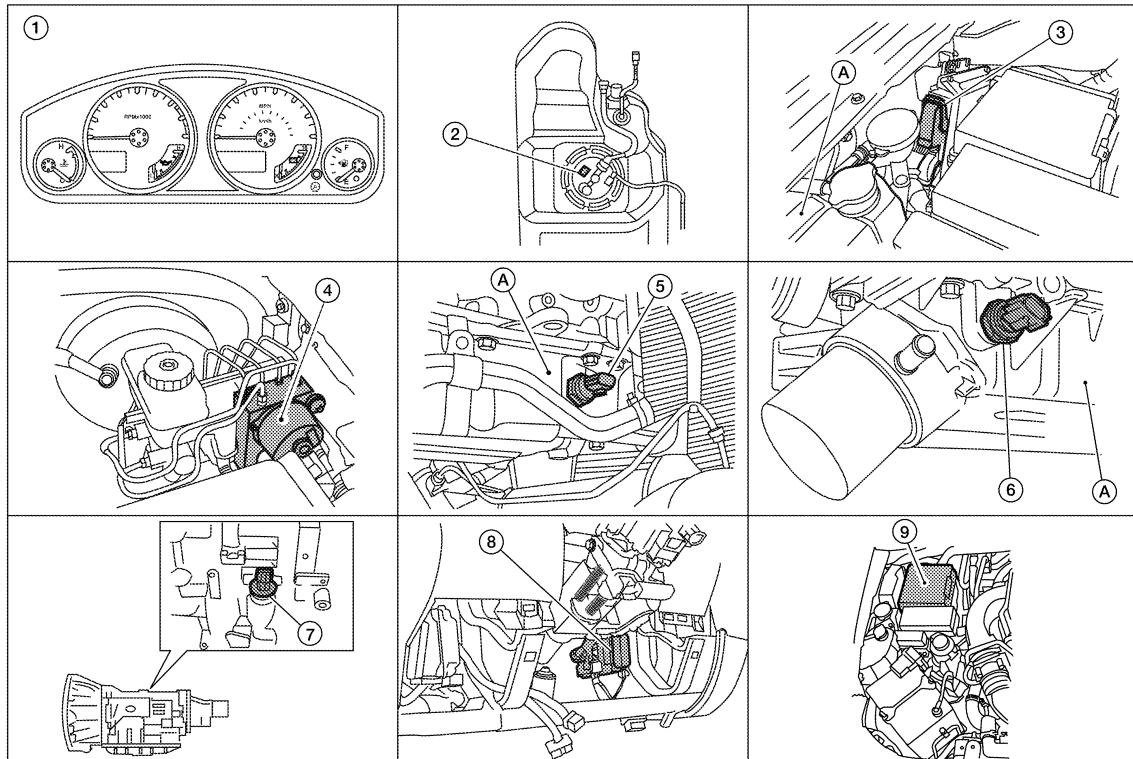

AWNIA0217ZZ

- | | | |
|---------------------------------------------------------------------------------------------------------------------------------------------------------------------------------------------------------|----------------------------------------------------------------------------------------------------------------------------------------------------------------------------------------------------------------------------------|------------------------------------------------------------------------------------------------------------------------------------------------|
| <p>1. Combination meter M24</p> <p>4. ABS actuator and electric unit (control unit)
E125 (with VQ40DE)
E127 (with VK56DE)</p> <p>7. A/T assembly
F9 (with VQ40DE)
F70 (with VK56DE)</p> | <p>2. Fuel level sensor unit and fuel pump C5
(view with fuel tank removed)</p> <p>5. Oil pressure switch E208 (with VQ40DE)
A. Oil pan (upper)</p> <p>8. BCM M18, M19 (view with instrument lower panel LH removed)</p> | <p>3. ECM E16 (view with ECM cover removed)
A. Coolant reservoir</p> <p>6. Oil pressure switch F4 (with VK56DE)
A: Oil pan (upper)</p> |
|---------------------------------------------------------------------------------------------------------------------------------------------------------------------------------------------------------|----------------------------------------------------------------------------------------------------------------------------------------------------------------------------------------------------------------------------------|------------------------------------------------------------------------------------------------------------------------------------------------|

METER SYSTEM : Component Description

INFOID:000000003935303

Unit	Description
Combination meter	<p>Controls the following with the signals received from each unit via CAN communication and the signals from switches and sensors.</p> <ul style="list-style-type: none"> • Speedometer • Engine coolant temperature gauge • Engine oil pressure gauge • Voltage gauge • Warning lamps • Trip computer • Tachometer • Fuel gauge • Odo/trip meter • Indicator lamps • Warning chime
IPDM E/R	IPDM E/R reads the ON/OFF signals of the oil pressure switch and transmits the oil pressure switch signal to the combination meter via BCM with CAN communication line.
Fuel level sensor unit	Refer to MWI-32, "Description" .
Oil pressure switch	Refer to MWI-34, "Description" .

METER SYSTEM

< FUNCTION DIAGNOSIS >

Unit	Description
ECM	Transmits the following signals to the combination meter with CAN communication line. <ul style="list-style-type: none"> • Engine speed signal • Engine coolant temperature signal • Fuel consumption monitor signal
ABS actuator and electric unit (control unit)	Transmits the vehicle speed signal to the combination meter with CAN communication line.
BCM	<ul style="list-style-type: none"> • Transmits signals provided by various units to the combination meter with CAN communication line. • Transmits the security signal to the combination meter.
TCM	Transmits shift position signal to the combination meter with CAN communication line.

SPEEDOMETER

SPEEDOMETER : System Diagram

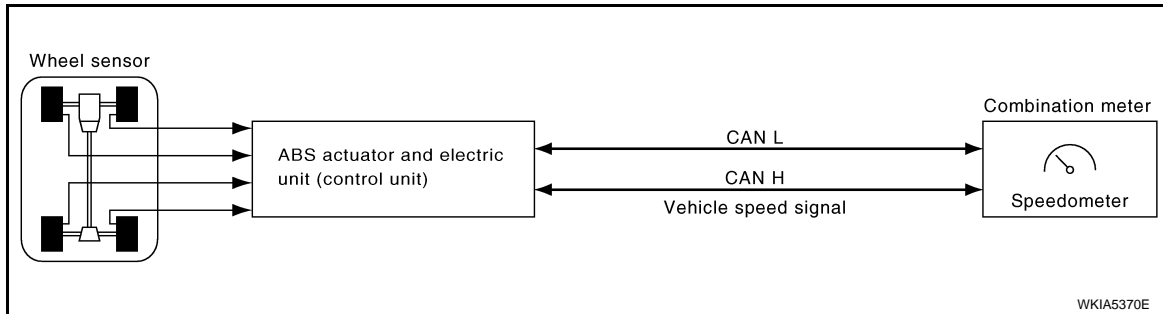

SPEEDOMETER : System Description

The ABS actuator and electric unit (control unit) provides a vehicle speed signal to the combination meter via CAN communication lines.

SPEEDOMETER : Component Parts Location

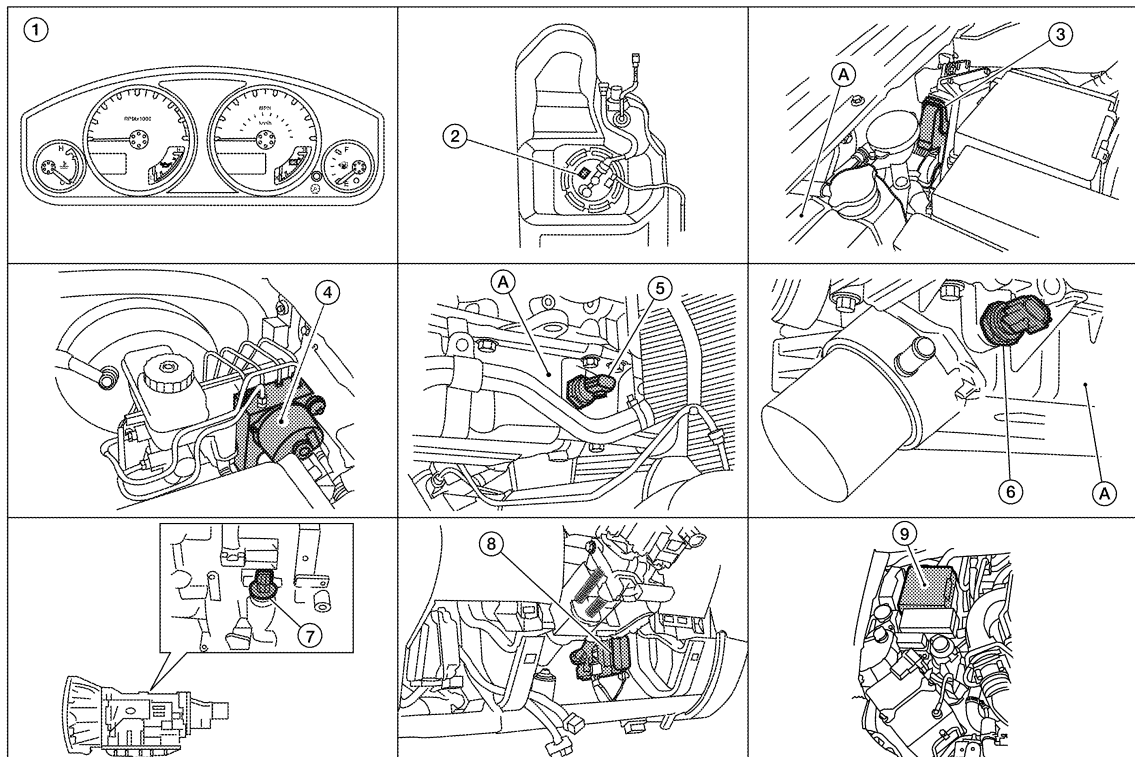

METER SYSTEM

< FUNCTION DIAGNOSIS >

- | | | |
|----------------------------------------------------------------------------------------------|--------------------------------------------------------------------------|------------------------------------------------------------------|
| 1. Combination meter M24 | 2. Fuel level sensor unit and fuel pump C5 (view with fuel tank removed) | 3. ECM E16 (view with ECM cover removed)
A. Coolant reservoir |
| 4. ABS actuator and electric unit (control unit)
E125 (with VQ40DE)
E127 (with VK56DE) | 5. Oil pressure switch E208 (with VQ40DE)
A. Oil pan (upper) | 6. Oil pressure switch F4 (with VK56DE)
A: Oil pan (upper) |
| 7. A/T assembly
F9 (with VQ40DE)
F70 (with VK56DE) | 8. BCM M18, M19 (view with instrument lower panel LH removed) | |

SPEEDOMETER : Component Description

INFOID:000000003935307

Unit	Description
Combination meter	Indicates the vehicle speed according to the vehicle speed signal received from ABS actuator and electric unit (control unit) via CAN communication.
ABS actuator and electric unit (control unit)	Transmits the vehicle speed signal to the combination meter with CAN communication line.

TACHOMETER

TACHOMETER : System Diagram

INFOID:000000003935308

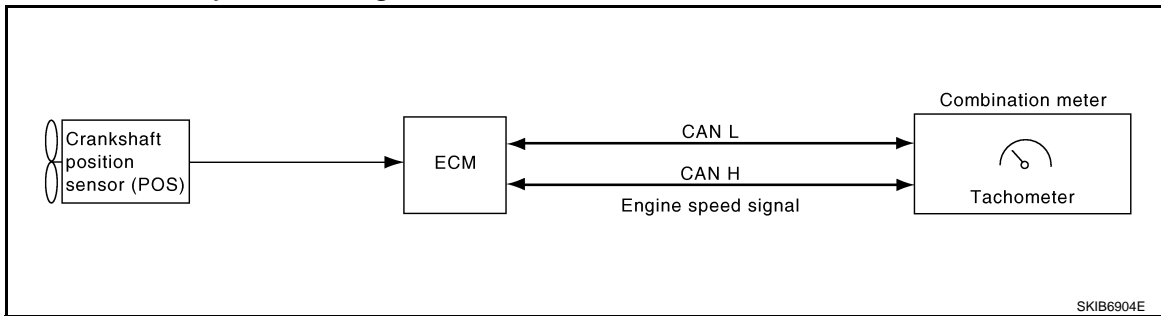

TACHOMETER : System Description

INFOID:000000003935309

The tachometer indicates engine speed in revolutions per minute (rpm).
The ECM provides an engine speed signal to the combination meter via CAN communication lines.

METER SYSTEM

< FUNCTION DIAGNOSIS >

TACHOMETER : Component Parts Location

INFOID:000000004428611

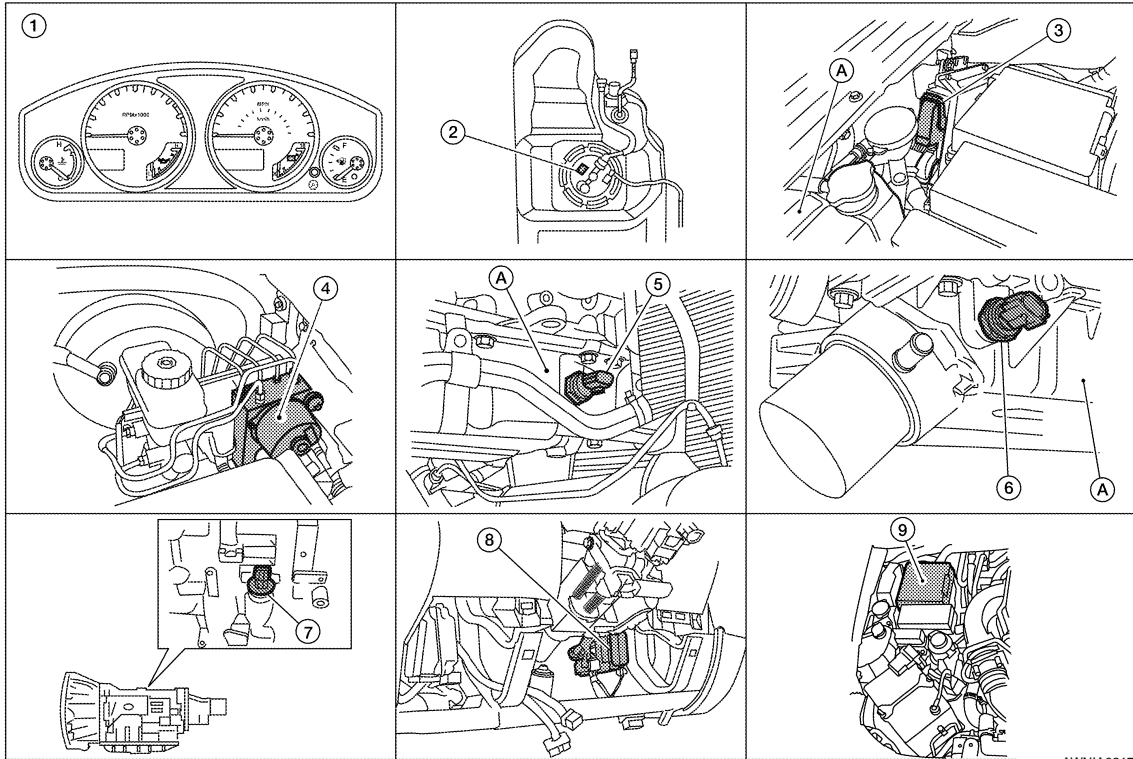

AWNIA0217ZZ

- | | | |
|----------------------------------------------------------------------------------------------|-----------------------------------------------------------------------------|------------------------------------------------------------------|
| 1. Combination meter M24 | 2. Fuel level sensor unit and fuel pump C5
(view with fuel tank removed) | 3. ECM E16 (view with ECM cover removed)
A. Coolant reservoir |
| 4. ABS actuator and electric unit (control unit)
E125 (with VQ40DE)
E127 (with VK56DE) | 5. Oil pressure switch E208 (with VQ40DE)
A. Oil pan (upper) | 6. Oil pressure switch F4 (with VK56DE)
A: Oil pan (upper) |
| 7. A/T assembly
F9 (with VQ40DE)
F70 (with VK56DE) | 8. BCM M18, M19 (view with instrument lower panel LH removed) | |

TACHOMETER : Component Description

INFOID:0000000003935311

Unit	Description
Combination meter	Indicates the engine speed in RPM according to the engine speed signal received from ECM via CAN communication.
ECM	Transmits the engine speed signal to the combination meter with CAN communication line.

ENGINE COOLANT TEMPERATURE GAUGE

A
B
C
D
E
F
G
H
I
J
K
L
M
N
O
P

MWI

METER SYSTEM

< FUNCTION DIAGNOSIS >

ENGINE COOLANT TEMPERATURE GAUGE : System Diagram

INFOID:000000003935312

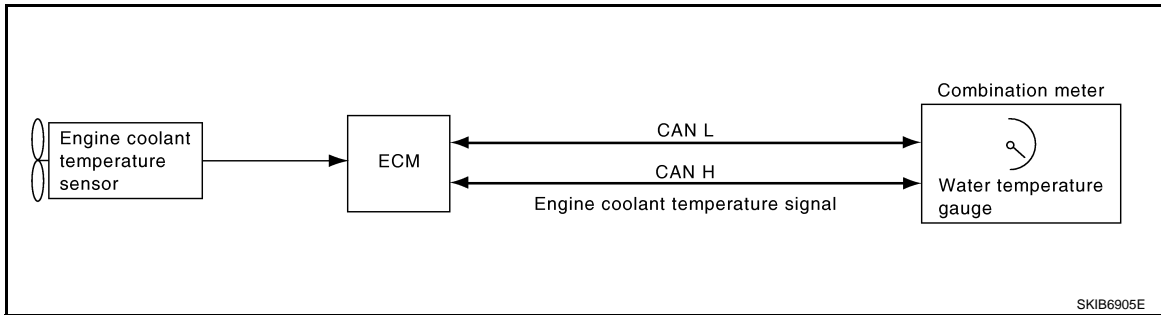

SKIB6905E

ENGINE COOLANT TEMPERATURE GAUGE : System Description

INFOID:0000000003935313

The engine coolant temperature gauge indicates the engine coolant temperature. The ECM provides an engine coolant temperature signal to the combination meter via CAN communication lines.

ENGINE COOLANT TEMPERATURE GAUGE : Component Parts Location

INFOID:0000000004428612

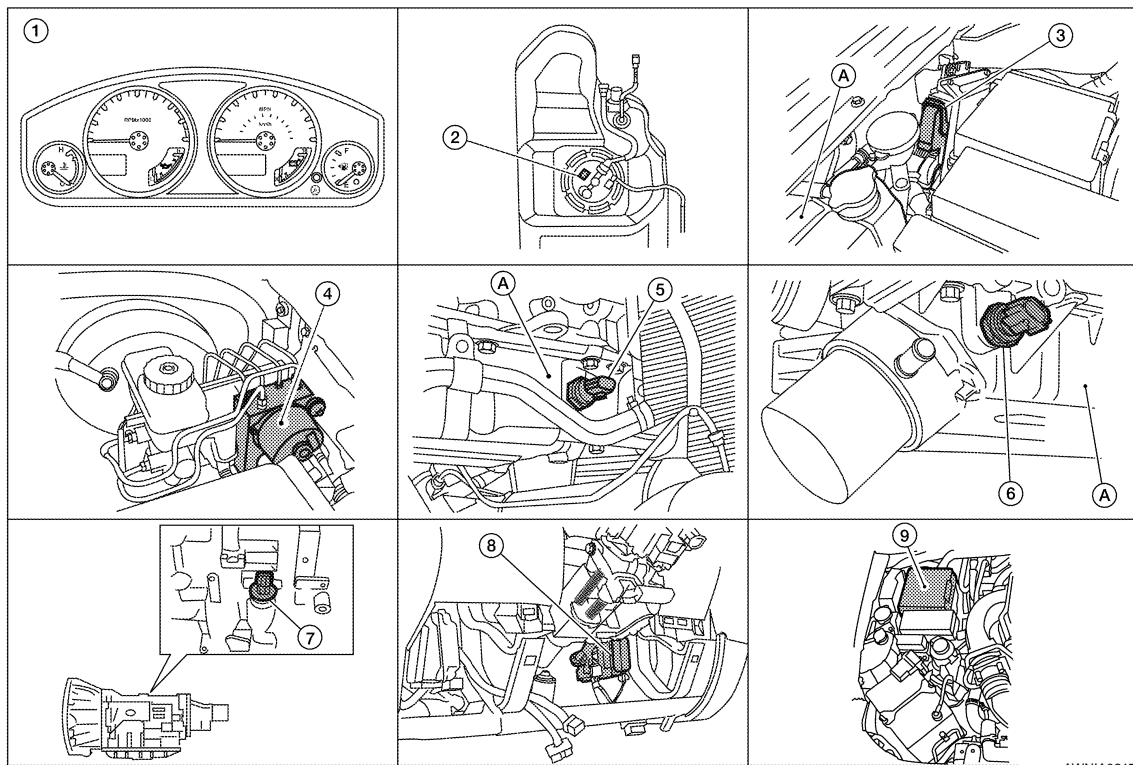

AWNIA0217ZZ

- | | | |
|----------------------------------------------------------------------------------------------|--------------------------------------------------------------------------|------------------------------------------------------------------|
| 1. Combination meter M24 | 2. Fuel level sensor unit and fuel pump C5 (view with fuel tank removed) | 3. ECM E16 (view with ECM cover removed)
A. Coolant reservoir |
| 4. ABS actuator and electric unit (control unit)
E125 (with VQ40DE)
E127 (with VK56DE) | 5. Oil pressure switch E208 (with VQ40DE)
A. Oil pan (upper) | 6. Oil pressure switch F4 (with VK56DE)
A: Oil pan (upper) |
| 7. A/T assembly
F9 (with VQ40DE)
F70 (with VK56DE) | 8. BCM M18, M19 (view with instrument lower panel LH removed) | |

METER SYSTEM

< FUNCTION DIAGNOSIS >

ENGINE COOLANT TEMPERATURE GAUGE : Component Description

INFOID:000000003935315

Unit	Description
Combination meter	Indicates the engine coolant temperature according to the engine coolant temperature signal received from ECM via CAN communication.
ECM	Transmits the engine coolant temperature signal to the combination meter via CAN communication.

FUEL GAUGE

FUEL GAUGE : System Diagram

INFOID:000000003935316

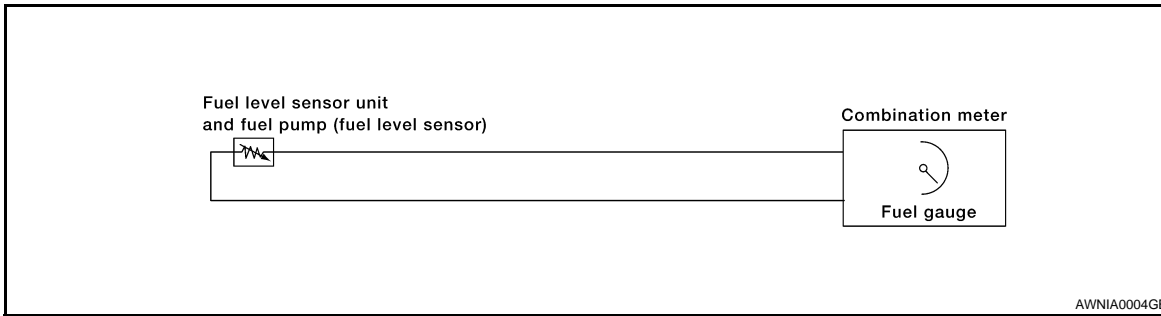

FUEL GAUGE : System Description

INFOID:000000003935317

The fuel gauge indicates the approximate fuel level in the fuel tank. The fuel gauge is regulated by the unified meter control unit and a variable resistor signal supplied by the fuel level sensor unit.

FUEL GAUGE : Component Parts Location

INFOID:000000004428613

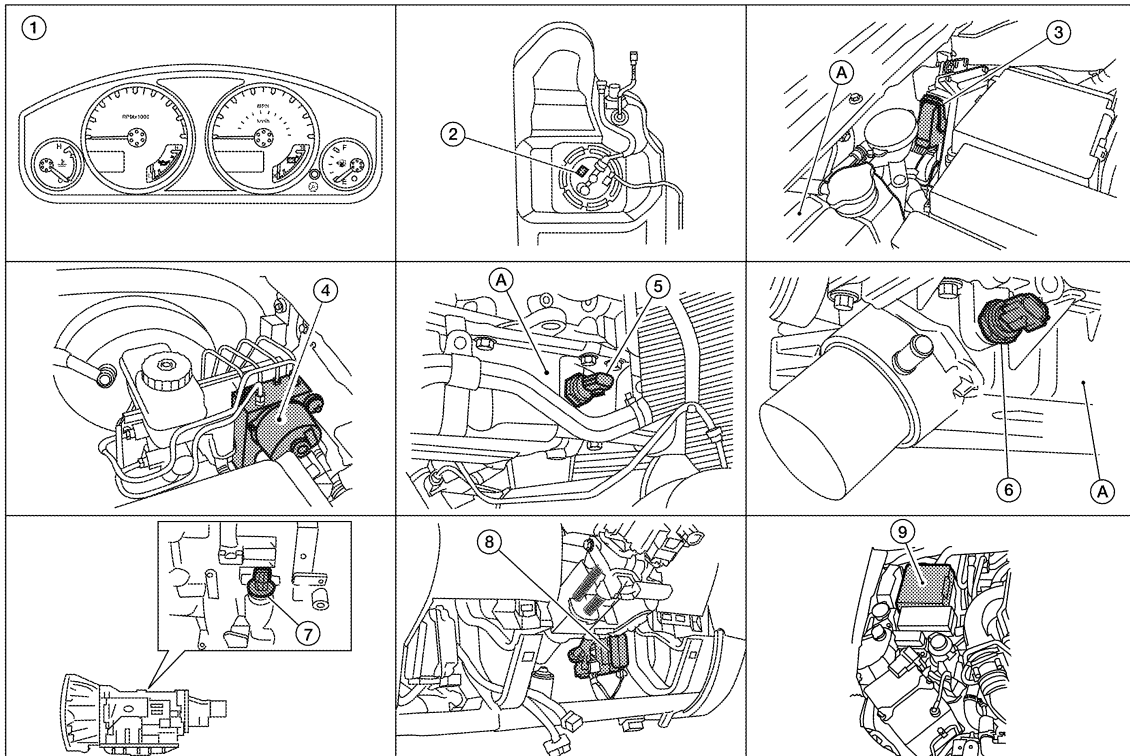

AWNIA0217ZZ

METER SYSTEM

< FUNCTION DIAGNOSIS >

- | | | |
|----------------------------------------------------------------------------------------------|--------------------------------------------------------------------------|------------------------------------------------------------------|
| 1. Combination meter M24 | 2. Fuel level sensor unit and fuel pump C5 (view with fuel tank removed) | 3. ECM E16 (view with ECM cover removed)
A. Coolant reservoir |
| 4. ABS actuator and electric unit (control unit)
E125 (with VQ40DE)
E127 (with VK56DE) | 5. Oil pressure switch E208 (with VQ40DE)
A. Oil pan (upper) | 6. Oil pressure switch F4 (with VK56DE)
A: Oil pan (upper) |
| 7. A/T assembly
F9 (with VQ40DE)
F70 (with VK56DE) | 8. BCM M18, M19 (view with instrument lower panel LH removed) | |

FUEL GAUGE : Component Description

INFOID:000000003935319

Unit	Description
Combination meter	Indicates the fuel level according to the fuel level sensor signal received from the fuel level sensor unit.
Fuel level sensor unit	Refer to MWI-32. "Description" .

ENGINE OIL PRESSURE GAUGE

ENGINE OIL PRESSURE GAUGE : System Diagram

INFOID:000000003935320

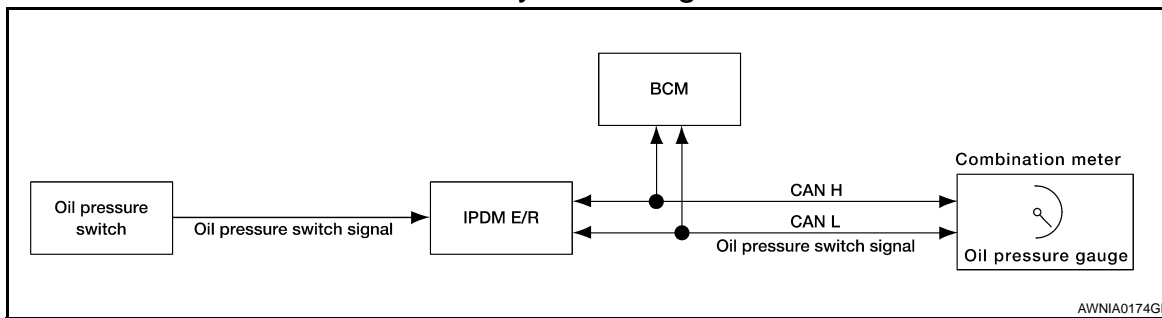

ENGINE OIL PRESSURE GAUGE : System Description

INFOID:000000003935321

The engine oil pressure gauge indicates whether the engine oil pressure is low or normal. The oil pressure gauge is controlled by the IPDM E/R. The IPDM E/R reads the ON/OFF signals from the oil pressure switch and transmits the oil pressure switch signal to the combination meter via BCM with the CAN communication line. The oil pressure gauge displays a low or normal indication according to the oil pressure switch signal received via CAN communication.

METER SYSTEM

< FUNCTION DIAGNOSIS >

ENGINE OIL PRESSURE GAUGE : Component Parts Location

INFOID:000000004428614

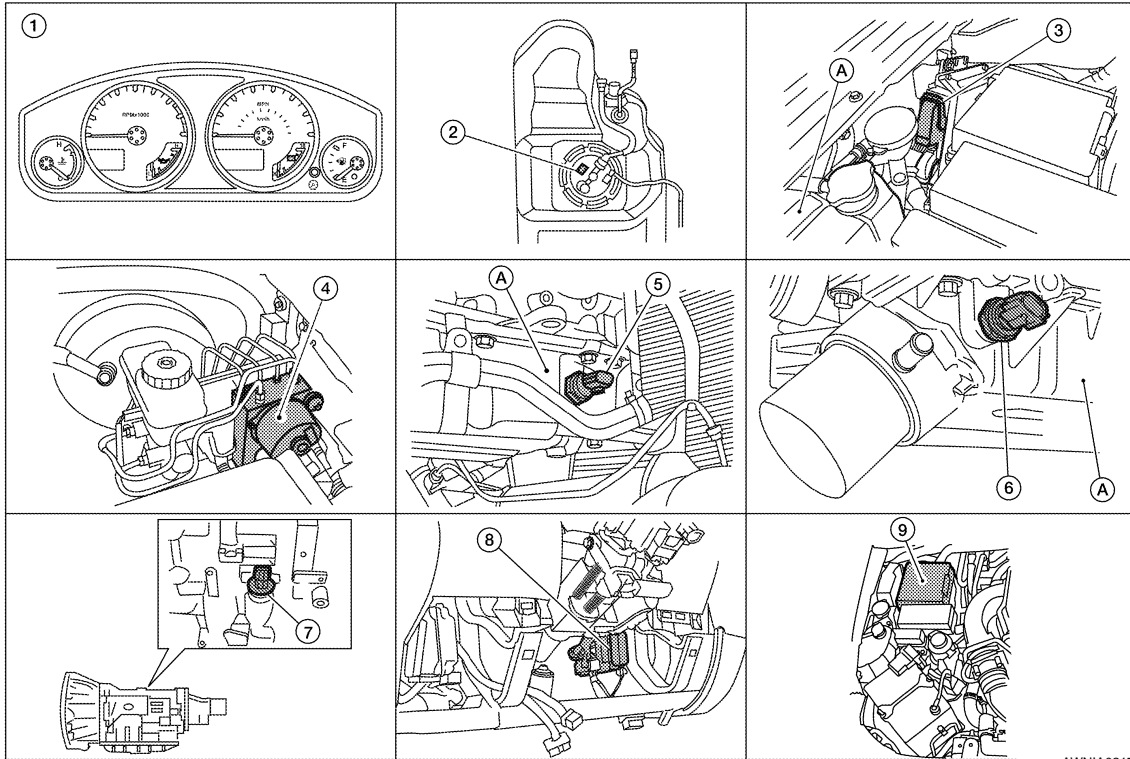

AWNIA0217ZZ

- | | | |
|----------------------------------------------------------------------------------------------|--------------------------------------------------------------------------|------------------------------------------------------------------|
| 1. Combination meter M24 | 2. Fuel level sensor unit and fuel pump C5 (view with fuel tank removed) | 3. ECM E16 (view with ECM cover removed)
A. Coolant reservoir |
| 4. ABS actuator and electric unit (control unit)
E125 (with VQ40DE)
E127 (with VK56DE) | 5. Oil pressure switch E208 (with VQ40DE)
A. Oil pan (upper) | 6. Oil pressure switch F4 (with VK56DE)
A: Oil pan (upper) |
| 7. A/T assembly
F9 (with VQ40DE)
F70 (with VK56DE) | 8. BCM M18, M19 (view with instrument lower panel LH removed) | |

ENGINE OIL PRESSURE GAUGE : Component Description

INFOID:000000003935323

Unit	Description
Combination meter	Indicates the engine oil pressure (low/normal) according to the oil pressure switch signal received from BCM with CAN communication line.
IPDM E/R	Reads the ON/OFF signals from the oil pressure switch and transmits the oil pressure switch signal to the combination meter via BCM with the CAN communication line.
Oil pressure switch	Refer to MWI-34, "Description" .
BCM	Transmits the oil pressure switch signal received from IPDM E/R via CAN communication to the combination meter via CAN communication.

VOLTAGE GAUGE

METER SYSTEM

< FUNCTION DIAGNOSIS >

VOLTAGE GAUGE : System Diagram

INFOID:000000003935324

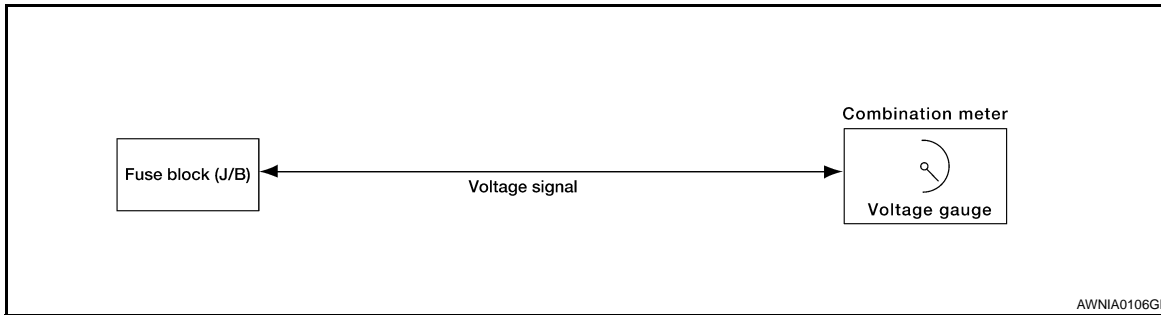

VOLTAGE GAUGE : System Description

INFOID:000000003935325

The voltage gauge indicates the battery/charging system voltage. The voltage gauge is regulated by the unified meter control unit.

VOLTAGE GAUGE : Component Parts Location

INFOID:000000004428615

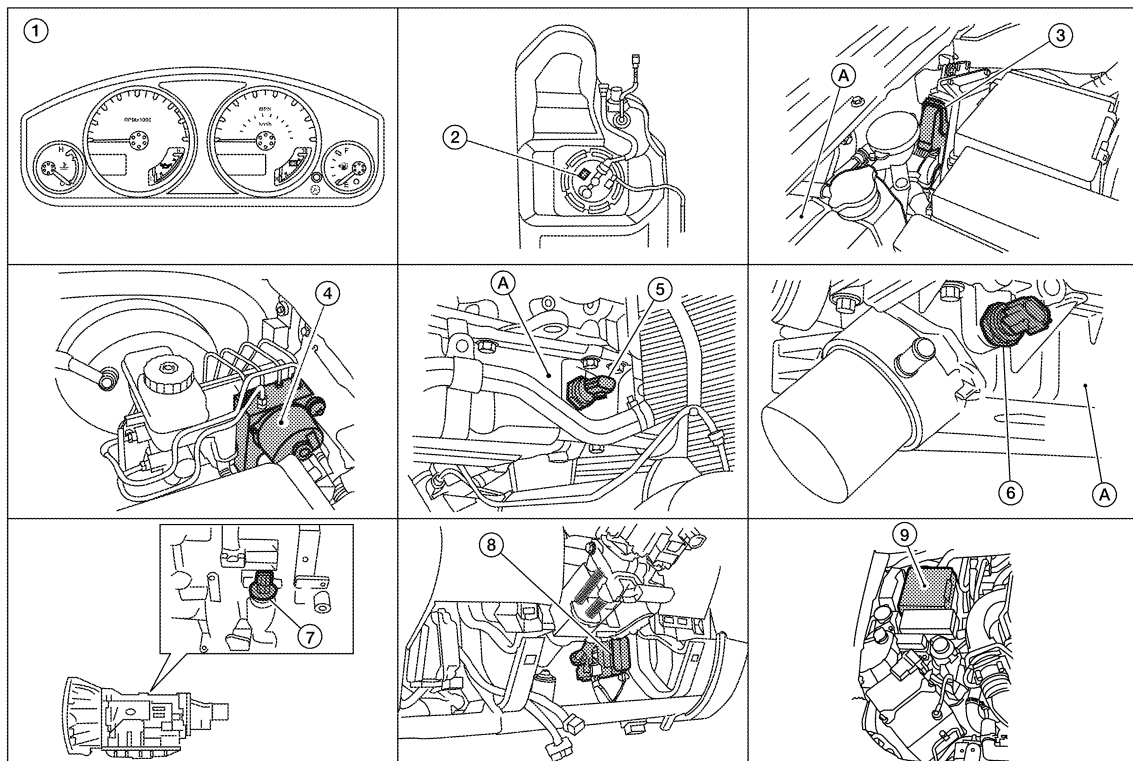

- | | | |
|---------------------------------------------------------------------------------------------------------------------------------------------------------------------------------------------------------|----------------------------------------------------------------------------------------------------------------------------------------------------------------------------------------------------------------------------------|------------------------------------------------------------------------------------------------------------------------------------------------|
| <p>1. Combination meter M24</p> <p>4. ABS actuator and electric unit (control unit)
E125 (with VQ40DE)
E127 (with VK56DE)</p> <p>7. A/T assembly
F9 (with VQ40DE)
F70 (with VK56DE)</p> | <p>2. Fuel level sensor unit and fuel pump C5
(view with fuel tank removed)</p> <p>5. Oil pressure switch E208 (with VQ40DE)
A. Oil pan (upper)</p> <p>8. BCM M18, M19 (view with instrument lower panel LH removed)</p> | <p>3. ECM E16 (view with ECM cover removed)
A. Coolant reservoir</p> <p>6. Oil pressure switch F4 (with VK56DE)
A: Oil pan (upper)</p> |
|---------------------------------------------------------------------------------------------------------------------------------------------------------------------------------------------------------|----------------------------------------------------------------------------------------------------------------------------------------------------------------------------------------------------------------------------------|------------------------------------------------------------------------------------------------------------------------------------------------|

METER SYSTEM

< FUNCTION DIAGNOSIS >

VOLTAGE GAUGE : Component Description

INFOID:000000003935327

Unit	Description
Combination meter	Indicates the battery voltage according to the voltage signal received from the fuse block (J/B).
Fuse block (J/B)	Transmits the battery voltage signal to the combination meter.

ODO/TRIP METER

ODO/TRIP METER : System Diagram

INFOID:000000003935328

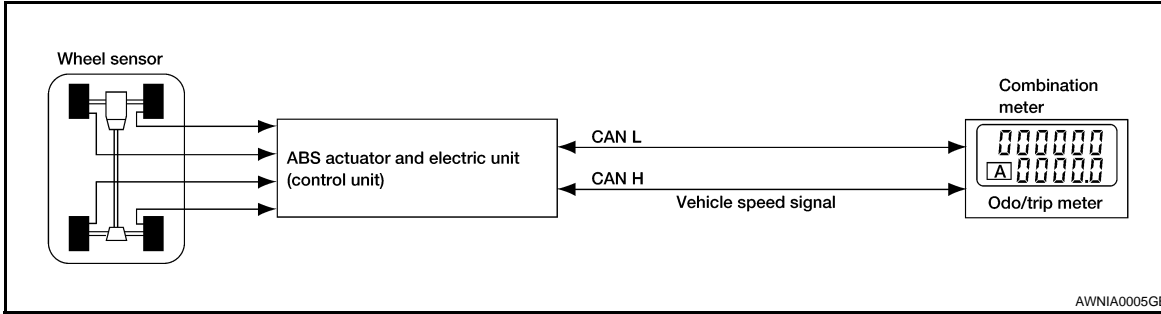

ODO/TRIP METER : System Description

INFOID:000000003935329

The vehicle speed signal and the memory signals from the meter memory circuit are processed by the combination meter and the mileage is displayed.

HOW TO CHANGE THE DISPLAY FOR ODO/TRIP METER

Refer to Owner's Manual for odo/trip meter operating instructions.

ODO/TRIP METER : Component Parts Location

INFOID:000000004428616

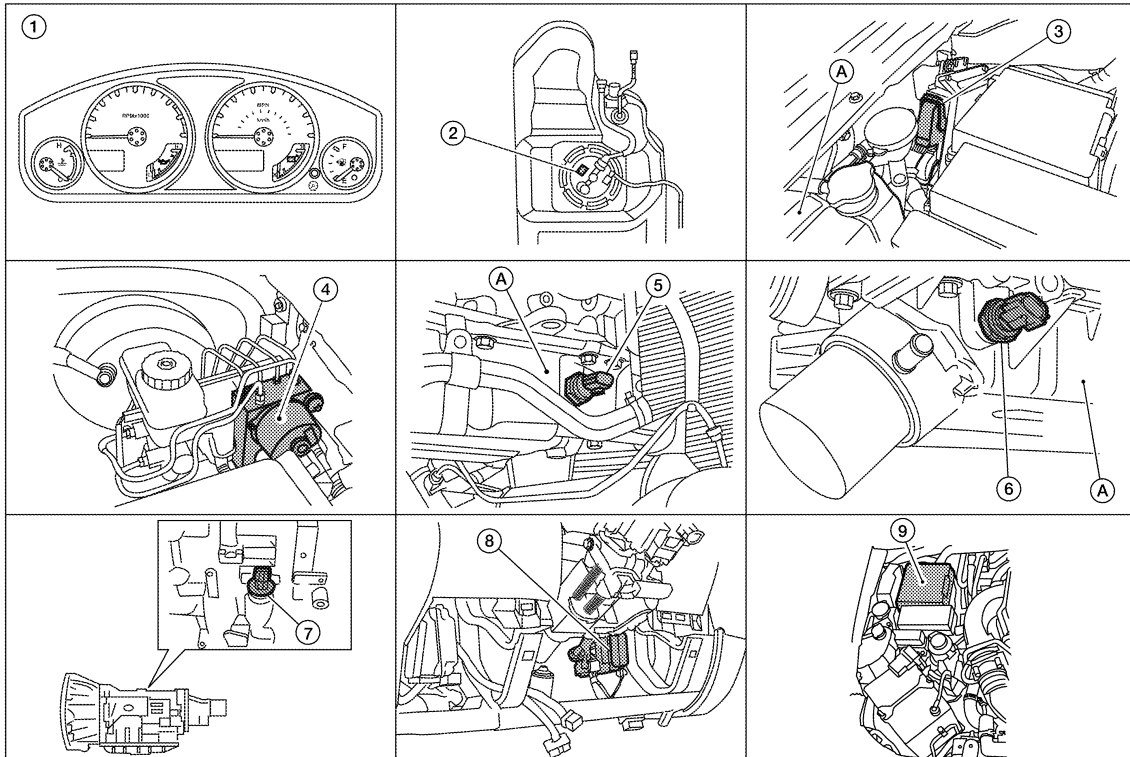

AWNIA0217ZZ

METER SYSTEM

< FUNCTION DIAGNOSIS >

- | | | |
|----------------------------------------------------------------------------------------------|--------------------------------------------------------------------------|------------------------------------------------------------------|
| 1. Combination meter M24 | 2. Fuel level sensor unit and fuel pump C5 (view with fuel tank removed) | 3. ECM E16 (view with ECM cover removed)
A. Coolant reservoir |
| 4. ABS actuator and electric unit (control unit)
E125 (with VQ40DE)
E127 (with VK56DE) | 5. Oil pressure switch E208 (with VQ40DE)
A. Oil pan (upper) | 6. Oil pressure switch F4 (with VK56DE)
A: Oil pan (upper) |
| 7. A/T assembly
F9 (with VQ40DE)
F70 (with VK56DE) | 8. BCM M18, M19 (view with instrument lower panel LH removed) | |

ODO/TRIP METER : Component Description

INFOID:000000003935331

Unit	Description
Combination meter	Converts the vehicle speed signal received from the ABS actuator and electric unit (control unit) via CAN communication to mileage, and it displays the accumulated mileage to the odo/trip meter.
ABS actuator and electric unit (control unit)	Transmits the vehicle speed signal to the combination meter via CAN communication.

SHIFT POSITION INDICATOR

SHIFT POSITION INDICATOR : System Diagram

INFOID:000000003935332

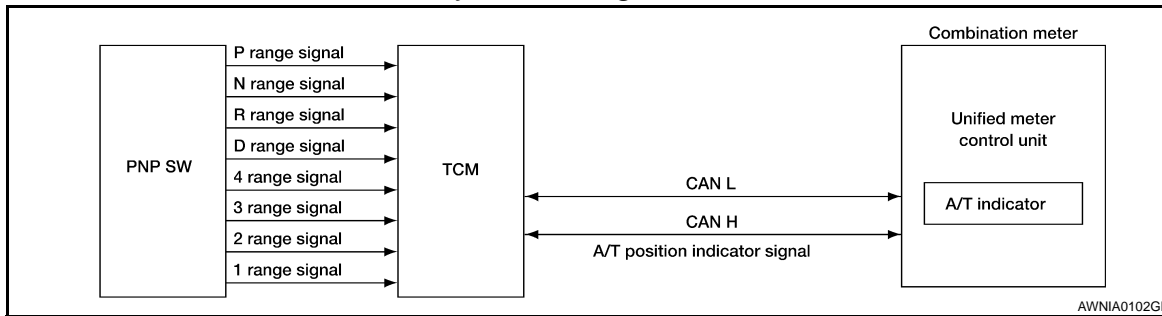

SHIFT POSITION INDICATOR : System Description

INFOID:000000003935333

The TCM receives A/T indicator signals from the park/neutral position (PNP) switch. The TCM then sends A/T position indicator signals to the combination meter via CAN communication lines. The combination meter indicates the received shift position.

METER SYSTEM

< FUNCTION DIAGNOSIS >

SHIFT POSITION INDICATOR : Component Parts Location

INFOID:000000004428617

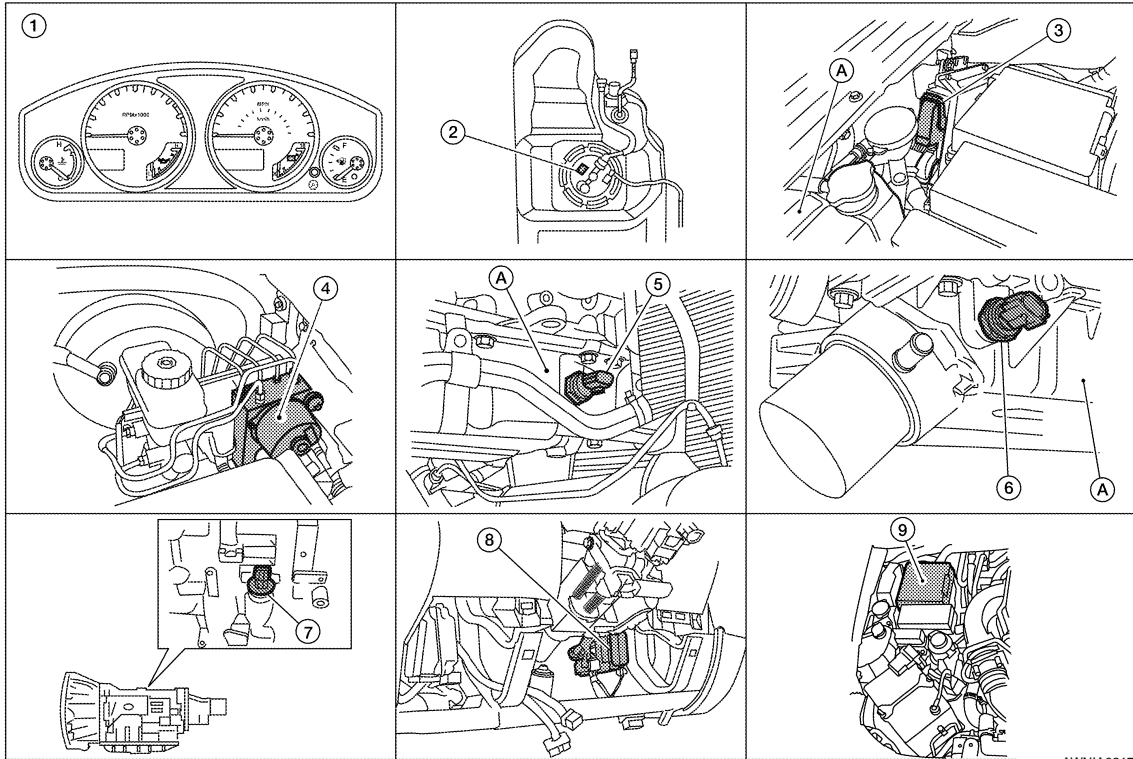

AWNIA0217ZZ

- | | | |
|----------------------------------------------------------------------------------------------|--------------------------------------------------------------------------|------------------------------------------------------------------|
| 1. Combination meter M24 | 2. Fuel level sensor unit and fuel pump C5 (view with fuel tank removed) | 3. ECM E16 (view with ECM cover removed)
A. Coolant reservoir |
| 4. ABS actuator and electric unit (control unit)
E125 (with VQ40DE)
E127 (with VK56DE) | 5. Oil pressure switch E208 (with VQ40DE)
A. Oil pan (upper) | 6. Oil pressure switch F4 (with VK56DE)
A: Oil pan (upper) |
| 7. A/T assembly
F9 (with VQ40DE)
F70 (with VK56DE) | 8. BCM M18, M19 (view with instrument lower panel LH removed) | |

SHIFT POSITION INDICATOR : Component Description

INFOID:0000000003935335

Unit	Description
Combination meter	Displays the shift position using shift position signal received from TCM.
TCM	Transmits the shift position signal to the combination meter via CAN communication.

WARNING LAMPS/INDICATOR LAMPS

WARNING LAMPS/INDICATOR LAMPS : System Diagram

INFOID:0000000003935336

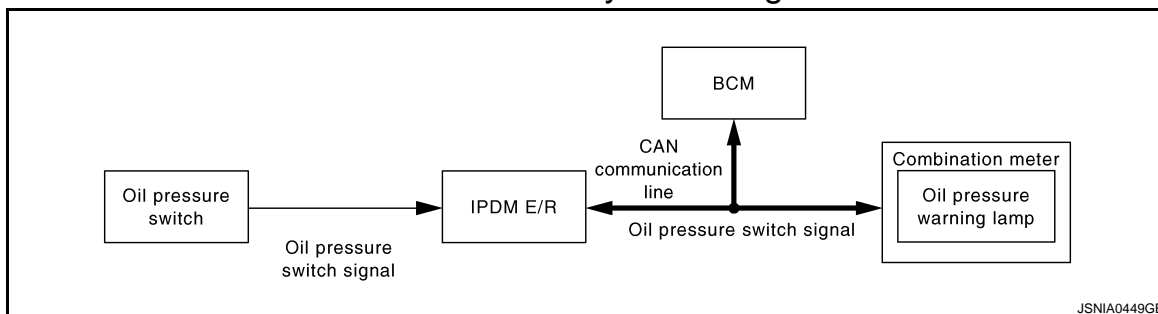

JSNIA0449GB

METER SYSTEM

< FUNCTION DIAGNOSIS >

WARNING LAMPS/INDICATOR LAMPS : System Description

INFOID:000000003935337

OIL PRESSURE WARNING LAMP

- IPDM E/R reads the ON/OFF signals from the oil pressure switch and transmits the oil pressure switch signal to the combination meter via BCM with the CAN communication line.
- The combination meter turns the oil pressure warning lamp ON/OFF according to the oil pressure switch signal received via CAN communication.

WARNING LAMPS/INDICATOR LAMPS : Component Parts Location

INFOID:000000004428618

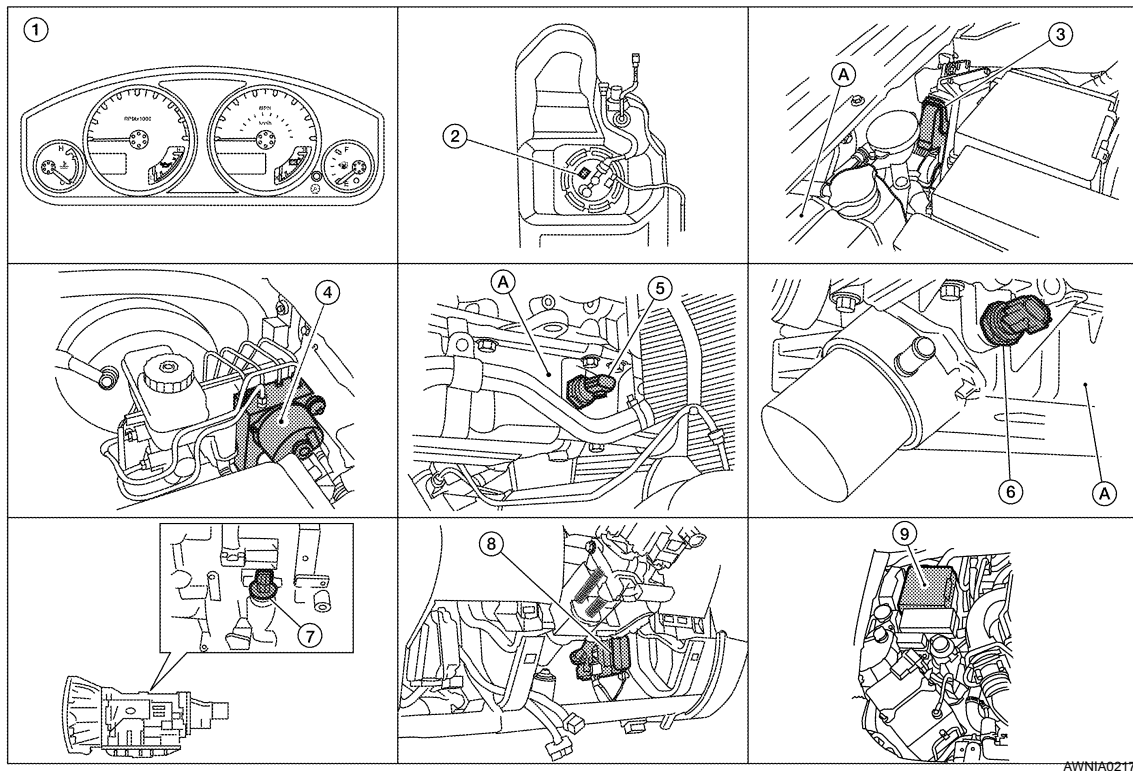

AWNIA0217ZZ

- | | | |
|----------------------------------------------------------------------------------------------|--------------------------------------------------------------------------|------------------------------------------------------------------|
| 1. Combination meter M24 | 2. Fuel level sensor unit and fuel pump C5 (view with fuel tank removed) | 3. ECM E16 (view with ECM cover removed)
A. Coolant reservoir |
| 4. ABS actuator and electric unit (control unit)
E125 (with VQ40DE)
E127 (with VK56DE) | 5. Oil pressure switch E208 (with VQ40DE)
A. Oil pan (upper) | 6. Oil pressure switch F4 (with VK56DE)
A: Oil pan (upper) |
| 7. A/T assembly
F9 (with VQ40DE)
F70 (with VK56DE) | 8. BCM M18, M19 (view with instrument lower panel LH removed) | |

WARNING LAMPS/INDICATOR LAMPS : Component Description

INFOID:000000003935339

Unit	Description
Combination meter	Turns the oil pressure warning lamp ON/OFF according to the oil pressure switch signal received from BCM by means of communication.
IPDM E/R	Reads the ON/OFF signals from the oil pressure switch and transmits the oil pressure switch signal to the combination meter via BCM with the CAN communication line.
Oil pressure switch	Refer to MWI-34, "Description" .
BCM	Transmits the oil pressure switch signal received from IPDM E/R via CAN communication to the combination meter via CAN communication.

METER SYSTEM

< FUNCTION DIAGNOSIS >

TRIP COMPUTER

TRIP COMPUTER : System Diagram

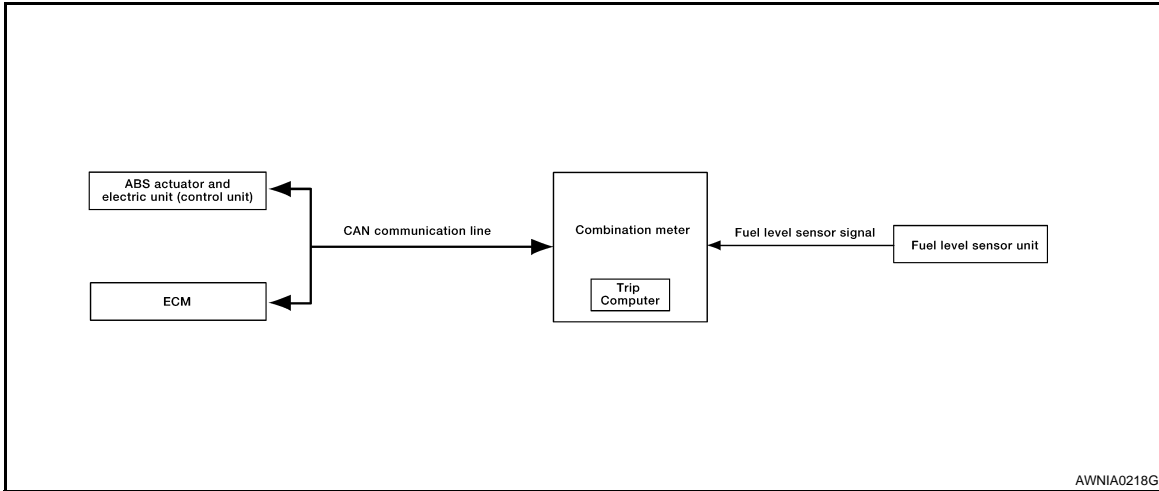

TRIP COMPUTER : System Description

INFOID:000000003935341

FUNCTION

The trip computer can indicate the following items.

- DTE (distance to empty)
- Trip distance
- Trip time
- Average fuel consumption
- Average vehicle speed

DTE (DISTANCE TO EMPTY) INDICATION

The range indication provides the driver with an estimation of the distance that can be driven before refueling. The range is calculated by signals from the fuel level sensor unit (fuel remaining), ECM (fuel consumption) and the ABS actuator and electric unit (vehicle speed). The indication will be refreshed every 30 seconds. When fuel remaining is less than approximately 11.6 ℓ (3 1/8 US gal, 2 1/2 Imp gal), the indication will blink as a warning. If the fuel remaining is less than approximately 9.6 ℓ (2 1/2 US gal, 2 1/8 Imp gal), the indication will show “---”. In this case, the display will change to the DTE mode even though the display is showing a different mode. When the battery is disconnected and reconnected, DTE mode will display “---” until the vehicle is driven 0.3 miles (0.5 km).

TRIP DISTANCE

Trip distance is calculated by signal from the ABS actuator and electric unit (vehicle speed). If trip distance is reset, trip time will be reset at the same time.

TRIP TIME

Trip time displays cumulative ignition switch ON time. If trip time is reset, trip distance will be reset at the same time.

AVERAGE FUEL CONSUMPTION

Average fuel consumption indication is calculated by signals from the ABS actuator and electric unit (vehicle speed) and the ECM (fuel consumption). The indication will be refreshed every 30 seconds.

AVERAGE VEHICLE SPEED

Average vehicle speed indication is calculated by running distance and running time. The indication will be refreshed every 30 seconds. If average vehicle speed is reset, average fuel consumption will be reset at the same time. After resetting, the display will show “---” for 30 seconds.

HOW TO CHANGE/RESET INDICATION

Refer to Owner's Manual for trip computer operating instructions.

A
B
C
D
E
F

G
H
I
J
K
L

M

MWI

O

P

METER SYSTEM

< FUNCTION DIAGNOSIS >

TRIP COMPUTER : Component Parts Location

INFOID:000000004428619

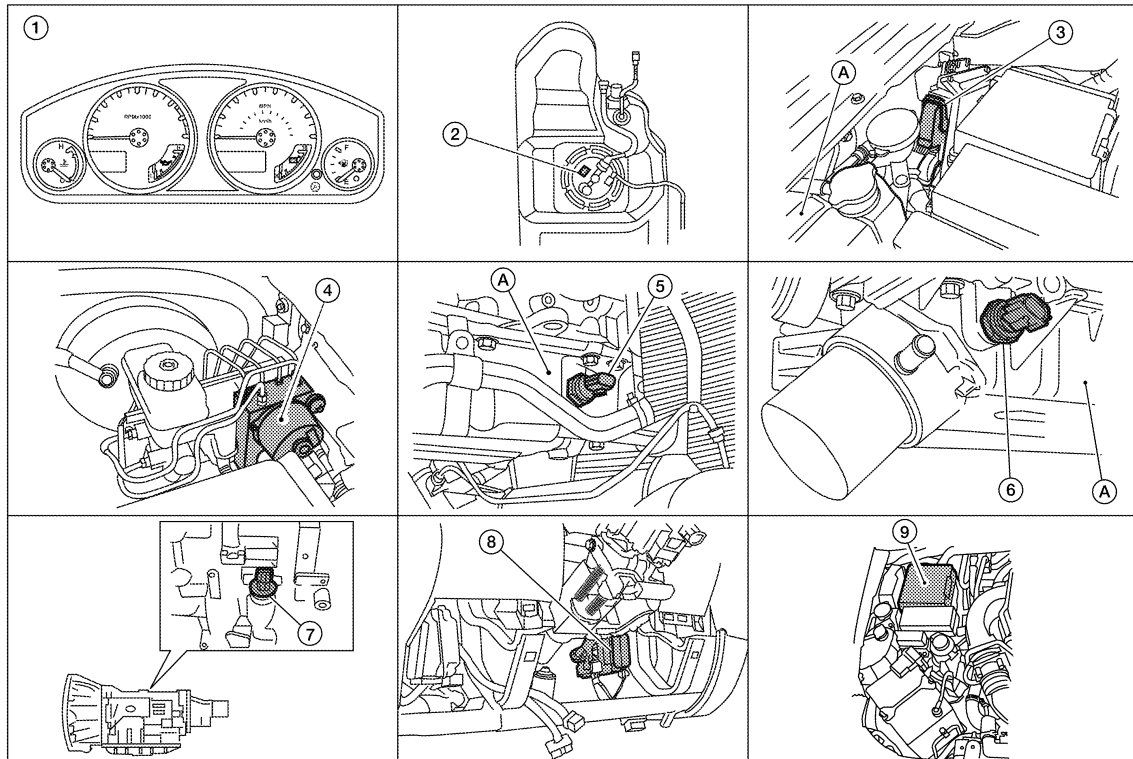

AWNIA0217ZZ

- | | | |
|---------------------------------------------------------------------------------------------------------------------------------------------------------------------------------------------------------|------------------------------------------------------------------------------------------------------------------------------------------------------------------------------------------------------------------------------|------------------------------------------------------------------------------------------------------------------------------------------------|
| <p>1. Combination meter M24</p> <p>4. ABS actuator and electric unit (control unit)
E125 (with VQ40DE)
E127 (with VK56DE)</p> <p>7. A/T assembly
F9 (with VQ40DE)
F70 (with VK56DE)</p> | <p>2. Fuel level sensor unit and fuel pump C5 (view with fuel tank removed)</p> <p>5. Oil pressure switch E208 (with VQ40DE)
A. Oil pan (upper)</p> <p>8. BCM M18, M19 (view with instrument lower panel LH removed)</p> | <p>3. ECM E16 (view with ECM cover removed)
A. Coolant reservoir</p> <p>6. Oil pressure switch F4 (with VK56DE)
A: Oil pan (upper)</p> |
|---------------------------------------------------------------------------------------------------------------------------------------------------------------------------------------------------------|------------------------------------------------------------------------------------------------------------------------------------------------------------------------------------------------------------------------------|------------------------------------------------------------------------------------------------------------------------------------------------|

TRIP COMPUTER : Component Description

INFOID:0000000003935343

Unit	Description
Combination meter	Controls the information display according to the signal received from each unit.
Fuel level sensor unit	Refer to MWI-32, "Description" .
ECM	Transmits the following signals to the combination meter via CAN communication line. <ul style="list-style-type: none"> • Engine speed signal • Fuel consumption monitor signal
ABS actuator and electric unit (control unit)	Transmits the vehicle speed signal to the combination meter via CAN communication line.

COMPASS

< FUNCTION DIAGNOSIS >

COMPASS

Description

INFOID:000000003935344

DESCRIPTION

With the ignition switch in the ON position, and the mode or (N) switch ON, the compass display will indicate the direction the vehicle is heading.

Vehicle direction is displayed as follows:

- N: north
- E: east
- S: south
- W: west

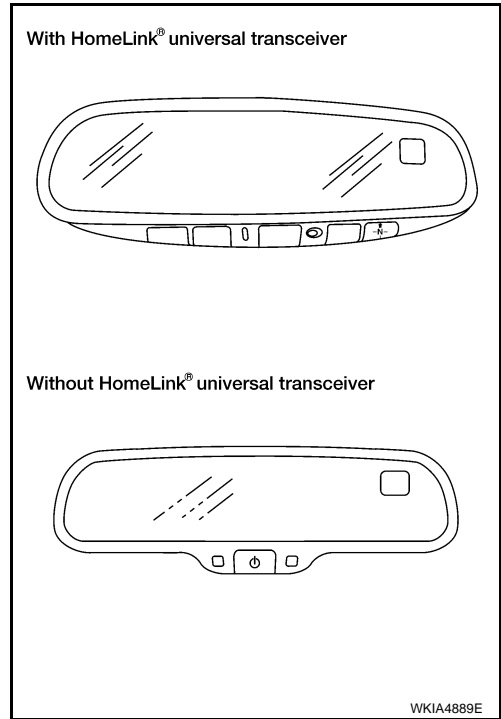

ZONE VARIATION SETTING PROCEDURE

The difference between magnetic north and geographical north can sometimes be great enough to cause false compass readings. This difference is known as variance. In order for the compass to operate properly (accurately) in a particular zone, the zone variation must be calibrated using the following procedure.

Zone Variation Chart

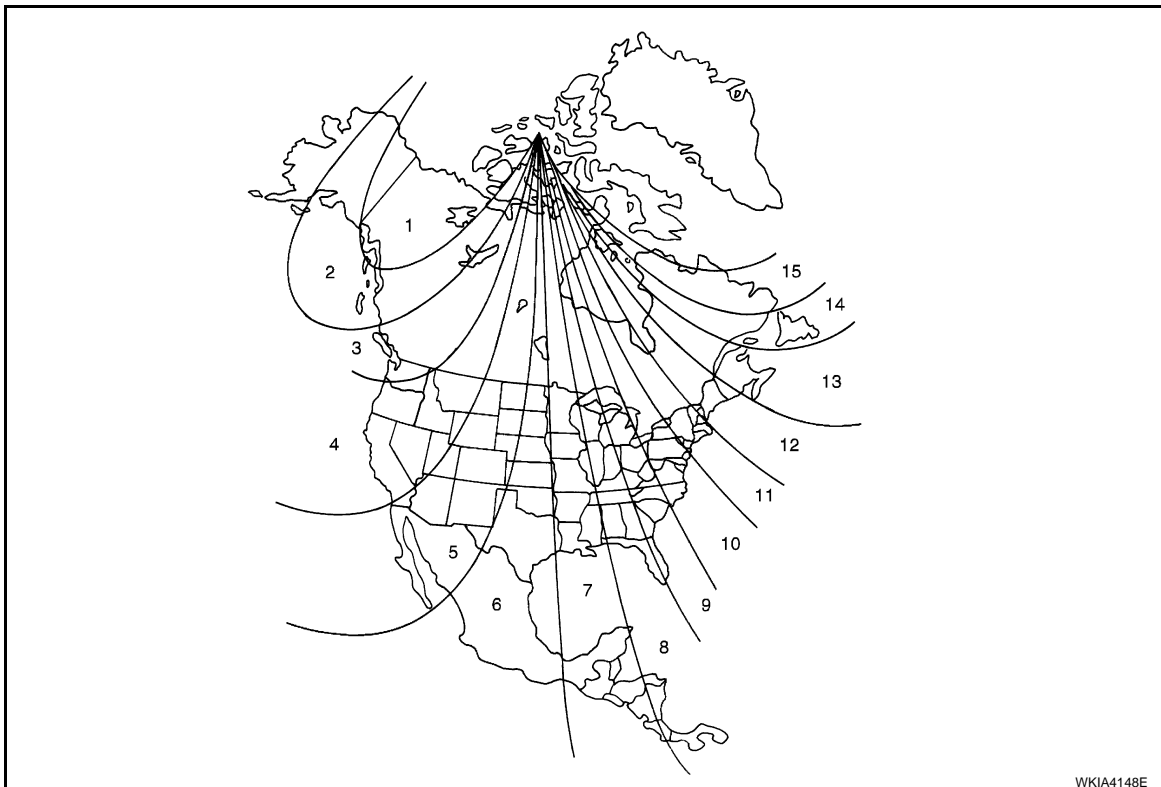

WKIA4148E

A
B
C
D
E
F
G
H
I
J
K
L
M
N
O
P

COMPASS

< FUNCTION DIAGNOSIS >

1. Determine your location on the zone map.
2. Turn the ignition switch to the ON position.
3. Press and hold the (N) switch for about 8 seconds (with HomeLink universal transceiver) or the mode switch for about 11 seconds (without HomeLink universal transceiver). The current zone number will appear in the display.
4. Press the mode or (N) switch repeatedly until the desired zone number appears in the display.

Once the desired zone number is displayed, stop pressing the mode or (N) switch and the display will show a compass direction after a few seconds.

NOTE:

Use zone number 5 for Hawaii.

CALIBRATION PROCEDURE

The compass display is equipped with an automatic correction function. If the compass display reads "CAL" or the direction is not shown correctly, perform the correction procedure below.

1. Press and hold the (N) switch for about 10 seconds (with HomeLink universal transceiver) or the mode switch for about 13 seconds (without HomeLink universal transceiver). The display will read "CAL".
2. Drive the vehicle slowly in a circle, in an open, safe place. The initial calibration is completed in about 3 turns.

NOTE:

In places where the terrestrial magnetism is extremely disturbed, the initial correction may start automatically.

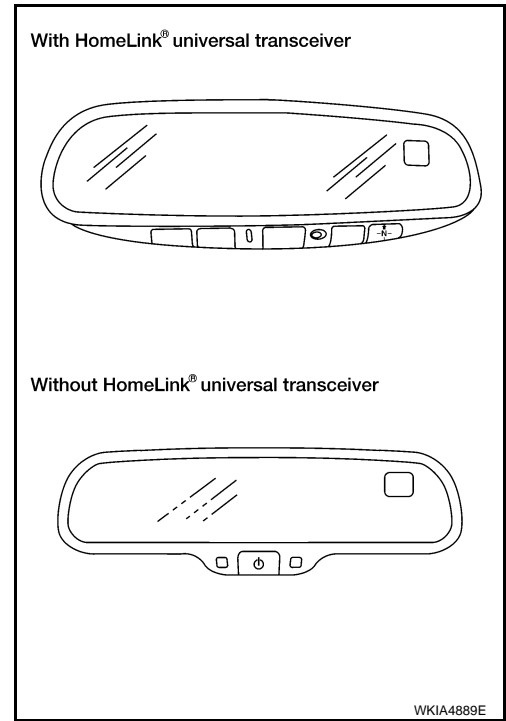

DIAGNOSIS SYSTEM (METER)

< FUNCTION DIAGNOSIS >

DIAGNOSIS SYSTEM (METER)

Diagnosis Description

INFOID:000000003935345

SELF-DIAGNOSIS MODE

The following items can be checked during Combination Meter Self-Diagnosis Mode.

- Gauge sweep and present gauge values.
- Illuminates all odometer/trip meters and A/T indicator segments.
- Illuminates all micro controlled lamps/LEDs regardless of switch position.
- Displays estimated present battery voltage.
- Displays seat belt buckle switch LH status.

OPERATION PROCEDURE

NOTE:

- Once entered, combination meter self-diagnosis mode will function with the ignition switch in ON or START. Combination meter self-diagnosis mode will exit upon turning the ignition switch to OFF or ACC.
- If the diagnosis function is activated with trip A displayed, the mileage on trip A is reset to 0000.0. (Trip B operates the same way.)

To initiate combination meter self-diagnosis mode, refer to the following procedure.

1. Turn the ignition switch ON, while pressing the odometer/trip meter switch for 5 - 8 seconds. When the diagnosis function is activated, the odometer/trip meter will display tEst.

NOTE:

Check combination meter power supply and ground circuit when self-diagnosis mode of combination meter does not start. Refer to [MWI-29, "COMBINATION METER : Diagnosis Procedure"](#). Replace combination meter if normal. Refer to [MWI-94, "Removal and Installation"](#).

COMBINATION METER SELF-DIAGNOSIS MODE FUNCTIONS

To interpret combination meter self-diagnosis mode functions, refer to the following table.

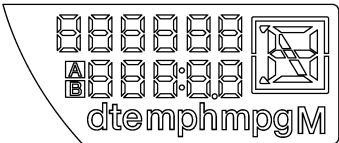
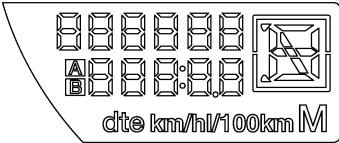
Event	Odometer Display	Description of Test/Data	Notes:
Odometer/trip meter A/B switch held from 5 to 8 seconds (or until released)	tEst		Initiating self-diagnosis mode
Switch released	GAGE	Performs sweep of all gauges, then displays present gauge values.	Gauges sweep within 10 seconds
Switch pressed	(All segments illuminated)	Lights all LCD segments. Compare with picture.	USA  <small>AWNIA0219ZZ</small> Canada  <small>AWNIA0220ZZ</small>
Switch pressed	bulb	Illuminates all micro-controlled lamps/LEDs.	Part may not be configured for all lamps (functions) that turn on during test. This is normal.
Switch pressed	r XXXX, FAIL	Return to normal operation of all lamps/LEDs and displays "r XXXX".	If a malfunction exists, "FAIL" will flash.

DIAGNOSIS SYSTEM (METER)

< FUNCTION DIAGNOSIS >

Event	Odometer Display	Description of Test/Data	Notes:
Switch pressed	nrXXXX	Displays Hex ROM rev as stored in NVM.	
Switch pressed	EE XX, FAIL	Displays "EE XX".	If a malfunction exists, "FAIL" will flash.
Switch pressed	dtXXXX	Hex coding of final manufacturing test date.	
Switch pressed (3 times)	Sc1 XX through Epr XX	Displays 8 bit software configuration value in Hex format	
Switch pressed	1nF XX	Displays 8-bit market info value in Hex format.	\$31 = USA \$2A = Canada
Switch pressed (3 times)	cYL XX through tF	N/A	
Switch pressed	ot1 XX	Displays oil pressure tell-tale "" in Hex format.	
Switch pressed	ot0 XX	Displays oil pressure tell-tale "" in Hex format.	
Switch pressed	XXXXXX	"Corrected" speed value in hundredths of MPH. Gauge indication may be slightly higher. This is normal.	Will display "----" if message is not received. Will display "99999" if data received is invalid.
Switch pressed	XXXXXX	"Corrected" speed value in hundredths of KPH. Gauge indication may be slightly different. This is normal.	Will display "----" if message is not received. Will display "99999" if data received is invalid.
Switch pressed	t XXXX	Tachometer value in RPM. Gauge indication may be higher at higher RPM. This is normal.	Will display "----" if message is not received.
Switch pressed	F1XXXX	Present fuel level A/D input. This input represents fuel sender input.	000-009 = Short circuit 010-254 = Normal range 255 = Open circuit
Switch pressed	XXXXC	Last temperature gauge input value in degrees C. Temperature gauge indicates present temperature per indication standard.	Will display "---"C if message is not received. Will display "999" if data received is invalid. High = 130 deg C Normal = 70 - 105 deg C Low = less than 50 deg C
Switch pressed	BAtXX.X	Estimated present battery voltage.	
Switch pressed	rES -X	Seat belt buckle switch LH status.	1 = Buckled 0 = Unbuckled
Switch pressed (30 times)	PA -XX through PA1-XX	N/A	
Switch pressed	GAGE		Return to beginning of self-diagnosis cycle.

CONSULT-III Function (METER/M&A)

INFOID:000000003935346

CONSULT-III can display each diagnostic item using the diagnostic test modes shown following.

DIAGNOSIS SYSTEM (METER)

< FUNCTION DIAGNOSIS >

METER/M&A diagnosis mode	Description
SELF-DIAG RESULTS	Displays combination meter self-diagnosis results.
DATA MONITOR	Displays combination meter input/output data in real time.
CAN DIAG SUPPORT MNTR	The result of transmit/receive diagnosis of CAN communication can be read.

SELF-DIAG RESULTS

Display Item List

Refer to [MWI-59, "DTC Index"](#).

DATA MONITOR

Display Item List

X: Applicable

Display item [Unit]	MAIN SIGNALS	SELECTION FROM MENU	Description
SPEED METER [km/h] or [mph]	X	X	Displays the value of vehicle speed signal.
SPEED OUTPUT [km/h] or [mph]	X	X	Displays the value of vehicle speed signal, which is transmitted to each unit with CAN communication.
TACHO METER [rpm]	X	X	Displays the value of engine speed signal, which is input from ECM.
FUEL METER [lit.]	X	X	Displays the value, which processes a resistance signal from fuel gauge.
W TEMP METER [°C] or [°F]	X	X	Displays the value of engine coolant temperature signal, which is input from ECM.
ABS W/L [ON/OFF]		X	Displays [ON/OFF] condition of ABS warning lamp.
VDC/TCS IND [ON/OFF]		X	Displays [ON/OFF] condition of VDC OFF indicator lamp.
SLIP IND [ON/OFF]		X	Displays [ON/OFF] condition of SLIP indicator lamp.
BRAKE W/L [ON/OFF]		X	Displays [ON/OFF] condition of brake warning lamp.*
DOOR W/L [ON/OFF]		X	Displays [ON/OFF] condition of door ajar warning lamp.
HI-BEAM IND [ON/OFF]		X	Displays [ON/OFF] condition of high beam indicator.
TURN IND [ON/OFF]		X	Displays [ON/OFF] condition of turn indicator.
OIL W/L [ON/OFF]		X	Displays [ON/OFF] condition of oil pressure warning lamp.
C-ENG W/L [ON/OFF]		X	Displays [ON/OFF] condition of malfunction indicator lamp.
CRUISE IND [ON/OFF]		X	Displays [ON/OFF] condition of CRUISE indicator.
SET IND [ON/OFF]		X	Displays [ON/OFF] condition of SET indicator.
O/D OFF W/L [ON/OFF]		X	Displays [ON/OFF] condition of AT CHECK (with manual mode) or O/D OFF (without manual mode) warning lamp.
FUEL W/L [ON/OFF]	X	X	Displays [ON/OFF] condition of low-fuel warning lamp.
AIR PRES W/L [ON/OFF]		X	Displays [ON/OFF] condition of tire pressure warning lamp.
KEY G W/L [ON/OFF]		X	Displays [ON/OFF] condition of key green warning lamp.
KEY R W/L [ON/OFF]		X	Displays [ON/OFF] condition of key red warning lamp.
KEY KNOB W/L [ON/OFF]		X	Displays [ON/OFF] condition of key knob warning lamp.
M RANGE SW [ON/OFF]	X	X	Displays [ON/OFF] condition of manual mode range switch.
NM RANGE SW [ON/OFF]	X	X	Displays [ON/OFF] condition of except for manual mode range switch.
AT SFT UP SW [ON/OFF]	X	X	Displays [ON/OFF] condition of A/T shift-up switch.
AT SFT DWN SW [ON/OFF]	X	X	Displays [ON/OFF] condition of A/T shift-down switch.
DISTANCE [km] or [mile]	X	X	Displays the value, which is calculated by vehicle speed signal, fuel gauge and fuel consumption from ECM.
BUZZER [ON/OFF]	X	X	Displays [ON/OFF] condition of buzzer.
BRAKE SW [ON/OFF]		X	Indicates [ON/OFF] condition of parking brake switch.

DIAGNOSIS SYSTEM (METER)

< FUNCTION DIAGNOSIS >

Display item [Unit]	MAIN SIGNALS	SELECTION FROM MENU	Description
AT-M IND [ON/OFF]	X	X	Indicates [ON/OFF] condition of A/T manual mode indicator.
AT-M GEAR [1, 2, 3, 4, 5]	X	X	Indicates [1, 2, 3, 4, 5] condition of A/T manual mode gear position.
P RANGE IND [ON/OFF]	X	X	Indicates [ON/OFF] condition of A/T shift P range indicator.
R RANGE IND [ON/OFF]	X	X	Indicates [ON/OFF] condition of A/T shift R range indicator.
N RANGE IND [ON/OFF]	X	X	Indicates [ON/OFF] condition of A/T shift N range indicator.
D RANGE IND [ON/OFF]	X	X	Indicates [ON/OFF] condition of A/T shift D range indicator.
4 RANGE IND [ON/OFF]	X	X	Indicates [ON/OFF] condition of A/T shift 4 range indicator.
3 RANGE IND [ON/OFF]	X	X	Indicates [ON/OFF] condition of A/T shift 3 range indicator.
2 RANGE IND [ON/OFF]	X	X	Indicates [ON/OFF] condition of A/T shift 2 range indicator.
1 RANGE IND [ON/OFF]	X	X	Indicates [ON/OFF] condition of A/T shift 1 range indicator.
4WD LOCK SW [ON/OFF]		X	Indicates [ON/OFF] condition of 4WD lock switch.
4WD LOCK IND [ON/OFF]		X	Indicates [ON/OFF] condition of 4WD lock indicator.
SEAT BELT W/L [ON/OFF]		X	Indicates [ON/OFF] condition of seat belt warning lamp.
O/D OFF SWITCH [ON/OFF]		X	Indicates [ON/OFF] condition of O/D OFF switch.
FR FOG IND [ON/OFF]		X	This item is not used for this model. "OFF" is always displayed.
RR FOG IND [ON/OFF]		X	This item is not used for this model. "OFF" is always displayed.

NOTE:

Some items are not available due to vehicle specification.

*: The monitor will indicate "OFF" even though the brake warning lamp is on if either of the following conditions exist.

- The parking brake is engaged
- The brake fluid level is low

DTC U1000 CAN COMMUNICATION

< COMPONENT DIAGNOSIS >

COMPONENT DIAGNOSIS

DTC U1000 CAN COMMUNICATION

DTC Logic

INFOID:000000003935347

DTC DETECTION LOGIC

DTC	CONSULT-III display	Detection condition
U1000	CAN COMM CIRC [U1000]	When combination meter is not receiving CAN communication signals for 2 seconds or more.

Diagnosis Procedure

INFOID:000000003935348

Symptom: Displays "CAN COMM CIRC [U1000]" as a self-diagnosis result of combination meter.

1. CHECK CAN COMMUNICATION

Select "SELF-DIAG RESULTS" mode for "METER/M&A" with CONSULT-III.

>> Go to "LAN system". Refer to [LAN-14. "Trouble Diagnosis Flow Chart"](#).

A
B
C
D
E
F
G
H
I
J
K
L
M
O
P

MWI

DTC B2205 VEHICLE SPEED CIRCUIT

< COMPONENT DIAGNOSIS >

DTC B2205 VEHICLE SPEED CIRCUIT

Description

INFOID:000000003935349

The ABS actuator and electric unit (control unit) provides a vehicle speed signal to the combination meter via CAN communication lines.

DTC Logic

INFOID:000000003935350

DTC	CONSULT-III display	Detection condition
B2205	VEHICLE SPEED CIRC [B2205]	Malfunction is detected when an erroneous speed signal is received for 2 seconds or more.

Diagnosis Procedure

INFOID:000000003935351

Symptom: Displays "VEHICLE SPEED CIRC [B2205]" as a self-diagnosis result of combination meter.

1. CHECK COMBINATION METER INPUT SIGNAL

1. Start engine and select "METER/M&A" on CONSULT-III.
2. Using "SPEED METER" on "DATA MONITOR", compare the value of DATA MONITOR with speedometer pointer of combination meter. Speedometer and DATA MONITOR indications should be close.

Is the inspection result normal?

- YES >> Perform ABS actuator and electric unit (control unit) self-diagnosis. Refer to [BRC-26, "CONSULT-III Function \(ABS\)"](#) (Type 1) or [BRC-153, "CONSULT-III Function \(ABS\)"](#) (Type 2).
- NO >> Replace combination meter. Refer to [MWI-94, "Removal and Installation"](#).

POWER SUPPLY AND GROUND CIRCUIT

< COMPONENT DIAGNOSIS >

POWER SUPPLY AND GROUND CIRCUIT COMBINATION METER

COMBINATION METER : Diagnosis Procedure

INFOID:000000003935352

1. CHECK FUSES

Check for blown combination meter fuses.

Unit	Power source	Fuse No.
Combination meter	Battery	19
	Ignition switch ON or START	14

Is the inspection result normal?

YES >> GO TO 2

NO >> If fuse is blown, be sure to eliminate cause of malfunction before installing new fuse.

2. POWER SUPPLY CIRCUIT CHECK

1. Disconnect combination meter connector M24.
2. Check voltage between combination meter harness connector M24 terminals 3, 16 and ground.

Terminals		(-)	Ignition switch position		
(+)			OFF	ACC	ON
Connector	Terminal				
M24	3	Ground	Battery voltage	Battery voltage	Battery voltage
	16		0V	0V	Battery voltage

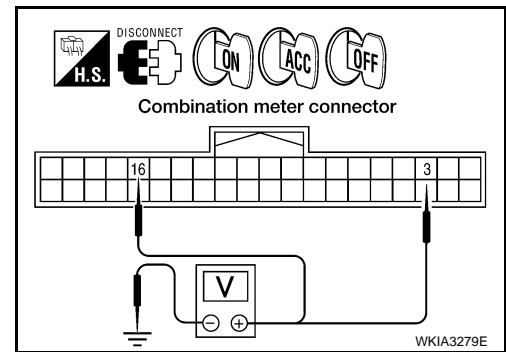

Is the inspection result normal?

YES >> GO TO 3

NO >> Check harness for open between combination meter and fuse.

3. GROUND CIRCUIT CHECK

1. Turn ignition switch OFF.
2. Check continuity between combination meter harness connector M24 terminals 13, 23 and ground.

Terminals		(-)	Continuity
(+)			
Connector	Terminal		
M24	13	Ground	Yes
	23		

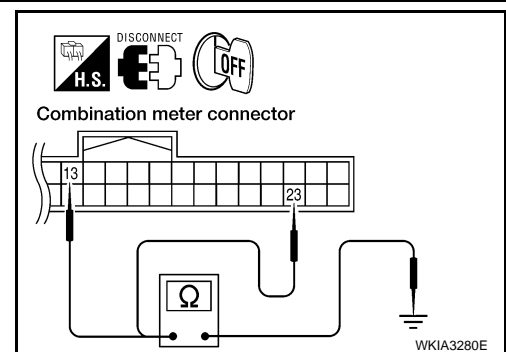

Is the inspection result normal?

YES >> Inspection End.

NO >> Check ground harness.

BCM (BODY CONTROL MODULE)

BCM (BODY CONTROL MODULE) : Diagnosis Procedure

INFOID:000000003935353

1. CHECK FUSES AND FUSIBLE LINK

Check that the following fuses and fusible link are not blown.

A
B
C
D
E
F
G
H
I
J
K
L
M
N
O
P

POWER SUPPLY AND GROUND CIRCUIT

< COMPONENT DIAGNOSIS >

Terminal No.	Signal name	Fuses and fusible link No.
57	Battery power supply	18 (10A)
70		G (50A)
11	Ignition ACC or ON	4 (10A)
38	Ignition ON or START	1 (10A)

Is the fuse blown?

- YES >> Replace the blown fuse or fusible link after repairing the affected circuit.
 NO >> GO TO 2

2. CHECK POWER SUPPLY CIRCUIT

- Turn ignition switch OFF.
- Disconnect BCM.
- Check voltage between BCM harness connector and ground.

Connector	Terminals		Power source	Condition	Voltage (V) (Approx.)
	(+)	(-)			
M18	11	Ground	ACC power supply	Ignition switch ACC or ON	Battery voltage
	38	Ground	Ignition power supply	Ignition switch ON or START	Battery voltage
M20	57	Ground	Battery power supply	Ignition switch OFF	Battery voltage
	70	Ground	Battery power supply	Ignition switch OFF	Battery voltage

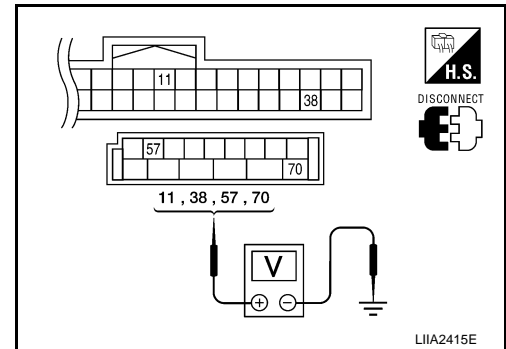

Is the measurement value normal?

- YES >> GO TO 3
 NO >> Repair or replace harness.

3. CHECK GROUND CIRCUIT

Check continuity between BCM harness connector and ground.

BCM		Ground	Continuity
Connector	Terminal		
M20	67		Yes

Does continuity exist?

- YES >> INSPECTION END
 NO >> Repair or replace harness.

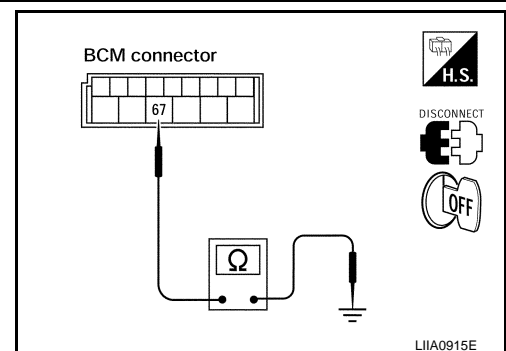

IPDM E/R (INTELLIGENT POWER DISTRIBUTION MODULE ENGINE ROOM)

IPDM E/R (INTELLIGENT POWER DISTRIBUTION MODULE ENGINE ROOM) : Diagnosis Procedure

INFOID:000000003935354

1. CHECK FUSES AND FUSIBLE LINK

Check that the following IPDM E/R fuses or fusible link are not blown.

POWER SUPPLY AND GROUND CIRCUIT

< COMPONENT DIAGNOSIS >

Terminal No.	Signal name	Fuses and fusible link No.
1	Battery	A, D
2	Battery	C

Is the fuse blown?

YES >> Replace the blown fuse or fusible link after repairing the affected circuit.

NO >> GO TO 2

2. CHECK BATTERY POWER SUPPLY CIRCUIT

- Turn ignition switch OFF.
- Disconnect IPDM E/R.
- Check voltage between IPDM E/R harness connectors and ground.

Terminals		Ignition switch position	Ignition switch position		
(+)	(-)		OFF	ON	START
Connector	Terminal	Ground	Battery voltage	Battery voltage	Battery voltage
E118	1		Battery voltage	Battery voltage	Battery voltage
	2		Battery voltage	Battery voltage	Battery voltage

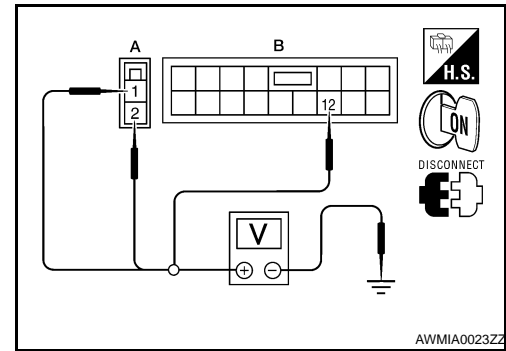

Is the measurement value normal?

YES >> GO TO 3

NO >> Repair or replace harness.

3. CHECK GROUND CIRCUIT

- Turn ignition switch OFF.
- Check continuity between IPDM E/R harness connectors and ground.

IPDM E/R		Ground	Continuity
Connector	Terminal		Yes
E122 (A)	38		Yes
E124 (B)	59		

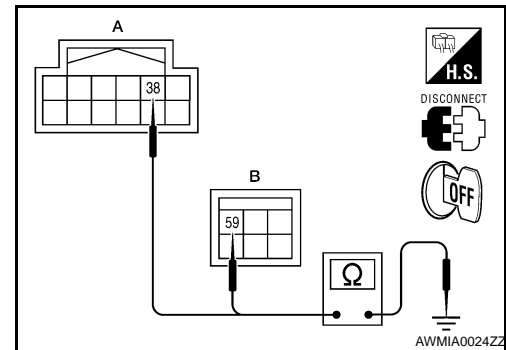

Does continuity exist?

YES >> Inspection End.

NO >> Repair or replace harness.

A
B
C
D
E
F
G
H
I
J
K
L
M
N
O
P

FUEL LEVEL SENSOR SIGNAL CIRCUIT

< COMPONENT DIAGNOSIS >

FUEL LEVEL SENSOR SIGNAL CIRCUIT

Description

INFOID:000000003935355

The fuel level sensor unit and fuel pump detects the approximate fuel level in the fuel tank and transmits the fuel level signal to the combination meter.

Component Function Check

INFOID:000000003935356

1.COMBINATION METER INPUT SIGNAL

1. Select "METER/M&A" on CONSULT-III.
2. Using "FUEL METER" of "DATA MONITOR", compare the value of DATA MONITOR with fuel gauge pointer of combination meter.

Fuel gauge pointer	Reference value of data monitor [lit.]
Full	Approx. 79.3
3/4	Approx. 58.5
1/2	Approx. 37.1
1/4	Approx. 22.4
Empty	Approx. 7.6

Does the data monitor value approximately match the fuel gauge indication?

YES >> Inspection End.

NO >> Replace combination meter. Refer to [MWI-94. "Removal and Installation"](#).

Diagnosis Procedure

INFOID:000000003935357

1.CHECK HARNESS CONNECTOR

1. Turn ignition switch OFF.
2. Check combination meter and fuel level sensor unit terminals (meter-side and harness-side) for poor connection.

Is the inspection result normal?

YES >> GO TO 2

NO >> Repair or replace terminals or connectors.

2.CHECK FUEL LEVEL SENSOR UNIT CIRCUIT

1. Disconnect combination meter connector and fuel level sensor unit connector.
2. Check continuity between combination meter harness connector and fuel level sensor unit and fuel pump harness connector.

Terminals				Continuity
(+)		(-)		
Connector	Terminal	Connector	Terminal	
C5	2	M24	9	Yes

3. Check continuity between fuel level sensor unit and fuel pump harness connector and ground.

Terminals			Continuity
(+)		(-)	
Connector	Terminal	Ground	
C5	2	Ground	No

Is the inspection result normal?

YES >> GO TO 3

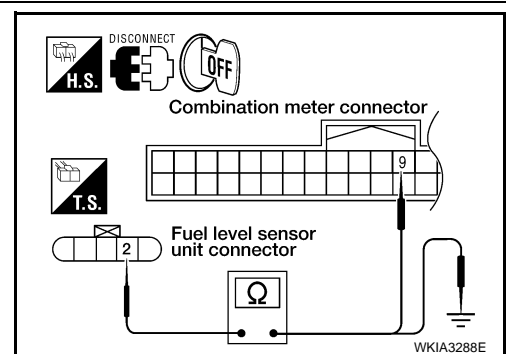

FUEL LEVEL SENSOR SIGNAL CIRCUIT

< COMPONENT DIAGNOSIS >

NO >> Repair harness or connector.

3. CHECK FUEL LEVEL SENSOR UNIT GROUND CIRCUIT

1. Check continuity between combination meter harness connector and fuel level sensor unit and fuel pump harness connector.

Terminals				Continuity
(+)		(-)		
Connector	Terminal	Connector	Terminal	
C5	5	M24	4	Yes

2. Check continuity between fuel level sensor unit and fuel pump harness connector and ground.

Terminals				Continuity
(+)		(-)		
Connector	Terminal	Ground		
C5	5	Ground		No

Is the inspection result normal?

YES >> GO TO 4

NO >> Repair harness or connector.

4. CHECK INSTALLATION CONDITION

Check fuel level sensor unit installation, and check whether the float arm interferes or binds with any of the internal components in the fuel tank.

Is the inspection result normal?

YES >> Inspection End.

NO >> Install the fuel level sensor unit properly.

Component Inspection

INFOID:000000003935358

1. REMOVE FUEL LEVEL SENSOR UNIT

Remove the fuel level sensor unit. Refer to [FL-11, "Removal and Installation"](#).

>> GO TO 2

2. CHECK FUEL LEVEL SENSOR UNIT AND FUEL PUMP

Check the resistance between terminals 2 and 5.

Terminal		Float position mm (in)		Resistance value (Approx.)
2	5	*1	Empty	10 (0.4)
		*2	Full	211.1 (8.3)
				5Ω

*1 and *2: When float arm is in contact with stopper.

Is inspection result normal?

YES >> Inspection End.

NO >> Replace fuel level sensor unit and fuel pump. Refer to [FL-11, "Removal and Installation"](#).

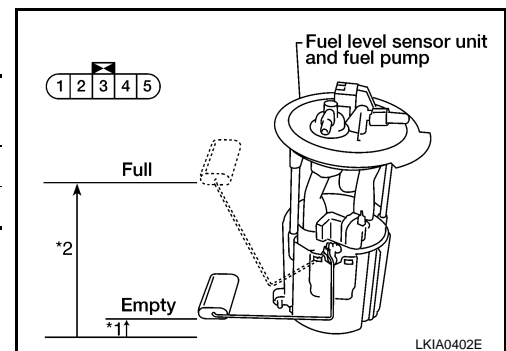
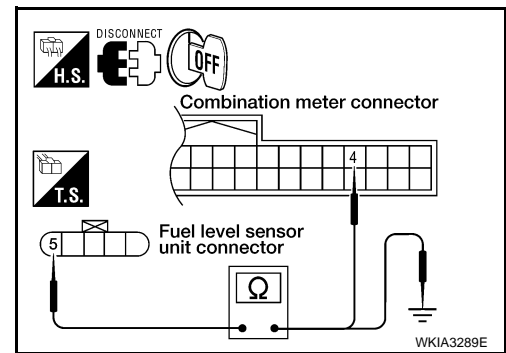

OIL PRESSURE SWITCH SIGNAL CIRCUIT

< COMPONENT DIAGNOSIS >

OIL PRESSURE SWITCH SIGNAL CIRCUIT

Description

INFOID:000000003935359

Detects the engine oil pressure and transmits the oil pressure switch signal to the IPDM E/R.

Component Function Check

INFOID:000000003935360

1.COMBINATION METER INPUT SIGNAL

1. Select "METER/M&A" on CONSULT-III.
2. Monitor "OIL W/L" of "DATA MONITOR" while operating ignition switch.

OIL W/L

When ignition switch is in ON : ON
position (Engine stopped)

When engine is running : OFF

>> Inspection End.

Diagnosis Procedure

INFOID:000000003935361

1.CHECK OIL PRESSURE SWITCH CIRCUIT

1. Turn ignition switch OFF.
2. Disconnect IPDM E/R connector E122 and oil pressure switch connector E208 (VQ40DE) or F4 (VK56DE).
3. Check continuity between IPDM E/R harness connector E122 (A) terminal 42 and oil pressure switch harness connector E208 (VQ40DE) or F4 (VK56DE) (B) terminal 1.

Continuity should exist.

Is the inspection result normal?

- YES >> Inspection End.
NO >> Repair harness or connector.

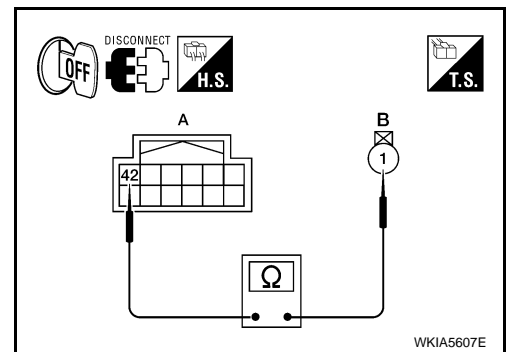

Component Inspection

INFOID:000000003935362

1.CHECK OIL PRESSURE SWITCH

Check continuity between oil pressure switch and ground.

Condition	Oil pressure [kPa (kg/cm ² , psi)]	Continuity
Engine stopped	Less than 29 (0.3, 4)	Yes
Engine running	More than 29 (0.3, 4)	No

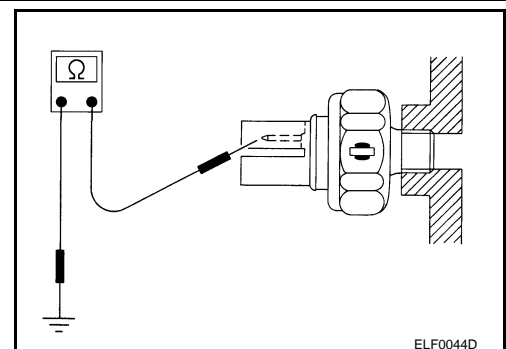

Is the inspection result normal?

- YES >> Inspection End.
NO >> Replace the oil pressure switch.

COMPASS

< COMPONENT DIAGNOSIS >

COMPASS

Wiring Diagram — With HomeLink® Universal Transceiver

INFOID:000000003935363

COMPASS - WITH HOMELINK UNIVERSAL TRANSCEIVER

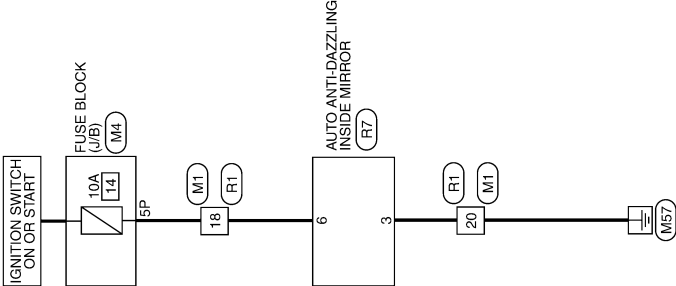

A
B
C
D
E
F
G
H
I
J
K
L
M
O
P

MWI

ABNWA0163GE

COMPASS CONNECTORS - WITH HOMELINK UNIVERSAL TRANSCIEVER

Connector No.	M1
Connector Name	WIRE TO WIRE
Connector Color	WHITE

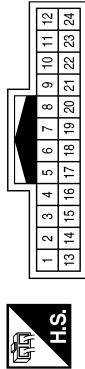

Connector No.	M4
Connector Name	FUSE BLOCK (J/B)
Connector Color	WHITE

Terminal No.	Color of Wire	Signal Name
18	W/G	-
20	B	-

Terminal No.	Color of Wire	Signal Name
5P	W/G	-

Connector No.	R1
Connector Name	WIRE TO WIRE
Connector Color	WHITE

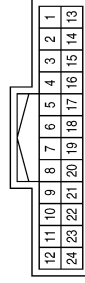

Terminal No.	Color of Wire	Signal Name
18	W/G	-
20	B	-

Connector No.	R7
Connector Name	AUTO ANTI-DAZZLING INSIDE MIRROR (WITH HOMELINK UNIVERSAL TRANSCIEVER)
Connector Color	BLACK

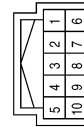

Terminal No.	Color of Wire	Signal Name
3	B	GND
6	W/G	IGN

COMPASS - WITHOUT HOMELINK UNIVERSAL TRANSCEIVER

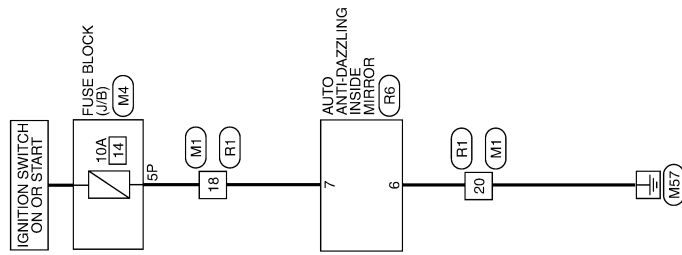

A
B
C
D
E
F
G
H
I
J
K
L
M
O
P

MWI

COMPASS CONNECTORS - WITHOUT HOMELINK UNIVERSAL TRANSCEIVER

Connector No.	M1
Connector Name	WIRE TO WIRE
Connector Color	WHITE

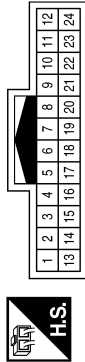

Terminal No.	Color of Wire	Signal Name
18	W/G	-
20	B	-

Connector No.	M4
Connector Name	FUSE BLOCK (J/B)
Connector Color	WHITE



Terminal No.	Color of Wire	Signal Name
5P	W/G	-

Connector No.	R1
Connector Name	WIRE TO WIRE
Connector Color	WHITE

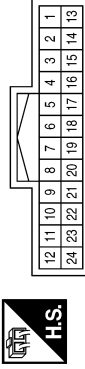

Terminal No.	Color of Wire	Signal Name
18	W/G	-
20	B	-

Connector No.	R6
Connector Name	AUTO ANTI-DAZZLING INSIDE MIRROR (WITHOUT HOMELINK UNIVERSAL TRANSCEIVER)
Connector Color	RED

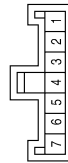

Terminal No.	Color of Wire	Signal Name
6	B	GND
7	W/G	IGN

COMBINATION METER

< ECU DIAGNOSIS >

ECU DIAGNOSIS

COMBINATION METER

Reference Value

INFOID:000000003935365

TERMINAL LAYOUT

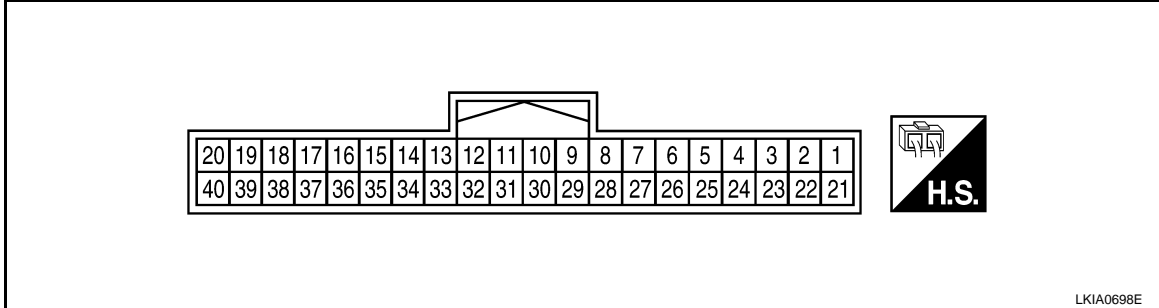

PHYSICAL VALUES

Terminal	Wire color	Item	Condition		Reference value (V) (Approx.)
			Ignition switch	Operation or condition	
2	P	Generator	ON	Generator voltage low	0
				Generator voltage normal	Battery voltage
3	R/Y	Battery power supply	—	—	Battery voltage
4	B/Y	Fuel level sensor ground	ON	—	0
5	W	Vehicle speed signal output	ON	Speedometer operated [When vehicle speed is approx. 40 km/h (25 MPH)]	<p>ELF1080D</p>
6	LG	Vehicle speed signal output (8-pulse)	ON	Speedometer operated [When vehicle speed is approx. 40 km/h (25 MPH)]	<p>NOTE: Maximum voltage may be 12V due to specifications (connected units).</p> <p>PKIC0643E</p>
9	BR	Fuel level sensor signal	—	—	Refer to MWI-11, "FUEL GAUGE : System Description" .
11	P	CAN-L	—	—	—
12	L	CAN-H	—	—	—
13	GR	Ground	—	—	0
16	W/G	Ignition switch ON or START	ON	—	Battery voltage
22	BR	Illumination control switch	—	—	Refer to INL-9, "System Description" .
23	B	Ground	—	—	0

A
B
C
D
E
F
G
H
I
J
K
L
M
N
O
P

MWI

COMBINATION METER

< ECU DIAGNOSIS >

Terminal	Wire color	Item	Condition		Reference value (V) (Approx.)
			Ignition switch	Operation or condition	
24	V	Seat belt buckle switch LH	ON	Unfastened (ON)	0
				Fastened (OFF)	Battery voltage
31	G	Parking brake switch	ON	Parking brake depressed	0
				Parking brake released	Battery voltage
32	SB	Brake fluid level switch	ON	Brake fluid level low	0
				Brake fluid level normal	Battery voltage
33	LG	Stop lamp switch	—	Brake pedal depressed	Battery voltage
				Brake pedal released	0
34	L	Washer fluid level switch	ON	Washer fluid level low	0
				Washer fluid level normal	Battery voltage
37	SB	Air bag warning lamp input	ON	Air bag warning lamp ON	4
				Air bag warning lamp OFF	0
39	G	Security indicator input	OFF	Security indicator ON	0
				Security indicator OFF	Battery voltage
40	LG	Seat belt buckle switch RH	ON	Unfastened (ON)	0
				Fastened (OFF)	Battery voltage

COMBINATION METER

< ECU DIAGNOSIS >

Wiring Diagram

INFOID:000000003935366

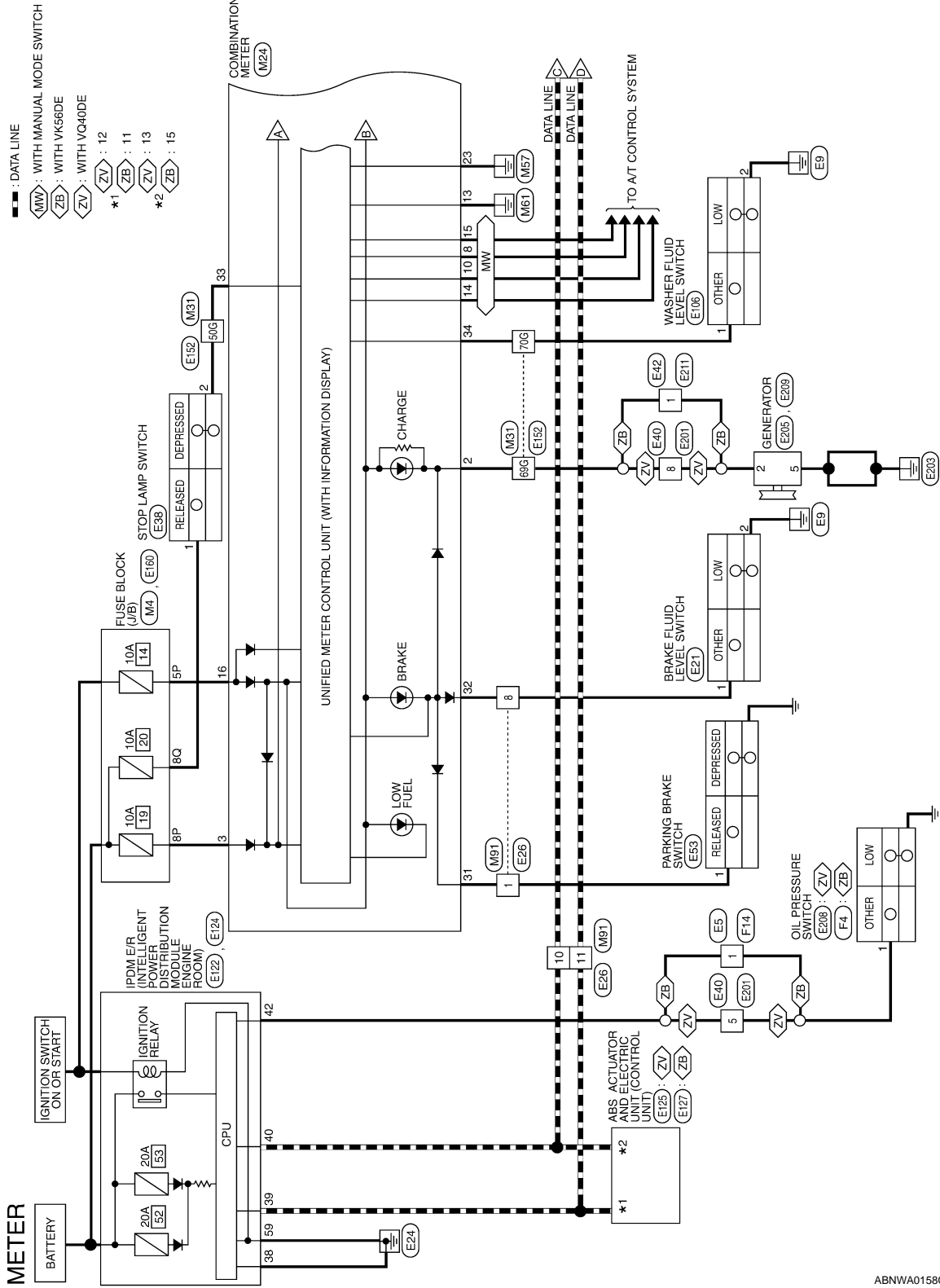

A
B
C
D
E
F
G
H
I
J
K
L
M
N
O
P

MWI

ABNWA0158GE

COMBINATION METER

< ECU DIAGNOSIS >

- : DATA LINE
- ◊ : WITH INTELLIGENT KEY SYSTEM
- ◊ : WITH SUNROOF

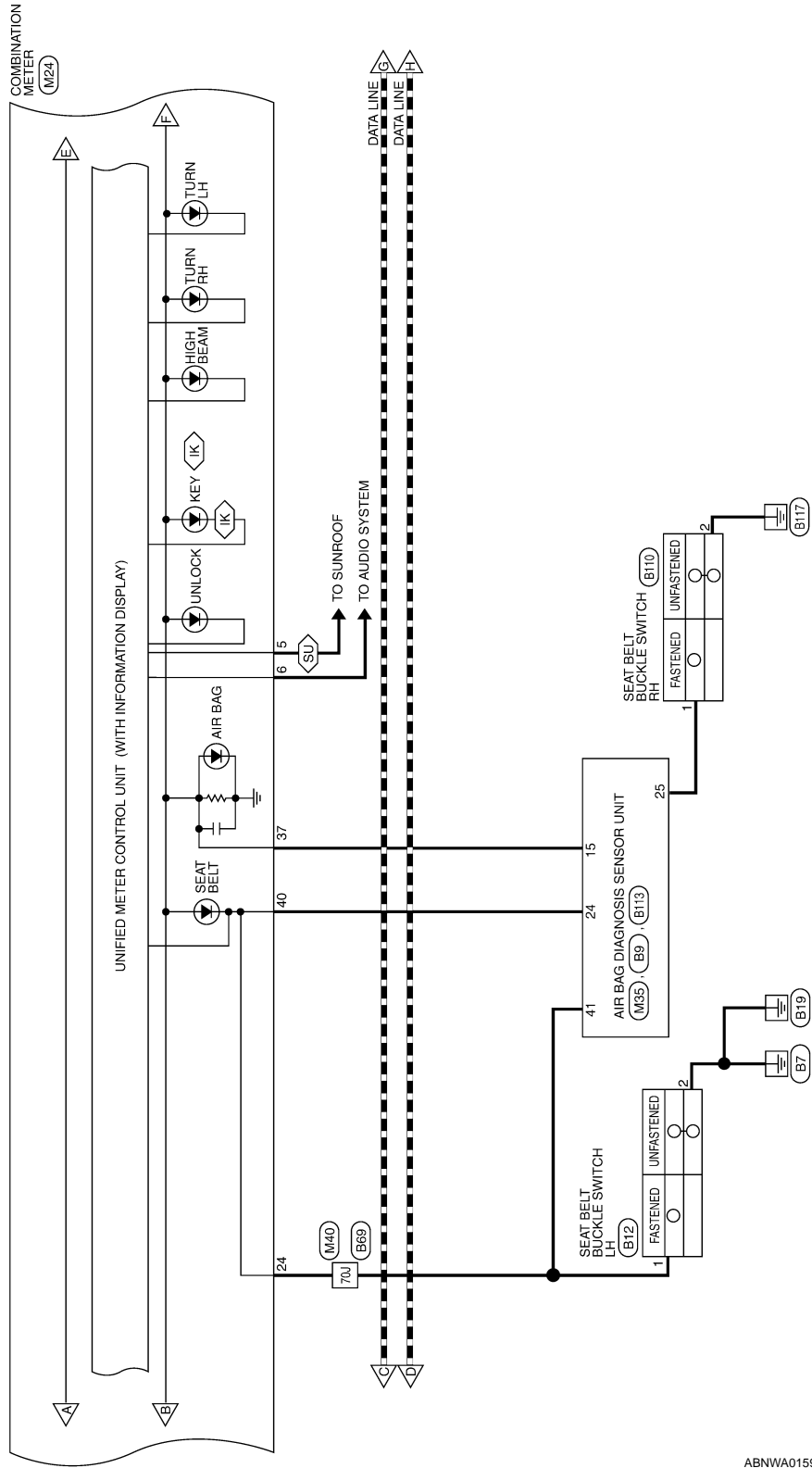

ABNWA0159Gf

COMBINATION METER

< ECU DIAGNOSIS >

- ▬ : DATA LINE
- ◊(IK) : WITH INTELLIGENT KEY SYSTEM
- ◊(MX) : WITHOUT MANUAL MODE SWITCH
- ◊(ZB) : WITH VK58DE
- ◊(ZV) : WITH VQ40DE
- *5 ◊(ZV) : 12
- ◊(ZB) : 11
- ◊(ZV) : 13
- *6 ◊(ZB) : 15

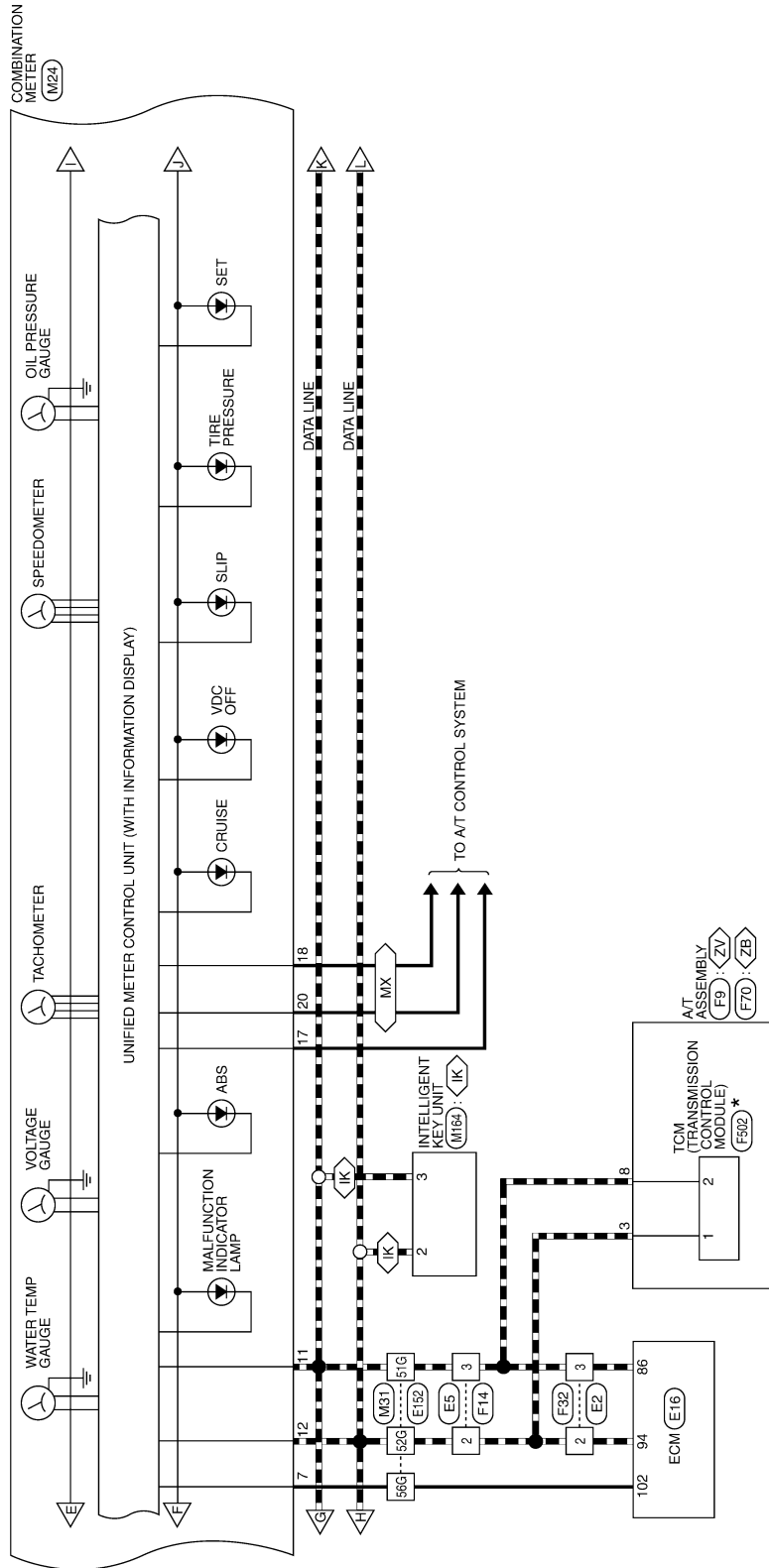

* THIS CONNECTORS IS NOT SHOW IN "HARNES LAYOUT" OF PG SECTION

ABNWA0160GE

A
B
C
D
E
F
G
H
I
J
K
L
M
N
O
P

MWI

COMBINATION METER

< ECU DIAGNOSIS >

— : DATA LINE

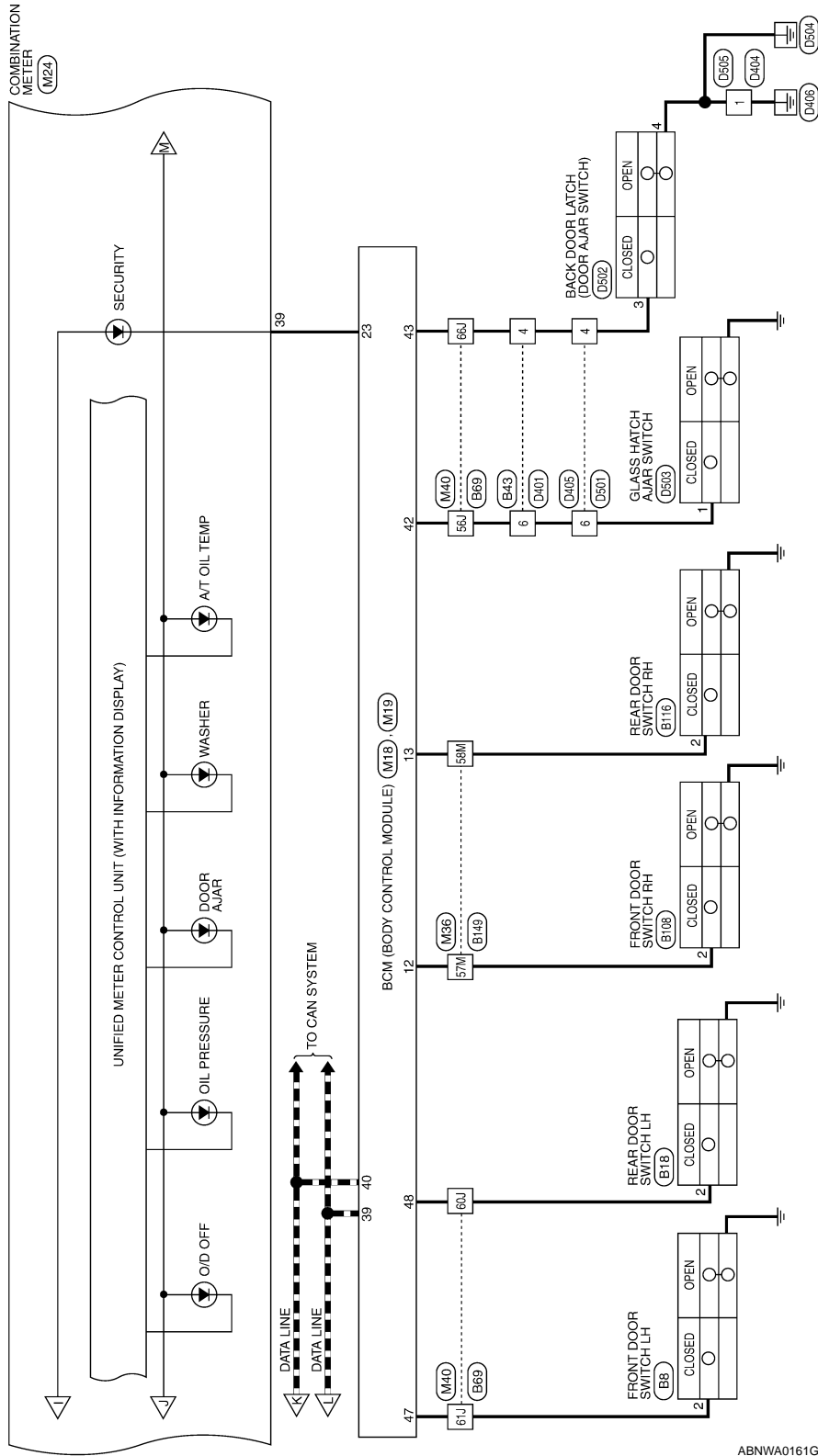

ABNWA0161GE

COMBINATION METER

< ECU DIAGNOSIS >

- : WITH 4-WHEEL DRIVE
- : ALL-MODE 4WD SYSTEM
- : WITH HILL DESCENT CONTROL AND HILL START ASSIST
- : PART TIME 4WD SYSTEM
- *1 : *2 : *3 : *4 : *5 :
- *6 : *7 : *8 : *9 :
- *10 : *11 : *12 : *13 :
- *14 : *15 : *16 : *17 :

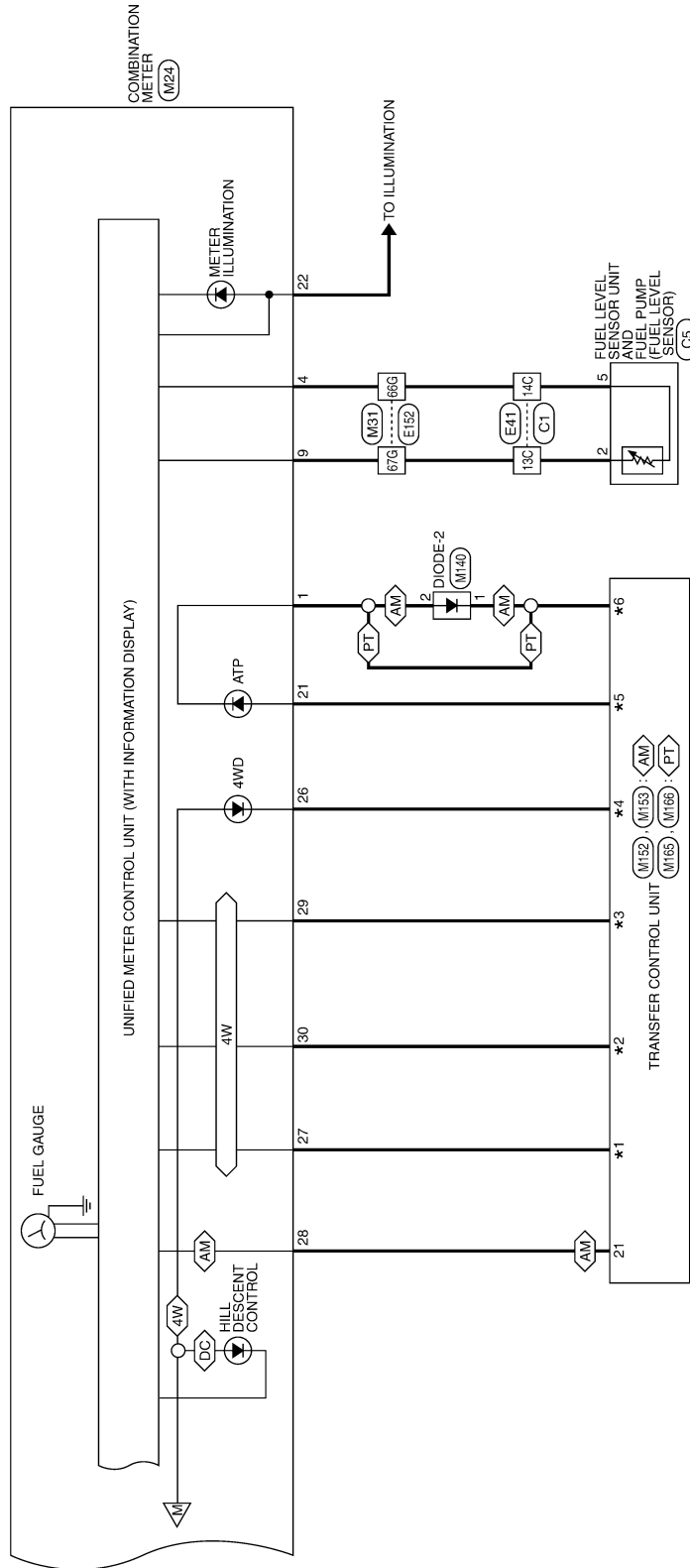

A
B
C
D
E
F
G
H
I
J
K
L
M
N
O
P

MWI

ABNWA0162GE

COMBINATION METER

< ECU DIAGNOSIS >

METER CONNECTORS

Connector No.	M4
Connector Name	FUSE BLOCK (J/B)
Connector Color	WHITE

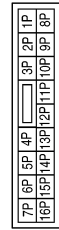

Terminal No.	Color of Wire	Signal Name
5P	W/G	-
8P	R/Y	-

Connector No.	M18
Connector Name	BCM (BODY CONTROL MODULE)
Connector Color	WHITE

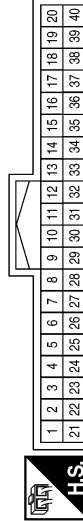

Terminal No.	Color of Wire	Signal Name
12	LG	DOOR SW (AS)
13	L	DOOR SW (RR)
23	G	SECURITY INDICATOR OUTPUT
39	L	CAN-H
40	P	CAN-L

Connector No.	M19
Connector Name	BCM (BODY CONTROL MODULE)
Connector Color	WHITE

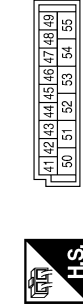

Terminal No.	Color of Wire	Signal Name
42	LG	GLASS HATCH STATUS SW
43	SB	BACK DOOR SW
47	GR	DOOR SW (DR)
48	P	DOOR SW (RL)

Connector No.	M24
Connector Name	COMBINATION METER
Connector Color	WHITE

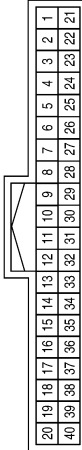

Terminal No.	Color of Wire	Signal Name
1	R	ATP-
2	P	CHARGE (ALT) INPUT
3	R/Y	BATTERY
4	B/Y	FUEL SENDER RETURN
5	W	SPEED OUT 2
6	LG	SPEED OUT 8
7	G	AT-PN ECM
8	SB	-
9	BR	FUEL SENDER INPUT
10	LG	-
11	P	CAN-L
12	L	CAN-H

Terminal No.	Color of Wire	Signal Name
13	GR	GROUND
14	O	-
15	W	-
16	W/G	RUN START
17	B	AT-PN SWITCH
18	L	AT 1 RANGE SWITCH (WITHOUT MANUAL MODE SWITCH)
18	-	-(WITH MANUAL MODE SWITCH)
19	-	-
20	Y	O/D OFF SWITCH (WITHOUT MANUAL MODE SWITCH)
20	-	-(WITH MANUAL MODE SWITCH)
21	LG	ATP+
22	BR	ILLUMINATION CONTROL
23	B	POWER GND
24	V	BUCKLE (SEATBELT) SW

Terminal No.	Color of Wire	Signal Name
25	-	-
26	GR	4WD FAIL
27	BR	4WD (LOCK) INPUT
28	B	4WD (AUTO) INPUT
29	O	4WD (4 LO) INPUT
30	V	4WD (2 WD) INPUT
31	G	PARK BRAKE SW
32	SB	BRAKE OIL SWITCH
33	LG	BRAKE PEDAL SW
34	L	WASHER FLUID SW
35	-	-
36	-	-
37	SB	AIRBAG CONT
38	-	-
39	G	SECURITY
40	LG	PASS SEATBELT

ABNIA0497GB

COMBINATION METER

< ECU DIAGNOSIS >

Connector No.	M31
Connector Name	WIRE TO WIRE
Connector Color	WHITE

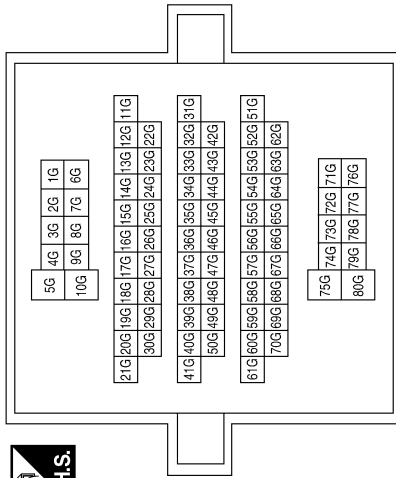

Terminal No.	Color of Wire	Signal Name
50G	L	-
51G	P	-
52G	L	-
56G	G	-
66G	BY	-
67G	BR	-
69G	P	-
70G	L	-

Connector No.	M35
Connector Name	AIR BAG DIAGNOSIS SENSOR UNIT
Connector Color	YELLOW

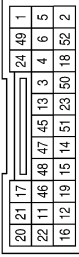

Terminal No.	Color of Wire	Signal Name
15	SB	WARN LP
24	LG	SEATBELT REMIND AS

Connector No.	M36
Connector Name	WIRE TO WIRE
Connector Color	WHITE

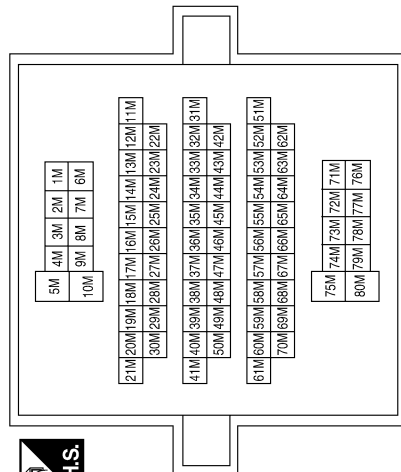

Terminal No.	Color of Wire	Signal Name
57M	LG	-
58M	L	-

A
B
C
D
E
F
G
H
I
J
K
L
M
MWI
O
P

ABNIA0498GB

COMBINATION METER

< ECU DIAGNOSIS >

Connector No.	M40
Connector Name	WIRE TO WIRE
Connector Color	WHITE

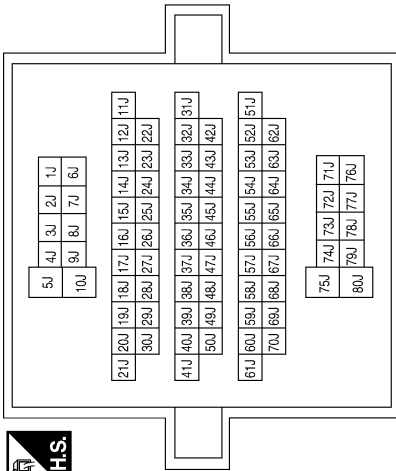

Terminal No.	Color of Wire	Signal Name
56J	LG	-
60J	P	-
61J	GR	-
66J	P	-
70J	V	-

Connector No.	M91
Connector Name	WIRE TO WIRE
Connector Color	WHITE

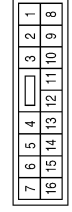

Terminal No.	Color of Wire	Signal Name
1	G	-
8	SB	-
10	P	-
11	L	-

Connector No.	M140
Connector Name	DIODE-2
Connector Color	BLACK



Terminal No.	Color of Wire	Signal Name
1	V	-
2	R	-

Connector No.	M152
Connector Name	TRANSFER CONTROL UNIT (ALL-MODE 4WD SYSTEM)
Connector Color	WHITE



Terminal No.	Color of Wire	Signal Name
2	V	2WD IND
5	GR	ETS FAIL
11	BR	LOCK IND
12	O	4LO IND
15	LG	ATP-IND
21	B	AUTO IND

Connector No.	M153
Connector Name	TRANSFER CONTROL UNIT (ALL-MODE 4WD SYSTEM)
Connector Color	WHITE

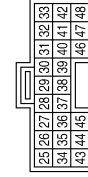

Terminal No.	Color of Wire	Signal Name
40	R	ATP-SW

COMBINATION METER

< ECU DIAGNOSIS >

Connector No.	M166
Connector Name	TRANSFER CONTROL UNIT (PART TIME 4WD SYSTEM)
Connector Color	WHITE

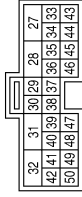

Terminal No.	Color of Wire	Signal Name
35	V	2WD IND
36	BR	4H IND
37	O	4LO IND
38	GR	4WD FAIL
39	LG	ATP IND

Connector No.	M165
Connector Name	TRANSFER CONTROL UNIT (PART TIME 4WD SYSTEM)
Connector Color	WHITE

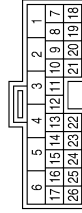

Terminal No.	Color of Wire	Signal Name
23	R	ATP-SW

Connector No.	M164
Connector Name	INTELLIGENT KEY UNIT
Connector Color	WHITE

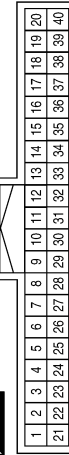

Terminal No.	Color of Wire	Signal Name
2	L	CAN-H
3	P	CAN-L

Connector No.	E16
Connector Name	ECM
Connector Color	BLACK

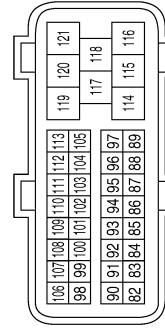

Terminal No.	Color of Wire	Signal Name
86	P	CAN-L
94	L	CAN-H
102	O	NEUT

Connector No.	E5
Connector Name	WIRE TO WIRE
Connector Color	WHITE

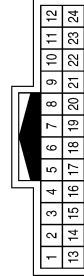

Terminal No.	Color of Wire	Signal Name
1	GR	-
2	L	-
3	P	-

Connector No.	E2
Connector Name	WIRE TO WIRE
Connector Color	WHITE

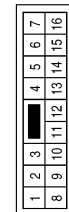

Terminal No.	Color of Wire	Signal Name
2	L	-
3	P	-

ABNIA0500GB

COMBINATION METER

< ECU DIAGNOSIS >

Connector No.	E21
Connector Name	BRAKE FLUID LEVEL SWITCH
Connector Color	GRAY



Terminal No.	Color of Wire	Signal Name
1	SB	-
2	B	-

Connector No.	E26
Connector Name	WIRE TO WIRE
Connector Color	WHITE

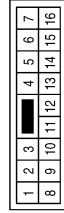

Terminal No.	Color of Wire	Signal Name
1	G	-
8	SB	-
10	P	-
11	L	-

Connector No.	E38
Connector Name	STOP LAMP SWITCH
Connector Color	WHITE



Terminal No.	Color of Wire	Signal Name
1	R/B	-
2	Y	-

Connector No.	E40
Connector Name	WIRE TO WIRE
Connector Color	GRAY

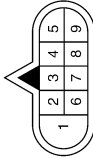

Terminal No.	Color of Wire	Signal Name
5	GR	-
8	P	-

Connector No.	E41
Connector Name	WIRE TO WIRE
Connector Color	BLACK

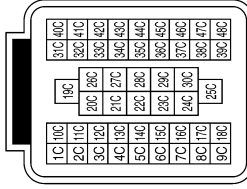

Terminal No.	Color of Wire	Signal Name
13C	BR	-
14C	B/Y	-

Connector No.	E42
Connector Name	WIRE TO WIRE
Connector Color	BLACK



Terminal No.	Color of Wire	Signal Name
1	P	-

COMBINATION METER

< ECU DIAGNOSIS >

Connector No.	E53
Connector Name	PARKING BRAKE SWITCH
Connector Color	BLACK



Terminal No.	Color of Wire	Signal Name
1	G	-

Connector No.	E106
Connector Name	WASHER FLUID LEVEL SWITCH
Connector Color	BROWN

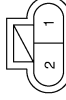

Terminal No.	Color of Wire	Signal Name
1	L	-
2	B	-

Connector No.	E122
Connector Name	IPDM E/R (INTELLIGENT POWER DISTRIBUTION MODULE ENGINE ROOM)
Connector Color	WHITE

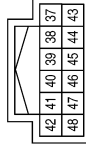

Terminal No.	Color of Wire	Signal Name
38	B	GND (SIGNAL)
39	L	CAN-H
40	P	CAN-L
42	GR	OIL PRESSURE SW

Connector No.	E124
Connector Name	IPDM E/R (INTELLIGENT POWER DISTRIBUTION MODULE ENGINE ROOM)
Connector Color	BLACK



Terminal No.	Color of Wire	Signal Name
59	B	GND (POWER)

Connector No.	E125
Connector Name	ABS ACTUATOR AND ELECTRIC UNIT (CONTROL UNIT) (WITH VQ40DE)
Connector Color	BLACK

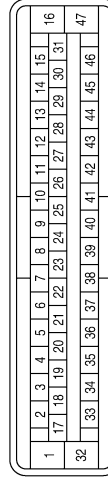

Terminal No.	Color of Wire	Signal Name
12	L	CAN H
13	P	CAN L

Connector No.	E127
Connector Name	ABS ACTUATOR AND ELECTRIC UNIT (CONTROL UNIT) (WITH VK56DE)
Connector Color	BLACK

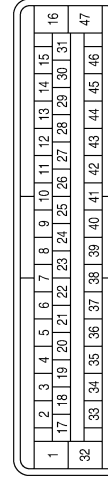

Terminal No.	Color of Wire	Signal Name
11	L	CAN H
15	P	CAN L

ABNIA0502GB

COMBINATION METER

< ECU DIAGNOSIS >

Connector No.	E160
Connector Name	FUSE BLOCK (J/B)
Connector Color	WHITE

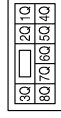

Terminal No.	Color of Wire	Signal Name
8Q	R/B	-

Terminal No.	Color of Wire	Signal Name
50G	L	-
51G	P	-
52G	L	-
56G	G	-
66G	B/Y	-
67G	BR	-
69G	P	-
70G	L	-

Connector No.	E152
Connector Name	WIRE TO WIRE
Connector Color	WHITE

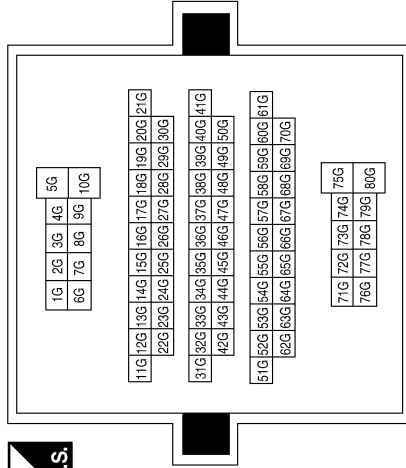

Connector No.	E208
Connector Name	OIL PRESSURE SWITCH (WITH VQ40DE)
Connector Color	GRAY



Terminal No.	Color of Wire	Signal Name
1	GR	-

Connector No.	E205
Connector Name	GENERATOR
Connector Color	BLACK



Terminal No.	Color of Wire	Signal Name
2	P	L

Connector No.	E201
Connector Name	WIRE TO WIRE
Connector Color	GRAY

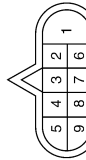

Terminal No.	Color of Wire	Signal Name
5	GR	-
8	P	-

ABNIA0503GB

COMBINATION METER

< ECU DIAGNOSIS >

Connector No.	E209
Connector Name	GENERATOR
Connector Color	-



Terminal No.	5	Color of Wire	B	Signal Name	E
--------------	---	---------------	---	-------------	---

Connector No.	E211
Connector Name	WIRE TO WIRE
Connector Color	BLACK



Terminal No.	1	Color of Wire	P	Signal Name	-
--------------	---	---------------	---	-------------	---

Connector No.	F4
Connector Name	OIL PRESSURE SWITCH (WITH VK56DE)
Connector Color	GRAY



Terminal No.	1	Color of Wire	GR	Signal Name	-
--------------	---	---------------	----	-------------	---

Connector No.	F9
Connector Name	A/T ASSEMBLY (WITH VQ40DE)
Connector Color	GREEN



Terminal No.	3	Color of Wire	L	Signal Name	-
Terminal No.	8	Color of Wire	P	Signal Name	-

Connector No.	F14
Connector Name	WIRE TO WIRE
Connector Color	WHITE



Terminal No.	1	Color of Wire	GR	Signal Name	-
Terminal No.	2	Color of Wire	L	Signal Name	-
Terminal No.	3	Color of Wire	P	Signal Name	-

Connector No.	F32
Connector Name	WIRE TO WIRE
Connector Color	WHITE



Terminal No.	2	Color of Wire	L	Signal Name	-
Terminal No.	3	Color of Wire	P	Signal Name	-

COMBINATION METER

< ECU DIAGNOSIS >

Connector No.	F70
Connector Name	A/T ASSEMBLY (WITH VK56DE)
Connector Color	GREEN



Terminal No.	Color of Wire	Signal Name
3	L	-
8	P	-

Connector No.	F502
Connector Name	TCM (TRANSMISSION CONTROL MODULE)
Connector Color	GRAY



Terminal No.	Color of Wire	Signal Name
1	BR	CAN-H
2	L/Y	CAN-L

Connector No.	C1
Connector Name	WIRE TO WIRE
Connector Color	BLACK

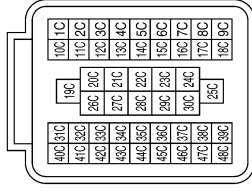

Terminal No.	Color of Wire	Signal Name
13C	BR	-
14C	B/Y	-

Connector No.	C5
Connector Name	FUEL LEVEL SENSOR UNIT AND FUEL PUMP
Connector Color	GRAY



Terminal No.	Color of Wire	Signal Name
2	BR	-
5	B/Y	-

Connector No.	B8
Connector Name	FRONT DOOR SWITCH LH
Connector Color	WHITE

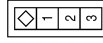

Terminal No.	Color of Wire	Signal Name
2	GR	-

Connector No.	B9
Connector Name	AIR BAG DIAGNOSIS SENSOR UNIT
Connector Color	YELLOW

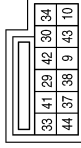

Terminal No.	Color of Wire	Signal Name
41	O	BUCKLE SW LH

COMBINATION METER

< ECU DIAGNOSIS >

Connector No.	B43
Connector Name	WIRE TO WIRE
Connector Color	WHITE

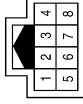

Terminal No.	Color of Wire	Signal Name
4	P	-
6	LG	-

Connector No.	B18
Connector Name	REAR DOOR SWITCH LH
Connector Color	WHITE

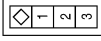

Terminal No.	Color of Wire	Signal Name
2	P	-

Connector No.	B12
Connector Name	SEAT BELT BUCKLE SWITCH LH
Connector Color	WHITE

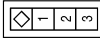

Terminal No.	Color of Wire	Signal Name
1	O	-
2	B	-

Connector No.	B108
Connector Name	FRONT DOOR SWITCH RH
Connector Color	WHITE

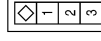

Terminal No.	Color of Wire	Signal Name
2	LG	-

Terminal No.	Color of Wire	Signal Name
56J	LG	-
60J	P	-
61J	GR	-
66J	P	-
70J	V	-

Connector No.	B69
Connector Name	WIRE TO WIRE
Connector Color	WHITE

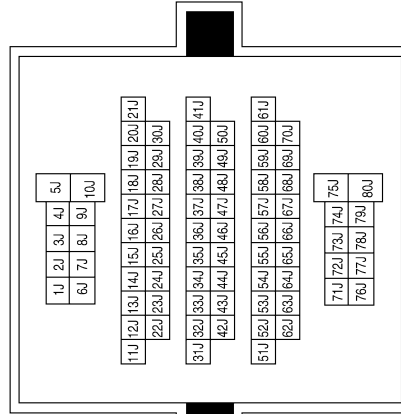

ABNIA0506GB

A
B
C
D
E
F
G
H
I
J
K
L
M
N
O
P

COMBINATION METER

< ECU DIAGNOSIS >

Connector No.	B116
Connector Name	REAR DOOR SWITCH RH
Connector Color	WHITE

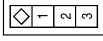

Terminal No.	2	Color of Wire	L	Signal Name	-
--------------	---	---------------	---	-------------	---

Connector No.	B113
Connector Name	AIR BAG DIAGNOSIS SENSOR UNIT
Connector Color	YELLOW

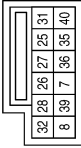

Terminal No.	25	Color of Wire	L	Signal Name	BUCKLE SW AS
--------------	----	---------------	---	-------------	--------------

Connector No.	B110
Connector Name	SEAT BELT BUCKLE SWITCH RH
Connector Color	WHITE

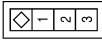

Terminal No.	1	Color of Wire	L	Signal Name	-
Terminal No.	2	Color of Wire	B	Signal Name	-

Connector No.	D401
Connector Name	WIRE TO WIRE
Connector Color	WHITE

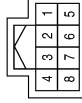

Terminal No.	4	Color of Wire	P	Signal Name	-
Terminal No.	6	Color of Wire	LG	Signal Name	-

Terminal No.	57M	Color of Wire	LG	Signal Name	-
Terminal No.	58M	Color of Wire	L	Signal Name	-

Connector No.	B149
Connector Name	WIRE TO WIRE
Connector Color	WHITE

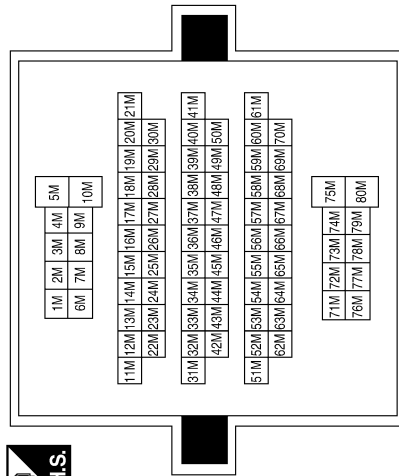

ABNIA0507GB

COMBINATION METER

< ECU DIAGNOSIS >

Connector No.	D501
Connector Name	WIRE TO WIRE
Connector Color	WHITE

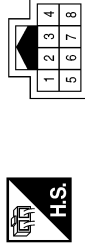

Terminal No.	Color of Wire	Signal Name
4	P	-
6	LG	-

Connector No.	D405
Connector Name	WIRE TO WIRE
Connector Color	WHITE

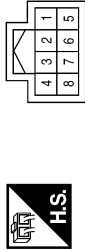

Terminal No.	Color of Wire	Signal Name
4	P	-
6	LG	-

Connector No.	D404
Connector Name	WIRE TO WIRE
Connector Color	WHITE



Terminal No.	Color of Wire	Signal Name
1	B	-

Connector No.	D505
Connector Name	WIRE TO WIRE
Connector Color	WHITE



Terminal No.	Color of Wire	Signal Name
1	B	-

Connector No.	D503
Connector Name	GLASS HATCH AJAR SWITCH
Connector Color	BLACK



Terminal No.	Color of Wire	Signal Name
1	LG	-

Connector No.	D502
Connector Name	BACK DOOR LATCH
Connector Color	WHITE



Terminal No.	Color of Wire	Signal Name
3	P	-
4	BR	-

Fail Safe

The combination meter performs a fail-safe operation for the functions listed below when communication is lost.

ABNIA0508GB

INFOID:000000003935367

COMBINATION METER

< ECU DIAGNOSIS >

Function		Specifications
Speedometer		Zero indication.
Tachometer		
Fuel gauge		
Engine coolant temperature gauge		
Engine oil pressure gauge		
Voltage gauge		
Illumination control	Meter illumination	Change to nighttime mode when communication is lost.
Segment LCD	Odometer	Freeze current indication.
	A/T position	Display turns off.
Buzzer		Buzzer turns off.
Warning lamp/indicator lamp	ABS warning lamp	Lamp turns on when communication is lost.
	Brake warning lamp	
	VDC OFF indicator lamp	
	SLIP indicator lamp	
	Shift P warning lamp	
	AT oil temp warning lamp	Lamp turns off when communication is lost.
	Low washer fluid warning lamp	
	Hill descent control indicator lamp	
	Door ajar warning lamp	
	CRUISE indicator lamp	
	SET indicator lamp	
	A/T CHECK warning lamp (with manual mode)	
	O/D OFF indicator lamp (without manual mode)	
	Oil pressure warning lamp	
	Malfunction indicator lamp	
	Air bag warning lamp	
	High beam indicator	
	Turn signal indicator lamp	
	Intelligent Key system warning lamp	
	Driver and passenger seat belt warning lamp	
Charge warning lamp		
Security indicator lamp		
4WD indicator lamp		
ATP indicator lamp		
Low tire pressure warning lamp		Lamp will flash every second for 1 minute and then stay on continuously thereafter.

COMBINATION METER

< ECU DIAGNOSIS >

DTC Index

INFOID:000000003935368

CONSULT-III display	Malfunction	Reference page
CAN COMM CIRC [U1000]	Malfunction is detected in CAN communication. CAUTION: Even when there is no malfunction on CAN communication system, malfunction may be misinterpreted when battery has low voltage (when maintaining 7 - 8 V for about 2 seconds) or 10A fuse [No. 19, located in the fuse block (J/B)] is disconnected.	MWI-27
VEHICLE SPEED CIRC [B2205]	Malfunction is detected when an erroneous speed signal is input. CAUTION: Even when there is no malfunction on speed signal system, malfunction may be misinterpreted when battery has low voltage (when maintaining 7 - 8 V for about 2 seconds).	MWI-28

NOTE:

“TIME” indicates the following.

- 0: Indicates that a malfunction is detected at present.
- 1-63: Indicates that a malfunction was detected in the past. (Displays number of ignition switch OFF → ON cycles after malfunction is detected. Self-diagnosis result is erased when “63” is exceeded.)

A
B
C
D
E
F
G
H
I
J
K
L
M

MWI

O
P

BCM (BODY CONTROL MODULE)

< ECU DIAGNOSIS >

BCM (BODY CONTROL MODULE)

Reference Value

INFOID:000000004428622

VALUES ON THE DIAGNOSIS TOOL

Monitor Item	Condition	Value/Status
AIR COND SW	A/C switch OFF	OFF
	A/C switch ON	ON
AUT LIGHT SYS	Outside of the room is dark	OFF
	Outside of the room is bright	ON
AUTO LIGHT SW	Lighting switch OFF	OFF
	Lighting switch AUTO	ON
BACK DOOR SW	Back door closed	OFF
	Back door opened	ON
CDL LOCK SW	Door lock/unlock switch does not operate	OFF
	Press door lock/unlock switch to the LOCK side	ON
CDL UNLOCK SW	Door lock/unlock switch does not operate	OFF
	Press door lock/unlock switch to the UNLOCK side	ON
DOOR SW-AS	Front door RH closed	OFF
	Front door RH opened	ON
DOOR SW-DR	Front door LH closed	OFF
	Front door LH opened	ON
DOOR SW-RL	Rear door LH closed	OFF
	Rear door LH opened	ON
DOOR SW-RR	Rear door RH closed	OFF
	Rear door RH opened	ON
ENGINE RUN	Engine stopped	OFF
	Engine running	ON
FR FOG SW	Front fog lamp switch OFF	OFF
	Front fog lamp switch ON	ON
FR WASHER SW	Front washer switch OFF	OFF
	Front washer switch ON	ON
FR WIPER LOW	Front wiper switch OFF	OFF
	Front wiper switch LO	ON
FR WIPER HI	Front wiper switch OFF	OFF
	Front wiper switch HI	ON
FR WIPER INT	Front wiper switch OFF	OFF
	Front wiper switch INT	ON
FR WIPER STOP	Any position other than front wiper stop position	OFF
	Front wiper stop position	ON
HAZARD SW	When hazard switch is not pressed	OFF
	When hazard switch is pressed	ON
LIGHT SW 1ST	Lighting switch OFF	OFF
	Lighting switch 1st	ON

BCM (BODY CONTROL MODULE)

< ECU DIAGNOSIS >

Monitor Item	Condition	Value/Status	
HEADLAMP SW1	Headlamp switch OFF	OFF	A
	Headlamp switch 1st	ON	
HEADLAMP SW2	Headlamp switch OFF	OFF	B
	Headlamp switch 1st	ON	
HI BEAM SW	High beam switch OFF	OFF	C
	High beam switch HI	ON	
H/L WASH SW	NOTE: The item is indicated, but not monitored	OFF	D
IGN ON SW	Ignition switch OFF or ACC	OFF	E
	Ignition switch ON	ON	
IGN SW CAN	Ignition switch OFF or ACC	OFF	F
	Ignition switch ON	ON	
INT VOLUME	Wiper intermittent dial is in a dial position 1 - 7	1 - 7	G
I-KEY LOCK ¹	LOCK button of Intelligent Key is not pressed	OFF	H
	LOCK button of Intelligent Key is pressed	ON	
I-KEY UNLOCK ¹	UNLOCK button of Intelligent Key is not pressed	OFF	I
	UNLOCK button of Intelligent Key is pressed	ON	
KEY ON SW	Mechanical key is removed from key cylinder	OFF	J
	Mechanical key is inserted to key cylinder	ON	
KEYLESS LOCK ²	LOCK button of key fob is not pressed	OFF	K
	LOCK button of key fob is pressed	ON	
KEYLESS UNLOCK ²	UNLOCK button of key fob is not pressed	OFF	L
	UNLOCK button of key fob is pressed	ON	
OIL PRESS SW	<ul style="list-style-type: none"> • Ignition switch OFF or ACC • Engine running 	OFF	M
	Ignition switch ON	ON	
PASSING SW	Other than lighting switch PASS	OFF	
	Lighting switch PASS	ON	
PUSH SW ¹	Return to ignition switch to LOCK position	OFF	
	Press ignition switch	ON	
REAR DEF SW	Rear window defogger switch OFF	OFF	
	Rear window defogger switch ON	ON	
RKE LOCK AND UNLOCK ²	NOTE: The item is indicated, but not monitored	OFF	
		ON	
RR WASHER SW	Rear washer switch OFF	OFF	MWI
	Rear washer switch ON	ON	
RR WIPER INT	Rear wiper switch OFF	OFF	O
	Rear wiper switch INT	ON	
RR WIPER ON	Rear wiper switch OFF	OFF	P
	Rear wiper switch ON	ON	
RR WIPER STOP	Rear wiper stop position	OFF	
	Other than rear wiper stop position	ON	
TAIL LAMP SW	Lighting switch OFF	OFF	
	Lighting switch 1ST	ON	

BCM (BODY CONTROL MODULE)

< ECU DIAGNOSIS >

Monitor Item	Condition	Value/Status
TRNK OPNR SW	When back door opener switch is not pressed	OFF
	When back door opener switch is pressed	ON
TURN SIGNAL L	Turn signal switch OFF	OFF
	Turn signal switch LH	ON
TURN SIGNAL R	Turn signal switch OFF	OFF
	Turn signal switch RH	ON
VEHICLE SPEED	While driving	Equivalent to speedometer reading

1: With Intelligent Key

2: With remote keyless entry system

BCM (BODY CONTROL MODULE)

< ECU DIAGNOSIS >

Terminal Layout

INFOID:000000004428623

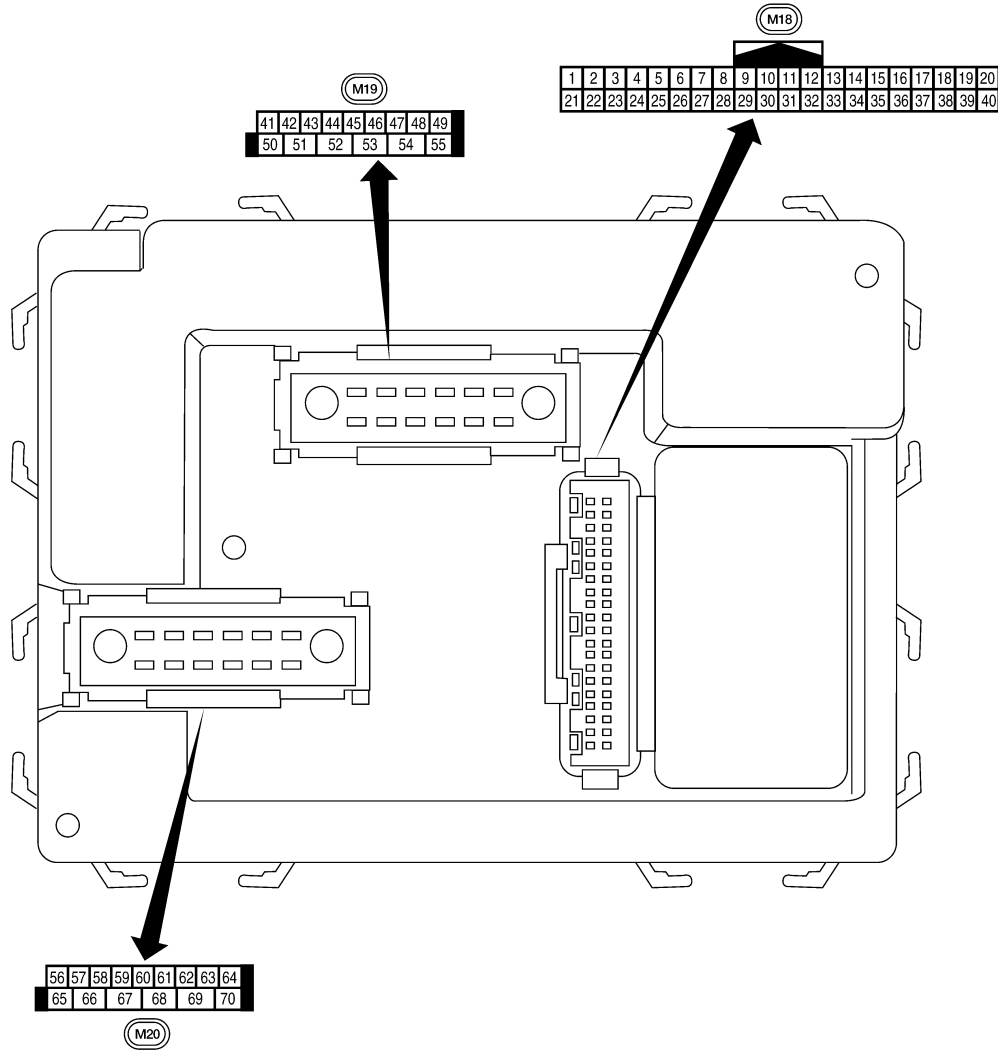

A
B
C
D
E
F
G
H
I
J
K
L
M

MWI



Physical Values

LIA2443E

INFOID:000000004428624

BCM (BODY CONTROL MODULE)

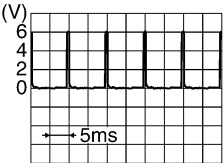
< ECU DIAGNOSIS >

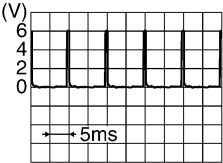
Terminal	Wire color	Signal name	Signal input/output	Measuring condition		Reference value or waveform (Approx.)
				Ignition switch	Operation or condition	
1	BR	Ignition keyhole illumination	Output	OFF	Door is locked (SW OFF)	Battery voltage
					Door is unlocked (SW ON)	0V
2	P	Combination switch input 5	Input	ON	Lighting, turn, wiper OFF Wiper dial position 4	 <p style="text-align: right; font-size: small;">SKIA5291E</p>
3	SB	Combination switch input 4	Input	ON	Lighting, turn, wiper OFF Wiper dial position 4	 <p style="text-align: right; font-size: small;">SKIA5292E</p>
4	V	Combination switch input 3	Input	ON	Lighting, turn, wiper OFF Wiper dial position 4	 <p style="text-align: right; font-size: small;">SKIA5291E</p>
5	L	Combination switch input 2	Input	ON	Lighting, turn, wiper OFF Wiper dial position 4	 <p style="text-align: right; font-size: small;">SKIA5292E</p>
6	R	Combination switch input 1				
9	Y	Rear window defogger switch	Input	ON	Rear window defogger switch ON	0V
					Rear window defogger switch OFF	5V
11	G/B	Ignition switch (ACC or ON)	Input	ACC or ON	Ignition switch ACC or ON	Battery voltage
12	LG	Front door switch RH	Input	OFF	ON (open)	0V
					OFF (closed)	Battery voltage
13	L	Rear door switch RH	Input	OFF	ON (open)	0V
					OFF (closed)	Battery voltage
15	W	Tire pressure warning check connector	Input	OFF	—	5V
18	BR	Remote keyless entry receiver and optical sensor (ground)	Output	OFF	—	0V

BCM (BODY CONTROL MODULE)

< ECU DIAGNOSIS >





Terminal	Wire color	Signal name	Signal input/output	Measuring condition		Reference value or waveform (Approx.)
				Ignition switch	Operation or condition	
19	V	Remote keyless entry receiver (power supply)	Output	OFF	Ignition switch OFF	<p style="text-align: right;">LIA1893E</p>
20	G	Remote keyless entry receiver (signal)	Input	OFF	Stand-by (keyfob buttons released)	<p style="text-align: right;">LIA1894E</p>
					When remote keyless entry receiver receives signal from keyfob (keyfob buttons pressed)	<p style="text-align: right;">LIA1895E</p>
21	GR	NATS antenna amp.	Input	OFF → ON	Ignition switch (OFF → ON)	Just after turning ignition switch ON: Pointer of tester should move for approx. 1 second, then return to battery voltage.
22	V	BUS	—	—	Ignition switch ON or power window timer operates	<p style="text-align: right;">PIIA2344E</p>
23	G	Security indicator lamp	Output	OFF	Goes OFF → illuminates (Every 2.4 seconds)	Battery voltage → 0V
25	BR	NATS antenna amp.	Input	OFF → ON	Ignition switch (OFF → ON)	Just after turning ignition switch ON: Pointer of tester should move for approx. 1 second, then return to battery voltage.
27	W	Compressor ON signal	Input	ON	A/C switch OFF	5V
					A/C switch ON	0V
28	LG	Front blower monitor	Input	ON	Front blower motor OFF	Battery voltage
					Front blower motor ON	0V
29	G	Hazard switch	Input	OFF	ON	0V
					OFF	5V
30 ¹	G	Back door opener switch	Input	OFF	ON (open)	0V
					OFF (closed)	Battery voltage
30 ²	SB	Back door opener switch	Input	OFF	ON (open)	0V
					OFF (closed)	Battery voltage

A
B
C
D
E
F
G
H
I
J
K
L
M
O
P

MWI

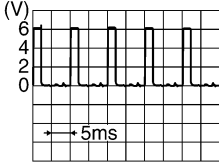
BCM (BODY CONTROL MODULE)

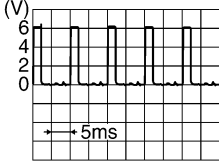
< ECU DIAGNOSIS >

Terminal	Wire color	Signal name	Signal input/output	Measuring condition		Reference value or waveform (Approx.)
				Ignition switch	Operation or condition	
32	O	Combination switch output 5	Output	ON	Lighting, turn, wiper OFF Wiper dial position 4	 <p style="text-align: right; font-size: small;">SKIA5291E</p>
33	GR	Combination switch output 4	Output	ON	Lighting, turn, wiper OFF Wiper dial position 4	 <p style="text-align: right; font-size: small;">SKIA5292E</p>
34	G	Combination switch output 3	Output	ON	Lighting, turn, wiper OFF Wiper dial position 4	 <p style="text-align: right; font-size: small;">SKIA5291E</p>
35	BR	Combination switch output 2	Output	ON	Lighting, turn, wiper OFF Wiper dial position 4	 <p style="text-align: right; font-size: small;">SKIA5292E</p>
36	LG	Combination switch output 1				
37 ¹	B	Key switch and key lock solenoid	Input	OFF	Key inserted	Battery voltage
					Key inserted	0V
37 ²	B	Key switch and ignition knob switch	Input	OFF	Intelligent Key inserted	Battery voltage
					Intelligent Key inserted	0V
38	W/R	Ignition switch (ON)	Input	ON	—	Battery voltage
39	L	CAN-H	—	—	—	—
40	P	CAN-L	—	—	—	—
42	LG	Glass hatch ajar switch	Input	ON	Glass hatch open	0
					Glass hatch closed	Battery
43	P	Back door latch switch	Input	OFF	ON (open)	0V
					OFF (closed)	Battery voltage

BCM (BODY CONTROL MODULE)

< ECU DIAGNOSIS >

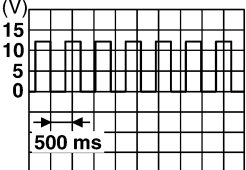
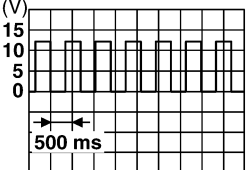
Terminal	Wire color	Signal name	Signal input/output	Measuring condition		Reference value or waveform (Approx.)
				Ignition switch	Operation or condition	
44	O	Rear wiper auto stop switch	Input	ON	Rise up position (rear wiper arm on stopper)	0V
					A Position (full clockwise stop position)	Battery voltage
					Forward sweep (counterclockwise direction)	Fluctuating
					B Position (full counterclockwise stop position)	0V
					Reverse sweep (clockwise direction)	Fluctuating
47	GR	Front door switch LH	Input	OFF	ON (open)	0V
					OFF (closed)	Battery voltage
48	P	Rear door switch LH	Input	OFF	ON (open)	0V
					OFF (closed)	Battery voltage
49	L	Cargo lamp	Output	OFF	Any door open (ON)	0V
					All doors closed (OFF)	Battery voltage
51	G	Trailer turn signal (right)	Output	ON	Turn right ON	 <small>SKIA3009J</small>
52	V	Trailer turn signal (left)	Output	ON	Turn left ON	 <small>SKIA3009J</small>
53	L	Back door latch actuator	Output	OFF	OFF	0
					ON	Battery voltage
55	W	Rear wiper output circuit 1	Output	ON	OFF	0
					ON	Battery voltage
56	V	Battery saver output	Output	OFF	30 minutes after ignition switch is turned OFF	0V
				ON	—	Battery voltage
57	R/Y	Battery power supply	Input	OFF	—	Battery voltage
58	W	Optical sensor	Input	ON	When optical sensor is illuminated	3.1V or more
					When optical sensor is not illuminated	0.6V or less
59	GR	Front door lock assembly LH actuator (unlock)	Output	OFF	OFF (neutral)	0V
					ON (unlock)	Battery voltage

A
B
C
D
E
F
G
H
I
J
K
L
M
O
P

MWI

BCM (BODY CONTROL MODULE)

< ECU DIAGNOSIS >

Terminal	Wire color	Signal name	Signal input/output	Measuring condition		Reference value or waveform (Approx.)	
				Ignition switch	Operation or condition		
60	LG	Turn signal (left)	Output	ON	Turn left ON	<p style="text-align: right; font-size: small;">SKIA3009J</p>	
61	G	Turn signal (right)	Output	ON	Turn right ON	<p style="text-align: right; font-size: small;">SKIA3009J</p>	
63	BR	Interior room/map lamp	Output	OFF	Any door switch	ON (open)	0V
						OFF (closed)	Battery voltage
65	V	All door lock actuators (lock)	Output	OFF	OFF (neutral)	0V	
					ON (lock)	Battery voltage	
66	L	Front door lock actuator RH, rear door lock actuators LH/RH and glass hatch lock actuator (unlock)	Output	OFF	OFF (neutral)	0V	
					ON (unlock)	Battery voltage	
67	B	Ground	Input	ON	—	0V	
68	O	Power window power supply (RAP)	Output	—	Ignition switch ON	Battery voltage	
					Within 45 seconds after ignition switch OFF	Battery voltage	
					More than 45 seconds after ignition switch OFF	0V	
					When front door LH or RH is open or power window timer operates	0V	
69	L	Power window power supply	Output	—	—	Battery voltage	
70	W	Battery power supply	Input	OFF	—	Battery voltage	

1: With remote keyless entry system

2: With Intelligent Key system

BCM (BODY CONTROL MODULE)

< ECU DIAGNOSIS >

BCM (BODY CONTROL MODULE) CONNECTORS

Connector No.	M18
Connector Name	BCM (BODY CONTROL MODULE)
Connector Color	WHITE



1	2	3	4	5	6	7	8	9	10	11	12	13	14	15	16	17	18	19	20
21	22	23	24	25	26	27	28	29	30	31	32	33	34	35	36	37	38	39	40

Terminal No.	Color of Wire	Signal Name
1	BR	KEY RING OUTPUT
2	P	INPUT 5
3	SB	INPUT 4
4	V	INPUT 3
5	L	INPUT 2
6	R	INPUT 1
7	-	-
8	-	-
9	Y	REAR DEFOGGER SW
10	-	-

Connector No.	M19
Connector Name	BCM (BODY CONTROL MODULE)
Connector Color	WHITE



41	42	43	44	45	46	47	48	49
50	51	52	53	54	55			

Terminal No.	Color of Wire	Signal Name
41	-	-
42	LG	GLASS HATCH SW
43	P	BACK DOOR SW

Terminal No.	Color of Wire	Signal Name
11	G/B	ACC SW
12	LG	DOOR SW (AS)
13	L	DOOR SW (RR)
14	-	-
15	W	TPMS MODE TRIGGER SW
16	-	-
17	-	-
18	BR	KEYLESS AND AUTOLIGHT SENSOR GND
19	V	KEYLESS TUNER POWER SUPPLY OUTPUT
20	G	KEYLESS TUNER SIGNAL
21	GR	IMMOBILIZER ANTENNA SIG (CLOCK)
22	V	ANTI-PINCH SERIAL LINK (RX, TX)
23	G	SECURITY INDICATOR OUTPUT

Terminal No.	Color of Wire	Signal Name
25	BR	IMMOBILIZER ANTENNA SIGNAL (TX, RX)
26	-	-
27	W	AIRCON SW
28	LG	BLOWER FAN SW
29	G	HAZARD SW
30	SB	BACK DOOR AUTO CLOSURE (WITH INTELLIGENT KEY SYSTEM)
30	G	LIFTGATE OPENER SW (WITHOUT INTELLIGENT KEY SYSTEM)
31	-	-
32	O	OUTPUT 5
33	GR	OUTPUT 4
34	G	OUTPUT 3
35	BR	OUTPUT 2
36	LG	OUTPUT 1
37	B	KEY SW
38	W/R	IGN SW
39	L	CAN-H
40	P	CAN-L

Terminal No.	Color of Wire	Signal Name
44	O	REAR WIPE AUTO STOP SW1
45	-	-
46	-	-
47	GR	DOOR SW (DR)
48	P	DOOR SW (RL)
49	L	LUGGAGE LAMP OUTPUT
50	-	-
51	G	TRAILER FLASHER OUTPUT (RIGHT)

Terminal No.	Color of Wire	Signal Name
52	V	TRAILER FLASHER OUTPUT (LEFT)
53	L	LIFTGATE OPENER OUTPUT
54	-	-
55	W	REAR WIPE MOTOR OUTPUT1

ABMIA0161GB

A
B
C
D
E
F
G
H
I
J
K
L
M
N
O
P

BCM (BODY CONTROL MODULE)

< ECU DIAGNOSIS >

Connector No.	M20
Connector Name	BCM (BODY CONTROL MODULE)
Connector Color	BLACK



56	57	58	59	60	61	62	63	64
65	66	67	68	69	70			

Terminal No.	Color of Wire	Signal Name
56	V	BAT SAVER OUTPUT
57	R/Y	BAT (FUSE)
58	W	AUTO LIGHT SENSOR INPUT 2
59	GR	DOOR UNLOCK OUTPUT (DR)
60	LG	FLASHER OUTPUT (LEFT)

Connector No.	M28
Connector Name	COMBINATION SWITCH
Connector Color	WHITE



12	13	10	9	8	7		
14	11	1	2	3	4	5	6

Terminal No.	Color of Wire	Signal Name
61	G	FLASHER OUTPUT (RIGHT)
62	-	-
63	BR	ROOM LAMP
64	-	-
65	V	DOOR LOCK OUTPUT (ALL)
66	L	DOOR UNLOCK OUTPUT (OTHER)
67	B	GND (POWER)
68	O	POWER WINDOW POWER SUPPLY OUTPUT (LINKED TO RAP)
69	L	POWER WINDOW POWER SUPPLY OUTPUT (BAT)
70	W	BAT (F/L)

Terminal No.	Color of Wire	Signal Name
1	LG	INPUT 1
2	BR	INPUT 2
3	G	INPUT 3
4	GR	INPUT 4
5	O	INPUT 5
6	R	OUTPUT 1
7	L	OUTPUT 2
8	P	OUTPUT 5
9	SB	OUTPUT 4
10	V	OUTPUT 3
11	O	WASHER MOTOR (RR+)
12	B	GND
13	L	WASHER MOTOR (RR-)
14	W/G	IGN

Fail Safe

Fail-safe index

BCM performs fail-safe control when any DTC listed below is detected.

ABMIA0162GB

INFOID:000000004428626

BCM (BODY CONTROL MODULE)

< ECU DIAGNOSIS >

Display contents of CONSULT	Fail-safe	Cancellation
U1000: CAN COMM CIRCUIT	Inhibit engine cranking	When the BCM re-establishes communication with the other modules.
U1010: CONTROL UNIT (CAN)	Inhibit engine cranking	When the BCM re-start communicating with the other modules.

DTC Inspection Priority Chart

INFOID:000000004428627

If some DTCs are displayed at the same time, perform inspections one by one based on the following priority chart.

Priority	DTC
1	<ul style="list-style-type: none"> • U1000: CAN COMM CIRCUIT • U1010: CONTROL UNIT (CAN)
2	<ul style="list-style-type: none"> • B2190: NATS ANTENNA AMP • B2191: DIFFERENCE OF KEY • B2192: ID DISCORD BCM-ECM • B2193: CHAIN OF BCM-ECM • B2013: STRG COMM 1 • B2552: INTELLIGENT KEY • B2590: NATS MALFUNCTION
3	<ul style="list-style-type: none"> • C1729: VHCL SPEED SIG ERR • C1735: IGNITION SIGNAL
4	<ul style="list-style-type: none"> • C1704: LOW PRESSURE FL • C1705: LOW PRESSURE FR • C1706: LOW PRESSURE RR • C1707: LOW PRESSURE RL • C1708: [NO DATA] FL • C1709: [NO DATA] FR • C1710: [NO DATA] RR • C1711: [NO DATA] RL • C1712: [CHECKSUM ERR] FL • C1713: [CHECKSUM ERR] FR • C1714: [CHECKSUM ERR] RR • C1715: [CHECKSUM ERR] RL • C1716: [PRESSDATA ERR] FL • C1717: [PRESSDATA ERR] FR • C1718: [PRESSDATA ERR] RR • C1719: [PRESSDATA ERR] RL • C1720: [CODE ERR] FL • C1721: [CODE ERR] FR • C1722: [CODE ERR] RR • C1723: [CODE ERR] RL • C1724: [BATT VOLT LOW] FL • C1725: [BATT VOLT LOW] FR • C1726: [BATT VOLT LOW] RR • C1727: [BATT VOLT LOW] RL

DTC Index

INFOID:000000004428628

NOTE:

- Details of time display
- CRNT: Displays when there is a malfunction now or after returning to the normal condition until turning ignition switch OFF → ON again.
- 1 - 39: Displayed if any previous malfunction is present when current condition is normal. It increases like 1 → 2 → 3...38 → 39 after returning to the normal condition whenever ignition switch OFF → ON. The counter remains at 39 even if the number of cycles exceeds it. It is counted from 1 again when turning ignition switch OFF → ON after returning to the normal condition if the malfunction is detected again.

BCM (BODY CONTROL MODULE)

< ECU DIAGNOSIS >

CONSULT display	Fail-safe	Intelligent Key warning lamp ON	Tire pressure monitor warning lamp ON	Reference page
No DTC is detected. further testing may be required.	—	—	—	—
U1000: CAN COMM CIRCUIT	—	—	—	BCS-33
U1010: CONTROL UNIT (CAN)	—	—	—	BCS-34
B2013: STRG COMM 1	—	—	—	SEC-27
B2190: NATS ANTENA AMP	—	—	—	SEC-30 (with I- Key), SEC-136 (without I-Key)
B2191: DIFFERENCE OF KEY	—	—	—	SEC-33 (with I- Key), SEC-139 (without I-Key)
B2192: ID DISCORD BCM-ECM	—	—	—	SEC-34 (with I- Key), SEC-140 (without I-Key)
B2193: CHAIN OF BCM-ECM	—	—	—	SEC-36 (with I- Key), SEC-142 (without I-Key)
B2552: INTELLIGENT KEY	—	—	—	SEC-38
B2590: NATS MALFUNCTION	—	—	—	SEC-39
C1708: [NO DATA] FL	—	—	—	WT-14
C1709: [NO DATA] FR	—	—	—	WT-14
C1710: [NO DATA] RR	—	—	—	WT-14
C1711: [NO DATA] RL	—	—	—	WT-14
C1712: [CHECKSUM ERR] FL	—	—	—	WT-16
C1713: [CHECKSUM ERR] FR	—	—	—	WT-16
C1714: [CHECKSUM ERR] RR	—	—	—	WT-16
C1715: [CHECKSUM ERR] RL	—	—	—	WT-16
C1716: [PRESSDATA ERR] FL	—	—	—	WT-18
C1717: [PRESSDATA ERR] FR	—	—	—	WT-18
C1718: [PRESSDATA ERR] RR	—	—	—	WT-18
C1719: [PRESSDATA ERR] RL	—	—	—	WT-18
C1720: [CODE ERR] FL	—	—	—	WT-16
C1721: [CODE ERR] FR	—	—	—	WT-16
C1722: [CODE ERR] RR	—	—	—	WT-16
C1723: [CODE ERR] RL	—	—	—	WT-16
C1724: [BATT VOLT LOW] FL	—	—	—	WT-16
C1725: [BATT VOLT LOW] FR	—	—	—	WT-16
C1726: [BATT VOLT LOW] RR	—	—	—	WT-16
C1727: [BATT VOLT LOW] RL	—	—	—	WT-16
C1729: VHCL SPEED SIG ERR	—	—	—	WT-19
C1735: IGNITION SWITCH	—	—	—	—

IPDM E/R (INTELLIGENT POWER DISTRIBUTION MODULE ENGINE ROOM)

< ECU DIAGNOSIS >

IPDM E/R (INTELLIGENT POWER DISTRIBUTION MODULE ENGINE ROOM)

Reference Value

INFOID:000000004428629

VALUES ON THE DIAGNOSIS TOOL

Monitor Item	Condition		Value/Status
MOTOR FAN REQ	Engine idle speed	Changes depending on engine coolant temperature, air conditioner operation status, vehicle speed, etc.	0 - 100 %
A/C COMP REQ	A/C switch OFF		OFF
	A/C switch ON		ON
TAIL&CLR REQ	Lighting switch OFF		OFF
	Lighting switch 1ST, 2ND, HI or AUTO (Light is illuminated)		ON
HL LO REQ	Lighting switch OFF		OFF
	Lighting switch 2ND HI or AUTO (Light is illuminated)		ON
HL HI REQ	Lighting switch OFF		OFF
	Lighting switch HI		ON
FR FOG REQ	Lighting switch 2ND or AUTO (Light is illuminated)	Front fog lamp switch OFF	OFF
		<ul style="list-style-type: none"> • Front fog lamp switch ON • Daytime light activated (Canada only) 	ON
H L WASHER REQ	NOTE: This item is displayed, but cannot be monitored.		OFF
FR WIP REQ	Ignition switch ON	Front wiper switch OFF	STOP
		Front wiper switch INT	1LOW
		Front wiper switch LO	LOW
		Front wiper switch HI	HI
WIP AUTO STOP	Ignition switch ON	Front wiper stop position	STOP P
		Any position other than front wiper stop position	ACT P
WIP PROT	Ignition switch ON	Front wiper operates normally	OFF
		Front wiper stops at fail-safe operation	BLOCK
ST RLY REQ	Ignition switch OFF or ACC		OFF
	Ignition switch START		ON
IGN RLY	Ignition switch OFF or ACC		OFF
	Ignition switch ON		ON
RR DEF REQ	Rear defogger switch OFF		OFF
	Rear defogger switch ON		ON
OIL P SW	Ignition switch OFF, ACC or engine running		OPEN
	Ignition switch ON		CLOSE
DTRL REQ	NOTE: This item is displayed, but cannot be monitored.		OFF
HOOD SW	NOTE: This item is displayed, but cannot be monitored.		OFF

A

B

C

D

E

F

G

H

I

J

K

L

M

MWI

O

P

IPDM E/R (INTELLIGENT POWER DISTRIBUTION MODULE ENGINE ROOM)

< ECU DIAGNOSIS >

Monitor Item	Condition	Value/Status
THFT HRN REQ	Not operated	OFF
	<ul style="list-style-type: none">• Panic alarm is activated• Horn is activated with VEHICLE SECURITY (THEFT WARNING) SYSTEM	ON
HORN CHIRP	Not operated	OFF
	Door locking with keyfob or Intelligent Key (if equipped) (horn chirp mode)	ON

IPDM E/R (INTELLIGENT POWER DISTRIBUTION MODULE ENGINE ROOM)

< ECU DIAGNOSIS >

Terminal Layout

INFOID:000000004428630

TERMINAL LAYOUT

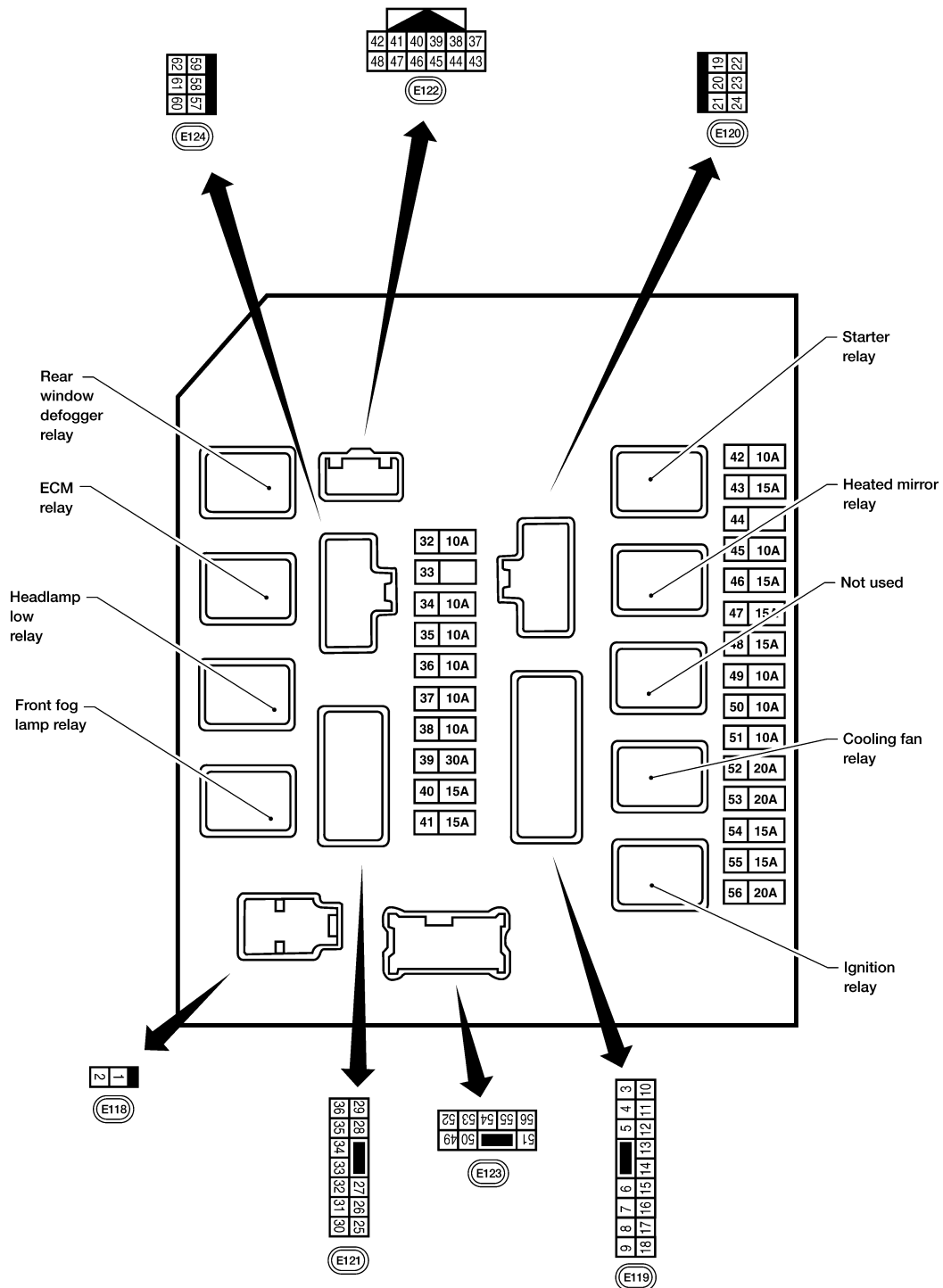

A
B
C
D
E
F
G
H
I
J
K
L
M
N
O
P

MWI

Physical Values

PHYSICAL VALUES

WKIA5852E

INFOID:000000004428631

IPDM E/R (INTELLIGENT POWER DISTRIBUTION MODULE ENGINE ROOM)

< ECU DIAGNOSIS >

Terminal	Wire color	Signal name	Signal input/output	Measuring condition		Reference value (Approx.)
				Ignition switch	Operation or condition	
1	W	Battery power supply	Input	OFF	—	Battery voltage
2	R	Battery power supply	Input	OFF	—	Battery voltage
3	G	ECM relay	Output	—	Ignition switch ON or START	Battery voltage
					Ignition switch OFF or ACC	0V
4	P	ECM relay	Output	—	Ignition switch ON or START	Battery voltage
					Ignition switch OFF or ACC	0V
6	V	Throttle control motor relay	Output	—	Ignition switch ON or START	Battery voltage
					Ignition switch OFF or ACC	0V
7	BR	ECM relay control	Input	—	Ignition switch ON or START	0V
					Ignition switch OFF or ACC	Battery voltage
8	W/R	Fuse 54	Output	—	Ignition switch ON or START	Battery voltage
					Ignition switch OFF or ACC	0V
10	R/B	Fuse 45	Output	ON	Daytime light system active	0V
					Daytime light system inactive	Battery voltage
11	Y	A/C compressor	Output	ON or START	A/C switch ON or defrost A/C switch	Battery voltage
					A/C switch OFF or defrost A/C switch	0V
12	W/G	Ignition switch supplied power	Input	—	OFF or ACC	0V
					ON or START	Battery voltage
13	R	Fuel pump relay	Output	—	Ignition switch ON or START	Battery voltage
					Ignition switch OFF or ACC	0V
14	W/G	Fuse 49	Output	—	Ignition switch ON or START	Battery voltage
					Ignition switch OFF or ACC	0V
15	W/R	Fuse 50 (ABS)	Output	—	Ignition switch ON or START	Battery voltage
					Ignition switch OFF or ACC	0V
16	W/G	Fuse 51	Output	—	Ignition switch ON or START	Battery voltage
					Ignition switch OFF or ACC	0V
17	W/G	Fuse 55	Output	—	Ignition switch ON or START	Battery voltage
					Ignition switch OFF or ACC	0V
19	W	Starter motor	Output	START	—	Battery voltage
20	BR	Cooling fan motor (low)	Output	ON or START	—	Battery voltage
21	GR	Ignition switch supplied power	Input	—	OFF or ACC	0V
					START	Battery voltage
22	G	Battery power supply	Output	OFF	—	Battery voltage
23	LG	Door mirror defogger output signal	Output	—	When rear defogger switch is ON	Battery voltage
					When raker defogger switch is OFF	0V

IPDM E/R (INTELLIGENT POWER DISTRIBUTION MODULE ENGINE ROOM)

< ECU DIAGNOSIS >

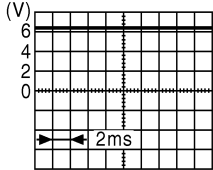
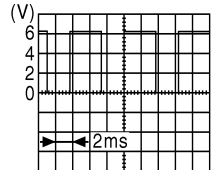
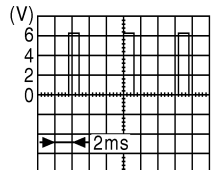
Terminal	Wire color	Signal name	Signal input/output	Measuring condition		Reference value (Approx.)
				Ignition switch	Operation or condition	
24	P	Cooling fan motor (high)	Output	—	Conditions correct for cooling fan operation	Battery voltage
					Conditions not correct for cooling fan operation	0V
27	W	Fuse 38	Output	—	Ignition switch ON or START	Battery voltage
					Ignition switch OFF or ACC	0V
28	R	LH front parking and front side marker lamp	Output	OFF	Lighting switch 1st position OFF	0V
					Lighting switch 1st position ON	Battery voltage
29	G	Trailer tow relay	Output	ON	Lighting switch 1st position OFF	0V
					Lighting switch 1st position ON	Battery voltage
30	R/B	Fuse 53	Output	—	Ignition switch ON or START	Battery voltage
					Ignition switch OFF or ACC	0V
32	GR	Wiper low speed signal	Output	ON or START	Wiper switch OFF	Battery voltage
					Wiper switch LO or INT	0V
35	L	Wiper high speed signal	Output	ON or START	Wiper switch OFF, LO, INT	Battery voltage
					Wiper switch HI	0V
37	Y	Power generation command signal	Output	—	Ignition switch ON	 <p>6.3 V</p>
					40% is set on "Active test," "ALTERNATOR DUTY" of "ENGINE"	 <p>3.8 V</p>
					40% is set on "Active test," "ALTERNATOR DUTY" of "ENGINE"	 <p>1.4 V</p>
38	B	Ground	Input	—	—	0V
39	L	CAN-H	—	ON	—	—
40	P	CAN-L	—	ON	—	—
42	GR	Oil pressure switch	Input	—	Engine running	Battery voltage
					Engine stopped	0V

A
B
C
D
E
F
G
H
I
J
K
L
M
N
O
P

MWI

IPDM E/R (INTELLIGENT POWER DISTRIBUTION MODULE ENGINE ROOM)

< ECU DIAGNOSIS >

Terminal	Wire color	Signal name	Signal input/output	Measuring condition		Reference value (Approx.)
				Ignition switch	Operation or condition	
43	G	Wiper auto stop signal	Input	ON or START	Wiper switch OFF, LO, INT	Battery voltage
44	R	Daytime light relay control	Input	ON	Daytime light system active	0V
					Daytime light system inactive	Battery voltage
45	LG	Horn relay control	Input	ON	When door locks are operated using keyfob or Intelligent Key (if equipped) (OFF → ON)*	Battery voltage → 0V
46	V	Fuel pump relay control	Input	—	Ignition switch ON or START	0V
					Ignition switch OFF or ACC	Battery voltage
47	O	Throttle control motor relay control	Input	—	Ignition switch ON or START	0V
					Ignition switch OFF or ACC	Battery voltage
48	R	Starter relay (inhibit switch)	Input	ON or START	Selector lever in "P" or "N"	0V
					Selector lever any other position	Battery voltage
49	GR	Front RH parking and front side marker lamp	Output	OFF	Lighting switch 1st position OFF	0V
					ON	Battery voltage
50	W	Front fog lamp (LH)	Output	ON or START	Lighting switch must be in the 2nd position (LOW beam is ON) and the front fog lamp switch OFF	0V
					ON	Battery voltage
51	V	Front fog lamp (RH)	Output	ON or START	Lighting switch must be in the 2nd position (LOW beam is ON) and the front fog lamp switch OFF	0V
					ON	Battery voltage
52	P	LH low beam headlamp	Output	—	Lighting switch in 2nd position	Battery voltage
54	R	RH low beam headlamp	Output	—	Lighting switch in 2nd position	Battery voltage
55	G	LH high beam headlamp	Output	—	Lighting switch in 2nd position and placed in HIGH or PASS position	Battery voltage
56	L	RH high beam headlamp	Output	—	Lighting switch in 2nd position and placed in HIGH or PASS position	Battery voltage
57	GR	Parking, license, and tail lamp	Output	ON	Lighting switch 1st position OFF	0V
					ON	Battery voltage
59	B	Ground	Input	—	—	0V
60	GR	Rear window defogger relay	Output	ON or START	Rear defogger switch ON	Battery voltage
					Rear defogger switch OFF	0V
61	R/B	Fuse 32	Output	OFF	—	Battery voltage

IPDM E/R (INTELLIGENT POWER DISTRIBUTION MODULE ENGINE ROOM)

< ECU DIAGNOSIS >

IPDM E/R (INTELLIGENT POWER DISTRIBUTION MODULE ENGINE ROOM) CONNECTORS

Connector No.	E30
Connector Name	FUSIBLE LINK BOX (BATTERY)
Connector Color	-



Terminal No.	Color of Wire	Signal Name
3	R	-

Connector No.	E118
Connector Name	IPDM E/R (INTELLIGENT POWER DISTRIBUTION MODULE ENGINE ROOM)
Connector Color	BLACK



Terminal No.	Color of Wire	Signal Name
1	W	F/LUSM
2	R	F/LMAIN

Connector No.	E119
Connector Name	IPDM E/R (INTELLIGENT POWER DISTRIBUTION MODULE ENGINE ROOM)
Connector Color	WHITE

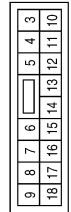

Terminal No.	Color of Wire	Signal Name
3	G	IGN_COIL
4	P	ENG_SUPPLY
5	-	-

Terminal No.	Color of Wire	Signal Name
6	V	ELEC_THROTTLE
7	BR	ECM_RLY_CONT
8	W/R	O2_SENS
9	-	-
10	R/B	DTRL_RLY_SUPPLY
11	Y	A/C_COMPRESSOR
12	W/G	IGN_SW_(IG1)
13	R	FUEL_PUMP
14	W/G	AT_ECU_IGN_SUPPLY
15	W/R	ABS_IGN_SUPPLY
16	W/G	REVERS_LAMP
17	W/G	INJECTION
18	-	-

Connector No.	E120
Connector Name	IPDM E/R (INTELLIGENT POWER DISTRIBUTION MODULE ENGINE ROOM)
Connector Color	WHITE

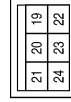

Terminal No.	Color of Wire	Signal Name
19	W	STARTER_MOTOR
20	BR	M/FAN_1
21	GR	IGN_SW_(ST)
22	G	MOTOR_FAN
23	LG	HEATED_MIRROR
24	P	M/FAN_2

ABMIA0008GB

IPDM E/R (INTELLIGENT POWER DISTRIBUTION MODULE ENGINE ROOM)

< ECU DIAGNOSIS >

Terminal No.	Color of Wire	Signal Name
31	-	-
32	GR	FR_WIPER_LO
33	-	-
34	-	-
35	L	FR_WIPER_HI
36	-	-

Terminal No.	Color of Wire	Signal Name
25	-	-
26	-	-
27	W	T_TOW_REV_LAMP
28	R	CLEARANCE_FRONT_LH
29	G	TRAILER_FLY_CONT

Connector No.	E121
Connector Name	IPDM E/R (INTELLIGENT POWER DISTRIBUTION MODULE ENGINE ROOM)
Connector Color	BROWN

9	8	7	6	5	4	3		
18	17	16	15	14	13	12	11	10



Connector No.	E124
Connector Name	IPDM E/R (INTELLIGENT POWER DISTRIBUTION MODULE ENGINE ROOM)
Connector Color	BLACK

59	58	57
62	61	60



Terminal No.	Color of Wire	Signal Name
57	GR	TAIL_LAMPS
58	-	-
59	B	GND (POWER)
60	GR	RR_DEF
61	R/B	TRAILER_RLY_SUPPLY
62	-	-

Connector No.	E123
Connector Name	IPDM E/R (INTELLIGENT POWER DISTRIBUTION MODULE ENGINE ROOM)
Connector Color	BROWN

51	50	49		
56	55	54	53	52



Terminal No.	Color of Wire	Signal Name
49	GR	CLEARANCE_FRONT_RH
50	W	FR_FOG_LAMP_LH
51	V	FR_FOG_LAMP_RH
52	P	H/LAMP_LO_LH
53	-	-
54	R	H/LAMP_LO_RH
55	G	H/LAMP_HI_LH
56	L	H/LAMP_HI_RH

Connector No.	E122
Connector Name	IPDM E/R (INTELLIGENT POWER DISTRIBUTION MODULE ENGINE ROOM)
Connector Color	WHITE

42	41	40	39	38	37
48	47	46	45	44	43



Terminal No.	Color of Wire	Signal Name
37	Y	ALT-C

Terminal No.	Color of Wire	Signal Name
38	B	GND (SIGNAL)
39	L	CAN-H
40	P	CAN-L
41	-	-
42	GR	OIL PRESSURE SW
43	G	AUTO_STOP_SW
44	R	DTRL RLY CONT
45	LG	HORN RLY
46	V	ECM (FUEL_PUMP_RLY_CONT)
47	O	ECM (ETC_RLY_CONT)
48	R	INHIBIT

ABMIA0262GB

IPDM E/R (INTELLIGENT POWER DISTRIBUTION MODULE ENGINE ROOM)

< ECU DIAGNOSIS >

A
B
C
D
E
F
G
H
I
J
K
L
M
N
O
P

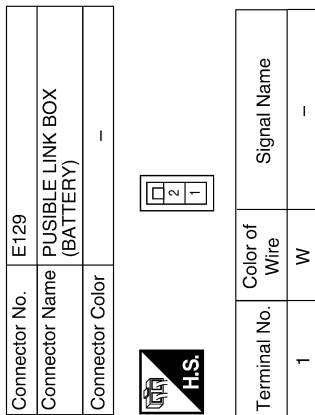

MWI

Fail Safe

ABMIA0338GB

INFOID:000000004428633

CAN COMMUNICATION CONTROL

When CAN communication with ECM and BCM is impossible, IPDM E/R performs fail-safe control. After CAN communication recovers normally, it also returns to normal control.

If No CAN Communication Is Available With ECM

IPDM E/R (INTELLIGENT POWER DISTRIBUTION MODULE ENGINE ROOM)

< ECU DIAGNOSIS >

Control part	Fail-safe in operation
Cooling fan	<ul style="list-style-type: none"> • Turns ON the cooling fan relay when the ignition switch is turned ON • Turns OFF the cooling fan relay when the ignition switch is turned OFF

If No CAN Communication Is Available With BCM

Control part	Fail-safe in operation
Headlamp	<ul style="list-style-type: none"> • Turns ON the headlamp low relay when the ignition switch is turned ON • Turns OFF the headlamp low relay when the ignition switch is turned OFF • Headlamp (LH/RH) high relays OFF
<ul style="list-style-type: none"> • Parking lamps • License plate lamps • Tail lamps 	<ul style="list-style-type: none"> • Turns ON the tail lamp relay when the ignition switch is turned ON • Turns OFF the tail lamp relay when the ignition switch is turned OFF
Front wiper	<ul style="list-style-type: none"> • The status just before activation of fail-safe control is maintained until the ignition switch is turned OFF while the front wiper is operating at LO or HI speed. • The wiper is operated at LO speed until the ignition switch is turned OFF if the fail-safe control is activated while the front wiper is set in the INT mode and the front wiper motor is operating.
Rear window defogger	Rear window defogger relay OFF
A/C compressor	A/C relay OFF
Front fog lamps (if equipped)	Front fog lamp relay OFF

IGNITION RELAY MALFUNCTION DETECTION FUNCTION

- IPDM E/R monitors the voltage at the contact circuit and excitation coil circuit of the ignition relay inside it.
- IPDM E/R judges the ignition relay error if the voltage differs between the contact circuit and the excitation coil circuit.
- If the ignition relay cannot turn OFF due to contact seizure, it activates the tail lamp relay for 10 minutes to alert the user to the ignition relay malfunction when the ignition switch is turned OFF.

Ignition switch	Ignition relay	Tail lamp relay
ON	ON	—
OFF	OFF	—

NOTE:

The tail lamp turns OFF when the ignition switch is turned ON.

FRONT WIPER CONTROL

IPDM E/R detects front wiper stop position by a front wiper auto stop signal.

When a front wiper auto stop signal is in the conditions listed below, IPDM E/R stops power supply to wiper after repeating a front wiper 10 second activation and 20 second stop five times.

Ignition switch	Front wiper switch	Auto stop signal
ON	OFF	Front wiper stop position signal cannot be input 10 seconds.
	ON	The signal does not change for 10 seconds.

NOTE:

This operation status can be confirmed on the IPDM E/R “DATA MONITOR” that displays “Block” for the item “WIP PROT” while the wiper is stopped.

STARTER MOTOR PROTECTION FUNCTION

IPDM E/R turns OFF the starter control relay to protect the starter motor when the starter control relay remains active for 90 seconds.

IPDM E/R (INTELLIGENT POWER DISTRIBUTION MODULE ENGINE ROOM)

< ECU DIAGNOSIS >

DTC Index

INFOID:000000004428634

CONSULT-III display	Fail-safe	TIME ^{NOTE}		Refer to
No DTC is detected. further testing may be required.	—	—	—	—
U1000: CAN COMM CIRCUIT	×	CRNT	1 – 39	PCS-17

NOTE:

The details of TIME display are as follows.

- CRNT: The malfunctions that are detected now
- 1 - 39: The number is indicated when it is normal at present and a malfunction was detected in the past. It increases like 0 → 1 → 2 ... 38 → 39 after returning to the normal condition whenever IGN OFF → ON. It is fixed to 39 until the self-diagnosis results are erased if it is over 39. It returns to 0 when a malfunction is detected again in the process.

A
B
C
D
E
F
G
H
I
J
K
L
M
O
P

MWI

THE FUEL GAUGE POINTER DOES NOT MOVE

< SYMPTOM DIAGNOSIS >

SYMPTOM DIAGNOSIS

THE FUEL GAUGE POINTER DOES NOT MOVE

Description

INFOID:000000003935381

Fuel gauge needle will not move from a certain position.

Diagnosis Procedure

INFOID:000000003935382

1. CHECK COMBINATION METER INPUT SIGNAL

1. Select "METER/M&A" on CONSULT-III.
2. Using "FUEL METER" of "DATA MONITOR", compare the monitor value with the fuel gauge reading on the combination meter. Refer to [MWI-32, "Component Function Check"](#).

Does monitor value match fuel gauge reading?

YES >> GO TO 2

NO >> Replace combination meter. Refer to [MWI-94, "Removal and Installation"](#).

2. CHECK FUEL LEVEL SENSOR SIGNAL CIRCUIT

Check the fuel level sensor signal circuit. Refer to [MWI-32, "Diagnosis Procedure"](#).

Is the inspection result normal?

YES >> GO TO 3

NO >> Repair harness or connector.

3. CHECK FUEL LEVEL SENSOR UNIT

Perform a unit check for the fuel level sensor unit. Refer to [MWI-33, "Component Inspection"](#).

Is the inspection result normal?

YES >> GO TO 4

NO >> Replace fuel level sensor unit. Refer to [FL-11, "Removal and Installation"](#).

4. CHECK FLOAT INTERFERENCE

Check that the float arm does not interfere or bind with any of the components in the fuel tank.

Is the inspection result normal?

YES >> Replace combination meter. Refer to [MWI-94, "Removal and Installation"](#).

NO >> Repair or replace malfunctioning parts.

THE FUEL GAUGE POINTER DOES NOT MOVE TO "F" WHEN REFUELING

< SYMPTOM DIAGNOSIS >

THE FUEL GAUGE POINTER DOES NOT MOVE TO "F" WHEN REFUELING

Description

INFOID:000000003935383

The fuel gauge needle will not move to "F" position when refueling.

Diagnosis Procedure

INFOID:000000003935384

1.OBSERVE FUEL GAUGE

Does it take a long time for the pointer to move to FULL position?

YES or NO

YES >> GO TO 2

NO >> GO TO 3

2.IDENTIFY FUELING CONDITION

Was the vehicle fueled with the ignition switch ON?

YES or NO

YES >> Be sure to fuel the vehicle with the ignition switch OFF. Otherwise, it will take a long time to move to FULL position because of the characteristic of the fuel gauge.

NO >> GO TO 3

3.OBSERVE VEHICLE POSITION

Is the vehicle parked on an incline?

YES or NO

YES >> Check the fuel level indication with vehicle on a level surface.

NO >> GO TO 4

4.OBSERVE FUEL GAUGE POINTER

During driving, does the fuel gauge pointer move gradually toward EMPTY position?

YES or NO

YES >> Check the components. Refer to [MWI-33, "Component Inspection"](#).

NO >> The float arm may interfere or bind with any of the components in the fuel tank.

A
B
C
D
E
F
G
H
I
J
K
L
M
O
P

MWI

THE OIL PRESSURE WARNING LAMP DOES NOT TURN ON

< SYMPTOM DIAGNOSIS >

THE OIL PRESSURE WARNING LAMP DOES NOT TURN ON

Description

INFOID:000000003935385

The oil pressure warning lamp stays off when the ignition switch is turned ON.

Diagnosis Procedure

INFOID:000000003935386

1. CHECK OIL PRESSURE WARNING LAMP

Perform IPDM E/R auto active test. Refer to [PCS-12, "Diagnosis Description"](#).

Is oil pressure warning lamp illuminated?

YES >> GO TO 2

NO >> Replace combination meter. Refer to [MWI-94, "Removal and Installation"](#).

2. CHECK OIL PRESSURE SWITCH SIGNAL CIRCUIT

Check the oil pressure switch signal circuit. Refer to [MWI-34, "Diagnosis Procedure"](#).

Is the inspection result normal?

YES >> GO TO 3

NO >> Repair harness or connector.

3. CHECK OIL PRESSURE SWITCH UNIT

Perform a unit check for the oil pressure switch. Refer to [MWI-34, "Component Inspection"](#).

Is the inspection result normal?

YES >> Replace IPDM E/R. Refer to [PCS-33, "Removal and Installation of IPDM E/R"](#).

NO >> Replace oil pressure switch.

THE OIL PRESSURE WARNING LAMP DOES NOT TURN OFF

< SYMPTOM DIAGNOSIS >

THE OIL PRESSURE WARNING LAMP DOES NOT TURN OFF

Description

INFOID:000000003935387

The oil pressure warning lamp remains illuminated while the engine is running (normal oil pressure).

Diagnosis Procedure

INFOID:000000003935388

1. CHECK OIL PRESSURE WARNING LAMP

Perform IPDM E/R auto active test. Refer to [PCS-12, "Diagnosis Description"](#).

Is oil pressure warning lamp illuminated?

YES >> GO TO 2

NO >> Replace combination meter. Refer to [MWI-94, "Removal and Installation"](#).

2. CHECK IPDM E/R OUTPUT VOLTAGE

1. Turn ignition switch OFF.
2. Disconnect the oil pressure switch connector.
3. Turn ignition switch ON.
4. Check voltage between the oil pressure switch harness connector E208 (VQ40DE) or F4 (VK56DE) terminal 1 and ground.

1 – Ground : Approx. 12V

Is the inspection result normal?

YES >> GO TO 3

NO >> GO TO 4

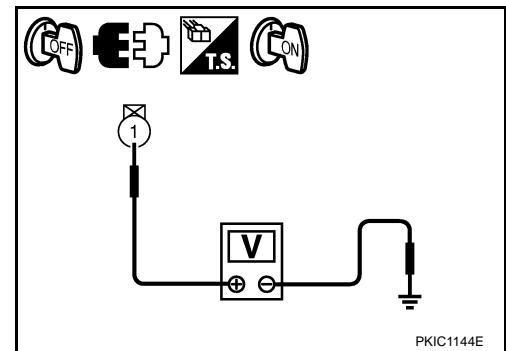

3. CHECK OIL PRESSURE SWITCH

Perform a unit check for the oil pressure switch. Refer to [MWI-34, "Component Inspection"](#).

Is the inspection result normal?

YES >> Replace IPDM E/R. Refer to [PCS-33, "Removal and Installation of IPDM E/R"](#).

NO >> Replace oil pressure switch.

4. CHECK OIL PRESSURE SWITCH SIGNAL CIRCUIT

Check the oil pressure switch signal circuit. Refer to [MWI-34, "Diagnosis Procedure"](#).

Is the inspection result normal?

YES >> Replace IPDM E/R. Refer to [PCS-33, "Removal and Installation of IPDM E/R"](#).

NO >> Repair harness or connector.

A
B
C
D
E
F
G
H
I
J
K
L
M
O
P

MWI

NORMAL OPERATING CONDITION

< SYMPTOM DIAGNOSIS >

NORMAL OPERATING CONDITION COMPASS

COMPASS : Description

INFOID:000000003935389

COMPASS

- The electronic compass is highly protected from changes in most magnetic fields. However, some large changes in magnetic fields can affect it. Some examples are (but not limited to): high tension power lines, large steel buildings, subways, steel bridges, automatic car washes, large piles of scrap metal, etc. While this does not happen very often, it is possible.
- During normal operation, the Compass Mirror will continuously update the compass calibration to adjust for gradual changes in the vehicle's magnetic "remnant" field. If the vehicle is subjected to high magnetic influences, the compass may appear to indicate false headings, become locked, or appear that it is unable to be calibrated. If this occurs, perform the calibration procedure.
- If at any time the compass continually displays the incorrect direction or the reading is erratic or locked, verify the correct zone variance.

Symptom Chart

Symptom	Cause	Solution / Reference
The compass display reads "C".	<ul style="list-style-type: none"> • Compass is not calibrated. • Incorrect zone variance setting. • Large change in magnetic field (Steel bridges, subways, concentrations of metal, car washes, etc.) • Compass was calibrated incorrectly or in the presence of a strong magnetic field. 	Perform Calibration. Refer to MWI-21, "Description" .
Compass shows the wrong direction.		
Compass does not change direction appears "Locked".		
Compass does not show all the directions, one or more is missing.		
The compass was calibrated but it "loses" calibration.		
On long trips the compass shows the wrong direction.	Perform Zone Variation Setting if correct reading is desired in that location. Refer to MWI-21, "Description" .	

PRECAUTIONS

< PRECAUTION >

PRECAUTION

PRECAUTIONS

Supplemental Restraint System (SRS) "AIR BAG" and "SEAT BELT PRE-TENSIONER"

INFOID:000000003935390

The Supplemental Restraint System such as "AIR BAG" and "SEAT BELT PRE-TENSIONER", used along with a front seat belt, helps to reduce the risk or severity of injury to the driver and front passenger for certain types of collision. This system includes seat belt switch inputs and dual stage front air bag modules. The SRS system uses the seat belt switches to determine the front air bag deployment, and may only deploy one front air bag, depending on the severity of a collision and whether the front occupants are belted or unbelted. Information necessary to service the system safely is included in the SR and SB section of this Service Manual.

WARNING:

- To avoid rendering the SRS inoperative, which could increase the risk of personal injury or death in the event of a collision which would result in air bag inflation, all maintenance must be performed by an authorized NISSAN/INFINITI dealer.
- Improper maintenance, including incorrect removal and installation of the SRS, can lead to personal injury caused by unintentional activation of the system. For removal of Spiral Cable and Air Bag Module, see the SR section.
- Do not use electrical test equipment on any circuit related to the SRS unless instructed to in this Service Manual. SRS wiring harnesses can be identified by yellow and/or orange harnesses or harness connectors.

Precaution Necessary for Steering Wheel Rotation After Battery Disconnect

INFOID:000000004411061

NOTE:

- This Procedure is applied only to models with Intelligent Key system and NATS (NISSAN ANTI-THEFT SYSTEM).
- Remove and install all control units after disconnecting both battery cables with the ignition knob in the "LOCK" position.
- Always use CONSULT-III to perform self-diagnosis as a part of each function inspection after finishing work. If DTC is detected, perform trouble diagnosis according to self-diagnostic results.

For models equipped with the Intelligent Key system and NATS, an electrically controlled steering lock mechanism is adopted on the key cylinder.

For this reason, if the battery is disconnected or if the battery is discharged, the steering wheel will lock and steering wheel rotation will become impossible.

If steering wheel rotation is required when battery power is interrupted, follow the procedure below before starting the repair operation.

OPERATION PROCEDURE

1. Connect both battery cables.

NOTE:

Supply power using jumper cables if battery is discharged.

2. Use the Intelligent Key or mechanical key to turn the ignition switch to the "ACC" position. At this time, the steering lock will be released.
3. Disconnect both battery cables. The steering lock will remain released and the steering wheel can be rotated.
4. Perform the necessary repair operation.
5. When the repair work is completed, return the ignition switch to the "LOCK" position before connecting the battery cables. (At this time, the steering lock mechanism will engage.)
6. Perform a self-diagnosis check of all control units using CONSULT-III.

A
B
C
D
E
F
G
H
I
J
K
L
M
N
O
P

COMBINATION METER

< ON-VEHICLE REPAIR >

ON-VEHICLE REPAIR

COMBINATION METER

Removal and Installation

INFOID:000000003935391

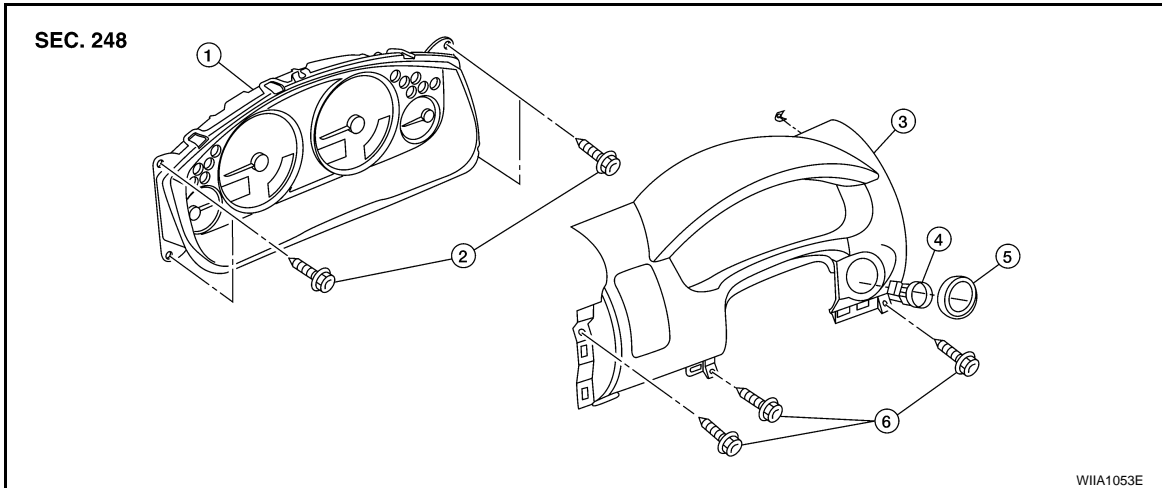

- | | | |
|-------------------------------|-----------------------------|-------------------------|
| 1. Combination meter | 2. Combination meter screws | 3. Cluster lid A |
| 4. Ignition key lamp assembly | 5. Steering lock escutcheon | 6. Cluster lid A screws |

REMOVAL

1. Disconnect the negative battery terminal.
2. Remove the cluster lid A, using power tool. Refer to [IP-11, "Removal and Installation"](#).
3. Remove the combination meter screws, using power tool.
4. Pull out the combination meter and disconnect the combination meter electrical connector.

INSTALLATION

Installation is in the reverse order of removal.