

A
B
C

SECTION **AP**

ADJUSTABLE PEDAL

CONTENTS

BASIC INSPECTION	2	Wiring Diagram	8	
DIAGNOSIS AND REPAIR WORKFLOW	2	SYMPTOM DIAGNOSIS	11	
Repair Work Flow	2	ADJUSTABLE PEDAL SYSTEM	11	G
INSPECTION AND ADJUSTMENT	4	Symptom Table	11	
Preliminary Check	4	PRECAUTION	12	H
FUNCTION DIAGNOSIS	5	PRECAUTIONS	12	
ADJUSTABLE PEDAL SYSTEM	5	Precaution for Supplemental Restraint System (SRS) "AIR BAG" and "SEAT BELT PRE-TEN- SIONER"	12	I
Automatic Drive Positioner Interlocking Adjustable Pedal	5	Precaution Necessary for Steering Wheel Rota- tion After Battery Disconnect	12	AP
Component Parts Location	5	Precaution for Work	13	
Component Description	5	ON-VEHICLE REPAIR	14	K
COMPONENT DIAGNOSIS	6	ADJUSTABLE PEDAL SYSTEM	14	
ADJUSTABLE PEDAL SYSTEM	6	Removal and Installation	14	L
Pedal Adjusting Switch Power Supply and Ground Circuit Inspection	6			
Pedal Adjusting Motor Circuit Inspection	6			M

DIAGNOSIS AND REPAIR WORKFLOW

< BASIC INSPECTION >

BASIC INSPECTION

DIAGNOSIS AND REPAIR WORKFLOW

Repair Work Flow

INFOID:000000005260238

WORK FLOW

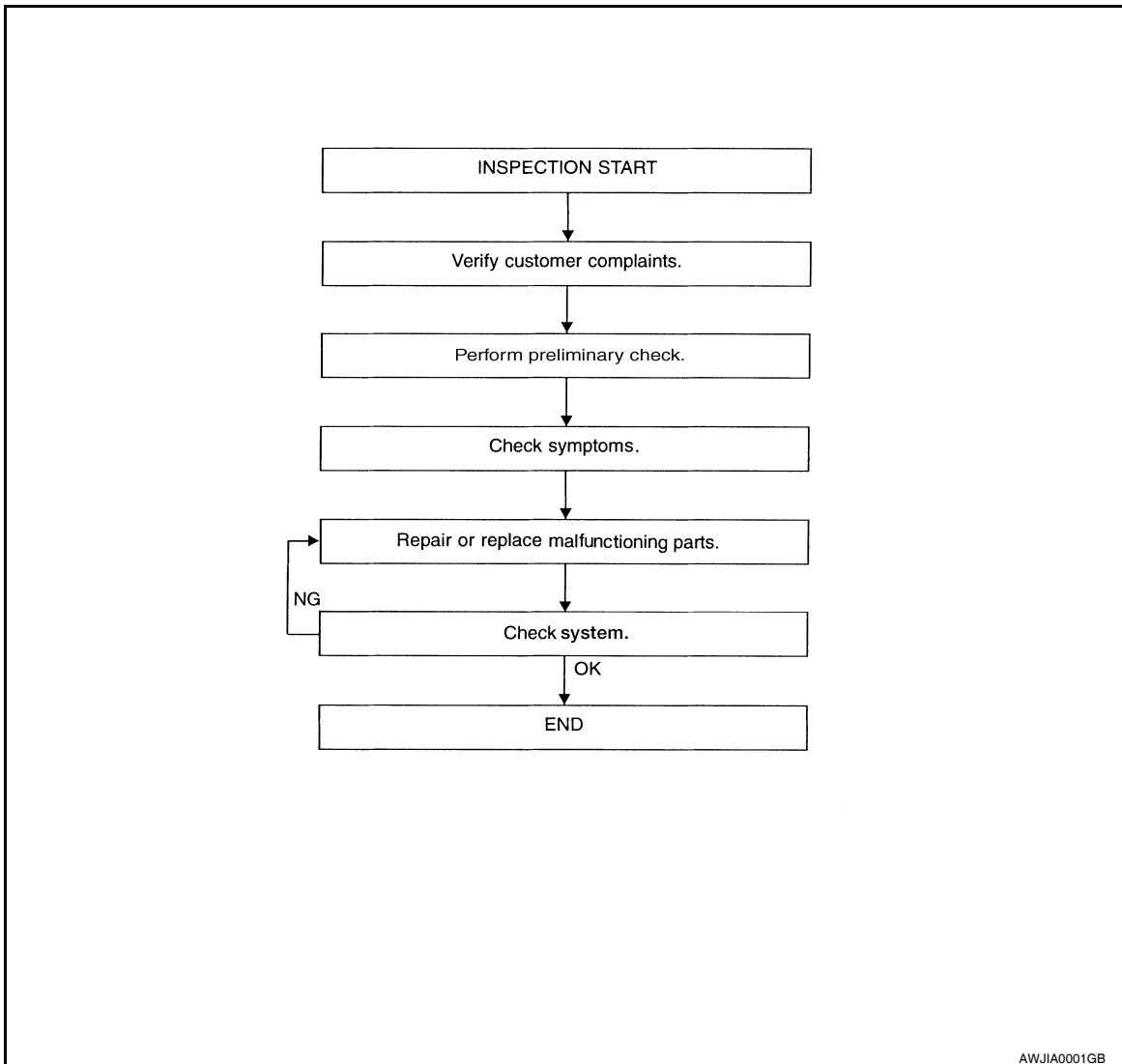

DETAILED FLOW

1. CUSTOMER INFORMATION

Talk to the customer to obtain detailed information about the symptom.

>> GO TO 2

2. PRELIMINARY CHECK

Perform preliminary check. Refer to [AP-4, "Preliminary Check"](#).

>> GO TO 3

3. SYMPTOM

Check for symptoms. Refer to [AP-11, "Symptom Table"](#).

DIAGNOSIS AND REPAIR WORKFLOW

< BASIC INSPECTION >

>> GO TO 4

4. MALFUNCTIONING PARTS

Repair or replace the applicable parts.

>> GO TO 5

5. SYSTEM CHECK

Operate the pedal adjusting switch to ensure that the pedals move completely forward and backward.

Does the system operate normally?

YES >> Inspection End.

NO >> Refer to [GI-37, "Intermittent Incident"](#).

A
B
C
D
E
F
G
H
I
K
L
M
N
O
P

AP

INSPECTION AND ADJUSTMENT

< BASIC INSPECTION >

INSPECTION AND ADJUSTMENT

Preliminary Check

INFOID:000000005260239

1. FOREIGN OBJECTS

Check the following:

- objects on or behind the pedals that could cause binding

Are there any foreign objects that could be causing interference with the pedals?

YES >> Remove objects.

NO >> GO TO 2

2. WIRING CONNECTIONS

1. Disconnect pedal adjusting motor.
2. Check terminals for damage or loose connections.
3. Reconnect harness connectors.

Are any connectors damaged or loose?

YES >> Repair or replace damaged parts.

NO >> GO TO 3

3. POWER AND GROUND

Check power supply and ground circuits for pedal adjusting switch. Refer to [AP-6. "Pedal Adjusting Switch Power Supply and Ground Circuit Inspection"](#).

Is the inspection result normal?

YES >> Refer to [AP-11. "Symptom Table"](#).

NO >> Repair or replace as necessary.

ADJUSTABLE PEDAL SYSTEM

< FUNCTION DIAGNOSIS >

FUNCTION DIAGNOSIS

ADJUSTABLE PEDAL SYSTEM

Automatic Drive Positioner Interlocking Adjustable Pedal

INFOID:000000005260240

Refer to [ADP-11, "AUTOMATIC DRIVE POSITIONER SYSTEM : System Description"](#).

Component Parts Location

INFOID:000000005260241

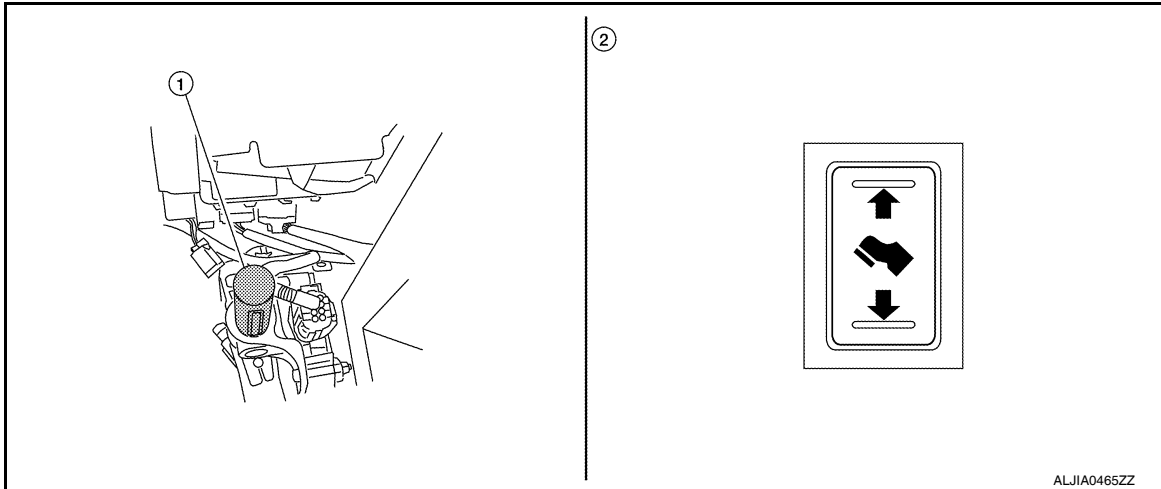

1. Pedal adjusting motor E167 (view with lower instrument panel LH removed) 2. Pedal adjusting switch M84

Component Description

INFOID:000000005260242

Component	Function
Pedal adjusting switch	Provide move forward/backward signals to pedal adjusting motor
Pedal adjusting motor	Move pedal assembly forward and backward

A
B
C
D
E
F
G
H
I
AP
K
L
M
N
O
P

ADJUSTABLE PEDAL SYSTEM

< COMPONENT DIAGNOSIS >

COMPONENT DIAGNOSIS

ADJUSTABLE PEDAL SYSTEM

Pedal Adjusting Switch Power Supply and Ground Circuit Inspection

INFOID:000000005260243

1. CHECK PEDAL ADJUSTING SWITCH POWER SUPPLY

1. Turn ignition switch OFF.
2. Disconnect pedal adjusting switch.
3. Check voltage between pedal adjusting switch connector M84 terminal 1 and ground.

1 - Ground : **Battery voltage**

Is inspection result normal?

- YES >> GO TO 2
NO >> Repair or replace harness.

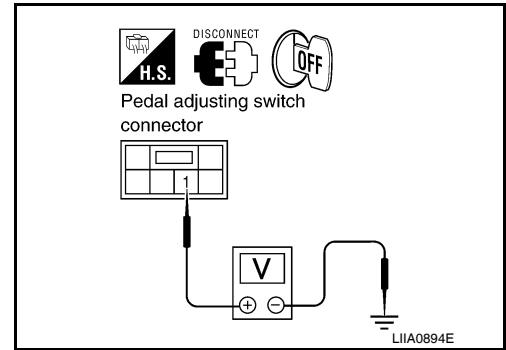

2. CHECK PEDAL ADJUSTING SWITCH GROUND CIRCUIT

Check continuity between pedal adjusting switch connector M84 terminal 4 and ground.

4 - Ground : **Continuity should exist.**

Is inspection result normal?

- YES >> Pedal adjusting switch power supply and ground circuit is OK.
NO >> Repair or replace harness.

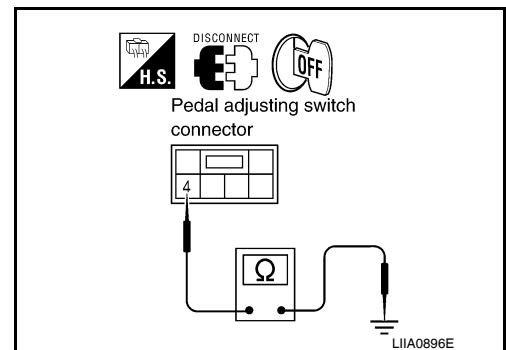

Pedal Adjusting Motor Circuit Inspection

INFOID:000000005260244

1. CHECK PEDAL ADJUSTING SWITCH

1. Turn ignition switch OFF.
2. Disconnect pedal adjusting switch.
3. Check continuity between pedal adjusting switch terminals as follows.

Terminals	Condition	Continuity
3	1	Pedal adjusting switch forward. Continuity should exist.
	1	Pedal adjusting switch neutral. Continuity should not exist.
	4	Pedal adjusting switch backward. Continuity should exist.
	4	Pedal adjusting switch neutral. Continuity should not exist.
2	1	Pedal adjusting switch backward. Continuity should exist.
	1	Pedal adjusting switch neutral. Continuity should not exist.
	4	Pedal adjusting switch forward. Continuity should exist.
	4	Pedal adjusting switch neutral. Continuity should not exist.

Is inspection result normal?

- YES >> GO TO 2
NO >> Replace pedal adjusting switch.

2. CHECK PEDAL ADJUSTING MOTOR HARNESS

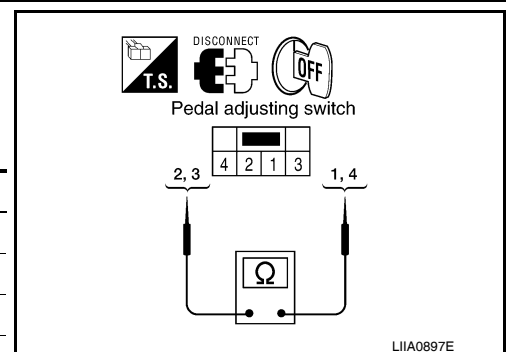

ADJUSTABLE PEDAL SYSTEM

< COMPONENT DIAGNOSIS >

1. Disconnect pedal adjusting motor.
2. Check continuity between pedal adjusting switch connector M84 terminals 2, 3 and pedal adjusting motor connector E167 terminals 1, 2.

2 - 1 : Continuity should exist.

3 - 2 : Continuity should exist.

3. Check continuity between pedal adjusting switch connector M84 terminals 2, 3 and ground.

2 - Ground : Continuity should not exist.

3 - Ground : Continuity should not exist.

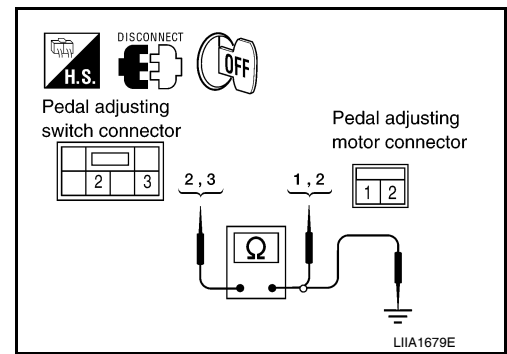

Is inspection result normal?

YES >> GO TO 3

NO >> Repair or replace harness.

3. CHECK PEDAL ADJUSTING MOTOR POWER SUPPLY

1. Connect pedal adjusting switch.
2. Check voltage between pedal adjusting motor connector E167 and ground.

Connector	Terminals		Condition	Voltage (V) (Approx.)
	(+)	(-)		
E167	1	Ground	Pedal adjusting switch back-ward	Battery voltage
			Other than above	0
	2		Pedal adjusting switch forward	Battery voltage
			Other than above	0

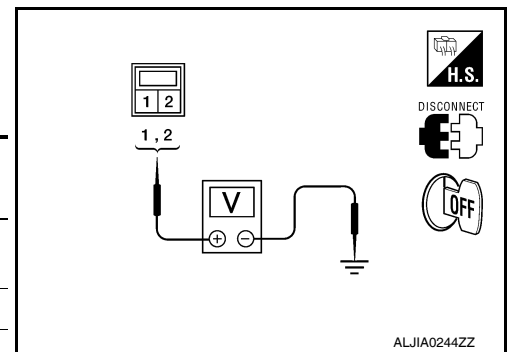

Is inspection result normal?

YES >> Replace pedal adjusting motor. Refer to [ACC-5. "Removal and Installation"](#).

NO >> Repair or replace harness.

A
B
C
D
E
F
G
H
I
K
L
M
N
O
P

AP

ADJUSTABLE PEDAL SYSTEM

< COMPONENT DIAGNOSIS >

Wiring Diagram

INFOID:000000005260245

ADJUSTABLE PEDAL SYSTEM

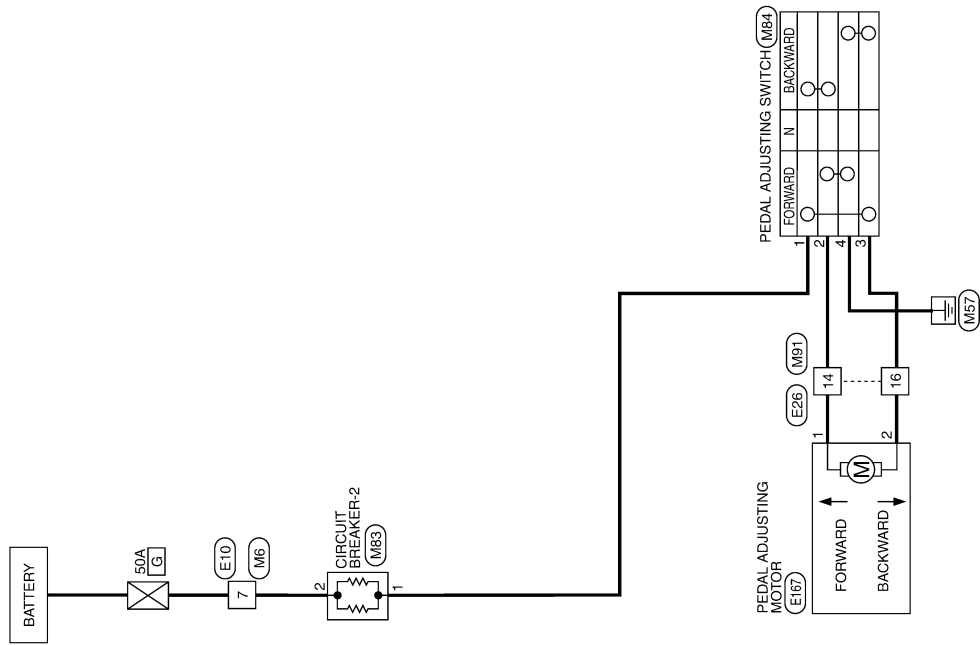

ABJWA0002GB

ADJUSTABLE PEDAL SYSTEM

< COMPONENT DIAGNOSIS >

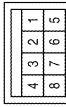

ADJUSTABLE PEDAL SYSTEM CONNECTORS

Connector No.	M6
Connector Name	WIRE TO WIRE
Connector Color	WHITE



Terminal No.	Color of Wire	Signal Name
7	W	--

Connector No.	M83
Connector Name	CIRCUIT BREAKER-2 (WITHOUT AUTOMATIC DRIVE POSITIONER)
Connector Color	WHITE

Terminal No.	Color of Wire	Signal Name
1	W	--
2	P	--

Connector No.	M84
Connector Name	PEDAL ADJUSTING SWITCH (WITHOUT AUTOMATIC DRIVE POSITIONER)
Connector Color	BROWN

Terminal No.	Color of Wire	Signal Name
1	W	--
2	BR	--
3	G	--
4	B	--

Connector No.	M91
Connector Name	WIRE TO WIRE
Connector Color	WHITE

Terminal No.	Color of Wire	Signal Name
14	BR	--
16	G	--

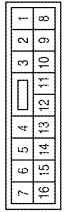
Connector No.	E10
Connector Name	WIRE TO WIRE
Connector Color	WHITE

Terminal No.	Color of Wire	Signal Name
7	W	--

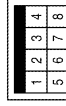
Connector No.	E26
Connector Name	WIRE TO WIRE
Connector Color	WHITE

Terminal No.	Color of Wire	Signal Name
14	BR	--
16	G	--

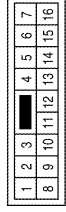
ABJIA0369GB

A
B
C
D
E
F
G
H
I
AP
K
L
M
N
O
P

ADJUSTABLE PEDAL SYSTEM

< COMPONENT DIAGNOSIS >

Connector No.	E167
Connector Name	PEDAL ADJUSTING MOTOR
Connector Color	GRAY



Terminal No.	Color of Wire	Signal Name
1	BR	-
2	G	-

ABJIA0003GB

ADJUSTABLE PEDAL SYSTEM

< SYMPTOM DIAGNOSIS >

SYMPTOM DIAGNOSIS

ADJUSTABLE PEDAL SYSTEM

Symptom Table

INFOID:000000005260246

NOTE:

Always check the WORK FLOW before troubleshooting. Refer to "WORK FLOW".

Symptom	Diagnosis/Service procedure	Reference page
Adjustable pedal system does not operate.	1. Pedal adjusting switch power supply and ground circuit inspection.	AP-6
	2. Pedal adjusting motor circuit inspection.	AP-6

A
B
C
D
E
F
G
H
I
K
L
M
N
O
P

AP

PRECAUTIONS

< PRECAUTION >

PRECAUTION

PRECAUTIONS

Precaution for Supplemental Restraint System (SRS) "AIR BAG" and "SEAT BELT PRE-TENSIONER"

INFOID:000000005501531

The Supplemental Restraint System such as "AIR BAG" and "SEAT BELT PRE-TENSIONER", used along with a front seat belt, helps to reduce the risk or severity of injury to the driver and front passenger for certain types of collision. This system includes seat belt switch inputs and dual stage front air bag modules. The SRS system uses the seat belt switches to determine the front air bag deployment, and may only deploy one front air bag, depending on the severity of a collision and whether the front occupants are belted or unbelted. Information necessary to service the system safely is included in the SR and SB section of this Service Manual.

WARNING:

- To avoid rendering the SRS inoperative, which could increase the risk of personal injury or death in the event of a collision which would result in air bag inflation, all maintenance must be performed by an authorized NISSAN/INFINITI dealer.
- Improper maintenance, including incorrect removal and installation of the SRS, can lead to personal injury caused by unintentional activation of the system. For removal of Spiral Cable and Air Bag Module, see the SR section.
- Do not use electrical test equipment on any circuit related to the SRS unless instructed to in this Service Manual. SRS wiring harnesses can be identified by yellow and/or orange harnesses or harness connectors.

PRECAUTIONS WHEN USING POWER TOOLS (AIR OR ELECTRIC) AND HAMMERS

WARNING:

- When working near the Airbag Diagnosis Sensor Unit or other Airbag System sensors with the Ignition ON or engine running, DO NOT use air or electric power tools or strike near the sensor(s) with a hammer. Heavy vibration could activate the sensor(s) and deploy the air bag(s), possibly causing serious injury.
- When using air or electric power tools or hammers, always switch the Ignition OFF, disconnect the battery, and wait at least 3 minutes before performing any service.

Precaution Necessary for Steering Wheel Rotation After Battery Disconnect

INFOID:000000005501532

NOTE:

- This Procedure is applied only to models with Intelligent Key system and NATS (NISSAN ANTI-THEFT SYSTEM).
- Remove and install all control units after disconnecting both battery cables with the ignition knob in the "LOCK" position.
- Always use CONSULT-III to perform self-diagnosis as a part of each function inspection after finishing work. If DTC is detected, perform trouble diagnosis according to self-diagnostic results.

For models equipped with the Intelligent Key system and NATS, an electrically controlled steering lock mechanism is adopted on the key cylinder.

For this reason, if the battery is disconnected or if the battery is discharged, the steering wheel will lock and steering wheel rotation will become impossible.

If steering wheel rotation is required when battery power is interrupted, follow the procedure below before starting the repair operation.

OPERATION PROCEDURE

1. Connect both battery cables.

NOTE:

Supply power using jumper cables if battery is discharged.

2. Use the Intelligent Key or mechanical key to turn the ignition switch to the "ACC" position. At this time, the steering lock will be released.
3. Disconnect both battery cables. The steering lock will remain released and the steering wheel can be rotated.
4. Perform the necessary repair operation.

PRECAUTIONS

< PRECAUTION >

5. When the repair work is completed, return the ignition switch to the "LOCK" position before connecting the battery cables. (At this time, the steering lock mechanism will engage.)
6. Perform a self-diagnosis check of all control units using CONSULT-III.

Precaution for Work

INFOID:000000005260248

- When removing or disassembling each component, be careful not to damage or deform it. If a component may be subject to interference, be sure to protect it with a shop cloth.
- When removing (disengaging) components with a screwdriver or similar tool, be sure to wrap the component with a shop cloth or vinyl tape to protect it.
- Protect the removed parts with a shop cloth and keep them.
- Replace a deformed or damaged clip.
- If a part is specified as a non-reusable part, always replace it with new one.
- Be sure to tighten bolts and nuts securely to the specified torque.
- After re-installation is completed, be sure to check that each part works normally.
- Follow the steps below to clean components.
- Water soluble foul: Dip a soft cloth into lukewarm water, and wring the water out of the cloth to wipe the fouled area.
Then rub with a soft and dry cloth.
- Oily foul: Dip a soft cloth into lukewarm water with mild detergent (concentration: within 2 to 3%), and wipe the fouled area.
Then dip a cloth into fresh water, and wring the water out of the cloth to wipe the detergent off. Then rub with a soft and dry cloth.
- Do not use organic solvent such as thinner, benzene, alcohol, or gasoline.
- For genuine leather seats, use a genuine leather seat cleaner.

A
B
C
D
E
F
G
H
I
K
L
M
N
O
P

AP

ADJUSTABLE PEDAL SYSTEM

< ON-VEHICLE REPAIR >

ON-VEHICLE REPAIR

ADJUSTABLE PEDAL SYSTEM

Removal and Installation

INFOID:000000005260249

Refer to [ACC-5, "Removal and Installation"](#).