

SECTION **INT**
INTERIOR

A
B
C
D
E
F
G
H
I
INT
K
L
M
N
O
P

CONTENTS

SYMPTOM DIAGNOSIS	2	Special Service Tool	13
SQUEAK AND RATTLE TROUBLE DIAG- NOSES	2	Commercial Service Tool	13
Work Flow	2	ON-VEHICLE REPAIR	14
Generic Squeak and Rattle Troubleshooting	4	DOOR FINISHER	14
Diagnostic Worksheet	6	Removal and Installation	14
CLIP AND FASTENER	8	BODY SIDE TRIM	16
Clip and Fastener	8	Component	16
PRECAUTION	11	Removal and Installation	17
PRECAUTIONS	11	FLOOR TRIM	18
Precaution for Supplemental Restraint System (SRS) "AIR BAG" and "SEAT BELT PRE-TEN- SIONER"	11	Removal and Installation	18
Precaution Necessary for Steering Wheel Rota- tion After Battery Disconnect	11	HEADLINING	19
Service Notice	12	Removal and Installation	19
PREPARATION	13	LUGGAGE FLOOR TRIM	21
PREPARATION	13	Component	21
		Removal and Installation	22
		BACK DOOR TRIM	24
		Removal and Installation	24

SQUEAK AND RATTLE TROUBLE DIAGNOSES

< SYMPTOM DIAGNOSIS >

SYMPTOM DIAGNOSIS

SQUEAK AND RATTLE TROUBLE DIAGNOSES

Work Flow

INFOID:000000005256484

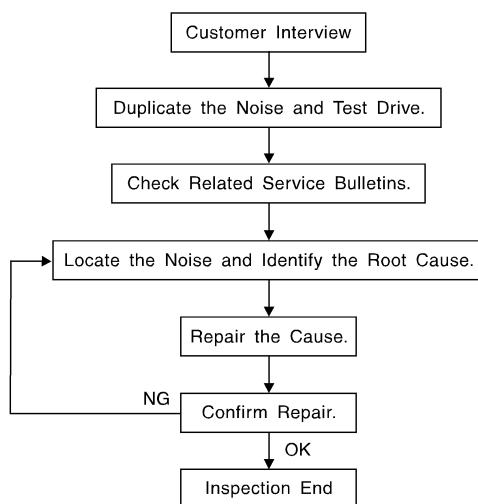

SBT842

CUSTOMER INTERVIEW

Interview the customer if possible, to determine the conditions that exist when the noise occurs. Use the Diagnostic Worksheet during the interview to document the facts and conditions when the noise occurs and any customer's comments; refer to [INT-6, "Diagnostic Worksheet"](#). This information is necessary to duplicate the conditions that exist when the noise occurs.

- The customer may not be able to provide a detailed description or the location of the noise. Attempt to obtain all the facts and conditions that exist when the noise occurs (or does not occur).
- If there is more than one noise in the vehicle, be sure to diagnose and repair the noise that the customer is concerned about. This can be accomplished by test driving the vehicle with the customer.
- After identifying the type of noise, isolate the noise in terms of its characteristics. The noise characteristics are provided so the customer, service adviser and technician are all speaking the same language when defining the noise.
- Squeak —(Like tennis shoes on a clean floor)
Squeak characteristics include the light contact/fast movement/brought on by road conditions/hard surfaces = higher pitch noise/softer surfaces = lower pitch noises/edge to surface = chirping.
- Creak—(Like walking on an old wooden floor)
Creak characteristics include firm contact/slow movement/twisting with a rotational movement/pitch dependent on materials/often brought on by activity.
- Rattle—(Like shaking a baby rattle)
Rattle characteristics include the fast repeated contact/vibration or similar movement/loose parts/missing clip or fastener/incorrect clearance.
- Knock —(Like a knock on a door)
Knock characteristics include hollow sounding/sometimes repeating/often brought on by driver action.
- Tick—(Like a clock second hand)
Tick characteristics include gentle contacting of light materials/loose components/can be caused by driver action or road conditions.
- Thump—(Heavy, muffled knock noise)
Thump characteristics include softer knock/dead sound often brought on by activity.
- Buzz—(Like a bumble bee)
Buzz characteristics include high frequency rattle/firm contact.
- Often the degree of acceptable noise level will vary depending upon the person. A noise that you may judge as acceptable may be very irritating to the customer.
- Weather conditions, especially humidity and temperature, may have a great effect on noise level.

DUPLICATE THE NOISE AND TEST DRIVE

SQUEAK AND RATTLE TROUBLE DIAGNOSES

< SYMPTOM DIAGNOSIS >

If possible, drive the vehicle with the customer until the noise is duplicated. Note any additional information on the Diagnostic Worksheet regarding the conditions or location of the noise. This information can be used to duplicate the same conditions when you confirm the repair.

If the noise can be duplicated easily during the test drive, to help identify the source of the noise, try to duplicate the noise with the vehicle stopped by doing one or all of the following:

- 1) Close a door.
 - 2) Tap or push/pull around the area where the noise appears to be coming from.
 - 3) Rev the engine.
 - 4) Use a floor jack to recreate vehicle "twist".
 - 5) At idle, apply engine load (electrical load, A/T in drive position).
 - 6) Raise the vehicle on a hoist and hit a tire with a rubber hammer.
- Drive the vehicle and attempt to duplicate the conditions the customer states exist when the noise occurs.
 - If it is difficult to duplicate the noise, drive the vehicle slowly on an undulating or rough road to stress the vehicle body.

CHECK RELATED SERVICE BULLETINS

After verifying the customer concern or symptom, check ASIST for Technical Service Bulletins (TSBs) related to that concern or symptom.

If a TSB relates to the symptom, follow the procedure to repair the noise.

LOCATE THE NOISE AND IDENTIFY THE ROOT CAUSE

1. Narrow down the noise to a general area. To help pinpoint the source of the noise, use a listening tool (Chassis Ear: J-39570, Engine Ear: J-39565 and mechanic's stethoscope).
2. Narrow down the noise to a more specific area and identify the cause of the noise by:
 - removing the components in the area that you suspect the noise is coming from.
Do not use too much force when removing clips and fasteners, otherwise clips and fasteners can be broken or lost during the repair, resulting in the creation of new noise.
 - tapping or pushing/pulling the component that you suspect is causing the noise.
Do not tap or push/pull the component with excessive force, otherwise the noise will be eliminated only temporarily.
 - feeling for a vibration with your hand by touching the component(s) that you suspect is (are) causing the noise.
 - placing a piece of paper between components that you suspect are causing the noise.
 - looking for loose components and contact marks.
Refer to [INT-4, "Generic Squeak and Rattle Troubleshooting"](#).

REPAIR THE CAUSE

- If the cause is a loose component, tighten the component securely.
- If the cause is insufficient clearance between components:
 - separate components by repositioning or loosening and retightening the component, if possible.
 - insulate components with a suitable insulator such as urethane pads, foam blocks, felt cloth tape or urethane tape. A NISSAN Squeak and Rattle Kit (J-43980) is available through your authorized NISSAN Parts Department.

CAUTION:

Do not use excessive force as many components are constructed of plastic and may be damaged.

Always check with the Parts Department for the latest parts information.

The following materials are contained in the NISSAN Squeak and Rattle Kit (J-43980). Each item can be ordered separately as needed.

URETHANE PADS [1.5 mm (0.059 in) thick]

Insulates connectors, harness, etc.

76268-9E005: 100×135 mm (3.94×5.31 in)/76884-71L01: 60×85 mm (2.36×3.35 in)/76884-71L02: 15×25 mm (0.59×0.98 in)

INSULATOR (Foam blocks)

Insulates components from contact. Can be used to fill space behind a panel.

73982-9E000: 45 mm (1.77 in) thick, 50×50 mm (1.97×1.97 in)/73982-50Y00: 10 mm (0.39 in) thick, 50×50 mm (1.97×1.97 in)

INSULATOR (Light foam block)

80845-71L00: 30 mm (1.18 in) thick, 30×50 mm (1.18×1.97 in)

FELT CLOTH TAPE

Used to insulate where movement does not occur. Ideal for instrument panel applications.

SQUEAK AND RATTLE TROUBLE DIAGNOSES

< SYMPTOM DIAGNOSIS >

68370-4B000: 15×25 mm (0.59×0.98 in) pad/68239-13E00: 5 mm (0.20 in) wide tape roll. The following materials not found in the kit can also be used to repair squeaks and rattles.

UHMW (TEFLON) TAPE

Insulates where slight movement is present. Ideal for instrument panel applications.

SILICONE GREASE

Used instead of UHMW tape that will be visible or not fit.

Note: Will only last a few months.

SILICONE SPRAY

Use when grease cannot be applied.

DUCT TAPE

Use to eliminate movement.

CONFIRM THE REPAIR

Confirm that the cause of a noise is repaired by test driving the vehicle. Operate the vehicle under the same conditions as when the noise originally occurred. Refer to the notes on the Diagnostic Worksheet.

Generic Squeak and Rattle Troubleshooting

INFOID:000000005256485

Refer to Table of Contents for specific component removal and installation information.

INSTRUMENT PANEL

Most incidents are caused by contact and movement between:

1. The cluster lid A and instrument panel
2. Acrylic lens and combination meter housing
3. Instrument panel to front pillar garnish
4. Instrument panel to windshield
5. Instrument panel mounting pins
6. Wiring harnesses behind the combination meter
7. A/C defroster duct and duct joint

These incidents can usually be located by tapping or moving the components to duplicate the noise or by pressing on the components while driving to stop the noise. Most of these incidents can be repaired by applying felt cloth tape or silicone spray (in hard to reach areas). Urethane pads can be used to insulate wiring harness.

CAUTION:

Do not use silicone spray to isolate a squeak or rattle. If you saturate the area with silicone, you will not be able to recheck the repair.

CENTER CONSOLE

Components to pay attention to include:

1. Shifter assembly cover to finisher
2. A/C control unit and cluster lid C
3. Wiring harnesses behind audio and A/C control unit

The instrument panel repair and isolation procedures also apply to the center console.

DOORS

Pay attention to the:

1. Finisher and inner panel making a slapping noise
2. Inside handle escutcheon to door finisher
3. Wiring harnesses tapping
4. Door striker out of alignment causing a popping noise on starts and stops

Tapping or moving the components or pressing on them while driving to duplicate the conditions can isolate many of these incidents. You can usually insulate the areas with felt cloth tape or insulator foam blocks from the NISSAN Squeak and Rattle Kit (J-43980) to repair the noise.

TRUNK

Trunk noises are often caused by a loose jack or loose items put into the trunk by the owner.

In addition look for:

1. Trunk lid bumpers out of adjustment

SQUEAK AND RATTLE TROUBLE DIAGNOSES

< SYMPTOM DIAGNOSIS >

2. Trunk lid striker out of adjustment
3. The trunk lid torsion bars knocking together
4. A loose license plate or bracket

Most of these incidents can be repaired by adjusting, securing or insulating the item(s) or component(s) causing the noise.

SUNROOF/HEADLINING

Noises in the sunroof/headlining area can often be traced to one of the following:

1. Sunroof lid, rail, linkage or seals making a rattle or light knocking noise
2. Sun visor shaft shaking in the holder
3. Front or rear windshield touching headliner and squeaking

Again, pressing on the components to stop the noise while duplicating the conditions can isolate most of these incidents. Repairs usually consist of insulating with felt cloth tape.

OVERHEAD CONSOLE (FRONT AND REAR)

Overhead console noises are often caused by the console panel clips not being engaged correctly. Most of these incidents are repaired by pushing up on the console at the clip locations until the clips engage.

In addition look for:

1. Loose harness or harness connectors.
2. Front console map/reading lamp lens loose.
3. Loose screws at console attachment points.

SEATS

When isolating seat noise it's important to note the position the seat is in and the load placed on the seat when the noise is present. These conditions should be duplicated when verifying and isolating the cause of the noise.

Cause of seat noise include:

1. Headrest rods and holder
2. A squeak between the seat pad cushion and frame
3. The rear seatback lock and bracket

These noises can be isolated by moving or pressing on the suspected components while duplicating the conditions under which the noise occurs. Most of these incidents can be repaired by repositioning the component or applying urethane tape to the contact area.

UNDERHOOD

Some interior noise may be caused by components under the hood or on the engine wall. The noise is then transmitted into the passenger compartment.

Causes of transmitted underhood noise include:

1. Any component mounted to the engine wall
2. Components that pass through the engine wall
3. Engine wall mounts and connectors
4. Loose radiator mounting pins
5. Hood bumpers out of adjustment
6. Hood striker out of adjustment

These noises can be difficult to isolate since they cannot be reached from the interior of the vehicle. The best method is to secure, move or insulate one component at a time and test drive the vehicle. Also, engine RPM or load can be changed to isolate the noise. Repairs can usually be made by moving, adjusting, securing, or insulating the component causing the noise.

A

B

C

D

E

F

G

H

I

INT

K

L

M

N

O

P

SQUEAK AND RATTLE TROUBLE DIAGNOSES

< SYMPTOM DIAGNOSIS >

Diagnostic Worksheet

INFOID:000000005256486

Dear Customer:

We are concerned about your satisfaction with your vehicle. Repairing a squeak or rattle sometimes can be very difficult. To help us fix your vehicle right the first time, please take a moment to note the area of the vehicle where the squeak or rattle occurs and under what conditions. You may be asked to take a test drive with a service advisor or technician to ensure we confirm the noise you are hearing.

SQUEAK & RATTLE DIAGNOSTIC WORKSHEET

I. WHERE DOES THE NOISE COME FROM? (circle the area of the vehicle)

The illustrations are for reference only, and may not reflect the actual configuration of your vehicle.

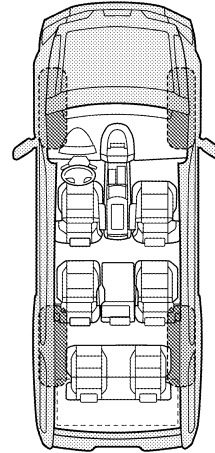
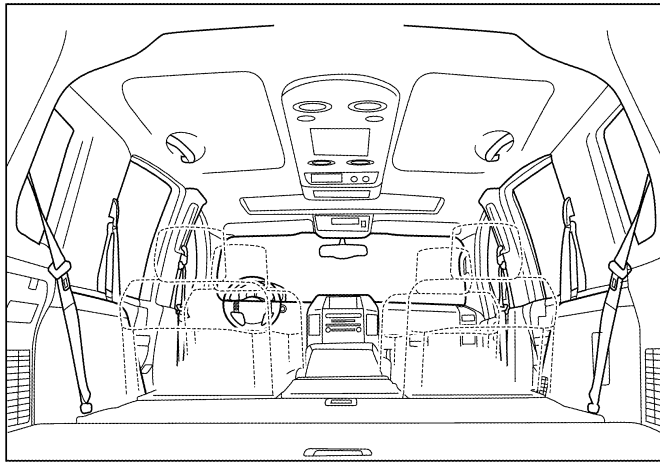
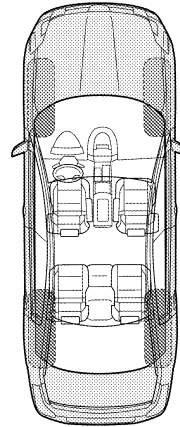
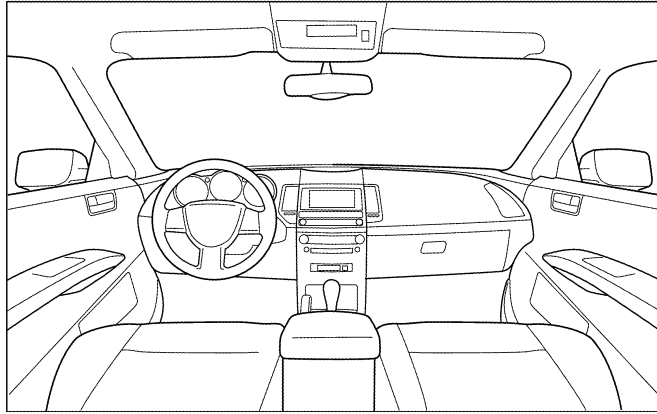

Continue to page 2 of the worksheet and briefly describe the location of the noise or rattle. In addition, please indicate the conditions which are present when the noise occurs.

SQUEAK AND RATTLE TROUBLE DIAGNOSES

< SYMPTOM DIAGNOSIS >

SQUEAK & RATTLE DIAGNOSTIC WORKSHEET - page 2

Briefly describe the location where the noise occurs:

II. WHEN DOES IT OCCUR? (please check the boxes that apply)

- | | |
|---|--|
| <input type="checkbox"/> Anytime | <input type="checkbox"/> After sitting out in the rain |
| <input type="checkbox"/> 1st time in the morning | <input type="checkbox"/> When it is raining or wet |
| <input type="checkbox"/> Only when it is cold outside | <input type="checkbox"/> Dry or dusty conditions |
| <input type="checkbox"/> Only when it is hot outside | <input type="checkbox"/> Other: |

III. WHEN DRIVING:

- Through driveways
- Over rough roads
- Over speed bumps
- Only about ____ mph
- On acceleration
- Coming to a stop
- On turns: left, right or either (circle)
- With passengers or cargo
- Other: _____
- After driving ____ miles or ____ minutes

IV. WHAT TYPE OF NOISE

- Squeak (like tennis shoes on a clean floor)
- Creak (like walking on an old wooden floor)
- Rattle (like shaking a baby rattle)
- Knock (like a knock at the door)
- Tick (like a clock second hand)
- Thump (heavy muffled knock noise)
- Buzz (like a bumble bee)

TO BE COMPLETED BY DEALERSHIP PERSONNEL

Test Drive Notes:

	YES	NO	Initials of person performing
Vehicle test driven with customer	<input type="checkbox"/>	<input type="checkbox"/>	_____
- Noise verified on test drive	<input type="checkbox"/>	<input type="checkbox"/>	_____
- Noise source located and repaired	<input type="checkbox"/>	<input type="checkbox"/>	_____
- Follow up test drive performed to confirm repair	<input type="checkbox"/>	<input type="checkbox"/>	_____

VIN: _____ Customer Name _____

W.O.# _____ Date: _____

This form must be attached to Work Order

LAIA0071E

A
B
C
D
E
F
G
H
I
INT
K
L
M
N
O
P







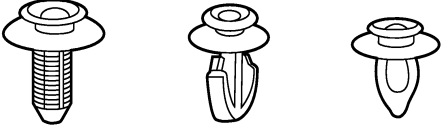

CLIP AND FASTENER

< SYMPTOM DIAGNOSIS >

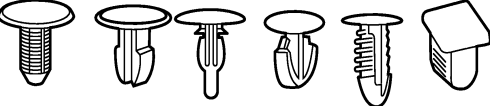
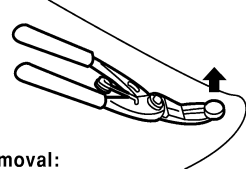
CLIP AND FASTENER

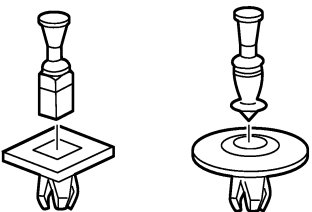
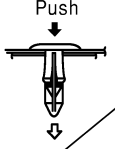
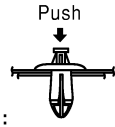
Clip and Fastener

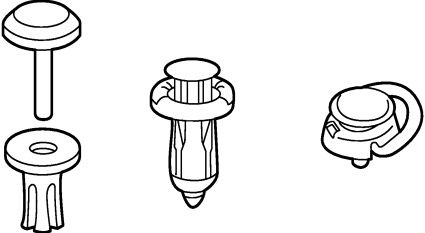
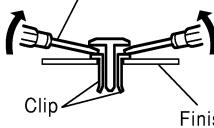

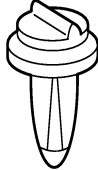
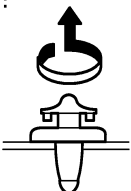





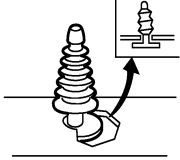
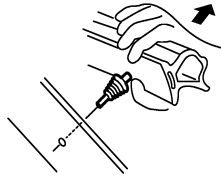

INFOID:000000005256487

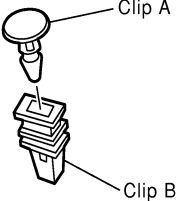
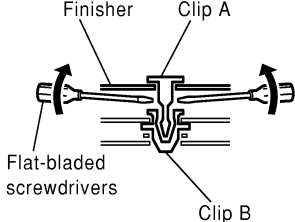
Symbol No.	Shapes	Removal & Installation
<p>C101</p> 		<p>Removal: Remove by bending up with flat-bladed screwdrivers or clip remover.</p> 
<p>C103</p> 		 <p>Removal: Remove with a clip remover.</p>
<p>C203</p> 		<p>Removal: Push center pin to catching position. (Do not remove center pin by hitting it.)</p>  <p>Push</p>  <p>Push</p> <p>Installation:</p>
<p>C205</p> 		<p>Removal: Flat-bladed screwdriver</p>  <p>Clip Finisher</p>
<p>C206</p> 		<p>Removal:</p> 

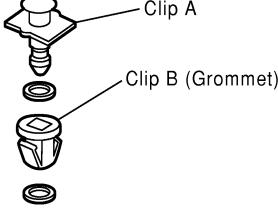
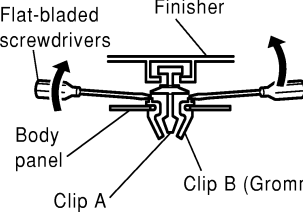
SIIA0315E

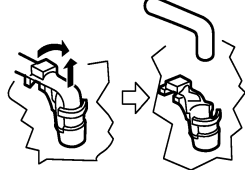
CLIP AND FASTENER

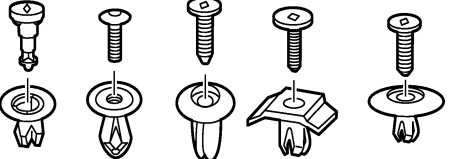
< SYMPTOM DIAGNOSIS >









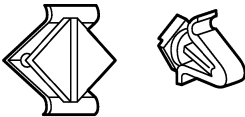

Symbol No.	Shapes	Removal & Installation
<p>CE103</p> 		<p>Removal:</p> 
<p>CF110</p> 		<p>Removal:</p> 
<p>CF118</p> 		<p>Removal:</p> 
<p>CR103</p> 		<p>Removal: Holder portion of clip must be spread out to remove rod.</p> 
<p>CS101</p> 		<p>Removal:</p> <ol style="list-style-type: none"> 1. Screw out with a Phillips screwdriver. 2. Remove female portion with flat-bladed screwdriver. 

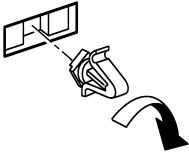
SIIA0316E

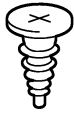
A
B
C
D
E
F
G
H
I
INT
K
L
M
N
O
P

CLIP AND FASTENER

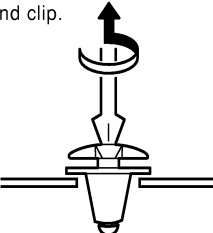
< SYMPTOM DIAGNOSIS >

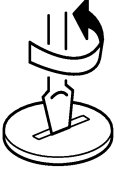
Symbol No.	Shapes	Removal & Installation	
CG101 		Removal:  Rotate 45° to remove	Installation: 
CS102 			
CS113 		Removal: Disconnect upper connection of clip with a flat-bladed screwdriver, then remove clip while inserting a flat-bladed screwdriver between body panel and clip. 	
C111 			

SIIA0317E

PRECAUTIONS

< PRECAUTION >

PRECAUTION

PRECAUTIONS

Precaution for Supplemental Restraint System (SRS) "AIR BAG" and "SEAT BELT PRE-TENSIONER"

INFOID:000000005569567

The Supplemental Restraint System such as "AIR BAG" and "SEAT BELT PRE-TENSIONER", used along with a front seat belt, helps to reduce the risk or severity of injury to the driver and front passenger for certain types of collision. This system includes seat belt switch inputs and dual stage front air bag modules. The SRS system uses the seat belt switches to determine the front air bag deployment, and may only deploy one front air bag, depending on the severity of a collision and whether the front occupants are belted or unbelted. Information necessary to service the system safely is included in the SR and SB section of this Service Manual.

WARNING:

- To avoid rendering the SRS inoperative, which could increase the risk of personal injury or death in the event of a collision which would result in air bag inflation, all maintenance must be performed by an authorized NISSAN/INFINITI dealer.
- Improper maintenance, including incorrect removal and installation of the SRS, can lead to personal injury caused by unintentional activation of the system. For removal of Spiral Cable and Air Bag Module, see the SR section.
- Do not use electrical test equipment on any circuit related to the SRS unless instructed to in this Service Manual. SRS wiring harnesses can be identified by yellow and/or orange harnesses or harness connectors.

PRECAUTIONS WHEN USING POWER TOOLS (AIR OR ELECTRIC) AND HAMMERS

WARNING:

- When working near the Airbag Diagnosis Sensor Unit or other Airbag System sensors with the Ignition ON or engine running, DO NOT use air or electric power tools or strike near the sensor(s) with a hammer. Heavy vibration could activate the sensor(s) and deploy the air bag(s), possibly causing serious injury.
- When using air or electric power tools or hammers, always switch the Ignition OFF, disconnect the battery, and wait at least 3 minutes before performing any service.

Precaution Necessary for Steering Wheel Rotation After Battery Disconnect

INFOID:000000005256489

NOTE:

- This Procedure is applied only to models with Intelligent Key system and NATS (NISSAN ANTI-THEFT SYSTEM).
- Remove and install all control units after disconnecting both battery cables with the ignition knob in the "LOCK" position.
- Always use CONSULT-III to perform self-diagnosis as a part of each function inspection after finishing work. If DTC is detected, perform trouble diagnosis according to self-diagnostic results.

For models equipped with the Intelligent Key system and NATS, an electrically controlled steering lock mechanism is adopted on the key cylinder.

For this reason, if the battery is disconnected or if the battery is discharged, the steering wheel will lock and steering wheel rotation will become impossible.

If steering wheel rotation is required when battery power is interrupted, follow the procedure below before starting the repair operation.

OPERATION PROCEDURE

1. Connect both battery cables.

NOTE:

Supply power using jumper cables if battery is discharged.

2. Use the Intelligent Key or mechanical key to turn the ignition switch to the "ACC" position. At this time, the steering lock will be released.
3. Disconnect both battery cables. The steering lock will remain released and the steering wheel can be rotated.
4. Perform the necessary repair operation.

A
B
C
D
E
F
G
H
I
INT
K
L
M
N
O
P

PRECAUTIONS

< PRECAUTION >

5. When the repair work is completed, return the ignition switch to the "LOCK" position before connecting the battery cables. (At this time, the steering lock mechanism will engage.)
6. Perform a self-diagnosis check of all control units using CONSULT-III.

Service Notice

INFOID:000000005256490

- When removing or installing various parts, place a cloth or padding on the vehicle body to prevent scratches.
- Handle trim, molding, instruments, grille, etc. carefully during removing or installing. Be careful not to soil or damage them.
- Apply sealing compound where necessary when installing parts.
- When applying sealing compound, be careful that the sealing compound does not protrude from parts.
- When replacing any metal parts (for example body outer panel, members, etc.), be sure to take rust prevention measures.

PREPARATION

< PREPARATION >

PREPARATION

PREPARATION

Special Service Tool

INFOID:000000005256491

The actual shapes of Kent-Moore tools may differ from those of special service tools illustrated here.

Tool number (Kent-Moore No.) Tool name	Description
— (J-39570) Chassis ear	Locating the noise
— (J-43980) NISSAN Squeak and Rattle kit	Repairing the cause of noise

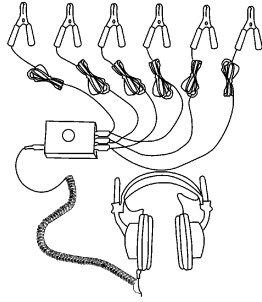

SBT839

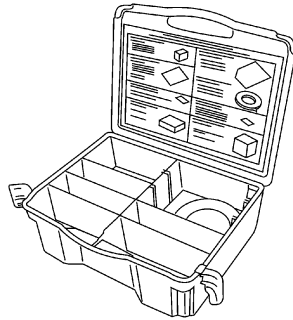

SBT840

Commercial Service Tool

INFOID:000000005256492

(Kent-Moore No.) Tool name	Description
(J-39565) Engine ear	Locating the noise

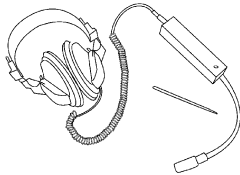

SIIA0995E

A
B
C
D
E
F
G
H
I
INT
K
L
M
N
O
P

DOOR FINISHER

< ON-VEHICLE REPAIR >

ON-VEHICLE REPAIR

DOOR FINISHER

Removal and Installation

INFOID:000000005256493

FRONT DOOR

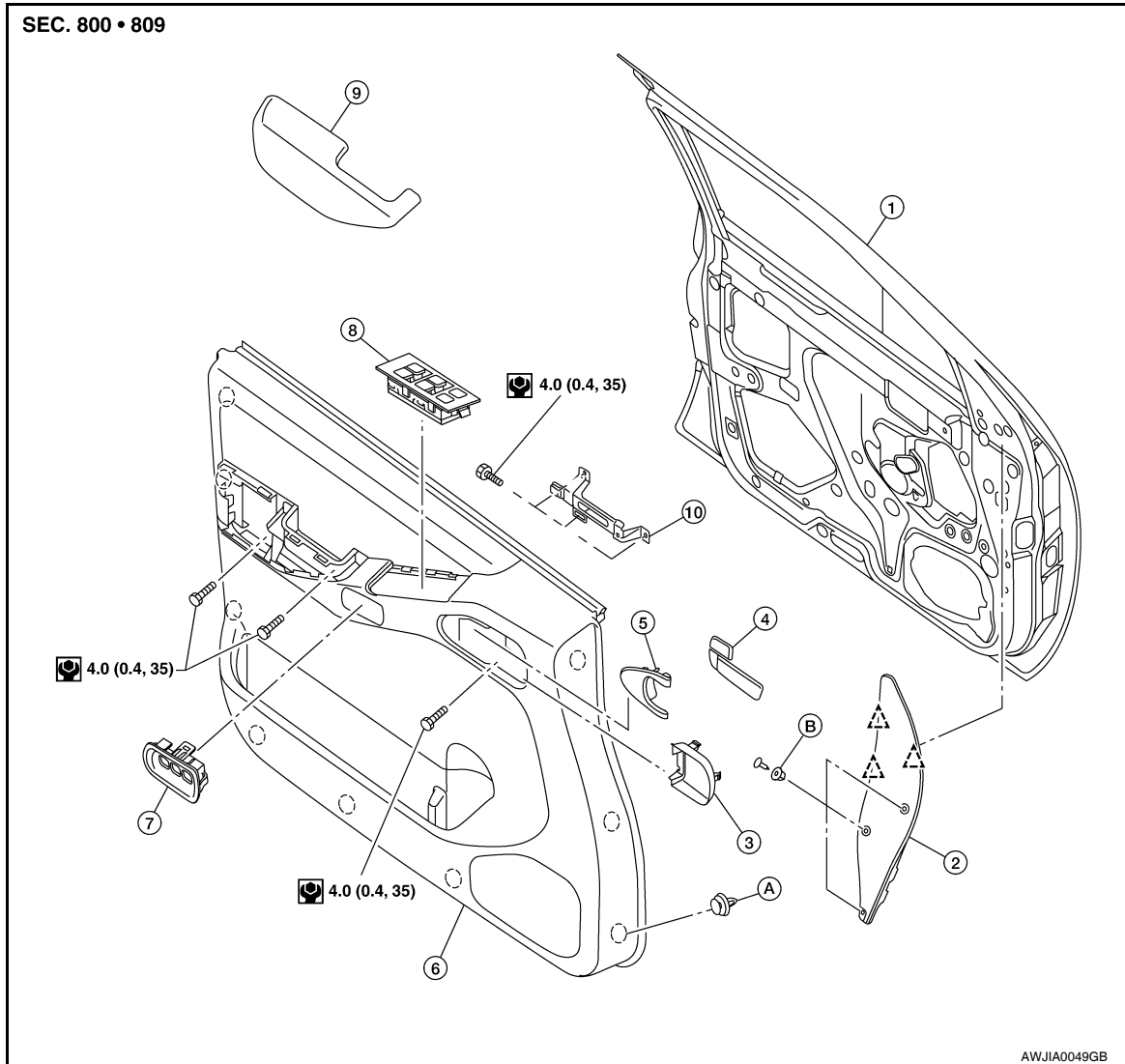

- | | | |
|-------------------------------------|--------------------------------------|---------------------------|
| 1. Front door | 2. Mirror bolt cover LH | 3. Pull handle escutcheon |
| 4. Pull handle/lock lever assembly | 5. Pull handle cover | 6. Front door finisher LH |
| 7. Seat memory switch (if equipped) | 8. Power window/lock switch assembly | 9. Armrest |
| 10. Front door handle bracket | A. Clip C101 | B. Clip C205 |

 Clip

Removal

1. Remove the power window switch assembly.
 - Disconnect the harness connectors.
2. Remove the pull handle escutcheon.
3. Remove the pull handle cover and remove screw.
4. Lift the armrest upward to release clips and remove armrest.
 - Remove the screws behind armrest.
5. Release the clips and remove the door finisher.

DOOR FINISHER

< ON-VEHICLE REPAIR >

- Disconnect lock cable and handle cable from door handle assembly. Refer to [DLK-199, "Removal and Installation"](#).
6. Remove the memory seat switch (if equipped).
 - Disconnect the harness connector.
 7. Remove the pull handle/lock lever assembly.

Installation

Installation is in the reverse order of removal.

REAR DOOR

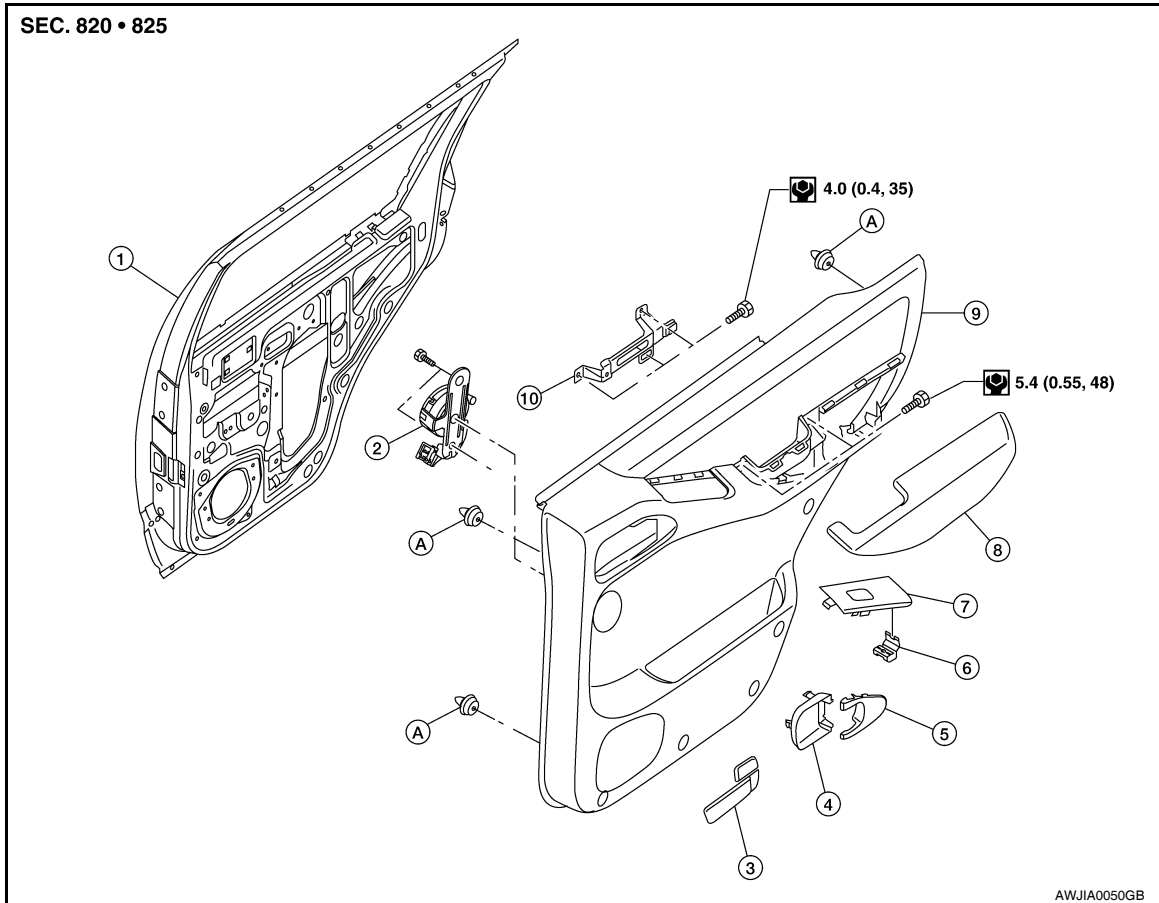

- | | | |
|---------------------------------|----------------------|------------------------------------|
| 1. Rear door | 2. Rear door tweeter | 3. Pull handle/lock lever assembly |
| 4. Pull handle escutcheon | 5. Pull handle cover | 6. Metal clip |
| 7. Power window switch assembly | 8. Armrest | 9. Rear door finisher (RH shown) |
| 10. Rear door handle bracket | A. Clip C101 | |

Removal

1. Remove the power window switch assembly.
 - Disconnect the harness connector.
2. Remove the pull handle cover.
 - Remove the screw behind the pull handle cover.
3. Remove the pull handle escutcheon.
4. Lift upward to release clips and remove the armrest.
 - Remove the screws behind armrest.
5. Release the clips and remove the rear door finisher.
 - Disconnect the rear door tweeter connector, then remove the rear door tweeter screws and remove the rear door tweeter.

Installation

Installation is in the reverse order of removal.

A

B

C

D

E

F

G

H

I

INT

K

L

M

N

O

P

BODY SIDE TRIM

< ON-VEHICLE REPAIR >

BODY SIDE TRIM

Component

INFOID:000000005256494

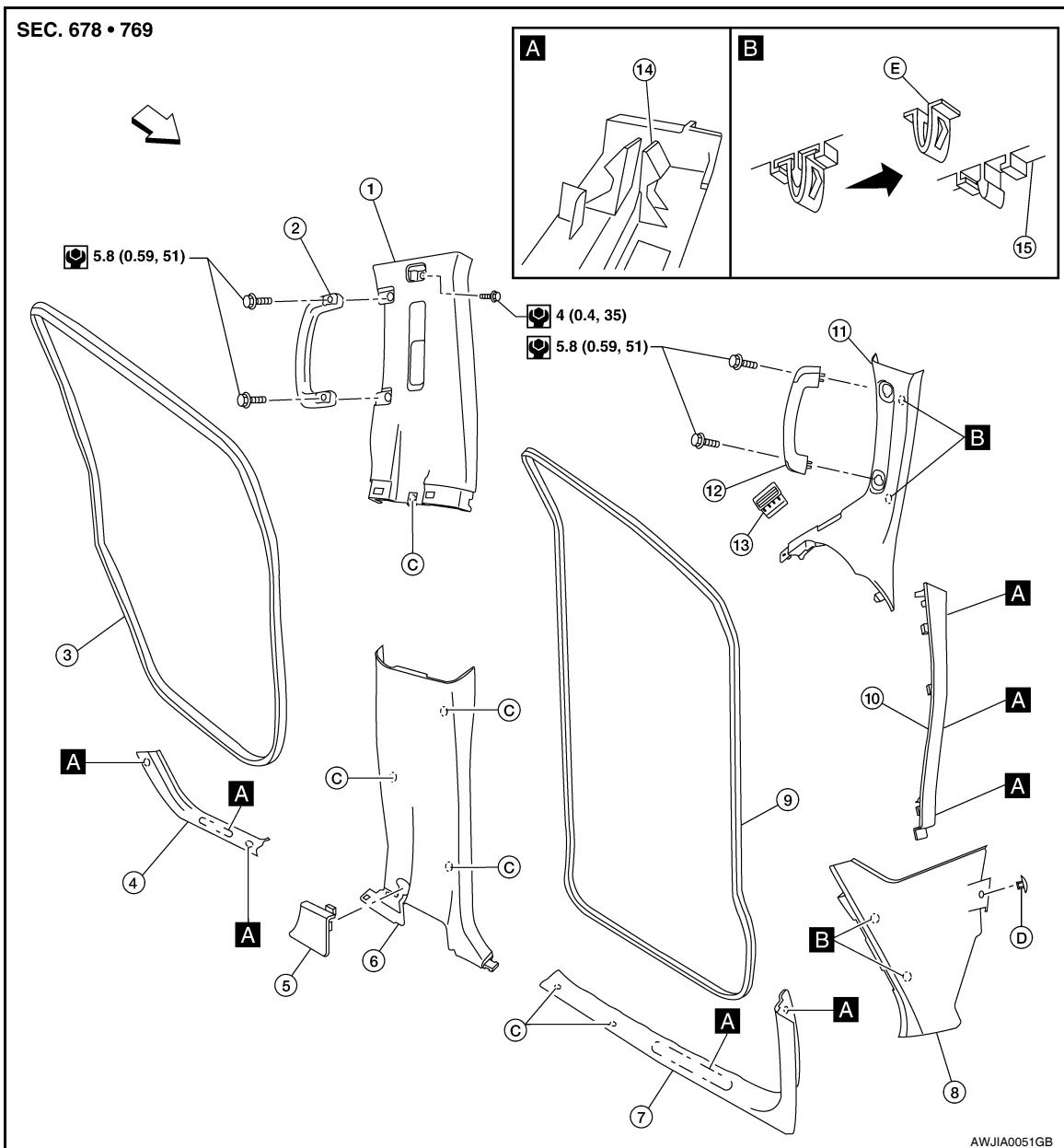

- | | | |
|---------------------------------|---------------------------------|---------------------------------|
| 1. Center pillar upper finisher | 2. Center pillar assist grip | 3. Rear door welt |
| 4. Rear kick plate | 5. Access cover (RH side only) | 6. Center pillar lower finisher |
| 7. Front kick plate | 8. Lower dash side finisher | 9. Front door welt |
| 10. Front pillar lower finisher | 11. Front pillar upper finisher | 12. Front pillar assist grip |
| 13. LH side demister grille | 14. Molded plastic clip | 15. Garnish |
| C. Clip C101 | D. Clip C111 | E. Metal clip |
- ↶ Vehicle front

CAUTION:

- Wrap the tip of flat-bladed screwdriver with a cloth when removing metal clips from finishers.
- When removing or installing body side welts, do not allow butyl seal to come in contact with pillar finisher.

BODY SIDE TRIM

< ON-VEHICLE REPAIR >

Removal and Installation

INFOID:000000005256495

LOWER DASH SIDE FINISHER

Removal

1. Remove the push pin from lower dash side finisher.
2. Remove the front kick plate from center pillar lower finisher.
3. Remove the lower dash side finisher and the front kick plate together.
4. Remove the lower dash side finisher from the front kick plate.

Installation

Installation is in the reverse order of removal.

CENTER PILLAR LOWER FINISHER

Removal

1. Remove the seat belt anchor. Refer to [SB-12. "Removal and Installation"](#).
 - On RH side, disconnect seat belt tension sensor.
2. Remove the front and rear kick plates.
3. Remove the center pillar lower finisher.

Installation

Installation is in the reverse order of removal.

CENTER PILLAR UPPER FINISHER

Removal

1. Remove the front and rear door welts.
2. Remove the seat belt shoulder anchor and D-ring. Refer to [SB-12. "Removal and Installation"](#).
3. Remove the front and rear kick plates.
4. Remove the center pillar lower finisher.
5. Remove the center pillar assist grip.
6. Remove the center pillar upper finisher.

Installation

Installation is in the reverse order of removal.

FRONT PILLAR UPPER FINISHER

Removal

1. Remove the front pillar assist grip.
2. Remove the front pillar upper finisher bolt.
3. Remove the front pillar upper finisher.

Installation

Installation is in the reverse order of removal.

FRONT PILLAR LOWER FINISHER

Removal

1. Partially remove the front door welt.
2. Remove the front pillar lower finisher.

Installation

Installation is in the reverse order of removal.

KICK PLATES

Removal

Release clips and remove the front and/or rear kick plates.

Installation

Installation is in the reverse order of removal.

A

B

C

D

E

F

G

H

I

INT

K

L

M

N

O

P

FLOOR TRIM

< ON-VEHICLE REPAIR >

FLOOR TRIM

Removal and Installation

INFOID:000000005256496

Front and Rear Floor Carpet

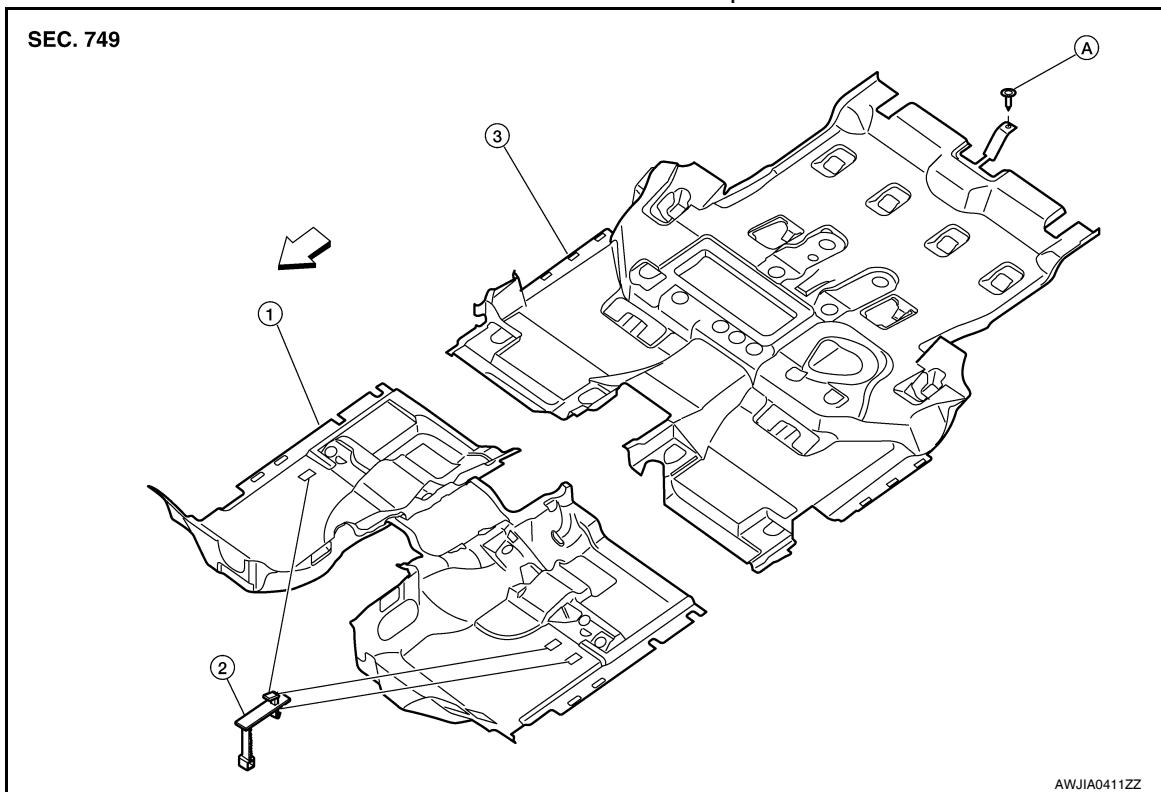

- 1. Front carpet
- A. Clip C103

- 2. Floor mat hooks
- ↔ Vehicle front

- 3. Rear carpet

REMOVAL

Front Carpet

1. Remove the front seats. Refer to [SE-30, "Removal and Installation"](#).
2. Remove the lower seat belt anchors. Refer to [SB-12, "Removal and Installation"](#).
3. Remove the lower body side trim panels. Refer to [INT-17, "Removal and Installation"](#).
4. Remove the center console. Refer to [IP-12, "Removal and Installation"](#).
5. Remove the floor mat hooks from the front carpet.
6. Remove the front carpet.

Rear Carpet

1. Remove the second and third row seats. Refer to [SE-31, "Removal and Installation"](#).
2. Remove the luggage side lower finisher RH and LH. Refer to [INT-22, "Removal and Installation"](#).
3. Remove the flipper doors and the floor tray. Refer to [INT-22, "Removal and Installation"](#).
4. Remove the bolts and the storage box. Refer to [INT-22, "Removal and Installation"](#).
5. Remove the rear carpet.

INSTALLATION

Installation is in the reverse order of removal.

HEADLINING

< ON-VEHICLE REPAIR >

HEADLINING

Removal and Installation

INFOID:000000005256497

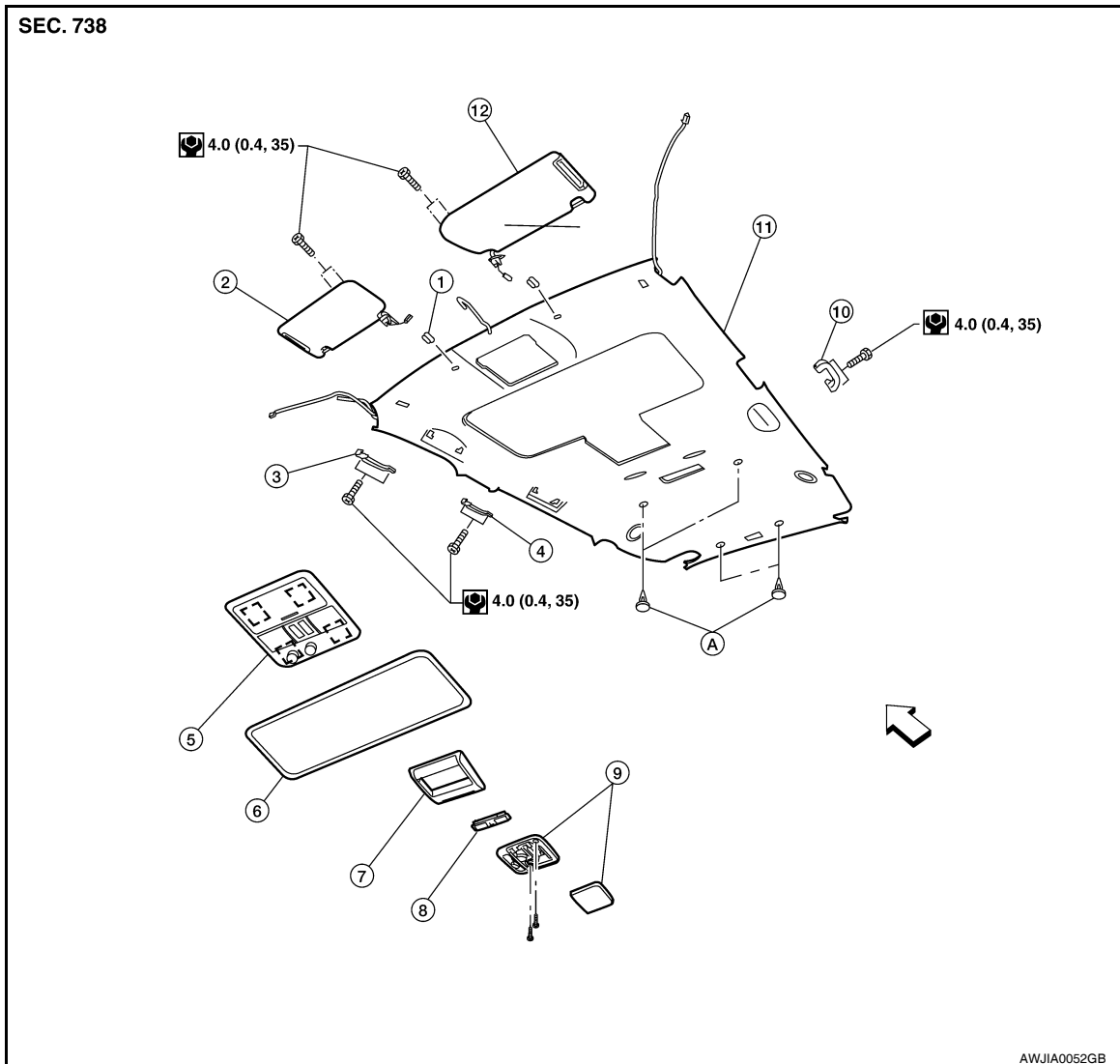

A

B

C

D

E

F

G

H

I

INT

K

L

M

N

O

P

- | | | |
|---|--|-------------------------------|
| 1. Sun visor holder LH/RH | 2. Sun visor assembly RH | 3. Front assist grip RH |
| 4. Rear assist grip RH | 5. Front roof console with front room lamp assembly and sunglass bin | 6. Sunroof welt (if equipped) |
| 7. DVD video monitor finisher (if equipped) | 8. Center room lamp assembly | 9. Rear room lamp assembly |
| 10. Rear assist grip LH | 11. Headlining | 12. Sun visor assembly LH |
| A. Clip C103 | ↔ Vehicle front | ☐ Metal clip |

REMOVAL

1. Remove the body side trim panels. Refer to [INT-16, "Component"](#).
2. Remove the luggage floor trim upper panels. Refer to [INT-21, "Component"](#).
3. Remove the sun visor assemblies, both LH and RH.
4. Remove the sun visor holders LH and RH.
5. Remove the sunroof welt (if equipped).
6. Remove the DVD video monitor assembly (if equipped). Refer to [AV-148, "Removal and Installation of Video Monitor"](#) (Mid audio), [AV-301, "Removal and Installation of Video Monitor"](#) (BOSE audio without navigation) and [AV-468, "Removal and Installation of Video Monitor"](#) (BOSE audio with navigation).

HEADLINING

< ON-VEHICLE REPAIR >

- Disconnect the harnesses.
- 7. Remove the front and rear RH and LH assist grips.
- 8. Release the front roof console clips, using a suitable tool and remove the front roof console.
 - Disconnect the harness.
- 9. Remove the center room and the rear room lamp assemblies.
- 10. Remove the rear upper overhead duct (if equipped). Refer to [VTL-34. "Removal and Installation"](#).
- 11. Remove the headlining.

NOTE:
Use an assistant to steady the headlining while lowering from roof.

 - Remove the clips from center of headlining.
 - Remove the clips from rear of headlining.
 - Disconnect the rear washer tube at front connection, allow to drain.
 - Disconnect the harnesses and rear washer tube rear connections.
- 12. Remove the overhead grilles, then transfer them to the new headlining.
- 13. Remove the assist grip brackets from the roof.

INSTALLATION

Installation is in the reverse order of removal.

LUGGAGE FLOOR TRIM

< ON-VEHICLE REPAIR >

LUGGAGE FLOOR TRIM

Component

INFOID:00000005256498

Luggage Trim - Side

SEC. 850

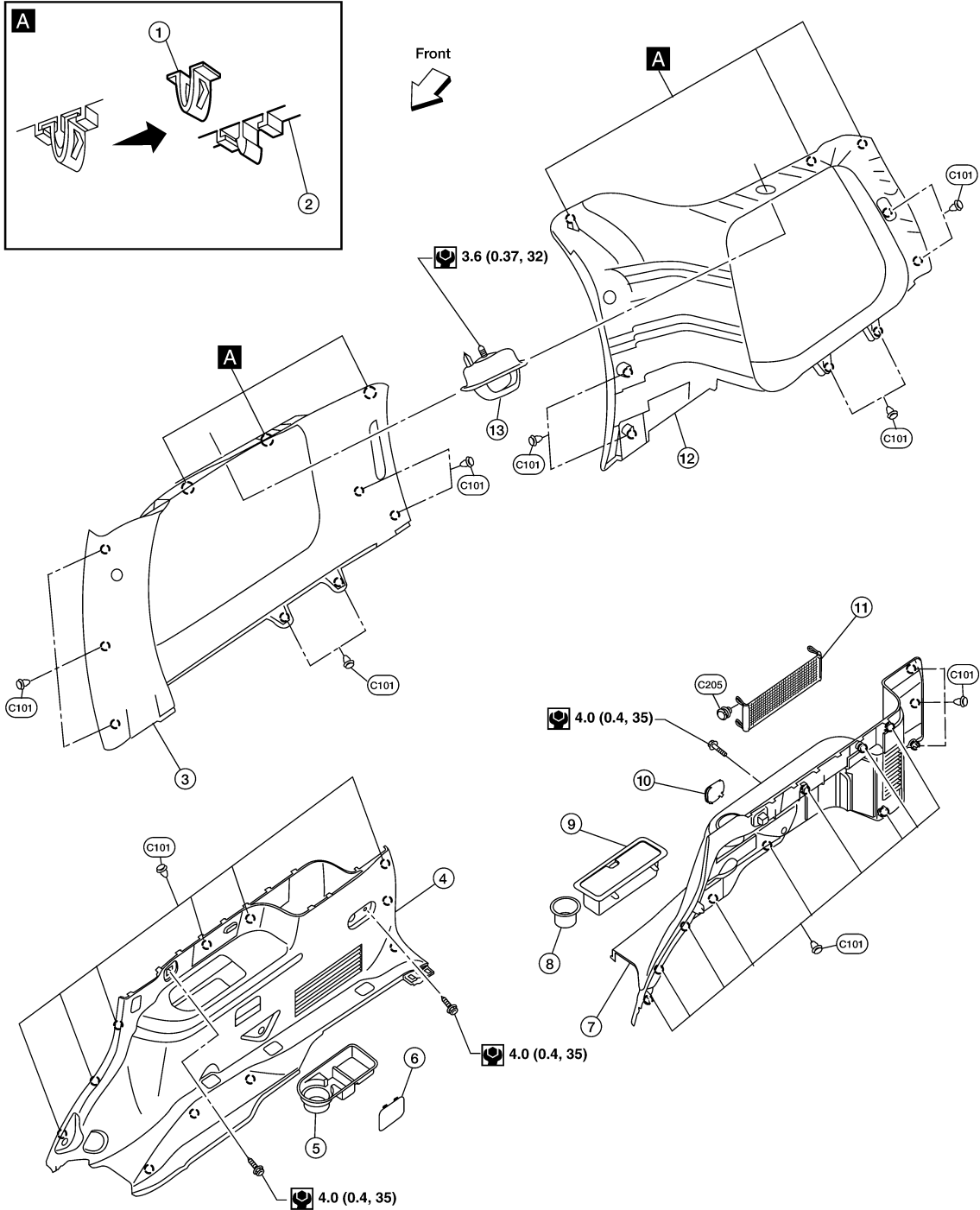

N·m (kg·m, in·lb)

LIIA1783E

- | | | |
|-----------------------------------|------------------------|-----------------------------------|
| 1. Metal clip | 2. Garnish | 3. Luggage side upper finisher RH |
| 4. Luggage side lower finisher RH | 5. Cup holder and tray | 6. Access cover |
| 7. Luggage side lower finisher LH | 8. Cup holder | 9. Storage bin |

A
B
C
D
E
F
G
H
I
INT
K
L
M
N
O
P

LUGGAGE FLOOR TRIM

< ON-VEHICLE REPAIR >

- 10. Access cover
- 13. Coat hook

- 11. Side cargo net

- 12. Luggage side upper finisher LH

Luggage Trim - Floor

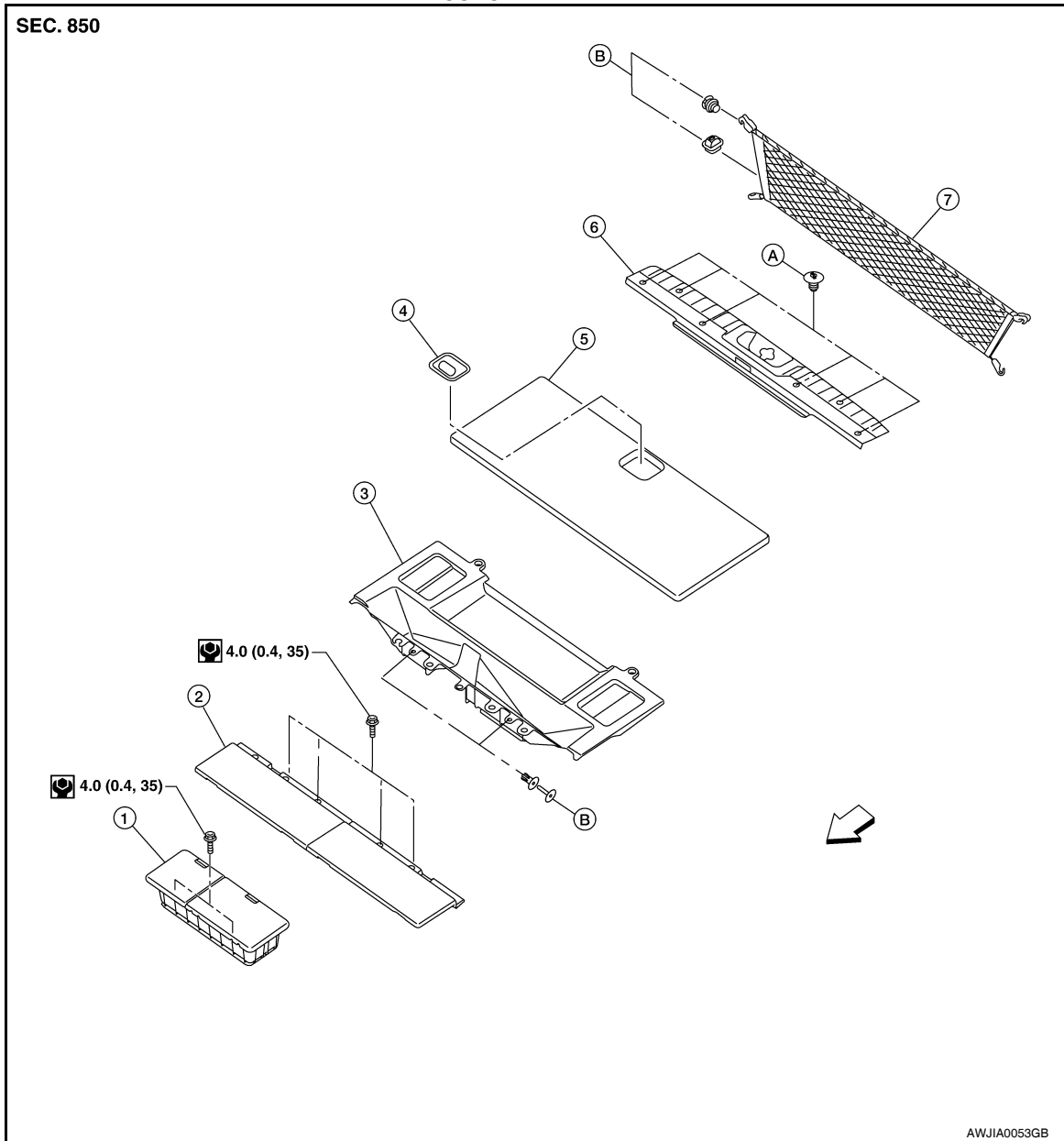

- | | | |
|------------------------------|------------------------|------------------------|
| 1. Floor storage bin | 2. Flipper panel | 3. Storage tray |
| 4. Luggage floor board latch | 5. Luggage floor board | 6. Tailgate kick plate |
| 7. Cargo net | A. Clip C101 | B. Clip C205 |
- ↶ Vehicle front

Removal and Installation

INFOID:000000005256499

REMOVAL

1. Remove the 2nd and 3rd row seat belts. Refer to [SB-6, "Removal and Installation of Rear Seat Belt"](#) and [SB-8, "Removal and Installation of Third Row Seat Belt"](#).
2. Remove the third row seat belt buckles. Refer to [SB-8, "Removal and Installation of Third Row Seat Belt"](#).
3. Remove the rear door kick plates. refer to [INT-16](#).
4. Remove the tailgate kick plate.

LUGGAGE FLOOR TRIM

< ON-VEHICLE REPAIR >

5. Disconnect the door open/close link. Refer to [DLK-203. "Component Structure"](#).
6. Remove the cargo net hooks.
7. Remove the LH and RH luggage side lower finishers.
 - Disconnect the power point on the RH side.
8. Remove the LH and RH coat hooks.
9. Remove the LH and RH luggage side upper finishers.
10. Remove the cargo net hooks LH/RH.
11. Remove the luggage floor board.
12. Remove the flipper panel.
13. Remove the storage tray.
14. Remove the floor storage bin.

INSTALLATION

Installation is in the reverse order of removal.

A

B

C

D

E

F

G

H

I

INT

K

L

M

N

O

P

BACK DOOR TRIM

< ON-VEHICLE REPAIR >

BACK DOOR TRIM

Removal and Installation

INFOID:000000005256500

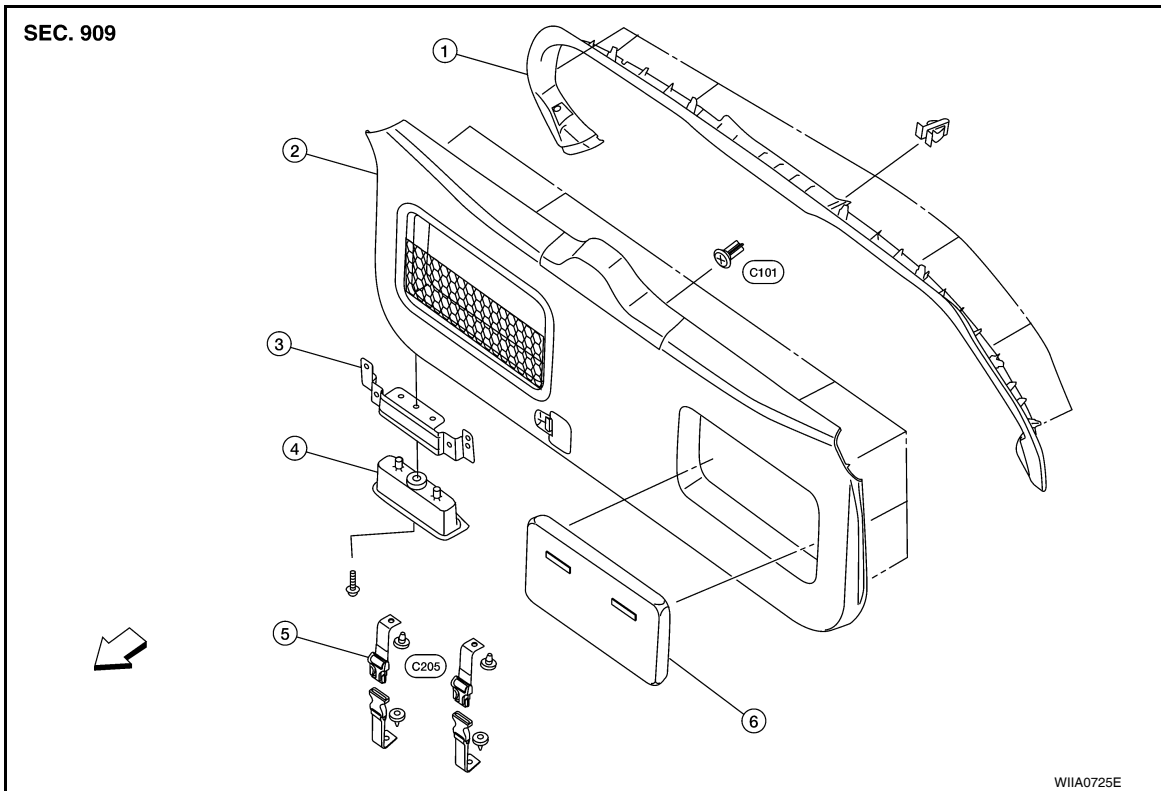

- | | | |
|-----------------------------|------------------------|-----------------------------|
| 1. Back door window garnish | 2. Back door finisher | 3. Back door handle bracket |
| 4. Back door handle | 5. First aid kit strap | 6. First aid kit |
- ← Vehicle front

REMOVAL

1. Open the back door glass.
2. Disconnect the gas spring LH and RH from the back door (through window garnish).
3. Open the back door, release the clips and remove the back door window garnish.
4. Remove the screw and the back door handle.
5. Release the clips and remove the back door finisher assembly.

INSTALLATION

Installation is in the reverse order of removal.