

SECTION **DEF**
DEFOGGER

A
 B
 C
 D
 E
 F
 G
 H
 I
 J
 K
DEF
 M
 N
 O
 P

CONTENTS

PRECAUTION	3	DTC/CIRCUIT DIAGNOSIS	26
PRECAUTIONS	3	REAR WINDOW DEFOGGER SWITCH	26
Precaution for Supplemental Restraint System (SRS) "AIR BAG" and "SEAT BELT PRE-TENSIONER"	3	Description	26
Handling for Adhesive and Primer	3	Component Function Check	26
SYSTEM DESCRIPTION	4	Diagnosis Procedure	26
COMPONENT PARTS	4	REAR WINDOW DEFOGGER RELAY	31
Component Parts Location	4	Description	31
Component Description	5	Component Function Check	31
SYSTEM	6	Diagnosis Procedure	31
System Diagram	6	Component Inspection	32
System Description	6	REAR WINDOW DEFOGGER POWER SUPPLY AND GROUND CIRCUIT	33
DIAGNOSIS SYSTEM (BCM)	7	Description	33
COMMON ITEM	7	Component Function Check	33
COMMON ITEM : CONSULT Function (BCM - COMMON ITEM)	7	Diagnosis Procedure	33
REAR WINDOW DEFOGGER	8	Component Inspection	34
REAR WINDOW DEFOGGER : CONSULT Function (BCM - REAR DEFOGGER)	8	DOOR MIRROR DEFOGGER LH (WITH AROUND VIEW MONITOR)	35
ECU DIAGNOSIS INFORMATION	9	Description	35
BCM	9	Component Function Check	35
List of ECU Reference	9	Diagnosis Procedure	35
WIRING DIAGRAM	10	Component Inspection	36
REAR WINDOW DEFOGGER SYSTEM	10	DOOR MIRROR DEFOGGER LH (WITH AROUND VIEW MONITOR)	37
Wiring Diagram	10	Description	37
BASIC INSPECTION	23	Component Function Check	37
DIAGNOSIS AND REPAIR WORK FLOW	23	Diagnosis Procedure	37
Work Flow	23	Component Inspection	38
		DOOR MIRROR DEFOGGER RH (WITHOUT AROUND VIEW MONITOR)	39
		Description	39
		Component Function Check	39
		Diagnosis Procedure	39
		Component Inspection	40

DOOR MIRROR DEFOGGER RH (WITH AROUND VIEW MONITOR)	41	Diagnosis Procedure	46
Description	41	DRIVER SIDE DOOR MIRROR DEFOGGER DOES NOT OPERATE.	48
Component Function Check	41	Diagnosis Procedure	48
Diagnosis Procedure	41	PASSENGER SIDE DOOR MIRROR DEFOGGER DOES NOT OPERATE.	49
Component Inspection	42	Diagnosis Procedure	49
SYMPTOM DIAGNOSIS	43	REAR WINDOW DEFOGGER SWITCH DOES NOT LIGHT, BUT REAR WINDOW DEFOGGER OPERATES	50
DEFOGGER SYSTEM SYMPTOMS	43	Diagnosis Procedure	50
Symptom Table	43	REMOVAL AND INSTALLATION	51
REAR WINDOW DEFOGGER AND DOOR MIRROR DEFOGGER DO NOT OPERATE.	44	FILAMENT	51
Diagnosis Procedure	44	Inspection and Repair	51
REAR WINDOW DEFOGGER DOES NOT OPERATE BUT BOTH OF DOOR MIRROR DEFOGGER OPERATE.	45	CONDENSER	53
Diagnosis Procedure	45	Removal and Installation	53
BOTH DOORS MIRROR DEFOGGER DON'T OPERATE BUT REAR WINDOW DEFOGGER OPERATES	46		

PRECAUTIONS

< PRECAUTION >

PRECAUTION

PRECAUTIONS

Precaution for Supplemental Restraint System (SRS) "AIR BAG" and "SEAT BELT PRE-TENSIONER"

INFOID:000000009745227

The Supplemental Restraint System such as "AIR BAG" and "SEAT BELT PRE-TENSIONER", used along with a front seat belt, helps to reduce the risk or severity of injury to the driver and front passenger for certain types of collision. Information necessary to service the system safely is included in the SR and SB section of this Service Manual.

WARNING:

- To avoid rendering the SRS inoperative, which could increase the risk of personal injury or death in the event of a collision which would result in air bag inflation, all maintenance must be performed by an authorized NISSAN/INFINITI dealer.
- Improper maintenance, including incorrect removal and installation of the SRS, can lead to personal injury caused by unintentional activation of the system. For removal of Spiral Cable and Air Bag Module, see the SR section.
- Do not use electrical test equipment on any circuit related to the SRS unless instructed to in this Service Manual. SRS wiring harnesses can be identified by yellow and/or orange harnesses or harness connectors.

PRECAUTIONS WHEN USING POWER TOOLS (AIR OR ELECTRIC) AND HAMMERS

WARNING:

- When working near the Airbag Diagnosis Sensor Unit or other Airbag System sensors with the Ignition ON or engine running, DO NOT use air or electric power tools or strike near the sensor(s) with a hammer. Heavy vibration could activate the sensor(s) and deploy the air bag(s), possibly causing serious injury.
- When using air or electric power tools or hammers, always switch the Ignition OFF, disconnect the battery and wait at least three minutes before performing any service.

Handling for Adhesive and Primer

INFOID:000000009725689

- Do not use an adhesive which is past its usable date. Shelf life of this product is limited to six months after the date of manufacture. Carefully adhere to the expiration or manufacture date printed on the box.
- Keep primers and adhesive in a cool, dry place. Ideally, they should be stored in a refrigerator.
- Open the seal of the primer and adhesive just before application. Discard the remainder.
- Before application, be sure to shake the primer container to stir the contents. If any floating material is found, do not use it.
- If any primer or adhesive contacts the skin, wipe it off with gasoline or equivalent and wash the skin with soap.
- When using primer and adhesive, always observe the precautions in the instruction manual.

A
B
C
D
E
F
G
H
I
J
K
DEF
M
N
O
P

COMPONENT PARTS

< SYSTEM DESCRIPTION >

SYSTEM DESCRIPTION

COMPONENT PARTS

Component Parts Location

INFOID:000000009175546

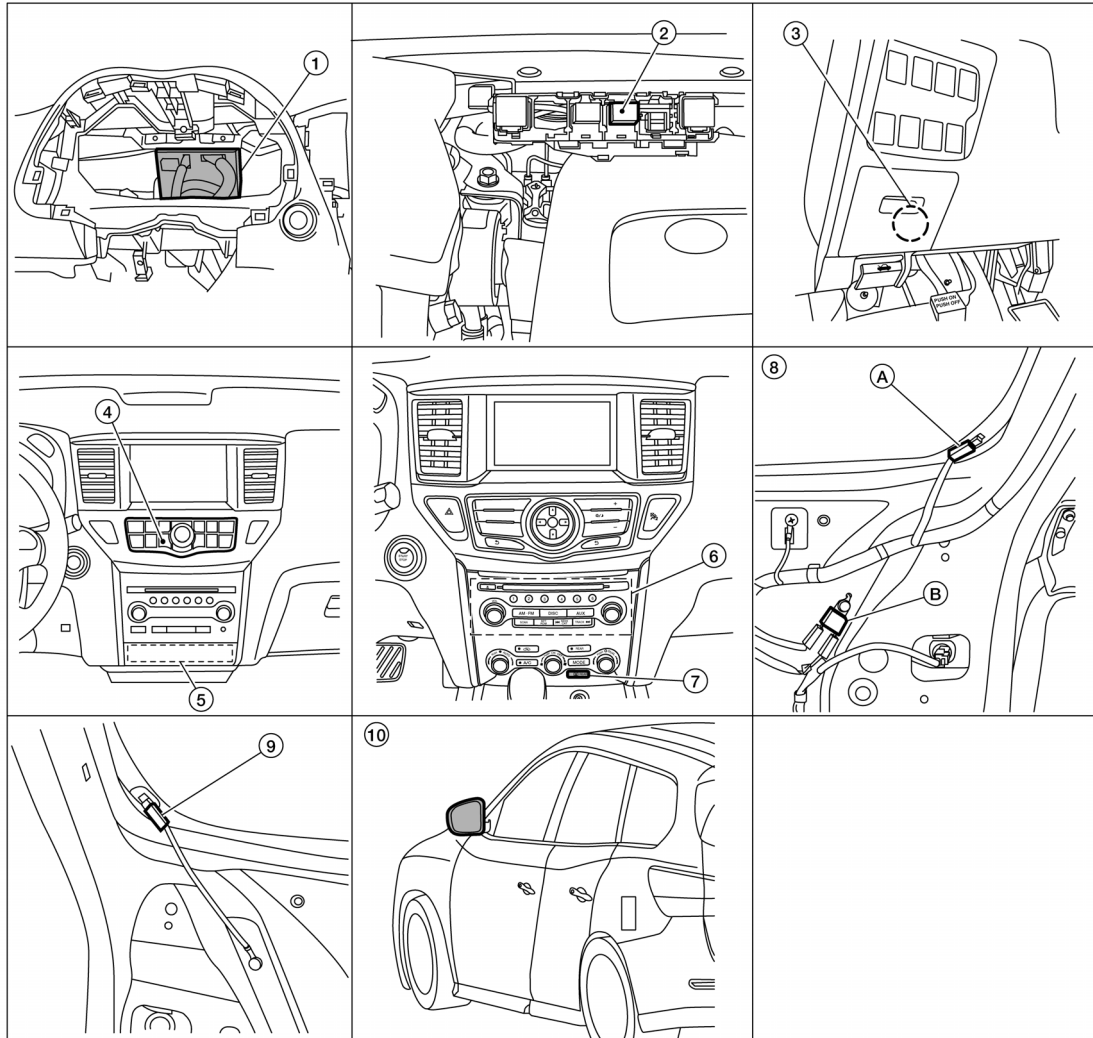

ALLIA1186ZZ

- | | | |
|--|--|---|
| 1. BCM (view with instrument panel removed) | 2. Accessory relay-2 | 3. Fuse block (J/B) (Rear window defogger relay) |
| 4. A/C switch assembly (rear window defogger switch) (with base audio system) | 5. A/C auto amp. | 6. AV control unit |
| 7. A/C and AV switch assembly (rear window defogger switch) (except base audio system) | 8. A. Rear window defogger power connector
B. Rear window defogger condenser (view with back door lower finisher removed) | 9. Rear window defogger ground connector (view with back door lower finisher removed) |
| 10. Door mirror LH (door mirror defogger) (RH similar) | | |

COMPONENT PARTS

< SYSTEM DESCRIPTION >

Component Description

INFOID:000000009175547

Component	Description
AV control unit ²	<ul style="list-style-type: none"> AV control unit transmits A/C switch operation signal to the BCM via CAN communication line.
BCM	<ul style="list-style-type: none"> Operates the rear window defogger relay with the operation of rear window defogger switch. Performs the timer control of rear window defogger.
A/C auto amp ¹	<ul style="list-style-type: none"> Transmits rear window defogger switch ON signal to the BCM. Turns the indicator lamp ON when detecting the operation of rear window defogger.
Rear window defogger relay	<ul style="list-style-type: none"> Operates the rear window defogger and the door mirror defogger with the control signal from BCM.
A/C switch assembly ¹ (rear window defogger switch)	<ul style="list-style-type: none"> Transmits rear window defogger switch ON signal. Turns the indicator lamp ON when detecting the operation of rear window defogger.
A/C and AV switch assembly ² (rear window defogger switch)	<ul style="list-style-type: none"> Transmits rear window defogger switch ON signal. Turns the indicator lamp ON when detecting the operation of rear window defogger.
Rear window defogger	<ul style="list-style-type: none"> Heats the heating wire with the power supply from the rear window defogger relay to prevent the rear window from fogging up.
Door mirror defogger ³	<ul style="list-style-type: none"> Heats the heating wire with the power supply from the rear window defogger relay to prevent the door mirror from fogging up.

¹: With Base audio system

²: Except base audio system

³: With heated mirrors

A
B
C
D
E
F
G
H
I
J
K
DEF
M
N
O
P

SYSTEM

< SYSTEM DESCRIPTION >

SYSTEM

System Diagram

INFOID:000000009175548

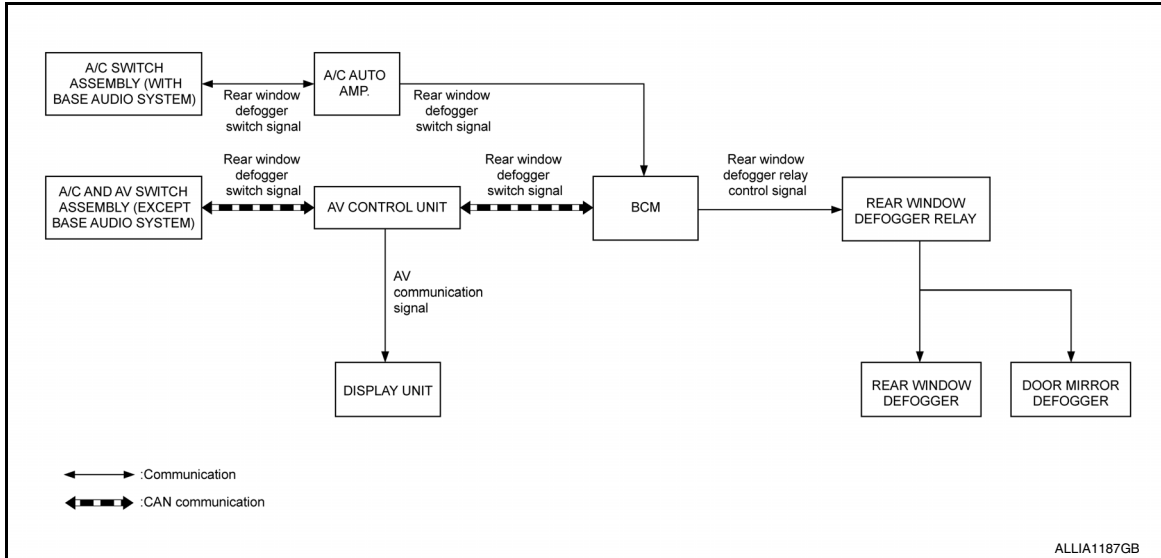

System Description

INFOID:000000009175549

Operation Description

- When rear window defogger switch is turned ON while ignition switch is ON, the rear window defogger switch signal is transmitted to the BCM.
- BCM turns rear window defogger relay ON when rear window defogger switch signal is received.
- Rear window defogger and door mirror defogger are supplied with power and operate when rear window defogger relay turns ON.
- Rear window defogger ON is displayed when signal is received.
- For vehicles with base audio system, A/C auto amp. transmits rear window defogger control signal to A/C switch assembly when rear window defogger operates.
- For vehicles without base audio system, BCM transmits rear window defogger control signal to AV control unit and A/C and AV switch assembly via CAN communication when rear window defogger operates.

Timer function

- BCM turns rear window defogger relay ON for approximately 15 minutes when rear window defogger switch is turned ON while ignition switch is ON. It makes rear window defogger and door mirror defogger (with door mirror defogger) operate.
- Timer is canceled after pressing rear window defogger switch again during timer operation. Then BCM turns rear window defogger relay OFF. The same reaction also occurs during timer operation, if the ignition switch is turned OFF.

INPUT/OUTPUT SIGNAL CHART

Switch	Input signal to BCM	BCM function	Actuator
Rear window defogger switch	Defogger switch signal	Rear window defogger and door mirror defogger control	Rear window defogger Door mirror defogger
Push button ignition switch	Ignition signal		

DIAGNOSIS SYSTEM (BCM)

< SYSTEM DESCRIPTION >

DIAGNOSIS SYSTEM (BCM)

COMMON ITEM

COMMON ITEM : CONSULT Function (BCM - COMMON ITEM)

INFOID:000000009763997

CAUTION:

After disconnecting the CONSULT vehicle interface (VI) from the data link connector, the ignition must be cycled OFF → ON (for at least 5 seconds) → OFF. If this step is not performed, the BCM may not go to "sleep mode", potentially causing a discharged battery and no-start condition.

APPLICATION ITEM

CONSULT performs the following functions via CAN communication with BCM.

Direct Diagnostic Mode	Description
Ecu Identification	The BCM part number is displayed.
Self Diagnostic Result	The BCM self diagnostic results are displayed.
Data Monitor	The BCM input/output data is displayed in real time.
Active Test	The BCM activates outputs to test components.
Work support	The settings for BCM functions can be changed.
Configuration	<ul style="list-style-type: none"> The vehicle specification can be read and saved. The vehicle specification can be written when replacing BCM.
CAN Diag Support Mntr	The result of transmit/receive diagnosis of CAN communication is displayed.

SYSTEM APPLICATION

BCM can perform the following functions.

System	Sub System	Direct Diagnostic Mode						
		Ecu Identification	Self Diagnostic Result	Data Monitor	Active Test	Work support	Configuration	CAN Diag Support Mntr
Door lock	DOOR LOCK		×	×	×	×		
Rear window defogger	REAR DEFOGGER			×	×	×		
Warning chime	BUZZER			×	×			
Interior room lamp timer	INT LAMP			×	×	×		
Exterior lamp	HEADLAMP			×	×	×		
Wiper and washer	WIPER			×	×	×		
Turn signal and hazard warning lamps	FLASHER			×	×			
Air conditioner	AIR CONDITIONER			×				
Intelligent Key system	INTELLIGENT KEY		×	×	×	×		
Combination switch	COMB SW			×				
BCM	BCM	×	×			×	×	×
Immobilizer	IMMU		×	×	×			
Interior room lamp battery saver	BATTERY SAVER			×	×			
Back door open	TRUNK			×				
Vehicle security system	THEFT ALM			×	×	×		
RAP system	RETAINED PWR			×				

DIAGNOSIS SYSTEM (BCM)

< SYSTEM DESCRIPTION >

System	Sub System	Direct Diagnostic Mode						
		Ecu Identification	Self Diagnostic Result	Data Monitor	Active Test	Work support	Configuration	CAN Diag Support Mntr
Signal buffer system	SIGNAL BUFFER			×				
TPMS	AIR PRESSURE MONITOR		×	×	×	×		

REAR WINDOW DEFOGGER

REAR WINDOW DEFOGGER : CONSULT Function (BCM - REAR DEFOGGER)

INFOID:000000009763998

CAUTION:

After disconnecting the CONSULT vehicle interface (VI) from the data link connector, the ignition must be cycled OFF → ON (for at least 5 seconds) → OFF. If this step is not performed, the BCM may not go to "sleep mode", potentially causing a discharged battery and no-start condition.

DATA MONITOR

Monitor Item [Unit]	Description
PUSH SW [On/Off]	Indicates condition of push-button ignition switch.
REAR DEF SW [On/Off]	Indicates condition of rear window defogger switch.

ACTIVE TEST

Test Item	Description
REAR DEFOGGER	This test is able to check rear window defogger operation [Off/On].

WORK SUPPORT

Support Item	Setting	Description
SET R-DEF TIMER	MODE3	Rear defogger turns OFF after 1 minute.
	MODE2	Rear defogger remains ON until turned OFF.
	MODE1*	Rear defogger turns OFF after 15 minutes.

* : Initial setting

BCM

< ECU DIAGNOSIS INFORMATION >

ECU DIAGNOSIS INFORMATION

BCM

List of ECU Reference

INFOID:000000009175552

ECU	Reference
BCM	BCS-30. "Reference Value"
	BCS-50. "Fail Safe"
	BCS-50. "DTC Inspection Priority Chart"
	BCS-52. "DTC Index"

A
B
C
D
E
F
G
H
I
J
K
DEF
M
N
O
P

REAR WINDOW DEFOGGER SYSTEM

< WIRING DIAGRAM >

REAR WINDOW DEFOGGER CONNECTORS

Connector No.	M3
Connector Name	FUSE BLOCK (J/B)
Connector Color	WHITE

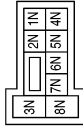

Terminal No.	Color of Wire	Signal Name
6N	W	-

Connector No.	M4
Connector Name	FUSE BLOCK (J/B)
Connector Color	WHITE



Terminal No.	Color of Wire	Signal Name
3P	G	-
4P	LG	-
5P	BR	-
6P	BG	-
7P	LG	-

Connector No.	M18
Connector Name	BCM (BODY CONTROL MODULE)
Connector Color	GREEN

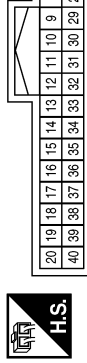

Terminal No.	Color of Wire	Signal Name
32	R	RR DEF SW

Connector No.	M19
Connector Name	BCM (BODY CONTROL MODULE)
Connector Color	BLACK



Terminal No.	Color of Wire	Signal Name
59	P	CAN-L
60	L	CAN-H
61	BG	REAR DEFOGGER RELAY OUT
67	G	IGN ELEC RELAY OUT 2

Connector No.	M31
Connector Name	WIRE TO WIRE
Connector Color	WHITE

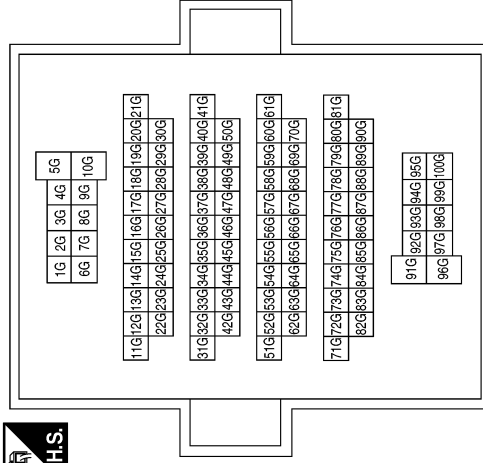

Terminal No.	Color of Wire	Signal Name
3G	P	-
10G	W	-
50G	L	-

REAR WINDOW DEFOGGER SYSTEM

< WIRING DIAGRAM >

Connector No.	M41
Connector Name	JOINT CONNECTOR-M18
Connector Color	WHITE



Terminal No.	Color of Wire	Signal Name
1	P	-
2	P	-

Terminal No.	Color of Wire	Signal Name
89A	L	-
90A	P	-

Connector No.	M40
Connector Name	WIRE TO WIRE
Connector Color	GRAY

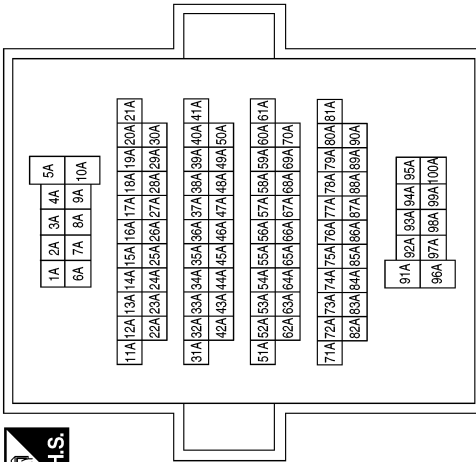

Connector No.	M45
Connector Name	AV CONTROL UNIT (WITH MID AUDIO SYSTEM - WITH BOSE AUDIO SYSTEM)
Connector Color	WHITE

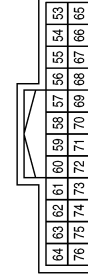

Terminal No.	Color of Wire	Signal Name
61	B	DISP IT
72	SHIELD	DISP SHIELD
73	W	IT DISP

Connector No.	M43
Connector Name	JOINT CONNECTOR-M17
Connector Color	WHITE

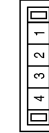

Terminal No.	Color of Wire	Signal Name
1	L	-
2	L	-

Connector No.	M42
Connector Name	AV CONTROL UNIT (WITH MID AUDIO SYSTEM - WITH BOSE AUDIO SYSTEM)
Connector Color	WHITE

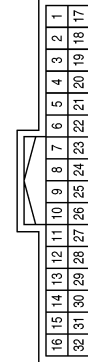

Terminal No.	Color of Wire	Signal Name
11	L	CAN-H
12	P	CAN-L
13	SB	M CAN-H
14	LG	M CAN-L

ABLIA5055GB

REAR WINDOW DEFOGGER SYSTEM

< WIRING DIAGRAM >

Connector No.	M50
Connector Name	A/C AUTO AMP.
Connector Color	WHITE



1	2	3	4	5	6	7	8	9	10	11	12	13	14	15	16	17	18	19	20
21	22	23	24	25	26	27	28	29	30	31	32	33	34	35	36	37	38	39	40

Terminal No.	Color of Wire	Signal Name
1	L	CAN-H
2	GR	GND
4	W	FR/TX
15	R	RR DEF SW
21	P	CAN-L
22	GR	GND (POWER)
23	LG	IGN
24	G	FR/RX
35	LG	RR DEF F/B

Connector No.	M68
Connector Name	FUSE BLOCK (J/B)
Connector Color	BROWN



76	68	58	48	38	28	18
16	58	48	38	28	18	10
10	8	10	8	10	8	10

Terminal No.	Color of Wire	Signal Name
13R	GR	-

Connector No.	M80
Connector Name	BCM (BODY CONTROL MODULE)
Connector Color	BLACK



116	115	114	113	112	111	110	109	108	107	106	105
128	127	126	125	124	123	122	121	120	119	118	117

Terminal No.	Color of Wire	Signal Name
113	L	ACC RELAY OUT

Connector No.	M81
Connector Name	BCM (BODY CONTROL MODULE)
Connector Color	WHITE



137	136	135	134	133	132	131	130	129
143	142	141	140	139	138			

Terminal No.	Color of Wire	Signal Name
131	W	BAT BCM FUSE
139	W	BAT POWER F/L

Connector No.	M84
Connector Name	WIRE TO WIRE
Connector Color	WHITE



116	115	114	113	112	111	110	9	8	7	6	5	4	3	2	1
32	31	30	29	28	27	26	25	24	23	22	21	20	19	18	17

Terminal No.	Color of Wire	Signal Name
17	L	-
18	P	-

Connector No.	M91
Connector Name	WIRE TO WIRE
Connector Color	WHITE



1	2	3	4	5	6	7	8	9	10	11	12	13	14	15	16
17	18	19	20	21	22	23	24	25	26	27	28	29	30	31	32

Terminal No.	Color of Wire	Signal Name
10	BR	-

REAR WINDOW DEFOGGER SYSTEM

< WIRING DIAGRAM >

Connector No.	M98
Connector Name	A/C AND AV SWITCH ASSEMBLY
Connector Color	WHITE

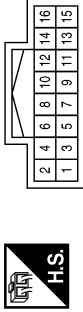

Terminal No.	Color of Wire	Signal Name
1	B	-
3	P	-
6	SB	-
8	LG	-

Connector No.	M93
Connector Name	DISPLAY UNIT (WITH MID AUDIO SYSTEM)
Connector Color	WHITE

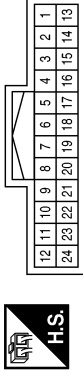

Terminal No.	Color of Wire	Signal Name
11	W	IT DISP
22	B	DISP IT
23	SHIELD	DISP SHIELD

Connector No.	M92
Connector Name	DISPLAY UNIT (WITH PREMIUM AUDIO SYSTEM)
Connector Color	WHITE

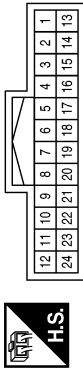

Terminal No.	Color of Wire	Signal Name
9	B	DISP IT
10	W	IT DISP
22	SHIELD	DISP SHIELD

Connector No.	M146
Connector Name	A/C SWITCH ASSEMBLY
Connector Color	WHITE

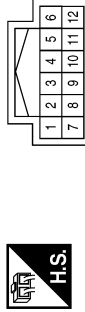

Terminal No.	Color of Wire	Signal Name
1	LG	-
2	B	-
3	W	-
4	G	-

Connector No.	M136
Connector Name	AV CONTROL UNIT (WITH MID AUDIO SYSTEM - WITHOUT BOSE AUDIO SYSTEM)
Connector Color	WHITE

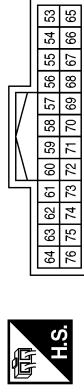

Terminal No.	Color of Wire	Signal Name
61	B	DISP IT
72	SHIELD	DISP SHIELD
73	W	IT DISP

Connector No.	M124
Connector Name	AV CONTROL UNIT (WITH MID AUDIO SYSTEM - WITHOUT BOSE AUDIO SYSTEM)
Connector Color	WHITE

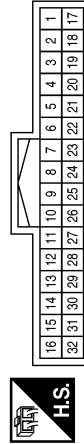

Terminal No.	Color of Wire	Signal Name
11	L	CAN-H
12	P	CAN-L
13	SB	M CAN-H
14	LG	M CAN-L

ABLIA5057GB

A
B
C
D
E
F
G
H
I
J
K
DEF
M
N
O
P

REAR WINDOW DEFOGGER SYSTEM

< WIRING DIAGRAM >

Connector No.	M158
Connector Name	WIRE TO WIRE
Connector Color	WHITE



1	2	3	4
5	6	7	8
9	10		

Terminal No.	8	Color of Wire	B	Signal Name	—
--------------	---	---------------	---	-------------	---

Connector No.	M163
Connector Name	AV CONTROL UNIT (WITH PREMIUM AUDIO SYSTEM - WITH NAVIGATION SYSTEM)
Connector Color	WHITE



49	50	51	52	53	54	55	56	57	58	59	60	61	62	63	64
65	66	67	68	69	70	71	72	73	74	75	76	77	78	79	80

Terminal No.	Color of Wire	Signal Name
61	W	IT DISP
62	P	CAN-L
63	LG	M CAN-L
76	SHIELD	DISP SHIELD
77	B	DISP IT
78	L	CAN-H
79	SB	M CAN-H

Connector No.	M167
Connector Name	WIRE TO WIRE
Connector Color	WHITE



1	2	3	4	5	6	7
8	9	10	11	12	13	14
15	16					

Terminal No.	3	Color of Wire	B	Signal Name	—
--------------	---	---------------	---	-------------	---

Connector No.	M168
Connector Name	WIRE TO WIRE
Connector Color	WHITE



1	2	3	4	5	6	7	8	9	10	11	12	13	14	15	16	17	18	19	20
21	22	23	24	25	26	27	28	29	30	31	32	33	34	35	36	37	38	39	40

Terminal No.	40	Color of Wire	BR	Signal Name	—
--------------	----	---------------	----	-------------	---

Connector No.	M176
Connector Name	JOINT CONNECTOR-M56
Connector Color	WHITE



4	3	2	1
---	---	---	---

Terminal No.	Color of Wire	Signal Name
1	SB	—
2	SB	—

Connector No.	M177
Connector Name	JOINT CONNECTOR-M57
Connector Color	WHITE



4	3	2	1
---	---	---	---

Terminal No.	Color of Wire	Signal Name
1	LG	—
2	LG	—

REAR WINDOW DEFOGGER SYSTEM

< WIRING DIAGRAM >

Connector No.	E44
Connector Name	JOINT CONNECTOR-E01
Connector Color	WHITE

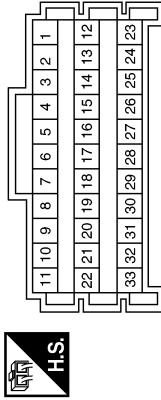

Terminal No.	Color of Wire	Signal Name
15	GR	-
17	B	-

Connector No.	E22
Connector Name	ACCESSORY RELAY-2
Connector Color	BLUE

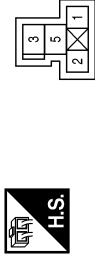

Terminal No.	Color of Wire	Signal Name
1	G	-
2	B	-
3	R	-
5	P	-

Connector No.	M181
Connector Name	JOINT CONNECTOR-M36
Connector Color	WHITE



Terminal No.	Color of Wire	Signal Name
1	W	-
2	W	-

Connector No.	B11
Connector Name	JOINT CONNECTOR-B09
Connector Color	WHITE



Terminal No.	Color of Wire	Signal Name
1	P	-
2	P	-

Terminal No.	Color of Wire	Signal Name
3G	P	-
10G	P	-
50G	G	-

Connector No.	E152
Connector Name	WIRE TO WIRE
Connector Color	WHITE

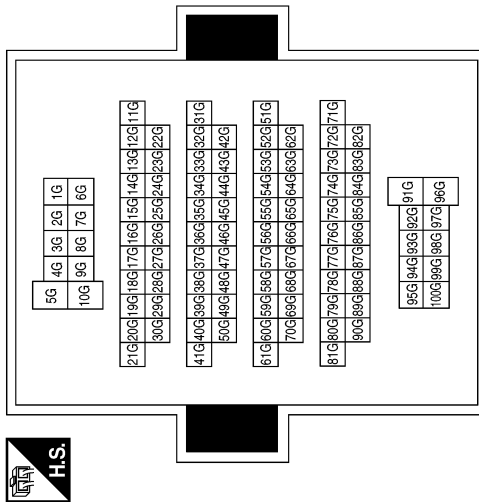

ABLIA5059GB

A
B
C
D
E
F
G
H
I
J
K
DEF
M
N
O
P

REAR WINDOW DEFOGGER SYSTEM

< WIRING DIAGRAM >

Connector No.	B17
Connector Name	JOINT CONNECTOR-B12
Connector Color	WHITE



Terminal No.	Color of Wire	Signal Name
1	L	-
2	L	-

Connector No.	B16
Connector Name	JOINT CONNECTOR-B11
Connector Color	WHITE

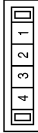

Terminal No.	Color of Wire	Signal Name
1	P	-
2	P	-

Connector No.	B12
Connector Name	JOINT CONNECTOR-B10
Connector Color	WHITE

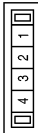

Terminal No.	Color of Wire	Signal Name
1	L	-
2	L	-

Connector No.	B47
Connector Name	WIRE TO WIRE
Connector Color	GRAY



Terminal No.	Color of Wire	Signal Name
1	W	-
5	G	-

Connector No.	B32
Connector Name	WIRE TO WIRE
Connector Color	WHITE

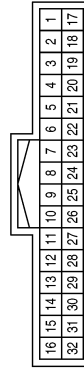

Terminal No.	Color of Wire	Signal Name
18	L	-
19	P	-

Connector No.	B29
Connector Name	FUSE BLOCK (J/B)
Connector Color	WHITE

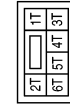

Terminal No.	Color of Wire	Signal Name
3T	W	-
5T	G	-

ABLIA5060GB

REAR WINDOW DEFOGGER SYSTEM

< WIRING DIAGRAM >

Connector No.	D101
Connector Name	WIRE TO WIRE
Connector Color	WHITE

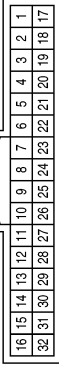

Terminal No.	Color of Wire	Signal Name
10	BR	-

Connector No.	D28
Connector Name	DOOR MIRROR LH (WITH AROUND VIEW MONITOR SYSTEM)
Connector Color	WHITE

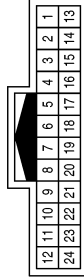

Terminal No.	Color of Wire	Signal Name
7	Y	-
19	B	-

Connector No.	D4
Connector Name	DOOR MIRROR LH (WITHOUT AROUND VIEW MONITOR SYSTEM)
Connector Color	WHITE

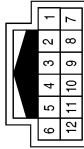

Terminal No.	Color of Wire	Signal Name
1	Y	-
2	B	-

Connector No.	D128
Connector Name	DOOR MIRROR RH (WITH AROUND VIEW MONITOR SYSTEM)
Connector Color	WHITE

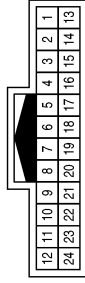

Terminal No.	Color of Wire	Signal Name
7	BR	-
19	B	-

Connector No.	D107
Connector Name	DOOR MIRROR RH (WITHOUT AROUND VIEW MONITOR SYSTEM)
Connector Color	WHITE



Terminal No.	Color of Wire	Signal Name
1	BR	-
2	B	-

Connector No.	D102
Connector Name	WIRE TO WIRE
Connector Color	WHITE

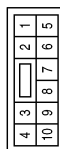

Terminal No.	Color of Wire	Signal Name
8	B	-

ABLIA5062GB

REAR WINDOW DEFOGGER SYSTEM

< WIRING DIAGRAM >

Connector No.	D509
Connector Name	REAR WINDOW DEFOGGER CONDENSER
Connector Color	BLACK



Terminal No.	Color of Wire	Signal Name
2	G	-

Connector No.	D508
Connector Name	REAR WINDOW DEFOGGER CONDENSER
Connector Color	BLACK



Terminal No.	Color of Wire	Signal Name
1	R	-

Connector No.	D502
Connector Name	WIRE TO WIRE
Connector Color	GRAY

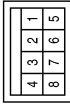

Terminal No.	Color of Wire	Signal Name
1	R	-
5	R	-

Connector No.	D525
Connector Name	REAR WINDOW DEFOGGER
Connector Color	BLACK



Terminal No.	Color of Wire	Signal Name
2	B	-

Connector No.	D510
Connector Name	REAR WINDOW DEFOGGER
Connector Color	BLACK



Terminal No.	Color of Wire	Signal Name
1	G	-

ABLIA5063GB

A
B
C
D
E
F
G
H
I
J
K
DEF
M
N
O
P

REAR WINDOW DEFOGGER SYSTEM

< WIRING DIAGRAM >

Connector No.	J-2
Connector Name	FUSE BLOCK (J/B) (REAR WINDOW DEFOGGER RELAY)
Connector Color	-

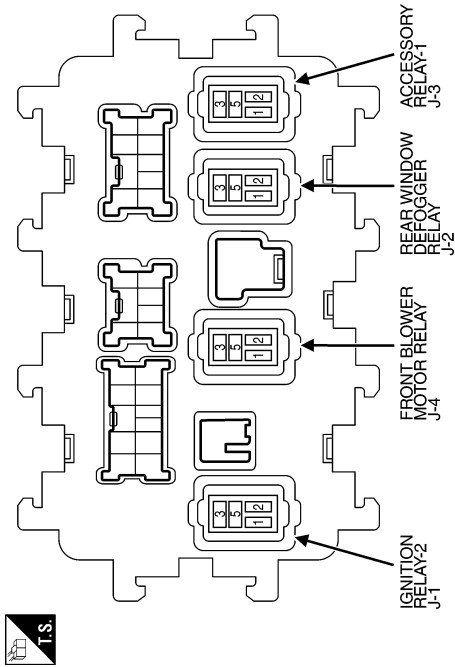

Connector No.	J-1
Connector Name	FUSE BLOCK (J/B) (IGNITION RELAY-2)
Connector Color	-

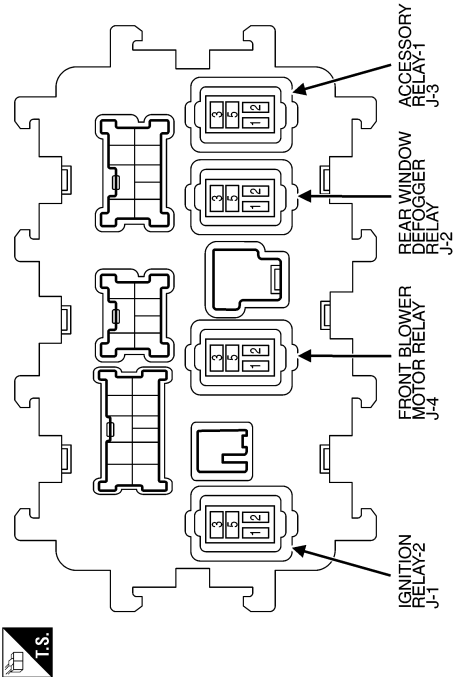

ABLIA5064GB

DIAGNOSIS AND REPAIR WORK FLOW

< BASIC INSPECTION >

BASIC INSPECTION

DIAGNOSIS AND REPAIR WORK FLOW

Work Flow

INFOID:000000009175554

OVERALL SEQUENCE

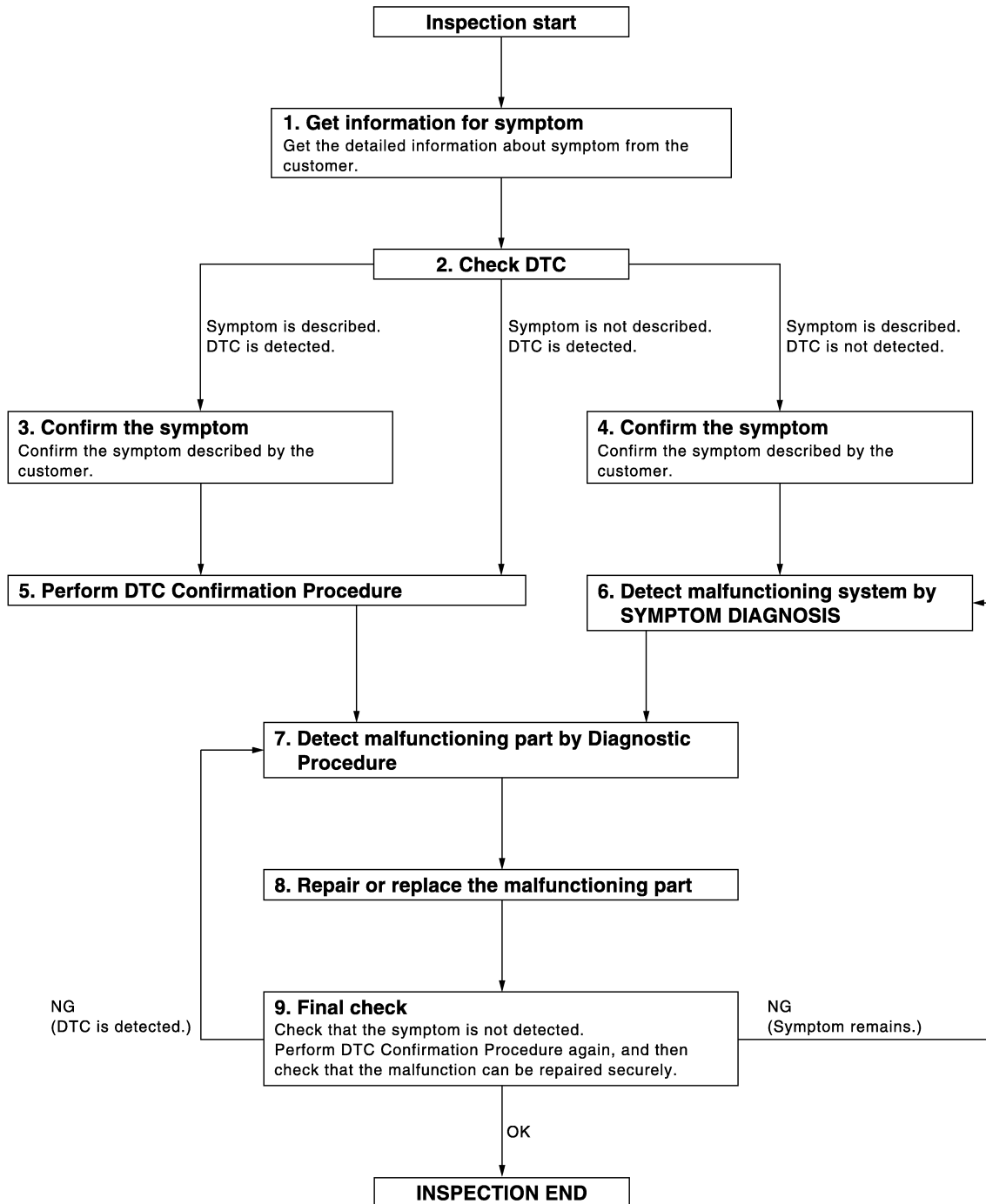

DETAILED FLOW

Revision: May 2013

DEF-23

JMKIA2270GB

2014 Pathfinder

DIAGNOSIS AND REPAIR WORK FLOW

< BASIC INSPECTION >

1. GET INFORMATION FOR SYMPTOM

Get the detailed information from the customer about the symptom (the condition and the environment when the incident/malfunction occurred).

>> GO TO 2.

2. CHECK DTC

1. Check DTC.
2. Perform the following procedure if DTC is displayed.
 - Record DTC and freeze frame data (Print them out with CONSULT.)
 - Erase DTC.
 - Study the relationship between the cause detected by DTC and the symptom described by the customer.
3. Check related service bulletins for information.

Is any symptom described and any DTC detected?

Symptom is described, DTC is displayed>>GO TO 3.

Symptom is described, DTC is not displayed>>GO TO 4.

Symptom is not described, DTC is displayed>>GO TO 5.

3. CONFIRM THE SYMPTOM

Confirm the symptom described by the customer.

Connect CONSULT to the vehicle in "DATA MONITOR" mode and check real time diagnosis results.

Verify relation between the symptom and the condition when the symptom is detected.

>> GO TO 5.

4. CONFIRM THE SYMPTOM

Confirm the symptom described by the customer.

Connect CONSULT to the vehicle in "DATA MONITOR" mode and check real time diagnosis results.

Verify relation between the symptom and the condition when the symptom is detected.

>> GO TO 6.

5. PERFORM DTC CONFIRMATION PROCEDURE

Perform DTC Confirmation Procedure for the displayed DTC, and then check that DTC is detected again.

At this time, always connect CONSULT to the vehicle, and check diagnostic results in real time.

If two or more DTCs are detected, refer to [BCS-50. "DTC Inspection Priority Chart"](#) and determine trouble diagnosis order.

NOTE:

- Freeze frame data is useful if the DTC is not detected.
- Perform Component Function Check if DTC Confirmation Procedure is not included in Service Manual. This simplified check procedure is an effective alternative though DTC cannot be detected during this check. If the result of Component Function Check is NG, it is the same as the detection of DTC by DTC Confirmation Procedure.

Is DTC detected?

YES >> GO TO 7.

NO >> Refer to [GI-49. "Intermittent Incident"](#).

6. DETECT MALFUNCTIONING SYSTEM BY SYMPTOM TABLE

Detect malfunctioning system according to [DEF-6. "System Description"](#) based on the confirmed symptom in step 4, and determine the trouble diagnosis order based on possible causes and symptom.

>> GO TO 7.

7. DETECT MALFUNCTIONING PART BY DIAGNOSTIC PROCEDURE

Inspect according to Diagnostic Procedure of the system.

NOTE:

DIAGNOSIS AND REPAIR WORK FLOW

< BASIC INSPECTION >

The Diagnostic Procedure described is based on open circuit inspection. A short circuit inspection is also required for the circuit check in the Diagnostic Procedure.

Is malfunctioning part detected?

YES >> GO TO 8.

NO >> Check voltage of related BCM terminals using CONSULT.

8. REPAIR OR REPLACE THE MALFUNCTIONING PART

1. Repair or replace the malfunctioning part.
2. Reconnect parts or connectors disconnected during Diagnostic Procedure again after repair and replacement.
3. Check DTC. If DTC is displayed, erase it.

>> GO TO 9.

9. FINAL CHECK

When DTC was detected in step 2, perform DTC Confirmation Procedure or Component Function Check again, and then check that the malfunction has been repaired securely.

When symptom was described from the customer, refer to confirmed symptom in step 3 or 4, and check that the symptom is not detected.

Does the symptom reappear?

YES (DTC is detected)>>GO TO 7.

YES (Symptom remains)>>GO TO 6.

NO >> Inspection End.

A
B
C
D
E
F
G
H
I
J
K
DEF
M
N
O
P

REAR WINDOW DEFOGGER SWITCH

< DTC/CIRCUIT DIAGNOSIS >

DTC/CIRCUIT DIAGNOSIS

REAR WINDOW DEFOGGER SWITCH

Description

INFOID:000000009175555

- The rear window defogger is operated by turning the rear window defogger switch ON.
- Turns the indicator lamp in the rear window defogger switch ON when operating the rear window defogger.

Component Function Check

INFOID:000000009175556

1. CHECK REAR WINDOW DEFOGGER SWITCH FUNCTION

Check that the indicator lamp of rear window defogger illuminates with rear window defogger switch ON.

Is the inspection result normal?

- YES >> Rear window defogger switch function is OK.
NO >> Refer to [DEF-26, "Diagnosis Procedure"](#).

Diagnosis Procedure

INFOID:000000009175557

Regarding Wiring Diagram information, refer to [DEF-10, "Wiring Diagram"](#).

BASE AUDIO SYSTEM

1. CHECK REAR WINDOW DEFOGGER RELAY OPERATION

1. Push the ignition switch to ON.
2. Check that an operation noise of rear window defogger relay [located in fuse block (J/B)] can be heard when pressing the rear window defogger switch ON and OFF.

Is the inspection result normal?

- YES >> GO TO 2.
NO >> GO TO 5.

2. CHECK FUSE

Check if Fuse 22 from the rear window defogger relay output is blown.

Is the fuse blown?

- YES >> Replace the blown fuse after repairing the affected circuit.
NO >> GO TO 3.

3. CHECK FOR VOLTAGE FROM THE REAR WINDOW DEFOGGER RELAY

1. Press rear window defogger switch.
2. Check for voltage between fuse block (J/B) connector and ground.

(+)		(-)	Condition	Voltage (V) (Approx.)	
Connector	Terminal				
M4	4P	Ground	Rear window de-fogger switch	ON	Battery voltage
				OFF	0

Is the inspection result normal?

- YES >> GO TO 4.
NO >> Perform rear window defogger relay diagnosis. Refer to [DEF-31, "Diagnosis Procedure"](#).

4. CHECK REAR WINDOW DEFOGGER SWITCH INDICATOR CIRCUIT

1. Press rear window defogger switch.
2. Check for voltage between A/C auto amp. connector and ground.

REAR WINDOW DEFOGGER SWITCH

< DTC/CIRCUIT DIAGNOSIS >

(+)		(-)	Condition	Voltage (V) (Approx.)	
A/C auto amp.					
Connector	Terminal				
M50	35	Ground	Rear window de-fogger switch	ON	Battery voltage
				OFF	0

Is the inspection result normal?

- YES >> Replace A/C auto amp. Refer to [HAC-157, "Removal and Installation"](#).
 NO >> Repair or replace harness.

5. CHECK A/C AUTO AMP. (REAR WINDOW DEFOGGER SWITCH) FUNCTION

1. Check ("REAR DEF SW") in BCM - REAR DEFOGGER "DATA MONITOR" mode by using CONSULT.
2. Operate rear window defogger switch and check the status on CONSULT screen.

Monitor Item	Condition	status	
REAR DEF SW	Rear window defogger switch	Pressed	On
		Released	Off

Is the inspection result normal?

- YES >> GO TO 8.
 NO >> GO TO 6.

6. CHECK REAR WINDOW DEFOGGER ON SIGNAL CIRCUIT

Check voltage between BCM connector and ground.

(+)		(-)	Condition	Voltage (V) (Approx.)	
BCM					
Connector	Terminal				
M18	32	Ground	Rear window de-fogger switch	ON	0
				OFF	5

Is the inspection result normal?

- YES >> Replace BCM. Refer to [BCS-80, "Removal and Installation"](#).
 NO >> GO TO 7.

7. CHECK HARNESS CONTINUITY

1. Push ignition switch to OFF.
2. Disconnect BCM and front air control.
3. Check continuity between BCM connector and A/C auto amp.

BCM		A/C auto amp.		Continuity
Connector	Terminal	Connector	Terminal	
M18	32	M50	15	Yes

4. Check continuity between BCM harness connector and ground.

BCM		Ground	Continuity
Connector	Terminal		
M18	32		No

Is the inspection result normal?

- YES >> Replace A/C auto amp. Refer to [HAC-157, "Removal and Installation"](#).
 NO >> Repair or replace harness.

8. CHECK REAR WINDOW DEFOGGER RELAY GROUND CIRCUIT

A
B
C
D
E
F
G
H
I
J
K
DEF
M
N
O
P

REAR WINDOW DEFOGGER SWITCH

< DTC/CIRCUIT DIAGNOSIS >

ⓑ CONSULT

1. Select BCM (REAR DEFOGGER) ACTIVE TEST.
2. Turn REAR DEFOGGER active test ON and OFF.
3. Check voltage between fuse block (J/B) connector and ground.

(+)		(-)	Condition	Voltage (V) (Approx.)	
Fuse block (J/B)					
Connector	Terminal				
M4	6P	Ground	Rear window defogger active test	ON	0
				OFF	Battery voltage

Is the inspection result normal?

- YES >> GO TO 11.
NO >> GO TO 9.

9. CHECK REAR WINDOW DEFOGGER RELAY CIRCUIT

Check voltage between fuse block (J/B) connector and ground.

(+)		(-)	Condition	Voltage (V) (Approx.)	
Fuse block (J/B)					
Connector	Terminal				
M4	6P	Ground	Rear window defogger switch	ON	0
				OFF	Battery voltage

Is the inspection result normal?

- YES >> Replace rear window defogger relay.
NO >> GO TO 10.

10. CHECK HARNESS CONTINUITY

1. Push ignition switch to OFF.
2. Disconnect BCM and fuse block (J/B).
3. Check continuity between BCM connector and fuse block (J/B) connector.

BCM		Fuse block (J/B)		Continuity
Connector	Terminal	Connector	Terminal	
M19	61	M4	6P	Yes

4. Check continuity between fuse block (J/B) connector M5 terminal 6P and ground.

Fuse block (J/B)		Ground	Continuity
Connector	Terminal		
M4	6P		No

Is the inspection result normal?

- YES >> Perform rear window defogger relay component inspection. Refer to [DEF-32. "Component Inspection"](#). If OK, replace BCM. Refer to [BCS-80. "Removal and Installation"](#).
NO >> Repair or replace harness.

11. CHECK REAR WINDOW DEFOGGER RELAY

Check rear window defogger relay.
Refer to [DEF-32. "Component Inspection"](#).

Is the inspection result normal?

- YES >> GO TO 12.
NO >> Replace rear window defogger relay.

12. CHECK INTERMITTENT INCIDENT

REAR WINDOW DEFOGGER SWITCH

< DTC/CIRCUIT DIAGNOSIS >

Check intermittent incident.
Refer to [GI-49, "Intermittent Incident"](#).

Is the inspection result normal?

- YES >> Check the following.
- Battery power supply circuit.
 - Fuse block (J/B).
- NO >> Repair or replace the malfunctioning parts.

EXCEPT BASE AUDIO SYSTEM

1. CHECK A/C AND AV SWITCH ASSEMBLY (REAR WINDOW DEFOGGER SWITCH) CIRCUIT

Operate the rear window defogger switch.

Is the inspection result normal?

- YES >> Inspection End.
NO >> GO TO 2.

2. CHECK A/C AND AV SWITCH ASSEMBLY (REAR WINDOW DEFOGGER SWITCH) CIRCUIT VOLTAGE

1. Turn ignition switch ON.
2. Check voltage between A/C and AV switch assembly harness connector M98 terminal 3 and ground.

(+)		(-)	Condition	Voltage (V) (Approx.)
Connector	Terminal			
M98	3	Ground	Ignition switch ON	Battery voltage
			OFF	0

Is the inspection result normal?

- YES >> Replace A/C and AV switch assembly. Refer to [HAC-155, "Removal and Installation - With Navigation"](#).
NO >> GO TO 3.

3. CHECK A/C AND AV SWITCH ASSEMBLY (REAR WINDOW DEFOGGER SWITCH) CIRCUIT FOR OPEN

1. Turn ignition switch OFF.
2. Disconnect accessory relay-2 connector E22.
3. Disconnect A/C and AV switch assembly connector M98.
4. Check continuity between A/C and AV switch assembly connector M98 terminal 3 and accessory relay-2 connector E22 terminal 5.

A/C and AV switch assembly		Accessory relay-2		Continuity
Connector	Terminal	Connector	Terminal	
M98	3	E22	5	Yes

Is the inspection result normal?

- YES >> GO TO 4.
NO >> Repair and replace harness.

4. CHECK A/C AND AV SWITCH ASSEMBLY (REAR WINDOW DEFOGGER SWITCH) CIRCUIT FOR SHORT

1. Turn ignition switch OFF.
2. Disconnect accessory relay-2 connector E22.
3. Disconnect A/C and AV switch assembly connector M98.
4. Check continuity between A/C and AV switch assembly connector M98 terminal 3 and ground.

A/C and AV switch assembly		Ground	Continuity
Connector	Terminal		
M98	3		No

A
B
C
D
E
F
G
H
I
J
K
DEF
M
N
O
P

REAR WINDOW DEFOGGER SWITCH

< DTC/CIRCUIT DIAGNOSIS >

Is the inspection result normal?

- YES >> Check the following:
- Accessory relay-2.
 - Battery power supply circuit.
- NO >> Repair or replace harness.

REAR WINDOW DEFOGGER RELAY

< DTC/CIRCUIT DIAGNOSIS >

REAR WINDOW DEFOGGER RELAY

Description

INFOID:000000009175558

Power is supplied to the rear window defogger with BCM control.

Component Function Check

INFOID:000000009175559

1. CHECK REAR WINDOW DEFOGGER RELAY POWER SUPPLY CIRCUIT

Check that an operation noise of rear window defogger relay [located in fuse block (J/B)] can be heard when turning the rear window defogger switch ON.

Is the inspection result normal?

- YES >> Rear window defogger relay power supply circuit is OK.
- NO >> Refer to [DEF-31, "Diagnosis Procedure"](#).

Diagnosis Procedure

INFOID:000000009175560

Regarding Wiring Diagram information, refer to [DEF-10, "Wiring Diagram"](#).

1. CHECK REAR WINDOW DEFOGGER RELAY GROUND CIRCUIT

1. Turn ignition switch ON.
2. Check voltage between BCM connector and ground.

(+)		(-)	Condition	Voltage (V) (Approx.)	
BCM					
Connector	Terminal				
M19	61	Ground	Rear window defogger switch	ON	0
				OFF	Battery voltage

Is the inspection result normal?

- YES >> Rear window defogger power supply circuit is OK.
- NO >> GO TO 2.

2. CHECK HARNESS CONTINUITY

1. Turn ignition switch OFF.
2. Disconnect BCM and fuse block (J/B).
3. Check continuity between BCM connector and fuse block (J/B) connector.

BCM		Fuse block (J/B)		Continuity
Connector	Terminal	Connector	Terminal	
M19	61	M4	6P	Yes

Is the inspection result normal?

- YES >> GO TO 3.
- NO >> Repair or replace harness.

3. CHECK REAR WINDOW DEFOGGER RELAY

Check rear window defogger relay.
Refer to [DEF-32, "Component Inspection"](#).

Is the inspection result normal?

- YES >> Check intermittent incident. Refer to [GI-49, "Intermittent Incident"](#)
- NO >> Replace rear window defogger relay.

A
B
C
D
E
F
G
H
I
J
K
DEF
M
N
O
P

REAR WINDOW DEFOGGER RELAY

< DTC/CIRCUIT DIAGNOSIS >

Component Inspection

INFOID:000000009175561

1. CHECK REAR WINDOW DEFOGGER RELAY

Check rear window defogger relay.

Terminal		Condition	Continuity
Rear window defogger relay			
3	5	12V direct current supply between terminals 1 and 2.	Yes
		No current supply	No

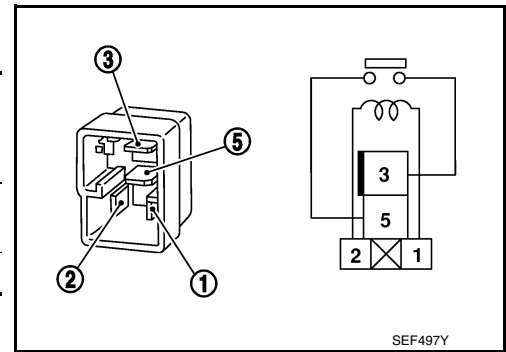

Is the inspection result normal?

- YES >> Inspection End.
- NO >> Replace rear window defogger relay.

REAR WINDOW DEFOGGER POWER SUPPLY AND GROUND CIRCUIT

< DTC/CIRCUIT DIAGNOSIS >

REAR WINDOW DEFOGGER POWER SUPPLY AND GROUND CIRCUIT

Description

INFOID:000000009175562

Heats the heating wire with the power supply from the rear window defogger relay to prevent the rear window from fogging up.

Component Function Check

INFOID:000000009175563

1. CHECK REAR WINDOW DEFOGGER

Check that the heating wire of rear window defogger is heated when turning the rear window defogger switch ON.

Is the inspection result normal?

- YES >> Rear window defogger is OK.
- NO >> Refer to [DEF-33. "Diagnosis Procedure"](#).

Diagnosis Procedure

INFOID:000000009175564

Regarding Wiring Diagram information, refer to [DEF-10. "Wiring Diagram"](#).

1. CHECK FUSES

Check if any of the following fuses in fuse block (J/B) are blown.

COMPONENT PARTS	AMPERE	FUSE NO.
Fuse block (J/B)	15A	23
	15A	24

Is the inspection result normal?

- YES >> GO TO 2.
- NO >> If fuse is blown, be sure to eliminate cause of malfunction before installing new fuse.

2. CHECK POWER SUPPLY CIRCUIT

1. Turn ignition switch ON.
2. Check voltage between rear window defogger connector and ground.

(+)		(-)	Condition	Voltage (V) (Approx.)
Connector	Terminal			
D510	1	Ground	Rear window defogger switch ON	Battery voltage
			Rear window defogger switch OFF	0

Is the inspection result normal?

- YES >> GO TO 3.
- NO >> GO TO 4.

3. CHECK GROUND CIRCUIT

1. Turn ignition switch OFF.
2. Disconnect rear window defogger.
3. Check continuity between rear window defogger connector and ground.

Rear window defogger		Ground	Continuity
Connector	Terminal		
D525	2		Yes

A
B
C
D
E
F
G
H
I
J
K
M
N
O
P

DEF

REAR WINDOW DEFOGGER POWER SUPPLY AND GROUND CIRCUIT

< DTC/CIRCUIT DIAGNOSIS >

Is the inspection result normal?

- YES >> GO TO 6.
NO >> Repair or replace harness.

4. CHECK HARNESS CONTINUITY 1

1. Turn ignition switch OFF.
2. Disconnect rear window defogger condenser and rear window defogger.
3. Check continuity between rear window defogger condenser connector and rear window defogger connector.

Rear window defogger condenser		Rear window defogger		Continuity
Connector	Terminal	Connector	Terminal	
D508	2	D525	1	Yes

Is the inspection result normal?

- YES >> GO TO 5.
NO >> Replace or repair harness.

5. CHECK HARNESS CONTINUITY 2

1. Disconnect fuse block (J/B).
2. Check continuity between fuse block (J/B) connector and rear window defogger condenser connector.

Fuse block (J/B)		Rear window defogger condenser		Continuity
Connector	Terminal	Connector	Terminal	
B29	3T	D508	1	Yes
	5T			

Is the inspection result normal?

- YES >> Replace rear window defogger condenser.
NO >> Replace or repair harness.

6. CHECK FILAMENT

Check filament. Refer to [DEF-34, "Component Inspection"](#).

Is the inspection result normal?

- YES >> Refer to [GI-49, "Intermittent Incident"](#).
NO >> Repair filament. Refer to [DEF-51, "Inspection and Repair"](#).

Component Inspection

INFOID:000000009175565

1. CHECK FILAMENT

Check the filament for damage or open circuits.
Refer to [DEF-51, "Inspection and Repair"](#).

Is the inspection result normal?

- YES >> Inspection End.
NO >> Repair filament. Refer to [DEF-51, "Inspection and Repair"](#).

DOOR MIRROR DEFOGGER LH (WITH AROUND VIEW MONITOR)

< DTC/CIRCUIT DIAGNOSIS >

DOOR MIRROR DEFOGGER LH (WITH AROUND VIEW MONITOR)

Description

INFOID:000000009175566

Heats the heating wire with the power supply from the rear window defogger relay to prevent the door mirror from fogging up.

Component Function Check

INFOID:000000009175567

1. CHECK DOOR MIRROR DEFOGGER LH

Check that heating wire of door mirror defogger LH is heated when turning the rear window defogger switch ON.

Is the inspection result normal?

- YES >> Door mirror defogger is OK.
- NO >> Refer to [DEF-35. "Diagnosis Procedure"](#).

Diagnosis Procedure

INFOID:000000009175568

Regarding Wiring Diagram information, refer to [DEF-10. "Wiring Diagram"](#).

1. CHECK POWER SUPPLY

Check if the following fuse in the fuse block (J/B) is blown.

COMPONENT PARTS	AMPERE	FUSE NO.
Fuse block (J/B)	10A	22

Is the inspection result normal?

- YES >> GO TO 2.
- NO >> If fuse is blown, be sure to eliminate cause of malfunction before installing new fuse.

2. CHECK DOOR MIRROR DEFOGGER POWER SUPPLY CIRCUIT

1. Turn ignition switch OFF.
2. Disconnect door mirror LH.
3. Turn ignition switch ON.
4. Check voltage between door mirror LH connector D4 terminal 1 and ground.

(+)		(-)	Condition	Voltage (V) (Approx.)
Connector	Terminal			
D4	1	Ground	Rear window defogger switch	Battery voltage
			ON	
			OFF	0

Is the inspection result normal?

- YES >> GO TO 3.
- NO >> Repair or replace harness.

3. CHECK DOOR MIRROR DEFOGGER GROUND CIRCUIT

1. Turn ignition switch OFF.
2. Check continuity between door mirror LH connector and ground.

Door mirror LH		Ground	Continuity
Connector	Terminal		
D4	2		Yes

Is the inspection result normal?

A
B
C
D
E
F
G
H
I
J
K
M
N
O
P

DEF

DOOR MIRROR DEFOGGER LH (WITH AROUND VIEW MONITOR)

< DTC/CIRCUIT DIAGNOSIS >

- YES >> GO TO 4.
NO >> Repair or replace harness.

4. CHECK DOOR MIRROR DEFOGGER LH

Check door mirror defogger LH.
Refer to [DEF-36. "Component Inspection"](#).

Is the inspection result normal?

- YES >> GO TO 5.
NO >> Replace door mirror. Refer to [MIR-17. "Removal and Installation"](#).

5. CHECK INTERMITTENT INCIDENT

Check intermittent incident.
Refer to [GI-49. "Intermittent Incident"](#).

Is the inspection result normal?

- YES >> Check the following:
- Battery power supply circuit
 - Fuse block (J/B)
- NO >> Repair or replace the malfunctioning parts.

Component Inspection

INFOID:000000009175569

1. CHECK DOOR MIRROR DEFOGGER

1. Turn ignition switch OFF.
2. Disconnect door mirror LH.
3. Check continuity between door mirror terminals.

Terminal		Continuity
1	2	Yes

Is the inspection result normal?

- YES >> Check the condition of the harness and the connector.
NO >> Replace malfunctioning door mirror LH. Refer to [MIR-17. "Removal and Installation"](#).

DOOR MIRROR DEFOGGER LH (WITH AROUND VIEW MONITOR)

< DTC/CIRCUIT DIAGNOSIS >

DOOR MIRROR DEFOGGER LH (WITH AROUND VIEW MONITOR)

Description

INFOID:000000009175570

Heats the heating wire with the power supply from the rear window defogger relay to prevent the door mirror from fogging up.

Component Function Check

INFOID:000000009175571

1. CHECK DOOR MIRROR DEFOGGER LH

Check that heating wire of door mirror defogger LH is heated when turning the rear window defogger switch ON.

Is the inspection result normal?

- YES >> Door mirror defogger is OK.
- NO >> Refer to [DEF-37. "Diagnosis Procedure"](#).

Diagnosis Procedure

INFOID:000000009175572

Regarding Wiring Diagram information, refer to [DEF-10. "Wiring Diagram"](#).

1. CHECK POWER SUPPLY

Check if the following fuse in the fuse block (J/B) is blown.

COMPONENT PARTS	AMPERE	FUSE NO.
Fuse block (J/B)	10A	22

Is the inspection result normal?

- YES >> GO TO 2.
- NO >> If fuse is blown, be sure to eliminate cause of malfunction before installing new fuse.

2. CHECK DOOR MIRROR DEFOGGER POWER SUPPLY CIRCUIT

1. Turn ignition switch OFF.
2. Disconnect door mirror LH.
3. Turn ignition switch ON.
4. Check voltage between door mirror LH connector D28 terminal 7 and ground.

(+)		(-)	Condition	Voltage (V) (Approx.)	
Connector	Terminal				
D28	7	Ground	Rear window defogger switch	ON	Battery voltage
			OFF	0	

Is the inspection result normal?

- YES >> GO TO 3.
- NO >> Repair or replace harness.

3. CHECK DOOR MIRROR DEFOGGER GROUND CIRCUIT

1. Turn ignition switch OFF.
2. Check continuity between door mirror LH connector and ground.

Door mirror LH		Ground	Continuity
Connector	Terminal		
D28	19		Yes

Is the inspection result normal?

A
B
C
D
E
F
G
H
I
J
K
M
N
O
P

DEF

DOOR MIRROR DEFOGGER LH (WITH AROUND VIEW MONITOR)

< DTC/CIRCUIT DIAGNOSIS >

- YES >> GO TO 4.
NO >> Repair or replace harness.

4. CHECK DOOR MIRROR DEFOGGER LH

Check door mirror defogger LH.
Refer to [DEF-38. "Component Inspection"](#).

Is the inspection result normal?

- YES >> GO TO 5.
NO >> Replace door mirror. Refer to [MIR-17. "Removal and Installation"](#).

5. CHECK INTERMITTENT INCIDENT

Check intermittent incident.
Refer to [GI-49. "Intermittent Incident"](#).

Is the inspection result normal?

- YES >> Check the following:
- Battery power supply circuit
 - Fuse block (J/B)
- NO >> Repair or replace the malfunctioning parts.

Component Inspection

INFOID:000000009175573

1. CHECK DOOR MIRROR DEFOGGER

1. Turn ignition switch OFF.
2. Disconnect door mirror LH.
3. Check continuity between door mirror terminals.

Terminal		Continuity
7	19	Yes

Is the inspection result normal?

- YES >> Check the condition of the harness and the connector.
NO >> Replace malfunctioning door mirror LH. Refer to [MIR-17. "Removal and Installation"](#).

DOOR MIRROR DEFOGGER RH (WITHOUT AROUND VIEW MONITOR)

< DTC/CIRCUIT DIAGNOSIS >

DOOR MIRROR DEFOGGER RH (WITHOUT AROUND VIEW MONITOR)

Description

INFOID:000000009175574

Heats the heating wire with the power supply from the rear window defogger relay to prevent the door mirror from fogging up.

Component Function Check

INFOID:000000009175575

1. CHECK DOOR MIRROR DEFOGGER RH

Check that the heating wire of door mirror defogger RH is heated when turning the rear window defogger switch ON.

Is the inspection result normal?

- YES >> Door mirror defogger RH is OK.
NO >> Refer to [DEF-39. "Diagnosis Procedure"](#).

Diagnosis Procedure

INFOID:000000009175576

Regarding Wiring Diagram information, refer to [DEF-10. "Wiring Diagram"](#).

1. CHECK POWER SUPPLY

Check if the following fuse in the fuse block (J/B) is blown.

COMPONENT PARTS	AMPERE	FUSE NO.
Fuse block (J/B)	10A	22

Is the inspection result normal?

- YES >> GO TO 2.
NO >> If fuse is blown, be sure to eliminate cause of malfunction before installing new fuse.

2. CHECK DOOR MIRROR DEFOGGER POWER SUPPLY CIRCUIT

1. Turn ignition switch OFF.
2. Disconnect door mirror RH.
3. Turn ignition switch ON.
4. Check voltage between door mirror RH connector D107 terminal 1 and ground.

(+)		(-)	Condition	Voltage (V) (Approx.)	
Connector	Terminal				
D107	1	Ground	Rear window defogger switch	ON OFF	Battery voltage 0

Is the inspection result normal?

- YES >> GO TO 3.
NO >> Repair or replace harness.

3. CHECK DOOR MIRROR DEFOGGER GROUND CIRCUIT

1. Turn ignition switch OFF.
2. Check continuity between door mirror RH connector and ground.

Door mirror RH		Ground	Continuity
Connector	Terminal		
D107	2		Yes

Is the inspection result normal?

A
B
C
D
E
F
G
H
I
J
K
M
N
O
P

DEF

DOOR MIRROR DEFOGGER RH (WITHOUT AROUND VIEW MONITOR)

< DTC/CIRCUIT DIAGNOSIS >

- YES >> GO TO 4.
- NO >> Repair or replace harness.

4. CHECK DOOR MIRROR DEFOGGER RH

Check door mirror defogger RH.
Refer to [DEF-40. "Component Inspection"](#).

Is the inspection result normal?

- YES >> GO TO 5.
- NO >> Replace door mirror. Refer to [MIR-17. "Removal and Installation"](#).

5. CHECK INTERMITTENT INCIDENT

Check intermittent incident.
Refer to [GI-49. "Intermittent Incident"](#).

Is the inspection result normal?

- YES >> Check the following:
 - Battery power supply circuit
 - Fuse block (J/B)
- NO >> Repair or replace the malfunctioning parts.

Component Inspection

INFOID:000000009175577

1. CHECK DOOR MIRROR DEFOGGER

1. Turn ignition switch OFF.
2. Disconnect door mirror RH.
3. Check continuity between door mirror terminals.

Terminal		Continuity
1	2	Yes

Is the inspection result normal?

- YES >> Check the condition of the harness and the connector.
- NO >> Replace malfunctioning door mirror RH. Refer to [MIR-17. "Removal and Installation"](#).

DOOR MIRROR DEFOGGER RH (WITH AROUND VIEW MONITOR)

< DTC/CIRCUIT DIAGNOSIS >

DOOR MIRROR DEFOGGER RH (WITH AROUND VIEW MONITOR)

Description

INFOID:000000009175578

Heats the heating wire with the power supply from the rear window defogger relay to prevent the door mirror from fogging up.

Component Function Check

INFOID:000000009175579

1. CHECK DOOR MIRROR DEFOGGER RH

Check that the heating wire of door mirror defogger RH is heated when turning the rear window defogger switch ON.

Is the inspection result normal?

- YES >> Door mirror defogger RH is OK.
- NO >> Refer to [DEF-41, "Diagnosis Procedure"](#).

Diagnosis Procedure

INFOID:000000009175580

Regarding Wiring Diagram information, refer to [DEF-10, "Wiring Diagram"](#).

1. CHECK POWER SUPPLY

Check if the following fuse in the fuse block (J/B) is blown.

COMPONENT PARTS	AMPERE	FUSE NO.
Fuse block (J/B)	10A	22

Is the inspection result normal?

- YES >> GO TO 2.
- NO >> If fuse is blown, be sure to eliminate cause of malfunction before installing new fuse.

2. CHECK DOOR MIRROR DEFOGGER POWER SUPPLY CIRCUIT

1. Turn ignition switch OFF.
2. Disconnect door mirror RH.
3. Turn ignition switch ON.
4. Check voltage between door mirror RH connector D128 terminal 7 and ground.

(+)		(-)	Condition	Voltage (V) (Approx.)
Connector	Terminal			
D128	7	Ground	Rear window defogger switch	Battery voltage
			ON	
			OFF	0

Is the inspection result normal?

- YES >> GO TO 3.
- NO >> Repair or replace harness.

3. CHECK DOOR MIRROR DEFOGGER GROUND CIRCUIT

1. Turn ignition switch OFF.
2. Check continuity between door mirror RH connector and ground.

Door mirror RH		Ground	Continuity
Connector	Terminal		
D128	19		Yes

Is the inspection result normal?

A
B
C
D
E
F
G
H
I
J
K
DEF
M
N
O
P

DOOR MIRROR DEFOGGER RH (WITH AROUND VIEW MONITOR)

< DTC/CIRCUIT DIAGNOSIS >

- YES >> GO TO 4.
NO >> Repair or replace harness.

4. CHECK DOOR MIRROR DEFOGGER RH

Check door mirror defogger RH. Refer to [DEF-42. "Component Inspection"](#).

Is the inspection result normal?

- YES >> GO TO 5.
NO >> Replace door mirror. Refer to [MIR-17. "Removal and Installation"](#).

5. CHECK INTERMITTENT INCIDENT

Check intermittent incident.

Refer to [GI-49. "Intermittent Incident"](#).

Is the inspection result normal?

- YES >> Check the following:
- Battery power supply circuit
 - Fuse block (J/B)
- NO >> Repair or replace the malfunctioning parts.

Component Inspection

INFOID:000000009175581

1. CHECK DOOR MIRROR DEFOGGER

1. Turn ignition switch OFF.
2. Disconnect door mirror RH.
3. Check continuity between door mirror terminals.

Terminal		Continuity
7	19	Yes

Is the inspection result normal?

- YES >> Check the condition of the harness and the connector.
NO >> Replace malfunctioning door mirror RH. Refer to [MIR-17. "Removal and Installation"](#).

DEFOGGER SYSTEM SYMPTOMS

< SYMPTOM DIAGNOSIS >

SYMPTOM DIAGNOSIS

DEFOGGER SYSTEM SYMPTOMS

Symptom Table

INFOID:000000009175582

Symptom	Reference page
Rear window defoggers and door mirror defoggers do not operate.	Refer to DEF-44, "Diagnosis Procedure" .
Rear window defoggers do not operate but both of the door mirror defoggers operate.	Refer to DEF-45, "Diagnosis Procedure" .
Both door mirror defoggers don't operate but rear window defoggers operate.	Refer to DEF-46, "Diagnosis Procedure" .
Driver side door mirror defogger does not operate.	Refer to DEF-46, "Diagnosis Procedure" .
Passenger side door mirror defogger does not operate.	Refer to DEF-49, "Diagnosis Procedure" .
Rear window defogger switch does not light, but rear window defogger operates.	Refer to DEF-50, "Diagnosis Procedure" .

A
B
C
D
E
F
G
H
I
J
K
DEF
M
N
O
P

REAR WINDOW DEFOGGER AND DOOR MIRROR DEFOGGER DO NOT OPERATE.

< SYMPTOM DIAGNOSIS >

REAR WINDOW DEFOGGER AND DOOR MIRROR DEFOGGER DO NOT OPERATE.

Diagnosis Procedure

INFOID:000000009175583

1. CHECK REAR WINDOW DEFOGGER SWITCH

Check rear window defogger switch.

Refer to [DEF-26, "Component Function Check"](#).

Is the inspection result normal?

YES >> GO TO 2.

NO >> Repair or replace the malfunctioning parts.

2. CHECK REAR WINDOW DEFOGGER RELAY

Check rear window defogger relay.

Refer to [DEF-31, "Component Function Check"](#).

Is the inspection result normal?

YES >> GO TO 3.

NO >> Repair or replace the malfunctioning parts.

3. CHECK REAR WINDOW DEFOGGER POWER SUPPLY AND GROUND CIRCUIT

Check rear window defogger power supply and ground circuit.

Refer to [DEF-33, "Component Function Check"](#).

Is the inspection result normal?

YES >> GO TO 4.

NO >> Repair or replace the malfunctioning parts.

4. CHECK DOOR MIRROR DEFOGGER

Check door mirror defogger.

Refer to [DEF-35, "Diagnosis Procedure"](#) (LH without around view monitor), [DEF-37, "Diagnosis Procedure"](#) (LH with around view monitor), [DEF-39, "Diagnosis Procedure"](#) (RH without around view monitor), [DEF-41, "Diagnosis Procedure"](#) (RH with around view monitor).

Is the inspection result normal?

YES >> Check intermittent incident. Refer to [GI-49, "Intermittent Incident"](#).

NO >> Repair or replace the malfunctioning parts.

REAR WINDOW DEFOGGER DOES NOT OPERATE BUT BOTH OF DOOR MIRROR DEFOGGER OPERATE.

< SYMPTOM DIAGNOSIS >

REAR WINDOW DEFOGGER DOES NOT OPERATE BUT BOTH OF DOOR MIRROR DEFOGGER OPERATE.

Diagnosis Procedure

INFOID:000000009175584

1. CHECK REAR WINDOW DEFOGGER POWER SUPPLY AND GROUND CIRCUIT

Check rear window defogger power supply and ground circuit.

Refer to [DEF-33, "Component Function Check"](#).

Is the inspection result normal?

YES >> Check intermittent incident. Refer to [GI-49, "Intermittent Incident"](#).

NO >> Repair or replace the malfunctioning parts.

A
B
C
D
E
F
G
H
I
J
K
DEF
M
N
O
P

BOTH DOORS MIRROR DEFOGGER DON'T OPERATE BUT REAR WINDOW DEFOGGER OPERATES

< SYMPTOM DIAGNOSIS >

BOTH DOORS MIRROR DEFOGGER DON'T OPERATE BUT REAR WINDOW DEFOGGER OPERATES

Diagnosis Procedure

INFOID:000000009175585

Regarding Wiring Diagram information, refer to [DEF-10. "Wiring Diagram"](#).

1. CHECK DOOR MIRROR DEFOGGER FUSE

Check if the following fuse in fuse block (J/B) is blown.

COMPONENT PARTS	AMPERE	FUSE NO.
Fuse block (J/B)	10A	22

Is the inspection result normal?

YES >> GO TO 2.

NO >> Replace the blown fuse after repairing the affected circuit.

2. CHECK DOOR MIRROR DEFOGGER CIRCUIT

1. Turn ignition switch OFF.
2. Disconnect the following harness connectors.
 - Fuse block (J/B) connector M4
 - Door mirror LH D4 (without around view monitor), D28 (with around view monitor)
 - Door mirror RH D107 (without around view monitor), D128 (with around view monitor)
3. Check continuity between fuse block (J/B) harness connector and door mirror defogger harness connectors.

Fuse block (J/B) Connector	Terminal	Door mirror Connectors	Terminal	Continuity
M4	5P	D4 (LH without around view monitor)	1	Yes
		D107 (RH without around view monitor)		
		D28 (LH with around view monitor)	7	
		D128 (RH with around view monitor)		

4. Check continuity between fuse block (J/B) harness connector M4 terminal 5P and ground.

Fuse block (J/B) connector	Terminal	Ground	Continuity
M4	5P		No

Is the inspection result normal?

YES >> GO TO 3.

NO >> Repair or replace harness.

3. CHECK DOOR MIRROR DEFOGGER

Check door mirror LH.

Refer to [DEF-35. "Component Function Check"](#) (without around view monitor) or [DEF-37. "Component Function Check"](#) (with around view monitor).

Check door mirror RH.

Refer to [DEF-39. "Component Function Check"](#) (without around view monitor) or [DEF-41. "Component Function Check"](#) (with around view monitor).

Is the inspection result normal?

BOTH DOORS MIRROR DEFOGGER DON'T OPERATE BUT REAR WINDOW DEFOGGER OPERATES

< SYMPTOM DIAGNOSIS >

- YES >> Check intermittent incident. Refer to [GI-49. "Intermittent Incident"](#).
- NO >> Repair or replace the malfunctioning parts.

- A
- B
- C
- D
- E
- F
- G
- H
- I
- J
- K
- DEF**
- M
- N
- O
- P

DRIVER SIDE DOOR MIRROR DEFOGGER DOES NOT OPERATE.

< SYMPTOM DIAGNOSIS >

DRIVER SIDE DOOR MIRROR DEFOGGER DOES NOT OPERATE.

Diagnosis Procedure

INFOID:000000009175586

1. CHECK DOOR MIRROR DEFOGGER LH

Check door mirror defogger LH.

Refer to [DEF-35. "Component Function Check"](#) (without around view monitor) or [DEF-37. "Component Function Check"](#) (with around view monitor).

Is the inspection result normal?

- YES >> Check intermittent incident. Refer to [GI-49. "Intermittent Incident"](#).
- NO >> Repair or replace the malfunctioning parts.

PASSENGER SIDE DOOR MIRROR DEFOGGER DOES NOT OPERATE.

< SYMPTOM DIAGNOSIS >

PASSENGER SIDE DOOR MIRROR DEFOGGER DOES NOT OPERATE.

Diagnosis Procedure

INFOID:000000009175587

1. CHECK DOOR MIRROR DEFOGGER RH

Check door mirror defogger RH.

Refer to [DEF-39. "Component Function Check"](#) (without around view monitor) or [DEF-41. "Component Function Check"](#) (with around view monitor).

Is the inspection result normal?

YES >> Check intermittent incident. Refer to [GI-49. "Intermittent Incident"](#).

NO >> Repair or replace the malfunctioning parts.

A
B
C
D
E
F
G
H
I
J
K
DEF
M
N
O
P

REAR WINDOW DEFOGGER SWITCH DOES NOT LIGHT, BUT REAR WINDOW DEFOGGER OPERATES

< SYMPTOM DIAGNOSIS >

REAR WINDOW DEFOGGER SWITCH DOES NOT LIGHT, BUT REAR WINDOW DEFOGGER OPERATES

Diagnosis Procedure

INFOID:000000009175588

1. CHECK A/C AND AV SWITCH ASSEMBLY (REAR WINDOW DEFOGGER SWITCH)

Check that A/C and AV switch assembly (rear window defogger switch) is operating normally.

Is the inspection result normal?

- YES >> Check intermittent incident. Refer to [GI-49, "Intermittent Incident"](#).
- NO >> Check rear window defogger switch. Refer to [DEF-26, "Diagnosis Procedure"](#).

FILAMENT

< REMOVAL AND INSTALLATION >

REMOVAL AND INSTALLATION

FILAMENT

Inspection and Repair

INFOID:000000009175589

INSPECTION

1. When measuring voltage, wrap tin foil around the top of the negative probe. Then press the foil against the wire with your finger.

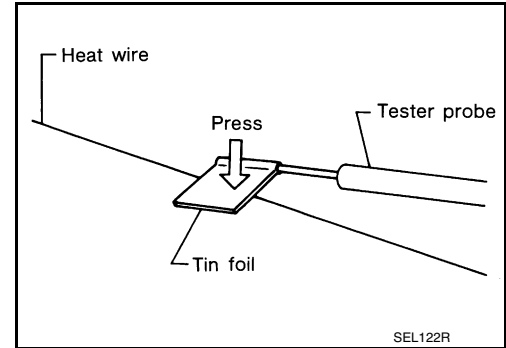

2. Attach probe circuit tester (in Volt range) to middle portion of each filament.

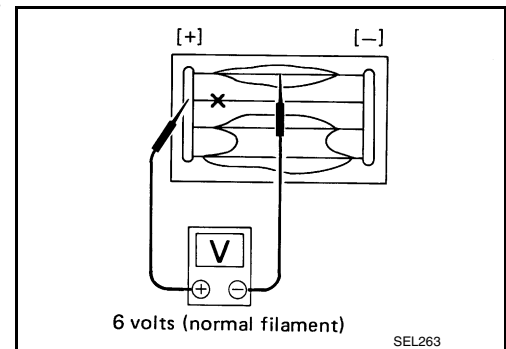

3. If a filament is burned out, circuit tester registers 0 or battery voltage.
4. To locate burned out point, move probe to left and right along filament. Test needle will swing abruptly when probe passes the point.

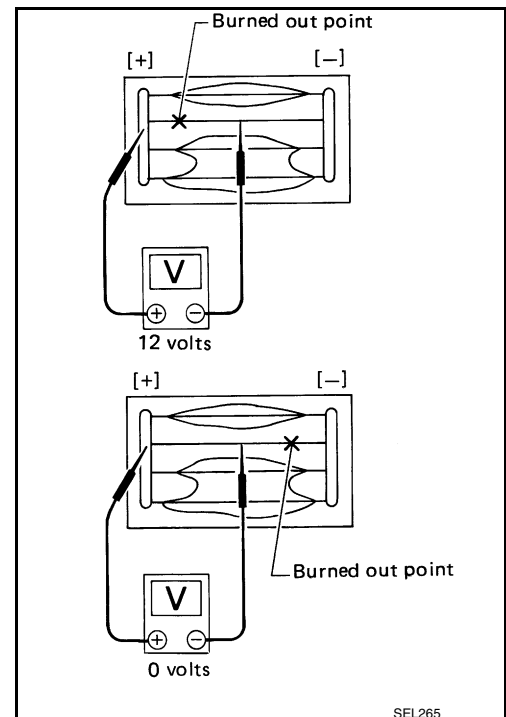

REPAIR

REPAIR EQUIPMENT

- Conductive silver composition (Dupont No. 4817 or equivalent)

A
B
C
D
E
F
G
H
I
J
K
DEF
M
N
O
P

FILAMENT

< REMOVAL AND INSTALLATION >

- Ruler 30 cm (11.8 in) long
- Drawing pen
- Heat gun
- Alcohol
- Cloth

REPAIRING PROCEDURE

1. Wipe broken heat wire and its surrounding area clean with a cloth dampened in alcohol.
2. Apply a small amount of conductive silver composition to tip of drawing pen.

NOTE:

Shake silver composition container before use.

3. Place ruler on glass along broken line. Deposit conductive silver composition on break with drawing pen. Slightly overlap existing heat wire on both sides [preferably 5 mm (0.20 in)] of the break.

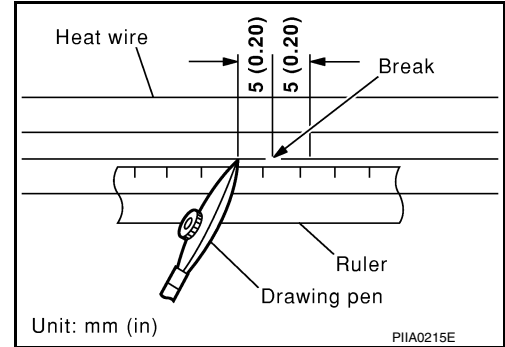

4. After repair has been completed, check repaired wire for continuity. This check should be conducted 10 minutes after silver composition is deposited.

CAUTION:

Do not touch repaired area while test is being conducted.

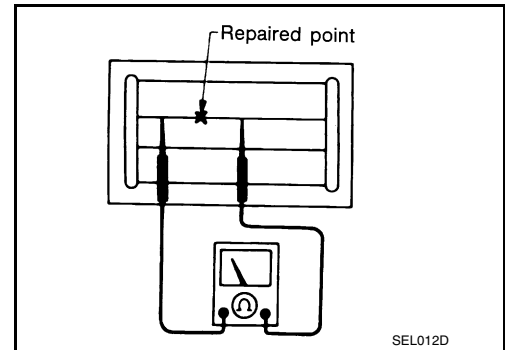

5. Apply a constant stream of hot air directly to the repaired area for approximately 20 minutes with a heat gun. A minimum distance of 3 cm (1.2 in) should be kept between repaired area and hot air outlet.

NOTE:

If a heat gun is not available, let the repaired area dry for 24 hours.

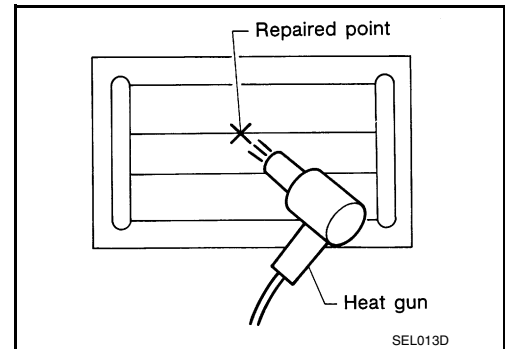

CONDENSER

< REMOVAL AND INSTALLATION >

CONDENSER

Removal and Installation

INFOID:000000009175590

REMOVAL

1. Remove the back door lower finisher. Refer to [INT-35. "BACK DOOR LOWER FINISHER : Removal and Installation"](#).
2. Disconnect the harness connectors (A) from the condenser (1).
3. Remove the bolt (B) and the condenser (1).

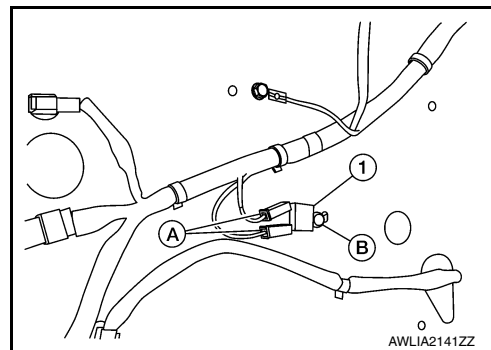

INSTALLATION

Installation is in the reverse order of removal.

A
B
C
D
E
F
G
H
I
J
K
DEF
M
N
O
P