

# MWI

## SECTION

### METER, WARNING LAMP & INDICATOR

A  
B  
C  
D  
E  
F  
G  
H  
I  
J  
K  
L  
M  
N  
O  
P

## CONTENTS

<b>PRECAUTION</b> .....	4	FUEL GAUGE : System Diagram .....	12
<b>PRECAUTIONS</b> .....	4	FUEL GAUGE : System Description .....	12
Precaution for Supplemental Restraint System (SRS) "AIR BAG" and "SEAT BELT PRE-TENSIONER" .....	4	<b>MASTER WARNING LAMP</b> .....	12
<b>PREPARATION</b> .....	5	MASTER WARNING LAMP : System Diagram .....	13
<b>PREPARATION</b> .....	5	MASTER WARNING LAMP : System Description .....	13
Commercial Service Tools .....	5	<b>METER ILLUMINATION CONTROL</b> .....	13
<b>SYSTEM DESCRIPTION</b> .....	6	METER ILLUMINATION CONTROL : System Diagram .....	13
<b>COMPONENT PARTS</b> .....	6	METER ILLUMINATION CONTROL : System Description .....	13
<b>METER SYSTEM</b> .....	6	<b>METER EFFECT FUNCTION</b> .....	13
METER SYSTEM : Component Parts Location .....	6	METER EFFECT FUNCTION : System Diagram .....	14
METER SYSTEM : Component Description .....	7	METER EFFECT FUNCTION : System Description .....	14
<b>SYSTEM</b> .....	9	<b>INFORMATION DISPLAY</b> .....	15
<b>METER SYSTEM</b> .....	9	INFORMATION DISPLAY : System Diagram .....	15
METER SYSTEM : System Diagram .....	9	INFORMATION DISPLAY : System Description .....	15
METER SYSTEM : System Description .....	9	<b>COMPASS</b> .....	16
METER SYSTEM : Arrangement of Combination Meter .....	10	COMPASS : Description .....	16
METER SYSTEM : Fail-Safe .....	10	<b>DIAGNOSIS SYSTEM (COMBINATION METER)</b> .....	19
<b>SPEEDOMETER</b> .....	11	Description .....	19
SPEEDOMETER : System Diagram .....	11	CONSULT Function (METER/M&A) .....	19
SPEEDOMETER : System Description .....	11	<b>ECU DIAGNOSIS INFORMATION</b> .....	24
<b>TACHOMETER</b> .....	11	<b>COMBINATION METER</b> .....	24
TACHOMETER : System Diagram .....	12	Reference Value .....	24
TACHOMETER : System Description .....	12	Fail-Safe .....	28
<b>ENGINE COOLANT TEMPERATURE GAUGE</b> .....	12	DTC Index .....	29
ENGINE COOLANT TEMPERATURE GAUGE : System Diagram .....	12	<b>BCM (BODY CONTROL MODULE)</b> .....	30
ENGINE COOLANT TEMPERATURE GAUGE : System Description .....	12	List of ECU Reference .....	30
<b>FUEL GAUGE</b> .....	12	<b>WIRING DIAGRAM</b> .....	31
		<b>METER SYSTEM</b> .....	31

MWI

Wiring Diagram .....	31	Component Inspection .....	67
<b>COMPASS .....</b>	<b>50</b>	<b>PARKING BRAKE SWITCH SIGNAL CIRCUIT .....</b>	<b>69</b>
Wiring Diagram .....	50	Description .....	69
<b>BASIC INSPECTION .....</b>	<b>52</b>	Component Function Check .....	69
<b>DIAGNOSIS AND REPAIR WORK FLOW .....</b>	<b>52</b>	Diagnosis Procedure .....	69
Work flow .....	52	Component Inspection .....	69
<b>DTC/CIRCUIT DIAGNOSIS .....</b>	<b>54</b>	<b>STEERING SWITCH .....</b>	<b>70</b>
<b>U1000 CAN COMM CIRCUIT .....</b>	<b>54</b>	Description .....	70
DTC Logic .....	54	Diagnosis Procedure .....	70
Diagnosis Procedure .....	54	Component Inspection .....	70
<b>U1010 CONTROL UNIT (CAN) .....</b>	<b>55</b>	<b>SYMPTOM DIAGNOSIS .....</b>	<b>72</b>
Description .....	55	<b>THE FUEL GAUGE INDICATOR DOES NOT OPERATE .....</b>	<b>72</b>
DTC Logic .....	55	Description .....	72
Diagnosis Procedure .....	55	Diagnosis Procedure .....	72
<b>B2205 VEHICLE SPEED .....</b>	<b>56</b>	<b>THE ILLUMINATION CONTROL SWITCH IS INOPERATIVE .....</b>	<b>73</b>
Description .....	56	Description .....	73
DTC Logic .....	56	Diagnosis Procedure .....	73
Diagnosis Procedure .....	56	<b>THE TRIP RESET SWITCH IS INOPERATIVE..</b>	<b>74</b>
<b>B2267 ENGINE SPEED .....</b>	<b>57</b>	Description .....	74
Description .....	57	Diagnosis Procedure .....	74
DTC Logic .....	57	<b>THE OIL PRESSURE WARNING CONTINUES DISPLAYING, OR DOES NOT DISPLAY..</b>	<b>75</b>
Diagnosis Procedure .....	57	Description .....	75
<b>B2268 WATER TEMP .....</b>	<b>58</b>	Diagnosis Procedure .....	75
Description .....	58	<b>THE PARKING BRAKE RELEASE WARNING CONTINUES DISPLAYING, OR DOES NOT DISPLAY .....</b>	<b>76</b>
DTC Logic .....	58	Description .....	76
Diagnosis Procedure .....	58	Diagnosis Procedure .....	76
<b>POWER SUPPLY AND GROUND CIRCUIT ....</b>	<b>59</b>	<b>THE LOW WASHER FLUID WARNING CONTINUES DISPLAYING, or DOES NOT DISPLAY .....</b>	<b>77</b>
<b>COMBINATION METER .....</b>	<b>59</b>	Description .....	77
COMBINATION METER : Diagnosis Procedure ...	59	Diagnosis Procedure .....	77
<b>BCM (BODY CONTROL MODULE) .....</b>	<b>59</b>	<b>THE DOOR OPEN WARNING CONTINUES DISPLAYING, OR DOES NOT DISPLAY .....</b>	<b>78</b>
BCM (BODY CONTROL MODULE) : Diagnosis Procedure .....	59	Description .....	78
<b>ILLUMINATION CONTROL SWITCH SIGNAL CIRCUIT .....</b>	<b>61</b>	Diagnosis Procedure .....	78
Diagnosis Procedure .....	61	<b>THE LIFTGATE OPEN WARNING CONTINUES DISPLAYING, OR DOES NOT DISPLAY..</b>	<b>79</b>
Component Inspection .....	61	Description .....	79
<b>TRIP RESET SWITCH SIGNAL CIRCUIT .....</b>	<b>63</b>	Diagnosis Procedure .....	79
Diagnosis Procedure .....	63	<b>THE STEERING SWITCHES ARE INOPERATIVE .....</b>	<b>80</b>
Component Inspection .....	63	Description .....	80
<b>FUEL LEVEL SENSOR SIGNAL CIRCUIT .....</b>	<b>65</b>	Diagnosis Procedure .....	80
Description .....	65	<b>WASHER FLUID LEVEL SWITCH CIRCUIT ...</b>	<b>67</b>
Component Function Check .....	65	Description .....	67
Diagnosis Procedure .....	65	Diagnosis Procedure .....	67
Component Inspection .....	66		

<b>THE AMBIENT TEMPERATURE DISPLAY IS INCORRECT</b> .....	<b>81</b>	<b>COMBINATION METER</b> .....	<b>82</b>	
Description .....	81	Removal and Installation .....	82	A
Diagnosis Procedure .....	81	<b>TRIP RESET AND ILLUMINATION CONTROL SWITCH</b> .....	<b>83</b>	
<b>REMOVAL AND INSTALLATION</b> .....	<b>82</b>	Removal and Installation .....	83	B

C  
D  
E  
F  
G  
H  
I  
J  
K  
L  
M  
O  
P

MWI

## PRECAUTIONS

< PRECAUTION >

### PRECAUTION

#### PRECAUTIONS

##### Precaution for Supplemental Restraint System (SRS) "AIR BAG" and "SEAT BELT PRE-TENSIONER"

INFOID:000000009745915

The Supplemental Restraint System such as "AIR BAG" and "SEAT BELT PRE-TENSIONER", used along with a front seat belt, helps to reduce the risk or severity of injury to the driver and front passenger for certain types of collision. Information necessary to service the system safely is included in the SR and SB section of this Service Manual.

**WARNING:**

- To avoid rendering the SRS inoperative, which could increase the risk of personal injury or death in the event of a collision which would result in air bag inflation, all maintenance must be performed by an authorized NISSAN/INFINITI dealer.
- Improper maintenance, including incorrect removal and installation of the SRS, can lead to personal injury caused by unintentional activation of the system. For removal of Spiral Cable and Air Bag Module, see the SR section.
- Do not use electrical test equipment on any circuit related to the SRS unless instructed to in this Service Manual. SRS wiring harnesses can be identified by yellow and/or orange harnesses or harness connectors.

##### PRECAUTIONS WHEN USING POWER TOOLS (AIR OR ELECTRIC) AND HAMMERS

**WARNING:**

- When working near the Airbag Diagnosis Sensor Unit or other Airbag System sensors with the Ignition ON or engine running, DO NOT use air or electric power tools or strike near the sensor(s) with a hammer. Heavy vibration could activate the sensor(s) and deploy the air bag(s), possibly causing serious injury.
- When using air or electric power tools or hammers, always switch the Ignition OFF, disconnect the battery and wait at least three minutes before performing any service.

# PREPARATION

< PREPARATION >

## PREPARATION

### PREPARATION

#### Commercial Service Tools

INFOID:000000009174216

Tool name	Description
<p data-bbox="167 415 277 443">Power tool</p>  <p data-bbox="829 632 898 651">PIIB1407E</p>	<p data-bbox="1013 415 1349 443">Loosening nuts, screws and bolts</p>

A  
B  
C  
D  
E  
F  
G  
H  
I  
J  
K  
L  
M  
O  
P

MWI

# COMPONENT PARTS

< SYSTEM DESCRIPTION >

## SYSTEM DESCRIPTION

### COMPONENT PARTS

#### METER SYSTEM

#### METER SYSTEM : Component Parts Location

INFOID:000000009174217

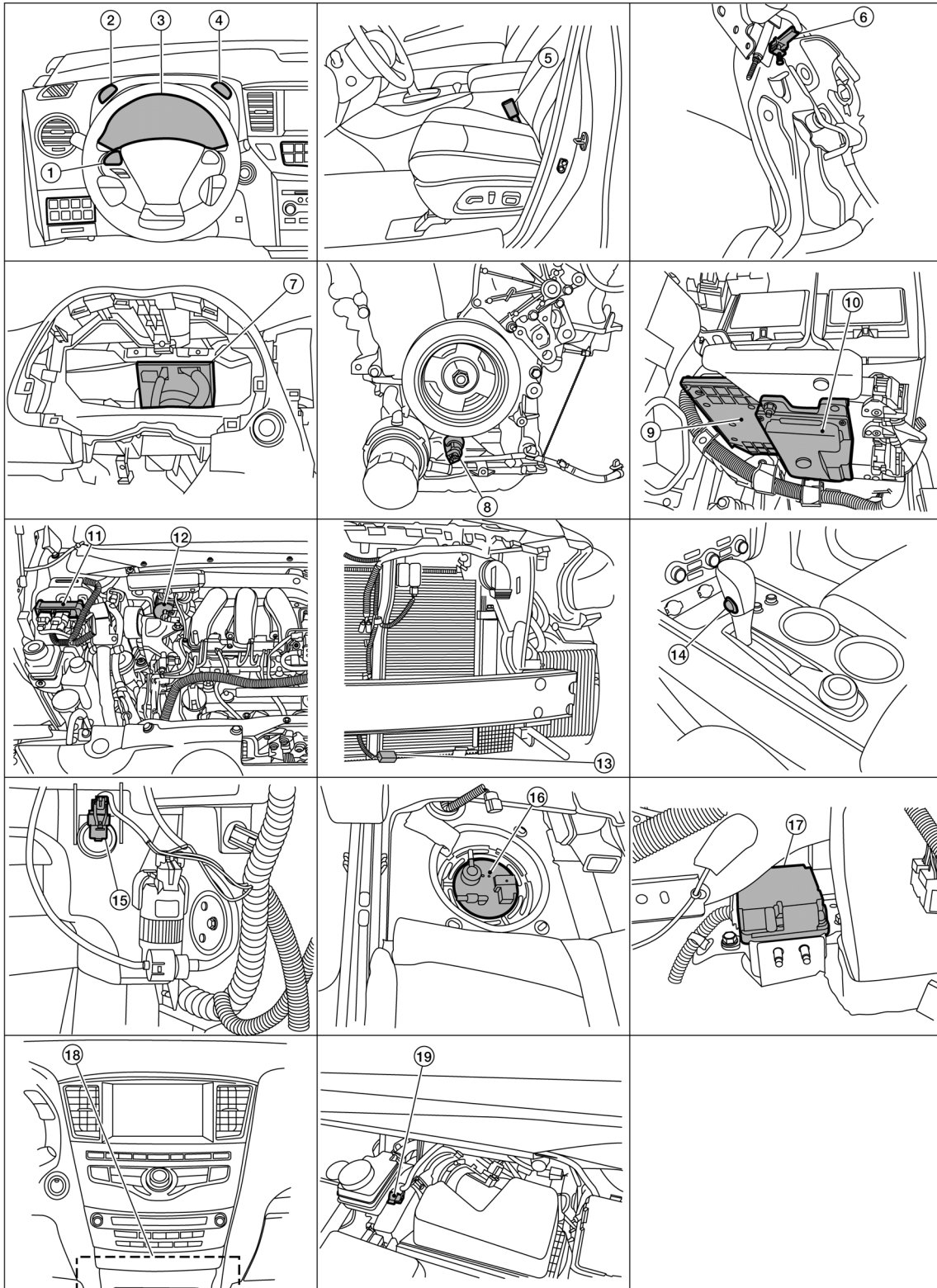

AWNIA2792ZZ

# COMPONENT PARTS

## < SYSTEM DESCRIPTION >

- |  |  |   |   |
|--|--|---|---|
| 1. Steering switch   | 2. Illumination control switch   | 3. Combination meter  | A |
| 4. Trip reset switch   | 5. Seat belt buckle switch (Driver seat)<br>(passenger similar)                  | 6. Parking brake switch   |   |
| 7. BCM<br>(view with combination meter removed)  | 8. Engine oil pressure sensor  | 9. ECM  | B |
| 10. TCM  | 11. Power steering control module  | 12. ABS actuator and electric unit (control unit)                 | C |
| 13. Ambient sensor<br>(view with front fascia removed)                                     | 14. CVT shift selector<br>(O/D OFF switch)                                       | 15. Washer fluid level switch<br>(view with front fascia removed) |   |
| 16. Fuel level sensor unit and fuel pump<br>(view with fuel pump inspection cover removed) | 17. Air bag diagnosis sensor unit<br>(view with center console assembly removed) | 18. A/C auto amp  | D |
| 19. Brake fluid level switch   |  |   | E |

## METER SYSTEM : Component Description

INFOID:000000009174218

Unit	Description
Combination meter	Controls the following with the signals received from each unit via CAN communication and the signals from switches and sensors: <ul style="list-style-type: none"> <li>• Speedometer</li> <li>• Tachometer</li> <li>• Engine coolant temperature gauge</li> <li>• Fuel gauge</li> <li>• Warning lamps</li> <li>• Indicator lamps</li> <li>• Meter illumination control</li> <li>• Meter effect function</li> <li>• Information display</li> </ul>
Illumination control switch	Transmits the following signals to the combination meter: <ul style="list-style-type: none"> <li>• Illumination control switch signal (+)</li> <li>• Illumination control switch signal (-)</li> </ul>
Trip reset switch	Transmits the trip reset switch signal to the combination meter.
ECM	Transmits the following signals to the combination meter via CAN communication: <ul style="list-style-type: none"> <li>• Engine speed signal</li> <li>• Engine coolant temperature signal</li> <li>• Engine oil pressure warning signal</li> <li>• Fuel consumption monitor signal</li> </ul>
ABS actuator and electric unit (control unit)	Transmits the vehicle speed signal to the combination meter via CAN communication.
Power steering control module	Transmits the EPS signal to the combination meter via CAN communication.
BCM	Transmits the following signals to the combination meter via CAN communication: <ul style="list-style-type: none"> <li>• Tire pressure information</li> <li>• Position light request signal</li> <li>• Low tire pressure warning lamp signal</li> <li>• Door switch signal</li> <li>• Back door switch signal</li> </ul>
TCM	Transmits the shift selector position signal to the combination meter via CAN communication.
CVT shift selector (O/D OFF switch)	Transmits the O/D OFF switch signal to the combination meter.
Fuel level sensor unit	Transmits the fuel level sensor signal to the combination meter.
Seat belt buckle switch (driver seat)	Transmits the seat belt buckle switch (driver seat) signal to the combination meter.
Air bag diagnosis sensor unit	Transmits the seat belt buckle switch (passenger seat) signal to the combination meter.
Engine oil pressure sensor	Transmits the engine oil pressure sensor signal to the ECM.
Ambient sensor	Transmits the ambient sensor signal to the A/C auto amp.

## COMPONENT PARTS

### < SYSTEM DESCRIPTION >

Unit	Description
A/C auto amp.	Transmits the ambient sensor signal to the combination meter via CAN communication.
Parking brake switch	Transmits the parking brake switch signal to the combination meter.
Washer fluid level switch	Transmits the washer fluid level switch signal to the combination meter.
Steering switch	Transmits the following signals to the information display: <ul style="list-style-type: none"><li>• Display signal</li><li>• Menu up signal</li><li>• Menu down signal</li><li>• Enter signal</li><li>• Back signal</li></ul>
Brake fluid level switch	Transmits the brake fluid level switch signal to the combination meter.



# SYSTEM

< SYSTEM DESCRIPTION >

## SYSTEM

### METER SYSTEM

#### METER SYSTEM : System Diagram

INFOID:000000009174219

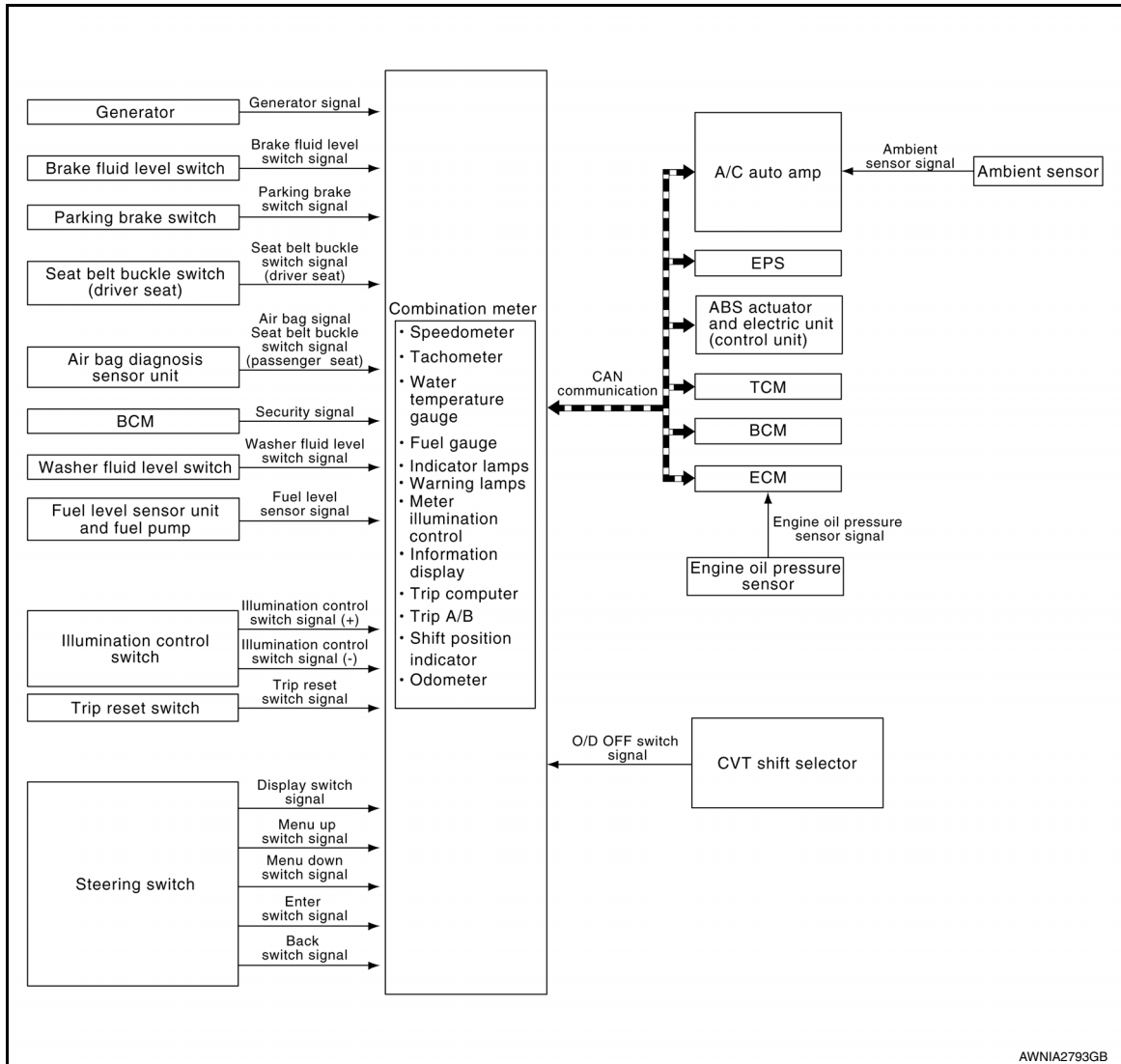

#### METER SYSTEM : System Description

INFOID:000000009174220

##### COMBINATION METER

- The combination meter receives signals from switches, sensors and modules to control the following functions:
  - Speedometer/tachometer
  - Warning lamps
  - Indicator lamps
  - Meter illumination control
  - Meter effect function
  - Information display
- The combination meter has an integrated buzzer that is activated when it receives a signal from the BCM via CAN communication. Refer to [WCS-6, "WARNING CHIME SYSTEM : System Description"](#) for further details.
- The combination meter includes an on-board diagnosis function.
- The combination meter can be diagnosed with CONSULT.

# SYSTEM

< SYSTEM DESCRIPTION >

## METER SYSTEM : Arrangement of Combination Meter

INFOID:000000009174221

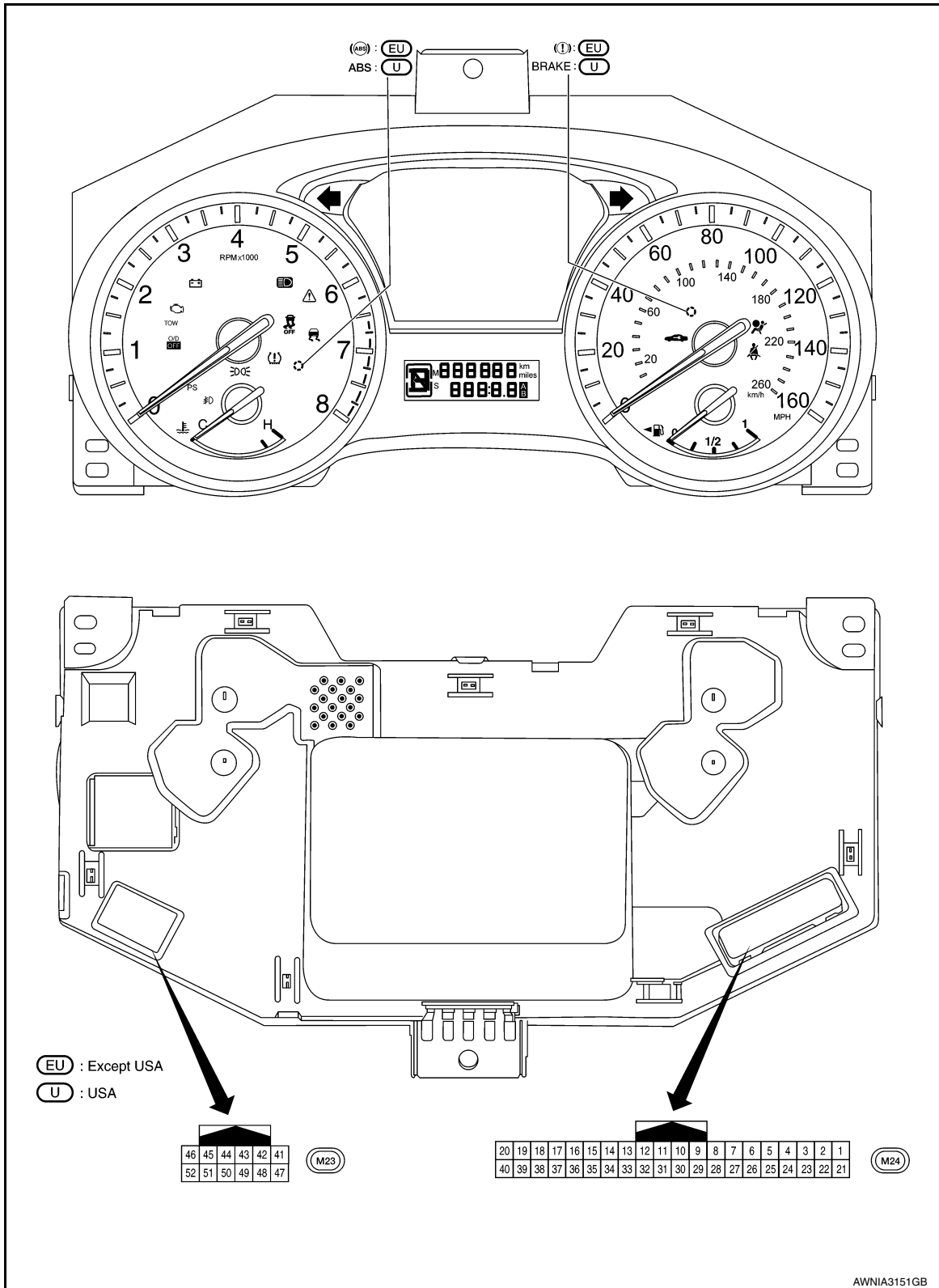

AWNIA3151GB

## METER SYSTEM : Fail-Safe

INFOID:000000009755007

### FAIL-SAFE

The combination meter activates the fail-safe control if CAN communication with each unit is malfunctioning.

# SYSTEM

## < SYSTEM DESCRIPTION >

Function		Specifications
Speedometer		Reset to zero by suspending communication.
Tachometer		
Engine coolant temperature gauge		
Illumination control		When suspending communication, changes to nighttime mode.
Information display	Odo/trip meter	An indicated value is maintained at communications blackout.
	Shift position indicator	The display turns OFF by suspending communication.
	Warning messages	The display turns OFF by suspending communication.
Buzzer		The buzzer turns OFF by suspending communication.
Warning lamp/indicator lamp	ABS warning lamp	The lamp turns ON by suspending communication.
	Slip indicator lamp	
	Brake warning lamp	
	O/D OFF indicator lamp	
	Malfunction indicator lamp	
	VDC OFF indicator lamp	
	EPS warning lamp	
	Low tire pressure warning lamp	The lamp blinking caused by suspending communication.
	High beam indicator lamp	The lamp turns OFF by suspending communication.
	Turn signal indicator lamp	
	Master warning lamp	
	Front lamp indicator lamp	
	Tow indicator lamp	
	Tail lamp indicator lamp	The lamp turns off when disconnected.
	Air bag warning lamp	
	Charge warning lamp	
Seat belt warning lamp		
Security indicator lamp		

## SPEEDOMETER

### SPEEDOMETER : System Diagram

INFOID:000000009174223

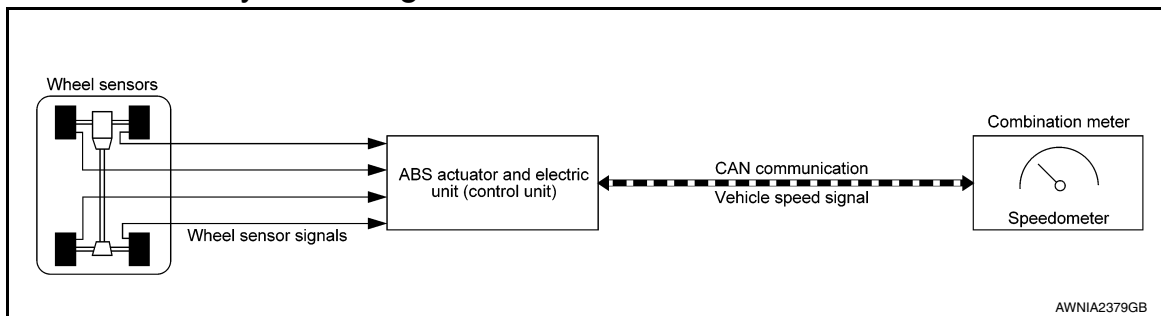

### SPEEDOMETER : System Description

INFOID:000000009174224

The ABS actuator and electric unit (control unit) receives each wheel speed sensor signal and provides a vehicle speed signal to the combination meter via CAN communication lines.

## TACHOMETER

# SYSTEM

< SYSTEM DESCRIPTION >

## TACHOMETER : System Diagram

INFOID:000000009174225

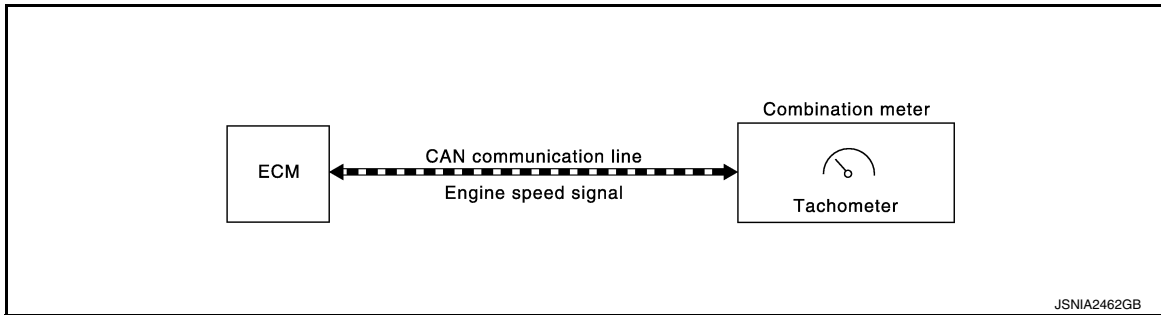

## TACHOMETER : System Description

INFOID:000000009174226

The crank position sensor sends a crankshaft position signal to the ECM. The ECM provides an engine speed signal to the combination meter via CAN communication lines. The tachometer indicates engine speed in revolutions per minute (rpm).

## ENGINE COOLANT TEMPERATURE GAUGE

## ENGINE COOLANT TEMPERATURE GAUGE : System Diagram

INFOID:000000009174227

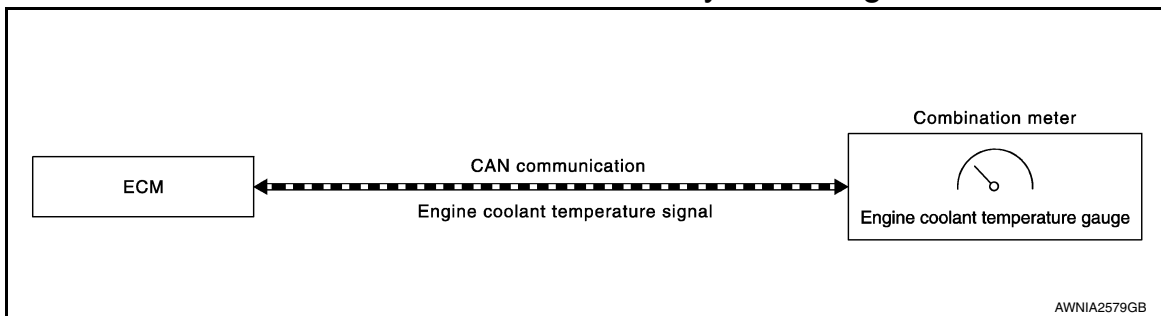

## ENGINE COOLANT TEMPERATURE GAUGE : System Description

INFOID:000000009174228

The engine coolant temperature sensor sends an engine coolant temperature signal to the ECM. The ECM provides an engine coolant temperature signal to the combination meter via CAN communication lines. The engine coolant temperature gauge indicates the engine coolant temperature.

## FUEL GAUGE

## FUEL GAUGE : System Diagram

INFOID:000000009174229

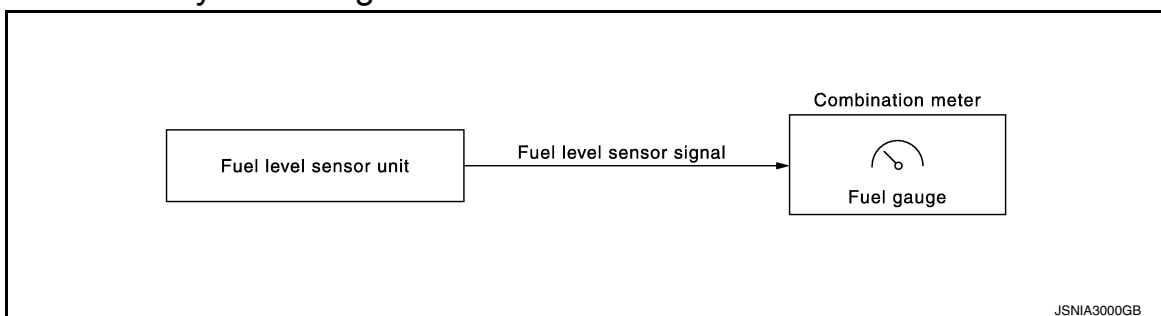

## FUEL GAUGE : System Description

INFOID:000000009174230

The fuel level sensor unit sends a variable resistor signal to the combination meter. The fuel gauge indicates the approximate fuel level in the fuel tank.

## MASTER WARNING LAMP

# SYSTEM

< SYSTEM DESCRIPTION >

## MASTER WARNING LAMP : System Diagram

INFOID:000000009174231

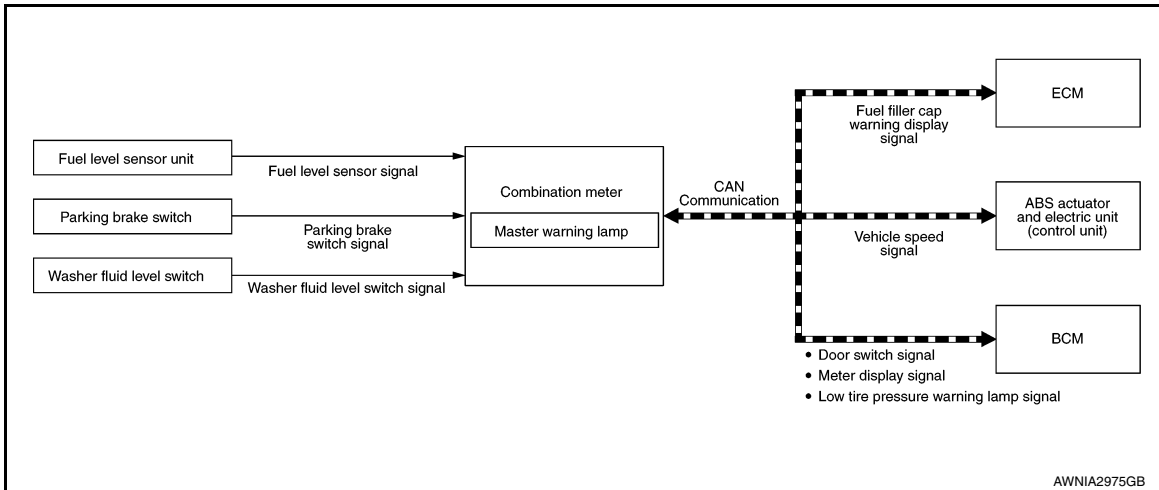

## MASTER WARNING LAMP : System Description

INFOID:000000009174232

When receiving a signal from each unit, switch, or sensor, the combination meter turns ON/OFF the master warning lamp in synchronization with the following warnings on the information display:

- Door open warning
- Parking brake release warning
- Low fuel warning
- Low washer fluid warning
- Low tire pressure warning
- Fuel filler cap warning

## METER ILLUMINATION CONTROL

### METER ILLUMINATION CONTROL : System Diagram

INFOID:000000009174233

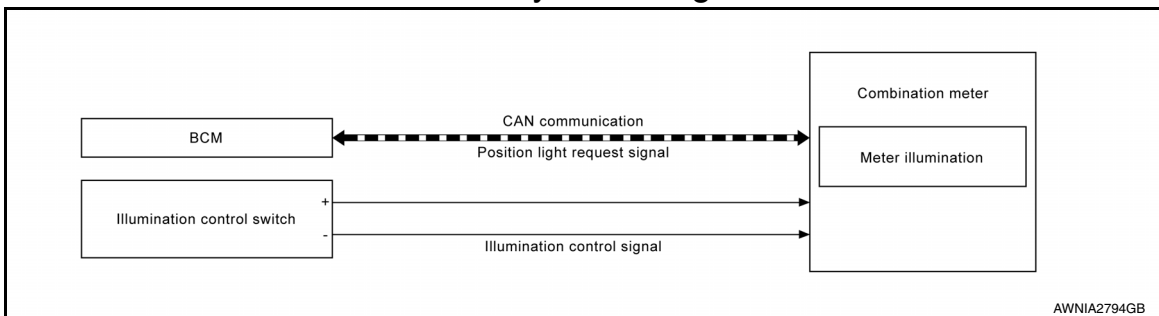

### METER ILLUMINATION CONTROL : System Description

INFOID:000000009174234

#### METER ILLUMINATION ON/OFF CONTROL FUNCTION

Meter illumination control is enabled when the meter receives a signal from the BCM that the combination switch is in the AUTO (if equipped and activated) or parking lamp position and the meter switches from Day-time mode to Nighttime mode.

#### METER ILLUMINATION CONTROL FUNCTION

The operation of the illumination control switch changes brightness of the meter illumination.

Meter illumination	The number of adjustable steps
Daytime	22 steps
Nighttime	22 steps

## METER EFFECT FUNCTION

A  
B  
C  
D  
E  
F  
G  
H  
I  
J  
K  
L  
M

MWI

O  
P

# SYSTEM

< SYSTEM DESCRIPTION >

## METER EFFECT FUNCTION : System Diagram

INFOID:000000009174235

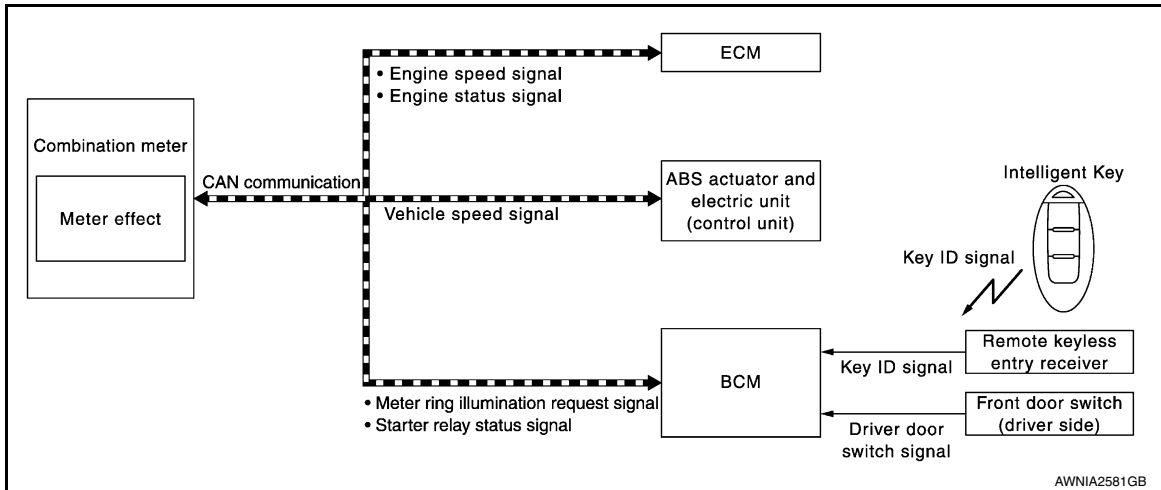

## METER EFFECT FUNCTION : System Description

INFOID:000000009174236

### ENGINE-START EFFECT FUNCTION

When recognizing an engine start, the combination meter controls the following items for producing the effect:

- Speedometer
- Tachometer
- Engine coolant temperature gauge
- Fuel gauge
- Meter illumination

### Meter and Illumination Operations During Engine-start Effect

The combination meter controls the following items during the engine-start effect.

Control item		Operation
Speedometer		Sweeps the pointer.
Tachometer		Sweeps the pointer.
Engine coolant temperature gauge		Stops the pointer.
Fuel gauge		Stops the pointer.
Meter illumination	Pointers	Turns on the illumination at the effect level.
	Information display	Turns on the illumination at the normal brightness level.
	Other than those above	Increases the brightness to the effect level in stages.

### NOTE:

The pointers are stopped and illumination is turned off while cranking the engine.

### Engine Start Judgement

The combination meter judges “engine-start” and activates the engine-start effect only once when the following operational conditions are all satisfied.

Condition	
Ignition switch	ON position
Vehicle speed	Less than 0.6 MPH (1 km/h)
Engine state	Other than the time of cranking the engine
	500 rpm or more
Information display (SETTING)	The setting of “EFFECT” is “ON.”

### NOTE:

# SYSTEM

## < SYSTEM DESCRIPTION >

Engine-start effect exits when any of the above operational conditions is cancelled during the engine-start effect.

## INFORMATION DISPLAY

### INFORMATION DISPLAY : System Diagram

INFOID:000000009174237

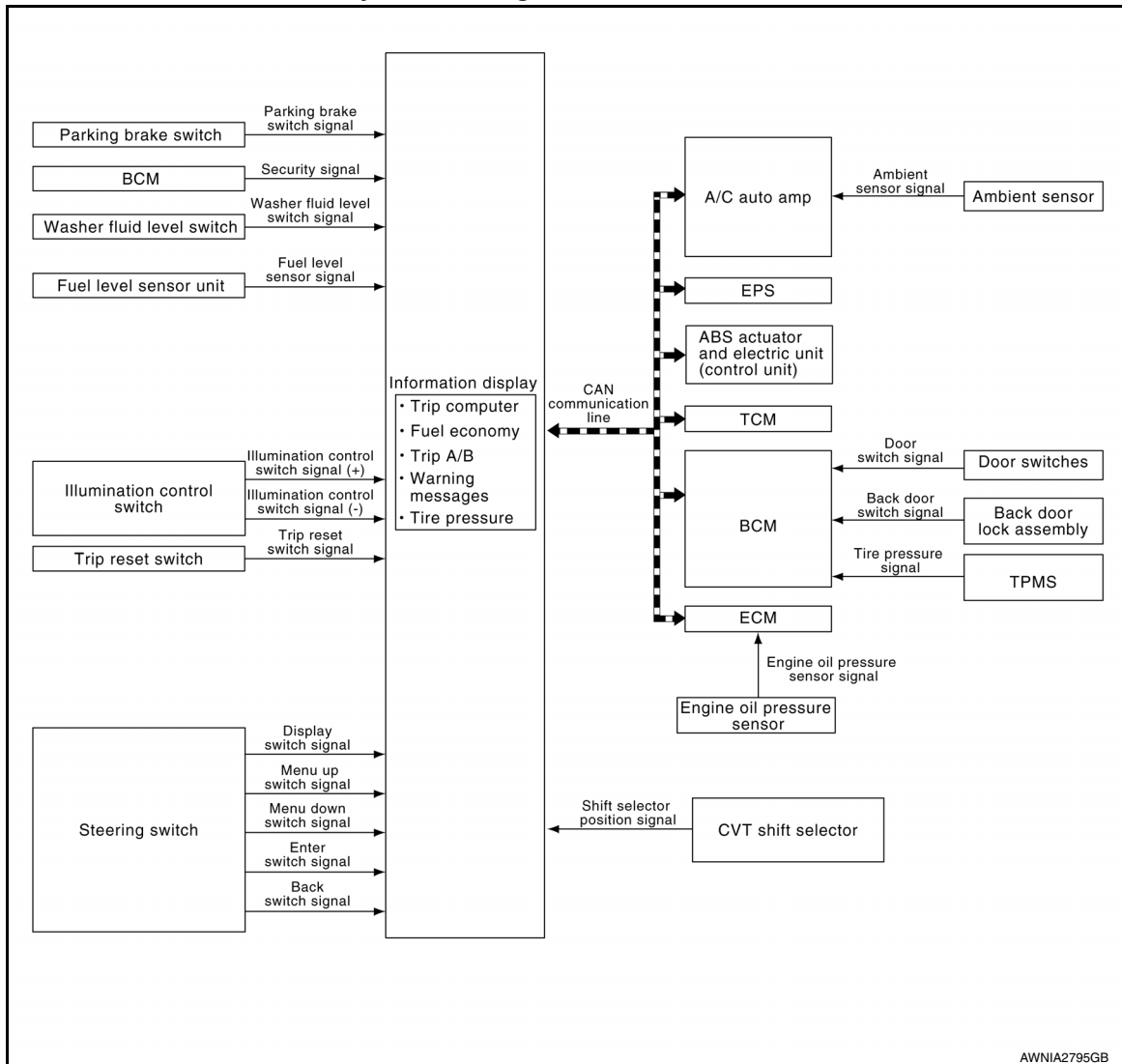

### INFORMATION DISPLAY : System Description

INFOID:000000009174238

#### FUNCTION

The information display can indicate the following items:

- Outside air temperature
- Trip computer
- Intelligent Key operation information
- CVT shift position indicator
- Odometer
- Warning/Indication messages (door open, liftgate open, low oil pressure, CVT, 4WD, I-Key, low fuel, low washer fluid, release parking brake, low tire pressure and loose fuel cap).

#### OUTSIDE AIR TEMPERATURE INDICATION

The ambient temperature sensor sends the ambient sensor signal to the A/C auto amp. The a/c auto amp, then sends the signal to the combination meter via CAN communication lines.

#### LOOSE FUEL CAP MESSAGE

A  
B  
C  
D  
E  
F  
G  
H  
I  
J  
K  
L  
M

MWI

O  
P

# SYSTEM

## < SYSTEM DESCRIPTION >

The LOOSE FUEL CAP message will display in the information display when the fuel-filler cap is not tightened correctly. The message will turn off as soon as the ECM detects the fuel-filler cap is properly tightened. The ECM provides a loose fuel cap signal to the combination meter via CAN communication lines.

### LOW TIRE PRESSURE WARNING

This warning appears when the BCM detects low inflation pressure or a system malfunction. The BCM sends a signal to the combination meter via CAN communication to illuminate the low tire pressure warning lamp. In addition, a warning message will be displayed in the vehicle information display.

### DOOR OPEN WARNING

This warning appears when the ignition switch is ON and the door is open. The BCM receives a door switch signal from the door switch. The BCM sends the door switch signal to the combination meter via CAN communication lines.

### LIFTGATE OPEN WARNING

This warning appears when the ignition switch is ON and the liftgate is opened. The BCM receives a back door switch signal from the back door switch. The BCM sends the door switch signal to the combination meter via CAN communication lines.

### LOW FUEL WARNING

This warning appears when the fuel level in the fuel tank is less than approximately 2.5 US gal (9.6 L, 2.1 Imp gal). A variable resistor signal is supplied to the combination meter from the fuel level sensor unit to determine the amount of fuel in the fuel tank.

### LOW WINDSHIELD WASHER FLUID WARNING

When the windshield washer fluid level is low, the washer fluid level switch provides a ground signal to the combination meter and the warning is displayed. Once fluid is added, the switch opens and the warning is no longer displayed.

### RELEASE PARKING BRAKE WARNING

When the parking brake is applied, the parking brake switch provides a ground signal to the combination meter. When the vehicle speed is greater than 4 MPH (7 km/h), the message is displayed and the warning chime sounds.

### SHIFT POSITION INDICATOR

The combination meter activates the shift position indicator information based on signals received from TCM via CAN communication.

### LOW OIL PRESSURE WARNING

The low oil pressure warning appears in the information display when the combination meter receives a low engine oil pressure signal from the ECM via CAN communication.

### WARNING CHECK INDICATION

The combination meter can cause an interrupt on the information display to indicate a warning, based on signals received from each unit and switch.

Refer to Owner's Manual for additional information display items.

## COMPASS

### COMPASS : Description

INFOID:000000009174239

### DESCRIPTION



# SYSTEM

## < SYSTEM DESCRIPTION >

With the ignition switch in the ON position, and the mode or (N) switch ON, the compass display will indicate the direction the vehicle is heading.

Vehicle direction is displayed as follows:

- N: north
- E: east
- S: south
- W: west

With HomeLink® universal transceiver

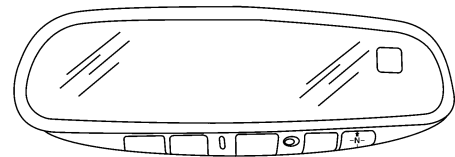

Without HomeLink® universal transceiver

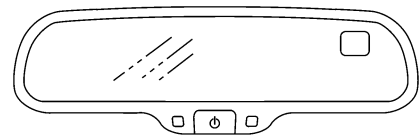

WKIA4889E

## ZONE VARIATION SETTING PROCEDURE

The difference between magnetic north and geographical north can sometimes be great enough to cause false compass readings. This difference is known as variance. In order for the compass to operate properly (accurately) in a particular zone, the zone variation must be calibrated using the following procedure.

Zone Variation Chart

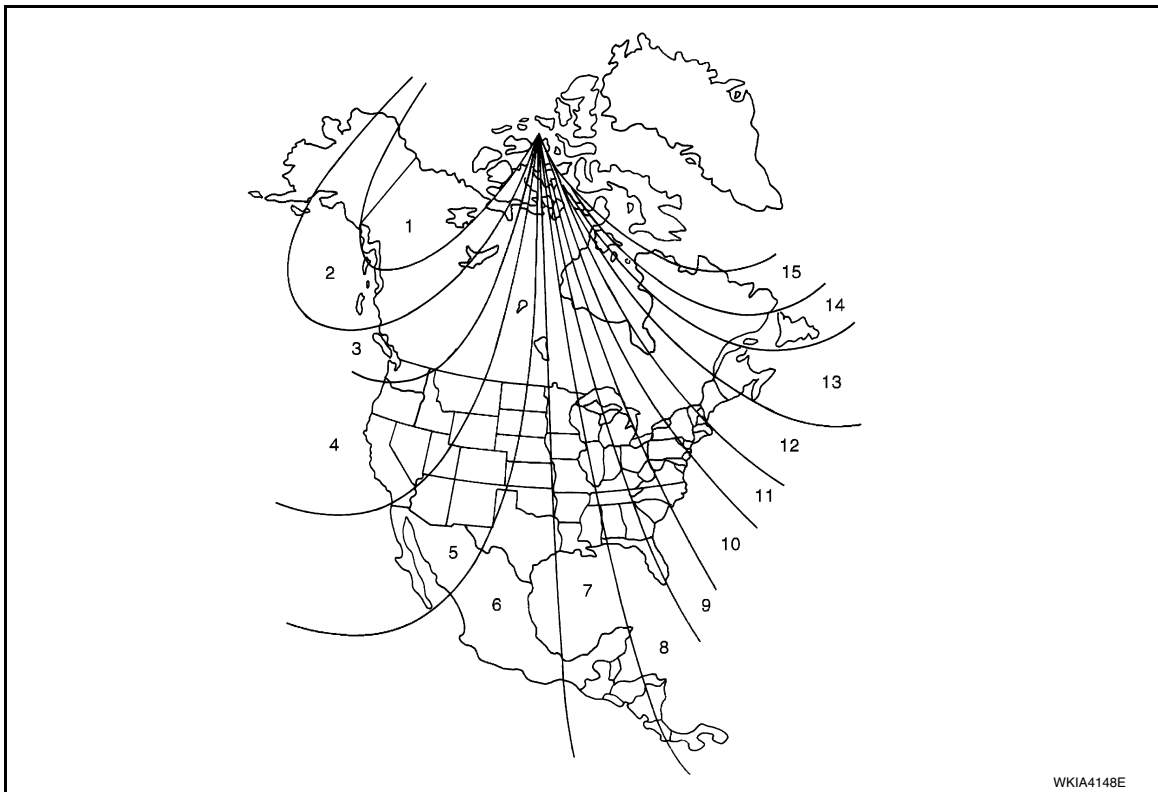

WKIA4148E

1. Determine your location on the zone map.
2. Turn the ignition switch to the ON position.
3. Press and hold the (N) switch for about 5 seconds (with HomeLink universal transceiver) or the mode switch for about 8 seconds (without HomeLink universal transceiver). The current zone number will appear in the display.

A  
B  
C  
D  
E  
F  
G  
H  
I  
J  
K  
L  
M  
N  
O  
P

MWI

# SYSTEM

## < SYSTEM DESCRIPTION >

4. Press the mode or (N) switch repeatedly until the desired zone number appears in the display. Once the desired zone number is displayed, stop pressing the mode or (N) switch and the display will show a compass direction after a few seconds.

**NOTE:**

Use zone number 5 for Hawaii.

### CALIBRATION PROCEDURE

The compass display is equipped with an automatic correction function. If the compass display reads “CAL” or the direction is not shown correctly, perform the correction procedure below.

1. Press and hold the (N) switch for about 10 seconds (with HomeLink universal transceiver) or the mode switch for about 13 seconds (without HomeLink universal transceiver). The display will read “CAL”.
2. Drive the vehicle slowly in a circle, in an open, safe place. The initial calibration is completed in about 3 turns.

**NOTE:**

In places where the terrestrial magnetism is extremely disturbed, the initial correction may start automatically.

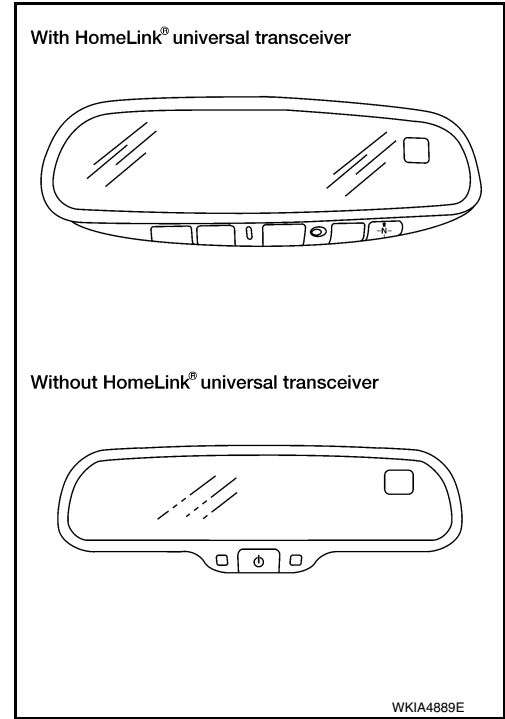

# DIAGNOSIS SYSTEM (COMBINATION METER)

< SYSTEM DESCRIPTION >

## DIAGNOSIS SYSTEM (COMBINATION METER)

### Description

INFOID:000000009174240

#### COMBINATION METER SELF-DIAGNOSIS MODE

The following meter functions can be checked during Combination Meter Self-Diagnosis Mode:

- Pointer sweep of speedometer, tachometer and gauges.
- Illumination of all LCD segments and color patterns for meter displays.
- Illumination of all lamps/LEDs that are controlled by the combination meter (regardless of switch status).

#### STARTING COMBINATION METER SELF-DIAGNOSIS MODE

##### NOTE:

- Check combination meter power supply and ground circuits if self-diagnosis mode does not start. Refer to [MWI-59, "COMBINATION METER : Diagnosis Procedure"](#). Replace combination meter if power supply and ground circuits are found to be normal and self-diagnosis mode does not start. Refer to [MWI-82, "Removal and Installation"](#).
- Combination meter self-diagnosis mode will function with the ignition switch in ON. Combination meter self-diagnosis mode will exit upon turning the ignition switch to OFF.

#### How to Initiate Self-Diagnosis Mode

1. Press and hold the trip reset switch while turning the ignition switch ON. After 2 seconds release trip reset switch, then press the trip reset switch 3 times within 7 seconds after the ignition switch is turned ON.
2. When the diagnosis function is activated, the meter illuminates all of the following:
  - Warning lights/indicators.
  - Meter assembly.
  - Information display color bars red, green, blue and white (1).
  - Odometer, trip A/B odometers and CVT indicator LCD display segments (2).
3. Pressing and holding the trip reset switch performs the pointer sweep test.

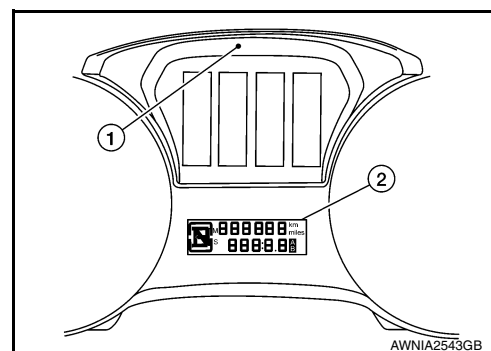

### CONSULT Function (METER/M&A)

INFOID:000000009174241

#### CAUTION:

After disconnecting the CONSULT vehicle interface (VI) from the data link connector, the ignition must be cycled OFF → ON (for at least 5 seconds) → OFF. If this step is not performed, the BCM may not go to "sleep mode", potentially causing a discharged battery and a no-start condition.

#### APPLICATION ITEMS

CONSULT can display each diagnostic item using the diagnostic test modes shown.

METER/M&A Diagnosis mode	Description
Self Diagnostic Result	Displays combination meter self-diagnosis results.
Data Monitor	Displays combination meter input/output data in real time.
Warning History	Lighting history of the warning lamp and indicator lamp can be checked.

#### SELF DIAG RESULT

Refer to [MWI-29, "DTC Index"](#).

#### DATA MONITOR

A  
B  
C  
D  
E  
F  
G  
H  
I  
J  
K  
L  
M

MWI

O  
P

## DIAGNOSIS SYSTEM (COMBINATION METER)

### < SYSTEM DESCRIPTION >

#### Display Item List

X: Applicable

Display item [Unit]	MAIN SIGNALS	Description
SPEED METER [mph or km/h]	X	Displays the value of vehicle speed signal.
SPEED OUTPUT [mph or km/h]	X	Vehicle speed signal value transmitted to other units via CAN communication.
ODO OUTPUT [mi or km]		Odometer signal value transmitted to other units via CAN communication.
TACHO METER [rpm]	X	Value of the engine speed signal received from ECM via CAN communication.
FUEL METER [L]	X	Fuel level indicated on combination meter.
W TEMP METER [°F] or [°C]	X	Displays the value of engine coolant temperature signal, which is input from ECM.
ABS W/L [On/Off]		Displays [ON/OFF] condition of ABS warning indicator.
VDC/TCS IND [On/Off]		Displays [ON/OFF] condition of VDC OFF warning lamp.
SLIP IND [On/Off]		Displays [ON/OFF] condition of SLIP indicator lamp.
BRAKE W/L [On/Off]		Displays [ON/OFF] condition of brake warning indicator.
DOOR W/L [ON/OFF]		Displays [ON/OFF] condition of door open or liftgate open warning message.
HI-BEAM IND [ON/OFF]		Displays [ON/OFF] condition of high beam indicator.
TURN IND [On/Off]		Displays [ON/OFF] condition of turn indicator.
FR FOG IND [On/Off]		Displays [ON/OFF] condition of front fog lamp indicator.
LIGHT IND [On/Off]		Displays [ON/OFF] condition of light indicator.
OIL W/L [ON/OFF]		Displays [ON/OFF] condition of low oil pressure warning message.
MIL [ON/OFF]		Displays [ON/OFF] condition of malfunction indicator.
CRUISE IND [Off]		Displays [ON/OFF] condition of CRUISE indicator in the information display.
SET IND [On/Off]		Displays [ON/OFF] condition of SET indicator in the information display.
O/D OFF IND [On/Off]		Displays [ON/OFF] condition of O/D OFF indicator.
CVT IND [On/Off]		Displays [ON/OFF] condition of CVT indicator in the information display.
4WD W/L [On/Off]		Displays [ON/OFF] condition of 4WD warning message in the information display.
FUEL W/L [On/Off]		Displays [ON/OFF] condition of low-fuel warning message.
WASHER W/L [On/Off]		Displays [ON/OFF] condition of low washer fluid warning message.
KEY G/Y W/L [On/Off]		Displays [ON/OFF] condition of key green warning lamp.

## DIAGNOSIS SYSTEM (COMBINATION METER)

### < SYSTEM DESCRIPTION >

Display item [Unit]	MAIN SIGNALS	Description	A
EPS W/L [On/Off]		Displays [ON/OFF] condition of EPS warning indicator.	A
LCD [B&P/Off]		Displays [B&P/OFF] condition of the shift selector button.	B
SHIFT IND [P,N,D,L]		Displays [P,N,D,L] shift selector position.	C
4WD IND [AUTO, LOCK, 2W]		Displays [ON/OFF] condition of 4WD modes in the information display.	D
TOW MODE IND [On/Off]		Displays [ON/OFF] condition of tow mode indicator.	D
FUEL CAP W/L [On/Off]		Displays [ON/OFF] condition of loose fuel cap warning message.	E
O/D OFF SW [On/Off]		Displays [ON/OFF] condition of O/D OFF switch.	F
COMP F/B SIG [On/Off]		A/C compressor activation condition that ECM judges according to the water temperature and the acceleration degree.	F
PKB SW [On/Off]		Displays [ON/OFF] condition of parking brake switch.	G
BRAKE OIL SW [On/Off]		Displays [ON/OFF] condition of brake fluid level switch.	G
BUCKLE SW [On/Off]		Displays [ON/OFF] condition of seat belt buckle switch (driver seat).	H
PASS BUCKLE SW [On/Off]		Displays [ON/OFF] condition of seat belt buckle switch (passenger seat).	H
TOW MODE SW [On/Off]		Displays [ON/OFF] condition of tow mode switch.	I
DISTANCE [mi] or [km]		Displays distance to empty.	J
OUTSIDE TEMP [°F or °C]		Displays the ambient temperature which is input from ambient sensor.	K
FUEL LOW SIG [On/Off]		Displays the [ON/OFF] condition the fuel level low warning signal.	K
BUZZER [On/Off]	X	Buzzer status (in the combination meter) is detected from the buzzer output signal received from each unit via CAN communication and the warning output condition of the combination meter.	L
BATTERY CIRCUIT STATUS [NORMAL/OPEN]		Displays [NORMAL/OPEN] condition of battery circuit status.	M
PARKING AIDS DSP [On/Off]		Displays [On/Off] condition of parking aids display setting.	MWI
PARKING AIDS SENSOR [On/Off]		Displays [On/Off] condition of parking aids sensor setting.	MWI
PARKING AIDS VOLUME [Low/Medium/High]		Displays [Low/Medium/High] condition of parking aids volume.	O
PARKING AIDS RANGE [Near/Medium/Far]		Displays [Near/Medium/Far] condition of parking aids range.	O
TPMS DISP [ON/OFF]		Displays [ON/OFF] condition of TPMS display.	P
TIRE STATUS FR [ON/OFF]		Displays [ON/OFF] condition of tire status.	P
TIRE STATUS FL [ON/OFF]		Displays [ON/OFF] condition of tire status.	P

## DIAGNOSIS SYSTEM (COMBINATION METER)

### < SYSTEM DESCRIPTION >

Display item [Unit]	MAIN SIGNALS	Description
TIRE STATUS RR [ON/OFF]		Displays [ON/OFF] condition of tire status.
TIRE STATUS RL [ON/OFF]		Displays [ON/OFF] condition of tire status.
SONER SET AVA [Available/Unavailable]		Displays [AVAILABLE/UNAVAILABLE] condition of meter setting.
STRG SW INPUT [SW1,SW2,SW3,SW4,SW5,SW6,SW7,SW8,SW9,SW10]		Displays [SW1,SW2,SW3,SW4,SW5,SW6,SW7,SW8,SW9,SW10] condition of steering switch.
ITS SONER SET OUTPUT		Displays status of sonar.
SONAR DET STA [ON/OFF]		Displays [ON/OFF] condition of sonar detection area.
SONAR WARN [OFF/SENSOR DEACTIVE/SENSOR ERROR]		Displays [OFF/SENSOR DEACTIVE/SENSOR ERROR] condition of sonar warning.
SONAR DET DSP RC [ON/OFF]		Displays [ON/OFF] condition of RC sonar detection display.
SONAR DSP AREA RC [ON/OFF]		Displays [ON/OFF] condition of RC sonar detection area image.
SONAR DET DSP RL [ON/OFF]		Displays [ON/OFF] condition of RL sonar detection display.
SONAR DSP AREA RL [ON/OFF]		Displays [ON/OFF] condition of RL sonar detection area image.
SONAR DET DSP RR [ON/OFF]		Displays [ON/OFF] condition of RR sonar detection display.
SONAR DSP AREA RR [ON/OFF]		Displays [ON/OFF] condition of RR sonar detection area image.
SONAR DET DSP FC [ON/OFF]		Displays [ON/OFF] condition of FC sonar detection area.
SONAR DSP AREA FC [ON/OFF]		Displays [ON/OFF] condition of FC sonar detection area image.
SONAR DET DSP FL [ON/OFF]		Displays [ON/OFF] condition of FL sonar detection display.
SONAR DSP AREA FL [ON/OFF]		Displays [ON/OFF] condition of FL sonar detection area image.
SONAR DET DSP FR [ON/OFF]		Displays [ON/OFF] condition of FR sonar detection display.
SONAR DSP AREA FR [ON/OFF]		Displays [ON/OFF] condition of FR sonar detection area image.
SONAR DIST DSP [ON/OFF]		Displays sonar distance status.
TPMS PRESS L [ON/OFF]		Displays [ON/OFF] condition of low tire pressure message in the information display.
TPMS MALF [ON/OFF]		Displays [ON/OFF] condition of TPMS warning indicator.
4WD CL TMP H [ON/OFF]		Displays [ON/OFF] condition of 4WD clutch high temperature message in the information display.
4WD TIRE CHCK [ON/OFF]		Displays [ON/OFF] condition of 4WD tire check message in the information display.
4WD SYS MALF [ON/OFF]		Displays [ON/OFF] condition of 4WD system malfunction message in the information display.

# DIAGNOSIS SYSTEM (COMBINATION METER)

## < SYSTEM DESCRIPTION >

Display item [Unit]	MAIN SIGNALS	Description	
TIRE PRESS FR [kPa, kg/cm2 or Psi]		Displays air pressure of front right tire.	A
TIRE PRESS FL [kPa, kg/cm2 or Psi]		Displays air pressure of front left tire.	B
TIRE PRESS RR [kPa, kg/cm2 or Psi]		Displays air pressure of rear right tire.	C
TIRE PRESS RL [kPa, kg/cm2 or Psi]		Displays air pressure of rear left tire.	D

**NOTE:**

Some items are not available according to vehicle specification.

### Warning History

- Stores histories when warning/indicator lamp is turned on.
- “Warning History” indicates the “TIME” when the warning/indicator lamp is turned on.
- The “TIME” above is:
  - 0: The condition that the warning/indicator lamp has been turned on 1 or more times after starting the engine and waiting for 30 seconds.
  - 1 - 39: The number of times the engine was restarted after the 0 condition.
  - NO Warning History: Stores NO (0) turning on history of warning/indicator lamp.

**NOTE:**

- Warning History is not stored for approximately 30 seconds after the engine starts.
- Brake warning lamp does not store any history when the parking brake is applied or the brake fluid level gets low.

A  
B  
C  
D  
E  
F  
G  
H  
I  
J  
K  
L  
M  
O  
P

MWI

# COMBINATION METER

< ECU DIAGNOSIS INFORMATION >

## ECU DIAGNOSIS INFORMATION

### COMBINATION METER

Reference Value

INFOID:000000009174242

VALUES ON THE DIAGNOSIS TOOL

Monitor Item	Condition		Value/Status
SPEED METER [mph or km/h]	Ignition switch ON	While driving	Input value of vehicle speed signal (CAN communication signal)
SPEED OUTPUT [mph or km/h]	Ignition switch ON	While driving	Output value of vehicle speed signal (CAN communication signal)
ODO OUTPUT [mi or km]	Ignition switch ON	—	Output value of odometer signal (CAN communication signal)
TACHO METER [rpm]	Ignition switch ON	Engine running	Input value of engine speed signal (CAN communication signal)
FUEL METER [L]	Ignition switch ON	—	Input value of fuel level sensor signal
W TEMP METER [°F] or [°C]	Ignition switch ON	—	Input value of engine coolant temperature signal (CAN communication signal)
ABS W/L	Ignition switch ON	ABS warning lamp ON	On
		ABS warning lamp OFF	Off
VDC/TCS IND	Ignition switch ON	VDC OFF indicator lamp ON	On
		VDC OFF indicator lamp OFF	Off
SLIP IND	Ignition switch ON	VDC warning lamp ON	On
		VDC warning lamp OFF	Off
BRAKE W/L	Ignition switch ON	Brake warning lamp ON	On
		Brake warning lamp OFF	Off
DOOR W/L	Ignition switch ON	Door open warning ON	On
		Other than the above	Off
HI-BEAM IND	Ignition switch ON	High beam indicator lamp ON	On
		High beam indicator lamp OFF	Off
TURN IND	Ignition switch ON	Turn signal indicator lamp ON	On
		Turn signal indicator lamp OFF	Off
FR FOG IND	Ignition switch ON	Front fog lamp indicator lamp ON	On
		Front fog lamp indicator lamp OFF	Off
LIGHT IND	Ignition switch ON	Tail lamp indicator lamp ON	On
		Tail lamp indicator lamp OFF	Off
OIL W/L	Ignition switch ON	Oil pressure warning	On
		Oil pressure warning	Off
MIL	Ignition switch ON	Malfunction indicator lamp ON	On
		Malfunction indicator lamp OFF	Off
CRUISE IND	Ignition switch ON	CRUISE indicator ON	On
		CRUISE indicator OFF	Off
SET IND	Ignition switch ON	SET indicator ON	On
		SET indicator OFF	Off



# COMBINATION METER

## < ECU DIAGNOSIS INFORMATION >

Monitor Item	Condition		Value/Status	
O/D OFF IND	Ignition switch ON	O/D OFF indicator ON	On	A
		O/D OFF indicator OFF	Off	
CVT IND	Ignition switch ON	CVT indicator ON	On	B
		CVT indicator OFF	Off	
4WD W/L	Ignition switch ON	4WD warning lamp ON	On	C
		4WD warning lamp OFF	Off	
FUEL W/L	Ignition switch ON	During low fuel level indication	On	D
		Except during low fuel level indication	Off	
WASHER W/L	Ignition switch ON	Low washer fluid warning indication	On	E
		Except during low washer fluid warning indication	Off	
KEY G/Y W/L	Ignition switch ON	KEY warning lamp (Green/Yellow) ON	On	F
		KEY warning lamp (Green/Yellow) OFF	Off	
EPS W/L	Ignition switch ON	EPS warning lamp ON	On	F
		EPS warning lamp OFF	Off	
LCD	Ignition switch ON	Shift selector button pressed	Off	G
		Shift selector button released	B&P	
SHIFT IND	Ignition switch ON	Shift position in park	P	H
		Shift position in neutral	N	
		Shift position in drive	D	I
		Shift position in low	L	
4WD IND	Engine running	4WD switch in AUTO position	AUTO	J
		4WD switch in LOCK position	LOCK	
TOW MODE IND	Ignition switch ON	TOW mode indicator lamp ON	On	J
		TOW mode indicator lamp OFF	Off	
FUEL CAP W/L	Ignition switch ON	Fuel filler cap warning display ON	On	K
		Fuel filler cap warning display OFF	Off	
O/D OFF SW	Ignition switch ON	Overdrive control switch ON	On	L
		Overdrive control switch OFF	Off	
PKB SW	Ignition switch ON	Parking brake switch ON	On	M
		Parking brake switch OFF	Off	
BUCKLE SW	Ignition switch ON	Driver seat belt not fastened	On	M
		Driver seat belt fastened	Off	
BRAKE OIL SW	Ignition switch ON	Brake fluid level switch ON	On	MWI
		Brake fluid level switch OFF	Off	
PASS BUCKLE SW	Ignition switch ON	Passenger seat belt not fastened	On	O
		Passenger seat belt fastened	Off	
TOW MODE SW	Ignition switch ON	TOW mode switch ON	On	P
		TOW mode switch OFF	Off	
DISTANCE [mph or km/h]	Ignition switch ON	—	Distance to empty	
OUTSIDE TEMP [°F] or [°C]	Ignition switch ON	—	Displays the ambient air temperature which is input from the ambient sensor	
FUEL LOW SIG	Ignition switch ON	During low fuel warning indication	On	
		Except during low fuel warning indication	Off	

# COMBINATION METER

## < ECU DIAGNOSIS INFORMATION >

Monitor Item	Condition	Value/Status
BUZZER	Ignition switch ON	Buzzer ON
		Buzzer OFF

## TERMINAL LAYOUT

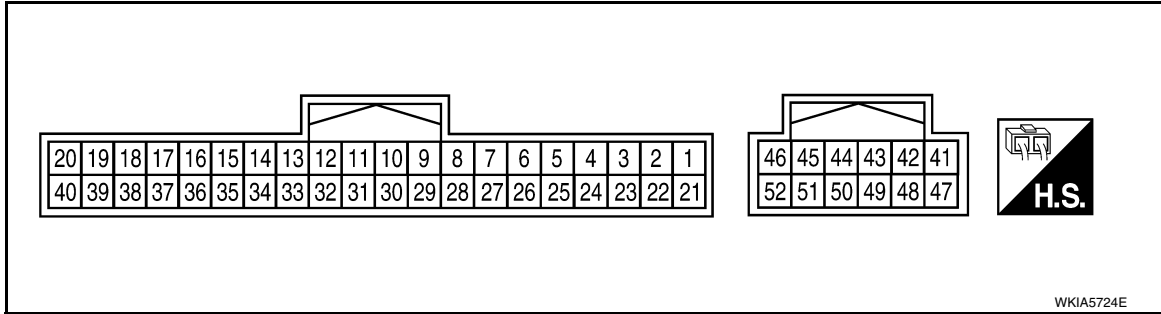

## PHYSICAL VALUES

Terminal No. (Wire color)		Description		Condition		Value (Approx.)
+	-	Signal name	Input/ Output			
1 (B)	Ground	Ground	Input	Ignition switch OFF	—	Battery voltage
2 (B)	Ground	Ground	Input	Ignition switch ON	—	Battery voltage
3 (P)	Ground	Steering switch input 1	—	—	—	—
4 (BG)	Ground	Steering switch input 2	—	—	—	—
5 (P)	Ground	ACC	—	Ignition switch ON	Ignition switch ACC or ON power supply	Battery voltage
6 (V)	Ground	Security signal	Input	Ignition switch ON	Security indicator ON	0 V
					Security indicator OFF	Battery voltage
7 (R)	Ground	Air bag signal	Input	Ignition switch ON	Air bag warning lamp ON	—
					Air bag warning lamp OFF	—
8 (G)	Ground	Passenger seat belt warning signal	Input	Ignition switch ON	Fastened	Battery voltage
					Unfastened	0 V
9 (Y)	Ground	Seat belt buckle switch signal (driver seat)	Input	Ignition switch ON	Fastened	Battery voltage
					Unfastened	0 V
11 (BG)	Ground	Alternator signal	Input	Ignition switch ON	Charge warning lamp ON	2 V
					Charge warning lamp OFF	Battery voltage
12 (G)	Ground	Parking brake switch signal	Input	Ignition switch ON	Parking brake applied	0 V
					Parking brake released	Battery voltage
14 <sup>1</sup> (Y)	Ground	Steering switch output 1	—	—	—	—

# COMBINATION METER

## < ECU DIAGNOSIS INFORMATION >

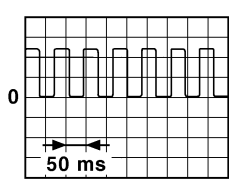
Terminal No. (Wire color)		Description		Condition		Value (Approx.)
+	-	Signal name	Input/ Output			
14 <sup>2</sup> (G)	Ground	Steering switch output 1	—	—	—	—
15 <sup>1</sup> (BR)	Ground	Steering switch output 2	—	—	—	—
15 <sup>2</sup> (W)	Ground	Steering switch output 2	—	—	—	—
16 <sup>1</sup> (G)	—	Steering switch output ground	—	—	—	0 V
16 <sup>2</sup> (B)	—	Steering switch output ground	—	—	—	0 V
19 (SB)	Ground	Tow mode switch signal	Input	Ignition switch ON	Tow mode switch is pressed	0 V
				Ignition switch OFF	Tow mode switch is released	Battery voltage
21 (BG)	—	Ignition signal	—	Ignition switch ON or START	—	Battery voltage
22 (W)	—	Battery power supply	—	Ignition switch OFF	—	Battery voltage
23 (B)	Ground	Illumination control output signal	—	Ignition switch ON	—	0 V
24 (R)	Ground	Steering switch ground	—	Ignition switch ON	—	0 V
25 (G)	Ground	Brake fluid level switch	Input	Ignition switch ON	Brake fluid level low	0 V
				Ignition switch OFF	Brake fluid level normal	Battery voltage
26 (R)	Ground	Fuel level sensor ground	—	Ignition switch ON	—	0 V
27 (W)	Ground	Fuel level sensor signal	—	—	—	—
33 (BR)	Ground	Vehicle speed signal (2-pulse)	Output	Ignition switch ON	Speedometer operated [When vehicle speed is approx. 25 MPH (40 km/h)]	<p><b>NOTE:</b> The maximum voltage varies depending on the specification (destination unit).</p>  <p style="text-align: right; font-size: small;">JSNIA0015GB</p>

A  
B  
C  
D  
E  
F  
G  
H  
I  
J  
K  
L  
M  
N  
O  
P

MWI

# COMBINATION METER

## < ECU DIAGNOSIS INFORMATION >

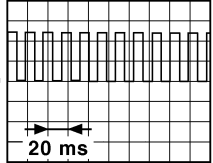
Terminal No. (Wire color)		Description		Condition		Value (Approx.)
+	-	Signal name	Input/ Output			
34 (GR)	Ground	Vehicle speed signal (8-pulse)	Output	Ignition switch ON	Speedometer operated [When vehicle speed is ap- prox. 25 MPH (40 km/h)]	<b>NOTE:</b> The maximum voltage varies de- pending on the specification (destination unit). 
38 (P)	Ground	CAN-L	—	—	—	—
39 (L)	Ground	CAN-H	—	—	—	—
41 (LG)	Ground	Trip/Reset signal	Input	Ignition switch ON	Trip/Reset switch is pressed	0 V
					Other than the above	5 V
42 (Y)	Ground	Illumination down switch signal	Input	Ignition switch ON	Illumination switch down is pressed	0 V
					Other than the above	5 V
47 (BR)	Ground	Illumination up switch sig- nal	Input	Ignition switch ON	Illumination switch up is pressed	0 V
					Other than the above	5 V
48 (G)	Ground	Switch ground	—	—	—	—
49 (P)	Ground	Washer fluid level switch signal	Input	Ignition switch ON	Washer fluid level switch ON	0 V
					Washer fluid level switch OFF	5 V
52 (P)	Ground	O/D OFF switch signal	Input	Ignition switch ON	O/D OFF switch is pressed	0 V
					O/D OFF switch is released	Battery voltage

1: With base audio

2: Except base audio

## Fail-Safe

INFOID:000000009174243

### FAIL-SAFE

The combination meter activates the fail-safe control if CAN communication with each unit is malfunctioning.

Function		Specifications
Speedometer		Reset to zero by suspending communication.
Tachometer		
Engine coolant temperature gauge		
Illumination control		When suspending communication, changes to nighttime mode.
Information display	Odo/trip meter	An indicated value is maintained at communications blackout.
	Shift position indicator	The display turns OFF by suspending communication.
	Warning messages	The display turns OFF by suspending communication.
Buzzer		The buzzer turns OFF by suspending communication.

# COMBINATION METER

## < ECU DIAGNOSIS INFORMATION >

	Function	Specifications	
Warning lamp/indicator lamp	ABS warning lamp	The lamp turns ON by suspending communication.	A
	Slip indicator lamp		B
	Brake warning lamp		C
	O/D OFF indicator lamp		D
	Malfunction indicator lamp		E
	VDC OFF indicator lamp		F
	EPS warning lamp	The lamp blinking caused by suspending communication.	G
	Low tire pressure warning lamp		H
	High beam indicator lamp		I
	Turn signal indicator lamp	The lamp turns OFF by suspending communication.	J
	Master warning lamp		K
	Front lamp indicator lamp		L
	Tow indicator lamp		M
	Tail lamp indicator lamp		N
	Air bag warning lamp	The lamp turns off when disconnected.	O
Charge warning lamp	P		
Seat belt warning lamp	Q		
Security indicator lamp	R		

## DTC Index

INFOID:000000009174244

Display contents of CONSULT	Diagnostic item is detected when...	Refer to
CAN COMM CIRCUIT [U1000]	When combination meter is not transmitting or receiving CAN communication signal for 2 seconds or more.	<a href="#">MWI-54</a>
CONTROL UNIT (CAN) [U1010]	When detecting error during the initial diagnosis of the CAN controller of combination meter.	<a href="#">MWI-55</a>
VEHICLE SPEED CIRC [B2205]	The abnormal vehicle speed signal is input from the ABS actuator and electric unit (control unit) for 2 seconds or more.	<a href="#">MWI-56</a>
TACHO METER [B2267]	If ECM continuously transmits abnormal engine speed signals for 2 seconds or more.	<a href="#">MWI-57</a>
WATER TEMP METER [B2268]	If ECM continuously transmits abnormal engine coolant temperature signals for 60 seconds or more.	<a href="#">MWI-58</a>

MWI

# BCM (BODY CONTROL MODULE)

< ECU DIAGNOSIS INFORMATION >

## BCM (BODY CONTROL MODULE)

### List of ECU Reference

INFOID:000000009174245

ECU	Reference
BCM	<a href="#">BCS-30. "Reference Value"</a>
	<a href="#">BCS-55. "Wiring Diagram"</a>
	<a href="#">BCS-50. "Fail Safe"</a>
	<a href="#">BCS-50. "DTC Inspection Priority Chart"</a>
	<a href="#">BCS-52. "DTC Index"</a>

# METER SYSTEM

< WIRING DIAGRAM >

## WIRING DIAGRAM

### METER SYSTEM

Wiring Diagram

INFOID:000000009174246

METER

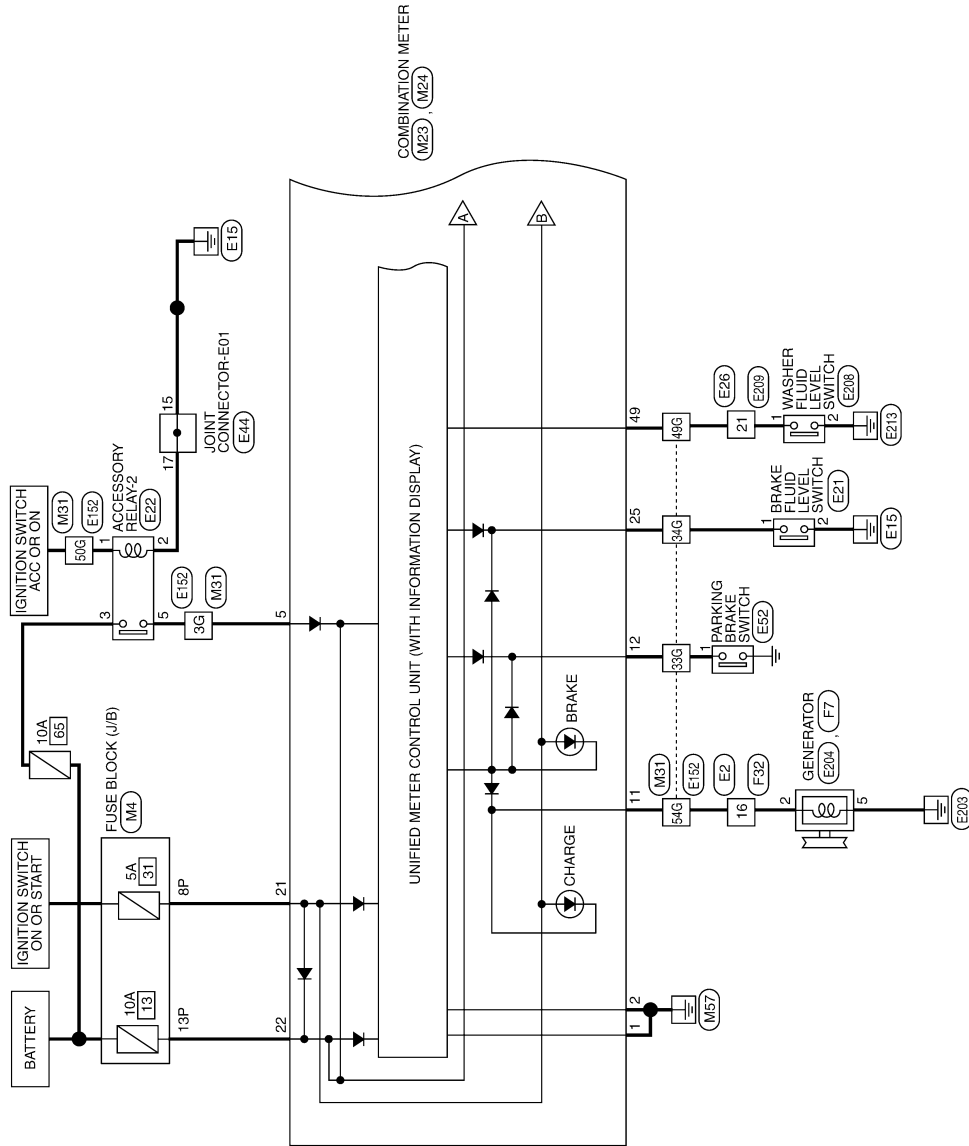

A  
B  
C  
D  
E  
F  
G  
H  
I  
J  
K  
L  
M  
N  
O  
P

MWI

ABNWA1828GB

# METER SYSTEM

< WIRING DIAGRAM >

Ⓣ : WITH TRAILER TOW

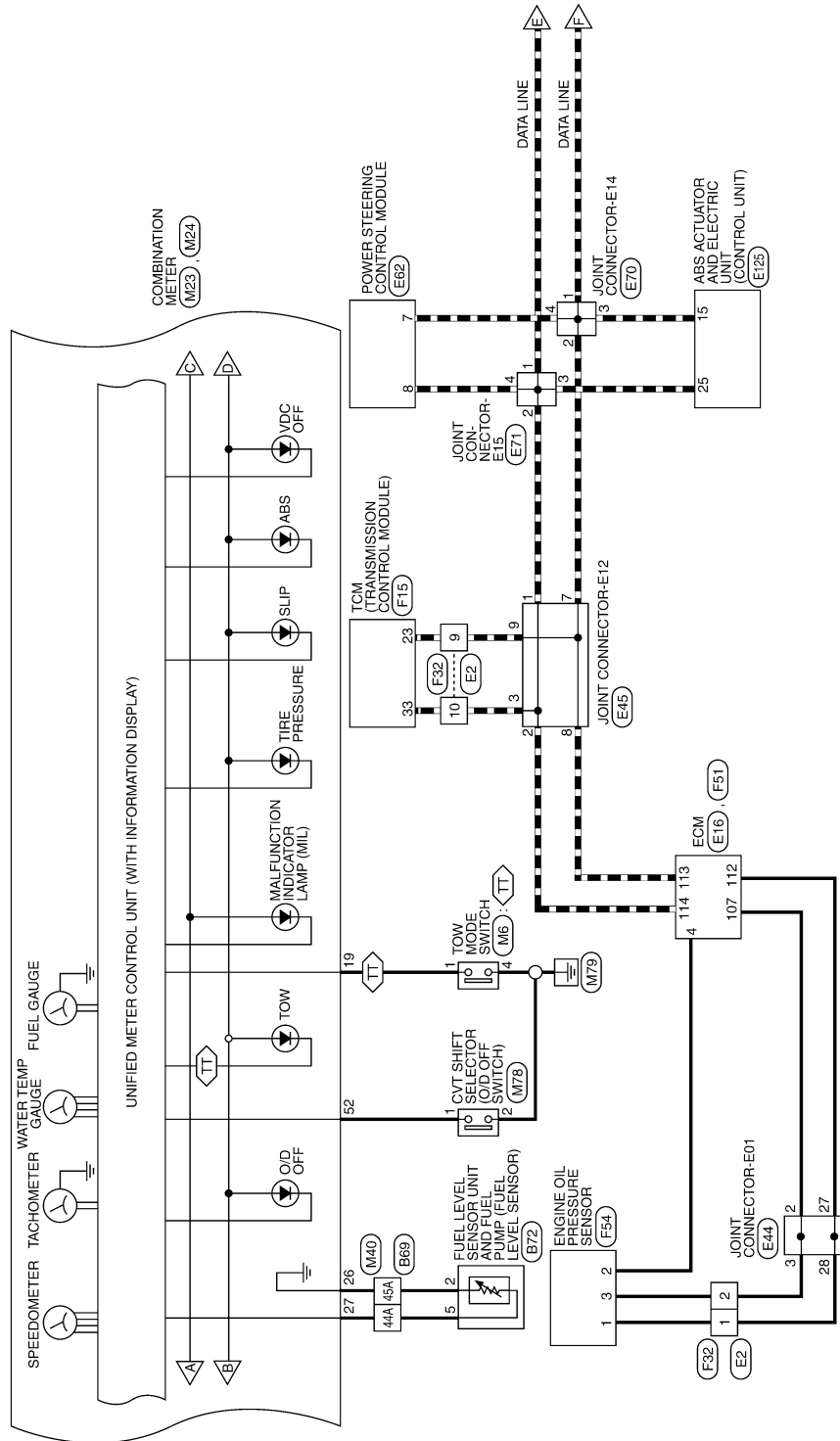

ABNWA1829GB



# METER SYSTEM

< WIRING DIAGRAM >

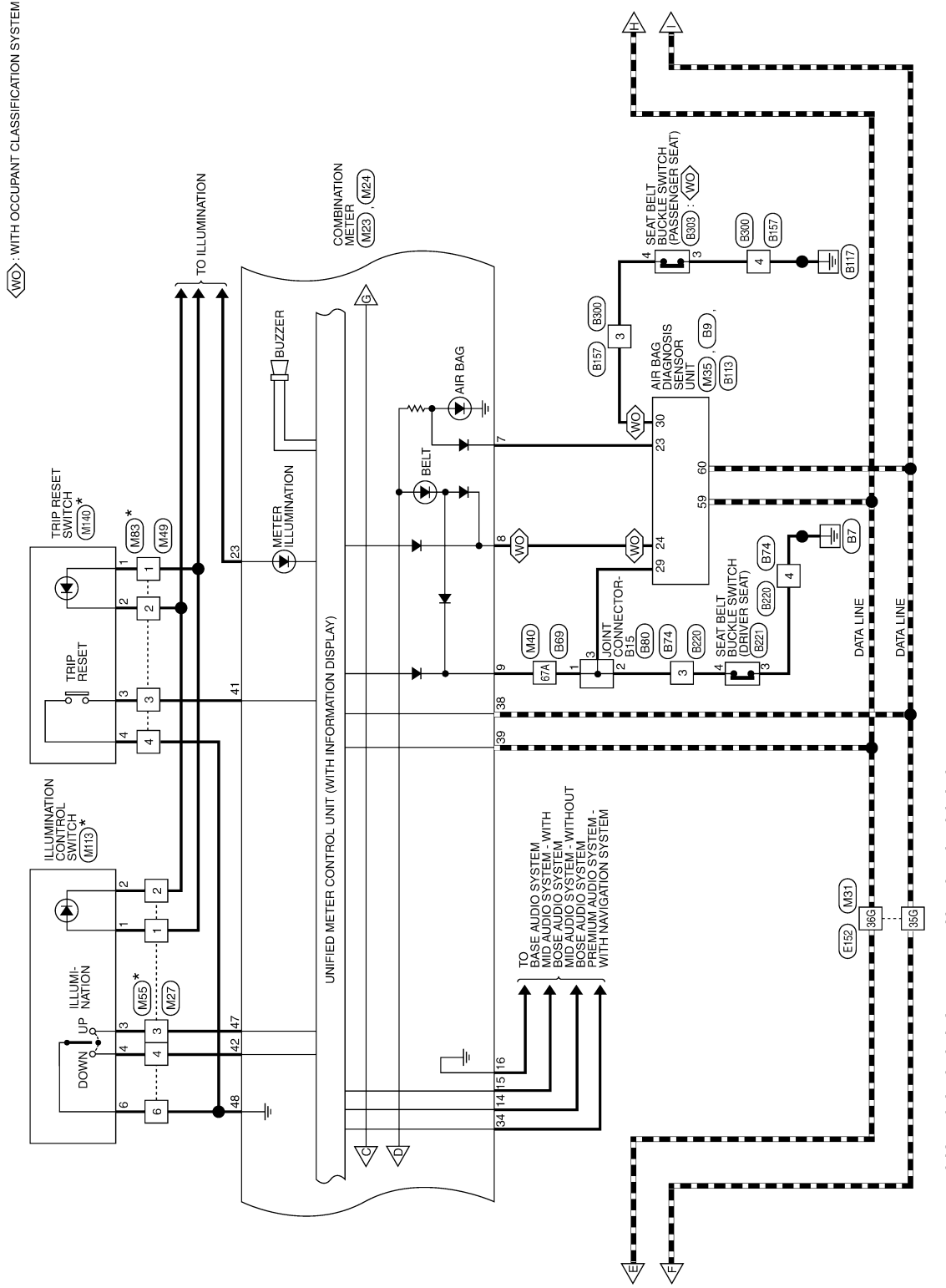

A  
B  
C  
D  
E  
F  
G  
H  
I  
J  
K  
L  
M  
N  
O  
P

MWI

# METER SYSTEM

< WIRING DIAGRAM >

- ◁ FM ▷ : WITH FRONT FOG LAMPS
- ◁ VD ▷ : WITH AROUND VIEW MONITOR
- ◁ VK ▷ : WITHOUT AROUND VIEW MONITOR

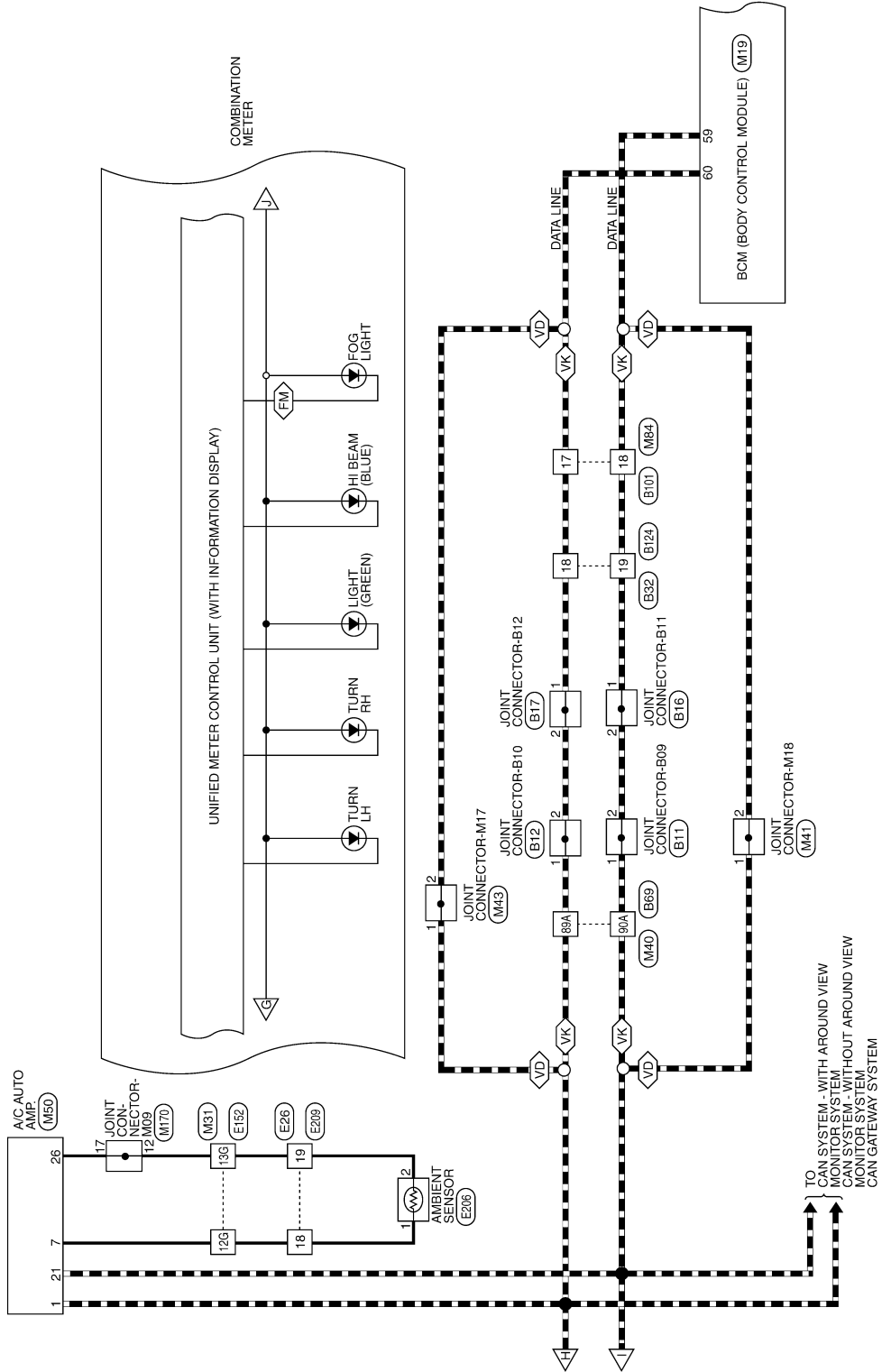

ABNWA1831GB

# METER SYSTEM

< WIRING DIAGRAM >

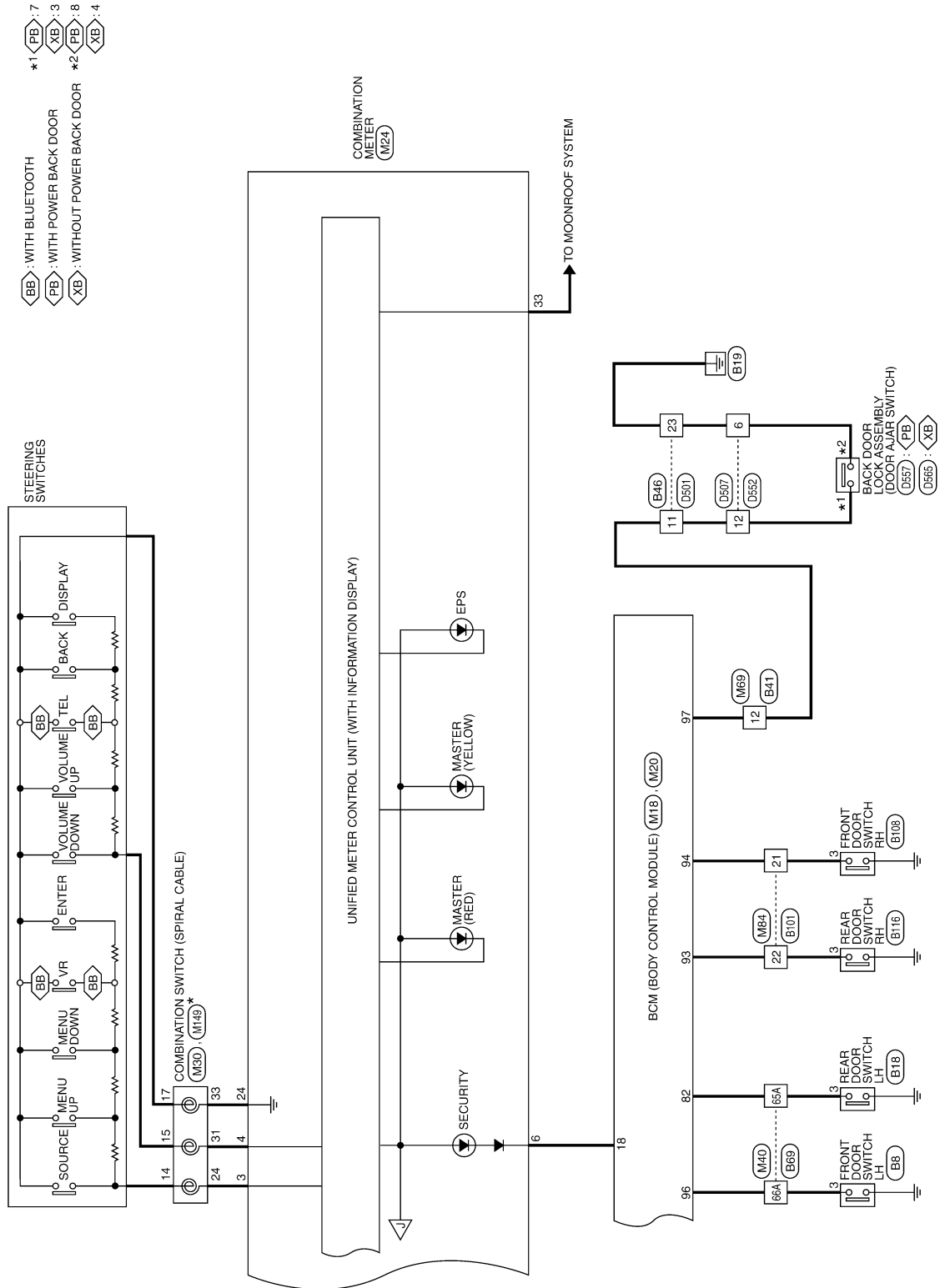

ABNWA1832GB

A  
B  
C  
D  
E  
F  
G  
H  
I  
J  
K  
L  
M  
N  
O  
P



# METER SYSTEM

< WIRING DIAGRAM >

## METER CONNECTORS

Connector No.	M4
Connector Name	FUSE BLOCK (J/B)
Connector Color	WHITE



Terminal No.	Color of Wire	Signal Name
8P	BG	-
13P	W	-

Connector No.	M6
Connector Name	TOW MODE SWITCH
Connector Color	GRAY



Terminal No.	Color of Wire	Signal Name
1	SB	-
4	B	-

Connector No.	M18
Connector Name	BCM (BODY CONTROL MODULE)
Connector Color	GREEN

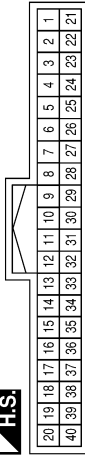

Terminal No.	Color of Wire	Signal Name
18	V	SECURITY INDICATOR

Connector No.	M19
Connector Name	BCM (BODY CONTROL MODULE)
Connector Color	BLACK

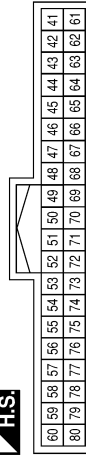

Terminal No.	Color of Wire	Signal Name
59	P	CAN-L
60	L	CAN-H

Connector No.	M20
Connector Name	BCM (BODY CONTROL MODULE)
Connector Color	GRAY

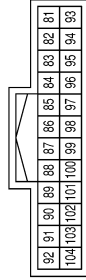

Terminal No.	Color of Wire	Signal Name
82	W	RL DOOR SW
93	R	RR DOOR SW
94	G	AS DOOR SW
96	BG	DR DOOR SW
97	W	BACK DOOR SW

Connector No.	M23
Connector Name	COMBINATION METER
Connector Color	WHITE

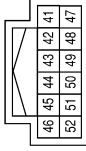

Terminal No.	Color of Wire	Signal Name
41	LG	TRIP/RESET
42	Y	ILLUMI DOWN SW
43	-	-
44	-	-
45	-	-
46	-	-
47	BR	ILLUMI UP SW
48	G	SW GND
49	P	WASHER LEVEL SW
50	-	-
51	-	-
52	P	O/D OFF/SPORTS SW

# METER SYSTEM

< WIRING DIAGRAM >

Connector No.	M24
Connector Name	COMBINATION METER
Connector Color	WHITE

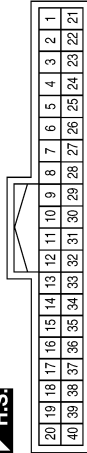

Terminal No.	Color of Wire	Signal Name
1	B	GND1
2	B	GND2
3	P	STRG SW INPUT 1
4	BG	STRG SW INPUT 2
5	P	ACC
6	V	SECURITY
7	R	AIR BAG
8	G	AS BELT
9	Y	DR BUCKLE SW
10	-	-
11	BG	ALTERNATOR (CHARGE)

Connector No.	M27
Connector Name	WIRE TO WIRE
Connector Color	WHITE

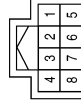

Terminal No.	Color of Wire	Signal Name
12	G	PKB
13	-	-
14	G	STRG SW OUTPUT 1 (EXCEPT BASE AUDIO)
14	Y	STRG SW OUTPUT 1 (WITH BASE AUDIO)
15	W	STRG SW OUTPUT 2 (EXCEPT BASE AUDIO)
15	BR	STRG SW OUTPUT 2 (WITH BASE AUDIO)
16	B	STRG SW OUTPUT GND (EXCEPT BASE AUDIO)
16	G	STRG SW OUTPUT GND (WITH BASE AUDIO)
17	-	-
18	-	-
19	SB	TOW MODE SW
20	-	-
21	BG	IGN
22	W	BAT
23	B	ILLUMI CONT OUT
24	R	STRG SW GND

Terminal No.	Color of Wire	Signal Name
25	G	BRAKE OIL SW
26	R	FUEL SENSOR GND
27	W	FUEL SENSOR
28	-	-
29	-	-
30	-	-
31	-	-
32	-	-
33	BR	SPEED 2P/R
34	GR	SPEED 8P/R
35	-	-
36	-	-
37	-	-
38	P	CAN-L
39	L	CAN-H
40	-	-

Terminal No.	Color of Wire	Signal Name
1	R	-
2	B	-
3	BR	-
4	Y	-
6	G	-

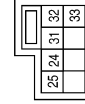

Connector No.	M30
Connector Name	COMBINATION SWITCH (SPIRAL CABLE)
Connector Color	GRAY

Terminal No.	Color of Wire	Signal Name
24	P	-
31	BG	-
33	R	-

ABNIA4746GB

A  
B  
C  
D  
E  
F  
G  
H  
I  
J  
K  
L  
M  
N  
O  
P

MWI

# METER SYSTEM

< WIRING DIAGRAM >

Connector No.	M40
Connector Name	WIRE TO WIRE
Connector Color	GRAY

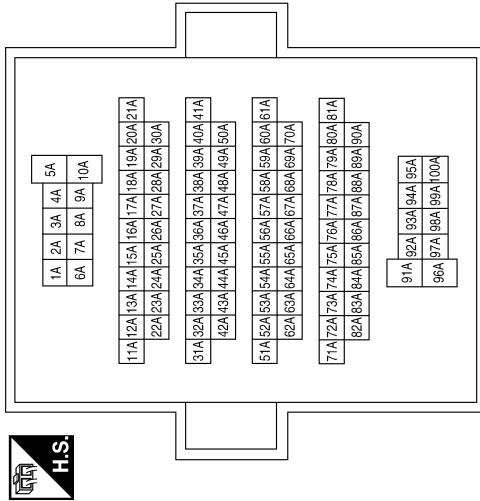

Terminal No.	Color of Wire	Signal Name
44A	W	-
45A	R	-
65A	W	-
66A	BG	-
67A	Y	-
89A	L	-
90A	P	-

Connector No.	M35
Connector Name	AIR BAG DIAGNOSIS SENSOR UNIT
Connector Color	YELLOW

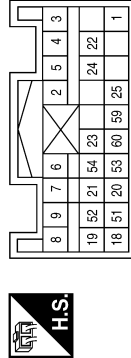

Terminal No.	Color of Wire	Signal Name
23	R	AIRBAG W/L
24	G	SEATBELT REMINDER
59	L	CAN-H
60	P	CAN-L

Connector No.	M31
Connector Name	WIRE TO WIRE
Connector Color	WHITE

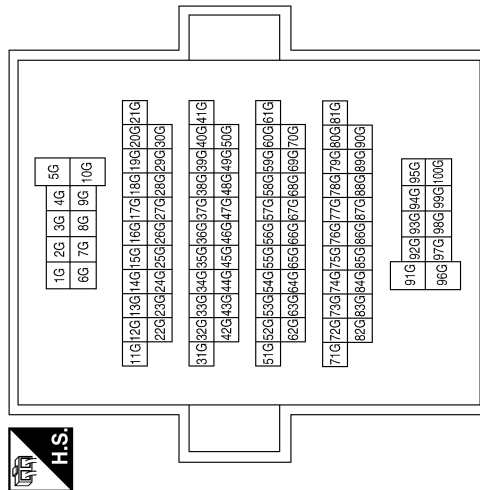

Terminal No.	Color of Wire	Signal Name
3G	P	-
12G	G	-
13G	G	-
33G	G	-
34G	G	-
35G	P	-
36G	L	-
49G	P	-
50G	L	-
54G	BG	-

ABNIA4747GB

# METER SYSTEM

< WIRING DIAGRAM >

Connector No.	M49
Connector Name	WIRE TO WIRE
Connector Color	WHITE

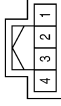

Terminal No.	Color of Wire	Signal Name
1	R	-
2	B	-
3	LG	-
4	G	-

Connector No.	M43
Connector Name	JOINT CONNECTOR-M17
Connector Color	WHITE

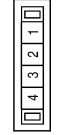

Terminal No.	Color of Wire	Signal Name
1	L	-
2	L	-

Connector No.	M41
Connector Name	JOINT CONNECTOR-M18
Connector Color	WHITE

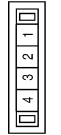

Terminal No.	Color of Wire	Signal Name
1	P	-
2	P	-

Connector No.	M69
Connector Name	WIRE TO WIRE
Connector Color	WHITE

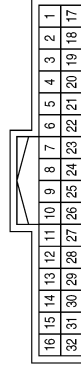

Terminal No.	Color of Wire	Signal Name
12	W	-

Connector No.	M55
Connector Name	WIRE TO WIRE
Connector Color	WHITE

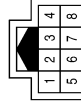

Terminal No.	Color of Wire	Signal Name
1	R	-
2	B	-
3	BR	-
4	Y	-
6	G	-

Connector No.	M50
Connector Name	A/C AUTO AMP.
Connector Color	WHITE

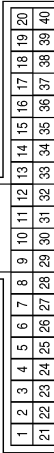

Terminal No.	Color of Wire	Signal Name
1	L	CAN-H
7	G	AMB SENS
21	P	CAN-L
26	G	SENS GND

ABNIA4748GB

A  
B  
C  
D  
E  
F  
G  
H  
I  
J  
K  
L  
M  
N  
O  
P

MWI

# METER SYSTEM

## < WIRING DIAGRAM >

Connector No.	M84
Connector Name	WIRE TO WIRE
Connector Color	WHITE

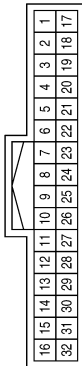

Terminal No.	Color of Wire	Signal Name
17	L	-
18	P	-
21	G	-
22	R	-

Connector No.	M83
Connector Name	WIRE TO WIRE
Connector Color	WHITE

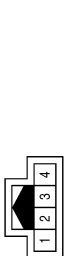
Terminal No.	Color of Wire	Signal Name
1	R	-
2	B	-
3	LG	-
4	G	-

Connector No.	M78
Connector Name	CVT SHIFT SELECTOR
Connector Color	WHITE

Terminal No.	Color of Wire	Signal Name
1	P	-
2	B	-

Connector No.	M149
Connector Name	COMBINATION SWITCH (SPIRAL CABLE)
Connector Color	GRAY

Terminal No.	Color of Wire	Signal Name
14	B	-
15	GR	-
17	BR	-

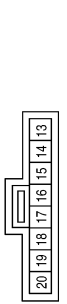
Connector No.	M140
Connector Name	TRIP RESET SWITCH
Connector Color	WHITE

Terminal No.	Color of Wire	Signal Name
1	R	-
2	B	-
3	LG	-
4	G	-
5	-	-

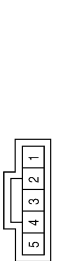
Connector No.	M113
Connector Name	ILLUMINATION CONTROL SWITCH
Connector Color	WHITE

Terminal No.	Color of Wire	Signal Name
1	R	-
2	B	-
3	BR	-
4	Y	-
5	-	-
6	G	-

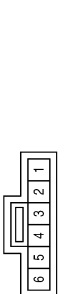
ABNIA4749GB



# METER SYSTEM

< WIRING DIAGRAM >

Connector No.	E16
Connector Name	ECM
Connector Color	GRAY

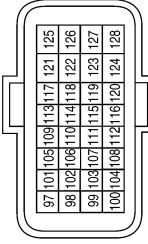

Terminal No.	Color of Wire	Signal Name
107	W	SENSOR POWER SUPPLY (EVAP CONTROL SYSTEM PRESSURE SENSOR, ENGINE OIL PRESSURE SENSOR)
112	G	SENSOR GROUND (EVAP CONTROL SYSTEM PRESSURE SENSOR, ENGINE OIL PRESSURE SENSOR)
113	P	CAN-L
114	L	CAN-H

Connector No.	E2
Connector Name	WIRE TO WIRE
Connector Color	WHITE

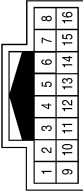

Terminal No.	Color of Wire	Signal Name
1	G	-
2	W	-
9	P	-
10	L	-
16	P	-

Connector No.	M170
Connector Name	JOINT CONNECTOR-M09
Connector Color	WHITE

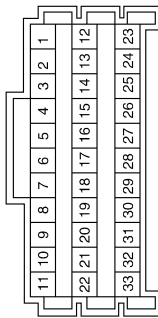

Terminal No.	Color of Wire	Signal Name
12	G	-
17	G	-

Connector No.	E26
Connector Name	WIRE TO WIRE
Connector Color	WHITE

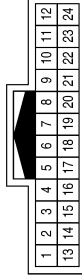

Terminal No.	Color of Wire	Signal Name
18	P	-
19	W	-
21	W	-

Connector No.	E22
Connector Name	ACCESSORY RELAY-2
Connector Color	BLUE



Terminal No.	Color of Wire	Signal Name
1	G	-
2	B	-
3	R	-
5	P	-

Connector No.	E21
Connector Name	BRAKE FLUID LEVEL SWITCH
Connector Color	GRAY

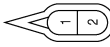

Terminal No.	Color of Wire	Signal Name
1	W	-
2	B	-

ABNIA4750GB

A  
B  
C  
D  
E  
F  
G  
H  
I  
J  
K  
L  
M  
N  
O  
P



# METER SYSTEM

< WIRING DIAGRAM >

Connector No.	E52
Connector Name	PARKING BRAKE SWITCH
Connector Color	BLACK



Terminal No.	Color of Wire	Signal Name
1	LG	-

Connector No.	E45
Connector Name	JOINT CONNECTOR-E12
Connector Color	BLUE

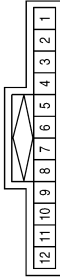

Terminal No.	Color of Wire	Signal Name
1	L	-
2	L	-
3	L	-
7	P	-
8	P	-
9	P	-

Connector No.	E44
Connector Name	JOINT CONNECTOR-E01
Connector Color	WHITE

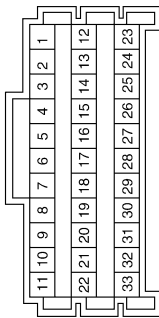

Terminal No.	Color of Wire	Signal Name
2	W	-
3	W	-
15	GR	-
17	B	-
27	G	-
28	G	-

Connector No.	E71
Connector Name	JOINT CONNECTOR-E15
Connector Color	BLACK

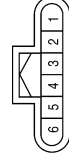

Terminal No.	Color of Wire	Signal Name
1	L	-
2	L	-
3	L	-
4	L	-

Connector No.	E70
Connector Name	JOINT CONNECTOR-E14
Connector Color	BLACK

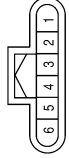

Terminal No.	Color of Wire	Signal Name
1	P	-
2	P	-
3	P	-
4	P	-

Connector No.	E62
Connector Name	POWER STEERING CONTROL MODULE
Connector Color	BLACK



Terminal No.	Color of Wire	Signal Name
7	P	CAN-L
8	L	CAN-H

ABNIA4751GB

# METER SYSTEM

< WIRING DIAGRAM >

Terminal No.	Color of Wire	Signal Name
3G	P	-
12G	P	-
13G	W	-
33G	LG	-
34G	W	-
35G	P	-
36G	L	-
49G	W	-
50G	G	-
54G	P	-

Connector No.	E152
Connector Name	WIRE TO WIRE
Connector Color	WHITE

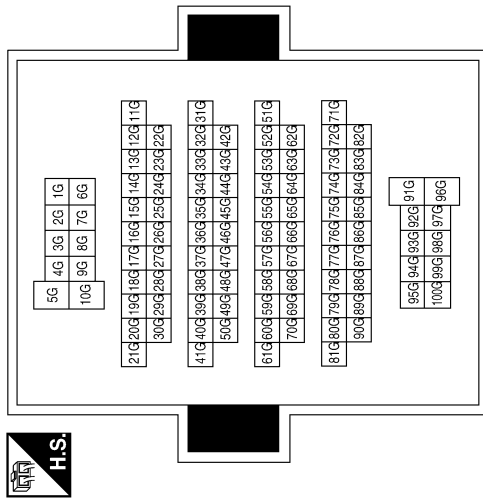

Connector No.	E125
Connector Name	ABS ACTUATOR AND ELECTRIC UNIT (CONTROL UNIT)
Connector Color	BLACK

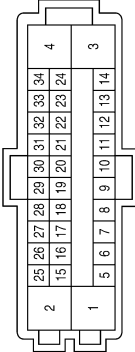

Terminal No.	Color of Wire	Signal Name
15	P	CAN-L
25	L	CAN-H

Connector No.	E208
Connector Name	WASHER FLUID LEVEL SWITCH
Connector Color	BLACK

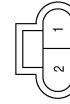

Connector No.	E206
Connector Name	AMBIENT SENSOR
Connector Color	BLACK



Connector No.	E204
Connector Name	GENERATOR
Connector Color	-



Terminal No.	Color of Wire	Signal Name
1	G	-
2	B	-

Terminal No.	Color of Wire	Signal Name
1	L	-
2	Y	-

Terminal No.	Color of Wire	Signal Name
5	B	-

ABNIA4752GB

A  
B  
C  
D  
E  
F  
G  
H  
I  
J  
K  
L  
M  
N  
O  
P

MWI

# METER SYSTEM

< WIRING DIAGRAM >

Connector No.	F15
Connector Name	TCM (TRANSMISSION CONTROL MODULE)
Connector Color	BLACK

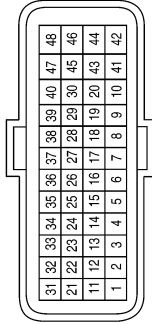

Terminal No.	Color of Wire	Signal Name
23	P	CAN-L
33	L	CAN-H

Connector No.	F7
Connector Name	GENERATOR
Connector Color	BLACK



Terminal No.	Color of Wire	Signal Name
2	GR	-

Connector No.	E209
Connector Name	WIRE TO WIRE
Connector Color	WHITE

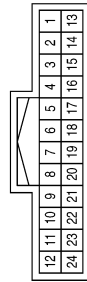

Terminal No.	Color of Wire	Signal Name
18	L	-
19	Y	-
21	G	-

Connector No.	F54
Connector Name	ENGINE OIL PRESSURE SENSOR
Connector Color	BLACK



Terminal No.	Color of Wire	Signal Name
1	BR	-
2	LG	-
3	Y	-

Connector No.	F51
Connector Name	ECM
Connector Color	BLACK

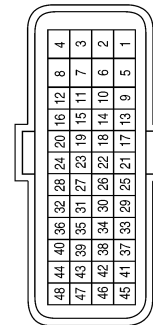

Terminal No.	Color of Wire	Signal Name
4	LG	ENGINE OIL PRESSURE SENSOR

Connector No.	F32
Connector Name	WIRE TO WIRE
Connector Color	WHITE

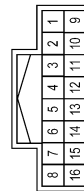

Terminal No.	Color of Wire	Signal Name
1	BR	-
2	Y	-
9	P	-
10	L	-
16	GR	-

ABNIA4753GB

# METER SYSTEM

< WIRING DIAGRAM >

Connector No.	B11
Connector Name	JOINT CONNECTOR-B09
Connector Color	WHITE



Terminal No.	Color of Wire	Signal Name
1	P	-
2	P	-

Connector No.	B9
Connector Name	AIR BAG DIAGNOSIS SENSOR UNIT
Connector Color	YELLOW

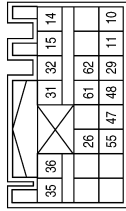

Terminal No.	Color of Wire	Signal Name
29	GR	LH SEAT BELT BUCKLE SWITCH +

Connector No.	B8
Connector Name	FRONT DOOR SWITCH LH
Connector Color	WHITE

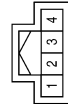

Terminal No.	Color of Wire	Signal Name
3	L	-

Connector No.	B17
Connector Name	JOINT CONNECTOR-B12
Connector Color	WHITE

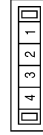

Terminal No.	Color of Wire	Signal Name
1	L	-
2	L	-

Connector No.	B16
Connector Name	JOINT CONNECTOR-B11
Connector Color	WHITE



Terminal No.	Color of Wire	Signal Name
1	P	-
2	P	-

Connector No.	B12
Connector Name	JOINT CONNECTOR-B10
Connector Color	WHITE



Terminal No.	Color of Wire	Signal Name
1	L	-
2	L	-

ABNIA4754GB

A  
B  
C  
D  
E  
F  
G  
H  
I  
J  
K  
L  
M  
N  
O  
P



# METER SYSTEM

## < WIRING DIAGRAM >

Connector No.	B18
Connector Name	REAR DOOR SWITCH LH
Connector Color	WHITE

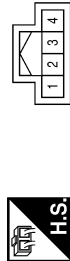

Terminal No.	Color of Wire	Signal Name
3	SB	—

Connector No.	B32
Connector Name	WIRE TO WIRE
Connector Color	WHITE



Terminal No.	Color of Wire	Signal Name
18	L	—
19	P	—

Connector No.	B41
Connector Name	WIRE TO WIRE
Connector Color	WHITE



Terminal No.	Color of Wire	Signal Name
12	G	—

Connector No.	B46
Connector Name	WIRE TO WIRE
Connector Color	WHITE

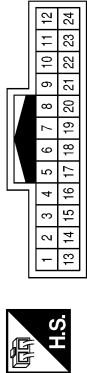

Terminal No.	Color of Wire	Signal Name
11	G	—
23	GR	—

Connector No.	B69
Connector Name	WIRE TO WIRE
Connector Color	GRAY

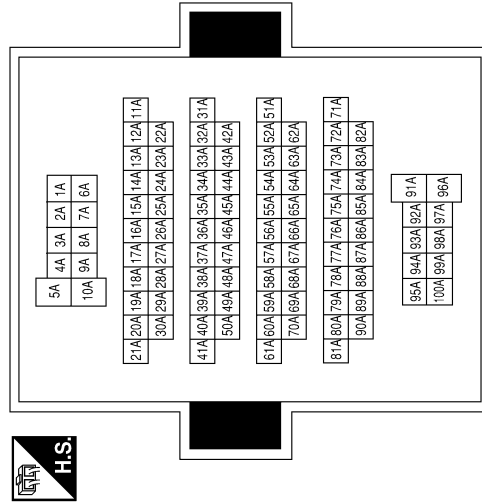

Terminal No.	Color of Wire	Signal Name
44A	V	—
45A	G	—
65A	SB	—
66A	L	—
67A	LG	—
89A	L	—
90A	P	—

# METER SYSTEM

< WIRING DIAGRAM >

Connector No.	B80
Connector Name	JOINT CONNECTOR-B15
Connector Color	WHITE

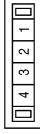

Terminal No.	Color of Wire	Signal Name
1	LG	-
2	LG	-
3	GR	-

Connector No.	B74
Connector Name	WIRE TO WIRE
Connector Color	WHITE

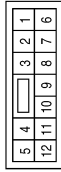

Terminal No.	Color of Wire	Signal Name
3	LG	-
4	B	-

Connector No.	B72
Connector Name	FUEL LEVEL SENSOR UNIT AND FUEL PUMP
Connector Color	GRAY

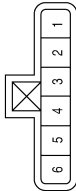

Terminal No.	Color of Wire	Signal Name
2	G	-
5	V	-

Connector No.	B113
Connector Name	AIR BAG DIAGNOSIS SENSOR UNIT
Connector Color	YELLOW

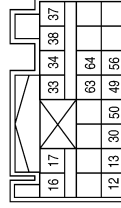

Terminal No.	Color of Wire	Signal Name
30	L	RH SEAT BELT BUCKLE SWITCH +

Connector No.	B108
Connector Name	FRONT DOOR SWITCH RH
Connector Color	WHITE

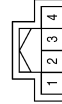

Terminal No.	Color of Wire	Signal Name
3	LG	-

Connector No.	B101
Connector Name	WIRE TO WIRE
Connector Color	WHITE



Terminal No.	Color of Wire	Signal Name
17	L	-
18	P	-
21	LG	-
22	LG	-

ABNIA4755GB

A  
B  
C  
D  
E  
F  
G  
H  
I  
J  
K  
L  
M  
N  
O  
P



# METER SYSTEM

< WIRING DIAGRAM >

Connector No.	B157
Connector Name	WIRE TO WIRE
Connector Color	WHITE

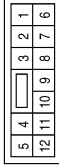

Terminal No.	Color of Wire	Signal Name
3	L	-
4	B	-

Connector No.	B124
Connector Name	WIRE TO WIRE
Connector Color	WHITE



Terminal No.	Color of Wire	Signal Name
18	L	-
19	P	-

Connector No.	B116
Connector Name	REAR DOOR SWITCH RH
Connector Color	WHITE

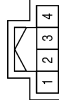

Terminal No.	Color of Wire	Signal Name
3	LG	-

Connector No.	B300
Connector Name	WIRE TO WIRE
Connector Color	WHITE

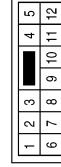

Terminal No.	Color of Wire	Signal Name
3	BG	-
4	GR	-

Connector No.	B221
Connector Name	SEAT BELT BUCKLE SWITCH (DRIVER SEAT)
Connector Color	WHITE



Terminal No.	Color of Wire	Signal Name
3	GR	-
4	BG	-

Connector No.	B220
Connector Name	WIRE TO WIRE
Connector Color	WHITE



Terminal No.	Color of Wire	Signal Name
3	BG	-
4	GR	-

ABNIA4756GB



# METER SYSTEM

< WIRING DIAGRAM >

Connector No.	D507
Connector Name	WIRE TO WIRE
Connector Color	WHITE

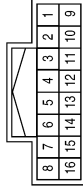

Terminal No.	Color of Wire	Signal Name
6	B	-
12	LG	-(WITHOUT POWER BACK DOOR)
12	P	-(WITH POWER BACK DOOR)

Connector No.	D501
Connector Name	WIRE TO WIRE
Connector Color	WHITE

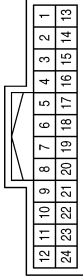

Terminal No.	Color of Wire	Signal Name
11	LG	-(WITHOUT POWER BACK DOOR)
11	P	-(WITH POWER BACK DOOR)
23	B	-

Connector No.	B303
Connector Name	SEAT BELT BUCKLE SWITCH (PASSENGER SEAT)
Connector Color	WHITE



Terminal No.	Color of Wire	Signal Name
3	GR	-
4	BG	-

Connector No.	D565
Connector Name	BACK DOOR LOCK ASSEMBLY (WITHOUT POWER BACK DOOR)
Connector Color	WHITE

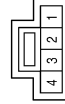

Terminal No.	Color of Wire	Signal Name
3	G	-
4	B	-

Connector No.	D557
Connector Name	BACK DOOR LOCK ASSEMBLY (WITH POWER BACK DOOR)
Connector Color	WHITE

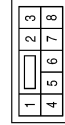

Terminal No.	Color of Wire	Signal Name
7	G	-
8	B	-

Connector No.	D552
Connector Name	WIRE TO WIRE
Connector Color	WHITE



Terminal No.	Color of Wire	Signal Name
6	B	-
12	G	-

ABNIA4757GB

A  
B  
C  
D  
E  
F  
G  
H  
I  
J  
K  
L  
M  
N  
O  
P



# COMPASS

< WIRING DIAGRAM >

## COMPASS

Wiring Diagram

INFOID:000000009174247

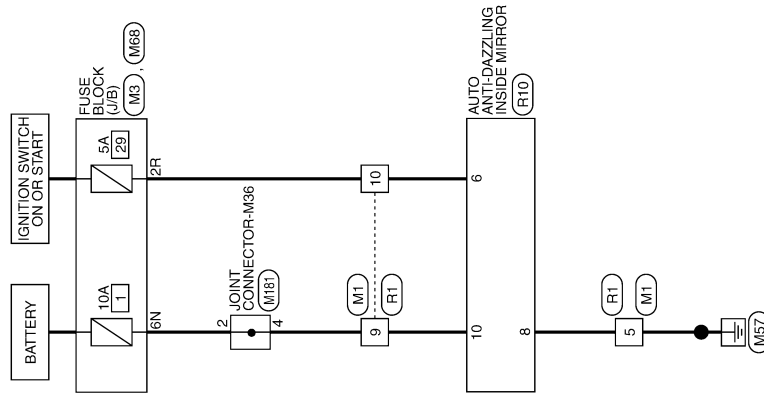

COMPASS

AANWA0704GB

# COMPASS

< WIRING DIAGRAM >

## COMPASS CONNECTORS

Connector No.	M1
Connector Name	WIRE TO WIRE
Connector Color	WHITE

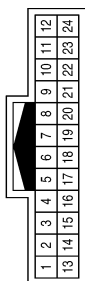

Terminal No.	Color of Wire	Signal Name
5	B	-
9	W	-
10	LG	-

Connector No.	M3
Connector Name	FUSE BLOCK (J/B)
Connector Color	WHITE

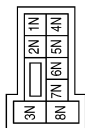

Terminal No.	Color of Wire	Signal Name
6N	W	-

Connector No.	M68
Connector Name	FUSE BLOCK (J/B)
Connector Color	BROWN



Terminal No.	Color of Wire	Signal Name
2R	LG	-

Connector No.	M181
Connector Name	JOINT CONNECTOR-M36
Connector Color	WHITE



Terminal No.	Color of Wire	Signal Name
2	W	-
4	W	-

Connector No.	R1
Connector Name	WIRE TO WIRE
Connector Color	WHITE

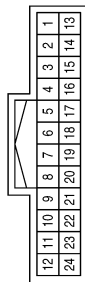

Terminal No.	Color of Wire	Signal Name
5	B	-
9	G	-
10	W	-

Connector No.	R10
Connector Name	AUTO ANTI-DAZZLING INSIDE MIRROR
Connector Color	BLACK

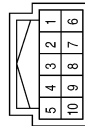

Terminal No.	Color of Wire	Signal Name
6	W	-
8	B	-
10	G	-

ABNIA4745GB

A  
B  
C  
D  
E  
F  
G  
H  
I  
J  
K  
L  
M  
MWI  
O  
P

# DIAGNOSIS AND REPAIR WORK FLOW

< BASIC INSPECTION >

## BASIC INSPECTION

### DIAGNOSIS AND REPAIR WORK FLOW

Work flow

INFOID:000000009174248

#### OVERALL SEQUENCE

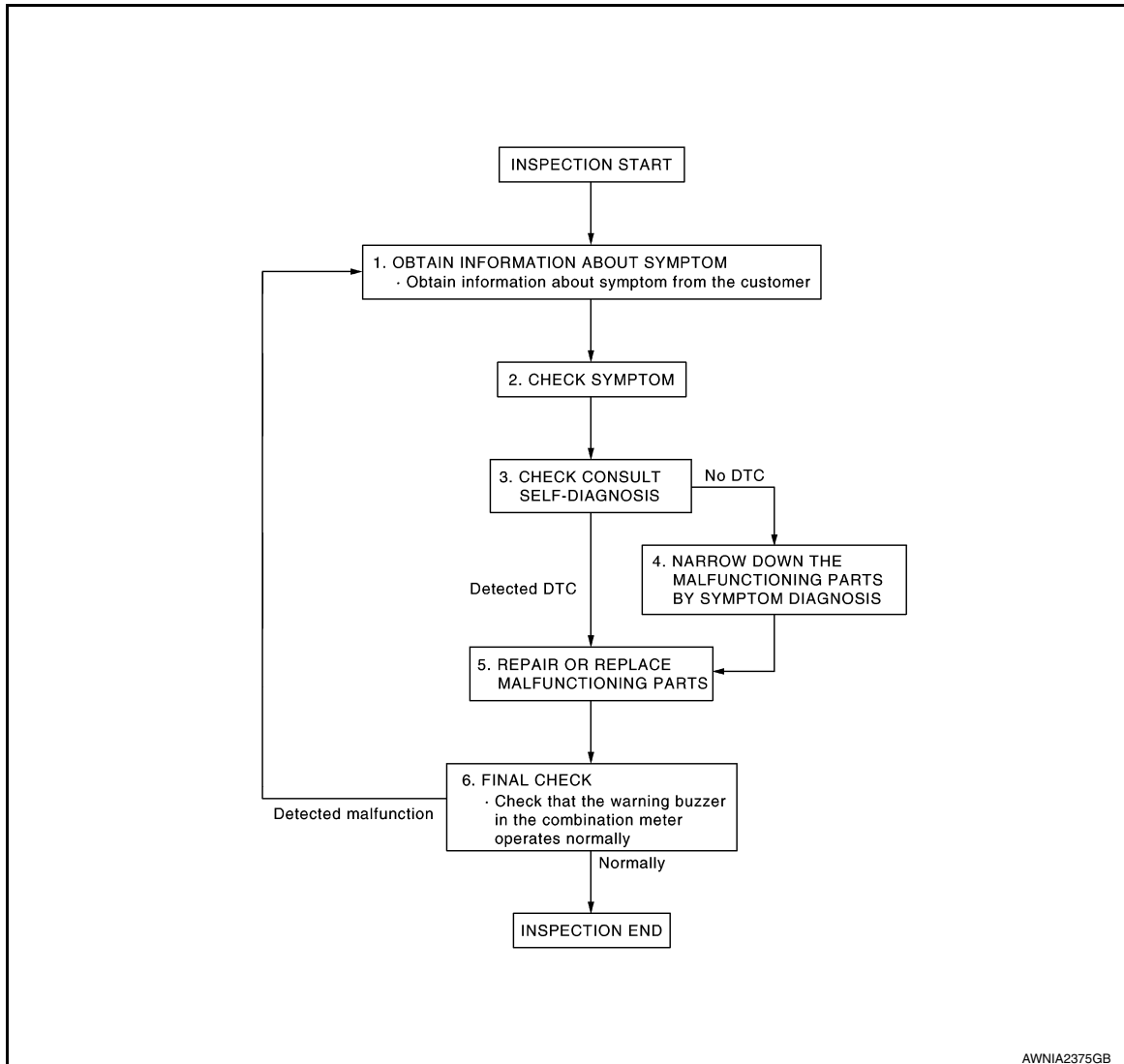

#### DETAILED FLOW

##### 1. OBTAIN INFORMATION ABOUT SYMPTOM

Interview the customer to obtain as much information as possible about the conditions and environment under which the malfunction occurred.

>> GO TO 2.

##### 2. CHECK SYMPTOM

- Check the symptom based on the information obtained from the customer.
- Check if any other malfunctions are present.

>> GO TO 3.

##### 3. CHECK CONSULT SELF-DIAGNOSIS RESULTS

Connect CONSULT and perform self-diagnosis. Refer to [MWI-29, "DTC Index"](#).

# DIAGNOSIS AND REPAIR WORK FLOW

## < BASIC INSPECTION >

---

Are self-diagnosis results normal?

YES >> GO TO 4.

NO >> GO TO 5.

A

## 4.NARROW DOWN MALFUNCTIONING PARTS BY SYMPTOM DIAGNOSIS

---

Perform symptom diagnosis and narrow down the malfunctioning parts.

B

>> GO TO 5.

C

## 5.REPAIR OR REPLACE MALFUNCTIONING PARTS

---

Repair or replace malfunctioning parts.

### **NOTE:**

If DTC is displayed, erase DTC after repairing or replacing malfunctioning parts.

D

>> GO TO 6.

E

## 6.FINAL CHECK

---

Check that the warning buzzer in the combination meter operates normally.

F

Does it operate normally?

YES >> Inspection End.

NO >> GO TO 1.

G

H

I

J

K

L

M

MWI

O

P

# U1000 CAN COMM CIRCUIT

< DTC/CIRCUIT DIAGNOSIS >

## DTC/CIRCUIT DIAGNOSIS

### U1000 CAN COMM CIRCUIT

#### DTC Logic

INFOID:000000009174249

#### DTC DETECTION LOGIC

DTC	CONSULT Display	Detection Condition	Possible Cause
U1000	CAN COMM CIRC [U1000]	When combination meter is not receiving CAN communication signals for 2 seconds or more.	Combination meter

#### Diagnosis Procedure

INFOID:000000009174250

#### 1.CHECK CAN COMMUNICATION

Select Self-Diagnosis Results mode for METER/M&A with CONSULT.

>> GO TO LAN system. Refer to [LAN-20, "Trouble Diagnosis Flow Chart"](#).

# U1010 CONTROL UNIT (CAN)

< DTC/CIRCUIT DIAGNOSIS >

## U1010 CONTROL UNIT (CAN)

### Description

INFOID:000000009174251

Initial diagnosis of combination meter.

### DTC Logic

INFOID:000000009174252

### DTC DETECTION LOGIC

DTC	CONSULT Display	Detection Condition	Possible Cause
U1010	CONTROL UNIT (CAN) [U1010]	When detecting error during the initial diagnosis of the CAN controller of combination meter.	Combination meter

### Diagnosis Procedure

INFOID:000000009174253

#### 1. REPLACE COMBINATION METER

When DTC U1010 is detected, replace combination meter. Refer to [MWI-82. "Removal and Installation"](#).

>> Inspection End.

A  
B  
C  
D  
E  
F  
G  
H  
I  
J  
K  
L  
M  
O  
P

MWI

## B2205 VEHICLE SPEED

< DTC/CIRCUIT DIAGNOSIS >

### B2205 VEHICLE SPEED

#### Description

INFOID:000000009174254

The ABS actuator and electric unit (control unit) provides a vehicle speed signal to the combination meter via CAN communication lines.

#### DTC Logic

INFOID:000000009174255

DTC	CONSULT Display	Detection Condition	Possible Cause
B2205	VEHICLE SPEED CIRC [B2205]	Malfunction is detected when an erroneous speed signal is received for 2 seconds or more.	<ul style="list-style-type: none"><li>Combination meter</li><li>ABS actuator and electric unit (control unit)</li></ul>

#### Diagnosis Procedure

INFOID:000000009174256

#### 1. CHECK COMBINATION METER INPUT SIGNAL

1. Start engine and select METER/M&A on CONSULT.
2. Using SPEED METER on Data Monitor, compare the value of DATA MONITOR with speedometer pointer of combination meter. Speedometer and DATA MONITOR indications should be close.

Is the inspection result normal?

- YES >> Perform ABS actuator and electric unit (control unit) self-diagnosis. Refer to [BRC-32. "CONSULT Function"](#).
- NO >> Replace combination meter. Refer to [MWI-82. "Removal and Installation"](#).



# B2267 ENGINE SPEED

< DTC/CIRCUIT DIAGNOSIS >

## B2267 ENGINE SPEED

### Description

INFOID:000000009174257

The engine speed signal is transmitted from ECM to the combination meter via CAN communication.

### DTC Logic

INFOID:000000009174258

### DTC DETECTION LOGIC

DTC	CONSULT Display	Detection Condition	Possible Cause
B2267	TACHO METER [B2267]	ECM continuously transmits abnormal engine speed signals for 2 seconds or more	<ul style="list-style-type: none"><li>• Crankshaft position sensor (POS)</li><li>• ECM</li></ul>

### Diagnosis Procedure

INFOID:000000009174259

#### 1. PERFORM SELF-DIAGNOSIS OF ECM

Perform Self-Diagnostic Result of ECM, and repair or replace malfunctioning parts.

>> Refer to [EC-61, "CONSULT Function"](#).

A  
B  
C  
D  
E  
F  
G  
H  
I  
J  
K  
L  
M  
O  
P

MWI

# B2268 WATER TEMP

< DTC/CIRCUIT DIAGNOSIS >

## B2268 WATER TEMP

### Description

INFOID:000000009174260

The engine coolant temperature signal is transmitted from ECM to the combination meter via CAN communication.

### DTC Logic

INFOID:000000009174261

### DTC DETECTION LOGIC

DTC	CONSULT Display	Detection condition	Probable Cause
B2268	WATER TEMP METER [B2268]	ECM continuously transmits abnormal engine coolant temperature signals for 60 seconds or more	<ul style="list-style-type: none"><li>• Engine coolant temperature sensor</li><li>• ECM</li></ul>

### Diagnosis Procedure

INFOID:000000009174262

#### 1. PERFORM SELF-DIAGNOSIS OF ECM

Perform Self-Diagnosis Result of ECM, and repair or replace malfunctioning parts.

>> Refer to [EC-61, "CONSULT Function"](#).

# POWER SUPPLY AND GROUND CIRCUIT

< DTC/CIRCUIT DIAGNOSIS >

## POWER SUPPLY AND GROUND CIRCUIT COMBINATION METER

### COMBINATION METER : Diagnosis Procedure

INFOID:000000009174263

Regarding Wiring Diagram information, refer to [MWI-31. "Wiring Diagram"](#).

#### 1. CHECK FUSES

Check that the following fuses are not blown.

Unit	Power source	Fuse No.
Combination meter	Battery	13
		65
	Ignition switch ON or START	31

Is the fuse blown?

YES >> GO TO 2.

NO >> Replace the blown fuse after repairing the affected circuit.

#### 2. POWER SUPPLY CIRCUIT CHECK

1. Disconnect combination meter connector.
2. Check voltage between combination meter harness connector M24 terminals 5, 21, 22 and ground.

Terminals		Ignition switch position				
(+)		(-)	OFF	ACC	ON	START
Connector	Terminal					
M24	22	Ground	Battery voltage	Battery voltage	Battery voltage	Battery voltage
	21		0V	0V	Battery voltage	Battery voltage
	5		0V	Battery voltage	Battery voltage	0V

Is the inspection result normal?

YES >> GO TO 3.

NO >> Repair or replace harness or connectors.

#### 3. GROUND CIRCUIT CHECK

1. Turn ignition switch OFF.
2. Check continuity between combination meter harness connector M24 terminals 1, 2 and ground.

Terminals		Continuity
(+)		
Connector	Terminal	(-)
M24	1	Ground
	2	

Is the inspection result normal?

YES >> Inspection End.

NO >> Repair or replace harness or connectors.

## BCM (BODY CONTROL MODULE)

### BCM (BODY CONTROL MODULE) : Diagnosis Procedure

INFOID:000000009764355

Regarding Wiring Diagram information, refer to [BCS-55. "Wiring Diagram"](#).

# POWER SUPPLY AND GROUND CIRCUIT

## < DTC/CIRCUIT DIAGNOSIS >

### 1. CHECK FUSE AND FUSIBLE LINK

Check that the following fuse and fusible link are not blown.

Terminal No.	Signal name	Fuse and fusible link No.
139	Fusible link battery power	O (40A)
131	BCM battery fuse	1 (10A)

Is the fuse or fusible link blown?

YES >> Replace the blown fuse or fusible link after repairing the affected circuit.

NO >> GO TO 2

### 2. CHECK POWER SUPPLY CIRCUIT

1. Disconnect BCM connector M81.
2. Check voltage between BCM connector M81 terminals 131, 139 and ground.

BCM		Ground	Voltage (Approx.)
Connector	Terminal		
M81	131	—	Battery voltage
	139		

Is the inspection result normal?

YES >> GO TO 3

NO >> Repair or replace harness or connectors.

### 3. CHECK GROUND CIRCUIT

Check continuity between BCM connector M81 terminals 134, 143 and ground.

BCM		Ground	Continuity
Connector	Terminal		
M81	134	—	Yes
	143		

Is the inspection result normal?

YES >> Inspection End.

NO >> Repair or replace harness or connectors.

# ILLUMINATION CONTROL SWITCH SIGNAL CIRCUIT

< DTC/CIRCUIT DIAGNOSIS >

## ILLUMINATION CONTROL SWITCH SIGNAL CIRCUIT

### Diagnosis Procedure

INFOID:000000009174265

Regarding Wiring Diagram information, refer to [MWI-31, "Wiring Diagram"](#).

### 1. CHECK METER ILLUMINATION CONTROL SWITCH SIGNAL

1. Turn ignition switch ON.
2. Check voltage between the following terminals of the illumination control switch harness connector M113.

Illumination control switch		Condition	Voltage (Approx.)
Connector	Terminals		
	(+)	(-)	
M113	4	When illumination control switch (-) is pressed	0 V
		Other than the above	5 V
	3	When illumination control switch (+) is pressed	0 V
		Other than the above	5 V

Is the inspection result normal?

YES >> Inspection End.

NO >> GO TO 2.

### 2. CHECK METER ILLUMINATION CONTROL SWITCH CIRCUIT

1. Turn ignition switch OFF.
2. Disconnect combination meter harness connector M23 and illumination control switch harness connector M113.
3. Check continuity between combination meter harness connector M23 and illumination control switch harness connector M113.

Combination meter		Illumination control switch		Continuity
Connector	Terminal	Connector	Terminal	
M23	42	M113	4	Yes
	47		3	
	48		6	

4. Check continuity between combination meter harness connector and ground.

Combination meter		Ground	Continuity
Connector	Terminal		
M23	42		No
	47		
	48		

Is the inspection result normal?

YES >> Check illumination control switch. Refer to [MWI-61, "Component Inspection"](#).

NO >> Repair or replace harness or connector.

### Component Inspection

INFOID:000000009174266

### 1. CHECK METER ILLUMINATION CONTROL SWITCH

1. Turn ignition switch OFF.
2. Disconnect illumination control switch connector.
3. Check illumination control switch.

A  
B  
C  
D  
E  
F  
G  
H  
I  
J  
K  
L  
M  
N  
O  
P

MWI

# ILLUMINATION CONTROL SWITCH SIGNAL CIRCUIT

< DTC/CIRCUIT DIAGNOSIS >

Illumination control switch		Condition	Continuity
Terminals			
4	6	When illumination control switch (-) is pressed	Yes
		Other than the above	No
3		When illumination control switch (+) is pressed	Yes
		Other than the above	No

Is the inspection result normal?

YES >> Inspection End.

NO >> Replace illumination control switch. Refer to [MWI-83, "Removal and Installation"](#).

# TRIP RESET SWITCH SIGNAL CIRCUIT

< DTC/CIRCUIT DIAGNOSIS >

## TRIP RESET SWITCH SIGNAL CIRCUIT

### Diagnosis Procedure

INFOID:000000009174267

Regarding Wiring Diagram information, refer to [MWI-31, "Wiring Diagram"](#).

### 1. CHECK TRIP RESET SWITCH SIGNAL

1. Turn ignition switch ON.
2. Check voltage between the following terminals of the trip reset switch harness connector M140.

Trip reset switch			Condition	Voltage (Approx.)
Connector	Terminals			
	(+)	(-)		
M140	3	4	When trip reset switch is pressed	0 V
			Other than the above	5 V

Is the inspection result normal?

YES >> Inspection End.

NO >> GO TO 2.

### 2. CHECK TRIP RESET SWITCH CIRCUIT

1. Turn ignition switch OFF.
2. Disconnect combination meter harness connector M23 and trip reset switch harness connector M140.
3. Check continuity between combination meter harness connector M23 and trip reset switch harness connector M140.

Combination meter		Trip reset switch		Continuity
Connector	Terminal	Connector	Terminal	
M23	41	M140	3	Yes
	48		4	

4. Check continuity between combination meter harness connector and ground.

Combination meter		Ground	Continuity
Connector	Terminal		
M23	41		
	48		

Is the inspection result normal?

YES >> Check the trip reset switch. Refer to [MWI-63, "Component Inspection"](#).

NO >> Repair or replace harness or connectors.

### Component Inspection

INFOID:000000009174268

### 1. CHECK TRIP RESET SWITCH

1. Turn ignition switch OFF.
2. Disconnect trip reset switch connector.
3. Check trip reset switch.

Trip reset switch		Condition	Continuity
Terminals			

A  
B  
C  
D  
E  
F  
G  
H  
I  
J  
K  
L  
M  
N  
O  
P

MWI

## TRIP RESET SWITCH SIGNAL CIRCUIT

< DTC/CIRCUIT DIAGNOSIS >

3	4	When trip reset switch is pressed	Yes
		Other than the above	No

Is the inspection result normal?

YES >> Inspection End.

NO >> Replace trip reset switch. Refer to [MWI-83, "Removal and Installation"](#).



# FUEL LEVEL SENSOR SIGNAL CIRCUIT

< DTC/CIRCUIT DIAGNOSIS >

## FUEL LEVEL SENSOR SIGNAL CIRCUIT

### Description

INFOID:000000009174269

The fuel level sensor unit and fuel pump detects the approximate fuel level in the fuel tank and transmits the fuel level signal to the combination meter.

### Component Function Check

INFOID:000000009174270

#### 1.COMBINATION METER INPUT SIGNAL

1. Select METER/M&A on CONSULT.
2. Using FUEL METER of DATA MONITOR, compare the value of DATA MONITOR with fuel gauge pointer of combination meter.

Fuel gauge pointer	Fuel tank volume [L] (Approx.)
Full	70.6
3/4	54.1
1/2	36.4
1/4	20
Empty	0

Does the data monitor value approximately match the fuel gauge indication?

- YES >> Inspection End.  
NO >> Replace combination meter. Refer to [MWI-82. "Removal and Installation"](#).

### Diagnosis Procedure

INFOID:000000009174271

Regarding Wiring Diagram information, refer to [MWI-31. "Wiring Diagram"](#).

#### 1.CHECK HARNESS CONNECTOR

1. Turn ignition switch OFF.
2. Check combination meter and fuel level sensor unit terminals (meter-side and harness-side) for poor connection.

Is the inspection result normal?

- YES >> GO TO 2.  
NO >> Repair or replace terminals or connectors.

#### 2.CHECK FUEL LEVEL SENSOR UNIT CIRCUIT

1. Disconnect combination meter harness connector M24 and fuel level sensor unit harness connector B72.
2. Check continuity between combination meter harness connector M24 and fuel level sensor unit and fuel pump harness connector B72.

Fuel level sensor unit and fuel pump		Combination meter		Continuity
Connector	Terminal	Connector	Terminal	
B72	5	M24	27	Yes

3. Check continuity between fuel level sensor unit and fuel pump harness connector and ground.

Connector	Terminal	Ground	Continuity
B72	5		No

Is the inspection result normal?

- YES >> GO TO 3.

A  
B  
C  
D  
E  
F  
G  
H  
I  
J  
K  
L  
M  
O  
P

MWI

# FUEL LEVEL SENSOR SIGNAL CIRCUIT

## < DTC/CIRCUIT DIAGNOSIS >

NO >> Repair or replace harness or connectors.

### 3. CHECK FUEL LEVEL SENSOR UNIT GROUND CIRCUIT

1. Check continuity between combination meter harness connector M24 and fuel level sensor unit and fuel pump harness connector B72.

Connector	Terminal	Connector	Terminal	Continuity
B72	2	M24	26	Yes

2. Check continuity between fuel level sensor unit and fuel pump harness connector and ground.

Connector	Terminal	Ground	Continuity
B72	2		No

Is the inspection result normal?

YES >> GO TO 4.

NO >> Repair or replace harness or connectors.

### 4. CHECK INSTALLATION CONDITION

Check fuel level sensor unit installation, and check whether the float arm interferes or binds with any of the internal components in the fuel tank.

Is the inspection result normal?

YES >> Inspection End.

NO >> Install the fuel level sensor unit properly. Refer to [FL-6, "Removal and Installation"](#).

## Component Inspection

INFOID:000000009174272

### 1. REMOVE FUEL LEVEL SENSOR UNIT

Remove the fuel level sensor unit. Refer to [FL-6, "Removal and Installation"](#).

>> GO TO 2.

### 2. CHECK FUEL LEVEL SENSOR UNIT AND FUEL PUMP

Check the resistance between terminals 2 and 5.

Terminal		Float position mm (in)		Resistance value (Approx.)
2	5	*1	Empty	15.7 (0.6)
		*2	Full	133 (5.2)

\*1 and \*2: When float arm is in contact with stopper.

Is inspection result OK?

YES >> Inspection End.

NO >> Replace fuel level sensor unit and fuel pump. Refer to [FL-6, "Removal and Installation"](#).

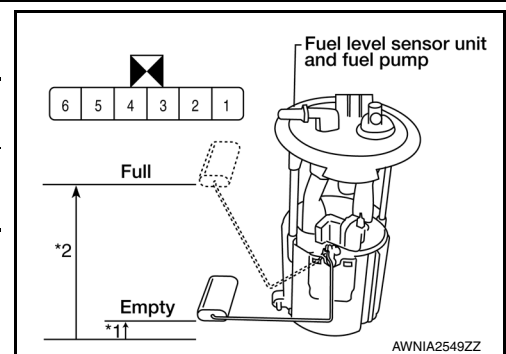

# WASHER FLUID LEVEL SWITCH CIRCUIT

< DTC/CIRCUIT DIAGNOSIS >

## WASHER FLUID LEVEL SWITCH CIRCUIT

### Description

INFOID:000000009174273

Transmits the washer fluid level switch signal to the combination meter.

### Diagnosis Procedure

INFOID:000000009174274

Regarding Wiring Diagram information, refer to [MWI-31, "Wiring Diagram"](#).

### 1. CHECK WASHER FLUID LEVEL SWITCH SIGNAL CIRCUIT

1. Turn ignition switch OFF.
2. Disconnect combination meter harness connector M24 and washer fluid level switch harness connector E208.
3. Check continuity between combination meter harness connector M24 and washer fluid level switch harness connector E208.

Combination meter		Washer fluid level switch		Continuity
Connector	Terminal	Connector	Terminal	
M24	49	E208	1	Yes

4. Check continuity between combination meter harness connector and ground.

Combination meter		Ground	Continuity
Connector	Terminal		
M24	49		No

Is the inspection result normal?

YES >> GO TO 2.

NO >> Repair or replace harness or connectors.

### 2. CHECK WASHER FLUID LEVEL SWITCH GROUND CIRCUIT

Check continuity between washer fluid level switch connector and ground.

Washer fluid level switch		Ground	Continuity
Connector	Terminal		
E208	2		Yes

Is the inspection result normal?

YES >> Inspection End.

NO >> Repair or replace harness or connectors.

### Component Inspection

INFOID:000000009174275

### 1. CHECK WASHER FLUID LEVEL SWITCH

1. Turn ignition switch OFF.
2. Disconnect washer fluid level switch connector.
3. Check washer fluid level switch.

Washer fluid level switch		Condition	Continuity
Terminals			
1	2	Washer fluid level switch ON	Yes
		Washer fluid level switch OFF	No

Is the inspection result normal?

A  
B  
C  
D  
E  
F  
G  
H  
I  
J  
K  
L  
M  
O  
P



## WASHER FLUID LEVEL SWITCH CIRCUIT

### < DTC/CIRCUIT DIAGNOSIS >

---

YES >> Inspection End.

NO >> Replace washer fluid level switch. Refer to [WW-57, "Removal and Installation"](#).

# PARKING BRAKE SWITCH SIGNAL CIRCUIT

< DTC/CIRCUIT DIAGNOSIS >

## PARKING BRAKE SWITCH SIGNAL CIRCUIT

### Description

INFOID:000000009174276

Transmits the parking brake switch signal to the combination meter.

### Component Function Check

INFOID:000000009174277

#### 1.COMBINATION METER INPUT SIGNAL

1. Start engine.
2. Monitor BRAKE W/L in DATA MONITOR while applying and releasing the parking brake.

**Condition**                      **CONSULT**  
**Parking brake applied**      : **ON**  
**Parking brake released**     : **OFF**

>> Inspection End.

### Diagnosis Procedure

INFOID:000000009174278

Regarding Wiring Diagram information, refer to [MWI-31, "Wiring Diagram"](#).

#### 1.CHECK PARKING BRAKE SWITCH CIRCUIT

1. Disconnect combination meter harness connector M24 and parking brake switch harness connector E52.
2. Check continuity between combination meter harness connector M24 terminal 12 and parking brake switch harness connector E52 terminal 1.

Combination meter		Parking brake switch		Continuity
Connector	Terminal	Connector	Terminal	
M24	12	E52	1	Yes

3. Check continuity between combination meter harness connector M24 terminal 12 and ground.

Combination meter		Ground	Continuity
Connector	Terminal		
M24	12		No

Is the inspection result normal?

- YES >> Inspection End.  
NO >> Repair or replace harness or connectors.

### Component Inspection

INFOID:000000009174279

#### 1.CHECK PARKING BRAKE SWITCH

Check continuity between parking brake switch terminal 1 and switch case ground.

Component	Terminal	Condition	Continuity
Parking brake switch	1	Parking brake applied	Yes
		Parking brake released	No

Is the inspection result normal?

- YES >> Inspection End.  
NO >> Replace parking brake switch. Refer to [PB-7, "Exploded View"](#).

A  
B  
C  
D  
E  
F  
G  
H  
I  
J  
K  
L  
M  
O  
P

MWI

# STEERING SWITCH

< DTC/CIRCUIT DIAGNOSIS >

## STEERING SWITCH

### Description

INFOID:000000009174280

When one of the steering switches is pushed, the resistance in the steering switch changes the signal to identify which button is controlling the information display.

### Diagnosis Procedure

INFOID:000000009174281

Regarding Wiring Diagram information, refer to [MWI-31, "Wiring Diagram"](#).

## 1. CHECK STEERING SWITCH CIRCUIT

1. Turn ignition switch OFF.
2. Disconnect combination meter harness connector M24 and spiral cable harness connector M30.
3. Check continuity between combination meter harness connector M24 and spiral cable harness connector M30.

Combination meter		Spiral cable		Continuity
Connector	Terminal	Connector	Terminal	
M24	3	M30	24	Yes
	4		31	
	24		33	

4. Check continuity between combination meter harness connector M24 and ground.

Combination meter		Ground	Continuity
Connector	Terminal		
M24	3	Ground	No
	4		
	24		

Is the inspection result normal?

- YES >> Inspection End.  
 NO >> Repair or replace harness or connectors.

### Component Inspection

INFOID:000000009174282

## 1. CHECK STEERING SWITCH RESISTANCE

Check resistance between the following steering switch terminals.

Terminal	Signal name	Condition	Resistance (Ω) (Approx.)
14	Display	Depress DISPLAY switch. □	2023
	Back	Depress BACK switch. ↶	723
15	Enter	Depress ENTER switch.	2023
	Menu Up	Depress ENTER switch up. △	121
	Menu Down	Depress ENTER switch down. ▽	321

Is the inspection result normal?

- YES >> GO TO 2.  
 NO >> Replace steering wheel switch. Refer to [AV-368, "Removal and Installation"](#).

# STEERING SWITCH

< DTC/CIRCUIT DIAGNOSIS >

## 2.CHECK SPIRAL CABLE

Check continuity between the following spiral cable terminals.

Terminals		Continuity
14	24	Yes
15	31	
17	33	

Is the inspection result normal?

YES >> Inspection End.

NO >> Replace spiral cable. Refer to [SR-15, "Removal and Installation"](#).

A  
B  
C  
D  
E  
F  
G  
H  
I  
J  
K  
L  
M  
O  
P

MWI

# THE FUEL GAUGE INDICATOR DOES NOT OPERATE

< SYMPTOM DIAGNOSIS >

---

## SYMPTOM DIAGNOSIS

### THE FUEL GAUGE INDICATOR DOES NOT OPERATE

#### Description

INFOID:000000009174283

Fuel gauge will not indicate from a certain position.

#### Diagnosis Procedure

INFOID:000000009174284

#### 1. CHECK COMBINATION METER INPUT SIGNAL

---

Perform component function check. Refer to [MWI-65. "Component Function Check"](#).

Does monitor value match fuel gauge reading?

YES >> GO TO 2.

NO >> Replace combination meter. Refer to [MWI-82. "Removal and Installation"](#).

#### 2. CHECK FUEL LEVEL SENSOR UNIT CIRCUITS

---

Check the fuel level sensor circuits. Refer to [MWI-65. "Diagnosis Procedure"](#).

Is the inspection result normal?

YES >> GO TO 3.

NO >> Repair or replace harness or connectors.

#### 3. CHECK FUEL LEVEL SENSOR UNIT

---

Perform a unit check for the fuel level sensor unit. Refer to [MWI-66. "Component Inspection"](#).

Is the inspection result normal?

YES >> GO TO 4.

NO >> Replace fuel level sensor unit. Refer to [FL-6. "Removal and Installation"](#).

#### 4. CHECK FLOAT INTERFERENCE

---

Check that the float arm does not interfere with or binds to other components in the fuel tank.

Is the inspection result normal?

YES >> Replace combination meter. Refer to [MWI-82. "Removal and Installation"](#).

NO >> Repair or replace malfunctioning parts.



# THE ILLUMINATION CONTROL SWITCH IS INOPERATIVE

< SYMPTOM DIAGNOSIS >

---

## THE ILLUMINATION CONTROL SWITCH IS INOPERATIVE

### Description

INFOID:000000009174285

The illumination control switch is inoperative when pressed.

### Diagnosis Procedure

INFOID:000000009174286

#### 1.CHECK ILLUMINATION CONTROL SWITCH CIRCUIT

---

Check the illumination control switch circuit. Refer to [MWI-61, "Diagnosis Procedure"](#).

Is the inspection result normal?

YES >> GO TO 2.

NO >> Repair or replace harness or connectors.

#### 2.CHECK ILLUMINATION CONTROL SWITCH

---

Perform a unit check for the illumination control switch. Refer to [MWI-61, "Component Inspection"](#).

Is the inspection result normal?

YES >> Replace combination meter. Refer to [MWI-82, "Removal and Installation"](#).

NO >> Replace illumination control switch. Refer to [MWI-83, "Removal and Installation"](#).

A  
B  
C  
D  
E  
F  
G  
H  
I  
J  
K  
L  
M  
O  
P

MWI

# THE TRIP RESET SWITCH IS INOPERATIVE

< SYMPTOM DIAGNOSIS >

---

## THE TRIP RESET SWITCH IS INOPERATIVE

### Description

INFOID:000000009174287

The trip reset switch is inoperative when pressed.

### Diagnosis Procedure

INFOID:000000009174288

#### 1. CHECK TRIP RESET SWITCH CIRCUIT

---

Check the trip reset switch circuit. Refer to [MWI-63, "Diagnosis Procedure"](#).

Is the inspection result normal?

YES >> GO TO 2.

NO >> Repair or replace harness or connectors.

#### 2. CHECK TRIP RESET SWITCH

---

Perform a unit check for the trip reset switch. Refer to [MWI-63, "Component Inspection"](#).

Is the inspection result normal?

YES >> Replace combination meter. Refer to [MWI-82, "Removal and Installation"](#).

NO >> Replace trip reset switch. Refer to [MWI-83, "Removal and Installation"](#).

# THE OIL PRESSURE WARNING CONTINUES DISPLAYING, OR DOES NOT DISPLAY

< SYMPTOM DIAGNOSIS >

## THE OIL PRESSURE WARNING CONTINUES DISPLAYING, OR DOES NOT DISPLAY

### Description

INFOID:000000009174289

- The low oil pressure warning message stays on when oil pressure is normal.
- The low oil pressure warning message stays off when oil pressure is low.

### Diagnosis Procedure

INFOID:000000009174290

#### 1. CHECK COMBINATION METER INPUT

1. Start the engine and select METER/M&A on CONSULT.
2. Observe OIL W/L DATA MONITOR and the operation of the low oil pressure warning message in the information display.

Component	Condition	CONSULT
Low oil pressure warning message	Engine running	OFF

#### Is the inspection result normal?

- YES >> Perform ECM self-diagnosis. Refer to [EC-61. "CONSULT Function"](#).
- NO >> Replace combination meter. Refer to [MWI-82. "Removal and Installation"](#).

A  
B  
C  
D  
E  
F  
G  
H  
I  
J  
K  
L  
M  
O  
P

MWI

# THE PARKING BRAKE RELEASE WARNING CONTINUES DISPLAYING, OR DOES NOT DISPLAY

< SYMPTOM DIAGNOSIS >

## THE PARKING BRAKE RELEASE WARNING CONTINUES DISPLAYING, OR DOES NOT DISPLAY

### Description

INFOID:000000009174291

- The parking brake warning is displayed during vehicle travel even though the parking brake is released.
- The parking brake warning is not displayed even though driving the vehicle with the parking brake applied.

### Diagnosis Procedure

INFOID:000000009174292

#### 1. CHECK PARKING BRAKE WARNING LAMP OPERATION

1. Start engine.
2. Check the operation of the brake warning lamp while operating the parking brake.

Condition	Warning lamp status
Parking brake applied	ON
Parking brake released	OFF

#### Is the inspection result normal?

- YES >> Replace combination meter. Refer to [MWI-82, "Removal and Installation"](#).  
NO >> GO TO 2.

#### 2. CHECK PARKING BRAKE SWITCH SIGNAL CIRCUIT

1. Turn ignition switch OFF.
2. Check the parking brake switch signal circuit. Refer to [MWI-69, "Diagnosis Procedure"](#).

#### Is the inspection result normal?

- YES >> GO TO 3.  
NO >> Repair or replace harness or connectors.

#### 3. CHECK PARKING BRAKE SWITCH UNIT

Perform a unit check for the parking brake switch. Refer to [MWI-69, "Component Inspection"](#).

#### Is the inspection result normal?

- YES >> Replace combination meter. Refer to [MWI-82, "Removal and Installation"](#).  
NO >> Replace parking brake switch. Refer to [PB-7, "Exploded View"](#).

# THE LOW WASHER FLUID WARNING CONTINUES DISPLAYING, OR DOES NOT DISPLAY

< SYMPTOM DIAGNOSIS >

## THE LOW WASHER FLUID WARNING CONTINUES DISPLAYING, OR DOES NOT DISPLAY

### Description

INFOID:000000009174293

- The warning is still displayed even after washer fluid is added.
- The warning is not displayed even though the washer tank is empty.

### Diagnosis Procedure

INFOID:000000009174294

#### 1. CHECK WASHER FLUID LEVEL SWITCH SIGNAL CIRCUIT

Check the washer fluid level switch signal circuit. Refer to [MWI-67. "Diagnosis Procedure"](#).

Is the inspection result normal?

- YES >> GO TO 2.
- NO >> Repair or replace harness or connectors.

#### 2. CHECK WASHER FLUID LEVEL SWITCH UNIT

Perform a unit check for the washer fluid level switch. Refer to [MWI-67. "Component Inspection"](#).

Is the inspection result normal?

- YES >> Replace combination meter. Refer to [MWI-82. "Removal and Installation"](#).
- NO >> Replace washer fluid level switch. Refer to [WW-57. "Removal and Installation"](#).

A  
B  
C  
D  
E  
F  
G  
H  
I  
J  
K  
L  
M  
O  
P

MWI

# THE DOOR OPEN WARNING CONTINUES DISPLAYING, OR DOES NOT DISPLAY

< SYMPTOM DIAGNOSIS >

## THE DOOR OPEN WARNING CONTINUES DISPLAYING, OR DOES NOT DISPLAY

### Description

INFOID:000000009174295

- The door open warning is displayed even though all of the doors are closed.
- The door open warning is not displayed even though a door is ajar.

### Diagnosis Procedure

INFOID:000000009174296

#### 1. CHECK BCM INPUT SIGNAL

Check the BCM input signal. Refer to [DLK-170. "Component Function Check"](#).

Is the inspection result normal?

- YES >> GO TO 2.
- NO >> GO TO 3.

#### 2. CHECK COMBINATION METER INPUT SIGNAL

Select the METER/M&A Data Monitor and check the DOOR W/L monitor value.

DOOR W/L	
Door open	: On
Door closed	: Off

Is the inspection result normal?

- YES >> Replace combination meter. Refer to [MWI-82. "Removal and Installation"](#).
- NO >> Replace BCM. Refer to [BCS-80. "Removal and Installation"](#).

#### 3. CHECK DOOR SWITCH SIGNAL CIRCUIT

Check the door switch signal circuit. Refer to [DLK-170. "Diagnosis Procedure"](#).

Is the inspection result normal?

- YES >> GO TO 4.
- NO >> Repair or replace harness or connectors.

#### 4. CHECK DOOR SWITCH

Perform a unit check for the door switch. Refer to [DLK-171. "Component Inspection"](#).

Is the inspection result normal?

- YES >> Replace combination meter. Refer to [MWI-82. "Removal and Installation"](#).
- NO >> Replace applicable door switch. Refer to [DLK-313. "Removal and Installation"](#).

# THE LIFTGATE OPEN WARNING CONTINUES DISPLAYING, OR DOES NOT DISPLAY

< SYMPTOM DIAGNOSIS >

## THE LIFTGATE OPEN WARNING CONTINUES DISPLAYING, OR DOES NOT DISPLAY

### Description

INFOID:000000009174297

- The liftgate open warning is displayed continuously even though the liftgate is closed.
- The liftgate open warning is not displayed even though the liftgate is open.

### Diagnosis Procedure

INFOID:000000009174298

#### 1.CHECK BCM INPUT SIGNAL

Check the BCM input signal. Refer to [DLK-172, "Component Function Check"](#).

Is the inspection result normal?

- YES >> GO TO 2.
- NO >> GO TO 3.

#### 2.CHECK COMBINATION METER INPUT SIGNAL

Select the METER/M&A Data Monitor and check the DOOR W/L monitor value.

DOOR W/L

Open : On  
Closed : Off

Is the inspection result normal?

- YES >> Replace combination meter. Refer to [MWI-82, "Removal and Installation"](#).
- NO >> Replace BCM. Refer to [BCS-80, "Removal and Installation"](#).

#### 3.CHECK BACK DOOR SWITCH SIGNAL CIRCUIT

Check the back door switch signal circuit. Refer to [DLK-172, "Diagnosis Procedure \(With Power Back Door\)"](#) or [DLK-173, "Diagnosis Procedure \(Without Power Back Door\)"](#).

Is the inspection result normal?

- YES >> GO TO 4.
- NO >> Repair or replace harness or connector.

#### 4.CHECK BACK DOOR SWITCH

Perform a unit check for the back door switch. Refer to [DLK-174, "Component Inspection \(With Power Back Door\)"](#) or [DLK-175, "Component Inspection \(Without Power Back Door\)"](#).

Is the inspection result normal?

- YES >> Replace combination meter. Refer to [MWI-82, "Removal and Installation"](#).
- NO >> Replace back door switch. Refer to [DLK-308, "DOOR LOCK : Removal and Installation"](#).

A  
B  
C  
D  
E  
F  
G  
H  
I  
J  
K  
L  
M

MWI

# THE STEERING SWITCHES ARE INOPERATIVE

< SYMPTOM DIAGNOSIS >

---

## THE STEERING SWITCHES ARE INOPERATIVE

### Description

INFOID:000000009174299

One or more of the steering switches to control the information display are inoperative.

### Diagnosis Procedure

INFOID:000000009174300

#### 1.CHECK STEERING SWITCH CIRCUIT

---

Check steering switch circuit. Refer to [MWI-70, "Diagnosis Procedure"](#).

Is the inspection result normal?

YES >> GO TO 2.

NO >> Repair or replace harness or connectors.

#### 2.CHECK STEERING SWITCH RESISTANCE

---

Check steering switch resistance. Refer to [MWI-70, "Component Inspection"](#).

Is the inspection result normal?

YES >> GO TO 3.

NO >> Replace steering switch. Refer to [AV-48, "Removal and Installation"](#).

#### 3.CHECK SPIRAL CABLE

---

Check spiral cable for continuity. Refer to [MWI-70, "Component Inspection"](#).

Is the inspection result normal?

YES >> Replace combination meter. Refer to [MWI-82, "Removal and Installation"](#).

NO >> Replace spiral cable. Refer to [SR-15, "Removal and Installation"](#).



# THE AMBIENT TEMPERATURE DISPLAY IS INCORRECT

< SYMPTOM DIAGNOSIS >

## THE AMBIENT TEMPERATURE DISPLAY IS INCORRECT

### Description

INFOID:000000009174301

- The displayed ambient air temperature is higher than the actual temperature.
- The displayed ambient air temperature is lower than the actual temperature.

### Diagnosis Procedure

INFOID:000000009174302

#### 1. CHECK COMBINATION METER INPUT SIGNAL

1. Select METER/M&A on CONSULT.
2. Check OUTSIDE TEMP of DATA MONITOR.

Does the ambient temperature approximately match the CONSULT display?

- YES >> Replace combination meter. Refer to [MWI-82. "Removal and Installation"](#).  
NO >> GO TO 2.

#### 2. CHECK AMBIENT SENSOR SIGNAL CIRCUIT

Check the ambient sensor signal circuit. Refer to [HAC-86. "Diagnosis Procedure"](#).

Is the inspection result normal?

- YES >> GO TO 3.  
NO >> Repair or replace harness or connectors.

#### 3. CHECK AMBIENT SENSOR

Check the ambient sensor. Refer to [HAC-87. "Component Inspection"](#).

Is the inspection result normal?

- YES >> Replace combination meter. Refer to [MWI-82. "Removal and Installation"](#).  
NO >> Replace ambient sensor. Refer to [HAC-158. "Removal and Installation"](#).

A  
B  
C  
D  
E  
F  
G  
H  
I  
J  
K  
L  
M  
O  
P

MWI

# COMBINATION METER

< REMOVAL AND INSTALLATION >

## REMOVAL AND INSTALLATION

### COMBINATION METER

#### Removal and Installation

INFOID:000000009174303

#### REMOVAL

1. Remove cluster lid A. Refer to [JP-21. "Removal and Installation"](#).
2. Remove the combination meter screws (A).
3. Disconnect the harness connector from the combination meter (1) and remove.

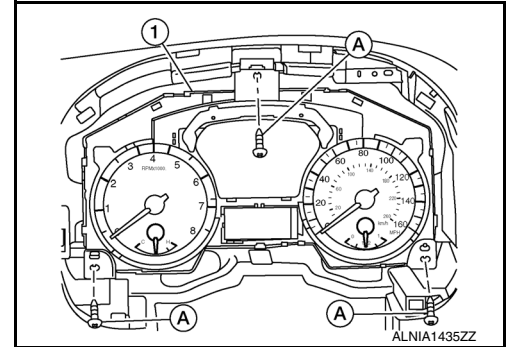

#### INSTALLATION

Installation is in the reverse order of removal.

# TRIP RESET AND ILLUMINATION CONTROL SWITCH

< REMOVAL AND INSTALLATION >

## TRIP RESET AND ILLUMINATION CONTROL SWITCH

### Removal and Installation

INFOID:000000009174304

#### ILLUMINATION CONTROL SWITCH

##### Removal

1. Remove cluster lid A. Refer to [IP-21. "Removal and Installation"](#).
2. Release the harness connector from cluster lid A.

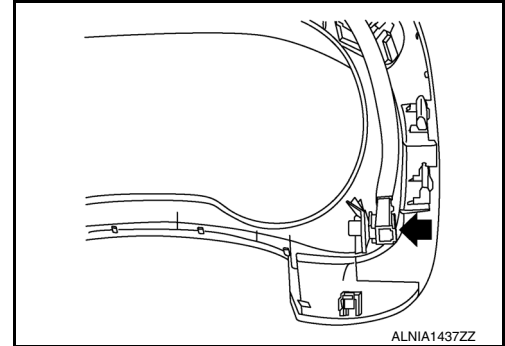

3. Release the clips (A) and remove illumination control switch (1) through the front of cluster lid A (2).

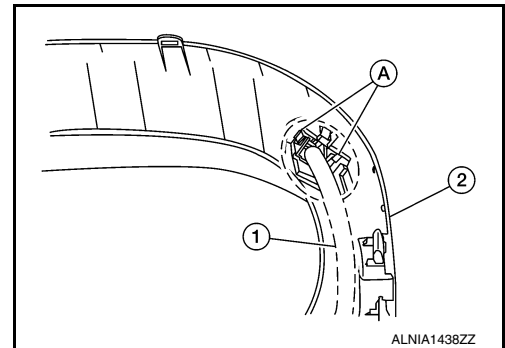

##### Installation

Installation is in the reverse order of removal.

#### TRIP RESET SWITCH

##### Removal

1. Remove cluster lid A. Refer to [IP-21. "Removal and Installation"](#).
2. Release the harness connector from cluster lid A.

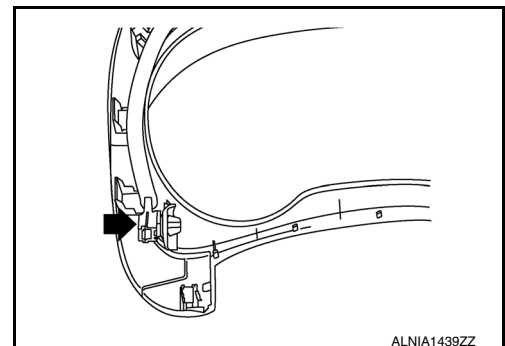

A  
B  
C  
D  
E  
F  
G  
H  
I  
J  
K  
L  
M  
MWI  
O  
P

## TRIP RESET AND ILLUMINATION CONTROL SWITCH

### < REMOVAL AND INSTALLATION >

3. Release the clips (A) and remove trip reset switch (1) through the front of cluster lid A (2).

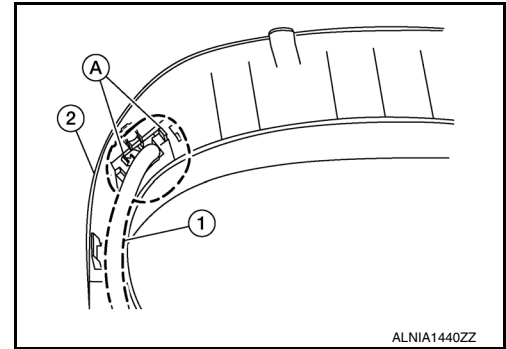

### Installation

Installation is in the reverse order of removal.