

SECTION **BCS**

BODY CONTROL SYSTEM

A
B
C
D
E
F
G
H
I
J
K
L
N
O
P

CONTENTS

BASIC INSPECTION	COMMON ITEM	
INSPECTION AND ADJUSTMENT	COMMON ITEM : CONSULT Function (BCM -	
	COMMON ITEM)	
ADDITIONAL SERVICE WHEN REPLACING	DOOR LOCK	
CONTROL UNIT (BCM)	DOOR LOCK : CONSULT Function (BCM -	
ADDITIONAL SERVICE WHEN REPLACING	DOOR LOCK)	
CONTROL UNIT (BCM) : Description	REAR WINDOW DEFOGGER	
ADDITIONAL SERVICE WHEN REPLACING	REAR WINDOW DEFOGGER : CONSULT Func-	
CONTROL UNIT (BCM) : Work Procedure	tion (BCM - REAR DEFOGGER)	
CONFIGURATION (BCM)	BUZZER	
CONFIGURATION (BCM) : Description	BUZZER : CONSULT Function (BCM - BUZZER)...	
CONFIGURATION (BCM) : Work Procedure	INT LAMP	
CONFIGURATION (BCM) : Configuration list	INT LAMP : CONSULT Function (BCM - INT	
TRANSIT MODE CANCEL OPERATION	LAMP)	
Description	HEADLAMP	
Work Procedure	HEADLAMP : CONSULT Function (BCM - HEAD	
SYSTEM DESCRIPTION	LAMP) (Xenon Type)	
BODY CONTROL SYSTEM	HEADLAMP : CONSULT Function (BCM - HEAD	
System Description	LAMP) (Halogen Type)	
Component Parts Location	WIPER	
COMBINATION SWITCH READING SYSTEM	WIPER : CONSULT Function (BCM - WIPER)	
	FLASHER	
System Diagram	FLASHER : CONSULT Function (BCM - FLASH-	
System Description	ER) (Xenon Type)	
SIGNAL BUFFER SYSTEM	FLASHER : CONSULT Function (BCM - FLASH-	
System Diagram	ER) (Halogen Type)	
System Description	INTELLIGENT KEY	
POWER CONSUMPTION CONTROL SYS-	INTELLIGENT KEY : CONSULT Function (BCM -	
TEM	INTELLIGENT KEY)	
System Diagram	COMB SW	
System Description	COMB SW : CONSULT Function (BCM - COMB	
Component Parts Location	SW)	
DIAGNOSIS SYSTEM (BCM)	BCM	
	BCM : CONSULT Function (BCM - BCM)	

BCS

IMMU	35	POWER SUPPLY AND GROUND CIRCUIT	45
IMMU : CONSULT Function (BCM - IMMU)	35	Diagnosis Procedure	45
BATTERY SAVER	35	COMBINATION SWITCH INPUT CIRCUIT	46
BATTERY SAVER : CONSULT Function (BCM - BATTERY SAVER)	35	Diagnosis Procedure	46
TRUNK	37	COMBINATION SWITCH OUTPUT CIRCUIT ...	48
TRUNK : CONSULT Function (BCM - TRUNK)	37	Diagnosis Procedure	48
THEFT ALM	37	ECU DIAGNOSIS INFORMATION	50
THEFT ALM : CONSULT Function (BCM - THEFT)	37	BCM (BODY CONTROL MODULE)	50
RETAINED PWR	38	Reference Value	50
RETAINED PWR : CONSULT Function (BCM - RE- TAINED PWR)	38	Wiring Diagram - BCM -	74
SIGNAL BUFFER	39	Fail-safe	88
SIGNAL BUFFER : CONSULT Function (BCM - SIGNAL BUFFER)	39	DTC Inspection Priority Chart	89
AIR PRESSURE MONITOR	39	DTC Index	90
AIR PRESSURE MONITOR : CONSULT Function (BCM - AIR PRESSURE MONITOR)	39	SYMPTOM DIAGNOSIS	93
DTC/CIRCUIT DIAGNOSIS	41	COMBINATION SWITCH SYSTEM SYMP- TOMS	93
U1000 CAN COMM CIRCUIT	41	Symptom Table	93
Description	41	NORMAL OPERATING CONDITION	94
DTC Logic	41	Description	94
Diagnosis Procedure	41	PRECAUTION	95
U1010 CONTROL UNIT (CAN)	42	PRECAUTIONS	95
DTC Logic	42	Precaution for Supplemental Restraint System (SRS) "AIR BAG" and "SEAT BELT PRE-TEN- SIONER"	95
Diagnosis Procedure	42	REMOVAL AND INSTALLATION	96
U0415 VEHICLE SPEED SIG	43	BCM (BODY CONTROL MODULE)	96
Description	43	Exploded View	96
DTC Logic	43	Removal and Installation	96
Diagnosis Procedure	43	COMBINATION SWITCH	97
B2562 LOW VOLTAGE	44	Exploded View	97
DTC Logic	44	Removal and Installation	97
Diagnosis Procedure	44		

INSPECTION AND ADJUSTMENT

< BASIC INSPECTION >

BASIC INSPECTION

INSPECTION AND ADJUSTMENT

ADDITIONAL SERVICE WHEN REPLACING CONTROL UNIT (BCM)

ADDITIONAL SERVICE WHEN REPLACING CONTROL UNIT (BCM) : Description

INFOID:000000009065439

BEFORE REPLACEMENT

When replacing BCM, save or print current vehicle specification with CONSULT configuration before replacement.

NOTE:

If "READ CONFIGURATION" can not be used, use the "WRITE CONFIGURATION - Manual selection" after replacing BCM.

AFTER REPLACEMENT

CAUTION:

When replacing BCM, always perform "WRITE CONFIGURATION" with CONSULT. Or not doing so, BCM control function does not operate normally.

- Complete the procedure of "WRITE CONFIGURATION" in order.
- Configuration is different for each vehicle model. Confirm configuration of each vehicle model.
- If you set incorrect "WRITE CONFIGURATION", incidents might occur.

NOTE:

When replacing BCM, perform the system initialization (NATS) (if equipped).

ADDITIONAL SERVICE WHEN REPLACING CONTROL UNIT (BCM) : Work Procedure

INFOID:000000009065440

1. SAVING VEHICLE SPECIFICATION

CONSULT Configuration

Perform "READ CONFIGURATION" to save or print current vehicle specification. Refer to [BCS-4, "CONFIGURATION \(BCM\) : Description"](#).

NOTE:

If "READ CONFIGURATION" can not be used, use the "WRITE CONFIGURATION - Manual selection" after replacing BCM.

>> GO TO 2.

2. REPLACE BCM

Replace BCM. Refer to [BCS-96, "Removal and Installation"](#).

>> GO TO 3.

3. WRITING VEHICLE SPECIFICATION

CONSULT Configuration

Perform "WRITE CONFIGURATION - Config file" or "WRITE CONFIGURATION - Manual selection" to write vehicle specification. Refer to [BCS-4, "CONFIGURATION \(BCM\) : Work Procedure"](#).

>> GO TO 4.

4. INITIALIZE BCM (NATS) (IF EQUIPPED)

Perform BCM initialization. (NATS)

>> WORK END

CONFIGURATION (BCM)

A
B
C
D
E
F
G
H
I
J
K
L
N
O
P

BCS

INSPECTION AND ADJUSTMENT

< BASIC INSPECTION >

CONFIGURATION (BCM) : Description

INFOID:000000009065441

Vehicle specification needs to be written with CONSULT because it is not written after replacing BCM. Configuration has three functions as follows.

Function	Description
READ CONFIGURATION	<ul style="list-style-type: none">• Reads the vehicle configuration of current BCM.• Saves the read vehicle configuration.
WRITE CONFIGURATION - Manual selection	Writes the vehicle configuration with manual selection.
WRITE CONFIGURATION - Config file	Writes the vehicle configuration with saved data.

NOTE:

Manual setting item: Items which need selection by vehicle specifications

Automatic setting item: Items which are written in automatically (Setting can not be changed)

For some models and specifications, the automatic setting item may not be displayed.

CAUTION:

When replacing BCM, always perform "WRITE CONFIGURATION" with CONSULT. Or not doing so, BCM control function does not operate normally.

- Complete the procedure of "WRITE CONFIGURATION" in order.
- Configuration is different for each vehicle model. Confirm configuration of each vehicle model.
- Never perform "WRITE CONFIGURATION" except for new BCM.
- If you set incorrect "WRITE CONFIGURATION", incidents might occur.

CONFIGURATION (BCM) : Work Procedure

INFOID:000000009065442

1. WRITING MODE SELECTION

 CONSULT Configuration
Select "CONFIGURATION" of BCM.

When writing saved data >> GO TO 2.

When writing manually >> GO TO 3.

2. PERFORM "WRITE CONFIGURATION - CONFIG FILE"

 CONSULT Configuration
Perform "WRITE CONFIGURATION - Config file".

>> WORK END

3. PERFORM "WRITE CONFIGURATION - MANUAL SELECTION"

-  CONSULT Configuration
1. Select "WRITE CONFIGURATION - Manual selection".
 2. Identify the correct model and configuration list. Refer to [BCS-5, "CONFIGURATION \(BCM\) : Configuration list"](#).
 3. Confirm and/or change setting value for each item.
CAUTION:
Thoroughly read and understand the vehicle specification. ECU control may not operate normally if the setting is not correct.
NOTE:
If items are not displayed, touch "SETTING". Refer to [BCS-5, "CONFIGURATION \(BCM\) : Configuration list"](#) for written items and setting value.
 4. Select "SETTING".
CAUTION:
Make sure to select "SETTING" even if the indicated configuration of brand new BCM is same as the desirable configuration. If not, configuration which is set automatically by selecting vehicle model can not be memorized.
 5. When "COMMAND FINISHED", select "END".

>> GO TO 4.

INSPECTION AND ADJUSTMENT

< BASIC INSPECTION >

4. OPERATION CHECK

Confirm that each function controlled by BCM operates normally.

>> WORK END

CONFIGURATION (BCM) : Configuration list

INFOID:000000009065443

CAUTION:

Thoroughly read and understand the vehicle specification. ECU control may not operate normally if the setting is not correct.

MANUAL SETTING ITEM		NOTE
Items	Setting value	
BATTERY SAVER FUNCTION	MODE1	—
ACC BAT SAVE FUNC	MODE1	—
DTRL	WITH ⇔ WITHOUT	<ul style="list-style-type: none"> • WITH: With daytime running light system • WITHOUT: Without daytime running light system

⇔: Items which confirm vehicle specifications

AUTO SETTING ITEM		NOTE
Items	Setting value	
UNLOCK WITH SHOCK	WITHOUT	—
AUTO DOOR LOCK SPEED	MODE2	—
P-POS WARN	MODE1	—
ROOF FUNCTION	W/O REQ SW	—
Trunk/Glass Hatch select	Glass Hatch	"Glass Hatch" is indicated also for vehicles without a glass hatch.
PANIC ALM TYPE	MODE1	—
TRANSIT MODE	WITH	—
TR OPEN SW (INT)	MODE1	—
H/L BULB	DEFAULT	—
AUTO LIGHT	WITH	—
FR FOG LAMP	WITH	—
RR FOG LAMP	WITH	"WITH" is indicated also for vehicles without a rear fog lamp.
DI LMP VARIAT	MODE2	—
LIGHT RECOG	MODE7	—
TRANSMISSION	AT with ABS	—
RAIN SENSOR CONFIG	WITHOUT	—
REAR WIPER	WITH	—
THEFT ALM AREA	MODE2	—
H/L WASHER	MODE1	—
TR CANCEL SW	WITHOUT	—
BCM AC CONTROL	MODE1	—
WELCOME LIGHT TIMER2	MODE4	—
TPMS	WITH	—
TIRE PRESSURE	230kPa	—
FR FOG LOGIC	MODE1	—
AUTO LOCK&UNLOCK FUNC	WITH	—

INSPECTION AND ADJUSTMENT

< BASIC INSPECTION >

AUTO SETTING ITEM		NOTE
Items	Setting value	
AUTO DOOR LOCK SELECT	WITH	—
AUTO DOOR UNLOCK SELECT	WITH	—
FOG ON WITH AUTO LIGHT	WITHOUT	—
Key Fob Type	MODE9	—
DROP WIP FUNCTION	FR & RR	—
WELCOME LIGHT OP SET	WITH	—

TRANSIT MODE CANCEL OPERATION

< BASIC INSPECTION >

TRANSIT MODE CANCEL OPERATION

Description

INFOID:000000009065444

- BCM is in transit mode if turn signal indicator on combination meter turns ON for 1 minute when ignition switch is turned from OFF to ON.
- In this case, cancel operation must be performed.

NOTE:

Do not cancel transit mode during storage of the vehicle. Always cancel transit mode before delivery of the vehicle to customer.

Work Procedure

INFOID:000000009065445

1. TRANSIT MODE CANCEL OPERATION

1. Turn ignition switch OFF.
2. Turn and hold front wiper switch to HI, and then operate turn signal switch to RH or LH.

>> GO TO 2.

2. TRANSIT MODE CANCEL CHECK

1. Turn front wiper switch and turn signal switch OFF.
2. Turn ignition switch ON.
3. Check that turn signal indicator on combination meter does not turn ON.

>> WORK END

A
B
C
D
E
F
G
H
I
J
K
L

BCS

N
O
P

BODY CONTROL SYSTEM

< SYSTEM DESCRIPTION >

SYSTEM DESCRIPTION

BODY CONTROL SYSTEM

System Description

INFOID:000000009065446

OUTLINE

- BCM (Body Control Module) controls the various electrical components. It inputs the information required to the control from CAN communication and the signal received from each switch and sensor.
- BCM has combination switch reading function for reading the operation status of combination switches (light, turn signal, wiper and washer) in addition to a function for controlling the operation of various electrical components. It also has the signal transmission function as the passed point of signal and the power saving control function that reduces the power consumption with the ignition switch OFF.
- BCM is equipped with the diagnosis function that performs the diagnosis with CONSULT and various settings.

BCM CONTROL FUNCTION LIST

System	Reference
Combination switch reading system	BCS-10, "System Diagram"
Signal buffer system	BCS-14, "System Diagram"
Power consumption control system	BCS-15, "System Diagram"
Auto light system	<ul style="list-style-type: none"> • EXL-15, "System Diagram" (Xenon type headlamp) • EXL-232, "System Diagram" (Halogen type headlamp)
Turn signal and hazard warning lamp system	<ul style="list-style-type: none"> • EXL-27, "System Diagram" (Xenon type headlamp) • EXL-240, "System Diagram" (Halogen type headlamp)
Headlamp system	<ul style="list-style-type: none"> • EXL-12, "System Diagram" (Xenon type headlamp) • EXL-229, "System Diagram" (Halogen type headlamp)
Parking, license plate and tail lamps system	<ul style="list-style-type: none"> • EXL-29, "System Diagram" (Xenon type headlamp) • EXL-242, "System Diagram" (Halogen type headlamp)
Front fog lamp system	<ul style="list-style-type: none"> • EXL-25, "System Diagram" (Xenon type headlamp) • EXL-238, "System Diagram" (Halogen type headlamp)
Exterior lamp battery saver system	<ul style="list-style-type: none"> • EXL-31, "System Diagram" (Xenon type headlamp) • EXL-244, "System Diagram" (Halogen type headlamp)
Daytime running light system	<ul style="list-style-type: none"> • EXL-18, "System Diagram" (Xenon type headlamp) • EXL-235, "System Diagram" (Halogen type headlamp)
Interior room lamp control system	INL-6, "System Diagram"
Step lamp system	
Interior room lamp battery saver system	INL-10, "System Diagram"
Front wiper and washer system	WW-6, "System Diagram"
Rear wiper and washer system	WW-11, "System Diagram"
Warning chime system	WCS-5, "WARNING CHIME SYSTEM : System Diagram"
Door lock system	DLK-11, "System Diagram"
Infiniti Vehicle Immobilizer System (IVIS) - NATS	SEC-14, "System Diagram"
Vehicle security system	SEC-18, "System Diagram"
Panic alarm	
Automatic drive positioner system	ADP-12, "AUTOMATIC DRIVE POSITIONER SYSTEM : System Diagram"
Rear window defogger system	DEF-4, "System Diagram"

BODY CONTROL SYSTEM

< SYSTEM DESCRIPTION >

System	Reference	
Intelligent Key system/engine start system	Door lock unlock function	
	Remote keyless function	
	Back door open function	DLK-15, "INTELLIGENT KEY SYSTEM : System Diagram"
	Warning function	
	Key reminder function	
	Engine start function	
Power window system	PWC-7, "System Diagram"	
Retained accessory power (RAP) system	PWC-7, "System Description"	
Tire pressure monitor system (TPMS) - AIR PRESSURE MONITOR	WT-7, "TIRE PRESSURE MONITORING SYSTEM : System Description"	

Component Parts Location

INFOID:000000009065447

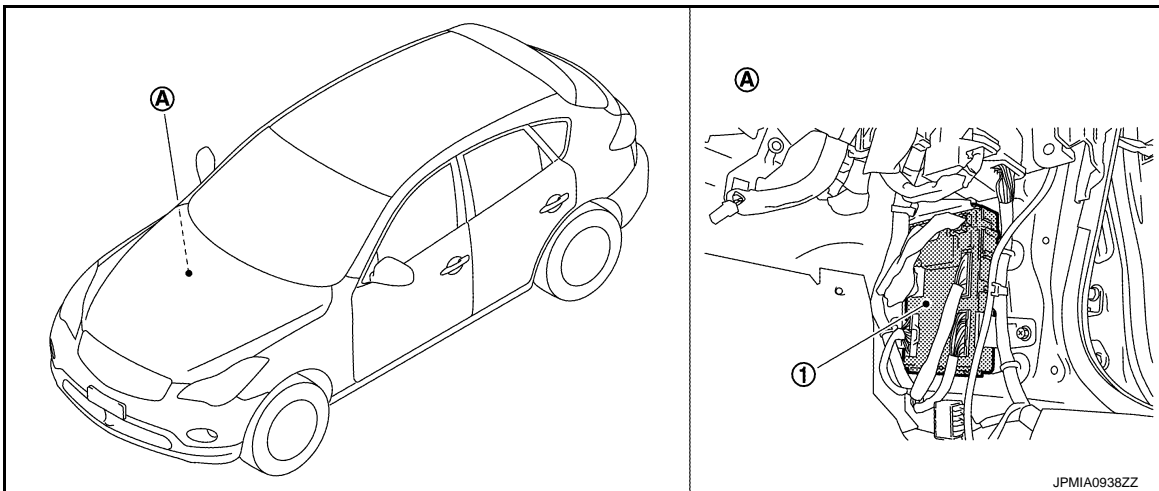

- 1. BCM
- A. Dash side lower (passenger side)

BCS

COMBINATION SWITCH READING SYSTEM

< SYSTEM DESCRIPTION >

COMBINATION SWITCH READING SYSTEM

System Diagram

INFOID:000000009065448

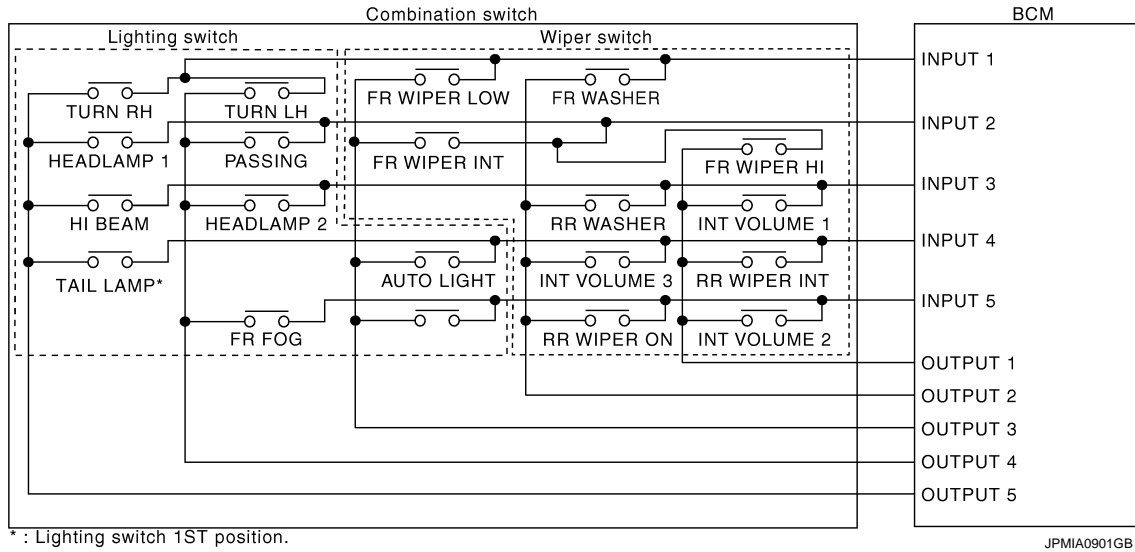

System Description

INFOID:000000009065449

OUTLINE

- BCM reads the status of the combination switch (light, turn signal, wiper and washer) and recognizes the status of each switch.
- BCM is a combination of 5 output terminals (OUTPUT 1 - 5) and 5 input terminals (INPUT 1 - 5). It reads a maximum of 20 switch status.

COMBINATION SWITCH MATRIX

Combination switch circuit

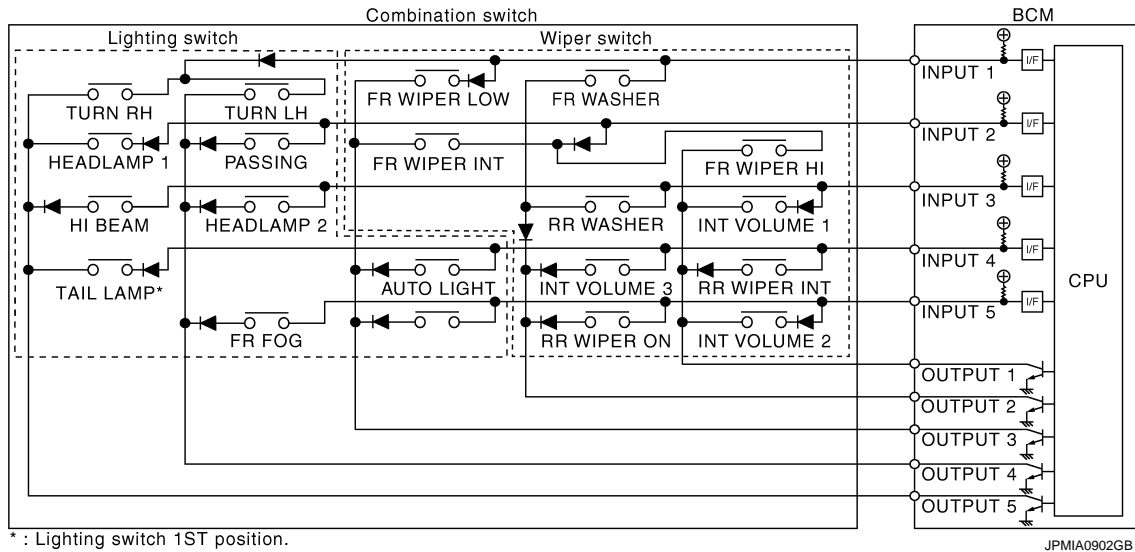

Combination switch INPUT-OUTPUT system list

System	OUTPUT 1	OUTPUT 2	OUTPUT 3	OUTPUT 4	OUTPUT 5
INPUT 1	—	FR WASHER	FR WIPER LOW	TURN LH	TURN RH
INPUT 2	FR WIPER HI	—	FR WIPER INT	PASSING	HEADLAMP 1
INPUT 3	INT VOLUME 1	RR WASHER	—	HEADLAMP 2	HI BEAM

COMBINATION SWITCH READING SYSTEM

< SYSTEM DESCRIPTION >

System	OUTPUT 1	OUTPUT 2	OUTPUT 3	OUTPUT 4	OUTPUT 5
INPUT 4	RR WIPER INT	INT VOLUME 3	AUTO LIGHT	—	TAIL LAMP
INPUT 5	INT VOLUME 2	RR WIPER ON	—	FR FOG	—

NOTE:

Headlamp has a dual system switch.

COMBINATION SWITCH READING FUNCTION

Description

- BCM reads the status of the combination switch at 10 ms interval normally.

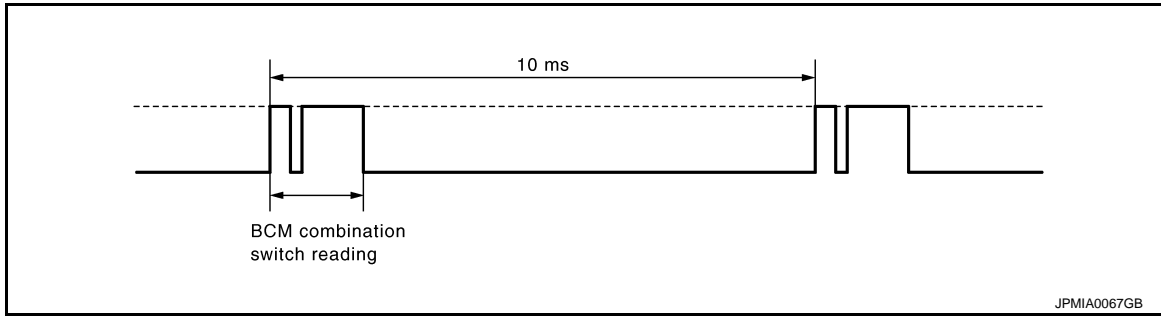

NOTE:

BCM reads the status of the combination switch at 60 ms interval when BCM is controlled at low power consumption mode.

- BCM operates as follows and judges the status of the combination switch.
 - INPUT 1 - 5 outputs the voltage waveforms of 5 systems simultaneously.
 - It operates the transistor on OUTPUT side in the following order: OUTPUT 5 → 4 → 3 → 2 → 1.
 - The voltage waveform of INPUT corresponding to the formed circuit changes according to the operation of the transistor on OUTPUT side if any (1 or more) switches are ON.
 - It reads this change of the voltage as the status signal of the combination switch.

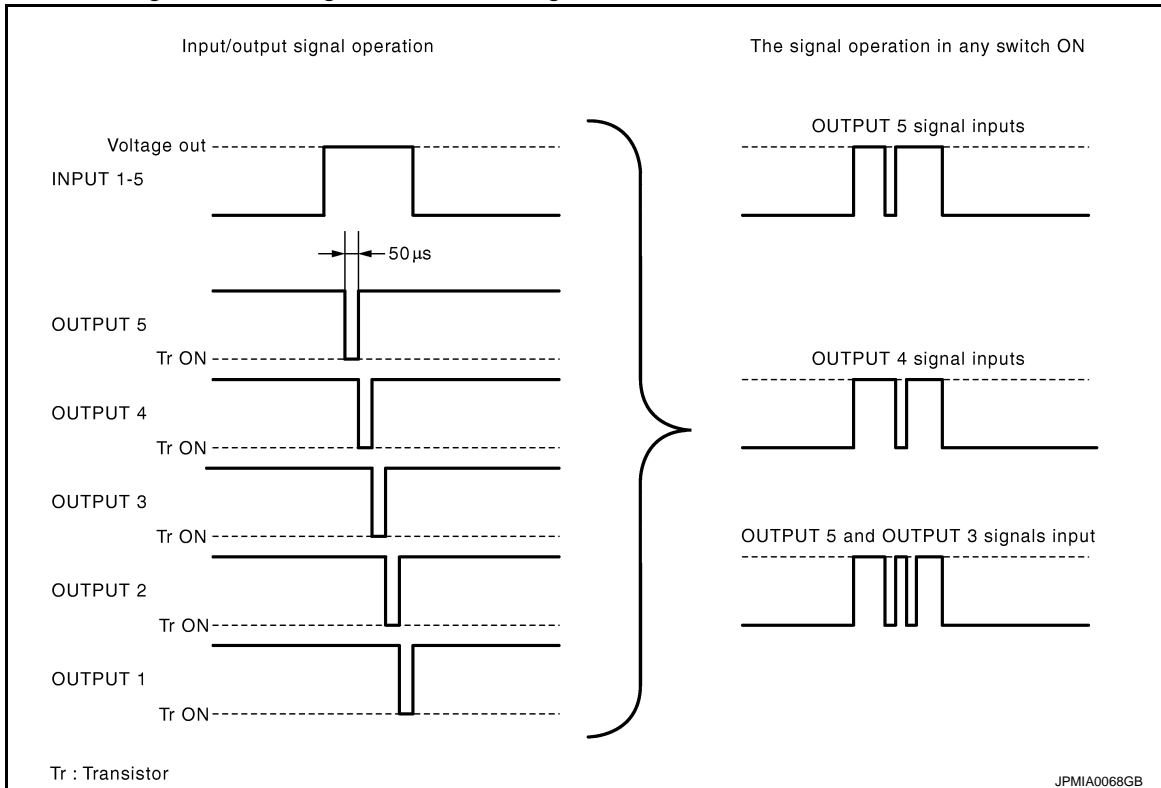

Operation Example

In the following operation example, the combination of the status signals of the combination switch is replaced as follows: INPUT 1 - 5 to "1 - 5" and OUTPUT 1 - 5 to "A - E".

Example 1: When a switch (TURN RH switch) is turned ON

A
B
C
D
E
F
G
H
I
J
K
L
N
O
P

BCS

COMBINATION SWITCH READING SYSTEM

< SYSTEM DESCRIPTION >

- The circuit between INPUT 1 and OUTPUT 5 is formed when the TURN RH switch is turned ON.

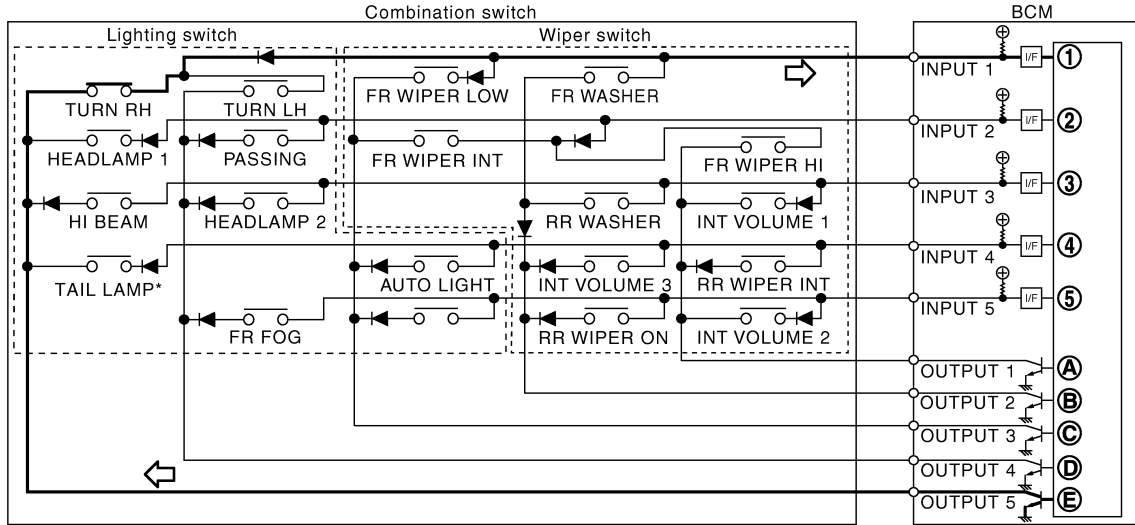

* : Lighting switch 1ST position.

JPMIA0903GB

- BCM detects the combination switch status signal "1E" when the signal of OUTPUT 5 is input to INPUT 1.
- BCM judges that the TURN RH switch is ON when the signal "1E" is detected.

Example 2: When some switches (turn RH switch, front wiper LO switch) are turned ON

- The circuits between INPUT 1 and OUTPUT 5 and between INPUT 1 and OUTPUT 3 are formed when the TURN RH switch and FR WIPER LOW switch are turned ON.

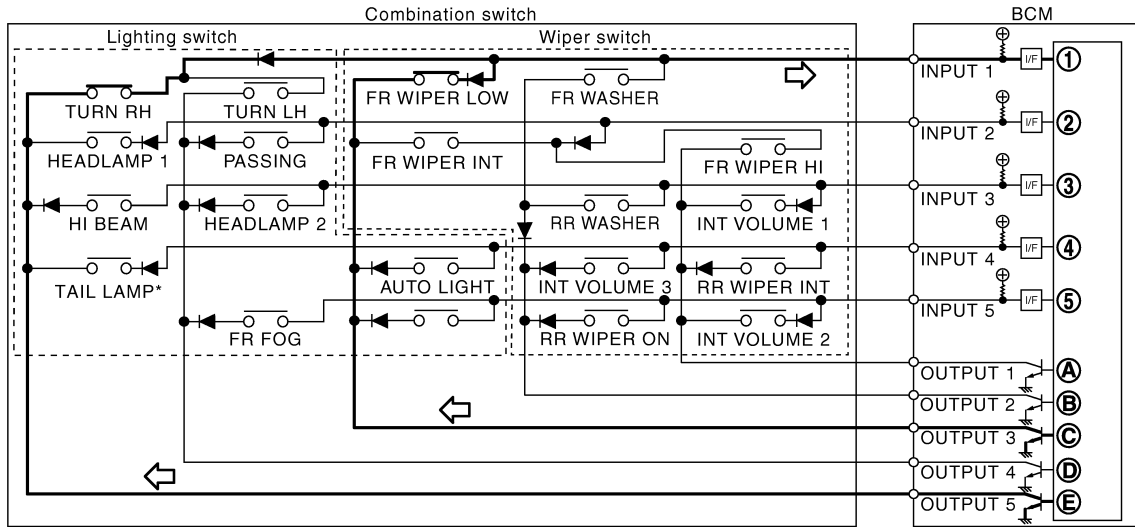

* : Lighting switch 1ST position.

JPMIA0904GB

- BCM detects the combination switch status signal "1CE" when the signals of OUTPUT 3 and OUTPUT 5 are input to INPUT 1.
- BCM judges that the TURN RH switch and FR WIPER LOW switch are ON when the signal "1CE" is detected.

WIPER INTERMITTENT DIAL POSITION

BCM judges the wiper intermittent dial 1 - 7 by the status of INT VOLUME 1, 2 and 3 switches.

Wiper intermittent dial position	Switch status		
	INT VOLUME 1	INT VOLUME 2	INT VOLUME 3
1	ON	ON	ON
2	ON	ON	OFF
3	ON	OFF	OFF
4	OFF	OFF	OFF
5	OFF	OFF	ON

COMBINATION SWITCH READING SYSTEM

< SYSTEM DESCRIPTION >

Wiper intermittent dial position	Switch status		
	INT VOLUME 1	INT VOLUME 2	INT VOLUME 3
6	OFF	ON	ON
7	OFF	ON	OFF

NOTE:

For details of wiper intermittent dial position, refer to [WW-6. "System Description"](#).

A
B
C
D
E
F
G
H
I
J
K
L
N
O
P

BCS

SIGNAL BUFFER SYSTEM

< SYSTEM DESCRIPTION >

SIGNAL BUFFER SYSTEM

System Diagram

INFOID:000000009065450

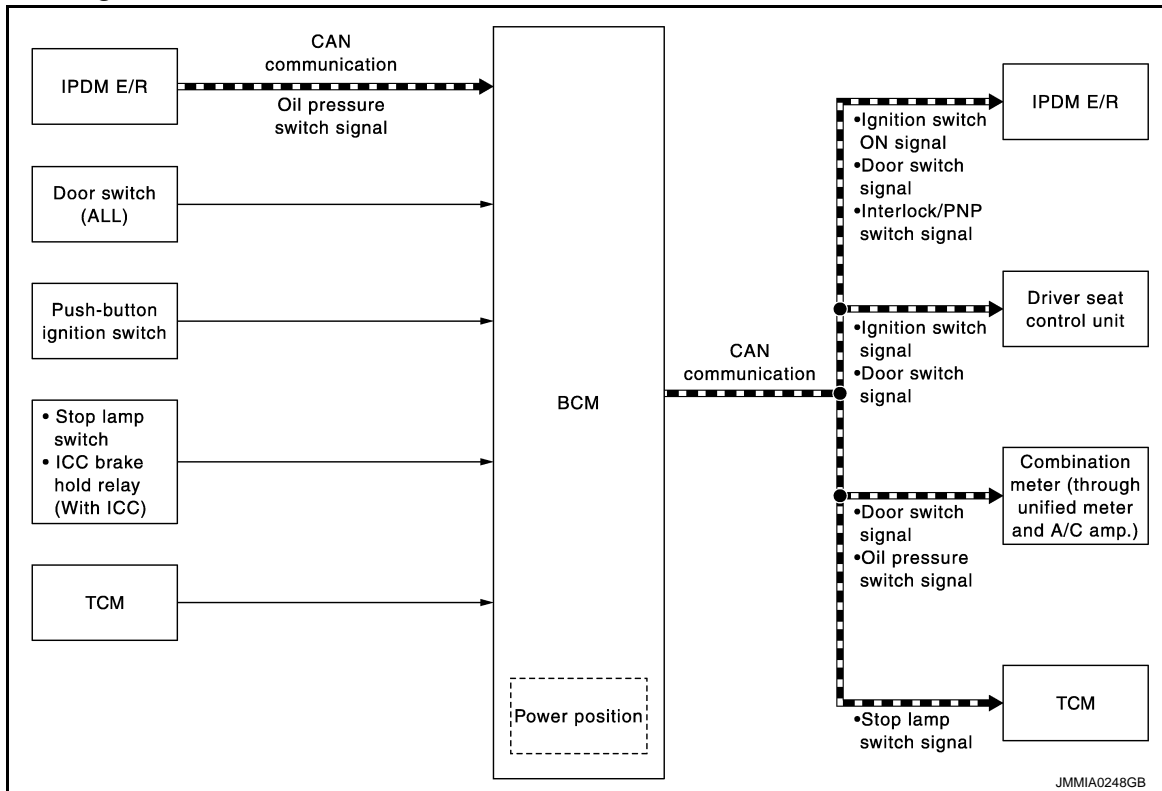

JMMIA0248GB

System Description

INFOID:000000009065451

OUTLINE

BCM has the signal transmission function that outputs/transmits each input/received signal to each unit.

Signal transmission function list

Signal name	Input	Output	Description
<ul style="list-style-type: none"> Ignition switch ON signal Ignition switch signal 	Push-button ignition switch (Push switch)	<ul style="list-style-type: none"> IPDM E/R (CAN) Driver seat control unit (CAN) 	Inputs the push-button ignition switch (push switch) signal and transmits the ignition switch status judged with BCM via CAN communication.
Door switch signal	Any door switch	<ul style="list-style-type: none"> Combination meter (through unified meter and A/C amp.) (CAN) IPDM E/R (CAN) Driver seat control unit (CAN) 	Inputs the door switch signal and transmits it via CAN communication.
Oil pressure switch signal	IPDM E/R (CAN)	Combination meter (through unified meter and A/C amp.) (CAN)	Transmits the received oil pressure switch signal via CAN communication.
Stop lamp switch signal	<ul style="list-style-type: none"> Stop lamp switch ICC brake hold relay (With ICC) 	TCM (CAN)	Inputs the stop lamp switch 1 signal, and stop lamp switch 2 signal or ICC brake hold relay (with ICC) signal, and transmits it via CAN communication.
Interlock/PNP switch signal	TCM	IPDM E/R (CAN)	Inputs the selector lever P/N position signal, and transmits the interlock/PNP switch signal via CAN communication.

POWER CONSUMPTION CONTROL SYSTEM

< SYSTEM DESCRIPTION >

POWER CONSUMPTION CONTROL SYSTEM

System Diagram

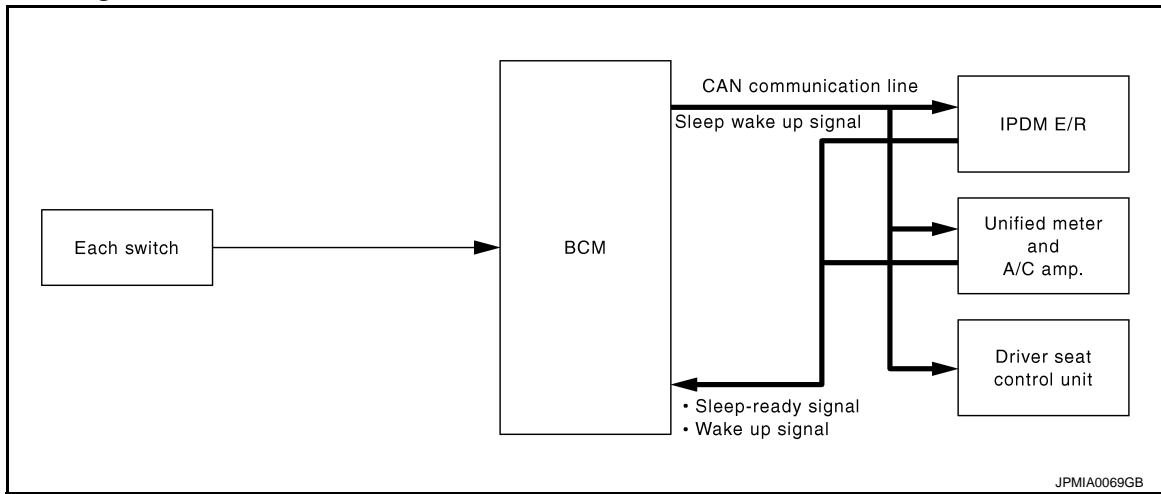

System Description

INFOID:000000009065453

OUTLINE

- BCM incorporates a power saving control function that reduces the power consumption according to the vehicle status.
- BCM switches the status (control mode) by itself with the power saving control function. It performs the sleep request to each unit [IPDM E/R, combination meter (unified meter and A/C amp.) and driver seat control unit] that operates with the ignition switch OFF.

Normal mode (wake-up)

- CAN communication is normally performed with other units
- Each control with BCM is operating properly

CAN communication sleep mode (CAN sleep)

- CAN transmission is stopped
- Control with BCM only is operating

Low power consumption mode (BCM sleep)

- Low power consumption control is active
- CAN transmission is stopped

LOW POWER CONSUMPTION CONTROL WITH BCM

BCM reduces the power consumption with the following operation in the low power consumption mode.

- The reading interval of the each switches changes from 10 ms interval to 60 ms interval.

Sleep mode activation

- BCM receives the sleep-ready signal (ready) from IPDM E/R and unified meter and A/C amp. via CAN communication.
- BCM transmits the sleep wake up signal (sleep) to each unit when all of the CAN sleep conditions are fulfilled.
- Each unit stops the transmission of CAN communication with the sleep wake up signal. BCM is in CAN communication sleep mode.
- BCM is in the low power consumption mode and perform the low power consumption control when all of the BCM sleep conditions are fulfilled with CAN sleep condition.

A
B
C
D
E
F
G
H
I
J
K
L
N
O
P

BCS

POWER CONSUMPTION CONTROL SYSTEM

< SYSTEM DESCRIPTION >

Sleep condition

CAN sleep condition	BCM sleep condition
<ul style="list-style-type: none"> • Receiving the sleep-ready signal (ready) from all units • Ignition switch: OFF • Vehicle security system and panic alarm: Not operation • Warning chime: Not operation • Intelligent Key system buzzer: Not operation • Stop lamp switch: OFF • ICC brake hold relay (with ICC): ON • Key slot (card switch) status: No change • Turn signal indicator lamp: Not operation • Exterior lamp: OFF • Door lock status: No change • CONSULT communication status: Not communication • Meter display signal: Non-transmission • Door switch status: No change • Rear window defogger: OFF 	<ul style="list-style-type: none"> • Interior room lamp battery saver: Time out • RAP system: OFF • Power window switch communication: No transmission • Push-button ignition switch illumination: OFF • Infiniti Vehicle Immobilizer System (IVIS) - NATS: Not operation • Remote keyless entry receiver communication status: No communication • Tire pressure monitor system (TPMS) - AIR PRESSURE MONITOR: Stop • LOCK indicator lamp: OFF • ACC indicator lamp: OFF • ON indicator lamp: OFF

Wake-up operation

- BCM changes from the low power consumption mode to the CAN communication sleep mode when the any of the BCM wake-up conditions is fulfilled. Only the control with BCM is activated.
- BCM transmits the sleep wake up signal (wake up) to each unit when any of the CAN wake-up conditions is fulfilled. It changes from the low power consumption mode or the CAN communication sleep mode to the normal mode.
- Each unit starts the transmission of CAN communication with the sleep wake up signal. In addition, the unified meter and A/C amp. transmits the wake up signal to BCM via CAN communication to report the CAN communication start.

Wake-up condition

BCM wake-up condition	CAN wake-up condition
<ul style="list-style-type: none"> • Power window switch communication: Receiving • Remote keyless entry receiver communication: Receiving 	<ul style="list-style-type: none"> • Receiving the sleep-ready signal (Not-ready) from any units • Key slot (key switch): OFF → ON, ON → OFF • Push-button ignition switch (push switch): OFF → ON • Hazard switch: OFF → ON • PASSING switch: OFF → ON, ON → OFF • TAIL LAMP switch: OFF → ON • Driver door switch: OFF → ON, ON → OFF • Passenger door switch: OFF → ON, ON → OFF • Rear RH door switch: OFF → ON, ON → OFF • Rear LH door switch: OFF → ON, ON → OFF • Back door switch: OFF → ON, ON → OFF • Driver door request switch: OFF → ON • Passenger door request switch: OFF → ON • Back door opener request switch: OFF → ON • Stop lamp switch: ON • ICC brake hold relay (with ICC): ON

POWER CONSUMPTION CONTROL SYSTEM

< SYSTEM DESCRIPTION >

Component Parts Location

INFOID:000000009065454

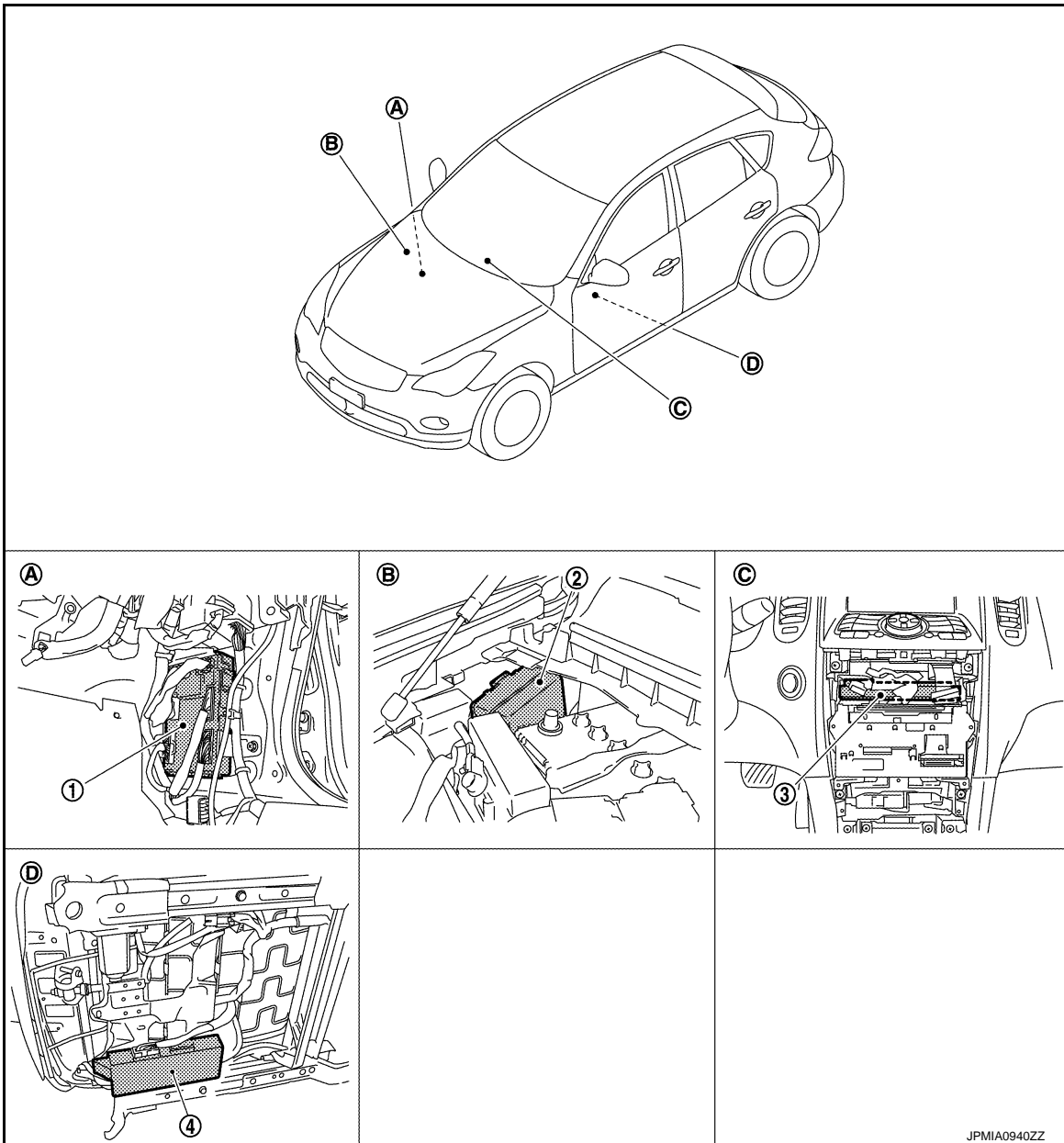

- | | | |
|---|--------------------------------|-------------------------------|
| 1. BCM | 2. IPDM E/R | 3. Unified meter and A/C amp. |
| 4. Driver seat control unit | | |
| A. Dash side lower (passenger side) | B. Engine room dash panel (RH) | C. Behind cluster lid C |
| D. Backside of the seat cushion (driver seat) | | |

A
B
C
D
E
F
G
H
I
J
K
L

BCS

N
O
P

DIAGNOSIS SYSTEM (BCM)

< SYSTEM DESCRIPTION >

DIAGNOSIS SYSTEM (BCM)

COMMON ITEM

COMMON ITEM : CONSULT Function (BCM - COMMON ITEM)

INFOID:000000009065455

APPLICATION ITEM

CONSULT performs the following functions via CAN communication with BCM.

Diagnosis mode	Function Description
Work Support	Changes the setting for each system function.
Self Diagnostic Result	Displays the diagnosis results judged by BCM.
CAN Diag Support Monitor	Monitors the reception status of CAN communication viewed from BCM.
Data Monitor	The BCM input/output signals are displayed.
Active Test	The signals used to activate each device are forcibly supplied from BCM.
Ecu Identification	The BCM part number is displayed.
Configuration	<ul style="list-style-type: none"> Read and save the vehicle specification. Write the vehicle specification when replacing BCM.

SYSTEM APPLICATION

BCM can perform the following functions for each system.

NOTE:

It can perform the diagnosis modes except the following for all sub system selection items.

×: Applicable item

System	Sub system selection item	Diagnosis mode		
		Work Support	Data Monitor	Active Test
Door lock	DOOR LOCK	×	×	×
Rear window defogger	REAR DEFOGGER		×	×
Warning chime	BUZZER		×	×
Interior room lamp timer	INT LAMP	×	×	×
Exterior lamp	HEAD LAMP	×	×	×
Wiper and washer	WIPER	×	×	×
Turn signal and hazard warning lamps	FLASHER	×	×	×
—	AIR CONDITONER*			
<ul style="list-style-type: none"> Intelligent Key system Engine start system 	INTELLIGENT KEY	×	×	×
Combination switch	COMB SW		×	
Body control system	BCM	×		
IVIS - NATS	IMMU		×	×
Interior room lamp battery saver	BATTERY SAVER	×	×	×
Back door open system	TRUNK		×	×
Vehicle security system	THEFT ALM	×	×	×
RAP system	RETAINED PWR		×	
Signal buffer system	SIGNAL BUFFER		×	×
TPMS	AIR PRESSURE MONITOR	×	×	×

NOTE:

*: This item is displayed, but is not used.

FREEZE FRAME DATA (FFD)

The BCM records the following vehicle condition at the time a particular DTC is detected, and displays on CONSULT.

DIAGNOSIS SYSTEM (BCM)

< SYSTEM DESCRIPTION >

CONSULT screen item	Indication/Unit	Description		
Vehicle Speed	km/h	Vehicle speed of the moment a particular DTC is detected		A
Odo/Trip Meter	km	Total mileage (Odometer value) of the moment a particular DTC is detected		
Vehicle Condition	SLEEP>LOCK	Power supply position status of the moment a particular DTC is detected*	While turning BCM status from low power consumption mode to normal mode (Power supply position is "LOCK"*)	B
	SLEEP>OFF		While turning BCM status from low power consumption mode to normal mode (Power supply position is "OFF".)	C
	LOCK>ACC		While turning power supply position from "LOCK"* to "ACC"	
	ACC>ON		While turning power supply position from "ACC" to "IGN"	D
	RUN>ACC		While turning power supply position from "RUN" to "ACC" (Except emergency stop operation)	
	CRANK>RUN		While turning power supply position from "CRANKING" to "RUN" (From cranking up the engine to run it)	E
	RUN>URGENT		While turning power supply position from "RUN" to "ACC" (Emergency stop operation)	
	ACC>OFF		While turning power supply position from "ACC" to "OFF"	F
	OFF>LOCK		While turning power supply position from "OFF" to "LOCK"*	
	OFF>ACC		While turning power supply position from "OFF" to "ACC"	G
	ON>CRANK		While turning power supply position from "IGN" to "CRANKING"	
	OFF>SLEEP		While turning BCM status from normal mode (Power supply position is "OFF".) to low power consumption mode	H
	LOCK>SLEEP		While turning BCM status from normal mode (Power supply position is "LOCK"*.) to low power consumption mode	
	LOCK		Power supply position is "LOCK"*	I
	OFF		Power supply position is "OFF" (Ignition switch OFF)	
	ACC		Power supply position is "ACC" (Ignition switch ACC)	J
	ON		Power supply position is "IGN" (Ignition switch ON with engine stopped)	
ENGINE RUN	Power supply position is "RUN" (Ignition switch ON with engine running)	K		
CRANKING	Power supply position is "CRANKING" (At engine cranking)			
IGN Counter	0 - 39	The number of times that ignition switch is turned ON after DTC is detected <ul style="list-style-type: none"> • The number is 0 when a malfunction is detected now. • The number increases like 1 → 2 → 3...38 → 39 after returning to the normal condition whenever ignition switch OFF → ON. • The number is fixed to 39 until the self-diagnosis results are erased if it is over 39. 		L

NOTE:

*: Power supply position shifts to "LOCK" from "OFF", when ignition switch is in the OFF position, selector lever is in the P position, and any of the following conditions are met.

- Closing door
- Opening door
- Door is locked using door request switch
- Door is locked using Intelligent Key

The power supply position shifts to "ACC" when the push-button ignition switch (push switch) is pushed at "LOCK".

DOOR LOCK

DOOR LOCK : CONSULT Function (BCM - DOOR LOCK)

INFOID:000000009374952

BCM CONSULT FUNCTION

CONSULT performs the following functions via CAN communication with BCM.

DIAGNOSIS SYSTEM (BCM)

< SYSTEM DESCRIPTION >

Diagnosis mode	Function Description
WORK SUPPORT	Changes the setting for each system function.
DATA MONITOR	The BCM input/output signals are displayed.
ACTIVE TEST	The signals used to activate each device are forcibly supplied from BCM.

WORK SUPPORT

Monitor item	Description
DOOR LOCK-UNLOCK SET	Selective unlock function mode can be changed to operate (WITH) or not operate (WITHOUT) with this mode.
AUTOMATIC DOOR LOCK SELECT	Automatic door lock function mode can be selected from the following in this mode. <ul style="list-style-type: none"> VH SPD: All doors are locked when vehicle speed more than 24km/h (15MPH) P RANGE: All doors are locked when shifting the selector lever from P position to other than the P position
AUTOMATIC DOOR UNLOCK SELECT	Automatic door unlock function mode can be selected from the following in the mode. <ul style="list-style-type: none"> MODE 1: All doors are unlocked when the power supply position is changed from ON to OFF MODE 2: All doors are unlocked when shifting the selector lever from any position other than the P to P position MODE 3: Driver side door is unlocked when the power supply position is changed from ON to OFF MODE 4: Driver side door is unlocked when shifting the selector lever from any position other than the P to P position
AUTOMATIC LOCK/UNLOCK SET	Automatic door lock/unlock function mode can be selected from the following in this mode. <ul style="list-style-type: none"> Off: non-operational Unlock Only: door unlock operation only Lock Only: door lock operation only Lock/Unlock: lock/unlock operation

DATA MONITOR

NOTE:

The following table includes information (items) inapplicable to this vehicle. For information (items) applicable to this vehicle, refer to CONSULT display items.

Monitor Item	Contents
REQ SW-DR	Indicated [ON/OFF] condition of door request switch (driver side).
REQ SW-AS	Indicated [ON/OFF] condition of door request switch (passenger side).
REQ SW-BD/TR	Indicated [ON/OFF] condition of back door request switch.
DOOR SW-DR	Indicated [ON/OFF] condition of front door switch (driver side).
DOOR SW-AS	Indicated [ON/OFF] condition of front door switch (passenger side).
DOOR SW-RR	Indicated [ON/OFF] condition of rear door switch RH.
DOOR SW-RL	Indicated [ON/OFF] condition of rear door switch LH.
DOOR SW-BK	Indicated [ON/OFF] condition of back door switch.
CDL LOCK SW	Indicated [ON/OFF] condition of lock signal from door lock unlock switch.
CDL UNLOCK SW	Indicated [ON/OFF] condition of unlock signal from door lock unlock switch.
KEY CYL LK-SW	Indicated [ON/OFF] condition of lock signal from door key cylinder.
KEY CYL UN-SW	Indicated [ON/OFF] condition of unlock signal from door key cylinder.

ACTIVE TEST

DIAGNOSIS SYSTEM (BCM)

< SYSTEM DESCRIPTION >

Test item	Description
DOOR LOCK	<p>This test is able to check door lock/unlock operation.</p> <ul style="list-style-type: none"> • The all door lock actuators are locked when "ALL LCK" on CONSULT screen is touched. • The all door lock actuators are unlocked when "ALL UNLK" on CONSULT screen is touched. • The door lock actuator (driver side) is unlocked when "DR UNLK" on CONSULT screen is touched. • The door lock actuator (passenger side) is unlocked when "AS UNLK" on CONSULT screen is touched. • The door lock actuator (rear LH and RH) is unlocked when "OTR ULK" on CONSULT screen is touched.

REAR WINDOW DEFOGGER

REAR WINDOW DEFOGGER : CONSULT Function (BCM - REAR DEFOGGER)

INFOID:000000009374965

DATA MONITOR

NOTE:

The following table includes information (items) inapplicable to this vehicle. For information (items) applicable to this vehicle, refer to CONSULT display items.

Monitor Item	Description
REAR DEF SW	This is displayed even when it is not equipped.
PUSH SW	Indicates [ON/OFF] condition of push switch.

ACTIVE TEST

Test Item	Description
REAR DEFOGGER	Rear window defogger operates when "ON" on CONSULT screen is touched.

BUZZER

BUZZER : CONSULT Function (BCM - BUZZER)

INFOID:000000009374966

CONSULT APPLICATION ITEMS

Test item	Diagnosis mode	Description
BUZZER	Data Monitor	Displays BCM input data in real time.
	Active Test	Operation of electrical loads can be checked by sending driving signal to them.

DATA MONITOR

NOTE:

The following table includes information (items) inapplicable to this vehicle. For information (items) applicable to this vehicle, refer to CONSULT display items.

Display item [Unit]	Description
VEH SPEED 1 [Km/h]	Value of vehicle speed signal received from ABS actuator and electric unit (control unit) with CAN communication line.
PUSH SW [On/Off]	Status of push button ignition switch judged by BCM.
UNLK SEN-DR [On/Off]	Status of unlock sensor judged by BCM.
KEY SW-SLOT [On/Off]	Status of key slot judged by BCM.
TAIL LAMP SW [On/Off]	Status of each switch judged by BCM using the combination switch readout function.

A
B
C
D
E
F
G
H
I
J
K
L
N
O
P

BCS

DIAGNOSIS SYSTEM (BCM)

< SYSTEM DESCRIPTION >

Display item [Unit]	Description
FR FOG SW [On/Off]	Status of front fog lamp switch judged by BCM.
DOOR SW-DR [On/Off]	Status of driver side door switch judged by BCM.

ACTIVE TEST

Display item [Unit]	Description
IGN KEY WARN ALM	The key warning chime operation can be checked by operating the relevant function (On/Off).
SEAT BELT WARN TEST	The seat belt warning chime operation can be checked by operating the relevant function (On/Off).
ID REGIST WARNING	The ID regist warning chime operation can be checked by operating the relevant function (On/Off).
LIGHT WARN ALM	The light warning chime operation can be checked by operating the relevant function (On/Off).

INT LAMP

INT LAMP : CONSULT Function (BCM - INT LAMP)

INFOID:000000009374962

WORK SUPPORT

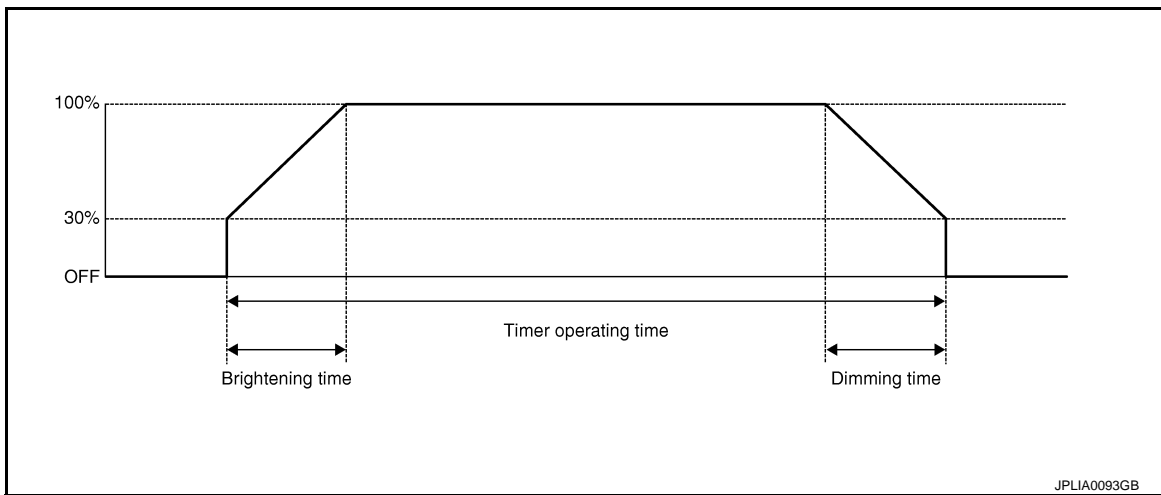

Service item	Setting item	Setting
SET I/L D-UNLCK INTCON	ON*	With the interior room lamp timer function
	OFF	Without the interior room lamp timer function
ROOM LAMP TIMER SET	MODE 2	7.5 sec.
	MODE 3*	15 sec.
	MODE 4	30 sec.
ROOM LAMP ON TIME SET	MODE 1	0.5 sec.
	MODE 2*	1 sec.
	MODE 3	2 sec.
	MODE 4	3 sec.
	MODE 5	0 sec.
ROOM LAMP OFF TIME SET	MODE 1	0.5 sec.
	MODE 2	1 sec.
	MODE 3	2 sec.
	MODE 4*	3 sec.
	MODE 5	0 sec.

DIAGNOSIS SYSTEM (BCM)

< SYSTEM DESCRIPTION >

Service item	Setting item	Setting
R LAMP TIMER LOGIC SET	MODE 1*	Interior room lamp timer activates with synchronizing all doors.
	MODE 2	Interior room lamp timer activates with synchronizing the driver door only.

*: Initial setting

DATA MONITOR

NOTE:

The following table includes information (items) inapplicable to this vehicle. For information (items) applicable to this vehicle, refer to CONSULT display items.

Monitor item [Unit]	Description
REQ SW-DR [On/Off]	Indicated [ON/OFF] condition of door request switch (driver side).
REQ SW-AS [On/Off]	Indicated [ON/OFF] condition of door request switch (passenger side).
PUSH SW [On/Off]	Indicates [ON/OFF] condition of push-button ignition switch.
KEY SW-SLOT [On/Off]	Indicates [ON/OFF] condition of key slot.
DOOR SW-DR [On/Off]	Indicated [ON/OFF] condition of front door switch (driver side).
DOOR SW-AS [On/Off]	Indicated [ON/OFF] condition of front door switch (passenger side).
DOOR SW-RR [On/Off]	Indicated [ON/OFF] condition of rear door switch RH.
DOOR SW- RL [On/Off]	Indicated [ON/OFF] condition of rear door switch LH.
DOOR SW-BK [On/Off]	Indicated [ON/OFF] condition of back door switch.
CDL LOCK SW [On/Off]	Indicated [ON/OFF] condition of lock signal from door lock unlock switch.
CDL UNLOCK SW [On/Off]	Indicated [ON/OFF] condition of unlock signal from door lock unlock switch.
KEY CYL LK-SW [On/Off]	Indicated [ON/OFF] condition of lock signal from door key cylinder.
KEY CYL UN-SW [On/Off]	Indicated [ON/OFF] condition of unlock signal from door key cylinder.
TRNK/HAT MNTR [On/Off]	NOTE: The item is indicated, but not monitored.
RKE-LOCK [On/Off]	Indicates [ON/OFF] condition of LOCK signal from Intelligent Key.
RKE-UNLOCK [On/Off]	Indicates [ON/OFF] condition of UNLOCK signal from Intelligent Key.

ACTIVE TEST

Test item	Operation	Description
INT LAMP	On	Outputs the interior room lamp control signal.
	Off	Stops the interior room lamp control signal.
STEP LAMP TEST	On	Outputs the step lamp control signal.
	Off	Stops the step lamp control signal.
LUGGAGE LAMP TEST	On	Outputs the trunk room lamp control signal.
	Off	Stops the trunk room lamp control signal.

DIAGNOSIS SYSTEM (BCM)

< SYSTEM DESCRIPTION >

HEADLAMP

HEADLAMP : CONSULT Function (BCM - HEAD LAMP) (Xenon Type)

INFOID:000000009374958

WORK SUPPORT

Service item	Setting item	Setting	
BATTERY SAVER SET	On*	With the exterior lamp battery saver function	
	Off	Without the exterior lamp battery saver function	
ILL DELAY SET	MODE 1*	45 sec.	Sets delay timer function timer operation time. (All doors closed)
	MODE 2	Without the function	
	MODE 3	30 sec.	
	MODE 4	60 sec.	
	MODE 5	90 sec.	
	MODE 6	120 sec.	
	MODE 7	150 sec.	
	MODE 8	180 sec.	
CUSTOM A/LIGHT SETTING	MODE 1*	Normal	
	MODE 2	More sensitive setting than normal setting (Turns ON earlier than normal operation.)	
	MODE 3	More sensitive setting than MODE 2 (Turns ON earlier than MODE 2.)	
	MODE 4	Less sensitive setting than normal setting (Turns ON later than normal operation.)	

*: Initial setting

DATA MONITOR

NOTE:

The following table includes information (items) inapplicable to this vehicle. For information (items) applicable to this vehicle, refer to CONSULT display items.

Monitor item [Unit]	Description
PUSH SW [On/Off]	Indicates [ON/OFF] condition of push-button ignition switch.
ENGINE STATE [Stop/Stall/Crank/Run]	Indicates [STOP/START/CRANK/RUN] condition of engine states.
VEH SPEED 1 [km/h]	Display the vehicle speed signal received from unified meter and A/C amp. by numerical value [Km/h].
KEY SW-SLOT [On/Off]	Indicates [ON/OFF] condition of key slot.

DIAGNOSIS SYSTEM (BCM)

< SYSTEM DESCRIPTION >

Monitor item [Unit]	Description	
TURN SIGNAL R [On/Off]	Each switch status that BCM judges from the combination switch reading function	A
TURN SIGNAL L [On/Off]		B
TAIL LAMP SW [On/Off]		C
HI BEAM SW [On/Off]		D
HEAD LAMP SW1 [On/Off]		E
HEAD LAMP SW2 [On/Off]		F
PASSING SW [On/Off]		G
AUTO LIGHT SW [On/Off]		H
FR FOG SW [On/Off]		I
RR FOG SW [On/Off]		J
DOOR SW-DR [On/Off]	Indicated [ON/OFF] condition of front door switch (driver side).	K
DOOR SW-AS [On/Off]	Indicated [ON/OFF] condition of front door switch (passenger side).	L
DOOR SW-RR [On/Off]	Indicated [ON/OFF] condition of rear door switch RH.	
DOOR SW- RL [On/Off]	Indicated [ON/OFF] condition of rear door switch LH.	
DOOR SW-BK [On/Off]	Indicated [ON/OFF] condition of back door switch.	
OPTICAL SENSOR [V]	The value of exterior brightness voltage input from the optical sensor	

ACTIVE TEST

Test item	Operation	Description	
TAIL LAMP	On	Transmits the position light request signal to IPDM E/R with CAN communication to turn the tail lamp ON.	BCS
	Off	Stops the position light request signal transmission.	
HEAD LAMP	Hi	Transmits the high beam request signal with CAN communication to turn the headlamp (HI).	N
	Low	Transmits the low beam request signal with CAN communication to turn the headlamp (LO).	O
	Off	Stops the high & low beam request signal transmission.	
FR FOG LAMP	On	Transmits the front fog light request signal to IPDM E/R with CAN communication to turn the front fog lamp ON.	P
	Off	Stops the front fog light request signal transmission.	
RR FOG LAMP	On	NOTE: The item is indicated, but cannot be tested.	
	Off		
DAYTIME RUNNING LIGHT	On	NOTE: The item is indicated, but cannot be tested.	
	Off		

DIAGNOSIS SYSTEM (BCM)

< SYSTEM DESCRIPTION >

Test item	Operation	Description
CORNERING LAMP	RH	NOTE: The item is indicated, but cannot be tested.
	LH	
	Off	
ILL DIM SIGNAL	On	NOTE: The item is indicated, but cannot be tested.
	Off	

HEADLAMP : CONSULT Function (BCM - HEAD LAMP) (Halogen Type)

INFOID:000000009374960

WORK SUPPORT

Service item	Setting item	Setting	
BATTERY SAVER SET	On*	With the exterior lamp battery saver function	
	Off	Without the exterior lamp battery saver function	
ILL DELAY SET	MODE 1*	45 sec.	Sets delay timer function timer operation time. (All doors closed)
	MODE 2	Without the function	
	MODE 3	30 sec.	
	MODE 4	60 sec.	
	MODE 5	90 sec.	
	MODE 6	120 sec.	
	MODE 7	150 sec.	
	MODE 8	180 sec.	
CUSTOM A/LIGHT SETTING	MODE 1*	Normal	
	MODE 2	More sensitive setting than normal setting (Turns ON earlier than normal operation.)	
	MODE 3	More sensitive setting than MODE 2 (Turns ON earlier than MODE 2.)	
	MODE 4	Less sensitive setting than normal setting (Turns ON later than normal operation.)	

*: Initial setting

DATA MONITOR

NOTE:

The following table includes information (items) inapplicable to this vehicle. For information (items) applicable to this vehicle, refer to CONSULT display items.

Monitor item [Unit]	Description
PUSH SW [On/Off]	Indicates [ON/OFF] condition of push-button ignition switch.
ENGINE STATE [Stop/Stall/Crank/Run]	Indicates [STOP/START/CRANK/RUN] condition of engine states.
VEH SPEED 1 [km/h]	Display the vehicle speed signal received from unified meter and A/C amp. by numerical value [Km/h].
KEY SW-SLOT [On/Off]	Indicates [ON/OFF] condition of key slot.

DIAGNOSIS SYSTEM (BCM)

< SYSTEM DESCRIPTION >

Monitor item [Unit]	Description	
TURN SIGNAL R [On/Off]	Each switch status that BCM judges from the combination switch reading function	A
TURN SIGNAL L [On/Off]		B
TAIL LAMP SW [On/Off]		C
HI BEAM SW [On/Off]		D
HEAD LAMP SW1 [On/Off]		E
HEAD LAMP SW2 [On/Off]		F
PASSING SW [On/Off]		G
AUTO LIGHT SW [On/Off]		H
FR FOG SW [On/Off]		I
RR FOG SW [On/Off]		J
DOOR SW-DR [On/Off]	Indicated [ON/OFF] condition of front door switch (driver side).	K
DOOR SW-AS [On/Off]	Indicated [ON/OFF] condition of front door switch (passenger side).	L
DOOR SW-RR [On/Off]	Indicated [ON/OFF] condition of rear door switch RH.	
DOOR SW-RL [On/Off]	Indicated [ON/OFF] condition of rear door switch LH.	
DOOR SW-BK [On/Off]	Indicated [ON/OFF] condition of back door switch.	
OPTICAL SENSOR [V]	The value of exterior brightness voltage input from the optical sensor	

ACTIVE TEST

Test item	Operation	Description	
TAIL LAMP	On	Transmits the position light request signal to IPDM E/R with CAN communication to turn the tail lamp ON.	BCS
	Off	Stops the position light request signal transmission.	
HEAD LAMP	Hi	Transmits the high beam request signal with CAN communication to turn the headlamp (HI).	N
	Low	Transmits the low beam request signal with CAN communication to turn the headlamp (LO).	O
	Off	Stops the high & low beam request signal transmission.	
FR FOG LAMP	On	Transmits the front fog light request signal to IPDM E/R with CAN communication to turn the front fog lamp ON.	P
	Off	Stops the front fog light request signal transmission.	
RR FOG LAMP	On	NOTE: The item is indicated, but cannot be tested.	
	Off		
DAYTIME RUNNING LIGHT	On	NOTE: The item is indicated, but cannot be tested.	
	Off		

DIAGNOSIS SYSTEM (BCM)

< SYSTEM DESCRIPTION >

Test item	Operation	Description
CORNERING LAMP	RH	NOTE: The item is indicated, but cannot be tested.
	LH	
	Off	
ILL DIM SIGNAL	On	NOTE: The item is indicated, but cannot be tested.
	Off	

WIPER

WIPER : CONSULT Function (BCM - WIPER)

INFOID:000000009374964

WORK SUPPORT

Service item	Setting item	Description
WIPER SPEED SETTING	On	With vehicle speed (Front wiper intermittent time linked with the vehicle speed and wiper intermittent dial position)
	Off*	Without vehicle speed (Front wiper intermittent time linked with the wiper intermittent dial position)

*:Factory setting

DATA MONITOR

NOTE:

The following table includes information (items) inapplicable to this vehicle. For information (items) applicable to this vehicle, refer to CONSULT display items.

Monitor Item [Unit]	Description
PUSH SW [Off/On]	The switch status input from push-button ignition switch.
VEHICLE SPEED 1 [km/h]	The value of the vehicle speed signal received from unified meter and A/C amp. with CAN communication.
FR WIPER HI [Off/On]	Each switch status that BCM judges from the combination switch reading function.
FR WIPER LOW [Off/On]	
FR WASHER SW [Off/On]	
FR WIPER INT [Off/On]	
FR WIPER STOP [Off/On]	Front wiper motor (stop position) status received from IPDM E/R with CAN communication.
INT VOLUME [1 - 7]	Each switch status that BCM judges from the combination switch reading function.
RR WIPER ON [Off/On]	Each switch status that BCM judges from the combination switch reading function.
RR WIPER INT [Off/On]	
RR WASHER SW [Off/On]	
RR WIPER STOP [Off/On]	
	Rear wiper motor (stop position) status input from the rear wiper motor.

ACTIVE TEST

DIAGNOSIS SYSTEM (BCM)

< SYSTEM DESCRIPTION >

Test item	Operation	Description
FR WIPER	Hi	Transmits the front wiper request signal (HI) to IPDM E/R with CAN communication to operate the front wiper HI operation.
	Lo	Transmits the front wiper request signal (LO) to IPDM E/R with CAN communication to operate the front wiper LO operation.
	INT	Transmits the front wiper request signal (INT) to IPDM E/R with CAN communication to operate the front wiper INT operation.
	Off	Stops transmitting the front wiper request signal to stop the front wiper operation.
RR WIPER	On	Outputs the voltage to operate the rear wiper motor.
	Off	Stops the voltage to stop.

FLASHER

FLASHER : CONSULT Function (BCM - FLASHER) (Xenon Type)

INFOID:000000009374959

WORK SUPPORT

Service item	Setting item	Setting
HAZARD ANSWER BACK	Lock Only*	With locking only
	Unlk Only	With unlocking only
	Lock/Unlk	With locking/unlocking
	Off	Without the function

Sets the hazard warning lamp answer back function when the door is lock/unlock with the request switch or the key fob.

*: Initial setting

DATA MONITOR

NOTE:

The following table includes information (items) inapplicable to this vehicle. For information (items) applicable to this vehicle, refer to CONSULT display items.

Monitor item [Unit]	Description
REQ SW-DR [On/Off]	Indicated [ON/OFF] condition of door request switch (driver side).
REQ SW-AS [On/Off]	Indicated [ON/OFF] condition of door request switch (passenger side).
PUSH SW [On/Off]	Indicates [ON/OFF] condition of push-button ignition switch.
TURN SIGNAL R [On/Off]	Each switch condition that BCM judges from the combination switch reading function
TURN SIGNAL L [On/Off]	
HAZARD SW [On/Off]	The switch status input from the hazard switch
RKE-LOCK [On/Off]	Indicates [ON/OFF] condition of LOCK signal from Intelligent Key.
RKE-UNLOCK [On/Off]	Indicates [ON/OFF] condition of UNLOCK signal from Intelligent Key.
RKE-PANIC [On/Off]	Indicates [ON/OFF] condition of PANIC button of Intelligent Key.

ACTIVE TEST

A
B
C
D
E
F
G
H
I
J
K
L
N
O
P

BCS

DIAGNOSIS SYSTEM (BCM)

< SYSTEM DESCRIPTION >

Test item	Operation	Description
FLASHER	RH	Outputs the voltage to blink the right side turn signal lamps.
	LH	Outputs the voltage to blink the left side turn signal lamps.
	Off	Stops the voltage to turn the turn signal lamps OFF.

FLASHER : CONSULT Function (BCM - FLASHER) (Halogen Type)

INFOID:000000009374961

WORK SUPPORT

Service item	Setting item	Setting	
HAZARD ANSWER BACK	Lock Only*	With locking only	Sets the hazard warning lamp answer back function when the door is lock/unlock with the request switch or the key fob.
	Unlk Only	With unlocking only	
	Lock/Unlk	With locking/unlocking	
	Off	Without the function	

*: Initial setting

DATA MONITOR

NOTE:

The following table includes information (items) inapplicable to this vehicle. For information (items) applicable to this vehicle, refer to CONSULT display items.

Monitor item [Unit]	Description
REQ SW-DR [On/Off]	Indicated [ON/OFF] condition of door request switch (driver side).
REQ SW-AS [On/Off]	Indicated [ON/OFF] condition of door request switch (passenger side).
PUSH SW [On/Off]	Indicates [ON/OFF] condition of push-button ignition switch.
TURN SIGNAL R [On/Off]	Each switch condition that BCM judges from the combination switch reading function
TURN SIGNAL L [On/Off]	
HAZARD SW [On/Off]	The switch status input from the hazard switch
RKE-LOCK [On/Off]	Indicates [ON/OFF] condition of LOCK signal from Intelligent Key.
RKE-UNLOCK [On/Off]	Indicates [ON/OFF] condition of UNLOCK signal from Intelligent Key.
RKE-PANIC [On/Off]	Indicates [ON/OFF] condition of PANIC button of Intelligent Key.

ACTIVE TEST

Test item	Operation	Description
FLASHER	RH	Outputs the voltage to blink the right side turn signal lamps.
	LH	Outputs the voltage to blink the left side turn signal lamps.
	Off	Stops the voltage to turn the turn signal lamps OFF.

INTELLIGENT KEY

INTELLIGENT KEY : CONSULT Function (BCM - INTELLIGENT KEY)

INFOID:000000009374953

WORK SUPPORT

DIAGNOSIS SYSTEM (BCM)

< SYSTEM DESCRIPTION >

Monitor item	Description
CONFIRM KEY FOB ID	It can be checked whether Intelligent Key ID code is registered or not in this mode.
AUTO LOCK SET	Auto door lock time can be changed in this mode. <ul style="list-style-type: none"> • MODE 1: 1 minute • MODE 2: 5 minutes • MODE 3: 30 seconds • MODE 4: 2 minutes
LOCK/UNLOCK BY I-KEY	Door lock/unlock function by door request switch (driver side, passenger side and back door) mode can be changed to operate (ON) or not operate (OFF) in this mode.
ENGINE START BY I-KEY	Engine start function mode can be changed to operate (ON) or not operate (OFF) with this mode.
TRUNK/GLASS HATCH OPEN	Buzzer reminder function mode by back door request switch can be changed to operate (ON) or not operate (OFF) with this mode.
PANIC ALARM SET	Panic alarm button pressing time on Intelligent Key remote control button can be selected from the following with this mode. <ul style="list-style-type: none"> • MODE 1: 0.5 sec. • MODE 2: Non-operation • MODE 3: 1.5 sec.
PW DOWN SET	Unlock button pressing time on Intelligent Key button can be selected from the following with this mode. <ul style="list-style-type: none"> • MODE 1: 3 sec. • MODE 2: Non-operation • MODE 3: 5 sec.
TAKE OUT FROM WIN WARN	NOTE: This item is displayed, but cannot be supported.
TRUNK OPEN DELAY	NOTE: This item is displayed, but cannot be supported.
LO- BATT OF KEY FOB WARN	Intelligent Key low battery warning mode can be changed to operate (ON) or not operate (OFF) with this mode.
ANTI KEY LOCK IN FUNCTI	Key reminder function mode can be changed to operate (ON) or not operate (OFF) with this mode.
HAZARD ANSWER BACK	Hazard reminder function mode can be selected from the following with this mode. <ul style="list-style-type: none"> • LOCK ONLY: Door lock operation only • UNLOCK ONLY: Door unlock operation only • LOCK/UNLOCK: Lock/unlock operation • OFF: Non-operation
ANS BACK I-KEY LOCK	Buzzer reminder function (lock operation) mode by door request switch (driver side and passenger side) can be selected from the following with this mode. <ul style="list-style-type: none"> • Horn chirp: Sound horn • Buzzer: Sound Intelligent Key warning buzzer • OFF: Non-operation
ANS BACK I-KEY UNLOCK	Buzzer reminder function (unlock operation) mode by door request switch can be changed to operate (ON) or not operate (OFF) with this mode.
SHORT CRANKING OUTPUT	Starter motor can operate during the times below. <ul style="list-style-type: none"> • 70 msec. • 100 msec. • 200 msec.
INSIDE ANT DIAGNOSIS	This function allows inside key antenna self-diagnosis.
HORN WITH KEYLESS LOCK	Horn reminder function mode by Intelligent Key button can be changed to operate (ON) or not operate (OFF) with this mode.
WELCOME LIGHT OP SET	Welcome light function mode can be changed to operate (WITH) or not operate (WITHOUT) with this mode.
WELCOME LIGHT SELECT	Welcome light function mode can be selected from the following with this mode. <ul style="list-style-type: none"> • Without room lamp • With room lamp • Without paddle lamp • With paddle lamp

A
B
C
D
E
F
G
H
I
J
K
L

BCS

N
O
P

DIAGNOSIS SYSTEM (BCM)

< SYSTEM DESCRIPTION >

SELF-DIAG RESULT

Refer to [BCS-90. "DTC Index"](#).

DATA MONITOR

NOTE:

The following table includes information (items) inapplicable to this vehicle. For information (items) applicable to this vehicle, refer to CONSULT display items.

Monitor Item	Condition
REQ SW -DR	Indicates [ON/OFF] condition of door request switch (driver side).
REQ SW -AS	Indicates [ON/OFF] condition of door request switch (passenger side).
REQ SW -RR	NOTE: This item is displayed, but cannot be monitored.
REQ SW -RL	NOTE: This item is displayed, but cannot be monitored.
REQ SW -BD/TR	Indicates [ON/OFF] condition of back door request switch.
PUSH SW	Indicates [ON/OFF] condition of push-button ignition switch.
IGN RLY2 -F/B	Indicates [ON/OFF] condition of ignition relay 2.
CLUCH SW	NOTE: This item is displayed, but cannot be monitored.
BRAKE SW 1	Indicates [ON/OFF] condition of brake switch power supply.
BRAKE SW 2	Indicates [ON/OFF] condition of brake switch.
DETE/CANCL SW	Indicates [ON/OFF] condition of P position.
SFT PN/N SW	Indicates [ON/OFF] condition of P or N position.
S/L -LOCK	NOTE: This item is displayed, but cannot be monitored.
S/L -UNLOCK	NOTE: This item is displayed, but cannot be monitored.
S/L RELAY -F/B	NOTE: This item is displayed, but cannot be monitored.
UNLK SEN -DR	Indicates [ON/OFF] condition of driver door UNLOCK status.
PUSH SW -IPDM	Indicates [ON/OFF] condition of push-button ignition switch.
IGN RLY1 -F/B	Indicates [ON/OFF] condition of ignition relay 1.
DETE SW -IPDM	Indicates [ON/OFF] condition of P position.
SFT PN -IPDM	Indicates [ON/OFF] condition of P or N position.
SFT P -MET	Indicates [ON/OFF] condition of P position.
SFT N -MET	Indicates [ON/OFF] condition of N position.
ENGINE STATE	Indicates [STOP/START/CRANK/RUN] condition of engine states.
S/L LOCK-IPDM	NOTE: This item is displayed, but cannot be monitored.
S/L UNLK-IPDM	NOTE: This item is displayed, but cannot be monitored.
S/L RELAY-REQ	NOTE: This item is displayed, but cannot be monitored.
VEH SPEED 1	Display the vehicle speed signal received from unified meter and A/C amp. by numerical value [Km/h].
VEH SPEED 2	Display the vehicle speed signal received from ABS or VDC or CVT by numerical value [Km/h].
DOOR STAT-DR	Indicates [LOCK/READY/UNLOCK] condition of driver side door status.
DOOR STAT-AS	Indicates [LOCK/READY/UNLOCK] condition of passenger side door status.
ID OK FLAG	Indicates [SET/RESET] condition of key ID.
PRMT ENG STRT	Indicates [SET/RESET] condition of engine start possibility.

DIAGNOSIS SYSTEM (BCM)

< SYSTEM DESCRIPTION >

Monitor Item	Condition
PRMT RKE STRT	NOTE: This item is displayed, but cannot be monitored.
KEY SW -SLOT	Indicates [ON/OFF] condition of key slot.
TRNK/HAT MNTR	NOTE: This item is displayed, but cannot be monitored.
RKE-LOCK	Indicates [ON/OFF] condition of LOCK signal from Intelligent Key.
RKE-UNLOCK	Indicates [ON/OFF] condition of UNLOCK signal from Intelligent Key.
RKE-TR/BD	NOTE: This item is displayed, but cannot be monitored.
RKE-PANIC	Indicates [ON/OFF] condition of PANIC button of Intelligent Key.
RKE-P/W OPEN	Indicates [ON/OFF] condition of P/W DOWN signal from Intelligent Key.
RKE-MODE CHG	Indicates [ON/OFF] condition of MODE CHANGE signal from Intelligent Key.
RKE OPE COUN1	When remote keyless entry receiver receives the signal transmitted while operating on Intelligent Key, the numerical value start changing.
RKE OPE COUN2	NOTE: This item is displayed, but cannot be monitored.

ACTIVE TEST

Test item	Description
BATTERY SAVER	This test is able to check interior room lamp operation. The interior room lamp will be activated after "ON" on CONSULT screen is touched.
PW REMOTO DOWN SET	This test is able to check power window down operation. The power window down will be activated after "ON" on CONSULT screen is touched.
INSIDE BUZZER	This test is able to check warning chime in combination meter operation. <ul style="list-style-type: none"> • Take away warning chime sounds when "TAKE OUT" on CONSULT screen is touched. • Key warning chime sounds when "KEY WARN" on CONSULT screen is touched. • P position warning chime sounds when "P RNG WARN" on CONSULT screen is touched. • ACC warning chime sounds when "ACC WARN" on CONSULT screen is touched.
OUTSIDE BUZZER	This test is able to check Intelligent Key warning buzzer operation. The Intelligent Key warning buzzer will be activated after "ON" on CONSULT screen is touched.
INDICATOR	This test is able to check warning lamp operation. <ul style="list-style-type: none"> • "KEY" Warning lamp illuminates when "KEY ON" on CONSULT screen is touched. • "KEY" Warning lamp flashes when "KEY IND" on CONSULT screen is touched.
INT LAMP	This test is able to check interior room lamp operation. The interior room lamp will be activated after "ON" on CONSULT screen is touched.
LCD	This test is able to check meter display information <ul style="list-style-type: none"> • Engine start information displays when "BP N" on CONSULT screen is touched. • Engine start information displays when "BP I" on CONSULT screen is touched. • Key ID warning displays when "ID NG" on CONSULT screen is touched. • ROTAT: This item is displayed, but cannot be tested. • P position warning displays when "SFT P" on CONSULT screen is touched. • Intelligent Key insert information displays when "INSRT" on CONSULT screen is touched. • Intelligent Key low battery warning displays when "BATT" on CONSULT screen is touched. • Take away through window warning displays when "NO KY" on CONSULT screen is touched. • Take away warning display when "OUTKY" on CONSULT screen is touched. • OFF position warning display when "LK WN" on CONSULT screen is touched.
TRUNK/GLASS HATCH	This test is able to check back door opener actuator open operation. This actuator opens when "ON" on CONSULT screen is touched.
FLASHER	This test is able to check hazard warning lamp operation. The hazard warning lamps will be activated after "ON" on CONSULT screen is touched.
HORN	This test is able to check horn operation. The horn will be activated after "ON" on CONSULT screen is touched.
P RANGE	This test is able to check A/T shift selector power supply A/T shift selector power is supplied when "ON" on CONSULT screen is touched.

DIAGNOSIS SYSTEM (BCM)

< SYSTEM DESCRIPTION >

Test item	Description
ENGINE SW ILLUMI	This test is able to check push-ignition switch illumination operation. Push-ignition switch illumination illuminates when "ON" on CONSULT screen is touched.
LOCK INDICATOR	This test is able to check LOCK indicator in push-ignition switch operation. LOCK indicator in push-ignition switch illuminates when "ON" on CONSULT screen is touched;
ACC INDICATOR	This test is able to check ACC indicator in push-ignition switch operation. Indicator in push-ignition switch illuminates when "ON" on CONSULT screen is touched.
IGNITION ON IND	This test is able to check ON indicator in push-ignition switch operation. Indicator in push-ignition switch illuminates when "ON" on CONSULT screen is touched.
KEY SLOT ILLUMI	This test is able to check key slot illumination operation. Key slot illumination flash when "ON" on CONSULT screen is touched.
TRUNK/BACK DOOR	NOTE: This item is displayed, but cannot be tested.

COMB SW

COMB SW : CONSULT Function (BCM - COMB SW)

INFOID:000000009065466

DATA MONITOR

NOTE:

The following table includes information (items) inapplicable to this vehicle. For information (items) applicable to this vehicle, refer to CONSULT display items.

Monitor item [UNIT]	Description
FR WIPER HI [Off/On]	Displays the status of the FR WIPER HI switch in combination switch judged by BCM with the combination switch reading function.
FR WIPER LOW [Off/On]	Displays the status of the FR WIPER LOW switch in combination switch judged by BCM with the combination switch reading function.
FR WASHER SW [Off/On]	Displays the status of the FR WASHER switch in combination switch judged by BCM with the combination switch reading function.
FR WIPER INT [Off/On]	Displays the status of the FR WIPER INT switch in combination switch judged by BCM with the combination switch reading function.
FR WIPER STOP [Off/On]	Displays the status of the front wiper stop position signal received from IPDM E/R via CAN communication.
INT VOLUME [1 - 7]	Displays the status of wiper intermittent dial position judged by BCM with the combination switch reading function.
RR WIPER ON [Off/On]	Displays the status of the RR WIPER ON switch in combination switch judged by BCM with the combination switch reading function.
RR WIPER INT [Off/On]	Displays the status of the RR WIPER INT switch in combination switch judged by BCM with the combination switch reading function.
RR WASHER SW [Off/On]	Displays the status of the RR WASHER switch in combination switch judged by BCM with the combination switch reading function.
RR WIPER STOP [Off/On]	Displays the status of the rear wiper stop position signal received from rear wiper motor.
TURN SIGNAL R [Off/On]	Displays the status of the TURN RH switch in combination switch judged by BCM with the combination switch reading function.
TURN SIGNAL L [Off/On]	Displays the status of the TURN LH switch in combination switch judged by BCM with the combination switch reading function.
TAIL LAMP SW [Off/On]	Displays the status of the TAIL LAMP switch in combination switch judged by BCM with the combination switch reading function.
HI BEAM SW [Off/On]	Displays the status of the HI BEAM switch in combination switch judged by BCM with the combination switch reading function.
HEAD LAMP SW 1 [Off/On]	Displays the status of the HEADLAMP 1 switch in combination switch judged by BCM with the combination switch reading function.

DIAGNOSIS SYSTEM (BCM)

< SYSTEM DESCRIPTION >

Monitor item [UNIT]	Description
HEAD LAMP SW 2 [Off/On]	Displays the status of the HEADLAMP 2 switch in combination switch judged by BCM with the combination switch reading function.
PASSING SW [Off/On]	Displays the status of the PASSING switch in combination switch judged by BCM with the combination switch reading function.
AUTO LIGHT SW [Off/On]	Displays the status of the AUTO LIGHT switch in combination switch judged by BCM with the combination switch reading function.
FR FOG SW [Off/On]	Displays the status of the FR FOG switch in combination switch judged by BCM with the combination switch reading function.
RR FOG SW [Off/On]	NOTE: The item is indicated, but not monitored.

BCM

BCM : CONSULT Function (BCM - BCM)

INFOID:000000009065467

WORK SUPPORT

Item	Description
RESET SETTING VALUE	Return a value set with Work Support of each system to a default value in factory shipment.

IMMU

IMMU : CONSULT Function (BCM - IMMU)

INFOID:000000009374956

DATA MONITOR

NOTE:

The following table includes information (items) inapplicable to this vehicle. For information (items) applicable to this vehicle, refer to CONSULT display items.

Monitor item	Content
CONFIRM ID ALL	Indicates [YET] at all time. Switch to [DONE] when a registered Intelligent Key is inserted into the key slot.
CONFIRM ID4	
CONFIRM ID3	
CONFIRM ID2	
CONFIRM ID1	
TP 4	Indicates the number of ID which has been registered.
TP 3	
TP 2	
TP 1	
PUSH SW	Indicates [ON/OFF] condition of push-button ignition switch.
KEY SW -SLOT	Indicates [ON/OFF] condition of key slot.

ACTIVE TEST

Test item	Description
THEFT IND	This test is able to check security indicator lamp operation. The lamp will be turned on when "ON" on CONSULT screen touched.

BATTERY SAVER

BATTERY SAVER : CONSULT Function (BCM - BATTERY SAVER)

INFOID:000000009374963

WORK SUPPORT

DIAGNOSIS SYSTEM (BCM)

< SYSTEM DESCRIPTION >

Service item	Setting item	Setting	
BATTERY SAVER SET	On*	With the exterior lamp battery saver function	
	Off	Without the exterior lamp battery saver function	
ROOM LAMP BAT SAV SET	On*	With the interior room lamp battery saver function	
	Off	Without the interior room lamp battery saver function	
ROOM LAMP TIMER SET	MODE 1	30 min.	Sets the interior room lamp battery saver timer operating time.
	MODE 2	60 min.	
	MODE 3*	15 min.	

*: Initial setting

DATA MONITOR

NOTE:

The following table includes information (items) inapplicable to this vehicle. For information (items) applicable to this vehicle, refer to CONSULT display items.

Monitor item [Unit]	Description
REQ SW-DR [On/Off]	Indicated [ON/OFF] condition of door request switch (driver side).
REQ SW-AS [On/Off]	Indicated [ON/OFF] condition of door request switch (passenger side).
PUSH SW [On/Off]	Indicates [ON/OFF] condition of push-button ignition switch.
KEY SW-SLOT [On/Off]	Indicates [ON/OFF] condition of key slot.
DOOR SW-DR [On/Off]	Indicated [ON/OFF] condition of front door switch (driver side).
DOOR SW-AS [On/Off]	Indicated [ON/OFF] condition of front door switch (passenger side).
DOOR SW-RR [On/Off]	Indicated [ON/OFF] condition of rear door switch RH.
DOOR SW- RL [On/Off]	Indicated [ON/OFF] condition of rear door switch LH.
DOOR SW-BK [On/Off]	Indicated [ON/OFF] condition of back door switch.
CDL LOCK SW [On/Off]	Indicated [ON/OFF] condition of lock signal from door lock unlock switch.
CDL UNLOCK SW [On/Off]	Indicated [ON/OFF] condition of unlock signal from door lock unlock switch.
KEY CYL LK-SW [On/Off]	Indicated [ON/OFF] condition of lock signal from door key cylinder.
KEY CYL UN-SW [On/Off]	Indicated [ON/OFF] condition of unlock signal from door key cylinder.
TRNK/HAT MNTR [On/Off]	NOTE: The item is indicated, but not monitored.
RKE-LOCK [On/Off]	Indicates [ON/OFF] condition of LOCK signal from Intelligent Key.
RKE-UNLOCK [On/Off]	Indicates [ON/OFF] condition of UNLOCK signal from Intelligent Key.

ACTIVE TEST

DIAGNOSIS SYSTEM (BCM)

< SYSTEM DESCRIPTION >

Test item	Operation	Description
BATTERY SAVER	Off	Cuts the interior room lamp power supply.
	On	Outputs the interior room lamp power supply.

TRUNK

TRUNK : CONSULT Function (BCM - TRUNK)

INFOID:000000009374954

BCM CONSULT FUNCTION

CONSULT performs the following functions via CAN communication with BCM.

Diagnosis mode	Function Description
DATA MONITOR	The BCM input/output signals are displayed.
ACTIVE TEST	The signals used to activate each device are forcibly supplied from BCM.

DATA MONITOR

NOTE:

The following table includes information (items) inapplicable to this vehicle. For information (items) applicable to this vehicle, refer to CONSULT display items.

Monitor Item	Contents
PUSH SW	Indicates [ON/OFF] condition of push-button ignition switch.
UNLK SEN -DR	Indicates [ON/OFF] condition of driver door UNLOCK status.
VEH SPEED 1	Indicates [Km/h] condition of vehicle speed signal from combination meter.
KEY CYL SW-TR	NOTE: This item is displayed, but cannot be monitored.
TR CANCEL SW	NOTE: This item is displayed, but cannot be monitored.
TR/BD OPEN SW	Indicates [ON/OFF] condition of back door opener switch.
TRNK/HAT MNTR	NOTE: This item is displayed, but cannot be monitored.
RKE-TR/BD*	NOTE: This item is displayed, but cannot be monitored.

ACTIVE TEST

Test item	Description
TRUNK/GLASS HATCH	This test is able to check back door opener actuator open operation. This actuator opens when ""

THEFT ALM

THEFT ALM : CONSULT Function (BCM - THEFT)

INFOID:000000009374955

DATA MONITOR

NOTE:

The following table includes information (items) inapplicable to this vehicle. For information (items) applicable to this vehicle, refer to CONSULT display items.

Monitored Item	Description
REQ SW -DR	Indicates [ON/OFF] condition of door request switch (driver side).
REQ SW -AS	Indicates [ON/OFF] condition of door request switch (passenger side).
REQ SW -RR	NOTE: This is displayed even when it is not equipped.

DIAGNOSIS SYSTEM (BCM)

< SYSTEM DESCRIPTION >

Monitored Item	Description
REQ SW -RL	NOTE: This is displayed even when it is not equipped.
REQ SW -BD/TR	Indicates [ON/OFF] condition of back door request switch.
PUSH SW	Indicates [ON/OFF] condition of push-button ignition switch
UNLK SEN -DR	Indicates [ON/OFF] condition of driver door UNLOCK status.
KEY SW -SLOT	Indicates [ON/OFF] condition of key slot.
DOOR SW-DR	Indicates [ON/OFF] condition of front door switch LH.
DOOR SW-AS	Indicates [ON/OFF] condition of front door switch RH.
DOOR SW-RR	Indicates [ON/OFF] condition of rear door switch RH.
DOOR SW-RL	Indicates [ON/OFF] condition of rear door switch LH.
DOOR SW-BK	Indicates [ON/OFF] condition of back door switch.
CDL LOCK SW	Indicates [ON/OFF] condition of lock signal from door lock/unlock switch LH and RH.
CDL UNLOCK SW	Indicates [ON/OFF] condition of unlock signal from door lock/unlock switch LH and RH.
KEY CYL LK-SW	Indicates [ON/OFF] condition of lock signal from front door key cylinder switch.
KEY CYL UN-SW	Indicates [ON/OFF] condition of unlock signal from front door key cylinder switch.
KEY CYL SW-TR	NOTE: This is displayed even when it is not equipped.
TR/BD OPEN SW	Indicates [ON/OFF] condition of back door opener switch.
TRNK/HAT MNTR	NOTE: This is displayed even when it is not equipped.
RKE-LOCK	Indicates [ON/OFF] condition of LOCK signal from Intelligent Key.
RKE-UNLOCK	Indicates [ON/OFF] condition of UNLOCK signal from Intelligent Key.
RKE-TR/BD	NOTE: This is displayed even when it is not equipped.

WORK SUPPORT

Test Item	Description
SECURITY ALARM SET	This mode is able to confirm and change security alarm ON-OFF setting.
THEFT ALM TRG	The switch which triggered vehicle security alarm is recorded. This mode is able to confirm and erase the record of vehicle security alarm. The trigger data can be erased by touching "CLEAR" on CONSULT screen.

ACTIVE TEST

Test Item	Description
THEFT IND	This test is able to check security indicator lamp operation. The lamp will be turned on when "ON" on CONSULT screen is touched.
VEHICLE SECURITY HORN	This test is able to check vehicle security horn operation. The horns will be activated for 0.5 seconds after "ON" on CONSULT screen is touched.
HEADLAMP(HI)	This test is able to check vehicle security lamp operation. The headlamps will be activated for 0.5 seconds after "ON" on CONSULT screen is touched.
FLASHER	This test is able to check vehicle security hazard lamp operation. The hazard lamps will be activated after "ON" on CONSULT screen is touched.

RETAINED PWR

RETAINED PWR : CONSULT Function (BCM - RETAINED PWR)

INFOID:000000009374957

Data monitor

NOTE:

DIAGNOSIS SYSTEM (BCM)

< SYSTEM DESCRIPTION >

The following table includes information (items) inapplicable to this vehicle. For information (items) applicable to this vehicle, refer to CONSULT display items.

Monitor Item	Description
DOOR SW-DR	Indicates [ON/OFF] condition of driver side door switch.
DOOR SW-AS	Indicates [ON/OFF] condition of passenger side door switch.

SIGNAL BUFFER

SIGNAL BUFFER : CONSULT Function (BCM - SIGNAL BUFFER)

INFOID:000000009065473

DATA MONITOR

NOTE:

The following table includes information (items) inapplicable to this vehicle. For information (items) applicable to this vehicle, refer to CONSULT display items.

Monitor item [UNIT]	Description
PUSH SW [Off/On]	Displays the status of the push-button ignition switch (push switch) judged by BCM.

ACTIVE TEST

Test item	Operation	Description
OIL PRESSURE SW	Off	OFF
	On	BCM transmits the oil pressure switch signal to the unified meter and A/C amp. via CAN communication, which illuminates the oil pressure warning lamp in the combination meter.

AIR PRESSURE MONITOR

AIR PRESSURE MONITOR : CONSULT Function (BCM - AIR PRESSURE MONITOR)

INFOID:000000009374951

WORK SUPPORT MODE

ID Read

The registered ID number is displayed.

ID Regist

Refer to [WT-21, "Work Procedure"](#).

SELF-DIAG RESULTS MODE

Operation Procedure

Refer to [BCS-90, "DTC Index"](#).

DATA MONITOR MODE

Screen of data monitor mode is displayed.

NOTE:

- When malfunction is detected, CONSULT perform REAL-TIME DIAGNOSIS.
- Also, any malfunction detected while in this mode will be displayed at real time.
- The following table includes information (items) inapplicable to this vehicle. For information (items) applicable to this vehicle, refer to CONSULT display items.

A
B
C
D
E
F
G
H
I
J
K
L
N
O
P

BCS

DIAGNOSIS SYSTEM (BCM)

< SYSTEM DESCRIPTION >

Display item list

Monitor	Condition	Specification
AIR PRESS FL AIR PRESS FR AIR PRESS RR AIR PRESS RL	<ul style="list-style-type: none">• Drive vehicle for a few minutes. or• Ignition switch ON and tire pressure sensor tire pressure sensor activation tool is transmitting activation signals.	Tire pressure (kPa, kg/cm ² or Psi)
ID REGST FL1 ID REGST FR1 ID REGST RR1 ID REGST RL1	Ignition switch ON	Registration ID: Green No registration: Red
WARNING LAMP		Low tire pressure warning lamp ON: on Low tire pressure warning lamp OFF: off
BUZZER		Buzzer in combination meter ON: on Buzzer in combination meter OFF: off

NOTE:

Before performing the self-diagnosis, be sure to register the ID, or erase the actual malfunction location may be different from that displayed on CONSULT.

ACTIVE TEST MODE

NOTE:

Before performing the self-diagnosis, be sure to register the ID, or erase the actual malfunction may be different from that displayed on CONSULT.

TEST ITEM LIST

Test item	Content
WARNING LAMP	This test is able to check to check that the low tire pressure warning lamp turns on.
ID REGIST WARNING	This test is able to check to check that the buzzer sounds or the low tire pressure warning lamp turns on.
FLASHER	This test is able to check to check that each turn signal lamp turns on.
HORN	This test is able to check to check that the horn sounds.

U1000 CAN COMM CIRCUIT

< DTC/CIRCUIT DIAGNOSIS >

DTC/CIRCUIT DIAGNOSIS

U1000 CAN COMM CIRCUIT

Description

INFOID:000000009065475

CAN (Controller Area Network) is a serial communication line for real time applications. It is an on-vehicle multiplex communication line with high data communication speed and excellent error detection ability. Modern vehicle is equipped with many electronic control unit, and each control unit shares information and links with other control units during operation (not independent). In CAN communication, control units are connected with 2 communication lines (CAN H-line, CAN L-line) allowing a high rate of information transmission with less wiring. Each control unit transmits/receives data but selectively reads required data only.
CAN Communication Signal Chart. Refer to [LAN-25, "CAN Communication Signal Chart"](#).

DTC Logic

INFOID:000000009065476

DTC DETECTION LOGIC

DTC	CONSULT display description	DTC Detection Condition	Possible cause
U1000	CAN COMM	When BCM cannot communicate CAN communication signal continuously for 2 seconds or more.	CAN communication system

Diagnosis Procedure

INFOID:000000009065477

1.PERFORM SELF DIAGNOSTIC

1. Turn ignition switch ON and wait for 2 seconds or more.
2. Check "Self Diagnostic Result".

Is DTC "U1000" displayed?

- YES >> Refer to [LAN-16, "Trouble Diagnosis Flow Chart"](#).
NO >> Refer to [GI-42, "Intermittent Incident"](#).

A
B
C
D
E
F
G
H
I
J
K
L

BCS

N
O
P

U1010 CONTROL UNIT (CAN)

< DTC/CIRCUIT DIAGNOSIS >

U1010 CONTROL UNIT (CAN)

DTC Logic

INFOID:000000009065478

DTC DETECTION LOGIC

DTC	CONSULT display de- scription	DTC Detection Condition	Possible cause
U1010	CONTROL UNIT(CAN)	BCM detected internal CAN communication circuit malfunction.	BCM

Diagnosis Procedure

INFOID:000000009065479

1.REPLACE BCM

When DTC "U1010" is detected, replace BCM.

>> Replace BCM. Refer to [BCS-96. "Exploded View"](#).

U0415 VEHICLE SPEED SIG

< DTC/CIRCUIT DIAGNOSIS >

U0415 VEHICLE SPEED SIG

Description

INFOID:000000009065480

U0415 is displayed if any unusual condition is present in the reception status of the vehicle speed signal from the ABS actuator and electric unit (control unit).

DTC Logic

INFOID:000000009065481

DTC DETECTION LOGIC

DTC	CONSULT display description	DTC Detection Condition	Probable cause
U0415	VEHICLE SPEED	When the vehicle speed signal received from the ABS actuator and electric unit (control unit) remains abnormal for 2 seconds or more.	<ul style="list-style-type: none">• ABS actuator and electric unit (control unit)• BCM

DTC CONFIRMATION PROCEDURE

1. DTC CONFIRMATION

1. Erase the DTC.
2. Turn ignition switch OFF.
3. Perform the "Self Diagnostic Result" of CONSULT, when passed 2 seconds or more after the ignition switch is turned ON.

Is any DTC detected?

- YES >> Refer to [BCS-43, "Diagnosis Procedure"](#).
NO >> INSPECTION END

Diagnosis Procedure

INFOID:000000009065482

1. ABS ACTUATOR AND ELECTRIC UNIT (CONTROL UNIT) SELF-DIAG RESULTS

Perform "Self-Diagnostic Result" of ABS actuator and electric unit (control unit) with CONSULT. Refer to [BRC-31, "CONSULT Function"](#).

Is any DTC detected?

- YES >> Repair or replace the malfunctioning part.
NO >> Replace BCM. Refer to [BCS-96, "Exploded View"](#).

A
B
C
D
E
F
G
H
I
J
K
L

BCS

N
O
P

B2562 LOW VOLTAGE

< DTC/CIRCUIT DIAGNOSIS >

B2562 LOW VOLTAGE

DTC Logic

INFOID:000000009065483

DTC DETECTION LOGIC

DTC	CONSULT display description	DTC Detection Condition	Possible cause
B2562	LOW VOLTAGE	When the power supply voltage to BCM remains less than 8.8 V for 120 seconds or more	Harness or connector (power supply circuit)

DTC CONFIRMATION PROCEDURE

1. DTC CONFIRMATION

1. Erase DTC.
2. Turn ignition switch OFF.
3. Perform the "Self Diagnostic Result" of CONSULT, when passed 120 seconds or more after the ignition switch is turned ON.

Is any DTC detected?

- YES >> Refer to [BCS-44, "Diagnosis Procedure"](#).
NO >> INSPECTION END

Diagnosis Procedure

INFOID:000000009065484

1. CHECK POWER SUPPLY CIRCUIT

Check BCM power supply circuit. Refer to [BCS-45, "Diagnosis Procedure"](#).

Is the circuit normal?

- YES >> Replace BCM. Refer to [BCS-96, "Exploded View"](#).
NO >> Repair the malfunctioning part.

POWER SUPPLY AND GROUND CIRCUIT

< DTC/CIRCUIT DIAGNOSIS >

POWER SUPPLY AND GROUND CIRCUIT

Diagnosis Procedure

INFOID:000000009065485

1.CHECK FUSE AND FUSIBLE LINK

Check that the following fuse and fusible link are not blown.

Signal name	Fuse and fusible link No.
Battery power supply	K
	10

Is the fuse fusing?

- YES >> Replace the blown fuse or fusible link after repairing the affected circuit if a fuse or fusible link is blown.
NO >> GO TO 2.

2.CHECK POWER SUPPLY CIRCUIT

1. Turn ignition switch OFF.
2. Disconnect BCM connectors.
3. Check voltage between BCM harness connector and ground.

Terminals		Voltage (Approx.)
(+)	(-)	
BCM		Ground Battery voltage
Connector	Terminal	
M118	1	
M119	11	

Is the measurement value normal?

- YES >> GO TO 3.
NO >> Repair harness or connector.

3.CHECK GROUND CIRCUIT

Check continuity between BCM harness connector and ground.

BCM		Ground	Continuity
Connector	Terminal		
M119	13		Existed

Does continuity exist?

- YES >> INSPECTION END
NO >> Repair harness or connector.

A
B
C
D
E
F
G
H
I
J
K
L
N
O
P

BCS

COMBINATION SWITCH INPUT CIRCUIT

< DTC/CIRCUIT DIAGNOSIS >

COMBINATION SWITCH INPUT CIRCUIT

Diagnosis Procedure

INFOID:000000009065486

1. CHECK INPUT 1 - 5 SYSTEM CIRCUIT FOR OPEN

1. Turn the ignition switch OFF.
2. Disconnect the BCM and combination switch connectors.
3. Check continuity between BCM harness connector and combination switch harness connector.

System	BCM		Combination switch		Continuity
	Connector	Terminal	Connector	Terminal	
INPUT 1	M122	107	M33	11	Existed
INPUT 2		109		9	
INPUT 3		88		7	
INPUT 4		108		10	
INPUT 5		87		13	

Does continuity exist?

YES >> GO TO 2.

NO >> Repair the harnesses or connectors.

2. CHECK INPUT 1 - 5 SYSTEM CIRCUIT FOR SHORT

Check for continuity between BCM harness connector and ground.

System	BCM		Ground	Continuity
	Connector	Terminal		
INPUT 1	M122	107	Ground	Not existed
INPUT 2		109		
INPUT 3		88		
INPUT 4		108		
INPUT 5		87		

Does continuity exist?

YES >> Repair the harnesses or connectors.

NO >> GO TO 3.

3. CHECK BCM OUTPUT VOLTAGE

1. Connect the BCM connector.
2. Check voltage between BCM harness connector and ground.

System	Terminals		Voltage (Approx.)
	(+)	(-)	
	BCM		
	Connector	Terminal	
INPUT 1	M122	107	Ground
INPUT 2		109	
INPUT 3		88	
INPUT 4		108	
INPUT 5		87	

Is the measurement value normal?

YES >> GO TO 4.

NO >> Replace BCM. Refer to [BCS-96. "Exploded View"](#).

COMBINATION SWITCH INPUT CIRCUIT

< DTC/CIRCUIT DIAGNOSIS >

4. CHECK BCM INPUT SIGNAL

1. Connect the combination switch connector.
2. Turn ON any switch in the system that is malfunctioning.
3. Check voltage between BCM harness connector and ground.

System	Terminals		Voltage (Approx.)
	(+)	(-)	
	BCM		
	Connector	Terminal	
INPUT 1	M122	107	Ground Refer to BCS-50 . "Reference Value".
INPUT 2		109	
INPUT 3		88	
INPUT 4		108	
INPUT 5		87	

Is the measurement value normal when any of the switches is turned ON?

- YES >> Replace BCM. Refer to [BCS-96](#). "Exploded View".
NO >> Replace the combination switch.

A
B
C
D
E
F
G
H
I
J
K
L
N
O
P

BCS

COMBINATION SWITCH OUTPUT CIRCUIT

< DTC/CIRCUIT DIAGNOSIS >

COMBINATION SWITCH OUTPUT CIRCUIT

Diagnosis Procedure

INFOID:000000009065487

1. CHECK OUTPUT 1 - 5 SYSTEM CIRCUIT FOR OPEN

1. Turn the ignition switch OFF.
2. Disconnect the BCM and combination switch connectors.

NOTE:

BCM connector disconnects M123 only.

3. Check continuity between BCM harness connector and combination switch harness connector.

System	BCM		Combination switch		Continuity
	Connector	Terminal	Connector	Terminal	
OUTPUT 1	M123	143	M33	12	Existed
OUTPUT 2		144		14	
OUTPUT 3		145		5	
OUTPUT 4		146		2	
OUTPUT 5		142		8	

Does continuity exist?

YES >> GO TO 2.

NO >> Repair the harnesses or connectors.

2. CHECK OUTPUT 1 - 5 SYSTEM CIRCUIT FOR SHORT

Check for continuity between BCM harness connector and ground.

System	BCM		Ground	Continuity
	Connector	Terminal		
OUTPUT 1	M123	143	Ground	Not existed
OUTPUT 2		144		
OUTPUT 3		145		
OUTPUT 4		146		
OUTPUT 5		142		

Does continuity exist?

YES >> Repair the harnesses or connectors.

NO >> GO TO 3.

3. CHECK COMBINATION SWITCH INTERNAL CIRCUIT

1. Connect the combination switch connector.
2. Turn ON any switch in the system that is malfunctioning.
3. Check voltage between combination switch harness connector and ground.

NOTE:

Check that the combination switch outputs a signal from combination switch input system.

COMBINATION SWITCH OUTPUT CIRCUIT

< DTC/CIRCUIT DIAGNOSIS >

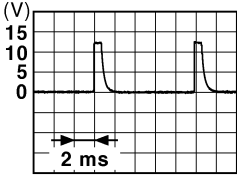
System	Terminals		Value (Approx.)
	(+)	(-)	
	Combination switch		
	Connector	Terminal	
OUTPUT 1	M33	12	 1.4 V
OUTPUT 2		14	
OUTPUT 3		5	
OUTPUT 4		2	
OUTPUT 5		8	
		Ground	

Is the measurement value normal when any of the switches is turned ON?

- YES >> Replace BCM. Refer to [BCS-96, "Exploded View"](#).
- NO >> Replace the combination switch.

A
B
C
D
E
F
G
H
I
J
K
L
N
O
P

BCS

BCM (BODY CONTROL MODULE)

< ECU DIAGNOSIS INFORMATION >

ECU DIAGNOSIS INFORMATION

BCM (BODY CONTROL MODULE)

Reference Value

INFOID:000000009065488

VALUES ON THE DIAGNOSIS TOOL

NOTE:

The following table includes information (items) inapplicable to this vehicle. For information (items) applicable to this vehicle, refer to CONSULT display items.

CONSULT MONITOR ITEM

Monitor Item	Condition	Value/Status
FR WIPER HI	Other than front wiper switch HI	Off
	Front wiper switch HI	On
FR WIPER LOW	Other than front wiper switch LO	Off
	Front wiper switch LO	On
FR WASHER SW	Front washer switch OFF	Off
	Front washer switch ON	On
FR WIPER INT	Other than front wiper switch INT	Off
	Front wiper switch INT	On
FR WIPER STOP	Front wiper is not in STOP position	Off
	Front wiper is in STOP position	On
INT VOLUME	Wiper intermittent dial is in a dial position 1 - 7	Wiper intermittent dial position
RR WIPER ON	Other than rear wiper switch ON	Off
	Rear wiper switch ON	On
RR WIPER INT	Other than rear wiper switch INT	Off
	Rear wiper switch INT	On
RR WASHER SW	Rear washer switch OFF	Off
	Rear washer switch ON	On
RR WIPER STOP	Rear wiper is in STOP position	Off
	Rear wiper is not in STOP position	On
TURN SIGNAL R	Other than turn signal switch RH	Off
	Turn signal switch RH	On
TURN SIGNAL L	Other than turn signal switch LH	Off
	Turn signal switch LH	On
TAIL LAMP SW	Other than lighting switch 1ST and 2ND	Off
	Lighting switch 1ST or 2ND	On
HI BEAM SW	Other than lighting switch HI	Off
	Lighting switch HI	On
HEAD LAMP SW 1	Other than lighting switch 2ND	Off
	Lighting switch 2ND	On
HEAD LAMP SW 2	Other than lighting switch 2ND	Off
	Lighting switch 2ND	On
PASSING SW	Other than lighting switch PASS	Off
	Lighting switch PASS	On
AUTO LIGHT SW	Other than lighting switch AUTO	Off
	Lighting switch AUTO	On

BCM (BODY CONTROL MODULE)

< ECU DIAGNOSIS INFORMATION >

Monitor Item	Condition	Value/Status	
FR FOG SW	Front fog lamp switch OFF	Off	A
	Front fog lamp switch ON	On	
RR FOG SW	NOTE: The item is indicated, but not monitored.	Off	B
DOOR SW-DR	Driver door closed	Off	C
	Driver door opened	On	
DOOR SW-AS	Passenger door closed	Off	D
	Passenger door opened	On	
DOOR SW-RR	Rear RH door closed	Off	E
	Rear RH door opened	On	
DOOR SW-RL	Rear LH door closed	Off	F
	Rear LH door opened	On	
DOOR SW-BK	Back door closed	Off	G
	Back door opened	On	
CDL LOCK SW	Other than power door lock switch LOCK	Off	H
	Power door lock switch LOCK	On	
CDL UNLOCK SW	Other than power door lock switch UNLOCK	Off	I
	Power door lock switch UNLOCK	On	
KEY CYL LK-SW	Other than driver door key cylinder LOCK position	Off	J
	Driver door key cylinder LOCK position	On	
KEY CYL UN-SW	Other than driver door key cylinder UNLOCK position	Off	K
	Driver door key cylinder UNLOCK position	On	
KEY CYL SW-TR	NOTE: The item is indicated, but not monitored.	Off	L
HAZARD SW	Hazard switch is OFF	Off	L
	Hazard switch is ON	On	
REAR DEF SW	NOTE: The item is indicated, but not monitored.	Off	
TR CANCEL SW	NOTE: The item is indicated, but not monitored.	Off	
TR/BD OPEN SW	Back door opener switch OFF	Off	BCS
	While the back door opener switch is turned ON	On	
TRNK/HAT MNTR	NOTE: The item is indicated, but not monitored.	Off	
REVERSE SW	NOTE: The item is indicated, but not monitored.	Off	N
RKE-LOCK	LOCK button of the key is not pressed	Off	O
	LOCK button of the key is pressed	On	
RKE-UNLOCK	UNLOCK button of the key is not pressed	Off	P
	UNLOCK button of the key is pressed	On	
RKE-TR/BD	NOTE: The item is indicated, but not monitored.	Off	
RKE-PANIC	PANIC button of the key is not pressed	Off	
	PANIC button of the key is pressed	On	
RKE-P/W OPEN	UNLOCK button of the key is not pressed	Off	
	UNLOCK button of the key is pressed and held	On	

BCM (BODY CONTROL MODULE)

< ECU DIAGNOSIS INFORMATION >

Monitor Item	Condition	Value/Status
RKE-MODE CHG	LOCK/UNLOCK button of the key is not pressed and held simultaneously	Off
	LOCK/UNLOCK button of the key is pressed and held simultaneously	On
OPTICAL SENSOR	Bright outside of the vehicle	Close to 5 V
	Dark outside of the vehicle	Close to 0 V
REQ SW -DR	Driver door request switch is not pressed	Off
	Driver door request switch is pressed	On
REQ SW -AS	Passenger door request switch is not pressed	Off
	Passenger door request switch is pressed	On
REQ SW -RR	NOTE: The item is indicated, but not monitored.	Off
REQ SW -RL	NOTE: The item is indicated, but not monitored.	Off
REQ SW -BD/TR	Back door request switch is not pressed	Off
	Back door request switch is pressed	On
PUSH SW	Push-button ignition switch (push switch) is not pressed	Off
	Push-button ignition switch (push switch) is pressed	On
IGN RLY2 -F/B	NOTE: The item is indicated, but not monitored.	Off
ACC RLY -F/B	NOTE: The item is indicated, but not monitored.	Off
CLUCH SW	NOTE: The item is indicated, but not monitored.	Off
BRAKE SW 1	The brake pedal is depressed when No. 7 fuse is blown	Off
	The brake pedal is not depressed when No. 7 fuse is blown, or No. 7 fuse is normal	On
BRAKE SW 2	The brake pedal is not depressed	Off
	The brake pedal is depressed	On
DETE/CANCL SW	Selector lever in P position	Off
	Selector lever in any position other than P	On
SFT PN/N SW	Selector lever in any position other than P and N	Off
	Selector lever in P or N position	On
S/L -LOCK	NOTE: The item is indicated, but not monitored.	Off
S/L -UNLOCK	NOTE: The item is indicated, but not monitored.	Off
S/L RELAY-F/B	NOTE: The item is indicated, but not monitored.	Off
UNLK SEN -DR	Driver door is unlocked	Off
	Driver door is locked	On
PUSH SW -IPDM	Push-button ignition switch (push-switch) is not pressed	Off
	Push-button ignition switch (push-switch) is pressed	On
IGN RLY1 -F/B	Ignition switch in OFF or ACC position	Off
	Ignition switch in ON position	On
DETE SW -IPDM	Selector lever in any position other than P	Off
	Selector lever in P position	On
SFT PN -IPDM	Selector lever in any position other than P and N	Off
	Selector lever in P or N position	On

BCM (BODY CONTROL MODULE)

< ECU DIAGNOSIS INFORMATION >

Monitor Item	Condition	Value/Status	
SFT P -MET	Selector lever in any position other than P	Off	A
	Selector lever in P position	On	
SFT N -MET	Selector lever in any position other than N	Off	B
	Selector lever in N position	On	
ENGINE STATE	Engine stopped	Stop	
	While the engine stalls	Stall	C
	At engine cranking	Crank	
	Engine running	Run	D
S/L LOCK-IPDM	NOTE: The item is indicated, but not monitored.	Off	
S/L UNLK-IPDM	NOTE: The item is indicated, but not monitored.	Off	E
S/L RELAY-REQ	NOTE: The item is indicated, but not monitored.	Off	
VEH SPEED 1	While driving	Equivalent to speedometer reading	F
VEH SPEED 2	While driving	Equivalent to speedometer reading	G
DOOR STAT-DR	Driver door is locked	LOCK	
	Wait with selective UNLOCK operation (5 seconds)	READY	H
	Driver door is unlocked	UNLOCK	
DOOR STAT-AS	Passenger door is locked	LOCK	
	Wait with selective UNLOCK operation (5 seconds)	READY	I
	Passenger door is unlocked	UNLOCK	
ID OK FLAG	Driver side door is open after ignition switch is turned OFF (Shift position is in the P position)	Reset	J
	Ignition switch ON	Set	
PRMT ENG STRT	The engine start is prohibited	Reset	K
	The engine start is permitted	Set	
PRMT RKE STRT	NOTE: The item is indicated, but not monitored.	Reset	L
KEY SW -SLOT	The key is not inserted into key slot	Off	
	The key is inserted into key slot	On	
RKE OPE COUN1	During the operation of the key	Operation frequency of the key	BCS
RKE OPE COUN2	NOTE: The item is indicated, but not monitored.	—	N
CONFIRM ID ALL	The key ID that the key slot receives does not accord with any key ID registered to BCM.	Yet	
	The key ID that the key slot receives accords with any key ID registered to BCM.	Done	O
CONFIRM ID4	The key ID that the key slot receives does not accord with the fourth key ID registered to BCM.	Yet	P
	The key ID that the key slot receives accords with the fourth key ID registered to BCM.	Done	
CONFIRM ID3	The key ID that the key slot receives does not accord with the third key ID registered to BCM.	Yet	
	The key ID that the key slot receives accords with the third key ID registered to BCM.	Done	

BCM (BODY CONTROL MODULE)

< ECU DIAGNOSIS INFORMATION >

Monitor Item	Condition	Value/Status
CONFIRM ID2	The key ID that the key slot receives does not accord with the second key ID registered to BCM.	Yet
	The key ID that the key slot receives accords with the second key ID registered to BCM.	Done
CONFIRM ID1	The key ID that the key slot receives does not accord with the first key ID registered to BCM.	Yet
	The key ID that the key slot receives accords with the first key ID registered to BCM.	Done
TP 4	The ID of fourth key is not registered to BCM	Yet
	The ID of fourth key is registered to BCM	Done
TP 3	The ID of third key is not registered to BCM	Yet
	The ID of third key is registered to BCM	Done
TP 2	The ID of second key is not registered to BCM	Yet
	The ID of second key is registered to BCM	Done
TP 1	The ID of first key is not registered to BCM	Yet
	The ID of first key is registered to BCM	Done
AIR PRESS FL	Ignition switch ON (Only when the signal from the transmitter is received)	Air pressure of front LH tire
AIR PRESS FR	Ignition switch ON (Only when the signal from the transmitter is received)	Air pressure of front RH tire
AIR PRESS RR	Ignition switch ON (Only when the signal from the transmitter is received)	Air pressure of rear RH tire
AIR PRESS RL	Ignition switch ON (Only when the signal from the transmitter is received)	Air pressure of rear LH tire
ID REGST FL1	ID of front LH tire transmitter is registered	Done
	ID of front LH tire transmitter is not registered	Yet
ID REGST FR1	ID of front RH tire transmitter is registered	Done
	ID of front RH tire transmitter is not registered	Yet
ID REGST RR1	ID of rear RH tire transmitter is registered	Done
	ID of rear RH tire transmitter is not registered	Yet
ID REGST RL1	ID of rear LH tire transmitter is registered	Done
	ID of rear LH tire transmitter is not registered	Yet
WARNING LAMP	Tire pressure indicator OFF	Off
	Tire pressure indicator ON	On
BUZZER	Tire pressure warning alarm is not sounding	Off
	Tire pressure warning alarm is sounding	On

BCM (BODY CONTROL MODULE)

< ECU DIAGNOSIS INFORMATION >

TERMINAL LAYOUT

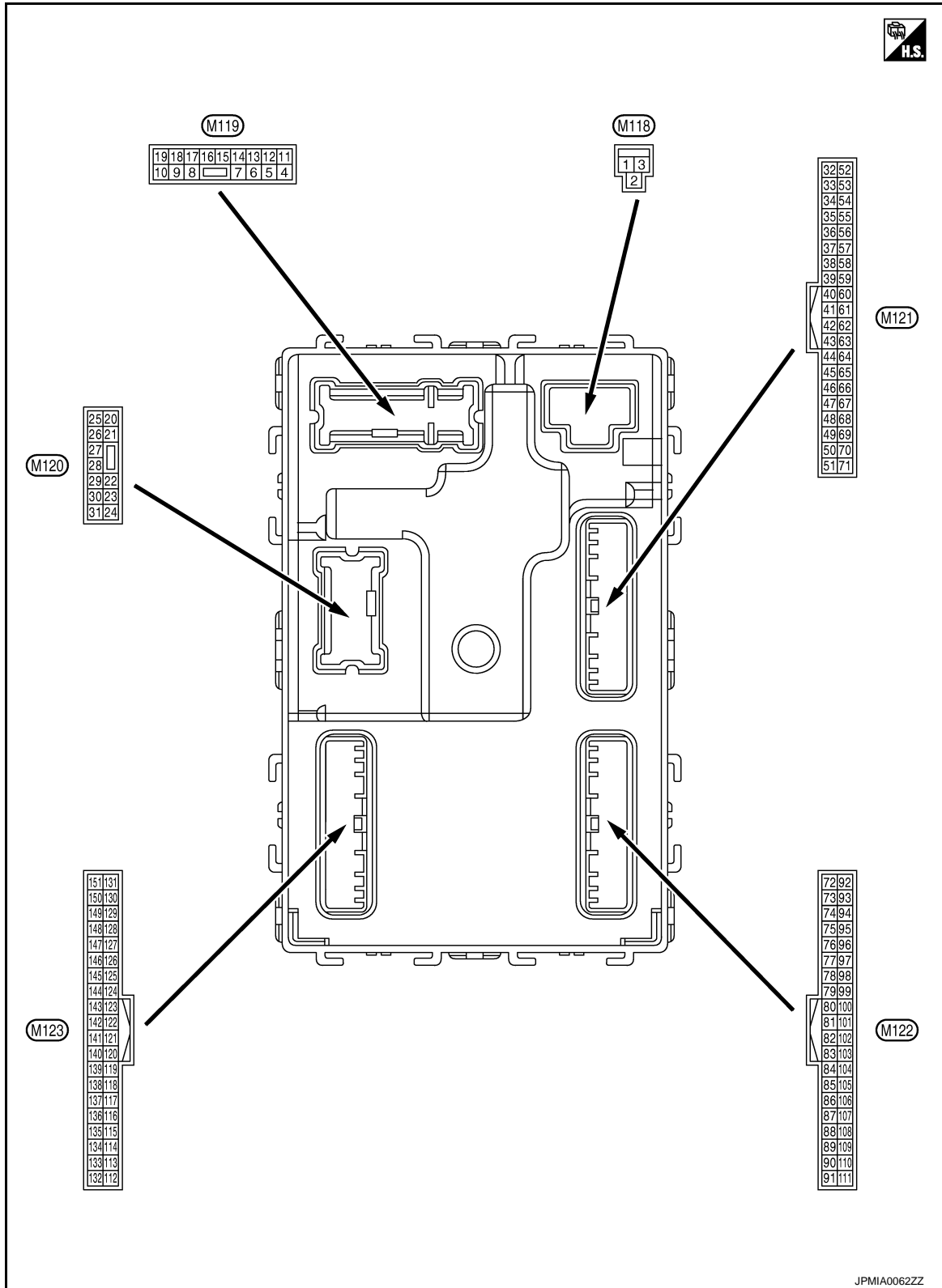

PHYSICAL VALUES

A
B
C
D
E
F
G
H
I
J
K
L
M
N
O
P

BCS

BCM (BODY CONTROL MODULE)

< ECU DIAGNOSIS INFORMATION >

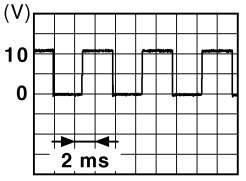
Terminal No. (Wire color)		Description		Condition		Value (Approx.)
		Signal name	Input/ Output			
+	-					
1 (W)	Ground	Battery power supply	Input	Ignition switch OFF		Battery voltage
2 (W)	Ground	P/W power supply (BAT)	Output	Ignition switch OFF		Battery voltage
3 (Y)	Ground	P/W power supply (RAP)	Output	Ignition switch ON		Battery voltage
4 (LG)	Ground	Interior room lamp power supply	Output	Interior room lamp battery saver is activated. (Cuts the interior room lamp power supply)		0 V
				Interior room lamp battery saver is not activated. (Outputs the interior room lamp power supply)		Battery voltage
5 (L)	Ground	Passenger door UN- LOCK	Output	Passenger door	UNLOCK (Actuator is activated)	Battery voltage
					Other than UNLOCK (Actuator is not activated)	0 V
7 (Y)	Ground	Step lamp	Output	Step lamp	ON	0 V
					OFF	Battery voltage
8 (V)	Ground	All doors, fuel lid LOCK	Output	All doors	LOCK (Actuator is activated)	Battery voltage
					Other than LOCK (Actuator is not activated)	0 V
9 (G)	Ground	Driver door, fuel lid UNLOCK	Output	Driver door	UNLOCK (Actuator is activated)	Battery voltage
					Other than UNLOCK (Actuator is not activated)	0 V
10 (BR)	Ground	Rear RH door and rear LH door UN- LOCK	Output	Rear RH door and rear LH door	UNLOCK (Actuator is activated)	Battery voltage
					Other than UNLOCK (Actuator is not activated)	0 V
11 (R)	Ground	Battery power supply	Input	Ignition switch OFF		Battery voltage
13 (B)	Ground	Ground	—	Ignition switch ON		0 V
14 (W)	Ground	Push-button ignition switch illumination ground	Output	Tail lamp	OFF	0 V
					ON	<p>NOTE: When the illumination brightening/dimming level is in the neutral position</p>  <p style="text-align: right; font-size: small;">JSNIA0010GB</p>
15 (Y)	Ground	ACC indicator lamp	Output	Ignition switch	OFF or ON	Battery voltage
					ACC	0 V

BCM (BODY CONTROL MODULE)

< ECU DIAGNOSIS INFORMATION >

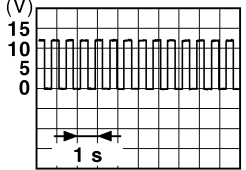
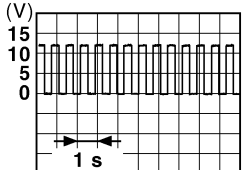
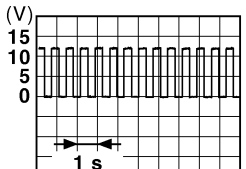
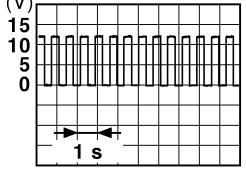
Terminal No. (Wire color)		Description		Condition	Value (Approx.)
+	-	Signal name	Input/ Output		
17 (W)	Ground	Turn signal RH (Front)	Output	Ignition switch ON	Turn signal switch OFF 0 V
				Turn signal switch RH	 <small>PKID0926E</small> 6.5 V
18 (BG)	Ground	Turn signal LH (Front)	Output	Ignition switch ON	Turn signal switch OFF 0 V
				Turn signal switch LH	 <small>PKID0926E</small> 6.5 V
19 (V)	Ground	Room lamp timer control	Output	Interior room lamp	OFF Battery voltage
				ON	0 V
20 (V)	Ground	Turn signal RH (Rear)	Output	Ignition switch ON	Turn signal switch OFF 0 V
				Turn signal switch RH	 <small>PKID0926E</small> 6.5 V
23 (G)	Ground	Back door open	Output	Back door	OPEN (Back door opener actuator is activated) Battery voltage
				Other than OPEN (Back door opener actuator is not activated)	0 V
25 (G)	Ground	Turn signal LH (Rear)	Output	Ignition switch ON	Turn signal switch OFF 0 V
				Turn signal switch LH	 <small>PKID0926E</small> 6.5 V
26 (G)	Ground	Rear wiper	Output	Rear wiper	OFF (Stopped) 0 V
				ON (Operated)	Battery voltage

A
B
C
D
E
F
G
H
I
J
K
L
N
O
P

BCS

BCM (BODY CONTROL MODULE)

< ECU DIAGNOSIS INFORMATION >

Terminal No. (Wire color)		Description		Condition	Value (Approx.)
+	-	Signal name	Input/ Output		
34 (SB)	Ground	Luggage room antenna (-)	Output	Ignition switch OFF	<p style="text-align: right; font-size: small;">JMKIA0062GB</p>
				When Intelligent Key is not in the passenger compartment	<p style="text-align: right; font-size: small;">JMKIA0063GB</p>
35 (V)	Ground	Luggage room antenna (+)	Output	Ignition switch OFF	<p style="text-align: right; font-size: small;">JMKIA0062GB</p>
				When Intelligent Key is not in the passenger compartment	<p style="text-align: right; font-size: small;">JMKIA0063GB</p>
38 (B)	Ground	Back door antenna (-)	Output	When the back door opener request switch is operated with ignition switch OFF	<p style="text-align: right; font-size: small;">JMKIA0062GB</p>
				When Intelligent Key is not in the antenna detection area	<p style="text-align: right; font-size: small;">JMKIA0063GB</p>

BCM (BODY CONTROL MODULE)

< ECU DIAGNOSIS INFORMATION >

Terminal No. (Wire color)		Description		Condition	Value (Approx.)
+	-	Signal name	Input/ Output		
39 (W)	Ground	Back door antenna (+)	Output	When Intelligent Key is in the antenna detection area	<p style="text-align: right; font-size: small;">JMKIA0062GB</p>
				When Intelligent Key is not in the antenna detection area	<p style="text-align: right; font-size: small;">JMKIA0063GB</p>
47 (Y)	Ground	Ignition relay (IPDM E/R) control	Output	Ignition switch	OFF or ACC Battery voltage
				ON	0 V
52 (SB)	Ground	Starter relay control	Output	Ignition switch ON	When selector lever is in P or N position Battery voltage
				When selector lever is not in P or N position	0 V
60 (BR)	Ground	Push-button ignition switch (Push switch)	Input	Push-button igni- tion switch (push switch)	Pressed 0 V
				Not pressed	Battery voltage
61 (W)	Ground	Back door opener re- quest switch	Input	Back door opener request switch	ON (Pressed) 0 V
				OFF (Not pressed)	<p style="text-align: right; font-size: small;">JPMIA0016GB</p>
64 (V)	Ground	Intelligent Key warn- ing buzzer (Engine room)	Output	Intelligent Key warning buzzer (Engine room)	Sounding 0 V
				Not sounding	Battery voltage
65 (BG)	Ground	Rear wiper stop posi- tion	Input	Rear wiper	In stop position
				Not in stop position	<p style="text-align: right; font-size: small;">JPMIA0016GB</p>
					1.0 V
					0 V

A
B
C
D
E
F
G
H
I
J
K
L
N
O
P

BCS

BCM (BODY CONTROL MODULE)

< ECU DIAGNOSIS INFORMATION >

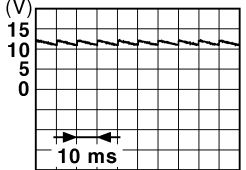
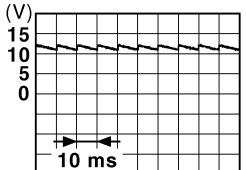
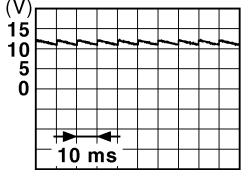
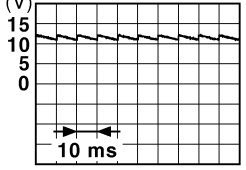
Terminal No. (Wire color)		Description		Condition	Value (Approx.)	
+	-	Signal name	Input/ Output			
66 (R)	Ground	Back door switch	Input	Back door switch	OFF (Door close)	 <small>JPMIA0011GB</small> 11.8 V
					ON (Door open)	0 V
67 (GR)	Ground	Back door opener switch	Input	Back door opener switch	Pressed	0 V
					Not pressed	 <small>JPMIA0011GB</small> 11.8 V
68 (BR)	Ground	Rear RH door switch	Input	Rear RH door switch	OFF (Door close)	 <small>JPMIA0011GB</small> 11.8 V
					ON (Door open)	0 V
69 (R)	Ground	Rear LH door switch	Input	Rear LH door switch	OFF (Door close)	 <small>JPMIA0011GB</small> 11.8 V
					ON (Door open)	0 V

BCM (BODY CONTROL MODULE)

< ECU DIAGNOSIS INFORMATION >

Terminal No. (Wire color)		Description		Condition	Value (Approx.)
+	-	Signal name	Input/ Output		
74 (SB)	Ground	Passenger door antenna (-)	Output	When Intelligent Key is in the antenna detection area	
				When the passenger door request switch is operated with ignition switch OFF	
75 (GR)	Ground	Passenger door antenna (+)	Output	When Intelligent Key is in the antenna detection area	
				When the passenger door request switch is operated with ignition switch OFF	
76 (V)	Ground	Driver door antenna (-)	Output	When Intelligent Key is in the antenna detection area	
				When the driver door request switch is operated with ignition switch OFF	

A
B
C
D
E
F
G
H
I
J
K
L

BCS

N
O
P

BCM (BODY CONTROL MODULE)

< ECU DIAGNOSIS INFORMATION >

Terminal No. (Wire color)		Description		Condition	Value (Approx.)
+	-	Signal name	Input/ Output		
77 (LG)	Ground	Driver door antenna (+)	Output	When the driver door request switch is operated with ignition switch OFF	<p style="text-align: right; font-size: small;">JMKIA0062GB</p>
				When Intelligent Key is not in the antenna detection area	<p style="text-align: right; font-size: small;">JMKIA0063GB</p>
78 (Y)	Ground	Room antenna 1 (-) (Instrument panel)	Output	Ignition switch OFF	<p style="text-align: right; font-size: small;">JMKIA0062GB</p>
				When Intelligent Key is not in the passenger compartment	<p style="text-align: right; font-size: small;">JMKIA0063GB</p>
79 (BR)	Ground	Room antenna 1 (+) (Instrument panel)	Output	Ignition switch OFF	<p style="text-align: right; font-size: small;">JMKIA0062GB</p>
				When Intelligent Key is not in the passenger compartment	<p style="text-align: right; font-size: small;">JMKIA0063GB</p>

BCM (BODY CONTROL MODULE)

< ECU DIAGNOSIS INFORMATION >

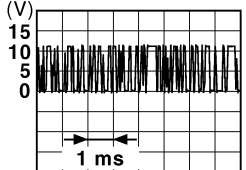
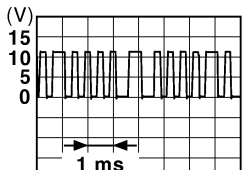

Terminal No. (Wire color)		Description		Condition		Value (Approx.)
		Signal name	Input/ Output			
+	-					
80 (GR)	Ground	NATS antenna amp.	Input/ Output	During waiting	Ignition switch is pressed while inserting the key into the key slot.	Just after pressing ignition switch. Pointer of tester should move.
81 (W)	Ground	NATS antenna amp.	Input/ Output	During waiting	Ignition switch is pressed while inserting the key into the key slot.	Just after pressing ignition switch. Pointer of tester should move.
82 (R)	Ground	Ignition relay [Fuse block (J/B)] control	Output	Ignition switch	OFF or ACC	0 V
					ON	Battery voltage
83 (Y)	Ground	Remote keyless entry receiver communication	Input/ Output	During waiting		 <p style="text-align: right; font-size: small;">JMKIA0064GB</p>
				When operating either button on the key		 <p style="text-align: right; font-size: small;">JMKIA0065GB</p>

A
B
C
D
E
F
G
H
I
J
K
L
N
O
P

BCS

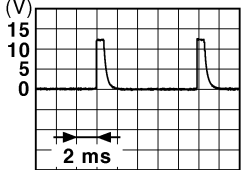

BCM (BODY CONTROL MODULE)

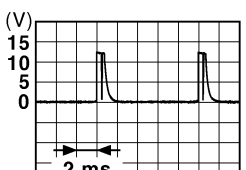
< ECU DIAGNOSIS INFORMATION >

Terminal No. (Wire color)		Description		Condition	Value (Approx.)	
		Signal name	Input/ Output			
+	-					
87 (BR)	Ground	Combination switch INPUT 5	Input	Combination switch	All switches OFF (Wiper intermittent dial 4)	 <small>JPMIA0041GB</small> 1.4 V
				Combination switch	Front fog lamp switch ON (Wiper intermittent dial 4)	 <small>JPMIA0037GB</small> 1.3 V
				Combination switch	Rear wiper switch ON (Wiper intermittent dial 4)	 <small>JPMIA0039GB</small> 1.3 V
				Combination switch	Any of the conditions below with all switches OFF	<ul style="list-style-type: none"> • Wiper intermittent dial 1 • Wiper intermittent dial 2 • Wiper intermittent dial 6 • Wiper intermittent dial 7

BCM (BODY CONTROL MODULE)

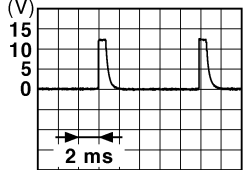
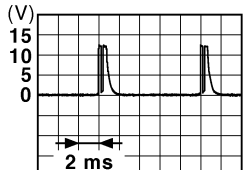
< ECU DIAGNOSIS INFORMATION >

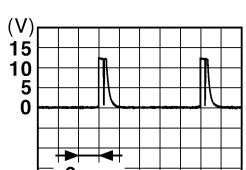
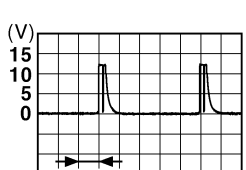
Terminal No. (Wire color)		Description		Condition	Value (Approx.)	
+	-	Signal name	Input/ Output			
88 (V)	Ground	Combination switch INPUT 3	Input	Combination switch	All switches OFF (Wiper intermittent dial 4)	 <p style="text-align: right;">1.4 V</p>
					Lighting switch HI (Wiper intermittent dial 4)	 <p style="text-align: right;">1.3 V</p>
					Lighting switch 2ND (Wiper intermittent dial 4)	 <p style="text-align: right;">1.3 V</p>
					Rear washer switch ON (Wiper intermittent dial 4)	 <p style="text-align: right;">1.3 V</p>
					Any of the conditions below with all switches OFF	 <p style="text-align: right;">1.3 V</p>
					<ul style="list-style-type: none"> • Wiper intermittent dial 1 • Wiper intermittent dial 2 • Wiper intermittent dial 3 	
90 (P)	Ground	CAN-L	Input/ Output	—	—	
91 (L)	Ground	CAN-H	Input/ Output	—	—	

A
B
C
D
E
F
G
H
I
J
K
L
N
O
P

BCS

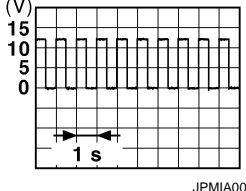
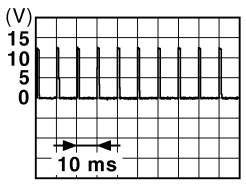
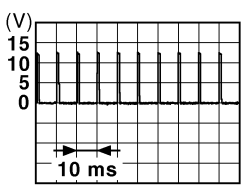

BCM (BODY CONTROL MODULE)

< ECU DIAGNOSIS INFORMATION >

Terminal No. (Wire color)		Description		Condition		Value (Approx.)
+	-	Signal name	Input/ Output			
92 (LG)	Ground	Key slot illumination	Output	Key slot illumination	OFF	Battery voltage
					Blinking	 <p style="text-align: center;">6.5 V</p>
93 (V)	Ground	ON indicator lamp	Output	Ignition switch	OFF or ACC	Battery voltage
					ON	0 V
94 (Y)	Ground	Puddle lamp control	Output	Puddle lamp	OFF	Battery voltage
					ON	0 V
95 (BG)	Ground	ACC relay control	Output	Ignition switch	OFF	0 V
					ACC or ON	Battery voltage
96 (GR)	Ground	A/T shift selector (Detention switch) power supply	Output	—		Battery voltage
99 (R)	Ground	Selector lever P position switch	Input	Selector lever	P position	0 V
					Any position other than P	Battery voltage
100 (G)	Ground	Passenger door request switch	Input	Passenger door request switch	ON (Pressed)	0 V
					OFF (Not pressed)	 <p style="text-align: center;">1.0 V</p>
101 (SB)	Ground	Driver door request switch	Input	Driver door request switch	ON (Pressed)	0 V
					OFF (Not pressed)	 <p style="text-align: center;">1.0 V</p>
102 (BG)	Ground	Blower fan motor relay control	Output	Ignition switch	OFF or ACC	0 V
					ON	Battery voltage
103 (LG)	Ground	Remote keyless entry receiver power supply	Output	Ignition switch OFF		Battery voltage

BCM (BODY CONTROL MODULE)

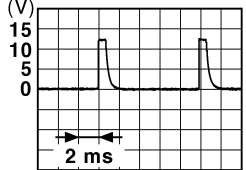
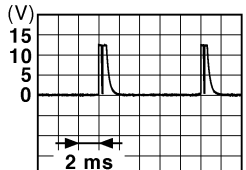
< ECU DIAGNOSIS INFORMATION >

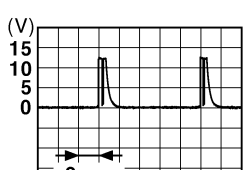
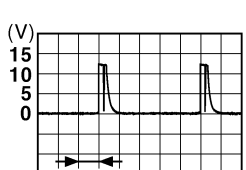
Terminal No. (Wire color)		Description		Condition	Value (Approx.)	
		Signal name	Input/ Output			
+	-					
107 (LG)	Ground	Combination switch INPUT 1	Input	Combination switch (Wiper intermittent dial 4)	All switches OFF	 <p style="text-align: right;">1.4 V</p>
					Turn signal switch LH	 <p style="text-align: right;">1.3 V</p>
					Turn signal switch RH	 <p style="text-align: right;">1.3 V</p>
					Front wiper switch LO	 <p style="text-align: right;">1.3 V</p>
					Front washer switch ON	 <p style="text-align: right;">1.3 V</p>

A
B
C
D
E
F
G
H
I
J
K
L
N
O
P

BCS

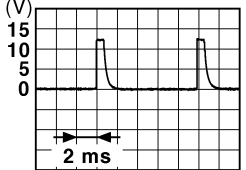
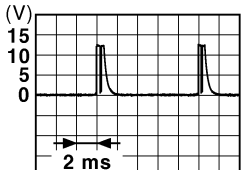
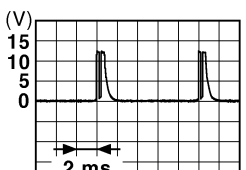
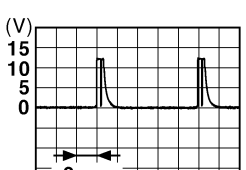
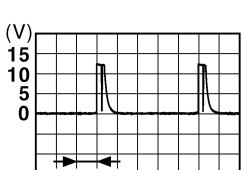

BCM (BODY CONTROL MODULE)

< ECU DIAGNOSIS INFORMATION >

Terminal No. (Wire color)		Description		Condition	Value (Approx.)	
		Signal name	Input/ Output			
+	-					
108 (R)	Ground	Combination switch INPUT 4	Input	Combination switch	All switches OFF (Wiper intermittent dial 4)	 <p style="text-align: right; font-size: small;">JPMIA0041GB</p> <p style="text-align: center;">1.4 V</p>
					Lighting switch AUTO (Wiper intermittent dial 4)	 <p style="text-align: right; font-size: small;">JPMIA0038GB</p> <p style="text-align: center;">1.3 V</p>
					Lighting switch 1ST (Wiper intermittent dial 4)	 <p style="text-align: right; font-size: small;">JPMIA0036GB</p> <p style="text-align: center;">1.3 V</p>
					Rear wiper switch INT (Wiper intermittent dial 4)	 <p style="text-align: right; font-size: small;">JPMIA0040GB</p> <p style="text-align: center;">1.3 V</p>
					Any of the conditions below with all switches OFF	 <p style="text-align: right; font-size: small;">JPMIA0039GB</p> <p style="text-align: center;">1.3 V</p>
				<ul style="list-style-type: none"> • Wiper intermittent dial 1 • Wiper intermittent dial 5 • Wiper intermittent dial 6 		

BCM (BODY CONTROL MODULE)

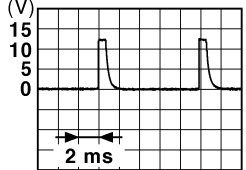
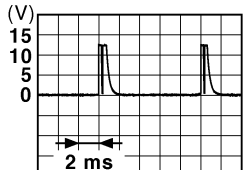
< ECU DIAGNOSIS INFORMATION >

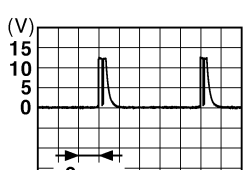
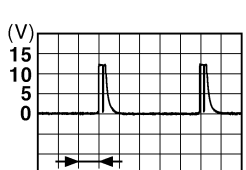
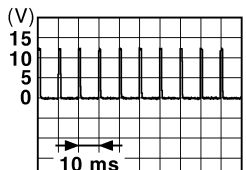
Terminal No. (Wire color)		Description		Condition	Value (Approx.)		
		Signal name	Input/ Output				
+	-						
109 (Y)	Ground	Combination switch INPUT 2	Input	Combination switch (Wiper intermit- tent dial 4)	All switches OFF	 <p style="text-align: right;">1.4 V</p>	A
					Lighting switch PASS	 <p style="text-align: right;">1.3 V</p>	B
					Lighting switch 2ND	 <p style="text-align: right;">1.3 V</p>	C
					Front wiper switch INT	 <p style="text-align: right;">1.3 V</p>	D
					Front wiper switch HI	 <p style="text-align: right;">1.3 V</p>	E
					ON	0 V	
110 (G)	Ground	Hazard switch	Input	Hazard switch	OFF	 <p style="text-align: right;">1.1 V</p>	F

BCS

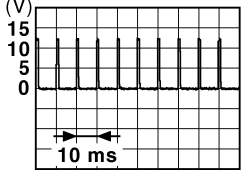
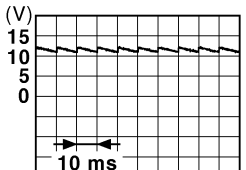
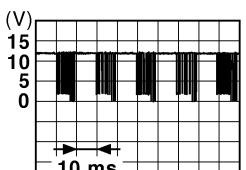

BCM (BODY CONTROL MODULE)

< ECU DIAGNOSIS INFORMATION >

Terminal No. (Wire color)		Description		Condition		Value (Approx.)
		Signal name	Input/ Output			
+	-					
113 (P)	Ground	Optical sensor	Input	Ignition switch ON	When bright outside of the vehicle	Close to 5 V
					When dark outside of the vehicle	Close to 0 V
116 (SB)	Ground	Stop lamp switch 1	Input	—		Battery voltage
118 (P)	Ground	Stop lamp switch 2 (Without ICC)	Input	Stop lamp switch	OFF (Brake pedal is not depressed)	0 V
					ON (Brake pedal is de- pressed)	Battery voltage
		Stop lamp switch 2 (With ICC)		Stop lamp switch OFF (Brake pedal is not de- pressed) and ICC brake hold relay OFF	0 V	
				Stop lamp switch ON (Brake pedal is de- pressed) or ICC brake hold relay ON	Battery voltage	
119 (SB)	Ground	Front door lock as- sembly driver side (Unlock sensor)	Input	Driver door	LOCK status (Unlock sensor switch OFF)	 1.1 V
					UNLOCK status (Unlock switch sensor ON)	0 V
121 (BR)	Ground	Key slot switch	Input	When the key is inserted into key slot		Battery voltage
				When the key is not inserted into key slot		0 V
123 (W)	Ground	IGN feedback	Input	Ignition switch	OFF or ACC	0 V
					ON	Battery voltage
124 (LG)	Ground	Passenger door switch	Input	Passenger door switch	OFF (Door close)	 11.8 V
					ON (Door open)	0 V
132 (BR)	Ground	Power window switch communication	Input/ Output	Ignition switch ON	 10.2 V	
				Ignition switch OFF or ACC	Battery voltage	

BCM (BODY CONTROL MODULE)

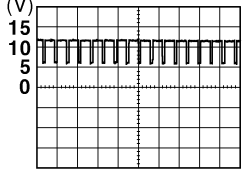
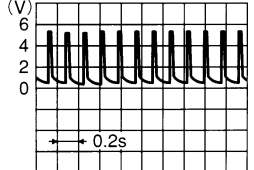
< ECU DIAGNOSIS INFORMATION >

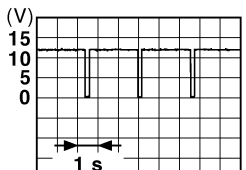
Terminal No. (Wire color)		Description		Condition	Value (Approx.)
+	-	Signal name	Input/ Output		
133 (W)	Ground	Push-button ignition switch illumination	Output	ON (Tail lamps OFF)	9.5 V
				ON (Tail lamps ON)	NOTE: The pulse width of this wave is varied by the illumination bright- ening/dimming level. 
134 (GR)	Ground	LOCK indicator lamp	Output	LOCK indicator lamp	Battery voltage
				OFF	0 V
137 (BG)	Ground	Receiver and sensor ground	Input	Ignition switch ON	0 V
138 (Y)	Ground	Receiver and sensor power supply	Output	Ignition switch	OFF
				ACC or ON	5.0 V
139 (L)	Ground	Tire pressure receiv- er communication	Input/ Output	Ignition switch ON	Standby state 
				When receiving the signal from the transmitter	
140 (GR)	Ground	Selector lever P/N position	Input	Selector lever	P or N position
				Except P and N positions	0 V
141 (G)	Ground	Security indicator	Output	Security indicator	ON
				Blinking	
				OFF	Battery voltage

A
B
C
D
E
F
G
H
I
J
K
L
N
O
P

BCS

BCM (BODY CONTROL MODULE)

< ECU DIAGNOSIS INFORMATION >

Terminal No. (Wire color)		Description		Condition	Value (Approx.)	
+	-	Signal name	Input/ Output			
142 (BG)	Ground	Combination switch OUTPUT 5	Output	Combination switch (Wiper intermit- tent dial 4)	All switches OFF	0 V
					Lighting switch 1ST	
					Lighting switch HI	
					Lighting switch 2ND	
					Turn signal switch RH	
10.7 V						
143 (P)	Ground	Combination switch OUTPUT 1	Output	Combination switch	All switches OFF (Wiper intermittent dial 4)	0 V
					Front wiper switch HI (Wiper intermittent dial 4)	
					Rear wiper switch INT (Wiper intermittent dial 4)	
					Any of the conditions below with all switches OFF	
					• Wiper intermittent dial 1 • Wiper intermittent dial 2 • Wiper intermittent dial 3 • Wiper intermittent dial 6 • Wiper intermittent dial 7	
10.7 V						
144 (G)	Ground	Combination switch OUTPUT 2	Output	Combination switch	All switches OFF (Wiper intermittent dial 4)	0 V
					Front washer switch ON (Wiper intermittent dial 4)	
					Rear wiper switch ON (Wiper intermittent dial 4)	
					Rear washer switch ON (Wiper intermittent dial 4)	
					Any of the conditions below with all switches OFF	
• Wiper intermittent dial 1 • Wiper intermittent dial 5 • Wiper intermittent dial 6						
10.7 V						
145 (L)	Ground	Combination switch OUTPUT 3	Output	Combination switch (Wiper intermit- tent dial 4)	All switches OFF	0 V
					Front wiper switch INT	
					Front wiper switch LO	
					Lighting switch AUTO	
10.7 V						

BCM (BODY CONTROL MODULE)

< ECU DIAGNOSIS INFORMATION >

Terminal No. (Wire color)		Description		Condition	Value (Approx.)	
		Signal name	Input/ Output			
+	-					
146 (SB)	Ground	Combination switch OUTPUT 4	Output	Combination switch (Wiper intermit- tent dial 4)	All switches OFF	0 V
					Front fog lamp switch ON	<p style="text-align: right; font-size: small;">JPMIA0035GB</p>
					Lighting switch 2ND	
					Lighting switch PASS	
					Turn signal switch LH	
150 (LG)	Ground	Driver door switch	Input	Driver door switch	OFF (Door close)	<p style="text-align: right; font-size: small;">JPMIA0011GB</p>
					ON (Door open)	0 V
151 (G)	Ground	Rear window defog- ger relay control	Output	Rear window de- fogger	Active	0 V
				Not activated	Battery voltage	

A
B
C
D
E
F
G
H
I
J
K
L
N
O
P

BCS

BCM (BODY CONTROL MODULE)

< ECU DIAGNOSIS INFORMATION >

Wiring Diagram - BCM -

INFOID:000000009065489

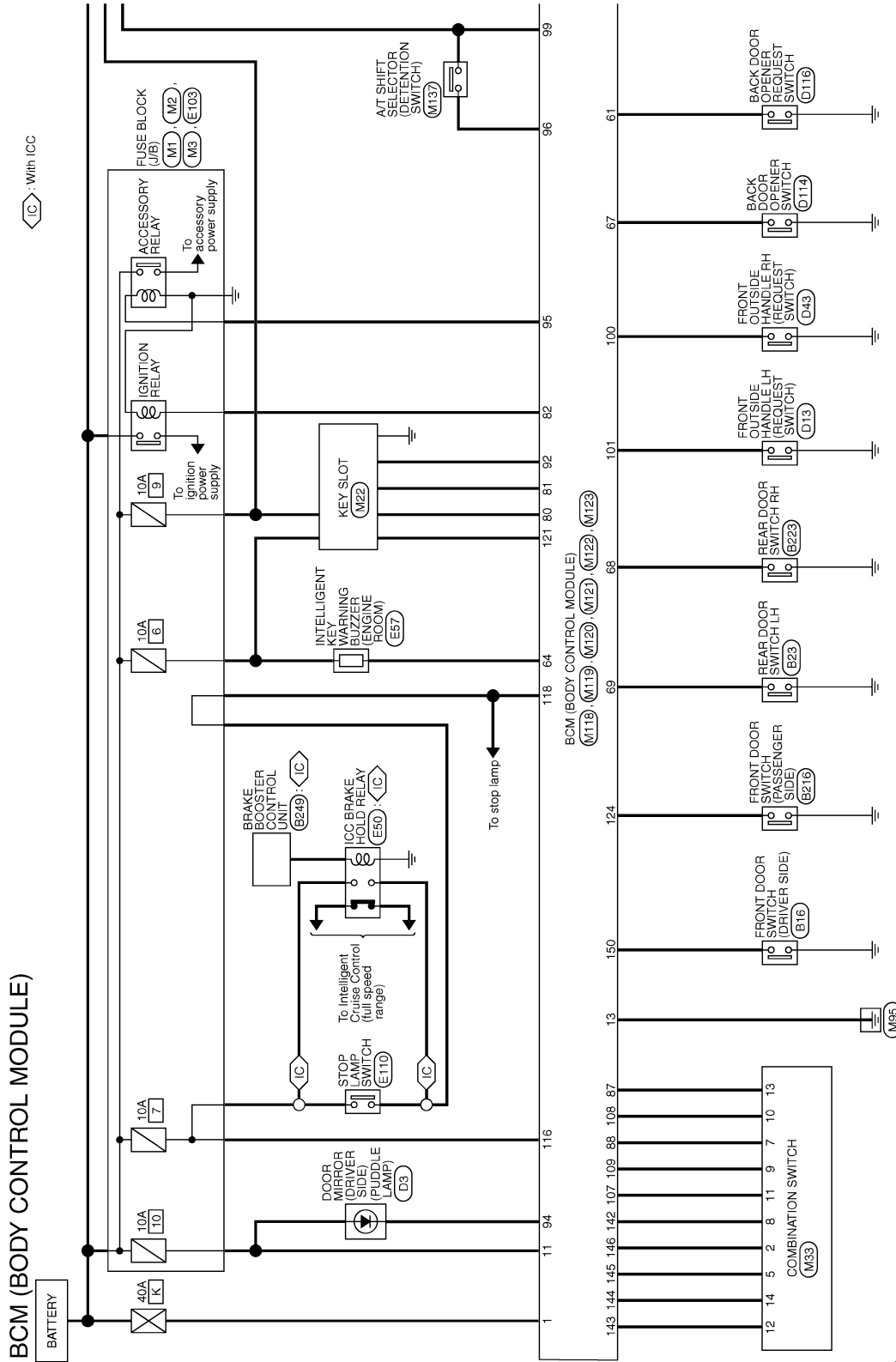

JRMWD2709GB

2012/06/11

BCM (BODY CONTROL MODULE)

< ECU DIAGNOSIS INFORMATION >

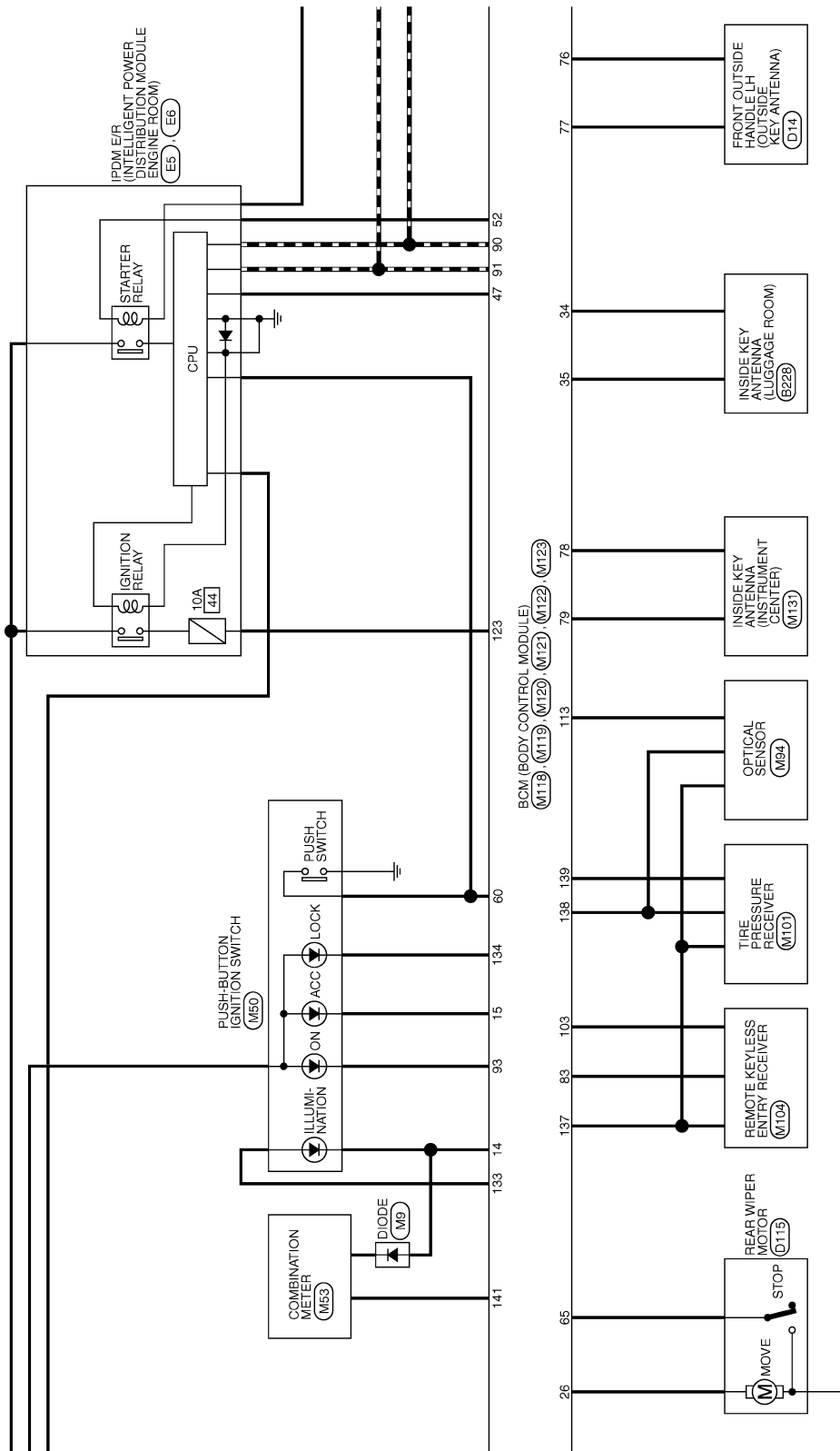

JRMWD2710GB

A
B
C
D
E
F
G
H
I
J
K
L
N
O
P

BCS

BCM (BODY CONTROL MODULE)

< ECU DIAGNOSIS INFORMATION >

- With sunroof
- With automatic drive positioner
- Without automatic drive positioner

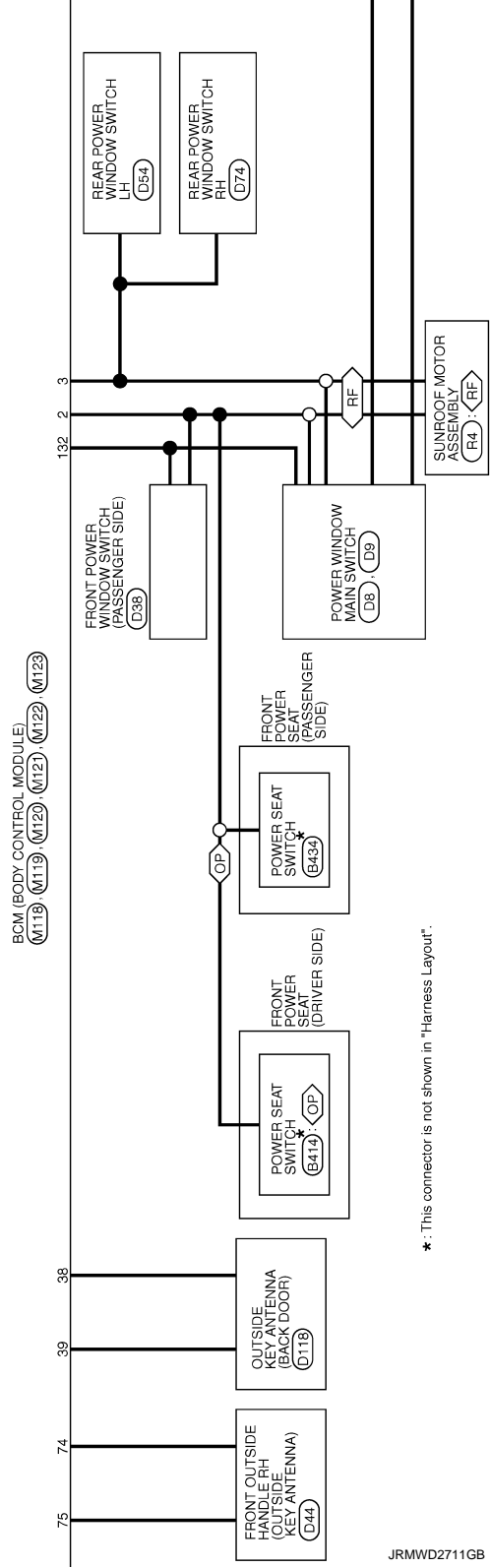
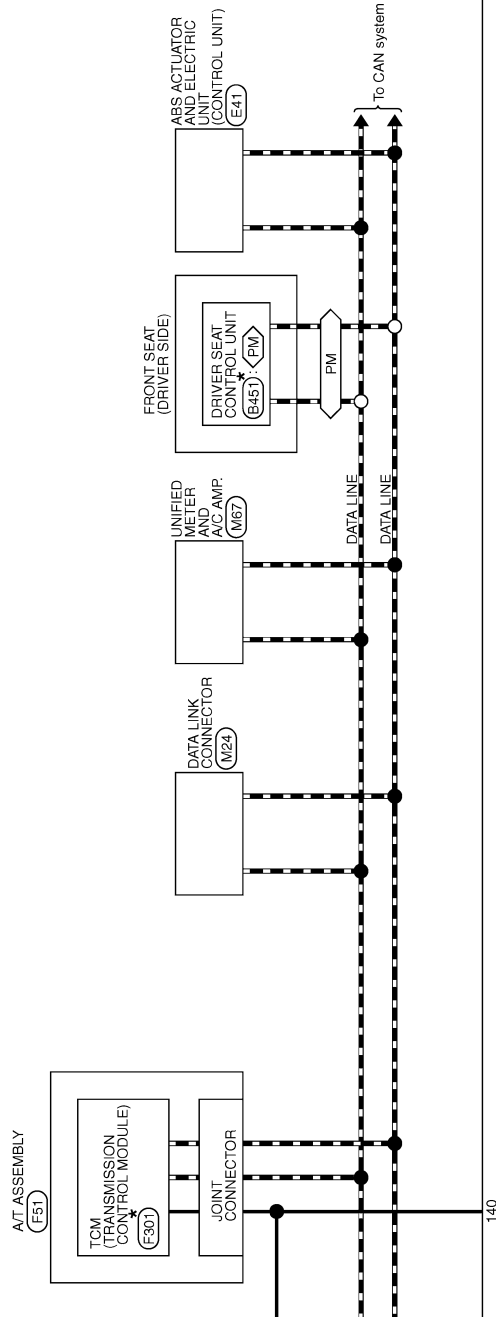

*: This connector is not shown in "Harness Layout".

JRMWD2711GB

BCM (BODY CONTROL MODULE)

< ECU DIAGNOSIS INFORMATION >

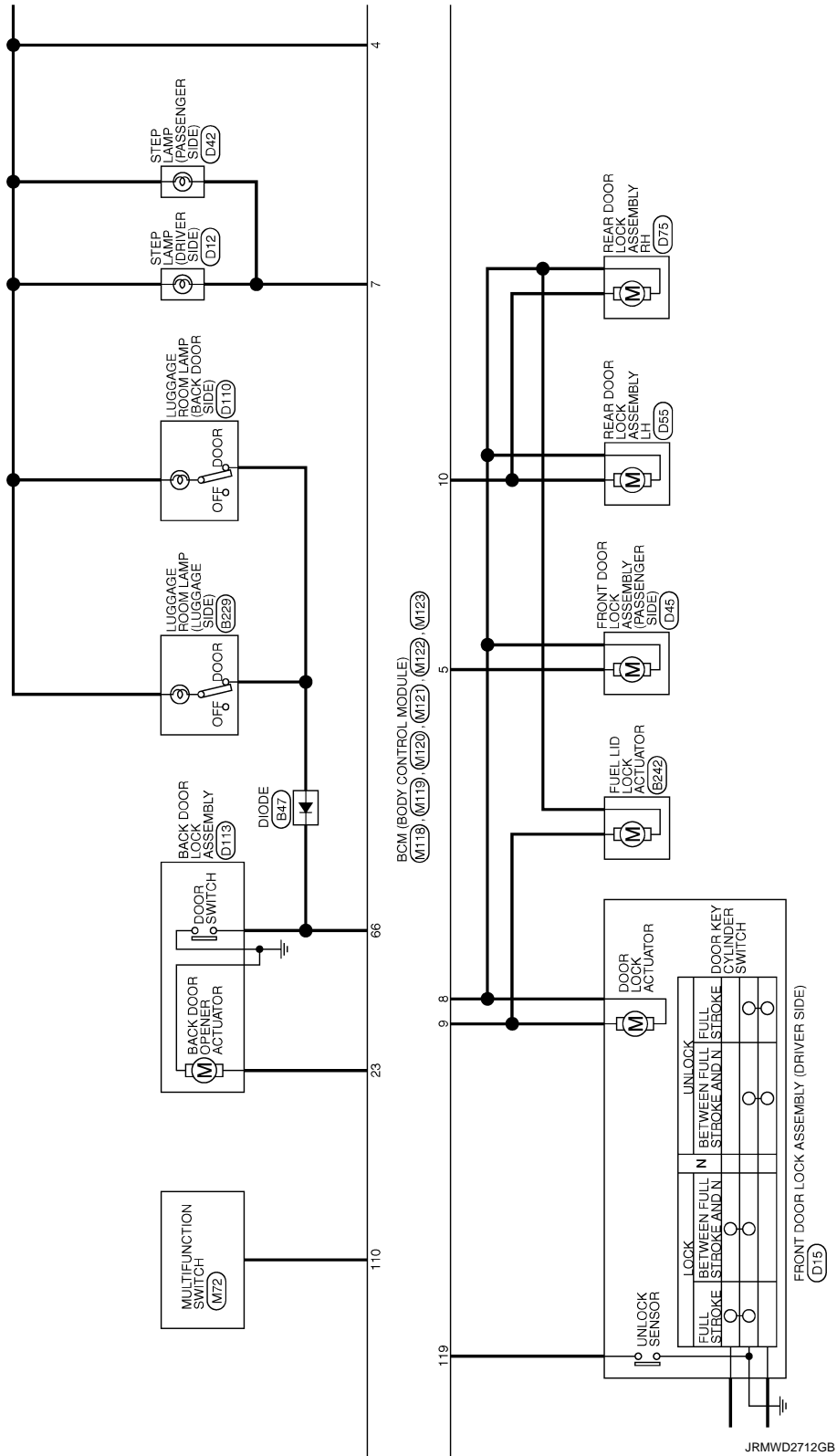

A
B
C
D
E
F
G
H
I
J
K
L
N
O
P

BCS

BCM (BODY CONTROL MODULE)



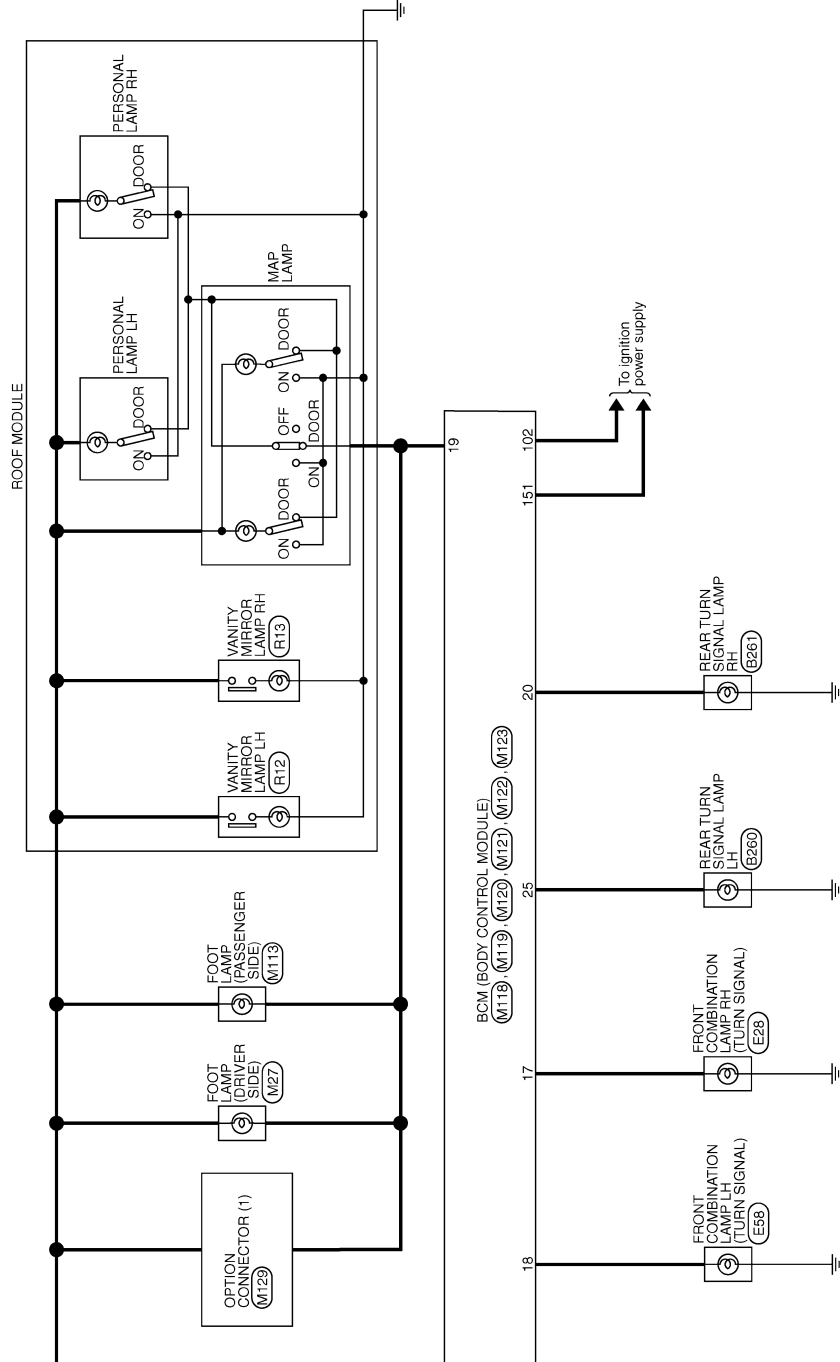





< ECU DIAGNOSIS INFORMATION >



JRMWD2713GB

BCM (BODY CONTROL MODULE)

< ECU DIAGNOSIS INFORMATION >

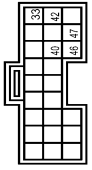
Connector No.	Terminal No.	Wire	Signal Name [Specification]
B16	1	B	FRONT DOOR SWITCH (DRIVER SIDE)
B16	2	L	FRONT DOOR SWITCH (PASSENGER SIDE)
			
H.S.			
B23	2	V	REAR DOOR SWITCH LH
B23	2	L	REAR DOOR SWITCH RH
			
H.S.			
B28	1	GR	INSIDE KEY ANTENNA (LUGGAGE ROOM)
B28	2	L	LUGGAGE ROOM LAMP (LUGGAGE SIDE)
			
H.S.			
B29	1	GR	LUGGAGE ROOM LAMP (LUGGAGE SIDE)
B29	2	L	LUGGAGE ROOM LAMP (LUGGAGE SIDE)
			
H.S.			
B24	1	R	FUEL LID LOCK ACTUATOR
B24	2	V	FUEL LID LOCK ACTUATOR
			
H.S.			
B29	1	SB	LUGGAGE ROOM LAMP (LUGGAGE SIDE)
B29	2	SB	LUGGAGE ROOM LAMP (LUGGAGE SIDE)
			
H.S.			
B23	1	GR	REAR DOOR SWITCH RH
B23	2	L	REAR DOOR SWITCH RH
			
H.S.			
B47	2	BR	DIODE
B47	2	LG	DIODE
			
H.S.			
B249	33	BR	IGNITION
B249	40	SB	IGNITION
B249	42	G	IGNITION
B249	46	B	GROUND
B249	47	V	BRAKE HOLD RLY DRIVE SIGNAL
			
H.S.			

BCM (BODY CONTROL MODULE)

A
B
C
D
E
F
G
H
I
J
K
L
N
O
P

BCS

JRMWD8153GB

BCM (BODY CONTROL MODULE)

< ECU DIAGNOSIS INFORMATION >

BCM (BODY CONTROL MODULE)

Connector No.	B260
Connector Name	REAR TURN SIGNAL LAMP LH
Connector Type	HS02FG-W



Terminal No.	Color Of Wire	Signal Name [Specification]
1	G	-
2	B	-

HS

Connector No.	B261
Connector Name	REAR TURN SIGNAL LAMP RH
Connector Type	HS02FG-W



Terminal No.	Color Of Wire	Signal Name [Specification]
1	V	-
2	B	-

Connector No.	B414
Connector Name	POWER SEAT SWITCH
Connector Type	NS10FW-C5

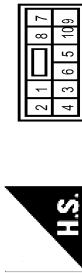

Terminal No.	Color Of Wire	Signal Name [Specification]
1	R	-
2	B	-
3	G/Y	-
4	P	-
5	W	-
6	V	-
7	L/Y	-
8	L	-
9	L/R	-
10	G/W	-

HS

Connector No.	B434
Connector Name	POWER SEAT SWITCH
Connector Type	NS10FW-C5



Terminal No.	Color Of Wire	Signal Name [Specification]
1	R	-
2	B	-
3	G/Y	-
5	W	-
6	V	-
7	L/Y	-
8	L	-
9	L/R	-
10	G/W	-

Connector No.	B451
Connector Name	DRIVER SEAT CONTROL UNIT
Connector Type	TH52FW

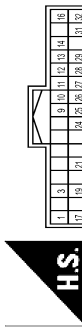

Terminal No.	Color Of Wire	Signal Name [Specification]
1	L/W	RX
3	R/Y	CANH
9	W/G	PULSE (RECLINING)
10	P/B	PULSE (RL LIFTING)
11	BR	SLIDING SW (BACKWARD)
12	SB	RECLINING SW (BACKWARD)
13	L/G/R	FRONT LIFTING SW (DOWNWARD)
14	G/B	REAR LIFTING SW (DOWNWARD)
16	O	VCC
17	Y/R	TX
19	V	CANH
21	L/Y	PRANGE SW
24	R	PULSE (SLIDING)
25	Y/B	PULSE (FL LIFTING)
26	Y	SLIDING SW (FORWARD)
27	R/G	RECLINING SW (FORWARD)
28	W/B	FRONT LIFTING SW (UPWARD)
29	P/L	REAR LIFTING SW (UPWARD)
31	GR	SENSOR GND
32	B/W	GND (SIGNAL)

Connector No.	D3
Connector Name	DOOR MIRROR (DRIVER SIDE)
Connector Type	TH24MV-NH



Terminal No.	Color Of Wire	Signal Name [Specification]
2	O	-
3	B	SIDE CAMERA LH COMM
5	Y	SIDE CAMERA LH IMAGE SIGNAL
6	R	SIDE CAMERA LH POWER SUPPLY
7	W	-
10	G	-
11	P	-
12	O	-
14	LG	-
17	G	SIDE CAMERA LH IMAGE GND
18	W	SIDE CAMERA LH GND
19	B	-
21	GR	-
22	BR	-
23	Y	-
24	V	-

HS

Connector No.	D8
Connector Name	POWER WINDOW MAIN SWITCH
Connector Type	NS16FW-C5

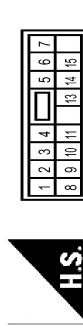

Terminal No.	Color Of Wire	Signal Name [Specification]
1	W	-
2	BR	-
3	GR	-
4	V	-

BCM (BODY CONTROL MODULE)

< ECU DIAGNOSIS INFORMATION >

BCM (BODY CONTROL MODULE)

5	O	-
6	Y	-
7	BR	-
8	L	-
9	O	-
10	Y	-
11	G	-
13	P	-
14	V	-
15	B	-

Connector No.	D9
Connector Name	POWER WINDOW MAIN SWITCH
Connector Type	NS03FW-GS



Terminal No.	Wire	Signal Name [Specification]
17	B	-
19	W	-

Connector No.	D12
Connector Name	STEP LAMP (DRIVER SIDE)
Connector Type	TB02FW



Terminal Color Of No.	Wire	Signal Name [Specification]
1	R	-
2	SB	-

Connector No.	D13
Connector Name	FRONT OUTSIDE HANDLE LH (REQUEST SWITCH)
Connector Type	RK02FL



Terminal Color Of No.	Wire	Signal Name [Specification]
1	Y	-
2	B	-

Connector No.	D14
Connector Name	FRONT OUTSIDE HANDLE LH (OUTSIDE KEY ANTENNA)
Connector Type	RK02MGY



Terminal Color Of No.	Wire	Signal Name [Specification]
1	O	-
2	SB	-

Connector No.	D15
Connector Name	FRONT DOOR LOCK ASSEMBLY (DRIVER SIDE)
Connector Type	EWBFGY-RS



Terminal Color Of No.	Wire	Signal Name [Specification]
1	LG	-
2	P	-
3	L	-
4	B	-
5	V	-
6	V	-

Connector No.	D38
Connector Name	FRONT POWER WINDOW SWITCH (PASSENGER SIDE)
Connector Type	NS16FW-GS

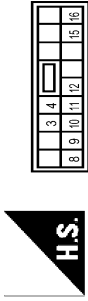

Terminal Color Of No.	Wire	Signal Name [Specification]
3	L	-
4	G	-
8	W	-
9	G	-
10	W	-
11	B	-
12	R	-
15	O	-
16	V	-

Connector No.	D42
Connector Name	STEP LAMP (PASSENGER SIDE)
Connector Type	TB02FW



Terminal Color Of No.	Wire	Signal Name [Specification]
1	R	-
2	SB	-

Connector No.	D43
Connector Name	FRONT OUTSIDE HANDLE RH (REQUEST SWITCH)
Connector Type	RK02FL



Terminal Color Of No.	Wire	Signal Name [Specification]
1	W	-
2	B	-

JRMWD8155GB

A
B
C
D
E
F
G
H
I
J
K
L
N
O
P

BCS

BCM (BODY CONTROL MODULE)

< ECU DIAGNOSIS INFORMATION >

BCM (BODY CONTROL MODULE)

Connector No.	D44
Connector Name	FRONT OUTSIDE HANDLE RH (OUTSIDE KEY ANTENNA)
Connector Type	RK02MGY



Terminal No.	Color Of Wire	Signal Name [Specification]
1	P	-
2	V	-

Connector No.	D45
Connector Name	FRONT DOOR LOCK ASSEMBLY (PASSENGER SIDE)
Connector Type	EB0FGY-RS



Terminal No.	Color Of Wire	Signal Name [Specification]
1	P	-
2	LG	-

Connector No.	D54
Connector Name	REAR POWER WINDOW SWITCH LH
Connector Type	NS08FW-CS

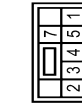

Terminal No.	Color Of Wire	Signal Name [Specification]
1	Y	-
2	V	-
3	G	-
4	L	-
5	W	-
7	B	-

Connector No.	D55
Connector Name	REAR DOOR LOCK ASSEMBLY LH
Connector Type	EB0FGY-RS



Terminal No.	Color Of Wire	Signal Name [Specification]
1	V	-
2	G	-

Connector No.	D74
Connector Name	REAR POWER WINDOW SWITCH RH
Connector Type	NS08FW-CS

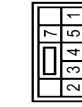

Terminal No.	Color Of Wire	Signal Name [Specification]
1	W	-
2	V	-
3	G	-
4	P	-
5	O	-
7	B	-

Connector No.	D75
Connector Name	REAR DOOR LOCK ASSEMBLY RH
Connector Type	EB0FGY-RS



Terminal No.	Color Of Wire	Signal Name [Specification]
1	G	-
2	V	-

Connector No.	DT10
Connector Name	LUGGAGE ROOM LAMP (BACK DOOR SIDE)
Connector Type	TK03FW



Terminal No.	Color Of Wire	Signal Name [Specification]
1	V	-
2	P	-

Connector No.	DT13
Connector Name	BACK DOOR LOCK ASSEMBLY
Connector Type	NS04FW-CS



Terminal No.	Color Of Wire	Signal Name [Specification]
1	Y	-
2	B	-
3	V	-
4	B	-

JRMWD8156GB

BCM (BODY CONTROL MODULE)

< ECU DIAGNOSIS INFORMATION >

BCM (BODY CONTROL MODULE)

Connector No.	D114
Connector Name	BACK DOOR OPENER SWITCH
Connector Type	TK02MBR-P



Terminal No.	Color Of Wire	Signal Name [Specification]
1	GR	-
2	B	-

Connector No.	D115
Connector Name	REAR WIPER MOTOR
Connector Type	CJ04FN-1V



Terminal No.	Color Of Wire	Signal Name [Specification]
2	G	-
3	O	-
4	B	-

Connector No.	D116
Connector Name	BACK DOOR OPENER REQUEST SWITCH
Connector Type	TK02MBR-P



Terminal No.	Color Of Wire	Signal Name [Specification]
1	W	-
2	B	-

Connector No.	D118
Connector Name	OUTSIDE KEY ANTENNA (BACK DOOR)
Connector Type	RK02FGY



Terminal No.	Color Of Wire	Signal Name [Specification]
1	BR	-
2	R	-

Connector No.	E5
Connector Name	POWER INTELLIGENT POWER DISTRIBUTION MODULE (ENGINE ROOM)
Connector Type	TH20FW-CS12-M4-1V



Terminal No.	Color Of Wire	Signal Name [Specification]
4	V	-
5	L	-
7	R	-
12	EW	-
13	Y	-
16	LG	-
19	W	-
23	G	-
26	R	-
27	BG	-
28	L	-
30	GR	-
36	G	-

Connector No.	E5
Connector Name	POWER INTELLIGENT POWER DISTRIBUTION MODULE (ENGINE ROOM)
Connector Type	TH08FW-NH



Terminal No.	Color Of Wire	Signal Name [Specification]
39	P	-
40	L	-
41	EW	-
43	SB	-
44	BR	-
45	G	-
46	R	-

Connector No.	E28
Connector Name	FRONT COMBINATION LAMP RH
Connector Type	RS08FB-PR



Terminal No.	Color Of Wire	Signal Name [Specification]
2	B	-
3	BY	-
4	EW	-
5	BG	-
6	V	-
7	BR	-
8	P	-

Connector No.	E41
Connector Name	ABS ACTUATOR AND ELECTRIC LAMP CONTROL UNIT
Connector Type	BA44ZFBAK24-LH

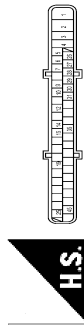

Terminal No.	Color Of Wire	Signal Name [Specification]
1	B	GROUND
2	G	UBMR
3	R	LEVR
4	B	GROUND
5	Y	DS FL
6	BG	DP RL
7	BR	DP RR
9	B	DP FR
10	W	DS FR
12	L	VAC
14	P	CANL
15	SHIELD	GROUND
19	P	UST

A
B
C
D
E
F
G
H
I
J
K
L
N
O
P

BCS

JRMWD8157GB

BCM (BODY CONTROL MODULE)

< ECU DIAGNOSIS INFORMATION >

BCM (BODY CONTROL MODULE)

25	Y	BUS-L
26	LG	DP-FL
27	GR	DS-RL
28	G	UZ
29	LG	DS-RR
30	SB	BLS
31	R	VDC OFF SW
35	L	CAN-H
45	B	BUS-H

Connector No.	E50
Connector Name	ICC BRAKE HOLD RELAY
Connector Type	MG8FGY-R-US



HS.

Terminal No.	Color Of Wire	Signal Name [Specification]
1	V	-
2	B	-
3	P	-
4	SB	-
6	P	-
7	R	-

Connector No.	E57
Connector Name	INTELLIGENT KEY WARNING BUZZER (ENGINE ROOM)
Connector Type	RK03FBR



HS.

Terminal No.	Color Of Wire	Signal Name [Specification]
1	V	-
3	V	-

Connector No.	E58
Connector Name	FRONT COMBINATION LAMP LH
Connector Type	RS08FB-PR



HS.

Terminal No.	Color Of Wire	Signal Name [Specification]
2	B	-
3	BY	-
4	B/W	-
5	V	-
6	G	-
7	P	-
8	B/G	-

Connector No.	E103
Connector Name	FUSE BLOCK (I/B)
Connector Type	NS16FW-CS

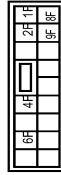

HS.

Terminal No.	Color Of Wire	Signal Name [Specification]
1F	SB	-
2F	W	-
4F	G	-
6F	BR	-
8F	L	-
9F	R	-

Connector No.	E110
Connector Name	STOP LAMP SWITCH
Connector Type	MO4FW-LC



HS.

Terminal No.	Color Of Wire	Signal Name [Specification]
1	L	-
2	W	-
3	Y	-
4	SB	-

Connector No.	F51
Connector Name	A/T ASSEMBLY
Connector Type	RK10FG-DSY



HS.

Terminal No.	Color Of Wire	Signal Name [Specification]
1	Y	IGNITION POWER SUPPLY
2	BR	BATTERY POWER SUPPLY
3	O	CAN-H
4	V	K-LINE
5	B	GROUND
6	Y	IGNITION POWER SUPPLY
7	R	BACKUP LAMP RELAY
8	LG	CANL
9	GR	STARTER RELAY
10	B	GROUND

Connector No.	F301
Connector Name	TCM (TRANSMISSION CONTROL MODULE)
Connector Type	SP10FG



HS.

Terminal No.	Color Of Wire	Signal Name [Specification]
1	-	IGNITION POWER SUPPLY
2	-	BATTERY POWER SUPPLY
3	-	CAN-H
4	-	K-LINE
5	-	GROUND
6	-	IGNITION POWER SUPPLY
7	-	BACKUP LAMP RELAY
8	-	CANL
9	-	STARTER RELAY
10	-	GROUND

Connector No.	MT
Connector Name	FUSE BLOCK (I/B)
Connector Type	NS06FW-M2

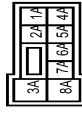

HS.

Terminal No.	Color Of Wire	Signal Name [Specification]
1A	GR	-
2A	G	-
3A	L	-
4A	P	-
5A	V	-
6A	Y	-
7A	R	-
8A	L	-

BCM (BODY CONTROL MODULE)

< ECU DIAGNOSIS INFORMATION >

BCM (BODY CONTROL MODULE)

Connector No.	M2
Connector Name	FUSE BLOCK (J/B)
Connector Type	NS10FW-CS



Terminal No.	Color Of Wire	Signal Name [Specification]
3B	P	-
4R	G	-
5B	BG	-
6B	Y	-
7B	R	-
8B	P	-
9B	SB	-

Connector No.	M3
Connector Name	FUSE BLOCK (J/B)
Connector Type	NS12FW-CS



Terminal No.	Color Of Wire	Signal Name [Specification]
10C	L	-
11C	R	-
12C	BG	-
6C	R	-
7C	B	-
9C	BG	-

Connector No.	M9
Connector Name	DIODE
Connector Type	24335_C9900



Terminal No.	Color Of Wire	Signal Name [Specification]
1	R	-
2	W	-

Connector No.	M22
Connector Name	KEY SLOT
Connector Type	TH12FW-NH

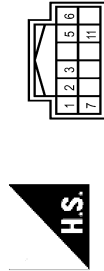

Terminal No.	Color Of Wire	Signal Name [Specification]
1	R	BAT
2	GR	GLOCK
3	W	DATA
5	Y	ILL BAT
6	LG	ILL
7	B	GROUND
11	BR	KEY SWITCH SIGNAL

Connector No.	M24
Connector Name	DATA LINK CONNECTOR
Connector Type	BD16FW



Terminal No.	Color Of Wire	Signal Name [Specification]
3	LG	-
4	B	-
5	B	-
6	L	-
7	V	-
8	G	-
11	SB	-
14	P	-
16	Y	-

Connector No.	M27
Connector Name	FOOT LAMP (DRIVER SIDE)
Connector Type	A02FW



Terminal No.	Color Of Wire	Signal Name [Specification]
1	R	-
2	BR	-

Connector No.	M33
Connector Name	COMBINATION SWITCH
Connector Type	TH16FW-NH

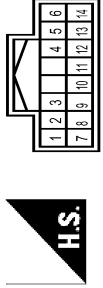

Terminal No.	Color Of Wire	Signal Name [Specification]
1	P	FR WASHER(-)
2	SB	OUTPUT 4
3	GR	FR WASHER(+)
4	G	IGN
5	L	OUTPUT 3
6	B	GROUND
7	V	INPUT 3
8	BG	OUTPUT 5
9	Y	INPUT 2
10	R	INPUT 4
11	LG	INPUT 1
12	P	OUTPUT 1
13	BR	INPUT 5
14	G	OUTPUT 2

Connector No.	M50
Connector Name	PUSH-BUTTON IGNITION SWITCH
Connector Type	TK08FBR

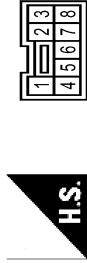

Terminal No.	Color Of Wire	Signal Name [Specification]
1	B	-
2	W	-
3	W	-
4	BR	-
5	GR	-
6	Y	-

A
B
C
D
E
F
G
H
I
J
K
L
N
O
P

BCS

BCM (BODY CONTROL MODULE)

< ECU DIAGNOSIS INFORMATION >

BCM (BODY CONTROL MODULE)

Connector No.	M53
Connector Name	COMBINATION METER
Connector Type	TH40FV-AH



Terminal No.	Color Of Wire	Signal Name [Specification]
1	GR	BATTERY POWER SUPPLY
2	LG	COMMUNICATION SIGNAL (METER-AMP.)
3	GR	COMMUNICATION SIGNAL (AMP-METER)
5	B	GROUND
6	P	ALTERNATOR SIGNAL
7	BR	AIR BAG SIGNAL
10	G	SECURITY SIGNAL
15	B	GROUND
16	B	METER CONTROL SWITCH-GROUND
19	B	ILL GND
20	R	ILL
21	BG	IGNITION SIGNAL
22	B	GROUND
24	BR	COMMUNICATION SIGNAL (LCD-AMP.)
25	Y	COMMUNICATION SIGNAL (AMP-LCD)
26	R	VEHICLE SPEED SIGNAL (R-PULSE)
27	V	PARKING BRAKE SWITCH SIGNAL
28	W	BRAKE FLUID LEVEL SWITCH SIGNAL
29	SB	SEAT BELT BUCKLE SWITCH SIGNAL (DRIVER SIDE)
30	G	SEAT BELT BUCKLE SWITCH SIGNAL (PASSENGER SIDE)
31	L	WASHER LEVEL SWITCH SIGNAL
33	B	ILLUMINATION CONTROL SIGNAL
36	LG	SELECT SWITCH SIGNAL
37	SB	ENTER SWITCH SIGNAL
38	L	TRIP AIR RESET SWITCH SIGNAL
39	P	ILLUMINATION CONTROL SWITCH SIGNAL (1)
40	BG	ILLUMINATION CONTROL SWITCH SIGNAL (2)

Connector No.	M67
Connector Name	UNIFIED METER AND A/C AMP.
Connector Type	TH22FV-AH



Terminal No.	Color Of Wire	Signal Name [Specification]
41	V	ACC POWER SUPPLY
42	Y	FUEL LEVEL SENSOR SIGNAL
43	R	INTAKE SENSOR SIGNAL
44	LG	ILL CONT
45	P	IN-VEHICLE SENSOR SIGNAL
46	BG	AMBIENT SENSOR SIGNAL
47	G	SUNLOAD SENSOR SIGNAL
53	G	IGNITION POWER SUPPLY
54	Y	BATTERY POWER SUPPLY
55	B	GROUND
56	L	CAN-H
57	W	BRAKE FLUID LEVEL SWITCH SIGNAL
58	BR	FUEL LEVEL SENSOR GROUND
59	GR	INTAKE SENSOR GROUND
60	L	IN-VEHICLE SENSOR GROUND
61	BR	AMBIENT SENSOR GROUND
62	SB	SUNLOAD SENSOR GROUND
63	R	-
65	BG	ECV SIGNAL
69	L	A/C LAN SIGNAL
70	R	EACH DOOR MOTOR POWER SUPPLY
71	B	GROUND
72	P	CAN-L

Connector No.	M72
Connector Name	MULTIFUNCTION SWITCH
Connector Type	TH16FV-AH

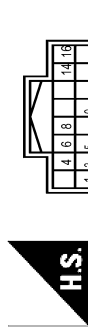

Terminal No.	Color Of Wire	Signal Name [Specification]
1	B	GROUND
3	V	ACC
4	R	ILL
5	Y	ILL CONT
6	SB	AV COMM (H)
8	LG	AV COMM (L)
9	B	SW GND
14	Y	DISK SELECT SIGNAL
16	G	HAZARD ON

Connector No.	M94
Connector Name	OPTICAL SENSOR
Connector Type	TK02FW



Terminal No.	Color Of Wire	Signal Name [Specification]
1	Y	POWER
2	P	OUTPUT
3	B	GROUND

Connector No.	M101
Connector Name	TIRE PRESSURE RECEIVER
Connector Type	TK04FW



Terminal No.	Color Of Wire	Signal Name [Specification]
1	BG	GROUND
2	L	SIGNAL
4	Y	BATTERY

Connector No.	M104
Connector Name	REMOTE KEYLESS ENTRY RECEIVER
Connector Type	JAS04FB



Terminal No.	Color Of Wire	Signal Name [Specification]
1	BG	GROUND
2	Y	SIGNAL OUTPUT
4	LG	BATTERY

JRMWD8160GB

BCM (BODY CONTROL MODULE)

< ECU DIAGNOSIS INFORMATION >

BCM (BODY CONTROL MODULE)

Connector No.	MT13
Connector Name	FOOT LAMP (PASSENGER SIDE)
Connector Type	A02FW



Terminal No.	Color Of Wire	Signal Name [Specification]
1	R	-
2	BR	-

Connector No.	MT18
Connector Name	BCM (BODY CONTROL MODULE)
Connector Type	MG3FBL-C



Terminal No.	Color Of Wire	Signal Name [Specification]
1	W	BAT (F/L)
2	W	POWER WINDOW POWER SUPPLY(BAT)
3	Y	POWER WINDOW POWER SUPPLY(RAP)

Connector No.	MT19
Connector Name	BCM (BODY CONTROL MODULE)
Connector Type	NS16FW-CS

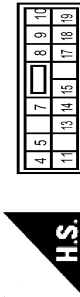

Terminal No.	Color Of Wire	Signal Name [Specification]
4	LG	INTERIOR ROOM LAMP POWER SUPPLY
5	L	PASSENGER DOOR UNLOCK OUTPUT
7	Y	STEP LAMP CONT.
8	V	ALL DOOR FUEL LID LOCK OUTPUT
9	G	DRIVER DOOR FUEL LID UNLOCK OUTPUT
10	BR	REAR DOOR UNLOCK OUTPUT
11	R	BAT (USE)
13	B	GROUND
14	W	PUSH-BUTTON IGNITION SW (LL GND)
15	Y	ACC-IND
17	W	TURN SIGNAL RH (FRONT)
18	EG	TURN SIGNAL LH (FRONT)
19	V	INT ROOM LAMP CONT.

Connector No.	MT20
Connector Name	BCM (BODY CONTROL MODULE)
Connector Type	NS12FW-CS



Terminal No.	Color Of Wire	Signal Name [Specification]
20	V	TURN SIGNAL RH (REAR)
23	G	BACK DOOR OPEN OUTPUT
25	G	TURN SIGNAL LH (REAR)
26	G	REAR WIPER OUTPUT

Connector No.	MT21
Connector Name	BCM (BODY CONTROL MODULE)
Connector Type	TH40FG-Y-NH

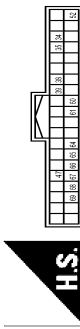

Terminal No.	Color Of Wire	Signal Name [Specification]
34	SB	LUCKGAGE ROOM ANT-
35	V	LUCKGAGE ROOM ANT+
38	B	BACK DOOR ANT-
39	W	BACK DOOR ANT+
47	V	IGN RELAY (IPDM E/R) CONT
52	SB	STARTER RELAY CONT
60	BR	FRESH SW
61	W	BACK DOOR OPENER REQUEST SW
64	V	TRAY WARN BUZZER (ENG ROOM)
65	BG	REAR WIPER STOP POSITION
66	R	BACK DOOR SW
67	GR	BACK DOOR OPENER SW
68	BR	REAR RH DOOR SW
69	R	REAR LH DOOR SW

Connector No.	MT22
Connector Name	BCM (BODY CONTROL MODULE)
Connector Type	TH40FB-NH

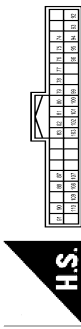

Terminal No.	Color Of Wire	Signal Name [Specification]
74	SB	PASSENGER DOOR ANT-
75	GR	PASSENGER DOOR ANT+
76	V	DRIVER DOOR ANT-
77	LG	DRIVER DOOR ANT+
78	V	ROOM ANT-
79	BR	ROOM ANT+

80	GR	NAVS ANT AMP.
81	W	NAVS ANT AMP.
82	R	IGN RELAY (F/B) CONT
83	Y	KEYLESS ENTRY RECEIVER COMM.
87	BR	COMBI SW INPUT 5
88	V	COMBI SW INPUT 3
90	P	CANL
91	L	CANH
92	LG	KEY SLOT ILL CONT
93	V	ON IND
94	Y	PUDDLE LAMP CONT
95	BG	ACC RELAY CONT
96	GR	AT SHIFT SELECTOR POWER SUPPLY
99	R	SHIFT P
100	G	PASSENGER DOOR REQUEST SW
101	SB	DRIVER DOOR REQUEST SW
102	BG	BLOWER FAN MOTOR RELAY CONT
103	LG	KEYLESS ENTRY RECEIVER POWER SUPPLY
107	LG	COMBI SW INPUT 1
108	R	COMBI SW INPUT 4
109	Y	COMBI SW INPUT 2
110	G	HAZARD SW

Connector No.	MT23
Connector Name	BCM (BODY CONTROL MODULE)
Connector Type	TH40FG-NH

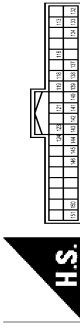

Terminal No.	Color Of Wire	Signal Name [Specification]
113	P	OPTICAL SENSOR
116	SB	STOP LAMP SW 1
118	P	STOP LAMP SW 2
119	SB	DR DOOR UNLOCK SENSOR
121	BR	KEY SLOT SW
122	W	IGN/FB
123	W	PASSENGER DOOR SW
124	LG	POWER WINDOW SW COMM
132	BR	PUSH-BUTTON IGNITION SW ILL POWER
133	W	LOCK IND
134	GR	RECEIVER SENSOR GND
137	BG	RECEIVER SENSOR POWER SUPPLY
138	Y	RECEIVER SENSOR POWER SUPPLY

A
B
C
D
E
F
G
H
I
J
K
L
N
O
P

BCS

BCM (BODY CONTROL MODULE)

< ECU DIAGNOSIS INFORMATION >

BCM (BODY CONTROL MODULE)

139	L	TIRE PRESSURE RECEIVER COMM
140	GR	SHIFT NP
141	G	SECURITY IND LAMP CONT
142	BG	COMBI SW OUTPUT 5
143	P	COMBI SW OUTPUT 1
144	G	COMBI SW OUTPUT 2
145	L	COMBI SW OUTPUT 3
146	SB	COMBI SW OUTPUT 4
150	LG	DRIVER DOOR SW
151	G	REAR WINDOW DEFOGGER RELAY CONT

Connector No.	M129
Connector Name	OPTION CONNECTOR (1)
Connector Type	TH88MVA-NH



Terminal No.	Color Of Wire	Signal Name [Specification]
3	G	-
6	R	-

Connector No.	M131
Connector Name	INSIDE KEY ANTENNA (INSTRUMENT CENTER)
Connector Type	RK02FGY



Terminal No.	Color Of Wire	Signal Name [Specification]
1	BR	-
2	Y	-

Connector No.	M137
Connector Name	A/T SHIFT SELECTOR
Connector Type	TH12FVA-NH

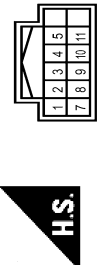

Terminal No.	Color Of Wire	Signal Name [Specification]
1	W	-
2	V	-
3	L	-
4	B	-
5	G	-
7	R	-
8	SB	-
9	B	-
10	GR	-
11	R	-

Connector No.	R4
Connector Name	SUNROOF MOTOR ASSEMBLY
Connector Type	YEA10DFGY



Terminal No.	Color Of Wire	Signal Name [Specification]
1	GR	SW-BIT1
5	P	SW-BIT0
7	BR	+B
8	L	SPEED SENSOR(2P)
9	Y	TIMER(+IGN)
10	G	GROUND

Connector No.	RT2
Connector Name	VANITY MIRROR LAMP LH
Connector Type	MCA02FW



Terminal No.	Color Of Wire	Signal Name [Specification]
1	-	-
2	-	-

Connector No.	RT3
Connector Name	VANITY MIRROR LAMP RH
Connector Type	MCA02FW



Terminal No.	Color Of Wire	Signal Name [Specification]
1	-	-
2	-	-

JRMWD8162GB

INFOID:000000009065490

Fail-safe

FAIL-SAFE CONTROL BY DTC

BCM performs fail-safe control when any DTC are detected.

BCM (BODY CONTROL MODULE)

< ECU DIAGNOSIS INFORMATION >

Display contents of CONSULT	Fail-safe	Cancellation
B2190: NATS ANTENNA AMP	Inhibit engine cranking	Erase DTC
B2191: DIFFERENCE OF KEY	Inhibit engine cranking	Erase DTC
B2192: ID DISCORD BCM-ECM	Inhibit engine cranking	Erase DTC
B2193: CHAIN OF BCM-ECM	Inhibit engine cranking	Erase DTC
B2195: ANTI SCANNING	Inhibit engine cranking	Ignition switch ON → OFF
B2560: STARTER CONT RELAY	Inhibit engine cranking	500 ms after the following CAN signal communication status becomes consistent <ul style="list-style-type: none"> • Starter control relay signal • Starter relay status signal
B2608: STARTER RELAY	Inhibit engine cranking	500 ms after the following signal communication status becomes consistent <ul style="list-style-type: none"> • Starter motor relay control signal • Starter relay status signal (CAN)
B260A: IGNITION RELAY	Inhibit engine cranking	500 ms after the following conditions are fulfilled <ul style="list-style-type: none"> • IGN relay (IPDM E/R) control signal: OFF (Battery voltage) • Ignition ON signal (CAN to IPDM E/R): OFF (Request signal) • Ignition ON signal (CAN from IPDM E/R): OFF (Condition signal)
B260F: ENG STATE SIG LOST	Maintains the power supply position attained at the time of DTC detection	When any of the following conditions are fulfilled <ul style="list-style-type: none"> • Power position changes to ACC • Receives engine status signal (CAN)
B2617: STARTER RELAY CIRC	Inhibit engine cranking	1 second after the starter motor relay control inside BCM becomes normal
B2618: BCM	Inhibit engine cranking	1 second after the ignition relay (IPDM E/R) control inside BCM becomes normal
B261E: VEHICLE TYPE	Inhibit engine cranking	BCM initialization

REAR WIPER MOTOR PROTECTION

BCM detects the rear wiper stopping position according to the rear wiper stop position signal. When the rear wiper stop position signal does not change for more than 5 seconds while driving the rear wiper, BCM stops power supply to protect the rear wiper motor.

Condition of cancellation

1. More than 1 minute is passed after the rear wiper stops.
2. Turn rear wiper switch OFF.
3. Operate the rear wiper switch or rear washer switch.

DTC Inspection Priority Chart

INFOID:000000009065491

If some DTCs are displayed at the same time, perform inspections one by one based on the following priority chart.

Priority	DTC
1	B2562: LOW VOLTAGE
2	<ul style="list-style-type: none"> • U1000: CAN COMM CIRCUIT • U1010: CONTROL UNIT (CAN)
3	<ul style="list-style-type: none"> • B2190: NATS ANTENNA AMP • B2191: DIFFERENCE OF KEY • B2192: ID DISCORD BCM-ECM • B2193: CHAIN OF BCM-ECM • B2195: ANTI SCANNING

BCM (BODY CONTROL MODULE)

< ECU DIAGNOSIS INFORMATION >

Priority	DTC
4	<ul style="list-style-type: none"> • B2553: IGNITION RELAY • B2555: STOP LAMP • B2556: PUSH-BTN IGN SW • B2557: VEHICLE SPEED • B2560: STARTER CONT RELAY • B2601: SHIFT POSITION • B2602: SHIFT POSITION • B2603: SHIFT POSI STATUS • B2604: PNP SW • B2605: PNP SW • B2608: STARTER RELAY • B260A: IGNITION RELAY • B260F: ENG STATE SIG LOST • B2614: ACC RELAY CIRC • B2615: BLOWER RELAY CIRC • B2616: IGN RELAY CIRC • B2617: STARTER RELAY CIRC • B2618: BCM • B261A: PUSH-BTN IGN SW • B261E: VEHICLE TYPE • B26EA: KEY REGISTRATION • C1729: VHCL SPEED SIG ERR • U0415: VEHICLE SPEED SIG
5	<ul style="list-style-type: none"> • C1704: LOW PRESSURE FL • C1705: LOW PRESSURE FR • C1706: LOW PRESSURE RR • C1707: LOW PRESSURE RL • C1708: [NO DATA] FL • C1709: [NO DATA] FR • C1710: [NO DATA] RR • C1711: [NO DATA] RL • C1716: [PRESSDATA ERR] FL • C1717: [PRESSDATA ERR] FR • C1718: [PRESSDATA ERR] RR • C1719: [PRESSDATA ERR] RL • C1734: CONTROL UNIT
6	<ul style="list-style-type: none"> • B2621: INSIDE ANTENNA • B2623: INSIDE ANTENNA

DTC Index

INFOID:000000009065492

NOTE:

The details of time display are as follows.

- CRNT: A malfunction is detected now.
- PAST: A malfunction was detected in the past.

IGN counter is displayed on Freeze Frame Data. For details of Freeze Frame Data, refer to [BCS-18. "COMMON ITEM : CONSULT Function \(BCM - COMMON ITEM\)"](#).

CONSULT display	Fail-safe	Freeze Frame Data •Vehicle Speed •Odo/Trip Meter •Vehicle Condition	Intelligent Key warning lamp ON	Tire pressure monitor warning lamp ON	Reference page
No DTC is detected. further testing may be required.	—	—	—	—	—
U1000: CAN COMM CIRCUIT	—	—	—	—	BCS-41
U1010: CONTROL UNIT (CAN)	—	—	—	—	BCS-42
U0415: VEHICLE SPEED SIG	—	—	—	—	BCS-43
B2190: NATS ANTENNA AMP	×	—	—	—	SEC-40

BCM (BODY CONTROL MODULE)

< ECU DIAGNOSIS INFORMATION >

CONSULT display	Fail-safe	Freeze Frame Data •Vehicle Speed •Odo/Trip Meter •Vehicle Condition	Intelligent Key warning lamp ON	Tire pressure monitor warning lamp ON	Reference page
B2191: DIFFERENCE OF KEY	×	—	—	—	SEC-43
B2192: ID DISCORD BCM-ECM	×	—	—	—	SEC-44
B2193: CHAIN OF BCM-ECM	×	—	—	—	SEC-45
B2195: ANTI SCANNING	×	—	—	—	SEC-46
B2553: IGNITION RELAY	—	×	—	—	PCS-48
B2555: STOP LAMP	—	×	—	—	SEC-47
B2556: PUSH-BTN IGN SW	—	×	×	—	SEC-49
B2557: VEHICLE SPEED	×	×	×	—	SEC-51
B2560: STARTER CONT RELAY	×	×	×	—	SEC-52
B2562: LOW VOLTAGE	—	×	—	—	BCS-44
B2601: SHIFT POSITION	×	×	×	—	SEC-53
B2602: SHIFT POSITION	×	×	×	—	SEC-56
B2603: SHIFT POSI STATUS	×	×	×	—	SEC-59
B2604: PNP SW	×	×	×	—	SEC-62
B2605: PNP SW	×	×	×	—	SEC-64
B2608: STARTER RELAY	×	×	×	—	SEC-66
B260A: IGNITION RELAY	×	×	×	—	PCS-50
B260F: ENG STATE SIG LOST	×	×	×	—	SEC-68
B2614: ACC RELAY CIRC	—	×	×	—	PCS-52
B2615: BLOWER RELAY CIRC	—	×	×	—	PCS-55
B2616: IGN RELAY CIRC	—	×	×	—	PCS-58
B2617: STARTER RELAY CIRC	×	×	×	—	SEC-71
B2618: BCM	×	×	×	—	PCS-61
B261A: PUSH-BTN IGN SW	—	×	×	—	SEC-73
B261E: VEHICLE TYPE	×	×	× (Turn ON for 15 seconds)	—	SEC-76
B2621: INSIDE ANTENNA	—	×	—	—	DLK-58
B2623: INSIDE ANTENNA	—	×	—	—	DLK-60
B26E1: ENG STATE NO RES	×	×	×	—	SEC-69
B26EA: KEY REGISTRATION	—	×	× (Turn ON for 15 seconds)	—	SEC-70
C1704: LOW PRESSURE FL	—	—	—	×	WT-23
C1705: LOW PRESSURE FR	—	—	—	×	
C1706: LOW PRESSURE RR	—	—	—	×	
C1707: LOW PRESSURE RL	—	—	—	×	
C1708: [NO DATA] FL	—	—	—	×	WT-25
C1709: [NO DATA] FR	—	—	—	×	
C1710: [NO DATA] RR	—	—	—	×	
C1711: [NO DATA] RL	—	—	—	×	

A

B

C

D

E

F

G

H

I

J

K

L

BCS

N

O

P

BCM (BODY CONTROL MODULE)

< ECU DIAGNOSIS INFORMATION >

CONSULT display	Fail-safe	Freeze Frame Data •Vehicle Speed •Odo/Trip Meter •Vehicle Condition	Intelligent Key warning lamp ON	Tire pressure monitor warning lamp ON	Reference page
C1716: [PRESSDATA ERR] FL	—	—	—	×	WT-28
C1717: [PRESSDATA ERR] FR	—	—	—	×	
C1718: [PRESSDATA ERR] RR	—	—	—	×	
C1719: [PRESSDATA ERR] RL	—	—	—	×	
C1729: VHCL SPEED SIG ERR	—	—	—	×	WT-30
C1734: CONTROL UNIT	—	—	—	×	WT-32

COMBINATION SWITCH SYSTEM SYMPTOMS

< SYMPTOM DIAGNOSIS >

SYMPTOM DIAGNOSIS

COMBINATION SWITCH SYSTEM SYMPTOMS

Symptom Table

INFOID:000000009065493

1. Perform "Data Monitor" of CONSULT to check for any malfunctioning item.
2. Check the malfunction combinations.

Malfunction item: x

Malfunction combination	Data monitor item																
	FR WIPER HI	FR WIPER LOW	FR WASHER SW	FR WIPER INT	RR WIPER ON	RR WIPER INT	RR WASHER SW	INT VOLUME	TURN SIGNAL R	TURN SIGNAL L	TAIL LAMP SW	HI BEAM SW	HEAD LAMP SW 1	HEAD LAMP SW 2	PASSING SW	AUTO LIGHT SW	FR FOG SW
A		x	x						x	x							
B	x			x									x		x		
C							x	x				x		x			
D						x		x			x					x	
E					x			x									x
F	x					x		x									
G			x		x		x	x									
H		x		x												x	
I										x				x	x		x
J									x		x	x	x				
K	All Items																
L	If only one item is detected or the item is not applicable to the combinations A to K																

3. Identify the malfunctioning part from the agreed combination and repair or replace the part.

Malfunction combination	Malfunctioning part	Repair or replace
A	Combination switch INPUT 1 circuit	Inspect the combination switch input circuit applicable to the malfunctioning part. Refer to BCS-46, "Diagnosis Procedure" .
B	Combination switch INPUT 2 circuit	
C	Combination switch INPUT 3 circuit	
D	Combination switch INPUT 4 circuit	
E	Combination switch INPUT 5 circuit	
F	Combination switch OUTPUT 1 circuit	Inspect the combination switch output circuit applicable to the malfunctioning part. Refer to BCS-48, "Diagnosis Procedure" .
G	Combination switch OUTPUT 2 circuit	
H	Combination switch OUTPUT 3 circuit	
I	Combination switch OUTPUT 4 circuit	
J	Combination switch OUTPUT 5 circuit	
K	BCM	Replace BCM. Refer to BCS-96, "Exploded View" .
L	Combination switch	Replace the combination switch.

NORMAL OPERATING CONDITION

< SYMPTOM DIAGNOSIS >

NORMAL OPERATING CONDITION

Description

INFOID:000000009065494

TRANSIT MODE

- Transit mode inhibits battery power consumption during transportation or storage of the vehicle.
- BCM is set to transit mode before delivery.
- In transit mode, remote keyless entry function, headlamp ON/OFF function, theft warning alarm function, and other BCM control functions do not operate normally.
- Therefore, cancel operation must be performed so that the vehicle is used in normal status.
- For transit mode cancel operation, refer to [BCS-7, "Description"](#).

NOTE:

Do not cancel transit mode during storage of the vehicle. Always cancel transit mode before delivery of the vehicle to customer.

PRECAUTIONS

< PRECAUTION >

PRECAUTION

PRECAUTIONS

Precaution for Supplemental Restraint System (SRS) "AIR BAG" and "SEAT BELT PRE-TENSIONER"

INFOID:000000009065495

The Supplemental Restraint System such as "AIR BAG" and "SEAT BELT PRE-TENSIONER", used along with a front seat belt, helps to reduce the risk or severity of injury to the driver and front passenger for certain types of collision. This system includes seat belt switch inputs and dual stage front air bag modules. The SRS system uses the seat belt switches to determine the front air bag deployment, and may only deploy one front air bag, depending on the severity of a collision and whether the front occupants are belted or unbelted. Information necessary to service the system safely is included in the "SRS AIR BAG" and "SEAT BELT" of this Service Manual.

WARNING:

Always observe the following items for preventing accidental activation.

- To avoid rendering the SRS inoperative, which could increase the risk of personal injury or death in the event of a collision that would result in air bag inflation, all maintenance must be performed by an authorized NISSAN/INFINITI dealer.
- Improper maintenance, including incorrect removal and installation of the SRS, can lead to personal injury caused by unintentional activation of the system. For removal of Spiral Cable and Air Bag Module, see "SRS AIR BAG".
- Never use electrical test equipment on any circuit related to the SRS unless instructed to in this Service Manual. SRS wiring harnesses can be identified by yellow and/or orange harnesses or harness connectors.

PRECAUTIONS WHEN USING POWER TOOLS (AIR OR ELECTRIC) AND HAMMERS

WARNING:

Always observe the following items for preventing accidental activation.

- When working near the Air Bag Diagnosis Sensor Unit or other Air Bag System sensors with the ignition ON or engine running, never use air or electric power tools or strike near the sensor(s) with a hammer. Heavy vibration could activate the sensor(s) and deploy the air bag(s), possibly causing serious injury.
- When using air or electric power tools or hammers, always switch the ignition OFF, disconnect the battery, and wait at least 3 minutes before performing any service.

A
B
C
D
E
F
G
H
I
J
K
L

BCS

N
O
P

BCM (BODY CONTROL MODULE)

< REMOVAL AND INSTALLATION >

REMOVAL AND INSTALLATION

BCM (BODY CONTROL MODULE)

Exploded View

INFOID:000000009065496

NOTE:

Before replacing BCM, perform "READ CONFIGURATION" to save or print current vehicle specification. Refer to [BCS-3, "ADDITIONAL SERVICE WHEN REPLACING CONTROL UNIT \(BCM\) : Description"](#).

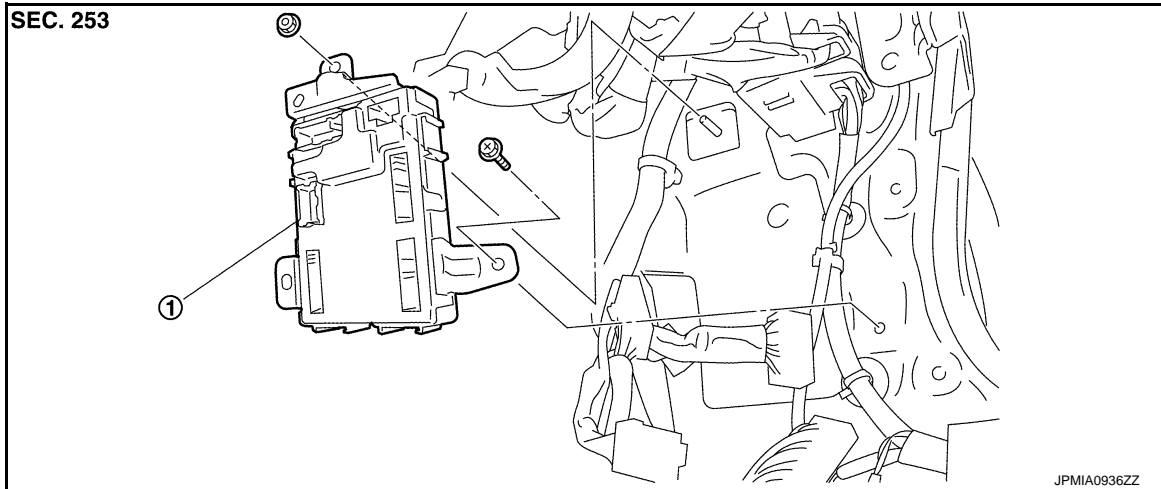

1. BCM

Removal and Installation

INFOID:000000009065497

NOTE:

Before replacing BCM, perform "READ CONFIGURATION" to save or print current vehicle specification. Refer to [BCS-3, "ADDITIONAL SERVICE WHEN REPLACING CONTROL UNIT \(BCM\) : Description"](#).

REMOVAL

1. Remove dash side finisher (passenger side). Refer to [INT-20, "Exploded View"](#).
2. Remove bolt and nut.
3. Remove BCM and disconnect the connector.

INSTALLATION

Install in the reverse order of removal.

CAUTION:

Be sure to perform "WRITE CONFIGURATION" when replacing BCM. Or not doing so, BCM control function does not operate normally.

NOTE:

Be sure to perform the system initialization (NATS) when replacing BCM. Refer to [BCS-3, "ADDITIONAL SERVICE WHEN REPLACING CONTROL UNIT \(BCM\) : Work Procedure"](#).

COMBINATION SWITCH

< REMOVAL AND INSTALLATION >

COMBINATION SWITCH

Exploded View

INFOID:000000009065498

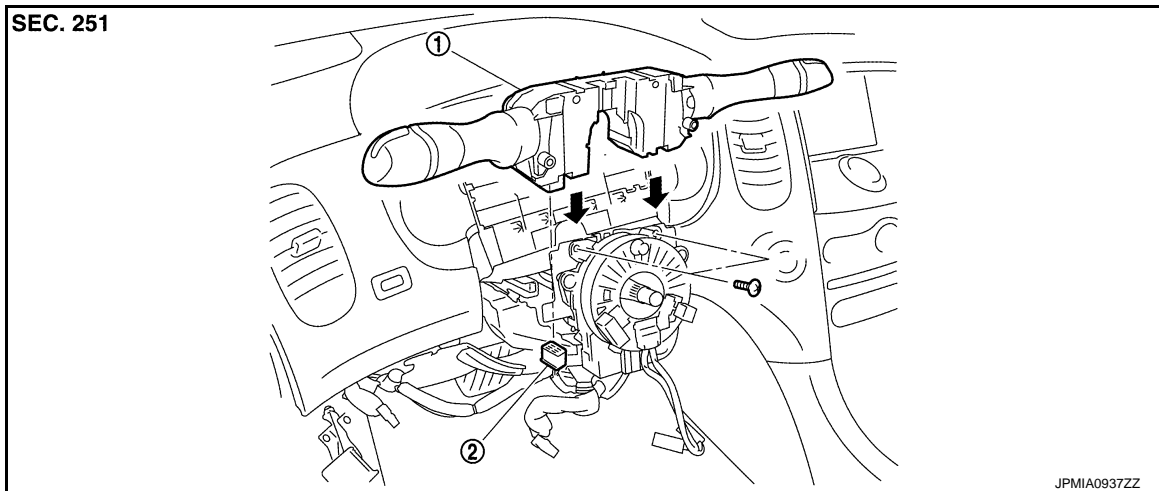

1. Combination switch

2. Combination switch connector

Removal and Installation

INFOID:000000009065499

REMOVAL

1. Remove steering column cover. Refer to [IP-12. "Exploded View"](#).
2. Remove screws.
3. Disconnect the connector.
4. Pull up the combination switch to remove it.

INSTALLATION

Install in the reverse order of removal.

A
B
C
D
E
F
G
H
I
J
K
L

BCS

N
O
P