

SECTION SN
SONAR SYSTEM

A
B
C
D
E
F
G
H
I
J
K
L
M
N
O
P

CONTENTS

BASIC INSPECTION	3	Component Inspection	18
DIAGNOSIS AND REPAIR WORKFLOW	3	SONAR SYSTEM OFF SWITCH CIRCUIT INSPECTION	19
Work Flow	3	Description	19
INSPECTION AND ADJUSTMENT	5	Diagnosis Procedure (With Rear Sonar System)	19
Preliminary Check	5	Diagnosis Procedure (With Front and Rear Sonar System)	19
FUNCTION DIAGNOSIS	6	Component Inspection	20
REAR SONAR SYSTEM	6	ECU DIAGNOSIS	21
System Diagram	6	SONAR CONTROL UNIT FOR REAR SONAR SYSTEM	21
System Description	6	Reference Value	21
Component Parts Location	7	Wiring Diagram	23
Component Description	7	DTC Index	30
Self-Diagnosis Function	7	SONAR CONTROL UNIT FOR FRONT AND REAR SONAR SYSTEM	31
FRONT AND REAR SONAR SYSTEM	10	Reference Value	31
System Diagram	10	Wiring Diagram	33
System Description	10	DTC Index	44
Component Parts Location	11	SYMPTOM DIAGNOSIS	45
Component Description	12	SONAR SYSTEM SYMPTOMS	45
CONSULT-III Function (SONAR)	12	Symptom Table	45
COMPONENT DIAGNOSIS	13	PRECAUTION	46
POWER SUPPLY AND GROUND CIRCUIT	13	PRECAUTION	46
Diagnosis Procedure (With Rear Sonar System)	13	Precaution for Supplemental Restraint System (SRS) "AIR BAG" and "SEAT BELT PRE-TENSIONER"	46
Diagnosis Procedure (With Front and Rear Sonar System)	13	Precaution Necessary for Steering Wheel Rotation After Battery Disconnect	46
SONAR SENSOR CIRCUIT INSPECTION	15	PREPARATION	48
Description	15	PREPARATION	48
Diagnosis Procedure (With Rear Sonar System)	15	Commercial Service Tool	48
Diagnosis Procedure (With Front and Rear Sonar System)	15		
SONAR BUZZER CIRCUIT INSPECTION	17		
Description	17		
Diagnosis Procedure (With Rear Sonar System)	17		
Diagnosis Procedure (With Front and Rear Sonar System)	17		

REMOVAL AND INSTALLATION	49	SONAR CONTROL UNIT	50
SONAR SENSOR	49	Removal and Installation	50
Removal and Installation	49	BUZZER	51
		Removal and Installation	51

DIAGNOSIS AND REPAIR WORKFLOW

< BASIC INSPECTION >

BASIC INSPECTION

DIAGNOSIS AND REPAIR WORKFLOW

Work Flow

INFOID:000000003776737

WORK FLOW

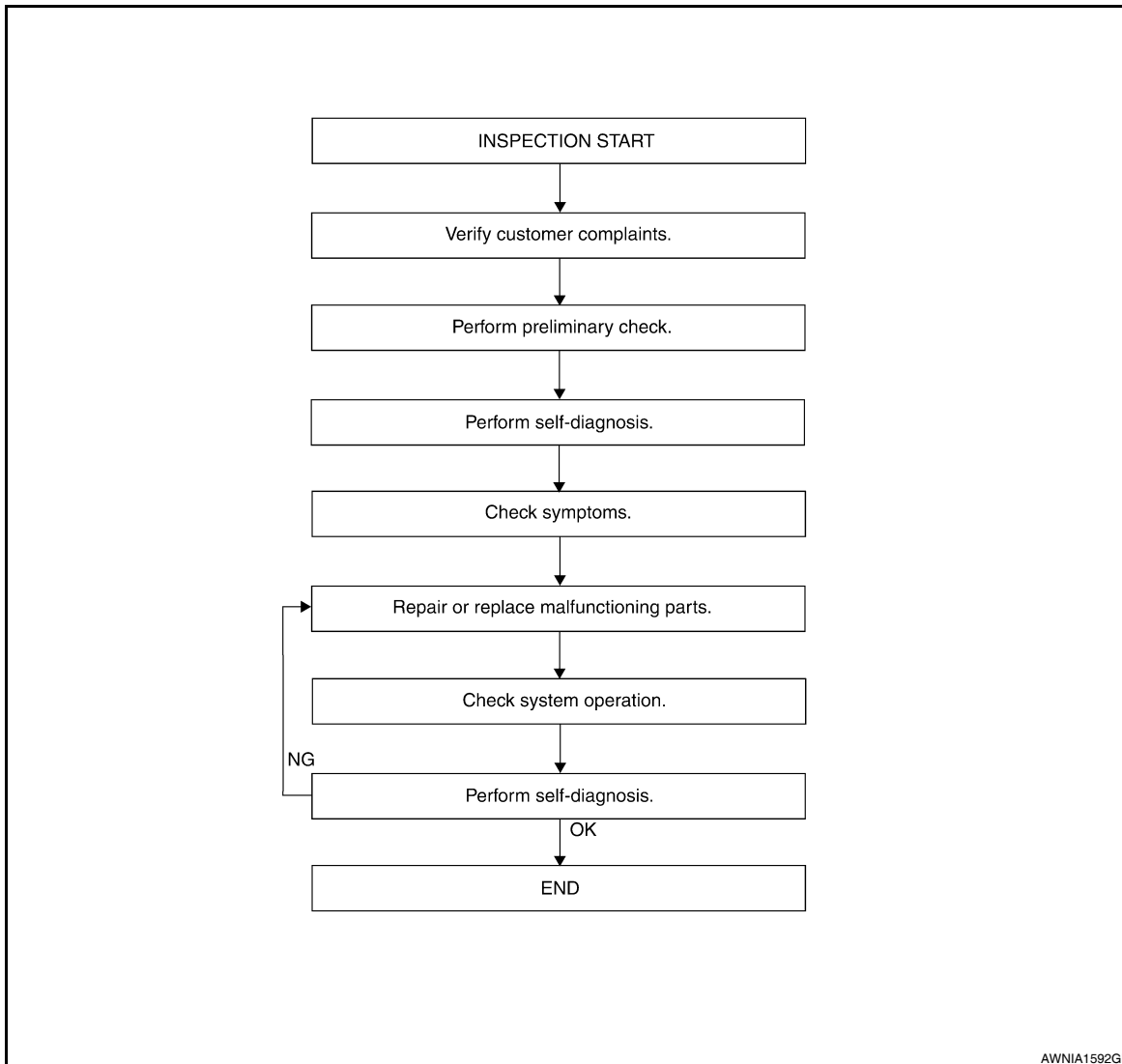

DETAILED FLOW

1. CUSTOMER INFORMATION

Interview the customer to obtain detailed information about the symptom.

>> GO TO 2

2. PRELIMINARY CHECK

Perform preliminary check. Refer to [SN-5. "Preliminary Check"](#).

>> GO TO 3

3. SELF-DIAGNOSIS

A
B
C
D
E
F
G
H
I
J
K
L
M

SN

O
P

DIAGNOSIS AND REPAIR WORKFLOW

< BASIC INSPECTION >

Perform self-diagnosis. Refer to [SN-7. "Self-Diagnosis Function"](#) (with rear sonar system) or [SN-12. "CONSULT-III Function \(SONAR\)"](#) (with front and rear sonar system).

>> GO TO 4

4.SYMPTOM

Check for symptoms. Refer to [SN-45. "Symptom Table"](#).

>> GO TO 5

5.MALFUNCTIONING PARTS

Repair or replace the applicable parts.

>> GO TO 6

6.SYSTEM OPERATION

Check system operation. Refer to [SN-5. "Preliminary Check"](#).

>> GO TO 7

7.SELF-DIAGNOSIS

Perform self-diagnosis. Refer to [SN-7. "Self-Diagnosis Function"](#) (with rear sonar system) or [SN-12. "CONSULT-III Function \(SONAR\)"](#) (with front and rear sonar system).

Are any fault codes displayed?

YES >> GO TO 5
NO >> Inspection End.

INSPECTION AND ADJUSTMENT

< BASIC INSPECTION >

INSPECTION AND ADJUSTMENT

Preliminary Check

INFOID:000000003776738

DESCRIPTION

The purpose of the sonar sensor preliminary check is to confirm that there are no outside factors affecting the sonar system.

CONDITIONS

- Ignition switch ON
- No obstructions within 3.0 m (10 ft.) of sonar sensors

SONAR SENSOR STATUS CHECK

- Check that the sonar sensors are properly aligned (no deformation in sensor mounting areas).
- Check that snow, mud or other foreign objects are not adhering to the sonar sensors.
- Check that there is no deformation, scratches or other damage to the sonar sensors.
- Check that water has not accumulated in the sonar sensors.

CAUTION:

Use water, cotton swab, or other soft material for cleaning the sensors.

1. Check that there are no obstacles within each sonar sensor's detection range.

Sonar sensors	Detection range
Front	Approx. 1.0 m (3 ft.) maximum
Rear	Approx. 1.8 m (5.9 ft.) maximum

2. Check that there are no nearby ultrasound sources such as the sounds of vehicle horns, motorcycle engines or truck air brakes.
3. Check that the vehicle is on a level surface.

A
B
C
D
E
F
G
H
I
J
K
L
M
O
P

SN

REAR SONAR SYSTEM

< FUNCTION DIAGNOSIS >

FUNCTION DIAGNOSIS

REAR SONAR SYSTEM

System Diagram

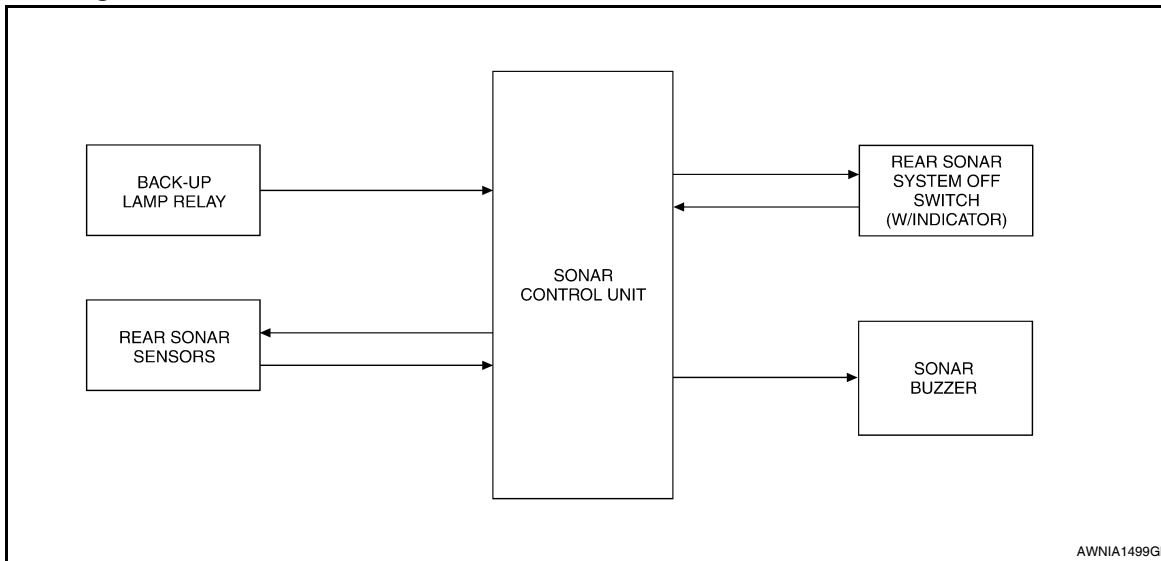

System Description

INFOID:000000004173796

FUNCTION

With power and ground supplied, transmission gear selector lever in R position, and the rear sonar system OFF switch ON, the rear sonar system will detect obstacles within 1.8 m (5.9 ft.) of the rear sonar sensors. The vehicle operator is notified of obstacles by varied rate of tone from the sonar buzzer depending on distance of obstacle being sensed.

REAR SONAR SYSTEM OFF SWITCH

With power and ground supplied to the sonar control unit, transmission gear selector lever in R position, the sonar system can be disabled and the sonar buzzer silenced by momentarily pressing the rear sonar system OFF switch. The sonar system OFF indicator lamp will be illuminated in the rear sonar system OFF switch. The rear sonar system and buzzer will be disabled and the sonar system OFF indicator will be illuminated until the ignition switch is turned OFF. When the ignition switch is turned ON, the rear sonar system will be enabled. Depressing the rear sonar system OFF switch again will enable the rear sonar system also. Enabling the rear sonar system will cause the rear sonar system OFF indicator to go out. If the indicator light is blinking there is a malfunction in the system.

SONAR BUZZER

With power and ground supplied to the sonar control unit and the A/T selector lever in R position, a stationary object that is at least 7.0 cm (2.8 in.) wide and 1.0 m (39.0 in.) tall and that is closer than 1.8 m (5.9 ft.) will be detected by the rear sonar sensors, causing the sonar buzzer to sound a tone. As the vehicle moves closer to the object, the rate of the tone will increase. When the object is less than 25.0 cm (10 in.) from the rear bumper, the tone will sound continuously.

REAR SONAR SENSORS

With power and ground supplied to the rear sonar sensors, the sonar sensors transmit an ultrasonic signal. This signal is reflected back to the sensor by objects large enough and close enough to be detected. The rear sonar sensors measure the time from the transmitted signal to the time the signal is reflected back and sends this information to the sonar control unit.

BACK-UP LAMP RELAY

The back-up lamp relay provides a reverse signal to the sonar control unit.

REAR SONAR SYSTEM

< FUNCTION DIAGNOSIS >

Component Parts Location

INFOID:000000004173797

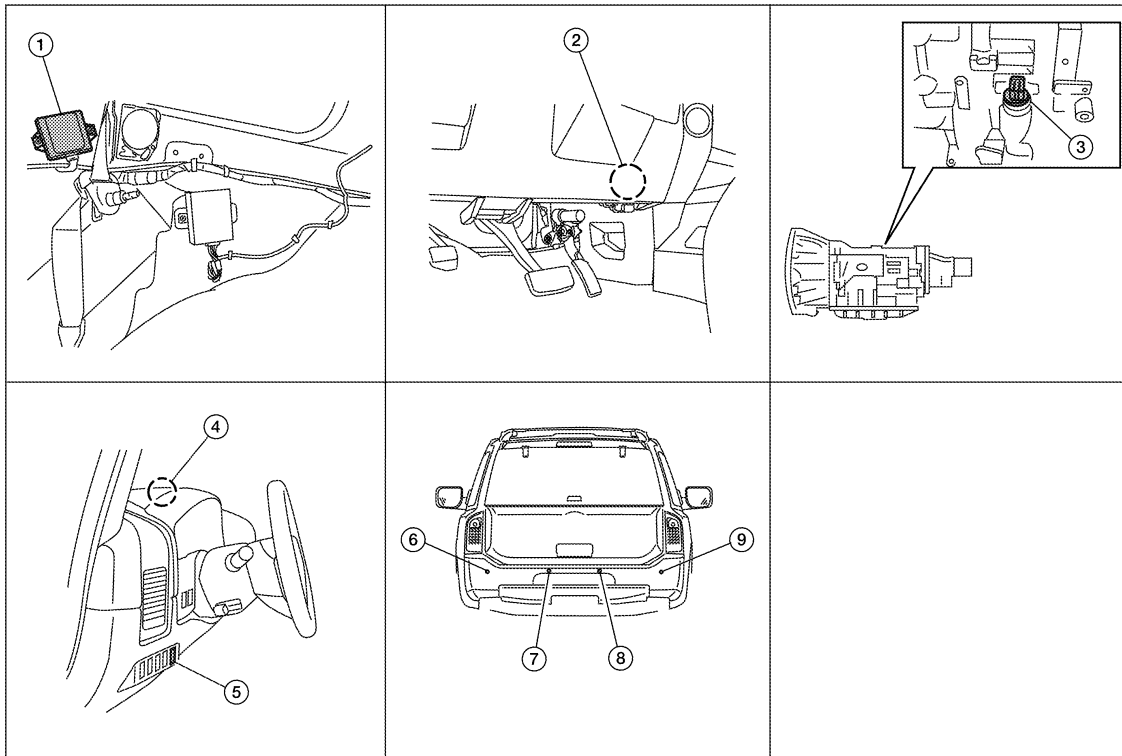

AWNIA1588ZZ

- | | | |
|---|---|------------------------------------|
| 1. Sonar control unit B24
(view with luggage side finisher LH removed) | 2. Back-up lamp relay M73 | 3. A/T assembly F9 |
| 4. Sonar buzzer M47 | 5. Rear sonar system OFF switch M117
(with sonar system OFF indicator) | 6. Rear sonar sensor LH outer C102 |
| 7. Rear sonar sensor LH inner C103 | 8. Rear sonar sensor RH inner C104 | 9. Rear sonar sensor RH outer C105 |

Component Description

INFOID:000000004173798

Component	Function
Sonar control unit	Controls sonar system and provides self-diagnosis
Back-up lamp relay	Provides reverse signal for sonar control unit
A/T assembly	Controls back-up lamp relay
Sonar buzzer	Sounds a signal when objects are detected in the rear of the vehicle
Rear sonar system OFF switch	Enables the driver to turn system off and signals a system malfunction
Sonar sensor	Senses objects in the rear of the vehicle

Self-Diagnosis Function

INFOID:000000004173799

There are four modes of self-diagnosis. These modes must be followed in the following order:

1. Entering diagnostics mode
2. Requesting number of fault codes mode
3. Requesting fault codes mode
4. Clearing fault codes mode

Self-diagnosis can be manually exited by turning the ignition OFF or selecting reverse gear. Self-diagnosis will exit unless a fault code request occurs before a message is repeated five times without acknowledgement.

ENTERING DIAGNOSTICS MODE

REAR SONAR SYSTEM

< FUNCTION DIAGNOSIS >

1. Turn ignition switch ON. Rear sonar system OFF switch indicator lamp illuminates for three seconds and then turns off.
2. Immediately push rear sonar system OFF switch ten times within five seconds.
3. The sonar buzzer will sound once and the sonar system OFF indicator will flash once.

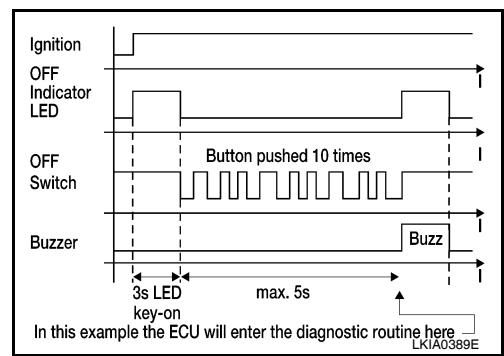

REQUESTING NUMBER OF FAULT CODES MODE

1. While in "entering diagnostic mode", push rear sonar system OFF switch once within 30 seconds of entering diagnostic mode.

NOTE:

If the number of fault codes is not requested within 30 seconds after entering diagnostic mode, the system will return to regular operation mode.

2. The sonar buzzer will sound once.
3. Sonar system OFF indicator will flash once and sonar buzzer will sound once for each fault code detected.
4. There will be a four second pause.
5. The number of fault codes will repeat five times then pause.

NOTE:

Self-diagnosis will exit unless "requesting fault codes mode" occurs before five repeats ends.

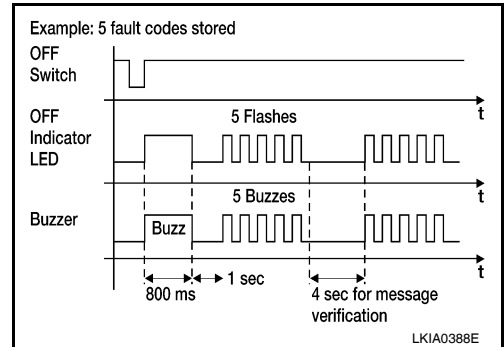

REQUESTING FAULT CODES MODE

1. While in "requesting number of fault codes" mode, push rear sonar system OFF switch once.
2. The sonar buzzer will sound once.
3. Sonar system OFF indicator will flash and sonar buzzer will sound the first digit of the fault code followed by a one second pause.
4. Sonar system OFF indicator will flash and sonar buzzer will sound the second digit of the fault code followed by a four second pause.

5. Each fault code will repeat five times then pause.
6. Write down each fault code. Then, acknowledge the fault code by pushing the rear sonar system OFF switch once (the sonar buzzer may sound).

NOTE:

"Requesting fault codes mode" will exit unless the fault code is acknowledged before it is repeated five times. When all fault codes have been indicated, "clearing fault codes mode" will be entered. Refer to [SN-30. "DTC Index"](#).

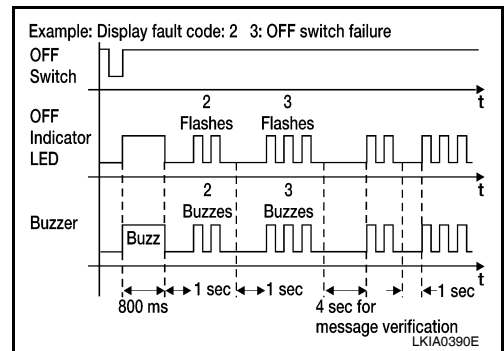

CLEARING FAULT CODES MODE

NOTE:

While in "clearing fault codes mode", self-diagnosis will automatically exit if no activity occurs for 30 seconds.

REAR SONAR SYSTEM

< FUNCTION DIAGNOSIS >

1. Push and hold rear sonar system OFF switch for three seconds to reset time-out counter.
2. Push and hold rear sonar system OFF switch for three seconds to clear codes.

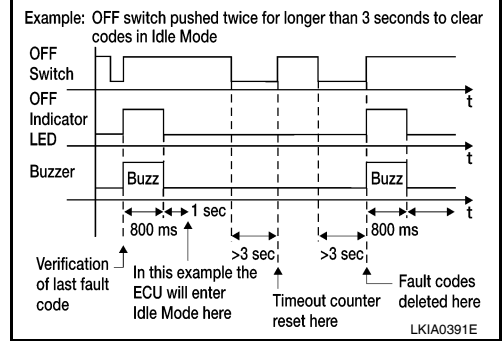

A
B
C
D
E
F
G
H
I
J
K
L
M
SN
O
P

FRONT AND REAR SONAR SYSTEM

< FUNCTION DIAGNOSIS >

FRONT AND REAR SONAR SYSTEM

System Diagram

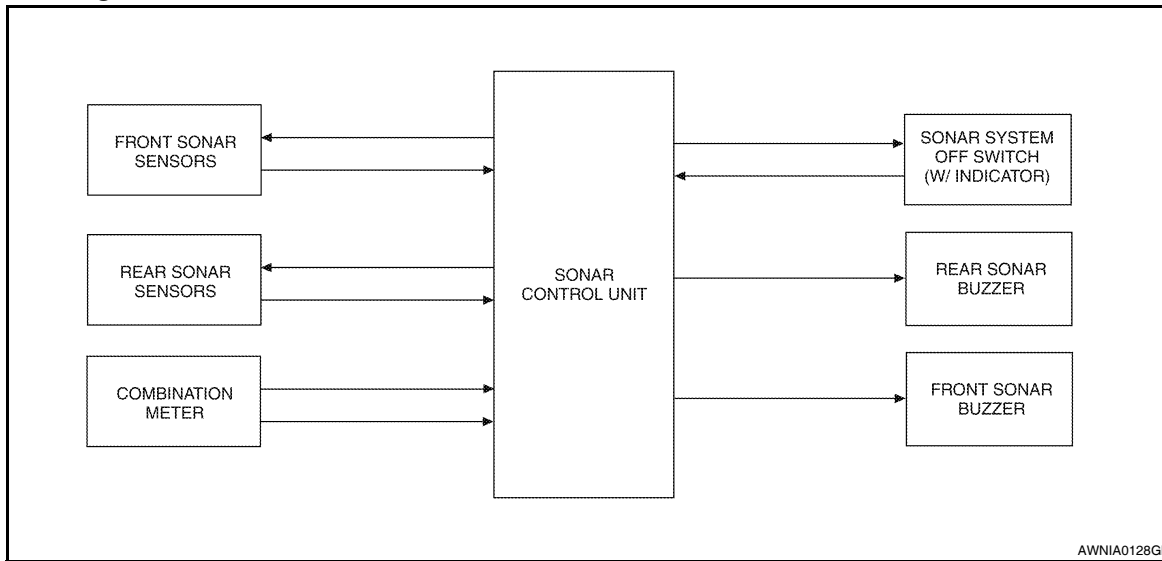

System Description

FUNCTION

With power and ground supplied, transmission gear selector lever in R position, and the sonar system OFF switch ON, the sonar system will detect obstacles within 1.8 m (5.9 ft.) of the rear sonar sensors and the two outer front sonar sensors. The vehicle operator is notified of obstacles by varied rate of tone from the rear sonar buzzer depending on distance of obstacle being sensed. If the vehicle speed reaches 50 km/h (31 MPH) the sonar system will shut down.

With power and ground supplied, transmission gear selector lever in a forward drive gear, and the sonar system OFF switch ON, the front sonar system will detect obstacles within 1.0 m (3 ft.) of the front sonar sensors. The vehicle operator is notified of obstacles by varied rate of tone from the front sonar buzzer depending on distance of obstacle being sensed. When the vehicle accelerates to 12 km/h (7.5 MPH) the sonar system will shut down. When the vehicle decelerates to 8 km/h (5 MPH) the sonar system will turn back on.

SONAR SYSTEM OFF SWITCH

With power and ground supplied to the sonar control unit, transmission gear selector lever in a position other than P, the sonar system can be disabled and the sonar buzzers silenced by momentarily pressing the sonar system OFF switch. The sonar system OFF indicator lamp will be illuminated in the sonar system OFF switch. The sonar system and buzzers will be disabled and the sonar system OFF indicator will be illuminated until the ignition switch is turned OFF. When the ignition switch is turned ON, the sonar system will be enabled. Depressing the sonar system OFF switch again will enable the sonar system also. Enabling the sonar system will cause the sonar system OFF indicator to go out. The indicator will flash if a malfunction exists in the system.

SONAR BUZZERS

With power and ground supplied to the sonar control unit and the A/T selector lever in R position, a stationary object that is at least 9.0 cm (3.5 in.) wide and that is closer than 1.8 m (5.9 ft.) will be detected by the rear sonar sensors and the two outer front sonar sensors, causing the rear sonar buzzer to sound a tone. As the vehicle moves closer to the object, the rate of the tone will increase. When the object is less than 25.0 cm (10 in.) from the rear bumper, the tone will sound continuously.

With power and ground supplied to the sonar control unit and the A/T selector lever in a forward drive gear, a stationary object that is at least 9.0 cm (3.5 in.) wide and that is closer than 1.0 m (3 ft.) will be detected by the front sonar sensors, causing the front sonar buzzer to sound a tone. As the vehicle moves closer to the object, the rate of the tone will increase. When the object is less than 30 cm (12 in.) from the front bumper, the tone will sound continuously.

REAR SONAR SENSORS

With power and ground supplied to the rear sonar sensors, the sonar sensors transmit an ultrasonic signal. This signal is reflected back to the sensor by objects large enough and close enough to be detected. The rear

FRONT AND REAR SONAR SYSTEM

< FUNCTION DIAGNOSIS >

sonar sensors measure the time from the transmitted signal to the time the signal is reflected back and send this information to the sonar control unit.

FRONT SONAR SENSORS

With power and ground supplied to the front sonar sensors, the sonar sensors transmit an ultrasonic signal. This signal is reflected back to the sensor by objects large enough and close enough to be detected. The front sonar sensors measure the time from the transmitted signal to the time the signal is reflected back and send this information to the sonar control unit.

COMBINATION METER

The combination meter provides the vehicle speed and park signals to the sonar control unit.

Component Parts Location

INFOID:000000003776746

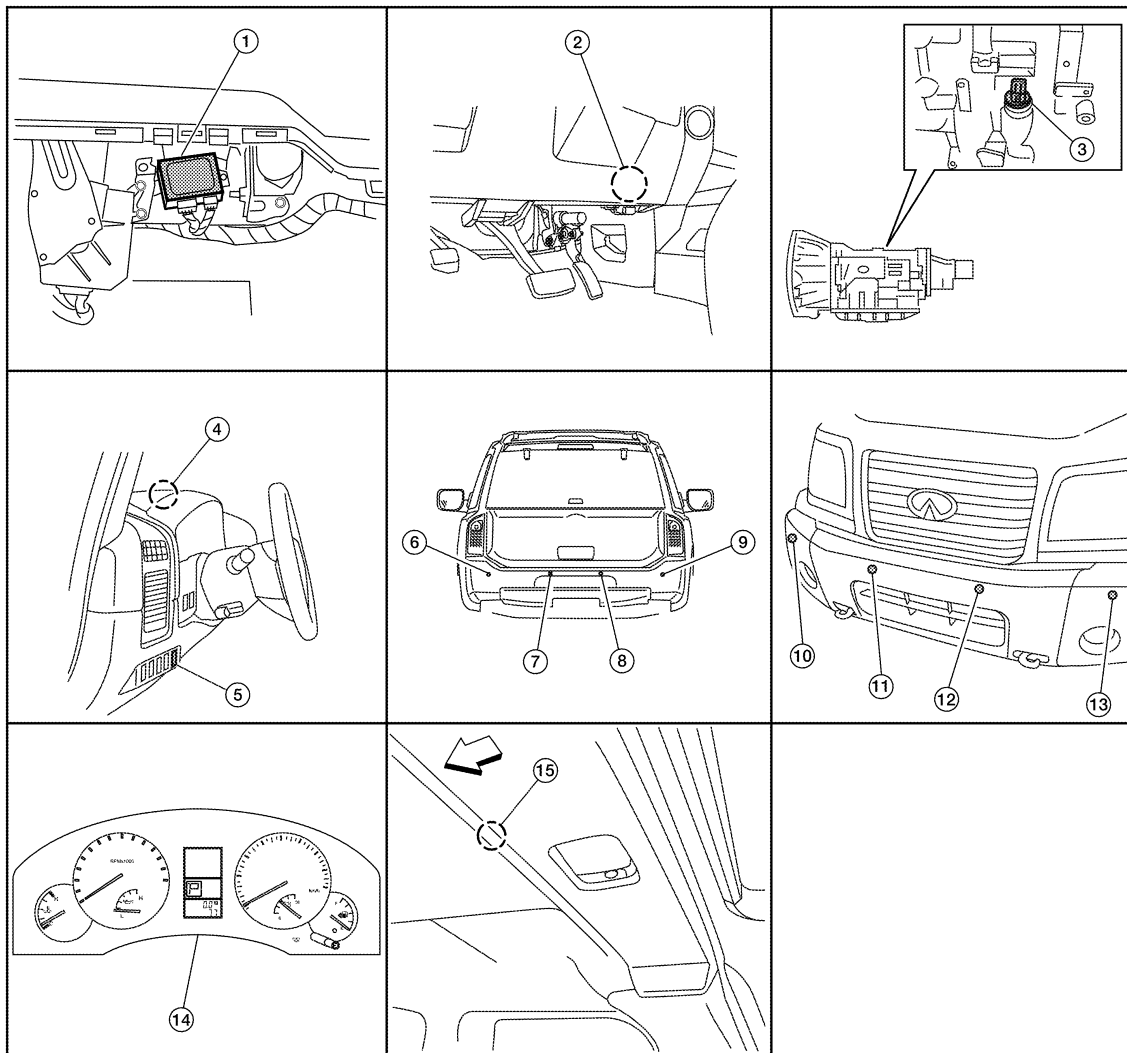

AWNIA1853ZZ

← Front

- | | | |
|--|--|--|
| 1. Sonar control unit B56, B57
(View with luggage side finisher LH removed) | 2. Back-up lamp relay M73 | 3. A/T assembly F9 |
| 4. Front sonar buzzer M118 | 5. Sonar system OFF switch M116
(with sonar system OFF indicator) | 6. Rear sonar sensor LH outer C102 |
| 7. Rear sonar sensor LH inner C103 | 8. Rear sonar sensor RH inner C104 | 9. Rear sonar sensor RH outer C105 |
| 10. Front sonar sensor RH outer E166 | 11. Front sonar sensor RH inner E163 | 12. Front sonar sensor LH inner E162 |
| 13. Front sonar sensor LH outer E158 | 14. Combination meter M23, M24 | 15. Rear sonar buzzer B166
(View with back door open) |

A
B
C
D
E
F
G
H
I
J
K
L
M
SN

FRONT AND REAR SONAR SYSTEM

< FUNCTION DIAGNOSIS >

Component Description

INFOID:000000003776747

Component	Function
Sonar control unit	Controls sonar system and provides self-diagnosis
Back-up lamp relay	Provides reverse signal for sonar control unit
A/T assembly	Controls back-up lamp relay
Front sonar buzzer	Sounds a signal when objects are detected in the front of the vehicle
Rear sonar buzzer	Sounds a signal when objects are detected in the rear of the vehicle
Sonar system OFF switch	Enables the driver to turn the system off and signals a system malfunction
Front sonar sensors	Senses objects in the front of the vehicle
Rear sonar sensors	Senses objects in the rear of the vehicle
Combination meter	Provides Park and vehicle speed signals for sonar control unit

CONSULT-III Function (SONAR)

INFOID:000000003776748

Diagnosis mode	Description
SELF-DIAG RESULTS	Displays sonar control unit self-diagnosis results.

SELF DIAGNOSTIC PROCEDURE

CONSULT-III can be used to read and clear DTCs. Refer to [GI-46, "Description"](#).

SELF DIAGNOSTIC RESULTS

Refer to [SN-44, "DTC Index"](#).

POWER SUPPLY AND GROUND CIRCUIT

< COMPONENT DIAGNOSIS >

COMPONENT DIAGNOSIS

POWER SUPPLY AND GROUND CIRCUIT

Diagnosis Procedure (With Rear Sonar System)

INFOID:000000004173800

INSPECTION FOR POWER SUPPLY AND GROUND CIRCUIT

1.CHECK FUSES

Check for blown rear sonar system fuses.

Unit	Power Source	Fuse	Location
Sonar control unit	ON or START	12	Fuse block (J/B)
		51	IPDM E/R

Are any fuses blown?

YES >> If fuse is blown, be sure to eliminate cause of malfunction before installing new fuse. Refer to [GL-41. "Circuit Inspection"](#).

NO >> GO TO 2.

2.CHECK POWER SUPPLY CIRCUIT

1. Disconnect sonar control unit connector.
2. Turn ignition switch ON.
3. Check voltage between sonar control unit connector B24 terminal 8 and ground.

Terminals		Ignition switch position
(+)	(-)	
Connector	Terminal	ON or START
B24	8	Battery voltage

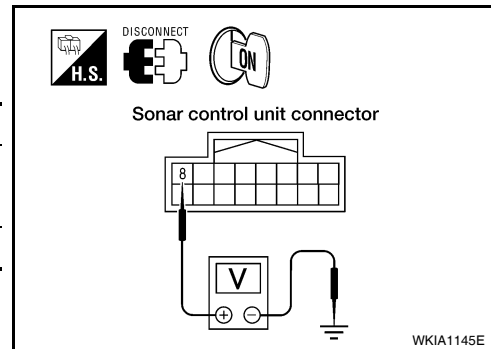

Is there battery voltage?

YES >> GO TO 3.

NO >> Check harness for open between sonar control unit and fuse.

3.CHECK GROUND CIRCUIT

1. Turn ignition switch OFF.
2. Check continuity between sonar control unit connector B24 terminal 6 and ground.

Terminals		Continuity
(+)	(-)	
Connector	Terminal	
B24	6	Ground
		Yes

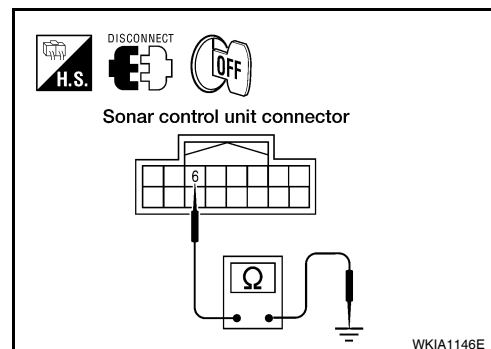

Is there continuity?

YES >> Inspection End.

NO >> Check harness ground circuit.

Diagnosis Procedure (With Front and Rear Sonar System)

INFOID:000000004173801

INSPECTION FOR POWER SUPPLY AND GROUND CIRCUIT

1.CHECK FUSES

Check for blown sonar system fuses.

POWER SUPPLY AND GROUND CIRCUIT

< COMPONENT DIAGNOSIS >

Unit	Power Source	Fuse	Location
Sonar control unit	ON or START	12	Fuse block (J/B)
		51	IPDM E/R

Are any fuses blown?

YES >> If fuse is blown, be sure to eliminate cause of malfunction before installing new fuse. Refer to [GL-41. "Circuit Inspection"](#).

NO >> GO TO 2.

2. CHECK POWER SUPPLY CIRCUIT

1. Disconnect sonar control unit connector B56.
2. Turn ignition switch ON.
3. Check voltage between sonar control unit connector B56 terminal 1 and ground.

Terminals		(-)	Voltage
(+)			
Connector	Terminal		
B56	1	Ground	Battery voltage

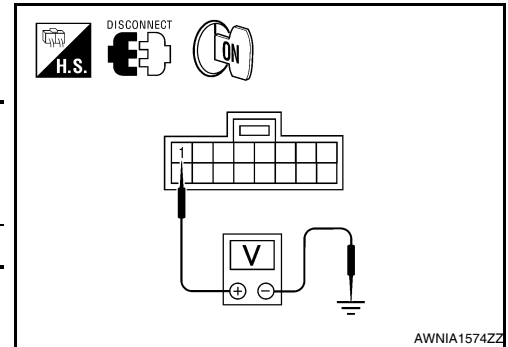

Is there battery voltage?

YES >> GO TO 3.

NO >> Check harness for open between sonar control unit and fuse.

3. CHECK GROUND CIRCUIT

1. Turn ignition switch OFF.
2. Check continuity between sonar control unit connector B56 terminal 4 and ground.

Terminals		(-)	Continuity
(+)			
Connector	Terminal		
B56	4	Ground	Yes

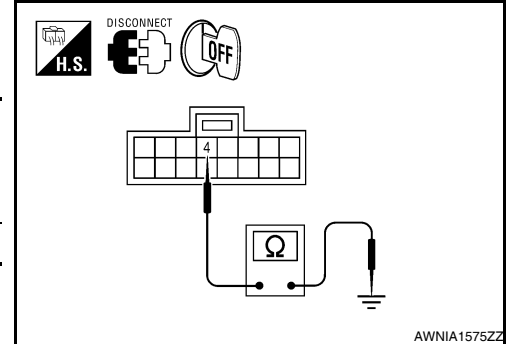

Is there continuity?

YES >> Inspection End.

NO >> Check harness ground circuit.

SONAR SENSOR CIRCUIT INSPECTION

< COMPONENT DIAGNOSIS >

SONAR SENSOR CIRCUIT INSPECTION

Description

INFOID:000000004173802

With power and ground supplied to the sonar sensors, the sonar sensors transmit an ultrasonic signal. This signal is reflected back to the sensor by objects large enough and close enough to be detected. The sonar sensors measure the time from the transmitted signal to the time the signal is reflected back and send this information to the sonar control unit.

Diagnosis Procedure (With Rear Sonar System)

INFOID:000000004173803

1. CHECK REAR SONAR SENSOR CIRCUITS

1. Turn ignition switch OFF.
2. Disconnect sonar control unit connector and rear sonar sensor connectors.
3. Check continuity between sonar control unit harness connector (A) and rear sonar sensor harness connectors (B).

Connector	Terminal	Connector	Terminal	Continuity
B24 (A)	16	C102, C103, C104, C105 (B)	1	Yes
	15		3	
	9, 10, 11, 12		2	

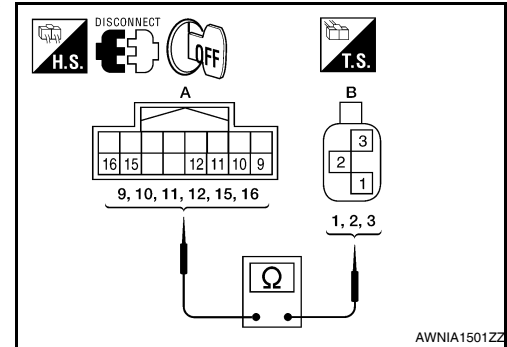

4. Check continuity between sonar control unit harness connector and ground.

Connector	Terminal	Continuity
B24	9, 10, 11, 12, 15, 16	No

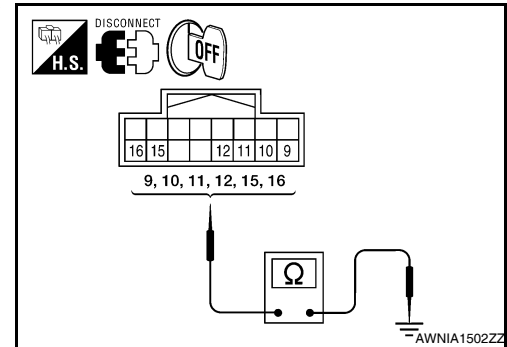

Are the inspection results normal?

- YES >> Inspection End.
 NO >> Repair harness or connector.

Diagnosis Procedure (With Front and Rear Sonar System)

INFOID:000000004173804

1. CHECK SONAR SENSOR CIRCUITS

1. Turn ignition switch OFF.
2. Disconnect sonar control unit connectors and sonar sensor connectors.
3. Check continuity between sonar control unit harness connectors (A, B) and sonar sensor harness connectors (C).

Connector	Terminal	Connector	Terminal	Continuity
B56 (A)	9	C102, C103, C104, C105 (C)	1	Yes
	12		3	
	13, 14, 15, 16		2	
B57 (B)	17	E158, E162, E163, E166 (C)	1	Yes
	26		3	
	19, 20, 24, 25		2	

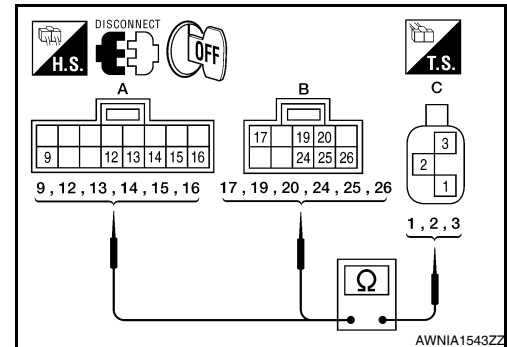

A
B
C
D
E
F
G
H
I
J
K
L
M
N
O
P

SN

SONAR SENSOR CIRCUIT INSPECTION

< COMPONENT DIAGNOSIS >

4. Check continuity between sonar control unit harness connectors (A, B) and ground.

Connector	Terminal	Continuity
B56 (A)	9, 12, 13, 14, 15, 16	Ground
B57 (B)	17, 19, 20, 24, 25, 26	

Are the inspection results normal?

- YES >> Inspection End.
 NO >> Repair harness or connector.

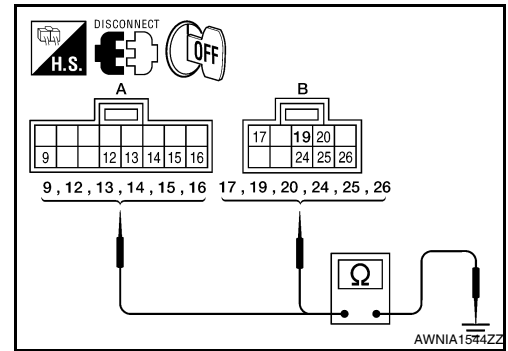

SONAR BUZZER CIRCUIT INSPECTION

< COMPONENT DIAGNOSIS >

SONAR BUZZER CIRCUIT INSPECTION

Description

INFOID:000000004173805

When the A/T selector lever is not in park or neutral, a stationary object will be detected by the sonar sensors causing the front or rear sonar buzzer to sound a tone. As the vehicle moves closer to the object, the rate of the tone will increase. When the object is very close to the vehicle, the tone will sound continuously.

Diagnosis Procedure (With Rear Sonar System)

INFOID:000000004173806

1. CHECK SONAR BUZZER

Refer to [SN-18. "Component Inspection"](#).

Is the inspection result normal?

YES >> GO TO 2.

NO >> Replace sonar buzzer. Refer to [SN-51. "Removal and Installation"](#).

2. CHECK SONAR BUZZER CIRCUITS

1. Turn ignition switch OFF.
2. Disconnect sonar control unit connector and sonar buzzer connector.
3. Check continuity between sonar control unit harness connector (A) and sonar buzzer harness connector (B).

Connector	Terminal	Connector	Terminal	Continuity
B24 (A)	3	M47 (B)	2	Yes
	7		1	

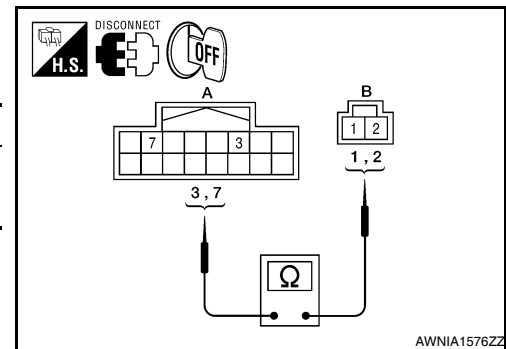

4. Check continuity between sonar control unit harness connector and ground.

Connector	Terminal	Continuity
B24	3, 7	No

Are the inspection results normal?

YES >> Inspection End.

NO >> Repair harness or connector.

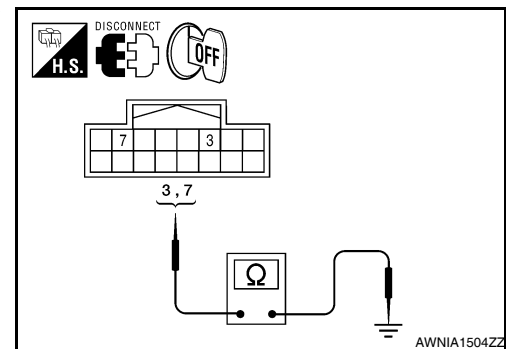

Diagnosis Procedure (With Front and Rear Sonar System)

INFOID:000000004173807

1. CHECK BUZZERS

Refer to [SN-18. "Component Inspection"](#).

Is the inspection result normal?

YES >> GO TO 2.

NO >> Replace buzzer. Refer to [SN-51. "Removal and Installation"](#).

2. CHECK BUZZER CIRCUITS

1. Turn ignition switch OFF.
2. Disconnect sonar control unit connectors and sonar buzzer connectors.

A
B
C
D
E
F
G
H
I
J
K
L
M
O
P

SN

SONAR BUZZER CIRCUIT INSPECTION

< COMPONENT DIAGNOSIS >

- Check continuity between sonar control unit harness connectors (A, B) and sonar buzzer harness connectors (C).

Connector	Terminal	Connector	Terminal	Continuity
B56 (A)	2	B166, M118 (C)	1	Yes
	6	B166 (C)	2	
B57 (B)	23	M118 (C)		

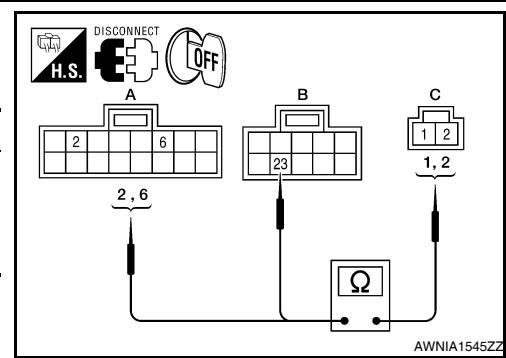

- Check continuity between sonar control unit harness connectors (A, B) and ground.

Connector	Terminal	Continuity
B56 (A)	2, 6	Ground
B57 (B)	23	

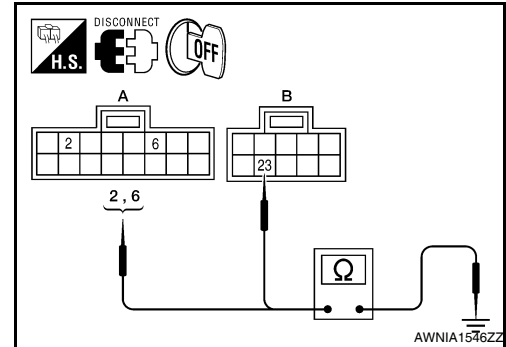

Are the inspection results normal?

- YES >> Inspection End.
 NO >> Repair harness or connector.

Component Inspection

SONAR BUZZER

- Disconnect the sonar buzzer connector.
- Check continuity between sonar buzzer terminals 1 and 2.

1 - 2 : Continuity should exist

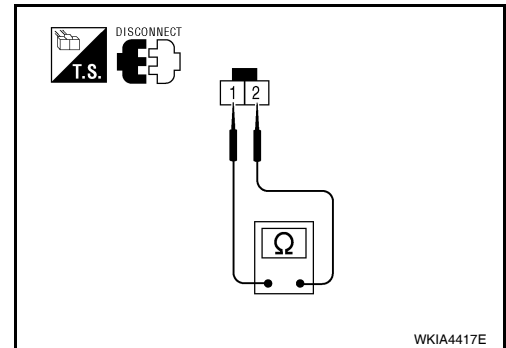

INFOID:000000004173808

SONAR SYSTEM OFF SWITCH CIRCUIT INSPECTION

< COMPONENT DIAGNOSIS >

SONAR SYSTEM OFF SWITCH CIRCUIT INSPECTION

Description

INFOID:000000004173809

The sonar system can be disabled by momentarily pressing the sonar system OFF switch. The sonar system OFF indicator lamp will be illuminated when the sonar system is OFF. Enabling the sonar system will cause the sonar system OFF indicator to go out. The indicator will flash if a malfunction exists in the system.

Diagnosis Procedure (With Rear Sonar System)

INFOID:000000004173810

1. CHECK REAR SONAR SYSTEM OFF SWITCH

Refer to [SN-20. "Component Inspection"](#).

Is the inspection result normal?

YES >> GO TO 2.

NO >> Replace rear sonar system OFF switch. Refer to [IP-15. "Removal and Installation"](#).

2. CHECK REAR SONAR SYSTEM OFF SWITCH CIRCUITS

1. Turn ignition switch OFF.
2. Disconnect sonar control unit connector and rear sonar system OFF switch connector.
3. Check continuity between sonar control unit harness connector (A) and rear sonar system OFF switch harness connector (B).

Connector	Terminal	Connector	Terminal	Continuity
B24 (A)	4	M117 (B)	5	Yes
	13		1	

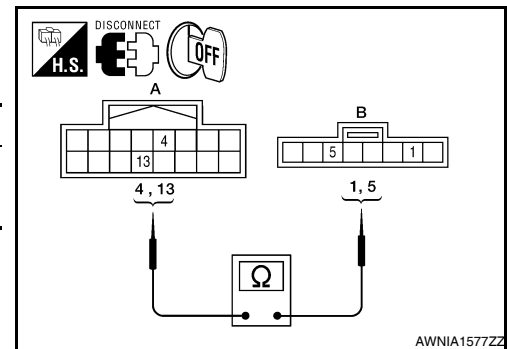

4. Check continuity between rear sonar system OFF switch harness connector and ground.

Connector	Terminal	Continuity
M117	1, 5	No
	2, 6	Yes

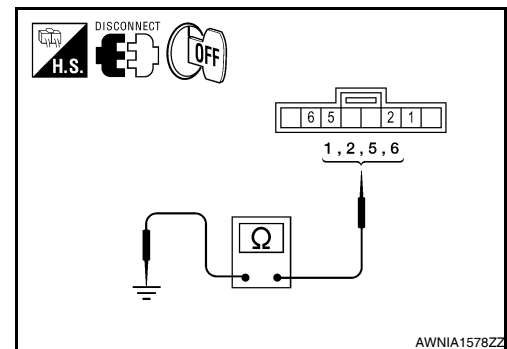

Are the inspection results normal?

YES >> Inspection End.

NO >> Repair harness or connector.

Diagnosis Procedure (With Front and Rear Sonar System)

INFOID:000000004173811

1. CHECK SONAR SYSTEM OFF SWITCH

Refer to [SN-20. "Component Inspection"](#).

Is the inspection result normal?

YES >> GO TO 2.

NO >> Replace sonar system OFF switch. Refer to [IP-15. "Removal and Installation"](#).

2. CHECK SONAR SYSTEM OFF SWITCH CIRCUITS

1. Turn ignition switch OFF.
2. Disconnect sonar control unit connector and sonar system OFF switch connector.

A
B
C
D
E
F
G
H
I
J
K
L
M
N
O
P

SN

SONAR SYSTEM OFF SWITCH CIRCUIT INSPECTION

< COMPONENT DIAGNOSIS >

3. Check continuity between sonar control unit harness connector (A) and sonar system OFF switch harness connector (B).

Connector	Terminal	Connector	Terminal	Continuity
B56 (A)	5	M116 (B)	5	Yes
	11		1	

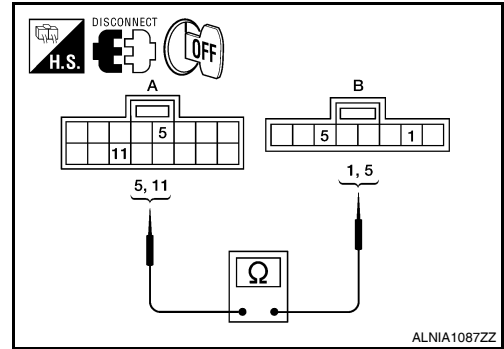

4. Check continuity between sonar system OFF switch harness connector and ground.

Connector	Terminal	Continuity
M116	1, 5	No
	2, 6	Yes

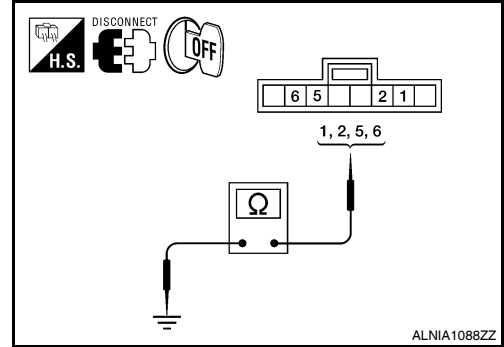

Are the inspection results normal?

- YES >> Inspection End.
NO >> Repair harness or connector.

Component Inspection

SONAR SYSTEM OFF SWITCH

1. Disconnect the sonar system OFF switch connector.
2. Check continuity between the following switch terminals.

Sonar system OFF switch	Terminals	Continuity
Depressed	1 - 2	Yes
Released		No

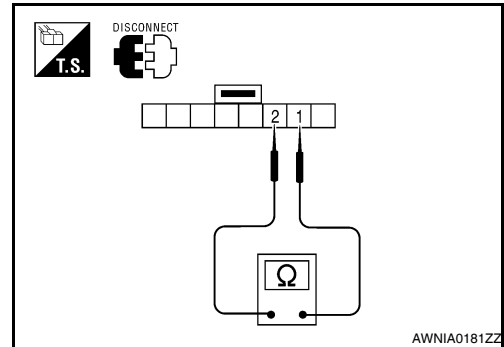

SONAR SYSTEM OFF INDICATOR

1. Disconnect the sonar system OFF switch connector.
2. Apply battery voltage to switch terminal 5.
3. Check the sonar system OFF indicator operation when switch terminal 6 is connected to battery ground.

	Terminals	Condition	Operation
Sonar system OFF switch	5	Battery voltage	Indicator ON
	6	Ground	

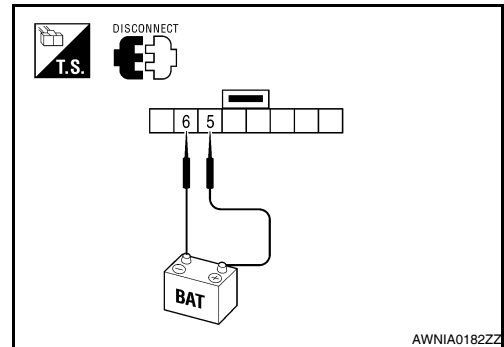

SONAR CONTROL UNIT FOR REAR SONAR SYSTEM

< ECU DIAGNOSIS >

ECU DIAGNOSIS

SONAR CONTROL UNIT FOR REAR SONAR SYSTEM

Reference Value

INFOID:000000003776753

SONAR CONTROL UNIT TERMINAL LAYOUT

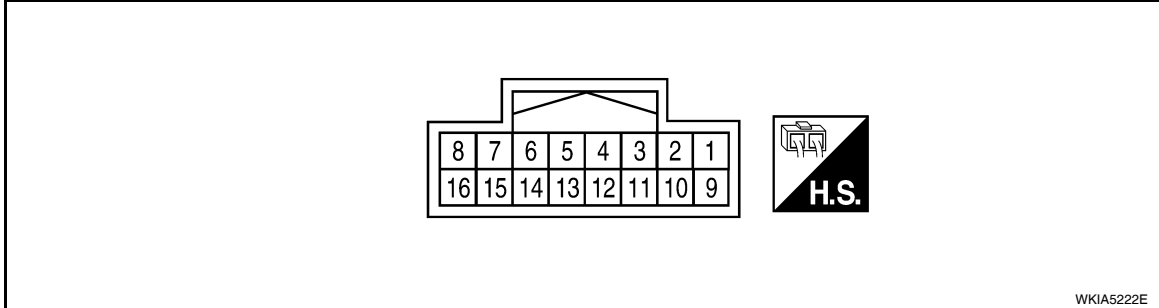

TERMINALS AND REFERENCE VALUES FOR SONAR CONTROL UNIT

Terminal (wire color)	Item	Condition		Reference value (V) (Approx.)	
		Ignition switch	Operation		
3 (R)	Sonar buzzer return	ON	—	0 - 12 (variable)	
4 (BR/Y)	Sonar system OFF indicator output	ON	Rear sonar system OFF switch	ON OFF	0 Battery voltage
			5 (G/W)	Reverse signal	ON
Transmission gear se- lector lever	Not R position	0			
6 (B)	Sonar control unit ground	—	—	0	
7 (L)	Sonar buzzer drive signal	ON	—	Battery voltage	
8 (G/R)	Sonar control unit power	ON	—	Battery voltage	
9 (GR)	Rear sonar sensor signal - RH outer	ON	<ul style="list-style-type: none"> • Rear sonar system OFF switch ON • Transmission gear selector lever in R po- sition • No obstacles 	Battery voltage	
10 (P)	Rear sonar sensor signal - LH outer	ON	<ul style="list-style-type: none"> • Rear sonar system OFF switch ON • Transmission gear selector lever in R po- sition • No obstacles 	Battery voltage	
11 (O)	Rear sonar sensor signal - LH inner	ON	<ul style="list-style-type: none"> • Rear sonar system OFF switch ON • Transmission gear selector lever in R po- sition • Distance obstacles 	Battery voltage	
12 (LG)	Rear sonar sensor signal - RH inner	ON	<ul style="list-style-type: none"> • Rear sonar system OFF switch ON • Transmission gear selector lever in R po- sition • Distance obstacles 	Battery voltage	
13 (LG)	Rear sonar system OFF switch signal	ON	Rear sonar system OFF switch	ON	0
				OFF	Battery voltage

SONAR CONTROL UNIT FOR REAR SONAR SYSTEM

< ECU DIAGNOSIS >

Terminal (wire color)	Item	Condition		Reference value (V) (Approx.)
		Ignition switch	Operation	
15 (Y)	Rear sonar sensor ground	ON	—	0
16 (LG/B)	Rear sonar sensor power	ON	Ignition switch ON	Battery voltage

SONAR CONTROL UNIT FOR REAR SONAR SYSTEM

< ECU DIAGNOSIS >

Wiring Diagram

INFOID:00000003776754

SONAR SYSTEM - REAR

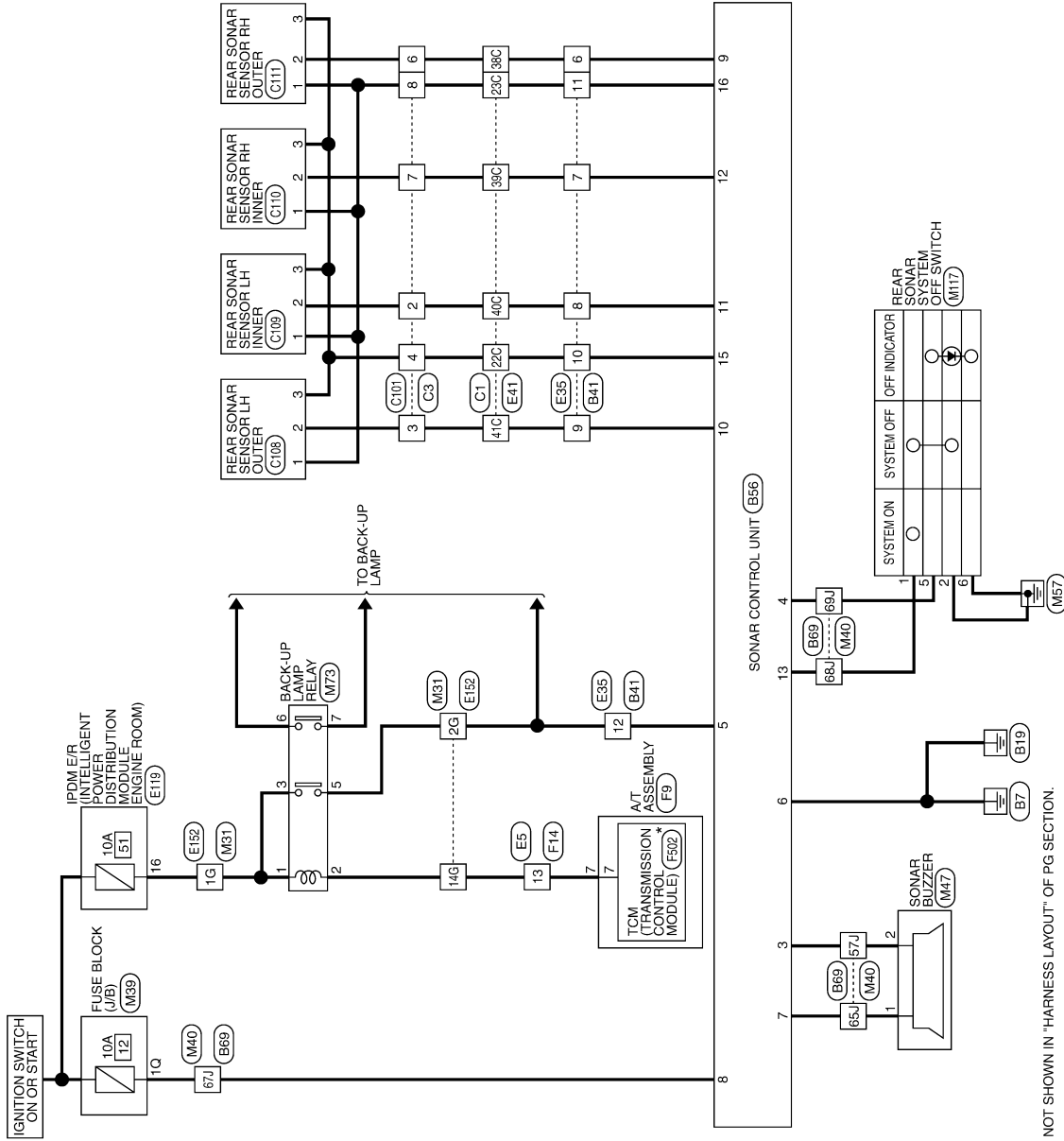

*: THIS CONNECTOR IS NOT SHOWN IN "HARNES LAYOUT" OF PG SECTION.

ABNWA0033Gf

A
B
C
D
E
F
G
H
I
J
K
L
M
N
O
P

SN

SONAR CONTROL UNIT FOR REAR SONAR SYSTEM

< ECU DIAGNOSIS >

SONAR SYSTEM CONNECTORS - REAR

Connector No.	M31
Connector Name	WIRE TO WIRE
Connector Color	WHITE

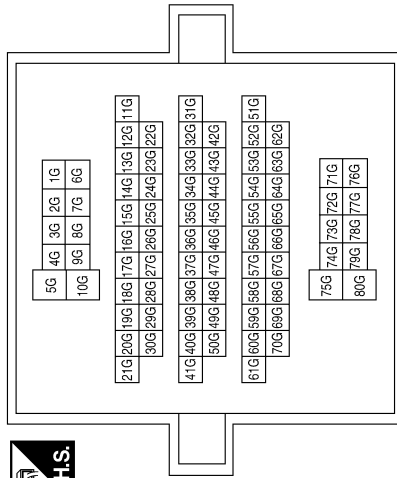

Terminal No.	Color of Wire	Signal Name
1G	G	-
2G	G/W	-
14G	R	-

Connector No.	M39
Connector Name	FUSE BLOCK (J/B)
Connector Color	WHITE

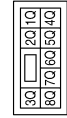

Terminal No.	Color of Wire	Signal Name
1Q	G/R	-

Connector No.	M40
Connector Name	WIRE TO WIRE
Connector Color	WHITE

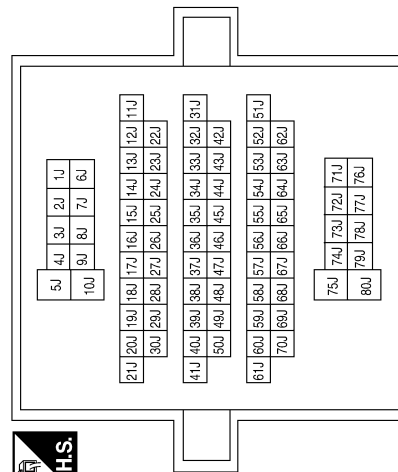

Terminal No.	Color of Wire	Signal Name
57J	R	-
65J	L	-
67J	G/R	-
68J	LG	-
69J	BR/Y	-

Connector No.	M47
Connector Name	SONAR BUZZER
Connector Color	BLACK



Terminal No.	Color of Wire	Signal Name
1	L	-
2	R	-

ABNIA0077GB

SONAR CONTROL UNIT FOR REAR SONAR SYSTEM

< ECU DIAGNOSIS >

Connector No.	E5
Connector Name	WIRE TO WIRE
Connector Color	WHITE

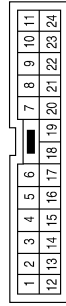

Terminal No.	Color of Wire	Signal Name
13	R	-

Connector No.	M117
Connector Name	REAR SONAR SYSTEM OFF SWITCH
Connector Color	GRAY

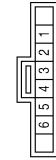

Terminal No.	Color of Wire	Signal Name
1	LG	-
2	B	-
5	BR/Y	-
6	B	-

Connector No.	M73
Connector Name	BACK-UP LAMP RELAY
Connector Color	BROWN



Terminal No.	Color of Wire	Signal Name
1	G	-
2	R	-
3	G	-
5	G/W	-
6	W/B	-
7	Y/R	-

Terminal No.	Color of Wire	Signal Name
22C	Y	-
23C	LG/B	-
38C	GR	-
39C	LG	-
40C	O	-
41C	P	-

Connector No.	E41
Connector Name	WIRE TO WIRE
Connector Color	GRAY

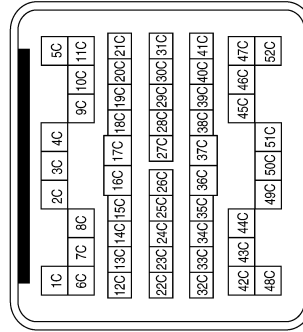

Connector No.	E35
Connector Name	WIRE TO WIRE
Connector Color	WHITE

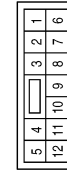

Terminal No.	Color of Wire	Signal Name
6	GR	-
7	LG	-
8	O	-
9	P	-
10	Y	-
11	LG/B	-
12	G/W	-

ABNIA0078GB

A
B
C
D
E
F
G
H
I
J
K
L
M
N
O
P

SN

SONAR CONTROL UNIT FOR REAR SONAR SYSTEM

< ECU DIAGNOSIS >

Connector No.	E119
Connector Name	IPDM E/R (INTELLIGENT POWER DISTRIBUTION MODULE ENGINE ROOM)
Connector Color	WHITE

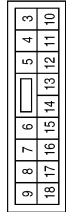

Terminal No.	Color of Wire	Signal Name
16	G	REVERSE LAMP

Connector No.	E152
Connector Name	WIRE TO WIRE
Connector Color	WHITE

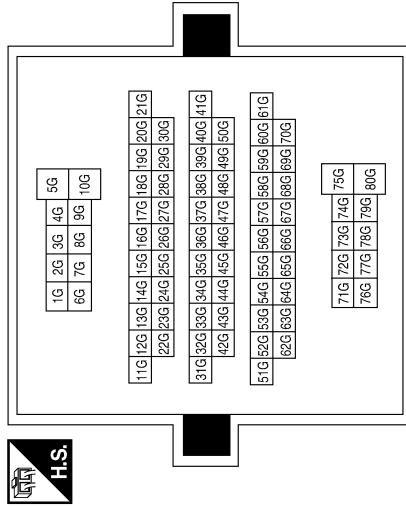

Terminal No.	Color of Wire	Signal Name
1G	G	-
2G	G/W	-
14G	R	-

Connector No.	F9
Connector Name	A/T ASSEMBLY
Connector Color	GREEN

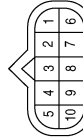

Terminal No.	Color of Wire	Signal Name
7	R	-

Connector No.	F14
Connector Name	WIRE TO WIRE
Connector Color	WHITE

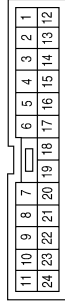

Terminal No.	Color of Wire	Signal Name
13	R	-

Connector No.	F502
Connector Name	TCM (TRANSMISSION CONTROL MODULE)
Connector Color	GRAY

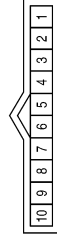

Terminal No.	Color of Wire	Signal Name
7	R	REV LAMP RLY

SONAR CONTROL UNIT FOR REAR SONAR SYSTEM

< ECU DIAGNOSIS >

Connector No.	C3
Connector Name	WIRE TO WIRE
Connector Color	GRAY

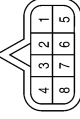

Terminal No.	Color of Wire	Signal Name
2	O	-
3	P	-
4	Y	-
6	GR	-
7	LG	-
8	LG/B	-

Terminal No.	Color of Wire	Signal Name
22C	Y	-
23C	LG/B	-
38C	GR	-
39C	LG	-
40C	O	-
41C	P	-

Connector No.	C1
Connector Name	WIRE TO WIRE
Connector Color	GRAY

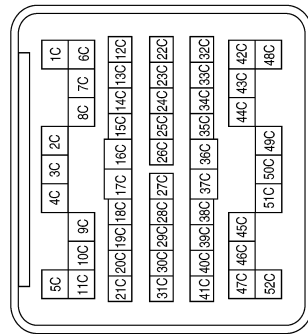

Connector No.	C103
Connector Name	REAR SONAR SENSOR LH INNER
Connector Color	BLACK

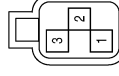

Terminal No.	Color of Wire	Signal Name
1	LG/B	PWR
2	O	SIGNAL
3	Y	GND

Connector No.	C102
Connector Name	REAR SONAR SENSOR LH OUTER
Connector Color	BLACK

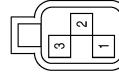

Terminal No.	Color of Wire	Signal Name
1	LG/B	PWR
2	P	SIGNAL
3	Y	GND

Connector No.	C101
Connector Name	WIRE TO WIRE
Connector Color	GRAY

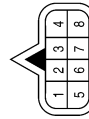

Terminal No.	Color of Wire	Signal Name
2	O	-
3	P	-
4	Y	-
6	GR	-
7	LG	-
8	LG/B	-

ABNIA0080GB

A B C D E F G H I J K L M N O P

SN

SONAR CONTROL UNIT FOR REAR SONAR SYSTEM

< ECU DIAGNOSIS >

Connector No.	C105
Connector Name	REAR SONAR SENSOR RH OUTER
Connector Color	BLACK

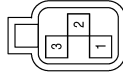

Terminal No.	Color of Wire	Signal Name
1	LG/B	PWR
2	GR	SIGNAL
3	Y	GND

Connector No.	C104
Connector Name	REAR SONAR SENSOR RH INNER
Connector Color	BLACK

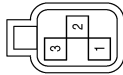

Terminal No.	Color of Wire	Signal Name
1	LG/B	PWR
2	LG	SIGNAL
3	Y	GND

Connector No.	B41
Connector Name	WIRE TO WIRE
Connector Color	WHITE



Terminal No.	Color of Wire	Signal Name
9	GR	SENSOR SIGNAL ROR
10	P	SENSOR SIGNAL ROL
11	O	SENSOR SIGNAL RIL
12	LG	SENSOR SIGNAL RIR
13	LG	ON/OFF SWITCH
14	-	-
15	Y	REAR SENSOR GND
16	LG/B	REAR SENSOR PWR

Connector No.	B24
Connector Name	SONAR CONTROL UNIT
Connector Color	WHITE

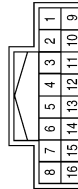

Terminal No.	Color of Wire	Signal Name
1	-	-
2	-	-
3	R	SOUNDER -
4	BR/Y	STATUS LED
5	G/W	REVERSE LAMP SIGNAL
6	B	AI GND
7	L	SOUNDER +
8	G/R	AI POWER

Terminal No.	Color of Wire	Signal Name
6	GR	-
7	LG	-
8	O	-
9	P	-
10	Y	-
11	LG/B	-
12	G/W	-

ABNIA0081GB

SONAR CONTROL UNIT FOR REAR SONAR SYSTEM

< ECU DIAGNOSIS >

A
B
C
D
E
F
G
H
I
J
K
L
M
SN
O
P

Terminal No.	Color of Wire	Signal Name
57J	R	-
65J	L	-
67J	G/R	-
68J	LG	-
69J	BR/Y	-

Connector No.	B69
Connector Name	WIRE TO WIRE
Connector Color	WHITE

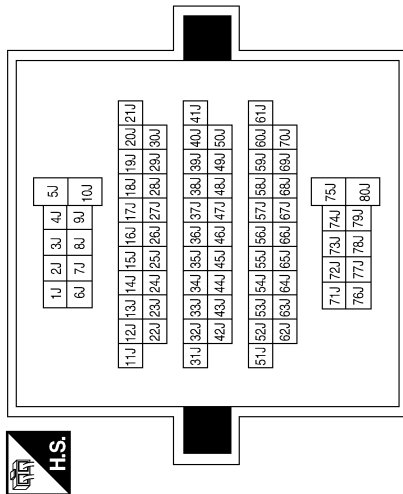

ABNIA0082GB

SONAR CONTROL UNIT FOR REAR SONAR SYSTEM

< ECU DIAGNOSIS >

DTC Index

INFOID:000000003776755

Fault Code	Malfunction	Service Procedure
11	Rear sonar sensor LH outer	<ol style="list-style-type: none">1. Check harness for open or short.2. Replace sonar sensor. Refer to SN-49, "Removal and Installation".
12	Rear sonar sensor LH inner	
13	Rear sonar sensor RH inner	
14	Rear sonar sensor RH outer	
21	Sonar buzzer	<ol style="list-style-type: none">1. Refer to SN-17, "Diagnosis Procedure (With Rear Sonar System)".2. Check harness for open or short.3. Refer to SN-45, "Symptom Table".
22	Sonar system OFF indicator	<ol style="list-style-type: none">1. Refer to SN-19, "Diagnosis Procedure (With Rear Sonar System)".2. Check harness for open or short.3. Refer to symptom table.
23	Rear sonar system OFF switch	
24	Sonar control unit	Replace sonar control unit. Refer to SN-50, "Removal and Installation" .

SONAR CONTROL UNIT FOR FRONT AND REAR SONAR SYSTEM

< ECU DIAGNOSIS >

SONAR CONTROL UNIT FOR FRONT AND REAR SONAR SYSTEM

Reference Value

INFOID:000000003776756

SONAR CONTROL UNIT HARNESS TERMINAL LAYOUT

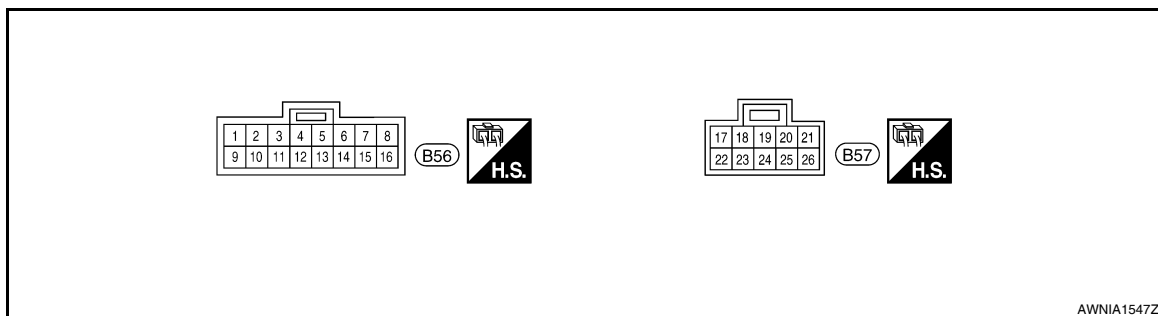

TERMINALS AND REFERENCE VALUES FOR SONAR CONTROL UNIT

Terminal (color)	Item	Condition		Reference value (V) (Approx.)	
		Ignition switch	Operation		
1 (G/R)	Sonar control unit power	ON	—	Battery voltage	
2 (L)	Sonar buzzer drive signal	ON	Object sensed	Battery voltage	
3 (G/W)	Reverse signal	ON	Transmission gear selector lever in R position	Battery voltage	
			Transmission gear selector lever not in R position	0	
4 (B)	Sonar control unit ground	—	—	—	
5 (BR/Y)	Sonar system OFF indicator output	ON	Sonar system OFF switch	ON	0
				OFF	Battery voltage
6 (R)	Rear sonar buzzer return	ON	—	0 - 12 (variable)	
8 (G/W)	K-line	ON	—	—	
9 (LG/B)	Rear sonar sensor power	ON	Ignition switch ON	Battery voltage	
11 (LG)	Sonar system OFF switch signal	ON	Sonar system OFF switch	ON	0
				OFF	Battery voltage
12 (Y)	Rear sonar sensor ground	ON	—	—	
13 (LG)	Rear sonar sensor signal - RH inner	ON	<ul style="list-style-type: none"> • Sonar system OFF switch ON • Transmission gear selector lever in R position • Distance obstacles 	Battery voltage	
14 (O)	Rear sonar sensor signal - LH inner	ON	<ul style="list-style-type: none"> • Sonar system OFF switch ON • Transmission gear selector lever in R position • Distance obstacles 	Battery voltage	
15 (P)	Rear sonar sensor signal - LH outer	ON	<ul style="list-style-type: none"> • Sonar system OFF switch ON • Transmission gear selector lever in R position • No obstacles 	Battery voltage	

SONAR CONTROL UNIT FOR FRONT AND REAR SONAR SYSTEM

< ECU DIAGNOSIS >

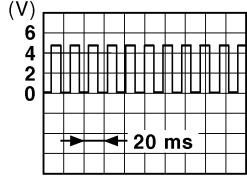
Terminal (color)	Item	Condition		Reference value (V) (Approx.)
		Ignition switch	Operation	
16 (GR)	Rear sonar sensor signal - RH outer	ON	<ul style="list-style-type: none"> • Sonar system OFF switch ON • Transmission gear selector lever in R position • No obstacles 	Battery voltage
17 (LG/B)	Front sonar sensor power	ON	Ignition switch ON	Battery voltage
18 (GR/R)	Park position signal	ON	Vehicle in PARK	12
19 (GR)	Front sonar sensor signal - RH outer	ON	<ul style="list-style-type: none"> • Sonar system OFF switch ON • Transmission gear selector lever in a forward drive gear • Distance obstacles 	Battery voltage
20 (LG)	Front sonar sensor signal - RH inner	ON	<ul style="list-style-type: none"> • Sonar system OFF switch ON • Transmission gear selector lever in reverse or a forward drive gear • No obstacles 	Battery voltage
21 (W/R)	Vehicle speed signal	ON	Speedometer operated [When vehicle speed is approx. 40 km/h (25 MPH)]	<p>NOTE: Maximum voltage may be 12V due to specifications (connected units).</p>  <p style="text-align: right; font-size: small;">PKIC0643E</p>
23 (R)	Front sonar buzzer return	ON	—	0 - 12 (variable)
24 (P)	Front sonar sensor signal - LH outer	ON	<ul style="list-style-type: none"> • Sonar system OFF switch ON • Transmission gear selector lever in reverse or a forward drive gear • No obstacles 	Battery voltage
25 (O)	Front sonar sensor signal - LH inner	ON	<ul style="list-style-type: none"> • Sonar system OFF switch ON • Transmission gear selector lever in a forward drive gear • Distance obstacles 	Battery voltage
26 (Y)	Front sonar sensor ground	ON	—	—

SONAR CONTROL UNIT FOR FRONT AND REAR SONAR SYSTEM

< ECU DIAGNOSIS >

Wiring Diagram

INFOID:000000003776757

SONAR SYSTEM - FRONT AND REAR

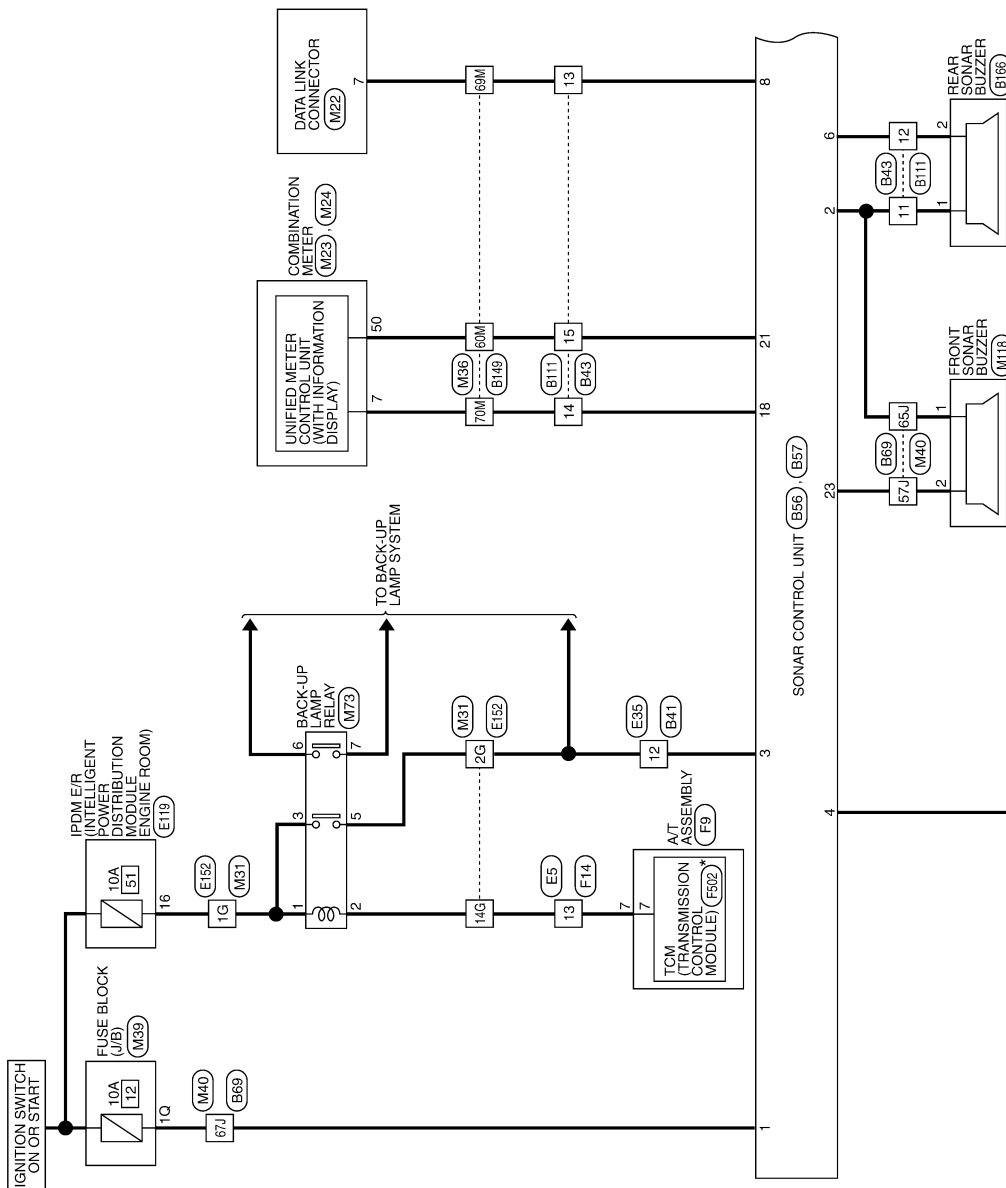

*: THIS CONNECTOR IS NOT SHOWN IN "HARNES LAYOUT" OF PG SECTION.

ABNWA0034Gf

A
B
C
D
E
F
G
H
I
J
K
L
M
N
O
P

SN

SONAR CONTROL UNIT FOR FRONT AND REAR SONAR SYSTEM

< ECU DIAGNOSIS >

SONAR SYSTEM CONNECTORS - FRONT AND REAR

Connector No.	M22
Connector Name	DATA LINK CONNECTOR
Connector Color	WHITE

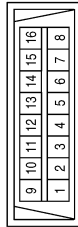

Terminal No.	Color of Wire	Signal Name
7	G/W	-

Connector No.	M23
Connector Name	COMBINATION METER
Connector Color	WHITE

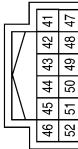

Terminal No.	Color of Wire	Signal Name
50	W/R	SPEED OUT

Connector No.	M24
Connector Name	COMBINATION METER
Connector Color	WHITE

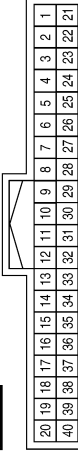

Terminal No.	Color of Wire	Signal Name
7	GR/R	PN REVERSE

Connector No.	M31
Connector Name	WIRE TO WIRE
Connector Color	WHITE

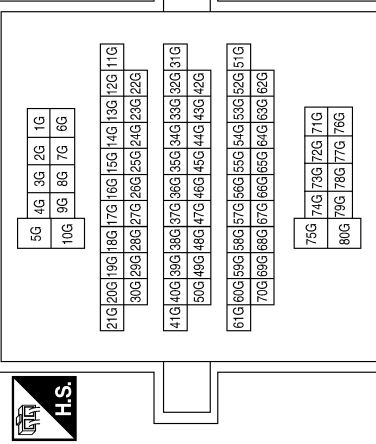

Terminal No.	Color of Wire	Signal Name
1G	G	-
2G	G/W	-
14G	R	-

Connector No.	M36
Connector Name	WIRE TO WIRE
Connector Color	WHITE

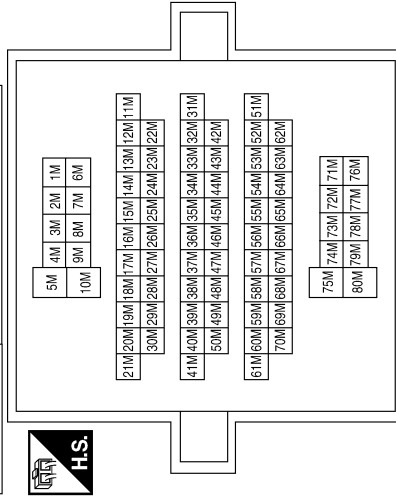

Terminal No.	Color of Wire	Signal Name
60M	W/R	-
69M	G/W	-
70M	GR/R	-

Connector No.	M39
Connector Name	FUSE BLOCK (J/B)
Connector Color	WHITE



Terminal No.	Color of Wire	Signal Name
1Q	G/R	-

ABNIA0083GB

A
B
C
D
E
F
G
H
I
J
K
L
M
N
O
P

SN

SONAR CONTROL UNIT FOR FRONT AND REAR SONAR SYSTEM

< ECU DIAGNOSIS >

Connector No.	M40
Connector Name	WIRE TO WIRE
Connector Color	WHITE

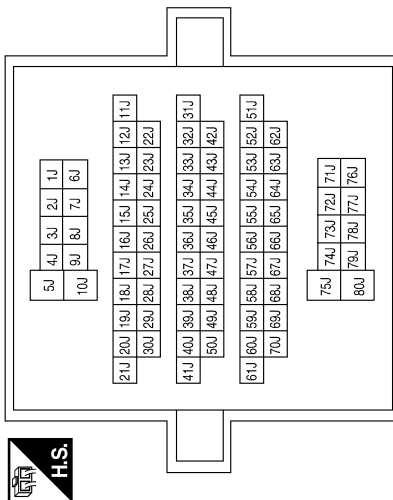

Terminal No.	Color of Wire	Signal Name
57J	R	-
65J	L	-
67J	G/R	-
68J	LG	-
69J	BR/Y	-

Connector No.	M73
Connector Name	BACK-UP LAMP RELAY
Connector Color	BROWN



Terminal No.	Color of Wire	Signal Name
1	G	-
2	R	-
3	G	-
5	G/W	-
6	W/B	-
7	Y/R	-

Connector No.	M116
Connector Name	SONAR SYSTEM OFF SWITCH
Connector Color	GRAY

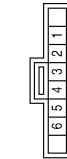

Terminal No.	Color of Wire	Signal Name
1	LG	-
2	B	-
5	BR/Y	-
6	B	-

Connector No.	M118
Connector Name	FRONT SONAR BUZZER
Connector Color	BLACK



Terminal No.	Color of Wire	Signal Name
1	L	-
2	R	-

Connector No.	E5
Connector Name	WIRE TO WIRE
Connector Color	

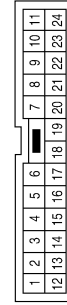

Terminal No.	Color of Wire	Signal Name
13	R	-

ABNIA0084GB

SONAR CONTROL UNIT FOR FRONT AND REAR SONAR SYSTEM

< ECU DIAGNOSIS >

Connector No.	E35
Connector Name	WIRE TO WIRE
Connector Color	WHITE

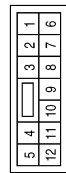

Terminal No.	Color of Wire	Signal Name
6	GR	-
7	LG	-
8	O	-
9	P	-
10	Y	-
11	LG/B	-
12	G/W	-

Connector No.	E34
Connector Name	WIRE TO WIRE
Connector Color	WHITE

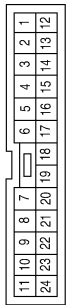

Terminal No.	Color of Wire	Signal Name
16	LG/B	-
17	Y	-
18	P	-
19	O	-
21	LG	-
22	GR	-

Connector No.	E119
Connector Name	IPDM E/R (INTELLIGENT POWER DISTRIBUTION MODULE ENGINE ROOM)
Connector Color	WHITE

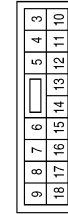

Terminal No.	16	Color of Wire	G	Signal Name	REVERSE LAMP
--------------	----	---------------	---	-------------	--------------

Terminal No.	Color of Wire	Signal Name
22C	Y	-
23C	LG/B	-
38C	GR	-
39C	LG	-
40C	O	-
41C	P	-

Connector No.	E41
Connector Name	WIRE TO WIRE
Connector Color	GRAY

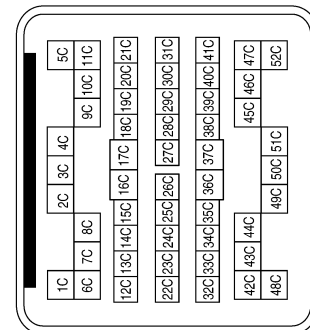

ABNIA0085GB

A
B
C
D
E
F
G
H
I
J
K
L
M
N
O
P

SN

SONAR CONTROL UNIT FOR FRONT AND REAR SONAR SYSTEM

< ECU DIAGNOSIS >

Connector No.	E152
Connector Name	WIRE TO WIRE
Connector Color	WHITE

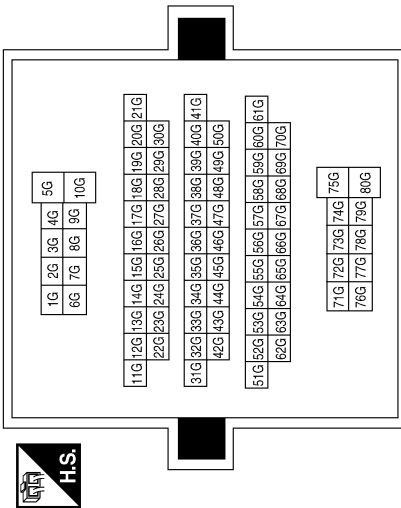

Terminal No.	Color of Wire	Signal Name
1G	G	-
2G	G/W	-
14G	R	-

Connector No.	E158
Connector Name	FRONT SONAR SENSOR LH OUTER
Connector Color	BLACK

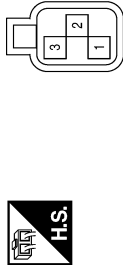

Terminal No.	Color of Wire	Signal Name
1	LG/B	PWR
2	P	SIGNAL
3	Y	GND

Connector No.	E159
Connector Name	WIRE TO WIRE
Connector Color	GRAY

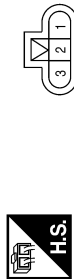

Connector No.	E160
Connector Name	WIRE TO WIRE
Connector Color	GRAY



Terminal No.	Color of Wire	Signal Name
1	LG/B	-
2	O	-
3	Y	-

Connector No.	E162
Connector Name	FRONT SONAR SENSOR LH INNER
Connector Color	BLACK

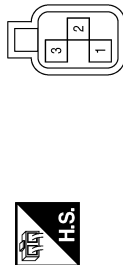

Terminal No.	Color of Wire	Signal Name
1	LG/B	PWR
2	O	SIGNAL
3	Y	GND

ABNIA0086GB

SONAR CONTROL UNIT FOR FRONT AND REAR SONAR SYSTEM

< ECU DIAGNOSIS >

Connector No.	E165
Connector Name	WIRE TO WIRE
Connector Color	GRAY



Terminal No.	Color of Wire	Signal Name
1	LG/B	-
2	LG	-
3	Y	-

Connector No.	E164
Connector Name	WIRE TO WIRE
Connector Color	GRAY



Terminal No.	Color of Wire	Signal Name
1	LG/B	-
2	O	-
3	Y	-

Connector No.	E163
Connector Name	FRONT SONAR SENSOR RH INNER
Connector Color	BLACK

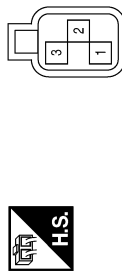

Terminal No.	Color of Wire	Signal Name
1	LG/B	PWR
2	LG	SIGNAL
3	Y	GND

Connector No.	F14
Connector Name	WIRE TO WIRE
Connector Color	WHITE

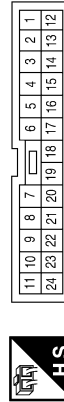

Terminal No.	Color of Wire	Signal Name
13	R	-

Connector No.	F9
Connector Name	A/T ASSEMBLY
Connector Color	GREEN



Terminal No.	Color of Wire	Signal Name
7	R	-

Connector No.	E166
Connector Name	FRONT SONAR SENSOR RH OUTER
Connector Color	BLACK



Terminal No.	Color of Wire	Signal Name
1	LG/B	PWR
2	GR	SIGNAL
3	Y	GND

ABNIA0087GB

A
B
C
D
E
F
G
H
I
J
K
L
M
N
O
P

SN

SONAR CONTROL UNIT FOR FRONT AND REAR SONAR SYSTEM

< ECU DIAGNOSIS >

Connector No.	F502
Connector Name	TCM (TRANSMISSION CONTROL MODULE)
Connector Color	GRAY

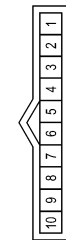

Terminal No.	Color of Wire	Signal Name
7	R	REV LAMP RLY

Connector No.	C1
Connector Name	WIRE TO WIRE
Connector Color	GRAY

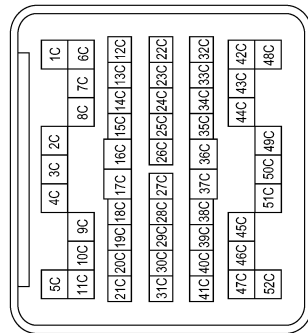

Terminal No.	Color of Wire	Signal Name
22C	Y	-
23C	LG/B	-
38C	GR	-
39C	LG	-
40C	O	-
41C	P	-

Connector No.	C3
Connector Name	WIRE TO WIRE
Connector Color	GRAY

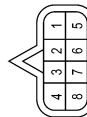

Terminal No.	Color of Wire	Signal Name
2	O	-
3	P	-
4	Y	-
6	GR	-
7	LG	-
8	LG/B	-

Connector No.	C101
Connector Name	WIRE TO WIRE
Connector Color	GRAY

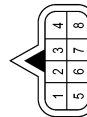

Terminal No.	Color of Wire	Signal Name
2	O	-
3	P	-
4	Y	-
6	GR	-
7	LG	-
8	LG/B	-

Connector No.	C102
Connector Name	REAR SONAR SENSOR LH OUTER
Connector Color	BLACK

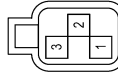

Terminal No.	Color of Wire	Signal Name
1	LG/B	PWR
2	P	SIGNAL
3	Y	GND

SONAR CONTROL UNIT FOR FRONT AND REAR SONAR SYSTEM

< ECU DIAGNOSIS >

Connector No.	C105
Connector Name	REAR SONAR SENSOR RH OUTER
Connector Color	BLACK

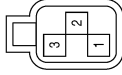

Terminal No.	Color of Wire	Signal Name
1	LG/B	PWR
2	GR	SIGNAL
3	Y	GND

Connector No.	C104
Connector Name	REAR SONAR SENSOR RH INNER
Connector Color	BLACK

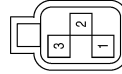

Terminal No.	Color of Wire	Signal Name
1	LG/B	PWR
2	LG	SIGNAL
3	Y	GND

Connector No.	C103
Connector Name	REAR SONAR SENSOR LH INNER
Connector Color	BLACK

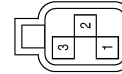

Terminal No.	Color of Wire	Signal Name
1	LG/B	PWR
2	O	SIGNAL
3	Y	GND

Connector No.	B43
Connector Name	WIRE TO WIRE
Connector Color	WHITE



Terminal No.	Color of Wire	Signal Name
11	L	-
12	R	-
13	G/W	-
14	GR/R	-
15	W/R	-

Connector No.	B41
Connector Name	WIRE TO WIRE
Connector Color	WHITE



Terminal No.	Color of Wire	Signal Name
6	GR	-
7	LG	-
8	O	-
9	P	-
10	Y	-
11	LG/B	-
12	G/W	-

Connector No.	B40
Connector Name	WIRE TO WIRE
Connector Color	WHITE



Terminal No.	Color of Wire	Signal Name
16	LG/B	-
17	Y	-
18	P	-
19	O	-
21	LG	-
22	GR	-

ABNIA0089GB

A
B
C
D
E
F
G
H
I
J
K
L
M
N
O
P

SN

SONAR CONTROL UNIT FOR FRONT AND REAR SONAR SYSTEM

< ECU DIAGNOSIS >

Connector No.	B56
Connector Name	SONAR CONTROL UNIT
Connector Color	GRAY

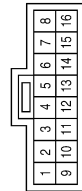

Terminal No.	Color of Wire	Signal Name
1	G/R	IGN
2	L	RR_SOUNDER (+)
3	G/W	REVERSE_LAMP_SIG
4	B	GND

Terminal No.	Color of Wire	Signal Name
5	BR/Y	LED_STATUS
6	R	RR_SOUNDER (-)
7	-	-
8	G/W	K-LINE
9	LG/B	PWR
10	-	-
11	LG	DISABLE_SW
12	Y	GND
13	LG	RIR
14	O	RIL
15	P	ROL
16	GR	ROR

Connector No.	B57
Connector Name	SONAR CONTROL UNIT
Connector Color	GRAY

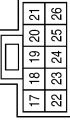

Terminal No.	Color of Wire	Signal Name
17	LG/B	POWER
18	GR/R	PARK-POS
19	GR	FOR
20	LG	FIR
21	W/R	VEHICLE_SPEED
22	-	-
23	R	FR_SOUNDER(-)
24	P	FOL
25	O	FIL
26	Y	GND

Connector No.	B69
Connector Name	WIRE TO WIRE
Connector Color	WHITE

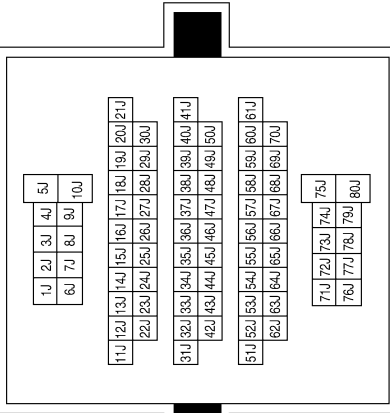

Terminal No.	Color of Wire	Signal Name
57J	R	-
65J	L	-
67J	G/R	-
68J	LG	-
69J	BR/Y	-

Connector No.	B111
Connector Name	WIRE TO WIRE
Connector Color	WHITE



Terminal No.	Color of Wire	Signal Name
11	L	-
12	R	-
13	G/W	-
14	GR/R	-
15	W/R	-

SONAR CONTROL UNIT FOR FRONT AND REAR SONAR SYSTEM

< ECU DIAGNOSIS >

Connector No.	B166
Connector Name	REAR SONAR BUZZER
Connector Color	BLACK



Terminal No.	Color of Wire	Signal Name
1	L	-
2	R	-

Connector No.	B149
Connector Name	WIRE TO WIRE
Connector Color	WHITE

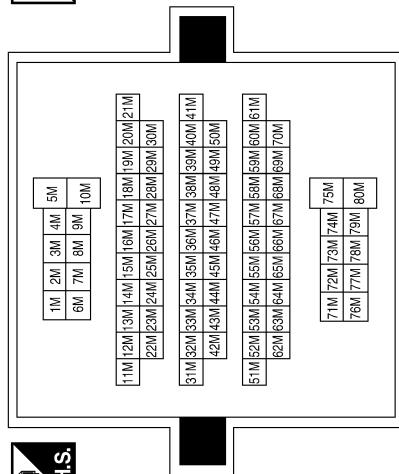

Terminal No.	Color of Wire	Signal Name
60M	W/R	-
69M	G/W	-
70M	GR/R	-

A
B
C
D
E
F
G
H
I
J
K
L
M
N
O
P

SN

ABNIA0091GB

SONAR CONTROL UNIT FOR FRONT AND REAR SONAR SYSTEM

< ECU DIAGNOSIS >

DTC Index

INFOID:000000003776758

DTC	Malfunction	Service Procedure
B2700	Front sonar sensor LH outer	Replace sonar sensor. Refer to SN-49, "Removal and Installation" .
B2701	Front sonar sensor LH outer harness	<ol style="list-style-type: none"> 1. Check harness for open or short. Refer to SN-15, "Diagnosis Procedure (With Front and Rear Sonar System)". 2. Replace sonar sensor. Refer to SN-49, "Removal and Installation".
B2702	Front sonar sensor RH outer	Replace sonar sensor. Refer to SN-49, "Removal and Installation" .
B2703	Front sonar sensor RH outer harness	<ol style="list-style-type: none"> 1. Check harness for open or short. Refer to SN-15, "Diagnosis Procedure (With Front and Rear Sonar System)". 2. Replace sonar sensor. Refer to SN-49, "Removal and Installation".
B2704	Rear sonar sensor LH outer	Replace sonar sensor. Refer to SN-49, "Removal and Installation" .
B2705	Rear sonar sensor LH outer harness	<ol style="list-style-type: none"> 1. Check harness for open or short. Refer to SN-15, "Diagnosis Procedure (With Front and Rear Sonar System)". 2. Replace sonar sensor. Refer to SN-49, "Removal and Installation".
B2706	Rear sonar sensor RH outer	Replace sonar sensor. Refer to SN-49, "Removal and Installation" .
B2707	Rear sonar sensor RH outer harness	<ol style="list-style-type: none"> 1. Check harness for open or short. Refer to SN-15, "Diagnosis Procedure (With Front and Rear Sonar System)". 2. Replace sonar sensor. Refer to SN-49, "Removal and Installation".
B2708	Rear sonar sensor LH inner	Replace sonar sensor. Refer to SN-49, "Removal and Installation" .
B2709	Rear sonar sensor LH inner harness	<ol style="list-style-type: none"> 1. Check harness for open or short. Refer to SN-15, "Diagnosis Procedure (With Front and Rear Sonar System)". 2. Replace sonar sensor. Refer to SN-49, "Removal and Installation".
B270A	Rear sonar sensor RH inner	Replace sonar sensor. Refer to SN-49, "Removal and Installation" .
B270B	Rear sonar sensor RH inner harness	<ol style="list-style-type: none"> 1. Check harness for open or short. Refer to SN-15, "Diagnosis Procedure (With Front and Rear Sonar System)". 2. Replace sonar sensor. Refer to SN-49, "Removal and Installation".
B270C	Front sonar sensor LH inner	Replace sonar sensor. Refer to SN-49, "Removal and Installation" .
B270D	Front sonar sensor LH inner harness	<ol style="list-style-type: none"> 1. Check harness for open or short. Refer to SN-15, "Diagnosis Procedure (With Front and Rear Sonar System)". 2. Replace sonar sensor. Refer to SN-49, "Removal and Installation".
B270E	Front sonar sensor RH inner	Replace sonar sensor. Refer to SN-49, "Removal and Installation" .
B270F	Front sonar sensor RH inner harness	<ol style="list-style-type: none"> 1. Check harness for open or short. Refer to SN-15, "Diagnosis Procedure (With Front and Rear Sonar System)". 2. Replace sonar sensor. Refer to SN-49, "Removal and Installation".

SONAR SYSTEM SYMPTOMS

< SYMPTOM DIAGNOSIS >

SYMPTOM DIAGNOSIS

SONAR SYSTEM SYMPTOMS

Symptom Table

INFOID:000000003776759

Symptom	Repair order
When the sonar system is OFF, the OFF indicator does not light and the sonar buzzer does not sound.	<ol style="list-style-type: none"> 1. Check sonar system OFF switch. Refer to SN-20, "Component Inspection" or SN-19, "Diagnosis Procedure (With Front and Rear Sonar System)". 2. Check harness and connections for sonar system OFF switch. 3. Replace sonar control unit. Refer to SN-50, "Removal and Installation".
When the sonar system is OFF, the OFF indicator lamp does not light but the sonar buzzer does sound.	<ol style="list-style-type: none"> 1. Check sonar system OFF switch. Refer to SN-19, "Diagnosis Procedure (With Rear Sonar System)" or SN-19, "Diagnosis Procedure (With Front and Rear Sonar System)". 2. Check harness and connections for sonar system OFF indicator lamp. 3. Replace sonar control unit.
When the sonar system is OFF, the sonar buzzer does not sound but the OFF indicator lamp lights.	<ol style="list-style-type: none"> 1. Check sonar buzzer. Refer to SN-18, "Component Inspection" or SN-17, "Diagnosis Procedure (With Front and Rear Sonar System)". 2. Check harness and connections between sonar buzzer and sonar control unit. 3. Replace sonar control unit.
When sonar system is ON, the sonar system OFF indicator lamp lights up and the sonar buzzer sounds intermittently (for about 4 seconds). (Rear sonar system only)	<ol style="list-style-type: none"> 1. Check harnesses between sonar sensors and sonar control unit for an open condition. 2. Check sonar sensors. Refer to SN-5, "Preliminary Check". 3. Replace sonar control unit.
The sonar system still operates when the sonar system is OFF.	<ol style="list-style-type: none"> 1. Replace sonar control unit.
When the transmission gear selector lever is in the R position and the sonar system is ON, the rear sonar system does not operate.	<ol style="list-style-type: none"> 1. Check transmission range switch. Refer to TM-44, "Diagnosis Procedure". 2. Check back-up lamp relay. 3. Check related harness and connections for back-up lamp relay. 4. Replace sonar control unit.
When the transmission gear selector lever is in a forward drive gear and the sonar system is ON, the front sonar system does not operate. (With front and rear sonar system only)	<ol style="list-style-type: none"> 1. Check harness and connections between sonar control unit and combination meter. 2. Replace sonar control unit.
Sonar system OFF indicator lamp lights up and buzzer sounds although there are no obstacles within the detection range.	<ol style="list-style-type: none"> 1. Check sonar sensors. 2. Check harness and connections between sonar sensors and sonar control unit. 3. Replace sonar control unit.
The sonar sensors do not detect objects in the detectable range.	<ol style="list-style-type: none"> 1. Check sonar sensors. 2. Replace sonar control unit.

PRECAUTION

< PRECAUTION >

PRECAUTION

PRECAUTION

Precaution for Supplemental Restraint System (SRS) "AIR BAG" and "SEAT BELT PRE-TENSIONER"

INFOID:000000005855116

The Supplemental Restraint System such as "AIR BAG" and "SEAT BELT PRE-TENSIONER", used along with a front seat belt, helps to reduce the risk or severity of injury to the driver and front passenger for certain types of collision. This system includes seat belt switch inputs and dual stage front air bag modules. The SRS system uses the seat belt switches to determine the front air bag deployment, and may only deploy one front air bag, depending on the severity of a collision and whether the front occupants are belted or unbelted. Information necessary to service the system safely is included in the SR and SB section of this Service Manual.

WARNING:

- To avoid rendering the SRS inoperative, which could increase the risk of personal injury or death in the event of a collision which would result in air bag inflation, all maintenance must be performed by an authorized NISSAN/INFINITI dealer.
- Improper maintenance, including incorrect removal and installation of the SRS, can lead to personal injury caused by unintentional activation of the system. For removal of Spiral Cable and Air Bag Module, see the SR section.
- Do not use electrical test equipment on any circuit related to the SRS unless instructed to in this Service Manual. SRS wiring harnesses can be identified by yellow and/or orange harnesses or harness connectors.

PRECAUTIONS WHEN USING POWER TOOLS (AIR OR ELECTRIC) AND HAMMERS

WARNING:

- When working near the Airbag Diagnosis Sensor Unit or other Airbag System sensors with the Ignition ON or engine running, DO NOT use air or electric power tools or strike near the sensor(s) with a hammer. Heavy vibration could activate the sensor(s) and deploy the air bag(s), possibly causing serious injury.
- When using air or electric power tools or hammers, always switch the Ignition OFF, disconnect the battery, and wait at least 3 minutes before performing any service.

Precaution Necessary for Steering Wheel Rotation After Battery Disconnect

INFOID:000000005855117

NOTE:

- This Procedure is applied only to models with Intelligent Key system and NATS (NISSAN ANTI-THEFT SYSTEM).
- Remove and install all control units after disconnecting both battery cables with the ignition knob in the "LOCK" position.
- Always use CONSULT-III to perform self-diagnosis as a part of each function inspection after finishing work. If DTC is detected, perform trouble diagnosis according to self-diagnostic results.

For models equipped with the Intelligent Key system and NATS, an electrically controlled steering lock mechanism is adopted on the key cylinder.

For this reason, if the battery is disconnected or if the battery is discharged, the steering wheel will lock and steering wheel rotation will become impossible.

If steering wheel rotation is required when battery power is interrupted, follow the procedure below before starting the repair operation.

OPERATION PROCEDURE

1. Connect both battery cables.

NOTE:

Supply power using jumper cables if battery is discharged.

2. Use the Intelligent Key or mechanical key to turn the ignition switch to the "ACC" position. At this time, the steering lock will be released.
3. Disconnect both battery cables. The steering lock will remain released and the steering wheel can be rotated.
4. Perform the necessary repair operation.

PRECAUTION

< PRECAUTION >

5. When the repair work is completed, return the ignition switch to the "LOCK" position before connecting the battery cables. (At this time, the steering lock mechanism will engage.)
6. Perform a self-diagnosis check of all control units using CONSULT-III.

A

B

C

D

E

F

G

H

I

J

K

L

M

SN

O

P

PREPARATION

< PREPARATION >

PREPARATION

PREPARATION

Commercial Service Tool

INFOID:000000003776761

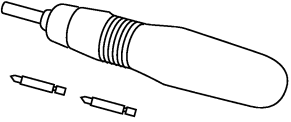
Tool name	Description
<p data-bbox="162 415 272 441">Power tool</p>  <p data-bbox="850 632 922 646">PBIC0191E</p>	<p data-bbox="1013 415 1268 441">Loosening bolts and nuts.</p>

SONAR SENSOR

< REMOVAL AND INSTALLATION >

REMOVAL AND INSTALLATION

SONAR SENSOR

Removal and Installation

INFOID:000000003776762

FRONT SONAR SENSOR

Removal

1. Remove the front fascia assembly. Refer to [EXT-13. "Removal and Installation"](#).
2. Remove the front sonar sensor (1) from the front fascia assembly.
3. Disconnect the front sonar sensor connector.
4. Remove the front sonar sensor retainer from the front fascia assembly.

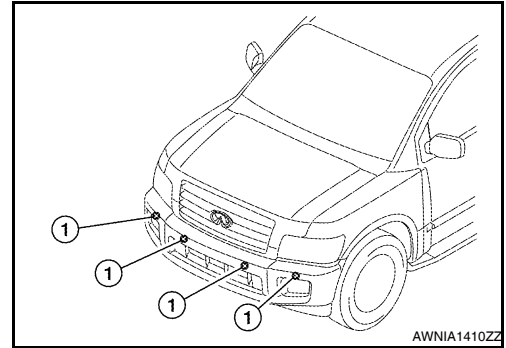

Installation

Installation is in the reverse order of removal.

REAR SONAR SENSOR

Removal

1. Remove the rear fascia assembly. Refer to [EXT-15. "Removal and Installation"](#).
2. Remove the rear sonar sensor (1) from the rear fascia assembly.
3. Disconnect the rear sonar sensor connector.
4. Remove the rear sonar sensor retainer from the rear fascia assembly.

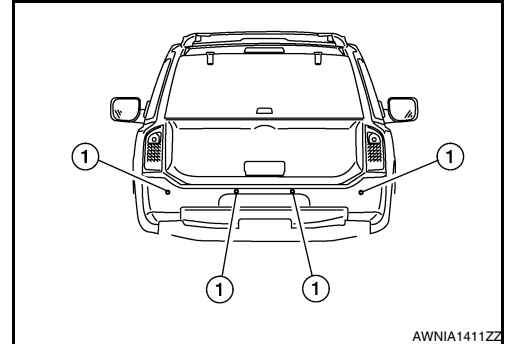

Installation

Installation is in the reverse order of removal.

A
B
C
D
E
F
G
H
I
J
K
L
M
O
P

SN

SONAR CONTROL UNIT

< REMOVAL AND INSTALLATION >

SONAR CONTROL UNIT

Removal and Installation

INFOID:000000003776763

REMOVAL

1. Remove the luggage side finisher lower and upper LH. Refer to [INT-19. "Removal and Installation"](#).
2. Disconnect the sonar control unit electrical connectors.
3. Remove the bolt, then remove the sonar control unit.
 - Front and rear system sonar control unit (1)

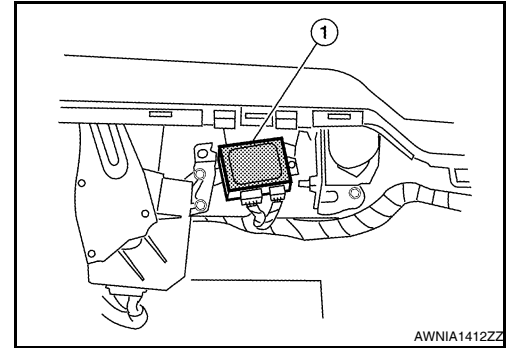

- Rear system sonar control unit (1)

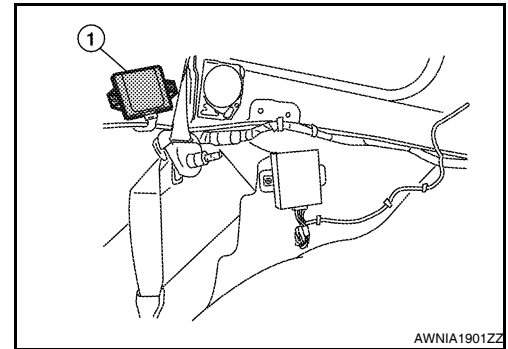

INSTALLATION

Installation is in the reverse order of removal.

BUZZER

< REMOVAL AND INSTALLATION >

BUZZER

Removal and Installation

INFOID:000000003776764

FRONT BUZZER

Removal

1. Remove the instrument panel upper cover. Refer to [IP-12, "Exploded View"](#).
2. Remove the two bolts (1), disconnect the connector (2) and remove the front buzzer.

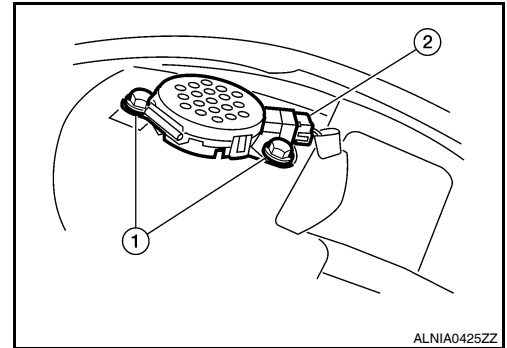

Installation

Installation is in the reverse order of removal.

REAR BUZZER

NOTE:

Rear buzzer location used only for vehicles equipped with both front and rear sonar systems.

Removal

1. Partially remove the rear headliner. Refer to [INT-17, "Removal and Installation"](#).
2. Release the buzzer from the bracket, disconnect the connector and remove the buzzer.

Installation

Installation is in the reverse order of removal.

A
B
C
D
E
F
G
H
I
J
K
L
M
O
P

SN