

SECTION **SRC**

SRS AIRBAG CONTROL SYSTEM

A
B
C
D
E
F
G
H
I
J
K
L
M
N
O
P

CONTENTS

<p>BASIC INSPECTION 3</p> <p>DIAGNOSIS AND REPAIR WORK FLOW 3</p> <p style="padding-left: 20px;">Work Flow3</p> <p>INTERMITTENTS INCIDENT 5</p> <p style="padding-left: 20px;">Inspection Procedure5</p> <p style="padding-left: 20px;">Trouble Diagnosis with CONSULT-III5</p> <p>FUNCTION DIAGNOSIS 6</p> <p>SRS AIR BAG SYSTEM 6</p> <p style="padding-left: 20px;">SRS Configuration6</p> <p style="padding-left: 20px;">SRS Component Parts Location7</p> <p style="padding-left: 20px;">Driver Air Bag Module7</p> <p style="padding-left: 20px;">Front Passenger Air Bag Module8</p> <p style="padding-left: 20px;">Front Side Air Bag8</p> <p style="padding-left: 20px;">Side Curtain Air Bag8</p> <p style="padding-left: 20px;">Front Seat Belt Pre-tensioner with Load Limiter8</p> <p style="padding-left: 20px;">Direct-connect SRS Component Connectors9</p> <p>OCCUPANT CLASSIFICATION SYSTEM10</p> <p style="padding-left: 20px;">System Diagram10</p> <p style="padding-left: 20px;">Occupant Classification System (OCS)10</p> <p>PASSENGER SEAT BELT WARNING SYSTEM12</p> <p style="padding-left: 20px;">System Diagram12</p> <p style="padding-left: 20px;">System Description12</p> <p style="padding-left: 20px;">Component Parts Location12</p> <p>ON BOARD DIAGNOSTIC (OBD) SYSTEM13</p> <p style="padding-left: 20px;">Trouble Diagnosis Introduction13</p> <p style="padding-left: 20px;">SRS Operation Check13</p> <p style="padding-left: 20px;">Trouble Diagnosis without CONSULT-III15</p> <p style="padding-left: 20px;">CONSULT-III Function (AIR BAG)15</p> <p style="padding-left: 20px;">Self-Diagnosis Function (Without CONSULT-III)15</p> <p>COMPONENT DIAGNOSIS17</p> <p>B1049 – B1052, B1054 – B1057 DRIVER AIR-BAG MODULE17</p>	<p style="padding-left: 20px;">Description17</p> <p style="padding-left: 20px;">DTC Logic17</p> <p style="padding-left: 20px;">Diagnosis Procedure (Component Diagnosis)18</p> <p>B1065 – B1068, B1070 – B1073 PASSENGER AIRBAG MODULE20</p> <p style="padding-left: 20px;">Description20</p> <p style="padding-left: 20px;">DTC Logic20</p> <p style="padding-left: 20px;">Diagnosis Procedure (Component Diagnosis)21</p> <p>B1134 – B1137 SIDE AIRBAG MODULE LH ...23</p> <p style="padding-left: 20px;">Description23</p> <p style="padding-left: 20px;">DTC Logic23</p> <p style="padding-left: 20px;">Diagnosis Procedure (Component Diagnosis)24</p> <p>B1129 – B1132 SIDE AIRBAG MODULE RH ...26</p> <p style="padding-left: 20px;">Description26</p> <p style="padding-left: 20px;">DTC Logic26</p> <p style="padding-left: 20px;">Diagnosis Procedure (Component Diagnosis)27</p> <p>B1198 – B1201 SIDE CURTAIN AIR BAG MODULE LH (FRONT)29</p> <p style="padding-left: 20px;">Description29</p> <p style="padding-left: 20px;">DTC Logic29</p> <p style="padding-left: 20px;">Diagnosis Procedure (Component Diagnosis)30</p> <p>B1193 – B1196 SIDE CURTAIN AIR BAG MODULE RH (FRONT)32</p> <p style="padding-left: 20px;">Description32</p> <p style="padding-left: 20px;">DTC Logic32</p> <p style="padding-left: 20px;">Diagnosis Procedure (Component Diagnosis)33</p> <p>B1150 – B1153 SIDE CURTAIN AIR BAG MODULE LH (REAR)35</p> <p style="padding-left: 20px;">Description35</p> <p style="padding-left: 20px;">DTC Logic35</p> <p style="padding-left: 20px;">Diagnosis Procedure (Component Diagnosis)36</p> <p>B1145 – B1148 SIDE CURTAIN AIR BAG MODULE RH (REAR)38</p> <p style="padding-left: 20px;">Description38</p> <p style="padding-left: 20px;">DTC Logic38</p>
--	---

SRC

Diagnosis Procedure (Component Diagnosis)	39	B1023 PASSENGER AIR BAG OFF INDICATOR	64
B1086 – B1089 SEAT BELT PRE-TENSIONER LH	41	Description	64
Description	41	DTC Logic	64
DTC Logic	41	Diagnosis Procedure (Component Diagnosis)	65
Diagnosis Procedure (Component Diagnosis)	42	B1017 – B1022 OCCUPANT CLASSIFICATION SYSTEM	67
B1081 – B1084 SEAT BELT PRE-TENSIONER RH	44	Description	67
Description	44	DTC Logic	67
DTC Logic	44	Diagnosis Procedure (Component Diagnosis)	68
Diagnosis Procedure (Component Diagnosis)	45	B1209 – B1211 COLLISION DETECTION	71
B1182 - B1185 SEAT BELT BUCKLE PRE-TENSIONER LH	47	Description	71
Description	47	DTC Logic	71
DTC Logic	47	Diagnosis Procedure (Component Diagnosis)	71
Diagnosis Procedure (Component Diagnosis)	48	ECU DIAGNOSIS	72
B1177 - B1180 SEAT BELT BUCKLE PRE-TENSIONER RH	50	DIAGNOSIS SENSOR UNIT	72
Description	50	Wiring Diagram	72
DTC Logic	50	Trouble Diagnosis with CONSULT-III	81
Diagnosis Procedure (Component Diagnosis)	51	Trouble Diagnosis without CONSULT-III	85
B1033 – B1035 CRASH ZONE SENSOR	53	SYMPTOM DIAGNOSIS	90
Description	53	SRS AIR BAG SYSTEM	90
DTC Logic	53	"AIR BAG" Warning Lamp Does Not Turn Off	90
Diagnosis Procedure (Component Diagnosis)	54	"AIR BAG" Warning Lamp Does Not Turn On	90
B1118 – B1120 SATELLITE SENSOR LH	56	PASSENGER SEAT BELT WARNING SYSTEM	92
Description	56	Seat Belt Warning System Does Not Function	92
DTC Logic	56	PRECAUTION	93
Diagnosis Procedure (Component Diagnosis)	57	PRECAUTIONS	93
B1113 – B1115 SATELLITE SENSOR RH	59	Precaution for Supplemental Restraint System (SRS) "AIR BAG" and "SEAT BELT PRE-TENSIONER"	93
Description	59	Precaution for SRS "AIR BAG" and "SEAT BELT PRE-TENSIONER" Service	93
DTC Logic	59	Occupant Classification System Precaution	93
Diagnosis Procedure (Component Diagnosis)	60		
B1XXX AIR BAG DIAGNOSIS SENSOR UNIT...	62		
Description	62		
DTC Logic	62		
Diagnosis Procedure (Component Diagnosis)	63		

DIAGNOSIS AND REPAIR WORK FLOW

< BASIC INSPECTION >

BASIC INSPECTION

DIAGNOSIS AND REPAIR WORK FLOW

Work Flow

INFOID:000000003775168

OVERALL SEQUENCE

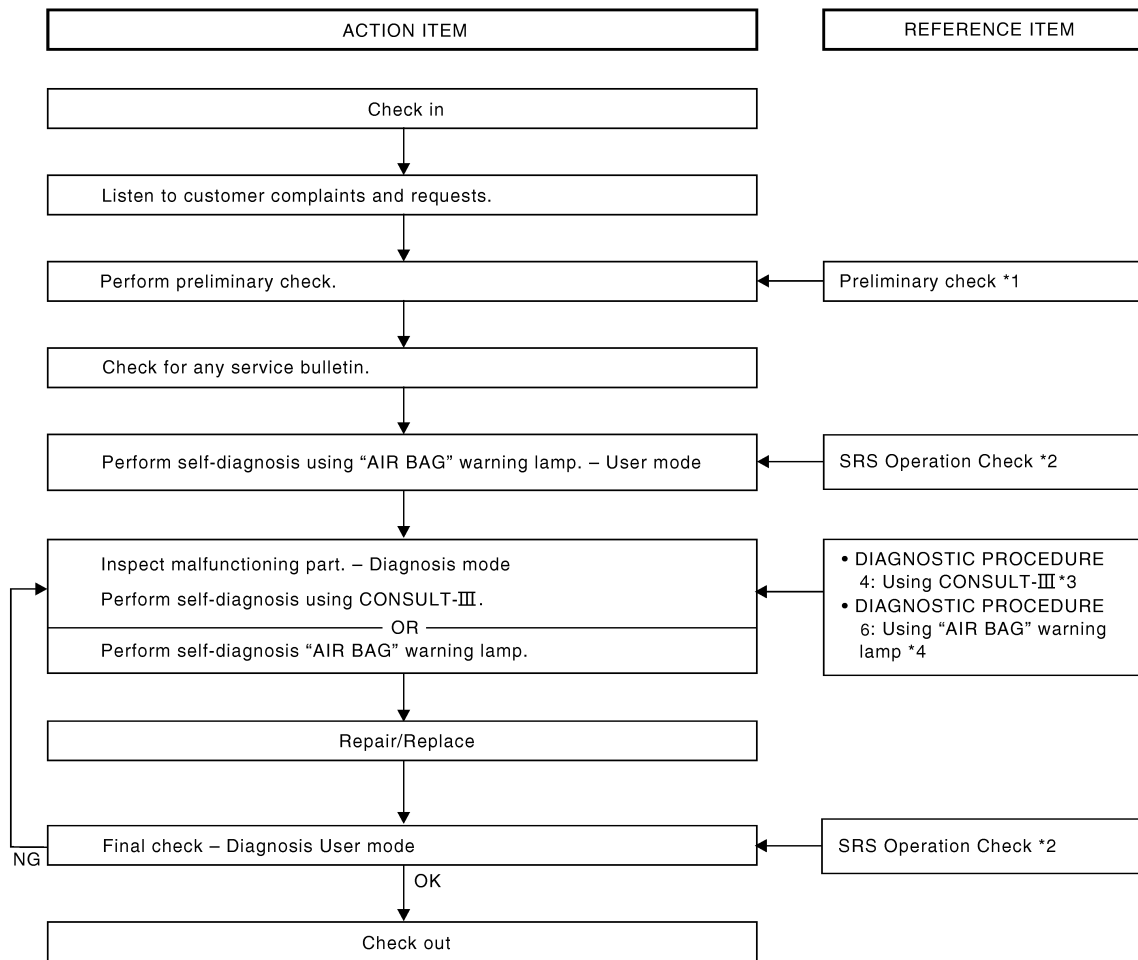

A

B

C

D

E

F

G

SRC

I

J

K

L

M

WHIA0348E

*1 [SRC-13. "Trouble Diagnosis Introduction"](#)

*2 [SRC-13. "SRS Operation Check"](#)

*3 [SRC-5. "Trouble Diagnosis with CONSULT-III"](#)

*4 [SRC-15. "Self-Diagnosis Function \(Without CONSULT-III\)"](#)

N

O

DETAILED WORK FLOW

1. CUSTOMER INFORMATION

Get detailed information from the customer about the symptom.

>> GO TO 2

2. PRELIMINARY CHECK

Perform preliminary check. Refer to [SRC-13. "Trouble Diagnosis Introduction"](#).

P

DIAGNOSIS AND REPAIR WORK FLOW

< BASIC INSPECTION >

>> GO TO 3

3. TECHNICAL SERVICE BULLETINS

Check for technical service bulletins.

>> GO TO 4

4. USER MODE

Perform self-diagnosis using the "AIR BAG" warning lamp in User mode. Refer to [SRC-13, "SRS Operation Check"](#).

>> GO TO 5

5. SELF-DIAGNOSIS

Perform SELF-DIAGNOSIS. Refer to [SRC-5, "Trouble Diagnosis with CONSULT-III"](#) (w/CONSULT-III) or [SRC-15, "Self-Diagnosis Function \(Without CONSULT-III\)"](#) (w/o CONSULT- III).

>> GO TO 6

6. REPLACE PART

Replace the malfunctioning part.

>> GO TO 7

7. FINAL CHECK

Check SRS using Diagnosis mode and User mode.

Does Diagnosis mode and User mode indicate SRS normal?

YES >> Inspection end.

NO >> GO TO 5

INTERMITTENTS INCIDENT

< BASIC INSPECTION >

INTERMITTENTS INCIDENT

Inspection Procedure

INFOID:000000003775169

INTERMITTENT TROUBLE

An intermittent incident may have occurred in the past but is not being detected currently. This DTC will not be detected on SELF DIAG [CURRENT], but may be viewed on SELF DIAG [PAST] using CONSULT-III.

Trouble Diagnosis with CONSULT-III

INFOID:000000003775170

DIAGNOSTIC PROCEDURE 4

Check SRS Repair History

1.CONSIDER POSSIBILITY THAT SELF-DIAGNOSTIC RESULT WAS NOT ERASED AFTER REPAIR

Check repair history of the SRS.

Have any previous repairs been made to the SRS?

- Yes >> Self-diagnostic result "SELF-DIAG [PAST]" (previously stored in the memory) might not be erased after repair. Go to "DIAGNOSTIC PROCEDURE 3". Refer to [SRC-15, "Self-Diagnosis Function \(Without CONSULT-III\)"](#).
- No >> Go to "DIAGNOSTIC PROCEDURE 2". Refer to [SRC-13, "SRS Operation Check"](#).

A
B
C
D
E
F
G
I
J
K
L
M
N
O
P

SRC

SRS AIR BAG SYSTEM

< FUNCTION DIAGNOSIS >

FUNCTION DIAGNOSIS

SRS AIR BAG SYSTEM

SRS Configuration

INFOID:000000003775171

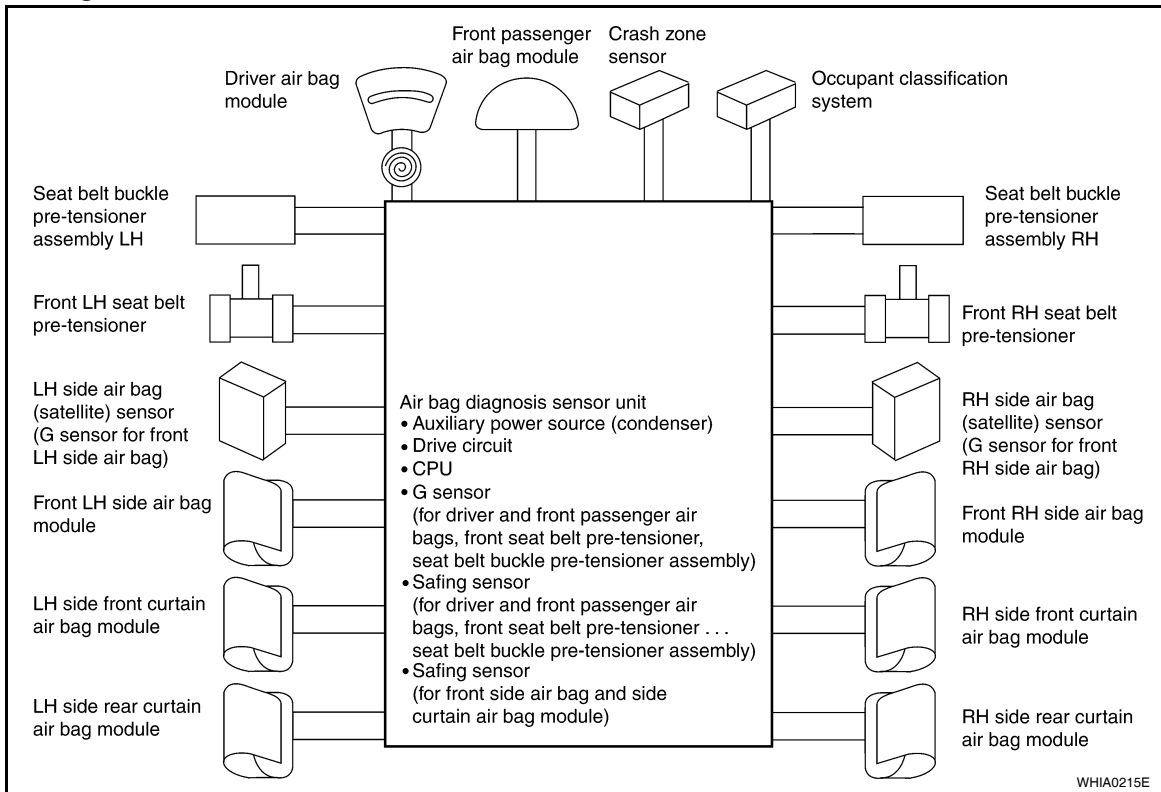

The air bag deploys if the air bag diagnosis sensor unit is activated while the ignition switch is in the ON or START position.

The collision modes for which supplemental restraint systems are activated are different among the SRS systems. For example, the driver air bag module, front passenger air bag module, front seat belt pre-tensioners and seat belt buckle pre-tensioner assemblies are activated in a frontal collision but not in a side collision. SRS configurations for some collision modes are as follows:

SRS configuration	Frontal collision	Left side collision	Right side collision	Rollover
Driver air bag module	x	—	—	—
Front passenger air bag module	x	—	—	—
Front LH seat belt pre-tensioner	x	—	—	x
Front LH seat belt buckle pre-tensioner assembly	x	—	—	x
Front RH seat belt pre-tensioner	x	—	—	x
Front RH seat belt buckle pre-tensioner assembly	x	—	—	x
Front LH side air bag module	—	x	—	—
Front RH side air bag module	—	—	x	—
LH side curtain air bag module	—	x	—	x
RH side curtain air bag module	—	—	x	x

SRS AIR BAG SYSTEM

< FUNCTION DIAGNOSIS >

SRS Component Parts Location

INFOID:000000003775172

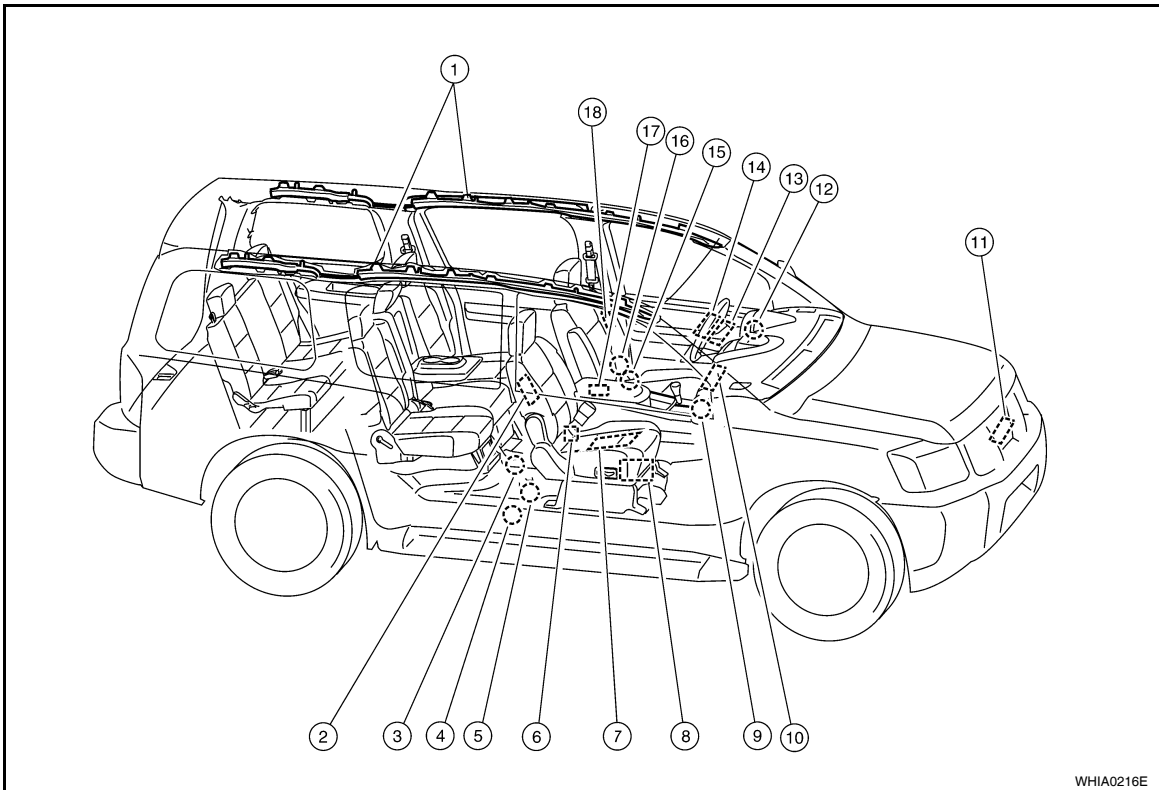

- | | | |
|--|--|---|
| 1. Side curtain air bag modules | 2. Front RH side air bag module | 3. Belt tension sensor |
| 4. RH side air bag (satellite) sensor | 5. Front RH seat belt pre-tensioner | 6. Seat belt buckle pre-tensioner assembly RH |
| 7. Occupant classification system sensor | 8. Occupant classification system control unit | 9. Front passenger air bag off indicator |
| 10. Front passenger air bag module | 11. Crash zone sensor | 12. Air bag warning lamp |
| 13. Spiral cable | 14. Driver air bag module | 15. LH side air bag (satellite) sensor |
| 16. Front LH seat belt pre-tensioner | 17. Air bag diagnosis sensor unit | 18. Front LH side air bag module |

Driver Air Bag Module

INFOID:000000003775173

The driver air bag module is dual stage and located in the steering wheel assembly. It operates with the SRS system in a frontal collision exceeding a specified level.

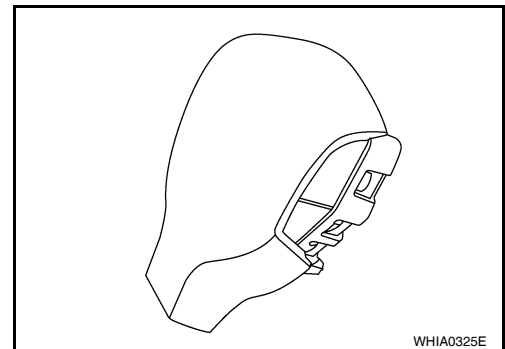

A
B
C
D
E
F
G
SRC
I
J
K
L
M
N
O
P

SRS AIR BAG SYSTEM

< FUNCTION DIAGNOSIS >

Front Passenger Air Bag Module

INFOID:000000003775174

The front passenger air bag module is located behind the instrument panel assembly. It operates with the SRS system in a frontal collision exceeding a specified level. Refer to [SRC-10, "Occupant Classification System \(OCS\)"](#) for more information.

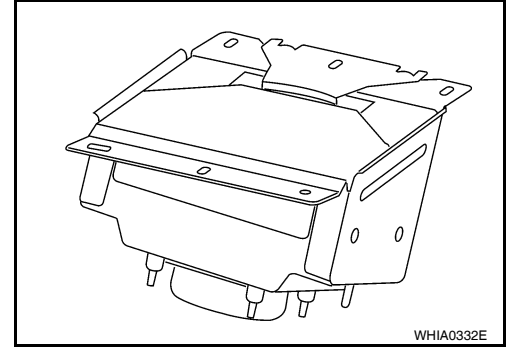

WHIA0332E

Front Side Air Bag

INFOID:000000003775175

Front side air bag modules are built into the front seatback assemblies. Vehicles with side air bags are equipped with labels as shown.

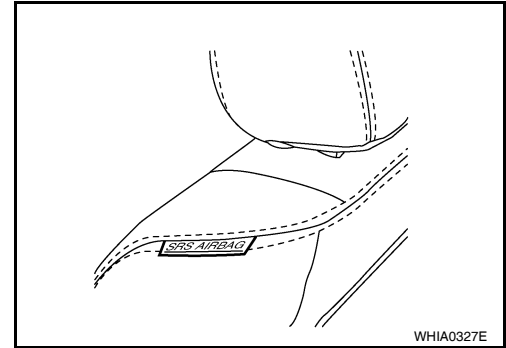

WHIA0327E

Side Curtain Air Bag

INFOID:000000003775176

Side curtain air bag modules are located above the vehicle headlining. Vehicles with side curtain air bags are equipped with labels as shown.



WHIA0041E

Front Seat Belt Pre-tensioner with Load Limiter

INFOID:000000003775177

The seat belt pre-tensioner system with load limiter is installed for both the driver's seat and the front passenger's seat. It operates simultaneously with the SRS air bag system in the event of a frontal collision with an impact exceeding a specified level.

When the frontal collision with an impact exceeding a specified level occurs, seat belt slack resulting from clothing or other factors is immediately taken up by the pre-tensioner. Vehicle passengers are securely restrained.

When passengers in a vehicle are thrown forward in a collision and the restraining force of the seat belt exceeds a specified level, the load limiter permits the specified extension of the seat belt by the twisting of the ELR shaft, and a relaxation of the chest-area seat belt web tension while maintaining force.

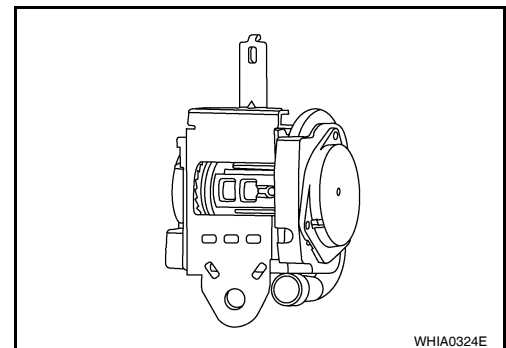

WHIA0324E

SRS AIR BAG SYSTEM

< FUNCTION DIAGNOSIS >

Direct-connect SRS Component Connectors

INFOID:000000003775178

The following SRS components use direct-connect style harness connectors.

- Driver air bag module
- Front passenger air bag module
- LH side front curtain air bag module
- LH side rear curtain air bag module
- RH side front curtain air bag module
- RH side rear curtain air bag module
- Front LH seat belt pre-tensioner
- Front RH seat belt pre-tensioner
- Seat belt buckle pre-tensioner assembly LH
- Seat belt buckle pre-tensioner assembly RH

Always pull up to release locking tab prior to removing connector from SRS component.

Always push down to lock black locking tab after installing connector to SRS component. When locked, the black locking tab is level with the connector housing.

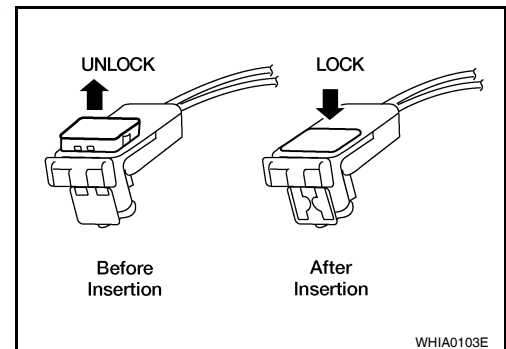

A

B

C

D

E

F

G

SRC

I

J

K

L

M

N

O

P

OCCUPANT CLASSIFICATION SYSTEM

< FUNCTION DIAGNOSIS >

OCCUPANT CLASSIFICATION SYSTEM

System Diagram

INFOID:000000003775179

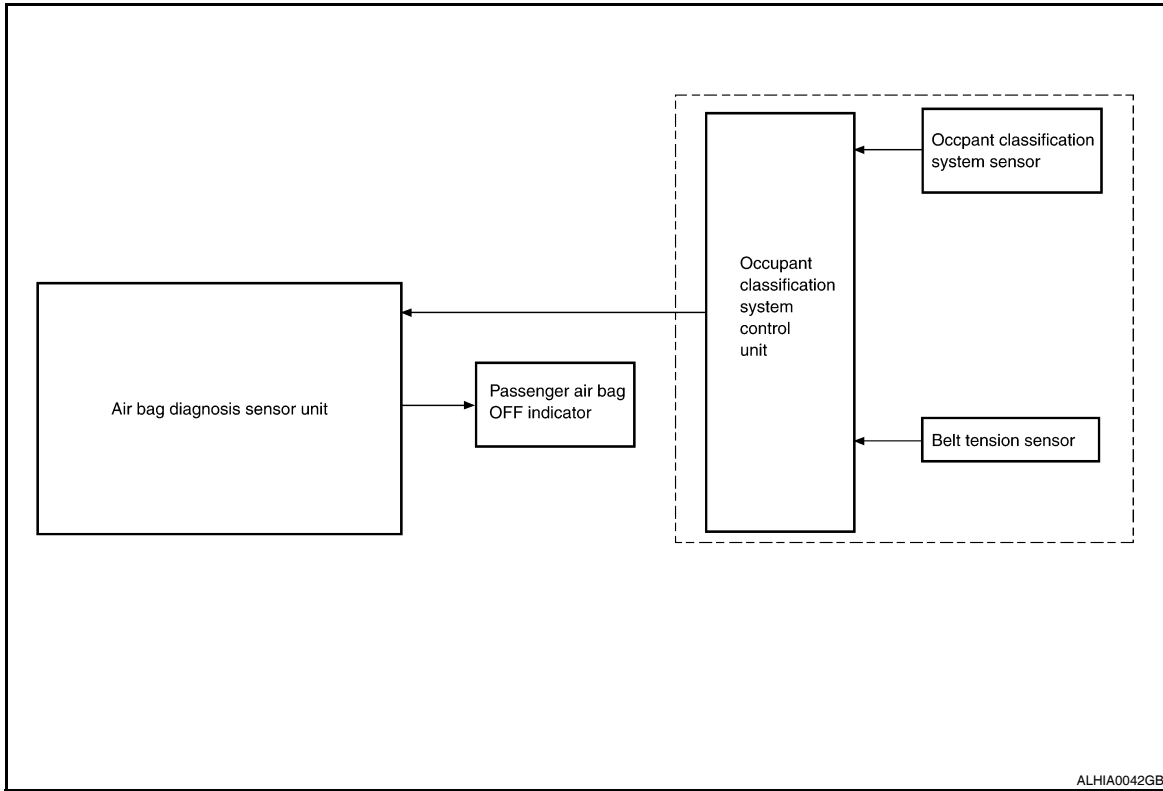

ALHIA0042GB

Occupant Classification System (OCS)

INFOID:000000003775180

The occupant classification system (OCS) identifies different size occupants, out of position occupants, and detects if child seat is present in the front passenger seat. The OCS receives inputs from the occupant classification sensor (located inside the passenger seat cushion assembly) and belt tension sensor (part of the passenger front seat belt assembly and located at the belt anchor location). Depending on classification of the passenger, the OCS sends a signal to the air bag diagnosis sensor unit. The air bag diagnosis sensor unit uses this signal and the seat belt buckle switch RH signal to determine deployment or non deployment of the passenger front air bag in the event of a collision. Depending on the signals received, the air bag diagnosis sensor unit can disable the passenger front air bag completely.

NOTE:

In case of customer concern, CONSULT-III can be used to confirm the passenger air bag status (readiness).

Passenger Air Bag Status Conditions

Front Passenger Seat (Condition)	PASS AIR BAG OFF Indicator (Status)	Passenger Air Bag Status (Readiness)	CONSULT-III Display
Seat occupied	OFF	Active (enabled)	ON
Seat occupied ^{NOTE}	ON	Deactivated (disabled)	OFF
Seat empty	OFF	Deactivated (disabled)	OFF

NOTE:

OCCUPANT CLASSIFICATION SYSTEM

< FUNCTION DIAGNOSIS >

Passenger does not meet Occupant Classification System specifications for passenger air bag activation.

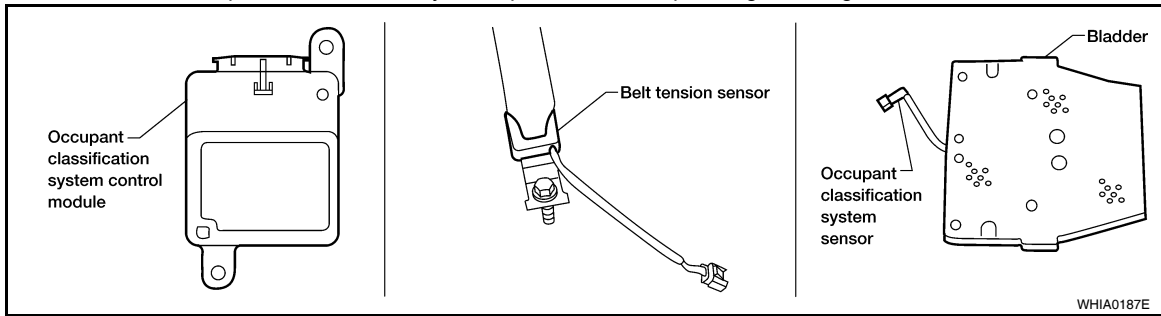

- A
- B
- C
- D
- E
- F
- G
- SRC**
- I
- J
- K
- L
- M
- N
- O
- P

PASSENGER SEAT BELT WARNING SYSTEM

< FUNCTION DIAGNOSIS >

PASSENGER SEAT BELT WARNING SYSTEM

System Diagram

INFOID:000000003775181

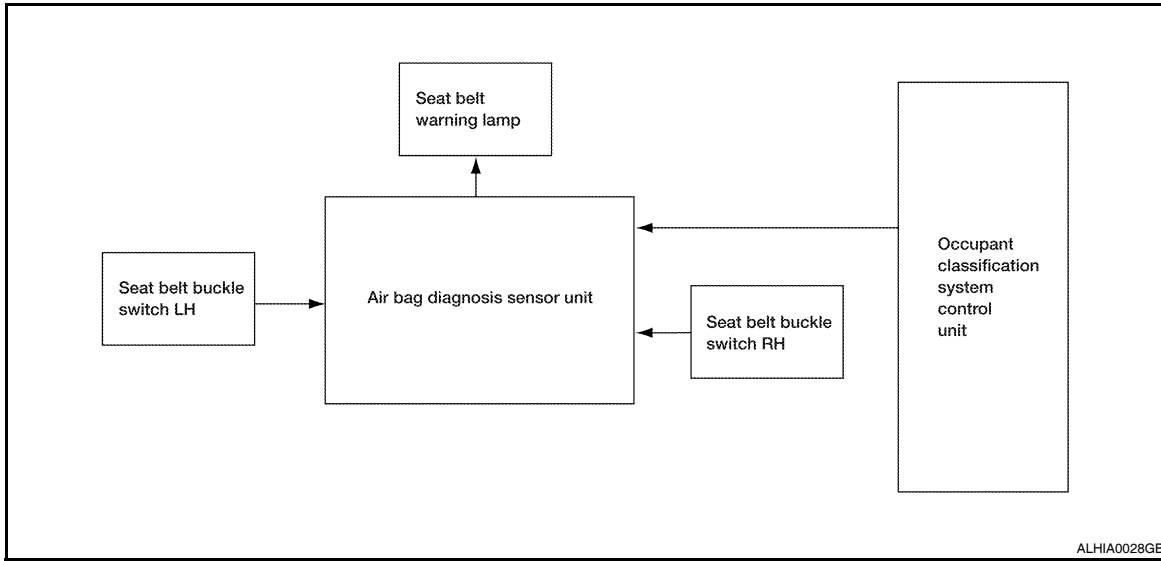

System Description

INFOID:000000003775182

The passenger seat belt warning system will remind the driver if the driver or front passenger seat belt should be buckled by turning on the seat belt warning light (1). The system works in conjunction with the occupant classification system. Refer to [SRC-10, "Occupant Classification System \(OCS\)"](#).

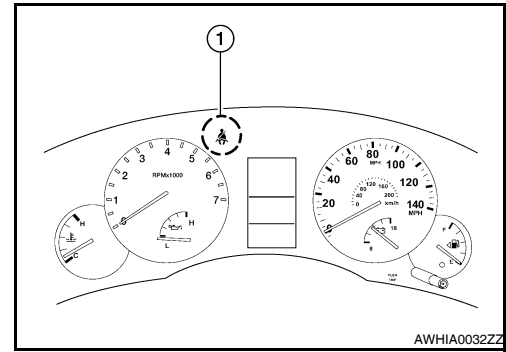

AWHIA0032ZZ

Passenger Seat Belt Warning System Operation

Driver seat status (Ignition switch ON)	Passenger seat status	Seat belt buckle switch LH status	Seat belt buckle switch RH status	Seat belt warning lamp
Seat occupied	Seat occupied	Buckled	Buckled	Off
			Unbuckled	On
	Seat unoccupied	Unbuckled	—	Off
			On	

Component Parts Location

INFOID:000000003775183

Refer to [SRC-7, "SRS Component Parts Location"](#).

ON BOARD DIAGNOSTIC (OBD) SYSTEM

< FUNCTION DIAGNOSIS >

ON BOARD DIAGNOSTIC (OBD) SYSTEM

Trouble Diagnosis Introduction

INFOID:000000003775184

CAUTION:

- Do not use electrical test equipment on any circuit related to the SRS unless instructed to do so in this Service Manual. SRS wiring harnesses can be identified by yellow and/or orange harness connectors.
- Do not attempt to repair, splice or modify SRS wiring harnesses. If a harness is damaged, replace it with a new one.
- Keep ground connections clean.

DIAGNOSIS FUNCTION

The SRS self-diagnosis results can be read by using “AIR BAG” warning lamp and/or CONSULT-III.

The User mode is exclusively prepared for the customer (driver). This mode warns the driver of a system malfunction through the operation of the “AIR BAG” warning lamp.

The Diagnosis mode allows the technician to locate and inspect the malfunctioning part.

The mode applications for the “AIR BAG” warning lamp and CONSULT-III are as follows:

	User mode	Diagnosis mode	Display type
“AIR BAG” warning lamp	X	X	ON-OFF operation
CONSULT-III	—	X	Monitoring

HOW TO PERFORM TROUBLE DIAGNOSES FOR QUICK AND ACCURATE REPAIR

A good understanding of the malfunction conditions can make troubleshooting faster and more accurate.

In general, each customer feels differently about a malfunction. It is important to fully understand the symptoms or conditions for a customer complaint.

Information From Customer

WHAT - Vehicle model

WHEN - Date, Frequencies

WHERE - Road conditions

HOW - Operating conditions, Symptoms

Preliminary Check

Check that the following parts are in good order.

- Battery
- Fuse
- System component-to-harness connections

SRS Operation Check

INFOID:000000003775185

DIAGNOSTIC PROCEDURE 1

Checking SRS Operation Using “AIR BAG” Warning Lamp—User Mode

1. Turn the ignition switch from OFF to ON, and check that the air bag warning lamp blinks.
2. Compare the SRS air bag warning lamp blinking pattern with the examples.



ON BOARD DIAGNOSTIC (OBD) SYSTEM

< FUNCTION DIAGNOSIS >

SRS Air bag warning lamp examples

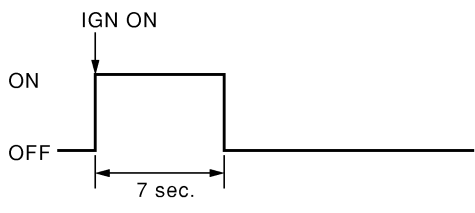
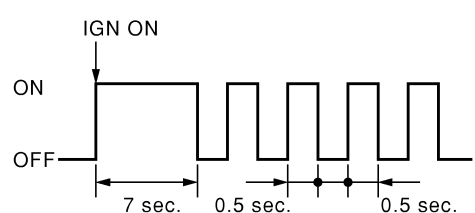
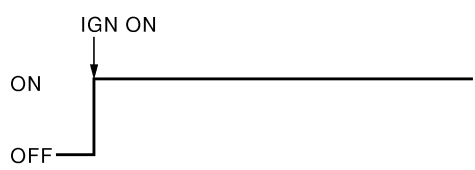
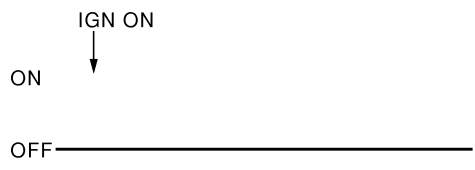
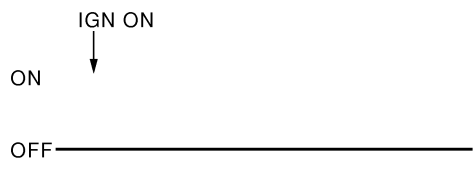
"AIR BAG" warning lamp (User mode)	SRS condition	Reference item
 <p>SHIA0011E</p>	<ul style="list-style-type: none"> No malfunction is detected. No further action is necessary. 	—
 <p>SHIA0012E</p>	The system is malfunctioning and needs to be repaired as indicated.	Go to DIAGNOSTIC PROCEDURE 2 that follows (with CONSULT-III) or SRC-15, "Trouble Diagnosis without CONSULT-III" (without CONSULT-III).
 <p>SHIA0013E</p>	<ul style="list-style-type: none"> Air bag is deployed. Seat belt pre-tensioner is deployed. 	Go to COLLISION DIAGNOSIS SR-20, "For Frontal Collision" or SR-22, "For Side and Rollover Collision" .
 <p>SHIA0014E</p>	<ul style="list-style-type: none"> Air bag diagnosis sensor unit is malfunctioning. Air bag power supply circuit is malfunctioning. SRS air bag warning lamp circuit is malfunctioning. 	Go to SRC-90, ""AIR BAG" Warning Lamp Does Not Turn Off" .
 <p>SHIA0014E</p>	<ul style="list-style-type: none"> Air bag diagnosis sensor unit is malfunctioning. Air bag warning lamp circuit is malfunctioning. 	Go to SRC-90, ""AIR BAG" Warning Lamp Does Not Turn On" .

DIAGNOSTIC PROCEDURE 2

1. Connect CONSULT-III.
2. Diagnostic code is displayed on "SELF-DIAG [CURRENT]".
If no malfunction is detected on "SELF-DIAG [CURRENT]", but malfunction is detected in "SRS Operation Check" using the "AIR BAG" warning lamp, the following cases may exist:
 - "SELF-DIAG [PAST]" memory might not be erased.
 - The SRS system malfunctions intermittently.
 Perform DIAGNOSTIC PROCEDURE 4. Refer to [SRC-15, "Self-Diagnosis Function \(Without CONSULT-III\)"](#).

ON BOARD DIAGNOSTIC (OBD) SYSTEM

< FUNCTION DIAGNOSIS >

Trouble Diagnosis without CONSULT-III

INFOID:000000003775186

DIAGNOSTIC PROCEDURE 6

Inspect SRS Malfunction Using "AIR BAG" Warning Lamp—Diagnosis Mode

NOTE:

SRS will not enter Diagnosis mode if no malfunction is detected in User mode.

1. Turn ignition switch ON.
2. After "AIR BAG" warning lamp lights for 7 seconds, turn ignition switch OFF within 1 second.
3. Wait more than 3 seconds.
4. Repeat steps 1 to 3 two more times (3 times total).
5. Turn ignition switch ON.

SRS is now in Diagnosis mode. Refer to [SRC-85, "Trouble Diagnosis without CONSULT-III"](#).

CONSULT-III Function (AIR BAG)

INFOID:000000003775187

CONSULT-III can display each diagnostic item using the diagnostic test modes shown following.

AIR BAG diagnostic mode	Description
SELF-DIAG [CURRENT]	A current Self-diagnosis result (also indicated by the number of warning lamp flashes in the Diagnosis mode) is displayed on the CONSULT-III screen in real time. This refers to a malfunctioning part requiring repairs.
SELF-DIAG [PAST]	Diagnosis results previously stored in the memory are displayed on the CONSULT-III screen. The stored results will remain until memory erasing is executed.
TROUBLE DIAG RECORD	With TROUBLE DIAG RECORD, diagnosis results previously erased by a reset operation can be displayed on the CONSULT-III screen.
ECU DISCRIMINATED NO.	Air bag diagnosis sensor unit ECU discriminated number (identification number) is displayed. Air bag diagnosis sensor unit has individual ECU discriminated number (identification number) based on model and equipment.
PASSENGER AIR BAG	The STATUS (readiness) of the front passenger air bag module is displayed. The STATUS displayed (ON/OFF) depends on the signals supplied to the occupant classification system control module and air bag diagnosis sensor unit. Refer to SRC-10, "Occupant Classification System (OCS)" for more information.

Self-Diagnosis Function (Without CONSULT-III)

INFOID:000000003775188

- The reading of these results is accomplished using one of two modes — "User mode" and "Diagnosis mode".
- After a malfunction is repaired, turn the ignition switch OFF for at least one second, then back ON. Diagnosis mode returns to the User mode. At that time, the self-diagnostic result is cleared.

ON BOARD DIAGNOSTIC (OBD) SYSTEM

< FUNCTION DIAGNOSIS >

HOW TO CHANGE SELF-DIAGNOSIS MODE

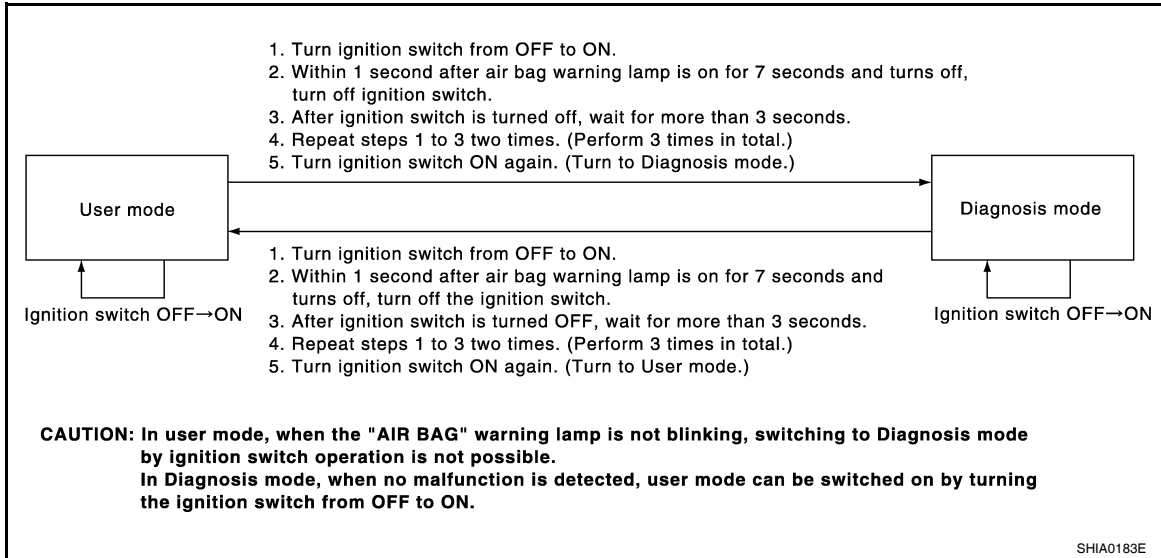

DIAGNOSTIC PROCEDURE 3

Final Check of SRS Using CONSULT-III—Diagnosis Mode

1. Connect CONSULT-III.
2. If no DTC is detected on "SELF-DIAG [CURRENT]", repair of SRS is completed. Go to step 3.
If any DTC is detected on "SELF-DIAG [CURRENT]", the malfunctioning part has not been repaired completely or another malfunctioning part is being detected. Perform DIAGNOSTIC PROCEDURE 2. Refer to [SRC-13, "SRS Operation Check"](#).
3. Touch "ERASE".
NOTE:
Touch "ERASE" to clear the memory of the malfunction ("SELF-DIAG [PAST]").
If the memory of the malfunction in "SELF-DIAG [PAST]" is not erased, the User mode shows the system malfunction by the operation of the warning lamp even if the malfunction is repaired completely.
4. Touch "BACK" key of CONSULT-III. Touch "SELF-DIAG [PAST]".
5. Check that no malfunction is detected on "SELF-DIAG [PAST]".
6. Touch "BACK" key of CONSULT-III to return to User mode from Diagnosis mode.
7. Turn ignition switch OFF and then turn off and disconnect CONSULT-III.
8. Go to [SRC-13, "SRS Operation Check"](#).

DIAGNOSTIC PROCEDURE 4

Check SRS Repair History

1. CONSIDER POSSIBILITY THAT SELF-DIAGNOSTIC RESULT WAS NOT ERASED AFTER REPAIR

Check repair history of the SRS.

Have any previous repairs been made to the SRS?

- Yes >> Self-diagnostic result "SELF-DIAG [PAST]" (previously stored in the memory) might not be erased after repair. Perform DIAGNOSTIC PROCEDURE 3. Refer to [SRC-15, "Self-Diagnosis Function \(Without CONSULT-III\)"](#).
- No >> Perform DIAGNOSTIC PROCEDURE 2. Refer to [SRC-13, "SRS Operation Check"](#).

B1049 – B1052, B1054 – B1057 DRIVER AIRBAG MODULE

< COMPONENT DIAGNOSIS >

COMPONENT DIAGNOSIS

B1049 – B1052, B1054 – B1057 DRIVER AIRBAG MODULE

Description

INFOID:000000003775189

DTC B1049 – B1052, B1054 – B1057 DRIVER AIRBAG MODULE

The driver air bag module is dual stage and wired to the air bag diagnosis sensor unit through the spiral cable. The air bag diagnosis sensor unit will monitor for opens and shorts in detected lines to the driver air bag module including the spiral cable.

PART LOCATION

Refer to [SRC-7, "SRS Component Parts Location"](#).

DTC Logic

INFOID:000000004221421

DTC DETECTION LOGIC

With CONSULT-III

CONSULT-III name	DTC	DTC detecting condition	Repair order
DRIVER AIRBAG MODULE [OPEN]	B1049	Driver air bag module circuit (DR1) is open (including the spiral cable).	<ol style="list-style-type: none"> 1. Visually check the wiring harness connection. 2. Replace the harness if it has visible damage. 3. Replace the driver air bag module. 4. Replace the spiral cable. 5. Replace the air bag diagnosis sensor unit. 6. Replace the related harness.
	B1054	Driver air bag module circuit (DR2) is open (including the spiral cable).	
DRIVER AIRBAG MODULE [VB-SHORT]	B1050	Driver air bag module circuit (DR1) is shorted to a power supply circuit (including the spiral cable).	
	B1055	Driver air bag module circuit (DR2) is shorted to a power supply circuit (including the spiral cable).	
DRIVER AIRBAG MODULE [GND-SHORT]	B1051	Driver air bag module circuit (DR1) is shorted to ground (including the spiral cable).	
	B1056	Driver air bag module circuit (DR2) is shorted to ground (including the spiral cable).	
DRIVER AIRBAG MODULE [SHORT]	B1052	Driver air bag module circuits (DR1) are shorted to each other (including the spiral cable).	
	B1057	Driver air bag module circuits (DR2) are shorted to each other (including the spiral cable).	

Without CONSULT-III

<Driver air bag module>	
Flash pattern	Repair order
<p>a through d are repeated. d: Two flashes indicate malfunctioning driver air bag module circuits.</p>	<ol style="list-style-type: none"> 1. Visually check the wiring harness connection. 2. Replace the harness if it has visible damage. 3. Replace the spiral cable. 4. Replace driver air bag module. 5. Replace the air bag diagnosis sensor unit. 6. Replace the related harness.

WHIA0260E

DTC CONFIRMATION PROCEDURE (With CONSULT-III)

B1049 – B1052, B1054 – B1057 DRIVER AIRBAG MODULE

< COMPONENT DIAGNOSIS >

1.INSPECTION START

Turn ignition switch ON.

>> GO TO 2.

2.CHECK SELF-DIAG RESULT

Check for the DTC on CONSULT-III.

Is the DTC detected?

- YES >> Refer to [SRC-18. "Diagnosis Procedure \(Component Diagnosis\)".](#)
- NO >> Inspection End.

DTC CONFIRMATION PROCEDURE (Without CONSULT-III)

NOTE:

SRS will not enter diagnosis mode if no malfunction is detected in user mode.

1.IGNITION SWITCH

Turn ignition switch ON.

>> GO TO 2

2.IGNITION SWITCH

After air bag warning lamp lights for 7 seconds, turn ignition switch OFF within 1 second.

>> GO TO 3

3.WAIT TIME

Wait more than 3 seconds.

>> GO TO 4

4.REPEAT STEPS

Repeat steps 1 to 3 twice.

>> GO TO 5.

5.IGNITION SWITCH

Turn ignition switch ON.

>> GO TO 6.

6.DIAGNOSTIC MODE

SRS system is now in diagnostic mode and AIR BAG warning lamp flashes. Refer to [SRC-85. "Trouble Diagnosis without CONSULT-III".](#)

>> **END**

Diagnosis Procedure (Component Diagnosis)

INFOID:000000003775191

Recheck SRS after each replacement.

1.HARNES CONNECTOR

Is there any visible damage to the connector?

YES or NO

- YES >> Replace the harness.
- NO >> GO TO 2

B1049 – B1052, B1054 – B1057 DRIVER AIRBAG MODULE

< COMPONENT DIAGNOSIS >

2. WIRING HARNESS

Is there any visible damage to the harness?

YES or NO

YES >> Replace the harness.

NO >> GO TO 3

3. DRIVER AIR BAG MODULE

Replace the driver air bag module. Refer to [SR-5, "Removal and Installation"](#).

>> GO TO 4

4. SPIRAL CABLE

Replace the spiral cable. Refer to [SR-7, "Removal and Installation"](#).

>> GO TO 5

5. AIR BAG DIAGNOSIS SENSOR UNIT

Replace the air bag diagnosis sensor unit. Refer to [SR-17, "Removal and Installation"](#).

>> GO TO 6

6. RELATED HARNESS

Replace the related harness.

>> **END**

A
B
C
D
E
F
G
I
J
K
L
M
N
O
P

SRC

B1065 – B1068, B1070 – B1073 PASSENGER AIRBAG MODULE

< COMPONENT DIAGNOSIS >

B1065 – B1068, B1070 – B1073 PASSENGER AIRBAG MODULE

Description

INFOID:000000003775192

DTC B1065 – B1068, B1070 – B1073 PASSENGER AIR BAG MODULE

The passenger air bag module is dual stage and wired to the air bag diagnosis sensor unit. The air bag diagnosis sensor unit will monitor for opens and shorts in detected lines to the passenger air bag module.

PART LOCATION

Refer to [SRC-7, "SRS Component Parts Location"](#).

DTC Logic

INFOID:000000004221422

DTC DETECTION LOGIC

With CONSULT-III

CONSULT-III name	DTC	DTC detecting condition	Repair order
ASSIST A/B MODULE [OPEN]	B1065	Front passenger air bag module circuit (AS1) is open.	<ol style="list-style-type: none"> 1. Visually check the wiring harness connection. 2. Replace the harness if it has visible damage. 3. Replace the front passenger air bag module. 4. Replace the air bag diagnosis sensor unit. 5. Replace the related harness.
	B1070	Front passenger air bag module circuit (AS2) is open.	
ASSIST A/B MODULE [VB-SHORT]	B1066	Front passenger air bag module circuit (AS1) is shorted to a power supply circuit.	
	B1071	Front passenger air bag module circuit (AS2) is shorted to a power supply circuit.	
ASSIST A/B MODULE [GND-SHORT]	B1067	Front passenger air bag module circuit (AS1) is shorted to ground.	
	B1072	Front passenger air bag module circuit (AS2) is shorted to ground.	
ASSIST A/B MODULE [SHORT]	B1068	Front passenger air bag module circuits (AS1) are shorted to each other.	
	B1073	Front passenger air bag module circuits (AS2) are shorted to each other.	

Without CONSULT-III

<Front passenger air bag module>	
Flash pattern	Repair order
<p>a through d are repeated. d: Eight flashes indicate malfunctioning front passenger air bag module circuit.</p>	<ol style="list-style-type: none"> 1. Visually check the wiring harness connection. 2. Replace the harness if it has visible damage. 3. Replace front passenger air bag module. 4. Replace the air bag diagnosis sensor unit. 5. Replace the related harness.

WHIA0261E

DTC CONFIRMATION PROCEDURE (With CONSULT-III)

1. INSPECTION START

Turn ignition switch ON.

>> GO TO 2.

2. CHECK SELF-DIAG RESULT

Check for the DTC on CONSULT-III.

B1065 – B1068, B1070 – B1073 PASSENGER AIRBAG MODULE

< COMPONENT DIAGNOSIS >

Is the DTC detected?

- YES >> Refer to [SRC-21, "Diagnosis Procedure \(Component Diagnosis\)"](#).
NO >> Inspection End.

DTC CONFIRMATION PROCEDURE (Without CONSULT-III)

NOTE:

SRS will not enter diagnosis mode if no malfunction is detected in user mode.

1.IGNITION SWITCH

Turn ignition switch ON.

>> GO TO 2

2.IGNITION SWITCH

After air bag warning lamp lights for 7 seconds, turn ignition switch OFF within 1 second.

>> GO TO 3

3.WAIT TIME

Wait more than 3 seconds.

>> GO TO 4

4.REPEAT STEPS

Repeat steps 1 to 3 twice.

>> GO TO 5

5.IGNITION SWITCH

Turn ignition switch ON.

>> GO TO 6

6.DIAGNOSTIC MODE

SRS system is now in diagnostic mode and AIR BAG warning lamp flashes. Refer to [SRC-85, "Trouble Diagnosis without CONSULT-III"](#).

>> **END**

Diagnosis Procedure (Component Diagnosis)

INFOID:000000003775194

Recheck SRS after each replacement.

1.HARNESS CONNECTOR

Is there any visible damage to the connector?

YES or NO

- YES >> Replace the harness.
NO >> GO TO 2

2.WIRING HARNESS

Is there any visible damage to the harness?

YES or NO

- YES >> Replace the harness.
NO >> GO TO 3

3.FRONT PASSENGER AIR BAG MODULE

Replace the front passenger air bag module. Refer to [SR-10, "Removal and Installation"](#).

B1065 – B1068, B1070 – B1073 PASSENGER AIRBAG MODULE

< COMPONENT DIAGNOSIS >

>> GO TO 4

4.AIR BAG DIAGNOSIS SENSOR UNIT

Replace the air bag diagnosis sensor unit. Refer to [SR-17. "Removal and Installation"](#).

>> GO TO 5

5.RELATED HARNESS

Replace the related harness.

>> **END**

B1134 – B1137 SIDE AIRBAG MODULE LH

< COMPONENT DIAGNOSIS >

B1134 – B1137 SIDE AIRBAG MODULE LH

Description

INFOID:000000003775195

DTC B1134 – B1137 FRONT LH SIDE AIR BAG MODULE

The front LH side air bag module is wired to the air bag diagnosis sensor unit. The air bag diagnosis sensor unit will monitor for opens and shorts in detected lines to the front LH side air bag module.

PART LOCATION

Refer to [SRC-7, "SRS Component Parts Location"](#).

DTC Logic

INFOID:000000004221423

DTC DETECTION LOGIC

With CONSULT-III

CONSULT-III name	DTC	DTC detecting condition	Repair order
SIDE MODULE LH [OPEN]	B1134	Front LH side air bag module circuit is open.	<ol style="list-style-type: none"> 1. Visually check the wiring harness connection. 2. Replace the harness if it has visible damage. 3. Replace the front LH seat back assembly. 4. Replace the air bag diagnosis sensor unit. 5. Replace the related harness.
SIDE MODULE LH [VB-SHORT]	B1135	Front LH side air bag module circuit is shorted to a power supply circuit.	
SIDE MODULE LH [GND-SHORT]	B1136	Front LH side air bag module circuit is shorted to ground.	
SIDE MODULE LH [SHORT]	B1137	Front LH side air bag module circuits are shorted to each other.	

Without CONSULT-III

<Front LH side air bag module>	
Flash pattern	Repair order
<p>a through f are repeated. f: Two flashes indicate malfunctioning front LH side air bag module circuit.</p>	<ol style="list-style-type: none"> 1. Visually check the wiring harness connection. 2. Replace the harness if it has visible damage. 3. Replace front LH seat back assembly. 4. Replace the air bag diagnosis sensor unit. 5. Replace the related harness.

WHIA0265E

DTC CONFIRMATION PROCEDURE (With CONSULT-III)

1.INSPECTION START

Turn ignition switch ON.

>> GO TO 2.

2.CHECK SELF-DIAG RESULT

Check for the DTC on CONSULT-III.

Is the DTC detected?

- YES >> Refer to [SRC-24, "Diagnosis Procedure \(Component Diagnosis\)"](#).
NO >> Inspection End.

DTC CONFIRMATION PROCEDURE (Without CONSULT-III)

NOTE:

SRS will not enter diagnosis mode if no malfunction is detected in user mode.

1.IGNITION SWITCH

B1134 – B1137 SIDE AIRBAG MODULE LH

< COMPONENT DIAGNOSIS >

Turn ignition switch ON.

>> GO TO 2

2.IGNITION SWITCH

After air bag warning lamp lights for 7 seconds, turn ignition switch OFF within 1 second.

>> GO TO 3

3.WAIT TIME

Wait more than 3 seconds.

>> GO TO 4

4.REPEAT STEPS

Repeat steps 1 to 3 twice.

>> GO TO 5

5.IGNITION SWITCH

Turn ignition switch ON.

>> GO TO 6

6.DIAGNOSTIC MODE

SRS system is now in diagnostic mode and AIR BAG warning lamp flashes. Refer to [SRC-85, "Trouble Diagnosis without CONSULT-III"](#).

>> **END**

Diagnosis Procedure (Component Diagnosis)

INFOID:000000003775197

Recheck SRS after each replacement.

1.HARNES CONNECTOR

Is there any visible damage to the connector?

YES or NO

YES >> Replace the harness.

NO >> GO TO 2

2.WIRING HARNESS

Is there any visible damage to the harness?

YES or NO

YES >> Replace the harness.

NO >> GO TO 3

3.FRONT LH SIDE AIR BAG MODULE

Replace the front LH seat back assembly. Refer to [SE-50, "Removal and Installation"](#).

>> GO TO 4

4.AIR BAG DIAGNOSIS SENSOR UNIT

Replace the air bag diagnosis sensor unit. Refer to [SR-17, "Removal and Installation"](#).

>> GO TO 5

5.RELATED HARNESS

B1134 – B1137 SIDE AIRBAG MODULE LH

< COMPONENT DIAGNOSIS >

Replace the related harness.

>> END

A

B

C

D

E

F

G

SRC

I

J

K

L

M

N

O

P

B1129 – B1132 SIDE AIRBAG MODULE RH

< COMPONENT DIAGNOSIS >

B1129 – B1132 SIDE AIRBAG MODULE RH

Description

INFOID:000000003775198

DTC B1129 – B1132 FRONT RH SIDE AIR BAG MODULE

The front RH side air bag module is wired to the air bag diagnosis sensor unit. The air bag diagnosis sensor unit will monitor for opens and shorts in detected lines to the front RH side air bag module.

PART LOCATION

Refer to [SRC-7, "SRS Component Parts Location"](#).

DTC Logic

INFOID:000000004221424

DTC DETECTION LOGIC

With CONSULT-III

CONSULT-III name	DTC	DTC detecting condition	Repair order
SIDE MODULE RH [OPEN]	B1129	Front RH side air bag module circuit is open.	<ol style="list-style-type: none"> 1. Visually check the wiring harness connection. 2. Replace the harness if it has visible damage. 3. Replace the front RH seat back assembly. 4. Replace the air bag diagnosis sensor unit. 5. Replace the related harness.
SIDE MODULE RH [VB-SHORT]	B1130	Front RH side air bag module circuit is shorted to a power supply circuit.	
SIDE MODULE RH [GND-SHORT]	B1131	Front RH side air bag module circuit is shorted to ground.	
SIDE MODULE RH [SHORT]	B1132	Front RH side air bag module circuits are shorted to each other.	

Without CONSULT-III

<Front RH side air bag module>	
Flash pattern	Repair order
<p>a through f are repeated. f: One flash indicate malfunctioning front RH side air bag module circuit.</p>	<ol style="list-style-type: none"> 1. Visually check the wiring harness connection. 2. Replace the harness if it has visible damage. 3. Replace front RH seat back assembly. 4. Replace the air bag diagnosis sensor unit. 5. Replace the related harness.

WHIA0264E

DTC CONFIRMATION PROCEDURE (With CONSULT-III)

1.INSPECTION START

Turn ignition switch ON.

>> GO TO 2.

2.CHECK SELF-DIAG RESULT

Check for the DTC on CONSULT-III.

Is the DTC detected?

- YES >> Refer to [SRC-27, "Diagnosis Procedure \(Component Diagnosis\)"](#).
NO >> Inspection End.

DTC CONFIRMATION PROCEDURE (Without CONSULT-III)

NOTE:

SRS will not enter diagnosis mode if no malfunction is detected in user mode.

1.IGNITION SWITCH

B1129 – B1132 SIDE AIRBAG MODULE RH

< COMPONENT DIAGNOSIS >

Turn ignition switch ON.

>> GO TO 2

2.IGNITION SWITCH

After air bag warning lamp lights for 7 seconds, turn ignition switch OFF within 1 second.

>> GO TO 3

3.WAIT TIME

Wait more than 3 seconds.

>> GO TO 4

4.REPEAT STEPS

Repeat steps 1 to 3 twice.

>> GO TO 5

5.IGNITION SWITCH

Turn ignition switch ON.

>> GO TO 6

6.DIAGNOSTIC MODE

SRS system is now in diagnostic mode and AIR BAG warning lamp flashes. Refer to [SRC-85, "Trouble Diagnosis without CONSULT-III"](#).

>> **END**

Diagnosis Procedure (Component Diagnosis)

INFOID:000000003775200

Recheck SRS after each replacement.

1.HARNES CONNECTOR

Is there any visible damage to the connector?

YES or NO

YES >> Replace the harness.

NO >> GO TO 2

2.WIRING HARNESS

Is there any visible damage to the harness?

YES or NO

YES >> Replace the harness.

NO >> GO TO 3

3.FRONT RH SIDE AIR BAG MODULE

Replace the front RH seat back assembly. Refer to [SE-50, "Removal and Installation"](#).

>> GO TO 4

4.AIR BAG DIAGNOSIS SENSOR UNIT

Replace the air bag diagnosis sensor unit. Refer to [SR-17, "Removal and Installation"](#).

>> GO TO 5

5.RELATED HARNESS

A

B

C

D

E

F

G

SRC

I

J

K

L

M

N

O

P

B1129 – B1132 SIDE AIRBAG MODULE RH

< COMPONENT DIAGNOSIS >

Replace the related harness.

>> **END**

B1198 – B1201 SIDE CURTAIN AIR BAG MODULE LH (FRONT)

< COMPONENT DIAGNOSIS >

Turn ignition switch ON.

>> GO TO 2

2.IGNITION SWITCH

After air bag warning lamp lights for 7 seconds, turn ignition switch OFF within 1 second.

>> GO TO 3

3.WAIT TIME

Wait more than 3 seconds.

>> GO TO 4

4.REPEAT STEPS

Repeat steps 1 to 3 twice.

>> GO TO 5

5.IGNITION SWITCH

Turn ignition switch ON.

>> GO TO 6

6.DIAGNOSTIC MODE

SRS system is now in diagnostic mode and AIR BAG warning lamp flashes. Refer to [SRC-85, "Trouble Diagnosis without CONSULT-III"](#).

>> **END**

Diagnosis Procedure (Component Diagnosis)

INFOID:000000003775203

Recheck SRS after each replacement.

1.HARNESS CONNECTOR

Is there any visible damage to the connector?

YES or NO

YES >> Replace the harness.

NO >> GO TO 2

2.WIRING HARNESS

Is there any visible damage to the harness?

YES or NO

YES >> Replace the harness.

NO >> GO TO 3

3.LH SIDE CURTAIN AIR BAG MODULE

Replace the LH side curtain air bag module. Refer to [SR-13, "Removal and Installation"](#).

>> GO TO 4

4.AIR BAG DIAGNOSIS SENSOR UNIT

Replace the air bag diagnosis sensor unit. [SR-17, "Removal and Installation"](#).

>> GO TO 5

5.RELATED HARNESS

B1198 – B1201 SIDE CURTAIN AIR BAG MODULE LH (FRONT)

< COMPONENT DIAGNOSIS >

Replace the related harness.

>> END

A

B

C

D

E

F

G

SRC

I

J

K

L

M

N

O

P

B1193 – B1196 SIDE CURTAIN AIR BAG MODULE RH (FRONT)

< COMPONENT DIAGNOSIS >

B1193 – B1196 SIDE CURTAIN AIR BAG MODULE RH (FRONT)

Description

INFOID:000000003775204

DTC B1193 – B1196 RH SIDE CURTAIN AIR BAG MODULE (FRONT)

The RH side curtain air bag module (front) is wired to the air bag diagnosis sensor unit. The air bag diagnosis sensor unit will monitor for opens and shorts in detected lines to the RH side curtain air bag module (front).

PART LOCATION

Refer to [SRC-7, "SRS Component Parts Location"](#).

DTC Logic

INFOID:000000004221426

DTC DETECTION LOGIC

With CONSULT-III

CONSULT-III name	DTC	DTC detecting condition	Repair order
FR CURTN MODULE RH [OPEN]	B1193	RH side curtain air bag module (front) circuit is open.	<ol style="list-style-type: none"> 1. Visually check the wiring harness connection. 2. Replace the harness if it has visible damage. 3. Replace the RH side curtain air bag module. 4. Replace the air bag diagnosis sensor unit. 5. Replace the related harness.
FR CURTN MODULE RH [VB-SHORT]	B1194	RH side curtain air bag module (front) circuit is shorted to a power supply circuit.	
FR CURTN MODULE RH [GND-SHORT]	B1195	RH side curtain air bag module (front) circuit is shorted to ground.	
FR CURTN MODULE RH [SHORT]	B1196	RH side curtain air bag module (front) circuits are shorted to each other.	

Without CONSULT-III

<RH side curtain air bag module (front)>	
Flash pattern	Repair order
<p>a through f are repeated. f: Seven flashes indicate malfunctioning RH side curtain air bag module (front) circuit.</p>	<ol style="list-style-type: none"> 1. Visually check the wiring harness connection. 2. Replace the harness if it has visible damage. 3. Replace RH side curtain air bag module. 4. Replace the air bag diagnosis sensor unit. 5. Replace the related harness.

WHIA0253E

DTC CONFIRMATION PROCEDURE (With CONSULT-III)

1.INSPECTION START

Turn ignition switch ON.

>> GO TO 2.

2.CHECK SELF-DIAG RESULT

Check for the DTC on CONSULT-III.

Is the DTC detected?

- YES >> Refer to [SRC-33, "Diagnosis Procedure \(Component Diagnosis\)"](#).
NO >> Inspection End.

DTC CONFIRMATION PROCEDURE (Without CONSULT-III)

NOTE:

SRS will not enter diagnosis mode if no malfunction is detected in user mode.

1.IGNITION SWITCH

B1193 – B1196 SIDE CURTAIN AIR BAG MODULE RH (FRONT)

< COMPONENT DIAGNOSIS >

Turn ignition switch ON.

>> GO TO 2

2.IGNITION SWITCH

After air bag warning lamp lights for 7 seconds, turn ignition switch OFF within 1 second.

>> GO TO 3

3.WAIT TIME

Wait more than 3 seconds.

>> GO TO 4

4.REPEAT STEPS

Repeat steps 1 to 3 twice.

>> GO TO 5

5.IGNITION SWITCH

Turn ignition switch ON.

>> GO TO 6

6.DIAGNOSTIC MODE

SRS system is now in diagnostic mode and AIR BAG warning lamp flashes. Refer to [SRC-85, "Trouble Diagnosis without CONSULT-III"](#).

>> END

Diagnosis Procedure (Component Diagnosis)

INFOID:000000003775206

Recheck SRS after each replacement.

1.HARNES CONNECTOR

Is there any visible damage to the connector?

YES or NO

YES >> Replace the harness.

NO >> GO TO 2

2.WIRING HARNESS

Is there any visible damage to the harness?

YES or NO

YES >> Replace the harness.

NO >> GO TO 3

3.RH SIDE CURTAIN AIR BAG MODULE

Replace the RH side curtain air bag module. Refer to [SR-13, "Removal and Installation"](#).

>> GO TO 4

4.AIR BAG DIAGNOSIS SENSOR UNIT

Replace the air bag diagnosis sensor unit. Refer to [SR-17, "Removal and Installation"](#).

>> GO TO 5

5.RELATED HARNESS

A
B
C
D
E
F
G
SRC
I
J
K
L
M
N
O
P

B1193 – B1196 SIDE CURTAIN AIR BAG MODULE RH (FRONT)

< COMPONENT DIAGNOSIS >

Replace the related harness.

>> **END**

B1150 – B1153 SIDE CURTAIN AIR BAG MODULE LH (REAR)

< COMPONENT DIAGNOSIS >

B1150 – B1153 SIDE CURTAIN AIR BAG MODULE LH (REAR)

Description

INFOID:000000003775207

DTC B1150 – B1153 LH SIDE CURTAIN AIR BAG MODULE (REAR)

The LH side curtain air bag module (rear) is wired to the air bag diagnosis sensor unit. The air bag diagnosis sensor unit will monitor for opens and shorts in detected lines to the LH side curtain air bag module (rear).

PART LOCATION

Refer to [SRC-7, "SRS Component Parts Location"](#).

DTC Logic

INFOID:000000004221428

DTC DETECTION LOGIC

With CONSULT-III

CONSULT-III name	DTC	DTC detecting condition	Repair order
CURTAIN MODULE LH [OPEN]	B1150	LH side curtain air bag module (rear) circuit is open.	<ol style="list-style-type: none"> 1. Visually check the wiring harness connection. 2. Replace the harness if it has visible damage. 3. Replace the LH side curtain air bag module. 4. Replace the air bag diagnosis sensor unit. 5. Replace the related harness.
CURTAIN MODULE LH [VB-SHORT]	B1151	LH side curtain air bag module (rear) circuit is shorted to a power supply circuit.	
CURTAIN MODULE LH [GND-SHORT]	B1152	LH side curtain air bag module (rear) circuit is shorted to ground.	
CURTAIN MODULE LH [SHORT]	B1153	LH side curtain air bag module (rear) circuits are shorted to each other.	

Without CONSULT-III

<LH side curtain air bag module (rear)>	
Flash pattern	Repair order
<p>a through f are repeated. f: Six flashes indicate malfunctioning LH side curtain air bag module (rear) circuit.</p>	<ol style="list-style-type: none"> 1. Visually check the wiring harness connection. 2. Replace the harness if it has visible damage. 3. Replace LH side curtain air bag module. 4. Replace the air bag diagnosis sensor unit. 5. Replace the related harness.

WHIA0254E

DTC CONFIRMATION PROCEDURE (With CONSULT-III)

1.INSPECTION START

Turn ignition switch ON.

>> GO TO 2.

2.CHECK SELF-DIAG RESULT

Check for the DTC on CONSULT-III.

Is the DTC detected?

YES >> Refer to [SRC-36, "Diagnosis Procedure \(Component Diagnosis\)"](#).

NO >> Inspection End.

DTC CONFIRMATION PROCEDURE (Without CONSULT-III)

NOTE:

SRS will not enter diagnosis mode if no malfunction is detected in user mode.

1.IGNITION SWITCH

B1150 – B1153 SIDE CURTAIN AIR BAG MODULE LH (REAR)

< COMPONENT DIAGNOSIS >

Turn ignition switch ON.

>> GO TO 2

2.IGNITION SWITCH

After air bag warning lamp lights for 7 seconds, turn ignition switch OFF within 1 second.

>> GO TO 3

3.WAIT TIME

Wait more than 3 seconds.

>> GO TO 4

4.REPEAT STEPS

Repeat steps 1 to 3 twice.

>> GO TO 5

5.IGNITION SWITCH

Turn ignition switch ON.

>> GO TO 6

6.DIAGNOSTIC MODE

SRS system is now in diagnostic mode and AIR BAG warning lamp flashes. Refer to [SRC-85, "Trouble Diagnosis without CONSULT-III"](#).

>> **END**

Diagnosis Procedure (Component Diagnosis)

INFOID:000000003775209

Recheck SRS after each replacement.

1.HARNESS CONNECTOR

Is there any visible damage to the connector?

YES or NO

YES >> Replace the harness.

NO >> GO TO 2

2.WIRING HARNESS

Is there any visible damage to the harness?

YES or NO

YES >> Replace the harness.

NO >> GO TO 3

3.LH SIDE CURTAIN AIR BAG MODULE

Replace the LH side curtain air bag module. Refer to [SR-13, "Removal and Installation"](#).

>> GO TO 4

4.AIR BAG DIAGNOSIS SENSOR UNIT

Replace the air bag diagnosis sensor unit. Refer to [SR-17, "Removal and Installation"](#).

>> GO TO 5

5.RELATED HARNESS

B1150 – B1153 SIDE CURTAIN AIR BAG MODULE LH (REAR)

< COMPONENT DIAGNOSIS >

Replace the related harness.

>> END

A

B

C

D

E

F

G

SRC

I

J

K

L

M

N

O

P

B1145 – B1148 SIDE CURTAIN AIR BAG MODULE RH (REAR)

< COMPONENT DIAGNOSIS >

B1145 – B1148 SIDE CURTAIN AIR BAG MODULE RH (REAR)

Description

INFOID:000000003775210

DTC B1145 – B1148 RH SIDE CURTAIN AIR BAG MODULE (REAR)

The RH side curtain air bag module (rear) is wired to the air bag diagnosis sensor unit. The air bag diagnosis sensor unit will monitor for opens and shorts in detected lines to the RH side curtain air bag module (rear).

PART LOCATION

Refer to [SRC-7, "SRS Component Parts Location"](#).

DTC Logic

INFOID:000000004221429

DTC DETECTION LOGIC

With CONSULT-III

CONSULT-III name	DTC	DTC detecting condition	Repair order
CURTAIN MODULE RH [OPEN]	B1145	RH side curtain air bag module (rear) circuit is open.	<ol style="list-style-type: none"> 1. Visually check the wiring harness connection. 2. Replace the harness if it has visible damage. 3. Replace the RH side curtain air bag module. 4. Replace the air bag diagnosis sensor unit. 5. Replace the related harness.
CURTAIN MODULE RH [VB-SHORT]	B1146	RH side curtain air bag module (rear) circuit is shorted to a power supply circuit.	
CURTAIN MODULE RH [GND-SHORT]	B1147	RH side curtain air bag module (rear) circuit is shorted to ground.	
CURTAIN MODULE RH [SHORT]	B1148	RH side curtain air bag module (rear) circuits are shorted to each other.	

Without CONSULT-III

<RH side curtain air bag module (rear)>	
Flash pattern	Repair order
<p>a through f are repeated. f: Five flashes indicate malfunctioning RH side curtain air bag module (rear) circuit.</p> <p>5 flashes</p> <p>ON OFF</p> <p>7 sec. 1.5 sec. 1.5 sec. 0.5 sec. 0.5 sec. 0.5 sec. 2 sec. 2 sec. 2 sec. 2 sec.</p>	<ol style="list-style-type: none"> 1. Visually check the wiring harness connection. 2. Replace the harness if it has visible damage. 3. Replace RH side curtain air bag module. 4. Replace the air bag diagnosis sensor unit. 5. Replace the related harness.

WHIA0252E

DTC CONFIRMATION PROCEDURE (With CONSULT-III)

1.INSPECTION START

Turn ignition switch ON.

>> GO TO 2.

2.CHECK SELF-DIAG RESULT

Check for the DTC on CONSULT-III.

Is the DTC detected?

- YES >> Refer to [SRC-39, "Diagnosis Procedure \(Component Diagnosis\)"](#).
NO >> Inspection End.

DTC CONFIRMATION PROCEDURE (Without CONSULT-III)

NOTE:

SRS will not enter diagnosis mode if no malfunction is detected in user mode.

1.IGNITION SWITCH

B1145 – B1148 SIDE CURTAIN AIR BAG MODULE RH (REAR)

< COMPONENT DIAGNOSIS >

Turn ignition switch ON.

>> GO TO 2

2.IGNITION SWITCH

After air bag warning lamp lights for 7 seconds, turn ignition switch OFF within 1 second.

>> GO TO 3

3.WAIT TIME

Wait more than 3 seconds.

>> GO TO 4

4.REPEAT STEPS

Repeat steps 1 to 3 twice.

>> GO TO 5

5.IGNITION SWITCH

Turn ignition switch ON.

>> GO TO 6

6.DIAGNOSTIC MODE

SRS system is now in diagnostic mode and AIR BAG warning lamp flashes. Refer to [SRC-85, "Trouble Diagnosis without CONSULT-III"](#).

>> END

Diagnosis Procedure (Component Diagnosis)

INFOID:000000003775212

Recheck SRS after each replacement.

1.HARNES CONNECTOR

Is there any visible damage to the connector?

YES or NO

YES >> Replace the harness.

NO >> GO TO 2

2.WIRING HARNESS

Is there any visible damage to the harness?

YES or NO

YES >> Replace the harness.

NO >> GO TO 3

3.RH SIDE CURTAIN AIR BAG MODULE

Replace the RH side curtain air bag module. Refer to [SR-13, "Removal and Installation"](#).

>> GO TO 4

4.AIR BAG DIAGNOSIS SENSOR UNIT

Replace the air bag diagnosis sensor unit. Refer to [SR-17, "Removal and Installation"](#).

>> GO TO 5

5.RELATED HARNESS

A
B
C
D
E
F
G
SRC
I
J
K
L
M
N
O
P

B1145 – B1148 SIDE CURTAIN AIR BAG MODULE RH (REAR)

< COMPONENT DIAGNOSIS >

Replace the related harness.

>> **END**

B1086 – B1089 SEAT BELT PRE-TENSIONER LH

< COMPONENT DIAGNOSIS >

B1086 – B1089 SEAT BELT PRE-TENSIONER LH

Description

INFOID:000000003775213

DTC B1086 – B1089 SEAT BELT PRE-TENSIONER LH

The seat belt pre-tensioner LH is wired to the air bag diagnosis sensor unit. The air bag diagnosis sensor unit will monitor for opens and shorts in detected lines to the seat belt pre-tensioner LH.

PART LOCATION

Refer to [SRC-7, "SRS Component Parts Location"](#).

DTC Logic

INFOID:000000004221430

DTC DETECTION LOGIC

With CONSULT-III

CONSULT-III name	DTC	DTC detecting condition	Repair order
PRE-TEN FRONT LH [OPEN]	B1086	LH seat belt pre-tensioner circuit is open.	<ol style="list-style-type: none"> 1. Visually check the wiring harness connection. 2. Replace the harness if it has visible damage. 3. Replace the front LH seat belt pre-tensioner. 4. Replace the air bag diagnosis sensor unit. 5. Replace the related harness.
PRE-TEN FRONT LH [VB-SHORT]	B1087	LH seat belt pre-tensioner circuit is shorted to a power supply circuit.	
PRE-TEN FRONT LH [GND-SHORT]	B1088	LH seat belt pre-tensioner circuit is shorted to ground.	
PRE-TEN FRONT LH [SHORT]	B1089	LH seat belt pre-tensioner circuits are shorted to each other.	

Without CONSULT-III

<Front LH seat belt pre-tensioner>	
Flash pattern	Repair order
<p>a through d are repeated. d: Three flashes indicate malfunctioning front LH seat belt pre-tensioner circuit.</p>	<ol style="list-style-type: none"> 1. Visually check the wiring harness connections. 2. Replace the harness if it has visible damage. 3. Replace front LH seat belt pre-tensioner. 4. Replace the air bag diagnosis sensor unit. 5. Replace the related harness.

WHIA0263E

DTC CONFIRMATION PROCEDURE (With CONSULT-III)

1.INSPECTION START

Turn ignition switch ON.

>> GO TO 2.

2.CHECK SELF-DIAG RESULT

Check for the DTC on CONSULT-III.

Is the DTC detected?

- YES >> Refer to [SRC-42, "Diagnosis Procedure \(Component Diagnosis\)"](#).
NO >> Inspection End.

DTC CONFIRMATION PROCEDURE (Without CONSULT-III)

NOTE:

SRS will not enter diagnosis mode if no malfunction is detected in user mode.

1.IGNITION SWITCH

B1086 – B1089 SEAT BELT PRE-TENSIONER LH

< COMPONENT DIAGNOSIS >

Turn ignition switch ON.

>> GO TO 2

2.IGNITION SWITCH

After air bag warning lamp lights for 7 seconds, turn ignition switch OFF within 1 second.

>> GO TO 3

3.WAIT TIME

Wait more than 3 seconds.

>> GO TO 4

4.REPEAT STEPS

Repeat steps 1 to 3 twice.

>> GO TO 5

5.IGNITION SWITCH

Turn ignition switch ON.

>> GO TO 6

6.DIAGNOSTIC MODE

SRS system is now in diagnostic mode and AIR BAG warning lamp flashes. Refer to [SRC-85, "Trouble Diagnosis without CONSULT-III"](#).

>> **END**

Diagnosis Procedure (Component Diagnosis)

INFOID:000000003775215

Recheck SRS after each replacement.

1.HARNESS CONNECTOR

Is there any visible damage to the connector?

YES or NO

YES >> Replace the harness.

NO >> GO TO 2

2.WIRING HARNESS

Is there any visible damage to the harness?

YES or NO

YES >> Replace the harness.

NO >> GO TO 3

3.FRONT LH SEAT BELT PRE-TENSIONER

Replace the front LH seat belt pre-tensioner. Refer to [SR-16, "Removal and Installation"](#).

>> GO TO 4

4.AIR BAG DIAGNOSIS SENSOR UNIT

Replace the air bag diagnosis sensor unit. Refer to [SR-17, "Removal and Installation"](#).

>> GO TO 5

5.RELATED HARNESS

B1086 – B1089 SEAT BELT PRE-TENSIONER LH

< COMPONENT DIAGNOSIS >

Replace the related harness.

>> END

A

B

C

D

E

F

G

SRC

I

J

K

L

M

N

O

P

B1081 – B1084 SEAT BELT PRE-TENSIONER RH

< COMPONENT DIAGNOSIS >

B1081 – B1084 SEAT BELT PRE-TENSIONER RH

Description

INFOID:000000003775216

DTC B1081 – B1084 SEAT BELT PRE-TENSIONER RH

The seat belt pre-tensioner RH is wired to the air bag diagnosis sensor unit. The air bag diagnosis sensor unit will monitor for opens and shorts in detected lines to the seat belt pre-tensioner RH.

PART LOCATION

Refer to [SRC-7, "SRS Component Parts Location"](#).

DTC Logic

INFOID:000000004221431

DTC DETECTION LOGIC

With CONSULT-III

CONSULT-III name	DTC	DTC detecting condition	Repair order
PRE-TEN FRONT RH [OPEN]	B1081	RH seat belt pre-tensioner circuit is open.	<ol style="list-style-type: none"> 1. Visually check the wiring harness connection. 2. Replace the harness if it has visible damage. 3. Replace the front RH seat belt pre-tensioner. 4. Replace the air bag diagnosis sensor unit. 5. Replace the related harness.
PRE-TEN FRONT RH [VB-SHORT]	B1082	RH seat belt pre-tensioner circuit is shorted to a power supply circuit.	
PRE-TEN FRONT RH [GND-SHORT]	B1083	RH seat belt pre-tensioner circuit is shorted to ground.	
PRE-TEN FRONT RH [SHORT]	B1084	RH seat belt pre-tensioner circuits are shorted to each other.	

Without CONSULT-III

<Front RH seat belt pre-tensioner>	
Flash pattern	Repair order
<p>a through d are repeated. d: One flash indicates malfunctioning front RH seat belt pre-tensioner circuit.</p> <p>ON OFF</p> <p>7 sec. 2 sec. 3 sec. 2 sec. 0.5 sec. 2 sec. 3 sec. 2 sec.</p> <p>a b 1 flash c d a b</p>	<ol style="list-style-type: none"> 1. Visually check the wiring harness connections. 2. Replace the harness if it has visible damage. 3. Replace front RH seat belt pre-tensioner. 4. Replace the air bag diagnosis sensor unit. 5. Replace the related harness.

WHIA0262E

DTC CONFIRMATION PROCEDURE (With CONSULT-III)

1.INSPECTION START

Turn ignition switch ON.

>> GO TO 2.

2.CHECK SELF-DIAG RESULT

Check for the DTC on CONSULT-III.

Is the DTC detected?

- YES >> Refer to [SRC-45, "Diagnosis Procedure \(Component Diagnosis\)"](#).
NO >> Inspection End.

DTC CONFIRMATION PROCEDURE (Without CONSULT-III)

NOTE:

SRS will not enter diagnosis mode if no malfunction is detected in user mode.

1.IGNITION SWITCH

B1081 – B1084 SEAT BELT PRE-TENSIONER RH

< COMPONENT DIAGNOSIS >

Turn ignition switch ON.

>> GO TO 2

2.IGNITION SWITCH

After air bag warning lamp lights for 7 seconds, turn ignition switch OFF within 1 second.

>> GO TO 3

3.WAIT TIME

Wait more than 3 seconds.

>> GO TO 4

4.REPEAT STEPS

Repeat steps 1 to 3 twice.

>> GO TO 5

5.IGNITION SWITCH

Turn ignition switch ON.

>> GO TO 6

6.DIAGNOSTIC MODE

SRS system is now in diagnostic mode and AIR BAG warning lamp flashes. Refer to [SRC-85, "Trouble Diagnosis without CONSULT-III"](#).

>> END

Diagnosis Procedure (Component Diagnosis)

INFOID:000000003775218

Recheck SRS after each replacement.

1.HARNES CONNECTOR

Is there any visible damage to the connector?

YES or NO

YES >> Replace the harness.

NO >> GO TO 2

2.WIRING HARNESS

Is there any visible damage to the harness?

YES or NO

YES >> Replace the harness.

NO >> GO TO 3

3.FRONT RH SEAT BELT PRE-TENSIONER

Replace the front RH seat belt pre-tensioner. Refer to [SR-16, "Removal and Installation"](#).

>> GO TO 4

4.AIR BAG DIAGNOSIS SENSOR UNIT

Replace the air bag diagnosis sensor unit. Refer to [SR-17, "Removal and Installation"](#).

>> GO TO 5

5.RELATED HARNESS

A
B
C
D
E
F
G
SRC
I
J
K
L
M
N
O
P

B1081 – B1084 SEAT BELT PRE-TENSIONER RH

< COMPONENT DIAGNOSIS >

Replace the related harness.

>> **END**

B1182 - B1185 SEAT BELT BUCKLE PRE-TENSIONER LH

< COMPONENT DIAGNOSIS >

B1182 - B1185 SEAT BELT BUCKLE PRE-TENSIONER LH

Description

INFOID:000000003775219

DTC B1182 – B1185 SEAT BELT BUCKLE PRE-TENSIONER LH

The seat belt buckle pre-tensioner LH is wired to the air bag diagnosis sensor unit. The air bag diagnosis sensor unit will monitor for opens and shorts in detected lines to the seat belt buckle pre-tensioner LH.

PART LOCATION

Refer to [SRC-7, "SRS Component Parts Location"](#).

DTC Logic

INFOID:000000004221432

DTC DETECTION LOGIC

With CONSULT-III

CONSULT-III name	DTC	DTC detecting condition	Repair order
PRE-TEN2 FRONT LH [OPEN]	B1182	LH seat belt buckle pre-tensioner circuit is open.	<ol style="list-style-type: none"> 1. Visually check the wiring harness connection. 2. Replace the harness if it has visible damage. 3. Replace the front LH seat belt buckle pre-tensioner. 4. Replace the air bag diagnosis sensor unit. 5. Replace the related harness.
PRE-TEN2 FRONT LH [VB-SHORT]	B1183	LH seat belt buckle pre-tensioner circuit is shorted to a power supply circuit.	
PRE-TEN2 FRONT LH [GND-SHORT]	B1184	LH seat belt buckle pre-tensioner circuit is shorted to ground.	
PRE-TEN2 FRONT LH [SHORT]	B1185	LH seat belt buckle pre-tensioner circuits are shorted to each other.	

Without CONSULT-III

Flash pattern	Repair order
<p><Seat belt buckle pre-tensioner assembly LH></p> <p>a through d are repeated. d: Thirteen flashes indicate malfunctioning seat belt buckle pre-tensioner assembly LH circuit.</p>	<ol style="list-style-type: none"> 1. Visually check the wiring harness connections. 2. Replace the harness if it has visible damage. 3. Replace the seat belt buckle pre-tensioner assembly LH. 4. Replace the air bag diagnosis sensor unit. 5. Replace the related harness.

WHIA0251E

DTC CONFIRMATION PROCEDURE (With CONSULT-III)

1.INSPECTION START

Turn ignition switch ON.

>> GO TO 2.

2.CHECK SELF-DIAG RESULT

Check for the DTC on CONSULT-III.

Is the DTC detected?

- YES >> Refer to [SRC-48, "Diagnosis Procedure \(Component Diagnosis\)"](#).
 NO >> Inspection End.

DTC CONFIRMATION PROCEDURE (Without CONSULT-III)

NOTE:

SRS will not enter diagnosis mode if no malfunction is detected in user mode.

1.IGNITION SWITCH

B1182 - B1185 SEAT BELT BUCKLE PRE-TENSIONER LH

< COMPONENT DIAGNOSIS >

Turn ignition switch ON.

>> GO TO 2

2.IGNITION SWITCH

After air bag warning lamp lights for 7 seconds, turn ignition switch OFF within 1 second.

>> GO TO 3

3.WAIT TIME

Wait more than 3 seconds.

>> GO TO 4

4.REPEAT STEPS

Repeat steps 1 to 3 twice.

>> GO TO 5

5.IGNITION SWITCH

Turn ignition switch ON.

>> GO TO 6

6.DIAGNOSTIC MODE

SRS system is now in diagnostic mode and AIR BAG warning lamp flashes. Refer to [SRC-85, "Trouble Diagnosis without CONSULT-III"](#).

>> **END**

Diagnosis Procedure (Component Diagnosis)

INFOID:000000003775221

Recheck SRS after each replacement.

1.HARNES CONNECTOR

Is there any visible damage to the connector?

YES or NO

YES >> Replace the harness.

NO >> GO TO 2

2.WIRING HARNESS

Is there any visible damage to the harness?

YES or NO

YES >> Replace the harness.

NO >> GO TO 3

3.FRONT LH SEAT BELT BUCKLE PRE-TENSIONER

Replace the front LH seat belt buckle pre-tensioner. Refer to [SR-16, "Removal and Installation"](#).

>> GO TO 4

4.AIR BAG DIAGNOSIS SENSOR UNIT

Replace the air bag diagnosis sensor unit. Refer to [SR-17, "Removal and Installation"](#).

>> GO TO 5

5.RELATED HARNESS

B1182 - B1185 SEAT BELT BUCKLE PRE-TENSIONER LH

< COMPONENT DIAGNOSIS >

Replace the related harness.

>> END

A

B

C

D

E

F

G

SRC

I

J

K

L

M

N

O

P

B1177 - B1180 SEAT BELT BUCKLE PRE-TENSIONER RH

< COMPONENT DIAGNOSIS >

B1177 - B1180 SEAT BELT BUCKLE PRE-TENSIONER RH

Description

INFOID:000000003775222

DTC B1177 – B1180 SEAT BELT BUCKLE PRE-TENSIONER RH

The seat belt buckle pre-tensioner RH is wired to the air bag diagnosis sensor unit. The air bag diagnosis sensor unit will monitor for opens and shorts in detected lines to the seat belt buckle pre-tensioner RH.

PART LOCATION

Refer to [SRC-7, "SRS Component Parts Location"](#).

DTC Logic

INFOID:000000004221433

DTC DETECTION LOGIC

With CONSULT-III

CONSULT-III name	DTC	DTC detecting condition	Repair order
PRE-TEN2 FRONT RH [OPEN]	B1177	RH seat belt buckle pre-tensioner circuit is open.	<ol style="list-style-type: none"> 1. Visually check the wiring harness connection. 2. Replace the harness if it has visible damage. 3. Replace the front RH seat belt buckle pre-tensioner. 4. Replace the air bag diagnosis sensor unit. 5. Replace the related harness.
PRE-TEN2 FRONT RH [VB-SHORT]	B1178	RH seat belt buckle pre-tensioner circuit is shorted to a power supply circuit.	
PRE-TEN2 FRONT RH [GND-SHORT]	B1179	RH seat belt buckle pre-tensioner circuit is shorted to ground.	
PRE-TEN2 FRONT RH [SHORT]	B1180	RH seat belt buckle pre-tensioner circuits are shorted to each other.	

Without CONSULT-III

< Seat belt buckle pre-tensioner assembly RH >	
Flash pattern	Repair order
<p>a through d are repeated. d: Twelve flashes indicate malfunctioning seat belt buckle pre-tensioner assembly RH circuit</p>	<ol style="list-style-type: none"> 1. Visually check the wiring harness connections. 2. Replace the harness if it has visible damage. 3. Replace seat belt buckle pre-tensioner assembly RH. 4. Replace the air bag diagnosis sensor unit. 5. Replace the related harness.

WHIA0250E

DTC CONFIRMATION PROCEDURE (With CONSULT-III)

1.INSPECTION START

Turn ignition switch ON.

>> GO TO 2.

2.CHECK SELF-DIAG RESULT

Check for the DTC on CONSULT-III.

Is the DTC detected?

- YES >> Refer to [SRC-51, "Diagnosis Procedure \(Component Diagnosis\)"](#).
 NO >> Inspection End.

DTC CONFIRMATION PROCEDURE (Without CONSULT-III)

NOTE:

SRS will not enter diagnosis mode if no malfunction is detected in user mode.

1.IGNITION SWITCH

B1177 - B1180 SEAT BELT BUCKLE PRE-TENSIONER RH

< COMPONENT DIAGNOSIS >

Turn ignition switch ON.

>> GO TO 2

2.IGNITION SWITCH

After air bag warning lamp lights for 7 seconds, turn ignition switch OFF within 1 second.

>> GO TO 3

3.WAIT TIME

Wait more than 3 seconds.

>> GO TO 4

4.REPEAT STEPS

Repeat steps 1 to 3 twice.

>> GO TO 5

5.IGNITION SWITCH

Turn ignition switch ON.

>> GO TO 6

6.DIAGNOSTIC MODE

SRS system is now in diagnostic mode and AIR BAG warning lamp flashes. Refer to [SRC-85, "Trouble Diagnosis without CONSULT-III"](#).

>> END

Diagnosis Procedure (Component Diagnosis)

INFOID:000000003775224

Recheck SRS after each replacement.

1.HARNES CONNECTOR

Is there any visible damage to the connector?

YES or NO

YES >> Replace the harness.

NO >> GO TO 2

2.WIRING HARNESS

Is there any visible damage to the harness?

YES or NO

YES >> Replace the harness.

NO >> GO TO 3

3.FRONT RH SEAT BELT BUCKLE PRE-TENSIONER

Replace the front RH seat belt buckle pre-tensioner. Refer to [SR-16, "Removal and Installation"](#).

>> GO TO 4

4.AIR BAG DIAGNOSIS SENSOR UNIT

Replace the air bag diagnosis sensor unit. Refer to [SR-17, "Removal and Installation"](#).

>> GO TO 5

5.RELATED HARNESS

A

B

C

D

E

F

G

SRC

I

J

K

L

M

N

O

P

B1177 - B1180 SEAT BELT BUCKLE PRE-TENSIONER RH

< COMPONENT DIAGNOSIS >

Replace the related harness.

>> **END**

B1033 – B1035 CRASH ZONE SENSOR

< COMPONENT DIAGNOSIS >

B1033 – B1035 CRASH ZONE SENSOR

Description

INFOID:000000003775225

DTC B1033 – B1035 CRASH ZONE SENSOR

The crash zone sensor is wired to the air bag diagnosis sensor unit. The air bag diagnosis sensor unit will monitor for opens and shorts in detected lines to the crash zone sensor.

PART LOCATION

Refer to [SRC-7, "SRS Component Parts Location"](#).

DTC Logic

INFOID:000000004221434

DTC DETECTION LOGIC

With CONSULT-III

CONSULT-III name	DTC	DTC detecting condition	Repair order
CRASH ZONE SEN [UNIT FAIL]	B1033	Crash zone sensor has malfunctioned.	<ol style="list-style-type: none"> 1. Visually check the wiring harness connection. 2. Replace the harness if it has visible damage. 3. Replace the crash zone sensor.
	B1034		
CRASH ZONE SEN [COMM FAIL]	B1035	Crash zone sensor communication error.	<ol style="list-style-type: none"> 4. Replace the air bag diagnosis sensor unit. 5. Replace the related harness.

Without CONSULT-III

<Crash zone sensor>	
Flash pattern	Repair order
<p>a through d are repeated. d: Six flashes indicate malfunctioning crash zone sensor circuit.</p>	<ol style="list-style-type: none"> 1. Visually check the wiring harness connection. 2. Replace the harness if it has visible damage. 3. Replace the crash zone sensor. 4. Replace the air bag diagnosis sensor unit. 5. Replace the related harness.

WHIA0200E

DTC CONFIRMATION PROCEDURE (With CONSULT-III)

1.INSPECTION START

Turn ignition switch ON.

>> GO TO 2.

2.CHECK SELF-DIAG RESULT

Check for the DTC on CONSULT-III.

Is the DTC detected?

- YES >> Refer to [SRC-54, "Diagnosis Procedure \(Component Diagnosis\)"](#).
NO >> Inspection End.

DTC CONFIRMATION PROCEDURE (Without CONSULT-III)

NOTE:

SRS will not enter diagnosis mode if no malfunction is detected in user mode.

1.IGNITION SWITCH

Turn ignition switch ON.

>> GO TO 2

B1033 – B1035 CRASH ZONE SENSOR

< COMPONENT DIAGNOSIS >

2.IGNITION SWITCH

After air bag warning lamp lights for 7 seconds, turn ignition switch OFF within 1 second.

>> GO TO 3

3.WAIT TIME

Wait more than 3 seconds.

>> GO TO 4

4.REPEAT STEPS

Repeat steps 1 to 3 twice.

>> GO TO 5

5.IGNITION SWITCH

Turn ignition switch ON.

>> GO TO 6

6.DIAGNOSTIC MODE

SRS system is now in diagnostic mode and AIR BAG warning lamp flashes. Refer to [SRC-85, "Trouble Diagnosis without CONSULT-III"](#).

>> **END**

Diagnosis Procedure (Component Diagnosis)

INFOID:000000003775227

Recheck SRS after each replacement.

1.HARNESS CONNECTOR

Is there any visible damage to the connector?

YES or NO

YES >> Replace the harness.

NO >> GO TO 2

2.WIRING HARNESS

Is there any visible damage to the harness?

YES or NO

YES >> Replace the harness.

NO >> GO TO 3

3.CRASH ZONE SENSOR

Replace the crash zone sensor. Refer to [SR-14, "Removal and Installation"](#).

>> GO TO 4

4.AIR BAG DIAGNOSIS SENSOR UNIT

Replace the air bag diagnosis sensor unit. Refer to [SR-17, "Removal and Installation"](#).

>> GO TO 5

5.RELATED HARNESS

Replace the related harness.

B1033 – B1035 CRASH ZONE SENSOR

< COMPONENT DIAGNOSIS >

>> END

A

B

C

D

E

F

G

SRC

I

J

K

L

M

N

O

P

B1118 – B1120 SATELLITE SENSOR LH

< COMPONENT DIAGNOSIS >

B1118 – B1120 SATELLITE SENSOR LH

Description

INFOID:000000003775238

DTC B1118 – B1120 SATELLITE SENSOR LH

The satellite sensor LH is wired to the air bag diagnosis sensor unit. The air bag diagnosis sensor unit will monitor the satellite sensor LH for internal failures and it's circuits for communication errors.

PART LOCATION

Refer to [SRC-7, "SRS Component Parts Location"](#).

DTC Logic

INFOID:000000004221435

DTC DETECTION LOGIC

With CONSULT-III

CONSULT-III name	DTC	DTC detecting condition	Repair order
SATELLITE SENS LH [UNIT FAIL]	B1118	LH side air bag satellite sensor has mal- functioned.	1. Visually check the wiring harness connection. 2. Replace the harness if it has visible damage. 3. Replace the LH side air bag satellite sensor.
	B1119		
SATELLITE SENS LH [COMM FAIL]	B1120	LH side air bag satellite sensor communi- cation error.	4. Replace the air bag diagnosis sensor unit. 5. Replace the related harness.

Without CONSULT-III

<LH side air bag (Satellite) sensor>	
Flash pattern	Repair order
<p>a through f are repeated. f: Four flashes indicate malfunctioning LH side air bag (Satellite) sensor.</p> <p>4 flashes</p> <p>ON OFF</p> <p>7 sec.</p> <p>2 sec.</p> <p>1.5 sec.</p> <p>1.5 sec.</p> <p>1.5 sec.</p> <p>1.5 sec.</p> <p>0.5 sec.</p> <p>0.5 sec.</p>	<ol style="list-style-type: none"> 1. Visually check the wiring harness connection. 2. Replace the harness if it has visible damage. 3. Replace the LH side air bag (Satellite) sensor. 4. Replace the air bag diagnosis sensor unit. 5. Replace the related harness.

WHIA0204E

DTC CONFIRMATION PROCEDURE (With CONSULT-III)

1.INSPECTION START

Turn ignition switch ON.

>> GO TO 2.

2.CHECK SELF-DIAG RESULT

Check for the DTC on CONSULT-III.

Is the DTC detected?

- YES >> Refer to [SRC-57, "Diagnosis Procedure \(Component Diagnosis\)"](#).
NO >> Inspection End.

DTC CONFIRMATION PROCEDURE (Without CONSULT-III)

NOTE:

SRS will not enter diagnosis mode if no malfunction is detected in user mode.

1.IGNITION SWITCH

Turn ignition switch ON.

>> GO TO 2

B1118 – B1120 SATELLITE SENSOR LH

< COMPONENT DIAGNOSIS >

2.IGNITION SWITCH

After air bag warning lamp lights for 7 seconds, turn ignition switch OFF within 1 second.

>> GO TO 3

3.WAIT TIME

Wait more than 3 seconds.

>> GO TO 4

4.REPEAT STEPS

Repeat steps 1 to 3 twice.

>> GO TO 5

5.IGNITION SWITCH

Turn ignition switch ON.

>> GO TO 6

6.DIAGNOSTIC MODE

SRS system is now in diagnostic mode and AIR BAG warning lamp flashes. Refer to [SRC-85, "Trouble Diagnosis without CONSULT-III"](#).

>> **END**

Diagnosis Procedure (Component Diagnosis)

INFOID:000000003775230

Recheck SRS after each replacement.

1.HARNES CONNECTOR

Is there any visible damage to the connector?

YES or NO

YES >> Replace the harness.

NO >> GO TO 2

2.WIRING HARNESS

Is there any visible damage to the harness?

YES or NO

YES >> Replace the harness.

NO >> GO TO 3

3.LH SIDE AIR BAG SATELLITE SENSOR

Replace the LH side air bag satellite sensor. Refer to [SR-15, "Removal and Installation"](#).

>> GO TO 4

4.AIR BAG DIAGNOSIS SENSOR UNIT

Replace the air bag diagnosis sensor unit. Refer to [SR-17, "Removal and Installation"](#).

>> GO TO 5

5.RELATED HARNESS

Replace the related harness.

A

B

C

D

E

F

G

SRC

I

J

K

L

M

N

O

P

B1118 – B1120 SATELLITE SENSOR LH

< COMPONENT DIAGNOSIS >

>> END

B1113 – B1115 SATELLITE SENSOR RH

< COMPONENT DIAGNOSIS >

B1113 – B1115 SATELLITE SENSOR RH

Description

INFOID:000000003775231

DTC B1113 – B1115 SATELLITE SENSOR RH

The satellite sensor RH is wired to the air bag diagnosis sensor unit. The air bag diagnosis sensor unit will monitor the satellite sensor RH for internal failures and it's circuits for communication errors.

PART LOCATION

Refer to [SRC-7, "SRS Component Parts Location"](#).

DTC Logic

INFOID:000000004221436

DTC DETECTION LOGIC

With CONSULT-III

CONSULT-III name	DTC	DTC detecting condition	Repair order
SATELLITE SENS RH [UNIT FAIL]	B1113	RH side air bag satellite sensor has mal- functioned.	1. Visually check the wiring harness connection. 2. Replace the harness if it has visible damage. 3. Replace the RH side air bag satellite sensor.
	B1114		
SATELLITE SENS RH [COMM FAIL]	B1115	RH side air bag satellite sensor communi- cation error.	4. Replace the air bag diagnosis sensor unit. 5. Replace the related harness.

Without CONSULT-III

SRC

<RH side air bag (Satellite) sensor>	
Flash pattern	Repair order
<p>a through f are repeated. f: Three flashes indicate malfunctioning RH side air bag (Satellite) sensor circuit.</p>	<ol style="list-style-type: none"> 1. Visually check the wiring harness connection. 2. Replace the harness if it has visible damage. 3. Replace the RH side air bag (Satellite) sensor. 4. Replace the air bag diagnosis sensor unit. 5. Replace the related harness.

WHIA0203E

DTC CONFIRMATION PROCEDURE (With CONSULT-III)

1.INSPECTION START

Turn ignition switch ON.

>> GO TO 2.

2.CHECK SELF-DIAG RESULT

Check for the DTC on CONSULT-III.

Is the DTC detected?

- YES >> Refer to [SRC-60, "Diagnosis Procedure \(Component Diagnosis\)"](#).
NO >> Inspection End.

DTC CONFIRMATION PROCEDURE (Without CONSULT-III)

NOTE:

SRS will not enter diagnosis mode if no malfunction is detected in user mode.

1.IGNITION SWITCH

Turn ignition switch ON.

>> GO TO 2

B1113 – B1115 SATELLITE SENSOR RH

< COMPONENT DIAGNOSIS >

2.IGNITION SWITCH

After air bag warning lamp lights for 7 seconds, turn ignition switch OFF within 1 second.

>> GO TO 3

3.WAIT TIME

Wait more than 3 seconds.

>> GO TO 4

4.REPEAT STEPS

Repeat steps 1 to 3 twice.

>> GO TO 5

5.IGNITION SWITCH

Turn ignition switch ON.

>> GO TO 6

6.DIAGNOSTIC MODE

SRS system is now in diagnostic mode and AIR BAG warning lamp flashes. Refer to [SRC-85, "Trouble Diagnosis without CONSULT-III"](#).

>> **END**

Diagnosis Procedure (Component Diagnosis)

INFOID:000000003775233

Recheck SRS after each replacement.

1.HARNESS CONNECTOR

Is there any visible damage to the connector?

YES or NO

YES >> Replace the harness.

NO >> GO TO 2

2.WIRING HARNESS

Is there any visible damage to the harness?

YES or NO

YES >> Replace the harness.

NO >> GO TO 3

3.RH SIDE AIR BAG SATELLITE SENSOR

Replace the RH side air bag satellite sensor. Refer to [SR-15, "Removal and Installation"](#).

>> GO TO 4

4.AIR BAG DIAGNOSIS SENSOR UNIT

Replace the air bag diagnosis sensor unit. Refer to [SR-17, "Removal and Installation"](#).

>> GO TO 5

5.RELATED HARNESS

Replace the related harness.

B1113 – B1115 SATELLITE SENSOR RH

< COMPONENT DIAGNOSIS >

>> END

A

B

C

D

E

F

G

SRC

I

J

K

L

M

N

O

P

B1XXX AIR BAG DIAGNOSIS SENSOR UNIT

< COMPONENT DIAGNOSIS >

B1XXX AIR BAG DIAGNOSIS SENSOR UNIT

Description

INFOID:000000003775234

DTC B1XXX AIR BAG DIAGNOSIS SENSOR UNIT

The air bag diagnosis sensor unit will run self diagnostics when the ignition switch is turned ON. It has the potential to set many diagnostic trouble codes which will conform to the B1XXX format, but will not match any other SRS diagnostic trouble codes. Refer to [SRC-81. "Trouble Diagnosis with CONSULT-III"](#).

PART LOCATION

Refer to [SRC-7. "SRS Component Parts Location"](#).

DTC Logic

INFOID:000000004221437

DTC DETECTION LOGIC

With CONSULT-III

CONSULT-III name	DTC	DTC detecting condition	Repair order
CONTROL UNIT	B1XXX	Air bag diagnosis sensor unit is malfunctioning.	<ol style="list-style-type: none">1. Visually check the wiring harness connection.2. Replace the harness if it has visible damage.3. Replace the air bag diagnosis sensor unit.4. Replace the related harness.

Without CONSULT-III

<Air bag diagnosis sensor unit>	Repair order
<p>Flash pattern</p> <p>a through d are repeated. d: Seven flashes indicate malfunctioning diagnosis sensor unit circuit.</p>	<ol style="list-style-type: none">1. Visually check the wiring harness connections.2. Replace the harness if it has visible damage.3. Replace the air bag diagnosis sensor unit.4. Replace the related harness.

WHIA0198E

DTC CONFIRMATION PROCEDURE (With CONSULT-III)

1.INSPECTION START

Turn ignition switch ON.

>> GO TO 2.

2.CHECK SELF-DIAG RESULT

Check for the DTC on CONSULT-III.

Is the DTC detected?

- YES >> Refer to [SRC-63. "Diagnosis Procedure \(Component Diagnosis\)"](#).
NO >> Inspection End.

DTC CONFIRMATION PROCEDURE (Without CONSULT-III)

NOTE:

SRS will not enter diagnosis mode if no malfunction is detected in user mode.

1.IGNITION SWITCH

Turn ignition switch ON.

>> GO TO 2

B1XXX AIR BAG DIAGNOSIS SENSOR UNIT

< COMPONENT DIAGNOSIS >

2.IGNITION SWITCH

After air bag warning lamp lights for 7 seconds, turn ignition switch OFF within 1 second.

>> GO TO 3

3.WAIT TIME

Wait more than 3 seconds.

>> GO TO 4

4.REPEAT STEPS

Repeat steps 1 to 3 twice.

>> GO TO 5

5.IGNITION SWITCH

Turn ignition switch ON.

>> GO TO 6

6.DIAGNOSTIC MODE

SRS system is now in diagnostic mode and AIR BAG warning lamp flashes. Refer to [SRC-85, "Trouble Diagnosis without CONSULT-III"](#).

>> **END**

Diagnosis Procedure (Component Diagnosis)

INFOID:000000003775236

Recheck SRS after each replacement.

1.HARNES CONNECTOR

Is there any visible damage to the connector?

YES or NO

YES >> Replace the harness.

NO >> GO TO 2

2.WIRING HARNESS

Is there any visible damage to the harness?

YES or NO

YES >> Replace the harness.

NO >> GO TO 3

3.AIR BAG DIAGNOSIS SENSOR UNIT

Replace the air bag diagnosis sensor unit. Refer to [SR-17, "Removal and Installation"](#).

>> GO TO 4

4.RELATED HARNESS

Replace the related harness.

>> **END**

A
B
C
D
E
F
G
I
J
K
L
M
N
O
P

SRC

B1023 PASSENGER AIR BAG OFF INDICATOR

< COMPONENT DIAGNOSIS >

B1023 PASSENGER AIR BAG OFF INDICATOR

Description

INFOID:000000003775237

DTC B1023 FRONT PASSENGER AIR BAG OFF INDICATOR

The front passenger air bag off indicator is wired to the air bag diagnosis sensor unit. The air bag diagnosis sensor unit monitors the front passenger air bag off indicator and circuit for failures.

PART LOCATION

Refer to [SRC-7, "SRS Component Parts Location"](#).

DTC Logic

INFOID:000000004221438

DTC DETECTION LOGIC

With CONSULT-III

CONSULT-III name	DTC	DTC detecting condition	Repair order
PASS A/B INDCTR CKT	B1023	Front passenger air bag off indicator is malfunctioning.	<ol style="list-style-type: none"> 1. Visually check the wiring harness connection. 2. Replace the harness if it has visible damage. 3. Replace the front passenger air bag off indicator. 4. Replace the air bag diagnosis sensor unit. 5. Replace the related harness.

Without CONSULT-III

<Front passenger air bag off indicator>	
Flash pattern	Repair order
<p>a through d are repeated. d: Eleven flashes indicate malfunctioning front passenger air bag off indicator.</p>	<ol style="list-style-type: none"> 1. Visually check the wiring harness connection. 2. Replace the harness if it has visible damage. 3. Replace front passenger air bag off indicator. 4. Replace the air bag diagnosis sensor unit. 5. Replace the related harness.

WHIA0212E

DTC CONFIRMATION PROCEDURE (With CONSULT-III)

1.INSPECTION START

Turn ignition switch ON.

>> GO TO 2.

2.CHECK SELF-DIAG RESULT

Check for the DTC on CONSULT-III.

Is the DTC detected?

- YES >> Refer to [SRC-65, "Diagnosis Procedure \(Component Diagnosis\)"](#).
 NO >> Inspection End.

DTC CONFIRMATION PROCEDURE (Without CONSULT-III)

NOTE:

SRS will not enter diagnosis mode if no malfunction is detected in user mode.

1.IGNITION SWITCH

Turn ignition switch ON.

B1023 PASSENGER AIR BAG OFF INDICATOR

< COMPONENT DIAGNOSIS >

>> GO TO 2

2.IGNITION SWITCH

After air bag warning lamp lights for 7 seconds, turn ignition switch OFF within 1 second.

>> GO TO 3

3.WAIT TIME

Wait more than 3 seconds.

>> GO TO 4

4.REPEAT STEPS

Repeat steps 1 to 3 twice.

>> GO TO 5

5.IGNITION SWITCH

Turn ignition switch ON.

>> GO TO 6

6.DIAGNOSTIC MODE

SRS system is now in diagnostic mode and AIR BAG warning lamp flashes. Refer to [SRC-85, "Trouble Diagnosis without CONSULT-III"](#).

>> **END**

Diagnosis Procedure (Component Diagnosis)

INFOID:000000003775239

Recheck SRS after each replacement.

1.HARNES CONNECTOR

Is there any visible damage to the connector?

YES or NO

YES >> Replace the harness.

NO >> GO TO 2

2.WIRING HARNESS

Is there any visible damage to the harness?

YES or NO

YES >> Replace the harness.

NO >> GO TO 3

3.FRONT PASSENGER AIR BAG OFF INDICATOR

Replace the front passenger air bag off indicator. Refer to [IP-16, "Removal and Installation"](#).

>> GO TO 4

4.AIR BAG DIAGNOSIS SENSOR UNIT

Replace the air bag diagnosis sensor unit. Refer to [SR-17, "Removal and Installation"](#).

>> GO TO 5

5.RELATED HARNESS

Replace the related harness.

A

B

C

D

E

F

G

SRC

I

J

K

L

M

N

O

P

B1023 PASSENGER AIR BAG OFF INDICATOR

< COMPONENT DIAGNOSIS >

>> END

B1017 – B1022 OCCUPANT CLASSIFICATION SYSTEM

< COMPONENT DIAGNOSIS >

B1017 – B1022 OCCUPANT CLASSIFICATION SYSTEM

Description

INFOID:000000005867460

DTC B1017 – B1022 OCCUPANT CLASSIFICATION SYSTEM (OCS)

The OCS control unit is wired to the air bag diagnosis sensor unit. The air bag diagnosis sensor unit will monitor the OCS for failures and interruptions in communication between the OCS control unit and the air bag diagnosis sensor unit.

PART LOCATION

Refer to [SRC-7, "SRS Component Parts Location"](#).

DTC Logic

INFOID:000000005867461

DTC DETECTION LOGIC

With CONSULT-III

CONSULT-III name	DTC	DTC detecting condition	Repair order
OCCUPANT SENS C/U [UNIT FAIL]	B1017	The OCS control unit is malfunctioning.	1. Replace the RH front seat cushion assembly. Do not disassemble the seat cushion assembly.
	B1021		
	B1020	The OCS control unit is malfunctioning.	1. Replace the harness if it has visible damage. 2. Replace the RH front seat cushion assembly. Do not disassemble the seat cushion assembly. 3. Replace the RH front seat belt assembly.
OCCUPANT SENS [UNIT FAIL]	B1018	The OCS sensor is malfunctioning.	1. Visually check the wiring harness connection to the OCS sensor. 2. Replace the RH front seat cushion assembly. Do not disassemble the seat cushion assembly.
BELT TENSION SENS [UNIT FAIL]	B1019	The belt tension sensor is malfunctioning.	1. Visually check the wiring harness connection. 2. Replace the harness if it has visible damage. 3. Replace the RH front seat belt assembly. 4. Replace the RH front seat cushion assembly. Do not disassemble the seat cushion assembly. 5. Replace the related harness.
OCCUPANT SENS C/U [COMM FAIL]	B1022	Communication between the OCS control unit and the air bag diagnosis sensor unit is interrupted.	1. Visually check the wiring harness connection. 2. Replace the harness if it has visible damage. 3. Replace the RH front seat cushion assembly. Do not disassemble the seat cushion assembly. 4. Replace the air bag diagnosis sensor unit. 5. Replace the related harness.

Without CONSULT-III

<Occupant classification system>	Flash pattern	Repair order
	<p>a through d are repeated. d: Five flashes indicate malfunctioning occupant classification system control unit.</p>	<ol style="list-style-type: none"> 1. Visually check the wiring harness connection. 2. Replace the harness if it has visible damage. 3. Replace the RH front seat cushion occupant classification system control unit assembly. 4. Replace the air bag diagnosis sensor unit.

WHIA0211E

B1017 – B1022 OCCUPANT CLASSIFICATION SYSTEM

< COMPONENT DIAGNOSIS >

DTC CONFIRMATION PROCEDURE (With CONSULT-III)

1.INSPECTION START

Turn ignition switch ON.

>> GO TO 2.

2.CHECK SELF-DIAG RESULT

Check for the DTC on CONSULT-III.

Is the DTC detected?

YES >> Refer to [SRC-68. "Diagnosis Procedure \(Component Diagnosis\)".](#)

NO >> Inspection End.

DTC CONFIRMATION PROCEDURE (Without CONSULT-III)

NOTE:

SRS will not enter diagnosis mode if no malfunction is detected in user mode.

1.IGNITION SWITCH

Turn ignition switch ON.

>> GO TO 2

2.IGNITION SWITCH

After air bag warning lamp lights for 7 seconds, turn ignition switch OFF within 1 second.

>> GO TO 3

3.WAIT TIME

Wait more than 3 seconds.

>> GO TO 4

4.REPEAT STEPS

Repeat steps 1 to 3 twice.

>> GO TO 5

5.IGNITION SWITCH

Turn ignition switch ON.

>> GO TO 6

6.DIAGNOSTIC MODE

SRS system is now in diagnostic mode and AIR BAG warning lamp flashes. Refer to [SRC-7. "SRS Component Parts Location".](#)

>> **END**

Diagnosis Procedure (Component Diagnosis)

INFOID:000000005867462

Recheck SRS after each corrective action.

1.CHECK CURRENT DTC

Does CONSULT-III indicate B1018, B1019, B1020 or B1022?

YES or NO

YES >> GO TO 2

NO >> GO TO 13

B1017 – B1022 OCCUPANT CLASSIFICATION SYSTEM

< COMPONENT DIAGNOSIS >

2. HARNESS CONNECTOR

Is there any visible damage to the OCS sub-harness connector (DTC B1022) or to the belt tension sensor connector (DTC B1019)?

YES or NO

YES >> Replace the harness.

NO >> GO TO 3

3. WIRING HARNESS

Is there any visible damage to the body or seat sub harness?

YES or NO

YES >> Replace the harness.

NO >> GO TO 4

4. CHECK CURRENT DTC

Does CONSULT-III indicate B1022?

YES or NO

YES >> GO TO 5

NO >> GO TO 6

5. OCS CONTROL UNIT HARNESS CONNECTOR

Is the OCS control unit or body harness connector disconnected?

YES or NO

YES >> Connect the harness. Clear the DTC.

NO >> GO TO 13

6. CHECK CURRENT DTC

Does CONSULT-III indicate B1018?

YES or NO

YES >> GO TO 7

NO >> GO TO 8

7. OCS SENSOR HARNESS CONNECTOR

Is the OCS sensor harness connector disconnected?

YES or NO

YES >> Connect the harness. Clear the DTC.

NO >> GO TO 8

8. CHECK CURRENT DTC

Does CONSULT-III indicate B1020?

YES or NO

YES >> GO TO 9

NO >> GO TO 10

9. BELT TENSION SENSOR

Inspect the belt tension sensor, belt tension sensor connector and harness.

Are the inspection results normal?

YES >> GO TO 10

NO >> GO TO 12

10. CHECK CURRENT DTC

Does CONSULT-III indicate B1019?

YES or NO

YES >> GO TO 11

NO >> GO TO 12

11. BELT TENSION SENSOR HARNESS CONNECTOR

A
B
C
D
E
F
G
I
J
K
L
M
N
O
P

SRC

B1017 – B1022 OCCUPANT CLASSIFICATION SYSTEM

< COMPONENT DIAGNOSIS >

Is the belt tension sensor harness connector disconnected?

YES or NO

YES >> Connect the harness. Clear the DTC.

NO >> GO TO 12

12.REPLACE RH FRONT SEAT BELT ASSEMBLY

Replace the RH front seat belt assembly.

>> GO TO 13

13.REPLACE RH FRONT SEAT CUSHION ASSEMBLY

Replace the RH front seat cushion assembly. Refer to [SE-50, "Removal and Installation"](#).

>> GO TO 14

14.AIR BAG DIAGNOSIS SENSOR UNIT

Replace the air bag diagnosis sensor unit. Refer to [SR-17, "Removal and Installation"](#).

>> **END.**

B1209 – B1211 COLLISION DETECTION

< COMPONENT DIAGNOSIS >

B1209 – B1211 COLLISION DETECTION

Description

INFOID:000000003775243

DTC B1209 - B1211 COLLISION DETECTION

The air bag diagnosis sensor unit will set this DTC if it has detected a collision or rollover which has resulted in a deployment of one or more air bags or pre-tensioners. If this DTC is detected after a SRS repair, the air bag diagnosis sensor unit has not yet been replaced. This DTC can not be erased.

PART LOCATION

Refer to [SRC-7, "SRS Component Parts Location"](#).

DTC Logic

INFOID:000000004221440

DTC DETECTION LOGIC

With CONSULT-III

CONSULT-III name	DTC	DTC detecting condition	Repair order
FRONTAL COLLISION DETECTION	B1209	Driver and/or front passenger air bag modules are deployed.	Refer to SR-20, "For Frontal Collision" .
SIDE COLLISION DETECTION	B1210	Side and/or curtain air bag modules are deployed.	Refer to SR-22, "For Side and Rollover Collision" .
ROLLOVER DETECTION	B1211	Curtain air bag module and seat belt pretensioner are deployed.	

A

B

C

D

E

F

G

SRC

DTC CONFIRMATION PROCEDURE (With CONSULT-III)

1.INSPECTION START

Turn ignition switch ON.

>> GO TO 2.

2.CHECK SELF-DIAG RESULT

Check for the DTC on CONSULT-III.

Is the DTC detected?

YES >> Refer to [SRC-71, "Diagnosis Procedure \(Component Diagnosis\)"](#).

NO >> Inspection End.

Diagnosis Procedure (Component Diagnosis)

INFOID:000000003775245

Refer to [SR-20, "For Frontal Collision"](#) or [SR-22, "For Side and Rollover Collision"](#).

I

J

K

L

M

N

O

P

DIAGNOSIS SENSOR UNIT

< ECU DIAGNOSIS >

▬ : DATA LINE

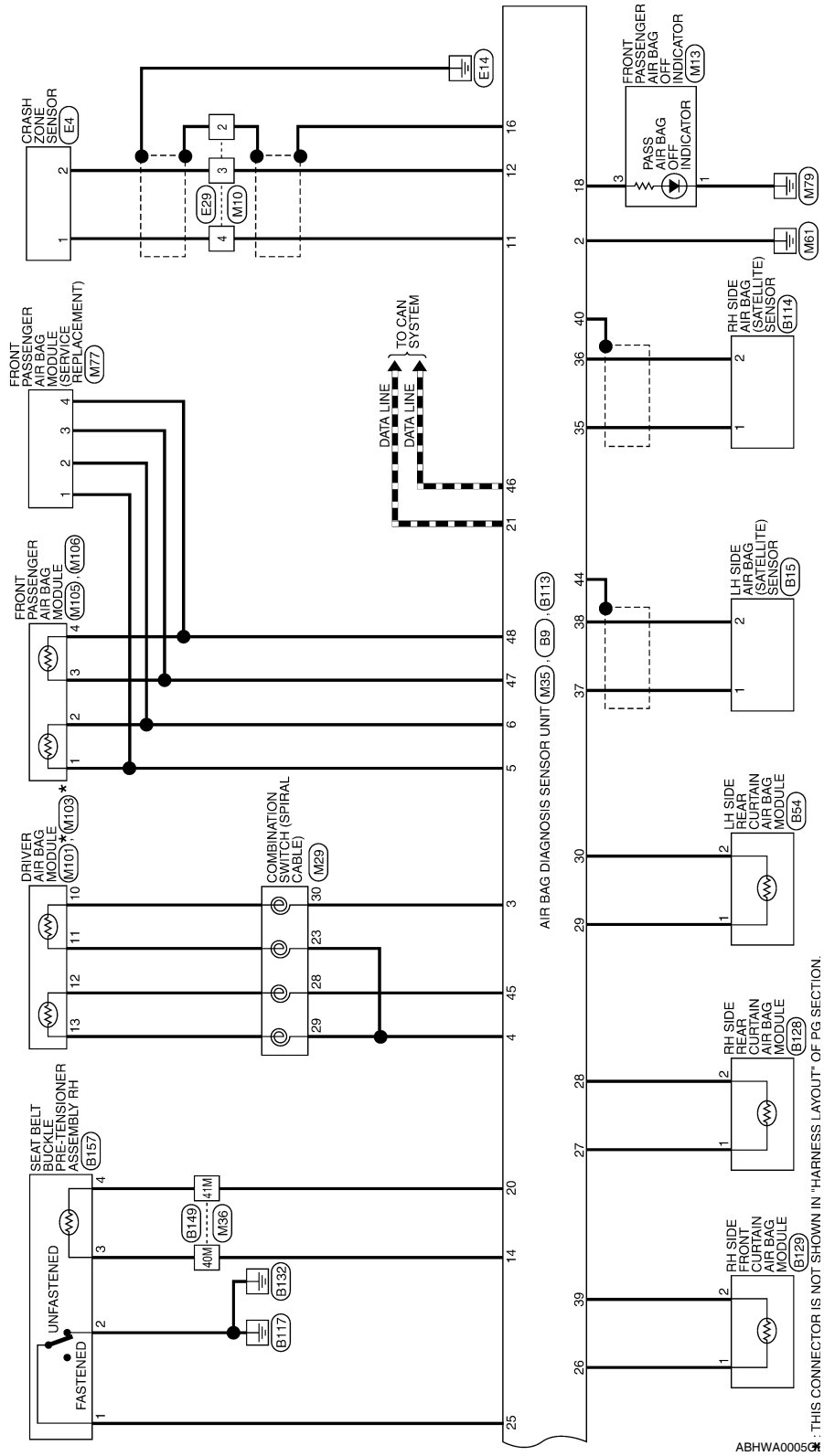

* THIS CONNECTOR IS NOT SHOWN IN "HARNES LAYOUT" OF PG SECTION.

A
B
C
D
E
F
G
H
I
J
K
L
M
N
O
P

SRC

DIAGNOSIS SENSOR UNIT

< ECU DIAGNOSIS >

SRS AIR BAG CONTROL SYSTEM CONNECTORS

Connector No.	M4
Connector Name	FUSE BLOCK (J/B)
Connector Color	WHITE



Terminal No.	Color of Wire	Signal Name
5P	O/L	-
6P	W/L	-

Connector No.	M10
Connector Name	WIRE TO WIRE
Connector Color	YELLOW

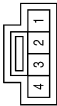

Terminal No.	Color of Wire	Signal Name
2	SHIELD	-
3	B	-
4	W	-

Connector No.	M13
Connector Name	FRONT PASSENGER AIR BAG OFF INDICATOR
Connector Color	BROWN



Terminal No.	Color of Wire	Signal Name
1	B	-
3	R/Y	-

Connector No.	M22
Connector Name	DATA LINK CONNECTOR
Connector Color	WHITE

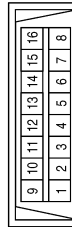

Terminal No.	Color of Wire	Signal Name
7	G/W	K-LINE

Connector No.	M23
Connector Name	COMBINATION METER
Connector Color	WHITE



Terminal No.	Color of Wire	Signal Name
47	B	POWER GND
52	B	POWER GND

Connector No.	M24
Connector Name	COMBINATION METER
Connector Color	WHITE

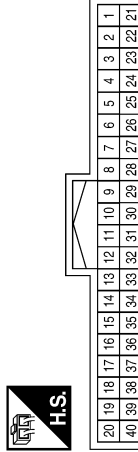

Terminal No.	Color of Wire	Signal Name
13	P	AIR BAG
20	B	GROUND
21	O/L	RUN/START
24	O/B	SEAT BELT
25	P/L	PASS SEAT BELT

DIAGNOSIS SENSOR UNIT

< ECU DIAGNOSIS >

Terminal No.	Color of Wire	Signal Name
12	B	ECZS (-)
14	G/Y	P-RH2 (+)
15	P	WARN LAMP
16	SHIELD	CZS SHLD
18	R/Y	CUTOFF TELL TALE
20	L/Y	P-RH2 (-)
21	L	CAN-H
22	G/W	K-LINE
24	P/L	SEATBELT MINDER
45	Y/G	DR2 (+)
46	P	CAN-L
47	Y/BR	AS2 (+)
48	Y/V	AS2 (-)
49	P/B	ODS IN
50	BR/Y	P-LH2 (+)
52	R/Y	P-LH2 (-)

Connector No.	M35
Connector Name	AIR BAG DIAGNOSIS SENSOR UNIT
Connector Color	YELLOW

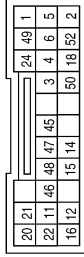

Terminal No.	Color of Wire	Signal Name
1	W/L	IGN
2	B	GND
3	Y	DR1 (+)
4	Y/B	DR1/DR2
5	Y/G	AS1 (+)
6	Y/R	AS1 (-)
11	W	ECZS (+)

Connector No.	M29
Connector Name	COMBINATION SWITCH (SPIRAL CABLE)
Connector Color	YELLOW



Terminal No.	Color of Wire	Signal Name
23	Y/B	-
28	Y/L	-
29	Y/B	-
30	Y	-

Terminal No.	Color of Wire	Signal Name
40M	G/Y	-
41M	L/Y	-
62M	W/L	-
63M	P/B	-

Connector No.	M36
Connector Name	WIRE TO WIRE
Connector Color	WHITE

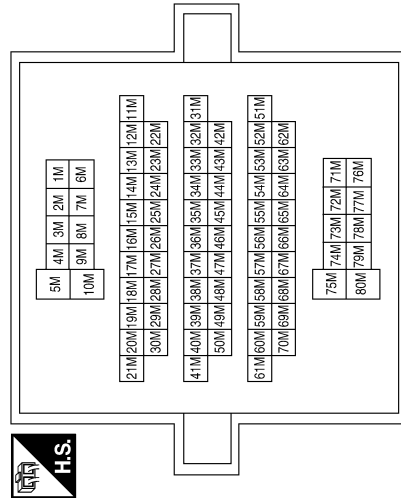

ABHIA0011GB

A
B
C
D
E
F
G
H
I
J
K
L
M
N
O
P

SRC

DIAGNOSIS SENSOR UNIT

< ECU DIAGNOSIS >

Connector No.	M77
Connector Name	FRONT PASSENGER AIR BAG MODULE (SERVICE REPLACEMENT)
Connector Color	YELLOW

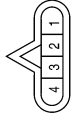

Terminal No.	Color of Wire	Signal Name
1	Y/G	-
2	Y/R	-
3	Y/BR	-
4	Y/V	-

Terminal No.	Color of Wire	Signal Name
20J	BR/Y	-
21J	R/Y	-
70J	O/B	-

Connector No.	M40
Connector Name	WIRE TO WIRE
Connector Color	WHITE

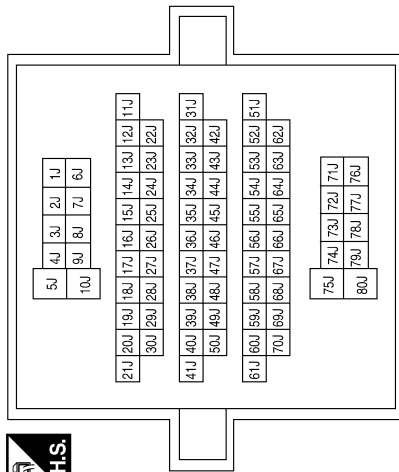

Connector No.	M105
Connector Name	FRONT PASSENGER AIR BAG MODULE
Connector Color	YELLOW



Terminal No.	Color of Wire	Signal Name
1	Y/G	-
2	Y/R	-

Connector No.	M103
Connector Name	DRIVER AIR BAG MODULE
Connector Color	ORANGE



Terminal No.	Color of Wire	Signal Name
12	R	-
13	BR	-

Connector No.	M101
Connector Name	DRIVER AIR BAG MODULE
Connector Color	YELLOW



Terminal No.	Color of Wire	Signal Name
10	W	-
11	BR	-

ABHIA0012GB

DIAGNOSIS SENSOR UNIT

< ECU DIAGNOSIS >

Connector No.	E29
Connector Name	WIRE TO WIRE
Connector Color	YELLOW

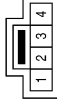

Terminal No.	Color of Wire	Signal Name
2	SHIELD	-
3	O	-
4	W	-

Connector No.	E4
Connector Name	CRASH ZONE SENSOR
Connector Color	YELLOW



Terminal No.	Color of Wire	Signal Name
1	W	-
2	O	-

Connector No.	M106
Connector Name	FRONT PASSENGER AIR BAG MODULE
Connector Color	ORANGE



Terminal No.	Color of Wire	Signal Name
3	Y/BR	-
4	Y/V	-

Connector No.	B14
Connector Name	FRONT LH SEAT BELT PRE-TENSIONER
Connector Color	YELLOW



Terminal No.	Color of Wire	Signal Name
1	Y/G	-
2	Y/R	-

Connector No.	B10
Connector Name	FRONT LH SIDE AIR BAG MODULE
Connector Color	YELLOW



Terminal No.	Color of Wire	Signal Name
1	Y/G	-
2	Y/R	-

Connector No.	B9
Connector Name	AIR BAG DIAGNOSIS SENSOR UNIT
Connector Color	YELLOW

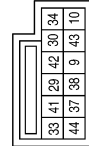

Terminal No.	Color of Wire	Signal Name
9	Y/G	P-LH1(+)
10	Y/R	P-LH1(-)
29	Y	C-LH1(-)
30	BR	C-LH1(+)
33	Y/G	S-LH1(+)
34	Y/R	S-LH1(-)
37	Y/G	SAT SEN LH(-)
38	Y/L	SAT SEN LH(+)
41	O/B	BUCKLE SW-LH
42	LG	C-LH2(+)
43	B/Y	C-LH2(-)
44	SHIELD	SHIELD GND

ABHIA0013GB

A
B
C
D
E
F
G
H
I
J
K
L
M
N
O
P

SRC

DIAGNOSIS SENSOR UNIT

< ECU DIAGNOSIS >

Connector No.	B15
Connector Name	LH SIDE AIR BAG (SATELLITE) SENSOR
Connector Color	YELLOW



Terminal No.	Color of Wire	Signal Name
1	Y/G	AGR(+)
2	Y/L	AGR(-)

Connector No.	B38
Connector Name	LH SIDE FRONT CURTAIN AIR BAG MODULE
Connector Color	YELLOW



Terminal No.	Color of Wire	Signal Name
1	LG	-
2	B/Y	-

Connector No.	B54
Connector Name	LH SIDE REAR CURTAIN AIR BAG MODULE
Connector Color	YELLOW



Terminal No.	Color of Wire	Signal Name
1	Y	-
2	BR	-

Connector No.	B69
Connector Name	WIRE TO WIRE
Connector Color	WHITE

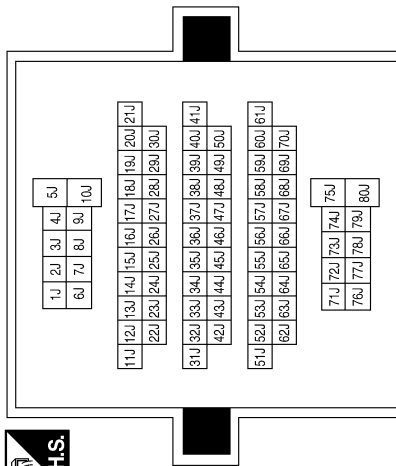

Terminal No.	Color of Wire	Signal Name
20J	BR/Y	-
21J	R/Y	-
70J	O/B	-

Connector No.	B74
Connector Name	SEAT BELT BUCKLE PRETENSIONER ASSEMBLY LH
Connector Color	YELLOW

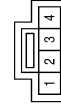

Terminal No.	Color of Wire	Signal Name
1	O/B	-
2	B	-
3	BR/Y	-
4	R/Y	-

Connector No.	B113
Connector Name	AIR BAG DIAGNOSIS SENSOR UNIT
Connector Color	YELLOW

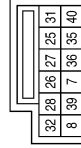

Terminal No.	Color of Wire	Signal Name
7	Y	PRH (+)
8	Y/B	PRH (-)
25	L	BUCKLE SW RH
26	G	INF CURTAIN2 RH (+)
27	G	INF CURTAIN RH (+)
28	L	INF CURTAIN RH (-)
31	Y	S-RHI (+)
32	Y/B	S-RH1 (-)
35	W/L	SAT SENS RH (+)
36	O/L	SAT SENS RH (-)
39	L	INF CURTAIN2 RH (-)
40	SHIELD	GND

DIAGNOSIS SENSOR UNIT

< ECU DIAGNOSIS >

Connector No.	B127
Connector Name	FRONT RH SEAT BELT PRE-TENSIONER
Connector Color	YELLOW



Terminal No.	Color of Wire	Signal Name
1	Y	-
2	Y/B	-

Connector No.	B126
Connector Name	FRONT RH SIDE AIR BAG MODULE
Connector Color	YELLOW



Terminal No.	Color of Wire	Signal Name
1	Y	-
2	Y/B	-

Connector No.	B114
Connector Name	RH SIDE AIR BAG (SATELLITE) SENSOR
Connector Color	YELLOW



Terminal No.	Color of Wire	Signal Name
1	W/L	DGR (+)
2	O/L	DGR (-)

Connector No.	B136
Connector Name	WIRE TO WIRE
Connector Color	WHITE

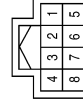

Terminal No.	Color of Wire	Signal Name
1	B/Y	-
2	P/B	-
4	W/L	-
5	B	-
6	Y/W	-
8	Y/B	-

Connector No.	B129
Connector Name	RH SIDE FRONT CURTAIN AIR BAG MODULE
Connector Color	YELLOW



Terminal No.	Color of Wire	Signal Name
1	G	-
2	L	-

Connector No.	B128
Connector Name	RH SIDE REAR CURTAIN AIR BAG MODULE
Connector Color	YELLOW



Terminal No.	Color of Wire	Signal Name
1	G	-
2	L	-

ABHIA0015GB

A
B
C
D
E
F
G
H
I
J
K
L
M
N
O
P

SRC

DIAGNOSIS SENSOR UNIT

< ECU DIAGNOSIS >

Terminal No.	Color of Wire	Signal Name
40M	G/Y	-
41M	L/Y	-
62M	W/L	-
63M	P/B	-

Connector No.	B149
Connector Name	WIRE TO WIRE
Connector Color	WHITE

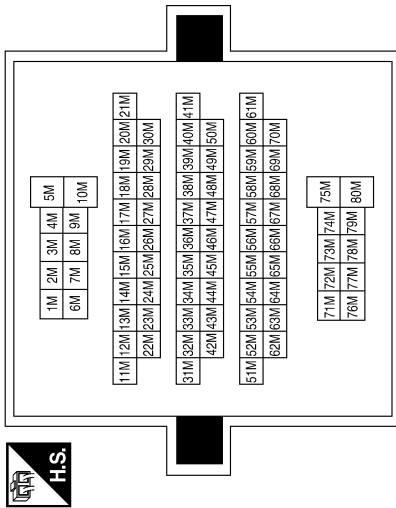

Connector No.	B137
Connector Name	BELT TENSION SENSOR
Connector Color	WHITE

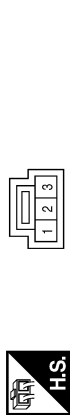

Terminal No.	Color of Wire	Signal Name
1	Y/W	VCC
2	B/Y	GND
3	Y/B	SIG

Connector No.	B350
Connector Name	WIRE TO WIRE
Connector Color	WHITE



Connector No.	B157
Connector Name	SEAT BELT BUCKLE PRE-TENSIONER ASSEMBLY RH
Connector Color	YELLOW



Terminal No.	Color of Wire	Signal Name
1	R/Y	-
2	BR/W	-
4	L/B	-
5	G/B	-
6	P/L	-
8	R	-

Terminal No.	Color of Wire	Signal Name
1	L	-
2	B	-
3	G/Y	-
4	L/Y	-

ABHIA0016GB

DIAGNOSIS SENSOR UNIT

< ECU DIAGNOSIS >

Connector No.	B352
Connector Name	OCCUPANT CLASSIFICATION SYSTEM SENSOR
Connector Color	BLACK



Terminal No.	Color of Wire	Signal Name
1	G	-
2	Y/R	-
3	O	-

Terminal No.	Color of Wire	Signal Name
10	-	-
11	-	-
12	-	-
13	-	-
14	R/Y	BTS (-)
15	O	(-)
16	P/L	BTS (+)
17	-	-
18	BRW	ODS LED

Connector No.	B351
Connector Name	OCCUPANT CLASSIFICATION SYSTEM CONTROL UNIT
Connector Color	BLACK

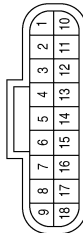

Terminal No.	Color of Wire	Signal Name
1	-	-
2	-	-
3	-	-
4	R	BTS SIG
5	G/B	GND
6	Y/R	SIG
7	G	(+)
8	-	-
9	L/B	IGN

A
B
C
D
E
F
G
H
I
J
K
L
M
N
O
P

SRC

ABHIA0017GB

INFOID:000000003775247

Trouble Diagnosis with CONSULT-III

DIAGNOSTIC CODE CHART

NOTE:

Follow the procedures in numerical order when repairing malfunctioning parts. Confirm whether malfunction is eliminated using air bag warning lamp or CONSULT-III each time repair is finished. If malfunction is still observed, proceed to the next step. When malfunction is eliminated, further repair work is not required.

DIAGNOSIS SENSOR UNIT

< ECU DIAGNOSIS >

CONSULT-III name	DTC	DTC detecting condition	Repair order
DRIVER AIRBAG MODULE [OPEN]	B1049	Driver air bag module circuit (DR1) is open (including the spiral cable).	<ol style="list-style-type: none"> 1. Visually check the wiring harness connection. 2. Replace the harness if it has visible damage. 3. Replace the driver air bag module. 4. Replace the spiral cable. 5. Replace the air bag diagnosis sensor unit. 6. Replace the related harness.
	B1054	Driver air bag module circuit (DR2) is open (including the spiral cable).	
DRIVER AIRBAG MODULE [VB-SHORT]	B1050	Driver air bag module circuit (DR1) is shorted to a power supply circuit (including the spiral cable).	
	B1055	Driver air bag module circuit (DR2) is shorted to a power supply circuit (including the spiral cable).	
DRIVER AIRBAG MODULE [GND-SHORT]	B1051	Driver air bag module circuit (DR1) is shorted to ground (including the spiral cable).	
	B1056	Driver air bag module circuit (DR2) is shorted to ground (including the spiral cable).	
DRIVER AIRBAG MODULE [SHORT]	B1052	Driver air bag module circuits (DR1) are shorted to each other (including the spiral cable).	
	B1057	Driver air bag module circuits (DR2) are shorted to each other (including the spiral cable).	
ASSIST A/B MODULE [OPEN]	B1065	Front passenger air bag module circuit (AS1) is open.	
	B1070	Front passenger air bag module circuit (AS2) is open.	
ASSIST A/B MODULE [VB-SHORT]	B1066	Front passenger air bag module circuit (AS1) is shorted to a power supply circuit.	
	B1071	Front passenger air bag module circuit (AS2) is shorted to a power supply circuit.	
ASSIST A/B MODULE [GND-SHORT]	B1067	Front passenger air bag module circuit (AS1) is shorted to ground.	
	B1072	Front passenger air bag module circuit (AS2) is shorted to ground.	
ASSIST A/B MODULE [SHORT]	B1068	Front passenger air bag module circuits (AS1) are shorted to each other.	
	B1073	Front passenger air bag module circuits (AS2) are shorted to each other.	
SIDE MODULE LH [OPEN]	B1134	Front LH side air bag module circuit is open.	<ol style="list-style-type: none"> 1. Visually check the wiring harness connection. 2. Replace the harness if it has visible damage. 3. Replace the front LH seat back assembly. 4. Replace the air bag diagnosis sensor unit. 5. Replace the related harness.
SIDE MODULE LH [VB-SHORT]	B1135	Front LH side air bag module circuit is shorted to a power supply circuit.	
SIDE MODULE LH [GND-SHORT]	B1136	Front LH side air bag module circuit is shorted to ground.	
SIDE MODULE LH [SHORT]	B1137	Front LH side air bag module circuits are shorted to each other.	

DIAGNOSIS SENSOR UNIT

< ECU DIAGNOSIS >

CONSULT-III name	DTC	DTC detecting condition	Repair order
SIDE MODULE RH [OPEN]	B1129	Front RH side air bag module circuit is open.	<ol style="list-style-type: none"> 1. Visually check the wiring harness connection. 2. Replace the harness if it has visible damage. 3. Replace the front RH seat back assembly. 4. Replace the air bag diagnosis sensor unit. 5. Replace the related harness.
SIDE MODULE RH [VB-SHORT]	B1130	Front RH side air bag module circuit is shorted to a power supply circuit.	
SIDE MODULE RH [GND-SHORT]	B1131	Front RH side air bag module circuit is shorted to ground.	
SIDE MODULE RH [SHORT]	B1132	Front RH side air bag module circuits are shorted to each other.	
FR CURTN MODULE LH [OPEN]	B1198	LH side curtain air bag module (front) circuit is open.	<ol style="list-style-type: none"> 1. Visually check the wiring harness connection. 2. Replace the harness if it has visible damage. 3. Replace the LH side curtain air bag module. 4. Replace the air bag diagnosis sensor unit. 5. Replace the related harness.
FR CURTN MODULE LH [VB-SHORT]	B1199	LH side curtain air bag module (front) circuit is shorted to a power supply circuit.	
FR CURTN MODULE LH [GND-SHORT]	B1200	LH side curtain air bag module (front) circuit is shorted to ground.	
FR CURTN MODULE LH [SHORT]	B1201	LH side curtain air bag module (front) circuits are shorted to each other.	
FR CURTN MODULE RH [OPEN]	B1193	RH side curtain air bag module (front) circuit is open.	<ol style="list-style-type: none"> 1. Visually check the wiring harness connection. 2. Replace the harness if it has visible damage. 3. Replace the RH side curtain air bag module. 4. Replace the air bag diagnosis sensor unit. 5. Replace the related harness.
FR CURTN MODULE RH [VB-SHORT]	B1194	RH side curtain air bag module (front) circuit is shorted to a power supply circuit.	
FR CURTN MODULE RH [GND-SHORT]	B1195	RH side curtain air bag module (front) circuit is shorted to ground.	
FR CURTN MODULE RH [SHORT]	B1196	RH side curtain air bag module (front) circuits are shorted to each other.	
CURTAIN MODULE LH [OPEN]	B1150	LH side curtain air bag module (rear) circuit is open.	<ol style="list-style-type: none"> 1. Visually check the wiring harness connection. 2. Replace the harness if it has visible damage. 3. Replace the LH side curtain air bag module. 4. Replace the air bag diagnosis sensor unit. 5. Replace the related harness.
CURTAIN MODULE LH [VB-SHORT]	B1151	LH side curtain air bag module (rear) circuit is shorted to a power supply circuit.	
CURTAIN MODULE LH [GND-SHORT]	B1152	LH side curtain air bag module (rear) circuit is shorted to ground.	
CURTAIN MODULE LH [SHORT]	B1153	LH side curtain air bag module (rear) circuits are shorted to each other.	
CURTAIN MODULE RH [OPEN]	B1145	RH side curtain air bag module (rear) circuit is open.	<ol style="list-style-type: none"> 1. Visually check the wiring harness connection. 2. Replace the harness if it has visible damage. 3. Replace the RH side curtain air bag module. 4. Replace the air bag diagnosis sensor unit. 5. Replace the related harness.
CURTAIN MODULE RH [VB-SHORT]	B1146	RH side curtain air bag module (rear) circuit is shorted to a power supply circuit.	
CURTAIN MODULE RH [GND-SHORT]	B1147	RH side curtain air bag module (rear) circuit is shorted to ground.	
CURTAIN MODULE RH [SHORT]	B1148	RH side curtain air bag module (rear) circuits are shorted to each other.	
PRE-TEN FRONT LH [OPEN]	B1086	LH seat belt pre-tensioner circuit is open.	<ol style="list-style-type: none"> 1. Visually check the wiring harness connection. 2. Replace the harness if it has visible damage. 3. Replace the front LH seat belt pre-tensioner. 4. Replace the air bag diagnosis sensor unit. 5. Replace the related harness.
PRE-TEN FRONT LH [VB-SHORT]	B1087	LH seat belt pre-tensioner circuit is shorted to a power supply circuit.	
PRE-TEN FRONT LH [GND-SHORT]	B1088	LH seat belt pre-tensioner circuit is shorted to ground.	
PRE-TEN FRONT LH [SHORT]	B1089	LH seat belt pre-tensioner circuits are shorted to each other.	

A
B
C
D
E
F
G
I
J
K
L
M
N
O
P

SRC

DIAGNOSIS SENSOR UNIT

< ECU DIAGNOSIS >

CONSULT-III name	DTC	DTC detecting condition	Repair order
PRE-TEN FRONT RH [OPEN]	B1081	RH seat belt pre-tensioner circuit is open.	<ol style="list-style-type: none"> 1. Visually check the wiring harness connection. 2. Replace the harness if it has visible damage. 3. Replace the front RH seat belt pre-tensioner. 4. Replace the air bag diagnosis sensor unit. 5. Replace the related harness.
PRE-TEN FRONT RH [VB-SHORT]	B1082	RH seat belt pre-tensioner circuit is shorted to a power supply circuit.	
PRE-TEN FRONT RH [GND-SHORT]	B1083	RH seat belt pre-tensioner circuit is shorted to ground.	
PRE-TEN FRONT RH [SHORT]	B1084	RH seat belt pre-tensioner circuits are shorted to each other.	
PRE-TEN2 FRONT LH [OPEN]	B1182	LH seat belt buckle pre-tensioner circuit is open.	<ol style="list-style-type: none"> 1. Visually check the wiring harness connection. 2. Replace the harness if it has visible damage. 3. Replace the front LH seat belt buckle pre-tensioner. 4. Replace the air bag diagnosis sensor unit. 5. Replace the related harness.
PRE-TEN2 FRONT LH [VB-SHORT]	B1183	LH seat belt buckle pre-tensioner circuit is shorted to a power supply circuit.	
PRE-TEN2 FRONT LH [GND-SHORT]	B1184	LH seat belt buckle pre-tensioner circuit is shorted to ground.	
PRE-TEN2 FRONT LH [SHORT]	B1185	LH seat belt buckle pre-tensioner circuits are shorted to each other.	
PRE-TEN2 FRONT RH [OPEN]	B1177	RH seat belt buckle pre-tensioner circuit is open.	
PRE-TEN2 FRONT RH [VB-SHORT]	B1178	RH seat belt buckle pre-tensioner circuit is shorted to a power supply circuit.	<ol style="list-style-type: none"> 1. Visually check the wiring harness connection. 2. Replace the harness if it has visible damage. 3. Replace the front RH seat belt buckle pre-tensioner. 4. Replace the air bag diagnosis sensor unit. 5. Replace the related harness.
PRE-TEN2 FRONT RH [GND-SHORT]	B1179	RH seat belt buckle pre-tensioner circuit is shorted to ground.	
PRE-TEN2 FRONT RH [SHORT]	B1180	RH seat belt buckle pre-tensioner circuits are shorted to each other.	
CRASH ZONE SEN [UNIT FAIL]	B1033 B1034	Crash zone sensor has malfunctioned.	
CRASH ZONE SEN [COMM FAIL]	B1035	Crash zone sensor communication error.	<ol style="list-style-type: none"> 4. Replace the air bag diagnosis sensor unit. 5. Replace the related harness.
SATELLITE SENS LH [UNIT FAIL]	B1118 B1119	LH side air bag satellite sensor has malfunctioned.	<ol style="list-style-type: none"> 1. Visually check the wiring harness connection. 2. Replace the harness if it has visible damage. 3. Replace the LH side air bag satellite sensor. 4. Replace the air bag diagnosis sensor unit. 5. Replace the related harness.
SATELLITE SENS LH [COMM FAIL]	B1120	LH side air bag satellite sensor communication error.	
SATELLITE SENS RH [UNIT FAIL]	B1113 B1114	RH side air bag satellite sensor has malfunctioned.	<ol style="list-style-type: none"> 1. Visually check the wiring harness connection. 2. Replace the harness if it has visible damage. 3. Replace the RH side air bag satellite sensor. 4. Replace the air bag diagnosis sensor unit. 5. Replace the related harness.
SATELLITE SENS RH [COMM FAIL]	B1115	RH side air bag satellite sensor communication error.	
CONTROL UNIT	B1XXX	Air bag diagnosis sensor unit is malfunctioning.	<ol style="list-style-type: none"> 1. Visually check the wiring harness connection. 2. Replace the harness if it has visible damage. 3. Replace the air bag diagnosis sensor unit. 4. Replace the related harness.
PASS A/B INDCTR CKT	B1023	Front passenger air bag OFF indicator is malfunctioning.	<ol style="list-style-type: none"> 1. Visually check the wiring harness connection. 2. Replace the harness if it has visible damage. 3. Replace the front passenger air bag OFF indicator. 4. Replace the air bag diagnosis sensor unit. 5. Replace the related harness.
OCCUPANT SENS C/U [UNIT FAIL]	B1017	The OCS control unit is malfunctioning.	<ol style="list-style-type: none"> 1. Replace the RH front seat cushion assembly. Do not disassemble the seat cushion assembly.
	B1020		
	B1021		
OCCUPANT SENS [UNIT FAIL]	B1018	The OCS sensor is malfunctioning.	

DIAGNOSIS SENSOR UNIT

< ECU DIAGNOSIS >

CONSULT-III name	DTC	DTC detecting condition	Repair order
BELT TENSION SENS [UNIT FAIL]	B1019	The belt tension sensor is malfunctioning.	<ol style="list-style-type: none"> 1. Visually check the wiring harness connection. 2. Replace the harness if it has visible damage. 3. Replace the RH front seat belt assembly. 4. Replace the RH front seat cushion assembly. Do not disassemble the seat cushion assembly. 5. Replace the related harness.
OCCUPANT SENS C/U [COMM FAIL]	B1022	Communication between the OCS control unit and the air bag diagnosis sensor unit is interrupted.	<ol style="list-style-type: none"> 1. Visually check the wiring harness connection. 2. Replace the harness if it has visible damage. 3. Replace the RH front seat cushion assembly. Do not disassemble the seat cushion assembly. 4. Replace the air bag diagnosis sensor unit. 5. Replace the related harness.
FRONTAL COLLISION DETECTION	B1209	Driver and/or front passenger air bag modules are deployed.	Refer to SR-20 .
SIDE COLLISION DETECTION	B1210	Side and/or curtain air bag modules are deployed.	Refer to SR-22 .
ROLLOVER DETECTION	B1211	Curtain air bag module and seat belt pre-tensioner are deployed.	

Trouble Diagnosis without CONSULT-III

INFOID:000000003775248

WARNING LAMP FLASH CODE CHART

NOTE:

Follow the procedures in numerical order when repairing malfunctioning parts. Confirm whether malfunction is eliminated using air bag warning lamp each time repair is finished. If malfunction is still observed, proceed to the next step. When malfunction is eliminated, further repair work is not required.

<Diagnosis results (previously stored in the memory) might not be erased after repair or intermittent malfunctions have been detected in the past.>	
Flash pattern	Repair order
<p>a through b are repeated.</p>	<ol style="list-style-type: none"> 1. Go to DIAGNOSTIC PROCEDURES 2 and 3.

SHIA0026E

<Driver air bag module>	
Flash pattern	Repair order
<p>a through d are repeated. d: Two flashes indicate malfunctioning driver air bag module circuits.</p>	<ol style="list-style-type: none"> 1. Visually check the wiring harness connection. 2. Replace the harness if it has visible damage. 3. Replace the spiral cable. 4. Replace driver air bag module. 5. Replace the air bag diagnosis sensor unit. 6. Replace the related harness.

WHIA0260E

DIAGNOSIS SENSOR UNIT

< ECU DIAGNOSIS >

<Air bag diagnosis sensor unit>	
Flash pattern	Repair order
<p>a through d are repeated. d: Seven flashes indicate malfunctioning diagnosis sensor unit circuit.</p>	<ol style="list-style-type: none"> 1. Visually check the wiring harness connections. 2. Replace the harness if it has visible damage. 3. Replace the air bag diagnosis sensor unit. 4. Replace the related harness.

WHIA0198E

<Front passenger air bag module>	
Flash pattern	Repair order
<p>a through d are repeated. d: Eight flashes indicate malfunctioning front passenger air bag module circuit.</p>	<ol style="list-style-type: none"> 1. Visually check the wiring harness connection. 2. Replace the harness if it has visible damage. 3. Replace front passenger air bag module. 4. Replace the air bag diagnosis sensor unit. 5. Replace the related harness.

WHIA0261E

<Crash zone sensor>	
Flash pattern	Repair order
<p>a through d are repeated. d: Six flashes indicate malfunctioning crash zone sensor circuit.</p>	<ol style="list-style-type: none"> 1. Visually check the wiring harness connection. 2. Replace the harness if it has visible damage. 3. Replace the crash zone sensor. 4. Replace the air bag diagnosis sensor unit. 5. Replace the related harness.

WHIA0200E

<Front RH seat belt pre-tensioner>	
Flash pattern	Repair order
<p>a through d are repeated. d: One flash indicates malfunctioning front RH seat belt pre-tensioner circuit.</p>	<ol style="list-style-type: none"> 1. Visually check the wiring harness connections. 2. Replace the harness if it has visible damage. 3. Replace front RH seat belt pre-tensioner. 4. Replace the air bag diagnosis sensor unit. 5. Replace the related harness.

WHIA0262E

<Front LH seat belt pre-tensioner>	
Flash pattern	Repair order
<p>a through d are repeated. d: Three flashes indicate malfunctioning front LH seat belt pre-tensioner circuit.</p>	<ol style="list-style-type: none"> 1. Visually check the wiring harness connections. 2. Replace the harness if it has visible damage. 3. Replace front LH seat belt pre-tensioner. 4. Replace the air bag diagnosis sensor unit. 5. Replace the related harness.

WHIA0263E

DIAGNOSIS SENSOR UNIT

< ECU DIAGNOSIS >

Flash pattern	Repair order
<p>< Seat belt buckle pre-tensioner assembly RH ></p> <p>a through d are repeated. d: Twelve flashes indicate malfunctioning seat belt buckle pre-tensioner assembly RH circuit</p>	<ol style="list-style-type: none"> 1. Visually check the wiring harness connections. 2. Replace the harness if it has visible damage. 3. Replace seat belt buckle pre-tensioner assembly RH. 4. Replace the air bag diagnosis sensor unit. 5. Replace the related harness.

WHIA0250E

Flash pattern	Repair order
<p><Seat belt buckle pre-tensioner assembly LH ></p> <p>a through d are repeated. d:Thirteen flashes indicate malfunctioning seat belt buckle pre-tensioner assembly LH circuit.</p>	<ol style="list-style-type: none"> 1. Visually check the wiring harness connections. 2. Replace the harness if it has visible damage. 3. Replace the seat belt buckle pre-tensioner assembly LH. 4. Replace the air bag diagnosis sensor unit. 5. Replace the related harness.

WHIA0251E

Flash pattern	Repair order
<p><RH side air bag (Satellite) sensor ></p> <p>a through f are repeated. f: Three flashes indicate malfunctioning RH side air bag (Satellite) sensor circuit.</p>	<ol style="list-style-type: none"> 1. Visually check the wiring harness connection. 2. Replace the harness if it has visible damage. 3. Replace the RH side air bag (Satellite) sensor. 4. Replace the air bag diagnosis sensor unit. 5. Replace the related harness.

WHIA0203E

Flash pattern	Repair order
<p><LH side air bag (Satellite) sensor ></p> <p>a through f are repeated. f: Four flashes indicate malfunctioning LH side air bag (Satellite) sensor.</p>	<ol style="list-style-type: none"> 1. Visually check the wiring harness connection. 2. Replace the harness if it has visible damage. 3. Replace the LH side air bag (Satellite) sensor. 4. Replace the air bag diagnosis sensor unit. 5. Replace the related harness.

WHIA0204E

Flash pattern	Repair order
<p><Front RH side air bag module ></p> <p>a through f are repeated. f: One flash indicate malfunctioning front RH side air bag module circuit.</p>	<ol style="list-style-type: none"> 1. Visually check the wiring harness connection. 2. Replace the harness if it has visible damage. 3. Replace front RH seat back assembly. 4. Replace the air bag diagnosis sensor unit. 5. Replace the related harness.

WHIA0264E

A

B

C

D

E

F

G

SRC

I

J

K

L

M

N

O

P

DIAGNOSIS SENSOR UNIT

< ECU DIAGNOSIS >

<Front LH side air bag module>	
Flash pattern	Repair order
<p>a through f are repeated. f: Two flashes indicate malfunctioning front LH side air bag module circuit.</p>	<ol style="list-style-type: none"> 1. Visually check the wiring harness connection. 2. Replace the harness if it has visible damage. 3. Replace front LH seat back assembly. 4. Replace the air bag diagnosis sensor unit. 5. Replace the related harness.

WHIA0265E

<LH side curtain air bag module (front)>	
Flash pattern	Repair order
<p>a through f are repeated. f: Eight flashes indicate malfunctioning LH side curtain air bag module (front) circuit.</p>	<ol style="list-style-type: none"> 1. Visually check the wiring harness connection. 2. Replace the harness if it has visible damage. 3. Replace LH side curtain air bag module. 4. Replace the air bag diagnosis sensor unit. 5. Replace the related harness.

WHIA0255E

<RH side curtain air bag module (front)>	
Flash pattern	Repair order
<p>a through f are repeated. f: Seven flashes indicate malfunctioning RH side curtain air bag module (front) circuit.</p>	<ol style="list-style-type: none"> 1. Visually check the wiring harness connection. 2. Replace the harness if it has visible damage. 3. Replace RH side curtain air bag module. 4. Replace the air bag diagnosis sensor unit. 5. Replace the related harness.

WHIA0253E

<LH side curtain air bag module (rear)>	
Flash pattern	Repair order
<p>a through f are repeated. f: Six flashes indicate malfunctioning LH side curtain air bag module (rear) circuit.</p>	<ol style="list-style-type: none"> 1. Visually check the wiring harness connection. 2. Replace the harness if it has visible damage. 3. Replace LH side curtain air bag module. 4. Replace the air bag diagnosis sensor unit. 5. Replace the related harness.

WHIA0254E

<RH side curtain air bag module (rear)>	
Flash pattern	Repair order
<p>a through f are repeated. f: Five flashes indicate malfunctioning RH side curtain air bag module (rear) circuit.</p>	<ol style="list-style-type: none"> 1. Visually check the wiring harness connection. 2. Replace the harness if it has visible damage. 3. Replace RH side curtain air bag module. 4. Replace the air bag diagnosis sensor unit. 5. Replace the related harness.

WHIA0252E

DIAGNOSIS SENSOR UNIT

< ECU DIAGNOSIS >

<Occupant classification system>	
Flash pattern	Repair order
<p>a through d are repeated. d: Five flashes indicate malfunctioning occupant classification system control unit.</p>	<ol style="list-style-type: none"> 1. Visually check the wiring harness connection. 2. Replace the harness if it has visible damage. 3. Replace the RH front seat cushion occupant classification system control unit assembly. 4. Replace the air bag diagnosis sensor unit.

WHIA0211E

<Front passenger air bag off indicator>	
Flash pattern	Repair order
<p>a through d are repeated. d: Eleven flashes indicate malfunctioning front passenger air bag off indicator.</p>	<ol style="list-style-type: none"> 1. Visually check the wiring harness connection. 2. Replace the harness if it has visible damage. 3. Replace front passenger air bag off indicator. 4. Replace the air bag diagnosis sensor unit. 5. Replace the related harness.

WHIA0212E

A

B

C

D

E

F

G

SRC

I

J

K

L

M

N

O

P

SRS AIR BAG SYSTEM

< SYMPTOM DIAGNOSIS >

SYMPTOM DIAGNOSIS

SRS AIR BAG SYSTEM

"AIR BAG" Warning Lamp Does Not Turn Off

INFOID:000000003775249

DIAGNOSTIC PROCEDURE 7

1.CHECK CONDITION OF AIR BAG MODULE

Inspect for any deployed air bag modules or seat belt pre-tensioners.

Are any air bag modules or seat belt pre-tensioners deployed?

- YES >> Refer to [SR-20. "For Frontal Collision"](#) or [SR-22. "For Side and Rollover Collision"](#).
- NO >> GO TO 2

2.CHECK THE AIR BAG FUSE

Check 10A fuse [No. 13, located in the fuse block (J/B)].

Is the fuse blown?

- Yes >> GO TO 3
- No >> GO TO 4

3.CHECK AIR BAG FUSE AGAIN

Replace 10A fuse [No. 13, located in the fuse block (J/B)] and turn ignition switch ON.

Does the fuse blow again?

- YES >> Replace harness.
- NO >> Inspection End.

4.CHECK AIR BAG DIAGNOSIS SENSOR UNIT

Connect CONSULT-III.

Is "AIR BAG" displayed on CONSULT-III?

- YES >> GO TO 5
- NO >> Visually inspect the air bag diagnosis sensor unit harness connections. If the connections are OK, replace the air bag diagnosis sensor unit. Refer to [SR-17. "Removal and Installation"](#).

5.CHECK HARNESS CONNECTION

Check for loose connections between the combination meter and the air bag diagnosis sensor unit.

Are there any loose connections?

- Yes >> Properly connect the combination meter and air bag diagnosis sensor unit harness connectors. If "AIR BAG" warning lamp still does not turn off, replace the wiring harness.
- No >> Replace air bag diagnosis sensor unit.

"AIR BAG" Warning Lamp Does Not Turn On

INFOID:000000003775250

DIAGNOSTIC PROCEDURE 8

1.CHECK METER FUSE

Check the 10A fuse [No. 14, located in the fuse block (J/B)] .

Is the fuse blown?

- Yes >> GO TO 2
- No >> GO TO 3

2.REPLACE METER FUSE AND CHECK AGAIN

Replace 10A fuse [No. 14, located in the fuse block (J/B)] and turn ignition switch ON.

Does the fuse blow again?

- Yes >> Replace harness.
- No >> Inspection End.

3.CHECK HARNESS CONNECTIONS BETWEEN AIR BAG DIAGNOSIS SENSOR UNIT AND COMBINA-

SRS AIR BAG SYSTEM

< SYMPTOM DIAGNOSIS >

COMBINATION METER

Inspect the harness and connectors between the air bag diagnosis sensor unit and the combination meter.

Do the harness or connectors have any visible damage?

Yes >> Replace harness.

No >> GO TO 4

4. CHECK COMBINATION METER

Disconnect the air bag diagnosis sensor unit harness connectors and turn ignition switch ON.

Does "AIR BAG" warning lamp turn on?

Yes >> Replace the air bag diagnosis sensor unit. Refer to [SR-17, "Removal and Installation"](#).

No >> Replace the combination meter. Refer to [MWI-102, "Removal and Installation"](#).

A
B
C
D
E
F
G
I
J
K
L
M
N
O
P

SRC

PASSENGER SEAT BELT WARNING SYSTEM

< SYMPTOM DIAGNOSIS >

PASSENGER SEAT BELT WARNING SYSTEM

Seat Belt Warning System Does Not Function

INFOID:000000003775251

1. SEAT BELT WARNING LIGHT

Turn ignition switch ON.

Does the seat belt warning lamp come ON?

YES >> GO TO 2

- NO >> • Check 10A fuse [No. 14, located in the fuse block (J/B)].
- Check seat belt buckle switch LH.
 - Check harness between combination meter and seat belt buckle switch LH.
 - Check combination meter. Refer to [MWI-25, "CONSULT-III Function \(METER/M&A\)"](#).

2. SEAT BELT BUCKLE LH

Fasten the seat belt buckle LH.

Does the seat belt warning lamp go OFF?

YES >> GO TO 3

- NO >> • Check seat belt buckle switch LH.
- Check harness between combination meter and seat belt buckle switch LH.

3. OCCUPANT CLASSIFICATION SYSTEM

Have a helper sit in the passenger seat.

Does the seat belt warning lamp go ON?

YES >> GO TO 4

- NO >> • Check occupant classification system. Refer to [SRC-10, "Occupant Classification System \(OCS\)"](#).
- Check harness between occupant classification control unit and air bag diagnosis sensor unit.

4. SEAT BELT BUCKLE RH

Fasten the seat belt buckle RH.

Does the seat belt warning lamp go OFF?

YES >> System OK.

- NO >> • Check seat belt buckle switch RH.
- Check harness between seat belt buckle switch RH and air bag diagnosis sensor unit.
 - Replace air bag diagnosis sensor unit. Refer to [SR-17, "Removal and Installation"](#).

PRECAUTIONS

< PRECAUTION >

PRECAUTION

PRECAUTIONS

Precaution for Supplemental Restraint System (SRS) "AIR BAG" and "SEAT BELT PRE-TENSIONER"

INFOID:000000005867464

The Supplemental Restraint System such as "AIR BAG" and "SEAT BELT PRE-TENSIONER", used along with a front seat belt, helps to reduce the risk or severity of injury to the driver and front passenger for certain types of collision. This system includes seat belt switch inputs and dual stage front air bag modules. The SRS system uses the seat belt switches to determine the front air bag deployment, and may only deploy one front air bag, depending on the severity of a collision and whether the front occupants are belted or unbelted. Information necessary to service the system safely is included in the SR and SB section of this Service Manual.

WARNING:

- To avoid rendering the SRS inoperative, which could increase the risk of personal injury or death in the event of a collision which would result in air bag inflation, all maintenance must be performed by an authorized NISSAN/INFINITI dealer.
- Improper maintenance, including incorrect removal and installation of the SRS, can lead to personal injury caused by unintentional activation of the system. For removal of Spiral Cable and Air Bag Module, see the SR section.
- Do not use electrical test equipment on any circuit related to the SRS unless instructed to in this Service Manual. SRS wiring harnesses can be identified by yellow and/or orange harnesses or harness connectors.

PRECAUTIONS WHEN USING POWER TOOLS (AIR OR ELECTRIC) AND HAMMERS

WARNING:

- When working near the Airbag Diagnosis Sensor Unit or other Airbag System sensors with the Ignition ON or engine running, DO NOT use air or electric power tools or strike near the sensor(s) with a hammer. Heavy vibration could activate the sensor(s) and deploy the air bag(s), possibly causing serious injury.
- When using air or electric power tools or hammers, always switch the Ignition OFF, disconnect the battery, and wait at least 3 minutes before performing any service.

Precaution for SRS "AIR BAG" and "SEAT BELT PRE-TENSIONER" Service

INFOID:000000003775253

- Do not use electrical test equipment to check SRS circuits unless instructed to in this Service Manual.
- Before servicing the SRS, turn ignition switch OFF, disconnect both battery cables and wait at least 3 minutes.
For approximately 3 minutes after the cables are removed, it is still possible for the air bag and seat belt pretensioner to deploy. Therefore, do not work on any SRS connectors or wires until at least 3 minutes have passed.
- The air bag diagnosis sensor unit must always be installed with the arrow mark "←" pointing toward the front of the vehicle for proper operation. Also check air bag diagnosis sensor unit for cracks, deformities or rust before installation and replace as required.
- The spiral cable must be aligned with the neutral position since its rotations are limited. Do not attempt to turn steering wheel or column after removal of steering gear.
- Handle air bag module carefully. Always place driver and front passenger air bag modules with the pad side facing upward and seat mounted front side air bag module standing with the stud bolt side facing down.
- Conduct self-diagnosis to check entire SRS for proper function after replacing any components.
- After air bag inflates, the front instrument panel assembly should be replaced if damaged.

Occupant Classification System Precaution

INFOID:000000003775254

Replace occupant classification system control unit and passenger front seat cushion as an assembly.