

# SECTION **PWC**

## POWER WINDOW CONTROL SYSTEM

A  
B  
C  
D  
E  
F  
G  
H  
I  
J  
L  
M  
N  
O  
P

### CONTENTS

<b>PRECAUTION</b> .....	4	<b>FRONT POWER WINDOW SWITCH (PAS-SENGER SIDE)</b> .....	16
<b>PRECAUTIONS</b> .....	4	Reference Value .....	16
Precaution for Supplemental Restraint System (SRS) "AIR BAG" and "SEAT BELT PRE-TENSIONER" .....	4	Fail-safe .....	17
Precaution for Procedure without Cowl Top Cover.....	4	<b>REAR POWER WINDOW SWITCH LH</b> .....	18
<b>PREPARATION</b> .....	5	Reference Value .....	18
<b>PREPARATION</b> .....	5	Fail-safe .....	19
Commercial Service Tools .....	5	<b>REAR POWER WINDOW SWITCH RH</b> .....	20
<b>SYSTEM DESCRIPTION</b> .....	6	Reference Value .....	20
<b>COMPONENT PARTS</b> .....	6	Fail-safe .....	21
Component Parts Location .....	6	<b>WIRING DIAGRAM</b> .....	22
Component Description .....	7	<b>POWER WINDOW SYSTEM</b> .....	22
<b>SYSTEM</b> .....	8	Wiring Diagram .....	22
System Diagram .....	8	<b>BASIC INSPECTION</b> .....	23
System Description .....	8	<b>DIAGNOSIS AND REPAIR WORKFLOW</b> .....	23
Fail-safe .....	10	Work Flow .....	23
<b>DIAGNOSIS SYSTEM (BCM)</b> .....	11	<b>ADDITIONAL SERVICE WHEN REMOVING BATTERY NEGATIVE TERMINAL</b> .....	24
<b>COMMON ITEM</b> .....	11	Description .....	24
COMMON ITEM : CONSULT Function (BCM - COMMON ITEM) .....	11	Work Procedure .....	24
<b>RETAIND PWR</b> .....	12	<b>ADDITIONAL SERVICE WHEN REPLACING CONTROL UNIT</b> .....	25
RETAIND PWR : CONSULT Function (BCM - RETAINED PWR) .....	12	Description .....	25
<b>ECU DIAGNOSIS INFORMATION</b> .....	13	Work Procedure .....	25
<b>BCM (BODY CONTROL MODULE)</b> .....	13	<b>SYSTEM INITIALIZATION</b> .....	26
List of ECU Reference .....	13	Description .....	26
<b>POWER WINDOW MAIN SWITCH</b> .....	14	Work Procedure .....	26
Reference Value .....	14	<b>CHECK ANTI-PINCH FUNCTION</b> .....	27
Fail-safe .....	15	Description .....	27
		Work Procedure .....	27
		<b>DTC/CIRCUIT DIAGNOSIS</b> .....	28

PWC

<b>POWER SUPPLY AND GROUND CIRCUIT</b> ....	28	POWER WINDOW MAIN SWITCH : Diagnosis Procedure .....	48
<b>POWER WINDOW MAIN SWITCH</b> .....	28	<b>FRONT POWER WINDOW SWITCH (PASSENGER SIDE)</b> .....	49
POWER WINDOW MAIN SWITCH : Diagnosis Procedure .....	28	FRONT POWER WINDOW SWITCH (PASSENGER SIDE) : Component Function Check .....	49
<b>FRONT POWER WINDOW SWITCH (PASSENGER SIDE)</b> .....	29	FRONT POWER WINDOW SWITCH (PASSENGER SIDE) : Diagnosis Procedure .....	49
FRONT POWER WINDOW SWITCH (PASSENGER SIDE) : Diagnosis Procedure .....	29	<b>REAR POWER WINDOW SWITCH LH</b> .....	50
<b>REAR POWER WINDOW SWITCH</b> .....	30	REAR POWER WINDOW SWITCH LH : Component Function Check .....	51
REAR POWER WINDOW SWITCH : Diagnosis Procedure .....	30	REAR POWER WINDOW SWITCH LH : Diagnosis Procedure .....	51
<b>POWER WINDOW MOTOR</b> .....	32	<b>REAR POWER WINDOW SWITCH RH</b> .....	52
<b>DRIVER SIDE</b> .....	32	REAR POWER WINDOW SWITCH RH : Component Function Check .....	52
DRIVER SIDE : Component Function Check .....	32	REAR POWER WINDOW SWITCH RH : Diagnosis Procedure .....	52
DRIVER SIDE : Diagnosis Procedure .....	32	<b>SYMPTOM DIAGNOSIS</b> .....	54
<b>PASSENGER SIDE</b> .....	32	<b>POWER WINDOWS DO NOT OPERATE WITH POWER WINDOW MAIN SWITCH</b> .....	54
PASSENGER SIDE : Component Function Check .....	33	Diagnosis Procedure .....	54
PASSENGER SIDE : Diagnosis Procedure .....	33	<b>DRIVER SIDE POWER WINDOW ALONE DOES NOT OPERATE</b> .....	55
<b>REAR LH</b> .....	33	Diagnosis Procedure .....	55
REAR LH : Component Function Check .....	34	<b>FRONT PASSENGER SIDE POWER WINDOW DOES NOT OPERATE</b> .....	56
REAR LH : Diagnosis Procedure .....	34	<b>WHEN POWER WINDOW MAIN SWITCH IS OPERATED</b> .....	56
<b>REAR RH</b> .....	34	WHEN POWER WINDOW MAIN SWITCH IS OPERATED : Diagnosis Procedure .....	56
REAR RH : Component Function Check .....	34	<b>WHEN FRONT POWER WINDOW SWITCH (PASSENGER SIDE) IS OPERATED</b> .....	56
REAR RH : Diagnosis Procedure .....	35	WHEN FRONT POWER WINDOW SWITCH (PASSENGER SIDE) IS OPERATED : Diagnosis Procedure .....	56
<b>ENCODER</b> .....	36	<b>WHEN BOTH POWER WINDOW MAIN SWITCH AND FRONT POWER WINDOW SWITCH ARE OPERATED</b> .....	56
<b>DRIVER SIDE</b> .....	36	WHEN BOTH POWER WINDOW MAIN SWITCH AND FRONT POWER WINDOW SWITCH ARE OPERATED : Diagnosis Procedure .....	56
DRIVER SIDE : Component Function Check .....	36	<b>REAR LH SIDE POWER WINDOW ALONE DOES NOT OPERATE</b> .....	57
DRIVER SIDE : Diagnosis Procedure .....	36	<b>WHEN POWER WINDOW MAIN SWITCH IS OPERATED</b> .....	57
<b>PASSENGER SIDE</b> .....	38	WHEN POWER WINDOW MAIN SWITCH IS OPERATED : Diagnosis Procedure .....	57
PASSENGER SIDE : Component Function Check .....	38	<b>DOOR KEY CYLINDER SWITCH</b> .....	46
PASSENGER SIDE : Diagnosis Procedure .....	38	Component Function Check .....	46
<b>REAR LH</b> .....	40	Diagnosis Procedure .....	46
REAR LH : Component Function Check .....	40	Component Inspection .....	47
REAR LH : Diagnosis Procedure .....	40	<b>POWER WINDOW SERIAL LINK</b> .....	48
<b>REAR RH</b> .....	42	<b>POWER WINDOW MAIN SWITCH</b> .....	48
REAR RH : Component Function Check .....	42	POWER WINDOW MAIN SWITCH : Component Function Check .....	48
REAR RH : Diagnosis Procedure .....	43		

<b>WHEN REAR POWER WINDOW SWITCH LH IS OPERATED</b> .....	<b>57</b>	<b>REAR RH</b> .....	<b>60</b>	
WHEN REAR POWER WINDOW SWITCH LH IS OPERATED : Diagnosis Procedure .....	57	REAR RH : Diagnosis Procedure .....	60	A
<b>WHEN BOTH POWER WINDOW MAIN SWITCH AND REAR POWER WINDOW SWITCH LH ARE OPERATED</b> .....	<b>57</b>	<b>ANTI-PINCH FUNCTION DOES NOT OPERATE</b> .....	<b>61</b>	B
WHEN BOTH POWER WINDOW MAIN SWITCH AND REAR POWER WINDOW SWITCH LH ARE OPERATED : Diagnosis Procedure .....	57	Diagnosis Procedure .....	61	
<b>REAR RH SIDE POWER WINDOW ALONE DOES NOT OPERATE</b> .....	<b>58</b>	<b>POWER WINDOW RETAINED POWER FUNCTION DOES NOT OPERATE NORMALLY</b> .....	<b>62</b>	C
<b>WHEN POWER WINDOW MAIN SWITCH IS OPERATED</b> .....	<b>58</b>	Diagnosis Procedure .....	62	
WHEN POWER WINDOW MAIN SWITCH IS OPERATED : Diagnosis Procedure .....	58	<b>DOOR KEY CYLINDER SWITCH DOES NOT OPERATE POWER WINDOWS</b> .....	<b>63</b>	D
<b>WHEN REAR POWER WINDOW SWITCH RH IS OPERATED</b> .....	<b>58</b>	Diagnosis Procedure .....	63	E
WHEN REAR POWER WINDOW SWITCH RH IS OPERATED : Diagnosis Procedure .....	58	<b>KEYLESS POWER WINDOW DOWN DOES NOT OPERATE</b> .....	<b>64</b>	F
<b>WHEN BOTH POWER WINDOW MAIN SWITCH AND REAR POWER WINDOW SWITCH RH ARE OPERATED</b> .....	<b>58</b>	Diagnosis Procedure .....	64	
WHEN BOTH POWER WINDOW MAIN SWITCH AND REAR POWER WINDOW SWITCH RH ARE OPERATED : Diagnosis Procedure .....	58	<b>POWER WINDOW LOCK SWITCH DOES NOT FUNCTION</b> .....	<b>65</b>	G
<b>AUTO OPERATION DOES NOT OPERATE BUT MANUAL OPERATE NORMALLY</b> .....	<b>59</b>	Diagnosis Procedure .....	65	
<b>DRIVER SIDE</b> .....	<b>59</b>	<b>POWER WINDOW SWITCH DOES NOT ILLUMINATE</b> .....	<b>66</b>	H
DRIVER SIDE : Diagnosis Procedure .....	59	<b>DRIVER SIDE</b> .....	<b>66</b>	
<b>PASSENGER SIDE</b> .....	<b>59</b>	DRIVER SIDE : Diagnosis Procedure .....	66	I
PASSENGER SIDE : Diagnosis Procedure .....	59	<b>PASSENGER SIDE</b> .....	<b>66</b>	
<b>REAR LH</b> .....	<b>59</b>	PASSENGER SIDE : Diagnosis Procedure .....	66	J
REAR LH : Diagnosis Procedure .....	59	<b>REAR LH</b> .....	<b>66</b>	
		REAR LH : Diagnosis Procedure .....	66	
		<b>REAR RH</b> .....	<b>66</b>	
		REAR RH : Diagnosis Procedure .....	66	
		<b>REMOVAL AND INSTALLATION</b> .....	<b>67</b>	
		<b>POWER WINDOW MAIN SWITCH</b> .....	<b>67</b>	L
		Removal and Installation .....	67	

**PWC**

# PRECAUTIONS

< PRECAUTION >

## PRECAUTION

### PRECAUTIONS

#### Precaution for Supplemental Restraint System (SRS) "AIR BAG" and "SEAT BELT PRE-TENSIONER"

INFOID:000000007626073

The Supplemental Restraint System such as "AIR BAG" and "SEAT BELT PRE-TENSIONER", used along with a front seat belt, helps to reduce the risk or severity of injury to the driver and front passenger for certain types of collision. This system includes seat belt switch inputs and dual stage front air bag modules. The SRS system uses the seat belt switches to determine the front air bag deployment, and may only deploy one front air bag, depending on the severity of a collision and whether the front occupants are belted or unbelted. Information necessary to service the system safely is included in the "SRS AIR BAG" and "SEAT BELT" of this Service Manual.

#### **WARNING:**

Always observe the following items for preventing accidental activation.

- To avoid rendering the SRS inoperative, which could increase the risk of personal injury or death in the event of a collision that would result in air bag inflation, all maintenance must be performed by an authorized NISSAN/INFINITI dealer.
- Improper maintenance, including incorrect removal and installation of the SRS, can lead to personal injury caused by unintentional activation of the system. For removal of Spiral Cable and Air Bag Module, see "SRS AIR BAG".
- Never use electrical test equipment on any circuit related to the SRS unless instructed to in this Service Manual. SRS wiring harnesses can be identified by yellow and/or orange harnesses or harness connectors.

#### PRECAUTIONS WHEN USING POWER TOOLS (AIR OR ELECTRIC) AND HAMMERS

#### **WARNING:**

Always observe the following items for preventing accidental activation.

- When working near the Air Bag Diagnosis Sensor Unit or other Air Bag System sensors with the ignition ON or engine running, never use air or electric power tools or strike near the sensor(s) with a hammer. Heavy vibration could activate the sensor(s) and deploy the air bag(s), possibly causing serious injury.
- When using air or electric power tools or hammers, always switch the ignition OFF, disconnect the battery, and wait at least 3 minutes before performing any service.

#### Precaution for Procedure without Cowl Top Cover

INFOID:000000007626074

When performing the procedure after removing cowl top cover, cover the lower end of windshield with urethane, etc to prevent damage to windshield.

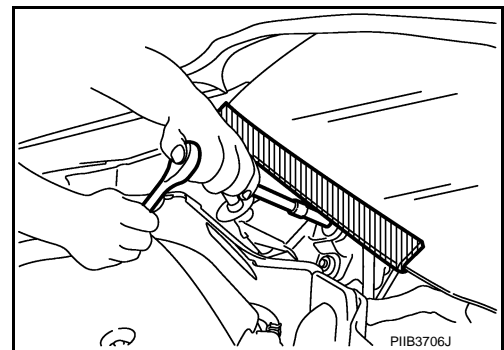

# PREPARATION

< PREPARATION >

## PREPARATION

### PREPARATION

#### Commercial Service Tools

INFOID:000000007626132

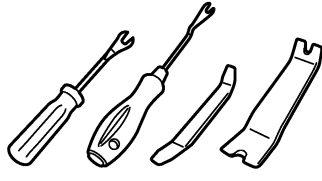
Tool name	Description
Remover tool  JMKIA3050ZZ	Removes the clips, pawls and metal clips

A  
B  
C  
D  
E  
F  
G  
H  
I  
J  
L  
M  
N  
O  
P

PWC

# COMPONENT PARTS

< SYSTEM DESCRIPTION >

## SYSTEM DESCRIPTION

### COMPONENT PARTS

#### Component Parts Location

INFOID:000000007377416

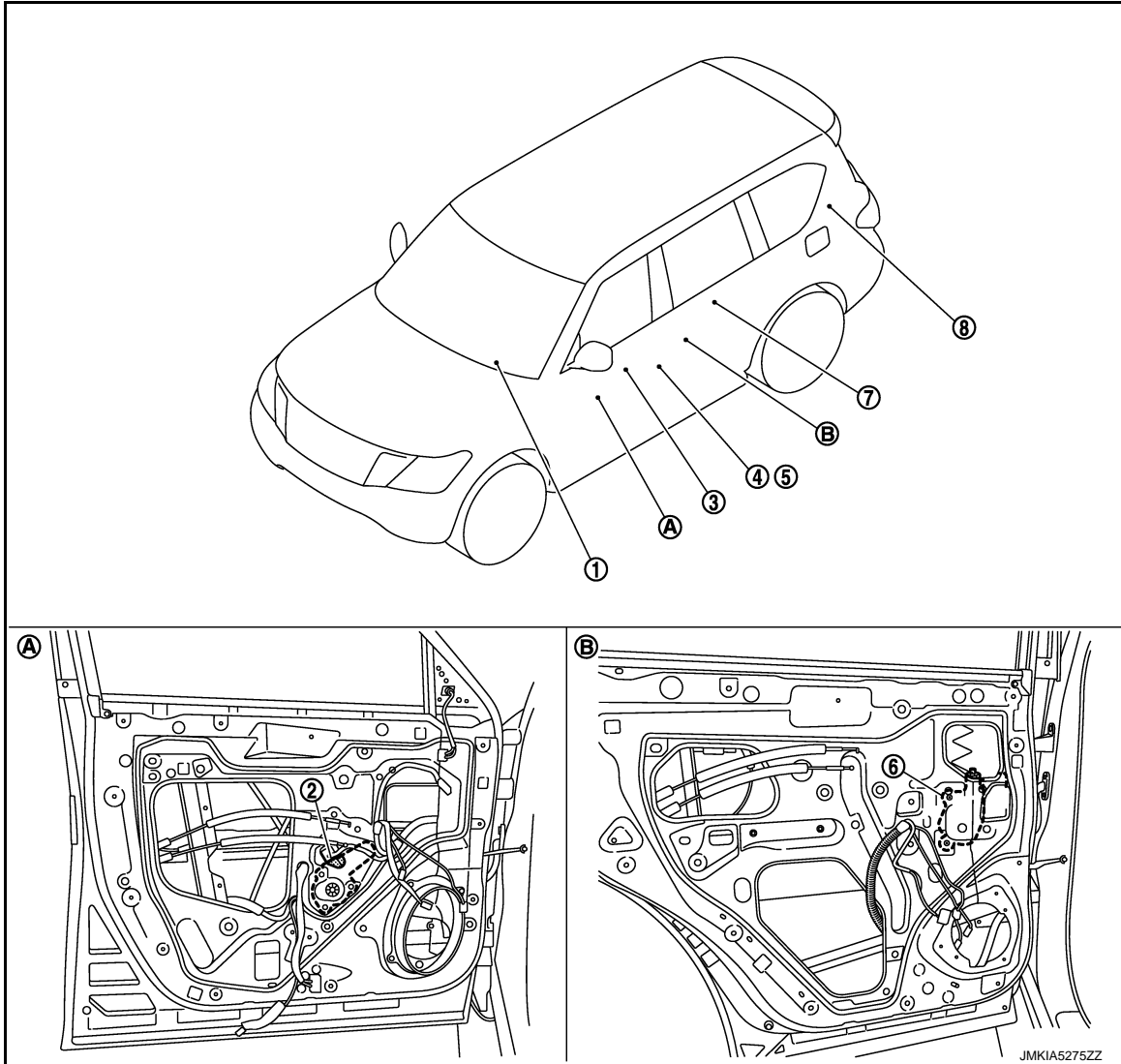

- |  |  |                               |
|--|--|-------------------------------|
| 1. BCM<br>Refer to <a href="#">BCS-4, "BODY CONTROL SYSTEM : Component Parts Location"</a> | 2. Front power window motor (driver side)  | 3. Power window main switch   |
| 4. Front door lock assembly (driver side) (door key cylinder switch)                       | 5. Front door switch (driver side)   | 6. Rear power window motor LH |
| 7. Rear power window switch LH   | 8. Remote keyless entry receiver<br>Refer to <a href="#">DLK-11, "DOOR LOCK SYSTEM : Component Parts Location"</a> |                               |
| A. View with front door finisher removed   | B. View with rear door finisher removed  |                               |

# COMPONENT PARTS

< SYSTEM DESCRIPTION >

## Component Description

INFOID:000000007377417

Component	Function
BCM	<ul style="list-style-type: none"> <li>Supplies power supply to power window switch.</li> <li>Controls retained power.</li> </ul>
Power window main switch	<ul style="list-style-type: none"> <li>Directly controls all power window motor of all doors.</li> <li>Controls anti-pinch operation of power window.</li> </ul>
Front power window switch (passenger side)	<ul style="list-style-type: none"> <li>Controls anti-pinch operation of power window.</li> <li>Controls power window motor of passenger door.</li> </ul>
Rear power window switch	<ul style="list-style-type: none"> <li>Controls anti-pinch operation of power window.</li> <li>Controls power window motor of rear right and left doors.</li> </ul>
Power window motor	<ul style="list-style-type: none"> <li>Integrates the ENCODER and WINDOW MOTOR.</li> <li>Starts operating with signals from each power window switch.</li> <li>Transmits power window motor rotation as a pulse signal to power window switch.</li> </ul>
Remote keyless entry receiver	Receives lock/unlock signal from the intelligent key, and then transmits to BCM.
Front door lock assembly (door key cylinder switch)	Transmits operation condition of door key cylinder switch to power window main switch.
Front door switch (driver side/passenger side)	Front door open/close condition and transmits to BCM.

A  
B  
C  
D  
E  
F  
G  
H  
I  
J  
L  
M  
N  
O  
P

**PWC**

# SYSTEM

< SYSTEM DESCRIPTION >

## SYSTEM

### System Diagram

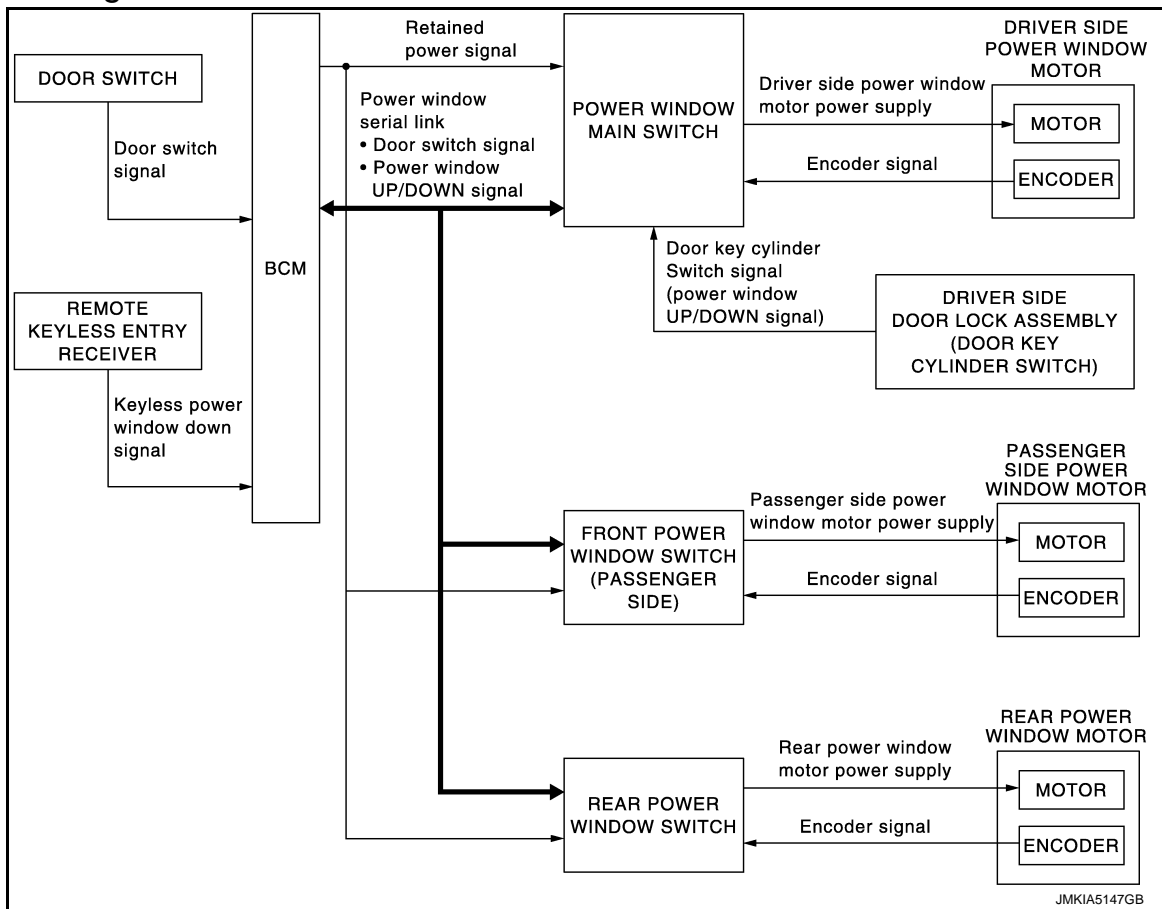

### System Description

INFOID:000000007377419

#### POWER WINDOW OPERATION

- Power window system is activated by power window switch operation when ignition switch turns ON, or during the retained power operation after ignition switch turns OFF.
- Power window main switch can open/close door glass.
- Front and rear power window switch can open/close the corresponding door glass.
- Power window lock switch can lock all power windows other than driver seat.
- All power windows close when pressing Intelligent Key lock button or unlock button for 3 seconds.
- If door glass receives resistance that is the specified value or more while power window of each seat is in AUTO-UP operation, power window operates in the reverse direction.
- Power window serial link transmits the signals from power window main switch to each power window switch.
- AUTO-UP/DOWN operation can be performed when front power window switch turns to AUTO.

#### POWER WINDOW AUTO-OPERATION

- AUTO-UP/DOWN operation can be performed when each power window motor turns to AUTO.
- Encoder continues detecting the movement of power window motor and output the encoder pulse signal to power window switch while power window motor is operating.
- Power window switch reads the changes of encoder signal and stops AUTO operation when door glass is at fully opened/closed position.
- Power window motor is operable in case encoder is malfunctioning.
- AUTO function does not operate if encoder is malfunctioning.

#### POWER WINDOW SERIAL LINK

Power window main switch, front power window switch (passenger side), rear power window switch LH/RH and BCM transmit and receive the signal by power window serial link.



# SYSTEM

## < SYSTEM DESCRIPTION >

The signal mentioned below is transmitted from BCM to power window main switch, front power window switch (passenger side) and rear power window switch LH/RH.

- Keyless power window down signal
- Door switch signal

The signal mentioned below is transmitted from power window main switch to front power window switch (passenger side) and rear power window switch LH/RH.

- Front passenger side door window and rear door window operation signal
- Power window control by door key cylinder switch signal
- Power window lock switch signal
- Retained power operation signal

### RETAINED POWER OPERATION

- Retained power operation is an additional power supply function that enables power window system to operate during the 45 seconds even when ignition switch is turned OFF.

Retained Power Function Cancel Conditions

- Front door CLOSE (door switch OFF)→OPEN (door switch ON).
- When ignition switch is ON again.
- When timer time passes. (45 seconds)

### POWER WINDOW LOCK FUNCTION

Ground circuit inside power window main switch shuts off when power window lock switch is ON. This inhibits power window switch operation except with the power window main switch.

### ANTI-PINCH OPERATION

- Anti-pinch foreign lowers door glass 150 mm (5.9 in) when foreign material is pinched in door glass during AUTO-UP operation.
- Encoder continues detecting the movement of power window motor and output the encoder pulse signal to power window switch I while power window motor is operating.
- Resistance is applied to the power window motor rotation that changes the frequency of encoder pulse signal if foreign material is trapped in the door glass.
- Power window switch controls to lower the door glass for 150 mm (5.9 in) after it detects encoder pulse signal frequency change.

Operation Condition

When all door glass AUTO-UP operation is performed (anti-pinch function does not operate just before the door glass closes and is fully closed)

#### **NOTE:**

Depending on environment and driving conditions, if a similar impact or load is applied to the door glass, it may lower.

### DOOR KEY CYLINDER SWITCH OPERATION

Hold the door key cylinder to the LOCK or UNLOCK direction for 1.5 seconds or more to OPEN or CLOSE all power windows when ignition switch is OFF. In addition, it stops when key position is moved to NEUTRAL when operating.

Operation Condition

- Ignition switch OFF.
- Hold door key cylinder to LOCK position for 1.5 seconds or more to perform CLOSE operation of the door glass.
- Hold door key cylinder to UNLOCK position for 1.5 seconds or more to perform OPEN operation of the door glass.

### KEYLESS POWER WINDOW DOWN FUNCTION

All power windows open when the unlock button on Intelligent Key is activated and kept pressed for more than 3 seconds with the ignition switch OFF. The windows keep opening if the unlock button is continuously pressed.

The power window opening stops when the following operations are performed.

- When the unlock button is kept pressed more than 15 seconds.
- When the ignition switch is turned ON while the power window opening is operated.
- When the unlock button is released.

While retained power operation activate, keyless power window down function cannot be operated.

A  
B  
C  
D  
E  
F  
G  
H  
I  
J  
L  
M  
N  
O  
P

PWC

# SYSTEM

## < SYSTEM DESCRIPTION >

Keyless power window down operation function can be changed by "PW DOWN SET" in "WORK SUPPORT" mode of "INTELLIGENT KEY" of "BCM" using CONSULT. Refer to [DLK-42, "INTELLIGENT KEY : CONSULT Function \(BCM - INTELLIGENT KEY\)"](#).

## Fail-safe

INFOID:000000007377420

### FAIL-SAFE CONTROL

Switches to fail-safe control when malfunction is detected in encoder signal that detects up/down speed and direction of door glass. Switches to fail-safe control when a signal that is out of the specified value is detected between the fully closed position and the actual position of the glass.

Malfunction	Malfunction condition
Pulse sensor malfunction	When one pulse signal that is the specified value or more is detected continuously for the specified time or more, while door glass is being operated UP or DOWN.
Both pulse sensors malfunction	When both pulse signals are not detected continuously for the specified time or more, while door glass is being operated UP or DOWN.
Pulse direction malfunction	When a pulse signal indicating that window is moving in the opposite direction against the power window motor is detected for the specified value or more, while door glass is being operated UP or DOWN.
Glass recognition position malfunction 1	When the actual door glass position that is out of specified value is detected compared to the door glass fully closed position memorized in module, while door glass is being operated UP or DOWN.
Glass recognition position malfunction 2	When pulse count that is out of the door glass full stroke value or more is detected, while door glass is being operated UP or DOWN.

If fail-safe control, the system changes to a non-initialized condition and the following function do not operate.

- Auto-up operation
- Anti-pinch function
- Retained power function

When fail-safe control is activated, perform the initialization procedure to recover. However, if a malfunction is still detected in power window switch, the fail-safe control is activated again.

# DIAGNOSIS SYSTEM (BCM)

< SYSTEM DESCRIPTION >

## DIAGNOSIS SYSTEM (BCM)

### COMMON ITEM

#### COMMON ITEM : CONSULT Function (BCM - COMMON ITEM)

INFOID:000000007625985

#### APPLICATION ITEM

CONSULT performs the following functions via CAN communication with BCM.

Diagnosis mode	Function Description
Work Support	Changes the setting for each system function.
Self Diagnostic Result	Displays the diagnosis results judged by BCM. Refer to <a href="#">BCS-57, "DTC Index"</a> .
CAN Diag Support Monitor	Monitors the reception status of CAN communication viewed from BCM.
Data Monitor	The BCM input/output signals are displayed.
Active Test	The signals used to activate each device are forcibly supplied from BCM.
Ecu Identification	The BCM part number is displayed.
Configuration	<ul style="list-style-type: none"> <li>Read and save the vehicle specification.</li> <li>Write the vehicle specification when replacing BCM.</li> </ul>

#### SYSTEM APPLICATION

BCM can perform the following functions for each system.

#### NOTE:

It can perform the diagnosis modes except the following for all sub system selection items.

x: Applicable item

System	Sub system selection item	Diagnosis mode		
		Work Support	Data Monitor	Active Test
Door lock	DOOR LOCK	x	x	x
Rear window defogger	REAR DEFOGGER		x	x
Warning chime	BUZZER		x	x
Interior room lamp timer	INT LAMP	x	x	x
Exterior lamp	HEAD LAMP	x	x	x
Wiper and washer	WIPER	x	x	x
Turn signal and hazard warning lamps	FLASHER	x	x	x
—	AIR CONDITONER*		x	x
<ul style="list-style-type: none"> <li>Intelligent Key system</li> <li>Engine start system</li> </ul>	INTELLIGENT KEY	x	x	x
Combination switch	COMB SW		x	
Body control system	BCM	x		
IVIS	IMMU	x	x	x
Interior room lamp battery saver	BATTERY SAVER	x	x	x
Back door	TRUNK		x	
Vehicle security system	THEFT ALM	x	x	x
RAP system	RETAINED PWR		x	
Signal buffer system	SIGNAL BUFFER		x	x
—	AIR PRESSURE MONITOR*	x	x	x

\*: This item is indicated, but not used.

#### FREEZE FRAME DATA (FFD)

The BCM records the following vehicle condition at the time a particular DTC is detected, and displays on CONSULT.

# DIAGNOSIS SYSTEM (BCM)

## < SYSTEM DESCRIPTION >

CONSULT screen item	Indication/Unit	Description	
Vehicle Speed	km/h	Vehicle speed of the moment a particular DTC is detected	
Odo/Trip Meter	km	Total mileage (Odometer value) of the moment a particular DTC is detected	
Vehicle Condition	SLEEP>LOCK	Power position status of the moment a particular DTC is detected	While turning BCM status from low power consumption mode to normal mode (Power supply position is "LOCK")
	SLEEP>OFF		While turning BCM status from low power consumption mode to normal mode (Power supply position is "OFF".)
	LOCK>ACC		While turning power supply position from "LOCK" to "ACC"
	ACC>ON		While turning power supply position from "ACC" to "IGN"
	RUN>ACC		While turning power supply position from "RUN" to "ACC" (Vehicle is stopping and selector lever is except P position.)
	CRANK>RUN		While turning power supply position from "CRANKING" to "RUN" (From cranking up the engine to run it)
	RUN>URGENT		While turning power supply position from "RUN" to "ACC" (Emergency stop operation)
	ACC>OFF		While turning power supply position from "ACC" to "OFF"
	OFF>LOCK		While turning power supply position from "OFF" to "LOCK"
	OFF>ACC		While turning power supply position from "OFF" to "ACC"
	ON>CRANK		While turning power supply position from "IGN" to "CRANKING"
	OFF>SLEEP		While turning BCM status from normal mode (Power supply position is "OFF".) to low power consumption mode
	LOCK>SLEEP		While turning BCM status from normal mode (Power supply position is "LOCK".) to low power consumption mode
	LOCK		Power supply position is "LOCK" (Ignition switch OFF with steering is locked.)
	OFF		Power supply position is "OFF" (Ignition switch OFF with steering is unlocked.)
	ACC		Power supply position is "ACC" (Ignition switch ACC)
	ON		Power supply position is "IGN" (Ignition switch ON with engine stopped)
ENGINE RUN	Power supply position is "RUN" (Ignition switch ON with engine running)		
CRANKING	Power supply position is "CRANKING" (At engine cranking)		
IGN Counter	0 - 39	<p>The number of times that ignition switch is turned ON after DTC is detected</p> <ul style="list-style-type: none"> <li>• The number is 0 when a malfunction is detected now.</li> <li>• The number increases like 1 → 2 → 3...38 → 39 after returning to the normal condition whenever ignition switch OFF → ON.</li> <li>• The number is fixed to 39 until the self-diagnosis results are erased if it is over 39.</li> </ul>	

## RETAINED PWR

### RETAINED PWR : CONSULT Function (BCM - RETAINED PWR)

INFOID:000000007377422

#### Data monitor

Monitor Item	Description
DOOR SW-DR	Indicates [ON/OFF] condition of driver side door switch.
DOOR SW-AS	Indicates [ON/OFF] condition of passenger side door switch.

# BCM (BODY CONTROL MODULE)

< ECU DIAGNOSIS INFORMATION >

## ECU DIAGNOSIS INFORMATION

### BCM (BODY CONTROL MODULE)

List of ECU Reference

INFOID:000000007377423

ECU	Reference
BCM	<a href="#">BCS-35. "Reference Value"</a>
	<a href="#">BCS-56. "Fail-safe"</a>
	<a href="#">BCS-57. "DTC Inspection Priority Chart"</a>
	<a href="#">BCS-57. "DTC Index"</a>

A  
B  
C  
D  
E  
F  
G  
H  
I  
J  
L  
M  
N  
O  
P

PWC

# POWER WINDOW MAIN SWITCH

< ECU DIAGNOSIS INFORMATION >

## POWER WINDOW MAIN SWITCH

Reference Value

INFOID:000000007377424

### TERMINAL LAYOUT

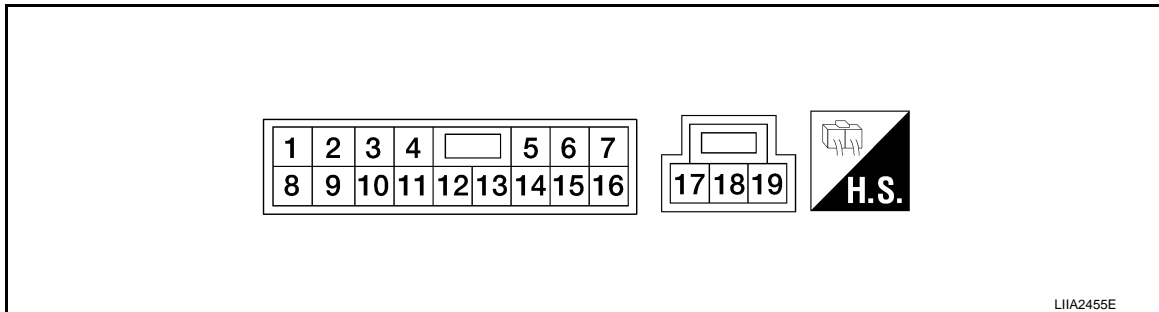

### PHYSICAL VALUES

#### POWER WINDOW MAIN SWITCH

Terminal No. (wire color)		Description		Condition	Voltage [V] (Approx.)
+	-	Signal name	Input/ Output		
2 (W/B)	Ground	Encoder ground	—	—	0
4 (R)	Ground	Door key cylinder switch LOCK signal	Input	Key position (Neutral →Locked)	5 → 0
6 (W)	Ground	Door key cylinder switch UN- LOCK signal	Input	Key position (Neutral →Unlocked)	5 → 0
8 (L)	Ground	Front driver side power win- dow motor UP signal	Output	When front LH switch in power window main switch is operated UP	12
9 (G/W)	Ground	Encoder pulse signal 2	Input	When power window mo- tor operates.	
10 (Y)	Ground	Retained power signal	Input	IGN SW ON	12
				Within 45 second after ig- nition switch is turned to OFF	12
				When driver side or pas- senger side door is opened during retained power operation	0
11 (G)	Ground	Front driver side power win- dow motor DOWN signal	Output	When front LH switch in power window main switch is operated DOWN	12

# POWER WINDOW MAIN SWITCH

## < ECU DIAGNOSIS INFORMATION >

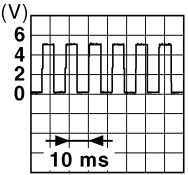
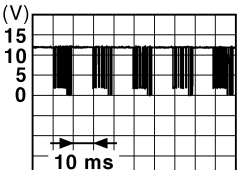
Terminal No. (wire color)		Description		Condition	Voltage [V] (Approx.)
+	-	Signal name	Input/ Output		
13 (G/Y)	Ground	Encoder pulse signal 1	Input	When power window motor operates.	
14 (V)	Ground	Power window serial link	Input/ Output	IGN SW ON or power window timer operating.	
15 (G/R)	Ground	Encoder power supply	Output	When ignition switch ON or power window timer operates.	12
17 (B)	Ground	Ground	—	—	0
19 (W)	Ground	Battery power supply	Input	—	12

## Fail-safe

INFOID:000000007626510

## FAIL-SAFE CONTROL

Switches to fail-safe control when malfunction is detected in encoder signal that detects up/down speed and direction of door glass. Switches to fail-safe control when a signal that is out of the specified value is detected between the fully closed position and the actual position of the glass.

Malfunction	Malfunction condition
Pulse sensor malfunction	When one pulse signal that is the specified value or more is detected continuously for the specified time or more, while door glass is being operated UP or DOWN.
Both pulse sensors malfunction	When both pulse signals are not detected continuously for the specified time or more, while door glass is being operated UP or DOWN.
Pulse direction malfunction	When a pulse signal indicating that window is moving in the opposite direction against the power window motor is detected for the specified value or more, while door glass is being operated UP or DOWN.
Glass recognition position malfunction 1	When the actual door glass position that is out of specified value is detected compared to the door glass fully closed position memorized in module, while door glass is being operated UP or DOWN.
Glass recognition position malfunction 2	When pulse count that is out of the door glass full stroke value or more is detected, while door glass is being operated UP or DOWN.

If fail-safe control, the system changes to a non-initialized condition and the following function do not operate.

- Auto-up operation
- Anti-pinch function
- Retained power function

When fail-safe control is activated, perform the initialization procedure to recover. However, if a malfunction is still detected in power window switch, the fail-safe control is activated again.

# FRONT POWER WINDOW SWITCH (PASSENGER SIDE)

< ECU DIAGNOSIS INFORMATION >

## FRONT POWER WINDOW SWITCH (PASSENGER SIDE)

Reference Value

INFOID:000000007377426

### TERMINAL LAYOUT

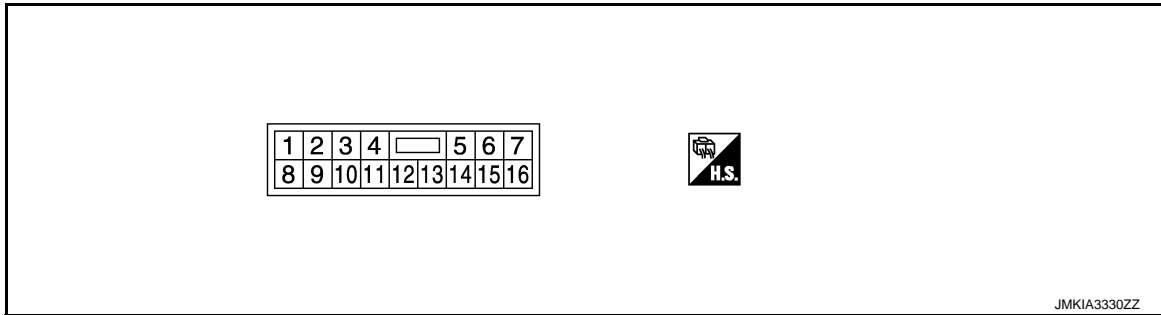

### PHYSICAL VALUES

#### FRONT POWER WINDOW SWITCH

Terminal No. (wire color)		Description		Condition	Voltage [V] (Approx.)
+	-	Signal name	Input/ Output		
3 (W/B)	Ground	Encoder ground	—	—	0
4 (G/R)	Ground	Encoder power supply	Output	When ignition switch ON or power window timer operates	12
8 (L)	Ground	Power window motor UP signal	Output	When power window motor is operated UP	12
9 (G)	Ground	Power window motor DOWN signal	Output	When power window motor is operated DOWN	12
10 (W)	Ground	Battery power supply	Input	—	12
11 (B)	Ground	Ground	—	—	0
12 (G/Y)	Ground	Encoder pulse signal 1	Input	When power window motor operates	

JMKIA0070GB



# FRONT POWER WINDOW SWITCH (PASSENGER SIDE)

< ECU DIAGNOSIS INFORMATION >

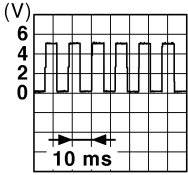
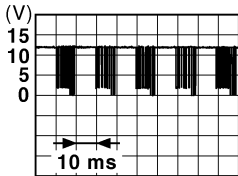
Terminal No. (wire color)		Description		Condition	Voltage [V] (Approx.)
+	-	Signal name	Input/ Output		
15 (G/W)	Ground	Encoder pulse signal 2	Input	When power window motor operates	 <p>JMKIA0070GB</p>
16 (V)	Ground	Power window serial link	Input/ Output	When ignition switch ON or power window timer operates	 <p>JPMIA0013GB</p>

## Fail-safe

INFOID:000000007626511

### FAIL-SAFE CONTROL

Switches to fail-safe control when malfunction is detected in encoder signal that detects up/down speed and direction of door glass. Switches to fail-safe control when a signal that is out of the specified value is detected between the fully closed position and the actual position of the glass.

Malfunction	Malfunction condition
Pulse sensor malfunction	When one pulse signal that is the specified value or more is detected continuously for the specified time or more, while door glass is being operated UP or DOWN.
Both pulse sensors malfunction	When both pulse signals are not detected continuously for the specified time or more, while door glass is being operated UP or DOWN.
Pulse direction malfunction	When a pulse signal indicating that window is moving in the opposite direction against the power window motor is detected for the specified value or more, while door glass is being operated UP or DOWN.
Glass recognition position malfunction 1	When the actual door glass position that is out of specified value is detected compared to the door glass fully closed position memorized in module, while door glass is being operated UP or DOWN.
Glass recognition position malfunction 2	When pulse count that is out of the door glass full stroke value or more is detected, while door glass is being operated UP or DOWN.

If fail-safe control, the system changes to a non-initialized condition and the following function do not operate.

- Auto-up operation
- Anti-pinch function
- Retained power function

When fail-safe control is activated, perform the initialization procedure to recover. However, if a malfunction is still detected in power window switch, the fail-safe control is activated again.

# REAR POWER WINDOW SWITCH LH

< ECU DIAGNOSIS INFORMATION >

## REAR POWER WINDOW SWITCH LH

Reference Value

INFOID:000000007377428

### TERMINAL LAYOUT

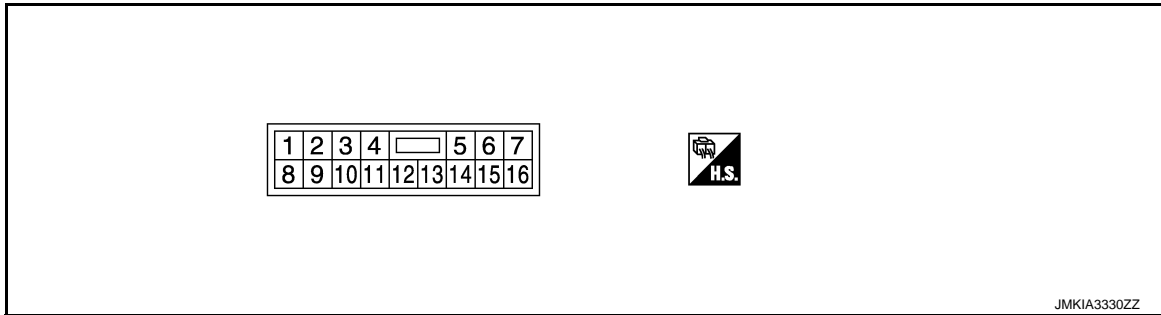

### PHYSICAL VALUES

#### REAR POWER WINDOW SWITCH

Terminal No. (wire color)		Description		Condition	Voltage [V] (Approx.)
+	-	Signal name	Input/ Output		
3 (SB)	Ground	Encoder ground	—	—	0
4 (LG)	Ground	Encoder power supply	Output	When ignition switch ON or power window timer operates	12
8 (Y)	Ground	Power window motor UP signal	Output	When power window motor is operated UP	12
9 (G)	Ground	Power window motor DOWN signal	Output	When power window motor is operated DOWN	12
10 (W)	Ground	Battery power supply	Input	—	12
11 (B)	Ground	Ground	—	—	0
12 (BR)	Ground	Encoder pulse signal 1	Input	When power window motor operates	

JMKIA0070GB

# REAR POWER WINDOW SWITCH LH

## < ECU DIAGNOSIS INFORMATION >

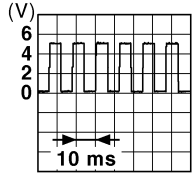
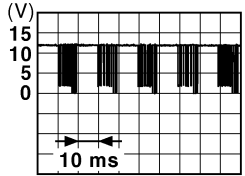
Terminal No. (wire color)		Description		Condition	Voltage [V] (Approx.)
+	-	Signal name	Input/ Output		
15 (L)	Ground	Encoder pulse signal 2	Input	When power window motor operates.	 <small>JMKIA0070GB</small>
16 (V)	Ground	Power window serial link	Input/ Output	When ignition switch ON or power window timer operates	 <small>JPMIA0013GB</small>

## Fail-safe

INFOID:000000007626512

### FAIL-SAFE CONTROL

Switches to fail-safe control when malfunction is detected in encoder signal that detects up/down speed and direction of door glass. Switches to fail-safe control when a signal that is out of the specified value is detected between the fully closed position and the actual position of the glass.

Malfunction	Malfunction condition
Pulse sensor malfunction	When one pulse signal that is the specified value or more is detected continuously for the specified time or more, while door glass is being operated UP or DOWN.
Both pulse sensors malfunction	When both pulse signals are not detected continuously for the specified time or more, while door glass is being operated UP or DOWN.
Pulse direction malfunction	When a pulse signal indicating that window is moving in the opposite direction against the power window motor is detected for the specified value or more, while door glass is being operated UP or DOWN.
Glass recognition position malfunction 1	When the actual door glass position that is out of specified value is detected compared to the door glass fully closed position memorized in module, while door glass is being operated UP or DOWN.
Glass recognition position malfunction 2	When pulse count that is out of the door glass full stroke value or more is detected, while door glass is being operated UP or DOWN.

If fail-safe control, the system changes to a non-initialized condition and the following function do not operate.

- Auto-up operation
- Anti-pinch function
- Retained power function

When fail-safe control is activated, perform the initialization procedure to recover. However, if a malfunction is still detected in power window switch, the fail-safe control is activated again.

# REAR POWER WINDOW SWITCH RH

< ECU DIAGNOSIS INFORMATION >

## REAR POWER WINDOW SWITCH RH

Reference Value

INFOID:000000007377430

### TERMINAL LAYOUT

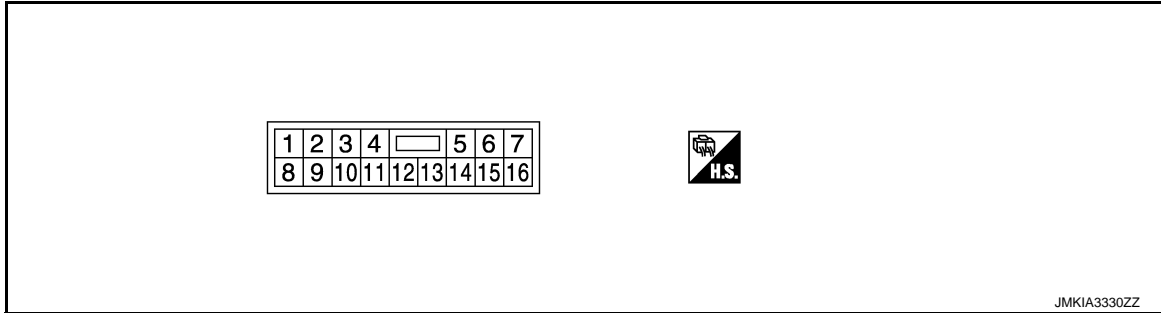

### PHYSICAL VALUES

#### REAR POWER WINDOW SWITCH

Terminal No. (wire color)		Description		Condition	Voltage [V] (Approx.)
+	-	Signal name	Input/ Output		
3 (P)	Ground	Encoder ground	—	—	0
4 (Y)	Ground	Encoder power supply	Output	When ignition switch ON or power window timer operates	12
8 (W/R)	Ground	Power window motor UP signal	Output	When power window motor is operated UP	12
9 (R)	Ground	Power window motor DOWN signal	Output	When power window motor is operated DOWN	12
10 (W)	Ground	Battery power supply	Input	—	12
11 (B)	Ground	Ground	—	—	0
12 (O)	Ground	Encoder pulse signal 1	Input	When power window motor operates	

JMKIA0070GB

# REAR POWER WINDOW SWITCH RH

## < ECU DIAGNOSIS INFORMATION >

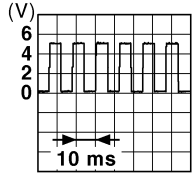
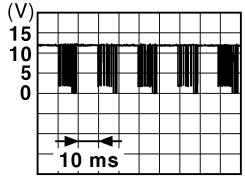
Terminal No. (wire color)		Description		Condition	Voltage [V] (Approx.)
+	-	Signal name	Input/ Output		
15 (G)	Ground	Encoder pulse signal 2	Input	When power window motor operates.	 <small>JMKIA0070GB</small>
16 (V)	Ground	Power window serial link	Input/ Output	When ignition switch ON or power window timer operates	 <small>JPMIA0013GB</small>

## Fail-safe

INFOID:000000007626513

### FAIL-SAFE CONTROL

Switches to fail-safe control when malfunction is detected in encoder signal that detects up/down speed and direction of door glass. Switches to fail-safe control when a signal that is out of the specified value is detected between the fully closed position and the actual position of the glass.

Malfunction	Malfunction condition
Pulse sensor malfunction	When one pulse signal that is the specified value or more is detected continuously for the specified time or more, while door glass is being operated UP or DOWN.
Both pulse sensors malfunction	When both pulse signals are not detected continuously for the specified time or more, while door glass is being operated UP or DOWN.
Pulse direction malfunction	When a pulse signal indicating that window is moving in the opposite direction against the power window motor is detected for the specified value or more, while door glass is being operated UP or DOWN.
Glass recognition position malfunction 1	When the actual door glass position that is out of specified value is detected compared to the door glass fully closed position memorized in module, while door glass is being operated UP or DOWN.
Glass recognition position malfunction 2	When pulse count that is out of the door glass full stroke value or more is detected, while door glass is being operated UP or DOWN.

If fail-safe control, the system changes to a non-initialized condition and the following function do not operate.

- Auto-up operation
- Anti-pinch function
- Retained power function

When fail-safe control is activated, perform the initialization procedure to recover. However, if a malfunction is still detected in power window switch, the fail-safe control is activated again.

# POWER WINDOW SYSTEM

< WIRING DIAGRAM >

## WIRING DIAGRAM

### POWER WINDOW SYSTEM

#### Wiring Diagram

INFOID:000000007377432

For connector terminal arrangements, harness layouts, and alphabets in a  (option abbreviation; if not described in wiring diagram), refer to [GI-12. "Connector Information"](#).

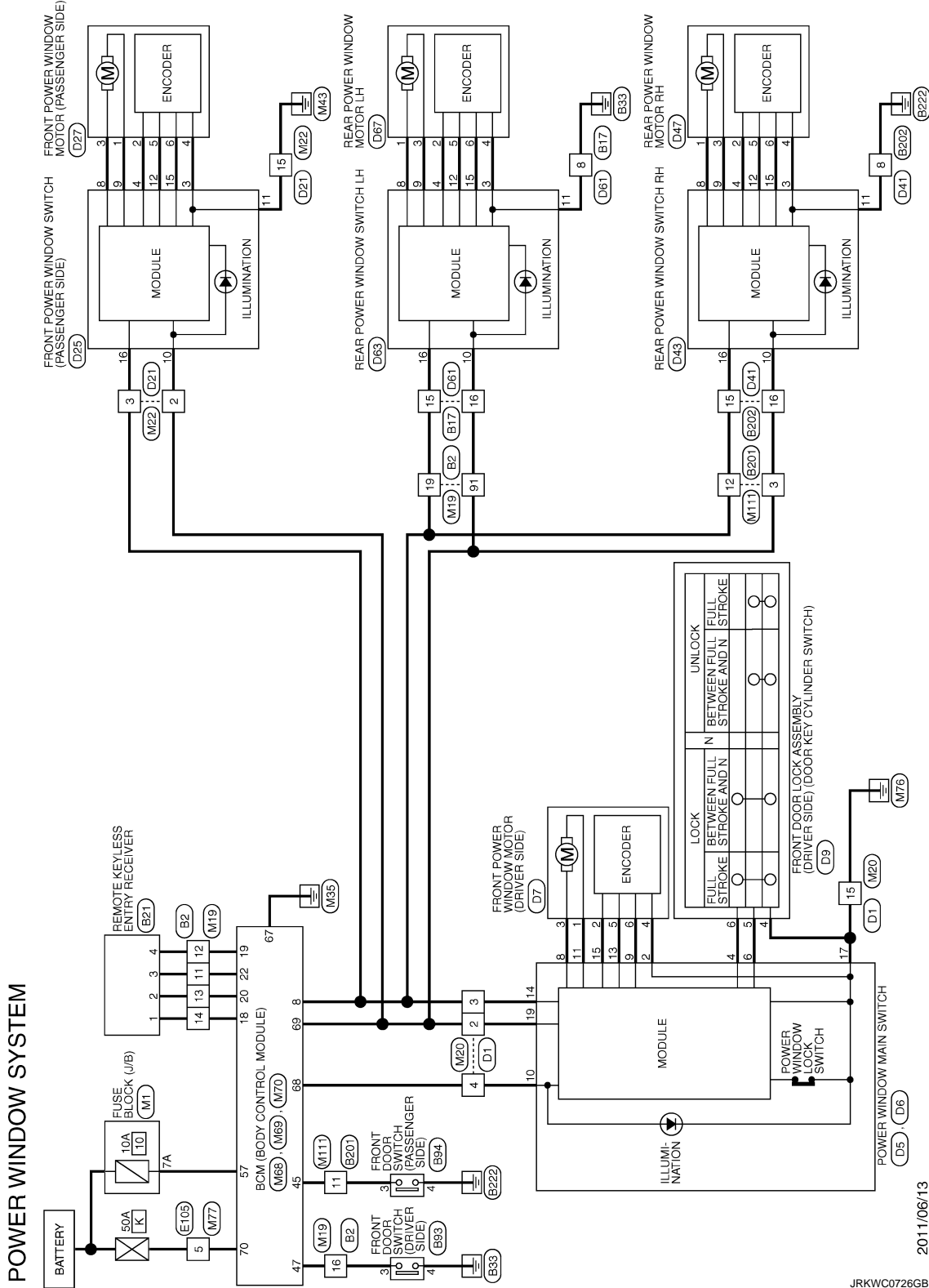

2011/06/13

JRWK0726GB

# DIAGNOSIS AND REPAIR WORKFLOW

< BASIC INSPECTION >

## BASIC INSPECTION

### DIAGNOSIS AND REPAIR WORKFLOW

Work Flow

INFOID:000000007377433

DETAILED FLOW

#### 1.OBTAIN INFORMATION ABOUT SYMPTOM

Interview the customer to obtain as much malfunction information (conditions and environment when the malfunction occurred) as possible when the customer brings the vehicle in.

>> GO TO 2.

#### 2.REPRODUCE THE MALFUNCTION INFORMATION

Check the malfunction on the vehicle that the customer describes.  
Inspect the relation of the symptoms and the condition when the symptoms occur.

>> GO TO 3.

#### 3.IDENTIFY THE MALFUNCTIONING SYSTEM WITH "SYMPTOM DIAGNOSIS"

Use "Symptom diagnosis" from the symptom inspection result in step 2. Then identify where to start the diagnosis based on possible causes and symptoms.

>> GO TO 4.

#### 4.IDENTIFY MALFUNCTIONING PARTS WITH "COMPONENT DIAGNOSIS"

Perform the diagnosis with "Component diagnosis" of the applicable system.

>> GO TO 5.

#### 5.REPAIR OR REPLACE THE MALFUNCTIONING PARTS

Repair or replace the specified malfunctioning parts.

>> GO TO 6.

#### 6.FINAL CHECK

Check that malfunctions are not reproduced when obtaining the malfunction information from the customer, referring to the symptom inspection result in step 2.

Is the malfunctioning part repaired or replaced?

YES >> Trouble diagnosis is completed.

NO >> GO TO 3.

A  
B  
C  
D  
E  
F  
G  
H  
I  
J  
PWC  
L  
M  
N  
O  
P

## ADDITIONAL SERVICE WHEN REMOVING BATTERY NEGATIVE TERMINAL

< BASIC INSPECTION >

---

### ADDITIONAL SERVICE WHEN REMOVING BATTERY NEGATIVE TERMINAL

#### Description

INFOID:000000007377434

When the battery negative terminal is disconnected, the initialization is necessary for normal operation of power window system.

**CAUTION:**

The following specified operations can not be performed under the non-initialized condition.

- Auto-up operation
- Anti-pinch function

#### Work Procedure

INFOID:000000007377435

#### 1.SYSTEM INITIALIZATION

---

Perform system initialization. Refer to [PWC-26. "Work Procedure"](#).

>> GO TO 2.

#### 2.CHECK ANTI-PINCH FUNCTION

---

Check anti-pinch function. Refer to [PWC-27. "Work Procedure"](#).

>> END



## ADDITIONAL SERVICE WHEN REPLACING CONTROL UNIT

< BASIC INSPECTION >

---

### ADDITIONAL SERVICE WHEN REPLACING CONTROL UNIT

#### Description

INFOID:000000007626514

When the battery negative terminal is disconnected, the initialization is necessary for normal operation of power window system.

**CAUTION:**

The following specified operations can not be performed under the non-initialized condition.

- Auto-up operation
- Anti-pinch function

#### Work Procedure

INFOID:000000007377437

#### 1.SYSTEM INITIALIZATION

---

Perform system initialization. Refer to [PWC-26. "Work Procedure"](#).

>> GO TO 2.

#### 2.CHECK ANTI-PINCH FUNCTION

---

Check anti-pinch function. Refer to [PWC-27. "Work Procedure"](#).

>> END

A  
B  
C  
D  
E  
F  
G  
H  
I  
J  
L  
M  
N  
O  
P

PWC

# SYSTEM INITIALIZATION

< BASIC INSPECTION >

---

## SYSTEM INITIALIZATION

### Description

INFOID:000000007377438

If any of the following operations are performed, the initialization is necessary for normal operation of power window system.

- When control unit replaced.
- Electric power supply to power window switch or motor is interrupted by blown fuse or disconnection and connection of the negative terminal of battery, etc.
- Removal and installation of regulator assembly.
- Power supply to the power window main switch or power window motor is cut off by the removal of battery terminal or if the battery fuse is blown.
- Disconnection and connection of power window main switch harness connector.
- Removal and installation of motor from regulator assembly.
- Operation of regulator assembly as an independent unit.
- Removal and installation of door glass.
- Removal and installation of door glass run.

The following specified operations can not be performed under the non-initialized condition.

- Auto-up operation
- Anti-pinch function

### Work Procedure

INFOID:000000007377439

#### 1.STEP 1

- 
1. Turn ignition switch ON.
  2. Operate power window switch to fully open the window. (This operation is unnecessary if the window is already fully open)
  3. Continue pulling the power window switch UP (AUTO-UP operation). Even after glass stops at fully closed position, keep pulling the switch for 2 seconds or more.
  4. Check that AUTO-UP function operates normally.

>> GO TO 2.

#### 2.STEP 2

---

Check anti-pinch function. Refer to [PWC-27. "Work Procedure"](#).

>> END

# CHECK ANTI-PINCH FUNCTION

< BASIC INSPECTION >

## CHECK ANTI-PINCH FUNCTION

### Description

INFOID:000000007626515

If any of the following operations are performed, the initialization is necessary for normal operation of power window system.

- When control unit replaced.
- Electric power supply to power window switch or motor is interrupted by blown fuse or disconnection and connection of the negative terminal of battery, etc.
- Removal and installation of regulator assembly.
- Power supply to the power window main switch or power window motor is cut off by the removal of battery terminal or if the battery fuse is blown.
- Disconnection and connection of power window main switch harness connector.
- Removal and installation of motor from regulator assembly.
- Operation of regulator assembly as an independent unit.
- Removal and installation of door glass.
- Removal and installation of door glass run.

The following specified operations can not be performed under the non-initialized condition.

- Auto-up operation
- Anti-pinch function

### Work Procedure

INFOID:000000007377441

#### 1. CHECK ANTI-PINCH FUNCTION

- Fully open the door window.
- Place a piece of wood near fully closed position.
- Close door glass completely with AUTO-UP.
- Check the following conditions
  - Check that glass lowers for approximately 150 mm (5.9 in) without pinching piece of wood and stops.
  - Check that glass does not rise not when operating the power window main switch while lowering.

#### **CAUTION:**

- **Perform initial setting when AUTO-UP operation or anti-pinch function does not operate normally.**
- **Check that AUTO-UP operates before inspection when system initialization is performed.**
- **Do not check with hands and other body parts because they may be pinched. Do not get pinched.**

>> END

PWC

# POWER SUPPLY AND GROUND CIRCUIT

< DTC/CIRCUIT DIAGNOSIS >

## DTC/CIRCUIT DIAGNOSIS

### POWER SUPPLY AND GROUND CIRCUIT

#### POWER WINDOW MAIN SWITCH

#### POWER WINDOW MAIN SWITCH : Diagnosis Procedure

INFOID:000000007377442

#### 1. CHECK POWER SUPPLY

1. Turn ignition switch OFF.
2. Disconnect power window main switch connectors.
3. Turn ignition switch ON.
4. Check voltage between power window main switch harness connector and ground.

(+)		(-)	Voltage (V) (Approx.)
Power window main switch			
Connector	Terminal	Ground	12
D5	10		
D6	19		

Is the inspection result normal?

YES >> GO TO 3.

NO >> GO TO 2.

#### 2. CHECK POWER SUPPLY CIRCUIT

1. Turn ignition switch OFF.
2. Disconnect BCM connector.
3. Check continuity between BCM harness connector and power window main switch harness connector.

BCM		Power window main switch		Continuity
Connector	Terminal	Connector	Terminal	
M70	68	D5	10	Existed
	69	D6	19	

4. Check continuity between BCM harness connector and ground.

BCM		Ground	Continuity
Connector	Terminal		
M70	68		Not existed
	69		

Is the inspection result normal?

YES >> Replace BCM. Refer to [BCS-82, "Removal and Installation"](#).

NO >> Repair or replace harness.

#### 3. CHECK GROUND CIRCUIT

1. Turn ignition switch OFF.
2. Check continuity between power window main switch harness connector and ground.

Power window main switch		Ground	Continuity
Connector	Terminal		
D6	17		Existed

Is the inspection result normal?

YES >> GO TO 4.

NO >> Repair or replace harness.

#### 4. CHECK INTERMITTENT INCIDENT

# POWER SUPPLY AND GROUND CIRCUIT

< DTC/CIRCUIT DIAGNOSIS >

Refer to [GI-43. "Intermittent Incident"](#).

>> INSPECTION END

## FRONT POWER WINDOW SWITCH (PASSENGER SIDE)

### FRONT POWER WINDOW SWITCH (PASSENGER SIDE) : Diagnosis Procedure

INFOID:000000007377443

#### 1. CHECK POWER SUPPLY

1. Turn ignition switch OFF.
2. Disconnect front power window switch (passenger side) connector.
3. Check voltage between front power window switch (passenger side) harness connector and ground.

(+)		(-)	Voltage (V) (Approx.)
Front power window switch (passenger side)			
Connector	Terminal	Ground	12
D25	10		

Is the inspection result normal?

YES >> GO TO 3.

NO >> GO TO 2.

#### 2. CHECK POWER SUPPLY CIRCUIT

1. Disconnect BCM connector.
2. Check continuity between BCM harness connector and front power window switch (passenger side) harness connector.

BCM		Front power window switch (passenger side)		Continuity
Connector	Terminal	Connector	Terminal	
M70	69	D25	10	Existed

3. Check continuity between BCM harness connector and ground.

BCM		Ground	Continuity
Connector	Terminal		
M70	69		Not existed

Is the inspection result normal?

YES >> Replace BCM. Refer to [BCS-82. "Removal and Installation"](#).

NO >> Repair or replace harness.

#### 3. CHECK GROUND CIRCUIT

Check continuity between front power window switch (passenger side) harness connector and ground.

Front power window switch (passenger side)		Ground	Continuity
Connector	Terminal		
D25	11		Existed

Is the inspection result normal?

YES >> GO TO 4.

NO >> Repair or replace harness.

#### 4. CHECK INTERMITTENT INCIDENT

Refer to [GI-43. "Intermittent Incident"](#).

A  
B  
C  
D  
E  
F  
G  
H  
I  
J  
L  
M  
N  
O  
P

PWC

# POWER SUPPLY AND GROUND CIRCUIT

< DTC/CIRCUIT DIAGNOSIS >

>> INSPECTION END

## REAR POWER WINDOW SWITCH

### REAR POWER WINDOW SWITCH : Diagnosis Procedure

INFOID:000000007377444

#### 1. CHECK POWER SUPPLY

1. Turn ignition switch OFF.
2. Disconnect rear power window switch LH connector and rear power window switch RH connector.
3. Turn ignition switch ON.
4. Check voltage between rear power window switch harness connector and ground.

(+)		Terminal	(-)	Voltage (V) (Approx.)
Rear power window switch				
Connector		Terminal	Ground	12
LH	D63	10		
RH	D43			

Is the inspection result normal?

YES >> GO TO 3.

NO >> GO TO 2.

#### 2. CHECK POWER SUPPLY CIRCUIT

1. Turn ignition switch OFF.
2. Disconnect BCM connector.
3. Check continuity between BCM harness connector and rear power window switch harness connector.

BCM		Rear power window switch		Continuity
Connector	Terminal	Connector	Terminal	
M70	69	LH	D63	Existed
		RH	D43	

4. Check continuity between BCM harness connector and ground.

BCM		Ground	Continuity
Connector	Terminal		
M70	69	Ground	Not existed

Is the inspection result normal?

YES >> Replace BCM. Refer to [BCS-82. "Removal and Installation"](#).

NO >> Repair or replace harness.

#### 3. CHECK GROUND CIRCUIT

1. Turn ignition switch OFF.
2. Check continuity between rear power window switch harness connector and ground.

Rear power window switch		Terminal	Ground	Continuity
Connector				
LH	D63	11	Ground	Existed
RH	D43			

Is the inspection result normal?

YES >> GO TO 4.

NO >> Repair or replace harness.

#### 4. CHECK INTERMITTENT INCIDENT

Refer to [GI-43. "Intermittent Incident"](#).

# POWER SUPPLY AND GROUND CIRCUIT

< DTC/CIRCUIT DIAGNOSIS >

---

>> INSPECTION END

A

B

C

D

E

F

G

H

I

J

**PWC**

L

M

N

O

P

# POWER WINDOW MOTOR

< DTC/CIRCUIT DIAGNOSIS >

## POWER WINDOW MOTOR DRIVER SIDE

### DRIVER SIDE : Component Function Check

INFOID:000000007377445

#### 1.CHECK POWER WINDOW MOTOR CIRCUIT

Check front power window motor (driver side) operation with power window main switch.

Is the inspection result normal?

- YES >> Front power window motor (driver side) is OK.  
 NO >> Refer to [PWC-32. "DRIVER SIDE : Diagnosis Procedure"](#).

### DRIVER SIDE : Diagnosis Procedure

INFOID:000000007377446

#### 1.CHECK FRONT POWER WINDOW MOTOR INPUT SIGNAL

1. Turn ignition switch OFF.
2. Disconnect front power window motor (driver side) connector.
3. Turn ignition switch ON.
4. Check voltage between front power window motor (driver side) harness connector and ground.

(+)		(-)	Condition	Voltage (V) (Approx.)	
Connector	Terminal				
D7	3	Ground	Power window main switch	UP	12
				DOWN	0
	1			UP	0
				DOWN	12

Is the inspection result normal?

- YES >> Replace front power window motor (driver side). Refer to [GW-21. "Removal and Installation"](#).  
 NO >> GO TO 2.

#### 2.CHECK POWER WINDOW MOTOR CIRCUIT

1. Turn ignition switch OFF.
2. Disconnect power window main switch connector.
3. Check continuity between power window main switch harness connector and front power window motor (driver side) harness connector.

Power window main switch		Front power window motor (driver side)		Continuity
Connector	Terminal	Connector	Terminal	
D5	8	D7	3	Existed
	11		1	

4. Check continuity between power window main switch harness connector and ground.

Power window main switch		Ground	Continuity
Connector	Terminal		
D5	8		Not existed
	11		

Is the inspection result normal?

- YES >> Replace power window main switch. Refer to [PWC-67. "Removal and Installation"](#).  
 NO >> Repair or replace harness.

## PASSENGER SIDE



# POWER WINDOW MOTOR

< DTC/CIRCUIT DIAGNOSIS >

## PASSENGER SIDE : Component Function Check

INFOID:000000007377447

### 1. CHECK POWER WINDOW MOTOR CIRCUIT

Check front power window motor (passenger side) operation with power window main switch or front power window switch (passenger side).

Is the inspection result normal?

- YES >> Front power window motor (passenger side) is OK.
- NO >> Refer to [PWC-33, "PASSENGER SIDE : Diagnosis Procedure"](#).

## PASSENGER SIDE : Diagnosis Procedure

INFOID:000000007377448

### 1. CHECK FRONT POWER WINDOW MOTOR INPUT SIGNAL

1. Turn ignition switch OFF.
2. Disconnect front power window motor (passenger side) connector.
3. Turn ignition switch ON.
4. Check voltage between front power window motor (passenger side) harness connector and ground.

(+)		(-)	Condition	Voltage (V) (Approx.)
Connector	Terminal			
D27	3	Ground	Front power window switch (passenger side) UP	12
			DOWN	0
	1		UP	0
			DOWN	12

Is the inspection result normal?

- YES >> Replace front power window motor (passenger side). Refer to [GW-21, "Removal and Installation"](#).
- NO >> GO TO 2.

### 2. CHECK POWER WINDOW MOTOR CIRCUIT

1. Turn ignition switch OFF.
2. Disconnect front power window switch (passenger side) connector.
3. Check continuity between front power window switch (passenger side) harness connector and front power window motor (passenger side) harness connector.

Front power window switch (passenger side)		Front power window motor (passenger side)		Continuity
Connector	Terminal	Connector	Terminal	
D25	8	D27	3	Existed
	9		1	

4. Check continuity between front power window switch (passenger side) connector and ground.

Front power window switch (passenger side)		Ground	Continuity
Connector	Terminal		
D25	8		Not existed
	9		

Is the inspection result normal?

- YES >> Replace front power window switch (passenger side). Refer to [PWC-67, "Removal and Installation"](#).
- NO >> Repair or replace harness.

## REAR LH

A  
B  
C  
D  
E  
F  
G  
H  
I  
J  
L  
M  
N  
O  
P

PWC

# POWER WINDOW MOTOR

< DTC/CIRCUIT DIAGNOSIS >

## REAR LH : Component Function Check

INFOID:000000007377449

### 1.CHECK POWER WINDOW MOTOR CIRCUIT

Check rear power window motor LH operation with power window main switch or rear power window switch LH.

Is the inspection result normal?

- YES >> Rear power window motor LH is OK.
- NO >> Refer to [PWC-34, "REAR LH : Diagnosis Procedure"](#).

## REAR LH : Diagnosis Procedure

INFOID:000000007377450

### 1.CHECK REAR POWER WINDOW MOTOR INPUT SIGNAL

1. Turn ignition switch OFF.
2. Disconnect rear power window motor LH connector.
3. Turn ignition switch ON.
4. Check voltage between rear power window motor LH harness connector and ground.

(+)		(-)	Condition	Voltage (V) (Approx.)	
Connector	Terminal				
D67	1	Ground	Rear power window switch LH	UP	12
				DOWN	0
	3			UP	0
				DOWN	12

Is the inspection result normal?

- YES >> Replace rear power window motor LH. Refer to [GW-26, "Removal and Installation"](#).
- NO >> GO TO 2.

### 2.CHECK POWER WINDOW MOTOR CIRCUIT

1. Turn ignition switch OFF.
2. Disconnect rear power window switch LH connector.
3. Check continuity between rear power window switch LH harness connector and rear power window motor LH harness connector.

Rear power window switch LH		Rear power window motor LH		Continuity
Connector	Terminal	Connector	Terminal	
D63	8	D67	1	Existed
	9		3	

4. Check continuity between rear power window switch LH harness connector and ground.

Rear power window switch LH		Ground	Continuity
Connector	Terminal		
D63	8		Not existed
	9		

Is the inspection result normal?

- YES >> Replace rear power window switch LH. Refer to [PWC-67, "Removal and Installation"](#).
- NO >> Repair or replace harness.

## REAR RH

## REAR RH : Component Function Check

INFOID:000000007377451

### 1. CHECK POWER WINDOW MOTOR CIRCUIT

# POWER WINDOW MOTOR

## < DTC/CIRCUIT DIAGNOSIS >

Check rear power window motor RH operation with power window main switch or rear power window switch RH.

Is the inspection result normal?

- YES >> Rear power window motor RH is OK.
- NO >> Refer to [PWC-35, "REAR RH : Diagnosis Procedure"](#).

## REAR RH : Diagnosis Procedure

INFOID:000000007377452

### 1. CHECK REAR POWER WINDOW MOTOR INPUT SIGNAL

1. Turn ignition switch OFF.
2. Disconnect rear power window motor RH connector.
3. Turn ignition switch ON.
4. Check voltage between rear power window motor RH harness connector and ground.

(+)		(-)	Condition	Voltage (V) (Approx.)
Connector	Terminal			
D47	1	Ground	Rear power window switch RH	UP 12
			DOWN 0	
	3		UP 0	
			DOWN 12	

Is the inspection result normal?

- YES >> Replace rear power window motor RH. Refer to [GW-26, "Removal and Installation"](#).
- NO >> GO TO 2.

### 2. CHECK POWER WINDOW MOTOR CIRCUIT

1. Turn ignition switch OFF.
2. Disconnect rear power window switch RH connector.
3. Check continuity between rear power window switch RH harness connector and rear power window motor RH harness connector.

Rear power window switch RH		Rear power window motor RH		Continuity
Connector	Terminal	Connector	Terminal	
D43	8	D47	1	Existed
	9		3	

4. Check continuity between rear power window switch RH harness connector and ground.

Rear power window switch RH		Ground	Continuity
Connector	Terminal		
D43	8		Not existed
	9		

Is the inspection result normal?

- YES >> Replace rear power window switch RH. Refer to [PWC-67, "Removal and Installation"](#).
- NO >> Repair or replace harness.

# ENCODER

< DTC/CIRCUIT DIAGNOSIS >

## ENCODER DRIVER SIDE

### DRIVER SIDE : Component Function Check

INFOID:000000007377453

#### 1.CHECK ENCODER

Check that driver side door glass performs AUTO open/close operation normally by power window main switch.

Is the inspection result normal?

- YES >> Encoder is OK.  
NO >> Refer to [PWC-36, "DRIVER SIDE : Diagnosis Procedure"](#).

### DRIVER SIDE : Diagnosis Procedure

INFOID:000000007377454

#### 1.CHECK ENCODER SIGNAL

- Turn ignition switch ON.
- Check signal between power window main switch harness connector and ground with oscilloscope.

Signal name	(+)		(-)	Signal (Reference value)
	Power window main switch			
	Connector	Terminal		
Encoder signal 1	D5	13	Ground	Refer to following signal
Encoder signal 2		9		

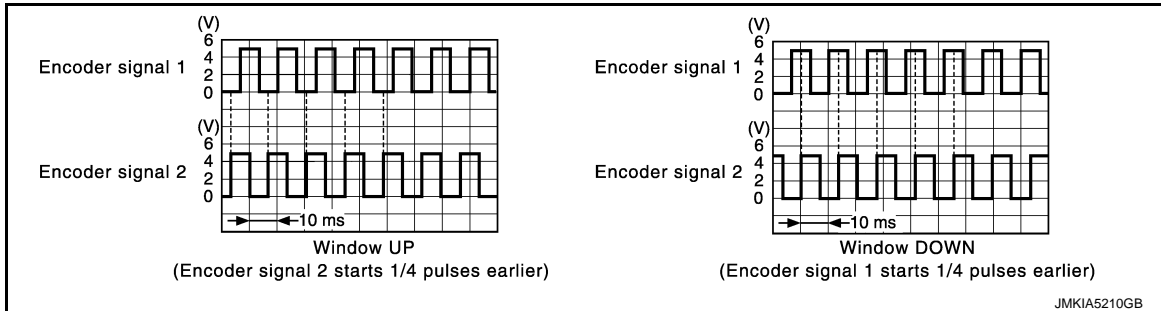

Is the inspection result normal?

- YES >> Replace power window main switch. Refer to [PWC-67, "Removal and Installation"](#).  
NO >> GO TO 2.

#### 2.CHECK ENCODER SIGNAL CIRCUIT

- Turn ignition switch OFF.
- Disconnect power window main switch connector and front power window motor (driver side) connector.
- Check continuity between power window main switch harness connector and front power window motor (driver side) harness connector.

Power window main switch		Front power window motor (driver side)		Continuity
Connector	Terminal	Connector	Terminal	
D5	9	D7	6	Existed
	13		5	

- Check continuity between power window main switch harness connector and ground.

# ENCODER

## < DTC/CIRCUIT DIAGNOSIS >

Power window main switch		Ground	Continuity
Connector	Terminal		
D5	9		Not existed
	13		

Is the inspection result normal?

YES >> GO TO 3.

NO >> Repair or replace harness.

### 3.CHECK ENCORDER POWER SUPPLY

1. Connect power window main switch connector.
2. Turn ignition switch ON.
3. Check voltage between front power window motor (driver side) harness connector and ground.

(+)		(-)	Voltage (V) (Approx.)
Front power window motor (driver side)			
Connector	Terminal		
D7	2	Ground	12

Is the inspection result normal?

YES >> GO TO 5.

NO >> GO TO 4.

### 4.CHECK ENCORDER POWER SUPPLY CIRCUIT

1. Turn ignition switch OFF.
2. Disconnect power window main switch connector.
3. Check continuity between power window main switch harness connector and front power window motor (driver side) harness connector.

Power window main switch		Front power window motor (driver side)		Continuity
Connector	Terminal	Connector	Terminal	
D5	15	D7	2	Existed

4. Check continuity between power window main switch harness connector and ground.

Power window main switch		Ground	Continuity
Connector	Terminal		
D5	15		Not existed

Is the inspection result normal?

YES >> Replace power window main switch. Refer to [PWC-67. "Removal and Installation"](#).

NO >> Repair or replace harness.

### 5.CHECK GROUND CIRCUIT 1

1. Turn ignition switch OFF.
2. Check continuity between front power window motor (driver side) harness connector and ground.

Front power window motor (driver side)		Ground	Continuity
Connector	Terminal		
D7	4		Existed

Is the inspection result normal?

YES >> Replace front power window motor (driver side). Refer to [GW-21. "Removal and Installation"](#).

NO >> GO TO 6.

### 6.CHECK GROUND CIRCUIT 2

1. Disconnect power window main switch connector.

# ENCODER

## < DTC/CIRCUIT DIAGNOSIS >

- Check continuity between power window main switch harness connector and front power window motor (driver side) harness connector.

Power window main switch		Front power window motor (driver side)		Continuity
Connector	Terminal	Connector	Terminal	
D5	2	D7	4	Existed

- Check continuity between power window main switch harness connector and ground.

Power window main switch		Ground	Continuity
Connector	Terminal		
D5	2		Not existed

Is the inspection result normal?

YES >> Replace power window main switch. Refer to [PWC-67. "Removal and Installation"](#).

NO >> Repair or replace harness.

## PASSENGER SIDE

### PASSENGER SIDE : Component Function Check

INFOID:000000007377455

#### 1.CHECK ENCODER

Check that passenger side door glass performs AUTO open/close operation normally by power window main switch or front power window switch (passenger side).

Is the inspection result normal?

YES >> Encoder is OK.

NO >> Refer to [PWC-38. "PASSENGER SIDE : Diagnosis Procedure"](#).

### PASSENGER SIDE : Diagnosis Procedure

INFOID:000000007377456

#### 1.CHECK ENCODER SIGNAL

- Turn ignition switch ON.
- Check signal between front power window switch (passenger side) harness connector and ground with oscilloscope.

Signal name	(+)		(-)	Signal (Reference value)
	Front power window switch (passenger side)			
	Connector	Terminal		
Encoder signal 1	D25	12	Ground	Refer to following signal
Encoder signal 2		15		

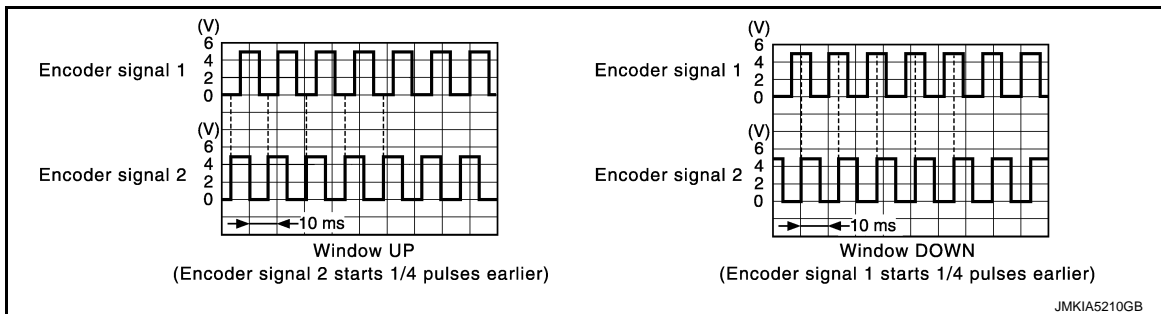

Is the inspection result normal?

YES >> Replace front power window switch (passenger side). Refer to [PWC-67. "Removal and Installation"](#).

NO >> GO TO 2.

#### 2.CHECK ENCODER SIGNAL CIRCUIT

- Turn ignition switch OFF.

# ENCODER

## < DTC/CIRCUIT DIAGNOSIS >

2. Disconnect front power window switch (passenger side) connector and front power window motor (passenger side) connector.
3. Check continuity between front power window switch (passenger side) harness connector and front power window motor (passenger side) harness connector.

Front power window switch (passenger side)		Front power window motor (passenger side)		Continuity
Connector	Terminal	Connector	Terminal	
D25	12	D27	5	Existed
	15		6	

4. Check continuity between front power window switch (passenger side) harness connector and ground.

Front power window switch (passenger side)		Ground	Continuity
Connector	Terminal		
D25	12		Not existed
	15		

Is the inspection result normal?

YES >> GO TO 3.

NO >> Repair or replace harness.

### 3.CHECK ENCODER POWER SUPPLY

1. Connect front power window switch (passenger side) connector.
2. Turn ignition switch ON.
3. Check voltage between front power window motor (passenger side) harness connector and ground.

(+)		(-)	Voltage (V) (Approx.)
Front power window motor (passenger side)			
Connector	Terminal	Ground	12
D27	2		

Is the inspection result normal?

YES >> GO TO 5.

NO >> GO TO 4.

### 4.CHECK ENCODER POWER SUPPLY CIRCUIT

1. Turn ignition switch OFF.
2. Disconnect front power window switch (passenger side) connector.
3. Check continuity between front power window switch (passenger side) harness connector and front power window motor (passenger side) harness connector.

Front power window switch (passenger side)		Front power window motor (passenger side)		Continuity
Connector	Terminal	Connector	Terminal	
D25	4	D27	2	Existed

4. Check continuity between front power window switch (passenger side) harness connector and ground.

Front power window switch (passenger side)		Ground	Continuity
Connector	Terminal		
D25	4		Not existed

Is the inspection result normal?

YES >> Replace front power window switch (passenger side). Refer to [PWC-67. "Removal and Installation"](#).

NO >> Repair or replace harness.

### 5.CHECK GROUND CIRCUIT 1

1. Turn ignition switch OFF.

A  
B  
C  
D  
E  
F  
G  
H  
I  
J  
L  
M  
N  
O  
P

PWC

# ENCODER

## < DTC/CIRCUIT DIAGNOSIS >

2. Check continuity between front power window motor (passenger side) harness connector and ground.

Front power window motor (passenger side)		Ground	Continuity
Connector	Terminal		Existed
D27	4		

### Is the inspection result normal?

- YES >> Replace front power window motor (passenger side). Refer to [GW-21, "Removal and Installation"](#).  
 NO >> GO TO 6.

## 6.CHECK GROUND CIRCUIT 2

1. Disconnect front power window switch (passenger side) connector.
2. Check continuity between front power window switch (passenger side) harness connector and front power window motor (passenger side) harness connector.

Front power window switch (passenger side)		Front power window motor (passenger side)		Continuity
Connector	Terminal	Connector	Terminal	
D25	3	D27	4	Existed

3. Check continuity between front power window switch (passenger side) harness connector and ground.

Front power window switch (passenger side)		Ground	Continuity
Connector	Terminal		Not existed
D25	3		

### Is the inspection result normal?

- YES >> Replace front power window switch (passenger side). Refer to [PWC-67, "Removal and Installation"](#).  
 NO >> Repair or replace harness.

## REAR LH

### REAR LH : Component Function Check

INFOID:000000007377457

## 1.CHECK ENCODER OPERATION

Check that rear door LH glass performs AUTO open/close operation normally by power window main switch or rear power window switch LH.

### Is the inspection result normal?

- YES >> Encoder operation is OK.  
 NO >> Refer to [PWC-40, "REAR LH : Diagnosis Procedure"](#).

## REAR LH : Diagnosis Procedure

INFOID:000000007377458

## 1.CHECK ENCODER SIGNAL

1. Turn ignition switch ON.
2. Check signal between rear power window switch LH harness connector and ground with oscilloscope.

Signal name	(+)		(-)	Signal (Reference value)
	Rear power window switch LH			
	Connector	Terminal		
Encoder signal 1	D63	12	Ground	Refer to following signal
Encoder signal 2		15		



# ENCODER

## < DTC/CIRCUIT DIAGNOSIS >

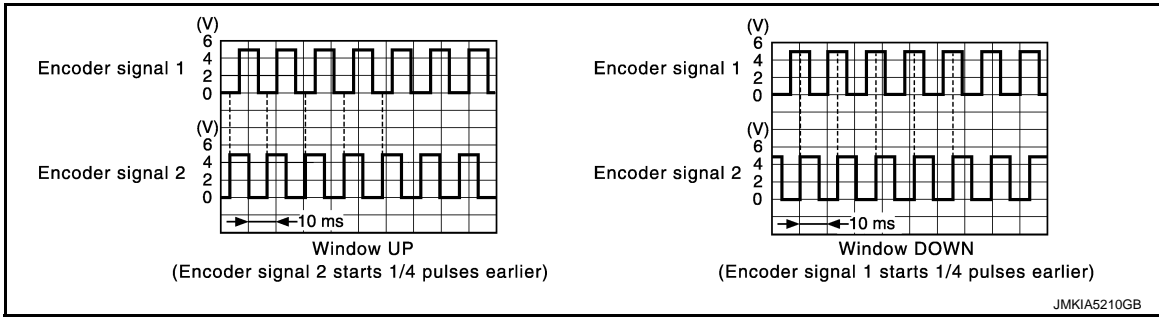

Is the inspection result normal?

- YES >> Replace rear power window switch LH. Refer to [PWC-67, "Removal and Installation"](#).  
 NO >> GO TO 2.

### 2.CHECK ENCODER SIGNAL CIRCUIT

- Turn ignition switch OFF.
- Disconnect rear power window switch LH connector and rear power window motor LH connector.
- Check continuity between rear power window switch LH harness connector and rear power window motor LH harness connector.

Rear power window switch LH		Rear power window motor LH		Continuity
Connector	Terminal	Connector	Terminal	
D63	12	D67	5	Existed
	15		6	

- Check continuity rear power window switch LH harness connector and ground.

Rear power window switch LH		Ground	Continuity
Connector	Terminal		
D63	12		Not existed
	15		

Is the inspection result normal?

- YES >> GO TO 3.  
 NO >> Repair or replace harness.

### 3.CHECK ENCODER POWER SUPPLY

- Connect rear power window switch LH connector.
- Turn ignition switch ON.
- Check voltage between rear power window motor LH harness connector and ground.

(+)		(-)	Voltage (V) (Approx.)
Rear power window motor LH			
Connector	Terminal		
D67	2	Ground	12

Is the inspection result normal?

- YES >> GO TO 5.  
 NO >> GO TO 4.

### 4.CHECK ENCODER POWER SUPPLY CIRCUIT

- Turn ignition switch OFF.
- Disconnect rear power window switch LH connector.
- Check continuity between rear power window switch LH harness connector and rear power window motor LH harness connector.

# ENCODER

## < DTC/CIRCUIT DIAGNOSIS >

Rear power window switch LH		Rear power window motor LH		Continuity
Connector	Terminal	Connector	Terminal	
D63	4	D67	2	Existed

4. Check continuity between rear power window switch LH harness connector and ground.

Rear power window switch LH		Ground	Continuity
Connector	Terminal		
D63	4		Not existed

Is the inspection result normal?

- YES >> Replace rear power window switch LH. Refer to [PWC-67, "Removal and Installation"](#).  
NO >> Repair or replace harness.

### 5.CHECK GROUND CIRCUIT 1

1. Turn ignition switch OFF.
2. Check continuity between rear power window motor LH harness connector and ground.

Rear power window motor LH		Ground	Continuity
Connector	Terminal		
D67	4		Existed

Is the inspection result normal?

- YES >> Replace rear power window motor LH. Refer to [GW-26, "Removal and Installation"](#).  
NO >> GO TO 6.

### 6.CHECK GROUND CIRCUIT 2

1. Disconnect rear power window switch LH harness connector.
2. Check continuity between rear power window switch LH harness connector and rear power window motor LH harness connector.

Rear power window switch LH		Rear power window motor LH		Continuity
Connector	Terminal	Connector	Terminal	
D63	3	D67	4	Existed

3. Check continuity between rear power window switch LH harness connector and ground.

Rear power window switch LH		Ground	Continuity
Connector	Terminal		
D63	3		Not existed

Is the inspection result normal?

- YES >> Replace rear power window switch LH. Refer to [PWC-67, "Removal and Installation"](#).  
NO >> Repair or replace harness.

## REAR RH

### REAR RH : Component Function Check

INFOID:000000007377459

#### 1.CHECK ENCODER OPERATION

Check that rear door RH glass performs AUTO open/close operation normally by power window main switch or rear power window switch RH.

Is the inspection result normal?

- YES >> Encoder operation is OK.  
NO >> Refer to [PWC-43, "REAR RH : Diagnosis Procedure"](#).

# ENCODER

< DTC/CIRCUIT DIAGNOSIS >

## REAR RH : Diagnosis Procedure

INFOID:000000007377460

### 1.CHECK ENCODER SIGNAL

1. Turn ignition switch ON.
2. Check signal between rear power window switch RH harness connector and ground with oscilloscope.

Signal name	(+)		(-)	Signal (Reference value)
	Rear power window switch RH			
	Connector	Terminal		
Encoder signal 1	D43	12	Ground	Refer to following signal
Encoder signal 2		15		

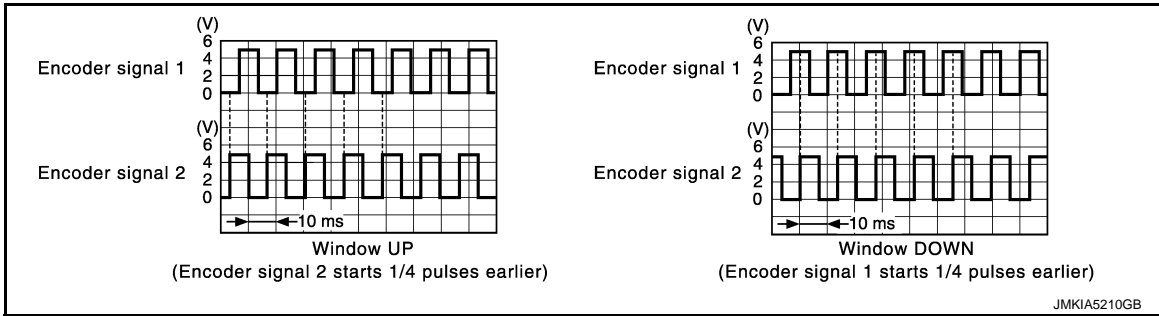

Is the inspection result normal?

- YES >> Replace rear power window switch RH. Refer to [PWC-67. "Removal and Installation"](#).
- NO >> GO TO 2.

### 2.CHECK ENCODER SIGNAL CIRCUIT

1. Turn ignition switch OFF.
2. Disconnect rear power window switch RH connector and rear power window motor RH connector.
3. Check continuity between rear power window switch RH harness connector and rear power window motor RH harness connector.

Rear power window switch RH		Rear power window motor RH		Continuity
Connector	Terminal	Connector	Terminal	
D43	12	D47	5	Existed
	15		6	

4. Check continuity rear power window switch RH harness connector and ground.

Rear power window switch RH		Ground	Continuity
Connector	Terminal		
D43	12		Ground
	15		

Is the inspection result normal?

- YES >> GO TO 3.
- NO >> Repair or replace harness.

### 3.CHECK ENCODER POWER SUPPLY

1. Connect rear power window switch RH connector.
2. Turn ignition switch ON.
3. Check voltage between rear power window motor RH harness connector and ground.

# ENCODER

## < DTC/CIRCUIT DIAGNOSIS >

(+)		(-)	Voltage (V) (Approx.)
Rear power window motor RH			
Connector	Terminal		
D47	2	Ground	12

Is the inspection result normal?

YES >> GO TO 5.

NO >> GO TO 4.

### 4.CHECK ENCODER POWER SUPPLY CIRCUIT

1. Turn ignition switch OFF.
2. Disconnect rear power window switch RH connector.
3. Check continuity between rear power window switch RH harness connector and rear power window motor RH harness connector.

Rear power window switch RH		Rear power window motor RH		Continuity
Connector	Terminal	Connector	Terminal	
D43	4	D47	2	Existed

4. Check continuity between rear power window switch RH harness connector and ground.

Rear power window switch RH		Ground	Continuity
Connector	Terminal		
D43	4		Not existed

Is the inspection result normal?

YES >> Replace rear power window switch RH. Refer to [PWC-67, "Removal and Installation"](#).

NO >> Repair or replace harness.

### 5.CHECK GROUND CIRCUIT 1

1. Turn ignition switch OFF.
2. Check continuity between rear power window motor RH harness connector and ground.

Rear power window motor RH		Ground	Continuity
Connector	Terminal		
D47	4		Existed

Is the inspection result normal?

YES >> Replace rear power window motor RH. Refer to [GW-26, "Removal and Installation"](#).

NO >> GO TO 6.

### 6.CHECK GROUND CIRCUIT 2

1. Disconnect rear power window switch RH harness connector.
2. Check continuity between rear power window switch RH harness connector and rear power window motor RH harness connector.

Rear power window switch RH		Rear power window motor RH		Continuity
Connector	Terminal	Connector	Terminal	
D43	3	D47	4	Existed

3. Check continuity between rear power window switch RH harness connector and ground.

Rear power window switch RH		Ground	Continuity
Connector	Terminal		
D43	3		Not existed

Is the inspection result normal?

YES >> Replace rear power window switch RH. Refer to [PWC-67, "Removal and Installation"](#).

# ENCODER

< DTC/CIRCUIT DIAGNOSIS >

---

NO >> Repair or replace harness.

A  
B  
C  
D  
E  
F  
G  
H  
I  
J  
L  
M  
N  
O  
P

**PWC**

# DOOR KEY CYLINDER SWITCH

< DTC/CIRCUIT DIAGNOSIS >

## DOOR KEY CYLINDER SWITCH

### Component Function Check

INFOID:000000007377461

#### 1. CHECK DOOR KEY CYLINDER SWITCH INPUT SIGNAL

Check ("KEY CYL LK-SW", "KEY CYL UN-SW") in "DATA MONITOR" mode for "POWER DOOR LOCK SYSTEM" with CONSULT. Refer to [DLK-40, "DOOR LOCK : CONSULT Function \(BCM - DOOR LOCK\)"](#).

Monitor item	Condition
KEY CYL LK-SW	Lock : ON
	Neutral / Unlock : OFF
KEY CYL UN-SW	Unlock : ON
	Neutral / Lock : OFF

Is the inspection result normal?

- YES >> Door key cylinder switch is OK.  
 NO >> Refer to [PWC-46, "Diagnosis Procedure"](#).

### Diagnosis Procedure

INFOID:000000007377462

#### 1. CHECK DOOR KEY CYLINDER SWITCH SIGNAL

- Turn ignition switch OFF.
- Disconnect front door lock assembly (driver side) (door key cylinder switch) connect.
- Turn ignition switch ON.
- Check voltage between front door lock assembly (driver side) (door key cylinder switch) harness connector and ground.

(+)		(-)	Voltage (V) (Approx.)
Front door lock assembly (driver side) (door key cylinder switch)			
Connector	Terminal	Ground	5
D9	5		
	6		

Is the inspection result normal?

- YES >> GO TO 3.  
 NO >> GO TO 2.

#### 2. CHECK DOOR KEY CYLINDER SWITCH CIRCUIT

- Turn ignition switch OFF.
- Disconnect power window main switch connector.
- Check continuity between power window main switch harness connector and front door lock assembly (driver side) (door key cylinder switch) harness connector.

Power window main switch		Front door lock assembly (driver side) (door key cylinder switch)		Continuity
Connector	Terminal	Connector	Terminal	
D5	4	D9	6	Existed
	6		5	

- Check continuity between power window main switch harness connector and ground.

# DOOR KEY CYLINDER SWITCH

## < DTC/CIRCUIT DIAGNOSIS >

Power window main switch		Ground	Continuity
Connector	Terminal		
D5	4		Not existed
	6		

Is the inspection result normal?

- YES >> Replace power window main switch. Refer to [PWC-67. "Removal and Installation"](#).  
 NO >> Repair or replace harness.

### 3.CHECK DOOR KEY CYLINDER SWITCH GROUND CIRCUIT

Check continuity between front door lock assembly (driver side) (door key cylinder switch) harness connector and ground.

Front door lock assembly (driver side) (door key cylinder switch)		Ground	Continuity
Connector	Terminal		
D9	4		Existed

Is the inspection result normal?

- YES >> GO TO 4.  
 NO >> Repair or replace harness.

### 4.CHECK DOOR KEY CYLINDER SWITCH

Check front door lock assembly (driver side) (door key cylinder switch).  
 Refer to [PWC-47. "Component Inspection"](#).

Is the inspection result normal?

- YES >> GO TO 5.  
 NO >> Replace front door lock assembly (driver side) (door key cylinder switch). Refer to [DLK-223. "DOOR LOCK : Removal and Installation"](#).

### 5.CHECK INTERMITTENT INCIDENT

Refer to [GI-43. "Intermittent Incident"](#).

>> INSPECTION END

## Component Inspection

INFOID:000000007377463

### COMPONENT INSPECTION

#### 1.CHECK DOOR KEY CYLINDER SWITCH

- Turn ignition switch OFF.
- Disconnect front door lock assembly (driver side) (door key cylinder switch) connector.
- Check front door lock assembly (driver side) (door key cylinder switch).

Front door lock assembly (driver side) (door key cylinder switch)		Key position	Continuity
Terminal			
5	4	Unlock	Existed
		Neutral / Lock	Not existed
6		Lock	Existed
		Neutral / Unlock	Not existed

Is the inspection result normal?

- YES >> INSPECTION END  
 NO >> Replace front door lock assembly (driver side) (door key cylinder switch). Refer to [DLK-223. "DOOR LOCK : Removal and Installation"](#).

# POWER WINDOW SERIAL LINK

< DTC/CIRCUIT DIAGNOSIS >

## POWER WINDOW SERIAL LINK

### POWER WINDOW MAIN SWITCH

#### POWER WINDOW MAIN SWITCH : Component Function Check

INFOID:000000007377464

#### 1. CHECK POWER WINDOW SWITCH OUTPUT SIGNAL

##### With CONSULT

Check ("CDL LOCK SW", "CDL UNLOCK SW") in "DATA MONITOR" mode for "POWER DOOR LOCK SYSTEM" with CONSULT. Refer to [DLK-40, "DOOR LOCK : CONSULT Function \(BCM - DOOR LOCK\)"](#).

Monitor item	Condition
CDL LOCK SW	LOCK : ON
	UNLOCK : OFF
CDL UNLOCK SW	LOCK : OFF
	UNLOCK : ON

Is the inspection result normal?

YES >> Power window serial link is OK.

NO >> Refer to [PWC-48, "POWER WINDOW MAIN SWITCH : Diagnosis Procedure"](#).

#### POWER WINDOW MAIN SWITCH : Diagnosis Procedure

INFOID:000000007377465

#### 1. CHECK POWER WINDOW SWITCH INPUT SIGNAL

1. Turn ignition switch ON.
2. Check signal between power window main switch harness connector and ground with oscilloscope.

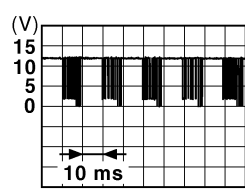
(+) power window main switch		(-)	Signal (Reference value)
Connector	Terminal		
D5	14	Ground	 <p style="text-align: right; font-size: small;">JPMIA0013GB</p>

Is the inspection result normal?

YES >> GO TO 4.

NO >> GO TO 2.

#### 2. CHECK POWER WINDOW SERIAL LINK SIGNAL

1. Turn ignition switch OFF.
2. Disconnect power window main switch connector.
3. Turn ignition switch ON.
4. Check voltage between power window main switch harness connector and ground.

(+) Power window main switch		(-)	Voltage (V) (Approx.)
Connector	Terminal		
D5	14	Ground	12

Is the inspection result normal?

YES >> Replace power window main switch. Refer to [PWC-67, "Removal and Installation"](#).



# POWER WINDOW SERIAL LINK

## < DTC/CIRCUIT DIAGNOSIS >

NO >> GO TO 3.

### 3.CHECK POWER WINDOW SERIAL LINK CIRCUIT

1. Disconnect BCM connector and power window main switch connector.
2. Check continuity between BCM harness connector and power window main switch harness connector.

BCM		Power window main switch		Continuity
Connector	Terminal	Connector	Terminal	
M68	8	D5	14	Existed

3. Check continuity between BCM harness connector and ground.

BCM		Ground	Continuity
Connector	Terminal		
M68	8		Not existed

Is the inspection result normal?

YES >> Replace BCM. Refer to [BCS-82, "Removal and Installation"](#).

NO >> Repair or replace harness.

### 4.CHECK INTERMITTENT INCIDENT

Refer to [GI-43, "Intermittent Incident"](#).

>> INSPECTION END

## FRONT POWER WINDOW SWITCH (PASSENGER SIDE)

### FRONT POWER WINDOW SWITCH (PASSENGER SIDE) : Component Function Check

INFOID:000000007377466

#### 1.CHECK POWER WINDOW SWITCH OUTPUT SIGNAL

##### With CONSULT

Check ("CDL LOCK SW", "CDL UNLOCK SW") in "DATA MONITOR" mode for "POWER DOOR LOCK SYSTEM" with CONSULT. Refer to [DLK-40, "DOOR LOCK : CONSULT Function \(BCM - DOOR LOCK\)"](#).

PWC

Monitor item	Condition
CDL LOCK SW	LOCK : ON
	UNLOCK : OFF
CDL UNLOCK SW	LOCK : OFF
	UNLOCK : ON

Is the inspection result normal?

YES >> Power window serial link is OK.

NO >> Refer to [PWC-49, "FRONT POWER WINDOW SWITCH \(PASSENGER SIDE\) : Diagnosis Procedure"](#).

### FRONT POWER WINDOW SWITCH (PASSENGER SIDE) : Diagnosis Procedure

INFOID:000000007377467

#### 1.CHECK POWER WINDOW SWITCH INPUT SIGNAL

1. Turn ignition switch ON.
2. Check signal between front power window switch (passenger side) harness connector and ground with oscilloscope.

# POWER WINDOW SERIAL LINK

## < DTC/CIRCUIT DIAGNOSIS >

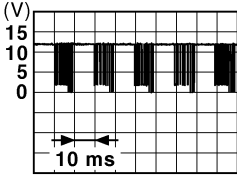
(+)		(-)	Signal (Reference value)
Front power window switch (passenger side)			
Connector	Terminal		
D25	16	Ground	 <p>(V) 15 10 5 0</p> <p>10 ms</p> <p>JPMIA0013GB</p>

Is the inspection result normal?

YES >> Replace front power window switch (passenger side). Refer to [PWC-67, "Removal and Installation"](#).

NO >> GO TO 2.

### 2. CHECK POWER WINDOW SERIAL LINK SIGNAL

1. Turn ignition switch OFF.
2. Disconnect front power window switch (passenger side) connector.
3. Turn ignition switch ON.
4. Check voltage between front power window switch (passenger side) harness connector and ground.

(+)		(-)	Voltage (V) (Approx.)
Front power window switch (passenger side)			
Connector	Terminal		
D25	16	Ground	12

Is the inspection result normal?

YES >> Replace power window main switch. Refer to [PWC-67, "Removal and Installation"](#).

NO >> GO TO 3.

### 3. CHECK POWER WINDOW SERIAL LINK CIRCUIT

1. Disconnect power window main switch connector.
2. Check continuity between power window main switch harness connector and front power window switch (passenger side) harness connector.

Power window main switch		Front power window switch (passenger side)		Continuity
Connector	Terminal	Connector	Terminal	
D5	14	D25	16	Existed

3. Check continuity between power window main switch harness connector and ground.

Power window main switch		Ground	Continuity
Connector	Terminal		
D5	14		Not existed

Is the inspection result normal?

YES >> GO TO 4.

NO >> Repair or replace harness.

### 4. CHECK INTERMITTENT INCIDENT

Refer to [GI-43, "Intermittent Incident"](#).

>> INSPECTION END

## REAR POWER WINDOW SWITCH LH

# POWER WINDOW SERIAL LINK

< DTC/CIRCUIT DIAGNOSIS >

## REAR POWER WINDOW SWITCH LH : Component Function Check

INFOID:000000007377468

### 1. CHECK POWER WINDOW SWITCH OUTPUT SIGNAL

#### With CONSULT

Check ("CDL LOCK SW", "CDL UNLOCK SW") in "DATA MONITOR" mode for "POWER DOOR LOCK SYSTEM" with CONSULT. Refer to [DLK-40, "DOOR LOCK : CONSULT Function \(BCM - DOOR LOCK\)"](#).

Monitor item	Condition
CDL LOCK SW	LOCK : ON
	UNLOCK : OFF
CDL UNLOCK SW	LOCK : OFF
	UNLOCK : ON

Is the inspection result normal?

YES >> Power window serial link is OK.

NO >> Refer to [PWC-51, "REAR POWER WINDOW SWITCH LH : Diagnosis Procedure"](#).

## REAR POWER WINDOW SWITCH LH : Diagnosis Procedure

INFOID:000000007377469

### 1. CHECK POWER WINDOW SWITCH INPUT SIGNAL

- Turn ignition switch ON.
- Check signal between rear power window switch LH harness connector and ground with oscilloscope.

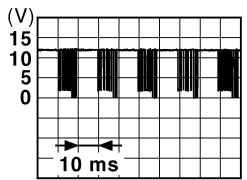
(+)		(-)	Signal (Reference value)
Connector	Terminal		
D63	16	Ground	 <p style="text-align: right;">JPMA0013GB</p>

Is the inspection result normal?

YES >> Replace rear power window switch LH. Refer to [PWC-67, "Removal and Installation"](#).

NO >> GO TO 2.

### 2. CHECK POWER WINDOW SERIAL LINK SIGNAL

- Turn ignition switch OFF.
- Disconnect rear power window switch LH connector.
- Turn ignition switch ON.
- Check voltage between rear power window switch LH harness connector and ground.

(+)		(-)	Voltage (V) (Approx.)
Connector	Terminal		
D63	16	Ground	12

Is the inspection result normal?

YES >> Replace power window main switch. Refer to [PWC-67, "Removal and Installation"](#).

NO >> GO TO 3.

### 3. CHECK POWER WINDOW SERIAL LINK CIRCUIT

- Disconnect power window main switch connector.

A  
B  
C  
D  
E  
F  
G  
H  
I  
J  
L  
M  
N  
O  
P



# POWER WINDOW SERIAL LINK

## < DTC/CIRCUIT DIAGNOSIS >

2. Check continuity between power window main switch harness connector and rear power window switch LH harness connector.

Power window main switch		Rear power window switch LH		Continuity
Connector	Terminal	Connector	Terminal	
D5	14	D63	16	Existed

3. Check continuity between power window main switch harness connector and ground.

Power window main switch		Ground	Continuity
Connector	Terminal		
D5	14		Not existed

Is the inspection result normal?

- YES >> GO TO 4.  
 NO >> Repair or replace harness.

## 4.CHECK INTERMITTENT INCIDENT

Refer to [GI-43. "Intermittent Incident"](#).

>> INSPECTION END

## REAR POWER WINDOW SWITCH RH

### REAR POWER WINDOW SWITCH RH : Component Function Check

INFOID:000000007377470

#### 1.CHECK POWER WINDOW SWITCH OUTPUT SIGNAL

##### With CONSULT

Check ("CDL LOCK SW ", "CDL UNLOCK SW") in "DATA MONITOR" mode for "POWER DOOR LOCK SYSTEM" with CONSULT. Refer to [DLK-40. "DOOR LOCK : CONSULT Function \(BCM - DOOR LOCK\)"](#).

Monitor item	Condition	
CDL LOCK SW	LOCK	: ON
	UNLOCK	: OFF
CDL UNLOCK SW	LOCK	: OFF
	UNLOCK	: ON

Is the inspection result normal?

- YES >> Power window serial link is OK.  
 NO >> Refer to [PWC-52. "REAR POWER WINDOW SWITCH RH : Diagnosis Procedure"](#).

### REAR POWER WINDOW SWITCH RH : Diagnosis Procedure

INFOID:000000007377471

#### 1.CHECK POWER WINDOW SWITCH INPUT SIGNAL

1. Turn ignition switch ON.
2. Check signal between rear power window switch RH harness connector and ground with oscilloscope.

# POWER WINDOW SERIAL LINK

## < DTC/CIRCUIT DIAGNOSIS >

(+)		(-)	Signal (Reference value)
Rear power window switch RH			
Connector	Terminal		
D43	16	Ground	<p style="text-align: right; font-size: small;">JPMA0013GB</p>

Is the inspection result normal?

- YES >> Replace rear power window switch RH. Refer to [PWC-67, "Removal and Installation"](#).  
 NO >> GO TO 2.

### 2.CHECK POWER WINDOW SERIAL LINK SIGNAL

1. Turn ignition switch OFF.
2. Disconnect rear power window switch RH connector.
3. Turn ignition switch ON.
4. Check voltage between rear power window switch RH harness connector and ground.

(+)		(-)	Voltage (V) (Approx.)
Rear power window switch RH			
Connector	Terminal		
D43	16	Ground	12

Is the inspection result normal?

- YES >> Replace power window main switch. Refer to [PWC-67, "Removal and Installation"](#).  
 NO >> GO TO 3.

### 3.CHECK POWER WINDOW SERIAL LINK CIRCUIT

1. Disconnect power window main switch connector.
2. Check continuity between power window main switch harness connector and rear power window switch RH harness connector.

Power window main switch		Rear power window switch RH		Continuity
Connector	Terminal	Connector	Terminal	
D5	14	D43	16	Existed

3. Check continuity between power window main switch harness connector and ground.

Power window main switch		Ground	Continuity
Connector	Terminal		
D5	14		Not existed

Is the inspection result normal?

- YES >> GO TO 4.  
 NO >> Repair or replace harness.

### 4.CHECK INTERMITTENT INCIDENT

Refer to [GI-43, "Intermittent Incident"](#).

>> INSPECTION END

# POWER WINDOWS DO NOT OPERATE WITH POWER WINDOW MAIN SWITCH

< SYMPTOM DIAGNOSIS >

## SYMPTOM DIAGNOSIS

### POWER WINDOWS DO NOT OPERATE WITH POWER WINDOW MAIN SWITCH

#### Diagnosis Procedure

INFOID:000000007377472

#### 1. CHECK BCM POWER SUPPLY AND GROUND CIRCUIT

---

Check BCM power supply and ground circuit.

[BCS-82. "Removal and Installation"](#).

Is the inspection result normal?

YES >> GO TO 2.

NO >> Repair or replace the malfunctioning parts.

#### 2. CHECK POWER WINDOW MAIN SWITCH POWER SUPPLY AND GROUND CIRCUIT

---

Check power window switch power supply and ground circuit.

Refer to [PWC-28. "POWER WINDOW MAIN SWITCH : Diagnosis Procedure"](#).

Is the inspection result normal?

YES >> GO TO 3.

NO >> Repair or replace the malfunctioning parts.

#### 3. CHECK POWER WINDOW MAIN SWITCH SERIAL LINK CIRCUIT

---

Check power window serial link circuit.

Refer to [PWC-48. "POWER WINDOW MAIN SWITCH : Component Function Check"](#).

Is the inspection result normal?

YES >> GO TO 4.

NO >> Repair or replace the malfunctioning parts.

#### 4. CONFIRM THE OPERATION

---

Confirm the operation again.

Is the result normal?

YES >> Check intermittent incident. Refer to [GI-43. "Intermittent Incident"](#).

NO >> GO TO 1.

# DRIVER SIDE POWER WINDOW ALONE DOES NOT OPERATE

< SYMPTOM DIAGNOSIS >

## DRIVER SIDE POWER WINDOW ALONE DOES NOT OPERATE

### Diagnosis Procedure

INFOID:000000007377473

#### 1. CHECK DRIVER SIDE POWER WINDOW MOTOR

Check driver side power window motor.

Refer to [PWC-32, "DRIVER SIDE : Component Function Check"](#).

Is the measurement value within the specification?

YES >> GO TO 2.

NO >> Repair or replace the malfunctioning parts.

#### 2. CONFIRM THE OPERATION

Confirm the operation again.

Is the result normal?

YES >> Check intermittent incident. Refer to [GI-43, "Intermittent Incident"](#).

NO >> GO TO 1.

A  
B  
C  
D  
E  
F  
G  
H  
I  
J  
L  
M  
N  
O  
P

PWC

# FRONT PASSENGER SIDE POWER WINDOW DOES NOT OPERATE

< SYMPTOM DIAGNOSIS >

---

## FRONT PASSENGER SIDE POWER WINDOW DOES NOT OPERATE WHEN POWER WINDOW MAIN SWITCH IS OPERATED

WHEN POWER WINDOW MAIN SWITCH IS OPERATED : Diagnosis Procedure

INFOID:000000007377474

### 1. CHECK FRONT POWER WINDOW SWITCH (PASSENGER SIDE) SERIAL LINK CIRCUIT

Check front power window switch (passenger side) serial link circuit.

Refer to [PWC-49. "FRONT POWER WINDOW SWITCH \(PASSENGER SIDE\) : Component Function Check"](#).

Is the inspection result normal?

YES >> GO TO 2.

NO >> Repair or replace the malfunctioning parts.

### 2. CONFIRM THE OPERATION

Confirm the operation again.

Is the result normal?

YES >> Check intermittent incident. Refer to [GI-43. "Intermittent Incident"](#).

NO >> GO TO 1.

## WHEN FRONT POWER WINDOW SWITCH (PASSENGER SIDE) IS OPERATED

WHEN FRONT POWER WINDOW SWITCH (PASSENGER SIDE) IS OPERATED :  
Diagnosis Procedure

INFOID:000000007377475

### 1. REPLACE FRONT POWER WINDOW SWITCH (PASSENGER SIDE)

Replace front power window switch (passenger side).

Refer to [PWC-67. "Removal and Installation"](#)

>> INSPECTION END

## WHEN BOTH POWER WINDOW MAIN SWITCH AND FRONT POWER WINDOW SWITCH ARE OPERATED

WHEN BOTH POWER WINDOW MAIN SWITCH AND FRONT POWER WINDOW  
SWITCH ARE OPERATED : Diagnosis Procedure

INFOID:000000007377476

### 1. CHECK FRONT POWER WINDOW SWITCH (PASSENGER SIDE) POWER SUPPLY AND GROUND CIR- CUIT

Check front power window switch (passenger side) power supply and ground circuit.

Refer to [PWC-29. "FRONT POWER WINDOW SWITCH \(PASSENGER SIDE\) : Diagnosis Procedure"](#).

Is the inspection result normal?

YES >> GO TO 2.

NO >> Repair or replace the malfunctioning parts.

### 2. CHECK PASSENGER SIDE POWER WINDOW MOTOR CIRCUIT

Check passenger side power window motor circuit.

Refer to [PWC-33. "PASSENGER SIDE : Component Function Check"](#).

Is the inspection result normal?

YES >> GO TO 3.

NO >> Repair or replace the malfunctioning parts.

### 3. CONFIRM THE OPERATION

Confirm the operation again.

Is the result normal?

YES >> Check intermittent incident. Refer to [GI-43. "Intermittent Incident"](#).

NO >> GO TO 1.



# REAR LH SIDE POWER WINDOW ALONE DOES NOT OPERATE

< SYMPTOM DIAGNOSIS >

## REAR LH SIDE POWER WINDOW ALONE DOES NOT OPERATE WHEN POWER WINDOW MAIN SWITCH IS OPERATED

WHEN POWER WINDOW MAIN SWITCH IS OPERATED : Diagnosis Procedure

INFOID:000000007377477

### 1. CHECK REAR POWER WINDOW SWITCH LH SERIAL LINK CIRCUIT

Check rear power window switch LH serial link circuit.

Refer to [PWC-51, "REAR POWER WINDOW SWITCH LH : Component Function Check"](#).

Is the inspection result normal?

YES >> GO TO 2.

NO >> Repair or replace the malfunctioning parts.

### 2. CONFIRM THE OPERATION

Confirm the operation again.

Is the result normal?

YES >> Check intermittent incident. Refer to [GI-43, "Intermittent Incident"](#).

NO >> GO TO 1.

## WHEN REAR POWER WINDOW SWITCH LH IS OPERATED

WHEN REAR POWER WINDOW SWITCH LH IS OPERATED : Diagnosis Procedure

INFOID:000000007377478

### 1. REPLACE REAR POWER WINDOW SWITCH LH

Replace rear power window switch LH.

Refer to [PWC-67, "Removal and Installation"](#)

>> INSPECTION END

## WHEN BOTH POWER WINDOW MAIN SWITCH AND REAR POWER WINDOW SWITCH LH ARE OPERATED

WHEN BOTH POWER WINDOW MAIN SWITCH AND REAR POWER WINDOW  
SWITCH LH ARE OPERATED : Diagnosis Procedure

INFOID:000000007377479

PWC

### 1. CHECK REAR POWER WINDOW SWITCH POWER SUPPLY AND GROUND CIRCUIT

Check rear power window switch power supply and ground circuit.

Refer to [PWC-30, "REAR POWER WINDOW SWITCH : Diagnosis Procedure"](#).

Is the inspection result normal?

YES >> GO TO 2.

NO >> Repair or replace the malfunctioning parts.

### 2. CHECK REAR POWER WINDOW MOTOR LH

Check rear power window motor LH.

Refer to [PWC-34, "REAR LH : Component Function Check"](#).

Is the inspection result normal?

YES >> GO TO 3.

NO >> Repair or replace the malfunctioning parts.

### 3. CONFIRM THE OPERATION

Confirm the operation again.

Is the result normal?

YES >> Check intermittent incident. Refer to [GI-43, "Intermittent Incident"](#).

NO >> GO TO 1.

## REAR RH SIDE POWER WINDOW ALONE DOES NOT OPERATE

< SYMPTOM DIAGNOSIS >

### REAR RH SIDE POWER WINDOW ALONE DOES NOT OPERATE WHEN POWER WINDOW MAIN SWITCH IS OPERATED

WHEN POWER WINDOW MAIN SWITCH IS OPERATED : Diagnosis Procedure

INFOID:000000007377480

#### 1. CHECK REAR POWER WINDOW SWITCH RH SERIAL LINK CIRCUIT

Check rear power window switch RH serial link circuit.

Refer to [PWC-52, "REAR POWER WINDOW SWITCH RH : Component Function Check"](#).

Is the inspection result normal?

YES >> GO TO 2.

NO >> Repair or replace the malfunctioning parts.

#### 2. CONFIRM THE OPERATION

Confirm the operation again.

Is the result normal?

YES >> Check intermittent incident. Refer to [GI-43, "Intermittent Incident"](#).

NO >> GO TO 1.

### WHEN REAR POWER WINDOW SWITCH RH IS OPERATED

WHEN REAR POWER WINDOW SWITCH RH IS OPERATED : Diagnosis Procedure

INFOID:000000007377481

#### 1. REPLACE REAR POWER WINDOW SWITCH RH

Replace rear power window switch RH.

Refer to [PWC-67, "Removal and Installation"](#)

>> INSPECTION END

### WHEN BOTH POWER WINDOW MAIN SWITCH AND REAR POWER WINDOW SWITCH RH ARE OPERATED

WHEN BOTH POWER WINDOW MAIN SWITCH AND REAR POWER WINDOW  
SWITCH RH ARE OPERATED : Diagnosis Procedure

INFOID:000000007377482

#### 1. CHECK REAR POWER WINDOW SWITCH POWER SUPPLY AND GROUND CIRCUIT

Check rear power window switch power supply and ground circuit.

Refer to [PWC-30, "REAR POWER WINDOW SWITCH : Diagnosis Procedure"](#).

Is the inspection result normal?

YES >> GO TO 2.

NO >> Repair or replace the malfunctioning parts.

#### 2. CHECK REAR POWER WINDOW MOTOR RH

Check rear power window motor RH.

Refer to [PWC-34, "REAR RH : Component Function Check"](#).

Is the inspection result normal?

YES >> GO TO 3.

NO >> Repair or replace the malfunctioning parts.

#### 3. CONFIRM THE OPERATION

Confirm the operation again.

Is the result normal?

YES >> Check intermittent incident. Refer to [GI-43, "Intermittent Incident"](#).

NO >> GO TO 1.

# AUTO OPERATION DOES NOT OPERATE BUT MANUAL OPERATE NORMALLY

< SYMPTOM DIAGNOSIS >

## AUTO OPERATION DOES NOT OPERATE BUT MANUAL OPERATE NORMALLY

### DRIVER SIDE

#### DRIVER SIDE : Diagnosis Procedure

INFOID:000000007377483

#### 1.PERFORM INITIALIZATION PROCEDURE

Initialization procedure is performed and operation is confirmed.  
Refer to [PWC-26, "Work Procedure"](#).

Is the inspection result normal?

YES >> INSPECTION END  
NO >> GO TO 2.

#### 2.CHECK ENCODER (DRIVER SIDE) CIRCUIT

Check encoder (driver side) circuit.  
Refer to [PWC-36, "DRIVER SIDE : Component Function Check"](#).

Is the inspection result normal?

YES >> GO TO 3.  
NO >> Repair or replace the malfunctioning parts.

#### 3.CONFIRM THE OPERATION

Confirm the operation again.

Is the result normal?

YES >> Check intermittent incident. Refer to [GI-43, "Intermittent Incident"](#).  
NO >> GO TO 1.

### PASSENGER SIDE

#### PASSENGER SIDE : Diagnosis Procedure

INFOID:000000007377484

#### 1.PERFORM INITIALIZAITON PROCEDURE

Initialization procedure is performed and operation is confirmed.  
Refer to [PWC-26, "Work Procedure"](#).

Is the inspection result normal?

YES >> INSPECTION END  
NO >> GO TO 2.

#### 2.CHECK ENCODER (PASSENGER SIDE) CIRCUIT

Check encoder (passenger side) circuit.  
Refer to [PWC-38, "PASSENGER SIDE : Component Function Check"](#).

Is the inspection result normal?

YES >> GO TO 3.  
NO >> Repair or replace the malfunctioning parts.

#### 3.CONFIRM THE OPERATION

Confirm the operation again.

Is the result normal?

YES >> Check intermittent incident. Refer to [GI-43, "Intermittent Incident"](#).  
NO >> GO TO 1.

### REAR LH

#### REAR LH : Diagnosis Procedure

INFOID:000000007377485

#### 1.PERFORM INITIALIZATION PROCEDURE

Initialization procedure is performed and operation is confirmed.

A  
B  
C  
D  
E  
F  
G  
H  
I  
J  
L  
M  
N  
O  
P

PWC

# AUTO OPERATION DOES NOT OPERATE BUT MANUAL OPERATE NORMALLY

## < SYMPTOM DIAGNOSIS >

---

Refer to [PWC-26. "Work Procedure"](#)

Is the inspection result normal?

- YES >> INSPECTION END
- NO >> GO TO 2.

### 2. CHECK ENCODER (REAR LH) CIRCUIT

---

Check encoder (rear LH) circuit.

Refer to [PWC-40. "REAR LH : Component Function Check"](#).

Is the inspection result normal?

- YES >> GO TO 3.
- NO >> Repair or replace the malfunctioning parts.

### 3. CONFIRM THE OPERATION

---

Confirm the operation again.

Is the result normal?

- YES >> Check intermittent incident. Refer to [GI-43. "Intermittent Incident"](#).
- NO >> GO TO 1.

## REAR RH

### REAR RH : Diagnosis Procedure

INFOID:000000007377486

#### 1. PERFORM INITIALIZATION PROCEDURE

---

Initialization procedure is performed and operation is confirmed.

Refer to [PWC-26. "Work Procedure"](#).

Is the inspection result normal?

- YES >> INSPECTION END
- NO >> GO TO 2.

#### 2. CHECK ENCODER (REAR RH) CIRCUIT

---

Check encoder (rear RH) circuit.

Refer to [PWC-42. "REAR RH : Component Function Check"](#).

Is the inspection result normal?

- YES >> GO TO 3.
- NO >> Repair or replace the malfunctioning parts.

#### 3. CONFIRM THE OPERATION

---

Confirm the operation again.

Is the result normal?

- YES >> Check intermittent incident. Refer to [GI-43. "Intermittent Incident"](#).
- NO >> GO TO 1.

# ANTI-PINCH FUNCTION DOES NOT OPERATE

< SYMPTOM DIAGNOSIS >

## ANTI-PINCH FUNCTION DOES NOT OPERATE

### Diagnosis Procedure

INFOID:000000007377487

#### 1. CHECK POWER WINDOW AUTO OPERATION

Check AUTO operation of the door when anti-pinch function does not operate.

Is the inspection result normal?

YES >> GO TO 2.

NO >> Refer to [PWC-59, "DRIVER SIDE : Diagnosis Procedure"](#) (driver side), [PWC-59, "PASSENGER SIDE : Diagnosis Procedure"](#) (passenger side), [PWC-59, "REAR LH : Diagnosis Procedure"](#) (rear LH), [PWC-60, "REAR RH : Diagnosis Procedure"](#) (rear RH).

#### 2. CONFIRM THE OPERATION

Confirm the operation again.

Is the inspection result normal?

YES >> Check intermittent incident. Refer to [GI-43, "Intermittent Incident"](#).

NO >> GO TO 1.

A  
B  
C  
D  
E  
F  
G  
H  
I  
J  
L  
M  
N  
O  
P

PWC

# POWER WINDOW RETAINED POWER FUNCTION DOES NOT OPERATE NORMALLY

< SYMPTOM DIAGNOSIS >

---

## POWER WINDOW RETAINED POWER FUNCTION DOES NOT OPERATE NORMALLY

### Diagnosis Procedure

INFOID:000000007377488

#### 1. CHECK DOOR SWITCH

---

Check door switch.

Refer to [DLK-99, "Component Function Check"](#).

Is the inspection result normal?

YES >> GO TO 2.

NO >> Repair or replace the malfunctioning parts.

#### 2. CONFIRM THE OPERATION

---

Confirm the operation again.

Is the result normal?

YES >> Check intermittent incident. Refer to [GI-43, "Intermittent Incident"](#).

NO >> GO TO 1.

# DOOR KEY CYLINDER SWITCH DOES NOT OPERATE POWER WINDOWS

< SYMPTOM DIAGNOSIS >

## DOOR KEY CYLINDER SWITCH DOES NOT OPERATE POWER WINDOWS

### Diagnosis Procedure

INFOID:000000007377489

#### 1.PERFORM INITIALIZATION PROCEDURE

Initialization procedure is performed and operation is confirmed.

Refer to [PWC-26, "Work Procedure"](#)

Is the inspection result normal?

YES >> INSPECTION END

NO >> GO TO 2.

#### 2.CHECK DRIVER SIDE DOOR LOCK ASSEMBLY (DOOR KEY CYLINDER SWITCH)

Check front door lock assembly (driver side) (door key cylinder switch).

Refer to [PWC-46, "Component Function Check"](#)

Is the inspection result normal?

YES >> GO TO 3.

NO >> Repair or replace the malfunctioning parts.

#### 3.CONFIRM THE OPERATION

Confirm the operation again.

Is the result normal?

YES >> Check intermittent incident. Refer to [GI-43, "Intermittent Incident"](#).

NO >> GO TO 1.

A  
B  
C  
D  
E  
F  
G  
H  
I  
J  
L  
M  
N  
O  
P

PWC

# KEYLESS POWER WINDOW DOWN DOES NOT OPERATE

< SYMPTOM DIAGNOSIS >

---

## KEYLESS POWER WINDOW DOWN DOES NOT OPERATE

### Diagnosis Procedure

INFOID:000000007377490

#### 1. CHECK REMOTE KEYLESS ENTRY FUNCTION

---

Check remote keyless entry function.

Does door lock/unlock with Intelligent key button?

YES >> GO TO 2.

NO >> Refer to [DLK-158, "Diagnosis Procedure"](#).

#### 2. CHECK POWER WINDOW OPERATION

---

Check power window operation.

Does power window up/down with power window main switch?

YES >> GO TO 3.

NO >> Refer to [PWC-28, "POWER WINDOW MAIN SWITCH : Diagnosis Procedure"](#).

#### 3. CHECK "PW DOWN SET" SETTING IN "WORK SUPPORT"

---

Check "PW DOWN SET" setting in "WORK SUPPORT".

Refer to [DLK-42, "INTELLIGENT KEY : CONSULT Function \(BCM - INTELLIGENT KEY\)"](#).

Is the inspection result normal?

YES >> GO TO 4.

NO >> Set "PW DOWN SET" setting in "WORK SUPPORT".

#### 4. CONFIRM THE OPERATION

---

Confirm the operation again.

Is the result normal?

YES >> Check intermittent incident. Refer to [GI-43, "Intermittent Incident"](#).

NO >> GO TO 1.



# POWER WINDOW LOCK SWITCH DOES NOT FUNCTION

< SYMPTOM DIAGNOSIS >

---

## POWER WINDOW LOCK SWITCH DOES NOT FUNCTION

Diagnosis Procedure

INFOID:000000007377491

### 1. REPLACE POWER WINDOW MAIN SWITCH

---

Replace power window main switch. Refer to [PWC-67, "Removal and Installation"](#).

>> INSPECTION END

A  
B  
C  
D  
E  
F  
G  
H  
I  
J  
L  
M  
N  
O  
P

PWC

# POWER WINDOW SWITCH DOES NOT ILLUMINATE

< SYMPTOM DIAGNOSIS >

---

## POWER WINDOW SWITCH DOES NOT ILLUMINATE

### DRIVER SIDE

#### DRIVER SIDE : Diagnosis Procedure

INFOID:000000007377492

#### 1. REPLACE POWER WINDOW MAIN SWITCH

---

Replace power window main switch.

Refer to [PWC-67, "Removal and Installation"](#).

>> INSPECTION END

### PASSENGER SIDE

#### PASSENGER SIDE : Diagnosis Procedure

INFOID:000000007377493

#### 1. REPLACE FRONT POWER WINDOW SWITCH (PASSENGER SIDE)

---

Replace front power window switch (passenger side).

Refer to [PWC-67, "Removal and Installation"](#).

>> INSPECTION END

### REAR LH

#### REAR LH : Diagnosis Procedure

INFOID:000000007377494

#### 1. REPLACE REAR POWER WINDOW SWITCH LH

---

Replace rear power window switch LH.

Refer to [PWC-67, "Removal and Installation"](#).

>> INSPECTION END

### REAR RH

#### REAR RH : Diagnosis Procedure

INFOID:000000007377495

#### 1. REPLACE REAR POWER WINDOW SWITCH RH

---

Replace rear power window switch RH.

Refer to [PWC-67, "Removal and Installation"](#).

>> INSPECTION END

# POWER WINDOW MAIN SWITCH

< REMOVAL AND INSTALLATION >

## REMOVAL AND INSTALLATION

### POWER WINDOW MAIN SWITCH

#### Removal and Installation

INFOID:000000007377496

#### REMOVAL

1. Remove the power window main switch finisher.  
Refer to [INT-13, "Removal and Installation"](#).
2. Power window main switch is removed from power window main switch finisher using remover tool.

#### **CAUTION:**

**Never fold the pawl of power window main switch finisher.**

#### **NOTE:**

The same procedure is also performed for front power window switch (passenger side) and rear power window switch (LH & RH).

#### INSTALLATION

Install in the reverse order of removal.

#### **NOTE:**

When power window switch is replaced or is removed, it is necessary to do the initialization procedure.  
Refer to [PWC-25, "Work Procedure"](#).

A  
B  
C  
D  
E  
F  
G  
H  
I  
J  
L  
M  
N  
O  
P

PWC