

SECTION **PWO**  
POWER OUTLET

A  
B  
C

CONTENTS

<b>POWER SOCKET</b>	<b>SYSTEM DESCRIPTION</b> .....	12	F
<b>PRECAUTION</b> .....	<b>COMPONENT PARTS</b> .....	12	G
<b>PRECAUTIONS</b> .....	Component Parts Location .....	12	H
Precaution for Supplemental Restraint System (SRS) "AIR BAG" and "SEAT BELT PRE-TENSIONER" .....	Component Description .....	12	I
Precaution for Work .....	Inverter Unit .....	12	J
<b>PREPARATION</b> .....	AC 120V Outlet Main Switch .....	12	K
<b>PREPARATION</b> .....	AC 120V Outlet .....	12	L
Special Service Tool .....	<b>SYSTEM</b> .....	13	PWO
<b>SYSTEM DESCRIPTION</b> .....	System Diagram .....	13	N
<b>COMPONENT PARTS</b> .....	System Description .....	13	O
Component Parts Location .....	Fail-safe .....	13	P
<b>WIRING DIAGRAM</b> .....	<b>ECU DIAGNOSIS INFORMATION</b> .....	14	
<b>POWER SOCKET</b> .....	<b>INVERTER UNIT</b> .....	14	
Wiring Diagram .....	Reference Value .....	14	
<b>REMOVAL AND INSTALLATION</b> .....	Fail-safe .....	15	
<b>POWER SOCKET</b> .....	<b>WIRING DIAGRAM</b> .....	16	
Removal and Installation .....	<b>INVERTER UNIT</b> .....	16	
<b>AC 120 V OUTLET</b>	Wiring Diagram .....	16	
<b>PRECAUTION</b> .....	<b>BASIC INSPECTION</b> .....	20	
<b>PRECAUTIONS</b> .....	<b>DIAGNOSIS AND REPAIR WORK FLOW</b> .....	20	
Precaution for Supplemental Restraint System (SRS) "AIR BAG" and "SEAT BELT PRE-TENSIONER" .....	Work Flow .....	20	
Precaution for Work .....	<b>DTC/CIRCUIT DIAGNOSIS</b> .....	22	
<b>PREPARATION</b> .....	<b>POWER SUPPLY AND GROUND CIRCUIT</b> .....	22	
<b>PREPARATION</b> .....	Diagnosis Procedure .....	22	
Special Service Tool .....	<b>AC 120 V OUTLET MAIN SWITCH POWER SUPPLY CIRCUIT</b> .....	23	
	Diagnosis Procedure .....	23	
	<b>AC 120 V OUTLET MAIN SWITCH INPUT SIGNAL CIRCUIT</b> .....	24	
	Diagnosis Procedure .....	24	

Component Inspection (AC 120V Outlet Main Switch) .....	24	Description .....	31
<b>AC 120 V POWER OUTPUT CIRCUIT .....</b>	<b>26</b>	<b>REMOVAL AND INSTALLATION .....</b>	<b>32</b>
Diagnosis Procedure .....	26	<b>INVERTER UNIT .....</b>	<b>32</b>
<b>AC 120 V OUTLET MAIN SWITCH INDICATOR CIRCUIT .....</b>	<b>28</b>	Removal and Installation .....	32
Diagnosis Procedure .....	28	<b>AC 120V OUTLET MAIN SW .....</b>	<b>33</b>
<b>SYMPTOM DIAGNOSIS .....</b>	<b>29</b>	Removal and Installation .....	33
<b>NO OUTPUT FROM AC 120 V OUTLET .....</b>	<b>29</b>	<b>AC 120 V OUTLET .....</b>	<b>34</b>
Diagnosis Procedure .....	29	Removal and Installation .....	34
<b>AC 120 V OUTLET MAIN SWITCH INDICATOR DOES NOT TURN ON .....</b>	<b>30</b>	<b>SERVICE DATA AND SPECIFICATIONS (SDS) .....</b>	<b>35</b>
Diagnosis Procedure .....	30	<b>SERVICE DATA AND SPECIFICATIONS (SDS) .....</b>	<b>35</b>
<b>NORMAL OPERATING CONDITION .....</b>	<b>31</b>	AC 120V Power Outlet .....	35

PRECAUTION

PRECAUTIONS

Precaution for Supplemental Restraint System (SRS) "AIR BAG" and "SEAT BELT PRE-TENSIONER"

INFOID:000000011133871

The Supplemental Restraint System such as "AIR BAG" and "SEAT BELT PRE-TENSIONER", used along with a front seat belt, helps to reduce the risk or severity of injury to the driver and front passenger for certain types of collision. This system includes dual stage front air bag modules. The SRS system may only deploy one front air bag, depending on the severity of a collision and whether the front passenger seat is occupied. Information necessary to service the system safely is included in the SR and SB section of this Service Manual.

**WARNING:**

- To avoid rendering the SRS inoperative, which could increase the risk of personal injury or death in the event of a collision which would result in air bag inflation, all maintenance must be performed by an authorized NISSAN/INFINITI dealer.
- Improper maintenance, including incorrect removal and installation of the SRS, can lead to personal injury caused by unintentional activation of the system. For removal of Spiral Cable and Air Bag Module, see the SR section.
- Do not use electrical test equipment on any circuit related to the SRS unless instructed to in this Service Manual. SRS wiring harnesses can be identified by yellow and/or orange harnesses or harness connectors.

PRECAUTIONS WHEN USING POWER TOOLS (AIR OR ELECTRIC) AND HAMMERS

**WARNING:**

- When working near the Airbag Diagnosis Sensor Unit or other Airbag System sensors with the Ignition ON or engine running, DO NOT use air or electric power tools or strike near the sensor(s) with a hammer. Heavy vibration could activate the sensor(s) and deploy the air bag(s), possibly causing serious injury.
- When using air or electric power tools or hammers, always switch the Ignition OFF, disconnect the battery and wait at least three minutes before performing any service.

Precaution for Work

INFOID:000000011133872

- When removing or disassembling each component, be careful not to damage or deform it. If a component may be subject to interference, be sure to protect it with a shop cloth.
- When removing (disengaging) components with a screwdriver or similar tool, be sure to wrap the component with a shop cloth or vinyl tape to protect it.
- Protect the removed parts with a shop cloth and prevent them from being dropped.
- Replace a deformed or damaged clip.
- If a part is specified as a non-reusable part, always replace it with a new one.
- Be sure to tighten bolts and nuts securely to the specified torque.
- After installation is complete, be sure to check that each part works properly.
- Follow the steps below to clean components:
  - Water soluble dirt:
    - Dip a soft cloth into lukewarm water, wring the water out of the cloth and wipe the dirty area.
    - Then rub with a soft, dry cloth.
  - Oily dirt:
    - Dip a soft cloth into lukewarm water with mild detergent (concentration: within 2 to 3%) and wipe the dirty area.
    - Then dip a cloth into fresh water, wring the water out of the cloth and wipe the detergent off.
    - Then rub with a soft, dry cloth.
  - Do not use organic solvent such as thinner, benzene, alcohol or gasoline.
  - For genuine leather seats, use a genuine leather seat cleaner.

PWO

PREPARATION

PREPARATION

Special Service Tool

INFOID:000000011133873

The actual shape of the tools may differ from those illustrated here.

Tool number (TechMate No.) Tool name	Description
— (J-42059) Power Socket Removal Tool	Removing power sockets
— (J-46534) Trim Tool Set	Removing trim components

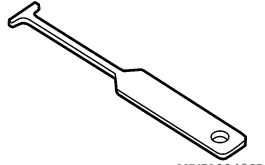

AWMIA1148GB

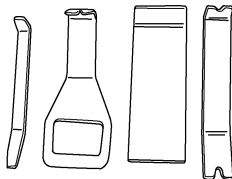

AWJIA0483ZZ

# COMPONENT PARTS

< SYSTEM DESCRIPTION >

[POWER SOCKET]

## SYSTEM DESCRIPTION

### COMPONENT PARTS

#### Component Parts Location

INFOID:000000011133874

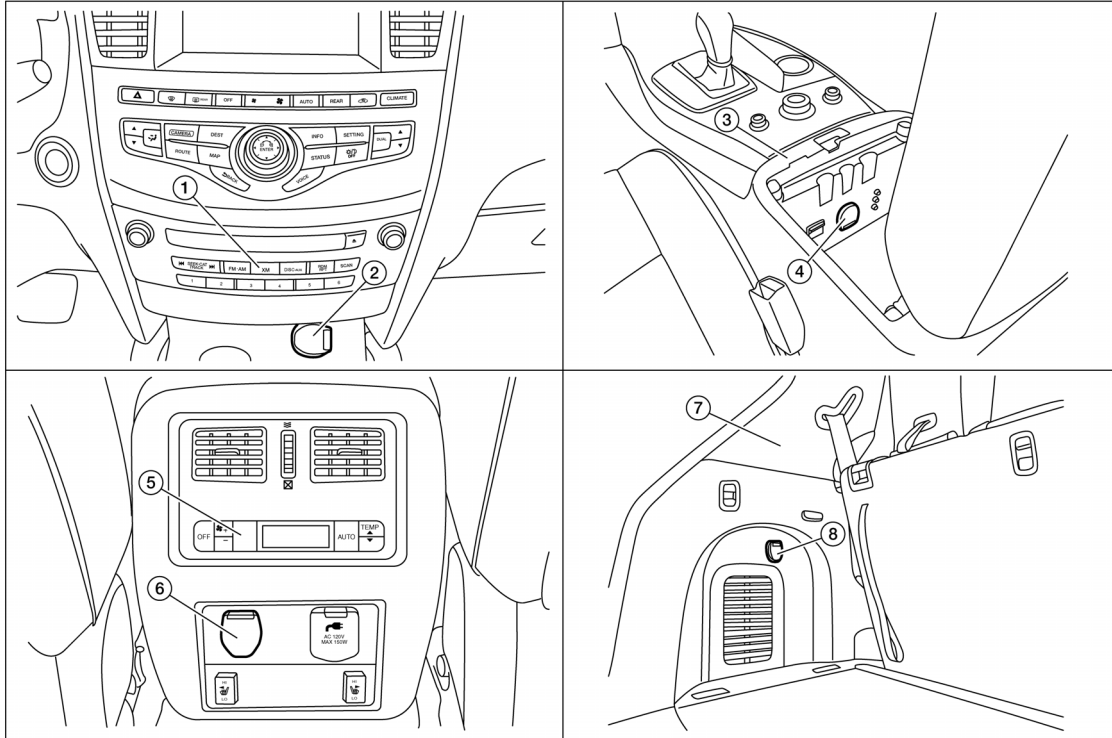

ALMIA05492Z

- |                                   |   |                              |
|-----------------------------------|---|------------------------------|
| 1. A/C and AV switch assembly     | 2. Front power socket (for cigarette lighter) | 3. Center console            |
| 4. Front console power socket     | 5. Rear air control                           | 6. Rear console power socket |
| 7. Luggage side finisher lower LH | 8. Rear cargo power socket                    |                              |

A  
B  
C  
D  
E  
F  
G  
H  
I  
J  
K  
L  
N  
O  
P

PWO

# POWER SOCKET

< WIRING DIAGRAM >

[POWER SOCKET]

## WIRING DIAGRAM

### POWER SOCKET

Wiring Diagram

INFOID:000000011133875

POWER SOCKET

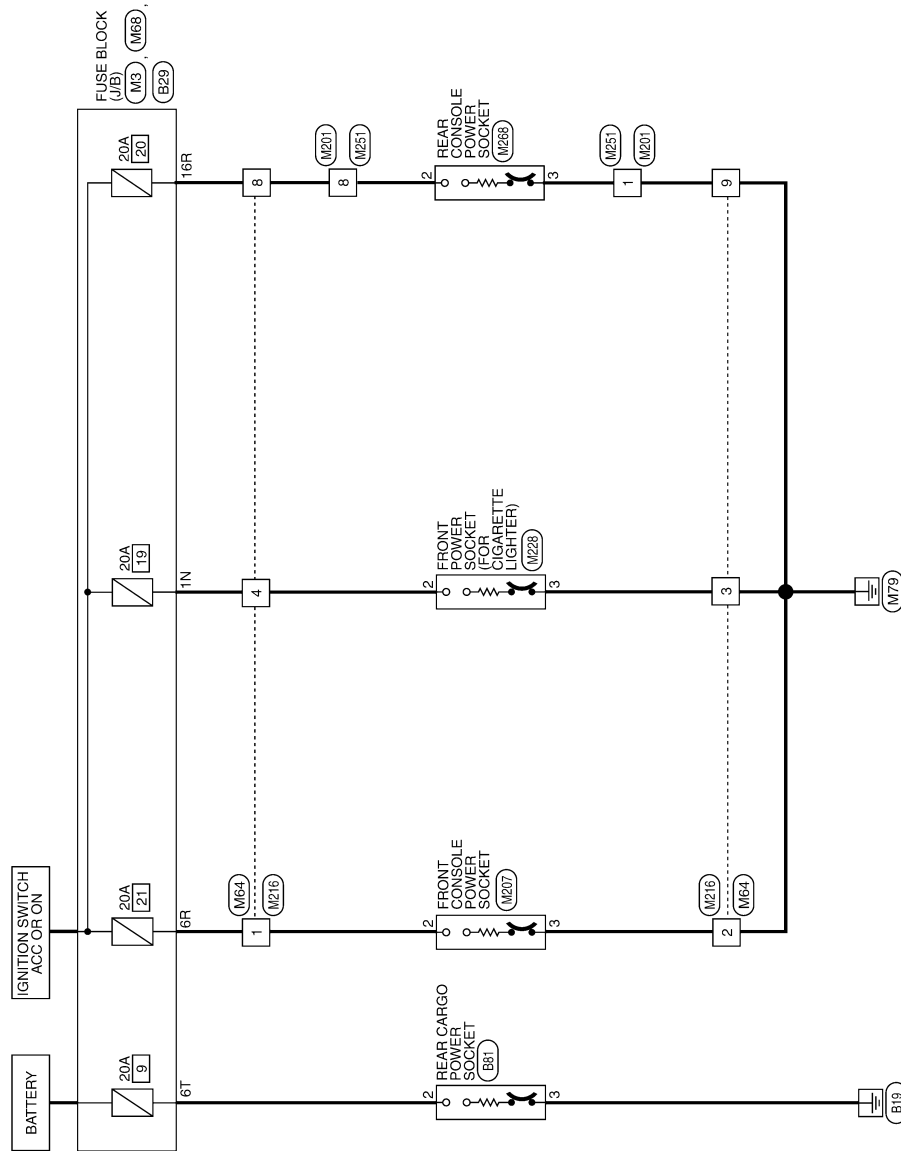

ABMWA2086GB

POWER SOCKET CONNECTORS

Connector No.	M3
Connector Name	FUSE BLOCK (J/B)
Connector Color	WHITE

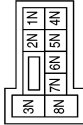

Terminal No.	Color of Wire	Signal Name
1N	LG	-

Connector No.	M64
Connector Name	WIRE TO WIRE
Connector Color	WHITE

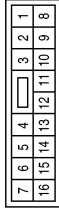

Terminal No.	Color of Wire	Signal Name
1	Y	-
2	B	-
3	B	-
4	LG	-
8	BG	-
9	B	-

Connector No.	M68
Connector Name	FUSE BLOCK (J/B)
Connector Color	BROWN



Terminal No.	Color of Wire	Signal Name
6R	Y	-
16R	BG	-

Connector No.	M201
Connector Name	WIRE TO WIRE
Connector Color	WHITE

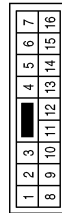

Terminal No.	Color of Wire	Signal Name
1	B	-
8	BG	-

Connector No.	M207
Connector Name	FRONT CONSOLE POWER SOCKET
Connector Color	GRAY



Terminal No.	Color of Wire	Signal Name
2	BG	-
3	B	-

Connector No.	M216
Connector Name	WIRE TO WIRE
Connector Color	WHITE



Terminal No.	Color of Wire	Signal Name
1	BG	-
2	B	-
3	B	-
4	R	-
8	BG	-
9	B	-

A  
B  
C  
D  
E  
F  
G  
H  
I  
J  
K  
L  
N  
O  
P

PWO

ABMIA6860GB

# POWER SOCKET

< WIRING DIAGRAM >

[POWER SOCKET]

Connector No.	M268
Connector Name	REAR CONSOLE POWER SOCKET
Connector Color	GRAY



Terminal No.	Color of Wire	Signal Name
2	BG	-
3	B	-

Connector No.	M251
Connector Name	WIRE TO WIRE
Connector Color	WHITE

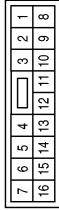

Terminal No.	Color of Wire	Signal Name
1	B	-
8	BG	-

Connector No.	M228
Connector Name	FRONT POWER SOCKET (FOR CIGARETTE LIGHTER)
Connector Color	GRAY



Terminal No.	Color of Wire	Signal Name
2	R	-
3	B	-

Connector No.	B81
Connector Name	REAR CARGO POWER SOCKET
Connector Color	GRAY



Terminal No.	Color of Wire	Signal Name
2	L	-
3	GR	-

Connector No.	B29
Connector Name	FUSE BLOCK (J/B)
Connector Color	WHITE

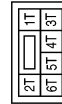

Terminal No.	Color of Wire	Signal Name
6T	L	-

ABMIA6861GB



# REMOVAL AND INSTALLATION

## POWER SOCKET

### Removal and Installation

INFOID:000000011133876

FRONT CONSOLE POWER SOCKET, CONSOLE POWER SOCKET, REAR CONSOLE POWER SOCKET or REAR CARGO POWER SOCKET

**NOTE:**

If unable to use the Tool because of power socket location or access to the harness connector, then further removal of interior components may be required. Refer to [IP-24, "Removal and Installation"](#) (Front Console Power Socket), [IP-18, "Removal and Installation"](#) (Console Power Socket), [IP-29, "Disassembly and Assembly"](#) (Rear Console Power Socket) or [INT-31, "LUGGAGE SIDE LOWER FINISHER : Removal and Installation"](#) (Rear Cargo Power Socket).

Removal

1. Remove the fuse for the power socket.
2. Insert one side of the Tool (A) into one of the square holes inside the power socket.

**Tool number** : — (J-42059)

3. Lift up the handle of the Tool until the other side snaps into the other square hole in the power socket.
4. Pull the power socket straight out with the Tool.

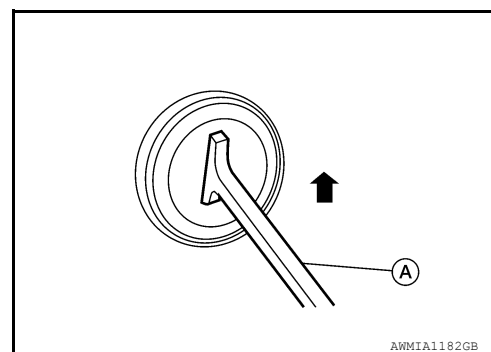

5. Disconnect the harness connector from the power socket.
6. Remove the ring from the power socket finisher while pressing the pawls.

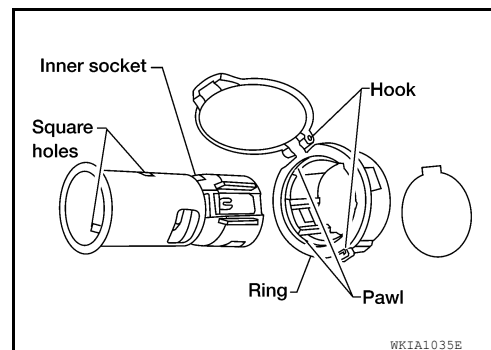

Installation

Installation is in the reverse order of removal.

**NOTE:**

Make sure to align the tab with the square notched area during installation.

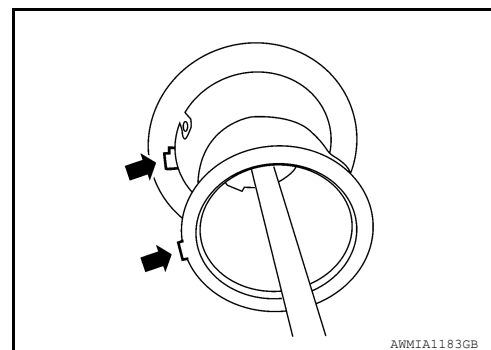

A  
B  
C  
D  
E  
F  
G  
H  
I  
J  
K  
L  
PWO  
N  
O  
P

## PRECAUTION

### PRECAUTIONS

#### Precaution for Supplemental Restraint System (SRS) "AIR BAG" and "SEAT BELT PRE-TENSIONER"

INFOID:000000011133877

The Supplemental Restraint System such as "AIR BAG" and "SEAT BELT PRE-TENSIONER", used along with a front seat belt, helps to reduce the risk or severity of injury to the driver and front passenger for certain types of collision. This system includes dual stage front air bag modules. The SRS system may only deploy one front air bag, depending on the severity of a collision and whether the front passenger seat is occupied. Information necessary to service the system safely is included in the SR and SB section of this Service Manual.

**WARNING:**

- To avoid rendering the SRS inoperative, which could increase the risk of personal injury or death in the event of a collision which would result in air bag inflation, all maintenance must be performed by an authorized NISSAN/INFINITI dealer.
- Improper maintenance, including incorrect removal and installation of the SRS, can lead to personal injury caused by unintentional activation of the system. For removal of Spiral Cable and Air Bag Module, see the SR section.
- Do not use electrical test equipment on any circuit related to the SRS unless instructed to in this Service Manual. SRS wiring harnesses can be identified by yellow and/or orange harnesses or harness connectors.

#### PRECAUTIONS WHEN USING POWER TOOLS (AIR OR ELECTRIC) AND HAMMERS

**WARNING:**

- When working near the Airbag Diagnosis Sensor Unit or other Airbag System sensors with the Ignition ON or engine running, DO NOT use air or electric power tools or strike near the sensor(s) with a hammer. Heavy vibration could activate the sensor(s) and deploy the air bag(s), possibly causing serious injury.
- When using air or electric power tools or hammers, always switch the Ignition OFF, disconnect the battery and wait at least three minutes before performing any service.

#### Precaution for Work

INFOID:000000011133878

- When removing or disassembling each component, be careful not to damage or deform it. If a component may be subject to interference, be sure to protect it with a shop cloth.
- When removing (disengaging) components with a screwdriver or similar tool, be sure to wrap the component with a shop cloth or vinyl tape to protect it.
- Protect the removed parts with a shop cloth and prevent them from being dropped.
- Replace a deformed or damaged clip.
- If a part is specified as a non-reusable part, always replace it with a new one.
- Be sure to tighten bolts and nuts securely to the specified torque.
- After installation is complete, be sure to check that each part works properly.
- Follow the steps below to clean components:
  - Water soluble dirt:
    - Dip a soft cloth into lukewarm water, wring the water out of the cloth and wipe the dirty area.
    - Then rub with a soft, dry cloth.
  - Oily dirt:
    - Dip a soft cloth into lukewarm water with mild detergent (concentration: within 2 to 3%) and wipe the dirty area.
    - Then dip a cloth into fresh water, wring the water out of the cloth and wipe the detergent off.
    - Then rub with a soft, dry cloth.
  - Do not use organic solvent such as thinner, benzene, alcohol or gasoline.
  - For genuine leather seats, use a genuine leather seat cleaner.

# PREPARATION

< PREPARATION >

[AC 120 V OUTLET]

## PREPARATION

### PREPARATION

#### Special Service Tool

INFOID:000000011133879

The actual shape of the tools may differ from those illustrated here.

Tool number (TechMate No.) Tool name	Description
— (J-46534) Trim Tool Set	Removing trim components

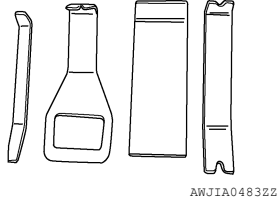

A  
B  
C  
D  
E  
F  
G  
H  
I  
J  
K  
L

PWO

# COMPONENT PARTS

< SYSTEM DESCRIPTION >

[AC 120 V OUTLET]

## SYSTEM DESCRIPTION

### COMPONENT PARTS

#### Component Parts Location

INFOID:000000011133880

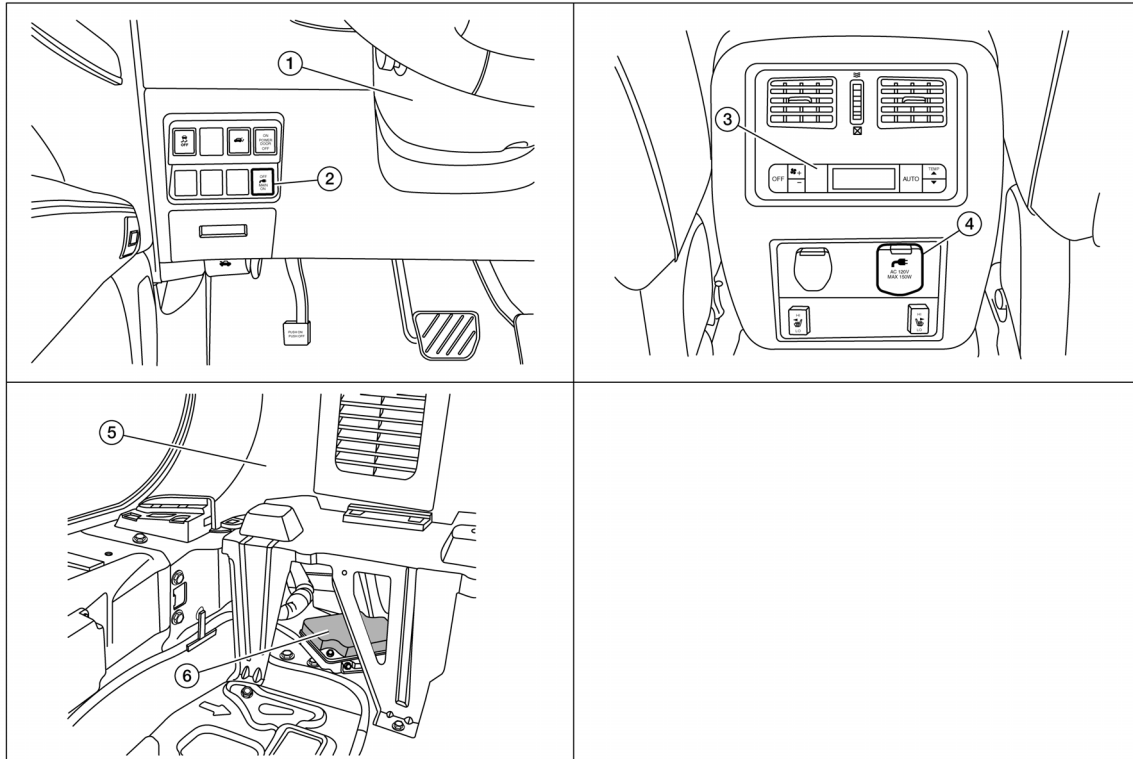

ALMIA05502Z

- |                    |                                   |  |
|--------------------|-----------------------------------|--|
| 1. Steering column | 2. AC 120V outlet main switch     | 3. Rear air control                              |
| 4. AC 120V outlet  | 5. Luggage side finisher lower LH | 6. Inverter unit (view with storage box removed) |

#### Component Description

INFOID:000000011133881

Component	Reference
Inverter unit	<a href="#">PWO-12. "Inverter Unit"</a>
AC 120V outlet main switch	<a href="#">PWO-12. "AC 120V Outlet Main Switch"</a>
AC 120V outlet	<a href="#">PWO-12. "AC 120V Outlet"</a>

#### Inverter Unit

INFOID:000000011133882

The inverter unit converts 12V DC to 120V AC.

#### AC 120V Outlet Main Switch

INFOID:000000011133883

The AC outlet main switch allows operation of the inverter unit in 150W AC 120V mode.

#### AC 120V Outlet

INFOID:000000011133884

The AC 120V outlet allow use of AC components up to 150W.

SYSTEM

System Diagram

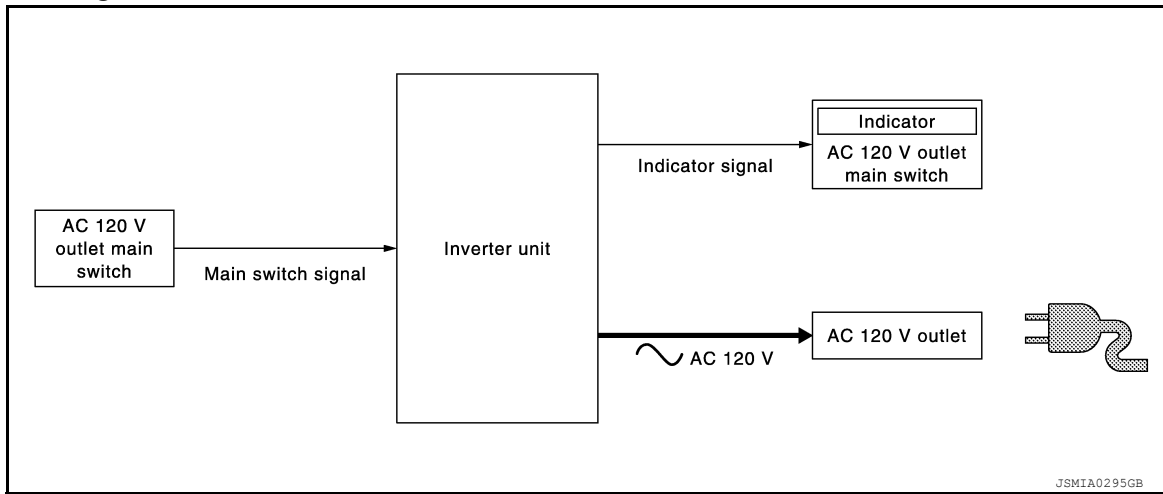

System Description

INFOID:000000011133886

- When turning ON the AC 120V outlet main switch with the ignition switch ON, the Indicator turns ON and the inverter unit is activated allowing the use of devices up to 150W.
- The inverter unit converts 12V DC to 120V AC and outputs the converted voltage to the AC 120V outlet two seconds after the AC 120V outlet main switch is turned ON.

Fail-safe

INFOID:000000011133887

When a malfunction listed below occurs, the inverter unit turns OFF the AC 120V outlet main switch indicator and stops the output.

Malfunction item	Fail-safe condition	Fail-safe cancellation condition
Inverter unit power supply voltage is greater than 15V	When inverter unit input voltage rises above 15V, the output will be suspended to protect the inverter unit.	After the inverter unit power supply voltage drops below 15V, the AC 120V outlet main switch ON ⇒ OFF ⇒ ON operation allows normal return.
Inverter unit power supply voltage is less than 11.5V for 2 seconds or more	When inverter unit input voltage is lowered, the output will be suspended to protect the battery from running out.	After the inverter unit power supply voltage rises above 11.5V, the AC 120V outlet main switch ON ⇒ OFF ⇒ ON operation allows normal return.
Inverter unit power supply voltage is less than 9V		
Inverter unit AC 120V output voltage is greater than 170V	When inverter unit AC 120V output voltage is greater than 170V, the output will be suspended.	After the inverter unit AC 120V output voltage drops below 170V, the AC 120V outlet main switch ON ⇒ OFF ⇒ ON operation allows normal return.
Inverter unit input current is greater than 13.3A	When inverter unit input current rises above 13.3A, the output will be suspended to prevent over current (e.g., connecting an electric appliance exceeding rated output).	After the inverter unit input current drops below 13.3A, the AC 120V outlet main switch ON ⇒ OFF ⇒ ON operation allows normal return.
Inverter unit is overheated	When the inverter unit is overheated [thermistor temperature above 100°C (212°F)], the output will be suspended to protect the inverter unit.	After the inverter unit temperature is lowered, the AC 120V outlet main switch ON ⇒ OFF ⇒ ON operation allows normal return.
Inverter unit output signal (AC 120V output signal) is shorted	When inverter unit output signal is shorted, the output will be suspended.	After recovering from inverter unit output signal short, the AC 120V outlet main switch ON ⇒ OFF ⇒ ON operation allows normal return.

A  
B  
C  
D  
E  
F  
G  
H  
I  
J  
K  
L  
P

PWO

# INVERTER UNIT

< ECU DIAGNOSIS INFORMATION >

[AC 120 V OUTLET]

## ECU DIAGNOSIS INFORMATION

### INVERTER UNIT

Reference Value

INFOID:000000011133888

#### TERMINAL LAYOUT

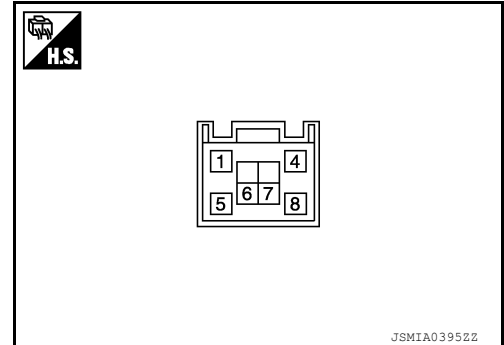

#### PHYSICAL VALUES

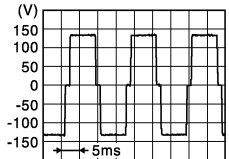
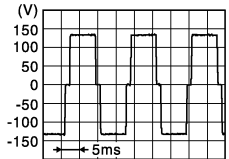
Terminal No. (Wire color)		Description		Condition	Value (Approx.)
+	-	Signal name	Input/ Output		
1 (W)	5 (B)	AC output 2	Output	Ignition switch OFF	0V
				AC 120V outlet main switch ON (Using circuit tester)	AC 120V
				AC 120V outlet main switch ON (Using oscilloscope)	Reference value  <small>RMS 120V</small> <small>JSMIA0397GB</small> AC 120V
4 (W)	Ground	Battery power supply	Input	Ignition switch OFF	Battery voltage
5 (B)	1 (W)	AC output 1	Output	Ignition switch OFF	0V
				AC 120V outlet main switch ON (Using circuit tester)	AC 120V
				AC 120V outlet main switch ON (Using oscilloscope)	Reference value  <small>RMS 120V</small> <small>JSMIA0397GB</small> AC 120V

# INVERTER UNIT

< ECU DIAGNOSIS INFORMATION >

[AC 120 V OUTLET]

Terminal No. (Wire color)		Description		Condition		Value (Approx.)
+	-	Signal name	Input/ Output			
6 (W)	Ground	AC 120 V outlet main switch	Input	Ignition switch OFF	AC 120V outlet main switch OFF	0V
				Ignition switch ON	AC 120V outlet main switch ON	12V
7 (G)		AC 120 V outlet main switch	Output	Ignition switch OFF	AC 120V outlet main switch OFF	0V
				Ignition switch ON	AC 120V outlet main switch ON	5.2V
8 (B)		Ground	—	Ignition switch ON		0V

**CAUTION:**

- To measure AC 120V output signal, always use the circuit tester or oscilloscope AC range. Never allow the probes to contact each other.
- Because of modified sine wave output of the AC 120V output signal, voltage cannot be measured accurately without using a circuit tester that can measure true RMS (root mean square).

### Fail-safe

INFOID:0000000011133889

When a malfunction listed below occurs, the inverter unit turns OFF the AC 120V outlet main switch indicator and stops the output.

Malfunction item	Fail-safe condition	Fail-safe cancellation condition
Inverter unit power supply voltage is greater than 15V	When inverter unit input voltage rises above 15V, the output will be suspended to protect the inverter unit.	After the inverter unit power supply voltage drops below 15V, the AC 120V outlet main switch ON ⇒ OFF ⇒ ON operation allows normal return.
Inverter unit power supply voltage is less than 11.5V for 2 seconds or more	When inverter unit input voltage is lowered, the output will be suspended to protect the battery from running out.	After the inverter unit power supply voltage rises above 11.5V, the AC 120V outlet main switch ON ⇒ OFF ⇒ ON operation allows normal return.
Inverter unit power supply voltage is less than 9V		
Inverter unit AC 120V output voltage is greater than 170V	When inverter unit AC 120V output voltage is greater than 170V, the output will be suspended.	After the inverter unit AC 120V output voltage drops below 170V, the AC 120V outlet main switch ON ⇒ OFF ⇒ ON operation allows normal return.
Inverter unit input current is greater than 13.3A	When inverter unit input current rises above 13.3A, the output will be suspended to prevent over current (e.g., connecting an electric appliance exceeding rated output).	After the inverter unit input current drops below 13.3A, the AC 120V outlet main switch ON ⇒ OFF ⇒ ON operation allows normal return.
Inverter unit is overheated	When the inverter unit is overheated [thermistor temperature above 100°C (212°F)], the output will be suspended to protect the inverter unit.	After the inverter unit temperature is lowered, the AC 120V outlet main switch ON ⇒ OFF ⇒ ON operation allows normal return.
Inverter unit output signal (AC 120V output signal) is shorted	When inverter unit output signal is shorted, the output will be suspended.	After recovering from inverter unit output signal short, the AC 120V outlet main switch ON ⇒ OFF ⇒ ON operation allows normal return.

# INVERTER UNIT

< WIRING DIAGRAM >

[AC 120 V OUTLET]

## WIRING DIAGRAM

### INVERTER UNIT

Wiring Diagram

INFOID:000000011133890

#### INVERTER SYSTEM

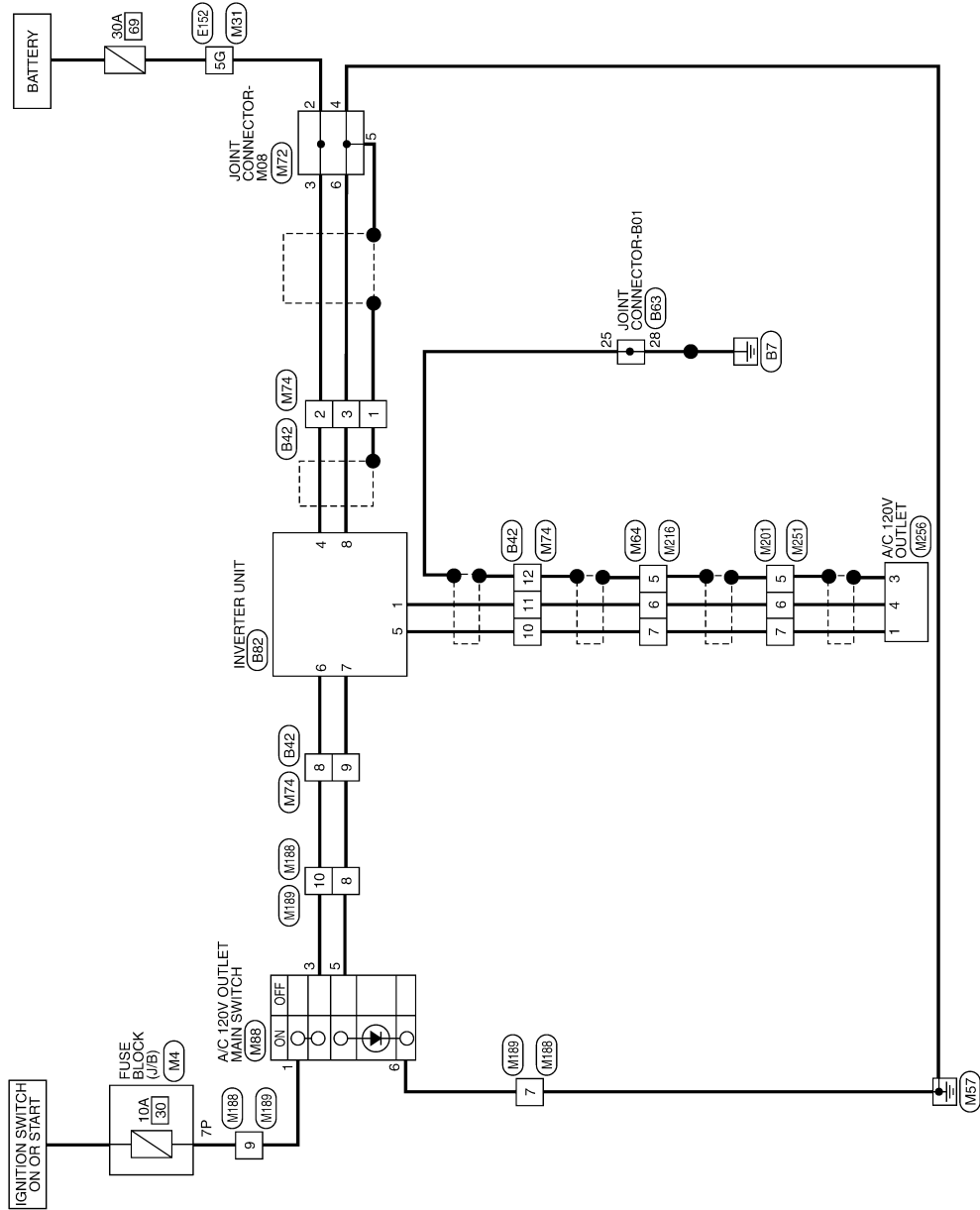

ABMWA2087GB



# INVERTER UNIT

< WIRING DIAGRAM >

[AC 120 V OUTLET]

## INVERTER SYSTEM CONNECTORS

Connector No.	M4
Connector Name	FUSE BLOCK (J/B)
Connector Color	WHITE



Terminal No.	Color of Wire	Signal Name
7P	LG	-

Connector No.	M31
Connector Name	WIRE TO WIRE
Connector Color	WHITE

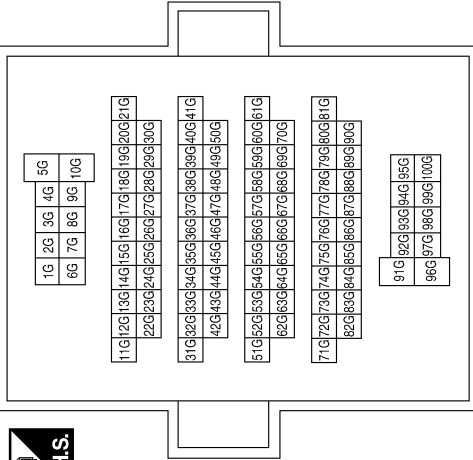

Terminal No.	Color of Wire	Signal Name
5G	P	-

Connector No.	M64
Connector Name	WIRE TO WIRE
Connector Color	WHITE

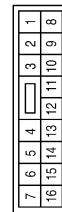

Terminal No.	Color of Wire	Signal Name
5	SHIELD	-
6	W	-
7	B	-

Connector No.	M72
Connector Name	JOINT CONNECTOR-M08
Connector Color	WHITE



Terminal No.	Color of Wire	Signal Name
2	P	-
3	W	-
4	B	-
5	SHIELD	-
6	B	-

Connector No.	M74
Connector Name	WIRE TO WIRE
Connector Color	BROWN

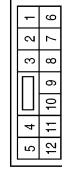

Terminal No.	Color of Wire	Signal Name
1	SHIELD	-
2	W	-
3	B	-
8	G	-
9	W	-
10	B	-
11	W	-
12	SHIELD	-

ABMIA4809GB

A  
B  
C  
D  
E  
F  
G  
H  
I  
J  
K  
L  
N  
O  
P

PWO

# INVERTER UNIT

< WIRING DIAGRAM >

[AC 120 V OUTLET]

Connector No.	M189
Connector Name	WIRE TO WIRE
Connector Color	WHITE

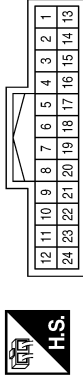

Terminal No.	Color of Wire	Signal Name
7	B	-
8	W	-
9	LG	-
10	G	-

Connector No.	M188
Connector Name	WIRE TO WIRE
Connector Color	WHITE

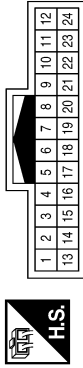

Terminal No.	Color of Wire	Signal Name
7	B	-
8	W	-
9	LG	-
10	G	-

Connector No.	M88
Connector Name	A/C 120V OUTLET MAIN SWITCH
Connector Color	BLACK

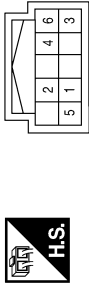

Terminal No.	Color of Wire	Signal Name
1	LG	-
3	G	-
5	W	-
6	B	-

Connector No.	M251
Connector Name	WIRE TO WIRE
Connector Color	WHITE



Terminal No.	Color of Wire	Signal Name
5	SHIELD	-
6	W	-
7	B	-

Connector No.	M216
Connector Name	WIRE TO WIRE
Connector Color	WHITE

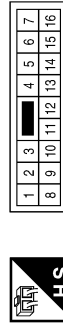

Terminal No.	Color of Wire	Signal Name
5	SHIELD	-
6	W	-
7	B	-

Connector No.	M201
Connector Name	WIRE TO WIRE
Connector Color	WHITE

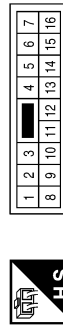

Terminal No.	Color of Wire	Signal Name
5	SHIELD	-
6	W	-
7	B	-

ABMIA4810GB

# INVERTER UNIT

< WIRING DIAGRAM >

[AC 120 V OUTLET]

Connector No.	M256
Connector Name	A/C 120V OUTLET
Connector Color	WHITE

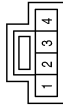

Terminal No.	Color of Wire	Signal Name
1	B	-
3	SHIELD	-
4	W	-

Connector No.	E152
Connector Name	WIRE TO WIRE
Connector Color	WHITE

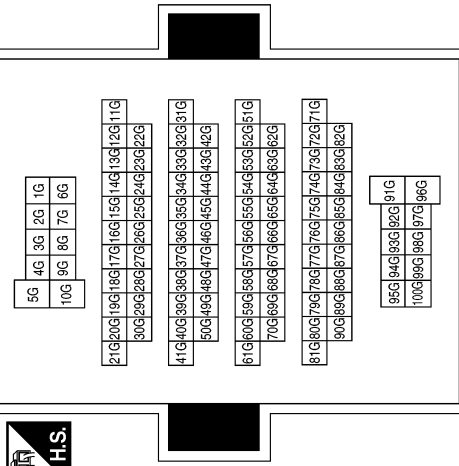

Terminal No.	Color of Wire	Signal Name
5G	P	-

Connector No.	B42
Connector Name	WIRE TO WIRE
Connector Color	BROWN

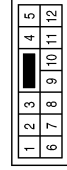

Terminal No.	Color of Wire	Signal Name
1	SHIELD	-
2	W	-
3	B	-
8	W	-
9	G	-
10	B	-
11	W	-
12	SHIELD	-

Connector No.	B63
Connector Name	JOINT CONNECTOR-B01
Connector Color	WHITE

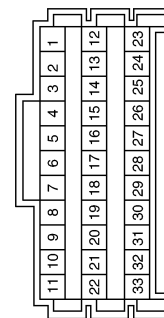

Terminal No.	Color of Wire	Signal Name
25	SHIELD	-
28	B	-

Connector No.	B62
Connector Name	INVERTER UNIT
Connector Color	BLACK

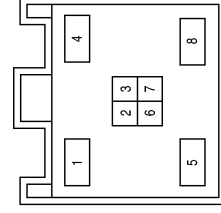

Terminal No.	Color of Wire	Signal Name
1	W	OUTPUT 2
2	-	-
3	-	-
4	W	+B
5	B	OUTPUT 1
6	W	SW INPUT
7	G	LED
8	B	GND

A B C D E F G H I J K L P

PWO

ABMIA6857GB

# DIAGNOSIS AND REPAIR WORK FLOW

< BASIC INSPECTION >

[AC 120 V OUTLET]

## BASIC INSPECTION

### DIAGNOSIS AND REPAIR WORK FLOW

Work Flow

INFOID:000000011133891

#### OVERALL SEQUENCE

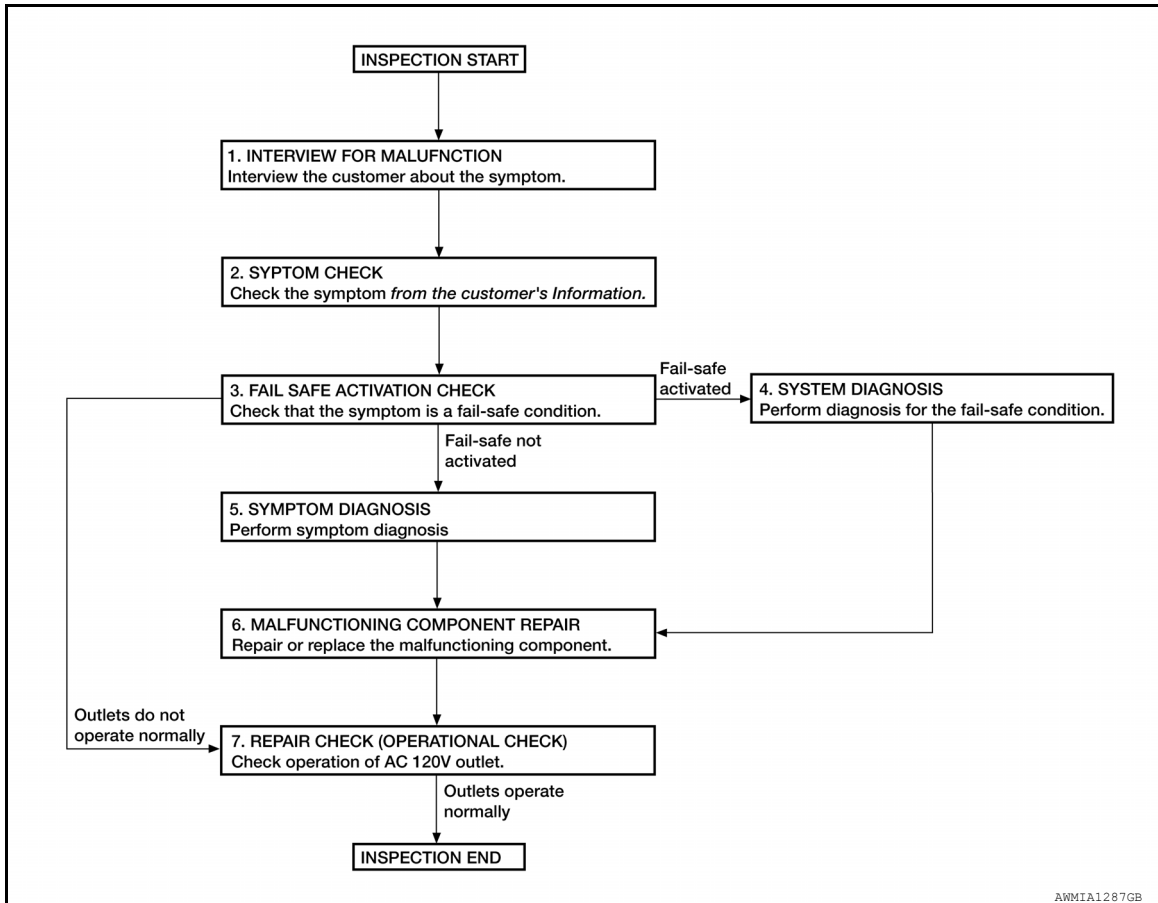

#### DETAILED FLOW

##### 1. INTERVIEW FOR MALFUNCTION

Interview the customer about the symptom.

>> GO TO 2.

##### 2. SYMPTOM CHECK

Check the symptom from the customer's information.

>> GO TO 3.

##### 3. FAIL-SAFE ACTIVATION CHECK

Check that the symptom is a fail-safe condition.

Is fail-safe activated?

YES >> GO TO 4.

NO >> GO TO 5.

##### 4. SYSTEM DIAGNOSIS

Perform diagnosis for the fail-safe activated system. Specify the malfunctioning component.

# DIAGNOSIS AND REPAIR WORK FLOW

< BASIC INSPECTION >

[AC 120 V OUTLET]

>> GO TO 6.

## 5. SYMPTOM DIAGNOSIS

Perform symptom diagnosis. Specify the malfunctioning component.

>> GO TO 6.

## 6. MALFUNCTIONING COMPONENT REPAIR

Repair or replace the malfunctioning component.

>> GO TO 7.

## 7. REPAIR CHECK (OPERATION CHECK)

Check operation of AC 120V outlet.

Does the outlet operate normally?

YES >> Inspection End.

NO >> GO TO 3.

A

B

C

D

E

F

G

H

I

J

K

L

PWO

N

O

P

# POWER SUPPLY AND GROUND CIRCUIT

< DTC/CIRCUIT DIAGNOSIS >

[AC 120 V OUTLET]

## DTC/CIRCUIT DIAGNOSIS

### POWER SUPPLY AND GROUND CIRCUIT

#### Diagnosis Procedure

INFOID:000000011133892

Regarding Wiring Diagram information, refer to [PWO-16. "Wiring Diagram"](#).

#### 1. CHECK FUSE AND FUSIBLE LINK

Check that the following fuse and fusible link are not blown.

Signal name	Fuse No.
Battery power supply	69 (30A)

##### Is the fuse blown?

- YES >> Replace the blown fuse after repairing the affected circuit.  
NO >> GO TO 2.

#### 2. CHECK INVERTER UNIT POWER SUPPLY CIRCUIT

1. Disconnect inverter unit connector B82.
2. Check voltage between inverter unit connector B82 terminal 4 and ground.

Inverter unit		Ground	Voltage (Approx.)
Connector	Terminal		
B82	4	—	Battery voltage

##### Is the inspection result normal?

- YES >> GO TO 3.  
NO >> Repair or replace the inverter unit power supply circuit.

#### 3. CHECK INVERTER UNIT GROUND CIRCUIT

Check continuity between inverter unit connector B82 terminal 8 and ground.

Inverter unit		Ground	Continuity
Connector	Terminal		
B82	8	—	Yes

##### Is the inspection result normal?

- YES >> Inspection End.  
NO >> Repair or replace the inverter unit ground circuit.

# AC 120 V OUTLET MAIN SWITCH POWER SUPPLY CIRCUIT

< DTC/CIRCUIT DIAGNOSIS >

[AC 120 V OUTLET]

## AC 120 V OUTLET MAIN SWITCH POWER SUPPLY CIRCUIT

### Diagnosis Procedure

INFOID:0000000011133893

Regarding Wiring Diagram information, refer to [PWO-16. "Wiring Diagram"](#).

### 1. CHECK FUSE

Check that the following fuse is not blown.

Signal name	Fuse No.
Ignition switch ON or START	30 (10A)

Is the fuse blown?

- YES >> Replace the blown fuse after repairing the affected circuit.
- NO >> GO TO 2.

### 2. CHECK POWER SUPPLY FOR AC 120V OUTLET MAIN SWITCH

1. Turn ignition switch ON.
2. Check voltage between AC 120V outlet main switch connector M88 terminal 1 and ground.

AC 120V outlet main switch		Ground	Condition	Voltage (Approx.)
Connector	Terminal			
M88	1	—	Ignition switch ON	Battery voltage
			Ignition switch OFF	0V

Is the inspection result normal?

- YES >> GO TO 3.
- NO >> Repair or replace the AC 120V main switch power supply circuit.

### 3. CHECK POWER SUPPLY FOR AC 120V OUTLET MAIN SWITCH

1. Turn ignition switch OFF.
2. Check continuity between AC 120V outlet main switch connector M88 terminal 6 and ground.

AC 120V outlet main switch		Ground	Continuity
Connector	Terminal		
M88	6	—	Yes

Is the inspection result normal?

- YES >> Inspection End.
- NO >> Repair or replace the AC 120V main switch ground circuit.

A  
B  
C  
D  
E  
F  
G  
H  
I  
J  
K  
L  
PWO  
N  
O  
P

# AC 120 V OUTLET MAIN SWITCH INPUT SIGNAL CIRCUIT

< DTC/CIRCUIT DIAGNOSIS >

[AC 120 V OUTLET]

## AC 120 V OUTLET MAIN SWITCH INPUT SIGNAL CIRCUIT

### Diagnosis Procedure

INFOID:0000000011133894

Regarding Wiring Diagram information, refer to [PWO-16. "Wiring Diagram"](#).

### 1. CHECK AC 120V OUTLET MAIN SWITCH INPUT SIGNAL

1. Turn ignition switch ON.
2. AC 120V outlet main switch ON.
3. Check for voltage between the inverter unit connector B82 terminal 6 and ground.

Inverter unit		Ground	Condition	Voltage (Approx.)
Connector	Terminal			
B82	6	—	AC 120V outlet main switch OFF	0V
			AC 120V outlet main switch ON	Battery voltage

Is the inspection result normal?

- YES >> Inspection End.  
NO >> GO TO 2.

### 2. CHECK AC 120V OUTLET MAIN SWITCH

Check AC 120V outlet main switch. Refer to [PWO-24. "Component Inspection \(AC 120V Outlet Main Switch\)"](#).

Is the inspection result normal?

- YES >> GO TO 3.  
NO >> Replace AC 120V outlet main switch.

### 3. CHECK HARNESS BETWEEN INVERTER UNIT AND AC 120V OUTLET MAIN SWITCH

1. Disconnect inverter unit connector.
2. Check for continuity between the inverter unit connector B82 terminal 6 and AC 120V outlet main switch connector M88 terminal 3.

Inverter unit		AC 120V outlet main switch		Continuity
Connector	Terminal	Connector	Terminal	
B82	6	M88	3	Yes

3. Check for continuity between inverter unit connector B82 terminal 6 and ground.

Inverter unit		Ground	Continuity
Connector	Terminal		
B82	6	—	No

Is the inspection result normal?

- YES >> Inspection End.  
NO >> Repair or replace the AC 120V outlet main switch input signal circuit.

### Component Inspection (AC 120V Outlet Main Switch)

INFOID:0000000011133895

### 1. CHECK AC 120V OUTLET MAIN SWITCH

1. Turn ignition switch OFF.
2. Disconnect AC 120V outlet main switch connector.
3. Check continuity between terminals 1 and 3 of AC 120V outlet main switch.



# AC 120 V OUTLET MAIN SWITCH INPUT SIGNAL CIRCUIT

< DTC/CIRCUIT DIAGNOSIS >

[AC 120 V OUTLET]

AC 120V outlet main switch terminals	Condition	Continuity
1 - 3	AC 120V outlet main switch ON	Yes
	AC 120V outlet main switch OFF	No

Is the inspection result normal?

YES >> Inspection End.

NO >> Replace AC 120V outlet main switch.

A

B

C

D

E

F

G

H

I

J

K

L

PWO

N

O

P

# AC 120 V POWER OUTPUT CIRCUIT

< DTC/CIRCUIT DIAGNOSIS >

[AC 120 V OUTLET]

## AC 120 V POWER OUTPUT CIRCUIT

### Diagnosis Procedure

INFOID:000000011133896

Regarding Wiring Diagram information, refer to [PWO-16. "Wiring Diagram"](#).

### 1. CHECK HARNESS BETWEEN INVERTER UNIT AND AC 120V OUTLET

1. Turn ignition switch OFF.
2. Disconnect inverter unit and AC 120V outlet connectors.
3. Check continuity between inverter unit connector B82 terminals 5, 1 and AC 120V outlet connector M256 terminals 1, 4.

Inverter unit		AC 120V outlet		Continuity
Connector	Terminal	Connector	Terminal	
B82	5	M256	1	Yes
	1		4	

4. Check continuity between inverter unit connector B82 terminals 5, 1 and ground.

Inverter unit		Ground	Continuity
Connector	Terminal		
B82	5	—	No
	1		

5. Check continuity between inverter unit connector B82 terminals 5 and 1.

Inverter unit			Continuity
Connector	Terminal		
B82	5	1	No

Is the inspection result normal?

YES >> GO TO 2.

NO >> Repair or replace the harness or connectors.

### 2. CHECK INVERTER UNIT OUTPUT SIGNAL

1. Connect inverter unit and AC 120V outlet connectors.
2. Turn ignition switch ON.
3. AC 120V outlet main switch ON (AC 120V outlet main switch indicator ON).
4. Check voltage between inverter unit connector B82 terminals 5 and 1.

**CAUTION:**

- To measure AC 120V output signal, always use the circuit tester AC range.
- Never allow the probes to contact each other.

Inverter unit connector B82 terminals		Condition	Voltage (Approx.)
(+)	(-)	AC 120V outlet main switch	
5	1	OFF	0V
		ON	AC 120V

Is the inspection result normal?

YES >> GO TO 3

NO >> Replace inverter unit.

### 3. CHECK AC 120V OUTLET VOLTAGE

Check voltage between AC 120V outlet M256 terminals 1 and 4.

# AC 120 V POWER OUTPUT CIRCUIT

< DTC/CIRCUIT DIAGNOSIS >

[AC 120 V OUTLET]

**CAUTION:**

- To measure AC 120V output signal, always use the circuit tester AC range.
- Never allow the probes to contact each other.

AC 120V outlet connector M256 terminals		Condition	Voltage (Approx.)
(+)	(-)	AC 120V outlet main switch	
1	4	OFF	0V
		ON	AC 120V

Is the inspection result normal?

YES >> GO TO 4

NO >> Replace AC 120V outlet.

## 4. CHECK AC 120V OUTLET GROUND CIRCUIT

1. AC 120V outlet main switch OFF.
2. Turn ignition switch OFF.
3. Disconnect AC 120V outlet connector.
4. Check continuity between AC 120V outlet connector M256 terminal 3 and ground.

AC 120V outlet		Ground	Continuity
Connector	Terminal		
M256	3	—	Yes

Is the inspection result normal?

YES >> Replace AC 120V outlet.

NO >> Repair AC 120V outlet ground circuit.

PWO

# AC 120 V OUTLET MAIN SWITCH INDICATOR CIRCUIT

< DTC/CIRCUIT DIAGNOSIS >

[AC 120 V OUTLET]

## AC 120 V OUTLET MAIN SWITCH INDICATOR CIRCUIT

### Diagnosis Procedure

INFOID:000000011133897

Regarding Wiring Diagram information, refer to [PWO-16. "Wiring Diagram"](#).

### 1. CHECK HARNESS BETWEEN INVERTER UNIT AND AC 120 V OUTLET MAIN SWITCH

1. Turn ignition switch OFF.
2. Disconnect inverter unit and AC 120 V outlet main switch connectors.
3. Check continuity between inverter unit connector B82 terminal 7 and AC 120 V main switch connector M88 terminal 5.

Inverter unit		AC 120 V outlet main switch		Continuity
Connector	Terminal	Connector	Terminal	
B82	7	M88	5	Yes

4. Check continuity between inverter unit connector B82 terminal 7 and ground.

Inverter unit		Ground	Continuity
Connector	Terminal		
B82	7		No

Is the inspection result normal?

YES >> GO TO 2.

NO >> Repair or replace the harness or connectors.

### 2. CHECK AC 120 V OUTLET MAIN SWITCH GROUND CIRCUIT

Check continuity between AC 120 V outlet main switch connector M88 terminal 6 and ground.

AC 120 V outlet main switch		Ground	Continuity
Connector	Terminal		
M88	6		Yes

Is the inspection result normal?

YES >> GO TO 3.

NO >> Repair AC 120 V outlet main switch ground circuit.

### 3. CHECK AC 120 V OUTLET MAIN SWITCH INDICATOR OUTPUT SIGNAL

1. Connect AC 120 V outlet main switch and inverter unit connectors.
2. Turn ignition switch ON.
3. AC 120 V outlet main switch ON.
4. Check voltage between the inverter unit connector B82 terminal 7 and ground.

Inverter unit		Ground	Condition	Voltage (Approx.)
Connector	Terminal		AC 120V outlet main switch	
B82	7	—	OFF	0V
			ON	5.2V

Is the inspection result normal?

YES >> Replace AC 120 V outlet main switch.

NO >> Replace inverter unit.

# NO OUTPUT FROM AC 120 V OUTLET

< SYMPTOM DIAGNOSIS >

[AC 120 V OUTLET]

## SYMPTOM DIAGNOSIS

### NO OUTPUT FROM AC 120 V OUTLET

#### Diagnosis Procedure

INFOID:000000011133898

#### 1. CHECK FAIL-SAFE ACTIVATION

Check if the symptom is caused by a fail-safe operation. Refer to [PWO-15, "Fail-safe"](#).

Is fail-safe operating?

YES >> Repair the part causing fail-safe operation.

NO >> GO TO 2.

#### 2. CHECK INVERTER UNIT POWER SUPPLY CIRCUIT

Check inverter unit power supply circuit. Refer to [PWO-22, "Diagnosis Procedure"](#).

Is the inspection result normal?

YES >> GO TO 3.

NO >> Repair or replace the malfunctioning parts.

#### 3. CHECK AC 120V OUTLET MAIN SWITCH POWER SUPPLY CIRCUIT

Check AC 120V outlet main switch power supply circuit. Refer to [PWO-23, "Diagnosis Procedure"](#).

Is the inspection result normal?

YES >> GO TO 4.

NO >> Repair or replace the malfunctioning parts.

#### 4. CHECK AC 120V OUTLET MAIN SWITCH INPUT SIGNAL CIRCUIT

Check AC 120V outlet main switch input signal circuit. Refer to [PWO-24, "Diagnosis Procedure"](#).

Is the inspection result normal?

YES >> GO TO 5.

NO >> Repair or replace the malfunctioning parts.

#### 5. CHECK INVERTER UNIT POWER OUTPUT CIRCUIT

Check inverter unit power output circuit. Refer to [PWO-26, "Diagnosis Procedure"](#).

Is the inspection result normal?

YES >> Refer to [GI-50, "Intermittent Incident"](#).

NO >> Repair or replace the malfunctioning parts.

A  
B  
C  
D  
E  
F  
G  
H  
I  
J  
K  
L  
N  
O  
P

PWO

# AC 120 V OUTLET MAIN SWITCH INDICATOR DOES NOT TURN ON

< SYMPTOM DIAGNOSIS >

[AC 120 V OUTLET]

## AC 120 V OUTLET MAIN SWITCH INDICATOR DOES NOT TURN ON

### Diagnosis Procedure

INFOID:000000011133899

#### 1. CHECK FAIL-SAFE ACTIVATION

Check if the symptom is caused by a fail-safe operation. Refer to [PWO-15, "Fail-safe"](#).

Is fail-safe operating?

- YES >> Repair the part causing fail-safe operation.
- NO >> GO TO 2.

#### 2. CHECK INVERTER UNIT POWER SUPPLY CIRCUIT

Check inverter unit power supply circuit. Refer to [PWO-22, "Diagnosis Procedure"](#).

Is the inspection result normal?

- YES >> GO TO 3.
- NO >> Repair or replace the malfunctioning parts.

#### 3. CHECK AC 120V OUTLET MAIN SWITCH POWER SUPPLY CIRCUIT

Check AC 120V outlet main switch power supply circuit. Refer to [PWO-23, "Diagnosis Procedure"](#).

Is the inspection result normal?

- YES >> GO TO 4.
- NO >> Repair or replace the malfunctioning parts.

#### 4. CHECK AC 120V OUTLET MAIN SWITCH INPUT SIGNAL CIRCUIT

Check AC 120V outlet main switch input signal circuit. Refer to [PWO-24, "Diagnosis Procedure"](#).

Is the inspection result normal?

- YES >> GO TO 5.
- NO >> Repair or replace the malfunctioning parts.

#### 5. CHECK AC 120V OUTLET MAIN SWITCH INDICATOR CIRCUIT

Check AC 120V outlet main switch indicator circuit. Refer to [PWO-28, "Diagnosis Procedure"](#).

Is the inspection result normal?

- YES >> Refer to [GI-50, "Intermittent Incident"](#).
- NO >> Repair or replace the malfunctioning parts.

# NORMAL OPERATING CONDITION

< SYMPTOM DIAGNOSIS >

[AC 120 V OUTLET]

## NORMAL OPERATING CONDITION

### Description

INFOID:000000011133900

Because of modified sine wave output, the AC 120V outlet may not operate normally for electric appliance of which electric power consumption is 150W or less.

- Electric appliances requiring a large amount of electric power consumption at startup (e.g., CRT-based TV, power tool)
- Measuring instruments for data requiring accuracy (e.g., medical equipment, measuring instrument)
- Microprocessor-controlled appliances (e.g., microprocessor-controlled blanket)

Noise may be caused in radio or TV, depending on an electric appliance.

A  
B  
C  
D  
E  
F  
G  
H  
I  
J  
K  
L

PWO

N  
O  
P

# INVERTER UNIT

< REMOVAL AND INSTALLATION >

[AC 120 V OUTLET]

## REMOVAL AND INSTALLATION

### INVERTER UNIT

#### Removal and Installation

INFOID:000000011133901

#### REMOVAL

1. Remove inverter unit fuse.
2. Remove storage box. Refer to [INT-30, "Exploded View"](#).
3. Remove luggage side lower finisher (LH). Refer to [INT-31, "LUGGAGE SIDE LOWER FINISHER : Removal and Installation"](#).

**NOTE:**

The inverter unit is located under the storage box bracket (LH) (1).

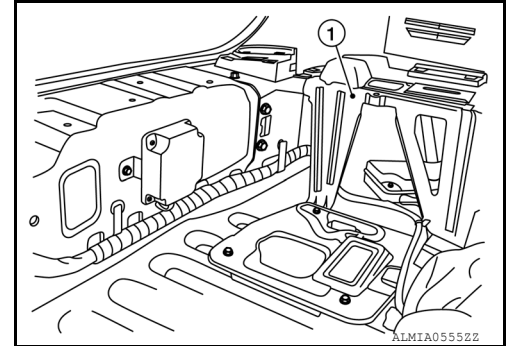

4. Remove the inverter unit bolts.
5. Disconnect the harness connector from the inverter unit (1).
6. Remove the inverter unit (1).

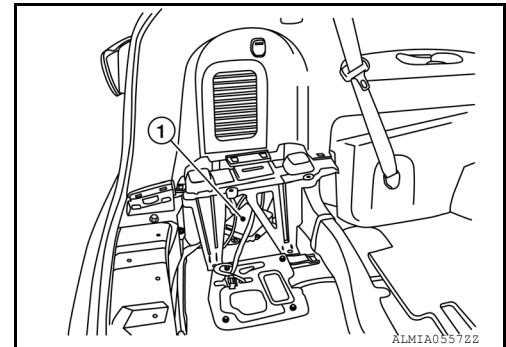

#### INSTALLATION

Installation is in the reverse order of removal.



## AC 120V OUTLET MAIN SW

### Removal and Installation

INFOID:000000011133902

#### REMOVAL

1. Remove the inverter unit fuse.
2. Remove the instrument lower panel LH. Refer to [IP-25, "Removal and Installation"](#).
3. Remove three screws (A,B,) that retain the lower switch assembly (2).  
 (1) Upper switch assembly  
 (C) Upper switch assembly screws

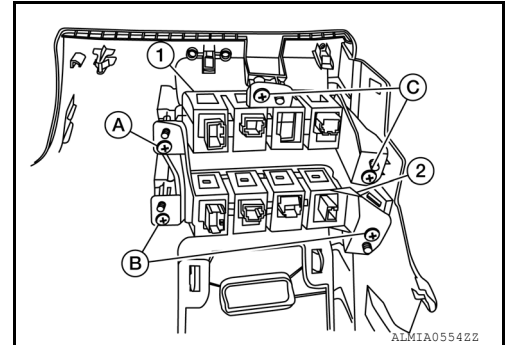

4. Release upper (B) and lower (C) tab using a suitable tool (A), then remove the A/C 120V outlet main switch (3) from the lower switch assembly.  
 (1) Warning system switch  
 (2) Dimmer switch  
 (4) Heated steering wheel switch

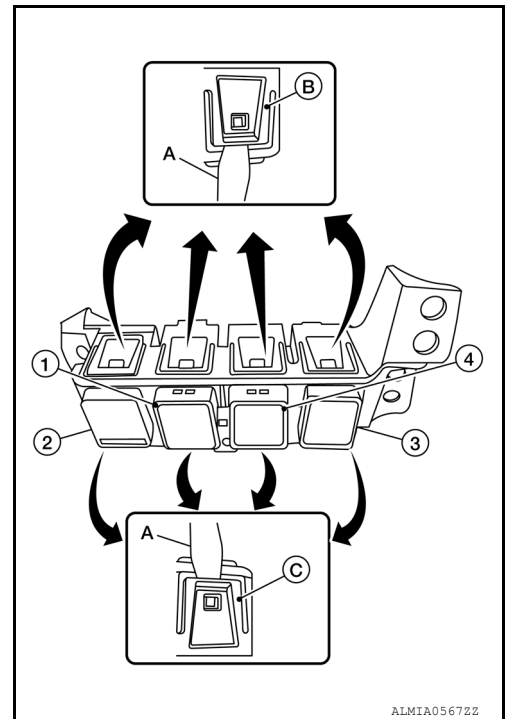

#### INSTALLATION

Installation is in the reverse order of removal.

A  
B  
C  
D  
E  
F  
G  
H  
I  
J  
K  
L  
N  
O  
P

PWO

## AC 120 V OUTLET

### Removal and Installation

INFOID:000000011133903

#### REMOVAL

1. Remove center console rear finisher. Refer to [IP-27. "Exploded View"](#).
2. Release the pawl from the back of the center console rear finisher to remove the AC 120 V outlet.

#### INSTALLATION

Installation is in the reverse order of removal.

# SERVICE DATA AND SPECIFICATIONS (SDS)

< SERVICE DATA AND SPECIFICATIONS (SDS)

[AC 120 V OUTLET]

## SERVICE DATA AND SPECIFICATIONS (SDS)

SERVICE DATA AND SPECIFICATIONS (SDS)

AC 120V Power Outlet

INFOID:0000000011133904

Rated voltage	AC 120 V
Maximum electric capacity	150 W or less (Total)
Maximum current	Up to 30 A (Total)

A  
B  
C  
D  
E  
F  
G  
H  
I  
J  
K  
L

PWO

N  
O  
P