

# SECTION **AV**

## AUDIO, VISUAL & NAVIGATION SYSTEM

A  
B  
C  
D  
E  
F  
G  
H  
I  
J  
K  
L  
M  
AV  
O  
P

### CONTENTS

<p><b>BASE AUDIO</b></p> <p><b>PRECAUTION</b> .....17</p> <p><b>PRECAUTIONS</b> .....17</p> <p style="padding-left: 20px;">Precaution for Supplemental Restraint System (SRS) "AIR BAG" and "SEAT BELT PRE-TENSIONER" .....17</p> <p style="padding-left: 20px;">Cautions in Removing Battery Terminal and AV Control Unit (Models with AV Control Unit) .....17</p> <p style="padding-left: 20px;">Precaution for Trouble Diagnosis .....17</p> <p style="padding-left: 20px;">Precaution for Harness Repair .....17</p> <p style="padding-left: 20px;">Precaution for Work .....18</p> <p><b>PREPARATION</b> .....19</p> <p><b>PREPARATION</b> .....19</p> <p style="padding-left: 20px;">Special Service Tool .....19</p> <p style="padding-left: 20px;">Commercial Service Tools .....19</p> <p><b>SYSTEM DESCRIPTION</b> .....20</p> <p><b>COMPONENT PARTS</b> .....20</p> <p style="padding-left: 20px;">Component Parts Location .....20</p> <p style="padding-left: 20px;">Component Description .....21</p> <p><b>SYSTEM</b> .....23</p> <p><b>MULTI AV SYSTEM</b> .....23</p> <p style="padding-left: 20px;">MULTI AV SYSTEM : System Diagram .....23</p> <p style="padding-left: 20px;">MULTI AV SYSTEM : System Description .....23</p> <p><b>DIAGNOSIS SYSTEM (AV CONTROL UNIT)</b>....26</p> <p style="padding-left: 20px;">Description .....26</p> <p style="padding-left: 20px;">On Board Diagnosis Function .....26</p> <p style="padding-left: 20px;">CONSULT Function .....33</p> <p><b>DIAGNOSIS SYSTEM (BLUETOOTH® CONTROL UNIT)</b> .....35</p> <p style="padding-left: 20px;">Diagnosis Description .....35</p> <p style="padding-left: 20px;">Work Flow .....35</p> <p><b>ECU DIAGNOSIS INFORMATION</b> .....36</p>	<p><b>AV CONTROL UNIT</b> .....36</p> <p style="padding-left: 20px;">Reference Value .....36</p> <p style="padding-left: 20px;">DTC Index .....42</p> <p><b>DISPLAY UNIT</b> .....44</p> <p style="padding-left: 20px;">Reference Value .....44</p> <p><b>SATELLITE RADIO TUNER</b> .....47</p> <p style="padding-left: 20px;">Reference Value .....47</p> <p><b>BLUETOOTH® CONTROL UNIT</b> .....49</p> <p style="padding-left: 20px;">Reference Value .....49</p> <p><b>WIRING DIAGRAM</b> .....51</p> <p><b>BASE AUDIO</b> .....51</p> <p style="padding-left: 20px;">Wiring Diagram .....51</p> <p><b>BASIC INSPECTION</b> .....77</p> <p><b>DIAGNOSIS AND REPAIR WORKFLOW</b> .....77</p> <p style="padding-left: 20px;">Work Flow .....77</p> <p><b>INSPECTION AND ADJUSTMENT</b> .....79</p> <p><b>ADDITIONAL SERVICE WHEN REPLACING AV CONTROL UNIT</b> .....79</p> <p style="padding-left: 20px;">ADDITIONAL SERVICE WHEN REPLACING AV CONTROL UNIT : Description .....79</p> <p style="padding-left: 20px;">ADDITIONAL SERVICE WHEN REPLACING AV CONTROL UNIT : Work Procedure .....79</p> <p><b>CONFIGURATION (AV CONTROL UNIT)</b> .....79</p> <p style="padding-left: 20px;">CONFIGURATION (AV CONTROL UNIT) : Description .....80</p> <p style="padding-left: 20px;">CONFIGURATION (AV CONTROL UNIT) : Work Procedure .....80</p> <p style="padding-left: 20px;">CONFIGURATION (AV CONTROL UNIT) : Configuration List .....81</p> <p><b>DTC/CIRCUIT DIAGNOSIS</b> .....82</p> <p><b>U1000 CAN COMM CIRCUIT</b> .....82</p>
---	--

DTC Logic .....	82	Diagnosis Procedure .....	106
Diagnosis Procedure .....	82	<b>BLUETOOTH® VOICE SIGNAL CIRCUIT .....</b>	<b>108</b>
<b>U1010 CONTROL UNIT (CAN) .....</b>	<b>83</b>	Diagnosis Procedure .....	108
DTC Logic .....	83	<b>RGB (R: RED) SIGNAL CIRCUIT .....</b>	<b>110</b>
<b>U1200 AV CONTROL UNIT .....</b>	<b>84</b>	Diagnosis Procedure .....	110
DTC Logic .....	84	<b>RGB (G: GREEN) SIGNAL CIRCUIT .....</b>	<b>111</b>
<b>U1216 AV CONTROL UNIT .....</b>	<b>85</b>	Diagnosis Procedure .....	111
DTC Logic .....	85	<b>RGB (B: BLUE) SIGNAL CIRCUIT .....</b>	<b>112</b>
<b>U1232 STEERING ANGLE SENSOR .....</b>	<b>86</b>	Diagnosis Procedure .....	112
DTC Logic .....	86	<b>RGB SYNCHRONIZING SIGNAL CIRCUIT ....</b>	<b>113</b>
Diagnosis Procedure .....	86	Diagnosis Procedure .....	113
<b>U1243 DISPLAY UNIT .....</b>	<b>87</b>	<b>RGB AREA (YS) SIGNAL CIRCUIT .....</b>	<b>114</b>
DTC Logic .....	87	Diagnosis Procedure .....	114
Diagnosis Procedure .....	87	<b>HORIZONTAL SYNCHRONIZING (HP) SIG-</b>	
<b>U1255 SATELLITE RADIO TUNER .....</b>	<b>89</b>	<b>NAL CIRCUIT .....</b>	<b>115</b>
DTC Logic .....	89	Diagnosis Procedure .....	115
Diagnosis Procedure .....	89	<b>VERTICAL SYNCHRONIZING (VP) SIGNAL</b>	
<b>U1300 AV COMM CIRCUIT .....</b>	<b>91</b>	<b>CIRCUIT .....</b>	<b>116</b>
Description .....	91	Diagnosis Procedure .....	116
<b>U1310 AV CONTROL UNIT .....</b>	<b>92</b>	<b>COMPOSITE IMAGE SIGNAL CIRCUIT .....</b>	<b>117</b>
DTC Logic .....	92	Diagnosis Procedure .....	117
<b>POWER SUPPLY AND GROUND CIRCUIT ....</b>	<b>93</b>	<b>AUX IMAGE SIGNAL CIRCUIT .....</b>	<b>119</b>
<b>AV CONTROL UNIT .....</b>	<b>93</b>	Diagnosis Procedure .....	119
AV CONTROL UNIT : Diagnosis Procedure .....	93	<b>CAMERA IMAGE SIGNAL CIRCUIT .....</b>	<b>121</b>
<b>DISPLAY UNIT .....</b>	<b>93</b>	Diagnosis Procedure .....	121
DISPLAY UNIT : Diagnosis Procedure .....	93	<b>DISK EJECT SIGNAL CIRCUIT .....</b>	<b>123</b>
<b>SATELLITE RADIO TUNER .....</b>	<b>95</b>	Diagnosis Procedure .....	123
SATELLITE RADIO TUNER : Diagnosis Proce-		<b>MICROPHONE SIGNAL CIRCUIT .....</b>	<b>124</b>
dure .....	95	Diagnosis Procedure .....	124
<b>BLUETOOTH® CONTROL UNIT .....</b>	<b>96</b>	<b>BLUETOOTH® CONTROL SIGNAL CIRCUIT.</b>	<b>126</b>
BLUETOOTH® CONTROL UNIT : Diagnosis Pro-		Diagnosis Procedure .....	126
cedure .....	96	<b>STEERING SWITCH .....</b>	<b>127</b>
<b>A/C AND AV SWITCH ASSEMBLY .....</b>	<b>97</b>	Diagnosis Procedure .....	127
A/C AND AV SWITCH ASSEMBLY : Diagnosis		<b>USB CONNECTOR .....</b>	<b>129</b>
Procedure .....	97	Diagnosis Procedure .....	129
<b>FRONT DOOR SPEAKER .....</b>	<b>98</b>	<b>SYMPTOM DIAGNOSIS .....</b>	<b>130</b>
Diagnosis Procedure .....	98	<b>MULTI AV SYSTEM .....</b>	<b>130</b>
<b>INSTRUMENT PANEL SPEAKER/TWEETER</b>	<b>100</b>	Symptom Table .....	130
Diagnosis Procedure .....	100	<b>NORMAL OPERATING CONDITION .....</b>	<b>134</b>
<b>REAR DOOR SPEAKER .....</b>	<b>102</b>	Description .....	134
Diagnosis Procedure .....	102	<b>REMOVAL AND INSTALLATION .....</b>	<b>136</b>
<b>FRONT AUXILIARY INPUT JACK AUDIO</b>		<b>AV CONTROL UNIT .....</b>	<b>136</b>
<b>SIGNAL CIRCUIT .....</b>	<b>104</b>	Exploded View .....	136
Diagnosis Procedure .....	104		
<b>SATELLITE AUDIO SIGNAL CIRCUIT .....</b>	<b>106</b>		

Removal and Installation - AV Control Unit .....	136	Cautions in Removing Battery Terminal and AV Control Unit (Models with AV Control Unit) .....	153	A
Removal and Installation - A/C and AV Switch Assembly .....	137	Precaution for Trouble Diagnosis .....	153	
<b>STEERING SWITCH .....</b>	<b>138</b>	Precaution for Harness Repair .....	153	B
Exploded View .....	138	Precaution for Work .....	154	
Removal and Installation .....	138	<b>PREPARATION .....</b>	<b>155</b>	
<b>DISPLAY UNIT .....</b>	<b>139</b>	<b>PREPARATION .....</b>	<b>155</b>	C
Exploded View .....	139	Special Service Tool .....	155	
Removal and Installation .....	139	Commercial Service Tools .....	155	
<b>FRONT DOOR SPEAKER .....</b>	<b>140</b>	<b>SYSTEM DESCRIPTION .....</b>	<b>156</b>	D
Exploded View .....	140	<b>COMPONENT PARTS .....</b>	<b>156</b>	
Removal and Installation .....	140	Component Parts Location .....	156	E
<b>INSTRUMENT PANEL SPEAKER/TWEETER.</b>	<b>141</b>	Component Description .....	157	
Removal and Installation .....	141	<b>SYSTEM .....</b>	<b>159</b>	F
<b>REAR DOOR SPEAKER .....</b>	<b>142</b>	<b>MULTI AV SYSTEM .....</b>	<b>159</b>	
Exploded View .....	142	MULTI AV SYSTEM : System Diagram .....	159	G
Removal and Installation .....	142	MULTI AV SYSTEM : System Description .....	159	
<b>REAR VIEW CAMERA .....</b>	<b>143</b>	<b>DIAGNOSIS SYSTEM (AV CONTROL UNIT) .</b>	<b>162</b>	H
Removal and Installation .....	143	Description .....	162	
<b>USB INTERFACE .....</b>	<b>144</b>	On Board Diagnosis Function .....	162	I
Removal and Installation .....	144	CONSULT Function .....	171	
<b>FRONT AUXILIARY INPUT JACKS .....</b>	<b>145</b>	<b>DIAGNOSIS SYSTEM (BLUETOOTH® CONTROL UNIT) .....</b>	<b>172</b>	J
Removal and Installation .....	145	Diagnosis Description .....	172	
<b>BLUETOOTH CONTROL UNIT .....</b>	<b>146</b>	Work Flow .....	172	K
Exploded View .....	146	<b>ECU DIAGNOSIS INFORMATION .....</b>	<b>173</b>	
Removal and Installation .....	146	<b>AV CONTROL UNIT .....</b>	<b>173</b>	L
<b>MICROPHONE .....</b>	<b>147</b>	Reference Value .....	173	
Removal and Installation .....	147	DTC Index .....	179	M
<b>SATELLITE RADIO TUNER .....</b>	<b>148</b>	<b>DISPLAY UNIT .....</b>	<b>181</b>	
Exploded View .....	148	Reference Value .....	181	
Removal and Installation .....	148	<b>BOSE AMP. ....</b>	<b>184</b>	
<b>AUDIO ANTENNA .....</b>	<b>149</b>	Reference Value .....	184	
Location of Antennas .....	149	<b>SATELLITE RADIO TUNER .....</b>	<b>187</b>	
Window Antenna Repair .....	149	Reference Value .....	187	AV
<b>BLUETOOTH® ANTENNA .....</b>	<b>151</b>	<b>BLUETOOTH® CONTROL UNIT .....</b>	<b>189</b>	
Removal and Installation .....	151	Reference Value .....	189	O
<b>SATELLITE RADIO ANTENNA .....</b>	<b>152</b>	<b>WIRING DIAGRAM .....</b>	<b>191</b>	
Removal and Installation .....	152	<b>BOSE AUDIO WITHOUT NAVIGATION .....</b>	<b>191</b>	P
Disassembly and Assembly .....	152	Wiring Diagram .....	191	
<b>BOSE AUDIO WITHOUT NAVIGATION</b>		<b>BASIC INSPECTION .....</b>	<b>219</b>	
<b>PRECAUTION .....</b>	<b>153</b>	<b>DIAGNOSIS AND REPAIR WORKFLOW .....</b>	<b>219</b>	
<b>PRECAUTIONS .....</b>	<b>153</b>	Work Flow .....	219	
Precaution for Supplemental Restraint System (SRS) "AIR BAG" and "SEAT BELT PRE-TENSIONER" .....	153	<b>INSPECTION AND ADJUSTMENT .....</b>	<b>221</b>	

<b>ADDITIONAL SERVICE WHEN REPLACING AV CONTROL UNIT</b> .....	221	Diagnosis Procedure .....	238
ADDITIONAL SERVICE WHEN REPLACING AV CONTROL UNIT : Description .....	221	<b>U162A CENTER SPEAKER</b> .....	<b>239</b>
ADDITIONAL SERVICE WHEN REPLACING AV CONTROL UNIT : Work Procedure .....	221	DTC Logic .....	239
<b>CONFIGURATION (AV CONTROL UNIT)</b> .....	<b>221</b>	Diagnosis Procedure .....	239
CONFIGURATION (AV CONTROL UNIT) : Description .....	222	<b>U1684, U1687, U168C, U168F REAR DOOR SPEAKER/TWEETER</b> .....	<b>240</b>
CONFIGURATION (AV CONTROL UNIT) : Work Procedure .....	222	DTC Logic .....	240
CONFIGURATION (AV CONTROL UNIT) : Configuration List .....	223	Diagnosis Procedure .....	240
<b>DTC/CIRCUIT DIAGNOSIS</b> .....	<b>224</b>	<b>U175D WOOFER</b> .....	<b>241</b>
<b>U1000 CAN COMM CIRCUIT</b> .....	<b>224</b>	DTC Logic .....	241
DTC Logic .....	224	Diagnosis Procedure .....	241
Diagnosis Procedure .....	224	<b>U176A, U1772 ROOF SPEAKER</b> .....	<b>242</b>
<b>U1010 CONTROL UNIT (CAN)</b> .....	<b>225</b>	DTC Logic .....	242
DTC Logic .....	225	Diagnosis Procedure .....	242
<b>U1200 AV CONTROL UNIT</b> .....	<b>226</b>	<b>POWER SUPPLY AND GROUND CIRCUIT</b> ...	<b>243</b>
DTC Logic .....	226	<b>AV CONTROL UNIT</b> .....	<b>243</b>
<b>U1216 AV CONTROL UNIT</b> .....	<b>227</b>	AV CONTROL UNIT : Diagnosis Procedure .....	243
DTC Logic .....	227	<b>DISPLAY UNIT</b> .....	<b>243</b>
<b>U1231 BOSE AMP.</b> .....	<b>228</b>	DISPLAY UNIT : Diagnosis Procedure .....	243
DTC Logic .....	228	<b>BOSE AMP.</b> .....	<b>245</b>
<b>U1232 STEERING ANGLE SENSOR</b> .....	<b>229</b>	BOSE AMP. : Diagnosis Procedure .....	245
DTC Logic .....	229	<b>SUBWOOFER</b> .....	<b>246</b>
Diagnosis Procedure .....	229	SUBWOOFER : Diagnosis Procedure .....	246
<b>U1243 DISPLAY UNIT</b> .....	<b>230</b>	<b>SATELLITE RADIO TUNER</b> .....	<b>246</b>
DTC Logic .....	230	SATELLITE RADIO TUNER : Diagnosis Procedure .....	246
Diagnosis Procedure .....	230	<b>BLUETOOTH® CONTROL UNIT</b> .....	<b>247</b>
<b>U1255 SATELLITE RADIO TUNER</b> .....	<b>232</b>	BLUETOOTH® CONTROL UNIT : Diagnosis Procedure .....	247
DTC Logic .....	232	<b>A/C AND AV SWITCH ASSEMBLY</b> .....	<b>248</b>
Diagnosis Procedure .....	232	A/C AND AV SWITCH ASSEMBLY : Diagnosis Procedure .....	248
<b>U1265 BOSE AMP.</b> .....	<b>234</b>	<b>CENTER SPEAKER</b> .....	<b>250</b>
DTC Logic .....	234	Diagnosis Procedure .....	250
Diagnosis Procedure .....	234	<b>INSTRUMENT PANEL SPEAKER/TWEETER</b> .....	<b>252</b>
<b>U1300 AV COMM CIRCUIT</b> .....	<b>235</b>	Diagnosis Procedure .....	252
Description .....	235	<b>FRONT TWEETER</b> .....	<b>255</b>
<b>U1310 AV CONTROL UNIT</b> .....	<b>236</b>	Diagnosis Procedure .....	255
DTC Logic .....	236	<b>FRONT DOOR SPEAKER</b> .....	<b>258</b>
<b>U1601, U1603, U1609, U160B FRONT DOOR SPEAKER/TWEETER</b> .....	<b>237</b>	Diagnosis Procedure .....	258
DTC Logic .....	237	<b>REAR DOOR SPEAKER</b> .....	<b>261</b>
Diagnosis Procedure .....	237	Diagnosis Procedure .....	261
<b>U1627, U162F TWEETER</b> .....	<b>238</b>	<b>REAR SPEAKER</b> .....	<b>264</b>
DTC Logic .....	238	Diagnosis Procedure .....	264
		<b>SUBWOOFER</b> .....	<b>267</b>

Diagnosis Procedure .....	267	<b>NORMAL OPERATING CONDITION .....</b>	<b>301</b>	
<b>FRONT AUXILIARY INPUT JACK AUDIO SIGNAL CIRCUIT .....</b>	<b>270</b>	Description .....	301	A
Diagnosis Procedure .....	270	<b>REMOVAL AND INSTALLATION .....</b>	<b>303</b>	
<b>SATELLITE AUDIO SIGNAL CIRCUIT .....</b>	<b>272</b>	<b>AV CONTROL UNIT .....</b>	<b>303</b>	B
Diagnosis Procedure .....	272	Exploded View .....	303	
<b>BLUETOOTH® VOICE SIGNAL CIRCUIT .....</b>	<b>274</b>	Removal and Installation - AV Control Unit .....	303	C
Diagnosis Procedure .....	274	Removal and Installation - A/C and AV Switch Assembly .....	304	
<b>RGB (R: RED) SIGNAL CIRCUIT .....</b>	<b>276</b>	<b>STEERING SWITCH .....</b>	<b>305</b>	D
Diagnosis Procedure .....	276	Exploded View .....	305	
<b>RGB (G: GREEN) SIGNAL CIRCUIT .....</b>	<b>277</b>	Removal and Installation .....	305	
Diagnosis Procedure .....	277	<b>DISPLAY UNIT .....</b>	<b>306</b>	E
<b>RGB (B: BLUE) SIGNAL CIRCUIT .....</b>	<b>278</b>	Exploded View .....	306	
Diagnosis Procedure .....	278	Removal and Installation .....	306	
<b>RGB SYNCHRONIZING SIGNAL CIRCUIT .....</b>	<b>279</b>	<b>BOSE SPEAKER AMP .....</b>	<b>307</b>	F
Diagnosis Procedure .....	279	Removal and Installation .....	307	
<b>RGB AREA (YS) SIGNAL CIRCUIT .....</b>	<b>280</b>	<b>FRONT DOOR SPEAKER .....</b>	<b>308</b>	G
Diagnosis Procedure .....	280	Exploded View .....	308	
<b>HORIZONTAL SYNCHRONIZING (HP) SIGNAL CIRCUIT .....</b>	<b>281</b>	Removal and Installation .....	308	
Diagnosis Procedure .....	281	<b>FRONT TWEETER .....</b>	<b>309</b>	H
<b>VERTICAL SYNCHRONIZING (VP) SIGNAL CIRCUIT .....</b>	<b>282</b>	Removal and Installation .....	309	
Diagnosis Procedure .....	282	<b>INSTRUMENT PANEL SPEAKER/TWEETER .....</b>	<b>310</b>	I
<b>COMPOSITE IMAGE SIGNAL CIRCUIT .....</b>	<b>283</b>	Removal and Installation .....	310	
Diagnosis Procedure .....	283	<b>CENTER SPEAKER .....</b>	<b>311</b>	J
<b>AUX IMAGE SIGNAL CIRCUIT .....</b>	<b>285</b>	Removal and Installation .....	311	
Diagnosis Procedure .....	285	<b>REAR DOOR SPEAKER .....</b>	<b>312</b>	K
<b>CAMERA IMAGE SIGNAL CIRCUIT .....</b>	<b>287</b>	Exploded View .....	312	
Diagnosis Procedure .....	287	Removal and Installation .....	312	
<b>DISK EJECT SIGNAL CIRCUIT .....</b>	<b>289</b>	<b>REAR SPEAKERS .....</b>	<b>313</b>	L
Diagnosis Procedure .....	289	Removal and Installation .....	313	
<b>MICROPHONE SIGNAL CIRCUIT .....</b>	<b>290</b>	<b>SUBWOOFER .....</b>	<b>314</b>	M
Diagnosis Procedure .....	290	Exploded View .....	314	
<b>BLUETOOTH® CONTROL SIGNAL CIRCUIT .....</b>	<b>292</b>	Removal and Installation .....	314	
Diagnosis Procedure .....	292	<b>REAR VIEW CAMERA .....</b>	<b>315</b>	AV
<b>STEERING SWITCH .....</b>	<b>293</b>	Removal and Installation .....	315	
Diagnosis Procedure .....	293	<b>USB INTERFACE .....</b>	<b>316</b>	O
<b>USB CONNECTOR .....</b>	<b>295</b>	Removal and Installation .....	316	
Diagnosis Procedure .....	295	<b>FRONT AUXILIARY INPUT JACKS .....</b>	<b>317</b>	P
<b>SYMPTOM DIAGNOSIS .....</b>	<b>296</b>	Removal and Installation .....	317	
<b>MULTI AV SYSTEM .....</b>	<b>296</b>	<b>BLUETOOTH CONTROL UNIT .....</b>	<b>318</b>	
Symptom Table .....	296	Exploded View .....	318	
		Removal and Installation .....	318	
		<b>MICROPHONE .....</b>	<b>319</b>	
		Removal and Installation .....	319	
		<b>SATELLITE RADIO TUNER .....</b>	<b>320</b>	

Exploded View .....	320	Fail-Safe .....	367
Removal and Installation .....	320	DTC Index .....	367
<b>AUDIO ANTENNA .....</b>	<b>321</b>	<b>DISPLAY UNIT .....</b>	<b>370</b>
Location of Antennas .....	321	Reference Value .....	370
Window Antenna Repair .....	321	<b>BOSE AMP. ....</b>	<b>372</b>
<b>BLUETOOTH® ANTENNA .....</b>	<b>323</b>	Reference Value .....	372
Removal and Installation .....	323	<b>VIDEO DISTRIBUTOR .....</b>	<b>375</b>
<b>SATELLITE RADIO ANTENNA .....</b>	<b>324</b>	Reference Value .....	375
Removal and Installation .....	324	<b>HEADREST DISPLAY UNIT .....</b>	<b>379</b>
Disassembly and Assembly .....	324	Reference Value .....	379
<b>BOSE AUDIO W/NAVI W/O SURROUND</b>		<b>AROUND VIEW MONITOR CONTROL UNIT .....</b>	<b>383</b>
<b>PRECAUTION .....</b>	<b>325</b>	Reference Value .....	383
<b>PRECAUTIONS .....</b>	<b>325</b>	DTC Index .....	386
Precaution for Supplemental Restraint System (SRS) "AIR BAG" and "SEAT BELT PRE-TENSIONER" .....	325	<b>SONAR CONTROL UNIT (WITH AROUND VIEW MONITOR) .....</b>	<b>387</b>
Cautions in Removing Battery Terminal and AV Control Unit (Models with AV Control Unit) .....	325	Reference Value .....	387
Precaution for Trouble Diagnosis .....	325	DTC Index .....	389
Precaution for Harness Repair .....	325	<b>WIRING DIAGRAM .....</b>	<b>390</b>
Precaution for Work .....	326	<b>BOSE AUDIO W/NAVI W/O SURROUND .....</b>	<b>390</b>
<b>PREPARATION .....</b>	<b>327</b>	Wiring Diagram .....	390
<b>PREPARATION .....</b>	<b>327</b>	<b>BASIC INSPECTION .....</b>	<b>442</b>
Special Service Tool .....	327	<b>DIAGNOSIS AND REPAIR WORKFLOW .....</b>	<b>442</b>
Commercial Service Tools .....	327	Work Flow (Multi AV System) .....	442
<b>SYSTEM DESCRIPTION .....</b>	<b>328</b>	Work Flow (Camera Assistance Sonar) .....	444
<b>COMPONENT PARTS .....</b>	<b>328</b>	<b>INSPECTION AND ADJUSTMENT .....</b>	<b>446</b>
Component Parts Location .....	328	<b>ADDITIONAL SERVICE WHEN REPLACING AV CONTROL UNIT .....</b>	<b>446</b>
Component Description .....	330	ADDITIONAL SERVICE WHEN REPLACING AV CONTROL UNIT : Description .....	446
<b>SYSTEM .....</b>	<b>333</b>	ADDITIONAL SERVICE WHEN REPLACING AV CONTROL UNIT : Work Procedure .....	446
<b>MULTI AV SYSTEM .....</b>	<b>333</b>	<b>CONFIGURATION (AV CONTROL UNIT) .....</b>	<b>446</b>
MULTI AV SYSTEM : System Diagram .....	333	CONFIGURATION (AV CONTROL UNIT) : Description .....	447
MULTI AV SYSTEM : System Description .....	333	CONFIGURATION (AV CONTROL UNIT) : Work Procedure .....	447
<b>DIAGNOSIS SYSTEM (AV CONTROL UNIT) .</b>	<b>341</b>	CONFIGURATION (AV CONTROL UNIT) : Configuration List .....	448
Description .....	341	<b>ADDITIONAL SERVICE WHEN REPLACING AROUND VIEW MONITOR CONTROL UNIT .....</b>	<b>448</b>
On Board Diagnosis Function .....	341	ADDITIONAL SERVICE WHEN REPLACING AROUND VIEW MONITOR CONTROL UNIT : Description .....	448
CONSULT Function .....	354	ADDITIONAL SERVICE WHEN REPLACING AROUND VIEW MONITOR CONTROL UNIT : Work Procedure .....	448
<b>DIAGNOSIS SYSTEM (AROUND VIEW MONITOR CONTROL UNIT) .....</b>	<b>356</b>	<b>CONFIGURATION (AROUND VIEW MONITOR CONTROL UNIT) .....</b>	<b>449</b>
CONSULT Function .....	356		
<b>DIAGNOSIS SYSTEM [SONAR CONTROL UNIT (WITH AROUND VIEW MONITOR)] .....</b>	<b>359</b>		
CONSULT Function .....	359		
<b>ECU DIAGNOSIS INFORMATION .....</b>	<b>361</b>		
<b>AV CONTROL UNIT .....</b>	<b>361</b>		
Reference Value .....	361		

CONFIGURATION (AROUND VIEW MONITOR CONTROL UNIT) : Description .....	449	DTC Logic .....	461	A
CONFIGURATION (AROUND VIEW MONITOR CONTROL UNIT) : Work Procedure .....	449	<b>U1201 AV CONTROL UNIT</b> .....	<b>462</b>	
CONFIGURATION (AROUND VIEW MONITOR CONTROL UNIT) : Configuration List .....	450	DTC Logic .....	462	B
<b>ADDITIONAL SERVICE WHEN REPLACING SONAR CONTROL UNIT</b> .....	<b>450</b>	<b>U1202 AV CONTROL UNIT</b> .....	<b>463</b>	
ADDITIONAL SERVICE WHEN REPLACING SONAR CONTROL UNIT : Description .....	450	DTC Logic .....	463	C
ADDITIONAL SERVICE WHEN REPLACING SONAR CONTROL UNIT : Work Procedure .....	450	<b>U1204 AV CONTROL UNIT</b> .....	<b>464</b>	
<b>CONFIGURATION (SONAR CONTROL UNIT)</b> .....	<b>451</b>	DTC Logic .....	464	D
CONFIGURATION (SONAR CONTROL UNIT) : Description .....	451	Diagnosis Procedure .....	464	
CONFIGURATION (SONAR CONTROL UNIT) : Work Procedure .....	451	<b>U1205 AV CONTROL UNIT</b> .....	<b>465</b>	E
CONFIGURATION (SONAR CONTROL UNIT) : Configuration List .....	452	DTC Logic .....	465	
<b>PREDICTED COURSE LINE CENTER POSITION ADJUSTMENT</b> .....	<b>452</b>	Diagnosis Procedure .....	465	F
PREDICTED COURSE LINE CENTER POSITION ADJUSTMENT : Description .....	452	<b>U1206 AV CONTROL UNIT</b> .....	<b>466</b>	
PREDICTED COURSE LINE CENTER POSITION ADJUSTMENT : Work Procedure .....	452	DTC Logic .....	466	G
<b>CALIBRATING CAMERA IMAGE (AROUND VIEW MONITOR)</b> .....	<b>452</b>	Diagnosis Procedure .....	466	
CALIBRATING CAMERA IMAGE (AROUND VIEW MONITOR) : Description .....	453	<b>U1207 AV CONTROL UNIT</b> .....	<b>467</b>	H
CALIBRATING CAMERA IMAGE (AROUND VIEW MONITOR) : Work Procedure .....	453	DTC Logic .....	467	
<b>DTC/CIRCUIT DIAGNOSIS</b> .....	<b>459</b>	Diagnosis Procedure .....	467	I
<b>U1000 CAN COMM CIRCUIT</b> .....	<b>459</b>	<b>U1216 AV CONTROL UNIT</b> .....	<b>468</b>	
<b>AV CONTROL UNIT</b> .....	<b>459</b>	DTC Logic .....	468	J
AV CONTROL UNIT : DTC Logic .....	459	<b>U1217 AV CONTROL UNIT</b> .....	<b>469</b>	
AV CONTROL UNIT : Diagnosis Procedure .....	459	DTC Logic .....	469	K
<b>SONAR CONTROL UNIT (WITH AROUND VIEW MONITOR)</b> .....	<b>459</b>	<b>U1218 AV CONTROL UNIT</b> .....	<b>470</b>	
SONAR CONTROL UNIT (WITH AROUND VIEW MONITOR) : DTC Logic .....	459	DTC Logic .....	470	L
SONAR CONTROL UNIT (WITH AROUND VIEW MONITOR) : Diagnosis Procedure .....	459	<b>U1219 AV CONTROL UNIT</b> .....	<b>471</b>	
<b>U1010 CONTROL UNIT (CAN)</b> .....	<b>460</b>	DTC Logic .....	471	M
<b>AV CONTROL UNIT</b> .....	<b>460</b>	<b>U121A AV CONTROL UNIT</b> .....	<b>472</b>	
AV CONTROL UNIT : DTC Logic .....	460	DTC Logic .....	472	K
<b>SONAR CONTROL UNIT (WITH AROUND VIEW MONITOR)</b> .....	<b>460</b>	<b>U121B AV CONTROL UNIT</b> .....	<b>473</b>	
SONAR CONTROL UNIT (WITH AROUND VIEW MONITOR) : DTC Logic .....	460	DTC Logic .....	473	L
SONAR CONTROL UNIT (WITH AROUND VIEW MONITOR) : Diagnosis Procedure .....	460	<b>U121C AV CONTROL UNIT</b> .....	<b>474</b>	
<b>U1200 AV CONTROL UNIT</b> .....	<b>461</b>	DTC Logic .....	474	M
		<b>U121D AV CONTROL UNIT</b> .....	<b>475</b>	
		DTC Logic .....	475	AV
		Diagnosis Procedure .....	475	
		<b>U121E AV CONTROL UNIT</b> .....	<b>476</b>	
		DTC Logic .....	476	O
		Diagnosis Procedure .....	476	
		<b>U1225 AV CONTROL UNIT</b> .....	<b>477</b>	
		DTC Logic .....	477	P
		<b>U1227 AV CONTROL UNIT</b> .....	<b>478</b>	
		DTC Logic .....	478	
		Diagnosis Procedure .....	478	
		<b>U1228 AV CONTROL UNIT</b> .....	<b>479</b>	
		DTC Logic .....	479	

<b>U1229 AV CONTROL UNIT</b> .....	<b>480</b>	DTC Logic .....	503
DTC Logic .....	480		
<b>U122A AV CONTROL UNIT</b> .....	<b>481</b>	<b>U1601, U1603, U1609, U160B FRONT DOOR</b>	
DTC Logic .....	481	<b>SPEAKER/TWEETER</b> .....	<b>504</b>
Diagnosis Procedure .....	481	DTC Logic .....	504
		Diagnosis Procedure .....	504
<b>U122E AV CONTROL UNIT</b> .....	<b>482</b>	<b>U1627, U162F TWEETER</b> .....	<b>505</b>
DTC Logic .....	482	DTC Logic .....	505
		Diagnosis Procedure .....	505
<b>U1231 BOSE AMP.</b> .....	<b>483</b>	<b>U162A CENTER SPEAKER</b> .....	<b>506</b>
DTC Logic .....	483	DTC Logic .....	506
		Diagnosis Procedure .....	506
<b>U1232 STEERING ANGLE SENSOR</b> .....	<b>484</b>	<b>U1684, U1687, U168C, U168F REAR DOOR</b>	
DTC Logic .....	484	<b>SPEAKER/TWEETER</b> .....	<b>507</b>
Diagnosis Procedure .....	484	DTC Logic .....	507
		Diagnosis Procedure .....	507
<b>U1243 DISPLAY UNIT</b> .....	<b>485</b>	<b>U175D WOOFER</b> .....	<b>508</b>
DTC Logic .....	485	DTC Logic .....	508
Diagnosis Procedure .....	485	Diagnosis Procedure .....	508
<b>U1244 GPS ANTENNA</b> .....	<b>487</b>	<b>U176A, U1772 ROOF SPEAKER</b> .....	<b>509</b>
DTC Logic .....	487	DTC Logic .....	509
Diagnosis Procedure .....	487	Diagnosis Procedure .....	509
<b>U1258 SATELLITE RADIO ANTENNA</b> .....	<b>488</b>	<b>B2720 CORNER SENSOR [RL]</b> .....	<b>510</b>
DTC Logic .....	488	DTC Logic .....	510
Diagnosis Procedure .....	488	Diagnosis Procedure .....	510
<b>U125A HEADREST DISPLAY UNIT</b> .....	<b>489</b>	<b>B2721 CENTER SENSOR [RL]</b> .....	<b>511</b>
DTC Logic .....	489	DTC Logic .....	511
Diagnosis Procedure .....	489	Diagnosis Procedure .....	511
<b>U1263 USB</b> .....	<b>490</b>	<b>B2722 CENTER SENSOR [RR]</b> .....	<b>512</b>
DTC Logic .....	490	DTC Logic .....	512
Diagnosis Procedure .....	490	Diagnosis Procedure .....	512
<b>U1264 ANTENNA AMP.</b> .....	<b>491</b>	<b>B2723 CORNER SENSOR [RR]</b> .....	<b>513</b>
DTC Logic .....	491	DTC Logic .....	513
Diagnosis Procedure .....	491	Diagnosis Procedure .....	513
<b>U1265 BOSE AMP.</b> .....	<b>492</b>	<b>B2724 SONAR CONTROL UNIT</b> .....	<b>514</b>
DTC Logic .....	492	DTC Logic .....	514
Diagnosis Procedure .....	492		
<b>U1300 AV COMM CIRCUIT</b> .....	<b>493</b>	<b>B2725 REAR BUZZER</b> .....	<b>515</b>
Description .....	493	DTC Logic .....	515
		Diagnosis Procedure .....	515
<b>U1302 CAMERA POWER VOLT</b> .....	<b>495</b>	<b>B2729 CORNER SENSOR [FL]</b> .....	<b>517</b>
DTC Logic .....	495	DTC Logic .....	517
Diagnosis Procedure .....	495	Diagnosis Procedure .....	517
<b>U1303 LED POWER SUPPLY VOLT</b> .....	<b>499</b>	<b>B272C CORNER SENSOR [FR]</b> .....	<b>518</b>
DTC Logic .....	499	DTC Logic .....	518
Diagnosis Procedure .....	499	Diagnosis Procedure .....	518
<b>U1304 CAMERA IMAGE CALIBRATION</b> .....	<b>501</b>	<b>POWER SUPPLY AND GROUND CIRCUIT</b> ...	<b>519</b>
DTC Logic .....	501	<b>AV CONTROL UNIT</b> .....	<b>519</b>
		AV CONTROL UNIT : Diagnosis Procedure .....	519
<b>U1305 CONFIG UNFINISH</b> .....	<b>502</b>		
DTC Logic .....	502		
<b>U1310 AV CONTROL UNIT</b> .....	<b>503</b>		



<b>DISPLAY UNIT</b> .....	<b>519</b>	<b>COMPOSITE IMAGE SIGNAL CIRCUIT (VIDEO DISTRIBUTOR TO HEADREST DISPLAY UNIT)</b> .....	<b>552</b>	A
DISPLAY UNIT : Diagnosis Procedure .....	519	Diagnosis Procedure .....	552	
<b>BOSE AMP.</b> .....	<b>520</b>	<b>AUX IMAGE SIGNAL CIRCUIT (FRONT AUXILIARY INPUT JACKS TO AV CONTROL UNIT)</b> .....	<b>553</b>	B
BOSE AMP. : Diagnosis Procedure .....	520	Diagnosis Procedure .....	553	
<b>SUBWOOFER</b> .....	<b>521</b>	<b>IMAGE SWITCH SIGNAL CIRCUIT</b> .....	<b>554</b>	C
SUBWOOFER : Diagnosis Procedure .....	521	Diagnosis Procedure .....	554	D
<b>A/C AND AV SWITCH ASSEMBLY</b> .....	<b>522</b>	<b>DISK EJECT SIGNAL CIRCUIT</b> .....	<b>555</b>	E
A/C AND AV SWITCH ASSEMBLY : Diagnosis Procedure .....	522	Diagnosis Procedure .....	555	
<b>VIDEO DISTRIBUTOR</b> .....	<b>523</b>	<b>MICROPHONE SIGNAL CIRCUIT</b> .....	<b>556</b>	F
VIDEO DISTRIBUTOR : Diagnosis Procedure .....	523	Diagnosis Procedure .....	556	
<b>HEADREST DISPLAY UNIT</b> .....	<b>523</b>	<b>STEERING SWITCH</b> .....	<b>558</b>	G
HEADREST DISPLAY UNIT : Diagnosis Procedure .....	524	Diagnosis Procedure .....	558	
<b>AROUND VIEW MONITOR CONTROL UNIT</b> .....	<b>524</b>	<b>USB CONNECTOR</b> .....	<b>560</b>	H
AROUND VIEW MONITOR CONTROL UNIT : Diagnosis Procedure .....	524	Diagnosis Procedure .....	560	
<b>SONAR CONTROL UNIT (WITH AROUND VIEW MONITOR)</b> .....	<b>525</b>	<b>FRONT CAMERA COMMUNICATION SIGNAL CIRCUIT</b> .....	<b>561</b>	I
SONAR CONTROL UNIT (WITH AROUND VIEW MONITOR) : Diagnosis Procedure .....	525	Diagnosis Procedure .....	561	
<b>CENTER SPEAKER</b> .....	<b>527</b>	<b>FRONT CAMERA IMAGE SIGNAL CIRCUIT</b> .....	<b>562</b>	J
Diagnosis Procedure .....	527	Diagnosis Procedure .....	562	
<b>INSTRUMENT PANEL SPEAKER/TWEETER.</b>	<b>529</b>	<b>REAR CAMERA COMMUNICATION SIGNAL CIRCUIT</b> .....	<b>563</b>	K
Diagnosis Procedure .....	529	Diagnosis Procedure .....	563	
<b>FRONT TWEETER</b> .....	<b>532</b>	<b>REAR CAMERA IMAGE SIGNAL CIRCUIT</b> .....	<b>564</b>	L
Diagnosis Procedure .....	532	Diagnosis Procedure .....	564	
<b>FRONT DOOR SPEAKER</b> .....	<b>535</b>	<b>SIDE CAMERA LH COMMUNICATION SIGNAL CIRCUIT</b> .....	<b>565</b>	M
Diagnosis Procedure .....	535	Diagnosis Procedure .....	565	
<b>REAR DOOR SPEAKER</b> .....	<b>538</b>	<b>SIDE CAMERA LH IMAGE SIGNAL CIRCUIT.</b>	<b>566</b>	AV
Diagnosis Procedure .....	538	Diagnosis Procedure .....	566	
<b>REAR SPEAKER</b> .....	<b>541</b>	<b>SIDE CAMERA RH COMMUNICATION SIGNAL CIRCUIT</b> .....	<b>567</b>	O
Diagnosis Procedure .....	541	Diagnosis Procedure .....	567	
<b>SUBWOOFER</b> .....	<b>544</b>	<b>SIDE CAMERA RH IMAGE SIGNAL CIRCUIT.</b>	<b>568</b>	P
Diagnosis Procedure .....	544	Diagnosis Procedure .....	568	
<b>FRONT AUXILIARY INPUT JACK AUDIO SIGNAL CIRCUIT</b> .....	<b>547</b>	<b>SYMPTOM DIAGNOSIS</b> .....	<b>569</b>	
Diagnosis Procedure .....	547			
<b>RGB DIGITAL IMAGE SIGNAL CIRCUIT</b> .....	<b>549</b>	<b>MULTI AV SYSTEM</b> .....	<b>569</b>	
Diagnosis Procedure .....	549	Symptom Table .....	569	
<b>COMPOSITE IMAGE SIGNAL CIRCUIT (AV CONTROL UNIT TO FRONT DISPLAY UNIT).</b>	<b>550</b>	<b>NORMAL OPERATING CONDITION</b> .....	<b>577</b>	
Diagnosis Procedure .....	550	Description .....	577	
<b>COMPOSITE IMAGE SIGNAL CIRCUIT (AV CONTROL UNIT TO VIDEO DISTRIBUTOR)</b> ..	<b>551</b>	<b>REMOVAL AND INSTALLATION</b> .....	<b>586</b>	
Diagnosis Procedure .....	551			

<b>AV CONTROL UNIT</b> .....	<b>586</b>	<b>HEADREST DISPLAY UNIT</b> .....	<b>605</b>
Exploded View .....	586	Removal and Installation .....	605
Removal and Installation - AV Control Unit .....	586	<b>REAR AUXILIARY INPUT JACKS</b> .....	<b>607</b>
Removal and Installation - A/C and AV Switch Assembly .....	587	Removal and Installation .....	607
<b>STEERING SWITCH</b> .....	<b>588</b>	<b>SONAR CONTROL UNIT</b> .....	<b>608</b>
Exploded View .....	588	Removal and Installation .....	608
Removal and Installation .....	588	<b>SONAR SENSOR</b> .....	<b>609</b>
<b>DISPLAY UNIT</b> .....	<b>589</b>	Removal and Installation .....	609
Exploded View .....	589	<b>BUZZER</b> .....	<b>611</b>
Removal and Installation .....	589	Removal and Installation .....	611
<b>BOSE SPEAKER AMP</b> .....	<b>590</b>	<b>AUDIO ANTENNA</b> .....	<b>612</b>
Removal and Installation .....	590	Location of Antennas .....	612
<b>FRONT DOOR SPEAKER</b> .....	<b>591</b>	Window Antenna Repair .....	612
Exploded View .....	591	<b>GPS ANTENNA</b> .....	<b>614</b>
Removal and Installation .....	591	Removal and Installation .....	614
<b>FRONT TWEETER</b> .....	<b>592</b>	<b>SATELLITE RADIO ANTENNA</b> .....	<b>615</b>
Removal and Installation .....	592	Removal and Installation .....	615
<b>INSTRUMENT PANEL SPEAKER/TWEETER</b> .....	<b>593</b>	Disassembly and Assembly .....	615
Removal and Installation .....	593	<b>BOSE AUDIO W/NAVI W/SURROUND</b>	
<b>CENTER SPEAKER</b> .....	<b>594</b>	<b>PRECAUTION</b> .....	<b>616</b>
Removal and Installation .....	594	<b>PRECAUTIONS</b> .....	<b>616</b>
<b>REAR DOOR SPEAKER</b> .....	<b>595</b>	Precaution for Supplemental Restraint System (SRS) "AIR BAG" and "SEAT BELT PRE-TENSIONER" .....	616
Exploded View .....	595	Cautions in Removing Battery Terminal and AV Control Unit (Models with AV Control Unit) .....	616
Removal and Installation .....	595	Precaution for Trouble Diagnosis .....	616
<b>REAR SPEAKERS</b> .....	<b>596</b>	Precaution for Harness Repair .....	616
Removal and Installation .....	596	Precaution for Work .....	617
<b>SUBWOOFER</b> .....	<b>597</b>	<b>PREPARATION</b> .....	<b>618</b>
Exploded View .....	597	<b>PREPARATION</b> .....	<b>618</b>
Removal and Installation .....	597	Special Service Tool .....	618
<b>USB INTERFACE</b> .....	<b>598</b>	Commercial Service Tools .....	618
Removal and Installation .....	598	<b>SYSTEM DESCRIPTION</b> .....	<b>619</b>
<b>FRONT AUXILIARY INPUT JACKS</b> .....	<b>599</b>	<b>COMPONENT PARTS</b> .....	<b>619</b>
Removal and Installation .....	599	Component Parts Location .....	619
<b>AROUND VIEW MONITOR CONTROL UNIT</b> .....	<b>600</b>	Component Description .....	621
Exploded View .....	600	<b>SYSTEM</b> .....	<b>625</b>
Removal and Installation .....	600	<b>MULTI AV SYSTEM</b> .....	<b>625</b>
<b>FRONT CAMERA</b> .....	<b>601</b>	MULTI AV SYSTEM : System Diagram .....	625
Removal and Installation .....	601	MULTI AV SYSTEM : System Description .....	625
<b>REAR VIEW CAMERA</b> .....	<b>602</b>	<b>DIAGNOSIS SYSTEM (AV CONTROL UNIT)</b> .....	<b>633</b>
Removal and Installation .....	602	Description .....	633
<b>SIDE CAMERA</b> .....	<b>603</b>	On Board Diagnosis Function .....	633
Removal and Installation .....	603	CONSULT Function .....	646
<b>VIDEO DISTRIBUTOR</b> .....	<b>604</b>		
Removal and Installation .....	604		

<b>DIAGNOSIS SYSTEM (AROUND VIEW MONITOR CONTROL UNIT)</b> .....	<b>648</b>	CONFIGURATION (AV CONTROL UNIT) : Configuration List .....	744	A
CONSULT Function .....	648			
<b>DIAGNOSIS SYSTEM [SONAR CONTROL UNIT (WITH AROUND VIEW MONITOR)]</b> .....	<b>651</b>	<b>ADDITIONAL SERVICE WHEN REPLACING AROUND VIEW MONITOR CONTROL UNIT</b> .....	<b>744</b>	B
CONSULT Function .....	651	ADDITIONAL SERVICE WHEN REPLACING AROUND VIEW MONITOR CONTROL UNIT : Description .....	744	
<b>ECU DIAGNOSIS INFORMATION</b> .....	<b>653</b>	ADDITIONAL SERVICE WHEN REPLACING AROUND VIEW MONITOR CONTROL UNIT : Work Procedure .....	744	C
<b>AV CONTROL UNIT</b> .....	<b>653</b>	<b>CONFIGURATION (AROUND VIEW MONITOR CONTROL UNIT)</b> .....	<b>745</b>	D
Reference Value .....	653	CONFIGURATION (AROUND VIEW MONITOR CONTROL UNIT) : Description .....	745	E
Fail-Safe .....	659	CONFIGURATION (AROUND VIEW MONITOR CONTROL UNIT) : Work Procedure .....	745	
DTC Index .....	660	CONFIGURATION (AROUND VIEW MONITOR CONTROL UNIT) : Configuration List .....	746	F
<b>DISPLAY UNIT</b> .....	<b>662</b>	<b>ADDITIONAL SERVICE WHEN REPLACING SONAR CONTROL UNIT</b> .....	<b>746</b>	G
Reference Value .....	662	ADDITIONAL SERVICE WHEN REPLACING SONAR CONTROL UNIT : Description .....	746	
<b>BOSE AMP.</b> .....	<b>664</b>	ADDITIONAL SERVICE WHEN REPLACING SONAR CONTROL UNIT : Work Procedure .....	746	H
Reference Value .....	664	<b>CONFIGURATION (SONAR CONTROL UNIT)</b> .....	<b>747</b>	I
<b>VIDEO DISTRIBUTOR</b> .....	<b>668</b>	CONFIGURATION (SONAR CONTROL UNIT) : Description .....	747	
Reference Value .....	668	CONFIGURATION (SONAR CONTROL UNIT) : Work Procedure .....	747	J
<b>HEADREST DISPLAY UNIT</b> .....	<b>672</b>	CONFIGURATION (SONAR CONTROL UNIT) : Configuration List .....	748	K
Reference Value .....	672	<b>PREDICTED COURSE LINE CENTER POSITION ADJUSTMENT</b> .....	<b>748</b>	L
<b>AROUND VIEW MONITOR CONTROL UNIT</b> ..	<b>676</b>	PREDICTED COURSE LINE CENTER POSITION ADJUSTMENT : Description .....	748	
Reference Value .....	676	PREDICTED COURSE LINE CENTER POSITION ADJUSTMENT : Work Procedure .....	748	M
DTC Index .....	679	<b>CALIBRATING CAMERA IMAGE (AROUND VIEW MONITOR)</b> .....	<b>748</b>	AV
<b>SONAR CONTROL UNIT (WITH AROUND VIEW MONITOR)</b> .....	<b>680</b>	CALIBRATING CAMERA IMAGE (AROUND VIEW MONITOR) : Description .....	749	
Reference Value .....	680	CALIBRATING CAMERA IMAGE (AROUND VIEW MONITOR) : Work Procedure .....	749	O
DTC Index .....	682	<b>DTC/CIRCUIT DIAGNOSIS</b> .....	<b>755</b>	
<b>WIRING DIAGRAM</b> .....	<b>683</b>	<b>U1000 CAN COMM CIRCUIT</b> .....	<b>755</b>	P
<b>BOSE AUDIO W/NAVI W/SURROUND</b> .....	<b>683</b>	<b>AV CONTROL UNIT</b> .....	<b>755</b>	
Wiring Diagram .....	683	AV CONTROL UNIT : DTC Logic .....	755	
<b>BASIC INSPECTION</b> .....	<b>738</b>	AV CONTROL UNIT : Diagnosis Procedure .....	755	
<b>DIAGNOSIS AND REPAIR WORKFLOW</b> .....	<b>738</b>	<b>SONAR CONTROL UNIT (WITH AROUND VIEW MONITOR)</b> .....	<b>755</b>	
Work Flow (Multi AV System) .....	738	SONAR CONTROL UNIT (WITH AROUND VIEW MONITOR) : DTC Logic .....	755	
Work Flow (Camera Assistance Sonar) .....	740			
<b>INSPECTION AND ADJUSTMENT</b> .....	<b>742</b>			
<b>ADDITIONAL SERVICE WHEN REPLACING AV CONTROL UNIT</b> .....	<b>742</b>			
ADDITIONAL SERVICE WHEN REPLACING AV CONTROL UNIT : Description .....	742			
ADDITIONAL SERVICE WHEN REPLACING AV CONTROL UNIT : Work Procedure .....	742			
<b>CONFIGURATION (AV CONTROL UNIT)</b> .....	<b>742</b>			
CONFIGURATION (AV CONTROL UNIT) : Description .....	743			
CONFIGURATION (AV CONTROL UNIT) : Work Procedure .....	743			

SONAR CONTROL UNIT (WITH AROUND VIEW MONITOR) : Diagnosis Procedure .....	755	DTC Logic .....	772
		Diagnosis Procedure .....	772
<b>U1010 CONTROL UNIT (CAN) .....</b>	<b>756</b>	<b>U1225 AV CONTROL UNIT .....</b>	<b>773</b>
<b>AV CONTROL UNIT .....</b>	<b>756</b>	DTC Logic .....	773
AV CONTROL UNIT : DTC Logic .....	756	<b>U1227 AV CONTROL UNIT .....</b>	<b>774</b>
<b>SONAR CONTROL UNIT (WITH AROUND VIEW MONITOR) .....</b>	<b>756</b>	DTC Logic .....	774
SONAR CONTROL UNIT (WITH AROUND VIEW MONITOR) : DTC Logic .....	756	Diagnosis Procedure .....	774
<b>U1200 AV CONTROL UNIT .....</b>	<b>757</b>	<b>U1228 AV CONTROL UNIT .....</b>	<b>775</b>
DTC Logic .....	757	DTC Logic .....	775
<b>U1201 AV CONTROL UNIT .....</b>	<b>758</b>	<b>U1229 AV CONTROL UNIT .....</b>	<b>776</b>
DTC Logic .....	758	DTC Logic .....	776
<b>U1202 AV CONTROL UNIT .....</b>	<b>759</b>	<b>U122A AV CONTROL UNIT .....</b>	<b>777</b>
DTC Logic .....	759	DTC Logic .....	777
<b>U1204 AV CONTROL UNIT .....</b>	<b>760</b>	Diagnosis Procedure .....	777
DTC Logic .....	760	<b>U122E AV CONTROL UNIT .....</b>	<b>778</b>
Diagnosis Procedure .....	760	DTC Logic .....	778
<b>U1205 AV CONTROL UNIT .....</b>	<b>761</b>	<b>U1231 BOSE AMP. ....</b>	<b>779</b>
DTC Logic .....	761	DTC Logic .....	779
Diagnosis Procedure .....	761	<b>U1232 STEERING ANGLE SENSOR .....</b>	<b>780</b>
<b>U1206 AV CONTROL UNIT .....</b>	<b>762</b>	DTC Logic .....	780
DTC Logic .....	762	Diagnosis Procedure .....	780
Diagnosis Procedure .....	762	<b>U1243 DISPLAY UNIT .....</b>	<b>781</b>
<b>U1207 AV CONTROL UNIT .....</b>	<b>763</b>	DTC Logic .....	781
DTC Logic .....	763	Diagnosis Procedure .....	781
Diagnosis Procedure .....	763	<b>U1244 GPS ANTENNA .....</b>	<b>783</b>
<b>U1216 AV CONTROL UNIT .....</b>	<b>764</b>	DTC Logic .....	783
DTC Logic .....	764	Diagnosis Procedure .....	783
<b>U1217 AV CONTROL UNIT .....</b>	<b>765</b>	<b>U1258 SATELLITE RADIO ANTENNA .....</b>	<b>784</b>
DTC Logic .....	765	DTC Logic .....	784
<b>U1218 AV CONTROL UNIT .....</b>	<b>766</b>	Diagnosis Procedure .....	784
DTC Logic .....	766	<b>U125A HEADREST DISPLAY UNIT .....</b>	<b>785</b>
<b>U1219 AV CONTROL UNIT .....</b>	<b>767</b>	DTC Logic .....	785
DTC Logic .....	767	Diagnosis Procedure .....	785
<b>U121A AV CONTROL UNIT .....</b>	<b>768</b>	<b>U1263 USB .....</b>	<b>786</b>
DTC Logic .....	768	DTC Logic .....	786
<b>U121B AV CONTROL UNIT .....</b>	<b>769</b>	Diagnosis Procedure .....	786
DTC Logic .....	769	<b>U1264 ANTENNA AMP. ....</b>	<b>787</b>
<b>U121C AV CONTROL UNIT .....</b>	<b>770</b>	DTC Logic .....	787
DTC Logic .....	770	Diagnosis Procedure .....	787
<b>U121D AV CONTROL UNIT .....</b>	<b>771</b>	<b>U1265 BOSE AMP. ....</b>	<b>788</b>
DTC Logic .....	771	DTC Logic .....	788
Diagnosis Procedure .....	771	Diagnosis Procedure .....	788
<b>U121E AV CONTROL UNIT .....</b>	<b>772</b>	<b>U1300 AV COMM CIRCUIT .....</b>	<b>789</b>
		Description .....	789
		<b>U1302 CAMERA POWER VOLT .....</b>	<b>791</b>
		DTC Logic .....	791

Diagnosis Procedure .....	791	<b>B2729 CORNER SENSOR [FL]</b> .....	<b>813</b>	A
<b>U1303 LED POWER SUPPLY VOLT</b> .....	<b>795</b>	DTC Logic .....	813	
DTC Logic .....	795	Diagnosis Procedure .....	813	
Diagnosis Procedure .....	795	<b>B272C CORNER SENSOR [FR]</b> .....	<b>814</b>	B
<b>U1304 CAMERA IMAGE CALIBRATION</b> .....	<b>797</b>	DTC Logic .....	814	
DTC Logic .....	797	Diagnosis Procedure .....	814	
<b>U1305 CONFIG UNFINISH</b> .....	<b>798</b>	<b>POWER SUPPLY AND GROUND CIRCUIT</b> ..	<b>815</b>	C
DTC Logic .....	798	<b>AV CONTROL UNIT</b> .....	<b>815</b>	
<b>U1310 AV CONTROL UNIT</b> .....	<b>799</b>	AV CONTROL UNIT : Diagnosis Procedure .....	815	D
DTC Logic .....	799	<b>DISPLAY UNIT</b> .....	<b>815</b>	
<b>U1601, U1603, U1609, U160B FRONT DOOR</b>		DISPLAY UNIT : Diagnosis Procedure .....	815	
<b>SPEAKER/TWEETER</b> .....	<b>800</b>	<b>BOSE AMP.</b> .....	<b>816</b>	E
DTC Logic .....	800	BOSE AMP. : Diagnosis Procedure .....	816	
Diagnosis Procedure .....	800	<b>SUBWOOFER</b> .....	<b>817</b>	F
<b>U1627, U162F TWEETER</b> .....	<b>801</b>	SUBWOOFER : Diagnosis Procedure .....	817	
DTC Logic .....	801	<b>A/C AND AV SWITCH ASSEMBLY</b> .....	<b>818</b>	G
Diagnosis Procedure .....	801	A/C AND AV SWITCH ASSEMBLY : Diagnosis		
<b>U162A CENTER SPEAKER</b> .....	<b>802</b>	Procedure .....	818	
DTC Logic .....	802	<b>VIDEO DISTRIBUTOR</b> .....	<b>819</b>	H
Diagnosis Procedure .....	802	VIDEO DISTRIBUTOR : Diagnosis Procedure .....	819	
<b>U1684, U1687, U168C, U168F REAR DOOR</b>		<b>HEADREST DISPLAY UNIT</b> .....	<b>819</b>	I
<b>SPEAKER/TWEETER</b> .....	<b>803</b>	HEADREST DISPLAY UNIT : Diagnosis Proce-		
DTC Logic .....	803	dure .....	820	
Diagnosis Procedure .....	803	<b>AROUND VIEW MONITOR CONTROL UNIT</b> .....	<b>820</b>	J
<b>U175D WOOFER</b> .....	<b>804</b>	AROUND VIEW MONITOR CONTROL UNIT : Di-		
DTC Logic .....	804	agnosis Procedure .....	820	
Diagnosis Procedure .....	804	<b>SONAR CONTROL UNIT (WITH AROUND VIEW</b>		
<b>U176A, U1772 ROOF SPEAKER</b> .....	<b>805</b>	<b>MONITOR)</b> .....	<b>821</b>	K
DTC Logic .....	805	SONAR CONTROL UNIT (WITH AROUND VIEW		
Diagnosis Procedure .....	805	MONITOR) : Diagnosis Procedure .....	821	L
<b>B2720 CORNER SENSOR [RL]</b> .....	<b>806</b>	<b>CENTER SPEAKER</b> .....	<b>823</b>	
DTC Logic .....	806	Diagnosis Procedure .....	823	M
Diagnosis Procedure .....	806	<b>INSTRUMENT PANEL SPEAKER/TWEETER.</b>	<b>825</b>	
<b>B2721 CENTER SENSOR [RL]</b> .....	<b>807</b>	Diagnosis Procedure .....	825	
DTC Logic .....	807	<b>FRONT TWEETER</b> .....	<b>828</b>	AV
Diagnosis Procedure .....	807	Diagnosis Procedure .....	828	
<b>B2722 CENTER SENSOR [RR]</b> .....	<b>808</b>	<b>FRONT DOOR SPEAKER</b> .....	<b>831</b>	O
DTC Logic .....	808	Diagnosis Procedure .....	831	
Diagnosis Procedure .....	808	<b>REAR DOOR TWEETER</b> .....	<b>834</b>	P
<b>B2723 CORNER SENSOR [RR]</b> .....	<b>809</b>	Diagnosis Procedure .....	834	
DTC Logic .....	809	<b>REAR DOOR SPEAKER</b> .....	<b>837</b>	
Diagnosis Procedure .....	809	Diagnosis Procedure .....	837	
<b>B2724 SONAR CONTROL UNIT</b> .....	<b>810</b>	<b>REAR SPEAKER</b> .....	<b>840</b>	
DTC Logic .....	810	Diagnosis Procedure .....	840	
<b>B2725 REAR BUZZER</b> .....	<b>811</b>	<b>SUBWOOFER</b> .....	<b>843</b>	
DTC Logic .....	811			
Diagnosis Procedure .....	811			

Diagnosis Procedure .....	843	Diagnosis Procedure .....	864
<b>FRONT AUXILIARY INPUT JACK AUDIO SIGNAL CIRCUIT</b> .....	<b>846</b>	<b>SIDE CAMERA RH IMAGE SIGNAL CIRCUIT.</b>	<b>865</b>
Diagnosis Procedure .....	846	Diagnosis Procedure .....	865
<b>RGB DIGITAL IMAGE SIGNAL CIRCUIT</b> .....	<b>848</b>	<b>SYMPTOM DIAGNOSIS</b> .....	<b>866</b>
Diagnosis Procedure .....	848	<b>MULTI AV SYSTEM</b> .....	<b>866</b>
<b>COMPOSITE IMAGE SIGNAL CIRCUIT (AV CONTROL UNIT TO FRONT DISPLAY UNIT).</b>	<b>849</b>	Symptom Table .....	866
Diagnosis Procedure .....	849	<b>NORMAL OPERATING CONDITION</b> .....	<b>874</b>
<b>COMPOSITE IMAGE SIGNAL CIRCUIT (AV CONTROL UNIT TO VIDEO DISTRIBUTOR).</b>	<b>850</b>	Description .....	874
Diagnosis Procedure .....	850	<b>REMOVAL AND INSTALLATION</b> .....	<b>883</b>
<b>COMPOSITE IMAGE SIGNAL CIRCUIT (VIDEO DISTRIBUTOR TO HEADREST DISPLAY UNIT)</b> .....	<b>851</b>	<b>AV CONTROL UNIT</b> .....	<b>883</b>
Diagnosis Procedure .....	851	Exploded View .....	883
<b>AUX IMAGE SIGNAL CIRCUIT (FRONT AUXILIARY INPUT JACKS TO AV CONTROL UNIT)</b> .....	<b>852</b>	Removal and Installation - AV Control Unit .....	883
Diagnosis Procedure .....	852	Removal and Installation - A/C and AV Switch Assembly .....	884
<b>IMAGE SWITCH SIGNAL CIRCUIT</b> .....	<b>853</b>	<b>STEERING SWITCH</b> .....	<b>885</b>
Diagnosis Procedure .....	853	Exploded View .....	885
<b>DISK EJECT SIGNAL CIRCUIT</b> .....	<b>854</b>	Removal and Installation .....	885
Diagnosis Procedure .....	854	<b>DISPLAY UNIT</b> .....	<b>886</b>
<b>STEERING SWITCH</b> .....	<b>855</b>	Exploded View .....	886
Diagnosis Procedure .....	855	Removal and Installation .....	886
<b>USB CONNECTOR</b> .....	<b>857</b>	<b>BOSE SPEAKER AMP</b> .....	<b>887</b>
Diagnosis Procedure .....	857	Removal and Installation .....	887
<b>FRONT CAMERA COMMUNICATION SIGNAL CIRCUIT</b> .....	<b>858</b>	<b>FRONT DOOR SPEAKER</b> .....	<b>888</b>
Diagnosis Procedure .....	858	Exploded View .....	888
<b>FRONT CAMERA IMAGE SIGNAL CIRCUIT</b> .....	<b>859</b>	Removal and Installation .....	888
Diagnosis Procedure .....	859	<b>FRONT TWEETER</b> .....	<b>889</b>
<b>REAR CAMERA COMMUNICATION SIGNAL CIRCUIT</b> .....	<b>860</b>	Removal and Installation .....	889
Diagnosis Procedure .....	860	<b>INSTRUMENT PANEL SPEAKER/TWEETER.</b>	<b>890</b>
<b>REAR CAMERA IMAGE SIGNAL CIRCUIT</b> .....	<b>861</b>	Removal and Installation .....	890
Diagnosis Procedure .....	861	<b>CENTER SPEAKER</b> .....	<b>891</b>
<b>SIDE CAMERA LH COMMUNICATION SIGNAL CIRCUIT</b> .....	<b>862</b>	Removal and Installation .....	891
Diagnosis Procedure .....	862	<b>REAR DOOR SPEAKER</b> .....	<b>892</b>
<b>SIDE CAMERA LH IMAGE SIGNAL CIRCUIT.</b>	<b>863</b>	Exploded View .....	892
Diagnosis Procedure .....	863	Removal and Installation .....	892
<b>SIDE CAMERA RH COMMUNICATION SIGNAL CIRCUIT</b> .....	<b>864</b>	<b>REAR DOOR TWEETER</b> .....	<b>893</b>
		Removal and Installation .....	893
		<b>REAR SPEAKERS</b> .....	<b>894</b>
		Removal and Installation .....	894
		<b>SUBWOOFER</b> .....	<b>895</b>
		Exploded View .....	895
		Removal and Installation .....	895
		<b>USB INTERFACE</b> .....	<b>896</b>
		Removal and Installation .....	896
		<b>FRONT AUXILIARY INPUT JACKS</b> .....	<b>897</b>

Removal and Installation .....	897	<b>SYSTEM DESCRIPTION .....</b>	<b>917</b>	A
<b>AROUND VIEW MONITOR CONTROL UNIT ..</b>	<b>898</b>	<b>COMPONENT PARTS .....</b>	<b>917</b>	B
Exploded View .....	898	Component Parts Location .....	917	
Removal and Installation .....	898	Component Description .....	917	
<b>FRONT CAMERA .....</b>	<b>899</b>	<b>SYSTEM .....</b>	<b>919</b>	C
Removal and Installation .....	899	<b>TELEMATICS SYSTEM .....</b>	<b>919</b>	
<b>REAR VIEW CAMERA .....</b>	<b>900</b>	TELEMATICS SYSTEM : System Diagram .....	919	
Removal and Installation .....	900	TELEMATICS SYSTEM : System Description .....	919	
<b>SIDE CAMERA .....</b>	<b>901</b>	<b>DIAGNOSIS SYSTEM (TCU) .....</b>	<b>920</b>	D
Removal and Installation .....	901	CONSULT Function .....	920	
<b>VIDEO DISTRIBUTOR .....</b>	<b>902</b>	<b>ECU DIAGNOSIS INFORMATION .....</b>	<b>921</b>	E
Removal and Installation .....	902	<b>AV CONTROL UNIT .....</b>	<b>921</b>	
<b>HEADREST DISPLAY UNIT .....</b>	<b>903</b>	List of ECU Reference .....	921	F
Removal and Installation .....	903	<b>TCU .....</b>	<b>922</b>	
<b>REAR AUXILIARY INPUT JACKS .....</b>	<b>905</b>	Reference Value .....	922	G
Removal and Installation .....	905	DTC Index .....	923	
<b>SONAR CONTROL UNIT .....</b>	<b>906</b>	<b>WIRING DIAGRAM .....</b>	<b>924</b>	H
Removal and Installation .....	906	<b>BOSE AUDIO W/NAVI W/O SURROUND .....</b>	<b>924</b>	
<b>SONAR SENSOR .....</b>	<b>907</b>	Wiring Diagram .....	924	I
Removal and Installation .....	907	<b>BOSE AUDIO W/NAVI W/SURROUND .....</b>	<b>976</b>	
<b>BUZZER .....</b>	<b>909</b>	Wiring Diagram .....	976	J
Removal and Installation .....	909	<b>BASIC INSPECTION .....</b>	<b>1031</b>	
<b>AUDIO ANTENNA .....</b>	<b>910</b>	<b>DIAGNOSIS AND REPAIR WORK FLOW ....</b>	<b>1031</b>	K
Location of Antennas .....	910	Work Flow .....	1031	
Window Antenna Repair .....	910	<b>INSPECTION AND ADJUSTMENT .....</b>	<b>1033</b>	L
<b>GPS ANTENNA .....</b>	<b>912</b>	<b>ADDITIONAL SERVICE WHEN REPLACING TCU</b>	<b>1033</b>	
Removal and Installation .....	912	ADDITIONAL SERVICE WHEN REPLACING		
<b>SATELLITE RADIO ANTENNA .....</b>	<b>913</b>	TCU : Description .....	1033	
Removal and Installation .....	913	ADDITIONAL SERVICE WHEN REPLACING		
Disassembly and Assembly .....	913	TCU : Work Procedure .....	1033	
<b>TELEMATICS SYSTEM</b>		<b>DTC/CIRCUIT DIAGNOSIS .....</b>	<b>1036</b>	M
<b>PRECAUTION .....</b>	<b>914</b>	<b>U1000 CAN COMM CIRCUIT .....</b>	<b>1036</b>	
<b>PRECAUTIONS .....</b>	<b>914</b>	DTC Logic .....	1036	AV
Precaution for Supplemental Restraint System (SRS) "AIR BAG" and "SEAT BELT PRE-TENSIONER" .....	914	Diagnosis Procedure .....	1036	
Cautions in Removing Battery Terminal and AV Control Unit (Models with AV Control Unit) .....	914	<b>U1010 CONTROL UNIT (CAN) .....</b>	<b>1037</b>	O
Precaution for Trouble Diagnosis .....	914	DTC Logic .....	1037	
Precaution for Harness Repair .....	914	<b>U1A00 TCU .....</b>	<b>1038</b>	P
Precaution for Work .....	915	DTC Logic .....	1038	
<b>PREPARATION .....</b>	<b>916</b>	Diagnosis Procedure .....	1038	
<b>PREPARATION .....</b>	<b>916</b>	<b>U1A01 TCU .....</b>	<b>1039</b>	
Special Service Tool .....	916	DTC Logic .....	1039	
Commercial Service Tools .....	916	<b>U1A02 TCU .....</b>	<b>1040</b>	
		DTC Logic .....	1040	

<b>U1A03 TCU</b> .....	<b>1041</b>	Diagnosis Procedure .....	1051
DTC Logic .....	1041		
<b>U1A04 TCU</b> .....	<b>1042</b>	<b>POWER SUPPLY AND GROUND CIRCUIT</b> ..	<b>1052</b>
DTC Logic .....	1042	Diagnosis Procedure .....	1052
<b>U1A05 TCU</b> .....	<b>1043</b>	<b>SYMPTOM DIAGNOSIS</b> .....	<b>1053</b>
DTC Logic .....	1043	<b>TELEMATICS SYSTEM</b> .....	<b>1053</b>
Diagnosis Procedure .....	1043	Symptom Table .....	1053
<b>U1A07 TEL ANTENNA</b> .....	<b>1044</b>	<b>NORMAL OPERATING CONDITION</b> .....	<b>1054</b>
DTC Logic .....	1044	Description .....	1054
Diagnosis Procedure .....	1044	<b>REMOVAL AND INSTALLATION</b> .....	<b>1055</b>
<b>U1A08 TEL ANTENNA</b> .....	<b>1045</b>	<b>AV CONTROL UNIT</b> .....	<b>1055</b>
DTC Logic .....	1045	Exploded View .....	1055
Diagnosis Procedure .....	1045	Removal and Installation - AV Control Unit .....	1055
<b>U1A0B MICROPHONE</b> .....	<b>1046</b>	Removal and Installation - A/C and AV Switch As-	
DTC Logic .....	1046	sembly .....	1056
Diagnosis Procedure .....	1046	<b>TCU</b> .....	<b>1057</b>
<b>U1A0C MICROPHONE</b> .....	<b>1048</b>	Removal and Installation .....	1057
DTC Logic .....	1048	<b>MICROPHONE</b> .....	<b>1058</b>
Diagnosis Procedure .....	1048	Removal and Installation .....	1058
<b>U1A0E TELEMATICS SWITCH</b> .....	<b>1050</b>	<b>GPS ANTENNA</b> .....	<b>1059</b>
DTC Logic .....	1050	Removal and Installation .....	1059
Diagnosis Procedure .....	1050	<b>TEL ANTENNA</b> .....	<b>1060</b>
<b>U1A0F TELEMATICS SWITCH</b> .....	<b>1051</b>	Removal and Installation .....	1060
DTC Logic .....	1051		



PRECAUTION

PRECAUTIONS

Precaution for Supplemental Restraint System (SRS) "AIR BAG" and "SEAT BELT PRE-TENSIONER"

INFOID:000000009128973

The Supplemental Restraint System such as "AIR BAG" and "SEAT BELT PRE-TENSIONER", used along with a front seat belt, helps to reduce the risk or severity of injury to the driver and front passenger for certain types of collision. This system includes dual stage front air bag modules. The SRS system may only deploy one front air bag, depending on the severity of a collision and whether the front passenger seat is occupied. Information necessary to service the system safely is included in the SR and SB section of this Service Manual.

**WARNING:**

- To avoid rendering the SRS inoperative, which could increase the risk of personal injury or death in the event of a collision which would result in air bag inflation, all maintenance must be performed by an authorized NISSAN/INFINITI dealer.
- Improper maintenance, including incorrect removal and installation of the SRS, can lead to personal injury caused by unintentional activation of the system. For removal of Spiral Cable and Air Bag Module, see the SR section.
- Do not use electrical test equipment on any circuit related to the SRS unless instructed to in this Service Manual. SRS wiring harnesses can be identified by yellow and/or orange harnesses or harness connectors.

PRECAUTIONS WHEN USING POWER TOOLS (AIR OR ELECTRIC) AND HAMMERS

**WARNING:**

- When working near the Airbag Diagnosis Sensor Unit or other Airbag System sensors with the Ignition ON or engine running, DO NOT use air or electric power tools or strike near the sensor(s) with a hammer. Heavy vibration could activate the sensor(s) and deploy the air bag(s), possibly causing serious injury.
- When using air or electric power tools or hammers, always switch the Ignition OFF, disconnect the battery and wait at least three minutes before performing any service.

Cautions in Removing Battery Terminal and AV Control Unit (Models with AV Control Unit)

INFOID:000000009128974

**CAUTION:**

Remove battery terminal and AV control unit 30 seconds or more after turning the ignition switch OFF.

**NOTE:**

After the ignition switch is turned OFF, the AV control unit continues operating for approximately 30 seconds. Therefore, data corruption may occur if battery voltage is cut off within 30 seconds.

Precaution for Trouble Diagnosis

INFOID:000000009128975

AV COMMUNICATION SYSTEM

- Do not apply voltage of 7.0 V or higher to the measurement terminals.
- Use the tester with its open terminal voltage being 7.0 V or less.
- Be sure to turn ignition switch OFF and disconnect the battery cable from the negative terminal before checking the circuit.

Precaution for Harness Repair

INFOID:000000009128976

AV COMMUNICATION SYSTEM

A  
B  
C  
D  
E  
F  
G  
H  
I  
J  
K  
L  
M  
O  
P

AV

# PRECAUTIONS

< PRECAUTION >

[BASE AUDIO]

- Solder the repaired parts, and wrap with tape. [Frays of twisted line must be within 110 mm (4.33 in).]

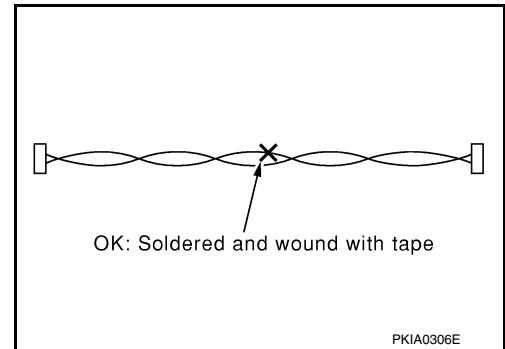

- Do not perform bypass wire connections for the repair parts. (The spliced wire will become separated and the characteristics of twisted line will be lost.)

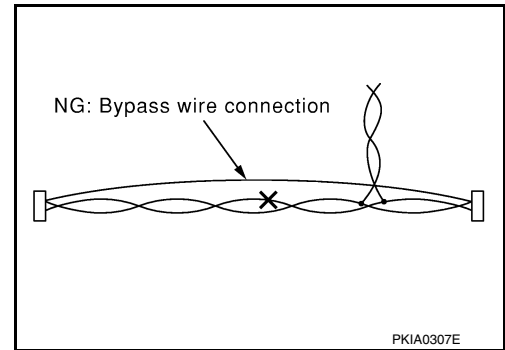

## Precaution for Work

INFOID:000000009128977

- When removing or disassembling each component, be careful not to damage or deform it. If a component may be subject to interference, be sure to protect it with a shop cloth.
- When removing (disengaging) components with a screwdriver or similar tool, be sure to wrap the component with a shop cloth or vinyl tape to protect it.
- Protect the removed parts with a shop cloth and prevent them from being dropped.
- Replace a deformed or damaged clip.
- If a part is specified as a non-reusable part, always replace it with a new one.
- Be sure to tighten bolts and nuts securely to the specified torque.
- After installation is complete, be sure to check that each part works properly.
- Follow the steps below to clean components:
  - Water soluble dirt:
    - Dip a soft cloth into lukewarm water, wring the water out of the cloth and wipe the dirty area.
    - Then rub with a soft, dry cloth.
  - Oily dirt:
    - Dip a soft cloth into lukewarm water with mild detergent (concentration: within 2 to 3%) and wipe the dirty area.
    - Then dip a cloth into fresh water, wring the water out of the cloth and wipe the detergent off.
    - Then rub with a soft, dry cloth.
  - Do not use organic solvent such as thinner, benzene, alcohol or gasoline.
  - For genuine leather seats, use a genuine leather seat cleaner.

# PREPARATION

< PREPARATION >

[BASE AUDIO]

## PREPARATION

### PREPARATION

#### Special Service Tool

INFOID:000000009128978

The actual shapes of Kent-Moore tools may differ from those of special service tools illustrated here.

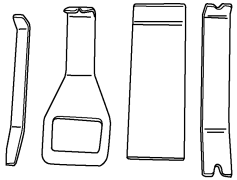
Tool number (Kent-Moore No.) Tool name	Description
— (J-46534) Trim Tool Set  AWJIA0483ZZ	Removing trim components

#### Commercial Service Tools

INFOID:000000009128979

Tool name	Description
Power tools  PIIB1407E	Loosening nuts, screws and bolts

A  
B  
C  
D  
E  
F  
G  
H  
I  
J  
K  
L  
M  
AV  
O  
P

# COMPONENT PARTS

< SYSTEM DESCRIPTION >

[BASE AUDIO]

## SYSTEM DESCRIPTION

### COMPONENT PARTS

#### Component Parts Location

INFOID:000000009128980

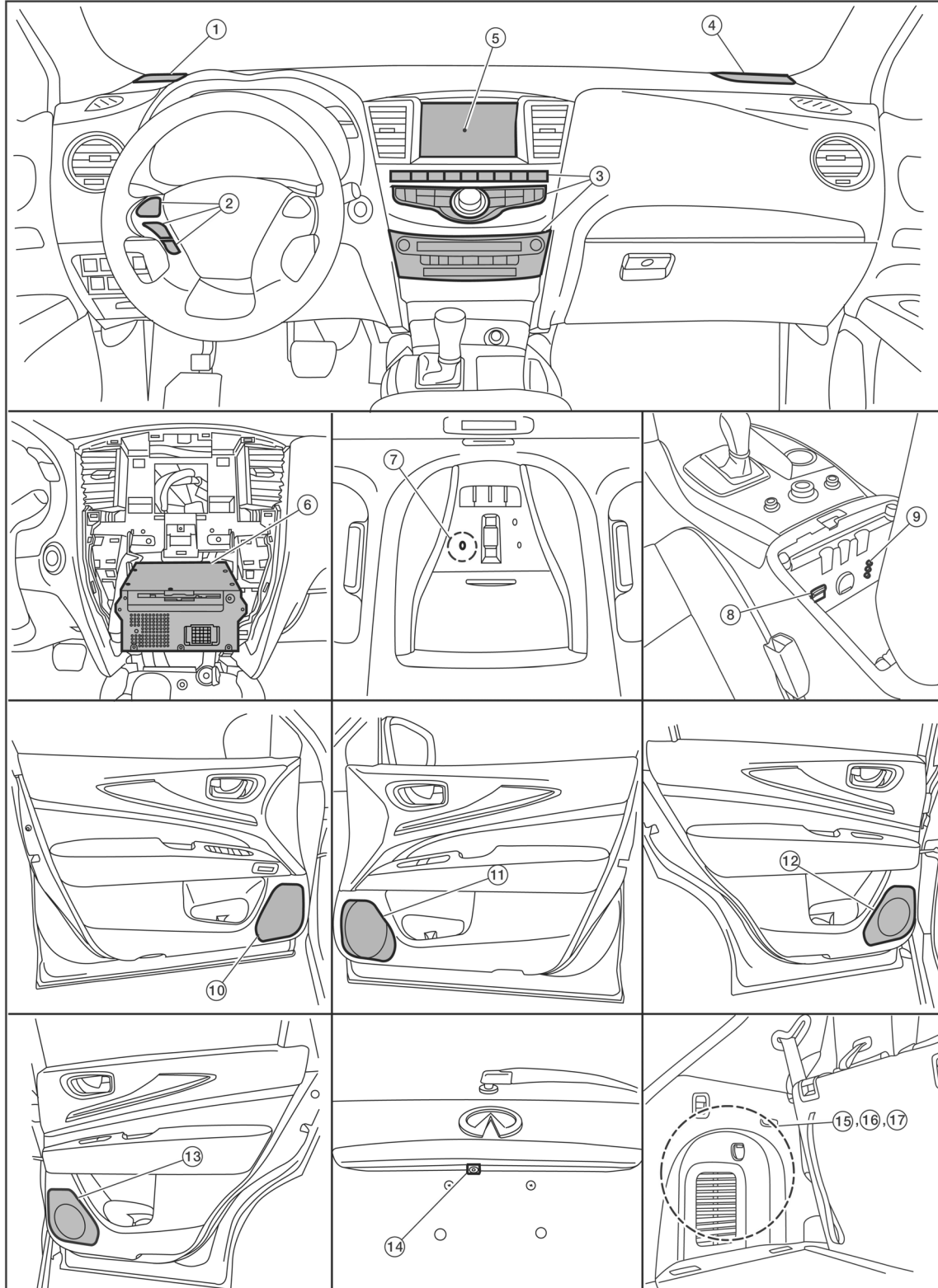

ALNIA1339ZZ

# COMPONENT PARTS

< SYSTEM DESCRIPTION >

[BASE AUDIO]

- |                                |                           |   |   |
|--------------------------------|---------------------------|---|---|
| 1. Instrument panel tweeter LH | 2. Steering switch        | 3. A/C and AV switch assembly                       | A |
| 4. Instrument panel tweeter RH | 5. Display unit           | 6. AV control unit (view with center stack removed) | B |
| 7. Microphone                  | 8. USB interface          | 9. Front auxiliary input jacks                      | B |
| 10. Front door speaker LH      | 11. Front door speaker RH | 12. Rear door speaker LH                            | C |
| 13. Rear door speaker RH       | 14. Rear view camera      | 15. Bluetooth® control unit                         | C |
| 16. Satellite radio tuner      | 17. Bluetooth® antenna    |   | D |

## Component Description

INFOID:000000009128981

Part name	Description	
AV control unit	<ul style="list-style-type: none"> <li>Master unit of MULTI AV system.</li> <li>AV control unit includes audio, USB connection and vehicle status functions.</li> <li>Connected to MULTI AV system control units via AV communication.</li> <li>Connected to other vehicle control units via CAN communication to obtain necessary information for vehicle information function.</li> <li>Receives steering angle signal via CAN communication from steering angle sensor and controls an expected course line during rear view monitor operation.</li> <li>Inputs signals for driving status recognition (vehicle speed, reverse and parking brake).</li> <li>TEL voice signal and voice guidance signal are input from Bluetooth® control unit.</li> <li>Camera image signal is received and transmitted to display unit.</li> </ul>	E
Display unit	<ul style="list-style-type: none"> <li>Display image is controlled by AV control unit via serial communication.</li> <li>Receives power (signal VCC and inverter VCC) from AV control unit.</li> <li>RGB image signals (RGB image, RGB area and RGB synchronizing) are input from AV control unit.</li> <li>Composite image signals are input from AV control unit.</li> <li>Synchronizing signals (HP, VP) are output to AV control unit.</li> </ul>	H
Front door speaker	Outputs low and mid range sounds.	
Instrument panel tweeter	Outputs high range sounds.	J
Rear door speaker	Outputs low, mid and high range sounds.	
A/C and AV switch assembly	<ul style="list-style-type: none"> <li>Operation panels are equipped with switches for audio and air conditioner operations.</li> <li>Operation signal is transmitted via AV communication to AV control unit.</li> <li>Disk eject operation signal is performed via hardwire.</li> </ul>	K
Rear view camera	<ul style="list-style-type: none"> <li>Camera power supply is input from AV control unit.</li> <li>Vehicle rear view image is transmitted to display unit via AV control unit.</li> </ul>	L
Steering angle sensor	Connected to AV control unit via CAN communication and transmits steering angle sensor signal.	M
Steering switch	<ul style="list-style-type: none"> <li>Operations for audio, hands-free phone and voice recognition are possible.</li> <li>Steering switch signal (operation signal) is output to AV control unit.</li> </ul>	
Microphone	<ul style="list-style-type: none"> <li>Used for hands-free phone and voice recognition operation.</li> <li>Microphone signal is transmitted to Bluetooth® control unit.</li> <li>Power (Microphone VCC) is supplied from Bluetooth® control unit.</li> </ul>	AV
Antenna amp.	<ul style="list-style-type: none"> <li>Radio signal received by window antenna is amplified and transmitted to AV control unit.</li> <li>Power (antenna amp. ON signal) is supplied from AV control unit.</li> </ul>	O
Satellite radio tuner	<ul style="list-style-type: none"> <li>Inputs satellite radio signal from satellite radio antenna and outputs sound signal to AV control unit.</li> <li>Controlled via serial communication (communication signal and request signal) by AV control unit.</li> </ul>	P
Satellite radio antenna	Satellite radio signal is received and transmitted to satellite radio tuner.	
Bluetooth® control unit	<ul style="list-style-type: none"> <li>Inputs TEL voice signal from Bluetooth® antenna and outputs it to AV control unit.</li> <li>Controlled via AV communication by AV control unit.</li> </ul>	

## COMPONENT PARTS

< SYSTEM DESCRIPTION >

[BASE AUDIO]

Part name	Description
Bluetooth® antenna	Receives TEL voice signal and outputs it to Bluetooth® control unit.
USB connector	USB sound and data input signals are transmitted to AV control unit.

SYSTEM  
MULTI AV SYSTEM  
MULTI AV SYSTEM : System Diagram

INFOID:000000009128982

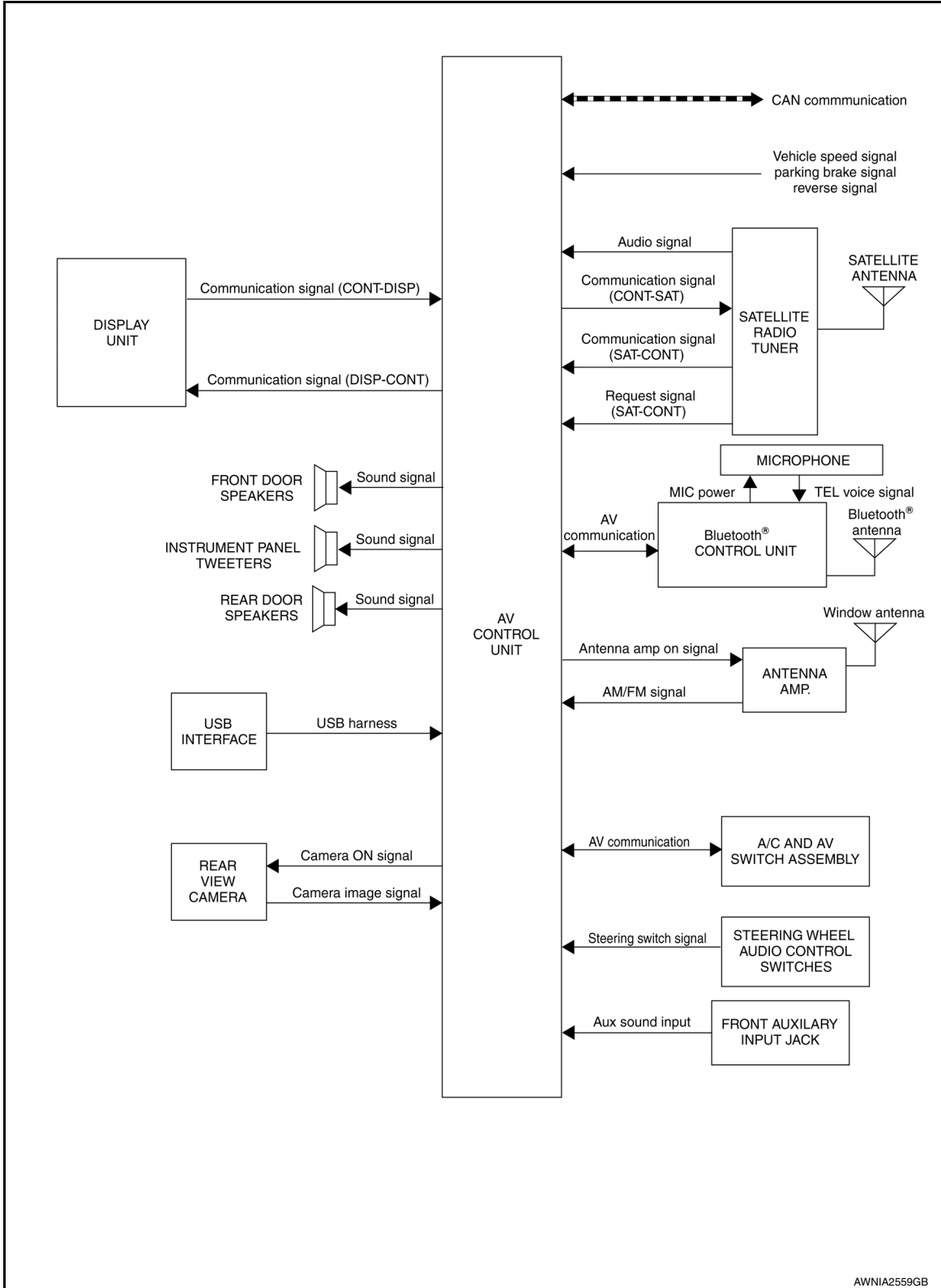

A  
B  
C  
D  
E  
F  
G  
H  
I  
J  
K  
L  
M  
O  
P

AV

MULTI AV SYSTEM : System Description

INFOID:000000009128983

AUDIO SYSTEM

The audio system consists of the following components

- AV control unit
- A/C and AV switch assembly
- Display unit
- Steering switch
- Front door speakers
- Instrument panel tweeters
- Rear door speakers
- Window antenna

When the audio system is on, radio signals are received by the window antenna. The AV control unit then sends audio signals to the front door speakers, instrument panel tweeters and rear door speakers.

Refer to Owner's Manual for audio system operating instructions.

### SATELLITE RADIO SYSTEM

The satellite radio system consists of the following components

- Satellite antenna
- Satellite radio tuner

When the satellite radio system is on, radio signals are supplied to the satellite radio tuner from the satellite antenna. The satellite radio tuner then sends audio signals to the AV control unit.

Refer to Owner's Manual for satellite radio system operating instructions.

### HANDS-FREE PHONE SYSTEM

System Operation

#### **NOTE:**

Cellular telephones must have their wireless connection set up (paired) before using the Bluetooth® telephone system.

The Bluetooth® telephone system allows users who have a Bluetooth® cellular telephone to make a wireless connection between their cellular telephone and the Bluetooth® control unit. Hands-free cellular telephone calls can be sent and received. Some Bluetooth® cellular telephones may not be recognized by the Bluetooth® control unit. When a cellular telephone or the Bluetooth® control unit is replaced, the telephone must be paired with the Bluetooth® control unit. Different cellular telephones may have different pairing procedures, refer to the cellular telephone operating manual.

Refer to the Owner's Manual for Bluetooth® telephone system operating instructions.

Bluetooth® Control Unit

When the ignition switch is turned to ACC or ON, the Bluetooth® control unit will power up. During power up, the Bluetooth® control unit is initialized and performs various self-checks. Initialization may take up to 20 seconds. If a phone is present in the vehicle and paired with the Bluetooth® control unit, Nissan Voice Recognition will then become active. Bluetooth® telephone functions can be turned off using the Nissan Voice Recognition system.

Steering Switch

When buttons on the steering switch are pushed, the resistance in steering switch circuit changes, depending on which button is pushed. The Bluetooth® control unit uses this signal to perform various functions while navigating through the voice recognition system.

The following functions can be performed using the steering switch:

- Initiate self-diagnosis of the Bluetooth® telephone system
- Start a voice recognition session
- Answer and end telephone calls
- Adjust the volume of calls

Microphone

The microphone is located in the roof console assembly. The microphone sends a signal to the Bluetooth® control unit. The microphone can be actively tested during self-diagnosis.

AV Control Unit

The AV control unit receives signals from the Bluetooth® control unit and sends audio signals to the speakers.

### REAR VIEW CAMERA SYSTEM



# SYSTEM

< SYSTEM DESCRIPTION >

[BASE AUDIO]

When the shift selector is in the R position, the display shows a view to the rear of the vehicle. Lines which indicate the vehicle clearance and distances are also displayed.

A

## SPEED SENSITIVE VOLUME SYSTEM

Volume level of this system goes up and down automatically in proportion to the vehicle speed. The control level can be selected by the customer. Refer to Owner's Manual for operating instructions.

B

C

D

E

F

G

H

I

J

K

L

M

AV

O

P

# DIAGNOSIS SYSTEM (AV CONTROL UNIT)

< SYSTEM DESCRIPTION >

[BASE AUDIO]

## DIAGNOSIS SYSTEM (AV CONTROL UNIT)

### Description

INFOID:000000009128984

The AV control unit on board diagnosis includes the following functions:

- A/C and AV switch assembly self diagnosis that checks the ON/OFF operation (continuity) of each switch in the A/C and AV switch assembly.

**NOTE:**

The hazard switch and disk eject switch are not included in this operation check.

- AV control unit on board diagnosis performs the following functions listed in the table below:

Mode	Description	
Self Diagnosis	<ul style="list-style-type: none"><li>• AV control unit diagnosis.</li><li>• Diagnoses the connections across system components (between AV control unit and each unit).</li></ul>	
Confirmation/ Adjustment	Display Diagnosis	<ul style="list-style-type: none"><li>• Color tone check using color spectrum bar display and white display.</li><li>• Light and shade check by gradation bar display.</li></ul>
	Vehicle Signals	Diagnosis of signals can be performed for vehicle speed, parking brake, lights, ignition and reverse.
	Speaker Test	Speaker connection can be confirmed by test tone.
	Error History	<ul style="list-style-type: none"><li>• The system malfunction and frequency of past occurrences is displayed.</li><li>• When malfunctioning item is selected, time and place that the malfunction last occurred are displayed.</li></ul>
	Camera Cont.	<ul style="list-style-type: none"><li>• Guiding line position that overlaps rear view camera image can be adjusted.</li><li>• Configuration stored in the AV control unit can be checked.</li></ul>
	Vehicle CAN Diagnosis	Transmit/receive function of CAN communication can be monitored.
	AV COMM Diagnosis	Communication condition of each unit of Multi AV system can be monitored.
	Delete Unit Connection Log	Erase connection history of unit and error history.
	Initialize Settings	Initializes the AV control unit memory.

Perform CONSULT diagnosis if the AV control unit on board diagnosis does not start, the screen does not display anything, or the A/C and AV switch assembly self diagnosis does not function.

### On Board Diagnosis Function

INFOID:000000009128985

#### METHOD OF STARTING

##### A/C and AV Switch Assembly Self Diagnosis

- Press the BACK and UP switches within 10 seconds after turning the ignition switch from OFF to ACC and hold them for 3 seconds or more.
- The buzzer sounds, all indicators of the switches illuminate, and the self-diagnosis mode begins.
- The ON position continuity of each switch can be checked by pressing the switch. The buzzer sounds if continuity is present.
- The self diagnosis mode is canceled when the ignition switch is turned OFF.

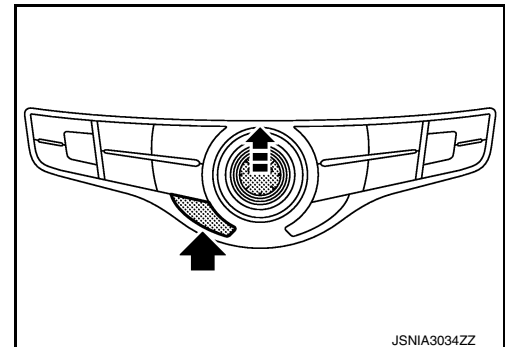

##### AV Control Unit Self Diagnosis

1. Turn the ignition ON.
2. Turn the audio system OFF.

# DIAGNOSIS SYSTEM (AV CONTROL UNIT)

[BASE AUDIO]

## < SYSTEM DESCRIPTION >

- While pressing the SETTING button, turn the volume control dial clockwise or counterclockwise for 40 clicks or more. When self-diagnosis mode begins, a short beep will be heard. Shifting from current screen to previous screen is performed by pressing BACK button.

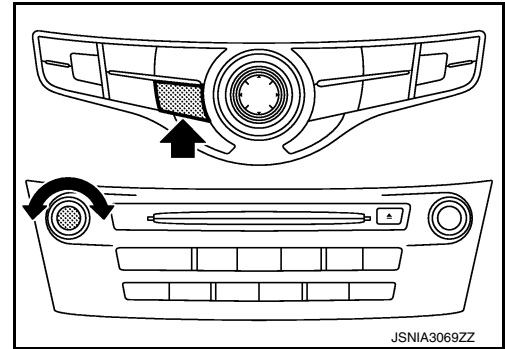

- The trouble diagnosis initial screen is displayed, and Self Diagnosis or Confirmation/Adjustment can be selected.

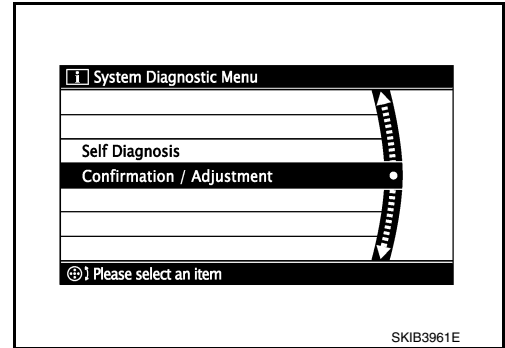

## SELF DIAGNOSIS MODE

### AV Control Unit Self Diagnosis

- Select Self Diagnosis.
- Self diagnosis screen is displayed. The bar graph visible in center of screen indicates progress of self diagnosis.
- Diagnosis results are displayed after self diagnosis is completed. Unit names and connection lines are color coded according to diagnostic results. Control Unit (AV control unit) is displayed in red.

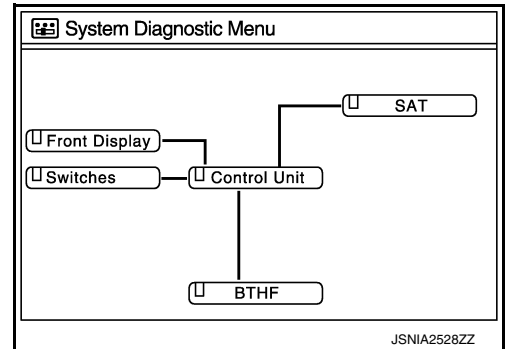

Diagnosis results	Unit	Connection line
Normal	Green	Green
Connection malfunction	Gray	Yellow
Unit malfunction <sup>1</sup>	Red	Green

1: Control Unit (AV control unit) is displayed in red.

- Replace AV control unit if Self Diagnosis did not run because control unit malfunction is indicated. The symptom is AV control unit internal error. Refer to [AV-136, "Removal and Installation - AV Control Unit"](#).
- If multiple errors occur at the same time for a single unit, the screen switch colors are determined according to the following order of priority: red > gray.

# DIAGNOSIS SYSTEM (AV CONTROL UNIT)

< SYSTEM DESCRIPTION >

[BASE AUDIO]

4. Comments of self diagnosis results can be viewed in the diagnosis result screen.

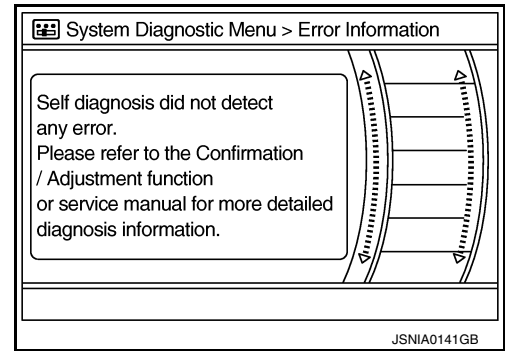

## AV Control Unit Self Diagnosis Results

Only Unit Part Is Displayed In Red		
Screen switch	Description	Possible cause
Control unit	Malfunction is detected in AV control unit power supply or ground circuit.	<ul style="list-style-type: none"> <li>AV control unit power supply or ground circuits. Refer to <a href="#">AV-93</a>.</li> <li>If no malfunction is detected in AV control unit power supply and ground circuits, replace AV control unit. Refer to <a href="#">AV-136</a>.</li> </ul>

A Connecting Cable Between Units Is Displayed In Yellow		
Area with yellow connection lines	Description	Possible cause
Control unit ↔ Front Display	Malfunction is detected in serial communication circuits between AV control unit and display unit.	Serial communication circuits between AV control unit and display unit. Refer to <a href="#">AV-87</a> .
Control unit ↔ SAT	When any of the following is detected: <ul style="list-style-type: none"> <li>satellite radio tuner power supply or ground circuit malfunction.</li> <li>communication circuit malfunction between AV control unit and satellite radio tuner.</li> <li>request signal circuit malfunction between AV control unit and satellite radio tuner.</li> </ul>	<ul style="list-style-type: none"> <li>Satellite radio tuner power supply or ground circuits. Refer to <a href="#">AV-95</a>.</li> <li>Communication circuit between AV control unit and satellite radio tuner. Refer to <a href="#">AV-89</a>.</li> <li>Request signal circuit between AV control unit and satellite radio tuner. Refer to <a href="#">AV-89</a>.</li> </ul>
Control unit ↔ BTHF	When any of the following is detected: <ul style="list-style-type: none"> <li>Bluetooth® control unit power supply or ground circuit malfunction.</li> <li>AV communication circuit malfunction between AV control unit and Bluetooth® control unit.</li> </ul>	<ul style="list-style-type: none"> <li>Bluetooth® control unit power supply or ground circuits. Refer to <a href="#">AV-96</a>.</li> <li>AV communication circuits between AV control unit and Bluetooth® control unit.</li> </ul>

## AV Control Unit Confirmation/Adjustment

- Select Confirmation/Adjustment.
- Select each switch on the Confirmation/Adjustment screen to display the relevant trouble diagnosis screen. Press the BACK switch to return to the initial Confirmation/Adjustment screen.

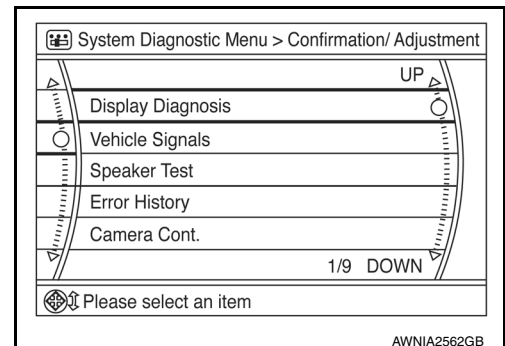

# DIAGNOSIS SYSTEM (AV CONTROL UNIT)

< SYSTEM DESCRIPTION >

[BASE AUDIO]

## Display Diagnosis

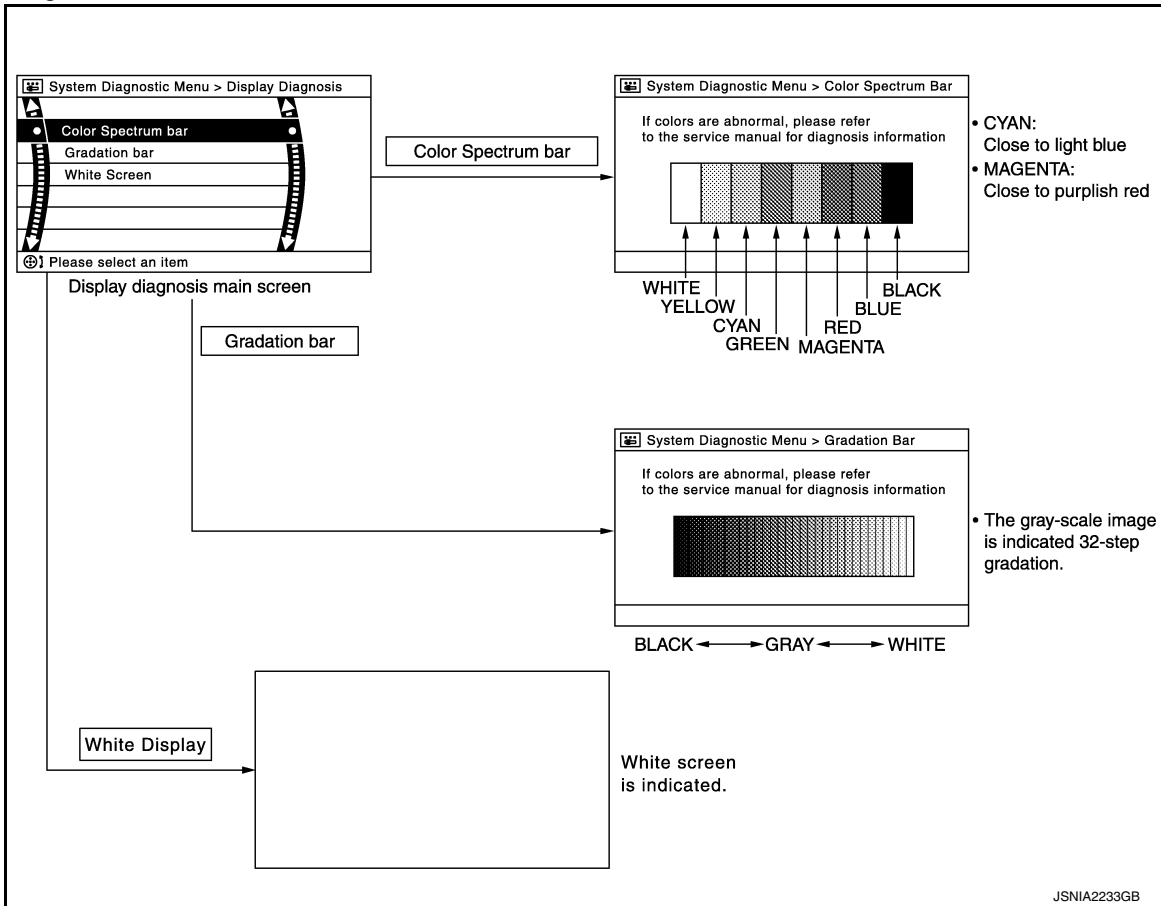

A  
B  
C  
D  
E  
F  
G  
H  
I  
J  
K  
L  
M  
O  
P

## Vehicle Signals

A comparison check can be made of each actual vehicle signal and the signals recognized by the system.

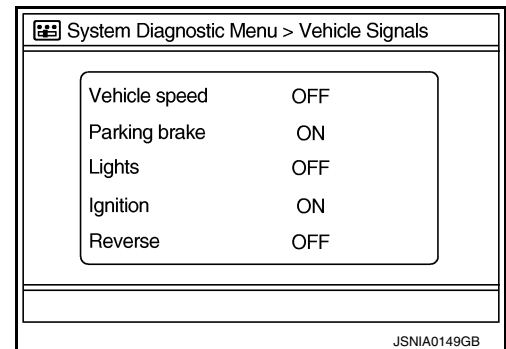

## Speaker Test

Select Speaker Test to display the Speaker Diagnosis screen. Press Start to generate a test tone in a speaker. Press Start again to generate a test tone in the next speaker. Press End to stop the test tones.

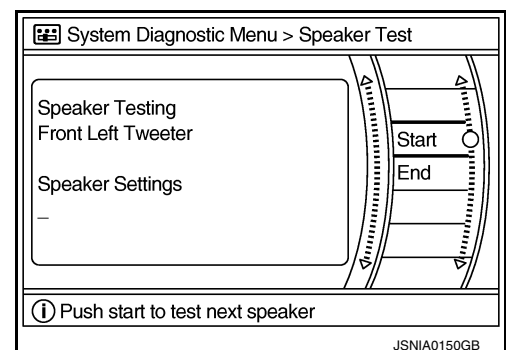

## Error History

The self diagnosis results are judged depending on whether any error occurs from when Self diagnosis is selected until the self diagnosis results are displayed.

# DIAGNOSIS SYSTEM (AV CONTROL UNIT)

< SYSTEM DESCRIPTION >

[BASE AUDIO]

However, the diagnosis results are judged normal if an error has occurred before the ignition switch is turned ON and then no error has occurred until the self diagnosis start. Check the Error Record to detect any error that may have occurred before the self diagnosis start because of this situation.

The frequency of occurrence is displayed in a count up manner. The actual count up method differs depending on the error item.

Count up method A

- The counter resets to 0 if an error occurs when ignition switch is turned ON. The counter increases by 1 if the condition is normal at a next ignition ON cycle.
- The counter upper limit is 39. Any counts exceeding 39 are ignored. The counter can be reset (no error record display) with the "Delete log" switch or CONSULT.

Count up method B

- The counter increases by 1 if an error occurs when ignition switch is ON. The counter will not decrease even if the condition is normal at the next ignition ON cycle.
- The counter upper limit is 50. Any counts exceeding 50 are ignored. The counter can be reset (no error record display) with the "Delete log" switch or CONSULT.

Display type of occurrence frequency	Error history display item
Count up method A	CAN communication line, control unit (CAN), AV communication line, control unit (AV)
Count up method B	Other than the above

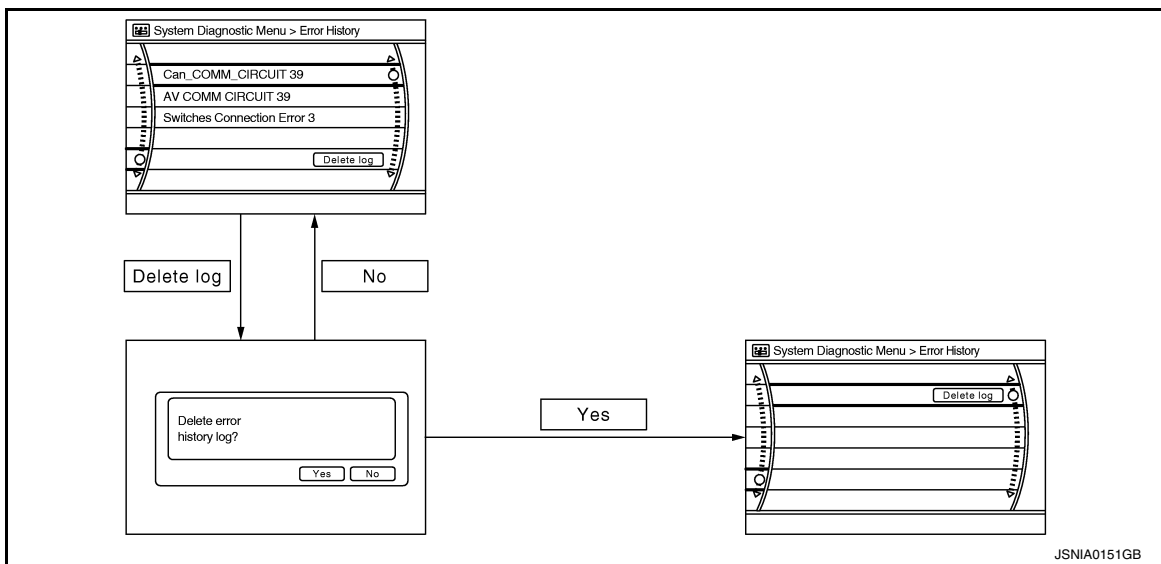

Error item

Some error items may be displayed simultaneously according to the cause. If some error items are displayed simultaneously, the detection of the cause can be performed by the combination of display items

Error item	Description	Possible cause
CAN COMM CIRCUIT	CAN communication malfunction is detected.	Perform diagnosis with CONSULT, then repair the malfunctioning components according to diagnosis results. Refer to <a href="#">AV-33</a>
CONTROL UNIT (CAN)	CAN initial diagnosis malfunction is detected.	Replace the AV control unit if the malfunction occurs constantly. Refer to <a href="#">AV-136</a> .
CONTROL UNIT (AV)	AV communication circuit initial diagnosis malfunction is detected.	
FLASH-ROM Error Of Control Unit CAN Controller Memory Error	AV control unit malfunction is detected.	
Steer. Angle Sensor Calibration	Predictive course line center position adjustment of the steering angle sensor is incomplete.	Adjust the predictive course line center position of the steering angle sensor. Refer to <a href="#">BRC-60</a> .

# DIAGNOSIS SYSTEM (AV CONTROL UNIT)

< SYSTEM DESCRIPTION >

[BASE AUDIO]

Error item	Description	Possible cause
Display Connection Error	When any of the following is detected: <ul style="list-style-type: none"> <li>display unit power supply or ground circuits malfunction.</li> <li>communication circuit malfunction between AV control unit and display unit.</li> </ul>	<ul style="list-style-type: none"> <li>Display unit power supply or ground circuits. Refer to <a href="#">AV-93</a>.</li> <li>Communication circuits between AV control unit and display unit. Refer to <a href="#">AV-87</a>.</li> </ul>
XM Connection Error	When any of the following is detected: <ul style="list-style-type: none"> <li>satellite radio tuner power supply or ground circuit malfunction.</li> <li>communication circuit malfunction between AV control unit and satellite radio tuner.</li> <li>request signal circuit malfunction between AV control unit and satellite radio tuner.</li> </ul>	<ul style="list-style-type: none"> <li>Satellite radio tuner power supply or ground circuits. Refer to <a href="#">AV-95</a>.</li> <li>Communication circuit between AV control unit and satellite radio tuner. Refer to <a href="#">AV-89</a>.</li> <li>Request signal circuit between AV control unit and satellite radio tuner. Refer to <a href="#">AV-89</a>.</li> </ul>
<ul style="list-style-type: none"> <li>AV COMM CIRCUIT</li> <li>Switches Connection Error</li> </ul>	When any of the following is detected: <ul style="list-style-type: none"> <li>A/C and AV switch assembly power supply or ground circuit malfunction.</li> <li>AV communication circuit malfunction between AV control unit and A/C and AV switch assembly.</li> </ul>	<ul style="list-style-type: none"> <li>A/C and AV switch assembly power supply or ground circuits. Refer to <a href="#">AV-97</a>.</li> <li>AV communication circuits between AV control unit and A/C and AV switch assembly.</li> </ul>
<ul style="list-style-type: none"> <li>AV COMM CIRCUIT</li> <li>BTHF Unit Connection Error</li> </ul>	When any of the following is detected: <ul style="list-style-type: none"> <li>Bluetooth® control unit power supply or ground circuit malfunction.</li> <li>AV communication circuit malfunction between AV control unit and Bluetooth® control unit.</li> </ul>	<ul style="list-style-type: none"> <li>Bluetooth® control unit power supply or ground circuits. Refer to <a href="#">AV-96</a>.</li> <li>AV communication circuits between AV control unit and Bluetooth® control unit.</li> </ul>
<ul style="list-style-type: none"> <li>AV COMM CIRCUIT</li> <li>Switches Connection Error</li> <li>BTHF Unit Connection Error</li> </ul>	AV communication circuit malfunction between AV control unit and A/C and AV switch assembly.	AV communication circuits between AV control unit and A/C and AV switch assembly.

## Camera Cont.

The two functions of “Correct Draw Line of Rear view Cam”, “Confirm Configuration” are available.

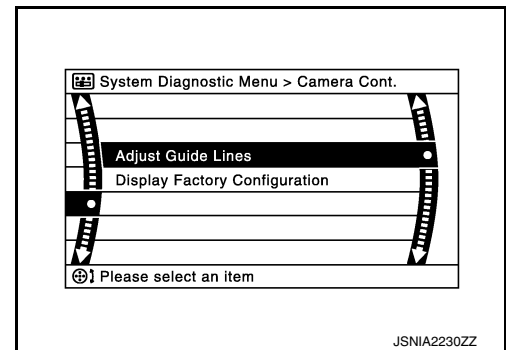

## Adjust Offset of Rear view Camera

- Use this mode to adjust the guide line display position of the rear view monitor if necessary after removing the rear view monitor camera.

### CAUTION:

**After the adjustment, never perform other operations for one minute.**

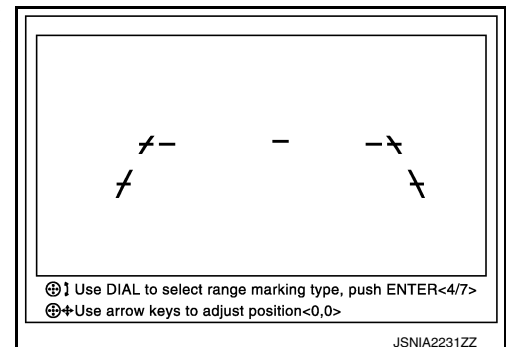

Factory Configuration Confirmation

# DIAGNOSIS SYSTEM (AV CONTROL UNIT)

< SYSTEM DESCRIPTION >

[BASE AUDIO]

- Configuration stored in the AV control unit can be checked.

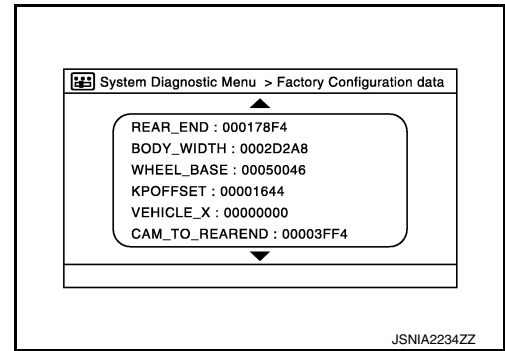

## Vehicle CAN Diagnosis

- CAN communication status and error counter is displayed.
- The error counter displays “OK” if any malfunction was not detected in the past and displays “0” if a malfunction is detected. It increases by 1 if the condition is normal at the next ignition switch ON cycle. The upper limit of the counter is 39.
- The error counter is erased if “Reset” is pressed.

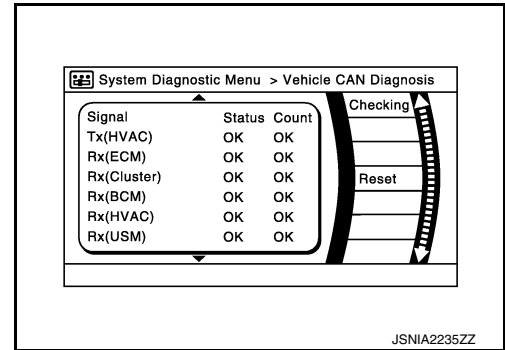

Items	Display (Current)	Malfunction counter (Past)
Tx(HVAC)	OK / ???	OK / 0 – 39
Rx(ECM)	OK / ???	OK / 0 – 39
Rx(Cluster)	OK / ???	OK / 0 – 39
Rx(BCM)	OK / ???	OK / 0 – 39
Rx(HVAC)	OK / ???	OK / 0 – 39
Rx(USM)	OK / ???	OK / 0 – 39
Rx(VDC)	OK / ???	OK / 0 – 39
Rx(STRG)	OK / ???	OK / 0 – 39

### NOTE:

“???” indicates UNKWN.

## AV COMM Diagnosis

- Displays the communication status between AV control unit and each unit.
- The error counter displays “OK” if any malfunction was not detected in the past and displays “0” if a malfunction is detected. It increases by 1 if the condition is normal at the next ignition switch ON cycle. The upper limit of the counter is 39.
- The error counter is erased if “Reset” is pressed.

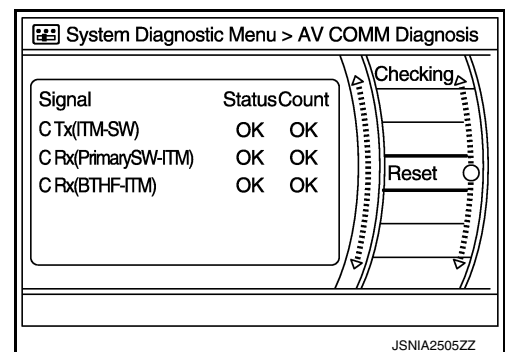

Items	Status (Current)	Counter (Past)
C Tx(ITM-SW)	OK / ???	OK / 0 – 39
C Rx(PrimarySW-ITM)	OK / ???	OK / 0 – 39
C Rx(BTHF-ITM)	OK / ???	OK / 0 – 39

### NOTE:

“???” indicates UNKWN.

Delete Unit Connection Log



# DIAGNOSIS SYSTEM (AV CONTROL UNIT)

< SYSTEM DESCRIPTION >

[BASE AUDIO]

Deletes any unit connection records and error records from the AV control unit memory. (Clear the records of the unit that has been removed.)

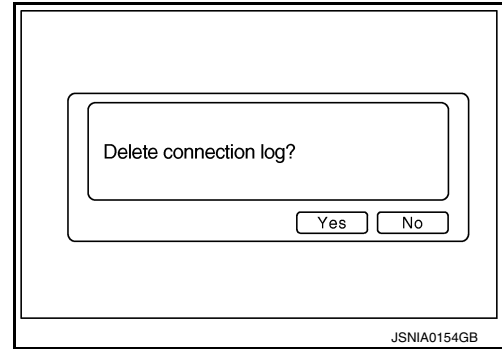

## Initialize Settings

“User Data Initialization” and “Accessory Number Initialization” are possible.

### CAUTION:

- Never perform Accessory Number Initialization except when configuration is unsuccessful.
- Accessory Number Initialization requires configuration. For details, refer to [AV-80, "CONFIGURATION \(AV CONTROL UNIT\) : Description"](#).

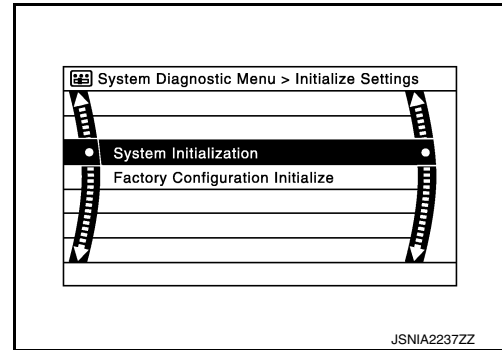

## CONSULT Function

INFOID:000000009128986

### CAUTION:

After disconnecting the CONSULT vehicle interface (VI) from the data link connector, the ignition must be cycled OFF → ON (for at least 5 seconds) → OFF. If this step is not performed, the BCM may not go to “sleep mode”, potentially causing a discharged battery and a no-start condition.

## CONSULT FUNCTIONS

CONSULT performs the following functions via communication with the AV control unit.

Direct Diagnostic Mode	Description
Ecu Identification	The AV control unit part number is displayed.
Self Diagnostic Result	The AV control unit self diagnostic results are displayed.
Data Monitor	The AV control unit input/output data is displayed in real time.
Work support	The settings for AV control unit functions can be changed.
Configuration	<ul style="list-style-type: none"> <li>• The vehicle specification can be read and saved.</li> <li>• The vehicle specification can be written when replacing AV control unit.</li> </ul>
CAN Diag Support Mntr	<ul style="list-style-type: none"> <li>• The result of transmit/receive diagnosis of AV communication is displayed.</li> <li>• The result of transmit/receive diagnosis of CAN communication is displayed.</li> </ul>

## ECU IDENTIFICATION

The part number of AV control unit is displayed.

## SELF DIAGNOSTIC RESULT

Refer to [AV-42, "DTC Index"](#).

## DATA MONITOR

Monitor Item [Unit]	Description
VHCL SPD SIG [On/Off]	Indicates vehicle speed signal received from combination meter on CAN communication line.
PKB SIG [On/Off]	Indicates condition of park brake signal.
ILLUM SIG [On/Off]	Indicates condition of illumination signal for the A/C and AV switch assembly.

A  
B  
C  
D  
E  
F  
G  
H  
I  
J  
K  
L  
M  
O  
P

AV

# DIAGNOSIS SYSTEM (AV CONTROL UNIT)

< SYSTEM DESCRIPTION >

[BASE AUDIO]

Monitor Item [Unit]	Description
IGN SIG [On/Off]	Indicates condition of ignition signal.
REV SIG [On/Off]	Indicates condition of reverse signal received from BCM.

## WORK SUPPORT

Conditions	Description
ST ANGLE SENSOR ADJUSTMENT	Steering angle sensor neutral position adjustment can be performed. Refer to <a href="#">BRC-60, "Description"</a> .

## CONFIGURATION

Refer to [AV-80, "CONFIGURATION \(AV CONTROL UNIT\) : Description"](#).

## CAN DIAG SUPPORT MNTR

Refer to [LAN-23, "CAN Diagnostic Support Monitor"](#).

# DIAGNOSIS SYSTEM (BLUETOOTH® CONTROL UNIT)

< SYSTEM DESCRIPTION >

[BASE AUDIO]



## DIAGNOSIS SYSTEM (BLUETOOTH® CONTROL UNIT)

### Diagnosis Description

INFOID:000000009128987

The Bluetooth® control unit has two diagnostic checks. The first diagnostic check is performed automatically every ignition cycle during control unit initialization. The second diagnostic check is performed by the technician using the steering switch prior to trouble diagnosis.



### Bluetooth® CONTROL UNIT INITIALIZATION CHECKS

- Internal control unit failure
- Bluetooth® antenna connection open or shorted
- Steering switch [  (PHONE/SEND),  (PHONE/END)] stuck closed
- Vehicle speed pulse count
- Microphone connection test (with playback to operator)
- Bluetooth® inquiry check

### OPERATION PROCEDURE

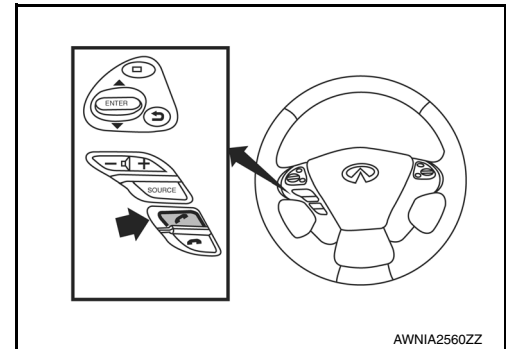
1. Turn ignition switch to ACC or ON.
2. Wait for the Bluetooth® system to complete initialization. This may take up to 20 seconds.
3. Press and hold the steering switch  (PHONE/SEND) button for at least 5 seconds. The Bluetooth® system will begin to play a verbal prompt.



4. While the prompt is playing, press and hold the steering switch  (PHONE/END) button until you hear the “Diagnostics mode” prompt. The Bluetooth® system will sound a 5-second beep.
5. While the beep is sounding, press and hold the steering switch  (PHONE/END) button again until you hear prompts.
6. The Bluetooth® system has now entered into the diagnostic mode. Results of the diagnostic checks will be verbalized to the technician. Refer to [AV-35, "Work Flow"](#).
7. After the failure records are reported, an interactive microphone test will be performed. Follow the voice prompt. If the microphone test fails, refer to [AV-35, "Work Flow"](#).

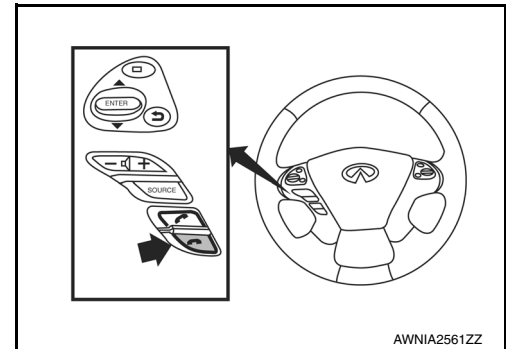

### Work Flow

INFOID:000000009128988

Failure Message	Action
“Internal failure”	Replace Bluetooth® control unit. Refer to <a href="#">AV-146, "Removal and Installation"</a> .
“Bluetooth® antenna open”	1. Inspect harness connection. 2. Replace Bluetooth® antenna. Refer to <a href="#">AV-146, "Removal and Installation"</a> .
“Bluetooth® antenna shorted”	
“Phone/Send for Hands Free System is stuck”	Check steering switch. Refer to <a href="#">AV-127, "Diagnosis Procedure"</a> .
“Phone/End for the Hands Free System is stuck”	
“Microphone test” (failed interactive test)	1. Inspect harness between Bluetooth® control unit and microphone. 2. Replace microphone. Refer to <a href="#">AV-147, "Removal and Installation"</a> .

# AV CONTROL UNIT

< ECU DIAGNOSIS INFORMATION >

[BASE AUDIO]

## ECU DIAGNOSIS INFORMATION

### AV CONTROL UNIT

Reference Value

INFOID:000000009128989

#### VALUES ON THE DIAGNOSIS TOOL

Monitor Item	Condition	Value/Status
VHCL SPD SIG	Vehicle speed = 0 km/h (0 MPH).	Off
	Vehicle speed > 0 km/h (0 MPH).	On
PKB SIG	Parking brake released.	Off
	Parking brake applied.	On
ILLUM SIG	Illumination signal is not received.	Off
	Illumination signal is received.	On
IGN SIG	Ignition switch OFF or ACC.	Off
	Ignition switch ON.	On
REV SIG	Selector lever in any position other than R.	Off
	Selector lever in R position.	On

#### TERMINAL LAYOUT

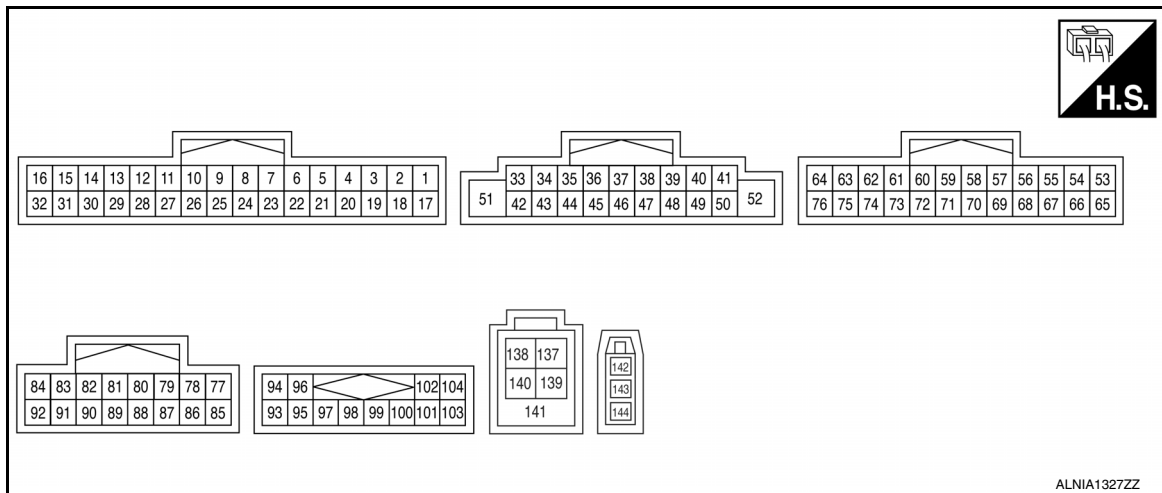

#### PHYSICAL VALUES

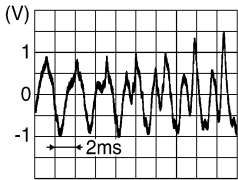
Terminal No. (Wire color)		Description		Condition		Value (Approx.)
+	-	Signal name	Input/ Output	Ignition switch	Operation	
5 (W)	4 (B)	Bluetooth® voice signal	Input	ON	During voice guide output with  switch pressed	 <small>SKIB3609E</small>
6 (Shield)	—	Bluetooth® voice signal shield	—	—	—	—

# AV CONTROL UNIT

< ECU DIAGNOSIS INFORMATION >

[BASE AUDIO]

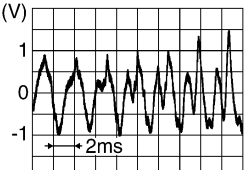
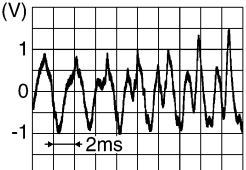
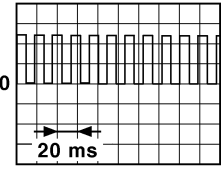





Terminal No. (Wire color)		Description		Condition		Value (Approx.)
+	-	Signal name	Input/ Output	Ignition switch	Operation	
10 (V)	Ground	Switch ground	—	ON	—	0 V
11 (L)	—	CAN-H	Input/ Output	—	—	—
12 (P)	—	CAN-L	Input/ Output	—	—	—
13 (SB)	—	AV communication signal (H)	Input/ Output	—	—	—
14 (LG)	—	AV communication signal (L)	Input/ Output	—	—	—
15 (SB)	—	AV communication signal (H)	Input/ Output	—	—	—
16 (LG)	—	AV communication signal (L)	Input/ Output	—	—	—
20 (R)	22 (B)	AUX sound signal RH	Input	ON	AUX mode selected	 <p style="text-align: right; font-size: small;">SKIB3609E</p>
21 (W)	22 (B)	AUX sound signal LH	Input	ON	AUX mode selected	 <p style="text-align: right; font-size: small;">SKIB3609E</p>
25 (Shield)	—	AUX sound signal shield	—	—	—	—
28 (Y)	Ground	Disk eject signal	Input	ON	Pressing eject switch	0 V
					Except above	5.0 V
29 (LG)	Ground	Ignition signal	Input	ON	—	Battery voltage
30 (R)	Ground	Reverse signal	Input	ON	Selector lever in R position	Battery voltage
					Selector lever in any position other than R	0 V
31 (G)	Ground	Parking brake signal	Input	ON	Parking brake applied	4.5 V
					Parking brake released	0 V
32 (BG)	Ground	Vehicle speed signal	Input	ON	Vehicle speed approx. 40 km/h (25 MPH)	<p><b>NOTE:</b> The maximum voltage varies depending on the specification (destination unit).</p>  <p style="text-align: right; font-size: small;">JSNIA0012GB</p>

A  
B  
C  
D  
E  
F  
G  
H  
I  
J  
K  
L  
M  
AV  
O  
P

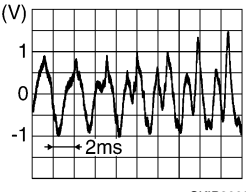
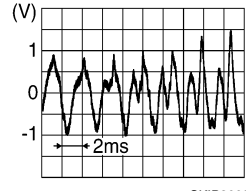
# AV CONTROL UNIT

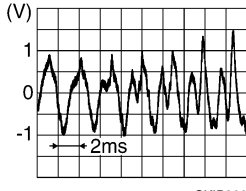
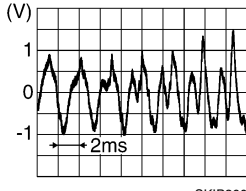
< ECU DIAGNOSIS INFORMATION >

[BASE AUDIO]

Terminal No. (Wire color)		Description	Input/ Output	Condition		Value (Approx.)
+	-			Signal name	Ignition switch	
34 (SB)	35 (V)	Sound signal front door speaker and instrument panel tweeter LH	Output	ON	Audio output	
36 (BR)	37 (Y)	Sound signal rear door speaker LH	Output	ON	Audio output	
38 (G)	47 (B)	Steering switch signal A	Input	ON	Press SOURCE switch	0V
					Press $\Delta$ switch	1.0V
					Press $\nabla$ switch	2.0V
					Press  switch	3.0V
					Press ENTER switch	4.0V
					Except above	5.0V
39 (P)	Ground	ACC power supply	Input	ACC	—	Battery voltage
41 (R)	Ground	Illumination signal	Input	OFF	Lighting switch OFF	0 V
					Lighting switch ON	Battery voltage
43 (BR)	44 (Y)	Sound signal front door speaker and instrument panel tweeter RH	Output	ON	Audio output	
45 (L)	46 (SB)	Sound signal rear door speaker RH	Output	ON	Audio output	
48 (W)	47 (B)	Steering switch signal B	Input	ON	Press  switch	0V
					Press  switch	1.0V
					Press  switch	2.0V
					Press  switch	3.0V
					Press DISP switch	4.0V
					Except above	5.0V

# AV CONTROL UNIT

< ECU DIAGNOSIS INFORMATION >

[BASE AUDIO]

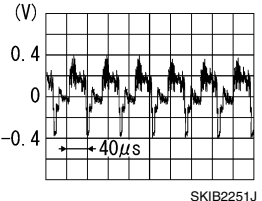
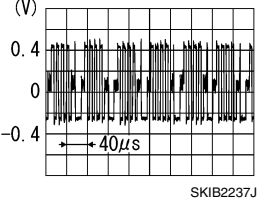
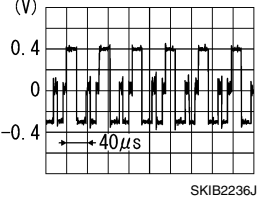
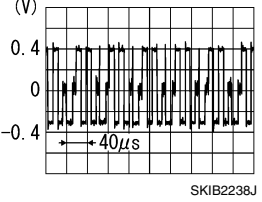
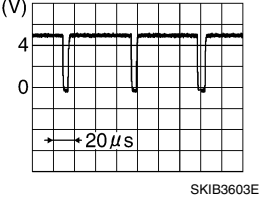
Terminal No. (Wire color)		Description		Condition		Value (Approx.)
+	-	Signal name	Input/ Output	Ignition switch	Operation	
51 (Y)	Ground	Battery power supply	Input	OFF	—	Battery voltage
52 (GR)	Ground	Ground	—	ON	—	0 V
53 (B)	Ground	Composite image signal	Output	ON	Camera image or AUX im- age displayed	
54 (W)	Ground	Composite image signal ground	—	ON	—	0 V
55 (W)	Ground	RGB signal (B: blue)	Output	ON	Begin Confirmation/Adjust- ment mode, then select “Color Spectrum Bar”	
56 (B)	Ground	RGB signal (G: green)	Output	ON	Begin Confirmation/Adjust- ment mode, then select “Color Spectrum Bar”	
57 (R)	Ground	RGB signal (R: red)	Output	ON	Begin Confirmation/Adjust- ment mode, then select “Color Spectrum Bar”	
58 (B)	Ground	RGB synchronizing signal	Output	ON	—	
59 (Shield)	—	Synchronizing signal shield	—	—	—	—

A  
B  
C  
D  
E  
F  
G  
H  
I  
J  
K  
L  
M  
O  
P

AV

# AV CONTROL UNIT

< ECU DIAGNOSIS INFORMATION >

[BASE AUDIO]

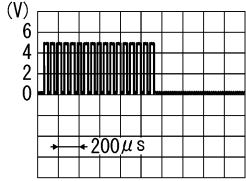
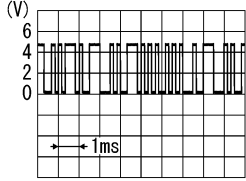
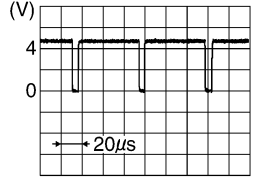
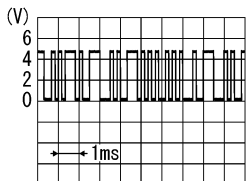
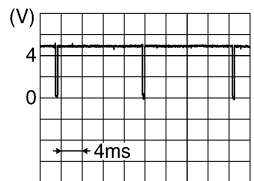
Terminal No. (Wire color)		Description		Condition		Value (Approx.)
+	-	Signal name	Input/ Output	Ignition switch	Operation	
60 (W)	Ground	RGB area (YS) signal	Output	ON	RGB image displayed	5.0 V
					AUX image displayed	 <p style="text-align: right; font-size: small;">PKIB4948J</p>
61 (B)	Ground	Communication signal (DISP→CONT)	Input	ON	Adjusting display bright- ness	 <p style="text-align: right; font-size: small;">PKIB5039J</p>
62 (G)	Ground	Horizontal synchronizing (HP) signal	Input	ON	—	 <p style="text-align: right; font-size: small;">SKIB3601E</p>
63 (B)	Ground	Signal ground	—	OFF	—	0 V
64 (V)	Ground	Signal VCC	Output	ACC	—	9.0 V
66 (Shield)	—	Composite image signal shield	—	—	—	—
67 (Shield)	—	RGB signal shield	—	—	—	—
72 (Shield)	—	Display communication sig- nal shield	—	—	—	—
73 (W)	Ground	Communication signal (CONT→DISP)	Output	ON	Adjusting display bright- ness	 <p style="text-align: right; font-size: small;">PKIB5039J</p>
74 (R)	Ground	Vertical synchronizing (VP) signal	Input	ON	—	 <p style="text-align: right; font-size: small;">SKIB3598E</p>
75 (LG)	Ground	Inverter ground	—	OFF	—	0 V



# AV CONTROL UNIT

< ECU DIAGNOSIS INFORMATION >

[BASE AUDIO]

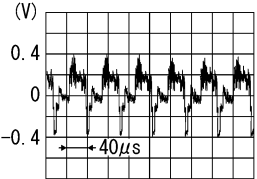
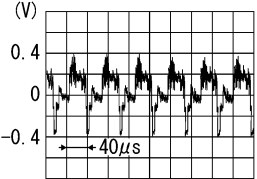
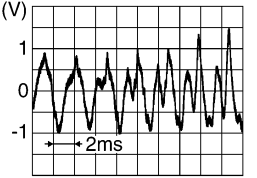
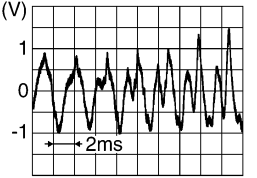
Terminal No. (Wire color)		Description		Condition		Value (Approx.)
+	-	Signal name	Input/ Output	Ignition switch	Operation	
76 (L)	Ground	Inverter VCC	Output	ACC	—	9.0 V
82 (W)	Ground	Camera image signal	Input	ON	Camera image displayed	 <p style="text-align: right; font-size: small;">SKIB2251J</p>
83 (W)	Ground	AUX image signal	Input	ON	AUX image displayed	 <p style="text-align: right; font-size: small;">SKIB2251J</p>
87 (R)	Ground	Camera power supply	Output	ON	Selector lever in "R" position	6.0 V
88 (B)	Ground	Camera ground	—	ON	—	0 V
89 (Shield)	—	Camera image signal shield	—	—	—	—
90 (Shield)	—	AUX image signal shield	—	—	—	—
91 (B)	Ground	AUX image signal ground	—	ON	—	0 V
94 (B)	93 (W)	Satellite radio sound signal LH	Input	ON	Satellite radio mode selected	 <p style="text-align: right; font-size: small;">SKIB3609E</p>
96 (G)	95 (R)	Satellite radio sound signal RH	Input	ON	Satellite radio mode selected	 <p style="text-align: right; font-size: small;">SKIB3609E</p>
97 (Shield)	—	Satellite radio sound signal shield	—	—	—	—
98 (Shield)	—	Satellite communication signal shield	—	—	—	—

A  
B  
C  
D  
E  
F  
G  
H  
I  
J  
K  
L  
M  
O  
P

AV

# AV CONTROL UNIT

< ECU DIAGNOSIS INFORMATION >

[BASE AUDIO]

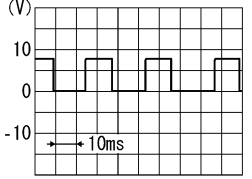
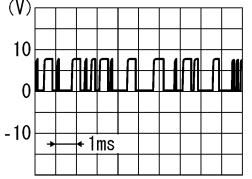
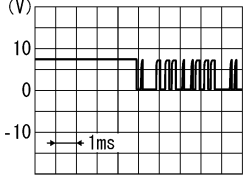
Terminal No. (Wire color)		Description		Condition		Value (Approx.)
+	-	Signal name	Input/ Output	Ignition switch	Operation	
100 (W)	Ground	Request signal (SAT→CONT)	Input	ON	Satellite radio mode select- ed	 <p style="text-align: right; font-size: small;">SKIA9299J</p>
101 (B)	Ground	Communication signal (SAT→CONT)	Input	ON	Satellite radio mode select- ed	 <p style="text-align: right; font-size: small;">SKIA9300J</p>
102 (R)	Ground	Communication signal (CONT→SAT)	Output	ON	Satellite radio mode select- ed	 <p style="text-align: right; font-size: small;">SKIA9301J</p>
137 (W)	—	V BUS signal	—	—	—	—
138 (G)	—	USB ground	—	—	—	—
139 (L)	—	USB D+ signal	—	—	—	—
140 (R)	—	USB D- signal	—	—	—	—
141 (Shield)	—	USB signal shield	—	—	—	—
142 (B)	—	Antenna amp. ON signal	Output	ON	—	Battery voltage
143 (B)	—	AM - FM main	Input	—	—	—
144 (B)	—	FM sub	Input	—	—	—

## DTC Index

INFOID:000000009128990

CONSULT Display	Reference Page
U1000: CAN COMM CIRCUIT	<a href="#">AV-82. "DTC Logic"</a>
U1010: CONTROL UNIT	<a href="#">AV-83. "DTC Logic"</a>
U1200: CONT UNIT	<a href="#">AV-84. "DTC Logic"</a>
U1216: CAN CONT	<a href="#">AV-85. "DTC Logic"</a>
U1232: ST ANGLE SEN CALIB	<a href="#">AV-86. "DTC Logic"</a>

# AV CONTROL UNIT

< ECU DIAGNOSIS INFORMATION >

[BASE AUDIO]

CONSULT Display	Reference Page
U1240: SWITCH CONN	<a href="#">AV-91. "Description"</a>
U1243: FRONT DISP CONN	<a href="#">AV-87. "DTC Logic"</a>
U1255: SAT CONN	<a href="#">AV-89. "DTC Logic"</a>
U1256: HAND FREE CONN	<a href="#">AV-91. "Description"</a>
U1300: AV COMM CIRCUIT	<a href="#">AV-91. "Description"</a>
U1310: CONTROL UNIT	<a href="#">AV-92. "DTC Logic"</a>

A  
B  
C

D

E

F

G

H

I

J

K

L

M

AV

O

P

# DISPLAY UNIT

< ECU DIAGNOSIS INFORMATION >

[BASE AUDIO]

## DISPLAY UNIT

Reference Value

INFOID:000000009128991

### TERMINAL LAYOUT

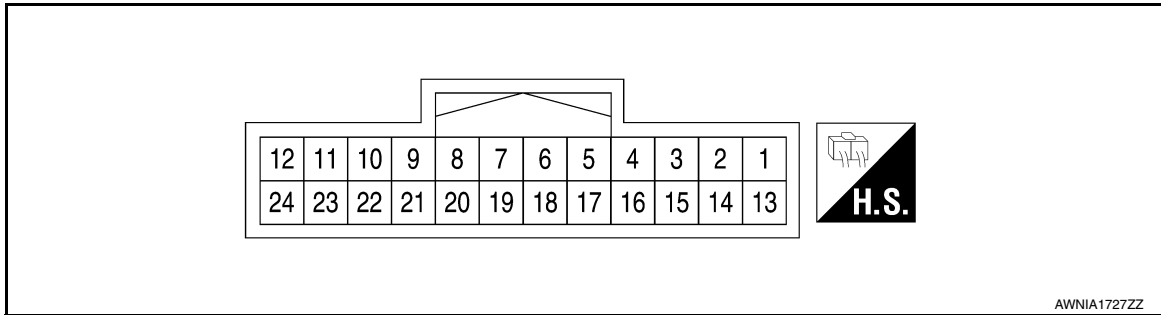

AWNIA1727ZZ

### PHYSICAL VALUES

Terminal (Wire color)		Description		Condition		Reference value (Approx.)
+	-	Signal name	Input/Output	Ignition switch	Operation	
1 (B)	Ground	Ground	—	ON	—	0V
2 (L)	Ground	Inverter VCC	Input	ACC	—	9V
3 (V)	Ground	Signal VCC	Input	ACC	—	9V
4 (W)	Ground	Composite image ground	—	ON	—	0V
5 (Shield)	—	Composite image signal shield	—	—	—	—
6 (B)	Ground	RGB signal (G: green)	Input	ON	Begin Confirmation/Adjustment mode, then select "Color Spectrum Bar"	<p>JSNIA1030ZZ</p>
7 (Shield)	—	RGB signal shield	—	—	—	—
8 (G)	Ground	Horizontal synchronizing (HP) signal	Output	ON	—	<p>SKIB3601E</p>

# DISPLAY UNIT

< ECU DIAGNOSIS INFORMATION >

[BASE AUDIO]

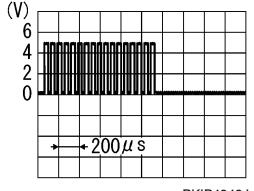
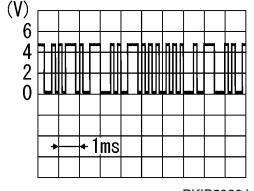
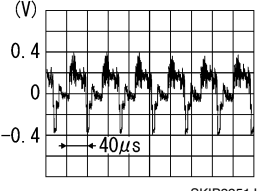
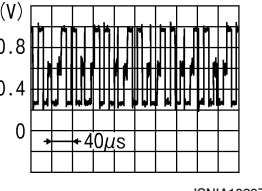
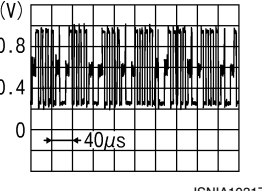
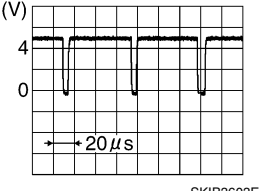
Terminal (Wire color)		Description		Condition		Reference value (Approx.)
+	-	Signal name	Input/ Output	Ignition switch	Operation	
9 (W)	Ground	RGB area (YS) signal	Input	ON	RGB image displayed	5V
					DVD image displayed	 <p>PKIB4948J</p>
11 (W)	Ground	Communication signal (CONT→DISP)	Input	ON	Adjusting display bright- ness	 <p>PKIB5039J</p>
13 (LG)	Ground	Inverter ground	—	ON	—	0V
14 (B)	Ground	Signal ground	—	ON	—	0V
15 (B)	Ground	Composite image signal	Input	ON	Camera image displayed	 <p>SKIB2251J</p>
17 (R)	Ground	RGB signal (R: red)	Input	ON	Begin Confirmation/Adjust- ment mode, then select "Color Spectrum Bar"	 <p>JSNIA1029ZZ</p>
18 (W)	Ground	RGB signal (B: blue)	Input	ON	Begin Confirmation/Adjust- ment mode, then select "Color Spectrum Bar"	 <p>JSNIA1031ZZ</p>
19 (B)	Ground	RGB synchronizing signal	Input	ON	—	 <p>SKIB3603E</p>

A  
B  
C  
D  
E  
F  
G  
H  
I  
J  
K  
L  
M

AV

O

P

# DISPLAY UNIT

< ECU DIAGNOSIS INFORMATION >

[BASE AUDIO]

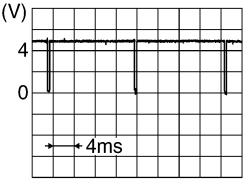
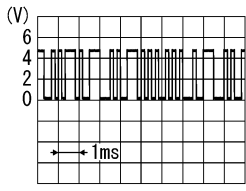
Terminal (Wire color)		Description		Condition		Reference value (Approx.)
+	-	Signal name	Input/ Output	Ignition switch	Operation	
20 (R)	Ground	Vertical synchronizing (VP) signal	Output	On	—	 <p style="text-align: right; font-size: small;">SKIB3598E</p>
21 (Shield)	—	Synchronizing signal shield	—	—	—	—
22 (B)	Ground	Communication signal (DISP→CONT)	Output	ON	Adjusting display bright- ness	 <p style="text-align: right; font-size: small;">PKIB5039J</p>
23 (Shield)	—	Communication signal shield	—	—	—	—

# SATELLITE RADIO TUNER

< ECU DIAGNOSIS INFORMATION >

[BASE AUDIO]

## SATELLITE RADIO TUNER

Reference Value

INFOID:000000009128992

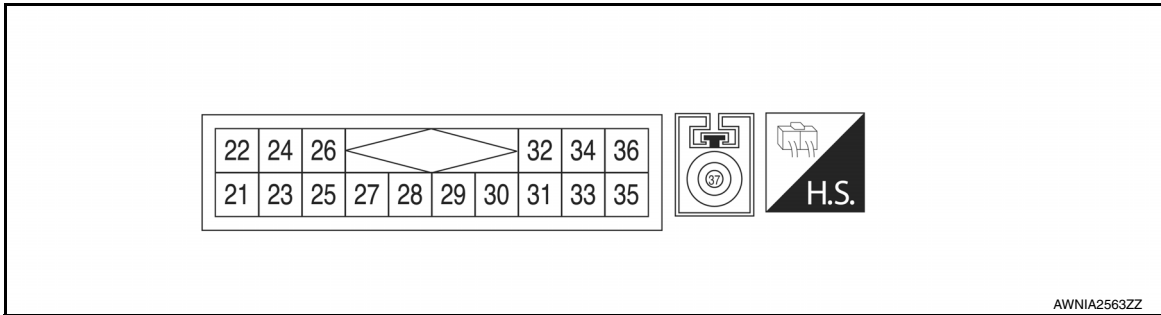

### PHYSICAL VALUES

Terminal (Wire color)		Description	Condition			Reference value (Approx.)
+	-	Signal name	Input/ Output	Ignition switch	Operation	
22 (B)	21 (W)	Satellite radio sound signal LH	Output	ON	Satellite radio mode select- ed	 SKIB3609E
24 (G)	23 (R)	Satellite radio sound signal RH	Output	ON	Satellite radio mode select- ed	 SKIB3609E
25 (Shield)	—	Satellite radio sound signal shield	—	—	—	—
26 (Shield)	—	Satellite control signal shield	—	—	—	—
28 (W)	Ground	Request signal (SAT→CONT)	Output	ON	Satellite radio mode select- ed	 SKIA9299J
29 (R)	Ground	Communication signal (SAT→CONT)	Output	ON	Satellite radio mode select- ed	 SKIA9300J

A  
B  
C  
D  
E  
F  
G  
H  
I  
J  
K  
L  
M  
AV  
O  
P

# SATELLITE RADIO TUNER

< ECU DIAGNOSIS INFORMATION >

[BASE AUDIO]

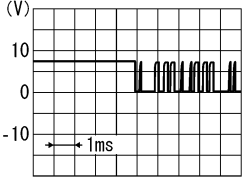
Terminal (Wire color)		Description		Condition		Reference value (Approx.)
+	-	Signal name	Input/ Output	Ignition switch	Operation	
30 (B)	Ground	Communication signal (CONT→SAT)	Input	ON	Satellite radio mode select- ed	 <p style="text-align: right; font-size: small;">SKIA9301J</p>
32 (SB)	Ground	Battery power supply	Input	OFF	—	Battery voltage
35 (GR)	Ground	Ground	—	ON	—	0V
36 (BG)	Ground	ACC power supply	Input	ACC	—	Battery voltage
37 (B)	—	Satellite antenna	—	—	—	—



# BLUETOOTH® CONTROL UNIT

< ECU DIAGNOSIS INFORMATION >

[BASE AUDIO]

## BLUETOOTH® CONTROL UNIT

Reference Value

INFOID:000000009128993

### TERMINAL LAYOUT

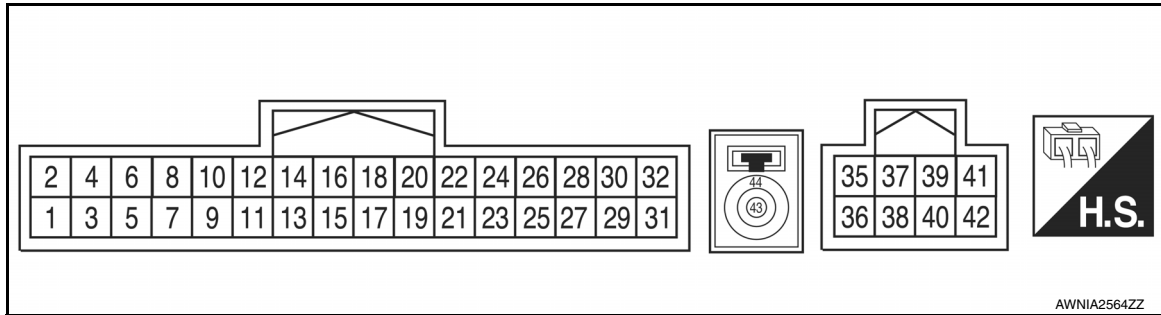

### PHYSICAL VALUES

Terminal (wire color)		Description	Condition			Reference value (Approx.)
+	-	Signal name	Input/output	Ignition switch	Operation	
1 (Y)	Ground	Battery power	Input	-	-	Battery voltage
2 (R)	Ground	ACC power	Input	ACC or ON	-	Battery voltage
3 (P)	Ground	IGN power	Input	ON or START	-	Battery voltage
4 (B)	Ground	Ground	-	ON	-	0V
5 (Shield)	-	Audio out shield	-	-	-	-
7 (B)	8 (Shield)	MIC in signal	Input	-	-	-
9 (W)	10 (B)	Audio out	Output	ACC or ON	Bluetooth® control unit sends audio signal	
20 (B)	Ground	Ground	-	ON	-	0V
23 (B)	Ground	Ground	-	ON	-	0V
24 (B)	Ground	Ground	-	ON	-	0V
27 (B)	Ground	Ground	-	ON	-	0V

# BLUETOOTH® CONTROL UNIT

< ECU DIAGNOSIS INFORMATION >

[BASE AUDIO]

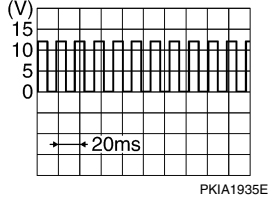
Terminal (wire color)		Description		Condition		Reference value (Approx.)
+	-	Signal name	Input/ output	Ignition switch	Operation	
28 (V)	Ground	Vehicle speed signal (8-pulse)	Input	ON	When vehicle speed is approx. 40 km/h (25 MPH)	
29 (W)	Ground	Microphone power	Output	ON	-	5V
35 (SB)	-	AV communication (H)	-	-	-	—
36 (LG)	-	AV communication (L)	-	-	-	—
43 (B)	-	Bluetooth® antenna	-	-	-	—
44 (Shield)	-	Bluetooth® antenna shield	-	-	-	—

# WIRING DIAGRAM

## BASE AUDIO

### Wiring Diagram

INFOID:000000009128994

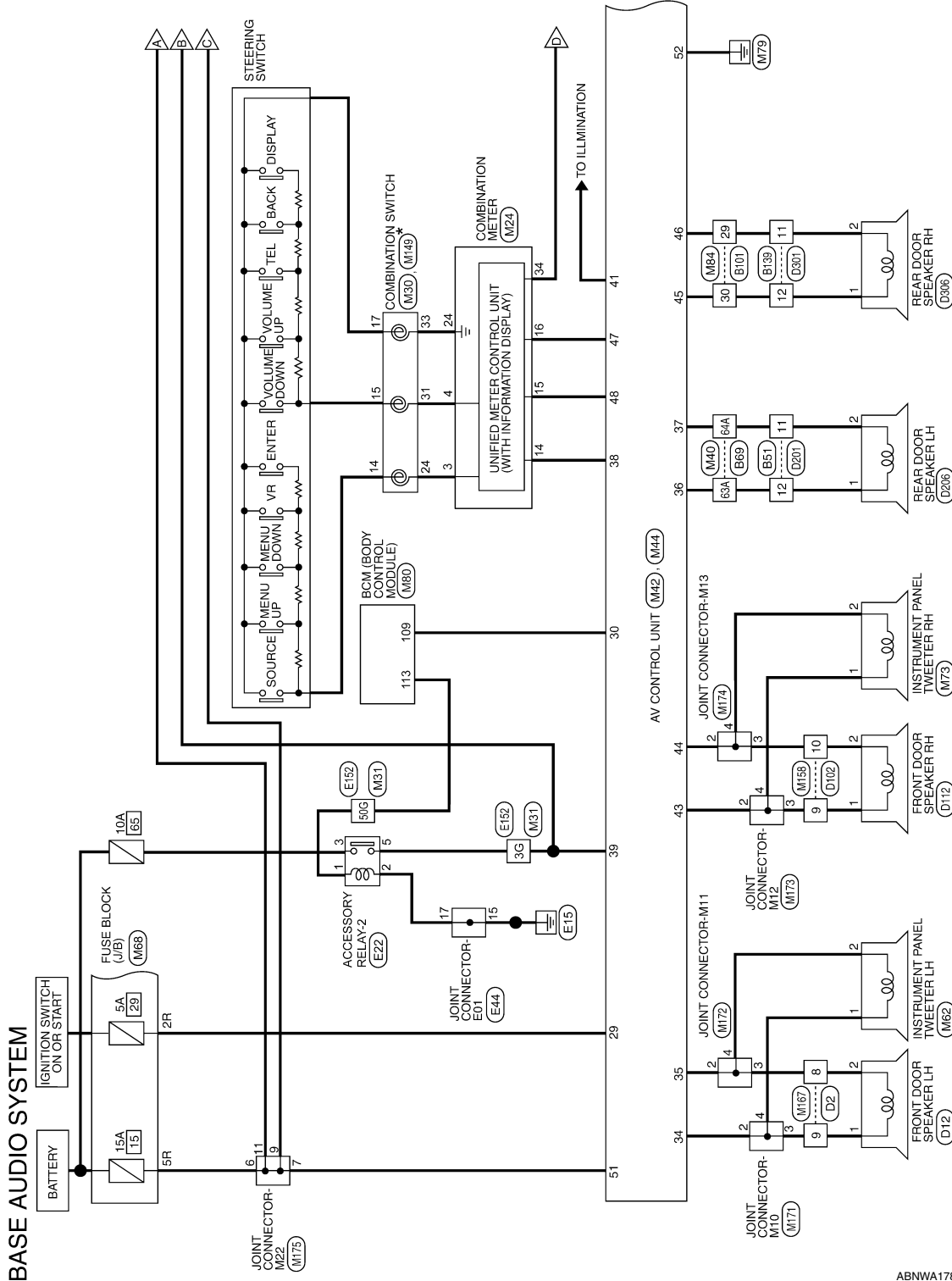

\* :THIS CONNECTOR IS NOT SHOWN IN "HARNES LAYOUT" OF PG SECTION.

ABNWA1789GB

A  
B  
C  
D  
E  
F  
G  
H  
I  
J  
K  
L  
M  
N  
O  
P

AV

# BASE AUDIO

< WIRING DIAGRAM >

[BASE AUDIO]

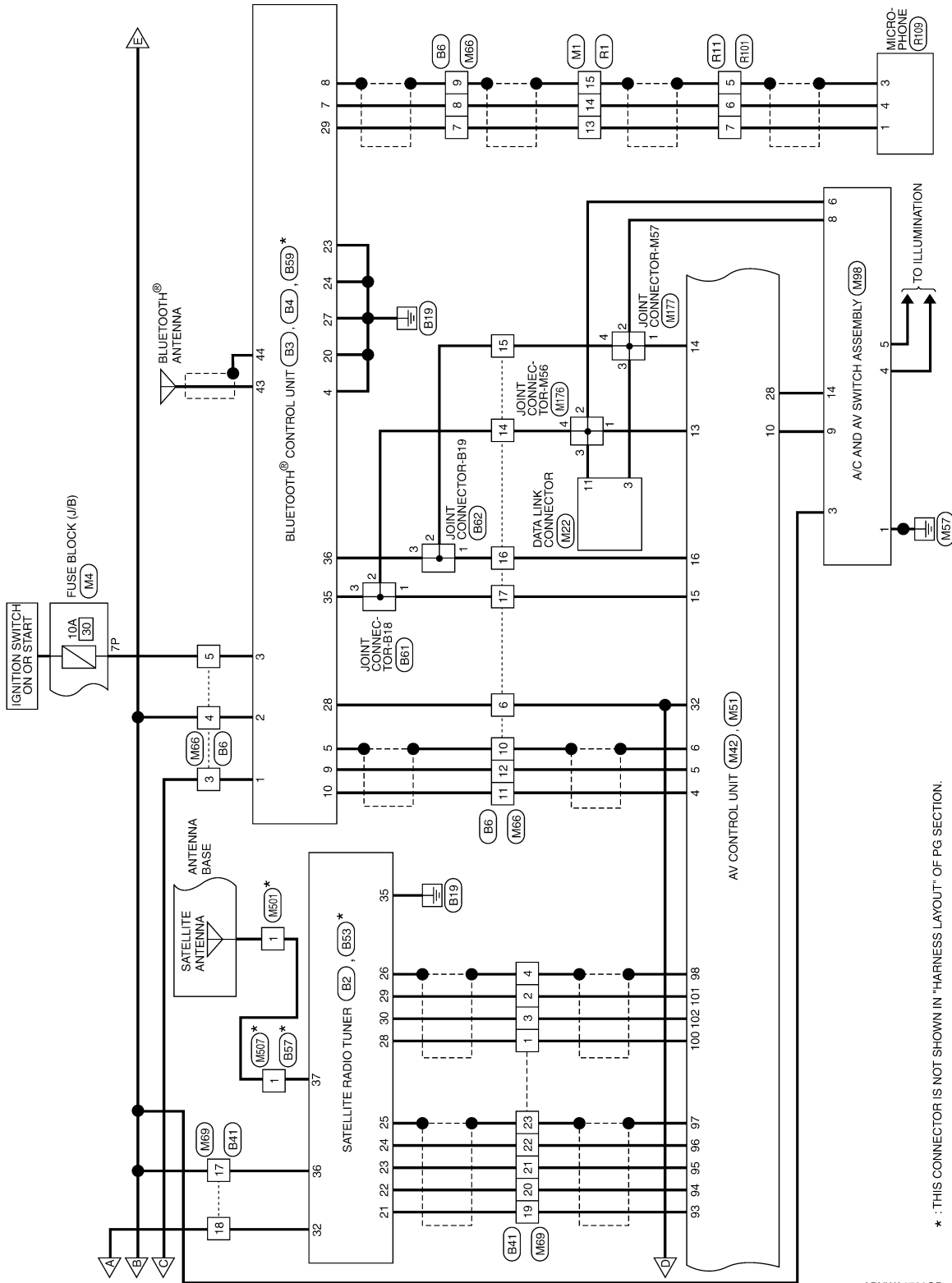

\* : THIS CONNECTOR IS NOT SHOWN IN "HARNES LAYOUT" OF PG SECTION.

ABNWA1790GB





# BASE AUDIO

< WIRING DIAGRAM >

[BASE AUDIO]

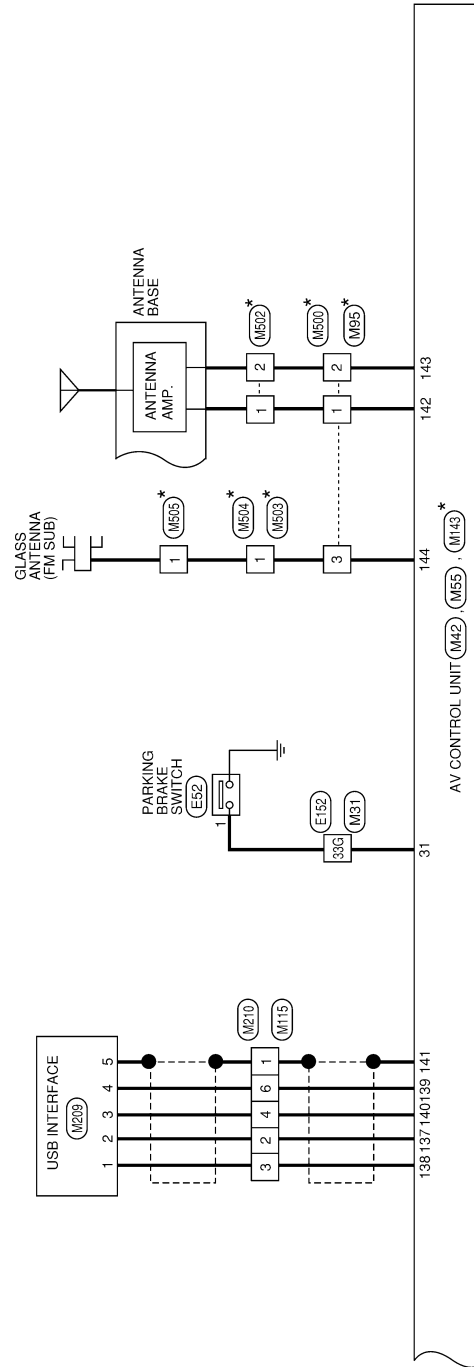

\* : THIS CONNECTOR IS NOT SHOWN IN "HARNES LAYOUT" OF PG SECTION.

ABNWA1793GB

A  
B  
C  
D  
E  
F  
G  
H  
I  
J  
K  
L  
M  
AV  
O  
P

BASE AUDIO SYSTEM CONNECTORS

Connector No.	M1
Connector Name	WIRE TO WIRE
Connector Color	WHITE

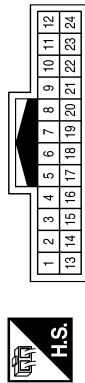

Terminal No.	Color of Wire	Signal Name
13	W	-
14	B	-
15	SHIELD	-

Connector No.	M4
Connector Name	FUSE BLOCK (J/B)
Connector Color	WHITE

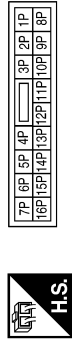

Terminal No.	Color of Wire	Signal Name
7P	LG	-

Connector No.	M9
Connector Name	WIRE TO WIRE
Connector Color	WHITE

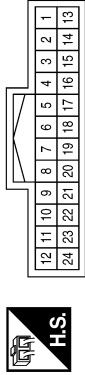

Terminal No.	Color of Wire	Signal Name
19	P	-
20	G	-
21	SHIELD	-
22	B	-
23	R	-
24	W	-

Connector No.	M22
Connector Name	DATA LINK CONNECTOR
Connector Color	WHITE

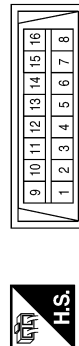

Terminal No.	Color of Wire	Signal Name
3	LG	-
11	SB	-

Connector No.	M24
Connector Name	COMBINATION METER
Connector Color	WHITE

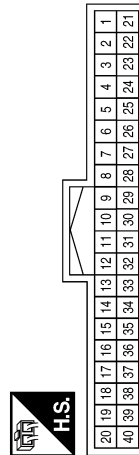

Terminal No.	Color of Wire	Signal Name
3	P	STRG SW INPUT1
4	BG	STRG SW INPUT 2
14	G	STRG SW OUTPUT1
15	W	STRG SW OUTPUT2
16	B	STRG SW OUTPUT GND
24	R	STRG SW GND
34	BG	SPEED 8 P/R

Connector No.	M30
Connector Name	COMBINATION SWITCH (SPIRAL CABLE)
Connector Color	GRAY



Terminal No.	Color of Wire	Signal Name
24	P	-
31	BG	-
33	R	-



# BASE AUDIO

< WIRING DIAGRAM >

[BASE AUDIO]

Connector No.	M40
Connector Name	WIRE TO WIRE
Connector Color	GRAY

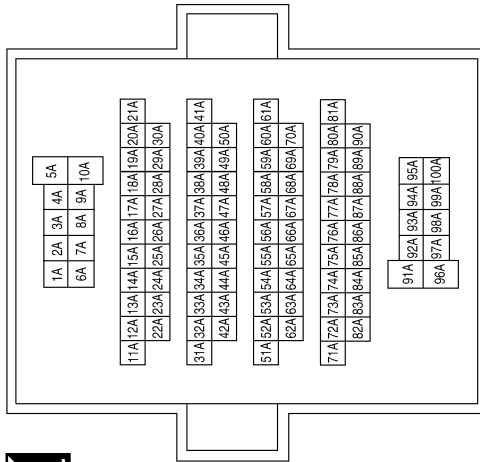

Terminal No.	Color of Wire	Signal Name
63A	BR	-
64A	Y	-

Connector No.	M31
Connector Name	WIRE TO WIRE
Connector Color	WHITE

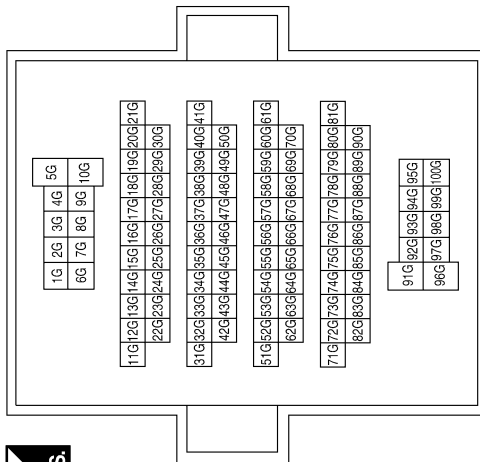

Terminal No.	Color of Wire	Signal Name
3G	P	-
33G	G	-
50G	L	-

ABNIA4590GB

A  
B  
C  
D  
E  
F  
G  
H  
I  
J  
K  
L  
M  
N  
O  
P

AV

# BASE AUDIO

< WIRING DIAGRAM >

[BASE AUDIO]

Connector No.	M42
Connector Name	AV CONTROL UNIT (WITH BASE AUDIO SYSTEM)
Connector Color	WHITE

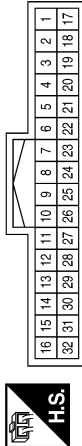

Terminal No.	Color of Wire	Signal Name
1	-	-
2	-	-
3	-	-
4	B	TEL VOICE-
5	W	TEL VOICE+
6	SHIELD	SHIELD
7	-	-

Terminal No.	Color of Wire	Signal Name
8	-	-
9	-	-
10	V	GND
11	L	CAN-H
12	P	CAN-L
13	SB	M-CAN1 H
14	LG	M-CAN1 L
15	SB	M-CAN2 H TRM
16	LG	M-CAN2 L TRM
17	-	-
18	-	-
19	-	-
20	R	AUX AUDIO RH+
21	W	AUX AUDIO LH+

Terminal No.	Color of Wire	Signal Name
22	B	AUX GND
23	-	-
24	-	-
25	SHIELD	SHIELD
26	-	-
27	-	-
28	Y	CD (DVD) EJECT
29	LG	IGN
30	R	REVERSE SIG
31	G	PKB SIG
32	BG	SPEED 8P

Connector No.	M44
Connector Name	AV CONTROL UNIT (WITH BASE AUDIO SYSTEM)
Connector Color	WHITE

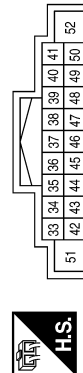

Terminal No.	Color of Wire	Signal Name
33	-	-
34	SB	FR LH SP+
35	V	FR LH SP-
36	BR	RR LH SP+
37	Y	RR LH SP-

Terminal No.	Color of Wire	Signal Name
38	G	STRG SW
39	P	ACC
40	-	-
41	R	ILL
42	-	-
43	BR	FR RH SP+
44	Y	FR RH SP-
45	L	RR RH SP+

Terminal No.	Color of Wire	Signal Name
46	SB	RR RH SP-
47	B	STRG SW GND
48	W	STRG SW B
49	-	-
50	-	-
51	Y	+B
52	GR	GND

ABNIA4591GB

# BASE AUDIO

< WIRING DIAGRAM >

[BASE AUDIO]

Connector No.	M45
Connector Name	AV CONTROL UNIT (WITH BASE AUDIO SYSTEM)
Connector Color	WHITE



Terminal No.	Color of Wire	Signal Name
53	B	COMP OUT-
54	W	COMP OUT+
55	W	B
56	B	G
57	R	R

Connector No.	M46
Connector Name	AV CONTROL UNIT (WITH BASE AUDIO SYSTEM)
Connector Color	WHITE

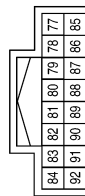

Terminal No.	Color of Wire	Signal Name
77	-	-
78	-	-
79	-	-
80	-	-
81	-	-
82	W	COMP2 IN +

Terminal No.	Color of Wire	Signal Name
58	B	RGB SYN
59	SHIELD	RGB SYN GND
60	W	YS
61	B	DISP IT
62	G	HP
63	B	SIG GND
64	V	SIG VC
65	-	-
66	SHIELD	SHIELD
67	SHIELD	SHIELD
68	-	-
69	-	-
70	-	-

Terminal No.	Color of Wire	Signal Name
71	-	-
72	SHIELD	SHIELD
73	W	IT DISP
74	R	VP
75	LG	INV GND
76	L	INV VC

Terminal No.	Color of Wire	Signal Name
83	W	COMP1 IN +
84	-	-
85	-	-
86	-	-
87	R	CAM 6.2
88	B	CAM GND
89	SHIELD	SHIELD
90	SHIELD	SHIELD
91	B	COMP IN
92	-	-

ABNIA4592GB

A  
B  
C  
D  
E  
F  
G  
H  
I  
J  
K  
L  
M  
N  
O  
P

AV

# BASE AUDIO

< WIRING DIAGRAM >

[BASE AUDIO]

Connector No.	M55
Connector Name	AV CONTROL UNIT
Connector Color	BLUE

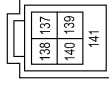

Terminal No.	Color of Wire	Signal Name
137	W	VBUS
138	G	USB GND
139	L	USB D+
140	R	USB D-
141	SHIELD	SHIELD

Terminal No.	Color of Wire	Signal Name
98	SHIELD	SHIELD
99	-	-
100	W	REQ1
101	B	TX
102	R	RX
103	-	-
104	-	-

Connector No.	M51
Connector Name	AV CONTROL UNIT (WITH BASE AUDIO SYSTEM)
Connector Color	WHITE

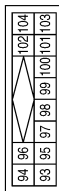

Terminal No.	Color of Wire	Signal Name
93	W	N BUS LH-
94	B	N BUS LH+
95	R	N BUS RH-
96	G	N BUS RH+
97	SHIELD	SHIELD

Connector No.	M65
Connector Name	WIRE TO WIRE
Connector Color	WHITE

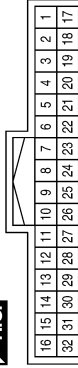

Terminal No.	Color of Wire	Signal Name
11	P	-
12	G	-
13	SHIELD	-
14	B	-
15	R	-
16	W	-
30	SHIELD	-
31	B	-
32	W	-

Connector No.	M64
Connector Name	WIRE TO WIRE
Connector Color	WHITE

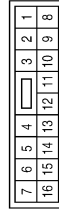

Terminal No.	Color of Wire	Signal Name
3	B	-

Connector No.	M62
Connector Name	INSTRUMENT PANEL TWEETER LH
Connector Color	BROWN



Terminal No.	Color of Wire	Signal Name
1	SB	- (WITH BASE AUDIO SYSTEM)
2	V	- (WITH BASE AUDIO SYSTEM)

ABNIA4593GB

# BASE AUDIO

< WIRING DIAGRAM >

[BASE AUDIO]

Connector No.	M68
Connector Name	FUSE BLOCK (J/B)
Connector Color	BROWN



Terminal No.	Color of Wire	Signal Name
2R	LG	-
5R	Y	-

Terminal No.	Color of Wire	Signal Name
7	W	-(WITHOUT REAR ENTERTAINMENT SYSTEM)
8	B	-(WITHOUT REAR ENTERTAINMENT SYSTEM)
9	SHIELD	-(WITHOUT REAR ENTERTAINMENT SYSTEM)
10	SHIELD	-
11	B	-(WITHOUT REAR ENTERTAINMENT SYSTEM)
12	W	-(WITHOUT REAR ENTERTAINMENT SYSTEM)
14	SB	-
15	LG	-
16	LG	-
17	SB	-

Connector No.	M66
Connector Name	WIRE TO WIRE
Connector Color	WHITE

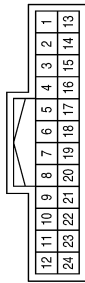

Terminal No.	Color of Wire	Signal Name
3	Y	-(WITHOUT REAR ENTERTAINMENT SYSTEM)
4	P	-(WITHOUT REAR ENTERTAINMENT SYSTEM)
5	LG	-(WITHOUT REAR ENTERTAINMENT SYSTEM)
6	BG	-(WITHOUT REAR ENTERTAINMENT SYSTEM)

Connector No.	M73
Connector Name	INSTRUMENT PANEL TWEETER RH
Connector Color	BROWN



Terminal No.	Color of Wire	Signal Name
1	BR	-(WITH BASE AUDIO SYSTEM)
2	Y	-(WITH BASE AUDIO SYSTEM)

Terminal No.	Color of Wire	Signal Name
18	Y	-(WITHOUT NAVI)
19	W	-(WITHOUT NAVI)
20	B	-(WITHOUT NAVI)
21	R	-(WITHOUT NAVI)
22	G	-(WITHOUT NAVI)
23	SHIELD	-(WITHOUT NAVI)
27	R	-(WITHOUT NAVI)
28	B	-(WITHOUT NAVI)
29	W	-(WITHOUT NAVI)
30	SHIELD	-

Connector No.	M69
Connector Name	WIRE TO WIRE
Connector Color	WHITE

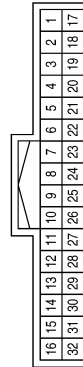

Terminal No.	Color of Wire	Signal Name
1	W	-(WITHOUT NAVI)
2	B	-(WITHOUT NAVI)
3	R	-(WITHOUT NAVI)
4	SHIELD	-
17	P	-(WITHOUT NAVI)

ABNIA4594GB

A  
B  
C  
D  
E  
F  
G  
H  
I  
J  
K  
L  
M  
N  
O  
P

AV

# BASE AUDIO

< WIRING DIAGRAM >

[BASE AUDIO]

Terminal No.	Color of Wire	Signal Name
7	R	– (WITHOUT REAR ENTERTAINMENT SYSTEM)
8	B	– (WITHOUT REAR ENTERTAINMENT SYSTEM)
9	SHIELD	–
29	SB	–
30	L	–

Connector No.	M84
Connector Name	WIRE TO WIRE
Connector Color	WHITE

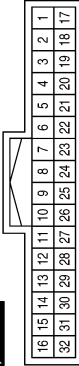

Terminal No.	Color of Wire	Signal Name
5	P	– (WITHOUT REAR ENTERTAINMENT SYSTEM)
6	W	– (WITHOUT REAR ENTERTAINMENT SYSTEM)

Connector No.	M80
Connector Name	BCM (BODY CONTROL MODULE)
Connector Color	BLACK

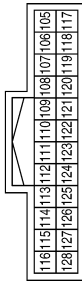

Terminal No.	Color of Wire	Signal Name
109	R	REVERSE SIGNAL
113	L	ACC RELAY OUT

Terminal No.	Color of Wire	Signal Name
18	W	B
19	B	RGB SYNC
20	R	VP
21	SHIELD	SYNC GND
22	B	UART OUT
23	SHIELD	UART GND
24	–	–

Terminal No.	Color of Wire	Signal Name
6	B	G
7	SHIELD	RGB GND
8	G	HP
9	W	YS
10	–	–
11	W	UART IN
12	–	–
13	LG	INV GND
14	B	SIG GND
15	B	COMP
16	–	–
17	R	R

Connector No.	M93
Connector Name	DISPLAY UNIT (WITHOUT NAVI)
Connector Color	WHITE

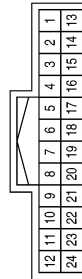

Terminal No.	Color of Wire	Signal Name
1	B	GND
2	L	INV VCC
3	V	SIG VCC
4	W	COMP GND
5	SHIELD	COMP SHIELD

ABNIA4595GB

# BASE AUDIO

< WIRING DIAGRAM >

[BASE AUDIO]

Terminal No.	Color of Wire	Signal Name
8	LG	-
9	V	-
14	Y	-

Connector No.	M98
Connector Name	A/C AND AV SWITCH ASSEMBLY
Connector Color	WHITE

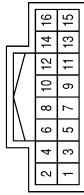

Terminal No.	Color of Wire	Signal Name
1	GR	-
3	P	-
4	R	-
5	B	-
6	SB	-

Connector No.	M95
Connector Name	WIRE TO WIRE
Connector Color	GRAY



Terminal No.	Color of Wire	Signal Name
1	B	-
2	B	-
3	B	-

Connector No.	M149
Connector Name	COMBINATION SWITCH (SPIRAL CABLE)
Connector Color	GRAY



Terminal No.	Color of Wire	Signal Name
14	B	-
15	GR	-
17	BR	-

Connector No.	M143
Connector Name	AV CONTROL UNIT
Connector Color	GRAY



Terminal No.	Color of Wire	Signal Name
142	B	ANT +B
143	B	ANT MAIN
144	B	ANT SUB

Connector No.	M115
Connector Name	WIRE TO WIRE
Connector Color	GRAY

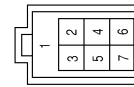

Terminal No.	Color of Wire	Signal Name
1	SHIELD	-
2	W	-
3	G	-
4	R	-
6	L	-

ABNIA4596GB

A  
B  
C  
D  
E  
F  
G  
H  
I  
J  
K  
L  
M  
N  
O  
P

AV

# BASE AUDIO

< WIRING DIAGRAM >

[BASE AUDIO]

Connector No.	M171
Connector Name	JOINT CONNECTOR-M10
Connector Color	WHITE



Terminal No.	Color of Wire	Signal Name
2	SB	-(WITH BASE AUDIO SYSTEM)
3	SB	-(WITH BASE AUDIO SYSTEM)
4	SB	-(WITH BASE AUDIO SYSTEM)

Connector No.	M167
Connector Name	WIRE TO WIRE
Connector Color	WHITE

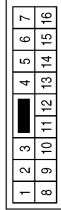

Terminal No.	Color of Wire	Signal Name
8	V	-(WITH BASE AUDIO SYSTEM)
9	SB	-(WITH BASE AUDIO SYSTEM)

Connector No.	M158
Connector Name	WIRE TO WIRE
Connector Color	WHITE

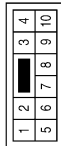

Terminal No.	Color of Wire	Signal Name
9	BR	-(WITH BASE AUDIO SYSTEM)
10	Y	-(WITH BASE AUDIO SYSTEM)

Connector No.	M174
Connector Name	JOINT CONNECTOR-M13
Connector Color	WHITE

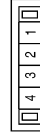

Terminal No.	Color of Wire	Signal Name
2	Y	-(WITH BASE AUDIO SYSTEM)
3	Y	-(WITH BASE AUDIO SYSTEM)
4	Y	-(WITH BASE AUDIO SYSTEM)

Connector No.	M173
Connector Name	JOINT CONNECTOR-M12
Connector Color	WHITE

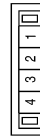

Terminal No.	Color of Wire	Signal Name
2	BR	-(WITH BASE AUDIO SYSTEM)
3	BR	-(WITH BASE AUDIO SYSTEM)
4	BR	-(WITH BASE AUDIO SYSTEM)

Connector No.	M172
Connector Name	JOINT CONNECTOR-M11
Connector Color	WHITE

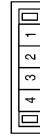

Terminal No.	Color of Wire	Signal Name
2	V	-(WITH BASE AUDIO SYSTEM)
3	V	-(WITH BASE AUDIO SYSTEM)
4	V	-(WITH BASE AUDIO SYSTEM)

ABNIA4597GB



# BASE AUDIO

< WIRING DIAGRAM >

[BASE AUDIO]

Connector No.	M177
Connector Name	JOINT CONNECTOR-M57
Connector Color	WHITE



Terminal No.	Color of Wire	Signal Name
1	LG	-
2	LG	-
3	LG	-
4	LG	-

Connector No.	M176
Connector Name	JOINT CONNECTOR-M56
Connector Color	WHITE



Terminal No.	Color of Wire	Signal Name
1	SB	-
2	SB	-
3	SB	-
4	SB	-

Connector No.	M175
Connector Name	JOINT CONNECTOR-M22
Connector Color	WHITE

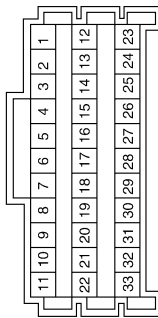

Terminal No.	Color of Wire	Signal Name
6	Y	-
7	Y	-
9	Y	-
11	Y	-

Connector No.	M210
Connector Name	WIRE TO WIRE
Connector Color	GRAY

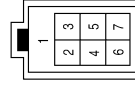

Terminal No.	Color of Wire	Signal Name
1	SHIELD	-
2	W	-
3	G	-
4	R	-
6	L	-

Connector No.	M209
Connector Name	USB INTERFACE
Connector Color	GREEN

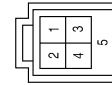

Terminal No.	Color of Wire	Signal Name
1	G	-
2	W	-
3	R	-
4	L	-
5	SHIELD	-

Connector No.	M205
Connector Name	FRONT AUXILIARY INPUT JACKS
Connector Color	WHITE

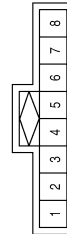

Terminal No.	Color of Wire	Signal Name
1	W	-
2	B	-
3	R	-
4	-	-
5	G	-
6	P	-
7	W	-
8	B	-

ABNIA4598GB

A  
B  
C  
D  
E  
F  
G  
H  
I  
J  
K  
L  
M  
N  
O  
P

AV

# BASE AUDIO

< WIRING DIAGRAM >

[BASE AUDIO]

Connector No.	M230
Connector Name	JOINT CONNECTOR-M01
Connector Color	GRAY

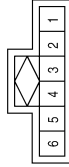

Terminal No.	Color of Wire	Signal Name
2	B	-
3	SHIELD	-
4	SHIELD	-

Connector No.	M217
Connector Name	WIRE TO WIRE
Connector Color	WHITE

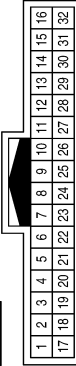

Terminal No.	Color of Wire	Signal Name
11	P	-
12	G	-
13	SHIELD	-
14	B	-
15	W	-
16	R	-
30	SHIELD	-
31	B	-
32	W	-

Connector No.	M216
Connector Name	WIRE TO WIRE
Connector Color	WHITE

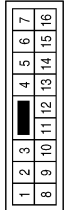

Terminal No.	Color of Wire	Signal Name
3	B	-

Connector No.	M502
Connector Name	ANTENNA BASE
Connector Color	GRAY



Terminal No.	Color of Wire	Signal Name
1	B	-
2	B	-

Connector No.	M501
Connector Name	ANTENNA BASE
Connector Color	GREEN

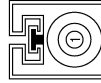

Terminal No.	Color of Wire	Signal Name
1	B	-

Connector No.	M500
Connector Name	WIRE TO WIRE
Connector Color	GRAY



Terminal No.	Color of Wire	Signal Name
1	B	-
2	B	-
3	B	-

ABNIA4599GB

# BASE AUDIO

< WIRING DIAGRAM >

[BASE AUDIO]

Connector No.	M505
Connector Name	GLASS ANTENNA (FM SUB)
Connector Color	GRAY



Terminal No.	Color of Wire	Signal Name
1	B	-

Connector No.	M504
Connector Name	WIRE TO WIRE
Connector Color	GRAY



Terminal No.	Color of Wire	Signal Name
1	B	-

Connector No.	M503
Connector Name	WIRE TO WIRE
Connector Color	GRAY



Terminal No.	Color of Wire	Signal Name
1	B	-

Connector No.	E44
Connector Name	JOINT CONNECTOR-E01
Connector Color	WHITE

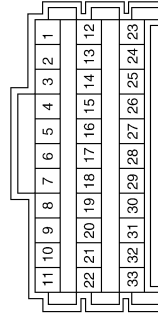

Terminal No.	Color of Wire	Signal Name
15	GR	-
17	B	-

Connector No.	E22
Connector Name	ACCESSORY RELAY-2
Connector Color	BLUE



Terminal No.	Color of Wire	Signal Name
1	G	-
2	B	-
3	R	-
5	P	-

Connector No.	M507
Connector Name	WIRE TO WIRE
Connector Color	GREEN

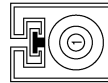

Terminal No.	Color of Wire	Signal Name
1	B	-

ABNIA4600GB

A  
B  
C  
D  
E  
F  
G  
H  
I  
J  
K  
L  
M  
N  
O  
P

AV

# BASE AUDIO

< WIRING DIAGRAM >

[BASE AUDIO]

Connector No.	B2
Connector Name	SATELLITE RADIO TUNER
Connector Color	WHITE

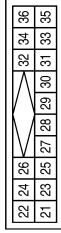

Terminal No.	Color of Wire	Signal Name
21	W	SAT LCH (-)
22	B	SAT LCH (+)
23	R	SAT RCH (-)
24	G	SAT RCH (+)
25	SHIELD	EARTH (SIG)
26	SHIELD	DATA EARTH
27	-	-
28	W	REQ1 (SAT-COMBI)
29	R	TXD (SAT-COMBI)
30	B	FXD (COMBI-SAT)
31	-	-
32	SB	BAT
33	-	-
34	-	-
35	GR	EARTH
36	BG	ACC

Connector No.	E152
Connector Name	WIRE TO WIRE
Connector Color	WHITE

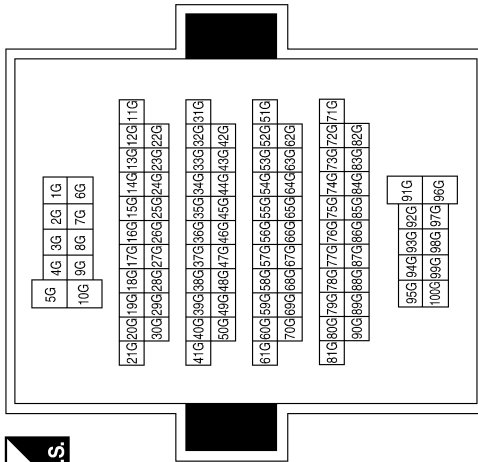

Terminal No.	Color of Wire	Signal Name
3G	P	-
33G	LG	-
50G	G	-

Connector No.	E52
Connector Name	PARKING BRAKE SWITCH
Connector Color	BLACK



Terminal No.	Color of Wire	Signal Name
1	LG	-

ABNIA4601GB

# BASE AUDIO

< WIRING DIAGRAM >

[BASE AUDIO]

Connector No.	B3
Connector Name	BLUETOOTH® CONTROL UNIT
Connector Color	WHITE

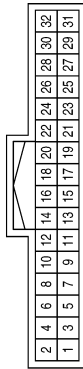

Terminal No.	Color of Wire	Signal Name
1	Y	B+
2	R	ACC
3	P	IGN
4	B	GND
5	SHIELD	AUDIO SHIELD
6	-	-
7	B	MIC IN +
8	SHIELD	MIC IN - (GND)
9	W	AUDIO OUT +
10	B	AUDIO OUT -
11	-	-
12	-	-
13	-	-

Terminal No.	Color of Wire	Signal Name
14	-	-
15	-	-
16	-	-
17	-	-
18	-	-
19	-	-
20	B	CONT 1
21	-	-
22	-	-
23	B	CONT 4
24	B	CONT 5
25	-	-
26	-	-
27	B	CONT 6
28	V	SPEED
29	W	MIC POWER
30	-	-
31	-	-
32	-	-

Connector No.	B4
Connector Name	BLUETOOTH® CONTROL UNIT
Connector Color	WHITE

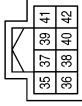

Terminal No.	Color of Wire	Signal Name
35	SB	CAN H
36	LG	CAN L
37	-	-
38	-	-
39	-	-
40	-	-
41	-	-
42	-	-

A  
B  
C  
D  
E  
F  
G  
H  
I  
J  
K  
L  
M  
AV  
O  
P

ABNIA4602GB

# BASE AUDIO

< WIRING DIAGRAM >

[BASE AUDIO]

Terminal No.	Color of Wire	Signal Name
10	SHIELD	-
11	W	-
12	SHIELD	-
13	B	-
14	R	-
15	B	-
16	L	-

Terminal No.	Color of Wire	Signal Name
2	SHIELD	-
3	W	-
4	SHIELD	-
5	B	-
6	R	-
7	G	-
8	R	-

Connector No.	B5
Connector Name	FRONT SEAT LH (PRE-WIRING)
Connector Color	WHITE

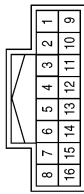

Connector No.	B32
Connector Name	WIRE TO WIRE
Connector Color	WHITE

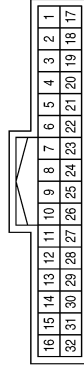

Terminal No.	Color of Wire	Signal Name
5	G	-
6	R	-
7	B	-
8	R	-
9	W	-
10	SHIELD	-
11	B	-
12	L	-
13	B	-
14	R	-
15	W	-
16	SHIELD	-

Terminal No.	Color of Wire	Signal Name
8	B	-(WITHOUT REAR ENTERTAINMENT SYSTEM)
9	SHIELD	-(WITHOUT REAR ENTERTAINMENT SYSTEM)
10	SHIELD	-
11	B	-(WITHOUT REAR ENTERTAINMENT SYSTEM)
12	W	-
14	SB	-
15	LG	-
16	LG	-
17	SB	-

Connector No.	B6
Connector Name	WIRE TO WIRE
Connector Color	WHITE

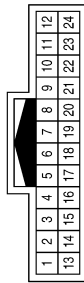

Terminal No.	Color of Wire	Signal Name
3	Y	-(WITHOUT REAR ENTERTAINMENT SYSTEM)
4	R	-(WITHOUT REAR ENTERTAINMENT SYSTEM)
5	P	-(WITHOUT REAR ENTERTAINMENT SYSTEM)
6	V	-(WITHOUT REAR ENTERTAINMENT SYSTEM)
7	W	-(WITHOUT REAR ENTERTAINMENT SYSTEM)

ABNIA4603GB

# BASE AUDIO

< WIRING DIAGRAM >

[BASE AUDIO]

Connector No.	B51
Connector Name	WIRE TO WIRE
Connector Color	WHITE

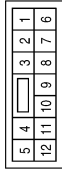

Terminal No.	Color of Wire	Signal Name
11	R	-
12	P	-

Connector No.	B46
Connector Name	WIRE TO WIRE
Connector Color	WHITE

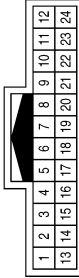

Terminal No.	Color of Wire	Signal Name
13	R	-(WITHOUT NAVI)
14	B	-(WITHOUT NAVI)
15	W	-(WITHOUT NAVI)
16	SHIELD	-

Connector No.	B41
Connector Name	WIRE TO WIRE
Connector Color	WHITE

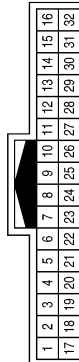

Terminal No.	Color of Wire	Signal Name
1	W	-(WITHOUT NAVI)
2	R	-(WITHOUT NAVI)
3	B	-
4	SHIELD	-
17	BG	-(WITHOUT NAVI)
18	SB	-(WITHOUT NAVI)
19	W	-(WITHOUT NAVI)
20	B	-(WITHOUT NAVI)
21	R	-(WITHOUT NAVI)
22	G	-(WITHOUT NAVI)
23	SHIELD	-(WITHOUT NAVI)
27	R	-(WITHOUT NAVI)
28	B	-(WITHOUT NAVI)
29	W	-(WITHOUT NAVI)
30	SHIELD	-(WITHOUT NAVI)

Connector No.	B59
Connector Name	BLUETOOTH® CONTROL UNIT
Connector Color	GRAY

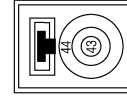

Terminal No.	Color of Wire	Signal Name
43	B	-
44	SHIELD	-

Connector No.	B57
Connector Name	WIRE TO WIRE
Connector Color	GRAY



Terminal No.	Color of Wire	Signal Name
1	B	-

Connector No.	B53
Connector Name	SATELLITE ANTENNA
Connector Color	GREEN

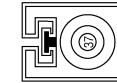

Terminal No.	Color of Wire	Signal Name
37	B	-

ABNIA4604GB

A  
B  
C  
D  
E  
F  
G  
H  
I  
J  
K  
L  
M  
N  
O  
P

AV

# BASE AUDIO

< WIRING DIAGRAM >

[BASE AUDIO]

Connector No.	B61
Connector Name	JOINT CONNECTOR-B18
Connector Color	WHITE



Terminal No.	Color of Wire	Signal Name
1	SB	-
2	SB	-
3	SB	-

Connector No.	B62
Connector Name	JOINT CONNECTOR-B19
Connector Color	WHITE



Terminal No.	Color of Wire	Signal Name
1	LG	-
2	LG	-
3	LG	-

Connector No.	B69
Connector Name	WIRE TO WIRE
Connector Color	GRAY

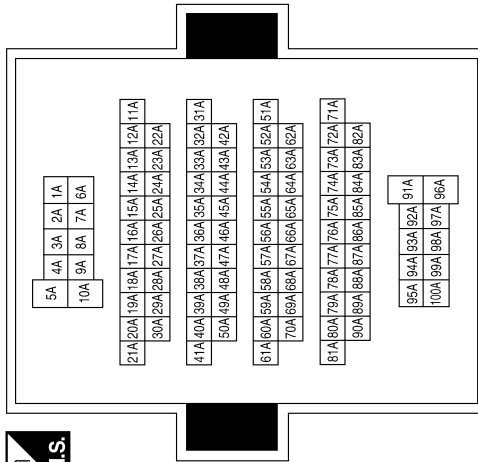

Terminal No.	Color of Wire	Signal Name
63A	P	-
64A	R	-

Connector No.	B101
Connector Name	WIRE TO WIRE
Connector Color	WHITE

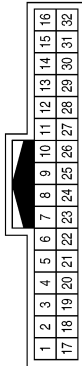

Terminal No.	Color of Wire	Signal Name
5	V	-(WITHOUT REAR ENTERTAINMENT SYSTEM)
6	W	-(WITHOUT REAR ENTERTAINMENT SYSTEM)
7	R	-(WITHOUT REAR ENTERTAINMENT SYSTEM)
8	B	-(WITHOUT REAR ENTERTAINMENT SYSTEM)
9	SHIELD	-
29	SB	-
30	LG	-

Connector No.	B107
Connector Name	WIRE TO WIRE
Connector Color	WHITE

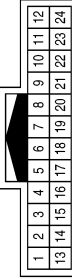

Terminal No.	Color of Wire	Signal Name
19	V	-
20	Y	-
21	SHIELD	-
22	B	-
23	R	-
24	W	-



# BASE AUDIO

< WIRING DIAGRAM >

[BASE AUDIO]

Terminal No.	Color of Wire	Signal Name
16	SHIELD	-
17	SHIELD	-
18	B	-
19	G	-
20	R	-
21	G	-
22	R	-
23	W	-
24	SHIELD	-

Terminal No.	Color of Wire	Signal Name
6	B	-
7	L	-
8	G	-
9	R	-
10	W	-
11	SHIELD	-
12	V	-
13	B	-
14	R	-
15	W	-

Connector No.	B110
Connector Name	FRONT SEAT RH (PRE-WIRING)
Connector Color	WHITE

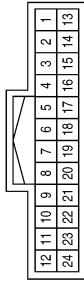

Terminal No.	Color of Wire	Signal Name
1	Y	-
2	V	-
3	B	-
4	R	-
5	W	-

Connector No.	B139
Connector Name	WIRE TO WIRE
Connector Color	WHITE

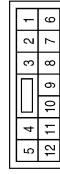

Terminal No.	Color of Wire	Signal Name
7	G	-
8	R	-
9	W	-
10	SHIELD	-
11	B	-
12	L	-
13	G	-
14	R	-
15	W	-
16	SHIELD	-

Connector No.	B124
Connector Name	WIRE TO WIRE
Connector Color	WHITE

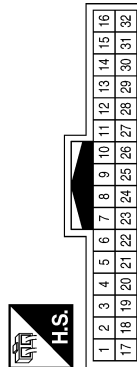

Terminal No.	Color of Wire	Signal Name
5	G	-
6	R	-

Terminal No.	Color of Wire	Signal Name
11	SB	-(WITH BASE AUDIO SYSTEM)
12	LG	-(WITH BASE AUDIO SYSTEM)

ABNIA4606GB

A  
B  
C  
D  
E  
F  
G  
H  
I  
J  
K  
L  
M  
N  
O  
P

AV

# BASE AUDIO

< WIRING DIAGRAM >

[BASE AUDIO]

Connector No.	R1
Connector Name	WIRE TO WIRE
Connector Color	WHITE

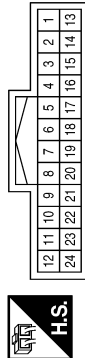

Terminal No.	Color of Wire	Signal Name
13	W	-
14	B	-
15	SHIELD	-

Connector No.	R11
Connector Name	WIRE TO WIRE
Connector Color	WHITE

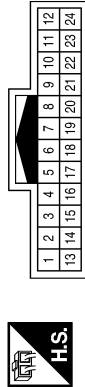

Terminal No.	Color of Wire	Signal Name
5	SHIELD	-
6	B	-
7	W	-

Connector No.	R101
Connector Name	WIRE TO WIRE
Connector Color	WHITE

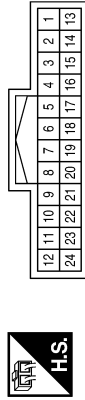

Terminal No.	Color of Wire	Signal Name
5	GR	-
6	L	-
7	R	-

Connector No.	R109
Connector Name	MICROPHONE
Connector Color	WHITE



Terminal No.	Color of Wire	Signal Name
1	R	-
2	-	-
3	GR	-
4	L	-

Connector No.	D2
Connector Name	WIRE TO WIRE
Connector Color	WHITE

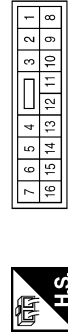

Terminal No.	Color of Wire	Signal Name
8	W	-
9	G	-

Connector No.	D12
Connector Name	FRONT DOOR SPEAKER LH
Connector Color	WHITE



Terminal No.	Color of Wire	Signal Name
1	G	-
2	W	-

# BASE AUDIO

< WIRING DIAGRAM >

[BASE AUDIO]

Connector No.	D201
Connector Name	WIRE TO WIRE
Connector Color	WHITE

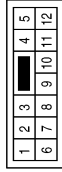

Terminal No.	Color of Wire	Signal Name
11	Y	-
12	LG	-

Connector No.	D112
Connector Name	FRONT DOOR SPEAKER RH
Connector Color	WHITE



Terminal No.	Color of Wire	Signal Name
1	G	-
2	W	-

Connector No.	D102
Connector Name	WIRE TO WIRE
Connector Color	WHITE

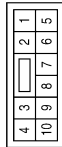

Terminal No.	Color of Wire	Signal Name
9	G	-
10	W	-

Connector No.	D306
Connector Name	REAR DOOR SPEAKER RH
Connector Color	WHITE



Terminal No.	Color of Wire	Signal Name
1	W	-
2	G	-

Connector No.	D301
Connector Name	WIRE TO WIRE
Connector Color	WHITE

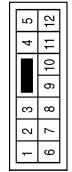

Terminal No.	Color of Wire	Signal Name
11	G	-
12	W	-

Connector No.	D206
Connector Name	REAR DOOR SPEAKER LH
Connector Color	WHITE



Terminal No.	Color of Wire	Signal Name
1	LG	-
2	Y	-

ABNIA4608GB

A  
B  
C  
D  
E  
F  
G  
H  
I  
J  
K  
L  
M  
N  
O  
P

AV

# BASE AUDIO

< WIRING DIAGRAM >

[BASE AUDIO]

Connector No.	D504
Connector Name	REAR VIEW CAMERA
Connector Color	WHITE

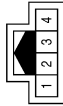

Terminal No.	Color of Wire	Signal Name
1	W	-
2	B	-
3	R	-
4	SHIELD	-

Connector No.	D501
Connector Name	WIRE TO WIRE
Connector Color	WHITE

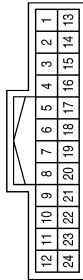

Terminal No.	Color of Wire	Signal Name
13	W	-
14	B	-
15	R	-
16	SHIELD	-

ABNIA4609GB

## BASIC INSPECTION

### DIAGNOSIS AND REPAIR WORKFLOW

#### Work Flow

INFOID:000000009128995

#### OVERALL SEQUENCE

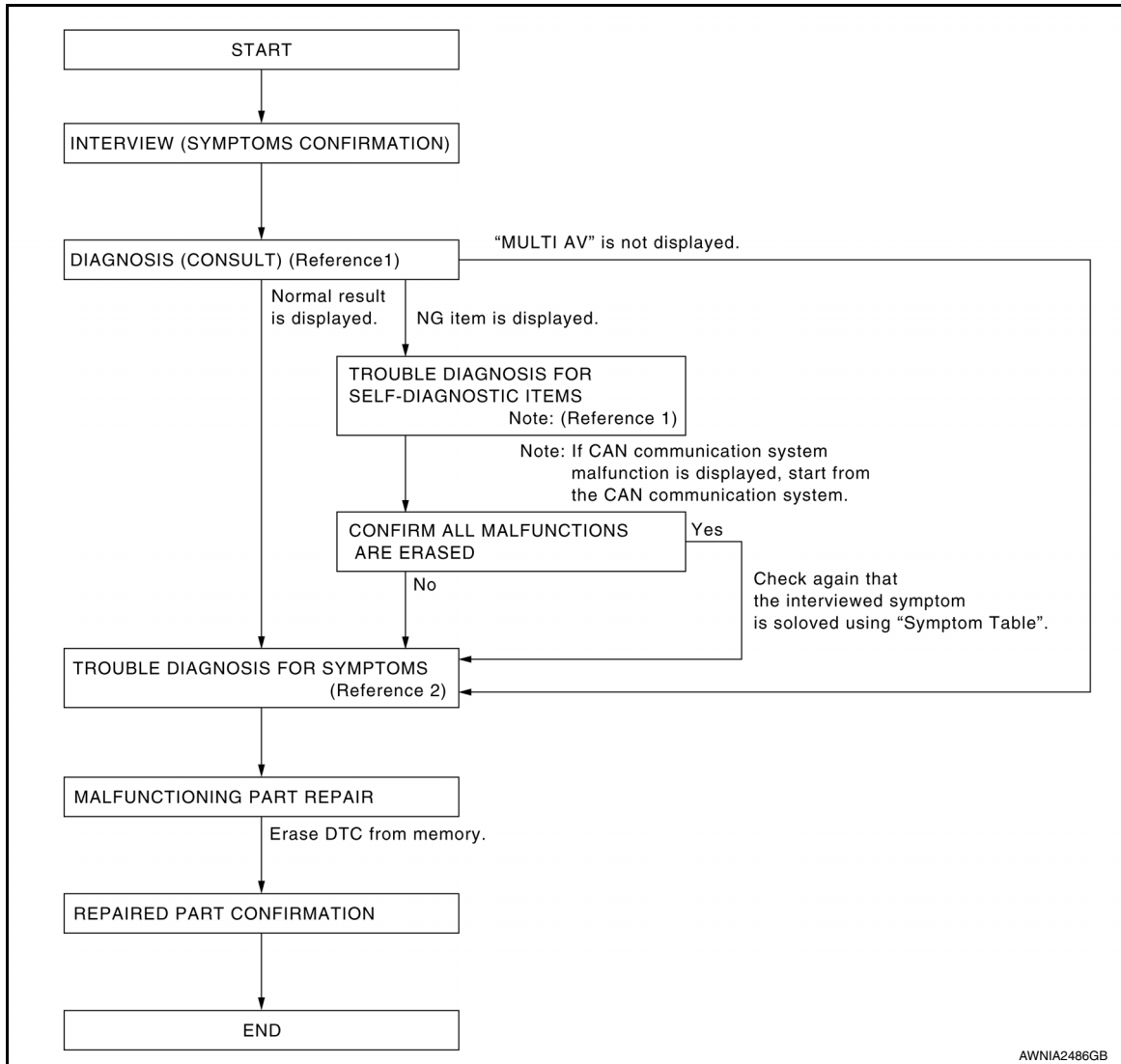

Reference 1: Refer to [AV-33, "CONSULT Function"](#).

Reference 2: Refer to [AV-130, "Symptom Table"](#).

#### DETAILED FLOW

##### 1. CHECK SYMPTOM

Check the malfunction symptoms by performing the following items:

- Interview the customer to obtain the malfunction information (conditions and environment when the malfunction occurred).
- Check the symptom.

>> GO TO 2

##### 2. SELF-DIAGNOSIS (CONSULT)

1. Connect CONSULT and perform "SELF-DIAGNOSIS" for "MULTI AV".

**NOTE:**

Skip to step 4 of the diagnosis procedure if "MULTI AV" is not displayed.

2. Check if any DTC No. is displayed in the self-diagnosis results.

A  
B  
C  
D  
E  
F  
G  
H  
I  
J  
K  
L  
M

AV

O  
P

# DIAGNOSIS AND REPAIR WORKFLOW

[BASE AUDIO]

< BASIC INSPECTION >

Is any DTC No. displayed?

- YES >> GO TO 3
- NO >> GO TO 4

## 3. CHECK SELF-DIAGNOSIS RESULTS (CONSULT)

1. Check the DTC No. indicated in the self-diagnosis results.
2. Perform the relevant diagnosis referring to the DTC No. list. Refer to [AV-42, "DTC Index"](#).

**NOTE:**

Start with the diagnosis for the CAN communication system if "CAN COMM CIRCUIT [U1000] or CONTROL UNIT (CAN) [U1010]" is displayed.

>> GO TO 5

## 4. PERFORM DIAGNOSIS BY SYMPTOM

Perform the relevant diagnosis referring to the diagnosis chart by symptom. Refer to [AV-130, "Symptom Table"](#).

>> GO TO 5

## 5. REPAIR OR REPLACE MALFUNCTIONING PARTS

Repair or replace the identified malfunctioning parts.

**NOTE:**

Erase the stored self-diagnosis results after repairing or replacing the relevant components if any DTC No. has been indicated in the self-diagnosis results.

>> GO TO 6

## 6. CHECK AFTER REPAIR

1. Perform self-diagnosis for "MULTI AV" with CONSULT after repairing or replacing the malfunctioning parts.
2. Check if any DTC No. is displayed in the self-diagnosis results.

Is any DTC No. displayed?

- YES >> GO TO 3
- NO >> GO TO 7

## 7. FINAL CHECK

Perform the operation check to confirm that the malfunction symptom is solved or that any other symptoms are present.

Are any symptoms present?

- YES >> GO TO 4
- NO >> Inspection End.

## INSPECTION AND ADJUSTMENT

## ADDITIONAL SERVICE WHEN REPLACING AV CONTROL UNIT

## ADDITIONAL SERVICE WHEN REPLACING AV CONTROL UNIT : Description

INFOID:000000009128996

## BEFORE REPLACEMENT

When replacing AV control unit, save or print current vehicle specification with CONSULT configuration before replacement.

**NOTE:**

If "Before Replace ECU" cannot be used, use the "After Replace ECU" or "Manual Configuration" after replacing AV control unit.

## AFTER REPLACEMENT

**CAUTION:**

When replacing AV control unit, you must perform "After Replace ECU" with CONSULT.

- Complete the procedure of "After Replace ECU" in order.
- If you set incorrect "After Replace ECU", incidents might occur.
- Configuration is different for each vehicle model. Confirm configuration of each vehicle model.

## ADDITIONAL SERVICE WHEN REPLACING AV CONTROL UNIT : Work Procedure

INFOID:000000009128997

## 1. SAVING VEHICLE SPECIFICATION

## ④-CONSULT

Enter "Re/Programming, Configuration" and perform "Before Replace ECU" to save or print current vehicle specification.

**NOTE:**

If "Before Replace ECU" cannot be used, use the "After Replace ECU" or "Manual Configuration" after replacing AV control unit.

>> GO TO 2.

## 2. REPLACE AV CONTROL UNIT

Replace AV control unit. Refer to [AV-136, "Removal and Installation - AV Control Unit"](#).

>> GO TO 3.

## 3. WRITING VEHICLE SPECIFICATION

## ④CONSULT

1. Enter "Re/Programming, Configuration".
2. If "Before Replace ECU" operation was performed, automatically an "Operation Log Selection" screen will be displayed. Select the applicable file from the "Saved Data List" and press "Confirm" to write vehicle specification. Refer to [AV-80, "CONFIGURATION \(AV CONTROL UNIT\) : Work Procedure"](#).
3. If "Before Replace ECU" operation was not performed, select "After Replace ECU" or "Manual Configuration" to write vehicle specification. Refer to [AV-80, "CONFIGURATION \(AV CONTROL UNIT\) : Work Procedure"](#).

>> GO TO 4.

## 4. OPERATION CHECK

Check that the operation of the AV control unit and camera images (fixed guide lines and predictive course lines) are normal.

>> Work End.

## CONFIGURATION (AV CONTROL UNIT)

# INSPECTION AND ADJUSTMENT

< BASIC INSPECTION >

[BASE AUDIO]

## CONFIGURATION (AV CONTROL UNIT) : Description

INFOID:000000009128998

Vehicle specification needs to be written with CONSULT because it is not written after replacing AV control unit.

Configuration has three functions as follows:

Function	Description
"Before Replace ECU"	<ul style="list-style-type: none"><li>• Reads the vehicle configuration of current AV control unit.</li><li>• Saves the read vehicle configuration.</li></ul>
"After Replace ECU"	Writes the vehicle configuration with manual selection.
"Select Saved Data List"	Writes the vehicle configuration with saved data.

### CAUTION:

- When replacing AV control unit, you must perform "Select Saved Data List" or "After Replace ECU" with CONSULT.
- Complete the procedure of "Select Saved Data List" or "After Replace ECU" in order.
- If you set incorrect "Select Saved Data List" or "After Replace ECU", incidents might occur.
- Configuration is different for each vehicle model. Confirm configuration of each vehicle model.
- Never perform "Select Saved Data List" or "After Replace ECU" except for new AV control unit.

## CONFIGURATION (AV CONTROL UNIT) : Work Procedure

INFOID:000000009128999

### 1. WRITING MODE SELECTION

#### CONSULT

Select "Reprogramming, Configuration" of AV control unit.

When writing saved data >> GO TO 2.

When writing manually >> GO TO 3.

### 2. PERFORM "SAVED DATA LIST"

#### CONSULT

Automatically "Operation Log Selection" window will display if "Before Replace ECU" was performed. Select applicable file from the "Save Data List" and press "Confirm".

>> Work End.

### 3. PERFORM "AFTER REPLACE ECU" OR "MANUAL CONFIGURATION"

#### CONSULT

1. Select "After Replace ECU" or "Manual Configuration".
2. Identify the correct model and configuration list. Refer to [AV-81. "CONFIGURATION \(AV CONTROL UNIT\) : Configuration List"](#).
3. Confirm and/or change setting value for each item.

#### CAUTION:

**Thoroughly read and understand the vehicle specification. ECU control may not operate normally if the setting is not correct.**

4. Select "Next".

#### CAUTION:

**Make sure to select "Next", confirm each setting value and press "OK" even if the indicated configuration of brand new AV control unit is same as the desirable configuration. If not, configuration which is set automatically by selecting vehicle model can not be memorized.**

5. When "Completed", select "End".

>> GO TO 4.

### 4. OPERATION CHECK

Confirm that each function controlled by AV control unit operates normally.



# INSPECTION AND ADJUSTMENT

< BASIC INSPECTION >

[BASE AUDIO]

>> Work End.

## CONFIGURATION (AV CONTROL UNIT) : Configuration List

INFOID:000000009129000

### CAUTION:

Thoroughly read and understand the vehicle specification. Incorrect settings may result in abnormal control of ECU.

MANUAL SETTING ITEM	
Items	Setting value
CAMERA SYSTEM	NONE/AVM ⇔ REAR CAMERA
SOUND SYSTEM	BASE ⇔ BOSE

⇔: Items which confirm vehicle specifications

A  
B  
C  
D  
E  
F  
G  
H  
I  
J  
K  
L  
M  
O  
P

AV

# U1000 CAN COMM CIRCUIT

< DTC/CIRCUIT DIAGNOSIS >

[BASE AUDIO]

## DTC/CIRCUIT DIAGNOSIS

### U1000 CAN COMM CIRCUIT

#### DTC Logic

INFOID:000000009129001

#### DTC DETECTION LOGIC

CONSULT Display	DTC Detection Condition	Possible Cause
CAN COMM CIRCUIT [U1000]	AV control unit is not transmitting or receiving CAN communication signal for 2 seconds or more.	CAN communication system.

#### Diagnosis Procedure

INFOID:000000009129002

### 1. PERFORM SELF DIAGNOSTIC RESULT

1. Turn ignition switch ON and wait for 2 seconds or more.
2. Perform Self Diagnostic Result for MULTI AV.

#### Is CAN COMM CIRCUIT displayed?

- YES >> Refer to [LAN-26, "Trouble Diagnosis Flow Chart"](#).  
NO >> Refer to [GI-53, "Intermittent Incident"](#).

# U1010 CONTROL UNIT (CAN)

< DTC/CIRCUIT DIAGNOSIS >

[BASE AUDIO]

## U1010 CONTROL UNIT (CAN)

### DTC Logic

INFOID:000000009129003

### DTC DETECTION LOGIC

CONSULT Display	DTC Detection Condition	Possible Cause
CONTROL UNIT (CAN) [U1010]	CAN initial diagnosis malfunction is detected.	Replace the AV control unit if the malfunction occurs constantly. Refer to <a href="#">AV-136, "Removal and Installation - AV Control Unit"</a> .

A  
B  
C  
D  
E  
F  
G  
H  
I  
J  
K  
L  
M  
O  
P

AV

# U1200 AV CONTROL UNIT

< DTC/CIRCUIT DIAGNOSIS >

[BASE AUDIO]

## U1200 AV CONTROL UNIT

### DTC Logic

INFOID:000000009129004

CONSULT Display	DTC Detection Condition	Possible Cause
CONT UNIT [U1200]	AV control unit malfunction is detected.	Replace the AV control unit if the malfunction occurs constantly. Refer to <a href="#">AV-136. "Removal and Installation - AV Control Unit"</a> .

# U1216 AV CONTROL UNIT

< DTC/CIRCUIT DIAGNOSIS >

[BASE AUDIO]

## U1216 AV CONTROL UNIT

### DTC Logic

INFOID:000000009129005

CONSULT Display	DTC Detection Condition	Possible Cause
CAN CONT [U1216]	AV control unit malfunction is detected.	Replace the AV control unit if the malfunction occurs constantly. Refer to <a href="#">AV-136. "Removal and Installation - AV Control Unit"</a> .

A

B

C

D

E

F

G

H

I

J

K

L

M

AV

O

P

# U1232 STEERING ANGLE SENSOR

< DTC/CIRCUIT DIAGNOSIS >

[BASE AUDIO]

## U1232 STEERING ANGLE SENSOR

### DTC Logic

INFOID:000000009129006

CONSULT Display	DTC Detection Condition	Possible Cause
ST ANGLE SEN CALIB [U1232]	Predictive course line center position adjustment of the steering angle sensor is incomplete.	Adjust the predictive course line center position of the steering angle sensor. Refer to <a href="#">BRC-60. "Work Procedure"</a> .

### Diagnosis Procedure

INFOID:000000009129007

#### 1. ADJUST THE PREDICTIVE COURSE LINE CENTER POSITION OF THE STEERING ANGLE SENSOR

When U1232 is detected, adjust the predictive course line center position of the steering angle sensor.

>> Refer to [BRC-60. "Work Procedure"](#).

# U1243 DISPLAY UNIT

< DTC/CIRCUIT DIAGNOSIS >

[BASE AUDIO]

## U1243 DISPLAY UNIT

### DTC Logic

INFOID:000000009129008

CONSULT Display	DTC Detection Condition	Possible Cause
FRONT DISP CONN [U1243]	When any of the following is detected: <ul style="list-style-type: none"> <li>display unit power supply or ground circuit malfunction.</li> <li>serial communication circuit malfunction between display unit and AV control unit.</li> </ul>	<ul style="list-style-type: none"> <li>Display unit power supply and ground circuits.</li> <li>Serial communication circuits between display unit and AV control unit.</li> </ul>

### Diagnosis Procedure

INFOID:000000009129009

Regarding Wiring Diagram information, refer to [AV-51, "Wiring Diagram"](#).

#### 1. CHECK DISPLAY UNIT POWER SUPPLY AND GROUND CIRCUIT

Check display unit power supply and ground circuits. Refer to [AV-93, "DISPLAY UNIT : Diagnosis Procedure"](#).  
Is the inspection result normal?

YES >> GO TO 2.

NO >> Repair or replace harness or connectors.

#### 2. CHECK COMMUNICATION CIRCUIT CONTINUITY

- Turn ignition switch OFF.
- Disconnect display unit connector and AV control unit connector M45.
- Check continuity between display unit connector M93 terminals 11, 22 and AV control unit connector M45 terminals 73, 61.

Display unit		AV control unit		Continuity
Connector	Terminals	Connector	Terminals	
M93	11	M45	73	Yes
	22		61	

- Check continuity between display unit connector M93 terminals 11, 22 and ground.

Display unit		Ground	Continuity
Connector	Terminals		
M93	11	—	No
	12		

Is the inspection result normal?

YES >> GO TO 3.

NO >> Repair or replace harness or connectors.

#### 3. CHECK COMMUNICATION SIGNAL (DISP→CONT)

- Connect display unit connector and AV control unit connector M45.
- Turn ignition switch ON.
- Check signal between display unit connector M93 terminal 11 and ground.

# U1243 DISPLAY UNIT

< DTC/CIRCUIT DIAGNOSIS >

[BASE AUDIO]

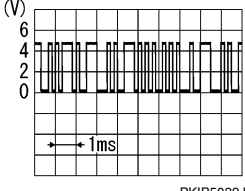
Display unit		Ground	Condition	Reference value
(+)		(-)		
Connector	Terminal			
M93	11	—	When adjusting display brightness.	

Is the inspection result normal?

YES >> GO TO 4.

NO >> Replace AV control unit. Refer to [AV-136. "Removal and Installation - AV Control Unit"](#).

## 4. CHECK COMMUNICATION SIGNAL (CONT→DISP)

Check signal between display unit connector M93 terminal 22 and ground.

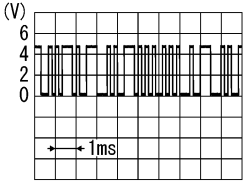
Display unit		Ground	Condition	Reference value
(+)		(-)		
Connector	Terminal			
M93	22	—	When adjusting display brightness.	

Is the inspection result normal?

YES >> Inspection End.

NO >> Replace display unit. Refer to [AV-139. "Removal and Installation"](#).



# U1255 SATELLITE RADIO TUNER

< DTC/CIRCUIT DIAGNOSIS >

[BASE AUDIO]

## U1255 SATELLITE RADIO TUNER

### DTC Logic

INFOID:000000009129010

CONSULT Display	DTC Detection Condition	Possible Cause
SAT CONN [U1255]	When any of the following is detected: <ul style="list-style-type: none"> <li>satellite radio tuner power supply or ground circuit malfunction.</li> <li>communication circuit malfunction between AV control unit and satellite radio tuner.</li> <li>request signal circuit malfunction between AV control unit and satellite radio tuner.</li> </ul>	<ul style="list-style-type: none"> <li>Satellite radio tuner power supply and ground circuits.</li> <li>Communication circuits between AV control unit and satellite radio tuner.</li> <li>Request signal circuits between AV control unit and satellite radio tuner.</li> </ul>

### Diagnosis Procedure

INFOID:000000009129011

Regarding Wiring Diagram information, refer to [AV-51. "Wiring Diagram"](#).

### 1. CHECK SATELLITE RADIO TUNER POWER SUPPLY AND GROUND CIRCUIT

Check satellite radio tuner power supply and ground circuit. Refer to [AV-95. "SATELLITE RADIO TUNER : Diagnosis Procedure"](#).

Is the inspection result normal?

YES >> GO TO 2.

NO >> Repair or replace harness or connectors.

### 2. CHECK COMMUNICATION CIRCUIT AND REQUEST SIGNAL CIRCUIT CONTINUITY

- Turn ignition switch OFF.
- Disconnect AV control unit connector M51 and satellite radio tuner connector B2.
- Check continuity between AV control unit connector M51 terminals 100, 101, 102 and satellite radio tuner connector B2 terminals 28, 29, 30.

AV control unit		Satellite radio tuner		Continuity
Connector	Terminals	Connector	Terminals	
M51	100	B2	28	Yes
	101		29	
	102		30	

- Check continuity between AV control unit connector M51 terminals 100, 101, 102 and ground.

AV control unit		Ground	Continuity
Connector	Terminals		
M51	100	Ground	No
	101		
	102		

Is the inspection result normal?

YES >> GO TO 3.

NO >> Repair or replace harness or connectors.

### 3. CHECK AV CONTROL UNIT VOLTAGE

- Connect AV control unit connector M51.
- Turn ignition switch ON.
- Check signal between AV control unit connector M51 terminals 100, 101 and ground.

# U1255 SATELLITE RADIO TUNER

< DTC/CIRCUIT DIAGNOSIS >

[BASE AUDIO]

AV control unit		Ground	Voltage (Approx.)
(+) Connector		(-)	
Connector	Terminals		
M51	100	—	7.0 V
	101		

Is the inspection result normal?

YES >> GO TO 4.

NO >> Replace AV control unit. Refer to [AV-136. "Removal and Installation - AV Control Unit"](#).

## 4. CHECK SATELLITE RADIO TUNER VOLTAGE

1. Turn ignition switch OFF.
2. Disconnect AV control unit connector M51.
3. Connect satellite radio tuner connector B2.
4. Turn ignition switch ON.
5. Check signal between satellite radio tuner connector B2 terminal 30 and ground.

Satellite radio tuner		Ground	Voltage (Approx.)
(+) Connector		(-)	
Connector	Terminals		
B2	30	—	7.0 V

Is the inspection result normal?

YES >> Inspection End.

NO >> Replace satellite radio tuner. Refer to [AV-148. "Removal and Installation"](#).

# U1300 AV COMM CIRCUIT

< DTC/CIRCUIT DIAGNOSIS >

[BASE AUDIO]

## U1300 AV COMM CIRCUIT

### Description

INFOID:000000009129012

U1300 is indicated when a malfunction occurs in the communication signal of the multi AV system. Indicated simultaneously, without fail, the malfunction of control units connected to the AV control unit through communication circuits. Determine the possible malfunction cause from the table below.

### SELF-DIAGNOSIS RESULTS DISPLAY ITEM

CONSULT Display	DTC Detection Condition	Possible Cause
<ul style="list-style-type: none"><li>• AV COMM CIRCUIT [U1300]</li><li>• SWITCH CONN [U1240]</li></ul>	<p>When any of the following is detected:</p> <ul style="list-style-type: none"><li>• A/C and AV switch assembly power supply or ground circuit malfunction.</li><li>• AV communication circuit malfunction between AV control unit and A/C and AV switch assembly.</li></ul>	<ul style="list-style-type: none"><li>• A/C and AV switch assembly power supply and ground circuits.</li><li>• AV communication circuits between AV control unit and A/C and AV switch assembly.</li></ul>
<ul style="list-style-type: none"><li>• AV COMM CIRCUIT [U1300]</li><li>• HAND FREE CONN [U1256]</li></ul>	<p>When any of the following is detected:</p> <ul style="list-style-type: none"><li>• Bluetooth® control unit power supply or ground circuit malfunction.</li><li>• AV communication circuit malfunction between AV control unit and Bluetooth® control unit.</li></ul>	<ul style="list-style-type: none"><li>• Bluetooth® control unit power supply and ground circuits.</li><li>• AV communication circuits between AV control unit and Bluetooth® control unit.</li></ul>
<ul style="list-style-type: none"><li>• AV COMM CIRCUIT [U1300]</li><li>• SWITCH CONN [U1240]</li><li>• HAND FREE CONN [U1256]</li></ul>	<p>AV communication circuit malfunction between AV control unit and A/C and AV switch assembly.</p>	<p>AV communication circuits between AV control unit and A/C and AV switch assembly.</p>

A  
B  
C  
D  
E  
F  
G  
H  
I  
J  
K  
L  
M  
N  
O  
P

AV

# U1310 AV CONTROL UNIT

< DTC/CIRCUIT DIAGNOSIS >

[BASE AUDIO]

## U1310 AV CONTROL UNIT

### DTC Logic

INFOID:000000009129013

CONSULT Display	DTC Detection Condition	Possible Cause
CONTROL UNIT (AV) [U1310]	An initial diagnosis error is detected in AV communication circuit.	Replace the AV control unit if the malfunction occurs constantly. Refer to <a href="#">AV-136. "Removal and Installation - AV Control Unit"</a> .

# POWER SUPPLY AND GROUND CIRCUIT

< DTC/CIRCUIT DIAGNOSIS >

[BASE AUDIO]

## POWER SUPPLY AND GROUND CIRCUIT

### AV CONTROL UNIT

#### AV CONTROL UNIT : Diagnosis Procedure

INFOID:000000009129014

Regarding Wiring Diagram information, refer to [AV-51. "Wiring Diagram"](#).

#### 1. CHECK FUSE

Check that the following fuses are not blown.

Terminal No.	Signal name	Fuse No.
29	Ignition signal	29 (5A)
39	ACC power supply	65 (10A)
51	Battery power supply	15 (15A)

##### Are the fuses blown?

YES >> Replace the blown fuse after repairing the affected circuit.

NO >> GO TO 2.

#### 2. CHECK POWER SUPPLY CIRCUIT

1. Turn ignition switch OFF.
2. Disconnect AV control unit connectors M42 and M44.
3. Check voltage between AV control unit connectors and ground.

AV control unit		Ground	Condition	Voltage (Approx.)
Connector	Terminal			
M42	29	—	Ignition switch: ON	Battery voltage
M44	39		Ignition switch: ACC	
	51		Ignition switch: OFF	

##### Is the inspection result normal?

YES >> GO TO 3.

NO >> Repair or replace harness or connectors.

#### 3. CHECK GROUND CIRCUIT

1. Turn ignition switch OFF.
2. Check continuity between AV control unit connector M44 terminal 52 and ground.

AV control unit		Ground	Continuity
Connector	Terminal		
M44	52	—	Yes

##### Is the inspection result normal?

YES >> Inspection End.

NO >> Repair or replace harness or connectors.

## DISPLAY UNIT

#### DISPLAY UNIT : Diagnosis Procedure

INFOID:000000009129015

Regarding Wiring Diagram information, refer to [AV-51. "Wiring Diagram"](#).

#### 1. CHECK INVERTER VCC AND SIGNAL VCC (POWER SUPPLY) CIRCUIT 1

# POWER SUPPLY AND GROUND CIRCUIT

< DTC/CIRCUIT DIAGNOSIS >

[BASE AUDIO]

Check voltage between display unit harness connector M93 terminals 2, 3 and ground.

Display unit		Ground	Condition	Voltage (Approx.)
Connector	Terminal			
M93	2	—	Ignition switch: ACC	9.0 V
	3			

Is the inspection result normal?

YES >> GO TO 4.

NO >> GO TO 2.

## 2. CHECK INVERTER VCC AND SIGNAL VCC (POWER SUPPLY) CIRCUIT CONTINUITY

1. Turn ignition switch OFF.
2. Disconnect AV control unit connector M45 and display unit connector.
3. Check continuity between AV control unit connector M45 terminals 64, 76 and display unit connector M93 terminals 3, 2.

AV control unit		Display unit		Continuity
Connector	Terminal	Connector	Terminal	
M45	64	M93	3	Yes
	76		2	

4. Check continuity between AV control unit connector M45 terminals 64, 76 and ground.

AV control unit		Ground	Continuity
Connector	Terminal		
M45	64	—	No
	76		

Is the inspection result normal?

YES >> GO TO 3.

NO >> Repair or replace harness or connectors.

## 3. CHECK INVERTER VCC AND SIGNAL VCC (POWER SUPPLY) CIRCUIT 2

1. Connect the AV control unit connector M45.
2. Check voltage between AV control unit connector M45 terminals 64, 76 and ground.

AV control unit		Ground	Condition	Voltage (Approx.)
(+)				
Connector	Terminal			
M45	64	—	Ignition switch: ACC	9.0 V
	76			

Is the inspection result normal?

YES >> Inspection End.

NO >> Replace AV control unit. Refer to [AV-136. "Removal and Installation - AV Control Unit"](#).

## 4. CHECK INVERTER GROUND AND SIGNAL GROUND CIRCUIT CONTINUITY

1. Turn ignition switch OFF.
2. Disconnect AV control unit connector M45 and display unit connector.
3. Check continuity between AV control unit connector M45 terminals 63, 75 and display unit connector M93 terminals 14, 13.

# POWER SUPPLY AND GROUND CIRCUIT

< DTC/CIRCUIT DIAGNOSIS >

[BASE AUDIO]

AV control unit		Display unit		Continuity
Connector	Terminal	Connector	Terminal	
M45	63	M93	14	Yes
	75		13	

Is the inspection result normal?

YES >> GO TO 5.

NO >> Repair or replace harness or connectors.

## 5.CHECK DISPLAY UNIT GROUND CIRCUIT

Check continuity between display unit connector M93 terminal 1 and ground.

Display unit		Ground	Continuity
Connector	Terminal		
M93	1	—	Yes

Is the inspection result normal?

YES >> Inspection End.

NO >> Repair or replace harness or connectors.

## SATELLITE RADIO TUNER

### SATELLITE RADIO TUNER : Diagnosis Procedure

INFOID:000000009129016

Regarding Wiring Diagram information, refer to [AV-51, "Wiring Diagram"](#).

## 1.CHECK FUSE

Check that the following fuses are not blown.

Terminal No.	Signal name	Fuse No.
32	Battery power supply	15 (15A)
36	ACC power supply	65 (10A)

Are the fuses blown?

YES >> Replace the blown fuse after repairing the affected circuit.

NO >> GO TO 2.

## 2.CHECK POWER SUPPLY CIRCUIT

1. Turn ignition switch OFF.
2. Disconnect satellite radio tuner connector B2.
3. Check voltage between satellite radio tuner connector B2 terminal 32, 36 and ground.

Satellite radio tuner		Ground	Condition	Voltage (Approx.)
Connector	Terminal			
B2	32	—	Ignition switch: OFF	Battery voltage
	36		Ignition switch: ACC	

Is the inspection result normal?

YES >> GO TO 3.

NO >> Repair or replace harness or connectors.

## 3.CHECK GROUND CIRCUIT

1. Turn ignition switch OFF.
2. Check continuity between satellite radio tuner connector B2 terminal 35 and ground.

# POWER SUPPLY AND GROUND CIRCUIT

< DTC/CIRCUIT DIAGNOSIS >

[BASE AUDIO]

Satellite radio tuner		Ground	Continuity
Connector	Terminal		
B2	35	—	Yes

Is the inspection result normal?

- YES >> Inspection End.  
 NO >> Repair or replace harness or connectors.

## BLUETOOTH® CONTROL UNIT

### BLUETOOTH® CONTROL UNIT : Diagnosis Procedure

INFOID:000000009129017

Regarding Wiring Diagram information, refer to [AV-51. "Wiring Diagram"](#).

## 1.CHECK FUSE

Check that the following fuses are not blown.

Terminal No.	Signal name	Fuse No.
1	Battery power supply	15 (15A)
2	ACC power supply	65 (10A)
3	Ignition signal	30 (10A)

Are the fuses blown?

- YES >> Replace the blown fuse after repairing the affected circuit.  
 NO >> GO TO 2.

## 2.CHECK POWER SUPPLY CIRCUIT

- Turn ignition switch OFF.
- Disconnect Bluetooth® control unit connector B3.
- Check voltage between Bluetooth® control unit connector B3 and ground.

Bluetooth® control unit		Ground	Condition	Voltage (Approx.)
Connector	Terminal			
B3	1	—	Ignition switch: OFF	Battery voltage
	2		Ignition switch: ACC	
	3		Ignition switch: ON	

Is the inspection result normal?

- YES >> GO TO 3.  
 NO >> Repair or replace harness or connectors.

## 3.CHECK GROUND CIRCUIT

- Turn ignition switch OFF.
- Check continuity between Bluetooth® control unit connector B3 and ground.

Bluetooth® control unit		Ground	Continuity
Connector	Terminal		
B3	4	—	Yes
	23		
	27		

Is the inspection result normal?

- YES >> Inspection End.



# POWER SUPPLY AND GROUND CIRCUIT

< DTC/CIRCUIT DIAGNOSIS >

[BASE AUDIO]

NO >> Repair or replace harness or connectors.

## A/C AND AV SWITCH ASSEMBLY

### A/C AND AV SWITCH ASSEMBLY : Diagnosis Procedure

INFOID:000000009129018

Regarding Wiring Diagram information, refer to [AV-51, "Wiring Diagram"](#).

#### 1. CHECK FUSE

Check that the following fuse is not blown.

Terminal No.	Signal name	Fuse No.
36	ACC power supply	65 (10A)

Is the fuse blown?

YES >> Replace the blown fuse after repairing the affected circuit.

NO >> GO TO 2.

#### 2. CHECK POWER SUPPLY CIRCUIT

1. Turn ignition switch OFF.
2. Disconnect A/C and AV switch assembly connector.
3. Check voltage between A/C and AV switch assembly connector M98 terminal 3 and ground.

A/C and AV switch assembly		Ground	Condition	Voltage (Approx.)
Connector	Terminal			
M98	3	—	Ignition switch: ACC	Battery voltage

Is the inspection result normal?

YES >> GO TO 3.

NO >> Repair or replace harness or connectors.

#### 3. CHECK CONTROL UNIT GROUND CIRCUIT

1. Turn ignition switch OFF.
2. Disconnect AV control unit connector M42.
3. Check continuity between A/C and AV switch assembly connector M98 terminal 9 and AV control unit connector M42 terminal 10.

A/C and AV switch assembly		AV control unit		Continuity
Connector	Terminal	Connector	Terminal	
M98	9	M42	10	Yes

Is the inspection result normal?

YES >> GO TO 4.

NO >> Repair or replace harness or connectors.

#### 4. CHECK SWITCH GROUND CIRCUIT

Check continuity between A/C and AV switch assembly connector M98 terminal 1 and ground.

A/C and AV switch assembly		Ground	Continuity
Connector	Terminal		
M98	1	—	Yes

Is the inspection result normal?

YES >> Inspection End.

NO >> Repair or replace harness or connectors.

A  
B  
C  
D  
E  
F  
G  
H  
I  
J  
K  
L  
M

AV

O  
P

# FRONT DOOR SPEAKER

[BASE AUDIO]

< DTC/CIRCUIT DIAGNOSIS >

## FRONT DOOR SPEAKER

### Diagnosis Procedure

INFOID:000000009129019

Regarding Wiring Diagram information, refer to [AV-51. "Wiring Diagram"](#).

### 1. CONNECTOR CHECK

Check the AV control unit and speaker connectors for the following:

- Proper connection
- Damage
- Disconnected or loose terminals

Is the inspection result normal?

YES >> GO TO 2

NO >> Repair the terminals or connectors.

### 2. CHECK FRONT DOOR SPEAKER SIGNAL CIRCUIT CONTINUITY

1. Disconnect AV control unit connector M44 and suspect front door speaker connector.
2. Check continuity between AV control unit connector M44 and suspect front door speaker connector.

AV control unit		Front door speaker		Continuity
Connector	Terminal	Connector	Terminal	
M44	34	D12 (LH)	1	Yes
	35		2	
	43	D112 (RH)	1	
	44		2	

3. Check continuity between AV control unit connector M44 and ground.

AV control unit		Ground	Continuity
Connector	Terminal		
M44	34	—	No
	35		
	43		
	44		

Is the inspection result normal?

YES >> GO TO 3

NO >> Repair or replace harness or connectors.

### 3. CHECK FRONT DOOR SPEAKER SIGNAL

1. Connect AV control unit connector M44 and suspect front door speaker connector.
2. Turn ignition switch to ACC.
3. Push AV control unit POWER switch.
4. Check signal between terminals of AV control unit connector M44.

AV control unit connector M44		Condition	Reference value
(+)	(-)		
Terminal	Terminal		

# FRONT DOOR SPEAKER

< DTC/CIRCUIT DIAGNOSIS >

[BASE AUDIO]

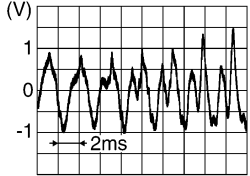
34	35	Audio signal output	
43	44		

Is the inspection result normal?

- YES >> Replace front door speaker. Refer to [AV-140. "Removal and Installation"](#).
- NO >> Replace AV control unit. Refer to [AV-136. "Removal and Installation - AV Control Unit"](#).

A  
B  
C  
D  
E  
F  
G  
H  
I  
J  
K  
L  
M  
O  
P

AV

# INSTRUMENT PANEL SPEAKER/TWEETER

< DTC/CIRCUIT DIAGNOSIS >

[BASE AUDIO]

## INSTRUMENT PANEL SPEAKER/TWEETER

### Diagnosis Procedure

INFOID:000000009129020

Regarding Wiring Diagram information, refer to [AV-51. "Wiring Diagram"](#).

### 1. CONNECTOR CHECK

Check the AV control unit and speaker connectors for the following:

- Proper connection
- Damage
- Disconnected or loose terminals

Is the inspection result normal?

YES >> GO TO 2

NO >> Repair the terminals or connectors.

### 2. CHECK INSTRUMENT PANEL TWEETER SIGNAL CIRCUIT CONTINUITY

1. Disconnect AV control unit connector M44 and suspect instrument panel tweeter connector.
2. Check continuity between AV control unit connector M44 and suspect instrument panel tweeter connector.

AV control unit		Instrument panel tweeter		Continuity
Connector	Terminal	Connector	Terminal	
M44	34	M62 (LH)	1	Yes
	35		2	
	43	M73 (RH)	1	
	44		2	

3. Check continuity between AV control unit connector M44 and ground.

AV control unit		Ground	Continuity
Connector	Terminal		
M44	34	—	No
	35		
	43		
	44		

Is the inspection result normal?

YES >> GO TO 3

NO >> Repair or replace harness or connectors.

### 3. CHECK INSTRUMENT PANEL TWEETER SIGNAL

1. Connect AV control unit connector M44 and suspect instrument panel tweeter connector.
2. Turn ignition switch to ACC.
3. Push AV control unit POWER switch.
4. Check signal between terminals of AV control unit connector M44.

AV control unit connector M44		Condition	Reference value
(+)	(-)		
Terminal	Terminal		

# INSTRUMENT PANEL SPEAKER/TWEETER

< DTC/CIRCUIT DIAGNOSIS >

[BASE AUDIO]

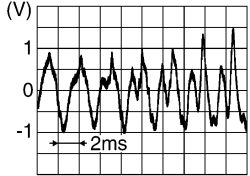
34	35	Audio signal output	
43	44		

Is the inspection result normal?

- YES >> Replace instrument panel tweeter. Refer to [AV-141, "Removal and Installation"](#).
- NO >> Replace AV control unit. Refer to [AV-136, "Removal and Installation - AV Control Unit"](#).

A  
B  
C  
D  
E  
F  
G  
H  
I  
J  
K  
L  
M

AV

O  
P

## REAR DOOR SPEAKER

### Diagnosis Procedure

INFOID:000000009129021

Regarding Wiring Diagram information, refer to [AV-51. "Wiring Diagram"](#).

### 1. CONNECTOR CHECK

Check the AV control unit and speaker connectors for the following:

- Proper connection
- Damage
- Disconnected or loose terminals

Is the inspection result normal?

YES >> GO TO 2

NO >> Repair the terminals or connectors.

### 2. CHECK REAR DOOR SPEAKER SIGNAL CIRCUIT CONTINUITY

1. Disconnect AV control unit connector M44 and suspect rear door speaker connector.
2. Check continuity between AV control unit connector M44 and suspect rear door speaker connector.

AV control unit		Rear door speaker		Continuity
Connector	Terminal	Connector	Terminal	
M44	36	D206 (LH)	1	Yes
	37		2	
	45	D306 (RH)	1	
	46		2	

3. Check continuity between AV control unit connector M44 and ground.

AV control unit		Ground	Continuity
Connector	Terminal		
M44	36	—	No
	37		
	45		
	46		

Is the inspection result normal?

YES >> GO TO 3

NO >> Repair or replace harness or connectors.

### 3. CHECK REAR DOOR SPEAKER SIGNAL

1. Connect AV control unit connector M44 and suspect rear door speaker connector.
2. Turn ignition switch to ACC.
3. Push AV control unit POWER switch.
4. Check signal between terminals of AV control unit connector M44.

AV control unit connector M44		Condition	Reference value
(+)	(-)		
Terminal	Terminal		

# REAR DOOR SPEAKER

< DTC/CIRCUIT DIAGNOSIS >

[BASE AUDIO]

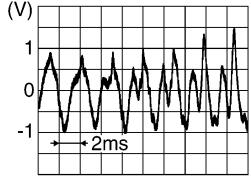
36	37	Audio signal output	
45	46		

Is the inspection result normal?

- YES >> Replace rear door speaker. Refer to [AV-142. "Removal and Installation"](#).
- NO >> Replace AV control unit. Refer to [AV-136. "Removal and Installation - AV Control Unit"](#).

A  
B  
C  
D  
E  
F  
G  
H  
I  
J  
K  
L  
M  
O  
P

AV

# FRONT AUXILIARY INPUT JACK AUDIO SIGNAL CIRCUIT

< DTC/CIRCUIT DIAGNOSIS >

[BASE AUDIO]

## FRONT AUXILIARY INPUT JACK AUDIO SIGNAL CIRCUIT

### Diagnosis Procedure

INFOID:000000009129022

Regarding Wiring Diagram information, refer to [AV-51. "Wiring Diagram"](#).

#### 1. CHECK AUX SOUND SIGNAL CIRCUIT CONTINUITY

1. Turn ignition OFF.
2. Disconnect AV control unit connector M42 and front auxiliary input jacks connector.
3. Check continuity between AV control unit connector M42 and front auxiliary input jacks connector M205.

AV control unit		Front auxiliary input jacks		Continuity
Connector	Terminal	Connector	Terminal	
M42	20	M205	1	Yes
	21		3	

4. Check continuity between AV control unit connector M42 and ground.

AV control unit		Ground	Continuity
Connector	Terminal		
M42	20	—	No
	21		

Is inspection result normal?

- YES >> GO TO 2.  
 NO >> Repair or replace harness or connectors.

#### 2. CHECK AUX SOUND SIGNAL GROUND CIRCUIT CONTINUITY

Check continuity between AV control unit connector M42 and front auxiliary input jacks connector M205.

AV control unit		Front auxiliary input jacks		Continuity
Connector	Terminal	Connector	Terminal	
M42	22	M205	2	Yes

Is inspection result normal?

- YES >> GO TO 3.  
 NO >> Repair or replace harness or connectors.

#### 3. CHECK AUX SOUND SIGNAL

1. Connect AV control unit connector M42 and front auxiliary input jacks connector.
2. Turn ignition switch to ACC.
3. Select AUX mode.
4. Check signal between terminals of AV control unit connector M42.

AV control unit connector M42		Condition	Reference value
(+)	(-)		
Terminal	Terminal		



# FRONT AUXILIARY INPUT JACK AUDIO SIGNAL CIRCUIT

< DTC/CIRCUIT DIAGNOSIS >

[BASE AUDIO]

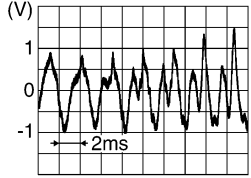
20	22	AUX mode selected	
21	22		

Is the inspection result normal?

- YES >> Replace front auxiliary input jacks. Refer to [AV-145. "Removal and Installation"](#).
- NO >> Replace AV control unit. Refer to [AV-136. "Removal and Installation - AV Control Unit"](#).

A  
B  
C  
D  
E  
F  
G  
H  
I  
J  
K  
L  
M

AV

O  
P

# SATELLITE AUDIO SIGNAL CIRCUIT

< DTC/CIRCUIT DIAGNOSIS >

[BASE AUDIO]

## SATELLITE AUDIO SIGNAL CIRCUIT

### Diagnosis Procedure

INFOID:000000009129023

Regarding Wiring Diagram information, refer to [AV-51. "Wiring Diagram"](#).

### 1. CHECK SATELLITE SOUND SIGNAL CIRCUIT CONTINUITY

1. Turn ignition switch OFF.
2. Disconnect AV control unit connector M51 and satellite radio tuner connector B2.
3. Check continuity between AV control unit connector M51 and satellite radio tuner connector B2.

AV control unit		Satellite radio tuner		Continuity
Connector	Terminals	Connector	Terminals	
M51	94	B2	22	Yes
	96		24	

4. Check continuity between AV control unit connector M51 and ground.

AV control unit		Ground	Continuity
Connector	Terminals		
M51	94		No
	96		

Is the inspection result normal?

YES >> GO TO 2.

NO >> Repair or replace harness or connectors.

### 2. CHECK SATELLITE SOUND SIGNAL GROUND CIRCUIT CONTINUITY

Check continuity between AV control unit connector M51 and satellite radio tuner connector B2.

AV control unit		Satellite radio tuner		Continuity
Connector	Terminals	Connector	Terminals	
M51	93	B2	21	Yes
	95		23	

Is the inspection result normal?

YES >> GO TO 3.

NO >> Repair or replace harness or connectors.

### 3. CHECK SATELLITE SOUND SIGNAL

1. Connect AV control unit connector M51 and satellite radio tuner connector B2.
2. Turn ignition switch to ACC.
3. Select satellite radio mode.
4. Check signal between terminals of AV control unit connector M51.

AV control unit connector M51		Condition	Reference value
(+)	(-)		
Terminal	Terminal		

# SATELLITE AUDIO SIGNAL CIRCUIT

< DTC/CIRCUIT DIAGNOSIS >

[BASE AUDIO]

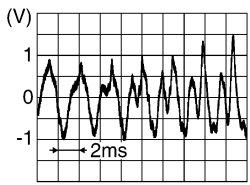
94	93	Satellite radio mode selected	
96	95		

Is the inspection result normal?

- YES >> Replace satellite radio tuner. Refer to [AV-148. "Removal and Installation"](#).
- NO >> Replace AV control unit. Refer to [AV-136. "Removal and Installation - AV Control Unit"](#).

A  
B  
C  
D  
E  
F  
G  
H  
I  
J  
K  
L  
M  
O  
P

AV

# BLUETOOTH® VOICE SIGNAL CIRCUIT

< DTC/CIRCUIT DIAGNOSIS >

[BASE AUDIO]

## BLUETOOTH® VOICE SIGNAL CIRCUIT

### Diagnosis Procedure

INFOID:000000009129024

Regarding Wiring Diagram information, refer to [AV-51. "Wiring Diagram"](#).

### 1. CHECK BLUETOOTH® VOICE SIGNAL CIRCUIT CONTINUITY

1. Turn ignition switch OFF.
2. Disconnect AV control unit connector M42 and Bluetooth® control unit connector B3.
3. Check continuity between AV control unit connector M42 terminal 5 and Bluetooth® control unit connector B3 terminal 9.

AV control unit		Bluetooth® control unit		Continuity
Connector	Terminal	Connector	Terminal	
M42	5	B3	9	Yes

4. Check continuity between AV control unit connector M42 terminal 5 and ground.

AV control unit		Ground	Continuity
Connector	Terminal		
M42	5	—	No

Is inspection result normal?

YES >> GO TO 2.

NO >> Repair or replace harness or connectors.

### 2. CHECK BLUETOOTH® VOICE SIGNAL GROUND CIRCUIT CONTINUITY

Check continuity between AV control unit connector M42 terminal 4 and Bluetooth® control unit connector B3 terminal 10.

AV control unit		Bluetooth® control unit		Continuity
Connector	Terminal	Connector	Terminal	
M42	4	B3	10	Yes

Is inspection result normal?

YES >> GO TO 3.

NO >> Repair or replace harness or connectors.

### 3. CHECK BLUETOOTH® VOICE SIGNAL

1. Connect AV control unit connector M42 and Bluetooth® control unit connector B3.
2. Turn ignition switch to ACC.
3. Press  switch.
4. Check signal between terminals of AV control unit connector M42.

# BLUETOOTH® VOICE SIGNAL CIRCUIT

< DTC/CIRCUIT DIAGNOSIS >

[BASE AUDIO]

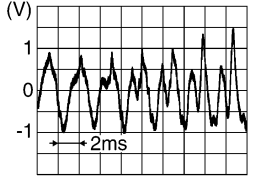
AV control unit connector M42		Condition	Reference value
(+) Terminal	(-) Terminal		
5	4	During voice guide output with  switch pressed.	

Is the inspection result normal?

- YES >> Replace Bluetooth® control unit. Refer to [AV-146. "Removal and Installation"](#).
- NO >> Replace AV control unit. Refer to [AV-136. "Removal and Installation - AV Control Unit"](#).

A  
B  
C  
D  
E  
F  
G  
H  
I  
J  
K  
L  
M

AV

O  
P

# RGB (R: RED) SIGNAL CIRCUIT

< DTC/CIRCUIT DIAGNOSIS >

[BASE AUDIO]

## RGB (R: RED) SIGNAL CIRCUIT

### Diagnosis Procedure

INFOID:000000009129025

Regarding Wiring Diagram information, refer to [AV-51. "Wiring Diagram"](#).

#### 1. CHECK RGB (R: RED) SIGNAL CIRCUIT CONTINUITY

1. Turn ignition switch OFF.
2. Disconnect AV control unit connector M45 and display unit connector.
3. Check continuity between AV control unit connector M45 terminal 57 and display unit connector M93 terminal 17.

AV control unit		Display unit		Continuity
Connector	Terminal	Connector	Terminal	
M45	57	M93	17	Yes

4. Check continuity between AV control unit connector M45 terminal 57 and ground.

AV control unit		Ground	Continuity
Connector	Terminal		
M45	57		No

Is inspection result normal?

YES >> GO TO 2.

NO >> Repair or replace harness or connectors.

#### 2. CHECK RGB (R: RED) SIGNAL

1. Connect AV control unit connector M45 and display unit connector.
2. Turn ignition switch ON.
3. Check signal between display unit connector M93 terminal 17 and ground.

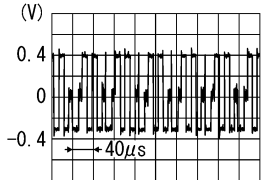
Display unit (+)		Ground (-)	Condition	Reference value
Connector	Terminal			
M93	17	—	"Color Spectrum Bar" on DISPLAY DIAGNOSIS screen.	 <p>SKIB2238J</p>

Is inspection result normal?

YES >> Replace display unit. Refer to [AV-139. "Removal and Installation"](#).

NO >> Replace AV control unit. Refer to [AV-136. "Removal and Installation - AV Control Unit"](#).

# RGB (G: GREEN) SIGNAL CIRCUIT

< DTC/CIRCUIT DIAGNOSIS >

[BASE AUDIO]

## RGB (G: GREEN) SIGNAL CIRCUIT

### Diagnosis Procedure

INFOID:000000009129026

Regarding Wiring Diagram information, refer to [AV-51. "Wiring Diagram"](#).

#### 1. CHECK RGB (G: GREEN) SIGNAL CIRCUIT CONTINUITY

1. Turn ignition switch OFF.
2. Disconnect AV control unit connector M45 and display unit connector.
3. Check continuity between AV control unit connector M45 terminal 56 and display unit connector M93 terminal 6.

AV control unit		Display unit		Continuity
Connector	Terminal	Connector	Terminal	
M45	56	M93	6	Yes

4. Check continuity between AV control unit connector M45 terminal 56 and ground.

AV control unit		Ground	Continuity
Connector	Terminal		
M45	56		No

Is inspection result normal?

YES >> GO TO 2.

NO >> Repair or replace harness or connectors.

#### 2. CHECK RGB (G: GREEN) SIGNAL

1. Connect AV control unit connector M45 and display unit connector.
2. Turn ignition switch ON.
3. Check signal between display unit connector M93 terminal 6 and ground.

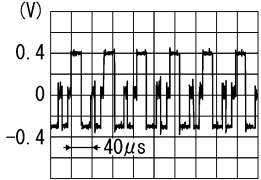
Display unit (+)		Ground (-)	Condition	Reference value
Connector	Terminal			
M93	6	—	"Color Spectrum Bar" on DISPLAY DIAGNOSIS screen.	 <p>SKIB2236J</p>

Is inspection result normal?

YES >> Replace display unit. Refer to [AV-139. "Removal and Installation"](#).

NO >> Replace AV control unit. Refer to [AV-136. "Removal and Installation - AV Control Unit"](#).

# RGB (B: BLUE) SIGNAL CIRCUIT

< DTC/CIRCUIT DIAGNOSIS >

[BASE AUDIO]

## RGB (B: BLUE) SIGNAL CIRCUIT

### Diagnosis Procedure

INFOID:000000009129027

Regarding Wiring Diagram information, refer to [AV-51, "Wiring Diagram"](#).

#### 1. CHECK RGB (B: BLUE) SIGNAL CIRCUIT CONTINUITY

1. Turn ignition switch OFF.
2. Disconnect AV control unit connector M45 and display unit connector.
3. Check continuity between AV control unit connector M45 terminal 55 and display unit connector M93 terminal 18.

AV control unit		Display unit		Continuity
Connector	Terminal	Connector	Terminal	
M45	55	M93	18	Yes

4. Check continuity between AV control unit connector M45 terminal 55 and ground.

AV control unit		Ground	Continuity
Connector	Terminal		
M45	55		No

Is inspection result normal?

YES >> GO TO 2.

NO >> Repair or replace harness or connectors.

#### 2. CHECK RGB (B: BLUE) SIGNAL

1. Connect AV control unit connector M45 and display unit connector.
2. Turn ignition switch ON.
3. Check signal between display unit connector M93 terminal 18 and ground.

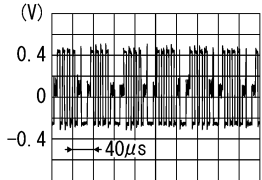
Display unit (+)		Ground (-)	Condition	Reference value
Connector	Terminal			
M93	18	—	"Color Spectrum Bar" on DISPLAY DIAGNOSIS screen.	 <p>SKIB2237J</p>

Is inspection result normal?

YES >> Replace display unit. Refer to [AV-139, "Removal and Installation"](#).

NO >> Replace AV control unit. Refer to [AV-136, "Removal and Installation - AV Control Unit"](#).



# RGB SYNCHRONIZING SIGNAL CIRCUIT

< DTC/CIRCUIT DIAGNOSIS >

[BASE AUDIO]

## RGB SYNCHRONIZING SIGNAL CIRCUIT

### Diagnosis Procedure

INFOID:000000009129028

Regarding Wiring Diagram information, refer to [AV-51. "Wiring Diagram"](#).

#### 1. CHECK RGB SYNCHRONIZING SIGNAL CIRCUIT CONTINUITY

1. Turn ignition switch OFF.
2. Disconnect AV control unit connector M45 and display unit connector.
3. Check continuity between AV control unit connector M45 terminal 58 and display unit connector M93 terminal 19.

AV control unit		Display unit		Continuity
Connector	Terminal	Connector	Terminal	
M45	58	M93	19	Yes

4. Check continuity between AV control unit connector M45 terminal 58 and ground.

AV control unit		Ground	Continuity
Connector	Terminal		
M45	58		No

Is inspection result normal?

YES >> GO TO 2.

NO >> Repair or replace harness or connectors.

#### 2. CHECK RGB SYNCHRONIZING SIGNAL

1. Connect AV control unit connector M45 and display unit connector.
2. Turn ignition switch ON.
3. Check signal between display unit connector M93 terminal 19 and ground.

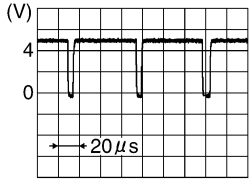
Display unit (+)		Ground (-)	Reference value
Connector	Terminal		
M93	19	—	 <p>SKIB3603E</p>

Is inspection result normal?

YES >> Replace display unit. Refer to [AV-139. "Removal and Installation"](#).

NO >> Replace AV control unit. Refer to [AV-136. "Removal and Installation - AV Control Unit"](#).

# RGB AREA (YS) SIGNAL CIRCUIT

< DTC/CIRCUIT DIAGNOSIS >

[BASE AUDIO]

## RGB AREA (YS) SIGNAL CIRCUIT

### Diagnosis Procedure

INFOID:000000009129029

Regarding Wiring Diagram information, refer to [AV-51. "Wiring Diagram"](#).

#### 1. CHECK RGB AREA (YS) SIGNAL CIRCUIT CONTINUITY

1. Turn ignition switch OFF.
2. Disconnect AV control unit connector M45 and display unit connector.
3. Check continuity between AV control unit connector M45 terminal 60 and display unit connector M93 terminal 9.

AV control unit		Display unit		Continuity
Connector	Terminal	Connector	Terminal	
M45	60	M93	9	Yes

4. Check continuity between AV control unit connector M45 terminal 60 and ground.

AV control unit		Ground	Continuity
Connector	Terminal		
M45	60		No

Is inspection result normal?

YES >> GO TO 2.

NO >> Repair or replace harness or connectors.

#### 2. CHECK RGB AREA (YS) SIGNAL

1. Connect AV control unit connector M45 and display unit connector.
2. Turn ignition switch ON.
3. Check signal between display unit connector M93 terminal 9 and ground.

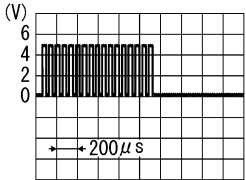
Display unit (+)		Ground (-)	Condition	Reference value
Connector	Terminal			
M93	9	—	RGB image displayed.	5.0 V
			AUX image displayed.	 <p style="text-align: right; font-size: small;">PKIB4948J</p>

Is inspection result normal?

YES >> Replace display unit. Refer to [AV-139. "Removal and Installation"](#).

NO >> Replace AV control unit. Refer to [AV-136. "Removal and Installation - AV Control Unit"](#).

# HORIZONTAL SYNCHRONIZING (HP) SIGNAL CIRCUIT

< DTC/CIRCUIT DIAGNOSIS >

[BASE AUDIO]

## HORIZONTAL SYNCHRONIZING (HP) SIGNAL CIRCUIT

### Diagnosis Procedure

INFOID:000000009129030

Regarding Wiring Diagram information, refer to [AV-51. "Wiring Diagram"](#).

#### 1. CHECK HORIZONTAL SYNCHRONIZING (HP) SIGNAL CIRCUIT CONTINUITY

1. Turn ignition switch OFF.
2. Disconnect AV control unit connector M45 and display unit connector.
3. Check continuity between AV control unit connector M45 terminal 62 and display unit connector M93 terminal 8.

AV control unit		Display unit		Continuity
Connector	Terminal	Connector	Terminal	
M45	62	M93	8	Yes

4. Check continuity between AV control unit connector M45 terminal 62 and ground.

AV control unit		Ground	Continuity
Connector	Terminal		
M45	62		No

Is inspection result normal?

YES >> GO TO 2.

NO >> Repair or replace harness or connectors.

#### 2. CHECK HORIZONTAL SYNCHRONIZING (HP) SIGNAL

1. Connect AV control unit connector M45 and display unit connector.
2. Turn ignition switch ON.
3. Check signal between display unit connector M93 terminal 8 and ground.

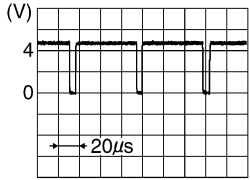
Display unit (+)		Ground (-)	Reference value
Connector	Terminal		
M93	8	—	 <p>SKIB3601E</p>

Is inspection result normal?

YES >> Replace AV control unit. Refer to [AV-136. "Removal and Installation - AV Control Unit"](#).

NO >> Replace display unit. Refer to [AV-139. "Removal and Installation"](#).

A  
B  
C  
D  
E  
F  
G  
H  
I  
J  
K  
L  
M  
O  
P

AV

# VERTICAL SYNCHRONIZING (VP) SIGNAL CIRCUIT

< DTC/CIRCUIT DIAGNOSIS >

[BASE AUDIO]

## VERTICAL SYNCHRONIZING (VP) SIGNAL CIRCUIT

### Diagnosis Procedure

INFOID:000000009129031

Regarding Wiring Diagram information, refer to [AV-51. "Wiring Diagram"](#).

#### 1. CHECK VERTICAL SYNCHRONIZING (VP) SIGNAL CIRCUIT CONTINUITY

1. Turn ignition switch OFF.
2. Disconnect AV control unit connector M45 and display unit connector.
3. Check continuity between AV control unit connector M45 terminal 74 and display unit connector M93 terminal 20.

AV control unit		Display unit		Continuity
Connector	Terminal	Connector	Terminal	
M45	74	M93	20	Yes

4. Check continuity between AV control unit connector M45 terminal 74 and ground.

AV control unit		Ground	Continuity
Connector	Terminal		
M45	74		No

Is inspection result normal?

- YES >> GO TO 2.  
 NO >> Repair or replace harness or connectors.

#### 2. CHECK VERTICAL SYNCHRONIZING (VP) SIGNAL

1. Connect AV control unit connector M45 and display unit connector.
2. Turn ignition switch ON.
3. Check signal between display unit connector M93 terminal 20 and ground.

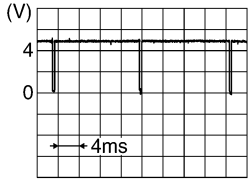
Display unit (+)		Ground (-)	Reference value
Connector	Terminal		
M93	20	—	 <p style="text-align: right; font-size: small;">SKIB3598E</p>

Is inspection result normal?

- YES >> Replace AV control unit. Refer to [AV-136. "Removal and Installation - AV Control Unit"](#).  
 NO >> Replace display unit. Refer to [AV-139. "Removal and Installation"](#).

# COMPOSITE IMAGE SIGNAL CIRCUIT

< DTC/CIRCUIT DIAGNOSIS >

[BASE AUDIO]

## COMPOSITE IMAGE SIGNAL CIRCUIT

### Diagnosis Procedure

INFOID:000000009129032

Regarding Wiring Diagram information, refer to [AV-51. "Wiring Diagram"](#).

### 1. CHECK COMPOSITE IMAGE SIGNAL CIRCUIT CONTINUITY

1. Turn ignition switch OFF.
2. Disconnect AV control unit connector M45 and display unit connector.
3. Check continuity between AV control unit connector M45 terminal 53 and display unit connector M93 terminal 15.

AV control unit		Display unit		Continuity
Connector	Terminal	Connector	Terminal	
M45	53	M93	15	Yes

4. Check continuity between AV control unit connector M45 terminal 53 and ground.

AV control unit		Ground	Continuity
Connector	Terminal		
M45	53		No

Is inspection result normal?

YES >> GO TO 2.

NO >> Repair or replace harness or connectors.

### 2. CHECK COMPOSITE IMAGE SIGNAL GROUND CIRCUIT CONTINUITY

- Check continuity between AV control unit connector M45 terminal 54 and display unit connector M93 terminal 4.

AV control unit		Display unit		Continuity
Connector	Terminal	Connector	Terminal	
M45	54	M93	4	Yes

Is inspection result normal?

YES >> GO TO 3.

NO >> Repair or replace harness or connectors.

### 3. CHECK COMPOSITE IMAGE SIGNAL

1. Connect AV control unit connector M45 and display unit connector.
2. Turn ignition switch ON.
3. Check signal between display unit connector M93 terminal 15 and ground.

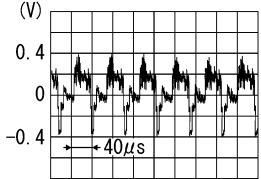
AV control unit		Ground	Condition	Reference value
(+)		(-)		
Connector	Terminal			
M45	53	—	Camera image displayed.	 <p>SKIB2251J</p>

A  
B  
C  
D  
E  
F  
G  
H  
I  
J  
K  
L  
M  
N  
O  
P

AV

## COMPOSITE IMAGE SIGNAL CIRCUIT

< DTC/CIRCUIT DIAGNOSIS >

[BASE AUDIO]

---

Is inspection result normal?

YES >> Replace display unit. Refer to [AV-139, "Removal and Installation"](#).

NO >> Replace AV control unit. Refer to [AV-136, "Removal and Installation - AV Control Unit"](#).

# AUX IMAGE SIGNAL CIRCUIT

< DTC/CIRCUIT DIAGNOSIS >

[BASE AUDIO]

## AUX IMAGE SIGNAL CIRCUIT

### Diagnosis Procedure

INFOID:000000009129033

Regarding Wiring Diagram information, refer to [AV-51. "Wiring Diagram"](#).

#### 1. CHECK AUX IMAGE SIGNAL CIRCUIT CONTINUITY

1. Turn ignition switch OFF.
2. Disconnect AV control unit connector M46 and front auxiliary input jacks connector.
3. Check continuity between AV control unit connector M46 terminal 83 and front auxiliary input jacks connector M205 terminal 7.

AV control unit		Front auxiliary input jacks		Continuity
Connector	Terminal	Connector	Terminal	
M46	83	M205	7	Yes

4. Check continuity between AV control unit connector M46 terminal 83 and ground.

AV control unit		Ground	Continuity
Connector	Terminal		
M46	83		No

Is inspection result normal?

YES >> GO TO 2.

NO >> Repair or replace harness or connectors.

#### 2. CHECK AUX IMAGE SIGNAL GROUND CIRCUIT CONTINUITY

1. Turn ignition switch OFF.
2. Disconnect AV control unit connector M46 and front auxiliary input jacks connector.
3. Check continuity between AV control unit connector M46 terminal 91 and front auxiliary input jacks connector M205 terminal 8.

AV control unit		Front auxiliary input jacks		Continuity
Connector	Terminal	Connector	Terminal	
M46	91	M205	8	Yes

Is inspection result normal?

YES >> GO TO 3.

NO >> Repair or replace harness or connectors.

#### 3. CHECK AUX IMAGE SIGNAL

1. Connect AV control unit connector M46 and front auxiliary input jacks connector.
2. Turn ignition switch ON.
3. Check signal between front auxiliary input jacks connector M205 terminal 7 and ground.

A  
B  
C  
D  
E  
F  
G  
H  
I  
J  
K  
L  
M  
O  
P

AV

# AUX IMAGE SIGNAL CIRCUIT

< DTC/CIRCUIT DIAGNOSIS >

[BASE AUDIO]

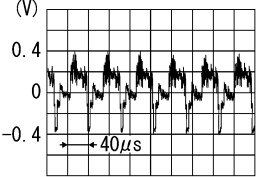
Front auxiliary input jacks		Ground	Condition	Reference value
(+) (–)		(–)		
Connector	Terminal			
M205	7	—	AUX image displayed.	 <p>(V) 0.4 0 -0.4 40µs</p> <p>SKIB2251J</p>

Is inspection result normal?

- YES >> Replace AV control unit. Refer to [AV-136. "Removal and Installation - AV Control Unit"](#).  
 NO >> Replace front auxiliary input jacks. Refer to [AV-145. "Removal and Installation"](#).



# CAMERA IMAGE SIGNAL CIRCUIT

< DTC/CIRCUIT DIAGNOSIS >

[BASE AUDIO]

## CAMERA IMAGE SIGNAL CIRCUIT

### Diagnosis Procedure

INFOID:000000009129034

Regarding Wiring Diagram information, refer to [AV-51. "Wiring Diagram"](#).

### 1. CHECK REVERSE INPUT SIGNAL

1. Turn ignition switch ON.
2. Shift the selector lever to R (reverse).
3. Check voltage between AV control unit connector M42 and ground.

AV control unit		Ground	Condition	Voltage (Approx.)
(+)		(-)		
Connector	Terminal			
M42	30	—	Selector lever in R (reverse)	Battery Voltage

Is inspection result normal?

YES >> GO TO 2.

NO >> Repair or replace harness or connectors.

### 2. CHECK CAMERA POWER SUPPLY CIRCUIT CONTINUITY

1. Turn ignition switch OFF.
2. Disconnect AV control unit connector M46 and rear view camera connector.
3. Check continuity between AV control unit connector M46 terminal 87 and rear view camera connector D504 terminal 1.

AV control unit		Rear view camera		Continuity
Connector	Terminal	Connector	Terminal	
M46	87	D504	1	Yes

4. Check continuity between AV control unit connector M46 terminal 87 and ground.

AV control unit		Ground	Continuity
Connector	Terminal		
M46	87		No

Is inspection result normal?

YES >> GO TO 3.

NO >> Repair or replace harness or connectors.

### 3. CHECK CAMERA POWER SUPPLY VOLTAGE

1. Connect AV control unit connector M46 and rear view camera connector.
2. Turn ignition switch ON.
3. Shift the selector lever to "R".
4. Check voltage between AV control unit connector M46 terminal 87 and ground.

AV control unit		Ground	Condition	Voltage (Approx.)
(+)		(-)		
Connector	Terminal			
M46	87	—	Selector lever is in "R".	6.0 V

Is inspection result normal?

YES >> GO TO 4.

A  
B  
C  
D  
E  
F  
G  
H  
I  
J  
K  
L  
M  
O  
P

AV

# CAMERA IMAGE SIGNAL CIRCUIT

< DTC/CIRCUIT DIAGNOSIS >

[BASE AUDIO]

NO >> Replace AV control unit. Refer to [AV-136, "Removal and Installation - AV Control Unit"](#).

## 4. CHECK CAMERA IMAGE SIGNAL CIRCUIT CONTINUITY

1. Turn ignition switch OFF.
2. Disconnect AV control unit connector M46 and rear view camera connector.
3. Check continuity between AV control unit connector M46 terminal 82 and rear view camera connector D504 terminal 3.

AV control unit		Rear view camera		Continuity
Connector	Terminal	Connector	Terminal	
M46	82	D504	3	Yes

4. Check continuity between AV control unit connector M46 terminal 82 and ground.

AV control unit		Ground	Continuity
Connector	Terminal		
M46	82		No

Is inspection result normal?

- YES >> GO TO 5.  
 NO >> Repair or replace harness or connectors.

## 5. CHECK CAMERA GROUND CIRCUIT CONTINUITY

Check continuity between AV control unit connector M46 terminal 88 and rear view camera connector D504 terminal 2.

AV control unit		Rear view camera		Continuity
Connector	Terminal	Connector	Terminal	
M46	88	D504	2	Yes

Is inspection result normal?

- YES >> GO TO 6.  
 NO >> Repair or replace harness or connectors.

## 6. CHECK CAMERA IMAGE SIGNAL

1. Connect AV control unit connector M46 and rear view camera connector.
2. Turn ignition switch ON.
3. Shift the selector lever to "R".
4. Check signal between AV control unit connector M46 terminal 82 and ground.

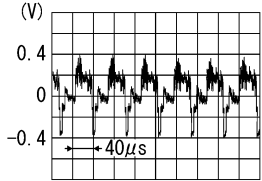
AV control unit		Ground	Condition	Reference value
(+)		(-)		
Connector	Terminal			
M46	82	—	Camera image displayed.	 <p style="text-align: right; font-size: small;">SKIB2251J</p>

Is inspection result normal?

- YES >> Replace AV control unit. Refer to [AV-136, "Removal and Installation - AV Control Unit"](#).  
 NO >> Replace rear view camera. Refer to [AV-143, "Removal and Installation"](#).

# DISK EJECT SIGNAL CIRCUIT

< DTC/CIRCUIT DIAGNOSIS >

[BASE AUDIO]

## DISK EJECT SIGNAL CIRCUIT

### Diagnosis Procedure

INFOID:000000009129035

Regarding Wiring Diagram information, refer to [AV-51, "Wiring Diagram"](#).

#### 1. CHECK DISK EJECT SIGNAL CIRCUIT CONTINUITY

1. Turn ignition switch OFF.
2. Disconnect AV control unit connector M42 and A/C and AV switch assembly connector.
3. Check continuity between AV control unit connector M42 terminal 28 and A/C and AV switch assembly connector M98 terminal 14.

AV control unit		A/C and AV switch assembly		Continuity
Connector	Terminal	Connector	Terminal	
M42	28	M98	14	Yes

4. Check continuity between AV control unit connector M42 terminal 28 and ground.

AV control unit		Ground	Continuity
Connector	Terminal		
M42	28		No

Is inspection result normal?

YES >> GO TO 2.

NO >> Repair or replace harness or connectors.

#### 2. CHECK AV CONTROL UNIT VOLTAGE

1. Connect AV control unit connector M42 and A/C and AV switch assembly connector.
2. Turn ignition switch ON.
3. Check voltage between AV control unit connector M42 terminal 28 and ground.

AV control unit		Ground	Condition	Voltage (Approx.)
(+)				
Connector	Terminal			
M42	28	—	Pressing eject switch	0 V
			Except above	5.0 V

Is the inspection result normal?

YES >> Replace A/C and AV switch assembly. Refer to [AV-137, "Removal and Installation - A/C and AV Switch Assembly"](#).

NO >> Replace AV control unit. Refer to [AV-136, "Removal and Installation - AV Control Unit"](#).

A  
B  
C  
D  
E  
F  
G  
H  
I  
J  
K  
L  
M  
O  
P

AV

# MICROPHONE SIGNAL CIRCUIT

< DTC/CIRCUIT DIAGNOSIS >

[BASE AUDIO]

## MICROPHONE SIGNAL CIRCUIT

### Diagnosis Procedure

INFOID:000000009129036

Regarding Wiring Diagram information, refer to [AV-51. "Wiring Diagram"](#).

### 1. CHECK MICROPHONE SIGNAL CIRCUIT CONTINUITY

1. Turn ignition switch OFF.
2. Disconnect Bluetooth<sup>®</sup> control unit connector B3 and microphone connector.
3. Check continuity between Bluetooth<sup>®</sup> control unit connector B3 terminals 7, 8, 29 and microphone connector R109 terminals 4, 3, 1.

Bluetooth <sup>®</sup> control unit		Microphone		Continuity
Connector	Terminal	Connector	Terminal	
B3	7	R109	4	Yes
	8		3	
	29		1	

4. Check continuity between Bluetooth<sup>®</sup> control unit connector B3 terminals 7, 8, 29 and ground.

Bluetooth <sup>®</sup> control unit		Ground	Continuity
Connector	Terminal		
B3	7	—	No
	8		
	29		

Is inspection result normal?

YES >> GO TO 2.

NO >> Repair or replace harness or connectors.

### 2. CHECK MICROPHONE VCC VOLTAGE

1. Connect Bluetooth<sup>®</sup> control unit connector B3.
2. Turn ignition switch ON.
3. Check voltage between terminals of Bluetooth<sup>®</sup> control unit connector B3.

Bluetooth <sup>®</sup> control unit connector B3		Voltage (Approx.)
(+)	(-)	
Terminal	Terminal	
29	8	5.0 V

Is the inspection result normal?

YES >> GO TO 3.

NO >> Replace Bluetooth<sup>®</sup> control unit. Refer to [AV-146. "Removal and Installation"](#).

### 3. CHECK MICROPHONE SIGNAL

1. Connect microphone connector.
2. Check signal between terminals of Bluetooth<sup>®</sup> control unit connector B3.

# MICROPHONE SIGNAL CIRCUIT

< DTC/CIRCUIT DIAGNOSIS >

[BASE AUDIO]

Bluetooth® control unit connector B3		Condition	Reference value
(+) Terminal	(-) Terminal		
7	8	Speak into microphone.	

Is the inspection result normal?

YES >> Replace Bluetooth® control unit. Refer to [AV-146. "Removal and Installation"](#).

NO >> Replace microphone. Refer to [AV-147. "Removal and Installation"](#).

A  
B  
C  
D  
E  
F  
G  
H  
I  
J  
K  
L  
M  
O  
P

AV

# BLUETOOTH® CONTROL SIGNAL CIRCUIT

< DTC/CIRCUIT DIAGNOSIS >

[BASE AUDIO]

## BLUETOOTH® CONTROL SIGNAL CIRCUIT

### Diagnosis Procedure

INFOID:000000009129037

#### 1. CHECK CONTROL SIGNAL CIRCUIT CONTINUITY

1. Turn ignition switch OFF.
2. Disconnect Bluetooth® control unit connector B3.
3. Check continuity between Bluetooth® control unit connector B3 terminals 20, 24 and ground.

Bluetooth® control unit		Ground	Continuity
Connector	Terminals		
B3	20	—	Yes
	24		

Is the inspection result normal?

- YES >> Replace Bluetooth® control unit. Refer to [AV-146, "Removal and Installation"](#).  
NO >> Repair or replace harness or connectors.

# STEERING SWITCH

< DTC/CIRCUIT DIAGNOSIS >

[BASE AUDIO]

## STEERING SWITCH





### Diagnosis Procedure

INFOID:000000009129038

Regarding Wiring Diagram information, refer to [AV-51. "Wiring Diagram"](#).

### 1. CHECK STEERING WHEEL AUDIO CONTROL SWITCH RESISTANCE

1. Turn ignition switch OFF.
2. Disconnect combination switch connector M149.
3. Check resistance between combination switch connector terminals.

Combination switch connector M149		Condition	Resistance $\Omega$ (Approx.)
Terminal	Terminal		
14	17	Depress SOURCE switch.	1
		Depress $\Delta$ switch.	121
		Depress $\nabla$ switch.	321
		Depress  switch.	723
		Depress ENTER switch.	2023
15		Depress $-$  switch.	1
		Depress  + switch.	121
		Depress  switch.	321
		Depress  switch.	723
		Depress DISP switch.	2023

Is the inspection result normal?

YES >> GO TO 2.

NO >> Replace steering wheel audio control switch. Refer to [AV-138. "Removal and Installation"](#).

### 2. CHECK HARNESS BETWEEN COMBINATION SWITCH AND COMBINATION METER

1. Disconnect combination meter connector M24 and combination switch connector M30.
2. Check continuity between combination meter connector M24 and combination switch connector M30.

Combination meter		Combination switch		Continuity
Connector	Terminal	Connector	Terminal	
M24	3	M30	24	Yes
	24		33	
	4		31	

3. Check continuity between combination meter connector M24 and ground.

Combination meter		Ground	Continuity
Connector	Terminal		
M24	3	—	No
	24		
	4		

Is the inspection result normal?

# STEERING SWITCH

< DTC/CIRCUIT DIAGNOSIS >

[BASE AUDIO]

- YES >> GO TO 3.  
NO >> Repair or replace harness or connectors.

## 3.CHECK COMBINATION SWITCH

Check continuity between combination switch connectors M30 and M149.

Combination switch				Continuity
Connector	Terminal	Connector	Terminal	
M30	24	M149	14	Yes
	31		15	
	33		17	

Is the inspection result normal?

- YES >> GO TO 4.  
NO >> Replace spiral cable. Refer to [SR-15. "Removal and Installation"](#).

## 4.CHECK HARNESS BETWEEN COMBINATION METER AND AV CONTROL UNIT

1. Disconnect AV control unit connector M44.
2. Check continuity between combination meter connector M24 and AV control unit connector M44.

Combination meter		AV control unit		Continuity
Connector	Terminal	Connector	Terminal	
M24	14	M44	38	Yes
	15		48	
	16		47	

3. Check continuity between combination meter connector M24 and ground.

Combination meter		Ground	Continuity
Connector	Terminal		
M24	14	—	No
	15		
	16		

Is the inspection result normal?

- YES >> GO TO 5.  
NO >> Repair or replace harness or connectors.

## 5.CHECK AV CONTROL UNIT VOLTAGE

1. Connect combination meter connector M24 and AV control unit connector M44.
2. Turn ignition switch ON.
3. Check voltage between terminals of AV control unit connector M44.

AV control unit connector M44		Voltage (Approx.)
(+)	(-)	
Terminal	Terminal	
38	47	5.0 V
48		

Is the inspection result normal?

- YES >> Replace combination meter. Refer to [MWI-95. "Removal and Installation"](#).  
NO >> Replace AV control unit. Refer to [AV-136. "Removal and Installation - AV Control Unit"](#).



## USB CONNECTOR

### Diagnosis Procedure

INFOID:000000009129039

Regarding Wiring Diagram information, refer to [AV-51. "Wiring Diagram"](#).

#### 1. CHECK USB INTERFACE HARNESS CONTINUITY

1. Turn ignition switch OFF.
2. Disconnect AV control unit connector M55 and USB interface connector M209.
3. Check continuity between AV control unit connector M55 and USB interface connector M209.

AV control unit		USB interface		Continuity
Connector	Terminal	Connector	Terminal	
M55	138	M209	1	Yes
	137		2	
	140		3	
	139		4	
	141		5	

4. Check continuity between AV control unit connector M55 and ground.

AV control unit		—	Continuity
Connector	Terminal		
M55	137	Ground	No
	139		

Is the inspection result normal?

- YES >> Replace the USB interface. Refer to [AV-144. "Removal and Installation"](#).  
 NO >> Repair or replace harness or connectors.

A  
B  
C  
D  
E  
F  
G  
H  
I  
J  
K  
L  
M  
O  
P

AV

# SYMPTOM DIAGNOSIS

## MULTI AV SYSTEM

### Symptom Table

INFOID:000000009129040

#### RELATED TO AUDIO

Symptoms	Check items	Probable malfunction location
The disk cannot be removed.	AV control unit	Malfunction in AV control unit. Refer to <a href="#">AV-26. "On Board Diagnosis Function"</a> .
No sound comes out or the level of the sound is low.	No sound from all speakers.	<ul style="list-style-type: none"> <li>• Speaker circuit shorted to ground. Refer to <a href="#">AV-51. "Wiring Diagram"</a>.</li> <li>• AV control unit power supply and ground circuits malfunction. Refer to <a href="#">AV-93. "AV CONTROL UNIT : Diagnosis Procedure"</a>.</li> </ul>
	Only a certain speaker (front door speaker LH, front door speaker RH, instrument panel tweeter LH, instrument panel tweeter RH, rear speaker LH, rear speaker RH) does not output sound.	<ul style="list-style-type: none"> <li>• Poor connector connection of speaker.</li> <li>• Sound signal circuit malfunction between AV control unit and speaker. Refer to:                             <ul style="list-style-type: none"> <li>- <a href="#">AV-98. "Diagnosis Procedure"</a> (front door speaker).</li> <li>- <a href="#">AV-100. "Diagnosis Procedure"</a> (instrument panel tweeter).</li> <li>- <a href="#">AV-102. "Diagnosis Procedure"</a> (rear door speaker).</li> </ul> </li> <li>• Malfunction in speaker. Refer to:                             <ul style="list-style-type: none"> <li>- <a href="#">AV-140. "Removal and Installation"</a> (front door speaker).</li> <li>- <a href="#">AV-141. "Removal and Installation"</a> (instrument panel tweeter).</li> <li>- <a href="#">AV-142. "Removal and Installation"</a> (rear door speaker).</li> </ul> </li> <li>• Malfunction in AV control unit. Refer to <a href="#">AV-26. "On Board Diagnosis Function"</a>.</li> </ul>

# MULTI AV SYSTEM

< SYMPTOM DIAGNOSIS >

[BASE AUDIO]

Symptoms	Check items	Probable malfunction location
Noise is mixed with audio.	Noise comes out from all speakers.	Malfunction in AV control unit. Refer to <a href="#">AV-26, "On Board Diagnosis Function"</a> .
	Noise comes out only from a certain speaker (front door speaker LH, front door speaker RH, instrument panel tweeter LH, instrument panel tweeter RH, rear speaker LH, rear speaker RH).	<ul style="list-style-type: none"> <li>Poor connector connection of speaker.</li> <li>Sound signal circuit malfunction between AV control unit and speaker. Refer to:                             <ul style="list-style-type: none"> <li><a href="#">AV-98, "Diagnosis Procedure"</a> (front door speaker).</li> <li><a href="#">AV-100, "Diagnosis Procedure"</a> (instrument panel tweeter).</li> <li><a href="#">AV-102, "Diagnosis Procedure"</a> (rear door speaker).</li> </ul> </li> <li>Malfunction in speaker.</li> <li>Poor Installation of speaker (e.g. backlash and looseness). Refer to:                             <ul style="list-style-type: none"> <li><a href="#">AV-140, "Removal and Installation"</a> (front door speaker).</li> <li><a href="#">AV-141, "Removal and Installation"</a> (instrument panel tweeter).</li> <li><a href="#">AV-142, "Removal and Installation"</a> (rear door speaker).</li> </ul> </li> <li>Malfunction in AV control unit. Refer to <a href="#">AV-26, "On Board Diagnosis Function"</a>.</li> </ul>
	Noise is mixed with radio only (when the vehicle hits a bump or while driving over bad roads)	Poor connector connection of antenna or antenna feeder. Refer to <a href="#">AV-149, "Location of Antennas"</a> .
No radio reception or poor reception.	<ul style="list-style-type: none"> <li>Other audio sounds are normal.</li> <li>Any radio station cannot be received or poor reception is caused even after moving to a service area with good reception (e.g. a place with clear view and no obstacles generating external noises).</li> </ul>	<ul style="list-style-type: none"> <li>Antenna amp. ON signal circuit malfunction. Refer to <a href="#">AV-36, "Reference Value"</a>.</li> <li>Poor connector connection of antenna or antenna feeder. Refer to <a href="#">AV-149, "Location of Antennas"</a>.</li> </ul>
No satellite radio reception.	There is malfunction in the CONSULT self diagnosis result. Refer to <a href="#">AV-33, "CONSULT Function"</a> .	<ul style="list-style-type: none"> <li>Malfunction in antenna, antenna feeder or AV control unit. Perform DTC diagnosis. Refer to <a href="#">AV-33, "CONSULT Function"</a>.</li> <li>Poor continuity in antenna feeder.</li> <li>Poor connector connection of antenna or antenna feeder. Refer to <a href="#">AV-149, "Location of Antennas"</a>.</li> </ul>
	There is no malfunction in the CONSULT self diagnosis result. Refer to <a href="#">AV-33, "CONSULT Function"</a> .	<ul style="list-style-type: none"> <li>Poor continuity in antenna feeder.</li> <li>Poor connector connection of antenna or antenna feeder.</li> <li>Loose satellite radio antenna mounting nut. Refer to <a href="#">AV-149, "Location of Antennas"</a>.</li> </ul>
Buzz/rattle sound from speaker	The majority of buzz/rattle sounds are not indicative of an issue with the speaker, usually something nearby the speaker is causing the buzz/rattle.	Refer to "SQUEAK AND RATTLE TROUBLE DIAGNOSIS" in the appropriate interior trim section.

## RELATED TO HANDS-FREE PHONE

- Before performing diagnosis, confirm that the cellular phone being used by the customer is compatible with the vehicle.
- It is possible that a malfunction is occurring due to a version change of the phone even though the phone is a compatible type. This can be confirmed by changing the cellular phone to another compatible type, and check that it operates normally. It is important to determine whether the cause of the malfunction is the vehicle or the cellular phone.

# MULTI AV SYSTEM

[BASE AUDIO]









## < SYMPTOM DIAGNOSIS >

### Check Compatibility

1. Make sure the customer's Bluetooth® related concern is understood.
2. Verify the customer's concern.
 

**NOTE:**  
The customer's phone may be required, depending upon their concern.
3. Write down the customer's phone brand, model and service provider.
 

**NOTE:**  
It is necessary to know the service provider. On occasion, a given phone may be on the approved list with one provider, but may not be on the approved list with other providers.
4. Go to "www.nissanusa.com/bluetooth/".
  - a. Using the website's search engine, find out if the customer's phone is on the approved list.
  - b. If the customer's phone is NOT on the approved list:  
Stop diagnosis here. The customer needs to obtain a Bluetooth® phone that is on the approved list before any further action.
  - c. If the feature related to the customer's concern shows as "N" (not compatible):  
Stop diagnosis here. If the customer still wants the feature to function, they will need to get an approved phone showing the feature as "Y" (compatible) in the "Basic Features".
  - d. If the feature related to the customer's concern shows as "Y" (compatible):  
Perform diagnosis as per the following table.

Symptoms	Check items	Probable malfunction location
Does not recognize cellular phone connection (no connection is displayed on the display at the guide).	Repeat the registration of cellular phone.	
Hands-free phone cannot be established.	<ul style="list-style-type: none"> <li>• Hands-free phone operation can be made, but the communication cannot be established.</li> <li>• Hands-free phone operation can be performed, however, voice between each other cannot be heard during the conversation.</li> </ul>	Malfunction in AV control unit. Replace AV control unit. Refer to <a href="#">AV-136. "Removal and Installation - AV Control Unit"</a> .
The other party's voice cannot be heard by hands-free phone.	Check the "microphone speaker" in Inspection & Adjustment Mode if sound is heard.	
Originating sound is not heard by the other party with hands-free phone communication.	Sound operation function is normal.	
	Sound operation function does not work.	Microphone signal circuit malfunction. Refer to <a href="#">AV-124. "Diagnosis Procedure"</a> .
The system cannot be operated.	Steering switch's  ,  , and  switch works, but  does not work.	Steering switch malfunction. Replace steering switch. Refer to <a href="#">AV-138. "Removal and Installation"</a> .
	Steering switch's  ,  ,  , and  switches do not work.	Steering switch signal circuit malfunction. Refer to <a href="#">AV-127. "Diagnosis Procedure"</a> .
	All steering switches do not work.	Steering switch ground circuit malfunction. Refer to <a href="#">AV-127. "Diagnosis Procedure"</a> .

### RELATED TO REAR VIEW CAMERA

# MULTI AV SYSTEM

< SYMPTOM DIAGNOSIS >

[BASE AUDIO]

Symptoms	Check items	Probable malfunction location
Rear view camera is inoperative.	Reverse signal circuit malfunction.	Reverse signal circuit malfunction between BCM and AV control unit. Refer to <a href="#">AV-121, "Diagnosis Procedure"</a> .
	Camera image signal circuit malfunction.	Camera image signal circuit malfunction between rear view camera and AV control unit. Refer to <a href="#">AV-121, "Diagnosis Procedure"</a> .
	Rear view camera malfunction.	Replace rear view camera. Refer to <a href="#">AV-143, "Removal and Installation"</a> .

A  
B  
C  
D  
E  
F  
G  
H  
I  
J  
K  
L  
M  
N  
O  
P

AV

# NORMAL OPERATING CONDITION

< SYMPTOM DIAGNOSIS >

[BASE AUDIO]

## NORMAL OPERATING CONDITION

### Description

INFOID:000000009129041

#### RELATED TO NOISE

The majority of the audio concerns are the result of outside causes (bad CD, electromagnetic interference, etc.).

The following noise results from variations in field strength, such as fading noise and multi-path noise, or external noise from trains and other sources. It is not a malfunction.

- Fading noise: This noise occurs because of variations in the field strength in a narrow range due to mountains or buildings blocking the signal.
- Multi-path noise: This noise results from the waves sent directly from the broadcast station arriving at the antenna at a different time from the waves which reflect off mountains or buildings.

The vehicle itself can be a source of noise if noise prevention parts or electrical equipment is malfunctioning. Check if noise is caused and/or changed by engine speed, ignition switch turned to each position, and operation of each piece of electrical equipment, and determine the cause.

**NOTE:**

The source of the noise can be found easily by listening to the noise while removing the fuses of electrical components, one by one.

#### Type of Noise and Possible Cause

Occurrence condition		Possible cause
Occurs only when engine is ON.	A continuous growling noise occurs. The speed of the noise varies with changes in the engine speed.	<ul style="list-style-type: none"> <li>• Ignition components</li> </ul>
The occurrence of the noise is linked with the operation of the fuel pump.		<ul style="list-style-type: none"> <li>• Fuel pump condenser</li> </ul>
Noise only occurs when various electrical components are operating.	A cracking or snapping sound occurs with the operation of various switches.	<ul style="list-style-type: none"> <li>• Relay malfunction, AV control unit malfunction</li> </ul>
	The noise occurs when various motors are operating.	<ul style="list-style-type: none"> <li>• Motor case ground</li> <li>• Motor</li> </ul>
The noise occurs constantly, not just under certain conditions.		<ul style="list-style-type: none"> <li>• Rear defogger coil malfunction</li> <li>• Open circuit in printed heater</li> <li>• Poor ground of antenna feeder line</li> </ul>
A cracking or snapping sound occurs while the vehicle is being driven, especially when it is vibrating excessively.		<ul style="list-style-type: none"> <li>• Ground wire of body parts</li> <li>• Ground due to improper part installation</li> <li>• Wiring connections or a short circuit</li> </ul>

#### RELATED TO HANDS-FREE PHONE

Symptom	Cause and Counter measure
Does not recognize cellular phone connection (No connection is displayed on the display at the guide).	<p>Some Bluetooth<sup>®</sup> enabled cellular phones may not be recognized by the in-vehicle phone module.</p> <p>Refer to "RELATED TO HANDS-FREE PHONE (Check Compatibility)" in <a href="#">AV-130, "Symptom Table"</a>.</p>
Cannot use hands-free phone.	<p>Customer will not be able to use a hands-free phone under the following conditions:</p> <ul style="list-style-type: none"> <li>• The vehicle is outside of the telephone service area.</li> <li>• The vehicle is in an area where it is difficult to receive radio waves; such as in a tunnel, in an underground parking garage, near a tall building or in a mountainous area.</li> <li>• The cellular phone is locked to prevent it from being dialed.</li> </ul> <p><b>NOTE:</b></p> <p>While a cellular phone is connected through the Bluetooth<sup>®</sup> wireless connection, the battery power of the cellular phone may discharge quicker than usual. The Bluetooth<sup>®</sup> Hands-Free Phone System cannot charge cellular phones.</p>

# NORMAL OPERATING CONDITION

< SYMPTOM DIAGNOSIS >

[BASE AUDIO]

Symptom	Cause and Counter measure
The other party's voice cannot be heard by hands-free phone.	When the radio wave condition is not ideal or ambient sound is too loud, it may be difficult to hear the other person's voice during a call.
Poor sound quality.	Do not place the cellular phone in an area surrounded by metal or far away from the in-vehicle phone module to prevent tone quality degradation and wireless connection disruption.

A

B

C

D

E

F

G

H

I

J

K

L

M

AV

O

P

## REMOVAL AND INSTALLATION

### AV CONTROL UNIT

#### Exploded View

INFOID:000000009129042

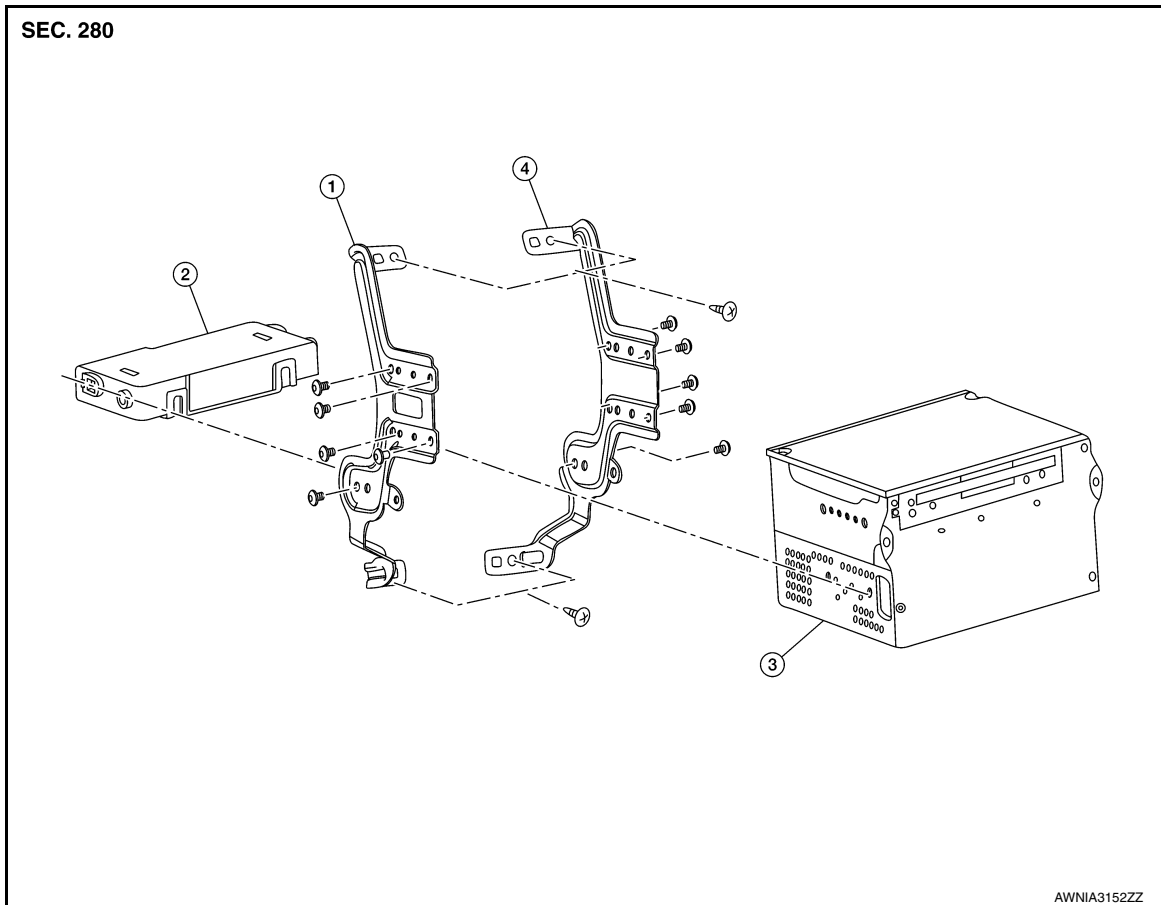

1. AV control unit bracket (LH)    2. A/C auto amp.    3. AV control unit  
 4. AV control unit bracket (RH)

### Removal and Installation - AV Control Unit

INFOID:000000009129043

#### REMOVAL

##### CAUTION:

- Remove battery terminal and AV control unit after a lapse of 30 seconds or more after turning the ignition switch OFF.
- Before replacing AV control unit, perform "READ CONFIGURATION" to save current vehicle specification. Refer to [AV-80, "CONFIGURATION \(AV CONTROL UNIT\) : Description"](#).

##### NOTE:

After the ignition switch is turned OFF, the AV control unit continues operating for approximately 30 seconds. Therefore, data corruption may occur if battery voltage is cut off within 30 seconds.

1. Disconnect the negative battery terminal. Refer to [PG-93, "Removal and Installation"](#).
2. Remove cluster lid C upper. Refer to [IP-23, "CLUSTER LID C UPPER : Removal and Installation"](#).
3. Remove the screws, then pull out the AV control unit.
4. Disconnect the harness connectors from the AV control unit and remove.

#### INSTALLATION

Installation is in the reverse order of removal.

##### CAUTION:



# AV CONTROL UNIT

< REMOVAL AND INSTALLATION >

[BASE AUDIO]

- When replacing AV control unit, perform "WRITE CONFIGURATION". Refer to [AV-80, "CONFIGURATION \(AV CONTROL UNIT\) : Description"](#).

## Removal and Installation - A/C and AV Switch Assembly

INFOID:000000009129044

### REMOVAL

1. Remove cluster lid C. Refer to [IP-22, "CLUSTER LID C : Removal and Installation"](#).
2. Remove the A/C and AV switch assembly lower screws.
3. Release upper pawls and remove A/C and AV switch assembly.

### INSTALLATION

Installation is in the reverse order of removal.

A  
B  
C  
D  
E  
F  
G  
H  
I  
J  
K  
L  
M  
O  
P

AV

# STEERING SWITCH

< REMOVAL AND INSTALLATION >

[BASE AUDIO]

## STEERING SWITCH

Exploded View

INFOID:000000009772724

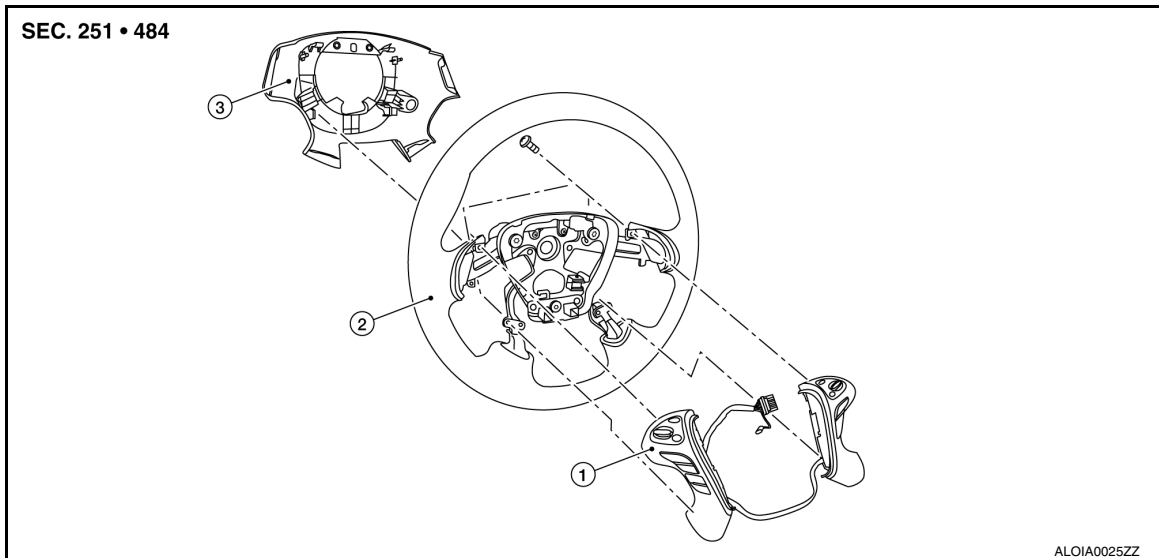

1. Steering switch

2. Steering wheel

3. Steering wheel rear finisher

## Removal and Installation

INFOID:000000009760492

### REMOVAL

#### NOTE:

The steering switch is serviced as an assembly.

1. Remove steering wheel. Refer to [ST-46, "Removal and Installation"](#).
2. Release pawls and remove steering wheel rear finisher (1) from steering wheel (2).

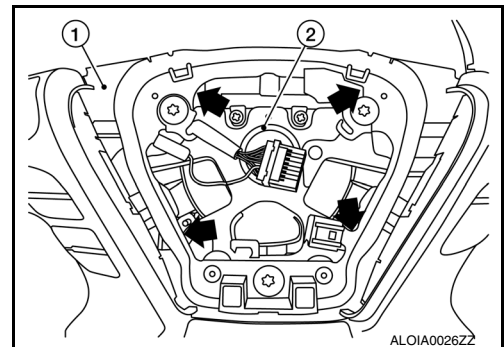

3. Remove steering switch screws.
4. Remove steering switch (1) from steering wheel (2).

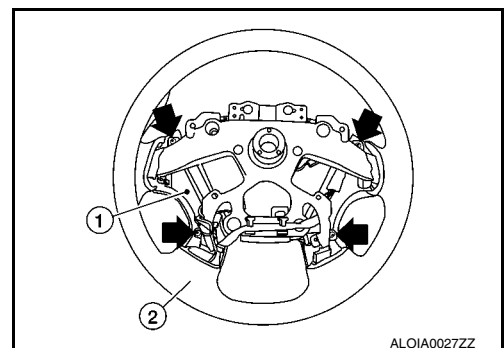

### INSTALLATION

Installation is in the reverse order of removal.

# DISPLAY UNIT

< REMOVAL AND INSTALLATION >

[BASE AUDIO]

## DISPLAY UNIT

### Exploded View

INFOID:000000009129046

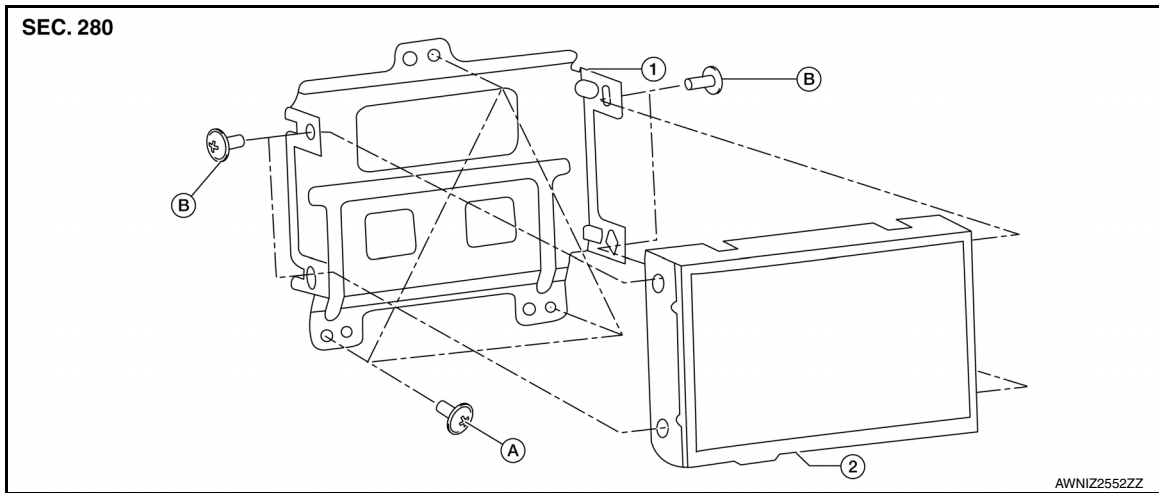

1. Display unit bracket

2. Display unit

A. Display unit bracket screws

B. Display unit screws

## Removal and Installation

INFOID:000000009129047

### REMOVAL

1. Remove cluster lid D. Refer to [IP-24, "Removal and Installation"](#).
2. Remove the display unit screws, and then pull out the display unit and bracket.
3. Disconnect harness connector from the display unit, then remove the display unit and bracket.
4. Remove the display unit brackets screws, then remove the display unit from the display unit bracket (if necessary).

### INSTALLATION

Installation is in the reverse order of removal.

A  
B  
C  
D  
E  
F  
G  
H  
I  
J  
K  
L  
M  
O  
P

AV

# FRONT DOOR SPEAKER

< REMOVAL AND INSTALLATION >

[BASE AUDIO]

## FRONT DOOR SPEAKER

### Exploded View

INFOID:000000009760460

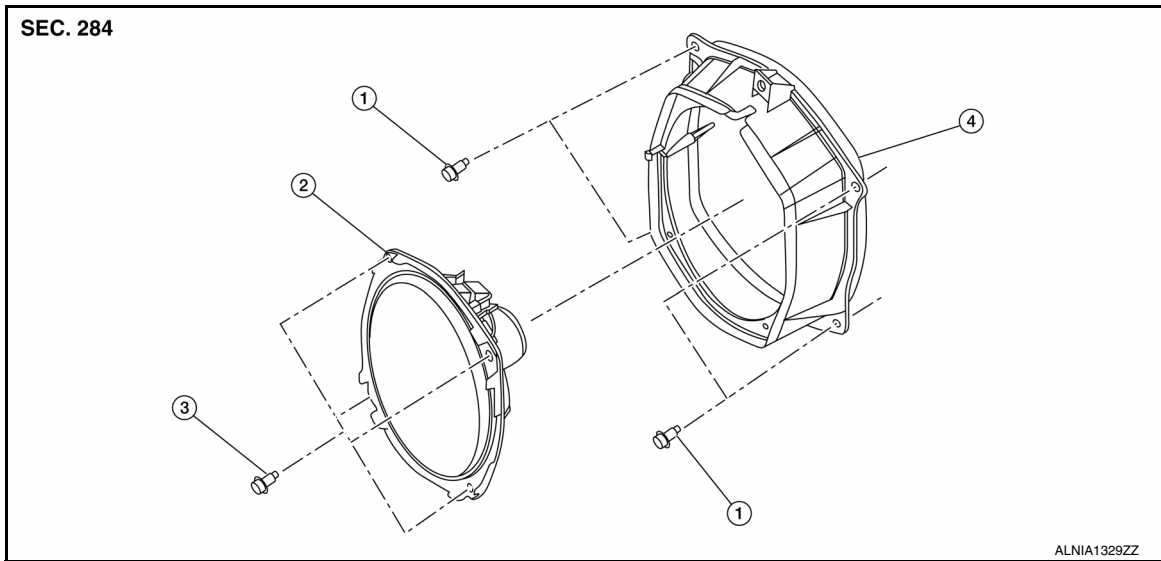

1. Speaker bracket bolt
2. Front door speaker
3. Speaker bolt
4. Speaker bracket

### Removal and Installation

INFOID:000000009760459

#### REMOVAL

1. Remove front door finisher. Refer to [INT-15. "Removal and Installation"](#).
2. Remove front door speaker bolts.
3. Disconnect harness connector from front door speaker, then remove front door speaker from speaker bracket.
4. Remove speaker bracket bolts (if necessary).
5. Remove speaker bracket from front door (if necessary).

#### INSTALLATION

Installation is in the reverse order of removal.

# INSTRUMENT PANEL SPEAKER/TWEETER

< REMOVAL AND INSTALLATION >

[BASE AUDIO]

## INSTRUMENT PANEL SPEAKER/TWEETER

### Removal and Installation

INFOID:000000009760461

#### REMOVAL

1. Remove instrument panel tweeter grille. Refer to [IP-14, "Exploded View"](#).
2. Remove the screws (A), then pull out the instrument panel tweeter (1).
3. Disconnect the harness connector from the instrument panel tweeter (1) and remove.

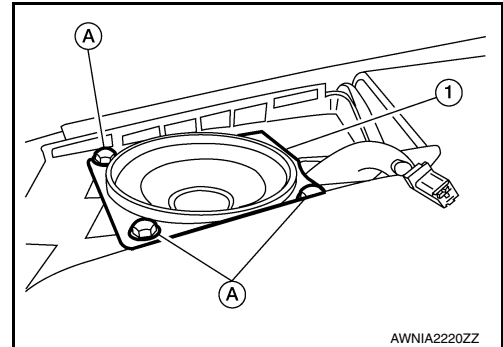

#### INSTALLATION

Installation is in the reverse order of removal.

A  
B  
C  
D  
E  
F  
G  
H  
I  
J  
K  
L  
M  
O  
P

AV

# REAR DOOR SPEAKER

< REMOVAL AND INSTALLATION >

[BASE AUDIO]

## REAR DOOR SPEAKER

Exploded View

INFOID:000000009760463

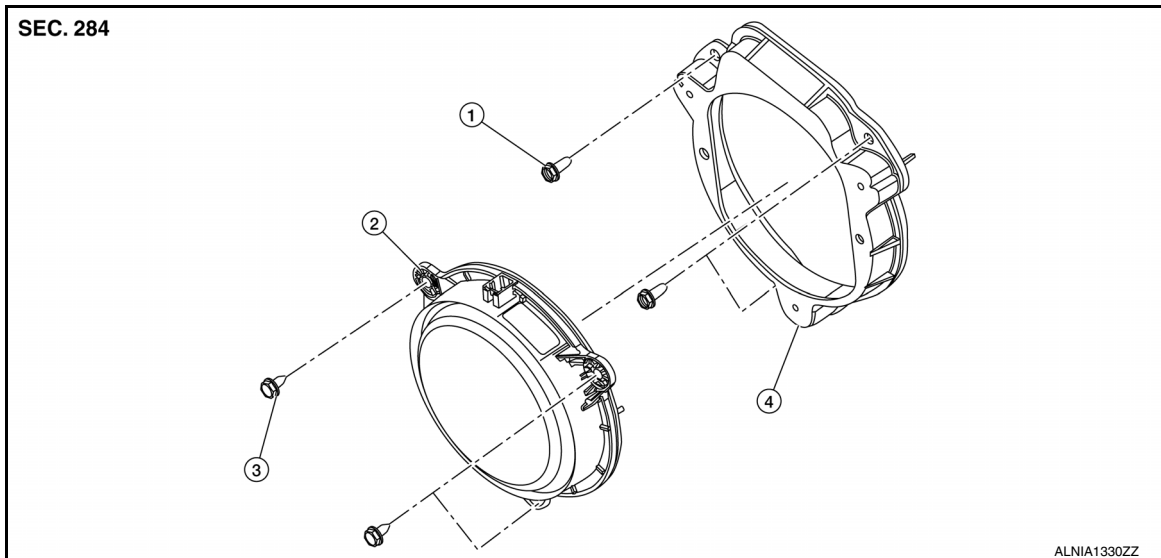

- 1. Speaker bracket bolt
- 2. Rear door speaker
- 3. Speaker bolt
- 4. Speaker bracket

## Removal and Installation

INFOID:000000009760462

### REMOVAL

1. Remove rear door finisher. Refer to [INT-17, "Removal and Installation"](#).
2. Remove rear door speaker bolts.
3. Disconnect harness connector from the rear door speaker, then remove rear door speaker from speaker bracket.
4. Remove speaker bracket bolts (if necessary).
5. Remove rear door speaker bracket (if necessary).

### INSTALLATION

Installation is in the reverse order of removal.

# REAR VIEW CAMERA

< REMOVAL AND INSTALLATION >

[BASE AUDIO]

## REAR VIEW CAMERA

### Removal and Installation

INFOID:000000009760464

#### REMOVAL

1. Remove back door outer upper finisher. Refer to [EXT-44. "Removal and Installation"](#).
2. Remove rear view camera screws (A), then remove rear view camera (1) from the back door outer upper finisher (2).

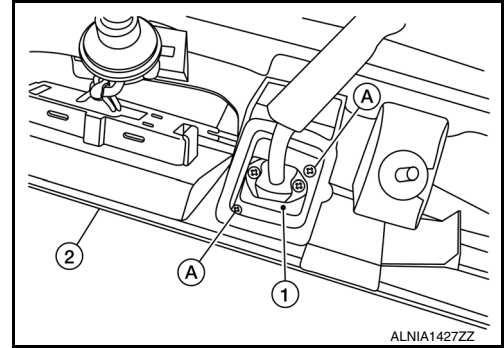

#### INSTALLATION

Installation is in the reverse order of removal.

A  
B  
C  
D  
E  
F  
G  
H  
I  
J  
K  
L  
M  
AV  
O  
P

## USB INTERFACE

### Removal and Installation

INFOID:000000009760465

#### REMOVAL

1. Remove shift selector finisher. Refer to [JP-27, "Exploded View"](#).
2. Disconnect harness connector from the USB interface.
3. Release the pawl from the back of USB interface, then remove USB interface.

#### INSTALLATION

Installation is in the reverse order of removal.



# FRONT AUXILIARY INPUT JACKS

< REMOVAL AND INSTALLATION >

[BASE AUDIO]

## FRONT AUXILIARY INPUT JACKS

### Removal and Installation

INFOID:000000009760466

#### REMOVAL

1. Remove shift selector finisher. Refer to [IP-27. "Exploded View"](#).
2. Disconnect harness connector from the front auxiliary input jack.
3. Remove front auxiliary input jack screws and front auxiliary input jack.

#### INSTALLATION

Installation is in the reverse order of removal.

A  
B  
C  
D  
E  
F  
G  
H  
I  
J  
K  
L  
M  
O  
P

AV

# BLUETOOTH CONTROL UNIT

< REMOVAL AND INSTALLATION >

[BASE AUDIO]

## BLUETOOTH CONTROL UNIT

Exploded View

INFOID:000000009129056

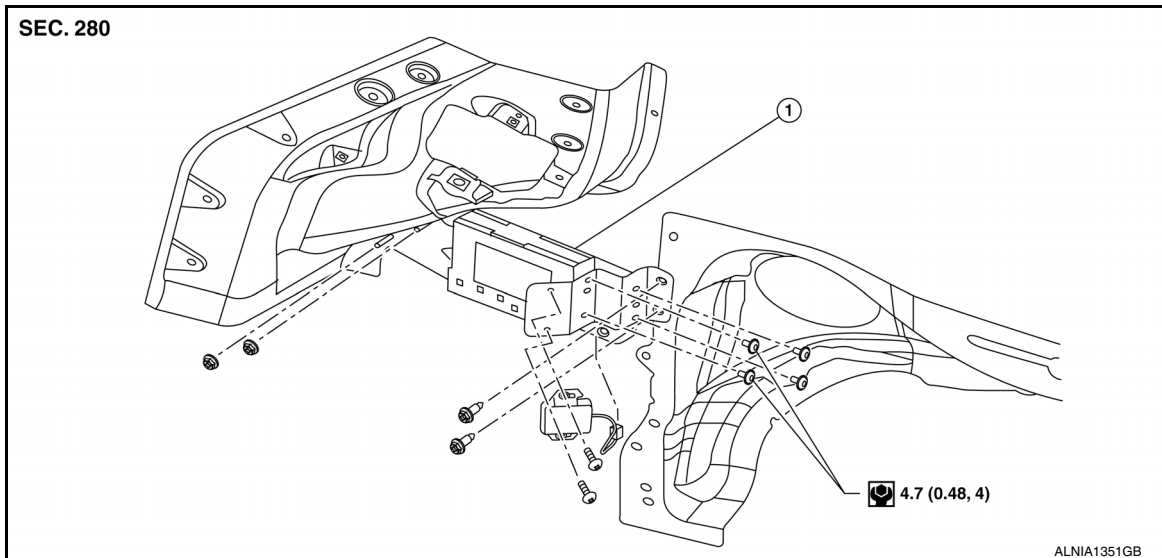

1. Bluetooth control unit

### Removal and Installation

INFOID:000000009129057

#### REMOVAL

1. Remove satellite radio tuner. Refer to [AV-148, "Removal and Installation"](#)
2. Disconnect harness connector from bluetooth control unit.
3. Remove bluetooth control unit bolts, then remove bluetooth control unit.

#### INSTALLATION

Installation is in the reverse order of removal.

# MICROPHONE

< REMOVAL AND INSTALLATION >

[BASE AUDIO]

## MICROPHONE

### Removal and Installation

INFOID:000000009760467

#### REMOVAL

1. Remove the front room/map lamp assembly. Refer to [INL-60. "Removal and Installation"](#).
2. Release the pawls, then remove the microphone (1) from the front room/map lamp assembly.

**CAUTION:**

Carefully handle the pawls that retain the microphone to avoid damaging.

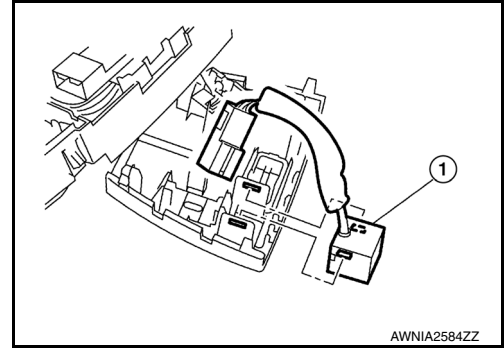

#### INSTALLATION

Installation is in the reverse order of removal.

**NOTE:**

Check the microphone for looseness after installation.

A  
B  
C  
D  
E  
F  
G  
H  
I  
J  
K  
L  
M  
O  
P

AV

# SATELLITE RADIO TUNER

< REMOVAL AND INSTALLATION >

[BASE AUDIO]

## SATELLITE RADIO TUNER

Exploded View

INFOID:000000009129059

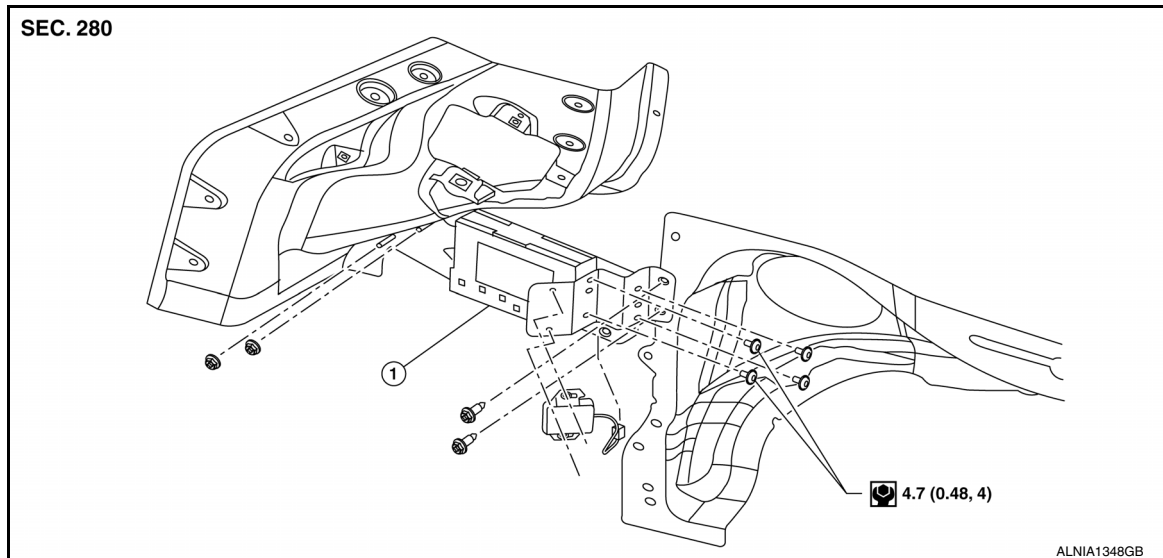

1. Satellite radio tuner

## Removal and Installation

INFOID:000000009129060

### REMOVAL

1. Remove luggage side lower finisher (LH). Refer to [INT-31. "LUGGAGE SIDE LOWER FINISHER : Removal and Installation"](#).
2. Disconnect harness connector from satellite antenna.
3. Remove bolts and the satellite radio tuner.

### INSTALLATION

Installation is in the reverse order of removal.

## AUDIO ANTENNA

### Location of Antennas

INFOID:000000009129061

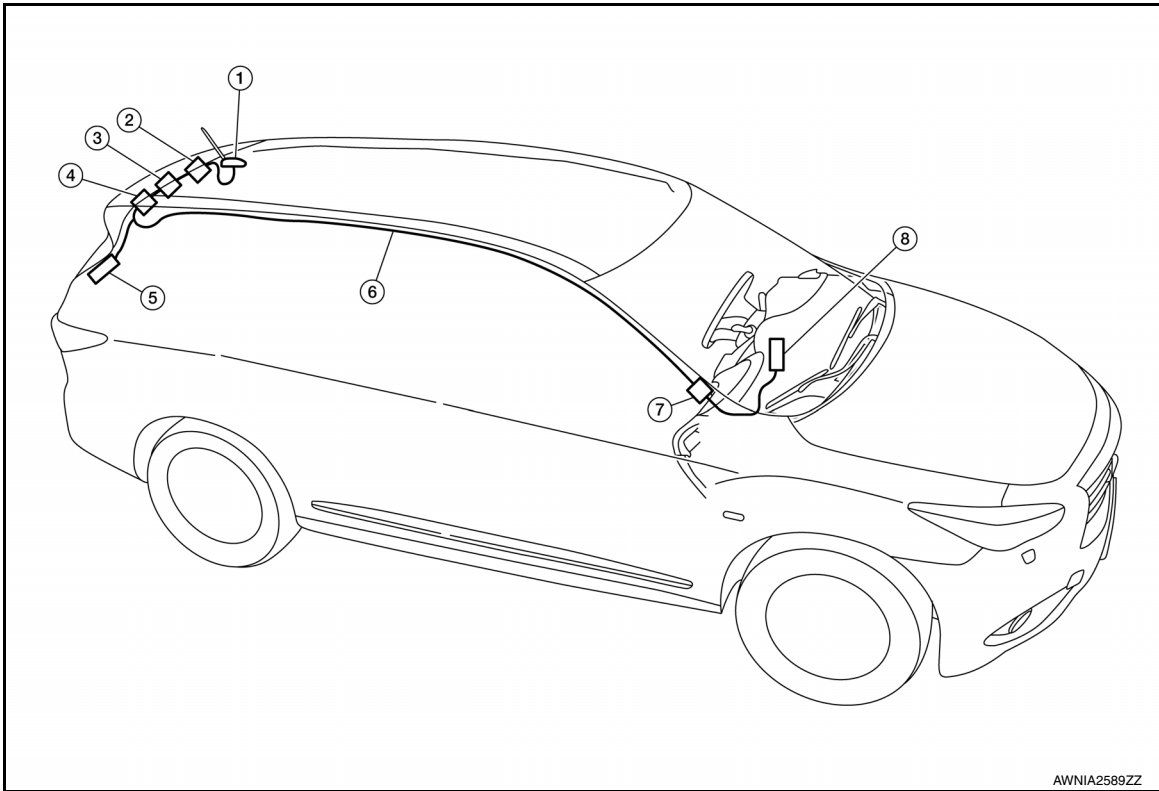

- |   |                         |                   |
|---|-------------------------|-------------------|
| 1. Antenna base (satellite antenna and antenna amp) | 2. M502                 | 3. M501           |
| 4. M503, M504                                       | 5. M505                 | 6. Antenna Feeder |
| 7. M95, M500  | 8. AV control unit M124 |                   |

### Window Antenna Repair

INFOID:000000009129062

#### ELEMENT CHECK

1. Attach probe circuit tester (ohm setting) to antenna terminal on each side.

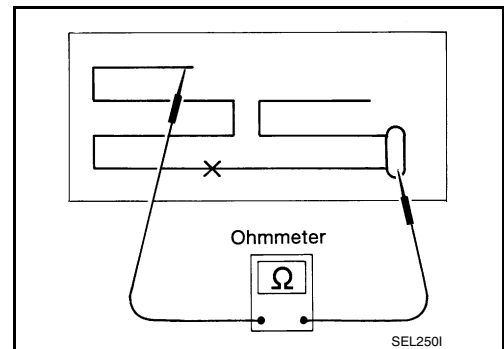

A  
B  
C  
D  
E  
F  
G  
H  
I  
J  
K  
L  
M  
AV  
O  
P

# AUDIO ANTENNA

< REMOVAL AND INSTALLATION >

[BASE AUDIO]

- When measuring continuity, wrap tin foil around the top of probe. Then, press the foil against the wire with your finger.

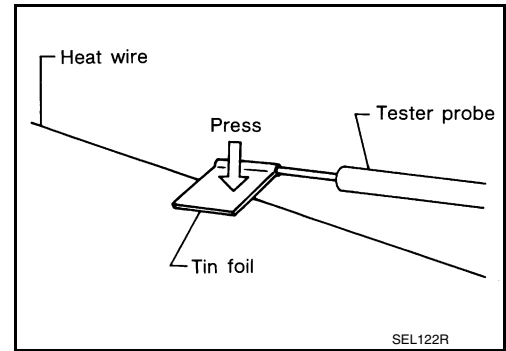

2. If an element is broken, no continuity will exist.

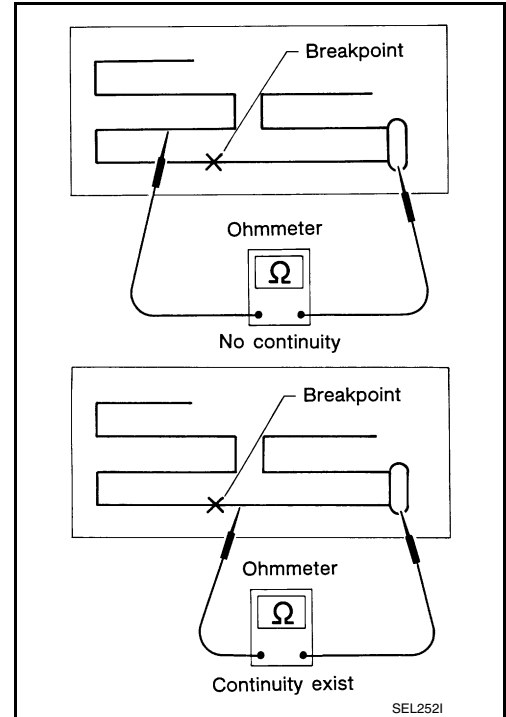

3. To locate a break, move probe along element. Tester indication will change abruptly when probe passes the broken point.

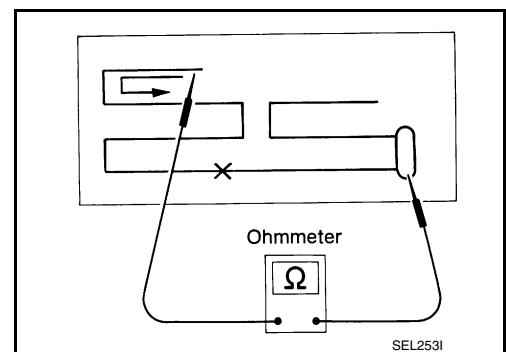

## BLUETOOTH® ANTENNA

### Removal and Installation

INFOID:000000009763915

#### REMOVAL

1. Remove luggage side lower finisher (LH). Refer to [INT-31. "LUGGAGE SIDE LOWER FINISHER : Removal and Installation"](#).
2. Disconnect the bluetooth antenna harness connector from bluetooth control unit.
3. Remove bolts and the bluetooth antenna from bracket.

#### INSTALLATION

Installation is in the reverse order of removal.

A

B

C

D

E

F

G

H

I

J

K

L

M

AV

O

P

# SATELLITE RADIO ANTENNA

< REMOVAL AND INSTALLATION >

[BASE AUDIO]

## SATELLITE RADIO ANTENNA

### Removal and Installation

INFOID:000000009763913

#### REMOVAL

1. Lower headlining (rear). Refer to [INT-27, "Removal and Installation"](#).
2. Disconnect harness connector from antenna feeder.
3. Remove nut from satellite radio antenna and remove.  
↳ Front

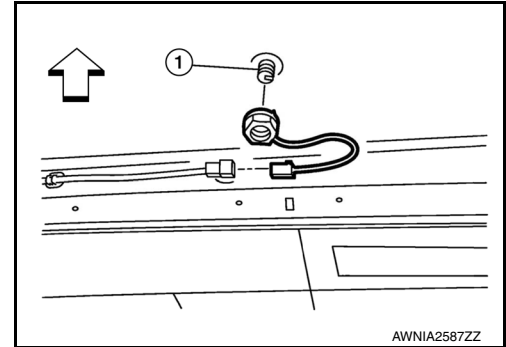

#### INSTALLATION

Installation is in the reverse order of removal.

#### CAUTION:

**If the satellite radio antenna nut is not tightened to the specified torque, lower sensitivity of the antenna may be experienced. If the nut is tightened tighter than the specified torque, this will deform the roof panel.**

### Disassembly and Assembly

INFOID:000000009763914

#### DISASSEMBLY

Insert a suitable tool into gaps between satellite radio antenna (2) and the cover (1), then remove the cover (1) from satellite radio antenna (2).

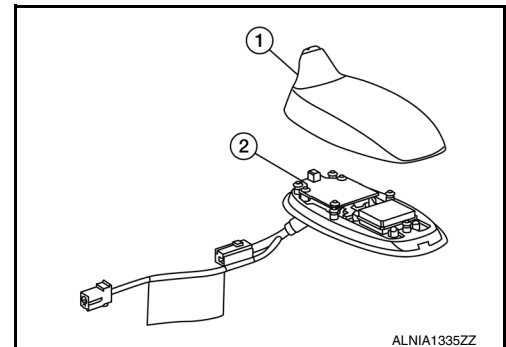

#### ASSEMBLY

Assembly is in the reverse order of disassembly.



PRECAUTION

PRECAUTIONS

Precaution for Supplemental Restraint System (SRS) "AIR BAG" and "SEAT BELT PRE-TENSIONER"

INFOID:000000009724866

The Supplemental Restraint System such as "AIR BAG" and "SEAT BELT PRE-TENSIONER", used along with a front seat belt, helps to reduce the risk or severity of injury to the driver and front passenger for certain types of collision. This system includes dual stage front air bag modules. The SRS system may only deploy one front air bag, depending on the severity of a collision and whether the front passenger seat is occupied. Information necessary to service the system safely is included in the SR and SB section of this Service Manual.

**WARNING:**

- To avoid rendering the SRS inoperative, which could increase the risk of personal injury or death in the event of a collision which would result in air bag inflation, all maintenance must be performed by an authorized NISSAN/INFINITI dealer.
- Improper maintenance, including incorrect removal and installation of the SRS, can lead to personal injury caused by unintentional activation of the system. For removal of Spiral Cable and Air Bag Module, see the SR section.
- Do not use electrical test equipment on any circuit related to the SRS unless instructed to in this Service Manual. SRS wiring harnesses can be identified by yellow and/or orange harnesses or harness connectors.

PRECAUTIONS WHEN USING POWER TOOLS (AIR OR ELECTRIC) AND HAMMERS

**WARNING:**

- When working near the Airbag Diagnosis Sensor Unit or other Airbag System sensors with the Ignition ON or engine running, DO NOT use air or electric power tools or strike near the sensor(s) with a hammer. Heavy vibration could activate the sensor(s) and deploy the air bag(s), possibly causing serious injury.
- When using air or electric power tools or hammers, always switch the Ignition OFF, disconnect the battery and wait at least three minutes before performing any service.

Cautions in Removing Battery Terminal and AV Control Unit (Models with AV Control Unit)

INFOID:000000009724867

**CAUTION:**

Remove battery terminal and AV control unit 30 seconds or more after turning the ignition switch OFF.

**NOTE:**

After the ignition switch is turned OFF, the AV control unit continues operating for approximately 30 seconds. Therefore, data corruption may occur if battery voltage is cut off within 30 seconds.

Precaution for Trouble Diagnosis

INFOID:000000009724868

AV COMMUNICATION SYSTEM

- Do not apply voltage of 7.0 V or higher to the measurement terminals.
- Use the tester with its open terminal voltage being 7.0 V or less.
- Be sure to turn ignition switch OFF and disconnect the battery cable from the negative terminal before checking the circuit.

AV

Precaution for Harness Repair

INFOID:000000009724869

AV COMMUNICATION SYSTEM

P

# PRECAUTIONS

## [BOSE AUDIO WITHOUT NAVIGATION]

### < PRECAUTION >

- Solder the repaired parts, and wrap with tape. [Frays of twisted line must be within 110 mm (4.33 in).]

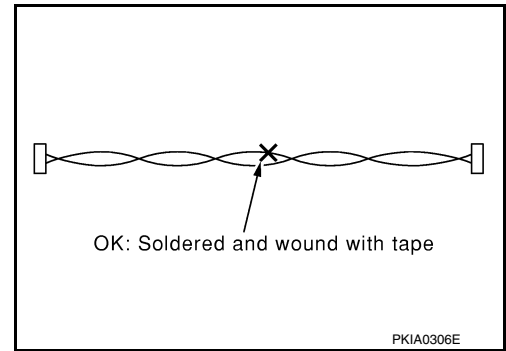

- Do not perform bypass wire connections for the repair parts. (The spliced wire will become separated and the characteristics of twisted line will be lost.)

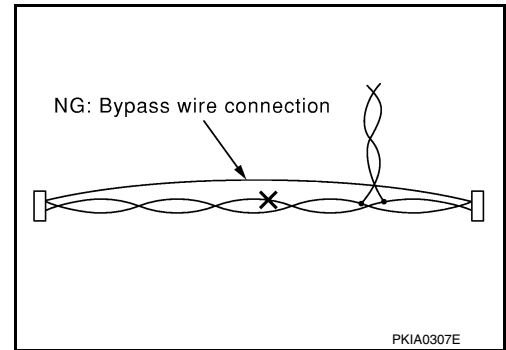

### Precaution for Work

INFOID:000000009724870

- When removing or disassembling each component, be careful not to damage or deform it. If a component may be subject to interference, be sure to protect it with a shop cloth.
- When removing (disengaging) components with a screwdriver or similar tool, be sure to wrap the component with a shop cloth or vinyl tape to protect it.
- Protect the removed parts with a shop cloth and prevent them from being dropped.
- Replace a deformed or damaged clip.
- If a part is specified as a non-reusable part, always replace it with a new one.
- Be sure to tighten bolts and nuts securely to the specified torque.
- After installation is complete, be sure to check that each part works properly.
- Follow the steps below to clean components:
  - Water soluble dirt:
    - Dip a soft cloth into lukewarm water, wring the water out of the cloth and wipe the dirty area.
    - Then rub with a soft, dry cloth.
  - Oily dirt:
    - Dip a soft cloth into lukewarm water with mild detergent (concentration: within 2 to 3%) and wipe the dirty area.
    - Then dip a cloth into fresh water, wring the water out of the cloth and wipe the detergent off.
    - Then rub with a soft, dry cloth.
  - Do not use organic solvent such as thinner, benzene, alcohol or gasoline.
  - For genuine leather seats, use a genuine leather seat cleaner.

# PREPARATION

[BOSE AUDIO WITHOUT NAVIGATION]

< PREPARATION >

## PREPARATION

### PREPARATION

#### Special Service Tool

INFOID:000000009724871

The actual shapes of Kent-Moore tools may differ from those of special service tools illustrated here.

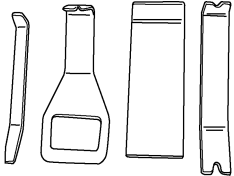
Tool number (Kent-Moore No.) Tool name	Description
— (J-46534) Trim Tool Set  AWJIA0483ZZ	Removing trim components

#### Commercial Service Tools

INFOID:000000009724872

Tool name	Description
Power tools  PIIB1407E	Loosening nuts, screws and bolts

A  
B  
C  
D  
E  
F  
G  
H  
I  
J  
K  
L  
M  
AV  
O  
P

AV

# COMPONENT PARTS

< SYSTEM DESCRIPTION >

[BOSE AUDIO WITHOUT NAVIGATION]

## SYSTEM DESCRIPTION

### COMPONENT PARTS

#### Component Parts Location

INFOID:000000009724873

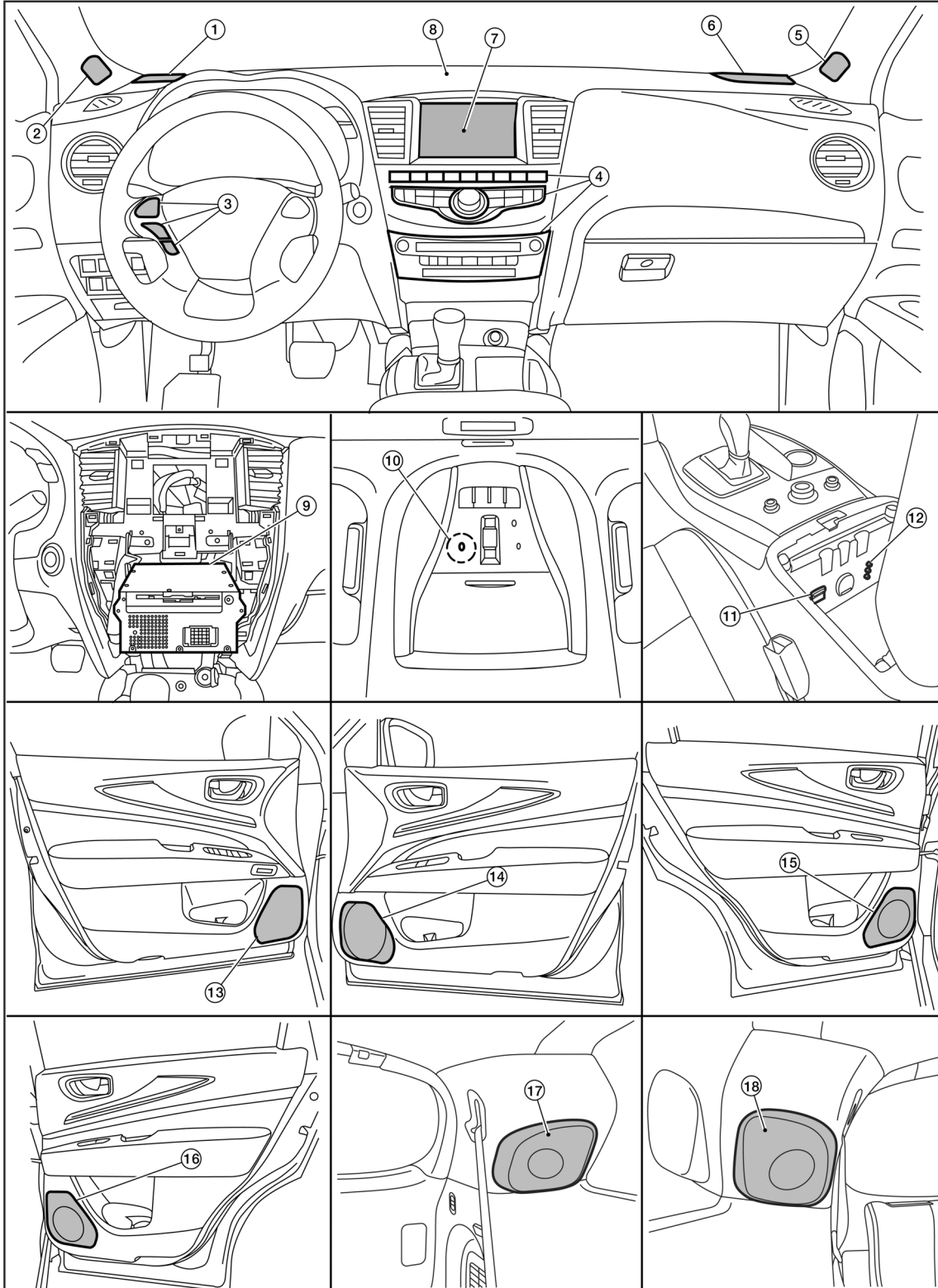

AWNIA2568ZZ

# COMPONENT PARTS

< SYSTEM DESCRIPTION >

[BOSE AUDIO WITHOUT NAVIGATION]

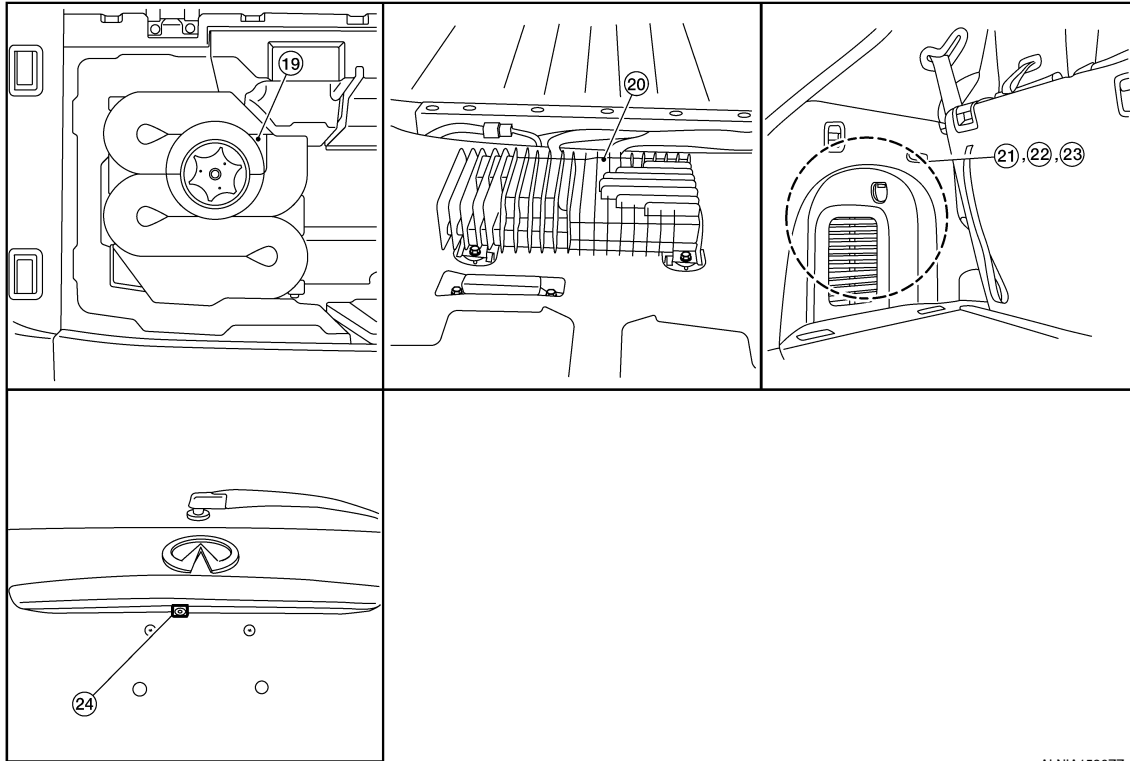

ALNIA1526ZZ

- |                                |                           |   |
|--------------------------------|---------------------------|---|
| 1. Instrument panel tweeter LH | 2. Front tweeter LH       | 3. Steering switch                                  |
| 4. A/C and AV switch assembly  | 5. Front tweeter RH       | 6. Instrument panel tweeter RH                      |
| 7. Display unit                | 8. Center speaker         | 9. AV control unit (view with center stack removed) |
| 10. Microphone                 | 11. USB interface         | 12. Front auxiliary input jacks                     |
| 13. Front door speaker LH      | 14. Front door speaker RH | 15. Rear door speaker LH                            |
| 16. Rear door speaker RH       | 17. Rear side speaker LH  | 18. Rear side speaker RH                            |
| 19. Subwoofer                  | 20. Bose® speaker amp.    | 21. Bluetooth® control unit                         |
| 22. Satellite radio tuner      | 23. Bluetooth® antenna    | 24. Rear camera                                     |

## Component Description

INFOID:000000009724874

Part name	Description
AV control unit	<ul style="list-style-type: none"> <li>• Master unit of MULTI AV system.</li> <li>• AV control unit includes audio, USB connection and vehicle status functions.</li> <li>• Connected to MULTI AV system control units via AV communication.</li> <li>• Connected to other vehicle control units via CAN communication to obtain necessary information for vehicle information function.</li> <li>• Receives steering angle signal via CAN communication from steering angle sensor and controls an expected course line during rear view monitor operation.</li> <li>• Inputs signals for driving status recognition (vehicle speed, reverse and parking brake).</li> <li>• TEL voice signal and voice guidance signal are input from Bluetooth® control unit.</li> <li>• Camera image signal is received and transmitted to display unit.</li> </ul>
Display unit	<ul style="list-style-type: none"> <li>• Display image is controlled by AV control unit via serial communication.</li> <li>• Receives power (signal VCC and inverter VCC) from AV control unit.</li> <li>• RGB image signals (RGB image, RGB area and RGB synchronizing) are input from AV control unit.</li> <li>• Composite image signals are input from AV control unit.</li> <li>• Synchronizing signals (HP, VP) are output to AV control unit.</li> </ul>

## COMPONENT PARTS

< SYSTEM DESCRIPTION >

[BOSE AUDIO WITHOUT NAVIGATION]

Part name	Description
BOSE speaker amp.	Receives sound signals from AV control unit and outputs sound signals to each speaker.
Instrument panel tweeter	Outputs high range sound signals from BOSE speaker amp.
Center speaker	Outputs mid and high range sound signals from BOSE speaker amp.
Front tweeter	Outputs high range sound signals from BOSE speaker amp.
Front door speaker	Outputs low, mid and high range sound signals from BOSE speaker amp.
Rear door speaker	Outputs low, mid and high range sound signals from BOSE speaker amp.
Rear side speaker	Outputs low, mid and high range sound signals from BOSE speaker amp.
Subwoofer	Outputs low range sound signals from BOSE speaker amp.
A/C and AV switch assembly	<ul style="list-style-type: none"><li>• Operation panels are equipped with switches for audio and air conditioner operations.</li><li>• Operation signal is transmitted via AV communication to AV control unit.</li><li>• Disk eject operation signal is performed via hardwire.</li></ul>
Rear view camera	<ul style="list-style-type: none"><li>• Camera power supply is input from AV control unit.</li><li>• Vehicle rear view image is transmitted to display unit via AV control unit.</li></ul>
Steering angle sensor	Connected to AV control unit via CAN communication and transmits steering angle sensor signal.
Steering switch	<ul style="list-style-type: none"><li>• Operations for audio, hands-free phone and voice recognition are possible.</li><li>• Steering switch signal (operation signal) is output to AV control unit.</li></ul>
Microphone	<ul style="list-style-type: none"><li>• Used for hands-free phone and voice recognition operation.</li><li>• Microphone signal is transmitted to Bluetooth® control unit.</li><li>• Power (Microphone VCC) is supplied from Bluetooth® control unit.</li></ul>
Antenna amp.	<ul style="list-style-type: none"><li>• Radio signal received by window antenna is amplified and transmitted to AV control unit.</li><li>• Power (antenna amp. ON signal) is supplied from AV control unit.</li></ul>
Satellite radio tuner	<ul style="list-style-type: none"><li>• Inputs satellite radio signal from satellite radio antenna and outputs sound signal to AV control unit.</li><li>• Controlled via serial communication (communication signal and request signal) by AV control unit.</li></ul>
Satellite radio antenna	Satellite radio signal is received and transmitted to satellite radio tuner.
Bluetooth® control unit	<ul style="list-style-type: none"><li>• Inputs TEL voice signal from Bluetooth® antenna and outputs it to AV control unit.</li><li>• Controlled via AV communication by AV control unit.</li></ul>
Bluetooth® antenna	Receives TEL voice signal and outputs it to Bluetooth® control unit.
Front auxiliary input jacks	Transmits image and sound signals to AV control unit.
USB connector	USB sound and data input signals are transmitted to AV control unit.

SYSTEM

MULTI AV SYSTEM

MULTI AV SYSTEM : System Diagram

INFOID:000000009724875

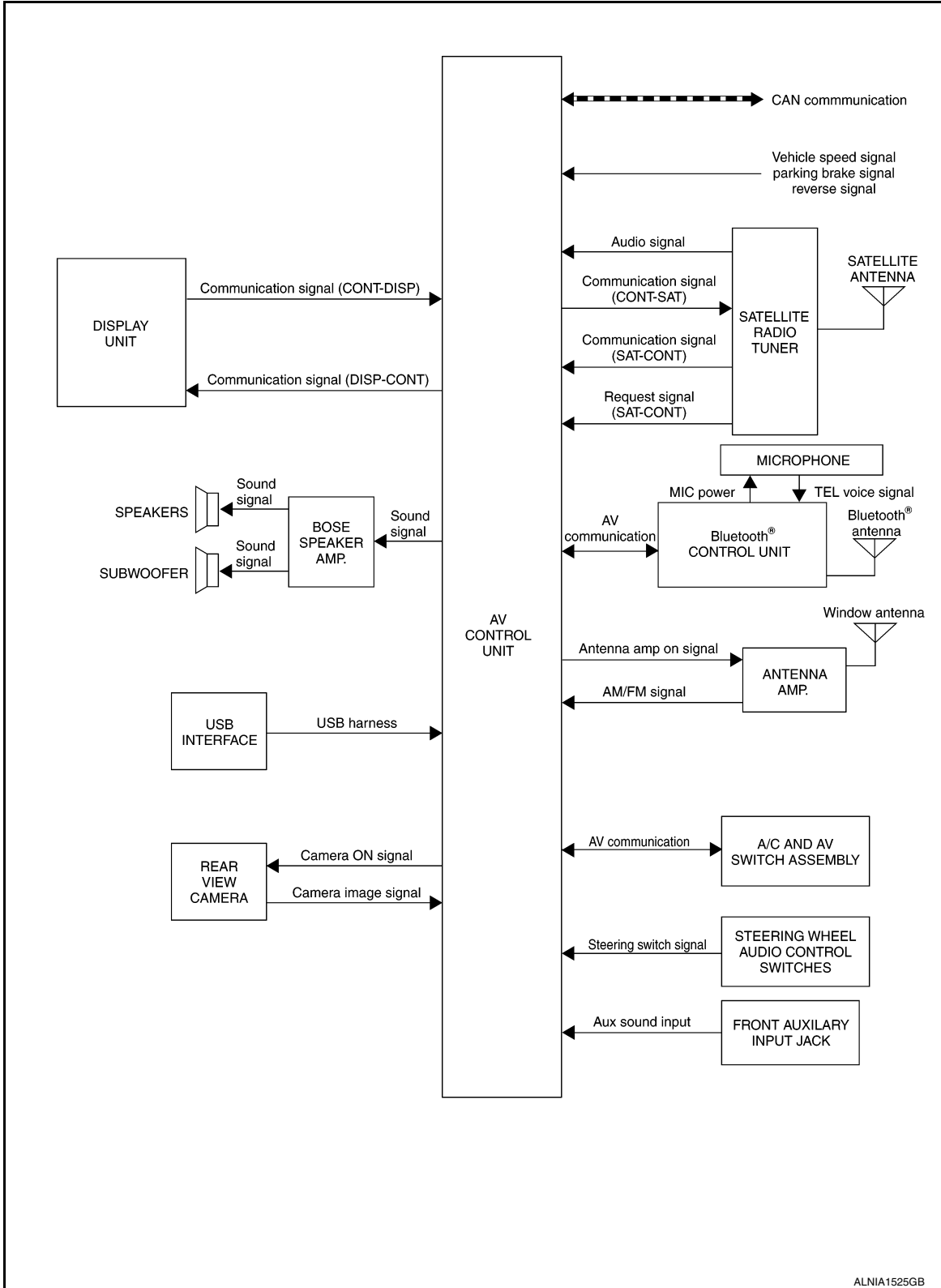

A  
B  
C  
D  
E  
F  
G  
H  
I  
J  
K  
L  
M  
O  
P

AV

MULTI AV SYSTEM : System Description

INFOID:000000009724876

AUDIO SYSTEM

### < SYSTEM DESCRIPTION >

The audio system consists of the following components

- AV control unit
- A/C and AV switch assembly
- Display unit
- Steering wheel audio control switches
- BOSE speaker amp.
- Center speaker
- Instrument panel tweeters
- Front tweeters
- Front door speakers
- Rear door speakers
- Rear side speakers
- Subwoofer
- Window antenna

When the audio system is on, radio signals are received by the window antenna. The AV control unit then sends audio signals to the front door speakers, instrument panel tweeters and rear door speakers. Refer to Owner's Manual for audio system operating instructions.

### SATELLITE RADIO SYSTEM

The satellite radio system consists of the following components

- Satellite antenna
- Satellite radio tuner

When the satellite radio system is on, radio signals are supplied to the satellite radio tuner from the satellite antenna. The satellite radio tuner then sends audio signals to the AV control unit. Refer to Owner's Manual for satellite radio system operating instructions.

### HANDS-FREE PHONE SYSTEM

System Operation

#### **NOTE:**

Cellular telephones must have their wireless connection set up (paired) before using the Bluetooth® telephone system.

The Bluetooth® telephone system allows users who have a Bluetooth® cellular telephone to make a wireless connection between their cellular telephone and the Bluetooth® control unit. Hands-free cellular telephone calls can be sent and received. Some Bluetooth® cellular telephones may not be recognized by the Bluetooth® control unit. When a cellular telephone or the Bluetooth® control unit is replaced, the telephone must be paired with the Bluetooth® control unit. Different cellular telephones may have different pairing procedures, refer to the cellular telephone operating manual.

Refer to the Owner's Manual for Bluetooth® telephone system operating instructions.

Bluetooth® Control Unit

When the ignition switch is turned to ACC or ON, the Bluetooth® control unit will power up. During power up, the Bluetooth® control unit is initialized and performs various self-checks. Initialization may take up to 20 seconds. If a phone is present in the vehicle and paired with the Bluetooth® control unit, Nissan Voice Recognition will then become active. Bluetooth® telephone functions can be turned off using the Nissan Voice Recognition system.

Steering Wheel Audio Control Switches

When buttons on the steering wheel audio control switch are pushed, the resistance in steering wheel audio control switch circuit changes, depending on which button is pushed. The Bluetooth® control unit uses this signal to perform various functions while navigating through the voice recognition system.

The following functions can be performed using the steering wheel audio control switch:

- Initiate self-diagnosis of the Bluetooth® telephone system
- Start a voice recognition session
- Answer and end telephone calls
- Adjust the volume of calls

Microphone

The microphone is located in the roof console assembly. The microphone sends a signal to the Bluetooth® control unit. The microphone can be actively tested during self-diagnosis.



# SYSTEM

< SYSTEM DESCRIPTION >

[BOSE AUDIO WITHOUT NAVIGATION]

## AV Control Unit

The AV control unit receives signals from the Bluetooth® control unit and sends audio signals to the speakers.

A

## REAR VIEW CAMERA SYSTEM

When the shift selector is in the R position, the display shows a view to the rear of the vehicle. Lines which indicate the vehicle clearance and distances are also displayed.

B

## SPEED SENSITIVE VOLUME SYSTEM

Volume level of this system goes up and down automatically in proportion to the vehicle speed. The control level can be selected by the customer. Refer to Owner's Manual for operating instructions.

C

## FRONT AUXILIARY INPUT JACKS

- Image and sound can be output from an external device connected to the front auxiliary input jacks.
- AUX image signals are transmitted to each unit as follows:
  - To the display unit via AV control unit.
- AUX sound signals are transmitted to each unit as follows:
  - To each speaker via AV control unit and BOSE speaker amp.

D

E

F

G

H

I

J

K

L

M

AV

O

P

# DIAGNOSIS SYSTEM (AV CONTROL UNIT)

< SYSTEM DESCRIPTION >

[BOSE AUDIO WITHOUT NAVIGATION]

## DIAGNOSIS SYSTEM (AV CONTROL UNIT)

### Description

INFOID:000000009724877

The AV control unit on board diagnosis includes the following functions:

- A/C and AV switch assembly self diagnosis that checks the ON/OFF operation (continuity) of each switch in the A/C and AV switch assembly.

**NOTE:**

The hazard switch and disk eject switch are not included in this operation check.

- AV control unit on board diagnosis performs the following functions listed in the table below:

Mode	Description	
Self Diagnosis	<ul style="list-style-type: none"><li>• AV control unit diagnosis.</li><li>• Diagnoses the connections across system components (between AV control unit and each unit).</li></ul>	
Confirmation/ Adjustment	Display Diagnosis	<ul style="list-style-type: none"><li>• Color tone check using color spectrum bar display and white display.</li><li>• Light and shade check by gradation bar display.</li></ul>
	Vehicle Signals	Diagnosis of signals can be performed for vehicle speed, parking brake, lights, ignition and reverse.
	Speaker Test	Speaker connection can be confirmed by test tone.
	Error History	<ul style="list-style-type: none"><li>• The system malfunction and frequency of past occurrences is displayed.</li><li>• When malfunctioning item is selected, time and place that the malfunction last occurred are displayed.</li></ul>
	Camera Cont.	<ul style="list-style-type: none"><li>• Guiding line position that overlaps rear view camera image can be adjusted.</li><li>• Configuration stored in the AV control unit can be checked.</li></ul>
	Vehicle CAN Diagnosis	Transmit/receive function of CAN communication can be monitored.
	AV COMM Diagnosis	Communication condition of each unit of Multi AV system can be monitored.
	Delete Unit Connection Log	Erase connection history of unit and error history.
	Initialize Settings	Initializes the AV control unit memory.

Perform CONSULT diagnosis if the AV control unit on board diagnosis does not start, the screen does not display anything, or the A/C and AV switch assembly self diagnosis does not function.

### On Board Diagnosis Function

INFOID:000000009724878

#### METHOD OF STARTING

##### A/C and AV Switch Assembly Self Diagnosis

- Press the BACK and UP switches within 10 seconds after turning the ignition switch from OFF to ACC and hold them for 3 seconds or more.
- The buzzer sounds, all indicators of the switches illuminate, and the self-diagnosis mode begins.
- The ON position continuity of each switch can be checked by pressing the switch. The buzzer sounds if continuity is present.
- The self diagnosis mode is canceled when the ignition switch is turned OFF.

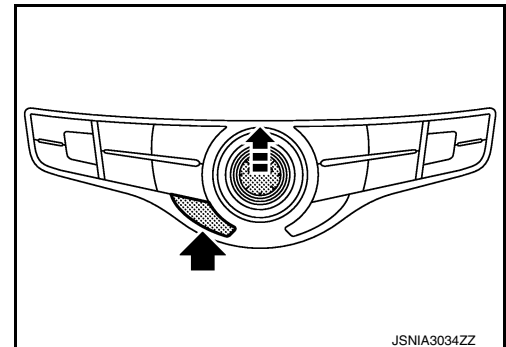

JSNIA3034ZZ

##### AV Control Unit Self Diagnosis

1. Turn the ignition ON.
2. Turn the audio system OFF.

# DIAGNOSIS SYSTEM (AV CONTROL UNIT)

[BOSE AUDIO WITHOUT NAVIGATION]

## < SYSTEM DESCRIPTION >

- While pressing the SETTING button, turn the volume control dial clockwise or counterclockwise for 40 clicks or more. When self-diagnosis mode begins, a short beep will be heard. Shifting from current screen to previous screen is performed by pressing BACK button.

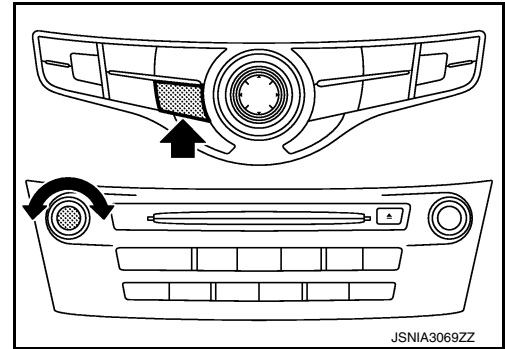

- The trouble diagnosis initial screen is displayed, and Self Diagnosis or Confirmation/Adjustment can be selected.

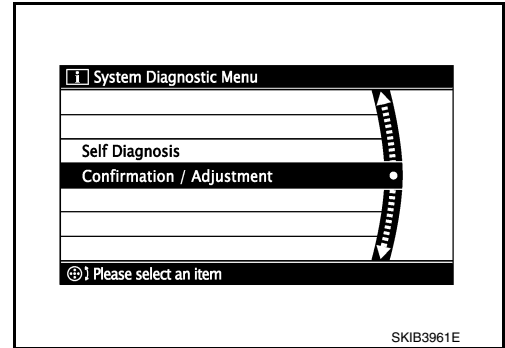

## SELF DIAGNOSIS MODE

### AV Control Unit Self Diagnosis

- Select Self Diagnosis.
- Self diagnosis screen is displayed. The bar graph visible in center of screen indicates progress of self diagnosis.
- Diagnosis results are displayed after self diagnosis is completed. Unit names and connection lines are color coded according to diagnostic results. Control Unit (AV control unit) is displayed in red.

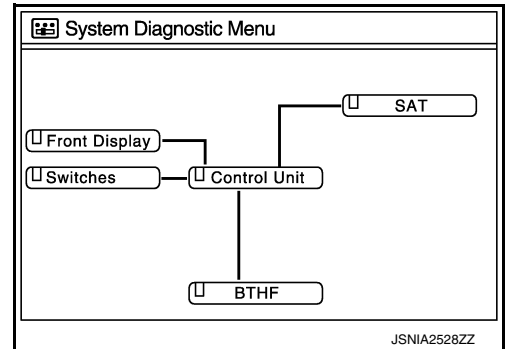

Diagnosis results	Unit	Connection line
Normal	Green	Green
Connection malfunction	Gray	Yellow
Unit malfunction <sup>1</sup>	Red	Green

1: Control Unit (AV control unit) is displayed in red.

- Replace AV control unit if Self Diagnosis did not run because control unit malfunction is indicated. The symptom is AV control unit internal error. Refer to [AV-303, "Removal and Installation - AV Control Unit"](#).
- If multiple errors occur at the same time for a single unit, the screen switch colors are determined according to the following order of priority: red > gray.

# DIAGNOSIS SYSTEM (AV CONTROL UNIT)

[BOSE AUDIO WITHOUT NAVIGATION]

< SYSTEM DESCRIPTION >

4. Comments of self diagnosis results can be viewed in the diagnosis result screen.

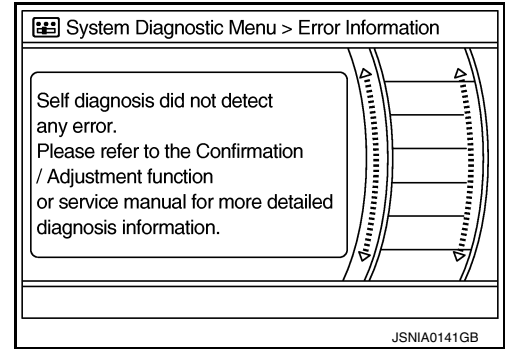

## AV Control Unit Self Diagnosis Results

Only Unit Part Is Displayed In Red		
Screen switch	Description	Possible cause
Control unit	Malfunction is detected in AV control unit power supply or ground circuit.	<ul style="list-style-type: none"> <li>AV control unit power supply or ground circuits. Refer to <a href="#">AV-243</a>.</li> <li>If no malfunction is detected in AV control unit power supply and ground circuits, replace AV control unit. Refer to <a href="#">AV-303</a>.</li> </ul>
Amplifier	When either one of the following items are detected: <ul style="list-style-type: none"> <li>sound signal circuits between BOSE amp. and each speaker are malfunctioning.</li> <li>BOSE amp. malfunction is detected.</li> </ul>	<ul style="list-style-type: none"> <li>Malfunctioning speaker circuits</li> <li>Replace BOSE amp. Refer to <a href="#">AV-307</a>, "<a href="#">Removal and Installation</a>".</li> </ul>

A Connecting Cable Between Units Is Displayed In Yellow		
Area with yellow connection lines	Description	Possible cause
Control unit ↔ Front Display	Malfunction is detected in serial communication circuits between AV control unit and display unit.	Serial communication circuits between AV control unit and display unit. Refer to <a href="#">AV-303</a> .
Control unit ↔ SAT	When any of the following is detected: <ul style="list-style-type: none"> <li>satellite radio tuner power supply or ground circuit malfunction.</li> <li>communication circuit malfunction between AV control unit and satellite radio tuner.</li> <li>request signal circuit malfunction between AV control unit and satellite radio tuner.</li> </ul>	<ul style="list-style-type: none"> <li>Satellite radio tuner power supply or ground circuits. Refer to <a href="#">AV-246</a>.</li> <li>Communication circuit between AV control unit and satellite radio tuner. Refer to <a href="#">AV-232</a>.</li> <li>Request signal circuit between AV control unit and satellite radio tuner. Refer to <a href="#">AV-232</a>.</li> </ul>
Control unit ↔ BTHF	When any of the following is detected: <ul style="list-style-type: none"> <li>Bluetooth® control unit power supply or ground circuit malfunction.</li> <li>AV communication circuit malfunction between AV control unit and Bluetooth® control unit.</li> </ul>	<ul style="list-style-type: none"> <li>Bluetooth® control unit power supply or ground circuits. Refer to <a href="#">AV-247</a>.</li> <li>AV communication circuits between AV control unit and Bluetooth® control unit.</li> </ul>
Control unit ↔ Amplifier	When either one of the following items are detected: <ul style="list-style-type: none"> <li>BOSE amp. power supply and ground circuits are malfunctioning.</li> <li>AV communication circuits between headrest display unit LH and BOSE amp. are malfunctioning.</li> </ul>	<ul style="list-style-type: none"> <li>BOSE amp. power supply and ground circuits. Refer to <a href="#">AV-520</a>, "<a href="#">BOSE AMP. : Diagnosis Procedure</a>".</li> <li>AV communication circuits between headrest display unit LH and BOSE amp.</li> </ul>

## AV Control Unit Confirmation/Adjustment

1. Select Confirmation/Adjustment.

# DIAGNOSIS SYSTEM (AV CONTROL UNIT)

[BOSE AUDIO WITHOUT NAVIGATION]

< SYSTEM DESCRIPTION >

- Select each switch on the Confirmation/Adjustment screen to display the relevant trouble diagnosis screen. Press the BACK switch to return to the initial Confirmation/Adjustment screen.

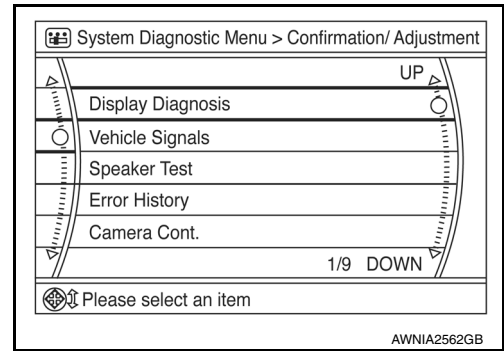

## Display Diagnosis

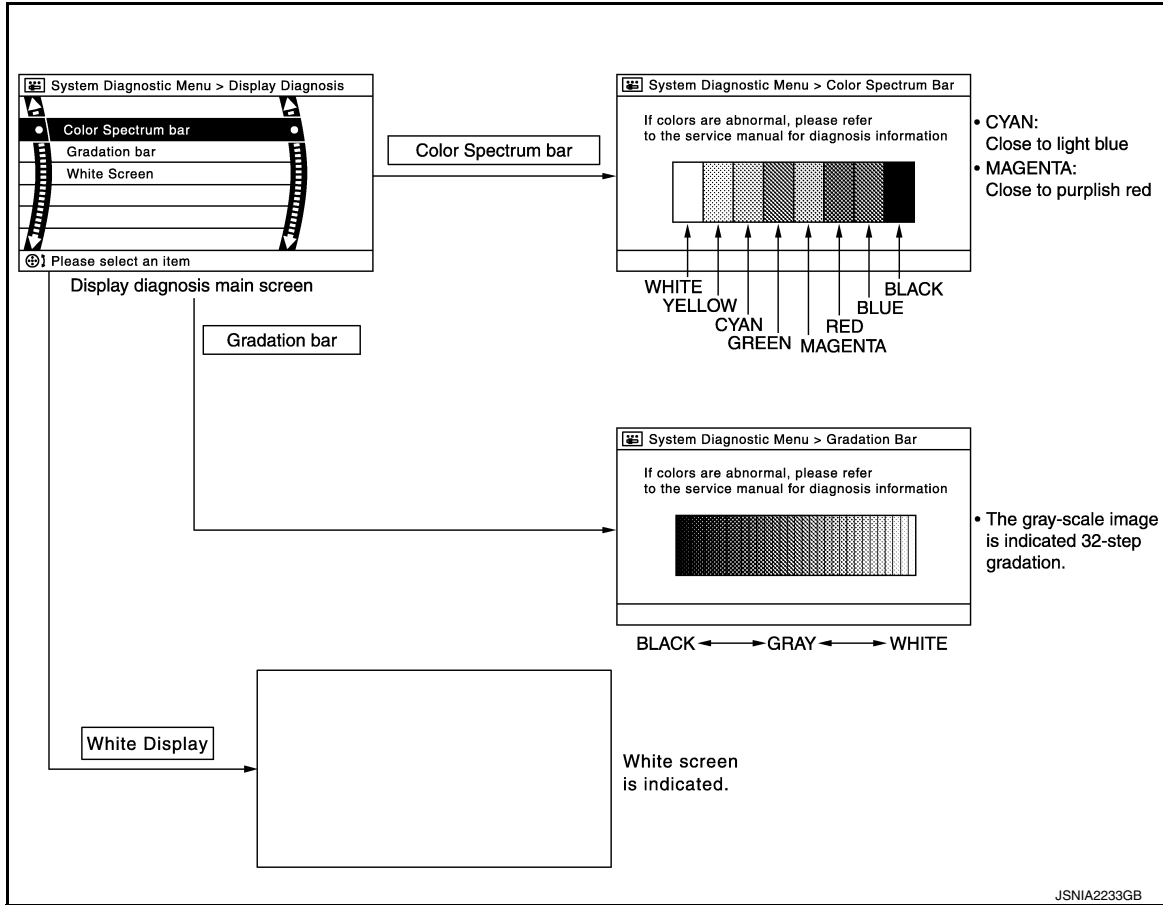

## Vehicle Signals

A comparison check can be made of each actual vehicle signal and the signals recognized by the system.

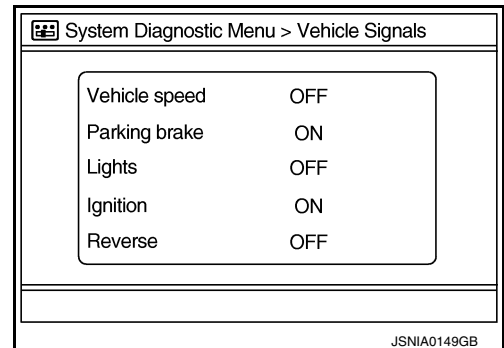

## Speaker Test

A  
B  
C  
D  
E  
F  
G  
H  
I  
J  
K  
L  
M  
N  
O  
P

AV

# DIAGNOSIS SYSTEM (AV CONTROL UNIT)

[BOSE AUDIO WITHOUT NAVIGATION]

## < SYSTEM DESCRIPTION >

Select Speaker Test to display the Speaker Diagnosis screen. Press Start to generate a test tone in a speaker. Press Start again to generate a test tone in the next speaker. Press End to stop the test tones.

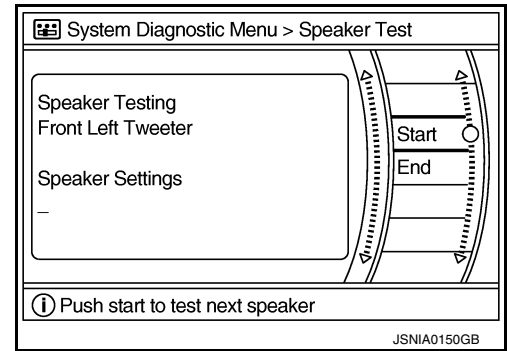

### Error History

The self diagnosis results are judged depending on whether any error occurs from when Self diagnosis is selected until the self diagnosis results are displayed.

However, the diagnosis results are judged normal if an error has occurred before the ignition switch is turned ON and then no error has occurred until the self diagnosis start. Check the Error Record to detect any error that may have occurred before the self diagnosis start because of this situation.

The frequency of occurrence is displayed in a count up manner. The actual count up method differs depending on the error item.

#### Count up method A

- The counter resets to 0 if an error occurs when ignition switch is turned ON. The counter increases by 1 if the condition is normal at a next ignition ON cycle.
- The counter upper limit is 39. Any counts exceeding 39 are ignored. The counter can be reset (no error record display) with the "Delete log" switch or CONSULT.

#### Count up method B

- The counter increases by 1 if an error occurs when ignition switch is ON. The counter will not decrease even if the condition is normal at the next ignition ON cycle.
- The counter upper limit is 50. Any counts exceeding 50 are ignored. The counter can be reset (no error record display) with the "Delete log" switch or CONSULT.

Display type of occurrence frequency	Error history display item
Count up method A	CAN communication line, control unit (CAN), AV communication line, control unit (AV)
Count up method B	Other than the above

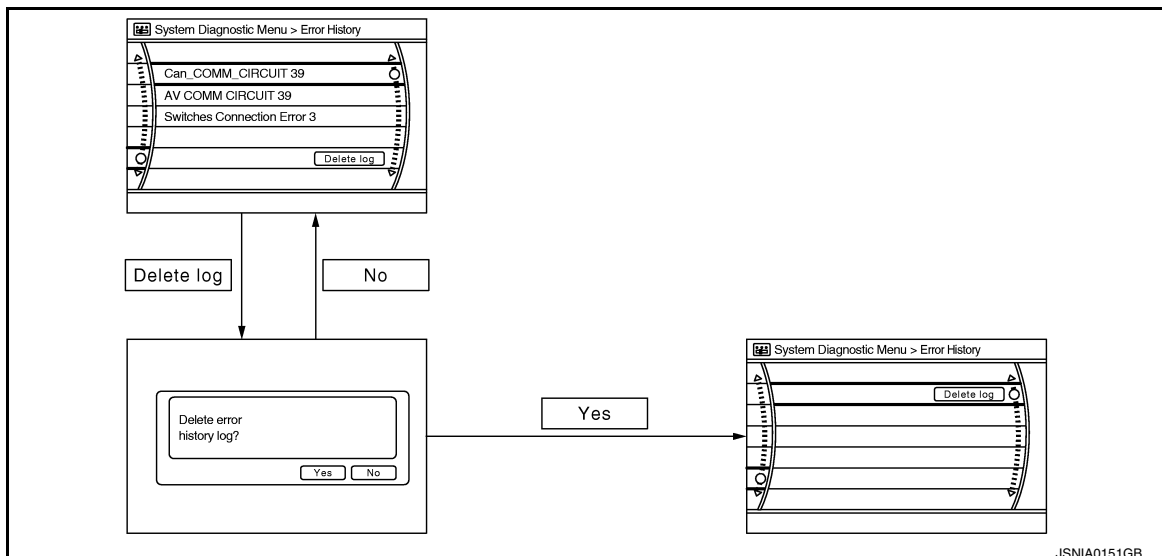

### Error item

Some error items may be displayed simultaneously according to the cause. If some error items are displayed simultaneously, the detection of the cause can be performed by the combination of display items

# DIAGNOSIS SYSTEM (AV CONTROL UNIT)

< SYSTEM DESCRIPTION >

[BOSE AUDIO WITHOUT NAVIGATION]

Error item	Description	Possible cause	A
CAN COMM CIRCUIT	CAN communication malfunction is detected.	Perform diagnosis with CONSULT, then repair the malfunctioning components according to diagnosis results. Refer to <a href="#">AV-171</a> .	B
CONTROL UNIT (CAN)	CAN initial diagnosis malfunction is detected.	Replace the AV control unit if the malfunction occurs constantly. Refer to <a href="#">AV-303</a> .	C
CONTROL UNIT (AV)	AV communication circuit initial diagnosis malfunction is detected.		D
FLASH-ROM Error Of Control Unit CAN Controller Memory Error	AV control unit malfunction is detected.		E
Steer. Angle Sensor Calibration	Predictive course line center position adjustment of the steering angle sensor is incomplete.	Adjust the predictive course line center position of the steering angle sensor. Refer to <a href="#">BRC-60</a> , "Description".	F
Amplifier Temperature Error	BOSE amp. malfunction is detected.	Replace the BOSE amp. Refer to <a href="#">AV-307</a> , "Removal and Installation".	G
Display Connection Error	When any of the following is detected: • display unit power supply or ground circuits malfunction. • communication circuit malfunction between AV control unit and display unit.	<ul style="list-style-type: none"> <li>• Display unit power supply or ground circuits. Refer to <a href="#">AV-243</a>.</li> <li>• Communication circuits between AV control unit and display unit. Refer to <a href="#">AV-230</a>.</li> </ul>	H
XM Connection Error	When any of the following is detected: • satellite radio tuner power supply or ground circuit malfunction. • communication circuit malfunction between AV control unit and satellite radio tuner. • request signal circuit malfunction between AV control unit and satellite radio tuner.	<ul style="list-style-type: none"> <li>• Satellite radio tuner power supply or ground circuits. Refer to <a href="#">AV-246</a>.</li> <li>• Communication circuit between AV control unit and satellite radio tuner. Refer to <a href="#">AV-232</a>.</li> <li>• Request signal circuit between AV control unit and satellite radio tuner. Refer to <a href="#">AV-232</a>.</li> </ul>	I
FL-DOOR SPEAKER OUT: open	When either one of the following items are detected: • sound signal circuits between BOSE amp. and front door speaker LH are malfunctioning. • sound signal circuits between BOSE amp. and front door tweeter LH are malfunctioning.	<ul style="list-style-type: none"> <li>• Sound signal circuits between BOSE amp. and front door speaker LH.</li> <li>• Sound signal circuits between BOSE amp. and front door tweeter LH.</li> </ul>	J
FL-DOOR SPEAKER OUT: short			K
FL-DOOR SPEAKER: short to ground			L
FL-DOOR SPEAKER: short to battery			M
FL-DOOR TWEETER OUT: open			AV
FL-DOOR TWEETER OUT: short			O
FL-DOOR TWEETER OUT: short to ground			P
FR-DOOR SPEAKER OUT: open	When either one of the following items are detected: • sound signal circuits between BOSE amp. and front door speaker RH are malfunctioning. • sound signal circuits between BOSE amp. and front door tweeter RH are malfunctioning.	<ul style="list-style-type: none"> <li>• Sound signal circuits between BOSE amp. and front door speaker RH.</li> <li>• Sound signal circuits between BOSE amp. and front door tweeter RH.</li> </ul>	O
FR-DOOR SPEAKER OUT: short			P
FR-DOOR SPEAKER OUT: short to ground			O
FR-DOOR SPEAKER OUT: short to battery			P
FR-DOOR TWEETER OUT: open			O
FR-DOOR TWEETER OUT: short			P
FR-DOOR TWEETER OUT: short to ground			O
FR-DOOR TWEETER OUT: short to battery	P		

# DIAGNOSIS SYSTEM (AV CONTROL UNIT)

< SYSTEM DESCRIPTION >

[BOSE AUDIO WITHOUT NAVIGATION]

Error item	Description	Possible cause
FL-INST TWEETER OUT: open	Sound signal circuits between BOSE amp. and tweeter LH are malfunctioning.	Sound signal circuits between BOSE amp. and tweeter LH.
FL-INST TWEETER OUT: short		
FL-INST TWEETER OUT: short to ground		
FL-INST TWEETER OUT: short to battery		
FC-INST SPEAKER OUT: open	Malfunction is detected sound signal circuits between BOSE amp. and center speaker.	Sound signal circuits between BOSE amp. and center speaker.
FC-INST SPEAKER OUT: short		
FC-INST SPEAKER OUT: short to ground		
FC-INST SPEAKER OUT: short to battery		
FR-INST TWEETER OUT: open	Sound signal circuits between BOSE amp. and tweeter RH are malfunctioning.	Sound signal circuits between BOSE amp. and tweeter RH.
FR-INST TWEETER OUT: short		
FR-INST TWEETER OUT: short to ground		
FR-INST TWEETER OUT: short to battery		
2L-DOOR SPEAKER OUT: open	Sound signal circuits between BOSE amp. and rear door speaker LH are malfunctioning.	Sound signal circuits between BOSE amp. and rear door speaker LH.
2L-DOOR SPEAKER OUT: short		
2L-DOOR SPEAKER OUT: short to ground		
2L-DOOR SPEAKER OUT: short to battery		
2R-DOOR SPEAKER OUT: open	Sound signal circuits between BOSE amp. and rear door speaker RH are malfunctioning.	Sound signal circuits between BOSE amp. and rear door speaker RH.
2R-DOOR SPEAKER OUT: short		
2R-DOOR SPEAKER OUT: short to ground		
2R-DOOR SPEAKER OUT: short to battery		
RL-SPEAKER OUT: open	Sound signal circuits between BOSE amp. and rear speaker LH are malfunctioning.	Sound signal circuits between BOSE amp. and rear speaker LH.
RL-SPEAKER OUT: short		
RL-SPEAKER OUT: short to ground		
RL-SPEAKER OUT: short to battery		
RR-SPEAKER OUT: open	Sound signal circuits between BOSE amp. and rear speaker RH are malfunctioning.	Sound signal circuits between BOSE amp. and rear speaker RH.
RR-SPEAKER OUT: short		
RR-SPEAKER OUT: short to ground		
RR-SPEAKER OUT: short to battery		
SUBWOOFER OUT: open	Sound signal circuits between BOSE amp. and subwoofer are malfunctioning.	Sound signal circuits between BOSE amp. and subwoofer.
SUBWOOFER OUT: short		
SUBWOOFER OUT: short to ground		
SUBWOOFER OUT: short to battery		
<ul style="list-style-type: none"> <li>• AV COMM CIRCUIT</li> <li>• Switches Connection Error</li> </ul>	When any of the following is detected: <ul style="list-style-type: none"> <li>• A/C and AV switch assembly power supply or ground circuit malfunction.</li> <li>• AV communication circuit malfunction between AV control unit and A/C and AV switch assembly.</li> </ul>	<ul style="list-style-type: none"> <li>• A/C and AV switch assembly power supply or ground circuits. Refer to <a href="#">AV-248</a>.</li> <li>• AV communication circuits between AV control unit and A/C and AV switch assembly.</li> </ul>
<ul style="list-style-type: none"> <li>• AV COMM CIRCUIT</li> <li>• Amplifier Connection Error</li> </ul>	When either one of the following items are detected: <ul style="list-style-type: none"> <li>• BOSE amp. power supply and ground circuits are malfunctioning.</li> <li>• AV communication circuits between headrest display unit LH and BOSE amp. are malfunctioning.</li> </ul>	<ul style="list-style-type: none"> <li>• BOSE amp. power supply and ground circuits. Refer to <a href="#">AV-245</a>.</li> <li>• AV communication circuits between headrest display unit LH and BOSE amp.</li> </ul>



# DIAGNOSIS SYSTEM (AV CONTROL UNIT)

< SYSTEM DESCRIPTION >

[BOSE AUDIO WITHOUT NAVIGATION]

Error item	Description	Possible cause
<ul style="list-style-type: none"> <li>• AV COMM CIRCUIT</li> <li>• BTHF Unit Connection Error</li> </ul>	When any of the following is detected: <ul style="list-style-type: none"> <li>• Bluetooth® control unit power supply or ground circuit malfunction.</li> <li>• AV communication circuit malfunction between AV control unit and Bluetooth® control unit.</li> </ul>	<ul style="list-style-type: none"> <li>• Bluetooth® control unit power supply or ground circuits. Refer to <a href="#">AV-247</a>.</li> <li>• AV communication circuits between AV control unit and Bluetooth® control unit.</li> </ul>
<ul style="list-style-type: none"> <li>• AV COMM CIRCUIT</li> <li>• Switches Connection Error</li> <li>• BTHF Unit Connection Error</li> </ul>	AV communication circuit malfunction between AV control unit and A/C and AV switch assembly.	AV communication circuits between AV control unit and A/C and AV switch assembly.

## Camera Cont.

The two functions of “Correct Draw Line of Rear view Cam”, “Confirm Configuration” are available.

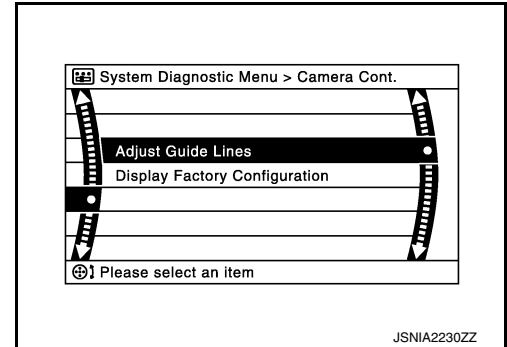

## Adjust Offset of Rear view Camera

- Use this mode to adjust the guide line display position of the rear view monitor if necessary after removing the rear view monitor camera.

### CAUTION:

After the adjustment, never perform other operations for one minute.

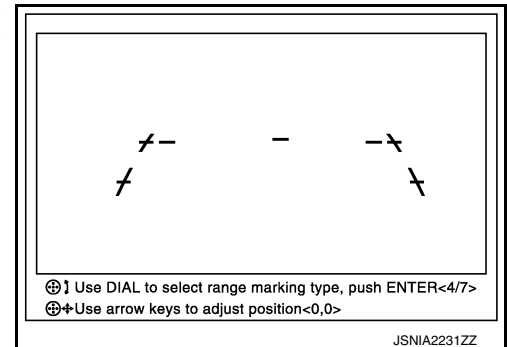

## Factory Configuration Confirmation

- Configuration stored in the AV control unit can be checked.

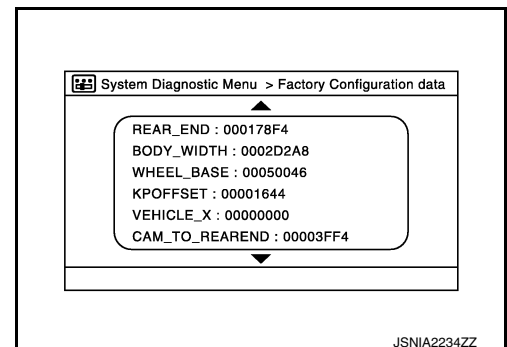

## Vehicle CAN Diagnosis

A  
B  
C  
D  
E  
F  
G  
H  
I  
J  
K  
L  
M  
AV  
O  
P

# DIAGNOSIS SYSTEM (AV CONTROL UNIT)

[BOSE AUDIO WITHOUT NAVIGATION]

## < SYSTEM DESCRIPTION >

- CAN communication status and error counter is displayed.
- The error counter displays “OK” if any malfunction was not detected in the past and displays “0” if a malfunction is detected. It increases by 1 if the condition is normal at the next ignition switch ON cycle. The upper limit of the counter is 39.
- The error counter is erased if “Reset” is pressed.

Items	Display (Current)	Malfunction counter (Past)
Tx(HVAC)	OK / ???	OK / 0 – 39
Rx(ECM)	OK / ???	OK / 0 – 39
Rx(Cluster)	OK / ???	OK / 0 – 39
Rx(BCM)	OK / ???	OK / 0 – 39
Rx(HVAC)	OK / ???	OK / 0 – 39
Rx(USM)	OK / ???	OK / 0 – 39
Rx(VDC)	OK / ???	OK / 0 – 39
Rx(STRG)	OK / ???	OK / 0 – 39

### NOTE:

“???” indicates UNKWN.

### AV COMM Diagnosis

- Displays the communication status between AV control unit and each unit.
- The error counter displays “OK” if any malfunction was not detected in the past and displays “0” if a malfunction is detected. It increases by 1 if the condition is normal at the next ignition switch ON cycle. The upper limit of the counter is 39.
- The error counter is erased if “Reset” is pressed.

Items	Status (Current)	Counter (Past)
C Tx(ITM-SW)	OK / ???	OK / 0 – 39
C Rx(PrimarySW-ITM)	OK / ???	OK / 0 – 39
C Rx(BTHF-ITM)	OK / ???	OK / 0 – 39

### NOTE:

“???” indicates UNKWN.

### Delete Unit Connection Log

Deletes any unit connection records and error records from the AV control unit memory. (Clear the records of the unit that has been removed.)

### Initialize Settings

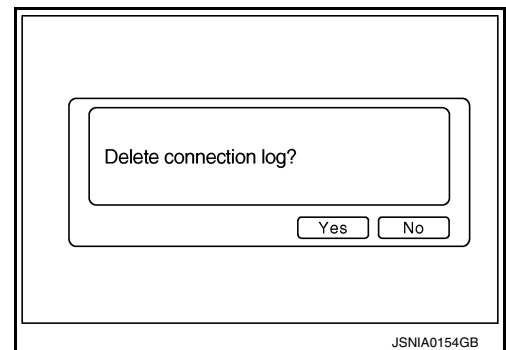
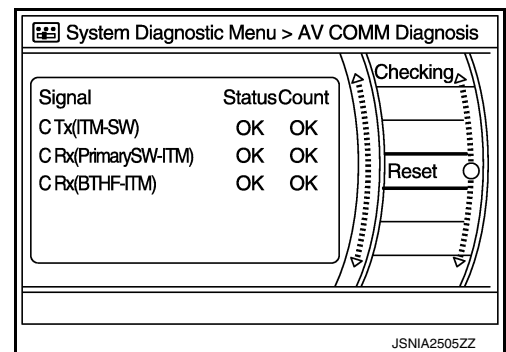
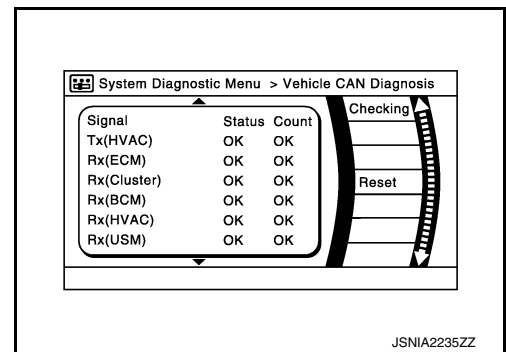

# DIAGNOSIS SYSTEM (AV CONTROL UNIT)

[BOSE AUDIO WITHOUT NAVIGATION]

< SYSTEM DESCRIPTION >

“User Data Initialization” and “Accessory Number Initialization” are possible.

**CAUTION:**

- Never perform Accessory Number Initialization except when configuration is unsuccessful.
- Accessory Number Initialization requires configuration. For details, refer to [AV-222, "CONFIGURATION \(AV CONTROL UNIT\) : Description"](#).

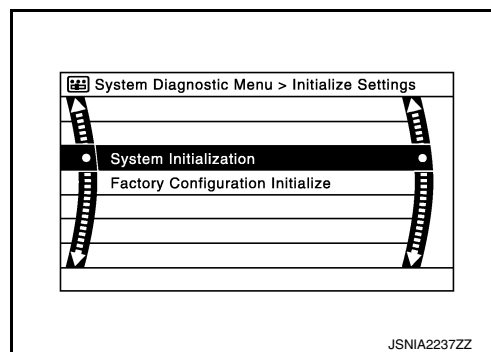

INFOID:000000009724879

## CONSULT Function

**CAUTION:**

After disconnecting the CONSULT vehicle interface (VI) from the data link connector, the ignition must be cycled OFF → ON (for at least 5 seconds) → OFF. If this step is not performed, the BCM may not go to “sleep mode”, potentially causing a discharged battery and a no-start condition.

## CONSULT FUNCTIONS

CONSULT performs the following functions via communication with the AV control unit.

Direct Diagnostic Mode	Description
Ecu Identification	The AV control unit part number is displayed.
Self Diagnostic Result	The AV control unit self diagnostic results are displayed.
Data Monitor	The AV control unit input/output data is displayed in real time.
Work support	The settings for AV control unit functions can be changed.
Configuration	<ul style="list-style-type: none"> <li>• The vehicle specification can be read and saved.</li> <li>• The vehicle specification can be written when replacing AV control unit.</li> </ul>
CAN Diag Support Mntr	<ul style="list-style-type: none"> <li>• The result of transmit/receive diagnosis of AV communication is displayed.</li> <li>• The result of transmit/receive diagnosis of CAN communication is displayed.</li> </ul>

## ECU IDENTIFICATION

The part number of AV control unit is displayed.

## SELF DIAGNOSTIC RESULT

Refer to [AV-179, "DTC Index"](#).

## DATA MONITOR

Monitor Item [Unit]	Description
VHCL SPD SIG [On/Off]	Indicates vehicle speed signal received from combination meter on CAN communication line.
PKB SIG [On/Off]	Indicates condition of park brake signal.
ILLUM SIG [On/Off]	Indicates condition of illumination signal for the A/C and AV switch assembly.
IGN SIG [On/Off]	Indicates condition of ignition signal.
REV SIG [On/Off]	Indicates condition of reverse signal received from BCM.

## WORK SUPPORT

Conditions	Description
ST ANGLE SENSOR ADJUSTMENT	Steering angle sensor neutral position adjustment can be performed. Refer to <a href="#">BRC-60, "Description"</a> .

## CONFIGURATION

Refer to [AV-222, "CONFIGURATION \(AV CONTROL UNIT\) : Description"](#).

## CAN DIAG SUPPORT MNTR

Refer to [LAN-23, "CAN Diagnostic Support Monitor"](#).

# DIAGNOSIS SYSTEM (BLUETOOTH® CONTROL UNIT)

< SYSTEM DESCRIPTION >

[BOSE AUDIO WITHOUT NAVIGATION]

## DIAGNOSIS SYSTEM (BLUETOOTH® CONTROL UNIT)

### Diagnosis Description

INFOID:000000009724880

The Bluetooth® control unit has two diagnostic checks. The first diagnostic check is performed automatically every ignition cycle during control unit initialization. The second diagnostic check is performed by the technician using the steering wheel audio control switches prior to trouble diagnosis.

### Bluetooth® CONTROL UNIT INITIALIZATION CHECKS

- Internal control unit failure
- Bluetooth® antenna connection open or shorted
- Steering wheel audio control switches [☎ (PHONE/SEND), ☎ (PHONE/END)] stuck closed
- Vehicle speed pulse count
- Microphone connection test (with playback to operator)
- Bluetooth® inquiry check

### OPERATION PROCEDURE

1. Turn ignition switch to ACC or ON.
2. Wait for the Bluetooth® system to complete initialization. This may take up to 20 seconds.
3. Press and hold the steering wheel audio control switch ☎ (PHONE/SEND) button for at least 5 seconds. The Bluetooth® system will begin to play a verbal prompt.

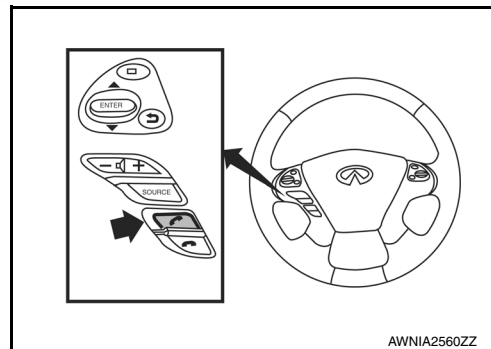

4. While the prompt is playing, press and hold the steering wheel audio control switch ☎ (PHONE/END) button until you hear the "Diagnostics mode" prompt. The Bluetooth® system will sound a 5-second beep.
5. While the beep is sounding, press and hold the steering wheel audio control switch ☎ (PHONE/END) button again until you hear prompts.
6. The Bluetooth® system has now entered into the diagnostic mode. Results of the diagnostic checks will be verbalized to the technician. Refer to [AV-172, "Work Flow"](#).
7. After the failure records are reported, an interactive microphone test will be performed. Follow the voice prompt. If the microphone test fails, refer to [AV-172, "Work Flow"](#).

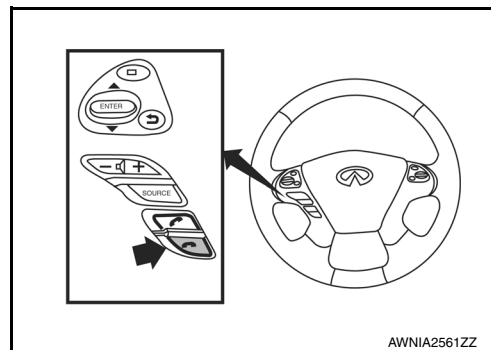

### Work Flow

INFOID:000000009724881

Failure Message	Action
"Internal failure"	Replace Bluetooth® control unit. Refer to <a href="#">AV-318, "Removal and Installation"</a> .
"Bluetooth® antenna open"	<ol style="list-style-type: none"> <li>1. Inspect harness connection.</li> <li>2. Replace Bluetooth® antenna. Refer to <a href="#">AV-318, "Removal and Installation"</a>.</li> </ol>
"Bluetooth® antenna shorted"	
"Phone/Send for Hands Free System is stuck"	Check steering wheel audio control switches. Refer to <a href="#">AV-293, "Diagnosis Procedure"</a> .
"Phone/End for the Hands Free System is stuck"	
"Microphone test" (failed interactive test)	<ol style="list-style-type: none"> <li>1. Inspect harness between Bluetooth® control unit and microphone.</li> <li>2. Replace microphone. Refer to <a href="#">AV-319, "Removal and Installation"</a>.</li> </ol>

# AV CONTROL UNIT

< ECU DIAGNOSIS INFORMATION >

[BOSE AUDIO WITHOUT NAVIGATION]

## ECU DIAGNOSIS INFORMATION

### AV CONTROL UNIT

#### Reference Value

INFOID:000000009724882

#### VALUES ON THE DIAGNOSIS TOOL

Monitor Item	Condition	Value/Status
VHCL SPD SIG	Vehicle speed = 0 km/h (0 MPH).	Off
	Vehicle speed > 0 km/h (0 MPH).	On
PKB SIG	Parking brake released.	Off
	Parking brake applied.	On
ILLUM SIG	Illumination signal is not received.	Off
	Illumination signal is received.	On
IGN SIG	Ignition switch OFF or ACC.	Off
	Ignition switch ON.	On
REV SIG	Selector lever in any position other than R.	Off
	Selector lever in R position.	On

#### TERMINAL LAYOUT

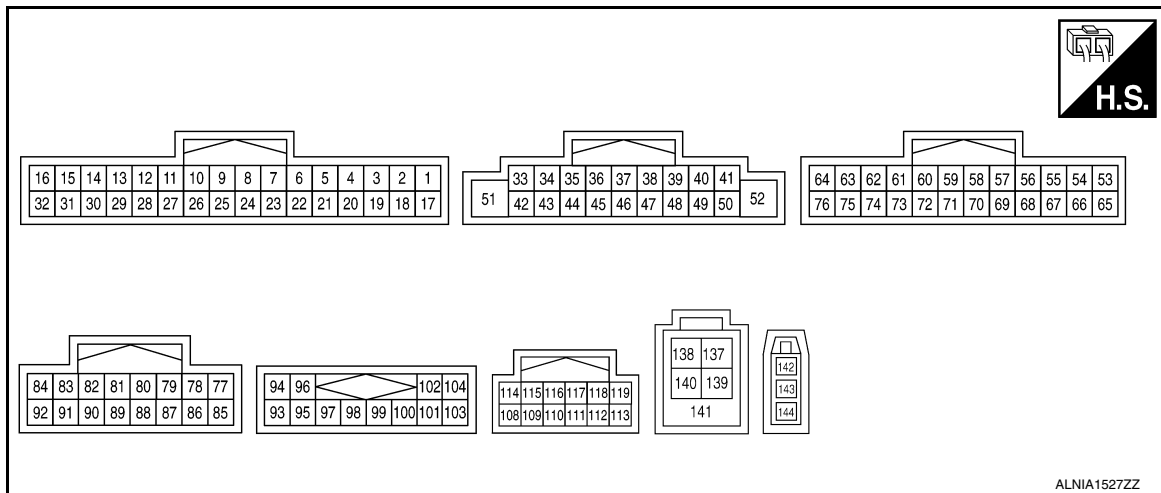

#### PHYSICAL VALUES

Terminal No. (Wire color)	Description	Condition	Value (Approx.)
+ -	Signal name Input/ Output	Ignition switch Operation	
5 (W)	Bluetooth® voice signal Input	ON During voice guide output with  switch pressed	 SKIB3609E
6 (Shield)	Bluetooth® voice signal shield	-	-

# AV CONTROL UNIT

< ECU DIAGNOSIS INFORMATION >



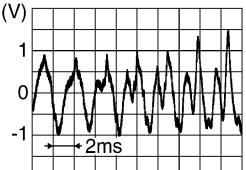
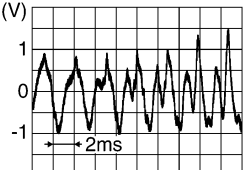
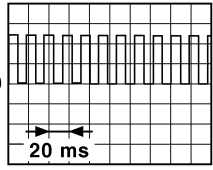

[BOSE AUDIO WITHOUT NAVIGATION]

Terminal No. (Wire color)		Description	Input/ Output	Condition		Value (Approx.)
+	-			Signal name	Ignition switch	
10 (V)	Ground	Switch ground	—	ON	—	0 V
11 (L)	—	CAN-H	Input/ Output	—	—	—
12 (P)	—	CAN-L	Input/ Output	—	—	—
13 (SB)	—	AV communication signal (H)	Input/ Output	—	—	—
14 (LG)	—	AV communication signal (L)	Input/ Output	—	—	—
15 (SB)	—	AV communication signal (H)	Input/ Output	—	—	—
16 (LG)	—	AV communication signal (L)	Input/ Output	—	—	—
20 (R)	22 (B)	AUX sound signal RH	Input	ON	AUX mode selected	 <small>SKIB3609E</small>
21 (W)	22 (B)	AUX sound signal LH	Input	ON	AUX mode selected	 <small>SKIB3609E</small>
25 (Shield)	—	AUX sound signal shield	—	—	—	—
28 (Y)	Ground	Disk eject signal	Input	ON	Pressing eject switch	0 V
					Except above	5.0 V
29 (LG)	Ground	Ignition signal	Input	ON	—	Battery voltage
30 (R)	Ground	Reverse signal	Input	ON	Selector lever in R position	Battery voltage
					Selector lever in any position other than R	0 V
31 (G)	Ground	Parking brake signal	Input	ON	Parking brake applied	4.5 V
					Parking brake released	0 V
32 (BG)	Ground	Vehicle speed signal	Input	ON	Vehicle speed approx. 40 km/h (25 MPH)	<p><b>NOTE:</b> The maximum voltage varies depending on the specification (destination unit).</p>  <small>JSNIA0012GB</small>

# AV CONTROL UNIT

< ECU DIAGNOSIS INFORMATION >

[BOSE AUDIO WITHOUT NAVIGATION]

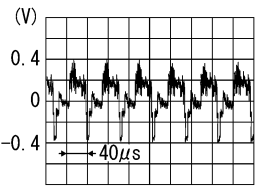
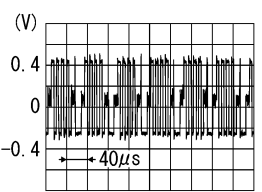
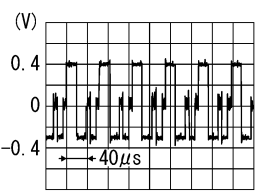
Terminal No. (Wire color)		Description		Condition		Value (Approx.)
+	-	Signal name	Input/ Output	Ignition switch	Operation	
38 (G)	47 (B)	Steering switch signal A	Input	ON	Press SOURCE switch	0V
					Press $\Delta$ switch	1.0V
					Press $\nabla$ switch	2.0V
					Press  switch	3.0V
					Press ENTER switch	4.0V
					Except above	5.0V
39 (P)	Ground	ACC power supply	Input	ACC	—	Battery voltage
41 (R)	Ground	Illumination signal	Input	OFF	Lighting switch OFF	0 V
					Lighting switch ON	Battery voltage
48 (W)	47 (B)	Steering switch signal B	Input	ON	Press -  switch	0V
					Press  + switch	1.0V
					Press  switch	2.0V
					Press  switch	3.0V
					Press DISP switch	4.0V
					Except above	5.0V
51 (Y)	Ground	Battery power supply	Input	OFF	—	Battery voltage
52 (GR)	Ground	Ground	—	ON	—	0 V
53 (B)	Ground	Composite image signal	Output	ON	Camera image or AUX im- age displayed	 <p style="text-align: right; font-size: small;">SKIB2251J</p>
54 (W)	Ground	Composite image signal ground	—	ON	—	0 V
55 (W)	Ground	RGB signal (B: blue)	Output	ON	Begin Confirmation/Adjust- ment mode, then select "Color Spectrum Bar"	 <p style="text-align: right; font-size: small;">SKIB2237J</p>
56 (B)	Ground	RGB signal (G: green)	Output	ON	Begin Confirmation/Adjust- ment mode, then select "Color Spectrum Bar"	 <p style="text-align: right; font-size: small;">SKIB2236J</p>

A  
B  
C  
D  
E  
F  
G  
H  
I  
J  
K  
L  
M  
O  
P

AV

# AV CONTROL UNIT

< ECU DIAGNOSIS INFORMATION >

[BOSE AUDIO WITHOUT NAVIGATION]

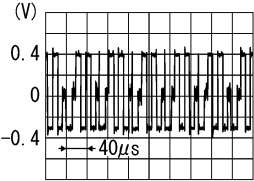
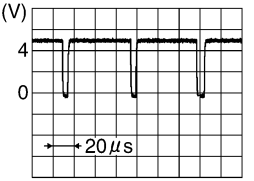
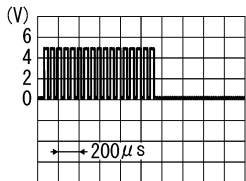
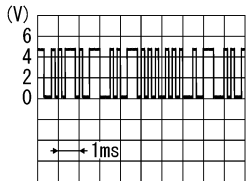
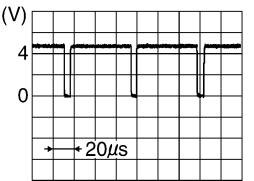
Terminal No. (Wire color)		Description		Condition		Value (Approx.)
+	-	Signal name	Input/ Output	Ignition switch	Operation	
57 (R)	Ground	RGB signal (R: red)	Output	ON	Begin Confirmation/Adjustment mode, then select "Color Spectrum Bar"	 <p style="text-align: right; font-size: small;">SKIB2238J</p>
58 (B)	Ground	RGB synchronizing signal	Output	ON	—	 <p style="text-align: right; font-size: small;">SKIB3603E</p>
59 (Shield)	—	Synchronizing signal shield	—	—	—	—
60 (W)	Ground	RGB area (YS) signal	Output	ON	RGB image displayed	5.0 V
					AUX image displayed	 <p style="text-align: right; font-size: small;">PKIB4948J</p>
61 (B)	Ground	Communication signal (DISP→CONT)	Input	ON	Adjusting display brightness	 <p style="text-align: right; font-size: small;">PKIB5039J</p>
62 (G)	Ground	Horizontal synchronizing (HP) signal	Input	ON	—	 <p style="text-align: right; font-size: small;">SKIB3601E</p>
63 (B)	Ground	Signal ground	—	OFF	—	0 V
64 (V)	Ground	Signal VCC	Output	ACC	—	9.0 V
66 (Shield)	—	Composite image signal shield	—	—	—	—
67 (Shield)	—	RGB signal shield	—	—	—	—
72 (Shield)	—	Display communication signal shield	—	—	—	—



# AV CONTROL UNIT

< ECU DIAGNOSIS INFORMATION >

[BOSE AUDIO WITHOUT NAVIGATION]

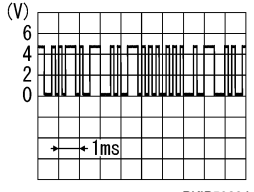
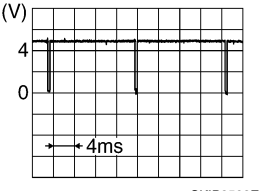
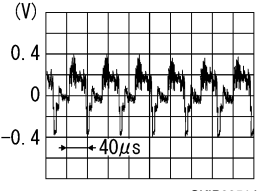
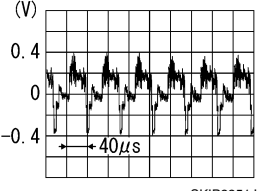
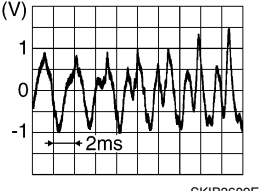
Terminal No. (Wire color)		Description		Condition		Value (Approx.)
+	-	Signal name	Input/ Output	Ignition switch	Operation	
73 (W)	Ground	Communication signal (CONT→DISP)	Output	ON	Adjusting display bright- ness	 <p style="text-align: right; font-size: small;">PKIB5039J</p>
74 (R)	Ground	Vertical synchronizing (VP) signal	Input	ON	—	 <p style="text-align: right; font-size: small;">SKIB3598E</p>
75 (LG)	Ground	Inverter ground	—	OFF	—	0 V
76 (L)	Ground	Inverter VCC	Output	ACC	—	9.0 V
82 (W)	Ground	Camera image signal	Input	ON	Camera image displayed	 <p style="text-align: right; font-size: small;">SKIB2251J</p>
83 (W)	Ground	AUX image signal	Input	ON	AUX image displayed	 <p style="text-align: right; font-size: small;">SKIB2251J</p>
87 (R)	Ground	Camera power supply	Output	ON	Selector lever in "R" posi- tion	6.0 V
88 (B)	Ground	Camera ground	—	ON	—	0 V
89 (Shield)	—	Camera image signal shield	—	—	—	—
90 (Shield)	—	AUX image signal shield	—	—	—	—
91 (B)	Ground	AUX image signal ground	—	ON	—	0 V
94 (B)	93 (W)	Satellite radio sound signal LH	Input	ON	Satellite radio mode select- ed	 <p style="text-align: right; font-size: small;">SKIB3609E</p>

A  
B  
C  
D  
E  
F  
G  
H  
I  
J  
K  
L  
M  
O  
P

AV

# AV CONTROL UNIT

< ECU DIAGNOSIS INFORMATION >

[BOSE AUDIO WITHOUT NAVIGATION]

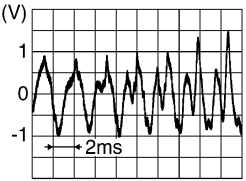
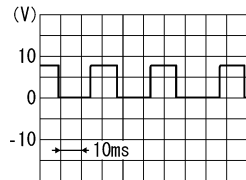
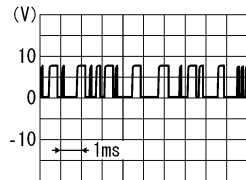
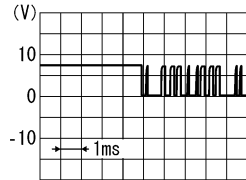
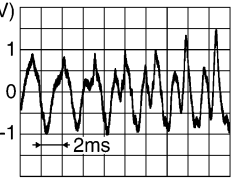
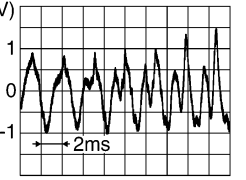
Terminal No. (Wire color)		Description	Input/ Output	Condition		Value (Approx.)
+	-			Signal name	Ignition switch	
96 (G)	95 (R)	Satellite radio sound signal RH	Input	ON	Satellite radio mode select- ed	 <p style="text-align: right; font-size: small;">SKIB3609E</p>
97 (Shield)	—	Satellite radio sound signal shield	—	—	—	—
98 (Shield)	—	Satellite communication signal shield	—	—	—	—
100 (W)	Ground	Request signal (SAT→CONT)	Input	ON	Satellite radio mode select- ed	 <p style="text-align: right; font-size: small;">SKIA9299J</p>
101 (B)	Ground	Communication signal (SAT→CONT)	Input	ON	Satellite radio mode select- ed	 <p style="text-align: right; font-size: small;">SKIA9300J</p>
102 (R)	Ground	Communication signal (CONT→SAT)	Output	ON	Satellite radio mode select- ed	 <p style="text-align: right; font-size: small;">SKIA9301J</p>
108 (B)	114 (W)	Pre amp sound signal rear RH	Output	ON	Sound output	 <p style="text-align: right; font-size: small;">SKIB3609E</p>
109 (W)	115 (B)	Pre amp sound signal front RH	Output	ON	Sound output	 <p style="text-align: right; font-size: small;">SKIB3609E</p>
110 (SB)	Ground	BOSE amp. ON signal	Output	ACC	—	Battery voltage

# AV CONTROL UNIT

< ECU DIAGNOSIS INFORMATION >

[BOSE AUDIO WITHOUT NAVIGATION]

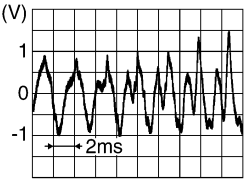
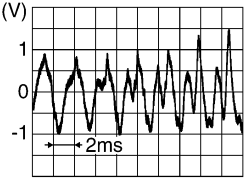
Terminal No. (Wire color)		Description		Condition		Value (Approx.)
+	-	Signal name	Input/ Output	Ignition switch	Operation	
111 (BR)	—	Pre amp sound signal shield	—	—	—	—
112 (B)	118 (W)	Pre amp sound signal rear LH	Output	ON	Sound output	 SKIB3609E
113 (B)	119 (W)	Pre amp sound signal front LH	Output	ON	Sound output	 SKIB3609E
137 (W)	—	V BUS signal	—	—	—	—
138 (G)	—	USB ground	—	—	—	—
139 (L)	—	USB D+ signal	—	—	—	—
140 (R)	—	USB D- signal	—	—	—	—
141 (Shield)	—	USB signal shield	—	—	—	—
142 (B)	—	AM - FM main	Input	—	—	—
143 (B)	—	Antenna amp. ON signal	Output	ON	—	Battery voltage
144 (B)	—	FM sub	Input	—	—	—

## DTC Index

INFOID:000000009724883

CONSULT Display	Reference Page
U1000: CAN COMM CIRCUIT	<a href="#">AV-224, "DTC Logic"</a>
U1010: CONTROL UNIT	<a href="#">AV-225, "DTC Logic"</a>
U1200: CONT UNIT	<a href="#">AV-226, "DTC Logic"</a>
U1216: CAN CONT	<a href="#">AV-227, "DTC Logic"</a>
U1231: AMP TEMP	<a href="#">AV-483, "DTC Logic"</a>
U1232: ST ANGLE SEN CALIB	<a href="#">AV-229, "DTC Logic"</a>
U1240: SWITCH CONN	<a href="#">AV-235, "Description"</a>
U1243: FRONT DISP CONN	<a href="#">AV-230, "DTC Logic"</a>
U1255: SAT CONN	<a href="#">AV-232, "DTC Logic"</a>
U1256: HAND FREE CONN	<a href="#">AV-235, "Description"</a>

## AV CONTROL UNIT

< ECU DIAGNOSIS INFORMATION >

[BOSE AUDIO WITHOUT NAVIGATION]

CONSULT Display	Reference Page
U1265: AMP ON TERMINAL (GND-SHORT or VB-SHORT)	<a href="#">AV-492, "DTC Logic"</a>
U1300: AV COMM CIRCUIT	<a href="#">AV-235, "Description"</a>
U1310: CONTROL UNIT	<a href="#">AV-236, "DTC Logic"</a>
U1601: FL-DOOR WOOFER/TWEETER (OPEN, SHORT, GND-SHORT)	<a href="#">AV-504, "DTC Logic"</a>
U1603: FL-DOOR WOOFER/TWEETER (VB-SHOR)	
U1609: FR-DOOR WOOFER/TWEETER (OPEN, SHORT, GND-SHORT)	
U160B: FR-DOOR WOOFER/TWEETER (VB-SHOR)	
U1627: F-INST L-TWEETER (OPEN, SHORT, GND-SHORT or VB-SHOR)	<a href="#">AV-505, "DTC Logic"</a>
U162F: F-INST R-TWEETER (OPEN, SHORT, GND-SHORT or VB-SHOR)	
U162A: F-INST C-SQAWK (OPEN, SHORT, GND-SHORT or VB-SHOR)	<a href="#">AV-506, "DTC Logic"</a>
U1684: 2L-DOOR SPEAKER/TWEETER (OPEN, SHORT, GND-SHORT)	<a href="#">AV-507, "DTC Logic"</a>
U1687: 2L-DOOR SPEAKER/TWEETER (VB-SHOR)	
U162C: 2R-DOOR SPEAKER/TWEETER (OPEN, SHORT, GND-SHORT)	
U162F: 2R-DOOR SPEAKER/TWEETER (VB-SHOR)	
U175D: R-LUGGAGE L-WOOFER (OPEN, SHORT, GND-SHORT or VB-SHOR)	<a href="#">AV-508, "DTC Logic"</a>
U176A: R-ROOF L-WK (OPEN, SHORT, GND-SHORT or VB-SHOR)	<a href="#">AV-509, "DTC Logic"</a>
U1772: R-ROOF R-WK (OPEN, SHORT, GND-SHORT or VB-SHOR)	

# DISPLAY UNIT

< ECU DIAGNOSIS INFORMATION >

[BOSE AUDIO WITHOUT NAVIGATION]

## DISPLAY UNIT

Reference Value

INFOID:000000009724884

### TERMINAL LAYOUT

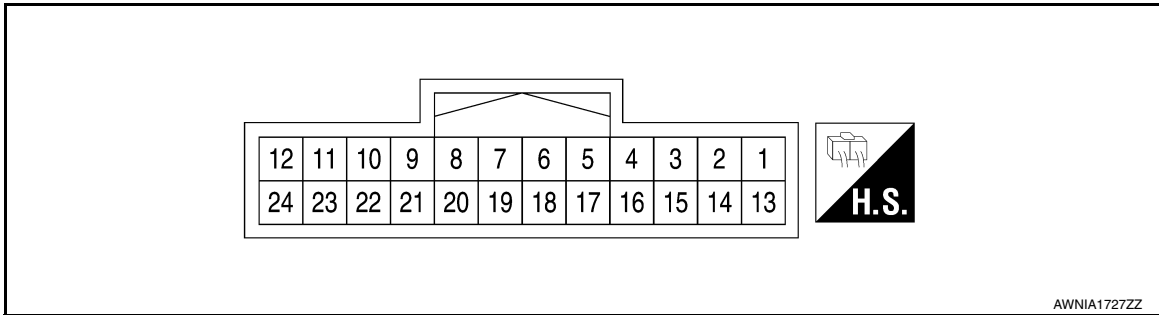

### PHYSICAL VALUES

Terminal (Wire color)		Description	Condition			Reference value (Approx.)
+	-	Signal name	Input/Output	Ignition switch	Operation	
1 (B)	Ground	Ground	—	ON	—	0V
2 (L)	Ground	Inverter VCC	Input	ACC	—	9V
3 (V)	Ground	Signal VCC	Input	ACC	—	9V
4 (W)	Ground	Composite image ground	—	ON	—	0V
5 (Shield)	—	Composite image signal shield	—	—	—	—
6 (B)	Ground	RGB signal (G: green)	Input	ON	Begin Confirmation/Adjustment mode, then select "Color Spectrum Bar"	<p>JSNIA1030ZZ</p>
7 (Shield)	—	RGB signal shield	—	—	—	—
8 (G)	Ground	Horizontal synchronizing (HP) signal	Output	ON	—	<p>SKIB3601E</p>

# DISPLAY UNIT

< ECU DIAGNOSIS INFORMATION >

[BOSE AUDIO WITHOUT NAVIGATION]

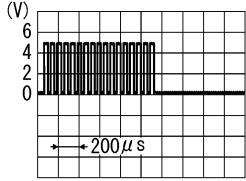
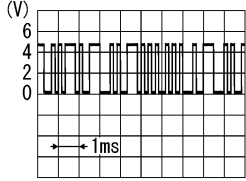
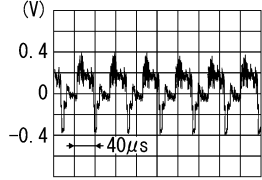
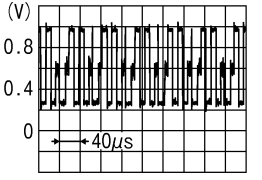
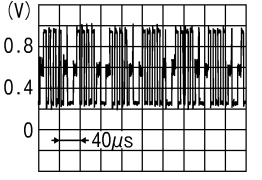
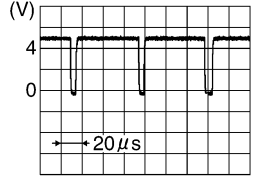
Terminal (Wire color)		Description		Condition		Reference value (Approx.)
+	-	Signal name	Input/ Output	Ignition switch	Operation	
9 (W)	Ground	RGB area (YS) signal	Input	ON	RGB image displayed	5V
					DVD image displayed	 <p style="text-align: right; font-size: small;">PKIB4948J</p>
11 (W)	Ground	Communication signal (CONT→DISP)	Input	ON	Adjusting display bright- ness	 <p style="text-align: right; font-size: small;">PKIB5039J</p>
13 (LG)	Ground	Inverter ground	—	ON	—	0V
14 (B)	Ground	Signal ground	—	ON	—	0V
15 (B)	Ground	Composite image signal	Input	ON	Camera image displayed	 <p style="text-align: right; font-size: small;">SKIB2251J</p>
17 (R)	Ground	RGB signal (R: red)	Input	ON	Begin Confirmation/Adjust- ment mode, then select "Color Spectrum Bar"	 <p style="text-align: right; font-size: small;">JSNIA1029ZZ</p>
18 (W)	Ground	RGB signal (B: blue)	Input	ON	Begin Confirmation/Adjust- ment mode, then select "Color Spectrum Bar"	 <p style="text-align: right; font-size: small;">JSNIA1031ZZ</p>
19 (B)	Ground	RGB synchronizing signal	Input	ON	—	 <p style="text-align: right; font-size: small;">SKIB3603E</p>

# DISPLAY UNIT

< ECU DIAGNOSIS INFORMATION >

[BOSE AUDIO WITHOUT NAVIGATION]

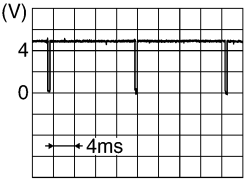
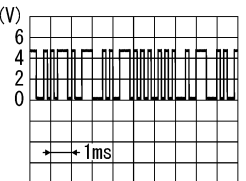
Terminal (Wire color)		Description		Condition		Reference value (Approx.)
+	-	Signal name	Input/ Output	Ignition switch	Operation	
20 (R)	Ground	Vertical synchronizing (VP) signal	Output	On	—	 <p style="text-align: right; font-size: small;">SKIB3598E</p>
21 (Shield)	—	Synchronizing signal shield	—	—	—	—
22 (B)	Ground	Communication signal (DISP→CONT)	Output	ON	Adjusting display bright- ness	 <p style="text-align: right; font-size: small;">PKIB5039J</p>
23 (Shield)	—	Communication signal shield	—	—	—	—

A  
B  
C  
D  
E  
F  
G  
H  
I  
J  
K  
L  
M  
AV  
O  
P

# BOSE AMP.

< ECU DIAGNOSIS INFORMATION >

[BOSE AUDIO WITHOUT NAVIGATION]

## BOSE AMP.

### Reference Value

INFOID:000000009729120

### TERMINAL LAYOUT

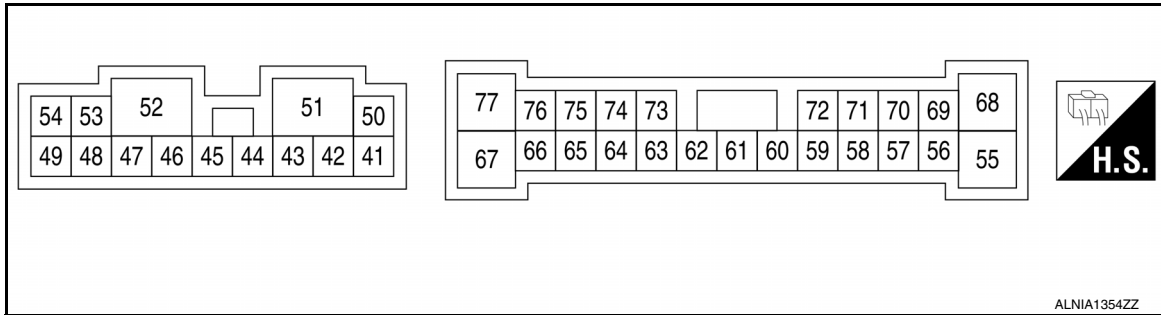

### PHYSICAL VALUES

Terminal (Wire color)		Description	Condition			Reference value (Approx.)
+	-	Signal name	Input/ Output	Ignition switch	Operation	
41 (R)	42 (G)	Sound signal tweeter LH	Output	ON	Sound output	 SKIB3609E
44 (W)	43 (G)	Sound signal rear side speaker RH	Output	ON	Sound output	 SKIB3609E
45 (G)	46 (W)	Sound signal tweeter RH	Output	ON	Sound output	 SKIB3609E
47 (B)	—	Ground	—	ON	—	0 V
50 (LG)	Ground	Battery power supply	Input	OFF	—	Battery voltage
51 (Y)	Ground	Battery power supply	Input	OFF	—	Battery voltage
52 (B)	—	Ground	—	ON	—	0 V



# BOSE AMP.

< ECU DIAGNOSIS INFORMATION >

[BOSE AUDIO WITHOUT NAVIGATION]

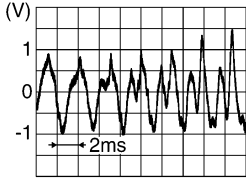
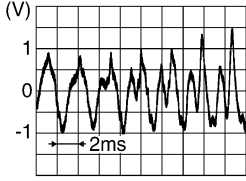
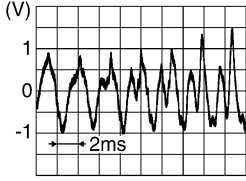
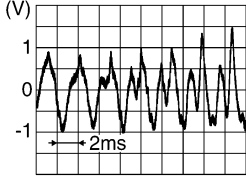
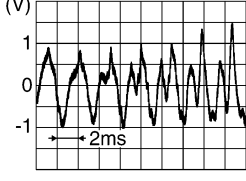
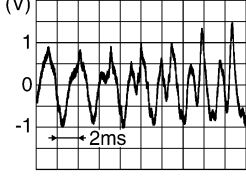
Terminal (Wire color)		Description		Condition		Reference value (Approx.)
+	-	Signal name	Input/ Output	Ignition switch	Operation	
53 (W)	48 (G)	Sound signal rear side speaker LH	Output	ON	Sound output	 <p style="text-align: right; font-size: small;">SKIB3609E</p>
54 (G)	49 (W)	Sound signal rear door speaker RH	Output	ON	Sound output	 <p style="text-align: right; font-size: small;">SKIB3609E</p>
57 (W)	56 (B)	Sound signal subwoofer	Output	ON	Sound output	 <p style="text-align: right; font-size: small;">SKIB3609E</p>
58 (G)	59 (R)	Sound signal front door speaker and front tweeter LH	Output	ON	Sound output	 <p style="text-align: right; font-size: small;">SKIB3609E</p>
60 (W)	Ground	BOSE amp. ON signal	Input	ON	—	Battery voltage
61 (Shield)	—	Subwoofer sound signal shield	—	—	—	—
62 (W)	—	—	—	—	—	—
64 (B)	63 (W)	Pre amp sound signal rear LH	Input	ON	Sound output	 <p style="text-align: right; font-size: small;">SKIB3609E</p>
66 (B)	65 (W)	Pre amp sound signal rear RH	Input	ON	Sound output	 <p style="text-align: right; font-size: small;">SKIB3609E</p>

A  
B  
C  
D  
E  
F  
G  
H  
I  
J  
K  
L  
M  
AV  
O  
P

# BOSE AMP.

< ECU DIAGNOSIS INFORMATION >

[BOSE AUDIO WITHOUT NAVIGATION]

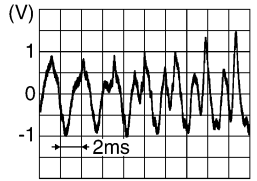
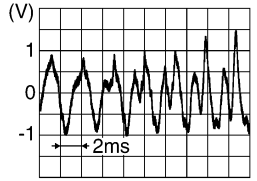
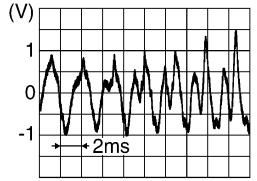
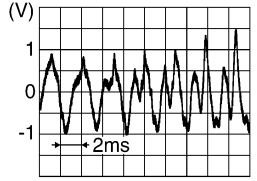
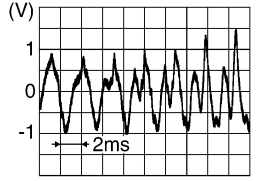
Terminal (Wire color)		Description	Condition			Reference value (Approx.)
+	-		Signal name	Input/ Output	Ignition switch	
68 (P)	55 (R)	Sound signal rear door speaker LH	Output	ON	Sound output	 <p>SKIB3609E</p>
69 (P)	70 (R)	Sound signal center speaker	Output	ON	Sound output	 <p>SKIB3609E</p>
71 (W)	72 (P)	Sound signal front door speaker and front tweeter RH	Output	ON	Sound output	 <p>SKIB3609E</p>
73 (B)	74 (W)	Pre amp sound signal front RH	Input	ON	Sound output	 <p>SKIB3609E</p>
75 (B)	76 (W)	Pre amp sound signal front LH	Input	ON	Sound output	 <p>SKIB3609E</p>

# SATELLITE RADIO TUNER

< ECU DIAGNOSIS INFORMATION >

[BOSE AUDIO WITHOUT NAVIGATION]

## SATELLITE RADIO TUNER

Reference Value

INFOID:000000009724885

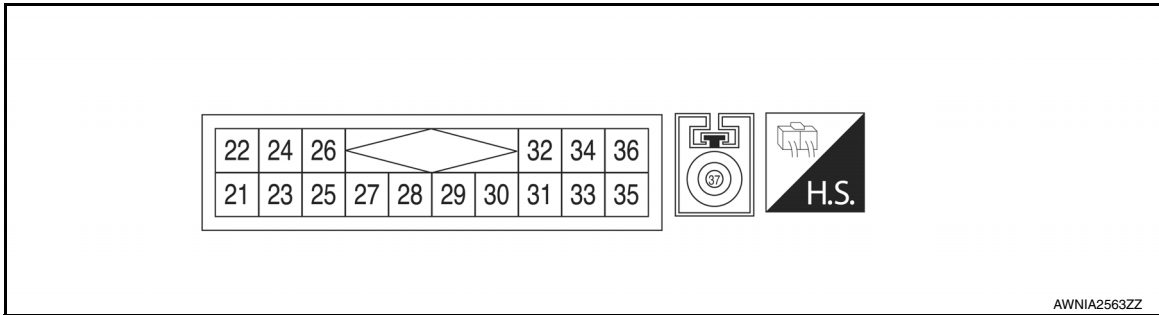

### PHYSICAL VALUES

Terminal (Wire color)		Description	Condition			Reference value (Approx.)
+	-	Signal name	Input/ Output	Ignition switch	Operation	
22 (B)	21 (W)	Satellite radio sound signal LH	Output	ON	Satellite radio mode select- ed	 SKIB3609E
24 (G)	23 (R)	Satellite radio sound signal RH	Output	ON	Satellite radio mode select- ed	 SKIB3609E
25 (Shield)	—	Satellite radio sound signal shield	—	—	—	—
26 (Shield)	—	Satellite control signal shield	—	—	—	—
28 (W)	Ground	Request signal (SAT→CONT)	Output	ON	Satellite radio mode select- ed	 SKIA9299J
29 (R)	Ground	Communication signal (SAT→CONT)	Output	ON	Satellite radio mode select- ed	 SKIA9300J

A  
B  
C  
D  
E  
F  
G  
H  
I  
J  
K  
L  
M  
AV  
O  
P

# SATELLITE RADIO TUNER

< ECU DIAGNOSIS INFORMATION >

[BOSE AUDIO WITHOUT NAVIGATION]

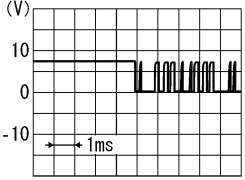
Terminal (Wire color)		Description		Condition		Reference value (Approx.)
+	-	Signal name	Input/ Output	Ignition switch	Operation	
30 (B)	Ground	Communication signal (CONT→SAT)	Input	ON	Satellite radio mode select- ed	 <p style="text-align: right; font-size: small;">SKIA9301J</p>
32 (SB)	Ground	Battery power supply	Input	OFF	—	Battery voltage
35 (GR)	Ground	Ground	—	ON	—	0V
36 (BG)	Ground	ACC power supply	Input	ACC	—	Battery voltage
37 (B)	—	Satellite antenna	—	—	—	—

# BLUETOOTH® CONTROL UNIT

< ECU DIAGNOSIS INFORMATION >

[BOSE AUDIO WITHOUT NAVIGATION]

## BLUETOOTH® CONTROL UNIT

Reference Value

INFOID:000000009724886

### TERMINAL LAYOUT

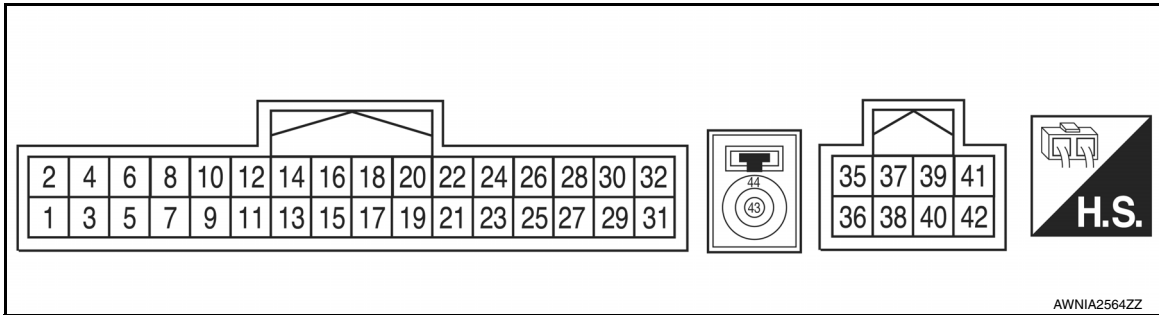

### PHYSICAL VALUES

Terminal (wire color)		Description		Condition		Reference value (Approx.)
+	-	Signal name	Input/output	Ignition switch	Operation	
1 (Y)	Ground	Battery power	Input	-	-	Battery voltage
2 (R)	Ground	ACC power	Input	ACC or ON	-	Battery voltage
3 (P)	Ground	IGN power	Input	ON or START	-	Battery voltage
4 (B)	Ground	Ground	-	ON	-	0V
5 (Shield)	-	Audio out shield	-	-	-	-
7 (B)	8 (Shield)	MIC in signal	Input	-	-	-
9 (W)	10 (B)	Audio out	Output	ACC or ON	Bluetooth® control unit sends audio signal	<p>SKIB3609E</p>
20 (B)	Ground	Ground	-	ON	-	0V
23 (B)	Ground	Ground	-	ON	-	0V
24 (B)	Ground	Ground	-	ON	-	0V
27 (B)	Ground	Ground	-	ON	-	0V

# BLUETOOTH® CONTROL UNIT

< ECU DIAGNOSIS INFORMATION >

[BOSE AUDIO WITHOUT NAVIGATION]

Terminal (wire color)		Description	Input/ output	Condition		Reference value (Approx.)
+	-			Signal name	Ignition switch	
28 (V)	Ground	Vehicle speed signal (8-pulse)	Input	ON	When vehicle speed is approx. 40 km/h (25 MPH)	
29 (W)	Ground	Microphone power	Output	ON	-	5V
35 (SB)	-	AV communication (H)	-	-	-	-
36 (LG)	-	AV communication (L)	-	-	-	-
43 (B)	-	Bluetooth® antenna	-	-	-	-
44 (Shield)	-	Bluetooth® antenna shield	-	-	-	-

# BOSE AUDIO WITHOUT NAVIGATION

[BOSE AUDIO WITHOUT NAVIGATION]

< WIRING DIAGRAM >

## WIRING DIAGRAM

### BOSE AUDIO WITHOUT NAVIGATION

#### Wiring Diagram

INFOID:000000009724887

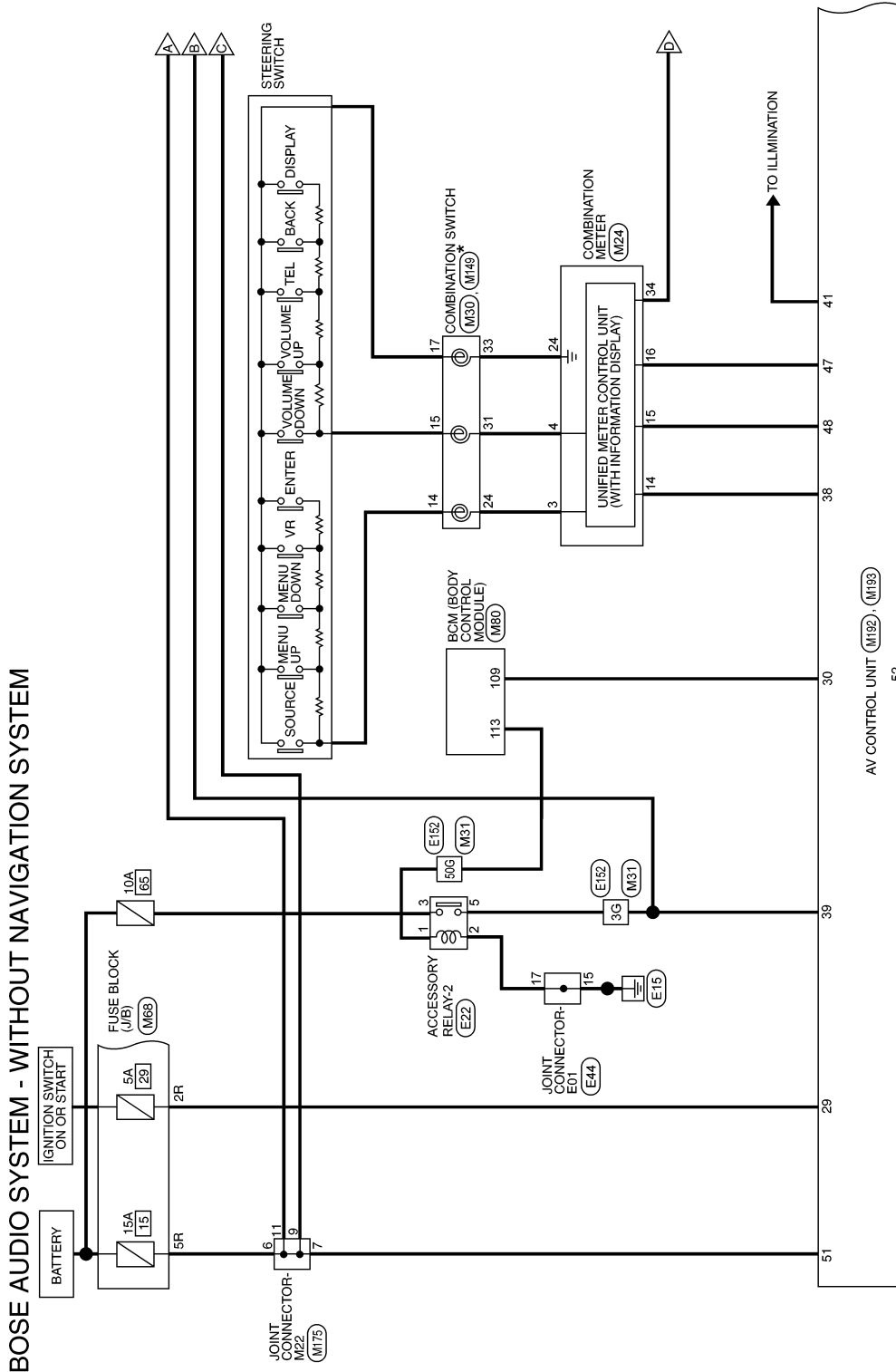

\* : THIS CONNECTOR IS NOT SHOWN IN "HARNESS LAYOUT" OF PG SECTION.

ABNWA1818GB

A  
B  
C  
D  
E  
F  
G  
H  
I  
J  
K  
L  
M  
N  
O  
P

AV

# BOSE AUDIO WITHOUT NAVIGATION

## [BOSE AUDIO WITHOUT NAVIGATION]

< WIRING DIAGRAM >

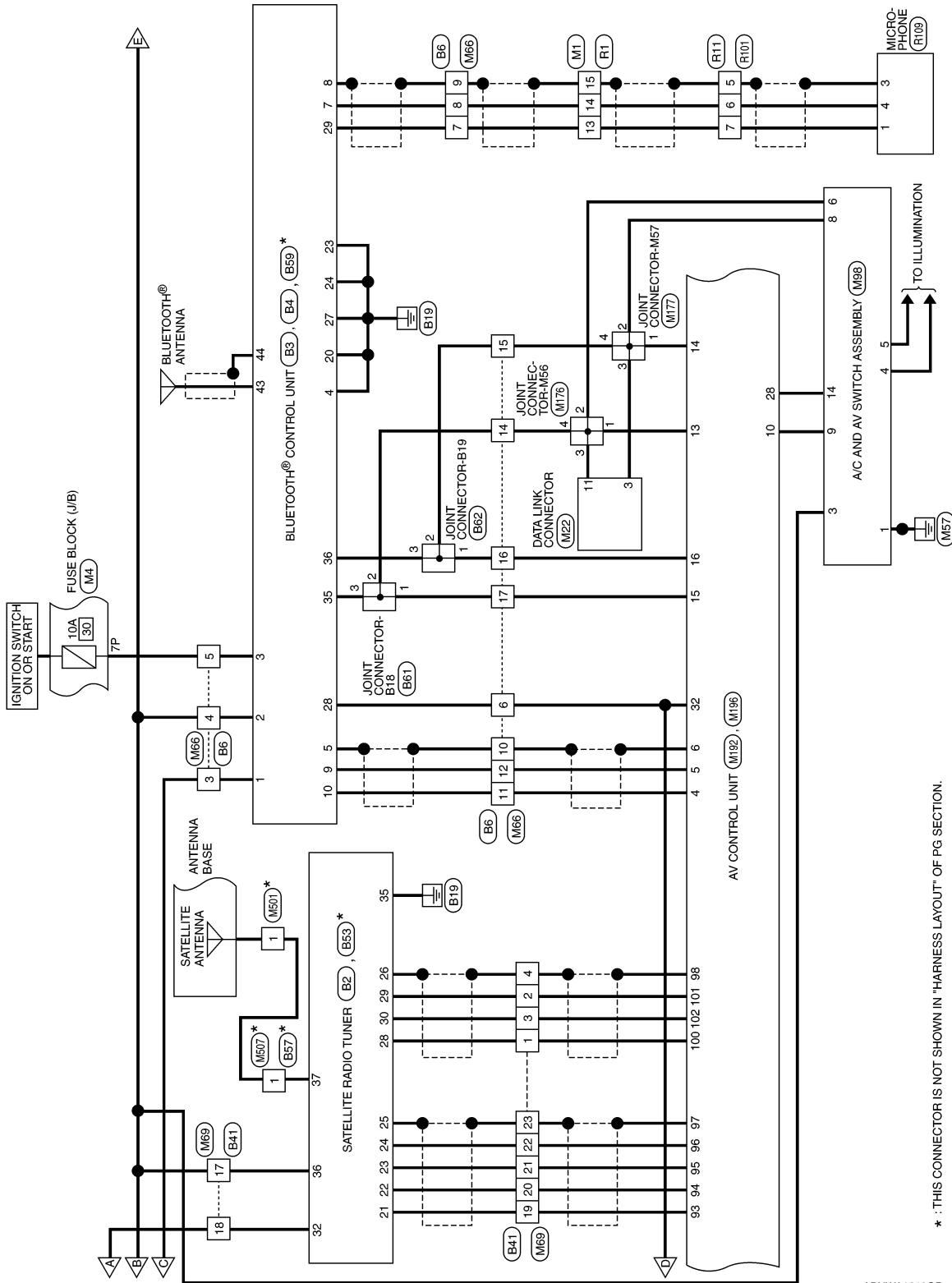

\* : THIS CONNECTOR IS NOT SHOWN IN "HARNES LAYOUT" OF PG SECTION.

ABNWA1819GB



# BOSE AUDIO WITHOUT NAVIGATION

[BOSE AUDIO WITHOUT NAVIGATION]

< WIRING DIAGRAM >

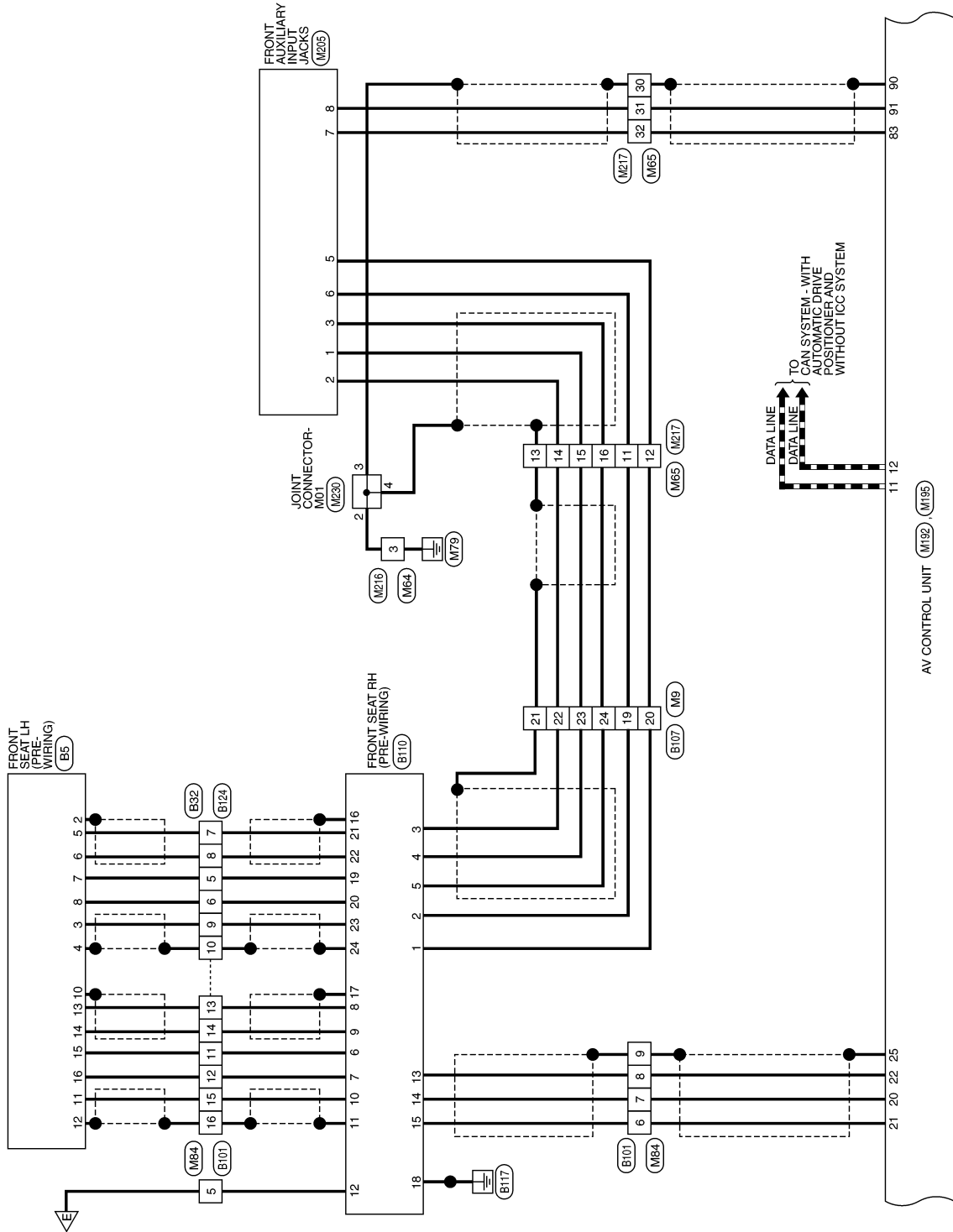

ABNWA1820GB

A  
B  
C  
D  
E  
F  
G  
H  
I  
J  
K  
L  
M  
N  
O  
P

AV

# BOSE AUDIO WITHOUT NAVIGATION

< WIRING DIAGRAM >

[BOSE AUDIO WITHOUT NAVIGATION]

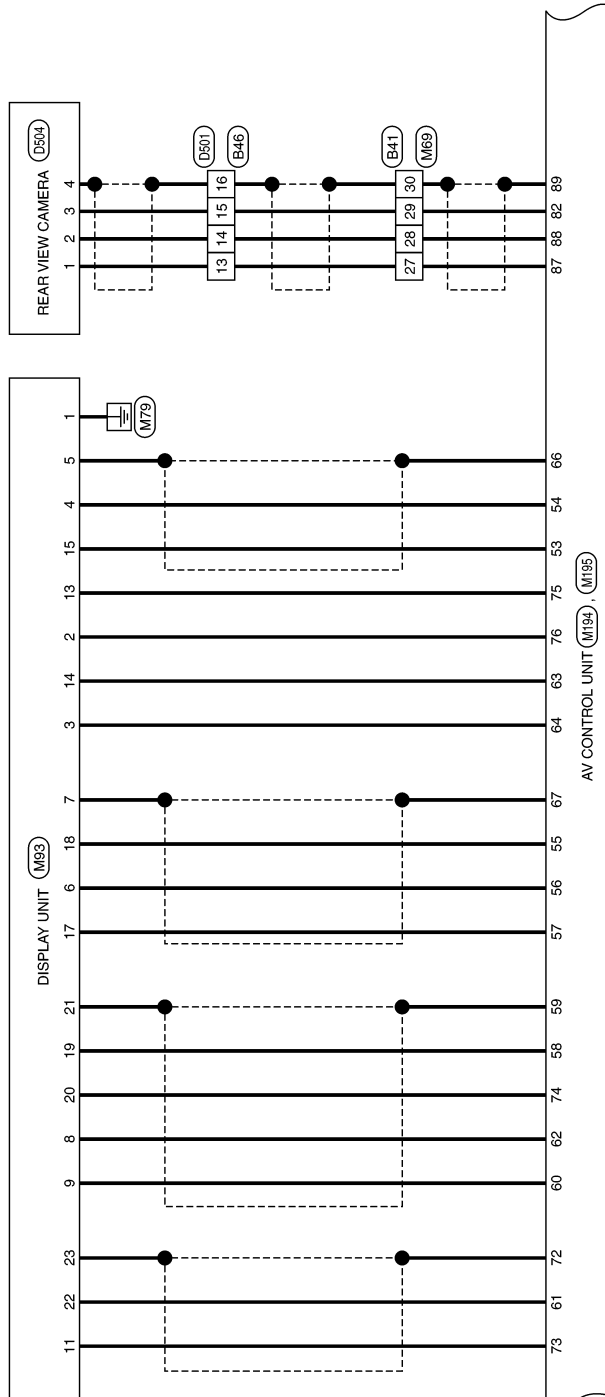

ABNWA1821GB

# BOSE AUDIO WITHOUT NAVIGATION

< WIRING DIAGRAM >

[BOSE AUDIO WITHOUT NAVIGATION]

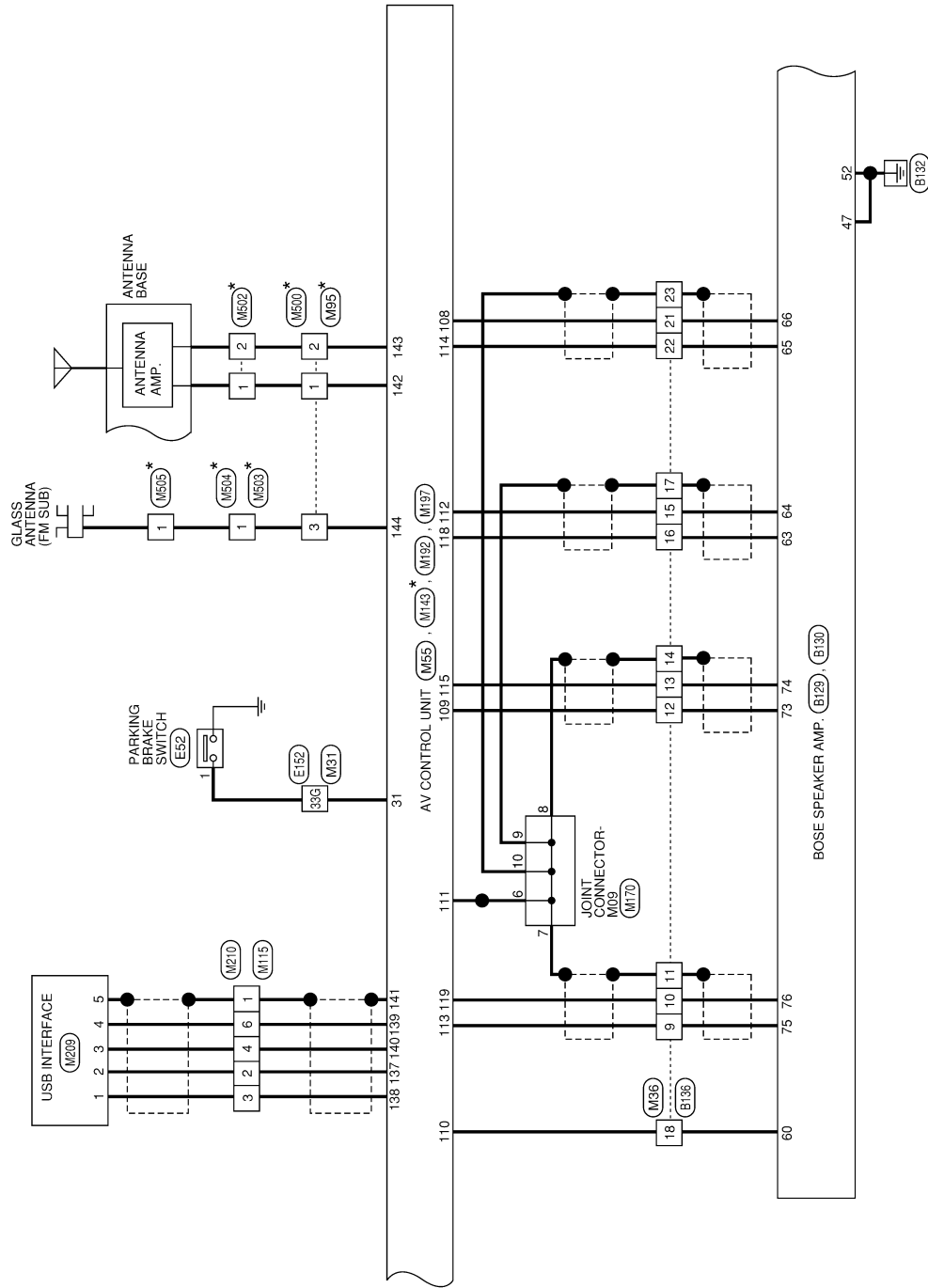

\* : THIS CONNECTOR IS NOT SHOWN IN "HARNESS LAYOUT" OF PG SECTION.

ABNWA1822GB

A  
B  
C  
D  
E  
F  
G  
H  
I  
J  
K  
L  
M  
N  
O  
P

AV

# BOSE AUDIO WITHOUT NAVIGATION

## [BOSE AUDIO WITHOUT NAVIGATION]

< WIRING DIAGRAM >

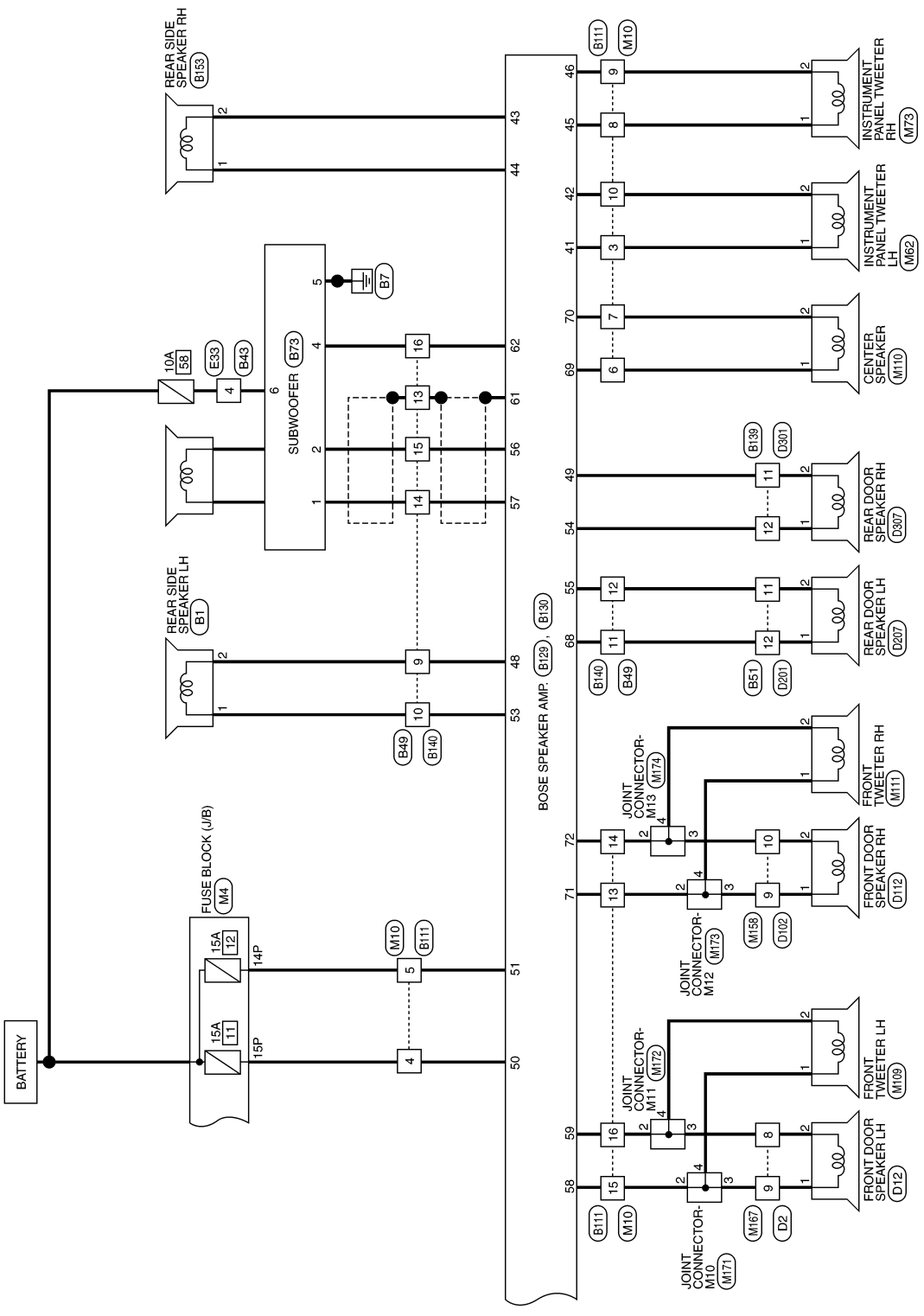

ABNWA1823GB

# BOSE AUDIO WITHOUT NAVIGATION

[BOSE AUDIO WITHOUT NAVIGATION]

< WIRING DIAGRAM >

## BOSE AUDIO SYSTEM CONNECTORS - WITHOUT NAVIGATION SYSTEM

Connector No.	M1
Connector Name	WIRE TO WIRE
Connector Color	WHITE



Terminal No.	Color of Wire	Signal Name
13	W	-
14	B	-
15	SHIELD	-

Connector No.	M4
Connector Name	FUSE BLOCK (J/B)
Connector Color	WHITE



Terminal No.	Color of Wire	Signal Name
7P	LG	-
14P	Y	-
15P	L	-

Connector No.	M9
Connector Name	WIRE TO WIRE
Connector Color	WHITE

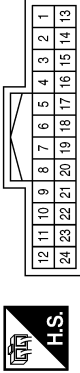

Terminal No.	Color of Wire	Signal Name
19	P	-
20	G	-
21	SHIELD	-
22	B	-
23	R	-
24	W	-

Connector No.	M10
Connector Name	WIRE TO WIRE
Connector Color	BROWN

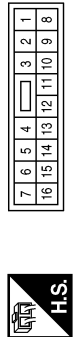

Terminal No.	Color of Wire	Signal Name
3	G	-
4	L	-
5	Y	-
6	G	-
7	W	-
8	G	-
9	W	-
10	W	-
13	G	-
14	W	-
15	P	- (WITH BOSE AUDIO SYSTEM WITHOUT SURROUND SOUND SYSTEM)
16	W	-

Connector No.	M22
Connector Name	DATA LINK CONNECTOR
Connector Color	WHITE

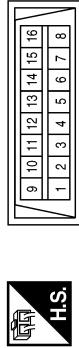

Terminal No.	Color of Wire	Signal Name
3	LG	-
11	SB	-

Connector No.	M24
Connector Name	COMBINATION METER
Connector Color	WHITE

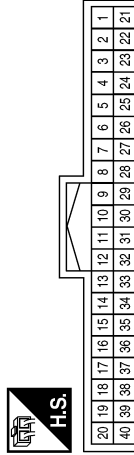

Terminal No.	Color of Wire	Signal Name
3	P	STRG SW INPUT1
4	BG	STRG SW INPUT 2
14	G	STRG SW OUTPUT1
15	W	STRG SW OUTPUT2
16	B	STRG SW OUTPUT GND
24	R	STRG SW GND
34	BG	SPEED 8 P/R

ABNIA4713GB

A B C D E F G H I J K L M O P

AV

# BOSE AUDIO WITHOUT NAVIGATION

[BOSE AUDIO WITHOUT NAVIGATION]

< WIRING DIAGRAM >

Terminal No.	Color of Wire	Signal Name
3G	P	-
33G	G	-
50G	L	-

Connector No.	M31
Connector Name	WIRE TO WIRE
Connector Color	WHITE

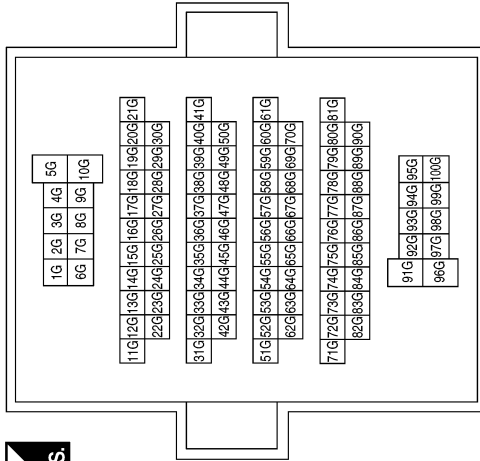

Connector No.	M30
Connector Name	COMBINATION SWITCH (SPIRAL CABLE)
Connector Color	GRAY

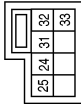

Terminal No.	Color of Wire	Signal Name
24	P	-
31	BG	-
33	R	-

Terminal No.	Color of Wire	Signal Name
16	W	-
17	SHIELD	-
18	SB	-
21	B	-
22	W	-
23	SHIELD	-

Terminal No.	Color of Wire	Signal Name
9	B	-
10	W	-
11	SHIELD	-
12	W	-
13	B	-
14	SHIELD	-
15	B	-

Connector No.	M36
Connector Name	WIRE TO WIRE
Connector Color	WHITE

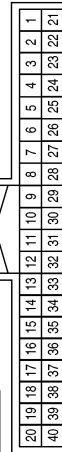

ABNIA4714GB

# BOSE AUDIO WITHOUT NAVIGATION

## [BOSE AUDIO WITHOUT NAVIGATION]

< WIRING DIAGRAM >

Connector No.	M64
Connector Name	WIRE TO WIRE
Connector Color	WHITE

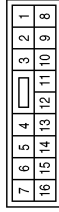

Terminal No.	Color of Wire	Signal Name
3	B	-

Connector No.	M62
Connector Name	INSTRUMENT PANEL TWEETER LH
Connector Color	BROWN



Terminal No.	Color of Wire	Signal Name
1	G	- (WITH BOSE AUDIO SYSTEM)
2	W	- (WITH BOSE AUDIO SYSTEM)

Connector No.	M55
Connector Name	AV CONTROL UNIT
Connector Color	BLUE

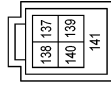

Terminal No.	Color of Wire	Signal Name
137	W	VBUS
138	G	USB GND
139	L	USB D+
140	R	USB D-
141	SHIELD	SHIELD

Terminal No.	Color of Wire	Signal Name
7	W	- (WITHOUT REAR ENTERTAINMENT SYSTEM)
8	B	- (WITHOUT REAR ENTERTAINMENT SYSTEM)
9	SHIELD	- (WITHOUT REAR ENTERTAINMENT SYSTEM)
10	SHIELD	-
11	B	- (WITHOUT REAR ENTERTAINMENT SYSTEM)
12	W	- (WITHOUT REAR ENTERTAINMENT SYSTEM)
14	SB	-
15	LG	-
16	LG	-
17	SB	-

Connector No.	M66
Connector Name	WIRE TO WIRE
Connector Color	WHITE

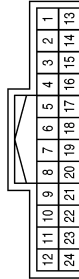

Terminal No.	Color of Wire	Signal Name
3	Y	- (WITHOUT REAR ENTERTAINMENT SYSTEM)
4	P	- (WITHOUT REAR ENTERTAINMENT SYSTEM)
5	LG	- (WITHOUT REAR ENTERTAINMENT SYSTEM)
6	BG	- (WITHOUT REAR ENTERTAINMENT SYSTEM)

Connector No.	M65
Connector Name	WIRE TO WIRE
Connector Color	WHITE

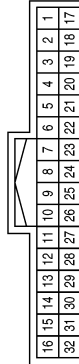

Terminal No.	Color of Wire	Signal Name
11	P	-
12	G	-
13	SHIELD	-
14	B	-
15	R	-
16	W	-
30	SHIELD	-
31	B	-
32	W	-

ABNIA4715GB

A  
B  
C  
D  
E  
F  
G  
H  
I  
J  
K  
L  
M  
N  
O  
P

AV

# BOSE AUDIO WITHOUT NAVIGATION

## [BOSE AUDIO WITHOUT NAVIGATION]

< WIRING DIAGRAM >

Terminal No.	Color of Wire	Signal Name
18	Y	-(WITHOUT NAVI)
19	W	-(WITHOUT NAVI)
20	B	-(WITHOUT NAVI)
21	R	-(WITHOUT NAVI)
22	G	-(WITHOUT NAVI)
23	SHIELD	-(WITHOUT NAVI)
27	R	-(WITHOUT NAVI)
28	B	-(WITHOUT NAVI)
29	W	-(WITHOUT NAVI)
30	SHIELD	-

Connector No.	M69
Connector Name	WIRE TO WIRE
Connector Color	WHITE

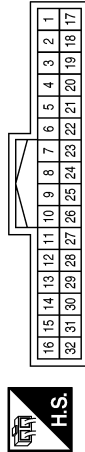

Terminal No.	Color of Wire	Signal Name
1	W	-(WITHOUT NAVI)
2	B	-(WITHOUT NAVI)
3	R	-(WITHOUT NAVI)
4	SHIELD	-
17	P	-(WITHOUT NAVI)

Connector No.	M68
Connector Name	FUSE BLOCK (J/B)
Connector Color	BROWN



Terminal No.	Color of Wire	Signal Name
2R	LG	-
5R	Y	-

Connector No.	M84
Connector Name	WIRE TO WIRE
Connector Color	WHITE

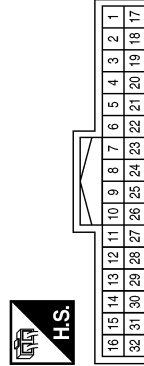

Terminal No.	Color of Wire	Signal Name
5	P	-(WITHOUT REAR ENTERTAINMENT SYSTEM)
6	W	-(WITHOUT REAR ENTERTAINMENT SYSTEM)
7	R	-(WITHOUT REAR ENTERTAINMENT SYSTEM)
8	B	-(WITHOUT REAR ENTERTAINMENT SYSTEM)
9	SHIELD	-

Connector No.	M80
Connector Name	BCM (BODY CONTROL MODULE)
Connector Color	BLACK

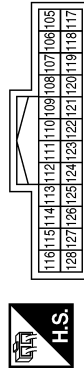

Terminal No.	Color of Wire	Signal Name
109	R	REVERSE SIGNAL
113	L	ACC RELAY OUT

Connector No.	M73
Connector Name	INSTRUMENT PANEL TWEETER RH
Connector Color	BROWN



Terminal No.	Color of Wire	Signal Name
1	G	-(WITH BOSE AUDIO SYSTEM)
2	W	-(WITH BOSE AUDIO SYSTEM)

ABNIA4716GB



# BOSE AUDIO WITHOUT NAVIGATION

## [BOSE AUDIO WITHOUT NAVIGATION]

< WIRING DIAGRAM >

Terminal No.	Color of Wire	Signal Name
18	W	B
19	B	RGB SYNC
20	R	VP
21	SHIELD	SYNC GND
22	B	UART OUT
23	SHIELD	UART GND
24	-	-

Terminal No.	Color of Wire	Signal Name
6	B	G
7	SHIELD	RGB GND
8	G	HP
9	W	YS
10	-	-
11	W	UART IN
12	-	-
13	LG	INV GND
14	B	SIG GND
15	B	COMP
16	-	-
17	R	R

Connector No.	M93
Connector Name	DISPLAY UNIT (WITHOUT NAVI)
Connector Color	WHITE

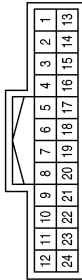

Terminal No.	Color of Wire	Signal Name
1	B	GND
2	L	INV VCC
3	V	SIG VCC
4	W	COMP GND
5	SHIELD	COMP SHIELD

Connector No.	M109
Connector Name	FRONT TWEETER LH
Connector Color	BROWN



Connector No.	M98
Connector Name	A/C AND AV SWITCH ASSEMBLY
Connector Color	WHITE

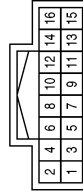

Connector No.	M95
Connector Name	WIRE TO WIRE
Connector Color	GRAY



Terminal No.	Color of Wire	Signal Name
1	P	-(WITH BOSE AUDIO SYSTEM WITHOUT SURROUND SOUND SYSTEM)
2	W	-(WITH BOSE AUDIO SYSTEM WITHOUT SURROUND SOUND SYSTEM)

Terminal No.	Color of Wire	Signal Name
1	GR	-
3	P	-
4	R	-
5	B	-
6	SB	-
8	LG	-
9	V	-
14	Y	-

Terminal No.	Color of Wire	Signal Name
1	B	-
2	B	-
3	B	-

ABNIA4717GB

A  
B  
C  
D  
E  
F  
G  
H  
I  
J  
K  
L  
M  
N  
O  
P

AV

# BOSE AUDIO WITHOUT NAVIGATION

< WIRING DIAGRAM >

[BOSE AUDIO WITHOUT NAVIGATION]

Connector No.	M110
Connector Name	CENTER SPEAKER
Connector Color	BROWN



Terminal No.	Color of Wire	Signal Name
1	G	-
2	W	-

Connector No.	M111
Connector Name	FRONT TWEETER RH
Connector Color	BROWN



Terminal No.	Color of Wire	Signal Name
1	G	-(WITH BOSE AUDIO SYSTEM WITHOUT SURROUND SOUND SYSTEM)
2	W	-(WITH BOSE AUDIO SYSTEM WITHOUT SURROUND SOUND SYSTEM)

Connector No.	M115
Connector Name	WIRE TO WIRE
Connector Color	GRAY

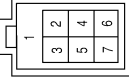

Terminal No.	Color of Wire	Signal Name
1	SHIELD	-
2	W	-
3	G	-
4	R	-
6	L	-

Connector No.	M143
Connector Name	AV CONTROL UNIT
Connector Color	GRAY



Terminal No.	Color of Wire	Signal Name
142	B	ANT +B
143	B	ANT MAIN
144	B	ANT SUB

Connector No.	M149
Connector Name	COMBINATION SWITCH (SPIRAL CABLE)
Connector Color	GRAY

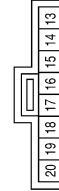

Terminal No.	Color of Wire	Signal Name
14	B	-
15	GR	-
17	BR	-

Connector No.	M158
Connector Name	WIRE TO WIRE
Connector Color	WHITE



Terminal No.	Color of Wire	Signal Name
9	G	-(WITH BOSE AUDIO SYSTEM)
10	W	-(WITH BOSE AUDIO SYSTEM)

# BOSE AUDIO WITHOUT NAVIGATION

< WIRING DIAGRAM >

[BOSE AUDIO WITHOUT NAVIGATION]

Connector No.	M171
Connector Name	JOINT CONNECTOR-M10
Connector Color	WHITE

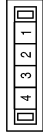

Terminal No.	Color of Wire	Signal Name
2	P	-(WITH BOSE AUDIO SYSTEM)
3	P	-(WITH BOSE AUDIO SYSTEM)
4	P	-(WITH BOSE AUDIO SYSTEM)

Connector No.	M170
Connector Name	JOINT CONNECTOR-M09
Connector Color	WHITE

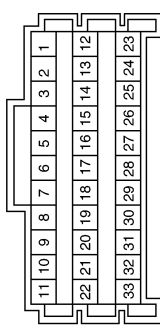

Terminal No.	Color of Wire	Signal Name
6	GR	-
7	SHIELD	-
8	SHIELD	-
9	SHIELD	-
10	SHIELD	-

Connector No.	M167
Connector Name	WIRE TO WIRE
Connector Color	WHITE

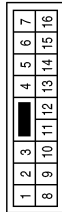

Terminal No.	Color of Wire	Signal Name
8	W	-(WITH BOSE AUDIO SYSTEM)
9	P	-(WITH BOSE AUDIO SYSTEM WITHOUT SURROUND SOUND SYSTEM)

Connector No.	M174
Connector Name	JOINT CONNECTOR-M13
Connector Color	WHITE



Terminal No.	Color of Wire	Signal Name
2	W	-(WITH BOSE AUDIO SYSTEM)
3	W	-(WITH BOSE AUDIO SYSTEM)
4	W	-(WITH BOSE AUDIO SYSTEM)

Connector No.	M173
Connector Name	JOINT CONNECTOR-M12
Connector Color	WHITE



Terminal No.	Color of Wire	Signal Name
2	G	-(WITH BOSE AUDIO SYSTEM)
3	G	-(WITH BOSE AUDIO SYSTEM)
4	G	-(WITH BOSE AUDIO SYSTEM)

Connector No.	M172
Connector Name	JOINT CONNECTOR-M11
Connector Color	WHITE



Terminal No.	Color of Wire	Signal Name
2	W	-(WITH BOSE AUDIO SYSTEM)
3	W	-(WITH BOSE AUDIO SYSTEM)
4	W	-(WITH BOSE AUDIO SYSTEM)

ABNIA4719GB

A  
B  
C  
D  
E  
F  
G  
H  
I  
J  
K  
L  
M  
N  
O  
P

AV

# BOSE AUDIO WITHOUT NAVIGATION

[BOSE AUDIO WITHOUT NAVIGATION]

< WIRING DIAGRAM >

Connector No.	M177
Connector Name	JOINT CONNECTOR-M57
Connector Color	WHITE

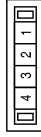

Terminal No.	Color of Wire	Signal Name
1	LG	-
2	LG	-
3	LG	-
4	LG	-

Connector No.	M176
Connector Name	JOINT CONNECTOR-M56
Connector Color	WHITE



Terminal No.	Color of Wire	Signal Name
1	SB	-
2	SB	-
3	SB	-
4	SB	-

Connector No.	M175
Connector Name	JOINT CONNECTOR-M22
Connector Color	WHITE

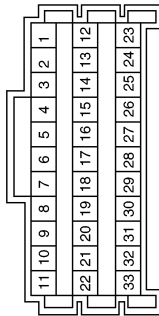

Terminal No.	Color of Wire	Signal Name
6	Y	-
7	Y	-
9	Y	-
11	Y	-

Terminal No.	Color of Wire	Signal Name
24	-	-
25	SHIELD	SHIELD
26	-	-
27	-	-
28	Y	CD (DVD) EJECT
29	LG	IGN
30	R	REVERSE SIG
31	G	PKB SIG
32	BG	SPEED 8P

Terminal No.	Color of Wire	Signal Name
8	-	-
9	-	-
10	V	GND
11	L	CAN-H
12	P	CAN-L
13	SB	M-CAN1 H
14	LG	M-CAN1 L
15	SB	M-CAN2 H TRM
16	LG	M-CAN2 L TRM
17	-	-
18	-	-
19	-	-
20	R	AUX AUDIO RH+
21	W	AUX AUDIO LH+
22	B	AUX GND
23	-	-

Connector No.	M192
Connector Name	AV CONTROL UNIT (WITH BOSE AUDIO SYSTEM WITHOUT NAV)
Connector Color	WHITE



Terminal No.	Color of Wire	Signal Name
1	-	-
2	-	-
3	-	-
4	B	TEL VOICE-
5	W	TEL VOICE+
6	SHIELD	SHIELD
7	-	-

ABNIA4720GB

# BOSE AUDIO WITHOUT NAVIGATION

[BOSE AUDIO WITHOUT NAVIGATION]

< WIRING DIAGRAM >

Connector No.	M195
Connector Name	AV CONTROL UNIT (WITH BOSE AUDIO SYSTEM WITHOUT NAVI)
Connector Color	WHITE

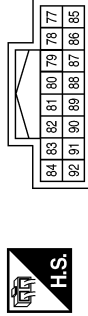

Terminal No.	Color of Wire	Signal Name
77	-	-
78	-	-
79	-	-
80	-	-
81	-	-
82	W	COMP2 IN +
83	W	COMP1 IN +
84	-	-
85	-	-
86	-	-
87	R	CAM 6.2
88	B	CAM GND
89	SHIELD	SHIELD
90	SHIELD	SHIELD
91	B	COMP IN
92	-	-

Connector No.	M194
Connector Name	AV CONTROL UNIT (WITH BOSE AUDIO SYSTEM WITHOUT NAVI)
Connector Color	WHITE

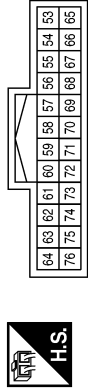

Terminal No.	Color of Wire	Signal Name
53	B	COMP OUT-
54	W	COMP OUT+
55	W	B
56	B	G
57	R	R
58	B	RGB SYN
59	SHIELD	RGB SYN GND
60	W	YS
61	B	DISP IT
62	G	HP
63	B	SIG GND
64	V	SIG VC
65	-	-
66	SHIELD	SHIELD
67	SHIELD	SHIELD
68	-	-
69	-	-
70	-	-
71	-	-
72	SHIELD	SHIELD
73	W	IT DISP
74	R	VP
75	LG	INV GND
76	L	INV VC

Connector No.	M193
Connector Name	AV CONTROL UNIT (WITH BOSE AUDIO SYSTEM WITHOUT NAVI)
Connector Color	WHITE

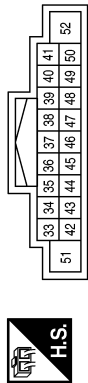

Terminal No.	Color of Wire	Signal Name
33	-	-
34	-	-
35	-	-
36	-	-
37	-	-
38	G	STRG SW
39	P	ACC
40	-	-
41	R	ILL
42	-	-
43	-	-
44	-	-
45	-	-
46	-	-
47	B	STRG SW GND
48	W	STRG SW B
49	-	-
50	-	-
51	Y	+B
52	GR	GND

ABNIA4721GB

A  
B  
C  
D  
E  
F  
G  
H  
I  
J  
K  
L  
M  
N  
O  
P

AV

# BOSE AUDIO WITHOUT NAVIGATION

[BOSE AUDIO WITHOUT NAVIGATION]

< WIRING DIAGRAM >

Connector No.	M196
Connector Name	AV CONTROL UNIT (WITH BOSE AUDIO SYSTEM WITHOUT NAV)
Connector Color	WHITE

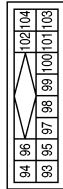

Terminal No.	Color of Wire	Signal Name
93	W	N BUS LH-
94	B	N BUS LH+
95	R	N BUS RH-
96	G	N BUS RH+
97	SHIELD	SHIELD
98	SHIELD	SHIELD
99	-	-
100	W	REQ1
101	B	TX
102	R	RX
103	-	-
104	-	-

Connector No.	M197
Connector Name	AV CONTROL UNIT (WITH BOSE AUDIO SYSTEM WITHOUT NAV)
Connector Color	WHITE

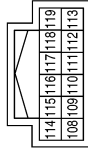

Terminal No.	Color of Wire	Signal Name
108	B	RR RH PRE+
109	W	FR RH PRE+
110	SB	AMP ON
111	BR	SHIELD
112	B	RR LH PRE+
113	B	FR LH PRE+
114	W	RR RH PRE-
115	B	FR RH PRE-
116	-	-
117	-	-
118	W	RR LH PRE-
119	W	FR LH PRE-

Connector No.	M205
Connector Name	FRONT AUXILIARY INPUT JACKS
Connector Color	WHITE

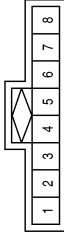

Terminal No.	Color of Wire	Signal Name
1	W	-
2	B	-
3	R	-
4	-	-
5	G	-
6	P	-
7	W	-
8	B	-

Connector No.	M209
Connector Name	USB INTERFACE
Connector Color	GREEN

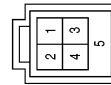

Terminal No.	Color of Wire	Signal Name
1	G	-
2	W	-
3	R	-
4	L	-
5	SHIELD	-

ABNIA4722GB

# BOSE AUDIO WITHOUT NAVIGATION

## [BOSE AUDIO WITHOUT NAVIGATION]

< WIRING DIAGRAM >

Connector No.	M217
Connector Name	WIRE TO WIRE
Connector Color	WHITE



Terminal No.	Color of Wire	Signal Name
11	P	-
12	G	-
13	SHIELD	-
14	B	-
15	W	-
16	R	-
30	SHIELD	-
31	B	-
32	W	-

Connector No.	M216
Connector Name	WIRE TO WIRE
Connector Color	WHITE

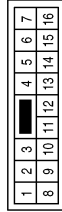

Terminal No.	Color of Wire	Signal Name
3	B	-

Connector No.	M210
Connector Name	WIRE TO WIRE
Connector Color	GRAY

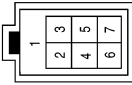

Terminal No	Color of Wire	Signal Name
1	SHIELD	-
2	W	-
3	G	-
4	R	-
6	L	-

Connector No.	M501
Connector Name	ANTENNA BASE
Connector Color	GREEN

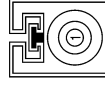

Terminal No.	Color of Wire	Signal Name
1	B	-

Connector No.	M500
Connector Name	WIRE TO WIRE
Connector Color	GRAY



Terminal No.	Color of Wire	Signal Name
1	B	-
2	B	-
3	B	-

Connector No.	M230
Connector Name	JOINT CONNECTOR-M01
Connector Color	GRAY

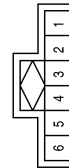

Terminal No.	Color of Wire	Signal Name
2	B	-
3	SHIELD	-
4	SHIELD	-

ABNIA4723GB

A  
B  
C  
D  
E  
F  
G  
H  
I  
J  
K  
L  
M  
N  
O  
P



# BOSE AUDIO WITHOUT NAVIGATION

[BOSE AUDIO WITHOUT NAVIGATION]

< WIRING DIAGRAM >

Connector No.	M504
Connector Name	WIRE TO WIRE
Connector Color	GRAY



Terminal No.	Color of Wire	Signal Name
1	B	-

Connector No.	M503
Connector Name	WIRE TO WIRE
Connector Color	GRAY



Terminal No.	Color of Wire	Signal Name
1	B	-

Connector No.	M502
Connector Name	ANTENNA BASE
Connector Color	GRAY



Terminal No.	Color of Wire	Signal Name
1	B	-
2	B	-

Connector No.	E22
Connector Name	ACCESSORY RELAY-2
Connector Color	BLUE



Terminal No.	Color of Wire	Signal Name
1	G	-
2	B	-
3	R	-
5	P	-

Connector No.	M507
Connector Name	WIRE TO WIRE
Connector Color	GREEN

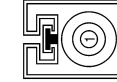

Terminal No.	Color of Wire	Signal Name
1	B	-

Connector No.	M505
Connector Name	GLASS ANTENNA (FM SUB)
Connector Color	GRAY



Terminal No.	Color of Wire	Signal Name
1	B	-

ABNIA4724GB



# BOSE AUDIO WITHOUT NAVIGATION

[BOSE AUDIO WITHOUT NAVIGATION]

< WIRING DIAGRAM >

Connector No.	E52
Connector Name	PARKING BRAKE SWITCH
Connector Color	BLACK



Terminal No.	Color of Wire	Signal Name
1	LG	-

Connector No.	E44
Connector Name	JOINT CONNECTOR-E01
Connector Color	WHITE

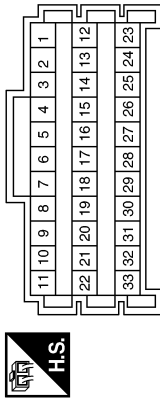

Terminal No.	Color of Wire	Signal Name
15	GR	-
17	B	-

Connector No.	E33
Connector Name	WIRE TO WIRE
Connector Color	WHITE

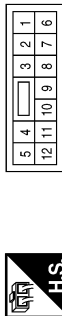

Terminal No.	Color of Wire	Signal Name
4	P	-

Connector No.	B1
Connector Name	REAR SIDE SPEAKER LH
Connector Color	BROWN



Terminal No.	Color of Wire	Signal Name
1	W	-
2	G	-

Terminal No.	Color of Wire	Signal Name
3G	P	-
33G	LG	-
50G	G	-

Connector No.	E152
Connector Name	WIRE TO WIRE
Connector Color	WHITE

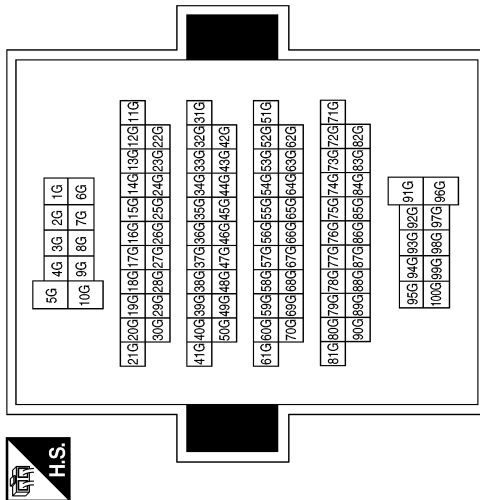

ABNIA4725GB

A  
B  
C  
D  
E  
F  
G  
H  
I  
J  
K  
L  
M  
AV  
O  
P

# BOSE AUDIO WITHOUT NAVIGATION

[BOSE AUDIO WITHOUT NAVIGATION]

< WIRING DIAGRAM >

Terminal No.	Color of Wire	Signal Name
14	-	-
15	-	-
16	-	-
17	-	-
18	-	-
19	-	-
20	B	CONT 1
21	-	-
22	-	-
23	B	CONT 4
24	B	CONT 5
25	-	-
26	-	-
27	B	CONT 6
28	V	SPEED
29	W	MIC POWER
30	-	-
31	-	-
32	-	-

Connector No.	B3
Connector Name	BLUETOOTH® CONTROL UNIT
Connector Color	WHITE

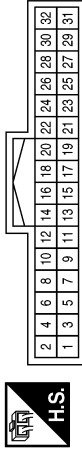

Terminal No.	Color of Wire	Signal Name
1	Y	B+
2	R	ACC
3	P	IGN
4	B	GND
5	SHIELD	AUDIO SHIELD
6	-	-
7	B	MIC IN +
8	SHIELD	MIC IN - (GND)
9	W	AUDIO OUT +
10	B	AUDIO OUT -
11	-	-
12	-	-
13	-	-

Connector No.	B2
Connector Name	SATELLITE RADIO TUNER
Connector Color	WHITE



Terminal No.	Color of Wire	Signal Name
21	W	SAT LCH (-)
22	B	SAT LCH (+)
23	R	SAT RCH (-)
24	G	SAT RCH (+)
25	SHIELD	EARTH (SIG)
26	SHIELD	DATA EARTH
27	-	-
28	W	REQ1 (SAT-COMBI)
29	R	TXD (SAT-COMBI)
30	B	RXD (COMBI-SAT)
31	-	-
32	SB	BAT
33	-	-
34	-	-
35	GR	EARTH
36	BG	ACC

Terminal No.	Color of Wire	Signal Name
40	-	-
41	-	-
42	-	-

Terminal No.	Color of Wire	Signal Name
35	SB	CAN H
36	LG	CAN L
37	-	-
38	-	-
39	-	-

Connector No.	B4
Connector Name	BLUETOOTH® CONTROL UNIT
Connector Color	WHITE





ABNIA4726GB

# BOSE AUDIO WITHOUT NAVIGATION

## [BOSE AUDIO WITHOUT NAVIGATION]

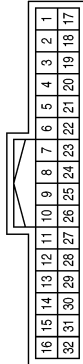

< WIRING DIAGRAM >

Connector No.	B32
Connector Name	WIRE TO WIRE
Connector Color	WHITE

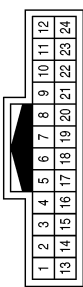

Terminal No.	Color of Wire	Signal Name
5	G	-
6	R	-
7	B	-
8	R	-
9	W	-
10	SHIELD	-
11	B	-
12	L	-
13	B	-
14	R	-
15	W	-
16	SHIELD	-

Connector No.	B6
Connector Name	WIRE TO WIRE
Connector Color	WHITE

Terminal No.	Color of Wire	Signal Name
3	Y	-(WITHOUT REAR ENTERTAINMENT SYSTEM)
4	R	-(WITHOUT REAR ENTERTAINMENT SYSTEM)
5	P	-(WITHOUT REAR ENTERTAINMENT SYSTEM)
6	V	-(WITHOUT REAR ENTERTAINMENT SYSTEM)
7	W	-(WITHOUT REAR ENTERTAINMENT SYSTEM)
8	B	-(WITHOUT REAR ENTERTAINMENT SYSTEM)
9	SHIELD	-(WITHOUT REAR ENTERTAINMENT SYSTEM)
10	SHIELD	-
11	B	-(WITHOUT REAR ENTERTAINMENT SYSTEM)
12	W	-
14	SB	-
15	LG	-
16	LG	-
17	SB	-

Connector No.	B5
Connector Name	FRONT SEAT LH (PRE-WIRING)
Connector Color	WHITE

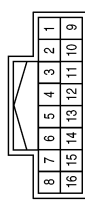
Terminal No.	Color of Wire	Signal Name
2	SHIELD	-
3	W	-
4	SHIELD	-
5	B	-
6	R	-
7	G	-
8	R	-
10	SHIELD	-
11	W	-
12	SHIELD	-
13	B	-
14	R	-
15	B	-
16	L	-

ABNIA4727GB

A  
B  
C  
D  
E  
F  
G  
H  
I  
J  
K  
L  
M  
N  
O  
P

AV

# BOSE AUDIO WITHOUT NAVIGATION

[BOSE AUDIO WITHOUT NAVIGATION]

< WIRING DIAGRAM >

Connector No.	B43
Connector Name	WIRE TO WIRE
Connector Color	WHITE

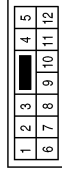

Terminal No.	Color of Wire	Signal Name
4	G	-

Terminal No.	Color of Wire	Signal Name
19	W	-(WITHOUT NAVI)
20	B	-(WITHOUT NAVI)
21	R	-(WITHOUT NAVI)
22	G	-(WITHOUT NAVI)
23	SHIELD	-(WITHOUT NAVI)
27	R	-(WITHOUT NAVI)
28	B	-(WITHOUT NAVI)
29	W	-(WITHOUT NAVI)
30	SHIELD	-(WITHOUT NAVI)

Connector No.	B41
Connector Name	WIRE TO WIRE
Connector Color	WHITE

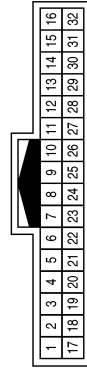

Terminal No.	Color of Wire	Signal Name
1	W	-(WITHOUT NAVI)
2	R	-(WITHOUT NAVI)
3	B	-
4	SHIELD	-
17	BG	-(WITHOUT NAVI)
18	SB	-(WITHOUT NAVI)

Connector No.	B51
Connector Name	WIRE TO WIRE
Connector Color	WHITE

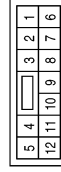

Terminal No.	Color of Wire	Signal Name
11	R	-
12	P	-

Connector No.	B49
Connector Name	WIRE TO WIRE
Connector Color	WHITE



Terminal No.	Color of Wire	Signal Name
9	G	-
10	W	-
11	P	-
12	R	-
13	SHIELD	-
14	B	-
15	W	-
16	W	-

Connector No.	B46
Connector Name	WIRE TO WIRE
Connector Color	WHITE



Terminal No.	Color of Wire	Signal Name
13	R	-(WITHOUT NAVI)
14	B	-(WITHOUT NAVI)
15	W	-(WITHOUT NAVI)
16	SHIELD	-

ABNIA4728GB

# BOSE AUDIO WITHOUT NAVIGATION

## [BOSE AUDIO WITHOUT NAVIGATION]

< WIRING DIAGRAM >

Connector No.	B59
Connector Name	BLUETOOTH® CONTROL UNIT
Connector Color	GRAY

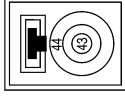

Terminal No.	Color of Wire	Signal Name
43	B	-
44	SHIELD	-

Connector No.	B57
Connector Name	WIRE TO WIRE
Connector Color	GRAY



Terminal No.	Color of Wire	Signal Name
1	B	-

Connector No.	B53
Connector Name	SATELLITE ANTENNA
Connector Color	GREEN



Terminal No.	Color of Wire	Signal Name
37	B	-

Connector No.	B73
Connector Name	SUBWOOFER
Connector Color	GRAY



Terminal No.	Color of Wire	Signal Name
1	B	-
2	W	-
3	-	-
4	W	-
5	B	-
6	G	-

Connector No.	B62
Connector Name	JOINT CONNECTOR-B19
Connector Color	WHITE



Terminal No.	Color of Wire	Signal Name
1	LG	-
2	LG	-
3	LG	-

Connector No.	B61
Connector Name	JOINT CONNECTOR-B18
Connector Color	WHITE

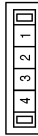

Terminal No.	Color of Wire	Signal Name
1	SB	-
2	SB	-
3	SB	-

ABNIA4729GB

A  
B  
C  
D  
E  
F  
G  
H  
I  
J  
K  
L  
M  
N  
O  
P

AV

# BOSE AUDIO WITHOUT NAVIGATION

[BOSE AUDIO WITHOUT NAVIGATION]

< WIRING DIAGRAM >

Connector No.	B101
Connector Name	WIRE TO WIRE
Connector Color	WHITE



1	2	3	4	5	6	7	8	9	10	11	12	13	14	15	16
17	18	19	20	21	22	23	24	25	26	27	28	29	30	31	32

Terminal No.	Color of Wire	Signal Name
5	V	-(WITHOUT REAR ENTERTAINMENT SYSTEM)
6	W	-(WITHOUT REAR ENTERTAINMENT SYSTEM)
7	R	-(WITHOUT REAR ENTERTAINMENT SYSTEM)
8	B	-(WITHOUT REAR ENTERTAINMENT SYSTEM)
9	SHIELD	-

Connector No.	B107
Connector Name	WIRE TO WIRE
Connector Color	WHITE



1	2	3	4	5	6	7	8	9	10	11	12
13	14	15	16	17	18	19	20	21	22	23	24

Terminal No.	Color of Wire	Signal Name
19	V	-
20	Y	-
21	SHIELD	-
22	B	-
23	R	-
24	W	-

Connector No.	B110
Connector Name	FRONT SEAT RH (PRE-WIRING)
Connector Color	WHITE



12	11	10	9	8	7	6	5	4	3	2	1
24	23	22	21	20	19	18	17	16	15	14	13

Terminal No.	Color of Wire	Signal Name
1	Y	-
2	V	-
3	B	-
4	R	-
5	W	-

Terminal No.	Color of Wire	Signal Name
6	B	-
7	L	-
8	G	-
9	R	-
10	W	-
11	SHIELD	-
12	V	-
13	B	-
14	R	-
15	W	-

Terminal No.	Color of Wire	Signal Name
16	SHIELD	-
17	SHIELD	-
18	B	-
19	G	-
20	R	-
21	G	-
22	R	-
23	W	-
24	SHIELD	-

ABNIA4730GB

# BOSE AUDIO WITHOUT NAVIGATION

## [BOSE AUDIO WITHOUT NAVIGATION]

< WIRING DIAGRAM >

Connector No.	B129
Connector Name	BOSE SPEAKER AMP.
Connector Color	BROWN

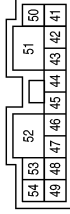

Terminal No.	Color of Wire	Signal Name
41	R	-
42	G	-
43	G	-
44	W	-
45	G	-
46	W	-
47	B	-
48	G	-
49	W	-
50	LG	-
51	Y	-
52	B	-
53	W	-
54	G	-

Connector No.	B124
Connector Name	WIRE TO WIRE
Connector Color	WHITE



Terminal No.	Color of Wire	Signal Name
5	G	-
6	R	-
7	G	-
8	R	-
9	W	-
10	SHIELD	-
11	B	-
12	L	-
13	G	-
14	R	-
15	W	-
16	SHIELD	-

Connector No.	B111
Connector Name	WIRE TO WIRE
Connector Color	BROWN

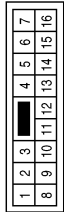

Terminal No.	Color of Wire	Signal Name
3	R	-
4	LG	-
5	Y	-
6	P	-
7	R	-
8	G	-
9	W	-
10	G	-
13	W	-
14	P	-
15	G	-
16	R	-

Terminal No.	Color of Wire	Signal Name
68	P	-
69	P	-
70	R	-
71	W	-
72	P	-
73	B	-
74	W	-
75	B	-
76	W	-
77	-	-
78	-	-

Terminal No.	Color of Wire	Signal Name
58	G	-
59	R	-
60	W	-
61	SHIELD	-
62	W	-
63	W	-
64	B	-
65	W	-
66	B	-
67	-	-

Connector No.	B130
Connector Name	BOSE SPEAKER AMP.
Connector Color	BROWN

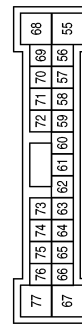

Terminal No.	Color of Wire	Signal Name
55	R	-
56	B	-
57	W	-

ABNIA4731GB

A  
B  
C  
D  
E  
F  
G  
H  
I  
J  
K  
L  
M  
N  
O  
P

AV

# BOSE AUDIO WITHOUT NAVIGATION

## [BOSE AUDIO WITHOUT NAVIGATION]

< WIRING DIAGRAM >

Connector No.	B140
Connector Name	WIRE TO WIRE
Connector Color	WHITE



1	2	3	4	5	6	7		
8	9	10	11	12	13	14	15	16

Terminal No.	Color of Wire	Signal Name
9	G	-
10	W	-
11	P	-
12	R	-
13	SHIELD	-
14	W	-
15	B	-
16	W	-

Connector No.	B139
Connector Name	WIRE TO WIRE
Connector Color	WHITE



5	4	3	2	1		
12	11	10	9	8	7	6

Terminal No.	Color of Wire	Signal Name
11	SB	-(WITH BOSE AUDIO SYSTEM)
12	LG	-(WITH BOSE AUDIO SYSTEM)

Connector No.	B136
Connector Name	WIRE TO WIRE
Connector Color	WHITE



1	2	3	4	5	6	7	8	9	10	11	12	13	14	15	16	17	18	19	20
21	22	23	24	25	26	27	28	29	30	31	32	33	34	35	36	37	38	39	40

Terminal No.	Color of Wire	Signal Name
9	B	-
10	W	-
11	SHIELD	-
12	B	-
13	W	-
14	SHIELD	-
15	B	-
16	W	-
17	SHIELD	-
18	W	-
21	B	-
22	W	-
23	SHIELD	-

Connector No.	R11
Connector Name	WIRE TO WIRE
Connector Color	WHITE



1	2	3	4	5	6	7	8	9	10	11	12
13	14	15	16	17	18	19	20	21	22	23	24

Terminal No.	Color of Wire	Signal Name
5	SHIELD	-
6	B	-
7	W	-

Connector No.	R1
Connector Name	WIRE TO WIRE
Connector Color	WHITE



12	11	10	9	8	7	6	5	4	3	2	1
24	23	22	21	20	19	18	17	16	15	14	13

Terminal No.	Color of Wire	Signal Name
13	W	-
14	B	-
15	SHIELD	-

Connector No.	B153
Connector Name	REAR SIDE SPEAKER RH
Connector Color	BROWN



2	1
---	---

Terminal No.	Color of Wire	Signal Name
1	W	-
2	G	-

ABNIA4732GB



# BOSE AUDIO WITHOUT NAVIGATION

[BOSE AUDIO WITHOUT NAVIGATION]

< WIRING DIAGRAM >

Connector No.	D2
Connector Name	WIRE TO WIRE
Connector Color	WHITE

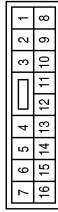

Terminal No.	Color of Wire	Signal Name
8	W	-
9	G	-

Connector No.	R109
Connector Name	MICROPHONE
Connector Color	WHITE

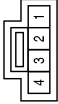

Terminal No.	Color of Wire	Signal Name
1	R	-
2	-	-
3	GR	-
4	L	-

Connector No.	R101
Connector Name	WIRE TO WIRE
Connector Color	WHITE

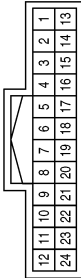

Terminal No.	Color of Wire	Signal Name
5	GR	-
6	L	-
7	R	-

Connector No.	D112
Connector Name	FRONT DOOR SPEAKER RH
Connector Color	WHITE



Terminal No.	Color of Wire	Signal Name
1	G	-
2	W	-

Connector No.	D102
Connector Name	WIRE TO WIRE
Connector Color	WHITE



Terminal No.	Color of Wire	Signal Name
9	G	-
10	W	-

Connector No.	D12
Connector Name	FRONT DOOR SPEAKER LH
Connector Color	WHITE



Terminal No.	Color of Wire	Signal Name
1	G	-
2	W	-

ABNIA4733GB

A  
B  
C  
D  
E  
F  
G  
H  
I  
J  
K  
L  
M  
N  
O  
P

AV

# BOSE AUDIO WITHOUT NAVIGATION

[BOSE AUDIO WITHOUT NAVIGATION]

< WIRING DIAGRAM >

Connector No.	D301
Connector Name	WIRE TO WIRE
Connector Color	WHITE

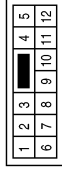

Terminal No.	Color of Wire	Signal Name
11	G	-
12	W	-

Connector No.	D207
Connector Name	REAR DOOR SPEAKER LH
Connector Color	BROWN



Terminal No.	Color of Wire	Signal Name
1	LG	-
2	Y	-

Connector No.	D201
Connector Name	WIRE TO WIRE
Connector Color	WHITE

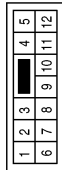

Terminal No.	Color of Wire	Signal Name
11	Y	-
12	LG	-

Connector No.	D504
Connector Name	REAR VIEW CAMERA
Connector Color	WHITE



Terminal No.	Color of Wire	Signal Name
1	W	-
2	B	-
3	R	-
4	SHIELD	-

Connector No.	D501
Connector Name	WIRE TO WIRE
Connector Color	WHITE

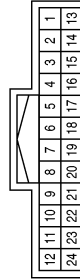

Terminal No.	Color of Wire	Signal Name
13	W	-
14	B	-
15	R	-
16	SHIELD	-

Connector No.	D307
Connector Name	REAR DOOR SPEAKER RH
Connector Color	BROWN



Terminal No.	Color of Wire	Signal Name
1	W	-
2	G	-

ABNIA4734GB

## BASIC INSPECTION

### DIAGNOSIS AND REPAIR WORKFLOW

#### Work Flow

INFOID:000000009724888

#### OVERALL SEQUENCE

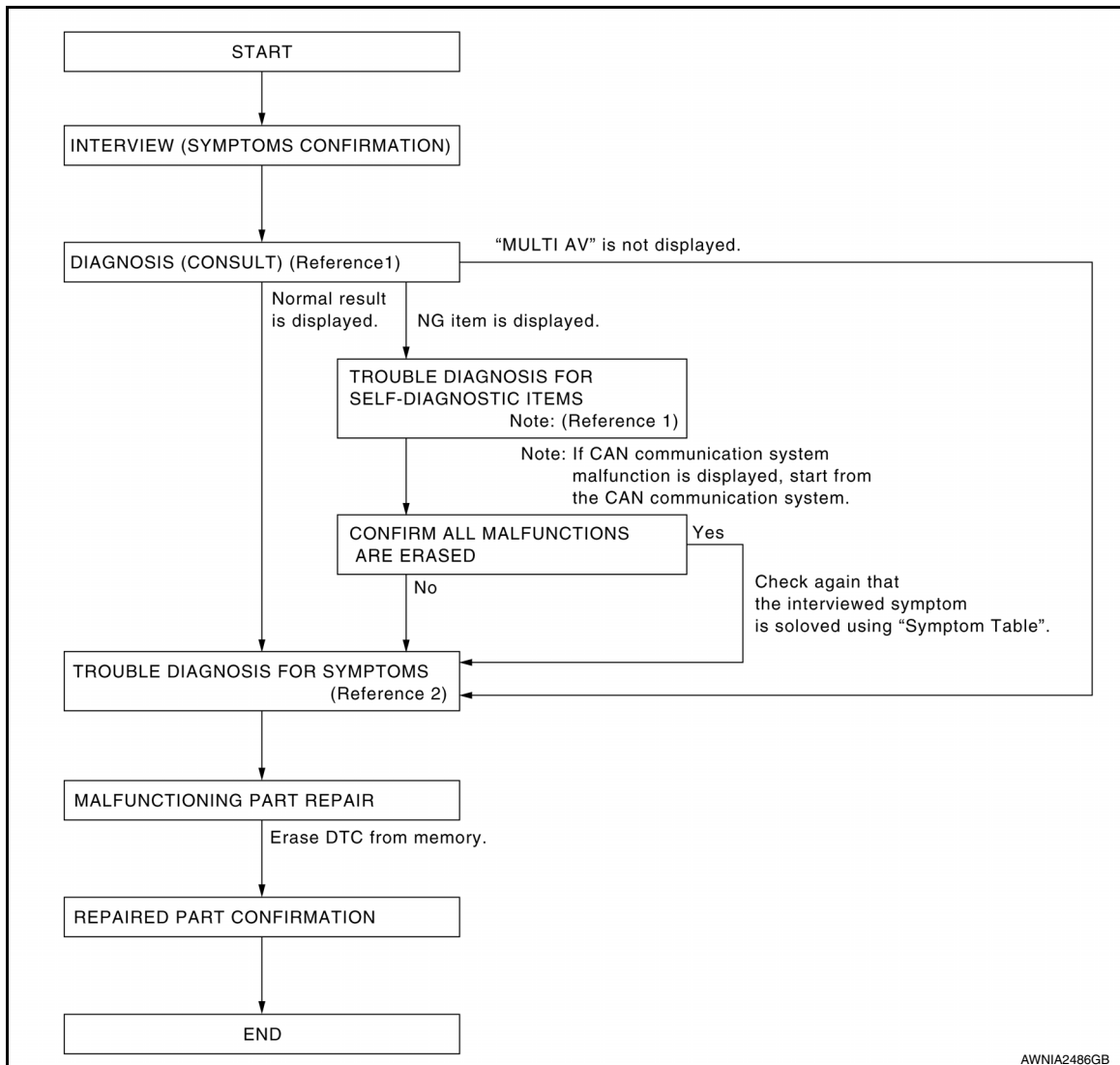

Reference 1: Refer to [AV-171, "CONSULT Function"](#).

Reference 2: Refer to [AV-296, "Symptom Table"](#).

#### DETAILED FLOW

##### 1. CHECK SYMPTOM

Check the malfunction symptoms by performing the following items:

- Interview the customer to obtain the malfunction information (conditions and environment when the malfunction occurred).
- Check the symptom.

>> GO TO 2

##### 2. SELF-DIAGNOSIS (CONSULT)

1. Connect CONSULT and perform "SELF-DIAGNOSIS" for "MULTI AV".

**NOTE:**

Skip to step 4 of the diagnosis procedure if "MULTI AV" is not displayed.

2. Check if any DTC No. is displayed in the self-diagnosis results.

A  
B  
C  
D  
E  
F  
G  
H  
I  
J  
K  
L  
M

AV

O  
P

# DIAGNOSIS AND REPAIR WORKFLOW

[BOSE AUDIO WITHOUT NAVIGATION]

< BASIC INSPECTION >

Is any DTC No. displayed?

YES >> GO TO 3

NO >> GO TO 4

## 3. CHECK SELF-DIAGNOSIS RESULTS (CONSULT)

1. Check the DTC No. indicated in the self-diagnosis results.
2. Perform the relevant diagnosis referring to the DTC No. list. Refer to [AV-179, "DTC Index"](#).

**NOTE:**

Start with the diagnosis for the CAN communication system if "CAN COMM CIRCUIT [U1000] or CONTROL UNIT (CAN) [U1010]" is displayed.

>> GO TO 5

## 4. PERFORM DIAGNOSIS BY SYMPTOM

Perform the relevant diagnosis referring to the diagnosis chart by symptom. Refer to [AV-296, "Symptom Table"](#).

>> GO TO 5

## 5. REPAIR OR REPLACE MALFUNCTIONING PARTS

Repair or replace the identified malfunctioning parts.

**NOTE:**

Erase the stored self-diagnosis results after repairing or replacing the relevant components if any DTC No. has been indicated in the self-diagnosis results.

>> GO TO 6

## 6. CHECK AFTER REPAIR

1. Perform self-diagnosis for "MULTI AV" with CONSULT after repairing or replacing the malfunctioning parts.
2. Check if any DTC No. is displayed in the self-diagnosis results.

Is any DTC No. displayed?

YES >> GO TO 3

NO >> GO TO 7

## 7. FINAL CHECK

Perform the operation check to confirm that the malfunction symptom is solved or that any other symptoms are present.

Are any symptoms present?

YES >> GO TO 4

NO >> Inspection End.

## INSPECTION AND ADJUSTMENT

## ADDITIONAL SERVICE WHEN REPLACING AV CONTROL UNIT

## ADDITIONAL SERVICE WHEN REPLACING AV CONTROL UNIT : Description

INFOID:000000009724889

## BEFORE REPLACEMENT

When replacing AV control unit, save or print current vehicle specification with CONSULT configuration before replacement.

**NOTE:**

If "Before Replace ECU" cannot be used, use the "After Replace ECU" or "Manual Configuration" after replacing AV control unit.

## AFTER REPLACEMENT

**CAUTION:**

When replacing AV control unit, you must perform "After Replace ECU" with CONSULT.

- Complete the procedure of "After Replace ECU" in order.
- If you set incorrect "After Replace ECU", incidents might occur.
- Configuration is different for each vehicle model. Confirm configuration of each vehicle model.

## ADDITIONAL SERVICE WHEN REPLACING AV CONTROL UNIT : Work Procedure

INFOID:000000009724889

## 1. SAVING VEHICLE SPECIFICATION

## ④-CONSULT

Enter "Re/Programming, Configuration" and perform "Before Replace ECU" to save or print current vehicle specification.

**NOTE:**

If "Before Replace ECU" cannot be used, use the "After Replace ECU" or "Manual Configuration" after replacing AV control unit.

>> GO TO 2.

## 2. REPLACE AV CONTROL UNIT

Replace AV control unit. Refer to [AV-303, "Removal and Installation - AV Control Unit"](#).

>> GO TO 3.

## 3. WRITING VEHICLE SPECIFICATION

## ④CONSULT

1. Enter "Re/Programming, Configuration".
2. If "Before Replace ECU" operation was performed, automatically an "Operation Log Selection" screen will be displayed. Select the applicable file from the "Saved Data List" and press "Confirm" to write vehicle specification. Refer to [AV-222, "CONFIGURATION \(AV CONTROL UNIT\) : Work Procedure"](#).
3. If "Before Replace ECU" operation was not performed, select "After Replace ECU" or "Manual Configuration" to write vehicle specification. Refer to [AV-222, "CONFIGURATION \(AV CONTROL UNIT\) : Work Procedure"](#).

>> GO TO 4.

## 4. OPERATION CHECK

Check that the operation of the AV control unit and camera images (fixed guide lines and predictive course lines) are normal.

>> Work End.

## CONFIGURATION (AV CONTROL UNIT)

# INSPECTION AND ADJUSTMENT

< BASIC INSPECTION >

[BOSE AUDIO WITHOUT NAVIGATION]

## CONFIGURATION (AV CONTROL UNIT) : Description

INFOID:000000009724891

Vehicle specification needs to be written with CONSULT because it is not written after replacing AV control unit.

Configuration has three functions as follows:

Function	Description
"Before Replace ECU"	<ul style="list-style-type: none"><li>• Reads the vehicle configuration of current AV control unit.</li><li>• Saves the read vehicle configuration.</li></ul>
"After Replace ECU"	Writes the vehicle configuration with manual selection.
"Select Saved Data List"	Writes the vehicle configuration with saved data.

### CAUTION:

- When replacing AV control unit, you must perform "Select Saved Data List" or "After Replace ECU" with CONSULT.
- Complete the procedure of "Select Saved Data List" or "After Replace ECU" in order.
- If you set incorrect "Select Saved Data List" or "After Replace ECU", incidents might occur.
- Configuration is different for each vehicle model. Confirm configuration of each vehicle model.
- Never perform "Select Saved Data List" or "After Replace ECU" except for new AV control unit.

## CONFIGURATION (AV CONTROL UNIT) : Work Procedure

INFOID:000000009724892

### 1. WRITING MODE SELECTION

#### CONSULT

Select "Reprogramming, Configuration" of AV control unit.

When writing saved data >> GO TO 2.

When writing manually >> GO TO 3.

### 2. PERFORM "SAVED DATA LIST"

#### CONSULT

Automatically "Operation Log Selection" window will display if "Before Replace ECU" was performed. Select applicable file from the "Save Data List" and press "Confirm".

>> Work End.

### 3. PERFORM "AFTER REPLACE ECU" OR "MANUAL CONFIGURATION"

#### CONSULT

1. Select "After Replace ECU" or "Manual Configuration".
2. Identify the correct model and configuration list. Refer to [AV-223. "CONFIGURATION \(AV CONTROL UNIT\) : Configuration List"](#).
3. Confirm and/or change setting value for each item.

#### CAUTION:

Thoroughly read and understand the vehicle specification. ECU control may not operate normally if the setting is not correct.

4. Select "Next".

#### CAUTION:

Make sure to select "Next", confirm each setting value and press "OK" even if the indicated configuration of brand new AV control unit is same as the desirable configuration. If not, configuration which is set automatically by selecting vehicle model can not be memorized.

5. When "Completed", select "End".

>> GO TO 4.

### 4. OPERATION CHECK

Confirm that each function controlled by AV control unit operates normally.

# INSPECTION AND ADJUSTMENT

< BASIC INSPECTION >

[BOSE AUDIO WITHOUT NAVIGATION]

>> Work End.

## CONFIGURATION (AV CONTROL UNIT) : Configuration List

INFOID:000000009724893

### CAUTION:

Thoroughly read and understand the vehicle specification. Incorrect settings may result in abnormal control of ECU.

MANUAL SETTING ITEM	
Items	Setting value
CAMERA SYSTEM	NONE/AVM ⇔ REAR CAMERA
SOUND SYSTEM	BASE ⇔ BOSE

⇔: Items which confirm vehicle specifications

A  
B  
C  
D  
E  
F  
G  
H  
I  
J  
K  
L  
M  
O  
P

AV

# U1000 CAN COMM CIRCUIT

< DTC/CIRCUIT DIAGNOSIS >

[BOSE AUDIO WITHOUT NAVIGATION]

## DTC/CIRCUIT DIAGNOSIS

### U1000 CAN COMM CIRCUIT

#### DTC Logic

INFOID:000000009724894

#### DTC DETECTION LOGIC

CONSULT Display	DTC Detection Condition	Possible Cause
CAN COMM CIRCUIT [U1000]	AV control unit is not transmitting or receiving CAN communication signal for 2 seconds or more.	CAN communication system.

#### Diagnosis Procedure

INFOID:000000009724895

### 1. PERFORM SELF DIAGNOSTIC RESULT

1. Turn ignition switch ON and wait for 2 seconds or more.
2. Perform Self Diagnostic Result for MULTI AV.

#### Is CAN COMM CIRCUIT displayed?

- YES >> Refer to [LAN-26, "Trouble Diagnosis Flow Chart"](#).  
NO >> Refer to [GI-53, "Intermittent Incident"](#).



# U1010 CONTROL UNIT (CAN)

< DTC/CIRCUIT DIAGNOSIS >

[BOSE AUDIO WITHOUT NAVIGATION]

## U1010 CONTROL UNIT (CAN)

### DTC Logic

INFOID:000000009724896

### DTC DETECTION LOGIC

CONSULT Display	DTC Detection Condition	Possible Cause
CONTROL UNIT (CAN) [U1010]	CAN initial diagnosis malfunction is detected.	Replace the AV control unit if the malfunction occurs constantly. Refer to <a href="#">AV-303, "Removal and Installation - AV Control Unit"</a> .

A  
B  
C  
D  
E  
F  
G  
H  
I  
J  
K  
L  
M  
O  
P

AV

# U1200 AV CONTROL UNIT

< DTC/CIRCUIT DIAGNOSIS >

[BOSE AUDIO WITHOUT NAVIGATION]

## U1200 AV CONTROL UNIT

### DTC Logic

INFOID:000000009724897

CONSULT Display	DTC Detection Condition	Possible Cause
CONT UNIT [U1200]	AV control unit malfunction is detected.	Replace the AV control unit if the malfunction occurs constantly. Refer to <a href="#">AV-303. "Removal and Installation - AV Control Unit"</a> .

# U1216 AV CONTROL UNIT

< DTC/CIRCUIT DIAGNOSIS >

[BOSE AUDIO WITHOUT NAVIGATION]

## U1216 AV CONTROL UNIT

### DTC Logic

INFOID:000000009724898

CONSULT Display	DTC Detection Condition	Possible Cause
CAN CONT [U1216]	AV control unit malfunction is detected.	Replace the AV control unit if the malfunction occurs constantly. Refer to <a href="#">AV-303. "Removal and Installation - AV Control Unit"</a> .

A  
B  
C  
D  
E  
F  
G  
H  
I  
J  
K  
L  
M  
N  
O  
P

AV

# U1231 BOSE AMP.

< DTC/CIRCUIT DIAGNOSIS >

[BOSE AUDIO WITHOUT NAVIGATION]

## U1231 BOSE AMP.

### DTC Logic

INFOID:000000009763084

CONSULT Display	DTC Detection Condition	Possible Cause
AMP TEMP [U1231]	BOSE amp. malfunction is detected.	Replace BOSE amp. if malfunction occurs constantly. Refer to <a href="#">AV-307. "Removal and Installation"</a> .

# U1232 STEERING ANGLE SENSOR

< DTC/CIRCUIT DIAGNOSIS >

[BOSE AUDIO WITHOUT NAVIGATION]

## U1232 STEERING ANGLE SENSOR

### DTC Logic

INFOID:000000009724899

CONSULT Display	DTC Detection Condition	Possible Cause
ST ANGLE SEN CALIB [U1232]	Predictive course line center position adjustment of the steering angle sensor is incomplete.	Adjust the predictive course line center position of the steering angle sensor. Refer to <a href="#">AV-221. "ADDITIONAL SERVICE WHEN REPLACING AV CONTROL UNIT : Work Procedure"</a> .

### Diagnosis Procedure

INFOID:000000009724900

#### 1. ADJUST THE PREDICTIVE COURSE LINE CENTER POSITION OF THE STEERING ANGLE SENSOR

When U1232 is detected, adjust the predictive course line center position of the steering angle sensor.

>> Refer to [AV-221. "ADDITIONAL SERVICE WHEN REPLACING AV CONTROL UNIT : Work Procedure"](#).

A  
B  
C  
D  
E  
F  
G  
H  
I  
J  
K  
L  
M

AV

O  
P

# U1243 DISPLAY UNIT

< DTC/CIRCUIT DIAGNOSIS >

[BOSE AUDIO WITHOUT NAVIGATION]

## U1243 DISPLAY UNIT

### DTC Logic

INFOID:000000009724901

CONSULT Display	DTC Detection Condition	Possible Cause
FRONT DISP CONN [U1243]	When any of the following is detected: <ul style="list-style-type: none"><li>display unit power supply or ground circuit malfunction.</li><li>serial communication circuit malfunction between display unit and AV control unit.</li></ul>	<ul style="list-style-type: none"><li>Display unit power supply and ground circuits.</li><li>Serial communication circuits between display unit and AV control unit.</li></ul>

### Diagnosis Procedure

INFOID:000000009724902

Regarding Wiring Diagram information, refer to [AV-191, "Wiring Diagram"](#).

#### 1. CHECK DISPLAY UNIT POWER SUPPLY AND GROUND CIRCUIT

Check display unit power supply and ground circuits. Refer to [AV-243, "DISPLAY UNIT : Diagnosis Procedure"](#).

Is the inspection result normal?

YES >> GO TO 2.

NO >> Repair or replace harness or connectors.

#### 2. CHECK COMMUNICATION CIRCUIT CONTINUITY

- Turn ignition switch OFF.
- Disconnect display unit connector and AV control unit connector M194.
- Check continuity between display unit connector M93 terminals 11, 22 and AV control unit connector M194 terminals 73, 61.

Display unit		AV control unit		Continuity
Connector	Terminals	Connector	Terminals	
M93	11	M194	73	Yes
	22		61	

- Check continuity between display unit connector M93 terminals 11, 22 and ground.

Display unit		Ground	Continuity
Connector	Terminals		
M93	11	—	No
	12		

Is the inspection result normal?

YES >> GO TO 3.

NO >> Repair or replace harness or connectors.

#### 3. CHECK COMMUNICATION SIGNAL (DISP→CONT)

- Connect display unit connector and AV control unit connector M194.
- Turn ignition switch ON.
- Check signal between display unit connector M93 terminal 11 and ground.

# U1243 DISPLAY UNIT

< DTC/CIRCUIT DIAGNOSIS >

[BOSE AUDIO WITHOUT NAVIGATION]

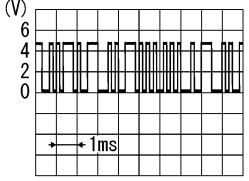
Display unit		Ground	Condition	Reference value
(+)		(-)		
Connector	Terminal			
M93	11	—	When adjusting display brightness.	 <p>(V)</p> <p>PKIB5039J</p>

Is the inspection result normal?

YES >> GO TO 4.

NO >> Replace AV control unit. Refer to [AV-303. "Removal and Installation - AV Control Unit"](#).

## 4. CHECK COMMUNICATION SIGNAL (CONT→DISP)

Check signal between display unit connector M93 terminal 22 and ground.

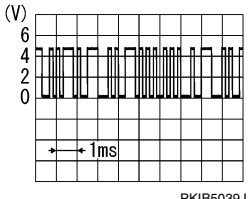
Display unit		Ground	Condition	Reference value
(+)		(-)		
Connector	Terminal			
M93	22	—	When adjusting display brightness.	 <p>(V)</p> <p>PKIB5039J</p>

Is the inspection result normal?

YES >> Inspection End.

NO >> Replace display unit. Refer to [AV-306. "Removal and Installation"](#).

A  
B  
C  
D  
E  
F  
G  
H  
I  
J  
K  
L  
M  
O  
P

AV

# U1255 SATELLITE RADIO TUNER

< DTC/CIRCUIT DIAGNOSIS >

[BOSE AUDIO WITHOUT NAVIGATION]

## U1255 SATELLITE RADIO TUNER

### DTC Logic

INFOID:000000009724903

CONSULT Display	DTC Detection Condition	Possible Cause
SAT CONN [U1255]	When any of the following is detected: <ul style="list-style-type: none"><li>• satellite radio tuner power supply or ground circuit malfunction.</li><li>• communication circuit malfunction between AV control unit and satellite radio tuner.</li><li>• request signal circuit malfunction between AV control unit and satellite radio tuner.</li></ul>	<ul style="list-style-type: none"><li>• Satellite radio tuner power supply and ground circuits.</li><li>• Communication circuits between AV control unit and satellite radio tuner.</li><li>• Request signal circuits between AV control unit and satellite radio tuner.</li></ul>

### Diagnosis Procedure

INFOID:000000009724904

Regarding Wiring Diagram information, refer to [AV-191. "Wiring Diagram"](#).

### 1. CHECK SATELLITE RADIO TUNER POWER SUPPLY AND GROUND CIRCUIT

Check satellite radio tuner power supply and ground circuit. Refer to [AV-246. "SATELLITE RADIO TUNER : Diagnosis Procedure"](#).

Is the inspection result normal?

YES >> GO TO 2.

NO >> Repair or replace harness or connectors.

### 2. CHECK COMMUNICATION CIRCUIT AND REQUEST SIGNAL CIRCUIT CONTINUITY

1. Turn ignition switch OFF.
2. Disconnect AV control unit connector M196 and satellite radio tuner connector B2.
3. Check continuity between AV control unit connector M196 terminals 100, 101, 102 and satellite radio tuner connector B2 terminals 28, 29, 30.

AV control unit		Satellite radio tuner		Continuity
Connector	Terminals	Connector	Terminals	
M196	100	B2	28	Yes
	101		29	
	102		30	

4. Check continuity between AV control unit connector M196 terminals 100, 101, 102 and ground.

AV control unit		Ground	Continuity
Connector	Terminals		
M196	100		No
	101		
	102		

Is the inspection result normal?

YES >> GO TO 3.

NO >> Repair or replace harness or connectors.

### 3. CHECK AV CONTROL UNIT VOLTAGE

1. Connect AV control unit connector M196.
2. Turn ignition switch ON.
3. Check signal between AV control unit connector M196 terminals 100, 101 and ground.



# U1255 SATELLITE RADIO TUNER

< DTC/CIRCUIT DIAGNOSIS >

[BOSE AUDIO WITHOUT NAVIGATION]

AV control unit		Ground	Voltage (Approx.)
(+) Connector		(-)	
Connector	Terminals		
M196	100	—	7.0 V
	101		

Is the inspection result normal?

YES >> GO TO 4.

NO >> Replace AV control unit. Refer to [AV-303. "Removal and Installation - AV Control Unit"](#).

## 4. CHECK SATELLITE RADIO TUNER VOLTAGE

1. Turn ignition switch OFF.
2. Disconnect AV control unit connector M196.
3. Connect satellite radio tuner connector B2.
4. Turn ignition switch ON.
5. Check signal between satellite radio tuner connector B2 terminal 30 and ground.

Satellite radio tuner		Ground	Voltage (Approx.)
(+) Connector		(-)	
Connector	Terminals		
B2	30	—	7.0 V

Is the inspection result normal?

YES >> Inspection End.

NO >> Replace satellite radio tuner. Refer to [AV-320. "Removal and Installation"](#).

AV

# U1265 BOSE AMP.

< DTC/CIRCUIT DIAGNOSIS >

[BOSE AUDIO WITHOUT NAVIGATION]

## U1265 BOSE AMP.

### DTC Logic

INFOID:000000009763085

CONSULT Display	DTC Detection Condition	Possible Cause
AMP ON TERMINAL [U1265]	BOSE amp. ON signal circuit open or short circuited.	BOSE amp. ON signal circuit between AV control unit and BOSE amp.

### Diagnosis Procedure

INFOID:000000009763086

Regarding Wiring Diagram information, refer to [AV-191, "Wiring Diagram"](#).

#### 1. CHECK CONTINUITY BETWEEN AV CONTROL UNIT AND BOSE SPEAKER AMP.

1. Turn ignition switch OFF.
2. Disconnect AV control unit connector M197 and Bose speaker amp. connector B130.
3. Check continuity between AV control unit connector M197 and Bose speaker amp. connector B130.

AV control unit		Bose speaker amp.		Continuity
Connector	Terminal	Connector	Terminal	
M197	110	B130	60	Yes

4. Check continuity between AV control unit connector M197 and ground.

AV control unit		Ground	Continuity
Connector	Terminal		
M197	110	—	No

Is the inspection result normal?

- YES >> GO TO 2.  
NO >> Repair or replace harness or connectors.

#### 2. CHECK AV CONTROL UNIT VOLTAGE

1. Connect AV control unit connector M197.
2. Turn ignition switch ON.
3. Check voltage between AV control unit connector M197 and ground.

AV control unit		Ground	Voltage (Approx.)
(+)			
Connector	Terminal	(-)	
M197	110	—	Battery voltage

Is the inspection result normal?

- YES >> Replace Bose speaker amp. Refer to [AV-307, "Removal and Installation"](#).  
NO >> Replace AV control unit. Refer to [AV-303, "Removal and Installation - AV Control Unit"](#).

# U1300 AV COMM CIRCUIT

< DTC/CIRCUIT DIAGNOSIS >

[BOSE AUDIO WITHOUT NAVIGATION]

## U1300 AV COMM CIRCUIT

### Description

INFOID:000000009724905

U1300 is indicated when a malfunction occurs in the communication signal of the multi AV system. Indicated simultaneously, without fail, the malfunction of control units connected to the AV control unit through communication circuits. Determine the possible malfunction cause from the table below.

### SELF-DIAGNOSIS RESULTS DISPLAY ITEM

CONSULT Display	DTC Detection Condition	Possible Cause
<ul style="list-style-type: none"> <li>• AV COMM CIRCUIT [U1300]</li> <li>• SWITCH CONN [U1240]</li> </ul>	When any of the following is detected: <ul style="list-style-type: none"> <li>• A/C and AV switch assembly power supply or ground circuit malfunction.</li> <li>• AV communication circuit malfunction between AV control unit and A/C and AV switch assembly.</li> </ul>	<ul style="list-style-type: none"> <li>• A/C and AV switch assembly power supply and ground circuits.</li> <li>• AV communication circuits between AV control unit and A/C and AV switch assembly.</li> </ul>
<ul style="list-style-type: none"> <li>• AV COMM CIRCUIT [U1300]</li> <li>• AMP CONN [U124E]</li> </ul>	When any of the following is detected: <ul style="list-style-type: none"> <li>• BOSE speaker amp. power supply or ground circuit malfunction.</li> <li>• AV communication circuits between AV control unit and BOSE speaker amp. are malfunctioning.</li> </ul>	<ul style="list-style-type: none"> <li>• BOSE speaker amp. power supply and ground circuits. Refer to <a href="#">AV-520. "BOSE AMP. : Diagnosis Procedure"</a>.</li> <li>• AV communication circuits between AV control unit and BOSE speaker amp.</li> </ul>
<ul style="list-style-type: none"> <li>• AV COMM CIRCUIT [U1300]</li> <li>• HAND FREE CONN [U1256]</li> </ul>	When any of the following is detected: <ul style="list-style-type: none"> <li>• Bluetooth® control unit power supply or ground circuit malfunction.</li> <li>• AV communication circuit malfunction between AV control unit and Bluetooth® control unit.</li> </ul>	<ul style="list-style-type: none"> <li>• Bluetooth® control unit power supply and ground circuits.</li> <li>• AV communication circuits between AV control unit and Bluetooth® control unit.</li> </ul>
<ul style="list-style-type: none"> <li>• AV COMM CIRCUIT [U1300]</li> <li>• SWITCH CONN [U1240]</li> <li>• HAND FREE CONN [U1256]</li> </ul>	AV communication circuit malfunction between AV control unit and A/C and AV switch assembly.	AV communication circuits between AV control unit and A/C and AV switch assembly.

A  
B  
C  
D  
E  
F  
G  
H  
I  
J  
K  
L  
M

AV

O  
P

# U1310 AV CONTROL UNIT

< DTC/CIRCUIT DIAGNOSIS >

[BOSE AUDIO WITHOUT NAVIGATION]

## U1310 AV CONTROL UNIT

### DTC Logic

INFOID:000000009724906

CONSULT Display	DTC Detection Condition	Possible Cause
CONTROL UNIT (AV) [U1310]	An initial diagnosis error is detected in AV communication circuit.	Replace the AV control unit if the malfunction occurs constantly. Refer to <a href="#">AV-303, "Removal and Installation - AV Control Unit"</a> .

# U1601, U1603, U1609, U160B FRONT DOOR SPEAKER/TWEETER

< DTC/CIRCUIT DIAGNOSIS >

[BOSE AUDIO WITHOUT NAVIGATION]

## U1601, U1603, U1609, U160B FRONT DOOR SPEAKER/TWEETER

### DTC Logic

INFOID:000000009763087

### DTC DETECTION LOGIC

CONSULT Display	DTC Detection Condition	Possible Cause
FL-DOOR WOOFER (OPEN, SHORT, GND- SHORT) [U1601] FL-DOOR WOOFER (VB-SHOR) [U1603]	When any of the following is detected: <ul style="list-style-type: none"><li>• Sound signal circuit malfunction between BOSE speaker amp. and front door speaker LH.</li><li>• Sound signal circuit malfunction between BOSE speaker amp. and front tweeter LH.</li></ul>	<ul style="list-style-type: none"><li>• Sound signal circuits between BOSE speaker amp. and front door speaker LH. Refer to <a href="#">AV-258, "Diagnosis Procedure"</a>.</li><li>• Sound signal circuits between BOSE speaker amp. and front tweeter LH. Refer to <a href="#">AV-255, "Diagnosis Procedure"</a>.</li></ul>
FR-DOOR WOOFER (OPEN, SHORT, GND- SHORT) [U1609] FR-DOOR WOOFER (VB-SHOR) [U160B]	When any of the following is detected: <ul style="list-style-type: none"><li>• Sound signal circuit malfunction between BOSE speaker amp. and front door speaker RH.</li><li>• Sound signal circuit malfunction between BOSE speaker amp. and front tweeter RH.</li></ul>	<ul style="list-style-type: none"><li>• Sound signal circuits between BOSE speaker amp. and front door speaker RH. Refer to <a href="#">AV-258, "Diagnosis Procedure"</a>.</li><li>• Sound signal circuits between BOSE speaker amp. and front tweeter RH. Refer to <a href="#">AV-255, "Diagnosis Procedure"</a>.</li></ul>

### Diagnosis Procedure

INFOID:000000009763088

#### 1. PERFORM SELF DIAGNOSTIC RESULT

1. Perform Self Diagnostic Result for MULTI AV.
2. Erase Self Diagnostic Result. Turn ignition switch OFF.
3. Turn ignition switch ON. Perform Self Diagnostic Result again.

Is DTC U1601, U1603, U1609 or U160B detected?

- YES >> Refer to [AV-258, "Diagnosis Procedure"](#).  
NO >> Refer to [GI-53, "Intermittent Incident"](#).

A  
B  
C  
D  
E  
F  
G  
H  
I  
J  
K  
L  
M  
AV  
O  
P

# U1627, U162F TWEETER

< DTC/CIRCUIT DIAGNOSIS >

[BOSE AUDIO WITHOUT NAVIGATION]

## U1627, U162F TWEETER

### DTC Logic

INFOID:000000009763089

### DTC DETECTION LOGIC

CONSULT Display	DTC Detection Condition	Possible Cause
F-INST L-TWEETER (OPEN, SHORT, GND- SHORT or VB-SHOR) [U1627]	Sound signal circuit malfunction between BOSE speaker amp. and instrument panel tweeter LH.	Sound signal circuits between BOSE speaker amp. and instrument panel tweeter LH. Refer to <a href="#">AV-252, "Diagnosis Procedure"</a> .
F-INST R-TWEETER (OPEN, SHORT, GND- SHORT or VB-SHOR) [U162F]	Sound signal circuit malfunction between BOSE speaker amp. and instrument panel tweeter RH.	Sound signal circuits between BOSE speaker amp. and instrument panel tweeter RH. Refer to <a href="#">AV-252, "Diagnosis Procedure"</a> .

### Diagnosis Procedure

INFOID:000000009763090

#### 1. PERFORM SELF DIAGNOSTIC RESULT

1. Perform Self Diagnostic Result for MULTI AV.
2. Erase Self Diagnostic Result. Turn ignition switch OFF.
3. Turn ignition switch ON. Perform Self Diagnostic Result again.

Is DTC U1627 or U162F detected?

- YES >> Refer to [AV-252, "Diagnosis Procedure"](#).  
NO >> Refer to [GI-53, "Intermittent Incident"](#).

# U162A CENTER SPEAKER

< DTC/CIRCUIT DIAGNOSIS >

[BOSE AUDIO WITHOUT NAVIGATION]

## U162A CENTER SPEAKER

### DTC Logic

INFOID:000000009763091

### DTC DETECTION LOGIC

CONSULT Display	DTC Detection Condition	Possible Cause
F-INST C-SQUAWK (OPEN, SHORT, GND- SHORT, or VB-SHORT) [U162A]	Sound signal circuit malfunction between BOSE speaker amp. and center speaker.	Sound signal circuits between BOSE speaker amp. and center speaker. Refer to <a href="#">AV-250, "Diagnosis Procedure"</a> .

### Diagnosis Procedure

INFOID:000000009763092

#### 1. PERFORM SELF DIAGNOSTIC RESULT

1. Perform Self Diagnostic Result for MULTI AV.
2. Erase Self Diagnostic Result. Turn ignition switch OFF.
3. Turn ignition switch ON. Perform Self Diagnostic Result again.

#### Is DTC U162A detected?

- YES >> Refer to [AV-250, "Diagnosis Procedure"](#).  
NO >> Refer to [GI-53, "Intermittent Incident"](#).

A  
B  
C  
D  
E  
F  
G  
H  
I  
J  
K  
L  
M

AV

O  
P

# U1684, U1687, U168C, U168F REAR DOOR SPEAKER/TWEETER

< DTC/CIRCUIT DIAGNOSIS >

[BOSE AUDIO WITHOUT NAVIGATION]

## U1684, U1687, U168C, U168F REAR DOOR SPEAKER/TWEETER

### DTC Logic

INFOID:000000009763093

### DTC DETECTION LOGIC

CONSULT Display	DTC Detection Condition	Possible Cause
2L-DOOR SPEAKER (OPEN, SHORT, GND- SHORT) [U1684] 2L-DOOR SPEAKER (VB- SHOR) [U1687]	Sound signal circuit malfunction between BOSE speaker amp. and rear door speaker LH.	Sound signal circuits between BOSE speaker amp. and rear door speaker LH. Refer to <a href="#">AV-261, "Diagnosis Procedure"</a> .
2R-DOOR SPEAKER (OPEN, SHORT, GND- SHORT) [U168C] 2R-DOOR SPEAKER (VB- SHOR) [U168F]	Sound signal circuit malfunction between BOSE speaker amp. and rear door speaker RH.	Sound signal circuits between BOSE speaker amp. and rear door speaker RH. Refer to <a href="#">AV-261, "Diagnosis Procedure"</a> .

### Diagnosis Procedure

INFOID:000000009763094

#### 1. PERFORM SELF DIAGNOSTIC RESULT

1. Perform Self Diagnostic Result for MULTI AV.
2. Erase Self Diagnostic Result. Turn ignition switch OFF.
3. Turn ignition switch ON. Perform Self Diagnostic Result again.

#### Is DTC U1684, U1687, U168C or U168F detected?

- YES >> Refer to [AV-261, "Diagnosis Procedure"](#).  
NO >> Refer to [GI-53, "Intermittent Incident"](#).



# U175D WOOFER

< DTC/CIRCUIT DIAGNOSIS >

[BOSE AUDIO WITHOUT NAVIGATION]

## U175D WOOFER

### DTC Logic

INFOID:000000009763095

### DTC DETECTION LOGIC

CONSULT Display	DTC Detection Condition	Possible Cause
R-LUGGAGE L-WOOFER (OPEN, SHORT, GND- SHORT or VB-SHOR) [U175D]	Sound signal circuit malfunction between BOSE speaker amp. and subwoofer.	Sound signal circuits between BOSE speaker amp. and subwoofer. Refer to <a href="#">AV-267, "Diagnosis Procedure"</a> .

### Diagnosis Procedure

INFOID:000000009763096

#### 1. PERFORM SELF DIAGNOSTIC RESULT

1. Perform Self Diagnostic Result for MULTI AV.
2. Erase Self Diagnostic Result. Turn ignition switch OFF.
3. Turn ignition switch ON. Perform Self Diagnostic Result again.

#### Is DTC U175D detected?

- YES >> Refer to [AV-267, "Diagnosis Procedure"](#).  
NO >> Refer to [GI-53, "Intermittent Incident"](#).

A  
B  
C  
D  
E  
F  
G  
H  
I  
J  
K  
L  
M

AV

O  
P

# U176A, U1772 ROOF SPEAKER

< DTC/CIRCUIT DIAGNOSIS >

[BOSE AUDIO WITHOUT NAVIGATION]

## U176A, U1772 ROOF SPEAKER

### DTC Logic

INFOID:000000009763097

### DTC DETECTION LOGIC

CONSULT Display	DTC Detection Condition	Possible Cause
R-ROOF L-SQAWK (OPEN, SHORT, GND- SHORT or VB-SHOR) [U176A]	Sound signal circuit malfunction between BOSE speaker amp. and rear side speaker LH.	Sound signal circuits between BOSE speaker amp. and rear side speaker LH. Refer to <a href="#">AV-264, "Diagnosis Procedure"</a> .
R-ROOF R-SQAWK (OPEN, SHORT, GND- SHORT or VB-SHOR) [U1772]	Sound signal circuit malfunction between BOSE speaker amp. and rear side speaker RH.	Sound signal circuits between BOSE speaker amp. and rear side speaker RH. Refer to <a href="#">AV-264, "Diagnosis Procedure"</a> .

### Diagnosis Procedure

INFOID:000000009763098

#### 1. PERFORM SELF DIAGNOSTIC RESULT

1. Perform Self Diagnostic Result for MULTI AV.
2. Erase Self Diagnostic Result. Turn ignition switch OFF.
3. Turn ignition switch ON. Perform Self Diagnostic Result again.

Is DTC U176A or U1772 detected?

- YES >> Refer to [AV-264, "Diagnosis Procedure"](#).  
NO >> Refer to [GI-53, "Intermittent Incident"](#).

# POWER SUPPLY AND GROUND CIRCUIT

< DTC/CIRCUIT DIAGNOSIS >

[BOSE AUDIO WITHOUT NAVIGATION]

## POWER SUPPLY AND GROUND CIRCUIT

### AV CONTROL UNIT

#### AV CONTROL UNIT : Diagnosis Procedure

INFOID:000000009724907

Regarding Wiring Diagram information, refer to [AV-191. "Wiring Diagram"](#).

#### 1. CHECK FUSE

Check that the following fuses are not blown.

Terminal No.	Signal name	Fuse No.
29	Ignition signal	29 (5A)
39	ACC power supply	65 (10A)
51	Battery power supply	15 (15A)

##### Are the fuses blown?

YES >> Replace the blown fuse after repairing the affected circuit.

NO >> GO TO 2.

#### 2. CHECK POWER SUPPLY CIRCUIT

1. Turn ignition switch OFF.
2. Disconnect AV control unit connectors M192 and M193.
3. Check voltage between AV control unit connectors and ground.

AV control unit		Ground	Condition	Voltage (Approx.)
Connector	Terminal			
M192	29	—	Ignition switch: ON	Battery voltage
M193	39		Ignition switch: ACC	
	51		Ignition switch: OFF	

##### Is the inspection result normal?

YES >> GO TO 3.

NO >> Repair or replace harness or connectors.

#### 3. CHECK GROUND CIRCUIT

1. Turn ignition switch OFF.
2. Check continuity between AV control unit connector M193 terminal 52 and ground.

AV control unit		Ground	Continuity
Connector	Terminal		
M193	52	—	Yes

##### Is the inspection result normal?

YES >> Inspection End.

NO >> Repair or replace harness or connectors.

## DISPLAY UNIT

#### DISPLAY UNIT : Diagnosis Procedure

INFOID:000000009724908

Regarding Wiring Diagram information, refer to [AV-191. "Wiring Diagram"](#).

#### 1. CHECK INVERTER VCC AND SIGNAL VCC (POWER SUPPLY) CIRCUIT 1

# POWER SUPPLY AND GROUND CIRCUIT

< DTC/CIRCUIT DIAGNOSIS >

[BOSE AUDIO WITHOUT NAVIGATION]

Check voltage between display unit harness connector M93 terminals 2, 3 and ground.

Display unit		Ground	Condition	Voltage (Approx.)
Connector	Terminal			
M93	2	—	Ignition switch: ACC	9.0 V
	3			

Is the inspection result normal?

YES >> GO TO 4.

NO >> GO TO 2.

## 2. CHECK INVERTER VCC AND SIGNAL VCC (POWER SUPPLY) CIRCUIT CONTINUITY

1. Turn ignition switch OFF.
2. Disconnect AV control unit connector M194 and display unit connector.
3. Check continuity between AV control unit connector M194 terminals 64, 76 and display unit connector M93 terminals 3, 2.

AV control unit		Display unit		Continuity
Connector	Terminal	Connector	Terminal	
M194	64	M93	3	Yes
	76		2	

4. Check continuity between AV control unit connector M194 terminals 64, 76 and ground.

AV control unit		Ground	Continuity
Connector	Terminal		
M194	64	—	No
	76		

Is the inspection result normal?

YES >> GO TO 3.

NO >> Repair or replace harness or connectors.

## 3. CHECK INVERTER VCC AND SIGNAL VCC (POWER SUPPLY) CIRCUIT 2

1. Connect the AV control unit connector M194.
2. Check voltage between AV control unit connector M194 terminals 64, 76 and ground.

AV control unit		Ground	Condition	Voltage (Approx.)
(+)				
Connector	Terminal			
M194	64	—	Ignition switch: ACC	9.0 V
	76			

Is the inspection result normal?

YES >> Inspection End.

NO >> Replace AV control unit. Refer to [AV-303. "Removal and Installation - AV Control Unit"](#).

## 4. CHECK INVERTER GROUND AND SIGNAL GROUND CIRCUIT CONTINUITY

1. Turn ignition switch OFF.
2. Disconnect AV control unit connector M194 and display unit connector.
3. Check continuity between AV control unit connector M194 terminals 63, 75 and display unit connector M93 terminals 14, 13.

# POWER SUPPLY AND GROUND CIRCUIT

< DTC/CIRCUIT DIAGNOSIS >

[BOSE AUDIO WITHOUT NAVIGATION]

AV control unit		Display unit		Continuity
Connector	Terminal	Connector	Terminal	
M194	63	M93	14	Yes
	75		13	

Is the inspection result normal?

YES >> GO TO 5.

NO >> Repair or replace harness or connectors.

## 5.CHECK DISPLAY UNIT GROUND CIRCUIT

Check continuity between display unit connector M93 terminal 1 and ground.

Display unit		Ground	Continuity
Connector	Terminal		
M93	1	—	Yes

Is the inspection result normal?

YES >> Inspection End.

NO >> Repair or replace harness or connectors.

## BOSE AMP.

### BOSE AMP. : Diagnosis Procedure

INFOID:000000009726864

Regarding Wiring Diagram information, refer to [AV-390, "Wiring Diagram"](#).

## 1.CHECK FUSE

Check that the following fuses are not blown.

Terminal No.	Signal name	Fuse No.
50	Battery power supply	11 (15A)
51		12 (15A)

Are the fuses blown?

YES >> Replace the blown fuse after repairing the affected circuit.

NO >> GO TO 2.

## 2.CHECK POWER SUPPLY CIRCUIT

1. Disconnect BOSE speaker amp. connector B129.
2. Check voltage between BOSE speaker amp. connector B129 and ground.

BOSE speaker amp.		Ground	Voltage (Approx.)
Connector	Terminal		
B129	50	—	Battery voltage
	51		

Is the inspection result normal?

YES >> GO TO 3.

NO >> Repair or replace harness or connectors.

## 3.CHECK GROUND CIRCUIT

1. Turn ignition switch OFF.
2. Check continuity between BOSE speaker amp. connector B129 and ground.

A  
B  
C  
D  
E  
F  
G  
H  
I  
J  
K  
L  
M  
O  
P

AV

# POWER SUPPLY AND GROUND CIRCUIT

< DTC/CIRCUIT DIAGNOSIS >

[BOSE AUDIO WITHOUT NAVIGATION]

BOSE speaker amp.		Ground	Continuity
Connector	Terminal		
B129	47	—	Yes
	52		

Is the inspection result normal?

- YES >> Inspection End.  
NO >> Repair or replace harness or connectors.

## SUBWOOFER

### SUBWOOFER : Diagnosis Procedure

INFOID:000000009726865

Regarding Wiring Diagram information, refer to [AV-390, "Wiring Diagram"](#).

## 1.CHECK FUSE

Check that the following fuses are not blown.

Terminal No.	Signal name	Fuse No.
6	Battery power supply	58 (10A)

Are the fuses blown?

- YES >> Replace the blown fuse after repairing the affected circuit.  
NO >> GO TO 2.

## 2.CHECK POWER SUPPLY CIRCUIT

1. Disconnect subwoofer connector.
2. Check voltage between subwoofer connector B73 and ground.

Subwoofer		Ground	Voltage (Approx.)
Connector	Terminal		
B73	6	—	Battery voltage

Is the inspection result normal?

- YES >> GO TO 3.  
NO >> Repair or replace harness or connectors.

## 3.CHECK GROUND CIRCUIT

1. Turn ignition switch OFF.
2. Check continuity between subwoofer connector B73 and ground.

Subwoofer		Ground	Continuity
Connector	Terminal		
B73	5	—	Yes

Is the inspection result normal?

- YES >> Inspection End.  
NO >> Repair or replace harness or connectors.

## SATELLITE RADIO TUNER

### SATELLITE RADIO TUNER : Diagnosis Procedure

INFOID:000000009724909

Regarding Wiring Diagram information, refer to [AV-191, "Wiring Diagram"](#).

# POWER SUPPLY AND GROUND CIRCUIT

< DTC/CIRCUIT DIAGNOSIS >

[BOSE AUDIO WITHOUT NAVIGATION]

## 1.CHECK FUSE

Check that the following fuses are not blown.

Terminal No.	Signal name	Fuse No.
32	Battery power supply	15 (15A)
36	ACC power supply	65 (10A)

Are the fuses blown?

- YES >> Replace the blown fuse after repairing the affected circuit.  
NO >> GO TO 2.

## 2.CHECK POWER SUPPLY CIRCUIT

1. Turn ignition switch OFF.
2. Disconnect satellite radio tuner connector B2.
3. Check voltage between satellite radio tuner connector B2 terminal 32, 36 and ground.

Satellite radio tuner		Ground	Condition	Voltage (Approx.)
Connector	Terminal			
B2	32	—	Ignition switch: OFF	Battery voltage
	36		Ignition switch: ACC	

Is the inspection result normal?

- YES >> GO TO 3.  
NO >> Repair or replace harness or connectors.

## 3.CHECK GROUND CIRCUIT

1. Turn ignition switch OFF.
2. Check continuity between satellite radio tuner connector B2 terminal 35 and ground.

Satellite radio tuner		Ground	Continuity
Connector	Terminal		
B2	35	—	Yes

Is the inspection result normal?

- YES >> Inspection End.  
NO >> Repair or replace harness or connectors.

## BLUETOOTH® CONTROL UNIT

### BLUETOOTH® CONTROL UNIT : Diagnosis Procedure

INFOID:000000009724910

Regarding Wiring Diagram information, refer to [AV-191, "Wiring Diagram"](#).

## 1.CHECK FUSE

Check that the following fuses are not blown.

Terminal No.	Signal name	Fuse No.
1	Battery power supply	15 (15A)
2	ACC power supply	65 (10A)
3	Ignition signal	30 (10A)

Are the fuses blown?

- YES >> Replace the blown fuse after repairing the affected circuit.  
NO >> GO TO 2.

A  
B  
C  
D  
E  
F  
G  
H  
I  
J  
K  
L  
M  
AV  
O  
P

# POWER SUPPLY AND GROUND CIRCUIT

< DTC/CIRCUIT DIAGNOSIS >

[BOSE AUDIO WITHOUT NAVIGATION]

## 2.CHECK POWER SUPPLY CIRCUIT

1. Turn ignition switch OFF.
2. Disconnect Bluetooth® control unit connector B3.
3. Check voltage between Bluetooth® control unit connector B3 and ground.

Bluetooth® control unit		Ground	Condition	Voltage (Approx.)
Connector	Terminal			
B3	1	—	Ignition switch: OFF	Battery voltage
	2		Ignition switch: ACC	
	3		Ignition switch: ON	

Is the inspection result normal?

YES >> GO TO 3.

NO >> Repair or replace harness or connectors.

## 3.CHECK GROUND CIRCUIT

1. Turn ignition switch OFF.
2. Check continuity between Bluetooth® control unit connector B3 and ground.

Bluetooth® control unit		Ground	Continuity
Connector	Terminal		
B3	4	—	Yes
	23		
	27		

Is the inspection result normal?

YES >> Inspection End.

NO >> Repair or replace harness or connectors.

## A/C AND AV SWITCH ASSEMBLY

### A/C AND AV SWITCH ASSEMBLY : Diagnosis Procedure

INFOID:000000009724911

Regarding Wiring Diagram information, refer to [AV-191. "Wiring Diagram"](#).

## 1.CHECK FUSE

Check that the following fuse is not blown.

Terminal No.	Signal name	Fuse No.
36	ACC power supply	65 (10A)

Is the fuse blown?

YES >> Replace the blown fuse after repairing the affected circuit.

NO >> GO TO 2.

## 2.CHECK POWER SUPPLY CIRCUIT

1. Turn ignition switch OFF.
2. Disconnect A/C and AV switch assembly connector.
3. Check voltage between A/C and AV switch assembly connector M98 terminal 3 and ground.

A/C and AV switch assembly		Ground	Condition	Voltage (Approx.)
Connector	Terminal			
M98	3	—	Ignition switch: ACC	Battery voltage



# POWER SUPPLY AND GROUND CIRCUIT

[BOSE AUDIO WITHOUT NAVIGATION]

< DTC/CIRCUIT DIAGNOSIS >

Is the inspection result normal?

YES >> GO TO 3.

NO >> Repair or replace harness or connectors.

## 3.CHECK CONTROL UNIT GROUND CIRCUIT

1. Turn ignition switch OFF.
2. Disconnect AV control unit connector M192.
3. Check continuity between A/C and AV switch assembly connector M98 terminal 9 and AV control unit connector M192 terminal 10.

A/C and AV switch assembly		AV control unit		Continuity
Connector	Terminal	Connector	Terminal	
M98	9	M192	10	Yes

Is the inspection result normal?

YES >> GO TO 4.

NO >> Repair or replace harness or connectors.

## 4.CHECK SWITCH GROUND CIRCUIT

Check continuity between A/C and AV switch assembly connector M98 terminal 1 and ground.

A/C and AV switch assembly		Ground	Continuity
Connector	Terminal		
M98	1	—	Yes

Is the inspection result normal?

YES >> Inspection End.

NO >> Repair or replace harness or connectors.

A  
B  
C  
D  
E  
F  
G  
H  
I  
J  
K  
L  
M  
O  
P

AV

# CENTER SPEAKER

< DTC/CIRCUIT DIAGNOSIS >

[BOSE AUDIO WITHOUT NAVIGATION]

## CENTER SPEAKER

### Diagnosis Procedure

INFOID:000000009726866

Regarding Wiring Diagram information, refer to [AV-390. "Wiring Diagram"](#).

### 1. CONNECTOR CHECK

Check the AV control unit, BOSE speaker amp. and speaker connectors for the following:

- Proper connection
- Damage
- Disconnected or loose terminals

Is the inspection result normal?

YES >> GO TO 2.

NO >> Repair the terminals or connectors.

### 2. CHECK CENTER SPEAKER SIGNAL CIRCUIT CONTINUITY

1. Disconnect BOSE speaker amp. connector B130 and center speaker connector.
2. Check continuity between BOSE speaker amp. connector B130 and center speaker connector M110.

BOSE speaker amp.		Center speaker		Continuity
Connector	Terminal	Connector	Terminal	
B130	69	M110	1	Yes
	70		2	

3. Check continuity between BOSE speaker amp. connector B130 and ground.

BOSE speaker amp.		Ground	Continuity
Connector	Terminal		
B130	69	—	No
	70		

Is the inspection result normal?

YES >> GO TO 3.

NO >> Repair or replace harness or connectors.

### 3. CHECK CENTER SPEAKER SIGNAL

1. Connect BOSE speaker amp. connector B130 and center speaker connector M110.
2. Turn ignition switch to ACC.
3. Push AV control unit POWER switch.
4. Check signal between terminals of BOSE speaker amp. connector B130.

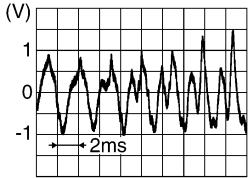
BOSE speaker amp. connector B130		Condition	Reference value
(+) Terminal	(-) Terminal		
69	70	Audio signal output	

Is the inspection result normal?

# CENTER SPEAKER

**[BOSE AUDIO WITHOUT NAVIGATION]**

< DTC/CIRCUIT DIAGNOSIS >

- YES >> Replace center speaker. Refer to [AV-594, "Removal and Installation"](#).  
 NO >> GO TO 4.

## 4. CHECK PRE-AMP SIGNAL CIRCUIT CONTINUITY

1. Disconnect AV control unit connector M197 and BOSE speaker amp. connector B130.
2. Check continuity between AV control unit connector M197 and BOSE speaker amp. connector B130.

AV control unit		BOSE speaker amp.		Continuity
Connector	Terminal	Connector	Terminal	
M197	113	B130	75	Yes
	119		76	
	109		73	
	115		74	

3. Check continuity between AV control unit connector M197 and ground.

AV control unit		Ground	Continuity
Connector	Terminal		
M197	113	—	No
	119		
	109		
	115		

Is the inspection result normal?

- YES >> GO TO 5.  
 NO >> Repair or replace harness or connectors.

## 5. CHECK PRE-AMP SIGNAL

1. Connect AV control unit connector M197 and BOSE speaker amp. connector B130.
2. Turn ignition switch to ACC.
3. Push AV control unit POWER switch.
4. Check signal between the terminals of AV control unit connector M197.

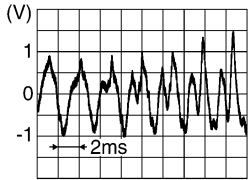
AV control unit connector M197		Condition	Reference value
(+) Terminal	(-) Terminal		
113	119	Audio signal output	
109	115		

Is the inspection result normal?

- YES >> Replace BOSE speaker amp. Refer to [AV-307, "Removal and Installation"](#).  
 NO >> Replace AV control unit. Refer to [AV-303, "Removal and Installation - AV Control Unit"](#).

# INSTRUMENT PANEL SPEAKER/TWEETER

< DTC/CIRCUIT DIAGNOSIS >

[BOSE AUDIO WITHOUT NAVIGATION]

## INSTRUMENT PANEL SPEAKER/TWEETER

### Diagnosis Procedure

INFOID:000000009763099

Regarding Wiring Diagram information, refer to [AV-191. "Wiring Diagram"](#).

### 1. CONNECTOR CHECK

Check the AV control unit, BOSE speaker amp. and speaker connectors for the following:

- Proper connection
- Damage
- Disconnected or loose terminals

Is the inspection result normal?

YES >> GO TO 2.

NO >> Repair the terminals or connectors.

### 2. CHECK INSTRUMENT PANEL TWEETER SIGNAL CIRCUIT CONTINUITY

1. Disconnect BOSE speaker amp. connector B129 and suspect instrument panel tweeter connector.
2. Check continuity between BOSE speaker amp. connector B129 and suspect instrument panel tweeter connector.

BOSE speaker amp.		Instrument panel tweeter		Continuity
Connector	Terminal	Connector	Terminal	
B129	41	M62 (LH)	1	Yes
	42		2	
	45	M73 (RH)	1	
	46		2	

3. Check continuity between BOSE speaker amp. connector B129 and ground.

BOSE speaker amp.		Ground	Continuity
Connector	Terminal		
B129	41	—	No
	42		
	45		
	46		

Is the inspection result normal?

YES >> GO TO 3.

NO >> Repair or replace harness or connectors.

### 3. CHECK INSTRUMENT PANEL TWEETER SIGNAL

1. Connect BOSE speaker amp. connector B129 and suspect instrument panel tweeter connector.
2. Turn ignition switch to ACC.
3. Push AV control unit POWER switch.
4. Check signal between terminals of BOSE speaker amp. connector B129.

BOSE speaker amp.		Condition	Reference value
(+)	(-)		
Terminal	Terminal		

# INSTRUMENT PANEL SPEAKER/TWEETER

< DTC/CIRCUIT DIAGNOSIS >

[BOSE AUDIO WITHOUT NAVIGATION]

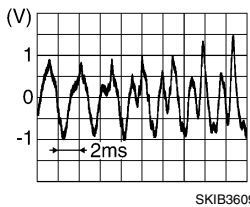
41	42	Audio signal output	
45	46		

Is the inspection result normal?

YES >> Replace instrument panel tweeter. Refer to [AV-310. "Removal and Installation"](#).

NO >> GO TO 4.

## 4. CHECK PRE-AMP SIGNAL CIRCUIT CONTINUITY

1. Disconnect AV control unit connector M197 and BOSE speaker amp. connector B130.
2. Check continuity between AV control unit connector M197 and BOSE speaker amp. connector B130.

AV control unit		BOSE speaker amp.		Continuity
Connector	Terminal	Connector	Terminal	
M197	113	B130	75	Yes
	119		76	
	109		73	
	115		74	

3. Check continuity between AV control unit connector M197 and ground.

AV control unit		Ground	Continuity
Connector	Terminal		
M197	113	—	No
	119		
	109		
	115		

Is the inspection result normal?

YES >> GO TO 5.

NO >> Repair or replace harness or connectors.

## 5. CHECK PRE-AMP SIGNAL

1. Connect AV control unit connector M197 and BOSE speaker amp. connector B130.
2. Turn ignition switch to ACC.
3. Push AV control unit POWER switch.
4. Check signal between the terminals of AV control unit connector M197.

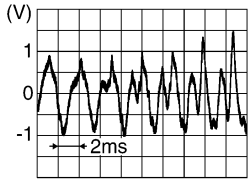
AV control unit connector M197		Condition	Reference value
(+)	(-)		
Terminal	Terminal	Audio signal output	
113	119		
109	115		

Is the inspection result normal?

YES >> Replace BOSE speaker amp. Refer to [AV-307. "Removal and Installation"](#).

A  
B  
C  
D  
E  
F  
G  
H  
I  
J  
K  
L  
M  
AV  
O  
P

## INSTRUMENT PANEL SPEAKER/TWEETER

< DTC/CIRCUIT DIAGNOSIS >

[BOSE AUDIO WITHOUT NAVIGATION]

---

NO >> Replace AV control unit. Refer to [AV-303. "Removal and Installation - AV Control Unit"](#).

# FRONT TWEETER

< DTC/CIRCUIT DIAGNOSIS >

[BOSE AUDIO WITHOUT NAVIGATION]

## FRONT TWEETER

### Diagnosis Procedure

INFOID:000000009726867

Regarding Wiring Diagram information, refer to [AV-390. "Wiring Diagram"](#).

### 1. CONNECTOR CHECK

Check the AV control unit, BOSE speaker amp. and speaker connectors for the following:

- Proper connection
- Damage
- Disconnected or loose terminals

Is the inspection result normal?

YES >> GO TO 2.

NO >> Repair the terminals or connectors.

### 2. CHECK FRONT TWEETER SIGNAL CIRCUIT CONTINUITY

1. Disconnect BOSE speaker amp. connector B130 and suspect front tweeter connector.
2. Check continuity between BOSE speaker amp. connector B130 and suspect front door speaker connector.

BOSE speaker amp.		Front tweeter		Continuity
Connector	Terminal	Connector	Terminal	
B130	58	M109 (LH)	1	Yes
	59		2	
	71	M111 (RH)	1	
	72		2	

3. Check continuity between BOSE speaker amp. connector B130 and ground.

BOSE speaker amp.		Ground	Continuity
Connector	Terminal		
B130	58	—	No
	59		
	71		
	72		

Is the inspection result normal?

YES >> GO TO 3.

NO >> Repair or replace harness or connectors.

### 3. CHECK FRONT TWEETER SIGNAL

1. Connect BOSE speaker amp. connector B130 and suspect front tweeter connector.
2. Turn ignition switch to ACC.
3. Push AV control unit POWER switch.
4. Check signal between terminals of BOSE speaker amp. connector B130.

BOSE speaker amp. connector B130		Condition	Reference value
(+)	(-)		
Terminal	Terminal		

A  
B  
C  
D  
E  
F  
G  
H  
I  
J  
K  
L  
M  
O  
P

AV

# FRONT TWEETER

< DTC/CIRCUIT DIAGNOSIS >

[BOSE AUDIO WITHOUT NAVIGATION]

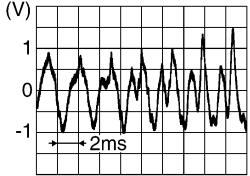
58	59	Audio signal output	
71	72		

Is the inspection result normal?

- YES >> Replace front tweeter. Refer to [AV-592. "Removal and Installation"](#).  
 NO >> GO TO 4.

## 4. CHECK PRE-AMP SIGNAL CIRCUIT CONTINUITY

1. Disconnect AV control unit connector M197 and BOSE speaker amp. connector B130.
2. Check continuity between AV control unit connector M197 and BOSE speaker amp. connector B130.

AV control unit		BOSE speaker amp.		Continuity
Connector	Terminal	Connector	Terminal	
M197	113	B130	75	Yes
	119		76	
	109		73	
	115		74	

3. Check continuity between AV control unit connector M197 and ground.

AV control unit		Ground	Continuity
Connector	Terminal		
M197	113	—	No
	119		
	109		
	115		

Is the inspection result normal?

- YES >> GO TO 5.  
 NO >> Repair or replace harness or connectors.

## 5. CHECK PRE-AMP SIGNAL

1. Connect AV control unit connector M197 and BOSE speaker amp. connector B130.
2. Turn ignition switch to ACC.
3. Push AV control unit POWER switch.
4. Check signal between the terminals of AV control unit connector M197.

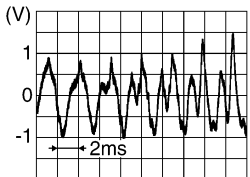
AV control unit connector M197		Condition	Reference value
(+)	(-)		
Terminal	Terminal	Audio signal output	
113	119		
109	115		

Is the inspection result normal?

- YES >> Replace BOSE speaker amp. Refer to [AV-590. "Removal and Installation"](#).



# FRONT TWEETER

< DTC/CIRCUIT DIAGNOSIS >

[BOSE AUDIO WITHOUT NAVIGATION]

NO >> Replace AV control unit. Refer to [AV-303, "Removal and Installation - AV Control Unit"](#).

A

B

C

D

E

F

G

H

I

J

K

L

M

AV

O

P

# FRONT DOOR SPEAKER

[BOSE AUDIO WITHOUT NAVIGATION]

< DTC/CIRCUIT DIAGNOSIS >

## FRONT DOOR SPEAKER

### Diagnosis Procedure

INFOID:000000009763100

Regarding Wiring Diagram information, refer to [AV-191. "Wiring Diagram"](#).

### 1. CONNECTOR CHECK

Check the AV control unit, BOSE speaker amp. and speaker connectors for the following:

- Proper connection
- Damage
- Disconnected or loose terminals

Is the inspection result normal?

YES >> GO TO 2.

NO >> Repair the terminals or connectors.

### 2. CHECK FRONT DOOR SPEAKER SIGNAL CIRCUIT CONTINUITY

1. Disconnect BOSE speaker amp. connector B130 and suspect front door speaker connector.
2. Check continuity between BOSE speaker amp. connector B130 and suspect front door speaker connector.

BOSE speaker amp.		Front door speaker		Continuity
Connector	Terminal	Connector	Terminal	
B130	58	D12 (LH)	1	Yes
	59		2	
	71	D112 (RH)	1	
	72		2	

3. Check continuity between BOSE speaker amp. connector B130 and ground.

BOSE speaker amp.		Ground	Continuity
Connector	Terminal		
B130	58	—	No
	59		
	71		
	72		

Is the inspection result normal?

YES >> GO TO 3.

NO >> Repair or replace harness or connectors.

### 3. CHECK FRONT DOOR SPEAKER SIGNAL

1. Connect BOSE speaker amp. connector B130 and suspect front door speaker connector.
2. Turn ignition switch to ACC.
3. Push AV control unit POWER switch.
4. Check signal between terminals of BOSE speaker amp. connector B130.

BOSE speaker amp. connector B130		Condition	Reference value
(+)	(-)		
Terminal	Terminal		

# FRONT DOOR SPEAKER

[BOSE AUDIO WITHOUT NAVIGATION]

< DTC/CIRCUIT DIAGNOSIS >

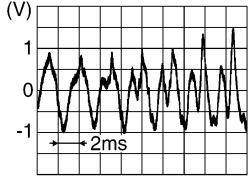
58	59	Audio signal output	
71	72		

Is the inspection result normal?

YES >> Replace front door speaker. Refer to [AV-308. "Removal and Installation"](#).

NO >> GO TO 4.

## 4. CHECK PRE-AMP SIGNAL CIRCUIT CONTINUITY

1. Disconnect AV control unit connector M197 and BOSE speaker amp. connector B130.
2. Check continuity between AV control unit connector M197 and BOSE speaker amp. connector B130.

AV control unit		BOSE speaker amp.		Continuity
Connector	Terminal	Connector	Terminal	
M197	113	B130	75	Yes
	119		76	
	109		73	
	115		74	

3. Check continuity between AV control unit connector M197 and ground.

AV control unit		Ground	Continuity
Connector	Terminal		
M197	113	—	No
	119		
	109		
	115		

Is the inspection result normal?

YES >> GO TO 5.

NO >> Repair or replace harness or connectors.

## 5. CHECK PRE-AMP SIGNAL

1. Connect AV control unit connector M197 and BOSE speaker amp. connector B130.
2. Turn ignition switch to ACC.
3. Push AV control unit POWER switch.
4. Check signal between the terminals of AV control unit connector M197.

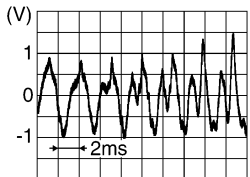
AV control unit connector M197		Condition	Reference value
(+) Terminal	(-) Terminal		
113	119	Audio signal output	
109	115		

Is the inspection result normal?

YES >> Replace BOSE speaker amp. Refer to [AV-307. "Removal and Installation"](#).

A  
B  
C  
D  
E  
F  
G  
H  
I  
J  
K  
L  
M  
O  
P

AV

## FRONT DOOR SPEAKER

< DTC/CIRCUIT DIAGNOSIS >

[BOSE AUDIO WITHOUT NAVIGATION]

---

NO >> Replace AV control unit. Refer to [AV-303. "Removal and Installation - AV Control Unit"](#).

# REAR DOOR SPEAKER

[BOSE AUDIO WITHOUT NAVIGATION]

< DTC/CIRCUIT DIAGNOSIS >

## REAR DOOR SPEAKER

### Diagnosis Procedure

INFOID:000000009763101

Regarding Wiring Diagram information, refer to [AV-191. "Wiring Diagram"](#).

### 1. CONNECTOR CHECK

Check the AV control unit, BOSE speaker amp. and speaker connectors for the following:

- Proper connection
- Damage
- Disconnected or loose terminals

Is the inspection result normal?

YES >> GO TO 2.

NO >> Repair the terminals or connectors.

### 2. CHECK REAR DOOR SPEAKER SIGNAL CIRCUIT CONTINUITY

1. Disconnect BOSE speaker amp. connectors and suspect rear door speaker connector.
2. Check continuity between BOSE speaker amp. connectors and suspect rear door speaker connector.

BOSE speaker amp.		Rear door speaker		Continuity
Connector	Terminal	Connector	Terminal	
B130	68	D207 (LH)	1	Yes
	55		2	
B129	54	D307 (RH)	1	
	49		2	

3. Check continuity between BOSE speaker amp. connectors and ground.

BOSE speaker amp.		Ground	Continuity
Connector	Terminal		
B130	68	—	No
	55		
B129	54		
	49		

Is the inspection result normal?

YES >> GO TO 3.

NO >> Repair or replace harness or connectors.

### 3. CHECK REAR DOOR SPEAKER SIGNAL

1. Connect BOSE speaker amp. connectors and suspect rear door speaker connector.
2. Turn ignition switch to ACC.
3. Push AV control unit POWER switch.
4. Check signal between terminals of BOSE speaker amp. connectors.

A  
B  
C  
D  
E  
F  
G  
H  
I  
J  
K  
L  
M  
AV  
O  
P

# REAR DOOR SPEAKER

< DTC/CIRCUIT DIAGNOSIS >

[BOSE AUDIO WITHOUT NAVIGATION]

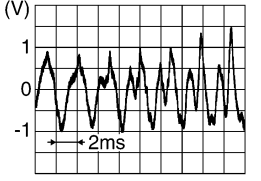
BOSE speaker amp.			Condition	Reference value
Connector	(+) Terminal	(-) Terminal		
B130	68	55	Audio signal output	
B129	54	49		

Is the inspection result normal?

- YES >> Replace rear door speaker. Refer to [AV-312, "Removal and Installation"](#).  
 NO >> GO TO 3.

## 4. CHECK PRE-AMP SIGNAL CIRCUIT CONTINUITY

1. Disconnect AV control unit connector M197 and BOSE speaker amp. connector B130.
2. Check continuity between AV control unit connector M197 and BOSE speaker amp. connector B130.

AV control unit		BOSE speaker amp.		Continuity
Connector	Terminal	Connector	Terminal	
M197	112	B130	64	Yes
	118		63	
	108		66	
	114		65	

3. Check continuity between AV control unit connector M197 and ground.

AV control unit		Ground	Continuity
Connector	Terminal		
M197	112	—	No
	118		
	108		
	114		

Is the inspection result normal?

- YES >> GO TO 5.  
 NO >> Repair or replace harness or connectors.

## 5. CHECK PRE-AMP SIGNAL

1. Connect AV control unit connector M197 and BOSE speaker amp. connector B130.
2. Turn ignition switch to ACC.
3. Push AV control unit POWER switch.
4. Check signal between the terminals of AV control unit connector M197.

AV control unit connector M197		Condition	Reference value
(+) Terminal	(-) Terminal		

# REAR DOOR SPEAKER

[BOSE AUDIO WITHOUT NAVIGATION]

< DTC/CIRCUIT DIAGNOSIS >

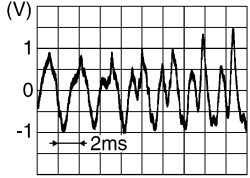
112	118		
108	114	Audio signal output	

Is the inspection result normal?

- YES >> Replace BOSE speaker amp. Refer to [AV-307. "Removal and Installation"](#).
- NO >> Replace AV control unit. Refer to [AV-303. "Removal and Installation - AV Control Unit"](#).

A  
B  
C  
D  
E  
F  
G  
H  
I  
J  
K  
L  
M  
O  
P

AV

# REAR SPEAKER

< DTC/CIRCUIT DIAGNOSIS >

[BOSE AUDIO WITHOUT NAVIGATION]

## REAR SPEAKER

### Diagnosis Procedure

INFOID:000000009726868

Regarding Wiring Diagram information, refer to [AV-390. "Wiring Diagram"](#).

### 1. CONNECTOR CHECK

Check the AV control unit, BOSE speaker amp. and speaker connectors for the following:

- Proper connection
- Damage
- Disconnected or loose terminals

Is the inspection result normal?

YES >> GO TO 2.

NO >> Repair the terminals or connectors.

### 2. CHECK REAR SIDE SPEAKER SIGNAL CIRCUIT CONTINUITY

1. Disconnect BOSE speaker amp. connector B129 and suspect rear side speaker connector.
2. Check continuity between BOSE speaker amp. connector B129 and suspect rear side speaker connector.

BOSE speaker amp.		Rear side speaker		Continuity
Connector	Terminal	Connector	Terminal	
B129	53	B1 (LH)	1	Yes
	48		2	
	44	B153 (RH)	1	
	43		2	

3. Check continuity between BOSE speaker amp. connector B129 and ground.

BOSE speaker amp.		Ground	Continuity
Connector	Terminal		
B129	53	—	No
	48		
	44		
	43		

Is the inspection result normal?

YES >> GO TO 3.

NO >> Repair or replace harness or connectors.

### 3. CHECK REAR SIDE SPEAKER SIGNAL

1. Connect BOSE speaker amp. connector B129 and suspect rear side speaker connector.
2. Turn ignition switch to ACC.
3. Push AV control unit POWER switch.
4. Check signal between terminals of BOSE speaker amp. connector B129.



# REAR SPEAKER

< DTC/CIRCUIT DIAGNOSIS >

[BOSE AUDIO WITHOUT NAVIGATION]

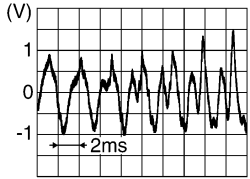
BOSE speaker amp. connector B129		Condition	Reference value
(+)	(-)		
Terminal	Terminal		
53	48	Audio signal output	
44	43		

Is the inspection result normal?

- YES >> Replace rear side speaker. Refer to [AV-596. "Removal and Installation"](#).  
 NO >> GO TO 4.

## 4. CHECK PRE-AMP SIGNAL CIRCUIT CONTINUITY

- Disconnect AV control unit connector M197 and BOSE speaker amp. connector B130.
- Check continuity between AV control unit connector M197 and BOSE speaker amp. connector B130.

AV control unit		BOSE speaker amp.		Continuity
Connector	Terminal	Connector	Terminal	
M197	112	B130	64	Yes
	118		63	
	108		66	
	114		65	

- Check continuity between AV control unit connector M197 and ground.

AV control unit		Ground	Continuity
Connector	Terminal		
M197	112	—	No
	118		
	108		
	114		

Is the inspection result normal?

- YES >> GO TO 5.  
 NO >> Repair or replace harness or connectors.

## 5. CHECK PRE-AMP SIGNAL

- Connect AV control unit connector M197 and BOSE speaker amp. connector B130.
- Turn ignition switch to ACC.
- Push AV control unit POWER switch.
- Check signal between the terminals of AV control unit connector M197.

AV control unit connector M197		Condition	Reference value
(+)	(-)		
Terminal	Terminal		

A  
B  
C  
D  
E  
F  
G  
H  
I  
J  
K  
L  
M  
O  
P

AV

# REAR SPEAKER

< DTC/CIRCUIT DIAGNOSIS >

[BOSE AUDIO WITHOUT NAVIGATION]

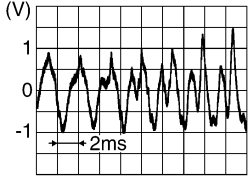
112	118	Audio signal output	
108	114		

SKIB3609E

Is the inspection result normal?

YES >> Replace BOSE speaker amp. Refer to [AV-590. "Removal and Installation"](#).

NO >> Replace AV control unit. Refer to [AV-303. "Removal and Installation - AV Control Unit"](#).

# SUBWOOFER

< DTC/CIRCUIT DIAGNOSIS >

[BOSE AUDIO WITHOUT NAVIGATION]

## SUBWOOFER

### Diagnosis Procedure

INFOID:00000009726869

Regarding Wiring Diagram information, refer to [AV-390. "Wiring Diagram"](#).

#### 1. CONNECTOR CHECK

Check the AV control unit, BOSE speaker amp. and subwoofer connectors for the following:

- Proper connection
- Damage
- Disconnected or loose terminals

Is the inspection result normal?

YES >> GO TO 2.

NO >> Repair the terminal and connector.

#### 2. VERIFY SUBWOOFER POWER SUPPLY AND GROUND

Check subwoofer power supply and ground. Refer to [AV-245. "BOSE AMP. : Diagnosis Procedure"](#).

Is the inspection result normal?

YES >> GO TO 3.

NO >> Repair or replace harness or connectors.

#### 3. CHECK SUBWOOFER AMP ON CIRCUIT CONTINUITY

1. Turn ignition switch OFF.
2. Disconnect Bose speaker amp. connector B130 and subwoofer connector.
3. Check continuity between Bose speaker amp. connector B130 and subwoofer connector B73.

Bose speaker amp.		Subwoofer		Continuity
Connector	Terminal	Connector	Terminal	
B130	62	B73	4	Yes

4. Check continuity between Bose speaker amp. connector B130 and ground.

Bose speaker amp.		Ground	Continuity
Connector	Terminal		
B130	62	—	No

Is the inspection result normal?

YES >> GO TO 4.

NO >> Repair or replace harness or connectors.

#### 4. CHECK SUBWOOFER AMP ON CIRCUIT VOLTAGE

1. Connect Bose speaker amp. connector B130.
2. Turn ignition switch ON.
3. Check voltage between Bose speaker amp. connector B130 and ground.

Bose speaker amp.		Ground	Voltage (Approx.)
(+)			
Connector	Terminal		
B130	62	—	Battery voltage

Is the inspection result normal?

YES >> GO TO 5.

NO >> Replace Bose speaker amp. Refer to [AV-590. "Removal and Installation"](#).

A  
B  
C  
D  
E  
F  
G  
H  
I  
J  
K  
L  
M  
AV  
O  
P

# SUBWOOFER

< DTC/CIRCUIT DIAGNOSIS >

[BOSE AUDIO WITHOUT NAVIGATION]

## 5. CHECK SUBWOOFER SIGNAL CIRCUIT CONTINUITY

1. Disconnect BOSE speaker amp. connector B130 and subwoofer connector.
2. Check continuity between BOSE speaker amp. connector B130 and subwoofer connector.

BOSE speaker amp.		Subwoofer		Continuity
Connector	Terminal	Connector	Terminal	
B130	56	B73	2	Yes
	57		1	

3. Check continuity between BOSE speaker amp. connector B130 and ground.

BOSE speaker amp.		Ground	Continuity
Connector	Terminal		
B130	56	—	No
	57		

Is the inspection result normal?

YES >> GO TO 6.

NO >> Repair or replace harness or connectors.

## 6. CHECK SUBWOOFER SIGNAL

1. Connect BOSE speaker amp. connector B130 and subwoofer connector.
2. Turn ignition switch to ACC.
3. Push AV control unit POWER switch.
4. Check the signal between the terminals of BOSE speaker amp. connector B130.

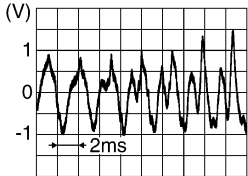
BOSE speaker amp. connector B130		Condition	Reference value
(+) Terminal	(-) Terminal		
56	57	Audio signal output	 <p style="text-align: right; font-size: small;">SKIB3609E</p>

Is the inspection result normal?

YES >> Replace subwoofer. Refer to [AV-597. "Removal and Installation"](#).

NO >> GO TO 7.

## 7. CHECK PRE-AMP SIGNAL CIRCUIT CONTINUITY

1. Disconnect AV control unit connector M197 and BOSE speaker amp. connector B130.
2. Check continuity between AV control unit connector M197 and BOSE speaker amp. connector B130.

AV control unit		BOSE speaker amp.		Continuity
Connector	Terminal	Connector	Terminal	
M197	112	B130	64	Yes
	118		63	
	108		66	
	114		65	

3. Check continuity between AV control unit connector M197 and ground.

# SUBWOOFER

< DTC/CIRCUIT DIAGNOSIS >

[BOSE AUDIO WITHOUT NAVIGATION]

AV control unit		Ground	Continuity
Connector	Terminal		
M197	112	—	No
	118		
	108		
	114		

Is the inspection result normal?

YES >> GO TO 8.

NO >> Repair or replace harness or connectors.

## 8. CHECK PRE-AMP SIGNAL

1. Connect AV control unit connector M197 and BOSE speaker amp. connector B130.
2. Turn ignition switch to ACC.
3. Push AV control unit POWER switch.
4. Check signal between the terminals of AV control unit connector M197.

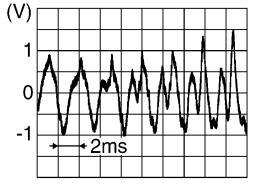
AV control unit connector M197		Condition	Reference value
(+) Terminal	(-) Terminal		
112	118	Audio signal output	
108	114		

Is the inspection result normal?

YES >> Replace BOSE speaker amp. Refer to [AV-307, "Removal and Installation"](#).

NO >> Replace AV control unit. Refer to [AV-303, "Removal and Installation - AV Control Unit"](#).

AV

# FRONT AUXILIARY INPUT JACK AUDIO SIGNAL CIRCUIT

< DTC/CIRCUIT DIAGNOSIS >

[BOSE AUDIO WITHOUT NAVIGATION]

## FRONT AUXILIARY INPUT JACK AUDIO SIGNAL CIRCUIT

### Diagnosis Procedure

INFOID:000000009724915

Regarding Wiring Diagram information, refer to [AV-191. "Wiring Diagram"](#).

### 1. CHECK AUX SOUND SIGNAL CIRCUIT CONTINUITY

1. Turn ignition OFF.
2. Disconnect AV control unit connector M192 and front auxiliary input jacks connector.
3. Check continuity between AV control unit connector M192 and front auxiliary input jacks connector M205.

AV control unit		Front auxiliary input jacks		Continuity
Connector	Terminal	Connector	Terminal	
M192	20	M205	1	Yes
	21		3	

4. Check continuity between AV control unit connector M192 and ground.

AV control unit		Ground	Continuity
Connector	Terminal		
M192	20	—	No
	21		

Is inspection result normal?

YES >> GO TO 2.

NO >> Repair or replace harness or connectors.

### 2. CHECK AUX SOUND SIGNAL GROUND CIRCUIT CONTINUITY

Check continuity between AV control unit connector M192 and front auxiliary input jacks connector M205.

AV control unit		Front auxiliary input jacks		Continuity
Connector	Terminal	Connector	Terminal	
M192	22	M205	2	Yes

Is inspection result normal?

YES >> GO TO 3.

NO >> Repair or replace harness or connectors.

### 3. CHECK AUX SOUND SIGNAL

1. Connect AV control unit connector M192 and front auxiliary input jacks connector.
2. Turn ignition switch to ACC.
3. Select AUX mode.
4. Check signal between terminals of AV control unit connector M192.

AV control unit connector M192		Condition	Reference value
(+)	(-)		
Terminal	Terminal		

# FRONT AUXILIARY INPUT JACK AUDIO SIGNAL CIRCUIT

< DTC/CIRCUIT DIAGNOSIS >

[BOSE AUDIO WITHOUT NAVIGATION]

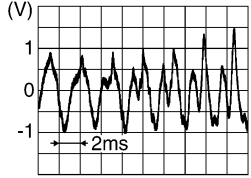
20	22		
21	22	AUX mode selected	

Is the inspection result normal?

- YES >> Replace front auxiliary input jacks. Refer to [AV-317, "Removal and Installation"](#).
- NO >> Replace AV control unit. Refer to [AV-303, "Removal and Installation - AV Control Unit"](#).

A  
B  
C  
D  
E  
F  
G  
H  
I  
J  
K  
L  
M  
O  
P

AV

# SATELLITE AUDIO SIGNAL CIRCUIT

< DTC/CIRCUIT DIAGNOSIS >

[BOSE AUDIO WITHOUT NAVIGATION]

## SATELLITE AUDIO SIGNAL CIRCUIT

### Diagnosis Procedure

INFOID:000000009724916

Regarding Wiring Diagram information, refer to [AV-191. "Wiring Diagram"](#).

### 1. CHECK SATELLITE SOUND SIGNAL CIRCUIT CONTINUITY

1. Turn ignition switch OFF.
2. Disconnect AV control unit connector M196 and satellite radio tuner connector B2.
3. Check continuity between AV control unit connector M196 and satellite radio tuner connector B2.

AV control unit		Satellite radio tuner		Continuity
Connector	Terminals	Connector	Terminals	
M196	94	B2	22	Yes
	96		24	

4. Check continuity between AV control unit connector M196 and ground.

AV control unit		Ground	Continuity
Connector	Terminals		
M196	94		No
	96		

Is the inspection result normal?

- YES >> GO TO 2.  
 NO >> Repair or replace harness or connectors.

### 2. CHECK SATELLITE SOUND SIGNAL GROUND CIRCUIT CONTINUITY

Check continuity between AV control unit connector M196 and satellite radio tuner connector B2.

AV control unit		Satellite radio tuner		Continuity
Connector	Terminals	Connector	Terminals	
M196	93	B2	21	Yes
	95		23	

Is the inspection result normal?

- YES >> GO TO 3.  
 NO >> Repair or replace harness or connectors.

### 3. CHECK SATELLITE SOUND SIGNAL

1. Connect AV control unit connector M196 and satellite radio tuner connector B2.
2. Turn ignition switch to ACC.
3. Select satellite radio mode.
4. Check signal between terminals of AV control unit connector M196.

AV control unit connector M196		Condition	Reference value
(+)	(-)		
Terminal	Terminal		



# SATELLITE AUDIO SIGNAL CIRCUIT

< DTC/CIRCUIT DIAGNOSIS >

[BOSE AUDIO WITHOUT NAVIGATION]

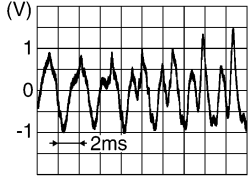
94	93	Satellite radio mode selected	
96	95		

Is the inspection result normal?

- YES >> Replace satellite radio tuner. Refer to [AV-320. "Removal and Installation"](#).
- NO >> Replace AV control unit. Refer to [AV-303. "Removal and Installation - AV Control Unit"](#).

A  
B  
C  
D  
E  
F  
G  
H  
I  
J  
K  
L  
M  
O  
P

AV

# BLUETOOTH® VOICE SIGNAL CIRCUIT

< DTC/CIRCUIT DIAGNOSIS >

[BOSE AUDIO WITHOUT NAVIGATION]

## BLUETOOTH® VOICE SIGNAL CIRCUIT

### Diagnosis Procedure

INFOID:000000009724917

Regarding Wiring Diagram information, refer to [AV-191. "Wiring Diagram"](#).

### 1. CHECK BLUETOOTH® VOICE SIGNAL CIRCUIT CONTINUITY

1. Turn ignition switch OFF.
2. Disconnect AV control unit connector M192 and Bluetooth® control unit connector B3.
3. Check continuity between AV control unit connector M192 terminal 5 and Bluetooth® control unit connector B3 terminal 9.

AV control unit		Bluetooth® control unit		Continuity
Connector	Terminal	Connector	Terminal	
M192	5	B3	9	Yes

4. Check continuity between AV control unit connector M192 terminal 5 and ground.

AV control unit		Ground	Continuity
Connector	Terminal		
M192	5	—	No

Is inspection result normal?

YES >> GO TO 2.

NO >> Repair or replace harness or connectors.

### 2. CHECK BLUETOOTH® VOICE SIGNAL GROUND CIRCUIT CONTINUITY

Check continuity between AV control unit connector M192 terminal 4 and Bluetooth® control unit connector B3 terminal 10.

AV control unit		Bluetooth® control unit		Continuity
Connector	Terminal	Connector	Terminal	
M192	4	B3	10	Yes

Is inspection result normal?

YES >> GO TO 3.

NO >> Repair or replace harness or connectors.

### 3. CHECK BLUETOOTH® VOICE SIGNAL

1. Connect AV control unit connector M192 and Bluetooth® control unit connector B3.
2. Turn ignition switch to ACC.
3. Press  switch.
4. Check signal between terminals of AV control unit connector M192.

# BLUETOOTH® VOICE SIGNAL CIRCUIT

< DTC/CIRCUIT DIAGNOSIS >

[BOSE AUDIO WITHOUT NAVIGATION]

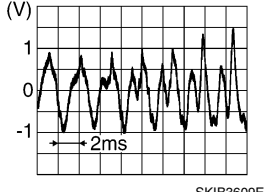
AV control unit connector M192		Condition	Reference value
(+)	(-)		
Terminal	Terminal		
5	4	During voice guide output with  switch pressed.	

Is the inspection result normal?

YES >> Replace Bluetooth® control unit. Refer to [AV-318. "Removal and Installation"](#).

NO >> Replace AV control unit. Refer to [AV-303. "Removal and Installation - AV Control Unit"](#).

A  
B  
C  
D  
E  
F  
G  
H  
I  
J  
K  
L  
M

AV

O  
P

# RGB (R: RED) SIGNAL CIRCUIT

< DTC/CIRCUIT DIAGNOSIS >

[BOSE AUDIO WITHOUT NAVIGATION]

## RGB (R: RED) SIGNAL CIRCUIT

### Diagnosis Procedure

INFOID:000000009724918

Regarding Wiring Diagram information, refer to [AV-191, "Wiring Diagram"](#).

#### 1. CHECK RGB (R: RED) SIGNAL CIRCUIT CONTINUITY

1. Turn ignition switch OFF.
2. Disconnect AV control unit connector M194 and display unit connector.
3. Check continuity between AV control unit connector M194 terminal 57 and display unit connector M93 terminal 17.

AV control unit		Display unit		Continuity
Connector	Terminal	Connector	Terminal	
M194	57	M93	17	Yes

4. Check continuity between AV control unit connector M194 terminal 57 and ground.

AV control unit		Ground	Continuity
Connector	Terminal		
M194	57		No

Is inspection result normal?

YES >> GO TO 2.

NO >> Repair or replace harness or connectors.

#### 2. CHECK RGB (R: RED) SIGNAL

1. Connect AV control unit connector M194 and display unit connector.
2. Turn ignition switch ON.
3. Check signal between display unit connector M93 terminal 17 and ground.

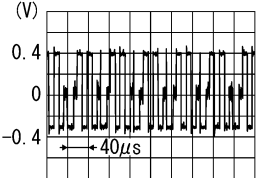
Display unit (+)		Ground (-)	Condition	Reference value
Connector	Terminal			
M93	17	—	"Color Spectrum Bar" on DISPLAY DIAGNOSIS screen.	 <p>SKIB2238J</p>

Is inspection result normal?

YES >> Replace display unit. Refer to [AV-306, "Removal and Installation"](#).

NO >> Replace AV control unit. Refer to [AV-303, "Removal and Installation - AV Control Unit"](#).

# RGB (G: GREEN) SIGNAL CIRCUIT

< DTC/CIRCUIT DIAGNOSIS >

[BOSE AUDIO WITHOUT NAVIGATION]

## RGB (G: GREEN) SIGNAL CIRCUIT

### Diagnosis Procedure

INFOID:000000009724919

Regarding Wiring Diagram information, refer to [AV-191. "Wiring Diagram"](#).

#### 1. CHECK RGB (G: GREEN) SIGNAL CIRCUIT CONTINUITY

1. Turn ignition switch OFF.
2. Disconnect AV control unit connector M194 and display unit connector.
3. Check continuity between AV control unit connector M194 terminal 56 and display unit connector M93 terminal 6.

AV control unit		Display unit		Continuity
Connector	Terminal	Connector	Terminal	
M194	56	M93	6	Yes

4. Check continuity between AV control unit connector M194 terminal 56 and ground.

AV control unit		Ground	Continuity
Connector	Terminal		
M194	56		No

Is inspection result normal?

YES >> GO TO 2.

NO >> Repair or replace harness or connectors.

#### 2. CHECK RGB (G: GREEN) SIGNAL

1. Connect AV control unit connector M194 and display unit connector.
2. Turn ignition switch ON.
3. Check signal between display unit connector M93 terminal 6 and ground.

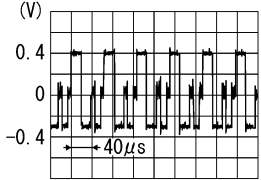
Display unit (+)		Ground (-)	Condition	Reference value
Connector	Terminal			
M93	6	—	"Color Spectrum Bar" on DISPLAY DIAGNOSIS screen.	 <p>SKIB2236J</p>

Is inspection result normal?

YES >> Replace display unit. Refer to [AV-306. "Removal and Installation"](#).

NO >> Replace AV control unit. Refer to [AV-303. "Removal and Installation - AV Control Unit"](#).

# RGB (B: BLUE) SIGNAL CIRCUIT

< DTC/CIRCUIT DIAGNOSIS >

[BOSE AUDIO WITHOUT NAVIGATION]

## RGB (B: BLUE) SIGNAL CIRCUIT

### Diagnosis Procedure

INFOID:000000009724920

Regarding Wiring Diagram information, refer to [AV-191, "Wiring Diagram"](#).

#### 1. CHECK RGB (B: BLUE) SIGNAL CIRCUIT CONTINUITY

1. Turn ignition switch OFF.
2. Disconnect AV control unit connector M194 and display unit connector.
3. Check continuity between AV control unit connector M194 terminal 55 and display unit connector M93 terminal 18.

AV control unit		Display unit		Continuity
Connector	Terminal	Connector	Terminal	
M194	55	M93	18	Yes

4. Check continuity between AV control unit connector M194 terminal 55 and ground.

AV control unit		Ground	Continuity
Connector	Terminal		
M194	55		No

Is inspection result normal?

YES >> GO TO 2.

NO >> Repair or replace harness or connectors.

#### 2. CHECK RGB (B: BLUE) SIGNAL

1. Connect AV control unit connector M194 and display unit connector.
2. Turn ignition switch ON.
3. Check signal between display unit connector M93 terminal 18 and ground.

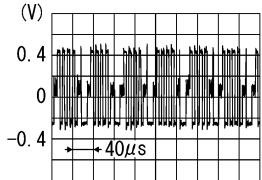
Display unit (+)		Ground (-)	Condition	Reference value
Connector	Terminal			
M93	18	—	"Color Spectrum Bar" on DISPLAY DIAGNOSIS screen.	 <p>SKIB2237J</p>

Is inspection result normal?

YES >> Replace display unit. Refer to [AV-306, "Removal and Installation"](#).

NO >> Replace AV control unit. Refer to [AV-303, "Removal and Installation - AV Control Unit"](#).

# RGB SYNCHRONIZING SIGNAL CIRCUIT

< DTC/CIRCUIT DIAGNOSIS >

[BOSE AUDIO WITHOUT NAVIGATION]

## RGB SYNCHRONIZING SIGNAL CIRCUIT

### Diagnosis Procedure

INFOID:000000009724921

Regarding Wiring Diagram information, refer to [AV-191. "Wiring Diagram"](#).

#### 1. CHECK RGB SYNCHRONIZING SIGNAL CIRCUIT CONTINUITY

1. Turn ignition switch OFF.
2. Disconnect AV control unit connector M194 and display unit connector.
3. Check continuity between AV control unit connector M194 terminal 58 and display unit connector M93 terminal 19.

AV control unit		Display unit		Continuity
Connector	Terminal	Connector	Terminal	
M194	58	M93	19	Yes

4. Check continuity between AV control unit connector M194 terminal 58 and ground.

AV control unit		Ground	Continuity
Connector	Terminal		
M194	58		No

Is inspection result normal?

YES >> GO TO 2.

NO >> Repair or replace harness or connectors.

#### 2. CHECK RGB SYNCHRONIZING SIGNAL

1. Connect AV control unit connector M194 and display unit connector.
2. Turn ignition switch ON.
3. Check signal between display unit connector M93 terminal 19 and ground.

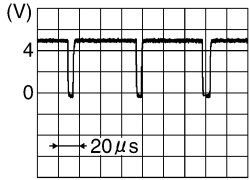
Display unit (+)		Ground (-)	Reference value
Connector	Terminal		
M93	19	—	 <p>SKIB3603E</p>

Is inspection result normal?

YES >> Replace display unit. Refer to [AV-306. "Removal and Installation"](#).

NO >> Replace AV control unit. Refer to [AV-303. "Removal and Installation - AV Control Unit"](#).

A  
B  
C  
D  
E  
F  
G  
H  
I  
J  
K  
L  
M  
AV  
O  
P

# RGB AREA (YS) SIGNAL CIRCUIT

< DTC/CIRCUIT DIAGNOSIS >

[BOSE AUDIO WITHOUT NAVIGATION]

## RGB AREA (YS) SIGNAL CIRCUIT

### Diagnosis Procedure

INFOID:000000009724922

Regarding Wiring Diagram information, refer to [AV-191, "Wiring Diagram"](#).

#### 1. CHECK RGB AREA (YS) SIGNAL CIRCUIT CONTINUITY

1. Turn ignition switch OFF.
2. Disconnect AV control unit connector M194 and display unit connector.
3. Check continuity between AV control unit connector M194 terminal 60 and display unit connector M93 terminal 9.

AV control unit		Display unit		Continuity
Connector	Terminal	Connector	Terminal	
M194	60	M93	9	Yes

4. Check continuity between AV control unit connector M194 terminal 60 and ground.

AV control unit		Ground	Continuity
Connector	Terminal		
M194	60		No

Is inspection result normal?

YES >> GO TO 2.

NO >> Repair or replace harness or connectors.

#### 2. CHECK RGB AREA (YS) SIGNAL

1. Connect AV control unit connector M194 and display unit connector.
2. Turn ignition switch ON.
3. Check signal between display unit connector M93 terminal 9 and ground.

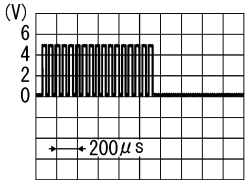
Display unit (+)		Ground (-)	Condition	Reference value
Connector	Terminal			
M93	9	—	RGB image displayed.	5.0 V
			AUX image displayed.	 <p style="text-align: right; font-size: small;">PKIB4948J</p>

Is inspection result normal?

YES >> Replace display unit. Refer to [AV-306, "Removal and Installation"](#).

NO >> Replace AV control unit. Refer to [AV-303, "Removal and Installation - AV Control Unit"](#).



# HORIZONTAL SYNCHRONIZING (HP) SIGNAL CIRCUIT

< DTC/CIRCUIT DIAGNOSIS >

[BOSE AUDIO WITHOUT NAVIGATION]

## HORIZONTAL SYNCHRONIZING (HP) SIGNAL CIRCUIT

### Diagnosis Procedure

INFOID:000000009724923

Regarding Wiring Diagram information, refer to [AV-191. "Wiring Diagram"](#).

### 1. CHECK HORIZONTAL SYNCHRONIZING (HP) SIGNAL CIRCUIT CONTINUITY

1. Turn ignition switch OFF.
2. Disconnect AV control unit connector M194 and display unit connector.
3. Check continuity between AV control unit connector M194 terminal 62 and display unit connector M93 terminal 8.

AV control unit		Display unit		Continuity
Connector	Terminal	Connector	Terminal	
M194	62	M93	8	Yes

4. Check continuity between AV control unit connector M194 terminal 62 and ground.

AV control unit		Ground	Continuity
Connector	Terminal		
M194	62		No

Is inspection result normal?

YES >> GO TO 2.

NO >> Repair or replace harness or connectors.

### 2. CHECK HORIZONTAL SYNCHRONIZING (HP) SIGNAL

1. Connect AV control unit connector M194 and display unit connector.
2. Turn ignition switch ON.
3. Check signal between display unit connector M93 terminal 8 and ground.

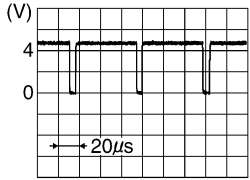
Display unit (+)		Ground (-)	Reference value
Connector	Terminal		
M93	8	—	 <p>SKIB3601E</p>

Is inspection result normal?

YES >> Replace AV control unit. Refer to [AV-303. "Removal and Installation - AV Control Unit"](#).

NO >> Replace display unit. Refer to [AV-306. "Removal and Installation"](#).

A  
B  
C  
D  
E  
F  
G  
H  
I  
J  
K  
L  
M  
O  
P

AV

# VERTICAL SYNCHRONIZING (VP) SIGNAL CIRCUIT

< DTC/CIRCUIT DIAGNOSIS >

[BOSE AUDIO WITHOUT NAVIGATION]

## VERTICAL SYNCHRONIZING (VP) SIGNAL CIRCUIT

### Diagnosis Procedure

INFOID:000000009724924

Regarding Wiring Diagram information, refer to [AV-191. "Wiring Diagram"](#).

#### 1. CHECK VERTICAL SYNCHRONIZING (VP) SIGNAL CIRCUIT CONTINUITY

1. Turn ignition switch OFF.
2. Disconnect AV control unit connector M194 and display unit connector.
3. Check continuity between AV control unit connector M194 terminal 74 and display unit connector M93 terminal 20.

AV control unit		Display unit		Continuity
Connector	Terminal	Connector	Terminal	
M194	74	M93	20	Yes

4. Check continuity between AV control unit connector M194 terminal 74 and ground.

AV control unit		Ground	Continuity
Connector	Terminal		
M194	74		No

Is inspection result normal?

YES >> GO TO 2.

NO >> Repair or replace harness or connectors.

#### 2. CHECK VERTICAL SYNCHRONIZING (VP) SIGNAL

1. Connect AV control unit connector M194 and display unit connector.
2. Turn ignition switch ON.
3. Check signal between display unit connector M93 terminal 20 and ground.

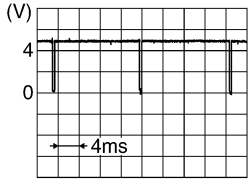
Display unit (+)		Ground (-)	Reference value
Connector	Terminal		
M93	20	—	 <p style="text-align: right; font-size: small;">SKIB3598E</p>

Is inspection result normal?

YES >> Replace AV control unit. Refer to [AV-303. "Removal and Installation - AV Control Unit"](#).

NO >> Replace display unit. Refer to [AV-306. "Removal and Installation"](#).

# COMPOSITE IMAGE SIGNAL CIRCUIT

< DTC/CIRCUIT DIAGNOSIS >

[BOSE AUDIO WITHOUT NAVIGATION]

## COMPOSITE IMAGE SIGNAL CIRCUIT

### Diagnosis Procedure

INFOID:000000009724925

Regarding Wiring Diagram information, refer to [AV-191. "Wiring Diagram"](#).

### 1. CHECK COMPOSITE IMAGE SIGNAL CIRCUIT CONTINUITY

1. Turn ignition switch OFF.
2. Disconnect AV control unit connector M194 and display unit connector.
3. Check continuity between AV control unit connector M194 terminal 53 and display unit connector M93 terminal 15.

AV control unit		Display unit		Continuity
Connector	Terminal	Connector	Terminal	
M194	53	M93	15	Yes

4. Check continuity between AV control unit connector M194 terminal 53 and ground.

AV control unit		Ground	Continuity
Connector	Terminal		
M194	53		No

Is inspection result normal?

YES >> GO TO 2.

NO >> Repair or replace harness or connectors.

### 2. CHECK COMPOSITE IMAGE SIGNAL GROUND CIRCUIT CONTINUITY

- Check continuity between AV control unit connector M194 terminal 54 and display unit connector M93 terminal 4.

AV control unit		Display unit		Continuity
Connector	Terminal	Connector	Terminal	
M194	54	M93	4	Yes

Is inspection result normal?

YES >> GO TO 3.

NO >> Repair or replace harness or connectors.

### 3. CHECK COMPOSITE IMAGE SIGNAL

1. Connect AV control unit connector M194 and display unit connector.
2. Turn ignition switch ON.
3. Check signal between display unit connector M93 terminal 15 and ground.

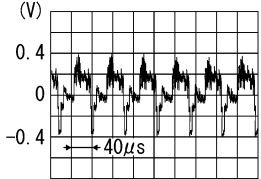
Display unit		Ground	Condition	Reference value
(+)		(-)		
Connector	Terminal			
M93	15	—	Camera image displayed.	 <p>SKIB2251J</p>

A  
B  
C  
D  
E  
F  
G  
H  
I  
J  
K  
L  
M  
O  
P

AV

## COMPOSITE IMAGE SIGNAL CIRCUIT

< DTC/CIRCUIT DIAGNOSIS >

[BOSE AUDIO WITHOUT NAVIGATION]

---

Is inspection result normal?

YES >> Replace display unit. Refer to [AV-306, "Removal and Installation"](#).

NO >> Replace AV control unit. Refer to [AV-303, "Removal and Installation - AV Control Unit"](#).

# AUX IMAGE SIGNAL CIRCUIT

< DTC/CIRCUIT DIAGNOSIS >

[BOSE AUDIO WITHOUT NAVIGATION]

## AUX IMAGE SIGNAL CIRCUIT

### Diagnosis Procedure

INFOID:000000009724926

Regarding Wiring Diagram information, refer to [AV-191. "Wiring Diagram"](#).

#### 1. CHECK AUX IMAGE SIGNAL CIRCUIT CONTINUITY

1. Turn ignition switch OFF.
2. Disconnect AV control unit connector M195 and front auxiliary input jacks connector.
3. Check continuity between AV control unit connector M195 terminal 83 and front auxiliary input jacks connector M205 terminal 7.

AV control unit		Front auxiliary input jacks		Continuity
Connector	Terminal	Connector	Terminal	
M195	83	M205	7	Yes

4. Check continuity between AV control unit connector M195 terminal 83 and ground.

AV control unit		Ground	Continuity
Connector	Terminal		
M195	83		No

Is inspection result normal?

YES >> GO TO 2.

NO >> Repair or replace harness or connectors.

#### 2. CHECK AUX IMAGE SIGNAL GROUND CIRCUIT CONTINUITY

1. Turn ignition switch OFF.
2. Disconnect AV control unit connector M195 and front auxiliary input jacks connector.
3. Check continuity between AV control unit connector M195 terminal 91 and front auxiliary input jacks connector M205 terminal 8.

AV control unit		Front auxiliary input jacks		Continuity
Connector	Terminal	Connector	Terminal	
M195	91	M205	8	Yes

Is inspection result normal?

YES >> GO TO 3.

NO >> Repair or replace harness or connectors.

#### 3. CHECK AUX IMAGE SIGNAL

1. Connect AV control unit connector M195 and front auxiliary input jacks connector.
2. Turn ignition switch ON.
3. Check signal between front auxiliary input jacks connector M205 terminal 7 and ground.

A  
B  
C  
D  
E  
F  
G  
H  
I  
J  
K  
L  
M  
O  
P

AV

# AUX IMAGE SIGNAL CIRCUIT

< DTC/CIRCUIT DIAGNOSIS >

[BOSE AUDIO WITHOUT NAVIGATION]

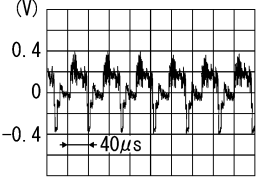
Front auxiliary input jacks		Ground	Condition	Reference value
(+) (–)		(–)		
Connector	Terminal			
M205	7	—	AUX image displayed.	 <p style="text-align: right; font-size: small;">SKIB2251J</p>

Is inspection result normal?

- YES >> Replace AV control unit. Refer to [AV-303. "Removal and Installation - AV Control Unit"](#).
- NO >> Replace front auxiliary input jacks. Refer to [AV-317. "Removal and Installation"](#).

# CAMERA IMAGE SIGNAL CIRCUIT

< DTC/CIRCUIT DIAGNOSIS >

[BOSE AUDIO WITHOUT NAVIGATION]

## CAMERA IMAGE SIGNAL CIRCUIT

### Diagnosis Procedure

INFOID:000000009724927

Regarding Wiring Diagram information, refer to [AV-191. "Wiring Diagram"](#).

### 1. CHECK REVERSE INPUT SIGNAL

1. Turn ignition switch ON.
2. Shift the selector lever to R (reverse).
3. Check voltage between AV control unit connector M192 and ground.

AV control unit		Ground	Condition	Voltage (Approx.)
(+)		(-)		
Connector	Terminal			
M192	30	—	Selector lever in R (reverse)	Battery Voltage

Is inspection result normal?

- YES >> GO TO 2.  
NO >> Repair or replace harness or connectors.

### 2. CHECK CAMERA POWER SUPPLY CIRCUIT CONTINUITY

1. Turn ignition switch OFF.
2. Disconnect AV control unit connector M195 and rear view camera connector.
3. Check continuity between AV control unit connector M195 terminal 87 and rear view camera connector D504 terminal 1.

AV control unit		Rear view camera		Continuity
Connector	Terminal	Connector	Terminal	
M195	87	D504	1	Yes

4. Check continuity between AV control unit connector M195 terminal 87 and ground.

AV control unit		Ground	Continuity
Connector	Terminal		
M195	87		No

Is inspection result normal?

- YES >> GO TO 3.  
NO >> Repair or replace harness or connectors.

### 3. CHECK CAMERA POWER SUPPLY VOLTAGE

1. Connect AV control unit connector M195 and rear view camera connector.
2. Turn ignition switch ON.
3. Shift the selector lever to "R".
4. Check voltage between AV control unit connector M195 terminal 87 and ground.

AV control unit		Ground	Condition	Voltage (Approx.)
(+)		(-)		
Connector	Terminal			
M195	87	—	Selector lever is in "R".	6.0 V

Is inspection result normal?

- YES >> GO TO 4.

A  
B  
C  
D  
E  
F  
G  
H  
I  
J  
K  
L  
M  
O  
P

AV

# CAMERA IMAGE SIGNAL CIRCUIT

[BOSE AUDIO WITHOUT NAVIGATION]

< DTC/CIRCUIT DIAGNOSIS >

NO >> Replace AV control unit. Refer to [AV-303, "Removal and Installation - AV Control Unit"](#).

## 4. CHECK CAMERA IMAGE SIGNAL CIRCUIT CONTINUITY

1. Turn ignition switch OFF.
2. Disconnect AV control unit connector M195 and rear view camera connector.
3. Check continuity between AV control unit connector M195 terminal 82 and rear view camera connector D504 terminal 3.

AV control unit		Rear view camera		Continuity
Connector	Terminal	Connector	Terminal	
M195	82	D504	3	Yes

4. Check continuity between AV control unit connector M195 terminal 82 and ground.

AV control unit		Ground	Continuity
Connector	Terminal		
M195	82		No

Is inspection result normal?

YES >> GO TO 5.

NO >> Repair or replace harness or connectors.

## 5. CHECK CAMERA GROUND CIRCUIT CONTINUITY

Check continuity between AV control unit connector M195 terminal 88 and rear view camera connector D504 terminal 2.

AV control unit		Rear view camera		Continuity
Connector	Terminal	Connector	Terminal	
M195	88	D504	2	Yes

Is inspection result normal?

YES >> GO TO 6.

NO >> Repair or replace harness or connectors.

## 6. CHECK CAMERA IMAGE SIGNAL

1. Connect AV control unit connector M195 and rear view camera connector.
2. Turn ignition switch ON.
3. Shift the selector lever to "R".
4. Check signal between AV control unit connector M195 terminal 82 and ground.

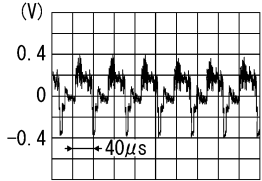
AV control unit		Ground	Condition	Reference value
(+)		(-)		
Connector	Terminal			
M195	82	—	Camera image displayed.	 <p style="text-align: right; font-size: small;">SKIB2251J</p>

Is inspection result normal?

YES >> Replace AV control unit. Refer to [AV-303, "Removal and Installation - AV Control Unit"](#).

NO >> Replace rear view camera. Refer to [AV-315, "Removal and Installation"](#).



# DISK EJECT SIGNAL CIRCUIT

< DTC/CIRCUIT DIAGNOSIS >

[BOSE AUDIO WITHOUT NAVIGATION]

## DISK EJECT SIGNAL CIRCUIT

### Diagnosis Procedure

INFOID:00000009724928

Regarding Wiring Diagram information, refer to [AV-191, "Wiring Diagram"](#).

#### 1. CHECK DISK EJECT SIGNAL CIRCUIT CONTINUITY

1. Turn ignition switch OFF.
2. Disconnect AV control unit connector M192 and A/C and AV switch assembly connector.
3. Check continuity between AV control unit connector M192 terminal 28 and A/C and AV switch assembly connector M98 terminal 14.

AV control unit		A/C and AV switch assembly		Continuity
Connector	Terminal	Connector	Terminal	
M192	28	M98	14	Yes

4. Check continuity between AV control unit connector M192 terminal 28 and ground.

AV control unit		Ground	Continuity
Connector	Terminal		
M192	28		No

Is inspection result normal?

YES >> GO TO 2.

NO >> Repair or replace harness or connectors.

#### 2. CHECK AV CONTROL UNIT VOLTAGE

1. Connect AV control unit connector M192 and A/C and AV switch assembly connector.
2. Turn ignition switch ON.
3. Check voltage between AV control unit connector M192 terminal 28 and ground.

AV control unit		Ground	Condition	Voltage (Approx.)
(+)				
Connector	Terminal			
M192	28	—	Pressing eject switch	0 V
			Except above	5.0 V

Is the inspection result normal?

YES >> Replace A/C and AV switch assembly. Refer to [AV-304, "Removal and Installation - A/C and AV Switch Assembly"](#).

NO >> Replace AV control unit. Refer to [AV-303, "Removal and Installation - AV Control Unit"](#).

A  
B  
C  
D  
E  
F  
G  
H  
I  
J  
K  
L  
M  
O  
P

AV

# MICROPHONE SIGNAL CIRCUIT

< DTC/CIRCUIT DIAGNOSIS >

[BOSE AUDIO WITHOUT NAVIGATION]

## MICROPHONE SIGNAL CIRCUIT

### Diagnosis Procedure

INFOID:000000009724929

Regarding Wiring Diagram information, refer to [AV-191. "Wiring Diagram"](#).

### 1. CHECK MICROPHONE SIGNAL CIRCUIT CONTINUITY

1. Turn ignition switch OFF.
2. Disconnect Bluetooth® control unit connector B3 and microphone connector.
3. Check continuity between Bluetooth® control unit connector B3 terminals 7, 8, 29 and microphone connector R109 terminals 4, 3, 1.

Bluetooth® control unit		Microphone		Continuity
Connector	Terminal	Connector	Terminal	
B3	7	R109	4	Yes
	8		3	
	29		1	

4. Check continuity between Bluetooth® control unit connector B3 terminals 7, 8, 29 and ground.

Bluetooth® control unit		Ground	Continuity
Connector	Terminal		
B3	7	—	No
	8		
	29		

Is inspection result normal?

YES >> GO TO 2.

NO >> Repair or replace harness or connectors.

### 2. CHECK MICROPHONE VCC VOLTAGE

1. Connect Bluetooth® control unit connector B3.
2. Turn ignition switch ON.
3. Check voltage between terminals of Bluetooth® control unit connector B3.

Bluetooth® control unit connector B3		Voltage (Approx.)
(+)	(-)	
Terminal	Terminal	
29	8	5.0 V

Is the inspection result normal?

YES >> GO TO 3.

NO >> Replace Bluetooth® control unit. Refer to [AV-318. "Removal and Installation"](#).

### 3. CHECK MICROPHONE SIGNAL

1. Connect microphone connector.
2. Check signal between terminals of Bluetooth® control unit connector B3.

# MICROPHONE SIGNAL CIRCUIT

< DTC/CIRCUIT DIAGNOSIS >

[BOSE AUDIO WITHOUT NAVIGATION]

Bluetooth® control unit connector B3		Condition	Reference value
(+) Terminal	(-) Terminal		
7	8	Speak into microphone.	

Is the inspection result normal?

YES >> Replace Bluetooth® control unit. Refer to [AV-318. "Removal and Installation"](#).

NO >> Replace microphone. Refer to [AV-319. "Removal and Installation"](#).

A  
B  
C  
D  
E  
F  
G  
H  
I  
J  
K  
L  
M  
O  
P

AV

# BLUETOOTH® CONTROL SIGNAL CIRCUIT

< DTC/CIRCUIT DIAGNOSIS >

[BOSE AUDIO WITHOUT NAVIGATION]

## BLUETOOTH® CONTROL SIGNAL CIRCUIT

### Diagnosis Procedure

INFOID:000000009724930

#### 1. CHECK CONTROL SIGNAL CIRCUIT CONTINUITY

1. Turn ignition switch OFF.
2. Disconnect Bluetooth® control unit connector B3.
3. Check continuity between Bluetooth® control unit connector B3 terminals 20, 24 and ground.

Bluetooth® control unit		Ground	Continuity
Connector	Terminals		
B3	20	—	Yes
	24		

Is the inspection result normal?

- YES >> Replace Bluetooth® control unit. Refer to [AV-318, "Removal and Installation"](#).  
NO >> Repair or replace harness or connectors.

# STEERING SWITCH

< DTC/CIRCUIT DIAGNOSIS >

[BOSE AUDIO WITHOUT NAVIGATION]

## STEERING SWITCH





### Diagnosis Procedure

INFOID:000000009724931

Regarding Wiring Diagram information, refer to [AV-191. "Wiring Diagram"](#).

### 1. CHECK STEERING WHEEL AUDIO CONTROL SWITCH RESISTANCE

1. Turn ignition switch OFF.
2. Disconnect combination switch connector M149.
3. Check resistance between combination switch connector terminals.

Combination switch connector M149		Condition	Resistance $\Omega$ (Approx.)
Terminal	Terminal		
14	17	Depress SOURCE switch.	1
		Depress $\Delta$ switch.	121
		Depress $\nabla$ switch.	321
		Depress  switch.	723
		Depress ENTER switch.	2023
15		Depress  switch.	1
		Depress  + switch.	121
		Depress  switch.	321
		Depress  switch.	723
		Depress DISP switch.	2023

Is the inspection result normal?

YES >> GO TO 2.

NO >> Replace steering wheel audio control switch. Refer to [AV-305. "Removal and Installation"](#).

### 2. CHECK HARNESS BETWEEN COMBINATION SWITCH AND COMBINATION METER

1. Disconnect combination meter connector M24 and combination switch connector M30.
2. Check continuity between combination meter connector M24 and combination switch connector M30.

Combination meter		Combination switch		Continuity
Connector	Terminal	Connector	Terminal	
M24	3	M30	24	Yes
	24		33	
	4		31	

3. Check continuity between combination meter connector M24 and ground.

Combination meter		Ground	Continuity
Connector	Terminal		
M24	3	—	No
	24		
	4		

Is the inspection result normal?

# STEERING SWITCH

[BOSE AUDIO WITHOUT NAVIGATION]

< DTC/CIRCUIT DIAGNOSIS >

- YES >> GO TO 3.  
 NO >> Repair or replace harness or connectors.

## 3.CHECK COMBINATION SWITCH

Check continuity between combination switch connectors M30 and M149.

Combination switch				Continuity
Connector	Terminal	Connector	Terminal	
M30	24	M149	14	Yes
	31		15	
	33		17	

Is the inspection result normal?

- YES >> GO TO 4.  
 NO >> Replace spiral cable. Refer to [SR-15, "Removal and Installation"](#).

## 4.CHECK HARNESS BETWEEN COMBINATION METER AND AV CONTROL UNIT

1. Disconnect AV control unit connector M193.
2. Check continuity between combination meter connector M24 and AV control unit connector M193.

Combination meter		AV control unit		Continuity
Connector	Terminal	Connector	Terminal	
M24	14	M193	38	Yes
	15		48	
	16		47	

3. Check continuity between combination meter connector M24 and ground.

Combination meter		Ground	Continuity
Connector	Terminal		
M24	14	—	No
	15		
	16		

Is the inspection result normal?

- YES >> GO TO 5.  
 NO >> Repair or replace harness or connectors.

## 5.CHECK AV CONTROL UNIT VOLTAGE

1. Connect combination meter connector M24 and AV control unit connector M193.
2. Turn ignition switch ON.
3. Check voltage between terminals of AV control unit connector M193.

AV control unit connector M193		Voltage (Approx.)
(+)	(-)	
Terminal	Terminal	
38	47	5.0 V
48		

Is the inspection result normal?

- YES >> Replace combination meter. Refer to [MWI-95, "Removal and Installation"](#).  
 NO >> Replace AV control unit. Refer to [AV-303, "Removal and Installation - AV Control Unit"](#).

# USB CONNECTOR

< DTC/CIRCUIT DIAGNOSIS >

[BOSE AUDIO WITHOUT NAVIGATION]

## USB CONNECTOR

### Diagnosis Procedure

INFOID:000000009724932

Regarding Wiring Diagram information, refer to [AV-191. "Wiring Diagram"](#).

#### 1. CHECK USB INTERFACE HARNESS CONTINUITY

1. Turn ignition switch OFF.
2. Disconnect AV control unit connector M55 and USB interface connector M209.
3. Check continuity between AV control unit connector M55 and USB interface connector M209.

AV control unit		USB interface		Continuity
Connector	Terminal	Connector	Terminal	
M55	138	M209	1	Yes
	137		2	
	140		3	
	139		4	
	141		5	

4. Check continuity between AV control unit connector M55 and ground.

AV control unit		—	Continuity
Connector	Terminal		
M55	137	Ground	No
	139		

Is the inspection result normal?

- YES >> Replace the USB interface. Refer to [AV-316. "Removal and Installation"](#).  
NO >> Repair or replace harness or connectors.

A  
B  
C  
D  
E  
F  
G  
H  
I  
J  
K  
L  
M  
O  
P

AV

# MULTI AV SYSTEM

< SYMPTOM DIAGNOSIS >

[BOSE AUDIO WITHOUT NAVIGATION]

## SYMPTOM DIAGNOSIS

### MULTI AV SYSTEM

#### Symptom Table

INFOID:000000009724933

#### RELATED TO AUDIO

Symptoms	Check items	Probable malfunction location
The disk cannot be removed.	AV control unit	Malfunction in AV control unit. Refer to <a href="#">AV-162. "On Board Diagnosis Function"</a> .



# MULTI AV SYSTEM

## [BOSE AUDIO WITHOUT NAVIGATION]

### < SYMPTOM DIAGNOSIS >

Symptoms	Check items	Probable malfunction location
	No sound from all speakers.	<ul style="list-style-type: none"> <li>• Speaker circuit shorted to ground. Refer to <a href="#">AV-390, "Wiring Diagram"</a>.</li> <li>• Bose amp. ON signal circuit malfunction. Refer to <a href="#">AV-492, "Diagnosis Procedure"</a>.</li> <li>• Bose speaker amp. power supply and ground circuits malfunction. Refer to <a href="#">AV-520, "BOSE AMP. : Diagnosis Procedure"</a>.</li> </ul>
No sound comes out or the level of the sound is low.	Only a certain speaker (front door speaker LH, front door speaker RH, front tweeter LH, front tweeter RH, instrument panel tweeter LH, instrument panel tweeter RH, center speaker, rear door speaker LH, rear door speaker RH, rear side speaker LH, rear side speaker RH, subwoofer) does not output sound.	<ul style="list-style-type: none"> <li>• Poor connector connection of speaker.</li> <li>• Sound signal circuit malfunction between AV control unit and Bose speaker amp. Refer to:               <ul style="list-style-type: none"> <li>- <a href="#">AV-535, "Diagnosis Procedure"</a> (front door speaker).</li> <li>- <a href="#">AV-532, "Diagnosis Procedure"</a> (front tweeter).</li> <li>- <a href="#">AV-529, "Diagnosis Procedure"</a> (instrument panel tweeter).</li> <li>- <a href="#">AV-527, "Diagnosis Procedure"</a> (center speaker).</li> <li>- <a href="#">AV-538, "Diagnosis Procedure"</a> (rear door speaker).</li> <li>- <a href="#">AV-541, "Diagnosis Procedure"</a> (rear side speaker).</li> <li>- <a href="#">AV-544, "Diagnosis Procedure"</a> (subwoofer).</li> </ul> </li> <li>• Sound signal circuit malfunction between Bose speaker amp. and speaker. Refer to:               <ul style="list-style-type: none"> <li>- <a href="#">AV-535, "Diagnosis Procedure"</a> (front door speaker).</li> <li>- <a href="#">AV-532, "Diagnosis Procedure"</a> (front tweeter).</li> <li>- <a href="#">AV-529, "Diagnosis Procedure"</a> (instrument panel tweeter).</li> <li>- <a href="#">AV-527, "Diagnosis Procedure"</a> (center speaker).</li> <li>- <a href="#">AV-538, "Diagnosis Procedure"</a> (rear door speaker).</li> <li>- <a href="#">AV-541, "Diagnosis Procedure"</a> (rear side speaker).</li> <li>- <a href="#">AV-544, "Diagnosis Procedure"</a> (subwoofer).</li> </ul> </li> <li>• Malfunction in speaker. Refer to:               <ul style="list-style-type: none"> <li>- <a href="#">AV-308, "Removal and Installation"</a> (front door speaker).</li> <li>- <a href="#">AV-309, "Removal and Installation"</a> (front tweeter).</li> <li>- <a href="#">AV-310, "Removal and Installation"</a> (instrument panel tweeter).</li> <li>- <a href="#">AV-311, "Removal and Installation"</a> (center speaker).</li> <li>- <a href="#">AV-312, "Removal and Installation"</a> (rear door speaker).</li> <li>- <a href="#">AV-313, "Removal and Installation"</a> (rear side speaker).</li> <li>- <a href="#">AV-314, "Removal and Installation"</a> (subwoofer).</li> </ul> </li> <li>• Malfunction in AV control unit. Refer to <a href="#">AV-341, "On Board Diagnosis Function"</a>.</li> <li>• Malfunction in Bose speaker amp. Replace Bose speaker amp. Refer to <a href="#">AV-590, "Removal and Installation"</a>.</li> </ul>

A  
B  
C  
D  
E  
F  
G  
H  
I  
J  
K  
L  
M  
AV  
O  
P

# MULTI AV SYSTEM

## [BOSE AUDIO WITHOUT NAVIGATION]

### < SYMPTOM DIAGNOSIS >

Symptoms	Check items	Probable malfunction location
	Noise comes out from all speakers.	<ul style="list-style-type: none"> <li>Malfunction in AV control unit. Refer to <a href="#">AV-341, "On Board Diagnosis Function"</a>.</li> <li>Malfunction in Bose speaker amp. Replace Bose speaker amp. Refer to <a href="#">AV-590, "Removal and Installation"</a>.</li> </ul>
Noise is mixed with audio.	Noise comes out only from a certain speaker (front door speaker LH, front door speaker RH, front tweeter LH, front tweeter RH, instrument panel tweeter LH, instrument panel tweeter RH, center speaker, rear door speaker LH, rear door speaker RH, rear side speaker LH, rear side speaker RH, subwoofer).	<ul style="list-style-type: none"> <li>Poor connector connection of speaker.</li> <li>Sound signal circuit malfunction between AV control unit and Bose speaker amp. Refer to:               <ul style="list-style-type: none"> <li><a href="#">AV-535, "Diagnosis Procedure"</a> (front door speaker).</li> <li><a href="#">AV-532, "Diagnosis Procedure"</a> (front tweeter).</li> <li><a href="#">AV-529, "Diagnosis Procedure"</a> (instrument panel tweeter).</li> <li><a href="#">AV-527, "Diagnosis Procedure"</a> (center speaker).</li> <li><a href="#">AV-538, "Diagnosis Procedure"</a> (rear door speaker).</li> <li><a href="#">AV-541, "Diagnosis Procedure"</a> (rear side speaker).</li> <li><a href="#">AV-544, "Diagnosis Procedure"</a> (subwoofer).</li> </ul> </li> <li>Sound signal circuit malfunction between Bose speaker amp. and speaker. Refer to:               <ul style="list-style-type: none"> <li><a href="#">AV-535, "Diagnosis Procedure"</a> (front door speaker).</li> <li><a href="#">AV-532, "Diagnosis Procedure"</a> (front tweeter).</li> <li><a href="#">AV-529, "Diagnosis Procedure"</a> (instrument panel tweeter).</li> <li><a href="#">AV-527, "Diagnosis Procedure"</a> (center speaker).</li> <li><a href="#">AV-538, "Diagnosis Procedure"</a> (rear door speaker).</li> <li><a href="#">AV-541, "Diagnosis Procedure"</a> (rear side speaker).</li> <li><a href="#">AV-544, "Diagnosis Procedure"</a> (subwoofer).</li> </ul> </li> <li>Malfunction in speaker.</li> <li>Poor Installation of speaker (e.g. backlash and looseness). Refer to:               <ul style="list-style-type: none"> <li><a href="#">AV-308, "Removal and Installation"</a> (front door speaker).</li> <li><a href="#">AV-309, "Removal and Installation"</a> (front tweeter).</li> <li><a href="#">AV-310, "Removal and Installation"</a> (instrument panel tweeter).</li> <li><a href="#">AV-311, "Removal and Installation"</a> (center speaker).</li> <li><a href="#">AV-312, "Removal and Installation"</a> (rear door speaker).</li> <li><a href="#">AV-313, "Removal and Installation"</a> (rear side speaker).</li> <li><a href="#">AV-314, "Removal and Installation"</a> (subwoofer).</li> </ul> </li> <li>Malfunction in AV control unit. Refer to <a href="#">AV-341, "On Board Diagnosis Function"</a>.</li> <li>Malfunction in Bose speaker amp. Replace Bose speaker amp. Refer to <a href="#">AV-590, "Removal and Installation"</a>.</li> </ul>
	Noise is mixed with radio only (when the vehicle hits a bump or while driving over bad roads).	Poor connector connection of antenna or antenna feeder. Refer to <a href="#">AV-612, "Location of Antennas"</a>

# MULTI AV SYSTEM

## [BOSE AUDIO WITHOUT NAVIGATION]

### < SYMPTOM DIAGNOSIS >

Symptoms	Check items	Probable malfunction location
No radio reception or poor reception.	<ul style="list-style-type: none"> <li>Other audio sounds are normal.</li> <li>Any radio station cannot be received or poor reception is caused even after moving to a service area with good reception (e.g. a place with clear view and no obstacles generating external noises).</li> </ul>	<ul style="list-style-type: none"> <li>Antenna amp. ON signal circuit malfunction. Refer to <a href="#">AV-173, "Reference Value"</a>.</li> <li>Poor connector connection of antenna or antenna feeder. Refer to <a href="#">AV-321, "Location of Antennas"</a>.</li> </ul>
No satellite radio reception.	<p>There is malfunction in the CONSULT self diagnosis result. Refer to <a href="#">AV-171, "CONSULT Function"</a>.</p>	<ul style="list-style-type: none"> <li>Malfunction in antenna, antenna feeder or AV control unit. Perform DTC diagnosis. Refer to <a href="#">AV-171, "CONSULT Function"</a>.</li> <li>Poor continuity in antenna feeder.</li> <li>Poor connector connection of antenna or antenna feeder. Refer to <a href="#">AV-321, "Location of Antennas"</a>.</li> </ul>
	<p>There is no malfunction in the CONSULT self diagnosis result. Refer to <a href="#">AV-171, "CONSULT Function"</a>.</p>	<ul style="list-style-type: none"> <li>Poor continuity in antenna feeder.</li> <li>Poor connector connection of antenna or antenna feeder.</li> <li>Loose satellite radio antenna mounting nut. Refer to <a href="#">AV-321, "Location of Antennas"</a>.</li> </ul>
Buzz/rattle sound from speaker	<p>The majority of buzz/rattle sounds are not indicative of an issue with the speaker, usually something nearby the speaker is causing the buzz/rattle.</p>	<p>Refer to "SQUEAK AND RATTLE TROUBLE DIAGNOSIS" in the appropriate interior trim section.</p>

### RELATED TO HANDS-FREE PHONE

- Before performing diagnosis, confirm that the cellular phone being used by the customer is compatible with the vehicle.
- It is possible that a malfunction is occurring due to a version change of the phone even though the phone is a compatible type. This can be confirmed by changing the cellular phone to another compatible type, and check that it operates normally. It is important to determine whether the cause of the malfunction is the vehicle or the cellular phone.

#### Check Compatibility

- Make sure the customer's Bluetooth® related concern is understood.
- Verify the customer's concern.
 

**NOTE:**  
The customer's phone may be required, depending upon their concern.
- Write down the customer's phone brand, model and service provider.
 

**NOTE:**  
It is necessary to know the service provider. On occasion, a given phone may be on the approved list with one provider, but may not be on the approved list with other providers.
- Go to "www.nissanusa.com/bluetooth/".
  - Using the website's search engine, find out if the customer's phone is on the approved list.
  - If the customer's phone is NOT on the approved list:
 

Stop diagnosis here. The customer needs to obtain a Bluetooth® phone that is on the approved list before any further action.
  - If the feature related to the customer's concern shows as "N" (not compatible):
 









Stop diagnosis here. If the customer still wants the feature to function, they will need to get an approved phone showing the feature as "Y" (compatible) in the "Basic Features".
  - If the feature related to the customer's concern shows as "Y" (compatible):
 

Perform diagnosis as per the following table.

# MULTI AV SYSTEM

[BOSE AUDIO WITHOUT NAVIGATION]

## < SYMPTOM DIAGNOSIS >

Symptoms	Check items	Probable malfunction location
Does not recognize cellular phone connection (no connection is displayed on the display at the guide).	Repeat the registration of cellular phone.	
Hands-free phone cannot be established.	<ul style="list-style-type: none"> <li>Hands-free phone operation can be made, but the communication cannot be established.</li> <li>Hands-free phone operation can be performed, however, voice between each other cannot be heard during the conversation.</li> </ul>	Malfunction in AV control unit. Replace AV control unit. Refer to <a href="#">AV-303, "Removal and Installation - AV Control Unit"</a> .
The other party's voice cannot be heard by hands-free phone.	Check the "microphone speaker" in Inspection & Adjustment Mode if sound is heard.	
Originating sound is not heard by the other party with hands-free phone communication.	Sound operation function is normal.	
	Sound operation function does not work.	Microphone signal circuit malfunction. Refer to <a href="#">AV-290, "Diagnosis Procedure"</a> .
The system cannot be operated.	Steering switch's  ,  , and  switch works, but  does not work.	Steering switch malfunction. Replace steering switch. Refer to <a href="#">AV-305, "Removal and Installation"</a> .
	Steering switch's  ,  ,  , and  switches do not work.	Steering switch signal circuit malfunction. Refer to <a href="#">AV-293, "Diagnosis Procedure"</a> .
	All steering switches do not work.	Steering switch ground circuit malfunction. Refer to <a href="#">AV-293, "Diagnosis Procedure"</a> .

## RELATED TO REAR VIEW CAMERA

Symptoms	Check items	Probable malfunction location
Rear view camera is inoperative.	Reverse signal circuit malfunction.	Reverse signal circuit malfunction between BCM and AV control unit. Refer to <a href="#">AV-287, "Diagnosis Procedure"</a> .
	Camera image signal circuit malfunction.	Camera image signal circuit malfunction between rear view camera and AV control unit. Refer to <a href="#">AV-287, "Diagnosis Procedure"</a> .
	Rear view camera malfunction.	Replace rear view camera. Refer to <a href="#">AV-315, "Removal and Installation"</a> .

# NORMAL OPERATING CONDITION

< SYMPTOM DIAGNOSIS >

[BOSE AUDIO WITHOUT NAVIGATION]

## NORMAL OPERATING CONDITION

### Description

INFOID:000000009724934

#### RELATED TO NOISE

The majority of the audio concerns are the result of outside causes (bad CD, electromagnetic interference, etc.).

The following noise results from variations in field strength, such as fading noise and multi-path noise, or external noise from trains and other sources. It is not a malfunction.

- Fading noise: This noise occurs because of variations in the field strength in a narrow range due to mountains or buildings blocking the signal.
- Multi-path noise: This noise results from the waves sent directly from the broadcast station arriving at the antenna at a different time from the waves which reflect off mountains or buildings.

The vehicle itself can be a source of noise if noise prevention parts or electrical equipment is malfunctioning. Check if noise is caused and/or changed by engine speed, ignition switch turned to each position, and operation of each piece of electrical equipment, and determine the cause.

#### NOTE:

The source of the noise can be found easily by listening to the noise while removing the fuses of electrical components, one by one.

#### Type of Noise and Possible Cause

Occurrence condition		Possible cause
Occurs only when engine is ON.	A continuous growling noise occurs. The speed of the noise varies with changes in the engine speed.	<ul style="list-style-type: none"> <li>• Ignition components</li> </ul>
The occurrence of the noise is linked with the operation of the fuel pump.		<ul style="list-style-type: none"> <li>• Fuel pump condenser</li> </ul>
Noise only occurs when various electrical components are operating.	A cracking or snapping sound occurs with the operation of various switches.	<ul style="list-style-type: none"> <li>• Relay malfunction, AV control unit malfunction</li> </ul>
	The noise occurs when various motors are operating.	<ul style="list-style-type: none"> <li>• Motor case ground</li> <li>• Motor</li> </ul>
The noise occurs constantly, not just under certain conditions.		<ul style="list-style-type: none"> <li>• Rear defogger coil malfunction</li> <li>• Open circuit in printed heater</li> <li>• Poor ground of antenna feeder line</li> </ul>
A cracking or snapping sound occurs while the vehicle is being driven, especially when it is vibrating excessively.		<ul style="list-style-type: none"> <li>• Ground wire of body parts</li> <li>• Ground due to improper part installation</li> <li>• Wiring connections or a short circuit</li> </ul>

#### RELATED TO HANDS-FREE PHONE

Symptom	Cause and Counter measure
Does not recognize cellular phone connection (No connection is displayed on the display at the guide).	<p>Some Bluetooth<sup>®</sup> enabled cellular phones may not be recognized by the in-vehicle phone module.</p> <p>Refer to "RELATED TO HANDS-FREE PHONE (Check Compatibility)" in <a href="#">AV-296, "Symptom Table"</a>.</p>
Cannot use hands-free phone.	<p>Customer will not be able to use a hands-free phone under the following conditions:</p> <ul style="list-style-type: none"> <li>• The vehicle is outside of the telephone service area.</li> <li>• The vehicle is in an area where it is difficult to receive radio waves; such as in a tunnel, in an underground parking garage, near a tall building or in a mountainous area.</li> <li>• The cellular phone is locked to prevent it from being dialed.</li> </ul> <p><b>NOTE:</b></p> <p>While a cellular phone is connected through the Bluetooth<sup>®</sup> wireless connection, the battery power of the cellular phone may discharge quicker than usual. The Bluetooth<sup>®</sup> Hands-Free Phone System cannot charge cellular phones.</p>

## NORMAL OPERATING CONDITION

< SYMPTOM DIAGNOSIS >

[BOSE AUDIO WITHOUT NAVIGATION]

Symptom	Cause and Counter measure
The other party's voice cannot be heard by hands-free phone.	When the radio wave condition is not ideal or ambient sound is too loud, it may be difficult to hear the other person's voice during a call.
Poor sound quality.	Do not place the cellular phone in an area surrounded by metal or far away from the in-vehicle phone module to prevent tone quality degradation and wireless connection disruption.

# AV CONTROL UNIT

< REMOVAL AND INSTALLATION >

[BOSE AUDIO WITHOUT NAVIGATION]

## REMOVAL AND INSTALLATION

### AV CONTROL UNIT

Exploded View

INFOID:000000009763456

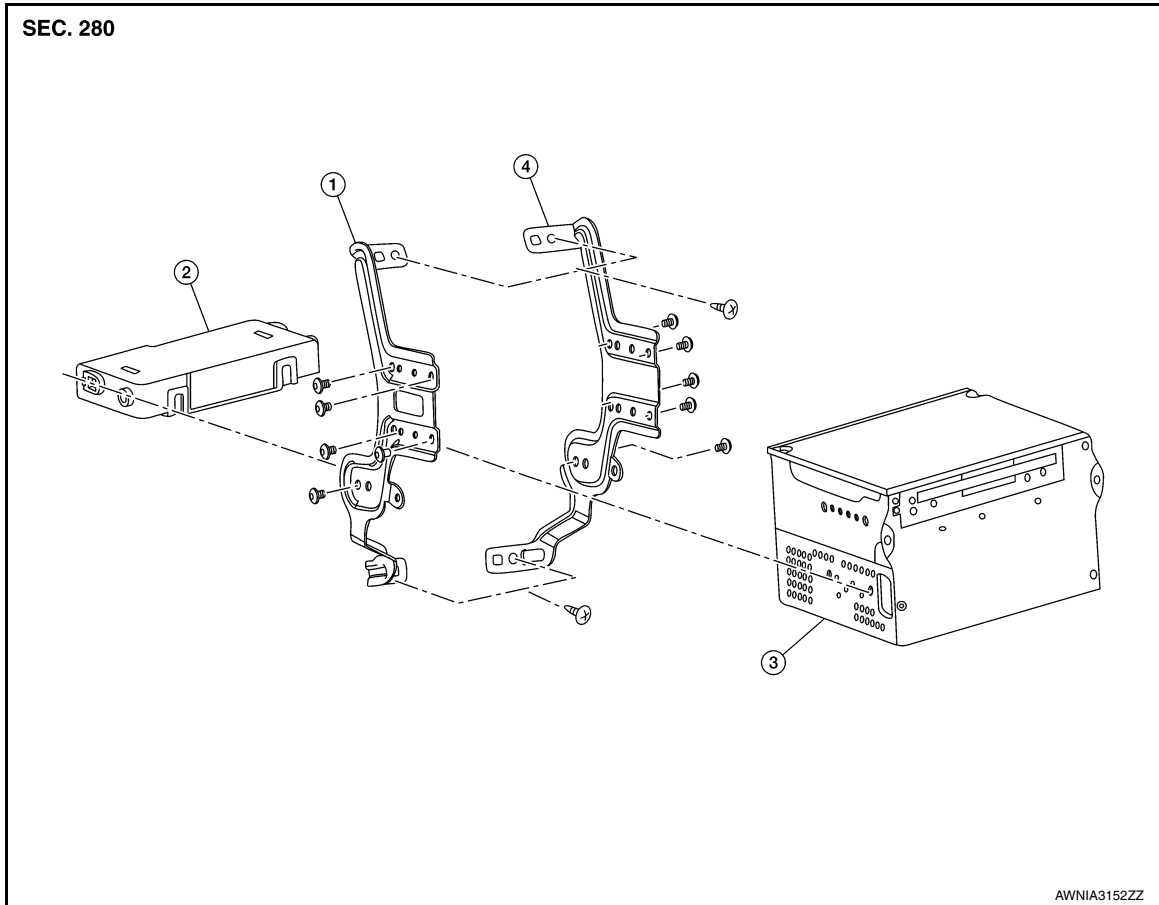

1. AV control unit bracket (LH)    2. A/C auto amp.    3. AV control unit  
4. AV control unit bracket (RH)

### Removal and Installation - AV Control Unit

INFOID:000000009763455

#### REMOVAL

##### CAUTION:

- Remove battery terminal and AV control unit after a lapse of 30 seconds or more after turning the ignition switch OFF.
- Before replacing AV control unit, perform "READ CONFIGURATION" to save current vehicle specification. Refer to [AV-221, "ADDITIONAL SERVICE WHEN REPLACING AV CONTROL UNIT : Description"](#).

##### NOTE:

After the ignition switch is turned OFF, the AV control unit continues operating for approximately 30 seconds. Therefore, data corruption may occur if battery voltage is cut off within 30 seconds.

1. Disconnect the negative battery terminal. Refer to [PG-93, "Removal and Installation"](#).
2. Remove cluster lid C upper. Refer to [IP-23, "CLUSTER LID C UPPER : Removal and Installation"](#).
3. Remove the screws, then pull out the AV control unit.
4. Disconnect the harness connectors from the AV control unit and remove.

#### INSTALLATION

Installation is in the reverse order of removal.

A  
B  
C  
D  
E  
F  
G  
H  
I  
J  
K  
L  
M  
O  
P

AV

## AV CONTROL UNIT

< REMOVAL AND INSTALLATION >

[BOSE AUDIO WITHOUT NAVIGATION]

---

### CAUTION:

- When replacing AV control unit, perform "WRITE CONFIGURATION". Refer to [AV-80, "CONFIGURATION \(AV CONTROL UNIT\) : Description"](#).

### Removal and Installation - A/C and AV Switch Assembly

INFOID:000000009763454

#### REMOVAL

1. Remove cluster lid C. Refer to [JP-22, "CLUSTER LID C : Removal and Installation"](#).
2. Remove the A/C and AV switch assembly lower screws.
3. Release upper pawls and remove A/C and AV switch assembly.

#### INSTALLATION

Installation is in the reverse order of removal.



# STEERING SWITCH

< REMOVAL AND INSTALLATION >

[BOSE AUDIO WITHOUT NAVIGATION]

## STEERING SWITCH

Exploded View

INFOID:000000009772725

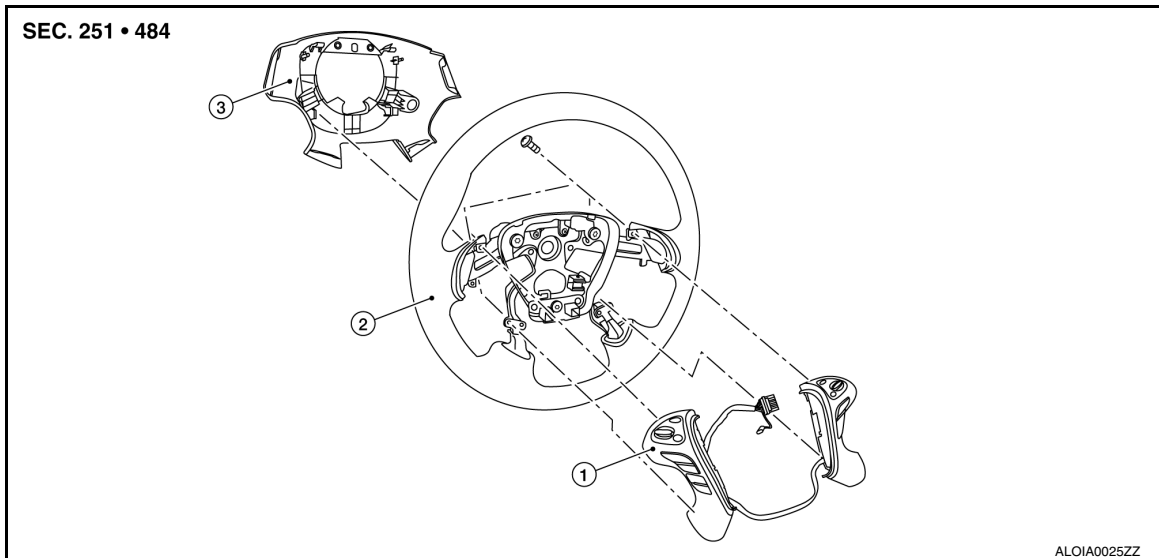

1. Steering switch

2. Steering wheel

3. Steering wheel rear finisher

## Removal and Installation

INFOID:000000009724938

### REMOVAL

#### NOTE:

The steering switch is serviced as an assembly.

1. Remove steering wheel. Refer to [ST-46. "Removal and Installation"](#).
2. Release pawls and remove steering wheel rear finisher (1) from steering wheel (2).

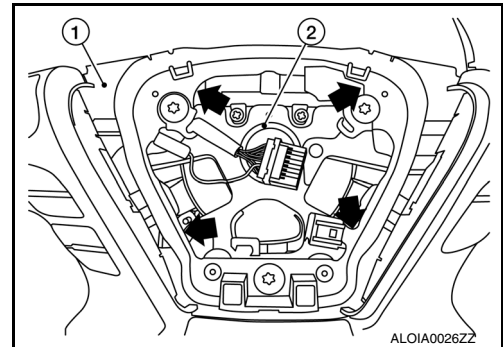

3. Remove steering switch screws.
4. Remove steering switch (1) from steering wheel (2).

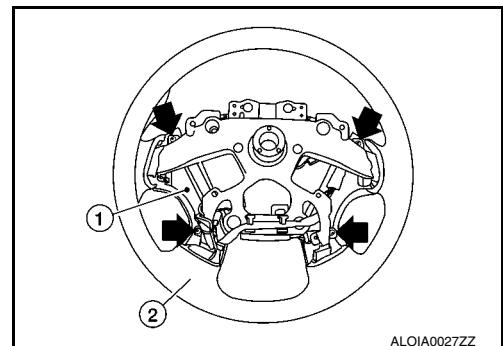

### INSTALLATION

Installation is in the reverse order of removal.

A  
B  
C  
D  
E  
F  
G  
H  
I  
J  
K  
L  
M  
AV  
O  
P

# DISPLAY UNIT

< REMOVAL AND INSTALLATION >

[BOSE AUDIO WITHOUT NAVIGATION]

## DISPLAY UNIT

### Exploded View

INFOID:000000009763650

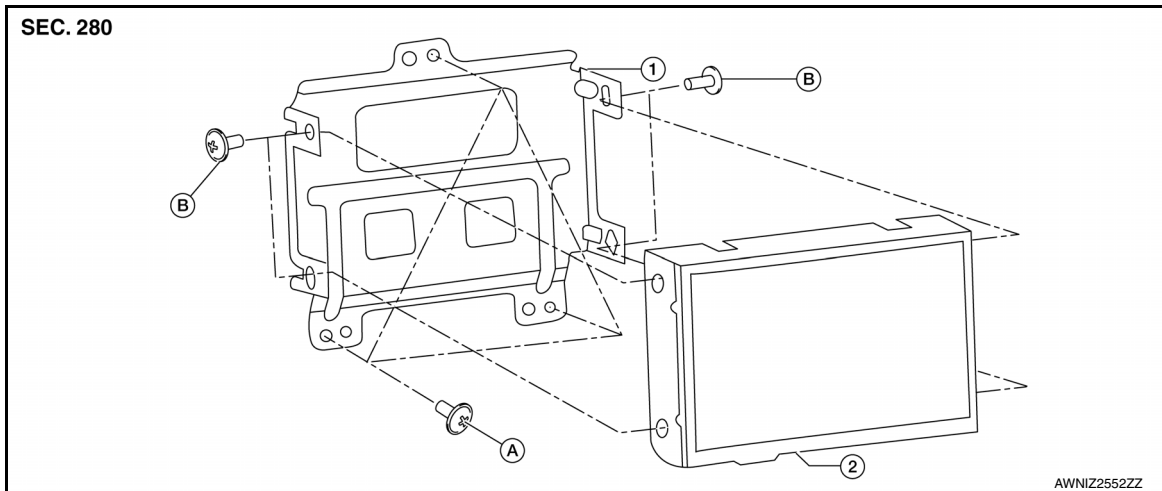

- 1. Display unit bracket
- 2. Display unit
- A. Display unit bracket screws
- B. Display unit screws

## Removal and Installation

INFOID:000000009763649

### REMOVAL

1. Remove cluster lid D. Refer to [IP-24, "Removal and Installation"](#).
2. Remove the display unit screws, and then pull out the display unit and bracket.
3. Disconnect harness connector from the display unit, then remove the display unit and bracket.
4. Remove the display unit brackets screws, then remove the display unit from the display unit bracket (if necessary).

### INSTALLATION

Installation is in the reverse order of removal.

# BOSE SPEAKER AMP

< REMOVAL AND INSTALLATION >

[BOSE AUDIO WITHOUT NAVIGATION]

## BOSE SPEAKER AMP

### Removal and Installation

INFOID:000000009763444

#### REMOVAL

1. Disconnect the negative battery terminal. Refer to [PG-93, "Exploded View"](#)
2. Remove third row seat. Refer to [SE-135, "Removal and Installation"](#).
3. Remove Bose speaker amp screws (A).
4. Disconnect the harness connectors (B) from the Bose speaker amp. (1) and remove.

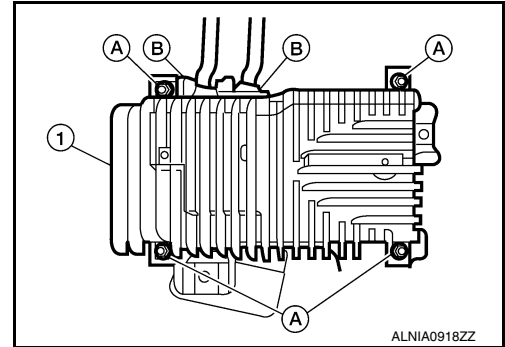

#### INSTALLATION

Installation is in the reverse order of removal.

A  
B  
C  
D  
E  
F  
G  
H  
I  
J  
K  
L  
M  
O  
P

AV

# FRONT DOOR SPEAKER

< REMOVAL AND INSTALLATION >

[BOSE AUDIO WITHOUT NAVIGATION]

## FRONT DOOR SPEAKER

### Exploded View

INFOID:000000009724941

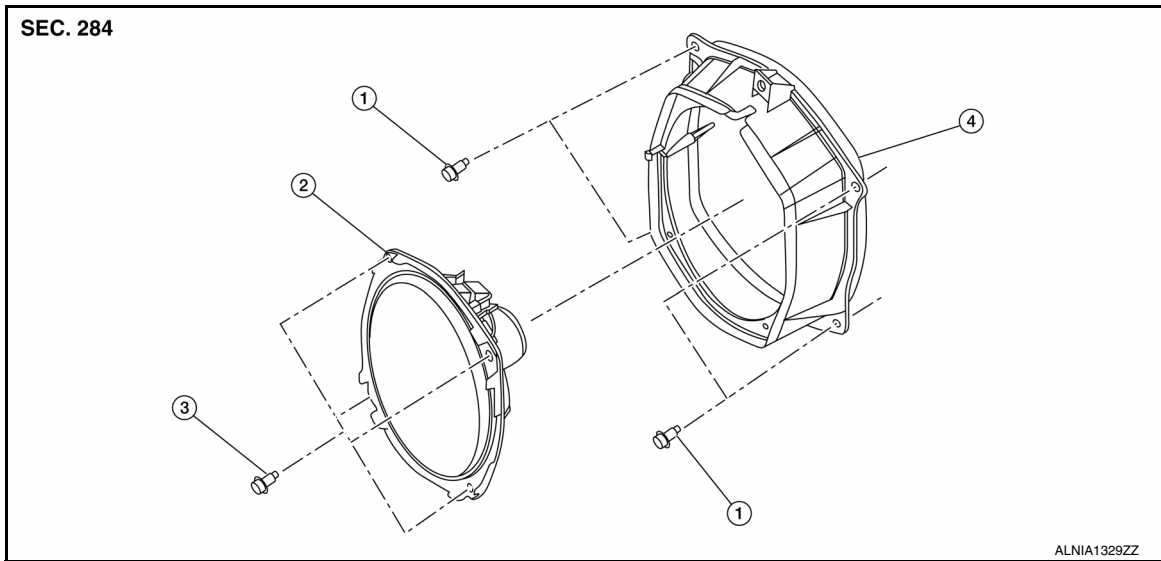

- 1. Speaker bracket bolt
- 2. Front door speaker
- 3. Speaker bolt
- 4. Speaker bracket

### Removal and Installation

INFOID:000000009724942

#### REMOVAL

1. Remove front door finisher. Refer to [INT-15. "Removal and Installation"](#).
2. Remove front door speaker bolts.
3. Disconnect harness connector from front door speaker, then remove front door speaker from speaker bracket.
4. Remove speaker bracket bolts (if necessary).
5. Remove speaker bracket from front door (if necessary).

#### INSTALLATION

Installation is in the reverse order of removal.

# FRONT TWEETER

< REMOVAL AND INSTALLATION >

[BOSE AUDIO WITHOUT NAVIGATION]

## FRONT TWEETER

### Removal and Installation

INFOID:000000009763445

#### REMOVAL

1. Remove front pillar finisher. Refer to [INT-19. "FRONT PILLAR FINISHER : Removal and Installation"](#)
2. Remove two front tweeter screws.
3. Remove front tweeter (2) from front pillar finisher (1).

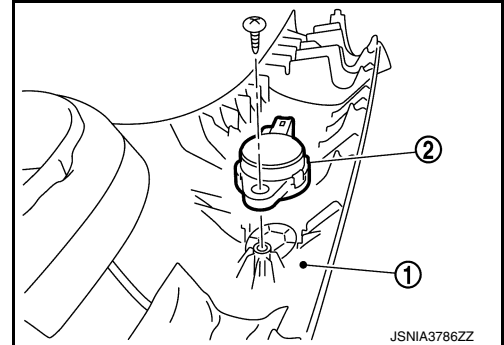

#### INSTALLATION

Installation is in the reverse order of removal.

A  
B  
C  
D  
E  
F  
G  
H  
I  
J  
K  
L  
M  
AV  
O  
P

# INSTRUMENT PANEL SPEAKER/TWEETER

< REMOVAL AND INSTALLATION >

[BOSE AUDIO WITHOUT NAVIGATION]

## INSTRUMENT PANEL SPEAKER/TWEETER

### Removal and Installation

INFOID:000000009724943

#### REMOVAL

1. Remove instrument panel tweeter grille. Refer to [IP-14. "Exploded View"](#).
2. Remove the screws (A), then pull out the instrument panel tweeter (1).
3. Disconnect the harness connector from the instrument panel tweeter (1) and remove.

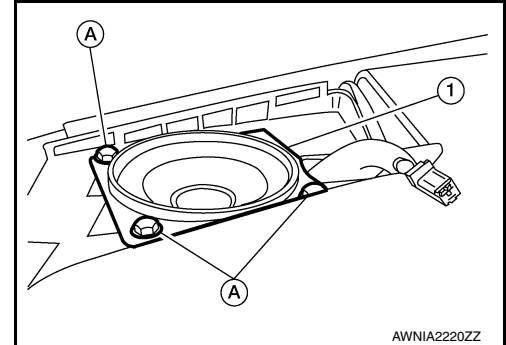

#### INSTALLATION

Installation is in the reverse order of removal.

# CENTER SPEAKER

< REMOVAL AND INSTALLATION >

[BOSE AUDIO WITHOUT NAVIGATION]

## CENTER SPEAKER

### Removal and Installation

INFOID:000000009763446

#### REMOVAL

1. Remove center speaker grille. Refer to [IP-14, "Exploded View"](#).
2. Remove the center speaker bolts (A).
3. Pull out the center speaker (1), disconnect harness connector, then remove center speaker.

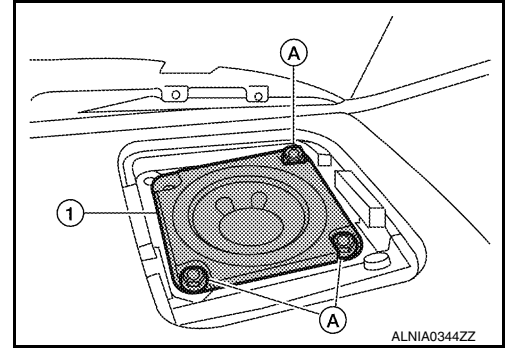

#### INSTALLATION

Installation is in the reverse order of removal.

A  
B  
C  
D  
E  
F  
G  
H  
I  
J  
K  
L  
M  
AV  
O  
P

## REAR DOOR SPEAKER

< REMOVAL AND INSTALLATION >

[BOSE AUDIO WITHOUT NAVIGATION]

### REAR DOOR SPEAKER

Exploded View

INFOID:000000009724944

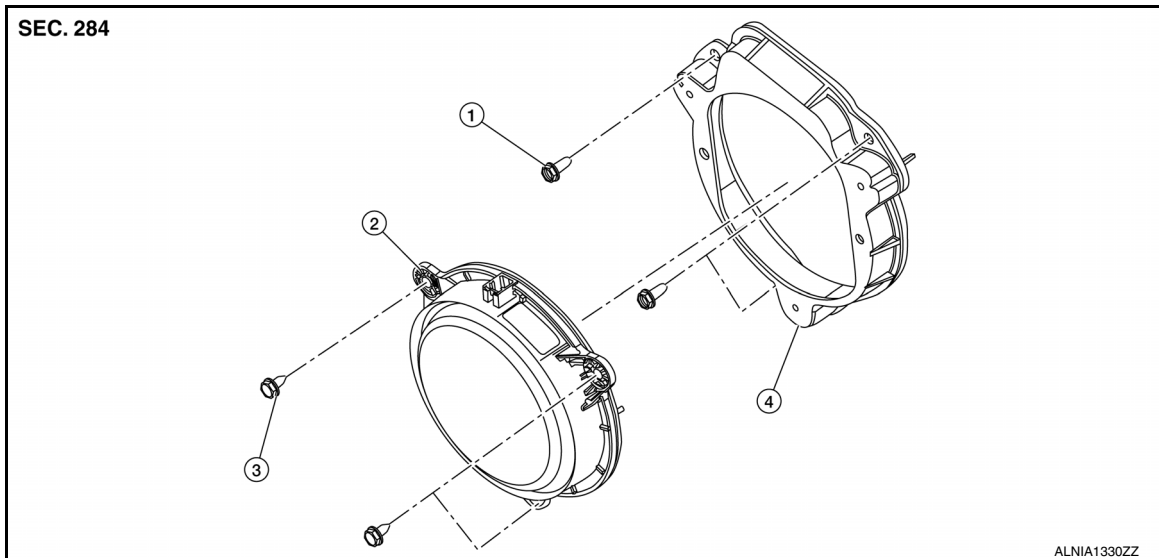

- |                         |                      |                 |
|-------------------------|----------------------|-----------------|
| 1. Speaker bracket bolt | 2. Rear door speaker | 3. Speaker bolt |
| 4. Speaker bracket      |                      |                 |

### Removal and Installation

INFOID:000000009724945

#### REMOVAL

1. Remove rear door finisher. Refer to [INT-17, "Removal and Installation"](#).
2. Remove rear door speaker bolts.
3. Disconnect harness connector from the rear door speaker, then remove rear door speaker from speaker bracket.
4. Remove speaker bracket bolts (if necessary).
5. Remove rear door speaker bracket (if necessary).

#### INSTALLATION

Installation is in the reverse order of removal.



# REAR SPEAKERS

< REMOVAL AND INSTALLATION >

[BOSE AUDIO WITHOUT NAVIGATION]

## REAR SPEAKERS

### Removal and Installation

INFOID:000000009763447

#### REMOVAL

1. Remove back pillar finisher. Refer to [INT-32. "BACK PILLAR FINISHER : Removal and Installation"](#).  
**CAUTION:**  
**Do not reuse back pillar finisher.**
2. Remove rear speaker bolts (A).
3. Remove bracket (2), then remove rear speaker (3).

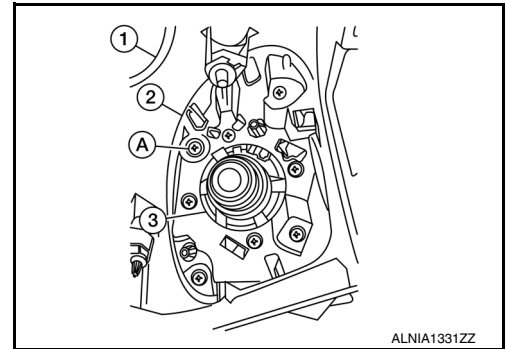

#### INSTALLATION

Installation is in the reverse order of removal.

A  
B  
C  
D  
E  
F  
G  
H  
I  
J  
K  
L  
M

AV

O  
P

# SUBWOOFER

< REMOVAL AND INSTALLATION >

[BOSE AUDIO WITHOUT NAVIGATION]

## SUBWOOFER

### Exploded View

INFOID:000000009763448

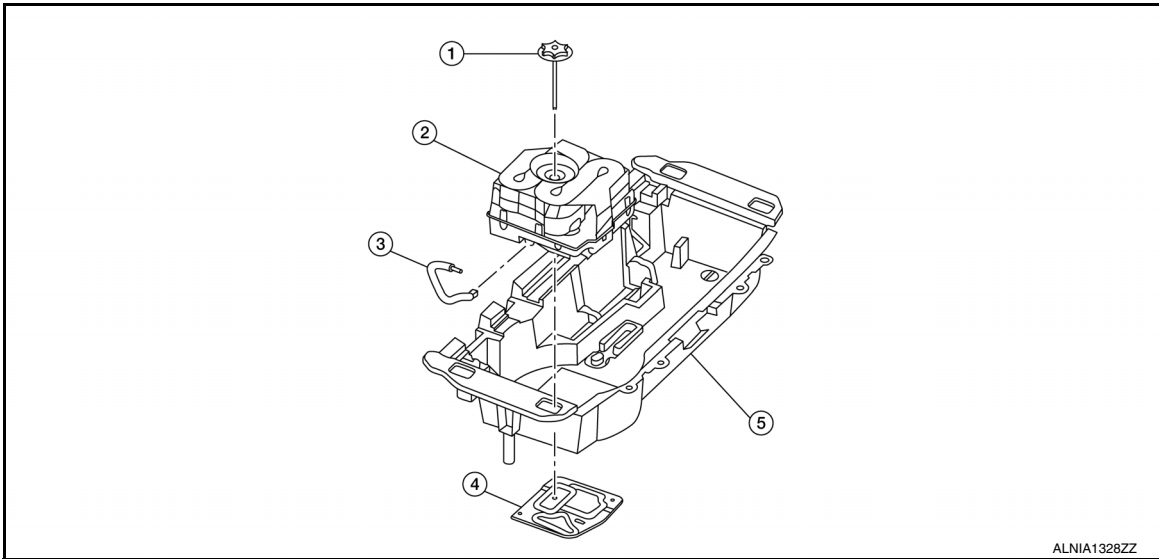

ALNIA1328ZZ

- |                     |                     |            |
|---------------------|---------------------|------------|
| 1. Spare tire clamp | 2. Subwoofer        | 3. Harness |
| 4. Bracket          | 5. Rear storage box |            |

### Removal and Installation

INFOID:000000009763449

#### REMOVAL

1. Open the storage box lid.
2. Remove the spare tire clamp.
3. Lift subwoofer to disconnect harness connector, then remove subwoofer.

#### INSTALLATION

Installation is in the reverse order of removal.

# REAR VIEW CAMERA

< REMOVAL AND INSTALLATION >

[BOSE AUDIO WITHOUT NAVIGATION]

## REAR VIEW CAMERA

### Removal and Installation

INFOID:000000009724946

#### REMOVAL

1. Remove back door outer upper finisher. Refer to [EXT-44. "Removal and Installation"](#).
2. Remove rear view camera screws (A), then remove rear view camera (1) from the back door outer upper finisher (2).

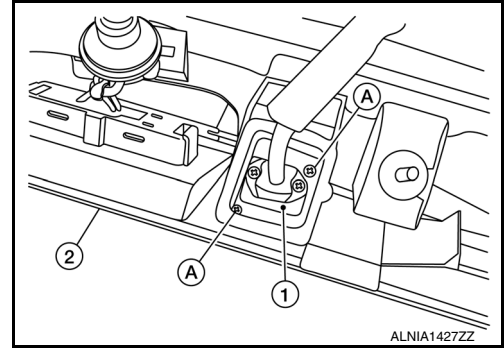

#### INSTALLATION

Installation is in the reverse order of removal.

A  
B  
C  
D  
E  
F  
G  
H  
I  
J  
K  
L  
M  
O  
P

AV

## USB INTERFACE

### Removal and Installation

INFOID:000000009724947

#### REMOVAL

1. Remove shift selector finisher. Refer to [JP-27, "Exploded View"](#).
2. Disconnect harness connector from the USB interface.
3. Release the pawl from the back of USB interface, then remove USB interface.

#### INSTALLATION

Installation is in the reverse order of removal.

# FRONT AUXILIARY INPUT JACKS

< REMOVAL AND INSTALLATION >

[BOSE AUDIO WITHOUT NAVIGATION]

## FRONT AUXILIARY INPUT JACKS

### Removal and Installation

INFOID:000000009724948

#### REMOVAL

1. Remove shift selector finisher. Refer to [IP-27. "Exploded View"](#).
2. Disconnect harness connector from the front auxiliary input jack.
3. Remove front auxiliary input jack screws and front auxiliary input jack.

#### INSTALLATION

Installation is in the reverse order of removal.

A

B

C

D

E

F

G

H

I

J

K

L

M

AV

O

P

# BLUETOOTH CONTROL UNIT

< REMOVAL AND INSTALLATION >

[BOSE AUDIO WITHOUT NAVIGATION]

## BLUETOOTH CONTROL UNIT

Exploded View

INFOID:000000009763652

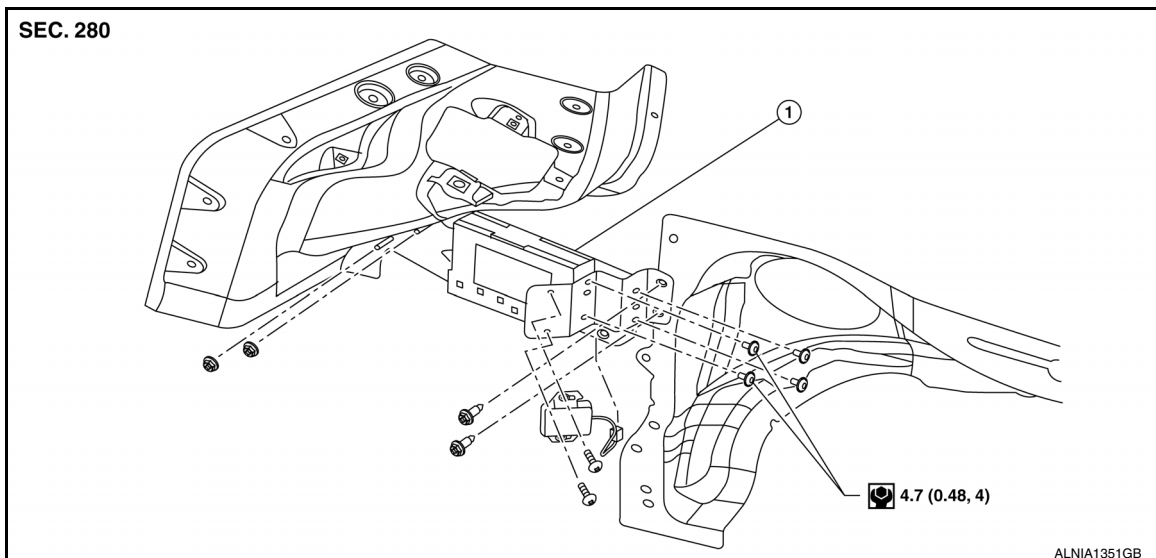

1. Bluetooth control unit

## Removal and Installation

INFOID:000000009763651

### REMOVAL

1. Remove satellite radio tuner. Refer to [AV-320. "Removal and Installation"](#)
2. Disconnect harness connector from bluetooth control unit.
3. Remove bluetooth control unit bolts, then remove bluetooth control unit.

### INSTALLATION

Installation is in the reverse order of removal.

# MICROPHONE

< REMOVAL AND INSTALLATION >

[BOSE AUDIO WITHOUT NAVIGATION]

## MICROPHONE

### Removal and Installation

INFOID:000000009724951

#### REMOVAL

1. Remove the front room/map lamp assembly. Refer to [INL-60. "Removal and Installation"](#).
2. Release the pawls, then remove the microphone (1) from the front room/map lamp assembly.

**CAUTION:**

Carefully handle the pawls that retain the microphone to avoid damaging.

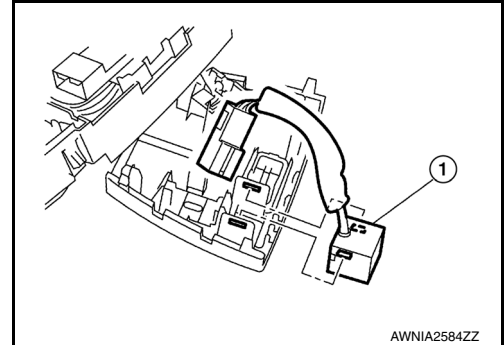

#### INSTALLATION

Installation is in the reverse order of removal.

**NOTE:**

Check the microphone for looseness after installation.

A  
B  
C  
D  
E  
F  
G  
H  
I  
J  
K  
L  
M  
AV  
O  
P

# SATELLITE RADIO TUNER

< REMOVAL AND INSTALLATION >

[BOSE AUDIO WITHOUT NAVIGATION]

## SATELLITE RADIO TUNER

Exploded View

INFOID:000000009763654

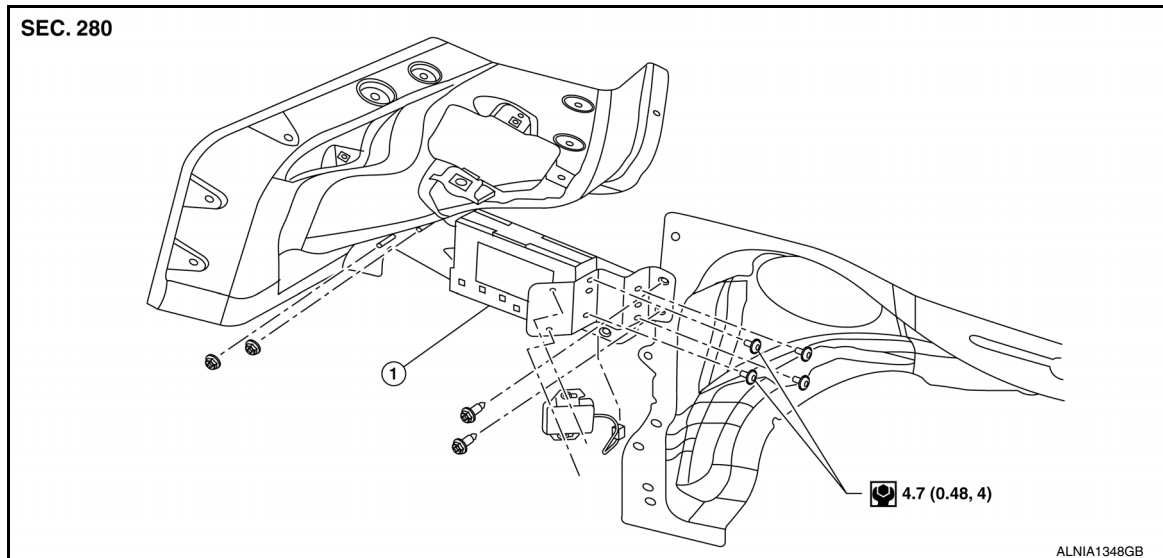

1. Satellite radio tuner

## Removal and Installation

INFOID:000000009763653

### REMOVAL

1. Remove luggage side lower finisher (LH). Refer to [INT-31. "LUGGAGE SIDE LOWER FINISHER : Removal and Installation"](#).
2. Disconnect harness connector from satellite antenna.
3. Remove bolts and the satellite radio tuner.

### INSTALLATION

Installation is in the reverse order of removal.



# AUDIO ANTENNA

< REMOVAL AND INSTALLATION >

[BOSE AUDIO WITHOUT NAVIGATION]

## AUDIO ANTENNA

### Location of Antennas

INFOID:000000009724954

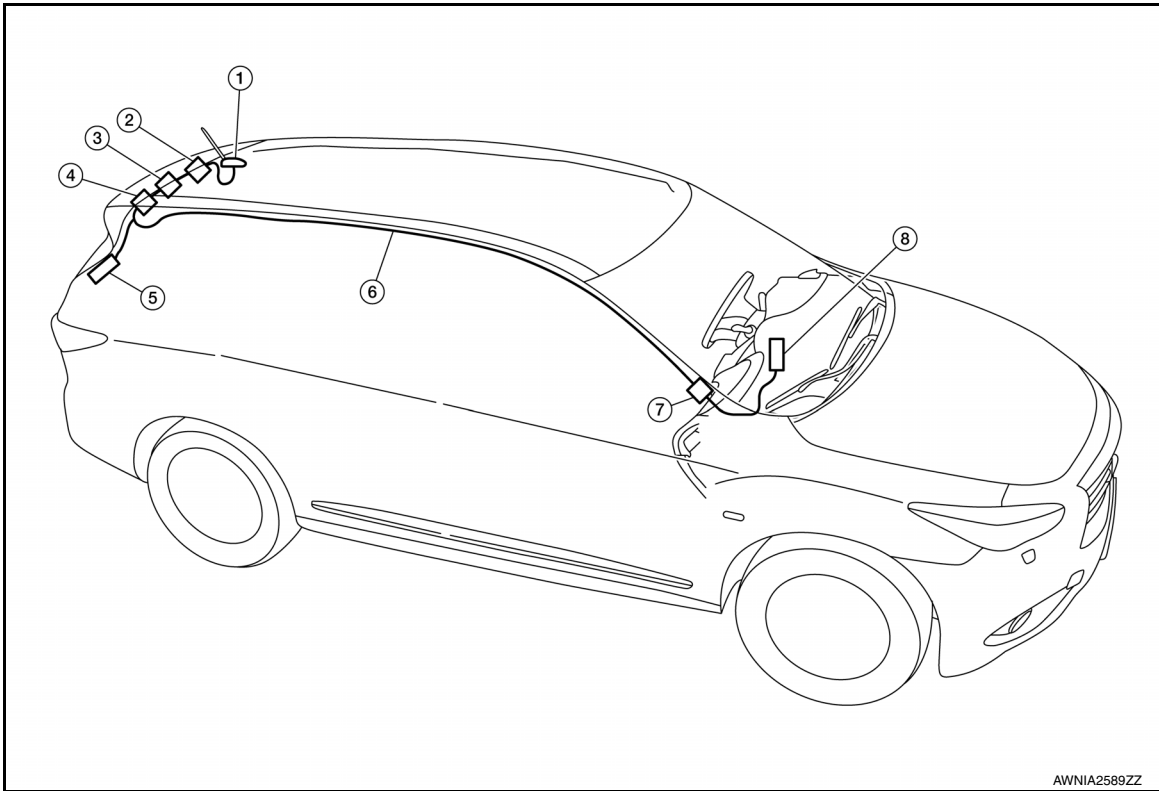

- |   |                         |                   |
|---|-------------------------|-------------------|
| 1. Antenna base (satellite antenna and antenna amp) | 2. M502                 | 3. M501           |
| 4. M503, M504                                       | 5. M505                 | 6. Antenna Feeder |
| 7. M95, M500  | 8. AV control unit M124 |                   |

### Window Antenna Repair

INFOID:000000009724955

#### ELEMENT CHECK

1. Attach probe circuit tester (ohm setting) to antenna terminal on each side.

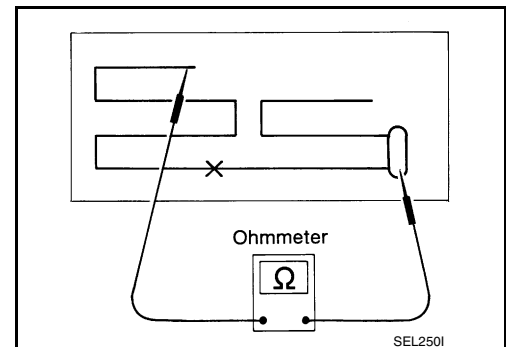

A  
B  
C  
D  
E  
F  
G  
H  
I  
J  
K  
L  
M  
AV  
O  
P

# AUDIO ANTENNA

< REMOVAL AND INSTALLATION >

[BOSE AUDIO WITHOUT NAVIGATION]

- When measuring continuity, wrap tin foil around the top of probe. Then, press the foil against the wire with your finger.

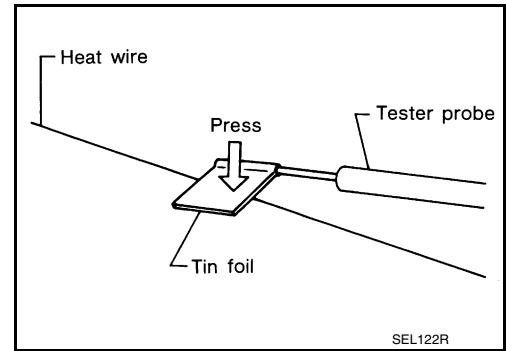

2. If an element is broken, no continuity will exist.

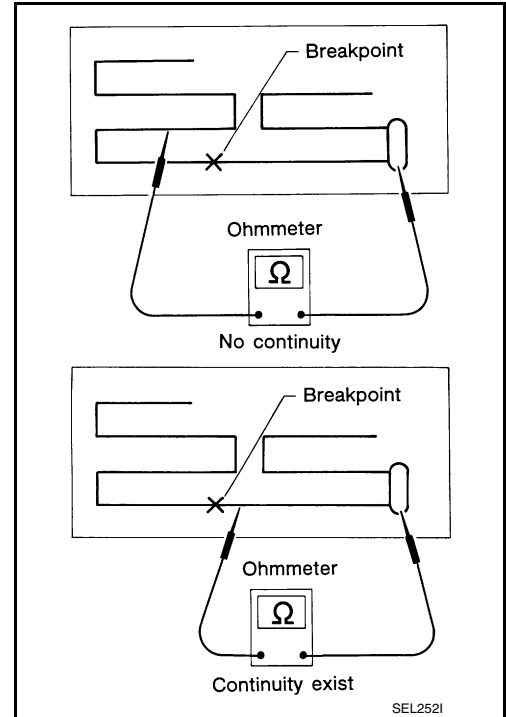

3. To locate a break, move probe along element. Tester indication will change abruptly when probe passes the broken point.

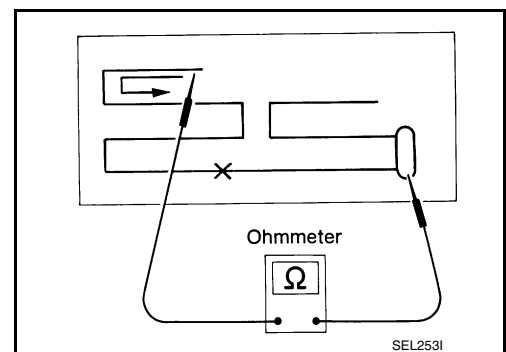

# BLUETOOTH® ANTENNA

< REMOVAL AND INSTALLATION >

[BOSE AUDIO WITHOUT NAVIGATION]

## BLUETOOTH® ANTENNA

### Removal and Installation

INFOID:000000009763919

#### REMOVAL

1. Remove luggage side lower finisher (LH). Refer to [INT-31. "LUGGAGE SIDE LOWER FINISHER : Removal and Installation"](#).
2. Disconnect the bluetooth antenna harness connector from bluetooth control unit.
3. Remove bolts and the bluetooth antenna from bracket.

#### INSTALLATION

Installation is in the reverse order of removal.

A  
B  
C  
D  
E  
F  
G  
H  
I  
J  
K  
L  
M  
O  
P

AV

# SATELLITE RADIO ANTENNA

< REMOVAL AND INSTALLATION >

[BOSE AUDIO WITHOUT NAVIGATION]

## SATELLITE RADIO ANTENNA

### Removal and Installation

INFOID:000000009763920

#### REMOVAL

1. Lower headlining (rear). Refer to [INT-27, "Removal and Installation"](#).
2. Disconnect harness connector from antenna feeder.
3. Remove nut from satellite radio antenna and remove.  
↳ Front

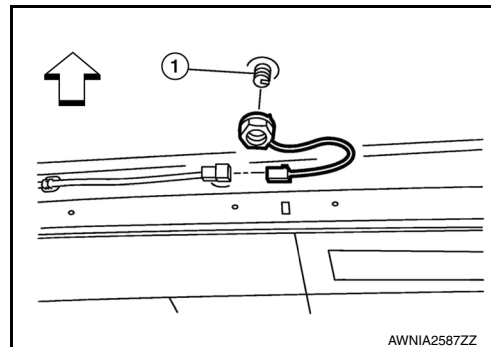

#### INSTALLATION

Installation is in the reverse order of removal.

#### CAUTION:

If the satellite radio antenna nut is not tightened to the specified torque, lower sensitivity of the antenna may be experienced. If the nut is tightened tighter than the specified torque, this will deform the roof panel.

#### Disassembly and Assembly

INFOID:000000009763921

#### DISASSEMBLY

Insert a suitable tool into gaps between satellite radio antenna (2) and the cover (1), then remove the cover (1) from satellite radio antenna (2).

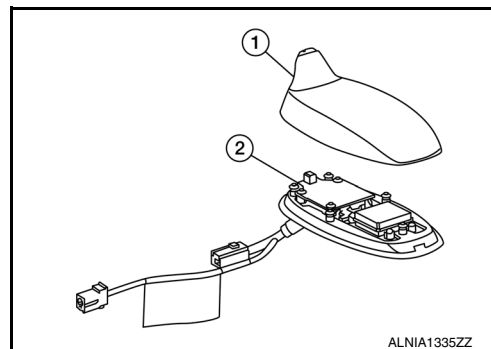

#### ASSEMBLY

Assembly is in the reverse order of disassembly.

# PRECAUTIONS

[BOSE AUDIO W/NAVI W/O SURROUND]

< PRECAUTION >

## PRECAUTION

### PRECAUTIONS

#### Precaution for Supplemental Restraint System (SRS) "AIR BAG" and "SEAT BELT PRE-TENSIONER"

INFOID:000000009129063

The Supplemental Restraint System such as "AIR BAG" and "SEAT BELT PRE-TENSIONER", used along with a front seat belt, helps to reduce the risk or severity of injury to the driver and front passenger for certain types of collision. This system includes dual stage front air bag modules. The SRS system may only deploy one front air bag, depending on the severity of a collision and whether the front passenger seat is occupied. Information necessary to service the system safely is included in the SR and SB section of this Service Manual.

#### **WARNING:**

- To avoid rendering the SRS inoperative, which could increase the risk of personal injury or death in the event of a collision which would result in air bag inflation, all maintenance must be performed by an authorized NISSAN/INFINITI dealer.
- Improper maintenance, including incorrect removal and installation of the SRS, can lead to personal injury caused by unintentional activation of the system. For removal of Spiral Cable and Air Bag Module, see the SR section.
- Do not use electrical test equipment on any circuit related to the SRS unless instructed to in this Service Manual. SRS wiring harnesses can be identified by yellow and/or orange harnesses or harness connectors.

#### PRECAUTIONS WHEN USING POWER TOOLS (AIR OR ELECTRIC) AND HAMMERS

#### **WARNING:**

- When working near the Airbag Diagnosis Sensor Unit or other Airbag System sensors with the Ignition ON or engine running, DO NOT use air or electric power tools or strike near the sensor(s) with a hammer. Heavy vibration could activate the sensor(s) and deploy the air bag(s), possibly causing serious injury.
- When using air or electric power tools or hammers, always switch the Ignition OFF, disconnect the battery and wait at least three minutes before performing any service.

#### Cautions in Removing Battery Terminal and AV Control Unit (Models with AV Control Unit)

INFOID:000000009129064

#### **CAUTION:**

Remove battery terminal and AV control unit 30 seconds or more after turning the ignition switch OFF.

#### **NOTE:**

After the ignition switch is turned OFF, the AV control unit continues operating for approximately 30 seconds. Therefore, data corruption may occur if battery voltage is cut off within 30 seconds.

#### Precaution for Trouble Diagnosis

INFOID:000000009129065

#### AV COMMUNICATION SYSTEM

- Do not apply voltage of 7.0 V or higher to the measurement terminals.
- Use the tester with its open terminal voltage being 7.0 V or less.
- Be sure to turn ignition switch OFF and disconnect the battery cable from the negative terminal before checking the circuit.

AV

#### Precaution for Harness Repair

INFOID:000000009129066

#### AV COMMUNICATION SYSTEM

## PRECAUTIONS

[BOSE AUDIO W/NAVI W/O SURROUND]

< PRECAUTION >

- Solder the repaired parts, and wrap with tape. [Frays of twisted line must be within 110 mm (4.33 in).]

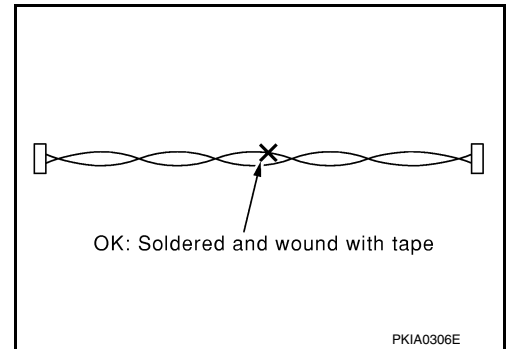

- Do not perform bypass wire connections for the repair parts. (The spliced wire will become separated and the characteristics of twisted line will be lost.)

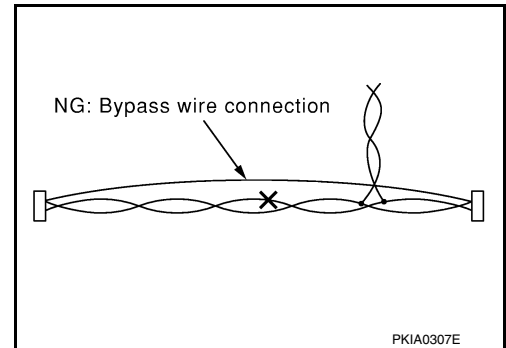

### Precaution for Work

INFOID:000000009129067

- When removing or disassembling each component, be careful not to damage or deform it. If a component may be subject to interference, be sure to protect it with a shop cloth.
- When removing (disengaging) components with a screwdriver or similar tool, be sure to wrap the component with a shop cloth or vinyl tape to protect it.
- Protect the removed parts with a shop cloth and prevent them from being dropped.
- Replace a deformed or damaged clip.
- If a part is specified as a non-reusable part, always replace it with a new one.
- Be sure to tighten bolts and nuts securely to the specified torque.
- After installation is complete, be sure to check that each part works properly.
- Follow the steps below to clean components:
  - Water soluble dirt:
    - Dip a soft cloth into lukewarm water, wring the water out of the cloth and wipe the dirty area.
    - Then rub with a soft, dry cloth.
  - Oily dirt:
    - Dip a soft cloth into lukewarm water with mild detergent (concentration: within 2 to 3%) and wipe the dirty area.
    - Then dip a cloth into fresh water, wring the water out of the cloth and wipe the detergent off.
    - Then rub with a soft, dry cloth.
  - Do not use organic solvent such as thinner, benzene, alcohol or gasoline.
  - For genuine leather seats, use a genuine leather seat cleaner.

# PREPARATION

[BOSE AUDIO W/NAVI W/O SURROUND]

< PREPARATION >

## PREPARATION

### PREPARATION

#### Special Service Tool

INFOID:000000009129068

The actual shapes of Kent-Moore tools may differ from those of special service tools illustrated here.

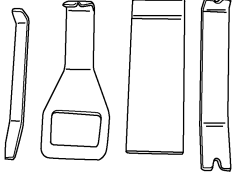
Tool number (Kent-Moore No.) Tool name	Description
— (J-46534) Trim Tool Set  AWJIA0483ZZ	Removing trim components

#### Commercial Service Tools

INFOID:000000009129069

Tool name	Description
Power tools  PIIB1407E	Loosening nuts, screws and bolts

A  
B  
C  
D  
E  
F  
G  
H  
I  
J  
K  
L  
M  
AV  
O  
P

# COMPONENT PARTS

< SYSTEM DESCRIPTION >

[BOSE AUDIO W/NAVI W/O SURROUND]

## SYSTEM DESCRIPTION

### COMPONENT PARTS

#### Component Parts Location

INFOID:000000009129070

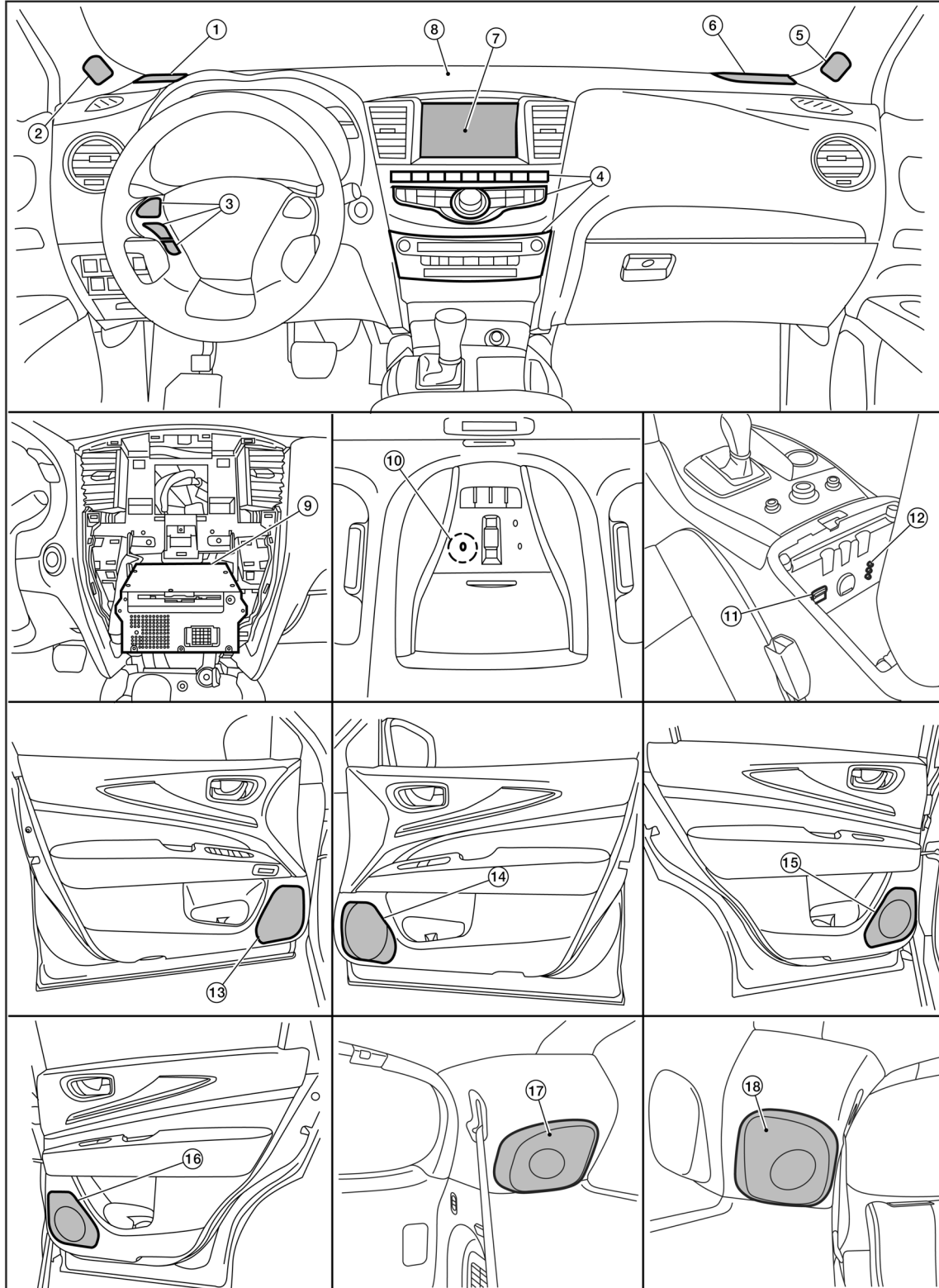

AWNIA2568ZZ



# COMPONENT PARTS

< SYSTEM DESCRIPTION >

[BOSE AUDIO W/NAVI W/O SURROUND]

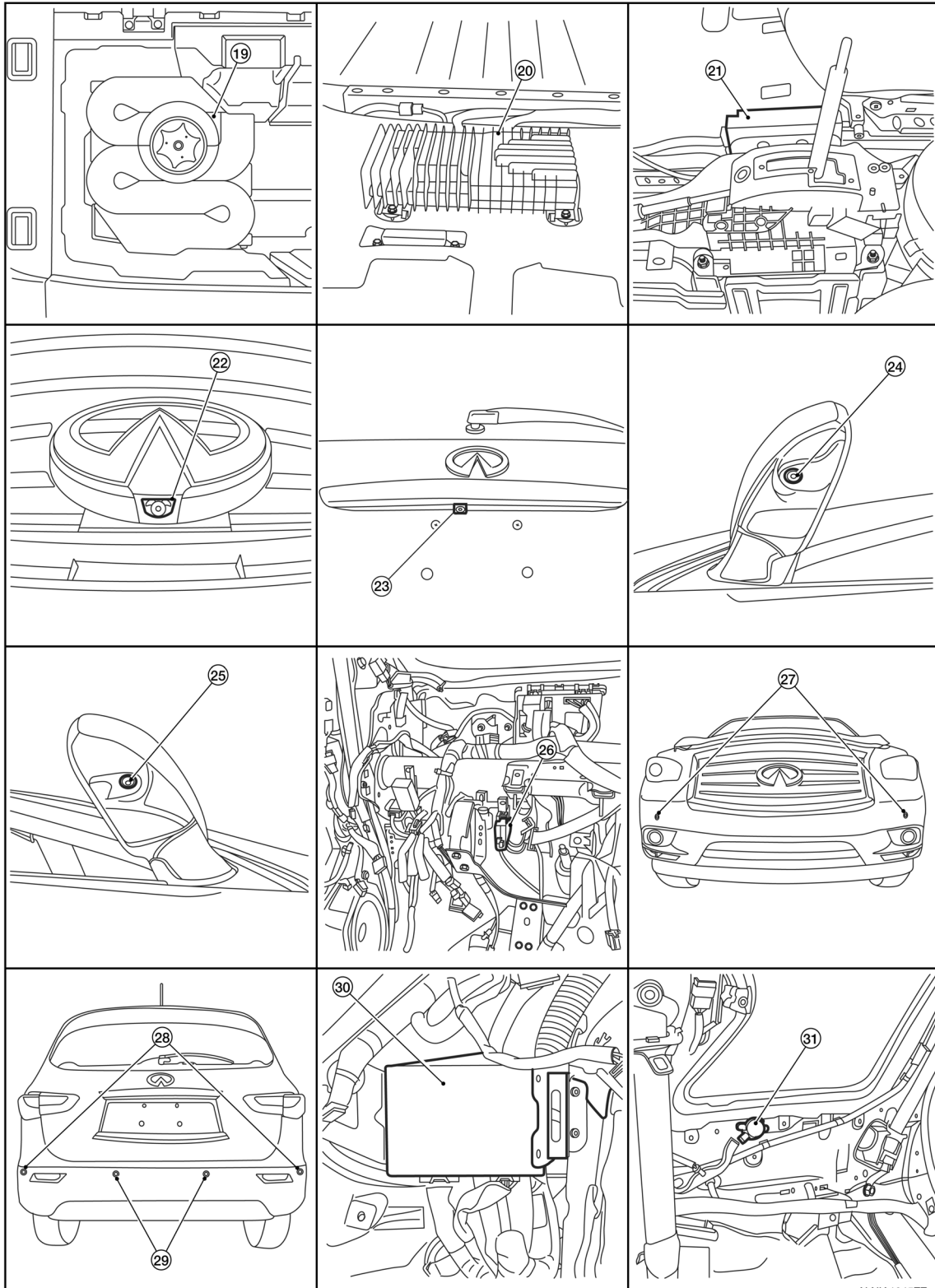

ALNIA1345ZZ

A  
B  
C  
D  
E  
F  
G  
H  
I  
J  
K  
L  
M  
AV  
O  
P

# COMPONENT PARTS

< SYSTEM DESCRIPTION >

[BOSE AUDIO W/NAVI W/O SURROUND]

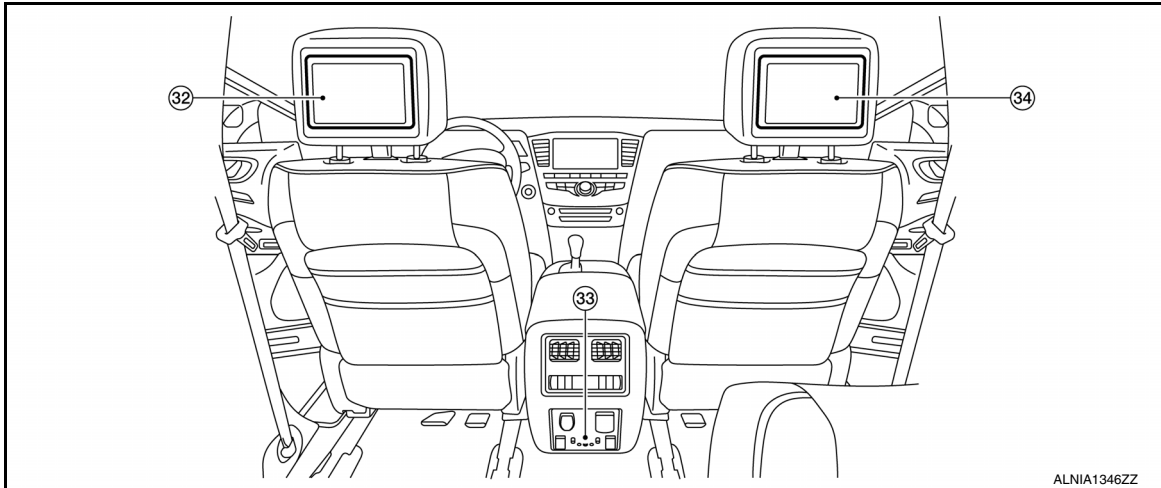

- |  |   |   |
|--|---|---|
| 1. Instrument panel tweeter LH             | 2. Front tweeter LH                     | 3. Steering switch                                  |
| 4. A/C and AV switch assembly              | 5. Front tweeter RH                     | 6. Instrument panel tweeter RH                      |
| 7. Display unit                            | 8. Center speaker                       | 9. AV control unit (view with center stack removed) |
| 10. Microphone                             | 11. USB interface                       | 12. Front auxiliary input jacks                     |
| 13. Front door speaker LH                  | 14. Front door speaker RH               | 15. Rear door speaker LH                            |
| 16. Rear door speaker RH                   | 17. Rear side speaker LH                | 18. Rear side speaker RH                            |
| 19. Subwoofer                              | 20. Bose® speaker amp.                  | 21. Around view monitor control unit                |
| 22. Front camera                           | 23. Rear camera                         | 24. Door mirror LH (side camera)                    |
| 25. Door mirror RH (side camera)           | 26. Sonar control unit                  | 27. Front sonar sensors outer                       |
| 28. Rear sonar sensors outer               | 29. Rear sonar sensors inner            | 30. Video distributor                               |
| 31. Sonar buzzer                           | 32. Headrest display unit (driver seat) | 33. Rear auxiliary input jacks                      |
| 34. Headrest display unit (passenger seat) |   |   |

## Component Description

INFOID:000000009129071

# COMPONENT PARTS

[BOSE AUDIO W/NAVI W/O SURROUND]

< SYSTEM DESCRIPTION >

Part name	Description
AV control unit	<ul style="list-style-type: none"> <li>• Master unit of MULTI AV system.</li> <li>• AV control unit includes audio, hands-free phone, navigation, USB connection, DVD play and vehicle status functions.</li> <li>• Integrates hard disk drive (HDD) allowing map data and music data to be stored.</li> <li>• Connected to MULTI AV system control units via AV communication.</li> <li>• Connected to other vehicle control units via CAN communication to obtain necessary information for vehicle function.</li> <li>• Receives steering angle signal via CAN communication from steering angle sensor and controls an expected course line during around view monitor operation.</li> <li>• Inputs signals for driving status recognition (vehicle speed, reverse and parking brake).</li> <li>• RGB digital image signal and composite image signal are output to front display unit.</li> <li>• Transmits image and sound output to video distributor and inputs image switch signal from headrest display units via AV communication.</li> <li>• Receives an intelligent key identification signal necessary for intelligent key interlocking function via hard wire from BCM.</li> <li>• Transmits Amp. ON signal to BOSE amp.</li> <li>• Update of map data is performed using DVD-ROM.</li> </ul>
Display unit	<ul style="list-style-type: none"> <li>• Display image is controlled by AV control unit via serial communication.</li> <li>• Receives power from AV control unit.</li> <li>• RGB and RGB digital image signals are input from AV control unit.</li> <li>• Composite image signals are input from AV control unit.</li> <li>• Synchronizing signals are output to AV control unit.</li> <li>• Camera image signals are input from around view monitor control unit via video output signal.</li> <li>• Touch panel functions can be operated by touching display directly.</li> </ul>
BOSE speaker amp.	Receives sound signals from AV control unit and outputs sound signals to each speaker.
Instrument panel tweeter	Outputs high range sound signals from BOSE speaker amp.
Center speaker	Outputs mid and high range sound signals from BOSE speaker amp.
Front tweeter	Outputs high range sound signals from BOSE speaker amp.
Front door speaker	Outputs low, mid and high range sound signals from BOSE speaker amp.
Rear door speaker	Outputs low, mid and high range sound signals from BOSE speaker amp.
Rear side speaker	Outputs low, mid and high range sound signals from BOSE speaker amp.
Subwoofer	Outputs low range sound signals from BOSE speaker amp.
A/C and AV switch assembly	<ul style="list-style-type: none"> <li>• Operation panels are equipped with switches for audio and air conditioner operations.</li> <li>• Operation signal is transmitted via AV communication to AV control unit and around view monitor.</li> <li>• Disk eject operation signal is performed via hardwire.</li> </ul>
Steering switch	<ul style="list-style-type: none"> <li>• Operations for audio, hands-free phone and voice recognition are possible.</li> <li>• Steering switch signal (operation signal) is output to AV control unit.</li> </ul>
Steering angle sensor	Connected to AV control unit via CAN communication and transmits steering angle sensor signal.
Video distributor	<ul style="list-style-type: none"> <li>• Receives image and sound signals from AV control unit and transmits them to headrest display units.</li> <li>• Receives image and sound signals from rear auxiliary input jacks and transmits them to headrest display units.</li> <li>• Transmits image and sound signals to headrest display unit and receives image switch signal from headrest display units.</li> </ul>
Headrest display units	<ul style="list-style-type: none"> <li>• Composite image signals are input from video distributor.</li> <li>• Receives DVD/AUX/USB sound signals from video distributor and transmits them to headphones.</li> <li>• Transmits image switch signal to video distributor according to remote control operation.</li> <li>• Transmits image switch signal to AV control unit via AV communication according to remote control operation.</li> </ul>

A  
B  
C  
D  
E  
F  
G  
H  
I  
J  
K  
L  
M

AV

O  
P

## COMPONENT PARTS

**[BOSE AUDIO W/NAVI W/O SURROUND]**

< SYSTEM DESCRIPTION >

Part name	Description
Front auxiliary input jacks	Transmits image and sound signals to AV control unit.
Rear auxiliary input jacks	Transmits image and sound signals to video distributor and headrest display units.
Around view monitor control unit	<ul style="list-style-type: none"> <li>• Supplies power to front, rear and side cameras.</li> <li>• Superimposes images from each camera and outputs them to display unit.</li> <li>• Superimposes guiding line, predicted course line and sonar indicator to camera image that outputs to display unit.</li> <li>• Performs reception/transmission of communication signals with cameras.</li> <li>• Transmits sonar operation signal from sonar control unit via CAN communication.</li> <li>• Receives sonar information from sonar control unit via CAN communication.</li> <li>• Transmits data received/transmitted from sonar control unit to AV control unit via CAN communication.</li> </ul>
Front camera	<ul style="list-style-type: none"> <li>• Inputs power supply from around view monitor control unit.</li> <li>• Outputs image of vehicle front to around view monitor control unit.</li> <li>• Performs reception/transmission of communication signal with around view monitor control unit.</li> </ul>
Rear camera	<ul style="list-style-type: none"> <li>• Inputs power supply from around view monitor control unit.</li> <li>• Outputs image of vehicle rear to around view monitor control unit.</li> <li>• Performs reception/transmission of communication signal with around view monitor control unit.</li> </ul>
Side camera LH	<ul style="list-style-type: none"> <li>• Inputs power supply from around view monitor control unit.</li> <li>• Outputs image of vehicle LH side to around view monitor control unit.</li> <li>• Performs reception/transmission of communication signal with around view monitor control unit.</li> </ul>
Side camera RH	<ul style="list-style-type: none"> <li>• Inputs power supply from around view monitor control unit.</li> <li>• Outputs image of vehicle RH side to around view monitor control unit.</li> <li>• Performs reception/transmission of communication signal with around view monitor control unit.</li> </ul>
Sonar control unit	<ul style="list-style-type: none"> <li>• Connected to around view monitor control unit via CAN communication.</li> <li>• Receives sonar operation signal from around view monitor control unit via CAN communication.</li> <li>• Transmits sonar detection status to around view monitor control unit via CAN communication.</li> <li>• Judges warning level according to signals from front and rear sensors.</li> </ul>
Front sensors	Detects front obstacle distance and transmits signal to sonar control unit.
Rear sensors	Detects rear obstacle distance and transmits signal to sonar control unit.
Microphone	<ul style="list-style-type: none"> <li>• Used for hands-free phone, voice recognition and INFINITI CONNECTIONS operations.</li> <li>• Microphone signal is transmitted to telematics control unit (TCU).</li> <li>• Power (Microphone VCC) is supplied from TCU.</li> </ul>
Telematics control unit (TCU)	<ul style="list-style-type: none"> <li>• Connected to the AV control unit via a USB harness for sound signal input/output and USB communication.</li> <li>• Data is sent to and received from the INFINITI CONNECTIONS data center via the TEL antenna.</li> <li>• Inputs TEL voice signal from TEL antenna and outputs it to AV control unit.</li> </ul>
TEL antenna	<ul style="list-style-type: none"> <li>• Receives TEL voice signals and outputs them to TCU.</li> <li>• Transmits TEL voice signals from TCU.</li> </ul>
GPS antenna	GPS signal is received and transmitted to AV control unit.
Antenna amp.	<ul style="list-style-type: none"> <li>• Radio signal received by window antenna is amplified and transmitted to AV control unit.</li> <li>• Power (antenna amp. ON signal) is supplied from AV control unit.</li> </ul>
Satellite radio antenna	Satellite radio signal is received and transmitted to AV control unit.
USB connector	USB sound and data input signals are transmitted to AV control unit.

# SYSTEM

[BOSE AUDIO W/NAVI W/O SURROUND]

< SYSTEM DESCRIPTION >

## SYSTEM MULTI AV SYSTEM

### MULTI AV SYSTEM : System Diagram

INFOID:000000009129072

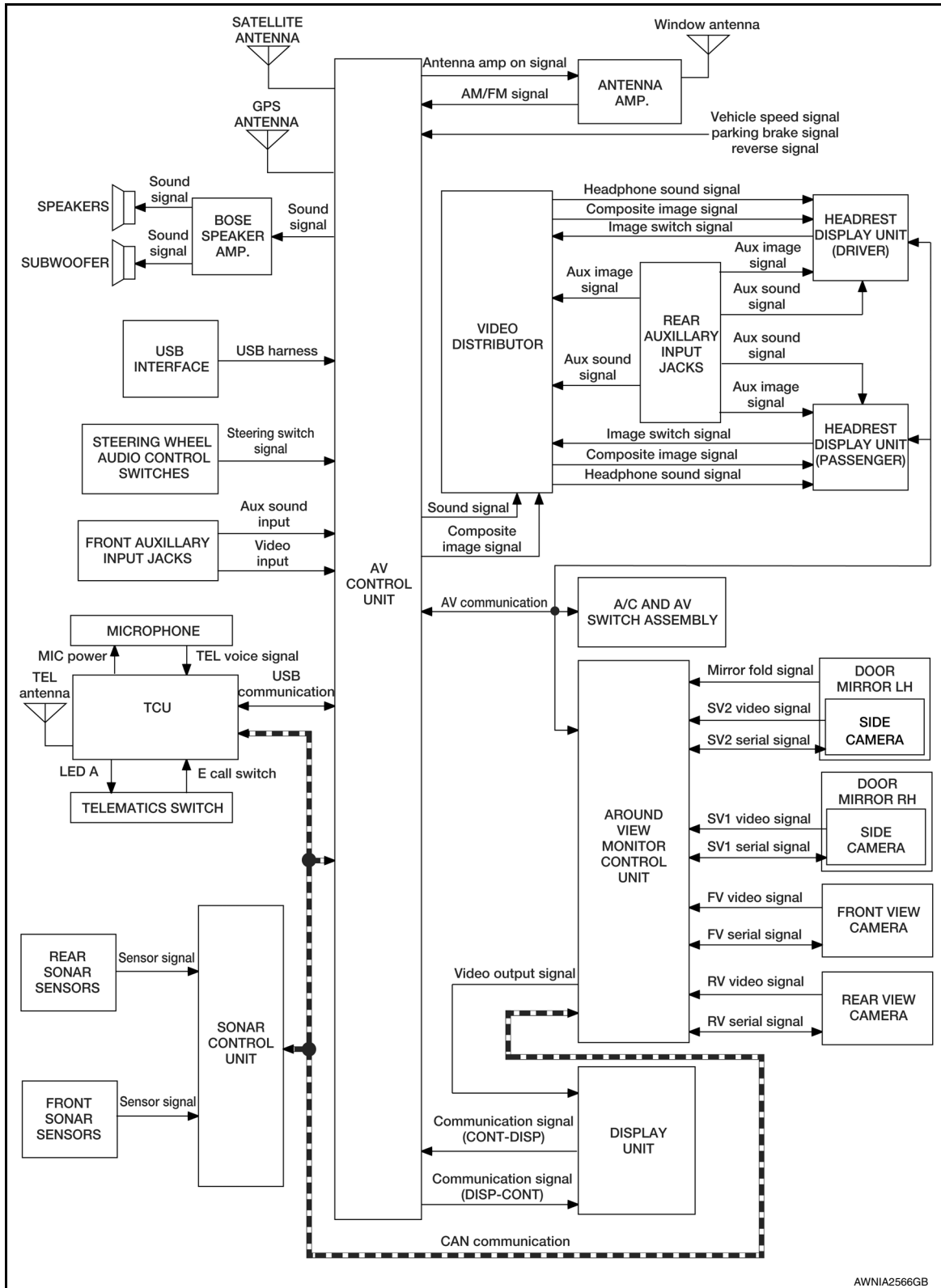

AWNIA2566GB

A  
B  
C  
D  
E  
F  
G  
H  
I  
J  
K  
L  
M  
N  
O  
P

AV

### MULTI AV SYSTEM : System Description

INFOID:000000009129073

#### AUDIO SYSTEM

Revision: August 2013

AV-333

2014 QX60

# SYSTEM

## < SYSTEM DESCRIPTION >

[BOSE AUDIO W/NAVI W/O SURROUND]

The audio system consists of the following components

- AV control unit
- A/C and AV switch assembly
- Display unit
- Steering wheel audio control switches
- BOSE speaker amp.
- Center speaker
- Instrument panel tweeters
- Front tweeters
- Front door speakers
- Rear door speakers
- Rear side speakers
- Subwoofer
- Window antenna

When the audio system is on, radio signals are received by the window antenna. The AV control unit then sends audio signals to the BOSE speaker amp. The BOSE speaker amp. amplifies the audio signals before sending them to the speakers, tweeters and subwoofer.

Refer to Owner's Manual for audio system operating instructions.

### SATELLITE RADIO SYSTEM

The satellite radio system consists of the following components

- Satellite antenna
- AV control unit

When the satellite radio system is on, radio signals are supplied to the AV control unit from the satellite antenna. The AV control unit then sends audio signals to the BOSE speaker amp.

Refer to Owner's Manual for satellite radio system operating instructions.

### HANDS-FREE PHONE SYSTEM

System Operation

#### **NOTE:**

Cellular telephones must have their wireless connection set up (paired) before using the Bluetooth® telephone system.

The Bluetooth® telephone system allows users who have a Bluetooth® cellular telephone to make a wireless connection between their cellular telephone and the AV control unit. Hands-free cellular telephone calls can be sent and received. Some Bluetooth® cellular telephones may not be recognized by the AV control unit. When a cellular telephone or the AV control unit is replaced, the telephone must be paired with the AV control unit. Different cellular telephones may have different pairing procedures, refer to the cellular telephone operating manual.

Refer to the Owner's Manual for Bluetooth® telephone system operating instructions.

AV Control Unit

When the ignition switch is turned to ACC or ON, the AV control unit will power up. During power up, the AV control unit is initialized and performs various self-checks. Initialization may take up to 20 seconds. If a phone is present in the vehicle and paired with the AV control unit, Infiniti Voice Recognition will then become active. Bluetooth® telephone functions can be turned off using the Infiniti Voice Recognition system.

Steering Wheel Audio Control Switches

When buttons on the steering wheel audio control switch are pushed, the resistance in steering wheel audio control switch circuit changes, depending on which button is pushed. The AV control unit uses this signal to perform various functions while navigating through the voice recognition system.

The following functions can be performed using the steering wheel audio control switch:

- Initiate self-diagnosis of the Bluetooth® telephone system
- Start a voice recognition session
- Answer and end telephone calls
- Adjust the volume of calls
- Record memos

Microphone

The microphone is located in the roof console assembly. The microphone sends a signal to the Telematics Control Unit (TCU), which transmits the signal to the AV control unit via the USB communication circuits. The microphone can be actively tested during self-diagnosis.

### < SYSTEM DESCRIPTION >

## NAVIGATION SYSTEM

### System Operation

**NOTE:**

Refer to NAVI System Owner's Manual for system operation.

The navigation system periodically calculates the vehicle's current position according to the following three signals: Travel distance of the vehicle as determined by the vehicle speed sensor, turning angle of the vehicle as determined by the gyroscope (angular velocity sensor), and the direction of vehicle travel as determined by the GPS antenna (GPS information).

The current position of the vehicle is then identified by comparing the calculated vehicle position with map data read from the map data, which is stored in the hard disk drive (HDD) (map-matching), and indicated on the screen with a current-location mark.

By comparing the vehicle position detection results found by the GPS and by map-matching, more accurate vehicle position data can be used.

The current vehicle position will be calculated by detecting the distance the vehicle moved from the previous calculation point and its direction.

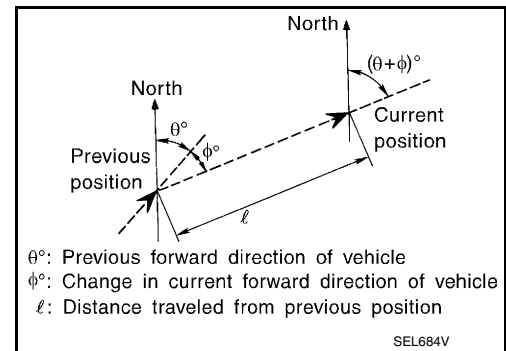

#### Travel Distance

Travel distance calculations are based on the vehicle speed input signal. Therefore, the calculation may become incorrect as the tires wear down. To prevent this, an automatic distance fine adjustment function has been adopted.

#### Travel Direction

Change in the travel direction of the vehicle is calculated by a gyroscope (angular velocity sensor) and a GPS antenna (GPS information). As the gyroscope and GPS antenna have both merit and demerit, input signals from them are prioritized in each situation. However, this order of priority may change in accordance with more detailed travel conditions so that the travel direction is detected more accurately.

Type	Advantage	Disadvantage
Gyroscope (angular velocity sensor)	<ul style="list-style-type: none"> <li>Can detect the vehicle's turning angle quite accurately.</li> </ul>	<ul style="list-style-type: none"> <li>Direction errors may accumulate when the vehicle is driven for long distances without stopping.</li> </ul>
GPS antenna (GPS information)	<ul style="list-style-type: none"> <li>Can detect the vehicle's travel direction (North/South/East/West).</li> </ul>	<ul style="list-style-type: none"> <li>Correct direction cannot be detected when the vehicle speed is low.</li> </ul>

#### Map-Matching

Map-matching is a function that repositions the vehicle on the road map when a new location is judged to be the most accurate. This is done by comparing the current vehicle position, calculated by the method described in the position detection principle, with the road map data around the vehicle, read from the map data stored on the HDD.

Therefore, the vehicle position may not be corrected after the vehicle is driven over a certain distance or time in which GPS information is hard to receive. In this case, the current-location mark on the display must be corrected manually.

**CAUTION:**

The road map data is based on data stored on the HDD.

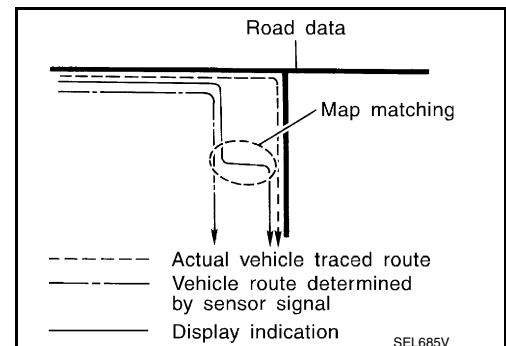

# SYSTEM

[BOSE AUDIO W/NAVI W/O SURROUND]

## < SYSTEM DESCRIPTION >

- In map-matching, alternative routes to reach the destination will be shown and prioritized, after the road on which the vehicle is currently driven has been judged and the current-location mark has been repositioned.

If there is an error in distance and/or direction, the alternative routes will be shown in different order of priority, and the wrong road can be avoided.

If two roads are running in parallel, they are of the same priority. Therefore, the current-location mark may appear on either of them alternately, depending on maneuvering of the steering wheel and configuration of the road.

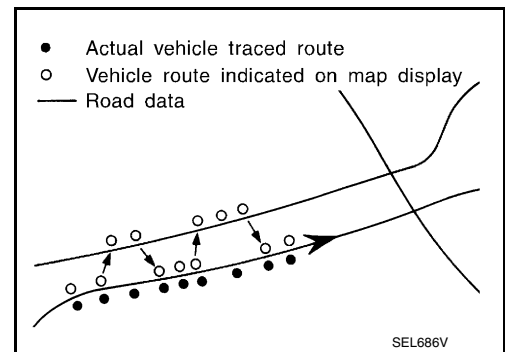

- Map-matching does not function correctly when the road on which the vehicle is driving is new and not recorded on the HDD, or when the road pattern stored in the map data and the actual road pattern are different due to repair.

When driving on a road not present in the map, the map-matching function may find another road and position the current-location mark on it. Then, when the correct road is detected, the current-location mark may leap to it.

- Effective range for comparing the vehicle position and travel direction calculated by the distance and direction with the road data read from the HDD is limited. Therefore, when there is an excessive gap between the current vehicle position and the position on the map, correction by map-matching is not possible.

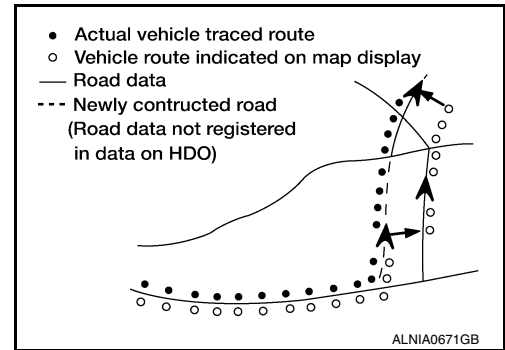

## GPS (Global Positioning System)

GPS (Global Positioning System) has been developed and controlled by the US Department of Defense. The system utilizes GPS satellite (NAVSTAR), sending out radio waves while flying on an orbit around the earth at the height of approx. 21,000 km (13,000 mi).

The GPS receiver calculates the vehicle's position in three dimensions (latitude/longitude/altitude) according to the time lag of the radio waves received from four or more GPS satellites (three-dimensional positioning). If radio waves were received only from three GPS satellites, the GPS receiver calculates the vehicle's position in two dimensions (latitude/longitude), utilizing the altitude data calculated previously by using radio waves from four or more GPS satellites (two-dimensional positioning).

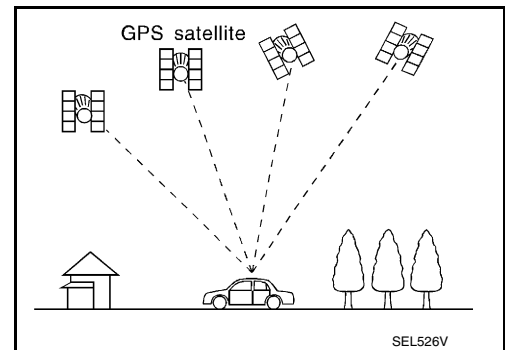

Accuracy of the GPS will deteriorate under the following conditions.

- In two-dimensional positioning, the GPS accuracy will deteriorate when the altitude of the vehicle position changes.
- There may be an error of approximately 10 m (30 ft.) in position detected by three-dimensional positioning, which is more accurate than two-dimensional positioning. The accuracy can be even lower depending on the arrangement of the GPS satellites utilized for the positioning.
- Position detection is not possible when the vehicle is in an area where radio waves from the GPS satellite do not reach, such as in a tunnel, parking lot in a building, and under an elevated highway. Radio waves from the GPS satellites may not be received when some object is located over the GPS antenna.
- Position correction by GPS is not available while the vehicle is stopped.

## SPEED SENSITIVE VOLUME SYSTEM

Volume level of this system goes up and down automatically in proportion to the vehicle speed. The control level can be selected by the customer. Refer to Owner's Manual for operating instructions.

## FRONT AUXILIARY INPUT JACKS

- Image and sound can be output from an external device connected to the front auxiliary input jacks.
- AUX image signals are transmitted to each unit as follows:
  - To the display unit via AV control unit.
  - To the headrest display units via AV control unit and video distributor.
- AUX sound signals are transmitted to each unit as follows:
  - To each speaker via AV control unit and BOSE speaker amp.



# SYSTEM

## < SYSTEM DESCRIPTION >

## [BOSE AUDIO W/NAVI W/O SURROUND]

- To video distributor via AV control unit.
- Headphone sound signals are transmitted via infrared communication between headrest display units and headphones.

### REAR ENTERTAINMENT SYSTEM

- Image and sound (DVD, USB memory-stored video data and front auxiliary input) played by AV control unit can be enjoyed in rear seat using headrest display units and headphones.
- Image and sound of an external device connected to rear auxiliary input jacks for rear seat can be enjoyed in rear seat using headrest display units and headphones. Also, image and sound from rear auxiliary input jacks can be selected and played individually on each side as well as on both sides.

#### **NOTE:**

Image signal and sound signal from rear auxiliary input jacks are not transmitted to front display unit and each speaker.

#### Operation Signal

- The rear entertainment system can be controlled by the rear seat remote control.
- The rear seat remote control transmits the operation signal to the remote control receiver built into headrest display units, which then transmits it to the AV control unit and video distributor.

#### Headphone Sound

- Sound signals output from AV control unit or rear auxiliary input jacks are transmitted to headrest display units via video distributor.
- Headphone sound signals are transmitted via infrared communication between headrest display units and headphones.

#### Headrest Display Units

- Composite image signals from AV control unit are transmitted to headrest display unit via video distributor.
- Image switch signals from headrest display units are transmitted to AV control unit and video distributor, according to rear seat remote control operation.
- When image switch signal is transmitted from headrest display unit to AV control unit via AV communication, image played by AV control unit (DVD, USB memory-stored video data, and front auxiliary input) switches.
- When image switch signal is transmitted from headrest display unit to video distributor, image output from AV control unit and image output from rear auxiliary input jacks switch.

### AROUND VIEW MONITOR SYSTEM

- This system is equipped with wide-angle high-resolution cameras on the front and rear of the vehicle and on both right and left door mirrors. The images from front view, rear view, front-side view (RH side), and birds-eye view that shows the view from the top of the vehicle are displayed to monitor the vehicle surroundings.
- Around view monitor control unit cuts out and expands the image received from each camera to create each view.
- The sonar indicator is viewed on display (superimposed on the camera image) in combination with the camera assistance sonar system to warn of the approach of an obstacle.
- In front view and rear view, the vehicle width, distance lines and predictive course lines are superimposed and displayed. In front-side view, the vehicle distance guiding line and vehicle width guiding line are displayed.
- The Birds-Eye view converts the images from 4 cameras into the overhead view and displays the status of the vehicle. The vehicle icon and sonar indicator on the Birds-Eye view display are rendered by around view monitor control unit.

#### Around View Monitor Screen

- Around view monitor combines and displays the travel direction view and Birds-Eye view, Front-Side view and then displays the sonar indicator on the Birds-Eye view, Front-Side view, Rear wide view.
- AV control unit renders the Change View switch, view icon, warning message on display.

#### Operation Description

##### **NOTE:**

The first, second, and third camera image displayed when switched to the camera image display depends on the settings of Camera View Priority.

- Around view monitor operates by pressing the CAMERA switch on the A/C and AV switch assembly and shifting the selector lever to the R position.
- When the selector lever is in any position other than R, the screen is switched to the around view monitor by pressing the CAMERA switch.
- The screen is switched to the around view monitor by shifting the selector lever to the R position.

A

B

C

D

E

F

G

H

I

J

K

L

M

AV

O

P

# SYSTEM

[BOSE AUDIO W/NAVI W/O SURROUND]

## < SYSTEM DESCRIPTION >

- The around view monitor's, Birds-Eye view, Front-side view or rear wide view (rear only) can be switched by pressing the CAMERA switch.
- The around view monitor is cancelled 3 minutes after pressing the CAMERA switch, and the display returns to the previous screen.
- ON/OFF setting of sonar indicator display on the Front-Side view screen can be performed.
- In Birds-Eye view, the invisible area is displayed on the image to specify the boundary of the 4 cameras. The invisible area is displayed in yellow in the Birds-Eye view after turning the ignition switch ON.
- The sonar operates only when the camera screen is displayed.

## SONAR SYSTEM

### System Operation Description

- Around view monitor control unit transmits the sonar operation signal via CAN communication to sonar control unit to control the operation of sonar indicator and sonar buzzer.
- Sonar control unit transmits the detection signal and detection distance signal via CAN communication to around view monitor control unit. Around view monitor control unit operates the applicable sonar indicator.
- When receiving a sonar operation signal from the around view monitor control unit, the sonar control unit converts the signal into a detection distance signal and transmits it to the AV control unit via CAN communication. When receiving the detection signal, the AV control unit activates the speakers via the BOSE speaker amp.
- The sonar control unit is capable of self diagnosis. It can detect sensor malfunction or sensor harness open circuits. It transmits the diagnosis results to around view monitor control unit and always displays the sonar indicator in red to inform the vehicle operator.

### Obstacle Detection Distance

- Sonar control unit changes the outputs of the sonar indicator and warning buzzer in 3 stages according to the obstacle detection distance from the corner sensor.
- The sonar control unit can change the setting of obstacle detection distance in 4 stages.

Obstacle detection image

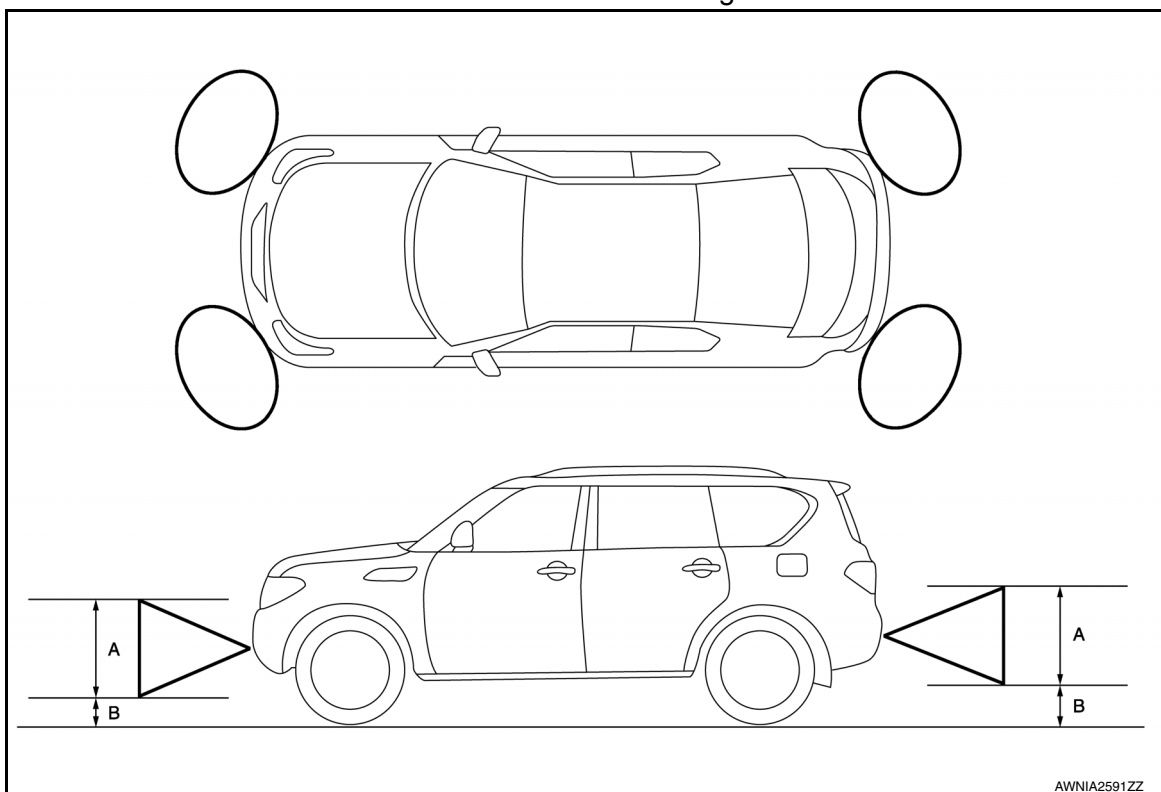

A. Approx. 50 cm (19.6 in)

B. Approx. 15 cm (5.9 in)

# SYSTEM

## < SYSTEM DESCRIPTION >

## [BOSE AUDIO W/NAVI W/O SURROUND]

### Detection distance

Warning item	Sensitivity level 1 (Fastest warning)	Sensitivity level 2 (Faster warning)	Sensitivity level 3 (Default value)	Sensitivity level 4 (Slower warning)
First stage warning	70 – 80 cm (27.5 – 31.4 in)	60 – 70 cm (23.6 – 27.5 in)	50 – 60 cm (19.6 – 23.6 in)	40 – 50 cm (15.7 – 19.6 in)
Second stage warning	50 – 70 cm (19.6 – 27.5 in)	40 – 60 cm (15.7 – 23.6 in)	30 – 50 cm (11.8 – 19.6 in)	30 – 40 cm (11.8 – 15.7 in)
Third stage warning	Less than 50 cm (19.6 in)	Less than 40 cm (15.7 in)	Less than 30 cm (11.8 in)	Less than 30 cm (11.8 in)

### Sonar Indicator Display

- Around view monitor control unit that receives the detection signal and detection distance signal from sonar control unit displays the sonar indicator on display.
- Around view monitor control unit changes the color or blinking cycle of the indicator according to the detection distance.

### Color and blinking cycle of sonar indicator

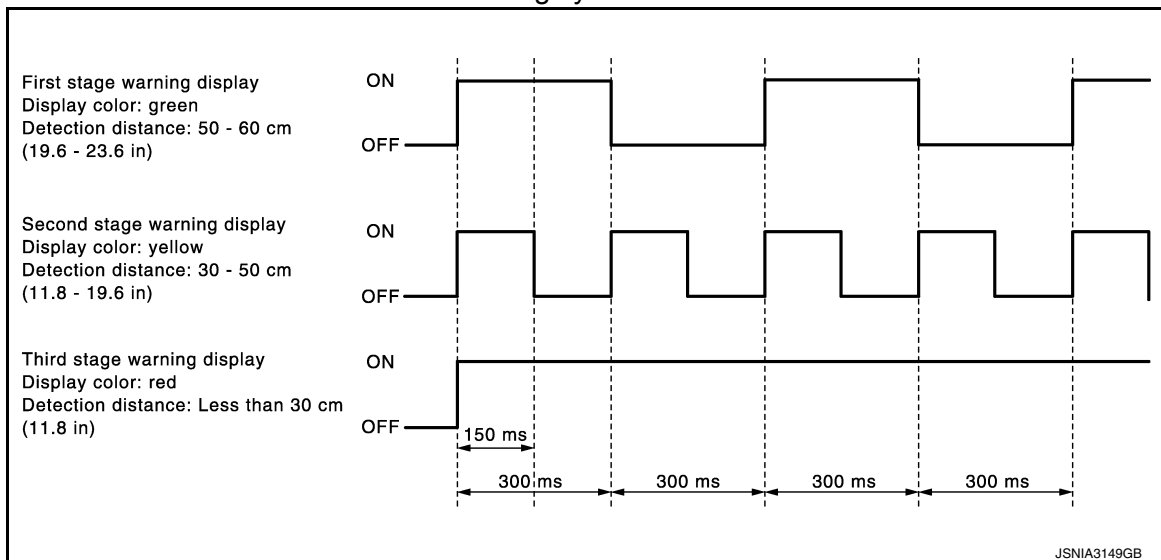

### Sonar Buzzer Operation

- Each sonar sensor transmits a sensor signal to the sonar control unit when detecting an obstacle.
- The sonar control unit converts a signal received from each sonar sensor into distance and transmits detection distance signal to the AV control unit via AV communication.
- The AV control unit transmits a buzzer signal to the BOSE amp. corresponding to each sonar sensor based on the received signal.
- When receiving a buzzer signal, the BOSE amp. transmits the buzzer signal to the each speaker. When each speaker receives a buzzer signal, a buzzer sounds.
- When the front corner sensor detects an obstacle, a buzzer is heard from the speakers on the front side.
- When the rear corner sensor detects an obstacle, a buzzer is heard from the speakers on the rear side.
- It changes the buzzer cycle in 3 stages according to the detection distance.

AV

# SYSTEM

< SYSTEM DESCRIPTION >

[BOSE AUDIO W/NAVI W/O SURROUND]

Sonar buzzer cycle

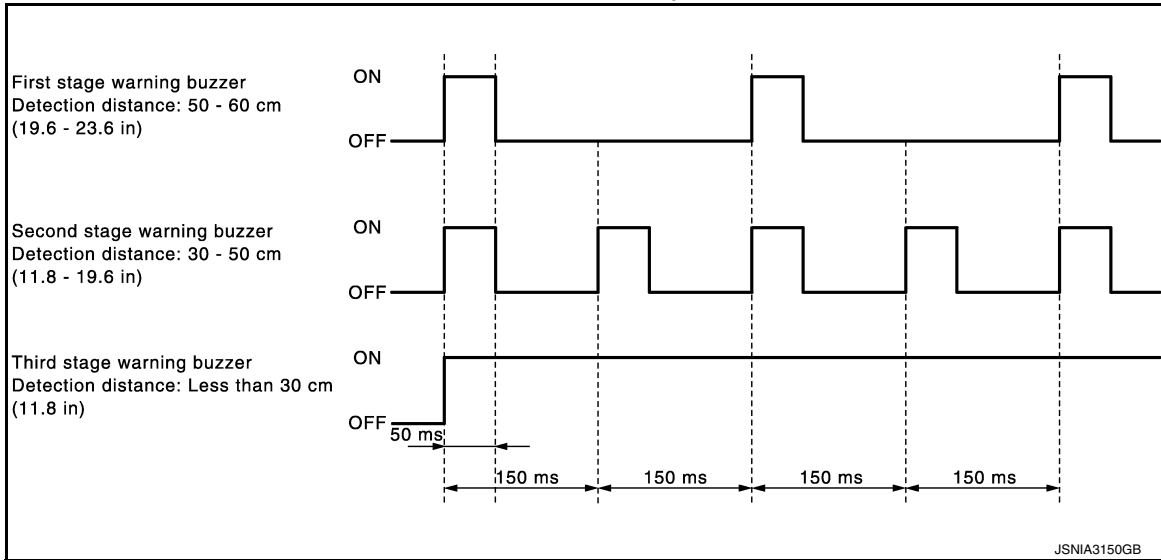

## VEHICLE INFORMATION FUNCTION

- Status of audio, climate control system, fuel economy, maintenance and navigation are displayed.
- AV control unit displays the fuel consumption status while receiving data signal through CAN communication from ECM and combination meter.
- AV control unit is connected to BCM via CAN communication transmitting/receiving for the vehicle settings function.

## INTELLIGENT KEY INTERLOCKING FUNCTION

The AV control unit recognizes a door-unlocked state of Intelligent Key according to an Intelligent Key recognition signal transmitted from BCM and saves two different types of audio settings and navigation settings.

Settings saved in the AV control unit

- Map display
- Route guidance
- Locator
- Route search
- Sound quality
- Radio preset
- Language

# DIAGNOSIS SYSTEM (AV CONTROL UNIT)

< SYSTEM DESCRIPTION >

[BOSE AUDIO W/NAVI W/O SURROUND]

## DIAGNOSIS SYSTEM (AV CONTROL UNIT)

### Description

INFOID:000000009129074

The AV control unit on board diagnosis includes the following functions:

- A/C and AV switch assembly self diagnosis that checks the ON/OFF operation (continuity) of each switch in the A/C and AV switch assembly.

**NOTE:**

The hazard switch and disk eject switch are not included in this operation check.

- AV control unit on board diagnosis performs the following functions listed in the table below:

Mode		Description	
Self Diagnosis		<ul style="list-style-type: none"> <li>• AV control unit diagnosis.</li> <li>• Diagnoses the connections across system components, between AV control unit and GPS antenna.</li> </ul>	
Confirmation/ Adjustment	Display Diagnosis	The following check functions are available: color tone check by color bar display and white display, light and shade check by gray scale display and touch panel calibration response check.	
	Vehicle Signals	Diagnosis of signals can be performed for vehicle speed, parking brake, lights, ignition, reverse, side view switch and room lamp.	
	Speaker Test	The connection of a speaker can be confirmed by test tone.	
	Navigation	Steering Angle Adjustment	When there is a difference between the actual turning angle and the vehicle mark turning angle, it can be adjusted.
		Speed Calibration	When there is a difference between the current location mark and the actual location, it can be adjusted.
	Error History	The system malfunction and the frequency when occurring in the past are displayed. When the malfunctioning item is selected, the time and place that the selected malfunction last occurred are displayed.	
	Synchronizer FES Clock	—	
	Vehicle CAN Diagnosis	The transmitting/receiving of CAN communication can be monitored.	
	AV COMM Diagnosis	The communication condition of each unit of Multi AV system can be monitored.	
	Handsfree Phone/Infiniti Connection	<ul style="list-style-type: none"> <li>• The received volume adjustment of hands-free phone, microphone speaker check, and erase memory can be performed.</li> <li>• Diagnosis of the Infiniti Connection system can be performed.</li> </ul>	
	XM	XM NaviTrffic	Change Channel
		XM NavWeather	<ul style="list-style-type: none"> <li>• Any necessary channels required to receive traffic information from the satellite radio system can be set.</li> </ul>
		XM CGS	Change Application ID
		Diag	<ul style="list-style-type: none"> <li>• Any application ID's required to receive traffic information from the satellite radio system can be set.</li> </ul>
Delete Unit Connection Log	Erase the connection history of unit and error history.		
Initialize Settings	Initializes the AV control unit memory.		
Version Information	Version information of the AV control unit is displayed.		

Perform CONSULT diagnosis if the AV control unit on board diagnosis does not start, the screen does not display anything, or the A/C and AV switch assembly self diagnosis does not function.

### On Board Diagnosis Function

INFOID:000000009129075

#### METHOD OF STARTING

A/C and AV Switch Assembly Self Diagnosis

# DIAGNOSIS SYSTEM (AV CONTROL UNIT)

[BOSE AUDIO W/NAVI W/O SURROUND]

## < SYSTEM DESCRIPTION >

- Press the BACK and UP switches within 10 seconds after turning the ignition switch from OFF to ACC and hold them for 3 seconds or more.
- The buzzer sounds, all indicators of the switches illuminate, and the self-diagnosis mode begins.
- The ON position continuity of each switch can be checked by pressing the switch. The buzzer sounds if continuity is present.
- The self diagnosis mode is canceled when the ignition switch is turned OFF.

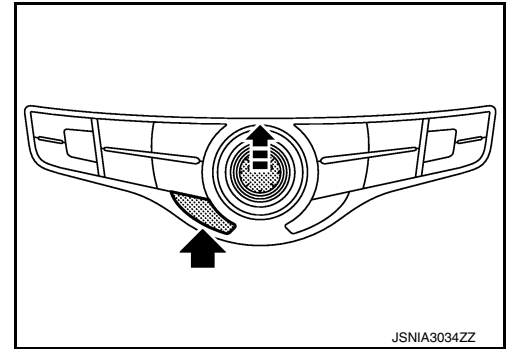

### AV Control Unit Self Diagnosis

1. Turn the ignition ON.
2. Turn the audio system OFF.
3. While pressing the SETTING button, turn the volume control dial clockwise or counterclockwise for 40 clicks or more. When self-diagnosis mode begins, a short beep will be heard. Shifting from current screen to previous screen is performed by pressing BACK button.

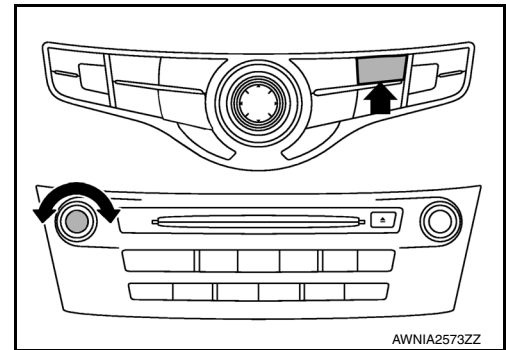

4. The trouble diagnosis initial screen is displayed, and Self Diagnosis or Confirmation/Adjustment can be selected.

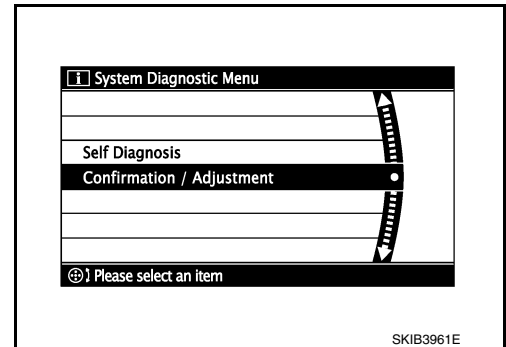

## SELF DIAGNOSIS MODE

### AV Control Unit Self Diagnosis

1. Select Self Diagnosis.
2. Self diagnosis screen is displayed. The bar graph visible in center of screen indicates progress of self diagnosis.

# DIAGNOSIS SYSTEM (AV CONTROL UNIT)

[BOSE AUDIO W/NAVI W/O SURROUND]

## < SYSTEM DESCRIPTION >

- Diagnosis results are displayed after the self-diagnosis is completed. The unit names and the connection lines are color-coded according to the diagnostic results.

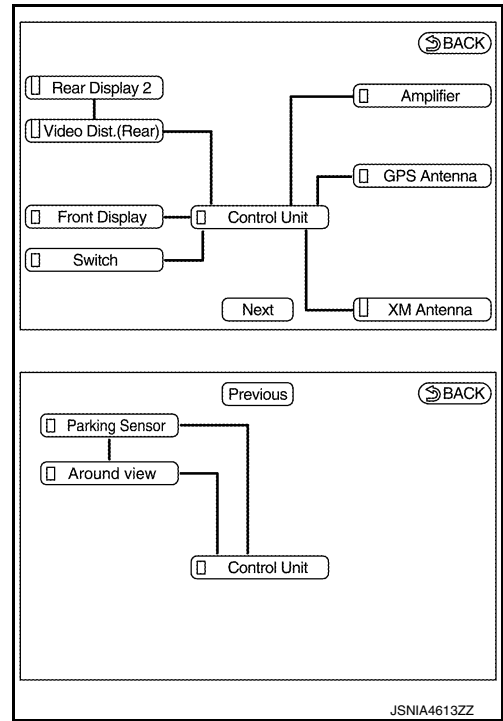

Diagnosis results	Unit	Connection line
Normal	Green	Green
Connection malfunction	Gray	Yellow
Unit malfunction <sup>1</sup>	Red	Green

1: Control Unit (AV control unit) is displayed in red.

- Replace AV control unit if Self Diagnosis did not run because control unit malfunction is indicated. The symptom is AV control unit internal error. Refer to [AV-586, "Removal and Installation - AV Control Unit"](#).
  - If multiple errors occur at the same time for a single unit, the screen switch colors are determined according to the following order of priority: red > gray.
- Comments of self diagnosis results can be viewed in the diagnosis result screen.

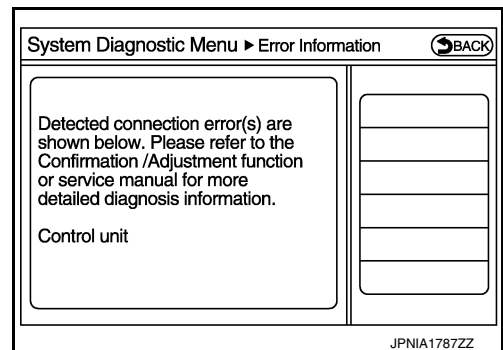

### AV Control Unit Self Diagnosis Results

# DIAGNOSIS SYSTEM (AV CONTROL UNIT)

< SYSTEM DESCRIPTION >

[BOSE AUDIO W/NAVI W/O SURROUND]

Only Unit Part Is Displayed In Red

Screen switch	Description	Possible cause
Control Unit	Malfunction is detected in AV control unit power supply and ground circuits.	<ul style="list-style-type: none"> <li>• AV control unit power supply or ground circuits. Refer to <a href="#">AV-519</a>.</li> <li>• If no malfunction is detected in AV control unit power supply and ground circuits, replace AV control unit. Refer to <a href="#">AV-586</a>.</li> </ul>
Amplifier	When either one of the following items are detected: <ul style="list-style-type: none"> <li>• sound signal circuits between BOSE amp. and each speaker are malfunctioning.</li> <li>• BOSE amp. malfunction is detected.</li> </ul>	<ul style="list-style-type: none"> <li>• Malfunctioning speaker circuits</li> <li>• Replace BOSE amp. Refer to <a href="#">AV-590</a>, "<a href="#">Removal and Installation</a>".</li> </ul>

A Connecting Cable Between Units Is Displayed In Yellow

Area with yellow connection lines	Description	Possible cause
Control unit ↔ Front Display	Serial communication circuits between AV control unit and front display unit are malfunctioning.	Serial communication circuits between AV control unit and front display unit.
Control unit ↔ GPS Antenna	GPS antenna connection malfunctions detected.	Check the connection of the GPS antenna connector.
Control unit ↔ XM Antenna	Satellite radio antenna connection malfunction is detected.	Satellite radio antenna disconnection
Control unit ↔ Amplifier	When either one of the following items are detected: <ul style="list-style-type: none"> <li>• BOSE amp. power supply and ground circuits are malfunctioning.</li> <li>• AV communication circuits between headrest display unit LH and BOSE amp. are malfunctioning.</li> </ul>	<ul style="list-style-type: none"> <li>• BOSE amp. power supply and ground circuits. Refer to <a href="#">AV-520</a>, "<a href="#">BOSE AMP. : Diagnosis Procedure</a>".</li> <li>• AV communication circuits between headrest display unit LH and BOSE amp.</li> </ul>
Control unit ↔ Around view Around view ↔ Parking Sensor	When either one of the following items are detected: <ul style="list-style-type: none"> <li>• around view monitor control unit power supply and ground circuits are malfunctioning.</li> <li>• AV communication circuits between AV control unit and around view monitor control unit are malfunctioning.</li> </ul>	<ul style="list-style-type: none"> <li>• Around view monitor control unit power supply and ground circuits.</li> <li>• AV communication circuits between AV control unit and around view monitor control unit.</li> </ul>
Control unit ↔ Parking Sensor Around view ↔ Parking Sensor	When either one of the following items are detected: <ul style="list-style-type: none"> <li>• sonar control unit power supply and ground circuits are malfunctioning.</li> <li>• AV communication circuits between AV control unit and sonar control unit are malfunctioning.</li> </ul>	<ul style="list-style-type: none"> <li>• Sonar control unit power supply and ground circuits.</li> <li>• AV communication circuits between AV control unit and sonar control unit.</li> </ul>



# DIAGNOSIS SYSTEM (AV CONTROL UNIT)

< SYSTEM DESCRIPTION >

[BOSE AUDIO W/NAVI W/O SURROUND]

A Connecting Cable Between Units Is Displayed In Yellow

Area with yellow connection lines	Description	Possible cause
Control unit ↔ Video Dist.(Rear) Video Dist.(Rear) ↔ Rear display 2	When either one of the following items are detected: <ul style="list-style-type: none"> <li>• video distributor power supply and ground circuits are malfunctioning.</li> <li>• headrest display unit LH power supply and ground circuits are malfunctioning.</li> <li>• AV communication circuits between AV control unit and headrest display unit LH are malfunctioning.</li> <li>• location recognition signal circuit between headrest display unit LH and ground is malfunctioning.</li> </ul>	<ul style="list-style-type: none"> <li>• Video distributor power supply and ground circuits.</li> <li>• Headrest display unit LH power supply and ground circuits.</li> <li>• AV communication circuits between AV control unit and headrest display unit LH.</li> <li>• Location recognition signal circuit between headrest display unit LH and ground.</li> </ul>
Video Dist.(Rear) ↔ Rear display 2	When either one of the following items are detected: <ul style="list-style-type: none"> <li>• headrest display unit RH power supply and ground circuits are malfunctioning.</li> <li>• AV communication circuits between headrest display unit LH and headrest display unit RH are malfunctioning.</li> <li>• location recognition signal circuit between headrest display unit RH and ground is malfunctioning.</li> </ul>	<ul style="list-style-type: none"> <li>• Headrest display unit RH power supply and ground circuits.</li> <li>• AV communication circuits between headrest display unit LH and headrest display unit RH.</li> <li>• Location recognition signal circuit between headrest display unit RH and ground.</li> </ul>

## AV Control Unit Confirmation/Adjustment

1. Select Confirmation/Adjustment.
2. Select each switch on the Confirmation/Adjustment screen to display the relevant trouble diagnosis screen. Press the BACK switch to return to the initial Confirmation/Adjustment screen.

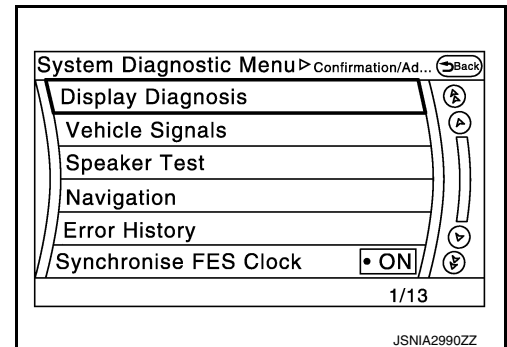

# DIAGNOSIS SYSTEM (AV CONTROL UNIT)

< SYSTEM DESCRIPTION >

[BOSE AUDIO W/NAVI W/O SURROUND]

## Display Diagnosis

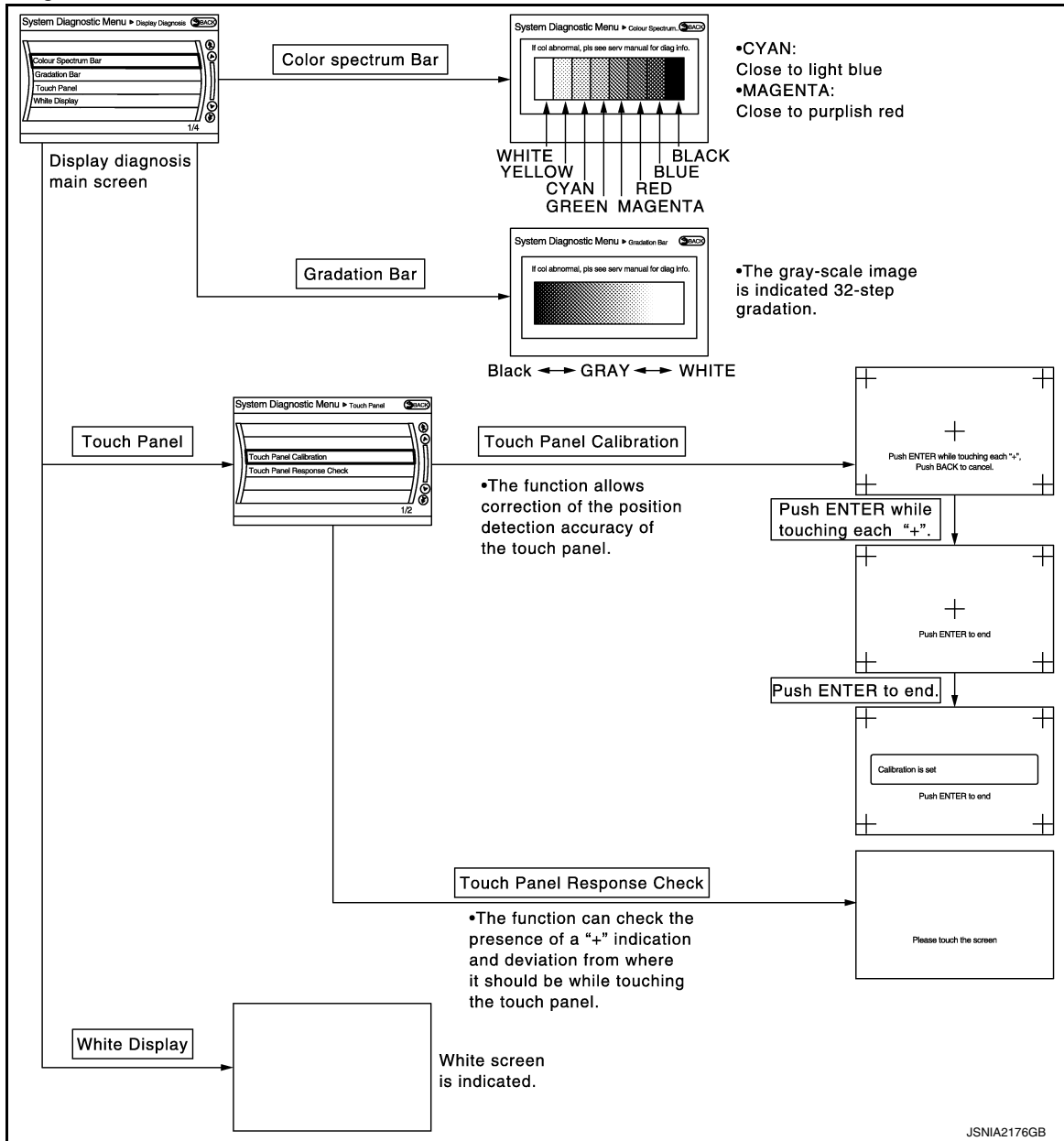

## Vehicle Signals

A comparison check can be made of each actual vehicle signal and the signals recognized by the system.

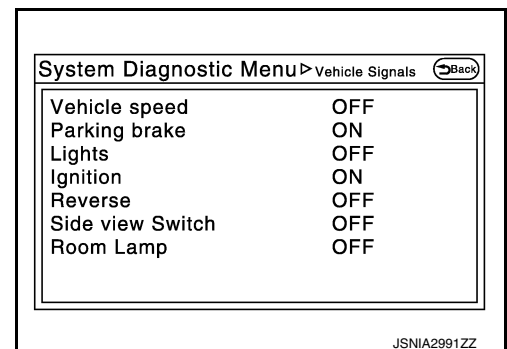

## Speaker Test

# DIAGNOSIS SYSTEM (AV CONTROL UNIT)

[BOSE AUDIO W/NAVI W/O SURROUND]

< SYSTEM DESCRIPTION >

Select Speaker Test to display the Speaker Diagnosis screen. Press Start to generate a test tone in a speaker. Press Start again to generate a test tone in the next speaker. Press End to stop the test tones.

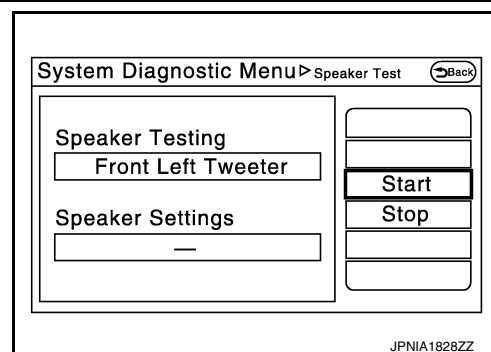

Navigation

## STEERING ANGLE ADJUSTMENT

The steering angle output value detected with the gyroscope is adjusted.

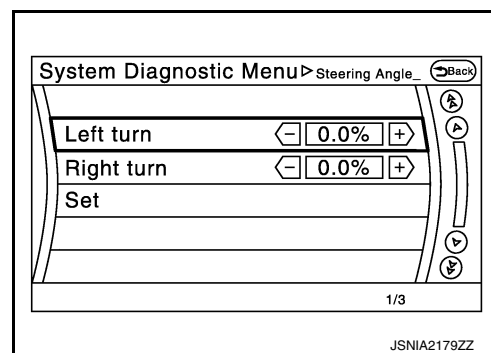

## SPEED CALIBRATION

During normal driving, distance error caused by tire wear and tire pressure change is automatically adjusted for by the automatic distance correction function. This function, on the other hand, is for immediate adjustment, in cases such as driving with tire chain fitted on tires.

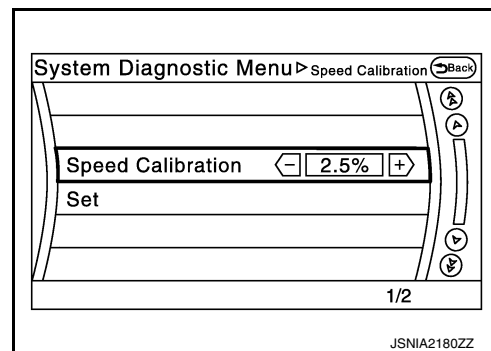

Error History

The self-diagnosis results are judged depending on whether any error occurs from when “Self-diagnosis” is selected until the self-diagnosis results are displayed.

However, the diagnosis results are judged normal if an error has occurred before the ignition switch is turned ON and then no error has occurred until the self-diagnosis start. Check the “Error Record” to detect any error that may have occurred before the self-diagnosis start because of this situation.

The error record displays the time and place of the most recent occurrence of that error. However, take note of the following points.

- If there is a malfunction with the GPS antenna circuit board in the AV control unit, the correct date and time of occurrence may not be able to be displayed.
- Place of the error occurrence is represented by the position of the current location mark at the time an error occurred. If current location mark has deviated from the correct position, then the place of the error occurrence cannot be located correctly.
- The frequency of occurrence is displayed in a count up manner. The actual count up method differs depending on the error item.

Count up method A

- The counter resets to 0 if an error occurs when ignition switch is turned ON. The counter increases by 1 if the condition is normal at a next ignition ON cycle.
- The counter upper limit is 39. Any counts exceeding 39 are ignored. The counter can be reset (no error record display) with the “Delete log” switch or CONSULT.

Count up method B

# DIAGNOSIS SYSTEM (AV CONTROL UNIT)

[BOSE AUDIO W/NAVI W/O SURROUND]

## < SYSTEM DESCRIPTION >

- The counter increases by 1 if an error occurs when ignition switch is ON. The counter will not decrease even if the condition is normal at the next ignition ON cycle.
- The counter upper limit is 50. Any counts exceeding 50 are ignored. “ The counter can be reset (no error record display) with the “Delete log” switch or CONSULT.

Display type of occurrence frequency	Error history display item
Count up method A	CAN communication line, control unit (CAN), AV communication line, control unit (AV)
Count up method B	Other than the above

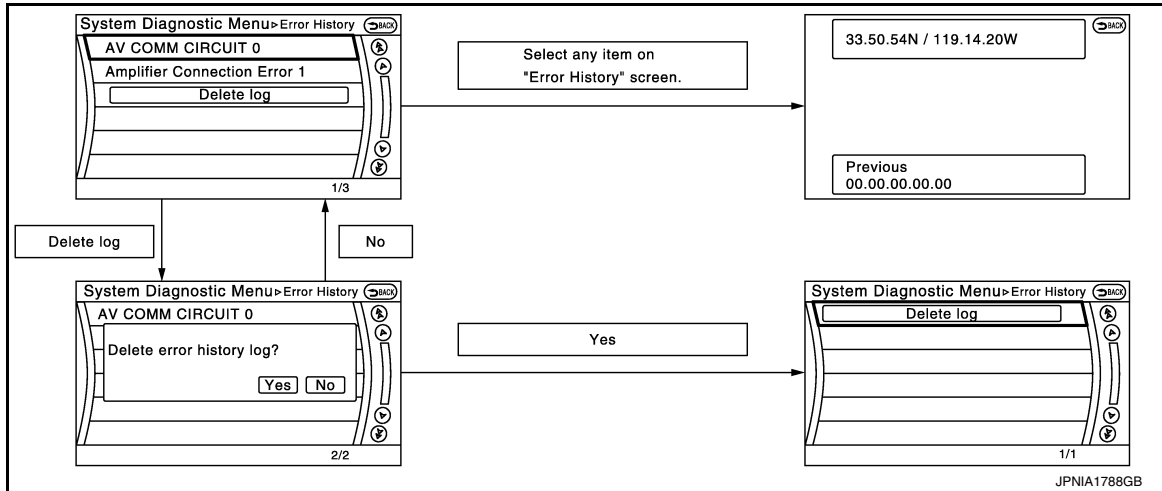

### Error item

Some error items may be displayed simultaneously according to the cause. If some error items are displayed simultaneously, the detection of the cause can be performed by the combination of display items

Error item	Description	Possible malfunction factor/Action to take
CAN COMM CIRCUIT	CAN communication malfunction is detected.	Perform diagnosis with CONSULT, and then repair the malfunctioning parts according to the diagnosis results. Refer to <a href="#">AV-354, "CONSULT Function"</a> .
CONTROL UNIT (CAN)	CAN initial diagnosis malfunction is detected.	Replace the AV control unit if the malfunction occurs constantly. Refer to <a href="#">AV-586, "Removal and Installation - AV Control Unit"</a> .
CONTROL UNIT (AV)	AV communication circuit initial diagnosis malfunction is detected.	
FLASH-ROM Error Of Control Unit	AV control unit malfunction is detected.	
Connection Of Gyro		
Connection of G Sensor		
CAN Controller Memory Error		
Bluetooth® Module Connection Error		
Sub CPU Connection Error		
Audio connection error	AV control unit malfunction is detected.	
DSP Connection Error		
DSP Communication Error	AV control unit malfunction is detected.	<ul style="list-style-type: none"> <li>• If a disc can be played, then there is a possibility of the detection of a temporary malfunction.</li> <li>• Replace the AV control unit if the malfunction occurs constantly.</li> </ul> Refer to <a href="#">AV-586, "Removal and Installation - AV Control Unit"</a> .

# DIAGNOSIS SYSTEM (AV CONTROL UNIT)

< SYSTEM DESCRIPTION >

[BOSE AUDIO W/NAVI W/O SURROUND]

Error item	Description	Possible malfunction factor/Action to take
HDD Connection Error	AV control unit malfunction is detected.	<ul style="list-style-type: none"> <li>• There is a possibility of the detection of a temporary malfunction.</li> <li>• Replace the AV control unit if the malfunction occurs constantly.</li> </ul> Refer to <a href="#">AV-586. "Removal and Installation - AV Control Unit"</a> .
HDD Read Error		
HDD Write Error		
HDD Communication Error		
HDD Access Error		
GPS Communication Error	GPS malfunction is detected.	<ul style="list-style-type: none"> <li>• An intermittent error caused by strong radio interference may be detected unless any symptom (GPS reception error, etc.) occurs.</li> <li>• Replace the AV control unit if the malfunction occurs constantly.</li> </ul> Refer to <a href="#">AV-586. "Removal and Installation - AV Control Unit"</a> .
GPS ROM Error		
GPS RAM Error		
GPS RTC Error		
Unfinished configuration	The writing of configuration data is incomplete.	Write configuration data with CONSULT.
USB Controller Communication Error	USB connection malfunction is detected.	Check that the connection to the USB connector is normal.
DVD Mechanism Communication Error	AV control unit malfunction is detected.	<ul style="list-style-type: none"> <li>• If DVD can be played, then there is a possibility of the detection of a temporary malfunction.</li> <li>• Replace the AV control unit if the malfunction occurs constantly.</li> </ul> Refer to <a href="#">AV-586. "Removal and Installation - AV Control Unit"</a> .
Steer. Angle Sensor Calibration	Predictive course line center position adjustment of the steering angle sensor is incomplete.	Adjust the predictive course line center position of the steering angle sensor. Refer to <a href="#">AV-354. "CONSULT Function"</a> .
Amplifier Temperature Error	BOSE amp. malfunction is detected.	Replace the BOSE amp. Refer to <a href="#">AV-590. "Removal and Installation"</a> .
Front Display Connection Error	When either one of the following items are detected: <ul style="list-style-type: none"> <li>• front display unit power supply and ground circuits are malfunctioning.</li> <li>• Serial communication circuits between AV control unit and front display unit are malfunctioning.</li> </ul>	<ul style="list-style-type: none"> <li>• Front display unit power supply and ground circuits.</li> <li>• Serial communication circuits between AV control unit and front display unit.</li> </ul>
<ul style="list-style-type: none"> <li>• AV COMM CIRCUIT</li> <li>• 2nd Display Connection Error</li> </ul>	When either one of the following items are detected: <ul style="list-style-type: none"> <li>• video distributor power supply and ground circuits are malfunctioning.</li> <li>• headrest display unit LH power supply and ground circuits are malfunctioning.</li> <li>• AV communication circuits between AV control unit and headrest display unit LH are malfunctioning.</li> <li>• location recognition signal circuit between headrest display unit LH and ground is malfunctioning.</li> </ul>	<ul style="list-style-type: none"> <li>• Video distributor power supply and ground circuits.</li> <li>• Headrest display unit LH power supply and ground circuits.</li> <li>• AV communication circuits between AV control unit and headrest display unit LH.</li> <li>• Location recognition signal circuit between headrest display unit LH and ground.</li> </ul>
3rd Display Connection Error	When either one of the following items are detected: <ul style="list-style-type: none"> <li>• headrest display unit RH power supply and ground circuits are malfunctioning.</li> <li>• AV communication circuits between headrest display unit LH and headrest display unit RH are malfunctioning.</li> <li>• location recognition signal circuit between headrest display unit RH and ground is malfunctioning.</li> </ul>	<ul style="list-style-type: none"> <li>• Headrest display unit RH power supply and ground circuits.</li> <li>• AV communication circuits between headrest display unit LH and headrest display unit RH.</li> <li>• Location recognition signal circuit between headrest display unit RH and ground.</li> </ul>

A

B

C

D

E

F

G

H

I

J

K

L

M

AV

O

P

# DIAGNOSIS SYSTEM (AV CONTROL UNIT)

< SYSTEM DESCRIPTION >

[BOSE AUDIO W/NAVI W/O SURROUND]

Error item	Description	Possible malfunction factor/Action to take
AM/FM antenna amplifier short to ground	Radio antenna amp. ON signal circuit malfunction is detected.	Radio antenna amp. ON signal circuit between AV control unit and antenna amp.
AM/FM antenna amplifier open		
Ext_Amp_ON output terminal short to ground	BOSE amp. ON signal circuit malfunction is detected.	BOSE amp. ON signal circuit between AV control unit and BOSE amp.
Ext_Amp_ON output terminal:open		
GPS Antenna Error	GPS antenna connection malfunction is detected.	Check the connection of the GPS antenna connector.
XM Antenna Connection Error	Satellite radio antenna connection malfunction is detected.	Satellite radio antenna disconnection.
USB electric current Error	Detection of overcurrent in USB connector.	Check USB harness between the AV control unit and USB connector.
FL-DOOR SPEAKER OUT: open	When either one of the following items are detected: <ul style="list-style-type: none"> <li>• sound signal circuits between BOSE amp. and front door speaker LH are malfunctioning.</li> <li>• sound signal circuits between BOSE amp. and front door tweeter LH are malfunctioning.</li> </ul>	<ul style="list-style-type: none"> <li>• Sound signal circuits between BOSE amp. and front door speaker LH.</li> <li>• Sound signal circuits between BOSE amp. and front door tweeter LH.</li> </ul>
FL-DOOR SPEAKER OUT: short		
FL-DOOR SPEAKER: short to ground		
FL-DOOR SPEAKER: short to battery		
FL-DOOR TWEETER OUT: open		
FL-DOOR TWEETER OUT: short		
FL-DOOR TWEETER OUT: short to ground		
FL-DOOR TWEETER OUT: short to battery		
FR-DOOR SPEAKER OUT: open	When either one of the following items are detected: <ul style="list-style-type: none"> <li>• sound signal circuits between BOSE amp. and front door speaker RH are malfunctioning.</li> <li>• sound signal circuits between BOSE amp. and front door tweeter RH are malfunctioning.</li> </ul>	<ul style="list-style-type: none"> <li>• Sound signal circuits between BOSE amp. and front door speaker RH.</li> <li>• Sound signal circuits between BOSE amp. and front door tweeter RH.</li> </ul>
FR-DOOR SPEAKER OUT: short		
FR-DOOR SPEAKER OUT: short to ground		
FR-DOOR SPEAKER OUT: short to battery		
FR-DOOR TWEETER OUT: open		
FR-DOOR TWEETER OUT: short		
FR-DOOR TWEETER OUT: short to ground		
FR-DOOR TWEETER OUT: short to battery		
FL-INST TWEETER OUT: open	Sound signal circuits between BOSE amp. and tweeter LH are malfunctioning.	Sound signal circuits between BOSE amp. and tweeter LH.
FL-INST TWEETER OUT: short		
FL-INST TWEETER OUT: short to ground		
FL-INST TWEETER OUT: short to battery		
FC-INST SPEAKER OUT: open	Malfunction is detected sound signal circuits between BOSE amp. and center speaker.	Sound signal circuits between BOSE amp. and center speaker.
FC-INST SPEAKER OUT: short		
FC-INST SPEAKER OUT: short to ground		
FC-INST SPEAKER OUT: short to battery		
FR-INST TWEETER OUT: open	Sound signal circuits between BOSE amp. and tweeter RH are malfunctioning.	Sound signal circuits between BOSE amp. and tweeter RH.
FR-INST TWEETER OUT: short		
FR-INST TWEETER OUT: short to ground		
FR-INST TWEETER OUT: short to battery		
2L-DOOR SPEAKER OUT: open	Sound signal circuits between BOSE amp. and rear door speaker LH are malfunctioning.	Sound signal circuits between BOSE amp. and rear door speaker LH.
2L-DOOR SPEAKER OUT: short		
2L-DOOR SPEAKER OUT: short to ground		
2L-DOOR SPEAKER OUT: short to battery		

# DIAGNOSIS SYSTEM (AV CONTROL UNIT)

< SYSTEM DESCRIPTION >

[BOSE AUDIO W/NAVI W/O SURROUND]

Error item	Description	Possible malfunction factor/Action to take	
2R-DOOR SPEAKER OUT: open	Sound signal circuits between BOSE amp. and rear door speaker RH are malfunctioning.	Sound signal circuits between BOSE amp. and rear door speaker RH.	A
2R-DOOR SPEAKER OUT: short			B
2R-DOOR SPEAKER OUT: short to ground			C
2R-DOOR SPEAKER OUT: short to battery			D
RL-SPEAKER OUT: open	Sound signal circuits between BOSE amp. and rear speaker LH are malfunctioning.	Sound signal circuits between BOSE amp. and rear speaker LH.	E
RL-SPEAKER OUT: short			F
RL-SPEAKER OUT: short to ground			G
RL-SPEAKER OUT: short to battery			H
RR-SPEAKER OUT: open	Sound signal circuits between BOSE amp. and rear speaker RH are malfunctioning.	Sound signal circuits between BOSE amp. and rear speaker RH.	I
RR-SPEAKER OUT: short			J
RR-SPEAKER OUT: short to ground			K
RR-SPEAKER OUT: short to battery			L
SUBWOOFER OUT: open	Sound signal circuits between BOSE amp. and subwoofer are malfunctioning.	Sound signal circuits between BOSE amp. and subwoofer.	M
SUBWOOFER OUT: short			N
SUBWOOFER OUT: short to ground			O
SUBWOOFER OUT: short to battery			P
<ul style="list-style-type: none"> <li>• AV COMM CIRCUIT</li> <li>• Switches Connection Error</li> </ul>	When either one of the following items are detected: <ul style="list-style-type: none"> <li>• multifunction switch power supply and ground circuits were malfunctioning.</li> <li>• AV communication circuits between AV control unit and multifunction switch are malfunctioning.</li> </ul>	<ul style="list-style-type: none"> <li>• Multifunction switch power supply and ground circuits.</li> <li>• AV communication circuits between AV control unit and multifunction switch.</li> </ul>	AV
<ul style="list-style-type: none"> <li>• AV COMM CIRCUIT</li> <li>• Amplifier Connection Error</li> </ul>	When either one of the following items are detected: <ul style="list-style-type: none"> <li>• BOSE amp. power supply and ground circuits are malfunctioning.</li> <li>• AV communication circuits between headrest display unit LH and BOSE amp. are malfunctioning.</li> </ul>	<ul style="list-style-type: none"> <li>• BOSE amp. power supply and ground circuits. Refer to <a href="#">AV-520, "BOSE AMP. : Diagnosis Procedure"</a>.</li> <li>• AV communication circuits between headrest display unit LH and BOSE amp.</li> </ul>	AV
<ul style="list-style-type: none"> <li>• AV COMM CIRCUIT</li> <li>• AVM Connection Error</li> </ul>	When either one of the following items are detected: <ul style="list-style-type: none"> <li>• around view monitor control unit power supply and ground circuits are malfunctioning.</li> <li>• AV communication circuits between AV control unit and around view monitor control unit are malfunctioning.</li> </ul>	<ul style="list-style-type: none"> <li>• Around view monitor control unit power supply and ground circuits.</li> <li>• AV communication circuits between AV control unit and around view monitor control unit.</li> </ul>	AV
<ul style="list-style-type: none"> <li>• AV COMM CIRCUIT</li> <li>• Sonar Connection Error</li> </ul>	When either one of the following items are detected: <ul style="list-style-type: none"> <li>• sonar control unit power supply and ground circuits are malfunctioning.</li> <li>• AV communication circuits between AV control unit and sonar control unit are malfunctioning.</li> </ul>	<ul style="list-style-type: none"> <li>• Sonar control unit power supply and ground circuits.</li> <li>• AV communication circuits between AV control unit and sonar control unit.</li> </ul>	AV

# DIAGNOSIS SYSTEM (AV CONTROL UNIT)

[BOSE AUDIO W/NAVI W/O SURROUND]

## < SYSTEM DESCRIPTION >

Error item	Description	Possible malfunction factor/Action to take
<ul style="list-style-type: none"> <li>• AV COMM CIRCUIT</li> <li>• Switches Connection Error</li> <li>• Sonar Connection Error</li> <li>• AVM Connection Error</li> <li>• 2nd Display Connection Error</li> </ul>	AV communication circuits between AV control unit and multifunction switch are malfunctioning.	AV communication circuits between AV control unit and multifunction switch.
<ul style="list-style-type: none"> <li>• AV COMM CIRCUIT</li> <li>• Switches Connection Error</li> <li>• Amplifier Connection Error</li> <li>• Sonar Connection Error</li> <li>• AVM Connection Error</li> <li>• 2nd Display Connection Error</li> </ul>		

### Vehicle CAN Diagnosis

- CAN communication status and error counter is displayed.
- The error counter displays “OK” if any malfunction was not detected in the past and displays “0” if a malfunction is detected. It increases by 1 if the condition is normal at the next ignition switch ON cycle. The upper limit of the counter is 39.
- The error counter is erased if “Reset” is pressed.

Items	Display (Current)	Malfunction counter (Past)
Tx(HVAC)	OK / ???	OK / 0 – 39
Rx(ECM)	OK / ???	OK / 0 – 39
Rx(Cluster)	OK / ???	OK / 0 – 39
Rx(HVAC)	OK / ???	OK / 0 – 39
Rx(USM)	OK / ???	OK / 0 – 39
Rx(TPMS)	OK / ???	OK / 0 – 39
Rx(STRG)	OK / ???	OK / 0 – 39
Rx(ACC)	OK / ???	OK / 0 – 39
RX(VDC)	OK / ???	OK / 0 – 39

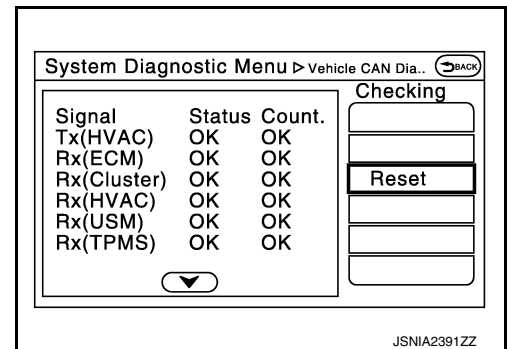

**NOTE:**

“???” indicates UNKWN.

### AV COMM Diagnosis

- Displays the communication status between AV control unit (master unit) and each unit.
- The error counter displays “OK” if any malfunction was not detected in the past and displays “0” if a malfunction is detected. It increases by 1 if the condition is normal at the next ignition switch ON cycle. The upper limit of the counter is 39.
- The error counter is erased if “Reset” is pressed.

Items	Status (Current)	Counter (Past)
C Tx(ITM-PrimarySW)	OK / ???	OK / 0 – 39
C Rx(PrimarySW-ITM)	OK / ???	OK / 0 – 39
C Rx(Amp-ITM)	OK / ???	OK / 0 – 39
C Rx(Amp-Audio)	OK / ???	OK / 0 – 39
C Rx(AVM-ITM)	OK / ???	OK / 0 – 39
C Rx(Disp.3-Video Dist)	OK / ??? / -	OK / 0 – 39
C Rx(Video Dist-ITM)	OK / ???	OK / 0 – 39
C Rx(Sonar-ITM)	OK / ???	OK / 0 – 39

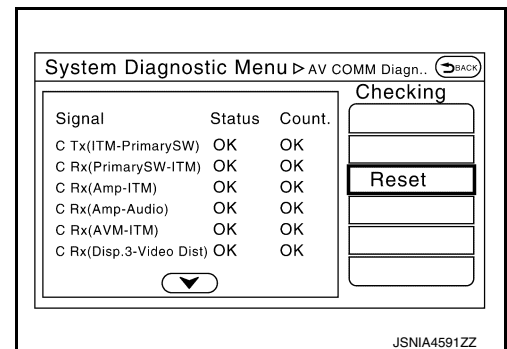



# DIAGNOSIS SYSTEM (AV CONTROL UNIT)

[BOSE AUDIO W/NAVI W/O SURROUND]

< SYSTEM DESCRIPTION >

Items	Status (Current)	Counter (Past)
C Rx(Sonar-AVM)	OK / ???	OK / 0 - 39
C Rx(R.RemoteCont-ITM)	OK / ???	OK / 0 - 39

**NOTE:**

“???” indicates UNKWN

**Hands-Free Phone**

The hands-free phone reception volume adjustment and microphone and speaker test functions are also available.

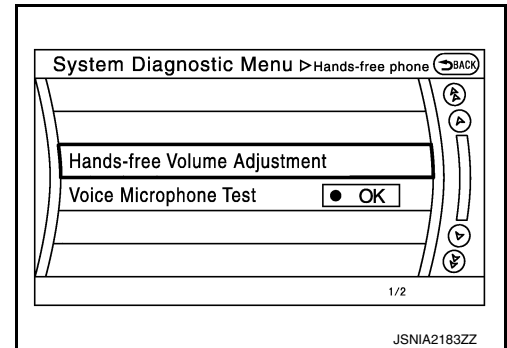

**XM**

- Change Channel
- Any necessary channels required to receive traffic information from the satellite radio system can be set.
- Change Application ID
- Any application ID'-s required to receive traffic information from the satellite radio system can be set.

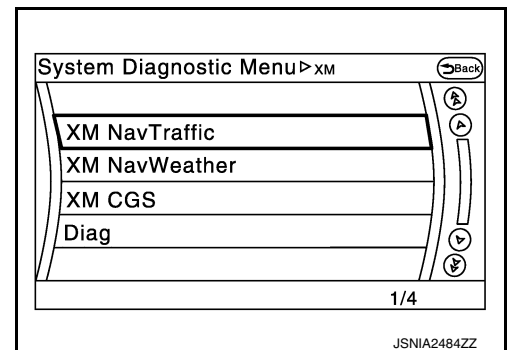

**Delete Unit Connection Log**

Deletes any unit connection records and error records from the AV control unit memory. (Clear the records of the unit that has been removed.)

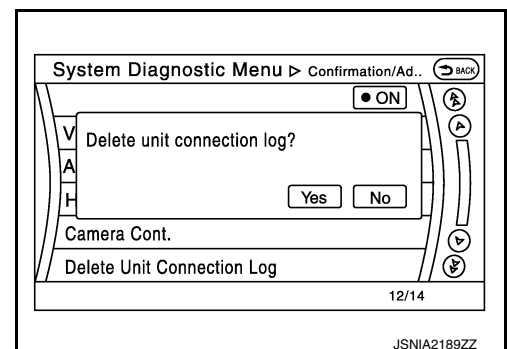

**Initialize Settings**

A  
B  
C  
D  
E  
F  
G  
H  
I  
J  
K  
L  
M  
O  
P

AV

# DIAGNOSIS SYSTEM (AV CONTROL UNIT)

[BOSE AUDIO W/NAVI W/O SURROUND]

< SYSTEM DESCRIPTION >

“User Data Initialization” and “Accessory Number Initialization” are possible.

**CAUTION:**

- Never perform Accessory Number Initialization except when configuration is unsuccessful.
- Accessory Number Initialization requires configuration. For details, refer to [AV-447, "CONFIGURATION \(AV CONTROL UNIT\) : Description"](#).

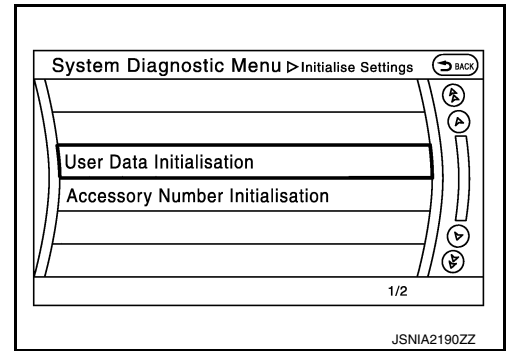

Version Information

Version information of the AV control unit is displayed.

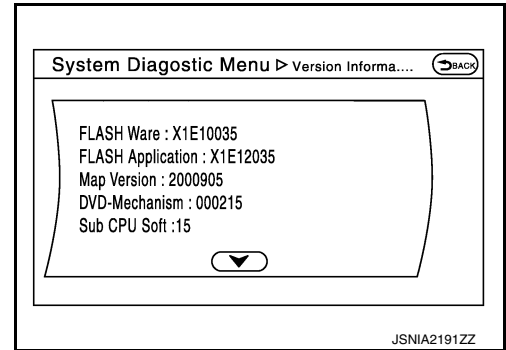

## CONSULT Function

INFOID:000000009129076

**CAUTION:**

After disconnecting the CONSULT vehicle interface (VI) from the data link connector, the ignition must be cycled OFF → ON (for at least 5 seconds) → OFF. If this step is not performed, the BCM may not go to “sleep mode”, potentially causing a discharged battery and a no-start condition.

## CONSULT FUNCTIONS

CONSULT performs the following functions via communication with the AV control unit.

Direct Diagnostic Mode	Description
Ecu Identification	The AV control unit part number is displayed.
Self Diagnostic Result	The AV control unit self diagnostic results are displayed.
Data Monitor	The AV control unit input/output data is displayed in real time.
Work support	The settings for AV control unit functions can be changed.
Configuration	<ul style="list-style-type: none"> <li>• The vehicle specification can be read and saved.</li> <li>• The vehicle specification can be written when replacing AV control unit.</li> </ul>
CAN Diag Support Mntr	<ul style="list-style-type: none"> <li>• The result of transmit/receive diagnosis of AV communication is displayed.</li> <li>• The result of transmit/receive diagnosis of CAN communication is displayed.</li> </ul>

## ECU IDENTIFICATION

The part number of AV control unit is displayed.

## SELF DIAGNOSTIC RESULT

Refer to [AV-367, "DTC Index"](#).

## DATA MONITOR

Monitor Item [Unit]	Description
VHCL SPD SIG [On/Off]	Indicates vehicle speed signal received from combination meter on CAN communication line.
PKB SIG [On/Off]	Indicates condition of park brake signal.
ILLUM SIG [On/Off]	Indicates condition of illumination signal for the A/C and AV switch assembly.

# DIAGNOSIS SYSTEM (AV CONTROL UNIT)

[BOSE AUDIO W/NAVI W/O SURROUND]

< SYSTEM DESCRIPTION >

Monitor Item [Unit]	Description
IGN SIG [On/Off]	Indicates condition of ignition signal.
REV SIG [On/Off]	Indicates condition of reverse signal received from BCM.

## WORK SUPPORT

Conditions	Description
ST ANGLE SENSOR ADJUSTMENT	Steering angle sensor neutral position adjustment can be performed. Refer to <a href="#">BRC-60</a> , "Description".

## CONFIGURATION

Refer to [AV-447](#), "CONFIGURATION (AV CONTROL UNIT) : Description".

## CAN DIAG SUPPORT MNTR

Refer to [LAN-23](#), "CAN Diagnostic Support Monitor".

A  
B  
C  
D  
E  
F  
G  
H  
I  
J  
K  
L  
M  
O  
P

AV

# DIAGNOSIS SYSTEM (AROUND VIEW MONITOR CONTROL UNIT)

< SYSTEM DESCRIPTION >

[BOSE AUDIO W/NAVI W/O SURROUND]

## DIAGNOSIS SYSTEM (AROUND VIEW MONITOR CONTROL UNIT)

### CONSULT Function

INFOID:000000009129077

#### CAUTION:

After disconnecting the CONSULT vehicle interface (VI) from the data link connector, the ignition must be cycled OFF → ON (for at least 5 seconds) → OFF. If this step is not performed, the BCM may not go to “sleep mode”, potentially causing a discharged battery and a no-start condition.

#### CONSULT FUNCTIONS

CONSULT performs the following functions via communication with the around view monitor control unit.

Direct Diagnostic Mode	Description
Ecu Identification	The around view monitor control unit part number is displayed.
Self Diagnostic Result	The around view monitor control unit self diagnostic results are displayed.
Data Monitor	The around view monitor control unit input/output data is displayed in real time.
Work support	The settings for around view monitor control unit functions can be changed.
Configuration	<ul style="list-style-type: none"><li>The vehicle specification can be read and saved.</li><li>The vehicle specification can be written when replacing around view monitor control unit.</li></ul>
CAN Diag Support Mntr	The result of transmit/receive diagnosis of CAN communication is displayed.

#### ECU IDENTIFICATION

The part number of around view monitor control unit is displayed.

#### SELF DIAGNOSTIC RESULT

Refer to [AV-386, "DTC Index"](#).

#### DATA MONITOR

Monitor Item	Description
ST ANGLE SENSOR SIGNAL [On/Off]	Indicates condition of steering angle sensor signal.
REVERSE SIGNAL [On/Off]	Indicates selector lever position.
VEHICLE SPEED SIGNAL [mph/km/h]	Indicates condition of vehicle speed signal.
CAMERA SWITCH SIGNAL [On/Off]	Indicates condition of camera switch signal.
CAMERA OFF SIGNAL [On/Off]	Indicates condition of camera OFF signal.
ST ANGLE SENSOR TYPE [Absolute]	Indicates steering angle sensor type.
ST GEAR RATIO TYPE [Type O]	Indicates steering gear ratio type.
STEERING POSITION [LHD/RHD]	Indicates drive type.
REAR CAMERA IMAGE SIGNAL [OK]	Indicates condition of camera image signal.
R-CAMERA COMM STATUS [OK]	Indicates condition of camera communication.
R-CAMERA COMM LINE [OK]	Indicates condition of camera communication signal.
F-CAMERA IMAGE SIGNAL [OK]	Indicates condition of camera image signal.
F-CAMERA COMM STATUS [OK]	Indicates condition of camera communication.
F-CAMERA COMM LINE [OK]	Indicates condition of camera communication signal.
DR-SIDE CAMERA IMAGE SIG [OK]	Indicates condition of camera image signal.
DR CAMERA COMM STATUS [OK]	Indicates condition of camera communication.
DR-SIDE CAMERA COMM LINE [OK]	Indicates condition of camera communication signal.
PA-SIDE CAMERA IMAGE SIG [OK]	Indicates condition of camera image signal.
PA CAMERA COMM STATUS [OK]	Indicates condition of camera communication.
PA-SIDE CAMERA COMM LINE [OK]	Indicates condition of camera communication signal.
ACC [OK]	Indicates condition of accessory signal.

# DIAGNOSIS SYSTEM (AROUND VIEW MONITOR CONTROL UNIT)

< SYSTEM DESCRIPTION >

[BOSE AUDIO W/NAVI W/O SURROUND]

Monitor Item	Description
FOLDING MOTOR VOLT 1 [On/Off]	indicates condition of mirror folding motor.
FOLDING MOTOR VOLT 2 [On/Off]	indicates condition of mirror folding motor.

## WORK SUPPORT

Support Item	Setting	Description
NON-VIEWABLE AREA REMINDER	—	ON/OFF setting of non-viewable area can be performed.
INITIALIZE CAMERA IMAGE CALIBRATION	—	Factory image calibration restoration can be performed.
STEERING ANGLE SENSOR ADJUSTMENT	—	Steering angle sensor neutral position adjustment can be performed.
CALIBRATING CAMERA IMAGE (FRONT CAMERA)	STATUS	Performs calibration of front camera.
	AXIS X	
	AXIS Y	
	ROTATE	
CALIBRATING CAMERA IMAGE (PASS-SIDE CAMERA)	STATUS	Performs calibration of passenger side camera.
	AXIS X	
	AXIS Y	
	ROTATE	
CALIBRATING CAMERA IMAGE (DR-SIDE CAMERA)	STATUS	Performs calibration of driver side camera.
	AXIS X	
	AXIS Y	
	ROTATE	
CALIBRATING CAMERA IMAGE (REAR CAMERA)	STATUS	Performs calibration of rear camera.
	AXIS X	
	AXIS Y	
	ROTATE	
FINE TUNING OF BIRDS-EYE VIEW	STATUS	Confirmation and adjustment of difference between each camera can be performed.
	SELECT	
	AXIS X	
	AXIS Y	
	ROTATE	
REAR WIDE-VIEW FIXED GUIDE LINE CORRECTION	STATUS	Performs calibration of rear wide-view guide line correction.
	AXIS X	
	AXIS Y	
	Pattern	
TURNING RADIUS CORRECTION	STATUS	Performs calibration of turning radius correction.
	Crrct	
PARTS WITH DOOR MIRROR AUTO FOLD FUNC	On	Performs setting of auto fold mirror function.
	Off	
SONAR Off POP-UP DISPLAY SETTING CHANGE	On	Performs setting of sonar pop-up display.
	Off	
FRONT WIDE-VIEW FIXED GUIDE LINE CORRECTION	STATUS	Performs calibration of front wide-view guide line correction.
	AXIS X	
	AXIS Y	
	Pattern	

A  
B  
C  
D  
E  
F  
G  
H  
I  
J  
K  
L  
M  
O  
P

AV

# DIAGNOSIS SYSTEM (AROUND VIEW MONITOR CONTROL UNIT)

< SYSTEM DESCRIPTION >

[BOSE AUDIO W/NAVI W/O SURROUND]

Support Item	Setting	Description
ZOOM FUNCTION	STATUS	Adjustment of magnification setting of cameras can be performed.
	SELECT	
	Mgnfct	

## CONFIGURATION

Refer to [AV-449, "CONFIGURATION \(AROUND VIEW MONITOR CONTROL UNIT\) : Description"](#).

## CAN DIAG SUPPORT MNTR

Refer to [LAN-23, "CAN Diagnostic Support Monitor"](#).

# DIAGNOSIS SYSTEM [SONAR CONTROL UNIT (WITH AROUND VIEW MONITOR)]

< SYSTEM DESCRIPTION >

[BOSE AUDIO W/NAVI W/O SURROUND]

## DIAGNOSIS SYSTEM [SONAR CONTROL UNIT (WITH AROUND VIEW MONITOR)]

### CONSULT Function

INFOID:000000009129078

#### CAUTION:

After disconnecting the CONSULT vehicle interface (VI) from the data link connector, the ignition must be cycled OFF → ON (for at least 5 seconds) → OFF. If this step is not performed, the BCM may not go to “sleep mode”, potentially causing a discharged battery and a no-start condition.

### APPLICATION ITEMS

CONSULT can display each diagnostic item using the diagnostic test modes shown as follows:

Test mode	Function
Ecu Identification	Sonar control unit part number can be read.
Self Diagnostic Result	Sonar control unit checks the conditions and displays memorized error.
Data Monitor	Sonar control unit input/output data in real time.
Active Test	Gives a drive signal to a load to check the operation.
Work support	Changes setting of each function.

### ECU IDENTIFICATION

Displays the part number of sonar control unit.

### SELF-DIAGNOSTIC RESULTS

For details, refer to [AV-389, "DTC Index"](#).

### DATA MONITOR

Monitor Item	Description
VEHICLE SPEED [mph/km/h]	Indicates vehicle speed signal received from combination meter on CAN communication line.
SONAR C/U POWER SUPPLY [V]	Indicates condition of supply voltage signal to sonar control unit.
SENSOR VOLTAGE [V]	Indicates condition of voltage signal to sonar sensors.
DETECTION MODE [Mode 1/Mode 2]	Indicates condition of display detection mode.
SW OPRT AFTR IGN ON [Yes/No]	Indicates condition of switch operation after ignition ON signal.
SONAR TEMPORARY OFF [Yes/No]	Indicates condition of sonar system.
SONAR PERMANENT OFF [Yes/No]	Indicates condition of sonar system.
P N RANGE [On/Off]	Indicates condition of selector lever P (park) or N (neutral) position.
LED [On/Off]	Indicates condition of LED.
TRAILER CONNECT [CON/N CON]	Indicates condition of Trailer connector.
REVERSE RANGE [On/Off]	Indicates condition of transmission range switch R (reverse) position.

# DIAGNOSIS SYSTEM [SONAR CONTROL UNIT (WITH AROUND VIEW MONITOR)]

[BOSE AUDIO W/NAVI W/O SURROUND]

## < SYSTEM DESCRIPTION >

Monitor Item	Description
SHRT DST FRM RR SENS [cm/in]	Indicates distance to obstacle.
SHRT DST FRM FR SENS [cm/in]	
COR[RL] [cm/in]	
COR[RL]->CEN[RL]/CEN[R] [cm/in]	
CEN[RL]/CEN[R]->COR[RL] [cm/in]	
CEN[RL]/CEN[R] [cm/in]	
CEN[RL]->CEN[RR] [cm/in]	
CEN[RR]->CEN[RL] [cm/in]	
CEN[RR] [cm/in]	
CEN[RR]/CEN[R]->COR[RR] [cm/in]	
COR[RR]-> CEN[RR]/CEN[R] [cm/in]	
COR[RR] [cm/in]	
COR[FL] [cm/in]	
COR[FR] [cm/in]	
RVRB TIME COR[RL] [ms/sec]	
RVRB TIME COR[RR] [ms/sec]	
RVRB TIME CEN[RL] [ms/sec]	
RVRB TIME CEN[RR] [ms/sec]	
RVRB TIME COR[FL] [ms/sec]	
RVRB TIME COR[FR] [ms/sec]	

## ACTIVE TEST

Test Item	Description
REAR BUZZER	This test is able to check rear buzzer operation [On/Off].

## WORK SUPPORT

Support Item	Setting	Description
VOLUME SETTING	Vol.1	Allows you to set volume of warning tone.
	Low	
	Vol.3	
	Middle	
	Vol.5	
	High	
	Off	
TRAILER HITCH DETECTION RANGE ADJUSTMENT	Qu	Allows you to adjust rear sonar sensors for trailer towing.
	UP	
	DOWN	
	Qd	



# AV CONTROL UNIT

< ECU DIAGNOSIS INFORMATION >

[BOSE AUDIO W/NAVI W/O SURROUND]

## ECU DIAGNOSIS INFORMATION

### AV CONTROL UNIT

Reference Value

INFOID:000000009129081

#### VALUES ON THE DIAGNOSIS TOOL

Monitor Item	Condition	Value/Status
VHCL SPD SIG	Vehicle speed = 0 km/h (0 MPH).	Off
	Vehicle speed > 0 km/h (0 MPH).	On
PKB SIG	Parking brake released.	Off
	Parking brake applied.	On
ILLUM SIG	Illumination signal is not received.	Off
	Illumination signal is received.	On
IGN SIG	Ignition switch OFF or ACC.	Off
	Ignition switch ON.	On
REV SIG	Selector lever in any position other than R.	Off
	Selector lever in R position.	On

#### TERMINAL LAYOUT

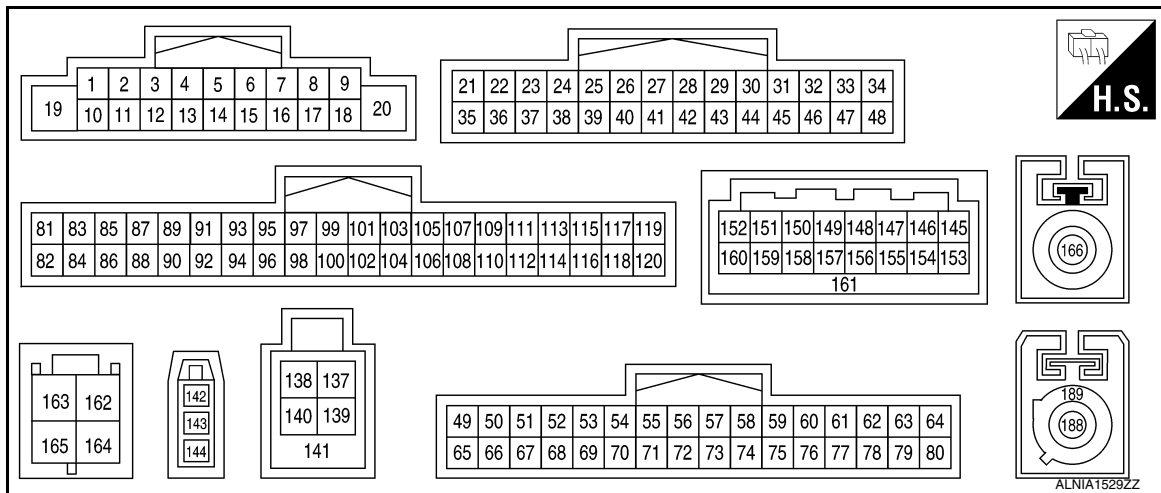

#### PHYSICAL VALUES







Terminal (Wire color)		Description	Input/Output	Condition		Reference value (Approx.)
+	-			Ignition switch	Operation	
1 (SB)	Ground	BOSE amp. ON signal	Output	ACC	—	Battery voltage
2 (B)	3 (W)	Pre amp sound signal front LH	Output	ON	Sound output	

SKIB3609E

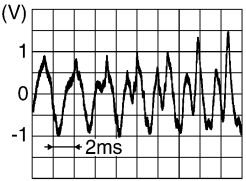
# AV CONTROL UNIT

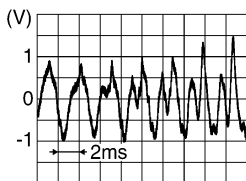
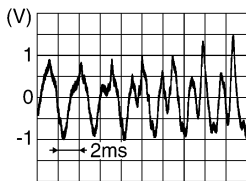
< ECU DIAGNOSIS INFORMATION >

[BOSE AUDIO W/NAVI W/O SURROUND]

Terminal (Wire color)		Description		Condition		Reference value (Approx.)
+	-	Signal name	Input/ Output	Ignition switch	Operation	
4 (B)	5 (W)	Pre amp sound signal rear LH	Output	ON	Sound output	 <small>SKIB3609E</small>
6 (G)	15 (B)	Steering switch signal A	Input	ON	Press SOURCE switch.	0 V
					Press $\Delta$ switch.	1.0 V
					Press $\nabla$ switch.	2.0 V
					Press  switch	3.0 V
					Press ENTER switch.	4.0 V
					Except for above.	5.0 V
7 <sup>1</sup> (G)	Ground	ACC power supply	Input	ACC	—	Battery voltage
7 <sup>2</sup> (P)	Ground	ACC power supply	Input	ACC	—	Battery voltage
10 (BR)	—	Pre amp sound signal shield	—	—	—	—
11 (W)	12 (B)	Pre amp sound signal front RH	Output	ON	Sound output	 <small>SKIB3609E</small>
13 (B)	14 (W)	Pre amp sound signal rear RH	Output	ON	Sound output	 <small>SKIB3609E</small>
16 (W)	15 (B)	Steering switch signal B	Input	ON	Press  switch.	0 V
					Press  switch.	1.0 V
					Press  switch.	2.0 V
					Press  switch.	3.0 V
					Except for above.	5.0 V
19 (Y)	Ground	Battery power supply	Input	OFF	—	Battery voltage
20 (GR)	Ground	Ground	—	ON	—	0 V

# AV CONTROL UNIT

< ECU DIAGNOSIS INFORMATION >

[BOSE AUDIO W/NAVI W/O SURROUND]

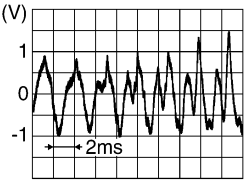
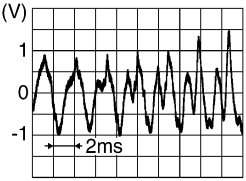
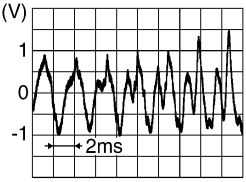
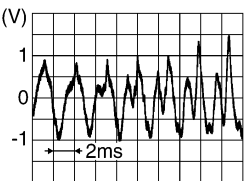
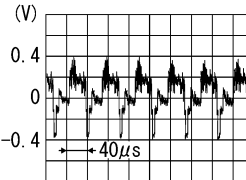
Terminal (Wire color)		Description		Condition		Reference value (Approx.)
+	-	Signal name	Input/ Output	Ignition switch	Operation	
24 (W)	39 (B)	Auxiliary sound signal LH	Input	ON	Sound output when front AUX mode selected	 <p style="text-align: right; font-size: small;">SKIB3609E</p>
26 (W)	40 (R)	Headphone sound signal LH	Output	ON	When DVD or USB mode is selected on headrest display unit LH or RH	 <p style="text-align: right; font-size: small;">SKIB3609E</p>
27 (B)	41 (G)	Headphone sound signal RH	Output	ON	When DVD or USB mode is selected on headrest display unit LH or RH	 <p style="text-align: right; font-size: small;">SKIB3609E</p>
37 (Shield)	—	Auxiliary sound signal shield	—	—	—	—
38 (R)	39 (B)	Auxiliary sound signal RH	Input	ON	Sound output when front AUX mode selected	 <p style="text-align: right; font-size: small;">SKIB3609E</p>
42 (Shield)	—	Headphone sound signal shield	—	—	—	—
53 (G)	Ground	Parking brake signal	Input	ON	Parking brake is applied Parking brake is released	0 V 4.5 V
55 (W)	Ground	Composite image signal ground	—	ON	—	0 V
56 (B)	Ground	Composite image signal	Output	ON	When DVD image is displayed	 <p style="text-align: right; font-size: small;">SKIB2251J</p>
57 (BG)	—	I-Key memory	—	—	—	—
58 (G)	—	AV-ACC (DCM)	—	—	—	—

A  
B  
C  
D  
E  
F  
G  
H  
I  
J  
K  
L  
M  
AV  
O  
P

# AV CONTROL UNIT

< ECU DIAGNOSIS INFORMATION >

[BOSE AUDIO W/NAVI W/O SURROUND]

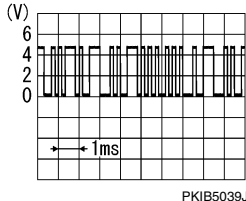
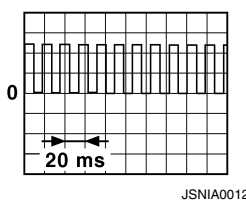
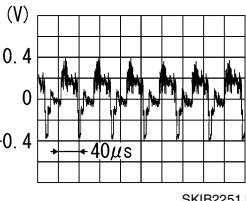
Terminal (Wire color)		Description		Condition		Reference value (Approx.)
+	-	Signal name	Input/ Output	Ignition switch	Operation	
59 (Shield)	—	Microphone signal shield	—	—	—	—
60 (W)	Ground	Microphone voltage	Output	ON	—	5.0 V
61 (W)	Ground	Communication signal (CONT→DISP)	Output	ON	When adjusting display brightness	
62 (P)	—	CAN L	Input/ Output	—	—	—
63 (LG)	—	AV communication signal (L)	Input/ Output	—	—	—
64 (LG)	—	AV communication signal (L) terminate	—	—	—	—
67 (P)	—	MR output	—	—	—	—
68 (LG)	Ground	Ignition signal	Input	ON	—	Battery voltage
69 (R)	Ground	Reverse signal	Input	ON	Selector lever is in R position	Battery voltage
					Selector lever is in other than R position	0 V
70 (BG)	Ground	Vehicle speed signal (8- pulse)	Input	ON	When vehicle speed is ap- prox. 40 km/h (25 MPH)	<p><b>NOTE:</b> The maximum voltage varies de- pending on the specification (des- tination unit).</p> 
71 (Shield)	—	Shield	—	—	—	—
72 (R)	Ground	Composite image synchro- nizing signal	Output	ON	When DVD image is dis- played	

# AV CONTROL UNIT

< ECU DIAGNOSIS INFORMATION >

[BOSE AUDIO W/NAVI W/O SURROUND]

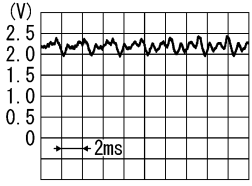
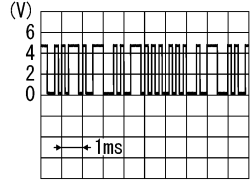
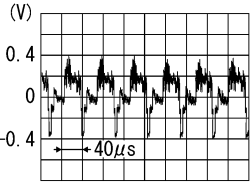
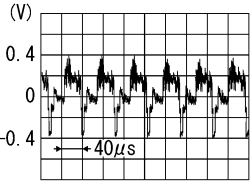
Terminal (Wire color)		Description		Condition		Reference value (Approx.)
+	-	Signal name	Input/ Output	Ignition switch	Operation	
75 (B)	59 (Shield)	Microphone signal	Input	ON	When speaking into microphone	 <p style="text-align: right; font-size: small;">PKIB5037J</p>
76 (Shield)	—	Communication signal shield	—	—	—	—
77 (B)	Ground	Communication signal (DISP→CONT)	Input	ON	When adjusting display brightness	 <p style="text-align: right; font-size: small;">PKIB5039J</p>
78 (L)	—	CAN-H	Input/ Output	—	—	—
79 (SB)	—	AV communication signal (H)	—	—	—	—
80 (SB)	—	AV communication signal (H) terminate	—	—	—	—
91 (W)	Ground	Auxiliary image signal	Input	ON	Video output when front AUX mode selected	 <p style="text-align: right; font-size: small;">SKIB2251J</p>
92 (B)	Ground	Auxiliary image signal ground	—	ON	—	0 V
94 (Shield)	—	Auxiliary image signal shield	—	—	—	—
97 (Y)	Ground	Disk eject signal	Input	ON	Pressing the eject switch	0 V
					Except for above	5.0 V
98 (V)	Ground	Switch ground	—	ON	—	0 V
105 (W)	Ground	Composite image signal ground	—	ON	—	0 V
106 (Shield)	—	Composite image signal shield	—	—	—	—
107 (B)	Ground	Composite image signal	Output	ON	When DVD, USB or front AUX image is displayed on headrest display unit LH or RH	 <p style="text-align: right; font-size: small;">SKIB2251J</p>

A  
B  
C  
D  
E  
F  
G  
H  
I  
J  
K  
L  
M  
AV  
O  
P

# AV CONTROL UNIT

< ECU DIAGNOSIS INFORMATION >

[BOSE AUDIO W/NAVI W/O SURROUND]

Terminal (Wire color)		Description		Condition		Reference value (Approx.)
+	-	Signal name	Input/ Output	Ignition switch	Operation	
137 (W)	—	V BUS signal (USB connector)	Input	—	—	—
138 (G)	—	USB ground (USB connector)	—	—	—	—
139 (L)	—	USB D+ signal (USB connector)	Input	—	—	—
140 (R)	—	USB D- signal (USB connector)	Input	—	—	—
141 (Shield)	—	USB shield (USB connector)	—	—	—	—
142 (B)	Ground	Antenna amp. ON signal	Input	ON	—	Battery voltage
143 (B)	—	AM-FM main	Input	—	—	—
144 (B)	—	FM sub	Input	—	—	—
145 (B)	—	USB D- signal (Telematics)	Input/ Output	—	—	—
146 (B)	—	USB VBUS signal (Telematics)	Input/ Output	—	—	—
147 (W)	—	Manufacturer specific sig- nal (Telematics)	Input	—	—	—
151 (L)	—	VOICE ground (Telematics)	—	—	—	—
152 (W)	—	U-VOICE signal (Telematics)	Input/ Output	—	—	—
153 (L/W)	—	USB D+ signal (Telematics)	Input/ Output	—	—	—
154 (Shield)	—	USB ground (Telematics)	—	—	—	—
160 (B)	—	D-VOICE signal (Telematics)	Input/ Output	—	—	—
161 (Shield)	—	USB shield (Telematics)	—	—	—	—
162 (Shield)	—	RGB digital image signal shield	—	—	—	—
163 (Shield)	—	RGB digital image signal shield	—	—	—	—
164 (B)	Ground	RGB digital image signal (-)	Output	ON	Connector disconnected	1.3 V
165 (B)	Ground	RGB digital image signal (+)	Output	ON	Connector disconnected	1.3 V
166 <sup>3</sup> (B)	Ground	Satellite radio antenna sig- nal	Input	ON	Connector disconnected	5.0 V
188 (B)	Ground	GPS antenna signal	Input	ON	Connector disconnected	5.0 V
189 (Shield)	—	GPS antenna signal shield	—	—	—	—

1. With telematics

# AV CONTROL UNIT

< ECU DIAGNOSIS INFORMATION >

[BOSE AUDIO W/NAVI W/O SURROUND]

2. Without telematics
3. Except Mexico

## Fail-Safe

INFOID:000000009129082

When the ambient temperature becomes extremely low or extremely high, AV control unit displays a message and limits the function of the AV control unit.

### FAIL-SAFE CONDITIONS

When the ambient temperature is  $-20^{\circ}\text{C}$  ( $-4^{\circ}\text{F}$ ) or lower, or when it is  $70^{\circ}\text{C}$  ( $158^{\circ}\text{F}$ ) or higher.

#### Display

The following messages are displayed during fail-safe:

Fail-safe mode	Display
When HDD temperature is low	HDD system is experiencing problems due to extreme low temperature. Normal operation will resume when temperature rises.
When HDD temperature is high	HDD system is experiencing problems due to extreme high temperature. Normal operation will resume when temperature drops.

## DESCRIPTION OF CONTROLS

Function	Fail-safe mode activated	
Air conditioner	Operation	A/C and AV switch assembly can be operated.
	Display	<ul style="list-style-type: none"> <li>• LEDs of A/C and AV switch assembly illuminate.</li> <li>• Temperature, mode and blower speed are displayed in a simplified mode.</li> </ul>
Audio	Operation	Only ON/OFF and volume control operations of A/C and AV switch assembly are available.
	Display	"Fail-safe mode" is displayed.
Camera	Operation	Image tone cannot be controlled.
	Display	Cannot be superimposed. (warning display, tone control display)
Hands-free phone	Operation	Inoperative.
Navigation	Operation	Inoperative.
Self diagnosis		Displays in a simplified mode.
CONSULT diagnosis		Inoperative.

#### Ability Operation Mode

If HDD data can be read, "Fail-safe mode" is displayed and functions listed above can be operated.

## DTC Index

INFOID:000000009129083

## SELF-DIAGNOSIS RESULTS DISPLAY ITEM

CONSULT Display	Reference Page
U1000: CAN COMM CIRCUIT	<a href="#">AV-459, "AV CONTROL UNIT : DTC Logic"</a>
U1010: CONTROL UNIT (CAN)	<a href="#">AV-460, "AV CONTROL UNIT : DTC Logic"</a>
U1200: CONT UNIT	<a href="#">AV-461, "DTC Logic"</a>
U1201: GYRO NO CONN	<a href="#">AV-462, "DTC Logic"</a>
U1202: G-SENSOR NO CONN	<a href="#">AV-463, "DTC Logic"</a>
U1204: GPS COMM	<a href="#">AV-464, "DTC Logic"</a>
U1205: GPS ROM	<a href="#">AV-465, "DTC Logic"</a>
U1206: GPS RAM	<a href="#">AV-466, "DTC Logic"</a>
U1207: GPS RTC	<a href="#">AV-467, "DTC Logic"</a>
U1216: CAN CONT	<a href="#">AV-468, "DTC Logic"</a>

# AV CONTROL UNIT

< ECU DIAGNOSIS INFORMATION >

[BOSE AUDIO W/NAVI W/O SURROUND]

CONSULT Display	Reference Page
U1217: BLUETOOTH MODULE	<a href="#">AV-469, "DTC Logic"</a>
U1218: HDD CONN	<a href="#">AV-470, "DTC Logic"</a>
U1219: HDD READ	<a href="#">AV-471, "DTC Logic"</a>
U121A: HDD WRITE	<a href="#">AV-472, "DTC Logic"</a>
U121B: HDD COMM	<a href="#">AV-473, "DTC Logic"</a>
U121C: HDD ACCESS	<a href="#">AV-474, "DTC Logic"</a>
U121D: DSP CONN	<a href="#">AV-475, "DTC Logic"</a>
U121E: DSP COMM	<a href="#">AV-476, "DTC Logic"</a>
U1225: USB CONTROLLER	<a href="#">AV-477, "DTC Logic"</a>
U1227: DVD COMM	<a href="#">AV-478, "DTC Logic"</a>
U1228: SUB CPU CONN	<a href="#">AV-479, "DTC Logic"</a>
U1229: iPod CERTIFICATION	<a href="#">AV-480, "DTC Logic"</a>
U122A: CONFIG UNFINISH	<a href="#">AV-481, "DTC Logic"</a>
U122E: Built-in AUDIO CONN	<a href="#">AV-482, "DTC Logic"</a>
U1231: AMP TEMP	<a href="#">AV-483, "DTC Logic"</a>
U1232: ST ANGLE SEN CALIB	<a href="#">AV-484, "DTC Logic"</a>
U1243: FRONT DISP CONN	<a href="#">AV-485, "DTC Logic"</a>
U1244: GPS ANTENNA CONN	<a href="#">AV-487, "DTC Logic"</a>
U1258: XM ANTENNA CONN	<a href="#">AV-488, "DTC Logic"</a>
U125A: 3RD DISP CONN	<a href="#">AV-489, "DTC Logic"</a>
U1263: USB OVERCURRENT	<a href="#">AV-490, "DTC Logic"</a>
U1264: ANTENNA AMP TERMINAL (OPEN or SHORT)	<a href="#">AV-491, "DTC Logic"</a>
U1265: AMP ON TERMINAL (GND-SHORT or VB-SHORT)	<a href="#">AV-492, "DTC Logic"</a>
<ul style="list-style-type: none"> <li>• U1300: AV COMM CIRCUIT</li> <li>• U1240: SWITCH CONN</li> </ul>	<a href="#">AV-493, "Description"</a>
<ul style="list-style-type: none"> <li>• U1300: AV COMM CIRCUIT</li> <li>• U124E: AMP CONN</li> </ul>	
<ul style="list-style-type: none"> <li>• U1300: AV COMM CIRCUIT</li> <li>• U1246: VIDEO DIST CONN</li> </ul>	
<ul style="list-style-type: none"> <li>• U1300: AV COMM CIRCUIT</li> <li>• U125B: AROUND CAMERA CONN</li> </ul>	
<ul style="list-style-type: none"> <li>• U1300: AV COMM CIRCUIT</li> <li>• U125C: SONAR CONN</li> </ul>	
<ul style="list-style-type: none"> <li>• U1300: AV COMM CIRCUIT</li> <li>• U1240: SWITCH CONN</li> <li>• U125C: SONAR CONN</li> <li>• U125B: AROUND CAMERA CONN</li> <li>• U1246: VIDEO DIST CONN</li> </ul>	
<ul style="list-style-type: none"> <li>• U1300: AV COMM CIRCUIT</li> <li>• U1240: SWITCH CONN</li> <li>• U124E: AMP CONN</li> <li>• U125C: SONAR CONN</li> <li>• U125B: AROUND CAMERA CONN</li> <li>• U1246: VIDEO DIST CONN</li> </ul>	
U1310: CONTROL UNIT (AV)	



# AV CONTROL UNIT

< ECU DIAGNOSIS INFORMATION >

[BOSE AUDIO W/NAVI W/O SURROUND]

CONSULT Display	Reference Page	
U1601: FL-DOOR WOOFER/TWEETER (OPEN, SHORT, GND-SHORT)	<a href="#">AV-504, "DTC Logic"</a>	A
U1603: FL-DOOR WOOFER/TWEETER (VB-SHOR)		B
U1609: FR-DOOR WOOFER/TWEETER (OPEN, SHORT, GND-SHORT)		C
U160B: FR-DOOR WOOFER/TWEETER (VB-SHOR)		D
U1627: F-INST L-TWEETER (OPEN, SHORT, GND-SHORT or VB-SHOR)	<a href="#">AV-505, "DTC Logic"</a>	D
U162F: F-INST R-TWEETER (OPEN, SHORT, GND-SHORT or VB-SHOR)		E
U162A: F-INST C-SQAWK (OPEN, SHORT, GND-SHORT or VB-SHOR)	<a href="#">AV-506, "DTC Logic"</a>	E
U1684: 2L-DOOR SPEAKER/TWEETER (OPEN, SHORT, GND-SHORT)	<a href="#">AV-507, "DTC Logic"</a>	F
U1687: 2L-DOOR SPEAKER/TWEETER (VB-SHOR)		G
U162C: 2R-DOOR SPEAKER/TWEETER (OPEN, SHORT, GND-SHORT)		H
U162F: 2R-DOOR SPEAKER/TWEETER (VB-SHOR)		H
U175D: R-LUGGAGE L-WOOFER (OPEN, SHORT, GND-SHORT or VB-SHOR)	<a href="#">AV-508, "DTC Logic"</a>	I
U176A: R-ROOF L-WK (OPEN, SHORT, GND-SHORT or VB-SHOR)	<a href="#">AV-509, "DTC Logic"</a>	I
U1772: R-ROOF R-WK (OPEN, SHORT, GND-SHORT or VB-SHOR)		J

A  
B  
C  
D  
E  
F  
G  
H  
I  
J  
K  
L  
M

AV

O  
P

# DISPLAY UNIT

< ECU DIAGNOSIS INFORMATION >

[BOSE AUDIO W/NAVI W/O SURROUND]

## DISPLAY UNIT

Reference Value

INFOID:000000009129084

### TERMINAL LAYOUT

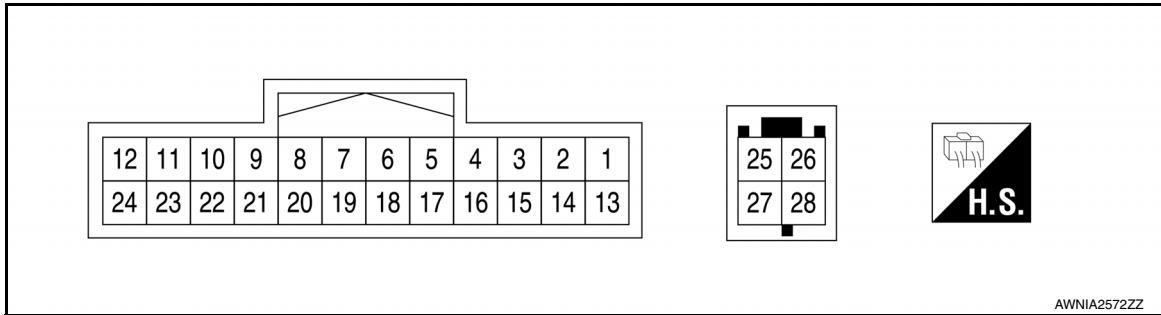

### PHYSICAL VALUES

Terminal (Wire color)		Description		Condition		Reference value (Approx.)
+	-	Signal name	Input/Output	Ignition switch	Operation	
6 (Shield)	—	Composite image signal shield	—	—	—	—
7 (Shield)	—	Camera image signal shield	—	—	—	—
8 (B)	Ground	Camera image signal	Input	ON	When camera image is displayed	<p>SKIB2251J</p>
9 (B)	Ground	Communication signal (DISP→CONT)	Output	ON	When adjusting display brightness	<p>PKIB5039J</p>
10 (W)	Ground	Communication signal (CONT→DISP)	Input	ON	When adjusting display brightness	<p>PKIB5039J</p>
11 (Y)	Ground	Battery power supply	Input	OFF	—	Battery voltage
12 (B)	Ground	Ground	—	ON	—	0 V

# DISPLAY UNIT

< ECU DIAGNOSIS INFORMATION >

[BOSE AUDIO W/NAVI W/O SURROUND]

Terminal (Wire color)		Description		Condition		Reference value (Approx.)
+	-	Signal name	Input/ Output	Ignition switch	Operation	
18 (B)	Ground	Composite image signal	Input	ON	When DVD image is displayed.	
19 (W)	Ground	Composite image signal ground	—	ON	—	0 V
20 (R)	Ground	Composite image synchronizing signal	Input	ON	—	
22 (Shield)	—	Communication signal shield	—	—	—	—
23 (P)	Ground	ACC power supply	Input	ACC	—	Battery voltage
25 (Shield)	—	RGB digital image signal shield	—	—	—	—
26 (Shield)	—	RGB digital image signal shield	—	—	—	—
27 (B)	—	RGB digital image signal (-)	Input	—	—	—
28 (B)	—	RGB digital image signal (+)	Input	—	—	—

A  
B  
C  
D  
E  
F  
G  
H  
I  
J  
K  
L  
M

AV

O  
P

# BOSE AMP.

< ECU DIAGNOSIS INFORMATION >

[BOSE AUDIO W/NAVI W/O SURROUND]

## BOSE AMP.

### Reference Value

INFOID:000000009129085

### TERMINAL LAYOUT

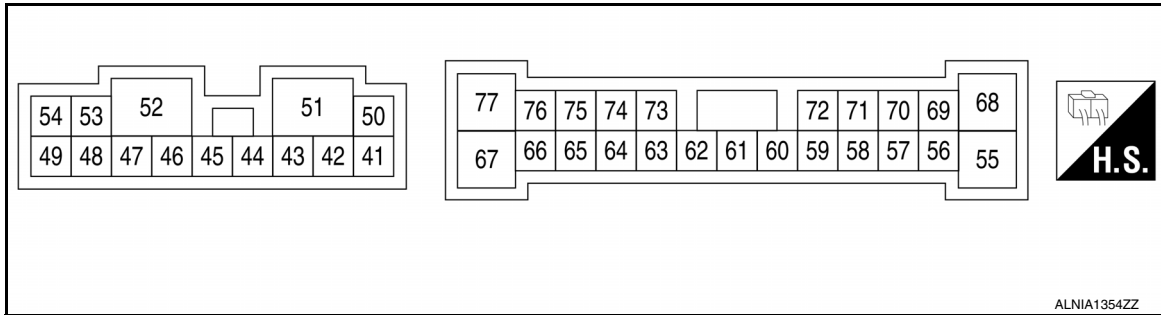

### PHYSICAL VALUES

Terminal (Wire color)		Description	Input/ Output	Condition		Reference value (Approx.)
+	-			Ignition switch	Operation	
41 (R)	42 (G)	Sound signal tweeter LH	Output	ON	Sound output	 SKIB3609E
44 (W)	43 (G)	Sound signal rear side speaker RH	Output	ON	Sound output	 SKIB3609E
45 (G)	46 (W)	Sound signal tweeter RH	Output	ON	Sound output	 SKIB3609E
47 (B)	—	Ground	—	ON	—	0 V
50 (LG)	Ground	Battery power supply	Input	OFF	—	Battery voltage
51 (Y)	Ground	Battery power supply	Input	OFF	—	Battery voltage
52 (B)	—	Ground	—	ON	—	0 V

# BOSE AMP.

< ECU DIAGNOSIS INFORMATION >

[BOSE AUDIO W/NAVI W/O SURROUND]

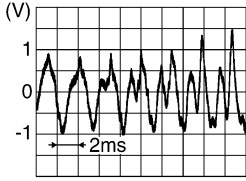
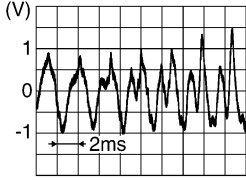
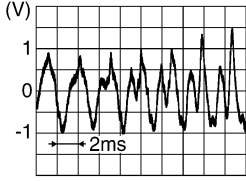
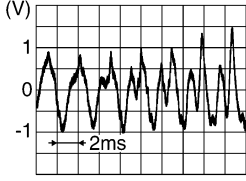
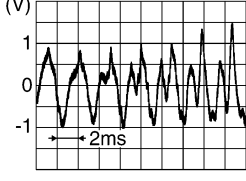
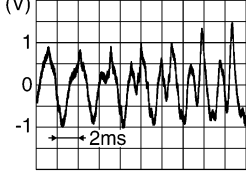
Terminal (Wire color)		Description		Condition		Reference value (Approx.)
+	-	Signal name	Input/ Output	Ignition switch	Operation	
53 (W)	48 (G)	Sound signal rear side speaker LH	Output	ON	Sound output	 <p style="text-align: right; font-size: small;">SKIB3609E</p>
54 (G)	49 (W)	Sound signal rear door speaker RH	Output	ON	Sound output	 <p style="text-align: right; font-size: small;">SKIB3609E</p>
57 (W)	56 (B)	Sound signal subwoofer	Output	ON	Sound output	 <p style="text-align: right; font-size: small;">SKIB3609E</p>
58 (G)	59 (R)	Sound signal front door speaker and front tweeter LH	Output	ON	Sound output	 <p style="text-align: right; font-size: small;">SKIB3609E</p>
60 (W)	Ground	BOSE amp. ON signal	Input	ON	—	Battery voltage
61 (Shield)	—	Subwoofer sound signal shield	—	—	—	—
62 (W)	—	—	—	—	—	—
64 (B)	63 (W)	Pre amp sound signal rear LH	Input	ON	Sound output	 <p style="text-align: right; font-size: small;">SKIB3609E</p>
66 (B)	65 (W)	Pre amp sound signal rear RH	Input	ON	Sound output	 <p style="text-align: right; font-size: small;">SKIB3609E</p>

A  
B  
C  
D  
E  
F  
G  
H  
I  
J  
K  
L  
M  
AV  
O  
P

# BOSE AMP.

< ECU DIAGNOSIS INFORMATION >

[BOSE AUDIO W/NAVI W/O SURROUND]

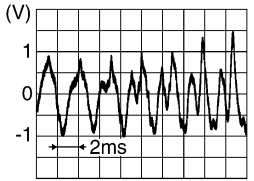
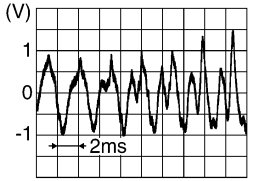
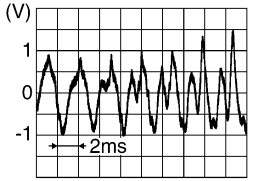
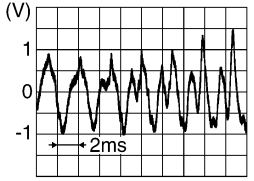
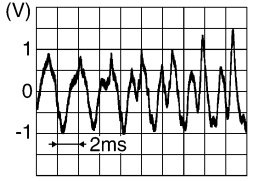
Terminal (Wire color)		Description	Condition			Reference value (Approx.)
+	-		Signal name	Input/ Output	Ignition switch	
68 (P)	55 (R)	Sound signal rear door speaker LH	Output	ON	Sound output	 <p>SKIB3609E</p>
69 (P)	70 (R)	Sound signal center speaker	Output	ON	Sound output	 <p>SKIB3609E</p>
71 (W)	72 (P)	Sound signal front door speaker and front tweeter RH	Output	ON	Sound output	 <p>SKIB3609E</p>
73 (B)	74 (W)	Pre amp sound signal front RH	Input	ON	Sound output	 <p>SKIB3609E</p>
75 (B)	76 (W)	Pre amp sound signal front LH	Input	ON	Sound output	 <p>SKIB3609E</p>

# VIDEO DISTRIBUTOR

< ECU DIAGNOSIS INFORMATION >

[BOSE AUDIO W/NAVI W/O SURROUND]

## VIDEO DISTRIBUTOR

### Reference Value

INFOID:000000009129086

### TERMINAL LAYOUT

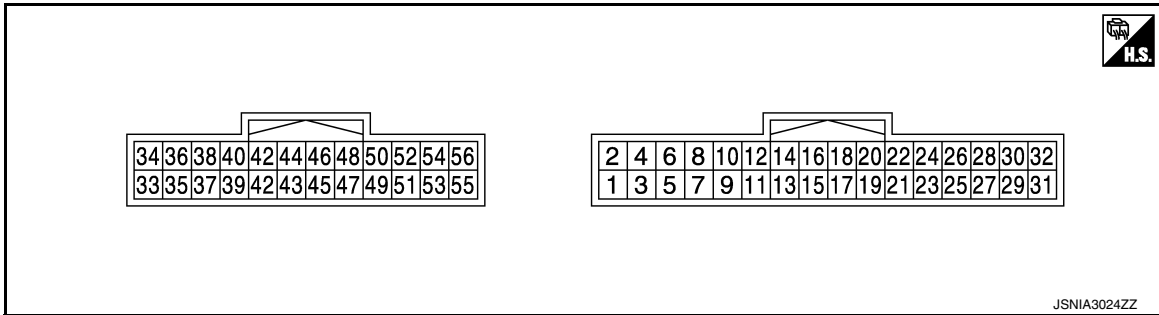

### PHYSICAL VALUES

Terminal (Wire color)		Description	Condition		Reference value (Approx.)
+	-	Signal name	Input/Output	Ignition switch / Operation	
1 (B)	—	Ground	—	ON	0 V
2 (V)	Ground	Battery power supply	Input	OFF	Battery voltage
3 (B)	—	Ground	—	ON	0 V
4 (W)	Ground	ACC power supply	Input	ACC	Battery voltage
5 (BR)	Ground	Headrest display unit RH control ground	—	ON	0 V
6 (L)	Ground	Headrest display unit RH ACC signal	Output	OFF	3.3 V
				ACC	0 V
7 (SB)	Ground	Headrest display unit LH control ground	—	ON	0 V
8 (BR)	Ground	Headrest display unit RH ACC signal	Output	OFF	3.3 V
				ACC	0 V
9 (SB)	Ground	Headrest display unit RH image switch signal	Input	ON	When DVD, USB or front AUX image is displayed on headrest display unit RH. 0.5 V
				ON	When rear AUX image is displayed on headrest display unit RH. 4.5 V
10 (L)	Ground	Headrest display unit LH image switch signal	Input	ON	When DVD, USB or front AUX image is displayed on headrest display unit LH. 0.5 V
				ON	When rear AUX image is displayed on headrest display unit LH. 4.5 V

# VIDEO DISTRIBUTOR

< ECU DIAGNOSIS INFORMATION >

[BOSE AUDIO W/NAVI W/O SURROUND]

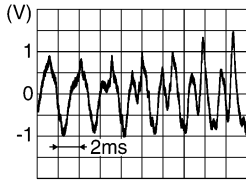
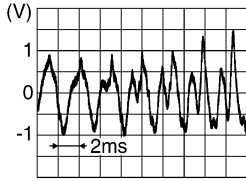
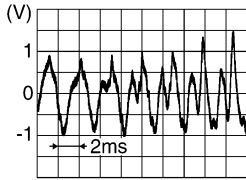
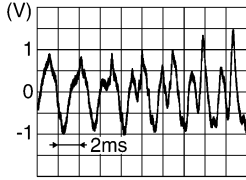
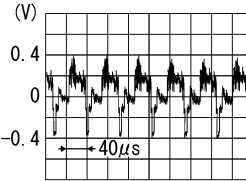
Terminal (Wire color)		Description		Condition		Reference value (Approx.)
+	-	Signal name	Input/ Output	Ignition switch	Operation	
14 (R)	15 (G)	Headrest display unit RH headphone sound signal RH	Output	ON	Output headphone sound from headrest display unit RH to headphone.	 <p style="text-align: right; font-size: small;">SKIB3609E</p>
16 (B)	17 (W)	Headrest display unit RH headphone sound signal LH	Output	ON	Output headphone sound from headrest display unit RH to headphone.	 <p style="text-align: right; font-size: small;">SKIB3609E</p>
18 (V)	Ground	Headrest display unit RH AV ground	—	ON	—	0 V
19 (V)	Ground	Headrest display unit LH AV ground	—	ON	—	0 V
20 (B)	21 (G)	Headrest display unit LH headphone sound signal RH	Output	ON	Output headphone sound from headrest display unit LH to headphone.	 <p style="text-align: right; font-size: small;">SKIB3609E</p>
22 (W)	23 (R)	Headrest display unit LH headphone sound signal LH	Output	ON	Output headphone sound from headrest display unit LH to headphone.	 <p style="text-align: right; font-size: small;">SKIB3609E</p>
27 (W)	Ground	Headrest display unit RH composite image signal ground	—	ON	—	0 V
28 (B)	Ground	Headrest display unit RH composite image signal	Output	ON	When DVD, USB, front AUX or rear AUX image is displayed on headrest dis- play unit RH.	 <p style="text-align: right; font-size: small;">SKIB2251J</p>
29 (Shield)	—	Headrest display unit RH composite image signal shield	—	—	—	—
30 (Shield)	—	Headrest display unit LH composite image signal shield	—	—	—	—



# VIDEO DISTRIBUTOR

< ECU DIAGNOSIS INFORMATION >

[BOSE AUDIO W/NAVI W/O SURROUND]

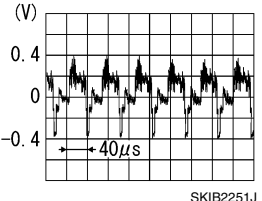
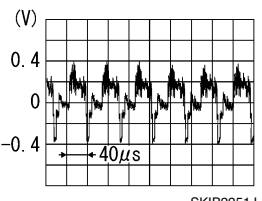
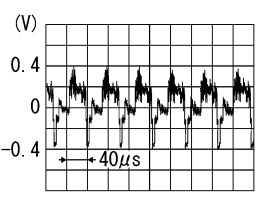
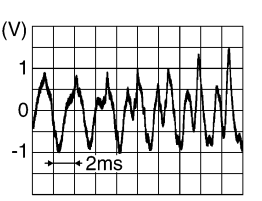
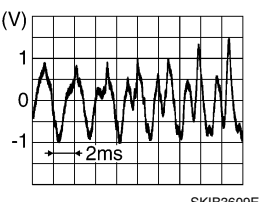
Terminal (Wire color)		Description		Condition		Reference value (Approx.)
+	-	Signal name	Input/ Output	Ignition switch	Operation	
31 (P)	Ground	Headrest display unit LH composite image signal ground	—	ON	—	0 V
32 (L)	Ground	Headrest display unit LH composite image signal	Output	ON	When DVD, USB, front AUX or rear AUX image is displayed on headrest dis- play unit LH.	
33 (W)	Ground	Composite image signal ground	—	ON	—	0 V
34 (B)	Ground	Composite image signal	Input	ON	When DVD, USB or front AUX image is displayed on headrest display unit LH or RH.	
35 (Shield)	—	Composite image signal shield	—	—	—	—
40 (B)	39 (W)	Auxiliary image signal	Input	ON	When rear AUX image is displayed on headrest dis- play unit LH or RH.	
41 (Shield)	—	Auxiliary image signal shield	—	—	—	—
45 (W)	46 (R)	Headphone sound signal LH	Input	ON	When DVD, USB or front AUX mode is selected on headrest display unit LH or RH.	
47 (B)	48 (G)	Headphone sound signal RH	Input	ON	When DVD, USB or front AUX mode is selected on headrest display unit LH or RH.	
49 (Shield)	—	Headphone sound signal shield	—	—	—	—
53 (Shield)	—	Auxiliary sound signal shield	—	—	—	—

A  
B  
C  
D  
E  
F  
G  
H  
I  
J  
K  
L  
M  
O  
P

AV

# VIDEO DISTRIBUTOR

< ECU DIAGNOSIS INFORMATION >

[BOSE AUDIO W/NAVI W/O SURROUND]

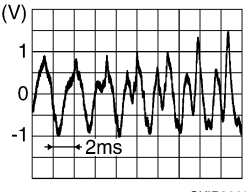
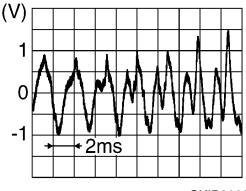
Terminal (Wire color)		Description		Condition		Reference value (Approx.)
+	-	Signal name	Input/ Output	Ignition switch	Operation	
54 (B)	56 (W)	Auxiliary sound signal LH	Input	ON	When rear AUX mode is selected on headrest display unit LH or RH.	
55 (R)	56 (W)	Auxiliary sound signal RH	Input	ON	When rear AUX mode is selected on headrest display unit LH or RH.	

# HEADREST DISPLAY UNIT

< ECU DIAGNOSIS INFORMATION >

[BOSE AUDIO W/NAVI W/O SURROUND]

## HEADREST DISPLAY UNIT

Reference Value

INFOID:000000009129087

### TERMINAL LAYOUT

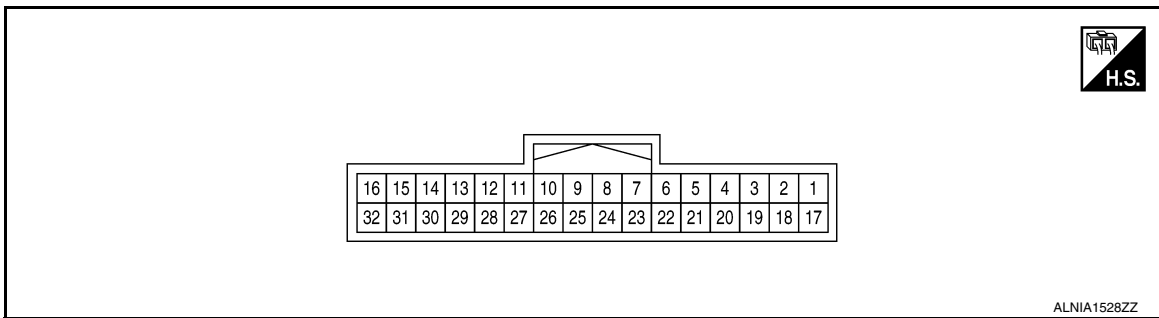

### PHYSICAL VALUES

Driver Seat

Terminal (Wire color)		Description		Condi- tion	Operation	Reference value (Approx.)
+	-	Signal name	Input/ Output	Ignition switch		
1 (W)	17 (B)	Headphone sound signal LH	Input	ON	Headphone sound output	
2 (G)	18 (R)	Headphone sound signal RH	Input	ON	Headphone sound output	
3 (LG)	—	Headphone sound signal shield	—	—	—	—
5 (Y)	Ground	Composite image signal	Input	ON	When DVD, USB or front AUX image is displayed on headrest display unit	
7 (W)	Ground	Image switch signal	Output	ON	When DVD, USB or front AUX image is displayed on headrest display unit	0.5 V
					When rear AUX image is displayed on headrest dis- play unit	4.5 V
8 (G)	Ground	ACC signal	Input	OFF	—	3.3 V
				ACC	—	0 V

A  
B  
C  
D  
E  
F  
G  
H  
I  
J  
K  
L  
M  
AV  
O  
P

# HEADREST DISPLAY UNIT

< ECU DIAGNOSIS INFORMATION >

[BOSE AUDIO W/NAVI W/O SURROUND]

Terminal (Wire color)		Description		Condi- tion		Reference value (Approx.)
+	-	Signal name	Input/ Output	Ignition switch	Operation	
10 (LG)	—	AV communication signal (L)	Input/ Output	—	—	—
11 (P)	—	AV communication signal (H)	Input/ Output	—	—	—
12 (G)	Ground	Ground	—	ON	—	0 V
13 (BR)	Ground	Illumination	Input	OFF	—	Battery voltage
15 (W)	Ground	Battery power supply	Input	OFF	—	Battery voltage
16 (W)	Ground	Battery power supply	Input	OFF	—	Battery voltage
19 (V)	Ground	AV ground	—	ON	—	0 V
20 (P)	—	Composite image signal shield	—	—	—	—
21 (G)	Ground	Composite image signal ground	—	ON	—	0 V
23 (Y)	Ground	Control ground	—	ON	—	0 V
24 (SB)	—	CON CK B	Input/ Output	—	—	—
26 (R)	—	AV communication signal (L)	Input/ Output	—	—	—
27 (LG)	—	AV communication signal (H)	Input/ Output	—	—	—
29 (GR)	—	CON CK B	Input/ Output	—	—	—
31 (G)	Ground	Ground	—	ON	—	0 V
32 (G)	Ground	Ground	—	ON	—	0 V

Passenger Seat

# HEADREST DISPLAY UNIT

< ECU DIAGNOSIS INFORMATION >

[BOSE AUDIO W/NAVI W/O SURROUND]

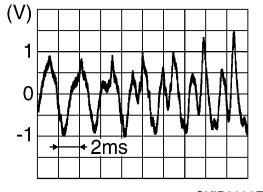
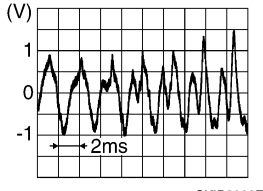
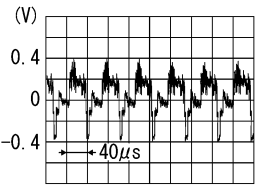
Terminal (Wire color)		Description		Condi- tion	Operation	Reference value (Approx.)
+	-	Signal name	Input/ Output	Ignition switch		
1 (W)	17 (B)	Headphone sound signal LH	Input	ON	Headphone sound output	 SKIB3609E
2 (G)	18 (R)	Headphone sound signal RH	Input	ON	Headphone sound output	 SKIB3609E
3 (LG)	—	Headphone sound signal shield	—	—	—	—
5 (Y)	Ground	Composite image signal	Input	ON	When DVD, USB or front AUX image is displayed on headrest display unit	 SKIB2251J
7 (W)	Ground	Image switch signal	Output	ON	When DVD, USB or front AUX image is displayed on headrest display unit	0.5 V
					When rear AUX image is displayed on headrest dis- play unit	4.5 V
8 (G)	Ground	ACC signal	Input	OFF	—	3.3 V
				ACC	—	0 V
10 (LG)	—	AV communication signal (L)	Input/ Output	—	—	—
11 (P)	—	AV communication signal (H)	Input/ Output	—	—	—
13 (BR)	Ground	Illumination	Input	OFF	—	Battery voltage
15 (W)	Ground	Battery power supply	Input	OFF	—	Battery voltage
16 (W)	Ground	Battery power supply	Input	OFF	—	Battery voltage
19 (V)	Ground	AV ground	—	ON	—	0 V
20 (P)	—	Composite image signal shield	—	—	—	—
21 (G)	Ground	Composite image signal ground	—	ON	—	0 V
23 (Y)	Ground	Control ground	—	ON	—	0 V

A  
B  
C  
D  
E  
F  
G  
H  
I  
J  
K  
L  
M  
P

AV

# HEADREST DISPLAY UNIT

< ECU DIAGNOSIS INFORMATION >

[BOSE AUDIO W/NAVI W/O SURROUND]

Terminal (Wire color)		Description		Condi- tion		Reference value (Approx.)
+	-	Signal name	Input/ Output	Ignition switch	Operation	
24 (SB)	—	CON CK B	Input/ Output	—	—	—
26 (R)	—	AV communication signal (L)	Input/ Output	—	—	—
27 (LG)	—	AV communication signal (H)	Input/ Output	—	—	—
28 (G)	Ground	Ground	—	ON	—	0 V
29 (GR)	—	CON CK B	Input/ Output	—	—	—
31 (G)	Ground	Ground	—	ON	—	0 V
32 (G)	Ground	Ground	—	ON	—	0 V

# AROUND VIEW MONITOR CONTROL UNIT

< ECU DIAGNOSIS INFORMATION >

[BOSE AUDIO W/NAVI W/O SURROUND]

## AROUND VIEW MONITOR CONTROL UNIT

### Reference Value

INFOID:000000009129088

### VALUES ON THE DIAGNOSIS TOOL

Monitor Item	Condition	Value/Status
ACC	Ignition switch in any position except ACC.	NG
	Ignition switch in ACC position.	OK
CAMERA OFF SIGNAL	CAMERA switch ON.	Off
	CAMERA switch OFF.	On
CAMERA SWITCH SIGNAL	CAMERA switch OFF.	Off
	CAMERA switch ON.	On
DR CAMERA COMM STATUS	Side camera LH inoperative.	NG
	Side camera LH operative.	OK
DR-SIDE CAMERA COMM LINE	Side camera LH inoperative.	NG
	Side camera LH operative.	OK
DR-SIDE CAMERA IMAGE SIG	Side camera LH inoperative.	NG
	Side camera LH operative.	OK
F-CAMERA COMM LINE	Front camera inoperative.	NG
	Front camera operative.	OK
F-CAMERA COMM STATUS	Front camera inoperative.	NG
	Front camera operative.	OK
F-CAMERA IMAGE SIG	Front camera inoperative.	NG
	Front camera operative.	OK
FOLDING MOTOR VOLT 1	Door mirror LH not in fold position.	Off
	Door mirror LH in fold position.	On
FOLDING MOTOR VOLT 2	Door mirror RH not in fold position.	Off
	Door mirror RH in fold position.	On
PA CAMERA COMM STATUS	Side camera RH inoperative.	NG
	Side camera RH operative.	OK
PA-SIDE CAMERA COMM LINE	Side camera RH inoperative.	NG
	Side camera RH operative.	OK
PA-SIDE CAMERA IMAGE SIG	Side camera RH inoperative.	NG
	Side camera RH operative.	OK
R-CAMERA COMM LINE	Rear camera LH inoperative.	NG
	Rear camera LH operative.	OK
R-CAMERA COMM STATUS	Rear camera LH inoperative.	NG
	Rear camera LH operative.	OK
REAR CAMERA IMAGE SIGNAL	Rear camera LH inoperative.	NG
	Rear camera LH operative.	OK
REVERSE SIGNAL	When selector lever is in any position other than R (reverse).	Off
	When selector lever in R (reverse).	On
ST ANGLE SENSOR SIGNAL	Around view monitor control unit is not receiving steering angle sensor signal.	Off
	Around view monitor control unit is receiving steering angle sensor signal.	On

# AROUND VIEW MONITOR CONTROL UNIT

< ECU DIAGNOSIS INFORMATION >

[BOSE AUDIO W/NAVI W/O SURROUND]

Monitor Item	Condition	Value/Status
ST ANGLE SENSOR TYPE	Steering angle sensor type.	Absolute
ST GEAR RATIO TYPE	Steering gear ratio type.	Type O
STEERING POSITION	Left hand drive vehicle.	LHD
	Right hand drive vehicle.	RHD
VEHICLE SPEED SIGNAL	While driving, equivalent to speedometer reading	mph, km/h

## TERMINAL LAYOUT

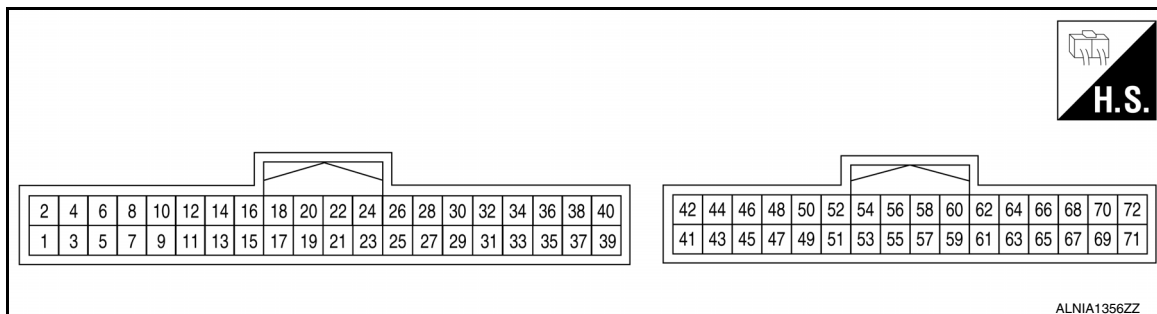

## PHYSICAL VALUES

Terminal (Wire color)		Description	Condition			Reference value (Approx.)
+	-	Signal name	Input/ Output	Ignition switch	Operation	
1 (B)	Ground	Ground	—	ON	—	0 V
2 (Y)	Ground	Battery power supply	Input	OFF	—	Battery voltage
3 (LG)	Ground	Ignition signal	Input	ON	—	Battery voltage
4 (P)	Ground	ACC power supply	Input	ACC	—	Battery voltage
19 (B)	—	AV communication signal (H)	Input/ Output	—	—	—
20 (W)	—	AV communication signal (L)	Input/ Output	—	—	—
23 (Shield)	—	AV communication signal shield	—	—	—	—
25 (LG)	Ground	Reverse signal	Input	ON	R position	Battery voltage
					Other than R position	0 V
27 (B)	—	CAN (H)	—	—	—	—
28 (W)	—	CAN (L)	—	—	—	—
29 (Shield)	—	CAN shield	—	—	—	—
30 (W)	—	Mirror signal 2	—	—	—	—
32 (G)	—	Mirror signal 1	—	—	—	—



# AROUND VIEW MONITOR CONTROL UNIT

< ECU DIAGNOSIS INFORMATION >

[BOSE AUDIO W/NAVI W/O SURROUND]

Terminal (Wire color)		Description		Condition		Reference value (Approx.)
+	-	Signal name	Input/ Output	Ignition switch	Operation	
47 (B)	Ground	Camera image signal	Output	ON	At camera image display	
48 (Shield)	—	Camera image signal shield	—	—	—	—
49 (W)	Ground	Rear view camera communication signal	Input/ Output	ON	“CAMERA” switch is ON or shift position is “R”.	
50 (B)	Ground	Rear view camera power supply	Output	ON	“CAMERA” switch is ON or shift position is “R”.	6.0 V
52 (R)	Ground	Rear view camera ground	—	ON	—	0 V
53 (G)	54	Rear view camera image signal	Input	ON	“CAMERA” switch is ON or shift position is “R”.	
55 (B)	Ground	Side camera LH communication signal	Input/ Output	ON	“CAMERA” switch is ON or shift position is “R”.	
56 (W)	Ground	Side camera LH power supply	Output	ON	“CAMERA” switch is ON or shift position is “R”.	6.0 V
58 (G)	Ground	Side camera LH ground	—	ON	—	0 V
59 (R)	60	Side camera LH image signal	Input	ON	“CAMERA” switch is ON or shift position is “R”.	

A  
B  
C  
D  
E  
F  
G  
H  
I  
J  
K  
L  
M  
O  
P

AV

# AROUND VIEW MONITOR CONTROL UNIT

< ECU DIAGNOSIS INFORMATION >

[BOSE AUDIO W/NAVI W/O SURROUND]

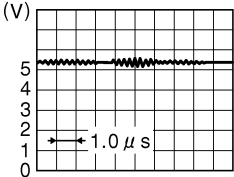
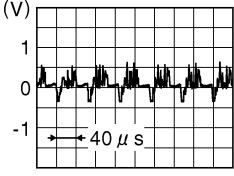
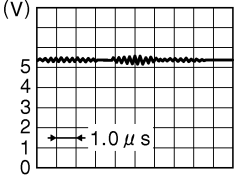
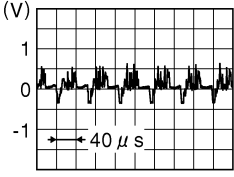
Terminal (Wire color)		Description		Condition		Reference value (Approx.)
+	-	Signal name	Input/ Output	Ignition switch	Operation	
61 (W)	Ground	Side camera RH communi- cation signal	Input/ Output	ON	"CAMERA" switch is ON or shift position is "R".	 <p style="text-align: right; font-size: small;">JSNIA0836GB</p>
62 (B)	Ground	Side camera RH power supply	Output	ON	"CAMERA" switch is ON or shift position is "R".	6.0 V
64 (R)	Ground	Side camera RH ground	—	ON	—	0 V
65 (G)	66	Side camera RH image sig- nal	Input	ON	"CAMERA" switch is ON or shift position is "R".	 <p style="text-align: right; font-size: small;">JSNIA0834GB</p>
67 (B)	Ground	Front camera communi- cation signal	Input/ Output	ON	"CAMERA" switch is ON or shift position is "R".	 <p style="text-align: right; font-size: small;">JSNIA0836GB</p>
68 (W)	Ground	Front camera power supply	Output	ON	"CAMERA" switch is ON or shift position is "R".	6.0 V
70 (G)	Ground	Front camera ground	—	ON	—	0 V
71 (R)	72	Front camera image signal	Input	ON	"CAMERA" switch is ON or shift position is "R".	 <p style="text-align: right; font-size: small;">JSNIA0834GB</p>

## DTC Index

INFOID:000000009129089

CONSULT Display	Reference Page
U1302: CAMERA SUPPLY POWER SUPPLY VOLTAGE ABNORMALITY	<a href="#">AV-495, "DTC Logic"</a>
U1303: LED SUPPLY POWER SUPPLY VOLTAGE ABNORMALITY	<a href="#">AV-499, "DTC Logic"</a>
U1304: NON-COMPLETION OF THE CALIBRATION	<a href="#">AV-501, "DTC Logic"</a>
U1305: NON-COMPLETION OF THE WRITE CONFIGURATION	<a href="#">AV-502, "DTC Logic"</a>

# SONAR CONTROL UNIT (WITH AROUND VIEW MONITOR)

< ECU DIAGNOSIS INFORMATION >

[BOSE AUDIO W/NAVI W/O SURROUND]

## SONAR CONTROL UNIT (WITH AROUND VIEW MONITOR)

### Reference Value

INFOID:000000009129090

### VALUES ON THE DIAGNOSIS TOOL

Monitor Item	Condition	Value/Status
CEN[RL]/CEN[R]	Key ON, selector lever in R (reverse) position.	cm/in
CEN[RL]/CEN[R]->COR[RL]		
CEN[RL]->CEN[RR]		
CEN[RR]		
CEN[RR]/CEN[R]->COR[RR]		
CEN[RR]->CEN[RL]		
COR[FL]		
COR[FR]		
COR[RL]		
COR[RR]		
COR[RL]->CEN[RL]/CEN[R]		
COR[RR]->CEN[RR]/CEN[R]		
DETECTION MODE		
	Mode 2	
LED	When LED is OFF.	Off
	When LED is ON.	On
P N RANGE	When selector lever is in any position other than P (park) or N (neutral).	Off
	When selector lever in P (park) or N (neutral) position.	On
REVERSE RANGE	When transmission range switch is in any position other than R (reverse).	Off
	When transmission range switch is in R (reverse) position.	On
RVRB TIME CEN[RL]	Key ON, selector lever in R (reverse) position.	ms/sec
RVRB TIME CEN[RR]		
RVRB TIME COR[FL]		
RVRB TIME COR[FR]		
RVRB TIME COR[RL]		
RVRB TIME COR[RR]		
SENSOR VOLTAGE		
SHRT DST FRM FR SENS	Key ON, selector lever in R (reverse) position.	cm/in
SHRT DST FRM RR SENS		
SONAR C/U POWER SUPPLY	Key ON.	Battery voltage
SONAR PERMANENT OFF	CAMERA switch ON.	No
	CAMERA switch OFF.	Yes
SONAR TEMPORARY OFF	Key ON, selector lever in R (reverse) position.	No
	When selector lever is in any position other than R (reverse).	Yes
SW OPRT AFTR IGN ON	CAMERA switch OFF after Key ON.	No
	CAMERA switch ON after Key ON.	Yes

# SONAR CONTROL UNIT (WITH AROUND VIEW MONITOR)

< ECU DIAGNOSIS INFORMATION >

[BOSE AUDIO W/NAVI W/O SURROUND]

Monitor Item	Condition	Value/Status
TRAILER CONNECT	No trailer connected to trailer hitch.	N CON
	Trailer connected to trailer hitch.	CON
VEHICLE SPEED	While driving, equivalent to speedometer reading	mph, km/h

## TERMINAL LAYOUT

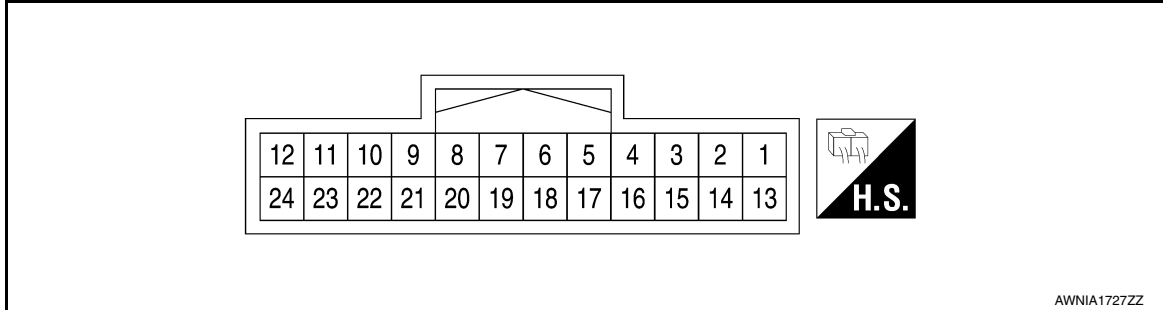

## PHYSICAL VALUES

Terminal No. (Wire color)		Description		Condition		Value (Approx.)
+	-	Signal name	Input/ Output	Ignition switch	Operation	
3 (R)	13 (B)	Outer sensor signal front LH	Input	ON	CAMERA mode or Selector lever R (reverse) position	<p style="text-align: right; font-size: x-small;">JSNIA0837GB</p>
4 (R)	13 (B)	Outer sensor signal front RH	Input	ON	CAMERA mode or Selector lever R (reverse) position	<p style="text-align: right; font-size: x-small;">JSNIA0837GB</p>
5 (B)	—	V-CAN (H)	Input/ Output	—	—	—
6 (W)	—	V-CAN (L)	Input/ Output	—	—	—
9 (W)	14 (B)	Inner sensor signal rear RH	Input	ON	CAMERA mode or Selector lever R (reverse) position	<p style="text-align: right; font-size: x-small;">JSNIA0837GB</p>

# SONAR CONTROL UNIT (WITH AROUND VIEW MONITOR)

< ECU DIAGNOSIS INFORMATION >

[BOSE AUDIO W/NAVI W/O SURROUND]

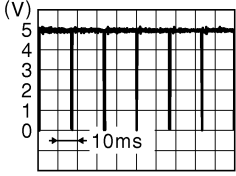
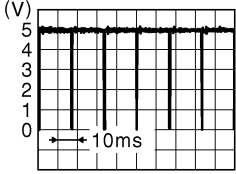
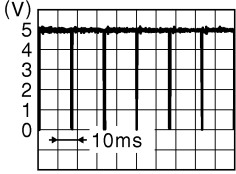
Terminal No. (Wire color)		Description		Condition		Value (Approx.)
+	-	Signal name	Input/ Output	Ignition switch	Operation	
10 (W)	14 (B)	Outer sensor signal rear RH	Input	ON	CAMERA mode or Selector lever R (reverse) position	 <p style="text-align: right; font-size: small;">JSNIA0837GB</p>
12 (LG)	Ground	ACC power supply	Input	ACC	—	Battery voltage
15 (GR)	Ground	Ground	—	ON	—	0 V
19 (BR)	20 (LG)	Buzzer	Input	ON	CAMERA mode or Selector lever R (reverse) position	Battery voltage
21 (W)	14 (B)	Inner sensor signal rear LH	Input	ON	CAMERA mode or Selector lever R (reverse) position	 <p style="text-align: right; font-size: small;">JSNIA0837GB</p>
22 (W)	14 (B)	Outer sensor signal rear LH	Input	ON	CAMERA mode or Selector lever R (reverse) position	 <p style="text-align: right; font-size: small;">JSNIA0837GB</p>

## DTC Index

INFOID:000000009129091

CONSULT Display	Reference Page
U1000: CAN COMM CIRCUIT	<a href="#">AV-459. "SONAR CONTROL UNIT (WITH AROUND VIEW MONITOR) : DTC Logic"</a>
U1010: CONTROL UNIT (CAN)	<a href="#">AV-460. "SONAR CONTROL UNIT (WITH AROUND VIEW MONITOR) : DTC Logic"</a>
B2720: REAR LEFT SIDE EXTERNAL SENSOR	<a href="#">AV-510. "DTC Logic"</a>
B2721: REAR LEFT SIDE INTERNAL SENSOR	<a href="#">AV-511. "DTC Logic"</a>
B2722: REAR RIGHT SIDE INTERNAL SENSOR	<a href="#">AV-512. "DTC Logic"</a>
B2723: REAR RIGHT SIDE EXTERNAL SENSOR	<a href="#">AV-513. "DTC Logic"</a>
B2724: ECU	<a href="#">AV-514. "DTC Logic"</a>
B2725: REAR BUZZER	<a href="#">AV-515. "DTC Logic"</a>
B2729: FRONT LEFT SIDE EXTERNAL SENSOR	<a href="#">AV-517. "DTC Logic"</a>
B272C: FRONT RIGHT SIDE EXTERNAL SENSOR	<a href="#">AV-518. "DTC Logic"</a>

# BOSE AUDIO W/NAVI W/O SURROUND

[BOSE AUDIO W/NAVI W/O SURROUND]

< WIRING DIAGRAM >

## WIRING DIAGRAM

### BOSE AUDIO W/NAVI W/O SURROUND

#### Wiring Diagram

INFOID:000000009129092

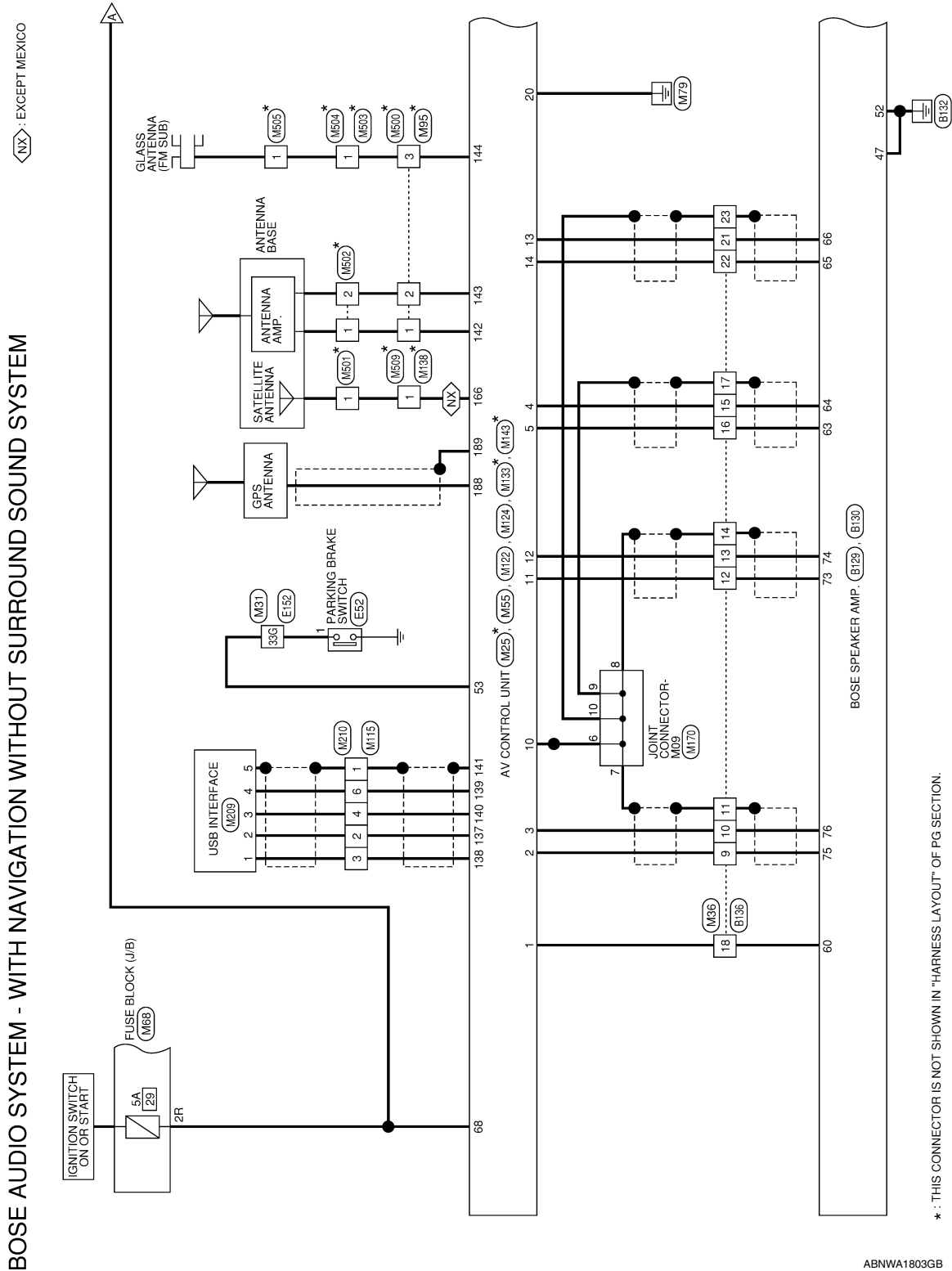

# BOSE AUDIO W/NAVI W/O SURROUND

[BOSE AUDIO W/NAVI W/O SURROUND]

< WIRING DIAGRAM >

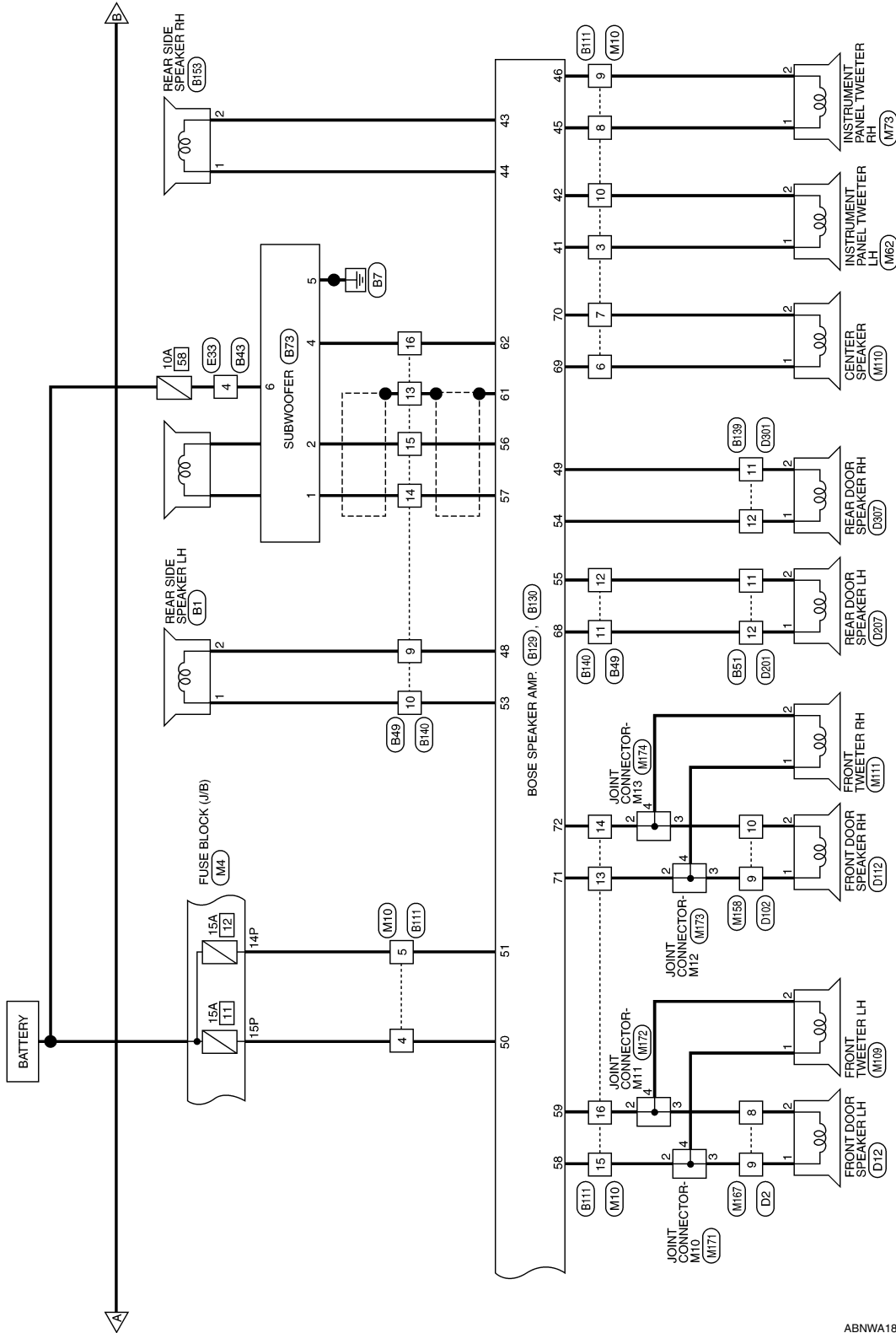

ABNWA1804GB

A  
B  
C  
D  
E  
F  
G  
H  
I  
J  
K  
L  
M  
N  
O  
P

AV

# BOSE AUDIO W/NAVI W/O SURROUND

[BOSE AUDIO W/NAVI W/O SURROUND]

< WIRING DIAGRAM >

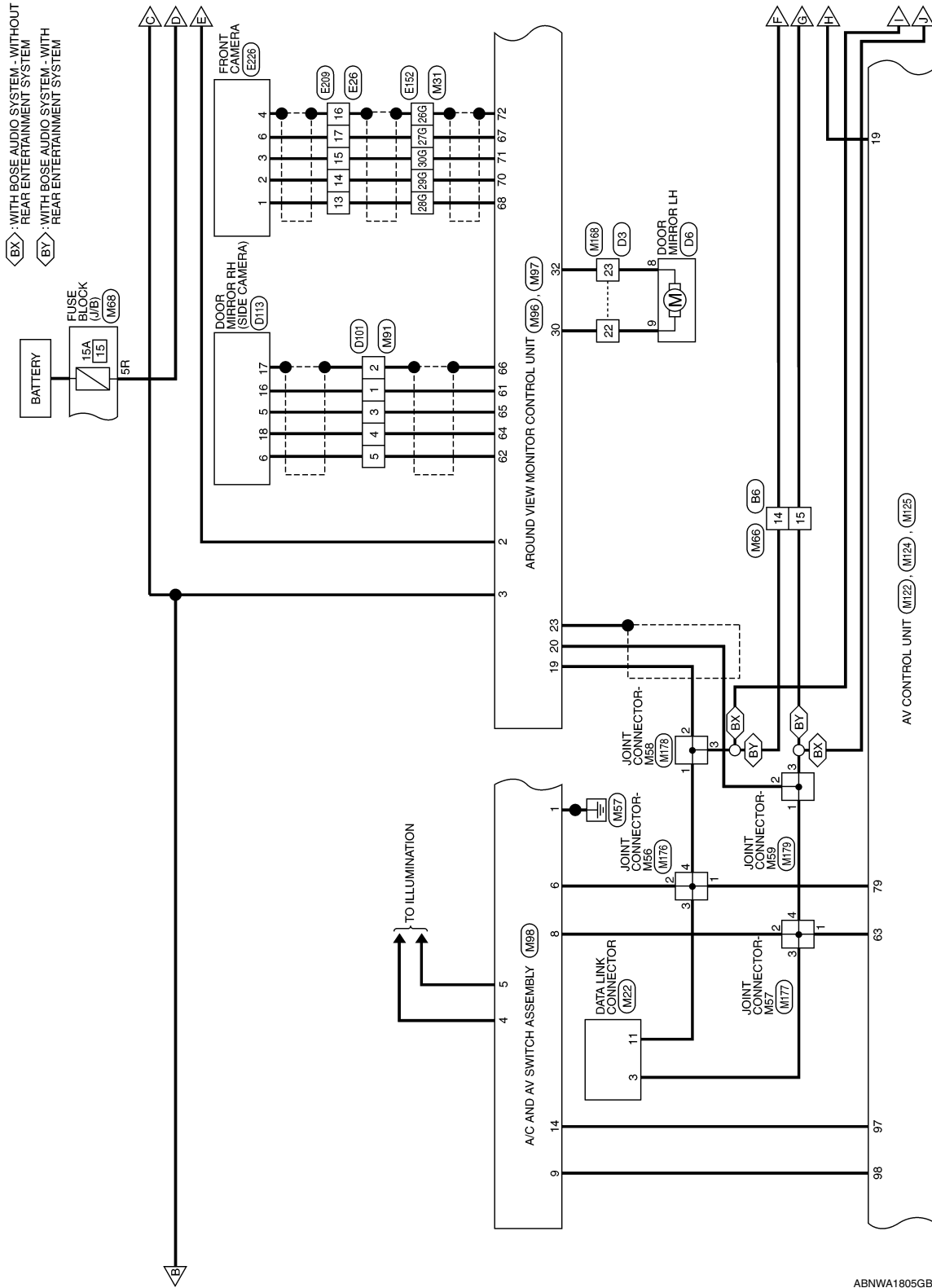

ABNWA1805GB



# BOSE AUDIO W/NAVI W/O SURROUND

< WIRING DIAGRAM >

[BOSE AUDIO W/NAVI W/O SURROUND]

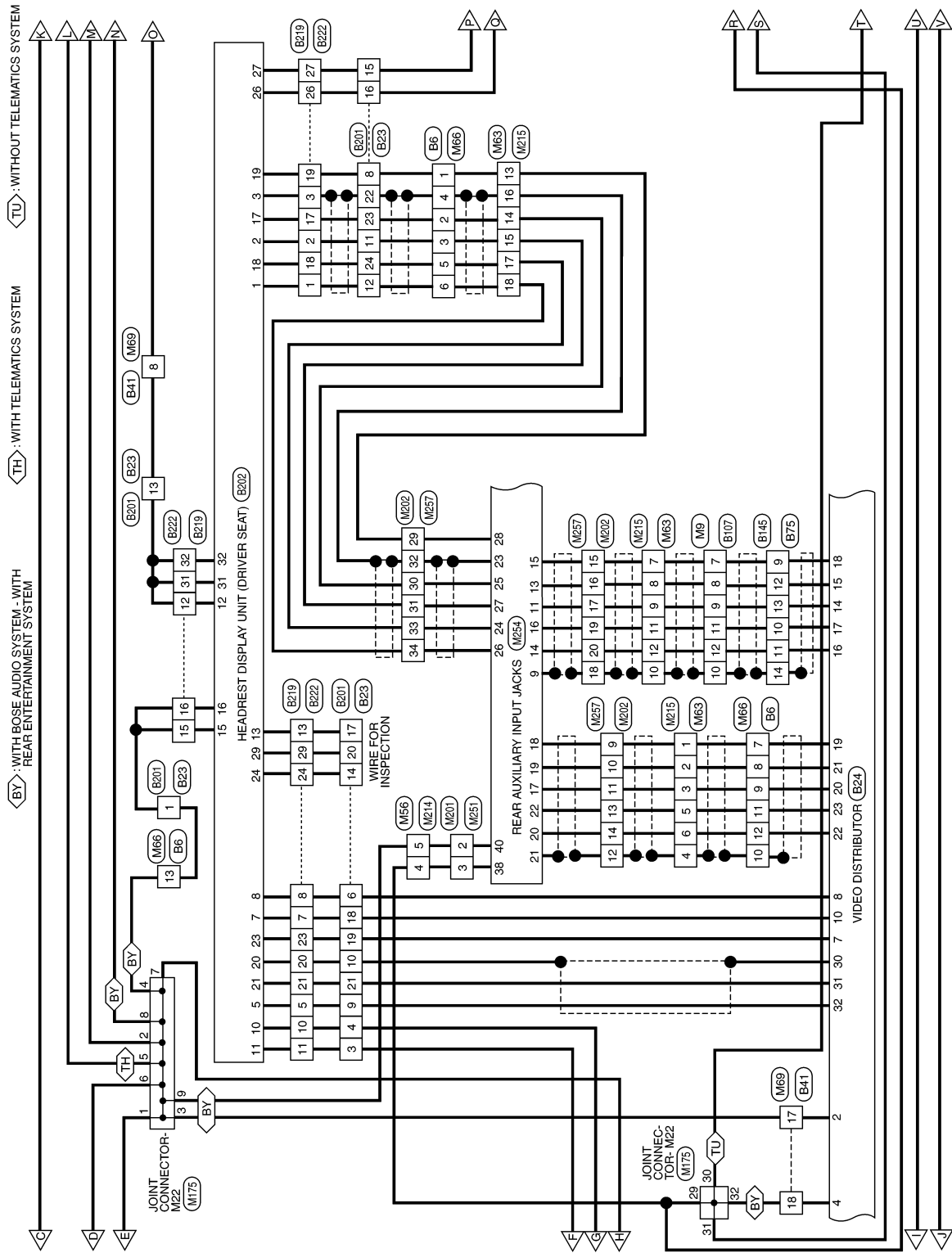

ABNWA1806GB

A  
B  
C  
D  
E  
F  
G  
H  
I  
J  
K  
L  
M  
N  
O  
P

AV



# BOSE AUDIO W/NAVI W/O SURROUND

[BOSE AUDIO W/NAVI W/O SURROUND]

< WIRING DIAGRAM >

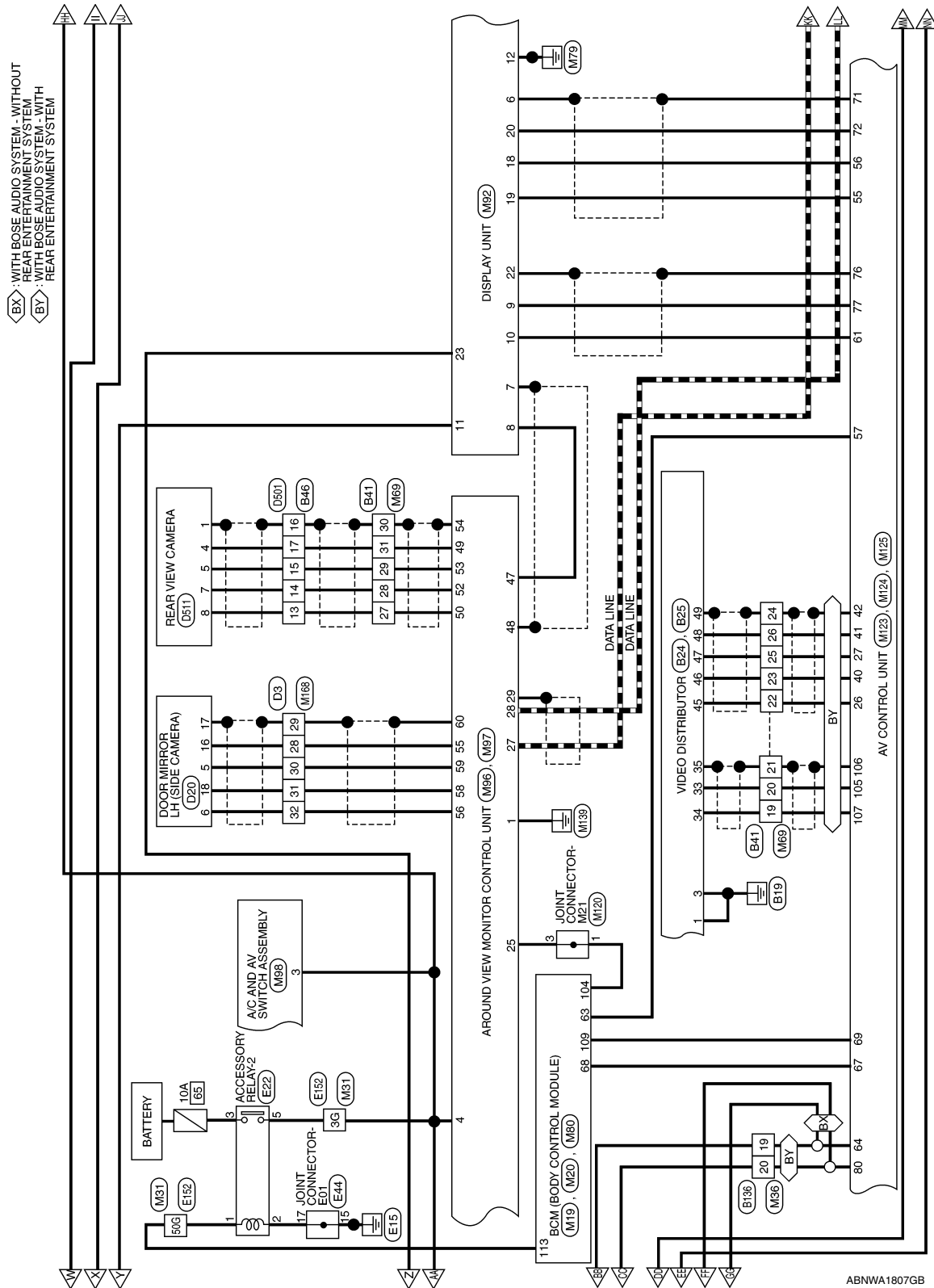

A  
B  
C  
D  
E  
F  
G  
H  
I  
J  
K  
L  
M  
N  
O  
P

AV

# BOSE AUDIO W/NAVI W/O SURROUND

[BOSE AUDIO W/NAVI W/O SURROUND]

< WIRING DIAGRAM >

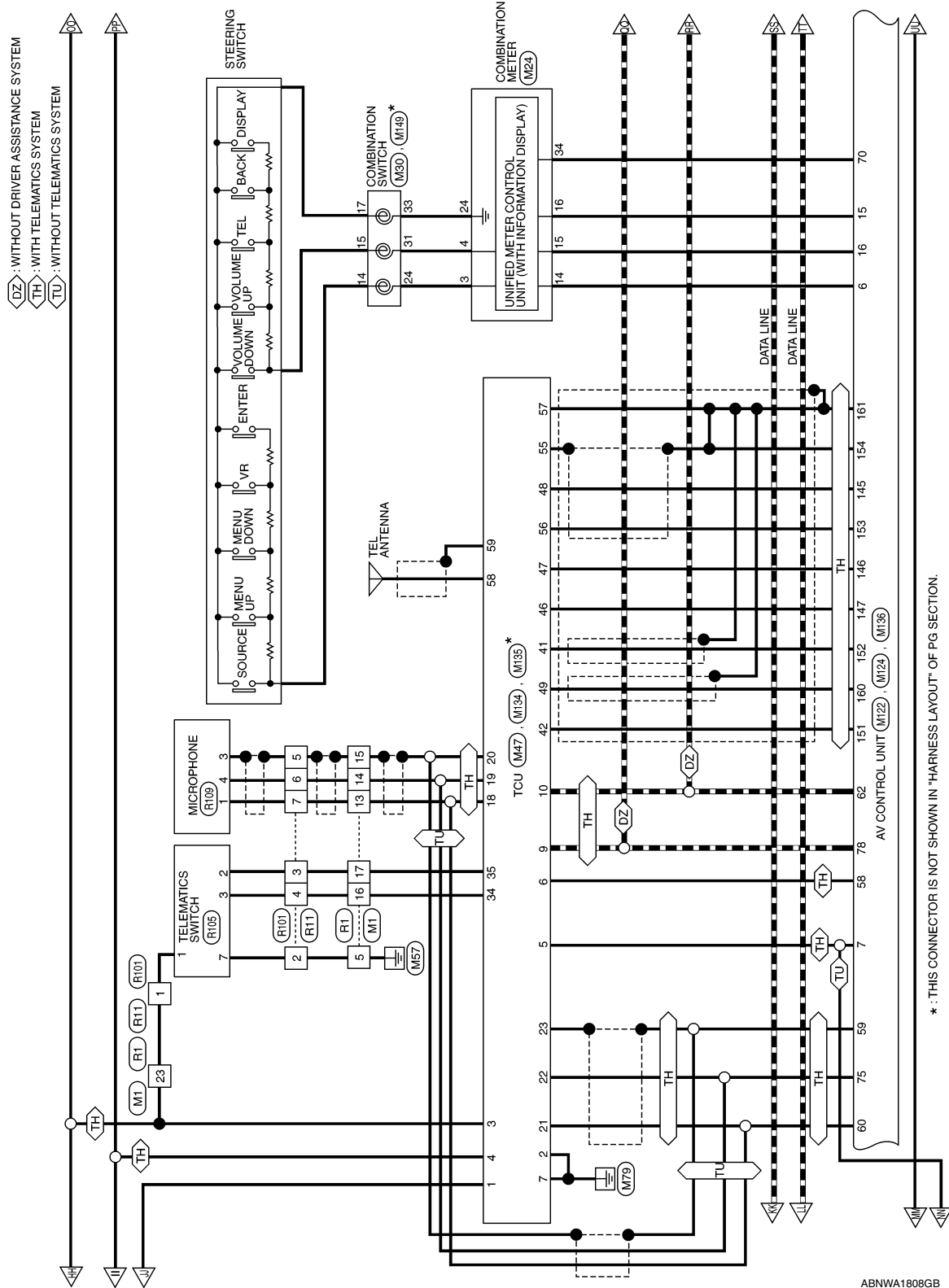

ABNWA1808GB

# BOSE AUDIO W/NAVI W/O SURROUND

[BOSE AUDIO W/NAVI W/O SURROUND]

< WIRING DIAGRAM >

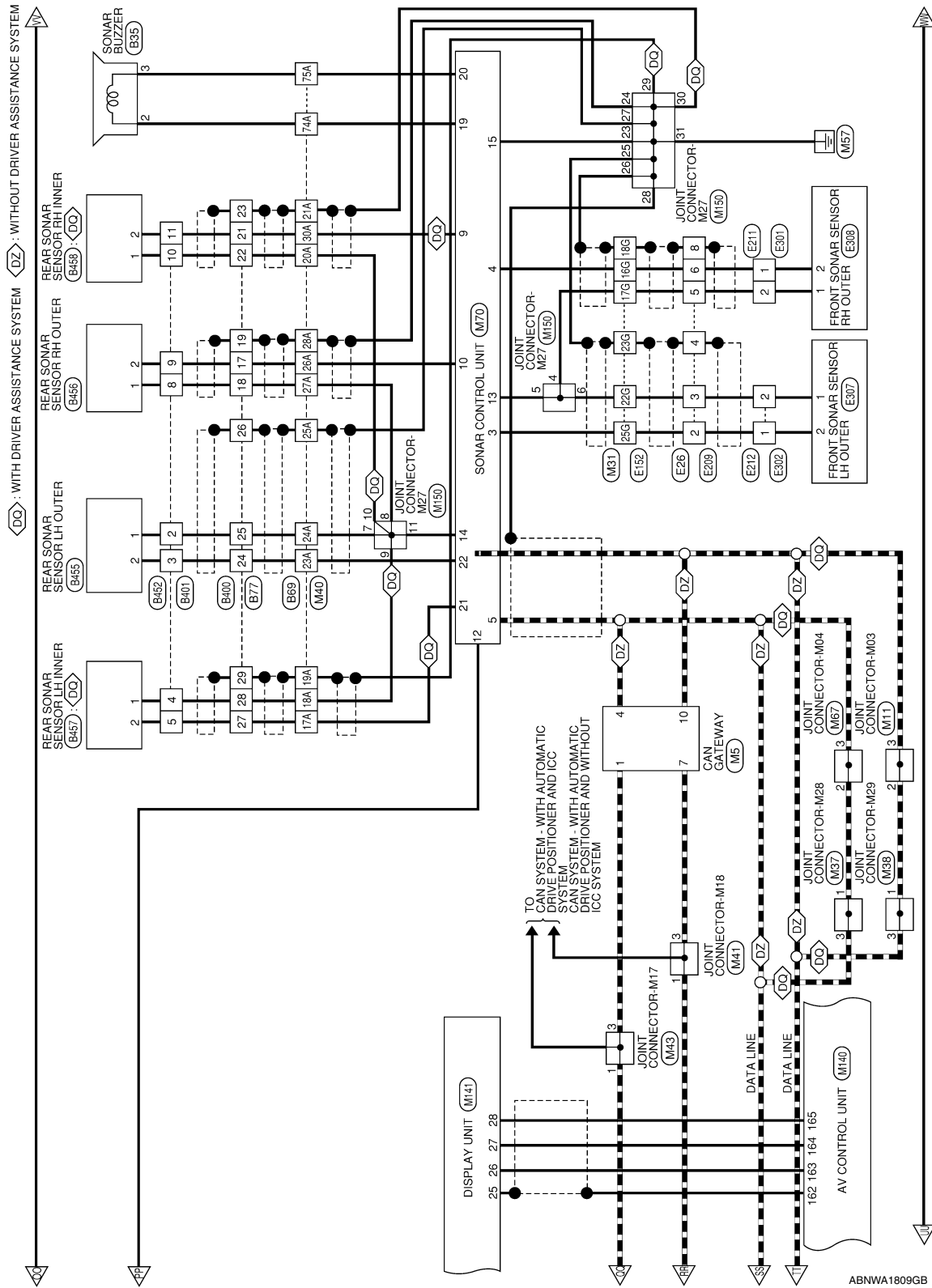

ABNWA1809GB

A  
B  
C  
D  
E  
F  
G  
H  
I  
J  
K  
L  
M  
N  
O  
P

AV

# BOSE AUDIO W/NAVI W/O SURROUND

[BOSE AUDIO W/NAVI W/O SURROUND]

< WIRING DIAGRAM >

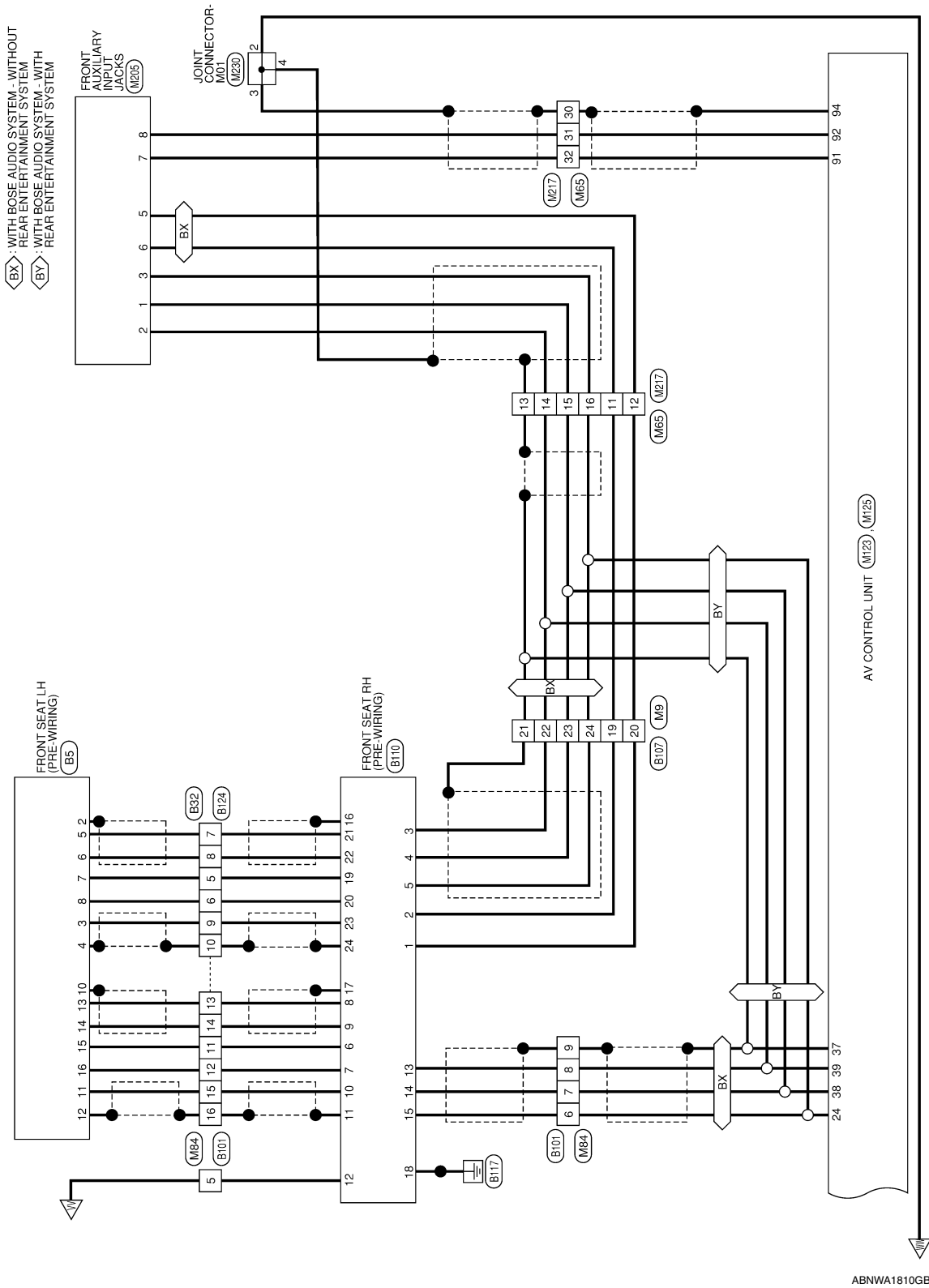

ABNWA1810GB

# BOSE AUDIO W/NAVI W/O SURROUND

[BOSE AUDIO W/NAVI W/O SURROUND]

< WIRING DIAGRAM >

## BOSE AUDIO SYSTEM CONNECTORS - WITH NAVIGATION WITHOUT SURROUND SOUND SYSTEM

Connector No.	M1
Connector Name	WIRE TO WIRE
Connector Color	WHITE

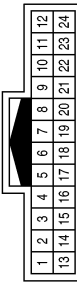

Terminal No.	Color of Wire	Signal Name
5	GR	-
13	W	-
14	B	-
15	SHIELD	-
16	R	-
17	W	-
23	P	-

Connector No.	M4
Connector Name	FUSE BLOCK (J/B)
Connector Color	WHITE



Terminal No.	Color of Wire	Signal Name
14P	Y	-
15P	L	-

Connector No.	M5
Connector Name	CAN GATEWAY
Connector Color	WHITE

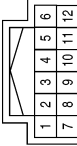

Terminal No.	Color of Wire	Signal Name
1	L	CAN-H
4	L	CAN-H
7	P	CAN-L
10	P	CAN-L

Connector No.	M9
Connector Name	WIRE TO WIRE
Connector Color	WHITE

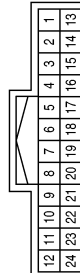

Terminal No.	Color of Wire	Signal Name
6	GR	-
7	V	-
8	G	-
9	R	-
10	SHIELD	-
11	W	-
12	B	-
19	P	-
20	G	-
21	SHIELD	-
22	B	-
23	R	-
24	W	-

Connector No.	M10
Connector Name	WIRE TO WIRE
Connector Color	BROWN

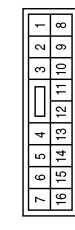

Terminal No.	Color of Wire	Signal Name
3	G	-
4	L	-
5	Y	-
6	G	-
7	W	-
8	G	-
9	W	-
10	W	-

Terminal No.	Color of Wire	Signal Name
13	G	-
14	W	-
15	P	-(WITH BOSE AUDIO SYSTEM WITHOUT SURROUND SOUND SYSTEM)
16	W	-

ABNIA4632GB

A  
B  
C  
D  
E  
F  
G  
H  
I  
J  
K  
L  
M  
N  
O  
P

AV

# BOSE AUDIO W/NAVI W/O SURROUND

[BOSE AUDIO W/NAVI W/O SURROUND]

< WIRING DIAGRAM >

Connector No.	M11
Connector Name	JOINT CONNECTOR-M03
Connector Color	WHITE



Terminal No.	Color of Wire	Signal Name
2	Y	-
3	W	-

Connector No.	M19
Connector Name	BCM (BODY CONTROL MODULE)
Connector Color	BLACK

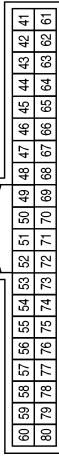

Terminal No.	Color of Wire	Signal Name
63	BG	I-KEY LINK SIGNAL
68	P	MR OUTPUT

Connector No.	M20
Connector Name	BCM (BODY CONTROL MODULE)
Connector Color	BLACK

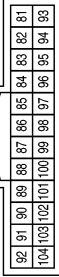

Terminal No.	Color of Wire	Signal Name
104	LG	REVERSE LAMP OUT

Connector No.	M22
Connector Name	DATA LINK CONNECTOR
Connector Color	WHITE

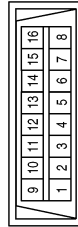

Terminal No.	Color of Wire	Signal Name
3	LG	-
11	SB	-

Connector No.	M24
Connector Name	COMBINATION METER
Connector Color	WHITE

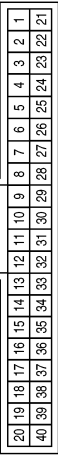

Terminal No.	Color of Wire	Signal Name
3	P	STRG SW INPUT 1
4	BG	STRG SW INPUT 2
14	G	STRG SW OUTPUT 1
15	W	STRG SW OUTPUT 2
16	B	STRG SW OUTPUT GND
24	R	STRG SW GND
34	BG	SPEED 8 P / R

Connector No.	M25
Connector Name	AV CONTROL UNIT
Connector Color	PINK

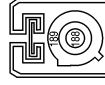

Terminal No.	Color of Wire	Signal Name
188	B	-
189	SHIELD	-



# BOSE AUDIO W/NAVI W/O SURROUND

## [BOSE AUDIO W/NAVI W/O SURROUND]

< WIRING DIAGRAM >

Terminal No.	Color of Wire	Signal Name
3G	P	-
16G	R	-
17G	B	-
18G	SHIELD	-
22G	B	-
23G	SHIELD	-
25G	R	-
26G	SHIELD	-
27G	B	-
28G	W	-
29G	G	-
30G	R	-
33G	G	-
50G	L	-

Connector No.	M31
Connector Name	WIRE TO WIRE
Connector Color	WHITE

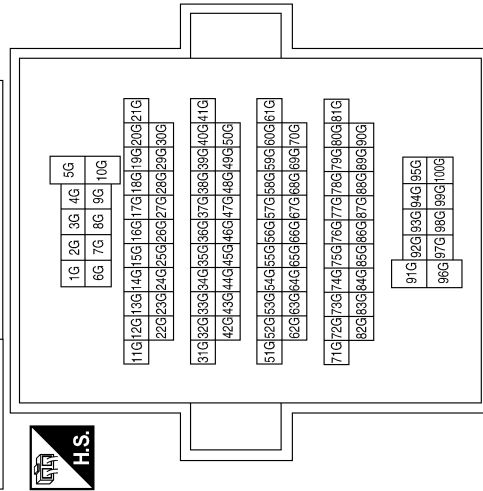

Connector No.	M30
Connector Name	COMBINATION SWITCH (SPIRAL CABLE)
Connector Color	GRAY

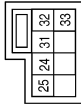

Terminal No.	Color of Wire	Signal Name
24	P	-
31	BG	-
33	R	-

Connector No.	M37
Connector Name	JOINT CONNECTOR-M28
Connector Color	WHITE



Terminal No.	Color of Wire	Signal Name
13	B	-
14	SHIELD	-
15	B	-
16	W	-
17	SHIELD	-
18	SB	-
19	LG	-
20	SB	-
21	B	-
22	W	-
23	SHIELD	-

Connector No.	M36
Connector Name	WIRE TO WIRE
Connector Color	WHITE

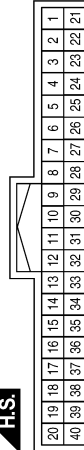

Terminal No.	Color of Wire	Signal Name
9	B	-
10	W	-
11	SHIELD	-
12	W	-

Terminal No.	Color of Wire	Signal Name
1	L	-
3	B	-

ABNIA4634GB

A  
B  
C  
D  
E  
F  
G  
H  
I  
J  
K  
L  
M  
N  
O  
P

AV

# BOSE AUDIO W/NAVI W/O SURROUND

[BOSE AUDIO W/NAVI W/O SURROUND]

< WIRING DIAGRAM >

Terminal No.	Color of Wire	Signal Name
17A	W	-
18A	B	-
19A	SHIELD	-
20A	B	-
21A	SHIELD	-
23A	W	-
24A	B	-
25A	SHIELD	-
26A	W	-
27A	B	-
28A	SHIELD	-
30A	W	-
74A	BR	-
75A	LG	-

Connector No.	M40
Connector Name	WIRE TO WIRE
Connector Color	GRAY

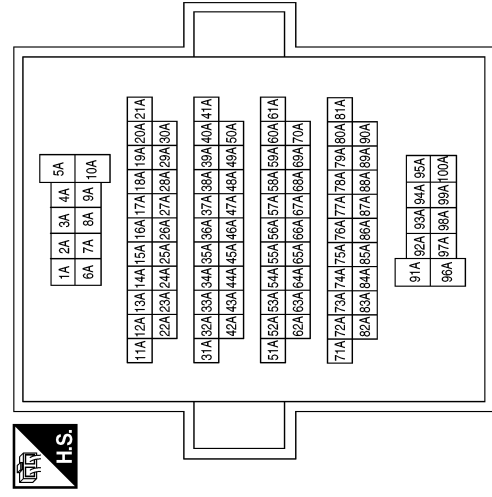

Connector No.	M38
Connector Name	JOINT CONNECTOR-M29
Connector Color	WHITE

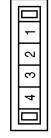

Terminal No.	Color of Wire	Signal Name
1	Y	-
3	W	-

Connector No.	M43
Connector Name	JOINT CONNECTOR-M17
Connector Color	WHITE

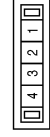

Terminal No.	Color of Wire	Signal Name
1	L	-
3	L	-

Connector No.	M41
Connector Name	JOINT CONNECTOR-M18
Connector Color	WHITE

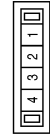

Terminal No.	Color of Wire	Signal Name
1	P	-
3	P	-

ABNIA4635GB

# BOSE AUDIO W/NAVI W/O SURROUND

[BOSE AUDIO W/NAVI W/O SURROUND]

< WIRING DIAGRAM >

Terminal No.	Color of Wire	Signal Name
24	-	-
25	-	-
26	-	-
27	-	-
28	-	-
29	-	-
30	-	-
31	-	-
32	-	-
33	-	-
34	R	ECALL SW
35	W	LED A
36	-	-
37	-	-
38	-	-
39	-	-
40	-	-

Terminal No.	Color of Wire	Signal Name
7	B	GND
8	-	-
9	L	V-CAN H
10	P	V-CAN L
11	-	-
12	-	-
13	-	-
14	-	-
15	-	-
16	-	-
17	-	-
18	W	MIC VCC
19	B	MIC SIG
20	SHIELD	MIC GND
21	W	MIC VCC DETECTION
22	B	DCM MIC SIG
23	SHIELD	DCM MIC GND

Connector No.	M47
Connector Name	TCU
Connector Color	WHITE



2	4	6	8	10	12	14	16	18	20	22	24	26	28	30	32	34	36	38	40
1	3	5	7	9	11	13	15	17	19	21	23	25	27	29	31	33	35	37	39

Terminal No.	Color of Wire	Signal Name
1	Y	B+
2	B	GND
3	P	ACC
4	LG	IGN
5	G	ACC OUT
6	G	AV ACC

Connector No.	M62
Connector Name	INSTRUMENT PANEL TWEETER LH
Connector Color	BROWN



2	1
---	---

Terminal No.	Color of Wire	Signal Name
1	G	-(WITH BOSE AUDIO SYSTEM)
2	W	-(WITH BOSE AUDIO SYSTEM)

Connector No.	M56
Connector Name	WIRE TO WIRE
Connector Color	WHITE



8	7	6	5	4	3	2	1
16	15	14	13	12	11	10	9

Terminal No.	Color of Wire	Signal Name
1	B	-
2	W	-
3	SHIELD	-
4	P	-
5	Y	-
13	R	-
14	W	-
15	B	-
16	SHIELD	-

Connector No.	M55
Connector Name	AV CONTROL UNIT
Connector Color	BLUE



138	137
140	139
141	

Terminal No.	Color of Wire	Signal Name
137	W	VBUS
138	G	USB GND
139	L	USB D+
140	R	USB D-
141	SHIELD	SHIELD

ABNIA4636GB

A  
B  
C  
D  
E  
F  
G  
H  
I  
J  
K  
L  
M  
N  
O  
P

AV

# BOSE AUDIO W/NAVI W/O SURROUND

[BOSE AUDIO W/NAVI W/O SURROUND]

< WIRING DIAGRAM >

Connector No.	M64
Connector Name	WIRE TO WIRE
Connector Color	WHITE

7	8	5	4	3	2	1		
16	15	14	13	12	11	10	9	8



Terminal No.	Color of Wire	Signal Name
3	B	-
9	B	-

Terminal No.	Color of Wire	Signal Name
10	SHIELD	-
11	W	-
12	B	-
13	L	-
14	G	-
15	R	-
16	SHIELD	-
17	W	-
18	B	-
19	L	-
20	G	-
21	R	-
22	SHIELD	-
23	W	-
24	B	-

Connector No.	M63
Connector Name	WIRE TO WIRE
Connector Color	WHITE

12	11	10	9	8	7	6	5	4	3	2	1
24	23	22	21	20	19	18	17	16	15	14	13



Terminal No.	Color of Wire	Signal Name
1	SB	-
2	G	-
3	R	-
4	SHIELD	-
5	W	-
6	B	-
7	V	-
8	G	-
9	R	-

Terminal No.	Color of Wire	Signal Name
6	B	-(WITH REAR ENTERTAINMENT SYSTEM)
7	SB	-(WITH REAR ENTERTAINMENT SYSTEM)
8	G	-(WITH REAR ENTERTAINMENT SYSTEM)
9	R	-(WITH REAR ENTERTAINMENT SYSTEM)
10	SHIELD	-
11	W	-(WITH REAR ENTERTAINMENT SYSTEM)
12	B	-(WITH REAR ENTERTAINMENT SYSTEM)
13	Y	-
14	SB	-
15	LG	-

Connector No.	M66
Connector Name	WIRE TO WIRE
Connector Color	WHITE

12	11	10	9	8	7	6	5	4	3	2	1
24	23	22	21	20	19	18	17	16	15	14	13



Terminal No.	Color of Wire	Signal Name
1	L	-
2	G	-
3	R	-(WITH REAR ENTERTAINMENT SYSTEM)
4	SHIELD	-(WITH REAR ENTERTAINMENT SYSTEM)
5	W	-(WITH REAR ENTERTAINMENT SYSTEM)

Connector No.	M65
Connector Name	WIRE TO WIRE
Connector Color	WHITE

16	15	14	13	12	11	10	9	8	7	6	5	4	3	2	1
32	31	30	29	28	27	26	25	24	23	22	21	20	19	18	17



Terminal No.	Color of Wire	Signal Name
11	P	-
12	G	-
13	SHIELD	-
14	B	-
15	R	-
16	W	-
30	SHIELD	-
31	B	-
32	W	-

ABNIA4637GB

# BOSE AUDIO W/NAVI W/O SURROUND

## [BOSE AUDIO W/NAVI W/O SURROUND]

< WIRING DIAGRAM >

Connector No.	M68
Connector Name	FUSE BLOCK (J/B)
Connector Color	BROWN



Terminal No.	Color of Wire	Signal Name
2R	LG	-
5R	Y	-

Connector No.	M67
Connector Name	JOINT CONNECTOR-M04
Connector Color	WHITE



Terminal No.	Color of Wire	Signal Name
2	L	-
3	B	-

Terminal No.	Color of Wire	Signal Name
22	W	-(WITH REAR ENTERTAINMENT SYSTEM)
23	R	-(WITH REAR ENTERTAINMENT SYSTEM)
24	SHIELD	-
25	B	-
26	G	-
27	B	-(WITH NAVI)
28	R	-(WITH NAVI)
29	G	-(WITH NAVI)
30	SHIELD	-
31	W	-

Terminal No.	Color of Wire	Signal Name
5	B	-
6	W	-
7	SHIELD	-
8	B	-
17	Y	-(WITH REAR ENTERTAINMENT SYSTEM)
18	P	-(WITH REAR ENTERTAINMENT SYSTEM)
19	B	-(WITH REAR ENTERTAINMENT SYSTEM)
20	W	-(WITH REAR ENTERTAINMENT SYSTEM)
21	SHIELD	-(WITH REAR ENTERTAINMENT SYSTEM)

Connector No.	M69
Connector Name	WIRE TO WIRE
Connector Color	WHITE

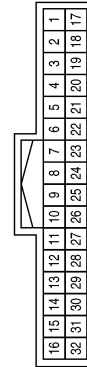

Terminal No.	Color of Wire	Signal Name
1	R	-(WITH REAR ENTERTAINMENT SYSTEM)
2	W	-(WITH REAR ENTERTAINMENT SYSTEM)
3	B	-(WITH REAR ENTERTAINMENT SYSTEM)
4	SHIELD	-

ABNIA4638GB

A  
B  
C  
D  
E  
F  
G  
H  
I  
J  
K  
L  
M  
N  
O  
P



# BOSE AUDIO W/NAVI W/O SURROUND

[BOSE AUDIO W/NAVI W/O SURROUND]

< WIRING DIAGRAM >

Connector No.	M73
Connector Name	INSTRUMENT PANEL TWEETER RH
Connector Color	BROWN



Terminal No.	Color of Wire	Signal Name
1	G	-(WITH BOSE AUDIO SYSTEM)
2	W	-(WITH BOSE AUDIO SYSTEM)

Terminal No.	Color of Wire	Signal Name
9	W	RIR SENSOR SIGNAL
10	W	ROR SENSOR SIGNAL
11	-	-
12	LG	IGN
13	B	FR SENSOR GND
14	B	RR SENSOR GND
15	GR	GND
16	-	-
17	-	-
18	-	-
19	BR	SPEAKER PWR
20	LG	SPEAKER RR SIGNAL
21	W	RIL SENSOR SIGNAL
22	W	ROL SENSOR SIGNAL
23	-	-
24	-	-

Connector No.	M70
Connector Name	SONAR CONTROL UNIT
Connector Color	WHITE

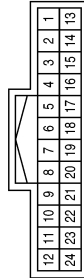

Terminal No.	Color of Wire	Signal Name
1	-	-
2	-	-
3	R	FOL SENSOR SIGNAL
4	R	FOR SENSOR SIGNAL
5	B	V CAN-H
6	W	V CAN-L
7	-	-
8	-	-

Terminal No.	Color of Wire	Signal Name
6	B	-(WITH REAR ENTERTAINMENT SYSTEM)
6	W	-(WITHOUT REAR ENTERTAINMENT SYSTEM)
7	W	-(WITH REAR ENTERTAINMENT SYSTEM)
7	R	-(WITHOUT REAR ENTERTAINMENT SYSTEM)
8	R	-(WITH REAR ENTERTAINMENT SYSTEM)
8	B	-(WITHOUT REAR ENTERTAINMENT SYSTEM)
9	SHIELD	-
10	G	-
11	L	-

Connector No.	M84
Connector Name	WIRE TO WIRE
Connector Color	WHITE

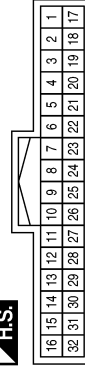

Terminal No.	Color of Wire	Signal Name
5	Y	-(WITH REAR ENTERTAINMENT SYSTEM)
5	P	-(WITHOUT REAR ENTERTAINMENT SYSTEM)

Connector No.	M80
Connector Name	BCM (BODY CONTROL MODULE)
Connector Color	BLACK

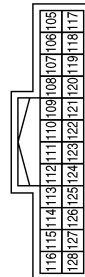

Terminal No.	Color of Wire	Signal Name
109	R	REVERSE SIGNAL
113	L	ACC RELAY OUT

ABNIA4639GB

# BOSE AUDIO W/NAVI W/O SURROUND

[BOSE AUDIO W/NAVI W/O SURROUND]

< WIRING DIAGRAM >

Terminal No.	Color of Wire	Signal Name
9	B	FRONT DISP IT
10	W	IT FRONT DISP
11	Y	BATT
12	B	GND
13	-	-
14	-	-
15	-	-
16	-	-
17	-	-
18	B	FRONT COMP +
19	W	FRONT COMP -
20	R	FRONT COMP SYNC
21	-	-
22	SHIELD	SHIELD
23	P	ACC
24	-	-

Connector No.	M92
Connector Name	DISPLAY UNIT (WITH NAVI)
Connector Color	WHITE

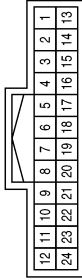

Terminal No.	Color of Wire	Signal Name
1	-	-
2	-	-
3	-	-
4	-	-
5	-	-
6	SHIELD	FRONT COMP SHIELD
7	SHIELD	SHIELD
8	B	R CAMERA COMP

Connector No.	M91
Connector Name	WIRE TO WIRE
Connector Color	WHITE

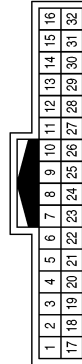

Terminal No.	Color of Wire	Signal Name
1	W	-
2	SHIELD	-
3	G	-
4	R	-
5	B	-

Connector No.	M95
Connector Name	WIRE TO WIRE
Connector Color	GRAY



Terminal No.	Color of Wire	Signal Name
1	B	-
2	B	-
3	B	-

ABNIA4640GB

A  
B  
C  
D  
E  
F  
G  
H  
I  
J  
K  
L  
M  
N  
O  
P

AV

# BOSE AUDIO W/NAVI W/O SURROUND

[BOSE AUDIO W/NAVI W/O SURROUND]

< WIRING DIAGRAM >

Terminal No.	Color of Wire	Signal Name
24	-	-
25	LG	REV
26	-	-
27	B	V-CAN1 H
28	W	V-CAN1 L
29	SHIELD	V-CAN1 GND
30	W	MIRROR SIGNAL 2
31	-	-
32	G	MIRROR SIGNAL 1
33	-	-
34	-	-
35	-	-
36	-	-
37	-	-
38	-	-
39	-	-
40	-	-

Terminal No.	Color of Wire	Signal Name
8	-	-
9	-	-
10	-	-
11	-	-
12	-	-
13	-	-
14	-	-
15	-	-
16	-	-
17	-	-
18	-	-
19	B	MCAN-1H
20	W	MCAN-1L
21	-	-
22	-	-
23	SHIELD	MCAN GND

Connector No.	M96
Connector Name	AROUND VIEW MONITOR CONTROL UNIT
Connector Color	WHITE



2	4	6	8	10	12	14	16	18	20	22	24	26	28	30	32	34	36	38	40
1	3	5	7	9	11	13	15	17	19	21	23	25	27	29	31	33	35	37	39

Terminal No.	Color of Wire	Signal Name
1	B	GND
2	Y	+B
3	LG	IGN
4	P	ACC
5	-	-
6	-	-
7	-	-

Terminal No.	Color of Wire	Signal Name
62	B	SV1 POWER
63	-	-
64	R	SV1 POWER GND
65	G	SV1 VIDEO +
66	SHIELD	SV1 VIDEO -
67	B	FV SERIAL SIGNAL
68	W	FV POWER
69	-	-
70	G	FV POWER GND
71	R	FV VIDEO +
72	SHIELD	FV VIDEO -

Terminal No.	Color of Wire	Signal Name
48	SHIELD	VIDEO OUTPUT -
49	W	RV SERIAL SIGNAL
50	B	RV POWER
51	-	-
52	R	RV POWER GND
53	G	RV VIDEO +
54	SHIELD	RV VIDEO -
55	B	SV2 SERIAL SIGNAL
56	W	SV2 POWER
57	-	-
58	G	SV2 POWER GND
59	R	SV2 VIDEO +
60	SHIELD	SV2 POWER GND
61	W	SV1 SERIAL SIGNAL

Connector No.	M97
Connector Name	AROUND VIEW MONITOR CONTROL UNIT
Connector Color	WHITE



42	44	46	48	50	52	54	56	58	60	62	64	66	68	70	72
41	43	45	47	49	51	53	55	57	59	61	63	65	67	69	71

Terminal No.	Color of Wire	Signal Name
41	-	-
42	-	-
43	-	-
44	-	-
45	-	-
46	-	-
47	B	VIDEO OUTPUT +

ABNIA4641GB



# BOSE AUDIO W/NAVI W/O SURROUND

## [BOSE AUDIO W/NAVI W/O SURROUND]

< WIRING DIAGRAM >

Connector No.	M110
Connector Name	CENTER SPEAKER
Connector Color	BROWN



Terminal No.	Color of Wire	Signal Name
1	G	-
2	W	-

Connector No.	M109
Connector Name	FRONT TWEETER LH
Connector Color	BROWN



Terminal No.	Color of Wire	Signal Name
1	P	-(WITH BOSE AUDIO SYSTEM WITHOUT SURROUND SOUND SYSTEM)
2	W	-(WITH BOSE AUDIO SYSTEM WITHOUT SURROUND SOUND SYSTEM)

Connector No.	M98
Connector Name	A/C AND AV SWITCH ASSEMBLY
Connector Color	WHITE

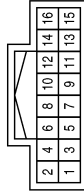

Terminal No.	Color of Wire	Signal Name
1	GR	-
3	P	-
4	R	-
5	B	-
6	SB	-
8	LG	-
9	V	-
14	Y	-

Connector No.	M120
Connector Name	JOINT CONNECTOR-M21
Connector Color	WHITE

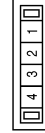

Terminal No.	Color of Wire	Signal Name
1	LG	-
3	LG	-

Connector No.	M115
Connector Name	WIRE TO WIRE
Connector Color	GRAY

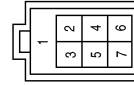

Terminal No.	Color of Wire	Signal Name
1	SHIELD	-
2	W	-
3	G	-
4	R	-
6	L	-

Connector No.	M111
Connector Name	FRONT TWEETER RH
Connector Color	BROWN



Terminal No.	Color of Wire	Signal Name
1	G	-(WITH BOSE AUDIO SYSTEM WITHOUT SURROUND SOUND SYSTEM)
2	W	-(WITH BOSE AUDIO SYSTEM WITHOUT SURROUND SOUND SYSTEM)

ABNIA4642GB

A  
B  
C  
D  
E  
F  
G  
H  
I  
J  
K  
L  
M  
N  
O  
P

AV

# BOSE AUDIO W/NAVI W/O SURROUND

[BOSE AUDIO W/NAVI W/O SURROUND]

< WIRING DIAGRAM >

Terminal No.	Color of Wire	Signal Name
12	B	FR RH PRE -
13	B	RR RH PRE +
14	W	RR RH PRE -
15	B	STRG SW GND
16	W	STRG SW B
17	-	-
18	-	-
19	Y	(+) B
20	GR	GND

Terminal No.	Color of Wire	Signal Name
3	W	FR LH PRE -
4	B	RR LH PRE +
5	W	RR LH PRE -
6	G	STRG SW A
7	G	ACC (WITH TELEMATICS SYSTEM)
7	P	ACC (WITHOUT TELEMATICS SYSTEM)
8	-	-
9	-	-
10	BR	SHIELD
11	W	FR RH PRE +

Connector No.	M122
Connector Name	AV CONTROL UNIT (WITH BOSE AUDIO SYSTEM - WITH NAVI WITHOUT SURROUND SOUND SYSTEM)
Connector Color	WHITE

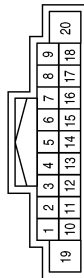

Terminal No.	Color of Wire	Signal Name
1	SB	AMP ON
2	B	FR LH PRE +

Terminal No.	Color of Wire	Signal Name
37	SHIELD	AUX SHIELD
38	R	AUX AUDIO RH
39	B	AUX AUDIO
40	R	HP 1 LH-
41	G	HP 1 RH-
42	SHIELD	HP 1 SHIELD
43	-	-
44	-	-
45	-	-
46	-	-
47	-	-
48	-	-

Terminal No.	Color of Wire	Signal Name
25	-	-
26	W	HP 1 LH+
27	B	HP 1 RH-
28	-	-
29	-	-
30	-	-
31	-	-
32	-	-
33	-	-
34	-	-
35	-	-
36	-	-

Connector No.	M123
Connector Name	AV CONTROL UNIT (WITH BOSE AUDIO SYSTEM - WITH NAVI WITHOUT SURROUND SOUND SYSTEM)
Connector Color	WHITE

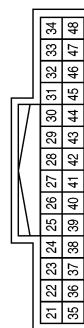

Terminal No.	Color of Wire	Signal Name
21	-	-
22	-	-
23	-	-
24	W	AUX AUDIO LH

ABNIA4643GB

# BOSE AUDIO W/NAVI W/O SURROUND

[BOSE AUDIO W/NAVI W/O SURROUND]

< WIRING DIAGRAM >

Terminal No.	Color of Wire	Signal Name
68	LG	IGN
69	R	REVERSE SIG
70	BG	SPEED
71	SHIELD	NAVI COMP 1 SHIELD
72	R	NAVI COMP 1 SYNC
73	-	-
74	-	-
75	B	MIC SIG
76	SHIELD	DISP SHIELD
77	B	DISP IT
78	L	CAN-H
79	SB	M CAN-H
80	SB	M CAN-H TRM

Terminal No.	Color of Wire	Signal Name
54	-	-
55	W	NAVI COMP 1-
56	B	NAVI COMP 1+
57	BG	I-KEY MEMORY
58	G	AV-ACC (DCM)
59	SHIELD	PKB SIGMIC GND
60	W	MIC VCC
61	W	IT DISP
62	P	CAN-L
63	LG	M CAN-L
64	LG	M CAN-L TRM
65	-	-
66	-	-
67	P	MR OUTPUT

Connector No.	M124
Connector Name	AV CONTROL UNIT (WITH BOSE AUDIO SYSTEM - WITH NAVI WITHOUT SURROUND SOUND SYSTEM)
Connector Color	WHITE

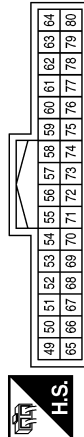

Terminal No.	Color of Wire	Signal Name
49	-	-
50	-	-
51	-	-
52	-	-
53	G	PKB SIG

Terminal No.	Color of Wire	Signal Name
104	-	-
105	W	NAVI COMP 2-
106	SHIELD	NAVI COMP 2 SHIELD
107	B	NAVI COMP 2+
108	-	-
109	-	-
110	-	-
111	-	-
112	-	-
113	-	-
114	-	-
115	-	-
116	-	-
117	-	-
118	-	-
119	-	-
120	-	-

Terminal No.	Color of Wire	Signal Name
87	-	-
88	-	-
89	-	-
90	-	-
91	W	AUX VIDEO+
92	B	AUX VIDEO-
93	-	-
94	SHIELD	VIDEO SHIELD
95	-	-
96	-	-
97	Y	DVD EJECT
98	V	EJECT GND
99	-	-
100	-	-
101	-	-
102	-	-
103	-	-

Connector No.	M125
Connector Name	AV CONTROL UNIT (WITH BOSE AUDIO SYSTEM - WITH NAVI WITHOUT SURROUND SOUND SYSTEM)
Connector Color	WHITE

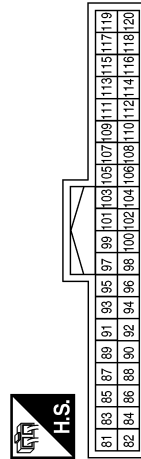

Terminal No.	Color of Wire	Signal Name
81	-	-
82	-	-
83	-	-
84	-	-
85	-	-
86	-	-

ABNIA4644GB

A  
B  
C  
D  
E  
F  
G  
H  
I  
J  
K  
L  
M  
N  
O  
P

AV

# BOSE AUDIO W/NAVI W/O SURROUND

< WIRING DIAGRAM >

[BOSE AUDIO W/NAVI W/O SURROUND]

Terminal No.	Color of Wire	Signal Name
46	W	MANUFACTURE SPECIFIC
47	B	USB VBUS
48	B	USB D-
49	B	D-VOICE
50	-	-
51	-	-
52	-	-
53	-	-
54	-	-
55	SHIELD	USB GND
56	L/W	D+
57	SHIELD	CONN CHASSIS GND

Connector No.	M134
Connector Name	TCU
Connector Color	GRAY

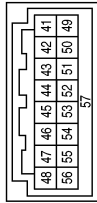

Terminal No.	Color of Wire	Signal Name
41	W	U-VOICE
42	L	VOICE GND
43	-	-
44	-	-
45	-	-

Connector No.	M133
Connector Name	AV CONTROL UNIT
Connector Color	BROWN

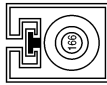

Terminal No.	Color of Wire	Signal Name
166	B	-

Terminal No.	Color of Wire	Signal Name
150	-	-
151	L	VOICE GND
152	W	U-VOICE
153	L/W	D+
154	SHIELD	USB GND
155	-	-
156	-	-
157	-	-
158	-	-
159	-	-
160	B	D-VOICE
161	SHIELD	CONN CHASSIS GND

Connector No.	M136
Connector Name	AV CONTROL UNIT
Connector Color	GRAY

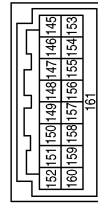

Terminal No.	Color of Wire	Signal Name
145	B	USB D-
146	B	USB VBUS
147	W	MANUFACTURE SPECIFIC
148	-	-
149	-	-

Connector No.	M135
Connector Name	TCU
Connector Color	BROWN



Terminal No.	Color of Wire	Signal Name
58	B	-
59	SHIELD	-

ABNIA4645GB

# BOSE AUDIO W/NAVI W/O SURROUND

[BOSE AUDIO W/NAVI W/O SURROUND]

< WIRING DIAGRAM >

Connector No.	M141
Connector Name	DISPLAY UNIT
Connector Color	BROWN



Terminal No.	Color of Wire	Signal Name
25	SHIELD	SHIELD
26	SHIELD	GND
27	B	GVIF+
28	B	GVIF-

Connector No.	M140
Connector Name	AV CONTROL UNIT
Connector Color	BLUE



Terminal No.	Color of Wire	Signal Name
162	SHIELD	SHIELD
163	SHIELD	GND
164	B	GVIF-
165	B	GVIF+

Connector No.	M138
Connector Name	WIRE TO WIRE
Connector Color	GREEN



Terminal No.	Color of Wire	Signal Name
1	B	-

Connector No.	M149
Connector Name	COMBINATION SWITCH (SPIRAL CABLE)
Connector Color	GRAY



Terminal No.	Color of Wire	Signal Name
14	B	-
15	GR	-
17	BR	-

Connector No.	M143
Connector Name	AV CONTROL UNIT
Connector Color	GRAY



Terminal No.	Color of Wire	Signal Name
142	B	ANT +B
143	B	ANT MAIN
144	B	ANT SUB

ABNIA4646GB

A  
B  
C  
D  
E  
F  
G  
H  
I  
J  
K  
L  
M  
N  
O  
P

AV

# BOSE AUDIO W/NAVI W/O SURROUND

< WIRING DIAGRAM >

[BOSE AUDIO W/NAVI W/O SURROUND]

Connector No.	M158
Connector Name	WIRE TO WIRE
Connector Color	WHITE

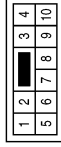

Terminal No.	Color of Wire	Signal Name
9	G	-(WITH BOSE AUDIO SYSTEM)
10	W	-(WITH BOSE AUDIO SYSTEM)

Terminal No.	Color of Wire	Signal Name
7	B	-
8	B	-
9	B	-
10	B	-
11	B	-
23	GR	-
24	SHIELD	-
25	SHIELD	-
26	SHIELD	-
27	SHIELD	-
28	SHIELD	-
29	SHIELD	-
30	SHIELD	-
31	GR	-

Connector No.	M150
Connector Name	JOINT CONNECTOR-M27
Connector Color	WHITE

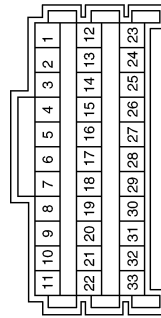

Terminal No.	Color of Wire	Signal Name
4	B	-
5	B	-
6	B	-

Connector No.	M170
Connector Name	JOINT CONNECTOR-M09
Connector Color	WHITE

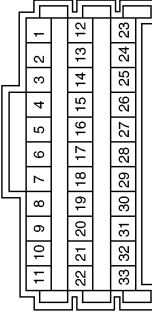

Connector No.	M168
Connector Name	WIRE TO WIRE
Connector Color	WHITE

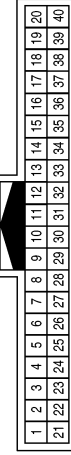

Terminal No.	Color of Wire	Signal Name
6	GR	-
7	SHIELD	-
8	SHIELD	-
9	SHIELD	-
10	SHIELD	-

Terminal No.	Color of Wire	Signal Name
22	W	-
23	G	-
28	B	-
29	SHIELD	-
30	R	-
31	G	-
32	W	-

Connector No.	M167
Connector Name	WIRE TO WIRE
Connector Color	WHITE



Terminal No.	Color of Wire	Signal Name
8	W	-(WITH BOSE AUDIO SYSTEM)
9	P	-(WITH BOSE AUDIO SYSTEM WITHOUT SURROUND SOUND SYSTEM)

ABNIA4647GB

# BOSE AUDIO W/NAVI W/O SURROUND

[BOSE AUDIO W/NAVI W/O SURROUND]

< WIRING DIAGRAM >

Connector No.	M171
Connector Name	JOINT CONNECTOR-M10
Connector Color	WHITE



Terminal No.	Color of Wire	Signal Name
2	P	-(WITH BOSE AUDIO SYSTEM)
3	P	-(WITH BOSE AUDIO SYSTEM)
4	P	-(WITH BOSE AUDIO SYSTEM)

Connector No.	M172
Connector Name	JOINT CONNECTOR-M11
Connector Color	WHITE

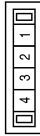

Terminal No.	Color of Wire	Signal Name
2	W	-(WITH BOSE AUDIO SYSTEM)
3	W	-(WITH BOSE AUDIO SYSTEM)
4	W	-(WITH BOSE AUDIO SYSTEM)

Connector No.	M173
Connector Name	JOINT CONNECTOR-M12
Connector Color	WHITE



Terminal No.	Color of Wire	Signal Name
2	G	-(WITH BOSE AUDIO SYSTEM)
3	G	-(WITH BOSE AUDIO SYSTEM)
4	G	-(WITH BOSE AUDIO SYSTEM)

Connector No.	M174
Connector Name	JOINT CONNECTOR-M13
Connector Color	WHITE

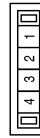

Terminal No.	Color of Wire	Signal Name
2	W	-(WITH BOSE AUDIO SYSTEM)
3	W	-(WITH BOSE AUDIO SYSTEM)
4	W	-(WITH BOSE AUDIO SYSTEM)

Connector No.	M175
Connector Name	JOINT CONNECTOR-M22
Connector Color	WHITE

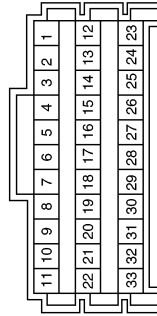

Terminal No.	Color of Wire	Signal Name
1	Y	-
2	Y	-
3	Y	-

Terminal No.	Color of Wire	Signal Name
4	Y	-
5	Y	-
6	Y	-
7	Y	-
8	Y	-
9	Y	-
29	P	-
30	P	-
31	P	-
32	P	-

ABNIA4648GB

A  
B  
C  
D  
E  
F  
G  
H  
I  
J  
K  
L  
M  
O  
P

AV

# BOSE AUDIO W/NAVI W/O SURROUND

[BOSE AUDIO W/NAVI W/O SURROUND]

< WIRING DIAGRAM >

Connector No.	M178
Connector Name	JOINT CONNECTOR-M58
Connector Color	WHITE



Terminal No.	Color of Wire	Signal Name
1	SB	-
2	B	-
3	SB	-

Connector No.	M177
Connector Name	JOINT CONNECTOR-M57
Connector Color	WHITE



Terminal No.	Color of Wire	Signal Name
1	LG	-
2	LG	-
3	LG	-
4	LG	-

Connector No.	M176
Connector Name	JOINT CONNECTOR-M56
Connector Color	WHITE



Terminal No.	Color of Wire	Signal Name
1	SB	-
2	SB	-
3	SB	-
4	SB	-

Connector No.	M201
Connector Name	WIRES TO WIRE
Connector Color	WHITE

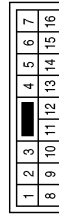

Terminal No.	Color of Wire	Signal Name
1	B	-
2	Y	-
3	V	-

Connector No.	M179
Connector Name	JOINT CONNECTOR-M59
Connector Color	WHITE



Terminal No.	Color of Wire	Signal Name
1	LG	-
2	W	-
3	LG	-

ABNIA4649GB



# BOSE AUDIO W/NAVI W/O SURROUND

[BOSE AUDIO W/NAVI W/O SURROUND]

< WIRING DIAGRAM >

Terminal No.	Color of Wire	Signal Name
28	W	-
29	L	-
30	G	-
31	R	-
32	SHIELD	-
33	W	-
34	B	-
35	L	-
36	G	-
37	R	-
38	SHIELD	-
39	W	-
40	B	-

Terminal No.	Color of Wire	Signal Name
11	R	-
12	SHIELD	-
13	W	-
14	B	-
15	V	-
16	G	-
17	R	-
18	SHIELD	-
19	W	-
20	B	-
24	B	-
25	SHIELD	-
26	B	-
27	R	-

Connector No.	M202
Connector Name	WIRE TO WIRE
Connector Color	WHITE

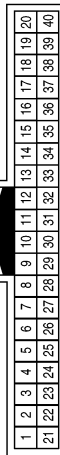

Terminal No.	Color of Wire	Signal Name
6	SHIELD	-
7	B	-
8	W	-
9	SB	-
10	G	-

Connector No.	M210
Connector Name	WIRE TO WIRE
Connector Color	GRAY

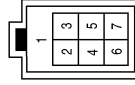

Connector No.	M209
Connector Name	USB INTERFACE
Connector Color	GREEN

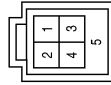

Connector No.	M205
Connector Name	FRONT AUXILIARY INPUT JACKS
Connector Color	WHITE

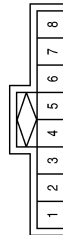

Terminal No.	Color of Wire	Signal Name
1	SHIELD	-
2	W	-
3	G	-
4	R	-
6	L	-

Terminal No.	Color of Wire	Signal Name
1	G	-
2	W	-
3	R	-
4	L	-
5	SHIELD	-

Terminal No.	Color of Wire	Signal Name
1	R	-
2	B	-
3	W	-
4	-	-
5	G	-
6	P	-
7	W	-
8	B	-

ABNIA4650GB

A  
B  
C  
D  
E  
F  
G  
H  
I  
J  
K  
L  
M  
N  
O  
P

AV

# BOSE AUDIO W/NAVI W/O SURROUND

[BOSE AUDIO W/NAVI W/O SURROUND]

< WIRING DIAGRAM >

Connector No.	M214
Connector Name	WIRE TO WIRE
Connector Color	WHITE



Terminal No.	Color of Wire	Signal Name
1	W	-
2	R	-
3	SHIELD	-
4	V	-
5	Y	-
13	W	-
14	R	-
15	B	-
16	SHIELD	-

Connector No.	M216
Connector Name	WIRE TO WIRE
Connector Color	WHITE

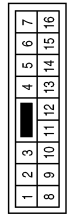

Terminal No.	Color of Wire	Signal Name
3	B	-
9	B	-

Connector No.	M215
Connector Name	WIRE TO WIRE
Connector Color	WHITE

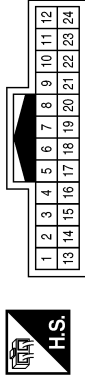

Terminal No.	Color of Wire	Signal Name
1	SB	-
2	G	-
3	R	-
4	SHIELD	-
5	W	-
6	B	-
7	V	-
8	G	-
9	R	-

Connector No.	M217
Connector Name	WIRE TO WIRE
Connector Color	WHITE

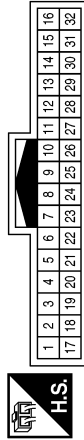

Terminal No.	Color of Wire	Signal Name
11	P	-
12	G	-
13	SHIELD	-
14	B	-
15	W	-
16	R	-
30	SHIELD	-
31	B	-
32	W	-

Terminal No.	Color of Wire	Signal Name
10	SHIELD	-
11	W	-
12	B	-
13	L	-
14	G	-
15	R	-
16	SHIELD	-
17	W	-
18	B	-
19	L	-
20	G	-
21	R	-
22	SHIELD	-
23	W	-
24	B	-

Connector No.	M230
Connector Name	JOINT CONNECTOR-M01
Connector Color	GRAY

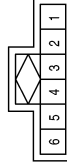

Terminal No.	Color of Wire	Signal Name
2	B	-
3	SHIELD	-
4	SHIELD	-

# BOSE AUDIO W/NAVI W/O SURROUND

< WIRING DIAGRAM >

[BOSE AUDIO W/NAVI W/O SURROUND]

Terminal No.	Color of Wire	Signal Name
17	R	-
18	BG	-
19	G	-
20	B	-
21	SHIELD	-
22	W	-
23	SHIELD	-
24	W	-
25	G	-
26	B	-
27	R	-
28	L	-
29	P	-
30	W	-
31	G	-
32	B	-
33	R	-
34	-	-
35	SHIELD	-
36	-	-
37	-	-
38	V	-
39	B	-
40	Y	-

Connector No.	M254
Connector Name	REAR AUXILIARY INPUT JACKS
Connector Color	WHITE

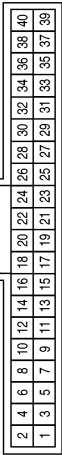
Terminal No.	Color of Wire	Signal Name
1	W	-
2	B	-
3	B	-
4	R	-
5	B	-
6	-	-
7	-	-
8	-	-
9	SHIELD	-
10	-	-
11	R	-
12	-	-
13	G	-
14	B	-
15	V	-
16	W	-

Connector No.	M251
Connector Name	WIRE TO WIRE
Connector Color	WHITE

Terminal No.	Color of Wire	Signal Name
1	B	-
2	Y	-
3	V	-

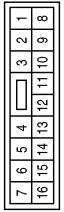
A  
B  
C  
D  
E  
F  
G  
H  
I  
J  
K  
L  
M  
N  
O  
P

AV

ABNIA4652GB

# BOSE AUDIO W/NAVI W/O SURROUND

[BOSE AUDIO W/NAVI W/O SURROUND]

< WIRING DIAGRAM >

Terminal No.	Color of Wire	Signal Name
27	B	-
28	W	-
29	L	-
30	G	-
31	R	-
32	SHIELD	-
33	W	-
34	B	-
35	P	-
36	G	-
37	R	-
38	SHIELD	-
39	W	-
40	B	-

Terminal No.	Color of Wire	Signal Name
12	SHIELD	-
13	W	-
14	B	-
15	V	-
16	G	-
17	R	-
18	SHIELD	-
19	W	-
20	B	-
24	B	-
25	SHIELD	-
26	R	-

Connector No.	M257
Connector Name	WIRE TO WIRE
Connector Color	WHITE

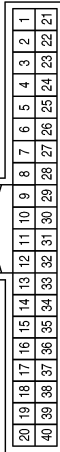

Terminal No.	Color of Wire	Signal Name
6	SHIELD	-
7	B	-
8	W	-
9	BG	-
10	G	-
11	R	-

Connector No.	M502
Connector Name	ANTENNA BASE
Connector Color	GRAY



Terminal No.	Color of Wire	Signal Name
1	B	-
2	B	-

Connector No.	M501
Connector Name	ANTENNA BASE
Connector Color	GREEN

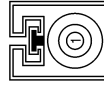

Terminal No.	Color of Wire	Signal Name
1	B	-

Connector No.	M500
Connector Name	WIRE TO WIRE
Connector Color	GRAY



Terminal No.	Color of Wire	Signal Name
1	B	-
2	B	-
3	B	-

ABNIA4653GB

# BOSE AUDIO W/NAVI W/O SURROUND

[BOSE AUDIO W/NAVI W/O SURROUND]

< WIRING DIAGRAM >

Connector No.	M505
Connector Name	GLASS ANTENNA (FM SUB)
Connector Color	GRAY



Terminal No.	Color of Wire	Signal Name
1	B	-

Connector No.	M504
Connector Name	WIRE TO WIRE
Connector Color	GRAY



Terminal No.	Color of Wire	Signal Name
1	B	-

Connector No.	M503
Connector Name	WIRE TO WIRE
Connector Color	GRAY



Terminal No.	Color of Wire	Signal Name
1	B	-

Connector No.	E26
Connector Name	WIRE TO WIRE
Connector Color	WHITE



Terminal No.	Color of Wire	Signal Name
2	W	-
3	B	-
4	SHIELD	-
5	B	-
6	R	-
8	SHIELD	-
13	R	-
14	B	-
15	G	-
16	SHIELD	-
17	W	-

Connector No.	E22
Connector Name	ACCESSORY RELAY-2
Connector Color	BLUE



Terminal No.	Color of Wire	Signal Name
1	G	-
2	B	-
3	R	-
5	P	-

Connector No.	M509
Connector Name	WIRE TO WIRE
Connector Color	GREEN

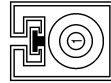

Terminal No.	Color of Wire	Signal Name
1	B	-

ABNIA4654GB

A  
B  
C  
D  
E  
F  
G  
H  
I  
J  
K  
L  
M  
N  
O  
P

AV

# BOSE AUDIO W/NAVI W/O SURROUND

[BOSE AUDIO W/NAVI W/O SURROUND]

< WIRING DIAGRAM >

Connector No.	E52
Connector Name	PARKING BRAKE SWITCH
Connector Color	BLACK



Terminal No.	Color of Wire	Signal Name
1	LG	-

Connector No.	E44
Connector Name	JOINT CONNECTOR-E01
Connector Color	WHITE

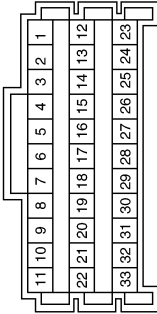

Terminal No.	Color of Wire	Signal Name
15	GR	-
17	B	-

Connector No.	E33
Connector Name	WIRE TO WIRE
Connector Color	WHITE

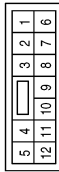

Terminal No.	Color of Wire	Signal Name
4	P	-

Connector No.	E209
Connector Name	WIRE TO WIRE
Connector Color	WHITE

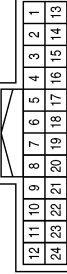

Terminal No.	Color of Wire	Signal Name
2	L	-
3	B	-
4	SHIELD	-
5	B	-
6	R	-
8	SHIELD	-
13	R	-
14	B	-
15	G	-
16	SHIELD	-
17	W	-

Terminal No.	Color of Wire	Signal Name
3G	P	-
16G	R	-
17G	B	-
18G	SHIELD	-
22G	B	-
23G	SHIELD	-
25G	W	-
26G	SHIELD	-
27G	W	-
28G	R	-
29G	B	-
30G	G	-
33G	LG	-
50G	G	-

Connector No.	E152
Connector Name	WIRE TO WIRE
Connector Color	WHITE

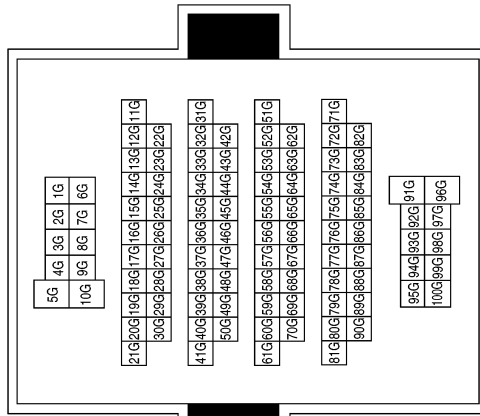

ABNIA4655GB

# BOSE AUDIO W/NAVI W/O SURROUND

## [BOSE AUDIO W/NAVI W/O SURROUND]

< WIRING DIAGRAM >

Connector No.	E226
Connector Name	FRONT CAMERA
Connector Color	BLACK

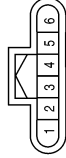

Terminal No.	Color of Wire	Signal Name
1	R	-
2	B	-
3	G	-
4	SHIELD	-
6	W	-

Connector No.	E212
Connector Name	WIRE TO WIRE
Connector Color	GRAY

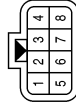

Terminal No.	Color of Wire	Signal Name
1	L	-
2	B	-

Connector No.	E211
Connector Name	WIRE TO WIRE
Connector Color	GRAY

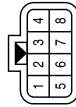

Terminal No.	Color of Wire	Signal Name
1	R	-
2	B	-

Connector No.	E307
Connector Name	FRONT SONAR SENSOR LH OUTER
Connector Color	BLACK



Terminal No.	Color of Wire	Signal Name
1	P	-
2	G	-

Connector No.	E302
Connector Name	WIRE TO WIRE
Connector Color	GRAY

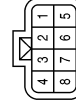

Terminal No.	Color of Wire	Signal Name
1	G	-
2	P	-

Connector No.	E301
Connector Name	WIRE TO WIRE
Connector Color	GRAY

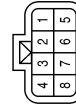

Terminal No.	Color of Wire	Signal Name
1	G	-
2	P	-

ABNIA4656GB

A  
B  
C  
D  
E  
F  
G  
H  
I  
J  
K  
L  
M  
AV  
O  
P

# BOSE AUDIO W/NAVI W/O SURROUND

[BOSE AUDIO W/NAVI W/O SURROUND]

< WIRING DIAGRAM >

Connector No.	B5
Connector Name	FRONT SEAT LH (PRE-WIRING)
Connector Color	WHITE

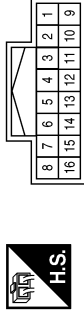

Terminal No.	Color of Wire	Signal Name
2	SHIELD	-
3	W	-
4	SHIELD	-
5	B	-
6	R	-
7	G	-
8	R	-
10	SHIELD	-
11	W	-
12	SHIELD	-
13	B	-
14	R	-
15	B	-
16	L	-

Connector No.	B1
Connector Name	REAR SIDE SPEAKER LH
Connector Color	BROWN



Terminal No.	Color of Wire	Signal Name
1	W	-
2	G	-

Connector No.	E308
Connector Name	FRONT SONAR SENSOR RH OUTER
Connector Color	BLACK



Terminal No.	Color of Wire	Signal Name
1	P	-
2	G	-

Terminal No.	Color of Wire	Signal Name
9	B	-(WITH REAR ENTERTAINMENT SYSTEM)
10	SHIELD	-
11	R	-(WITH REAR ENTERTAINMENT SYSTEM)
12	W	-
13	SB	-
14	SB	-
15	LG	-

Terminal No.	Color of Wire	Signal Name
4	SHIELD	-(WITH REAR ENTERTAINMENT SYSTEM)
5	W	-(WITH REAR ENTERTAINMENT SYSTEM)
6	B	-(WITH REAR ENTERTAINMENT SYSTEM)
7	V	-(WITH REAR ENTERTAINMENT SYSTEM)
8	G	-(WITH REAR ENTERTAINMENT SYSTEM)

Connector No.	B6
Connector Name	WIRE TO WIRE
Connector Color	WHITE

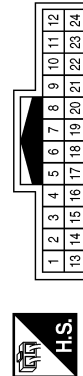

Terminal No.	Color of Wire	Signal Name
1	P	-
2	G	-
3	R	-(WITH REAR ENTERTAINMENT SYSTEM)

ABNIA4657GB



# BOSE AUDIO W/NAVI W/O SURROUND

< WIRING DIAGRAM >

[BOSE AUDIO W/NAVI W/O SURROUND]

Terminal No.	Color of Wire	Signal Name
13	-	-
14	R	-
15	G	-
16	B	-
17	W	-
18	V	-
19	V	-
20	B	-
21	G	-
22	W	-
23	R	-
24	-	-
25	-	-
26	-	-
27	W	-
28	B	-
29	SHIELD	-
30	SHIELD	-
31	P	-
32	L	-

Connector No.	B24
Connector Name	VIDEO DISTRIBUTOR
Connector Color	WHITE

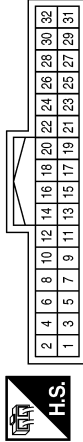

Terminal No.	Color of Wire	Signal Name
1	B	-
2	V	-
3	B	-
4	W	-
5	BR	-
6	L	-
7	SB	-
8	BR	-
9	SB	-
10	L	-
11	-	-
12	-	-

Connector No.	B23
Connector Name	WIRE TO WIRE
Connector Color	WHITE

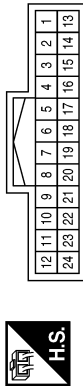

Terminal No.	Color of Wire	Signal Name
1	SB	-
3	SB	-
4	LG	-
6	BR	-
8	P	-
9	L	-
10	SHIELD	-
11	R	-
12	B	-
13	B	-
15	SB	-
16	LG	-
18	L	-
19	SB	-
21	P	-
22	SHIELD	-
23	G	-
24	W	-

ABNIA4658GB

A  
B  
C  
D  
E  
F  
G  
H  
I  
J  
K  
L  
M  
N  
O  
P

AV

# BOSE AUDIO W/NAVI W/O SURROUND

< WIRING DIAGRAM >

[BOSE AUDIO W/NAVI W/O SURROUND]

Terminal No.	Color of Wire	Signal Name
49	SHIELD	-
50	-	-
51	-	-
52	-	-
53	SHIELD	-
54	B	-
55	R	-
56	W	-

Terminal No.	Color of Wire	Signal Name
38	-	-
39	W	-
40	B	-
41	SHIELD	-
42	-	-
43	-	-
44	-	-
45	W	-
46	R	-
47	B	-
48	G	-

Connector No.	B25
Connector Name	VIDEO DISTRIBUTOR
Connector Color	WHITE

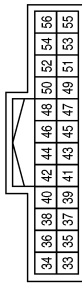

Terminal No.	Color of Wire	Signal Name
33	W	-
34	B	-
35	SHIELD	-
36	-	-
37	-	-

Connector No.	B35
Connector Name	SONAR BUZZER
Connector Color	WHITE

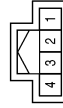

Terminal No.	Color of Wire	Signal Name
2	P	-
3	V	-

Terminal No.	Color of Wire	Signal Name
11	B	-
12	L	-
13	B	-
14	R	-
15	W	-
16	SHIELD	-

Connector No.	B32
Connector Name	WIRE TO WIRE
Connector Color	WHITE

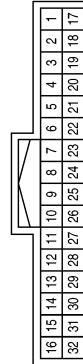

Terminal No.	Color of Wire	Signal Name
5	G	-
6	R	-
7	B	-
8	R	-
9	W	-
10	SHIELD	-

ABNIA4659GB

# BOSE AUDIO W/NAVI W/O SURROUND

## [BOSE AUDIO W/NAVI W/O SURROUND]

< WIRING DIAGRAM >

Terminal No.	Color of Wire	Signal Name
23	R	-- (WITH REAR ENTERTAINMENT SYSTEM)
24	SHIELD	--
25	B	--
26	G	--
27	W	-- (WITH NAVI)
28	R	-- (WITH NAVI)
29	G	-- (WITH NAVI)
30	SHIELD	--
31	B	--

Terminal No.	Color of Wire	Signal Name
6	W	--
7	SHIELD	--
8	B	--
17	V	-- (WITH REAR ENTERTAINMENT SYSTEM)
18	W	-- (WITH REAR ENTERTAINMENT SYSTEM)
19	B	-- (WITH REAR ENTERTAINMENT SYSTEM)
20	W	-- (WITH REAR ENTERTAINMENT SYSTEM)
21	SHIELD	-- (WITH REAR ENTERTAINMENT SYSTEM)
22	W	-- (WITH REAR ENTERTAINMENT SYSTEM)

Connector No.	B41
Connector Name	WIRE TO WIRE
Connector Color	WHITE

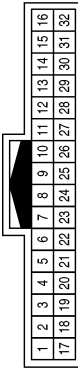

Terminal No.	Color of Wire	Signal Name
1	R	-- (WITH REAR ENTERTAINMENT SYSTEM)
2	W	-- (WITH REAR ENTERTAINMENT SYSTEM)
3	B	--
4	SHIELD	--
5	B	--

Connector No.	B49
Connector Name	WIRE TO WIRE
Connector Color	WHITE



Terminal No.	Color of Wire	Signal Name
9	G	--
10	W	--
11	P	--
12	R	--
13	SHIELD	--
14	B	--
15	W	--
16	W	--

Connector No.	B46
Connector Name	WIRE TO WIRE
Connector Color	WHITE



Terminal No.	Color of Wire	Signal Name
13	W	-- (WITH NAVI)
14	R	-- (WITH NAVI)
15	G	-- (WITH NAVI)
16	SHIELD	--
17	B	--

Connector No.	B43
Connector Name	WIRE TO WIRE
Connector Color	WHITE



Terminal No.	Color of Wire	Signal Name
4	G	--

ABNIA4660GB

A  
B  
C  
D  
E  
F  
G  
H  
I  
J  
K  
L  
M  
N  
O  
P

AV

# BOSE AUDIO W/NAVI W/O SURROUND

< WIRING DIAGRAM >

[BOSE AUDIO W/NAVI W/O SURROUND]

Terminal No.	Color of Wire	Signal Name
17A	W	-
18A	B	-
19A	SHIELD	-
20A	W	-
21A	SHIELD	-
23A	W	-
24A	B	-
25A	SHIELD	-
26A	W	-
27A	B	-
28A	SHIELD	-
30A	B	-
74A	P	-
75A	V	-

Connector No.	B69
Connector Name	WIRE TO WIRE
Connector Color	GRAY

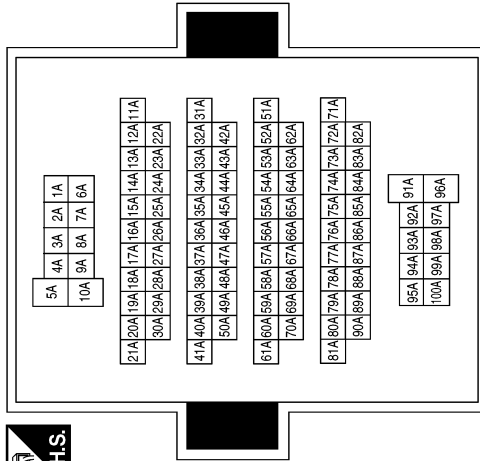

Connector No.	B51
Connector Name	WIRE TO WIRE
Connector Color	GRAY

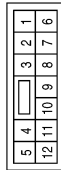

Terminal No.	Color of Wire	Signal Name
11	R	-
12	P	-

Terminal No.	Color of Wire	Signal Name
4	SB	-
5	BR	-
6	SHIELD	-
7	W	-
8	B	-
9	V	-
10	W	-
11	B	-
12	G	-
13	R	-
14	SHIELD	-

Connector No.	B75
Connector Name	WIRE TO WIRE
Connector Color	WHITE

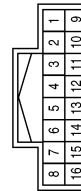

Terminal No.	Color of Wire	Signal Name
1	LG	-
2	SB	-
3	L	-

Connector No.	B73
Connector Name	SUBWOOFER
Connector Color	GRAY



Terminal No.	Color of Wire	Signal Name
1	B	-
2	W	-
4	W	-
5	B	-
6	G	-

ABNIA4661GB

# BOSE AUDIO W/NAVI W/O SURROUND

[BOSE AUDIO W/NAVI W/O SURROUND]

< WIRING DIAGRAM >

Connector No.	B107
Connector Name	WIRE TO WIRE
Connector Color	WHITE



1	2	3	4	5	6	7	8	9	10	11	12
13	14	15	16	17	18	19	20	21	22	23	24

Terminal No.	Color of Wire	Signal Name
6	B	-
7	V	-
8	G	-
9	R	-
10	SHIELD	-
11	B	-
12	W	-
19	P	-
20	G	-
21	SHIELD	-
22	B	-
23	R	-
24	W	-

Connector No.	B101
Connector Name	WIRE TO WIRE
Connector Color	WHITE



1	2	3	4	5	6	7	8	9	10	11	12	13	14	15	16
17	18	19	20	21	22	23	24	25	26	27	28	29	30	31	32

Terminal No.	Color of Wire	Signal Name
5	Y	-(WITH REAR ENTERTAINMENT SYSTEM)
5	V	-(WITHOUT REAR ENTERTAINMENT SYSTEM)
6	B	-(WITH REAR ENTERTAINMENT SYSTEM)
6	W	-(WITHOUT REAR ENTERTAINMENT SYSTEM)
7	W	-(WITH REAR ENTERTAINMENT SYSTEM)
7	R	-(WITHOUT REAR ENTERTAINMENT SYSTEM)
8	R	-(WITH REAR ENTERTAINMENT SYSTEM)
8	B	-(WITHOUT REAR ENTERTAINMENT SYSTEM)
9	SHIELD	-
10	G	-
11	SB	-

Connector No.	B77
Connector Name	WIRE TO WIRE
Connector Color	WHITE



1	2	3	4	5	6	7	8	9	10	11	12	13	14	15	16
17	18	19	20	21	22	23	24	25	26	27	28	29	30	31	32

Terminal No.	Color of Wire	Signal Name
17	W	-
18	B	-
19	SHIELD	-
21	B	-
22	W	-
23	SHIELD	-
24	W	-
25	B	-
26	SHIELD	-
27	W	-
28	B	-
29	SHIELD	-

ABNIA4662GB

A  
B  
C  
D  
E  
F  
G  
H  
I  
J  
K  
L  
M  
N  
O  
P



# BOSE AUDIO W/NAVI W/O SURROUND

[BOSE AUDIO W/NAVI W/O SURROUND]

< WIRING DIAGRAM >

Terminal No.	Color of Wire	Signal Name
16	SHIELD	-
17	SHIELD	-
18	B	-
19	G	-
20	R	-
21	G	-
22	R	-
23	W	-
24	SHIELD	-

Terminal No.	Color of Wire	Signal Name
5	W	-
6	B	-
7	L	-
8	G	-
9	R	-
10	W	-
11	SHIELD	-
12	V	-
13	B	-
14	R	-
15	W	-

Connector No.	B110
Connector Name	FRONT SEAT RH (PRE-WIRING)
Connector Color	WHITE

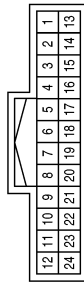

Terminal No.	Color of Wire	Signal Name
1	Y	-
2	V	-
3	B	-
4	R	-

Connector No.	B129
Connector Name	BOSE SPEAKER AMP.
Connector Color	BROWN

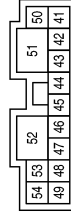

Connector No.	B124
Connector Name	WIRE TO WIRE
Connector Color	WHITE

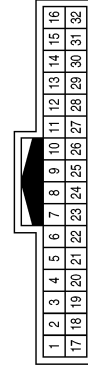

Terminal No.	Color of Wire	Signal Name
41	R	-
42	G	-
43	G	-
44	W	-
45	G	-
46	W	-
47	B	-
48	G	-
49	W	-
50	LG	-
51	Y	-
52	B	-
53	W	-
54	G	-

Terminal No.	Color of Wire	Signal Name
5	G	-
6	R	-
7	G	-
8	R	-
9	W	-
10	SHIELD	-
11	B	-
12	L	-
13	G	-
14	R	-
15	W	-
16	SHIELD	-

Terminal No.	Color of Wire	Signal Name
3	R	-
4	LG	-
5	Y	-
6	P	-
7	R	-
8	G	-
9	W	-
10	G	-
13	W	-
14	P	-
15	G	-
16	R	-

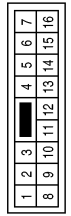

Connector No.	B111
Connector Name	WIRE TO WIRE
Connector Color	BROWN

ABNIA4663GB

# BOSE AUDIO W/NAVI W/O SURROUND

[BOSE AUDIO W/NAVI W/O SURROUND]

< WIRING DIAGRAM >

Connector No.	B137
Connector Name	WIRE TO WIRE
Connector Color	WHITE

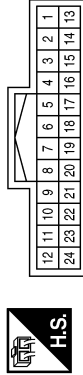

Terminal No.	Color of Wire	Signal Name
1	Y	-
3	SB	-
4	LG	-
6	SB	-
8	SB	-
9	O	-
10	SHIELD	-
11	R	-
12	B	-
13	B	-
15	SB	-(WITHOUT SURROUND SOUND SYSTEM)
16	L/G	-
18	LG	-
19	BR	-
21	Y	-
22	SHIELD	-
23	G	-
24	W	-

Connector No.	B136
Connector Name	WIRE TO WIRE
Connector Color	WHITE



Terminal No.	Color of Wire	Signal Name
9	B	-
10	W	-
11	SHIELD	-
12	B	-
13	W	-
14	SHIELD	-
15	B	-
16	W	-
17	SHIELD	-
18	W	-
19	LG	-(WITHOUT SURROUND SOUND SYSTEM)
20	SB	-(WITHOUT SURROUND SOUND SYSTEM)
21	B	-
22	W	-
23	SHIELD	-

Connector No.	B130
Connector Name	BOSE SPEAKER AMP.
Connector Color	BROWN

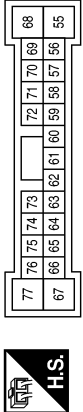

Terminal No.	Color of Wire	Signal Name
55	R	-
56	B	-
57	W	-
58	G	-
59	R	-
60	W	-
61	SHIELD	-
62	W	-
63	W	-
64	B	-
65	W	-
66	B	-
67	-	-
68	P	-
69	P	-
70	R	-
71	W	-
72	P	-
73	B	-
74	W	-
75	B	-
76	W	-
77	-	-

ABNIA4664GB

A  
B  
C  
D  
E  
F  
G  
H  
I  
J  
K  
L  
M  
N  
O  
P

AV

# BOSE AUDIO W/NAVI W/O SURROUND

< WIRING DIAGRAM >

[BOSE AUDIO W/NAVI W/O SURROUND]

Connector No.	B145
Connector Name	WIRE TO WIRE
Connector Color	WHITE

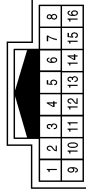

Terminal No.	Color of Wire	Signal Name
1	LG	-
2	SB	-
3	SB	-
4	L	-
5	BR	-
6	SHIELD	-
7	Y	-
8	O	-
9	V	-
10	B	-
11	W	-
12	G	-
13	R	-
14	SHIELD	-

Connector No.	B140
Connector Name	WIRE TO WIRE
Connector Color	WHITE

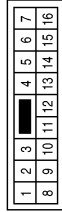

Terminal No.	Color of Wire	Signal Name
9	G	-
10	W	-
11	P	-
12	R	-
13	SHIELD	-
14	W	-
15	B	-
16	W	-

Connector No.	B139
Connector Name	WIRE TO WIRE
Connector Color	WHITE

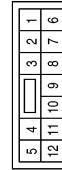

Terminal No.	Color of Wire	Signal Name
11	W	-(WITH BOSE AUDIO SYSTEM)
12	G	-(WITH BOSE AUDIO SYSTEM)

Connector No.	B153
Connector Name	REAR SIDE SPEAKER RH
Connector Color	BROWN



Terminal No.	Color of Wire	Signal Name
1	W	-
2	G	-

ABNIA4665GB





# BOSE AUDIO W/NAVI W/O SURROUND

< WIRING DIAGRAM >

[BOSE AUDIO W/NAVI W/O SURROUND]

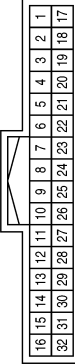

Terminal No.	Color of Wire	Signal Name
21	G	REAR1 COMP-
22	-	-
23	Y	CONT GND
24	SB	CON CK B
25	-	-
26	R	M-CAN 2L
27	LG	M-CAN 2H
28	-	-
29	GR	CON CK A
30	-	-
31	G	GND
32	G	GND

Connector No.	B202
Connector Name	HEADREST DISPLAY UNIT (DRIVER SEAT)
Connector Color	WHITE

Terminal No.	Color of Wire	Signal Name
1	W	REAR1 HP LH+
2	G	REAR1 HP RH+
3	LG	REAR1 HP SHIELD
4	-	-
5	Y	REAR1 COMP+
6	-	-
7	W	AUX REQ OUT
8	G	ACC DET IN
9	-	-
10	LG	M-CAN 1L
11	P	M-CAN 1H
12	G	LOCATION DET LH (LH ONLY)
13	BR	ILL
14	-	-
15	W	BAT
16	W	BAT
17	B	REAR1 HP LH-
18	R	REAR1 HP RH-
19	V	AV GND
20	P	REAR1 COMP SHIELD

Connector No.	B201
Connector Name	WIRE TO WIRE
Connector Color	WHITE

Terminal No.	Color of Wire	Signal Name
1	W	-
3	P	-
4	LG	-
6	G	-
8	V	-
9	Y	-
10	P	-
11	G	-
12	W	-
13	G	-
14	SB	-
15	LG	-
16	R	-
17	BR	-
18	W	-
19	Y	-
20	GR	-
21	G	-
22	LG	-
23	B	-
24	R	-

ABNIA4846GB

A  
B  
C  
D  
E  
F  
G  
H  
I  
J  
K  
L  
M  
N  
O  
P

AV

# BOSE AUDIO W/NAVI W/O SURROUND

< WIRING DIAGRAM >

[BOSE AUDIO W/NAVI W/O SURROUND]

Terminal No.	Color of Wire	Signal Name
26	R	-
27	LG	-
29	GR	-
31	G	-
32	G	-

Terminal No.	Color of Wire	Signal Name
10	LG	-
11	P	-
12	G	-
13	BR	-
15	W	-
16	W	-
17	B	-
18	R	-
19	V	-
20	P	-
21	G	-
23	Y	-
24	SB	-

Connector No.	B219
Connector Name	WIRE TO WIRE
Connector Color	WHITE

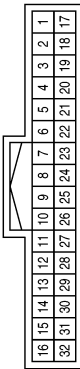

Terminal No.	Color of Wire	Signal Name
1	W	-
2	G	-
3	LG	-
5	Y	-
7	W	-
8	G	-

Terminal No.	Color of Wire	Signal Name
26	R	-
27	LG	-
29	GR	-
31	G	-
32	G	-

Terminal No.	Color of Wire	Signal Name
10	LG	-
11	P	-
12	G	-
13	BR	-
15	W	-
16	W	-
17	B	-
18	R	-
19	V	-
20	P	-
21	G	-
23	Y	-
24	SB	-

Connector No.	B222
Connector Name	WIRE TO WIRE
Connector Color	WHITE

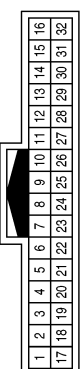

Terminal No.	Color of Wire	Signal Name
1	W	-
2	G	-
3	LG	-
5	Y	-
7	W	-
8	G	-

ABNIA4847GB



# BOSE AUDIO W/NAVI W/O SURROUND

< WIRING DIAGRAM >

[BOSE AUDIO W/NAVI W/O SURROUND]

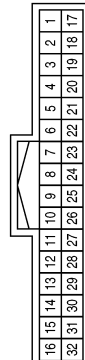

Terminal No.	Color of Wire	Signal Name
23	Y	CONT GND
24	SB	CON CK B
25	-	-
26	R	M-CAN 2L
27	LG	M-CAN 2H
28	G	LOCATION DET RH (RH ONLY)
29	GR	CON CK A
30	-	-
31	G	GND
32	G	GND

Connector No.	B302
Connector Name	HEADREST DISPLAY UNIT (DRIVER SEAT)
Connector Color	WHITE

Terminal No.	Color of Wire	Signal Name
1	W	REAR1 HP LH+
2	G	REAR1 HP RH+
3	LG	REAR1 HP SHIELD
4	-	-
5	Y	REAR1 COMP+
6	-	-
7	W	AUX REQ OUT
8	G	ACC DET IN
9	-	-
10	LG	M-CAN 1L
11	P	M-CAN 1H
12	-	-
13	BR	ILL
14	-	-
15	W	BAT
16	W	BAT
17	B	REAR1 HP LH-
18	R	REAR1 HP RH-
19	V	AV GND
20	P	REAR1 COMP SHIELD
21	G	REAR1 COMP-
22	-	-

Connector No.	B301
Connector Name	WIRE TO WIRE
Connector Color	WHITE

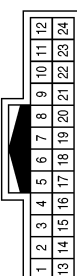
Terminal No.	Color of Wire	Signal Name
1	W	-
3	P	-
4	LG	-
6	G	-
8	V	-
9	Y	-
10	P	-
11	G	-
12	W	-
13	G	-
14	SB	-
15	LG	-
16	R	-
17	BR	-
18	W	-
19	Y	-
20	GR	-
21	G	-
22	LG	-
23	B	-
24	R	-

ABNIA4848GB

A  
B  
C  
D  
E  
F  
G  
H  
I  
J  
K  
L  
M  
N  
O  
P



# BOSE AUDIO W/NAVI W/O SURROUND

[BOSE AUDIO W/NAVI W/O SURROUND]

< WIRING DIAGRAM >

Terminal No.	Color of Wire	Signal Name
27	LG	-
28	G	-
29	GR	-
31	G	-
32	G	-

Terminal No.	Color of Wire	Signal Name
10	LG	-
11	P	-
13	BR	-
15	W	-
16	W	-
17	B	-
18	R	-
19	V	-
20	P	-
21	G	-
23	Y	-
24	SB	-
26	R	-

Connector No.	B316
Connector Name	WIRE TO WIRE
Connector Color	WHITE

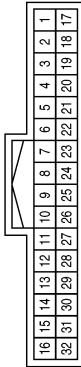

Terminal No.	Color of Wire	Signal Name
1	W	-
2	G	-
3	LG	-
5	Y	-
7	W	-
8	G	-

Terminal No.	Color of Wire	Signal Name
27	LG	-
28	G	-
29	GR	-
31	G	-
32	G	-

Terminal No.	Color of Wire	Signal Name
10	LG	-
11	P	-
13	BR	-
15	W	-
16	W	-
17	B	-
18	R	-
19	V	-
20	P	-
21	G	-
23	Y	-
24	SB	-
26	R	-

Connector No.	B317
Connector Name	WIRE TO WIRE
Connector Color	WHITE

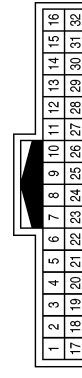

Terminal No.	Color of Wire	Signal Name
1	W	-
2	G	-
3	LG	-
5	Y	-
7	W	-
8	G	-

ABNIA4666GB

# BOSE AUDIO W/NAVI W/O SURROUND

[BOSE AUDIO W/NAVI W/O SURROUND]

< WIRING DIAGRAM >

Connector No.	B452
Connector Name	WIRE TO WIRE
Connector Color	BLACK

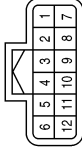

Terminal No.	Color of Wire	Signal Name
2	P	-
3	G	-
4	L	-
5	Y	-
8	L	-
9	W	-
10	P	-
11	G	-

Connector No.	B401
Connector Name	WIRE TO WIRE
Connector Color	BLACK

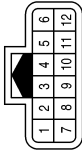

Terminal No.	Color of Wire	Signal Name
2	B	-
3	W	-
4	B	-
5	W	-
8	B	-
9	W	-
10	W	-
11	B	-

Connector No.	B400
Connector Name	WIRE TO WIRE
Connector Color	WHITE

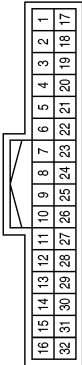

Terminal No.	Color of Wire	Signal Name
17	W	-
18	B	-
19	SHIELD	-
21	B	-
22	W	-
23	SHIELD	-
24	W	-
25	B	-
26	SHIELD	-
27	W	-
28	B	-
29	SHIELD	-

Connector No.	B457
Connector Name	REAR SONAR SENSOR LH INNER
Connector Color	BLACK



Terminal No.	Color of Wire	Signal Name
1	L	-
2	Y	-

Connector No.	B456
Connector Name	REAR SONAR SENSOR RH OUTER
Connector Color	BLACK



Terminal No.	Color of Wire	Signal Name
1	L	-
2	W	-

Connector No.	B455
Connector Name	REAR SONAR SENSOR LH OUTER
Connector Color	BLACK



Terminal No.	Color of Wire	Signal Name
1	P	-
2	G	-

ABNIA4667GB

A  
B  
C  
D  
E  
F  
G  
H  
I  
J  
K  
L  
M  
N  
O  
P

AV

# BOSE AUDIO W/NAVI W/O SURROUND

< WIRING DIAGRAM >

[BOSE AUDIO W/NAVI W/O SURROUND]

Connector No.	R11
Connector Name	WIRE TO WIRE
Connector Color	WHITE

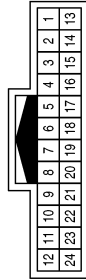

Terminal No.	Color of Wire	Signal Name
1	W	-
2	B	-
3	BG	-
4	P	-
5	SHIELD	-
6	B	-
7	W	-

Connector No.	R1
Connector Name	WIRE TO WIRE
Connector Color	WHITE

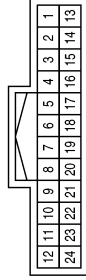

Terminal No.	Color of Wire	Signal Name
5	B	-
13	W	-
14	B	-
15	SHIELD	-
16	P	-
17	BG	-
23	W	-

Connector No.	B458
Connector Name	REAR SONAR SENSOR RH INNER
Connector Color	BLACK



Terminal No.	Color of Wire	Signal Name
1	P	-
2	G	-

Connector No.	R109
Connector Name	MICROPHONE
Connector Color	WHITE



Terminal No.	Color of Wire	Signal Name
1	R	-
2	-	-
3	GR	-
4	L	-

Connector No.	R105
Connector Name	TELEMATICS SWITCH
Connector Color	WHITE

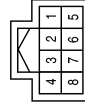

Terminal No.	Color of Wire	Signal Name
1	V	-
2	G	-
3	P	-
7	R	-

Connector No.	R101
Connector Name	WIRE TO WIRE
Connector Color	WHITE

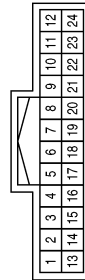

Terminal No.	Color of Wire	Signal Name
1	V	-
2	R	-
3	G	-
4	P	-
5	SHIELD	-
6	L	-
7	R	-

ABNIA4668GB

# BOSE AUDIO W/NAVI W/O SURROUND

## [BOSE AUDIO W/NAVI W/O SURROUND]

< WIRING DIAGRAM >

Connector No.	D6
Connector Name	DOOR MIRROR LH (WITH AROUND VIEW MONITOR)
Connector Color	WHITE

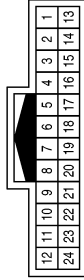

Terminal No.	Color of Wire	Signal Name
8	LG	-
9	Y	-

Connector No.	D3
Connector Name	WIRE TO WIRE
Connector Color	WHITE

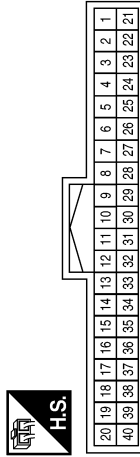

Terminal No.	Color of Wire	Signal Name
22	Y	-
23	LG	-
28	G	-
29	SHIELD	-
30	R	-
31	B	-
32	W	-

Connector No.	D2
Connector Name	WIRE TO WIRE
Connector Color	WHITE

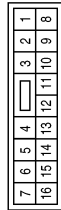

Terminal No.	Color of Wire	Signal Name
8	W	-
9	G	-

Connector No.	D101
Connector Name	WIRE TO WIRE
Connector Color	WHITE

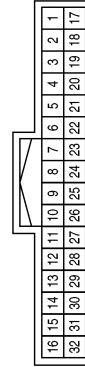

Terminal No.	Color of Wire	Signal Name
1	G	-
2	SHIELD	-
3	R	-
4	B	-
5	W	-

Connector No.	D20
Connector Name	DOOR MIRROR LH (SIDE CAMERA)
Connector Color	WHITE

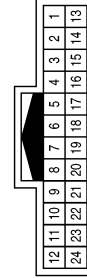

Terminal No.	Color of Wire	Signal Name
5	R	-
6	W	-
16	G	-
17	SHIELD	-
18	B	-

Connector No.	D12
Connector Name	FRONT DOOR SPEAKER LH
Connector Color	WHITE



Terminal No.	Color of Wire	Signal Name
1	G	-
2	W	-

ABNIA4669GB

A  
B  
C  
D  
E  
F  
G  
H  
I  
J  
K  
L  
M  
N  
O  
P

AV

# BOSE AUDIO W/NAVI W/O SURROUND

< WIRING DIAGRAM >

[BOSE AUDIO W/NAVI W/O SURROUND]

Connector No.	D113
Connector Name	DOOR MIRROR RH (SIDE CAMERA)
Connector Color	WHITE

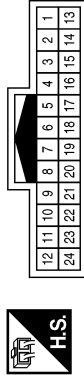

Terminal No.	Color of Wire	Signal Name
5	R	-
6	W	-
16	G	-
17	SHIELD	-
18	B	-

Connector No.	D112
Connector Name	FRONT DOOR SPEAKER RH
Connector Color	WHITE



Terminal No.	Color of Wire	Signal Name
1	G	-
2	W	-

Connector No.	D102
Connector Name	WIRE TO WIRE
Connector Color	WHITE

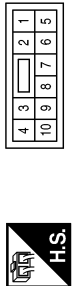

Terminal No.	Color of Wire	Signal Name
9	G	-
10	W	-

Connector No.	D301
Connector Name	WIRE TO WIRE
Connector Color	WHITE



Terminal No.	Color of Wire	Signal Name
11	G	-
12	W	-

Connector No.	D207
Connector Name	REAR DOOR SPEAKER LH
Connector Color	BROWN



Terminal No.	Color of Wire	Signal Name
1	LG	-
2	Y	-

Connector No.	D201
Connector Name	WIRE TO WIRE
Connector Color	WHITE



Terminal No.	Color of Wire	Signal Name
11	Y	-
12	LG	-

ABNIA4670GB



# BOSE AUDIO W/NAVI W/O SURROUND

< WIRING DIAGRAM >

[BOSE AUDIO W/NAVI W/O SURROUND]

Connector No.	D511
Connector Name	REAR VIEW CAMERA
Connector Color	WHITE

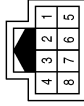

Terminal No.	Color of Wire	Signal Name
1	SHIELD	-
4	G	-
5	R	-
7	B	-
8	W	-

Connector No.	D501
Connector Name	WIRE TO WIRE
Connector Color	WHITE

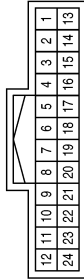

Terminal No.	Color of Wire	Signal Name
13	W	-
14	B	-
15	R	-
16	SHIELD	-
17	G	-

Connector No.	D307
Connector Name	REAR DOOR SPEAKER RH
Connector Color	BROWN



Terminal No.	Color of Wire	Signal Name
1	W	-
2	G	-

A  
B  
C  
D  
E  
F  
G  
H  
I  
J  
K  
L  
M  
O  
P

AV

ABNIA4671GB

## BASIC INSPECTION

### DIAGNOSIS AND REPAIR WORKFLOW

#### Work Flow (Multi AV System)

INFOID:000000009129093

#### OVERALL SEQUENCE

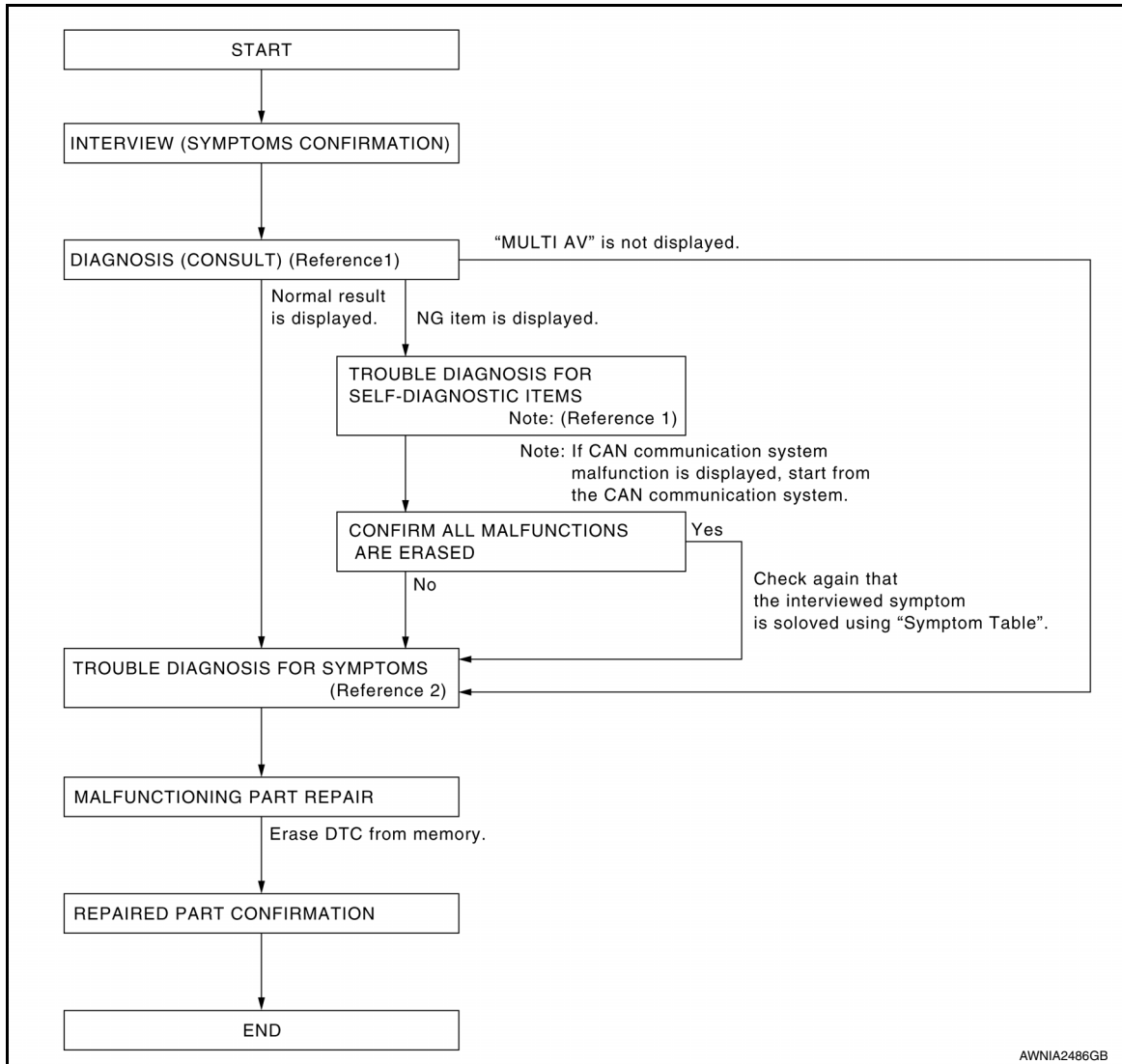

Reference 1: Refer to [AV-354, "CONSULT Function"](#).

Reference 2: Refer to [AV-569, "Symptom Table"](#).

#### DETAILED FLOW

##### 1. CHECK SYMPTOM

Check the malfunction symptoms by performing the following items.

- Interview the customer to obtain the malfunction information (conditions and environment when the malfunction occurred).
- Check the symptom.

>> GO TO 2

##### 2. SELF-DIAGNOSIS (CONSULT)

1. Connect CONSULT and perform "SELF-DIAGNOSIS" for "MULTI AV".

**NOTE:**

Skip to step 4 of the diagnosis procedure if "MULTI AV" is not displayed.

2. Check if any DTC No. is displayed in the self-diagnosis results.

# DIAGNOSIS AND REPAIR WORKFLOW

[BOSE AUDIO W/NAVI W/O SURROUND]

< BASIC INSPECTION >

Is any DTC No. displayed?

- YES >> GO TO 3
- NO >> GO TO 4

## 3. CHECK SELF-DIAGNOSIS RESULTS (CONSULT)

1. Check the DTC No. indicated in the self-diagnosis results.
2. Perform the relevant diagnosis referring to the DTC No. list. Refer to [AV-367, "DTC Index"](#).

### NOTE:

Start with the diagnosis for the CAN communication system if "CAN COMM CIRCUIT [U1000] or CONTROL UNIT (CAN) [U1010]" is displayed.

>> GO TO 5

## 4. PERFORM DIAGNOSIS BY SYMPTOM

Perform the relevant diagnosis referring to the diagnosis chart by symptom. Refer to [AV-569, "Symptom Table"](#).

>> GO TO 5

## 5. REPAIR OR REPLACE MALFUNCTIONING PARTS

Repair or replace the identified malfunctioning parts.

### NOTE:

Erase the stored self-diagnosis results after repairing or replacing the relevant components if any DTC No. has been indicated in the self-diagnosis results.

>> GO TO 6

## 6. CHECK AFTER REPAIR

1. Perform self-diagnosis for "MULTI AV" with CONSULT after repairing or replacing the malfunctioning parts.
2. Check if any DTC No. is displayed in the self-diagnosis results.

Is any DTC No. displayed?

- YES >> GO TO 3
- NO >> GO TO 7

## 7. FINAL CHECK

Perform the operation check to confirm that the malfunction symptom is solved or that any other symptoms are present.

Are any symptoms present?

- YES >> GO TO 4
- NO >> Inspection End.

A  
B  
C  
D  
E  
F  
G  
H  
I  
J  
K  
L  
M  
O  
P

AV

# DIAGNOSIS AND REPAIR WORKFLOW

< BASIC INSPECTION >

[BOSE AUDIO W/NAVI W/O SURROUND]

## Work Flow (Camera Assistance Sonar)

INFOID:000000009129094

### OVERALL SEQUENCE

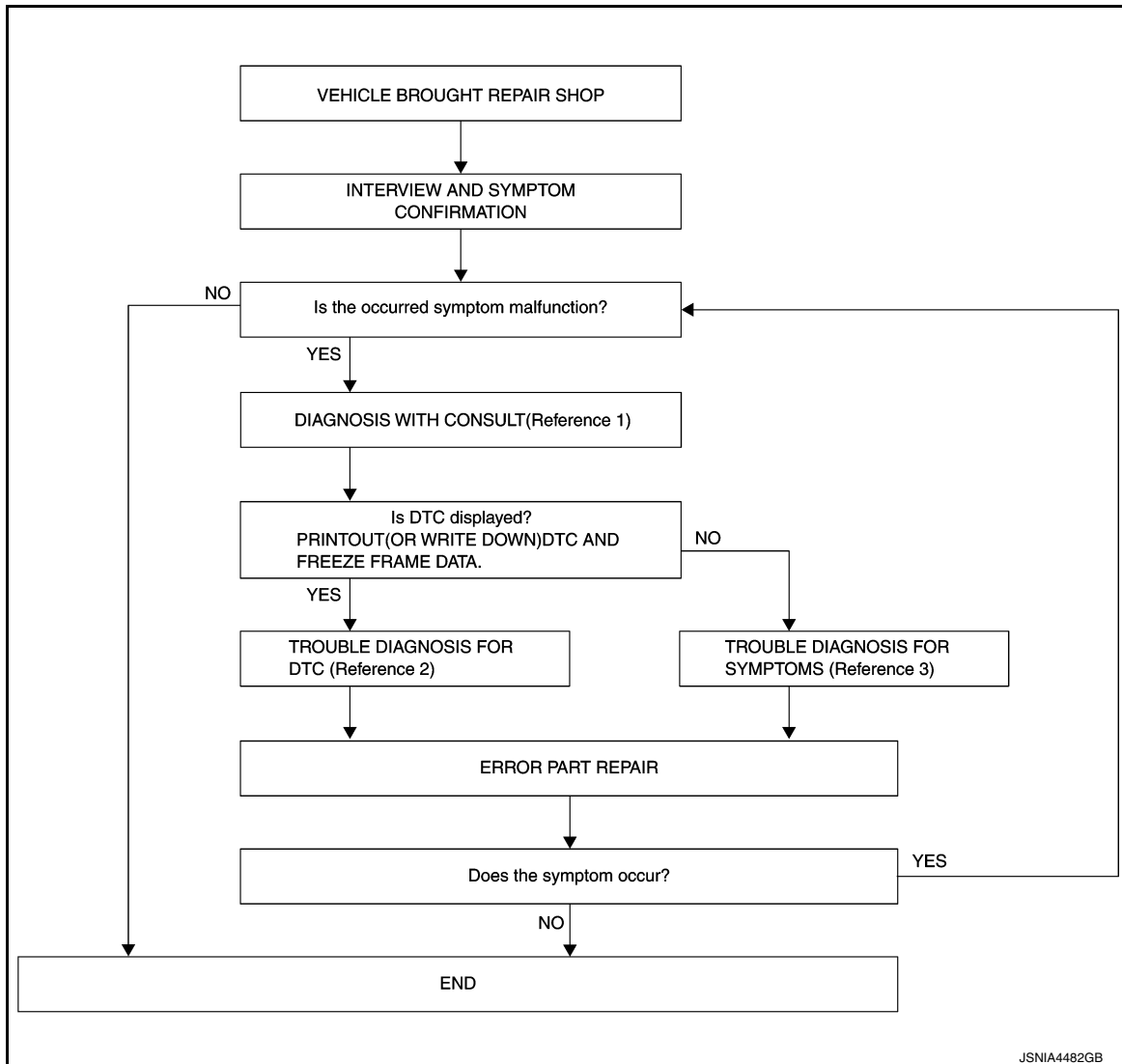

Reference 1: Refer to [AV-359, "CONSULT Function"](#).

Reference 2: Refer to [AV-389, "DTC Index"](#).

Reference 3: Refer to [AV-569, "Symptom Table"](#).

### DETAILED FLOW

#### 1. INTERVIEW AND SYMPTOM CONFIRMATION

Check the malfunction symptoms by performing the following items.

- Interview the customer to obtain the malfunction information (conditions and environment when the malfunction occurred).
- Check the symptom.

Is the occurred symptom malfunction?

YES >> GO TO 2.

NO >> Inspection End.

#### 2. DIAGNOSIS WITH CONSULT

1. Connect CONSULT and perform a self-diagnosis for "SONAR". Refer to [AV-359, "CONSULT Function"](#).

##### NOTE:

Skip to step 4 of the diagnosis procedure if "SONAR" is not displayed.

2. When DTC is detected, follow the instructions below:
  - Record DTC and Freeze Frame Data.

# DIAGNOSIS AND REPAIR WORKFLOW

[BOSE AUDIO W/NAVI W/O SURROUND]

< BASIC INSPECTION >

Is DTC displayed?

YES >> GO TO 3.

NO >> GO TO 4.

## 3. TROUBLE DIAGNOSIS FOR DTC

1. Check the DTC indicated in the self-diagnosis results.
2. Perform the relevant diagnosis referring to the DTC Index. Refer to [AV-389, "DTC Index"](#).

>> GO TO 5.

## 4. TROUBLE DIAGNOSIS FOR SYMPTOMS

Perform the relevant diagnosis referring to the diagnosis chart by symptom. Refer to [AV-569, "Symptom Table"](#).

>> GO TO 5.

## 5. ERROR PART REPAIR

1. Repair or replace the identified malfunctioning parts.
2. Perform a self-diagnosis for "SONAR" with CONSULT.

**NOTE:**

Erase the stored self-diagnosis results after repairing or replacing the relevant components if any DTC has been indicated in the self-diagnosis results.

3. Check that the symptom does not occur.

Does the symptom occur?

YES >> GO TO 1.

NO >> Inspection End.

A  
B  
C  
D  
E  
F  
G  
H  
I  
J  
K  
L  
M  
O  
P

AV

# INSPECTION AND ADJUSTMENT

< BASIC INSPECTION >

[BOSE AUDIO W/NAVI W/O SURROUND]

## INSPECTION AND ADJUSTMENT

### ADDITIONAL SERVICE WHEN REPLACING AV CONTROL UNIT

### ADDITIONAL SERVICE WHEN REPLACING AV CONTROL UNIT : Description

INFOID:000000009129095

#### BEFORE REPLACEMENT

When replacing AV control unit, save or print current vehicle specification with CONSULT configuration before replacement.

**NOTE:**

If "Before Replace ECU" cannot be used, use the "After Replace ECU" or "Manual Configuration" after replacing AV control unit.

#### AFTER REPLACEMENT

**CAUTION:**

When replacing AV control unit, you must perform "After Replace ECU" with CONSULT.

- Complete the procedure of "After Replace ECU" in order.
- If you set incorrect "After Replace ECU", incidents might occur.
- Configuration is different for each vehicle model. Confirm configuration of each vehicle model.

### ADDITIONAL SERVICE WHEN REPLACING AV CONTROL UNIT : Work Procedure

INFOID:000000009129095

## 1. SAVING VEHICLE SPECIFICATION

### Ⓟ-CONSULT

Enter "Re/Programming, Configuration" and perform "Before Replace ECU" to save or print current vehicle specification.

**NOTE:**

If "Before Replace ECU" cannot be used, use the "After Replace ECU" or "Manual Configuration" after replacing AV control unit.

>> GO TO 2.

## 2. REPLACE AV CONTROL UNIT

Replace AV control unit. Refer to [AV-586. "Removal and Installation - AV Control Unit"](#).

>> GO TO 3.

## 3. WRITING VEHICLE SPECIFICATION

### ⓅCONSULT

1. Enter "Re/Programming, Configuration".
2. If "Before Replace ECU" operation was performed, automatically an "Operation Log Selection" screen will be displayed. Select the applicable file from the "Saved Data List" and press "Confirm" to write vehicle specification. Refer to [AV-447. "CONFIGURATION \(AV CONTROL UNIT\) : Work Procedure"](#).
3. If "Before Replace ECU" operation was not performed, select "After Replace ECU" or "Manual Configuration" to write vehicle specification. Refer to [AV-447. "CONFIGURATION \(AV CONTROL UNIT\) : Work Procedure"](#).

>> GO TO 4.

## 4. OPERATION CHECK

Check that the operation of the AV control unit is normal.

>> Work End.

## CONFIGURATION (AV CONTROL UNIT)

# INSPECTION AND ADJUSTMENT

< BASIC INSPECTION >

[BOSE AUDIO W/NAVI W/O SURROUND]

## CONFIGURATION (AV CONTROL UNIT) : Description

INFOID:000000009129097

Vehicle specification needs to be written with CONSULT because it is not written after replacing AV control unit.

Configuration has three functions as follows:

Function	Description
"Before Replace ECU"	<ul style="list-style-type: none"><li>• Reads the vehicle configuration of current AV control unit.</li><li>• Saves the read vehicle configuration.</li></ul>
"After Replace ECU"	Writes the vehicle configuration with manual selection.
"Select Saved Data List"	Writes the vehicle configuration with saved data.

### CAUTION:

- When replacing AV control unit, you must perform "Select Saved Data List" or "After Replace ECU" with CONSULT.
- Complete the procedure of "Select Saved Data List" or "After Replace ECU" in order.
- If you set incorrect "Select Saved Data List" or "After Replace ECU", incidents might occur.
- Configuration is different for each vehicle model. Confirm configuration of each vehicle model.
- Never perform "Select Saved Data List" or "After Replace ECU" except for new AV control unit.

## CONFIGURATION (AV CONTROL UNIT) : Work Procedure

INFOID:000000009129098

### 1. WRITING MODE SELECTION

#### CONSULT

Select "Reprogramming, Configuration" of AV control unit.

When writing saved data >> GO TO 2.

When writing manually >> GO TO 3.

### 2. PERFORM "SAVED DATA LIST"

#### CONSULT

Automatically "Operation Log Selection" window will display if "Before Replace ECU" was performed. Select applicable file from the "Save Data List" and press "Confirm".

>> Work End.

### 3. PERFORM "AFTER REPLACE ECU" OR "MANUAL CONFIGURATION"

#### CONSULT

1. Select "After Replace ECU" or "Manual Configuration".
2. Identify the correct model and configuration list. Refer to [AV-448. "CONFIGURATION \(AV CONTROL UNIT\) : Configuration List"](#).
3. Confirm and/or change setting value for each item.

#### CAUTION:

Thoroughly read and understand the vehicle specification. ECU control may not operate normally if the setting is not correct.

4. Select "Next".

#### CAUTION:

Make sure to select "Next", confirm each setting value and press "OK" even if the indicated configuration of brand new AV control unit is same as the desirable configuration. If not, configuration which is set automatically by selecting vehicle model can not be memorized.

5. When "Completed", select "End".

>> GO TO 4.

### 4. OPERATION CHECK

Confirm that each function controlled by AV control unit operates normally.

A  
B  
C  
D  
E  
F  
G  
H  
I  
J  
K  
L  
M  
O  
P

AV

# INSPECTION AND ADJUSTMENT

< BASIC INSPECTION >

[BOSE AUDIO W/NAVI W/O SURROUND]

>> Work End.

## CONFIGURATION (AV CONTROL UNIT) : Configuration List

INFOID:000000009129099

### CAUTION:

Thoroughly read and understand the vehicle specification. Incorrect settings may result in abnormal control of ECU.

MANUAL SETTING ITEM	
Items	Setting value
ENGINE TYPE	NORMAL ↔ HYBRID
SOUND SYSTEM	BOSE SURROUND ↔ BOSE ↔ BASE

↔: Items which confirm vehicle specifications

## ADDITIONAL SERVICE WHEN REPLACING AROUND VIEW MONITOR CONTROL UNIT

### ADDITIONAL SERVICE WHEN REPLACING AROUND VIEW MONITOR CONTROL UNIT : Description

INFOID:000000009129100

#### BEFORE REPLACEMENT

When replacing around view monitor control unit, save or print current vehicle specification with CONSULT configuration before replacement.

#### NOTE:

If "Before Replace ECU" cannot be used, use the "After Replace ECU" or "Manual Configuration" after replacing around view monitor control unit.

#### AFTER REPLACEMENT

#### CAUTION:

When replacing around view monitor control unit, you must perform "After Replace ECU" with CONSULT.

- Complete the procedure of "After Replace ECU" in order.
- If you set incorrect "After Replace ECU", incidents might occur.
- Configuration is different for each vehicle model. Confirm configuration of each vehicle model.

## ADDITIONAL SERVICE WHEN REPLACING AROUND VIEW MONITOR CONTROL UNIT : Work Procedure

INFOID:000000009129101

### 1. SAVING VEHICLE SPECIFICATION

#### Ⓟ-CONSULT

Enter "Re/Programming, Configuration" and perform "Before Replace ECU" to save or print current vehicle specification.

#### NOTE:

If "Before Replace ECU" cannot be used, use the "After Replace ECU" or "Manual Configuration" after replacing around view monitor control unit.

>> GO TO 2.

### 2. REPLACE AROUND VIEW MONITOR CONTROL UNIT

Replace around view monitor control unit. Refer to [AV-600. "Removal and Installation"](#).

>> GO TO 3.

### 3. WRITING VEHICLE SPECIFICATION

#### ⓅCONSULT

1. Enter "Re/Programming, Configuration".
2. If "Before Replace ECU" operation was performed, automatically an "Operation Log Selection" screen will be displayed. Select the applicable file from the "Saved Data List" and press "Confirm" to write vehicle



# INSPECTION AND ADJUSTMENT

[BOSE AUDIO W/NAVI W/O SURROUND]

< BASIC INSPECTION >

specification. Refer to [AV-449. "CONFIGURATION \(AROUND VIEW MONITOR CONTROL UNIT\) : Work Procedure"](#).

3. If "Before Replace ECU" operation was not performed, select "After Replace ECU" or "Manual Configuration" to write vehicle specification. Refer to [AV-449. "CONFIGURATION \(AROUND VIEW MONITOR CONTROL UNIT\) : Work Procedure"](#).

>> GO TO 4.

## 4. OPERATION CHECK

Check that the operation of the around view monitor control unit and camera images (fixed guide lines and predictive course lines) are normal.

>> Work End.

## CONFIGURATION (AROUND VIEW MONITOR CONTROL UNIT)

### CONFIGURATION (AROUND VIEW MONITOR CONTROL UNIT) : Description

INFOID:000000009129102

Vehicle specification needs to be written with CONSULT because it is not written after replacing around view monitor control unit.

Configuration has three functions as follows:

Function	Description
"Before Replace ECU"	<ul style="list-style-type: none"><li>• Reads the vehicle configuration of current around view monitor control unit.</li><li>• Saves the read vehicle configuration.</li></ul>
"After Replace ECU"	Writes the vehicle configuration with manual selection.
"Select Saved Data List"	Writes the vehicle configuration with saved data.

#### CAUTION:

- When replacing around view monitor control unit, you must perform "Select Saved Data List" or "After Replace ECU" with CONSULT.
- Complete the procedure of "Select Saved Data List" or "After Replace ECU" in order.
- If you set incorrect "Select Saved Data List" or "After Replace ECU", incidents might occur.
- Configuration is different for each vehicle model. Confirm configuration of each vehicle model.
- Never perform "Select Saved Data List" or "After Replace ECU" except for new around view monitor control unit.

### CONFIGURATION (AROUND VIEW MONITOR CONTROL UNIT) : Work Procedure

INFOID:000000009129103

#### 1. WRITING MODE SELECTION

##### CONSULT

Select "Reprogramming, Configuration" of around view monitor control unit.

When writing saved data >> GO TO 2.

When writing manually >> GO TO 3.

#### 2. PERFORM "SAVED DATA LIST"

##### CONSULT

Automatically "Operation Log Selection" window will display if "Before Replace ECU" was performed. Select applicable file from the "Save Data List" and press "Confirm".

>> Work End.

#### 3. PERFORM "AFTER REPLACE ECU" OR "MANUAL CONFIGURATION"

##### CONSULT

1. Select "After Replace ECU" or "Manual Configuration".

A  
B  
C  
D  
E  
F  
G  
H  
I  
J  
K  
L  
M  
O  
P

AV

# INSPECTION AND ADJUSTMENT

< BASIC INSPECTION >

[BOSE AUDIO W/NAVI W/O SURROUND]

- Identify the correct model and configuration list. Refer to [AV-450. "CONFIGURATION \(AROUND VIEW MONITOR CONTROL UNIT\) : Configuration List"](#).
- Confirm and/or change setting value for each item.  
**CAUTION:**  
Thoroughly read and understand the vehicle specification. ECU control may not operate normally if the setting is not correct.
- Select "Next".  
**CAUTION:**  
Make sure to select "Next", confirm each setting value and press "OK" even if the indicated configuration of brand new around view monitor control unit is same as the desirable configuration. If not, configuration which is set automatically by selecting vehicle model can not be memorized.
- When "Completed", select "End".

>> GO TO 4.

## 4. OPERATION CHECK

Confirm that each function controlled by around view monitor control unit operates normally.

>> Work End.

## CONFIGURATION (AROUND VIEW MONITOR CONTROL UNIT) : Configuration List

INFOID:000000009129104

### CAUTION:

Thoroughly read and understand the vehicle specification. Incorrect settings may result in abnormal control of ECU.

MANUAL SETTING ITEM	
Items	Setting value
BCI FUNCTION	WITH ↔ WITHOUT

↔: Items which confirm vehicle specifications

## ADDITIONAL SERVICE WHEN REPLACING SONAR CONTROL UNIT

### ADDITIONAL SERVICE WHEN REPLACING SONAR CONTROL UNIT : Description

INFOID:000000009129105

#### BEFORE REPLACEMENT

When replacing sonar control unit, save or print current vehicle specification with CONSULT configuration before replacement.

#### NOTE:

If "Before Replace ECU" cannot be used, use the "After Replace ECU" or "Manual Configuration" after replacing sonar control unit.

#### AFTER REPLACEMENT

#### CAUTION:

When replacing sonar control unit, you must perform "After Replace ECU" with CONSULT.

- Complete the procedure of "After Replace ECU" in order.
- If you set incorrect "After Replace ECU", incidents might occur.
- Configuration is different for each vehicle model. Confirm configuration of each vehicle model.

### ADDITIONAL SERVICE WHEN REPLACING SONAR CONTROL UNIT : Work Procedure

INFOID:000000009129106

## 1. SAVING VEHICLE SPECIFICATION

### Ⓟ-CONSULT

Enter "Re/Programming, Configuration" and perform "Before Replace ECU" to save or print current vehicle specification.

#### NOTE:

# INSPECTION AND ADJUSTMENT

[BOSE AUDIO W/NAVI W/O SURROUND]

< BASIC INSPECTION >

If "Before Replace ECU" cannot be used, use the "After Replace ECU" or "Manual Configuration" after replacing sonar control unit.

>> GO TO 2.

## 2. REPLACE SONAR CONTROL UNIT

Replace sonar control unit. Refer to [AV-608, "Removal and Installation"](#).

>> GO TO 3.

## 3. WRITING VEHICLE SPECIFICATION

### CONSULT

1. Enter "Re/Programming, Configuration".
2. If "Before Replace ECU" operation was performed, automatically an "Operation Log Selection" screen will be displayed. Select the applicable file from the "Saved Data List" and press "Confirm" to write vehicle specification. Refer to [AV-451, "CONFIGURATION \(SONAR CONTROL UNIT\) : Work Procedure"](#).
3. If "Before Replace ECU" operation was not performed, select "After Replace ECU" or "Manual Configuration" to write vehicle specification. Refer to [AV-451, "CONFIGURATION \(SONAR CONTROL UNIT\) : Work Procedure"](#).

>> GO TO 4.

## 4. OPERATION CHECK

Check that the operation of the sonar control unit is normal.

>> Work End.

## CONFIGURATION (SONAR CONTROL UNIT)

### CONFIGURATION (SONAR CONTROL UNIT) : Description

INFOID:000000009129107

Vehicle specification needs to be written with CONSULT because it is not written after replacing sonar control unit.

Configuration has three functions as follows:

Function	Description
"Before Replace ECU"	<ul style="list-style-type: none"><li>• Reads the vehicle configuration of current sonar control unit.</li><li>• Saves the read vehicle configuration.</li></ul>
"After Replace ECU"	Writes the vehicle configuration with manual selection.
"Select Saved Data List"	Writes the vehicle configuration with saved data.

### CAUTION:

- When replacing sonar control unit, you must perform "Select Saved Data List" or "After Replace ECU" with CONSULT.
- Complete the procedure of "Select Saved Data List" or "After Replace ECU" in order.
- If you set incorrect "Select Saved Data List" or "After Replace ECU", incidents might occur.
- Configuration is different for each vehicle model. Confirm configuration of each vehicle model.
- Never perform "Select Saved Data List" or "After Replace ECU" except for new sonar control unit.

### CONFIGURATION (SONAR CONTROL UNIT) : Work Procedure

INFOID:000000009129108

## 1. WRITING MODE SELECTION

### CONSULT

Select "Reprogramming, Configuration" of sonar control unit.

When writing saved data>>GO TO 2.

When writing manually>>GO TO 3.

# INSPECTION AND ADJUSTMENT

< BASIC INSPECTION >

[BOSE AUDIO W/NAVI W/O SURROUND]

## 2. PERFORM "SAVED DATA LIST"

### CONSULT

Automatically "Operation Log Selection" window will display if "Before Replace ECU" was performed. Select applicable file from the "Save Data List" and press "Confirm".

>> Work End.

## 3. PERFORM "AFTER REPLACE ECU" OR "MANUAL CONFIGURATION"

### CONSULT

1. Select "After Replace ECU" or "Manual Configuration".
2. Identify the correct model and configuration list. Refer to [AV-452, "CONFIGURATION \(SONAR CONTROL UNIT\) : Configuration List"](#).
3. Confirm and/or change setting value for each item.  
**CAUTION:**  
Thoroughly read and understand the vehicle specification. ECU control may not operate normally if the setting is not correct.
4. Select "Next".  
**CAUTION:**  
Make sure to select "Next", confirm each setting value and press "OK" even if the indicated configuration of brand new sonar control unit is same as the desirable configuration. If not, configuration which is set automatically by selecting vehicle model can not be memorized.
5. When "Completed", select "End".

>> GO TO 4.

## 4. OPERATION CHECK

Confirm that each function controlled by sonar control unit operates normally.

>> Work End.

## CONFIGURATION (SONAR CONTROL UNIT) : Configuration List

INFOID:000000009129109

### CAUTION:

Thoroughly read and understand the vehicle specification. Incorrect settings may result in abnormal control of ECU.

MANUAL SETTING ITEM	
Items	Setting value
BCI FUNCTION	WITH ⇄ WITHOUT

⇄: Items which confirm vehicle specifications

## PREDICTED COURSE LINE CENTER POSITION ADJUSTMENT

### PREDICTED COURSE LINE CENTER POSITION ADJUSTMENT : Description

INFOID:000000009129110

Adjust the center position of the predictive course line of the rear view monitor if it is shifted.

### PREDICTED COURSE LINE CENTER POSITION ADJUSTMENT : Work Procedure

INFOID:000000009129111

## 1. DRIVING

Drive the vehicle straight ahead 100 m (328.1 ft) or more at a speed of 30 km/h (18.6 MPH) or more.

>> END

## CALIBRATING CAMERA IMAGE (AROUND VIEW MONITOR)

# INSPECTION AND ADJUSTMENT

< BASIC INSPECTION >

[BOSE AUDIO W/NAVI W/O SURROUND]

## CALIBRATING CAMERA IMAGE (AROUND VIEW MONITOR) : Description

INFOID:000000009129112

- Calibration must be performed after removing/replacing the cameras, removing parts (e.g. front grille, door mirror, and others) mounted on the cameras, or replacing the Around view monitor control unit.
- The use of CONSULT is required to perform calibration or writing of calibration results to the Around view monitor control unit.
- Align the white lines on the road near the vehicle at the boundary of each camera image by this camera calibration. The white lines far from the vehicle may not be aligned at the boundary of each camera image. The farther the line, the greater the difference is.

## CALIBRATING CAMERA IMAGE (AROUND VIEW MONITOR) : Work Procedure

INFOID:000000009129113

### CALIBRATION FLOWCHART

Following the flowchart shown in the figure, perform the calibration.

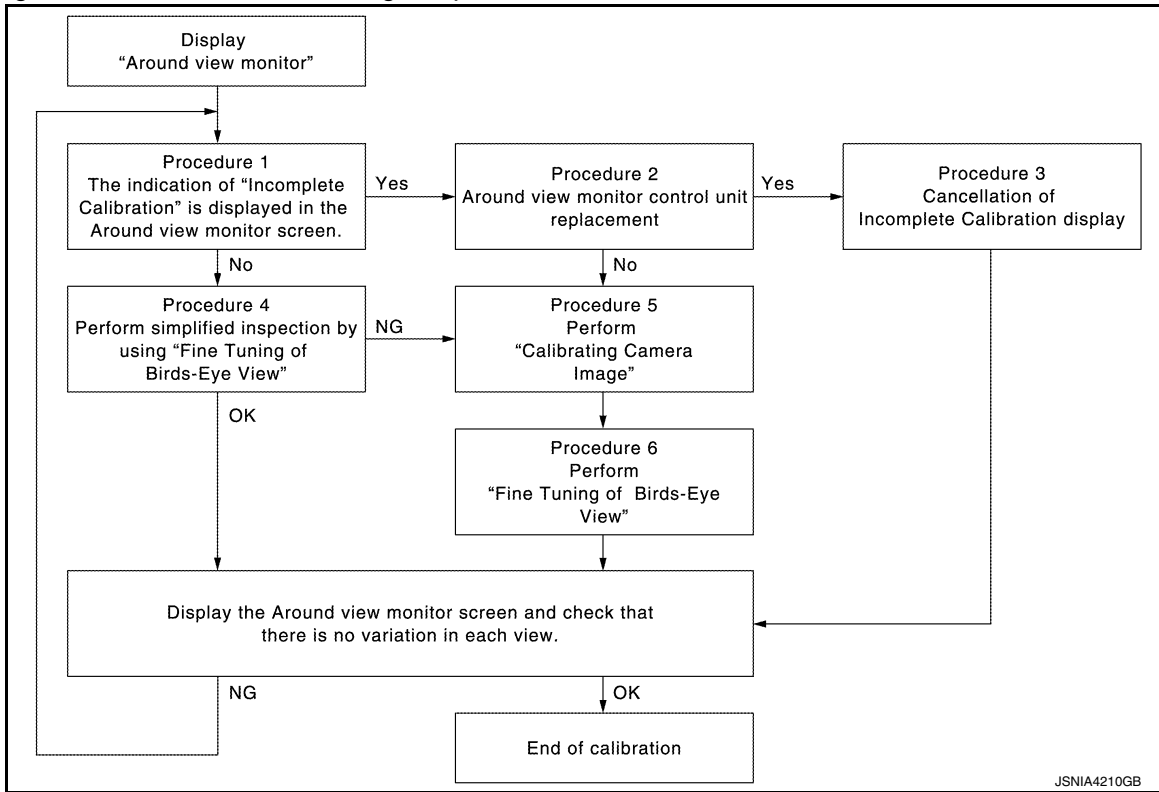

#### NOTE:

View in the incomplete calibration state is indicated by "⊠" on the around view monitor.

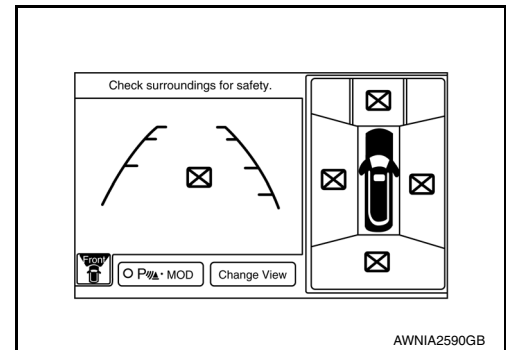

### CALIBRATION PROCEDURE

#### 1. AROUND VIEW MONITOR SCREEN CONFIRMATION

# INSPECTION AND ADJUSTMENT

[BOSE AUDIO W/NAVI W/O SURROUND]

## < BASIC INSPECTION >

Check that there is no indication of "Incomplete calibration".

Is the "Incomplete calibration" display visible?

- YES >> GO TO 2.
- NO >> GO TO 4.

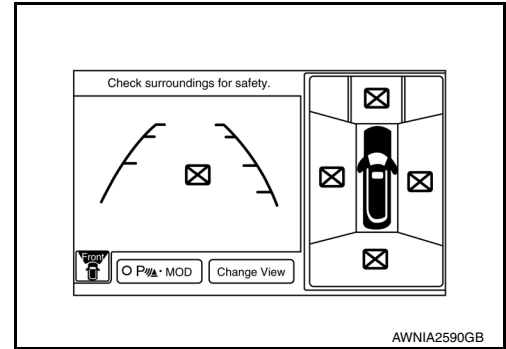

## 2. CHECK THAT AROUND VIEW MONITOR CONTROL UNIT IS REPLACED

Check that the around view monitor control unit is replaced.

Is the around view monitor control unit replaced?

- YES >> GO TO 3.
- NO >> GO TO 5.

## 3. CANCEL THE INDICATION OF INCOMPLETE CALIBRATION (PERFORM THIS ONLY AFTER REPLACING AROUND VIEW MONITOR CONTROL UNIT.)

CONSULT work support

1. On the CONSULT screen, touch "CALIBRATING CAMERA IMAGE (FRONT CAMERA)", "CALIBRATING CAMERA IMAGE (PASS-SIDE CAMERA)", "CALIBRATING CAMERA IMAGE (DR-SIDE CAMERA)", or "CALIBRATING CAMERA IMAGE (REAR CAMERA)" to accept the selection.

### NOTE:

To cancel the indication of Incomplete calibration, select items based on the target camera.

2. On the adjustment screen of each camera, touch "APPLY" button. After this, touch "OK" button.

### CAUTION:

- Never perform operations other than those mentioned above.
- Never perform "Initialize Camera Image Calibration".

3. Display the around view monitor screen to check that there is no errors, such as deviations among the camera images.

Is there a malfunction?

- YES >> Calibration end
- NO >> GO TO 1.

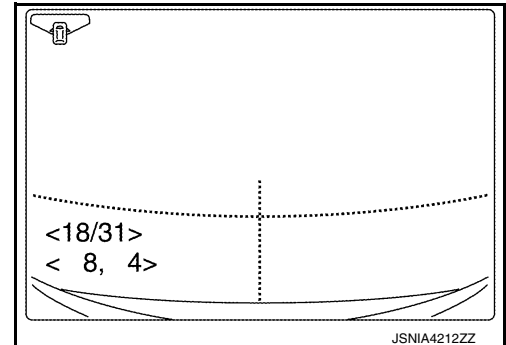

## 4. PERFORM SIMPLIFIED CONFIRMATION/ADJUSTMENT BY "FINE TUNING OF BIRDS-EYE VIEW"

1. Put target line 1 on the ground beside each axle using packing tape, etc.
2. Put target lines 2 equal to the vehicle total length + approximately 1.0 m (39.3 in) from the vehicle side (right and left) at approximately 30 cm (11.8 in) away from the vehicle (make the line as parallel with the vehicle as possible)

# INSPECTION AND ADJUSTMENT

< BASIC INSPECTION >

[BOSE AUDIO W/NAVI W/O SURROUND]

## Preparation of simplified target line

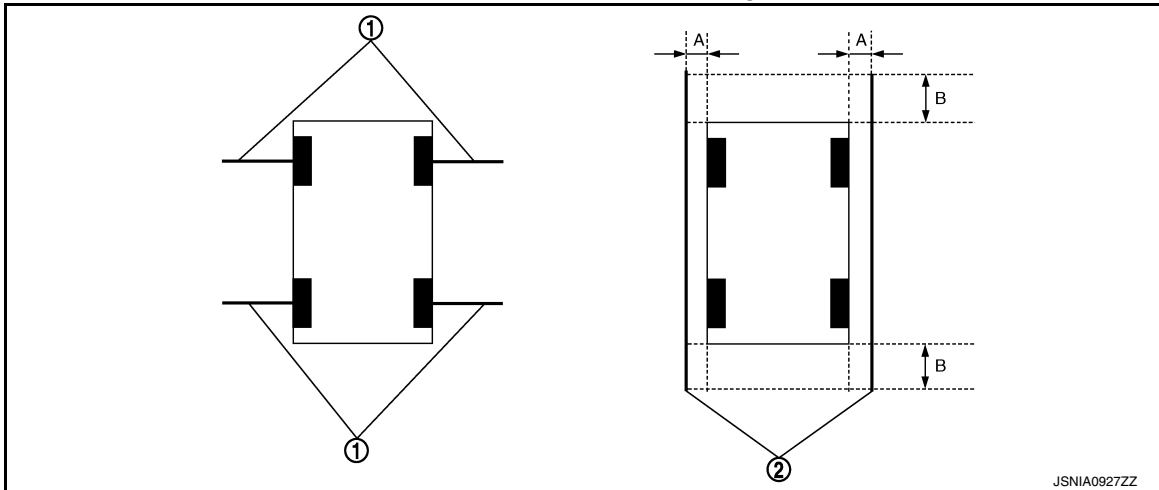

- 1. Target lines 1
- 2. Target lines 2
- A. Approx. 30 cm (11.8 in)
- B. Approx. 1.0 m (39.3 in)

3. CONSULT work support  
Touch "FINE TUNING OF BIRDS-EYE VIEW" on the CONSULT screen.
4. On the CONSULT screen, touch "SELECT" button to select right or left camera and perform camera calibration as instructed below:
  - If the marker on the screen deviates from Target line 1, touch "AXIS X" button and "AXIS Y" button to adjust so that the marker is placed on the Target line 1.
  - If Target line 2 is misaligned among the cameras, adjust each camera image to bring Target line 2 into a straight line.

**CAUTION:**

Never adjust the front camera and rear camera. Only adjust the right and left cameras.

## Simplified target line adjustment method

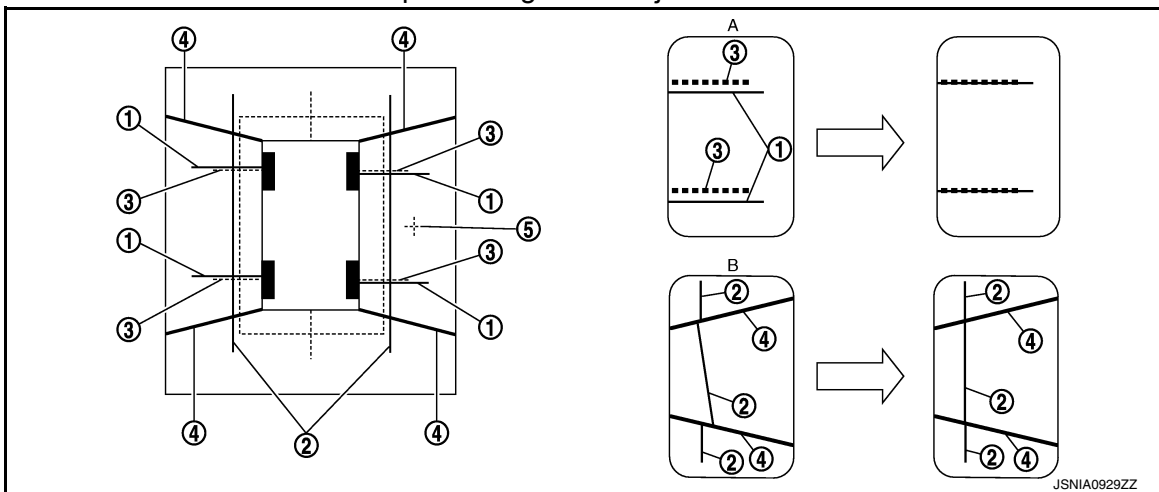

- 1. Target lines 1
- 2. Target lines 2
- 3. Marker for target line 1
- 4. Boundary between cameras
- 5. Crosshairs cursor (mark indicated the selected camera)
- A. Adjustment method for target lines 1 (right)
- B. Adjustment method for target lines 2 (right)

5. Adjust right and left cameras. Touch "APPLY" on the CONSULT screen to display adjustment results.
6. After adjusting right and left cameras, check that the marker is properly placed on the screen and there is no deviation in Target line 1.

**NOTE:**

- It can be initialized to the NISSAN factory default condition with "Initialize Camera Image Calibration".
- The adjustment value is cancelled on this mode by performing "Initialize Camera Image Calibration".

A  
B  
C  
D  
E  
F  
G  
H  
I  
J  
K  
L  
M  
O  
P

AV

# INSPECTION AND ADJUSTMENT

[BOSE AUDIO W/NAVI W/O SURROUND]

< BASIC INSPECTION >

Is the difference corrected?

YES >> On the CONSULT screen, touch "OK" button to complete writing to the around view monitor control unit.

NO >> GO TO 5.

## 5.PERFORM "CALIBRATING CAMERA IMAGE"

Preparation of target line

1. Hang a string with a weight as shown in the figure. Put the points FM0, RM0 (mark) on the ground at the center of the vehicle front end and rear end with white packing tape or a pen.
2. Route the vinyl string under the vehicle, and then pull and fix it on the point approximately 1.0 m (39.9 in) to the front and rear of the vehicle through the points FM0 and RM0 using packing tape.

Target line preparation procedure 1

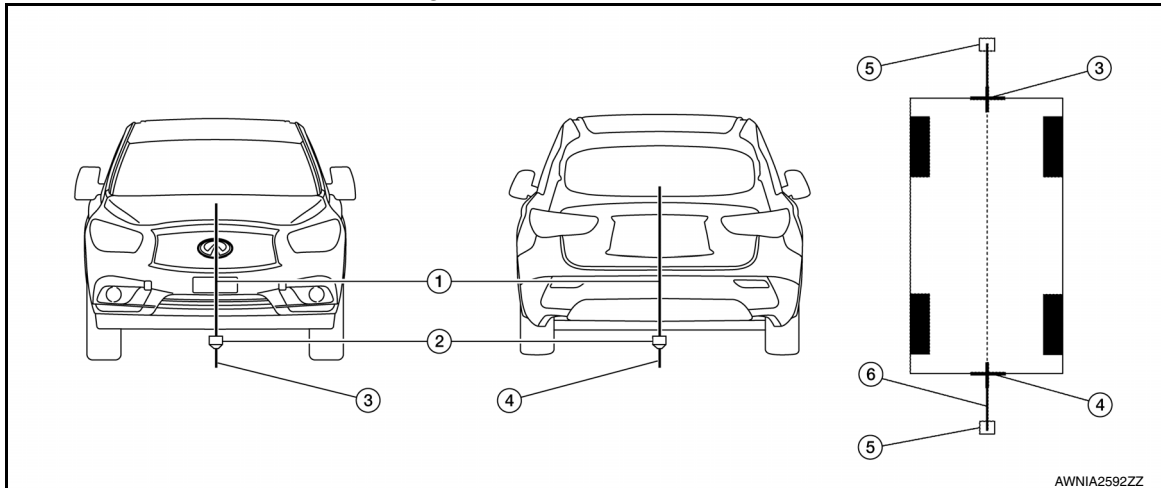

- |                     |   |                     |
|---------------------|---|---------------------|
| 1. Thread           | 2. Weight                                 | 3. Point FM0 (mark) |
| 4. Point RM0 (mark) | 5. Packing tape (to fix the vinyl string) | 6. Vinyl string     |

3. Put the points FM and RM (mark) 75 cm (29.5 in) from the points FM0 and RM0 individually.
4. Route the vinyl string through the points FM and RM using a triangle scale, and then fix it at approximately 1.5 m (59 in) on both sides with packing tape.
5. Put the points FL, FR, RL, and RR (mark) to both right and left [vehicle width / 2 + 30 cm (11.8 in)] from the points FM and RM.

Target line preparation procedure 2

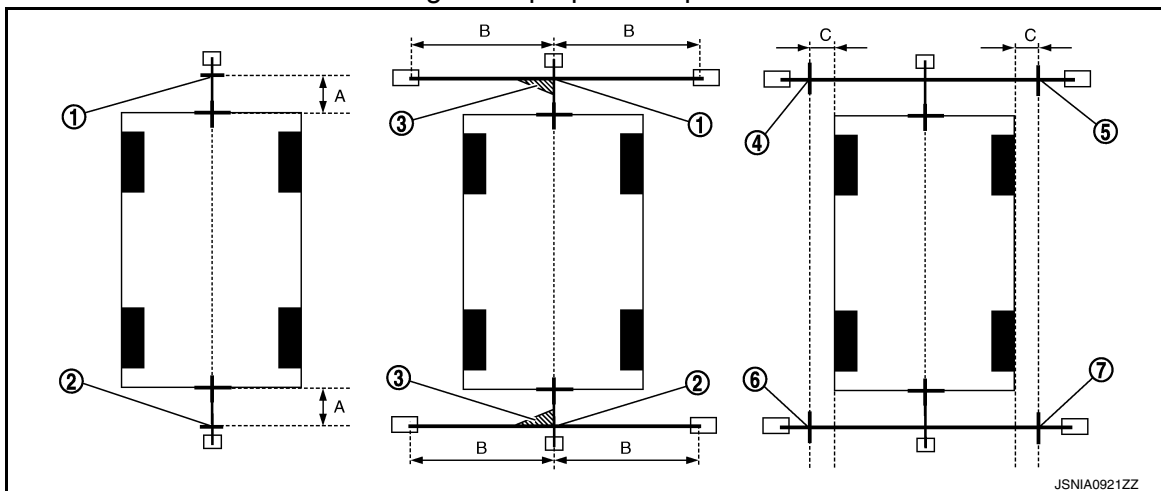

- |                    |                    |                    |
|--------------------|--------------------|--------------------|
| 1. Point FM        | 2. Point RM        | 3. Triangle scale  |
| 4. Point FL (mark) | 5. Point FR (mark) | 6. Point RL (mark) |



# INSPECTION AND ADJUSTMENT

[BOSE AUDIO W/NAVI W/O SURROUND]

## < BASIC INSPECTION >

7. Point RR (mark)

A. 75 cm (29.5 in)

B. Approx. 1.5 m (59 in)

30 cm (11.8 in)

C. [Vehicle width/ 2 + 30 cm (11.8 in)  
from the points FM and RM]

6. Draw the lines of the points FL – RL and FR – RR with vinyl string, and fix it with packing tape.

7. Put a mark on the center of each axle, draw vertical lines to the lines of the points FL – RL and FR – RR from the marks on the center of the axle using a triangle scale, and then fix the lines using packing tape.

Target line preparation procedure 3

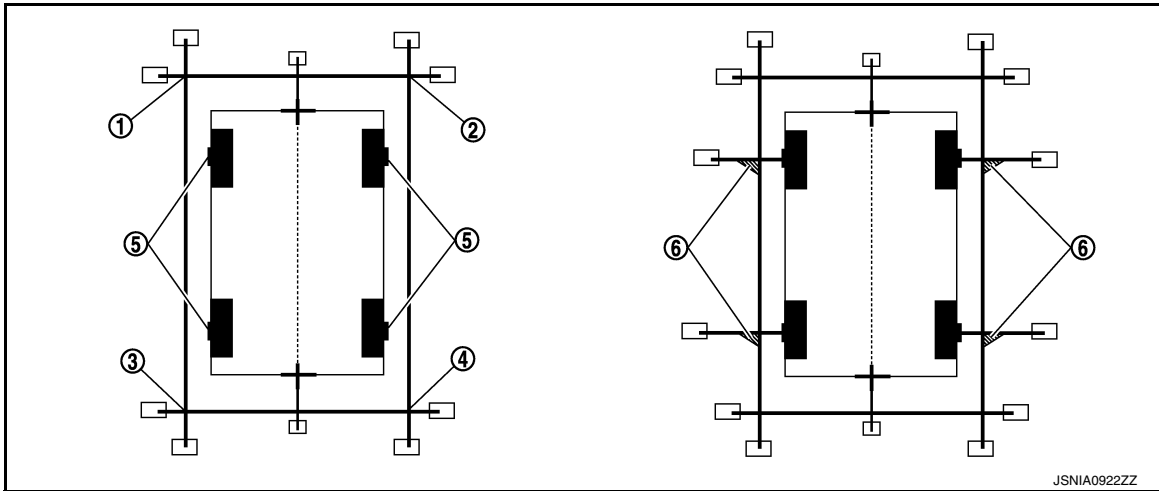

1. Point FL

2. Point FR

3. Point RL

4. Point RR

5. Center position of axle

6. Triangle scale

Perform “Calibrating Camera Image”

CONSULT work support

1. On the CONSULT screen, touch “CALIBRATING CAMERA IMAGE (FRONT CAMERA)”, “CALIBRATING CAMERA IMAGE (PASS-SIDE CAMERA)”, “CALIBRATING CAMERA IMAGE (DR-SIDE CAMERA)”, or “CALIBRATING CAMERA IMAGE (REAR CAMERA)” to accept the selection.

**NOTE:**

To cancel the indication of Incomplete calibration, select items based on the target camera.

2. On the adjustment screen of each camera, adjust the parameter by touching the “AXIS X” button, “AXIS Y” button, and “ROTATE” button to place the calibration marker shown on the camera screen on the target line drawn on the ground.

Adjustment range

Rotation direction (Center dial) : 31 patterns (16 on the center)

Upper/lower direction (upper/lower switch) : -22 – 22

Left/right direction (left/right switch) : -22 – 22

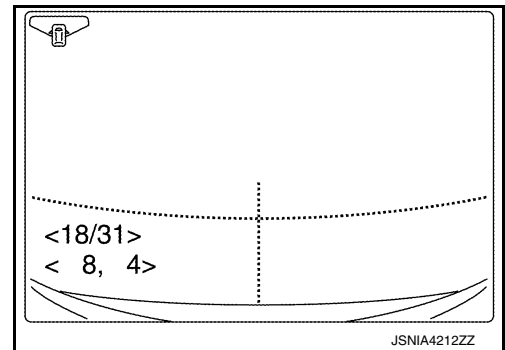

3. Touch “APPLY” button on the CONSULT screen. “PRCSNG” is displayed and adjustment results are shown on the camera screen.

**CAUTION:**

Check that “PRCSNG” is displayed. Do not perform other operations while “PRCSNG” is displayed.

4. Touch “OK” button on the CONSULT screen. “PRCSNG” is displayed and adjustment results are written to the around view monitor control unit.

**CAUTION:**

Check that “PRCSNG” is displayed. Do not perform other operations while “PRCSNG” is displayed.

>> GO TO 6.

## 6.PERFORM “FINE TUNING OF BIRDS-EYE VIEW”

## INSPECTION AND ADJUSTMENT

[BOSE AUDIO W/NAVI W/O SURROUND]

< BASIC INSPECTION >

This mode is designed to align the boundary between each camera image that could not be aligned in the "Calibrating Camera Image" mode.

CONSULT work support

1. Select "FINE TUNING OF BIRDS-EYE VIEW" by touching CONSULT screen.
2. On the adjustment screen of each camera, adjust the parameter by touching the "AXIS X" button, "AXIS Y" button", and "ROTATE" button to place the calibration marker shown on the camera screen on the target line drawn on the ground.

**NOTE:**

Touch "SELECT" button on the CONSULT screen to select the target camera.

3. Touch "APPLY" button on the CONSULT screen. "PRCSNG" is displayed and adjustment results are shown on the camera screen.

**CAUTION:**

**Check that "PRCSNG" is displayed. Do never perform other operations while "PRCSNG" is displayed.**

4. Touch "OK" button on the CONSULT screen. "PRCSNG" is displayed and adjustment results are written to the around view monitor control unit.

**CAUTION:**

• Check that "PRCSNG" is displayed. Never perform other operations while "PRCSNG" is displayed.

• After pressing the "OK" button, never press buttons other than the "BACK" button.

**NOTE:**

- It can be initialized to the NISSAN factory default condition with "Initialize Camera Image Calibration".
- The adjustment value is cancelled in this mode by performing "Initialize Camera Image Calibration".

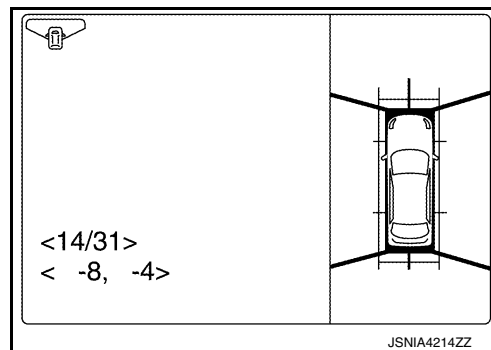

>> Calibration end

# U1000 CAN COMM CIRCUIT

< DTC/CIRCUIT DIAGNOSIS >

[BOSE AUDIO W/NAVI W/O SURROUND]

## DTC/CIRCUIT DIAGNOSIS

### U1000 CAN COMM CIRCUIT

#### AV CONTROL UNIT

#### AV CONTROL UNIT : DTC Logic

INFOID:000000009129114

#### DTC DETECTION LOGIC

CONSULT Display	DTC Detection Condition	Possible Cause
CAN COMM CIRCUIT [U1000]	AV control unit is not transmitting or receiving CAN communication signal for 2 seconds or more.	CAN communication system.

#### AV CONTROL UNIT : Diagnosis Procedure

INFOID:000000009129115

#### 1.PERFORM SELF DIAGNOSTIC RESULT

1. Turn ignition switch ON and wait for 2 seconds or more.
2. Perform Self Diagnostic Result for MULTI AV.

#### Is CAN COMM CIRCUIT displayed?

- YES >> Refer to [LAN-26, "Trouble Diagnosis Flow Chart"](#).  
NO >> Refer to [GI-53, "Intermittent Incident"](#).

#### SONAR CONTROL UNIT (WITH AROUND VIEW MONITOR)

#### SONAR CONTROL UNIT (WITH AROUND VIEW MONITOR) : DTC Logic

INFOID:000000009129116

#### DTC DETECTION LOGIC

CONSULT Display	DTC Detection Condition	Possible Cause
CAN COMM CIRCUIT [U1000]	Sonar control unit is not transmitting or receiving CAN communication signal for 2 seconds or more.	CAN communication system.

#### SONAR CONTROL UNIT (WITH AROUND VIEW MONITOR) : Diagnosis Procedure

INFOID:000000009129117

#### 1.PERFORM SELF DIAGNOSTIC RESULT

1. Turn ignition switch ON and wait for 2 seconds or more.
2. Perform Self Diagnostic Result for SONAR.

#### Is CAN COMM CIRCUIT displayed?

- YES >> Refer to [LAN-26, "Trouble Diagnosis Flow Chart"](#).  
NO >> Refer to [GI-53, "Intermittent Incident"](#).

# U1010 CONTROL UNIT (CAN)

[BOSE AUDIO W/NAVI W/O SURROUND]

< DTC/CIRCUIT DIAGNOSIS >

## U1010 CONTROL UNIT (CAN)

### AV CONTROL UNIT

#### AV CONTROL UNIT : DTC Logic

INFOID:000000009129118

#### DTC DETECTION LOGIC

CONSULT Display	DTC Detection Condition	Possible Cause
CONTROL UNIT (CAN) [U1010]	CAN initial diagnosis malfunction is detected.	Replace the AV control unit if the malfunction occurs constantly. Refer to <a href="#">AV-586</a> , " <a href="#">Removal and Installation - AV Control Unit</a> ".

## SONAR CONTROL UNIT (WITH AROUND VIEW MONITOR)

#### SONAR CONTROL UNIT (WITH AROUND VIEW MONITOR) : DTC Logic

INFOID:000000009129119

#### DTC DETECTION LOGIC

CONSULT Display	DTC Detection Condition	Possible Cause
CONTROL UNIT (CAN) [U1010]	CAN initial diagnosis malfunction is detected.	Replace the sonar control unit if the malfunction occurs constantly. Refer to <a href="#">AV-608</a> , " <a href="#">Removal and Installation</a> ".

# U1200 AV CONTROL UNIT

< DTC/CIRCUIT DIAGNOSIS >

[BOSE AUDIO W/NAVI W/O SURROUND]

## U1200 AV CONTROL UNIT

### DTC Logic

INFOID:000000009129120

CONSULT Display	DTC Detection Condition	Possible Cause
CONT UNIT [U1200]	AV control unit malfunction is detected.	Replace AV control unit if malfunction occurs constantly. Refer to <a href="#">AV-586. "Removal and Installation - AV Control Unit"</a> .

A  
B  
C  
D  
E  
F  
G  
H  
I  
J  
K  
L  
M  
O  
P

AV

# U1201 AV CONTROL UNIT

< DTC/CIRCUIT DIAGNOSIS >

[BOSE AUDIO W/NAVI W/O SURROUND]

## U1201 AV CONTROL UNIT

### DTC Logic

INFOID:000000009129121

CONSULT Display	DTC Detection Condition	Possible Cause
GYRO NO CONN [U1201]	AV control unit malfunction is detected.	Replace AV control unit if malfunction occurs constantly. Refer to <a href="#">AV-586. "Removal and Installation - AV Control Unit"</a> .

# U1202 AV CONTROL UNIT

< DTC/CIRCUIT DIAGNOSIS >

[BOSE AUDIO W/NAVI W/O SURROUND]

## U1202 AV CONTROL UNIT

### DTC Logic

INFOID:000000009129122

CONSULT Display	DTC Detection Condition	Possible Cause
G-SENSOR NO CONN [U1202]	AV control unit malfunction is detected.	Replace AV control unit if malfunction occurs constantly. Refer to <a href="#">AV-586. "Removal and Installation - AV Control Unit"</a> .

A  
B  
C  
D  
E  
F  
G  
H  
I  
J  
K  
L  
M

AV

O  
P

# U1204 AV CONTROL UNIT

< DTC/CIRCUIT DIAGNOSIS >

[BOSE AUDIO W/NAVI W/O SURROUND]

## U1204 AV CONTROL UNIT

### DTC Logic

INFOID:000000009129123

CONSULT Display	DTC Detection Condition	Possible Cause
GPS CONN [U1204]	GPS malfunction is detected.	An intermittent error caused by strong radio interference, GPS reception error, etc. may be detected. Replace AV control unit if malfunction occurs constantly. Refer to <a href="#">AV-586, "Removal and Installation - AV Control Unit"</a> .

### Diagnosis Procedure

INFOID:000000009129124

#### 1. PERFORM SELF DIAGNOSTIC RESULT

1. Perform Self Diagnostic Result for MULTI AV.
2. Erase Self Diagnostic Result. Turn ignition switch OFF.
3. Turn ignition switch ON. Perform Self Diagnostic Result again.

#### Is DTC U1204 detected?

- YES >> Replace AV control unit. Refer to [AV-586, "Removal and Installation - AV Control Unit"](#).
- NO >> Refer to [GI-53, "Intermittent Incident"](#).



# U1205 AV CONTROL UNIT

< DTC/CIRCUIT DIAGNOSIS >

[BOSE AUDIO W/NAVI W/O SURROUND]

## U1205 AV CONTROL UNIT

### DTC Logic

INFOID:000000009129125

CONSULT Display	DTC Detection Condition	Possible Cause
GPS ROM [U1205]	GPS malfunction is detected.	An intermittent error caused by strong radio interference, GPS reception error, etc. may be detected. Replace AV control unit if malfunction occurs constantly. Refer to <a href="#">AV-586, "Removal and Installation - AV Control Unit"</a> .

### Diagnosis Procedure

INFOID:000000009129126

#### 1. PERFORM SELF DIAGNOSTIC RESULT

1. Perform Self Diagnostic Result for MULTI AV.
2. Erase Self Diagnostic Result. Turn ignition switch OFF.
3. Turn ignition switch ON. Perform Self Diagnostic Result again.

#### Is DTC U1205 detected?

- YES >> Replace AV control unit. Refer to [AV-586, "Removal and Installation - AV Control Unit"](#).  
NO >> Refer to [GI-53, "Intermittent Incident"](#).

A  
B  
C  
D  
E  
F  
G  
H  
I  
J  
K  
L  
M  
O  
P

AV

# U1206 AV CONTROL UNIT

< DTC/CIRCUIT DIAGNOSIS >

[BOSE AUDIO W/NAVI W/O SURROUND]

## U1206 AV CONTROL UNIT

### DTC Logic

INFOID:000000009129127

CONSULT Display	DTC Detection Condition	Possible Cause
GPS RAM [U1206]	GPS malfunction is detected.	An intermittent error caused by strong radio interference, GPS reception error, etc. may be detected. Replace AV control unit if malfunction occurs constantly. Refer to <a href="#">AV-586, "Removal and Installation - AV Control Unit"</a> .

### Diagnosis Procedure

INFOID:000000009129128

#### 1. PERFORM SELF DIAGNOSTIC RESULT

1. Perform Self Diagnostic Result for MULTI AV.
2. Erase Self Diagnostic Result. Turn ignition switch OFF.
3. Turn ignition switch ON. Perform Self Diagnostic Result again.

#### Is DTC U1206 detected?

- YES >> Replace AV control unit. Refer to [AV-586, "Removal and Installation - AV Control Unit"](#).  
NO >> Refer to [GI-53, "Intermittent Incident"](#).

# U1207 AV CONTROL UNIT

< DTC/CIRCUIT DIAGNOSIS >

[BOSE AUDIO W/NAVI W/O SURROUND]

## U1207 AV CONTROL UNIT

### DTC Logic

INFOID:000000009129129

CONSULT Display	DTC Detection Condition	Possible Cause
GPS RTC [U1207]	GPS malfunction is detected.	An intermittent error caused by strong radio interference, GPS reception error, etc. may be detected. Replace AV control unit if malfunction occurs constantly. Refer to <a href="#">AV-586, "Removal and Installation - AV Control Unit"</a> .

### Diagnosis Procedure

INFOID:000000009129130

#### 1. PERFORM SELF DIAGNOSTIC RESULT

1. Perform Self Diagnostic Result for MULTI AV.
2. Erase Self Diagnostic Result. Turn ignition switch OFF.
3. Turn ignition switch ON. Perform Self Diagnostic Result again.

#### Is DTC U1207 detected?

- YES >> Replace AV control unit. Refer to [AV-586, "Removal and Installation - AV Control Unit"](#).  
NO >> Refer to [GI-53, "Intermittent Incident"](#).

A  
B  
C  
D  
E  
F  
G  
H  
I  
J  
K  
L  
M  
O  
P

AV

# U1216 AV CONTROL UNIT

< DTC/CIRCUIT DIAGNOSIS >

[BOSE AUDIO W/NAVI W/O SURROUND]

## U1216 AV CONTROL UNIT

### DTC Logic

INFOID:000000009129131

CONSULT Display	DTC Detection Condition	Possible Cause
CAN CONT [U1216]	AV control unit malfunction is detected.	Replace AV control unit if malfunction occurs constantly. Refer to <a href="#">AV-586. "Removal and Installation - AV Control Unit"</a> .

# U1217 AV CONTROL UNIT

< DTC/CIRCUIT DIAGNOSIS >

[BOSE AUDIO W/NAVI W/O SURROUND]

## U1217 AV CONTROL UNIT

### DTC Logic

INFOID:000000009129132

CONSULT Display	DTC Detection Condition	Possible Cause
BLUETOOTH MODULE [U1217]	AV control unit malfunction is detected.	Replace AV control unit if malfunction occurs constantly. Refer to <a href="#">AV-586. "Removal and Installation - AV Control Unit"</a> .

A  
B  
C  
D  
E  
F  
G  
H  
I  
J  
K  
L  
M  
N  
O  
P

AV

# U1218 AV CONTROL UNIT

< DTC/CIRCUIT DIAGNOSIS >

[BOSE AUDIO W/NAVI W/O SURROUND]

## U1218 AV CONTROL UNIT

### DTC Logic

INFOID:000000009129133

CONSULT Display	DTC Detection Condition	Possible Cause
HDD CONN [U1218]	AV control unit malfunction is detected.	An intermittent error causing HDD malfunction may be detected. Replace AV control unit if malfunction occurs constantly. Refer to <a href="#">AV-586. "Removal and Installation - AV Control Unit"</a> .

# U1219 AV CONTROL UNIT

< DTC/CIRCUIT DIAGNOSIS >

[BOSE AUDIO W/NAVI W/O SURROUND]

## U1219 AV CONTROL UNIT

### DTC Logic

INFOID:000000009129135

CONSULT Display	DTC Detection Condition	Possible Cause
HDD READ [U1219]	AV control unit malfunction is detected.	An intermittent error causing HDD malfunction may be detected. Replace AV control unit if malfunction occurs constantly. Refer to <a href="#">AV-586. "Removal and Installation - AV Control Unit"</a> .

A  
B  
C  
D  
E  
F  
G  
H  
I  
J  
K  
L  
M  
N  
O  
P

AV

# U121A AV CONTROL UNIT

< DTC/CIRCUIT DIAGNOSIS >

[BOSE AUDIO W/NAVI W/O SURROUND]

## U121A AV CONTROL UNIT

### DTC Logic

INFOID:000000009129137

CONSULT Display	DTC Detection Condition	Possible Cause
HDD WRITE [U121A]	AV control unit malfunction is detected.	An intermittent error causing HDD malfunction may be detected. Replace AV control unit if malfunction occurs constantly. Refer to <a href="#">AV-586. "Removal and Installation - AV Control Unit"</a> .



# U121B AV CONTROL UNIT

< DTC/CIRCUIT DIAGNOSIS >

[BOSE AUDIO W/NAVI W/O SURROUND]

## U121B AV CONTROL UNIT

### DTC Logic

INFOID:000000009129139

CONSULT Display	DTC Detection Condition	Possible Cause
HDD COMM [U121B]	AV control unit malfunction is detected.	An intermittent error causing HDD malfunction may be detected. Replace AV control unit if malfunction occurs constantly. Refer to <a href="#">AV-586. "Removal and Installation - AV Control Unit"</a> .

A  
B  
C  
D  
E  
F  
G  
H  
I  
J  
K  
L  
M  
N  
O  
P

AV

# U121C AV CONTROL UNIT

< DTC/CIRCUIT DIAGNOSIS >

[BOSE AUDIO W/NAVI W/O SURROUND]

## U121C AV CONTROL UNIT

### DTC Logic

INFOID:000000009129141

CONSULT Display	DTC Detection Condition	Possible Cause
HDD ACCESS [U121C]	AV control unit malfunction is detected.	An intermittent error causing HDD malfunction may be detected. Replace AV control unit if malfunction occurs constantly. Refer to <a href="#">AV-586. "Removal and Installation - AV Control Unit"</a> .

# U121D AV CONTROL UNIT

< DTC/CIRCUIT DIAGNOSIS >

[BOSE AUDIO W/NAVI W/O SURROUND]

## U121D AV CONTROL UNIT

### DTC Logic

INFOID:000000009129143

CONSULT Display	DTC Detection Condition	Possible Cause
DSP CONN [U121D]	AV control unit malfunction is detected.	An intermittent error causing disc player malfunction may be detected. Replace AV control unit if malfunction occurs constantly. Refer to <a href="#">AV-586, "Removal and Installation - AV Control Unit"</a> .

### Diagnosis Procedure

INFOID:000000009129144

#### 1. CHECK CD PLAYBACK

Check the CD playback operation of the AV control unit. Refer to Owner's Manual for audio system operating instructions.

Is the CD playback function of the AV control unit operating normally?

YES >> Refer to [GI-53, "Intermittent Incident"](#).

NO >> Replace AV control unit. Refer to [AV-586, "Removal and Installation - AV Control Unit"](#).

A  
B  
C  
D  
E  
F  
G  
H  
I  
J  
K  
L  
M  
O  
P

AV

# U121E AV CONTROL UNIT

< DTC/CIRCUIT DIAGNOSIS >

[BOSE AUDIO W/NAVI W/O SURROUND]

## U121E AV CONTROL UNIT

### DTC Logic

INFOID:000000009129145

CONSULT Display	DTC Detection Condition	Possible Cause
DSP COMM [U121E]	AV control unit malfunction is detected.	An intermittent error causing disc player malfunction may be detected. Replace AV control unit if malfunction occurs constantly. Refer to <a href="#">AV-586. "Removal and Installation - AV Control Unit"</a> .

### Diagnosis Procedure

INFOID:000000009129146

#### 1. CHECK CD PLAYBACK

Check the CD playback operation of the AV control unit. Refer to Owner's Manual for audio system operating instructions.

Is the CD playback function of the AV control unit operating normally?

YES >> Refer to [GI-53. "Intermittent Incident"](#).

NO >> Replace AV control unit. Refer to [AV-586. "Removal and Installation - AV Control Unit"](#).

# U1225 AV CONTROL UNIT

< DTC/CIRCUIT DIAGNOSIS >

[BOSE AUDIO W/NAVI W/O SURROUND]

## U1225 AV CONTROL UNIT

### DTC Logic

INFOID:000000009129147

CONSULT Display	DTC Detection Condition	Possible Cause
USB CONTROLLER [U1225] [U1225]	USB connection malfunction is detected.	Check that connection to USB connector is normal.

A

B

C

D

E

F

G

H

I

J

K

L

M

AV

O

P

# U1227 AV CONTROL UNIT

< DTC/CIRCUIT DIAGNOSIS >

[BOSE AUDIO W/NAVI W/O SURROUND]

## U1227 AV CONTROL UNIT

### DTC Logic

INFOID:000000009129148

CONSULT Display	DTC Detection Condition	Possible Cause
DVD COMM [U1227]	AV control unit malfunction is detected.	An intermittent error causing disc player malfunction may be detected. Replace AV control unit if malfunction occurs constantly. Refer to <a href="#">AV-586. "Removal and Installation - AV Control Unit"</a> .

### Diagnosis Procedure

INFOID:000000009129149

#### 1. CHECK DVD PLAYBACK

Check the DVD playback operation of the AV control unit. Refer to Owner's Manual for audio system operating instructions.

Is the DVD playback function of the AV control unit operating normally?

YES >> Refer to [GI-53. "Intermittent Incident"](#).

NO >> Replace AV control unit. Refer to [AV-586. "Removal and Installation - AV Control Unit"](#).

# U1228 AV CONTROL UNIT

< DTC/CIRCUIT DIAGNOSIS >

[BOSE AUDIO W/NAVI W/O SURROUND]

## U1228 AV CONTROL UNIT

### DTC Logic

INFOID:000000009129150

CONSULT Display	DTC Detection Condition	Possible Cause
SUB CPU CONN [U1228]	AV control unit malfunction is detected.	Replace AV control unit if malfunction occurs constantly. Refer to <a href="#">AV-586. "Removal and Installation - AV Control Unit"</a> .

A

B

C

D

E

F

G

H

I

J

K

L

M

AV

O

P

# U1229 AV CONTROL UNIT

< DTC/CIRCUIT DIAGNOSIS >

[BOSE AUDIO W/NAVI W/O SURROUND]

## U1229 AV CONTROL UNIT

### DTC Logic

INFOID:000000009129151

CONSULT Display	DTC Detection Condition	Possible Cause
iPod CERTIFICATION [U1229]	AV control unit malfunction is detected.	Replace AV control unit if malfunction occurs constantly. Refer to <a href="#">AV-586. "Removal and Installation - AV Control Unit"</a> .



# U122A AV CONTROL UNIT

< DTC/CIRCUIT DIAGNOSIS >

[BOSE AUDIO W/NAVI W/O SURROUND]

## U122A AV CONTROL UNIT

### DTC Logic

INFOID:000000009129152

CONSULT Display	DTC Detection Condition	Possible Cause
CONFIG UNFINISH [U122A]	Configuration data is incomplete.	Write configuration data. Refer to <a href="#">AV-447, "CONFIGURATION (AV CONTROL UNIT) : Work Procedure"</a> .

### Diagnosis Procedure

INFOID:000000009129153

#### 1.PERFORM CONFIGURATION

When U122A is detected, configuration data must be written.

>> Write configuration data with CONSULT. Refer to [AV-447, "CONFIGURATION \(AV CONTROL UNIT\) : Work Procedure"](#).

A  
B  
C  
D  
E  
F  
G  
H  
I  
J  
K  
L  
M

AV

O  
P

# U122E AV CONTROL UNIT

< DTC/CIRCUIT DIAGNOSIS >

[BOSE AUDIO W/NAVI W/O SURROUND]

## U122E AV CONTROL UNIT

### DTC Logic

INFOID:000000009129154

CONSULT Display	DTC Detection Condition	Possible Cause
Built-in AUDIO CONN [U122E]	AV control unit malfunction is detected.	Replace AV control unit if malfunction occurs constantly. Refer to <a href="#">AV-586. "Removal and Installation - AV Control Unit"</a> .

# U1231 BOSE AMP.

< DTC/CIRCUIT DIAGNOSIS >

[BOSE AUDIO W/NAVI W/O SURROUND]

## U1231 BOSE AMP.

### DTC Logic

INFOID:000000009129155

CONSULT Display	DTC Detection Condition	Possible Cause
AMP TEMP [U1231]	BOSE amp. malfunction is detected.	Replace BOSE amp. if malfunction occurs constantly. Refer to <a href="#">AV-590. "Removal and Installation"</a> .

A  
B  
C  
D  
E  
F  
G  
H  
I  
J  
K  
L  
M  
AV  
O  
P

# U1232 STEERING ANGLE SENSOR

< DTC/CIRCUIT DIAGNOSIS >

[BOSE AUDIO W/NAVI W/O SURROUND]

## U1232 STEERING ANGLE SENSOR

### DTC Logic

INFOID:000000009129156

CONSULT Display	DTC Detection Condition	Possible Cause
ST ANGLE SEN CALIB [U1232]	Predictive course line center position adjustment of steering angle sensor is incomplete.	Adjust predictive course line center position of steering angle sensor.

### Diagnosis Procedure

INFOID:000000009129157

#### 1. ADJUST PREDICTIVE COURSE LINE CENTER POSITION OF STEERING ANGLE SENSOR

When U1232 is detected, the predictive course line center position of the steering angle sensor needs to be adjusted.

>> Adjust the predictive course line center position of steering angle sensor. Refer to [AV-452. "PRE-DICTED COURSE LINE CENTER POSITION ADJUSTMENT : Work Procedure"](#).

# U1243 DISPLAY UNIT

[BOSE AUDIO W/NAVI W/O SURROUND]

< DTC/CIRCUIT DIAGNOSIS >

## U1243 DISPLAY UNIT

### DTC Logic

INFOID:000000009129158

CONSULT Display	DTC Detection Condition	Possible Cause
FRONT DISP CONN [U1243]	When any of the following is detected. <ul style="list-style-type: none"><li>display unit power supply or ground circuit malfunction.</li><li>serial communication circuit malfunction between front display unit and AV control unit.</li></ul>	<ul style="list-style-type: none"><li>Display unit power supply and ground circuits.</li><li>Serial communication circuits between front display unit and AV control unit.</li></ul>

### Diagnosis Procedure

INFOID:000000009129159

Regarding Wiring Diagram information, refer to [AV-390. "Wiring Diagram"](#).

#### 1. CHECK DISPLAY UNIT POWER SUPPLY AND GROUND CIRCUIT

Check display unit power supply and ground circuits. Refer to [AV-519. "DISPLAY UNIT : Diagnosis Procedure"](#).

Is the inspection result normal?

YES >> GO TO 2.

NO >> Repair or replace harness or connectors.

#### 2. CHECK COMMUNICATION CIRCUIT CONTINUITY

- Turn ignition switch OFF.
- Disconnect display unit connector M92 and AV control unit connector M124.
- Check continuity between display unit connector M92 terminals 9, 10 and AV control unit connector M124 terminals 77, 61.

Display unit		AV control unit		Continuity
Connector	Terminals	Connector	Terminals	
M92	9	M124	77	Yes
	10		61	

- Check continuity between display unit connector M92 terminals 9, 10 and ground.

Display unit		Ground	Continuity
Connector	Terminals		
M92	9	—	No
	10		

Is the inspection result normal?

YES >> GO TO 3.

NO >> Repair or replace harness or connectors.

#### 3. CHECK COMMUNICATION SIGNAL (DISP→CONT)

- Connect display unit connector M92 and AV control unit connector M124.
- Turn ignition switch ON.
- Check signal between display unit connector M92 terminal 9 and ground.

# U1243 DISPLAY UNIT

[BOSE AUDIO W/NAVI W/O SURROUND]

< DTC/CIRCUIT DIAGNOSIS >

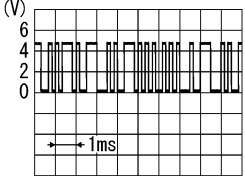
Display unit		Ground	Condition	Reference value
(+)		(-)		
Connector	Terminal			
M92	9	—	When adjusting display brightness.	 <p>PKIB5039J</p>

Is the inspection result normal?

YES >> GO TO 4.

NO >> Replace AV control unit. Refer to [AV-586. "Removal and Installation - AV Control Unit"](#).

## 4. CHECK COMMUNICATION SIGNAL (CONT→DISP)

Check signal between display unit connector M92 terminal 10 and ground.

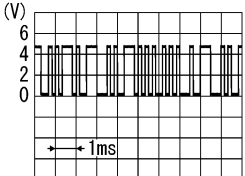
Display unit		Ground	Condition	Reference value
(+)		(-)		
Connector	Terminal			
M92	10	—	When adjusting display brightness.	 <p>PKIB5039J</p>

Is the inspection result normal?

YES >> Inspection End.

NO >> Replace display unit. Refer to [AV-589. "Removal and Installation"](#).

# U1244 GPS ANTENNA

[BOSE AUDIO W/NAVI W/O SURROUND]

< DTC/CIRCUIT DIAGNOSIS >

## U1244 GPS ANTENNA

### DTC Logic

INFOID:000000009129160

CONSULT Display	DTC Detection Condition	Possible Cause
GPS ANTENNA CONN [U1244]	GPS antenna connection malfunction is detected.	GPS antenna disconnection.

### Diagnosis Procedure

INFOID:000000009129161

Regarding Wiring Diagram information, refer to [AV-390, "Wiring Diagram"](#).

#### 1. GPS ANTENNA INSPECTION

Visually inspect the GPS antenna and antenna feeder. Refer to [AV-614, "Removal and Installation"](#).

Is inspection result normal?

YES >> GO TO 2.

NO >> Repair or replace harness or connectors.

#### 2. CHECK AV CONTROL UNIT VOLTAGE

1. Disconnect AV control unit connector M25.
2. Turn ignition switch ON.
3. Check voltage between AV control unit connector M25 and ground.

AV control unit		Ground	Voltage
Connector	Terminal		
M25	188	—	5.0 V

Is inspection result normal?

YES >> Inspection End.

NO >> Replace AV control unit. Refer to [AV-586, "Removal and Installation - AV Control Unit"](#).

A  
B  
C  
D  
E  
F  
G  
H  
I  
J  
K  
L  
M  
O  
P

AV

# U1258 SATELLITE RADIO ANTENNA

< DTC/CIRCUIT DIAGNOSIS >

[BOSE AUDIO W/NAVI W/O SURROUND]

## U1258 SATELLITE RADIO ANTENNA

### DTC Logic

INFOID:000000009129162

CONSULT Display	DTC Detection Condition	Possible Cause
XM ANTENNA CONN [U1258]	Satellite radio antenna connection malfunction is detected.	Satellite radio antenna disconnection.

### Diagnosis Procedure

INFOID:000000009129163

Regarding Wiring Diagram information, refer to [AV-390, "Wiring Diagram"](#).

#### 1. SATELLITE RADIO ANTENNA INSPECTION

Visually inspect the satellite radio antenna and antenna feeder. Refer to [AV-612, "Location of Antennas"](#).

Is inspection result normal?

- YES >> GO TO 2.
- NO >> Repair or replace harness or connectors.

#### 2. CHECK AV CONTROL UNIT VOLTAGE

1. Disconnect AV control unit connector M133.
2. Turn ignition switch ON.
3. Check voltage between AV control unit connector M133 and ground.

AV control unit		Ground	Voltage
Connector	Terminal		
M133	166	—	5.0 V

Is inspection result normal?

- YES >> Inspection End.
- NO >> Replace AV control unit. Refer to [AV-586, "Removal and Installation - AV Control Unit"](#).



# U125A HEADREST DISPLAY UNIT

< DTC/CIRCUIT DIAGNOSIS >

[BOSE AUDIO W/NAVI W/O SURROUND]

## U125A HEADREST DISPLAY UNIT

### DTC Logic

INFOID:000000009129164

CONSULT Display	DTC Detection Condition	Possible Cause
3RD DISP CONN [U125A]	When any of the following is detected. <ul style="list-style-type: none"> <li>headrest display unit power supply or ground circuit malfunction.</li> <li>AV communication circuit malfunction between headrest display units.</li> </ul>	<ul style="list-style-type: none"> <li>Headrest display unit power supply and ground circuits.</li> <li>AV communication circuits between headrest display units.</li> </ul>

### Diagnosis Procedure

INFOID:000000009129165

Regarding Wiring Diagram information, refer to [AV-390. "Wiring Diagram"](#).

#### 1. CHECK HEADREST DISPLAY UNIT POWER SUPPLY AND GROUND CIRCUIT

Check headrest display unit power supply and ground circuits. Refer to [AV-524. "HEADREST DISPLAY UNIT : Diagnosis Procedure"](#).

Is the inspection result normal?

YES >> GO TO 2.

NO >> Repair or replace harness or connectors.

#### 2. CHECK AV COMMUNICATION CIRCUIT CONTINUITY

- Turn ignition switch OFF.
- Disconnect headrest display unit connectors.
- Check continuity between headrest display unit (driver seat) connector B202 and headrest display unit (passenger seat) connector B302.

Headrest display unit (driver seat)		Headrest display unit (passenger seat)		Continuity
Connector	Terminals	Connector	Terminals	
B202	26	B302	10	Yes
	27		11	

- Check continuity between headrest display unit (driver seat) connector B202 and ground.

Headrest display unit (driver seat)		Ground	Continuity
Connector	Terminals		
B202	26	—	No
	27		

Is the inspection result normal?

YES >> Replace headrest display unit (passenger seat). Refer to [AV-605. "Removal and Installation"](#).

NO >> Repair or replace harness or connectors.

# U1263 USB

< DTC/CIRCUIT DIAGNOSIS >

[BOSE AUDIO W/NAVI W/O SURROUND]

## U1263 USB

### DTC Logic

INFOID:000000009129166

CONSULT Display	DTC Detection Condition	Possible Cause
USB OVERCURRENT [U126]	Overcurrent in USB connector is detected.	Check USB harness between the AV control unit and USB connector.

### Diagnosis Procedure

INFOID:000000009129167

#### 1. CHECK USB INTERFACE HARNESS

Visually inspect USB interface harness.

Is the inspection result normal?

YES >> GO TO 2.

NO >> Replace USB interface harness. Refer to [AV-598, "Removal and Installation"](#).

#### 2. CHECK USB INTERFACE HARNESS CONTINUITY

Check USB interface harness continuity. Refer to [AV-560, "Diagnosis Procedure"](#).

Is the inspection result normal?

YES >> Replace AV control unit. Refer to [AV-586, "Removal and Installation - AV Control Unit"](#).

NO >> Replace USB interface harness. Refer to [AV-598, "Removal and Installation"](#).

# U1264 ANTENNA AMP.

[BOSE AUDIO W/NAVI W/O SURROUND]

< DTC/CIRCUIT DIAGNOSIS >

## U1264 ANTENNA AMP.

### DTC Logic

INFOID:000000009129168

CONSULT Display	DTC Detection Condition	Possible Cause
ANTENNA AMP TERMINAL [U1264]	Antenna amp. ON signal circuit open or short circuited.	Antenna amp. ON signal circuit between AV control unit and antenna amp.

### Diagnosis Procedure

INFOID:000000009129169

Regarding Wiring Diagram information, refer to [AV-390, "Wiring Diagram"](#).

#### 1. CHECK CONTINUITY BETWEEN AV CONTROL UNIT AND ANTENNA BASE

1. Turn ignition switch OFF.
2. Disconnect AV control unit connector M143 and antenna base connector M502.
3. Check continuity between AV control unit connector M143 and antenna base connector M502.

AV control unit		Antenna base		Continuity
Connector	Terminal	Connector	Terminal	
M143	143	M502	1	Yes

4. Check continuity between AV control unit connector M143 and ground.

AV control unit		Ground	Continuity
Connector	Terminal		
M143	143	—	No

Is the inspection result normal?

- YES >> GO TO 2.  
NO >> Repair or replace harness or connectors.

#### 2. CHECK AV CONTROL UNIT VOLTAGE

1. Connect AV control unit connector M143.
2. Turn ignition switch ON.
3. Check voltage between AV control unit connector M143 and ground.

AV control unit (+)		Ground (-)	Voltage (Approx.)
Connector	Terminal		
M143	143	—	Battery voltage

Is the inspection result normal?

- YES >> Replace antenna base. Refer to [AV-615, "Removal and Installation"](#).  
NO >> Replace AV control unit. Refer to [AV-586, "Removal and Installation - AV Control Unit"](#).

# U1265 BOSE AMP.

< DTC/CIRCUIT DIAGNOSIS >

[BOSE AUDIO W/NAVI W/O SURROUND]

## U1265 BOSE AMP.

### DTC Logic

INFOID:000000009129170

CONSULT Display	DTC Detection Condition	Possible Cause
AMP ON TERMINAL [U1265]	BOSE amp. ON signal circuit open or short circuited.	BOSE amp. ON signal circuit between AV control unit and BOSE amp.

### Diagnosis Procedure

INFOID:000000009129171

Regarding Wiring Diagram information, refer to [AV-390. "Wiring Diagram"](#).

#### 1. CHECK CONTINUITY BETWEEN AV CONTROL UNIT AND BOSE SPEAKER AMP.

1. Turn ignition switch OFF.
2. Disconnect AV control unit connector M122 and Bose speaker amp. connector B130.
3. Check continuity between AV control unit connector M122 and Bose speaker amp. connector B130.

AV control unit		Bose speaker amp.		Continuity
Connector	Terminal	Connector	Terminal	
M122	1	B130	60	Yes

4. Check continuity between AV control unit connector M122 and ground.

AV control unit		Ground	Continuity
Connector	Terminal		
M122	1	—	No

Is the inspection result normal?

YES >> GO TO 2.

NO >> Repair or replace harness or connectors.

#### 2. CHECK AV CONTROL UNIT VOLTAGE

1. Connect AV control unit connector M122.
2. Turn ignition switch ON.
3. Check voltage between AV control unit connector M122 and ground.

AV control unit		Ground	Voltage (Approx.)
(+)			
Connector	Terminal	(-)	
M122	1	—	Battery voltage

Is the inspection result normal?

YES >> Replace Bose speaker amp. Refer to [AV-590. "Removal and Installation"](#).

NO >> Replace AV control unit. Refer to [AV-586. "Removal and Installation - AV Control Unit"](#).

# U1300 AV COMM CIRCUIT

[BOSE AUDIO W/NAVI W/O SURROUND]

< DTC/CIRCUIT DIAGNOSIS >

## U1300 AV COMM CIRCUIT

### Description

INFOID:00000009129172

U1300 is indicated when a malfunction occurs in the communication signal of the multi AV system. Indicated simultaneously, without fail, the malfunction of control units connected to the AV control unit through communication circuits. Determine the possible malfunction cause from the table below.

### SELF DIAGNOSTIC RESULT DISPLAY ITEM

CONSULT Display	DTC Detection Condition	Possible Cause
<ul style="list-style-type: none"> <li>AV COMM CIRCUIT [U1300]</li> <li>SWITCH CONN [U1240]</li> </ul>	When any of the following is detected: <ul style="list-style-type: none"> <li>A/C and AV switch assembly power supply or ground circuit malfunction.</li> <li>AV communication circuit malfunction between AV control unit and A/C and AV switch assembly.</li> </ul>	<ul style="list-style-type: none"> <li>A/C and AV switch assembly power supply and ground circuits. Refer to <a href="#">AV-522. "A/C AND AV SWITCH ASSEMBLY : Diagnosis Procedure"</a>.</li> <li>AV communication circuits between AV control unit and A/C and AV switch assembly.</li> </ul>
<ul style="list-style-type: none"> <li>AV COMM CIRCUIT [U1300]</li> <li>AMP CONN [U124E]</li> </ul>	When any of the following is detected: <ul style="list-style-type: none"> <li>BOSE speaker amp. power supply or ground circuit malfunction.</li> <li>AV communication circuits between AV control unit and BOSE speaker amp. are malfunctioning.</li> </ul>	<ul style="list-style-type: none"> <li>BOSE speaker amp. power supply and ground circuits. Refer to <a href="#">AV-520. "BOSE AMP. : Diagnosis Procedure"</a>.</li> <li>AV communication circuits between AV control unit and BOSE speaker amp.</li> </ul>
<ul style="list-style-type: none"> <li>AV COMM CIRCUIT [U1300]</li> <li>VIDEO DIST CONN [U1246]</li> </ul>	When any of the following is detected: <ul style="list-style-type: none"> <li>video distributor power supply or ground circuit malfunction.</li> <li>headrest display unit (driver seat) power supply or ground circuit malfunction.</li> <li>AV communication circuit malfunction between AV control unit and headrest display unit (driver seat).</li> </ul>	<ul style="list-style-type: none"> <li>Video distributor power supply and ground circuits. Refer to <a href="#">AV-523. "VIDEO DISTRIBUTOR : Diagnosis Procedure"</a>.</li> <li>Headrest display unit (driver seat) power supply and ground circuits. Refer to <a href="#">AV-524. "HEADREST DISPLAY UNIT : Diagnosis Procedure"</a>.</li> <li>AV communication circuits between AV control unit and headrest display unit (driver seat).</li> </ul>
<ul style="list-style-type: none"> <li>AV COMM CIRCUIT [U1300]</li> <li>AROUND CAMERA CONN [U125B]</li> </ul>	When any of the following is detected: <ul style="list-style-type: none"> <li>around view monitor control unit power supply or ground circuit malfunction.</li> <li>AV communication circuit malfunction between AV control unit and around view monitor control unit.</li> </ul>	<ul style="list-style-type: none"> <li>Around view monitor control unit power supply and ground circuits. Refer to <a href="#">AV-524. "AROUND VIEW MONITOR CONTROL UNIT : Diagnosis Procedure"</a>.</li> <li>AV communication circuits between AV control unit and around view monitor control unit.</li> </ul>
<ul style="list-style-type: none"> <li>AV COMM CIRCUIT [U1300]</li> <li>SONAR CONN [U125C]</li> </ul>	When any of the following is detected: <ul style="list-style-type: none"> <li>sonar control unit power supply or ground circuit malfunction.</li> <li>AV communication circuit malfunction between AV control unit and sonar control unit.</li> </ul>	<ul style="list-style-type: none"> <li>Sonar control unit power supply and ground circuits. Refer to <a href="#">AV-525. "SONAR CONTROL UNIT (WITH AROUND VIEW MONITOR) : Diagnosis Procedure"</a>.</li> <li>AV communication circuits between AV control unit and sonar control unit.</li> </ul>

A  
B  
C  
D  
E  
F  
G  
H  
I  
J  
K  
L  
M  
O  
P

AV

# U1300 AV COMM CIRCUIT

[BOSE AUDIO W/NAVI W/O SURROUND]

< DTC/CIRCUIT DIAGNOSIS >

CONSULT Display	DTC Detection Condition	Possible Cause
<ul style="list-style-type: none"><li>• AV COMM CIRCUIT [U1300]</li><li>• SWITCH CONN [U1240]</li><li>• SONAR CONN [U125C]</li><li>• AROUND CAMERA CONN [U125B]</li><li>• VIDEO DIST CONN [U1246]</li></ul>		
<ul style="list-style-type: none"><li>• AV COMM CIRCUIT [U1300]</li><li>• SWITCH CONN [U1240]</li><li>• AMP CONN [U124E]</li><li>• SONAR CONN [U125C]</li><li>• AROUND CAMERA CONN [U125B]</li><li>• VIDEO DIST CONN [U1246]</li></ul>	AV communication circuit malfunction between AV control unit and A/C and AV switch assembly.	AV communication circuits between AV control unit and A/C and AV switch assembly.

# U1302 CAMERA POWER VOLT

< DTC/CIRCUIT DIAGNOSIS >

[BOSE AUDIO W/NAVI W/O SURROUND]

## U1302 CAMERA POWER VOLT

### DTC Logic

INFOID:000000009129173

### DTC DETECTION LOGIC

CONSULT Display	DTC Detection Condition	Possible Cause
CAMERA SUPPLY POWER SUPPLY VOLTAGE ABNORMALITY [U1302]	Short in camera power circuit.	<ul style="list-style-type: none"> <li>• Harness or connectors.</li> <li>• Camera.</li> <li>• Around view monitor control unit.</li> </ul>

### Diagnosis Procedure

INFOID:000000009129174

Regarding Wiring Diagram information, refer to [AV-390, "Wiring Diagram"](#).

### 1. CHECK CAMERA DATA MONITOR

Check CAMERA IMAGE SIG, CAMERA COMM STATUS and CAMERA COMM LINE for each camera in "DATA MONITOR" of "AVM".

Is "OK" displayed for all cameras?

YES >> Refer to [GI-53, "Intermittent Incident"](#).

NO-1 (Front camera)>>GO TO 2.

NO-2 (Rear camera)>>GO TO 4.

NO-3 (LH side camera)>>GO TO 6.

NO-4 (RH side camera)>>GO TO 8.

### 2. CHECK FRONT CAMERA POWER SUPPLY AND POWER SUPPLY GROUND CIRCUIT CONTINUITY

1. Turn ignition switch OFF.
2. Disconnect around view monitor control unit connector M97 and camera connectors.
3. Check continuity between around view monitor control unit connector M97 and front camera connector E226.

Around view monitor control unit		Front camera		Continuity
Connector	Terminal	Connector	Terminal	
M97	68	E226	1	Yes
	70		2	

4. Check continuity between around view monitor control unit connector M97 and ground.

Around view monitor control unit		Ground	Continuity
Connector	Terminal		
M97	68	—	No

Is the inspection result normal?

YES >> GO TO 3.

NO >> Repair or replace harness or connectors.

### 3. CHECK AROUND VIEW MONITOR CONTROL UNIT VOLTAGE

1. Connect around view monitor control unit connector M97 and front camera connector E226.
2. Turn ignition switch ON.
3. Check voltage between around view monitor control unit connector M97 terminals.

## U1302 CAMERA POWER VOLT

< DTC/CIRCUIT DIAGNOSIS >

[BOSE AUDIO W/NAVI W/O SURROUND]

Around view monitor control unit M97		Condition	Voltage (Approx.)
(+)	(-)		
Terminal	Terminal		
68	70	CAMERA switch is ON or shift position is R.	6.0 V

Is the inspection result normal?

YES >> Replace front camera. Refer to [AV-601, "Removal and Installation"](#).

NO >> Replace around view monitor control unit. Refer to [AV-600, "Removal and Installation"](#).

### 4. CHECK REAR CAMERA POWER SUPPLY AND POWER SUPPLY GROUND CIRCUIT CONTINUITY

1. Turn ignition switch OFF.
2. Disconnect around view monitor control unit connector M97 and rear camera connector D511.
3. Check continuity between around view monitor control unit connector M97 and rear camera connector D511.

Around view monitor control unit		Rear camera		Continuity
Connector	Terminal	Connector	Terminal	
M97	50	D511	8	Yes
	52		7	

4. Check continuity between around view monitor control unit connector M97 and ground.

Around view monitor control unit		Ground	Continuity
Connector	Terminal		
M97	50	—	No

Is the inspection result normal?

YES >> GO TO 5.

NO >> Repair or replace harness or connectors.

### 5. CHECK AROUND VIEW MONITOR CONTROL UNIT VOLTAGE

1. Connect around view monitor control unit connector M97 and rear camera connector D511.
2. Turn ignition switch ON.
3. Check voltage between around view monitor control unit connector M97 terminals.

Around view monitor control unit M97		Condition	Voltage (Approx.)
(+)	(-)		
Terminal	Terminal		
50	52	CAMERA switch is ON or shift position is R.	6.0 V

Is the inspection result normal?

YES >> Replace rear camera. Refer to [AV-602, "Removal and Installation"](#).

NO >> Replace around view monitor control unit. Refer to [AV-600, "Removal and Installation"](#).

### 6. CHECK LH SIDE CAMERA POWER SUPPLY AND POWER SUPPLY GROUND CIRCUIT CONTINUITY

1. Turn ignition switch OFF.
2. Disconnect around view monitor control unit connector M97 and LH side camera connector D20.
3. Check continuity between around view monitor control unit connector M97 and LH side camera connector D20.

Around view monitor control unit		LH side camera		Continuity
Connector	Terminal	Connector	Terminal	



# U1302 CAMERA POWER VOLT

< DTC/CIRCUIT DIAGNOSIS >

[BOSE AUDIO W/NAVI W/O SURROUND]

M97	56	D20	6	Yes
	58		18	

4. Check continuity between around view monitor control unit connector M97 and ground.

Around view monitor control unit		Ground	Continuity
Connector	Terminal		
M97	56	—	No

Is the inspection result normal?

YES >> GO TO 7.

NO >> Repair or replace harness or connectors.

## 7. CHECK AROUND VIEW MONITOR CONTROL UNIT VOLTAGE

1. Connect around view monitor control unit connector M97 and LH side camera connector D20.
2. Turn ignition switch ON.
3. Check voltage between around view monitor control unit connector M97 terminals.

Around view monitor control unit M97		Condition	Voltage (Approx.)
(+)	(-)		
Terminal	Terminal		
56	58	CAMERA switch is ON or shift position is R.	6.0 V

Is the inspection result normal?

YES >> Replace LH side camera. Refer to [AV-603, "Removal and Installation"](#).

NO >> Replace around view monitor control unit. Refer to [AV-600, "Removal and Installation"](#).

## 8. CHECK RH SIDE CAMERA POWER SUPPLY AND POWER SUPPLY GROUND CIRCUIT CONTINUITY

1. Turn ignition switch OFF.
2. Disconnect around view monitor control unit connector M97 and RH side camera connector D113.
3. Check continuity between around view monitor control unit connector M97 and RH side camera connector D113.

Around view monitor control unit		RH side camera		Continuity
Connector	Terminal	Connector	Terminal	
M97	62	D113	6	Yes
	64		18	

4. Check continuity between around view monitor control unit connector M97 and ground.

Around view monitor control unit		Ground	Continuity
Connector	Terminal		
M97	62	—	No

Is the inspection result normal?

YES >> GO TO 9.

NO >> Repair or replace harness or connectors.

## 9. CHECK AROUND VIEW MONITOR CONTROL UNIT VOLTAGE

1. Connect around view monitor control unit connector M97 and RH side camera connector D113.
2. Turn ignition switch ON.
3. Check voltage between around view monitor control unit connector M97 terminals.

## U1302 CAMERA POWER VOLT

< DTC/CIRCUIT DIAGNOSIS >

[BOSE AUDIO W/NAVI W/O SURROUND]

Around view monitor control unit M97		Condition	Voltage (Approx.)
(+)	(-)		
Terminal	Terminal		
62	64	CAMERA switch is ON or shift position is R.	6.0 V

Is the inspection result normal?

YES >> Replace RH side camera. Refer to [AV-603. "Removal and Installation"](#).

NO >> Replace around view monitor control unit. Refer to [AV-600. "Removal and Installation"](#).

# U1303 LED POWER SUPPLY VOLT

< DTC/CIRCUIT DIAGNOSIS >

[BOSE AUDIO W/NAVI W/O SURROUND]

## U1303 LED POWER SUPPLY VOLT

### DTC Logic

INFOID:000000009129175

### DTC DETECTION LOGIC

CONSULT Display	DTC Detection Condition	Possible Cause
LED SUPPLY POWER SUPPLY VOLTAGE ABNORMALITY [U1303]	Short in camera power circuit.	<ul style="list-style-type: none"><li>• Harness or connectors.</li><li>• Camera.</li><li>• Around view monitor control unit.</li></ul>

### Diagnosis Procedure

INFOID:000000009129176

Regarding Wiring Diagram information, refer to [AV-390, "Wiring Diagram"](#).

### 1. CHECK CAMERA DATA MONITOR

Check CAMERA IMAGE SIG, CAMERA COMM STATUS and CAMERA COMM LINE for each camera in "DATA MONITOR" of "AVM".

Is "OK" displayed for all cameras?

YES >> Refer to [GI-53, "Intermittent Incident"](#).

NO-1 (LH side camera)>>GO TO 2.

NO-2 (RH side camera)>>GO TO 4.

### 2. CHECK LH SIDE CAMERA POWER SUPPLY AND POWER SUPPLY GROUND CIRCUIT CONTINUITY

1. Turn ignition switch OFF.
2. Disconnect around view monitor control unit connector M97 and LH side camera connector D20.
3. Check continuity between around view monitor control unit connector M97 and LH side camera connector D20.

Around view monitor control unit		LH side camera		Continuity
Connector	Terminal	Connector	Terminal	
M97	56	D20	6	Yes
	58		18	

4. Check continuity between around view monitor control unit connector M97 and ground.

Around view monitor control unit		Ground	Continuity
Connector	Terminal		
M97	56	—	No

Is the inspection result normal?

YES >> GO TO 3.

NO >> Repair or replace harness or connectors.

### 3. CHECK AROUND VIEW MONITOR CONTROL UNIT VOLTAGE

1. Connect around view monitor control unit connector M97 and LH side camera connector D20.
2. Turn ignition switch ON.
3. Check voltage between around view monitor control unit connector M97 terminals.

# U1303 LED POWER SUPPLY VOLT

< DTC/CIRCUIT DIAGNOSIS >

[BOSE AUDIO W/NAVI W/O SURROUND]

Around view monitor control unit M97		Condition	Voltage (Approx.)
(+)	(-)		
Terminal	Terminal		
56	58	CAMERA switch is ON or shift position is R.	6.0 V

Is the inspection result normal?

YES >> Replace LH side camera. Refer to [AV-603, "Removal and Installation"](#).

NO >> Replace around view monitor control unit. Refer to [AV-600, "Removal and Installation"](#).

## 4. CHECK RH SIDE CAMERA POWER SUPPLY AND POWER SUPPLY GROUND CIRCUIT CONTINUITY

1. Turn ignition switch OFF.
2. Disconnect around view monitor control unit connector M97 and RH side camera connector D113.
3. Check continuity between around view monitor control unit connector M97 and RH side camera connector D113.

Around view monitor control unit		RH side camera		Continuity
Connector	Terminal	Connector	Terminal	
M97	62	D113	6	Yes
	64		18	

4. Check continuity between around view monitor control unit connector M97 and ground.

Around view monitor control unit		Ground	Continuity
Connector	Terminal		
M97	62	—	No

Is the inspection result normal?

YES >> GO TO 5.

NO >> Repair or replace harness or connectors.

## 5. CHECK AROUND VIEW MONITOR CONTROL UNIT VOLTAGE

1. Connect around view monitor control unit connector M97 and RH side camera connector D113.
2. Turn ignition switch ON.
3. Check voltage between around view monitor control unit connector M97 terminals.

Around view monitor control unit M97		Condition	Voltage (Approx.)
(+)	(-)		
Terminal	Terminal		
62	64	CAMERA switch is ON or shift position is R.	6.0 V

Is the inspection result normal?

YES >> Replace RH side camera. Refer to [AV-603, "Removal and Installation"](#).

NO >> Replace around view monitor control unit. Refer to [AV-600, "Removal and Installation"](#).

# U1304 CAMERA IMAGE CALIBRATION

< DTC/CIRCUIT DIAGNOSIS >

[BOSE AUDIO W/NAVI W/O SURROUND]

## U1304 CAMERA IMAGE CALIBRATION

DTC Logic

INFOID:000000009129177

DTC DETECTION LOGIC

CONSULT Display	DTC Detection Condition	Possible Cause
NON-COMPLETION OF THE CALIBRATION [U1304]	Camera calibration malfunction.	Cameras are not calibrated. Refer to <a href="#">AV-453, "CALIBRATING CAMERA IMAGE (AROUND VIEW MONITOR) : Work Procedure"</a> .

A  
B  
C  
D  
E  
F  
G  
H  
I  
J  
K  
L  
M

AV

O  
P

# U1305 CONFIG UNFINISH

< DTC/CIRCUIT DIAGNOSIS >

[BOSE AUDIO W/NAVI W/O SURROUND]

## U1305 CONFIG UNFINISH

### DTC Logic

INFOID:000000009129178

### DTC DETECTION LOGIC

CONSULT Display	DTC Detection Condition	Possible Cause
NON-COMPLETION OF THE WRITE CONFIGURATION [U1305]	Around view monitor control unit configuration malfunction.	Around view monitor control unit not configured. Refer to <a href="#">AV-449. "CONFIGURATION (AROUND VIEW MONITOR CONTROL UNIT) : Work Procedure"</a> .

# U1310 AV CONTROL UNIT

< DTC/CIRCUIT DIAGNOSIS >

[BOSE AUDIO W/NAVI W/O SURROUND]

## U1310 AV CONTROL UNIT

### DTC Logic

INFOID:000000009129179

CONSULT Display	DTC Detection Condition	Possible Cause
CONTROL UNIT (AV) [U1310]	An initial diagnosis error is detected in AV communication circuit.	Replace AV control unit if malfunction occurs constantly. Refer to <a href="#">AV-586. "Removal and Installation - AV Control Unit"</a> .

A  
B  
C  
D  
E  
F  
G  
H  
I  
J  
K  
L  
M  
N  
O  
P

AV

# U1601, U1603, U1609, U160B FRONT DOOR SPEAKER/TWEETER

< DTC/CIRCUIT DIAGNOSIS >

[BOSE AUDIO W/NAVI W/O SURROUND]

## U1601, U1603, U1609, U160B FRONT DOOR SPEAKER/TWEETER

### DTC Logic

INFOID:000000009129180

### DTC DETECTION LOGIC

CONSULT Display	DTC Detection Condition	Possible Cause
FL-DOOR WOOFER (OPEN, SHORT, GND- SHORT) [U1601] FL-DOOR WOOFER (VB-SHOR) [U1603]	When any of the following is detected: <ul style="list-style-type: none"><li>• Sound signal circuit malfunction between BOSE speaker amp. and front door speaker LH.</li><li>• Sound signal circuit malfunction between BOSE speaker amp. and front tweeter LH.</li></ul>	<ul style="list-style-type: none"><li>• Sound signal circuits between BOSE speaker amp. and front door speaker LH. Refer to <a href="#">AV-535, "Diagnosis Procedure"</a>.</li><li>• Sound signal circuits between BOSE speaker amp. and front tweeter LH. Refer to <a href="#">AV-532, "Diagnosis Procedure"</a>.</li></ul>
FR-DOOR WOOFER (OPEN, SHORT, GND- SHORT) [U1609] FR-DOOR WOOFER (VB-SHOR) [U160B]	When any of the following is detected: <ul style="list-style-type: none"><li>• Sound signal circuit malfunction between BOSE speaker amp. and front door speaker RH.</li><li>• Sound signal circuit malfunction between BOSE speaker amp. and front tweeter RH.</li></ul>	<ul style="list-style-type: none"><li>• Sound signal circuits between BOSE speaker amp. and front door speaker RH. Refer to <a href="#">AV-535, "Diagnosis Procedure"</a>.</li><li>• Sound signal circuits between BOSE speaker amp. and front tweeter RH. Refer to <a href="#">AV-532, "Diagnosis Procedure"</a>.</li></ul>

### Diagnosis Procedure

INFOID:000000009129181

#### 1. PERFORM SELF DIAGNOSTIC RESULT

1. Perform Self Diagnostic Result for MULTI AV.
2. Erase Self Diagnostic Result. Turn ignition switch OFF.
3. Turn ignition switch ON. Perform Self Diagnostic Result again.

Is DTC U1601, U1603, U1609 or U160B detected?

- YES >> Refer to [AV-535, "Diagnosis Procedure"](#).  
NO >> Refer to [GI-53, "Intermittent Incident"](#).



# U1627, U162F TWEETER

< DTC/CIRCUIT DIAGNOSIS >

[BOSE AUDIO W/NAVI W/O SURROUND]

## U1627, U162F TWEETER

### DTC Logic

INFOID:000000009129182

### DTC DETECTION LOGIC

CONSULT Display	DTC Detection Condition	Possible Cause
F-INST L-TWEETER (OPEN, SHORT, GND- SHORT or VB-SHOR) [U1627]	Sound signal circuit malfunction between BOSE speaker amp. and instrument panel tweeter LH.	Sound signal circuits between BOSE speaker amp. and instrument panel tweeter LH. Refer to <a href="#">AV-529, "Diagnosis Procedure"</a> .
F-INST R-TWEETER (OPEN, SHORT, GND- SHORT or VB-SHOR) [U162F]	Sound signal circuit malfunction between BOSE speaker amp. and instrument panel tweeter RH.	Sound signal circuits between BOSE speaker amp. and instrument panel tweeter RH. Refer to <a href="#">AV-529, "Diagnosis Procedure"</a> .

### Diagnosis Procedure

INFOID:000000009129183

#### 1. PERFORM SELF DIAGNOSTIC RESULT

1. Perform Self Diagnostic Result for MULTI AV.
2. Erase Self Diagnostic Result. Turn ignition switch OFF.
3. Turn ignition switch ON. Perform Self Diagnostic Result again.

Is DTC U1627 or U162F detected?

- YES >> Refer to [AV-529, "Diagnosis Procedure"](#).  
NO >> Refer to [GI-53, "Intermittent Incident"](#).

A  
B  
C  
D  
E  
F  
G  
H  
I  
J  
K  
L  
M

AV

O  
P

# U162A CENTER SPEAKER

[BOSE AUDIO W/NAVI W/O SURROUND]

< DTC/CIRCUIT DIAGNOSIS >

## U162A CENTER SPEAKER

### DTC Logic

INFOID:000000009129184

### DTC DETECTION LOGIC

CONSULT Display	DTC Detection Condition	Possible Cause
F-INST C-SQUAWK (OPEN, SHORT, GND-SHORT, or VB-SHORT) [U162A]	Sound signal circuit malfunction between BOSE speaker amp. and center speaker.	Sound signal circuits between BOSE speaker amp. and center speaker. Refer to <a href="#">AV-527, "Diagnosis Procedure"</a> .

### Diagnosis Procedure

INFOID:000000009129185

#### 1. PERFORM SELF DIAGNOSTIC RESULT

1. Perform Self Diagnostic Result for MULTI AV.
2. Erase Self Diagnostic Result. Turn ignition switch OFF.
3. Turn ignition switch ON. Perform Self Diagnostic Result again.

#### Is DTC U162A detected?

- YES >> Refer to [AV-527, "Diagnosis Procedure"](#).  
NO >> Refer to [GI-53, "Intermittent Incident"](#).

# U1684, U1687, U168C, U168F REAR DOOR SPEAKER/TWEETER

< DTC/CIRCUIT DIAGNOSIS >

[BOSE AUDIO W/NAVI W/O SURROUND]

## U1684, U1687, U168C, U168F REAR DOOR SPEAKER/TWEETER

### DTC Logic

INFOID:000000009129186

### DTC DETECTION LOGIC

CONSULT Display	DTC Detection Condition	Possible Cause
2L-DOOR SPEAKER (OPEN, SHORT, GND- SHORT) [U1684] 2L-DOOR SPEAKER (VB- SHOR) [U1687]	Sound signal circuit malfunction between BOSE speaker amp. and rear door speaker LH.	Sound signal circuits between BOSE speaker amp. and rear door speaker LH. Refer to <a href="#">AV-538, "Diagnosis Procedure"</a> .
2R-DOOR SPEAKER (OPEN, SHORT, GND- SHORT) [U168C] 2R-DOOR SPEAKER (VB- SHOR) [U168F]	Sound signal circuit malfunction between BOSE speaker amp. and rear door speaker RH.	Sound signal circuits between BOSE speaker amp. and rear door speaker RH. Refer to <a href="#">AV-538, "Diagnosis Procedure"</a> .

### Diagnosis Procedure

INFOID:000000009129187

#### 1. PERFORM SELF DIAGNOSTIC RESULT

1. Perform Self Diagnostic Result for MULTI AV.
2. Erase Self Diagnostic Result. Turn ignition switch OFF.
3. Turn ignition switch ON. Perform Self Diagnostic Result again.

Is DTC U1684, U1687, U168C or U168F detected?

- YES >> Refer to [AV-538, "Diagnosis Procedure"](#).  
NO >> Refer to [GI-53, "Intermittent Incident"](#).

A  
B  
C  
D  
E  
F  
G  
H  
I  
J  
K  
L  
M  
O  
P

AV

# U175D WOOFER

[BOSE AUDIO W/NAVI W/O SURROUND]

< DTC/CIRCUIT DIAGNOSIS >

## U175D WOOFER

### DTC Logic

INFOID:000000009129188

### DTC DETECTION LOGIC

CONSULT Display	DTC Detection Condition	Possible Cause
R-LUGGAGE L-WOOFER (OPEN, SHORT, GND- SHORT or VB-SHOR) [U175D]	Sound signal circuit malfunction between BOSE speaker amp. and subwoofer.	Sound signal circuits between BOSE speaker amp. and subwoofer. Refer to <a href="#">AV-544, "Diagnosis Procedure"</a> .

### Diagnosis Procedure

INFOID:000000009129189

#### 1. PERFORM SELF DIAGNOSTIC RESULT

1. Perform Self Diagnostic Result for MULTI AV.
2. Erase Self Diagnostic Result. Turn ignition switch OFF.
3. Turn ignition switch ON. Perform Self Diagnostic Result again.

#### Is DTC U175D detected?

- YES >> Refer to [AV-544, "Diagnosis Procedure"](#).  
NO >> Refer to [GI-53, "Intermittent Incident"](#).

# U176A, U1772 ROOF SPEAKER

< DTC/CIRCUIT DIAGNOSIS >

[BOSE AUDIO W/NAVI W/O SURROUND]

## U176A, U1772 ROOF SPEAKER

### DTC Logic

INFOID:000000009129190

### DTC DETECTION LOGIC

CONSULT Display	DTC Detection Condition	Possible Cause
R-ROOF L-SQAWK (OPEN, SHORT, GND-SHORT or VB-SHOR) [U176A]	Sound signal circuit malfunction between BOSE speaker amp. and rear side speaker LH.	Sound signal circuits between BOSE speaker amp. and rear side speaker LH. Refer to <a href="#">AV-541, "Diagnosis Procedure"</a> .
R-ROOF R-SQAWK (OPEN, SHORT, GND-SHORT or VB-SHOR) [U1772]	Sound signal circuit malfunction between BOSE speaker amp. and rear side speaker RH.	Sound signal circuits between BOSE speaker amp. and rear side speaker RH. Refer to <a href="#">AV-541, "Diagnosis Procedure"</a> .

### Diagnosis Procedure

INFOID:000000009129191

#### 1. PERFORM SELF DIAGNOSTIC RESULT

1. Perform Self Diagnostic Result for MULTI AV.
2. Erase Self Diagnostic Result. Turn ignition switch OFF.
3. Turn ignition switch ON. Perform Self Diagnostic Result again.

Is DTC U176A or U1772 detected?

- YES >> Refer to [AV-541, "Diagnosis Procedure"](#).  
NO >> Refer to [GI-53, "Intermittent Incident"](#).

A  
B  
C  
D  
E  
F  
G  
H  
I  
J  
K  
L  
M  
O  
P

AV

# B2720 CORNER SENSOR [RL]

[BOSE AUDIO W/NAVI W/O SURROUND]

< DTC/CIRCUIT DIAGNOSIS >

## B2720 CORNER SENSOR [RL]

### DTC Logic

INFOID:000000009129192

### DTC DETECTION LOGIC

CONSULT Display	DTC Detection Condition	Possible Cause
REAR LEFT SIDE EXTERNAL SENSOR [B2720]	<ul style="list-style-type: none"><li>• Sensor is not configured.</li><li>• Sensor is open or short circuited.</li><li>• Sensor element malfunction.</li></ul>	<ul style="list-style-type: none"><li>• Sensor configuration.</li><li>• Harness or connectors.</li><li>• Rear sonar sensor LH outer.</li></ul>

### Diagnosis Procedure

INFOID:000000009129193

Regarding Wiring Diagram information, refer to [AV-390. "Wiring Diagram"](#).

#### 1. CHECK REAR SONAR SENSOR LH OUTER CIRCUIT CONTINUITY

1. Turn ignition switch OFF.
2. Disconnect sonar control unit connector and rear sonar sensor LH outer connector.
3. Check continuity between sonar control unit connector M70 and rear sonar sensor LH outer connector B455.

Sonar control unit		Rear sonar sensor LH outer		Continuity
Connector	Terminal	Connector	Terminal	
M70	22	B455	2	Yes
	14		1	

4. Check continuity between sonar control unit connector M70 and ground.

Sonar control unit		Ground	Continuity
Connector	Terminal		
M70	22	—	No

Is the inspection result normal?

- YES >> GO TO 2.  
NO >> Repair or replace harness or connectors.

#### 2. CHECK REAR SONAR SENSOR LH OUTER SIGNAL CIRCUIT SHORT TO BATTERY

1. Turn ignition switch ON.
2. Check voltage between sonar control unit connector M70 and ground.

Sonar control unit		Ground	Voltage (Approx.)
Connector	Terminal		
M70	22	—	0V

Is the inspection result normal?

- YES >> Replace rear sonar sensor LH outer. Refer to [AV-609. "Removal and Installation"](#).  
NO >> Repair or replace harness or connectors.

# B2721 CENTER SENSOR [RL]

[BOSE AUDIO W/NAVI W/O SURROUND]

< DTC/CIRCUIT DIAGNOSIS >

## B2721 CENTER SENSOR [RL]

### DTC Logic

INFOID:000000009129194

### DTC DETECTION LOGIC

CONSULT Display	DTC Detection Condition	Possible Cause
REAR LEFT SIDE INTER-NAL SENSOR [B2721]	<ul style="list-style-type: none"> <li>• Sensor is not configured.</li> <li>• Sensor is open or short circuited.</li> <li>• Sensor element malfunction.</li> </ul>	<ul style="list-style-type: none"> <li>• Sensor configuration.</li> <li>• Harness or connectors.</li> <li>• Rear sonar sensor LH inner.</li> </ul>

### Diagnosis Procedure

INFOID:000000009129195

Regarding Wiring Diagram information, refer to [AV-390. "Wiring Diagram"](#).

#### 1. CHECK REAR SONAR SENSOR LH INNER CIRCUIT CONTINUITY

1. Turn ignition switch OFF.
2. Disconnect sonar control unit connector and rear sonar sensor LH inner connector.
3. Check continuity between sonar control unit connector M70 and rear sonar sensor LH inner connector B457.

Sonar control unit		Rear sonar sensor LH inner		Continuity
Connector	Terminal	Connector	Terminal	
M70	21	B457	2	Yes
	14		1	

4. Check continuity between sonar control unit connector M70 and ground.

Sonar control unit		Ground	Continuity
Connector	Terminal		
M70	21	—	No

Is the inspection result normal?

- YES >> GO TO 2.  
 NO >> Repair or replace harness or connectors.

#### 2. CHECK REAR SONAR SENSOR LH INNER SIGNAL CIRCUIT SHORT TO BATTERY

1. Turn ignition switch ON.
2. Check voltage between sonar control unit connector M70 and ground.

Sonar control unit		Ground	Voltage (Approx.)
Connector	Terminal		
M70	21	—	0V

Is the inspection result normal?

- YES >> Replace rear sonar sensor LH inner. Refer to [AV-609. "Removal and Installation"](#).  
 NO >> Repair or replace harness or connectors.

# B2722 CENTER SENSOR [RR]

[BOSE AUDIO W/NAVI W/O SURROUND]

< DTC/CIRCUIT DIAGNOSIS >

## B2722 CENTER SENSOR [RR]

### DTC Logic

INFOID:000000009129196

### DTC DETECTION LOGIC

CONSULT Display	DTC Detection Condition	Possible Cause
REAR RIGHT SIDE INTER-NAL SENSOR [B2722]	<ul style="list-style-type: none"><li>• Sensor is not configured.</li><li>• Sensor is open or short circuited.</li><li>• Sensor element malfunction.</li></ul>	<ul style="list-style-type: none"><li>• Sensor configuration.</li><li>• Harness or connectors.</li><li>• Rear sonar sensor RH inner.</li></ul>

### Diagnosis Procedure

INFOID:000000009129197

Regarding Wiring Diagram information, refer to [AV-390. "Wiring Diagram"](#).

#### 1. CHECK REAR SONAR SENSOR RH INNER CIRCUIT CONTINUITY

1. Turn ignition switch OFF.
2. Disconnect sonar control unit connector and rear sonar sensor RH inner connector.
3. Check continuity between sonar control unit connector M70 and rear sonar sensor RH inner connector B458.

Sonar control unit		Rear sonar sensor RH inner		Continuity
Connector	Terminal	Connector	Terminal	
M70	9	B458	2	Yes
	14		1	

4. Check continuity between sonar control unit connector M70 and ground.

Sonar control unit		Ground	Continuity
Connector	Terminal		
M70	9	—	No

Is the inspection result normal?

YES >> GO TO 2.

NO >> Repair or replace harness or connectors.

#### 2. CHECK REAR SONAR SENSOR RH INNER SIGNAL CIRCUIT SHORT TO BATTERY

1. Turn ignition switch ON.
2. Check voltage between sonar control unit connector M70 and ground.

Sonar control unit		Ground	Voltage (Approx.)
Connector	Terminal		
M70	9	—	0V

Is the inspection result normal?

YES >> Replace rear sonar sensor RH inner. Refer to [AV-609. "Removal and Installation"](#).

NO >> Repair or replace harness or connectors.



# B2723 CORNER SENSOR [RR]

[BOSE AUDIO W/NAVI W/O SURROUND]

< DTC/CIRCUIT DIAGNOSIS >

## B2723 CORNER SENSOR [RR]

### DTC Logic

INFOID:000000009129198

### DTC DETECTION LOGIC

CONSULT Display	DTC Detection Condition	Possible Cause
REAR RIGHT SIDE EXTERNAL SENSOR [B2723]	<ul style="list-style-type: none"> <li>• Sensor is not configured.</li> <li>• Sensor is open or short circuited.</li> <li>• Sensor element malfunction.</li> </ul>	<ul style="list-style-type: none"> <li>• Sensor configuration.</li> <li>• Harness or connectors.</li> <li>• Rear sonar sensor RH outer.</li> </ul>

### Diagnosis Procedure

INFOID:000000009129198

Regarding Wiring Diagram information, refer to [AV-390. "Wiring Diagram"](#).

#### 1. CHECK REAR SONAR SENSOR RH OUTER SIGNAL CIRCUIT CONTINUITY

1. Turn ignition switch OFF.
2. Disconnect sonar control unit connector and rear sonar sensor RH outer connector.
3. Check continuity between sonar control unit connector M70 and rear sonar sensor RH outer connector B456.

Sonar control unit		Rear sonar sensor RH outer		Continuity
Connector	Terminal	Connector	Terminal	
M70	10	B456	2	Yes
	14		1	

4. Check continuity between sonar control unit connector M70 and ground.

Sonar control unit		Ground	Continuity
Connector	Terminal		
M70	10	—	No

Is the inspection result normal?

- YES >> GO TO 2.  
 NO >> Repair or replace harness or connectors.

#### 2. CHECK REAR SONAR SENSOR RH OUTER SIGNAL CIRCUIT SHORT TO BATTERY

1. Turn ignition switch ON.
2. Check voltage between sonar control unit connector M70 and ground.

Sonar control unit		Ground	Voltage (Approx.)
Connector	Terminal		
M70	10	—	0V

Is the inspection result normal?

- YES >> Replace rear sonar sensor RH outer. Refer to [AV-609. "Removal and Installation"](#).  
 NO >> Repair or replace harness or connectors.

# B2724 SONAR CONTROL UNIT

< DTC/CIRCUIT DIAGNOSIS >

[BOSE AUDIO W/NAVI W/O SURROUND]

## B2724 SONAR CONTROL UNIT

### DTC Logic

INFOID:000000009129200

### DTC DETECTION LOGIC

CONSULT Display	DTC Detection Condition	Possible Cause
ECU [B2724]	Sonar control module malfunction.	Replace sonar control module.

# B2725 REAR BUZZER

[BOSE AUDIO W/NAVI W/O SURROUND]

< DTC/CIRCUIT DIAGNOSIS >

## B2725 REAR BUZZER

### DTC Logic

INFOID:000000009129201

### DTC DETECTION LOGIC

CONSULT Display	DTC Detection Condition	Possible Cause
REAR BUZZER [B2725]	<ul style="list-style-type: none"> <li>Buzzer is open or short circuited.</li> <li>Buzzer malfunction.</li> </ul>	<ul style="list-style-type: none"> <li>Harness or connectors.</li> <li>Buzzer.</li> </ul>

### Diagnosis Procedure

INFOID:000000009129202

Regarding Wiring Diagram information, refer to [AV-51. "Wiring Diagram"](#).

#### 1. CHECK SONAR BUZZER SIGNAL CIRCUIT CONTINUITY

- Turn ignition switch OFF.
- Disconnect sonar control unit connector and sonar buzzer connector.
- Check continuity between sonar control unit connector M70 and sonar buzzer connector B35.

Sonar control unit		Sonar buzzer		Continuity
Connector	Terminal	Connector	Terminal	
M70	20	B35	3	Yes

- Check continuity between sonar control unit connector M70 and ground.

Sonar control unit		Ground	Continuity
Connector	Terminal		
M70	20	—	No

Is the inspection result normal?

- YES >> GO TO 2.  
NO >> Repair or replace harness or connectors.

#### 2. CHECK SONAR BUZZER SIGNAL CIRCUIT SHORT TO BATTERY

- Turn ignition switch ON.
- Check voltage between sonar control unit connector M70 and ground.

Sonar control unit		Ground	Voltage (Approx.)
Connector	Terminal		
M70	20	—	0V

Is the inspection result normal?

- YES >> GO TO 3.  
NO >> Repair or replace harness or connectors.

#### 3. CHECK SONAR BUZZER SIGNAL CIRCUIT SHORT TO BUZZER POWER

- Turn ignition switch OFF.
- Check continuity between sonar control unit connector M70 terminals.

Sonar control unit connector M70		Continuity
Terminal	Terminal	
19	20	No

Is the inspection result normal?

## B2725 REAR BUZZER

< DTC/CIRCUIT DIAGNOSIS >

[BOSE AUDIO W/NAVI W/O SURROUND]

---

- YES >> Replace sonar buzzer. Refer to [AV-611, "Removal and Installation"](#).
- NO >> Repair or replace harness or connectors.

# B2729 CORNER SENSOR [FL]

[BOSE AUDIO W/NAVI W/O SURROUND]

< DTC/CIRCUIT DIAGNOSIS >

## B2729 CORNER SENSOR [FL]

### DTC Logic

INFOID:000000009129203

### DTC DETECTION LOGIC

CONSULT Display	DTC Detection Condition	Possible Cause
FRONT LEFT SIDE EXTERNAL SENSOR [B2729]	<ul style="list-style-type: none"> <li>• Sensor is not configured.</li> <li>• Sensor is open or short circuited.</li> <li>• Sensor element malfunction.</li> </ul>	<ul style="list-style-type: none"> <li>• Sensor configuration.</li> <li>• Harness or connectors.</li> <li>• Front sonar sensor LH outer.</li> </ul>

### Diagnosis Procedure

INFOID:000000009129204

Regarding Wiring Diagram information, refer to [AV-390. "Wiring Diagram"](#).

#### 1. CHECK FRONT SONAR SENSOR LH OUTER CIRCUIT CONTINUITY

1. Turn ignition switch OFF.
2. Disconnect sonar control unit connector and front sonar sensor LH outer connector.
3. Check continuity between sonar control unit connector M70 and front sonar sensor LH outer connector E307.

Sonar control unit		Front sonar sensor LH outer		Continuity
Connector	Terminal	Connector	Terminal	
M70	3	E307	2	Yes
	13		1	

4. Check continuity between sonar control unit connector M70 and ground.

Sonar control unit		Ground	Continuity
Connector	Terminal		
M70	3	—	No

Is the inspection result normal?

- YES >> GO TO 2.  
 NO >> Repair or replace harness or connectors.

#### 2. CHECK FRONT SONAR SENSOR LH OUTER SIGNAL CIRCUIT SHORT TO BATTERY

1. Turn ignition switch ON.
2. Check voltage between sonar control unit connector M70 and ground.

Sonar control unit		Ground	Voltage (Approx.)
Connector	Terminal		
M70	3	—	0V

Is the inspection result normal?

- YES >> Replace front sonar sensor LH outer. Refer to [AV-609. "Removal and Installation"](#).  
 NO >> Repair or replace harness or connectors.

# B272C CORNER SENSOR [FR]

[BOSE AUDIO W/NAVI W/O SURROUND]

< DTC/CIRCUIT DIAGNOSIS >

## B272C CORNER SENSOR [FR]

### DTC Logic

INFOID:000000009129205

### DTC DETECTION LOGIC

CONSULT Display	DTC Detection Condition	Possible Cause
FRONT RIGHT SIDE EXTERNAL SENSOR [B272C]	<ul style="list-style-type: none"> <li>• Sensor is not configured.</li> <li>• Sensor is open or short circuited.</li> <li>• Sensor element malfunction.</li> </ul>	<ul style="list-style-type: none"> <li>• Sensor configuration.</li> <li>• Harness or connectors.</li> <li>• Front sonar sensor RH outer.</li> </ul>

### Diagnosis Procedure

INFOID:000000009129206

Regarding Wiring Diagram information, refer to [AV-390. "Wiring Diagram"](#).

#### 1. CHECK FRONT SONAR SENSOR RH OUTER CIRCUIT CONTINUITY

1. Turn ignition switch OFF.
2. Disconnect sonar control unit connector and front sonar sensor RH outer connector.
3. Check continuity between sonar control unit connector M70 and front sonar sensor RH outer connector E308.

Sonar control unit		Front sonar sensor RH outer		Continuity
Connector	Terminal	Connector	Terminal	
M70	4	E308	2	Yes
	13		1	

4. Check continuity between sonar control unit connector M70 and ground.

Sonar control unit		Ground	Continuity
Connector	Terminal		
M70	4	—	No

Is the inspection result normal?

- YES >> GO TO 2.  
 NO >> Repair or replace harness or connectors.

#### 2. CHECK FRONT SONAR SENSOR RH OUTER SIGNAL CIRCUIT SHORT TO BATTERY

1. Turn ignition switch ON.
2. Check voltage between sonar control unit connector M70 and ground.

Sonar control unit		Ground	Voltage (Approx.)
Connector	Terminal		
M70	4	—	0V

Is the inspection result normal?

- YES >> Replace front sonar sensor RH outer. Refer to [AV-609. "Removal and Installation"](#).  
 NO >> Repair or replace harness or connectors.

# POWER SUPPLY AND GROUND CIRCUIT

< DTC/CIRCUIT DIAGNOSIS >

[BOSE AUDIO W/NAVI W/O SURROUND]

## POWER SUPPLY AND GROUND CIRCUIT

### AV CONTROL UNIT

#### AV CONTROL UNIT : Diagnosis Procedure

INFOID:000000009129207

Regarding Wiring Diagram information, refer to [AV-390, "Wiring Diagram"](#).

#### 1.CHECK FUSE

Check that the following fuses are not blown.

Terminal No.	Signal name	Fuse No.
68	Ignition signal	29 (5A)
19	Battery power supply	15 (15A)

##### Are the fuses blown?

YES >> Replace the blown fuse after repairing the affected circuit.

NO >> GO TO 2.

#### 2.CHECK POWER SUPPLY CIRCUIT

1. Turn ignition switch OFF.
2. Disconnect AV control unit connectors M122 and M124.
3. Check voltage between AV control unit connectors and ground.

AV control unit		Ground	Condition	Voltage (Approx.)
Connector	Terminal			
M124	68	—	Ignition switch: ON	Battery voltage
M122	7		Ignition switch: ACC	
	19		Ignition switch: OFF	

##### Is the inspection result normal?

YES >> GO TO 3.

NO >> Repair or replace harness or connectors.

#### 3.CHECK GROUND CIRCUIT

1. Turn ignition switch OFF.
2. Check continuity between AV control unit connector M122 terminal 20 and ground.

AV control unit		Ground	Continuity
Connector	Terminal		
M122	20	—	Yes

##### Is the inspection result normal?

YES >> Inspection End.

NO >> Repair or replace harness or connectors.

## DISPLAY UNIT

#### DISPLAY UNIT : Diagnosis Procedure

INFOID:000000009129208

Regarding Wiring Diagram information, refer to [AV-390, "Wiring Diagram"](#).

#### 1.CHECK FUSE

Check that the following fuses are not blown.

# POWER SUPPLY AND GROUND CIRCUIT

< DTC/CIRCUIT DIAGNOSIS >

[BOSE AUDIO W/NAVI W/O SURROUND]

Terminal No.	Signal name	Fuse No.
11	Battery power supply	15 (15A)
23	ACC power supply	65 (10A)

Are the fuses blown?

YES >> Replace the blown fuse after repairing the affected circuit.

NO >> GO TO 2.

## 2.CHECK POWER SUPPLY CIRCUIT

1. Turn ignition switch OFF.
2. Disconnect display unit connector.
3. Check voltage between display connector M92 and ground.

Display unit		Ground	Condition	Voltage (Approx.)
Connector	Terminal			
M92	23	—	Ignition switch: ACC	Battery voltage
	11		Ignition switch: OFF	

Is the inspection result normal?

YES >> GO TO 3.

NO >> Repair or replace harness or connectors.

## 3.CHECK GROUND CIRCUIT

1. Turn ignition switch OFF.
2. Check continuity between display unit connector M92 terminal 12 and ground.

Display unit		Ground	Continuity
Connector	Terminal		
M92	12	—	Yes

Is the inspection result normal?

YES >> Inspection End.

NO >> Repair or replace harness or connectors.

**BOSE AMP.**

## BOSE AMP. : Diagnosis Procedure

INFOID:000000009129209

Regarding Wiring Diagram information, refer to [AV-390. "Wiring Diagram"](#).

## 1.CHECK FUSE

Check that the following fuses are not blown.

Terminal No.	Signal name	Fuse No.
50	Battery power supply	11 (15A)
51		12 (15A)

Are the fuses blown?

YES >> Replace the blown fuse after repairing the affected circuit.

NO >> GO TO 2.

## 2.CHECK POWER SUPPLY CIRCUIT

1. Disconnect BOSE speaker amp. connector B129.
2. Check voltage between BOSE speaker amp. connector B129 and ground.



# POWER SUPPLY AND GROUND CIRCUIT

< DTC/CIRCUIT DIAGNOSIS >

[BOSE AUDIO W/NAVI W/O SURROUND]

BOSE speaker amp.		Ground	Voltage (Approx.)
Connector	Terminal		
B129	50	—	Battery voltage
	51		

Is the inspection result normal?

YES >> GO TO 3.

NO >> Repair or replace harness or connectors.

## 3.CHECK GROUND CIRCUIT

1. Turn ignition switch OFF.
2. Check continuity between BOSE speaker amp. connector B129 and ground.

BOSE speaker amp.		Ground	Continuity
Connector	Terminal		
B129	47	—	Yes
	52		

Is the inspection result normal?

YES >> Inspection End.

NO >> Repair or replace harness or connectors.

## SUBWOOFER

### SUBWOOFER : Diagnosis Procedure

INFOID:000000009129210

Regarding Wiring Diagram information, refer to [AV-390. "Wiring Diagram"](#).

## 1.CHECK FUSE

Check that the following fuses are not blown.

Terminal No.	Signal name	Fuse No.
6	Battery power supply	58 (10A)

Are the fuses blown?

YES >> Replace the blown fuse after repairing the affected circuit.

NO >> GO TO 2.

## 2.CHECK POWER SUPPLY CIRCUIT

1. Disconnect subwoofer connector.
2. Check voltage between subwoofer connector B73 and ground.

Subwoofer		Ground	Voltage (Approx.)
Connector	Terminal		
B73	6	—	Battery voltage

Is the inspection result normal?

YES >> GO TO 3.

NO >> Repair or replace harness or connectors.

## 3.CHECK GROUND CIRCUIT

1. Turn ignition switch OFF.
2. Check continuity between subwoofer connector B73 and ground.

# POWER SUPPLY AND GROUND CIRCUIT

< DTC/CIRCUIT DIAGNOSIS >

[BOSE AUDIO W/NAVI W/O SURROUND]

Subwoofer		Ground	Continuity
Connector	Terminal		
B73	5	—	Yes

Is the inspection result normal?

YES >> Inspection End.

NO >> Repair or replace harness or connectors.

## A/C AND AV SWITCH ASSEMBLY

### A/C AND AV SWITCH ASSEMBLY : Diagnosis Procedure

INFOID:000000009129211

Regarding Wiring Diagram information, refer to [AV-390. "Wiring Diagram"](#).

#### 1. CHECK FUSE

Check that the following fuse is not blown.

Terminal No.	Signal name	Fuse No.
3	ACC power supply	65 (10A)

Is the fuse blown?

YES >> Replace the blown fuse after repairing the affected circuit.

NO >> GO TO 2.

#### 2. CHECK POWER SUPPLY CIRCUIT

1. Turn ignition switch OFF.
2. Disconnect A/C and AV switch assembly connector.
3. Check voltage between A/C and AV switch assembly connector M98 terminal 3 and ground.

A/C and AV switch assembly		Ground	Condition	Voltage (Approx.)
Connector	Terminal			
M98	3	—	Ignition switch: ACC	Battery voltage

Is the inspection result normal?

YES >> GO TO 3.

NO >> Repair or replace harness or connectors.

#### 3. CHECK CONTROL UNIT GROUND CIRCUIT

1. Turn ignition switch OFF.
2. Disconnect AV control unit connector M125.
3. Check continuity between A/C and AV switch assembly connector M98 terminal 9 and AV control unit connector M125 terminal 98.

A/C and AV switch assembly		AV control unit		Continuity
Connector	Terminal	Connector	Terminal	
M98	9	M125	98	Yes

Is the inspection result normal?

YES >> GO TO 4.

NO >> Repair or replace harness or connectors.

#### 4. CHECK SWITCH GROUND CIRCUIT

Check continuity between A/C and AV switch assembly connector M98 terminal 1 and ground.

# POWER SUPPLY AND GROUND CIRCUIT

< DTC/CIRCUIT DIAGNOSIS >

[BOSE AUDIO W/NAVI W/O SURROUND]

A/C and AV switch assembly		Ground	Continuity
Connector	Terminal		
M98	1	—	Yes

Is the inspection result normal?

- YES >> Inspection End.  
NO >> Repair or replace harness or connectors.

## VIDEO DISTRIBUTOR

### VIDEO DISTRIBUTOR : Diagnosis Procedure

INFOID:000000009129212

Regarding Wiring Diagram information, refer to [AV-390. "Wiring Diagram"](#).

### 1.CHECK FUSE

Check that the following fuses are not blown.

Terminal No.	Signal name	Fuse No.
4	ACC power supply	65 (10A)
2	Battery power supply	15 (15A)

Are the fuses blown?

- YES >> Replace the blown fuse after repairing the affected circuit.  
NO >> GO TO 2.

### 2.CHECK POWER SUPPLY CIRCUIT

1. Turn ignition switch OFF.
2. Disconnect video distributor connector B24.
3. Check voltage between video distributor connector B24 and ground.

Video distributor		Ground	Condition	Voltage (Approx.)
Connector	Terminal			
B24	2	—	Ignition switch: ACC	Battery voltage
	4		Ignition switch: OFF	

Is the inspection result normal?

- YES >> GO TO 3.  
NO >> Repair or replace harness or connectors.

### 3.CHECK GROUND CIRCUIT

1. Turn ignition switch OFF.
2. Check continuity between video distributor connector B24 and ground.

Video distributor		Ground	Continuity
Connector	Terminal		
B24	1	—	Yes
	3		

Is the inspection result normal?

- YES >> Inspection End.  
NO >> Repair or replace harness or connectors.

## HEADREST DISPLAY UNIT

# POWER SUPPLY AND GROUND CIRCUIT

< DTC/CIRCUIT DIAGNOSIS >

[BOSE AUDIO W/NAVI W/O SURROUND]

## HEADREST DISPLAY UNIT : Diagnosis Procedure

INFOID:000000009129213

Regarding Wiring Diagram information, refer to [AV-390, "Wiring Diagram"](#).

### 1.CHECK FUSE

Check that the following fuses are not blown.

Terminal No.	Signal name	Fuse No.
15, 16	Battery power supply	15 (15A)

#### Are the fuses blown?

YES >> Replace the blown fuse after repairing the affected circuit.

NO >> GO TO 2.

### 2.CHECK POWER SUPPLY CIRCUIT

1. Disconnect headrest display unit connector.
2. Check voltage between headrest display unit connector and ground.

Headrest display unit		Ground	Voltage (Approx.)
Connector	Terminal		
B202 (driver seat)	15, 16	—	Battery voltage
B302 (passenger seat)			

#### Is the inspection result normal?

YES >> GO TO 3.

NO >> Repair or replace harness or connectors.

### 3.CHECK GROUND CIRCUIT

1. Turn ignition switch OFF.
2. Check continuity between headrest display unit connector and ground.

Headrest display unit		Ground	Continuity
Connector	Terminal		
B202 (driver seat)	12, 31, 32	—	Yes
B302 (passenger seat)	28, 31, 32		

#### Is the inspection result normal?

YES >> Inspection End.

NO >> Repair or replace harness or connectors.

## AROUND VIEW MONITOR CONTROL UNIT

### AROUND VIEW MONITOR CONTROL UNIT : Diagnosis Procedure

INFOID:000000009129214

Regarding Wiring Diagram information, refer to [AV-390, "Wiring Diagram"](#).

### 1.CHECK FUSE

Check that the following fuses are not blown.

Terminal No.	Signal name	Fuse No.
3	Ignition signal	29 (5A)

# POWER SUPPLY AND GROUND CIRCUIT

< DTC/CIRCUIT DIAGNOSIS >

[BOSE AUDIO W/NAVI W/O SURROUND]

Terminal No.	Signal name	Fuse No.
4	ACC power supply	65 (10A)
2	Battery power supply	15 (15A)

Are the fuses blown?

- YES >> Replace the blown fuse after repairing the affected circuit.  
NO >> GO TO 2.

## 2.CHECK POWER SUPPLY CIRCUIT

1. Turn ignition switch OFF.
2. Disconnect around view monitor control unit connector M96.
3. Check voltage between around view monitor control unit connector M96 and ground.

Around view monitor control unit		Ground	Condition	Voltage (Approx.)
Connector	Terminal			
M96	3	—	Ignition switch: ON	Battery voltage
	4		Ignition switch: ACC	
	2		Ignition switch: OFF	

Is the inspection result normal?

- YES >> GO TO 3.  
NO >> Repair or replace harness or connectors.

## 3.CHECK GROUND CIRCUIT

1. Turn ignition switch OFF.
2. Check continuity between around view monitor control unit connector M96 and ground.

Around view monitor control unit		Ground	Continuity
Connector	Terminal		
M96	1	—	Yes

Is the inspection result normal?

- YES >> Inspection End.  
NO >> Repair or replace harness or connectors.

## SONAR CONTROL UNIT (WITH AROUND VIEW MONITOR)

### SONAR CONTROL UNIT (WITH AROUND VIEW MONITOR) : Diagnosis Procedure

INFOID:000000009129215

Regarding Wiring Diagram information, refer to [AV-390. "Wiring Diagram"](#).

## 1.CHECK FUSE

Check that the following fuses are not blown.

Terminal No.	Signal name	Fuse No.
12	ACC power supply	65 (10A)

Are the fuses blown?

- YES >> Replace the blown fuse after repairing the affected circuit.  
NO >> GO TO 2.

## 2.CHECK POWER SUPPLY CIRCUIT

1. Turn ignition switch OFF.
2. Disconnect sonar control unit connector M70.
3. Check voltage between sonar control unit connector M70 and ground.

A  
B  
C  
D  
E  
F  
G  
H  
I  
J  
K  
L  
M  
O  
P

AV

# POWER SUPPLY AND GROUND CIRCUIT

< DTC/CIRCUIT DIAGNOSIS >

[BOSE AUDIO W/NAVI W/O SURROUND]

Sonar control unit		Ground	Condition	Voltage (Approx.)
Connector	Terminal			
M70	12	—	Ignition switch: ACC	Battery voltage

Is the inspection result normal?

YES >> GO TO 3.

NO >> Repair or replace harness or connectors.

## 3. CHECK GROUND CIRCUIT

1. Turn ignition switch OFF.
2. Check continuity between sonar control unit connector M70 and ground.

Sonar control unit		Ground	Continuity
Connector	Terminal		
M70	15	—	Yes

Is the inspection result normal?

YES >> Inspection End.

NO >> Repair or replace harness or connectors.

# CENTER SPEAKER

< DTC/CIRCUIT DIAGNOSIS >

[BOSE AUDIO W/NAVI W/O SURROUND]

## CENTER SPEAKER

### Diagnosis Procedure

INFOID:000000009129216

Regarding Wiring Diagram information, refer to [AV-390. "Wiring Diagram"](#).

### 1. CONNECTOR CHECK

Check the AV control unit, BOSE speaker amp. and speaker connectors for the following:

- Proper connection
- Damage
- Disconnected or loose terminals

Is the inspection result normal?

YES >> GO TO 2.

NO >> Repair the terminals or connectors.

### 2. CHECK CENTER SPEAKER SIGNAL CIRCUIT CONTINUITY

1. Disconnect BOSE speaker amp. connector B130 and center speaker connector.
2. Check continuity between BOSE speaker amp. connector B130 and center speaker connector M110.

BOSE speaker amp.		Center speaker		Continuity
Connector	Terminal	Connector	Terminal	
B130	69	M110	1	Yes
	70		2	

3. Check continuity between BOSE speaker amp. connector B130 and ground.

BOSE speaker amp.		Ground	Continuity
Connector	Terminal		
B130	69	—	No
	70		

Is the inspection result normal?

YES >> GO TO 3.

NO >> Repair or replace harness or connectors.

### 3. CHECK CENTER SPEAKER SIGNAL

1. Connect BOSE speaker amp. connector B130 and center speaker connector M110.
2. Turn ignition switch to ACC.
3. Push AV control unit POWER switch.
4. Check signal between terminals of BOSE speaker amp. connector B130.

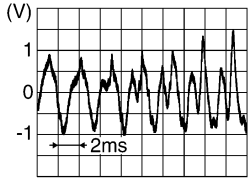
BOSE speaker amp. connector B130		Condition	Reference value
(+) Terminal	(-) Terminal		
69	70	Audio signal output	 <p style="text-align: right; font-size: small;">SKIB3609E</p>

Is the inspection result normal?

A  
B  
C  
D  
E  
F  
G  
H  
I  
J  
K  
L  
M

AV

O  
P

# CENTER SPEAKER

**[BOSE AUDIO W/NAVI W/O SURROUND]**

**< DTC/CIRCUIT DIAGNOSIS >**

- YES >> Replace center speaker. Refer to [AV-594, "Removal and Installation"](#).  
 NO >> GO TO 4.

**4. CHECK PRE-AMP SIGNAL CIRCUIT CONTINUITY**

1. Disconnect AV control unit connector M122 and BOSE speaker amp. connector B130.
2. Check continuity between AV control unit connector M122 and BOSE speaker amp. connector B130.

AV control unit		BOSE speaker amp.		Continuity
Connector	Terminal	Connector	Terminal	
M122	2	B130	75	Yes
	3		76	
	11		73	
	12		74	

3. Check continuity between AV control unit connector M122 and ground.

AV control unit		Ground	Continuity
Connector	Terminal		
M122	2	—	No
	3		
	11		
	12		

**Is the inspection result normal?**

- YES >> GO TO 5.  
 NO >> Repair or replace harness or connectors.

**5. CHECK PRE-AMP SIGNAL**

1. Connect AV control unit connector M122 and BOSE speaker amp. connector B130.
2. Turn ignition switch to ACC.
3. Push AV control unit POWER switch.
4. Check signal between the terminals of AV control unit connector M122.

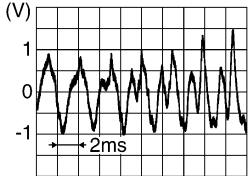
AV control unit connector M122		Condition	Reference value
(+) Terminal	(-) Terminal		
2	3	Audio signal output	 <p style="text-align: right; font-size: small;">SKIB3609E</p>
11	12		

**Is the inspection result normal?**

- YES >> Replace BOSE speaker amp. Refer to [AV-590, "Removal and Installation"](#).  
 NO >> Replace AV control unit. Refer to [AV-586, "Removal and Installation - AV Control Unit"](#).



# INSTRUMENT PANEL SPEAKER/TWEETER

< DTC/CIRCUIT DIAGNOSIS >

[BOSE AUDIO W/NAVI W/O SURROUND]

## INSTRUMENT PANEL SPEAKER/TWEETER

### Diagnosis Procedure

INFOID:000000009129217

Regarding Wiring Diagram information, refer to [AV-390. "Wiring Diagram"](#).

### 1. CONNECTOR CHECK

Check the AV control unit, BOSE speaker amp. and speaker connectors for the following:

- Proper connection
- Damage
- Disconnected or loose terminals

Is the inspection result normal?

YES >> GO TO 2.

NO >> Repair the terminals or connectors.

### 2. CHECK INSTRUMENT PANEL TWEETER SIGNAL CIRCUIT CONTINUITY

1. Disconnect BOSE speaker amp. connector B129 and suspect instrument panel tweeter connector.
2. Check continuity between BOSE speaker amp. connector B129 and suspect instrument panel tweeter connector.

BOSE speaker amp.		Instrument panel tweeter		Continuity
Connector	Terminal	Connector	Terminal	
B129	41	M62 (LH)	1	Yes
	42		2	
	45	M73 (RH)	1	
	46		2	

3. Check continuity between BOSE speaker amp. connector B129 and ground.

BOSE speaker amp.		Ground	Continuity
Connector	Terminal		
B129	41	—	No
	42		
	45		
	46		

Is the inspection result normal?

YES >> GO TO 3.

NO >> Repair or replace harness or connectors.

### 3. CHECK INSTRUMENT PANEL TWEETER SIGNAL

1. Connect BOSE speaker amp. connector B129 and suspect instrument panel tweeter connector.
2. Turn ignition switch to ACC.
3. Push AV control unit POWER switch.
4. Check signal between terminals of BOSE speaker amp. connector B129.

BOSE speaker amp.		Condition	Reference value
(+)	(-)		
Terminal	Terminal		

A  
B  
C  
D  
E  
F  
G  
H  
I  
J  
K  
L  
M  
N  
O  
P

AV

# INSTRUMENT PANEL SPEAKER/TWEETER

< DTC/CIRCUIT DIAGNOSIS >

[BOSE AUDIO W/NAVI W/O SURROUND]

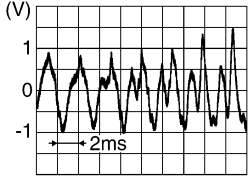
41	42	Audio signal output	
45	46		

Is the inspection result normal?

- YES >> Replace instrument panel tweeter. Refer to [AV-593. "Removal and Installation"](#).  
 NO >> GO TO 4.

## 4. CHECK PRE-AMP SIGNAL CIRCUIT CONTINUITY

1. Disconnect AV control unit connector M122 and BOSE speaker amp. connector B130.
2. Check continuity between AV control unit connector M122 and BOSE speaker amp. connector B130.

AV control unit		BOSE speaker amp.		Continuity
Connector	Terminal	Connector	Terminal	
M122	2	B130	75	Yes
	3		76	
	11		73	
	12		74	

3. Check continuity between AV control unit connector M122 and ground.

AV control unit		Ground	Continuity
Connector	Terminal		
M122	2	—	No
	3		
	11		
	12		

Is the inspection result normal?

- YES >> GO TO 5.  
 NO >> Repair or replace harness or connectors.

## 5. CHECK PRE-AMP SIGNAL

1. Connect AV control unit connector M122 and BOSE speaker amp. connector B130.
2. Turn ignition switch to ACC.
3. Push AV control unit POWER switch.
4. Check signal between the terminals of AV control unit connector M122.

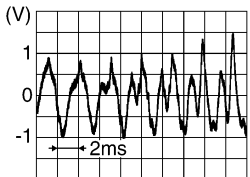
AV control unit connector M122		Condition	Reference value
(+)	(-)		
Terminal	Terminal	Audio signal output	
2	3		
11	12		

Is the inspection result normal?

- YES >> Replace BOSE speaker amp. Refer to [AV-590. "Removal and Installation"](#).

# INSTRUMENT PANEL SPEAKER/TWEETER

< DTC/CIRCUIT DIAGNOSIS >

[BOSE AUDIO W/NAVI W/O SURROUND]

NO >> Replace AV control unit. Refer to [AV-586. "Removal and Installation - AV Control Unit"](#).

A

B

C

D

E

F

G

H

I

J

K

L

M

AV

O

P

# FRONT TWEETER

[BOSE AUDIO W/NAVI W/O SURROUND]

< DTC/CIRCUIT DIAGNOSIS >

## FRONT TWEETER

### Diagnosis Procedure

INFOID:000000009129218

Regarding Wiring Diagram information, refer to [AV-390. "Wiring Diagram"](#).

### 1. CONNECTOR CHECK

Check the AV control unit, BOSE speaker amp. and speaker connectors for the following:

- Proper connection
- Damage
- Disconnected or loose terminals

Is the inspection result normal?

YES >> GO TO 2.

NO >> Repair the terminals or connectors.

### 2. CHECK FRONT TWEETER SIGNAL CIRCUIT CONTINUITY

1. Disconnect BOSE speaker amp. connector B130 and suspect front tweeter connector.
2. Check continuity between BOSE speaker amp. connector B130 and suspect front door speaker connector.

BOSE speaker amp.		Front tweeter		Continuity
Connector	Terminal	Connector	Terminal	
B130	58	M109 (LH)	1	Yes
	59		2	
	71	M111 (RH)	1	
	72		2	

3. Check continuity between BOSE speaker amp. connector B130 and ground.

BOSE speaker amp.		Ground	Continuity
Connector	Terminal		
B130	58	—	No
	59		
	71		
	72		

Is the inspection result normal?

YES >> GO TO 3.

NO >> Repair or replace harness or connectors.

### 3. CHECK FRONT TWEETER SIGNAL

1. Connect BOSE speaker amp. connector B130 and suspect front tweeter connector.
2. Turn ignition switch to ACC.
3. Push AV control unit POWER switch.
4. Check signal between terminals of BOSE speaker amp. connector B130.

BOSE speaker amp. connector B130		Condition	Reference value
(+)	(-)		
Terminal	Terminal		

# FRONT TWEETER

< DTC/CIRCUIT DIAGNOSIS >

[BOSE AUDIO W/NAVI W/O SURROUND]

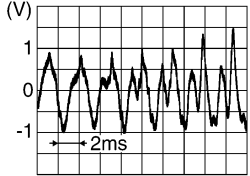
58	59	Audio signal output	
71	72		

Is the inspection result normal?

- YES >> Replace front tweeter. Refer to [AV-592. "Removal and Installation"](#).  
 NO >> GO TO 4.

## 4. CHECK PRE-AMP SIGNAL CIRCUIT CONTINUITY

1. Disconnect AV control unit connector M122 and BOSE speaker amp. connector B130.
2. Check continuity between AV control unit connector M122 and BOSE speaker amp. connector B130.

AV control unit		BOSE speaker amp.		Continuity
Connector	Terminal	Connector	Terminal	
M122	2	B130	75	Yes
	3		76	
	11		73	
	12		74	

3. Check continuity between AV control unit connector M122 and ground.

AV control unit		Ground	Continuity
Connector	Terminal		
M122	2	—	No
	3		
	11		
	12		

Is the inspection result normal?

- YES >> GO TO 5.  
 NO >> Repair or replace harness or connectors.

## 5. CHECK PRE-AMP SIGNAL

1. Connect AV control unit connector M122 and BOSE speaker amp. connector B130.
2. Turn ignition switch to ACC.
3. Push AV control unit POWER switch.
4. Check signal between the terminals of AV control unit connector M122.

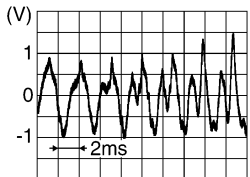
AV control unit connector M122		Condition	Reference value
(+) Terminal	(-) Terminal		
2	3	Audio signal output	
11	12		

Is the inspection result normal?

- YES >> Replace BOSE speaker amp. Refer to [AV-590. "Removal and Installation"](#).

A  
B  
C  
D  
E  
F  
G  
H  
I  
J  
K  
L  
M  
O  
P

AV

## FRONT TWEETER

< DTC/CIRCUIT DIAGNOSIS >

[BOSE AUDIO W/NAVI W/O SURROUND]

---

NO >> Replace AV control unit. Refer to [AV-586. "Removal and Installation - AV Control Unit"](#).

# FRONT DOOR SPEAKER

[BOSE AUDIO W/NAVI W/O SURROUND]

< DTC/CIRCUIT DIAGNOSIS >

## FRONT DOOR SPEAKER

### Diagnosis Procedure

INFOID:000000009129219

Regarding Wiring Diagram information, refer to [AV-390. "Wiring Diagram"](#).

### 1. CONNECTOR CHECK

Check the AV control unit, BOSE speaker amp. and speaker connectors for the following:

- Proper connection
- Damage
- Disconnected or loose terminals

Is the inspection result normal?

YES >> GO TO 2.

NO >> Repair the terminals or connectors.

### 2. CHECK FRONT DOOR SPEAKER SIGNAL CIRCUIT CONTINUITY

1. Disconnect BOSE speaker amp. connector B130 and suspect front door speaker connector.
2. Check continuity between BOSE speaker amp. connector B130 and suspect front door speaker connector.

BOSE speaker amp.		Front door speaker		Continuity
Connector	Terminal	Connector	Terminal	
B130	58	D12 (LH)	1	Yes
	59		2	
	71	D112 (RH)	1	
	72		2	

3. Check continuity between BOSE speaker amp. connector B130 and ground.

BOSE speaker amp.		Ground	Continuity
Connector	Terminal		
B130	58	—	No
	59		
	71		
	72		

Is the inspection result normal?

YES >> GO TO 3.

NO >> Repair or replace harness or connectors.

### 3. CHECK FRONT DOOR SPEAKER SIGNAL

1. Connect BOSE speaker amp. connector B130 and suspect front door speaker connector.
2. Turn ignition switch to ACC.
3. Push AV control unit POWER switch.
4. Check signal between terminals of BOSE speaker amp. connector B130.

BOSE speaker amp. connector B130		Condition	Reference value
(+)	(-)		
Terminal	Terminal		

A  
B  
C  
D  
E  
F  
G  
H  
I  
J  
K  
L  
M  
N  
O  
P

AV

# FRONT DOOR SPEAKER

< DTC/CIRCUIT DIAGNOSIS >

[BOSE AUDIO W/NAVI W/O SURROUND]

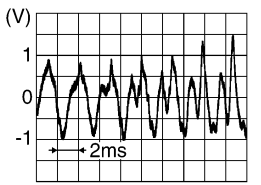
58	59	Audio signal output	
71	72		

Is the inspection result normal?

YES >> Replace front door speaker. Refer to [AV-591, "Removal and Installation"](#).

NO >> GO TO 4.

## 4. CHECK PRE-AMP SIGNAL CIRCUIT CONTINUITY

1. Disconnect AV control unit connector M122 and BOSE speaker amp. connector B130.
2. Check continuity between AV control unit connector M122 and BOSE speaker amp. connector B130.

AV control unit		BOSE speaker amp.		Continuity
Connector	Terminal	Connector	Terminal	
M122	2	B130	75	Yes
	3		76	
	11		73	
	12		74	

3. Check continuity between AV control unit connector M122 and ground.

AV control unit		Ground	Continuity
Connector	Terminal		
M122	2	—	No
	3		
	11		
	12		

Is the inspection result normal?

YES >> GO TO 5.

NO >> Repair or replace harness or connectors.

## 5. CHECK PRE-AMP SIGNAL

1. Connect AV control unit connector M122 and BOSE speaker amp. connector B130.
2. Turn ignition switch to ACC.
3. Push AV control unit POWER switch.
4. Check signal between the terminals of AV control unit connector M122.

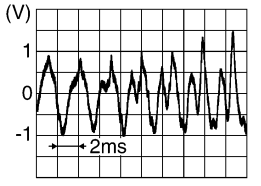
AV control unit connector M122		Condition	Reference value
(+) Terminal	(-) Terminal		
2	3	Audio signal output	
11	12		

Is the inspection result normal?

YES >> Replace BOSE speaker amp. Refer to [AV-590, "Removal and Installation"](#).



# FRONT DOOR SPEAKER

[BOSE AUDIO W/NAVI W/O SURROUND]

< DTC/CIRCUIT DIAGNOSIS >

NO >> Replace AV control unit. Refer to [AV-586. "Removal and Installation - AV Control Unit"](#).

A

B

C

D

E

F

G

H

I

J

K

L

M

AV

O

P

# REAR DOOR SPEAKER

[BOSE AUDIO W/NAVI W/O SURROUND]

< DTC/CIRCUIT DIAGNOSIS >

## REAR DOOR SPEAKER

### Diagnosis Procedure

INFOID:000000009129220

Regarding Wiring Diagram information, refer to [AV-390. "Wiring Diagram"](#).

### 1. CONNECTOR CHECK

Check the AV control unit, BOSE speaker amp. and speaker connectors for the following:

- Proper connection
- Damage
- Disconnected or loose terminals

Is the inspection result normal?

YES >> GO TO 2.

NO >> Repair the terminals or connectors.

### 2. CHECK REAR DOOR SPEAKER SIGNAL CIRCUIT CONTINUITY

1. Disconnect BOSE speaker amp. connectors and suspect rear door speaker connector.
2. Check continuity between BOSE speaker amp. connectors and suspect rear door speaker connector.

BOSE speaker amp.		Rear door speaker		Continuity
Connector	Terminal	Connector	Terminal	
B130	68	D207 (LH)	1	Yes
	55		2	
B129	54	D307 (RH)	1	
	49		2	

3. Check continuity between BOSE speaker amp. connectors and ground.

BOSE speaker amp.		Ground	Continuity
Connector	Terminal		
B130	68	—	No
	55		
B129	54		
	49		

Is the inspection result normal?

YES >> GO TO 3.

NO >> Repair or replace harness or connectors.

### 3. CHECK REAR DOOR SPEAKER SIGNAL

1. Connect BOSE speaker amp. connectors and suspect rear door speaker connector.
2. Turn ignition switch to ACC.
3. Push AV control unit POWER switch.
4. Check signal between terminals of BOSE speaker amp. connectors.

BOSE speaker amp.			Condition	Reference value
Connector	(+)	(-)		
	Terminal	Terminal		

# REAR DOOR SPEAKER

[BOSE AUDIO W/NAVI W/O SURROUND]

< DTC/CIRCUIT DIAGNOSIS >

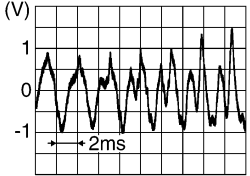
B130	68	55	Audio signal output	
B129	54	49		

Is the inspection result normal?

YES >> Replace rear door speaker. Refer to [AV-595. "Removal and Installation"](#).

NO >> GO TO 3.

## 4. CHECK PRE-AMP SIGNAL CIRCUIT CONTINUITY

1. Disconnect AV control unit connector M122 and BOSE speaker amp. connector B130.
2. Check continuity between AV control unit connector M122 and BOSE speaker amp. connector B130.

AV control unit		BOSE speaker amp.		Continuity
Connector	Terminal	Connector	Terminal	
M122	4	B130	64	Yes
	5		63	
	13		66	
	14		65	

3. Check continuity between AV control unit connector M122 and ground.

AV control unit		Ground	Continuity
Connector	Terminal		
M122	4	—	No
	5		
	13		
	14		

Is the inspection result normal?

YES >> GO TO 5.

NO >> Repair or replace harness or connectors.

## 5. CHECK PRE-AMP SIGNAL

1. Connect AV control unit connector M122 and BOSE speaker amp. connector B130.
2. Turn ignition switch to ACC.
3. Push AV control unit POWER switch.
4. Check signal between the terminals of AV control unit connector M122.

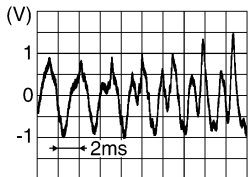
AV control unit connector M122		Condition	Reference value
(+) Terminal	(-) Terminal		
4	5	Audio signal output	
13	14		

Is the inspection result normal?

YES >> Replace BOSE speaker amp. Refer to [AV-590. "Removal and Installation"](#).

A  
B  
C  
D  
E  
F  
G  
H  
I  
J  
K  
L  
M  
N  
O  
P

AV

## REAR DOOR SPEAKER

< DTC/CIRCUIT DIAGNOSIS >

[BOSE AUDIO W/NAVI W/O SURROUND]

---

NO >> Replace AV control unit. Refer to [AV-586. "Removal and Installation - AV Control Unit"](#).

# REAR SPEAKER

[BOSE AUDIO W/NAVI W/O SURROUND]

< DTC/CIRCUIT DIAGNOSIS >

## REAR SPEAKER

### Diagnosis Procedure

INFOID:000000009129221

Regarding Wiring Diagram information, refer to [AV-390. "Wiring Diagram"](#).

### 1. CONNECTOR CHECK

Check the AV control unit, BOSE speaker amp. and speaker connectors for the following:

- Proper connection
- Damage
- Disconnected or loose terminals

Is the inspection result normal?

YES >> GO TO 2.

NO >> Repair the terminals or connectors.

### 2. CHECK REAR SIDE SPEAKER SIGNAL CIRCUIT CONTINUITY

1. Disconnect BOSE speaker amp. connector B129 and suspect rear side speaker connector.
2. Check continuity between BOSE speaker amp. connector B129 and suspect rear side speaker connector.

BOSE speaker amp.		Rear side speaker		Continuity
Connector	Terminal	Connector	Terminal	
B129	53	B1 (LH)	1	Yes
	48		2	
	44	B153 (RH)	1	
	43		2	

3. Check continuity between BOSE speaker amp. connector B129 and ground.

BOSE speaker amp.		Ground	Continuity
Connector	Terminal		
B129	53	—	No
	48		
	44		
	43		

Is the inspection result normal?

YES >> GO TO 3.

NO >> Repair or replace harness or connectors.

### 3. CHECK REAR SIDE SPEAKER SIGNAL

1. Connect BOSE speaker amp. connector B129 and suspect rear side speaker connector.
2. Turn ignition switch to ACC.
3. Push AV control unit POWER switch.
4. Check signal between terminals of BOSE speaker amp. connector B129.

BOSE speaker amp. connector B129		Condition	Reference value
(+)	(-)		
Terminal	Terminal		

A  
B  
C  
D  
E  
F  
G  
H  
I  
J  
K  
L  
M  
O  
P

AV

# REAR SPEAKER

< DTC/CIRCUIT DIAGNOSIS >

[BOSE AUDIO W/NAVI W/O SURROUND]

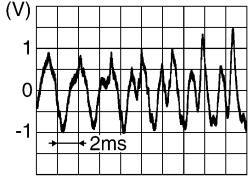
53	48	Audio signal output	
44	43		

Is the inspection result normal?

YES >> Replace rear side speaker. Refer to [AV-596. "Removal and Installation"](#).

NO >> GO TO 4.

## 4. CHECK PRE-AMP SIGNAL CIRCUIT CONTINUITY

1. Disconnect AV control unit connector M122 and BOSE speaker amp. connector B130.
2. Check continuity between AV control unit connector M122 and BOSE speaker amp. connector B130.

AV control unit		BOSE speaker amp.		Continuity
Connector	Terminal	Connector	Terminal	
M122	4	B130	64	Yes
	5		63	
	13		66	
	14		65	

3. Check continuity between AV control unit connector M122 and ground.

AV control unit		Ground	Continuity
Connector	Terminal		
M122	4	—	No
	5		
	13		
	14		

Is the inspection result normal?

YES >> GO TO 5.

NO >> Repair or replace harness or connectors.

## 5. CHECK PRE-AMP SIGNAL

1. Connect AV control unit connector M122 and BOSE speaker amp. connector B130.
2. Turn ignition switch to ACC.
3. Push AV control unit POWER switch.
4. Check signal between the terminals of AV control unit connector M122.

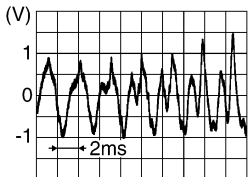
AV control unit connector M122		Condition	Reference value
(+) Terminal	(-) Terminal		
4	5	Audio signal output	
13	14		

Is the inspection result normal?

YES >> Replace BOSE speaker amp. Refer to [AV-590. "Removal and Installation"](#).

## REAR SPEAKER

< DTC/CIRCUIT DIAGNOSIS >

[BOSE AUDIO W/NAVI W/O SURROUND]

NO >> Replace AV control unit. Refer to [AV-586. "Removal and Installation - AV Control Unit"](#).

A

B

C

D

E

F

G

H

I

J

K

L

M

AV

O

P

# SUBWOOFER

< DTC/CIRCUIT DIAGNOSIS >

[BOSE AUDIO W/NAVI W/O SURROUND]

## SUBWOOFER

### Diagnosis Procedure

INFOID:000000009129222

Regarding Wiring Diagram information, refer to [AV-390. "Wiring Diagram"](#).

#### 1. CONNECTOR CHECK

Check the AV control unit, BOSE speaker amp. and subwoofer connectors for the following:

- Proper connection
- Damage
- Disconnected or loose terminals

Is the inspection result normal?

YES >> GO TO 2.

NO >> Repair the terminal and connector.

#### 2. VERIFY SUBWOOFER POWER SUPPLY AND GROUND

Check subwoofer power supply and ground. Refer to [AV-520. "BOSE AMP. : Diagnosis Procedure"](#).

Is the inspection result normal?

YES >> GO TO 3.

NO >> Repair or replace harness or connectors.

#### 3. CHECK SUBWOOFER AMP ON CIRCUIT CONTINUITY

1. Turn ignition switch OFF.
2. Disconnect Bose speaker amp. connector B130 and subwoofer connector.
3. Check continuity between Bose speaker amp. connector B130 and subwoofer connector B73.

Bose speaker amp.		Subwoofer		Continuity
Connector	Terminal	Connector	Terminal	
B130	62	B73	4	Yes

4. Check continuity between Bose speaker amp. connector B130 and ground.

Bose speaker amp.		Ground	Continuity
Connector	Terminal		
B130	62	—	No

Is the inspection result normal?

YES >> GO TO 4.

NO >> Repair or replace harness or connectors.

#### 4. CHECK SUBWOOFER AMP ON CIRCUIT VOLTAGE

1. Connect Bose speaker amp. connector B130.
2. Turn ignition switch ON.
3. Check voltage between Bose speaker amp. connector B130 and ground.

Bose speaker amp.		Ground	Voltage (Approx.)
(+)			
Connector	Terminal		
B130	62	—	Battery voltage

Is the inspection result normal?

YES >> GO TO 5.

NO >> Replace Bose speaker amp. Refer to [AV-590. "Removal and Installation"](#).



# SUBWOOFER

< DTC/CIRCUIT DIAGNOSIS >

[BOSE AUDIO W/NAVI W/O SURROUND]

## 5. CHECK SUBWOOFER SIGNAL CIRCUIT CONTINUITY

1. Disconnect BOSE speaker amp. connector B130 and subwoofer connector.
2. Check continuity between BOSE speaker amp. connector B130 and subwoofer connector.

BOSE speaker amp.		Subwoofer		Continuity
Connector	Terminal	Connector	Terminal	
B130	56	B73	2	Yes
	57		1	

3. Check continuity between BOSE speaker amp. connector B130 and ground.

BOSE speaker amp.		Ground	Continuity
Connector	Terminal		
B130	56	—	No
	57		

Is the inspection result normal?

- YES >> GO TO 6.  
 NO >> Repair or replace harness or connectors.

## 6. CHECK SUBWOOFER SIGNAL

1. Connect BOSE speaker amp. connector B130 and subwoofer connector.
2. Turn ignition switch to ACC.
3. Push AV control unit POWER switch.
4. Check the signal between the terminals of BOSE speaker amp. connector B130.

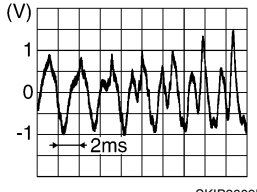
BOSE speaker amp. connector B130		Condition	Reference value
(+) Terminal	(-) Terminal		
56	57	Audio signal output	

Is the inspection result normal?

- YES >> Replace subwoofer. Refer to [AV-597. "Removal and Installation"](#).  
 NO >> GO TO 7.

## 7. CHECK PRE-AMP SIGNAL CIRCUIT CONTINUITY

1. Disconnect AV control unit connector M122 and BOSE speaker amp. connector B130.
2. Check continuity between AV control unit connector M122 and BOSE speaker amp. connector B130.

AV control unit		BOSE speaker amp.		Continuity
Connector	Terminal	Connector	Terminal	
M122	4	B130	64	Yes
	5		63	
	13		66	
	14		65	

3. Check continuity between AV control unit connector M122 and ground.

# SUBWOOFER

< DTC/CIRCUIT DIAGNOSIS >

[BOSE AUDIO W/NAVI W/O SURROUND]

AV control unit		Ground	Continuity
Connector	Terminal		
M143	4	—	No
	5		
	13		
	14		

Is the inspection result normal?

YES >> GO TO 8.

NO >> Repair or replace harness or connectors.

## 8. CHECK PRE-AMP SIGNAL

1. Connect AV control unit connector M122 and BOSE speaker amp. connector B130.
2. Turn ignition switch to ACC.
3. Push AV control unit POWER switch.
4. Check signal between the terminals of AV control unit connector M122.

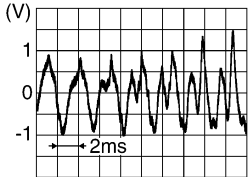
AV control unit connector M122		Condition	Reference value
(+)	(-)		
Terminal	Terminal	Audio signal output	
4	5		
13	14		

SKIB3609E

Is the inspection result normal?

YES >> Replace BOSE speaker amp. Refer to [AV-590, "Removal and Installation"](#).

NO >> Replace AV control unit. Refer to [AV-586, "Removal and Installation - AV Control Unit"](#).

# FRONT AUXILIARY INPUT JACK AUDIO SIGNAL CIRCUIT

< DTC/CIRCUIT DIAGNOSIS >

[BOSE AUDIO W/NAVI W/O SURROUND]

## FRONT AUXILIARY INPUT JACK AUDIO SIGNAL CIRCUIT

### Diagnosis Procedure

INFOID:000000009129223

Regarding Wiring Diagram information, refer to [AV-390. "Wiring Diagram"](#).

### 1. CHECK AUX SOUND SIGNAL CIRCUIT CONTINUITY

1. Turn ignition OFF.
2. Disconnect AV control unit connector M123 and front auxiliary input jacks connector.
3. Check continuity between AV control unit connector M123 and front auxiliary input jacks connector.

AV control unit		Front auxiliary input jacks		Continuity
Connector	Terminal	Connector	Terminal	
M123	24	M205	3	Yes
	38		1	

4. Check continuity between AV control unit connector M123 and ground.

AV control unit		Ground	Continuity
Connector	Terminal		
M123	24	—	No
	38		

Is inspection result normal?

- YES >> GO TO 2.  
 NO >> Repair or replace harness or connectors.

### 2. CHECK AUX SOUND SIGNAL GROUND CIRCUIT CONTINUITY

Check continuity between AV control unit connector M123 and front auxiliary input jacks connector.

AV control unit		Front auxiliary input jacks		Continuity
Connector	Terminal	Connector	Terminal	
M123	39	M205	2	Yes

Is inspection result normal?

- YES >> GO TO 3.  
 NO >> Repair or replace harness or connectors.

### 3. CHECK AUX SOUND SIGNAL

1. Connect AV control unit connector M123 and front auxiliary input jacks connector.
2. Turn ignition switch to ACC.
3. Select AUX mode.
4. Check signals between AV control unit connector M123 and ground.

AV control unit connector M123		Condition	Reference value
(+)	(-)		
Terminal	Terminal		

A  
B  
C  
D  
E  
F  
G  
H  
I  
J  
K  
L  
M  
O  
P

AV

# FRONT AUXILIARY INPUT JACK AUDIO SIGNAL CIRCUIT

< DTC/CIRCUIT DIAGNOSIS >

[BOSE AUDIO W/NAVI W/O SURROUND]

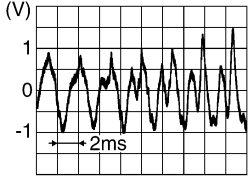
24	39	AUX mode selected	
38	39		

Is the inspection result normal?

- YES >> Replace front auxiliary input jacks. Refer to [AV-599. "Removal and Installation"](#).
- NO >> Replace AV control unit. Refer to [AV-586. "Removal and Installation - AV Control Unit"](#).

# RGB DIGITAL IMAGE SIGNAL CIRCUIT

< DTC/CIRCUIT DIAGNOSIS >

[BOSE AUDIO W/NAVI W/O SURROUND]

## RGB DIGITAL IMAGE SIGNAL CIRCUIT

### Diagnosis Procedure

INFOID:000000009129224

Regarding Wiring Diagram information, refer to [AV-390, "Wiring Diagram"](#).

#### 1. CHECK RGB DIGITAL IMAGE SIGNAL CIRCUIT CONTINUITY

1. Turn ignition switch OFF.
2. Disconnect AV control unit connector M140 and display unit connector M141.
3. Check continuity between AV control unit connector M140 and display unit connector M141.

AV control unit		Display unit		Continuity
Connector	Terminals	Connector	Terminals	
M140	165	M141	28	Yes
	164		27	

4. Check continuity between AV control unit connector M140 and ground.

AV control unit		Ground	Continuity
Connector	Terminals		
M140	165	—	No

Is the inspection result normal?

- YES >> GO TO 2.  
NO >> Repair or replace harness or connectors.

#### 2. CHECK RGB DIGITAL IMAGE SIGNAL

1. Connect AV control unit connector M140.
2. Turn ignition switch ON.
3. Check signal between terminals of display unit connector M141.

Display unit connector M141		Condition	Voltage (Approx.)
(+)	(-)		
Terminal	Terminal		
28	27	Audio system is ON.	1.3 V

Is the inspection result normal?

- YES >> Replace display unit. Refer to [AV-589, "Removal and Installation"](#).  
NO >> Replace AV control unit. Refer to [AV-586, "Removal and Installation - AV Control Unit"](#).

A  
B  
C  
D  
E  
F  
G  
H  
I  
J  
K  
L  
M  
O  
P

AV

# COMPOSITE IMAGE SIGNAL CIRCUIT (AV CONTROL UNIT TO FRONT DISPLAY UNIT)

< DTC/CIRCUIT DIAGNOSIS >

[BOSE AUDIO W/NAVI W/O SURROUND]

## COMPOSITE IMAGE SIGNAL CIRCUIT (AV CONTROL UNIT TO FRONT DISPLAY UNIT)

### Diagnosis Procedure

INFOID:000000009129225

Regarding Wiring Diagram information, refer to [AV-390. "Wiring Diagram"](#).

### 1. CHECK COMPOSITE IMAGE SIGNAL CIRCUIT CONTINUITY

1. Turn ignition switch OFF.
2. Disconnect AV control unit connector M124 and display unit connector M92.
3. Check continuity between AV control unit connector M124 and display unit connector M92.

AV control unit		Display unit		Continuity
Connector	Terminal	Connector	Terminal	
M124	56	M92	18	Yes
	55		19	

4. Check continuity between AV control unit connector M124 and ground.

AV control unit		Ground	Continuity
Connector	Terminal		
M124	56	—	No

Is the inspection result normal?

- YES >> GO TO 2.  
 NO >> Repair or replace harness or connectors.

### 2. CHECK COMPOSITE IMAGE SIGNAL

1. Connect AV control unit connector M124 and display unit connector M92.
2. Turn ignition switch ON.
3. Check signal between terminals of AV control unit connector M124.

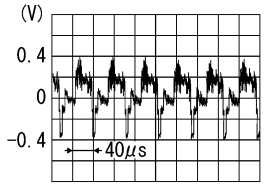
AV control unit connector M124		Condition	Reference value
(+)	(-)		
Terminal	Terminal		
56	55	DVD image is displayed.	

Is the inspection result normal?

- YES >> Replace display unit. Refer to [AV-589. "Removal and Installation"](#).  
 NO >> Replace AV control unit. Refer to [AV-586. "Removal and Installation - AV Control Unit"](#).

# COMPOSITE IMAGE SIGNAL CIRCUIT (AV CONTROL UNIT TO VIDEO DISTRIBUTOR)

< DTC/CIRCUIT DIAGNOSIS >

[BOSE AUDIO W/NAVI W/O SURROUND]

## COMPOSITE IMAGE SIGNAL CIRCUIT (AV CONTROL UNIT TO VIDEO DISTRIBUTOR)

### Diagnosis Procedure

INFOID:000000009129226

Regarding Wiring Diagram information, refer to [AV-390. "Wiring Diagram"](#).

### 1. CHECK COMPOSITE IMAGE SIGNAL CIRCUIT CONTINUITY

1. Turn ignition switch OFF.
2. Disconnect AV control unit connector M125 and video distributor connector B25.
3. Check continuity between AV control unit connector M125 and video distributor connector B25.

AV control unit		Video distributor		Continuity
Connector	Terminal	Connector	Terminal	
M125	107	B25	34	Yes
	105		33	

4. Check continuity between AV control unit connector M125 and ground.

AV control unit		Ground	Continuity
Connector	Terminal		
M125	107	—	No

Is the inspection result normal?

YES >> GO TO 2.

NO >> Repair or replace harness or connectors.

### 2. CHECK COMPOSITE IMAGE SIGNAL

1. Connect AV control unit connector M125 and video distributor connector B25.
2. Turn ignition switch ON.
3. Check signal between terminals of video distributor connector B25.

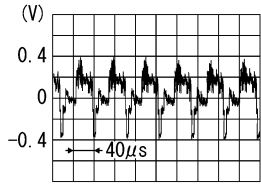
Video distributor connector B25		Condition	Reference value
(+) Terminal	(-) Terminal		
34	33	DVD, USB or front auxiliary input jacks image is displayed on headrest display.	

Is the inspection result normal?

YES >> Replace video distributor. Refer to [AV-604. "Removal and Installation"](#).

NO >> Replace AV control unit. Refer to [AV-586. "Removal and Installation - AV Control Unit"](#).

# COMPOSITE IMAGE SIGNAL CIRCUIT (VIDEO DISTRIBUTOR TO HEADREST DISPLAY UNIT)

< DTC/CIRCUIT DIAGNOSIS >

[BOSE AUDIO W/NAVI W/O SURROUND]

## COMPOSITE IMAGE SIGNAL CIRCUIT (VIDEO DISTRIBUTOR TO HEADREST DISPLAY UNIT)

### Diagnosis Procedure

INFOID:000000009129227

Regarding Wiring Diagram information, refer to [AV-390. "Wiring Diagram"](#).

### 1. CHECK COMPOSITE IMAGE SIGNAL CIRCUIT CONTINUITY

1. Turn ignition switch OFF.
2. Disconnect video distributor connector B24 and headrest display unit connectors.
3. Check continuity between video distributor connector B24 and headrest display unit connectors.

Video distributor		Headrest display unit		Continuity
Connector	Terminal	Connector	Terminal	
B24	32	B202 (driver seat)	5	Yes
	31		21	
	28	B302 (passenger seat)	5	Yes
	27		21	

4. Check continuity between video distributor connector B24 and ground.

Video distributor		Ground	Continuity
Connector	Terminal		
B24	32	—	No
	28		

Is the inspection result normal?

- YES >> GO TO 2.  
 NO >> Repair or replace harness or connectors.

### 2. CHECK COMPOSITE IMAGE SIGNAL

1. Connect video distributor connector B24 and headrest display unit connectors.
2. Turn ignition switch ON.
3. Check signal between terminals of headrest display unit connectors.

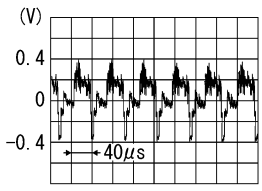
Headrest display unit			Condition	Reference value
Connector	(+) Terminal	(-) Terminal		
B202 (driver seat)			DVD, USB or front auxiliary input jacks image is displayed on headrest display.	 <p>SKIB2251J</p>
B302 (passenger seat)	5	21		

Is the inspection result normal?

- YES >> Replace headrest display unit. Refer to [AV-605. "Removal and Installation"](#).  
 NO >> Replace video distributor. Refer to [AV-604. "Removal and Installation"](#).



# AUX IMAGE SIGNAL CIRCUIT (FRONT AUXILIARY INPUT JACKS TO AV CONTROL UNIT)

< DTC/CIRCUIT DIAGNOSIS >

[BOSE AUDIO W/NAVI W/O SURROUND]

## AUX IMAGE SIGNAL CIRCUIT (FRONT AUXILIARY INPUT JACKS TO AV CONTROL UNIT)

### Diagnosis Procedure

INFOID:000000009129228

Regarding Wiring Diagram information, refer to [AV-390. "Wiring Diagram"](#).

### 1. CHECK AUX IMAGE SIGNAL CIRCUIT CONTINUITY

1. Turn ignition switch OFF.
2. Disconnect AV control unit connector M125 and front auxiliary input jacks connector M205.
3. Check continuity between AV control unit connector M125 and front auxiliary input jacks connector M205.

AV control unit		Front auxiliary input jacks		Continuity
Connector	Terminal	Connector	Terminal	
M125	91	M205	7	Yes
	92		8	

4. Check continuity between AV control unit connector M125 and ground.

AV control unit		Ground	Continuity
Connector	Terminal		
M125	91	—	No

Is the inspection result normal?

YES >> GO TO 2.

NO >> Repair or replace harness or connectors.

### 2. CHECK AUX IMAGE SIGNAL

1. Connect AV control unit connector M125 and front auxiliary input jacks connector M205.
2. Turn ignition switch ON.
3. Check signal between terminals of front auxiliary input jacks connector M205.

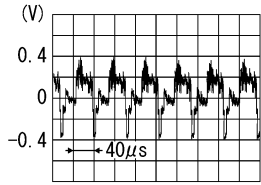
Front auxiliary input jacks connector M205		Condition	Reference value
(+) Terminal	(-) Terminal		
7	8	Front auxiliary input jacks image is displayed.	

Is the inspection result normal?

YES >> Replace front auxiliary input jacks. Refer to [AV-599. "Removal and Installation"](#).

NO >> Replace AV control unit. Refer to [AV-586. "Removal and Installation - AV Control Unit"](#).

# IMAGE SWITCH SIGNAL CIRCUIT

< DTC/CIRCUIT DIAGNOSIS >

[BOSE AUDIO W/NAVI W/O SURROUND]

## IMAGE SWITCH SIGNAL CIRCUIT

### Diagnosis Procedure

INFOID:000000009129229

Regarding Wiring Diagram information, refer to [AV-390, "Wiring Diagram"](#).

#### 1. CHECK CONTINUITY IMAGE SWITCH SIGNAL CIRCUIT

1. Turn ignition switch OFF.
2. Disconnect video distributor connector B24 and headrest display unit connectors.
3. Check continuity between video distributor connector B24 and headrest display unit connectors.

Video distributor		Headrest display unit		Continuity
Connector	Terminal	Connector	Terminal	
B24	10	B202 (driver seat)	7	Yes
	7		23	
	9	B302 (passenger seat)	7	
	5		23	

4. Check continuity between video distributor connector B24 and ground.

Video distributor		Ground	Continuity
Connector	Terminal		
B24	10	—	No
	9		

Is the inspection result normal?

YES >> GO TO 2.

NO >> Repair or replace harness or connectors.

#### 2. CHECK VIDEO DISTRIBUTOR VOLTAGE

1. Connect video distributor connector B24 and headrest display unit connectors.
2. Turn ignition switch ON.
3. Check voltage between terminals of video distributor connector B24.

Video distributor connector B24		Condition	Voltage (Approx.)
(+)	(-)		
Terminal	Terminal		
10	7	DVD, USB or front auxiliary input jacks image is displayed on headrest display.	0.5 V
		DVD, USB or rear auxiliary input jacks image is displayed on headrest display.	4.5 V
9	5	DVD, USB or front auxiliary input jacks image is displayed on headrest display.	0.5 V
		DVD, USB or rear auxiliary input jacks image is displayed on headrest display.	4.5 V

Is the inspection result normal?

YES >> Replace headrest display unit. Refer to [AV-605, "Removal and Installation"](#).

NO >> Replace video distributor. Refer to [AV-604, "Removal and Installation"](#).

# DISK EJECT SIGNAL CIRCUIT

< DTC/CIRCUIT DIAGNOSIS >

[BOSE AUDIO W/NAVI W/O SURROUND]

## DISK EJECT SIGNAL CIRCUIT

### Diagnosis Procedure

INFOID:000000009129230

Regarding Wiring Diagram information, refer to [AV-390, "Wiring Diagram"](#).

#### 1. CHECK DISK EJECT SIGNAL CIRCUIT CONTINUITY

1. Turn ignition switch OFF.
2. Disconnect AV control unit connector M125 and A/C and AV switch assembly connector.
3. Check continuity between AV control unit connector M125 terminal 97 and A/C and AV switch assembly connector M98 terminal 14.

AV control unit		A/C and AV switch assembly		Continuity
Connector	Terminal	Connector	Terminal	
M125	97	M98	14	Yes

4. Check continuity between AV control unit connector M125 terminal 97 and ground.

AV control unit		Ground	Continuity
Connector	Terminal		
M125	97		No

Is inspection result normal?

YES >> GO TO 2.

NO >> Repair or replace harness or connectors.

#### 2. CHECK AV CONTROL UNIT VOLTAGE

1. Connect AV control unit connector M125 and A/C and AV switch assembly connector.
2. Turn ignition switch ON.
3. Check voltage between AV control unit connector M125 terminal 97 and ground.

AV control unit		Ground	Condition	Voltage (Approx.)
(+)				
Connector	Terminal			
M125	97	—	Pressing eject switch	0 V
			Except above	5.0 V

Is the inspection result normal?

YES >> Replace A/C and AV switch assembly. Refer to [AV-587, "Removal and Installation - A/C and AV Switch Assembly"](#).

NO >> Replace AV control unit. Refer to [AV-586, "Removal and Installation - AV Control Unit"](#).

A  
B  
C  
D  
E  
F  
G  
H  
I  
J  
K  
L  
M  
O  
P

AV

# MICROPHONE SIGNAL CIRCUIT

< DTC/CIRCUIT DIAGNOSIS >

[BOSE AUDIO W/NAVI W/O SURROUND]

## MICROPHONE SIGNAL CIRCUIT

### Diagnosis Procedure

INFOID:000000009763696

Regarding Wiring Diagram information, refer to [AV-390. "Wiring Diagram"](#).

### 1. CHECK MICROPHONE SIGNAL CIRCUIT CONTINUITY

1. Turn ignition switch OFF.
2. Disconnect AV control unit connector M124 and microphone connector.
3. Check continuity between AV control unit connector M124 and microphone connector R109.

AV control unit		Microphone		Continuity
Connector	Terminal	Connector	Terminal	
M124	59	R109	3	Yes
	60		1	
	75		4	

4. Check continuity between AV control unit connector M124 and ground.

AV control unit		Ground	Continuity
Connector	Terminal		
M124	59	—	No
	60		
	75		

Is inspection result normal?

- YES >> GO TO 2.  
NO >> Repair or replace harness or connectors.

### 2. CHECK MICROPHONE VCC VOLTAGE

1. Connect AV control unit connector M124.
2. Turn ignition switch ON.
3. Check voltage between terminals of AV control unit connector M124.

AV control unit connector M124		Voltage (Approx.)
(+)	(-)	
Terminal	Terminal	
60	59	5.0 V

Is the inspection result normal?

- YES >> GO TO 3.  
NO >> Replace AV control unit. Refer to [AV-586. "Removal and Installation - AV Control Unit"](#).

### 3. CHECK MICROPHONE SIGNAL

1. Connect microphone connector.
2. Check signal between terminals of AV control unit connector M124.

# MICROPHONE SIGNAL CIRCUIT

< DTC/CIRCUIT DIAGNOSIS >

[BOSE AUDIO W/NAVI W/O SURROUND]

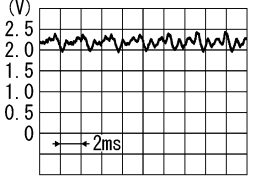
AV control unit connector M124		Condition	Reference value
(+)	(-)		
Terminal	Terminal		
75	59	Speak into microphone.	 <p style="text-align: right; font-size: small;">PKIB5037J</p>

Is the inspection result normal?

- YES >> Replace AV control unit. Refer to [AV-586. "Removal and Installation - AV Control Unit"](#).
- NO >> Replace microphone. Refer to [AV-1058. "Removal and Installation"](#).

A  
B  
C  
D  
E  
F  
G  
H  
I  
J  
K  
L  
M  
O  
P

AV

# STEERING SWITCH

[BOSE AUDIO W/NAVI W/O SURROUND]

< DTC/CIRCUIT DIAGNOSIS >

## STEERING SWITCH

### Diagnosis Procedure

INFOID:000000009129232

Regarding Wiring Diagram information, refer to [AV-390. "Wiring Diagram"](#).

### 1. CHECK STEERING WHEEL AUDIO CONTROL SWITCH RESISTANCE

1. Turn ignition switch OFF.
2. Disconnect combination switch connector M149.
3. Check resistance between combination switch connector terminals.

Combination switch connector M149		Condition	Resistance $\Omega$ (Approx.)
Terminal	Terminal		
14	17	Depress SOURCE switch.	1
		Depress $\Delta$ switch.	121
		Depress $\nabla$ switch.	321
		Depress $\text{⌂}$ switch.	723
		Depress ENTER switch.	2023
15		Depress $-$ $\text{⏏}$ switch.	1
		Depress $\text{⏏}+$ switch.	121
		Depress $\text{⏏}$ switch.	321
		Depress $\text{⏏}$ switch.	723
		Depress DISP switch.	2023

Is the inspection result normal?

YES >> GO TO 2.

NO >> Replace steering wheel audio control switch. Refer to [AV-588. "Removal and Installation"](#).

### 2. CHECK HARNESS BETWEEN COMBINATION SWITCH AND COMBINATION METER

1. Disconnect combination meter connector M24 and combination switch connector M30.
2. Check continuity between combination meter connector M24 and combination switch connector M30.

Combination meter		Combination switch		Continuity
Connector	Terminal	Connector	Terminal	
M24	3	M30	24	Yes
	24		33	
	4		31	

3. Check continuity between combination meter connector M24 and ground.

Combination meter		Ground	Continuity
Connector	Terminal		
M24	3	—	No
	24		
	4		

Is the inspection result normal?

# STEERING SWITCH

[BOSE AUDIO W/NAVI W/O SURROUND]

< DTC/CIRCUIT DIAGNOSIS >

- YES >> GO TO 3.  
 NO >> Repair or replace harness or connectors.

## 3.CHECK COMBINATION SWITCH

Check continuity between combination switch connectors M30 and M149.

Combination switch				Continuity
Connector	Terminal	Connector	Terminal	
M30	24	M149	14	Yes
	31		15	
	33		17	

Is the inspection result normal?

- YES >> GO TO 4.  
 NO >> Replace spiral cable. Refer to [SR-15, "Removal and Installation"](#).

## 4.CHECK HARNESS BETWEEN COMBINATION METER AND AV CONTROL UNIT

1. Disconnect AV control unit connector M122.
2. Check continuity between combination meter connector M24 and AV control unit connector M122.

Combination meter		AV control unit		Continuity
Connector	Terminal	Connector	Terminal	
M24	14	M122	6	Yes
	15		16	
	16		15	

3. Check continuity between combination meter connector M24 and ground.

Combination meter		Ground	Continuity
Connector	Terminal		
M24	14	—	No
	15		
	16		

Is the inspection result normal?

- YES >> GO TO 5.  
 NO >> Repair or replace harness or connectors.

## 5.CHECK AV CONTROL UNIT VOLTAGE

1. Connect combination meter connector M24 and AV control unit connector M122.
2. Turn ignition switch ON.
3. Check voltage between terminals of AV control unit connector M122.

AV control unit M122		Voltage (Approx.)
(+) Terminal	(-) Terminal	
6	15	5.0 V
16		

Is the inspection result normal?

- YES >> Replace combination meter. Refer to [MWI-95, "Removal and Installation"](#).  
 NO >> Replace AV control unit. Refer to [AV-586, "Removal and Installation - AV Control Unit"](#).

# USB CONNECTOR

[BOSE AUDIO W/NAVI W/O SURROUND]

< DTC/CIRCUIT DIAGNOSIS >

## USB CONNECTOR

### Diagnosis Procedure

INFOID:000000009129233

Regarding Wiring Diagram information, refer to [AV-390. "Wiring Diagram"](#).

#### 1. CHECK USB INTERFACE HARNESS CONTINUITY

1. Turn ignition switch OFF.
2. Disconnect AV control unit connector M55 and USB interface connector M209.
3. Check continuity between AV control unit connector M55 and USB interface connector M209.

AV control unit		USB interface		Continuity
Connector	Terminal	Connector	Terminal	
M55	138	M209	1	Yes
	137		2	
	140		3	
	139		4	
	141		5	

4. Check continuity between AV control unit connector M55 and ground.

AV control unit		—	Continuity
Connector	Terminal		
M55	137	Ground	No
	139		

Is the inspection result normal?

- YES >> Replace the USB interface. Refer to [AV-598. "Removal and Installation"](#).  
NO >> Repair or replace harness or connectors.



# FRONT CAMERA COMMUNICATION SIGNAL CIRCUIT

< DTC/CIRCUIT DIAGNOSIS >

[BOSE AUDIO W/NAVI W/O SURROUND]

## FRONT CAMERA COMMUNICATION SIGNAL CIRCUIT

### Diagnosis Procedure

INFOID:000000009129234

Regarding Wiring Diagram information, refer to [AV-390, "Wiring Diagram"](#).

### 1. CHECK COMMUNICATION SIGNAL CIRCUIT CONTINUITY

1. Turn ignition switch OFF.
2. Disconnect around view monitor control unit connector M97 and front camera connector E226.
3. Check continuity between around view monitor control unit connector M97 and front camera connector E226.

Around view monitor control unit		Front camera		Continuity
Connector	Terminal	Connector	Terminal	
M97	67	E226	6	Yes

4. Check continuity between around view monitor control unit connector M97 and ground.

Around view monitor control unit		Ground	Continuity
Connector	Terminal		
M97	67	—	No

Is inspection result normal?

YES >> GO TO 2.

NO >> Repair or replace harness or connectors.

### 2. CHECK COMMUNICATION SIGNAL

1. Connect around view monitor control unit connector M97 and front camera connector E226.
2. Turn ignition switch ON.
3. Check signal between around view monitor control unit connector M97 and ground.

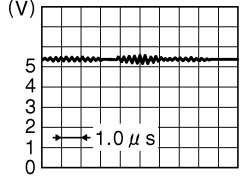
Around view monitor control unit		Ground	Condition	Reference value
(+)		(-)		
Connector	Terminal			
M97	67	—	CAMERA switch is ON or shift position is R.	 <p>JSNIA0836GB</p>

Is inspection result normal?

YES >> Replace around view monitor control unit. Refer to [AV-600, "Removal and Installation"](#).

NO >> Replace front camera. Refer to [AV-601, "Removal and Installation"](#).

# FRONT CAMERA IMAGE SIGNAL CIRCUIT

< DTC/CIRCUIT DIAGNOSIS >

[BOSE AUDIO W/NAVI W/O SURROUND]

## FRONT CAMERA IMAGE SIGNAL CIRCUIT

### Diagnosis Procedure

INFOID:000000009129235

Regarding Wiring Diagram information, refer to [AV-390, "Wiring Diagram"](#).

### 1. CHECK FRONT CAMERA IMAGE SIGNAL CIRCUIT CONTINUITY

1. Turn ignition switch OFF.
2. Disconnect around view monitor control unit connector M97 and front camera connector E226.
3. Check continuity between around view monitor control unit connector M97 and front camera connector E226.

Around view monitor control unit		Front camera		Continuity
Connector	Terminals	Connector	Terminals	
M97	71	E226	3	Yes
	72		4	

4. Check continuity between around view monitor control unit connector M97 and ground.

Around view monitor control unit		Ground	Continuity
Connector	Terminals		
M97	71	—	No

Is inspection result normal?

- YES >> GO TO 2.  
 NO >> Repair or replace harness or connectors.

### 2. CHECK FRONT CAMERA IMAGE SIGNAL

1. Connect around view monitor control unit connector M97 and front camera connector E226.
2. Turn ignition switch ON.
3. Check signal between around view monitor control unit connector M97 terminals.

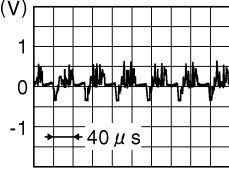
Around view monitor control unit		Condition	Reference value
(+)	(-)		
Terminal	Terminal		
71	72	CAMERA switch is ON or shift position is R.	 <p style="text-align: right; font-size: small;">JSNIA0834GB</p>

Is inspection result normal?

- YES >> Replace around view monitor control unit. Refer to [AV-600, "Removal and Installation"](#).  
 NO >> Replace front camera. Refer to [AV-601, "Removal and Installation"](#).

# REAR CAMERA COMMUNICATION SIGNAL CIRCUIT

< DTC/CIRCUIT DIAGNOSIS >

[BOSE AUDIO W/NAVI W/O SURROUND]

## REAR CAMERA COMMUNICATION SIGNAL CIRCUIT

### Diagnosis Procedure

INFOID:000000009129236

Regarding Wiring Diagram information, refer to [AV-390. "Wiring Diagram"](#).

### 1. CHECK COMMUNICATION SIGNAL CIRCUIT CONTINUITY

- Turn ignition switch OFF.
- Disconnect around view monitor control unit connector M97 and rear camera connector D511.
- Check continuity between around view monitor control unit connector M97 and front camera connector D511.

Around view monitor control unit		Rear camera		Continuity
Connector	Terminal	Connector	Terminal	
M97	49	D511	4	Yes

- Check continuity between around view monitor control unit connector M97 and ground.

Around view monitor control unit		Ground	Continuity
Connector	Terminal		
M97	49	—	No

Is inspection result normal?

YES >> GO TO 2.

NO >> Repair or replace harness or connectors.

### 2. CHECK COMMUNICATION SIGNAL

- Connect around view monitor control unit connector M97 and rear camera connector D511.
- Turn ignition switch ON.
- Check signal between around view monitor control unit connector M97 and ground.

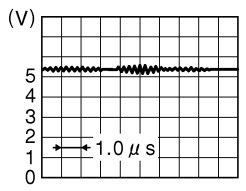
Around view monitor control unit		Ground	Condition	Reference value
(+)				
Connector	Terminal			
M97	49	—	CAMERA switch is ON or shift position is R.	 <p>JSNIA0836GB</p>

Is inspection result normal?

YES >> Replace around view monitor control unit. Refer to [AV-600. "Removal and Installation"](#).

NO >> Replace rear camera. Refer to [AV-602. "Removal and Installation"](#).

# REAR CAMERA IMAGE SIGNAL CIRCUIT

< DTC/CIRCUIT DIAGNOSIS >

[BOSE AUDIO W/NAVI W/O SURROUND]

## REAR CAMERA IMAGE SIGNAL CIRCUIT

### Diagnosis Procedure

INFOID:000000009129237

Regarding Wiring Diagram information, refer to [AV-390, "Wiring Diagram"](#).

### 1. CHECK REAR CAMERA IMAGE SIGNAL CIRCUIT CONTINUITY

1. Turn ignition switch OFF.
2. Disconnect around view monitor control unit connector M97 and rear camera connector D511.
3. Check continuity between around view monitor control unit connector M97 and rear camera connector D511.

Around view monitor control unit		Rear camera		Continuity
Connector	Terminals	Connector	Terminals	
M97	53	D511	5	Yes
	54		1	

4. Check continuity between around view monitor control unit connector M97 and ground.

Around view monitor control unit		Ground	Continuity
Connector	Terminals		
M97	53	—	No

Is inspection result normal?

- YES >> GO TO 2.  
 NO >> Repair or replace harness or connectors.

### 2. CHECK REAR CAMERA IMAGE SIGNAL

1. Connect around view monitor control unit connector M97 and rear camera connector D511.
2. Turn ignition switch ON.
3. Check signal between around view monitor control unit connector M97 terminals.

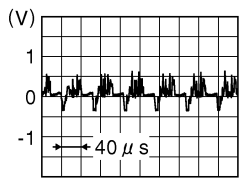
Around view monitor control unit		Condition	Reference value
(+)	(-)		
Terminal	Terminal		
53	54	CAMERA switch is ON or shift position is R.	 <p style="text-align: right; font-size: small;">JSNIA0834GB</p>

Is inspection result normal?

- YES >> Replace around view monitor control unit. Refer to [AV-600, "Removal and Installation"](#).  
 NO >> Replace rear camera. Refer to [AV-602, "Removal and Installation"](#).

# SIDE CAMERA LH COMMUNICATION SIGNAL CIRCUIT

< DTC/CIRCUIT DIAGNOSIS >

[BOSE AUDIO W/NAVI W/O SURROUND]

## SIDE CAMERA LH COMMUNICATION SIGNAL CIRCUIT

### Diagnosis Procedure

INFOID:000000009129238

Regarding Wiring Diagram information, refer to [AV-390. "Wiring Diagram"](#).

### 1. CHECK COMMUNICATION SIGNAL CIRCUIT CONTINUITY

1. Turn ignition switch OFF.
2. Disconnect around view monitor control unit connector M97 and LH side camera connector D20.
3. Check continuity between around view monitor control unit connector M97 and LH side camera connector D20.

Around view monitor control unit		LH side camera		Continuity
Connector	Terminal	Connector	Terminal	
M97	55	D20	16	Yes

4. Check continuity between around view monitor control unit connector M97 and ground.

Around view monitor control unit		Ground	Continuity
Connector	Terminal		
M97	55	—	No

Is inspection result normal?

YES >> GO TO 2.

NO >> Repair or replace harness or connectors.

### 2. CHECK COMMUNICATION SIGNAL

1. Connect around view monitor control unit connector M97 and LH side camera connector D20.
2. Turn ignition switch ON.
3. Check signal between around view monitor control unit connector M97 and ground.

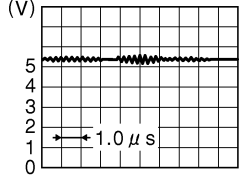
Around view monitor control unit		Ground	Condition	Reference value
(+)		(-)		
Connector	Terminal			
M97	55	—	CAMERA switch is ON or shift position is R.	 <p>JSNIA0836GB</p>

Is inspection result normal?

YES >> Replace around view monitor control unit. Refer to [AV-600. "Removal and Installation"](#).

NO >> Replace LH side camera. Refer to [AV-603. "Removal and Installation"](#).

# SIDE CAMERA LH IMAGE SIGNAL CIRCUIT

< DTC/CIRCUIT DIAGNOSIS >

[BOSE AUDIO W/NAVI W/O SURROUND]

## SIDE CAMERA LH IMAGE SIGNAL CIRCUIT

### Diagnosis Procedure

INFOID:000000009129239

Regarding Wiring Diagram information, refer to [AV-390. "Wiring Diagram"](#).

#### 1. CHECK LH SIDE CAMERA IMAGE SIGNAL CIRCUIT CONTINUITY

1. Turn ignition switch OFF.
2. Disconnect around view monitor control unit connector M97 and LH side camera connector D20.
3. Check continuity between around view monitor control unit connector M97 and LH side camera connector D20.

Around view monitor control unit		LH side camera		Continuity
Connector	Terminals	Connector	Terminals	
M97	59	D20	5	Yes
	60		17	

4. Check continuity between around view monitor control unit connector M97 and ground.

Around view monitor control unit		Ground	Continuity
Connector	Terminals		
M97	59	—	No

Is inspection result normal?

- YES >> GO TO 2.  
NO >> Repair or replace harness or connectors.

#### 2. CHECK LH SIDE CAMERA IMAGE SIGNAL

1. Connect around view monitor control unit connector M97 and LH side camera connector D20.
2. Turn ignition switch ON.
3. Check signal between around view monitor control unit connector M97 terminals.

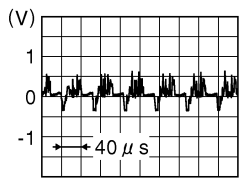
Around view monitor control unit		Condition	Reference value
(+)	(-)		
Terminal	Terminal		
59	60	CAMERA switch is ON or shift position is R.	

Is inspection result normal?

- YES >> Replace around view monitor control unit. Refer to [AV-600. "Removal and Installation"](#).  
NO >> Replace LH side camera. Refer to [AV-603. "Removal and Installation"](#).

# SIDE CAMERA RH COMMUNICATION SIGNAL CIRCUIT

< DTC/CIRCUIT DIAGNOSIS >

[BOSE AUDIO W/NAVI W/O SURROUND]

## SIDE CAMERA RH COMMUNICATION SIGNAL CIRCUIT

### Diagnosis Procedure

INFOID:000000009129240

Regarding Wiring Diagram information, refer to [AV-390. "Wiring Diagram"](#).

### 1. CHECK COMMUNICATION SIGNAL CIRCUIT CONTINUITY

1. Turn ignition switch OFF.
2. Disconnect around view monitor control unit connector M97 and RH side camera connector D113.
3. Check continuity between around view monitor control unit connector M97 and fRH side camera connector D113.

Around view monitor control unit		RH side camera		Continuity
Connector	Terminal	Connector	Terminal	
M97	61	D113	16	Yes

4. Check continuity between around view monitor control unit connector M97 and ground.

Around view monitor control unit		Ground	Continuity
Connector	Terminal		
M97	61	—	No

Is inspection result normal?

YES >> GO TO 2.

NO >> Repair or replace harness or connectors.

### 2. CHECK COMMUNICATION SIGNAL

1. Connect around view monitor control unit connector M97 and RH side camera connector D113.
2. Turn ignition switch ON.
3. Check signal between around view monitor control unit connector M97 and ground.

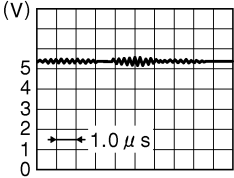
Around view monitor control unit		Ground	Condition	Reference value
(+)		(-)		
Connector	Terminal			
M97	61	—	CAMERA switch is ON or shift position is R.	 <p>JSNIA0836GB</p>

Is inspection result normal?

YES >> Replace around view monitor control unit. Refer to [AV-600. "Removal and Installation"](#).

NO >> Replace RH side camera. Refer to [AV-603. "Removal and Installation"](#).

A  
B  
C  
D  
E  
F  
G  
H  
I  
J  
K  
L  
M  
O  
P

AV

# SIDE CAMERA RH IMAGE SIGNAL CIRCUIT

< DTC/CIRCUIT DIAGNOSIS >

[BOSE AUDIO W/NAVI W/O SURROUND]

## SIDE CAMERA RH IMAGE SIGNAL CIRCUIT

### Diagnosis Procedure

INFOID:000000009129241

Regarding Wiring Diagram information, refer to [AV-390. "Wiring Diagram"](#).

#### 1. CHECK RH SIDE CAMERA IMAGE SIGNAL CIRCUIT CONTINUITY

1. Turn ignition switch OFF.
2. Disconnect around view monitor control unit connector M97 and RH side camera connector D113.
3. Check continuity between around view monitor control unit connector M97 and RH side camera connector D113.

Around view monitor control unit		RH side camera		Continuity
Connector	Terminals	Connector	Terminals	
M97	65	D113	5	Yes
	66		17	

4. Check continuity between around view monitor control unit connector M97 and ground.

Around view monitor control unit		Ground	Continuity
Connector	Terminals		
M97	65	—	No

Is inspection result normal?

- YES >> GO TO 2.  
NO >> Repair or replace harness or connectors.

#### 2. CHECK RH SIDE CAMERA IMAGE SIGNAL

1. Connect around view monitor control unit connector M97 and RH side camera connector D113.
2. Turn ignition switch ON.
3. Check signal between around view monitor control unit connector M97 terminals.

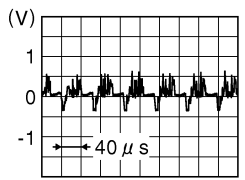
Around view monitor control unit		Condition	Reference value
(+)	(-)		
Terminal	Terminal		
65	66	CAMERA switch is ON or shift position is R.	

Is inspection result normal?

- YES >> Replace around view monitor control unit. Refer to [AV-600. "Removal and Installation"](#).  
NO >> Replace RH side camera. Refer to [AV-603. "Removal and Installation"](#).



# MULTI AV SYSTEM

< SYMPTOM DIAGNOSIS >

[BOSE AUDIO W/NAVI W/O SURROUND]

## SYMPTOM DIAGNOSIS

### MULTI AV SYSTEM

#### Symptom Table

INFOID:000000009129242

#### RELATED TO AUDIO

Symptoms	Check items	Probable malfunction location
The disk cannot be removed.	AV control unit	Malfunction in AV control unit. Refer to <a href="#">AV-341</a> , "On Board Diagnosis Function".

A  
B  
C  
D  
E  
F  
G  
H  
I  
J  
K  
L  
M  
O  
P

AV

# MULTI AV SYSTEM

[BOSE AUDIO W/NAVI W/O SURROUND]

< SYMPTOM DIAGNOSIS >

Symptoms	Check items	Probable malfunction location
<p>No sound comes out or the level of the sound is low.</p>	<p>No sound from all speakers.</p>	<ul style="list-style-type: none"> <li>• Speaker circuit shorted to ground. Refer to <a href="#">AV-390. "Wiring Diagram"</a>.</li> <li>• Bose amp. ON signal circuit malfunction. Refer to <a href="#">AV-492. "Diagnosis Procedure"</a>.</li> <li>• Bose speaker amp. power supply and ground circuits malfunction. Refer to <a href="#">AV-520. "BOSE AMP. : Diagnosis Procedure"</a>.</li> </ul>
	<p>Only a certain speaker (front door speaker LH, front door speaker RH, front tweeter LH, front tweeter RH, instrument panel tweeter LH, instrument panel tweeter RH, center speaker, rear door speaker LH, rear door speaker RH, rear side speaker LH, rear side speaker RH, subwoofer) does not output sound.</p>	<ul style="list-style-type: none"> <li>• Poor connector connection of speaker.</li> <li>• Sound signal circuit malfunction between AV control unit and Bose speaker amp. Refer to:               <ul style="list-style-type: none"> <li>- <a href="#">AV-535. "Diagnosis Procedure"</a> (front door speaker).</li> <li>- <a href="#">AV-532. "Diagnosis Procedure"</a> (front tweeter).</li> <li>- <a href="#">AV-529. "Diagnosis Procedure"</a> (instrument panel tweeter).</li> <li>- <a href="#">AV-527. "Diagnosis Procedure"</a> (center speaker).</li> <li>- <a href="#">AV-538. "Diagnosis Procedure"</a> (rear door speaker).</li> <li>- <a href="#">AV-541. "Diagnosis Procedure"</a> (rear side speaker).</li> <li>- <a href="#">AV-544. "Diagnosis Procedure"</a> (subwoofer).</li> </ul> </li> <li>• Sound signal circuit malfunction between Bose speaker amp. and speaker. Refer to:               <ul style="list-style-type: none"> <li>- <a href="#">AV-535. "Diagnosis Procedure"</a> (front door speaker).</li> <li>- <a href="#">AV-532. "Diagnosis Procedure"</a> (front tweeter).</li> <li>- <a href="#">AV-529. "Diagnosis Procedure"</a> (instrument panel tweeter).</li> <li>- <a href="#">AV-527. "Diagnosis Procedure"</a> (center speaker).</li> <li>- <a href="#">AV-538. "Diagnosis Procedure"</a> (rear door speaker).</li> <li>- <a href="#">AV-541. "Diagnosis Procedure"</a> (rear side speaker).</li> <li>- <a href="#">AV-544. "Diagnosis Procedure"</a> (subwoofer).</li> </ul> </li> <li>• Malfunction in speaker. Refer to:               <ul style="list-style-type: none"> <li>- <a href="#">AV-591. "Removal and Installation"</a> (front door speaker).</li> <li>- <a href="#">AV-592. "Removal and Installation"</a> (front tweeter).</li> <li>- <a href="#">AV-593. "Removal and Installation"</a> (instrument panel tweeter).</li> <li>- <a href="#">AV-594. "Removal and Installation"</a> (center speaker).</li> <li>- <a href="#">AV-595. "Removal and Installation"</a> (rear door speaker).</li> <li>- <a href="#">AV-596. "Removal and Installation"</a> (rear side speaker).</li> <li>- <a href="#">AV-597. "Removal and Installation"</a> (subwoofer).</li> </ul> </li> <li>• Malfunction in AV control unit. Refer to <a href="#">AV-341. "On Board Diagnosis Function"</a>.</li> <li>• Malfunction in Bose speaker amp. Replace Bose speaker amp. Refer to <a href="#">AV-590. "Removal and Installation"</a>.</li> </ul>

# MULTI AV SYSTEM

[BOSE AUDIO W/NAVI W/O SURROUND]

< SYMPTOM DIAGNOSIS >

Symptoms	Check items	Probable malfunction location
	Noise comes out from all speakers.	<ul style="list-style-type: none"> <li>Malfunction in AV control unit. Refer to <a href="#">AV-341. "On Board Diagnosis Function"</a>.</li> <li>Malfunction in Bose speaker amp. Replace Bose speaker amp. Refer to <a href="#">AV-590. "Removal and Installation"</a>.</li> </ul>
Noise is mixed with audio.	Noise comes out only from a certain speaker (front door speaker LH, front door speaker RH, front tweeter LH, front tweeter RH, instrument panel tweeter LH, instrument panel tweeter RH, center speaker, rear door speaker LH, rear door speaker RH, rear side speaker LH, rear side speaker RH, subwoofer).	<ul style="list-style-type: none"> <li>Poor connector connection of speaker.</li> <li>Sound signal circuit malfunction between AV control unit and Bose speaker amp. Refer to:                             <ul style="list-style-type: none"> <li><a href="#">AV-535. "Diagnosis Procedure"</a> (front door speaker).</li> <li><a href="#">AV-532. "Diagnosis Procedure"</a> (front tweeter).</li> <li><a href="#">AV-529. "Diagnosis Procedure"</a> (instrument panel tweeter).</li> <li><a href="#">AV-527. "Diagnosis Procedure"</a> (center speaker).</li> <li><a href="#">AV-538. "Diagnosis Procedure"</a> (rear door speaker).</li> <li><a href="#">AV-541. "Diagnosis Procedure"</a> (rear side speaker).</li> <li><a href="#">AV-544. "Diagnosis Procedure"</a> (subwoofer).</li> </ul> </li> <li>Sound signal circuit malfunction between Bose speaker amp. and speaker. Refer to:                             <ul style="list-style-type: none"> <li><a href="#">AV-535. "Diagnosis Procedure"</a> (front door speaker).</li> <li><a href="#">AV-532. "Diagnosis Procedure"</a> (front tweeter).</li> <li><a href="#">AV-529. "Diagnosis Procedure"</a> (instrument panel tweeter).</li> <li><a href="#">AV-527. "Diagnosis Procedure"</a> (center speaker).</li> <li><a href="#">AV-538. "Diagnosis Procedure"</a> (rear door speaker).</li> <li><a href="#">AV-541. "Diagnosis Procedure"</a> (rear side speaker).</li> <li><a href="#">AV-544. "Diagnosis Procedure"</a> (subwoofer).</li> </ul> </li> <li>Malfunction in speaker.</li> <li>Poor Installation of speaker (e.g. backlash and looseness). Refer to:                             <ul style="list-style-type: none"> <li><a href="#">AV-591. "Removal and Installation"</a> (front door speaker).</li> <li><a href="#">AV-592. "Removal and Installation"</a> (front tweeter).</li> <li><a href="#">AV-593. "Removal and Installation"</a> (instrument panel tweeter).</li> <li><a href="#">AV-594. "Removal and Installation"</a> (center speaker).</li> <li><a href="#">AV-595. "Removal and Installation"</a> (rear door speaker).</li> <li><a href="#">AV-596. "Removal and Installation"</a> (rear side speaker).</li> <li><a href="#">AV-597. "Removal and Installation"</a> (subwoofer).</li> </ul> </li> <li>Malfunction in AV control unit. Refer to <a href="#">AV-341. "On Board Diagnosis Function"</a>.</li> <li>Malfunction in Bose speaker amp. Replace Bose speaker amp. Refer to <a href="#">AV-590. "Removal and Installation"</a>.</li> </ul>
	Noise is mixed with radio only (when the vehicle hits a bump or while driving over bad roads)	<ul style="list-style-type: none"> <li>Poor connector connection of antenna or antenna feeder. Refer to <a href="#">AV-612. "Location of Antennas"</a>.</li> </ul>
No radio reception or poor reception.	<ul style="list-style-type: none"> <li>Other audio sounds are normal.</li> <li>Any radio station cannot be received or poor reception is caused even after moving to a service area with good reception (e.g. a place with clear view and no obstacles generating external noises).</li> </ul>	<ul style="list-style-type: none"> <li>Antenna amp. ON signal circuit malfunction. Refer to <a href="#">AV-491. "Diagnosis Procedure"</a>.</li> <li>Poor connector connection of antenna or antenna feeder. Refer to <a href="#">AV-612. "Location of Antennas"</a>.</li> </ul>

A  
B  
C  
D  
E  
F  
G  
H  
I  
J  
K  
L  
M  
AV  
O  
P









# MULTI AV SYSTEM

[BOSE AUDIO W/NAVI W/O SURROUND]

## < SYMPTOM DIAGNOSIS >

Symptoms	Check items	Probable malfunction location
No satellite radio reception.	There is malfunction in the CONSULT self diagnosis result. Refer to <a href="#">AV-354. "CONSULT Function"</a> .	<ul style="list-style-type: none"> <li>Malfunction in antenna, antenna feeder or AV control unit. Perform DTC diagnosis. Refer to <a href="#">AV-354. "CONSULT Function"</a>.</li> <li>Poor continuity in antenna feeder.</li> <li>Poor connector connection of antenna or antenna feeder. Refer to <a href="#">AV-612. "Location of Antennas"</a>.</li> </ul>
	There is no malfunction in the CONSULT self diagnosis result. Refer to <a href="#">AV-354. "CONSULT Function"</a> .	<ul style="list-style-type: none"> <li>Poor continuity in antenna feeder.</li> <li>Poor connector connection of antenna or antenna feeder.</li> <li>Loose satellite radio antenna mounting nut. Refer to <a href="#">AV-612. "Location of Antennas"</a>.</li> </ul>
Buzz/rattle sound from speaker	The majority of buzz/rattle sounds are not indicative of an issue with the speaker, usually something nearby the speaker is causing the buzz/rattle.	Refer to "SQUEAK AND RATTLE TROUBLE DIAGNOSIS" in the appropriate interior trim section.

## RELATED TO HANDS-FREE PHONE

Symptoms	Check items	Probable malfunction location
Does not recognize cellular phone connection (no connection is displayed on the display at the guide).	Repeat the registration of cellular phone.	Malfunction in AV control unit. Replace AV control unit. Refer to <a href="#">AV-586. "Removal and Installation - AV Control Unit"</a> .
Hands-free phone cannot be established.	<ul style="list-style-type: none"> <li>Hands-free phone operation can be made, but the communication cannot be established.</li> <li>Hands-free phone operation can be performed, however, voice between each other cannot be heard during the conversation.</li> </ul>	
The other party's voice cannot be heard by hands-free phone.	Check the "microphone speaker" in Inspection & Adjustment Mode if sound is heard.	
Originating sound is not heard by the other party with hands-free phone communication.	Sound operation function is normal.	Microphone signal circuit malfunction. Refer to <a href="#">AV-556. "Diagnosis Procedure"</a> .
	Sound operation function does not work.	
The system cannot be operated.	<ul style="list-style-type: none"> <li>The voice recognition can be controlled.</li> <li>Steering switch's + , - , and  switch works, but  does not work.</li> </ul>	Steering switch malfunction. Replace steering switch. Refer to <a href="#">AV-588. "Removal and Installation"</a> .
	Steering switch's  ,  + ,  - , and  switches do not work.	Steering switch signal circuit malfunction. Refer to <a href="#">AV-558. "Diagnosis Procedure"</a> .
	All steering switches do not work.	Steering switch ground circuit malfunction. Refer to <a href="#">AV-558. "Diagnosis Procedure"</a> .

## RELATED TO NAVIGATION

# MULTI AV SYSTEM

< SYMPTOM DIAGNOSIS >

[BOSE AUDIO W/NAVI W/O SURROUND]

Symptoms	Check items	Probable malfunction location
Navigation system is inoperative.	Navigation malfunction.	<ul style="list-style-type: none"> <li>Malfunction in hard disk drive (HDD).</li> <li>Malfunction in AV control unit.</li> </ul> Refer to <a href="#">AV-341, "On Board Diagnosis Function"</a> .
	Steering switches malfunction.	Steering switch signal circuit malfunction. Refer to <a href="#">AV-558, "Diagnosis Procedure"</a> .
	Voice activated control malfunction.	Microphone signal circuit malfunction. Refer to <a href="#">AV-556, "Diagnosis Procedure"</a> . Steering switch signal circuit malfunction. Refer to <a href="#">AV-558, "Diagnosis Procedure"</a> .

## RELATED TO AROUND VIEW MONITOR

Symptoms	Check items	Probable malfunction location
Display does not switch to camera image when "CAMERA" switch is pressed or selector lever is in R (reverse).	Around view monitor control unit malfunction.	Around view monitor control unit power supply and ground circuits malfunction. Refer to <a href="#">AV-524, "AROUND VIEW MONITOR CONTROL UNIT : Diagnosis Procedure"</a> .
	AV communication circuits malfunction.	AV communication circuits malfunction between around view monitor control unit and AV control unit. Refer to <a href="#">AV-383, "Reference Value"</a> .
	Camera image signal circuit (output) malfunction.	Camera image signal circuit (output) malfunction between around view monitor control unit and display unit. Refer to <a href="#">AV-383, "Reference Value"</a> .
Display switches to camera image when "CAMERA" switch is pressed or selector lever is in R (reverse), but all views are not displayed.	Camera image signal circuit (input) malfunction.	Camera image signal circuit (input) malfunction between camera and around view monitor control unit. Refer to: <ul style="list-style-type: none"> <li><a href="#">AV-562, "Diagnosis Procedure"</a> (front camera).</li> <li><a href="#">AV-564, "Diagnosis Procedure"</a> (rear camera).</li> <li><a href="#">AV-566, "Diagnosis Procedure"</a> (side camera LH).</li> <li><a href="#">AV-568, "Diagnosis Procedure"</a> (side camera RH).</li> </ul>
	Camera communication signal circuits malfunction.	Camera communication circuits malfunction between camera and around view monitor control unit. Refer to: <ul style="list-style-type: none"> <li><a href="#">AV-561, "Diagnosis Procedure"</a> (front camera).</li> <li><a href="#">AV-563, "Diagnosis Procedure"</a> (rear camera).</li> <li><a href="#">AV-565, "Diagnosis Procedure"</a> (side camera LH).</li> <li><a href="#">AV-567, "Diagnosis Procedure"</a> (side camera RH).</li> </ul>
Camera image is rolling.	Camera image signal circuit (output) malfunction.	Camera image signal circuit (output) malfunction between around view monitor control unit and display unit. Refer to <a href="#">AV-383, "Reference Value"</a> .
Display does not switch to rear view monitor even when selector lever is in R (reverse).	Reverse signal circuit malfunction.	Reverse signal circuit between BCM and around view monitor control unit. Refer to <a href="#">AV-383, "Reference Value"</a> .
Predicted course line display in front view and rear view is malfunctioning.	Steering angle sensor malfunction.	Predicted course line center position is malfunctioning. Refer to <a href="#">AV-452, "PREDICTED COURSE LINE CENTER POSITION ADJUSTMENT : Work Procedure"</a> .

# MULTI AV SYSTEM

[BOSE AUDIO W/NAVI W/O SURROUND]

< SYMPTOM DIAGNOSIS >

Symptoms	Check items	Probable malfunction location
Front view and front of birds-eye view is not displayed.	Front camera malfunction.	Front camera power supply and ground circuits malfunction. Refer to <a href="#">AV-495, "Diagnosis Procedure"</a> .
	Front camera image signal circuit malfunction.	Front camera image signal circuit malfunction between front camera and around view monitor control unit. Refer to <a href="#">AV-562, "Diagnosis Procedure"</a> .
	Front camera communication signal circuit malfunction.	Front camera communication signal circuit malfunction between front camera and around view monitor control unit. Refer to <a href="#">AV-561, "Diagnosis Procedure"</a> .
Rear view and rear of birds-eye view is not displayed.	Rear camera malfunction.	Rear camera power supply and ground circuits malfunction. Refer to <a href="#">AV-495, "Diagnosis Procedure"</a> .
	Rear camera image signal circuit malfunction.	Rear camera image signal circuit malfunction between rear camera and around view monitor control unit. Refer to <a href="#">AV-564, "Diagnosis Procedure"</a> .
	Rear camera communication signal circuit malfunction.	Rear camera communication signal circuit malfunction between rear camera and around view monitor control unit. Refer to <a href="#">AV-563, "Diagnosis Procedure"</a> .
Front-side and driver side of birds-eye view is not displayed.	Side camera LH malfunction.	Side camera LH power supply and ground circuits malfunction. Refer to <a href="#">AV-495, "Diagnosis Procedure"</a> .
	Side camera LH image signal circuit malfunction.	Side camera LH image signal circuit malfunction between side camera LH and around view monitor control unit. Refer to <a href="#">AV-566, "Diagnosis Procedure"</a> .
	Side camera LH communication signal circuit malfunction.	Side camera LH communication signal circuit malfunction between side camera LH and around view monitor control unit. Refer to <a href="#">AV-565, "Diagnosis Procedure"</a> .
Front-side and passenger side of birds-eye view is not displayed.	Side camera RH malfunction.	Side camera RH power supply and ground circuits malfunction. Refer to <a href="#">AV-495, "Diagnosis Procedure"</a> .
	Side camera RH image signal circuit malfunction.	Side camera RH image signal circuit malfunction between side camera RH and around view monitor control unit. Refer to <a href="#">AV-568, "Diagnosis Procedure"</a> .
	Side camera RH communication signal circuit malfunction.	Side camera RH communication signal circuit malfunction between side camera RH and around view monitor control unit. Refer to <a href="#">AV-567, "Diagnosis Procedure"</a> .
Selector lever is in a position other than R (reverse) and front, rear, front-side and Birds-Eye views are displayed even as vehicle speed increases.	Vehicle speed signal malfunction.	Vehicle speed signal malfunction between ABS actuator and electric unit (control unit) and around view monitor control unit. Refer to <a href="#">LAN-26, "Trouble Diagnosis Flow Chart"</a> .

RELATED TO CAMERA ASSISTANCE SONAR

# MULTI AV SYSTEM

< SYMPTOM DIAGNOSIS >

[BOSE AUDIO W/NAVI W/O SURROUND]

Symptoms	Check items	Probable malfunction location
Malfunction is detected in only 1 indicator (Always displayed in red).	Sonar sensor circuit malfunction.	Sonar sensor circuit malfunction between sonar sensor and sonar control unit. Refer to: <ul style="list-style-type: none"> <li>• <a href="#">AV-517, "Diagnosis Procedure"</a> (front LH outer).</li> <li>• <a href="#">AV-518, "Diagnosis Procedure"</a> (front RH outer).</li> <li>• <a href="#">AV-511, "Diagnosis Procedure"</a> (rear LH inner).</li> <li>• <a href="#">AV-512, "Diagnosis Procedure"</a> (rear RH inner).</li> <li>• <a href="#">AV-510, "Diagnosis Procedure"</a> (rear LH outer).</li> <li>• <a href="#">AV-513, "Diagnosis Procedure"</a> (rear RH outer).</li> </ul>
	Sonar sensor malfunction.	Malfunction in sonar sensor. Refer to <a href="#">AV-609, "Removal and Installation"</a> .
Malfunction is detected in all 5 indicators (Always displayed in red).	Sonar control unit malfunction.	Sonar control unit power supply and ground circuits malfunction. Refer to <a href="#">AV-525, "SONAR CONTROL UNIT (WITH AROUND VIEW MONITOR) : Diagnosis Procedure"</a> .
	CAN communication malfunction.	CAN communication malfunction between sonar control unit and combination meter. Refer to <a href="#">LAN-26, "Trouble Diagnosis Flow Chart"</a> .

## RELATED TO REAR DISPLAY (HEADREST-MOUNTED)

Perform diagnosis of the power supply and ground circuits of the following items before starting diagnosis by symptom:

- Video distributor. Refer to [AV-523, "VIDEO DISTRIBUTOR : Diagnosis Procedure"](#).
- Headrest display unit. Refer to [AV-524, "HEADREST DISPLAY UNIT : Diagnosis Procedure"](#).

Symptom	Check item		Possible malfunction location/Action to take
Video is not shown on the headrest display unit screen.	Use the touch button in front display to switch video images on the headrest display unit.	Video is shown.	Operate with the remote to see if videos can be switched.
		Video is not shown.	Replace headrest display unit. Refer to <a href="#">AV-605, "Removal and Installation"</a> .
Headrest display unit inoperative with the remote.	All keys inoperative.	<ul style="list-style-type: none"> <li>• Check battery polarity.</li> <li>• Replace battery.</li> </ul>	<ul style="list-style-type: none"> <li>• Check with a remote from the same vehicle family.</li> <li>• Check infrared* of the luminescent part (LED) of the remote.</li> </ul>
	Some keys inoperative.	<ul style="list-style-type: none"> <li>• Check with a remote from the same vehicle family.</li> <li>• Check infrared* of the luminescent part (LED) of the remote.</li> </ul>	The function corresponding to the remote operation is not included (this is not a malfunction).
Headrest display unit screen is black.	Play a DVD.	Video is not shown.	Switch from AUX mode to DVD mode and check video.
		Screen is dark.	Adjust screen for image quality (this is not a malfunction).
		Screen is black.	Replace headrest display unit. Refer to <a href="#">AV-605, "Removal and Installation"</a> .
Video shown on headrest display unit screen becomes distorted or rolls up/down	Adjust the color settings using the display screen menu items.		If the symptom does not change, replace headrest display unit. Refer to <a href="#">AV-605, "Removal and Installation"</a> .
Headrest display unit screen is blue.	—		Replace headrest display unit. Refer to <a href="#">AV-605, "Removal and Installation"</a> .

## MULTI AV SYSTEM

[BOSE AUDIO W/NAVI W/O SURROUND]

### < SYMPTOM DIAGNOSIS >

\*: To check infrared, check light of the luminescent part (LED) through the lens of digital camera when operating the remote.

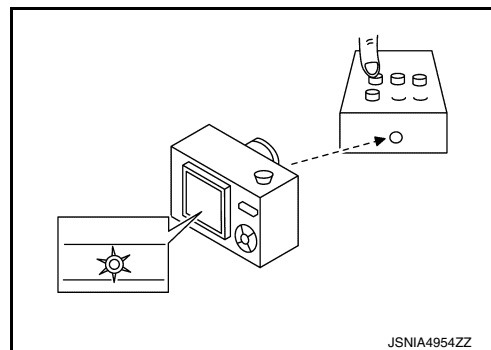

### RELATED TO HEADPHONES (HEADREST-MOUNTED)

Symptom	Check item		Possible malfunction location/Action to take
Audio cannot be heard from headphones.	<ul style="list-style-type: none"> <li>Turn ON the headrest display unit.</li> <li>Switch the slide switch on the left side of the headphones.</li> </ul>	Audio cannot be heard.	Check power supply of headphones.
Headphones cannot be turned ON.	<ul style="list-style-type: none"> <li>Battery polarity.</li> <li>Battery poor contact.</li> <li>Battery replacement.</li> </ul>	Power is ON (power indicator lamp: ON).	This is not a malfunction.
		Power cannot be turned ON (power indicator lamp: OFF).	Replace headphones.



# NORMAL OPERATING CONDITION

< SYMPTOM DIAGNOSIS >

[BOSE AUDIO W/NAVI W/O SURROUND]

## NORMAL OPERATING CONDITION

### Description

INFOID:000000009129243

#### RELATED TO NOISE

The majority of the audio concerns are the result of outside causes (bad CD, electromagnetic interference, etc.).

The following noise results from variations in field strength, such as fading noise and multi-path noise, or external noise from trains and other sources. It is not a malfunction.

- Fading noise: This noise occurs because of variations in the field strength in a narrow range due to mountains or buildings blocking the signal.
- Multi-path noise: This noise results from the waves sent directly from the broadcast station arriving at the antenna at a different time from the waves which reflect off mountains or buildings.

The vehicle itself can be a source of noise if noise prevention parts or electrical equipment is malfunctioning. Check if noise is caused and/or changed by engine speed, ignition switch turned to each position, and operation of each piece of electrical equipment, and determine the cause.

#### NOTE:

The source of the noise can be found easily by listening to the noise while removing the fuses of electrical components, one by one.

#### Type of Noise and Possible Cause

Occurrence condition		Possible cause
Occurs only when engine is ON.	A continuous growling noise occurs. The speed of the noise varies with changes in the engine speed.	<ul style="list-style-type: none"> <li>• Ignition components</li> </ul>
The occurrence of the noise is linked with the operation of the fuel pump.		<ul style="list-style-type: none"> <li>• Fuel pump condenser</li> </ul>
Noise only occurs when various electrical components are operating.	A cracking or snapping sound occurs with the operation of various switches.	<ul style="list-style-type: none"> <li>• Relay malfunction, AV control unit malfunction</li> </ul>
	The noise occurs when various motors are operating.	<ul style="list-style-type: none"> <li>• Motor case ground</li> <li>• Motor</li> </ul>
The noise occurs constantly, not just under certain conditions.		<ul style="list-style-type: none"> <li>• Rear defogger coil malfunction</li> <li>• Open circuit in printed heater</li> <li>• Poor ground of antenna feeder line</li> </ul>
A cracking or snapping sound occurs while the vehicle is being driven, especially when it is vibrating excessively.		<ul style="list-style-type: none"> <li>• Ground wire of body parts</li> <li>• Ground due to improper part installation</li> <li>• Wiring connections or a short circuit</li> </ul>

#### RELATED TO HANDS-FREE PHONE

Symptom	Cause and Counter measure
Does not recognize cellular phone connection (No connection is displayed on the display at the guide).	<p>Some Bluetooth<sup>®</sup> enabled cellular phones may not be recognized by the in-vehicle phone module.</p> <p>Refer to "RELATED TO HANDS-FREE PHONE (Check Compatibility)" in <a href="#">AV-569, "Symptom Table"</a>.</p>
Cannot use hands-free phone.	<p>Customer will not be able to use a hands-free phone under the following conditions:</p> <ul style="list-style-type: none"> <li>• The vehicle is outside of the telephone service area.</li> <li>• The vehicle is in an area where it is difficult to receive radio waves; such as in a tunnel, in an underground parking garage, near a tall building or in a mountainous area.</li> <li>• The cellular phone is locked to prevent it from being dialed.</li> </ul> <p><b>NOTE:</b></p> <p>While a cellular phone is connected through the Bluetooth<sup>®</sup> wireless connection, the battery power of the cellular phone may discharge quicker than usual. The Bluetooth<sup>®</sup> Hands-Free Phone System cannot charge cellular phones.</p>

## NORMAL OPERATING CONDITION

< SYMPTOM DIAGNOSIS >

[BOSE AUDIO W/NAVI W/O SURROUND]

Symptom	Cause and Counter measure
The other party's voice cannot be heard by hands-free phone.	When the radio wave condition is not ideal or ambient sound is too loud, it may be difficult to hear the other person's voice during a call.
Poor sound quality.	Do not place the cellular phone in an area surrounded by metal or far away from the in-vehicle phone module to prevent tone quality degradation and wireless connection disruption.

### RELATED TO NAVIGATION

#### Basic Operation

Symptom	Cause	Remedy
No image is shown.	Display brightness adjustment is set fully to DARK side.	Adjust the display brightness.
No guide sound is heard. Audio guide volume is too low or too high.	Volume control is set to OFF, MIN or MAX.	Adjust the audio guide volume.
	Audio guidance is not available while the vehicle is driving on a dark pink route.	System is not malfunctioning.
Screen is too dark. Motion of the image is too slow.	Temperature inside the vehicle is low.	Wait until the temperature inside the vehicle reaches the proper temperature.
Small black or bright spots appear on the screen.	Symptom peculiar to a liquid crystal display (display unit).	System is not malfunctioning.

#### Vehicle Mark

Symptom	Cause	Remedy
Map screen and BIRDVIEW™ Name of the place vary with the screen.	Some thinning of the character data is done to prevent the display becoming to complex. In some cases and in some locations, the display contents may differ. The same place name, street name, etc. may not be displayed every time on account of the data processing.	System is not malfunctioning.
Vehicle mark is not positioned correctly.	Vehicle is transferred by ferry or by towing after its ignition switch is turned to OFF.	Drive the vehicle for a while in the GPS satellite signal receiving condition.
Screen will not switch to nighttime mode after the lighting switch is turned ON.	The daytime screen is selected by the "SWITCH SCREENS" when the last time the screen dimming setting is done. Switching between daytime/nighttime screen may be inhibited by the automatic illumination adjustment function.	Perform screen dimming and select the nighttime screen by "SWITCH SCREENS".
Map screen will not scroll in accordance with the vehicle travel.	Current location is not displayed.	Press "MAP" button to display the current location.
Vehicle mark will not be shown.	Current location is not displayed.	Press "MAP" button to display the current location.
Accuracy indicator (GPS satellite mark) on the map screen stays gray.	GPS satellite signal is intercepted because the vehicle is in or behind a building.	Move the vehicle out to an open space.
	GPS satellite signal cannot be received because an obstacle is placed on top of the instrument panel.	Do not place anything on top of the meter display (instrument panel).
	GPS satellites are not visible from current location.	Wait until GPS satellites are visible by moving the vehicle.

## NORMAL OPERATING CONDITION

< SYMPTOM DIAGNOSIS >

[BOSE AUDIO W/NAVI W/O SURROUND]

Symptom	Cause	Remedy
Vehicle location accuracy is low.	Accuracy indicator (GPS satellite mark) on the map screen stays gray.	Current location is not determined.
	Vehicle speed setting by the vehicle speed pulse has been deviated (advanced or retarded) from the actual vehicle speed because tire chain is fitted or the system has been used on another vehicle.	Drive the vehicle for a while [for approx. 30 minutes at approx. 30 km/h (19 MPH)] and the deviation will be automatically adjusted. If advancement or retard still occur, perform the distance adjustment by CONFIRMATION/ADJUSTMENT mode of diagnosis function.
	Map data has error or omission. (Vehicle mark is always deviated to the same position.)	As a rule, an updated map DVD-ROM will be released once a year.

### Destination, Passing Points and Menu Items Cannot be Selected/Set

Symptom	Cause	Remedy
Destination cannot be set.	Destination to be set is on an expressway.	Set the destination on an ordinary road.
Passing point is not searched when re-searching the route.	The vehicle has already passed the passing point, or the system judged so.	To include the passing points that have been passed into the route again, set the route again.
Route information will not be displayed.	Route searching has not been done.	Set the destination and perform route searching.
	Vehicle mark is not on the recommended route.	Drive on the recommended route.
	Route guide is turned OFF.	Turn route guide ON.
	Route information is not available on the dark pink route.	System is not malfunctioning.
After the route searching, no guide sign will appear as the vehicle goes near the entrance/exit to the toll road.	Vehicle mark is not on the recommended route. (On the display, only guide signs related to the recommended route will be shown.)	Drive on the recommended route.
Automatic route searching is not possible.	Vehicle is driving on a highway (gray route), or no recommended route is available.	Drive on a road to be searched. Or re-search the route manually. In this case, however, the whole route will be searched.
Performed automatic detour search (or detour search). However, the result is the same as that of the previous search.	Performed search with every conditions considered. However, the result is the same as that of the previous search.	System is not malfunctioning.
Passing points cannot be set.	More than five passing points were set.	Passing points can be set up to five. To stop at more than five points, perform sharing in several steps.
When setting the route, the starting point cannot be selected.	The current vehicle location is always set as the starting point of a route.	System is not malfunctioning.
Some menu items cannot be selected.	The vehicle is being driven.	Stop the vehicle at a safe place and then operate the system.

### Voice Guide

## NORMAL OPERATING CONDITION

< SYMPTOM DIAGNOSIS >

[BOSE AUDIO W/NAVI W/O SURROUND]

Symptom	Cause	Remedy
Voice guide will not operate.	Note: Voice guide is only available at intersections that satisfy certain conditions (indicated by ● on the map). Therefore, guidance may not be given even when the route on the map changes direction.	System is not malfunctioning.
	The vehicle is not on the recommended route.	Return to the recommended route or re-search the route.
	Voice guide is turned OFF.	Turn voice guide ON.
	Route guide is turned OFF.	Turn route guide ON.
Voice guide does not match the actual road pattern.	Voice guide may vary with the direction to which the vehicle is turn and the connection of the road to other roads.	Drive in conformity to the actual traffic rules.

### Route Search

Symptom	Cause	Remedy
No route is shown.	No road to be searched is found around the destination.	Find wider road (orange road or wider) nearby and reset the destination and passing points onto it. Take care of the traveling direction when there are separate up and down roads.
	Starting point and the destination are too close.	Set the destination at more distant point.
	Conditional traffic regulation (day of the week/ time of the day) is set at the area around the current location or the destination.	Turn the time-regulating search conditions OFF. Turn "Avoid regulation time" in the search conditions OFF.
Indicated route is intermittent.	In some areas, highways (gray routes) are not used for the search <sup>(Note)</sup> Therefore, the route to the current location or the passing points may be intermittent.	System is not malfunctioning.
When the vehicle has passed the recommended route, it is deleted from the screen.	A recommended route is controlled by each section. When the vehicle has passed the passing point 1, then the map data from the starting point up to the passing point 1 will be deleted. (The data may remain undeleted in some area.)	System is not malfunctioning.
Detouring route is recommended.	In some areas, highways (gray routes) are not used for the search. (Note). Therefore, detour route may be recommended.	Set the route closer to the basic route (gray route).
	A detour route may be shown when some traffic regulation (one-way traffic, etc.) is set at the area around the starting point or the destination.	Slightly move the starting point or the destination, or set the passing point on the route of your choice.
	In the area where highways (gray routes) are used for the search, left turn has priority around the current location and the destination (passing points). For this reason, the recommended route may be detouring.	System is not malfunctioning.
Landmarks on the map do not match the actual ones.	This can be happen due to omission or error in the map data.	As a rule, an updated map DVD-ROM will be released once a year. Wait until the latest map has become available.
Recommended route is far from the starting point, passing points, and destination.	Starting point, passing points, and destination of the route guide were set far from the desired points because route searching data around these area were not stored.	Reset the destination onto the road nearby. If this road is one of the highways (gray routes), an ordinary road nearby may be displayed as the recommended route.

**NOTE:**

Except for the ordinance-designated cities. (Malfunctioning areas may be changed in the updated map disc.)

Examples of Current-Location Mark Displacement

# NORMAL OPERATING CONDITION

[BOSE AUDIO W/NAVI W/O SURROUND]

< SYMPTOM DIAGNOSIS >

Vehicle's travel amount is calculated by reading its travel distance and turning angle. Therefore, if the vehicle is driven in the following manner, an error will occur in the vehicle's current location display. If correct location has not been restored after driving the vehicle for a while, perform location correction.

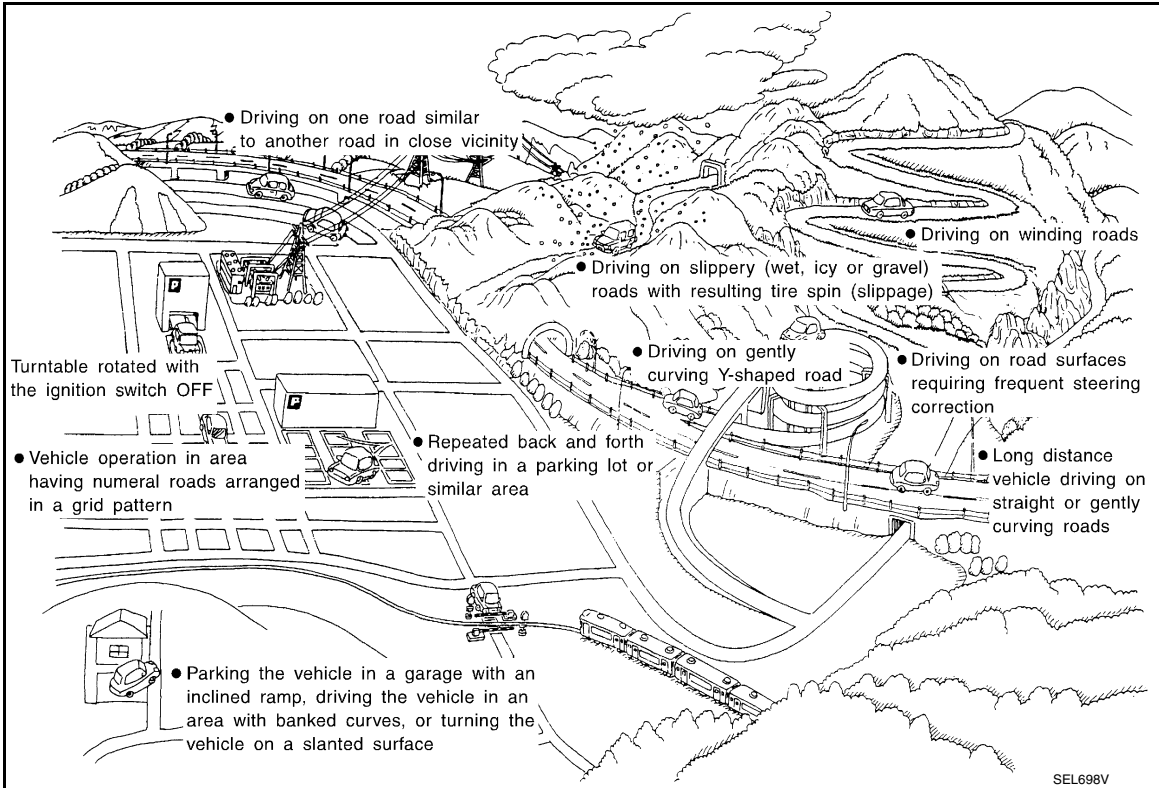

A  
B  
C  
D  
E  
F  
G  
H  
I  
J  
K  
L  
M

AV

O  
P

# NORMAL OPERATING CONDITION

< SYMPTOM DIAGNOSIS >

[BOSE AUDIO W/NAVI W/O SURROUND]

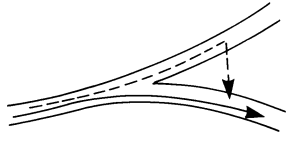
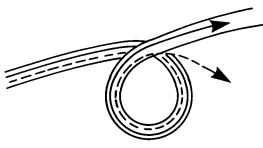
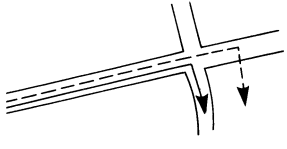
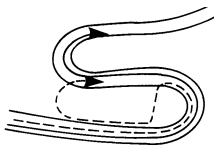
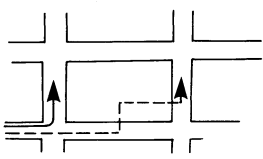
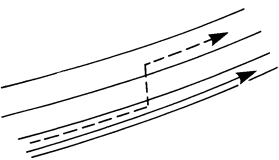
Cause (condition)    -: While driving    ooo: Display	Driving condition	Remarks (correction, etc.)
Y-intersections  ELK0192D	At a Y intersection or similar gradual division of roads, an error in the direction of travel deduced by the sensor may result in the current-location mark appearing on the wrong road.	If after travelling about 10 km (6 miles) the correct location has not been restored, perform location correction and, if necessary, direction correction.
Spiral roads  ELK0193D	When driving on a large, continuous spiral road (such as loop bridge), turning angle error is accumulated and the vehicle mark may deviate from the correct location.	
Straight roads  ELK0194D	When driving on a long, straight road and slow curve without stopping, map-matching does not work effectively enough and distance errors may accumulate. As a result, the vehicle mark may deviate from the correct location when the vehicle is turned at a corner.	
Zigzag roads  ELK0195D	When driving on a zigzag road, the map may be matched to other roads in the similar direction nearby at every turn, and the vehicle mark may deviate from the correct location.	
Roads laid out in a grid pattern  ELK0196D	When driving where roads are laid out in a grid pattern, or where many roads are running in the similar direction nearby, the map may be matched to them by mistake and the vehicle mark may deviate from the correct location.	
Parallel roads  ELK0197D	When two roads are running in parallel (such as highway and sideway), the map may be matched to the other road by mistake and the vehicle mark may deviate from the correct location.	

# NORMAL OPERATING CONDITION

< SYMPTOM DIAGNOSIS >

[BOSE AUDIO W/NAVI W/O SURROUND]

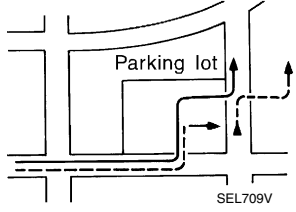
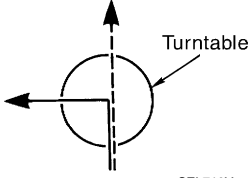
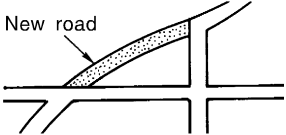
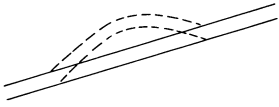
	Cause (condition)    -: While driving    ooo: Display	Driving condition	Remarks (correction, etc.)
Place	In a parking lot  SEL709V	When driving in a parking lot, or other location where there are no roads on the map, matching may place the vehicle mark on a nearby road. When the vehicle returns to the road, the vehicle mark may have deviated from the correct location. When driving in circle or turning the steering wheel repeatedly, direction errors accumulate, and the vehicle mark may deviate from the correct location.	If after travelling about 10 km (6 miles) the correct location has not been restored, perform location correction and, if necessary, direction correction.
	Turntable  SEL710V	When the ignition switch is OFF, the navigation system cannot get the signal from the gyroscope (angular speed sensor). Therefore, the displayed direction may be wrong and the correct road may not be easily returned to after rotating the vehicle on a turntable with the ignition OFF.	
	Slippery roads	On snow, wet roads, gravel, or other roads where tires may slip easily, accumulated mileage errors may cause the vehicle mark to deviate from the correct road.	
	Slopes	When parking in sloped garages, when travelling on banked roads, or in other cases where the vehicle turns when tilted, an error in the turning angle will occur, and the vehicle mark may deviate from the road.	
Map data	Road not displayed on the map screen  SEL699V	When driving on new roads or other roads not displayed on the map screen, map matching does not function correctly and matches the location to a nearby road. When the vehicle returns to a road which is on the map, the vehicle mark may deviate from the correct road.	
	Different road pattern (Changed due to repair)  ELK0201D	If the road pattern stored in the map data and the actual road pattern are different, map matching does not function correctly and matches the location to a nearby road. The vehicle mark may deviate from the correct road.	
Vehicle	Use of tire chains	When tire chains are used, the mileage is not correctly detected, and the vehicle mark may deviate from the correct road.	Drive the vehicle for a while. If the distance still deviates, adjust it by using the distance adjustment function. (If the tire chain is removed, recover the original value.)

A  
B  
C  
D  
E  
F  
G  
H  
I  
J  
K  
L  
M  
AV  
O  
P

# NORMAL OPERATING CONDITION

< SYMPTOM DIAGNOSIS >

[BOSE AUDIO W/NAVI W/O SURROUND]

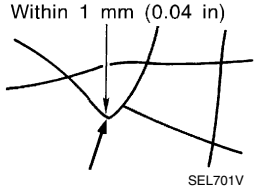
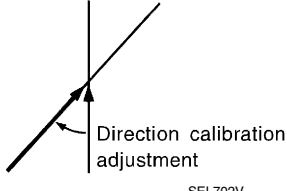
Cause (condition)	-: While driving    ooo: Display	Driving condition	Remarks (correction, etc.)
Precautions for driving	Just after the engine is started	If the vehicle is driven just after the engine is started when the gyroscope (angular speed sensor) correction is not completed, the vehicle can lose its direction and may have deviated from the correct location.	Wait for a short while before driving after starting the engine.
	Continuous driving without stopping	When driving long distances without stopping, direction errors may accumulate, and the current-location mark may deviate from the correct road.	Stop and adjust the orientation.
	Abusive driving	Spinning the wheels or engaging in other kinds of abusive driving may result in the system being unable to perform correct detection, and may cause the vehicle mark to deviate from the correct road.	If after travelling about 10 km (6 miles) the correct location has not been restored, perform location correction and, if necessary, direction correction.
How to correct location	Position correction accuracy 	If the accuracy of location settings is poor, accuracy may be reduced when the correct road cannot be found, particularly in places where there are many roads.	Enter in the road displayed on the screen with an accuracy of approx. 1mm. Caution: Whenever possible, use detailed map for the correction.
	Direction when location is corrected 	If the accuracy of location settings during correction is poor, accuracy may be reduced afterwards.	Perform direction correction.

### Location Correction by Map-Matching is Slow

- The map-matching function needs to refer to the data of the surrounding area. It is necessary to drive some distance for the function to work.
- Because map-matching operates on this principle, when there are many roads running in similar directions in the surrounding area, no matching determination may be made. The location may not be corrected until some special feature is found.

### Name of Road is Not Displayed

The current road name may not be displayed if there are no road names displayed on the map screen.

### Contents of Display Differ for Birdview™ and the (Flat) Map Screen

Difference of the BIRDVIEW™ screen from the flat map screen are as follows.

- The current place name displays names which are primarily in the direction of vehicle travel.
- The amount of time before the vehicle travel or turn angle is updated on the screen is longer than for the (flat) map display.
- The conditions for display of place names, roads, and other data are different for nearby areas and for more distant areas.
- Some thinning of the character data is done to prevent the display becoming too complex. In some cases and in some locations, the display contents may differ.
- The same place name, street name, etc. may be displayed multiple times.

### Vehicle Mark Shows a Position Which is Completely Wrong

In the following cases, the vehicle mark may appear on completely different position in the map depending on the GPS satellite signal receiving conditions. In this case, perform location correction and direction correction.

- When location correction has not been done
- If the receiving conditions of the GPS satellite signal is poor, if the vehicle mark becomes out of place, it may move to a completely different location and not come back if location correction is not done. The position will be corrected if the GPS signal can be received.
- When the vehicle has traveled by ferry, or when the vehicle has been being towed



## NORMAL OPERATING CONDITION

[BOSE AUDIO W/NAVI W/O SURROUND]

### < SYMPTOM DIAGNOSIS >

- Because calculation of the current location cannot be done when traveling with the ignition off, for example when traveling by ferry or when being towed, the location before travel is displayed. If the precise location can be detected with GPS, the location will be corrected.

#### Vehicle Mark Jumps

In the following cases, the vehicle mark may appear to jump as a result of automatic correction of the current location.

- When map matching has been done
- If the current location and the vehicle mark are different when map matching is done, the vehicle mark may seem to jump. At this time, the location may be “corrected” to the wrong road or to a location which is not on a road.
- When GPS location correction has been done
- If the current location and the vehicle mark are different when the location is corrected using GPS measurements, the vehicle mark may seem to jump. At this time, the location may be “corrected” to a location which is not on a road.

#### Vehicle Mark is in a River or Sea

The navigation system moves the vehicle mark with no distinction between land and rivers or sea. If the vehicle mark is somehow out of place, it may appear that the vehicle is driving in a river or the sea.

#### Vehicle Mark Automatically Rotates

The system wrongly memorizes the rotating status as stopping when the ignition switch is turned ON with the turntable rotating. That causes the vehicle mark to rotate when the vehicle is stopped.

#### When Driving on Same Road, Sometimes Vehicle Mark is in Right Place and Sometimes it is in Wrong Place

The conditions of the GPS antenna (GPS data) and gyroscope (angular speed sensor) change gradually. Depending on the road traveled and the operation of the steering wheel, the location detection results will be different. Therefore, even on a road on which the location has never been wrong, conditions may cause the vehicle mark to deviate.

### RELATED TO SONAR

Symptom	Possible cause
Unstable object detection	<ul style="list-style-type: none"> <li>• The vehicle is on a rough surface, such as stone or gravel.</li> <li>• When used in poor weather conditions, such as heavy snow/rain strong wind.</li> <li>• When subjected to an ultrasonic noise generated from exhaust muffler or brakes.</li> <li>• When left standing in the hot sun or in a cold climate.</li> <li>• When the surface of the sensor is frozen or covered with snow/dirt/moisture.</li> <li>• When a retrofitted xenon lamp, lighted license plate, or harness is close to the sensor body or sensor harness.</li> <li>• When subjected to loop coil noises generated from a vehicle detector placed at an intersection or coin parking area.</li> </ul>
Object undetectable	<ul style="list-style-type: none"> <li>• Air-containing objects, such as cloth, cotton, glass wool, dust, and snow.</li> <li>• Thin objects, such as rope, chain and wire.</li> <li>• Smooth-faced objects placed in a slanting direction.</li> <li>• Fast-moving small animals.</li> <li>• A corner of an angular object.</li> </ul> <p><b>NOTE:</b> If the sensor detection part is scratched, obstacles cannot be detected.</p>

# AV CONTROL UNIT

< REMOVAL AND INSTALLATION >

[BOSE AUDIO W/NAVI W/O SURROUND]

## REMOVAL AND INSTALLATION

### AV CONTROL UNIT

Exploded View

INFOID:000000009763657

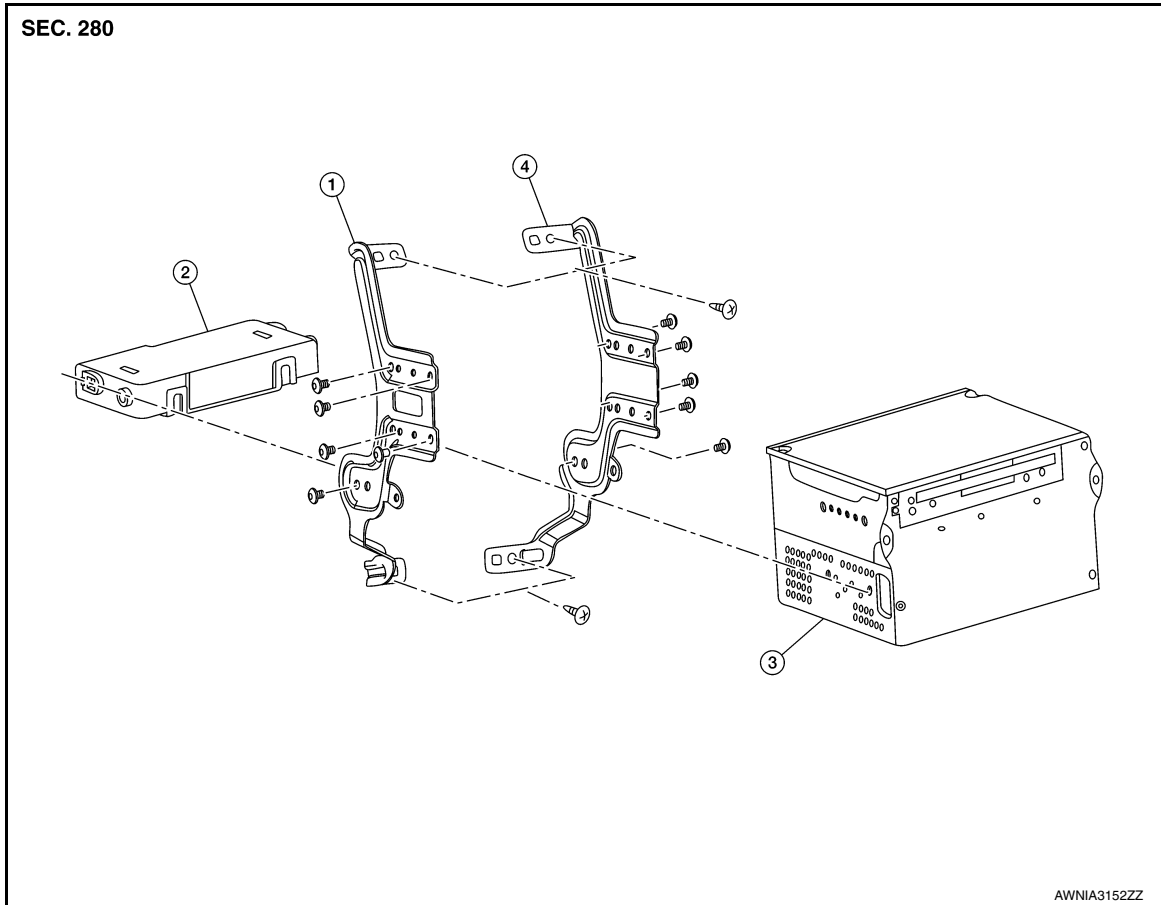

1. AV control unit bracket (LH)    2. A/C auto amp.    3. AV control unit  
4. AV control unit bracket (RH)

### Removal and Installation - AV Control Unit

INFOID:000000009763656

#### REMOVAL

##### CAUTION:

- Remove battery terminal and AV control unit after a lapse of 30 seconds or more after turning the ignition switch OFF.
- Before replacing AV control unit, perform "READ CONFIGURATION" to save current vehicle specification. Refer to [AV-446, "ADDITIONAL SERVICE WHEN REPLACING AV CONTROL UNIT : Description"](#).

##### NOTE:

After the ignition switch is turned OFF, the AV control unit continues operating for approximately 30 seconds. Therefore, data corruption may occur if battery voltage is cut off within 30 seconds.

1. Disconnect the negative battery terminal. Refer to [PG-93, "Removal and Installation"](#).
2. Remove cluster lid C upper. Refer to [IP-23, "CLUSTER LID C UPPER : Removal and Installation"](#).
3. Remove the screws, then pull out the AV control unit.
4. Disconnect the harness connectors from the AV control unit and remove.

#### INSTALLATION

Installation is in the reverse order of removal.

# AV CONTROL UNIT

< REMOVAL AND INSTALLATION >

[BOSE AUDIO W/NAVI W/O SURROUND]

## CAUTION:

- When replacing AV control unit, perform "WRITE CONFIGURATION". Refer to [AV-80, "CONFIGURATION \(AV CONTROL UNIT\) : Description"](#).

## Removal and Installation - A/C and AV Switch Assembly

INFOID:000000009763655

### REMOVAL

1. Remove cluster lid C. Refer to [IP-22, "CLUSTER LID C : Removal and Installation"](#).
2. Remove the A/C and AV switch assembly lower screws.
3. Release upper pawls and remove A/C and AV switch assembly.

### INSTALLATION

Installation is in the reverse order of removal.

A  
B  
C  
D  
E  
F  
G  
H  
I  
J  
K  
L  
M

AV

O  
P

# STEERING SWITCH

< REMOVAL AND INSTALLATION >

[BOSE AUDIO W/NAVI W/O SURROUND]

## STEERING SWITCH

Exploded View

INFOID:00000009773139

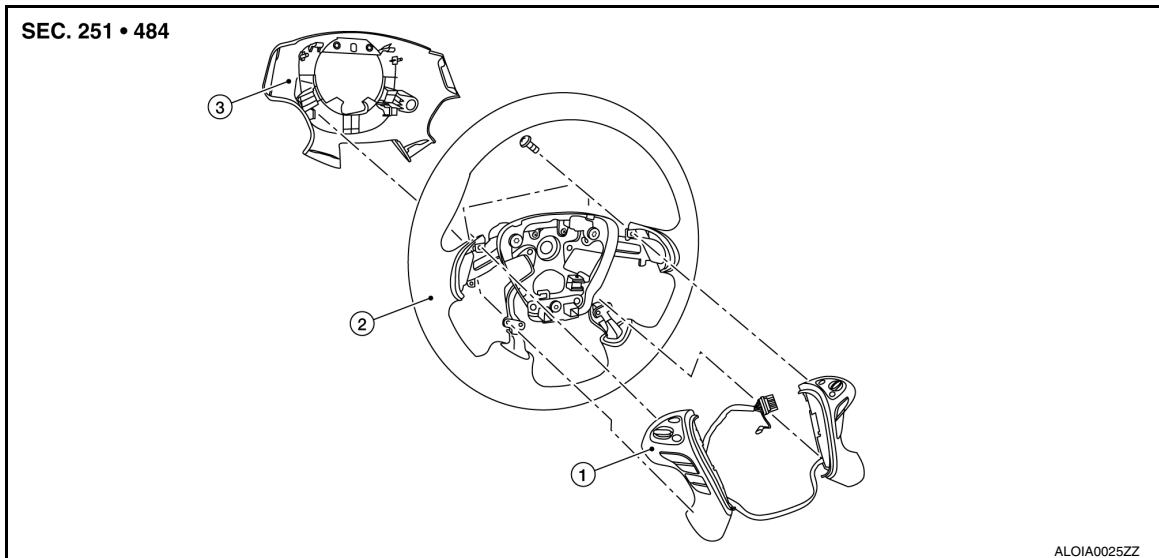

1. Steering switch

2. Steering wheel

3. Steering wheel rear finisher

## Removal and Installation

INFOID:000000009760560

### REMOVAL

#### NOTE:

The steering switch is serviced as an assembly.

1. Remove steering wheel. Refer to [ST-46, "Removal and Installation"](#).
2. Release pawls and remove steering wheel rear finisher (1) from steering wheel (2).

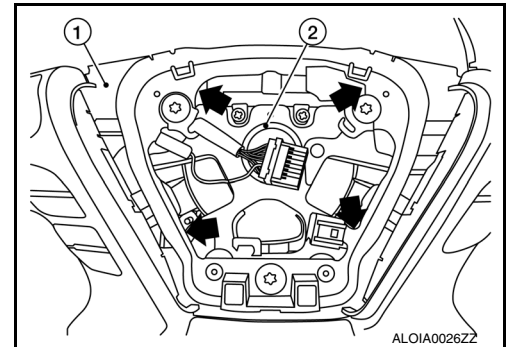

3. Remove steering switch screws.
4. Remove steering switch (1) from steering wheel (2).

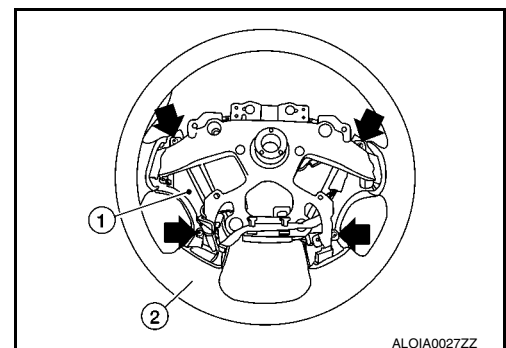

### INSTALLATION

Installation is in the reverse order of removal.

# DISPLAY UNIT

< REMOVAL AND INSTALLATION >

[BOSE AUDIO W/NAVI W/O SURROUND]

## DISPLAY UNIT

### Exploded View

INFOID:000000009763659

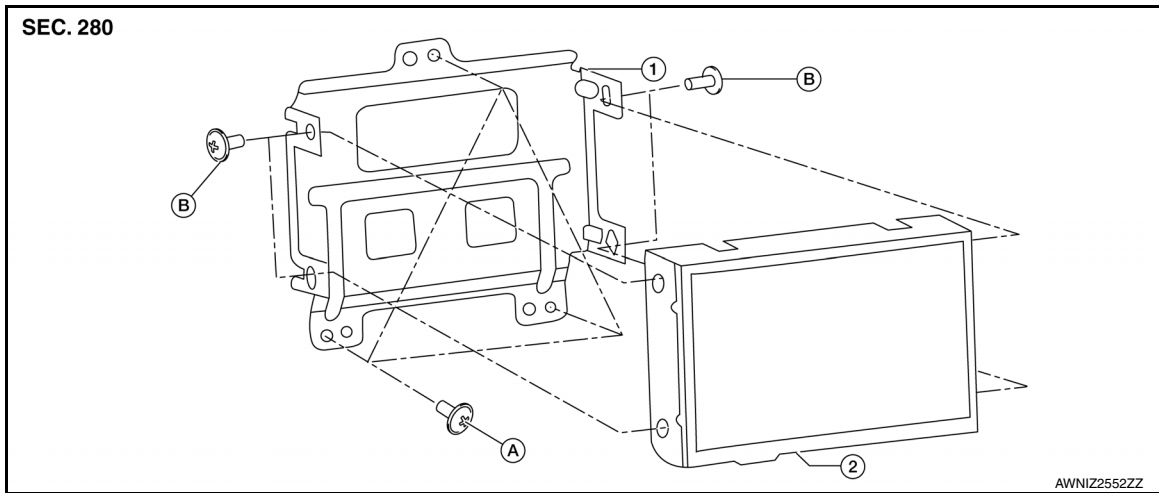

1. Display unit bracket

2. Display unit

A. Display unit bracket screws

B. Display unit screws

## Removal and Installation

INFOID:000000009763658

### REMOVAL

1. Remove cluster lid D. Refer to [IP-24, "Removal and Installation"](#).
2. Remove the display unit screws, and then pull out the display unit and bracket.
3. Disconnect harness connector from the display unit, then remove the display unit and bracket.
4. Remove the display unit brackets screws, then remove the display unit from the display unit bracket (if necessary).

### INSTALLATION

Installation is in the reverse order of removal.

A  
B  
C  
D  
E  
F  
G  
H  
I  
J  
K  
L  
M  
N  
O  
P

AV

## BOSE SPEAKER AMP

< REMOVAL AND INSTALLATION >

[BOSE AUDIO W/NAVI W/O SURROUND]

### BOSE SPEAKER AMP

#### Removal and Installation

INFOID:000000009129250

#### REMOVAL

1. Disconnect the negative battery terminal. Refer to [PG-93, "Exploded View"](#)
2. Remove third row seat. Refer to [SE-135, "Removal and Installation"](#).
3. Remove Bose speaker amp screws (A).
4. Disconnect the harness connectors (B) from the Bose speaker amp. (1) and remove.

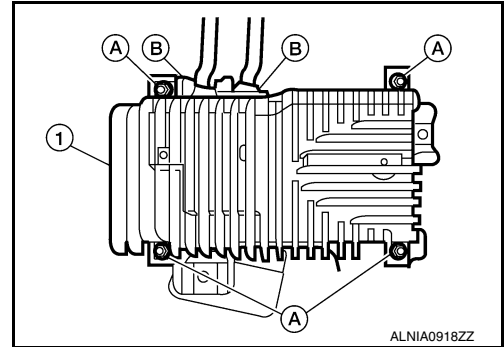

#### INSTALLATION

Installation is in the reverse order of removal.

# FRONT DOOR SPEAKER

< REMOVAL AND INSTALLATION >

[BOSE AUDIO W/NAVI W/O SURROUND]

## FRONT DOOR SPEAKER

### Exploded View

INFOID:000000009760562

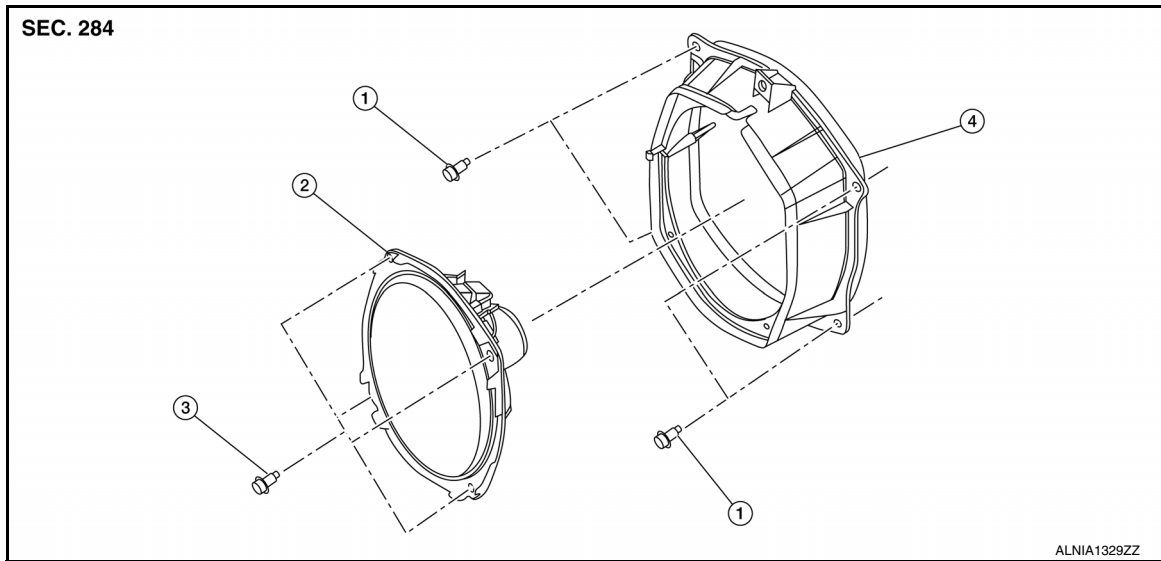

- 1. Speaker bracket bolt
- 2. Front door speaker
- 3. Speaker bolt
- 4. Speaker bracket

### Removal and Installation

INFOID:000000009760561

#### REMOVAL

1. Remove front door finisher. Refer to [INT-15, "Removal and Installation"](#).
2. Remove front door speaker bolts.
3. Disconnect harness connector from front door speaker, then remove front door speaker from speaker bracket.
4. Remove speaker bracket bolts (if necessary).
5. Remove speaker bracket from front door (if necessary).

#### INSTALLATION

Installation is in the reverse order of removal.

A  
B  
C  
D  
E  
F  
G  
H  
I  
J  
K  
L  
M  
O  
P

AV

## FRONT TWEETER

< REMOVAL AND INSTALLATION >

[BOSE AUDIO W/NAVI W/O SURROUND]

### FRONT TWEETER

#### Removal and Installation

INFOID:000000009129253

#### REMOVAL

1. Remove front pillar finisher. Refer to [INT-19. "FRONT PILLAR FINISHER : Removal and Installation"](#)
2. Remove two front tweeter screws.
3. Remove front tweeter (2) from front pillar finisher (1).

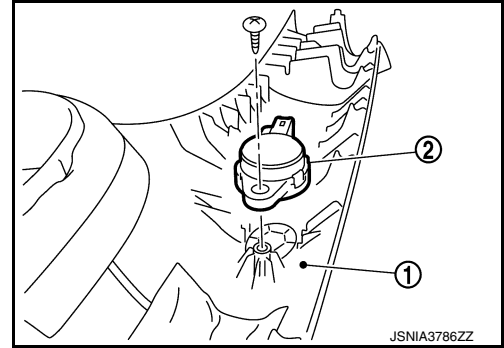

#### INSTALLATION

Installation is in the reverse order of removal.



# INSTRUMENT PANEL SPEAKER/TWEETER

< REMOVAL AND INSTALLATION >

[BOSE AUDIO W/NAVI W/O SURROUND]

## INSTRUMENT PANEL SPEAKER/TWEETER

### Removal and Installation

INFOID:000000009760564

#### REMOVAL

1. Remove instrument panel tweeter grille. Refer to [IP-14, "Exploded View"](#).
2. Remove the screws (A), then pull out the instrument panel tweeter (1).
3. Disconnect the harness connector from the instrument panel tweeter (1) and remove.

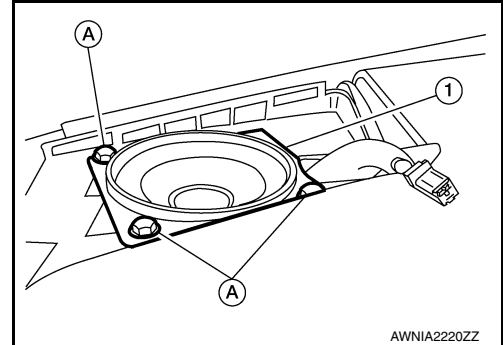

#### INSTALLATION

Installation is in the reverse order of removal.

A  
B  
C  
D  
E  
F  
G  
H  
I  
J  
K  
L  
M  
O  
P

AV

## CENTER SPEAKER

< REMOVAL AND INSTALLATION >

[BOSE AUDIO W/NAVI W/O SURROUND]

### CENTER SPEAKER

#### Removal and Installation

INFOID:000000009129255

#### REMOVAL

1. Remove center speaker grille. Refer to [IP-14, "Exploded View"](#).
2. Remove the center speaker bolts (A).
3. Pull out the center speaker (1), disconnect harness connector, then remove center speaker.

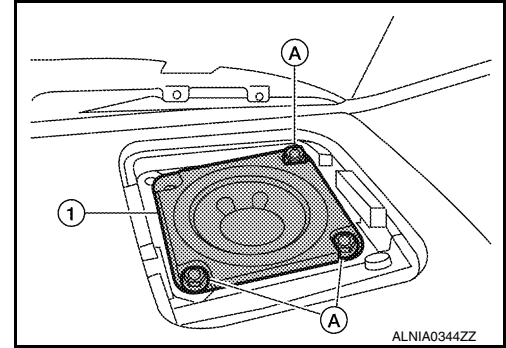

#### INSTALLATION

Installation is in the reverse order of removal.

# REAR DOOR SPEAKER

< REMOVAL AND INSTALLATION >

[BOSE AUDIO W/NAVI W/O SURROUND]

## REAR DOOR SPEAKER

Exploded View

INFOID:000000009760567

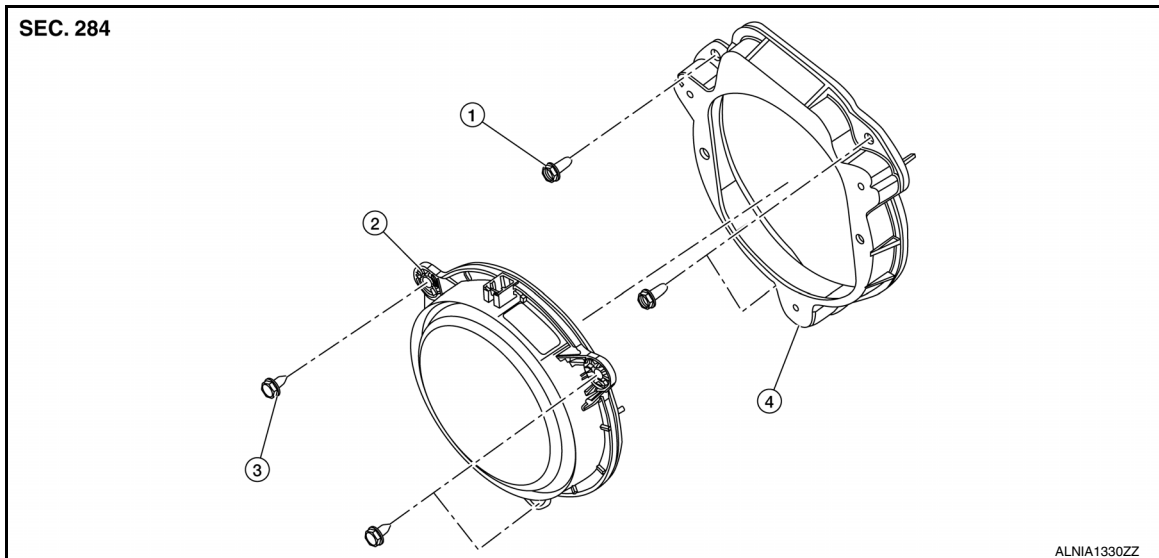

- 1. Speaker bracket bolt
- 2. Rear door speaker
- 3. Speaker bolt
- 4. Speaker bracket

## Removal and Installation

INFOID:000000009760566

### REMOVAL

1. Remove rear door finisher. Refer to [INT-17, "Removal and Installation"](#).
2. Remove rear door speaker bolts.
3. Disconnect harness connector from the rear door speaker, then remove rear door speaker from speaker bracket.
4. Remove speaker bracket bolts (if necessary).
5. Remove rear door speaker bracket (if necessary).

### INSTALLATION

Installation is in the reverse order of removal.

A  
B  
C  
D  
E  
F  
G  
H  
I  
J  
K  
L  
M  
O  
P

AV

## REAR SPEAKERS

< REMOVAL AND INSTALLATION >

[BOSE AUDIO W/NAVI W/O SURROUND]

### REAR SPEAKERS

#### Removal and Installation

INFOID:000000009129258

#### REMOVAL

1. Remove back pillar finisher. Refer to [INT-32. "BACK PILLAR FINISHER : Removal and Installation"](#).  
**CAUTION:**  
**Do not reuse back pillar finisher.**
2. Remove rear speaker bolts (A).
3. Remove bracket (2), then remove rear speaker (3).

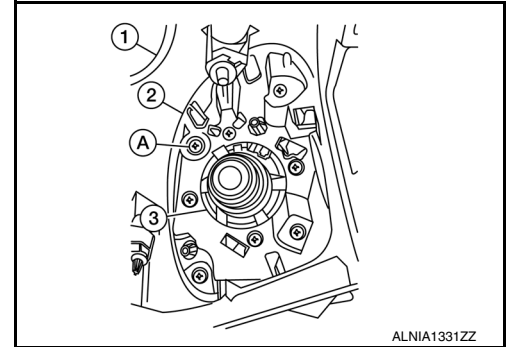

ALNIA1331ZZ

#### INSTALLATION

Installation is in the reverse order of removal.

# SUBWOOFER

< REMOVAL AND INSTALLATION >

[BOSE AUDIO W/NAVI W/O SURROUND]

## SUBWOOFER

### Exploded View

INFOID:000000009129259

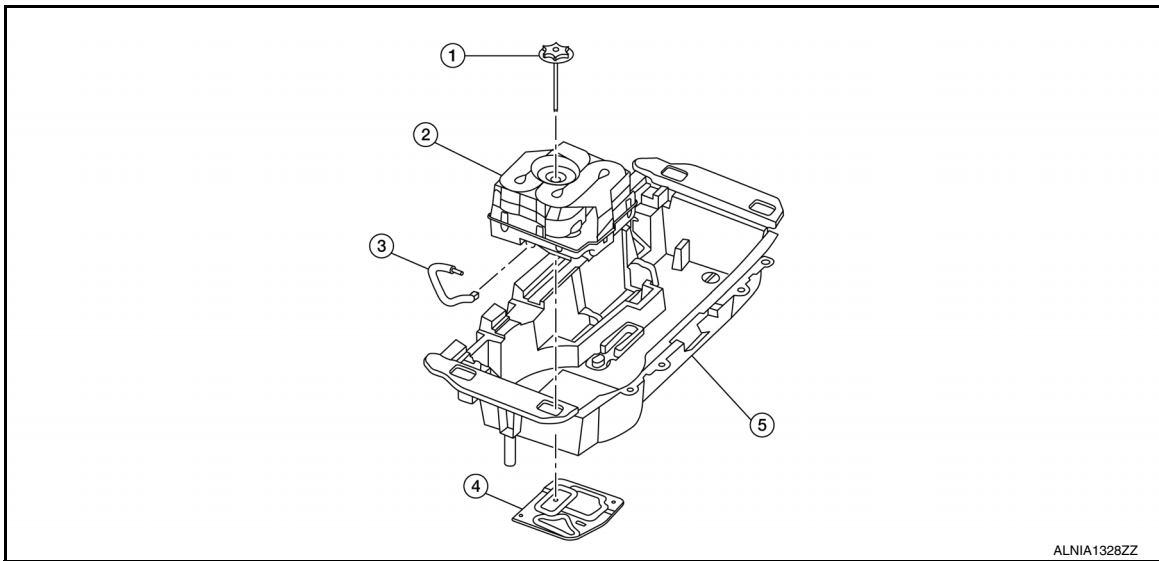

1. Spare tire clamp
4. Bracket

2. Subwoofer
5. Rear storage box

3. Harness

### Removal and Installation

INFOID:000000009129260

#### REMOVAL

1. Open the storage box lid.
2. Remove the spare tire clamp.
3. Lift subwoofer to disconnect harness connector, then remove subwoofer.

#### INSTALLATION

Installation is in the reverse order of removal.

A  
B  
C  
D  
E  
F  
G  
H  
I  
J  
K  
L  
M  
O  
P

AV

## USB INTERFACE

< REMOVAL AND INSTALLATION >

[BOSE AUDIO W/NAVI W/O SURROUND]

---

### USB INTERFACE

#### Removal and Installation

INFOID:000000009760569

#### REMOVAL

1. Remove shift selector finisher. Refer to [IP-27, "Exploded View"](#).
2. Disconnect harness connector from the USB interface.
3. Release the pawl from the back of USB interface, then remove USB interface.

#### INSTALLATION

Installation is in the reverse order of removal.

# FRONT AUXILIARY INPUT JACKS

< REMOVAL AND INSTALLATION >

[BOSE AUDIO W/NAVI W/O SURROUND]

## FRONT AUXILIARY INPUT JACKS

### Removal and Installation

INFOID:000000009760570

#### REMOVAL

1. Remove shift selector finisher. Refer to [IP-27. "Exploded View"](#).
2. Disconnect harness connector from the front auxiliary input jack.
3. Remove front auxiliary input jack screws and front auxiliary input jack.

#### INSTALLATION

Installation is in the reverse order of removal.

A

B

C

D

E

F

G

H

I

J

K

L

M

AV

O

P

# AROUND VIEW MONITOR CONTROL UNIT

< REMOVAL AND INSTALLATION >

[BOSE AUDIO W/NAVI W/O SURROUND]

## AROUND VIEW MONITOR CONTROL UNIT

### Exploded View

INFOID:000000009129263

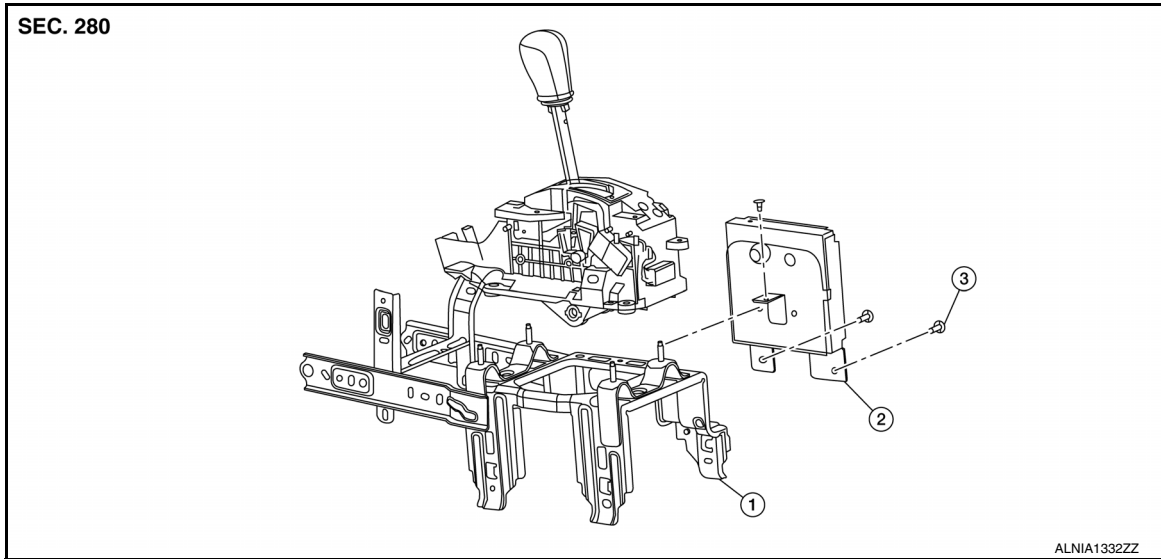

1. Bracket

2. Around view monitor control unit 3. Screw

### Removal and Installation

INFOID:000000009129264

#### REMOVAL

1. Remove center console assembly. Refer to [IP-18. "Removal and Installation"](#).
2. Remove the around view monitor control unit screws.
3. Disconnect harness connector from around view monitor control unit and remove.

#### INSTALLATION

Installation is in the reverse order of removal.

**NOTE:**

Perform camera image calibration. Refer to [AV-453. "CALIBRATING CAMERA IMAGE \(AROUND VIEW MONITOR\) : Work Procedure"](#).



# FRONT CAMERA

< REMOVAL AND INSTALLATION >

[BOSE AUDIO W/NAVI W/O SURROUND]

## FRONT CAMERA

### Removal and Installation

INFOID:000000009129265

#### REMOVAL

1. Remove front grille. Refer to [EXT-23, "Removal and Installation"](#).
2. Remove front camera screws and front camera (2) from front emblem (1).

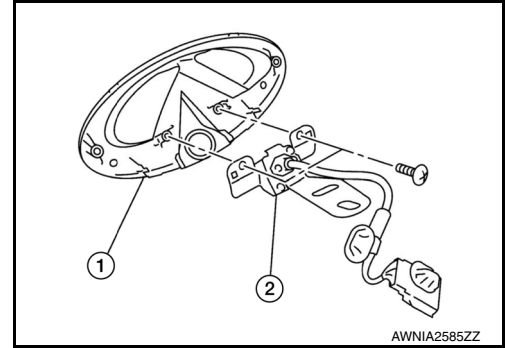

#### INSTALLATION

Installation is in the reverse order of removal.

**NOTE:**

Perform camera image calibration. Refer to [AV-453, "CALIBRATING CAMERA IMAGE \(AROUND VIEW MONITOR\) : Work Procedure"](#).

A  
B  
C  
D  
E  
F  
G  
H  
I  
J  
K  
L  
M  
O  
P

AV

## REAR VIEW CAMERA

< REMOVAL AND INSTALLATION >

[BOSE AUDIO W/NAVI W/O SURROUND]

### REAR VIEW CAMERA

#### Removal and Installation

INFOID:000000009760568

#### REMOVAL

1. Remove back door outer upper finisher. Refer to [EXT-44. "Removal and Installation"](#).
2. Remove rear view camera screws (A), then remove rear view camera (1) from the back door outer upper finisher (2).

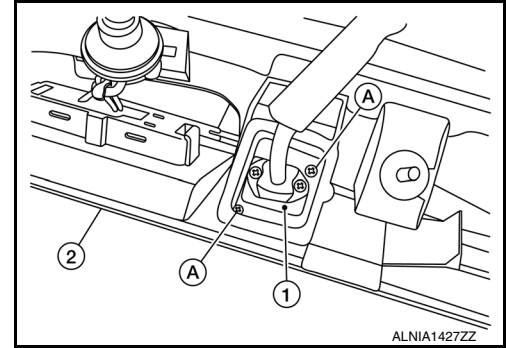

#### INSTALLATION

Installation is in the reverse order of removal.

# SIDE CAMERA

< REMOVAL AND INSTALLATION >

[BOSE AUDIO W/NAVI W/O SURROUND]

## SIDE CAMERA

### Removal and Installation

INFOID:000000009129267

#### REMOVAL

1. Remove the door mirror assembly. Refer to [MIR-29, "Removal and Installation"](#).
2. Remove the door mirror rear finisher. Refer to [MIR-31, "Removal and Installation"](#).
3. Release the side camera finisher pawls using a suitable tool, disconnect the harness connector from the side camera, then remove the side camera finisher.

○: Pawl

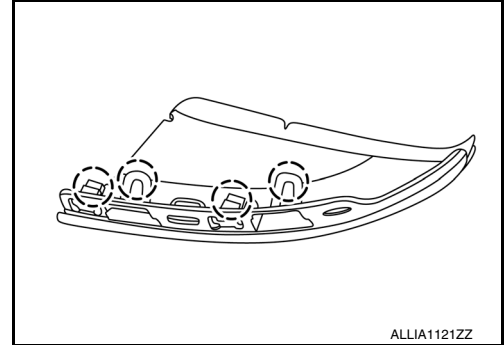

4. Remove the screws (1) and the side camera (2).

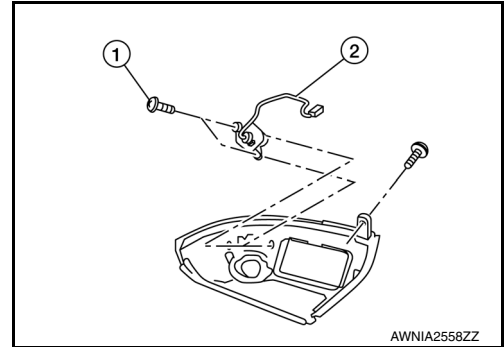

#### INSTALLATION

Installation is in the reverse order of removal.

A  
B  
C  
D  
E  
F  
G  
H  
I  
J  
K  
L  
M  
AV  
O  
P

# VIDEO DISTRIBUTOR

< REMOVAL AND INSTALLATION >

[BOSE AUDIO W/NAVI W/O SURROUND]

## VIDEO DISTRIBUTOR

### Removal and Installation

INFOID:000000009129268

#### REMOVAL

1. Remove luggage side lower finisher. Refer to [INT-31, "LUGGAGE SIDE LOWER FINISHER : Removal and Installation"](#).
2. Disconnect video distributor harness connectors (A).
3. Remove video distributor nuts (2) and bolts (4).
4. Remove video distributor (3) and brackets (1) (5) from the vehicle as a single unit.
5. Remove screws (B) (C), then remove video distributor (3).

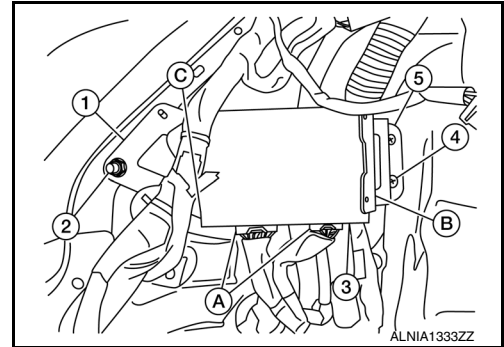

#### INSTALLATION

Installation is in the reverse order of removal.

# HEADREST DISPLAY UNIT

< REMOVAL AND INSTALLATION >

[BOSE AUDIO W/NAVI W/O SURROUND]

## HEADREST DISPLAY UNIT

### Removal and Installation

INFOID:00000009129269

#### REMOVAL

##### CAUTION:

- Do not press panel surface of display (glass area).
- Do not press or pull out the movable part of display.

1. Remove the headrest trim retainer (A).

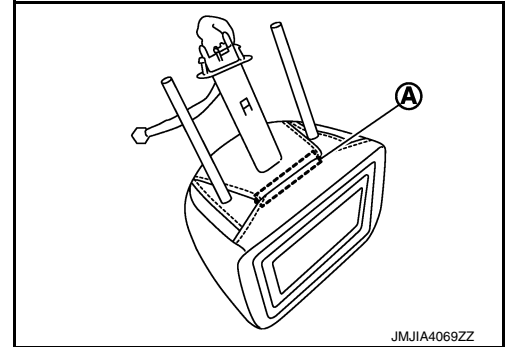

2. Remove the headrest display harness and upper tube screws (A), then remove headrest display unit bolts (B).

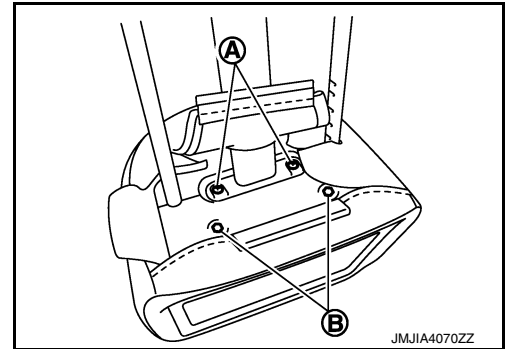

3. Remove the headrest display escutcheon and headrest display.

a. Insert a suitable tool (A) between lower side of headrest display escutcheon (1) and headrest trim (2) and pull out lower side of escutcheon.

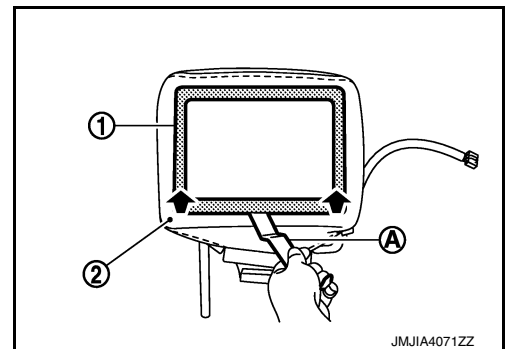

b. Pull out headrest display escutcheon (1) to the position that pawl is visible and disengage pawl.

○: Pawl

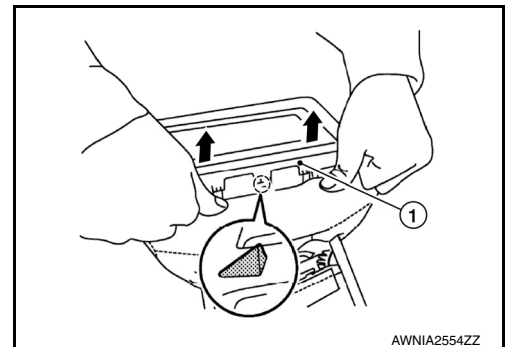

c. Pull out lower side of headrest display escutcheon from headrest.

A

B

C

D

E

F

G

H

I

J

K

L

M

AV

O

P

## HEADREST DISPLAY UNIT

< REMOVAL AND INSTALLATION >

[BOSE AUDIO W/NAVI W/O SURROUND]

### CAUTION:

Be careful not damage pawls on upper side headrest display escutcheon.

- d. Pull downward and remove headrest display escutcheon (1) and headrest display unit (2) by pulling them out and removing pins on upper side of display.

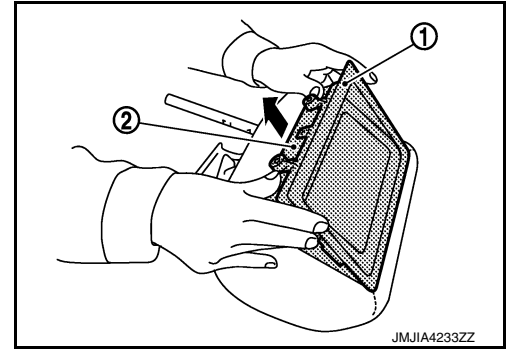

- e. Disconnect inner harness connector.  
f. Press headrest display escutcheon to the headrest display unit side. Disconnect pawls on upper side and remove headrest display escutcheon.  
4. Remove the headrest display harness upper tube from headrest trim.

### INSTALLATION

Installation is in the reverse order of removal.

# REAR AUXILIARY INPUT JACKS

< REMOVAL AND INSTALLATION >

[BOSE AUDIO W/NAVI W/O SURROUND]

## REAR AUXILIARY INPUT JACKS

### Removal and Installation

INFOID:000000009129270

#### REMOVAL

1. Remove rear center ventilator duct. Refer to [VTL-12. "REAR CENTER VENTILATOR DUCT : Removal and Installation"](#).
2. Remove rear auxiliary input jack screws and rear auxiliary input jack.

#### INSTALLATION

Installation is in the reverse order of removal.

A

B

C

D

E

F

G

H

I

J

K

L

M

AV

O

P

# SONAR CONTROL UNIT

< REMOVAL AND INSTALLATION >

[BOSE AUDIO W/NAVI W/O SURROUND]

## SONAR CONTROL UNIT

### Removal and Installation

INFOID:000000009129271

#### REMOVAL

1. Remove instrument lower panel LH. Refer to [IP-25. "Removal and Installation"](#).
2. Remove sonar control unit bolt (2).
3. Disconnect harness connector from the sonar control unit, then remove sonar control unit (1).

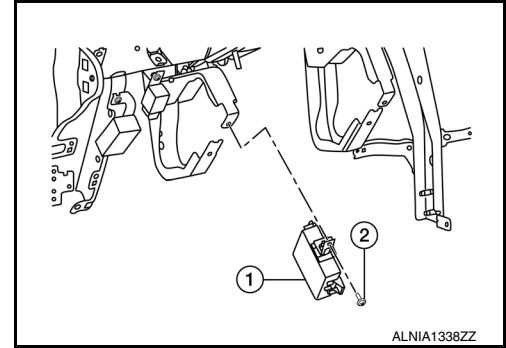

#### INSTALLATION

Installation is in the reverse order of removal.



# SONAR SENSOR

< REMOVAL AND INSTALLATION >

[BOSE AUDIO W/NAVI W/O SURROUND]

## SONAR SENSOR

### Removal and Installation

INFOID:000000009760638

#### REAR SONAR SENSORS

##### Removal

1. Remove rear bumper fascia. Refer to [EXT-20, "Removal and Installation"](#).
2. Press sonar sensor spring (←).
3. Remove the sonar sensor (1) from rear bumper (2) as shown (↔).
4. Disconnect the harness connector from sonar sensor (1) and remove.

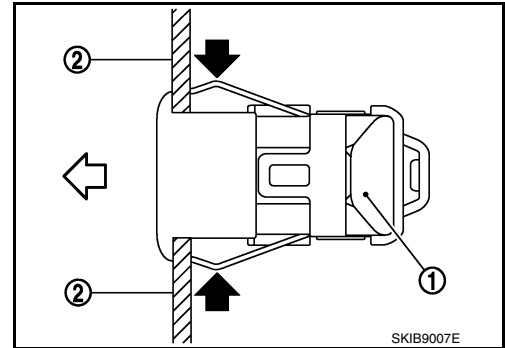

##### Installation

Installation is in the reverse order of removal.

##### CAUTION:

The connector direction is within  $\pm 10^\circ$  from the horizontal position when assembling the bumper.

(A) : Horizontal position

(a) :  $10^\circ$

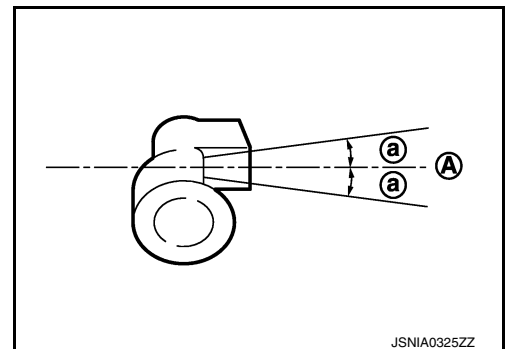

#### FRONT SONAR SENSORS

##### Removal

1. Remove front bumper fascia. Refer to [EXT-17, "Removal and Installation"](#).
2. Press sonar sensor spring (←).
3. Remove the sonar sensor (1) from front bumper (2) as shown (↔).
4. Disconnect harness connector from sonar sensor (1) and remove.

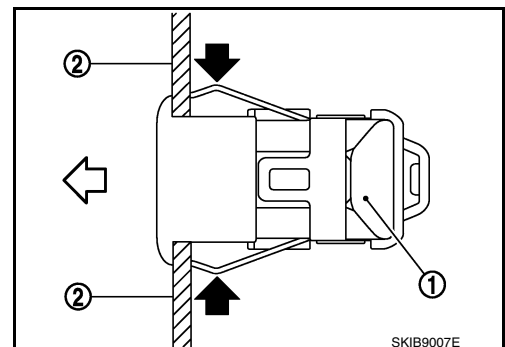

##### Installation

Installation is in the reverse order of removal.

##### CAUTION:

A  
B  
C  
D  
E  
F  
G  
H  
I  
J  
K  
L  
M  
AV  
O  
P

# SONAR SENSOR

< REMOVAL AND INSTALLATION >

[BOSE AUDIO W/NAVI W/O SURROUND]

The connector direction is within  $\pm 10^\circ$  from the horizontal position when assembling the bumper.

(A) : Horizontal position

(a) :  $10^\circ$

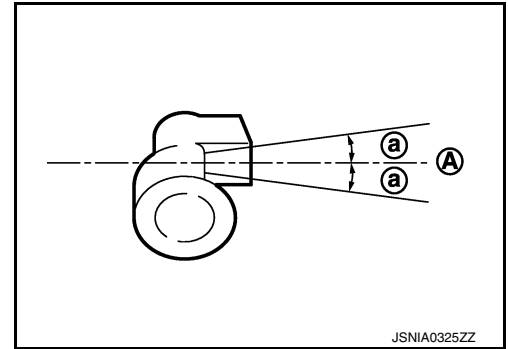

# BUZZER

< REMOVAL AND INSTALLATION >

[BOSE AUDIO W/NAVI W/O SURROUND]

## BUZZER

### Removal and Installation

INFOID:000000009129273

#### REMOVAL

1. Remove luggage side lower finisher (RH). Refer to [INT-31. "LUGGAGE SIDE LOWER FINISHER : Removal and Installation"](#).
2. Disconnect harness connector (1) from the buzzer.
3. Remove buzzer screws (A), then remove buzzer (2).

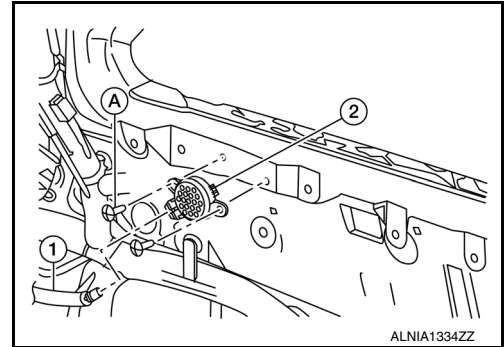

#### INSTALLATION

Installation is in the reverse order of removal.

A  
B  
C  
D  
E  
F  
G  
H  
I  
J  
K  
L  
M

AV

O  
P

# AUDIO ANTENNA

< REMOVAL AND INSTALLATION >

[BOSE AUDIO W/NAVI W/O SURROUND]

## AUDIO ANTENNA

### Location of Antennas

INFOID:000000009129274

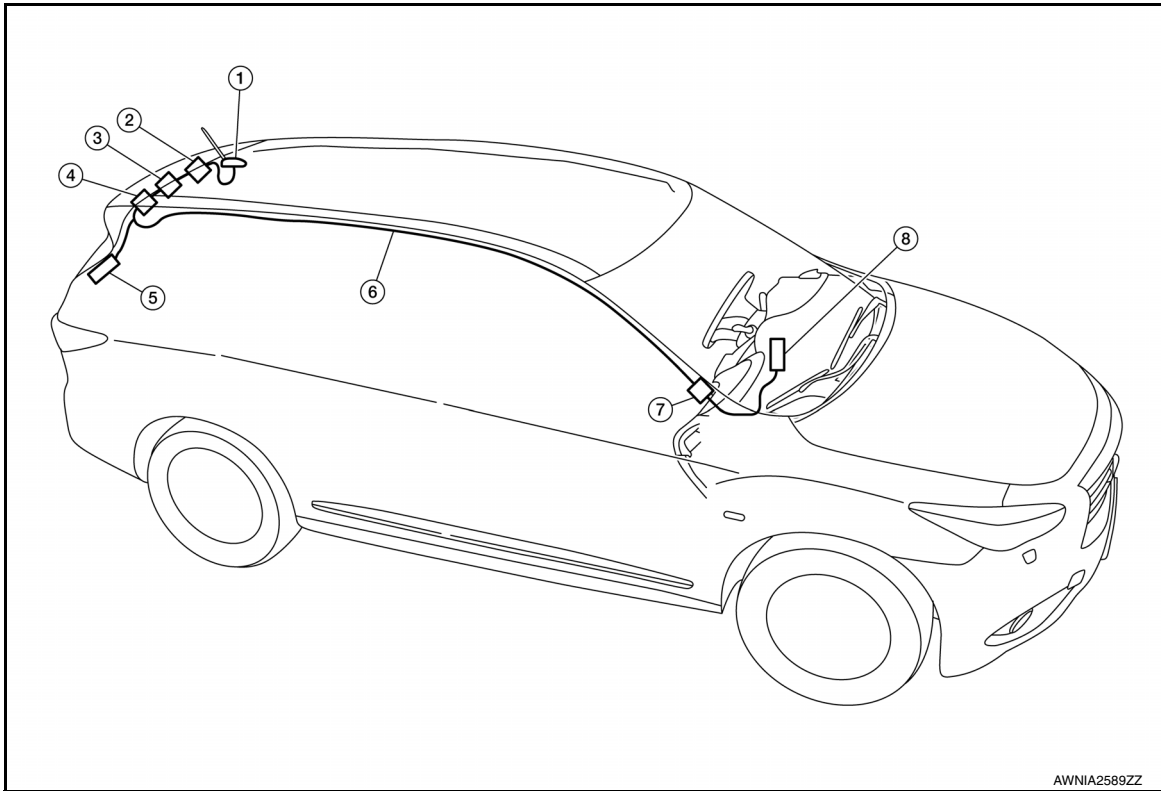

AWNIA2589ZZ

- |   |                               |                   |
|---|-------------------------------|-------------------|
| 1. Antenna base (satellite antenna and antenna amp) | 2. M502                       | 3. M501           |
| 4. M503, M504                                       | 5. M505                       | 6. Antenna Feeder |
| 7. M95, M138, M500, M509                            | 8. AV control unit M133, M143 |                   |

### Window Antenna Repair

INFOID:000000009129275

#### ELEMENT CHECK

1. Attach probe circuit tester (ohm setting) to antenna terminal on each side.

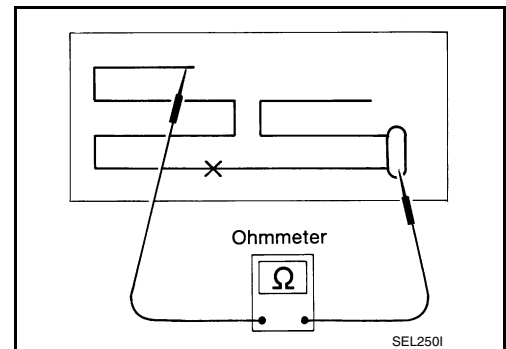

# AUDIO ANTENNA

< REMOVAL AND INSTALLATION >

[BOSE AUDIO W/NAVI W/O SURROUND]

- When measuring continuity, wrap tin foil around the top of probe. Then, press the foil against the wire with your finger.

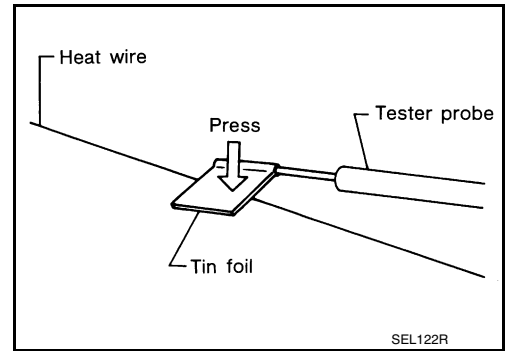

2. If an element is broken, no continuity will exist.

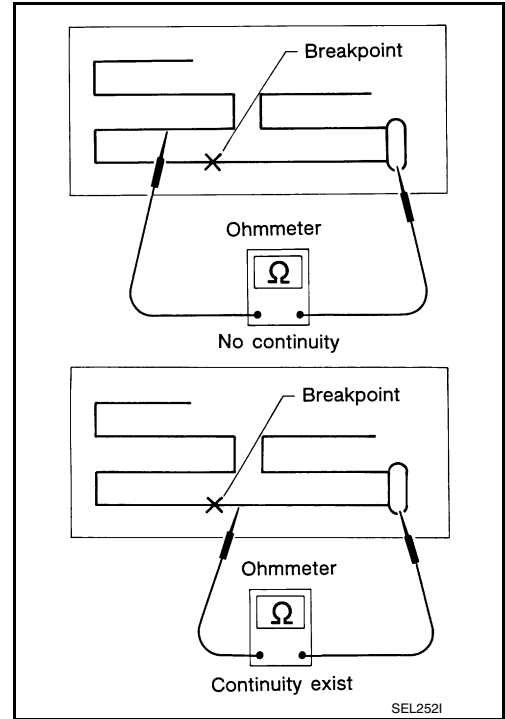

3. To locate a break, move probe along element. Tester indication will change abruptly when probe passes the broken point.

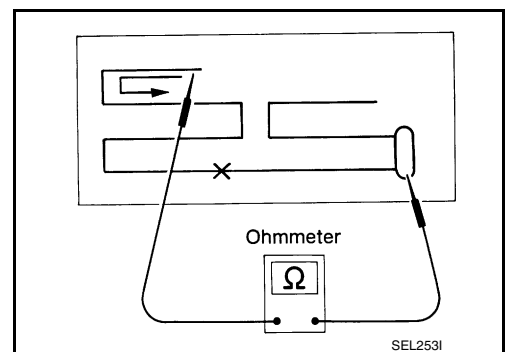

A  
B  
C  
D  
E  
F  
G  
H  
I  
J  
K  
L  
M  
AV  
O  
P

# GPS ANTENNA

< REMOVAL AND INSTALLATION >

[BOSE AUDIO W/NAVI W/O SURROUND]

## GPS ANTENNA

### Removal and Installation

INFOID:000000009129276

#### REMOVAL

1. Remove combination meter. Refer to [MWI-95. "Removal and Installation"](#).
2. Disconnect harness connector from AV control unit.
3. Remove harness feeder clips.
4. Remove GPS antenna screw and GPS antenna (1).

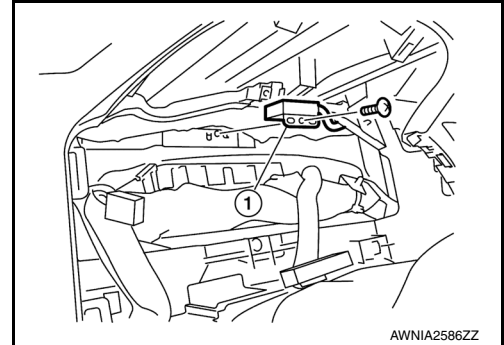

#### INSTALLATION

Installation is in the reverse order of removal.

# SATELLITE RADIO ANTENNA

< REMOVAL AND INSTALLATION >

[BOSE AUDIO W/NAVI W/O SURROUND]

## SATELLITE RADIO ANTENNA

### Removal and Installation

INFOID:000000009129277

#### REMOVAL

1. Lower headlining (rear). Refer to [INT-27. "Removal and Installation"](#).
2. Disconnect harness connector from antenna feeder.
3. Remove nut from satellite radio antenna and remove.  
⇐: Front

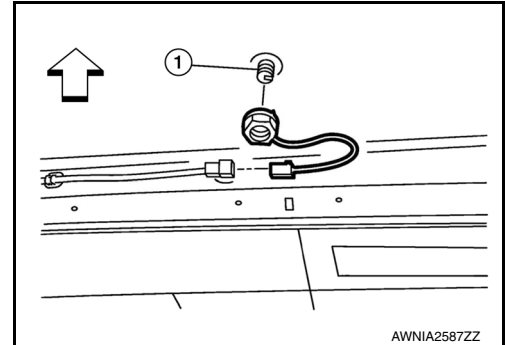

#### INSTALLATION

Installation is in the reverse order of removal.

#### CAUTION:

**If the satellite radio antenna nut is not tightened to the specified torque, lower sensitivity of the antenna may be experienced. If the nut is tightened tighter than the specified torque, this will deform the roof panel.**

#### Disassembly and Assembly

INFOID:000000009129278

#### DISASSEMBLY

Insert a suitable tool into gaps between satellite radio antenna (2) and the cover (1), then remove the cover (1) from satellite radio antenna (2).

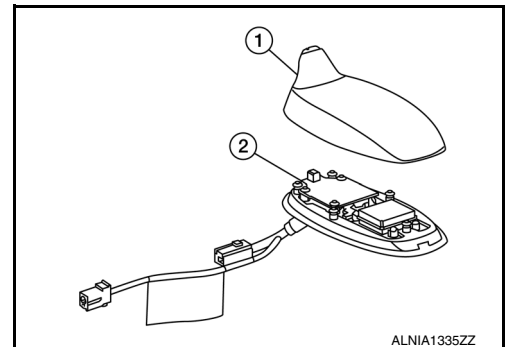

#### ASSEMBLY

Assembly is in the reverse order of disassembly.

A  
B  
C  
D  
E  
F  
G  
H  
I  
J  
K  
L  
M  
O  
P

AV

**PRECAUTION**

**PRECAUTIONS**

**Precaution for Supplemental Restraint System (SRS) "AIR BAG" and "SEAT BELT PRE-TENSIONER"**

*INFOID:000000009129279*

The Supplemental Restraint System such as "AIR BAG" and "SEAT BELT PRE-TENSIONER", used along with a front seat belt, helps to reduce the risk or severity of injury to the driver and front passenger for certain types of collision. This system includes dual stage front air bag modules. The SRS system may only deploy one front air bag, depending on the severity of a collision and whether the front passenger seat is occupied. Information necessary to service the system safely is included in the SR and SB section of this Service Manual.

**WARNING:**

- To avoid rendering the SRS inoperative, which could increase the risk of personal injury or death in the event of a collision which would result in air bag inflation, all maintenance must be performed by an authorized NISSAN/INFINITI dealer.
- Improper maintenance, including incorrect removal and installation of the SRS, can lead to personal injury caused by unintentional activation of the system. For removal of Spiral Cable and Air Bag Module, see the SR section.
- Do not use electrical test equipment on any circuit related to the SRS unless instructed to in this Service Manual. SRS wiring harnesses can be identified by yellow and/or orange harnesses or harness connectors.

**PRECAUTIONS WHEN USING POWER TOOLS (AIR OR ELECTRIC) AND HAMMERS**

**WARNING:**

- When working near the Airbag Diagnosis Sensor Unit or other Airbag System sensors with the Ignition ON or engine running, DO NOT use air or electric power tools or strike near the sensor(s) with a hammer. Heavy vibration could activate the sensor(s) and deploy the air bag(s), possibly causing serious injury.
- When using air or electric power tools or hammers, always switch the Ignition OFF, disconnect the battery and wait at least three minutes before performing any service.

**Cautions in Removing Battery Terminal and AV Control Unit (Models with AV Control Unit)**

*INFOID:000000009129280*

**CAUTION:**

**Remove battery terminal and AV control unit 30 seconds or more after turning the ignition switch OFF.**

**NOTE:**

After the ignition switch is turned OFF, the AV control unit continues operating for approximately 30 seconds. Therefore, data corruption may occur if battery voltage is cut off within 30 seconds.

**Precaution for Trouble Diagnosis**

*INFOID:000000009129281*

**AV COMMUNICATION SYSTEM**

- Do not apply voltage of 7.0 V or higher to the measurement terminals.
- Use the tester with its open terminal voltage being 7.0 V or less.
- Be sure to turn ignition switch OFF and disconnect the battery cable from the negative terminal before checking the circuit.

**Precaution for Harness Repair**

*INFOID:000000009129282*

**AV COMMUNICATION SYSTEM**



# PRECAUTIONS

[BOSE AUDIO W/NAVI W/SURROUND]

< PRECAUTION >

- Solder the repaired parts, and wrap with tape. [Frays of twisted line must be within 110 mm (4.33 in).]

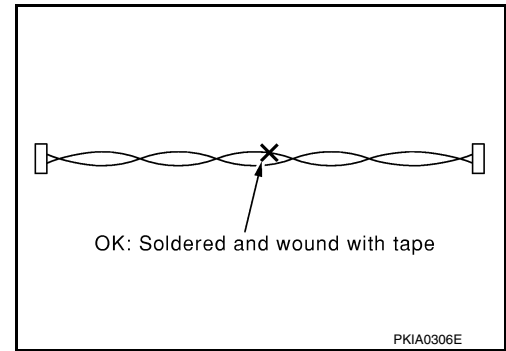

- Do not perform bypass wire connections for the repair parts. (The spliced wire will become separated and the characteristics of twisted line will be lost.)

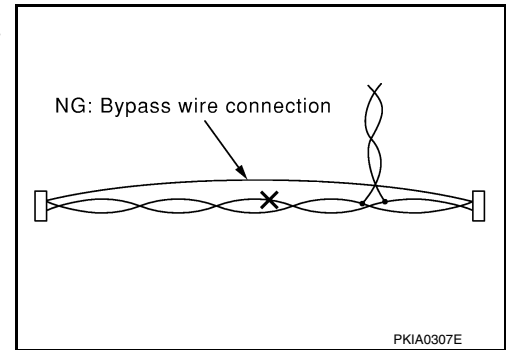

## Precaution for Work

INFOID:000000009129283

- When removing or disassembling each component, be careful not to damage or deform it. If a component may be subject to interference, be sure to protect it with a shop cloth.
- When removing (disengaging) components with a screwdriver or similar tool, be sure to wrap the component with a shop cloth or vinyl tape to protect it.
- Protect the removed parts with a shop cloth and prevent them from being dropped.
- Replace a deformed or damaged clip.
- If a part is specified as a non-reusable part, always replace it with a new one.
- Be sure to tighten bolts and nuts securely to the specified torque.
- After installation is complete, be sure to check that each part works properly.
- Follow the steps below to clean components:
  - Water soluble dirt:
    - Dip a soft cloth into lukewarm water, wring the water out of the cloth and wipe the dirty area.
    - Then rub with a soft, dry cloth.
  - Oily dirt:
    - Dip a soft cloth into lukewarm water with mild detergent (concentration: within 2 to 3%) and wipe the dirty area.
    - Then dip a cloth into fresh water, wring the water out of the cloth and wipe the detergent off.
    - Then rub with a soft, dry cloth.
  - Do not use organic solvent such as thinner, benzene, alcohol or gasoline.
  - For genuine leather seats, use a genuine leather seat cleaner.

# PREPARATION

[BOSE AUDIO W/NAVI W/SURROUND]

< PREPARATION >

## PREPARATION

### PREPARATION

#### Special Service Tool

INFOID:000000009129284

The actual shapes of Kent-Moore tools may differ from those of special service tools illustrated here.

Tool number (Kent-Moore No.) Tool name	Description
— (J-46534) Trim Tool Set	Removing trim components

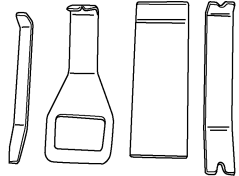

AWJIA0483ZZ

#### Commercial Service Tools

INFOID:000000009129285

Tool name	Description
Power tools	Loosening nuts, screws and bolts

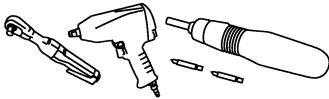

PIIB1407E

# COMPONENT PARTS

< SYSTEM DESCRIPTION >

[BOSE AUDIO W/NAVI W/SURROUND]

## SYSTEM DESCRIPTION

### COMPONENT PARTS

#### Component Parts Location

INFOID:000000009129286

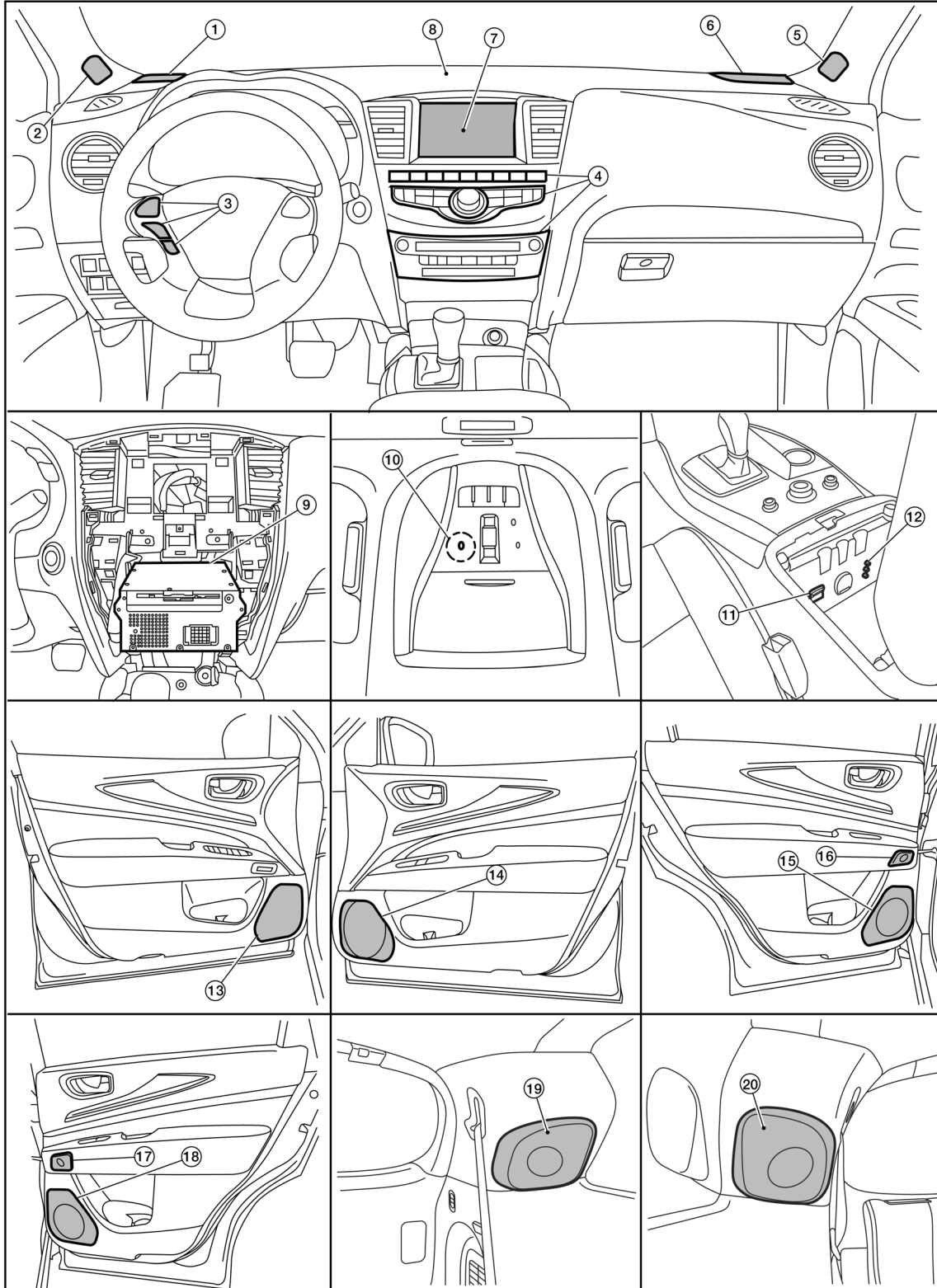

A  
B  
C  
D  
E  
F  
G  
H  
I  
J  
K  
L  
M  
AV  
O  
P

# COMPONENT PARTS

< SYSTEM DESCRIPTION >

[BOSE AUDIO W/NAVI W/SURROUND]

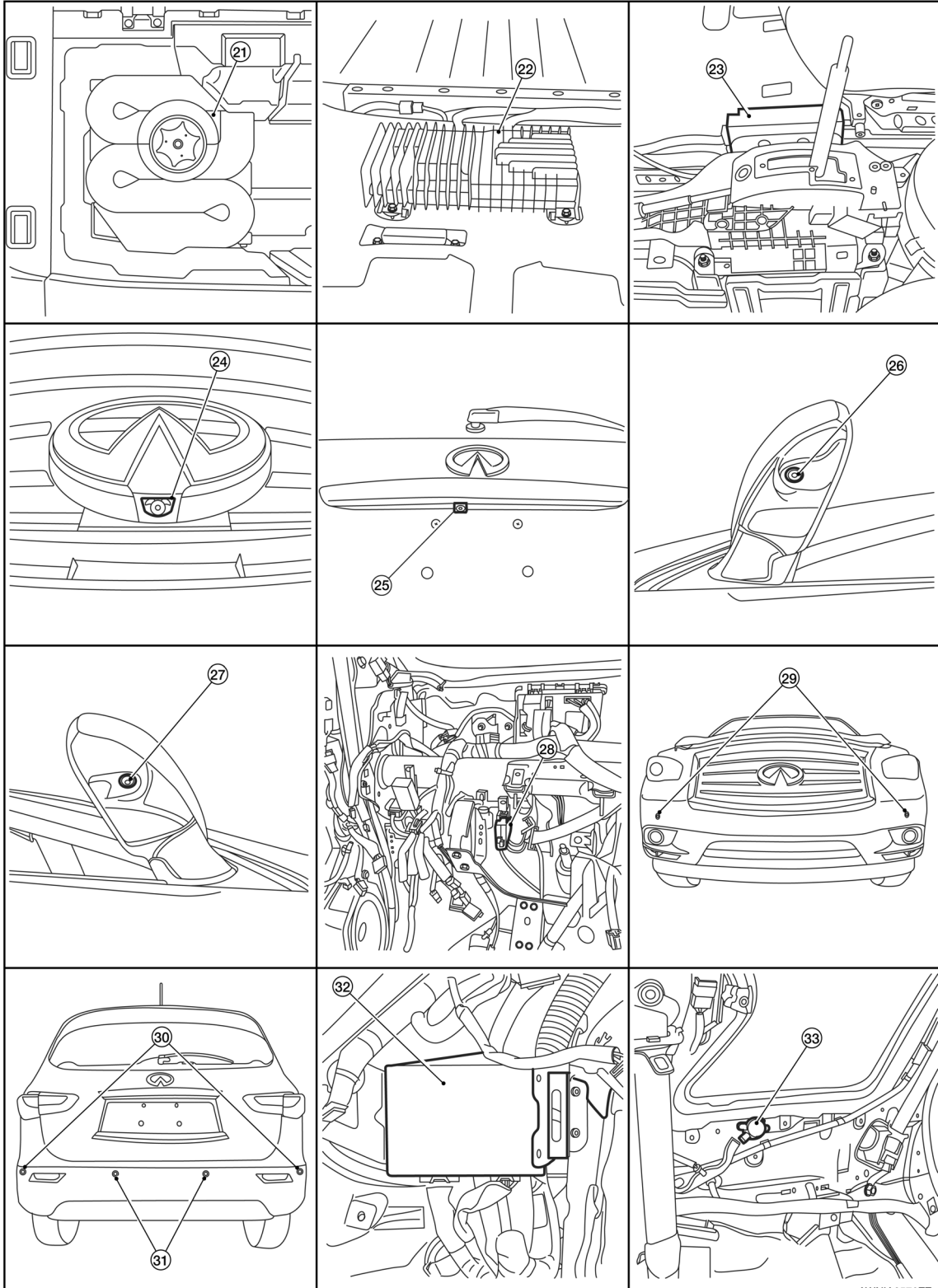

# COMPONENT PARTS

< SYSTEM DESCRIPTION >

[BOSE AUDIO W/NAVI W/SURROUND]

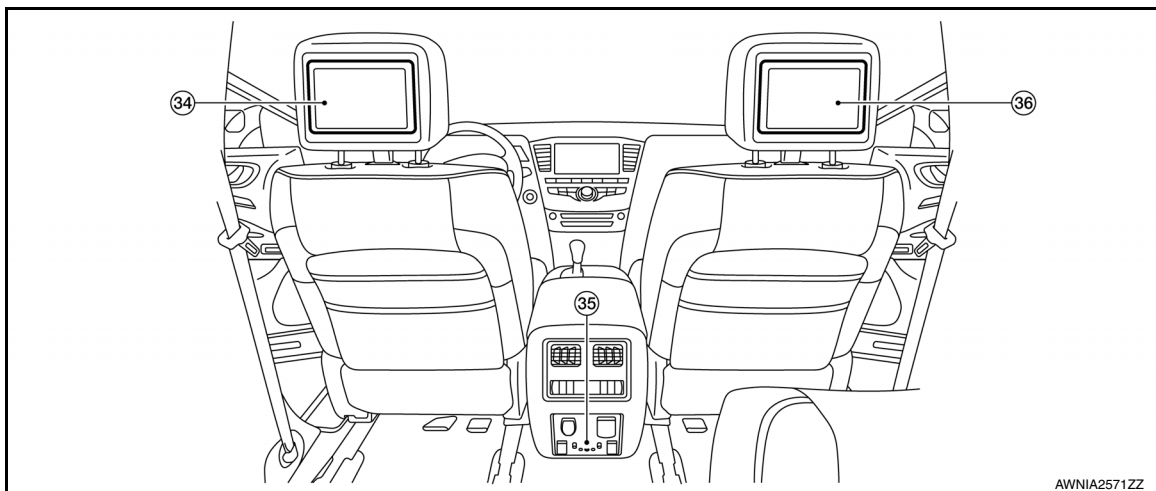

- |   |                                      |   |
|---|--------------------------------------|---|
| 1. Instrument panel tweeter LH          | 2. Front tweeter LH                  | 3. Steering switch                                  |
| 4. A/C and AV switch assembly           | 5. Front tweeter RH                  | 6. Instrument panel tweeter RH                      |
| 7. Display unit                         | 8. Center speaker                    | 9. AV control unit (view with center stack removed) |
| 10. Microphone                          | 11. USB interface                    | 12. Front auxiliary input jacks                     |
| 13. Front door speaker LH               | 14. Front door speaker RH            | 15. Rear door speaker LH                            |
| 16. Rear door tweeter LH                | 17. Rear door tweeter RH             | 18. Rear door speaker RH                            |
| 19. Rear side speaker LH                | 20. Rear side speaker RH             | 21. Subwoofer                                       |
| 22. Bose speaker amp.                   | 23. Around view monitor control unit | 24. Front camera                                    |
| 25. Rear camera                         | 26. Door mirror LH (side camera)     | 27. Door mirror RH (side camera)                    |
| 28. Sonar control unit                  | 29. Front sonar sensors outer        | 30. Rear sonar sensors outer                        |
| 31. Rear sonar sensors inner            | 32. Video distributor                | 33. Sonar buzzer                                    |
| 34. Headrest display unit (driver seat) | 35. Rear auxiliary input jacks       | 36. Headrest display unit (passenger seat)          |

## Component Description

INFOID:000000009129287

# COMPONENT PARTS

[BOSE AUDIO W/NAVI W/SURROUND]

< SYSTEM DESCRIPTION >

Part name	Description
AV control unit	<ul style="list-style-type: none"> <li>• Master unit of MULTI AV system.</li> <li>• AV control unit includes audio, hands-free phone, navigation, USB connection, DVD play and vehicle status functions.</li> <li>• Integrates hard disk drive (HDD) allowing map data and music data to be stored.</li> <li>• Connected to MULTI AV system control units via AV communication.</li> <li>• Connected to other vehicle control units via CAN communication to obtain necessary information for vehicle function.</li> <li>• Receives steering angle signal via CAN communication from steering angle sensor and controls an expected course line during around view monitor operation.</li> <li>• Inputs signals for driving status recognition (vehicle speed, reverse and parking brake).</li> <li>• RGB digital image signal and composite image signal are output to front display unit.</li> <li>• Transmits image and sound output to video distributor and inputs image switch signal from headrest display units via AV communication.</li> <li>• Receives an intelligent key identification signal necessary for intelligent key interlocking function via hard wire from BCM.</li> <li>• Transmits Amp. ON signal to BOSE amp.</li> <li>• Update of map data is performed using DVD-ROM.</li> </ul>
Display unit	<ul style="list-style-type: none"> <li>• Display image is controlled by AV control unit via serial communication.</li> <li>• Receives power from AV control unit.</li> <li>• RGB and RGB digital image signals are input from AV control unit.</li> <li>• Composite image signals are input from AV control unit.</li> <li>• Synchronizing signals are output to AV control unit.</li> <li>• Camera image signals are input from around view monitor control unit via video output signal.</li> <li>• Touch panel functions can be operated by touching display directly.</li> </ul>
BOSE speaker amp.	Receives sound signals from AV control unit and outputs sound signals to each speaker.
Instrument panel tweeter	Outputs high range sound signals from BOSE speaker amp.
Center speaker	Outputs mid and high range sound signals from BOSE speaker amp.
Front tweeter	Outputs high range sound signals from BOSE speaker amp.
Front door speaker	Outputs low, mid and high range sound signals from BOSE speaker amp.
Rear door tweeter	Outputs high range sound signals from BOSE speaker amp.
Rear door speaker	Outputs low, mid and high range sound signals from BOSE speaker amp.
Rear side speaker	Outputs low, mid and high range sound signals from BOSE speaker amp.
Subwoofer	Outputs low range sound signals from BOSE speaker amp.
A/C and AV switch assembly	<ul style="list-style-type: none"> <li>• Operation panels are equipped with switches for audio and air conditioner operations.</li> <li>• Operation signal is transmitted via AV communication to AV control unit and around view monitor.</li> <li>• Disk eject operation signal is performed via hardwire.</li> </ul>
Steering switch	<ul style="list-style-type: none"> <li>• Operations for audio, hands-free phone and voice recognition are possible.</li> <li>• Steering switch signal (operation signal) is output to AV control unit.</li> </ul>
Steering angle sensor	Connected to AV control unit via CAN communication and transmits steering angle sensor signal.
Video distributor	<ul style="list-style-type: none"> <li>• Receives image and sound signals from AV control unit and transmits them to headrest display units.</li> <li>• Receives image and sound signals from rear auxiliary input jacks and transmits them to headrest display units.</li> <li>• Transmits image and sound signals to headrest display unit and receives image switch signal from headrest display units.</li> </ul>

## COMPONENT PARTS

< SYSTEM DESCRIPTION >

[BOSE AUDIO W/NAVI W/SURROUND]

Part name	Description
Headrest display units	<ul style="list-style-type: none"> <li>• Composite image signals are input from video distributor.</li> <li>• Receives DVD/AUX/USB sound signals from video distributor and transmits them to headphones.</li> <li>• Transmits image switch signal to video distributor according to remote control operation.</li> <li>• Transmits image switch signal to AV control unit via AV communication according to remote control operation.</li> </ul>
Front auxiliary input jacks	Transmits image and sound signals to AV control unit.
Rear auxiliary input jacks	Transmits image and sound signals to video distributor and headrest display units.
Around view monitor control unit	<ul style="list-style-type: none"> <li>• Supplies power to front, rear and side cameras.</li> <li>• Superimposes images from each camera and outputs them to display unit.</li> <li>• Superimposes guiding line, predicted course line and sonar indicator to camera image that outputs to display unit.</li> <li>• Performs reception/transmission of communication signals with cameras.</li> <li>• Transmits sonar operation signal from sonar control unit via CAN communication.</li> <li>• Receives sonar information from sonar control unit via CAN communication.</li> <li>• Transmits data received/transmitted from sonar control unit to AV control unit via CAN communication.</li> </ul>
Front camera	<ul style="list-style-type: none"> <li>• Inputs power supply from around view monitor control unit.</li> <li>• Outputs image of vehicle front to around view monitor control unit.</li> <li>• Performs reception/transmission of communication signal with around view monitor control unit.</li> </ul>
Rear camera	<ul style="list-style-type: none"> <li>• Inputs power supply from around view monitor control unit.</li> <li>• Outputs image of vehicle rear to around view monitor control unit.</li> <li>• Performs reception/transmission of communication signal with around view monitor control unit.</li> </ul>
Side camera LH	<ul style="list-style-type: none"> <li>• Inputs power supply from around view monitor control unit.</li> <li>• Outputs image of vehicle LH side to around view monitor control unit.</li> <li>• Performs reception/transmission of communication signal with around view monitor control unit.</li> </ul>
Side camera RH	<ul style="list-style-type: none"> <li>• Inputs power supply from around view monitor control unit.</li> <li>• Outputs image of vehicle RH side to around view monitor control unit.</li> <li>• Performs reception/transmission of communication signal with around view monitor control unit.</li> </ul>
Sonar control unit	<ul style="list-style-type: none"> <li>• Connected to around view monitor control unit via CAN communication.</li> <li>• Receives sonar operation signal from around view monitor control unit via CAN communication.</li> <li>• Transmits sonar detection status to around view monitor control unit via CAN communication.</li> <li>• Judges warning level according to signals from front and rear sensors.</li> </ul>
Front sensors	Detects front obstacle distance and transmits signal to sonar control unit.
Rear sensors	Detects rear obstacle distance and transmits signal to sonar control unit.
Microphone	<ul style="list-style-type: none"> <li>• Used for hands-free phone, voice recognition and INFINITI CONNECTIONS operations.</li> <li>• Microphone signal is transmitted to telematics control unit (TCU).</li> <li>• Power (Microphone VCC) is supplied from TCU.</li> </ul>
Telematics control unit (TCU)	<ul style="list-style-type: none"> <li>• Connected to the AV control unit via a USB harness for sound signal input/output and USB communication.</li> <li>• Data is sent to and received from the INFINITI CONNECTIONS data center via the TEL antenna.</li> <li>• Inputs TEL voice signal from TEL antenna and outputs it to AV control unit.</li> </ul>
TEL antenna	<ul style="list-style-type: none"> <li>• Receives TEL voice signals and outputs them to TCU.</li> <li>• Transmits TEL voice signals from TCU.</li> </ul>
GPS antenna	GPS signal is received and transmitted to AV control unit.
Antenna amp.	<ul style="list-style-type: none"> <li>• Radio signal received by window antenna is amplified and transmitted to AV control unit.</li> <li>• Power (antenna amp. ON signal) is supplied from AV control unit.</li> </ul>

A  
B  
C  
D  
E  
F  
G  
H  
I  
J  
K  
L  
M  
AV  
O  
P

## COMPONENT PARTS

< SYSTEM DESCRIPTION >

[BOSE AUDIO W/NAVI W/SURROUND]

Part name	Description
Satellite radio antenna	Satellite radio signal is received and transmitted to AV control unit.
USB connector	USB sound and data input signals are transmitted to AV control unit.



# SYSTEM

[BOSE AUDIO W/NAVI W/SURROUND]

< SYSTEM DESCRIPTION >

## SYSTEM MULTI AV SYSTEM

### MULTI AV SYSTEM : System Diagram

INFOID:000000009129288

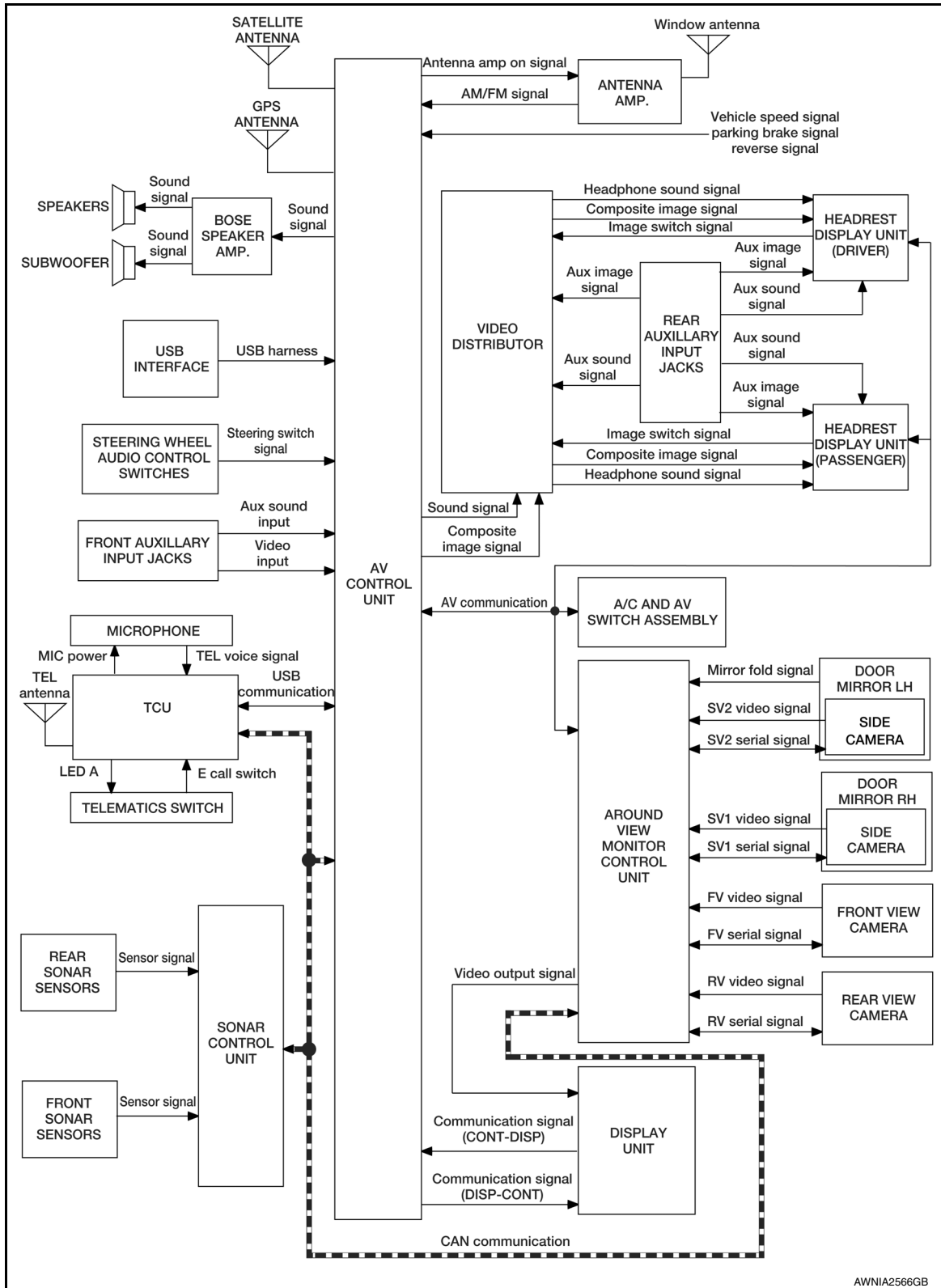

AWNIA2566GB

### MULTI AV SYSTEM : System Description

INFOID:000000009129289

#### AUDIO SYSTEM

Revision: August 2013

AV-625

2014 QX60

A  
B  
C  
D  
E  
F  
G  
H  
I  
J  
K  
L  
M  
N  
O  
P

AV

# SYSTEM

## < SYSTEM DESCRIPTION >

[BOSE AUDIO W/NAVI W/SURROUND]

The audio system consists of the following components

- AV control unit
- A/C and AV switch assembly
- Display unit
- Steering wheel audio control switches
- BOSE speaker amp.
- Center speaker
- Instrument panel tweeters
- Front tweeters
- Front door speakers
- Rear door speakers
- Rear side speakers
- Subwoofer
- Window antenna

When the audio system is on, radio signals are received by the window antenna. The AV control unit then sends audio signals to the BOSE speaker amp. The BOSE speaker amp. amplifies the audio signals before sending them to the speakers, tweeters and subwoofer.

Refer to Owner's Manual for audio system operating instructions.

### SATELLITE RADIO SYSTEM

The satellite radio system consists of the following components

- Satellite antenna
- AV control unit

When the satellite radio system is on, radio signals are supplied to the AV control unit from the satellite antenna. The AV control unit then sends audio signals to the BOSE speaker amp.

Refer to Owner's Manual for satellite radio system operating instructions.

### HANDS-FREE PHONE SYSTEM

System Operation

#### **NOTE:**

Cellular telephones must have their wireless connection set up (paired) before using the Bluetooth® telephone system.

The Bluetooth® telephone system allows users who have a Bluetooth® cellular telephone to make a wireless connection between their cellular telephone and the AV control unit. Hands-free cellular telephone calls can be sent and received. Some Bluetooth® cellular telephones may not be recognized by the AV control unit. When a cellular telephone or the AV control unit is replaced, the telephone must be paired with the AV control unit. Different cellular telephones may have different pairing procedures, refer to the cellular telephone operating manual.

Refer to the Owner's Manual for Bluetooth® telephone system operating instructions.

AV Control Unit

When the ignition switch is turned to ACC or ON, the AV control unit will power up. During power up, the AV control unit is initialized and performs various self-checks. Initialization may take up to 20 seconds. If a phone is present in the vehicle and paired with the AV control unit, Infiniti Voice Recognition will then become active. Bluetooth® telephone functions can be turned off using the Infiniti Voice Recognition system.

Steering Wheel Audio Control Switches

When buttons on the steering wheel audio control switch are pushed, the resistance in steering wheel audio control switch circuit changes, depending on which button is pushed. The AV control unit uses this signal to perform various functions while navigating through the voice recognition system.

The following functions can be performed using the steering wheel audio control switch:

- Initiate self-diagnosis of the Bluetooth® telephone system
- Start a voice recognition session
- Answer and end telephone calls
- Adjust the volume of calls
- Record memos

Microphone

The microphone is located in the roof console assembly. The microphone sends a signal to the Telematics Control Unit (TCU), which transmits the signal to the AV control unit via the USB communication circuits. The microphone can be actively tested during self-diagnosis.

< SYSTEM DESCRIPTION >

## NAVIGATION SYSTEM

### System Operation

**NOTE:**

Refer to NAVI System Owner's Manual for system operation.

The navigation system periodically calculates the vehicle's current position according to the following three signals: Travel distance of the vehicle as determined by the vehicle speed sensor, turning angle of the vehicle as determined by the gyroscope (angular velocity sensor), and the direction of vehicle travel as determined by the GPS antenna (GPS information).

The current position of the vehicle is then identified by comparing the calculated vehicle position with map data read from the map data, which is stored in the hard disk drive (HDD) (map-matching), and indicated on the screen with a current-location mark.

By comparing the vehicle position detection results found by the GPS and by map-matching, more accurate vehicle position data can be used.

The current vehicle position will be calculated by detecting the distance the vehicle moved from the previous calculation point and its direction.

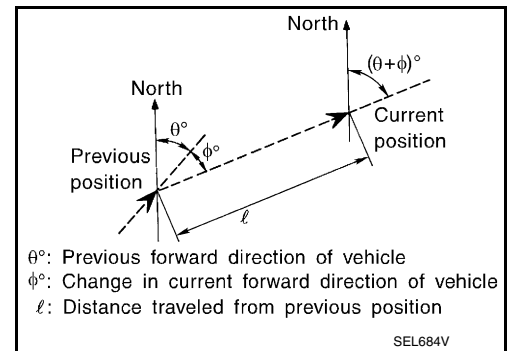

#### Travel Distance

Travel distance calculations are based on the vehicle speed input signal. Therefore, the calculation may become incorrect as the tires wear down. To prevent this, an automatic distance fine adjustment function has been adopted.

#### Travel Direction

Change in the travel direction of the vehicle is calculated by a gyroscope (angular velocity sensor) and a GPS antenna (GPS information). As the gyroscope and GPS antenna have both merit and demerit, input signals from them are prioritized in each situation. However, this order of priority may change in accordance with more detailed travel conditions so that the travel direction is detected more accurately.

Type	Advantage	Disadvantage
Gyroscope (angular velocity sensor)	<ul style="list-style-type: none"> <li>Can detect the vehicle's turning angle quite accurately.</li> </ul>	<ul style="list-style-type: none"> <li>Direction errors may accumulate when the vehicle is driven for long distances without stopping.</li> </ul>
GPS antenna (GPS information)	<ul style="list-style-type: none"> <li>Can detect the vehicle's travel direction (North/South/East/West).</li> </ul>	<ul style="list-style-type: none"> <li>Correct direction cannot be detected when the vehicle speed is low.</li> </ul>

#### Map-Matching

Map-matching is a function that repositions the vehicle on the road map when a new location is judged to be the most accurate. This is done by comparing the current vehicle position, calculated by the method described in the position detection principle, with the road map data around the vehicle, read from the map data stored on the HDD.

Therefore, the vehicle position may not be corrected after the vehicle is driven over a certain distance or time in which GPS information is hard to receive. In this case, the current-location mark on the display must be corrected manually.

**CAUTION:**

The road map data is based on data stored on the HDD.

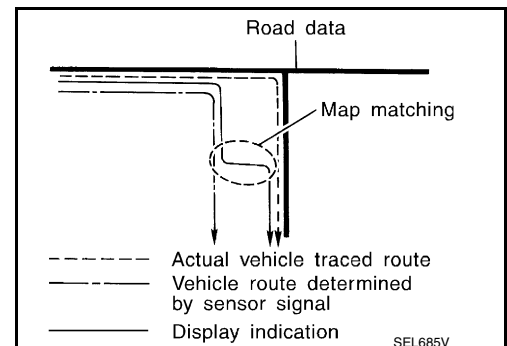

# SYSTEM

[BOSE AUDIO W/NAVI W/SURROUND]

## < SYSTEM DESCRIPTION >

- In map-matching, alternative routes to reach the destination will be shown and prioritized, after the road on which the vehicle is currently driven has been judged and the current-location mark has been repositioned.

If there is an error in distance and/or direction, the alternative routes will be shown in different order of priority, and the wrong road can be avoided.

If two roads are running in parallel, they are of the same priority. Therefore, the current-location mark may appear on either of them alternately, depending on maneuvering of the steering wheel and configuration of the road.

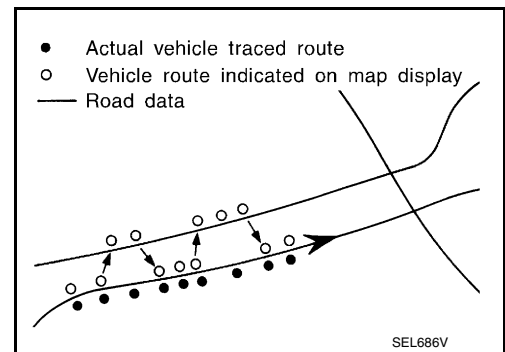

- Map-matching does not function correctly when the road on which the vehicle is driving is new and not recorded on the HDD, or when the road pattern stored in the map data and the actual road pattern are different due to repair.

When driving on a road not present in the map, the map-matching function may find another road and position the current-location mark on it. Then, when the correct road is detected, the current-location mark may leap to it.

- Effective range for comparing the vehicle position and travel direction calculated by the distance and direction with the road data read from the HDD is limited. Therefore, when there is an excessive gap between the current vehicle position and the position on the map, correction by map-matching is not possible.

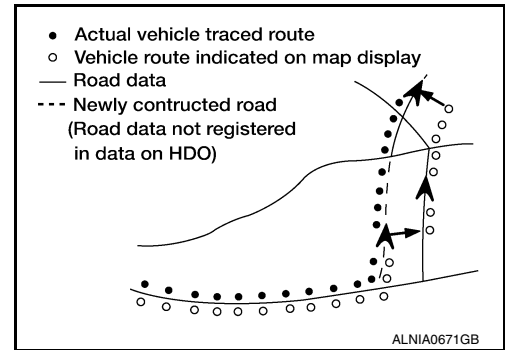

## GPS (Global Positioning System)

GPS (Global Positioning System) has been developed and controlled by the US Department of Defense. The system utilizes GPS satellite (NAVSTAR), sending out radio waves while flying on an orbit around the earth at the height of approx. 21,000 km (13,000 mi).

The GPS receiver calculates the vehicle's position in three dimensions (latitude/longitude/altitude) according to the time lag of the radio waves received from four or more GPS satellites (three-dimensional positioning). If radio waves were received only from three GPS satellites, the GPS receiver calculates the vehicle's position in two dimensions (latitude/longitude), utilizing the altitude data calculated previously by using radio waves from four or more GPS satellites (two-dimensional positioning).

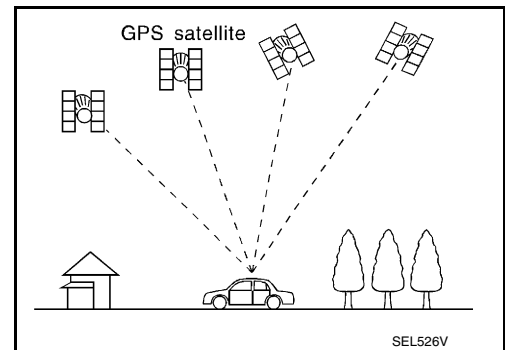

Accuracy of the GPS will deteriorate under the following conditions.

- In two-dimensional positioning, the GPS accuracy will deteriorate when the altitude of the vehicle position changes.
- There may be an error of approximately 10 m (30 ft.) in position detected by three-dimensional positioning, which is more accurate than two-dimensional positioning. The accuracy can be even lower depending on the arrangement of the GPS satellites utilized for the positioning.
- Position detection is not possible when the vehicle is in an area where radio waves from the GPS satellite do not reach, such as in a tunnel, parking lot in a building, and under an elevated highway. Radio waves from the GPS satellites may not be received when some object is located over the GPS antenna.
- Position correction by GPS is not available while the vehicle is stopped.

## SPEED SENSITIVE VOLUME SYSTEM

Volume level of this system goes up and down automatically in proportion to the vehicle speed. The control level can be selected by the customer. Refer to Owner's Manual for operating instructions.

## FRONT AUXILIARY INPUT JACKS

- Image and sound can be output from an external device connected to the front auxiliary input jacks.
- AUX image signals are transmitted to each unit as follows:
  - To the display unit via AV control unit.
  - To the headrest display units via AV control unit and video distributor.
- AUX sound signals are transmitted to each unit as follows:
  - To each speaker via AV control unit and BOSE speaker amp.

# SYSTEM

## < SYSTEM DESCRIPTION >

[BOSE AUDIO W/NAVI W/SURROUND]

- To video distributor via AV control unit.
- Headphone sound signals are transmitted via infrared communication between headrest display units and headphones.

### REAR ENTERTAINMENT SYSTEM

- Image and sound (DVD, USB memory-stored video data and front auxiliary input) played by AV control unit can be enjoyed in rear seat using headrest display units and headphones.
- Image and sound of an external device connected to rear auxiliary input jacks for rear seat can be enjoyed in rear seat using headrest display units and headphones. Also, image and sound from rear auxiliary input jacks can be selected and played individually on each side as well as on both sides.

#### NOTE:

Image signal and sound signal from rear auxiliary input jacks are not transmitted to front display unit and each speaker.

#### Operation Signal

- The rear entertainment system can be controlled by the rear seat remote control.
- The rear seat remote control transmits the operation signal to the remote control receiver built into headrest display units, which then transmits it to the AV control unit and video distributor.

#### Headphone Sound

- Sound signals output from AV control unit or rear auxiliary input jacks are transmitted to headrest display units via video distributor.
- Headphone sound signals are transmitted via infrared communication between headrest display units and headphones.

#### Headrest Display Units

- Composite image signals from AV control unit are transmitted to headrest display unit via video distributor.
- Image switch signals from headrest display units are transmitted to AV control unit and video distributor, according to rear seat remote control operation.
- When image switch signal is transmitted from headrest display unit to AV control unit via AV communication, image played by AV control unit (DVD, USB memory-stored video data, and front auxiliary input) switches.
- When image switch signal is transmitted from headrest display unit to video distributor, image output from AV control unit and image output from rear auxiliary input jacks switch.

### AROUND VIEW MONITOR SYSTEM

- This system is equipped with wide-angle high-resolution cameras on the front and rear of the vehicle and on both right and left door mirrors. The images from front view, rear view, front-side view (RH side), and birds-eye view that shows the view from the top of the vehicle are displayed to monitor the vehicle surroundings.
- Around view monitor control unit cuts out and expands the image received from each camera to create each view.
- The sonar indicator is viewed on display (superimposed on the camera image) in combination with the camera assistance sonar system to warn of the approach of an obstacle.
- In front view and rear view, the vehicle width, distance lines and predictive course lines are superimposed and displayed. In front-side view, the vehicle distance guiding line and vehicle width guiding line are displayed.
- The Birds-Eye view converts the images from 4 cameras into the overhead view and displays the status of the vehicle. The vehicle icon and sonar indicator on the Birds-Eye view display are rendered by around view monitor control unit.

#### Around View Monitor Screen

- Around view monitor combines and displays the travel direction view and Birds-Eye view, Front-Side view and then displays the sonar indicator on the Birds-Eye view, Front-Side view, Rear wide view.
- AV control unit renders the Change View switch, view icon, warning message on display.

#### Operation Description

##### NOTE:

The first, second, and third camera image displayed when switched to the camera image display depends on the settings of Camera View Priority.

- Around view monitor operates by pressing the CAMERA switch on the A/C and AV switch assembly and shifting the selector lever to the R position.
- When the selector lever is in any position other than R, the screen is switched to the around view monitor by pressing the CAMERA switch.
- The screen is switched to the around view monitor by shifting the selector lever to the R position.

A

B

C

D

E

F

G

H

I

J

K

L

M

AV

O

P

# SYSTEM

[BOSE AUDIO W/NAVI W/SURROUND]

## < SYSTEM DESCRIPTION >

- The around view monitor's, Birds-Eye view, Front-side view or rear wide view (rear only) can be switched by pressing the CAMERA switch.
- The around view monitor is cancelled 3 minutes after pressing the CAMERA switch, and the display returns to the previous screen.
- ON/OFF setting of sonar indicator display on the Front-Side view screen can be performed.
- In Birds-Eye view, the invisible area is displayed on the image to specify the boundary of the 4 cameras. The invisible area is displayed in yellow in the Birds-Eye view after turning the ignition switch ON.
- The sonar operates only when the camera screen is displayed.

## SONAR SYSTEM

### System Operation Description

- Around view monitor control unit transmits the sonar operation signal via CAN communication to sonar control unit to control the operation of sonar indicator and sonar buzzer.
- Sonar control unit transmits the detection signal and detection distance signal via CAN communication to around view monitor control unit. Around view monitor control unit operates the applicable sonar indicator.
- When receiving a sonar operation signal from the around view monitor control unit, the sonar control unit converts the signal into a detection distance signal and transmits it to the AV control unit via CAN communication. When receiving the detection signal, the AV control unit activates the speakers via the BOSE speaker amp.
- The sonar control unit is capable of self diagnosis. It can detect sensor malfunction or sensor harness open circuits. It transmits the diagnosis results to around view monitor control unit and always displays the sonar indicator in red to inform the vehicle operator.

### Obstacle Detection Distance

- Sonar control unit changes the outputs of the sonar indicator and warning buzzer in 3 stages according to the obstacle detection distance from the corner sensor.
- The sonar control unit can change the setting of obstacle detection distance in 4 stages.

Obstacle detection image

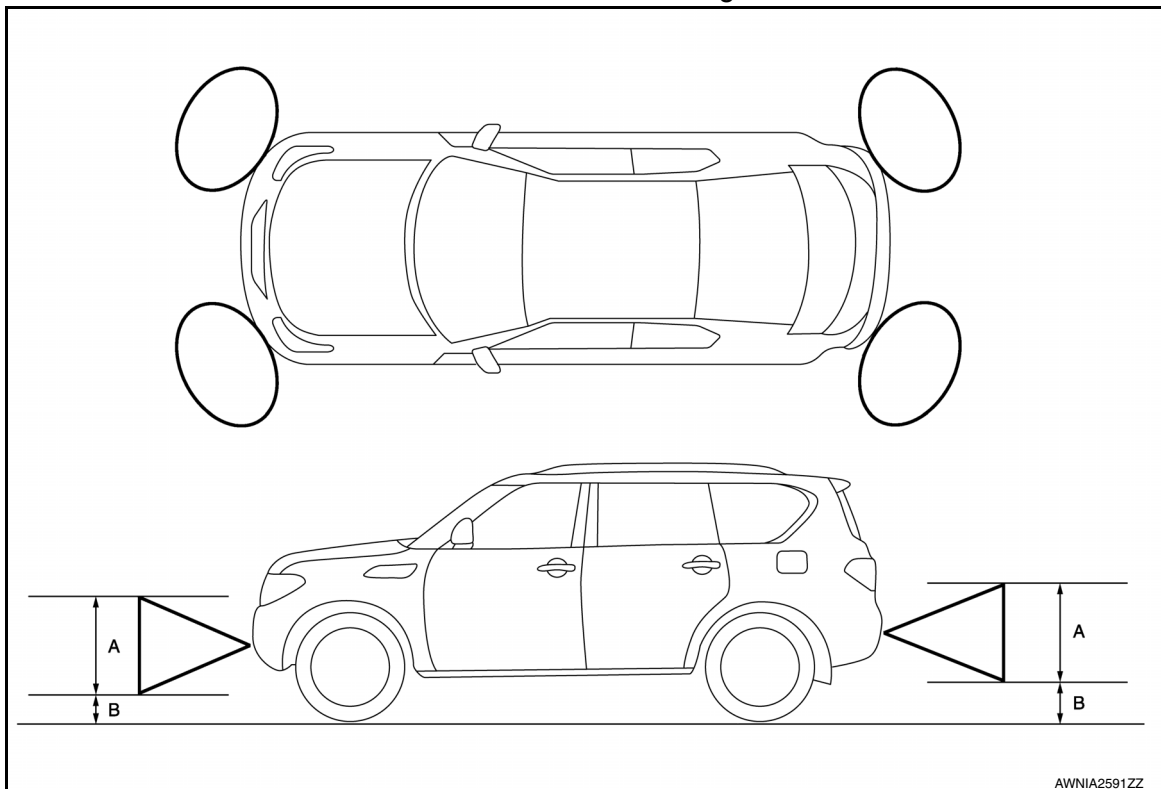

A. Approx. 50 cm (19.6 in)

B. Approx. 15 cm (5.9 in)

# SYSTEM

## < SYSTEM DESCRIPTION >

## [BOSE AUDIO W/NAVI W/SURROUND]

### Detection distance

Warning item	Sensitivity level 1 (Fastest warning)	Sensitivity level 2 (Faster warning)	Sensitivity level 3 (Default value)	Sensitivity level 4 (Slower warning)
First stage warning	70 – 80 cm (27.5 – 31.4 in)	60 – 70 cm (23.6 – 27.5 in)	50 – 60 cm (19.6 – 23.6 in)	40 – 50 cm (15.7 – 19.6 in)
Second stage warning	50 – 70 cm (19.6 – 27.5 in)	40 – 60 cm (15.7 – 23.6 in)	30 – 50 cm (11.8 – 19.6 in)	30 – 40 cm (11.8 – 15.7 in)
Third stage warning	Less than 50 cm (19.6 in)	Less than 40 cm (15.7 in)	Less than 30 cm (11.8 in)	Less than 30 cm (11.8 in)

### Sonar Indicator Display

- Around view monitor control unit that receives the detection signal and detection distance signal from sonar control unit displays the sonar indicator on display.
- Around view monitor control unit changes the color or blinking cycle of the indicator according to the detection distance.

### Color and blinking cycle of sonar indicator

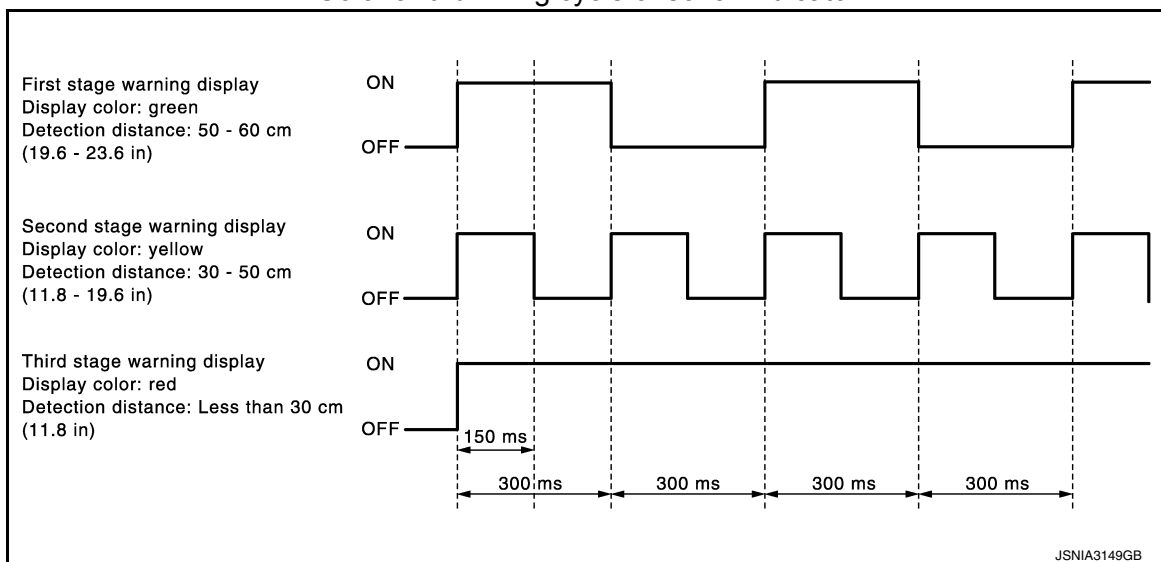

### Sonar Buzzer Operation

- Each sonar sensor transmits a sensor signal to the sonar control unit when detecting an obstacle.
- The sonar control unit converts a signal received from each sonar sensor into distance and transmits detection distance signal to the AV control unit via AV communication.
- The AV control unit transmits a buzzer signal to the BOSE amp. corresponding to each sonar sensor based on the received signal.
- When receiving a buzzer signal, the BOSE amp. transmits the buzzer signal to the each speaker. When each speaker receives a buzzer signal, a buzzer sounds.
- When the front corner sensor detects an obstacle, a buzzer is heard from the speakers on the front side.
- When the rear corner sensor detects an obstacle, a buzzer is heard from the speakers on the rear side.
- It changes the buzzer cycle in 3 stages according to the detection distance.

AV

# SYSTEM

< SYSTEM DESCRIPTION >

[BOSE AUDIO W/NAVI W/SURROUND]

Sonar buzzer cycle

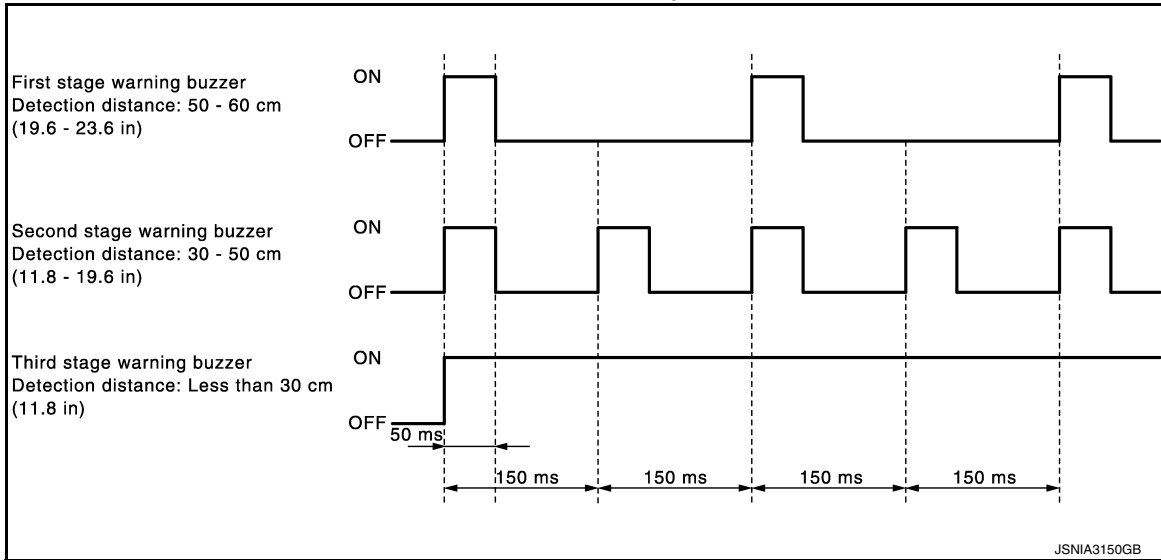

## VEHICLE INFORMATION FUNCTION

- Status of audio, climate control system, fuel economy, maintenance and navigation are displayed.
- AV control unit displays the fuel consumption status while receiving data signal through CAN communication from ECM and combination meter.
- AV control unit is connected to BCM via CAN communication transmitting/receiving for the vehicle settings function.

## INTELLIGENT KEY INTERLOCKING FUNCTION

The AV control unit recognizes a door-unlocked state of Intelligent Key according to an Intelligent Key recognition signal transmitted from BCM and saves two different types of audio settings and navigation settings.

Settings saved in the AV control unit

- Map display
- Route guidance
- Locator
- Route search
- Sound quality
- Radio preset
- Language



# DIAGNOSIS SYSTEM (AV CONTROL UNIT)

< SYSTEM DESCRIPTION >

[BOSE AUDIO W/NAVI W/SURROUND]

## DIAGNOSIS SYSTEM (AV CONTROL UNIT)

### Description

INFOID:000000009129290

The AV control unit on board diagnosis includes the following functions:

- A/C and AV switch assembly self diagnosis that checks the ON/OFF operation (continuity) of each switch in the A/C and AV switch assembly.

**NOTE:**

The hazard switch and disk eject switch are not included in this operation check.

- AV control unit on board diagnosis performs the following functions listed in the table below:

Mode		Description	
Self Diagnosis		<ul style="list-style-type: none"> <li>• AV control unit diagnosis.</li> <li>• Diagnoses the connections across system components, between AV control unit and GPS antenna.</li> </ul>	
Confirmation/ Adjustment	Display Diagnosis	The following check functions are available: color tone check by color bar display and white display, light and shade check by gray scale display and touch panel calibration response check.	
	Vehicle Signals	Diagnosis of signals can be performed for vehicle speed, parking brake, lights, ignition, reverse, side view switch and room lamp.	
	Speaker Test	The connection of a speaker can be confirmed by test tone.	
	Navigation	Steering Angle Adjustment	When there is a difference between the actual turning angle and the vehicle mark turning angle, it can be adjusted.
		Speed Calibration	When there is a difference between the current location mark and the actual location, it can be adjusted.
	Error History	The system malfunction and the frequency when occurring in the past are displayed. When the malfunctioning item is selected, the time and place that the selected malfunction last occurred are displayed.	
	Synchronizer FES Clock	—	
	Vehicle CAN Diagnosis	The transmitting/receiving of CAN communication can be monitored.	
	AV COMM Diagnosis	The communication condition of each unit of Multi AV system can be monitored.	
	Handsfree Phone/Infiniti Connection	<ul style="list-style-type: none"> <li>• The received volume adjustment of hands-free phone, microphone speaker check, and erase memory can be performed.</li> <li>• Diagnosis of the Infiniti Connection system can be performed.</li> </ul>	
	XM	XM NaviTrffic	Change Channel
		XM NavWeather	<ul style="list-style-type: none"> <li>• Any necessary channels required to receive traffic information from the satellite radio system can be set.</li> </ul>
		XM CGS	Change Application ID
		Diag	<ul style="list-style-type: none"> <li>• Any application ID's required to receive traffic information from the satellite radio system can be set.</li> </ul>
Delete Unit Connection Log	Erase the connection history of unit and error history.		
Initialize Settings	Initializes the AV control unit memory.		
Version Information	Version information of the AV control unit is displayed.		

Perform CONSULT diagnosis if the AV control unit on board diagnosis does not start, the screen does not display anything, or the A/C and AV switch assembly self diagnosis does not function.

### On Board Diagnosis Function

INFOID:000000009129291

#### METHOD OF STARTING

A/C and AV Switch Assembly Self Diagnosis

# DIAGNOSIS SYSTEM (AV CONTROL UNIT)

[BOSE AUDIO W/NAVI W/SURROUND]

## < SYSTEM DESCRIPTION >

- Press the BACK and UP switches within 10 seconds after turning the ignition switch from OFF to ACC and hold them for 3 seconds or more.
- The buzzer sounds, all indicators of the switches illuminate, and the self-diagnosis mode begins.
- The ON position continuity of each switch can be checked by pressing the switch. The buzzer sounds if continuity is present.
- The self diagnosis mode is canceled when the ignition switch is turned OFF.

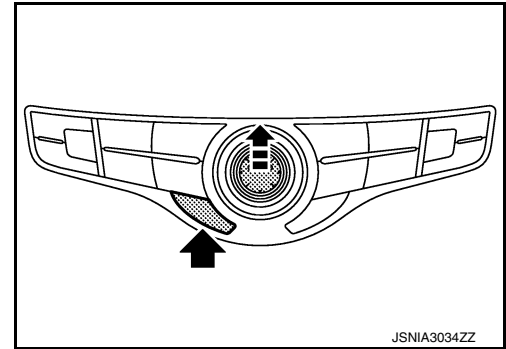

### AV Control Unit Self Diagnosis

1. Turn the ignition ON.
2. Turn the audio system OFF.
3. While pressing the SETTING button, turn the volume control dial clockwise or counterclockwise for 40 clicks or more. When self-diagnosis mode begins, a short beep will be heard. Shifting from current screen to previous screen is performed by pressing BACK button.

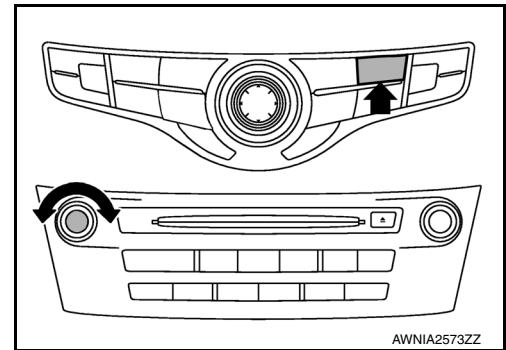

4. The trouble diagnosis initial screen is displayed, and Self Diagnosis or Confirmation/Adjustment can be selected.

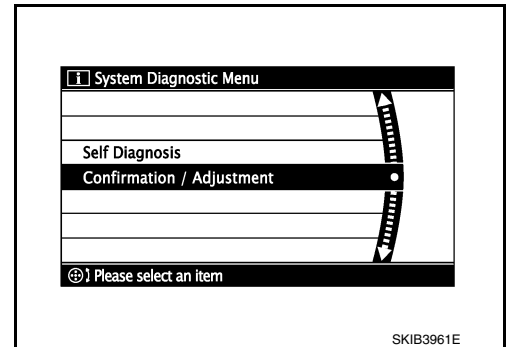

## SELF DIAGNOSIS MODE

### AV Control Unit Self Diagnosis

1. Select Self Diagnosis.
2. Self diagnosis screen is displayed. The bar graph visible in center of screen indicates progress of self diagnosis.

# DIAGNOSIS SYSTEM (AV CONTROL UNIT)

[BOSE AUDIO W/NAVI W/SURROUND]

## < SYSTEM DESCRIPTION >

- Diagnosis results are displayed after the self-diagnosis is completed. The unit names and the connection lines are color-coded according to the diagnostic results.

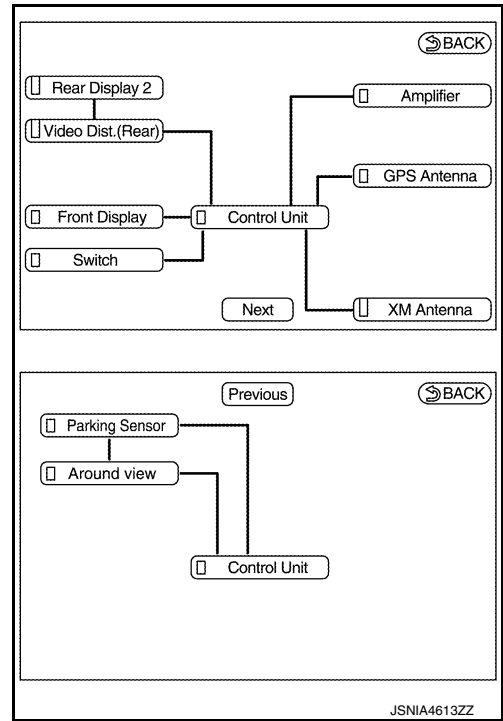

Diagnosis results	Unit	Connection line
Normal	Green	Green
Connection malfunction	Gray	Yellow
Unit malfunction <sup>1</sup>	Red	Green

1: Control Unit (AV control unit) is displayed in red.

- Replace AV control unit if Self Diagnosis did not run because control unit malfunction is indicated. The symptom is AV control unit internal error. Refer to [AV-883, "Removal and Installation - AV Control Unit"](#).
  - If multiple errors occur at the same time for a single unit, the screen switch colors are determined according to the following order of priority: red > gray.
- Comments of self diagnosis results can be viewed in the diagnosis result screen.

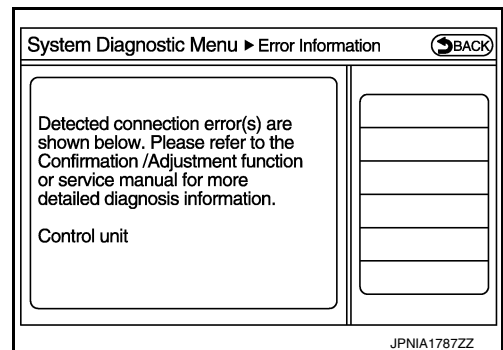

## AV Control Unit Self Diagnosis Results

# DIAGNOSIS SYSTEM (AV CONTROL UNIT)

< SYSTEM DESCRIPTION >

[BOSE AUDIO W/NAVI W/SURROUND]

## Only Unit Part Is Displayed In Red

Screen switch	Description	Possible cause
Control Unit	Malfunction is detected in AV control unit power supply and ground circuits.	<ul style="list-style-type: none"> <li>AV control unit power supply or ground circuits. Refer to <a href="#">AV-815, "AV CONTROL UNIT : Diagnosis Procedure"</a>.</li> <li>If no malfunction is detected in AV control unit power supply and ground circuits, replace AV control unit. Refer to <a href="#">AV-883, "Removal and Installation - AV Control Unit"</a>.</li> </ul>
Amplifier	When either one of the following items are detected: <ul style="list-style-type: none"> <li>sound signal circuits between BOSE amp. and each speaker are malfunctioning.</li> <li>BOSE amp. malfunction is detected.</li> </ul>	<ul style="list-style-type: none"> <li>Malfunctioning speaker circuits</li> <li>Replace BOSE amp. Refer to <a href="#">AV-887, "Removal and Installation"</a>.</li> </ul>

## A Connecting Cable Between Units Is Displayed In Yellow

Area with yellow connection lines	Description	Possible cause
Control unit ↔ Front Display	Serial communication circuits between AV control unit and front display unit are malfunctioning.	Serial communication circuits between AV control unit and front display unit.
Control unit ↔ GPS Antenna	GPS antenna connection malfunctions detected.	Check the connection of the GPS antenna connector.
Control unit ↔ XM Antenna	Satellite radio antenna connection malfunction is detected.	Satellite radio antenna disconnection
Control unit ↔ Amplifier	When either one of the following items are detected: <ul style="list-style-type: none"> <li>BOSE amp. power supply and ground circuits are malfunctioning.</li> <li>AV communication circuits between headrest display unit LH and BOSE amp. are malfunctioning.</li> </ul>	<ul style="list-style-type: none"> <li>BOSE amp. power supply and ground circuits. Refer to <a href="#">AV-816, "BOSE AMP. : Diagnosis Procedure"</a>.</li> <li>AV communication circuits between headrest display unit LH and BOSE amp.</li> </ul>
Control unit ↔ Around view Around view ↔ Parking Sensor	When either one of the following items are detected: <ul style="list-style-type: none"> <li>around view monitor control unit power supply and ground circuits are malfunctioning.</li> <li>AV communication circuits between AV control unit and around view monitor control unit are malfunctioning.</li> </ul>	<ul style="list-style-type: none"> <li>Around view monitor control unit power supply and ground circuits.</li> <li>AV communication circuits between AV control unit and around view monitor control unit.</li> </ul>
Control unit ↔ Parking Sensor Around view ↔ Parking Sensor	When either one of the following items are detected: <ul style="list-style-type: none"> <li>sonar control unit power supply and ground circuits are malfunctioning.</li> <li>AV communication circuits between AV control unit and sonar control unit are malfunctioning.</li> </ul>	<ul style="list-style-type: none"> <li>Sonar control unit power supply and ground circuits.</li> <li>AV communication circuits between AV control unit and sonar control unit.</li> </ul>

# DIAGNOSIS SYSTEM (AV CONTROL UNIT)

< SYSTEM DESCRIPTION >

[BOSE AUDIO W/NAVI W/SURROUND]

A Connecting Cable Between Units Is Displayed In Yellow

Area with yellow connection lines	Description	Possible cause
Control unit ↔ Video Dist.(Rear) Video Dist.(Rear) ↔ Rear display 2	When either one of the following items are detected: <ul style="list-style-type: none"> <li>• video distributor power supply and ground circuits are malfunctioning.</li> <li>• headrest display unit LH power supply and ground circuits are malfunctioning.</li> <li>• AV communication circuits between AV control unit and headrest display unit LH are malfunctioning.</li> <li>• location recognition signal circuit between headrest display unit LH and ground is malfunctioning.</li> </ul>	<ul style="list-style-type: none"> <li>• Video distributor power supply and ground circuits.</li> <li>• Headrest display unit LH power supply and ground circuits.</li> <li>• AV communication circuits between AV control unit and headrest display unit LH.</li> <li>• Location recognition signal circuit between headrest display unit LH and ground.</li> </ul>
Video Dist.(Rear) ↔ Rear display 2	When either one of the following items are detected: <ul style="list-style-type: none"> <li>• headrest display unit RH power supply and ground circuits are malfunctioning.</li> <li>• AV communication circuits between headrest display unit LH and headrest display unit RH are malfunctioning.</li> <li>• location recognition signal circuit between headrest display unit RH and ground is malfunctioning.</li> </ul>	<ul style="list-style-type: none"> <li>• Headrest display unit RH power supply and ground circuits.</li> <li>• AV communication circuits between headrest display unit LH and headrest display unit RH.</li> <li>• Location recognition signal circuit between headrest display unit RH and ground.</li> </ul>

## AV Control Unit Confirmation/Adjustment

1. Select Confirmation/Adjustment.
2. Select each switch on the Confirmation/Adjustment screen to display the relevant trouble diagnosis screen. Press the BACK switch to return to the initial Confirmation/Adjustment screen.

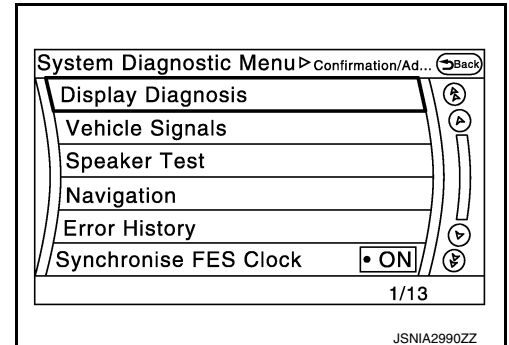

# DIAGNOSIS SYSTEM (AV CONTROL UNIT)

< SYSTEM DESCRIPTION >

[BOSE AUDIO W/NAVI W/SURROUND]

## Display Diagnosis

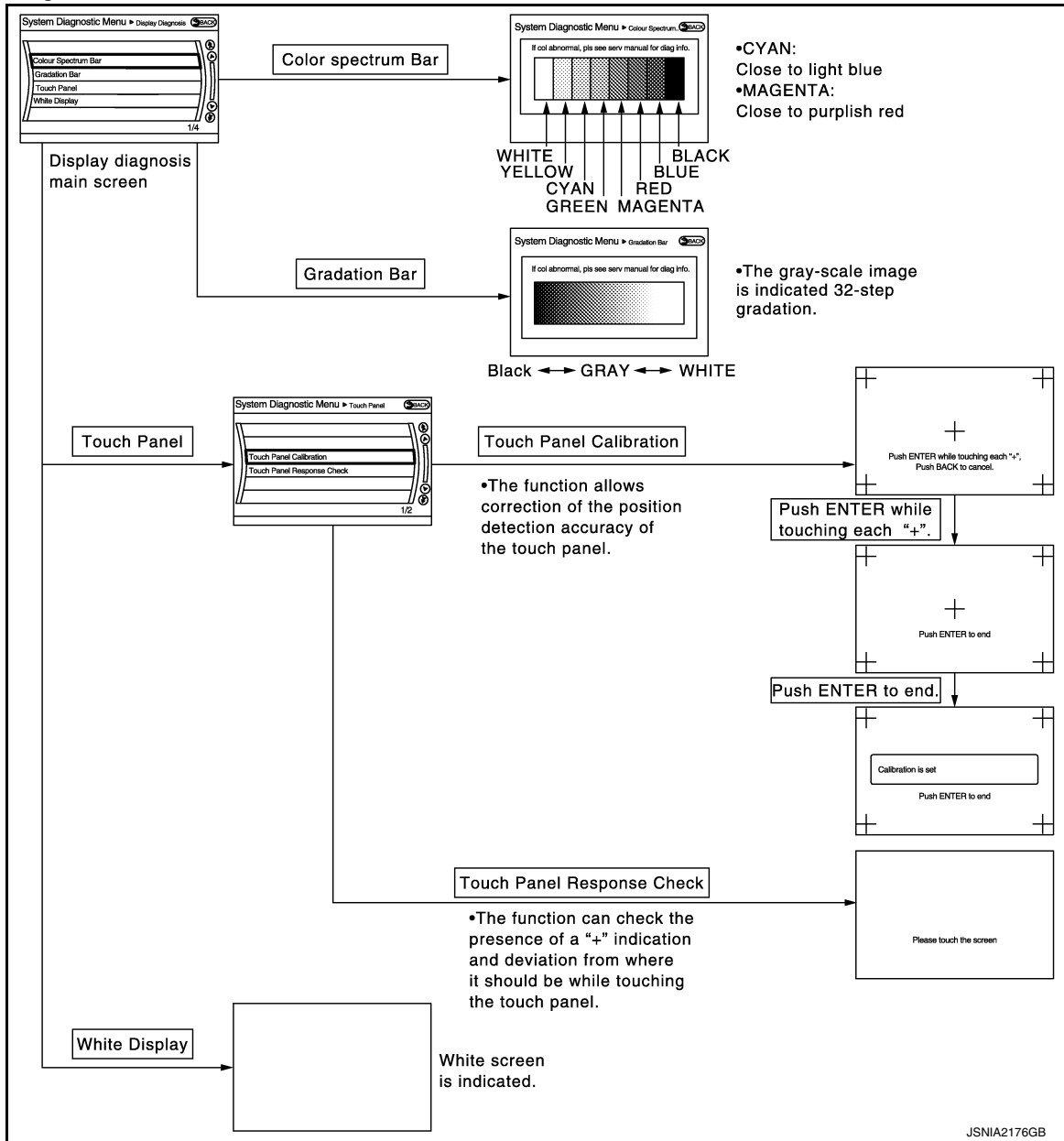

## Vehicle Signals

A comparison check can be made of each actual vehicle signal and the signals recognized by the system.

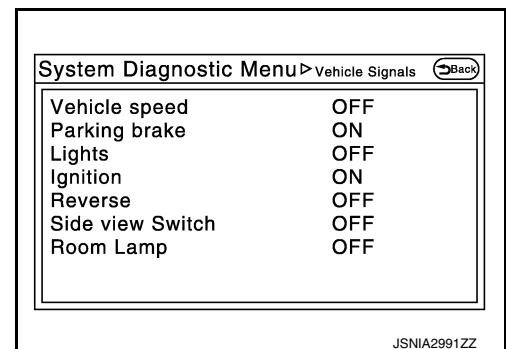

## Speaker Test

# DIAGNOSIS SYSTEM (AV CONTROL UNIT)

[BOSE AUDIO W/NAVI W/SURROUND]

< SYSTEM DESCRIPTION >

Select Speaker Test to display the Speaker Diagnosis screen. Press Start to generate a test tone in a speaker. Press Start again to generate a test tone in the next speaker. Press End to stop the test tones.

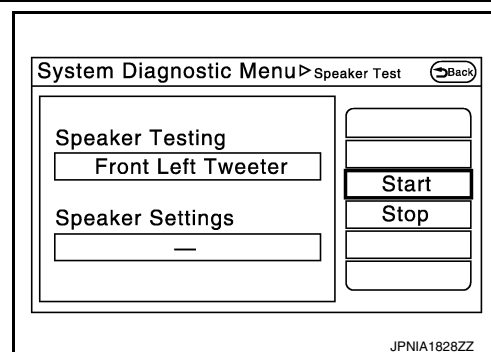

Navigation

## STEERING ANGLE ADJUSTMENT

The steering angle output value detected with the gyroscope is adjusted.

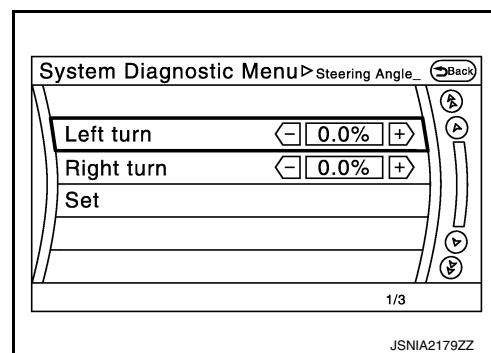

## SPEED CALIBRATION

During normal driving, distance error caused by tire wear and tire pressure change is automatically adjusted for by the automatic distance correction function. This function, on the other hand, is for immediate adjustment, in cases such as driving with tire chain fitted on tires.

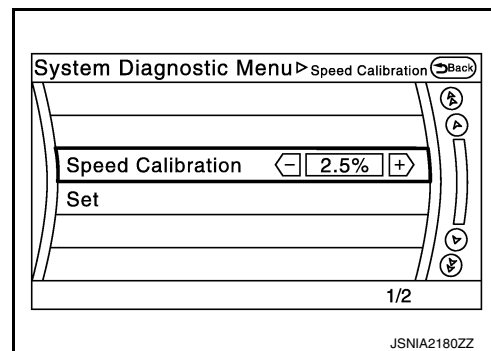

Error History

The self-diagnosis results are judged depending on whether any error occurs from when "Self-diagnosis" is selected until the self-diagnosis results are displayed.

However, the diagnosis results are judged normal if an error has occurred before the ignition switch is turned ON and then no error has occurred until the self-diagnosis start. Check the "Error Record" to detect any error that may have occurred before the self-diagnosis start because of this situation.

The error record displays the time and place of the most recent occurrence of that error. However, take note of the following points.

- If there is a malfunction with the GPS antenna circuit board in the AV control unit, the correct date and time of occurrence may not be able to be displayed.
- Place of the error occurrence is represented by the position of the current location mark at the time an error occurred. If current location mark has deviated from the correct position, then the place of the error occurrence cannot be located correctly.
- The frequency of occurrence is displayed in a count up manner. The actual count up method differs depending on the error item.

Count up method A

- The counter resets to 0 if an error occurs when ignition switch is turned ON. The counter increases by 1 if the condition is normal at a next ignition ON cycle.
- The counter upper limit is 39. Any counts exceeding 39 are ignored. The counter can be reset (no error record display) with the "Delete log" switch or CONSULT.

Count up method B

A  
B  
C  
D  
E  
F  
G  
H  
I  
J  
K  
L  
M  
AV

# DIAGNOSIS SYSTEM (AV CONTROL UNIT)

[BOSE AUDIO W/NAVI W/SURROUND]

## < SYSTEM DESCRIPTION >

- The counter increases by 1 if an error occurs when ignition switch is ON. The counter will not decrease even if the condition is normal at the next ignition ON cycle.
- The counter upper limit is 50. Any counts exceeding 50 are ignored. “ The counter can be reset (no error record display) with the “Delete log” switch or CONSULT.

Display type of occurrence frequency	Error history display item
Count up method A	CAN communication line, control unit (CAN), AV communication line, control unit (AV)
Count up method B	Other than the above

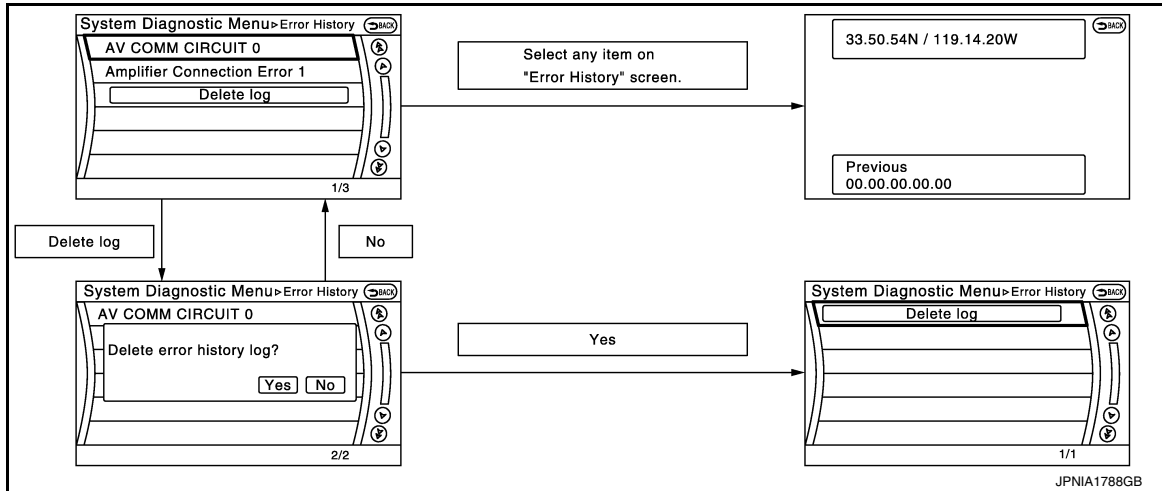

### Error item

Some error items may be displayed simultaneously according to the cause. If some error items are displayed simultaneously, the detection of the cause can be performed by the combination of display items

Error item	Description	Possible malfunction factor/Action to take
CAN COMM CIRCUIT	CAN communication malfunction is detected.	Perform diagnosis with CONSULT, and then repair the malfunctioning parts according to the diagnosis results. Refer to <a href="#">AV-646. "CONSULT Function"</a> .
CONTROL UNIT (CAN)	CAN initial diagnosis malfunction is detected.	Replace the AV control unit if the malfunction occurs constantly. Refer to <a href="#">AV-883. "Removal and Installation - AV Control Unit"</a> .
CONTROL UNIT (AV)	AV communication circuit initial diagnosis malfunction is detected.	
FLASH-ROM Error Of Control Unit	AV control unit malfunction is detected.	
Connection Of Gyro		
Connection of G Sensor		
CAN Controller Memory Error		
Bluetooth® Module Connection Error		
Sub CPU Connection Error		
Audio connection error	AV control unit malfunction is detected.	
DSP Connection Error		
DSP Communication Error	AV control unit malfunction is detected.	<ul style="list-style-type: none"> <li>• If a disc can be played, then there is a possibility of the detection of a temporary malfunction.</li> <li>• Replace the AV control unit if the malfunction occurs constantly. Refer to <a href="#">AV-883. "Removal and Installation - AV Control Unit"</a>.</li> </ul>



# DIAGNOSIS SYSTEM (AV CONTROL UNIT)

< SYSTEM DESCRIPTION >

[BOSE AUDIO W/NAVI W/SURROUND]

Error item	Description	Possible malfunction factor/Action to take
HDD Connection Error	AV control unit malfunction is detected.	<ul style="list-style-type: none"> <li>• There is a possibility of the detection of a temporary malfunction.</li> <li>• Replace the AV control unit if the malfunction occurs constantly.</li> </ul> Refer to <a href="#">AV-883, "Removal and Installation - AV Control Unit"</a> .
HDD Read Error		
HDD Write Error		
HDD Communication Error		
HDD Access Error		
GPS Communication Error	GPS malfunction is detected.	<ul style="list-style-type: none"> <li>• An intermittent error caused by strong radio interference may be detected unless any symptom (GPS reception error, etc.) occurs.</li> <li>• Replace the AV control unit if the malfunction occurs constantly.</li> </ul> Refer to <a href="#">AV-883, "Removal and Installation - AV Control Unit"</a> .
GPS ROM Error		
GPS RAM Error		
GPS RTC Error		
Unfinished configuration	The writing of configuration data is incomplete.	Write configuration data with CONSULT.
USB Controller Communication Error	USB connection malfunction is detected.	Check that the connection to the USB connector is normal.
DVD Mechanism Communication Error	AV control unit malfunction is detected.	<ul style="list-style-type: none"> <li>• If DVD can be played, then there is a possibility of the detection of a temporary malfunction.</li> <li>• Replace the AV control unit if the malfunction occurs constantly.</li> </ul> Refer to <a href="#">AV-883, "Removal and Installation - AV Control Unit"</a> .
Steer. Angle Sensor Calibration	Predictive course line center position adjustment of the steering angle sensor is incomplete.	Adjust the predictive course line center position of the steering angle sensor. Refer to <a href="#">AV-646, "CONSULT Function"</a> .
Amplifier Temperature Error	BOSE amp. malfunction is detected.	Replace the BOSE amp. Refer to <a href="#">AV-887, "Removal and Installation"</a> .
Front Display Connection Error	When either one of the following items are detected: <ul style="list-style-type: none"> <li>• front display unit power supply and ground circuits are malfunctioning.</li> <li>• Serial communication circuits between AV control unit and front display unit are malfunctioning.</li> </ul>	<ul style="list-style-type: none"> <li>• Front display unit power supply and ground circuits.</li> <li>• Serial communication circuits between AV control unit and front display unit.</li> </ul>
<ul style="list-style-type: none"> <li>• AV COMM CIRCUIT</li> <li>• 2nd Display Connection Error</li> </ul>	When either one of the following items are detected: <ul style="list-style-type: none"> <li>• video distributor power supply and ground circuits are malfunctioning.</li> <li>• headrest display unit LH power supply and ground circuits are malfunctioning.</li> <li>• AV communication circuits between AV control unit and headrest display unit LH are malfunctioning.</li> <li>• location recognition signal circuit between headrest display unit LH and ground is malfunctioning.</li> </ul>	<ul style="list-style-type: none"> <li>• Video distributor power supply and ground circuits.</li> <li>• Headrest display unit LH power supply and ground circuits.</li> <li>• AV communication circuits between AV control unit and headrest display unit LH.</li> <li>• Location recognition signal circuit between headrest display unit LH and ground.</li> </ul>
3rd Display Connection Error	When either one of the following items are detected: <ul style="list-style-type: none"> <li>• headrest display unit RH power supply and ground circuits are malfunctioning.</li> <li>• AV communication circuits between headrest display unit LH and headrest display unit RH are malfunctioning.</li> <li>• location recognition signal circuit between headrest display unit RH and ground is malfunctioning.</li> </ul>	<ul style="list-style-type: none"> <li>• Headrest display unit RH power supply and ground circuits.</li> <li>• AV communication circuits between headrest display unit LH and headrest display unit RH.</li> <li>• Location recognition signal circuit between headrest display unit RH and ground.</li> </ul>

A  
B  
C  
D  
E  
F  
G  
H  
I  
J  
K  
L  
M  
O  
P

AV

# DIAGNOSIS SYSTEM (AV CONTROL UNIT)

< SYSTEM DESCRIPTION >

[BOSE AUDIO W/NAVI W/SURROUND]

Error item	Description	Possible malfunction factor/Action to take
AM/FM antenna amplifier short to ground	Radio antenna amp. ON signal circuit malfunction is detected.	Radio antenna amp. ON signal circuit between AV control unit and antenna amp.
AM/FM antenna amplifier open		
Ext_Amp_ON output terminal short to ground	BOSE amp. ON signal circuit malfunction is detected.	BOSE amp. ON signal circuit between AV control unit and BOSE amp.
Ext_Amp_ON output terminal :open		
GPS Antenna Error	GPS antenna connection malfunction is detected.	Check the connection of the GPS antenna connector.
XM Antenna Connection Error	Satellite radio antenna connection malfunction is detected.	Satellite radio antenna disconnection.
USB electric current Error	Detection of overcurrent in USB connector.	Check USB harness between the AV control unit and USB connector.
FL-DOOR SPEAKER OUT: open	When either one of the following items are detected: <ul style="list-style-type: none"> <li>• sound signal circuits between BOSE amp. and front door speaker LH are malfunctioning.</li> <li>• sound signal circuits between BOSE amp. and front door tweeter LH are malfunctioning.</li> </ul>	<ul style="list-style-type: none"> <li>• Sound signal circuits between BOSE amp. and front door speaker LH.</li> <li>• Sound signal circuits between BOSE amp. and front door tweeter LH.</li> </ul>
FL-DOOR SPEAKER OUT: short		
FL-DOOR SPEAKER: short to ground		
FL-DOOR SPEAKER: short to battery		
FL-DOOR TWEETER OUT: open		
FL-DOOR TWEETER OUT: short		
FL-DOOR TWEETER OUT: short to ground		
FL-DOOR TWEETER OUT: short to battery		
FR-DOOR SPEAKER OUT: open	When either one of the following items are detected: <ul style="list-style-type: none"> <li>• sound signal circuits between BOSE amp. and front door speaker RH are malfunctioning.</li> <li>• sound signal circuits between BOSE amp. and front door tweeter RH are malfunctioning.</li> </ul>	<ul style="list-style-type: none"> <li>• Sound signal circuits between BOSE amp. and front door speaker RH.</li> <li>• Sound signal circuits between BOSE amp. and front door tweeter RH.</li> </ul>
FR-DOOR SPEAKER OUT: short		
FR-DOOR SPEAKER OUT: short to ground		
FR-DOOR SPEAKER OUT: short to battery		
FR-DOOR TWEETER OUT: open		
FR-DOOR TWEETER OUT: short		
FR-DOOR TWEETER OUT: short to ground		
FR-DOOR TWEETER OUT: short to battery		
FL-INST TWEETER OUT: open	Sound signal circuits between BOSE amp. and tweeter LH are malfunctioning.	Sound signal circuits between BOSE amp. and tweeter LH.
FL-INST TWEETER OUT: short		
FL-INST TWEETER OUT: short to ground		
FL-INST TWEETER OUT: short to battery		
FC-INST SPEAKER OUT: open	Malfunction is detected sound signal circuits between BOSE amp. and center speaker.	Sound signal circuits between BOSE amp. and center speaker.
FC-INST SPEAKER OUT: short		
FC-INST SPEAKER OUT: short to ground		
FC-INST SPEAKER OUT: short to battery		
FR-INST TWEETER OUT: open	Sound signal circuits between BOSE amp. and tweeter RH are malfunctioning.	Sound signal circuits between BOSE amp. and tweeter RH.
FR-INST TWEETER OUT: short		
FR-INST TWEETER OUT: short to ground		
FR-INST TWEETER OUT: short to battery		

# DIAGNOSIS SYSTEM (AV CONTROL UNIT)

< SYSTEM DESCRIPTION >

[BOSE AUDIO W/NAVI W/SURROUND]

Error item	Description	Possible malfunction factor/Action to take
2L-DOOR SPEAKER OUT: open	When either one of the following items are detected: • Sound signal circuits between BOSE amp. and rear door speaker LH are malfunctioning. • sound signal circuits between BOSE amp. and rear door tweeter LH are malfunctioning.	• Sound signal circuits between BOSE amp. and rear door speaker LH. • Sound signal circuits between BOSE amp. and rear door tweeter LH.
2L-DOOR SPEAKER OUT: short		
2L-DOOR SPEAKER OUT: short to ground		
2L-DOOR SPEAKER OUT: short to battery		
2L-DOOR TWEETER OUT: open		
2L-DOOR TWEETER OUT: short		
2L-DOOR TWEETER OUT: short to ground		
2L-DOOR TWEETER OUT: short to battery	When either one of the following items are detected: • Sound signal circuits between BOSE amp. and rear door speaker RH are malfunctioning. • Sound signal circuits between BOSE amp. and rear door tweeter RH are malfunctioning.	• Sound signal circuits between BOSE amp. and rear door speaker RH. • Sound signal circuits between BOSE amp. and rear door tweeter RH.
2R-DOOR SPEAKER OUT: open		
2R-DOOR SPEAKER OUT: short		
2R-DOOR SPEAKER OUT: short to ground		
2R-DOOR SPEAKER OUT: short to battery		
2R-DOOR TWEETER OUT: open		
2R-DOOR TWEETER OUT: short		
2R-DOOR TWEETER OUT: short to ground	Sound signal circuits between BOSE amp. and rear speaker LH are malfunctioning.	Sound signal circuits between BOSE amp. and rear speaker LH.
2R-DOOR TWEETER OUT: short to battery		
RL-SPEAKER OUT: open		
RL-SPEAKER OUT: short	Sound signal circuits between BOSE amp. and rear speaker RH are malfunctioning.	Sound signal circuits between BOSE amp. and rear speaker RH.
RL-SPEAKER OUT: short to ground		
RL-SPEAKER OUT: short to battery		
RR-SPEAKER OUT: open	Sound signal circuits between BOSE amp. and subwoofer are malfunctioning.	Sound signal circuits between BOSE amp. and subwoofer.
RR-SPEAKER OUT: short		
RR-SPEAKER OUT: short to ground		
RR-SPEAKER OUT: short to battery		
SUBWOOFER OUT: open	When either one of the following items are detected: • multifunction switch power supply and ground circuits were malfunctioning. • AV communication circuits between AV control unit and multifunction switch are malfunctioning.	• Multifunction switch power supply and ground circuits. • AV communication circuits between AV control unit and multifunction switch.
SUBWOOFER OUT: short		
SUBWOOFER OUT: short to ground		
SUBWOOFER OUT: short to battery		
• AV COMM CIRCUIT • Switches Connection Error	When either one of the following items are detected: • BOSE amp. power supply and ground circuits are malfunctioning. • AV communication circuits between headrest display unit LH and BOSE amp. are malfunctioning.	• BOSE amp. power supply and ground circuits. Refer to <a href="#">AV-816. "BOSE AMP. : Diagnosis Procedure"</a> . • AV communication circuits between headrest display unit LH and BOSE amp.
• AV COMM CIRCUIT • Amplifier Connection Error		

A  
B  
C  
D  
E  
F  
G  
H  
I  
J  
K  
L  
M  
AV  
O  
P

# DIAGNOSIS SYSTEM (AV CONTROL UNIT)

< SYSTEM DESCRIPTION >

[BOSE AUDIO W/NAVI W/SURROUND]

Error item	Description	Possible malfunction factor/Action to take
<ul style="list-style-type: none"> <li>• AV COMM CIRCUIT</li> <li>• AVM Connection Error</li> </ul>	When either one of the following items are detected: <ul style="list-style-type: none"> <li>• around view monitor control unit power supply and ground circuits are malfunctioning.</li> <li>• AV communication circuits between AV control unit and around view monitor control unit are malfunctioning.</li> </ul>	<ul style="list-style-type: none"> <li>• Around view monitor control unit power supply and ground circuits.</li> <li>• AV communication circuits between AV control unit and around view monitor control unit.</li> </ul>
<ul style="list-style-type: none"> <li>• AV COMM CIRCUIT</li> <li>• Sonar Connection Error</li> </ul>	When either one of the following items are detected: <ul style="list-style-type: none"> <li>• sonar control unit power supply and ground circuits are malfunctioning.</li> <li>• AV communication circuits between AV control unit and sonar control unit are malfunctioning.</li> </ul>	<ul style="list-style-type: none"> <li>• Sonar control unit power supply and ground circuits.</li> <li>• AV communication circuits between AV control unit and sonar control unit.</li> </ul>
<ul style="list-style-type: none"> <li>• AV COMM CIRCUIT</li> <li>• Switches Connection Error</li> <li>• Sonar Connection Error</li> <li>• AVM Connection Error</li> <li>• 2nd Display Connection Error</li> </ul>	AV communication circuits between AV control unit and multifunction switch are malfunctioning.	AV communication circuits between AV control unit and multifunction switch.
<ul style="list-style-type: none"> <li>• AV COMM CIRCUIT</li> <li>• Switches Connection Error</li> <li>• Amplifier Connection Error</li> <li>• Sonar Connection Error</li> <li>• AVM Connection Error</li> <li>• 2nd Display Connection Error</li> </ul>		

### Vehicle CAN Diagnosis

- CAN communication status and error counter is displayed.
- The error counter displays “OK” if any malfunction was not detected in the past and displays “0” if a malfunction is detected. It increases by 1 if the condition is normal at the next ignition switch ON cycle. The upper limit of the counter is 39.
- The error counter is erased if “Reset” is pressed.

Items	Display (Current)	Malfunction counter (Past)
Tx(HVAC)	OK / ???	OK / 0 – 39
Rx(ECM)	OK / ???	OK / 0 – 39
Rx(Cluster)	OK / ???	OK / 0 – 39
Rx(HVAC)	OK / ???	OK / 0 – 39
Rx(USM)	OK / ???	OK / 0 – 39
Rx(TPMS)	OK / ???	OK / 0 – 39
Rx(STRG)	OK / ???	OK / 0 – 39
Rx(ACC)	OK / ???	OK / 0 – 39
RX(VDC)	OK / ???	OK / 0 – 39

**NOTE:**

“???” indicates UNKWN.

### AV COMM Diagnosis

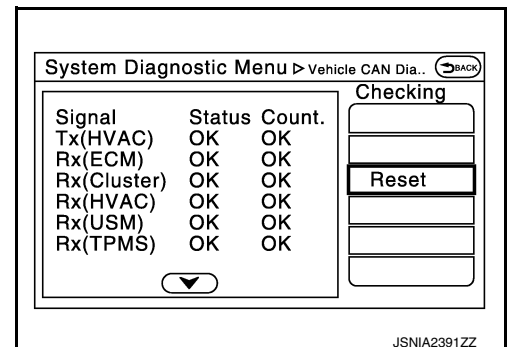

# DIAGNOSIS SYSTEM (AV CONTROL UNIT)

[BOSE AUDIO W/NAVI W/SURROUND]

## < SYSTEM DESCRIPTION >

- Displays the communication status between AV control unit (master unit) and each unit.
- The error counter displays “OK” if any malfunction was not detected in the past and displays “0” if a malfunction is detected. It increases by 1 if the condition is normal at the next ignition switch ON cycle. The upper limit of the counter is 39.
- The error counter is erased if “Reset” is pressed.

Items	Status (Current)	Counter (Past)
C Tx(ITM-PrimarySW)	OK / ???	OK / 0 – 39
C Rx(PrimarySW-ITM)	OK / ???	OK / 0 – 39
C Rx(Amp-ITM)	OK / ???	OK / 0 – 39
C Rx(Amp-Audio)	OK / ???	OK / 0 – 39
C Rx(AVM-ITM)	OK / ???	OK / 0 – 39
C Rx(Disp.3-Video Dist)	OK / ??? / –	OK / 0 – 39
C Rx(Video Dist-ITM)	OK / ???	OK / 0 – 39
C Rx(Sonar-ITM)	OK / ???	OK / 0 – 39
C Rx(Sonar-AVM)	OK / ???	OK / 0 – 39
C Rx(R.RemoteCont-ITM)	OK / ???	OK / 0 – 39

### NOTE:

“???” indicates UNKWN

### Hands-Free Phone

The hands-free phone reception volume adjustment and microphone and speaker test functions are also available.

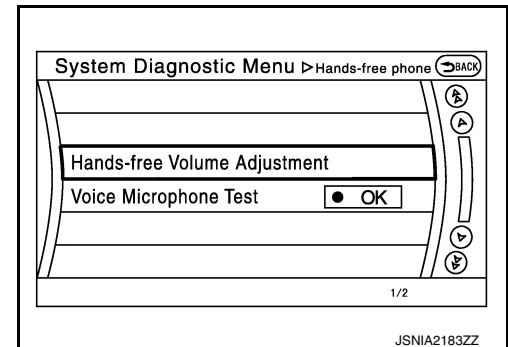
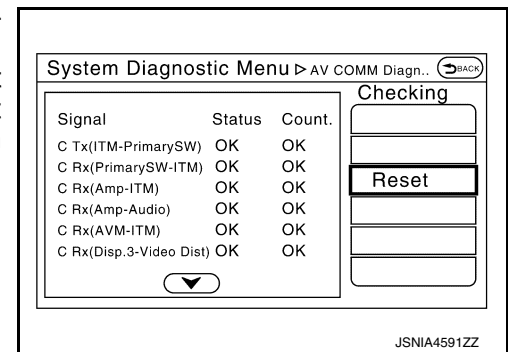

### XM

- Change Channel
  - Any necessary channels required to receive traffic information from the satellite radio system can be set.
- Change Application ID
  - Any application ID's required to receive traffic information from the satellite radio system can be set.

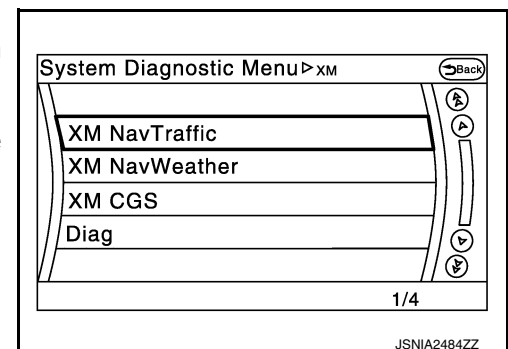

### Delete Unit Connection Log

# DIAGNOSIS SYSTEM (AV CONTROL UNIT)

[BOSE AUDIO W/NAVI W/SURROUND]

## < SYSTEM DESCRIPTION >

Deletes any unit connection records and error records from the AV control unit memory. (Clear the records of the unit that has been removed.)

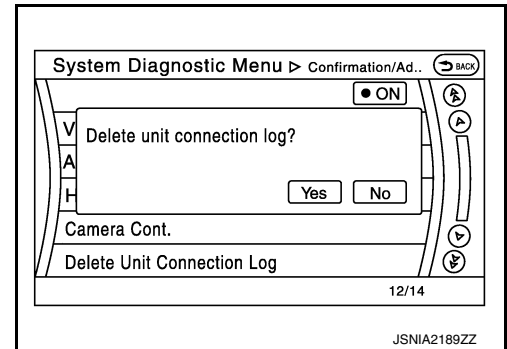

## Initialize Settings

“User Data Initialization” and “Accessory Number Initialization” are possible.

### CAUTION:

- **Never perform Accessory Number Initialization except when configuration is unsuccessful.**
- **Accessory Number Initialization requires configuration. For details, refer to [AV-743, "CONFIGURATION \(AV CONTROL UNIT\) : Description"](#).**

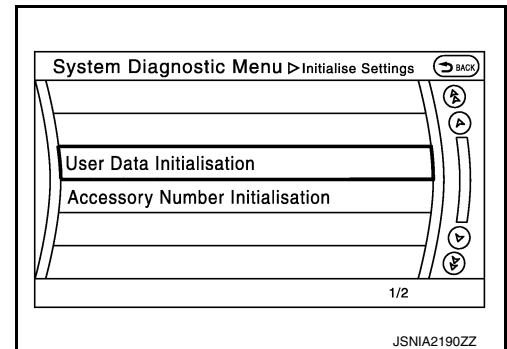

## Version Information

Version information of the AV control unit is displayed.

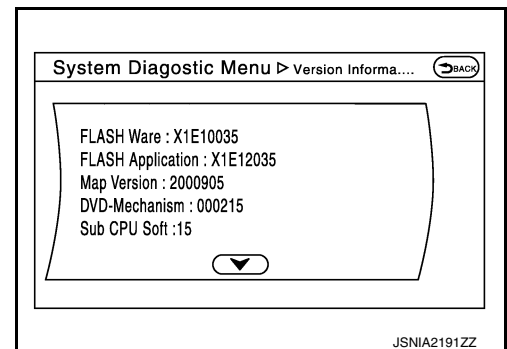

INFOID:000000009129292

## CONSULT Function

### CAUTION:

**After disconnecting the CONSULT vehicle interface (VI) from the data link connector, the ignition must be cycled OFF → ON (for at least 5 seconds) → OFF. If this step is not performed, the BCM may not go to “sleep mode”, potentially causing a discharged battery and a no-start condition.**

## CONSULT FUNCTIONS

CONSULT performs the following functions via communication with the AV control unit.

# DIAGNOSIS SYSTEM (AV CONTROL UNIT)

< SYSTEM DESCRIPTION >

[BOSE AUDIO W/NAVI W/SURROUND]

Direct Diagnostic Mode	Description
Ecu Identification	The AV control unit part number is displayed.
Self Diagnostic Result	The AV control unit self diagnostic results are displayed.
Data Monitor	The AV control unit input/output data is displayed in real time.
Work support	The settings for AV control unit functions can be changed.
Configuration	<ul style="list-style-type: none"><li>The vehicle specification can be read and saved.</li><li>The vehicle specification can be written when replacing AV control unit.</li></ul>
CAN Diag Support Mntr	<ul style="list-style-type: none"><li>The result of transmit/receive diagnosis of AV communication is displayed.</li><li>The result of transmit/receive diagnosis of CAN communication is displayed.</li></ul>

## ECU IDENTIFICATION

The part number of AV control unit is displayed.

## SELF DIAGNOSTIC RESULT

Refer to [AV-660, "DTC Index"](#).

## DATA MONITOR

Monitor Item [Unit]	Description
VHCL SPD SIG [On/Off]	Indicates vehicle speed signal received from combination meter on CAN communication line.
PKB SIG [On/Off]	Indicates condition of park brake signal.
ILLUM SIG [On/Off]	Indicates condition of illumination signal for the A/C and AV switch assembly.
IGN SIG [On/Off]	Indicates condition of ignition signal.
REV SIG [On/Off]	Indicates condition of reverse signal received from BCM.

## WORK SUPPORT

Conditions	Description
ST ANGLE SENSOR ADJUSTMENT	Steering angle sensor neutral position adjustment can be performed. Refer to <a href="#">BRC-60, "Description"</a> .

## CONFIGURATION

Refer to [AV-743, "CONFIGURATION \(AV CONTROL UNIT\) : Description"](#).

## CAN DIAG SUPPORT MNTR

Refer to [LAN-23, "CAN Diagnostic Support Monitor"](#).

A  
B  
C  
D  
E  
F  
G  
H  
I  
J  
K  
L  
M

AV

O  
P

# DIAGNOSIS SYSTEM (AROUND VIEW MONITOR CONTROL UNIT)

< SYSTEM DESCRIPTION >

[BOSE AUDIO W/NAVI W/SURROUND]

## DIAGNOSIS SYSTEM (AROUND VIEW MONITOR CONTROL UNIT)

### CONSULT Function

INFOID:000000009129293

#### CAUTION:

After disconnecting the CONSULT vehicle interface (VI) from the data link connector, the ignition must be cycled OFF → ON (for at least 5 seconds) → OFF. If this step is not performed, the BCM may not go to “sleep mode”, potentially causing a discharged battery and a no-start condition.

#### CONSULT FUNCTIONS

CONSULT performs the following functions via communication with the around view monitor control unit.

Direct Diagnostic Mode	Description
Ecu Identification	The around view monitor control unit part number is displayed.
Self Diagnostic Result	The around view monitor control unit self diagnostic results are displayed.
Data Monitor	The around view monitor control unit input/output data is displayed in real time.
Work support	The settings for around view monitor control unit functions can be changed.
Configuration	<ul style="list-style-type: none"><li>The vehicle specification can be read and saved.</li><li>The vehicle specification can be written when replacing around view monitor control unit.</li></ul>
CAN Diag Support Mntr	The result of transmit/receive diagnosis of CAN communication is displayed.

#### ECU IDENTIFICATION

The part number of around view monitor control unit is displayed.

#### SELF DIAGNOSTIC RESULT

Refer to [AV-679, "DTC Index"](#).

#### DATA MONITOR

Monitor Item	Description
ST ANGLE SENSOR SIGNAL [On/Off]	Indicates condition of steering angle sensor signal.
REVERSE SIGNAL [On/Off]	Indicates selector lever position.
VEHICLE SPEED SIGNAL [mph/km/h]	Indicates condition of vehicle speed signal.
CAMERA SWITCH SIGNAL [On/Off]	Indicates condition of camera switch signal.
CAMERA OFF SIGNAL [On/Off]	Indicates condition of camera OFF signal.
ST ANGLE SENSOR TYPE [Absolute]	Indicates steering angle sensor type.
ST GEAR RATIO TYPE [Type O]	Indicates steering gear ratio type.
STEERING POSITION [LHD/RHD]	Indicates drive type.
REAR CAMERA IMAGE SIGNAL [OK]	Indicates condition of camera image signal.
R-CAMERA COMM STATUS [OK]	Indicates condition of camera communication.
R-CAMERA COMM LINE [OK]	Indicates condition of camera communication signal.
F-CAMERA IMAGE SIGNAL [OK]	Indicates condition of camera image signal.
F-CAMERA COMM STATUS [OK]	Indicates condition of camera communication.
F-CAMERA COMM LINE [OK]	Indicates condition of camera communication signal.
DR-SIDE CAMERA IMAGE SIG [OK]	Indicates condition of camera image signal.
DR CAMERA COMM STATUS [OK]	Indicates condition of camera communication.
DR-SIDE CAMERA COMM LINE [OK]	Indicates condition of camera communication signal.
PA-SIDE CAMERA IMAGE SIG [OK]	Indicates condition of camera image signal.
PA CAMERA COMM STATUS [OK]	Indicates condition of camera communication.
PA-SIDE CAMERA COMM LINE [OK]	Indicates condition of camera communication signal.
ACC [OK]	Indicates condition of accessory signal.



# DIAGNOSIS SYSTEM (AROUND VIEW MONITOR CONTROL UNIT)

< SYSTEM DESCRIPTION >

[BOSE AUDIO W/NAVI W/SURROUND]

Monitor Item	Description
FOLDING MOTOR VOLT 1 [On/Off]	indicates condition of mirror folding motor.
FOLDING MOTOR VOLT 2 [On/Off]	indicates condition of mirror folding motor.

## WORK SUPPORT

Support Item	Setting	Description
NON-VIEWABLE AREA REMINDER	—	ON/OFF setting of non-viewable area can be performed.
INITIALIZE CAMERA IMAGE CALIBRATION	—	Factory image calibration restoration can be performed.
STEERING ANGLE SENSOR ADJUSTMENT	—	Steering angle sensor neutral position adjustment can be performed.
CALIBRATING CAMERA IMAGE (FRONT CAMERA)	STATUS	Performs calibration of front camera.
	AXIS X	
	AXIS Y	
	ROTATE	
CALIBRATING CAMERA IMAGE (PASS-SIDE CAMERA)	STATUS	Performs calibration of passenger side camera.
	AXIS X	
	AXIS Y	
	ROTATE	
CALIBRATING CAMERA IMAGE (DR-SIDE CAMERA)	STATUS	Performs calibration of driver side camera.
	AXIS X	
	AXIS Y	
	ROTATE	
CALIBRATING CAMERA IMAGE (REAR CAMERA)	STATUS	Performs calibration of rear camera.
	AXIS X	
	AXIS Y	
	ROTATE	
FINE TUNING OF BIRDS-EYE VIEW	STATUS	Confirmation and adjustment of difference between each camera can be performed.
	SELECT	
	AXIS X	
	AXIS Y	
	ROTATE	
REAR WIDE-VIEW FIXED GUIDE LINE CORRECTION	STATUS	Performs calibration of rear wide-view guide line correction.
	AXIS X	
	AXIS Y	
	Pattern	
TURNING RADIUS CORRECTION	STATUS	Performs calibration of turning radius correction.
	Crrct	
PARTS WITH DOOR MIRROR AUTO FOLD FUNC	On	Performs setting of auto fold mirror function.
	Off	
SONAR Off POP-UP DISPLAY SETTING CHANGE	On	Performs setting of sonar pop-up display.
	Off	
FRONT WIDE-VIEW FIXED GUIDE LINE CORRECTION	STATUS	Performs calibration of front wide-view guide line correction.
	AXIS X	
	AXIS Y	
	Pattern	

A  
B  
C  
D  
E  
F  
G  
H  
I  
J  
K  
L  
M  
O  
P

AV

# DIAGNOSIS SYSTEM (AROUND VIEW MONITOR CONTROL UNIT)

< SYSTEM DESCRIPTION >

[BOSE AUDIO W/NAVI W/SURROUND]

Support Item	Setting	Description
ZOOM FUNCTION	STATUS	Adjustment of magnification setting of cameras can be performed.
	SELECT	
	Mgnfct	

## CONFIGURATION

Refer to [AV-745, "CONFIGURATION \(AROUND VIEW MONITOR CONTROL UNIT\) : Description"](#).

## CAN DIAG SUPPORT MNTR

Refer to [LAN-23, "CAN Diagnostic Support Monitor"](#).

# DIAGNOSIS SYSTEM [SONAR CONTROL UNIT (WITH AROUND VIEW MONITOR)]

< SYSTEM DESCRIPTION >

[BOSE AUDIO W/NAVI W/SURROUND]

## DIAGNOSIS SYSTEM [SONAR CONTROL UNIT (WITH AROUND VIEW MONITOR)]

### CONSULT Function

INFOID:000000009129294

#### CAUTION:

After disconnecting the CONSULT vehicle interface (VI) from the data link connector, the ignition must be cycled OFF → ON (for at least 5 seconds) → OFF. If this step is not performed, the BCM may not go to “sleep mode”, potentially causing a discharged battery and a no-start condition.

#### APPLICATION ITEMS

CONSULT can display each diagnostic item using the diagnostic test modes shown as follows:

Test mode	Function
Ecu Identification	Sonar control unit part number can be read.
Self Diagnostic Result	Sonar control unit checks the conditions and displays memorized error.
Data Monitor	Sonar control unit input/output data in real time.
Active Test	Gives a drive signal to a load to check the operation.
Work support	Changes setting of each function.

#### ECU IDENTIFICATION

Displays the part number of sonar control unit.

#### SELF-DIAGNOSTIC RESULTS

For details, refer to [AV-682. "DTC Index"](#).

#### DATA MONITOR

Monitor Item	Description
VEHICLE SPEED [mph/km/h]	Indicates vehicle speed signal received from combination meter on CAN communication line.
SONAR C/U POWER SUPPLY [V]	Indicates condition of supply voltage signal to sonar control unit.
SENSOR VOLTAGE [V]	Indicates condition of voltage signal to sonar sensors.
DETECTION MODE [Mode 1/Mode 2]	Indicates condition of display detection mode.
SW OPRT AFTR IGN ON [Yes/No]	Indicates condition of switch operation after ignition ON signal.
SONAR TEMPORARY OFF [Yes/No]	Indicates condition of sonar system.
SONAR PERMANENT OFF [Yes/No]	Indicates condition of sonar system.
P N RANGE [On/Off]	Indicates condition of selector lever P (park) or N (neutral) position.
LED [On/Off]	Indicates condition of LED.
TRAILER CONNECT [CON/N CON]	Indicates condition of Trailer connector.
REVERSE RANGE [On/Off]	Indicates condition of transmission range switch R (reverse) position.

# DIAGNOSIS SYSTEM [SONAR CONTROL UNIT (WITH AROUND VIEW MONITOR)]

< SYSTEM DESCRIPTION >

[BOSE AUDIO W/NAVI W/SURROUND]

Monitor Item	Description
SHRT DST FRM RR SENS [cm/in]	Indicates distance to obstacle.
SHRT DST FRM FR SENS [cm/in]	
COR[RL] [cm/in]	
COR[RL]->CEN[RL]/CEN[R] [cm/in]	
CEN[RL]/CEN[R]->COR[RL] [cm/in]	
CEN[RL]/CEN[R] [cm/in]	
CEN[RL]->CEN[RR] [cm/in]	
CEN[RR]->CEN[RL] [cm/in]	
CEN[RR] [cm/in]	
CEN[RR]/CEN[R]->COR[RR] [cm/in]	
COR[RR]-> CEN[RR]/CEN[R] [cm/in]	
COR[RR] [cm/in]	
COR[FL] [cm/in]	
COR[FR] [cm/in]	
RVRB TIME COR[RL] [ms/sec]	Indicates distance to obstacle.
RVRB TIME COR[RR] [ms/sec]	
RVRB TIME CEN[RL] [ms/sec]	
RVRB TIME CEN[RR] [ms/sec]	
RVRB TIME COR[FL] [ms/sec]	
RVRB TIME COR[FR] [ms/sec]	

## ACTIVE TEST

Test Item	Description
REAR BUZZER	This test is able to check rear buzzer operation [On/Off].

## WORK SUPPORT

Support Item	Setting	Description
VOLUME SETTING	Vol.1	Allows you to set volume of warning tone.
	Low	
	Vol.3	
	Middle	
	Vol.5	
	High	
	Off	
TRAILER HITCH DETECTION RANGE ADJUSTMENT	Qu	Allows you to adjust rear sonar sensors for trailer towing.
	UP	
	DOWN	
	Qd	

# AV CONTROL UNIT

< ECU DIAGNOSIS INFORMATION >

[BOSE AUDIO W/NAVI W/SURROUND]

## ECU DIAGNOSIS INFORMATION

### AV CONTROL UNIT

Reference Value

INFOID:000000009129297

#### VALUES ON THE DIAGNOSIS TOOL

Monitor Item	Condition	Value/Status
VHCL SPD SIG	Vehicle speed = 0 km/h (0 MPH).	Off
	Vehicle speed > 0 km/h (0 MPH).	On
PKB SIG	Parking brake released.	Off
	Parking brake applied.	On
ILLUM SIG	Illumination signal is not received.	Off
	Illumination signal is received.	On
IGN SIG	Ignition switch OFF or ACC.	Off
	Ignition switch ON.	On
REV SIG	Selector lever in any position other than R.	Off
	Selector lever in R position.	On

#### TERMINAL LAYOUT

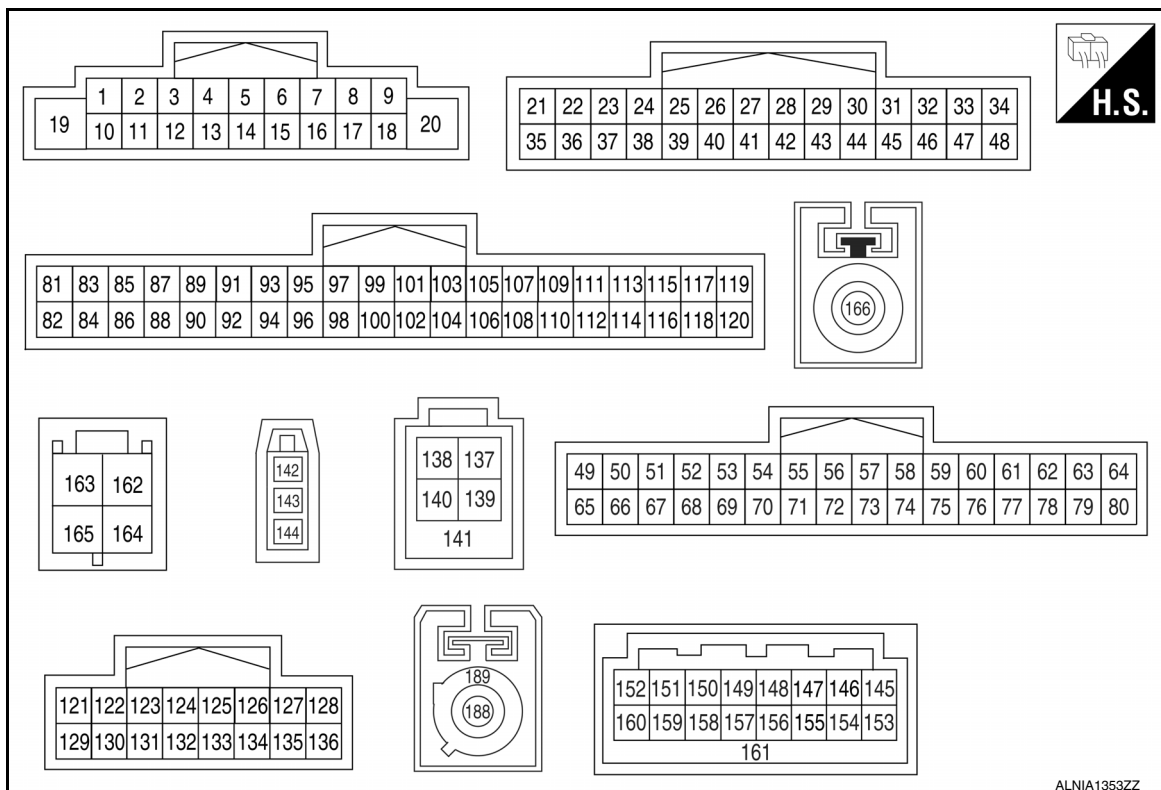





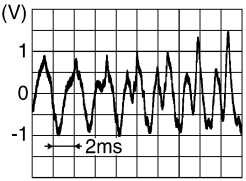
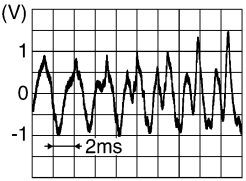

#### PHYSICAL VALUES

# AV CONTROL UNIT

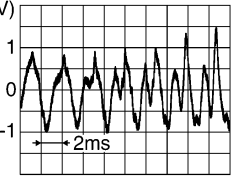
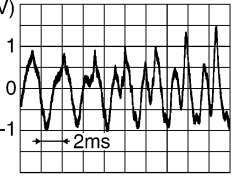
< ECU DIAGNOSIS INFORMATION >

[BOSE AUDIO W/NAVI W/SURROUND]

Terminal (Wire color)		Description		Condition		Reference value (Approx.)
+	-	Signal name	Input/ Output	Ignition switch	Operation	
2 (B)	3 (W)	Pre amp sound signal front LH	Output	ON	Sound output	 <p style="text-align: right; font-size: small;">SKIB3609E</p>
4 (B)	5 (W)	Pre amp sound signal rear LH	Output	ON	Sound output	 <p style="text-align: right; font-size: small;">SKIB3609E</p>
6 (G)	15 (B)	Steering switch signal A	Input	ON	Press SOURCE switch.	0 V
					Press $\Delta$ switch.	1.0 V
					Press $\nabla$ switch.	2.0 V
					Press  switch	3.0 V
					Press ENTER switch.	4.0 V
					Except for above.	5.0 V
7 (G)	Ground	ACC power supply	Input	ACC	—	Battery voltage
10 (BR)	—	Pre amp sound signal shield	—	—	—	—
11 (W)	12 (B)	Pre amp sound signal front RH	Output	ON	Sound output	 <p style="text-align: right; font-size: small;">SKIB3609E</p>
13 (B)	14 (W)	Pre amp sound signal rear RH	Output	ON	Sound output	 <p style="text-align: right; font-size: small;">SKIB3609E</p>
16 (W)	15 (B)	Steering switch signal B	Input	ON	Press  switch.	0 V
					Press  switch.	1.0 V
					Press  switch.	2.0 V
					Press  switch.	3.0 V
					Except for above.	5.0 V

# AV CONTROL UNIT

< ECU DIAGNOSIS INFORMATION >

[BOSE AUDIO W/NAVI W/SURROUND]

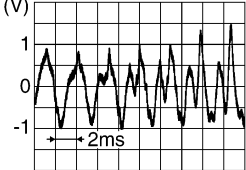
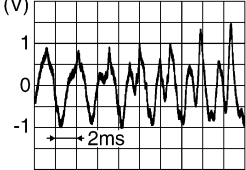
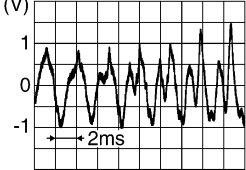
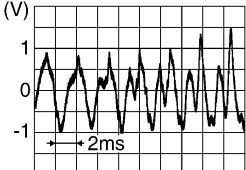
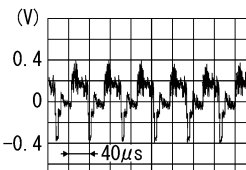
Terminal (Wire color)		Description		Condition		Reference value (Approx.)
+	-	Signal name	Input/ Output	Ignition switch	Operation	
19 (Y)	Ground	Battery power supply	Input	OFF	—	Battery voltage
20 (GR)	Ground	Ground	—	ON	—	0 V
24 (W)	39 (B)	Auxiliary sound signal LH	Input	ON	Sound output when front AUX mode selected	 <small>SKIB3609E</small>
26 (W)	40 (R)	Headphone sound signal LH	Output	ON	When DVD or USB mode is selected on headrest display unit LH or RH.	 <small>SKIB3609E</small>
27 (B)	41 (G)	Headphone sound signal RH	Output	ON	When DVD or USB mode is selected on headrest display unit LH or RH.	 <small>SKIB3609E</small>
37 (Shield)	—	Auxiliary sound signal shield	—	—	—	—
38 (R)	39 (B)	Auxiliary sound signal RH	Input	ON	When front AUX mode is selected.	 <small>SKIB3609E</small>
42 (Shield)	—	Headphone sound signal shield	—	—	—	—
53 (G)	Ground	Parking brake signal	Input	ON	Parking brake is applied.	0 V
					Parking brake is released.	4.5 V
55 (W)	Ground	Composite image signal ground	—	ON	—	0 V
56 (B)	Ground	Composite image signal	Output	ON	When DVD image is displayed.	 <small>SKIB2251J</small>

A  
B  
C  
D  
E  
F  
G  
H  
I  
J  
K  
L  
M  
AV  
O  
P

# AV CONTROL UNIT

< ECU DIAGNOSIS INFORMATION >

[BOSE AUDIO W/NAVI W/SURROUND]

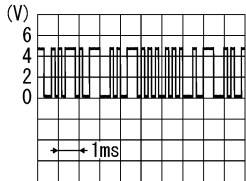
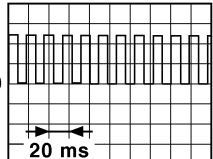
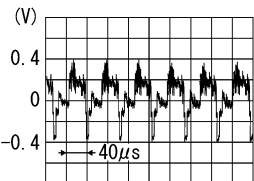
Terminal (Wire color)		Description		Condition		Reference value (Approx.)
+	-	Signal name	Input/ Output	Ignition switch	Operation	
57 (BG)	—	I-Key memory	—	—	—	—
58 (G)	—	AV-ACC (DCM)	—	—	—	—
59 (Shield)	—	Microphone signal shield	—	—	—	—
60 (W)	Ground	Microphone voltage	Output	ON	—	5.0 V
61 (W)	Ground	Communication signal (CONT→DISP)	Output	ON	When adjusting display brightness.	 <p style="text-align: right; font-size: small;">PKIB5039J</p>
62 (P)	—	CAN-L	Input/ Output	—	—	—
63 (LG)	—	AV communication signal (L)	Input/ Output	—	—	—
64 (LG)	—	AV communication signal (L) terminate	—	—	—	—
67 (P)	—	MR output	—	—	—	—
68 (LG)	Ground	Ignition signal	Input	ON	—	Battery voltage
69 (R)	Ground	Reverse signal	Input	ON	Selector lever is in R position.	Battery voltage
					Selector lever is in other than R position.	0 V
70 (BG)	Ground	Vehicle speed signal (8-pulse)	Input	ON	When vehicle speed is approx. 40 km/h (25 MPH)	<p><b>NOTE:</b> The maximum voltage varies depending on the specification (destination unit).</p>  <p style="text-align: right; font-size: small;">JSNIA0012GB</p>
71 (Shield)	—	Composite image signal shield	—	—	—	—
72 (R)	Ground	Composite image synchronizing signal	Output	ON	At DVD image is displayed.	 <p style="text-align: right; font-size: small;">SKIB2251J</p>



# AV CONTROL UNIT

< ECU DIAGNOSIS INFORMATION >

[BOSE AUDIO W/NAVI W/SURROUND]

Terminal (Wire color)		Description		Condition		Reference value (Approx.)
+	-	Signal name	Input/ Output	Ignition switch	Operation	
75 (B)	59 (Shield)	Microphone signal	Input	ON	Give a voice.	
76 (Shield)	—	Communication signal shield	—	—	—	—
77 (B)	Ground	Communication signal (DISP→CONT)	Input	ON	When adjusting display brightness.	
78 (L)	—	CAN-H	Input/ Output	—	—	—
79 (SB)	—	AV communication signal (H)	—	—	—	—
80 (SB)	—	AV communication signal (H) terminate	—	—	—	—
91 (W)	Ground	Auxiliary image signal	Input	ON	At front AUX image is displayed.	
92 (B)	Ground	Auxiliary image signal ground	—	ON	—	0 V
94 (Shield)	—	Auxiliary image signal shield	—	—	—	—
97 (Y)	Ground	Disk eject signal	Input	ON	Pressing the eject switch.	0 V
					Except for above.	5.0 V
98 (V)	Ground	Switch ground	—	ON	—	0 V
105 (W)	Ground	Composite image signal ground	—	ON	—	0 V
106 (Shield)	—	Composite image signal shield	—	—	—	—
107 (B)	Ground	Composite image signal	Output	ON	When DVD, USB or front AUX image is displayed on headrest display unit LH or RH.	

A  
B  
C  
D  
E  
F  
G  
H  
I  
J  
K  
L  
M  
AV  
O  
P

# AV CONTROL UNIT

< ECU DIAGNOSIS INFORMATION >

[BOSE AUDIO W/NAVI W/SURROUND]

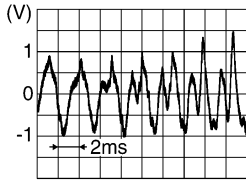
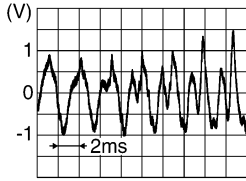
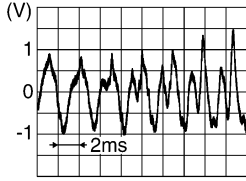
Terminal (Wire color)		Description	Input/ Output	Condition		Reference value (Approx.)
+	-			Signal name	Ignition switch	
122 (B)	123 (W)	Sound signal guide	Output	ON	Sound output	 <p style="text-align: right; font-size: small;">SKIB3609E</p>
124 (B)	132 (W)	Pre amp sound signal sub-woofer	Output	ON	Sound output	 <p style="text-align: right; font-size: small;">SKIB3609E</p>
125 (W)	133 (B)	Pre amp sound signal center	Output	ON	Sound output	 <p style="text-align: right; font-size: small;">SKIB3609E</p>
126 (Y)	—	Pre amp sound signal shield	—	—	—	—
131 (Shield)	—	Sound signal guide shield	—	—	—	—
137 (W)	—	VBUS signal (USB interface)	—	—	—	—
138 (G)	—	USB ground (USB interface)	—	—	—	—
139 (L)	—	USB D+ signal (USB interface)	—	—	—	—
140 (R)	—	USB D- signal (USB interface)	—	—	—	—
141 (Shield)	—	USB shield (USB interface)	—	—	—	—
142 (B)	Ground	Antenna amp. ON signal	Input	ON	—	Battery voltage
143 (B)	—	AM-FM main	Input	—	—	—
144 (B)	—	FM sub	Input	—	—	—
145 (B)	—	USB D- signal (Telematics)	Input	—	—	—
146 (B)	—	USB VBUS signal (Telematics)	Input	—	—	—
147 (W)	—	Manufacturer specific signal (Telematics)	Input	—	—	—

# AV CONTROL UNIT

< ECU DIAGNOSIS INFORMATION >

[BOSE AUDIO W/NAVI W/SURROUND]

Terminal (Wire color)		Description	Condition			Reference value (Approx.)
+	-	Signal name	Input/ Output	Ignition switch	Operation	
151 (L)	—	VOICE ground (Telematics)	Input	—	—	—
152 (W)	—	U-VOICE signal (Telematics)	Input	—	—	—
153 (L/W)	—	USB D+ signal (Telematics)	Input	—	—	—
154 (Shield)	—	USB ground	—	—	—	—
160 (B)	—	D-VOICE signal (Telematics)	—	—	—	—
161 (Shield)	—	USB shield (Telematics)	—	—	—	—
162 (Shield)	—	RGB digital image signal shield	—	—	—	—
163 (Shield)	—	RGB digital image signal shield	—	—	—	—
164 (B)	Ground	RGB digital image signal (-)	Output	ON	Connector disconnected.	1.3 V
165 (B)	Ground	RGB digital image signal (+)	Output	ON	Connector disconnected.	1.3 V
166 (B)	Ground	Satellite radio antenna sig- nal	Input	ON	Connector disconnected.	5.0 V
188 (B)	Ground	GPS antenna signal	Input	ON	Connector disconnected.	5.0 V
189 (Shield)	—	GPS antenna signal shield	—	—	—	—

## Fail-Safe

INFOID:000000009129298

When the ambient temperature becomes extremely low or extremely high, AV control unit displays a message and limits the function of the AV control unit.

### FAIL-SAFE CONDITIONS

When the ambient temperature is  $-20^{\circ}\text{C}$  ( $-4^{\circ}\text{F}$ ) or lower, or when it is  $70^{\circ}\text{C}$  ( $158^{\circ}\text{F}$ ) or higher.

#### Display

The following messages are displayed during fail-safe:

Fail-safe mode	Display
When HDD temperature is low	HDD system is experiencing problems due to extreme low temperature. Normal operation will resume when temperature rises.
When HDD temperature is high	HDD system is experiencing problems due to extreme high temperature. Normal operation will resume when temperature drops.

## DESCRIPTION OF CONTROLS

Function	Fail-safe mode activated	
Air conditioner	Operation	A/C and AV switch assembly can be operated.
	Display	<ul style="list-style-type: none"> <li>• LEDs of A/C and AV switch assembly illuminate.</li> <li>• Temperature, mode and blower speed are displayed in a simplified mode.</li> </ul>
Audio	Operation	Only ON/OFF and volume control operations of A/C and AV switch assembly are available.
	Display	"Fail-safe mode" is displayed.

# AV CONTROL UNIT

< ECU DIAGNOSIS INFORMATION >

[BOSE AUDIO W/NAVI W/SURROUND]

Function		Fail-safe mode activated
Camera	Operation	Image tone cannot be controlled.
	Display	Cannot be superimposed. (warning display, tone control display)
Hands-free phone	Operation	Inoperative.
Navigation	Operation	Inoperative.
Self diagnosis		Displays in a simplified mode.
CONSULT diagnosis		Inoperative.

## Ability Operation Mode

If HDD data can be read, "Fail-safe mode" is displayed and functions listed above can be operated.

## DTC Index

INFOID:000000009129299

## SELF-DIAGNOSIS RESULTS DISPLAY ITEM

CONSULT Display	Reference Page
U1000: CAN COMM CIRCUIT	<a href="#">AV-755, "AV CONTROL UNIT : DTC Logic"</a>
U1010: CONTROL UNIT (CAN)	<a href="#">AV-756, "AV CONTROL UNIT : DTC Logic"</a>
U1200: CONT UNIT	<a href="#">AV-757, "DTC Logic"</a>
U1201: GYRO NO CONN	<a href="#">AV-758, "DTC Logic"</a>
U1202: G-SENSOR NO CONN	<a href="#">AV-759, "DTC Logic"</a>
U1204: GPS COMM	<a href="#">AV-760, "DTC Logic"</a>
U1205: GPS ROM	<a href="#">AV-761, "DTC Logic"</a>
U1206: GPS RAM	<a href="#">AV-762, "DTC Logic"</a>
U1207: GPS RTC	<a href="#">AV-763, "DTC Logic"</a>
U1216: CAN CONT	<a href="#">AV-764, "DTC Logic"</a>
U1217: BLUETOOTH MODULE	<a href="#">AV-765, "DTC Logic"</a>
U1218: HDD CONN	<a href="#">AV-766, "DTC Logic"</a>
U1219: HDD READ	<a href="#">AV-767, "DTC Logic"</a>
U121A: HDD WRITE	<a href="#">AV-768, "DTC Logic"</a>
U121B: HDD COMM	<a href="#">AV-769, "DTC Logic"</a>
U121C: HDD ACCESS	<a href="#">AV-770, "DTC Logic"</a>
U121D: DSP CONN	<a href="#">AV-771, "DTC Logic"</a>
U121E: DSP COMM	<a href="#">AV-772, "DTC Logic"</a>
U1225: USB CONTROLLER	<a href="#">AV-773, "DTC Logic"</a>
U1227: DVD COMM	<a href="#">AV-774, "DTC Logic"</a>
U1228: SUB CPU CONN	<a href="#">AV-775, "DTC Logic"</a>
U1229: iPod CERTIFICATION	<a href="#">AV-776, "DTC Logic"</a>
U122A: CONFIG UNFINISH	<a href="#">AV-777, "DTC Logic"</a>
U122E: Built-in AUDIO CONN	<a href="#">AV-778, "DTC Logic"</a>
U1231: AMP TEMP	<a href="#">AV-779, "DTC Logic"</a>
U1232: ST ANGLE SEN CALIB	<a href="#">AV-780, "DTC Logic"</a>
U1243: FRONT DISP CONN	<a href="#">AV-781, "DTC Logic"</a>
U1244: GPS ANTENNA CONN	<a href="#">AV-783, "DTC Logic"</a>
U1258: XM ANTENNA CONN	<a href="#">AV-784, "DTC Logic"</a>
U125A: 3RD DISP CONN	<a href="#">AV-785, "DTC Logic"</a>
U1263: USB OVERCURRENT	<a href="#">AV-786, "DTC Logic"</a>
U1264: ANTENNA AMP TERMINAL (OPEN or SHORT)	<a href="#">AV-787, "DTC Logic"</a>

# AV CONTROL UNIT

< ECU DIAGNOSIS INFORMATION >

[BOSE AUDIO W/NAVI W/SURROUND]

CONSULT Display	Reference Page	
U1265: AMP ON TERMINAL (GND-SHORT or VB-SHORT)	<a href="#">AV-788, "DTC Logic"</a>	A
<ul style="list-style-type: none"> <li>• U1300: AV COMM CIRCUIT</li> <li>• U1240: SWITCH CONN</li> </ul>		B
<ul style="list-style-type: none"> <li>• U1300: AV COMM CIRCUIT</li> <li>• U124E: AMP CONN</li> </ul>		C
<ul style="list-style-type: none"> <li>• U1300: AV COMM CIRCUIT</li> <li>• U1246: VIDEO DIST CONN</li> </ul>		D
<ul style="list-style-type: none"> <li>• U1300: AV COMM CIRCUIT</li> <li>• U125B: AROUND CAMERA CONN</li> </ul>		E
<ul style="list-style-type: none"> <li>• U1300: AV COMM CIRCUIT</li> <li>• U125C: SONAR CONN</li> </ul>	<a href="#">AV-789, "Description"</a>	F
<ul style="list-style-type: none"> <li>• U1300: AV COMM CIRCUIT</li> <li>• U1240: SWITCH CONN</li> <li>• U125C: SONAR CONN</li> <li>• U125B: AROUND CAMERA CONN</li> <li>• U1246: VIDEO DIST CONN</li> </ul>		G
<ul style="list-style-type: none"> <li>• U1300: AV COMM CIRCUIT</li> <li>• U1240: SWITCH CONN</li> <li>• U124E: AMP CONN</li> <li>• U125C: SONAR CONN</li> <li>• U125B: AROUND CAMERA CONN</li> <li>• U1246: VIDEO DIST CONN</li> </ul>		H
U1310: CONTROL UNIT (AV)	<a href="#">AV-799, "DTC Logic"</a>	I
U1601: FL-DOOR WOOFER/TWEETER (OPEN, SHORT, GND-SHORT)		J
U1603: FL-DOOR WOOFER/TWEETER (VB-SHOR)	<a href="#">AV-800, "DTC Logic"</a>	K
U1609: FR-DOOR WOOFER/TWEETER (OPEN, SHORT, GND-SHORT)		L
U160B: FR-DOOR WOOFER/TWEETER (VB-SHOR)		M
U1627: F-INST L-TWEETER (OPEN, SHORT, GND-SHORT or VB-SHOR)	<a href="#">AV-801, "DTC Logic"</a>	N
U162F: F-INST R-TWEETER (OPEN, SHORT, GND-SHORT or VB-SHOR)		O
U162A: F-INST C-SQAWK (OPEN, SHORT, GND-SHORT or VB-SHOR)	<a href="#">AV-802, "DTC Logic"</a>	P
U1684: 2L-DOOR SPEAKER/TWEETER (OPEN, SHORT, GND-SHORT)		Q
U1687: 2L-DOOR SPEAKER/TWEETER (VB-SHOR)	<a href="#">AV-803, "DTC Logic"</a>	R
U162C: 2R-DOOR SPEAKER/TWEETER (OPEN, SHORT, GND-SHORT)		S
U162F: 2R-DOOR SPEAKER/TWEETER (VB-SHOR)		T
U175D: R-LUGGAGE L-WOOFER (OPEN, SHORT, GND-SHORT or VB-SHOR)	<a href="#">AV-804, "DTC Logic"</a>	U
U176A: R-ROOF L-WK (OPEN, SHORT, GND-SHORT or VB-SHOR)		V
U1772: R-ROOF R-WK (OPEN, SHORT, GND-SHORT or VB-SHOR)	<a href="#">AV-805, "DTC Logic"</a>	W

# DISPLAY UNIT

< ECU DIAGNOSIS INFORMATION >

[BOSE AUDIO W/NAVI W/SURROUND]

## DISPLAY UNIT

Reference Value

INFOID:000000009129300

### TERMINAL LAYOUT

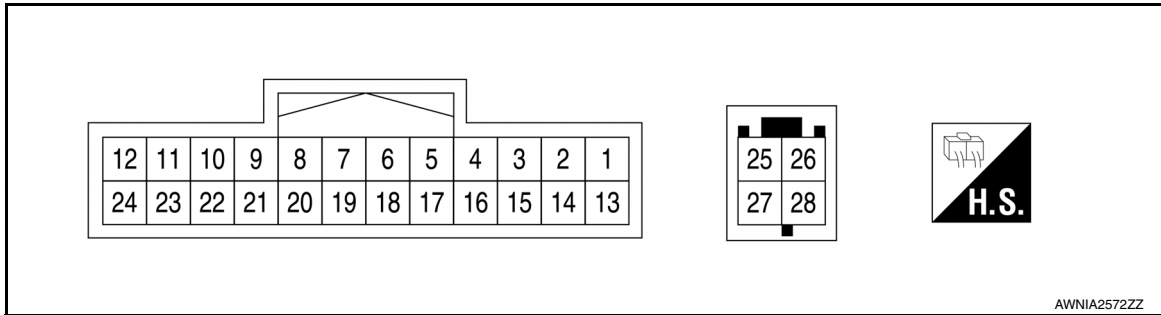

AWNIA2572ZZ

### PHYSICAL VALUES

Terminal (Wire color)		Description		Condition		Reference value (Approx.)
+	-	Signal name	Input/ Output	Ignition switch	Operation	
6 (Shield)	—	Composite image signal shield	—	—	—	—
7 (Shield)	—	Camera image signal shield	—	—	—	—
8 (B)	Ground	Camera image signal	Input	ON	When camera image is displayed	<p>SKIB2251J</p>
9 (B)	Ground	Communication signal (DISP→CONT)	Output	ON	When adjusting display brightness	<p>PKIB5039J</p>
10 (W)	Ground	Communication signal (CONT→DISP)	Input	ON	When adjusting display brightness	<p>PKIB5039J</p>
11 (Y)	Ground	Battery power supply	Input	OFF	—	Battery voltage
12 (B)	Ground	Ground	—	ON	—	0 V

# DISPLAY UNIT

< ECU DIAGNOSIS INFORMATION >

[BOSE AUDIO W/NAVI W/SURROUND]

Terminal (Wire color)		Description		Condition		Reference value (Approx.)
+	-	Signal name	Input/ Output	Ignition switch	Operation	
18 (B)	Ground	Composite image signal	Input	ON	When DVD image is displayed.	
19 (W)	Ground	Composite image signal ground	—	ON	—	0 V
20 (R)	Ground	Composite image synchronizing signal	Input	ON	—	
22 (Shield)	—	Communication signal shield	—	—	—	—
23 (P)	Ground	ACC power supply	Input	ACC	—	Battery voltage
25 (Shield)	—	RGB digital image signal shield	—	—	—	—
26 (Shield)	—	RGB digital image signal shield	—	—	—	—
27 (B)	—	RGB digital image signal (-)	Input	—	—	—
28 (B)	—	RGB digital image signal (+)	Input	—	—	—

A  
B  
C  
D  
E  
F  
G  
H  
I  
J  
K  
L  
M  
N  
O  
P

AV

# BOSE AMP.

< ECU DIAGNOSIS INFORMATION >

[BOSE AUDIO W/NAVI W/SURROUND]

## BOSE AMP.

### Reference Value

INFOID:000000009129301

### TERMINAL LAYOUT

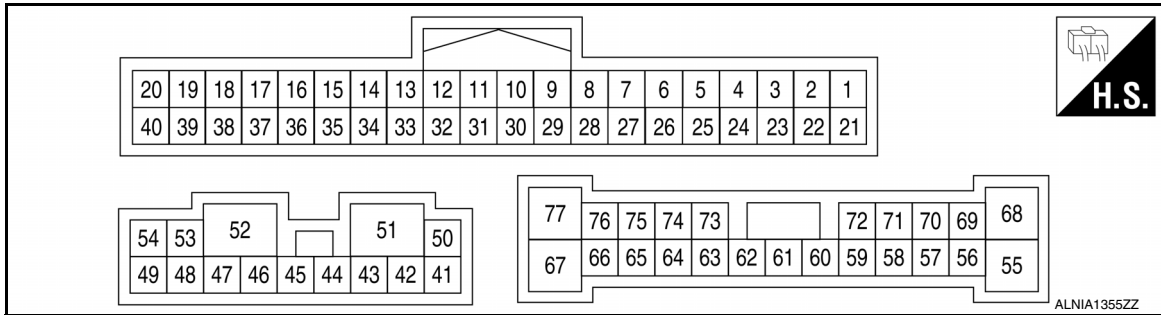

### PHYSICAL VALUES

Terminal (Wire color)		Description	Input/Output	Condition		Reference value (Approx.)
+	-			Ignition switch	Operation	
14 (B)	—	AV communication signal (H) terminate	—	—	—	—
15 (B)	—	AV communication signal (H)	—	—	—	—
16 (W)	Ground	ACC power supply	Input	ACC	—	Battery voltage
24 (B)	4 (W)	Sound signal guide	Input	ON	Sound output	 SKIB3609E
25 (B)	5 (W)	Pre amp sound signal front LH	Input	ON	Sound output	 SKIB3609E
26 (B)	6 (W)	Pre amp sound signal front RH	Input	ON	Sound output	 SKIB3609E



# BOSE AMP.

< ECU DIAGNOSIS INFORMATION >

[BOSE AUDIO W/NAVI W/SURROUND]

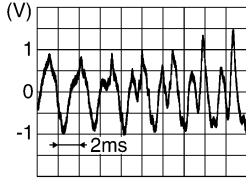
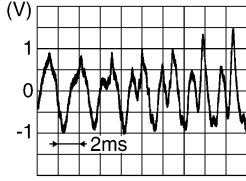
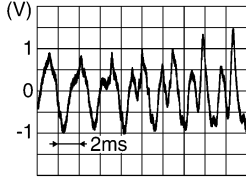
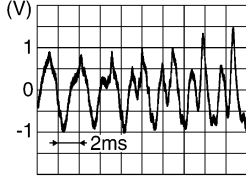
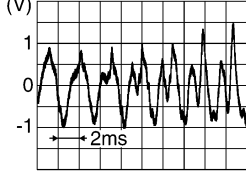
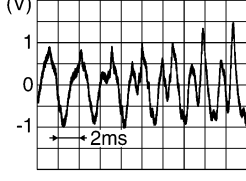
Terminal (Wire color)		Description	Input/ Output	Condition		Reference value (Approx.)
+	-			Signal name	Ignition switch	
27 (B)	7 (W)	Pre amp sound signal rear LH	Input	ON	Sound output	 <p style="text-align: right; font-size: small;">SKIB3609E</p>
28 (B)	8 (W)	Pre amp sound signal rear RH	Input	ON	Sound output	 <p style="text-align: right; font-size: small;">SKIB3609E</p>
29 (B)	9 (W)	Pre amp sound signal center	Input	ON	Sound output	 <p style="text-align: right; font-size: small;">SKIB3609E</p>
30 (B)	10 (W)	Pre amp sound signal center	Input	ON	Sound output	 <p style="text-align: right; font-size: small;">SKIB3609E</p>
34 (W)	—	AV communication signal (L) terminate	—	—	—	—
35 (W)	—	AV communication signal (L)	—	—	—	—
39 (B)	—	AV communication signal shield	—	—	—	—
41 (G)	42 (W)	Sound signal rear door speaker and rear door tweeter RH	Output	ON	Sound output	 <p style="text-align: right; font-size: small;">SKIB3609E</p>
43 (W)	44 (P)	Sound signal front door speaker RH	Output	ON	Sound output	 <p style="text-align: right; font-size: small;">SKIB3609E</p>

A  
B  
C  
D  
E  
F  
G  
H  
I  
J  
K  
L  
M  
O  
P

AV

# BOSE AMP.

< ECU DIAGNOSIS INFORMATION >

[BOSE AUDIO W/NAVI W/SURROUND]

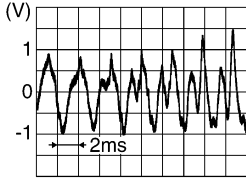
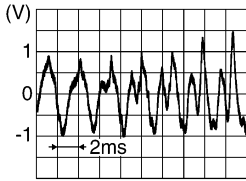
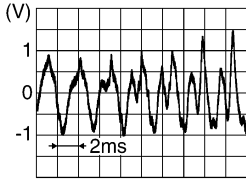
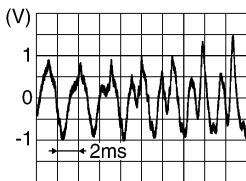
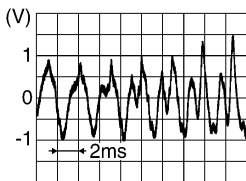
Terminal (Wire color)		Description	Condition			Reference value (Approx.)
+	-		Signal name	Input/ Output	Ignition switch	
45 (P)	46 (R)	Sound signal rear door speaker and rear door tweeter LH	Output	ON	Sound output	 <p style="text-align: right; font-size: small;">SKIB3609E</p>
47 (B)	—	Ground	—	ON	—	0 V
50 (LG)	Ground	Battery power supply	Input	OFF	—	Battery voltage
51 (Y)	Ground	Battery power supply	Input	OFF	—	Battery voltage
52 (B)	—	Ground	—	ON	—	0 V
53 (G)	48 (R)	Sound signal front door speaker LH	Output	ON	Sound output	 <p style="text-align: right; font-size: small;">SKIB3609E</p>
54 (B)	49 (W)	Sound signal subwoofer	Output	ON	Sound output	 <p style="text-align: right; font-size: small;">SKIB3609E</p>
55 (W)	Ground	Subwoofer amp. ON signal	Output	ACC	—	Battery voltage
56 (R)	69 (G)	Sound signal instrument panel tweeter LH	Output	ON	Sound output	 <p style="text-align: right; font-size: small;">SKIB3609E</p>
57 (P)	58 (R)	Sound signal center speaker	Output	ON	Sound output	 <p style="text-align: right; font-size: small;">SKIB3609E</p>

# BOSE AMP.

< ECU DIAGNOSIS INFORMATION >

[BOSE AUDIO W/NAVI W/SURROUND]

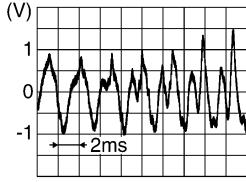
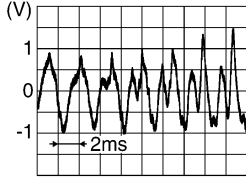
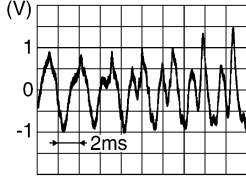
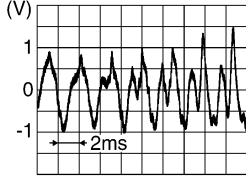
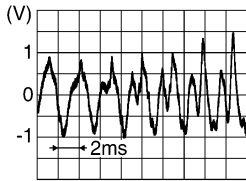
Terminal (Wire color)		Description	Input/ Output	Condition		Reference value (Approx.)
+	-			Signal name	Ignition switch	
59 (G)	72 (W)	Sound signal front tweeter RH	Output	ON	Sound output	 SKIB3609E
62 (W)	73 (G)	Sound signal rear side speaker LH	Output	ON	Sound output	 SKIB3609E
63 (W)	74 (G)	Sound signal rear side speaker RH	Output	ON	Sound output	 SKIB3609E
64 (G)	75 (W)	Sound signal front tweeter LH	Output	ON	Sound output	 SKIB3609E
65 (Shield)	—	Subwoofer sound signal shield	—	—	—	—
71 (G)	70 (W)	Sound signal tweeter RH	Output	ON	Sound output	 SKIB3609E

A  
B  
C  
D  
E  
F  
G  
H  
I  
J  
K  
L  
M  
O  
P

AV

# VIDEO DISTRIBUTOR

< ECU DIAGNOSIS INFORMATION >

[BOSE AUDIO W/NAVI W/SURROUND]

## VIDEO DISTRIBUTOR

### Reference Value

INFOID:000000009129302

### TERMINAL LAYOUT

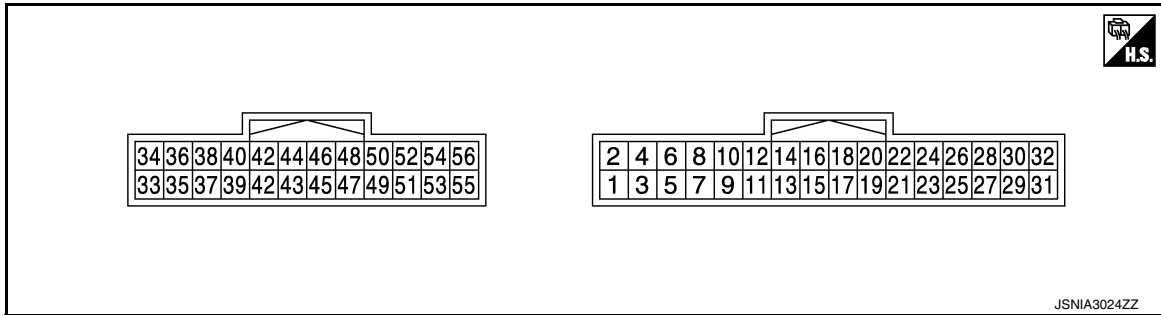

### PHYSICAL VALUES

Terminal (Wire color)		Description	Condition		Reference value (Approx.)	
+	-	Signal name	Input/ Output	Ignition switch		Operation
1 (B)	—	Ground	—	ON	—	0 V
2 (V)	Ground	Battery power supply	Input	OFF	—	Battery voltage
3 (B)	—	Ground	—	ON	—	0 V
4 (W)	Ground	ACC power supply	Input	ACC	—	Battery voltage
5 (BR)	Ground	Headrest display unit RH control ground	—	ON	—	0 V
6 (L)	Ground	Headrest display unit RH ACC signal	Output	OFF	—	3.3 V
				ACC	—	0 V
7 (SB)	Ground	Headrest display unit LH control ground	—	ON	—	0 V
8 (BR)	Ground	Headrest display unit RH ACC signal	Output	OFF	—	3.3 V
				ACC	—	0 V
9 (SB)	Ground	Headrest display unit RH image switch signal	Input	ON	When DVD, USB or front AUX image is displayed on headrest display unit RH.	0.5 V
					When rear AUX image is displayed on headrest dis- play unit RH.	4.5 V
10 (L)	Ground	Headrest display unit LH image switch signal	Input	ON	When DVD, USB or front AUX image is displayed on headrest display unit LH.	0.5 V
					When rear AUX image is displayed on headrest dis- play unit LH.	4.5 V

# VIDEO DISTRIBUTOR

< ECU DIAGNOSIS INFORMATION >

[BOSE AUDIO W/NAVI W/SURROUND]

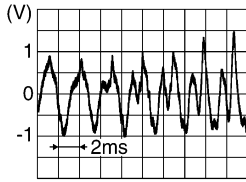
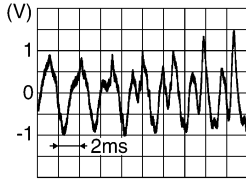
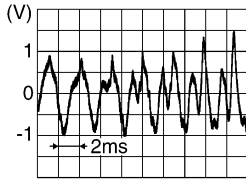
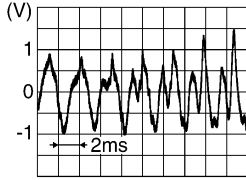
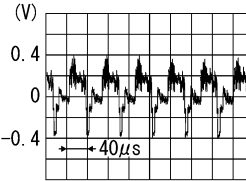
Terminal (Wire color)		Description		Condition		Reference value (Approx.)
+	-	Signal name	Input/ Output	Ignition switch	Operation	
14 (R)	15 (G)	Headrest display unit RH headphone sound signal RH	Output	ON	Output headphone sound from headrest display unit RH to headphone.	 <p style="text-align: right; font-size: small;">SKIB3609E</p>
16 (B)	17 (W)	Headrest display unit RH headphone sound signal LH	Output	ON	Output headphone sound from headrest display unit RH to headphone.	 <p style="text-align: right; font-size: small;">SKIB3609E</p>
18 (V)	Ground	Headrest display unit RH AV ground	—	ON	—	0 V
19 (V)	Ground	Headrest display unit LH AV ground	—	ON	—	0 V
20 (B)	21 (G)	Headrest display unit LH headphone sound signal RH	Output	ON	Output headphone sound from headrest display unit LH to headphone.	 <p style="text-align: right; font-size: small;">SKIB3609E</p>
22 (W)	23 (R)	Headrest display unit LH headphone sound signal LH	Output	ON	Output headphone sound from headrest display unit LH to headphone.	 <p style="text-align: right; font-size: small;">SKIB3609E</p>
27 (W)	Ground	Headrest display unit RH composite image signal ground	—	ON	—	0 V
28 (B)	Ground	Headrest display unit RH composite image signal	Output	ON	When DVD, USB, front AUX or rear AUX image is displayed on headrest dis- play unit RH.	 <p style="text-align: right; font-size: small;">SKIB2251J</p>
29 (Shield)	—	Headrest display unit RH composite image signal shield	—	—	—	—
30 (Shield)	—	Headrest display unit LH composite image signal shield	—	—	—	—

A  
B  
C  
D  
E  
F  
G  
H  
I  
J  
K  
L  
M  
AV  
O  
P

# VIDEO DISTRIBUTOR

< ECU DIAGNOSIS INFORMATION >

[BOSE AUDIO W/NAVI W/SURROUND]

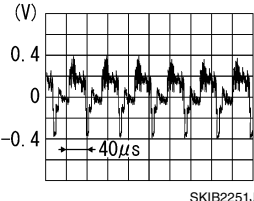
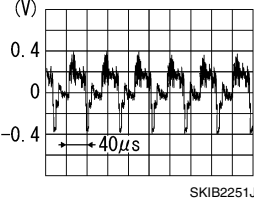
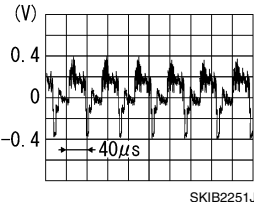
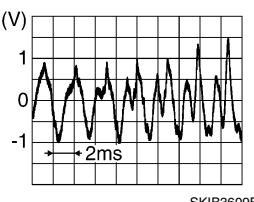
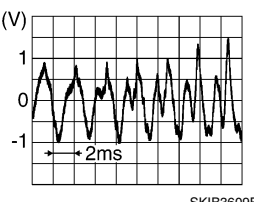
Terminal (Wire color)		Description		Condition		Reference value (Approx.)
+	-	Signal name	Input/ Output	Ignition switch	Operation	
31 (P)	Ground	Headrest display unit LH composite image signal ground	—	ON	—	0 V
32 (L)	Ground	Headrest display unit LH composite image signal	Output	ON	When DVD, USB, front AUX or rear AUX image is displayed on headrest dis- play unit LH.	
33 (W)	Ground	Composite image signal ground	—	ON	—	0 V
34 (B)	Ground	Composite image signal	Input	ON	When DVD, USB or front AUX image is displayed on headrest display unit LH or RH.	
35 (Shield)	—	Composite image signal shield	—	—	—	—
40 (B)	39 (W)	Auxiliary image signal	Input	ON	When rear AUX image is displayed on headrest dis- play unit LH or RH.	
41 (Shield)	—	Auxiliary image signal shield	—	—	—	—
45 (W)	46 (R)	Headphone sound signal LH	Input	ON	When DVD, USB or front AUX mode is selected on headrest display unit LH or RH.	
47 (B)	48 (G)	Headphone sound signal RH	Input	ON	When DVD, USB or front AUX mode is selected on headrest display unit LH or RH.	
49 (Shield)	—	Headphone sound signal shield	—	—	—	—
53 (Shield)	—	Auxiliary sound signal shield	—	—	—	—

# VIDEO DISTRIBUTOR

< ECU DIAGNOSIS INFORMATION >

[BOSE AUDIO W/NAVI W/SURROUND]

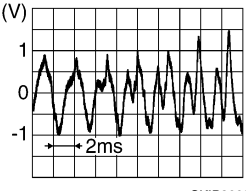
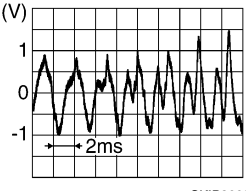
Terminal (Wire color)		Description		Condition		Reference value (Approx.)
+	-	Signal name	Input/ Output	Ignition switch	Operation	
54 (B)	56 (W)	Auxiliary sound signal LH	Input	ON	When rear AUX mode is selected on headrest display unit LH or RH.	
55 (R)	56 (W)	Auxiliary sound signal RH	Input	ON	When rear AUX mode is selected on headrest display unit LH or RH.	

A  
B  
C  
D  
E  
F  
G  
H  
I  
J  
K  
L  
M

AV

O  
P

# HEADREST DISPLAY UNIT

< ECU DIAGNOSIS INFORMATION >

[BOSE AUDIO W/NAVI W/SURROUND]

## HEADREST DISPLAY UNIT

Reference Value

INFOID:000000009129303

### TERMINAL LAYOUT

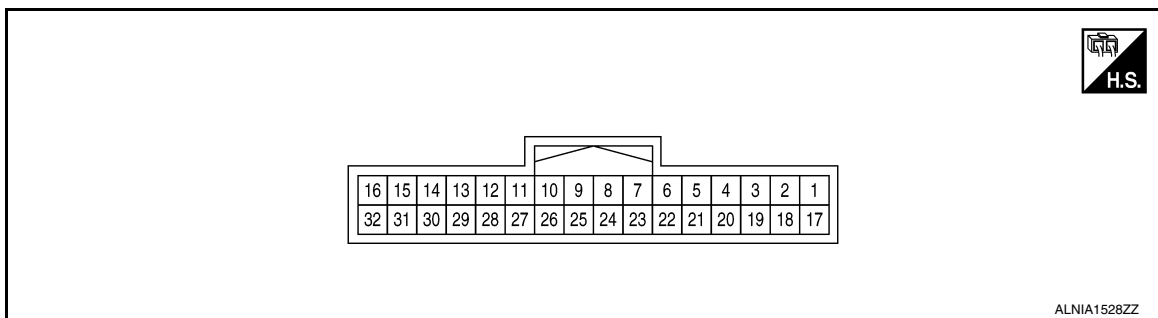

### PHYSICAL VALUES

Driver Seat

Terminal (Wire color)		Description		Condi- tion	Operation	Reference value (Approx.)
+	-	Signal name	Input/ Output	Ignition switch		
1 (W)	17 (B)	Headphone sound signal LH	Input	ON	Headphone sound output	 SKIB3609E
2 (G)	18 (R)	Headphone sound signal RH	Input	ON	Headphone sound output	 SKIB3609E
3 (LG)	—	Headphone sound signal shield	—	—	—	—
5 (Y)	Ground	Composite image signal	Input	ON	When DVD, USB or front AUX image is displayed on headrest display unit	 SKIB2251J
7 (W)	Ground	Image switch signal	Output	ON	When DVD, USB or front AUX image is displayed on headrest display unit	0.5 V
					When rear AUX image is displayed on headrest dis- play unit	4.5 V
8 (G)	Ground	ACC signal	Input	OFF	—	3.3 V
				ACC	—	0 V



# HEADREST DISPLAY UNIT

< ECU DIAGNOSIS INFORMATION >

[BOSE AUDIO W/NAVI W/SURROUND]

Terminal (Wire color)		Description		Condi- tion		Reference value (Approx.)
+	-	Signal name	Input/ Output	Ignition switch	Operation	
10 (LG)	—	AV communication signal (L)	Input/ Output	—	—	—
11 (P)	—	AV communication signal (H)	Input/ Output	—	—	—
12 (G)	Ground	Ground	—	ON	—	0 V
13 (BR)	Ground	Illumination	Input	OFF	—	Battery voltage
15 (W)	Ground	Battery power supply	Input	OFF	—	Battery voltage
16 (W)	Ground	Battery power supply	Input	OFF	—	Battery voltage
19 (V)	Ground	AV ground	—	ON	—	0 V
20 (P)	—	Composite image signal shield	—	—	—	—
21 (G)	Ground	Composite image signal ground	—	ON	—	0 V
23 (Y)	Ground	Control ground	—	ON	—	0 V
24 (SB)	—	CON CK B	Input/ Output	—	—	—
26 (R)	—	AV communication signal (L)	Input/ Output	—	—	—
27 (LG)	—	AV communication signal (H)	Input/ Output	—	—	—
29 (GR)	—	CON CK B	Input/ Output	—	—	—
31 (G)	Ground	Ground	—	ON	—	0 V
32 (G)	Ground	Ground	—	ON	—	0 V

Passenger Seat

A  
B  
C  
D  
E  
F  
G  
H  
I  
J  
K  
L  
M  
N  
O  
P

AV

# HEADREST DISPLAY UNIT

< ECU DIAGNOSIS INFORMATION >

[BOSE AUDIO W/NAVI W/SURROUND]

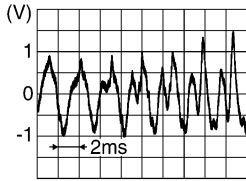
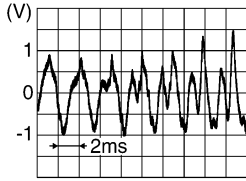
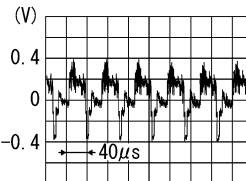
Terminal (Wire color)		Description		Condi- tion	Operation	Reference value (Approx.)
+	-	Signal name	Input/ Output	Ignition switch		
1 (W)	17 (B)	Headphone sound signal LH	Input	ON	Headphone sound output	 SKIB3609E
2 (G)	18 (R)	Headphone sound signal RH	Input	ON	Headphone sound output	 SKIB3609E
3 (LG)	—	Headphone sound signal shield	—	—	—	—
5 (Y)	Ground	Composite image signal	Input	ON	When DVD, USB or front AUX image is displayed on headrest display unit	 SKIB2251J
7 (W)	Ground	Image switch signal	Output	ON	When DVD, USB or front AUX image is displayed on headrest display unit	0.5 V
					When rear AUX image is displayed on headrest dis- play unit	4.5 V
8 (G)	Ground	ACC signal	Input	OFF	—	3.3 V
				ACC	—	0 V
10 (LG)	—	AV communication signal (L)	Input/ Output	—	—	—
11 (P)	—	AV communication signal (H)	Input/ Output	—	—	—
13 (BR)	Ground	Illumination	Input	OFF	—	Battery voltage
15 (W)	Ground	Battery power supply	Input	OFF	—	Battery voltage
16 (W)	Ground	Battery power supply	Input	OFF	—	Battery voltage
19 (V)	Ground	AV ground	—	ON	—	0 V
20 (P)	—	Composite image signal shield	—	—	—	—
21 (G)	Ground	Composite image signal ground	—	ON	—	0 V
23 (Y)	Ground	Control ground	—	ON	—	0 V

# HEADREST DISPLAY UNIT

< ECU DIAGNOSIS INFORMATION >

[BOSE AUDIO W/NAVI W/SURROUND]

Terminal (Wire color)		Description		Condi- tion		Reference value (Approx.)
+	-	Signal name	Input/ Output	Ignition switch	Operation	
24 (SB)	—	CON CK B	Input/ Output	—	—	—
26 (R)	—	AV communication signal (L)	Input/ Output	—	—	—
27 (LG)	—	AV communication signal (H)	Input/ Output	—	—	—
28 (G)	Ground	Ground	—	ON	—	0 V
29 (GR)	—	CON CK B	Input/ Output	—	—	—
31 (G)	Ground	Ground	—	ON	—	0 V
32 (G)	Ground	Ground	—	ON	—	0 V

A  
B  
C  
D  
E  
F  
G  
H  
I  
J  
K  
L  
M  
O  
P

AV

# AROUND VIEW MONITOR CONTROL UNIT

< ECU DIAGNOSIS INFORMATION >

[BOSE AUDIO W/NAVI W/SURROUND]

## AROUND VIEW MONITOR CONTROL UNIT

### Reference Value

INFOID:000000009129304

### VALUES ON THE DIAGNOSIS TOOL

Monitor Item	Condition	Value/Status
ACC	Ignition switch in any position except ACC.	NG
	Ignition switch in ACC position.	OK
CAMERA OFF SIGNAL	CAMERA switch ON.	Off
	CAMERA switch OFF.	On
CAMERA SWITCH SIGNAL	CAMERA switch OFF.	Off
	CAMERA switch ON.	On
DR CAMERA COMM STATUS	Side camera LH inoperative.	NG
	Side camera LH operative.	OK
DR-SIDE CAMERA COMM LINE	Side camera LH inoperative.	NG
	Side camera LH operative.	OK
DR-SIDE CAMERA IMAGE SIG	Side camera LH inoperative.	NG
	Side camera LH operative.	OK
F-CAMERA COMM LINE	Front camera inoperative.	NG
	Front camera operative.	OK
F-CAMERA COMM STATUS	Front camera inoperative.	NG
	Front camera operative.	OK
F-CAMERA IMAGE SIG	Front camera inoperative.	NG
	Front camera operative.	OK
FOLDING MOTOR VOLT 1	Door mirror LH not in fold position.	Off
	Door mirror LH in fold position.	On
FOLDING MOTOR VOLT 2	Door mirror RH not in fold position.	Off
	Door mirror RH in fold position.	On
PA CAMERA COMM STATUS	Side camera RH inoperative.	NG
	Side camera RH operative.	OK
PA-SIDE CAMERA COMM LINE	Side camera RH inoperative.	NG
	Side camera RH operative.	OK
PA-SIDE CAMERA IMAGE SIG	Side camera RH inoperative.	NG
	Side camera RH operative.	OK
R-CAMERA COMM LINE	Rear camera LH inoperative.	NG
	Rear camera LH operative.	OK
R-CAMERA COMM STATUS	Rear camera LH inoperative.	NG
	Rear camera LH operative.	OK
REAR CAMERA IMAGE SIGNAL	Rear camera LH inoperative.	NG
	Rear camera LH operative.	OK
REVERSE SIGNAL	When selector lever is in any position other than R (reverse).	Off
	When selector lever in R (reverse).	On
ST ANGLE SENSOR SIGNAL	Around view monitor control unit is not receiving steering angle sensor signal.	Off
	Around view monitor control unit is receiving steering angle sensor signal.	On

# AROUND VIEW MONITOR CONTROL UNIT

< ECU DIAGNOSIS INFORMATION >

[BOSE AUDIO W/NAVI W/SURROUND]

Monitor Item	Condition	Value/Status
ST ANGLE SENSOR TYPE	Steering angle sensor type.	Absolute
ST GEAR RATIO TYPE	Steering gear ratio type.	Type O
STEERING POSITION	Left hand drive vehicle.	LHD
	Right hand drive vehicle.	RHD
VEHICLE SPEED SIGNAL	While driving, equivalent to speedometer reading	mph, km/h

## TERMINAL LAYOUT

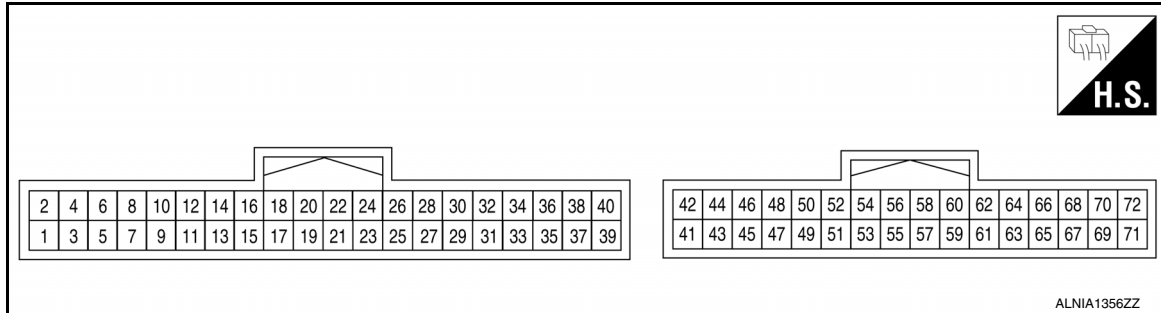

## PHYSICAL VALUES

Terminal (Wire color)		Description		Condition		Reference value (Approx.)
+	-	Signal name	Input/ Output	Ignition switch	Operation	
1 (B)	Ground	Ground	—	ON	—	0 V
2 (Y)	Ground	Battery power supply	Input	OFF	—	Battery voltage
3 (LG)	Ground	Ignition signal	Input	ON	—	Battery voltage
4 (P)	Ground	ACC power supply	Input	ACC	—	Battery voltage
19 (B)	—	AV communication signal (H)	Input/ Output	—	—	—
20 (W)	—	AV communication signal (L)	Input/ Output	—	—	—
23 (Shield)	—	AV communication signal shield	—	—	—	—
25 (LG)	Ground	Reverse signal	Input	ON	R position	Battery voltage
					Other than R position	0 V
27 (B)	—	CAN (H)	—	—	—	—
28 (W)	—	CAN (L)	—	—	—	—
29 (Shield)	—	CAN shield	—	—	—	—
30 (W)	—	Mirror signal 2	—	—	—	—
32 (G)	—	Mirror signal 1	—	—	—	—

# AROUND VIEW MONITOR CONTROL UNIT

< ECU DIAGNOSIS INFORMATION >

[BOSE AUDIO W/NAVI W/SURROUND]

Terminal (Wire color)		Description		Condition		Reference value (Approx.)
+	-	Signal name	Input/ Output	Ignition switch	Operation	
47 (B)	Ground	Camera image signal	Output	ON	At camera image display	
48 (Shield)	—	Camera image signal shield	—	—	—	—
49 (W)	Ground	Rear view camera communication signal	Input/ Output	ON	“CAMERA” switch is ON or shift position is “R”.	
50 (B)	Ground	Rear view camera power supply	Output	ON	“CAMERA” switch is ON or shift position is “R”.	6.0 V
52 (R)	Ground	Rear view camera ground	—	ON	—	0 V
53 (G)	54	Rear view camera image signal	Input	ON	“CAMERA” switch is ON or shift position is “R”.	
55 (B)	Ground	Side camera LH communication signal	Input/ Output	ON	“CAMERA” switch is ON or shift position is “R”.	
56 (W)	Ground	Side camera LH power supply	Output	ON	“CAMERA” switch is ON or shift position is “R”.	6.0 V
58 (G)	Ground	Side camera LH ground	—	ON	—	0 V
59 (R)	60	Side camera LH image signal	Input	ON	“CAMERA” switch is ON or shift position is “R”.	

# AROUND VIEW MONITOR CONTROL UNIT

< ECU DIAGNOSIS INFORMATION >

[BOSE AUDIO W/NAVI W/SURROUND]

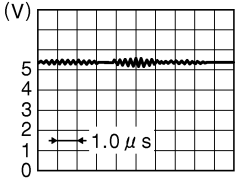
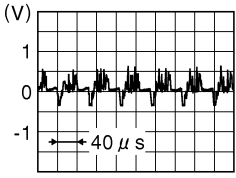
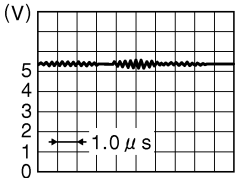
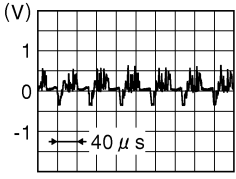
Terminal (Wire color)		Description	Input/ Output	Condition		Reference value (Approx.)
+	-			Signal name	Ignition switch	
61 (W)	Ground	Side camera RH communi- cation signal	Input/ Output	ON	"CAMERA" switch is ON or shift position is "R".	 <p style="text-align: right; font-size: small;">JSNIA0836GB</p>
62 (B)	Ground	Side camera RH power supply	Output	ON	"CAMERA" switch is ON or shift position is "R".	6.0 V
64 (R)	Ground	Side camera RH ground	—	ON	—	0 V
65 (G)	66	Side camera RH image sig- nal	Input	ON	"CAMERA" switch is ON or shift position is "R".	 <p style="text-align: right; font-size: small;">JSNIA0834GB</p>
67 (B)	Ground	Front camera communi- cation signal	Input/ Output	ON	"CAMERA" switch is ON or shift position is "R".	 <p style="text-align: right; font-size: small;">JSNIA0836GB</p>
68 (W)	Ground	Front camera power supply	Output	ON	"CAMERA" switch is ON or shift position is "R".	6.0 V
70 (G)	Ground	Front camera ground	—	ON	—	0 V
71 (R)	72	Front camera image signal	Input	ON	"CAMERA" switch is ON or shift position is "R".	 <p style="text-align: right; font-size: small;">JSNIA0834GB</p>

## DTC Index

INFOID:000000009129305

CONSULT Display	Reference Page
U1302: CAMERA SUPPLY POWER SUPPLY VOLTAGE ABNORMALITY	<a href="#">AV-791, "DTC Logic"</a>
U1303: LED SUPPLY POWER SUPPLY VOLTAGE ABNORMALITY	<a href="#">AV-795, "DTC Logic"</a>
U1304: NON-COMPLETION OF THE CALIBRATION	<a href="#">AV-797, "DTC Logic"</a>
U1305: NON-COMPLETION OF THE WRITE CONFIGURATION	<a href="#">AV-798, "DTC Logic"</a>

# SONAR CONTROL UNIT (WITH AROUND VIEW MONITOR)

< ECU DIAGNOSIS INFORMATION >

[BOSE AUDIO W/NAVI W/SURROUND]

## SONAR CONTROL UNIT (WITH AROUND VIEW MONITOR)

### Reference Value

INFOID:000000009129306

### VALUES ON THE DIAGNOSIS TOOL

Monitor Item	Condition	Value/Status
CEN[RL]/CEN[R]	Key ON, selector lever in R (reverse) position.	cm/in
CEN[RL]/CEN[R]->COR[RL]		
CEN[RL]->CEN[RR]		
CEN[RR]		
CEN[RR]/CEN[R]->COR[RR]		
CEN[RR]->CEN[RL]		
COR[FL]		
COR[FR]		
COR[RL]		
COR[RR]		
COR[RL]->CEN[RL]/CEN[R]		
COR[RR]->CEN[RR]/CEN[R]		
DETECTION MODE		
	Mode 2	
LED	When LED is OFF.	Off
	When LED is ON.	On
P N RANGE	When selector lever is in any position other than P (park) or N (neutral).	Off
	When selector lever in P (park) or N (neutral) position.	On
REVERSE RANGE	When transmission range switch is in any position other than R (reverse).	Off
	When transmission range switch is in R (reverse) position.	On
RVRB TIME CEN[RL]	Key ON, selector lever in R (reverse) position.	ms/sec
RVRB TIME CEN[RR]		
RVRB TIME COR[FL]		
RVRB TIME COR[FR]		
RVRB TIME COR[RL]		
RVRB TIME COR[RR]		
SENSOR VOLTAGE		
SHRT DST FRM FR SENS	cm/in	
SHRT DST FRM RR SENS		
SONAR C/U POWER SUPPLY	Key ON.	Battery voltage
SONAR PERMANENT OFF	CAMERA switch ON.	No
	CAMERA switch OFF.	Yes
SONAR TEMPORARY OFF	Key ON, selector lever in R (reverse) position.	No
	When selector lever is in any position other than R (reverse).	Yes
SW OPRT AFTR IGN ON	CAMERA switch OFF after Key ON.	No
	CAMERA switch ON after Key ON.	Yes



# SONAR CONTROL UNIT (WITH AROUND VIEW MONITOR)

< ECU DIAGNOSIS INFORMATION >

[BOSE AUDIO W/NAVI W/SURROUND]

Monitor Item	Condition	Value/Status
TRAILER CONNECT	No trailer connected to trailer hitch.	N CON
	Trailer connected to trailer hitch.	CON
VEHICLE SPEED	While driving, equivalent to speedometer reading	mph, km/h

## TERMINAL LAYOUT

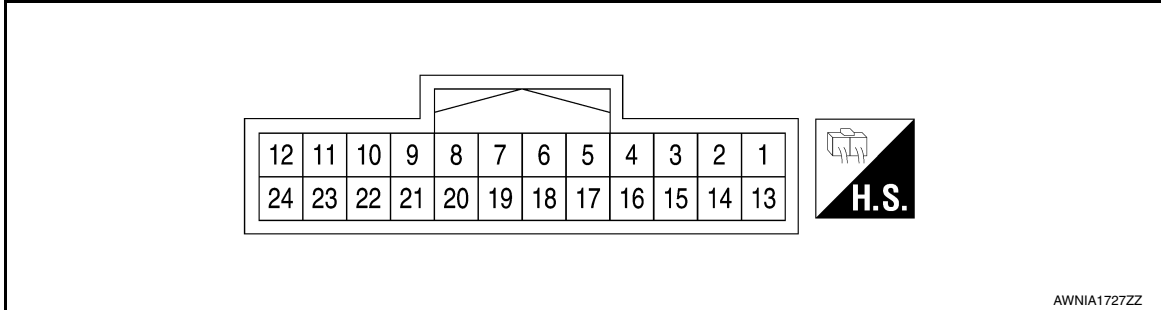

## PHYSICAL VALUES

Terminal No. (Wire color)		Description		Condition		Value (Approx.)
+	-	Signal name	Input/ Output	Ignition switch	Operation	
3 (R)	13 (B)	Outer sensor signal front LH	Input	ON	CAMERA mode or Selector lever R (reverse) position	<p style="text-align: right; font-size: x-small;">JSNIA0837GB</p>
4 (R)	13 (B)	Outer sensor signal front RH	Input	ON	CAMERA mode or Selector lever R (reverse) position	<p style="text-align: right; font-size: x-small;">JSNIA0837GB</p>
5 (B)	—	V-CAN (H)	Input/ Output	—	—	—
6 (W)	—	V-CAN (L)	Input/ Output	—	—	—
9 (W)	14 (B)	Inner sensor signal rear RH	Input	ON	CAMERA mode or Selector lever R (reverse) position	<p style="text-align: right; font-size: x-small;">JSNIA0837GB</p>

# SONAR CONTROL UNIT (WITH AROUND VIEW MONITOR)

< ECU DIAGNOSIS INFORMATION >

[BOSE AUDIO W/NAVI W/SURROUND]

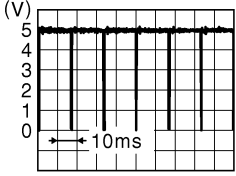
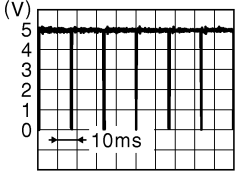
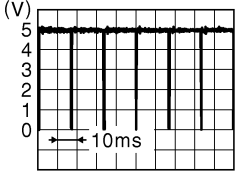
Terminal No. (Wire color)		Description		Condition		Value (Approx.)
+	-	Signal name	Input/ Output	Ignition switch	Operation	
10 (W)	14 (B)	Outer sensor signal rear RH	Input	ON	CAMERA mode or Selector lever R (reverse) position	 <p style="text-align: right; font-size: small;">JSNIA0837GB</p>
12 (LG)	Ground	ACC power supply	Input	ACC	—	Battery voltage
15 (GR)	Ground	Ground	—	ON	—	0 V
19 (BR)	20 (LG)	Buzzer	Input	ON	CAMERA mode or Selector lever R (reverse) position	Battery voltage
21 (W)	14 (B)	Inner sensor signal rear LH	Input	ON	CAMERA mode or Selector lever R (reverse) position	 <p style="text-align: right; font-size: small;">JSNIA0837GB</p>
22 (W)	14 (B)	Outer sensor signal rear LH	Input	ON	CAMERA mode or Selector lever R (reverse) position	 <p style="text-align: right; font-size: small;">JSNIA0837GB</p>

## DTC Index

INFOID:000000009129307

CONSULT Display	Reference Page
U1000: CAN COMM CIRCUIT	<a href="#">AV-755. "SONAR CONTROL UNIT (WITH AROUND VIEW MONITOR) : DTC Logic"</a>
U1010: CONTROL UNIT (CAN)	<a href="#">AV-756. "SONAR CONTROL UNIT (WITH AROUND VIEW MONITOR) : DTC Logic"</a>
B2720: REAR LEFT SIDE EXTERNAL SENSOR	<a href="#">AV-806. "DTC Logic"</a>
B2721: REAR LEFT SIDE INTERNAL SENSOR	<a href="#">AV-807. "DTC Logic"</a>
B2722: REAR RIGHT SIDE INTERNAL SENSOR	<a href="#">AV-808. "DTC Logic"</a>
B2723: REAR RIGHT SIDE EXTERNAL SENSOR	<a href="#">AV-809. "DTC Logic"</a>
B2724: ECU	<a href="#">AV-810. "DTC Logic"</a>
B2725: REAR BUZZER	<a href="#">AV-811. "DTC Logic"</a>
B2729: FRONT LEFT SIDE EXTERNAL SENSOR	<a href="#">AV-813. "DTC Logic"</a>
B272C: FRONT RIGHT SIDE EXTERNAL SENSOR	<a href="#">AV-814. "DTC Logic"</a>

# BOSE AUDIO W/NAVI W/SURROUND

[BOSE AUDIO W/NAVI W/SURROUND]

< WIRING DIAGRAM >

## WIRING DIAGRAM

### BOSE AUDIO W/NAVI W/SURROUND

#### Wiring Diagram

INFOID:000000009129308

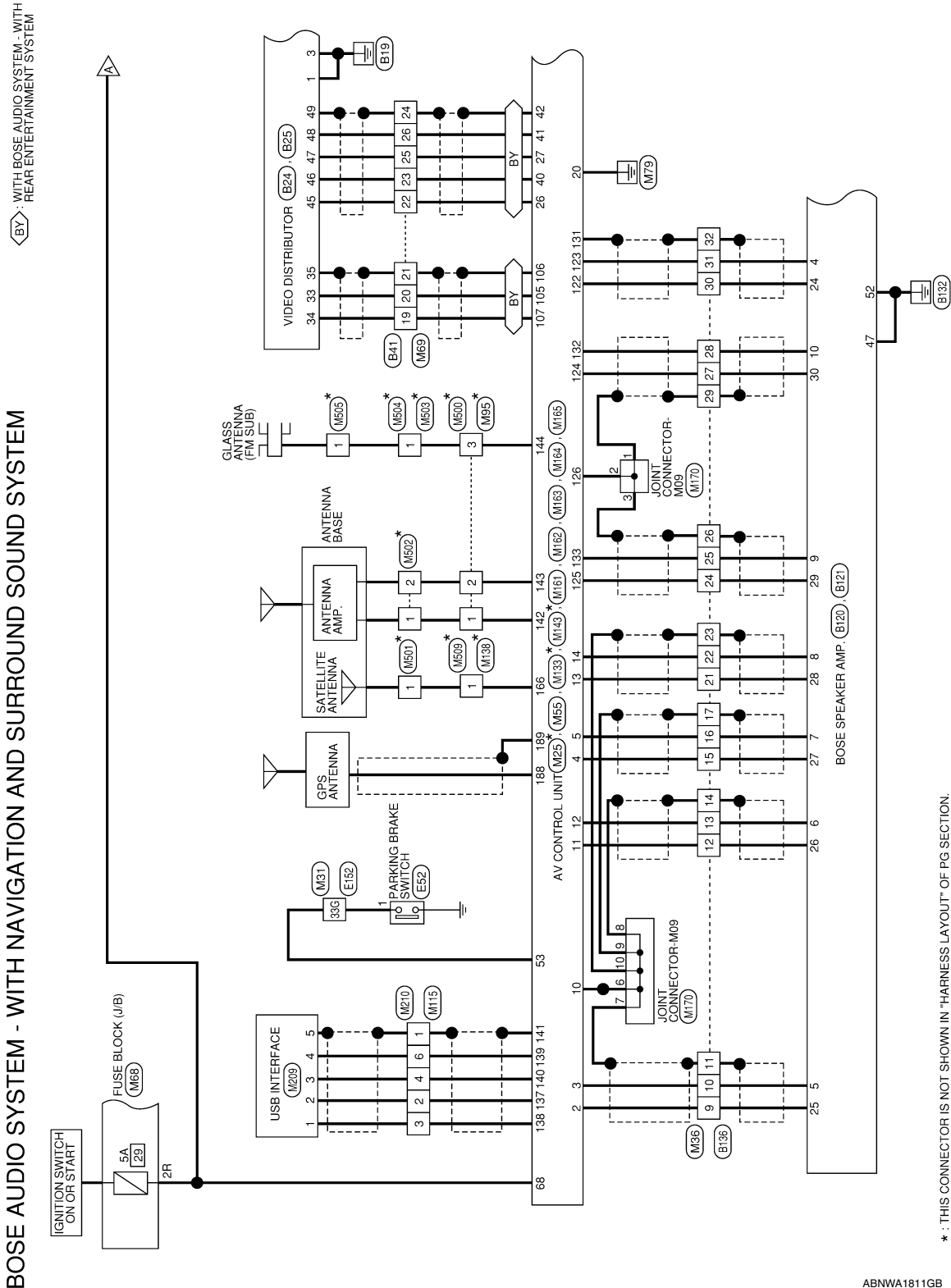

ABNWA1811GB

A  
B  
C  
D  
E  
F  
G  
H  
I  
J  
K  
L  
M  
N  
O  
P

AV

# BOSE AUDIO W/NAVI W/SURROUND

[BOSE AUDIO W/NAVI W/SURROUND]

< WIRING DIAGRAM >

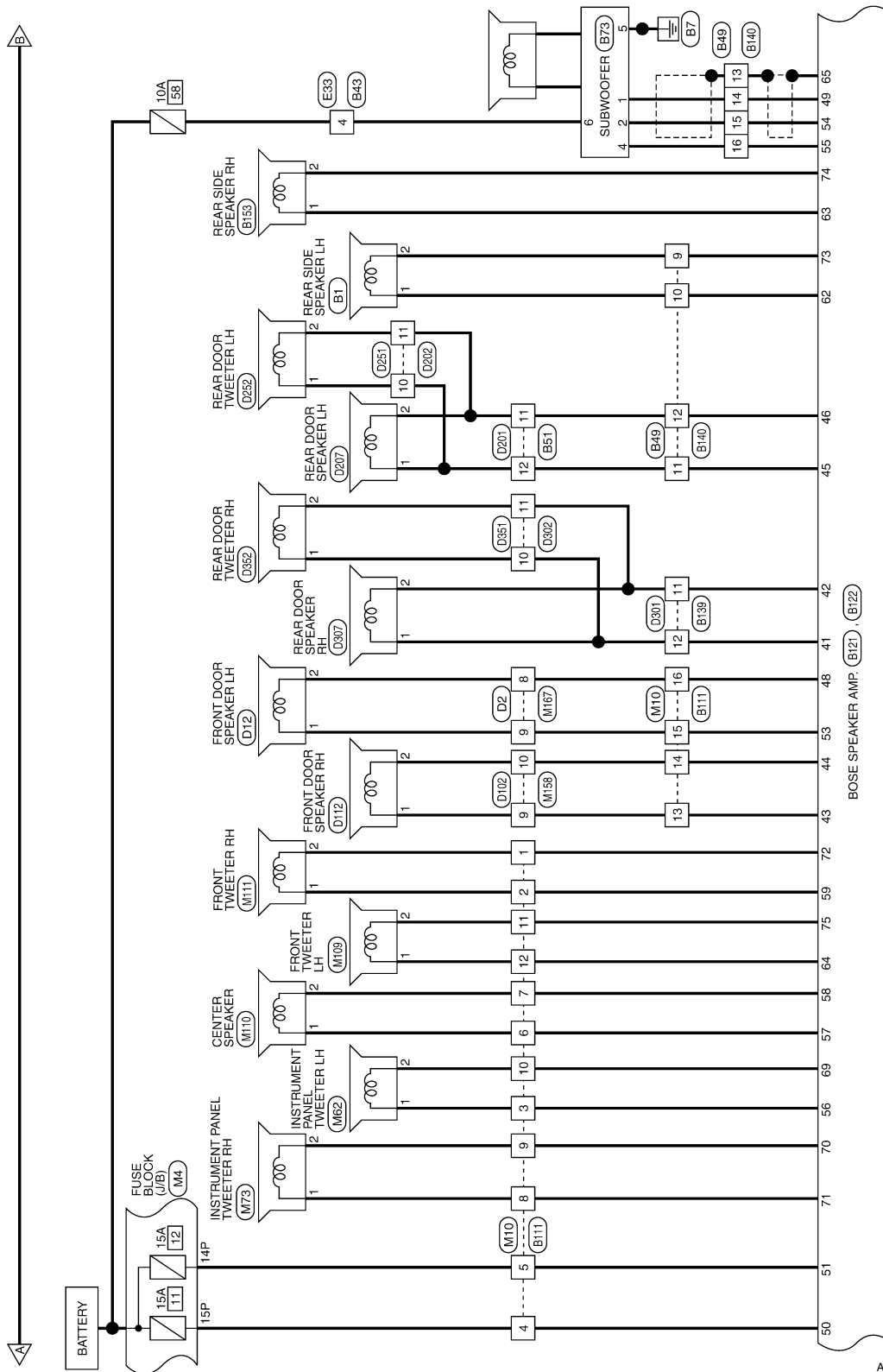

ABNWA1812GB

# BOSE AUDIO W/NAVI W/SURROUND

[BOSE AUDIO W/NAVI W/SURROUND]

< WIRING DIAGRAM >

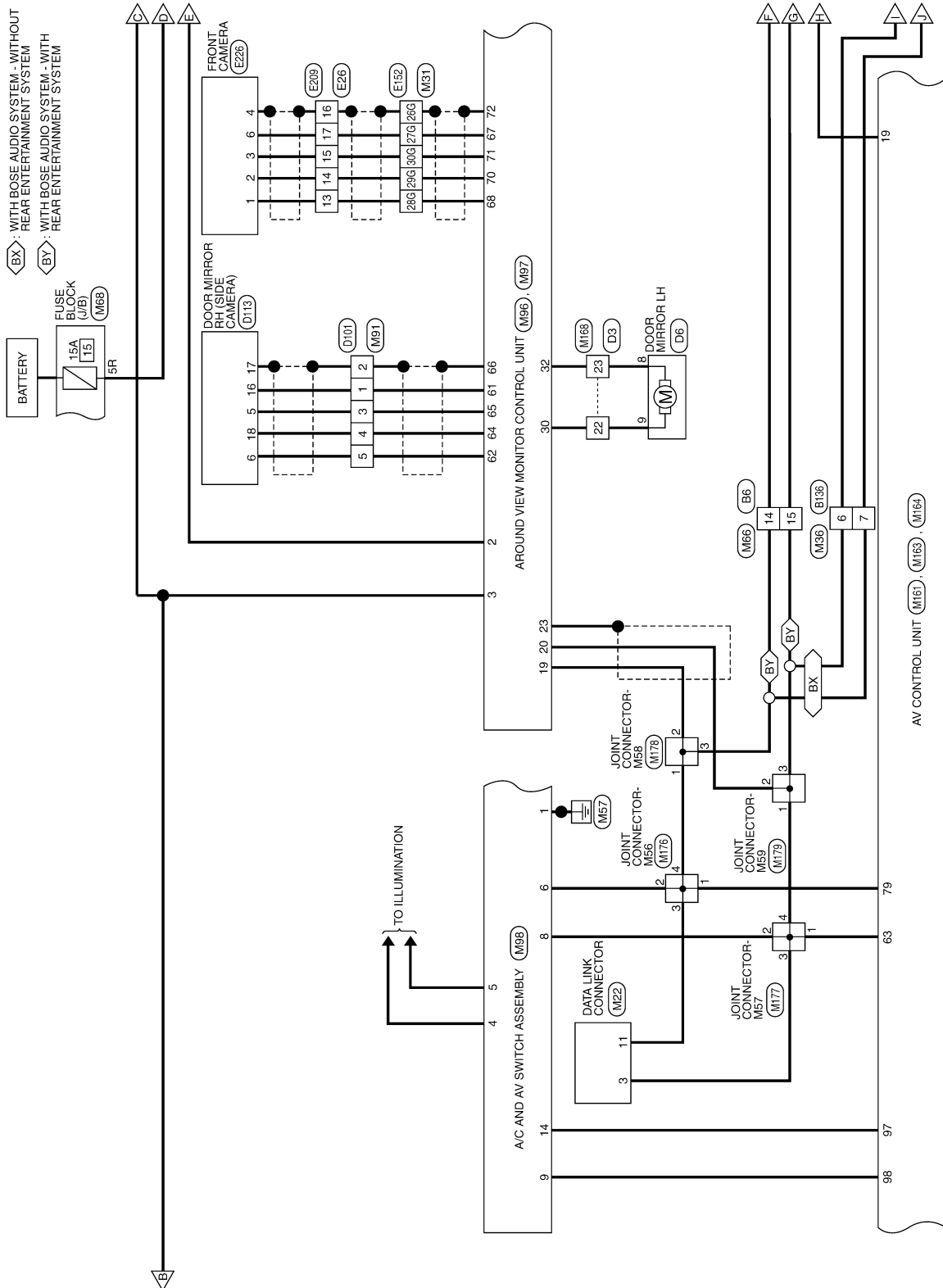

ABNWA1813GB

A  
B  
C  
D  
E  
F  
G  
H  
I  
J  
K  
L  
M  
N  
O  
P

AV

# BOSE AUDIO W/NAVI W/SURROUND

[BOSE AUDIO W/NAVI W/SURROUND]

< WIRING DIAGRAM >

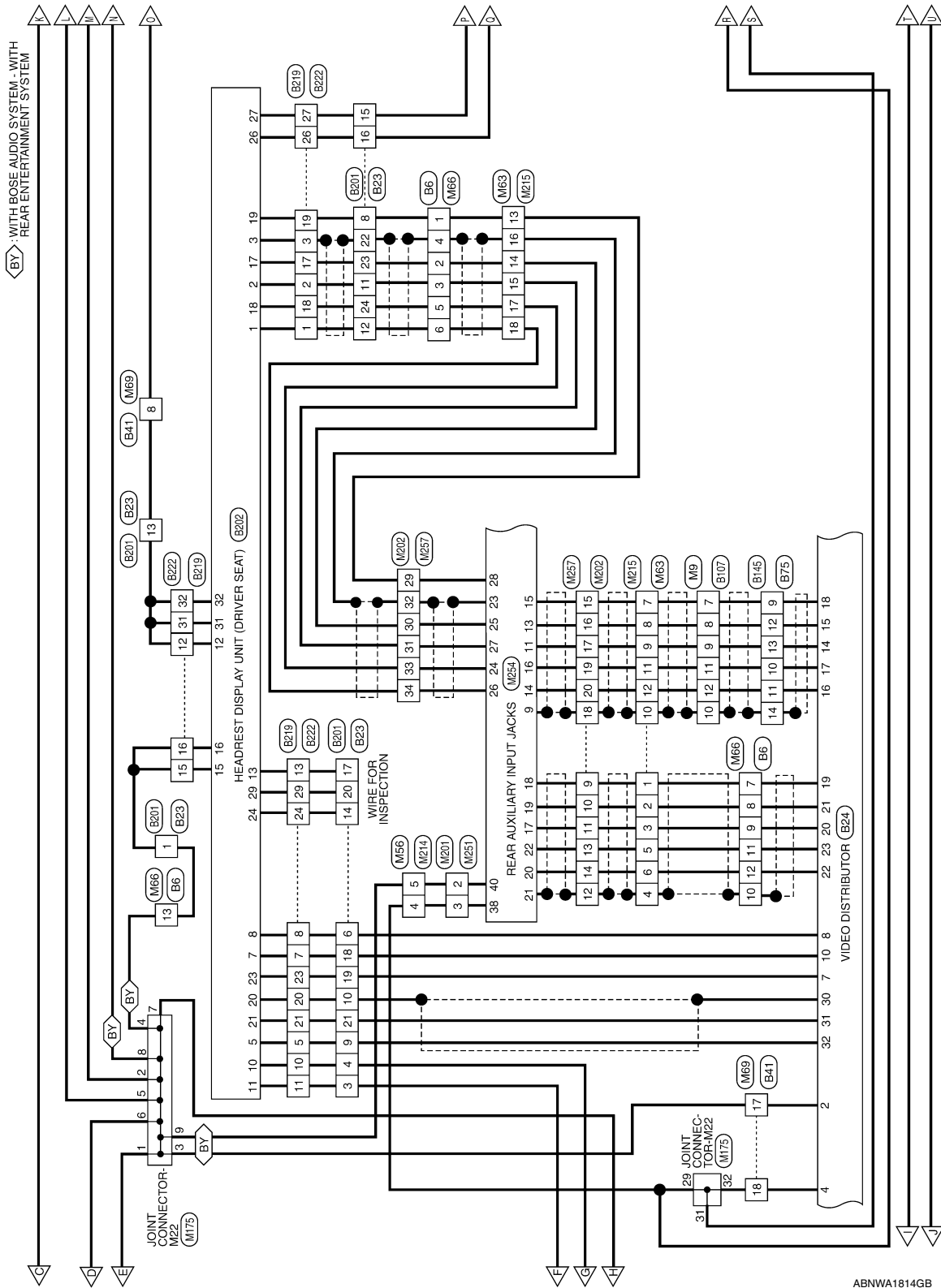

ABNWA1814GB

# BOSE AUDIO W/NAVI W/SURROUND

[BOSE AUDIO W/NAVI W/SURROUND]

< WIRING DIAGRAM >

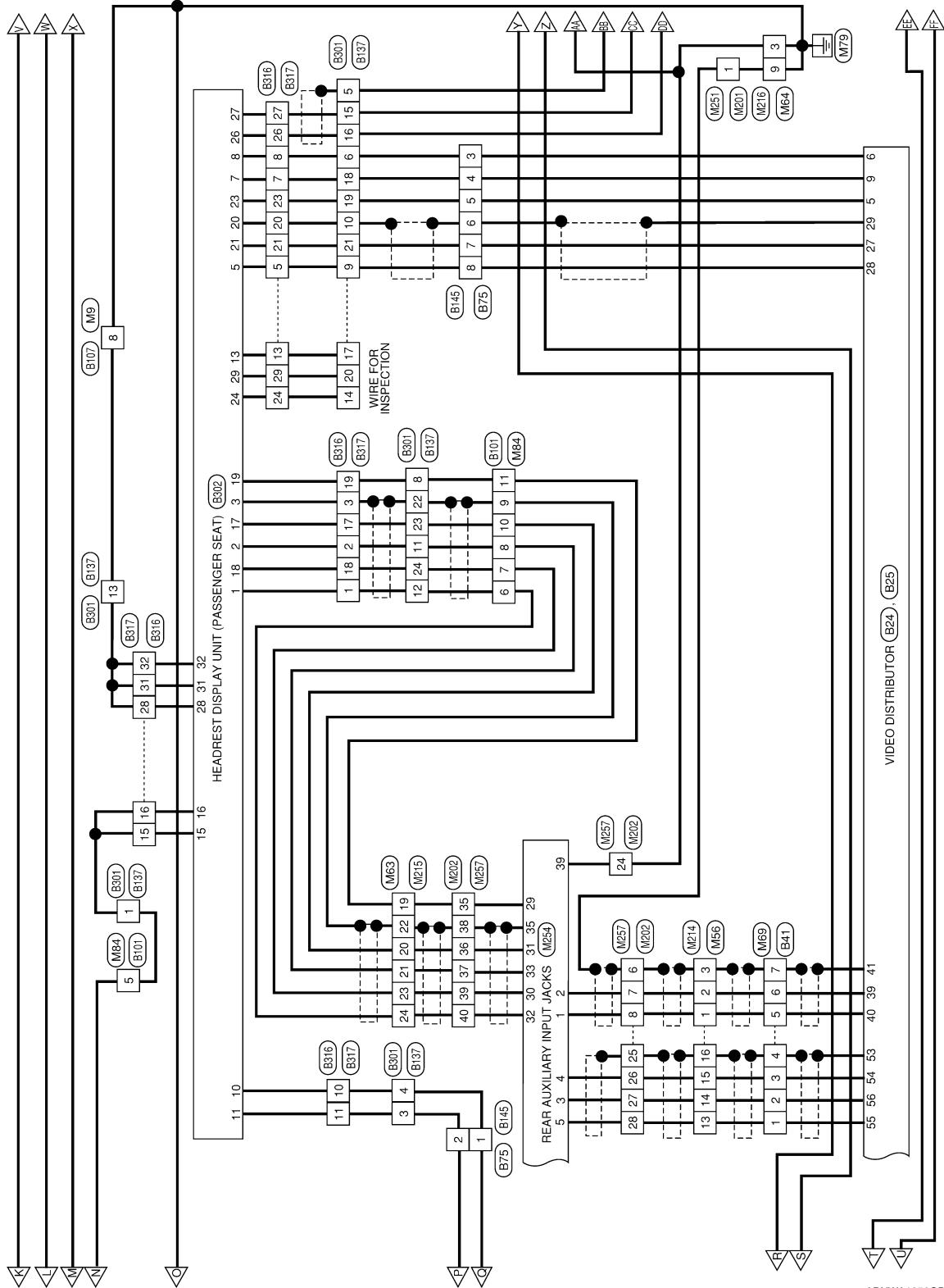

ABNWA1852GB

A  
B  
C  
D  
E  
F  
G  
H  
I  
J  
K  
L  
M  
N  
O  
P

AV

# BOSE AUDIO W/NAVI W/SURROUND

[BOSE AUDIO W/NAVI W/SURROUND]

< WIRING DIAGRAM >

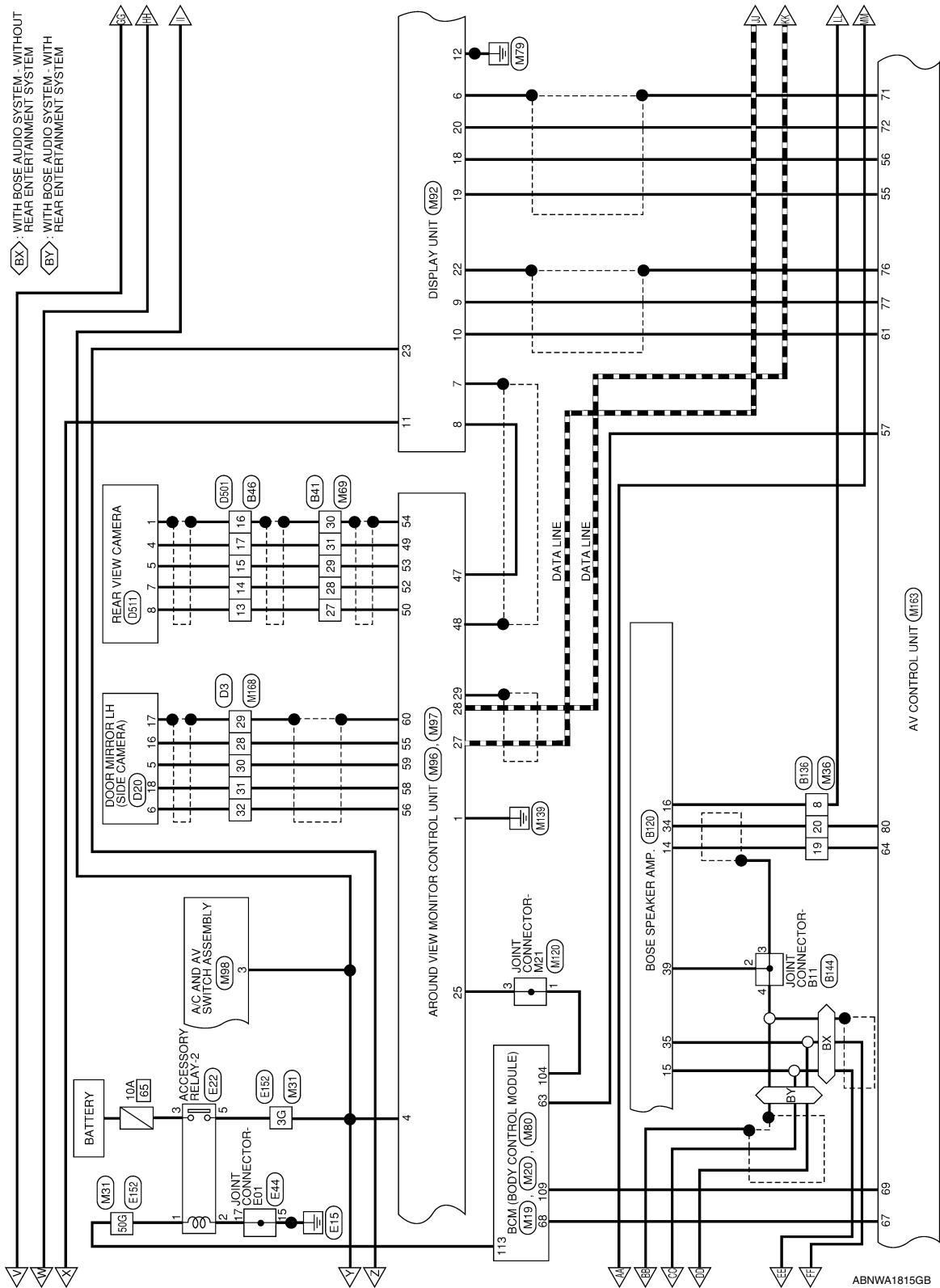



# BOSE AUDIO W/NAVI W/SURROUND

[BOSE AUDIO W/NAVI W/SURROUND]

< WIRING DIAGRAM >

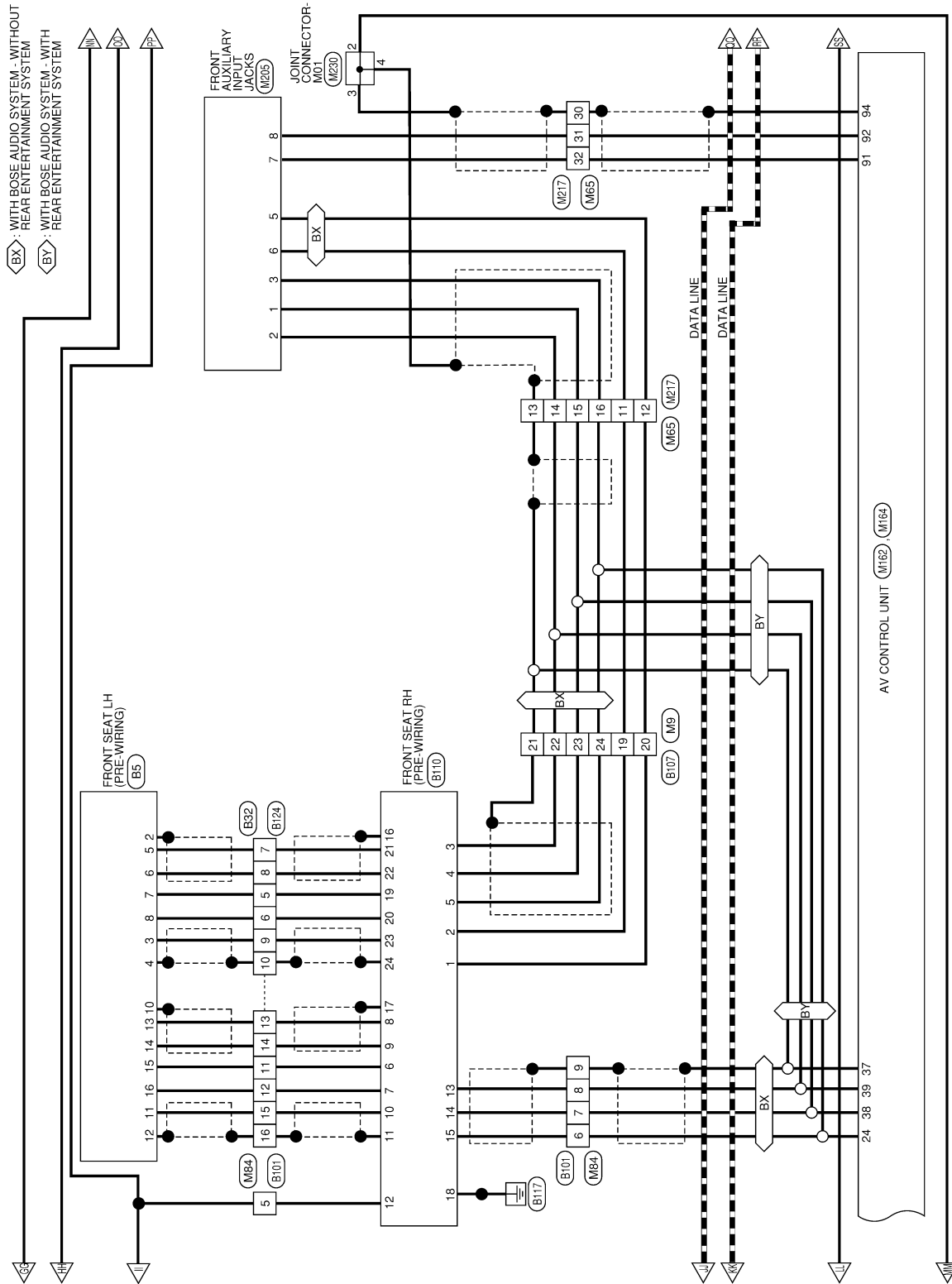

ABNWA1826GB

A  
B  
C  
D  
E  
F  
G  
H  
I  
J  
K  
L  
M  
N  
O  
P

AV

# BOSE AUDIO W/NAVI W/SURROUND

[BOSE AUDIO W/NAVI W/SURROUND]

< WIRING DIAGRAM >

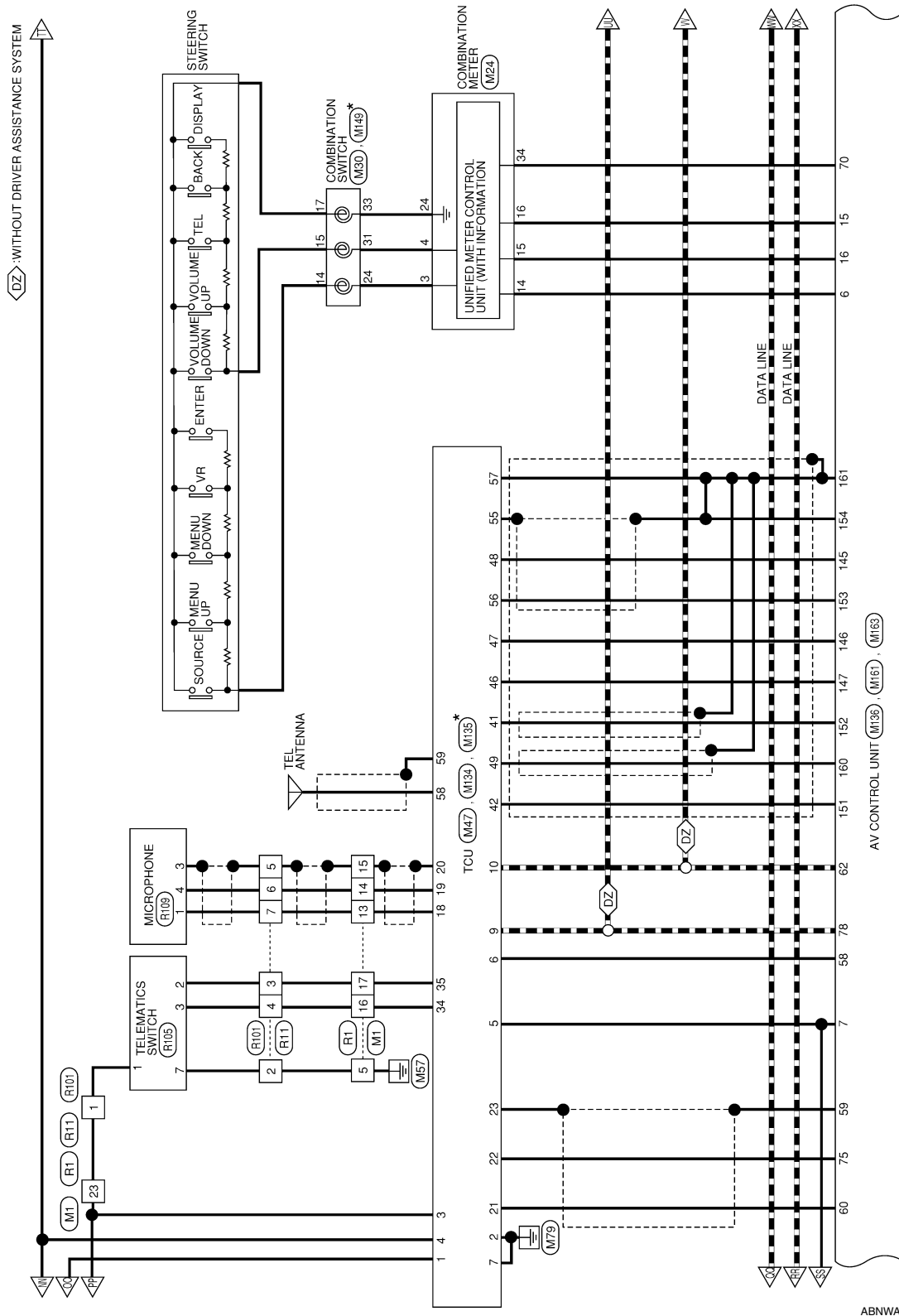

\* : THIS CONNECTOR IS NOT SHOWN IN "HARNES LAYOUT" OF PG SECTION.

ABNWA1816GB

# BOSE AUDIO W/NAVI W/SURROUND

[BOSE AUDIO W/NAVI W/SURROUND]

< WIRING DIAGRAM >

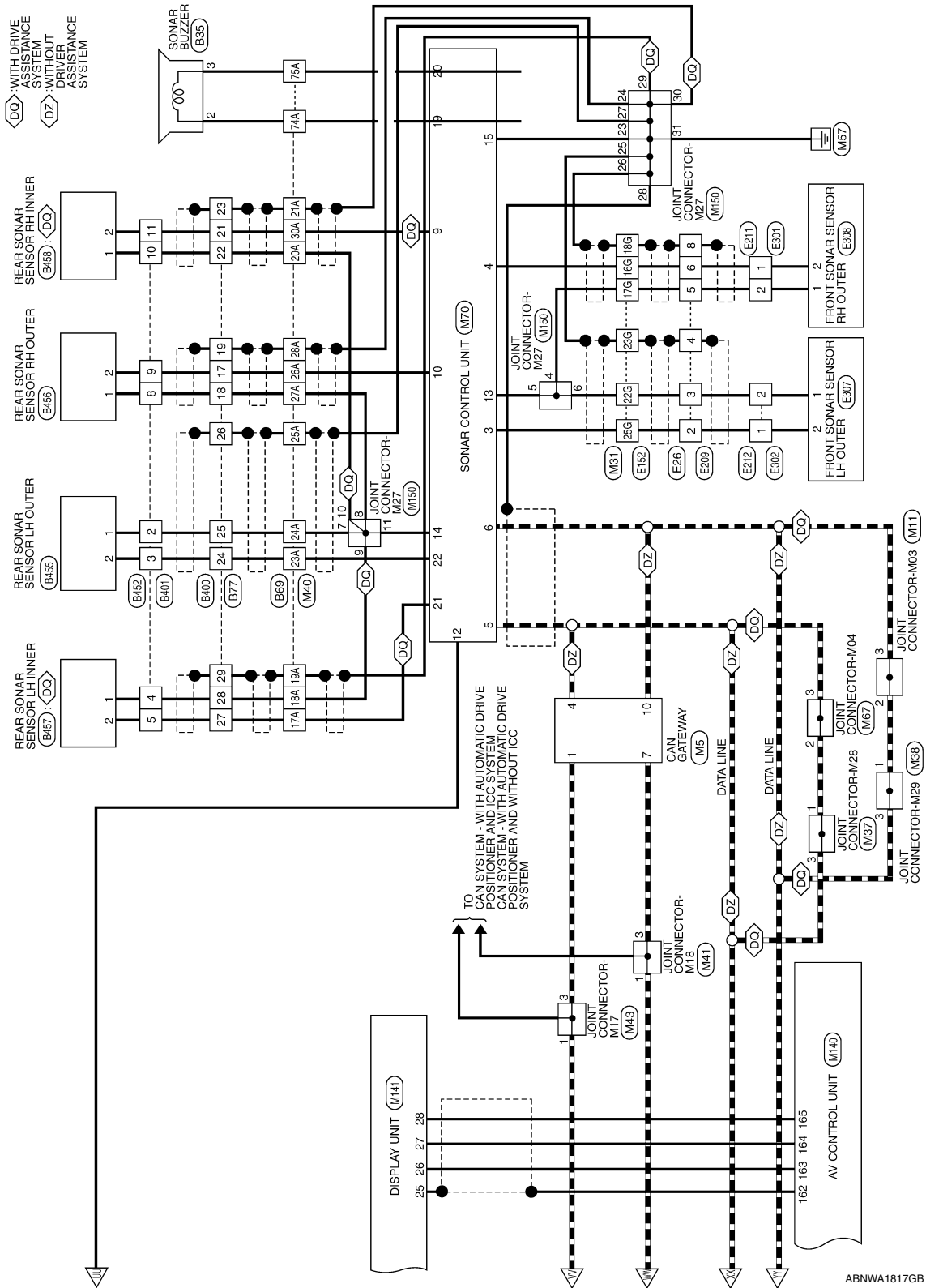

ABNWA1817GB

A  
B  
C  
D  
E  
F  
G  
H  
I  
J  
K  
L  
M  
N  
O  
P

AV

BOSE AUDIO SYSTEM CONNECTORS - WITH NAVIGATION AND SURROUND SOUND SYSTEM

Connector No.	M1
Connector Name	WIRE TO WIRE
Connector Color	WHITE

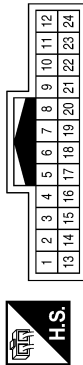

Terminal No.	Color of Wire	Signal Name
5	GR	-
13	W	-
14	B	-
15	SHIELD	-
16	R	-
17	W	-
23	P	-

Connector No.	M4
Connector Name	FUSE BLOCK (J/B)
Connector Color	WHITE

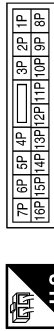

Terminal No.	Color of Wire	Signal Name
14P	Y	-
15P	L	-

Connector No.	M5
Connector Name	CAN GATEWAY
Connector Color	WHITE

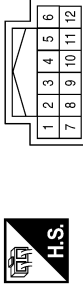

Terminal No.	Color of Wire	Signal Name
1	L	CAN-H
4	L	CAN-H
7	P	CAN-L
10	P	CAN-L

Connector No.	M9
Connector Name	WIRE TO WIRE
Connector Color	WHITE

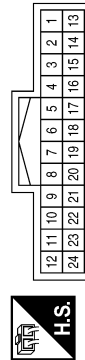

Terminal No.	Color of Wire	Signal Name
6	GR	-
7	V	-
8	G	-
9	R	-
10	SHIELD	-
11	W	-
12	B	-

Terminal No.	Color of Wire	Signal Name
19	P	-
20	G	-
21	SHIELD	-
22	B	-
23	R	-
24	W	-

ABNIA4673GB

# BOSE AUDIO W/NAVI W/SURROUND

## [BOSE AUDIO W/NAVI W/SURROUND]

< WIRING DIAGRAM >

Connector No.	M11
Connector Name	JOINT CONNECTOR-M03
Connector Color	WHITE

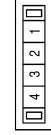

Terminal No.	Color of Wire	Signal Name
2	Y	-
3	W	-

Terminal No.	Color of Wire	Signal Name
6	G	-
7	W	-
8	G	-
9	W	-
10	W	-
11	R	-
12	G	-
13	G	-
14	W	-
15	G	-(WITH BOSE AUDIO SYSTEM AND SURROUND SOUND SYSTEM)
16	W	-

Connector No.	M10
Connector Name	WIRE TO WIRE
Connector Color	BROWN



Terminal No.	Color of Wire	Signal Name
1	B	-
2	W	-
3	G	-
4	L	-
5	Y	-

Connector No.	M22
Connector Name	DATA LINK CONNECTOR
Connector Color	WHITE

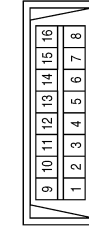

Terminal No.	Color of Wire	Signal Name
3	LG	-
11	SB	-

Connector No.	M20
Connector Name	BCM (BODY CONTROL MODULE)
Connector Color	BLACK

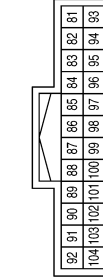

Terminal No.	Color of Wire	Signal Name
104	LG	REVERSE LAMP OUT

Connector No.	M19
Connector Name	BCM (BODY CONTROL MODULE)
Connector Color	BLACK

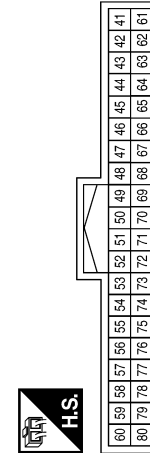

Terminal No.	Color of Wire	Signal Name
63	BG	I-KEY LINK SIGNAL
68	P	MR OUTPUT

ABNIA4674GB

A  
B  
C  
D  
E  
F  
G  
H  
I  
J  
K  
L  
M  
N  
O  
P

AV

# BOSE AUDIO W/NAVI W/SURROUND

[BOSE AUDIO W/NAVI W/SURROUND]

< WIRING DIAGRAM >

Connector No.	M25
Connector Name	AV CONTROL UNIT
Connector Color	PINK



Terminal No.	Color of Wire	Signal Name
188	B	-
189	SHIELD	-

Terminal No.	Color of Wire	Signal Name
3	P	STRG SW INPUT 1
4	BG	STRG SW INPUT 2
14	G	STRG SW OUTINPUT 1
15	W	STRG SW OUTINPUT 2
16	B	STRG SW OUTPUT GND
24	R	STRG SW GND
34	BG	SPEED 8P/R

Connector No.	M24
Connector Name	COMBINATION METER
Connector Color	WHITE

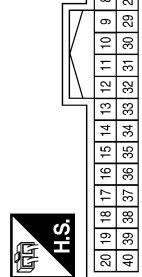

Terminal No.	Color of Wire	Signal Name
3G	P	-
16G	R	-
17G	B	-
18G	SHIELD	-
22G	B	-
23G	SHIELD	-
25G	R	-
26G	SHIELD	-
27G	B	-
28G	W	-
29G	G	-
30G	R	-
33G	G	-
50G	L	-

Connector No.	M31
Connector Name	WIRE TO WIRE
Connector Color	WHITE

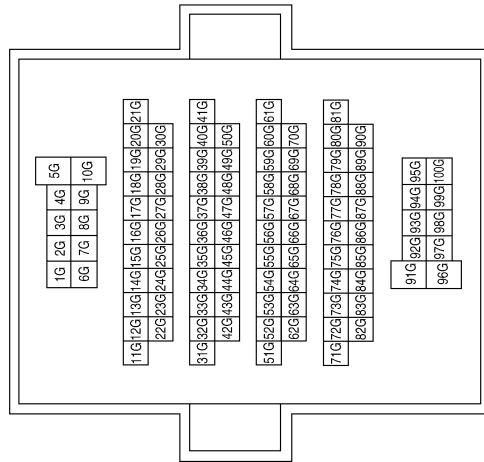

Connector No.	M30
Connector Name	COMBINATION SWITCH (SPIRAL CABLE)
Connector Color	GRAY

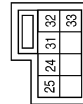

Terminal No.	Color of Wire	Signal Name
24	P	-
31	BG	-
33	R	-

ABNIA4675GB

# BOSE AUDIO W/NAVI W/SURROUND

[BOSE AUDIO W/NAVI W/SURROUND]

< WIRING DIAGRAM >

Terminal No.	Color of Wire	Signal Name
21	B	-
22	W	-
23	SHIELD	-
24	W	-
25	B	-
26	SHIELD	-
27	B	-
28	W	-
29	SHIELD	-
30	B	-
31	W	-
32	SHIELD	-

Terminal No.	Color of Wire	Signal Name
8	G	-
9	B	-
10	W	-
11	SHIELD	-
12	W	-
13	B	-
14	SHIELD	-
15	B	-
16	W	-
17	SHIELD	-
19	LG	-
20	SB	-

Connector No.	M36
Connector Name	WIRE TO WIRE
Connector Color	WHITE



20	19	18	17	16	15	14	13	12	11	10	9	8	7	6	5	4	3	2	1
40	39	38	37	36	35	34	33	32	31	30	29	28	27	26	25	24	23	22	21

Terminal No.	Color of Wire	Signal Name
6	LG	-
7	SB	-

Connector No.	M38
Connector Name	JOINT CONNECTOR-M29
Connector Color	WHITE



4	3	2	1
---	---	---	---

Terminal No.	Color of Wire	Signal Name
1	Y	-
3	W	-

Connector No.	M37
Connector Name	JOINT CONNECTOR-M28
Connector Color	WHITE



4	3	2	1
---	---	---	---

Terminal No.	Color of Wire	Signal Name
1	L	-
3	B	-

ABNIA4676GB

A  
B  
C  
D  
E  
F  
G  
H  
I  
J  
K  
L  
M  
N  
O  
P

AV

# BOSE AUDIO W/NAVI W/SURROUND

< WIRING DIAGRAM >

[BOSE AUDIO W/NAVI W/SURROUND]

Connector No.	M41
Connector Name	JOINT CONNECTOR-M18
Connector Color	WHITE

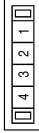

Terminal No.	Color of Wire	Signal Name
1	P	-
3	P	-

Terminal No.	Color of Wire	Signal Name
17A	W	-
18A	B	-
19A	SHIELD	-
20A	B	-
21A	SHIELD	-
23A	W	-
24A	B	-
25A	SHIELD	-
26A	W	-
27A	B	-
28A	SHIELD	-
30A	W	-
74A	BR	-
75A	LG	-

Connector No.	M40
Connector Name	WIRE TO WIRE
Connector Color	GRAY

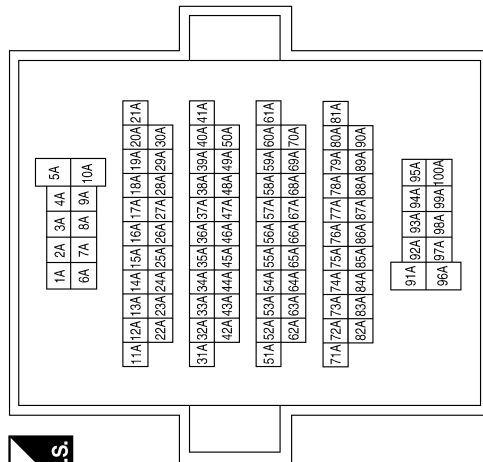

Connector No.	M43
Connector Name	JOINT CONNECTOR-M17
Connector Color	WHITE

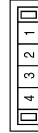

Terminal No.	Color of Wire	Signal Name
1	L	-
3	L	-

ABNIA4677GB



# BOSE AUDIO W/NAVI W/SURROUND

## [BOSE AUDIO W/NAVI W/SURROUND]

< WIRING DIAGRAM >

Terminal No.	Color of Wire	Signal Name
25	-	-
26	-	-
27	-	-
28	-	-
29	-	-
30	-	-
31	-	-
32	-	-
33	-	-
34	R	ECALL SW
35	W	LED A
36	-	-
37	-	-
38	-	-
39	-	-
40	-	-

Terminal No.	Color of Wire	Signal Name
8	-	-
9	L	V-CAN H
10	P	V-CAN L
11	-	-
12	-	-
13	-	-
14	-	-
15	-	-
16	-	-
17	-	-
18	W	MIC VCC
19	B	MIC SIG
20	SHIELD	MIC GND
21	W	MIC VCC DETECTION
22	B	DCM MIC SIG
23	SHIELD	DCM MIC GND
24	-	-

Connector No.	M47
Connector Name	TCU
Connector Color	WHITE



2	4	6	8	10	12	14	16	18	20	22	24	26	28	30	32	34	36	38	40
1	3	5	7	9	11	13	15	17	19	21	23	25	27	29	31	33	35	37	39

Terminal No.	Color of Wire	Signal Name
1	Y	B+
2	B	GND
3	P	ACC
4	LG	IGN
5	G	ACC OUT
6	G	AV ACC
7	B	GND

Terminal No.	Color of Wire	Signal Name
5	Y	-
13	R	-
14	W	-
15	B	-
16	SHIELD	-

Connector No.	M56
Connector Name	WIRE TO WIRE
Connector Color	WHITE



8	7	6	5	4	3	2	1
16	15	14	13	12	11	10	9

Connector No.	M55
Connector Name	AV CONTROL UNIT
Connector Color	BLUE



138	137
140	139
141	

Terminal No.	Color of Wire	Signal Name
1	B	-
2	W	-
3	SHIELD	-
4	P	-

Terminal No.	Color of Wire	Signal Name
137	W	VBUS
138	G	USB GND
139	L	USB D+
140	R	USB D-
141	SHIELD	SHIELD

ABNIA4678GB

A  
B  
C  
D  
E  
F  
G  
H  
I  
J  
K  
L  
M  
N  
O  
P

AV

# BOSE AUDIO W/NAVI W/SURROUND

[BOSE AUDIO W/NAVI W/SURROUND]

< WIRING DIAGRAM >

Terminal No.	Color of Wire	Signal Name
10	SHIELD	-
11	W	-
12	B	-
13	L	-
14	G	-
15	R	-
16	SHIELD	-
17	W	-
18	B	-
19	L	-
20	G	-
21	R	-
22	SHIELD	-
23	W	-
24	B	-

Connector No.	M63
Connector Name	WIRE TO WIRE
Connector Color	WHITE

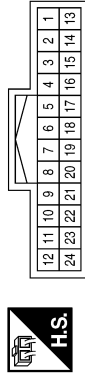

Terminal No.	Color of Wire	Signal Name
1	SB	-
2	G	-
3	R	-
4	SHIELD	-
5	W	-
6	B	-
7	V	-
8	G	-
9	R	-

Connector No.	M62
Connector Name	INSTRUMENT PANEL TWEETER LH
Connector Color	BROWN



Terminal No.	Color of Wire	Signal Name
1	G	-(WITH BOSE AUDIO SYSTEM)
2	W	-(WITH BOSE AUDIO SYSTEM)

Terminal No.	Color of Wire	Signal Name
16	W	-
30	SHIELD	-
31	B	-
32	W	-

Connector No.	M65
Connector Name	WIRE TO WIRE
Connector Color	WHITE

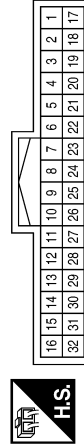

Terminal No.	Color of Wire	Signal Name
11	P	-
12	G	-
13	SHIELD	-
14	B	-
15	R	-

Connector No.	M64
Connector Name	WIRE TO WIRE
Connector Color	WHITE

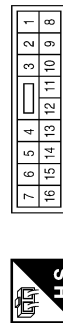

Terminal No.	Color of Wire	Signal Name
3	B	-
9	B	-

ABNIA4679GB

# BOSE AUDIO W/NAVI W/SURROUND

[BOSE AUDIO W/NAVI W/SURROUND]

< WIRING DIAGRAM >

Connector No.	M67
Connector Name	JOINT CONNECTOR-M04
Connector Color	WHITE

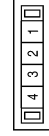

Terminal No.	Color of Wire	Signal Name
2	L	-
2	B	-

Terminal No.	Color of Wire	Signal Name
7	SB	-(WITH REAR ENTERTAINMENT SYSTEM)
8	G	-(WITH REAR ENTERTAINMENT SYSTEM)
9	R	-(WITH REAR ENTERTAINMENT SYSTEM)
10	SHIELD	-
11	W	-(WITH REAR ENTERTAINMENT SYSTEM)
12	Y	-(WITH REAR ENTERTAINMENT SYSTEM)
13	Y	-
14	SB	-
15	LG	-

Connector No.	M66
Connector Name	WIRE TO WIRE
Connector Color	WHITE

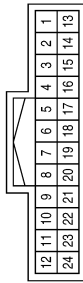

Terminal No.	Color of Wire	Signal Name
1	L	-
2	G	-
3	R	-(WITH REAR ENTERTAINMENT SYSTEM)
4	SHIELD	-(WITH REAR ENTERTAINMENT SYSTEM)
5	W	-(WITH REAR ENTERTAINMENT SYSTEM)
6	B	-(WITH REAR ENTERTAINMENT SYSTEM)

Connector No.	M68
Connector Name	FUSE BLOCK (J/B)
Connector Color	BROWN



Terminal No.	Color of Wire	Signal Name
2R	LG	-
5R	Y	-

ABNIA4680GB

A  
B  
C  
D  
E  
F  
G  
H  
I  
J  
K  
L  
M  
N  
O  
P

AV

# BOSE AUDIO W/NAVI W/SURROUND

[BOSE AUDIO W/NAVI W/SURROUND]

< WIRING DIAGRAM >

Connector No.	M70
Connector Name	SONAR CONTROL UNIT
Connector Color	WHITE

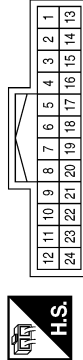

Terminal No.	Color of Wire	Signal Name
1	-	-
2	-	-
3	R	FOL SENSOR SIGNAL
4	R	FOR SENSOR SIGNAL
5	B	V CAN-H
6	W	V CAN-L
7	-	-
8	-	-
9	W	RIR SENSOR SIGNAL
10	W	ROR SENSOR SIGNAL
11	-	-
12	LG	IGN
13	B	FR SENSOR GND
14	B	FR SENSOR GND
15	GR	GND
16	-	-
17	-	-
18	-	-
19	BR	SPEAKER PWR
20	LG	SPEAKER RR SIGNAL
21	W	RIL SENSOR SIGNAL
22	W	ROL SENSOR SIGNAL
23	-	-
24	-	-

Terminal No.	Color of Wire	Signal Name
19	B	-(WITH REAR ENTERTAINMENT SYSTEM)
20	W	-(WITH REAR ENTERTAINMENT SYSTEM)
21	SHIELD	-(WITH REAR ENTERTAINMENT SYSTEM)
22	W	-(WITH REAR ENTERTAINMENT SYSTEM)
23	R	-(WITH REAR ENTERTAINMENT SYSTEM)
24	SHIELD	-
25	B	-
26	G	-
27	B	-(WITH NAVI)
28	R	-(WITH NAVI)
29	G	-(WITH NAVI)
30	SHIELD	-
31	W	-

Connector No.	M69
Connector Name	WIRE TO WIRE
Connector Color	WHITE

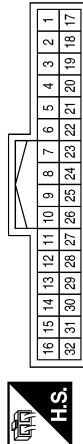

Terminal No.	Color of Wire	Signal Name
1	R	-(WITH REAR ENTERTAINMENT SYSTEM)
2	W	-(WITH REAR ENTERTAINMENT SYSTEM)
3	B	-(WITH REAR ENTERTAINMENT SYSTEM)
4	SHIELD	-
5	B	-
6	W	-
7	SHIELD	-
8	B	-
17	Y	-(WITH REAR ENTERTAINMENT SYSTEM)
18	P	-(WITH REAR ENTERTAINMENT SYSTEM)

ABNIA4681GB

# BOSE AUDIO W/NAVI W/SURROUND

< WIRING DIAGRAM >

[BOSE AUDIO W/NAVI W/SURROUND]

Connector No.	M73
Connector Name	INSTRUMENT PANEL TWEETER RH
Connector Color	BROWN



Terminal No.	Color of Wire	Signal Name
1	G	– (WITH BOSE AUDIO SYSTEM)
2	W	– (WITH BOSE AUDIO SYSTEM)

Connector No.	M80
Connector Name	BCM (BODY CONTROL MODULE)
Connector Color	BLACK

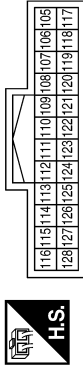

Terminal No.	Color of Wire	Signal Name
109	R	REVERSE SIGNAL
113	L	ACC RELAY OUT

Connector No.	M84
Connector Name	WIRE TO WIRE
Connector Color	WHITE

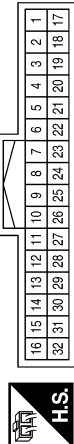

Terminal No.	Color of Wire	Signal Name
5	P	– (WITHOUT REAR ENTERTAINMENT SYSTEM)
5	Y	– (WITH REAR ENTERTAINMENT SYSTEM)
6	W	– (WITHOUT REAR ENTERTAINMENT SYSTEM)
6	B	– (WITH REAR ENTERTAINMENT SYSTEM)
7	R	– (WITHOUT REAR ENTERTAINMENT SYSTEM)

Terminal No.	Color of Wire	Signal Name
7	W	– (WITH REAR ENTERTAINMENT SYSTEM)
8	B	– (WITHOUT REAR ENTERTAINMENT SYSTEM)
8	R	– (WITH REAR ENTERTAINMENT SYSTEM)
9	SHIELD	–
10	G	–
11	L	–

Connector No.	M91
Connector Name	WIRE TO WIRE
Connector Color	BLACK

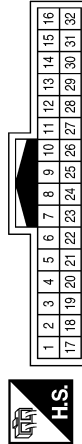

Terminal No.	Color of Wire	Signal Name
1	W	–
2	SHIELD	–
3	G	–
4	R	–
5	B	–

ABNIA4682GB

A  
B  
C  
D  
E  
F  
G  
H  
I  
J  
K  
L  
M  
N  
O  
P

AV

# BOSE AUDIO W/NAVI W/SURROUND

## [BOSE AUDIO W/NAVI W/SURROUND]

< WIRING DIAGRAM >

Connector No.	M95
Connector Name	WIRE TO WIRE
Connector Color	GRAY



Terminal No.	Color of Wire	Signal Name
1	B	-
2	B	-
3	B	-

Terminal No.	Color of Wire	Signal Name
9	B	FRONT DISP IT
10	W	IT FRONT DISP
11	Y	BATT
12	B	GND
13	-	-
14	-	-
15	-	-
16	-	-
17	-	-
18	B	FRONT COMP +
19	W	FRONT COMP -
20	R	FRONT COMP SYNC
21	-	-
22	SHIELD	SHIELD
23	P	ACC
24	-	-

Connector No.	M92
Connector Name	DISPLAY UNIT (WITH NAVI)
Connector Color	WHITE

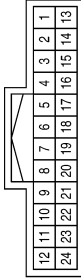

Terminal No.	Color of Wire	Signal Name
1	-	-
2	-	-
3	-	-
4	-	-
5	-	-
6	SHIELD	FRONT COMP SHIELD
7	SHIELD	SHIELD
8	B	R CAMERA COMP

Terminal No.	Color of Wire	Signal Name
27	B	V-CAN1 H
28	W	V-CAN1 L
29	SHIELD	V-CAN1 GND
30	W	MIRROR SIGNAL 2
31	-	-
32	G	MIRROR SIGNAL 1
33	-	-
34	-	-
35	-	-
36	-	-
37	-	-
38	-	-
39	-	-
40	-	-

Terminal No.	Color of Wire	Signal Name
10	-	-
11	-	-
12	-	-
13	-	-
14	-	-
15	-	-
16	-	-
17	-	-
18	-	-
19	B	M-CAN-1H
20	W	M-CAN-1L
21	-	-
22	-	-
23	SHIELD	M-CAN GND
24	-	-
25	LG	REV
26	-	-

Connector No.	M96
Connector Name	AROUND VIEW MONITOR CONTROL UNIT
Connector Color	WHITE

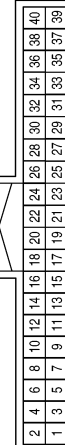

Terminal No.	Color of Wire	Signal Name
1	B	GND
2	Y	+B
3	LG	IGN
4	P	ACC
5	-	-
6	-	-
7	-	-
8	-	-
9	-	-

ABNIA4683GB

# BOSE AUDIO W/NAVI W/SURROUND

< WIRING DIAGRAM >

[BOSE AUDIO W/NAVI W/SURROUND]

Connector No.	M98
Connector Name	A/C AND AV SWITCH ASSEMBLY
Connector Color	WHITE

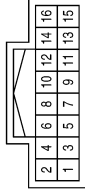

Terminal No.	Color of Wire	Signal Name
1	GR	-
3	P	-
4	R	-
5	B	-
6	SB	-
8	LG	-
9	V	-
14	Y	-

Terminal No.	Color of Wire	Signal Name
53	G	RV VIDEO +
54	SHIELD	RV VIDEO -
55	B	SV2 SERIAL SIGNAL
56	W	SV2 POWER
57	-	-
58	G	SV2 POWER GND
59	R	SV2 VIDEO +
60	SHIELD	SV2 POWER GND
61	W	SV1 SERIAL SIGNAL
62	B	SV1 POWER
63	-	-
64	R	SV1 POWER GND
65	G	SV1 VIDEO +
66	SHIELD	SV1 VIDEO -
67	B	FV SERIAL SIGNAL
68	W	FV POWER
69	-	-
70	G	FV POWER GND
71	R	FV VIDEO +
72	SHIELD	FV VIDEO -

Connector No.	M97
Connector Name	AROUND VIEW MONITOR CONTROL UNIT
Connector Color	WHITE

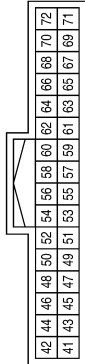

Terminal No.	Color of Wire	Signal Name
41	-	-
42	-	-
43	-	-
44	-	-
45	-	-
46	-	-
47	B	VIDEO OUTPUT +
48	SHIELD	VIDEO OUTPUT -
49	W	RV SERIAL SIGNAL
50	B	RV POWER
51	-	-
52	R	RV POWER GND

Connector No.	M111
Connector Name	FRONT TWEETER RH
Connector Color	BROWN



Terminal No.	Color of Wire	Signal Name
1	W	-(WITH BOSE AUDIO SYSTEM AND SURROUND SOUND SYSTEM)
2	B	-(WITH BOSE AUDIO SYSTEM AND SURROUND SOUND SYSTEM)

Connector No.	M110
Connector Name	CENTER SPEAKER
Connector Color	BROWN



Terminal No.	Color of Wire	Signal Name
1	G	-
2	W	-

Connector No.	M109
Connector Name	FRONT TWEETER LH
Connector Color	BROWN



Terminal No.	Color of Wire	Signal Name
1	G	-(WITH BOSE AUDIO SYSTEM AND SURROUND SOUND SYSTEM)
2	R	-(WITH BOSE AUDIO SYSTEM AND SURROUND SOUND SYSTEM)

ABNIA4684GB

A  
B  
C  
D  
E  
F  
G  
H  
I  
J  
K  
L  
M  
N  
O  
P

AV

# BOSE AUDIO W/NAVI W/SURROUND

## [BOSE AUDIO W/NAVI W/SURROUND]

< WIRING DIAGRAM >

Connector No.	M133
Connector Name	AV CONTROL UNIT
Connector Color	BROWN



Terminal No.	Color of Wire	Signal Name
166	B	-

Connector No.	M120
Connector Name	JOINT CONNECTOR-M21
Connector Color	WHITE



Terminal No.	Color of Wire	Signal Name
1	LG	-
3	LG	-

Connector No.	M115
Connector Name	WIRES TO WIRE
Connector Color	GRAY

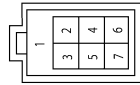

Terminal No.	Color of Wire	Signal Name
1	SHIELD	-
2	W	-
3	G	-
4	R	-
6	L	-

Connector No.	M135
Connector Name	TCU
Connector Color	BROWN



Terminal No.	Color of Wire	Signal Name
58	B	-
59	SHIELD	-

Terminal No.	Color of Wire	Signal Name
46	W	MANUFACTURE SPECIFIC
47	B	USB VBUS
48	B	USB D-
49	B	D-VOICE
50	-	-
51	-	-
52	-	-
53	-	-
54	-	-
55	SHIELD	USB GND
56	L/W	D+
57	SHIELD	CONN CHASSIS GND

Connector No.	M134
Connector Name	TCU
Connector Color	GRAY

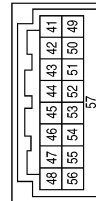

Terminal No.	Color of Wire	Signal Name
41	W	U-VOICE
42	L	VOICE GND
43	-	-
44	-	-
45	-	-

ABNIA4685GB



# BOSE AUDIO W/NAVI W/SURROUND

< WIRING DIAGRAM >

[BOSE AUDIO W/NAVI W/SURROUND]

Connector No.	M138
Connector Name	WIRE TO WIRE
Connector Color	GREEN

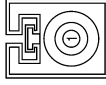

Terminal No.	Color of Wire	Signal Name
1	B	-

Terminal No.	Color of Wire	Signal Name
150	-	-
151	L	VOICE GND
152	W	U-VOICE
153	L/W	D+
154	SHIELD	USB GND
155	-	-
156	-	-
157	-	-
158	-	-
159	-	-
160	B	D-VOICE
161	SHIELD	CONN CHASSIS GND

Connector No.	M136
Connector Name	AV CONTROL UNIT
Connector Color	GRAY

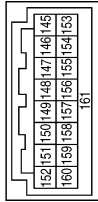

Terminal No.	Color of Wire	Signal Name
145	B	USB D-
146	B	USB VBUS
147	W	MANUFACTURE SPECIFIC
148	-	-
149	-	-

Connector No.	M143
Connector Name	AV CONTROL UNIT
Connector Color	GRAY

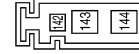

Terminal No.	Color of Wire	Signal Name
142	B	ANT +B
143	B	ANT MAIN
144	B	ANT SUB

Connector No.	M141
Connector Name	DISPLAY UNIT
Connector Color	BROWN

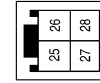

Terminal No.	Color of Wire	Signal Name
25	SHIELD	SHIELD
26	SHIELD	GND
27	B	GVIF+
28	B	GVIF-

Connector No.	M140
Connector Name	AV CONTROL UNIT
Connector Color	BLUE

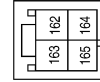

Terminal No.	Color of Wire	Signal Name
162	SHIELD	SHIELD
163	SHIELD	GND
164	B	GVIF-
165	B	GVIF+

ABNIA4686GB

A  
B  
C  
D  
E  
F  
G  
H  
I  
J  
K  
L  
M  
N  
O  
P

AV

# BOSE AUDIO W/NAVI W/SURROUND

< WIRING DIAGRAM >

[BOSE AUDIO W/NAVI W/SURROUND]

Terminal No.	Color of Wire	Signal Name
10	B	-
11	B	-
23	GR	-
24	SHIELD	-
25	SHIELD	-
26	SHIELD	-
27	SHIELD	-
28	SHIELD	-
29	SHIELD	-
30	SHIELD	-
31	GR	-

Connector No.	M150
Connector Name	JOINT CONNECTOR-M27
Connector Color	WHITE

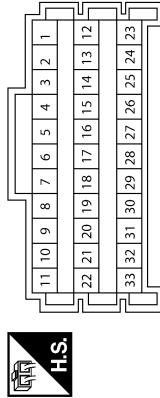

Terminal No.	Color of Wire	Signal Name
4	B	-
5	B	-
6	B	-
7	B	-
8	B	-
9	B	-

Connector No.	M149
Connector Name	COMBINATION SWITCH (SPIRAL CABLE)
Connector Color	GRAY



Terminal No.	Color of Wire	Signal Name
14	B	-
15	GR	-
17	BR	-

Terminal No.	Color of Wire	Signal Name
7	G	ACC
8	-	-
9	-	-
10	BR	SHIELD
11	W	FR RH PRE+
12	B	FR RH PRE-
13	B	RR RH PRE+
14	W	RR RH PRE-
15	B	STRG SW GND
16	W	STRG SW B
17	-	-
18	-	-
19	Y	+B
20	GR	GND

Connector No.	M161
Connector Name	AV CONTROL UNIT (WITH BOSE AUDIO SYSTEM - WITH NAVI AND SURROUND SOUND SYSTEM)
Connector Color	WHITE

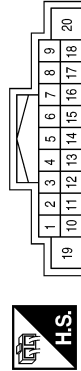

Terminal No.	Color of Wire	Signal Name
1	-	-
2	B	FR LH PRE+
3	W	FR LH PRE-
4	B	RR LH PRE+
5	W	RR LH PRE-
6	G	STRG SW A

Connector No.	M158
Connector Name	WIRE TO WIRE
Connector Color	WHITE



Terminal No.	Color of Wire	Signal Name
9	G	-(WITH BOSE AUDIO SYSTEM)
10	W	-(WITH BOSE AUDIO SYSTEM)

ABNIA4687GB

# BOSE AUDIO W/NAVI W/SURROUND

< WIRING DIAGRAM >

[BOSE AUDIO W/NAVI W/SURROUND]

Terminal No.	Color of Wire	Signal Name
39	B	AUX AUDIO-
40	R	HP1 LH-
41	G	HP1 RH-
42	SHIELD	HP1 SHIELD
43	-	-
44	-	-
45	-	-
46	-	-
47	-	-
48	-	-

Terminal No.	Color of Wire	Signal Name
28	-	-
29	-	-
30	-	-
31	-	-
32	-	-
33	-	-
34	-	-
35	-	-
36	-	-
37	SHIELD	AUX SHIELD
38	R	AUX AUDIO RH

Connector No.	M162
Connector Name	AV CONTROL UNIT (WITH BOSE AUDIO SYSTEM - WITH NAVI AND SURROUND SOUND SYSTEM)
Connector Color	WHITE

21	22	23	24	25	26	27	28	29	30	31	32	33	34
----	----	----	----	----	----	----	----	----	----	----	----	----	----

Terminal No.	Color of Wire	Signal Name
21	-	-
22	-	-
23	-	-
24	W	AUX AUDIO LH
25	-	-
26	W	HP1 LH+
27	B	HP1 RH+

Terminal No.	Color of Wire	Signal Name
68	LG	IGN
69	R	REVERSE SIG
70	BG	SPEED
71	SHIELD	NAVI COMP1 SHIELD
72	R	GND
73	-	-
74	-	-
75	B	MIC SIG
76	SHIELD	DISP SHIELD
77	B	DISP-IT
78	L	V-CAN H
79	SB	M-CAN H
80	SB	M-CAN H TRM

Terminal No.	Color of Wire	Signal Name
54	-	-
55	W	NAVI COMP1-
56	B	NAVI COMP1+
57	BG	RESERVE I1
58	G	RESERVE I2
59	SHIELD	MIC GND
60	W	MIC VCC
61	W	IT-DISP
62	P	V-CAN L
63	LG	M-CAN L
64	LG	M-CAN L TRM
65	-	-
66	-	-
67	P	MR OUTPUT

Connector No.	M163
Connector Name	AV CONTROL UNIT (WITH BOSE AUDIO SYSTEM - WITH NAVI AND SURROUND SOUND SYSTEM)
Connector Color	WHITE

49	50	51	52	53	54	55	56	57	58	59	60	61	62	63	64
----	----	----	----	----	----	----	----	----	----	----	----	----	----	----	----

Terminal No.	Color of Wire	Signal Name
49	-	-
50	-	-
51	-	-
52	-	-
53	G	PKB SIG

ABNIA4688GB

A  
B  
C  
D  
E  
F  
G  
H  
I  
J  
K  
L  
M  
N  
O  
P

AV

# BOSE AUDIO W/NAVI W/SURROUND

< WIRING DIAGRAM >

[BOSE AUDIO W/NAVI W/SURROUND]

Terminal No.	Color of Wire	Signal Name
105	W	NAVI COMP2-
106	SHIELD	NAVI COMP2 SHIELD
107	B	NAVI COMP2+
108	-	-
109	-	-
110	-	-
111	-	-
112	-	-
113	-	-
114	-	-
115	-	-
116	-	-
117	-	-
118	-	-
119	-	-
120	-	-

Terminal No.	Color of Wire	Signal Name
87	-	-
88	-	-
89	-	-
90	-	-
91	W	AUX VIDEO+
92	B	AUX VIDEO-
93	-	-
94	SHIELD	VIDEO SHIELD
95	-	-
96	-	-
97	Y	DVD EJECT
98	V	EJECT GND
99	-	-
100	-	-
101	-	-
102	-	-
103	-	-
104	-	-

Connector No.	M164
Connector Name	AV CONTROL UNIT (WITH BOSE AUDIO SYSTEM - WITH NAVI AND SURROUND SOUND SYSTEM)
Connector Color	WHITE



81	82	83	84	85	86	87	88	89	90	91	92	93	94	95	96	97	98	99	100	101	102	103	104	105	106	107	108	109	110	111	112	113	114	115	116	117	118	119	120
----	----	----	----	----	----	----	----	----	----	----	----	----	----	----	----	----	----	----	-----	-----	-----	-----	-----	-----	-----	-----	-----	-----	-----	-----	-----	-----	-----	-----	-----	-----	-----	-----	-----

Terminal No.	Color of Wire	Signal Name
81	-	-
82	-	-
83	-	-
84	-	-
85	-	-
86	-	-

Connector No.	M167
Connector Name	WIRE TO WIRE
Connector Color	WHITE



1	2	3	4	5	6	7		
8	9	10	11	12	13	14	15	16

Terminal No.	Color of Wire	Signal Name
8	W	-(WITH BOSE AUDIO SYSTEM)
9	G	-(WITH BOSE AUDIO SYSTEM AND SURROUND SOUND SYSTEM)

Terminal No.	Color of Wire	Signal Name
125	W	CENTER PRE+
126	Y	CENTER SHIELD
127	-	-
128	-	-
129	-	-
130	-	-
131	SHIELD	GUIDE SHIELD
132	W	SUB WOOFER PRE-
133	B	CENTER PRE-
134	-	-
135	-	-
136	-	-

Connector No.	M165
Connector Name	AV CONTROL UNIT (WITH BOSE AUDIO SYSTEM - WITH NAVI AND SURROUND SOUND SYSTEM)
Connector Color	WHITE



121	122	123	124	125	126	127	128
129	130	131	132	133	134	135	136

Terminal No.	Color of Wire	Signal Name
121	-	-
122	B	GUIDE+
123	W	GUIDE-
124	B	SUB WOOFER PRE+

ABNIA4689GB

# BOSE AUDIO W/NAVI W/SURROUND

< WIRING DIAGRAM >

[BOSE AUDIO W/NAVI W/SURROUND]

Connector No.	M175
Connector Name	JOINT CONNECTOR-M22
Connector Color	WHITE

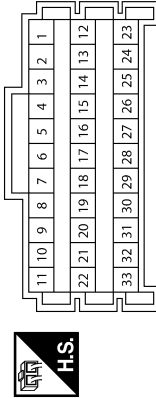

Terminal No.	Color of Wire	Signal Name
1	Y	-
2	Y	-
3	Y	-
4	Y	-
5	Y	-
6	Y	-
7	Y	-
8	Y	-
9	Y	-
29	P	-
31	P	-
32	P	-

Connector No.	M170
Connector Name	JOINT CONNECTOR-M09
Connector Color	WHITE

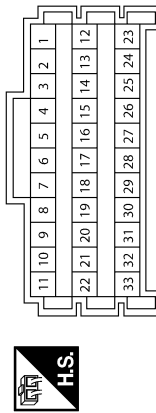

Terminal No.	Color of Wire	Signal Name
1	SHIELD	-
2	Y	-
3	SHIELD	-
6	GR	-
7	SHIELD	-
8	SHIELD	-
9	SHIELD	-
10	SHIELD	-

Connector No.	M168
Connector Name	WIRE TO WIRE
Connector Color	WHITE

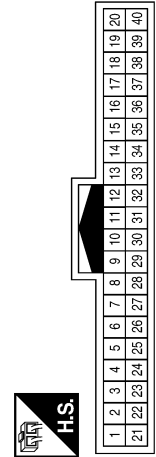

Terminal No.	Color of Wire	Signal Name
22	W	-
23	G	-
28	B	-
29	SHIELD	-
30	R	-
31	G	-
32	W	-

Connector No.	M178
Connector Name	JOINT CONNECTOR-M58
Connector Color	WHITE



Terminal No.	Color of Wire	Signal Name
1	SB	-
2	B	-
3	SB	-

Connector No.	M177
Connector Name	JOINT CONNECTOR-M57
Connector Color	WHITE

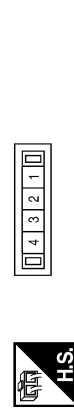

Terminal No.	Color of Wire	Signal Name
1	LG	-
2	LG	-
3	LG	-
4	LG	-

Connector No.	M176
Connector Name	JOINT CONNECTOR-M56
Connector Color	WHITE

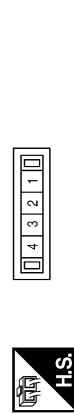

Terminal No.	Color of Wire	Signal Name
1	SB	-
2	SB	-
3	SB	-
4	SB	-

ABNIA4690GB

A  
B  
C  
D  
E  
F  
G  
H  
I  
J  
K  
L  
M  
N  
O  
P

AV

# BOSE AUDIO W/NAVI W/SURROUND

[BOSE AUDIO W/NAVI W/SURROUND]

< WIRING DIAGRAM >

Connector No.	M201
Connector Name	WIRE TO WIRE
Connector Color	WHITE

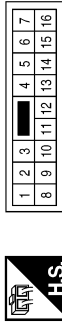

Terminal No.	Color of Wire	Signal Name
1	B	-
2	Y	-
3	V	-

Connector No.	M179
Connector Name	JOINT CONNECTOR-M59
Connector Color	WHITE



Terminal No.	Color of Wire	Signal Name
1	LG	-
2	W	-
3	LG	-

Connector No.	M202
Connector Name	WIRE TO WIRE
Connector Color	WHITE

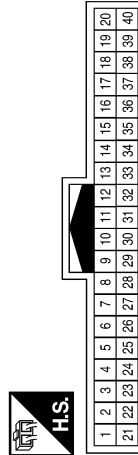

Terminal No.	Color of Wire	Signal Name
6	SHIELD	-
7	B	-
8	W	-
9	SB	-

Terminal No.	Color of Wire	Signal Name
27	R	-
28	W	-
29	L	-
30	G	-
31	R	-
32	SHIELD	-
33	W	-
34	B	-
35	L	-
36	G	-
37	R	-
38	SHIELD	-
39	W	-
40	B	-

Terminal No.	Color of Wire	Signal Name
10	G	-
11	R	-
12	SHIELD	-
13	W	-
14	B	-
15	V	-
16	G	-
17	R	-
18	SHIELD	-
19	W	-
20	B	-
24	B	-
25	SHIELD	-
26	B	-

ABNIA4691GB

# BOSE AUDIO W/NAVI W/SURROUND

## [BOSE AUDIO W/NAVI W/SURROUND]

< WIRING DIAGRAM >

Connector No.	M210
Connector Name	WIRE TO WIRE
Connector Color	GRAY

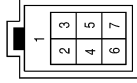

Terminal No.	Color of Wire	Signal Name
1	SHIELD	-
2	W	-
3	G	-
4	R	-
6	L	-

Connector No.	M209
Connector Name	USB INTERFACE
Connector Color	GREEN

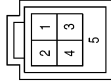

Terminal No.	Color of Wire	Signal Name
1	G	-
2	W	-
3	R	-
4	L	-
5	SHIELD	-

Connector No.	M205
Connector Name	FRONT AUXILIARY INPUT JACKS
Connector Color	WHITE

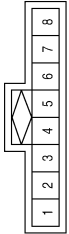

Terminal No.	Color of Wire	Signal Name
1	W	-
2	B	-
3	R	-
4	-	-
5	G	-
6	P	-
7	W	-
8	B	-

Terminal No.	Color of Wire	Signal Name
9	R	-
10	SHIELD	-
11	W	-
12	B	-
13	L	-
14	G	-
15	R	-
16	SHIELD	-
17	W	-
18	B	-
19	L	-
20	G	-
21	R	-
22	SHIELD	-
23	W	-
24	B	-

Connector No.	M215
Connector Name	WIRE TO WIRE
Connector Color	WHITE

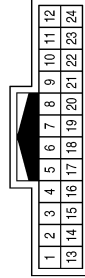

Terminal No.	Color of Wire	Signal Name
1	SB	-
2	G	-
3	R	-
4	SHIELD	-
5	W	-
6	B	-
7	V	-
8	G	-

Connector No.	M214
Connector Name	WIRE TO WIRE
Connector Color	WHITE

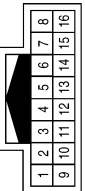

Terminal No.	Color of Wire	Signal Name
1	W	-
2	R	-
3	SHIELD	-
4	V	-
5	Y	-
13	W	-
14	R	-
15	B	-
16	SHIELD	-

ABNIA4692GB

A  
B  
C  
D  
E  
F  
G  
H  
I  
J  
K  
L  
M  
N  
O  
P

AV

# BOSE AUDIO W/NAVI W/SURROUND

[BOSE AUDIO W/NAVI W/SURROUND]

< WIRING DIAGRAM >

Connector No.	M230
Connector Name	JOINT CONNECTOR-M01
Connector Color	GRAY

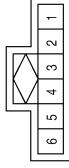

Terminal No.	Color of Wire	Signal Name
2	B	-
3	SHIELD	-
4	SHIELD	-

Connector No.	M217
Connector Name	WIRE TO WIRE
Connector Color	WHITE

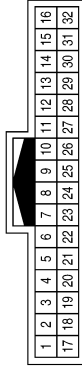

Terminal No.	Color of Wire	Signal Name
11	P	-
12	G	-
13	SHIELD	-
14	B	-
15	W	-
16	R	-
30	SHIELD	-
31	B	-
32	W	-

Connector No.	M216
Connector Name	WIRE TO WIRE
Connector Color	WHITE

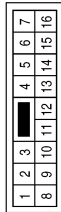

Terminal No.	Color of Wire	Signal Name
3	B	-
9	B	-

Connector No.	M251
Connector Name	WIRE TO WIRE
Connector Color	WHITE



Terminal No.	Color of Wire	Signal Name
1	B	-
2	Y	-
3	V	-

ABNIA4693GB



# BOSE AUDIO W/NAVI W/SURROUND

< WIRING DIAGRAM >

[BOSE AUDIO W/NAVI W/SURROUND]

Terminal No.	Color of Wire	Signal Name
26	B	-
27	R	-
28	L	-
29	P	-
30	W	-
31	G	-
32	B	-
33	R	-
34	-	-
35	SHIELD	-
36	-	-
37	-	-
38	V	-
39	B	-
40	Y	-

Terminal No.	Color of Wire	Signal Name
9	SHIELD	-
10	-	-
11	R	-
12	-	-
13	G	-
14	B	-
15	V	-
16	W	-
17	R	-
18	BG	-
19	G	-
20	B	-
21	SHIELD	-
22	W	-
23	SHIELD	-
24	W	-
25	G	-

Connector No.	M254
Connector Name	REAR AUXILIARY INPUT JACKS
Connector Color	WHITE



2	4	6	8	10	12	14	16	18	20	22	24	26	28	30	32	34	36	38	40
1	3	5	7	9	11	13	15	17	19	21	23	25	27	29	31	33	35	37	39

Terminal No.	Color of Wire	Signal Name
1	W	-
2	B	-
3	B	-
4	R	-
5	B	-
6	-	-
7	-	-
8	-	-

Terminal No.	Color of Wire	Signal Name
27	B	-
28	W	-
29	L	-
30	G	-
31	R	-
32	SHIELD	-
33	W	-
34	B	-
35	P	-
36	G	-
37	R	-
38	SHIELD	-
39	W	-
40	B	-

Terminal No.	Color of Wire	Signal Name
10	G	-
11	R	-
12	SHIELD	-
13	W	-
14	B	-
15	V	-
16	G	-
17	R	-
18	SHIELD	-
19	W	-
20	B	-
24	B	-
25	SHIELD	-
26	R	-

Connector No.	M257
Connector Name	WIRE TO WIRE
Connector Color	WHITE



20	19	18	17	16	15	14	13	12	11	10	9	8	7	6	5	4	3	2	1
40	39	38	37	36	35	34	33	32	31	30	29	28	27	26	25	24	23	22	21

Terminal No.	Color of Wire	Signal Name
6	SHIELD	-
7	B	-
8	W	-
9	BG	-

ABNIA4694GB

A  
B  
C  
D  
E  
F  
G  
H  
I  
J  
K  
L  
M  
N  
O  
P



# BOSE AUDIO W/NAVI W/SURROUND

< WIRING DIAGRAM >

[BOSE AUDIO W/NAVI W/SURROUND]

Connector No.	M502
Connector Name	ANTENNA BASE
Connector Color	GRAY



Terminal No.	Color of Wire	Signal Name
1	B	-
2	B	-

Connector No.	M501
Connector Name	ANTENNA BASE
Connector Color	GREEN

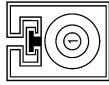

Terminal No.	Color of Wire	Signal Name
1	B	-

Connector No.	M500
Connector Name	WIRE TO WIRE
Connector Color	GRAY



Terminal No.	Color of Wire	Signal Name
1	B	-
2	B	-
3	B	-

Connector No.	M505
Connector Name	GLASS ANTENNA (FM SUB)
Connector Color	GRAY



Terminal No.	Color of Wire	Signal Name
1	B	-

Connector No.	M504
Connector Name	WIRE TO WIRE
Connector Color	GRAY



Terminal No.	Color of Wire	Signal Name
1	B	-

Connector No.	M503
Connector Name	WIRE TO WIRE
Connector Color	GRAY



Terminal No.	Color of Wire	Signal Name
1	B	-

ABNIA4695GB

# BOSE AUDIO W/NAVI W/SURROUND

< WIRING DIAGRAM >

[BOSE AUDIO W/NAVI W/SURROUND]

Connector No.	E26
Connector Name	WIRE TO WIRE
Connector Color	WHITE

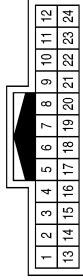

Terminal No.	Color of Wire	Signal Name
2	W	-
3	B	-
4	SHIELD	-
5	B	-
6	R	-
8	SHIELD	-
13	R	-
14	B	-
15	G	-
16	SHIELD	-
17	W	-

Connector No.	E22
Connector Name	ACCESSORY RELAY-2
Connector Color	BLUE



Terminal No.	Color of Wire	Signal Name
1	G	-
2	B	-
3	R	-
5	P	-

Connector No.	M509
Connector Name	WIRE TO WIRE
Connector Color	GREEN



Terminal No.	Color of Wire	Signal Name
1	B	-

Connector No.	E52
Connector Name	PARKING BRAKE SWITCH
Connector Color	BLACK



Terminal No.	Color of Wire	Signal Name
1	LG	-

Connector No.	E44
Connector Name	JOINT CONNECTOR-E01
Connector Color	WHITE

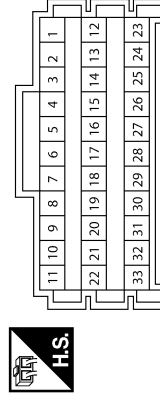

Terminal No.	Color of Wire	Signal Name
15	GR	-
17	B	-

Connector No.	E33
Connector Name	WIRE TO WIRE
Connector Color	WHITE

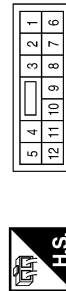

Terminal No.	Color of Wire	Signal Name
4	P	-

ABNIA4696GB

A  
B  
C  
D  
E  
F  
G  
H  
I  
J  
K  
L  
M  
N  
O  
P



# BOSE AUDIO W/NAVI W/SURROUND

< WIRING DIAGRAM >

[BOSE AUDIO W/NAVI W/SURROUND]

Connector No.	E209
Connector Name	WIRE TO WIRE
Connector Color	WHITE

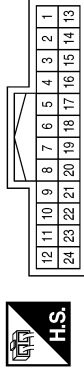

Terminal No.	Color of Wire	Signal Name
2	L	-
3	B	-
4	SHIELD	-
5	B	-
6	R	-
8	SHIELD	-
13	R	-
14	B	-
15	G	-
16	SHIELD	-
17	W	-

Connector No.	E226
Connector Name	FRONT CAMERA
Connector Color	BLACK



Terminal No.	Color of Wire	Signal Name
1	R	-
2	B	-
3	G	-
4	SHIELD	-
6	W	-

Terminal No.	Color of Wire	Signal Name
3G	P	-
16G	R	-
17G	B	-
18G	SHIELD	-
22G	B	-
23G	SHIELD	-
25G	W	-
26G	SHIELD	-
27G	W	-
28G	R	-
29G	B	-
30G	G	-
33G	LG	-
50G	G	-

Connector No.	E212
Connector Name	WIRE TO WIRE
Connector Color	GRAY



Terminal No.	Color of Wire	Signal Name
1	L	-
2	B	-

Connector No.	E152
Connector Name	WIRE TO WIRE
Connector Color	WHITE

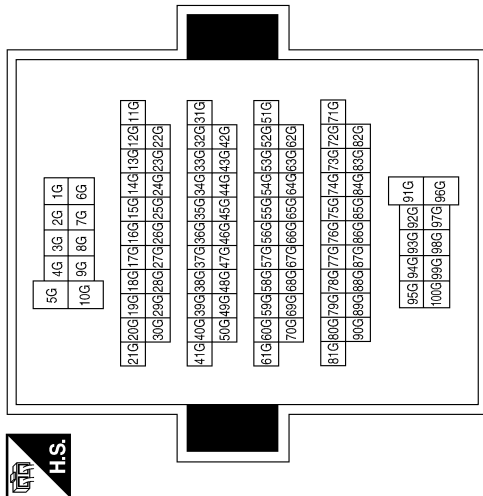

Connector No.	E211
Connector Name	WIRE TO WIRE
Connector Color	GRAY



Terminal No.	Color of Wire	Signal Name
1	R	-
2	B	-

ABNIA4697GB

# BOSE AUDIO W/NAVI W/SURROUND

< WIRING DIAGRAM >

[BOSE AUDIO W/NAVI W/SURROUND]

Connector No.	E307
Connector Name	FRONT SONAR SENSOR LH OUTER
Connector Color	BLACK



Terminal No.	Color of Wire	Signal Name
1	P	-
2	G	-

Connector No.	E302
Connector Name	WIRE TO WIRE
Connector Color	GRAY

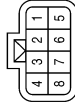

Terminal No.	Color of Wire	Signal Name
1	G	-
2	P	-

Connector No.	E301
Connector Name	WIRE TO WIRE
Connector Color	GRAY

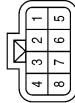

Terminal No.	Color of Wire	Signal Name
1	G	-
2	P	-

Connector No.	B5
Connector Name	FRONT SEAT LH (PRE-WIRING)
Connector Color	WHITE

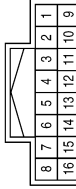

Terminal No.	Color of Wire	Signal Name
2	SHIELD	-
3	W	-
4	SHIELD	-
5	B	-
6	R	-
7	G	-
8	R	-
10	SHIELD	-
11	W	-
12	SHIELD	-
13	B	-
14	R	-
15	B	-
16	L	-

Connector No.	B1
Connector Name	REAR SIDE SPEAKER LH
Connector Color	BROWN



Terminal No.	Color of Wire	Signal Name
1	W	-
2	G	-

Connector No.	E308
Connector Name	FRONT SONAR SENSOR RH OUTER
Connector Color	BLACK



Terminal No.	Color of Wire	Signal Name
1	P	-
2	G	-

ABNIA4698GB

A  
B  
C  
D  
E  
F  
G  
H  
I  
J  
K  
L  
M  
AV  
O  
P

# BOSE AUDIO W/NAVI W/SURROUND

[BOSE AUDIO W/NAVI W/SURROUND]

< WIRING DIAGRAM >

Terminal No.	Color of Wire	Signal Name
12	W	-
13	SB	-
14	SB	-
15	LG	-

Terminal No.	Color of Wire	Signal Name
5	W	-(WITH REAR ENTERTAINMENT SYSTEM)
6	B	-(WITH REAR ENTERTAINMENT SYSTEM)
7	V	-(WITH REAR ENTERTAINMENT SYSTEM)
8	G	-(WITH REAR ENTERTAINMENT SYSTEM)
9	B	-(WITH REAR ENTERTAINMENT SYSTEM)
10	SHIELD	-(WITH REAR ENTERTAINMENT SYSTEM)
11	R	-(WITH REAR ENTERTAINMENT SYSTEM)

Connector No.	B6
Connector Name	WIRE TO WIRE
Connector Color	WHITE

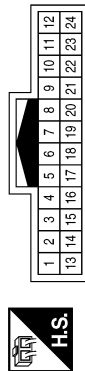

Terminal No.	Color of Wire	Signal Name
1	P	-
2	G	-
3	R	-(WITH REAR ENTERTAINMENT SYSTEM)
4	SHIELD	-(WITH REAR ENTERTAINMENT SYSTEM)

Terminal No.	Color of Wire	Signal Name
10	SHIELD	-
11	R	-
12	B	-
13	B	-
15	SB	-
16	LG	-
18	L	-
19	SB	-
21	P	-
22	SHIELD	-
23	G	-
24	W	-

Connector No.	B23
Connector Name	WIRE TO WIRE
Connector Color	WHITE

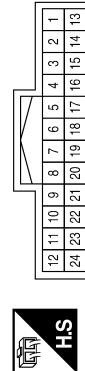

Terminal No.	Color of Wire	Signal Name
1	SB	-
3	SB	-
4	LG	-
6	BR	-
8	P	-
9	L	-

ABNIA4699GB

# BOSE AUDIO W/NAVI W/SURROUND

## [BOSE AUDIO W/NAVI W/SURROUND]

< WIRING DIAGRAM >

Terminal No.	Color of Wire	Signal Name
20	B	-
21	G	-
22	W	-
23	R	-
24	-	-
25	-	-
26	-	-
27	W	-
28	B	-
29	SHIELD	-
30	SHIELD	-
31	P	-
32	L	-

Terminal No.	Color of Wire	Signal Name
7	SB	-
8	BR	-
9	SB	-
10	L	-
11	-	-
12	-	-
13	-	-
14	R	-
15	G	-
16	B	-
17	W	-
18	V	-
19	V	-

Connector No.	B24
Connector Name	VIDEO DISTRIBUTOR
Connector Color	WHITE



2	4	6	8	10	12	14	16	18	20	22	24	26	28	30	32
1	3	5	7	9	11	13	15	17	19	21	23	25	27	29	31

Terminal No.	Color of Wire	Signal Name
1	B	-
2	V	-
3	B	-
4	W	-
5	BR	-
6	L	-

Connector No.	B32
Connector Name	WIRE TO WIRE
Connector Color	WHITE



16	15	14	13	12	11	10	9	8	7	6	5	4	3	2	1
32	31	30	29	28	27	26	25	24	23	22	21	20	19	18	17

Terminal No.	Color of Wire	Signal Name
5	G	-
6	R	-
7	B	-
8	R	-
9	W	-
10	SHIELD	-
11	B	-
12	L	-
13	B	-
14	R	-
15	W	-
16	SHIELD	-

Terminal No.	Color of Wire	Signal Name
41	SHIELD	-
42	-	-
43	-	-
44	-	-
45	W	-
46	R	-
47	B	-
48	G	-
49	SHIELD	-
50	-	-
51	-	-
52	-	-
53	SHIELD	-
54	B	-
55	R	-
56	W	-

Connector No.	B25
Connector Name	VIDEO DISTRIBUTOR
Connector Color	WHITE



34	38	36	40	42	44	46	48	50	52	54	56
33	35	37	39	41	43	45	47	49	51	53	55

Terminal No.	Color of Wire	Signal Name
33	W	-
34	B	-
35	SHIELD	-
36	-	-
37	-	-
38	-	-
39	W	-
40	B	-

ABNIA4700GB

A  
B  
C  
D  
E  
F  
G  
H  
I  
J  
K  
L  
M  
N  
O  
P

AV

# BOSE AUDIO W/NAVI W/SURROUND

< WIRING DIAGRAM >

[BOSE AUDIO W/NAVI W/SURROUND]

Connector No.	B35
Connector Name	SONAR BUZZER
Connector Color	WHITE

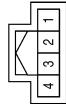

Terminal No.	Color of Wire	Signal Name
2	P	-
3	V	-

Connector No.	B41
Connector Name	WIRE TO WIRE
Connector Color	WHITE

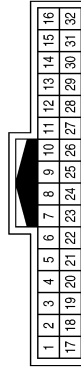

Terminal No.	Color of Wire	Signal Name
1	R	-(WITH REAT ENTERTAINMENT SYSTEM)
2	W	-(WITH REAT ENTERTAINMENT SYSTEM)
3	B	-
4	SHIELD	-
5	B	-

Terminal No.	Color of Wire	Signal Name
6	W	-
7	SHIELD	-
8	B	-
17	V	-(WITH REAT ENTERTAINMENT SYSTEM)
18	W	-(WITH REAT ENTERTAINMENT SYSTEM)
19	B	-(WITH REAT ENTERTAINMENT SYSTEM)
20	W	-(WITH REAT ENTERTAINMENT SYSTEM)
21	SHIELD	-(WITH REAT ENTERTAINMENT SYSTEM)

Terminal No.	Color of Wire	Signal Name
22	W	-(WITH REAT ENTERTAINMENT SYSTEM)
23	R	-(WITH REAT ENTERTAINMENT SYSTEM)
24	SHIELD	-
25	B	-
26	G	-
27	W	-(WITH NAVI)
28	R	-(WITH NAVI)
29	G	-(WITH NAVI)
30	SHIELD	-
31	B	-

ABNIA4701GB



# BOSE AUDIO W/NAVI W/SURROUND

## [BOSE AUDIO W/NAVI W/SURROUND]

< WIRING DIAGRAM >

Connector No.	B49
Connector Name	WIRE TO WIRE
Connector Color	WHITE

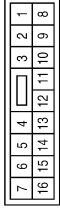

Terminal No.	Color of Wire	Signal Name
9	G	-
10	W	-
11	P	-
12	R	-
13	SHIELD	-
14	B	-
15	W	-
16	W	-

Connector No.	B46
Connector Name	WIRE TO WIRE
Connector Color	WHITE

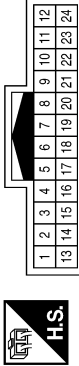

Terminal No.	Color of Wire	Signal Name
13	W	- (WITH NAVI)
14	R	- (WITH NAVI)
15	G	- (WITH NAVI)
16	SHIELD	-
17	B	-

Connector No.	B43
Connector Name	WIRE TO WIRE
Connector Color	WHITE



Terminal No.	Color of Wire	Signal Name
4	G	-

Terminal No.	Color of Wire	Signal Name
17A	W	-
18A	B	-
19A	SHIELD	-
20A	W	-
21A	SHIELD	-
23A	W	-
24A	B	-
25A	SHIELD	-
26A	W	-
27A	B	-
28A	SHIELD	-
30A	B	-
74A	P	-
75A	V	-

Connector No.	B69
Connector Name	WIRE TO WIRE
Connector Color	GRAY

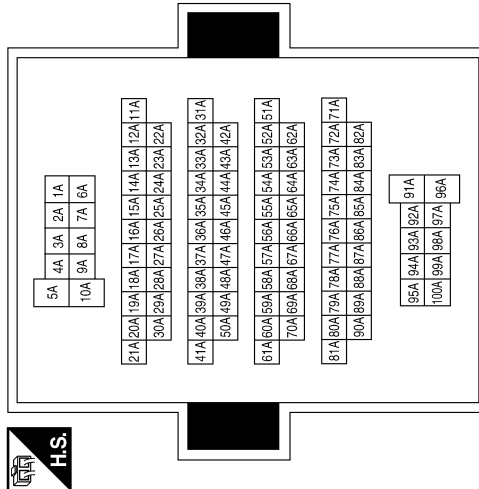

Connector No.	B51
Connector Name	WIRE TO WIRE
Connector Color	WHITE

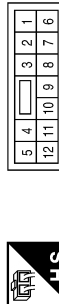

Terminal No.	Color of Wire	Signal Name
11	R	-
12	P	-

ABNIA4702GB

A  
B  
C  
D  
E  
F  
G  
H  
I  
J  
K  
L  
M  
N  
O  
P

AV

# BOSE AUDIO W/NAVI W/SURROUND

< WIRING DIAGRAM >

[BOSE AUDIO W/NAVI W/SURROUND]

Terminal No.	Color of Wire	Signal Name
6	SHIELD	-
7	W	-
8	B	-
9	V	-
10	W	-
11	B	-
12	G	-
13	R	-
14	SHIELD	-

Connector No.	B75
Connector Name	WIRE TO WIRE
Connector Color	WHITE

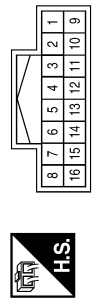

Terminal No.	Color of Wire	Signal Name
1	LG	-
2	SB	-
3	L	-
4	SB	-
5	BR	-

Connector No.	B73
Connector Name	SUBWOOFER
Connector Color	GRAY



Terminal No.	Color of Wire	Signal Name
1	B	-
2	W	-
4	W	-
5	B	-
6	G	-

Terminal No.	Color of Wire	Signal Name
8	B	- (WITHOUT REAR ENTERTAINMENT SYSTEM)
8	R	- (WITH REAR ENTERTAINMENT SYSTEM)
9	SHIELD	-
10	G	-
11	SB	-

Connector No.	B101
Connector Name	WIRE TO WIRE
Connector Color	WHITE

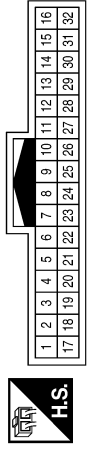

Terminal No.	Color of Wire	Signal Name
5	V	- (WITHOUT REAR ENTERTAINMENT SYSTEM)
5	Y	- (WITH REAR ENTERTAINMENT SYSTEM)
6	W	- (WITHOUT REAR ENTERTAINMENT SYSTEM)
6	B	- (WITH REAR ENTERTAINMENT SYSTEM)
7	R	- (WITHOUT REAR ENTERTAINMENT SYSTEM)
7	W	- (WITH REAR ENTERTAINMENT SYSTEM)

Connector No.	B77
Connector Name	WIRE TO WIRE
Connector Color	WHITE

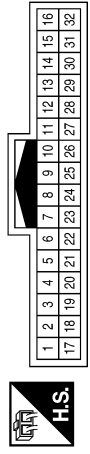

Terminal No.	Color of Wire	Signal Name
17	W	-
18	B	-
19	SHIELD	-
21	B	-
22	W	-
23	SHIELD	-
24	W	-
25	B	-
26	SHIELD	-
27	W	-
28	B	-
29	SHIELD	-

ABNIA4703GB

# BOSE AUDIO W/NAVI W/SURROUND

< WIRING DIAGRAM >

[BOSE AUDIO W/NAVI W/SURROUND]

Terminal No.	Color of Wire	Signal Name
13	B	-
14	R	-
15	W	-
16	SHIELD	-
17	SHIELD	-
18	B	-
19	G	-
20	R	-
21	G	-
22	R	-
23	W	-
24	SHIELD	-

Connector No.	B110
Connector Name	FRONT SEAT RH (PRE-WIRING)
Connector Color	WHITE

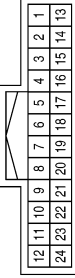

Terminal No.	Color of Wire	Signal Name
1	Y	-
2	V	-
3	B	-
4	R	-
5	W	-
6	B	-
7	L	-
8	G	-
9	R	-
10	W	-
11	SHIELD	-
12	V	-

Connector No.	B107
Connector Name	WIRE TO WIRE
Connector Color	WHITE

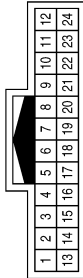

Terminal No.	Color of Wire	Signal Name
6	B	-
7	V	-
8	G	-
9	R	-
10	SHIELD	-
11	B	-
12	W	-
19	V	-
20	Y	-
21	SHIELD	-
22	B	-
23	R	-
24	W	-

Terminal No.	Color of Wire	Signal Name
13	W	-
14	P	-
15	G	-
16	R	-

Terminal No.	Color of Wire	Signal Name
4	LG	-
5	Y	-
6	P	-
7	R	-
8	G	-
9	W	-
10	G	-
11	W	-
12	G	-

Connector No.	B111
Connector Name	WIRE TO WIRE
Connector Color	BROWN

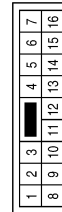

Terminal No.	Color of Wire	Signal Name
1	W	-
2	G	-
3	R	-

ABNIA4704GB

A  
B  
C  
D  
E  
F  
G  
H  
I  
J  
K  
L  
M  
N  
O  
P



# BOSE AUDIO W/NAVI W/SURROUND

< WIRING DIAGRAM >

[BOSE AUDIO W/NAVI W/SURROUND]

Connector No.	B121
Connector Name	BOSE SPEAKER AMP.
Connector Color	BROWN

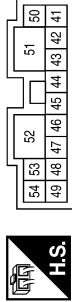

Terminal No.	Color of Wire	Signal Name
41	G	-
42	W	-
43	W	-
44	P	-
45	P	-
46	R	-
47	B	-
48	R	-
49	W	-
50	LG	-
51	Y	-
52	B	-
53	G	-
54	B	-

Terminal No.	Color of Wire	Signal Name
25	B	-
26	B	-
27	B	-
28	B	-
29	B	-
30	B	-
31	-	-
32	-	-
33	-	-
34	W	-
35	W	-
36	-	-
37	-	-
38	-	-
39	B	-
40	-	-

Connector No.	B120
Connector Name	BOSE SPEAKER AMP.
Connector Color	WHITE

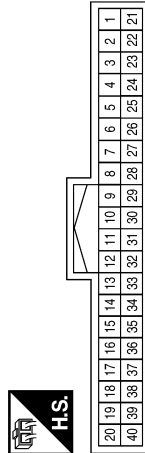

Terminal No.	Color of Wire	Signal Name
1	-	-
2	-	-
3	-	-
4	W	-
5	W	-
6	W	-
7	W	-
8	W	-
9	W	-
10	W	-
11	-	-
12	-	-
13	-	-
14	B	-
15	B	-
16	W	-
17	-	-
18	-	-
19	-	-
20	-	-
21	-	-
22	-	-
23	-	-
24	B	-

ABNIA4705GB

# BOSE AUDIO W/NAVI W/SURROUND

## [BOSE AUDIO W/NAVI W/SURROUND]

< WIRING DIAGRAM >

Connector No.	B136
Connector Name	WIRE TO WIRE
Connector Color	WHITE

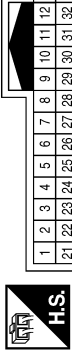

1	2	3	4	5	6	7	8	9	10	11	12	13	14	15	16	17	18	19	20
21	22	23	24	25	26	27	28	29	30	31	32	33	34	35	36	37	38	39	40

Terminal No.	Color of Wire	Signal Name
6	B	-
7	W	-
8	W	-
9	B	-
10	W	-
11	SHIELD	-
12	B	-
13	W	-
14	SHIELD	-
15	B	-
16	W	-
17	SHIELD	-
19	B	-(WITH SURROUND SOUND SYSTEM)
20	W	-(WITH SURROUND SOUND SYSTEM)
21	B	-
22	W	-
23	SHIELD	-
24	B	-
25	W	-
26	SHIELD	-
27	B	-
28	W	-
29	SHIELD	-
30	B	-
31	W	-
32	SHIELD	-

Connector No.	B124
Connector Name	WIRE TO WIRE
Connector Color	WHITE

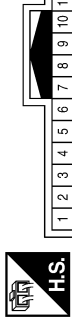

1	2	3	4	5	6	7	8	9	10	11	12	13	14	15	16
17	18	19	20	21	22	23	24	25	26	27	28	29	30	31	32

Terminal No.	Color of Wire	Signal Name
5	G	-
6	R	-
7	G	-
8	R	-
9	W	-
10	SHIELD	-
11	B	-
12	L	-
13	G	-
14	R	-
15	W	-
16	SHIELD	-

Connector No.	B122
Connector Name	BOSE SPEAKER AMP.
Connector Color	BROWN

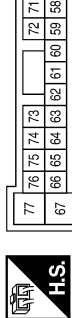

77	76	75	74	73	72	71	70	69	68			
67	66	65	64	63	62	61	60	59	58	57	56	55

Terminal No.	Color of Wire	Signal Name
55	W	-
56	R	-
57	P	-
58	R	-
59	G	-
60	-	-
61	-	-
62	W	-
63	W	-
64	G	-
65	SHIELD	-
66	-	-
67	-	-
68	-	-
69	G	-
70	W	-
71	G	-
72	W	-
73	G	-
74	G	-
75	W	-
76	-	-
77	-	-

ABNIA4706GB

A  
B  
C  
D  
E  
F  
G  
H  
I  
J  
K  
L  
M  
O  
P

AV

# BOSE AUDIO W/NAVI W/SURROUND

[BOSE AUDIO W/NAVI W/SURROUND]

< WIRING DIAGRAM >

Connector No.	B139
Connector Name	WIRE TO WIRE
Connector Color	WHITE

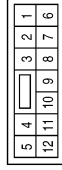

Terminal No.	Color of Wire	Signal Name
11	W	-(WITH BOSE AUDIO SYSTEM)
12	G	-(WITH BOSE AUDIO SYSTEM)

Terminal No.	Color of Wire	Signal Name
9	O	-
10	SHIELD	-
11	R	-
12	B	-
13	B	-
15	B/Y	-(WITH SURROUND SOUND SYSTEM)
16	L/G	-
18	LG	-
19	BR	-
21	Y	-
22	SHIELD	-
23	G	-
24	W	-

Connector No.	B137
Connector Name	WIRE TO WIRE
Connector Color	WHITE

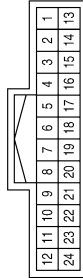

Terminal No.	Color of Wire	Signal Name
1	Y	-
3	SB	-
4	LG	-
5	SHIELD	-
6	SB	-
8	SB	-

Connector No.	B144
Connector Name	JOINT CONNECTOR-B11
Connector Color	WHITE



Terminal No.	Color of Wire	Signal Name
2	B	-
3	SHIELD	-
4	SHIELD	-

Connector No.	B140
Connector Name	WIRE TO WIRE
Connector Color	WHITE



Terminal No.	Color of Wire	Signal Name
9	G	-
10	W	-
11	P	-
12	R	-
13	SHIELD	-
14	W	-
15	B	-
16	W	-

ABNIA4707GB

# BOSE AUDIO W/NAVI W/SURROUND

## [BOSE AUDIO W/NAVI W/SURROUND]

< WIRING DIAGRAM >

Connector No.	B153
Connector Name	REAR SIDE SPEAKER RH
Connector Color	BROWN



Terminal No.	Color of Wire	Signal Name
1	W	-
2	G	-

Terminal No.	Color of Wire	Signal Name
7	Y	-
8	O	-
9	V	-
10	B	-
11	W	-
12	G	-
13	R	-
14	SHIELD	-

Connector No.	B145
Connector Name	WIRE TO WIRE
Connector Color	WHITE

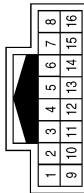

Terminal No.	Color of Wire	Signal Name
1	LG	-
2	SB	-
3	SB	-
4	L	-
5	BR	-
6	SHIELD	-

Terminal No.	Color of Wire	Signal Name
15	LG	-
16	R	-
17	BR	-
18	W	-
19	Y	-
20	GR	-
21	G	-
22	LG	-
23	B	-
24	R	-

Terminal No.	Color of Wire	Signal Name
4	LG	-
6	G	-
8	V	-
9	Y	-
10	P	-
11	G	-
12	W	-
13	G	-
14	SB	-

Connector No.	B201
Connector Name	WIRE TO WIRE
Connector Color	WHITE



Terminal No.	Color of Wire	Signal Name
1	W	-
3	P	-

ABNIA4849GB

A  
B  
C  
D  
E  
F  
G  
H  
I  
J  
K  
L  
M  
AV  
O  
P

# BOSE AUDIO W/NAVI W/SURROUND

[BOSE AUDIO W/NAVI W/SURROUND]

< WIRING DIAGRAM >

Connector No.	B202
Connector Name	HEADREST DISPLAY UNIT (DRIVER SEAT)
Connector Color	WHITE

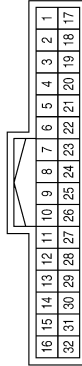

Terminal No.	Color of Wire	Signal Name
1	W	REAR1 HP LH+
2	G	REAR1 HP RH+
3	LG	REAR1 HP SHIELD
4	-	-
5	Y	REAR1 COMP+
6	-	-

Connector No.	B219
Connector Name	WIRE TO WIRE
Connector Color	WHITE

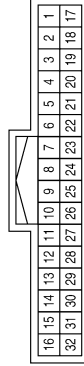

Terminal No.	Color of Wire	Signal Name
1	W	-
2	G	-
3	LG	-
5	Y	-
7	W	-
8	G	-

Terminal No.	Color of Wire	Signal Name
7	W	AUX REQ OUT
8	G	ACC DET IN
9	-	-
10	LG	M-CAN 1L
11	P	M-CAN 1H
12	G	LOCATION DET LH (LH ONLY)
13	BR	ILL
14	-	-
15	W	BAT
16	W	BAT
17	B	REAR1 HP LH-
18	R	REAR1 HP RH-
19	V	AV GND

Terminal No.	Color of Wire	Signal Name
20	P	REAR1 COMP SHIELD
21	G	REAR1 COMP-
22	-	-
23	Y	CONT GND
24	SB	CON CK B
25	-	-
26	R	M-CAN 2L
27	LG	M-CAN 2H
28	-	-
29	GR	CON CK A
30	-	-
31	G	GND
32	G	GND

Terminal No.	Color of Wire	Signal Name
10	LG	-
11	P	-
12	G	-
13	BR	-
15	W	-
16	W	-
17	B	-
18	R	-
19	V	-
20	P	-
21	G	-
23	Y	-
24	SB	-

Terminal No.	Color of Wire	Signal Name
26	R	-
27	LG	-
29	GR	-
31	G	-
32	G	-

ABNIA4850GB



# BOSE AUDIO W/NAVI W/SURROUND

[BOSE AUDIO W/NAVI W/SURROUND]

< WIRING DIAGRAM >

Terminal No.	Color of Wire	Signal Name
26	R	-
27	LG	-
29	GR	-
31	G	-
32	G	-

Terminal No.	Color of Wire	Signal Name
10	LG	-
11	P	-
12	G	-
13	BR	-
15	W	-
16	W	-
17	B	-
18	R	-
19	V	-
20	P	-
21	G	-
23	Y	-
24	SB	-

Connector No.	B222
Connector Name	WIRE TO WIRE
Connector Color	WHITE

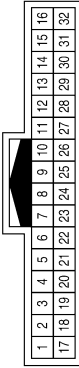

Terminal No.	Color of Wire	Signal Name
1	W	-
2	G	-
3	LG	-
5	Y	-
7	W	-
8	G	-

Connector No.	B301
Connector Name	WIRE TO WIRE
Connector Color	WHITE

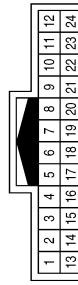

Terminal No.	Color of Wire	Signal Name
1	W	-
3	P	-
4	LG	-
5	SHIELD	-
6	G	-
8	V	-
9	Y	-
10	P	-
11	G	-

Terminal No.	Color of Wire	Signal Name
12	W	-
13	G	-
14	SB	-
15	LG	-
16	R	-
17	BR	-
18	W	-
19	Y	-
20	GR	-
21	G	-
22	LG	-
23	B	-
24	R	-

ABNIA4708GB

A  
B  
C  
D  
E  
F  
G  
H  
I  
J  
K  
L  
M  
N  
O  
P



# BOSE AUDIO W/NAVI W/SURROUND

< WIRING DIAGRAM >

[BOSE AUDIO W/NAVI W/SURROUND]

Terminal No.	Color of Wire	Signal Name
20	P	REAR1 COMP SHIELD
21	G	REAR1 COMP-
22	-	-
23	Y	CONT GND
24	SB	CON CK B
25	-	-
26	R	M-CAN 2L
27	LG	M-CAN 2H
28	G	LOCATION DET RH (RH ONLY)
29	GR	CON CK A
30	-	-
31	G	GND
32	G	GND

Terminal No.	Color of Wire	Signal Name
7	W	AUX REQ OUT
8	G	ACC DET IN
9	-	-
10	LG	M-CAN 1L
11	P	M-CAN 1H
12	-	-
13	BR	ILL
14	-	-
15	W	BAT
16	W	BAT
17	B	REAR1 HP LH-
18	R	REAR1 HP RH-
19	V	AV GND

Connector No.	B302
Connector Name	HEADREST DISPLAY UNIT (PASSENGER SEAT)
Connector Color	WHITE

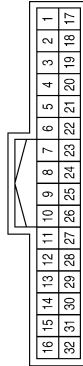

Terminal No.	Color of Wire	Signal Name
1	W	REAR1 HP LH+
2	G	REAR1 HP RH+
3	LG	REAR1 HP SHIELD
4	-	-
5	Y	REAR1 COMP+
6	-	-

Terminal No.	Color of Wire	Signal Name
27	LG	-
28	G	-
29	GR	-
31	G	-
32	G	-

Terminal No.	Color of Wire	Signal Name
10	LG	-
11	P	-
13	BR	-
15	W	-
16	W	-
17	B	-
18	R	-
19	V	-
20	P	-
21	G	-
23	Y	-
24	SB	-
26	R	-

Connector No.	B316
Connector Name	WIRE TO WIRE
Connector Color	WHITE

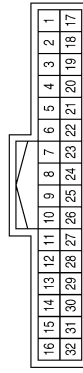

Terminal No.	Color of Wire	Signal Name
1	W	-
2	G	-
3	LG	-
5	Y	-
7	W	-
8	G	-

ABNIA4709GB

# BOSE AUDIO W/NAVI W/SURROUND

[BOSE AUDIO W/NAVI W/SURROUND]

< WIRING DIAGRAM >

Terminal No.	Color of Wire	Signal Name
27	LG	-
28	G	-
29	GR	-
31	G	-
32	G	-

Terminal No.	Color of Wire	Signal Name
10	LG	-
11	P	-
13	BR	-
15	W	-
16	W	-
17	B	-
18	R	-
19	V	-
20	P	-
21	G	-
23	Y	-
24	SB	-
26	R	-

Connector No.	B317
Connector Name	WIRE TO WIRE
Connector Color	WHITE

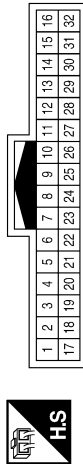

Terminal No.	Color of Wire	Signal Name
1	W	-
2	G	-
3	LG	-
5	Y	-
7	W	-
8	G	-

Connector No.	B401
Connector Name	WIRE TO WIRE
Connector Color	BLACK

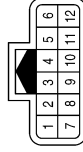

Terminal No.	Color of Wire	Signal Name
2	B	-
3	W	-
4	B	-
5	W	-
8	B	-
9	W	-
10	W	-
11	B	-

Terminal No.	Color of Wire	Signal Name
22	W	-
23	SHIELD	-
24	W	-
25	B	-
26	SHIELD	-
27	W	-
28	B	-
29	SHIELD	-

Connector No.	B400
Connector Name	WIRE TO WIRE
Connector Color	WHITE

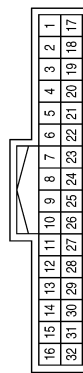

Terminal No.	Color of Wire	Signal Name
17	W	-
18	B	-
19	SHIELD	-
20	R	-
21	B	-

ABNIA4710GB

A  
B  
C  
D  
E  
F  
G  
H  
I  
J  
K  
L  
M  
N  
O  
P



# BOSE AUDIO W/NAVI W/SURROUND

< WIRING DIAGRAM >

[BOSE AUDIO W/NAVI W/SURROUND]

Connector No.	B452
Connector Name	WIRE TO WIRE
Connector Color	BLACK

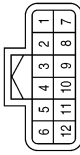

Terminal No.	Color of Wire	Signal Name
2	P	-
3	G	-
4	L	-
5	Y	-
8	L	-
9	W	-
10	P	-
11	G	-

Connector No.	B455
Connector Name	REAR SONAR SENSOR LH OUTER
Connector Color	BLACK



Terminal No.	Color of Wire	Signal Name
1	P	-
2	G	-

Connector No.	B456
Connector Name	REAR SONAR SENSOR RH OUTER
Connector Color	BLACK



Terminal No.	Color of Wire	Signal Name
1	L	-
2	W	-

Connector No.	B457
Connector Name	REAR SONAR SENSOR LH INNER
Connector Color	BLACK



Terminal No.	Color of Wire	Signal Name
1	L	-
2	Y	-

Connector No.	B458
Connector Name	REAR SONAR SENSOR RH INNER
Connector Color	BLACK



Terminal No.	Color of Wire	Signal Name
1	P	-
2	G	-

Connector No.	R1
Connector Name	WIRE TO WIRE
Connector Color	WHITE

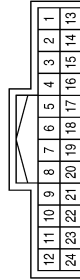

Terminal No.	Color of Wire	Signal Name
5	B	-
13	W	-
14	B	-
15	SHIELD	-
16	P	-
17	BG	-
23	W	-

# BOSE AUDIO W/NAVI W/SURROUND

## [BOSE AUDIO W/NAVI W/SURROUND]

< WIRING DIAGRAM >

Connector No.	R105
Connector Name	TELEMATICS SWITCH
Connector Color	WHITE



Terminal No.	Color of Wire	Signal Name
1	V	-
2	G	-
3	P	-
7	R	-

Connector No.	R101
Connector Name	WIRE TO WIRE
Connector Color	WHITE

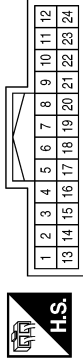

Terminal No.	Color of Wire	Signal Name
1	V	-
2	R	-
3	G	-
4	P	-
5	SHIELD	-
6	L	-
7	R	-

Connector No.	R11
Connector Name	WIRE TO WIRE
Connector Color	WHITE

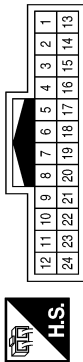

Terminal No.	Color of Wire	Signal Name
1	W	-
2	B	-
3	BG	-
4	P	-
5	SHIELD	-
6	B	-
7	W	-

Connector No.	D3
Connector Name	WIRE TO WIRE
Connector Color	WHITE



20	19	18	17	16	15	14	13	12	11	10	9	8	7	6	5	4	3	2	1
40	39	38	37	36	35	34	33	32	31	30	29	28	27	26	25	24	23	22	21

Terminal No.	Color of Wire	Signal Name
22	Y	-
23	LG	-
28	G	-
29	SHIELD	-
30	R	-
31	B	-
32	W	-

Connector No.	D2
Connector Name	WIRE TO WIRE
Connector Color	WHITE



7	6	5	4	3	2	1		
16	15	14	13	12	11	10	9	8

Terminal No.	Color of Wire	Signal Name
8	W	-
9	G	-

Connector No.	R109
Connector Name	MICROPHONE
Connector Color	WHITE



Terminal No.	Color of Wire	Signal Name
1	R	-
2	-	-
3	GR	-
4	L	-

ABNIA4712GB

A  
B  
C  
D  
E  
F  
G  
H  
I  
J  
K  
L  
M  
N  
O  
P

AV

# BOSE AUDIO W/NAVI W/SURROUND

< WIRING DIAGRAM >

[BOSE AUDIO W/NAVI W/SURROUND]

Connector No.	D20
Connector Name	DOOR MIRROR LH (SIDE CAMERA)
Connector Color	WHITE



Terminal No.	Color of Wire	Signal Name
5	R	-
6	W	-
16	G	-
17	SHIELD	-
18	B	-

Connector No.	D12
Connector Name	FRONT DOOR SPEAKER LH
Connector Color	WHITE



Terminal No.	Color of Wire	Signal Name
1	G	-
2	W	-

Connector No.	D6
Connector Name	DOOR MIRROR LH (WITH AROUND VIEW MONITOR)
Connector Color	WHITE



Terminal No.	Color of Wire	Signal Name
8	LG	-
9	Y	-

Connector No.	D112
Connector Name	FRONT DOOR SPEAKER RH
Connector Color	WHITE



Terminal No.	Color of Wire	Signal Name
1	G	-
2	W	-

Connector No.	D102
Connector Name	WIRE TO WIRE
Connector Color	WHITE

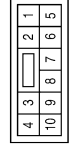

Terminal No.	Color of Wire	Signal Name
9	G	-
10	W	-

Connector No.	D101
Connector Name	WIRE TO WIRE
Connector Color	WHITE

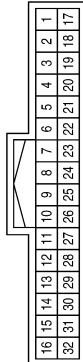

Terminal No.	Color of Wire	Signal Name
1	G	-
2	SHIELD	-
3	R	-
4	B	-
5	W	-

ABNIA4741GB

# BOSE AUDIO W/NAVI W/SURROUND

< WIRING DIAGRAM >

[BOSE AUDIO W/NAVI W/SURROUND]

Connector No.	D202
Connector Name	WIRE TO WIRE
Connector Color	WHITE

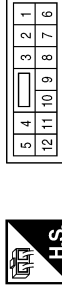

Terminal No.	Color of Wire	Signal Name
10	LG	-
11	Y	-

Connector No.	D201
Connector Name	WIRE TO WIRE
Connector Color	WHITE

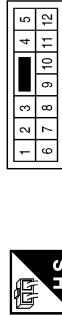

Terminal No.	Color of Wire	Signal Name
11	Y	-
12	LG	-

Connector No.	D113
Connector Name	DOOR MIRROR RH (SIDE CAMERA)
Connector Color	WHITE

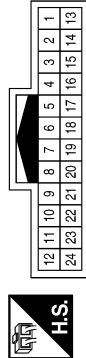

Terminal No.	Color of Wire	Signal Name
5	R	-
6	W	-
16	G	-
17	SHIELD	-
18	B	-

Connector No.	D252
Connector Name	REAR DOOR TWEETER LH
Connector Color	BROWN



Terminal No.	Color of Wire	Signal Name
1	LG	-
2	BR	-

Connector No.	D251
Connector Name	WIRE TO WIRE
Connector Color	WHITE

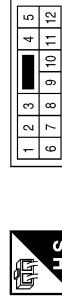

Terminal No.	Color of Wire	Signal Name
10	LG	-
11	BR	-

Connector No.	D207
Connector Name	REAR DOOR SPEAKER LH
Connector Color	BROWN



Terminal No.	Color of Wire	Signal Name
1	LG	-
2	Y	-

ABNIA4758GB

A  
B  
C  
D  
E  
F  
G  
H  
I  
J  
K  
L  
M  
N  
O  
P

AV

# BOSE AUDIO W/NAVI W/SURROUND

## [BOSE AUDIO W/NAVI W/SURROUND]

< WIRING DIAGRAM >

Connector No.	D307
Connector Name	REAR DOOR SPEAKER RH
Connector Color	BROWN



Terminal No.	Color of Wire	Signal Name
1	W	-
2	G	-

Connector No.	D302
Connector Name	WIRE TO WIRE
Connector Color	WHITE

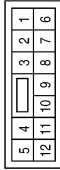

Terminal No.	Color of Wire	Signal Name
10	W	-
11	G	-

Connector No.	D301
Connector Name	WIRE TO WIRE
Connector Color	WHITE

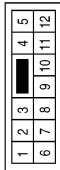

Terminal No.	Color of Wire	Signal Name
11	G	-
12	W	-

Connector No.	D501
Connector Name	WIRE TO WIRE
Connector Color	WHITE

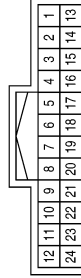

Terminal No.	Color of Wire	Signal Name
13	W	-
14	B	-
15	R	-
16	SHIELD	-
17	G	-

Connector No.	D352
Connector Name	REAR DOOR TWEETER RH
Connector Color	BROWN



Terminal No.	Color of Wire	Signal Name
1	LG	-
2	BR	-

Connector No.	D351
Connector Name	WIRE TO WIRE
Connector Color	WHITE



Terminal No.	Color of Wire	Signal Name
10	LG	-
11	BR	-

ABNIA4759GB



# BOSE AUDIO W/NAVI W/SURROUND

< WIRING DIAGRAM >

[BOSE AUDIO W/NAVI W/SURROUND]

A  
B  
C  
D  
E  
F  
G  
H  
I  
J  
K  
L  
M  
N  
O  
P

Connector No.	D511
Connector Name	REAR VIEW CAMERA
Connector Color	WHITE

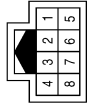

Terminal No.	Color of Wire	Signal Name
1	SHIELD	-
4	G	-
5	R	-
7	B	-
8	W	-

AV

AANIA2025GB

## BASIC INSPECTION

### DIAGNOSIS AND REPAIR WORKFLOW

#### Work Flow (Multi AV System)

INFOID:000000009129309

#### OVERALL SEQUENCE

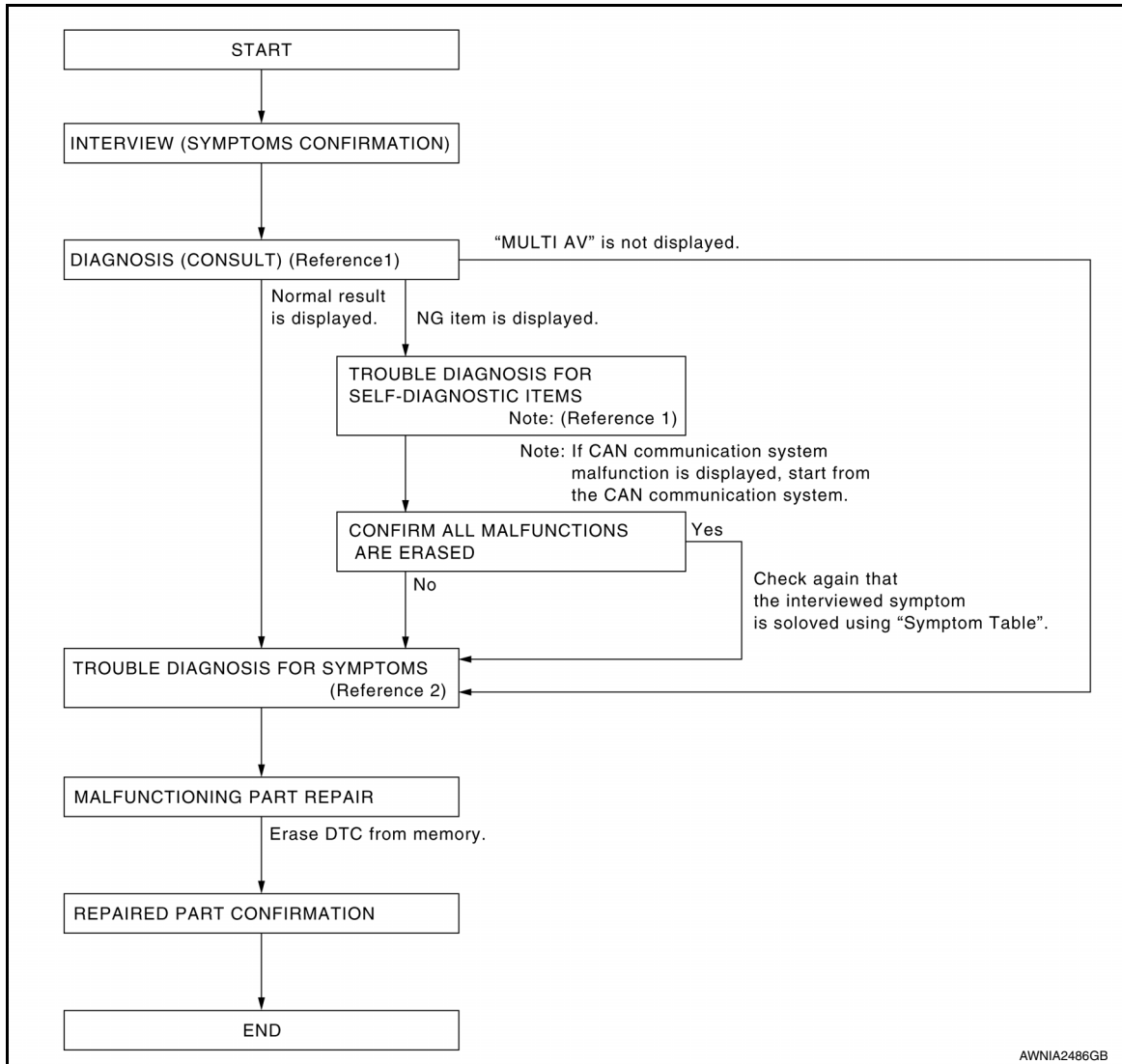

Reference 1: Refer to [AV-646. "CONSULT Function"](#).

Reference 2: Refer to [AV-866. "Symptom Table"](#).

#### DETAILED FLOW

##### 1. CHECK SYMPTOM

Check the malfunction symptoms by performing the following items.

- Interview the customer to obtain the malfunction information (conditions and environment when the malfunction occurred).
- Check the symptom.

>> GO TO 2

##### 2. SELF-DIAGNOSIS (CONSULT)

1. Connect CONSULT and perform "SELF-DIAGNOSIS" for "MULTI AV".

**NOTE:**

Skip to step 4 of the diagnosis procedure if "MULTI AV" is not displayed.

2. Check if any DTC No. is displayed in the self-diagnosis results.

# DIAGNOSIS AND REPAIR WORKFLOW

[BOSE AUDIO W/NAVI W/SURROUND]

< BASIC INSPECTION >

Is any DTC No. displayed?

- YES >> GO TO 3
- NO >> GO TO 4

## 3. CHECK SELF-DIAGNOSIS RESULTS (CONSULT)

1. Check the DTC No. indicated in the self-diagnosis results.
2. Perform the relevant diagnosis referring to the DTC No. list. Refer to [AV-660, "DTC Index"](#).

### NOTE:

Start with the diagnosis for the CAN communication system if "CAN COMM CIRCUIT [U1000] or CONTROL UNIT (CAN) [U1010]" is displayed.

>> GO TO 5

## 4. PERFORM DIAGNOSIS BY SYMPTOM

Perform the relevant diagnosis referring to the diagnosis chart by symptom. Refer to [AV-866, "Symptom Table"](#).

>> GO TO 5

## 5. REPAIR OR REPLACE MALFUNCTIONING PARTS

Repair or replace the identified malfunctioning parts.

### NOTE:

Erase the stored self-diagnosis results after repairing or replacing the relevant components if any DTC No. has been indicated in the self-diagnosis results.

>> GO TO 6

## 6. CHECK AFTER REPAIR

1. Perform self-diagnosis for "MULTI AV" with CONSULT after repairing or replacing the malfunctioning parts.
2. Check if any DTC No. is displayed in the self-diagnosis results.

Is any DTC No. displayed?

- YES >> GO TO 3
- NO >> GO TO 7

## 7. FINAL CHECK

Perform the operation check to confirm that the malfunction symptom is solved or that any other symptoms are present.

Are any symptoms present?

- YES >> GO TO 4
- NO >> Inspection End.

A  
B  
C  
D  
E  
F  
G  
H  
I  
J  
K  
L  
M  
O  
P

AV

# DIAGNOSIS AND REPAIR WORKFLOW

[BOSE AUDIO W/NAVI W/SURROUND]

< BASIC INSPECTION >

## Work Flow (Camera Assistance Sonar)

INFOID:000000009129310

### OVERALL SEQUENCE

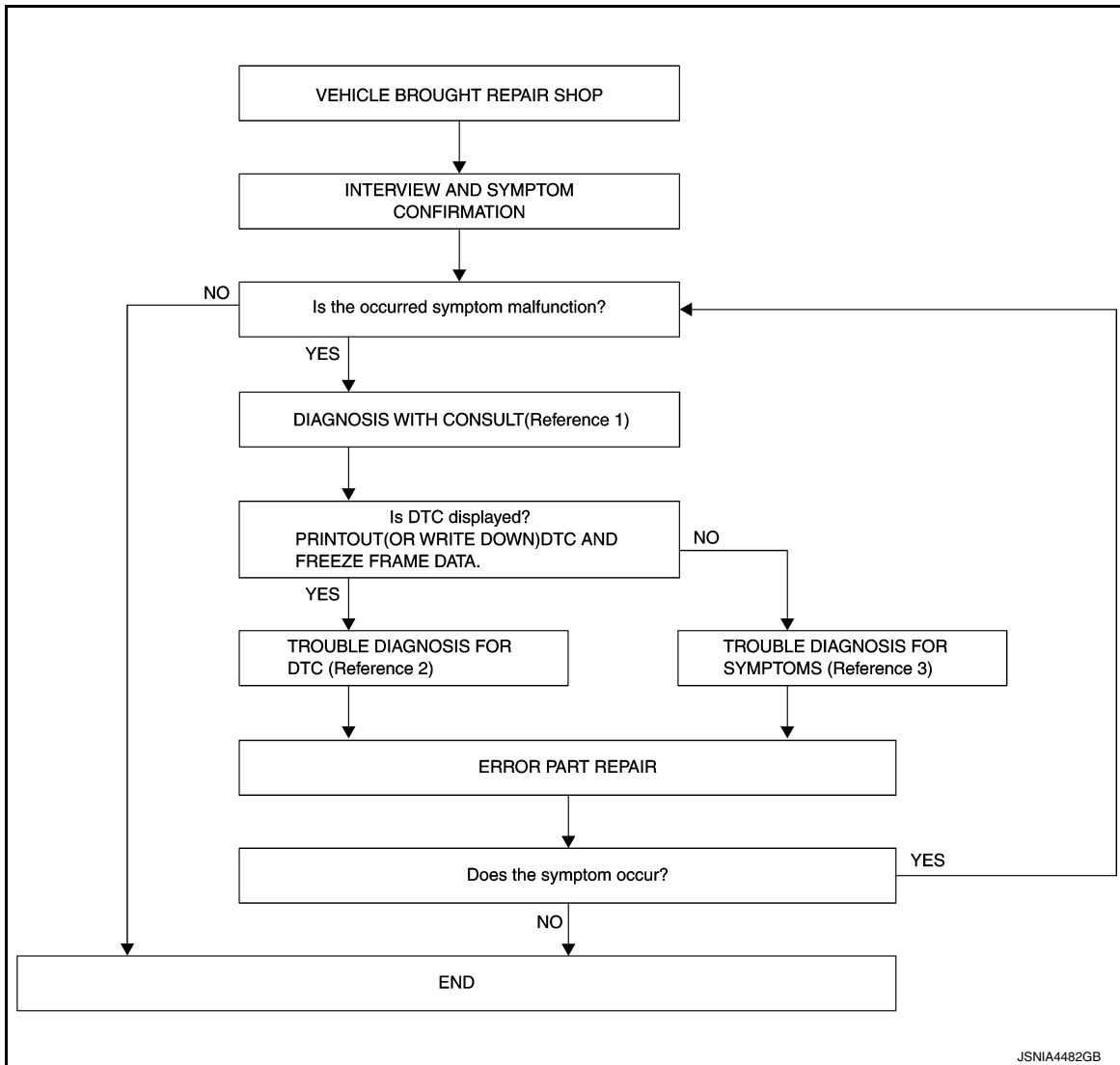

Reference 1: Refer to [AV-651, "CONSULT Function"](#).

Reference 2: Refer to [AV-682, "DTC Index"](#).

Reference 3: Refer to [AV-866, "Symptom Table"](#).

### DETAILED FLOW

#### 1. INTERVIEW AND SYMPTOM CONFIRMATION

Check the malfunction symptoms by performing the following items.

- Interview the customer to obtain the malfunction information (conditions and environment when the malfunction occurred).
- Check the symptom.

Is the occurred symptom malfunction?

YES >> GO TO 2.

NO >> INSPECTION END

#### 2. DIAGNOSIS WITH CONSULT

1. Connect CONSULT and perform a self-diagnosis for "SONAR". Refer to [AV-651, "CONSULT Function"](#).

**NOTE:**

Skip to step 4 of the diagnosis procedure if "SONAR" is not displayed.

2. When DTC is detected, follow the instructions below:
  - Record DTC and Freeze Frame Data.

# DIAGNOSIS AND REPAIR WORKFLOW

[BOSE AUDIO W/NAVI W/SURROUND]

< BASIC INSPECTION >

Is DTC displayed?

YES >> GO TO 3.

NO >> GO TO 4.

## 3. TROUBLE DIAGNOSIS FOR DTC

1. Check the DTC indicated in the self-diagnosis results.
2. Perform the relevant diagnosis referring to the DTC Index. Refer to [AV-682, "DTC Index"](#).

>> GO TO 5.

## 4. TROUBLE DIAGNOSIS FOR SYMPTOMS

Perform the relevant diagnosis referring to the diagnosis chart by symptom. Refer to [AV-866, "Symptom Table"](#).

>> GO TO 5.

## 5. ERROR PART REPAIR

1. Repair or replace the identified malfunctioning parts.
2. Perform a self-diagnosis for "SONAR" with CONSULT.

**NOTE:**

Erase the stored self-diagnosis results after repairing or replacing the relevant components if any DTC has been indicated in the self-diagnosis results.

3. Check that the symptom does not occur.

Does the symptom occur?

YES >> GO TO 1.

NO >> Inspection End.

A  
B  
C  
D  
E  
F  
G  
H  
I  
J  
K  
L  
M  
O  
P

AV

## INSPECTION AND ADJUSTMENT

### ADDITIONAL SERVICE WHEN REPLACING AV CONTROL UNIT

### ADDITIONAL SERVICE WHEN REPLACING AV CONTROL UNIT : Description

INFOID:000000009129312

#### BEFORE REPLACEMENT

When replacing AV control unit, save or print current vehicle specification with CONSULT configuration before replacement.

**NOTE:**

If "Before Replace ECU" cannot be used, use the "After Replace ECU" or "Manual Configuration" after replacing AV control unit.

#### AFTER REPLACEMENT

**CAUTION:**

When replacing AV control unit, you must perform "After Replace ECU" with CONSULT.

- Complete the procedure of "After Replace ECU" in order.
- If you set incorrect "After Replace ECU", incidents might occur.
- Configuration is different for each vehicle model. Confirm configuration of each vehicle model.

### ADDITIONAL SERVICE WHEN REPLACING AV CONTROL UNIT : Work Procedure

INFOID:000000009129312

## 1. SAVING VEHICLE SPECIFICATION

### Ⓟ-CONSULT

Enter "Re/Programming, Configuration" and perform "Before Replace ECU" to save or print current vehicle specification.

**NOTE:**

If "Before Replace ECU" cannot be used, use the "After Replace ECU" or "Manual Configuration" after replacing AV control unit.

>> GO TO 2.

## 2. REPLACE AV CONTROL UNIT

Replace AV control unit. Refer to [AV-883. "Removal and Installation - AV Control Unit"](#).

>> GO TO 3.

## 3. WRITING VEHICLE SPECIFICATION

### ⓅCONSULT

1. Enter "Re/Programming, Configuration".
2. If "Before Replace ECU" operation was performed, automatically an "Operation Log Selection" screen will be displayed. Select the applicable file from the "Saved Data List" and press "Confirm" to write vehicle specification. Refer to [AV-743. "CONFIGURATION \(AV CONTROL UNIT\) : Work Procedure"](#).
3. If "Before Replace ECU" operation was not performed, select "After Replace ECU" or "Manual Configuration" to write vehicle specification. Refer to [AV-743. "CONFIGURATION \(AV CONTROL UNIT\) : Work Procedure"](#).

>> GO TO 4.

## 4. OPERATION CHECK

Check that the operation of the AV control unit is normal.

>> Work End.

## CONFIGURATION (AV CONTROL UNIT)

# INSPECTION AND ADJUSTMENT

< BASIC INSPECTION >

[BOSE AUDIO W/NAVI W/SURROUND]

## CONFIGURATION (AV CONTROL UNIT) : Description

INFOID:000000009129313

Vehicle specification needs to be written with CONSULT because it is not written after replacing AV control unit.

Configuration has three functions as follows:

Function	Description
"Before Replace ECU"	<ul style="list-style-type: none"><li>• Reads the vehicle configuration of current AV control unit.</li><li>• Saves the read vehicle configuration.</li></ul>
"After Replace ECU"	Writes the vehicle configuration with manual selection.
"Select Saved Data List"	Writes the vehicle configuration with saved data.

### CAUTION:

- When replacing AV control unit, you must perform "Select Saved Data List" or "After Replace ECU" with CONSULT.
- Complete the procedure of "Select Saved Data List" or "After Replace ECU" in order.
- If you set incorrect "Select Saved Data List" or "After Replace ECU", incidents might occur.
- Configuration is different for each vehicle model. Confirm configuration of each vehicle model.
- Never perform "Select Saved Data List" or "After Replace ECU" except for new AV control unit.

## CONFIGURATION (AV CONTROL UNIT) : Work Procedure

INFOID:000000009129314

### 1. WRITING MODE SELECTION

#### CONSULT

Select "Reprogramming, Configuration" of AV control unit.

When writing saved data >> GO TO 2.

When writing manually >> GO TO 3.

### 2. PERFORM "SAVED DATA LIST"

#### CONSULT

Automatically "Operation Log Selection" window will display if "Before Replace ECU" was performed. Select applicable file from the "Save Data List" and press "Confirm".

>> Work End.

### 3. PERFORM "AFTER REPLACE ECU" OR "MANUAL CONFIGURATION"

#### CONSULT

1. Select "After Replace ECU" or "Manual Configuration".
2. Identify the correct model and configuration list. Refer to [AV-744. "CONFIGURATION \(AV CONTROL UNIT\) : Configuration List"](#).
3. Confirm and/or change setting value for each item.

#### CAUTION:

Thoroughly read and understand the vehicle specification. ECU control may not operate normally if the setting is not correct.

4. Select "Next".

#### CAUTION:

Make sure to select "Next", confirm each setting value and press "OK" even if the indicated configuration of brand new AV control unit is same as the desirable configuration. If not, configuration which is set automatically by selecting vehicle model can not be memorized.

5. When "Completed", select "End".

>> GO TO 4.

### 4. OPERATION CHECK

Confirm that each function controlled by AV control unit operates normally.

A  
B  
C  
D  
E  
F  
G  
H  
I  
J  
K  
L  
M  
O  
P

AV

# INSPECTION AND ADJUSTMENT

< BASIC INSPECTION >

[BOSE AUDIO W/NAVI W/SURROUND]

>> Work End.

## CONFIGURATION (AV CONTROL UNIT) : Configuration List

INFOID:000000009129315

### CAUTION:

Thoroughly read and understand the vehicle specification. Incorrect settings may result in abnormal control of ECU.

MANUAL SETTING ITEM	
Items	Setting value
ENGINE TYPE	NORMAL ↔ HYBRID
SOUND SYSTEM	BOSE SURROUND ↔ BOSE ↔ BASE

↔: Items which confirm vehicle specifications

## ADDITIONAL SERVICE WHEN REPLACING AROUND VIEW MONITOR CONTROL UNIT

### ADDITIONAL SERVICE WHEN REPLACING AROUND VIEW MONITOR CONTROL UNIT : Description

INFOID:000000009129316

#### BEFORE REPLACEMENT

When replacing around view monitor control unit, save or print current vehicle specification with CONSULT configuration before replacement.

#### NOTE:

If "Before Replace ECU" cannot be used, use the "After Replace ECU" or "Manual Configuration" after replacing around view monitor control unit.

#### AFTER REPLACEMENT

#### CAUTION:

When replacing around view monitor control unit, you must perform "After Replace ECU" with CONSULT.

- Complete the procedure of "After Replace ECU" in order.
- If you set incorrect "After Replace ECU", incidents might occur.
- Configuration is different for each vehicle model. Confirm configuration of each vehicle model.

## ADDITIONAL SERVICE WHEN REPLACING AROUND VIEW MONITOR CONTROL UNIT : Work Procedure

INFOID:000000009129317

### 1. SAVING VEHICLE SPECIFICATION

#### Ⓟ-CONSULT

Enter "Re/Programming, Configuration" and perform "Before Replace ECU" to save or print current vehicle specification.

#### NOTE:

If "Before Replace ECU" cannot be used, use the "After Replace ECU" or "Manual Configuration" after replacing around view monitor control unit.

>> GO TO 2.

### 2. REPLACE AROUND VIEW MONITOR CONTROL UNIT

Replace around view monitor control unit. Refer to [AV-898. "Removal and Installation"](#).

>> GO TO 3.

### 3. WRITING VEHICLE SPECIFICATION

#### ⓅCONSULT

1. Enter "Re/Programming, Configuration".
2. If "Before Replace ECU" operation was performed, automatically an "Operation Log Selection" screen will be displayed. Select the applicable file from the "Saved Data List" and press "Confirm" to write vehicle



# INSPECTION AND ADJUSTMENT

[BOSE AUDIO W/NAVI W/SURROUND]

< BASIC INSPECTION >

specification. Refer to [AV-745. "CONFIGURATION \(AROUND VIEW MONITOR CONTROL UNIT\) : Work Procedure"](#).

3. If "Before Replace ECU" operation was not performed, select "After Replace ECU" or "Manual Configuration" to write vehicle specification. Refer to [AV-745. "CONFIGURATION \(AROUND VIEW MONITOR CONTROL UNIT\) : Work Procedure"](#).

>> GO TO 4.

## 4. OPERATION CHECK

Check that the operation of the around view monitor control unit and camera images (fixed guide lines and predictive course lines) are normal.

>> Work End.

## CONFIGURATION (AROUND VIEW MONITOR CONTROL UNIT)

### CONFIGURATION (AROUND VIEW MONITOR CONTROL UNIT) : Description

INFOID:000000009129318

Vehicle specification needs to be written with CONSULT because it is not written after replacing around view monitor control unit.

Configuration has three functions as follows:

Function	Description
"Before Replace ECU"	<ul style="list-style-type: none"><li>• Reads the vehicle configuration of current around view monitor control unit.</li><li>• Saves the read vehicle configuration.</li></ul>
"After Replace ECU"	Writes the vehicle configuration with manual selection.
"Select Saved Data List"	Writes the vehicle configuration with saved data.

#### CAUTION:

- When replacing around view monitor control unit, you must perform "Select Saved Data List" or "After Replace ECU" with CONSULT.
- Complete the procedure of "Select Saved Data List" or "After Replace ECU" in order.
- If you set incorrect "Select Saved Data List" or "After Replace ECU", incidents might occur.
- Configuration is different for each vehicle model. Confirm configuration of each vehicle model.
- Never perform "Select Saved Data List" or "After Replace ECU" except for new around view monitor control unit.

### CONFIGURATION (AROUND VIEW MONITOR CONTROL UNIT) : Work Procedure

INFOID:000000009129319

#### 1. WRITING MODE SELECTION

##### CONSULT

Select "Reprogramming, Configuration" of around view monitor control unit.

When writing saved data >> GO TO 2.

When writing manually >> GO TO 3.

#### 2. PERFORM "SAVED DATA LIST"

##### CONSULT

Automatically "Operation Log Selection" window will display if "Before Replace ECU" was performed. Select applicable file from the "Save Data List" and press "Confirm".

>> Work End.

#### 3. PERFORM "AFTER REPLACE ECU" OR "MANUAL CONFIGURATION"

##### CONSULT

1. Select "After Replace ECU" or "Manual Configuration".

A  
B  
C  
D  
E  
F  
G  
H  
I  
J  
K  
L  
M  
O  
P

AV

# INSPECTION AND ADJUSTMENT

[BOSE AUDIO W/NAVI W/SURROUND]

< BASIC INSPECTION >

- Identify the correct model and configuration list. Refer to [AV-746. "CONFIGURATION \(AROUND VIEW MONITOR CONTROL UNIT\) : Configuration List"](#).
- Confirm and/or change setting value for each item.  
**CAUTION:**  
Thoroughly read and understand the vehicle specification. ECU control may not operate normally if the setting is not correct.
- Select "Next".  
**CAUTION:**  
Make sure to select "Next", confirm each setting value and press "OK" even if the indicated configuration of brand new around view monitor control unit is same as the desirable configuration. If not, configuration which is set automatically by selecting vehicle model can not be memorized.
- When "Completed", select "End".

>> GO TO 4.

## 4. OPERATION CHECK

Confirm that each function controlled by around view monitor control unit operates normally.

>> Work End.

## CONFIGURATION (AROUND VIEW MONITOR CONTROL UNIT) : Configuration List

INFOID:000000009129320

### CAUTION:

Thoroughly read and understand the vehicle specification. Incorrect settings may result in abnormal control of ECU.

MANUAL SETTING ITEM	
Items	Setting value
BCI FUNCTION	WITH ↔ WITHOUT

↔: Items which confirm vehicle specifications

## ADDITIONAL SERVICE WHEN REPLACING SONAR CONTROL UNIT

### ADDITIONAL SERVICE WHEN REPLACING SONAR CONTROL UNIT : Description

INFOID:000000009129321

#### BEFORE REPLACEMENT

When replacing sonar control unit, save or print current vehicle specification with CONSULT configuration before replacement.

#### NOTE:

If "Before Replace ECU" cannot be used, use the "After Replace ECU" or "Manual Configuration" after replacing sonar control unit.

#### AFTER REPLACEMENT

#### CAUTION:

When replacing sonar control unit, you must perform "After Replace ECU" with CONSULT.

- Complete the procedure of "After Replace ECU" in order.
- If you set incorrect "After Replace ECU", incidents might occur.
- Configuration is different for each vehicle model. Confirm configuration of each vehicle model.

### ADDITIONAL SERVICE WHEN REPLACING SONAR CONTROL UNIT : Work Procedure

INFOID:000000009129322

## 1. SAVING VEHICLE SPECIFICATION

### Ⓟ-CONSULT

Enter "Re/Programming, Configuration" and perform "Before Replace ECU" to save or print current vehicle specification.

#### NOTE:

# INSPECTION AND ADJUSTMENT

[BOSE AUDIO W/NAVI W/SURROUND]

< BASIC INSPECTION >

If "Before Replace ECU" cannot be used, use the "After Replace ECU" or "Manual Configuration" after replacing sonar control unit.

>> GO TO 2.

## 2. REPLACE SONAR CONTROL UNIT

Replace sonar control unit. Refer to [AV-906, "Removal and Installation"](#).

>> GO TO 3.

## 3. WRITING VEHICLE SPECIFICATION

CONSULT

1. Enter "Re/Programming, Configuration".
2. If "Before Replace ECU" operation was performed, automatically an "Operation Log Selection" screen will be displayed. Select the applicable file from the "Saved Data List" and press "Confirm" to write vehicle specification. Refer to [AV-747, "CONFIGURATION \(SONAR CONTROL UNIT\) : Work Procedure"](#).
3. If "Before Replace ECU" operation was not performed, select "After Replace ECU" or "Manual Configuration" to write vehicle specification. Refer to [AV-747, "CONFIGURATION \(SONAR CONTROL UNIT\) : Work Procedure"](#).

>> GO TO 4.

## 4. OPERATION CHECK

Check that the operation of the sonar control unit is normal.

>> Work End.

## CONFIGURATION (SONAR CONTROL UNIT)

### CONFIGURATION (SONAR CONTROL UNIT) : Description

INFOID:000000009129323

Vehicle specification needs to be written with CONSULT because it is not written after replacing sonar control unit.

Configuration has three functions as follows:

Function	Description
"Before Replace ECU"	<ul style="list-style-type: none"><li>• Reads the vehicle configuration of current sonar control unit.</li><li>• Saves the read vehicle configuration.</li></ul>
"After Replace ECU"	Writes the vehicle configuration with manual selection.
"Select Saved Data List"	Writes the vehicle configuration with saved data.

### CAUTION:

- When replacing sonar control unit, you must perform "Select Saved Data List" or "After Replace ECU" with CONSULT.
- Complete the procedure of "Select Saved Data List" or "After Replace ECU" in order.
- If you set incorrect "Select Saved Data List" or "After Replace ECU", incidents might occur.
- Configuration is different for each vehicle model. Confirm configuration of each vehicle model.
- Never perform "Select Saved Data List" or "After Replace ECU" except for new sonar control unit.

### CONFIGURATION (SONAR CONTROL UNIT) : Work Procedure

INFOID:000000009129324

## 1. WRITING MODE SELECTION

CONSULT

Select "Reprogramming, Configuration" of sonar control unit.

When writing saved data>>GO TO 2.

When writing manually>>GO TO 3.

# INSPECTION AND ADJUSTMENT

< BASIC INSPECTION >

[BOSE AUDIO W/NAVI W/SURROUND]

## 2.PERFORM "SAVED DATA LIST"

### CONSULT

Automatically "Operation Log Selection" window will display if "Before Replace ECU" was performed. Select applicable file from the "Save Data List" and press "Confirm".

>> Work End.

## 3.PERFORM "AFTER REPLACE ECU" OR "MANUAL CONFIGURATION"

### CONSULT

1. Select "After Replace ECU" or "Manual Configuration".
2. Identify the correct model and configuration list. Refer to [AV-748, "CONFIGURATION \(SONAR CONTROL UNIT\) : Configuration List"](#).
3. Confirm and/or change setting value for each item.  
**CAUTION:**  
Thoroughly read and understand the vehicle specification. ECU control may not operate normally if the setting is not correct.
4. Select "Next".  
**CAUTION:**  
Make sure to select "Next", confirm each setting value and press "OK" even if the indicated configuration of brand new sonar control unit is same as the desirable configuration. If not, configuration which is set automatically by selecting vehicle model can not be memorized.
5. When "Completed", select "End".

>> GO TO 4.

## 4.OPERATION CHECK

Confirm that each function controlled by sonar control unit operates normally.

>> Work End.

## CONFIGURATION (SONAR CONTROL UNIT) : Configuration List

INFOID:000000009129325

### CAUTION:

Thoroughly read and understand the vehicle specification. Incorrect settings may result in abnormal control of ECU.

MANUAL SETTING ITEM	
Items	Setting value
BCI FUNCTION	WITH ⇄ WITHOUT

⇄: Items which confirm vehicle specifications

## PREDICTED COURSE LINE CENTER POSITION ADJUSTMENT

### PREDICTED COURSE LINE CENTER POSITION ADJUSTMENT : Description

INFOID:000000009129326

Adjust the center position of the predictive course line of the rear view monitor if it is shifted.

### PREDICTED COURSE LINE CENTER POSITION ADJUSTMENT : Work Procedure

INFOID:000000009129327

## 1.DRIVING

Drive the vehicle straight ahead 100 m (328.1 ft) or more at a speed of 30 km/h (18.6 MPH) or more.

>> END

## CALIBRATING CAMERA IMAGE (AROUND VIEW MONITOR)

# INSPECTION AND ADJUSTMENT

< BASIC INSPECTION >

[BOSE AUDIO W/NAVI W/SURROUND]

## CALIBRATING CAMERA IMAGE (AROUND VIEW MONITOR) : Description

INFOID:000000009129328

- Calibration must be performed after removing/replacing the cameras, removing parts (e.g. front grille, door mirror, and others) mounted on the cameras, or replacing the Around view monitor control unit.
- The use of CONSULT is required to perform calibration or writing of calibration results to the Around view monitor control unit.
- Align the white lines on the road near the vehicle at the boundary of each camera image by this camera calibration. The white lines far from the vehicle may not be aligned at the boundary of each camera image. The farther the line, the greater the difference is.

## CALIBRATING CAMERA IMAGE (AROUND VIEW MONITOR) : Work Procedure

INFOID:000000009129329

### CALIBRATION FLOWCHART

Following the flowchart shown in the figure, perform the calibration.

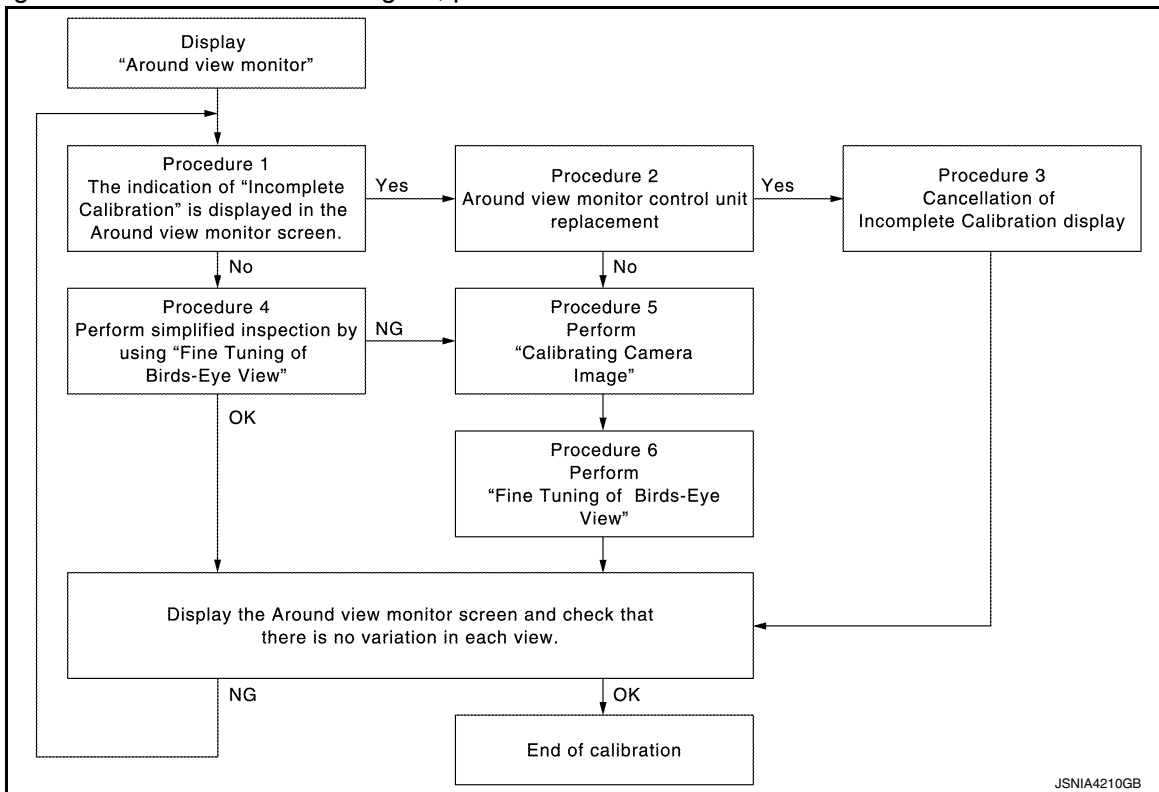

#### NOTE:

View in the incomplete calibration state is indicated by "☒" on the around view monitor.

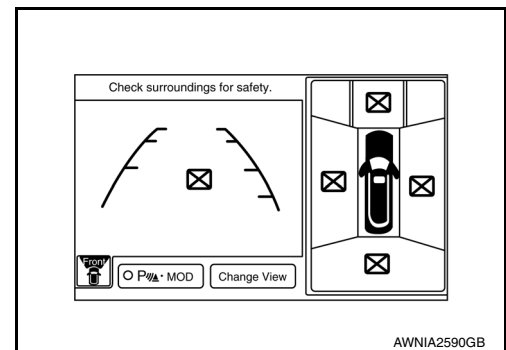

### CALIBRATION PROCEDURE

#### 1. AROUND VIEW MONITOR SCREEN CONFIRMATION

# INSPECTION AND ADJUSTMENT

[BOSE AUDIO W/NAVI W/SURROUND]

## < BASIC INSPECTION >

Check that there is no indication of "Incomplete calibration".

Is the "Incomplete calibration" display visible?

- YES >> GO TO 2.
- NO >> GO TO 4.

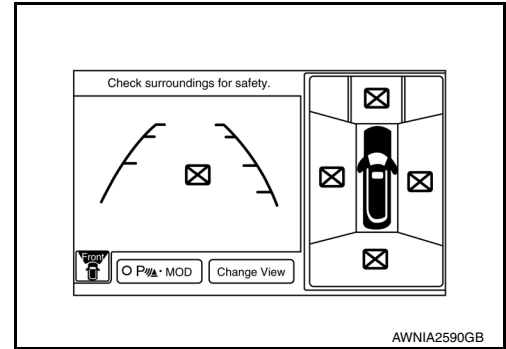

## 2. CHECK THAT AROUND VIEW MONITOR CONTROL UNIT IS REPLACED

Check that the around view monitor control unit is replaced.

Is the around view monitor control unit replaced?

- YES >> GO TO 3.
- NO >> GO TO 5.

## 3. CANCEL THE INDICATION OF INCOMPLETE CALIBRATION (PERFORM THIS ONLY AFTER REPLACING AROUND VIEW MONITOR CONTROL UNIT.)

CONSULT work support

1. On the CONSULT screen, touch "CALIBRATING CAMERA IMAGE (FRONT CAMERA)", "CALIBRATING CAMERA IMAGE (PASS-SIDE CAMERA)", "CALIBRATING CAMERA IMAGE (DR-SIDE CAMERA)", or "CALIBRATING CAMERA IMAGE (REAR CAMERA)" to accept the selection.

### NOTE:

To cancel the indication of Incomplete calibration, select items based on the target camera.

2. On the adjustment screen of each camera, touch "APPLY" button. After this, touch "OK" button.

### CAUTION:

- Never perform operations other than those mentioned above.
- Never perform "Initialize Camera Image Calibration".

3. Display the around view monitor screen to check that there is no errors, such as deviations among the camera images.

Is there a malfunction?

- YES >> Calibration end
- NO >> GO TO 1.

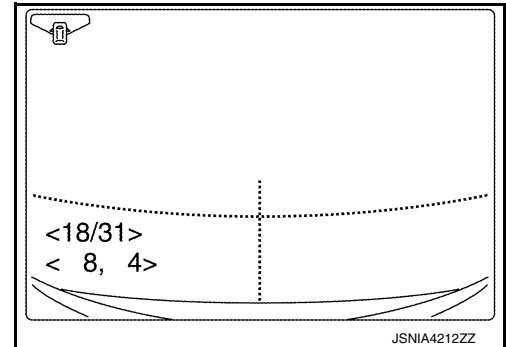

## 4. PERFORM SIMPLIFIED CONFIRMATION/ADJUSTMENT BY "FINE TUNING OF BIRDS-EYE VIEW"

1. Put target line 1 on the ground beside each axle using packing tape, etc.
2. Put target lines 2 equal to the vehicle total length + approximately 1.0 m (39.3 in) from the vehicle side (right and left) at approximately 30 cm (11.8 in) away from the vehicle (make the line as parallel with the vehicle as possible)

# INSPECTION AND ADJUSTMENT

< BASIC INSPECTION >

[BOSE AUDIO W/NAVI W/SURROUND]

## Preparation of simplified target line

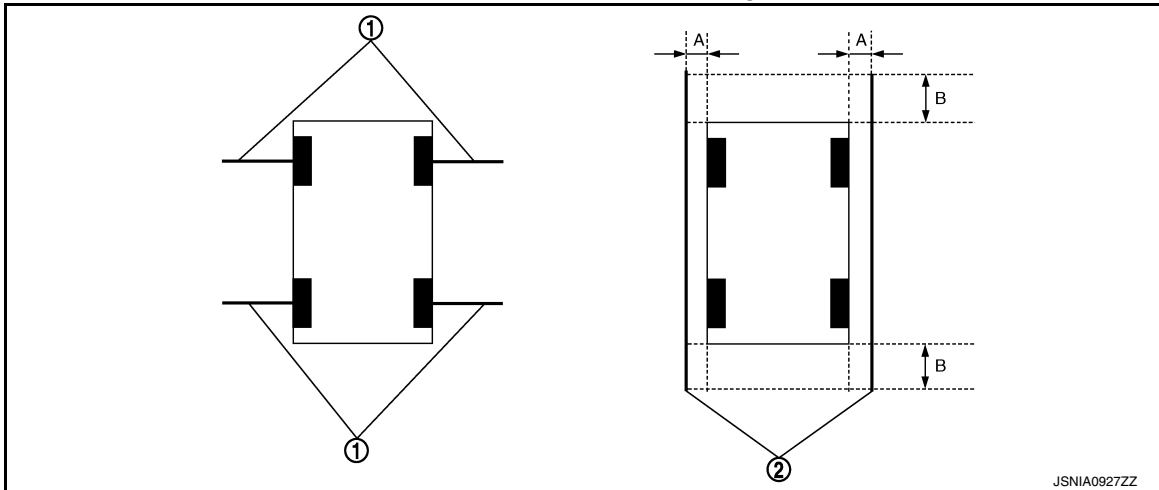

- |                            |                            |
|----------------------------|----------------------------|
| 1. Target lines 1          | 2. Target lines 2          |
| A. Approx. 30 cm (11.8 in) | B. Approx. 1.0 m (39.3 in) |

3. CONSULT work support  
Touch "FINE TUNING OF BIRDS-EYE VIEW" on the CONSULT screen.
4. On the CONSULT screen, touch "SELECT" button to select right or left camera and perform camera calibration as instructed below:
  - If the marker on the screen deviates from Target line 1, touch "AXIS X" button and "AXIS Y" button to adjust so that the marker is placed on the Target line 1.
  - If Target line 2 is misaligned among the cameras, adjust each camera image to bring Target line 2 into a straight line.

**CAUTION:**

Never adjust the front camera and rear camera. Only adjust the right and left cameras.

## Simplified target line adjustment method

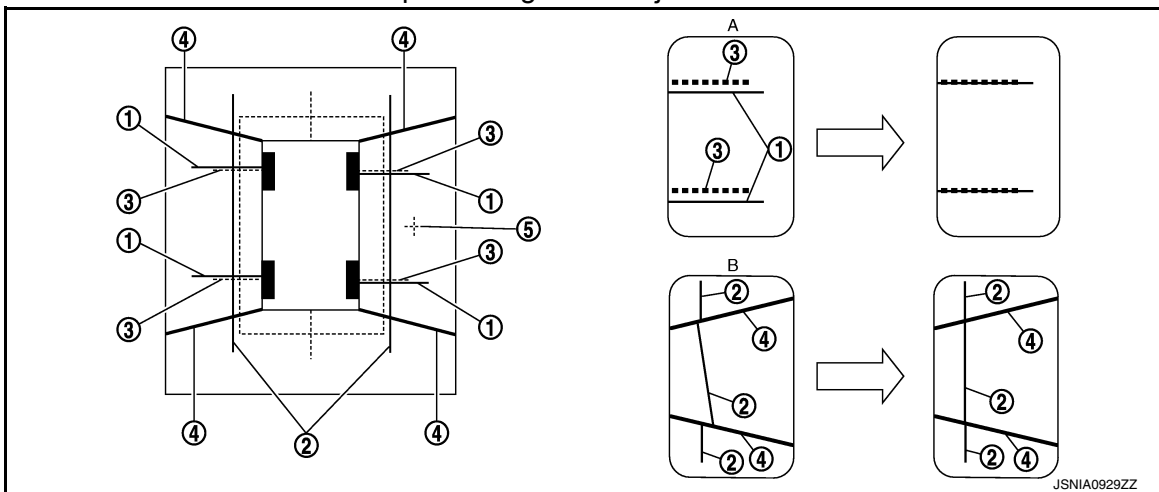

- |   |   |                             |
|---|---|-----------------------------|
| 1. Target lines 1                               | 2. Target lines 2   | 3. Marker for target line 1 |
| 4. Boundary between cameras                     | 5. Crosshairs cursor (mark indicated the selected camera) |                             |
| A. Adjustment method for target lines 1 (right) | B. Adjustment method for target lines 2 (right)           |                             |

5. Adjust right and left cameras. Touch "APPLY" on the CONSULT screen to display adjustment results.
6. After adjusting right and left cameras, check that the marker is properly placed on the screen and there is no deviation in Target line 1.

**NOTE:**

- It can be initialized to the NISSAN factory default condition with "Initialize Camera Image Calibration".
- The adjustment value is cancelled on this mode by performing "Initialize Camera Image Calibration".

A  
B  
C  
D  
E  
F  
G  
H  
I  
J  
K  
L  
M  
O  
P

AV

# INSPECTION AND ADJUSTMENT

[BOSE AUDIO W/NAVI W/SURROUND]

< BASIC INSPECTION >

Is the difference corrected?

YES >> On the CONSULT screen, touch "OK" button to complete writing to the around view monitor control unit.

NO >> GO TO 5.

## 5.PERFORM "CALIBRATING CAMERA IMAGE"

Preparation of target line

1. Hang a string with a weight as shown in the figure. Put the points FM0, RM0 (mark) on the ground at the center of the vehicle front end and rear end with white packing tape or a pen.
2. Route the vinyl string under the vehicle, and then pull and fix it on the point approximately 1.0 m (39.9 in) to the front and rear of the vehicle through the points FM0 and RM0 using packing tape.

Target line preparation procedure 1

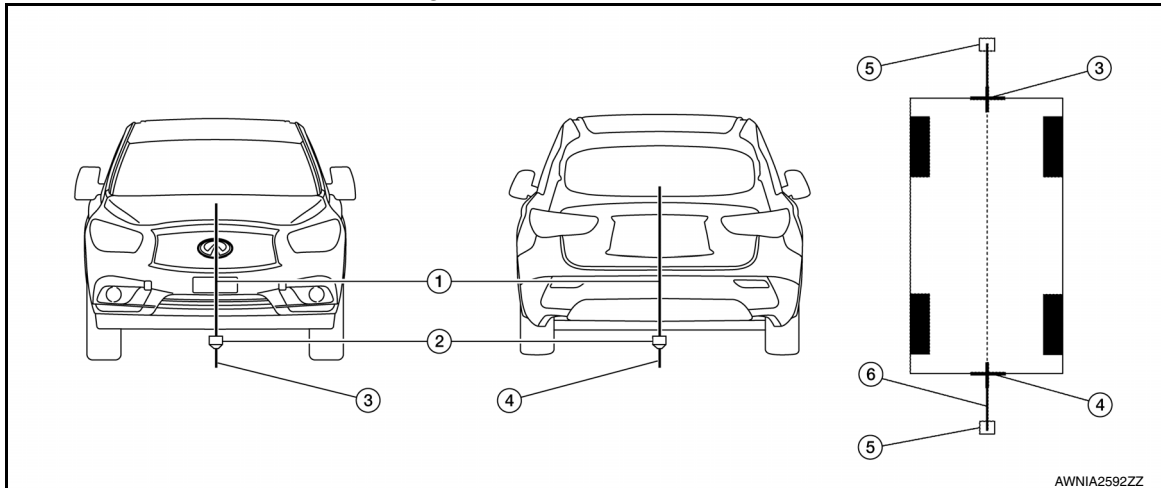

- |                     |   |                     |
|---------------------|---|---------------------|
| 1. Thread           | 2. Weight                                 | 3. Point FM0 (mark) |
| 4. Point RM0 (mark) | 5. Packing tape (to fix the vinyl string) | 6. Vinyl string     |

3. Put the points FM and RM (mark) 75 cm (29.5 in) from the points FM0 and RM0 individually.
4. Route the vinyl string through the points FM and RM using a triangle scale, and then fix it at approximately 1.5 m (59 in) on both sides with packing tape.
5. Put the points FL, FR, RL, and RR (mark) to both right and left [vehicle width / 2 + 30 cm (11.8 in)] from the points FM and RM.

Target line preparation procedure 2

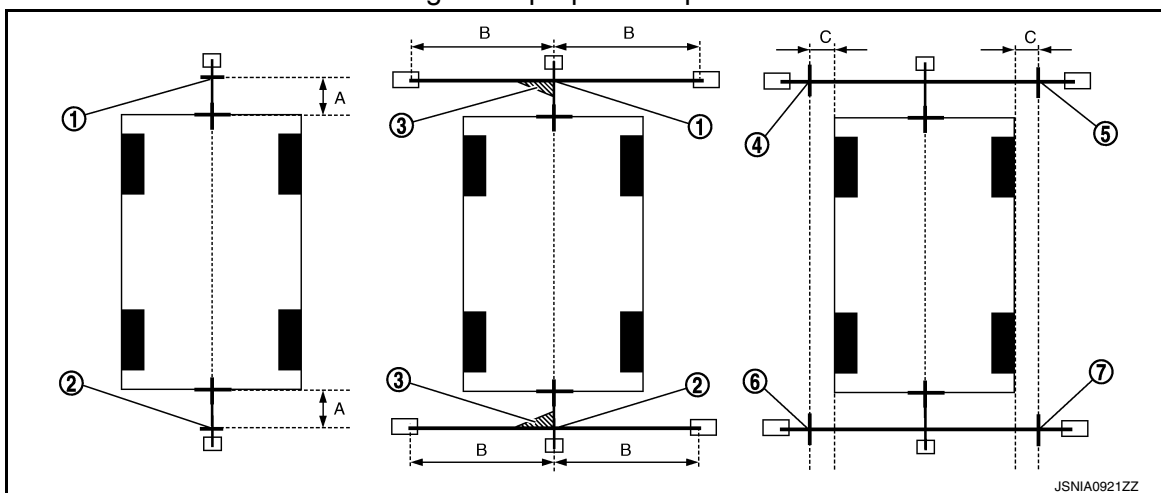

- |                    |                    |                    |
|--------------------|--------------------|--------------------|
| 1. Point FM        | 2. Point RM        | 3. Triangle scale  |
| 4. Point FL (mark) | 5. Point FR (mark) | 6. Point RL (mark) |



# INSPECTION AND ADJUSTMENT

< BASIC INSPECTION >

[BOSE AUDIO W/NAVI W/SURROUND]

7. Point RR (mark)
  - A. 75 cm (29.5 in)
  - B. Approx. 1.5 m (59 in)
  - C. 30 cm (11.8 in)  
[Vehicle width/ 2 + 30 cm (11.8 in) from the points FM and RM]
6. Draw the lines of the points FL – RL and FR – RR with vinyl string, and fix it with packing tape.
7. Put a mark on the center of each axle, draw vertical lines to the lines of the points FL – RL and FR – RR from the marks on the center of the axle using a triangle scale, and then fix the lines using packing tape.

Target line preparation procedure 3

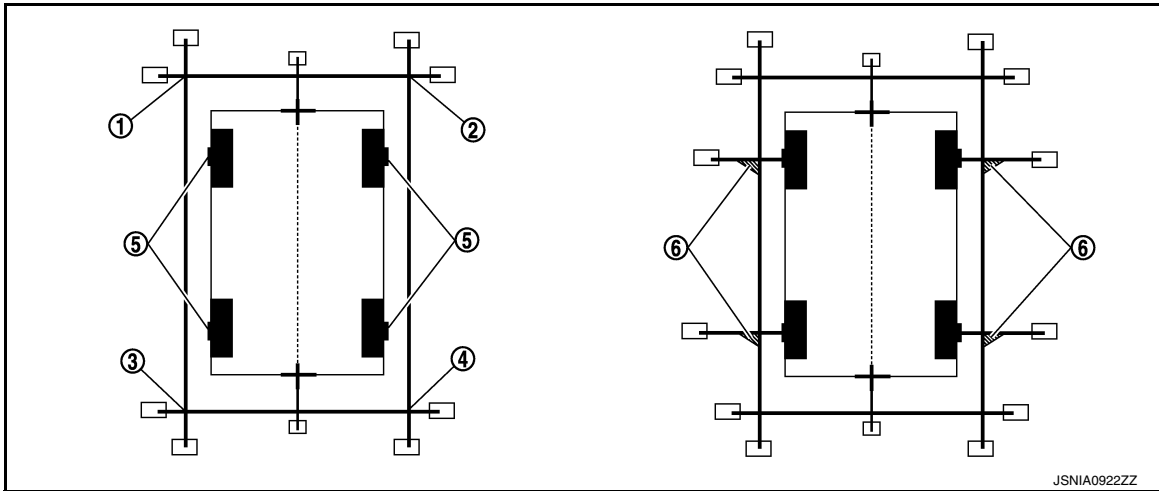

- |             |                            |                   |
|-------------|----------------------------|-------------------|
| 1. Point FL | 2. Point FR                | 3. Point RL       |
| 4. Point RR | 5. Center position of axle | 6. Triangle scale |

Perform “Calibrating Camera Image”

CONSULT work support

1. On the CONSULT screen, touch “CALIBRATING CAMERA IMAGE (FRONT CAMERA)”, “CALIBRATING CAMERA IMAGE (PASS-SIDE CAMERA)”, “CALIBRATING CAMERA IMAGE (DR-SIDE CAMERA)”, or “CALIBRATING CAMERA IMAGE (REAR CAMERA)” to accept the selection.

**NOTE:**

To cancel the indication of Incomplete calibration, select items based on the target camera.

2. On the adjustment screen of each camera, adjust the parameter by touching the “AXIS X” button, “AXIS Y” button, and “ROTATE” button to place the calibration marker shown on the camera screen on the target line drawn on the ground.

Adjustment range	
Rotation direction (Center dial)	: 31 patterns (16 on the center)
Upper/lower direction (upper/lower switch)	: -22 – 22
Left/right direction (left/right switch)	: -22 – 22

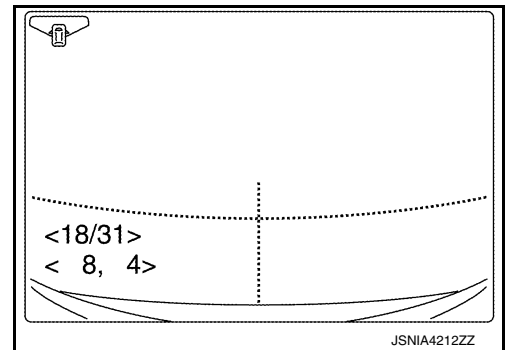

3. Touch “APPLY” button on the CONSULT screen. “PRCSNG” is displayed and adjustment results are shown on the camera screen.

**CAUTION:**

Check that “PRCSNG” is displayed. Do not perform other operations while “PRCSNG” is displayed.

4. Touch “OK” button on the CONSULT screen. “PRCSNG” is displayed and adjustment results are written to the around view monitor control unit.

**CAUTION:**

Check that “PRCSNG” is displayed. Do not perform other operations while “PRCSNG” is displayed.

>> GO TO 6.

## 6. PERFORM “FINE TUNING OF BIRDS-EYE VIEW”

# INSPECTION AND ADJUSTMENT

[BOSE AUDIO W/NAVI W/SURROUND]

## < BASIC INSPECTION >

This mode is designed to align the boundary between each camera image that could not be aligned in the "Calibrating Camera Image" mode.

### CONSULT work support

1. Select "FINE TUNING OF BIRDS-EYE VIEW" by touching CONSULT screen.
2. On the adjustment screen of each camera, adjust the parameter by touching the "AXIS X" button, "AXIS Y" button", and "ROTATE" button to place the calibration marker shown on the camera screen on the target line drawn on the ground.

#### NOTE:

Touch "SELECT" button on the CONSULT screen to select the target camera.

3. Touch "APPLY" button on the CONSULT screen. "PRCSNG" is displayed and adjustment results are shown on the camera screen.

#### CAUTION:

**Check that "PRCSNG" is displayed. Do never perform other operations while "PRCSNG" is displayed.**

4. Touch "OK" button on the CONSULT screen. "PRCSNG" is displayed and adjustment results are written to the around view monitor control unit.

#### CAUTION:

• Check that "PRCSNG" is displayed. Never perform other operations while "PRCSNG" is displayed.

• After pressing the "OK" button, never press buttons other than the "BACK" button.

#### NOTE:

- It can be initialized to the NISSAN factory default condition with "Initialize Camera Image Calibration".
- The adjustment value is cancelled in this mode by performing "Initialize Camera Image Calibration".

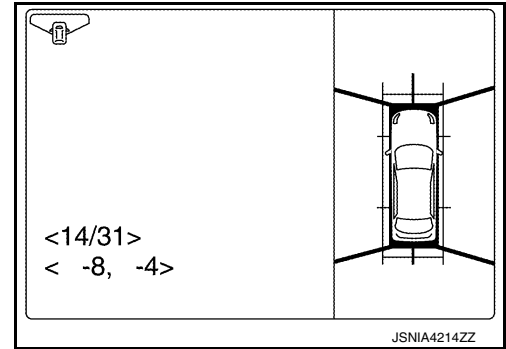

>> Calibration end

# U1000 CAN COMM CIRCUIT

< DTC/CIRCUIT DIAGNOSIS >

[BOSE AUDIO W/NAVI W/SURROUND]

## DTC/CIRCUIT DIAGNOSIS

U1000 CAN COMM CIRCUIT

AV CONTROL UNIT

AV CONTROL UNIT : DTC Logic

INFOID:000000009129330

DTC DETECTION LOGIC

CONSULT Display	DTC Detection Condition	Possible Cause
CAN COMM CIRCUIT [U1000]	AV control unit is not transmitting or receiving CAN communication signal for 2 seconds or more.	CAN communication system.

AV CONTROL UNIT : Diagnosis Procedure

INFOID:000000009129331

### 1.PERFORM SELF DIAGNOSTIC RESULT

1. Turn ignition switch ON and wait for 2 seconds or more.
2. Perform Self Diagnostic Result for MULTI AV.

Is CAN COMM CIRCUIT displayed?

- YES >> Refer to [LAN-26, "Trouble Diagnosis Flow Chart"](#).  
NO >> Refer to [GI-53, "Intermittent Incident"](#).

SONAR CONTROL UNIT (WITH AROUND VIEW MONITOR)

SONAR CONTROL UNIT (WITH AROUND VIEW MONITOR) : DTC Logic

INFOID:000000009129332

DTC DETECTION LOGIC

CONSULT Display	DTC Detection Condition	Possible Cause
CAN COMM CIRCUIT [U1000]	Sonar control unit is not transmitting or receiving CAN communication signal for 2 seconds or more.	CAN communication system.

SONAR CONTROL UNIT (WITH AROUND VIEW MONITOR) : Diagnosis Procedure

INFOID:000000009129333

### 1.PERFORM SELF DIAGNOSTIC RESULT

1. Turn ignition switch ON and wait for 2 seconds or more.
2. Perform Self Diagnostic Result for SONAR.

Is CAN COMM CIRCUIT displayed?

- YES >> Refer to [LAN-26, "Trouble Diagnosis Flow Chart"](#).  
NO >> Refer to [GI-53, "Intermittent Incident"](#).

A  
B  
C  
D  
E  
F  
G  
H  
I  
J  
K  
L  
M  
O  
P

AV

# U1010 CONTROL UNIT (CAN)

[BOSE AUDIO W/NAVI W/SURROUND]

< DTC/CIRCUIT DIAGNOSIS >

## U1010 CONTROL UNIT (CAN)

### AV CONTROL UNIT

#### AV CONTROL UNIT : DTC Logic

INFOID:000000009129334

#### DTC DETECTION LOGIC

CONSULT Display	DTC Detection Condition	Possible Cause
CONTROL UNIT (CAN) [U1010]	CAN initial diagnosis malfunction is detected.	Replace the AV control unit if the malfunction occurs constantly. Refer to <a href="#">AV-883</a> , " <a href="#">Removal and Installation - AV Control Unit</a> ".

## SONAR CONTROL UNIT (WITH AROUND VIEW MONITOR)

#### SONAR CONTROL UNIT (WITH AROUND VIEW MONITOR) : DTC Logic

INFOID:000000009129335

#### DTC DETECTION LOGIC

CONSULT Display	DTC Detection Condition	Possible Cause
CONTROL UNIT (CAN) [U1010]	CAN initial diagnosis malfunction is detected.	Replace the sonar control unit if the malfunction occurs constantly. Refer to <a href="#">AV-883</a> , " <a href="#">Removal and Installation - AV Control Unit</a> ".

# U1200 AV CONTROL UNIT

< DTC/CIRCUIT DIAGNOSIS >

[BOSE AUDIO W/NAVI W/SURROUND]

## U1200 AV CONTROL UNIT

### DTC Logic

INFOID:000000009129336

CONSULT Display	DTC Detection Condition	Possible Cause
CONT UNIT [U1200]	AV control unit malfunction is detected.	Replace AV control unit if malfunction occurs constantly. Refer to <a href="#">AV-883. "Removal and Installation - AV Control Unit"</a> .

A  
B  
C  
D  
E  
F  
G  
H  
I  
J  
K  
L  
M  
N  
O  
P

AV

# U1201 AV CONTROL UNIT

< DTC/CIRCUIT DIAGNOSIS >

[BOSE AUDIO W/NAVI W/SURROUND]

## U1201 AV CONTROL UNIT

### DTC Logic

INFOID:000000009129337

CONSULT Display	DTC Detection Condition	Possible Cause
GYRO NO CONN [U1201]	AV control unit malfunction is detected.	Replace AV control unit if malfunction occurs constantly. Refer to <a href="#">AV-883. "Removal and Installation - AV Control Unit"</a> .

# U1202 AV CONTROL UNIT

< DTC/CIRCUIT DIAGNOSIS >

[BOSE AUDIO W/NAVI W/SURROUND]

## U1202 AV CONTROL UNIT

### DTC Logic

INFOID:000000009129338

CONSULT Display	DTC Detection Condition	Possible Cause
G-SENSOR NO CONN [U1202]	AV control unit malfunction is detected.	Replace AV control unit if malfunction occurs constantly. Refer to <a href="#">AV-883. "Removal and Installation - AV Control Unit"</a> .

A  
B  
C  
D  
E  
F  
G  
H  
I  
J  
K  
L  
M

AV

O  
P

# U1204 AV CONTROL UNIT

< DTC/CIRCUIT DIAGNOSIS >

[BOSE AUDIO W/NAVI W/SURROUND]

## U1204 AV CONTROL UNIT

### DTC Logic

INFOID:000000009129339

CONSULT Display	DTC Detection Condition	Possible Cause
GPS CONN [U1204]	GPS malfunction is detected.	An intermittent error caused by strong radio interference, GPS reception error, etc. may be detected. Replace AV control unit if malfunction occurs constantly. Refer to <a href="#">AV-883, "Removal and Installation - AV Control Unit"</a> .

### Diagnosis Procedure

INFOID:000000009129340

#### 1. PERFORM SELF DIAGNOSTIC RESULT

1. Perform Self Diagnostic Result for MULTI AV.
2. Erase Self Diagnostic Result. Turn ignition switch OFF.
3. Turn ignition switch ON. Perform Self Diagnostic Result again.

#### Is DTC U1204 detected?

- YES >> Replace AV control unit. Refer to [AV-883, "Removal and Installation - AV Control Unit"](#).
- NO >> Refer to [GI-53, "Intermittent Incident"](#).



# U1205 AV CONTROL UNIT

< DTC/CIRCUIT DIAGNOSIS >

[BOSE AUDIO W/NAVI W/SURROUND]

## U1205 AV CONTROL UNIT

### DTC Logic

INFOID:000000009129341

CONSULT Display	DTC Detection Condition	Possible Cause
GPS ROM [U1205]	GPS malfunction is detected.	An intermittent error caused by strong radio interference, GPS reception error, etc. may be detected. Replace AV control unit if malfunction occurs constantly. Refer to <a href="#">AV-883, "Removal and Installation - AV Control Unit"</a> .

### Diagnosis Procedure

INFOID:000000009129342

#### 1. PERFORM SELF DIAGNOSTIC RESULT

1. Perform Self Diagnostic Result for MULTI AV.
2. Erase Self Diagnostic Result. Turn ignition switch OFF.
3. Turn ignition switch ON. Perform Self Diagnostic Result again.

#### Is DTC U1205 detected?

- YES >> Replace AV control unit. Refer to [AV-883, "Removal and Installation - AV Control Unit"](#).  
NO >> Refer to [GI-53, "Intermittent Incident"](#).

A  
B  
C  
D  
E  
F  
G  
H  
I  
J  
K  
L  
M  
O  
P

AV

# U1206 AV CONTROL UNIT

< DTC/CIRCUIT DIAGNOSIS >

[BOSE AUDIO W/NAVI W/SURROUND]

## U1206 AV CONTROL UNIT

### DTC Logic

INFOID:000000009129343

CONSULT Display	DTC Detection Condition	Possible Cause
GPS RAM [U1206]	GPS malfunction is detected.	An intermittent error caused by strong radio interference, GPS reception error, etc. may be detected. Replace AV control unit if malfunction occurs constantly. Refer to <a href="#">AV-883, "Removal and Installation - AV Control Unit"</a> .

### Diagnosis Procedure

INFOID:000000009129344

#### 1. PERFORM SELF DIAGNOSTIC RESULT

1. Perform Self Diagnostic Result for MULTI AV.
2. Erase Self Diagnostic Result. Turn ignition switch OFF.
3. Turn ignition switch ON. Perform Self Diagnostic Result again.

#### Is DTC U1206 detected?

- YES >> Replace AV control unit. Refer to [AV-883, "Removal and Installation - AV Control Unit"](#).  
NO >> Refer to [GI-53, "Intermittent Incident"](#).

# U1207 AV CONTROL UNIT

< DTC/CIRCUIT DIAGNOSIS >

[BOSE AUDIO W/NAVI W/SURROUND]

## U1207 AV CONTROL UNIT

### DTC Logic

INFOID:000000009129345

CONSULT Display	DTC Detection Condition	Possible Cause
GPS RTC [U1207]	GPS malfunction is detected.	An intermittent error caused by strong radio interference, GPS reception error, etc. may be detected. Replace AV control unit if malfunction occurs constantly. Refer to <a href="#">AV-883, "Removal and Installation - AV Control Unit"</a> .

### Diagnosis Procedure

INFOID:000000009129346

#### 1. PERFORM SELF DIAGNOSTIC RESULT

1. Perform Self Diagnostic Result for MULTI AV.
2. Erase Self Diagnostic Result. Turn ignition switch OFF.
3. Turn ignition switch ON. Perform Self Diagnostic Result again.

#### Is DTC U1207 detected?

- YES >> Replace AV control unit. Refer to [AV-883, "Removal and Installation - AV Control Unit"](#).  
NO >> Refer to [GI-53, "Intermittent Incident"](#).

A  
B  
C  
D  
E  
F  
G  
H  
I  
J  
K  
L  
M  
O  
P

AV

# U1216 AV CONTROL UNIT

< DTC/CIRCUIT DIAGNOSIS >

[BOSE AUDIO W/NAVI W/SURROUND]

## U1216 AV CONTROL UNIT

### DTC Logic

INFOID:000000009129347

CONSULT Display	DTC Detection Condition	Possible Cause
CAN CONT [U1216]	AV control unit malfunction is detected.	Replace AV control unit if malfunction occurs constantly. Refer to <a href="#">AV-883. "Removal and Installation - AV Control Unit"</a> .

# U1217 AV CONTROL UNIT

< DTC/CIRCUIT DIAGNOSIS >

[BOSE AUDIO W/NAVI W/SURROUND]

## U1217 AV CONTROL UNIT

### DTC Logic

INFOID:000000009129348

CONSULT Display	DTC Detection Condition	Possible Cause
BLUETOOTH MODULE [U1217]	AV control unit malfunction is detected.	Replace AV control unit if malfunction occurs constantly. Refer to <a href="#">AV-883. "Removal and Installation - AV Control Unit"</a> .

A  
B  
C  
D  
E  
F  
G  
H  
I  
J  
K  
L  
M  
O  
P

AV

# U1218 AV CONTROL UNIT

< DTC/CIRCUIT DIAGNOSIS >

[BOSE AUDIO W/NAVI W/SURROUND]

## U1218 AV CONTROL UNIT

### DTC Logic

INFOID:000000009129349

CONSULT Display	DTC Detection Condition	Possible Cause
HDD CONN [U1218]	AV control unit malfunction is detected.	An intermittent error causing HDD malfunction may be detected. Replace AV control unit if malfunction occurs constantly. Refer to <a href="#">AV-883. "Removal and Installation - AV Control Unit"</a> .

# U1219 AV CONTROL UNIT

< DTC/CIRCUIT DIAGNOSIS >

[BOSE AUDIO W/NAVI W/SURROUND]

## U1219 AV CONTROL UNIT

### DTC Logic

INFOID:000000009129351

CONSULT Display	DTC Detection Condition	Possible Cause
HDD READ [U1219]	AV control unit malfunction is detected.	An intermittent error causing HDD malfunction may be detected. Replace AV control unit if malfunction occurs constantly. Refer to <a href="#">AV-883. "Removal and Installation - AV Control Unit"</a> .

A  
B  
C  
D  
E  
F  
G  
H  
I  
J  
K  
L  
M  
O  
P

AV

# U121A AV CONTROL UNIT

< DTC/CIRCUIT DIAGNOSIS >

[BOSE AUDIO W/NAVI W/SURROUND]

## U121A AV CONTROL UNIT

### DTC Logic

INFOID:000000009129353

CONSULT Display	DTC Detection Condition	Possible Cause
HDD WRITE [U121A]	AV control unit malfunction is detected.	An intermittent error causing HDD malfunction may be detected. Replace AV control unit if malfunction occurs constantly. Refer to <a href="#">AV-883. "Removal and Installation - AV Control Unit"</a> .



# U121B AV CONTROL UNIT

< DTC/CIRCUIT DIAGNOSIS >

[BOSE AUDIO W/NAVI W/SURROUND]

## U121B AV CONTROL UNIT

### DTC Logic

INFOID:000000009129355

CONSULT Display	DTC Detection Condition	Possible Cause
HDD COMM [U121B]	AV control unit malfunction is detected.	An intermittent error causing HDD malfunction may be detected. Replace AV control unit if malfunction occurs constantly. Refer to <a href="#">AV-883. "Removal and Installation - AV Control Unit"</a> .

A  
B  
C  
D  
E  
F  
G  
H  
I  
J  
K  
L  
M  
O  
P

AV

# U121C AV CONTROL UNIT

< DTC/CIRCUIT DIAGNOSIS >

[BOSE AUDIO W/NAVI W/SURROUND]

## U121C AV CONTROL UNIT

### DTC Logic

INFOID:000000009129357

CONSULT Display	DTC Detection Condition	Possible Cause
HDD ACCESS [U121C]	AV control unit malfunction is detected.	An intermittent error causing HDD malfunction may be detected. Replace AV control unit if malfunction occurs constantly. Refer to <a href="#">AV-883. "Removal and Installation - AV Control Unit"</a> .

# U121D AV CONTROL UNIT

< DTC/CIRCUIT DIAGNOSIS >

[BOSE AUDIO W/NAVI W/SURROUND]

## U121D AV CONTROL UNIT

### DTC Logic

INFOID:000000009129359

CONSULT Display	DTC Detection Condition	Possible Cause
DSP CONN [U121D]	AV control unit malfunction is detected.	An intermittent error causing disc player malfunction may be detected. Replace AV control unit if malfunction occurs constantly. Refer to <a href="#">AV-883, "Removal and Installation - AV Control Unit"</a> .

### Diagnosis Procedure

INFOID:000000009129360

#### 1. CHECK CD PLAYBACK

Check the CD playback operation of the AV control unit. Refer to Owner's Manual for audio system operating instructions.

Is the CD playback function of the AV control unit operating normally?

YES >> Refer to [GI-53, "Intermittent Incident"](#).

NO >> Replace AV control unit. Refer to [AV-883, "Removal and Installation - AV Control Unit"](#).

A  
B  
C  
D  
E  
F  
G  
H  
I  
J  
K  
L  
M  
O  
P

AV

# U121E AV CONTROL UNIT

< DTC/CIRCUIT DIAGNOSIS >

[BOSE AUDIO W/NAVI W/SURROUND]

## U121E AV CONTROL UNIT

### DTC Logic

INFOID:000000009129361

CONSULT Display	DTC Detection Condition	Possible Cause
DSP COMM [U121E]	AV control unit malfunction is detected.	An intermittent error causing disc player malfunction may be detected. Replace AV control unit if malfunction occurs constantly. Refer to <a href="#">AV-883. "Removal and Installation - AV Control Unit"</a> .

### Diagnosis Procedure

INFOID:000000009129362

#### 1. CHECK CD PLAYBACK

Check the CD playback operation of the AV control unit. Refer to Owner's Manual for audio system operating instructions.

Is the CD playback function of the AV control unit operating normally?

YES >> Refer to [GI-53. "Intermittent Incident"](#).

NO >> Replace AV control unit. Refer to [AV-883. "Removal and Installation - AV Control Unit"](#).

# U1225 AV CONTROL UNIT

< DTC/CIRCUIT DIAGNOSIS >

[BOSE AUDIO W/NAVI W/SURROUND]

## U1225 AV CONTROL UNIT

### DTC Logic

INFOID:000000009129363

CONSULT Display	DTC Detection Condition	Possible Cause
USB CONTROLLER [U1225] [U1225]	USB connection malfunction is detected.	Check that connection to USB connector is normal.

A

B

C

D

E

F

G

H

I

J

K

L

M

AV

O

P

# U1227 AV CONTROL UNIT

< DTC/CIRCUIT DIAGNOSIS >

[BOSE AUDIO W/NAVI W/SURROUND]

## U1227 AV CONTROL UNIT

### DTC Logic

INFOID:000000009129364

CONSULT Display	DTC Detection Condition	Possible Cause
DVD COMM [U1227]	AV control unit malfunction is detected.	An intermittent error causing disc player malfunction may be detected. Replace AV control unit if malfunction occurs constantly. Refer to <a href="#">AV-883. "Removal and Installation - AV Control Unit"</a> .

### Diagnosis Procedure

INFOID:000000009129365

#### 1. CHECK DVD PLAYBACK

Check the DVD playback operation of the AV control unit. Refer to Owner's Manual for audio system operating instructions.

Is the DVD playback function of the AV control unit operating normally?

YES >> Refer to [GI-53. "Intermittent Incident"](#).

NO >> Replace AV control unit. Refer to [AV-883. "Removal and Installation - AV Control Unit"](#).

# U1228 AV CONTROL UNIT

< DTC/CIRCUIT DIAGNOSIS >

[BOSE AUDIO W/NAVI W/SURROUND]

## U1228 AV CONTROL UNIT

### DTC Logic

INFOID:000000009129366

CONSULT Display	DTC Detection Condition	Possible Cause
SUB CPU CONN [U1228]	AV control unit malfunction is detected.	Replace AV control unit if malfunction occurs constantly. Refer to <a href="#">AV-883. "Removal and Installation - AV Control Unit"</a> .

A  
B  
C  
D  
E  
F  
G  
H  
I  
J  
K  
L  
M  
O  
P

AV

# U1229 AV CONTROL UNIT

< DTC/CIRCUIT DIAGNOSIS >

[BOSE AUDIO W/NAVI W/SURROUND]

## U1229 AV CONTROL UNIT

### DTC Logic

INFOID:000000009129367

CONSULT Display	DTC Detection Condition	Possible Cause
iPod CERTIFICATION [U1229]	AV control unit malfunction is detected.	Replace AV control unit if malfunction occurs constantly. Refer to <a href="#">AV-883. "Removal and Installation - AV Control Unit"</a> .



# U122A AV CONTROL UNIT

< DTC/CIRCUIT DIAGNOSIS >

[BOSE AUDIO W/NAVI W/SURROUND]

## U122A AV CONTROL UNIT

### DTC Logic

INFOID:000000009129368

CONSULT Display	DTC Detection Condition	Possible Cause
CONFIG UNFINISH [U122A]	Configuration data is incomplete.	Write configuration data. Refer to <a href="#">AV-745. "CONFIGURATION (AROUND VIEW MONITOR CONTROL UNIT) : Work Procedure"</a> .

### Diagnosis Procedure

INFOID:000000009129369

#### 1.PERFORM CONFIGURATION

When U122A is detected, configuration data must be written.

>> Write configuration data with CONSULT. Refer to [AV-745. "CONFIGURATION \(AROUND VIEW MONITOR CONTROL UNIT\) : Work Procedure"](#).

A  
B  
C  
D  
E  
F  
G  
H  
I  
J  
K  
L  
M  
O  
P

AV

# U122E AV CONTROL UNIT

< DTC/CIRCUIT DIAGNOSIS >

[BOSE AUDIO W/NAVI W/SURROUND]

## U122E AV CONTROL UNIT

### DTC Logic

INFOID:000000009129370

CONSULT Display	DTC Detection Condition	Possible Cause
Built-in AUDIO CONN [U122E]	AV control unit malfunction is detected.	Replace AV control unit if malfunction occurs constantly. Refer to <a href="#">AV-883. "Removal and Installation - AV Control Unit"</a> .

# U1231 BOSE AMP.

< DTC/CIRCUIT DIAGNOSIS >

[BOSE AUDIO W/NAVI W/SURROUND]

## U1231 BOSE AMP.

### DTC Logic

INFOID:000000009129371

CONSULT Display	DTC Detection Condition	Possible Cause
AMP TEMP [U1231]	BOSE amp. malfunction is detected.	Replace BOSE amp. if malfunction occurs constantly. Refer to <a href="#">AV-887, "Removal and Installation"</a> .

A  
B  
C  
D  
E  
F  
G  
H  
I  
J  
K  
L  
M  
AV  
O  
P

# U1232 STEERING ANGLE SENSOR

< DTC/CIRCUIT DIAGNOSIS >

[BOSE AUDIO W/NAVI W/SURROUND]

## U1232 STEERING ANGLE SENSOR

### DTC Logic

INFOID:000000009129372

CONSULT Display	DTC Detection Condition	Possible Cause
ST ANGLE SEN CALIB [U1232]	Predictive course line center position adjustment of steering angle sensor is incomplete.	Adjust predictive course line center position of steering angle sensor.

### Diagnosis Procedure

INFOID:000000009129373

#### 1. ADJUST PREDICTIVE COURSE LINE CENTER POSITION OF STEERING ANGLE SENSOR

When U1232 is detected, the predictive course line center position of the steering angle sensor needs to be adjusted.

>> Adjust the predictive course line center position of steering angle sensor. Refer to [AV-748. "PRE-DICTED COURSE LINE CENTER POSITION ADJUSTMENT : Work Procedure"](#).

# U1243 DISPLAY UNIT

< DTC/CIRCUIT DIAGNOSIS >

[BOSE AUDIO W/NAVI W/SURROUND]

## U1243 DISPLAY UNIT

### DTC Logic

INFOID:000000009129374

CONSULT Display	DTC Detection Condition	Possible Cause
FRONT DISP CONN [U1243]	When any of the following is detected. <ul style="list-style-type: none"> <li>display unit power supply or ground circuit malfunction.</li> <li>serial communication circuit malfunction between front display unit and AV control unit.</li> </ul>	<ul style="list-style-type: none"> <li>Display unit power supply and ground circuits.</li> <li>Serial communication circuits between front display unit and AV control unit.</li> </ul>

### Diagnosis Procedure

INFOID:000000009129375

Regarding Wiring Diagram information, refer to [AV-683, "Wiring Diagram"](#).

#### 1. CHECK DISPLAY UNIT POWER SUPPLY AND GROUND CIRCUIT

Check display unit power supply and ground circuits. Refer to [AV-815, "DISPLAY UNIT : Diagnosis Procedure"](#).

Is the inspection result normal?

YES >> GO TO 2.

NO >> Repair or replace harness or connectors.

#### 2. CHECK COMMUNICATION CIRCUIT CONTINUITY

- Turn ignition switch OFF.
- Disconnect display unit connector M92 and AV control unit connector M124.
- Check continuity between display unit connector M92 terminals 9, 10 and AV control unit connector M124 terminals 77, 61.

Display unit		AV control unit		Continuity
Connector	Terminals	Connector	Terminals	
M92	9	M124	77	Yes
	10		61	

- Check continuity between display unit connector M92 terminals 9, 10 and ground.

Display unit		Ground	Continuity
Connector	Terminals		
M92	9	—	No
	10		

Is the inspection result normal?

YES >> GO TO 3.

NO >> Repair or replace harness or connectors.

#### 3. CHECK COMMUNICATION SIGNAL (DISP→CONT)

- Connect display unit connector M92 and AV control unit connector M124.
- Turn ignition switch ON.
- Check signal between display unit connector M92 terminal 9 and ground.

A  
B  
C  
D  
E  
F  
G  
H  
I  
J  
K  
L  
M  
O  
P

AV

# U1243 DISPLAY UNIT

< DTC/CIRCUIT DIAGNOSIS >

[BOSE AUDIO W/NAVI W/SURROUND]

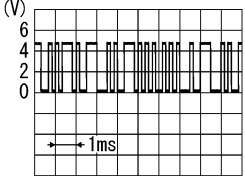
Display unit		Ground	Condition	Reference value
(+)		(-)		
Connector	Terminal			
M92	9	—	When adjusting display brightness.	 <p>PKIB5039J</p>

Is the inspection result normal?

YES >> GO TO 4.

NO >> Replace AV control unit. Refer to [AV-883. "Removal and Installation - AV Control Unit"](#).

## 4. CHECK COMMUNICATION SIGNAL (CONT→DISP)

Check signal between display unit connector M92 terminal 10 and ground.

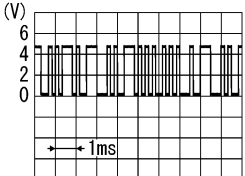
Display unit		Ground	Condition	Reference value
(+)		(-)		
Connector	Terminal			
M92	10	—	When adjusting display brightness.	 <p>PKIB5039J</p>

Is the inspection result normal?

YES >> Inspection End.

NO >> Replace display unit. Refer to [AV-886. "Removal and Installation"](#).

# U1244 GPS ANTENNA

[BOSE AUDIO W/NAVI W/SURROUND]

< DTC/CIRCUIT DIAGNOSIS >

## U1244 GPS ANTENNA

### DTC Logic

INFOID:000000009129376

CONSULT Display	DTC Detection Condition	Possible Cause
GPS ANTENNA CONN [U1244]	GPS antenna connection malfunction is detected.	GPS antenna disconnection.

### Diagnosis Procedure

INFOID:000000009129377

Regarding Wiring Diagram information, refer to [AV-683, "Wiring Diagram"](#).

#### 1. GPS ANTENNA INSPECTION

Visually inspect the GPS antenna and antenna feeder. Refer to [AV-912, "Removal and Installation"](#).

Is inspection result normal?

YES >> GO TO 2.

NO >> Repair or replace harness or connectors.

#### 2. CHECK AV CONTROL UNIT VOLTAGE

1. Disconnect AV control unit connector M25.
2. Turn ignition switch ON.
3. Check voltage between AV control unit connector M25 and ground.

AV control unit		Ground	Voltage
Connector	Terminal		
M25	188	—	5.0 V

Is inspection result normal?

YES >> Inspection End.

NO >> Replace AV control unit. Refer to [AV-883, "Removal and Installation - AV Control Unit"](#).

A  
B  
C  
D  
E  
F  
G  
H  
I  
J  
K  
L  
M  
O  
P

AV

# U1258 SATELLITE RADIO ANTENNA

< DTC/CIRCUIT DIAGNOSIS >

[BOSE AUDIO W/NAVI W/SURROUND]

## U1258 SATELLITE RADIO ANTENNA

### DTC Logic

INFOID:000000009129378

CONSULT Display	DTC Detection Condition	Possible Cause
XM ANTENNA CONN [U1258]	Satellite radio antenna connection malfunction is detected.	Satellite radio antenna disconnection.

### Diagnosis Procedure

INFOID:000000009129379

Regarding Wiring Diagram information, refer to [AV-683, "Wiring Diagram"](#).

#### 1. SATELLITE RADIO ANTENNA INSPECTION

Visually inspect the satellite radio antenna and antenna feeder. Refer to [AV-910, "Location of Antennas"](#).

Is inspection result normal?

- YES >> GO TO 2.
- NO >> Replace malfunctioning parts.

#### 2. CHECK AV CONTROL UNIT VOLTAGE

1. Disconnect AV control unit connector M133.
2. Turn ignition switch ON.
3. Check voltage between AV control unit connector M133 and ground.

AV control unit		Ground	Voltage
Connector	Terminal		
M133	166	—	5.0 V

Is inspection result normal?

- YES >> Inspection End.
- NO >> Replace AV control unit. Refer to [AV-883, "Removal and Installation - AV Control Unit"](#).



# U125A HEADREST DISPLAY UNIT

< DTC/CIRCUIT DIAGNOSIS >

[BOSE AUDIO W/NAVI W/SURROUND]

## U125A HEADREST DISPLAY UNIT

### DTC Logic

INFOID:000000009129380

CONSULT Display	DTC Detection Condition	Possible Cause
3RD DISP CONN [U125A]	When any of the following is detected. <ul style="list-style-type: none"><li>headrest display unit power supply or ground circuit malfunction.</li><li>AV communication circuit malfunction between headrest display units.</li></ul>	<ul style="list-style-type: none"><li>Headrest display unit power supply and ground circuits.</li><li>AV communication circuits between headrest display units.</li></ul>

### Diagnosis Procedure

INFOID:000000009129381

Regarding Wiring Diagram information, refer to [AV-683, "Wiring Diagram"](#).

#### 1. CHECK HEADREST DISPLAY UNIT POWER SUPPLY AND GROUND CIRCUIT

Check headrest display unit power supply and ground circuits. Refer to [AV-820, "HEADREST DISPLAY UNIT : Diagnosis Procedure"](#).

Is the inspection result normal?

YES >> GO TO 2.

NO >> Repair or replace harness or connectors.

#### 2. CHECK AV COMMUNICATION CIRCUIT CONTINUITY

- Turn ignition switch OFF.
- Disconnect headrest display unit connectors.
- Check continuity between headrest display unit (driver seat) connector B202 and headrest display unit (passenger seat) connector B302.

Headrest display unit (driver seat)		Headrest display unit (passenger seat)		Continuity
Connector	Terminals	Connector	Terminals	
B202	26	B302	10	Yes
	27		11	

- Check continuity between headrest display unit (driver seat) connector B202 and ground.

Headrest display unit (driver seat)		Ground	Continuity
Connector	Terminals		
B202	26	—	No
	27		

Is the inspection result normal?

YES >> Replace headrest display unit (passenger seat). Refer to [AV-903, "Removal and Installation"](#).

NO >> Repair or replace harness or connectors.

# U1263 USB

< DTC/CIRCUIT DIAGNOSIS >

[BOSE AUDIO W/NAVI W/SURROUND]

## U1263 USB

### DTC Logic

INFOID:000000009129382

CONSULT Display	DTC Detection Condition	Possible Cause
USB OVERCURRENT [U126]	Overcurrent in USB connector is detected.	Check USB harness between the AV control unit and USB connector.

### Diagnosis Procedure

INFOID:000000009129383

#### 1. CHECK USB INTERFACE HARNESS

Visually inspect USB interface harness.

Is the inspection result normal?

YES >> GO TO 2.

NO >> Replace USB interface harness. Refer to [AV-896, "Removal and Installation"](#).

#### 2. CHECK USB INTERFACE HARNESS CONTINUITY

Check USB interface harness continuity. Refer to [AV-857, "Diagnosis Procedure"](#).

Is the inspection result normal?

YES >> Replace AV control unit. Refer to [AV-883, "Removal and Installation - AV Control Unit"](#).

NO >> Replace USB interface harness. Refer to [AV-896, "Removal and Installation"](#).

# U1264 ANTENNA AMP.

[BOSE AUDIO W/NAVI W/SURROUND]

< DTC/CIRCUIT DIAGNOSIS >

## U1264 ANTENNA AMP.

### DTC Logic

INFOID:000000009129384

CONSULT Display	DTC Detection Condition	Possible Cause
ANTENNA AMP TERMINAL [U1264]	Antenna amp. ON signal circuit open or short circuited.	Antenna amp. ON signal circuit between AV control unit and antenna amp.

### Diagnosis Procedure

INFOID:000000009129385

Regarding Wiring Diagram information, refer to [AV-683, "Wiring Diagram"](#).

#### 1. CHECK CONTINUITY BETWEEN AV CONTROL UNIT AND ANTENNA BASE

- Turn ignition switch OFF.
- Disconnect AV control unit connector M143 and antenna base connector M502.
- Check continuity between AV control unit connector M143 and antenna base connector M502.

AV control unit		Antenna base		Continuity
Connector	Terminal	Connector	Terminal	
M143	143	M502	1	Yes

- Check continuity between AV control unit connector M143 and ground.

AV control unit		Ground	Continuity
Connector	Terminal		
M143	143	—	No

Is the inspection result normal?

- YES >> GO TO 2.  
 NO >> Repair or replace harness or connectors.

#### 2. CHECK AV CONTROL UNIT VOLTAGE

- Connect AV control unit connector M143.
- Turn ignition switch ON.
- Check voltage between AV control unit connector M143 and ground.

AV control unit (+)		Ground (-)	Voltage (Approx.)
Connector	Terminal		
M143	143	—	Battery voltage

Is the inspection result normal?

- YES >> Replace antenna base. Refer to [AV-913, "Removal and Installation"](#).  
 NO >> Replace AV control unit. Refer to [AV-883, "Removal and Installation - AV Control Unit"](#).

# U1265 BOSE AMP.

< DTC/CIRCUIT DIAGNOSIS >

[BOSE AUDIO W/NAVI W/SURROUND]

## U1265 BOSE AMP.

### DTC Logic

INFOID:000000009129386

CONSULT Display	DTC Detection Condition	Possible Cause
AMP ON TERMINAL [U1265]	BOSE amp. ON signal circuit open or short circuited.	BOSE amp. ON signal circuit between AV control unit and BOSE amp.

### Diagnosis Procedure

INFOID:000000009129387

Regarding Wiring Diagram information, refer to [AV-683. "Wiring Diagram"](#).

#### 1. CHECK CONTINUITY BETWEEN AV CONTROL UNIT AND BOSE SPEAKER AMP.

1. Turn ignition switch OFF.
2. Disconnect AV control unit connector M122 and Bose speaker amp. connector B130.
3. Check continuity between AV control unit connector M122 and Bose speaker amp. connector M130.

AV control unit		Bose speaker amp.		Continuity
Connector	Terminal	Connector	Terminal	
M122	1	B130	60	Yes

4. Check continuity between AV control unit connector M122 and ground.

AV control unit		Ground	Continuity
Connector	Terminal		
M122	1	—	No

Is the inspection result normal?

- YES >> GO TO 2.  
NO >> Repair or replace harness or connectors.

#### 2. CHECK AV CONTROL UNIT VOLTAGE

1. Connect AV control unit connector M122.
2. Turn ignition switch ON.
3. Check voltage between AV control unit connector M122 and ground.

AV control unit		Ground	Voltage (Approx.)
(+)			
Connector	Terminal	(-)	
M122	1	—	Battery voltage

Is the inspection result normal?

- YES >> Replace Bose speaker amp. Refer to [AV-887. "Removal and Installation"](#).  
NO >> Replace AV control unit. Refer to [AV-883. "Removal and Installation - AV Control Unit"](#).

# U1300 AV COMM CIRCUIT

< DTC/CIRCUIT DIAGNOSIS >

[BOSE AUDIO W/NAVI W/SURROUND]

## U1300 AV COMM CIRCUIT

### Description

INFOID:00000009129388

U1300 is indicated when a malfunction occurs in the communication signal of the multi AV system. Indicated simultaneously, without fail, the malfunction of control units connected to the AV control unit through communication circuits. Determine the possible malfunction cause from the table below.

### SELF DIAGNOSTIC RESULT DISPLAY ITEM

CONSULT Display	DTC Detection Condition	Possible Cause
<ul style="list-style-type: none"> <li>• AV COMM CIRCUIT [U1300]</li> <li>• SWITCH CONN [U1240]</li> </ul>	When any of the following is detected: <ul style="list-style-type: none"> <li>• A/C and AV switch assembly power supply or ground circuit malfunction.</li> <li>• AV communication circuit malfunction between AV control unit and A/C and AV switch assembly.</li> </ul>	<ul style="list-style-type: none"> <li>• A/C and AV switch assembly power supply and ground circuits. Refer to <a href="#">AV-818. "A/C AND AV SWITCH ASSEMBLY : Diagnosis Procedure"</a>.</li> <li>• AV communication circuits between AV control unit and A/C and AV switch assembly.</li> </ul>
<ul style="list-style-type: none"> <li>• AV COMM CIRCUIT [U1300]</li> <li>• AMP CONN [U124E]</li> </ul>	When any of the following is detected: <ul style="list-style-type: none"> <li>• BOSE speaker amp. power supply or ground circuit malfunction.</li> <li>• AV communication circuits between AV control unit and BOSE speaker amp. are malfunctioning.</li> </ul>	<ul style="list-style-type: none"> <li>• BOSE speaker amp. power supply and ground circuits. Refer to <a href="#">AV-816. "BOSE AMP. : Diagnosis Procedure"</a>.</li> <li>• AV communication circuits between AV control unit and BOSE speaker amp.</li> </ul>
<ul style="list-style-type: none"> <li>• AV COMM CIRCUIT [U1300]</li> <li>• VIDEO DIST CONN [U1246]</li> </ul>	When any of the following is detected: <ul style="list-style-type: none"> <li>• video distributor power supply or ground circuit malfunction.</li> <li>• headrest display unit (driver seat) power supply or ground circuit malfunction.</li> <li>• AV communication circuit malfunction between AV control unit and headrest display unit (driver seat).</li> </ul>	<ul style="list-style-type: none"> <li>• Video distributor power supply and ground circuits. Refer to <a href="#">AV-819. "VIDEO DISTRIBUTOR : Diagnosis Procedure"</a>.</li> <li>• Headrest display unit (driver seat) power supply and ground circuits. Refer to <a href="#">AV-820. "HEADREST DISPLAY UNIT : Diagnosis Procedure"</a>.</li> <li>• AV communication circuits between AV control unit and headrest display unit (driver seat).</li> </ul>
<ul style="list-style-type: none"> <li>• AV COMM CIRCUIT [U1300]</li> <li>• AROUND CAMERA CONN [U125B]</li> </ul>	When any of the following is detected: <ul style="list-style-type: none"> <li>• around view monitor control unit power supply or ground circuit malfunction.</li> <li>• AV communication circuit malfunction between AV control unit and around view monitor control unit.</li> </ul>	<ul style="list-style-type: none"> <li>• Around view monitor control unit power supply and ground circuits. Refer to <a href="#">AV-820. "AROUND VIEW MONITOR CONTROL UNIT : Diagnosis Procedure"</a>.</li> <li>• AV communication circuits between AV control unit and around view monitor control unit.</li> </ul>
<ul style="list-style-type: none"> <li>• AV COMM CIRCUIT [U1300]</li> <li>• SONAR CONN [U125C]</li> </ul>	When any of the following is detected: <ul style="list-style-type: none"> <li>• sonar control unit power supply or ground circuit malfunction.</li> <li>• AV communication circuit malfunction between AV control unit and sonar control unit.</li> </ul>	<ul style="list-style-type: none"> <li>• Sonar control unit power supply and ground circuits. Refer to <a href="#">AV-821. "SONAR CONTROL UNIT (WITH AROUND VIEW MONITOR) : Diagnosis Procedure"</a>.</li> <li>• AV communication circuits between AV control unit and sonar control unit.</li> </ul>

A

B

C

D

E

F

G

H

I

J

K

L

M

AV

O

P

# U1300 AV COMM CIRCUIT

< DTC/CIRCUIT DIAGNOSIS >

[BOSE AUDIO W/NAVI W/SURROUND]

CONSULT Display	DTC Detection Condition	Possible Cause
<ul style="list-style-type: none"><li>• AV COMM CIRCUIT [U1300]</li><li>• SWITCH CONN [U1240]</li><li>• SONAR CONN [U125C]</li><li>• AROUND CAMERA CONN [U125B]</li><li>• VIDEO DIST CONN [U1246]</li></ul>		
<ul style="list-style-type: none"><li>• AV COMM CIRCUIT [U1300]</li><li>• SWITCH CONN [U1240]</li><li>• AMP CONN [U124E]</li><li>• SONAR CONN [U125C]</li><li>• AROUND CAMERA CONN [U125B]</li><li>• VIDEO DIST CONN [U1246]</li></ul>	AV communication circuit malfunction between AV control unit and A/C and AV switch assembly.	AV communication circuits between AV control unit and A/C and AV switch assembly.

# U1302 CAMERA POWER VOLT

< DTC/CIRCUIT DIAGNOSIS >

[BOSE AUDIO W/NAVI W/SURROUND]

## U1302 CAMERA POWER VOLT

### DTC Logic

INFOID:000000009129389

### DTC DETECTION LOGIC

CONSULT Display	DTC Detection Condition	Possible Cause
CAMERA SUPPLY POWER SUPPLY VOLTAGE ABNORMALITY [U1302]	Short in camera power circuit.	<ul style="list-style-type: none"> <li>• Harness or connectors.</li> <li>• Camera.</li> <li>• Around view monitor control unit.</li> </ul>

### Diagnosis Procedure

INFOID:000000009129390

Regarding Wiring Diagram information, refer to [AV-683, "Wiring Diagram"](#).

### 1. CHECK CAMERA DATA MONITOR

Check CAMERA IMAGE SIG, CAMERA COMM STATUS and CAMERA COMM LINE for each camera in "DATA MONITOR" of "AVM".

Is "OK" displayed for all cameras?

YES >> Refer to [GI-53, "Intermittent Incident"](#).

NO-1 (Front camera)>>GO TO 2.

NO-2 (Rear camera)>>GO TO 4.

NO-3 (LH side camera)>>GO TO 6.

NO-4 (RH side camera)>>GO TO 8.

### 2. CHECK FRONT CAMERA POWER SUPPLY AND POWER SUPPLY GROUND CIRCUIT CONTINUITY

1. Turn ignition switch OFF.
2. Disconnect around view monitor control unit connector M97 and camera connectors.
3. Check continuity between around view monitor control unit connector M97 and front camera connector E226.

Around view monitor control unit		Front camera		Continuity
Connector	Terminal	Connector	Terminal	
M97	68	E226	1	Yes
	70		2	

4. Check continuity between around view monitor control unit connector M97 and ground.

Around view monitor control unit		Ground	Continuity
Connector	Terminal		
M97	68	—	No

Is the inspection result normal?

YES >> GO TO 3.

NO >> Repair or replace harness or connectors.

### 3. CHECK AROUND VIEW MONITOR CONTROL UNIT VOLTAGE

1. Connect around view monitor control unit connector M97 and front camera connector E226.
2. Turn ignition switch ON.
3. Check voltage between around view monitor control unit connector M97 terminals.

# U1302 CAMERA POWER VOLT

< DTC/CIRCUIT DIAGNOSIS >

[BOSE AUDIO W/NAVI W/SURROUND]

Around view monitor control unit M97		Condition	Voltage (Approx.)
(+)	(-)		
Terminal	Terminal		
68	70	CAMERA switch is ON or shift position is R.	6.0 V

Is the inspection result normal?

YES >> Replace front camera. Refer to [AV-601, "Removal and Installation"](#).

NO >> Replace around view monitor control unit. Refer to [AV-600, "Removal and Installation"](#).

## 4. CHECK REAR CAMERA POWER SUPPLY AND POWER SUPPLY GROUND CIRCUIT CONTINUITY

1. Turn ignition switch OFF.
2. Disconnect around view monitor control unit connector M97 and rear camera connector D511.
3. Check continuity between around view monitor control unit connector M97 and rear camera connector D511.

Around view monitor control unit		Rear camera		Continuity
Connector	Terminal	Connector	Terminal	
M97	50	D511	8	Yes
	52		7	

4. Check continuity between around view monitor control unit connector M97 and ground.

Around view monitor control unit		Ground	Continuity
Connector	Terminal		
M97	50	—	No

Is the inspection result normal?

YES >> GO TO 5.

NO >> Repair or replace harness or connectors.

## 5. CHECK AROUND VIEW MONITOR CONTROL UNIT VOLTAGE

1. Connect around view monitor control unit connector M97 and rear camera connector D511.
2. Turn ignition switch ON.
3. Check voltage between around view monitor control unit connector M97 terminals.

Around view monitor control unit M97		Condition	Voltage (Approx.)
(+)	(-)		
Terminal	Terminal		
50	52	CAMERA switch is ON or shift position is R.	6.0 V

Is the inspection result normal?

YES >> Replace rear camera. Refer to [AV-900, "Removal and Installation"](#).

NO >> Replace around view monitor control unit. Refer to [AV-898, "Removal and Installation"](#).

## 6. CHECK LH SIDE CAMERA POWER SUPPLY AND POWER SUPPLY GROUND CIRCUIT CONTINUITY

1. Turn ignition switch OFF.
2. Disconnect around view monitor control unit connector M97 and LH side camera connector D20.
3. Check continuity between around view monitor control unit connector M97 and LH side camera connector D20.

Around view monitor control unit		LH side camera		Continuity
Connector	Terminal	Connector	Terminal	



# U1302 CAMERA POWER VOLT

< DTC/CIRCUIT DIAGNOSIS >

[BOSE AUDIO W/NAVI W/SURROUND]

M97	56	D20	6	Yes
	58		18	

4. Check continuity between around view monitor control unit connector M97 and ground.

Around view monitor control unit		Ground	Continuity
Connector	Terminal		
M97	56	—	No

Is the inspection result normal?

YES >> GO TO 7.

NO >> Repair or replace harness or connectors.

## 7. CHECK AROUND VIEW MONITOR CONTROL UNIT VOLTAGE

1. Connect around view monitor control unit connector M97 and LH side camera connector D20.
2. Turn ignition switch ON.
3. Check voltage between around view monitor control unit connector M97 terminals.

Around view monitor control unit M97		Condition	Voltage (Approx.)
(+)	(-)		
Terminal	Terminal		
56	58	CAMERA switch is ON or shift position is R.	6.0 V

Is the inspection result normal?

YES >> Replace LH side camera. Refer to [AV-603. "Removal and Installation"](#).

NO >> Replace around view monitor control unit. Refer to [AV-600. "Removal and Installation"](#).

## 8. CHECK RH SIDE CAMERA POWER SUPPLY AND POWER SUPPLY GROUND CIRCUIT CONTINUITY

1. Turn ignition switch OFF.
2. Disconnect around view monitor control unit connector M97 and RH side camera connector D113.
3. Check continuity between around view monitor control unit connector M97 and RH side camera connector D113.

Around view monitor control unit		RH side camera		Continuity
Connector	Terminal	Connector	Terminal	
M97	62	D113	6	Yes
	64		18	

4. Check continuity between around view monitor control unit connector M97 and ground.

Around view monitor control unit		Ground	Continuity
Connector	Terminal		
M97	62	—	No

Is the inspection result normal?

YES >> GO TO 9.

NO >> Repair or replace harness or connectors.

## 9. CHECK AROUND VIEW MONITOR CONTROL UNIT VOLTAGE

1. Connect around view monitor control unit connector M97 and RH side camera connector D113.
2. Turn ignition switch ON.
3. Check voltage between around view monitor control unit connector M97 terminals.

## U1302 CAMERA POWER VOLT

< DTC/CIRCUIT DIAGNOSIS >

[BOSE AUDIO W/NAVI W/SURROUND]

Around view monitor control unit M97		Condition	Voltage (Approx.)
(+)	(-)		
Terminal	Terminal		
62	64	CAMERA switch is ON or shift position is R.	6.0 V

Is the inspection result normal?

YES >> Replace RH side camera. Refer to [AV-603. "Removal and Installation"](#).

NO >> Replace around view monitor control unit. Refer to [AV-600. "Removal and Installation"](#).

# U1303 LED POWER SUPPLY VOLT

< DTC/CIRCUIT DIAGNOSIS >

[BOSE AUDIO W/NAVI W/SURROUND]

## U1303 LED POWER SUPPLY VOLT

### DTC Logic

INFOID:000000009129391

### DTC DETECTION LOGIC

CONSULT Display	DTC Detection Condition	Possible Cause
LED SUPPLY POWER SUPPLY VOLTAGE ABNORMALITY [U1303]	Short in camera power circuit.	<ul style="list-style-type: none"> <li>• Harness or connectors.</li> <li>• Camera.</li> <li>• Around view monitor control unit.</li> </ul>

### Diagnosis Procedure

INFOID:000000009129392

Regarding Wiring Diagram information, refer to [AV-683, "Wiring Diagram"](#).

### 1.CHECK CAMERA DATA MONITOR

Check CAMERA IMAGE SIG, CAMERA COMM STATUS and CAMERA COMM LINE for each camera in "DATA MONITOR" of "AVM".

Is "OK" displayed for all cameras?

YES >> Refer to [GI-53, "Intermittent Incident"](#).

NO-1 (LH side camera)>>GO TO 2.

NO-2 (RH side camera)>>GO TO 4.

### 2.CHECK LH SIDE CAMERA POWER SUPPLY AND POWER SUPPLY GROUND CIRCUIT CONTINUITY

1. Turn ignition switch OFF.
2. Disconnect around view monitor control unit connector M97 and LH side camera connector D20.
3. Check continuity between around view monitor control unit connector M97 and LH side camera connector D20.

Around view monitor control unit		LH side camera		Continuity
Connector	Terminal	Connector	Terminal	
M97	56	D20	6	Yes
	58		18	

4. Check continuity between around view monitor control unit connector M97 and ground.

Around view monitor control unit		Ground	Continuity
Connector	Terminal		
M97	56	—	No

Is the inspection result normal?

YES >> GO TO 3.

NO >> Repair or replace harness or connectors.

### 3.CHECK AROUND VIEW MONITOR CONTROL UNIT VOLTAGE

1. Connect around view monitor control unit connector M97 and LH side camera connector D20.
2. Turn ignition switch ON.
3. Check voltage between around view monitor control unit connector M97 terminals.

# U1303 LED POWER SUPPLY VOLT

< DTC/CIRCUIT DIAGNOSIS >

[BOSE AUDIO W/NAVI W/SURROUND]

Around view monitor control unit M97		Condition	Voltage (Approx.)
(+)	(-)		
Terminal	Terminal		
56	58	CAMERA switch is ON or shift position is R.	6.0 V

Is the inspection result normal?

YES >> Replace LH side camera. Refer to [AV-603, "Removal and Installation"](#).

NO >> Replace around view monitor control unit. Refer to [AV-600, "Removal and Installation"](#).

## 4. CHECK RH SIDE CAMERA POWER SUPPLY AND POWER SUPPLY GROUND CIRCUIT CONTINUITY

1. Turn ignition switch OFF.
2. Disconnect around view monitor control unit connector M97 and RH side camera connector D113.
3. Check continuity between around view monitor control unit connector M97 and RH side camera connector D113.

Around view monitor control unit		RH side camera		Continuity
Connector	Terminal	Connector	Terminal	
M97	62	D113	6	Yes
	64		18	

4. Check continuity between around view monitor control unit connector M97 and ground.

Around view monitor control unit		Ground	Continuity
Connector	Terminal		
M97	62	—	No

Is the inspection result normal?

YES >> GO TO 5.

NO >> Repair or replace harness or connectors.

## 5. CHECK AROUND VIEW MONITOR CONTROL UNIT VOLTAGE

1. Connect around view monitor control unit connector M97 and RH side camera connector D113.
2. Turn ignition switch ON.
3. Check voltage between around view monitor control unit connector M97 terminals.

Around view monitor control unit M97		Condition	Voltage (Approx.)
(+)	(-)		
Terminal	Terminal		
62	64	CAMERA switch is ON or shift position is R.	6.0 V

Is the inspection result normal?

YES >> Replace RH side camera. Refer to [AV-603, "Removal and Installation"](#).

NO >> Replace around view monitor control unit. Refer to [AV-600, "Removal and Installation"](#).

# U1304 CAMERA IMAGE CALIBRATION

< DTC/CIRCUIT DIAGNOSIS >

[BOSE AUDIO W/NAVI W/SURROUND]

## U1304 CAMERA IMAGE CALIBRATION

DTC Logic

INFOID:000000009129393

DTC DETECTION LOGIC

CONSULT Display	DTC Detection Condition	Possible Cause
NON-COMPLETION OF THE CALIBRATION [U1304]	Camera calibration malfunction.	Cameras are not calibrated. Refer to <a href="#">AV-749, "CALIBRATING CAMERA IMAGE (AROUND VIEW MONITOR) : Work Procedure"</a> .

A  
B  
C  
D  
E  
F  
G  
H  
I  
J  
K  
L  
M  
N  
O  
P

AV

# U1305 CONFIG UNFINISH

< DTC/CIRCUIT DIAGNOSIS >

[BOSE AUDIO W/NAVI W/SURROUND]

## U1305 CONFIG UNFINISH

### DTC Logic

INFOID:000000009129394

### DTC DETECTION LOGIC

CONSULT Display	DTC Detection Condition	Possible Cause
NON-COMPLETION OF THE WRITE CONFIGURATION [U1305]	Around view monitor control unit configuration malfunction.	Around view monitor control unit not configured. Refer to <a href="#">AV-745. "CONFIGURATION (AROUND VIEW MONITOR CONTROL UNIT) : Work Procedure"</a> .

# U1310 AV CONTROL UNIT

< DTC/CIRCUIT DIAGNOSIS >

[BOSE AUDIO W/NAVI W/SURROUND]

## U1310 AV CONTROL UNIT

### DTC Logic

INFOID:000000009129395

CONSULT Display	DTC Detection Condition	Possible Cause
CONTROL UNIT (AV) [U1310]	An initial diagnosis error is detected in AV communication circuit.	Replace AV control unit if malfunction occurs constantly. Refer to <a href="#">AV-883. "Removal and Installation - AV Control Unit"</a> .

A

B

C

D

E

F

G

H

I

J

K

L

M

AV

O

P

# U1601, U1603, U1609, U160B FRONT DOOR SPEAKER/TWEETER

< DTC/CIRCUIT DIAGNOSIS >

[BOSE AUDIO W/NAVI W/SURROUND]

## U1601, U1603, U1609, U160B FRONT DOOR SPEAKER/TWEETER

### DTC Logic

INFOID:000000009129396

### DTC DETECTION LOGIC

CONSULT Display	DTC Detection Condition	Possible Cause
FL-DOOR WOOFER (OPEN, SHORT, GND- SHORT) [U1601] FL-DOOR WOOFER (VB-SHOR) [U1603]	When any of the following is detected: <ul style="list-style-type: none"><li>• Sound signal circuit malfunction between BOSE speaker amp. and front door speaker LH.</li><li>• Sound signal circuit malfunction between BOSE speaker amp. and front tweeter LH.</li></ul>	<ul style="list-style-type: none"><li>• Sound signal circuits between BOSE speaker amp. and front door speaker LH. Refer to <a href="#">AV-831, "Diagnosis Procedure"</a>.</li><li>• Sound signal circuits between BOSE speaker amp. and front tweeter LH. Refer to <a href="#">AV-828, "Diagnosis Procedure"</a>.</li></ul>
FR-DOOR WOOFER (OPEN, SHORT, GND- SHORT) [U1609] FR-DOOR WOOFER (VB-SHOR) [U160B]	When any of the following is detected: <ul style="list-style-type: none"><li>• Sound signal circuit malfunction between BOSE speaker amp. and front door speaker RH.</li><li>• Sound signal circuit malfunction between BOSE speaker amp. and front tweeter RH.</li></ul>	<ul style="list-style-type: none"><li>• Sound signal circuits between BOSE speaker amp. and front door speaker RH. Refer to <a href="#">AV-831, "Diagnosis Procedure"</a>.</li><li>• Sound signal circuits between BOSE speaker amp. and front tweeter RH. Refer to <a href="#">AV-828, "Diagnosis Procedure"</a>.</li></ul>

### Diagnosis Procedure

INFOID:000000009129397

#### 1. PERFORM SELF DIAGNOSTIC RESULT

1. Perform Self Diagnostic Result for MULTI AV.
2. Erase Self Diagnostic Result. Turn ignition switch OFF.
3. Turn ignition switch ON. Perform Self Diagnostic Result again.

Is DTC U1601, U1603, U1609 or U160B detected?

- YES >> Refer to [AV-831, "Diagnosis Procedure"](#).  
NO >> Refer to [GI-53, "Intermittent Incident"](#).



# U1627, U162F TWEETER

< DTC/CIRCUIT DIAGNOSIS >

[BOSE AUDIO W/NAVI W/SURROUND]

## U1627, U162F TWEETER

### DTC Logic

INFOID:000000009129398

### DTC DETECTION LOGIC

CONSULT Display	DTC Detection Condition	Possible Cause
F-INST L-TWEETER (OPEN, SHORT, GND- SHORT or VB-SHOR) [U1627]	Sound signal circuit malfunction between BOSE speaker amp. and instrument panel tweeter LH.	Sound signal circuits between BOSE speaker amp. and instrument panel tweeter LH. Refer to <a href="#">AV-825, "Diagnosis Procedure"</a> .
F-INST R-TWEETER (OPEN, SHORT, GND- SHORT or VB-SHOR) [U162F]	Sound signal circuit malfunction between BOSE speaker amp. and instrument panel tweeter RH.	Sound signal circuits between BOSE speaker amp. and instrument panel tweeter RH. Refer to <a href="#">AV-825, "Diagnosis Procedure"</a> .

### Diagnosis Procedure

INFOID:000000009129399

#### 1. PERFORM SELF DIAGNOSTIC RESULT

1. Perform Self Diagnostic Result for MULTI AV.
2. Erase Self Diagnostic Result. Turn ignition switch OFF.
3. Turn ignition switch ON. Perform Self Diagnostic Result again.

Is DTC U1627 or U162F detected?

- YES >> Refer to [AV-825, "Diagnosis Procedure"](#).  
NO >> Refer to [GI-53, "Intermittent Incident"](#).

A  
B  
C  
D  
E  
F  
G  
H  
I  
J  
K  
L  
M  
O  
P

AV

# U162A CENTER SPEAKER

< DTC/CIRCUIT DIAGNOSIS >

[BOSE AUDIO W/NAVI W/SURROUND]

## U162A CENTER SPEAKER

### DTC Logic

INFOID:000000009129400

### DTC DETECTION LOGIC

CONSULT Display	DTC Detection Condition	Possible Cause
F-INST C-SQUAWK (OPEN, SHORT, GND- SHORT, or VB-SHORT) [U162A]	Sound signal circuit malfunction between BOSE speaker amp. and center speaker.	Sound signal circuits between BOSE speaker amp. and center speaker. Refer to <a href="#">AV-823, "Diagnosis Procedure"</a> .

### Diagnosis Procedure

INFOID:000000009129401

#### 1. PERFORM SELF DIAGNOSTIC RESULT

1. Perform Self Diagnostic Result for MULTI AV.
2. Erase Self Diagnostic Result. Turn ignition switch OFF.
3. Turn ignition switch ON. Perform Self Diagnostic Result again.

#### Is DTC U162A detected?

- YES >> Refer to [AV-823, "Diagnosis Procedure"](#).  
NO >> Refer to [GI-53, "Intermittent Incident"](#).

# U1684, U1687, U168C, U168F REAR DOOR SPEAKER/TWEETER

< DTC/CIRCUIT DIAGNOSIS >

[BOSE AUDIO W/NAVI W/SURROUND]

## U1684, U1687, U168C, U168F REAR DOOR SPEAKER/TWEETER

### DTC Logic

INFOID:000000009129402

### DTC DETECTION LOGIC

CONSULT Display	DTC Detection Condition	Possible Cause
2L-DOOR SPEAKER (OPEN, SHORT, GND- SHORT) [U1684] 2L-DOOR SPEAKER (VB- SHOR) [U1687]	When any of the following is detected: <ul style="list-style-type: none"><li>• sound signal circuit malfunction between BOSE speaker amp. and rear door speaker LH.</li><li>• sound signal circuit malfunction between BOSE speaker amp. and rear door tweeter LH.</li></ul>	<ul style="list-style-type: none"><li>• Sound signal circuits between BOSE speaker amp. and rear door speaker LH. Refer to <a href="#">AV-837, "Diagnosis Procedure"</a>.</li><li>• Sound signal circuits between BOSE speaker amp. and rear door tweeter LH. Refer to <a href="#">AV-834, "Diagnosis Procedure"</a>.</li></ul>
2R-DOOR SPEAKER (OPEN, SHORT, GND- SHORT) [U168C] 2R-DOOR SPEAKER (VB- SHOR) [U168F]	When either one of the following items are detected: <ul style="list-style-type: none"><li>• sound signal circuit malfunction between BOSE speaker amp. and rear door speaker RH.</li><li>• sound signal circuit malfunction between BOSE speaker amp. and rear door tweeter RH.</li></ul>	<ul style="list-style-type: none"><li>• Sound signal circuits between BOSE speaker amp. and rear door speaker RH. Refer to <a href="#">AV-837, "Diagnosis Procedure"</a>.</li><li>• Sound signal circuits between BOSE speaker amp. and rear door tweeter RH. Refer to <a href="#">AV-834, "Diagnosis Procedure"</a>.</li></ul>

### Diagnosis Procedure

INFOID:000000009129403

#### 1. PERFORM SELF DIAGNOSTIC RESULT

1. Perform Self Diagnostic Result for MULTI AV.
2. Erase Self Diagnostic Result. Turn ignition switch OFF.
3. Turn ignition switch ON. Perform Self Diagnostic Result again.

Is DTC U1684, U1687, U168C or U168F detected?

- YES >> Refer to [AV-837, "Diagnosis Procedure"](#).  
NO >> Refer to [GI-53, "Intermittent Incident"](#).

A  
B  
C  
D  
E  
F  
G  
H  
I  
J  
K  
L  
M  
AV  
O  
P

# U175D WOOFER

< DTC/CIRCUIT DIAGNOSIS >

[BOSE AUDIO W/NAVI W/SURROUND]

## U175D WOOFER

### DTC Logic

INFOID:000000009129404

### DTC DETECTION LOGIC

CONSULT Display	DTC Detection Condition	Possible Cause
R-LUGGAGE L-WOOFER (OPEN, SHORT, GND- SHORT or VB-SHOR) [U175D]	Sound signal circuit malfunction between BOSE speaker amp. and subwoofer.	Sound signal circuits between BOSE speaker amp. and subwoofer. Refer to <a href="#">AV-843, "Diagnosis Procedure"</a> .

### Diagnosis Procedure

INFOID:000000009129405

#### 1. PERFORM SELF DIAGNOSTIC RESULT

1. Perform Self Diagnostic Result for MULTI AV.
2. Erase Self Diagnostic Result. Turn ignition switch OFF.
3. Turn ignition switch ON. Perform Self Diagnostic Result again.

#### Is DTC U175D detected?

- YES >> Refer to [AV-843, "Diagnosis Procedure"](#).  
NO >> Refer to [GI-53, "Intermittent Incident"](#).

# U176A, U1772 ROOF SPEAKER

< DTC/CIRCUIT DIAGNOSIS >

[BOSE AUDIO W/NAVI W/SURROUND]

## U176A, U1772 ROOF SPEAKER

### DTC Logic

INFOID:000000009129406

### DTC DETECTION LOGIC

CONSULT Display	DTC Detection Condition	Possible Cause
R-ROOF L-SQAWK (OPEN, SHORT, GND-SHORT or VB-SHOR) [U176A]	Sound signal circuit malfunction between BOSE speaker amp. and rear side speaker LH.	Sound signal circuits between BOSE speaker amp. and rear side speaker LH. Refer to <a href="#">AV-840, "Diagnosis Procedure"</a> .
R-ROOF R-SQAWK (OPEN, SHORT, GND-SHORT or VB-SHOR) [U1772]	Sound signal circuit malfunction between BOSE speaker amp. and rear side speaker RH.	Sound signal circuits between BOSE speaker amp. and rear side speaker RH. Refer to <a href="#">AV-840, "Diagnosis Procedure"</a> .

### Diagnosis Procedure

INFOID:000000009129407

#### 1. PERFORM SELF DIAGNOSTIC RESULT

1. Perform Self Diagnostic Result for MULTI AV.
2. Erase Self Diagnostic Result. Turn ignition switch OFF.
3. Turn ignition switch ON. Perform Self Diagnostic Result again.

Is DTC U176A or U1772 detected?

- YES >> Refer to [AV-840, "Diagnosis Procedure"](#).  
NO >> Refer to [GI-53, "Intermittent Incident"](#).

A  
B  
C  
D  
E  
F  
G  
H  
I  
J  
K  
L  
M  
O  
P

AV

# B2720 CORNER SENSOR [RL]

< DTC/CIRCUIT DIAGNOSIS >

[BOSE AUDIO W/NAVI W/SURROUND]

## B2720 CORNER SENSOR [RL]

### DTC Logic

INFOID:000000009129408

### DTC DETECTION LOGIC

CONSULT Display	DTC Detection Condition	Possible Cause
REAR LEFT SIDE EXTERNAL SENSOR [B2720]	<ul style="list-style-type: none"> <li>• Sensor is not configured.</li> <li>• Sensor is open or short circuited.</li> <li>• Sensor element malfunction.</li> </ul>	<ul style="list-style-type: none"> <li>• Sensor configuration.</li> <li>• Harness or connectors.</li> <li>• Rear sonar sensor LH outer.</li> </ul>

### Diagnosis Procedure

INFOID:000000009129408

Regarding Wiring Diagram information, refer to [AV-683. "Wiring Diagram"](#).

#### 1. CHECK REAR SONAR SENSOR LH OUTER CIRCUIT CONTINUITY

1. Turn ignition switch OFF.
2. Disconnect sonar control unit connector and rear sonar sensor LH outer connector.
3. Check continuity between sonar control unit connector M70 and rear sonar sensor LH outer connector B455.

Sonar control unit		Rear sonar sensor LH outer		Continuity
Connector	Terminal	Connector	Terminal	
M70	22	B455	2	Yes
	14		1	

4. Check continuity between sonar control unit connector M70 and ground.

Sonar control unit		Ground	Continuity
Connector	Terminal		
M70	22	—	No

Is the inspection result normal?

- YES >> GO TO 2.  
 NO >> Repair or replace harness or connectors.

#### 2. CHECK REAR SONAR SENSOR LH OUTER SIGNAL CIRCUIT SHORT TO BATTERY

1. Turn ignition switch ON.
2. Check voltage between sonar control unit connector M70 and ground.

Sonar control unit		Ground	Voltage (Approx.)
Connector	Terminal		
M70	22	—	0V

Is the inspection result normal?

- YES >> Replace rear sonar sensor LH outer. Refer to [AV-907. "Removal and Installation"](#).  
 NO >> Repair or replace harness or connectors.

# B2721 CENTER SENSOR [RL]

[BOSE AUDIO W/NAVI W/SURROUND]

< DTC/CIRCUIT DIAGNOSIS >

## B2721 CENTER SENSOR [RL]

### DTC Logic

INFOID:000000009129410

### DTC DETECTION LOGIC

CONSULT Display	DTC Detection Condition	Possible Cause
REAR LEFT SIDE INTER-NAL SENSOR [B2721]	<ul style="list-style-type: none"> <li>• Sensor is not configured.</li> <li>• Sensor is open or short circuited.</li> <li>• Sensor element malfunction.</li> </ul>	<ul style="list-style-type: none"> <li>• Sensor configuration.</li> <li>• Harness or connectors.</li> <li>• Rear sonar sensor LH inner.</li> </ul>

### Diagnosis Procedure

INFOID:000000009129411

Regarding Wiring Diagram information, refer to [AV-683. "Wiring Diagram"](#).

#### 1. CHECK REAR SONAR SENSOR LH INNER CIRCUIT CONTINUITY

1. Turn ignition switch OFF.
2. Disconnect sonar control unit connector and rear sonar sensor LH inner connector.
3. Check continuity between sonar control unit connector M70 and rear sonar sensor LH inner connector B457.

Sonar control unit		Rear sonar sensor LH inner		Continuity
Connector	Terminal	Connector	Terminal	
M70	21	B457	2	Yes
	14		1	

4. Check continuity between sonar control unit connector M70 and ground.

Sonar control unit		Ground	Continuity
Connector	Terminal		
M70	21	—	No

Is the inspection result normal?

- YES >> GO TO 2.  
 NO >> Repair or replace harness or connectors.

#### 2. CHECK REAR SONAR SENSOR LH INNER SIGNAL CIRCUIT SHORT TO BATTERY

1. Turn ignition switch ON.
2. Check voltage between sonar control unit connector M70 and ground.

Sonar control unit		Ground	Voltage (Approx.)
Connector	Terminal		
M70	21	—	0V

Is the inspection result normal?

- YES >> Replace rear sonar sensor LH inner. Refer to [AV-907. "Removal and Installation"](#).  
 NO >> Repair or replace harness or connectors.

# B2722 CENTER SENSOR [RR]

[BOSE AUDIO W/NAVI W/SURROUND]

< DTC/CIRCUIT DIAGNOSIS >

## B2722 CENTER SENSOR [RR]

### DTC Logic

INFOID:000000009129412

### DTC DETECTION LOGIC

CONSULT Display	DTC Detection Condition	Possible Cause
REAR RIGHT SIDE INTER-NAL SENSOR [B2722]	<ul style="list-style-type: none"><li>• Sensor is not configured.</li><li>• Sensor is open or short circuited.</li><li>• Sensor element malfunction.</li></ul>	<ul style="list-style-type: none"><li>• Sensor configuration.</li><li>• Harness or connectors.</li><li>• Rear sonar sensor RH inner.</li></ul>

### Diagnosis Procedure

INFOID:000000009129413

Regarding Wiring Diagram information, refer to [AV-683. "Wiring Diagram"](#).

#### 1. CHECK REAR SONAR SENSOR RH INNER CIRCUIT CONTINUITY

1. Turn ignition switch OFF.
2. Disconnect sonar control unit connector and rear sonar sensor RH inner connector.
3. Check continuity between sonar control unit connector M70 and rear sonar sensor RH inner connector B458.

Sonar control unit		Rear sonar sensor RH inner		Continuity
Connector	Terminal	Connector	Terminal	
M70	9	B458	2	Yes
	14		1	

4. Check continuity between sonar control unit connector M70 and ground.

Sonar control unit		Ground	Continuity
Connector	Terminal		
M70	9	—	No

Is the inspection result normal?

- YES >> GO TO 2.  
NO >> Repair or replace harness or connectors.

#### 2. CHECK REAR SONAR SENSOR RH INNER SIGNAL CIRCUIT SHORT TO BATTERY

1. Turn ignition switch ON.
2. Check voltage between sonar control unit connector M70 and ground.

Sonar control unit		Ground	Voltage (Approx.)
Connector	Terminal		
M70	9	—	0V

Is the inspection result normal?

- YES >> Replace rear sonar sensor RH inner. Refer to [AV-907. "Removal and Installation"](#).  
NO >> Repair or replace harness or connectors.



# B2723 CORNER SENSOR [RR]

[BOSE AUDIO W/NAVI W/SURROUND]

< DTC/CIRCUIT DIAGNOSIS >

## B2723 CORNER SENSOR [RR]

### DTC Logic

INFOID:000000009129414

### DTC DETECTION LOGIC

CONSULT Display	DTC Detection Condition	Possible Cause
REAR RIGHT SIDE EXTERNAL SENSOR [B2723]	<ul style="list-style-type: none"> <li>• Sensor is not configured.</li> <li>• Sensor is open or short circuited.</li> <li>• Sensor element malfunction.</li> </ul>	<ul style="list-style-type: none"> <li>• Sensor configuration.</li> <li>• Harness or connectors.</li> <li>• Rear sonar sensor RH outer.</li> </ul>

### Diagnosis Procedure

INFOID:000000009129415

Regarding Wiring Diagram information, refer to [AV-683. "Wiring Diagram"](#).

#### 1. CHECK REAR SONAR SENSOR RH OUTER SIGNAL CIRCUIT CONTINUITY

1. Turn ignition switch OFF.
2. Disconnect sonar control unit connector and rear sonar sensor RH outer connector.
3. Check continuity between sonar control unit connector M70 and rear sonar sensor RH outer connector B456.

Sonar control unit		Rear sonar sensor RH outer		Continuity
Connector	Terminal	Connector	Terminal	
M70	10	B456	2	Yes
	14		1	

4. Check continuity between sonar control unit connector M70 and ground.

Sonar control unit		Ground	Continuity
Connector	Terminal		
M70	10	—	No

Is the inspection result normal?

- YES >> GO TO 2.  
 NO >> Repair or replace harness or connectors.

#### 2. CHECK REAR SONAR SENSOR RH OUTER SIGNAL CIRCUIT SHORT TO BATTERY

1. Turn ignition switch ON.
2. Check voltage between sonar control unit connector M70 and ground.

Sonar control unit		Ground	Voltage (Approx.)
Connector	Terminal		
M70	10	—	0V

Is the inspection result normal?

- YES >> Replace rear sonar sensor RH outer. Refer to [AV-907. "Removal and Installation"](#).  
 NO >> Repair or replace harness or connectors.

# B2724 SONAR CONTROL UNIT

< DTC/CIRCUIT DIAGNOSIS >

[BOSE AUDIO W/NAVI W/SURROUND]

## B2724 SONAR CONTROL UNIT

DTC Logic

INFOID:000000009129416

DTC DETECTION LOGIC

CONSULT Display	DTC Detection Condition	Possible Cause
ECU [B2724]	Sonar control module malfunction.	Replace sonar control module.

# B2725 REAR BUZZER

[BOSE AUDIO W/NAVI W/SURROUND]

< DTC/CIRCUIT DIAGNOSIS >

## B2725 REAR BUZZER

### DTC Logic

INFOID:000000009129417

### DTC DETECTION LOGIC

CONSULT Display	DTC Detection Condition	Possible Cause
REAR BUZZER [B2725]	<ul style="list-style-type: none"><li>Buzzer is open or short circuited.</li><li>Buzzer malfunction.</li></ul>	<ul style="list-style-type: none"><li>Harness or connectors.</li><li>Buzzer.</li></ul>

### Diagnosis Procedure

INFOID:000000009129418

Regarding Wiring Diagram information, refer to [AV-683. "Wiring Diagram"](#).

#### 1. CHECK SONAR BUZZER SIGNAL CIRCUIT CONTINUITY

- Turn ignition switch OFF.
- Disconnect sonar control unit connector and sonar buzzer connector.
- Check continuity between sonar control unit connector M70 and sonar buzzer connector B35.

Sonar control unit		Sonar buzzer		Continuity
Connector	Terminal	Connector	Terminal	
M70	20	B35	3	Yes

- Check continuity between sonar control unit connector M70 and ground.

Sonar control unit		Ground	Continuity
Connector	Terminal		
M70	20	—	No

Is the inspection result normal?

- YES >> GO TO 2.  
NO >> Repair or replace harness or connectors.

#### 2. CHECK SONAR BUZZER SIGNAL CIRCUIT SHORT TO BATTERY

- Turn ignition switch ON.
- Check voltage between sonar control unit connector M70 and ground.

Sonar control unit		Ground	Voltage (Approx.)
Connector	Terminal		
M70	20	—	0V

Is the inspection result normal?

- YES >> GO TO 3.  
NO >> Repair or replace harness or connectors.

#### 3. CHECK SONAR BUZZER SIGNAL CIRCUIT SHORT TO BUZZER POWER

- Turn ignition switch OFF.
- Check continuity between sonar control unit connector M70 terminals.

Sonar control unit connector M70		Continuity
Terminal	Terminal	
19	20	No

Is the inspection result normal?

A  
B  
C  
D  
E  
F  
G  
H  
I  
J  
K  
L  
M  
AV  
O  
P

## B2725 REAR BUZZER

< DTC/CIRCUIT DIAGNOSIS >

[BOSE AUDIO W/NAVI W/SURROUND]

---

- YES >> Replace sonar buzzer. Refer to [AV-909. "Removal and Installation"](#).
- NO >> Repair or replace harness or connectors.

# B2729 CORNER SENSOR [FL]

[BOSE AUDIO W/NAVI W/SURROUND]

< DTC/CIRCUIT DIAGNOSIS >

## B2729 CORNER SENSOR [FL]

### DTC Logic

INFOID:000000009129419

### DTC DETECTION LOGIC

CONSULT Display	DTC Detection Condition	Possible Cause
FRONT LEFT SIDE EXTERNAL SENSOR [B2729]	<ul style="list-style-type: none"> <li>• Sensor is not configured.</li> <li>• Sensor is open or short circuited.</li> <li>• Sensor element malfunction.</li> </ul>	<ul style="list-style-type: none"> <li>• Sensor configuration.</li> <li>• Harness or connectors.</li> <li>• Front sonar sensor LH outer.</li> </ul>

### Diagnosis Procedure

INFOID:000000009129420

Regarding Wiring Diagram information, refer to [AV-683. "Wiring Diagram"](#).

#### 1. CHECK FRONT SONAR SENSOR LH OUTER CIRCUIT CONTINUITY

1. Turn ignition switch OFF.
2. Disconnect sonar control unit connector and front sonar sensor LH outer connector.
3. Check continuity between sonar control unit connector M70 and front sonar sensor LH outer connector E307.

Sonar control unit		Front sonar sensor LH outer		Continuity
Connector	Terminal	Connector	Terminal	
M70	3	E307	2	Yes
	13		1	

4. Check continuity between sonar control unit connector M70 and ground.

Sonar control unit		Ground	Continuity
Connector	Terminal		
M70	3	—	No

Is the inspection result normal?

- YES >> GO TO 2.  
 NO >> Repair or replace harness or connectors.

#### 2. CHECK FRONT SONAR SENSOR LH OUTER SIGNAL CIRCUIT SHORT TO BATTERY

1. Turn ignition switch ON.
2. Check voltage between sonar control unit connector M70 and ground.

Sonar control unit		Ground	Voltage (Approx.)
Connector	Terminal		
M70	3	—	0V

Is the inspection result normal?

- YES >> Replace front sonar sensor LH outer. Refer to [AV-907. "Removal and Installation"](#).  
 NO >> Repair or replace harness or connectors.

# B272C CORNER SENSOR [FR]

[BOSE AUDIO W/NAVI W/SURROUND]

< DTC/CIRCUIT DIAGNOSIS >

## B272C CORNER SENSOR [FR]

### DTC Logic

INFOID:000000009129421

### DTC DETECTION LOGIC

CONSULT Display	DTC Detection Condition	Possible Cause
FRONT RIGHT SIDE EXTERNAL SENSOR [B272C]	<ul style="list-style-type: none"> <li>• Sensor is not configured.</li> <li>• Sensor is open or short circuited.</li> <li>• Sensor element malfunction.</li> </ul>	<ul style="list-style-type: none"> <li>• Sensor configuration.</li> <li>• Harness or connectors.</li> <li>• Front sonar sensor RH outer.</li> </ul>

### Diagnosis Procedure

INFOID:000000009129422

Regarding Wiring Diagram information, refer to [AV-683. "Wiring Diagram"](#).

#### 1. CHECK FRONT SONAR SENSOR RH OUTER CIRCUIT CONTINUITY

1. Turn ignition switch OFF.
2. Disconnect sonar control unit connector and front sonar sensor RH outer connector.
3. Check continuity between sonar control unit connector M70 and front sonar sensor RH outer connector E308.

Sonar control unit		Front sonar sensor RH outer		Continuity
Connector	Terminal	Connector	Terminal	
M70	4	E308	2	Yes
	13		1	

4. Check continuity between sonar control unit connector M70 and ground.

Sonar control unit		Ground	Continuity
Connector	Terminal		
M70	4	—	No

Is the inspection result normal?

- YES >> GO TO 2.  
 NO >> Repair or replace harness or connectors.

#### 2. CHECK FRONT SONAR SENSOR RH OUTER SIGNAL CIRCUIT SHORT TO BATTERY

1. Turn ignition switch ON.
2. Check voltage between sonar control unit connector M70 and ground.

Sonar control unit		Ground	Voltage (Approx.)
Connector	Terminal		
M70	4	—	0V

Is the inspection result normal?

- YES >> Replace front sonar sensor RH outer. Refer to [AV-907. "Removal and Installation"](#).  
 NO >> Repair or replace harness or connectors.

# POWER SUPPLY AND GROUND CIRCUIT

< DTC/CIRCUIT DIAGNOSIS >

[BOSE AUDIO W/NAVI W/SURROUND]

## POWER SUPPLY AND GROUND CIRCUIT

### AV CONTROL UNIT

#### AV CONTROL UNIT : Diagnosis Procedure

INFOID:000000009129423

Regarding Wiring Diagram information, refer to [AV-683, "Wiring Diagram"](#).

#### 1.CHECK FUSE

Check that the following fuses are not blown.

Terminal No.	Signal name	Fuse No.
68	Ignition signal	29 (5A)
19	Battery power supply	15 (15A)

##### Are the fuses blown?

YES >> Replace the blown fuse after repairing the affected circuit.

NO >> GO TO 2.

#### 2.CHECK POWER SUPPLY CIRCUIT

1. Turn ignition switch OFF.
2. Disconnect AV control unit connectors M161 and M163.
3. Check voltage between AV control unit connectors and ground.

AV control unit		Ground	Condition	Voltage (Approx.)
Connector	Terminal			
M163	68	—	Ignition switch: ON	Battery voltage
M161	7		Ignition switch: ACC	
	19		Ignition switch: OFF	

##### Is the inspection result normal?

YES >> GO TO 3.

NO >> Repair or replace harness or connectors.

#### 3.CHECK GROUND CIRCUIT

1. Turn ignition switch OFF.
2. Check continuity between AV control unit connector M161 terminal 20 and ground.

AV control unit		Ground	Continuity
Connector	Terminal		
M161	20	—	Yes

##### Is the inspection result normal?

YES >> Inspection End.

NO >> Repair or replace harness or connectors.

## DISPLAY UNIT

#### DISPLAY UNIT : Diagnosis Procedure

INFOID:000000009129424

Regarding Wiring Diagram information, refer to [AV-683, "Wiring Diagram"](#).

#### 1.CHECK FUSE

Check that the following fuses are not blown.

# POWER SUPPLY AND GROUND CIRCUIT

< DTC/CIRCUIT DIAGNOSIS >

[BOSE AUDIO W/NAVI W/SURROUND]

Terminal No.	Signal name	Fuse No.
11	Battery power supply	15 (15A)
23	ACC power supply	65 (10A)

Are the fuses blown?

YES >> Replace the blown fuse after repairing the affected circuit.

NO >> GO TO 2.

## 2.CHECK POWER SUPPLY CIRCUIT

1. Turn ignition switch OFF.
2. Disconnect display unit connector.
3. Check voltage between display connector M92 and ground.

Display unit		Ground	Condition	Voltage (Approx.)
Connector	Terminal			
M92	23	—	Ignition switch: ACC	Battery voltage
	11		Ignition switch: OFF	

Is the inspection result normal?

YES >> GO TO 3.

NO >> Repair or replace harness or connectors.

## 3.CHECK GROUND CIRCUIT

1. Turn ignition switch OFF.
2. Check continuity between display unit connector M92 terminal 12 and ground.

Display unit		Ground	Continuity
Connector	Terminal		
M92	12	—	Yes

Is the inspection result normal?

YES >> Inspection End.

NO >> Repair or replace harness or connectors.

**BOSE AMP.**

## BOSE AMP. : Diagnosis Procedure

INFOID:000000009129425

Regarding Wiring Diagram information, refer to [AV-683. "Wiring Diagram"](#).

## 1.CHECK FUSE

Check that the following fuses are not blown.

Terminal No.	Signal name	Fuse No.
50	Battery power supply	11 (15A)
51		12 (15A)

Are the fuses blown?

YES >> Replace the blown fuse after repairing the affected circuit.

NO >> GO TO 2.

## 2.CHECK POWER SUPPLY CIRCUIT

1. Disconnect BOSE speaker amp. connector B121.
2. Check voltage between BOSE speaker amp. connector B121 and ground.



# POWER SUPPLY AND GROUND CIRCUIT

< DTC/CIRCUIT DIAGNOSIS >

[BOSE AUDIO W/NAVI W/SURROUND]

BOSE speaker amp.		Ground	Voltage (Approx.)
Connector	Terminal		
B121	50	—	Battery voltage
	51		

Is the inspection result normal?

YES >> GO TO 3.

NO >> Repair or replace harness or connectors.

## 3.CHECK GROUND CIRCUIT

1. Turn ignition switch OFF.
2. Check continuity between BOSE speaker amp. connector B121 and ground.

BOSE speaker amp.		Ground	Continuity
Connector	Terminal		
B121	47	—	Yes
	52		

Is the inspection result normal?

YES >> Inspection End.

NO >> Repair or replace harness or connectors.

## SUBWOOFER

### SUBWOOFER : Diagnosis Procedure

INFOID:000000009129426

Regarding Wiring Diagram information, refer to [AV-683. "Wiring Diagram"](#).

## 1.CHECK FUSE

Check that the following fuses are not blown.

Terminal No.	Signal name	Fuse No.
6	Battery power supply	58 (10A)

Are the fuses blown?

YES >> Replace the blown fuse after repairing the affected circuit.

NO >> GO TO 2.

## 2.CHECK POWER SUPPLY CIRCUIT

1. Disconnect subwoofer connector.
2. Check voltage between subwoofer connector B73 and ground.

Subwoofer		Ground	Voltage (Approx.)
Connector	Terminal		
B73	6	—	Battery voltage

Is the inspection result normal?

YES >> GO TO 3.

NO >> Repair or replace harness or connectors.

## 3.CHECK GROUND CIRCUIT

1. Turn ignition switch OFF.
2. Check continuity between subwoofer connector B73 and ground.

A  
B  
C  
D  
E  
F  
G  
H  
I  
J  
K  
L  
M  
AV  
O  
P

# POWER SUPPLY AND GROUND CIRCUIT

< DTC/CIRCUIT DIAGNOSIS >

[BOSE AUDIO W/NAVI W/SURROUND]

Subwoofer		Ground	Continuity
Connector	Terminal		
B73	5	—	Yes

Is the inspection result normal?

- YES >> Inspection End.  
NO >> Repair or replace harness or connectors.

## A/C AND AV SWITCH ASSEMBLY

### A/C AND AV SWITCH ASSEMBLY : Diagnosis Procedure

INFOID:000000009129427

Regarding Wiring Diagram information, refer to [AV-683. "Wiring Diagram"](#).

## 1.CHECK FUSE

Check that the following fuse is not blown.

Terminal No.	Signal name	Fuse No.
3	ACC power supply	65 (10A)

Is the fuse blown?

- YES >> Replace the blown fuse after repairing the affected circuit.  
NO >> GO TO 2.

## 2.CHECK POWER SUPPLY CIRCUIT

1. Turn ignition switch OFF.
2. Disconnect A/C and AV switch assembly connector.
3. Check voltage between A/C and AV switch assembly connector M98 terminal 3 and ground.

A/C and AV switch assembly		Ground	Condition	Voltage (Approx.)
Connector	Terminal			
M98	3	—	Ignition switch: ACC	Battery voltage

Is the inspection result normal?

- YES >> GO TO 3.  
NO >> Repair or replace harness or connectors.

## 3.CHECK CONTROL UNIT GROUND CIRCUIT

1. Turn ignition switch OFF.
2. Disconnect AV control unit connector M125.
3. Check continuity between A/C and AV switch assembly connector M98 terminal 9 and AV control unit connector M125 terminal 98.

A/C and AV switch assembly		AV control unit		Continuity
Connector	Terminal	Connector	Terminal	
M98	9	M125	98	Yes

Is the inspection result normal?

- YES >> GO TO 4.  
NO >> Repair or replace harness or connectors.

## 4.CHECK SWITCH GROUND CIRCUIT

Check continuity between A/C and AV switch assembly connector M98 terminal 1 and ground.

# POWER SUPPLY AND GROUND CIRCUIT

< DTC/CIRCUIT DIAGNOSIS >

[BOSE AUDIO W/NAVI W/SURROUND]

A/C and AV switch assembly		Ground	Continuity
Connector	Terminal		
M98	1	—	Yes

Is the inspection result normal?

YES >> Inspection End.

NO >> Repair or replace harness or connectors.

## VIDEO DISTRIBUTOR

### VIDEO DISTRIBUTOR : Diagnosis Procedure

INFOID:000000009129428

Regarding Wiring Diagram information, refer to [AV-683. "Wiring Diagram"](#).

#### 1.CHECK FUSE

Check that the following fuses are not blown.

Terminal No.	Signal name	Fuse No.
4	ACC power supply	65 (10A)
2	Battery power supply	15 (15A)

Are the fuses blown?

YES >> Replace the blown fuse after repairing the affected circuit.

NO >> GO TO 2.

#### 2.CHECK POWER SUPPLY CIRCUIT

1. Turn ignition switch OFF.
2. Disconnect video distributor connector B24.
3. Check voltage between video distributor connector B24 and ground.

Video distributor		Ground	Condition	Voltage (Approx.)
Connector	Terminal			
B24	2	—	Ignition switch: ACC	Battery voltage
	4		Ignition switch: OFF	

Is the inspection result normal?

YES >> GO TO 3.

NO >> Repair or replace harness or connectors.

#### 3.CHECK GROUND CIRCUIT

1. Turn ignition switch OFF.
2. Check continuity between video distributor connector B24 and ground.

Video distributor		Ground	Continuity
Connector	Terminal		
B24	1	—	Yes
	3		

Is the inspection result normal?

YES >> Inspection End.

NO >> Repair or replace harness or connectors.

## HEADREST DISPLAY UNIT

# POWER SUPPLY AND GROUND CIRCUIT

< DTC/CIRCUIT DIAGNOSIS >

[BOSE AUDIO W/NAVI W/SURROUND]

## HEADREST DISPLAY UNIT : Diagnosis Procedure

INFOID:000000009129429

Regarding Wiring Diagram information, refer to [AV-683, "Wiring Diagram"](#).

### 1.CHECK FUSE

Check that the following fuses are not blown.

Terminal No.	Signal name	Fuse No.
15, 16	Battery power supply	15 (15A)

#### Are the fuses blown?

YES >> Replace the blown fuse after repairing the affected circuit.

NO >> GO TO 2.

### 2.CHECK POWER SUPPLY CIRCUIT

1. Disconnect headrest display unit connector.
2. Check voltage between headrest display unit connector and ground.

Headrest displayl unit		Ground	Voltage (Approx.)
Connector	Terminal		
B202 (driver seat)	15, 16	—	Battery voltage
B302 (passenger seat)			

#### Is the inspection result normal?

YES >> GO TO 3.

NO >> Repair or replace harness or connectors.

### 3.CHECK GROUND CIRCUIT

1. Turn ignition switch OFF.
2. Check continuity between headrest display unit connector and ground.

Headrest displayl unit		Ground	Continuity
Connector	Terminal		
B202 (driver seat)	12, 31, 32	—	Yes
B302 (passenger seat)	28, 31, 32		

#### Is the inspection result normal?

YES >> Inspection End.

NO >> Repair or replace harness or connectors.

## AROUND VIEW MONITOR CONTROL UNIT

### AROUND VIEW MONITOR CONTROL UNIT : Diagnosis Procedure

INFOID:000000009129430

Regarding Wiring Diagram information, refer to [AV-683, "Wiring Diagram"](#).

### 1.CHECK FUSE

Check that the following fuses are not blown.

Terminal No.	Signal name	Fuse No.
3	Ignition signal	29 (5A)

# POWER SUPPLY AND GROUND CIRCUIT

< DTC/CIRCUIT DIAGNOSIS >

[BOSE AUDIO W/NAVI W/SURROUND]

Terminal No.	Signal name	Fuse No.
4	ACC power supply	65 (10A)
2	Battery power supply	15 (15A)

Are the fuses blown?

- YES >> Replace the blown fuse after repairing the affected circuit.  
NO >> GO TO 2.

## 2.CHECK POWER SUPPLY CIRCUIT

1. Turn ignition switch OFF.
2. Disconnect around view monitor control unit connector M96.
3. Check voltage between around view monitor control unit connector M96 and ground.

Around view monitor control unit		Ground	Condition	Voltage (Approx.)
Connector	Terminal			
M96	3	—	Ignition switch: ON	Battery voltage
	4		Ignition switch: ACC	
	2		Ignition switch: OFF	

Is the inspection result normal?

- YES >> GO TO 3.  
NO >> Repair or replace harness or connectors.

## 3.CHECK GROUND CIRCUIT

1. Turn ignition switch OFF.
2. Check continuity between around view monitor control unit connector M96 and ground.

Around view monitor control unit		Ground	Continuity
Connector	Terminal		
M96	1	—	Yes

Is the inspection result normal?

- YES >> Inspection End.  
NO >> Repair or replace harness or connectors.

## SONAR CONTROL UNIT (WITH AROUND VIEW MONITOR)

### SONAR CONTROL UNIT (WITH AROUND VIEW MONITOR) : Diagnosis Procedure

INFOID:000000009129431

Regarding Wiring Diagram information, refer to [AV-683. "Wiring Diagram"](#).

## 1.CHECK FUSE

Check that the following fuses are not blown.

Terminal No.	Signal name	Fuse No.
12	ACC power supply	65 (10A)

Are the fuses blown?

- YES >> Replace the blown fuse after repairing the affected circuit.  
NO >> GO TO 2.

## 2.CHECK POWER SUPPLY CIRCUIT

1. Turn ignition switch OFF.
2. Disconnect sonar control unit connector M70.
3. Check voltage between sonar control unit connector M70 and ground.

A  
B  
C  
D  
E  
F  
G  
H  
I  
J  
K  
L  
M  
O  
P

AV

# POWER SUPPLY AND GROUND CIRCUIT

< DTC/CIRCUIT DIAGNOSIS >

[BOSE AUDIO W/NAVI W/SURROUND]

Sonar control unit		Ground	Condition	Voltage (Approx.)
Connector	Terminal			
M70	12	—	Ignition switch: ACC	Battery voltage

Is the inspection result normal?

YES >> GO TO 3.

NO >> Repair or replace harness or connectors.

## 3. CHECK GROUND CIRCUIT

1. Turn ignition switch OFF.
2. Check continuity between sonar control unit connector M70 and ground.

Sonar control unit		Ground	Continuity
Connector	Terminal		
M70	15	—	Yes

Is the inspection result normal?

YES >> Inspection End.

NO >> Repair or replace harness or connectors.

# CENTER SPEAKER

< DTC/CIRCUIT DIAGNOSIS >

[BOSE AUDIO W/NAVI W/SURROUND]

## CENTER SPEAKER

### Diagnosis Procedure

INFOID:000000009129432

Regarding Wiring Diagram information, refer to [AV-683. "Wiring Diagram"](#).

### 1. CONNECTOR CHECK

Check the AV control unit, BOSE speaker amp. and speaker connectors for the following:

- Proper connection
- Damage
- Disconnected or loose terminals

Is the inspection result normal?

YES >> GO TO 2.

NO >> Repair the terminals or connectors.

### 2. CHECK CENTER SPEAKER SIGNAL CIRCUIT CONTINUITY

1. Disconnect BOSE speaker amp. connector B122 and center speaker connector M110.
2. Check continuity between BOSE speaker amp. connector B122 and center speaker connector M110.

BOSE speaker amp.		Center speaker		Continuity
Connector	Terminal	Connector	Terminal	
B122	57	M110	1	Yes
	58		2	

3. Check continuity between BOSE speaker amp. connector B122 and ground.

BOSE speaker amp.		Ground	Continuity
Connector	Terminal		
B122	57	—	No
	58		

Is the inspection result normal?

YES >> GO TO 3.

NO >> Repair or replace harness or connectors.

### 3. CHECK CENTER SPEAKER SIGNAL

1. Connect BOSE speaker amp. connector B122 and center speaker connector M110.
2. Turn ignition switch to ACC.
3. Push AV control unit POWER switch.
4. Check signal between the terminals of BOSE speaker amp. connector B122.

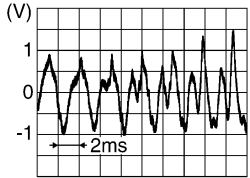
BOSE speaker amp. connector B122		Condition	Reference value
(+) Terminal	(-) Terminal		
57	58	Audio signal output	 <p>SKIB3609E</p>

Is the inspection result normal?

A  
B  
C  
D  
E  
F  
G  
H  
I  
J  
K  
L  
M  
AV  
O  
P

# CENTER SPEAKER

**[BOSE AUDIO W/NAVI W/SURROUND]**

< DTC/CIRCUIT DIAGNOSIS >

- YES >> Replace center speaker. Refer to [AV-891, "Removal and Installation"](#).  
 NO >> GO TO 4.

## 4. CHECK PRE-AMP SIGNAL CIRCUIT CONTINUITY

1. Disconnect AV control unit connector M165 and BOSE speaker amp. connector B120.
2. Check continuity between AV control unit connector M165 and BOSE speaker amp. connector B120.

AV control unit		BOSE speaker amp.		Continuity
Connector	Terminal	Connector	Terminal	
M165	125	B120	29	Yes
	133		9	

3. Check continuity between AV control unit connector M165 and ground.

AV control unit		Ground	Continuity
Connector	Terminal		
M122	125	—	No
	133		

Is the inspection result normal?

- YES >> GO TO 5.  
 NO >> Repair or replace harness or connectors.

## 5. CHECK PRE-AMP SIGNAL

1. Connect AV control unit connector M165 and BOSE speaker amp. connector B120.
2. Turn ignition switch to ACC.
3. Push AV control unit POWER switch.
4. Check signal between the terminals of AV control unit connector M165.

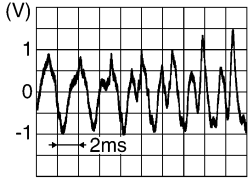
AV control unit connector M165		Condition	Reference value
(+) Terminal	(-) Terminal		
125	133	Audio signal output	 <p style="text-align: right; font-size: small;">SKIB3609E</p>

Is the inspection result normal?

- YES >> Replace BOSE speaker amp. Refer to [AV-887, "Removal and Installation"](#).  
 NO >> Replace AV control unit. Refer to [AV-883, "Removal and Installation - AV Control Unit"](#).



# INSTRUMENT PANEL SPEAKER/TWEETER

< DTC/CIRCUIT DIAGNOSIS >

[BOSE AUDIO W/NAVI W/SURROUND]

## INSTRUMENT PANEL SPEAKER/TWEETER

### Diagnosis Procedure

INFOID:000000009129433

Regarding Wiring Diagram information, refer to [AV-683. "Wiring Diagram"](#).

### 1. CONNECTOR CHECK

Check the AV control unit, BOSE speaker amp. and speaker connectors for the following:

- Proper connection
- Damage
- Disconnected or loose terminals

Is the inspection result normal?

YES >> GO TO 2.

NO >> Repair the terminals or connectors.

### 2. CHECK INSTRUMENT PANEL TWEETER SIGNAL CIRCUIT CONTINUITY

1. Disconnect BOSE speaker amp. connector B122 and suspect instrument panel tweeter connector.
2. Check continuity between BOSE speaker amp. connector B122 and suspect instrument panel tweeter connector.

BOSE speaker amp.		Instrument panel tweeter		Continuity
Connector	Terminal	Connector	Terminal	
B122	56	M62 (LH)	1	Yes
	69		2	
	71	M73 (RH)	1	
	70		2	

3. Check continuity between BOSE speaker amp. connector B122 and ground.

BOSE speaker amp.		Ground	Continuity
Connector	Terminal		
B122	56	—	No
	69		
	71		
	70		

Is the inspection result normal?

YES >> GO TO 3.

NO >> Repair or replace harness or connectors.

### 3. CHECK INSTRUMENT PANEL TWEETER SIGNAL

1. Connect BOSE speaker amp. connector B122 and suspect instrument panel tweeter connector.
2. Turn ignition switch to ACC.
3. Push AV control unit POWER switch.
4. Check signal between terminals of BOSE speaker amp. connector B122.

BOSE speaker amp.		Condition	Reference value
(+)	(-)		
Terminal	Terminal		

A  
B  
C  
D  
E  
F  
G  
H  
I  
J  
K  
L  
M  
N  
O  
P

AV

# INSTRUMENT PANEL SPEAKER/TWEETER

< DTC/CIRCUIT DIAGNOSIS >

[BOSE AUDIO W/NAVI W/SURROUND]

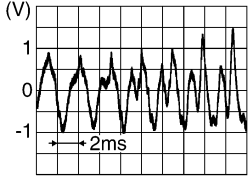
56	69	Audio signal output	
71	70		

Is the inspection result normal?

- YES >> Replace instrument panel tweeter. Refer to [AV-890. "Removal and Installation"](#).  
 NO >> GO TO 4.

## 4. CHECK PRE-AMP SIGNAL CIRCUIT CONTINUITY

1. Disconnect AV control unit connector M161 and BOSE speaker amp. connector B120.
2. Check continuity between AV control unit connector M161 and BOSE speaker amp. connector B120.

AV control unit		BOSE speaker amp.		Continuity
Connector	Terminal	Connector	Terminal	
M161	2	B120	25	Yes
	3		5	
	11		26	
	12		6	

3. Check continuity between AV control unit connector M161 and ground.

AV control unit		Ground	Continuity
Connector	Terminal		
M161	2	—	No
	3		
	11		
	12		

Is the inspection result normal?

- YES >> GO TO 5.  
 NO >> Repair or replace harness or connectors.

## 5. CHECK PRE-AMP SIGNAL

1. Connect AV control unit connector M161 and BOSE speaker amp. connector B120.
2. Turn ignition switch to ACC.
3. Push AV control unit POWER switch.
4. Check signal between the terminals of AV control unit connector M161.

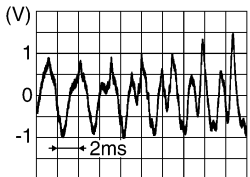
AV control unit connector M161		Condition	Reference value
(+) Terminal	(-) Terminal		
2	3	Audio signal output	
11	12		

Is the inspection result normal?

- YES >> Replace BOSE speaker amp. Refer to [AV-887. "Removal and Installation"](#).

# INSTRUMENT PANEL SPEAKER/TWEETER

< DTC/CIRCUIT DIAGNOSIS >

[BOSE AUDIO W/NAVI W/SURROUND]

NO >> Replace AV control unit. Refer to [AV-883, "Removal and Installation - AV Control Unit"](#).

A

B

C

D

E

F

G

H

I

J

K

L

M

AV

O

P

# FRONT TWEETER

[BOSE AUDIO W/NAVI W/SURROUND]

< DTC/CIRCUIT DIAGNOSIS >

## FRONT TWEETER

### Diagnosis Procedure

INFOID:000000009129434

Regarding Wiring Diagram information, refer to [AV-683. "Wiring Diagram"](#).

### 1. CONNECTOR CHECK

Check the AV control unit, BOSE speaker amp. and speaker connectors for the following:

- Proper connection
- Damage
- Disconnected or loose terminals

Is the inspection result normal?

YES >> GO TO 2.

NO >> Repair the terminals or connectors.

### 2. CHECK FRONT TWEETER SIGNAL CIRCUIT CONTINUITY

1. Disconnect BOSE speaker amp. connector B122 and suspect front tweeter connector.
2. Check continuity between BOSE speaker amp. connector B122 and suspect front door speaker connector.

BOSE speaker amp.		Front tweeter		Continuity
Connector	Terminal	Connector	Terminal	
B122	64	M109 (LH)	1	Yes
	75		2	
	59	M111 (RH)	1	
	72		2	

3. Check continuity between BOSE speaker amp. connector B130 and ground.

BOSE speaker amp.		Ground	Continuity
Connector	Terminal		
B122	64	—	No
	75		
	59		
	72		

Is the inspection result normal?

YES >> GO TO 3.

NO >> Repair or replace harness or connectors.

### 3. CHECK FRONT TWEETER SIGNAL

1. Connect BOSE speaker amp. connector B122 and suspect front tweeter connector.
2. Turn ignition switch to ACC.
3. Push AV control unit POWER switch.
4. Check signal between terminals of BOSE speaker amp. connector B122.

BOSE speaker amp. connector B122		Condition	Reference value
(+)	(-)		
Terminal	Terminal		

# FRONT TWEETER

< DTC/CIRCUIT DIAGNOSIS >

[BOSE AUDIO W/NAVI W/SURROUND]

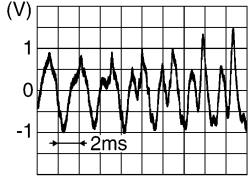
64	75	Audio signal output	
59	72		

Is the inspection result normal?

- YES >> Replace front tweeter. Refer to [AV-889. "Removal and Installation"](#).  
 NO >> GO TO 4.

## 4. CHECK PRE-AMP SIGNAL CIRCUIT CONTINUITY

1. Disconnect AV control unit connector M161 and BOSE speaker amp. connector B120.
2. Check continuity between AV control unit connector M161 and BOSE speaker amp. connector B120.

AV control unit		BOSE speaker amp.		Continuity
Connector	Terminal	Connector	Terminal	
M161	2	B120	25	Yes
	3		5	
	11		26	
	12		6	

3. Check continuity between AV control unit connector M161 and ground.

AV control unit		Ground	Continuity
Connector	Terminal		
M161	2	—	No
	3		
	11		
	12		

Is the inspection result normal?

- YES >> GO TO 5.  
 NO >> Repair or replace harness or connectors.

## 5. CHECK PRE-AMP SIGNAL

1. Connect AV control unit connector M161 and BOSE speaker amp. connector B120.
2. Turn ignition switch to ACC.
3. Push AV control unit POWER switch.
4. Check signal between the terminals of AV control unit connector M161.

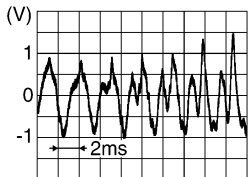
AV control unit connector M161		Condition	Reference value
(+)	(-)		
Terminal	Terminal	Audio signal output	
2	3		
11	12		

Is the inspection result normal?

- YES >> Replace BOSE speaker amp. Refer to [AV-887. "Removal and Installation"](#).

A  
B  
C  
D  
E  
F  
G  
H  
I  
J  
K  
L  
M

AV

O  
P

## FRONT TWEETER

< DTC/CIRCUIT DIAGNOSIS >

[BOSE AUDIO W/NAVI W/SURROUND]

---

NO >> Replace AV control unit. Refer to [AV-883. "Removal and Installation - AV Control Unit"](#).

# FRONT DOOR SPEAKER

< DTC/CIRCUIT DIAGNOSIS >

[BOSE AUDIO W/NAVI W/SURROUND]

## FRONT DOOR SPEAKER

### Diagnosis Procedure

INFOID:000000009129435

Regarding Wiring Diagram information, refer to [AV-683. "Wiring Diagram"](#).

### 1. CONNECTOR CHECK

Check the AV control unit, BOSE speaker amp. and speaker connectors for the following:

- Proper connection
- Damage
- Disconnected or loose terminals

Is the inspection result normal?

YES >> GO TO 2.

NO >> Repair the terminals or connectors.

### 2. CHECK FRONT DOOR SPEAKER SIGNAL CIRCUIT CONTINUITY

1. Disconnect BOSE speaker amp. connector B121 and suspect front door speaker connector.
2. Check continuity between BOSE speaker amp. connector B121 and suspect front door speaker connector.

BOSE speaker amp.		Front door speaker		Continuity
Connector	Terminal	Connector	Terminal	
B121	53	D12 (LH)	1	Yes
	48		2	
	43	D112 (RH)	1	
	44		2	

3. Check continuity between BOSE speaker amp. connector B121 and ground.

BOSE speaker amp.		Ground	Continuity
Connector	Terminal		
B121	53	—	No
	48		
	43		
	44		

Is the inspection result normal?

YES >> GO TO 3.

NO >> Repair or replace harness or connectors.

### 3. CHECK FRONT DOOR SPEAKER SIGNAL

1. Connect BOSE speaker amp. connector B121 and suspect front door speaker connector.
2. Turn ignition switch to ACC.
3. Push AV control unit POWER switch.
4. Check signal between terminals of BOSE speaker amp. connector B121.

BOSE speaker amp. connector B121		Condition	Reference value
(+)	(-)		
Terminal	Terminal		

A  
B  
C  
D  
E  
F  
G  
H  
I  
J  
K  
L  
M  
O  
P

AV

# FRONT DOOR SPEAKER

[BOSE AUDIO W/NAVI W/SURROUND]

< DTC/CIRCUIT DIAGNOSIS >

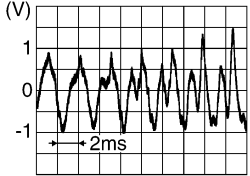
53	48	Audio signal output	
43	44		

Is the inspection result normal?

YES >> Replace front door speaker. Refer to [AV-888. "Removal and Installation"](#).

NO >> GO TO 3.

## 4. CHECK PRE-AMP SIGNAL CIRCUIT CONTINUITY

1. Disconnect AV control unit connector M161 and BOSE speaker amp. connector B120.
2. Check continuity between AV control unit connector M161 and BOSE speaker amp. connector B120.

AV control unit		BOSE speaker amp.		Continuity
Connector	Terminal	Connector	Terminal	
M161	2	B120	25	Yes
	3		5	
	11		26	
	12		6	

3. Check continuity between AV control unit connector M161 and ground.

AV control unit		Ground	Continuity
Connector	Terminal		
M161	2	—	No
	3		
	11		
	12		

Is the inspection result normal?

YES >> GO TO 5.

NO >> Repair or replace harness or connectors.

## 5. CHECK PRE-AMP SIGNAL

1. Connect AV control unit connector M161 and BOSE speaker amp. connector B120.
2. Turn ignition switch to ACC.
3. Push AV control unit POWER switch.
4. Check signal between the terminals of AV control unit connector M161.

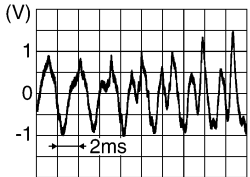
AV control unit connector M161		Condition	Reference value
(+)	(-)		
Terminal	Terminal	Audio signal output	
2	3		
11	12		

Is the inspection result normal?

YES >> Replace BOSE speaker amp. Refer to [AV-887. "Removal and Installation"](#).



# FRONT DOOR SPEAKER

< DTC/CIRCUIT DIAGNOSIS >

[BOSE AUDIO W/NAVI W/SURROUND]

NO >> Replace AV control unit. Refer to [AV-883, "Removal and Installation - AV Control Unit"](#).

A

B

C

D

E

F

G

H

I

J

K

L

M

AV

O

P

# REAR DOOR TWEETER

[BOSE AUDIO W/NAVI W/SURROUND]

< DTC/CIRCUIT DIAGNOSIS >

## REAR DOOR TWEETER

### Diagnosis Procedure

INFOID:000000009129436

Regarding Wiring Diagram information, refer to [AV-683. "Wiring Diagram"](#).

### 1. CONNECTOR CHECK

Check the AV control unit, BOSE speaker amp. and speaker connectors for the following:

- Proper connection
- Damage
- Disconnected or loose terminals

Is the inspection result normal?

YES >> GO TO 2.

NO >> Repair the terminals or connectors.

### 2. CHECK REAR DOOR TWEETER SIGNAL CIRCUIT CONTINUITY

1. Disconnect BOSE speaker amp. connector B121 and suspect rear door tweeter connector.
2. Check continuity between BOSE speaker amp. connector B121 and suspect rear door tweeter connector.

BOSE speaker amp.		Rear door tweeter		Continuity
Connector	Terminal	Connector	Terminal	
B121	45	D252 (LH)	1	Yes
	46		2	
	41	D352 (RH)	1	
	42		2	

3. Check continuity between BOSE speaker amp. connector B121 and ground.

BOSE speaker amp.		Ground	Continuity
Connector	Terminal		
B121	45	—	No
	46		
	41		
	42		

Is the inspection result normal?

YES >> GO TO 3.

NO >> Repair or replace harness or connectors.

### 3. CHECK REAR DOOR TWEETER SIGNAL

1. Connect BOSE speaker amp. connector B121 and suspect rear door tweeter connector.
2. Turn ignition switch to ACC.
3. Push AV control unit POWER switch.
4. Check signal between terminals of BOSE speaker amp. connector B121.

BOSE speaker amp. connector B121		Condition	Reference value
(+)	(-)		
Terminal	Terminal		

# REAR DOOR TWEETER

[BOSE AUDIO W/NAVI W/SURROUND]

## < DTC/CIRCUIT DIAGNOSIS >

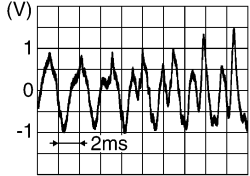
45	46	Audio signal output	
41	42		

Is the inspection result normal?

- YES >> Replace rear door tweeter. Refer to [AV-893. "Removal and Installation"](#).
- NO >> GO TO 4.

### 4. CHECK PRE-AMP SIGNAL CIRCUIT CONTINUITY

1. Disconnect AV control unit connector M161 and BOSE speaker amp. connector B120.
2. Check continuity between AV control unit connector M161 and BOSE speaker amp. connector B120.

AV control unit		BOSE speaker amp.		Continuity
Connector	Terminal	Connector	Terminal	
M161	4	B120	27	Yes
	5		7	
	13		28	
	14		8	

3. Check continuity between AV control unit connector M161 and ground.

AV control unit		Ground	Continuity
Connector	Terminal		
M161	4	—	No
	5		
	13		
	14		

Is the inspection result normal?

- YES >> GO TO 5.
- NO >> Repair or replace harness or connectors.

### 5. CHECK PRE-AMP SIGNAL

1. Connect AV control unit connector M161 and BOSE speaker amp. connector B120.
2. Turn ignition switch to ACC.
3. Push AV control unit POWER switch.
4. Check signal between the terminals of AV control unit connector M161.

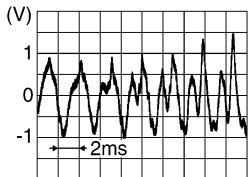
AV control unit connector M161		Condition	Reference value
(+) Terminal	(-) Terminal		
4	5	Audio signal output	
13	14		

Is the inspection result normal?

- YES >> Replace BOSE speaker amp. Refer to [AV-887. "Removal and Installation"](#).

A  
B  
C  
D  
E  
F  
G  
H  
I  
J  
K  
L  
M  
O  
P

AV

## REAR DOOR TWEETER

< DTC/CIRCUIT DIAGNOSIS >

[BOSE AUDIO W/NAVI W/SURROUND]

---

NO >> Replace AV control unit. Refer to [AV-883. "Removal and Installation - AV Control Unit"](#).

# REAR DOOR SPEAKER

[BOSE AUDIO W/NAVI W/SURROUND]

< DTC/CIRCUIT DIAGNOSIS >

## REAR DOOR SPEAKER

### Diagnosis Procedure

INFOID:000000009129437

Regarding Wiring Diagram information, refer to [AV-683. "Wiring Diagram"](#).

### 1. CONNECTOR CHECK

Check the AV control unit, BOSE speaker amp. and speaker connectors for the following:

- Proper connection
- Damage
- Disconnected or loose terminals

Is the inspection result normal?

YES >> GO TO 2.

NO >> Repair the terminals or connectors.

### 2. CHECK REAR DOOR SPEAKER SIGNAL CIRCUIT CONTINUITY

1. Disconnect BOSE speaker amp. connector B121 and suspect rear door speaker connector.
2. Check continuity between BOSE speaker amp. connector B121 and suspect rear door speaker connector.

BOSE speaker amp.		Rear door speaker		Continuity
Connector	Terminal	Connector	Terminal	
B121	45	D207 (LH)	1	Yes
	46		2	
	41	D307 (RH)	1	
	42		2	

3. Check continuity between BOSE speaker amp. connector B121 and ground.

BOSE speaker amp.		Ground	Continuity
Connector	Terminal		
B121	45	—	No
	46		
	41		
	42		

Is the inspection result normal?

YES >> GO TO 3.

NO >> Repair or replace harness or connectors.

### 3. CHECK REAR DOOR SPEAKER SIGNAL

1. Connect BOSE speaker amp. connector B121 and suspect rear door speaker connector.
2. Turn ignition switch to ACC.
3. Push AV control unit POWER switch.
4. Check signal between terminals of BOSE speaker amp. connector B121.

BOSE speaker amp. connector B121		Condition	Reference value
(+)	(-)		
Terminal	Terminal		

A  
B  
C  
D  
E  
F  
G  
H  
I  
J  
K  
L  
M  
AV  
O  
P

# REAR DOOR SPEAKER

[BOSE AUDIO W/NAVI W/SURROUND]

< DTC/CIRCUIT DIAGNOSIS >

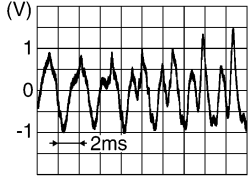
45	46	Audio signal output	
41	42		

Is the inspection result normal?

YES >> Replace rear door speaker. Refer to [AV-892. "Removal and Installation"](#).

NO >> GO TO 4.

## 4. CHECK PRE-AMP SIGNAL CIRCUIT CONTINUITY

1. Disconnect AV control unit connector M161 and BOSE speaker amp. connector B120.
2. Check continuity between AV control unit connector M161 and BOSE speaker amp. connector B120.

AV control unit		BOSE speaker amp.		Continuity
Connector	Terminal	Connector	Terminal	
M161	4	B120	27	Yes
	5		7	
	13		28	
	14		8	

3. Check continuity between AV control unit connector M161 and ground.

AV control unit		Ground	Continuity
Connector	Terminal		
M161	4	—	No
	5		
	13		
	14		

Is the inspection result normal?

YES >> GO TO 5.

NO >> Repair or replace harness or connectors.

## 5. CHECK PRE-AMP SIGNAL

1. Connect AV control unit connector M161 and BOSE speaker amp. connector B120.
2. Turn ignition switch to ACC.
3. Push AV control unit POWER switch.
4. Check signal between the terminals of AV control unit connector M161.

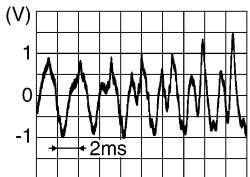
AV control unit connector M161		Condition	Reference value
(+) Terminal	(-) Terminal		
4	5	Audio signal output	
13	14		

Is the inspection result normal?

YES >> Replace BOSE speaker amp. Refer to [AV-887. "Removal and Installation"](#).

# REAR DOOR SPEAKER

< DTC/CIRCUIT DIAGNOSIS >

[BOSE AUDIO W/NAVI W/SURROUND]

NO >> Replace AV control unit. Refer to [AV-883, "Removal and Installation - AV Control Unit"](#).

A

B

C

D

E

F

G

H

I

J

K

L

M

AV

O

P

# REAR SPEAKER

[BOSE AUDIO W/NAVI W/SURROUND]

< DTC/CIRCUIT DIAGNOSIS >

## REAR SPEAKER

### Diagnosis Procedure

INFOID:000000009129438

Regarding Wiring Diagram information, refer to [AV-683. "Wiring Diagram"](#).

### 1. CONNECTOR CHECK

Check the AV control unit, BOSE speaker amp. and speaker connectors for the following:

- Proper connection
- Damage
- Disconnected or loose terminals

Is the inspection result normal?

YES >> GO TO 2.

NO >> Repair the terminals or connectors.

### 2. CHECK REAR SIDE SPEAKER SIGNAL CIRCUIT CONTINUITY

1. Disconnect BOSE speaker amp. connector B122 and suspect rear side speaker connector.
2. Check continuity between BOSE speaker amp. connector B122 and suspect rear side speaker connector.

BOSE speaker amp.		Rear side speaker		Continuity
Connector	Terminal	Connector	Terminal	
B122	62	B1 (LH)	1	Yes
	73		2	
	63	B153 (RH)	1	
	74		2	

3. Check continuity between BOSE speaker amp. connector B122 and ground.

BOSE speaker amp.		Ground	Continuity
Connector	Terminal		
B122	62	—	No
	73		
	63		
	74		

Is the inspection result normal?

YES >> GO TO 3.

NO >> Repair or replace harness or connectors.

### 3. CHECK REAR SIDE SPEAKER SIGNAL

1. Connect BOSE speaker amp. connector B122 and suspect rear side speaker connector.
2. Turn ignition switch to ACC.
3. Push AV control unit POWER switch.
4. Check signal between terminals of BOSE speaker amp. connector B122.

BOSE speaker amp. connector B122		Condition	Reference value
(+)	(-)		
Terminal	Terminal		



# REAR SPEAKER

[BOSE AUDIO W/NAVI W/SURROUND]

## < DTC/CIRCUIT DIAGNOSIS >

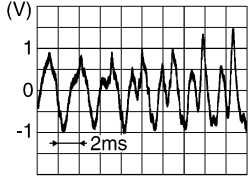
62	73	Audio signal output	
63	74		

Is the inspection result normal?

YES >> Replace rear side speaker. Refer to [AV-894. "Removal and Installation"](#).

NO >> GO TO 4.

### 4. CHECK PRE-AMP SIGNAL CIRCUIT CONTINUITY

1. Disconnect AV control unit connector M161 and BOSE speaker amp. connector B120.
2. Check continuity between AV control unit connector M161 and BOSE speaker amp. connector B120.

AV control unit		BOSE speaker amp.		Continuity
Connector	Terminal	Connector	Terminal	
M161	4	B120	27	Yes
	5		7	
	13		28	
	14		8	

3. Check continuity between AV control unit connector M161 and ground.

AV control unit		Ground	Continuity
Connector	Terminal		
M161	4	—	No
	5		
	13		
	14		

Is the inspection result normal?

YES >> GO TO 5.

NO >> Repair or replace harness or connectors.

### 5. CHECK PRE-AMP SIGNAL

1. Connect AV control unit connector M161 and BOSE speaker amp. connector B120.
2. Turn ignition switch to ACC.
3. Push AV control unit POWER switch.
4. Check signal between the terminals of AV control unit connector M161.

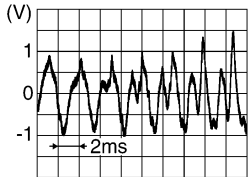
AV control unit connector M161		Condition	Reference value
(+) Terminal	(-) Terminal		
4	5	Audio signal output	
13	14		

Is the inspection result normal?

YES >> Replace BOSE speaker amp. Refer to [AV-887. "Removal and Installation"](#).

A  
B  
C  
D  
E  
F  
G  
H  
I  
J  
K  
L  
M  
O  
P

AV

## REAR SPEAKER

< DTC/CIRCUIT DIAGNOSIS >

[BOSE AUDIO W/NAVI W/SURROUND]

---

NO >> Replace AV control unit. Refer to [AV-883. "Removal and Installation - AV Control Unit"](#).

# SUBWOOFER

< DTC/CIRCUIT DIAGNOSIS >

[BOSE AUDIO W/NAVI W/SURROUND]

## SUBWOOFER

### Diagnosis Procedure

INFOID:000000009129439

Regarding Wiring Diagram information, refer to [AV-683. "Wiring Diagram"](#).

#### 1. CONNECTOR CHECK

Check the AV control unit, BOSE speaker amp. and subwoofer connectors for the following:

- Proper connection
- Damage
- Disconnected or loose terminals

Is the inspection result normal?

YES >> GO TO 2.

NO >> Repair the terminal and connector.

#### 2. VERIFY SUBWOOFER POWER SUPPLY AND GROUND

Check subwoofer power supply and ground. Refer to [AV-816. "BOSE AMP. : Diagnosis Procedure"](#).

Is the inspection result normal?

YES >> GO TO 3.

NO >> Repair or replace harness or connectors.

#### 3. CHECK SUBWOOFER AMP ON CIRCUIT CONTINUITY

1. Turn ignition switch OFF.
2. Disconnect Bose speaker amp. connector B122 and subwoofer connector.
3. Check continuity between Bose speaker amp. connector B122 and subwoofer connector B73.

Bose speaker amp.		Subwoofer		Continuity
Connector	Terminal	Connector	Terminal	
B122	55	B73	4	Yes

4. Check continuity between Bose speaker amp. connector B122 and ground.

Bose speaker amp.		Ground	Continuity
Connector	Terminal		
B122	55	—	No

Is the inspection result normal?

YES >> GO TO 4.

NO >> Repair or replace harness or connectors.

#### 4. CHECK SUBWOOFER AMP ON CIRCUIT VOLTAGE

1. Connect Bose speaker amp. connector B122.
2. Turn ignition switch ON.
3. Check voltage between Bose speaker amp. connector B122 and ground.

Bose speaker amp.		Ground	Voltage (Approx.)
(+)			
Connector	Terminal		
B122	55	—	Battery voltage

Is the inspection result normal?

YES >> GO TO 5.

NO >> Replace Bose speaker amp. Refer to [AV-887. "Removal and Installation"](#).

A  
B  
C  
D  
E  
F  
G  
H  
I  
J  
K  
L  
M  
AV  
O  
P

# SUBWOOFER

< DTC/CIRCUIT DIAGNOSIS >

[BOSE AUDIO W/NAVI W/SURROUND]

## 5. CHECK SUBWOOFER SIGNAL CIRCUIT CONTINUITY

1. Disconnect BOSE speaker amp. connector B121 and subwoofer connector.
2. Check continuity between BOSE speaker amp. connector B121 and subwoofer connector.

BOSE speaker amp.		Subwoofer		Continuity
Connector	Terminal	Connector	Terminal	
B121	54	B73	2	Yes
	49		1	

3. Check continuity between BOSE speaker amp. connector B121 and ground.

BOSE speaker amp.		Ground	Continuity
Connector	Terminal		
B121	54	—	No
	49		

Is the inspection result normal?

YES >> GO TO 6.

NO >> Repair or replace harness or connectors.

## 6. CHECK SUBWOOFER SIGNAL

1. Connect BOSE speaker amp. connector B121 and subwoofer connector.
2. Turn ignition switch to ACC.
3. Push AV control unit POWER switch.
4. Check the signal between the terminals of BOSE speaker amp. connector B121.

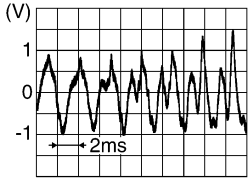
BOSE speaker amp. connector B121		Condition	Reference value
(+) Terminal	(-) Terminal		
54	49	Audio signal output	

Is the inspection result normal?

YES >> Replace subwoofer. Refer to [AV-895. "Removal and Installation"](#).

NO >> GO TO 7.

## 7. CHECK PRE-AMP SIGNAL CIRCUIT CONTINUITY

1. Disconnect AV control unit connector M165 and BOSE speaker amp. connector B120.
2. Check continuity between AV control unit connector M165 and BOSE speaker amp. connector B120.

AV control unit		BOSE speaker amp.		Continuity
Connector	Terminal	Connector	Terminal	
M165	124	B120	30	Yes
	132		10	

3. Check continuity between AV control unit connector M165 and ground.

# SUBWOOFER

< DTC/CIRCUIT DIAGNOSIS >

[BOSE AUDIO W/NAVI W/SURROUND]

AV control unit		Ground	Continuity
Connector	Terminal		
M165	124	—	No
	132		

Is the inspection result normal?

YES >> GO TO 8.

NO >> Repair or replace harness or connectors.

## 8. CHECK PRE-AMP SIGNAL

1. Connect AV control unit connector M165 and BOSE speaker amp. connector B120.
2. Turn ignition switch to ACC.
3. Push AV control unit POWER switch.
4. Check signal between the terminals of AV control unit connector M165.

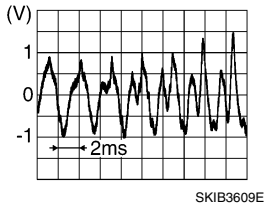
AV control unit connector M165		Condition	Reference value
(+)	(-)		
Terminal	Terminal		
124	132	Audio signal output	

Is the inspection result normal?

YES >> Replace BOSE speaker amp. Refer to [AV-887, "Removal and Installation"](#).

NO >> Replace AV control unit. Refer to [AV-883, "Removal and Installation - AV Control Unit"](#).

AV

# FRONT AUXILIARY INPUT JACK AUDIO SIGNAL CIRCUIT

< DTC/CIRCUIT DIAGNOSIS >

[BOSE AUDIO W/NAVI W/SURROUND]

## FRONT AUXILIARY INPUT JACK AUDIO SIGNAL CIRCUIT

### Diagnosis Procedure

INFOID:000000009129440

Regarding Wiring Diagram information, refer to [AV-683. "Wiring Diagram"](#).

### 1. CHECK AUX SOUND SIGNAL CIRCUIT CONTINUITY

1. Turn ignition OFF.
2. Disconnect AV control unit connector M162 and front auxiliary input jacks connector.
3. Check continuity between AV control unit connector M162 and front auxiliary input jacks connector.

AV control unit		Front auxiliary input jacks		Continuity
Connector	Terminal	Connector	Terminal	
M162	24	M205	3	Yes
	38		1	

4. Check continuity between AV control unit connector M162 and ground.

AV control unit		Ground	Continuity
Connector	Terminal		
M162	24	—	No
	38		

Is inspection result normal?

YES >> GO TO 2.

NO >> Repair or replace harness or connectors.

### 2. CHECK AUX SOUND SIGNAL GROUND CIRCUIT CONTINUITY

Check continuity between AV control unit connector M162 and front auxiliary input jacks connector.

AV control unit		Front auxiliary input jacks		Continuity
Connector	Terminal	Connector	Terminal	
M162	39	M205	2	Yes

Is inspection result normal?

YES >> GO TO 3.

NO >> Repair or replace harness or connectors.

### 3. CHECK AUX SOUND SIGNAL

1. Connect AV control unit connector M162 and front auxiliary input jacks connector.
2. Turn ignition switch to ACC.
3. Select AUX mode.
4. Check signals between terminals of AV control unit connector M162.

AV control unit connector M162		Condition	Reference value
(+)	(-)		
Terminal	Terminal		

# FRONT AUXILIARY INPUT JACK AUDIO SIGNAL CIRCUIT

< DTC/CIRCUIT DIAGNOSIS >

[BOSE AUDIO W/NAVI W/SURROUND]

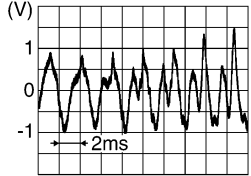
24	39	AUX mode selected	
38	39		

Is the inspection result normal?

- YES >> Replace front auxiliary input jacks. Refer to [AV-897. "Removal and Installation"](#).
- NO >> Replace AV control unit. Refer to [AV-883. "Removal and Installation - AV Control Unit"](#).

A  
B  
C  
D  
E  
F  
G  
H  
I  
J  
K  
L  
M  
O  
P

AV

# RGB DIGITAL IMAGE SIGNAL CIRCUIT

< DTC/CIRCUIT DIAGNOSIS >

[BOSE AUDIO W/NAVI W/SURROUND]

## RGB DIGITAL IMAGE SIGNAL CIRCUIT

### Diagnosis Procedure

INFOID:000000009129441

Regarding Wiring Diagram information, refer to [AV-683, "Wiring Diagram"](#).

#### 1. CHECK RGB DIGITAL IMAGE SIGNAL CIRCUIT CONTINUITY

1. Turn ignition switch OFF.
2. Disconnect AV control unit connector M140 and display unit connector M141.
3. Check continuity between AV control unit connector M140 and display unit connector M141.

AV control unit		Display unit		Continuity
Connector	Terminals	Connector	Terminals	
M140	165	M141	28	Yes
	164		27	

4. Check continuity between AV control unit connector M140 and ground.

AV control unit		Ground	Continuity
Connector	Terminals		
M140	165	—	No

Is the inspection result normal?

- YES >> GO TO 2.  
NO >> Repair or replace harness or connectors.

#### 2. CHECK RGB DIGITAL IMAGE SIGNAL

1. Connect AV control unit connector M140.
2. Turn ignition switch ON.
3. Check signal between terminals of display unit connector M141.

Display unit connector M141		Condition	Voltage (Approx.)
(+)	(-)		
Terminal	Terminal		
28	27	Audio system is ON.	1.3 V

Is the inspection result normal?

- YES >> Replace display unit. Refer to [AV-886, "Removal and Installation"](#).  
NO >> Replace AV control unit. Refer to [AV-883, "Removal and Installation - AV Control Unit"](#).



# COMPOSITE IMAGE SIGNAL CIRCUIT (AV CONTROL UNIT TO FRONT DISPLAY UNIT)

< DTC/CIRCUIT DIAGNOSIS >

[BOSE AUDIO W/NAVI W/SURROUND]

## COMPOSITE IMAGE SIGNAL CIRCUIT (AV CONTROL UNIT TO FRONT DISPLAY UNIT)

### Diagnosis Procedure

INFOID:000000009129442

Regarding Wiring Diagram information, refer to [AV-683. "Wiring Diagram"](#).

### 1. CHECK COMPOSITE IMAGE SIGNAL CIRCUIT CONTINUITY

1. Turn ignition switch OFF.
2. Disconnect AV control unit connector M163 and display unit connector M92.
3. Check continuity between AV control unit connector M163 and display unit connector M92.

AV control unit		Display unit		Continuity
Connector	Terminal	Connector	Terminal	
M163	56	M92	18	Yes
	55		19	

4. Check continuity between AV control unit connector M163 and ground.

AV control unit		Ground	Continuity
Connector	Terminal		
M163	56	—	No

Is the inspection result normal?

- YES >> GO TO 2.  
 NO >> Repair or replace harness or connectors.

### 2. CHECK COMPOSITE IMAGE SIGNAL

1. Connect AV control unit connector M163 and display unit connector M92.
2. Turn ignition switch ON.
3. Check signal between terminals of AV control unit connector M163.

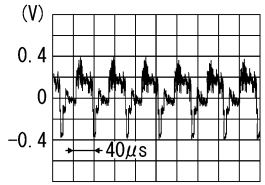
AV control unit connector M163		Condition	Reference value
(+)	(-)		
Terminal	Terminal		
56	55	DVD image is displayed.	

Is the inspection result normal?

- YES >> Replace display unit. Refer to [AV-886. "Removal and Installation"](#).  
 NO >> Replace AV control unit. Refer to [AV-883. "Removal and Installation - AV Control Unit"](#).

# COMPOSITE IMAGE SIGNAL CIRCUIT (AV CONTROL UNIT TO VIDEO DISTRIBUTOR)

< DTC/CIRCUIT DIAGNOSIS >

[BOSE AUDIO W/NAVI W/SURROUND]

## COMPOSITE IMAGE SIGNAL CIRCUIT (AV CONTROL UNIT TO VIDEO DISTRIBUTOR)

### Diagnosis Procedure

INFOID:000000009129443

Regarding Wiring Diagram information, refer to [AV-683. "Wiring Diagram"](#).

### 1. CHECK COMPOSITE IMAGE SIGNAL CIRCUIT CONTINUITY

1. Turn ignition switch OFF.
2. Disconnect AV control unit connector M164 and video distributor connector B25.
3. Check continuity between AV control unit connector M164 and video distributor connector B25.

AV control unit		Video distributor		Continuity
Connector	Terminal	Connector	Terminal	
M164	107	B25	34	Yes
	105		33	

4. Check continuity between AV control unit connector M164 and ground.

AV control unit		Ground	Continuity
Connector	Terminal		
M164	107	—	No

Is the inspection result normal?

YES >> GO TO 2.

NO >> Repair or replace harness or connectors.

### 2. CHECK COMPOSITE IMAGE SIGNAL

1. Connect AV control unit connector M164 and video distributor connector B25.
2. Turn ignition switch ON.
3. Check signal between terminals of video distributor connector B25.

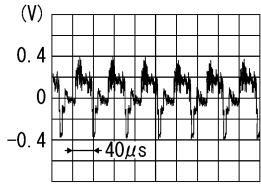
Video distributor connector B25		Condition	Reference value
(+)	(-)		
Terminal	Terminal		
34	33	DVD, USB or front auxiliary input jacks image is displayed on headrest display.	

Is the inspection result normal?

YES >> Replace video distributor. Refer to [AV-902. "Removal and Installation"](#).

NO >> Replace AV control unit. Refer to [AV-883. "Removal and Installation - AV Control Unit"](#).

# COMPOSITE IMAGE SIGNAL CIRCUIT (VIDEO DISTRIBUTOR TO HEADREST DISPLAY UNIT)

< DTC/CIRCUIT DIAGNOSIS >

[BOSE AUDIO W/NAVI W/SURROUND]

## COMPOSITE IMAGE SIGNAL CIRCUIT (VIDEO DISTRIBUTOR TO HEADREST DISPLAY UNIT)

### Diagnosis Procedure

INFOID:000000009129444

Regarding Wiring Diagram information, refer to [AV-683, "Wiring Diagram"](#).

### 1. CHECK COMPOSITE IMAGE SIGNAL CIRCUIT CONTINUITY

1. Turn ignition switch OFF.
2. Disconnect video distributor connector B24 and headrest display unit connectors.
3. Check continuity between video distributor connector B24 and headrest display unit connectors.

Video distributor		Headrest display unit		Continuity
Connector	Terminal	Connector	Terminal	
B24	32	B202 (driver seat)	5	Yes
	31		21	
	28	B302 (passenger seat)	5	Yes
	27		21	

4. Check continuity between video distributor connector B24 and ground.

Video distributor		Ground	Continuity
Connector	Terminal		
B24	32	—	No
	28		

Is the inspection result normal?

- YES >> GO TO 2.  
 NO >> Repair or replace harness or connectors.

### 2. CHECK COMPOSITE IMAGE SIGNAL

1. Connect video distributor connector B24 and headrest display unit connectors.
2. Turn ignition switch ON.
3. Check signal between terminals of headrest display unit connectors.

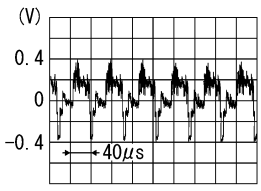
Connector	Headrest display unit		Condition	Reference value
	(+) Terminal	(-) Terminal		
B202 (driver seat)			DVD, USB or front auxiliary input jacks image is displayed on headrest display.	 <p>SKIB2251J</p>
B302 (passenger seat)	5	21		

Is the inspection result normal?

- YES >> Replace headrest display unit. Refer to [AV-605, "Removal and Installation"](#).  
 NO >> Replace video distributor. Refer to [AV-902, "Removal and Installation"](#).

# AUX IMAGE SIGNAL CIRCUIT (FRONT AUXILIARY INPUT JACKS TO AV CONTROL UNIT)

< DTC/CIRCUIT DIAGNOSIS >

[BOSE AUDIO W/NAVI W/SURROUND]

## AUX IMAGE SIGNAL CIRCUIT (FRONT AUXILIARY INPUT JACKS TO AV CONTROL UNIT)

### Diagnosis Procedure

INFOID:000000009129445

Regarding Wiring Diagram information, refer to [AV-683. "Wiring Diagram"](#).

### 1. CHECK AUX IMAGE SIGNAL CIRCUIT CONTINUITY

1. Turn ignition switch OFF.
2. Disconnect AV control unit connector M125 and front auxiliary input jacks connector M205.
3. Check continuity between AV control unit connector M125 and front auxiliary input jacks connector M205.

AV control unit		Front auxiliary input jacks		Continuity
Connector	Terminal	Connector	Terminal	
M125	91	M205	7	Yes
	92		8	

4. Check continuity between AV control unit connector M125 and ground.

AV control unit		Ground	Continuity
Connector	Terminal		
M125	91	—	No

Is the inspection result normal?

YES >> GO TO 2.

NO >> Repair or replace harness or connectors.

### 2. CHECK AUX IMAGE SIGNAL

1. Connect AV control unit connector M125 and front auxiliary input jacks connector M205.
2. Turn ignition switch ON.
3. Check signal between terminals of front auxiliary input jacks connector M205.

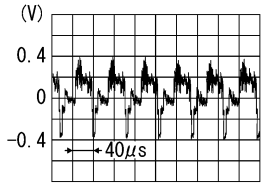
Front auxiliary input jacks connector M205		Condition	Reference value
(+) Terminal	(-) Terminal		
7	8	Front auxiliary input jacks image is displayed.	

Is the inspection result normal?

YES >> Replace front auxiliary input jacks. Refer to [AV-897. "Removal and Installation"](#).

NO >> Replace AV control unit. Refer to [AV-883. "Removal and Installation - AV Control Unit"](#).

# IMAGE SWITCH SIGNAL CIRCUIT

< DTC/CIRCUIT DIAGNOSIS >

[BOSE AUDIO W/NAVI W/SURROUND]

## IMAGE SWITCH SIGNAL CIRCUIT

### Diagnosis Procedure

INFOID:000000009129446

Regarding Wiring Diagram information, refer to [AV-683. "Wiring Diagram"](#).

### 1. CHECK CONTINUITY IMAGE SWITCH SIGNAL CIRCUIT

1. Turn ignition switch OFF.
2. Disconnect video distributor connector B24 and headrest display unit connectors.
3. Check continuity between video distributor connector B24 and headrest display unit connectors.

Video distributor		Headrest display unit		Continuity
Connector	Terminal	Connector	Terminal	
B24	10	B202 (driver seat)	7	Yes
	7		23	
	9	B302 (passenger seat)	7	
	5		23	

4. Check continuity between video distributor connector B24 and ground.

Video distributor		Ground	Continuity
Connector	Terminal		
B24	10	—	No
	9		

Is the inspection result normal?

YES >> GO TO 2.

NO >> Repair or replace harness or connectors.

### 2. CHECK VIDEO DISTRIBUTOR VOLTAGE

1. Connect video distributor connector B24 and headrest display unit connectors.
2. Turn ignition switch ON.
3. Check voltage between terminals of video distributor connector B24.

Video distributor connector B24		Condition	Voltage (Approx.)
(+)	(-)		
Terminal	Terminal		
10	7	DVD, USB or front auxiliary input jacks image is displayed on headrest display.	0.5 V
		DVD, USB or rear auxiliary input jacks image is displayed on headrest display.	4.5 V
9	5	DVD, USB or front auxiliary input jacks image is displayed on headrest display.	0.5 V
		DVD, USB or rear auxiliary input jacks image is displayed on headrest display.	4.5 V

Is the inspection result normal?

YES >> Replace headrest display unit. Refer to [AV-903. "Removal and Installation"](#).

NO >> Replace video distributor. Refer to [AV-902. "Removal and Installation"](#).

# DISK EJECT SIGNAL CIRCUIT

< DTC/CIRCUIT DIAGNOSIS >

[BOSE AUDIO W/NAVI W/SURROUND]

## DISK EJECT SIGNAL CIRCUIT

### Diagnosis Procedure

INFOID:000000009129447

Regarding Wiring Diagram information, refer to [AV-683, "Wiring Diagram"](#).

#### 1. CHECK DISK EJECT SIGNAL CIRCUIT CONTINUITY

1. Turn ignition switch OFF.
2. Disconnect AV control unit connector M164 and A/C and AV switch assembly connector.
3. Check continuity between AV control unit connector M164 terminal 97 and A/C and AV switch assembly connector M98 terminal 14.

AV control unit		A/C and AV switch assembly		Continuity
Connector	Terminal	Connector	Terminal	
M164	97	M98	14	Yes

4. Check continuity between AV control unit connector M164 terminal 97 and ground.

AV control unit		Ground	Continuity
Connector	Terminal		
M164	97		No

Is inspection result normal?

YES >> GO TO 2.

NO >> Repair or replace harness or connectors.

#### 2. CHECK AV CONTROL UNIT VOLTAGE

1. Connect AV control unit connector M164 and A/C and AV switch assembly connector.
2. Turn ignition switch ON.
3. Check voltage between AV control unit connector M164 terminal 97 and ground.

AV control unit		Ground	Condition	Voltage (Approx.)
(+)		(-)		
Connector	Terminal			
M164	97	—	Pressing eject switch	0 V
			Except above	5.0 V

Is the inspection result normal?

YES >> Replace A/C and AV switch assembly. Refer to [AV-884, "Removal and Installation - A/C and AV Switch Assembly"](#).

NO >> Replace AV control unit. Refer to [AV-883, "Removal and Installation - AV Control Unit"](#).

# STEERING SWITCH

< DTC/CIRCUIT DIAGNOSIS >

[BOSE AUDIO W/NAVI W/SURROUND]

## STEERING SWITCH

### Diagnosis Procedure

INFOID:000000009129448

Regarding Wiring Diagram information, refer to [AV-683. "Wiring Diagram"](#).

### 1. CHECK STEERING WHEEL AUDIO CONTROL SWITCH RESISTANCE

1. Turn ignition switch OFF.
2. Disconnect combination switch connector M149.
3. Check resistance between combination switch connector terminals.

Combination switch connector M149		Condition	Resistance Ω (Approx.)
Terminal	Terminal		
14	17	Depress SOURCE switch.	1
		Depress Δ switch.	121
		Depress ∇ switch.	321
		Depress ⚡ switch.	723
		Depress ENTER switch.	2023
15		Depress - 🔊 switch.	1
		Depress 🔊+ switch.	121
		Depress 🔄 switch.	321
		Depress ↻ switch.	723
		Depress DISP switch.	2023

Is the inspection result normal?

YES >> GO TO 2.

NO >> Replace steering wheel audio control switch. Refer to [AV-885. "Removal and Installation"](#).

### 2. CHECK HARNESS BETWEEN COMBINATION SWITCH AND COMBINATION METER

1. Disconnect combination meter connector M24 and combination switch connector M30.
2. Check continuity between combination meter connector M24 and combination switch connector M30.

Combination meter		Combination switch		Continuity
Connector	Terminal	Connector	Terminal	
M24	3	M30	24	Yes
	24		33	
	4		31	

3. Check continuity between combination meter connector M24 and ground.

Combination meter		Ground	Continuity
Connector	Terminal		
M24	3	—	No
	24		
	4		

Is the inspection result normal?

# STEERING SWITCH

[BOSE AUDIO W/NAVI W/SURROUND]

< DTC/CIRCUIT DIAGNOSIS >

- YES >> GO TO 3.  
NO >> Repair or replace harness or connectors.

## 3.CHECK COMBINATION SWITCH

Check continuity between combination switch connectors M30 and M149.

Combination switch				Continuity
Connector	Terminal	Connector	Terminal	
M30	24	M149	14	Yes
	31		15	
	33		17	

Is the inspection result normal?

- YES >> GO TO 4.  
NO >> Replace spiral cable. Refer to [SR-15, "Removal and Installation"](#).

## 4.CHECK HARNESS BETWEEN COMBINATION METER AND AV CONTROL UNIT

1. Disconnect AV control unit connector M122.
2. Check continuity between combination meter connector M24 and AV control unit connector M161.

Combination meter		AV control unit		Continuity
Connector	Terminal	Connector	Terminal	
M24	14	M161	6	Yes
	15		16	
	16		15	

3. Check continuity between combination meter connector M24 and ground.

Combination meter		Ground	Continuity
Connector	Terminal		
M24	14	—	No
	15		
	16		

Is the inspection result normal?

- YES >> GO TO 5.  
NO >> Repair or replace harness or connectors.

## 5.CHECK AV CONTROL UNIT VOLTAGE

1. Connect combination meter connector M24 and AV control unit connector M161.
2. Turn ignition switch ON.
3. Check voltage between terminals of AV control unit connector M122.

AV control unit M161		Voltage (Approx.)
(+)	(-)	
Terminal	Terminal	
6	15	5.0 V
16		

Is the inspection result normal?

- YES >> Replace combination meter. Refer to [MWI-95, "Removal and Installation"](#).  
NO >> Replace AV control unit. Refer to [AV-883, "Removal and Installation - AV Control Unit"](#).



# USB CONNECTOR

[BOSE AUDIO W/NAVI W/SURROUND]

< DTC/CIRCUIT DIAGNOSIS >

## USB CONNECTOR

### Diagnosis Procedure

INFOID:000000009129449

Regarding Wiring Diagram information, refer to [AV-683. "Wiring Diagram"](#).

#### 1. CHECK USB INTERFACE HARNESS CONTINUITY

1. Turn ignition switch OFF.
2. Disconnect AV control unit connector M55 and USB interface connector M209.
3. Check continuity between AV control unit connector M55 and USB interface connector M209.

AV control unit		USB interface		Continuity
Connector	Terminal	Connector	Terminal	
M55	137	M209	1	Yes
	138		2	
	139		3	
	140		4	
	141		5	

4. Check continuity between AV control unit connector M55 and ground.

AV control unit		—	Continuity
Connector	Terminal		
M55	137	Ground	No
	139		

Is the inspection result normal?

- YES >> Replace the USB interface. Refer to [AV-896. "Removal and Installation"](#).  
NO >> Repair or replace harness or connectors.

A  
B  
C  
D  
E  
F  
G  
H  
I  
J  
K  
L  
M  
O  
P

AV

# FRONT CAMERA COMMUNICATION SIGNAL CIRCUIT

< DTC/CIRCUIT DIAGNOSIS >

[BOSE AUDIO W/NAVI W/SURROUND]

## FRONT CAMERA COMMUNICATION SIGNAL CIRCUIT

### Diagnosis Procedure

INFOID:000000009129450

Regarding Wiring Diagram information, refer to [AV-683, "Wiring Diagram"](#).

#### 1. CHECK COMMUNICATION SIGNAL CIRCUIT CONTINUITY

1. Turn ignition switch OFF.
2. Disconnect around view monitor control unit connector M97 and front camera connector E226.
3. Check continuity between around view monitor control unit connector M97 and front camera connector E226.

Around view monitor control unit		Front camera		Continuity
Connector	Terminal	Connector	Terminal	
M97	67	E226	6	Yes

4. Check continuity between around view monitor control unit connector M97 and ground.

Around view monitor control unit		Ground	Continuity
Connector	Terminal		
M97	67	—	No

Is inspection result normal?

YES >> GO TO 2.

NO >> Repair or replace harness or connectors.

#### 2. CHECK COMMUNICATION SIGNAL

1. Connect around view monitor control unit connector M97 and front camera connector E226.
2. Turn ignition switch ON.
3. Check signal between around view monitor control unit connector M97 and ground.

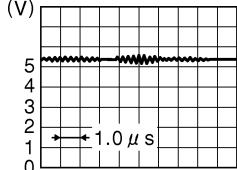
Around view monitor control unit		Ground	Condition	Reference value
(+)		(-)		
Connector	Terminal			
M97	67	—	CAMERA switch is ON or shift position is R.	 JSNIA0836GB

Is inspection result normal?

YES >> Replace around view monitor control unit. Refer to [AV-898, "Removal and Installation"](#).

NO >> Replace front camera. Refer to [AV-899, "Removal and Installation"](#).

# FRONT CAMERA IMAGE SIGNAL CIRCUIT

< DTC/CIRCUIT DIAGNOSIS >

[BOSE AUDIO W/NAVI W/SURROUND]

## FRONT CAMERA IMAGE SIGNAL CIRCUIT

### Diagnosis Procedure

INFOID:000000009129451

Regarding Wiring Diagram information, refer to [AV-683. "Wiring Diagram"](#).

### 1. CHECK FRONT CAMERA IMAGE SIGNAL CIRCUIT CONTINUITY

1. Turn ignition switch OFF.
2. Disconnect around view monitor control unit connector M97 and front camera connector E226.
3. Check continuity between around view monitor control unit connector M97 and front camera connector E226.

Around view monitor control unit		Front camera		Continuity
Connector	Terminals	Connector	Terminals	
M97	71	E226	3	Yes
	72		4	

4. Check continuity between around view monitor control unit connector M97 and ground.

Around view monitor control unit		Ground	Continuity
Connector	Terminals		
M97	71	—	No

Is inspection result normal?

- YES >> GO TO 2.  
 NO >> Repair or replace harness or connectors.

### 2. CHECK FRONT CAMERA IMAGE SIGNAL

1. Connect around view monitor control unit connector M97 and front camera connector E226.
2. Turn ignition switch ON.
3. Check signal between around view monitor control unit connector M97 terminals.

Around view monitor control unit		Condition	Reference value
(+)	(-)		
Terminal	Terminal		
71	72	CAMERA switch is ON or shift position is R.	

Is inspection result normal?

- YES >> Replace around view monitor control unit. Refer to [AV-898. "Removal and Installation"](#).  
 NO >> Replace front camera. Refer to [AV-899. "Removal and Installation"](#).

# REAR CAMERA COMMUNICATION SIGNAL CIRCUIT

< DTC/CIRCUIT DIAGNOSIS >

[BOSE AUDIO W/NAVI W/SURROUND]

## REAR CAMERA COMMUNICATION SIGNAL CIRCUIT

### Diagnosis Procedure

INFOID:000000009129452

Regarding Wiring Diagram information, refer to [AV-683. "Wiring Diagram"](#).

### 1. CHECK COMMUNICATION SIGNAL CIRCUIT CONTINUITY

1. Turn ignition switch OFF.
2. Disconnect around view monitor control unit connector M97 and rear camera connector D511.
3. Check continuity between around view monitor control unit connector M97 and front camera connector D511.

Around view monitor control unit		Rear camera		Continuity
Connector	Terminal	Connector	Terminal	
M97	49	D511	4	Yes

4. Check continuity between around view monitor control unit connector M97 and ground.

Around view monitor control unit		Ground	Continuity
Connector	Terminal		
M97	49	—	No

Is inspection result normal?

YES >> GO TO 2.

NO >> Repair or replace harness or connectors.

### 2. CHECK COMMUNICATION SIGNAL

1. Connect around view monitor control unit connector M97 and rear camera connector D511.
2. Turn ignition switch ON.
3. Check signal between around view monitor control unit connector M97 and ground.

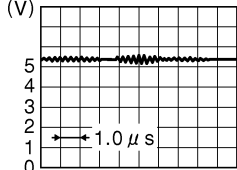
Around view monitor control unit		Ground	Condition	Reference value
(+)				
Connector	Terminal			
M97	49	—	CAMERA switch is ON or shift position is R.	 <p>(V)</p> <p>5 4 3 2 1 0</p> <p>1.0 μs</p> <p>JSNIA0836GB</p>

Is inspection result normal?

YES >> Replace around view monitor control unit. Refer to [AV-898. "Removal and Installation"](#).

NO >> Replace rear camera. Refer to [AV-900. "Removal and Installation"](#).

# REAR CAMERA IMAGE SIGNAL CIRCUIT

< DTC/CIRCUIT DIAGNOSIS >

[BOSE AUDIO W/NAVI W/SURROUND]

## REAR CAMERA IMAGE SIGNAL CIRCUIT

### Diagnosis Procedure

INFOID:000000009129453

Regarding Wiring Diagram information, refer to [AV-683, "Wiring Diagram"](#).

### 1. CHECK REAR CAMERA IMAGE SIGNAL CIRCUIT CONTINUITY

1. Turn ignition switch OFF.
2. Disconnect around view monitor control unit connector M97 and rear camera connector D511.
3. Check continuity between around view monitor control unit connector M97 and rear camera connector D511.

Around view monitor control unit		Rear camera		Continuity
Connector	Terminals	Connector	Terminals	
M97	53	D511	5	Yes
	54		1	

4. Check continuity between around view monitor control unit connector M97 and ground.

Around view monitor control unit		Ground	Continuity
Connector	Terminals		
M97	53	—	No

Is inspection result normal?

YES >> GO TO 2.

NO >> Repair or replace harness or connectors.

### 2. CHECK REAR CAMERA IMAGE SIGNAL

1. Connect around view monitor control unit connector M97 and rear camera connector D511.
2. Turn ignition switch ON.
3. Check signal between around view monitor control unit connector M97 terminals.

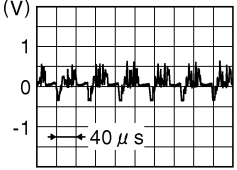
Around view monitor control unit		Condition	Reference value
(+)	(-)		
Terminal	Terminal		
53	54	CAMERA switch is ON or shift position is R.	

Is inspection result normal?

YES >> Replace around view monitor control unit. Refer to [AV-898, "Removal and Installation"](#).

NO >> Replace rear camera. Refer to [AV-900, "Removal and Installation"](#).

# SIDE CAMERA LH COMMUNICATION SIGNAL CIRCUIT

< DTC/CIRCUIT DIAGNOSIS >

[BOSE AUDIO W/NAVI W/SURROUND]

## SIDE CAMERA LH COMMUNICATION SIGNAL CIRCUIT

### Diagnosis Procedure

INFOID:000000009129454

Regarding Wiring Diagram information, refer to [AV-683. "Wiring Diagram"](#).

#### 1. CHECK COMMUNICATION SIGNAL CIRCUIT CONTINUITY

1. Turn ignition switch OFF.
2. Disconnect around view monitor control unit connector M97 and LH side camera connector D20.
3. Check continuity between around view monitor control unit connector M97 and LH side camera connector D20.

Around view monitor control unit		LH side camera		Continuity
Connector	Terminal	Connector	Terminal	
M97	55	D20	16	Yes

4. Check continuity between around view monitor control unit connector M97 and ground.

Around view monitor control unit		Ground	Continuity
Connector	Terminal		
M97	55	—	No

Is inspection result normal?

YES >> GO TO 2.

NO >> Repair or replace harness or connectors.

#### 2. CHECK COMMUNICATION SIGNAL

1. Connect around view monitor control unit connector M97 and LH side camera connector D20.
2. Turn ignition switch ON.
3. Check signal between around view monitor control unit connector M97 and ground.

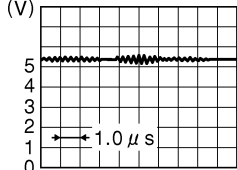
Around view monitor control unit		Ground	Condition	Reference value
(+)		(-)		
Connector	Terminal			
M97	55	—	CAMERA switch is ON or shift position is R.	 <p>(V)</p> <p>5 4 3 2 1 0</p> <p>1.0 μs</p> <p>JSNIA0836GB</p>

Is inspection result normal?

YES >> Replace around view monitor control unit. Refer to [AV-898. "Removal and Installation"](#).

NO >> Replace LH side camera. Refer to [AV-901. "Removal and Installation"](#).

# SIDE CAMERA LH IMAGE SIGNAL CIRCUIT

< DTC/CIRCUIT DIAGNOSIS >

[BOSE AUDIO W/NAVI W/SURROUND]

## SIDE CAMERA LH IMAGE SIGNAL CIRCUIT

### Diagnosis Procedure

INFOID:000000009129455

Regarding Wiring Diagram information, refer to [AV-683, "Wiring Diagram"](#).

### 1. CHECK LH SIDE CAMERA IMAGE SIGNAL CIRCUIT CONTINUITY

1. Turn ignition switch OFF.
2. Disconnect around view monitor control unit connector M97 and LH side camera connector D20.
3. Check continuity between around view monitor control unit connector M97 and LH side camera connector D20.

Around view monitor control unit		LH side camera		Continuity
Connector	Terminals	Connector	Terminals	
M97	59	D20	5	Yes
	60		17	

4. Check continuity between around view monitor control unit connector M97 and ground.

Around view monitor control unit		Ground	Continuity
Connector	Terminals		
M97	59	—	No

Is inspection result normal?

YES >> GO TO 2.

NO >> Repair or replace harness or connectors.

### 2. CHECK LH SIDE CAMERA IMAGE SIGNAL

1. Connect around view monitor control unit connector M97 and LH side camera connector D20.
2. Turn ignition switch ON.
3. Check signal between around view monitor control unit connector M97 terminals.

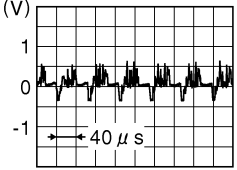
Around view monitor control unit		Condition	Reference value
(+)	(-)		
Terminal	Terminal		
59	60	CAMERA switch is ON or shift position is R.	 <p style="text-align: right; font-size: small;">JSNIA0834GB</p>

Is inspection result normal?

YES >> Replace around view monitor control unit. Refer to [AV-898, "Removal and Installation"](#).

NO >> Replace LH side camera. Refer to [AV-901, "Removal and Installation"](#).

# SIDE CAMERA RH COMMUNICATION SIGNAL CIRCUIT

< DTC/CIRCUIT DIAGNOSIS >

[BOSE AUDIO W/NAVI W/SURROUND]

## SIDE CAMERA RH COMMUNICATION SIGNAL CIRCUIT

### Diagnosis Procedure

INFOID:000000009129456

Regarding Wiring Diagram information, refer to [AV-683. "Wiring Diagram"](#).

#### 1. CHECK COMMUNICATION SIGNAL CIRCUIT CONTINUITY

1. Turn ignition switch OFF.
2. Disconnect around view monitor control unit connector M97 and RH side camera connector D113.
3. Check continuity between around view monitor control unit connector M97 and fRH side camera connector D113.

Around view monitor control unit		RH side camera		Continuity
Connector	Terminal	Connector	Terminal	
M97	61	D113	16	Yes

4. Check continuity between around view monitor control unit connector M97 and ground.

Around view monitor control unit		Ground	Continuity
Connector	Terminal		
M97	61	—	No

Is inspection result normal?

YES >> GO TO 2.

NO >> Repair or replace harness or connectors.

#### 2. CHECK COMMUNICATION SIGNAL

1. Connect around view monitor control unit connector M97 and RH side camera connector D113.
2. Turn ignition switch ON.
3. Check signal between around view monitor control unit connector M97 and ground.

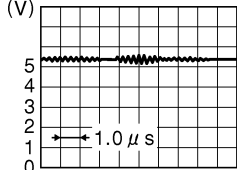
Around view monitor control unit		Ground	Condition	Reference value
(+)		(-)		
Connector	Terminal			
M97	61	—	CAMERA switch is ON or shift position is R.	 JSNIA0836GB

Is inspection result normal?

YES >> Replace around view monitor control unit. Refer to [AV-898. "Removal and Installation"](#).

NO >> Replace RH side camera. Refer to [AV-901. "Removal and Installation"](#).



# SIDE CAMERA RH IMAGE SIGNAL CIRCUIT

< DTC/CIRCUIT DIAGNOSIS >

[BOSE AUDIO W/NAVI W/SURROUND]

## SIDE CAMERA RH IMAGE SIGNAL CIRCUIT

### Diagnosis Procedure

INFOID:000000009129457

Regarding Wiring Diagram information, refer to [AV-683, "Wiring Diagram"](#).

### 1. CHECK RH SIDE CAMERA IMAGE SIGNAL CIRCUIT CONTINUITY

1. Turn ignition switch OFF.
2. Disconnect around view monitor control unit connector M97 and RH side camera connector D113.
3. Check continuity between around view monitor control unit connector M97 and fRH side camera connector D113.

Around view monitor control unit		RH side camera		Continuity
Connector	Terminals	Connector	Terminals	
M97	65	D113	5	Yes
	66		17	

4. Check continuity between around view monitor control unit connector M97 and ground.

Around view monitor control unit		Ground	Continuity
Connector	Terminals		
M97	65	—	No

Is inspection result normal?

YES >> GO TO 2.

NO >> Repair or replace harness or connectors.

### 2. CHECK RH SIDE CAMERA IMAGE SIGNAL

1. Connect around view monitor control unit connector M97 and RH side camera connector D113.
2. Turn ignition switch ON.
3. Check signal between around view monitor control unit connector M97 terminals.

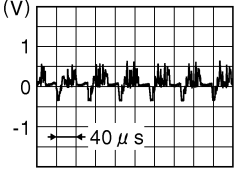
Around view monitor control unit		Condition	Reference value
(+)	(-)		
Terminal	Terminal		
65	66	CAMERA switch is ON or shift position is R.	 <p style="text-align: right;">JSNIA0834GB</p>

Is inspection result normal?

YES >> Replace around view monitor control unit. Refer to [AV-898, "Removal and Installation"](#).

NO >> Replace RH side camera. Refer to [AV-901, "Removal and Installation"](#).

# MULTI AV SYSTEM

< SYMPTOM DIAGNOSIS >

[BOSE AUDIO W/NAVI W/SURROUND]

## SYMPTOM DIAGNOSIS

### MULTI AV SYSTEM

#### Symptom Table

INFOID:000000009129458

#### RELATED TO AUDIO

Symptoms	Check items	Probable malfunction location
The disk cannot be removed.	AV control unit	Malfunction in AV control unit. Refer to <a href="#">AV-633, "On Board Diagnosis Function"</a> .

# MULTI AV SYSTEM

[BOSE AUDIO W/NAVI W/SURROUND]

< SYMPTOM DIAGNOSIS >

Symptoms	Check items	Probable malfunction location
<p>No sound comes out or the level of the sound is low.</p>	<p>No sound from all speakers.</p>	<ul style="list-style-type: none"> <li>• Speaker circuit shorted to ground. Refer to <a href="#">AV-683, "Wiring Diagram"</a>.</li> <li>• Bose amp. ON signal circuit malfunction. Refer to <a href="#">AV-788, "Diagnosis Procedure"</a>.</li> <li>• Bose speaker amp. power supply and ground circuits malfunction. Refer to <a href="#">AV-816, "BOSE AMP. : Diagnosis Procedure"</a>.</li> </ul>
	<p>Only a certain speaker (front door speaker LH, front door speaker RH, front tweeter LH, front tweeter RH, instrument panel tweeter LH, instrument panel tweeter RH, center speaker, rear door speaker LH, rear door speaker RH, rear door tweeter LH, rear door tweeter RH, rear side speaker LH, rear side speaker RH, subwoofer) does not output sound.</p>	<ul style="list-style-type: none"> <li>• Poor connector connection of speaker.</li> <li>• Sound signal circuit malfunction between AV control unit and Bose speaker amp. Refer to:                             <ul style="list-style-type: none"> <li>- <a href="#">AV-831, "Diagnosis Procedure"</a> (front door speaker).</li> <li>- <a href="#">AV-828, "Diagnosis Procedure"</a> (front tweeter).</li> <li>- <a href="#">AV-825, "Diagnosis Procedure"</a> (instrument panel tweeter).</li> <li>- <a href="#">AV-823, "Diagnosis Procedure"</a> (center speaker).</li> <li>- <a href="#">AV-837, "Diagnosis Procedure"</a> (rear door speaker).</li> <li>- <a href="#">AV-834, "Diagnosis Procedure"</a> (rear door tweeter).</li> <li>- <a href="#">AV-840, "Diagnosis Procedure"</a> (rear side speaker).</li> <li>- <a href="#">AV-843, "Diagnosis Procedure"</a> (subwoofer).</li> </ul> </li> <li>• Sound signal circuit malfunction between Bose speaker amp. and speaker. Refer to:                             <ul style="list-style-type: none"> <li>- <a href="#">AV-831, "Diagnosis Procedure"</a> (front door speaker).</li> <li>- <a href="#">AV-828, "Diagnosis Procedure"</a> (front tweeter).</li> <li>- <a href="#">AV-825, "Diagnosis Procedure"</a> (instrument panel tweeter).</li> <li>- <a href="#">AV-823, "Diagnosis Procedure"</a> (center speaker).</li> <li>- <a href="#">AV-837, "Diagnosis Procedure"</a> (rear door speaker).</li> <li>- <a href="#">AV-834, "Diagnosis Procedure"</a> (rear door tweeter).</li> <li>- <a href="#">AV-840, "Diagnosis Procedure"</a> (rear side speaker).</li> <li>- <a href="#">AV-843, "Diagnosis Procedure"</a> (subwoofer).</li> </ul> </li> <li>• Malfunction in speaker. Refer to:                             <ul style="list-style-type: none"> <li>- <a href="#">AV-888, "Removal and Installation"</a> (front door speaker).</li> <li>- <a href="#">AV-889, "Removal and Installation"</a> (front tweeter).</li> <li>- <a href="#">AV-890, "Removal and Installation"</a> (instrument panel tweeter).</li> <li>- <a href="#">AV-891, "Removal and Installation"</a> (center speaker).</li> <li>- <a href="#">AV-892, "Removal and Installation"</a> (rear door speaker).</li> <li>- <a href="#">AV-893, "Removal and Installation"</a> (rear door tweeter).</li> <li>- <a href="#">AV-894, "Removal and Installation"</a> (rear side speaker).</li> <li>- <a href="#">AV-895, "Removal and Installation"</a> (subwoofer).</li> </ul> </li> <li>• Malfunction in AV control unit. Refer to <a href="#">AV-633, "On Board Diagnosis Function"</a>.</li> <li>• Malfunction in Bose speaker amp. Replace Bose speaker amp. Refer to <a href="#">AV-887, "Removal and Installation"</a>.</li> </ul>

A  
B  
C  
D  
E  
F  
G  
H  
I  
J  
K  
L  
M  
AV  
O  
P

# MULTI AV SYSTEM

[BOSE AUDIO W/NAVI W/SURROUND]

< SYMPTOM DIAGNOSIS >

Symptoms	Check items	Probable malfunction location
	Noise comes out from all speakers.	<ul style="list-style-type: none"> <li>Malfunction in AV control unit. Refer to <a href="#">AV-633. "On Board Diagnosis Function"</a>.</li> <li>Malfunction in Bose speaker amp. Replace Bose speaker amp. Refer to <a href="#">AV-887. "Removal and Installation"</a>.</li> </ul>
Noise is mixed with audio.	Noise comes out only from a certain speaker (front door speaker LH, front door speaker RH, front tweeter LH, front tweeter RH, instrument panel tweeter LH, instrument panel tweeter RH, center speaker, rear door speaker LH, rear door speaker RH, rear door tweeter LH, rear door tweeter RH, rear side speaker LH, rear side speaker RH, subwoofer).	<ul style="list-style-type: none"> <li>Poor connector connection of speaker.</li> <li>Sound signal circuit malfunction between AV control unit and Bose speaker amp. Refer to:                             <ul style="list-style-type: none"> <li><a href="#">AV-831. "Diagnosis Procedure"</a> (front door speaker).</li> <li><a href="#">AV-828. "Diagnosis Procedure"</a> (front tweeter).</li> <li><a href="#">AV-825. "Diagnosis Procedure"</a> (instrument panel tweeter).</li> <li><a href="#">AV-823. "Diagnosis Procedure"</a> (center speaker).</li> <li><a href="#">AV-837. "Diagnosis Procedure"</a> (rear door speaker).</li> <li><a href="#">AV-834. "Diagnosis Procedure"</a> (rear door tweeter).</li> <li><a href="#">AV-840. "Diagnosis Procedure"</a> (rear side speaker).</li> <li><a href="#">AV-843. "Diagnosis Procedure"</a> (subwoofer).</li> </ul> </li> <li>Sound signal circuit malfunction between Bose speaker amp. and speaker. Refer to:                             <ul style="list-style-type: none"> <li><a href="#">AV-831. "Diagnosis Procedure"</a> (front door speaker).</li> <li><a href="#">AV-828. "Diagnosis Procedure"</a> (front tweeter).</li> <li><a href="#">AV-825. "Diagnosis Procedure"</a> (instrument panel tweeter).</li> <li><a href="#">AV-823. "Diagnosis Procedure"</a> (center speaker).</li> <li><a href="#">AV-837. "Diagnosis Procedure"</a> (rear door speaker).</li> <li><a href="#">AV-834. "Diagnosis Procedure"</a> (rear door tweeter).</li> <li><a href="#">AV-840. "Diagnosis Procedure"</a> (rear side speaker).</li> <li><a href="#">AV-843. "Diagnosis Procedure"</a> (subwoofer).</li> </ul> </li> <li>Malfunction in speaker.</li> <li>Poor Installation of speaker (e.g. backlash and looseness). Refer to:                             <ul style="list-style-type: none"> <li><a href="#">AV-888. "Removal and Installation"</a> (front door speaker).</li> <li><a href="#">AV-889. "Removal and Installation"</a> (front tweeter).</li> <li><a href="#">AV-890. "Removal and Installation"</a> (instrument panel tweeter).</li> <li><a href="#">AV-891. "Removal and Installation"</a> (center speaker).</li> <li><a href="#">AV-892. "Removal and Installation"</a> (rear door speaker).</li> <li><a href="#">AV-893. "Removal and Installation"</a> (rear door tweeter).</li> <li><a href="#">AV-894. "Removal and Installation"</a> (rear side speaker).</li> <li><a href="#">AV-895. "Removal and Installation"</a> (subwoofer).</li> </ul> </li> <li>Malfunction in AV control unit. Refer to <a href="#">AV-633. "On Board Diagnosis Function"</a>.</li> <li>Malfunction in Bose speaker amp. Replace Bose speaker amp. Refer to <a href="#">AV-887. "Removal and Installation"</a>.</li> </ul>
	Noise is mixed with radio only (when the vehicle hits a bump or while driving over bad roads)	<ul style="list-style-type: none"> <li>Poor connector connection of antenna or antenna feeder. Refer to <a href="#">AV-910. "Location of Antennas"</a>.</li> </ul>

# MULTI AV SYSTEM

[BOSE AUDIO W/NAVI W/SURROUND]

## < SYMPTOM DIAGNOSIS >

Symptoms	Check items	Probable malfunction location
No radio reception or poor reception.	<ul style="list-style-type: none"> <li>Other audio sounds are normal.</li> <li>Any radio station cannot be received or poor reception is caused even after moving to a service area with good reception (e.g. a place with clear view and no obstacles generating external noises).</li> </ul>	<ul style="list-style-type: none"> <li>Antenna amp. ON signal circuit malfunction. Refer to <a href="#">AV-787. "Diagnosis Procedure"</a>.</li> <li>Poor connector connection of antenna or antenna feeder. Refer to <a href="#">AV-910. "Location of Antennas"</a>.</li> </ul>
No satellite radio reception.	There is malfunction in the CONSULT self diagnosis result. Refer to <a href="#">AV-646. "CONSULT Function"</a> .	<ul style="list-style-type: none"> <li>Malfunction in antenna, antenna feeder or AV control unit. Perform DTC diagnosis. Refer to <a href="#">AV-646. "CONSULT Function"</a>.</li> <li>Poor continuity in antenna feeder.</li> <li>Poor connector connection of antenna or antenna feeder. Refer to <a href="#">AV-910. "Location of Antennas"</a>.</li> </ul>
	There is no malfunction in the CONSULT self diagnosis result. Refer to <a href="#">AV-646. "CONSULT Function"</a> .	<ul style="list-style-type: none"> <li>Poor continuity in antenna feeder.</li> <li>Poor connector connection of antenna or antenna feeder.</li> <li>Loose satellite radio antenna mounting nut. Refer to <a href="#">AV-910. "Location of Antennas"</a>.</li> </ul>
Buzz/rattle sound from speaker	The majority of buzz/rattle sounds are not indicative of an issue with the speaker, usually something nearby the speaker is causing the buzz/rattle.	Refer to "SQUEAK AND RATTLE TROUBLE DIAGNOSIS" in the appropriate interior trim section.

## RELATED TO HANDS-FREE PHONE

Symptoms	Check items	Probable malfunction location
Does not recognize cellular phone connection (no connection is displayed on the display at the guide).	Repeat the registration of cellular phone.	
Hands-free phone cannot be established.	<ul style="list-style-type: none"> <li>Hands-free phone operation can be made, but the communication cannot be established.</li> <li>Hands-free phone operation can be performed, however, voice between each other cannot be heard during the conversation.</li> </ul>	Malfunction in AV control unit. Replace AV control unit. Refer to <a href="#">AV-883. "Removal and Installation - AV Control Unit"</a> .
The other party's voice cannot be heard by hands-free phone.	Check the "microphone speaker" in Inspection & Adjustment Mode if sound is heard.	
Originating sound is not heard by the other party with hands-free phone communication.	Sound operation function is normal.	
	Sound operation function does not work.	Microphone signal circuit malfunction. Refer to <a href="#">AV-1046. "Diagnosis Procedure"</a> .
The system cannot be operated.	<ul style="list-style-type: none"> <li>The voice recognition can be controlled.</li> <li>Steering switch's  ,  , and  switch works, but  does not work.</li> </ul>	Steering switch malfunction. Replace steering switch. Refer to <a href="#">AV-885. "Removal and Installation"</a> .
	Steering switch's  ,  ,  , and  switches do not work.	Steering switch signal circuit malfunction. Refer to <a href="#">AV-855. "Diagnosis Procedure"</a> .
	All steering switches do not work.	Steering switch ground circuit malfunction. Refer to <a href="#">AV-855. "Diagnosis Procedure"</a> .

## RELATED TO NAVIGATION

# MULTI AV SYSTEM

< SYMPTOM DIAGNOSIS >

[BOSE AUDIO W/NAVI W/SURROUND]

Symptoms	Check items	Probable malfunction location
Navigation system is inoperative.	Navigation malfunction.	<ul style="list-style-type: none"> <li>Malfunction in hard disk drive (HDD).</li> <li>Malfunction in AV control unit.</li> </ul> Refer to <a href="#">AV-633, "On Board Diagnosis Function"</a> .
	Steering switches malfunction.	Steering switch signal circuit malfunction. Refer to <a href="#">AV-855, "Diagnosis Procedure"</a> .
	Voice activated control malfunction.	Microphone signal circuit malfunction. Refer to <a href="#">AV-1046, "Diagnosis Procedure"</a> . Steering switch signal circuit malfunction. Refer to <a href="#">AV-855, "Diagnosis Procedure"</a> .

## RELATED TO AROUND VIEW MONITOR

Symptoms	Check items	Probable malfunction location
Display does not switch to camera image when "CAMERA" switch is pressed or selector lever is in R (reverse).	Around view monitor control unit malfunction.	Around view monitor control unit power supply and ground circuits malfunction. Refer to <a href="#">AV-820, "AROUND VIEW MONITOR CONTROL UNIT : Diagnosis Procedure"</a> .
	AV communication circuits malfunction.	AV communication circuits malfunction between around view monitor control unit and AV control unit. Refer to <a href="#">AV-676, "Reference Value"</a> .
	Camera image signal circuit (output) malfunction.	Camera image signal circuit (output) malfunction between around view monitor control unit and display unit. Refer to <a href="#">AV-676, "Reference Value"</a> .
Display switches to camera image when "CAMERA" switch is pressed or selector lever is in R (reverse), but all views are not displayed.	Camera image signal circuit (input) malfunction.	Camera image signal circuit (input) malfunction between camera and around view monitor control unit. Refer to: <ul style="list-style-type: none"> <li><a href="#">AV-859, "Diagnosis Procedure"</a> (front camera).</li> <li><a href="#">AV-861, "Diagnosis Procedure"</a> (rear camera).</li> <li><a href="#">AV-863, "Diagnosis Procedure"</a> (side camera LH).</li> <li><a href="#">AV-865, "Diagnosis Procedure"</a> (side camera RH).</li> </ul>
	Camera communication signal circuits malfunction.	Camera communication circuits malfunction between camera and around view monitor control unit. Refer to: <ul style="list-style-type: none"> <li><a href="#">AV-858, "Diagnosis Procedure"</a> (front camera).</li> <li><a href="#">AV-860, "Diagnosis Procedure"</a> (rear camera).</li> <li><a href="#">AV-862, "Diagnosis Procedure"</a> (side camera LH).</li> <li><a href="#">AV-864, "Diagnosis Procedure"</a> (side camera RH).</li> </ul>
Camera image is rolling.	Camera image signal circuit (output) malfunction.	Camera image signal circuit (output) malfunction between around view monitor control unit and display unit. Refer to <a href="#">AV-676, "Reference Value"</a> .
Display does not switch to rear view monitor even when selector lever is in R (reverse).	Reverse signal circuit malfunction.	Reverse signal circuit between BCM and around view monitor control unit. Refer to <a href="#">AV-676, "Reference Value"</a> .
Predicted course line display in front view and rear view is malfunctioning.	Steering angle sensor malfunction.	Predicted course line center position is malfunctioning. Refer to <a href="#">AV-748, "PREDICTED COURSE LINE CENTER POSITION ADJUSTMENT : Work Procedure"</a> .

# MULTI AV SYSTEM

< SYMPTOM DIAGNOSIS >

[BOSE AUDIO W/NAVI W/SURROUND]

Symptoms	Check items	Probable malfunction location
Front view and front of birds-eye view is not displayed.	Front camera malfunction.	Front camera power supply and ground circuits malfunction. Refer to <a href="#">AV-791, "Diagnosis Procedure"</a> .
	Front camera image signal circuit malfunction.	Front camera image signal circuit malfunction between front camera and around view monitor control unit. Refer to <a href="#">AV-859, "Diagnosis Procedure"</a> .
	Front camera communication signal circuit malfunction.	Front camera communication signal circuit malfunction between front camera and around view monitor control unit. Refer to <a href="#">AV-858, "Diagnosis Procedure"</a> .
Rear view and rear of birds-eye view is not displayed.	Rear camera malfunction.	Rear camera power supply and ground circuits malfunction. Refer to <a href="#">AV-791, "Diagnosis Procedure"</a> .
	Rear camera image signal circuit malfunction.	Rear camera image signal circuit malfunction between rear camera and around view monitor control unit. Refer to <a href="#">AV-861, "Diagnosis Procedure"</a> .
	Rear camera communication signal circuit malfunction.	Rear camera communication signal circuit malfunction between rear camera and around view monitor control unit. Refer to <a href="#">AV-860, "Diagnosis Procedure"</a> .
Front-side and driver side of birds-eye view is not displayed.	Side camera LH malfunction.	Side camera LH power supply and ground circuits malfunction. Refer to <a href="#">AV-791, "Diagnosis Procedure"</a> .
	Side camera LH image signal circuit malfunction.	Side camera LH image signal circuit malfunction between side camera LH and around view monitor control unit. Refer to <a href="#">AV-863, "Diagnosis Procedure"</a> .
	Side camera LH communication signal circuit malfunction.	Side camera LH communication signal circuit malfunction between side camera LH and around view monitor control unit. Refer to <a href="#">AV-862, "Diagnosis Procedure"</a> .
Front-side and passenger side of birds-eye view is not displayed.	Side camera RH malfunction.	Side camera RH power supply and ground circuits malfunction. Refer to <a href="#">AV-791, "Diagnosis Procedure"</a> .
	Side camera RH image signal circuit malfunction.	Side camera RH image signal circuit malfunction between side camera RH and around view monitor control unit. Refer to <a href="#">AV-865, "Diagnosis Procedure"</a> .
	Side camera RH communication signal circuit malfunction.	Side camera RH communication signal circuit malfunction between side camera RH and around view monitor control unit. Refer to <a href="#">AV-864, "Diagnosis Procedure"</a> .
Selector lever is in a position other than R (reverse) and front, rear, front-side and Birds-Eye views are displayed even as vehicle speed increases.	Vehicle speed signal malfunction.	Vehicle speed signal malfunction between ABS actuator and electric unit (control unit) and around view monitor control unit. Refer to <a href="#">LAN-26, "Trouble Diagnosis Flow Chart"</a> .

RELATED TO CAMERA ASSISTANCE SONAR

A  
B  
C  
D  
E  
F  
G  
H  
I  
J  
K  
L  
M  
AV  
O  
P

# MULTI AV SYSTEM

< SYMPTOM DIAGNOSIS >

[BOSE AUDIO W/NAVI W/SURROUND]

Symptoms	Check items	Probable malfunction location
Malfunction is detected in only 1 indicator (Always displayed in red).	Sonar sensor circuit malfunction.	Sonar sensor circuit malfunction between sonar sensor and sonar control unit. Refer to: <ul style="list-style-type: none"> <li>• <a href="#">AV-813, "Diagnosis Procedure"</a> (front LH outer).</li> <li>• <a href="#">AV-814, "Diagnosis Procedure"</a> (front RH outer).</li> <li>• <a href="#">AV-807, "Diagnosis Procedure"</a> (rear LH inner).</li> <li>• <a href="#">AV-808, "Diagnosis Procedure"</a> (rear RH inner).</li> <li>• <a href="#">AV-806, "Diagnosis Procedure"</a> (rear LH outer).</li> <li>• <a href="#">AV-809, "Diagnosis Procedure"</a> (rear RH outer).</li> </ul>
	Sonar sensor malfunction.	Malfunction in sonar sensor. Refer to <a href="#">AV-907, "Removal and Installation"</a> .
Malfunction is detected in all 5 indicators (Always displayed in red).	Sonar control unit malfunction.	Sonar control unit power supply and ground circuits malfunction. Refer to <a href="#">AV-821, "SONAR CONTROL UNIT (WITH AROUND VIEW MONITOR) : Diagnosis Procedure"</a> .
	CAN communication malfunction.	CAN communication malfunction between sonar control unit and combination meter. Refer to <a href="#">LAN-26, "Trouble Diagnosis Flow Chart"</a> .

## RELATED TO REAR DISPLAY (HEADREST-MOUNTED)

Perform diagnosis of the power supply and ground circuits of the following items before starting diagnosis by symptom:

- Video distributor. Refer to [AV-819, "VIDEO DISTRIBUTOR : Diagnosis Procedure"](#).
- Headrest display unit. Refer to [AV-820, "HEADREST DISPLAY UNIT : Diagnosis Procedure"](#).

Symptom	Check item		Possible malfunction location/Action to take
Video is not shown on the headrest display unit screen.	Use the touch button in front display to switch video images on the headrest display unit.	Video is shown.	Operate with the remote to see if videos can be switched.
		Video is not shown.	Replace headrest display unit. Refer to <a href="#">AV-903, "Removal and Installation"</a> .
Headrest display unit inoperative with the remote.	All keys inoperative.	<ul style="list-style-type: none"> <li>• Check battery polarity.</li> <li>• Replace battery.</li> </ul>	<ul style="list-style-type: none"> <li>• Check with a remote from the same vehicle family.</li> <li>• Check infrared* of the luminescent part (LED) of the remote.</li> </ul>
	Some keys inoperative.	<ul style="list-style-type: none"> <li>• Check with a remote from the same vehicle family.</li> <li>• Check infrared* of the luminescent part (LED) of the remote.</li> </ul>	The function corresponding to the remote operation is not included (this is not a malfunction).
Headrest display unit screen is black.	Play a DVD.	Video is not shown.	Switch from AUX mode to DVD mode and check video.
		Screen is dark.	Adjust screen for image quality (this is not a malfunction).
		Screen is black.	Replace headrest display unit. Refer to <a href="#">AV-903, "Removal and Installation"</a> .
Video shown on headrest display unit screen becomes distorted or rolls up/down	Adjust the color settings using the display screen menu items.		If the symptom does not change, replace headrest display unit. Refer to <a href="#">AV-903, "Removal and Installation"</a> .
Headrest display unit screen is blue.	—		Replace headrest display unit. Refer to <a href="#">AV-903, "Removal and Installation"</a> .



# MULTI AV SYSTEM

[BOSE AUDIO W/NAVI W/SURROUND]

## < SYMPTOM DIAGNOSIS >

\*: To check infrared, check light of the luminescent part (LED) through the lens of digital camera when operating the remote.

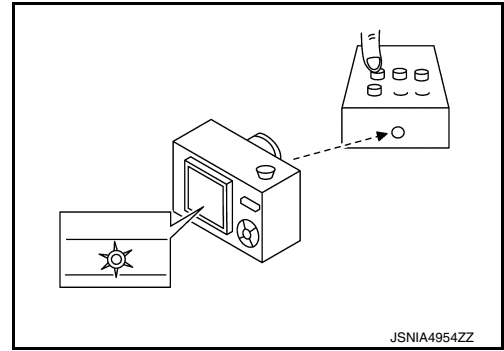

## RELATED TO HEADPHONES (HEADREST-MOUNTED)

Symptom	Check item	Possible malfunction location/Action to take
Audio cannot be heard from headphones.	<ul style="list-style-type: none"> <li>Turn ON the headrest display unit.</li> <li>Switch the slide switch on the left side of the headphones.</li> </ul>	Audio cannot be heard. Check power supply of headphones.
Headphones cannot be turned ON.	<ul style="list-style-type: none"> <li>Battery polarity.</li> <li>Battery poor contact.</li> <li>Battery replacement.</li> </ul>	Power is ON (power indicator lamp: ON). This is not a malfunction.
		Power cannot be turned ON (power indicator lamp: OFF). Replace headphones.

A  
B  
C  
D  
E  
F  
G  
H  
I  
J  
K  
L  
M

AV

O  
P

# NORMAL OPERATING CONDITION

< SYMPTOM DIAGNOSIS >

[BOSE AUDIO W/NAVI W/SURROUND]

## NORMAL OPERATING CONDITION

### Description

INFOID:000000009129459

#### RELATED TO NOISE

The majority of the audio concerns are the result of outside causes (bad CD, electromagnetic interference, etc.).

The following noise results from variations in field strength, such as fading noise and multi-path noise, or external noise from trains and other sources. It is not a malfunction.

- Fading noise: This noise occurs because of variations in the field strength in a narrow range due to mountains or buildings blocking the signal.
- Multi-path noise: This noise results from the waves sent directly from the broadcast station arriving at the antenna at a different time from the waves which reflect off mountains or buildings.

The vehicle itself can be a source of noise if noise prevention parts or electrical equipment is malfunctioning. Check if noise is caused and/or changed by engine speed, ignition switch turned to each position, and operation of each piece of electrical equipment, and determine the cause.

#### NOTE:

The source of the noise can be found easily by listening to the noise while removing the fuses of electrical components, one by one.

#### Type of Noise and Possible Cause

Occurrence condition		Possible cause
Occurs only when engine is ON.	A continuous growling noise occurs. The speed of the noise varies with changes in the engine speed.	<ul style="list-style-type: none"><li>• Ignition components</li></ul>
The occurrence of the noise is linked with the operation of the fuel pump.		<ul style="list-style-type: none"><li>• Fuel pump condenser</li></ul>
Noise only occurs when various electrical components are operating.	A cracking or snapping sound occurs with the operation of various switches.	<ul style="list-style-type: none"><li>• Relay malfunction, AV control unit malfunction</li></ul>
	The noise occurs when various motors are operating.	<ul style="list-style-type: none"><li>• Motor case ground</li><li>• Motor</li></ul>
The noise occurs constantly, not just under certain conditions.		<ul style="list-style-type: none"><li>• Rear defogger coil malfunction</li><li>• Open circuit in printed heater</li><li>• Poor ground of antenna feeder line</li></ul>
A cracking or snapping sound occurs while the vehicle is being driven, especially when it is vibrating excessively.		<ul style="list-style-type: none"><li>• Ground wire of body parts</li><li>• Ground due to improper part installation</li><li>• Wiring connections or a short circuit</li></ul>

#### RELATED TO HANDS-FREE PHONE

Symptom	Cause and Counter measure
Does not recognize cellular phone connection (No connection is displayed on the display at the guide).	Some Bluetooth <sup>®</sup> enabled cellular phones may not be recognized by the in-vehicle phone module. Refer to "RELATED TO HANDS-FREE PHONE (Check Compatibility)" in <a href="#">AV-866, "Symptom Table"</a> .
Cannot use hands-free phone.	Customer will not be able to use a hands-free phone under the following conditions: <ul style="list-style-type: none"><li>• The vehicle is outside of the telephone service area.</li><li>• The vehicle is in an area where it is difficult to receive radio waves; such as in a tunnel, in an underground parking garage, near a tall building or in a mountainous area.</li><li>• The cellular phone is locked to prevent it from being dialed.</li></ul> <b>NOTE:</b> While a cellular phone is connected through the Bluetooth <sup>®</sup> wireless connection, the battery power of the cellular phone may discharge quicker than usual. The Bluetooth <sup>®</sup> Hands-Free Phone System cannot charge cellular phones.

# NORMAL OPERATING CONDITION

< SYMPTOM DIAGNOSIS >

[BOSE AUDIO W/NAVI W/SURROUND]

Symptom	Cause and Counter measure
The other party's voice cannot be heard by hands-free phone.	When the radio wave condition is not ideal or ambient sound is too loud, it may be difficult to hear the other person's voice during a call.
Poor sound quality.	Do not place the cellular phone in an area surrounded by metal or far away from the in-vehicle phone module to prevent tone quality degradation and wireless connection disruption.

## RELATED TO NAVIGATION

### Basic Operation

Symptom	Cause	Remedy
No image is shown.	Display brightness adjustment is set fully to DARK side.	Adjust the display brightness.
No guide sound is heard. Audio guide volume is too low or too high.	Volume control is set to OFF, MIN or MAX.	Adjust the audio guide volume.
	Audio guidance is not available while the vehicle is driving on a dark pink route.	System is not malfunctioning.
Screen is too dark. Motion of the image is too slow.	Temperature inside the vehicle is low.	Wait until the temperature inside the vehicle reaches the proper temperature.
Small black or bright spots appear on the screen.	Symptom peculiar to a liquid crystal display (display unit).	System is not malfunctioning.

### Vehicle Mark

Symptom	Cause	Remedy
Map screen and BIRDVIEW™ Name of the place vary with the screen.	Some thinning of the character data is done to prevent the display becoming to complex. In some cases and in some locations, the display contents may differ. The same place name, street name, etc. may not be displayed every time on account of the data processing.	System is not malfunctioning.
Vehicle mark is not positioned correctly.	Vehicle is transferred by ferry or by towing after its ignition switch is turned to OFF.	Drive the vehicle for a while in the GPS satellite signal receiving condition.
Screen will not switch to nighttime mode after the lighting switch is turned ON.	The daytime screen is selected by the "SWITCH SCREENS" when the last time the screen dimming setting is done. Switching between daytime/nighttime screen may be inhibited by the automatic illumination adjustment function.	Perform screen dimming and select the nighttime screen by "SWITCH SCREENS".
Map screen will not scroll in accordance with the vehicle travel.	Current location is not displayed.	Press "MAP" button to display the current location.
Vehicle mark will not be shown.	Current location is not displayed.	Press "MAP" button to display the current location.
Accuracy indicator (GPS satellite mark) on the map screen stays gray.	GPS satellite signal is intercepted because the vehicle is in or behind a building.	Move the vehicle out to an open space.
	GPS satellite signal cannot be received because an obstacle is placed on top of the instrument panel.	Do not place anything on top of the meter display (instrument panel).
	GPS satellites are not visible from current location.	Wait until GPS satellites are visible by moving the vehicle.

## NORMAL OPERATING CONDITION

< SYMPTOM DIAGNOSIS >

[BOSE AUDIO W/NAVI W/SURROUND]

Symptom	Cause	Remedy
Vehicle location accuracy is low.	Accuracy indicator (GPS satellite mark) on the map screen stays gray.	Current location is not determined.
	Vehicle speed setting by the vehicle speed pulse has been deviated (advanced or retarded) from the actual vehicle speed because tire chain is fitted or the system has been used on another vehicle.	Drive the vehicle for a while [for approx. 30 minutes at approx. 30 km/h (19 MPH)] and the deviation will be automatically adjusted. If advancement or retard still occur, perform the distance adjustment by CONFIRMATION/ADJUSTMENT mode of diagnosis function.
	Map data has error or omission. (Vehicle mark is always deviated to the same position.)	As a rule, an updated map DVD-ROM will be released once a year.

### Destination, Passing Points and Menu Items Cannot be Selected/Set

Symptom	Cause	Remedy
Destination cannot be set.	Destination to be set is on an expressway.	Set the destination on an ordinary road.
Passing point is not searched when re-searching the route.	The vehicle has already passed the passing point, or the system judged so.	To include the passing points that have been passed into the route again, set the route again.
Route information will not be displayed.	Route searching has not been done.	Set the destination and perform route searching.
	Vehicle mark is not on the recommended route.	Drive on the recommended route.
	Route guide is turned OFF.	Turn route guide ON.
	Route information is not available on the dark pink route.	System is not malfunctioning.
After the route searching, no guide sign will appear as the vehicle goes near the entrance/exit to the toll road.	Vehicle mark is not on the recommended route. (On the display, only guide signs related to the recommended route will be shown.)	Drive on the recommended route.
Automatic route searching is not possible.	Vehicle is driving on a highway (gray route), or no recommended route is available.	Drive on a road to be searched. Or re-search the route manually. In this case, however, the whole route will be searched.
Performed automatic detour search (or detour search). However, the result is the same as that of the previous search.	Performed search with every conditions considered. However, the result is the same as that of the previous search.	System is not malfunctioning.
Passing points cannot be set.	More than five passing points were set.	Passing points can be set up to five. To stop at more than five points, perform sharing in several steps.
When setting the route, the starting point cannot be selected.	The current vehicle location is always set as the starting point of a route.	System is not malfunctioning.
Some menu items cannot be selected.	The vehicle is being driven.	Stop the vehicle at a safe place and then operate the system.

### Voice Guide

# NORMAL OPERATING CONDITION

< SYMPTOM DIAGNOSIS >

[BOSE AUDIO W/NAVI W/SURROUND]

Symptom	Cause	Remedy
Voice guide will not operate.	Note: Voice guide is only available at intersections that satisfy certain conditions (indicated by ● on the map). Therefore, guidance may not be given even when the route on the map changes direction.	System is not malfunctioning.
	The vehicle is not on the recommended route.	Return to the recommended route or re-search the route.
	Voice guide is turned OFF.	Turn voice guide ON.
	Route guide is turned OFF.	Turn route guide ON.
Voice guide does not match the actual road pattern.	Voice guide may vary with the direction to which the vehicle is turn and the connection of the road to other roads.	Drive in conformity to the actual traffic rules.

## Route Search

Symptom	Cause	Remedy
No route is shown.	No road to be searched is found around the destination.	Find wider road (orange road or wider) nearby and reset the destination and passing points onto it. Take care of the traveling direction when there are separate up and down roads.
	Starting point and the destination are too close.	Set the destination at more distant point.
	Conditional traffic regulation (day of the week/ time of the day) is set at the area around the current location or the destination.	Turn the time-regulating search conditions OFF. Turn "Avoid regulation time" in the search conditions OFF.
Indicated route is intermittent.	In some areas, highways (gray routes) are not used for the search <sup>(Note)</sup> Therefore, the route to the current location or the passing points may be intermittent.	System is not malfunctioning.
When the vehicle has passed the recommended route, it is deleted from the screen.	A recommended route is controlled by each section. When the vehicle has passed the passing point 1, then the map data from the starting point up to the passing point 1 will be deleted. (The data may remain undeleted in some area.)	System is not malfunctioning.
Detouring route is recommended.	In some areas, highways (gray routes) are not used for the search. (Note). Therefore, detour route may be recommended.	Set the route closer to the basic route (gray route).
	A detour route may be shown when some traffic regulation (one-way traffic, etc.) is set at the area around the starting point or the destination.	Slightly move the starting point or the destination, or set the passing point on the route of your choice.
	In the area where highways (gray routes) are used for the search, left turn has priority around the current location and the destination (passing points). For this reason, the recommended route may be detouring.	System is not malfunctioning.
Landmarks on the map do not match the actual ones.	This can be happen due to omission or error in the map data.	As a rule, an updated map DVD-ROM will be released once a year. Wait until the latest map has become available.
Recommended route is far from the starting point, passing points, and destination.	Starting point, passing points, and destination of the route guide were set far from the desired points because route searching data around these area were not stored.	Reset the destination onto the road nearby. If this road is one of the highways (gray routes), an ordinary road nearby may be displayed as the recommended route.

**NOTE:**

Except for the ordinance-designated cities. (Malfunctioning areas may be changed in the updated map disc.)

### Examples of Current-Location Mark Displacement

# NORMAL OPERATING CONDITION

< SYMPTOM DIAGNOSIS >

[BOSE AUDIO W/NAVI W/SURROUND]

Vehicle's travel amount is calculated by reading its travel distance and turning angle. Therefore, if the vehicle is driven in the following manner, an error will occur in the vehicle's current location display. If correct location has not been restored after driving the vehicle for a while, perform location correction.

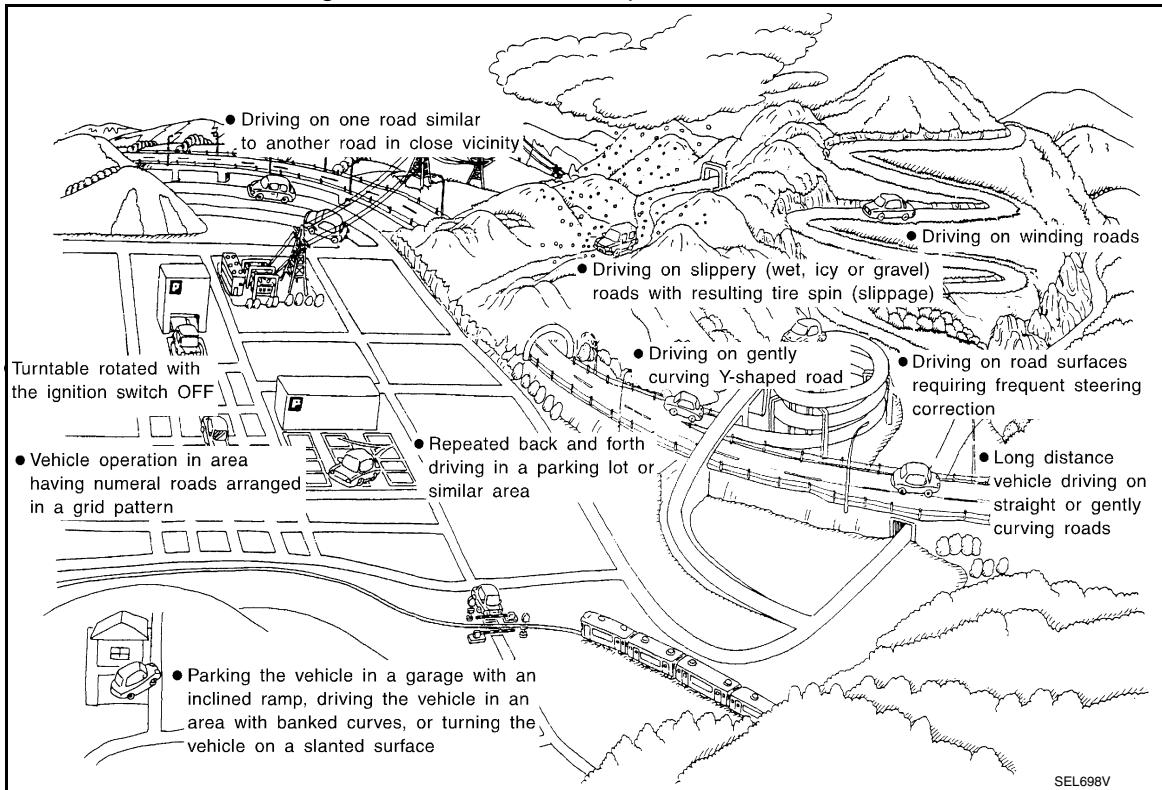

# NORMAL OPERATING CONDITION

< SYMPTOM DIAGNOSIS >

[BOSE AUDIO W/NAVI W/SURROUND]

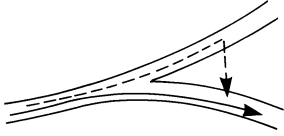
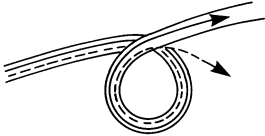
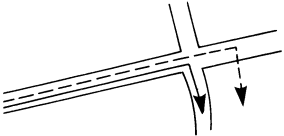
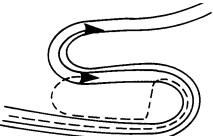
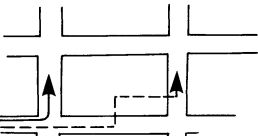
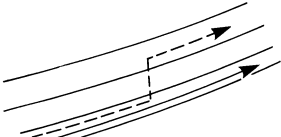
Cause (condition)    -: While driving    ooo: Display	Driving condition	Remarks (correction, etc.)
<p>Y-intersections</p>  <p style="text-align: center;">ELK0192D</p>	<p>At a Y intersection or similar gradual division of roads, an error in the direction of travel deduced by the sensor may result in the current-location mark appearing on the wrong road.</p>	
<p>Spiral roads</p>  <p style="text-align: center;">ELK0193D</p>	<p>When driving on a large, continuous spiral road (such as loop bridge), turning angle error is accumulated and the vehicle mark may deviate from the correct location.</p>	
<p>Straight roads</p>  <p style="text-align: center;">ELK0194D</p>	<p>When driving on a long, straight road and slow curve without stopping, map-matching does not work effectively enough and distance errors may accumulate. As a result, the vehicle mark may deviate from the correct location when the vehicle is turned at a corner.</p>	<p>If after travelling about 10 km (6 miles) the correct location has not been restored, perform location correction and, if necessary, direction correction.</p>
<p>Zigzag roads</p>  <p style="text-align: center;">ELK0195D</p>	<p>When driving on a zigzag road, the map may be matched to other roads in the similar direction nearby at every turn, and the vehicle mark may deviate from the correct location.</p>	
<p>Roads laid out in a grid pattern</p>  <p style="text-align: center;">ELK0196D</p>	<p>When driving where roads are laid out in a grid pattern, or where many roads are running in the similar direction nearby, the map may be matched to them by mistake and the vehicle mark may deviate from the correct location.</p>	
<p>Parallel roads</p>  <p style="text-align: center;">ELK0197D</p>	<p>When two roads are running in parallel (such as highway and sideway), the map may be matched to the other road by mistake and the vehicle mark may deviate from the correct location.</p>	

A  
B  
C  
D  
E  
F  
G  
H  
I  
J  
K  
L  
M  
AV  
O  
P

# NORMAL OPERATING CONDITION

< SYMPTOM DIAGNOSIS >

[BOSE AUDIO W/NAVI W/SURROUND]

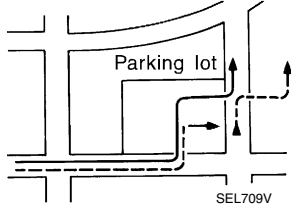
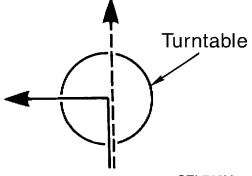
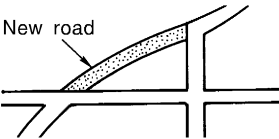
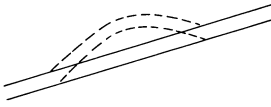
Cause (condition)    -: While driving    ooo: Display		Driving condition	Remarks (correction, etc.)
Place	In a parking lot  <small>SEL709V</small>	When driving in a parking lot, or other location where there are no roads on the map, matching may place the vehicle mark on a nearby road. When the vehicle returns to the road, the vehicle mark may have deviated from the correct location. When driving in circle or turning the steering wheel repeatedly, direction errors accumulate, and the vehicle mark may deviate from the correct location.	If after travelling about 10 km (6 miles) the correct location has not been restored, perform location correction and, if necessary, direction correction.
	Turntable  <small>SEL710V</small>	When the ignition switch is OFF, the navigation system cannot get the signal from the gyroscope (angular speed sensor). Therefore, the displayed direction may be wrong and the correct road may not be easily returned to after rotating the vehicle on a turntable with the ignition OFF.	
	Slippery roads	On snow, wet roads, gravel, or other roads where tires may slip easily, accumulated mileage errors may cause the vehicle mark to deviate from the correct road.	
	Slopes	When parking in sloped garages, when travelling on banked roads, or in other cases where the vehicle turns when tilted, an error in the turning angle will occur, and the vehicle mark may deviate from the road.	
Map data	Road not displayed on the map screen  <small>SEL699V</small>	When driving on new roads or other roads not displayed on the map screen, map matching does not function correctly and matches the location to a nearby road. When the vehicle returns to a road which is on the map, the vehicle mark may deviate from the correct road.	
	Different road pattern (Changed due to repair)  <small>ELK0201D</small>	If the road pattern stored in the map data and the actual road pattern are different, map matching does not function correctly and matches the location to a nearby road. The vehicle mark may deviate from the correct road.	
Vehicle	Use of tire chains	When tire chains are used, the mileage is not correctly detected, and the vehicle mark may deviate from the correct road.	Drive the vehicle for a while. If the distance still deviates, adjust it by using the distance adjustment function. (If the tire chain is removed, recover the original value.)



# NORMAL OPERATING CONDITION

< SYMPTOM DIAGNOSIS >

[BOSE AUDIO W/NAVI W/SURROUND]

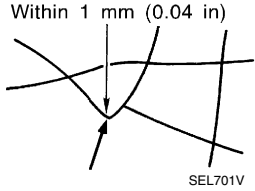
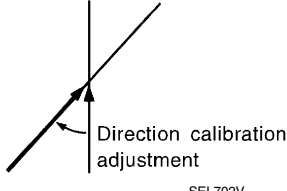
Cause (condition) –: While driving    ooo: Display	Driving condition	Remarks (correction, etc.)
Precautions for driving	Just after the engine is started	If the vehicle is driven just after the engine is started when the gyroscope (angular speed sensor) correction is not completed, the vehicle can lose its direction and may have deviated from the correct location.  Wait for a short while before driving after starting the engine.
	Continuous driving without stopping	When driving long distances without stopping, direction errors may accumulate, and the current-location mark may deviate from the correct road.  Stop and adjust the orientation.
	Abusive driving	Spinning the wheels or engaging in other kinds of abusive driving may result in the system being unable perform correct detection, and may cause the vehicle mark to deviate from the correct road.  If after travelling about 10 km (6 miles) the correct location has not been restored, perform location correction and, if necessary, direction correction.
How to correct location	Position correction accuracy 	If the accuracy of location settings is poor, accuracy may be reduced when the correct road cannot be found, particularly in places where there are many roads.  Enter in the road displayed on the screen with an accuracy of approx. 1mm. Caution: Whenever possible, use detailed map for the correction.
	Direction when location is corrected 	If the accuracy of location settings during correction is poor, accuracy may be reduced afterwards.  Perform direction correction.

### Location Correction by Map-Matching is Slow

- The map-matching function needs to refer to the data of the surrounding area. It is necessary to drive some distance for the function to work.
- Because map-matching operates on this principle, when there are many roads running in similar directions in the surrounding area, no matching determination may be made. The location may not be corrected until some special feature is found.

### Name of Road is Not Displayed

The current road name may not be displayed if there are no road names displayed on the map screen.

### Contents of Display Differ for Birdview™ and the (Flat) Map Screen

Difference of the BIRDVIEW™ screen from the flat map screen are as follows.

- The current place name displays names which are primarily in the direction of vehicle travel.
- The amount of time before the vehicle travel or turn angle is updated on the screen is longer than for the (flat) map display.
- The conditions for display of place names, roads, and other data are different for nearby areas and for more distant areas.
- Some thinning of the character data is done to prevent the display becoming too complex. In some cases and in some locations, the display contents may differ.
- The same place name, street name, etc. may be displayed multiple times.

### Vehicle Mark Shows a Position Which is Completely Wrong

In the following cases, the vehicle mark may appear on completely different position in the map depending on the GPS satellite signal receiving conditions. In this case, perform location correction and direction correction.

- When location correction has not been done
- If the receiving conditions of the GPS satellite signal is poor, if the vehicle mark becomes out of place, it may move to a completely different location and not come back if location correction is not done. The position will be corrected if the GPS signal can be received.
- When the vehicle has traveled by ferry, or when the vehicle has been being towed

## NORMAL OPERATING CONDITION

< SYMPTOM DIAGNOSIS >

[BOSE AUDIO W/NAVI W/SURROUND]

- Because calculation of the current location cannot be done when traveling with the ignition off, for example when traveling by ferry or when being towed, the location before travel is displayed. If the precise location can be detected with GPS, the location will be corrected.

### Vehicle Mark Jumps

In the following cases, the vehicle mark may appear to jump as a result of automatic correction of the current location.

- When map matching has been done
- If the current location and the vehicle mark are different when map matching is done, the vehicle mark may seem to jump. At this time, the location may be “corrected” to the wrong road or to a location which is not on a road.
- When GPS location correction has been done
- If the current location and the vehicle mark are different when the location is corrected using GPS measurements, the vehicle mark may seem to jump. At this time, the location may be “corrected” to a location which is not on a road.

### Vehicle Mark is in a River or Sea

The navigation system moves the vehicle mark with no distinction between land and rivers or sea. If the vehicle mark is somehow out of place, it may appear that the vehicle is driving in a river or the sea.

### Vehicle Mark Automatically Rotates

The system wrongly memorizes the rotating status as stopping when the ignition switch is turned ON with the turntable rotating. That causes the vehicle mark to rotate when the vehicle is stopped.

### When Driving on Same Road, Sometimes Vehicle Mark is in Right Place and Sometimes it is in Wrong Place

The conditions of the GPS antenna (GPS data) and gyroscope (angular speed sensor) change gradually. Depending on the road traveled and the operation of the steering wheel, the location detection results will be different. Therefore, even on a road on which the location has never been wrong, conditions may cause the vehicle mark to deviate.

## RELATED TO SONAR

Symptom	Possible cause
Unstable object detection	<ul style="list-style-type: none"><li>• The vehicle is on a rough surface, such as stone or gravel.</li><li>• When used in poor weather conditions, such as heavy snow/rain strong wind.</li><li>• When subjected to an ultrasonic noise generated from exhaust muffler or brakes.</li><li>• When left standing in the hot sun or in a cold climate.</li><li>• When the surface of the sensor is frozen or covered with snow/dirt/moisture.</li><li>• When a retrofitted xenon lamp, lighted license plate, or harness is close to the sensor body or sensor harness.</li><li>• When subjected to loop coil noises generated from a vehicle detector placed at an intersection or coin parking area.</li></ul>
Object undetectable	<ul style="list-style-type: none"><li>• Air-containing objects, such as cloth, cotton, glass wool, dust, and snow.</li><li>• Thin objects, such as rope, chain and wire.</li><li>• Smooth-faced objects placed in a slanting direction.</li><li>• Fast-moving small animals.</li><li>• A corner of an angular object.</li></ul> <p><b>NOTE:</b> If the sensor detection part is scratched, obstacles cannot be detected.</p>

# AV CONTROL UNIT

< REMOVAL AND INSTALLATION >

[BOSE AUDIO W/NAVI W/SURROUND]

## REMOVAL AND INSTALLATION

### AV CONTROL UNIT

Exploded View

INFOID:000000009763668

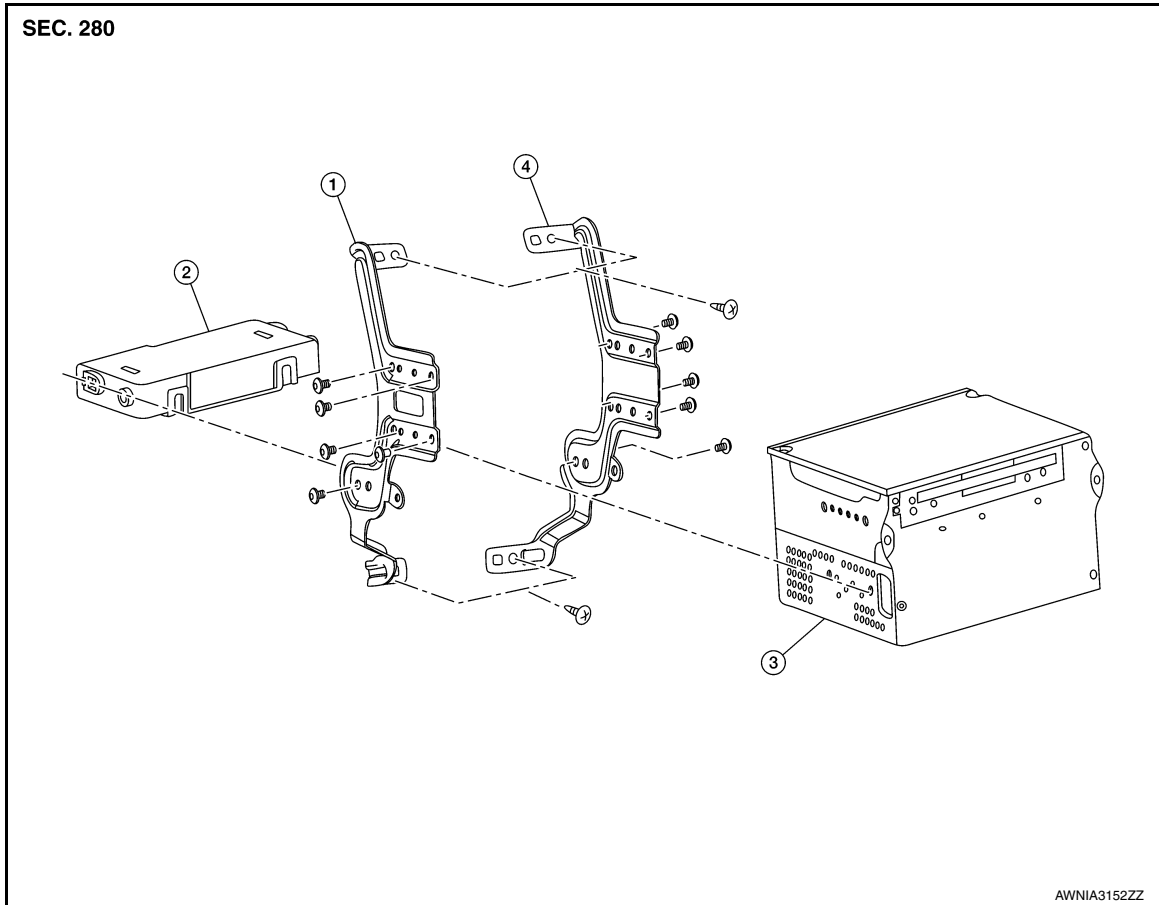

1. AV control unit bracket (LH)    2. A/C auto amp.    3. AV control unit  
4. AV control unit bracket (RH)

### Removal and Installation - AV Control Unit

INFOID:000000009763667

#### REMOVAL

##### CAUTION:

- Remove battery terminal and AV control unit after a lapse of 30 seconds or more after turning the ignition switch OFF.
- Before replacing AV control unit, perform "READ CONFIGURATION" to save current vehicle specification. Refer to [AV-742. "ADDITIONAL SERVICE WHEN REPLACING AV CONTROL UNIT : Description"](#).

##### NOTE:

After the ignition switch is turned OFF, the AV control unit continues operating for approximately 30 seconds. Therefore, data corruption may occur if battery voltage is cut off within 30 seconds.

1. Disconnect the negative battery terminal. Refer to [PG-93. "Removal and Installation"](#).
2. Remove cluster lid C upper. Refer to [IP-23. "CLUSTER LID C UPPER : Removal and Installation"](#).
3. Remove the screws, then pull out the AV control unit.
4. Disconnect the harness connectors from the AV control unit and remove.

#### INSTALLATION

Installation is in the reverse order of removal.

A  
B  
C  
D  
E  
F  
G  
H  
I  
J  
K  
L  
M  
O  
P

AV

## AV CONTROL UNIT

< REMOVAL AND INSTALLATION >

[BOSE AUDIO W/NAVI W/SURROUND]

---

### CAUTION:

- When replacing AV control unit, perform "WRITE CONFIGURATION". Refer to [AV-80, "CONFIGURATION \(AV CONTROL UNIT\) : Description"](#).

### Removal and Installation - A/C and AV Switch Assembly

INFOID:000000009763666

#### REMOVAL

1. Remove cluster lid C. Refer to [JP-22, "CLUSTER LID C : Removal and Installation"](#).
2. Remove the A/C and AV switch assembly lower screws.
3. Release upper pawls and remove A/C and AV switch assembly.

#### INSTALLATION

Installation is in the reverse order of removal.

# STEERING SWITCH

< REMOVAL AND INSTALLATION >

[BOSE AUDIO W/NAVI W/SURROUND]

## STEERING SWITCH

Exploded View

INFOID:000000009773693

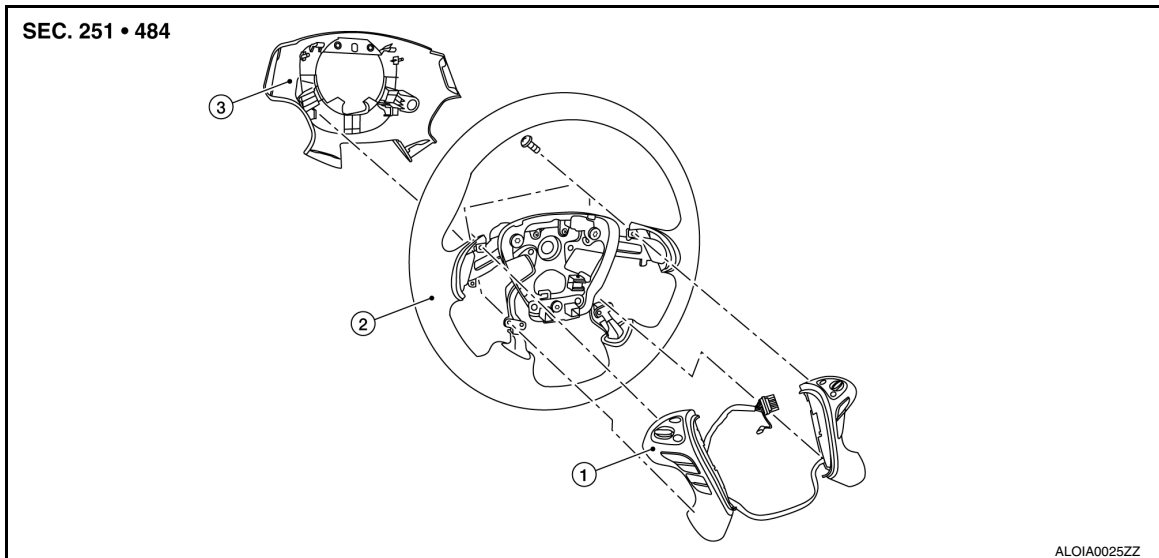

1. Steering switch

2. Steering wheel

3. Steering wheel rear finisher

## Removal and Installation

INFOID:000000009760573

### REMOVAL

#### NOTE:

The steering switch is serviced as an assembly.

1. Remove steering wheel. Refer to [ST-46. "Removal and Installation"](#).
2. Release pawls and remove steering wheel rear finisher (1) from steering wheel (2).

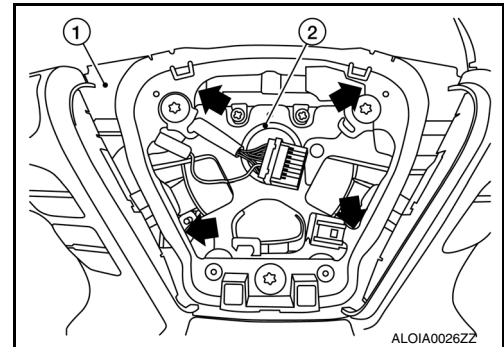

3. Remove steering switch screws.
4. Remove steering switch (1) from steering wheel (2).

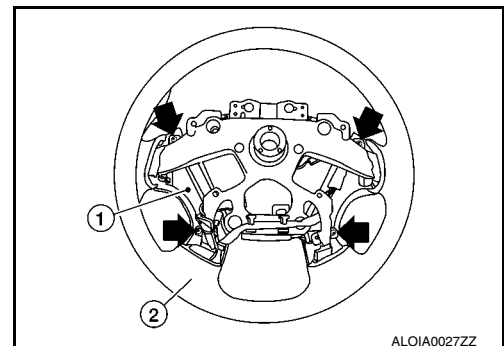

### INSTALLATION

Installation is in the reverse order of removal.

A  
B  
C  
D  
E  
F  
G  
H  
I  
J  
K  
L  
M  
AV  
O  
P

# DISPLAY UNIT

< REMOVAL AND INSTALLATION >

[BOSE AUDIO W/NAVI W/SURROUND]

## DISPLAY UNIT

### Exploded View

INFOID:000000009763670

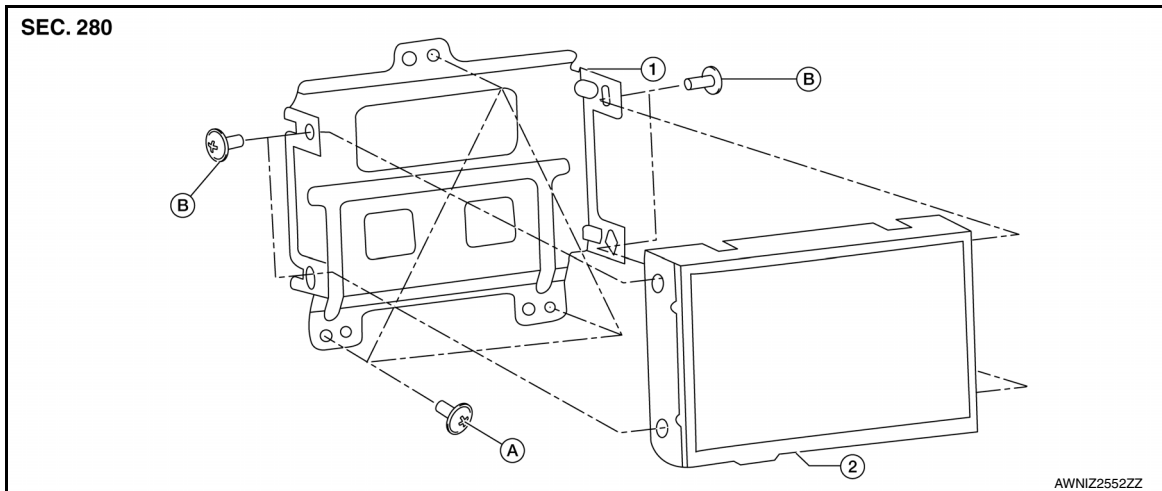

- 1. Display unit bracket
- 2. Display unit
- A. Display unit bracket screws
- B. Display unit screws

## Removal and Installation

INFOID:000000009763669

### REMOVAL

1. Remove cluster lid D. Refer to [IP-24, "Removal and Installation"](#).
2. Remove the display unit screws, and then pull out the display unit and bracket.
3. Disconnect harness connector from the display unit, then remove the display unit and bracket.
4. Remove the display unit brackets screws, then remove the display unit from the display unit bracket (if necessary).

### INSTALLATION

Installation is in the reverse order of removal.

# BOSE SPEAKER AMP

< REMOVAL AND INSTALLATION >

[BOSE AUDIO W/NAVI W/SURROUND]

## BOSE SPEAKER AMP

### Removal and Installation

INFOID:000000009760575

#### REMOVAL

1. Disconnect the negative battery terminal. Refer to [PG-93, "Exploded View"](#)
2. Remove third row seat. Refer to [SE-135, "Removal and Installation"](#).
3. Remove Bose speaker amp screws (A).
4. Disconnect the harness connectors (B) from the Bose speaker amp. (1) and remove.

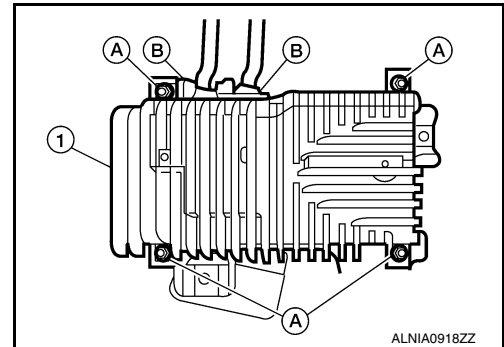

#### INSTALLATION

Installation is in the reverse order of removal.

A  
B  
C  
D  
E  
F  
G  
H  
I  
J  
K  
L  
M  
O  
P

AV

# FRONT DOOR SPEAKER

< REMOVAL AND INSTALLATION >

[BOSE AUDIO W/NAVI W/SURROUND]

## FRONT DOOR SPEAKER

### Exploded View

INFOID:000000009760577

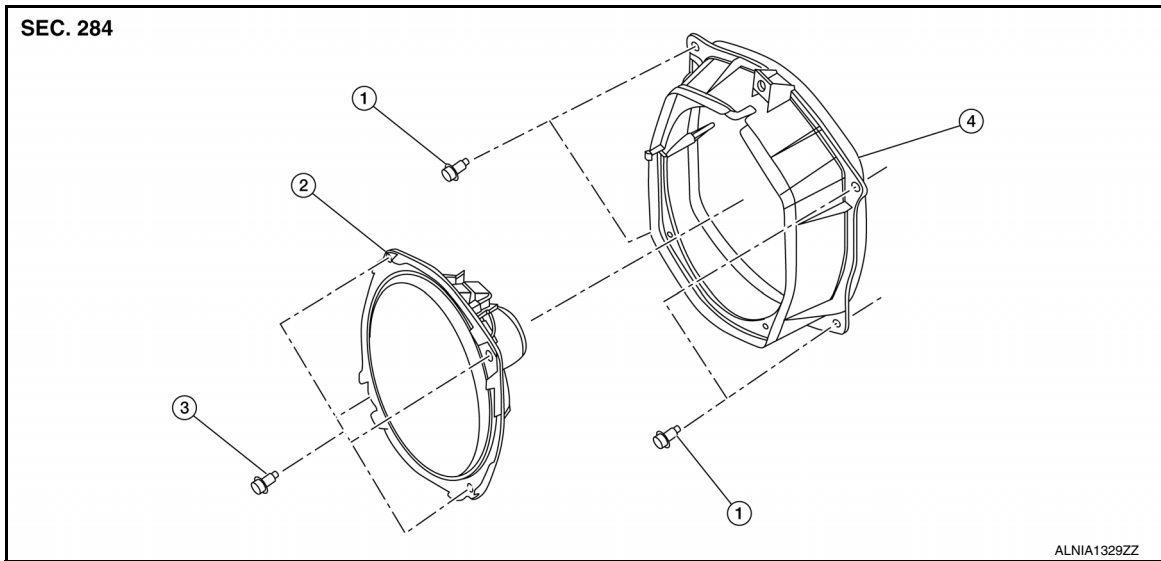

- 1. Speaker bracket bolt
- 2. Front door speaker
- 3. Speaker bolt
- 4. Speaker bracket

### Removal and Installation

INFOID:000000009760576

#### REMOVAL

1. Remove front door finisher. Refer to [INT-15. "Removal and Installation"](#).
2. Remove front door speaker bolts.
3. Disconnect harness connector from front door speaker, then remove front door speaker from speaker bracket.
4. Remove speaker bracket bolts (if necessary).
5. Remove speaker bracket from front door (if necessary).

#### INSTALLATION

Installation is in the reverse order of removal.



# FRONT TWEETER

< REMOVAL AND INSTALLATION >

[BOSE AUDIO W/NAVI W/SURROUND]

## FRONT TWEETER

### Removal and Installation

INFOID:000000009760579

#### REMOVAL

1. Remove front pillar finisher. Refer to [INT-19. "FRONT PILLAR FINISHER : Removal and Installation"](#)
2. Remove two front tweeter screws.
3. Remove front tweeter (2) from front pillar finisher (1).

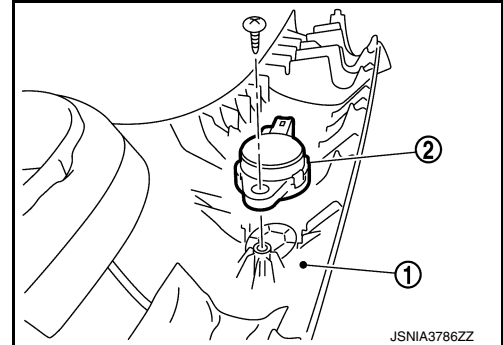

#### INSTALLATION

Installation is in the reverse order of removal.

A  
B  
C  
D  
E  
F  
G  
H  
I  
J  
K  
L  
M  
AV  
O  
P

## INSTRUMENT PANEL SPEAKER/TWEETER

< REMOVAL AND INSTALLATION >

[BOSE AUDIO W/NAVI W/SURROUND]

### INSTRUMENT PANEL SPEAKER/TWEETER

#### Removal and Installation

INFOID:000000009760578

#### REMOVAL

1. Remove instrument panel tweeter grille. Refer to [IP-14. "Exploded View"](#).
2. Remove the screws (A), then pull out the instrument panel tweeter (1).
3. Disconnect the harness connector from the instrument panel tweeter (1) and remove.

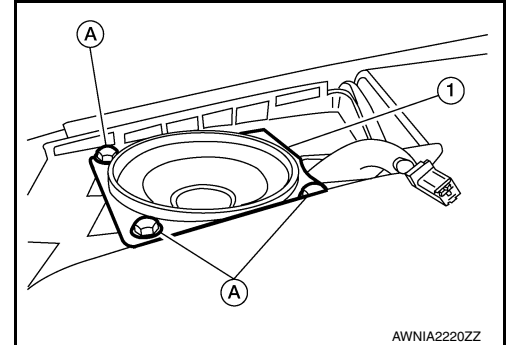

#### INSTALLATION

Installation is in the reverse order of removal.

# CENTER SPEAKER

< REMOVAL AND INSTALLATION >

[BOSE AUDIO W/NAVI W/SURROUND]

## CENTER SPEAKER

### Removal and Installation

INFOID:000000009760580

#### REMOVAL

1. Remove center speaker grille. Refer to [IP-14, "Exploded View"](#).
2. Remove the center speaker bolts (A).
3. Pull out the center speaker (1), disconnect harness connector, then remove center speaker.

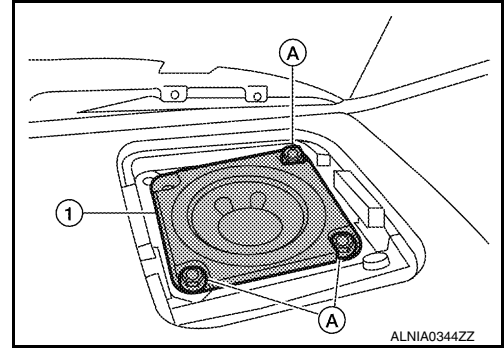

#### INSTALLATION

Installation is in the reverse order of removal.

A  
B  
C  
D  
E  
F  
G  
H  
I  
J  
K  
L  
M  
AV  
O  
P

## REAR DOOR SPEAKER

< REMOVAL AND INSTALLATION >

[BOSE AUDIO W/NAVI W/SURROUND]

### REAR DOOR SPEAKER

Exploded View

INFOID:000000009760582

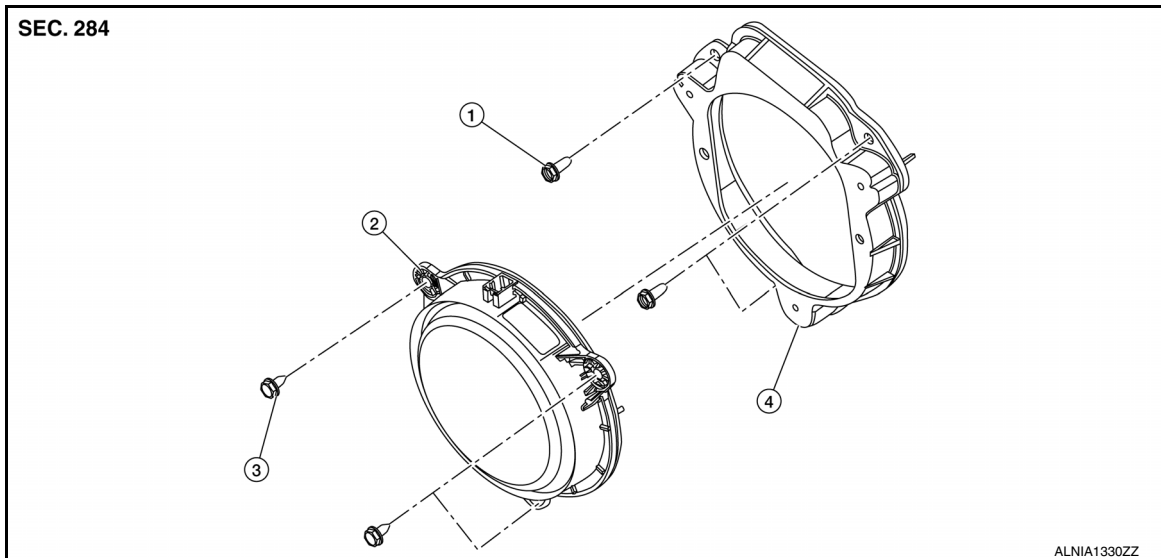

1. Speaker bracket bolt
2. Rear door speaker
3. Speaker bolt
4. Speaker bracket

### Removal and Installation

INFOID:000000009760581

#### REMOVAL

1. Remove rear door finisher. Refer to [INT-17, "Removal and Installation"](#).
2. Remove rear door speaker bolts.
3. Disconnect harness connector from the rear door speaker, then remove rear door speaker from speaker bracket.
4. Remove speaker bracket bolts (if necessary).
5. Remove rear door speaker bracket (if necessary).

#### INSTALLATION

Installation is in the reverse order of removal.

# REAR DOOR TWEETER

< REMOVAL AND INSTALLATION >

[BOSE AUDIO W/NAVI W/SURROUND]

## REAR DOOR TWEETER

### Removal and Installation

INFOID:000000009129475

#### REMOVAL

1. Remove rear door finisher. Refer to [INT-17. "Removal and Installation"](#).
2. Disconnect harness connector from the rear door tweeter.
3. Remove the rear door tweeter screws and rear door tweeter.

#### INSTALLATION

Installation is in the reverse order of removal.

A

B

C

D

E

F

G

H

I

J

K

L

M

AV

O

P

## REAR SPEAKERS

< REMOVAL AND INSTALLATION >

[BOSE AUDIO W/NAVI W/SURROUND]

### REAR SPEAKERS

#### Removal and Installation

INFOID:000000009760586

#### REMOVAL

1. Remove back pillar finisher. Refer to [INT-32. "BACK PILLAR FINISHER : Removal and Installation"](#).

**CAUTION:**

**Do not reuse back pillar finisher.**

2. Remove rear speaker bolts (A).
3. Remove bracket (2), then remove rear speaker (3).

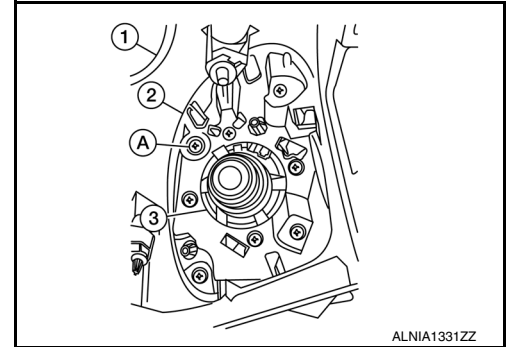

#### INSTALLATION

Installation is in the reverse order of removal.

# SUBWOOFER

< REMOVAL AND INSTALLATION >

[BOSE AUDIO W/NAVI W/SURROUND]

## SUBWOOFER

### Exploded View

INFOID:000000009760592

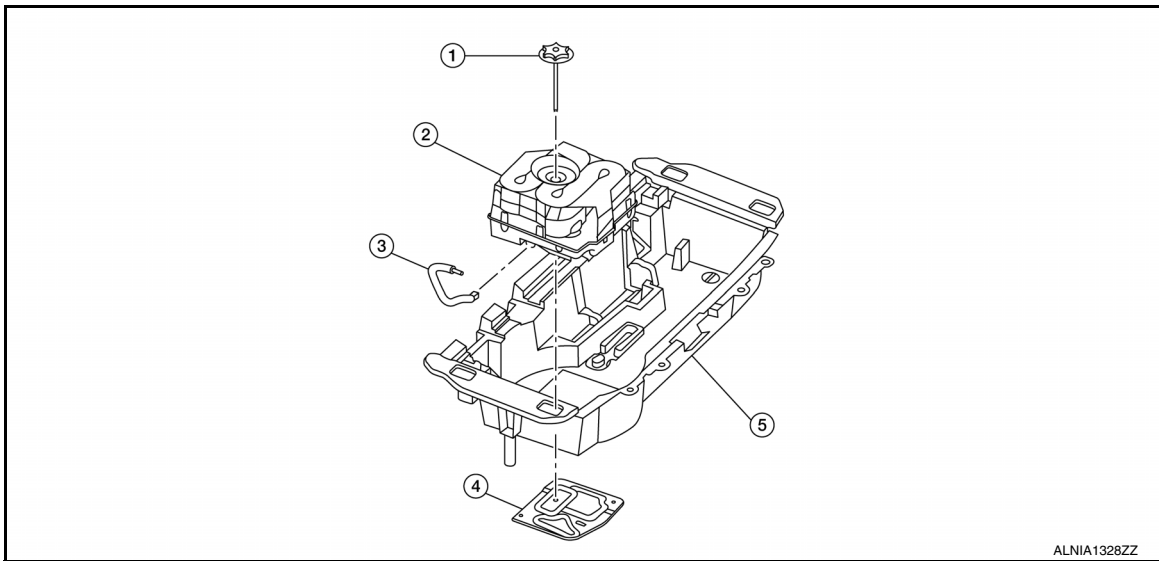

1. Spare tire clamp
4. Bracket

2. Subwoofer
5. Rear storage box

3. Harness

### Removal and Installation

INFOID:000000009760591

#### REMOVAL

1. Open the storage box lid.
2. Remove the spare tire clamp.
3. Lift subwoofer to disconnect harness connector, then remove subwoofer.

#### INSTALLATION

Installation is in the reverse order of removal.

A  
B  
C  
D  
E  
F  
G  
H  
I  
J  
K  
L  
M  
O  
P

AV

## USB INTERFACE

< REMOVAL AND INSTALLATION >

[BOSE AUDIO W/NAVI W/SURROUND]

---

### USB INTERFACE

#### Removal and Installation

INFOID:000000009760583

#### REMOVAL

1. Remove shift selector finisher. Refer to [JP-27, "Exploded View"](#).
2. Disconnect harness connector from the USB interface.
3. Release the pawl from the back of USB interface, then remove USB interface.

#### INSTALLATION

Installation is in the reverse order of removal.



# FRONT AUXILIARY INPUT JACKS

< REMOVAL AND INSTALLATION >

[BOSE AUDIO W/NAVI W/SURROUND]

## FRONT AUXILIARY INPUT JACKS

### Removal and Installation

INFOID:000000009760585

#### REMOVAL

1. Remove shift selector finisher. Refer to [IP-27. "Exploded View"](#).
2. Disconnect harness connector from the front auxiliary input jack.
3. Remove front auxiliary input jack screws and front auxiliary input jack.

#### INSTALLATION

Installation is in the reverse order of removal.

A

B

C

D

E

F

G

H

I

J

K

L

M

AV

O

P

# AROUND VIEW MONITOR CONTROL UNIT

< REMOVAL AND INSTALLATION >

[BOSE AUDIO W/NAVI W/SURROUND]

## AROUND VIEW MONITOR CONTROL UNIT

### Exploded View

INFOID:000000009760596

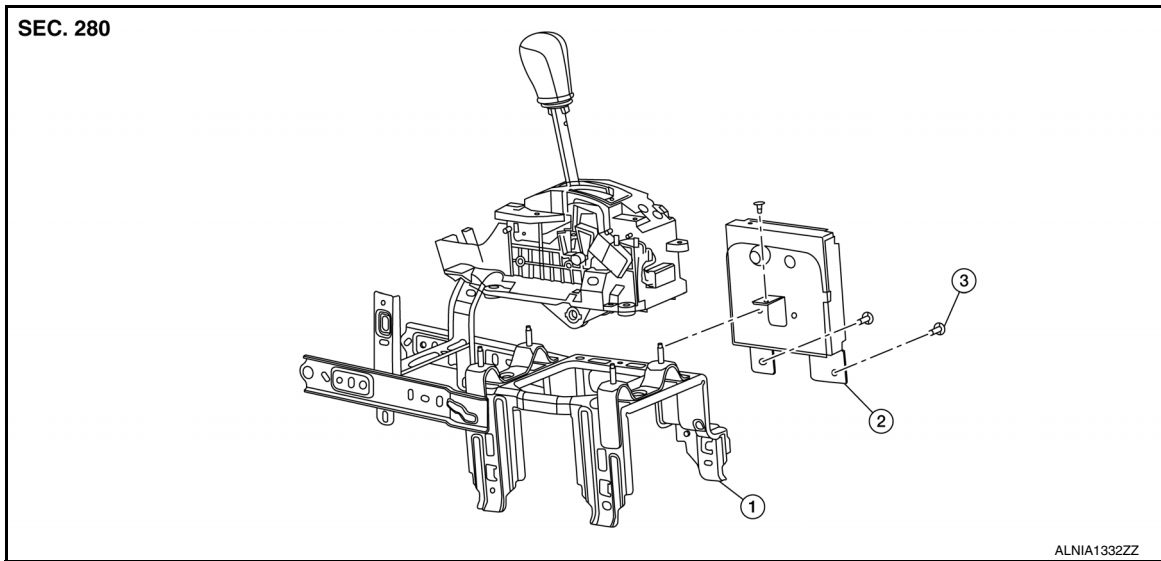

1. Bracket

2. Around view monitor control unit 3. Screw

### Removal and Installation

INFOID:000000009760595

#### REMOVAL

1. Remove center console assembly. Refer to [IP-18. "Removal and Installation"](#).
2. Remove the around view monitor control unit screws.
3. Disconnect harness connector from around view monitor control unit and remove.

#### INSTALLATION

Installation is in the reverse order of removal.

**NOTE:**

Perform camera image calibration. Refer to [AV-453. "CALIBRATING CAMERA IMAGE \(AROUND VIEW MONITOR\) : Work Procedure"](#).

# FRONT CAMERA

< REMOVAL AND INSTALLATION >

[BOSE AUDIO W/NAVI W/SURROUND]

## FRONT CAMERA

### Removal and Installation

INFOID:000000009760598

#### REMOVAL

1. Remove front grille. Refer to [EXT-23, "Removal and Installation"](#).
2. Remove front camera screws and front camera (2) from front emblem (1).

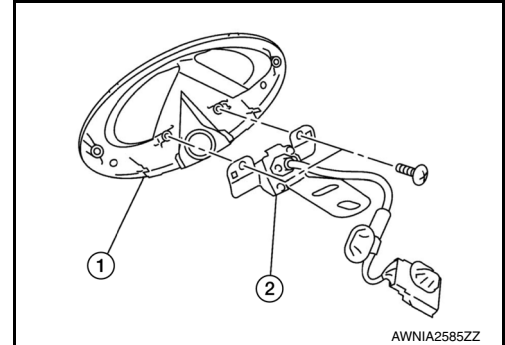

#### INSTALLATION

Installation is in the reverse order of removal.

**NOTE:**

Perform camera image calibration. Refer to [AV-453, "CALIBRATING CAMERA IMAGE \(AROUND VIEW MONITOR\) : Work Procedure"](#).

A  
B  
C  
D  
E  
F  
G  
H  
I  
J  
K  
L  
M  
O  
P

AV

## REAR VIEW CAMERA

< REMOVAL AND INSTALLATION >

[BOSE AUDIO W/NAVI W/SURROUND]

### REAR VIEW CAMERA

#### Removal and Installation

INFOID:000000009760584

#### REMOVAL

1. Remove back door outer upper finisher. Refer to [EXT-44. "Removal and Installation"](#).
2. Remove rear view camera screws (A), then remove rear view camera (1) from the back door outer upper finisher (2).

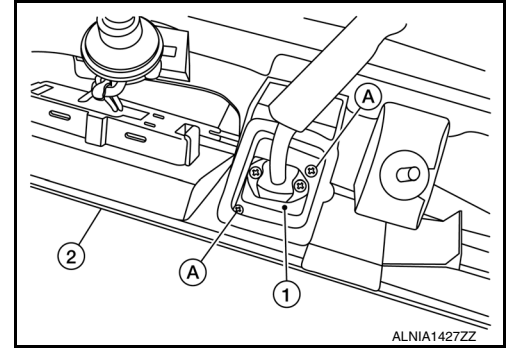

#### INSTALLATION

Installation is in the reverse order of removal.

# SIDE CAMERA

< REMOVAL AND INSTALLATION >

[BOSE AUDIO W/NAVI W/SURROUND]

## SIDE CAMERA

### Removal and Installation

INFOID:000000009760601

#### REMOVAL

1. Remove the door mirror assembly. Refer to [MIR-29, "Removal and Installation"](#).
2. Remove the door mirror rear finisher. Refer to [MIR-31, "Removal and Installation"](#).
3. Release the side camera finisher pawls using a suitable tool, disconnect the harness connector from the side camera, then remove the side camera finisher.

○: Pawl

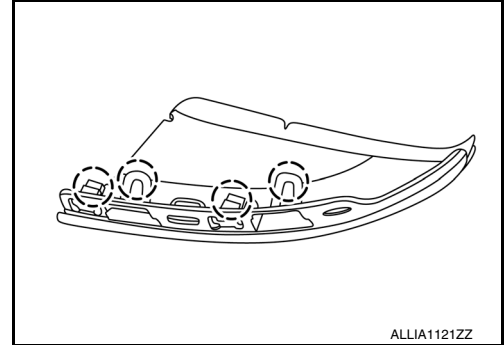

4. Remove the screws (1) and the side camera (2).

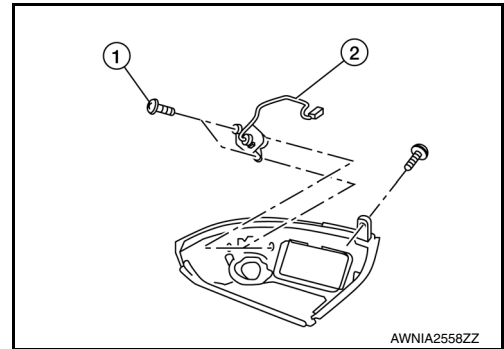

#### INSTALLATION

Installation is in the reverse order of removal.

A  
B  
C  
D  
E  
F  
G  
H  
I  
J  
K  
L  
M  
AV  
O  
P

# VIDEO DISTRIBUTOR

< REMOVAL AND INSTALLATION >

[BOSE AUDIO W/NAVI W/SURROUND]

## VIDEO DISTRIBUTOR

### Removal and Installation

INFOID:000000009760604

#### REMOVAL

1. Remove luggage side lower finisher. Refer to [INT-31, "LUGGAGE SIDE LOWER FINISHER : Removal and Installation"](#).
2. Disconnect video distributor harness connectors (A).
3. Remove video distributor nuts (2) and bolts (4).
4. Remove video distributor (3) and brackets (1) (5) from the vehicle as a single unit.
5. Remove screws (B) (C), then remove video distributor (3).

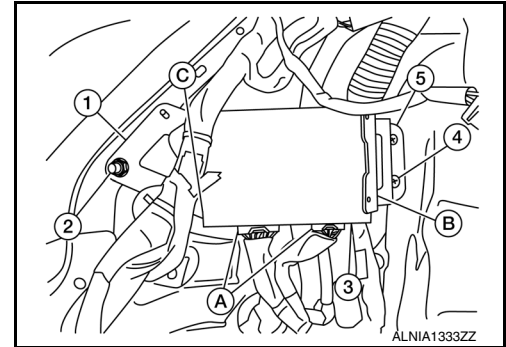

#### INSTALLATION

Installation is in the reverse order of removal.

# HEADREST DISPLAY UNIT

< REMOVAL AND INSTALLATION >

[BOSE AUDIO W/NAVI W/SURROUND]

## HEADREST DISPLAY UNIT

### Removal and Installation

INFOID:00000009760574

#### REMOVAL

##### CAUTION:

- Do not press panel surface of display (glass area).
- Do not press or pull out the movable part of display.

1. Remove the headrest trim retainer (A).

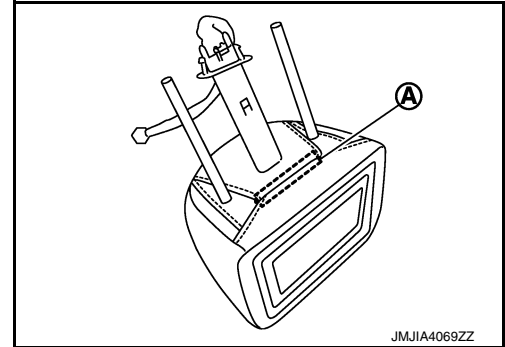

2. Remove the headrest display harness and upper tube screws (A), then remove headrest display unit bolts (B).

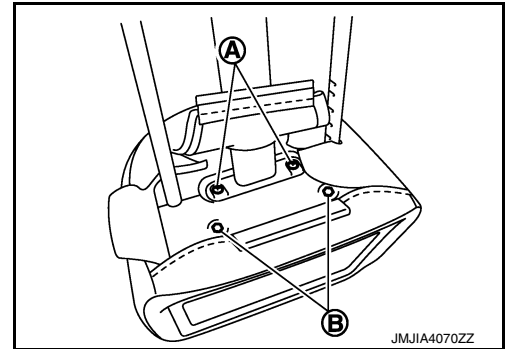

3. Remove the headrest display escutcheon and headrest display.

- a. Insert a suitable tool (A) between lower side of headrest display escutcheon (1) and headrest trim (2) and pull out lower side of escutcheon.

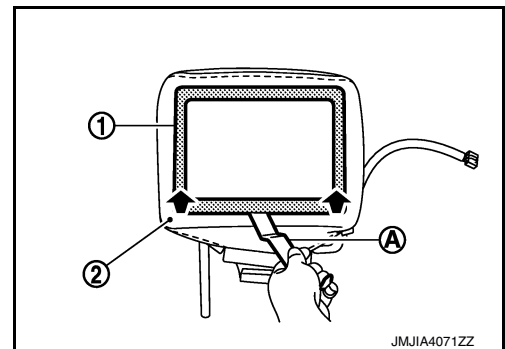

- b. Pull out headrest display escutcheon (1) to the position that pawl is visible and disengage pawl.

○: Pawl

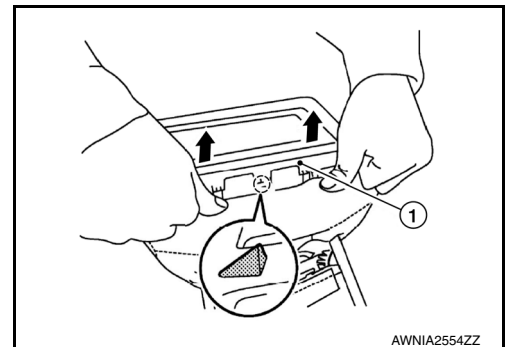

- c. Pull out lower side of headrest display escutcheon from headrest.

A

B

C

D

E

F

G

H

I

J

K

L

M

AV

O

P

## HEADREST DISPLAY UNIT

< REMOVAL AND INSTALLATION >

[BOSE AUDIO W/NAVI W/SURROUND]

### CAUTION:

Be careful not damage pawls on upper side headrest display escutcheon.

- d. Pull downward and remove headrest display escutcheon (1) and headrest display unit (2) by pulling them out and removing pins on upper side of display.

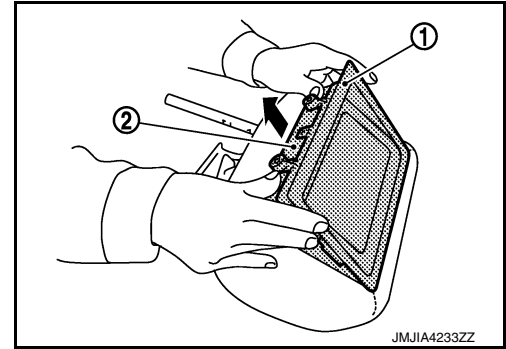

- e. Disconnect inner harness connector.  
f. Press headrest display escutcheon to the headrest display unit side. Disconnect pawls on upper side and remove headrest display escutcheon.  
4. Remove the headrest display harness upper tube from headrest trim.

### INSTALLATION

Installation is in the reverse order of removal.



## REAR AUXILIARY INPUT JACKS

< REMOVAL AND INSTALLATION >

[BOSE AUDIO W/NAVI W/SURROUND]

### REAR AUXILIARY INPUT JACKS

#### Removal and Installation

INFOID:000000009760605

#### REMOVAL

1. Remove rear center ventilator duct. Refer to [VTL-12. "REAR CENTER VENTILATOR DUCT : Removal and Installation"](#).
2. Remove rear auxiliary input jack screws and rear auxiliary input jack.

#### INSTALLATION

Installation is in the reverse order of removal.

A

B

C

D

E

F

G

H

I

J

K

L

M

AV

O

P

# SONAR CONTROL UNIT

< REMOVAL AND INSTALLATION >

[BOSE AUDIO W/NAVI W/SURROUND]

## SONAR CONTROL UNIT

### Removal and Installation

INFOID:000000009760606

#### REMOVAL

1. Remove instrument lower panel LH. Refer to [IP-25. "Removal and Installation"](#).
2. Remove sonar control unit bolt (2).
3. Disconnect harness connector from the sonar control unit, then remove sonar control unit (1).

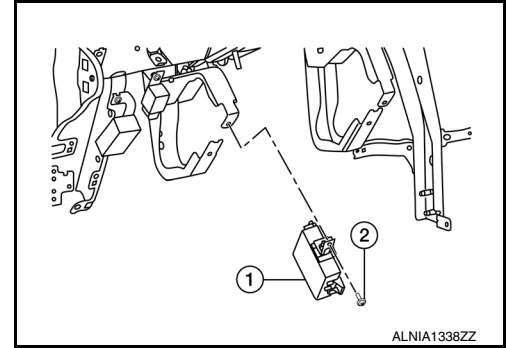

#### INSTALLATION

Installation is in the reverse order of removal.

# SONAR SENSOR

< REMOVAL AND INSTALLATION >

[BOSE AUDIO W/NAVI W/SURROUND]

## SONAR SENSOR

### Removal and Installation

INFOID:000000009129489

#### REAR SONAR SENSORS

##### Removal

1. Remove rear bumper fascia. Refer to [EXT-20, "Removal and Installation"](#).
2. Press sonar sensor spring (←).
3. Remove the sonar sensor (1) from rear bumper (2) as shown (↔).
4. Disconnect the harness connector from sonar sensor (1) and remove.

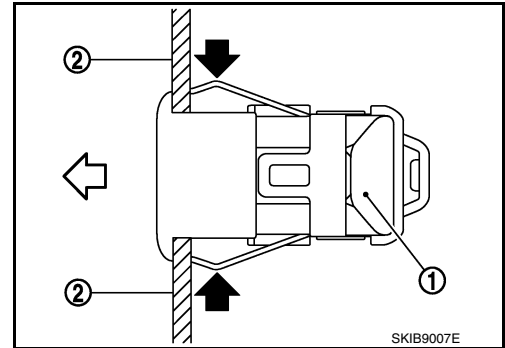

##### Installation

Installation is in the reverse order of removal.

##### CAUTION:

The connector direction is within  $\pm 10^\circ$  from the horizontal position when assembling the bumper.

(A) : Horizontal position

(a) :  $10^\circ$

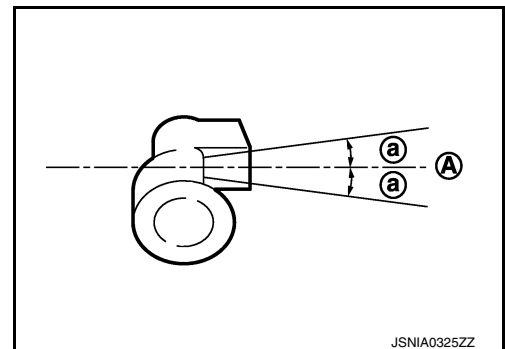

#### FRONT SONAR SENSORS

##### Removal

1. Remove front bumper fascia. Refer to [EXT-17, "Removal and Installation"](#).
2. Press sonar sensor spring (←).
3. Remove the sonar sensor (1) from front bumper (2) as shown (↔).
4. Disconnect harness connector from sonar sensor (1) and remove.

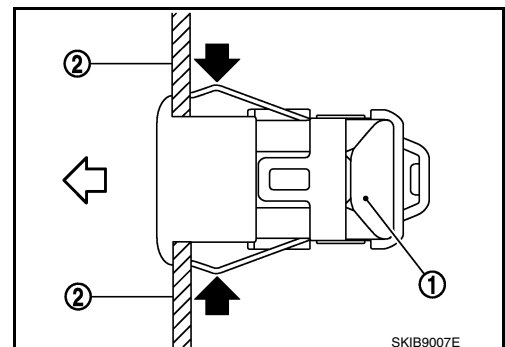

##### Installation

Installation is in the reverse order of removal.

##### CAUTION:

A  
B  
C  
D  
E  
F  
G  
H  
I  
J  
K  
L  
M  
AV  
O  
P

# SONAR SENSOR

< REMOVAL AND INSTALLATION >

[BOSE AUDIO W/NAVI W/SURROUND]

The connector direction is within  $\pm 10^\circ$  from the horizontal position when assembling the bumper.

- (A) : Horizontal position
- (a) :  $10^\circ$

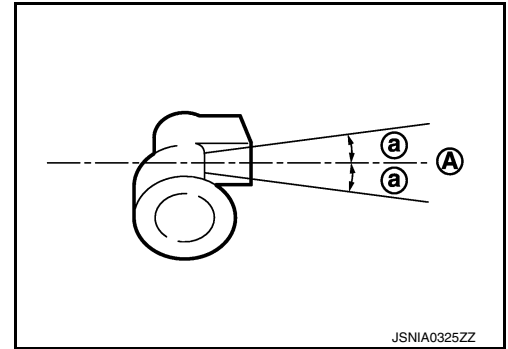

# BUZZER

< REMOVAL AND INSTALLATION >

[BOSE AUDIO W/NAVI W/SURROUND]

## BUZZER

### Removal and Installation

INFOID:000000009760616

#### REMOVAL

1. Remove luggage side lower finisher (RH). Refer to [INT-31. "LUGGAGE SIDE LOWER FINISHER : Removal and Installation"](#).
2. Disconnect harness connector (1) from the buzzer.
3. Remove buzzer screws (A), then remove buzzer (2).

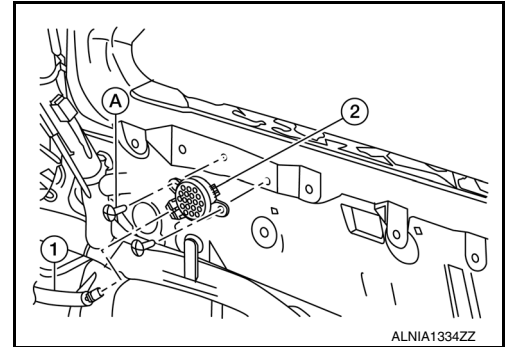

#### INSTALLATION

Installation is in the reverse order of removal.

A  
B  
C  
D  
E  
F  
G  
H  
I  
J  
K  
L  
M  
O  
P

AV

# AUDIO ANTENNA

< REMOVAL AND INSTALLATION >

[BOSE AUDIO W/NAVI W/SURROUND]

## AUDIO ANTENNA

### Location of Antennas

INFOID:000000009129491

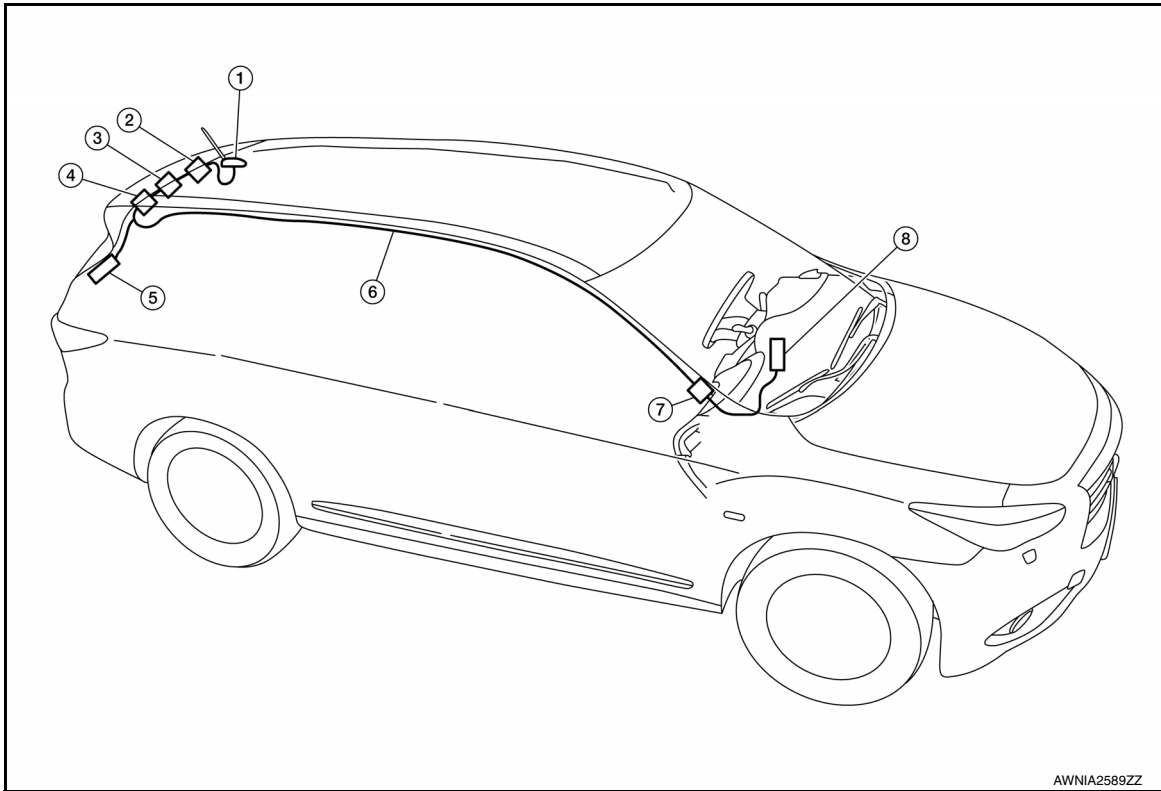

AWNIA2589ZZ

- |   |                               |                   |
|---|-------------------------------|-------------------|
| 1. Antenna base (satellite antenna and antenna amp) | 2. M502                       | 3. M501           |
| 4. M503, M504                                       | 5. M505                       | 6. Antenna Feeder |
| 7. M95, M138, M500, M509                            | 8. AV control unit M133, M143 |                   |

### Window Antenna Repair

INFOID:000000009129492

#### ELEMENT CHECK

1. Attach probe circuit tester (ohm setting) to antenna terminal on each side.

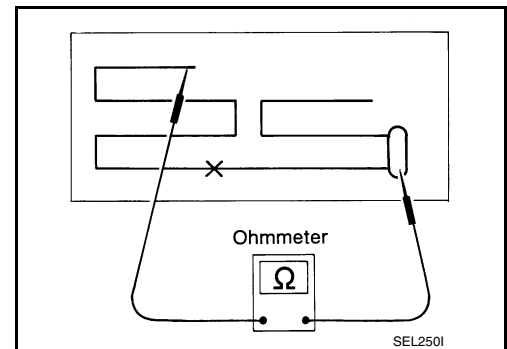

# AUDIO ANTENNA

< REMOVAL AND INSTALLATION >

[BOSE AUDIO W/NAVI W/SURROUND]

- When measuring continuity, wrap tin foil around the top of probe. Then, press the foil against the wire with your finger.

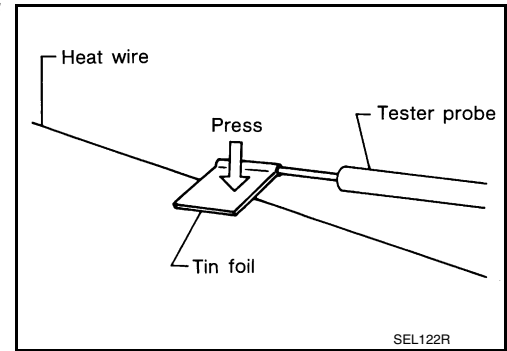

2. If an element is broken, no continuity will exist.

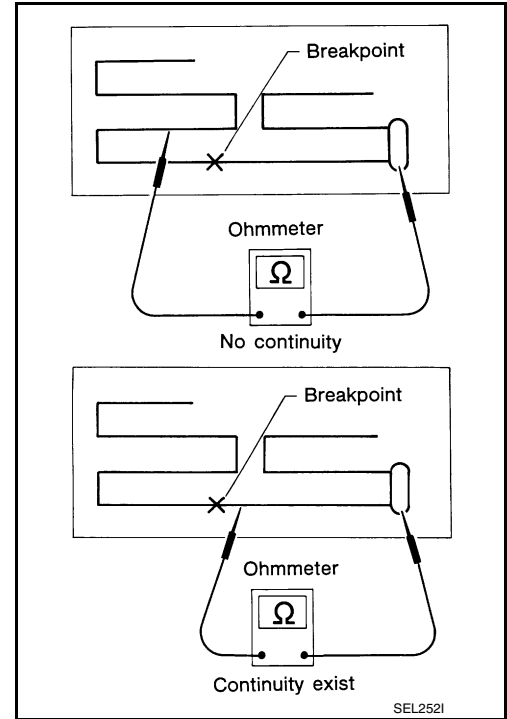

3. To locate a break, move probe along element. Tester indication will change abruptly when probe passes the broken point.

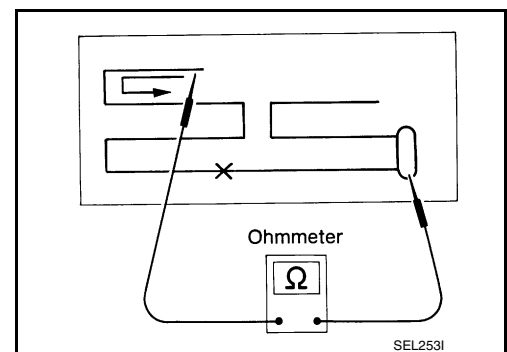

A  
B  
C  
D  
E  
F  
G  
H  
I  
J  
K  
L  
M  
AV  
O  
P

# GPS ANTENNA

< REMOVAL AND INSTALLATION >

[BOSE AUDIO W/NAVI W/SURROUND]

## GPS ANTENNA

### Removal and Installation

INFOID:000000009760619

#### REMOVAL

1. Remove combination meter. Refer to [MWI-95. "Removal and Installation"](#).
2. Disconnect harness connector from AV control unit.
3. Remove harness feeder clips.
4. Remove GPS antenna screw and GPS antenna (1).

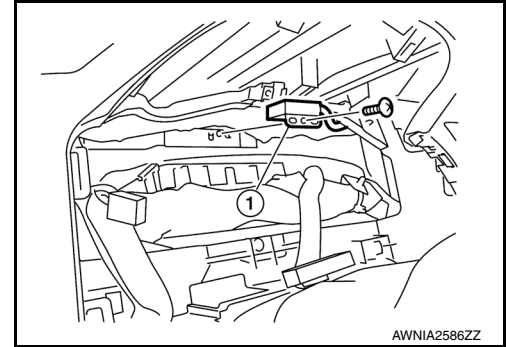

#### INSTALLATION

Installation is in the reverse order of removal.



# SATELLITE RADIO ANTENNA

< REMOVAL AND INSTALLATION >

[BOSE AUDIO W/NAVI W/SURROUND]

## SATELLITE RADIO ANTENNA

### Removal and Installation

INFOID:000000009760631

#### REMOVAL

1. Lower headlining (rear). Refer to [INT-27. "Removal and Installation"](#).
2. Disconnect harness connector from antenna feeder.
3. Remove nut from satellite radio antenna and remove.  
⇐: Front

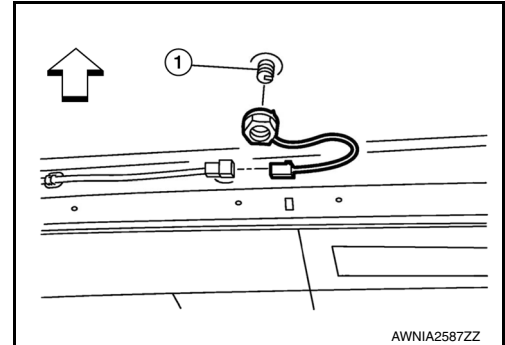

#### INSTALLATION

Installation is in the reverse order of removal.

#### CAUTION:

**If the satellite radio antenna nut is not tightened to the specified torque, lower sensitivity of the antenna may be experienced. If the nut is tightened tighter than the specified torque, this will deform the roof panel.**

#### Disassembly and Assembly

INFOID:000000009760630

#### DISASSEMBLY

Insert a suitable tool into gaps between satellite radio antenna (2) and the cover (1), then remove the cover (1) from satellite radio antenna (2).

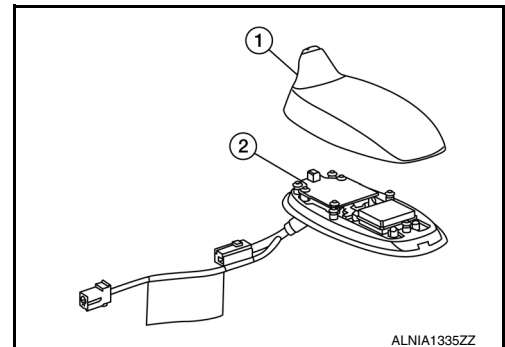

#### ASSEMBLY

Assembly is in the reverse order of disassembly.

A  
B  
C  
D  
E  
F  
G  
H  
I  
J  
K  
L  
M  
O  
P

AV

&lt; PRECAUTION &gt;

## PRECAUTION

### PRECAUTIONS

#### Precaution for Supplemental Restraint System (SRS) "AIR BAG" and "SEAT BELT PRE-TENSIONER"

INFOID:000000009129496

The Supplemental Restraint System such as "AIR BAG" and "SEAT BELT PRE-TENSIONER", used along with a front seat belt, helps to reduce the risk or severity of injury to the driver and front passenger for certain types of collision. This system includes dual stage front air bag modules. The SRS system may only deploy one front air bag, depending on the severity of a collision and whether the front passenger seat is occupied. Information necessary to service the system safely is included in the SR and SB section of this Service Manual.

**WARNING:**

- To avoid rendering the SRS inoperative, which could increase the risk of personal injury or death in the event of a collision which would result in air bag inflation, all maintenance must be performed by an authorized NISSAN/INFINITI dealer.
- Improper maintenance, including incorrect removal and installation of the SRS, can lead to personal injury caused by unintentional activation of the system. For removal of Spiral Cable and Air Bag Module, see the SR section.
- Do not use electrical test equipment on any circuit related to the SRS unless instructed to in this Service Manual. SRS wiring harnesses can be identified by yellow and/or orange harnesses or harness connectors.

#### PRECAUTIONS WHEN USING POWER TOOLS (AIR OR ELECTRIC) AND HAMMERS

**WARNING:**

- When working near the Airbag Diagnosis Sensor Unit or other Airbag System sensors with the Ignition ON or engine running, DO NOT use air or electric power tools or strike near the sensor(s) with a hammer. Heavy vibration could activate the sensor(s) and deploy the air bag(s), possibly causing serious injury.
- When using air or electric power tools or hammers, always switch the Ignition OFF, disconnect the battery and wait at least three minutes before performing any service.

#### Cautions in Removing Battery Terminal and AV Control Unit (Models with AV Control Unit)

INFOID:000000009129497

**CAUTION:**

Remove battery terminal and AV control unit 30 seconds or more after turning the ignition switch OFF.

**NOTE:**

After the ignition switch is turned OFF, the AV control unit continues operating for approximately 30 seconds. Therefore, data corruption may occur if battery voltage is cut off within 30 seconds.

#### Precaution for Trouble Diagnosis

INFOID:000000009129498

#### AV COMMUNICATION SYSTEM

- Do not apply voltage of 7.0 V or higher to the measurement terminals.
- Use the tester with its open terminal voltage being 7.0 V or less.
- Be sure to turn ignition switch OFF and disconnect the battery cable from the negative terminal before checking the circuit.

#### Precaution for Harness Repair

INFOID:000000009129499

#### AV COMMUNICATION SYSTEM

# PRECAUTIONS

## [TELEMATICS SYSTEM]

### < PRECAUTION >

- Solder the repaired parts, and wrap with tape. [Frays of twisted line must be within 110 mm (4.33 in).]

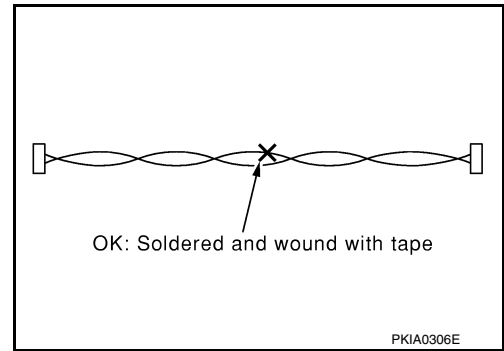

- Do not perform bypass wire connections for the repair parts. (The spliced wire will become separated and the characteristics of twisted line will be lost.)

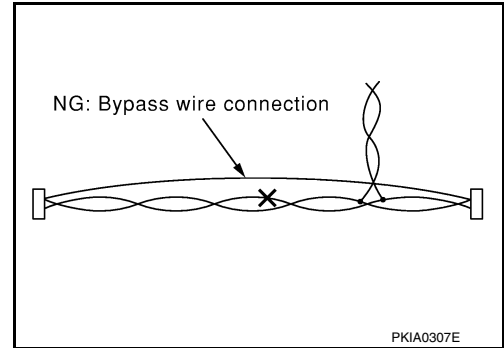

### Precaution for Work

INFOID:000000009129500

- When removing or disassembling each component, be careful not to damage or deform it. If a component may be subject to interference, be sure to protect it with a shop cloth.
- When removing (disengaging) components with a screwdriver or similar tool, be sure to wrap the component with a shop cloth or vinyl tape to protect it.
- Protect the removed parts with a shop cloth and prevent them from being dropped.
- Replace a deformed or damaged clip.
- If a part is specified as a non-reusable part, always replace it with a new one.
- Be sure to tighten bolts and nuts securely to the specified torque.
- After installation is complete, be sure to check that each part works properly.
- Follow the steps below to clean components:
  - Water soluble dirt:
    - Dip a soft cloth into lukewarm water, wring the water out of the cloth and wipe the dirty area.
    - Then rub with a soft, dry cloth.
  - Oily dirt:
    - Dip a soft cloth into lukewarm water with mild detergent (concentration: within 2 to 3%) and wipe the dirty area.
    - Then dip a cloth into fresh water, wring the water out of the cloth and wipe the detergent off.
    - Then rub with a soft, dry cloth.
  - Do not use organic solvent such as thinner, benzene, alcohol or gasoline.
  - For genuine leather seats, use a genuine leather seat cleaner.

A  
B  
C  
D  
E  
F  
G  
H  
I  
J  
K  
L  
M  
AV  
O  
P

# PREPARATION

< PREPARATION >

[TELEMATICS SYSTEM]

## PREPARATION

### PREPARATION

#### Special Service Tool

INFOID:000000009129501

The actual shapes of Kent-Moore tools may differ from those of special service tools illustrated here.

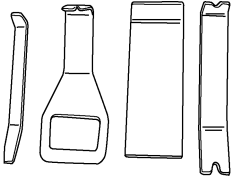
Tool number (Kent-Moore No.) Tool name	Description
— (J-46534) Trim Tool Set  AWJIA0483ZZ	Removing trim components

#### Commercial Service Tools

INFOID:000000009129502

Tool name	Description
Power tools  PIIB1407E	Loosening nuts, screws and bolts

## SYSTEM DESCRIPTION

### COMPONENT PARTS

#### Component Parts Location

INFOID:000000009129503

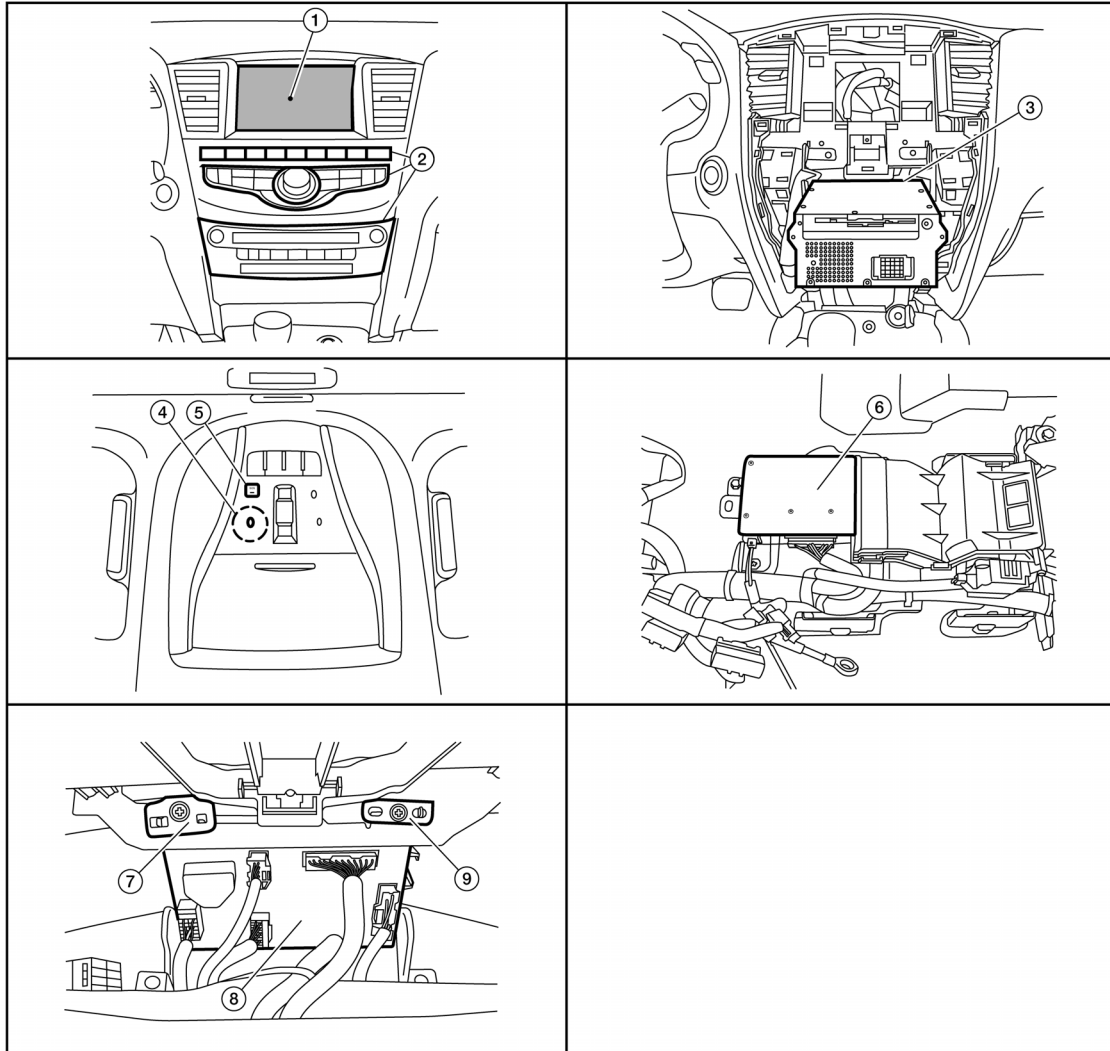

ALNIA1343ZZ

- |                 |                               |                                  |
|-----------------|-------------------------------|----------------------------------|
| 1. Display unit | 2. A/C and AV switch assembly | 3. AV control unit               |
| 4. Microphone   | 5. Telematics switch          | 6. Telematics control unit (TCU) |
| 7. GPS antenna  | 8. BCM                        | 9. TEL antenna                   |

#### Component Description

INFOID:000000009129504

##### TELEMATICS CONTROL UNIT (TCU)

The telematics control unit (TCU) is connected to the AV control unit using a USB harness for sound signal input/output and USB communication. A radio communication terminal and SIM card are built into the TCU. Data is sent to and received from the INFINITI CONNECTIONS data center via the TEL antenna.

##### AV CONTROL UNIT

The AV control unit is connected to the telematics control unit (TCU) using a USB harness for sound signal input/output and USB communication. The AV control unit receives input signals from the A/C and AV switch assembly through the AV communication circuits and transmits them to the TCU.

##### A/C AND AV SWITCH ASSEMBLY

A  
B  
C  
D  
E  
F  
G  
H  
I  
J  
K  
L  
M

AV

O  
P

## COMPONENT PARTS

< SYSTEM DESCRIPTION >

[TELEMATICS SYSTEM]

The A/C and AV switch assembly transmits input signals to the AV control unit through the AV communication circuits.

### GPS ANTENNA

The GPS antenna is used for vehicle location.

### TEL ANTENNA

The TEL antenna is used for sending and receiving data.

### TELEMATICS SWITCH

The telematics switch is used to turn ON the telematics system.

### MICROPHONE

The microphone is used for interaction with the INFINITI CONNECTIONS data center.

SYSTEM

TELEMATICS SYSTEM

TELEMATICS SYSTEM : System Diagram

INFOID:000000009129505

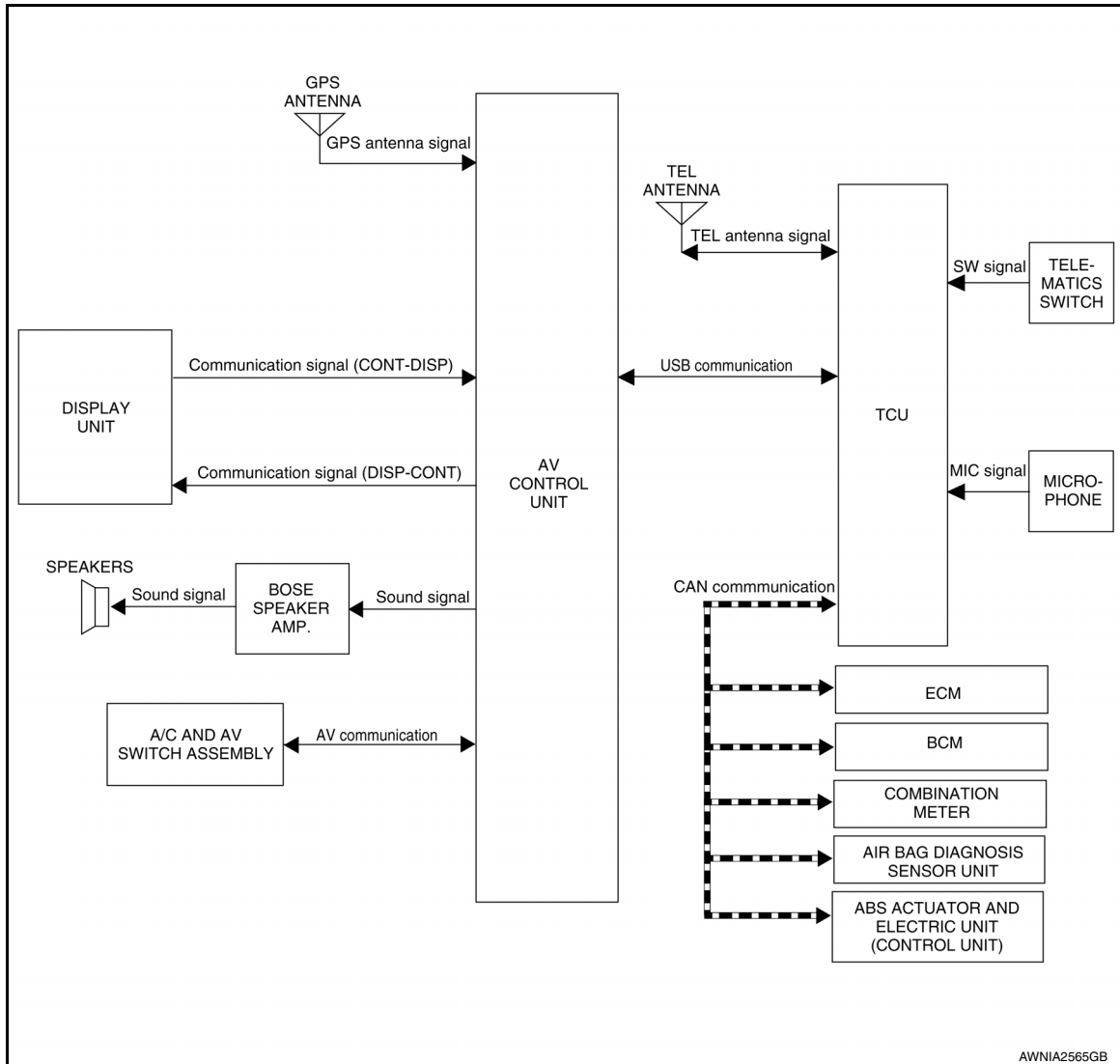

TELEMATICS SYSTEM : System Description

INFOID:000000009129506

The telematics system interacts with the INFINITI CONNECTION data center using GPS and GSM/GPRS technologies. The telematics control unit (TCU) can send messages to and receive commands from the INFINITI CONNECTION data center. This allows the INFINITI CONNECTION data center to monitor the vehicle and obtain actual position coordinates and automatically detected events, as well as initiate certain services from outside the vehicle. In addition, the vehicle operator can initiate services from inside the vehicle.

**NOTE:**

For additional information on the Telematics system, refer to the NAVIGATION SYSTEM OWNER'S MANUAL.

A  
B  
C  
D  
E  
F  
G  
H  
I  
J  
K  
L  
M  
N  
O  
P

AV

# DIAGNOSIS SYSTEM (TCU)

< SYSTEM DESCRIPTION >

[TELEMATICS SYSTEM]

## DIAGNOSIS SYSTEM (TCU)

### CONSULT Function

INFOID:000000009129507

#### CAUTION:

After disconnecting the CONSULT vehicle interface (VI) from the data link connector, the ignition must be cycled OFF → ON (for at least 5 seconds) → OFF. If this step is not performed, the BCM may not go to “sleep mode”, potentially causing a discharged battery and a no-start condition.

#### CONSULT FUNCTIONS

CONSULT performs the following functions via communication with the TCU.

Direct Diagnostic Mode	Description
Ecu Identification	The AV control unit part number is displayed.
Self Diagnostic Result	The AV control unit self diagnostic results are displayed.
Data Monitor	The AV control unit input/output data is displayed in real time.
Work support	The settings for AV control unit functions can be changed.
CAN Diag Support Mntr	<ul style="list-style-type: none"><li>The result of transmit/receive diagnosis of AV communication is displayed.</li><li>The result of transmit/receive diagnosis of CAN communication is displayed.</li></ul>

#### ECU IDENTIFICATION

The part number of TCU is displayed.

#### SELF DIAGNOSTIC RESULT

Refer to [AV-923. "DTC Index"](#).

#### DATA MONITOR

Monitor Item [Unit]	Description
HF TYPE [NO BT/]	HF type is displayed.
AUDIO UNIT TYPE [NAVI/]	AV control unit type is displayed.
CALL SWITCH TYPE [SOS/]	Call switch type is displayed.
ECHO CANCEL [TYPE 1/]	Echo cancel type is displayed.
NOISE CANCEL [TYPE 1/]	Noise cancel type is displayed.
TCU STANDBY TIME [2DAYS/14DAYS/30DAYS]	TCU standby time is displayed.
NAD OUTPUT STATUS [On/Off]	TCU activation is displayed.
ACN COMM SEQUENCE LOG [1–255]	ACN communication sequence log is displayed.
SOS COMM SEQUENCE LOG [1–10]	SOS communication sequence log is displayed.

#### WORK SUPPORT

Conditions	Description
SAVE VIN DATA	VIN data saved in TCU is stored in CONSULT.
CENTER CONNECTION SETTING	Connection to INFINITI CONNECTION data center can be set.
TCU ACTIVATE SETTING	Off: TCU activation Off.
	On: TCU activation On.
WRITE VIN DATA	VIN data from SAVE VIN DATA can be written to new TCU.
VIN REGISTRATION	VIN data can be manually written to new TCU.

#### CAN DIAG SUPPORT MNTR

Refer to [LAN-23. "CAN Diagnostic Support Monitor"](#).



ECU DIAGNOSIS INFORMATION

AV CONTROL UNIT

List of ECU Reference

INFOID:000000009129508

ECU	Reference
AV control unit (Bose Audio with Navigation w/o Surround)	<a href="#">AV-361, "Reference Value"</a>
	<a href="#">AV-367, "Fail-Safe"</a>
	<a href="#">AV-367, "DTC Index"</a>
AV control unit (Bose Audio with Navigation and Surround)	<a href="#">AV-653, "Reference Value"</a>
	<a href="#">AV-659, "Fail-Safe"</a>
	<a href="#">AV-660, "DTC Index"</a>

A  
B  
C  
D  
E  
F  
G  
H  
I  
J  
K  
L  
M  
N  
O  
P

AV

# TCU

< ECU DIAGNOSIS INFORMATION >

[TELEMATICS SYSTEM]

## TCU

### Reference Value

INFOID:000000009129509

### TERMINAL LAYOUT

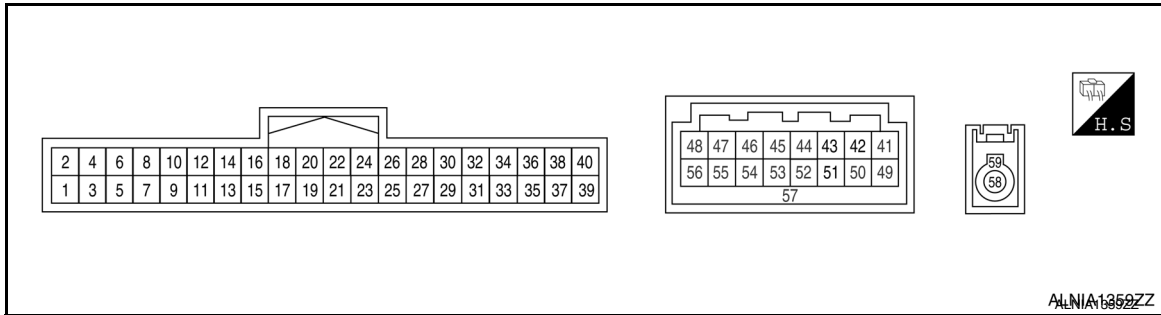

### INPUT/OUTPUT SIGNAL STANDARD

Terminal (Wire color)		Description		Condition		Reference value (Approx.)
+	-	Signal name	Input/ Output			
1 (Y)	Ground	Battery power supply	Input	Ignition switch OFF	—	Battery Voltage
2 (B)	—	Ground	—	—	—	—
3 (P)	Ground	ACC power supply	Input	Ignition switch ACC	—	Battery Voltage
4 (LG)	Ground	Ignition power supply	Input	Ignition switch ON	—	Battery Voltage
5 (G)	Ground	ACC OUT	Output	Ignition switch ACC	—	Battery Voltage
6 (G)	Ground	AV ACC	Output	Ignition switch ACC	—	Battery Voltage
7 (B)	—	Ground	—	—	—	—
9 (L)	—	V-CAN (H)	Input/ Output	—	—	—
10 (P)	—	V-CAN (L)	Input/ Output	—	—	—
18 (W)	20	MIC VCC	Input	Ignition switch ON	-	-
19 (B)	20	MIC SIG	Input	Ignition switch ON	-	-
21 (W)	23	DCM MIC VCC	Input	Ignition switch ON	-	-
22 (B)	20	DCM MIC SIG	Input	Ignition switch ON	-	-

# TCU

< ECU DIAGNOSIS INFORMATION >

[TELEMATICS SYSTEM]

Terminal (Wire color)		Description		Condition		Reference value (Approx.)
+	-	Signal name	Input/ Output			
34 (R)	Ground	ECALL SW	Input	Ignition switch ON	Telematics switch pressed	Battery Voltage
35 (W)	Ground	LED A	Output	Ignition switch ON	Telematics switch pressed	Battery Voltage
41 (W)	42 (L)	U-VOICE signal	Input	—	—	—
46 (W)	Ground	Manufacturer Specific signal	—	—	—	—
47 (B)	55	USB V BUS signal	Input	Ignition switch ON	—	5 V
48 (B)	55	USB D- signal	Input/ Output	—	—	—
49 (B)	42 (L)	D-VOICE signal	Output	—	—	—
56 (L/W)	55	USB D+ signal	Input/ Output	Ignition switch ON	—	—
57	—	Shield	—	—	—	—
58 (B)	—	TEL antenna signal	Input	Ignition switch ACC	TEL antenna disconnected.	2.8 V
59	—	Shield	—	—	—	—

## DTC Index

INFOID:000000009129510

CONSULT Display	Reference Page
U1000: CAN COMM CIRCUIT	<a href="#">AV-1036, "DTC Logic"</a>
U1010: CONTROL UNIT (CAN)	<a href="#">AV-1037, "DTC Logic"</a>
U1A00: ACC NO CONN	<a href="#">AV-1038, "DTC Logic"</a>
U1A01: INTERNAL ERROR (TCU)	<a href="#">AV-1039, "DTC Logic"</a>
U1A02: TEL COMMUNICATION MODULE	<a href="#">AV-1040, "DTC Logic"</a>
U1A03: SIM CARD	<a href="#">AV-1041, "DTC Logic"</a>
U1A04: VIN UNFINISHED	<a href="#">AV-1042, "DTC Logic"</a>
U1A05: USB COMM	<a href="#">AV-1043, "DTC Logic"</a>
U1A07: TEL ANTENNA SHORT	<a href="#">AV-1044, "DTC Logic"</a>
U1A08: TEL ANTENNA NO CONN	<a href="#">AV-1045, "DTC Logic"</a>
U1A0B: MIC IN CONN	<a href="#">AV-1046, "DTC Logic"</a>
U1A0C: MIC OUT CONN	<a href="#">AV-1048, "DTC Logic"</a>
U1A0E: SOS SWITCH ON STUCK	<a href="#">AV-1050, "DTC Logic"</a>
U1A0F: SOS SWITCH NO CONN	<a href="#">AV-1051, "DTC Logic"</a>

# BOSE AUDIO W/NAVI W/O SURROUND

< WIRING DIAGRAM >

[TELEMATICS SYSTEM]

## WIRING DIAGRAM

### BOSE AUDIO W/NAVI W/O SURROUND

#### Wiring Diagram

INFOID:000000009761235

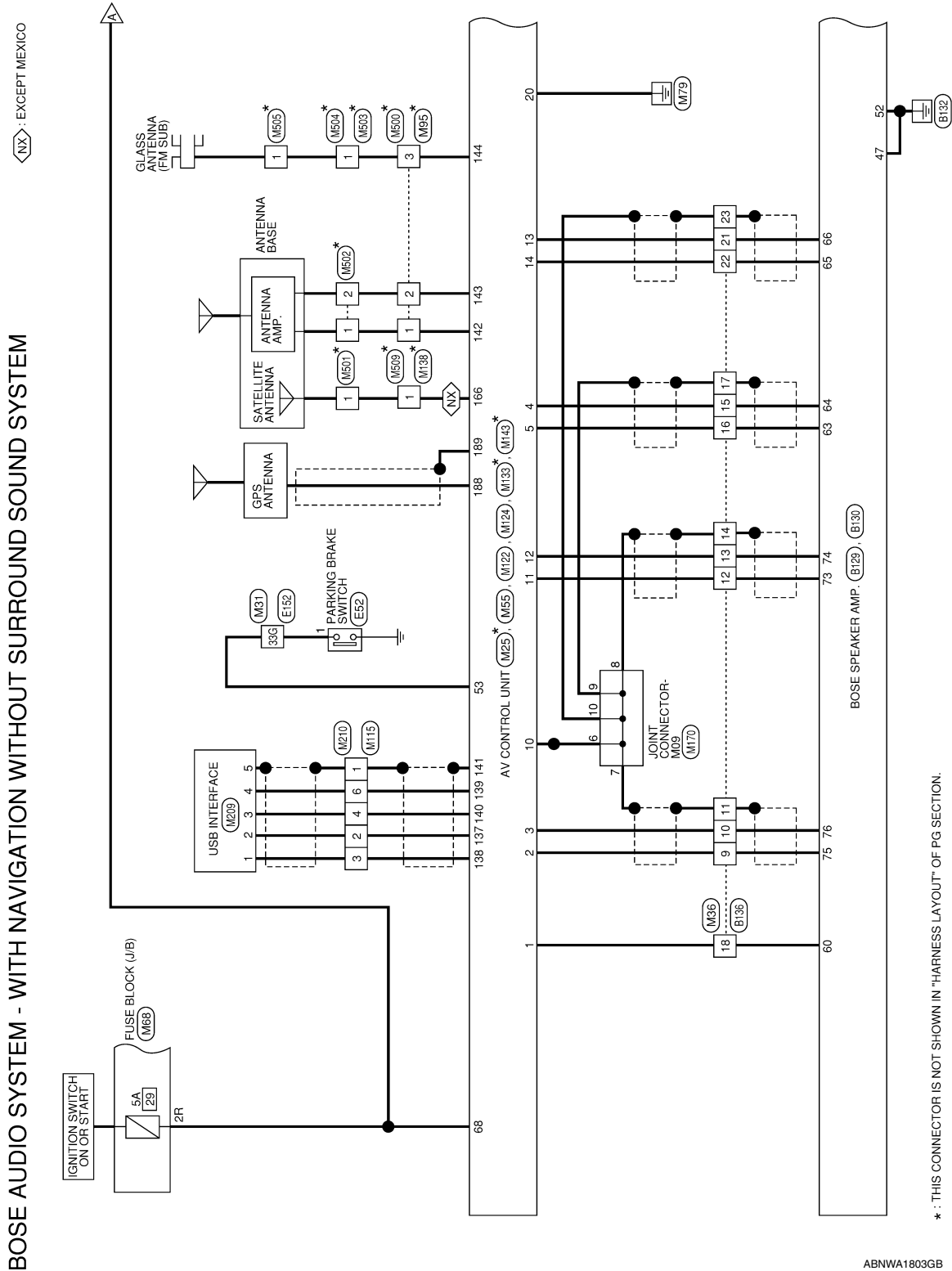

# BOSE AUDIO W/NAVI W/O SURROUND

< WIRING DIAGRAM >

[TELEMATICS SYSTEM]

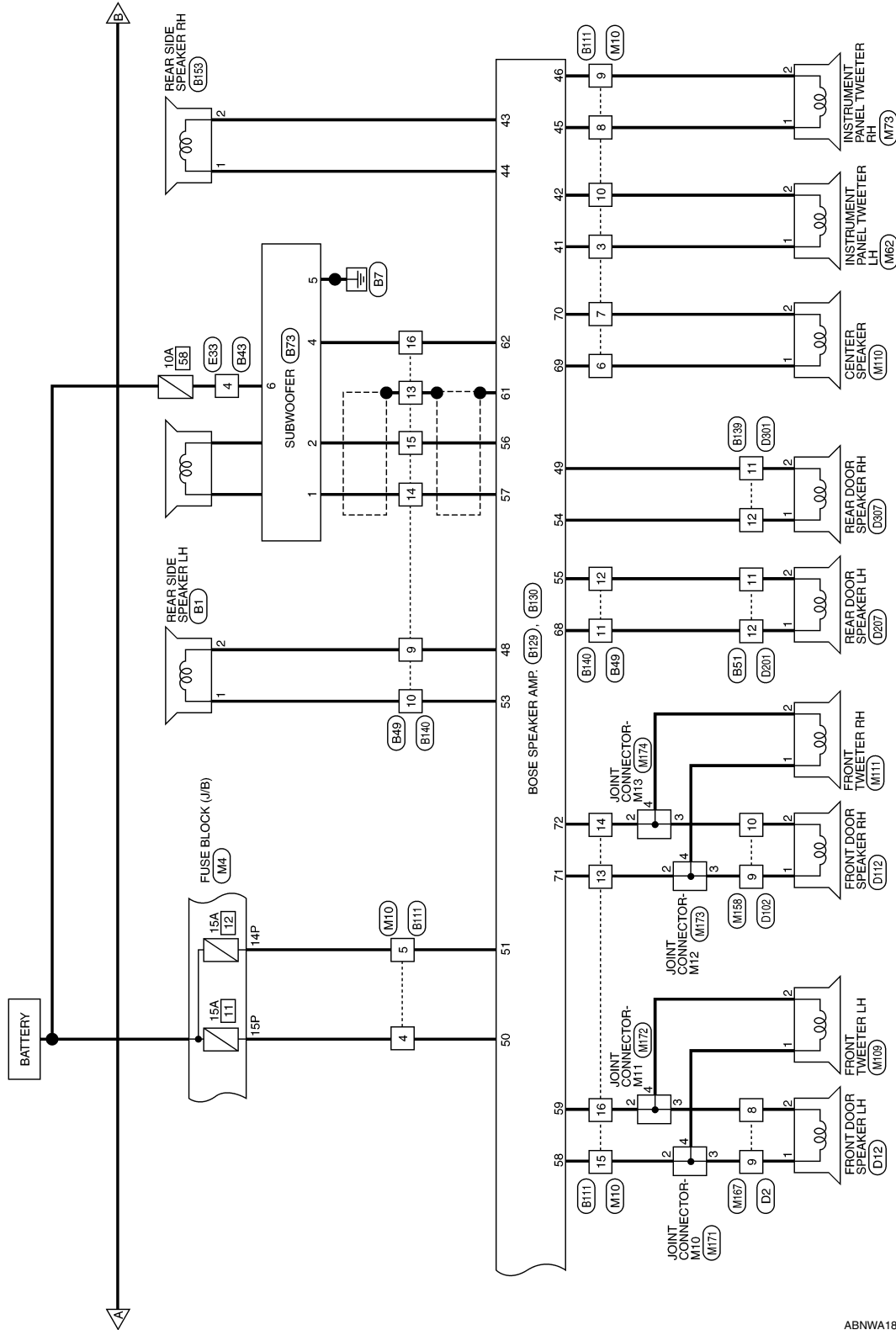

ABNWA1804GB

A  
B  
C  
D  
E  
F  
G  
H  
I  
J  
K  
L  
M  
N  
O  
P

AV

# BOSE AUDIO W/NAVI W/O SURROUND

< WIRING DIAGRAM >

[TELEMATICS SYSTEM]

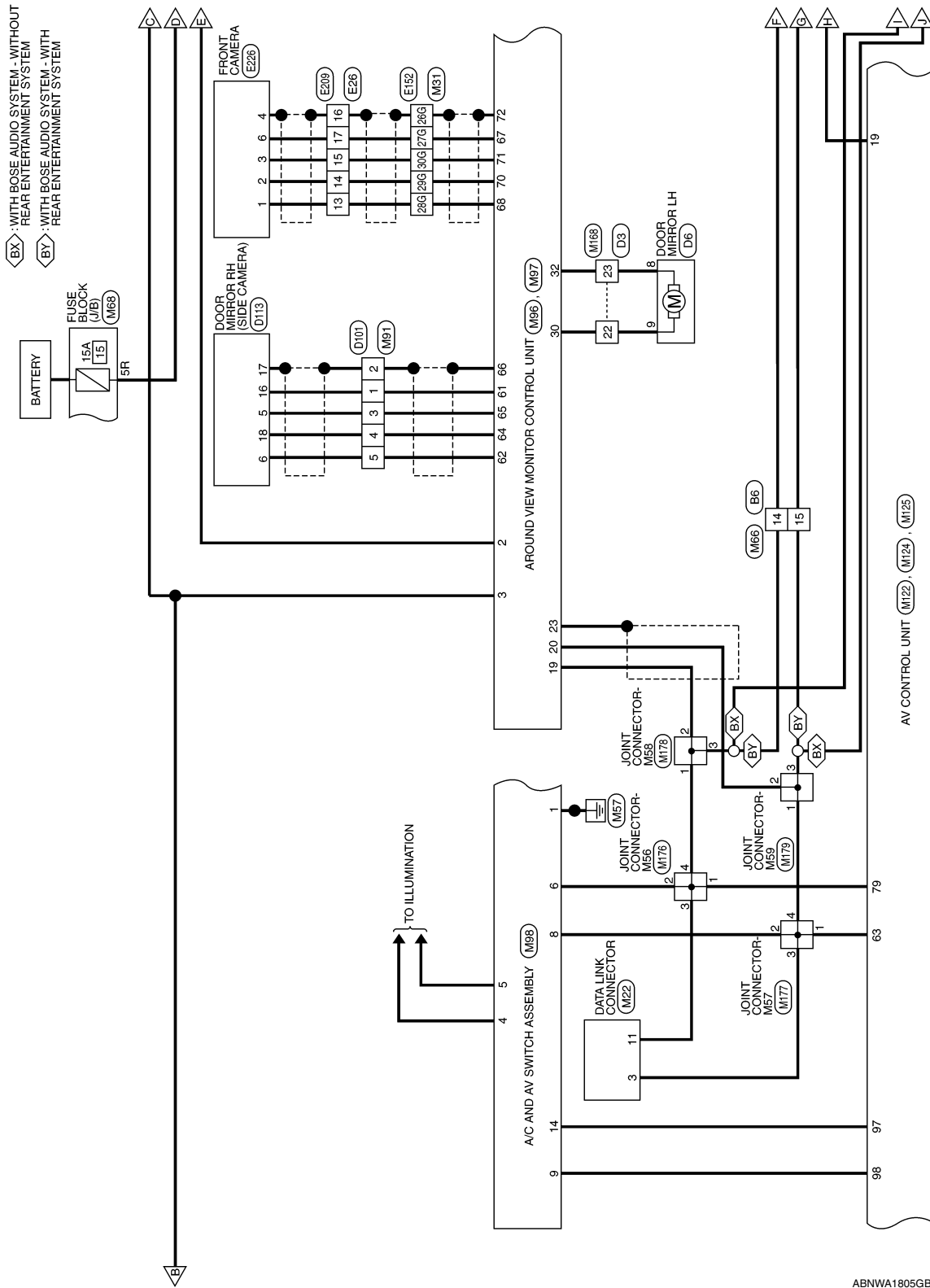

ABNWA1805GB



# BOSE AUDIO W/NAVI W/O SURROUND

< WIRING DIAGRAM >

[TELEMATICS SYSTEM]

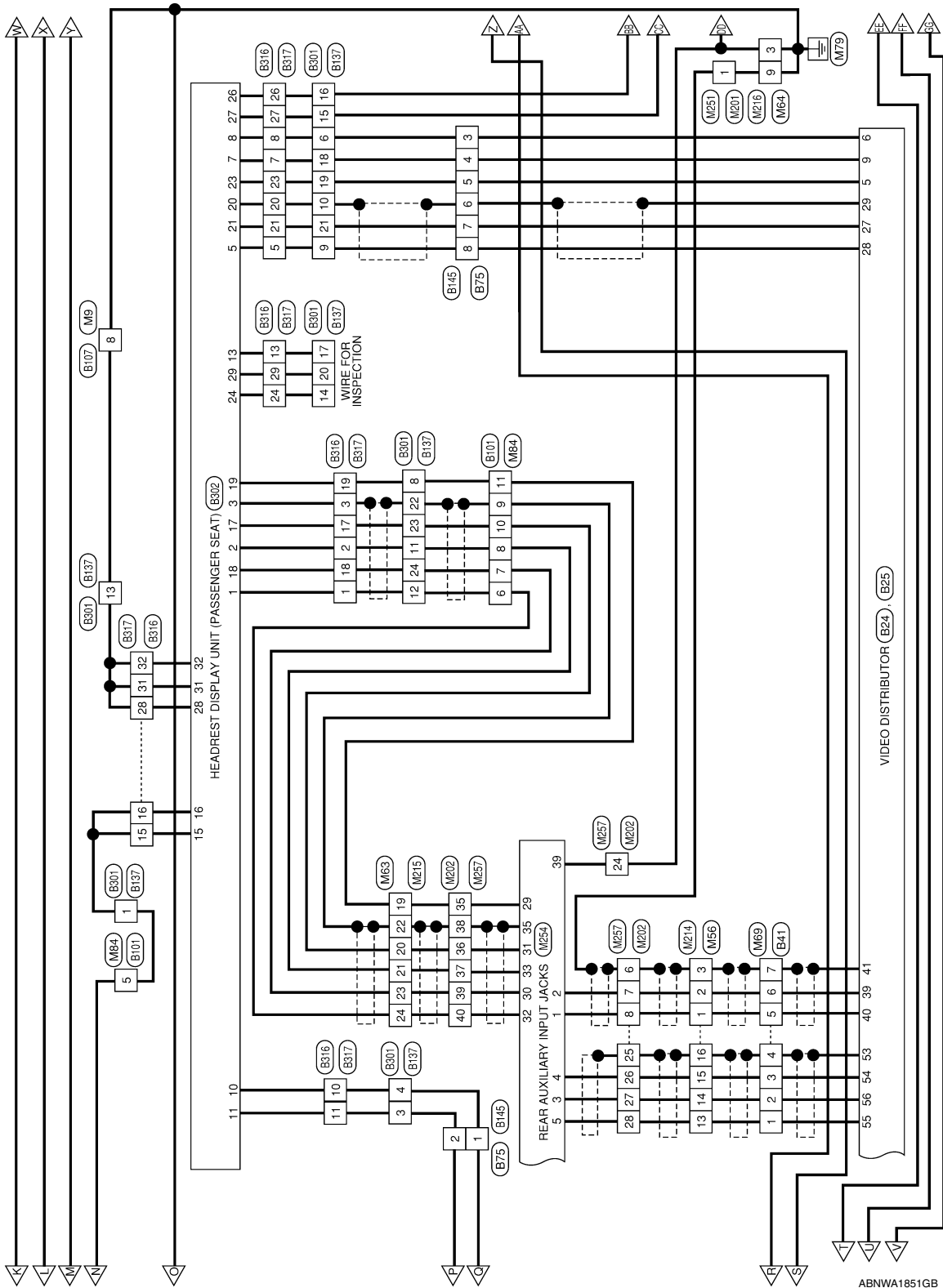



# BOSE AUDIO W/NAVI W/O SURROUND

< WIRING DIAGRAM >

[TELEMATICS SYSTEM]

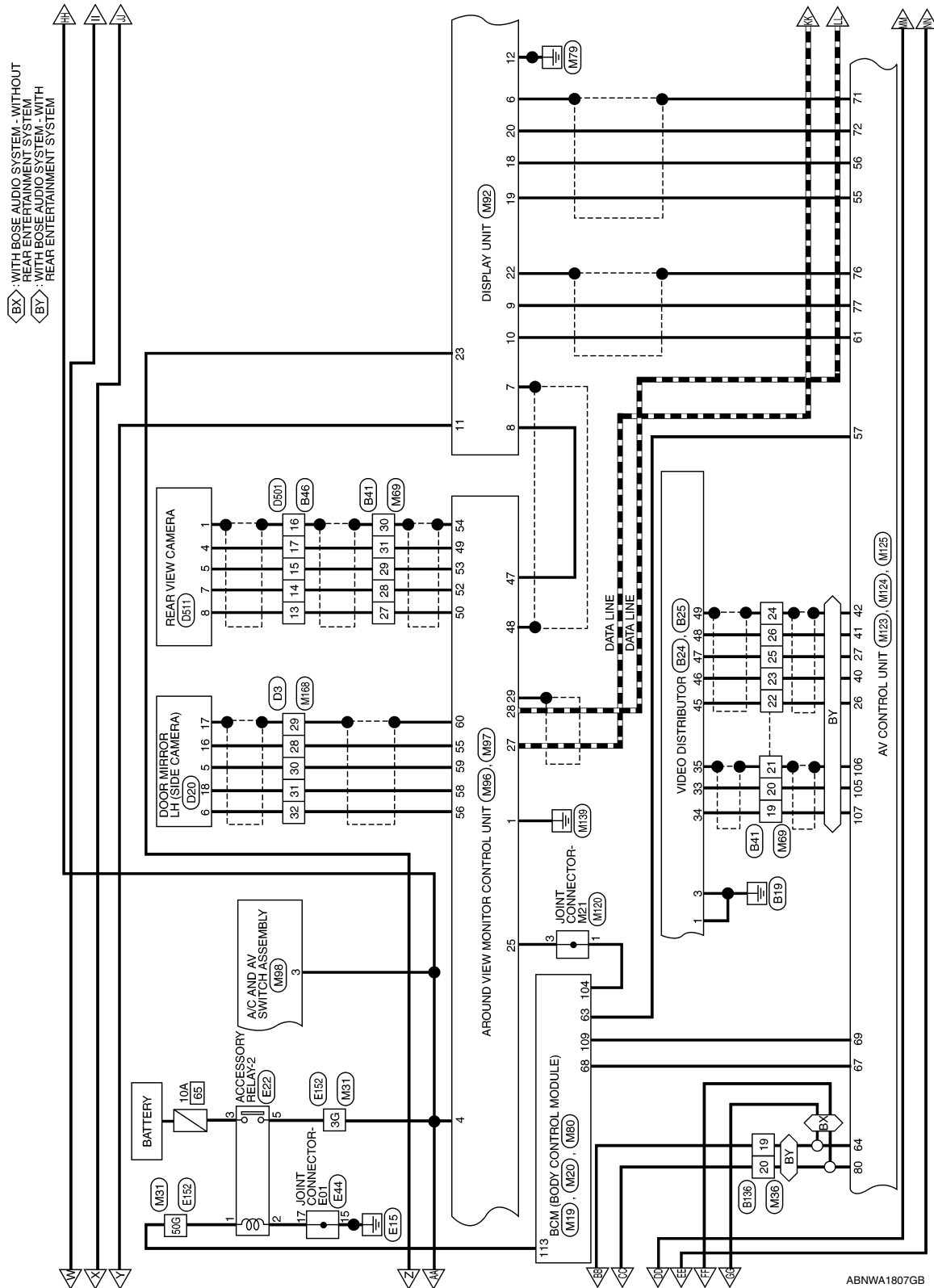

ABNWA1807GB

A  
B  
C  
D  
E  
F  
G  
H  
I  
J  
K  
L  
M  
N  
O  
P

AV

# BOSE AUDIO W/NAVI W/O SURROUND

< WIRING DIAGRAM >

[TELEMATICS SYSTEM]

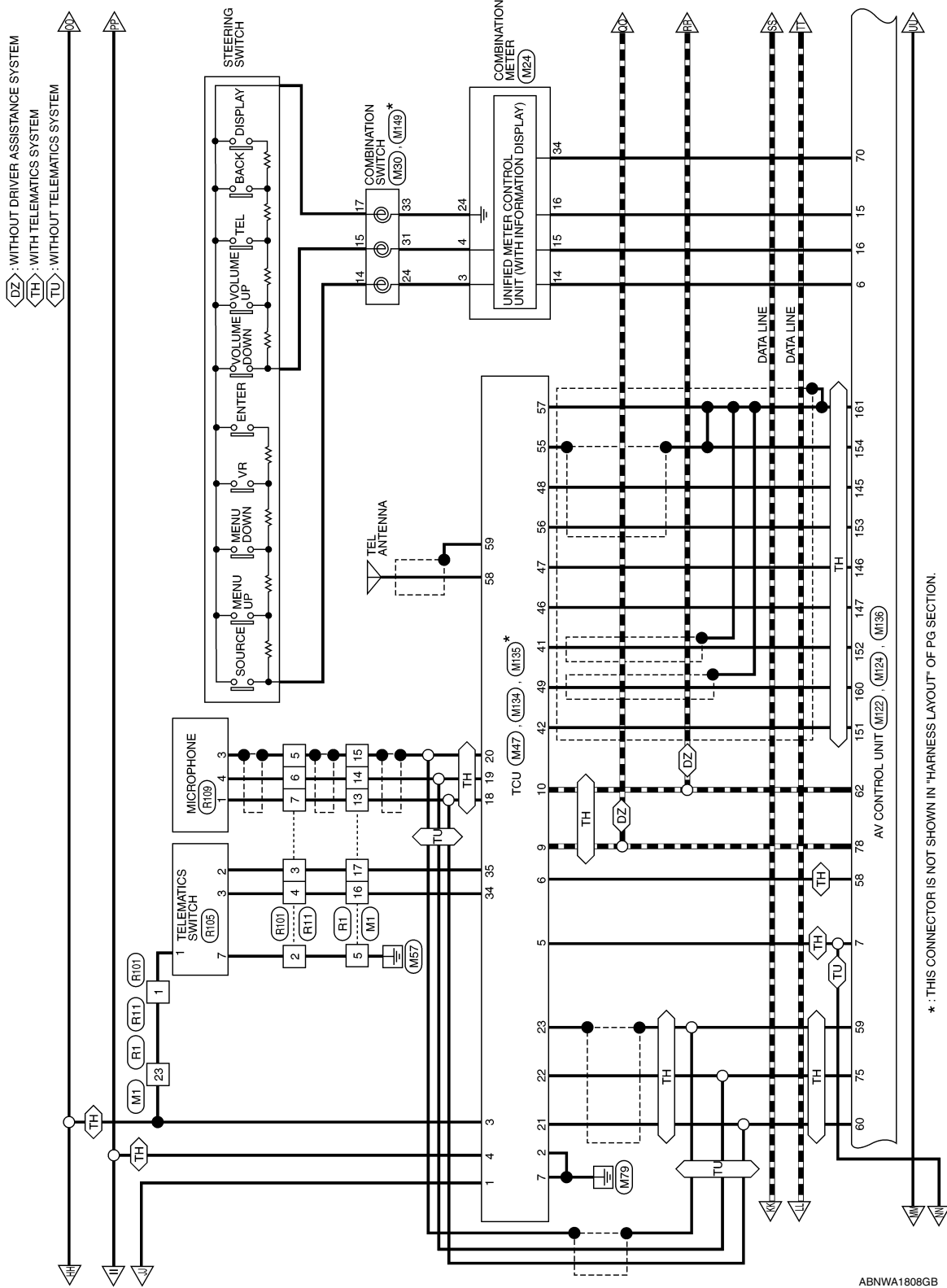

# BOSE AUDIO W/NAVI W/O SURROUND

< WIRING DIAGRAM >

[TELEMATICS SYSTEM]

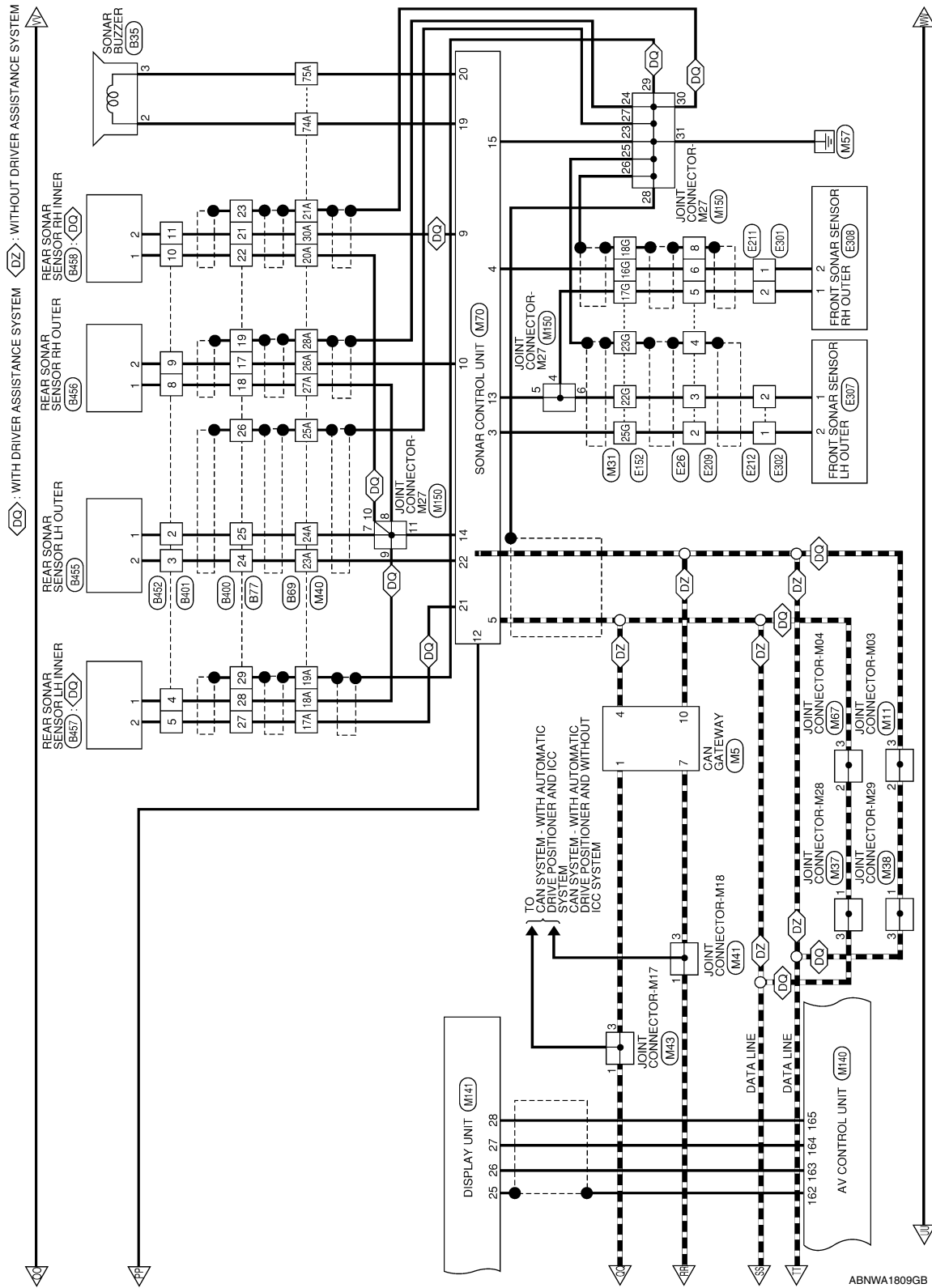

ABNWA1809GB

A  
B  
C  
D  
E  
F  
G  
H  
I  
J  
K  
L  
M  
N  
O  
P

AV

# BOSE AUDIO W/NAVI W/O SURROUND

< WIRING DIAGRAM >

[TELEMATICS SYSTEM]

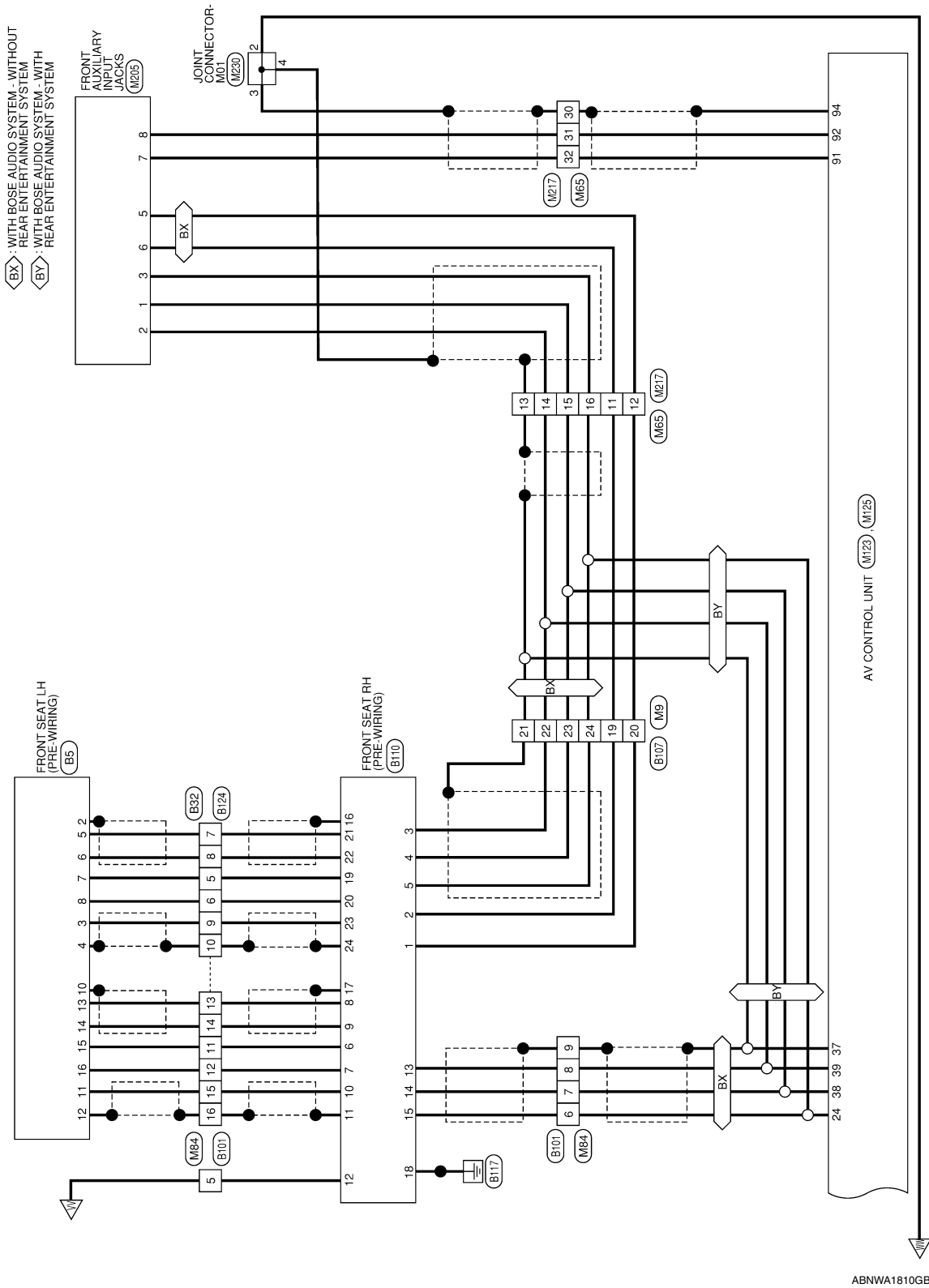

BOSE AUDIO SYSTEM CONNECTORS - WITH NAVIGATION WITHOUT SURROUND SOUND SYSTEM

Connector No.	M1
Connector Name	WIRE TO WIRE
Connector Color	WHITE

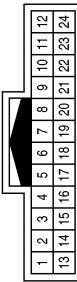

Terminal No.	Color of Wire	Signal Name
5	GR	-
13	W	-
14	B	-
15	SHIELD	-
16	R	-
17	W	-
23	P	-

Connector No.	M4
Connector Name	FUSE BLOCK (J/B)
Connector Color	WHITE



Terminal No.	Color of Wire	Signal Name
14P	Y	-
15P	L	-

Connector No.	M5
Connector Name	CAN GATEWAY
Connector Color	WHITE

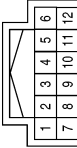

Terminal No.	Color of Wire	Signal Name
1	L	CAN-H
4	L	CAN-H
7	P	CAN-L
10	P	CAN-L

Connector No.	M9
Connector Name	WIRE TO WIRE
Connector Color	WHITE

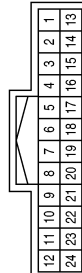

Terminal No.	Color of Wire	Signal Name
6	GR	-
7	V	-
8	G	-
9	R	-
10	SHIELD	-
11	W	-
12	B	-
19	P	-
20	G	-
21	SHIELD	-
22	B	-
23	R	-
24	W	-

Connector No.	M10
Connector Name	WIRE TO WIRE
Connector Color	BROWN

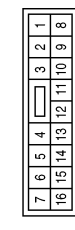

Terminal No.	Color of Wire	Signal Name
3	G	-
4	L	-
5	Y	-
6	G	-
7	W	-
8	G	-
9	W	-
10	W	-

Terminal No.	Color of Wire	Signal Name
13	G	-
14	W	-
15	P	-(WITH BOSE AUDIO SYSTEM WITHOUT SURROUND SOUND SYSTEM)
16	W	-

ABNIA4632GB

A  
B  
C  
D  
E  
F  
G  
H  
I  
J  
K  
L  
M  
N  
O  
P

AV

# BOSE AUDIO W/NAVI W/O SURROUND

< WIRING DIAGRAM >

[TELEMATICS SYSTEM]

Connector No.	M11
Connector Name	JOINT CONNECTOR-M03
Connector Color	WHITE



Terminal No.	Color of Wire	Signal Name
2	Y	-
3	W	-

Connector No.	M19
Connector Name	BCM (BODY CONTROL MODULE)
Connector Color	BLACK

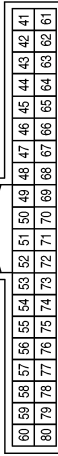

Terminal No.	Color of Wire	Signal Name
63	BG	I-KEY LINK SIGNAL
68	P	MR OUTPUT

Connector No.	M20
Connector Name	BCM (BODY CONTROL MODULE)
Connector Color	BLACK

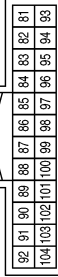

Terminal No.	Color of Wire	Signal Name
104	LG	REVERSE LAMP OUT

Connector No.	M22
Connector Name	DATA LINK CONNECTOR
Connector Color	WHITE

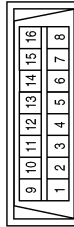

Terminal No.	Color of Wire	Signal Name
3	LG	-
11	SB	-

Connector No.	M24
Connector Name	COMBINATION METER
Connector Color	WHITE

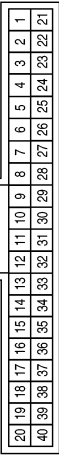

Terminal No.	Color of Wire	Signal Name
3	P	STRG SW INPUT 1
4	BG	STRG SW INPUT 2
14	G	STRG SW OUTPUT 1
15	W	STRG SW OUTPUT 2
16	B	STRG SW OUTPUT GND
24	R	STRG SW GND
34	BG	SPEED 8 P / R

Connector No.	M25
Connector Name	AV CONTROL UNIT
Connector Color	PINK



Terminal No.	Color of Wire	Signal Name
188	B	-
189	SHIELD	-

# BOSE AUDIO W/NAVI W/O SURROUND

< WIRING DIAGRAM >

[TELEMATICS SYSTEM]

Terminal No.	Color of Wire	Signal Name
3G	P	-
16G	R	-
17G	B	-
18G	SHIELD	-
22G	B	-
23G	SHIELD	-
25G	R	-
26G	SHIELD	-
27G	B	-
28G	W	-
29G	G	-
30G	R	-
33G	G	-
50G	L	-

Connector No.	M31
Connector Name	WIRE TO WIRE
Connector Color	WHITE

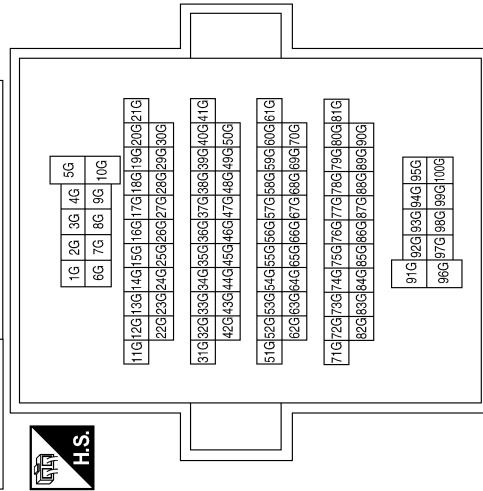

Connector No.	M30
Connector Name	COMBINATION SWITCH (SPIRAL CABLE)
Connector Color	GRAY

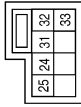

Terminal No.	Color of Wire	Signal Name
24	P	-
31	BG	-
33	R	-

Connector No.	M37
Connector Name	JOINT CONNECTOR-M28
Connector Color	WHITE



Terminal No.	Color of Wire	Signal Name
13	B	-
14	SHIELD	-
15	B	-
16	W	-
17	SHIELD	-
18	SB	-
19	LG	-
20	SB	-
21	B	-
22	W	-
23	SHIELD	-

Connector No.	M36
Connector Name	WIRE TO WIRE
Connector Color	WHITE

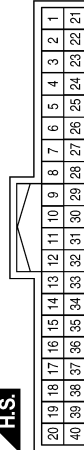

Terminal No.	Color of Wire	Signal Name
9	B	-
10	W	-
11	SHIELD	-
12	W	-

Terminal No.	Color of Wire	Signal Name
1	L	-
3	B	-

ABNIA4634GB

A  
B  
C  
D  
E  
F  
G  
H  
I  
J  
K  
L  
M  
N  
O  
P

AV

# BOSE AUDIO W/NAVI W/O SURROUND

< WIRING DIAGRAM >

[TELEMATICS SYSTEM]

Terminal No.	Color of Wire	Signal Name
17A	W	-
18A	B	-
19A	SHIELD	-
20A	B	-
21A	SHIELD	-
23A	W	-
24A	B	-
25A	SHIELD	-
26A	W	-
27A	B	-
28A	SHIELD	-
30A	W	-
74A	BR	-
75A	LG	-

Connector No.	M40
Connector Name	WIRE TO WIRE
Connector Color	GRAY

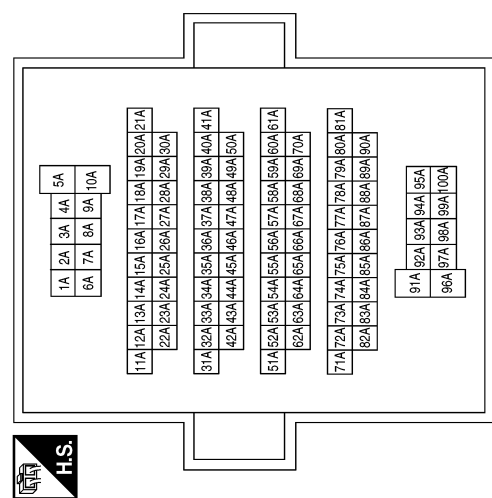

Connector No.	M38
Connector Name	JOINT CONNECTOR-M29
Connector Color	WHITE

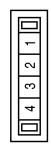

Terminal No.	Color of Wire	Signal Name
1	Y	-
3	W	-

Connector No.	M43
Connector Name	JOINT CONNECTOR-M17
Connector Color	WHITE

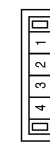

Terminal No.	Color of Wire	Signal Name
1	L	-
3	L	-

Connector No.	M41
Connector Name	JOINT CONNECTOR-M18
Connector Color	WHITE

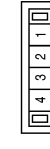

Terminal No.	Color of Wire	Signal Name
1	P	-
3	P	-

ABNIA4635GB



# BOSE AUDIO W/NAVI W/O SURROUND

< WIRING DIAGRAM >

[TELEMATICS SYSTEM]

Terminal No.	Color of Wire	Signal Name
24	-	-
25	-	-
26	-	-
27	-	-
28	-	-
29	-	-
30	-	-
31	-	-
32	-	-
33	-	-
34	R	ECALL SW
35	W	LED A
36	-	-
37	-	-
38	-	-
39	-	-
40	-	-

Terminal No.	Color of Wire	Signal Name
7	B	GND
8	-	-
9	L	V-CAN H
10	P	V-CAN L
11	-	-
12	-	-
13	-	-
14	-	-
15	-	-
16	-	-
17	-	-
18	W	MIC VCC
19	B	MIC SIG
20	SHIELD	MIC GND
21	W	MIC VCC DETECTION
22	B	DCM MIC SIG
23	SHIELD	DCM MIC GND

Connector No.	M47
Connector Name	TCU
Connector Color	WHITE

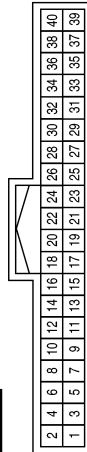

Terminal No.	Color of Wire	Signal Name
1	Y	B+
2	B	GND
3	P	ACC
4	LG	IGN
5	G	ACC OUT
6	G	AV ACC

Connector No.	M62
Connector Name	INSTRUMENT PANEL TWEETER LH
Connector Color	BROWN



Connector No.	M56
Connector Name	WIRE TO WIRE
Connector Color	WHITE

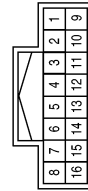

Terminal No.	Color of Wire	Signal Name
1	G	-(WITH BOSE AUDIO SYSTEM)
2	W	-(WITH BOSE AUDIO SYSTEM)

Terminal No.	Color of Wire	Signal Name
1	B	-
2	W	-
3	SHIELD	-
4	P	-
5	Y	-
13	R	-
14	W	-
15	B	-
16	SHIELD	-

Terminal No.	Color of Wire	Signal Name
137	W	VBUS
138	G	USB GND
139	L	USB D+
140	R	USB D-
141	SHIELD	SHIELD

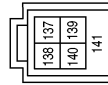

Connector No.	M55
Connector Name	AV CONTROL UNIT
Connector Color	BLUE



ABNIA4636GB

A  
B  
C  
D  
E  
F  
G  
H  
I  
J  
K  
L  
M  
N  
O  
P

AV

# BOSE AUDIO W/NAVI W/O SURROUND

< WIRING DIAGRAM >

[TELEMATICS SYSTEM]

Connector No.	M64
Connector Name	WIRE TO WIRE
Connector Color	WHITE

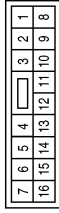

Terminal No.	Color of Wire	Signal Name
3	B	-
9	B	-

Terminal No.	Color of Wire	Signal Name
10	SHIELD	-
11	W	-
12	B	-
13	L	-
14	G	-
15	R	-
16	SHIELD	-
17	W	-
18	B	-
19	L	-
20	G	-
21	R	-
22	SHIELD	-
23	W	-
24	B	-

Connector No.	M63
Connector Name	WIRE TO WIRE
Connector Color	WHITE

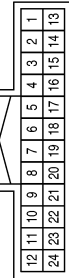

Terminal No.	Color of Wire	Signal Name
1	SB	-
2	G	-
3	R	-
4	SHIELD	-
5	W	-
6	B	-
7	V	-
8	G	-
9	R	-

Terminal No.	Color of Wire	Signal Name
6	B	-(WITH REAR ENTERTAINMENT SYSTEM)
7	SB	-(WITH REAR ENTERTAINMENT SYSTEM)
8	G	-(WITH REAR ENTERTAINMENT SYSTEM)
9	R	-(WITH REAR ENTERTAINMENT SYSTEM)
10	SHIELD	-
11	W	-(WITH REAR ENTERTAINMENT SYSTEM)
12	B	-(WITH REAR ENTERTAINMENT SYSTEM)
13	Y	-
14	SB	-
15	LG	-

Connector No.	M66
Connector Name	WIRE TO WIRE
Connector Color	WHITE

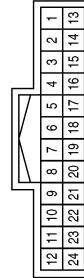

Terminal No.	Color of Wire	Signal Name
1	L	-
2	G	-
3	R	-(WITH REAR ENTERTAINMENT SYSTEM)
4	SHIELD	-(WITH REAR ENTERTAINMENT SYSTEM)
5	W	-(WITH REAR ENTERTAINMENT SYSTEM)

Connector No.	M65
Connector Name	WIRE TO WIRE
Connector Color	WHITE

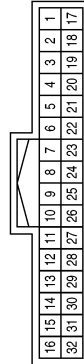

Terminal No.	Color of Wire	Signal Name
11	P	-
12	G	-
13	SHIELD	-
14	B	-
15	R	-
16	W	-
30	SHIELD	-
31	B	-
32	W	-

ABNIA4637GB

# BOSE AUDIO W/NAVI W/O SURROUND

< WIRING DIAGRAM >

[TELEMATICS SYSTEM]

Connector No.	M68
Connector Name	FUSE BLOCK (J/B)
Connector Color	BROWN



Terminal No.	Color of Wire	Signal Name
2R	LG	-
5R	Y	-

Connector No.	M67
Connector Name	JOINT CONNECTOR-M04
Connector Color	WHITE



Terminal No.	Color of Wire	Signal Name
2	L	-
3	B	-

Terminal No.	Color of Wire	Signal Name
22	W	-(WITH REAR ENTERTAINMENT SYSTEM)
23	R	-(WITH REAR ENTERTAINMENT SYSTEM)
24	SHIELD	-
25	B	-
26	G	-
27	B	-(WITH NAVI)
28	R	-(WITH NAVI)
29	G	-(WITH NAVI)
30	SHIELD	-
31	W	-

Terminal No.	Color of Wire	Signal Name
5	B	-
6	W	-
7	SHIELD	-
8	B	-
17	Y	-(WITH REAR ENTERTAINMENT SYSTEM)
18	P	-(WITH REAR ENTERTAINMENT SYSTEM)
19	B	-(WITH REAR ENTERTAINMENT SYSTEM)
20	W	-(WITH REAR ENTERTAINMENT SYSTEM)
21	SHIELD	-(WITH REAR ENTERTAINMENT SYSTEM)

Connector No.	M69
Connector Name	WIRE TO WIRE
Connector Color	WHITE

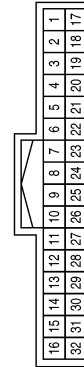

Terminal No.	Color of Wire	Signal Name
1	R	-(WITH REAR ENTERTAINMENT SYSTEM)
2	W	-(WITH REAR ENTERTAINMENT SYSTEM)
3	B	-(WITH REAR ENTERTAINMENT SYSTEM)
4	SHIELD	-

ABNIA4638GB

A  
B  
C  
D  
E  
F  
G  
H  
I  
J  
K  
L  
M  
N  
O  
P

AV

# BOSE AUDIO W/NAVI W/O SURROUND

< WIRING DIAGRAM >

[TELEMATICS SYSTEM]

Connector No.	M73
Connector Name	INSTRUMENT PANEL TWEETER RH
Connector Color	BROWN



Terminal No.	Color of Wire	Signal Name
1	G	-(WITH BOSE AUDIO SYSTEM)
2	W	-(WITH BOSE AUDIO SYSTEM)

Terminal No.	Color of Wire	Signal Name
9	W	RIR SENSOR SIGNAL
10	W	ROR SENSOR SIGNAL
11	-	-
12	LG	IGN
13	B	FR SENSOR GND
14	B	RR SENSOR GND
15	GR	GND
16	-	-
17	-	-
18	-	-
19	BR	SPEAKER PWR
20	LG	SPEAKER RR SIGNAL
21	W	RIL SENSOR SIGNAL
22	W	ROL SENSOR SIGNAL
23	-	-
24	-	-

Connector No.	M70
Connector Name	SONAR CONTROL UNIT
Connector Color	WHITE

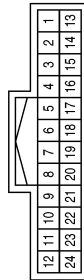

Terminal No.	Color of Wire	Signal Name
1	-	-
2	-	-
3	R	FOL SENSOR SIGNAL
4	R	FOR SENSOR SIGNAL
5	B	V CAN-H
6	W	V CAN-L
7	-	-
8	-	-

Terminal No.	Color of Wire	Signal Name
6	B	-(WITH REAR ENTERTAINMENT SYSTEM)
6	W	-(WITHOUT REAR ENTERTAINMENT SYSTEM)
7	W	-(WITH REAR ENTERTAINMENT SYSTEM)
7	R	-(WITHOUT REAR ENTERTAINMENT SYSTEM)
8	R	-(WITH REAR ENTERTAINMENT SYSTEM)
8	B	-(WITHOUT REAR ENTERTAINMENT SYSTEM)
9	SHIELD	-
10	G	-
11	L	-

Connector No.	M84
Connector Name	WIRE TO WIRE
Connector Color	WHITE

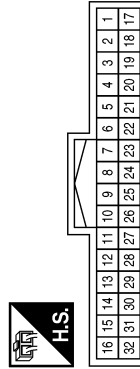

Terminal No.	Color of Wire	Signal Name
5	Y	-(WITH REAR ENTERTAINMENT SYSTEM)
5	P	-(WITHOUT REAR ENTERTAINMENT SYSTEM)

Connector No.	M80
Connector Name	BCM (BODY CONTROL MODULE)
Connector Color	BLACK

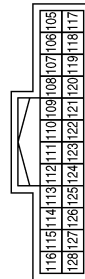

Terminal No.	Color of Wire	Signal Name
109	R	REVERSE SIGNAL
113	L	ACC RELAY OUT

ABNIA4639GB

# BOSE AUDIO W/NAVI W/O SURROUND

< WIRING DIAGRAM >

[TELEMATICS SYSTEM]

Terminal No.	Color of Wire	Signal Name
9	B	FRONT DISP IT
10	W	IT FRONT DISP
11	Y	BATT
12	B	GND
13	-	-
14	-	-
15	-	-
16	-	-
17	-	-
18	B	FRONT COMP +
19	W	FRONT COMP -
20	R	FRONT COMP SYNC
21	-	-
22	SHIELD	SHIELD
23	P	ACC
24	-	-

Connector No.	M92
Connector Name	DISPLAY UNIT (WITH NAVI)
Connector Color	WHITE

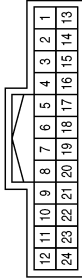

Terminal No.	Color of Wire	Signal Name
1	-	-
2	-	-
3	-	-
4	-	-
5	-	-
6	SHIELD	FRONT COMP SHIELD
7	SHIELD	SHIELD
8	B	R CAMERA COMP

Connector No.	M91
Connector Name	WIRE TO WIRE
Connector Color	WHITE

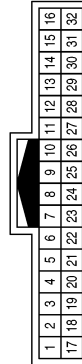

Terminal No.	Color of Wire	Signal Name
1	W	-
2	SHIELD	-
3	G	-
4	R	-
5	B	-

Connector No.	M95
Connector Name	WIRE TO WIRE
Connector Color	GRAY



Terminal No.	Color of Wire	Signal Name
1	B	-
2	B	-
3	B	-

ABNIA4640GB

A  
B  
C  
D  
E  
F  
G  
H  
I  
J  
K  
L  
M  
N  
O  
P

AV

# BOSE AUDIO W/NAVI W/O SURROUND

< WIRING DIAGRAM >

[TELEMATICS SYSTEM]

Terminal No.	Color of Wire	Signal Name
24	-	-
25	LG	REV
26	-	-
27	B	V-CAN1 H
28	W	V-CAN1 L
29	SHIELD	V-CAN1 GND
30	W	MIRROR SIGNAL 2
31	-	-
32	G	MIRROR SIGNAL 1
33	-	-
34	-	-
35	-	-
36	-	-
37	-	-
38	-	-
39	-	-
40	-	-

Terminal No.	Color of Wire	Signal Name
8	-	-
9	-	-
10	-	-
11	-	-
12	-	-
13	-	-
14	-	-
15	-	-
16	-	-
17	-	-
18	-	-
19	B	MCAN-1H
20	W	MCAN-1L
21	-	-
22	-	-
23	SHIELD	MCAN GND

Connector No.	M96
Connector Name	AROUND VIEW MONITOR CONTROL UNIT
Connector Color	WHITE



2	4	6	8	10	12	14	16	18	20	22	24	26	28	30	32	34	36	38	40
1	3	5	7	9	11	13	15	17	19	21	23	25	27	29	31	33	35	37	39

Terminal No.	Color of Wire	Signal Name
1	B	GND
2	Y	+B
3	LG	IGN
4	P	ACC
5	-	-
6	-	-
7	-	-

Terminal No.	Color of Wire	Signal Name
62	B	SV1 POWER
63	-	-
64	R	SV1 POWER GND
65	G	SV1 VIDEO +
66	SHIELD	SV1 VIDEO -
67	B	FV SERIAL SIGNAL
68	W	FV POWER
69	-	-
70	G	FV POWER GND
71	R	FV VIDEO +
72	SHIELD	FV VIDEO -

Terminal No.	Color of Wire	Signal Name
48	SHIELD	VIDEO OUTPUT -
49	W	RV SERIAL SIGNAL
50	B	RV POWER
51	-	-
52	R	RV POWER GND
53	G	RV VIDEO +
54	SHIELD	RV VIDEO -
55	B	SV2 SERIAL SIGNAL
56	W	SV2 POWER
57	-	-
58	G	SV2 POWER GND
59	R	SV2 VIDEO +
60	SHIELD	SV2 POWER GND
61	W	SV1 SERIAL SIGNAL

Connector No.	M97
Connector Name	AROUND VIEW MONITOR CONTROL UNIT
Connector Color	WHITE



42	44	46	48	50	52	54	56	58	60	62	64	66	68	70	72
41	43	45	47	49	51	53	55	57	59	61	63	65	67	69	71

Terminal No.	Color of Wire	Signal Name
41	-	-
42	-	-
43	-	-
44	-	-
45	-	-
46	-	-
47	B	VIDEO OUTPUT +

ABNIA4641GB

# BOSE AUDIO W/NAVI W/O SURROUND

< WIRING DIAGRAM >

[TELEMATICS SYSTEM]

Connector No.	M98
Connector Name	A/C AND AV SWITCH ASSEMBLY
Connector Color	WHITE

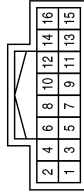

Terminal No.	Color of Wire	Signal Name
1	GR	-
3	P	-
4	R	-
5	B	-
6	SB	-
8	LG	-
9	V	-
14	Y	-

Connector No.	M109
Connector Name	FRONT TWEETER LH
Connector Color	BROWN



Terminal No.	Color of Wire	Signal Name
1	P	-(WITH BOSE AUDIO SYSTEM WITHOUT SURROUND SOUND SYSTEM)
2	W	-(WITH BOSE AUDIO SYSTEM WITHOUT SURROUND SOUND SYSTEM)

Connector No.	M110
Connector Name	CENTER SPEAKER
Connector Color	BROWN



Terminal No.	Color of Wire	Signal Name
1	G	-
2	W	-

Connector No.	M111
Connector Name	FRONT TWEETER RH
Connector Color	BROWN



Terminal No.	Color of Wire	Signal Name
1	G	-(WITH BOSE AUDIO SYSTEM WITHOUT SURROUND SOUND SYSTEM)
2	W	-(WITH BOSE AUDIO SYSTEM WITHOUT SURROUND SOUND SYSTEM)

Connector No.	M115
Connector Name	WIRE TO WIRE
Connector Color	GRAY

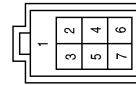

Terminal No.	Color of Wire	Signal Name
1	SHIELD	-
2	W	-
3	G	-
4	R	-
6	L	-

Connector No.	M120
Connector Name	JOINT CONNECTOR-M21
Connector Color	WHITE

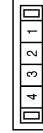

Terminal No.	Color of Wire	Signal Name
1	LG	-
3	LG	-

ABNIA4642GB

A  
B  
C  
D  
E  
F  
G  
H  
I  
J  
K  
L  
M  
N  
O  
P

AV

# BOSE AUDIO W/NAVI W/O SURROUND

< WIRING DIAGRAM >

[TELEMATICS SYSTEM]

Connector No.	M122
Connector Name	AV CONTROL UNIT (WITH BOSE AUDIO SYSTEM - WITH NAVI WITHOUT SURROUND SOUND SYSTEM)
Connector Color	WHITE

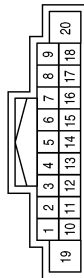

Terminal No.	Color of Wire	Signal Name
1	SB	AMP ON
2	B	FR LH PRE +

Terminal No.	Color of Wire	Signal Name
3	W	FR LH PRE -
4	B	RR LH PRE +
5	W	RR LH PRE -
6	G	STRG SW A
7	G	ACC (WITH TELEMATICS SYSTEM)
7	P	ACC (WITHOUT TELEMATICS SYSTEM)
8	-	-
9	-	-
10	BR	SHIELD
11	W	FR RH PRE +

Terminal No.	Color of Wire	Signal Name
12	B	FR RH PRE -
13	B	RR RH PRE +
14	W	RR RH PRE -
15	B	STRG SW GND
16	W	STRG SW B
17	-	-
18	-	-
19	Y	(+) B
20	GR	GND

Connector No.	M123
Connector Name	AV CONTROL UNIT (WITH BOSE AUDIO SYSTEM - WITH NAVI WITHOUT SURROUND SOUND SYSTEM)
Connector Color	WHITE

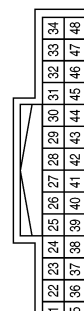

Terminal No.	Color of Wire	Signal Name
21	-	-
22	-	-
23	-	-
24	W	AUX AUDIO LH

Terminal No.	Color of Wire	Signal Name
25	-	-
26	W	HP 1 LH+
27	B	HP 1 RH-
28	-	-
29	-	-
30	-	-
31	-	-
32	-	-
33	-	-
34	-	-
35	-	-
36	-	-

Terminal No.	Color of Wire	Signal Name
37	SHIELD	AUX SHIELD
38	R	AUX AUDIO RH
39	B	AUX AUDIO
40	R	HP 1 LH-
41	G	HP 1 RH-
42	SHIELD	HP 1 SHIELD
43	-	-
44	-	-
45	-	-
46	-	-
47	-	-
48	-	-

ABNIA4643GB



# BOSE AUDIO W/NAVI W/O SURROUND

< WIRING DIAGRAM >

[TELEMATICS SYSTEM]

Terminal No.	Color of Wire	Signal Name
68	LG	IGN
69	R	REVERSE SIG
70	BG	SPEED
71	SHIELD	NAVI COMP 1 SHIELD
72	R	NAVI COMP 1 SYNC
73	-	-
74	-	-
75	B	MIC SIG
76	SHIELD	DISP SHIELD
77	B	DISP IT
78	L	CAN-H
79	SB	M CAN-H
80	SB	M CAN-H TRM

Terminal No.	Color of Wire	Signal Name
54	-	-
55	W	NAVI COMP 1-
56	B	NAVI COMP 1+
57	BG	I-KEY MEMORY
58	G	AV-ACC (DCM)
59	SHIELD	PKB SIGMIC GND
60	W	MIC VCC
61	W	IT DISP
62	P	CAN-L
63	LG	M CAN-L
64	LG	M CAN-L TRM
65	-	-
66	-	-
67	P	MR OUTPUT

Connector No.	M124
Connector Name	AV CONTROL UNIT (WITH BOSE AUDIO SYSTEM - WITH NAVI WITHOUT SURROUND SOUND SYSTEM)
Connector Color	WHITE

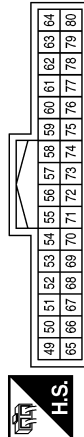

Terminal No.	Color of Wire	Signal Name
49	-	-
50	-	-
51	-	-
52	-	-
53	G	PKB SIG

Terminal No.	Color of Wire	Signal Name
104	-	-
105	W	NAVI COMP 2-
106	SHIELD	NAVI COMP 2 SHIELD
107	B	NAVI COMP 2+
108	-	-
109	-	-
110	-	-
111	-	-
112	-	-
113	-	-
114	-	-
115	-	-
116	-	-
117	-	-
118	-	-
119	-	-
120	-	-

Terminal No.	Color of Wire	Signal Name
87	-	-
88	-	-
89	-	-
90	-	-
91	W	AUX VIDEO+
92	B	AUX VIDEO-
93	-	-
94	SHIELD	VIDEO SHIELD
95	-	-
96	-	-
97	Y	DVD EJECT
98	V	EJECT GND
99	-	-
100	-	-
101	-	-
102	-	-
103	-	-

Connector No.	M125
Connector Name	AV CONTROL UNIT (WITH BOSE AUDIO SYSTEM - WITH NAVI WITHOUT SURROUND SOUND SYSTEM)
Connector Color	WHITE

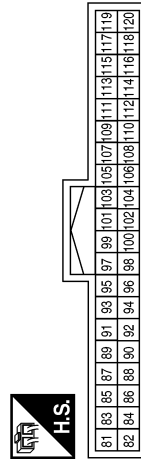

Terminal No.	Color of Wire	Signal Name
81	-	-
82	-	-
83	-	-
84	-	-
85	-	-
86	-	-

ABNIA4644GB

A  
B  
C  
D  
E  
F  
G  
H  
I  
J  
K  
L  
M  
N  
O  
P

AV

# BOSE AUDIO W/NAVI W/O SURROUND

< WIRING DIAGRAM >

[TELEMATICS SYSTEM]

Terminal No.	Color of Wire	Signal Name
46	W	MANUFACTURE SPECIFIC
47	B	USB VBUS
48	B	USB D-
49	B	D-VOICE
50	-	-
51	-	-
52	-	-
53	-	-
54	-	-
55	SHIELD	USB GND
56	L/W	D+
57	SHIELD	CONN CHASSIS GND

Connector No.	M134
Connector Name	TCU
Connector Color	GRAY

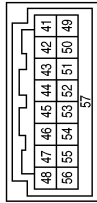

Terminal No.	Color of Wire	Signal Name
41	W	U-VOICE
42	L	VOICE GND
43	-	-
44	-	-
45	-	-

Connector No.	M133
Connector Name	AV CONTROL UNIT
Connector Color	BROWN

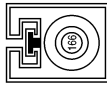

Terminal No.	Color of Wire	Signal Name
166	B	-

Terminal No.	Color of Wire	Signal Name
150	-	-
151	L	VOICE GND
152	W	U-VOICE
153	L/W	D+
154	SHIELD	USB GND
155	-	-
156	-	-
157	-	-
158	-	-
159	-	-
160	B	D-VOICE
161	SHIELD	CONN CHASSIS GND

Connector No.	M136
Connector Name	AV CONTROL UNIT
Connector Color	GRAY

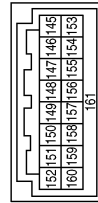

Terminal No.	Color of Wire	Signal Name
145	B	USB D-
146	B	USB VBUS
147	W	MANUFACTURE SPECIFIC
148	-	-
149	-	-

Connector No.	M135
Connector Name	TCU
Connector Color	BROWN



Terminal No.	Color of Wire	Signal Name
58	B	-
59	SHIELD	-

ABNIA4645GB

# BOSE AUDIO W/NAVI W/O SURROUND

< WIRING DIAGRAM >

[TELEMATICS SYSTEM]

Connector No.	M138
Connector Name	WIRE TO WIRE
Connector Color	GREEN



Terminal No.	Color of Wire	Signal Name
1	B	-

Connector No.	M140
Connector Name	AV CONTROL UNIT
Connector Color	BLUE



Terminal No.	Color of Wire	Signal Name
162	SHIELD	SHIELD
163	SHIELD	GND
164	B	GVIF-
165	B	GVIF+

Connector No.	M141
Connector Name	DISPLAY UNIT
Connector Color	BROWN



Terminal No.	Color of Wire	Signal Name
25	SHIELD	SHIELD
26	SHIELD	GND
27	B	GVIF+
28	B	GVIF-

Connector No.	M143
Connector Name	AV CONTROL UNIT
Connector Color	GRAY



Terminal No.	Color of Wire	Signal Name
142	B	ANT +B
143	B	ANT MAIN
144	B	ANT SUB

Connector No.	M149
Connector Name	COMBINATION SWITCH (SPIRAL CABLE)
Connector Color	GRAY

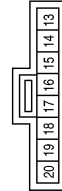

Terminal No.	Color of Wire	Signal Name
14	B	-
15	GR	-
17	BR	-

ABNIA4646GB

A  
B  
C  
D  
E  
F  
G  
H  
I  
J  
K  
L  
M  
N  
O  
P

AV

# BOSE AUDIO W/NAVI W/O SURROUND

< WIRING DIAGRAM >

[TELEMATICS SYSTEM]

Connector No.	M158
Connector Name	WIRE TO WIRE
Connector Color	WHITE

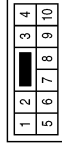

Terminal No.	Color of Wire	Signal Name
9	G	-(WITH BOSE AUDIO SYSTEM)
10	W	-(WITH BOSE AUDIO SYSTEM)

Terminal No.	Color of Wire	Signal Name
7	B	-
8	B	-
9	B	-
10	B	-
11	B	-
23	GR	-
24	SHIELD	-
25	SHIELD	-
26	SHIELD	-
27	SHIELD	-
28	SHIELD	-
29	SHIELD	-
30	SHIELD	-
31	GR	-

Connector No.	M150
Connector Name	JOINT CONNECTOR-M27
Connector Color	WHITE

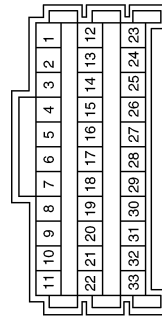

Terminal No.	Color of Wire	Signal Name
4	B	-
5	B	-
6	B	-

Connector No.	M170
Connector Name	JOINT CONNECTOR-M09
Connector Color	WHITE

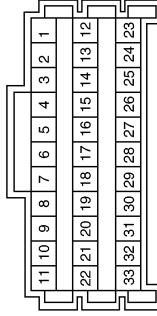

Terminal No.	Color of Wire	Signal Name
6	GR	-
7	SHIELD	-
8	SHIELD	-
9	SHIELD	-
10	SHIELD	-

Connector No.	M168
Connector Name	WIRE TO WIRE
Connector Color	WHITE

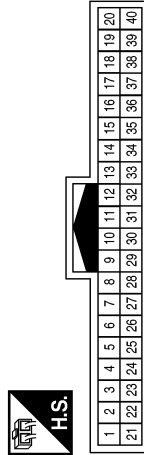

Terminal No.	Color of Wire	Signal Name
22	W	-
23	G	-
28	B	-
29	SHIELD	-
30	R	-
31	G	-
32	W	-

Connector No.	M167
Connector Name	WIRE TO WIRE
Connector Color	WHITE

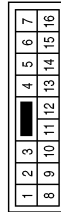

Terminal No.	Color of Wire	Signal Name
8	W	-(WITH BOSE AUDIO SYSTEM)
9	P	-(WITH BOSE AUDIO SYSTEM WITHOUT SURROUND SOUND SYSTEM)

ABNIA4647GB

# BOSE AUDIO W/NAVI W/O SURROUND

< WIRING DIAGRAM >

[TELEMATICS SYSTEM]

Connector No.	M171
Connector Name	JOINT CONNECTOR-M10
Connector Color	WHITE



Terminal No.	Color of Wire	Signal Name
2	P	-(WITH BOSE AUDIO SYSTEM)
3	P	-(WITH BOSE AUDIO SYSTEM)
4	P	-(WITH BOSE AUDIO SYSTEM)

Connector No.	M172
Connector Name	JOINT CONNECTOR-M11
Connector Color	WHITE



Terminal No.	Color of Wire	Signal Name
2	W	-(WITH BOSE AUDIO SYSTEM)
3	W	-(WITH BOSE AUDIO SYSTEM)
4	W	-(WITH BOSE AUDIO SYSTEM)

Connector No.	M173
Connector Name	JOINT CONNECTOR-M12
Connector Color	WHITE

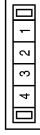

Terminal No.	Color of Wire	Signal Name
2	G	-(WITH BOSE AUDIO SYSTEM)
3	G	-(WITH BOSE AUDIO SYSTEM)
4	G	-(WITH BOSE AUDIO SYSTEM)

Connector No.	M174
Connector Name	JOINT CONNECTOR-M13
Connector Color	WHITE

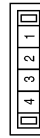

Terminal No.	Color of Wire	Signal Name
2	W	-(WITH BOSE AUDIO SYSTEM)
3	W	-(WITH BOSE AUDIO SYSTEM)
4	W	-(WITH BOSE AUDIO SYSTEM)

Connector No.	M175
Connector Name	JOINT CONNECTOR-M22
Connector Color	WHITE

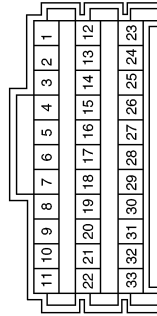

Terminal No.	Color of Wire	Signal Name
1	Y	-
2	Y	-
3	Y	-

Terminal No.	Color of Wire	Signal Name
4	Y	-
5	Y	-
6	Y	-
7	Y	-
8	Y	-
9	Y	-
29	P	-
30	P	-
31	P	-
32	P	-

ABNIA4648GB

A  
B  
C  
D  
E  
F  
G  
H  
I  
J  
K  
L  
M  
N  
O  
P

AV

# BOSE AUDIO W/NAVI W/O SURROUND

< WIRING DIAGRAM >

[TELEMATICS SYSTEM]

Connector No.	M178
Connector Name	JOINT CONNECTOR-M58
Connector Color	WHITE



Terminal No.	Color of Wire	Signal Name
1	SB	-
2	B	-
3	SB	-

Connector No.	M177
Connector Name	JOINT CONNECTOR-M57
Connector Color	WHITE



Terminal No.	Color of Wire	Signal Name
1	LG	-
2	LG	-
3	LG	-
4	LG	-

Connector No.	M176
Connector Name	JOINT CONNECTOR-M56
Connector Color	WHITE



Terminal No.	Color of Wire	Signal Name
1	SB	-
2	SB	-
3	SB	-
4	SB	-

Connector No.	M201
Connector Name	WIRES TO WIRE
Connector Color	WHITE

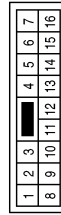

Terminal No.	Color of Wire	Signal Name
1	B	-
2	Y	-
3	V	-

Connector No.	M179
Connector Name	JOINT CONNECTOR-M59
Connector Color	WHITE



Terminal No.	Color of Wire	Signal Name
1	LG	-
2	W	-
3	LG	-

ABNIA4649GB

# BOSE AUDIO W/NAVI W/O SURROUND

< WIRING DIAGRAM >

[TELEMATICS SYSTEM]

Terminal No.	Color of Wire	Signal Name
28	W	-
29	L	-
30	G	-
31	R	-
32	SHIELD	-
33	W	-
34	B	-
35	L	-
36	G	-
37	R	-
38	SHIELD	-
39	W	-
40	B	-

Terminal No.	Color of Wire	Signal Name
11	R	-
12	SHIELD	-
13	W	-
14	B	-
15	V	-
16	G	-
17	R	-
18	SHIELD	-
19	W	-
20	B	-
24	B	-
25	SHIELD	-
26	B	-
27	R	-

Connector No.	M202
Connector Name	WIRE TO WIRE
Connector Color	WHITE

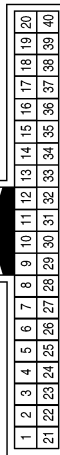

Terminal No.	Color of Wire	Signal Name
6	SHIELD	-
7	B	-
8	W	-
9	SB	-
10	G	-

Connector No.	M210
Connector Name	WIRE TO WIRE
Connector Color	GRAY

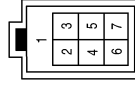

Connector No.	M209
Connector Name	USB INTERFACE
Connector Color	GREEN

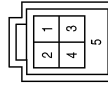

Connector No.	M205
Connector Name	FRONT AUXILIARY INPUT JACKS
Connector Color	WHITE

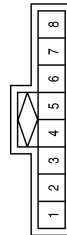

Terminal No.	Color of Wire	Signal Name
1	SHIELD	-
2	W	-
3	G	-
4	R	-
6	L	-

Terminal No.	Color of Wire	Signal Name
1	G	-
2	W	-
3	R	-
4	L	-
5	SHIELD	-

Terminal No.	Color of Wire	Signal Name
1	R	-
2	B	-
3	W	-
4	-	-
5	G	-
6	P	-
7	W	-
8	B	-

ABNIA4650GB

A  
B  
C  
D  
E  
F  
G  
H  
I  
J  
K  
L  
M  
N  
O  
P

AV

# BOSE AUDIO W/NAVI W/O SURROUND

< WIRING DIAGRAM >

[TELEMATICS SYSTEM]

Connector No.	M214
Connector Name	WIRE TO WIRE
Connector Color	WHITE

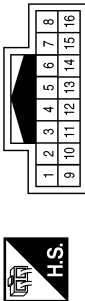

Terminal No.	Color of Wire	Signal Name
1	W	-
2	R	-
3	SHIELD	-
4	V	-
5	Y	-
13	W	-
14	R	-
15	B	-
16	SHIELD	-

Connector No.	M216
Connector Name	WIRE TO WIRE
Connector Color	WHITE

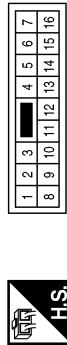

Terminal No.	Color of Wire	Signal Name
3	B	-
9	B	-

Connector No.	M215
Connector Name	WIRE TO WIRE
Connector Color	WHITE

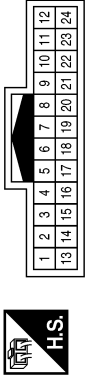

Terminal No.	Color of Wire	Signal Name
1	SB	-
2	G	-
3	R	-
4	SHIELD	-
5	W	-
6	B	-
7	V	-
8	G	-
9	R	-

Connector No.	M217
Connector Name	WIRE TO WIRE
Connector Color	WHITE

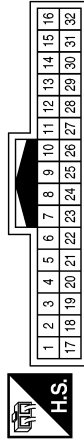

Terminal No.	Color of Wire	Signal Name
11	P	-
12	G	-
13	SHIELD	-
14	B	-
15	W	-
16	R	-
30	SHIELD	-
31	B	-
32	W	-

Terminal No.	Color of Wire	Signal Name
10	SHIELD	-
11	W	-
12	B	-
13	L	-
14	G	-
15	R	-
16	SHIELD	-
17	W	-
18	B	-
19	L	-
20	G	-
21	R	-
22	SHIELD	-
23	W	-
24	B	-

Connector No.	M230
Connector Name	JOINT CONNECTOR-M01
Connector Color	GRAY



Terminal No.	Color of Wire	Signal Name
2	B	-
3	SHIELD	-
4	SHIELD	-



# BOSE AUDIO W/NAVI W/O SURROUND

< WIRING DIAGRAM >

[TELEMATICS SYSTEM]

Terminal No.	Color of Wire	Signal Name
17	R	-
18	BG	-
19	G	-
20	B	-
21	SHIELD	-
22	W	-
23	SHIELD	-
24	W	-
25	G	-
26	B	-
27	R	-
28	L	-
29	P	-
30	W	-
31	G	-
32	B	-
33	R	-
34	-	-
35	SHIELD	-
36	-	-
37	-	-
38	V	-
39	B	-
40	Y	-

Connector No.	M254
Connector Name	REAR AUXILIARY INPUT JACKS
Connector Color	WHITE

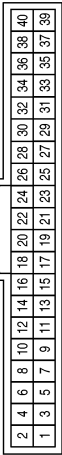
Terminal No.	Color of Wire	Signal Name
1	W	-
2	B	-
3	B	-
4	R	-
5	B	-
6	-	-
7	-	-
8	-	-
9	SHIELD	-
10	-	-
11	R	-
12	-	-
13	G	-
14	B	-
15	V	-
16	W	-

Connector No.	M251
Connector Name	WIRE TO WIRE
Connector Color	WHITE

Terminal No.	Color of Wire	Signal Name
1	B	-
2	Y	-
3	V	-

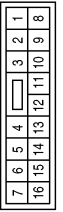
A  
B  
C  
D  
E  
F  
G  
H  
I  
J  
K  
L  
M  
N  
O  
P

AV

ABNIA4652GB

# BOSE AUDIO W/NAVI W/O SURROUND

< WIRING DIAGRAM >

[TELEMATICS SYSTEM]

Terminal No.	Color of Wire	Signal Name
27	B	-
28	W	-
29	L	-
30	G	-
31	R	-
32	SHIELD	-
33	W	-
34	B	-
35	P	-
36	G	-
37	R	-
38	SHIELD	-
39	W	-
40	B	-

Terminal No.	Color of Wire	Signal Name
12	SHIELD	-
13	W	-
14	B	-
15	V	-
16	G	-
17	R	-
18	SHIELD	-
19	W	-
20	B	-
24	B	-
25	SHIELD	-
26	R	-

Connector No.	M257
Connector Name	WIRE TO WIRE
Connector Color	WHITE

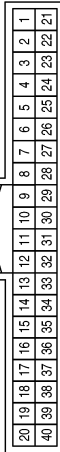

Terminal No.	Color of Wire	Signal Name
6	SHIELD	-
7	B	-
8	W	-
9	BG	-
10	G	-
11	R	-

Connector No.	M502
Connector Name	ANTENNA BASE
Connector Color	GRAY



Terminal No.	Color of Wire	Signal Name
1	B	-
2	B	-

Connector No.	M501
Connector Name	ANTENNA BASE
Connector Color	GREEN

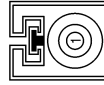

Terminal No.	Color of Wire	Signal Name
1	B	-

Connector No.	M500
Connector Name	WIRE TO WIRE
Connector Color	GRAY

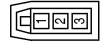

Terminal No.	Color of Wire	Signal Name
1	B	-
2	B	-
3	B	-

ABNIA4653GB

# BOSE AUDIO W/NAVI W/O SURROUND

< WIRING DIAGRAM >

[TELEMATICS SYSTEM]

Connector No.	M505
Connector Name	GLASS ANTENNA (FM SUB)
Connector Color	GRAY



Terminal No.	Color of Wire	Signal Name
1	B	-

Connector No.	M504
Connector Name	WIRE TO WIRE
Connector Color	GRAY



Terminal No.	Color of Wire	Signal Name
1	B	-

Connector No.	M503
Connector Name	WIRE TO WIRE
Connector Color	GRAY



Terminal No.	Color of Wire	Signal Name
1	B	-

Connector No.	E26
Connector Name	WIRE TO WIRE
Connector Color	WHITE



Terminal No.	Color of Wire	Signal Name
2	W	-
3	B	-
4	SHIELD	-
5	B	-
6	R	-
8	SHIELD	-
13	R	-
14	B	-
15	G	-
16	SHIELD	-
17	W	-

Connector No.	E22
Connector Name	ACCESSORY RELAY-2
Connector Color	BLUE



Terminal No.	Color of Wire	Signal Name
1	G	-
2	B	-
3	R	-
5	P	-

Connector No.	M509
Connector Name	WIRE TO WIRE
Connector Color	GREEN



Terminal No.	Color of Wire	Signal Name
1	B	-

ABNIA4654GB

A  
B  
C  
D  
E  
F  
G  
H  
I  
J  
K  
L  
M  
N  
O  
P

AV

# BOSE AUDIO W/NAVI W/O SURROUND

< WIRING DIAGRAM >

[TELEMATICS SYSTEM]

Connector No.	E52
Connector Name	PARKING BRAKE SWITCH
Connector Color	BLACK



Terminal No.	Color of Wire	Signal Name
1	LG	-

Connector No.	E44
Connector Name	JOINT CONNECTOR-E01
Connector Color	WHITE

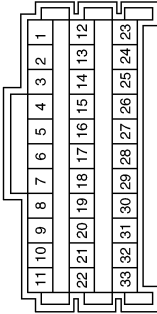

Terminal No.	Color of Wire	Signal Name
15	GR	-
17	B	-

Connector No.	E33
Connector Name	WIRE TO WIRE
Connector Color	WHITE

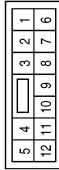

Terminal No.	Color of Wire	Signal Name
4	P	-

Connector No.	E209
Connector Name	WIRE TO WIRE
Connector Color	WHITE

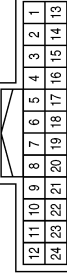

Terminal No.	Color of Wire	Signal Name
2	L	-
3	B	-
4	SHIELD	-
5	B	-
6	R	-
8	SHIELD	-
13	R	-
14	B	-
15	G	-
16	SHIELD	-
17	W	-

Terminal No.	Color of Wire	Signal Name
3G	P	-
16G	R	-
17G	B	-
18G	SHIELD	-
22G	B	-
23G	SHIELD	-
25G	W	-
26G	SHIELD	-
27G	W	-
28G	R	-
29G	B	-
30G	G	-
33G	LG	-
50G	G	-

Connector No.	E152
Connector Name	WIRE TO WIRE
Connector Color	WHITE

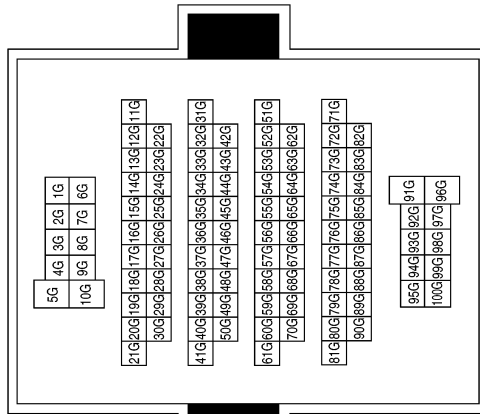

ABNIA4655GB

# BOSE AUDIO W/NAVI W/O SURROUND

< WIRING DIAGRAM >

[TELEMATICS SYSTEM]

Connector No.	E226
Connector Name	FRONT CAMERA
Connector Color	BLACK

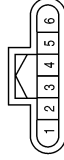

Terminal No.	Color of Wire	Signal Name
1	R	-
2	B	-
3	G	-
4	SHIELD	-
6	W	-

Connector No.	E212
Connector Name	WIRE TO WIRE
Connector Color	GRAY

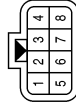

Terminal No.	Color of Wire	Signal Name
1	L	-
2	B	-

Connector No.	E211
Connector Name	WIRE TO WIRE
Connector Color	GRAY

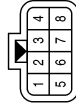

Terminal No.	Color of Wire	Signal Name
1	R	-
2	B	-

Connector No.	E307
Connector Name	FRONT SONAR SENSOR LH OUTER
Connector Color	BLACK



Terminal No.	Color of Wire	Signal Name
1	P	-
2	G	-

Connector No.	E302
Connector Name	WIRE TO WIRE
Connector Color	GRAY

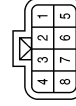

Terminal No.	Color of Wire	Signal Name
1	G	-
2	P	-

Connector No.	E301
Connector Name	WIRE TO WIRE
Connector Color	GRAY

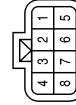

Terminal No.	Color of Wire	Signal Name
1	G	-
2	P	-

ABNIA4656GB

A  
B  
C  
D  
E  
F  
G  
H  
I  
J  
K  
L  
M  
N  
O  
P

AV

# BOSE AUDIO W/NAVI W/O SURROUND

< WIRING DIAGRAM >

[TELEMATICS SYSTEM]

Connector No.	E308
Connector Name	FRONT SONAR SENSOR RH OUTER
Connector Color	BLACK



Terminal No.	Color of Wire	Signal Name
1	P	-
2	G	-

Connector No.	B1
Connector Name	REAR SIDE SPEAKER LH
Connector Color	BROWN



Terminal No.	Color of Wire	Signal Name
1	W	-
2	G	-

Connector No.	B5
Connector Name	FRONT SEAT LH (PRE-WIRING)
Connector Color	WHITE

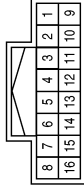

Terminal No.	Color of Wire	Signal Name
2	SHIELD	-
3	W	-
4	SHIELD	-
5	B	-
6	R	-
7	G	-
8	R	-
10	SHIELD	-
11	W	-
12	SHIELD	-
13	B	-
14	R	-
15	B	-
16	L	-

Connector No.	B6
Connector Name	WIRE TO WIRE
Connector Color	WHITE



Terminal No.	Color of Wire	Signal Name
1	P	-
2	G	-
3	R	-(WITH REAR ENTERTAINMENT SYSTEM)

Terminal No.	Color of Wire	Signal Name
4	SHIELD	-(WITH REAR ENTERTAINMENT SYSTEM)
5	W	-(WITH REAR ENTERTAINMENT SYSTEM)
6	B	-(WITH REAR ENTERTAINMENT SYSTEM)
7	V	-(WITH REAR ENTERTAINMENT SYSTEM)
8	G	-(WITH REAR ENTERTAINMENT SYSTEM)

Terminal No.	Color of Wire	Signal Name
9	B	-(WITH REAR ENTERTAINMENT SYSTEM)
10	SHIELD	-
11	R	-(WITH REAR ENTERTAINMENT SYSTEM)
12	W	-
13	SB	-
14	SB	-
15	LG	-

ABNIA4657GB

# BOSE AUDIO W/NAVI W/O SURROUND

< WIRING DIAGRAM >

[TELEMATICS SYSTEM]

Connector No.	B23
Connector Name	WIRE TO WIRE
Connector Color	WHITE

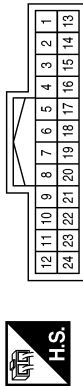

Terminal No.	Color of Wire	Signal Name
1	SB	-
3	SB	-
4	LG	-
6	BR	-
8	P	-
9	L	-
10	SHIELD	-
11	R	-
12	B	-
13	B	-
15	SB	-
16	LG	-
18	L	-
19	SB	-
21	P	-
22	SHIELD	-
23	G	-
24	W	-

Connector No.	B24
Connector Name	VIDEO DISTRIBUTOR
Connector Color	WHITE

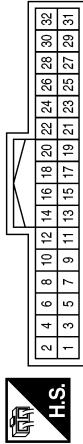

Terminal No.	Color of Wire	Signal Name
1	B	-
2	V	-
3	B	-
4	W	-
5	BR	-
6	L	-
7	SB	-
8	BR	-
9	SB	-
10	L	-
11	-	-
12	-	-

Terminal No.	Color of Wire	Signal Name
13	-	-
14	R	-
15	G	-
16	B	-
17	W	-
18	V	-
19	V	-
20	B	-
21	G	-
22	W	-
23	R	-
24	-	-
25	-	-
26	-	-
27	W	-
28	B	-
29	SHIELD	-
30	SHIELD	-
31	P	-
32	L	-

A  
B  
C  
D  
E  
F  
G  
H  
I  
J  
K  
L  
M  
N  
O  
P

AV

# BOSE AUDIO W/NAVI W/O SURROUND

< WIRING DIAGRAM >

[TELEMATICS SYSTEM]

Terminal No.	Color of Wire	Signal Name
49	SHIELD	-
50	-	-
51	-	-
52	-	-
53	SHIELD	-
54	B	-
55	R	-
56	W	-

Terminal No.	Color of Wire	Signal Name
38	-	-
39	W	-
40	B	-
41	SHIELD	-
42	-	-
43	-	-
44	-	-
45	W	-
46	R	-
47	B	-
48	G	-

Connector No.	B25
Connector Name	VIDEO DISTRIBUTOR
Connector Color	WHITE

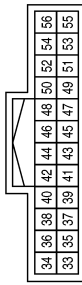

Terminal No.	Color of Wire	Signal Name
33	W	-
34	B	-
35	SHIELD	-
36	-	-
37	-	-

Connector No.	B35
Connector Name	SONAR BUZZER
Connector Color	WHITE

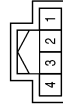

Terminal No.	Color of Wire	Signal Name
2	P	-
3	V	-

Terminal No.	Color of Wire	Signal Name
11	B	-
12	L	-
13	B	-
14	R	-
15	W	-
16	SHIELD	-

Connector No.	B32
Connector Name	WIRE TO WIRE
Connector Color	WHITE

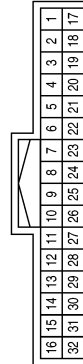

Terminal No.	Color of Wire	Signal Name
5	G	-
6	R	-
7	B	-
8	R	-
9	W	-
10	SHIELD	-

ABNIA4659GB



# BOSE AUDIO W/NAVI W/O SURROUND

< WIRING DIAGRAM >

[TELEMATICS SYSTEM]

Terminal No.	Color of Wire	Signal Name
23	R	-- (WITH REAR ENTERTAINMENT SYSTEM)
24	SHIELD	--
25	B	--
26	G	--
27	W	-- (WITH NAVI)
28	R	-- (WITH NAVI)
29	G	-- (WITH NAVI)
30	SHIELD	--
31	B	--

Terminal No.	Color of Wire	Signal Name
6	W	--
7	SHIELD	--
8	B	--
17	V	-- (WITH REAR ENTERTAINMENT SYSTEM)
18	W	-- (WITH REAR ENTERTAINMENT SYSTEM)
19	B	-- (WITH REAR ENTERTAINMENT SYSTEM)
20	W	-- (WITH REAR ENTERTAINMENT SYSTEM)
21	SHIELD	-- (WITH REAR ENTERTAINMENT SYSTEM)
22	W	-- (WITH REAR ENTERTAINMENT SYSTEM)

Connector No.	B41
Connector Name	WIRE TO WIRE
Connector Color	WHITE

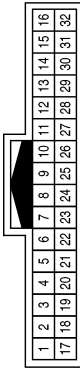

Terminal No.	Color of Wire	Signal Name
1	R	-- (WITH REAR ENTERTAINMENT SYSTEM)
2	W	-- (WITH REAR ENTERTAINMENT SYSTEM)
3	B	--
4	SHIELD	--
5	B	--

Connector No.	B49
Connector Name	WIRE TO WIRE
Connector Color	WHITE



Connector No.	B46
Connector Name	WIRE TO WIRE
Connector Color	WHITE



Connector No.	B43
Connector Name	WIRE TO WIRE
Connector Color	WHITE



Terminal No.	Color of Wire	Signal Name
9	G	--
10	W	--
11	P	--
12	R	--
13	SHIELD	--
14	B	--
15	W	--
16	W	--

Terminal No.	Color of Wire	Signal Name
13	W	-- (WITH NAVI)
14	R	-- (WITH NAVI)
15	G	-- (WITH NAVI)
16	SHIELD	--
17	B	--

Terminal No.	Color of Wire	Signal Name
4	G	--

ABNIA4660GB

A  
B  
C  
D  
E  
F  
G  
H  
I  
J  
K  
L  
M  
N  
O  
P

AV

# BOSE AUDIO W/NAVI W/O SURROUND

< WIRING DIAGRAM >

[TELEMATICS SYSTEM]

Terminal No.	Color of Wire	Signal Name
17A	W	-
18A	B	-
19A	SHIELD	-
20A	W	-
21A	SHIELD	-
23A	W	-
24A	B	-
25A	SHIELD	-
26A	W	-
27A	B	-
28A	SHIELD	-
30A	B	-
74A	P	-
75A	V	-

Connector No.	B69
Connector Name	WIRE TO WIRE
Connector Color	GRAY

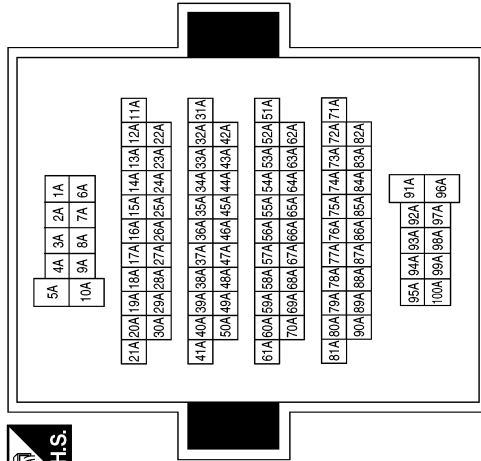

Connector No.	B51
Connector Name	WIRE TO WIRE
Connector Color	GRAY

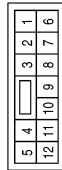

Terminal No.	Color of Wire	Signal Name
11	R	-
12	P	-

Terminal No.	Color of Wire	Signal Name
4	SB	-
5	BR	-
6	SHIELD	-
7	W	-
8	B	-
9	V	-
10	W	-
11	B	-
12	G	-
13	R	-
14	SHIELD	-

Connector No.	B75
Connector Name	WIRE TO WIRE
Connector Color	WHITE



Terminal No.	Color of Wire	Signal Name
1	LG	-
2	SB	-
3	L	-

Connector No.	B73
Connector Name	SUBWOOFER
Connector Color	GRAY



Terminal No.	Color of Wire	Signal Name
1	B	-
2	W	-
4	W	-
5	B	-
6	G	-

ABNIA4661GB

# BOSE AUDIO W/NAVI W/O SURROUND

< WIRING DIAGRAM >

[TELEMATICS SYSTEM]

Connector No.	B107
Connector Name	WIRE TO WIRE
Connector Color	WHITE

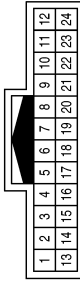

Terminal No.	Color of Wire	Signal Name
6	B	-
7	V	-
8	G	-
9	R	-
10	SHIELD	-
11	B	-
12	W	-
19	P	-
20	G	-
21	SHIELD	-
22	B	-
23	R	-
24	W	-

Connector No.	B101
Connector Name	WIRE TO WIRE
Connector Color	WHITE

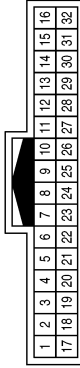

Terminal No.	Color of Wire	Signal Name
5	Y	- (WITH REAR ENTERTAINMENT SYSTEM)
5	V	- (WITHOUT REAR ENTERTAINMENT SYSTEM)
6	B	- (WITH REAR ENTERTAINMENT SYSTEM)
6	W	- (WITHOUT REAR ENTERTAINMENT SYSTEM)
7	W	- (WITH REAR ENTERTAINMENT SYSTEM)
7	R	- (WITHOUT REAR ENTERTAINMENT SYSTEM)
8	R	- (WITH REAR ENTERTAINMENT SYSTEM)
8	B	- (WITHOUT REAR ENTERTAINMENT SYSTEM)
9	SHIELD	-
10	G	-
11	SB	-

Connector No.	B77
Connector Name	WIRE TO WIRE
Connector Color	WHITE

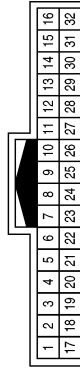

Terminal No.	Color of Wire	Signal Name
17	W	-
18	B	-
19	SHIELD	-
21	B	-
22	W	-
23	SHIELD	-
24	W	-
25	B	-
26	SHIELD	-
27	W	-
28	B	-
29	SHIELD	-

ABNIA4662GB

A  
B  
C  
D  
E  
F  
G  
H  
I  
J  
K  
L  
M  
N  
O  
P

AV

# BOSE AUDIO W/NAVI W/O SURROUND

< WIRING DIAGRAM >

[TELEMATICS SYSTEM]

Connector No.	B110
Connector Name	FRONT SEAT RH (PRE-WIRING)
Connector Color	WHITE

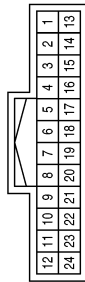

Terminal No.	Color of Wire	Signal Name
1	Y	-
2	V	-
3	B	-
4	R	-

Connector No.	B111
Connector Name	WIRE TO WIRE
Connector Color	BROWN

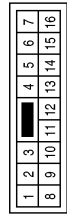

Terminal No.	Color of Wire	Signal Name
3	R	-
4	LG	-
5	Y	-
6	P	-
7	R	-
8	G	-
9	W	-
10	G	-
13	W	-
14	P	-
15	G	-
16	R	-

Terminal No.	Color of Wire	Signal Name
5	W	-
6	B	-
7	L	-
8	G	-
9	R	-
10	W	-
11	SHIELD	-
12	V	-
13	B	-
14	R	-
15	W	-

Connector No.	B124
Connector Name	WIRE TO WIRE
Connector Color	WHITE

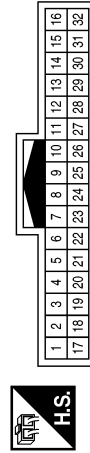

Terminal No.	Color of Wire	Signal Name
5	G	-
6	R	-
7	G	-
8	R	-
9	W	-
10	SHIELD	-
11	B	-
12	L	-
13	G	-
14	R	-
15	W	-
16	SHIELD	-

Terminal No.	Color of Wire	Signal Name
16	SHIELD	-
17	SHIELD	-
18	B	-
19	G	-
20	R	-
21	G	-
22	R	-
23	W	-
24	SHIELD	-

Connector No.	B129
Connector Name	BOSE SPEAKER AMP.
Connector Color	BROWN



Terminal No.	Color of Wire	Signal Name
41	R	-
42	G	-
43	G	-
44	W	-
45	G	-
46	W	-
47	B	-
48	G	-
49	W	-
50	LG	-
51	Y	-
52	B	-
53	W	-
54	G	-

# BOSE AUDIO W/NAVI W/O SURROUND

< WIRING DIAGRAM >

[TELEMATICS SYSTEM]

Connector No.	B130
Connector Name	BOSE SPEAKER AMP.
Connector Color	BROWN

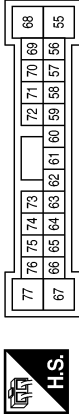

Terminal No.	Color of Wire	Signal Name
55	R	-
56	B	-
57	W	-
58	G	-
59	R	-
60	W	-
61	SHIELD	-
62	W	-
63	W	-
64	B	-
65	W	-
66	B	-
67	-	-
68	P	-
69	P	-
70	R	-
71	W	-
72	P	-
73	B	-
74	W	-
75	B	-
76	W	-
77	-	-

Connector No.	B136
Connector Name	WIRE TO WIRE
Connector Color	WHITE

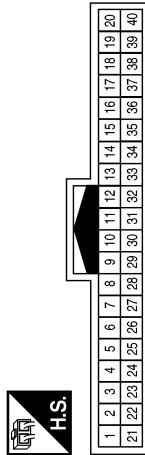

Terminal No.	Color of Wire	Signal Name
9	B	-
10	W	-
11	SHIELD	-
12	B	-
13	W	-
14	SHIELD	-
15	B	-
16	W	-
17	SHIELD	-
18	W	-
19	LG	-(WITHOUT SURROUND SOUND SYSTEM)
20	SB	-(WITHOUT SURROUND SOUND SYSTEM)
21	B	-
22	W	-
23	SHIELD	-

Connector No.	B137
Connector Name	WIRE TO WIRE
Connector Color	WHITE

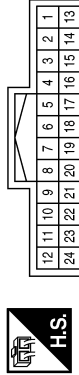

Terminal No.	Color of Wire	Signal Name
1	Y	-
3	SB	-
4	LG	-
6	SB	-
8	SB	-
9	O	-
10	SHIELD	-
11	R	-
12	B	-
13	B	-
15	SB	-(WITHOUT SURROUND SOUND SYSTEM)
16	L/G	-
18	LG	-
19	BR	-
21	Y	-
22	SHIELD	-
23	G	-
24	W	-

A  
B  
C  
D  
E  
F  
G  
H  
I  
J  
K  
L  
M  
N  
O  
P

AV

ABNIA4664GB

# BOSE AUDIO W/NAVI W/O SURROUND

< WIRING DIAGRAM >

[TELEMATICS SYSTEM]

Connector No.	B139
Connector Name	WIRE TO WIRE
Connector Color	WHITE

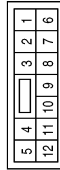

Terminal No.	Color of Wire	Signal Name
11	W	-(WITH BOSE AUDIO SYSTEM)
12	G	-(WITH BOSE AUDIO SYSTEM)

Connector No.	B140
Connector Name	WIRE TO WIRE
Connector Color	WHITE

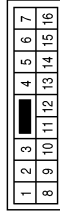

Terminal No.	Color of Wire	Signal Name
9	G	-
10	W	-
11	P	-
12	R	-
13	SHIELD	-
14	W	-
15	B	-
16	W	-

Connector No.	B145
Connector Name	WIRE TO WIRE
Connector Color	WHITE

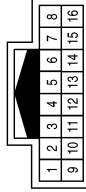

Terminal No.	Color of Wire	Signal Name
1	LG	-
2	SB	-
3	SB	-
4	L	-
5	BR	-
6	SHIELD	-
7	Y	-
8	O	-
9	V	-
10	B	-
11	W	-
12	G	-
13	R	-
14	SHIELD	-

Connector No.	B153
Connector Name	REAR SIDE SPEAKER RH
Connector Color	BROWN



Terminal No.	Color of Wire	Signal Name
1	W	-
2	G	-

ABNIA4665GB

# BOSE AUDIO W/NAVI W/O SURROUND

< WIRING DIAGRAM >

[TELEMATICS SYSTEM]

Terminal No.	Color of Wire	Signal Name
21	G	REAR1 COMP-
22	-	-
23	Y	CONT GND
24	SB	CON CK B
25	-	-
26	R	M-CAN 2L
27	LG	M-CAN 2H
28	-	-
29	GR	CON CK A
30	-	-
31	G	GND
32	G	GND

Connector No.	B202
Connector Name	HEADREST DISPLAY UNIT (DRIVER SEAT)
Connector Color	WHITE

Terminal No.	Color of Wire	Signal Name
1	W	REAR1 HP LH+
2	G	REAR1 HP RH+
3	LG	REAR1 HP SHIELD
4	-	-
5	Y	REAR1 COMP+
6	-	-
7	W	AUX REQ OUT
8	G	ACC DET IN
9	-	-
10	LG	M-CAN 1L
11	P	M-CAN 1H
12	G	LOCATION DET LH (LH ONLY)
13	BR	ILL
14	-	-
15	W	BAT
16	W	BAT
17	B	REAR1 HP LH-
18	R	REAR1 HP RH-
19	V	AV GND
20	P	REAR1 COMP SHIELD

Connector No.	B201
Connector Name	WIRE TO WIRE
Connector Color	WHITE

Terminal No.	Color of Wire	Signal Name
1	W	-
3	P	-
4	LG	-
6	G	-
8	V	-
9	Y	-
10	P	-
11	G	-
12	W	-
13	G	-
14	SB	-
15	LG	-
16	R	-
17	BR	-
18	W	-
19	Y	-
20	GR	-
21	G	-
22	LG	-
23	B	-
24	R	-

ABNIA4846GB

A  
B  
C  
D  
E  
F  
G  
H  
I  
J  
K  
L  
M  
N  
O  
P

AV

# BOSE AUDIO W/NAVI W/O SURROUND

< WIRING DIAGRAM >

[TELEMATICS SYSTEM]

Terminal No.	Color of Wire	Signal Name
26	R	-
27	LG	-
29	GR	-
31	G	-
32	G	-

Terminal No.	Color of Wire	Signal Name
10	LG	-
11	P	-
12	G	-
13	BR	-
15	W	-
16	W	-
17	B	-
18	R	-
19	V	-
20	P	-
21	G	-
23	Y	-
24	SB	-

Connector No.	B219
Connector Name	WIRE TO WIRE
Connector Color	WHITE

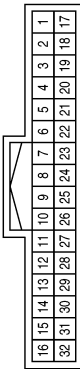

Terminal No.	Color of Wire	Signal Name
1	W	-
2	G	-
3	LG	-
5	Y	-
7	W	-
8	G	-

Terminal No.	Color of Wire	Signal Name
26	R	-
27	LG	-
29	GR	-
31	G	-
32	G	-

Terminal No.	Color of Wire	Signal Name
10	LG	-
11	P	-
12	G	-
13	BR	-
15	W	-
16	W	-
17	B	-
18	R	-
19	V	-
20	P	-
21	G	-
23	Y	-
24	SB	-

Connector No.	B222
Connector Name	WIRE TO WIRE
Connector Color	WHITE

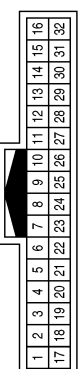

Terminal No.	Color of Wire	Signal Name
1	W	-
2	G	-
3	LG	-
5	Y	-
7	W	-
8	G	-

ABNIA4847GB



# BOSE AUDIO W/NAVI W/O SURROUND

< WIRING DIAGRAM >

[TELEMATICS SYSTEM]

Terminal No.	Color of Wire	Signal Name
23	Y	CONT GND
24	SB	CON CK B
25	-	-
26	R	M-CAN 2L
27	LG	M-CAN 2H
28	G	LOCATION DET RH (RH ONLY)
29	GR	CON CK A
30	-	-
31	G	GND
32	G	GND

Connector No.	B302
Connector Name	HEADREST DISPLAY UNIT (DRIVER SEAT)
Connector Color	WHITE

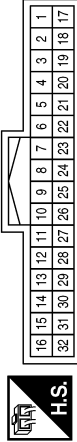

Terminal No.	Color of Wire	Signal Name
1	W	REAR1 HP LH+
2	G	REAR1 HP RH+
3	LG	REAR1 HP SHIELD
4	-	-
5	Y	REAR1 COMP+
6	-	-
7	W	AUX REQ OUT
8	G	ACC DET IN
9	-	-
10	LG	M-CAN 1L
11	P	M-CAN 1H
12	-	-
13	BR	ILL
14	-	-
15	W	BAT
16	W	BAT
17	B	REAR1 HP LH-
18	R	REAR1 HP RH-
19	V	AV GND
20	P	REAR1 COMP SHIELD
21	G	REAR1 COMP-
22	-	-

Connector No.	B301
Connector Name	WIRE TO WIRE
Connector Color	WHITE

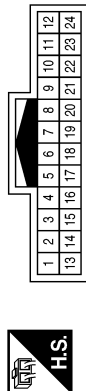

Terminal No.	Color of Wire	Signal Name
1	W	-
3	P	-
4	LG	-
6	G	-
8	V	-
9	Y	-
10	P	-
11	G	-
12	W	-
13	G	-
14	SB	-
15	LG	-
16	R	-
17	BR	-
18	W	-
19	Y	-
20	GR	-
21	G	-
22	LG	-
23	B	-
24	R	-

ABNIA4848GB

A  
B  
C  
D  
E  
F  
G  
H  
I  
J  
K  
L  
M  
N  
O  
P



# BOSE AUDIO W/NAVI W/O SURROUND

< WIRING DIAGRAM >

[TELEMATICS SYSTEM]

Terminal No.	Color of Wire	Signal Name
27	LG	-
28	G	-
29	GR	-
31	G	-
32	G	-

Terminal No.	Color of Wire	Signal Name
10	LG	-
11	P	-
13	BR	-
15	W	-
16	W	-
17	B	-
18	R	-
19	V	-
20	P	-
21	G	-
23	Y	-
24	SB	-
26	R	-

Connector No.	B316
Connector Name	WIRE TO WIRE
Connector Color	WHITE

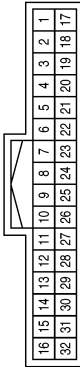

Terminal No.	Color of Wire	Signal Name
1	W	-
2	G	-
3	LG	-
5	Y	-
7	W	-
8	G	-

Terminal No.	Color of Wire	Signal Name
27	LG	-
28	G	-
29	GR	-
31	G	-
32	G	-

Terminal No.	Color of Wire	Signal Name
10	LG	-
11	P	-
13	BR	-
15	W	-
16	W	-
17	B	-
18	R	-
19	V	-
20	P	-
21	G	-
23	Y	-
24	SB	-
26	R	-

Connector No.	B317
Connector Name	WIRE TO WIRE
Connector Color	WHITE

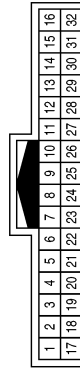

Terminal No.	Color of Wire	Signal Name
1	W	-
2	G	-
3	LG	-
5	Y	-
7	W	-
8	G	-

ABNIA4666GB

# BOSE AUDIO W/NAVI W/O SURROUND

< WIRING DIAGRAM >

[TELEMATICS SYSTEM]

Connector No.	B452
Connector Name	WIRE TO WIRE
Connector Color	BLACK



Terminal No.	Color of Wire	Signal Name
2	P	-
3	G	-
4	L	-
5	Y	-
8	L	-
9	W	-
10	P	-
11	G	-

Connector No.	B401
Connector Name	WIRE TO WIRE
Connector Color	BLACK



Terminal No.	Color of Wire	Signal Name
2	B	-
3	W	-
4	B	-
5	W	-
8	B	-
9	W	-
10	W	-
11	B	-

Connector No.	B400
Connector Name	WIRE TO WIRE
Connector Color	WHITE

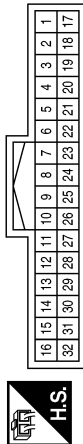

Terminal No.	Color of Wire	Signal Name
17	W	-
18	B	-
19	SHIELD	-
21	B	-
22	W	-
23	SHIELD	-
24	W	-
25	B	-
26	SHIELD	-
27	W	-
28	B	-
29	SHIELD	-

Connector No.	B457
Connector Name	REAR SONAR SENSOR LH INNER
Connector Color	BLACK



Terminal No.	Color of Wire	Signal Name
1	L	-
2	Y	-

Connector No.	B456
Connector Name	REAR SONAR SENSOR RH OUTER
Connector Color	BLACK



Terminal No.	Color of Wire	Signal Name
1	L	-
2	W	-

Connector No.	B455
Connector Name	REAR SONAR SENSOR LH OUTER
Connector Color	BLACK



Terminal No.	Color of Wire	Signal Name
1	P	-
2	G	-

ABNIA4667GB

A  
B  
C  
D  
E  
F  
G  
H  
I  
J  
K  
L  
M  
N  
O  
P

AV

# BOSE AUDIO W/NAVI W/O SURROUND

< WIRING DIAGRAM >

[TELEMATICS SYSTEM]

Connector No.	R11
Connector Name	WIRE TO WIRE
Connector Color	WHITE

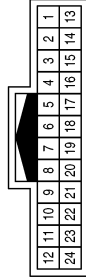

Terminal No.	Color of Wire	Signal Name
1	W	-
2	B	-
3	BG	-
4	P	-
5	SHIELD	-
6	B	-
7	W	-

Connector No.	R1
Connector Name	WIRE TO WIRE
Connector Color	WHITE

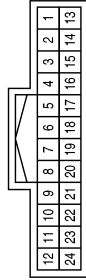

Terminal No.	Color of Wire	Signal Name
5	B	-
13	W	-
14	B	-
15	SHIELD	-
16	P	-
17	BG	-
23	W	-

Connector No.	B458
Connector Name	REAR SONAR SENSOR RH INNER
Connector Color	BLACK



Terminal No.	Color of Wire	Signal Name
1	P	-
2	G	-

Connector No.	R109
Connector Name	MICROPHONE
Connector Color	WHITE

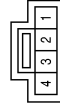

Terminal No.	Color of Wire	Signal Name
1	R	-
2	-	-
3	GR	-
4	L	-

Connector No.	R105
Connector Name	TELEMATICS SWITCH
Connector Color	WHITE

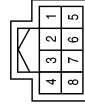

Terminal No.	Color of Wire	Signal Name
1	V	-
2	G	-
3	P	-
7	R	-

Connector No.	R101
Connector Name	WIRE TO WIRE
Connector Color	WHITE

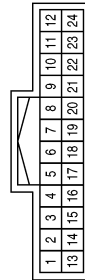

Terminal No.	Color of Wire	Signal Name
1	V	-
2	R	-
3	G	-
4	P	-
5	SHIELD	-
6	L	-
7	R	-

ABNIA4668GB

# BOSE AUDIO W/NAVI W/O SURROUND

< WIRING DIAGRAM >

[TELEMATICS SYSTEM]

Connector No.	D2
Connector Name	WIRE TO WIRE
Connector Color	WHITE

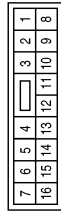

Terminal No.	Color of Wire	Signal Name
8	W	-
9	G	-

Connector No.	D3
Connector Name	WIRE TO WIRE
Connector Color	WHITE



Terminal No.	Color of Wire	Signal Name
22	Y	-
23	LG	-
28	G	-
29	SHIELD	-
30	R	-
31	B	-
32	W	-

Connector No.	D6
Connector Name	DOOR MIRROR LH (WITH AROUND VIEW MONITOR)
Connector Color	WHITE

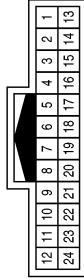

Terminal No.	Color of Wire	Signal Name
8	LG	-
9	Y	-

Connector No.	D12
Connector Name	FRONT DOOR SPEAKER LH
Connector Color	WHITE



Terminal No.	Color of Wire	Signal Name
1	G	-
2	W	-

Connector No.	D20
Connector Name	DOOR MIRROR LH (SIDE CAMERA)
Connector Color	WHITE

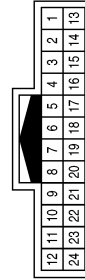

Terminal No.	Color of Wire	Signal Name
5	R	-
6	W	-
16	G	-
17	SHIELD	-
18	B	-

Connector No.	D101
Connector Name	WIRE TO WIRE
Connector Color	WHITE

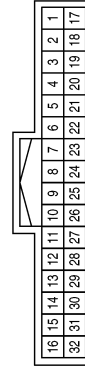

Terminal No.	Color of Wire	Signal Name
1	G	-
2	SHIELD	-
3	R	-
4	B	-
5	W	-

ABNIA4669GB

A  
B  
C  
D  
E  
F  
G  
H  
I  
J  
K  
L  
M  
N  
O  
P

AV

# BOSE AUDIO W/NAVI W/O SURROUND

< WIRING DIAGRAM >

[TELEMATICS SYSTEM]

Connector No.	D113
Connector Name	DOOR MIRROR RH (SIDE CAMERA)
Connector Color	WHITE

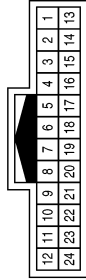

Terminal No.	Color of Wire	Signal Name
5	R	-
6	W	-
16	G	-
17	SHIELD	-
18	B	-

Connector No.	D112
Connector Name	FRONT DOOR SPEAKER RH
Connector Color	WHITE



Terminal No.	Color of Wire	Signal Name
1	G	-
2	W	-

Connector No.	D102
Connector Name	WIRE TO WIRE
Connector Color	WHITE

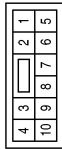

Terminal No.	Color of Wire	Signal Name
9	G	-
10	W	-

Connector No.	D301
Connector Name	WIRE TO WIRE
Connector Color	WHITE

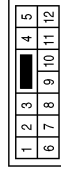

Terminal No.	Color of Wire	Signal Name
11	G	-
12	W	-

Connector No.	D207
Connector Name	REAR DOOR SPEAKER LH
Connector Color	BROWN



Terminal No.	Color of Wire	Signal Name
1	LG	-
2	Y	-

Connector No.	D201
Connector Name	WIRE TO WIRE
Connector Color	WHITE



Terminal No.	Color of Wire	Signal Name
11	Y	-
12	LG	-

ABNIA4670GB

# BOSE AUDIO W/NAVI W/O SURROUND

< WIRING DIAGRAM >

[TELEMATICS SYSTEM]

Connector No.	D511
Connector Name	REAR VIEW CAMERA
Connector Color	WHITE

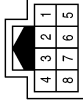

Terminal No.	Color of Wire	Signal Name
1	SHIELD	-
4	G	-
5	R	-
7	B	-
8	W	-

Connector No.	D501
Connector Name	WIRE TO WIRE
Connector Color	WHITE

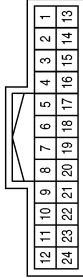

Terminal No.	Color of Wire	Signal Name
13	W	-
14	B	-
15	R	-
16	SHIELD	-
17	G	-

Connector No.	D307
Connector Name	REAR DOOR SPEAKER RH
Connector Color	BROWN



Terminal No.	Color of Wire	Signal Name
1	W	-
2	G	-

A  
B  
C  
D  
E  
F  
G  
H  
I  
J  
K  
L  
M  
AV  
O  
P

ABNIA4671GB

< WIRING DIAGRAM >

BOSE AUDIO W/NAVI W/SURROUND

Wiring Diagram

INFOID:000000009761236

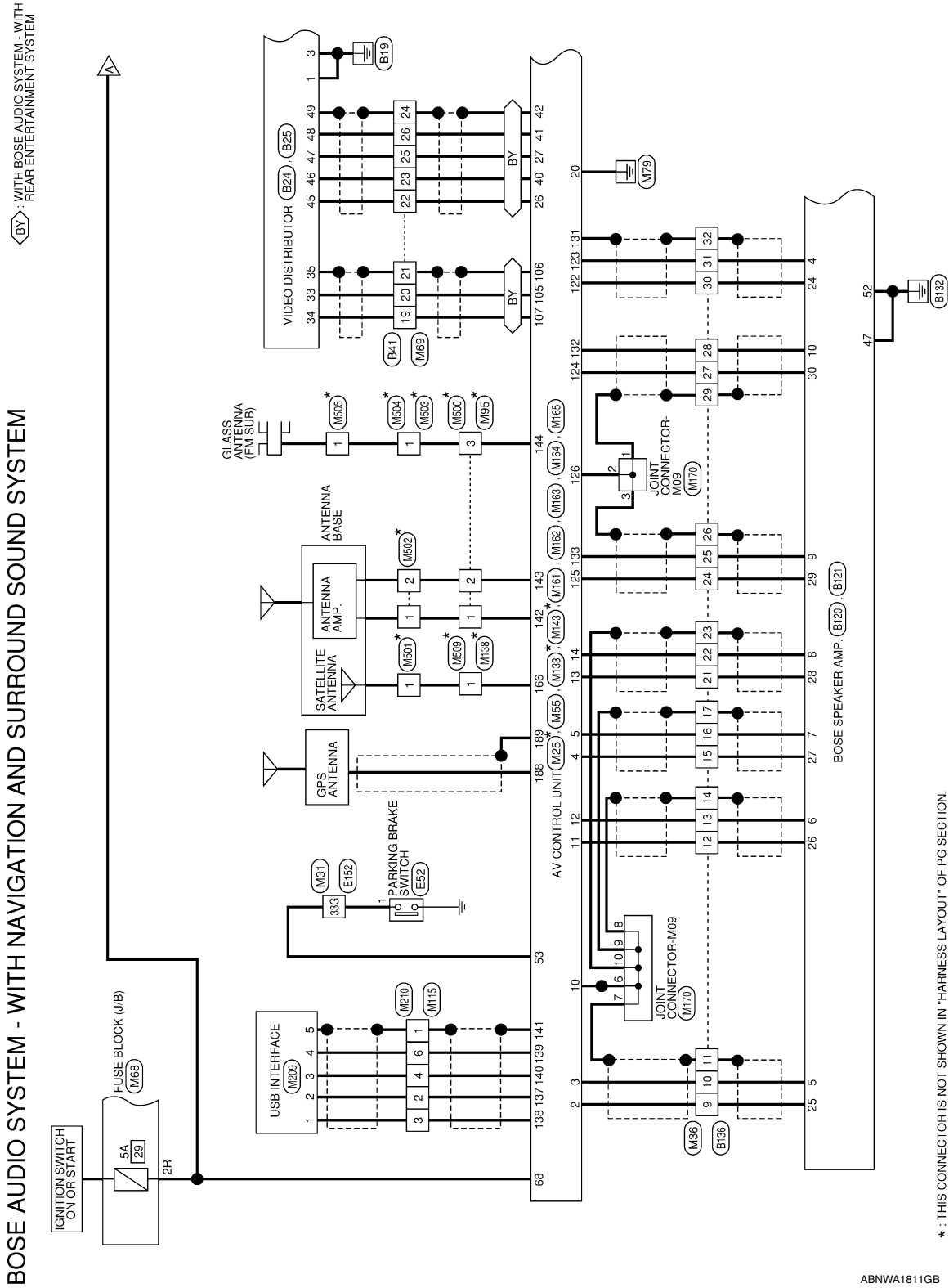

ABNWA1811GB



# BOSE AUDIO W/NAVI W/SURROUND

< WIRING DIAGRAM >

[TELEMATICS SYSTEM]

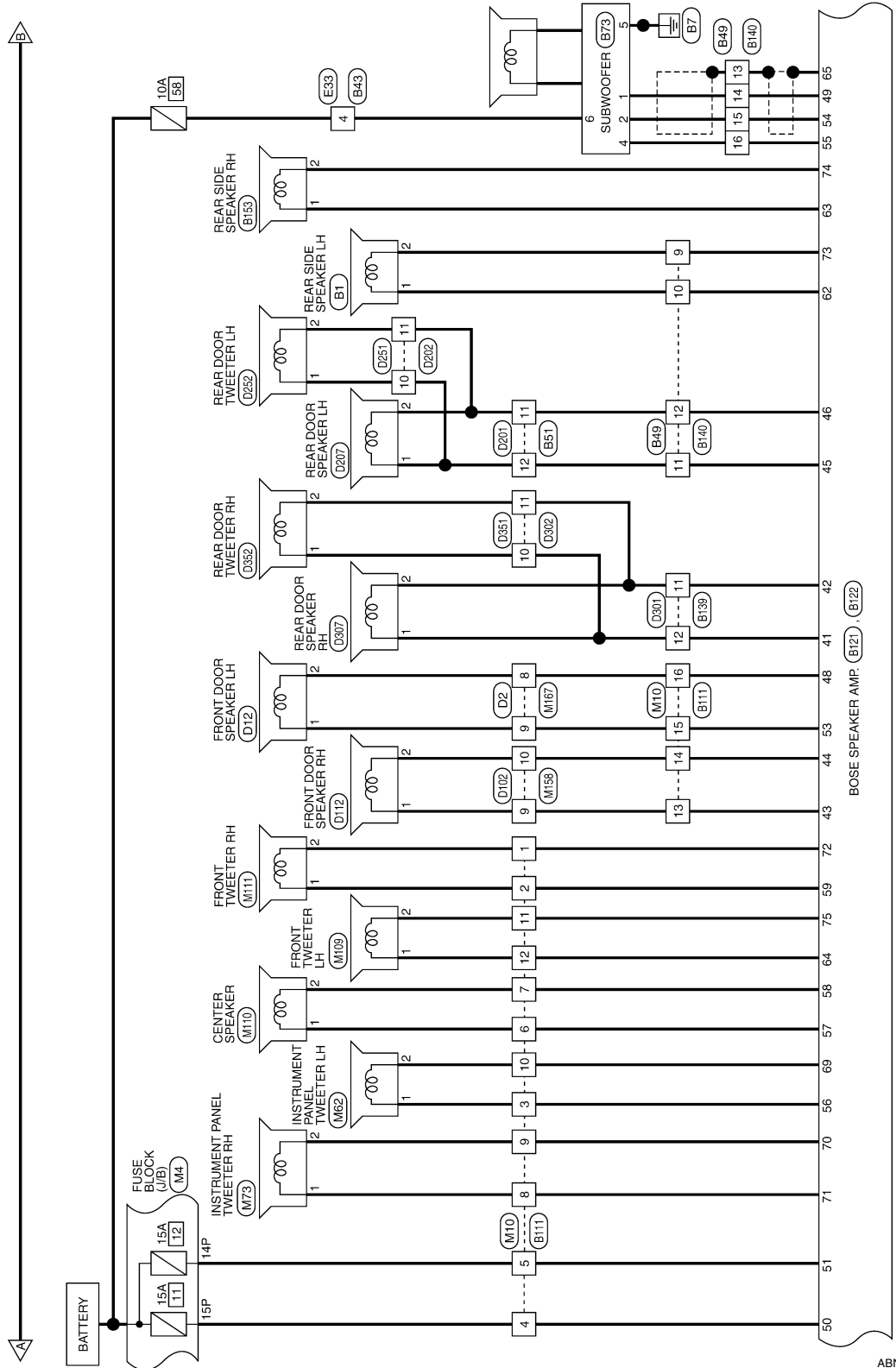

ABNWA1812GB

A  
B  
C  
D  
E  
F  
G  
H  
I  
J  
K  
L  
M  
N  
O  
P

AV

# BOSE AUDIO W/NAVI W/SURROUND

< WIRING DIAGRAM >

[TELEMATICS SYSTEM]

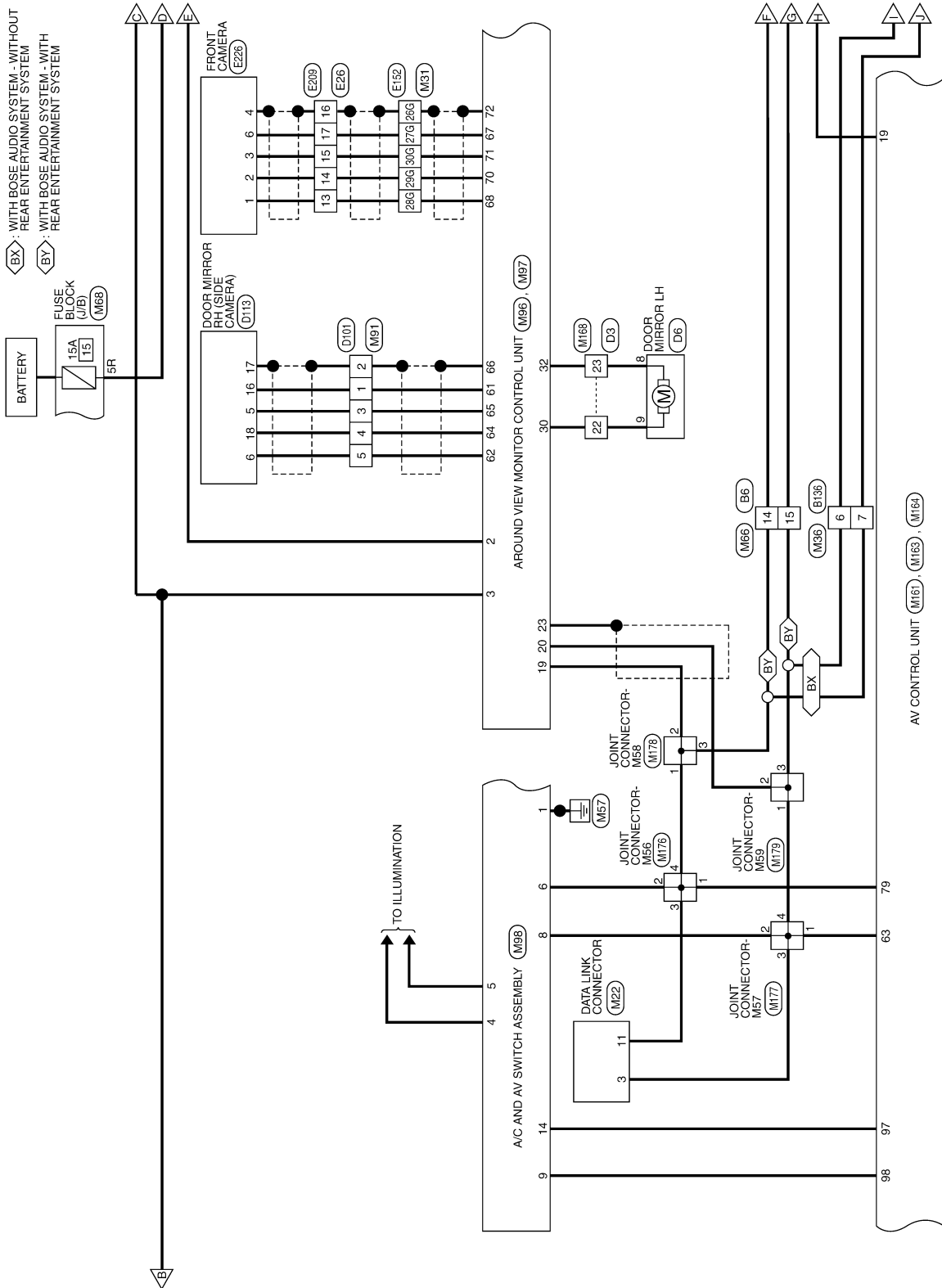

ABNWA1813GB

# BOSE AUDIO W/NAVI W/SURROUND

< WIRING DIAGRAM >

[TELEMATICS SYSTEM]

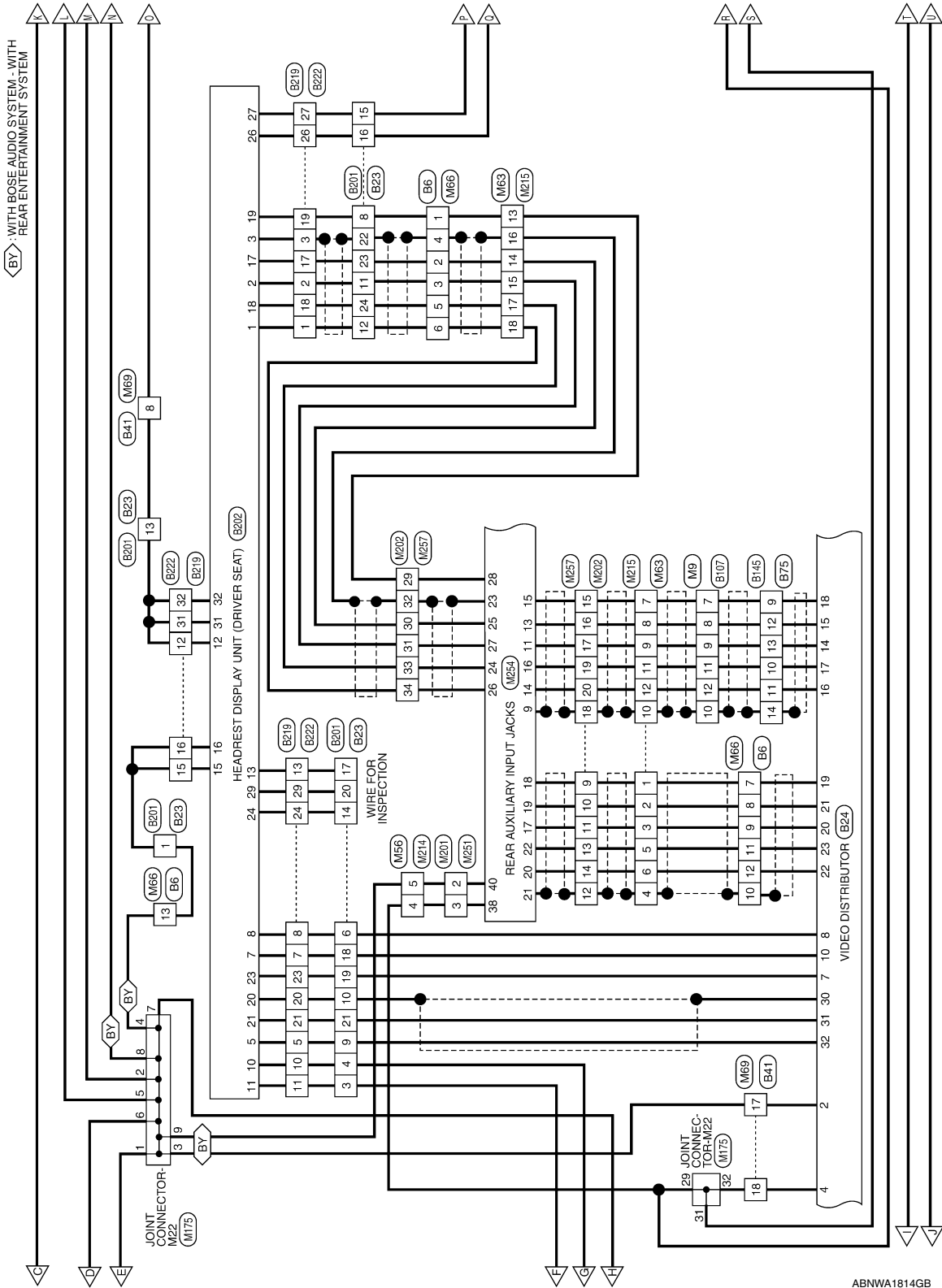

ABNWA1814GB

A  
B  
C  
D  
E  
F  
G  
H  
I  
J  
K  
L  
M  
N  
O  
P

AV



# BOSE AUDIO W/NAVI W/SURROUND

< WIRING DIAGRAM >

[TELEMATICS SYSTEM]

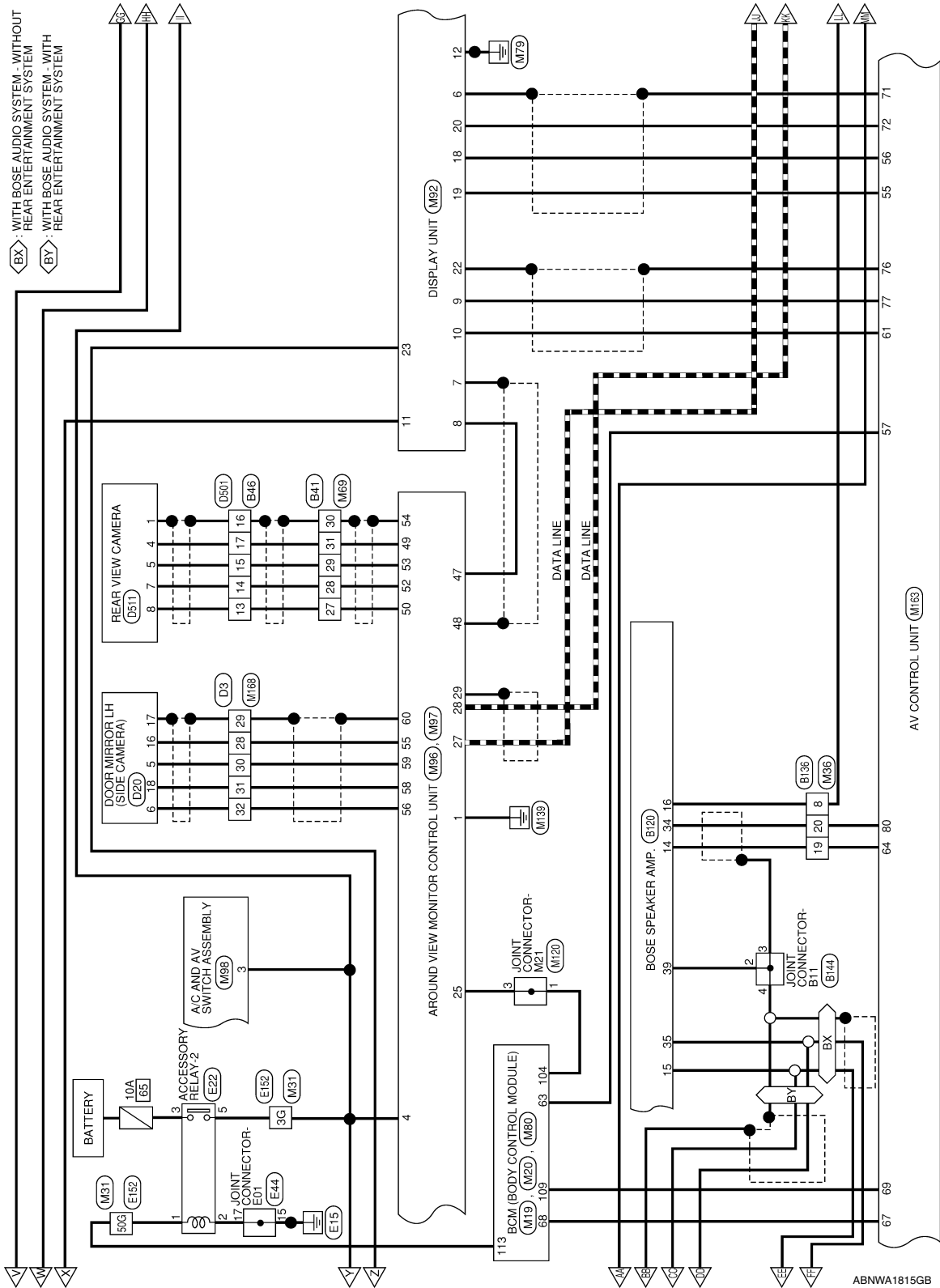

A  
B  
C  
D  
E  
F  
G  
H  
I  
J  
K  
L  
M  
O  
P

AV

# BOSE AUDIO W/NAVI W/SURROUND

< WIRING DIAGRAM >

[TELEMATICS SYSTEM]

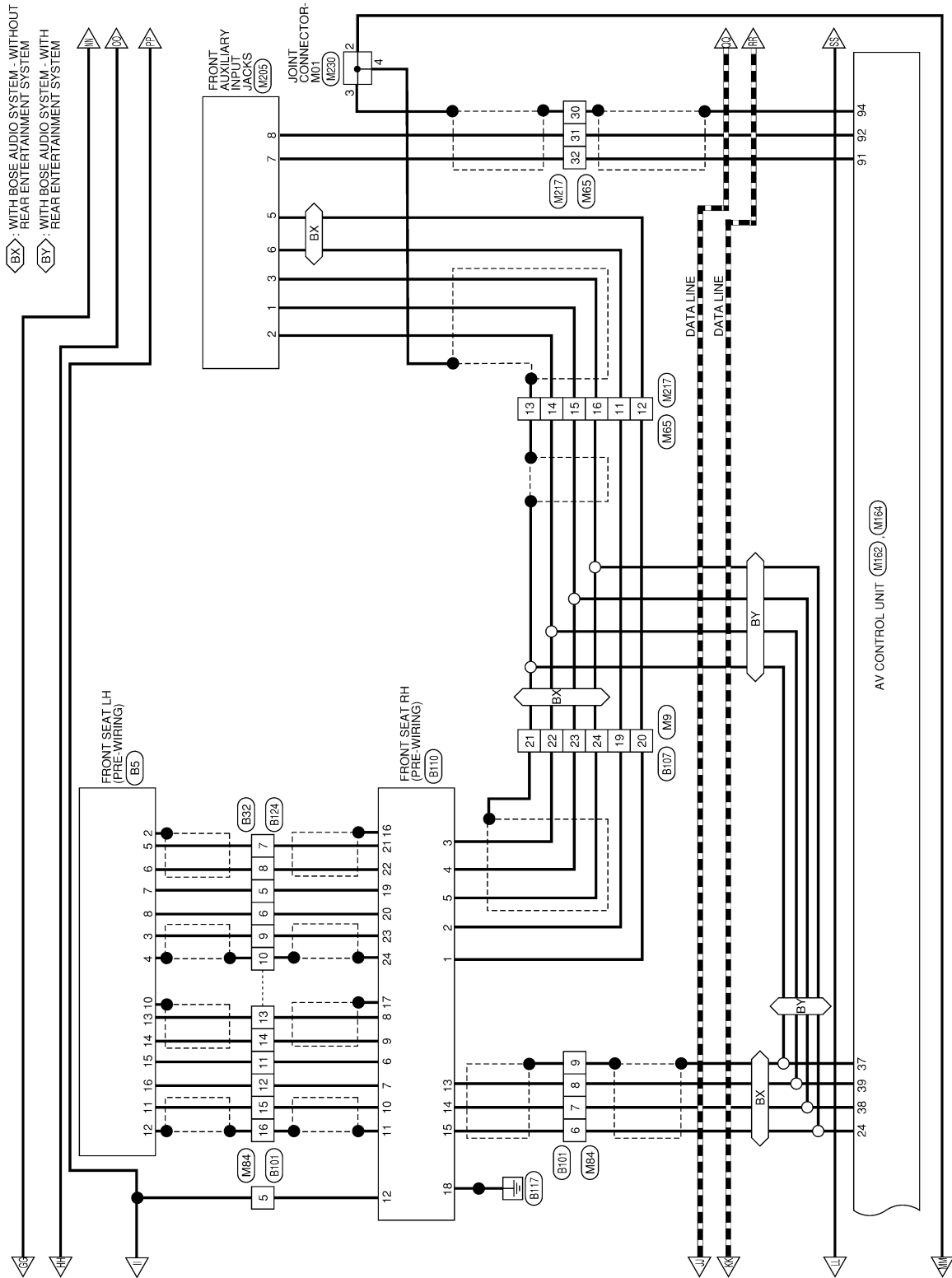

BX : WITH BOSE AUDIO SYSTEM - WITHOUT REAR ENTERTAINMENT SYSTEM  
 BY : WITH BOSE AUDIO SYSTEM - WITH REAR ENTERTAINMENT SYSTEM

ABNWA1826GB

# BOSE AUDIO W/NAVI W/SURROUND

< WIRING DIAGRAM >

[TELEMATICS SYSTEM]

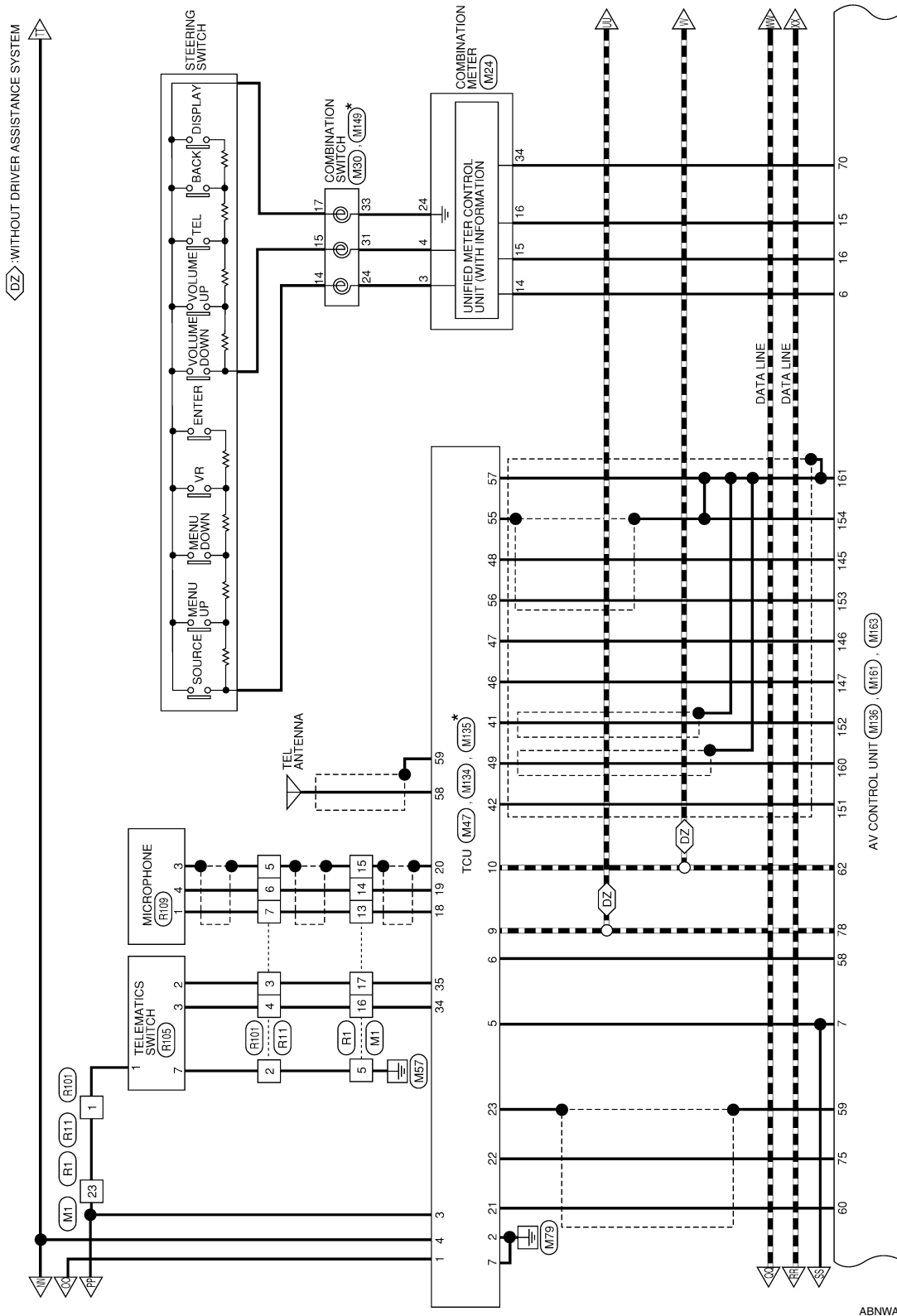

\* : THIS CONNECTOR IS NOT SHOWN IN "HARNES LAYOUT" OF PG SECTION.

ABNWA1816GB

A  
B  
C  
D  
E  
F  
G  
H  
I  
J  
K  
L  
M  
N  
O  
P

AV

# BOSE AUDIO W/NAVI W/SURROUND

< WIRING DIAGRAM >

[TELEMATICS SYSTEM]

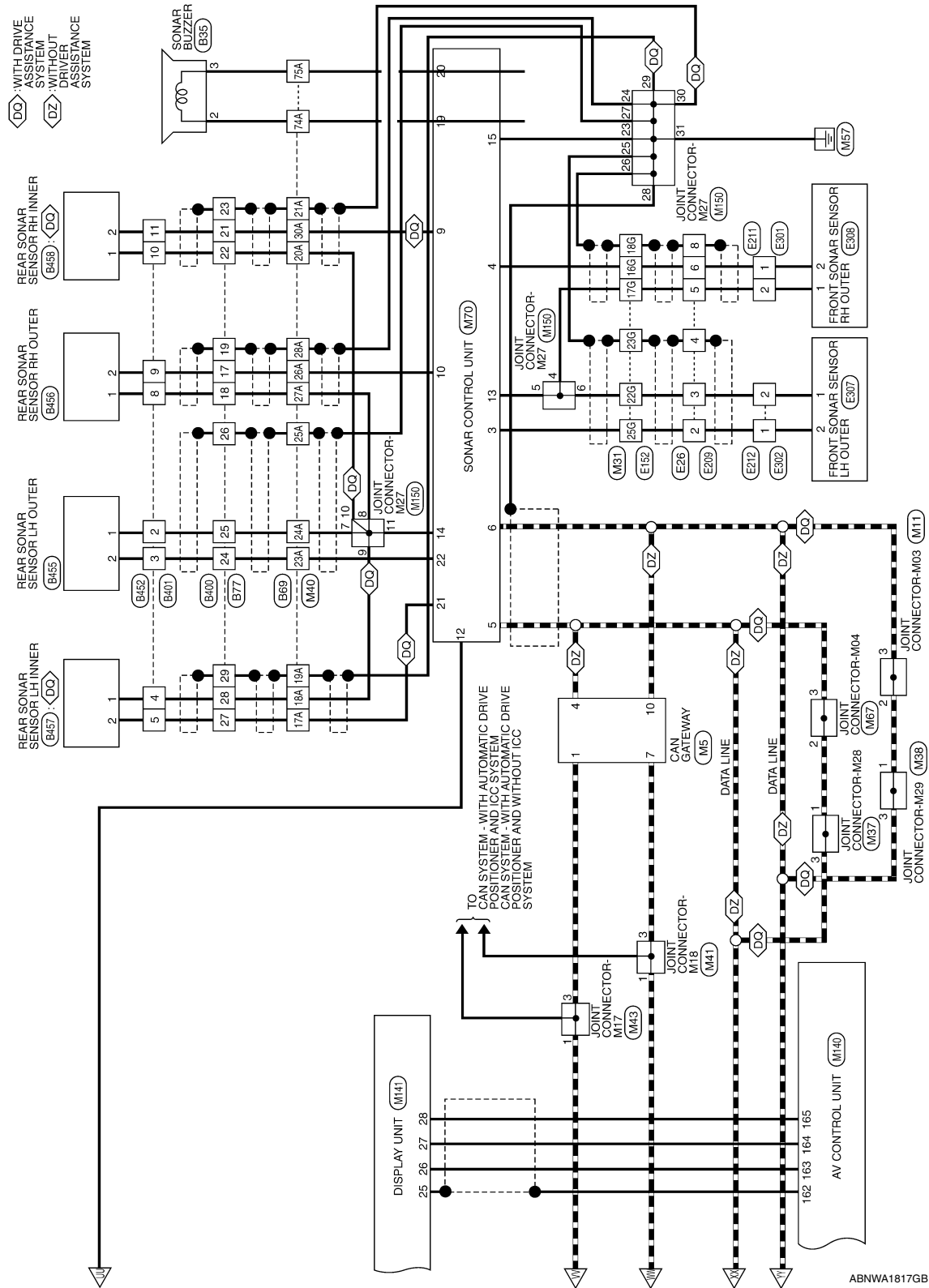

ABNWA1817GB



BOSE AUDIO SYSTEM CONNECTORS - WITH NAVIGATION AND SURROUND SOUND SYSTEM

Connector No.	M1
Connector Name	WIRE TO WIRE
Connector Color	WHITE

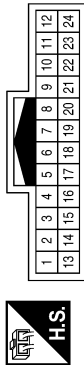

Terminal No.	Color of Wire	Signal Name
5	GR	-
13	W	-
14	B	-
15	SHIELD	-
16	R	-
17	W	-
23	P	-

Connector No.	M4
Connector Name	FUSE BLOCK (J/B)
Connector Color	WHITE

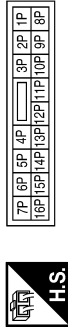

Terminal No.	Color of Wire	Signal Name
14P	Y	-
15P	L	-

Connector No.	M5
Connector Name	CAN GATEWAY
Connector Color	WHITE

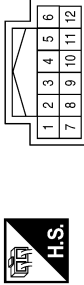

Terminal No.	Color of Wire	Signal Name
1	L	CAN-H
4	L	CAN-H
7	P	CAN-L
10	P	CAN-L

Connector No.	M9
Connector Name	WIRE TO WIRE
Connector Color	WHITE

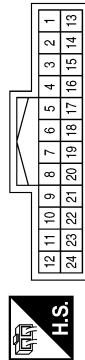

Terminal No.	Color of Wire	Signal Name
6	GR	-
7	V	-
8	G	-
9	R	-
10	SHIELD	-
11	W	-
12	B	-

Terminal No.	Color of Wire	Signal Name
19	P	-
20	G	-
21	SHIELD	-
22	B	-
23	R	-
24	W	-

ABNIA4673GB

A  
B  
C  
D  
E  
F  
G  
H  
I  
J  
K  
L  
M  
N  
O  
P

AV

# BOSE AUDIO W/NAVI W/SURROUND

< WIRING DIAGRAM >

[TELEMATICS SYSTEM]

Connector No.	M11
Connector Name	JOINT CONNECTOR-M03
Connector Color	WHITE



Terminal No.	Color of Wire	Signal Name
2	Y	-
3	W	-

Terminal No.	Color of Wire	Signal Name
6	G	-
7	W	-
8	G	-
9	W	-
10	W	-
11	R	-
12	G	-
13	G	-
14	W	-
15	G	-(WITH BOSE AUDIO SYSTEM AND SURROUND SOUND SYSTEM)
16	W	-

Connector No.	M10
Connector Name	WIRE TO WIRE
Connector Color	BROWN

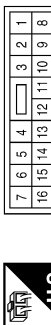

Terminal No.	Color of Wire	Signal Name
1	B	-
2	W	-
3	G	-
4	L	-
5	Y	-

Connector No.	M22
Connector Name	DATA LINK CONNECTOR
Connector Color	WHITE

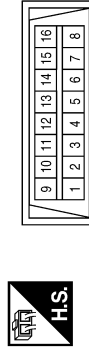

Terminal No.	Color of Wire	Signal Name
3	LG	-
11	SB	-

Connector No.	M20
Connector Name	BCM (BODY CONTROL MODULE)
Connector Color	BLACK

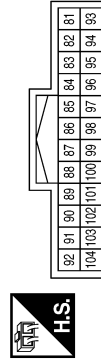

Terminal No.	Color of Wire	Signal Name
104	LG	REVERSE LAMP OUT

Connector No.	M19
Connector Name	BCM (BODY CONTROL MODULE)
Connector Color	BLACK

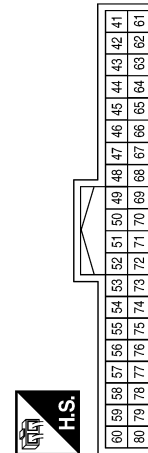

Terminal No.	Color of Wire	Signal Name
63	BG	I-KEY LINK SIGNAL
68	P	MR OUTPUT

ABNIA4674GB

# BOSE AUDIO W/NAVI W/SURROUND

< WIRING DIAGRAM >

[TELEMATICS SYSTEM]

Connector No.	M25
Connector Name	AV CONTROL UNIT
Connector Color	PINK



Terminal No.	Color of Wire	Signal Name
188	B	-
189	SHIELD	-

Terminal No.	Color of Wire	Signal Name
3	P	STRG SW INPUT 1
4	BG	STRG SW INPUT 2
14	G	STRG SW OUTPUT 1
15	W	STRG SW OUTPUT 2
16	B	STRG SW OUTPUT GND
24	R	STRG SW GND
34	BG	SPEED 8P/R

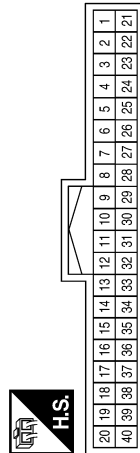

Connector No.	M24
Connector Name	COMBINATION METER
Connector Color	WHITE

Terminal No.	Color of Wire	Signal Name
3G	P	-
16G	R	-
17G	B	-
18G	SHIELD	-
22G	B	-
23G	SHIELD	-
25G	R	-
26G	SHIELD	-
27G	B	-
28G	W	-
29G	G	-
30G	R	-
33G	G	-
50G	L	-

Connector No.	M31
Connector Name	WIRE TO WIRE
Connector Color	WHITE

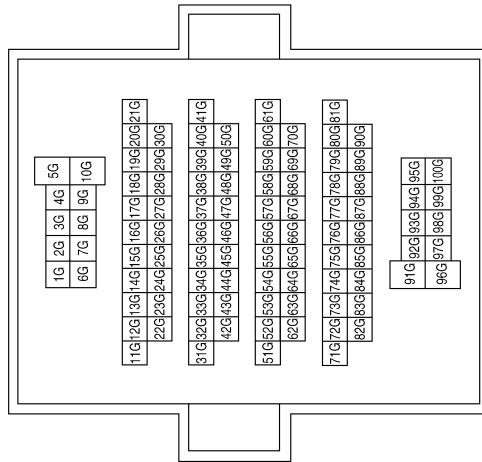

Connector No.	M30
Connector Name	COMBINATION SWITCH (SPIRAL CABLE)
Connector Color	GRAY

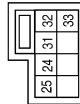

Terminal No.	Color of Wire	Signal Name
24	P	-
31	BG	-
33	R	-

AVNIA4675GB

A  
B  
C  
D  
E  
F  
G  
H  
I  
J  
K  
L  
M  
AV  
O  
P

# BOSE AUDIO W/NAVI W/SURROUND

< WIRING DIAGRAM >

[TELEMATICS SYSTEM]

Terminal No.	Color of Wire	Signal Name
21	B	-
22	W	-
23	SHIELD	-
24	W	-
25	B	-
26	SHIELD	-
27	B	-
28	W	-
29	SHIELD	-
30	B	-
31	W	-
32	SHIELD	-

Terminal No.	Color of Wire	Signal Name
8	G	-
9	B	-
10	W	-
11	SHIELD	-
12	W	-
13	B	-
14	SHIELD	-
15	B	-
16	W	-
17	SHIELD	-
19	LG	-
20	SB	-

Connector No.	M36
Connector Name	WIRE TO WIRE
Connector Color	WHITE



20	19	18	17	16	15	14	13	12	11	10	9	8	7	6	5	4	3	2	1
40	39	38	37	36	35	34	33	32	31	30	29	28	27	26	25	24	23	22	21

Terminal No.	Color of Wire	Signal Name
6	LG	-
7	SB	-

Connector No.	M38
Connector Name	JOINT CONNECTOR-M29
Connector Color	WHITE



4	3	2	1
---	---	---	---

Connector No.	M37
Connector Name	JOINT CONNECTOR-M28
Connector Color	WHITE



4	3	2	1
---	---	---	---

Terminal No.	Color of Wire	Signal Name
1	Y	-
3	W	-

Terminal No.	Color of Wire	Signal Name
1	L	-
3	B	-

ABNIA4676GB

# BOSE AUDIO W/NAVI W/SURROUND

< WIRING DIAGRAM >

[TELEMATICS SYSTEM]

Connector No.	M41
Connector Name	JOINT CONNECTOR-M18
Connector Color	WHITE



Terminal No.	Color of Wire	Signal Name
1	P	-
3	P	-

Terminal No.	Color of Wire	Signal Name
17A	W	-
18A	B	-
19A	SHIELD	-
20A	B	-
21A	SHIELD	-
23A	W	-
24A	B	-
25A	SHIELD	-
26A	W	-
27A	B	-
28A	SHIELD	-
30A	W	-
74A	BR	-
75A	LG	-

Connector No.	M40
Connector Name	WIRE TO WIRE
Connector Color	GRAY

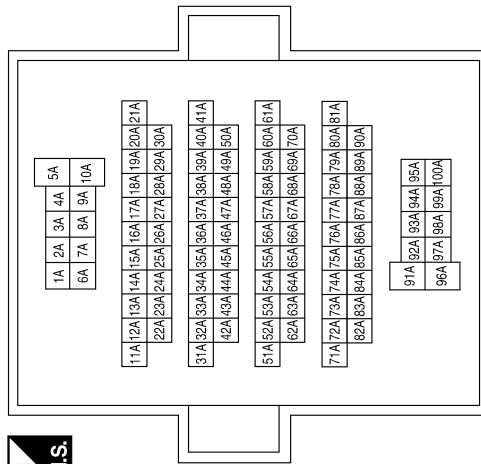

Connector No.	M43
Connector Name	JOINT CONNECTOR-M17
Connector Color	WHITE

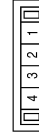

Terminal No.	Color of Wire	Signal Name
1	L	-
3	L	-

ABNIA4677GB

A  
B  
C  
D  
E  
F  
G  
H  
I  
J  
K  
L  
M  
N  
O  
P

AV

# BOSE AUDIO W/NAVI W/SURROUND

< WIRING DIAGRAM >

[TELEMATICS SYSTEM]

Connector No.	M47
Connector Name	TCU
Connector Color	WHITE



2	4	6	8	10	12	14	16	18	20	22	24	26	28	30	32	34	36	38	40
1	3	5	7	9	11	13	15	17	19	21	23	25	27	29	31	33	35	37	39

Terminal No.	Color of Wire	Signal Name
1	Y	B+
2	B	GND
3	P	ACC
4	LG	IGN
5	G	ACC OUT
6	G	AV ACC
7	B	GND



138	137	141
140	139	

Connector No.	M55
Connector Name	AV CONTROL UNIT
Connector Color	BLUE

Terminal No.	Color of Wire	Signal Name
137	W	VBUS
138	G	USB GND
139	L	USB D+
140	R	USB D-
141	SHIELD	SHIELD

Terminal No.	Color of Wire	Signal Name
8	-	-
9	L	V-CAN H
10	P	V-CAN L
11	-	-
12	-	-
13	-	-
14	-	-
15	-	-
16	-	-
17	-	-
18	W	MIC VCC
19	B	MIC SIG
20	SHIELD	MIC GND
21	W	MIC VCC DETECTION
22	B	DCM MIC SIG
23	SHIELD	DCM MIC GND
24	-	-



8	7	6	5	4	3	2	1
16	15	14	13	12	11	10	9

Connector No.	M56
Connector Name	WIRE TO WIRE
Connector Color	WHITE

Terminal No.	Color of Wire	Signal Name
1	B	-
2	W	-
3	SHIELD	-
4	P	-

Terminal No.	Color of Wire	Signal Name
25	-	-
26	-	-
27	-	-
28	-	-
29	-	-
30	-	-
31	-	-
32	-	-
33	-	-
34	R	ECALL SW
35	W	LED A
36	-	-
37	-	-
38	-	-
39	-	-
40	-	-

Terminal No.	Color of Wire	Signal Name
5	Y	-
13	R	-
14	W	-
15	B	-
16	SHIELD	-

# BOSE AUDIO W/NAVI W/SURROUND

< WIRING DIAGRAM >

[TELEMATICS SYSTEM]

Terminal No.	Color of Wire	Signal Name
10	SHIELD	-
11	W	-
12	B	-
13	L	-
14	G	-
15	R	-
16	SHIELD	-
17	W	-
18	B	-
19	L	-
20	G	-
21	R	-
22	SHIELD	-
23	W	-
24	B	-

Connector No.	M63
Connector Name	WIRE TO WIRE
Connector Color	WHITE

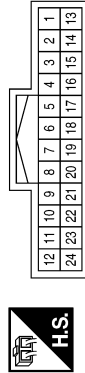

Terminal No.	Color of Wire	Signal Name
1	SB	-
2	G	-
3	R	-
4	SHIELD	-
5	W	-
6	B	-
7	V	-
8	G	-
9	R	-

Terminal No.	Color of Wire	Signal Name
16	W	-
30	SHIELD	-
31	B	-
32	W	-

Connector No.	M65
Connector Name	WIRE TO WIRE
Connector Color	WHITE

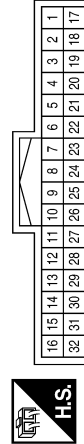

Terminal No.	Color of Wire	Signal Name
11	P	-
12	G	-
13	SHIELD	-
14	B	-
15	R	-

Connector No.	M62
Connector Name	INSTRUMENT PANEL TWEETER LH
Connector Color	BROWN



Terminal No.	Color of Wire	Signal Name
1	G	-(WITH BOSE AUDIO SYSTEM)
2	W	-(WITH BOSE AUDIO SYSTEM)

Connector No.	M64
Connector Name	WIRE TO WIRE
Connector Color	WHITE

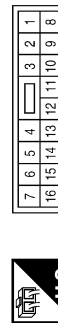

Terminal No.	Color of Wire	Signal Name
3	B	-
9	B	-

ABNIA4679GB

A  
B  
C  
D  
E  
F  
G  
H  
I  
J  
K  
L  
M  
N  
O  
P

AV

# BOSE AUDIO W/NAVI W/SURROUND

< WIRING DIAGRAM >

[TELEMATICS SYSTEM]

Connector No.	M67
Connector Name	JOINT CONNECTOR-M04
Connector Color	WHITE



Terminal No.	Color of Wire	Signal Name
2	L	-
2	B	-

Terminal No.	Color of Wire	Signal Name
7	SB	-(WITH REAR ENTERTAINMENT SYSTEM)
8	G	-(WITH REAR ENTERTAINMENT SYSTEM)
9	R	-(WITH REAR ENTERTAINMENT SYSTEM)
10	SHIELD	-
11	W	-(WITH REAR ENTERTAINMENT SYSTEM)
12	Y	-(WITH REAR ENTERTAINMENT SYSTEM)
13	Y	-
14	SB	-
15	LG	-

Connector No.	M66
Connector Name	WIRE TO WIRE
Connector Color	WHITE

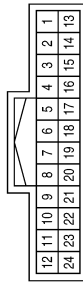

Terminal No.	Color of Wire	Signal Name
1	L	-
2	G	-
3	R	-(WITH REAR ENTERTAINMENT SYSTEM)
4	SHIELD	-(WITH REAR ENTERTAINMENT SYSTEM)
5	W	-(WITH REAR ENTERTAINMENT SYSTEM)
6	B	-(WITH REAR ENTERTAINMENT SYSTEM)

Connector No.	M68
Connector Name	FUSE BLOCK (J/B)
Connector Color	BROWN



Terminal No.	Color of Wire	Signal Name
2R	LG	-
5R	Y	-

ABNIA4680GB



# BOSE AUDIO W/NAVI W/SURROUND

< WIRING DIAGRAM >

[TELEMATICS SYSTEM]

Connector No.	M70
Connector Name	SONAR CONTROL UNIT
Connector Color	WHITE

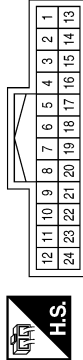

Terminal No.	Color of Wire	Signal Name
1	-	-
2	-	-
3	R	FOL SENSOR SIGNAL
4	R	FOR SENSOR SIGNAL
5	B	V CAN-H
6	W	V CAN-L
7	-	-
8	-	-
9	W	RIR SENSOR SIGNAL
10	W	ROR SENSOR SIGNAL
11	-	-
12	LG	IGN
13	B	FR SENSOR GND
14	B	FR SENSOR GND
15	GR	GND
16	-	-
17	-	-
18	-	-
19	BR	SPEAKER PWR
20	LG	SPEAKER RR SIGNAL
21	W	RIL SENSOR SIGNAL
22	W	ROL SENSOR SIGNAL
23	-	-
24	-	-

Terminal No.	Color of Wire	Signal Name
19	B	-(WITH REAR ENTERTAINMENT SYSTEM)
20	W	-(WITH REAR ENTERTAINMENT SYSTEM)
21	SHIELD	-(WITH REAR ENTERTAINMENT SYSTEM)
22	W	-(WITH REAR ENTERTAINMENT SYSTEM)
23	R	-(WITH REAR ENTERTAINMENT SYSTEM)
24	SHIELD	-
25	B	-
26	G	-
27	B	-(WITH NAVI)
28	R	-(WITH NAVI)
29	G	-(WITH NAVI)
30	SHIELD	-
31	W	-

Connector No.	M69
Connector Name	WIRE TO WIRE
Connector Color	WHITE

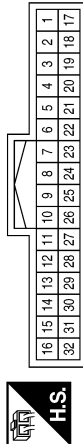

Terminal No.	Color of Wire	Signal Name
1	R	-(WITH REAR ENTERTAINMENT SYSTEM)
2	W	-(WITH REAR ENTERTAINMENT SYSTEM)
3	B	-(WITH REAR ENTERTAINMENT SYSTEM)
4	SHIELD	-
5	B	-
6	W	-
7	SHIELD	-
8	B	-
17	Y	-(WITH REAR ENTERTAINMENT SYSTEM)
18	P	-(WITH REAR ENTERTAINMENT SYSTEM)

ABNIA4681GB

A  
B  
C  
D  
E  
F  
G  
H  
I  
J  
K  
L  
M  
N  
O  
P

AV

# BOSE AUDIO W/NAVI W/SURROUND

< WIRING DIAGRAM >

[TELEMATICS SYSTEM]

Connector No.	M73
Connector Name	INSTRUMENT PANEL TWEETER RH
Connector Color	BROWN



Terminal No.	Color of Wire	Signal Name
1	G	– (WITH BOSE AUDIO SYSTEM)
2	W	– (WITH BOSE AUDIO SYSTEM)

Connector No.	M80
Connector Name	BCM (BODY CONTROL MODULE)
Connector Color	BLACK

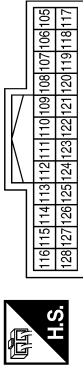

Terminal No.	Color of Wire	Signal Name
109	R	REVERSE SIGNAL
113	L	ACC RELAY OUT

Connector No.	M84
Connector Name	WIRE TO WIRE
Connector Color	WHITE

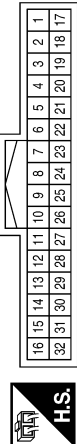

Terminal No.	Color of Wire	Signal Name
5	P	– (WITHOUT REAR ENTERTAINMENT SYSTEM)
5	Y	– (WITH REAR ENTERTAINMENT SYSTEM)
6	W	– (WITHOUT REAR ENTERTAINMENT SYSTEM)
6	B	– (WITH REAR ENTERTAINMENT SYSTEM)
7	R	– (WITHOUT REAR ENTERTAINMENT SYSTEM)

Terminal No.	Color of Wire	Signal Name
7	W	– (WITH REAR ENTERTAINMENT SYSTEM)
8	B	– (WITHOUT REAR ENTERTAINMENT SYSTEM)
8	R	– (WITH REAR ENTERTAINMENT SYSTEM)
9	SHIELD	–
10	G	–
11	L	–

Connector No.	M91
Connector Name	WIRE TO WIRE
Connector Color	BLACK

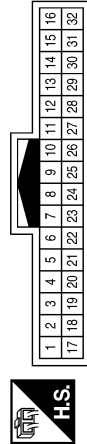

Terminal No.	Color of Wire	Signal Name
1	W	–
2	SHIELD	–
3	G	–
4	R	–
5	B	–

# BOSE AUDIO W/NAVI W/SURROUND

< WIRING DIAGRAM >

[TELEMATICS SYSTEM]

Connector No.	M95
Connector Name	WIRE TO WIRE
Connector Color	GRAY



Terminal No.	Color of Wire	Signal Name
1	B	-
2	B	-
3	B	-

Terminal No.	Color of Wire	Signal Name
9	B	FRONT DISP IT
10	W	IT FRONT DISP
11	Y	BATT
12	B	GND
13	-	-
14	-	-
15	-	-
16	-	-
17	-	-
18	B	FRONT COMP +
19	W	FRONT COMP -
20	R	FRONT COMP SYNC
21	-	-
22	SHIELD	SHIELD
23	P	ACC
24	-	-

Connector No.	M92
Connector Name	DISPLAY UNIT (WITH NAVI)
Connector Color	WHITE

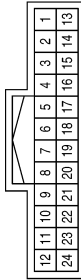

Terminal No.	Color of Wire	Signal Name
1	-	-
2	-	-
3	-	-
4	-	-
5	-	-
6	SHIELD	FRONT COMP SHIELD
7	SHIELD	SHIELD
8	B	R CAMERA COMP

Terminal No.	Color of Wire	Signal Name
27	B	V-CAN1 H
28	W	V-CAN1 L
29	SHIELD	V-CAN1 GND
30	W	MIRROR SIGNAL 2
31	-	-
32	G	MIRROR SIGNAL 1
33	-	-
34	-	-
35	-	-
36	-	-
37	-	-
38	-	-
39	-	-
40	-	-

Terminal No.	Color of Wire	Signal Name
10	-	-
11	-	-
12	-	-
13	-	-
14	-	-
15	-	-
16	-	-
17	-	-
18	-	-
19	B	M-CAN-1H
20	W	M-CAN-1L
21	-	-
22	-	-
23	SHIELD	M-CAN GND
24	-	-
25	LG	REV
26	-	-

Connector No.	M96
Connector Name	AROUND VIEW MONITOR CONTROL UNIT
Connector Color	WHITE

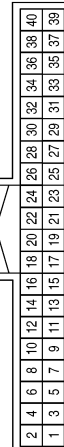

Terminal No.	Color of Wire	Signal Name
1	B	GND
2	Y	+B
3	LG	IGN
4	P	ACC
5	-	-
6	-	-
7	-	-
8	-	-
9	-	-

ABNIA4683GB

A  
B  
C  
D  
E  
F  
G  
H  
I  
J  
K  
L  
M  
N  
O  
P

AV

# BOSE AUDIO W/NAVI W/SURROUND

< WIRING DIAGRAM >

[TELEMATICS SYSTEM]

Connector No.	M98
Connector Name	A/C AND AV SWITCH ASSEMBLY
Connector Color	WHITE

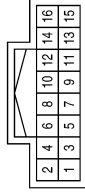

Terminal No.	Color of Wire	Signal Name
1	GR	-
3	P	-
4	R	-
5	B	-
6	SB	-
8	LG	-
9	V	-
14	Y	-

Terminal No.	Color of Wire	Signal Name
53	G	RV VIDEO +
54	SHIELD	RV VIDEO -
55	B	SV2 SERIAL SIGNAL
56	W	SV2 POWER
57	-	-
58	G	SV2 POWER GND
59	R	SV2 VIDEO +
60	SHIELD	SV2 POWER GND
61	W	SV1 SERIAL SIGNAL
62	B	SV1 POWER
63	-	-
64	R	SV1 POWER GND
65	G	SV1 VIDEO +
66	SHIELD	SV1 VIDEO -
67	B	FV SERIAL SIGNAL
68	W	FV POWER
69	-	-
70	G	FV POWER GND
71	R	FV VIDEO +
72	SHIELD	FV VIDEO -

Connector No.	M97
Connector Name	AROUND VIEW MONITOR CONTROL UNIT
Connector Color	WHITE

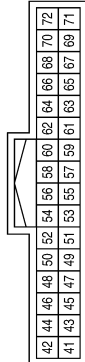

Terminal No.	Color of Wire	Signal Name
41	-	-
42	-	-
43	-	-
44	-	-
45	-	-
46	-	-
47	B	VIDEO OUTPUT +
48	SHIELD	VIDEO OUTPUT -
49	W	RV SERIAL SIGNAL
50	B	RV POWER
51	-	-
52	R	RV POWER GND

Connector No.	M111
Connector Name	FRONT TWEETER RH
Connector Color	BROWN



Terminal No.	Color of Wire	Signal Name
1	W	-(WITH BOSE AUDIO SYSTEM AND SURROUND SOUND SYSTEM)
2	B	-(WITH BOSE AUDIO SYSTEM AND SURROUND SOUND SYSTEM)

Connector No.	M110
Connector Name	CENTER SPEAKER
Connector Color	BROWN



Terminal No.	Color of Wire	Signal Name
1	G	-
2	W	-

Connector No.	M109
Connector Name	FRONT TWEETER LH
Connector Color	BROWN



Terminal No.	Color of Wire	Signal Name
1	G	-(WITH BOSE AUDIO SYSTEM AND SURROUND SOUND SYSTEM)
2	R	-(WITH BOSE AUDIO SYSTEM AND SURROUND SOUND SYSTEM)

ABNIA4684GB

# BOSE AUDIO W/NAVI W/SURROUND

< WIRING DIAGRAM >

[TELEMATICS SYSTEM]

Connector No.	M133
Connector Name	AV CONTROL UNIT
Connector Color	BROWN

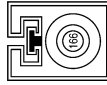

Terminal No.	Color of Wire	Signal Name
166	B	-

Connector No.	M120
Connector Name	JOINT CONNECTOR-M21
Connector Color	WHITE



Terminal No.	Color of Wire	Signal Name
1	LG	-
3	LG	-

Connector No.	M115
Connector Name	WIRE TO WIRE
Connector Color	GRAY

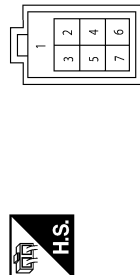

Terminal No.	Color of Wire	Signal Name
1	SHIELD	-
2	W	-
3	G	-
4	R	-
6	L	-

Connector No.	M135
Connector Name	TCU
Connector Color	BROWN



Terminal No.	Color of Wire	Signal Name
58	B	-
59	SHIELD	-

Terminal No.	Color of Wire	Signal Name
46	W	MANUFACTURE SPECIFIC
47	B	USB VBUS
48	B	USB D-
49	B	D-VOICE
50	-	-
51	-	-
52	-	-
53	-	-
54	-	-
55	SHIELD	USB GND
56	L/W	D+
57	SHIELD	CONN CHASSIS GND

Connector No.	M134
Connector Name	TCU
Connector Color	GRAY

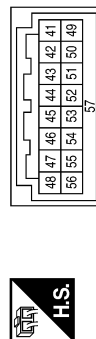

Terminal No.	Color of Wire	Signal Name
41	W	U-VOICE
42	L	VOICE GND
43	-	-
44	-	-
45	-	-

ABNIA4685GB

A  
B  
C  
D  
E  
F  
G  
H  
I  
J  
K  
L  
M  
N  
O  
P

AV

# BOSE AUDIO W/NAVI W/SURROUND

< WIRING DIAGRAM >

[TELEMATICS SYSTEM]

Connector No.	M138
Connector Name	WIRE TO WIRE
Connector Color	GREEN

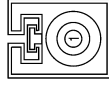

Terminal No.	Color of Wire	Signal Name
1	B	-

Terminal No.	Color of Wire	Signal Name
150	-	-
151	L	VOICE GND
152	W	U-VOICE
153	L/W	D+
154	SHIELD	USB GND
155	-	-
156	-	-
157	-	-
158	-	-
159	-	-
160	B	D-VOICE
161	SHIELD	CONN CHASSIS GND

Connector No.	M136
Connector Name	AV CONTROL UNIT
Connector Color	GRAY

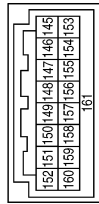

Terminal No.	Color of Wire	Signal Name
145	B	USB D-
146	B	USB VBUS
147	W	MANUFACTURE SPECIFIC
148	-	-
149	-	-

Connector No.	M143
Connector Name	AV CONTROL UNIT
Connector Color	GRAY



Terminal No.	Color of Wire	Signal Name
142	B	ANT +B
143	B	ANT MAIN
144	B	ANT SUB

Connector No.	M141
Connector Name	DISPLAY UNIT
Connector Color	BROWN



Terminal No.	Color of Wire	Signal Name
25	SHIELD	SHIELD
26	SHIELD	GND
27	B	GVIF+
28	B	GVIF-

Connector No.	M140
Connector Name	AV CONTROL UNIT
Connector Color	BLUE



Terminal No.	Color of Wire	Signal Name
162	SHIELD	SHIELD
163	SHIELD	GND
164	B	GVIF-
165	B	GVIF+

ABNIA4686GB

# BOSE AUDIO W/NAVI W/SURROUND

< WIRING DIAGRAM >

[TELEMATICS SYSTEM]

Terminal No.	Color of Wire	Signal Name
10	B	-
11	B	-
23	GR	-
24	SHIELD	-
25	SHIELD	-
26	SHIELD	-
27	SHIELD	-
28	SHIELD	-
29	SHIELD	-
30	SHIELD	-
31	GR	-

Connector No.	M150
Connector Name	JOINT CONNECTOR-M27
Connector Color	WHITE

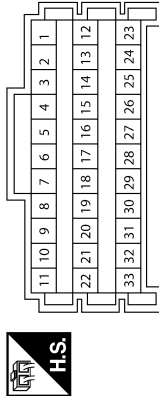

Terminal No.	Color of Wire	Signal Name
4	B	-
5	B	-
6	B	-
7	B	-
8	B	-
9	B	-

Connector No.	M149
Connector Name	COMBINATION SWITCH (SPIRAL CABLE)
Connector Color	GRAY



Terminal No.	Color of Wire	Signal Name
14	B	-
15	GR	-
17	BR	-

Terminal No.	Color of Wire	Signal Name
7	G	ACC
8	-	-
9	-	-
10	BR	SHIELD
11	W	FR RH PRE+
12	B	FR RH PRE-
13	B	RR RH PRE+
14	W	RR RH PRE-
15	B	STRG SW GND
16	W	STRG SW B
17	-	-
18	-	-
19	Y	+B
20	GR	GND

Connector No.	M161
Connector Name	AV CONTROL UNIT (WITH BOSE AUDIO SYSTEM - WITH NAVI AND SURROUND SOUND SYSTEM)
Connector Color	WHITE

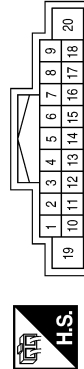

Terminal No.	Color of Wire	Signal Name
1	-	-
2	B	FR LH PRE+
3	W	FR LH PRE-
4	B	RR LH PRE+
5	W	RR LH PRE-
6	G	STRG SW A

Connector No.	M158
Connector Name	WIRE TO WIRE
Connector Color	WHITE



Terminal No.	Color of Wire	Signal Name
9	G	-(WITH BOSE AUDIO SYSTEM)
10	W	-(WITH BOSE AUDIO SYSTEM)

ABNIA4687GB

A  
B  
C  
D  
E  
F  
G  
H  
I  
J  
K  
L  
M  
N  
O  
P

AV

# BOSE AUDIO W/NAVI W/SURROUND

< WIRING DIAGRAM >

[TELEMATICS SYSTEM]

Terminal No.	Color of Wire	Signal Name
39	B	AUX AUDIO-
40	R	HP1 LH-
41	G	HP1 RH-
42	SHIELD	HP1 SHIELD
43	-	-
44	-	-
45	-	-
46	-	-
47	-	-
48	-	-

Terminal No.	Color of Wire	Signal Name
28	-	-
29	-	-
30	-	-
31	-	-
32	-	-
33	-	-
34	-	-
35	-	-
36	-	-
37	SHIELD	AUX SHIELD
38	R	AUX AUDIO RH

Connector No.	M162
Connector Name	AV CONTROL UNIT (WITH BOSE AUDIO SYSTEM - WITH NAVI AND SURROUND SOUND SYSTEM)
Connector Color	WHITE

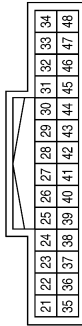

Terminal No.	Color of Wire	Signal Name
21	-	-
22	-	-
23	-	-
24	W	AUX AUDIO LH
25	-	-
26	W	HP1 LH+
27	B	HP1 RH+

Terminal No.	Color of Wire	Signal Name
68	LG	IGN
69	R	REVERSE SIG
70	BG	SPEED
71	SHIELD	NAVI COMP1 SHIELD
72	R	GND
73	-	-
74	-	-
75	B	MIC SIG
76	SHIELD	DISP SHIELD
77	B	DISP-IT
78	L	V-CAN H
79	SB	M-CAN H
80	SB	M-CAN H TRM

Terminal No.	Color of Wire	Signal Name
54	-	-
55	W	NAVI COMP1-
56	B	NAVI COMP1+
57	BG	RESERVE I1
58	G	RESERVE I2
59	SHIELD	MIC GND
60	W	MIC VCC
61	W	IT-DISP
62	P	V-CAN L
63	LG	M-CAN L
64	LG	M-CAN L TRM
65	-	-
66	-	-
67	P	MR OUTPUT

Connector No.	M163
Connector Name	AV CONTROL UNIT (WITH BOSE AUDIO SYSTEM - WITH NAVI AND SURROUND SOUND SYSTEM)
Connector Color	WHITE



Terminal No.	Color of Wire	Signal Name
49	-	-
50	-	-
51	-	-
52	-	-
53	G	PKB SIG

ABNIA4688GB



# BOSE AUDIO W/NAVI W/SURROUND

< WIRING DIAGRAM >

[TELEMATICS SYSTEM]

Terminal No.	Color of Wire	Signal Name
105	W	NAVI COMP2-
106	SHIELD	NAVI COMP2 SHIELD
107	B	NAVI COMP2+
108	-	-
109	-	-
110	-	-
111	-	-
112	-	-
113	-	-
114	-	-
115	-	-
116	-	-
117	-	-
118	-	-
119	-	-
120	-	-

Terminal No.	Color of Wire	Signal Name
87	-	-
88	-	-
89	-	-
90	-	-
91	W	AUX VIDEO+
92	B	AUX VIDEO-
93	-	-
94	SHIELD	VIDEO SHIELD
95	-	-
96	-	-
97	Y	DVD EJECT
98	V	EJECT GND
99	-	-
100	-	-
101	-	-
102	-	-
103	-	-
104	-	-

Connector No.	M164
Connector Name	AV CONTROL UNIT (WITH BOSE AUDIO SYSTEM - WITH NAVI AND SURROUND SOUND SYSTEM)
Connector Color	WHITE



81	85	87	89	91	93	95	97	99	101	103	105	107	109	111	113	115	117	119	
82	84	86	88	90	92	94	96	98	100	102	104	106	108	110	112	114	116	118	120

Terminal No.	Color of Wire	Signal Name
81	-	-
82	-	-
83	-	-
84	-	-
85	-	-
86	-	-

Connector No.	M167
Connector Name	WIRE TO WIRE
Connector Color	WHITE



1	2	3	4	5	6	7		
8	9	10	11	12	13	14	15	16

Terminal No.	Color of Wire	Signal Name
8	W	-(WITH BOSE AUDIO SYSTEM)
9	G	-(WITH BOSE AUDIO SYSTEM AND SURROUND SOUND SYSTEM)

Terminal No.	Color of Wire	Signal Name
125	W	CENTER PRE+
126	Y	CENTER SHIELD
127	-	-
128	-	-
129	-	-
130	-	-
131	SHIELD	GUIDE SHIELD
132	W	SUB WOOFER PRE-
133	B	CENTER PRE-
134	-	-
135	-	-
136	-	-

Connector No.	M165
Connector Name	AV CONTROL UNIT (WITH BOSE AUDIO SYSTEM - WITH NAVI AND SURROUND SOUND SYSTEM)
Connector Color	WHITE



121	122	123	124	125	126	127	128
129	130	131	132	133	134	135	136

Terminal No.	Color of Wire	Signal Name
121	-	-
122	B	GUIDE+
123	W	GUIDE-
124	B	SUB WOOFER PRE+

ABNIA4689GB

A  
B  
C  
D  
E  
F  
G  
H  
I  
J  
K  
L  
M  
N  
O  
P

AV

# BOSE AUDIO W/NAVI W/SURROUND

< WIRING DIAGRAM >

[TELEMATICS SYSTEM]

Connector No.	M175
Connector Name	JOINT CONNECTOR-M22
Connector Color	WHITE

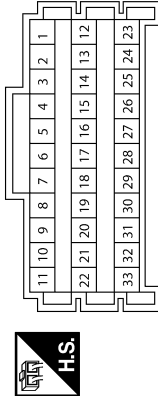

Terminal No.	Color of Wire	Signal Name
1	Y	-
2	Y	-
3	Y	-
4	Y	-
5	Y	-
6	Y	-
7	Y	-
8	Y	-
9	Y	-
29	P	-
31	P	-
32	P	-

Connector No.	M170
Connector Name	JOINT CONNECTOR-M09
Connector Color	WHITE

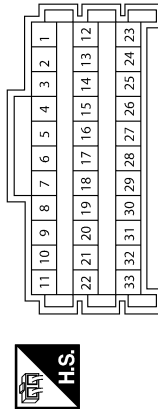

Terminal No.	Color of Wire	Signal Name
1	SHIELD	-
2	Y	-
3	SHIELD	-
6	GR	-
7	SHIELD	-
8	SHIELD	-
9	SHIELD	-
10	SHIELD	-

Connector No.	M168
Connector Name	WIRE TO WIRE
Connector Color	WHITE

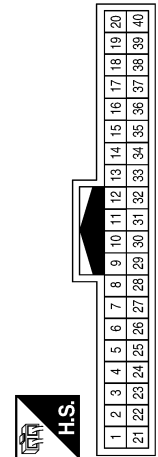

Terminal No.	Color of Wire	Signal Name
22	W	-
23	G	-
28	B	-
29	SHIELD	-
30	R	-
31	G	-
32	W	-

Connector No.	M178
Connector Name	JOINT CONNECTOR-M68
Connector Color	WHITE



Terminal No.	Color of Wire	Signal Name
1	SB	-
2	B	-
3	SB	-

Connector No.	M177
Connector Name	JOINT CONNECTOR-M57
Connector Color	WHITE



Terminal No.	Color of Wire	Signal Name
1	LG	-
2	LG	-
3	LG	-
4	LG	-

Connector No.	M176
Connector Name	JOINT CONNECTOR-M56
Connector Color	WHITE



Terminal No.	Color of Wire	Signal Name
1	SB	-
2	SB	-
3	SB	-
4	SB	-

ABNIA4690GB

# BOSE AUDIO W/NAVI W/SURROUND

< WIRING DIAGRAM >

[TELEMATICS SYSTEM]

Connector No.	M201
Connector Name	WIRE TO WIRE
Connector Color	WHITE

1	2	3	4	5	6	7		
8	9	10	11	12	13	14	15	16



Terminal No.	Color of Wire	Signal Name
1	B	-
2	Y	-
3	V	-

Connector No.	M179
Connector Name	JOINT CONNECTOR-M59
Connector Color	WHITE

4	3	2	1
---	---	---	---



Terminal No.	Color of Wire	Signal Name
1	LG	-
2	W	-
3	LG	-

Connector No.	M202
Connector Name	WIRE TO WIRE
Connector Color	WHITE

1	2	3	4	5	6	7	8	9	10	11	12	13	14	15	16	17	18	19	20
21	22	23	24	25	26	27	28	29	30	31	32	33	34	35	36	37	38	39	40



Terminal No.	Color of Wire	Signal Name
6	SHIELD	-
7	B	-
8	W	-
9	SB	-

Terminal No.	Color of Wire	Signal Name
27	R	-
28	W	-
29	L	-
30	G	-
31	R	-
32	SHIELD	-
33	W	-
34	B	-
35	L	-
36	G	-
37	R	-
38	SHIELD	-
39	W	-
40	B	-

Terminal No.	Color of Wire	Signal Name
10	G	-
11	R	-
12	SHIELD	-
13	W	-
14	B	-
15	V	-
16	G	-
17	R	-
18	SHIELD	-
19	W	-
20	B	-
24	B	-
25	SHIELD	-
26	B	-

ABNIA4691GB

A  
B  
C  
D  
E  
F  
G  
H  
I  
J  
K  
L  
M  
N  
O  
P



# BOSE AUDIO W/NAVI W/SURROUND

< WIRING DIAGRAM >

[TELEMATICS SYSTEM]

Connector No.	M205
Connector Name	FRONT AUXILIARY INPUT JACKS
Connector Color	WHITE

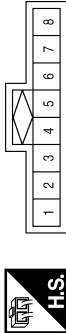

Terminal No.	Color of Wire	Signal Name
1	W	-
2	B	-
3	R	-
4	-	-
5	G	-
6	P	-
7	W	-
8	B	-

Connector No.	M209
Connector Name	USB INTERFACE
Connector Color	GREEN

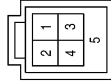

Terminal No.	Color of Wire	Signal Name
1	G	-
2	W	-
3	R	-
4	L	-
5	SHIELD	-

Connector No.	M210
Connector Name	WIRE TO WIRE
Connector Color	GRAY

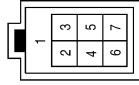

Terminal No.	Color of Wire	Signal Name
1	SHIELD	-
2	W	-
3	G	-
4	R	-
6	L	-

Connector No.	M214
Connector Name	WIRE TO WIRE
Connector Color	WHITE

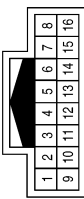

Terminal No.	Color of Wire	Signal Name
1	W	-
2	R	-
3	SHIELD	-
4	V	-
5	Y	-
13	W	-
14	R	-
15	B	-
16	SHIELD	-

Connector No.	M215
Connector Name	WIRE TO WIRE
Connector Color	WHITE

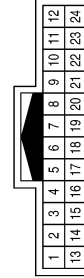

Terminal No.	Color of Wire	Signal Name
1	SB	-
2	G	-
3	R	-
4	SHIELD	-
5	W	-
6	B	-
7	V	-
8	G	-

Terminal No.	Color of Wire	Signal Name
9	R	-
10	SHIELD	-
11	W	-
12	B	-
13	L	-
14	G	-
15	R	-
16	SHIELD	-
17	W	-
18	B	-
19	L	-
20	G	-
21	R	-
22	SHIELD	-
23	W	-
24	B	-

ABNIA4692GB

# BOSE AUDIO W/NAVI W/SURROUND

< WIRING DIAGRAM >

[TELEMATICS SYSTEM]

Connector No.	M230
Connector Name	JOINT CONNECTOR-M01
Connector Color	GRAY

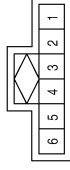

Terminal No.	Color of Wire	Signal Name
2	B	-
3	SHIELD	-
4	SHIELD	-

Connector No.	M217
Connector Name	WIRE TO WIRE
Connector Color	WHITE



Terminal No.	Color of Wire	Signal Name
11	P	-
12	G	-
13	SHIELD	-
14	B	-
15	W	-
16	R	-
30	SHIELD	-
31	B	-
32	W	-

Connector No.	M216
Connector Name	WIRE TO WIRE
Connector Color	WHITE

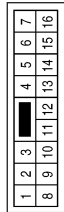

Terminal No.	Color of Wire	Signal Name
3	B	-
9	B	-

Connector No.	M251
Connector Name	WIRE TO WIRE
Connector Color	WHITE



Terminal No.	Color of Wire	Signal Name
1	B	-
2	Y	-
3	V	-

ABNIA4693GB

A  
B  
C  
D  
E  
F  
G  
H  
I  
J  
K  
L  
M  
N  
O  
P

AV

# BOSE AUDIO W/NAVI W/SURROUND

< WIRING DIAGRAM >

[TELEMATICS SYSTEM]

Connector No.	M254
Connector Name	REAR AUXILIARY INPUT JACKS
Connector Color	WHITE



2	4	6	8	10	12	14	16	18	20	22	24	26	28	30	32	34	36	38	40
1	3	5	7	9	11	13	15	17	19	21	23	25	27	29	31	33	35	37	39

Terminal No.	Color of Wire	Signal Name
1	W	-
2	B	-
3	B	-
4	R	-
5	B	-
6	-	-
7	-	-
8	-	-

Connector No.	M257
Connector Name	WIRE TO WIRE
Connector Color	WHITE



20	19	18	17	16	15	14	13	12	11	10	9	8	7	6	5	4	3	2	1
40	39	38	37	36	35	34	33	32	31	30	29	28	27	26	25	24	23	22	21

Terminal No.	Color of Wire	Signal Name
6	SHIELD	-
7	B	-
8	W	-
9	BG	-

Terminal No.	Color of Wire	Signal Name
9	SHIELD	-
10	-	-
11	R	-
12	-	-
13	G	-
14	B	-
15	V	-
16	W	-
17	R	-
18	BG	-
19	G	-
20	B	-
21	SHIELD	-
22	W	-
23	SHIELD	-
24	W	-
25	G	-

Terminal No.	Color of Wire	Signal Name
26	B	-
27	R	-
28	L	-
29	P	-
30	W	-
31	G	-
32	B	-
33	R	-
34	-	-
35	SHIELD	-
36	-	-
37	-	-
38	V	-
39	B	-
40	Y	-

Terminal No.	Color of Wire	Signal Name
10	G	-
11	R	-
12	SHIELD	-
13	W	-
14	B	-
15	V	-
16	G	-
17	R	-
18	SHIELD	-
19	W	-
20	B	-
24	B	-
25	SHIELD	-
26	R	-

Terminal No.	Color of Wire	Signal Name
27	B	-
28	W	-
29	L	-
30	G	-
31	R	-
32	SHIELD	-
33	W	-
34	B	-
35	P	-
36	G	-
37	R	-
38	SHIELD	-
39	W	-
40	B	-

ABNIA4694GB

# BOSE AUDIO W/NAVI W/SURROUND

< WIRING DIAGRAM >

[TELEMATICS SYSTEM]

Connector No.	M502
Connector Name	ANTENNA BASE
Connector Color	GRAY



Terminal No.	Color of Wire	Signal Name
1	B	-
2	B	-

Connector No.	M501
Connector Name	ANTENNA BASE
Connector Color	GREEN

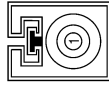

Terminal No.	Color of Wire	Signal Name
1	B	-

Connector No.	M500
Connector Name	WIRE TO WIRE
Connector Color	GRAY



Terminal No.	Color of Wire	Signal Name
1	B	-
2	B	-
3	B	-

Connector No.	M505
Connector Name	GLASS ANTENNA (FM SUB)
Connector Color	GRAY



Terminal No.	Color of Wire	Signal Name
1	B	-

Connector No.	M504
Connector Name	WIRE TO WIRE
Connector Color	GRAY



Terminal No.	Color of Wire	Signal Name
1	B	-

Connector No.	M503
Connector Name	WIRE TO WIRE
Connector Color	GRAY



Terminal No.	Color of Wire	Signal Name
1	B	-

ABNIA4695GB

A  
B  
C  
D  
E  
F  
G  
H  
I  
J  
K  
L  
M  
AV  
O  
P

# BOSE AUDIO W/NAVI W/SURROUND

< WIRING DIAGRAM >

[TELEMATICS SYSTEM]

Connector No.	E26
Connector Name	WIRE TO WIRE
Connector Color	WHITE

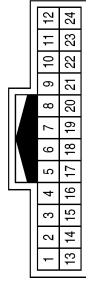

Terminal No.	Color of Wire	Signal Name
2	W	-
3	B	-
4	SHIELD	-
5	B	-
6	R	-
8	SHIELD	-
13	R	-
14	B	-
15	G	-
16	SHIELD	-
17	W	-

Connector No.	E22
Connector Name	ACCESSORY RELAY-2
Connector Color	BLUE



Terminal No.	Color of Wire	Signal Name
1	G	-
2	B	-
3	R	-
5	P	-

Connector No.	M509
Connector Name	WIRE TO WIRE
Connector Color	GREEN



Terminal No.	Color of Wire	Signal Name
1	B	-

Connector No.	E52
Connector Name	PARKING BRAKE SWITCH
Connector Color	BLACK



Terminal No.	Color of Wire	Signal Name
1	LG	-

Connector No.	E44
Connector Name	JOINT CONNECTOR-E01
Connector Color	WHITE

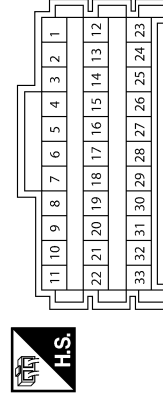

Terminal No.	Color of Wire	Signal Name
15	GR	-
17	B	-

Connector No.	E33
Connector Name	WIRE TO WIRE
Connector Color	WHITE

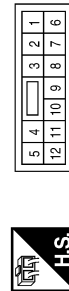

Terminal No.	Color of Wire	Signal Name
4	P	-

ABNIA4696GB



# BOSE AUDIO W/NAVI W/SURROUND

< WIRING DIAGRAM >

[TELEMATICS SYSTEM]

Connector No.	E209
Connector Name	WIRE TO WIRE
Connector Color	WHITE

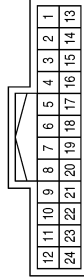

Terminal No.	Color of Wire	Signal Name
2	L	-
3	B	-
4	SHIELD	-
5	B	-
6	R	-
8	SHIELD	-
13	R	-
14	B	-
15	G	-
16	SHIELD	-
17	W	-

Terminal No.	Color of Wire	Signal Name
3G	P	-
16G	R	-
17G	B	-
18G	SHIELD	-
22G	B	-
23G	SHIELD	-
25G	W	-
26G	SHIELD	-
27G	W	-
28G	R	-
29G	B	-
30G	G	-
33G	LG	-
50G	G	-

Connector No.	E152
Connector Name	WIRE TO WIRE
Connector Color	WHITE

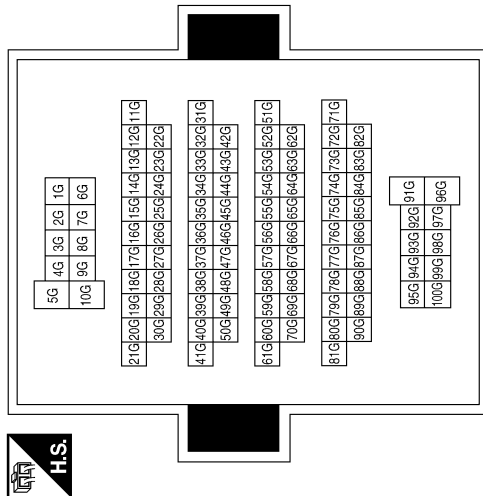

Connector No.	E226
Connector Name	FRONT CAMERA
Connector Color	BLACK

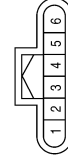

Terminal No.	Color of Wire	Signal Name
1	R	-
2	B	-
3	G	-
4	SHIELD	-
6	W	-

Connector No.	E212
Connector Name	WIRE TO WIRE
Connector Color	GRAY

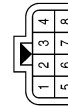

Terminal No.	Color of Wire	Signal Name
1	L	-
2	B	-

Connector No.	E211
Connector Name	WIRE TO WIRE
Connector Color	GRAY

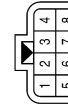

Terminal No.	Color of Wire	Signal Name
1	R	-
2	B	-

ABNIA4697GB

A  
B  
C  
D  
E  
F  
G  
H  
I  
J  
K  
L  
M  
N  
O  
P

AV

# BOSE AUDIO W/NAVI W/SURROUND

< WIRING DIAGRAM >

[TELEMATICS SYSTEM]

Connector No.	E307
Connector Name	FRONT SONAR SENSOR LH OUTER
Connector Color	BLACK



Terminal No.	Color of Wire	Signal Name
1	P	-
2	G	-

Connector No.	E302
Connector Name	WIRE TO WIRE
Connector Color	GRAY

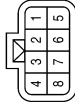

Terminal No.	Color of Wire	Signal Name
1	G	-
2	P	-

Connector No.	E301
Connector Name	WIRE TO WIRE
Connector Color	GRAY

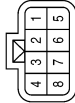

Terminal No.	Color of Wire	Signal Name
1	G	-
2	P	-

Connector No.	B5
Connector Name	FRONT SEAT LH (PRE-WIRING)
Connector Color	WHITE

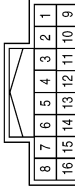

Terminal No.	Color of Wire	Signal Name
2	SHIELD	-
3	W	-
4	SHIELD	-
5	B	-
6	R	-
7	G	-
8	R	-
10	SHIELD	-
11	W	-
12	SHIELD	-
13	B	-
14	R	-
15	B	-
16	L	-

Connector No.	B1
Connector Name	REAR SIDE SPEAKER LH
Connector Color	BROWN



Terminal No.	Color of Wire	Signal Name
1	W	-
2	G	-

Connector No.	E308
Connector Name	FRONT SONAR SENSOR RH OUTER
Connector Color	BLACK



Terminal No.	Color of Wire	Signal Name
1	P	-
2	G	-

ABNIA4698GB

# BOSE AUDIO W/NAVI W/SURROUND

< WIRING DIAGRAM >

[TELEMATICS SYSTEM]

Terminal No.	Color of Wire	Signal Name
12	W	-
13	SB	-
14	SB	-
15	LG	-

Terminal No.	Color of Wire	Signal Name
5	W	-(WITH REAR ENTERTAINMENT SYSTEM)
6	B	-(WITH REAR ENTERTAINMENT SYSTEM)
7	V	-(WITH REAR ENTERTAINMENT SYSTEM)
8	G	-(WITH REAR ENTERTAINMENT SYSTEM)
9	B	-(WITH REAR ENTERTAINMENT SYSTEM)
10	SHIELD	-(WITH REAR ENTERTAINMENT SYSTEM)
11	R	-(WITH REAR ENTERTAINMENT SYSTEM)

Connector No.	B6
Connector Name	WIRE TO WIRE
Connector Color	WHITE

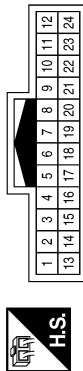

Terminal No.	Color of Wire	Signal Name
1	P	-
2	G	-
3	R	-(WITH REAR ENTERTAINMENT SYSTEM)
4	SHIELD	-(WITH REAR ENTERTAINMENT SYSTEM)

Terminal No.	Color of Wire	Signal Name
10	SHIELD	-
11	R	-
12	B	-
13	B	-
15	SB	-
16	LG	-
18	L	-
19	SB	-
21	P	-
22	SHIELD	-
23	G	-
24	W	-

Connector No.	B23
Connector Name	WIRE TO WIRE
Connector Color	WHITE

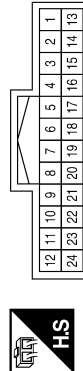

Terminal No.	Color of Wire	Signal Name
1	SB	-
3	SB	-
4	LG	-
6	BR	-
8	P	-
9	L	-

ABNIA4699GB

A  
B  
C  
D  
E  
F  
G  
H  
I  
J  
K  
L  
M  
N  
O  
P

AV

# BOSE AUDIO W/NAVI W/SURROUND

< WIRING DIAGRAM >

[TELEMATICS SYSTEM]

Connector No.	B24
Connector Name	VIDEO DISTRIBUTOR
Connector Color	WHITE

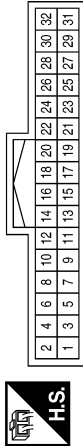

Terminal No.	Color of Wire	Signal Name
1	B	-
2	V	-
3	B	-
4	W	-
5	BR	-
6	L	-

Connector No.	B25
Connector Name	VIDEO DISTRIBUTOR
Connector Color	WHITE

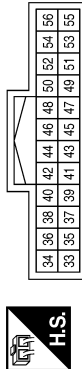

Terminal No.	Color of Wire	Signal Name
33	W	-
34	B	-
35	SHIELD	-
36	-	-
37	-	-
38	-	-
39	W	-
40	B	-

Terminal No.	Color of Wire	Signal Name
7	SB	-
8	BR	-
9	SB	-
10	L	-
11	-	-
12	-	-
13	-	-
14	R	-
15	G	-
16	B	-
17	W	-
18	V	-
19	V	-

Terminal No.	Color of Wire	Signal Name
41	SHIELD	-
42	-	-
43	-	-
44	-	-
45	W	-
46	R	-
47	B	-
48	G	-
49	SHIELD	-
50	-	-
51	-	-
52	-	-
53	SHIELD	-
54	B	-
55	R	-
56	W	-

Terminal No.	Color of Wire	Signal Name
20	B	-
21	G	-
22	W	-
23	R	-
24	-	-
25	-	-
26	-	-
27	W	-
28	B	-
29	SHIELD	-
30	SHIELD	-
31	P	-
32	L	-

Connector No.	B32
Connector Name	WIRE TO WIRE
Connector Color	WHITE

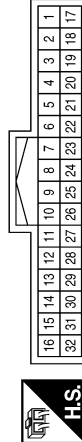

Terminal No.	Color of Wire	Signal Name
5	G	-
6	R	-
7	B	-
8	R	-
9	W	-
10	SHIELD	-
11	B	-
12	L	-
13	B	-
14	R	-
15	W	-
16	SHIELD	-

# BOSE AUDIO W/NAVI W/SURROUND

< WIRING DIAGRAM >

[TELEMATICS SYSTEM]

Connector No.	B35
Connector Name	SONAR BUZZER
Connector Color	WHITE

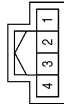

Terminal No.	Color of Wire	Signal Name
2	P	-
3	V	-

Connector No.	B41
Connector Name	WIRE TO WIRE
Connector Color	WHITE

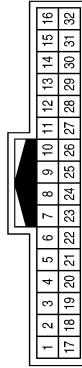

Terminal No.	Color of Wire	Signal Name
1	R	-(WITH REAT ENTERTAINMENT SYSTEM)
2	W	-(WITH REAT ENTERTAINMENT SYSTEM)
3	B	-
4	SHIELD	-
5	B	-

Terminal No.	Color of Wire	Signal Name
6	W	-
7	SHIELD	-
8	B	-
17	V	-(WITH REAT ENTERTAINMENT SYSTEM)
18	W	-(WITH REAT ENTERTAINMENT SYSTEM)
19	B	-(WITH REAT ENTERTAINMENT SYSTEM)
20	W	-(WITH REAT ENTERTAINMENT SYSTEM)
21	SHIELD	-(WITH REAT ENTERTAINMENT SYSTEM)

Terminal No.	Color of Wire	Signal Name
22	W	-(WITH REAT ENTERTAINMENT SYSTEM)
23	R	-(WITH REAT ENTERTAINMENT SYSTEM)
24	SHIELD	-
25	B	-
26	G	-
27	W	-(WITH NAVI)
28	R	-(WITH NAVI)
29	G	-(WITH NAVI)
30	SHIELD	-
31	B	-

ABNIA4701GB

A  
B  
C  
D  
E  
F  
G  
H  
I  
J  
K  
L  
M  
N  
O  
P

AV

# BOSE AUDIO W/NAVI W/SURROUND

< WIRING DIAGRAM >

[TELEMATICS SYSTEM]

Connector No.	B43
Connector Name	WIRE TO WIRE
Connector Color	WHITE

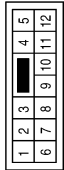

Terminal No.	Color of Wire	Signal Name
4	G	-

Connector No.	B46
Connector Name	WIRE TO WIRE
Connector Color	WHITE

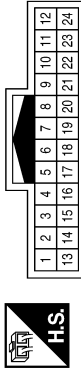

Terminal No.	Color of Wire	Signal Name
13	W	- (WITH NAVI)
14	R	- (WITH NAVI)
15	G	- (WITH NAVI)
16	SHIELD	-
17	B	-

Connector No.	B49
Connector Name	WIRE TO WIRE
Connector Color	WHITE

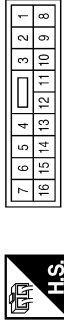

Terminal No.	Color of Wire	Signal Name
9	G	-
10	W	-
11	P	-
12	R	-
13	SHIELD	-
14	B	-
15	W	-
16	W	-

Connector No.	B69
Connector Name	WIRE TO WIRE
Connector Color	GRAY

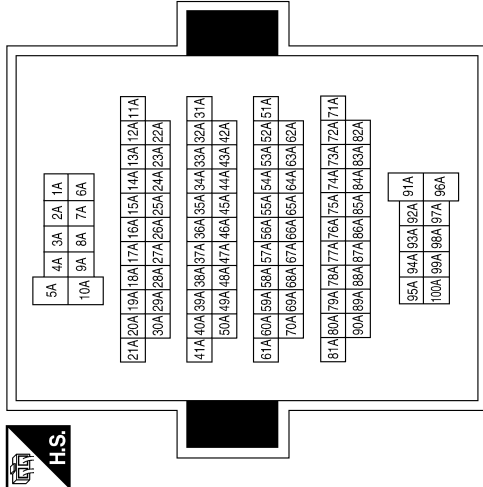

Connector No.	B51
Connector Name	WIRE TO WIRE
Connector Color	WHITE

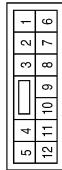

Terminal No.	Color of Wire	Signal Name
11	R	-
12	P	-

Terminal No.	Color of Wire	Signal Name
17A	W	-
18A	B	-
19A	SHIELD	-
20A	W	-
21A	SHIELD	-
23A	W	-
24A	B	-
25A	SHIELD	-
26A	W	-
27A	B	-
28A	SHIELD	-
30A	B	-
74A	P	-
75A	V	-

ABNIA4702GB

# BOSE AUDIO W/NAVI W/SURROUND

< WIRING DIAGRAM >

[TELEMATICS SYSTEM]

Terminal No.	Color of Wire	Signal Name
6	SHIELD	-
7	W	-
8	B	-
9	V	-
10	W	-
11	B	-
12	G	-
13	R	-
14	SHIELD	-

Connector No.	B75
Connector Name	WIRE TO WIRE
Connector Color	WHITE

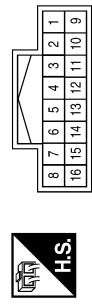

Terminal No.	Color of Wire	Signal Name
1	LG	-
2	SB	-
3	L	-
4	SB	-
5	BR	-

Connector No.	B73
Connector Name	SUBWOOFER
Connector Color	GRAY



Terminal No.	Color of Wire	Signal Name
1	B	-
2	W	-
4	W	-
5	B	-
6	G	-

Terminal No.	Color of Wire	Signal Name
8	B	-(WITHOUT REAR ENTERTAINMENT SYSTEM)
8	R	-(WITH REAR ENTERTAINMENT SYSTEM)
9	SHIELD	-
10	G	-
11	SB	-

Connector No.	B101
Connector Name	WIRE TO WIRE
Connector Color	WHITE

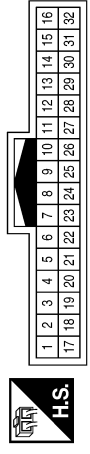

Terminal No.	Color of Wire	Signal Name
5	V	-(WITHOUT REAR ENTERTAINMENT SYSTEM)
5	Y	-(WITH REAR ENTERTAINMENT SYSTEM)
6	W	-(WITHOUT REAR ENTERTAINMENT SYSTEM)
6	B	-(WITH REAR ENTERTAINMENT SYSTEM)
7	R	-(WITHOUT REAR ENTERTAINMENT SYSTEM)
7	W	-(WITH REAR ENTERTAINMENT SYSTEM)

Connector No.	B77
Connector Name	WIRE TO WIRE
Connector Color	WHITE

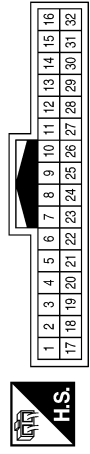

Terminal No.	Color of Wire	Signal Name
17	W	-
18	B	-
19	SHIELD	-
21	B	-
22	W	-
23	SHIELD	-
24	W	-
25	B	-
26	SHIELD	-
27	W	-
28	B	-
29	SHIELD	-

ABNIA4703GB

A  
B  
C  
D  
E  
F  
G  
H  
I  
J  
K  
L  
M  
N  
O  
P

AV

# BOSE AUDIO W/NAVI W/SURROUND

< WIRING DIAGRAM >

[TELEMATICS SYSTEM]

Connector No.	B107
Connector Name	WIRE TO WIRE
Connector Color	WHITE

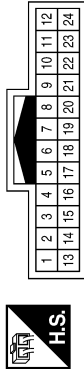

Terminal No.	Color of Wire	Signal Name
6	B	-
7	V	-
8	G	-
9	R	-
10	SHIELD	-
11	B	-
12	W	-
19	V	-
20	Y	-
21	SHIELD	-
22	B	-
23	R	-
24	W	-

Connector No.	B111
Connector Name	WIRE TO WIRE
Connector Color	BROWN

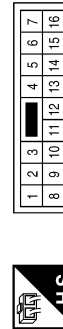

Terminal No.	Color of Wire	Signal Name
1	W	-
2	G	-
3	R	-

Connector No.	B110
Connector Name	FRONT SEAT RH (PRE-WIRING)
Connector Color	WHITE

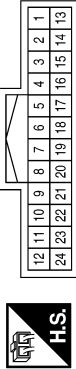

Terminal No.	Color of Wire	Signal Name
1	Y	-
2	V	-
3	B	-
4	R	-
5	W	-
6	B	-
7	L	-
8	G	-
9	R	-
10	W	-
11	SHIELD	-
12	V	-

Terminal No.	Color of Wire	Signal Name
4	LG	-
5	Y	-
6	P	-
7	R	-
8	G	-
9	W	-
10	G	-
11	W	-
12	G	-

Terminal No.	Color of Wire	Signal Name
13	B	-
14	R	-
15	W	-
16	SHIELD	-
17	SHIELD	-
18	B	-
19	G	-
20	R	-
21	G	-
22	R	-
23	W	-
24	SHIELD	-

Terminal No.	Color of Wire	Signal Name
13	W	-
14	P	-
15	G	-
16	R	-



# BOSE AUDIO W/NAVI W/SURROUND

< WIRING DIAGRAM >

[TELEMATICS SYSTEM]

Connector No.	B121
Connector Name	BOSE SPEAKER AMP.
Connector Color	BROWN

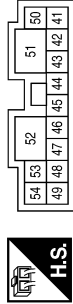

Terminal No.	Color of Wire	Signal Name
41	G	-
42	W	-
43	W	-
44	P	-
45	P	-
46	R	-
47	B	-
48	R	-
49	W	-
50	LG	-
51	Y	-
52	B	-
53	G	-
54	B	-

Terminal No.	Color of Wire	Signal Name
25	B	-
26	B	-
27	B	-
28	B	-
29	B	-
30	B	-
31	-	-
32	-	-
33	-	-
34	W	-
35	W	-
36	-	-
37	-	-
38	-	-
39	B	-
40	-	-

Connector No.	B120
Connector Name	BOSE SPEAKER AMP.
Connector Color	WHITE

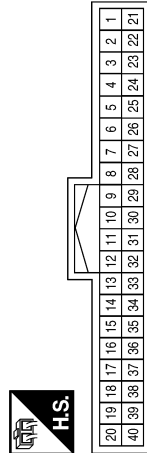

Terminal No.	Color of Wire	Signal Name
1	-	-
2	-	-
3	-	-
4	W	-
5	W	-
6	W	-
7	W	-
8	W	-
9	W	-
10	W	-
11	-	-
12	-	-
13	-	-
14	B	-
15	B	-
16	W	-
17	-	-
18	-	-
19	-	-
20	-	-
21	-	-
22	-	-
23	-	-
24	B	-

ABNIA4705GB

A  
B  
C  
D  
E  
F  
G  
H  
I  
J  
K  
L  
M  
N  
O  
P

AV

# BOSE AUDIO W/NAVI W/SURROUND

< WIRING DIAGRAM >

[TELEMATICS SYSTEM]

Connector No.	B136
Connector Name	WIRE TO WIRE
Connector Color	WHITE

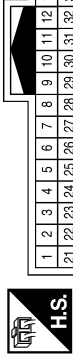

1	2	3	4	5	6	7	8	9	10	11	12	13	14	15	16	17	18	19	20
21	22	23	24	25	26	27	28	29	30	31	32	33	34	35	36	37	38	39	40

Terminal No.	Color of Wire	Signal Name
6	B	-
7	W	-
8	W	-
9	B	-
10	W	-
11	SHIELD	-
12	B	-
13	W	-
14	SHIELD	-
15	B	-
16	W	-
17	SHIELD	-
19	B	-(WITH SURROUND SOUND SYSTEM)
20	W	-(WITH SURROUND SOUND SYSTEM)
21	B	-
22	W	-
23	SHIELD	-
24	B	-
25	W	-
26	SHIELD	-
27	B	-
28	W	-
29	SHIELD	-
30	B	-
31	W	-
32	SHIELD	-

Connector No.	B124
Connector Name	WIRE TO WIRE
Connector Color	WHITE

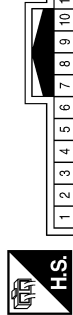

1	2	3	4	5	6	7	8	9	10	11	12	13	14	15	16
17	18	19	20	21	22	23	24	25	26	27	28	29	30	31	32

Terminal No.	Color of Wire	Signal Name
5	G	-
6	R	-
7	G	-
8	R	-
9	W	-
10	SHIELD	-
11	B	-
12	L	-
13	G	-
14	R	-
15	W	-
16	SHIELD	-

Connector No.	B122
Connector Name	BOSE SPEAKER AMP.
Connector Color	BROWN



77	76	75	74	73	72	71	70	69	68			
67	66	65	64	63	62	61	60	59	58	57	56	55

Terminal No.	Color of Wire	Signal Name
55	W	-
56	R	-
57	P	-
58	R	-
59	G	-
60	-	-
61	-	-
62	W	-
63	W	-
64	G	-
65	SHIELD	-
66	-	-
67	-	-
68	-	-
69	G	-
70	W	-
71	G	-
72	W	-
73	G	-
74	G	-
75	W	-
76	-	-
77	-	-

ABNIA4706GB

# BOSE AUDIO W/NAVI W/SURROUND

< WIRING DIAGRAM >

[TELEMATICS SYSTEM]

Connector No.	B139
Connector Name	WIRE TO WIRE
Connector Color	WHITE

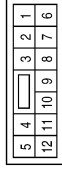

Terminal No.	Color of Wire	Signal Name
11	W	-(WITH BOSE AUDIO SYSTEM)
12	G	-(WITH BOSE AUDIO SYSTEM)

Terminal No.	Color of Wire	Signal Name
9	O	-
10	SHIELD	-
11	R	-
12	B	-
13	B	-
15	B/Y	-(WITH SURROUND SOUND SYSTEM)
16	L/G	-
18	LG	-
19	BR	-
21	Y	-
22	SHIELD	-
23	G	-
24	W	-

Connector No.	B137
Connector Name	WIRE TO WIRE
Connector Color	WHITE

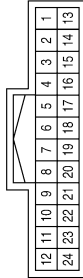

Terminal No.	Color of Wire	Signal Name
1	Y	-
3	SB	-
4	LG	-
5	SHIELD	-
6	SB	-
8	SB	-

Connector No.	B144
Connector Name	JOINT CONNECTOR-B11
Connector Color	WHITE



Terminal No.	Color of Wire	Signal Name
2	B	-
3	SHIELD	-
4	SHIELD	-

Connector No.	B140
Connector Name	WIRE TO WIRE
Connector Color	WHITE

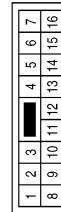

Terminal No.	Color of Wire	Signal Name
9	G	-
10	W	-
11	P	-
12	R	-
13	SHIELD	-
14	W	-
15	B	-
16	W	-

ABNIA4707GB

A  
B  
C  
D  
E  
F  
G  
H  
I  
J  
K  
L  
M  
N  
O  
P

AV

# BOSE AUDIO W/NAVI W/SURROUND

< WIRING DIAGRAM >

[TELEMATICS SYSTEM]

Connector No.	B153
Connector Name	REAR SIDE SPEAKER RH
Connector Color	BROWN



Terminal No.	Color of Wire	Signal Name
1	W	-
2	G	-

Terminal No.	Color of Wire	Signal Name
7	Y	-
8	O	-
9	V	-
10	B	-
11	W	-
12	G	-
13	R	-
14	SHIELD	-

Connector No.	B145
Connector Name	WIRE TO WIRE
Connector Color	WHITE

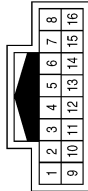

Terminal No.	Color of Wire	Signal Name
1	LG	-
2	SB	-
3	SB	-
4	L	-
5	BR	-
6	SHIELD	-

Terminal No.	Color of Wire	Signal Name
15	LG	-
16	R	-
17	BR	-
18	W	-
19	Y	-
20	GR	-
21	G	-
22	LG	-
23	B	-
24	R	-

Terminal No.	Color of Wire	Signal Name
4	LG	-
6	G	-
8	V	-
9	Y	-
10	P	-
11	G	-
12	W	-
13	G	-
14	SB	-

Connector No.	B201
Connector Name	WIRE TO WIRE
Connector Color	WHITE



Terminal No.	Color of Wire	Signal Name
1	W	-
3	P	-

ABNIA4849GB

# BOSE AUDIO W/NAVI W/SURROUND

< WIRING DIAGRAM >

[TELEMATICS SYSTEM]

Connector No.	B202
Connector Name	HEADREST DISPLAY UNIT (DRIVER SEAT)
Connector Color	WHITE

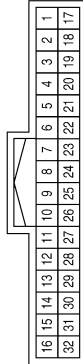

Terminal No.	Color of Wire	Signal Name
1	W	REAR1 HP LH+
2	G	REAR1 HP RH+
3	LG	REAR1 HP SHIELD
4	-	-
5	Y	REAR1 COMP+
6	-	-

Connector No.	B219
Connector Name	WIRE TO WIRE
Connector Color	WHITE

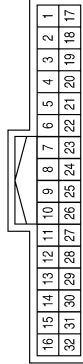

Terminal No.	Color of Wire	Signal Name
1	W	-
2	G	-
3	LG	-
5	Y	-
7	W	-
8	G	-

Terminal No.	Color of Wire	Signal Name
7	W	AUX REQ OUT
8	G	ACC DET IN
9	-	-
10	LG	M-CAN 1L
11	P	M-CAN 1H
12	G	LOCATION DET LH (LH ONLY)
13	BR	ILL
14	-	-
15	W	BAT
16	W	BAT
17	B	REAR1 HP LH-
18	R	REAR1 HP RH-
19	V	AV GND

Terminal No.	Color of Wire	Signal Name
20	P	REAR1 COMP SHIELD
21	G	REAR1 COMP-
22	-	-
23	Y	CONT GND
24	SB	CON CK B
25	-	-
26	R	M-CAN 2L
27	LG	M-CAN 2H
28	-	-
29	GR	CON CK A
30	-	-
31	G	GND
32	G	GND

Terminal No.	Color of Wire	Signal Name
10	LG	-
11	P	-
12	G	-
13	BR	-
15	W	-
16	W	-
17	B	-
18	R	-
19	V	-
20	P	-
21	G	-
23	Y	-
24	SB	-

Terminal No.	Color of Wire	Signal Name
26	R	-
27	LG	-
29	GR	-
31	G	-
32	G	-

ABNIA4850GB

A  
B  
C  
D  
E  
F  
G  
H  
I  
J  
K  
L  
M  
N  
O  
P

AV

# BOSE AUDIO W/NAVI W/SURROUND

< WIRING DIAGRAM >

[TELEMATICS SYSTEM]

Terminal No.	Color of Wire	Signal Name
26	R	-
27	LG	-
29	GR	-
31	G	-
32	G	-

Terminal No.	Color of Wire	Signal Name
10	LG	-
11	P	-
12	G	-
13	BR	-
15	W	-
16	W	-
17	B	-
18	R	-
19	V	-
20	P	-
21	G	-
23	Y	-
24	SB	-

Connector No.	B222
Connector Name	WIRE TO WIRE
Connector Color	WHITE

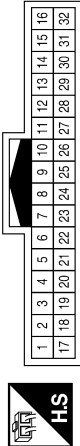

Terminal No.	Color of Wire	Signal Name
1	W	-
2	G	-
3	LG	-
5	Y	-
7	W	-
8	G	-

Terminal No.	Color of Wire	Signal Name
12	W	-
13	G	-
14	SB	-
15	LG	-
16	R	-
17	BR	-
18	W	-
19	Y	-
20	GR	-
21	G	-
22	LG	-
23	B	-
24	R	-

Connector No.	B301
Connector Name	WIRE TO WIRE
Connector Color	WHITE

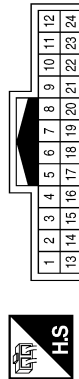

Terminal No.	Color of Wire	Signal Name
1	W	-
3	P	-
4	LG	-
5	SHIELD	-
6	G	-
8	V	-
9	Y	-
10	P	-
11	G	-

ABNIA4708GB

# BOSE AUDIO W/NAVI W/SURROUND

< WIRING DIAGRAM >

[TELEMATICS SYSTEM]

Connector No.	B302
Connector Name	HEADREST DISPLAY UNIT (PASSENGER SEAT)
Connector Color	WHITE

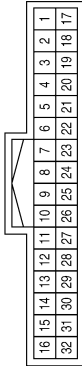

Terminal No.	Color of Wire	Signal Name
1	W	REAR1 HP LH+
2	G	REAR1 HP RH+
3	LG	REAR1 HP SHIELD
4	-	-
5	Y	REAR1 COMP+
6	-	-

Terminal No.	Color of Wire	Signal Name
7	W	AUX REQ OUT
8	G	ACC DET IN
9	-	-
10	LG	M-CAN 1L
11	P	M-CAN 1H
12	-	-
13	BR	ILL
14	-	-
15	W	BAT
16	W	BAT
17	B	REAR1 HP LH-
18	R	REAR1 HP RH-
19	V	AV GND

Terminal No.	Color of Wire	Signal Name
20	P	REAR1 COMP SHIELD
21	G	REAR1 COMP-
22	-	-
23	Y	CONT GND
24	SB	CON CK B
25	-	-
26	R	M-CAN 2L
27	LG	M-CAN 2H
28	G	LOCATION DET RH (RH ONLY)
29	GR	CON CK A
30	-	-
31	G	GND
32	G	GND

Connector No.	B316
Connector Name	WIRE TO WIRE
Connector Color	WHITE



Terminal No.	Color of Wire	Signal Name
1	W	-
2	G	-
3	LG	-
5	Y	-
7	W	-
8	G	-

Terminal No.	Color of Wire	Signal Name
10	LG	-
11	P	-
13	BR	-
15	W	-
16	W	-
17	B	-
18	R	-
19	V	-
20	P	-
21	G	-
23	Y	-
24	SB	-
26	R	-

Terminal No.	Color of Wire	Signal Name
27	LG	-
28	G	-
29	GR	-
31	G	-
32	G	-

ABNIA4709GB

A  
B  
C  
D  
E  
F  
G  
H  
I  
J  
K  
L  
M  
N  
O  
P

AV

# BOSE AUDIO W/NAVI W/SURROUND

< WIRING DIAGRAM >

[TELEMATICS SYSTEM]

Terminal No.	Color of Wire	Signal Name
27	LG	-
28	G	-
29	GR	-
31	G	-
32	G	-

Terminal No.	Color of Wire	Signal Name
10	LG	-
11	P	-
13	BR	-
15	W	-
16	W	-
17	B	-
18	R	-
19	V	-
20	P	-
21	G	-
23	Y	-
24	SB	-
26	R	-

Connector No.	B317
Connector Name	WIRE TO WIRE
Connector Color	WHITE

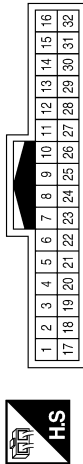

Terminal No.	Color of Wire	Signal Name
1	W	-
2	G	-
3	LG	-
5	Y	-
7	W	-
8	G	-

Connector No.	B401
Connector Name	WIRE TO WIRE
Connector Color	BLACK



Terminal No.	Color of Wire	Signal Name
22	W	-
23	SHIELD	-
24	W	-
25	B	-
26	SHIELD	-
27	W	-
28	B	-
29	SHIELD	-

Connector No.	B400
Connector Name	WIRE TO WIRE
Connector Color	WHITE

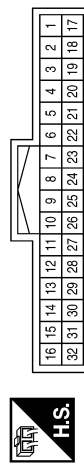

Terminal No.	Color of Wire	Signal Name
17	W	-
18	B	-
19	SHIELD	-
20	R	-
21	B	-

Terminal No.	Color of Wire	Signal Name
2	B	-
3	W	-
4	B	-
5	W	-
8	B	-
9	W	-
10	W	-
11	B	-

ABNIA4710GB



# BOSE AUDIO W/NAVI W/SURROUND

< WIRING DIAGRAM >

[TELEMATICS SYSTEM]

Connector No.	B452
Connector Name	WIRE TO WIRE
Connector Color	BLACK

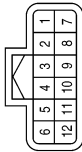

Terminal No.	Color of Wire	Signal Name
2	P	-
3	G	-
4	L	-
5	Y	-
8	L	-
9	W	-
10	P	-
11	G	-

Connector No.	B455
Connector Name	REAR SONAR SENSOR LH OUTER
Connector Color	BLACK



Terminal No.	Color of Wire	Signal Name
1	P	-
2	G	-

Connector No.	B456
Connector Name	REAR SONAR SENSOR RH OUTER
Connector Color	BLACK



Terminal No.	Color of Wire	Signal Name
1	L	-
2	W	-

Connector No.	B457
Connector Name	REAR SONAR SENSOR LH INNER
Connector Color	BLACK



Terminal No.	Color of Wire	Signal Name
1	L	-
2	Y	-

Connector No.	B458
Connector Name	REAR SONAR SENSOR RH INNER
Connector Color	BLACK



Terminal No.	Color of Wire	Signal Name
1	P	-
2	G	-

Connector No.	R1
Connector Name	WIRE TO WIRE
Connector Color	WHITE

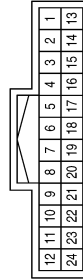

Terminal No.	Color of Wire	Signal Name
5	B	-
13	W	-
14	B	-
15	SHIELD	-
16	P	-
17	BG	-
23	W	-

ABNIA4711GB

A  
B  
C  
D  
E  
F  
G  
H  
I  
J  
K  
L  
M  
AV  
O  
P

# BOSE AUDIO W/NAVI W/SURROUND

< WIRING DIAGRAM >

[TELEMATICS SYSTEM]

Connector No.	R11
Connector Name	WIRE TO WIRE
Connector Color	WHITE

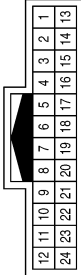
Terminal No.	Color of Wire	Signal Name
1	W	-
2	B	-
3	BG	-
4	P	-
5	SHIELD	-
6	B	-
7	W	-

Connector No.	R101
Connector Name	WIRE TO WIRE
Connector Color	WHITE

Terminal No.	Color of Wire	Signal Name
1	V	-
2	R	-
3	G	-
4	P	-
5	SHIELD	-
6	L	-
7	R	-

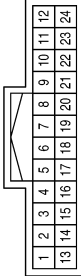
Connector No.	R105
Connector Name	TELEMATICS SWITCH
Connector Color	WHITE

Terminal No.	Color of Wire	Signal Name
1	V	-
2	G	-
3	P	-
7	R	-

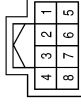
Connector No.	R109
Connector Name	MICROPHONE
Connector Color	WHITE



Terminal No.	Color of Wire	Signal Name
1	R	-
2	-	-
3	GR	-
4	L	-

Connector No.	D2
Connector Name	WIRE TO WIRE
Connector Color	WHITE



Terminal No.	Color of Wire	Signal Name
8	W	-
9	G	-

Connector No.	D3
Connector Name	WIRE TO WIRE
Connector Color	WHITE



Terminal No.	Color of Wire	Signal Name
22	Y	-
23	LG	-
28	G	-
29	SHIELD	-
30	R	-
31	B	-
32	W	-

ABNIA4712GB

# BOSE AUDIO W/NAVI W/SURROUND

< WIRING DIAGRAM >

[TELEMATICS SYSTEM]

Connector No.	D20
Connector Name	DOOR MIRROR LH (SIDE CAMERA)
Connector Color	WHITE

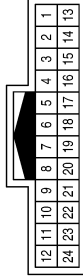

Terminal No.	Color of Wire	Signal Name
5	R	-
6	W	-
16	G	-
17	SHIELD	-
18	B	-

Connector No.	D12
Connector Name	FRONT DOOR SPEAKER LH
Connector Color	WHITE



Terminal No.	Color of Wire	Signal Name
1	G	-
2	W	-

Connector No.	D6
Connector Name	DOOR MIRROR LH (WITH AROUND VIEW MONITOR)
Connector Color	WHITE



Terminal No.	Color of Wire	Signal Name
8	LG	-
9	Y	-

Connector No.	D112
Connector Name	FRONT DOOR SPEAKER RH
Connector Color	WHITE



Terminal No.	Color of Wire	Signal Name
1	G	-
2	W	-

Connector No.	D102
Connector Name	WIRE TO WIRE
Connector Color	WHITE

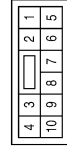

Terminal No.	Color of Wire	Signal Name
9	G	-
10	W	-

Connector No.	D101
Connector Name	WIRE TO WIRE
Connector Color	WHITE

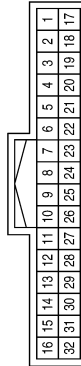

Terminal No.	Color of Wire	Signal Name
1	G	-
2	SHIELD	-
3	R	-
4	B	-
5	W	-

ABNIA4741GB

A  
B  
C  
D  
E  
F  
G  
H  
I  
J  
K  
L  
M  
N  
O  
P

AV

# BOSE AUDIO W/NAVI W/SURROUND

< WIRING DIAGRAM >

[TELEMATICS SYSTEM]

Connector No.	D202
Connector Name	WIRE TO WIRE
Connector Color	WHITE

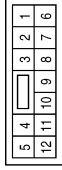

Terminal No.	Color of Wire	Signal Name
10	LG	-
11	Y	-

Connector No.	D201
Connector Name	WIRE TO WIRE
Connector Color	WHITE

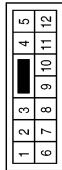

Terminal No.	Color of Wire	Signal Name
11	Y	-
12	LG	-

Connector No.	D113
Connector Name	DOOR MIRROR RH (SIDE CAMERA)
Connector Color	WHITE



Terminal No.	Color of Wire	Signal Name
5	R	-
6	W	-
16	G	-
17	SHIELD	-
18	B	-

Connector No.	D252
Connector Name	REAR DOOR TWEETER LH
Connector Color	BROWN



Terminal No.	Color of Wire	Signal Name
1	LG	-
2	BR	-

Connector No.	D251
Connector Name	WIRE TO WIRE
Connector Color	WHITE



Terminal No.	Color of Wire	Signal Name
10	LG	-
11	BR	-

Connector No.	D207
Connector Name	REAR DOOR SPEAKER LH
Connector Color	BROWN



Terminal No.	Color of Wire	Signal Name
1	LG	-
2	Y	-

ABNIA4758GB

# BOSE AUDIO W/NAVI W/SURROUND

< WIRING DIAGRAM >

[TELEMATICS SYSTEM]

Connector No.	D307
Connector Name	REAR DOOR SPEAKER RH
Connector Color	BROWN



Terminal No.	Color of Wire	Signal Name
1	W	-
2	G	-

Connector No.	D302
Connector Name	WIRE TO WIRE
Connector Color	WHITE

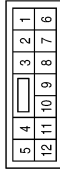

Terminal No.	Color of Wire	Signal Name
10	W	-
11	G	-

Connector No.	D301
Connector Name	WIRE TO WIRE
Connector Color	WHITE

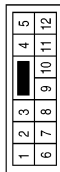

Terminal No.	Color of Wire	Signal Name
11	G	-
12	W	-

Connector No.	D501
Connector Name	WIRE TO WIRE
Connector Color	WHITE

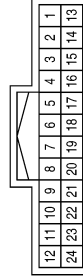

Terminal No.	Color of Wire	Signal Name
13	W	-
14	B	-
15	R	-
16	SHIELD	-
17	G	-

Connector No.	D352
Connector Name	REAR DOOR TWEETER RH
Connector Color	BROWN



Terminal No.	Color of Wire	Signal Name
1	LG	-
2	BR	-

Connector No.	D351
Connector Name	WIRE TO WIRE
Connector Color	WHITE

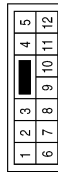

Terminal No.	Color of Wire	Signal Name
10	LG	-
11	BR	-

ABNIA4759GB

A  
B  
C  
D  
E  
F  
G  
H  
I  
J  
K  
L  
M  
N  
O  
P

AV

# BOSE AUDIO W/NAVI W/SURROUND

< WIRING DIAGRAM >

[TELEMATICS SYSTEM]

Connector No.	D511
Connector Name	REAR VIEW CAMERA
Connector Color	WHITE

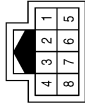

Terminal No.	Color of Wire	Signal Name
1	SHIELD	-
4	G	-
5	R	-
7	B	-
8	W	-

AANIA2025GB

## BASIC INSPECTION

### DIAGNOSIS AND REPAIR WORK FLOW

#### Work Flow

INFOID:000000009129513

#### OVERALL SEQUENCE

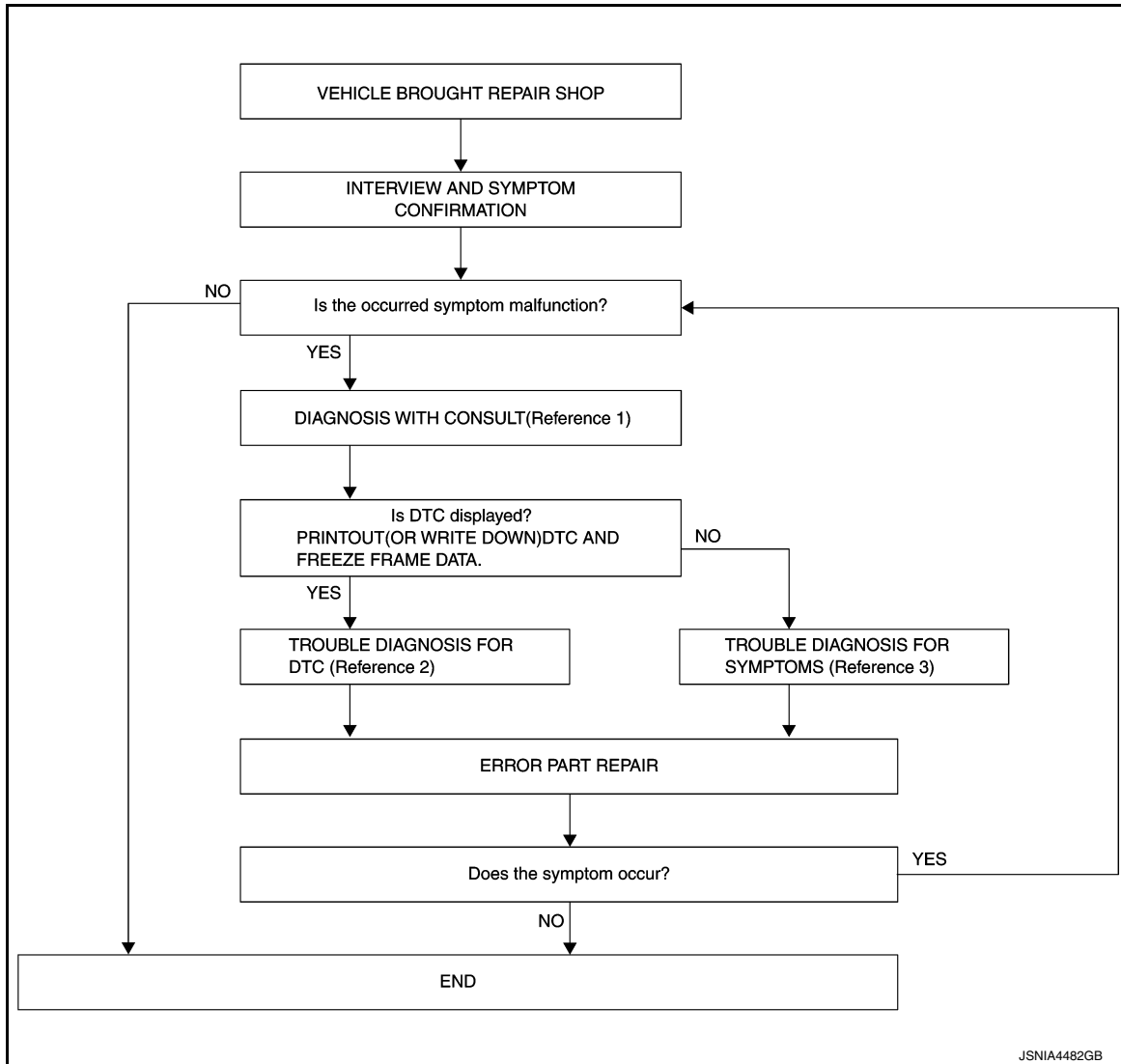

- Reference 1… Refer to [AV-920. "CONSULT Function"](#).
- Reference 2… Refer to [AV-923. "DTC Index"](#).
- Reference 3… Refer to [AV-1053. "Symptom Table"](#).

#### DETAILED FLOW

##### 1. INTERVIEW AND SYMPTOM CONFIRMATION

Check the malfunction symptoms by performing the following items.

- Interview the customer to obtain the malfunction information (conditions and environment when the malfunction occurred).
- Check the symptom.

##### Is the occurred symptom malfunction?

YES >> GO TO 2.

NO >> Inspection End.

##### 2. DIAGNOSIS WITH CONSULT

# DIAGNOSIS AND REPAIR WORK FLOW

[TELEMATICS SYSTEM]

< BASIC INSPECTION >

1. Connect CONSULT and perform a self-diagnosis for "TELEMATICS". Refer to [AV-920, "CONSULT Function"](#).
2. When DTC is detected, follow the instructions below:
  - Record DTC and Freeze Frame Data.

Is DTC displayed?

YES >> GO TO 4.

NO >> GO TO 5.

## 3. TROUBLE DIAGNOSIS FOR DTC

---

1. Check the DTC indicated in the self-diagnosis results.
2. Perform the relevant diagnosis referring to the DTC Index. Refer to [AV-923, "DTC Index"](#).

>> GO TO 6.

## 4. TROUBLE DIAGNOSIS FOR SYMPTOMS

---

Perform the relevant diagnosis referring to the symptom table. Refer to [AV-1053, "Symptom Table"](#).

>> GO TO 6.

## 5. ERROR PART REPAIR

---

1. Repair or replace the identified malfunctioning parts.
2. Perform a self-diagnosis for "TELEMATICS" with CONSULT.
3. Check that the symptom does not occur.

Does the symptom occur?

YES >> GO TO 1.

NO >> Inspection End.



## INSPECTION AND ADJUSTMENT

## ADDITIONAL SERVICE WHEN REPLACING TCU

## ADDITIONAL SERVICE WHEN REPLACING TCU : Description

INFOID:000000009129514

When TCU is replaced, TCU activation operation is required.

Preparation before activation operation

- Subscribe to telematics service
- Preregister user ID and password (can be performed from owner homepage)

## ADDITIONAL SERVICE WHEN REPLACING TCU : Work Procedure

INFOID:000000009129515

**1.**TURN TCU OFF

CONSULT Work support

1. Select TCU ACTIVATE SETTING, then Start.
2. Select Start, then select Off to turn OFF the TCU.
3. Select End to return to the Work support Test Item screen.
4. Select TCU ACTIVATE SETTING, then Start.
5. Select Start, and confirm that Off is displayed in the Current status field.
6. Select End to return to the Work support Test Item screen.

>> GO TO 2.

**2.**SAVE VIN DATA**NOTE:**

If the VIN data cannot be saved, it will have to be entered manually later in this procedure.

CONSULT Work support

1. Select SAVE VIN DATA, then Start.
2. Select Start to save the VIN data.
3. Select End to return to the Work support Test Item screen.

>> GO TO 3.

**3.**REMOVE TCU

Remove the TCU. Refer to [AV-1057, "Removal and Installation"](#).

>> GO TO 4.

**4.**RECORD TCU PART LABEL INFORMATION**NOTICE:**

Steps 4 and 5 must be performed after the original TCU has been removed from the vehicle and before the replacement TCU is installed.

Collect, record and have the following information ready:

- VIN.
- International Mobile Equipment Identity (IMEI) number of the original TCU. Located on the TCU part label.
- International Mobile Equipment Identity (IMEI) number of the replacement TCU. Located on the TCU part label.
- Serial number of the replacement TCU. Located on the TCU part label.



>> GO TO 5.

## 5. CONTACT INFINITI CONNECTION CALL CENTER

### NOTICE:

This step must be performed to activate the replacement TCU. If this step is not performed, the TCU will not be able to communicate with the INFINITI CONNECTION Data Center.

Call the INFINITI CONNECTION Call Center at 1-800-334-7858, press "4" and listen for additional applicable INFINITI retailer prompts. You will be asked for your name, retailer name, and the information collected in step 4. The call agent will deactivate the original TCU and activate the replacement TCU.

>> GO TO 6.

## 6. INSTALL TCU

Install the TCU. Refer to [AV-1057. "Removal and Installation"](#).

>> GO TO 7.

## 7. VIN DATA

Was the VIN data saved during step 2?

- YES >> GO TO 8.
- NO >> GO TO 9.

## 8. WRITE VIN DATA

CONSULT Work support

1. Select WRITE VIN DATA, then Start.
2. Select Start.
3. After the data writing has been completed, select End to return to the Work support Test Item screen.

>> GO TO 10.

## 9. MANUALLY ENTER VIN DATA

CONSULT Work support

1. Select VIN REGISTRATION.
2. Enter the VIN number in the VIN (1ST TIME) field.
3. Enter the VIN number in the VIN (2ND TIME) field.
4. Select Start.
5. After the VIN registration has been completed, select End to return to the Work support Test Item screen.

# INSPECTION AND ADJUSTMENT

< BASIC INSPECTION >

[TELEMATICS SYSTEM]

>> GO TO 10.

## 10. TURN TCU ON

④ CONSULT Work support

1. Select TCU ACTIVATE SETTING, then Start.
2. Select Start, then select On to turn ON the TCU.
3. Select End to return to the Work support Test Item screen.
4. Select TCU ACTIVATE SETTING, then Start.
5. Select Start, and confirm that On is displayed in the Current status field.

>> WORK END.

A

B

C

D

E

F

G

H

I

J

K

L

M

AV

O

P

# U1000 CAN COMM CIRCUIT

< DTC/CIRCUIT DIAGNOSIS >

[TELEMATICS SYSTEM]

## DTC/CIRCUIT DIAGNOSIS

### U1000 CAN COMM CIRCUIT

#### DTC Logic

INFOID:000000009129516

#### DTC DETECTION LOGIC

CONSULT Display	DTC Detection Condition	Possible Cause
CAN COMM CIRCUIT [U1000]	TCU is not transmitting or receiving CAN communication signal for 2 seconds or more.	CAN communication system.

#### Diagnosis Procedure

INFOID:000000009129517

### 1. PERFORM SELF DIAGNOSTIC RESULT

1. Turn ignition switch ON and wait for 2 seconds or more.
2. Perform Self Diagnostic Result for TELEMATICS.

#### Is CAN COMM CIRCUIT displayed?

- YES >> Refer to [LAN-26, "Trouble Diagnosis Flow Chart"](#).  
NO >> Refer to [GI-53, "Intermittent Incident"](#).

# U1010 CONTROL UNIT (CAN)

< DTC/CIRCUIT DIAGNOSIS >

[TELEMATICS SYSTEM]

## U1010 CONTROL UNIT (CAN)

### DTC Logic

INFOID:000000009129518

### DTC DETECTION LOGIC

CONSULT Display	DTC Detection Condition	Possible Cause
CONTROL UNIT (CAN) [U1010]	CAN initial diagnosis malfunction is detected.	Replace TCU if malfunction occurs constantly. Refer to <a href="#">AV-1057, "Removal and Installation"</a> .

A  
B  
C  
D  
E  
F  
G  
H  
I  
J  
K  
L  
M  
AV  
O  
P

# U1A00 TCU

< DTC/CIRCUIT DIAGNOSIS >

[TELEMATICS SYSTEM]

## U1A00 TCU

### DTC Logic

INFOID:000000009129519

CONSULT Display	DTC Detection Condition	Possible Cause
ACC NO CONN [U1A00]	No input of ACC signal	<ul style="list-style-type: none"><li>• ACC power circuit.</li><li>• TCU.</li></ul>

### Diagnosis Procedure

INFOID:000000009129520

Regarding Wiring Diagram information, refer to [AV-924, "Wiring Diagram"](#) (Bose Audio w/Navi w/o Surround) or [AV-976, "Wiring Diagram"](#) (Bose Audio w/Navi and Surround).

### 1. CHECK ACC POWER CIRCUIT

1. Turn ignition switch OFF.
2. Disconnect TCU connector M47.
3. Check voltage between TCU connector and ground.

TCU		Ground	Condition	Voltage (Approx.)
Connector	Terminal			
M47	3	—	Ignition switch: ACC	Battery voltage

Is the inspection result normal?

- YES >> Replace TCU. Refer to [AV-1057, "Removal and Installation"](#).  
NO >> Repair or replace harness or connectors.

# U1A01 TCU

< DTC/CIRCUIT DIAGNOSIS >

[TELEMATICS SYSTEM]

## U1A01 TCU

### DTC Logic

INFOID:000000009129521

CONSULT Display	DTC Detection Condition	Possible Cause
INTERNAL ERROR (TCU) [U1A01]	Malfunction in TCU is detected.	Replace TCU if malfunction occurs constantly. Refer to <a href="#">AV-1057</a> . "Removal and Installation".

A  
B  
C  
D  
E  
F  
G  
H  
I  
J  
K  
L  
M  
O  
P

AV

# U1A02 TCU

< DTC/CIRCUIT DIAGNOSIS >

[TELEMATICS SYSTEM]

## U1A02 TCU

### DTC Logic

INFOID:000000009129522

CONSULT Display	DTC Detection Condition	Possible Cause
TEL COMMUNICATION MODULE [U1A02]	Malfunction in communication module of TCU is detected.	Replace TCU if malfunction occurs constantly. Refer to <a href="#">AV-1057</a> , "Removal and Installation".



# U1A03 TCU

< DTC/CIRCUIT DIAGNOSIS >

[TELEMATICS SYSTEM]

## U1A03 TCU

### DTC Logic

INFOID:000000009129523

CONSULT Display	DTC Detection Condition	Possible Cause
SIM CARD [U1A03]	SIM card not inserted or unable to read.	<ul style="list-style-type: none"><li>• Check SIM card installation.</li><li>• Replace TCU if malfunction occurs constantly. Refer to <a href="#">AV-1057, "Removal and Installation"</a>.</li></ul>

A

B

C

D

E

F

G

H

I

J

K

L

M

AV

O

P

# U1A04 TCU

< DTC/CIRCUIT DIAGNOSIS >

[TELEMATICS SYSTEM]

## U1A04 TCU

### DTC Logic

INFOID:000000009129524

CONSULT Display	DTC Detection Condition	Possible Cause
VIN UNFINISHED [U1A04]	Unwritten VIN number is detected.	<ul style="list-style-type: none"><li>• Write VIN number using CONSULT. Refer to <a href="#">AV-1033. "ADDITIONAL SERVICE WHEN REPLACING TCU : Work Procedure"</a>.</li><li>• Replace TCU if malfunction occurs constantly. Refer to <a href="#">AV-1057. "Removal and Installation"</a>.</li></ul>

# U1A05 TCU

< DTC/CIRCUIT DIAGNOSIS >

[TELEMATICS SYSTEM]

## U1A05 TCU

### DTC Logic

INFOID:000000009129525

CONSULT Display	DTC Detection Condition	Possible Cause
USB COMM [U1A05]	Malfunction in USB communication between TCU and AV control unit.	<ul style="list-style-type: none"> <li>• Harness or connectors.</li> <li>• Replace TCU if malfunction occurs constantly. Refer to <a href="#">AV-1057. "Removal and Installation"</a>.</li> </ul>

### Diagnosis Procedure

INFOID:000000009129526

Regarding Wiring Diagram information, refer to [AV-924. "Wiring Diagram"](#) (Bose Audio w/Navi w/o Surround) or [AV-976. "Wiring Diagram"](#) (Bose Audio w/Navi and Surround).

#### 1. CHECK USB CIRCUITS CONTINUITY

1. Turn ignition switch OFF.
2. Disconnect TCU connector M134 and AV control unit connector M136.
3. Check continuity between TCU connector M134 and AV control unit connector M136.

TCU		AV control unit		Continuity
Connector	Terminal	Connector	Terminal	
M134	41	M136	152	Yes
	42		151	
	46		147	
	47		146	
	48		145	
	49		160	
	55		154	
	56		153	
	57		161	

4. Check the continuity between TCU connector M134 and ground.

TCU		Ground	Continuity
Connector	Terminal		
M134	41	—	No
	46		
	47		
	48		
	49		
	56		

Is the inspection result normal?

- YES >> Replace TCU. Refer to [AV-1057. "Removal and Installation"](#).  
 NO >> Repair or replace harness or connectors.

# U1A07 TEL ANTENNA

< DTC/CIRCUIT DIAGNOSIS >

[TELEMATICS SYSTEM]

## U1A07 TEL ANTENNA

### DTC Logic

INFOID:000000009129527

CONSULT Display	DTC Detection Condition	Possible Cause
TEL ANTENNA SHORT [U1A07]	TEL antenna short circuit.	<ul style="list-style-type: none"><li>• TEL antenna harness or connector.</li><li>• Replace TEL antenna if malfunction occurs constantly.</li></ul> Refer to <a href="#">AV-1060, "Removal and Installation"</a> .

### Diagnosis Procedure

INFOID:000000009129528

Regarding Wiring Diagram information, refer to [AV-924, "Wiring Diagram"](#) (Bose Audio w/Navi w/o Surround) or [AV-976, "Wiring Diagram"](#) (Bose Audio w/Navi and Surround).

### 1. CHECK TEL ANTENNA CONTINUITY

1. Turn ignition switch OFF.
2. Disconnect TEL antenna connector.
3. Check continuity between TEL antenna connector M135 terminals.

TEL antenna connector M135 terminals		Continuity
58	59	No

Is the inspection result normal?

- YES >> Replace TCU. Refer to [AV-1057, "Removal and Installation"](#).  
NO >> Replace TEL antenna. Refer to [AV-1060, "Removal and Installation"](#).

# U1A08 TEL ANTENNA

< DTC/CIRCUIT DIAGNOSIS >

[TELEMATICS SYSTEM]

## U1A08 TEL ANTENNA

### DTC Logic

INFOID:000000009129529

CONSULT Display	DTC Detection Condition	Possible Cause
TEL ANTENNA NO CONN [U1A08]	No TEL antenna connection.	<ul style="list-style-type: none"><li>• TEL antenna.</li><li>• Replace TCU if malfunction occurs constantly. Refer to <a href="#">AV-1057. "Removal and Installation"</a>.</li></ul>

### Diagnosis Procedure

INFOID:000000009129530

Regarding Wiring Diagram information, refer to [AV-924. "Wiring Diagram"](#) (Bose Audio w/Navi w/o Surround) or [AV-976. "Wiring Diagram"](#) (Bose Audio w/Navi and Surround).

#### 1. CHECK AV CONTROL UNIT VOLTAGE

1. Turn ignition switch ON.
2. Check voltage between TEL antenna connector M135 and ground.

TEL antenna (+)		Ground (-)	Reference value
Connector	Terminal		
M135	58	—	2.8 V

#### Is the inspection result normal?

- YES >> Replace TEL antenna. Refer to [AV-1060. "Removal and Installation"](#).  
NO >> Replace TCU. Refer to [AV-1057. "Removal and Installation"](#).

A  
B  
C  
D  
E  
F  
G  
H  
I  
J  
K  
L  
M  
O  
P

AV

# U1A0B MICROPHONE

< DTC/CIRCUIT DIAGNOSIS >

[TELEMATICS SYSTEM]

## U1A0B MICROPHONE

### DTC Logic

INFOID:000000009129531

CONSULT Display	DTC Detection Condition	Possible Cause
MIC IN CONN [U1A0B]	No input of microphone circuits.	<ul style="list-style-type: none"> <li>• Harness or connectors.</li> <li>• Microphone.</li> <li>• Replace TCU if malfunction occurs constantly. Refer to <a href="#">AV-1057</a>. "Removal and Installation".</li> </ul>

### Diagnosis Procedure

INFOID:000000009129532

Regarding Wiring Diagram information, refer to [AV-924](#). "Wiring Diagram" (Bose Audio w/Navi w/o Surround) or [AV-976](#). "Wiring Diagram" (Bose Audio w/Navi and Surround).

#### 1. CHECK MIC IN SIGNAL CIRCUIT AND MIC VCC CIRCUIT CONTINUITY

1. Turn ignition switch OFF.
2. Disconnect TCU connector M47 and microphone connector.
3. Check continuity between TCU connector M47 and microphone connector R109.

TCU		Microphone		Continuity
Connector	Terminal	Connector	Terminal	
M47	18	R109	1	Yes
	19		4	
	20		3	

4. Check the continuity between TCU connector M47 and ground.

TCU		Ground	Continuity
Connector	Terminal		
M47	18	—	No
	19		

Is the inspection result normal?

- YES >> GO TO 2.  
NO >> Repair or replace harness or connectors.

#### 2. CHECK MIC VCC VOLTAGE

1. Connect TCU connector M47 and microphone connector.
2. Turn ignition switch ON.
3. Check voltage between terminals of TCU connector M47.

TCU connector M47		Voltage (Approx.)
(+) Terminal	(-) Terminal	
18	20	5.0 V

Is the inspection result normal?

- YES >> GO TO 3.  
NO >> Replace TCU. Refer to [AV-1057](#). "Removal and Installation".

#### 3. CHECK MIC IN SIGNAL

Check signal between terminals of TCU connector M47.

# U1A0B MICROPHONE

< DTC/CIRCUIT DIAGNOSIS >

[TELEMATICS SYSTEM]

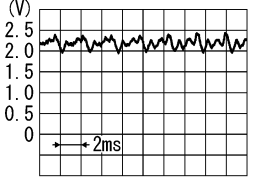
TCU connector M47		Condition	Reference value
(+) Terminal	(-) Terminal		
19	20	Speak into microphone.	 <p style="text-align: right; font-size: small;">PKIB5037J</p>

Is the inspection result normal?

- YES >> Replace TCU. Refer to [AV-1057. "Removal and Installation"](#).
- NO >> Replace microphone. Refer to [AV-1058. "Removal and Installation"](#).

A  
B  
C  
D  
E  
F  
G  
H  
I  
J  
K  
L  
M

AV

O  
P

# U1A0C MICROPHONE

[TELEMATICS SYSTEM]

< DTC/CIRCUIT DIAGNOSIS >

## U1A0C MICROPHONE

### DTC Logic

INFOID:000000009129533

CONSULT Display	DTC Detection Condition	Possible Cause
MIC OUT CONN [U1A0C]	No output of microphone circuits.	<ul style="list-style-type: none"> <li>• Harness or connectors.</li> <li>• Microphone.</li> <li>• Replace TCU if malfunction occurs constantly. Refer to <a href="#">AV-1057, "Removal and Installation"</a>.</li> </ul>

### Diagnosis Procedure

INFOID:000000009129534

Regarding Wiring Diagram information, refer to [AV-924, "Wiring Diagram"](#) (Bose Audio w/Navi w/o Surround) or [AV-976, "Wiring Diagram"](#) (Bose Audio w/Navi and Surround).

#### 1. CHECK DCM MIC SIGNAL CIRCUIT AND DCM MIC VCC CIRCUIT CONTINUITY

1. Turn ignition switch OFF.
2. Disconnect TCU connector M47 and AV control unit connector M122.
3. Check continuity between TCU connector M47 and AV control unit connector M122.

TCU		AV control unit		Continuity
Connector	Terminal	Connector	Terminal	
M47	21	M122	60	Yes
	22		75	
	23		59	

4. Check the continuity between TCU connector M47 and ground.

TCU		Ground	Continuity
Connector	Terminal		
M47	21	—	No
	22		

Is the inspection result normal?

- YES >> GO TO 2.  
NO >> Repair or replace harness or connectors.

#### 2. CHECK DCM MIC VCC VOLTAGE

1. Connect TCU connector M47 and AV control unit connector M122.
2. Turn ignition switch ON.
3. Check voltage between AV control unit connector M122 terminals.

AV control unit connector M122		Voltage (Approx.)
(+) Terminal	(-) Terminal	
60	59	5.0 V

Is the inspection result normal?

- YES >> GO TO 3.  
NO >> Replace TCU. Refer to [AV-1057, "Removal and Installation"](#).

#### 3. CHECK DCM MIC SIGNAL

Check signal between AV control unit connector M122.



# U1A0C MICROPHONE

< DTC/CIRCUIT DIAGNOSIS >

[TELEMATICS SYSTEM]

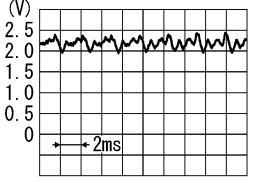
AV control unit connector M122		Condition	Reference value
(+)	(-)		
Terminal	Terminal		
60	59	Speak into microphone.	 <p style="text-align: right; font-size: small;">PKIB5037J</p>

Is the inspection result normal?

YES >> Replace TCU. Refer to [AV-1057. "Removal and Installation"](#).

NO >> Replace AV control unit. Refer to [AV-1055. "Removal and Installation - AV Control Unit"](#).

A  
B  
C  
D  
E  
F  
G  
H  
I  
J  
K  
L  
M  
O  
P

AV

# U1A0E TELEMATICS SWITCH

< DTC/CIRCUIT DIAGNOSIS >

[TELEMATICS SYSTEM]

## U1A0E TELEMATICS SWITCH

### DTC Logic

INFOID:000000009129535

CONSULT Display	DTC Detection Condition	Possible Cause
SOS SWITCH ON STUCK [U1A0E]	ECALL SW short circuit.	<ul style="list-style-type: none"> <li>• Harness or connectors.</li> <li>• Telematics switch.</li> <li>• Replace TCU if malfunction occurs constantly. Refer to <a href="#">AV-1057, "Removal and Installation"</a>.</li> </ul>

### Diagnosis Procedure

INFOID:000000009129536

Regarding Wiring Diagram information, refer to [AV-924, "Wiring Diagram"](#) (Bose Audio w/Navi w/o Surround) or [AV-976, "Wiring Diagram"](#) (Bose Audio w/Navi and Surround).

#### 1. CHECK ECALL SW CIRCUIT CONTINUITY

1. Turn ignition switch OFF.
2. Disconnect TCU connector M47 and telematics switch connector.
3. Check the continuity between TCU connector M47 and ground.

TCU		Ground	Continuity
Connector	Terminal		
M47	34	—	No

Is the inspection result normal?

- YES >> GO TO 2.  
NO >> Repair or replace harness or connectors.

#### 2. CHECK TELEMATICS SWITCH

Check continuity between telematics switch terminals.

Telematics switch		Condition	Continuity
Terminal	Terminal		
3	7	Switch pressed	Yes
		Switch released	No

Is the inspection result normal?

- YES >> Replace TCU. Refer to [AV-1057, "Removal and Installation"](#).  
NO >> Replace telematics switch.

# U1A0F TELEMATICS SWITCH

< DTC/CIRCUIT DIAGNOSIS >

[TELEMATICS SYSTEM]

## U1A0F TELEMATICS SWITCH

### DTC Logic

INFOID:000000009129537

CONSULT Display	DTC Detection Condition	Possible Cause
SOS SWITCH NO CONN [U1A0F]	LED A open circuit.	<ul style="list-style-type: none"> <li>• Harness or connectors.</li> <li>• Telematics switch.</li> <li>• Replace TCU if malfunction occurs constantly. Refer to <a href="#">AV-1057, "Removal and Installation"</a>.</li> </ul>

### Diagnosis Procedure

INFOID:000000009129538

Regarding Wiring Diagram information, refer to [AV-924, "Wiring Diagram"](#) (Bose Audio w/Navi w/o Surround) or [AV-976, "Wiring Diagram"](#) (Bose Audio w/Navi and Surround).

### 1. CHECK LED A CIRCUIT CONTINUITY

1. Turn ignition switch OFF.
2. Disconnect TCU connector M47 and telematics switch connector.
3. Check continuity between TCU connector M47 and telematics switch connector R105.

TCU		Telematics switch		Continuity
Connector	Terminal	Connector	Terminal	
M47	35	R105	2	Yes

Is the inspection result normal?

- YES >> GO TO 2.  
NO >> Repair or replace harness or connectors.

### 2. CHECK TELEMATICS SWITCH

Check continuity between telematics switch terminals.

Telematics switch		Condition	Continuity
Terminal	Terminal		
2	7	Switch pressed	Yes
		Switch released	No

Is the inspection result normal?

- YES >> Replace TCU. Refer to [AV-1057, "Removal and Installation"](#).  
NO >> Replace telematics switch.

A  
B  
C  
D  
E  
F  
G  
H  
I  
J  
K  
L  
M  
O  
P

AV

# POWER SUPPLY AND GROUND CIRCUIT

< DTC/CIRCUIT DIAGNOSIS >

[TELEMATICS SYSTEM]

## POWER SUPPLY AND GROUND CIRCUIT

### Diagnosis Procedure

INFOID:000000009129539

Regarding Wiring Diagram information, refer to [AV-924, "Wiring Diagram"](#) (Bose Audio w/Navi w/o Surround) or [AV-976, "Wiring Diagram"](#) (Bose Audio w/Navi and Surround).

### 1.CHECK FUSE

Check that the following fuses are not blown.

Terminal No.	Signal name	Fuse No.
1	Battery power supply	15 (15A)
3	ACC power supply	65 (10A)
4	Ignition signal	29 (5A)

Are the fuses blown?

YES >> Replace the blown fuse after repairing the affected circuit.

NO >> GO TO 2.

### 2.CHECK POWER SUPPLY CIRCUIT

1. Turn ignition switch OFF.
2. Disconnect TCU connector M47.
3. Check voltage between TCU connector and ground.

AV control unit		Ground	Condition	Voltage (Approx.)
Connector	Terminal			
M47	1	—	Ignition switch: OFF	Battery voltage
	3		Ignition switch: ACC	
	4		Ignition switch: ON	

Is the inspection result normal?

YES >> GO TO 3.

NO >> Repair or replace harness or connectors.

### 3.CHECK GROUND CIRCUIT

1. Turn ignition switch OFF.
2. Check continuity between TCU connector M47 and ground.

TCU		Ground	Continuity
Connector	Terminal		
M47	2	—	Yes
	7		

Is the inspection result normal?

YES >> Inspection End.

NO >> Repair or replace harness or connectors.



SYMPTOM DIAGNOSIS

TELEMATICS SYSTEM

Symptom Table

INFOID:000000009129540

TELEMATICS SYSTEM

Symptom	Display icon	Error message	Possible cause
Telematics operation not available.	—	Telematics unit is not connected.	Perform self-diagnosis with CONSULT. Refer to <a href="#">AV-920, "CONSULT Function"</a> .
		The connection to the center failed.	Check ON/OFF status of TCU using the data monitor of CONSULT. • Replace TCU if it is ON. Refer to <a href="#">AV-1057, "Removal and Installation"</a> . • Turn it ON again if it is OFF. Replace TCU if ON is switched to OFF. Refer to <a href="#">AV-1057, "Removal and Installation"</a> .
		No service.	Use a cellular phone to check reception. • If service is available, replace TCU or TEL antenna. - For TCU replacement, refer to <a href="#">AV-1057, "Removal and Installation"</a> . - For TEL antenna replacement, refer to <a href="#">AV-1060, "Removal and Installation"</a> . • If the service is not available, move the vehicle to the position where service is available and perform the operation again.
		Service inoperative due to poor reception.	Use a cellular phone to check reception. • If it is OK, there may be a cause at the INFINITI CONNECTION Data Center. Check connection after a short period of time. If there is no problem at the INFINITI CONNECTION Data Center, replace TCU or TEL antenna. - For TCU replacement, refer to <a href="#">AV-1057, "Removal and Installation"</a> . - For TEL antenna replacement, refer to <a href="#">AV-1060, "Removal and Installation"</a> . • If it is NG, check connection again after a short period of time.
		Service not registered.	Check input of user ID and password from the navigation setting screen. If malfunction such as input or no memory despite input is detected, replace AV control unit. Refer to <a href="#">AV-1055, "Removal and Installation - AV Control Unit"</a> .
		TCU line is used.	Check connection after a short period of time. Replace TCU if it is frequently displayed. Refer to <a href="#">AV-1057, "Removal and Installation"</a> .
		The connection to the center failed.	There may be a cause at the INFINITI CONNECTION Data Center. Check connection after a short period of time. If there is no problem at the INFINITI CONNECTION Data Center, replace TCU or TEL antenna. • For TCU replacement, refer to <a href="#">AV-1057, "Removal and Installation"</a> . • For TEL antenna replacement, refer to <a href="#">AV-1060, "Removal and Installation"</a> .

A  
B  
C  
D  
E  
F  
G  
H  
I  
J  
K  
L  
M  
O  
P

AV

# NORMAL OPERATING CONDITION

< SYMPTOM DIAGNOSIS >

[TELEMATICS SYSTEM]

## NORMAL OPERATING CONDITION

### Description

INFOID:000000009129541

**NOTE:**

For Telematics system operation detail information, refer to Navigation system Owner's Manual.

Symptom	Possible cause	Possible solution
The system cannot connect to the Infiniti CONNECT Data Center.	A subscription for the CONNECT service has not been established.	Sign up for a subscription to the CONNECT service. For details about subscriptions, contact an INFINITI retailer or visit the INFINITI CONNECT Data Center website.
	The user ID and password are not entered.	Enter the user ID and password.
	The communication line is busy.	Try again after a short period of time.
	The vehicle is in a location where reception is difficult.	When the vehicle moves to an area where radio waves can be transmitted sufficiently, communication will be restored. When the icon on the display shows that the vehicle is inside the communication area, the system can be used.
	TCU reception is insufficient.	When the vehicle moves to an area where radio waves can be transmitted sufficiently, communication will be restored. When the icon on the display shows that the vehicle is inside the communication area, the system can be used.
Some of the items that are displayed on the menu screen cannot be selected.	The vehicle is being driven and some menu items are disabled.	The vehicle is being driven. Stop the vehicle in a safe location and apply the parking brake before operating the functions.
Some parts of the screen are not displayed		Operate the system after stopping the vehicle in a safe location and applying the parking brake.
The system does not announce information.	The volume level is set to the minimum.	Adjust the volume level by operating the VOL switches located on the control panel or on the steering wheel switch while the system is announcing information.

# AV CONTROL UNIT

< REMOVAL AND INSTALLATION >

[TELEMATICS SYSTEM]

## REMOVAL AND INSTALLATION

### AV CONTROL UNIT

Exploded View

INFOID:000000009763673

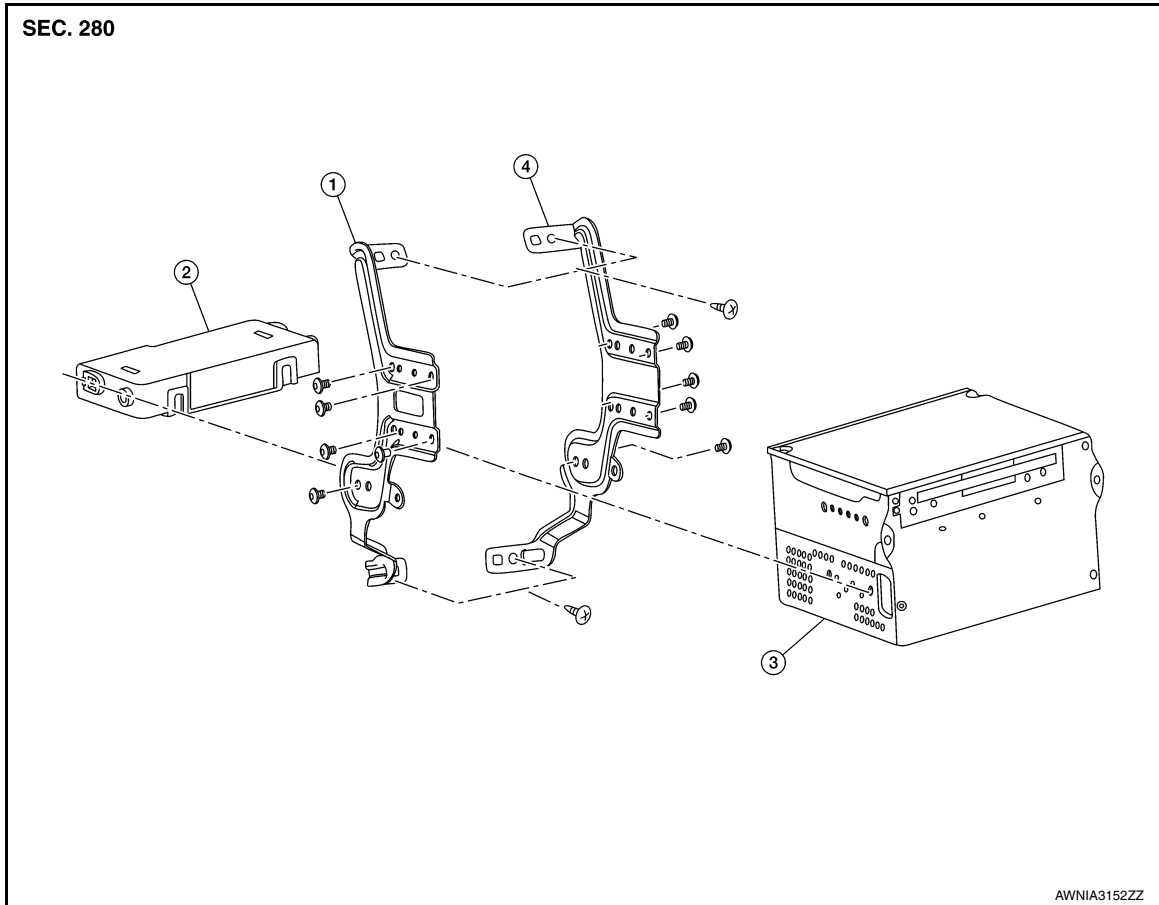

1. AV control unit bracket (LH)
2. A/C auto amp.
3. AV control unit
4. AV control unit bracket (RH)

### Removal and Installation - AV Control Unit

INFOID:000000009763672

#### REMOVAL

##### CAUTION:

- Remove battery terminal and AV control unit after a lapse of 30 seconds or more after turning the ignition switch OFF.
- Before replacing AV control unit, perform "READ CONFIGURATION" to save current vehicle specification. Refer to [AV-80, "CONFIGURATION \(AV CONTROL UNIT\) : Description"](#).

##### NOTE:

After the ignition switch is turned OFF, the AV control unit continues operating for approximately 30 seconds. Therefore, data corruption may occur if battery voltage is cut off within 30 seconds.

1. Disconnect the negative battery terminal. Refer to [PG-93, "Removal and Installation"](#).
2. Remove cluster lid C upper. Refer to [JP-23, "CLUSTER LID C UPPER : Removal and Installation"](#).
3. Remove the screws, then pull out the AV control unit.
4. Disconnect the harness connectors from the AV control unit and remove.

#### INSTALLATION

Installation is in the reverse order of removal.

##### CAUTION:

A

B

C

D

E

F

G

H

I

J

K

L

M

AV

O

P

# AV CONTROL UNIT

< REMOVAL AND INSTALLATION >

[TELEMATICS SYSTEM]

- When replacing AV control unit, perform "WRITE CONFIGURATION". Refer to [AV-80. "CONFIGURATION \(AV CONTROL UNIT\) : Description"](#).

## Removal and Installation - A/C and AV Switch Assembly

INFOID:000000009763671

### REMOVAL

1. Remove cluster lid C. Refer to [JP-22. "CLUSTER LID C : Removal and Installation"](#).
2. Remove the A/C and AV switch assembly lower screws.
3. Release upper pawls and remove A/C and AV switch assembly.

### INSTALLATION

Installation is in the reverse order of removal.



## TCU

## Removal and Installation

INFOID:000000009129545

## REMOVAL

1. Check the SIM ID. Refer to [AV-920, "CONSULT Function"](#).
2. Remove the shift selector. Refer to [TM-188, "Removal and Installation"](#).
3. Disconnect the harness connectors from TCU.
4. Remove the TCU screws, then remove TCU (A) with the bracket attached.
5. Remove the bracket screw and the bracket from TCU (A).

**NOTE:**

If it is difficult to remove the harness clip and the antenna feeder clip, remove the screw first and pull TCU forward together with the bracket. Be careful not to apply a load to the harness.

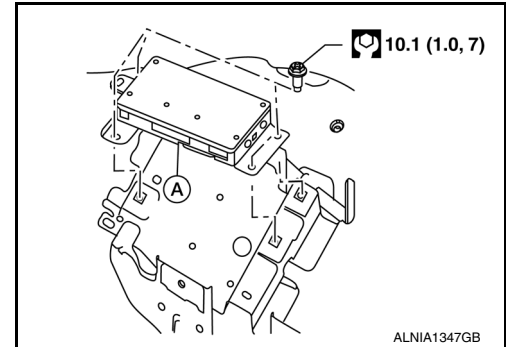

## INSTALLATION

Installation is in the reverse order of removal.

**NOTE:**

- When TCU is replaced, perform activation. Refer to [AV-1033, "ADDITIONAL SERVICE WHEN REPLACING TCU : Work Procedure"](#).
- When replacing the TCU, it is necessary to contact the communications service provider to activate the new TCU. Please refer to the appropriate INFINITI Technical Service Bulletin for the correct TCU activation procedure and communications provider contact information.

A  
B  
C  
D  
E  
F  
G  
H  
I  
J  
K  
L  
M  
O  
P

AV

## MICROPHONE

### Removal and Installation

INFOID:000000009760639

#### REMOVAL

1. Remove the front room/map lamp assembly. Refer to [INL-60. "Removal and Installation"](#).
2. Release the pawls, then remove the microphone (1) from the front room/map lamp assembly.

**CAUTION:**

Carefully handle the pawls that retain the microphone to avoid damaging.

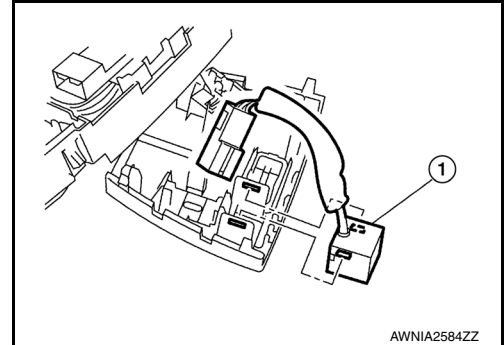

#### INSTALLATION

Installation is in the reverse order of removal.

**NOTE:**

Check the microphone for looseness after installation.

## GPS ANTENNA

### Removal and Installation

INFOID:000000009760640

#### REMOVAL

1. Remove combination meter. Refer to [MWI-95. "Removal and Installation"](#).
2. Disconnect harness connector from AV control unit.
3. Remove harness feeder clips.
4. Remove GPS antenna screw and GPS antenna (1).

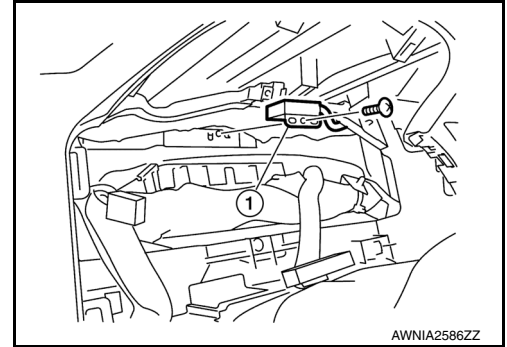

#### INSTALLATION

Installation is in the reverse order of removal.

A  
B  
C  
D  
E  
F  
G  
H  
I  
J  
K  
L  
M  
O  
P

AV

## TEL ANTENNA

### Removal and Installation

INFOID:000000009129549

#### REMOVAL

1. Remove combination meter. Refer to [MWI-95, "Removal and Installation"](#).
2. Remove center console assembly. Refer to [IP-18, "Removal and Installation"](#).
3. Disconnect harness connector from TCU.
4. Remove screws and TEL antenna.

#### INSTALLATION

Installation is in the reverse order of removal.