

# SECTION **DAS**

## DRIVER ASSISTANCE SYSTEM

A  
B  
C

### CONTENTS

D  
E

<b>ADAS CONTROL UNIT</b>		
<b>PRECAUTION</b> .....	17	
<b>PRECAUTIONS</b> .....	17	
Precaution for Supplemental Restraint System (SRS) "AIR BAG" and "SEAT BELT PRE-TENSIONER" .....	17	
Precautions For Harness Repair .....	17	
<b>SYSTEM DESCRIPTION</b> .....	18	
<b>COMPONENT PARTS</b> .....	18	
Component Parts Location .....	18	
Component Description .....	18	
<b>SYSTEM</b> .....	19	
System Diagram .....	19	
System Function .....	19	
Fail-safe (ADAS Control Unit) .....	23	
<b>DIAGNOSIS SYSTEM (ADAS CONTROL UNIT)</b> .....	25	
On Board Diagnosis Function .....	25	
CONSULT Function (ICC/ADAS) .....	26	
<b>ECU DIAGNOSIS INFORMATION</b> .....	39	
<b>ADAS CONTROL UNIT</b> .....	39	
Reference Value .....	39	
Fail-safe .....	44	
DTC Inspection Priority Chart .....	45	
DTC Index .....	47	
<b>WIRING DIAGRAM</b> .....	52	
<b>DRIVER ASSISTANCE SYSTEMS</b> .....	52	
Wiring Diagram .....	52	
<b>DTC/CIRCUIT DIAGNOSIS</b> .....	73	
<b>C1A00 CONTROL UNIT</b> .....	73	
DTC Logic .....	73	
Diagnosis Procedure .....	73	F
<b>C1A01 POWER SUPPLY CIRCUIT 1, C1A02 POWER SUPPLY CIRCUIT 2</b> .....	74	G
DTC Logic .....	74	
Diagnosis Procedure .....	74	
<b>U1000 CAN COMM CIRCUIT</b> .....	75	H
Description .....	75	
DTC Logic .....	75	
Diagnosis Procedure .....	75	I
<b>U1010 CONTROL UNIT (CAN)</b> .....	76	J
Description .....	76	
DTC Logic .....	76	
Diagnosis Procedure .....	76	
<b>U150F AV CAN 3</b> .....	77	K
DTC Logic .....	77	
Diagnosis Procedure .....	77	
<b>POWER SUPPLY AND GROUND CIRCUIT</b> ....	78	L
Diagnosis Procedure .....	78	
<b>REMOVAL AND INSTALLATION</b> .....	79	M
<b>ADAS CONTROL UNIT</b> .....	79	
Removal and Installation .....	79	
<b>DCA</b>		N
<b>PRECAUTION</b> .....	80	
<b>PRECAUTIONS</b> .....	80	
Precaution for Supplemental Restraint System (SRS) "AIR BAG" and "SEAT BELT PRE-TENSIONER" .....	80	P
Precautions For Harness Repair .....	80	
DCA System Service .....	81	
<b>SYSTEM DESCRIPTION</b> .....	82	
<b>COMPONENT PARTS</b> .....	82	
Component Parts Location .....	82	

F  
G  
H  
I  
J  
K  
L  
M  
N

DAS

Component Description .....	83	<b>ADDITIONAL SERVICE WHEN REPLACING ACCELERATOR PEDAL ASSEMBLY</b> .....	<b>156</b>
<b>SYSTEM</b> .....	<b>85</b>	Description .....	156
System Diagram .....	85	Work Procedure .....	156
System Function .....	85	<b>ACTION TEST</b> .....	<b>157</b>
Fail-safe (ADAS Control Unit) .....	89	Description .....	157
Fail-safe (ICC Sensor) .....	89	Work Procedure .....	157
<b>OPERATION</b> .....	<b>90</b>	<b>DTC/CIRCUIT DIAGNOSIS</b> .....	<b>158</b>
Switch Name and Function .....	90	<b>C1A00 CONTROL UNIT</b> .....	<b>158</b>
Menu Displayed by Pressing Each Switch .....	90	DTC Logic .....	158
<b>HANDLING PRECAUTION</b> .....	<b>93</b>	Diagnosis Procedure .....	158
Precautions for Distance Control Assist .....	93	<b>C1A01 POWER SUPPLY CIRCUIT 1, C1A02 POWER SUPPLY CIRCUIT 2</b> .....	<b>159</b>
<b>DIAGNOSIS SYSTEM (ADAS CONTROL UNIT)</b> .....	<b>95</b>	DTC Logic .....	159
On Board Diagnosis Function .....	95	Diagnosis Procedure .....	159
CONSULT Function (ICC/ADAS) .....	96	<b>C1A03 VEHICLE SPEED SENSOR</b> .....	<b>160</b>
<b>DIAGNOSIS SYSTEM (ICC SENSOR)</b> .....	<b>109</b>	DTC Logic .....	160
CONSULT Function (LASER/RADAR) .....	109	Diagnosis Procedure .....	160
<b>DIAGNOSIS SYSTEM (ACCELERATOR PEDAL ACTUATOR)</b> .....	<b>111</b>	<b>C1A04 ABS/TCS/VDC SYSTEM</b> .....	<b>162</b>
CONSULT Function (ACCELERATOR PEDAL ACT) .....	111	DTC Logic .....	162
<b>ECU DIAGNOSIS INFORMATION</b> .....	<b>114</b>	Diagnosis Procedure .....	162
<b>ADAS CONTROL UNIT</b> .....	<b>114</b>	<b>C1A05 BRAKE SW/STOP LAMP SW</b> .....	<b>163</b>
Reference Value .....	114	DTC Logic .....	163
Fail-safe .....	119	Diagnosis Procedure .....	163
DTC Inspection Priority Chart .....	120	Component Inspection (ICC Brake Switch) .....	166
DTC Index .....	122	Component Inspection (Stop Lamp Switch) .....	166
<b>ICC SENSOR</b> .....	<b>127</b>	<b>C1A06 OPERATION SW</b> .....	<b>167</b>
Reference Value .....	127	DTC Logic .....	167
Fail-safe .....	128	Diagnosis Procedure .....	167
DTC Inspection Priority Chart .....	128	Component Inspection .....	168
DTC Index .....	128	<b>C1A12 LASER BEAM OFF CENTER</b> .....	<b>170</b>
<b>ACCELERATOR PEDAL ACTUATOR</b> .....	<b>130</b>	DTC Logic .....	170
Reference Value .....	130	Diagnosis Procedure .....	170
DTC Inspection Priority Chart .....	131	<b>C1A13 STOP LAMP RELAY</b> .....	<b>171</b>
DTC Index .....	131	DTC Logic .....	171
<b>WIRING DIAGRAM</b> .....	<b>132</b>	Diagnosis Procedure .....	171
<b>DRIVER ASSISTANCE SYSTEMS</b> .....	<b>132</b>	Component Inspection .....	176
Wiring Diagram .....	132	<b>C1A14 ECM</b> .....	<b>177</b>
<b>BASIC INSPECTION</b> .....	<b>153</b>	DTC Logic .....	177
<b>DIAGNOSIS AND REPAIR WORK FLOW</b> .....	<b>153</b>	Diagnosis Procedure .....	177
Work Flow .....	153	<b>C1A15 GEAR POSITION</b> .....	<b>178</b>
<b>ADDITIONAL SERVICE WHEN REPLACING ICC SENSOR</b> .....	<b>155</b>	Description .....	178
Description .....	155	DTC Logic .....	178
Work Procedure .....	155	Diagnosis Procedure .....	178
		<b>C1A16 RADAR BLOCKED</b> .....	<b>180</b>
		DTC Logic .....	180
		Diagnosis Procedure .....	180
		<b>C1A17 ICC SENSOR</b> .....	<b>181</b>

DTC Logic .....	181	ADAS CONTROL UNIT : DTC Logic .....	196	
Diagnosis Procedure .....	181	ADAS CONTROL UNIT : Diagnosis Procedure ...	196	A
<b>C1A18 RADAR AIMING INCOMP .....</b>	<b>182</b>	<b>ACCELERATOR PEDAL ACTUATOR .....</b>	<b>196</b>	
DTC Logic .....	182	ACCELERATOR PEDAL ACTUATOR : DTC Log-		B
Diagnosis Procedure .....	182	ic .....	196	
<b>C1A21 UNIT HIGH TEMP .....</b>	<b>183</b>	ACCELERATOR PEDAL ACTUATOR : Diagnosis		C
DTC Logic .....	183	Procedure .....	197	
Diagnosis Procedure .....	183	<b>C1F02 ACCELERATOR PEDAL ACTUATOR. 198</b>		
<b>C1A24 NP RANGE .....</b>	<b>184</b>	<b>ADAS CONTROL UNIT .....</b>	<b>198</b>	D
DTC Logic .....	184	ADAS CONTROL UNIT : DTC Logic .....	198	
Diagnosis Procedure .....	184	ADAS CONTROL UNIT : Diagnosis Procedure ...	198	
<b>C1A26 ECD MODE MALFUNCTION .....</b>	<b>186</b>	<b>ACCELERATOR PEDAL ACTUATOR .....</b>	<b>198</b>	E
DTC Logic .....	186	ACCELERATOR PEDAL ACTUATOR : DTC Log-		
Diagnosis Procedure .....	186	ic .....	198	
<b>C1A27 ECD POWER SUPPLY CIRCUIT .....</b>	<b>187</b>	ACCELERATOR PEDAL ACTUATOR : Diagnosis		F
DTC Logic .....	187	Procedure .....	198	
Diagnosis Procedure .....	187	<b>C1F03 ACCELERATOR PEDAL ACTUATOR. 200</b>		
<b>C1A2A ICC SENSOR POWER SUPPLY CIR-</b>		DTC Logic .....	200	G
<b>CUIT .....</b>	<b>188</b>	Diagnosis Procedure .....	200	
DTC Logic .....	188	<b>C1F05 ACCELERATOR PEDAL ACTUATOR</b>		H
Diagnosis Procedure .....	188	<b>POWER SUPPLY CIRCUIT .....</b>	<b>201</b>	
<b>C1A33 CAN TRANSMISSION ERROR .....</b>	<b>189</b>	<b>ADAS CONTROL UNIT .....</b>	<b>201</b>	I
DTC Logic .....	189	ADAS CONTROL UNIT : DTC Logic .....	201	
Diagnosis Procedure .....	189	ADAS CONTROL UNIT : Diagnosis Procedure ...	201	
<b>C1A34 COMMAND ERROR .....</b>	<b>190</b>	<b>ACCELERATOR PEDAL ACTUATOR .....</b>	<b>201</b>	J
DTC Logic .....	190	ACCELERATOR PEDAL ACTUATOR : DTC Log-		
Diagnosis Procedure .....	190	ic .....	201	
<b>C1A35 ACCELERATOR PEDAL ACTUATOR. 191</b>		ACCELERATOR PEDAL ACTUATOR : Diagnosis		K
DTC Logic .....	191	Procedure .....	202	
Diagnosis Procedure .....	191	<b>C1F06 CAN CIRCUIT2 .....</b>	<b>203</b>	L
<b>C1A36 ACCELERATOR PEDAL ACTUATOR</b>		DTC Logic .....	203	
<b>CAN COMM .....</b>	<b>192</b>	Diagnosis Procedure .....	203	
DTC Logic .....	192	<b>C1F07 CAN CIRCUIT1 .....</b>	<b>204</b>	M
Diagnosis Procedure .....	192	DTC Logic .....	204	
<b>C1A37 ACCELERATOR PEDAL ACTUATOR</b>		Diagnosis Procedure .....	204	
<b>CAN 2 .....</b>	<b>193</b>	<b>U0121 VDC CAN 2 .....</b>	<b>205</b>	N
DTC Logic .....	193	DTC Logic .....	205	
Diagnosis Procedure .....	193	Diagnosis Procedure .....	205	
<b>C1A38 ACCELERATOR PEDAL ACTUATOR</b>		<b>U0126 STRG SEN CAN 1 .....</b>	<b>206</b>	DAS
<b>CAN 1 .....</b>	<b>194</b>	DTC Logic .....	206	
DTC Logic .....	194	Diagnosis Procedure .....	206	
Diagnosis Procedure .....	194	<b>U0235 ICC SENSOR CAN 1 .....</b>	<b>207</b>	P
<b>C1A39 STEERING ANGLE SENSOR .....</b>	<b>195</b>	DTC Logic .....	207	
DTC Logic .....	195	Diagnosis Procedure .....	207	
Diagnosis Procedure .....	195	<b>U0401 ECM CAN 1 .....</b>	<b>208</b>	
<b>C1F01 ACCELERATOR PEDAL ACTUATOR. 196</b>		DTC Logic .....	208	
<b>ADAS CONTROL UNIT .....</b>	<b>196</b>	Diagnosis Procedure .....	208	
		<b>U0402 TCM CAN 1 .....</b>	<b>209</b>	

DTC Logic .....	209	Diagnosis Procedure .....	220
Diagnosis Procedure .....	209		
<b>U0415 VDC CAN 1 .....</b>	<b>210</b>	<b>U1514 STRG SEN CAN 3 .....</b>	<b>221</b>
DTC Logic .....	210	DTC Logic .....	221
Diagnosis Procedure .....	210	Diagnosis Procedure .....	221
<b>U0428 STRG SEN CAN 2 .....</b>	<b>211</b>	<b>U1515 ICC SENSOR CAN 3 .....</b>	<b>222</b>
DTC Logic .....	211	DTC Logic .....	222
Diagnosis Procedure .....	211	Diagnosis Procedure .....	222
<b>U1000 CAN COMM CIRCUIT .....</b>	<b>212</b>	<b>U1517 ACCELERATOR PEDAL ACTUATOR CAN 3 .....</b>	<b>223</b>
<b>ADAS CONTROL UNIT .....</b>	<b>212</b>	DTC Logic .....	223
ADAS CONTROL UNIT : Description .....	212	Diagnosis Procedure .....	223
ADAS CONTROL UNIT : DTC Logic .....	212		
ADAS CONTROL UNIT : Diagnosis Procedure .....	212	<b>POWER SUPPLY AND GROUND CIRCUIT ...</b>	<b>224</b>
<b>ACCELERATOR PEDAL ACTUATOR .....</b>	<b>212</b>	<b>ADAS CONTROL UNIT .....</b>	<b>224</b>
ACCELERATOR PEDAL ACTUATOR : Descrip- tion .....	212	ADAS CONTROL UNIT : Diagnosis Procedure ...	224
ACCELERATOR PEDAL ACTUATOR : DTC Log- ic .....	212	<b>ACCELERATOR PEDAL ACTUATOR .....</b>	<b>224</b>
ACCELERATOR PEDAL ACTUATOR : Diagnosis Procedure .....	213	ACCELERATOR PEDAL ACTUATOR : Diagnosis Procedure .....	224
<b>U1010 CONTROL UNIT (CAN) .....</b>	<b>214</b>	<b>SYMPTOM DIAGNOSIS .....</b>	<b>226</b>
<b>ADAS CONTROL UNIT .....</b>	<b>214</b>	<b>DISTANCE CONTROL ASSIST SYSTEM SYMPTOMS .....</b>	<b>226</b>
ADAS CONTROL UNIT : Description .....	214	Symptom Table .....	226
ADAS CONTROL UNIT : DTC Logic .....	214		
ADAS CONTROL UNIT : Diagnosis Procedure ...	214	<b>SWITCH DOES NOT TURN ON / SWITCH DOES NOT TURN OFF .....</b>	<b>227</b>
<b>ACCELERATOR PEDAL ACTUATOR .....</b>	<b>214</b>	Description .....	227
ACCELERATOR PEDAL ACTUATOR : Descrip- tion .....	214	Diagnosis Procedure .....	227
ACCELERATOR PEDAL ACTUATOR : DTC Log- ic .....	214		
ACCELERATOR PEDAL ACTUATOR : Diagnosis Procedure .....	214	<b>DCA SYSTEM SETTINGS CANNOT BE TURNED ON/OFF IN VEHICLE INFORMA- TION DISPLAY .....</b>	<b>229</b>
<b>U150B ECM CAN 3 .....</b>	<b>215</b>	Description .....	229
DTC Logic .....	215	Diagnosis Procedure .....	229
Diagnosis Procedure .....	215	<b>DCA SYSTEM NOT ACTIVATED (SWITCH IS ON) .....</b>	<b>230</b>
<b>U150C VDC CAN 3 .....</b>	<b>216</b>	Description .....	230
DTC Logic .....	216	Diagnosis Procedure .....	230
Diagnosis Procedure .....	216	<b>CHIME DOES NOT SOUND .....</b>	<b>232</b>
<b>U150D TCM CAN 3 .....</b>	<b>217</b>	Description .....	232
DTC Logic .....	217	Diagnosis Procedure .....	232
Diagnosis Procedure .....	217	<b>NO FORCE GENERATED FOR PUTTING BACK THE ACCELERATOR PEDAL .....</b>	<b>234</b>
<b>U150E BCM CAN 3 .....</b>	<b>218</b>	Description .....	234
DTC Logic .....	218	Diagnosis Procedure .....	234
Diagnosis Procedure .....	218	<b>FREQUENTLY CANNOT DETECT THE VEHI- CLE AHEAD / DETECTION ZONE IS SHORT..</b>	<b>235</b>
<b>U1502 ICC SENSOR CAN COMM CIRC .....</b>	<b>219</b>	Description .....	235
DTC Logic .....	219	Diagnosis Procedure .....	235
Diagnosis Procedure .....	219	<b>THE SYSTEM DOES NOT DETECT THE VE- HICLE AHEAD AT ALL .....</b>	<b>237</b>
<b>U1513 METER CAN 3 .....</b>	<b>220</b>		
DTC Logic .....	220		



Description .....	237	<b>ECU DIAGNOSIS INFORMATION .....</b>	<b>272</b>	A
Diagnosis Procedure .....	237	<b>ADAS CONTROL UNIT .....</b>	<b>272</b>	B
<b>NORMAL OPERATING CONDITION .....</b>	<b>239</b>	Reference Value .....	272	
Description .....	239	Fail-safe .....	277	
<b>REMOVAL AND INSTALLATION .....</b>	<b>241</b>	DTC Inspection Priority Chart .....	278	
<b>ICC SENSOR .....</b>	<b>241</b>	DTC Index .....	280	
Exploded View .....	241	<b>ICC SENSOR .....</b>	<b>285</b>	C
Removal and Installation .....	241	Reference Value .....	285	
<b>ACCELERATOR PEDAL ASSEMBLY .....</b>	<b>243</b>	Fail-safe .....	286	
<b>MODELS WITH DISTANCE CONTROL ASSIST SYSTEM .....</b>	<b>243</b>	DTC Inspection Priority Chart .....	286	D
MODELS WITH DISTANCE CONTROL ASSIST SYSTEM : Exploded View .....	243	DTC Index .....	286	
MODELS WITH DISTANCE CONTROL ASSIST SYSTEM : Removal and Installation .....	243	<b>WIRING DIAGRAM .....</b>	<b>288</b>	E
MODELS WITH DISTANCE CONTROL ASSIST SYSTEM : Inspection .....	244	<b>DRIVER ASSISTANCE SYSTEMS .....</b>	<b>288</b>	
<b>DYNAMIC DRIVER ASSISTANCE SWITCH ..</b>	<b>245</b>	Wiring Diagram .....	288	
Removal and Installation .....	245	<b>BASIC INSPECTION .....</b>	<b>309</b>	F
<b>FCW</b>		<b>DIAGNOSIS AND REPAIR WORK FLOW .....</b>	<b>309</b>	
<b>PRECAUTION .....</b>	<b>246</b>	Work Flow .....	309	G
<b>PRECAUTIONS .....</b>	<b>246</b>	<b>SYMPTOM DIAGNOSIS .....</b>	<b>311</b>	
Precaution for Supplemental Restraint System (SRS) "AIR BAG" and "SEAT BELT PRE-TENSIONER" .....	246	<b>FORWARD COLLISION WARNING SYSTEM SYMPTOMS .....</b>	<b>311</b>	H
Precautions For Harness Repair .....	246	Symptom Table .....	311	
Precaution for FCW System Service .....	247	<b>FCW SYSTEM IS NOT ACTIVATED .....</b>	<b>312</b>	I
<b>SYSTEM DESCRIPTION .....</b>	<b>248</b>	Description .....	312	
<b>COMPONENT PARTS .....</b>	<b>248</b>	Diagnosis Procedure .....	312	J
Component Parts Location .....	248	<b>FCW SYSTEM SETTINGS CANNOT BE TURNED ON/OFF IN VEHICLE INFORMATION DISPLAY .....</b>	<b>313</b>	
Component Description .....	249	Description .....	313	K
<b>SYSTEM .....</b>	<b>250</b>	Diagnosis Procedure .....	313	
System Description .....	250	<b>NORMAL OPERATING CONDITION .....</b>	<b>314</b>	L
Fail-safe (ADAS Control Unit) .....	251	Description .....	314	
Fail-safe (ICC Sensor) .....	252	<b>REMOVAL AND INSTALLATION .....</b>	<b>315</b>	M
<b>OPERATION .....</b>	<b>253</b>	<b>WARNING SYSTEMS SWITCH .....</b>	<b>315</b>	
Switch Name and Function .....	253	Removal and Installation .....	315	N
Menu Displayed by Pressing Each Switch .....	253	<b>LDW &amp; LDP</b>		
<b>HANDLING PRECAUTION .....</b>	<b>255</b>	<b>PRECAUTION .....</b>	<b>316</b>	<b>DAS</b>
Precautions for Forward Collision Warning .....	255	<b>PRECAUTIONS .....</b>	<b>316</b>	
<b>DIAGNOSIS SYSTEM (ADAS CONTROL UNIT) .....</b>	<b>256</b>	Precaution for Supplemental Restraint System (SRS) "AIR BAG" and "SEAT BELT PRE-TENSIONER" .....	316	P
On Board Diagnosis Function .....	256	Precautions For Harness Repair .....	316	
CONSULT Function (ICC/ADAS) .....	257	Precaution for LDW/LDP System Service .....	317	
<b>DIAGNOSIS SYSTEM (ICC SENSOR) .....</b>	<b>270</b>	<b>SYSTEM DESCRIPTION .....</b>	<b>318</b>	
CONSULT Function (LASER/RADAR) .....	270	<b>COMPONENT PARTS .....</b>	<b>318</b>	

<b>LANE DEPARTURE WARNING (LDW) SYSTEM ..318</b>	<b>ADAS CONTROL UNIT .....351</b>
LANE DEPARTURE WARNING (LDW) SYSTEM	Reference Value ..... 351
: Component Parts Location .....318	Fail-safe ..... 356
LANE DEPARTURE WARNING (LDW) SYSTEM	DTC Inspection Priority Chart ..... 357
: Component Description .....319	DTC Index ..... 359
<b>LANE DEPARTURE PREVENTION (LDP) SYSTEM .....319</b>	<b>LANE CAMERA UNIT .....364</b>
LANE DEPARTURE PREVENTION (LDP) SYSTEM	Reference Value ..... 364
: Component Parts Location .....320	Fail-safe ..... 365
LANE DEPARTURE PREVENTION (LDP) SYSTEM	DTC Inspection Priority Chart ..... 365
: Component Description .....321	DTC Index ..... 366
<b>SYSTEM ..... 322</b>	<b>WIRING DIAGRAM ..... 367</b>
<b>LANE DEPARTURE WARNING (LDW) SYSTEM ..322</b>	<b>DRIVER ASSISTANCE SYSTEMS .....367</b>
LANE DEPARTURE WARNING (LDW) SYSTEM	Wiring Diagram ..... 367
: System Description .....322	<b>BASIC INSPECTION ..... 388</b>
LANE DEPARTURE WARNING (LDW) SYSTEM	<b>DIAGNOSIS AND REPAIR WORK FLOW .....388</b>
: Fail-safe (ADAS Control Unit) .....324	Work Flow ..... 388
LANE DEPARTURE WARNING (LDW) SYSTEM	Diagnostic Work Sheet ..... 389
: Fail-safe (Lane Camera Unit) .....325	<b>PRE-INSPECTION FOR DIAGNOSIS .....391</b>
<b>LANE DEPARTURE PREVENTION (LDP) SYSTEM .....325</b>	Inspection Procedure ..... 391
LANE DEPARTURE PREVENTION (LDP) SYSTEM	<b>ACTION TEST .....392</b>
: System Description .....325	Description ..... 392
LANE DEPARTURE PREVENTION (LDP) SYSTEM	Inspection Procedure ..... 392
: Fail-safe (ADAS Control Unit) .....328	<b>ADDITIONAL SERVICE WHEN REPLACING</b>
LANE DEPARTURE PREVENTION (LDP) SYSTEM	<b>LANE CAMERA UNIT .....395</b>
: Fail-safe (Lane Camera Unit) .....328	Description ..... 395
<b>OPERATION ..... 330</b>	Work Procedure ..... 395
<b>LANE DEPARTURE WARNING (LDW) SYSTEM ..330</b>	<b>CAMERA AIMING ADJUSTMENT .....396</b>
LANE DEPARTURE WARNING (LDW) SYSTEM	Description ..... 396
: Switch Name and Function .....330	Work Procedure (Preparation) ..... 396
LANE DEPARTURE WARNING (LDW) SYSTEM	Work Procedure (Target Setting) ..... 397
: Menu Displayed by Pressing Each Switch .....330	Work Procedure (Camera Aiming Adjustment) .... 398
<b>LANE DEPARTURE PREVENTION (LDP) SYSTEM .....331</b>	Work Procedure (Target Mark Sample) ..... 399
LANE DEPARTURE PREVENTION (LDP) SYSTEM	<b>DTC/CIRCUIT DIAGNOSIS ..... 401</b>
: Switch Name and Function .....331	<b>C1A00 CONTROL UNIT .....401</b>
LANE DEPARTURE PREVENTION (LDP) SYSTEM	DTC Logic ..... 401
: Menu Displayed by Pressing Each Switch..331	Diagnosis Procedure ..... 401
<b>HANDLING PRECAUTION ..... 333</b>	<b>C1A01 POWER SUPPLY CIRCUIT 1, C1A02</b>
Precautions for Lane Departure Warning/Lane	<b>POWER SUPPLY CIRCUIT 2 .....402</b>
Departure Prevention .....333	DTC Logic ..... 402
<b>DIAGNOSIS SYSTEM (ADAS CONTROL UNIT) ..... 335</b>	Diagnosis Procedure ..... 402
On Board Diagnosis Function .....335	<b>C1A03 VEHICLE SPEED SENSOR .....403</b>
CONSULT Function (ICC/ADAS) .....336	DTC Logic ..... 403
<b>DIAGNOSIS SYSTEM (LANE CAMERA UNIT) ..... 349</b>	Diagnosis Procedure ..... 403
CONSULT Function (LANE CAMERA) .....349	<b>C1A04 ABS/TCS/VDC SYSTEM .....404</b>
<b>ECU DIAGNOSIS INFORMATION .....351</b>	DTC Logic ..... 404
	Diagnosis Procedure ..... 404
	<b>C1A05 BRAKE SW/STOP LAMP SW .....405</b>

DTC Logic .....	405	Diagnosis Procedure .....	424	
Diagnosis Procedure .....	405	<b>U0126 STRG SEN CAN 1 .....</b>	<b>425</b>	A
Component Inspection (ICC Brake Switch) .....	408	DTC Logic .....	425	
Component Inspection (Stop Lamp Switch) .....	408	Diagnosis Procedure .....	425	B
<b>C1A06 OPERATION SW .....</b>	<b>409</b>	<b>U0401 ECM CAN 1 .....</b>	<b>426</b>	
DTC Logic .....	409	DTC Logic .....	426	C
Diagnosis Procedure .....	409	Diagnosis Procedure .....	426	
Component Inspection .....	410	<b>U0402 TCM CAN 1 .....</b>	<b>427</b>	D
<b>C1A14 ECM .....</b>	<b>412</b>	DTC Logic .....	427	
DTC Logic .....	412	Diagnosis Procedure .....	427	
Diagnosis Procedure .....	412	<b>U0405 ADAS CAN 2 .....</b>	<b>428</b>	E
<b>C1A15 GEAR POSITION .....</b>	<b>413</b>	DTC Logic .....	428	
Description .....	413	Diagnosis Procedure .....	428	
DTC Logic .....	413	<b>U0415 VDC CAN 1 .....</b>	<b>429</b>	F
Diagnosis Procedure .....	413	DTC Logic .....	429	
<b>C1A24 NP RANGE .....</b>	<b>415</b>	Diagnosis Procedure .....	429	
DTC Logic .....	415	<b>U0428 STRG SEN CAN 2 .....</b>	<b>430</b>	G
Diagnosis Procedure .....	415	DTC Logic .....	430	
<b>C1A50 ADAS CONTROL UNIT .....</b>	<b>417</b>	Diagnosis Procedure .....	430	
DTC Logic .....	417	<b>U1000 CAN COMM CIRCUIT .....</b>	<b>431</b>	H
Diagnosis Procedure .....	417	<b>ADAS CONTROL UNIT .....</b>	<b>431</b>	
<b>C1B00 CAMERA UNIT MALF .....</b>	<b>418</b>	ADAS CONTROL UNIT : Description .....	431	I
<b>ADAS CONTROL UNIT .....</b>	<b>418</b>	ADAS CONTROL UNIT : DTC Logic .....	431	
ADAS CONTROL UNIT : DTC Logic .....	418	ADAS CONTROL UNIT : Diagnosis Procedure ...	431	
ADAS CONTROL UNIT : Diagnosis Procedure ...	418	<b>LANE CAMERA UNIT .....</b>	<b>431</b>	J
<b>LANE CAMERA UNIT .....</b>	<b>418</b>	LANE CAMERA UNIT : Description .....	431	
LANE CAMERA UNIT : DTC Logic .....	418	LANE CAMERA UNIT : DTC Logic .....	431	
LANE CAMERA UNIT : Diagnosis Procedure .....	418	LANE CAMERA UNIT : Diagnosis Procedure .....	432	K
<b>C1B01 CAM AIMING INCMP .....</b>	<b>420</b>	<b>U1010 CONTROL UNIT (CAN) .....</b>	<b>433</b>	
<b>ADAS CONTROL UNIT .....</b>	<b>420</b>	<b>ADAS CONTROL UNIT .....</b>	<b>433</b>	L
ADAS CONTROL UNIT : DTC Logic .....	420	ADAS CONTROL UNIT : Description .....	433	
ADAS CONTROL UNIT : Diagnosis Procedure ...	420	ADAS CONTROL UNIT : DTC Logic .....	433	
<b>LANE CAMERA UNIT .....</b>	<b>420</b>	ADAS CONTROL UNIT : Diagnosis Procedure ...	433	M
LANE CAMERA UNIT : DTC Logic .....	420	<b>LANE CAMERA UNIT .....</b>	<b>433</b>	
LANE CAMERA UNIT : Diagnosis Procedure .....	421	LANE CAMERA UNIT : Description .....	433	
<b>C1B03 ABNRML TEMP DETECT .....</b>	<b>422</b>	LANE CAMERA UNIT : DTC Logic .....	433	
<b>ADAS CONTROL UNIT .....</b>	<b>422</b>	LANE CAMERA UNIT : Diagnosis Procedure .....	433	N
ADAS CONTROL UNIT : DTC Logic .....	422	<b>U150B ECM CAN 3 .....</b>	<b>434</b>	
ADAS CONTROL UNIT : Diagnosis Procedure ...	422	DTC Logic .....	434	
<b>LANE CAMERA UNIT .....</b>	<b>422</b>	Diagnosis Procedure .....	434	DAS
LANE CAMERA UNIT : DTC Logic .....	422	<b>U150C VDC CAN 3 .....</b>	<b>435</b>	
LANE CAMERA UNIT : Diagnosis Procedure .....	422	DTC Logic .....	435	
<b>U0104 ADAS CAN 1 .....</b>	<b>423</b>	Diagnosis Procedure .....	435	P
DTC Logic .....	423	<b>U150D TCM CAN 3 .....</b>	<b>436</b>	
Diagnosis Procedure .....	423	DTC Logic .....	436	
<b>U0121 VDC CAN 2 .....</b>	<b>424</b>	Diagnosis Procedure .....	436	
DTC Logic .....	424	<b>U150E BCM CAN 3 .....</b>	<b>437</b>	

DTC Logic .....	437	<b>THE SYSTEM OPERATES EVEN WHEN USING TURN SIGNAL .....</b>	<b>455</b>
Diagnosis Procedure .....	437	Description .....	455
<b>U1500 CAM CAN 2 .....</b>	<b>438</b>	Diagnosis Procedure .....	455
DTC Logic .....	438	<b>LDW/LDP SYSTEM SETTINGS CANNOT BE TURNED ON/OFF IN VEHICLE INFORMATION DISPLAY .....</b>	<b>456</b>
Diagnosis Procedure .....	438	Description .....	456
<b>U1501 CAM CAN 1 .....</b>	<b>439</b>	Diagnosis Procedure .....	456
DTC Logic .....	439	<b>NORMAL OPERATING CONDITION .....</b>	<b>457</b>
Diagnosis Procedure .....	439	Description .....	457
<b>U1512 HVAC CAN 3 .....</b>	<b>440</b>	<b>REMOVAL AND INSTALLATION .....</b>	<b>459</b>
DTC Logic .....	440	<b>LANE CAMERA UNIT .....</b>	<b>459</b>
Diagnosis Procedure .....	440	Exploded View .....	459
<b>U1513 METER CAN 3 .....</b>	<b>441</b>	Removal and Installation .....	459
DTC Logic .....	441	<b>WARNING SYSTEMS SWITCH .....</b>	<b>460</b>
Diagnosis Procedure .....	441	Removal and Installation .....	460
<b>U1516 CAM CAN 3 .....</b>	<b>442</b>	<b>DYNAMIC DRIVER ASSISTANCE SWITCH ..</b>	<b>461</b>
DTC Logic .....	442	Removal and Installation .....	461
Diagnosis Procedure .....	442	<b>WARNING BUZZER .....</b>	<b>462</b>
<b>POWER SUPPLY AND GROUND CIRCUIT ..</b>	<b>443</b>	Removal and Installation .....	462
<b>ADAS CONTROL UNIT .....</b>	<b>443</b>	<b>BLIND SPOT WARNING &amp; BLIND SPOT INTERVENTION</b>	
ADAS CONTROL UNIT : Diagnosis Procedure ..	443	<b>PRECAUTION .....</b>	<b>463</b>
<b>LANE CAMERA UNIT .....</b>	<b>443</b>	<b>PRECAUTIONS .....</b>	<b>463</b>
LANE CAMERA UNIT : Diagnosis Procedure ..	443	Precaution for Supplemental Restraint System (SRS) "AIR BAG" and "SEAT BELT PRE-TENSIONER" .....	463
<b>WARNING SYSTEMS SWITCH CIRCUIT .....</b>	<b>445</b>	Precautions For Harness Repair .....	463
Component Function Check .....	445	Precaution for Blind Spot Warning/Blind Spot Intervention System Service .....	464
Diagnosis Procedure .....	445	<b>SYSTEM DESCRIPTION .....</b>	<b>465</b>
Component Inspection .....	446	<b>COMPONENT PARTS .....</b>	<b>465</b>
<b>WARNING SYSTEMS ON INDICATOR CIRCUIT .....</b>	<b>447</b>	Component Parts Location .....	465
Component Function Check .....	447	Component Description .....	466
Diagnosis Procedure .....	447	<b>SYSTEM .....</b>	<b>468</b>
Component Inspection .....	448	<b>BLIND SPOT WARNING (BSW) SYSTEM .....</b>	<b>468</b>
<b>WARNING BUZZER CIRCUIT .....</b>	<b>449</b>	BLIND SPOT WARNING (BSW) SYSTEM : System Description .....	468
Component Function Check .....	449	BLIND SPOT WARNING (BSW) SYSTEM : Fail-safe (ADAS Control Unit) .....	471
Diagnosis Procedure .....	449	BLIND SPOT WARNING (BSW) SYSTEM : Fail-safe (Side Radar) .....	472
<b>SYMPTOM DIAGNOSIS .....</b>	<b>451</b>	<b>BLIND SPOT INTERVENTION SYSTEM .....</b>	<b>472</b>
<b>LDW &amp; LDP SYSTEM SYMPTOMS .....</b>	<b>451</b>	BLIND SPOT INTERVENTION SYSTEM : System Description .....	472
Symptom Table .....	451		
<b>LANE DEPARTURE WARNING LAMP DOES NOT TURNED ON .....</b>	<b>453</b>		
Description .....	453		
Diagnosis Procedure .....	453		
<b>LDP ON INDICATOR LAMP DOES NOT TURNED ON .....</b>	<b>454</b>		
Description .....	454		
Diagnosis Procedure .....	454		

BLIND SPOT INTERVENTION SYSTEM : Fail-safe (ADAS Control Unit) .....	476	Fail-safe .....	519	
BLIND SPOT INTERVENTION SYSTEM : Fail-safe (Lane Camera Unit) .....	477	DTC Inspection Priority Chart .....	519	A
BLIND SPOT INTERVENTION SYSTEM : Fail-safe (Side Radar) .....	477	DTC Index .....	520	
<b>OPERATION .....</b>	<b>478</b>	<b>WIRING DIAGRAM .....</b>	<b>521</b>	B
<b>BLIND SPOT WARNING (BSW) SYSTEM .....</b>	<b>478</b>	<b>DRIVER ASSISTANCE SYSTEMS .....</b>	<b>521</b>	
BLIND SPOT WARNING (BSW) SYSTEM : Switch Name and Function .....	478	Wiring Diagram .....	521	C
BLIND SPOT WARNING (BSW) SYSTEM : System Display and Warning .....	478	<b>BASIC INSPECTION .....</b>	<b>542</b>	
<b>BLIND SPOT INTERVENTION SYSTEM .....</b>	<b>479</b>	<b>DIAGNOSIS AND REPAIR WORK FLOW .....</b>	<b>542</b>	D
BLIND SPOT INTERVENTION SYSTEM : Switch Name and Function .....	479	Work Flow .....	542	
BLIND SPOT INTERVENTION SYSTEM : System Display and Warning .....	480	<b>PRE-INSPECTION FOR DIAGNOSIS .....</b>	<b>545</b>	E
<b>HANDLING PRECAUTION .....</b>	<b>481</b>	Inspection Procedure .....	545	
Precautions for Blind Spot Warning/Blind Spot Intervention .....	481	<b>ADDITIONAL SERVICE WHEN REPLACING LANE CAMERA UNIT .....</b>	<b>546</b>	F
<b>DIAGNOSIS SYSTEM (ADAS CONTROL UNIT) .....</b>	<b>483</b>	Description .....	546	
On Board Diagnosis Function .....	483	Work Procedure .....	546	G
CONSULT Function (ICC/ADAS) .....	484	<b>ACTION TEST .....</b>	<b>547</b>	
<b>DIAGNOSIS SYSTEM (SIDE RADAR LH) .....</b>	<b>497</b>	Description .....	547	
CONSULT Function (SIDE RADAR LEFT) .....	497	Work Procedure .....	547	H
<b>DIAGNOSIS SYSTEM (SIDE RADAR RH) .....</b>	<b>498</b>	<b>DTC/CIRCUIT DIAGNOSIS .....</b>	<b>550</b>	
CONSULT Function (SIDE RADAR RIGHT) .....	498	<b>C1A00 CONTROL UNIT .....</b>	<b>550</b>	I
<b>DIAGNOSIS SYSTEM (LANE CAMERA UNIT) .....</b>	<b>499</b>	DTC Logic .....	550	
CONSULT Function (LANE CAMERA) .....	499	Diagnosis Procedure .....	550	J
<b>ECU DIAGNOSIS INFORMATION .....</b>	<b>501</b>	<b>C1A01 POWER SUPPLY CIRCUIT 1, C1A02 POWER SUPPLY CIRCUIT 2 .....</b>	<b>551</b>	
<b>ADAS CONTROL UNIT .....</b>	<b>501</b>	DTC Logic .....	551	
Reference Value .....	501	Diagnosis Procedure .....	551	K
Fail-safe .....	506	<b>C1A03 VEHICLE SPEED SENSOR .....</b>	<b>552</b>	
DTC Inspection Priority Chart .....	507	DTC Logic .....	552	L
DTC Index .....	509	Diagnosis Procedure .....	552	
<b>SIDE RADAR LH .....</b>	<b>514</b>	<b>C1A04 ABS/TCS/VDC SYSTEM .....</b>	<b>553</b>	M
Reference Value .....	514	DTC Logic .....	553	
Fail-safe .....	514	Diagnosis Procedure .....	553	N
DTC Inspection Priority Chart .....	515	<b>C1A05 BRAKE SW/STOP LAMP SW .....</b>	<b>554</b>	
DTC Index .....	515	DTC Logic .....	554	
<b>SIDE RADAR RH .....</b>	<b>516</b>	Diagnosis Procedure .....	554	
Reference Value .....	516	Component Inspection (ICC Brake Switch) .....	557	
Fail-safe .....	516	Component Inspection (Stop Lamp Switch) .....	557	
DTC Inspection Priority Chart .....	517	<b>C1A06 OPERATION SW .....</b>	<b>558</b>	
DTC Index .....	517	DTC Logic .....	558	
<b>LANE CAMERA UNIT .....</b>	<b>518</b>	Diagnosis Procedure .....	558	
Reference Value .....	518	Component Inspection .....	559	
		<b>C1A14 ECM .....</b>	<b>561</b>	
		DTC Logic .....	561	
		Diagnosis Procedure .....	561	
		<b>C1A15 GEAR POSITION .....</b>	<b>562</b>	
		Description .....	562	

DTC Logic .....	562	Diagnosis Procedure .....	577
Diagnosis Procedure .....	562		
<b>C1A24 NP RANGE .....</b>	<b>564</b>	<b>C1B54 SIDE RADAR LEFT MALFUNCTION .....</b>	<b>578</b>
DTC Logic .....	564	DTC Logic .....	578
Diagnosis Procedure .....	564	Diagnosis Procedure .....	578
<b>C1A39 STEERING ANGLE SENSOR .....</b>	<b>566</b>	<b>C1B55 RADAR BLOCKAGE .....</b>	<b>579</b>
DTC Logic .....	566	DTC Logic .....	579
Diagnosis Procedure .....	566	Diagnosis Procedure .....	579
<b>C1A50 ADAS CONTROL UNIT .....</b>	<b>567</b>	<b>U1000 CAN COMM CIRCUIT .....</b>	<b>580</b>
DTC Logic .....	567	<b>SIDE RADAR LH .....</b>	<b>580</b>
Diagnosis Procedure .....	567	SIDE RADAR LH : Description .....	580
		SIDE RADAR LH : DTC Logic .....	580
<b>C1B00 CAMERA UNIT MALF .....</b>	<b>568</b>	SIDE RADAR LH : Diagnosis Procedure .....	580
<b>ADAS CONTROL UNIT .....</b>	<b>568</b>	<b>SIDE RADAR RH .....</b>	<b>580</b>
ADAS CONTROL UNIT : DTC Logic .....	568	SIDE RADAR RH : Description .....	580
ADAS CONTROL UNIT : Diagnosis Procedure .....	568	SIDE RADAR RH : DTC Logic .....	581
<b>LANE CAMERA UNIT .....</b>	<b>568</b>	SIDE RADAR RH : Diagnosis Procedure .....	581
LANE CAMERA UNIT : DTC Logic .....	568	<b>ADAS CONTROL UNIT .....</b>	<b>581</b>
LANE CAMERA UNIT : Diagnosis Procedure .....	568	ADAS CONTROL UNIT : Description .....	581
<b>C1B01 CAM AIMING INCOMP .....</b>	<b>570</b>	ADAS CONTROL UNIT : DTC Logic .....	581
<b>ADAS CONTROL UNIT .....</b>	<b>570</b>	ADAS CONTROL UNIT : Diagnosis Procedure .....	581
ADAS CONTROL UNIT : DTC Logic .....	570	<b>LANE CAMERA UNIT .....</b>	<b>582</b>
ADAS CONTROL UNIT : Diagnosis Procedure .....	570	LANE CAMERA UNIT : Description .....	582
<b>LANE CAMERA UNIT .....</b>	<b>570</b>	LANE CAMERA UNIT : DTC Logic .....	582
LANE CAMERA UNIT : DTC Logic .....	570	LANE CAMERA UNIT : Diagnosis Procedure .....	582
LANE CAMERA UNIT : Diagnosis Procedure .....	571	<b>U1010 CONTROL UNIT (CAN) .....</b>	<b>583</b>
<b>C1B03 ABRML TEMP DETECT .....</b>	<b>572</b>	<b>SIDE RADAR LH .....</b>	<b>583</b>
<b>ADAS CONTROL UNIT .....</b>	<b>572</b>	SIDE RADAR LH : Description .....	583
ADAS CONTROL UNIT : DTC Logic .....	572	SIDE RADAR LH : DTC Logic .....	583
ADAS CONTROL UNIT : Diagnosis Procedure .....	572	SIDE RADAR LH : Diagnosis Procedure .....	583
<b>LANE CAMERA UNIT .....</b>	<b>572</b>	<b>SIDE RADAR RH .....</b>	<b>583</b>
LANE CAMERA UNIT : DTC Logic .....	572	SIDE RADAR RH : Description .....	583
LANE CAMERA UNIT : Diagnosis Procedure .....	572	SIDE RADAR RH : DTC Logic .....	583
<b>C1B50 SIDE RADAR MALFUNCTION .....</b>	<b>573</b>	SIDE RADAR RH : Diagnosis Procedure .....	583
DTC LOGIC .....	573	<b>ADAS CONTROL UNIT .....</b>	<b>583</b>
Diagnosis Procedure .....	573	ADAS CONTROL UNIT : Description .....	583
<b>C1B51 BLIND SPOT WARNING/BLIND SPOT INTERVENTION INDICATOR SHORT CIRCUIT .....</b>	<b>574</b>	ADAS CONTROL UNIT : DTC Logic .....	584
DTC Logic .....	574	ADAS CONTROL UNIT : Diagnosis Procedure .....	584
Diagnosis Procedure .....	574	<b>LANE CAMERA UNIT .....</b>	<b>584</b>
<b>C1B52 BLIND SPOT WARNING/BLIND SPOT INTERVENTION INDICATOR OPEN CIRCUIT .....</b>	<b>575</b>	LANE CAMERA UNIT : Description .....	584
DTC Logic .....	575	LANE CAMERA UNIT : DTC Logic .....	584
Diagnosis Procedure .....	575	LANE CAMERA UNIT : Diagnosis Procedure .....	584
<b>C1B53 SIDE RADAR RIGHT MALFUNCTION .....</b>	<b>577</b>	<b>U0104 ADAS CAN 1 .....</b>	<b>585</b>
DTC Logic .....	577	<b>SIDE RADAR .....</b>	<b>585</b>
		SIDE RADAR : DTC Logic .....	585
		SIDE RADAR : Diagnosis Procedure .....	585
		<b>LANE CAMERA UNIT .....</b>	<b>585</b>
		LANE CAMERA UNIT : DTC Logic .....	585
		LANE CAMERA UNIT : Diagnosis Procedure .....	586

<b>U0121 VDC CAN 2</b> .....	<b>587</b>	DTC Logic .....	601	
DTC Logic .....	587	Diagnosis Procedure .....	601	A
Diagnosis Procedure .....	587			
<b>U0126 STRG SEN CAN 1</b> .....	<b>588</b>	<b>U1501 CAM CAN 1</b> .....	<b>602</b>	
		DTC Logic .....	602	B
<b>ADAS CONTROL UNIT</b> .....	<b>588</b>	Diagnosis Procedure .....	602	
ADAS CONTROL UNIT : DTC Logic .....	588	<b>U1503 SIDE RDR L CAN 2</b> .....	<b>603</b>	
ADAS CONTROL UNIT : Diagnosis Procedure ...	588	DTC Logic .....	603	C
		Diagnosis Procedure .....	603	
<b>LANE CAMERA UNIT</b> .....	<b>588</b>	<b>U1504 SIDE RDR L CAN 1</b> .....	<b>604</b>	
LANE CAMERA UNIT : DTC Logic .....	588	DTC Logic .....	604	D
LANE CAMERA UNIT : Diagnosis Procedure .....	589	Diagnosis Procedure .....	604	
<b>U0401 ECM CAN 1</b> .....	<b>590</b>	<b>U1505 SIDE RDR R CAN 2</b> .....	<b>605</b>	
DTC Logic .....	590	DTC Logic .....	605	E
Diagnosis Procedure .....	590	Diagnosis Procedure .....	605	
<b>U0402 TCM CAN 1</b> .....	<b>591</b>	<b>U1506 SIDE RDR R CAN 1</b> .....	<b>606</b>	
DTC Logic .....	591	DTC Logic .....	606	F
Diagnosis Procedure .....	591	Diagnosis Procedure .....	606	
<b>U0405 ADAS CAN 2</b> .....	<b>592</b>	<b>U1507 LOST COMM(SIDE RDR R)</b> .....	<b>607</b>	
<b>SIDE RADAR</b> .....	<b>592</b>	DTC Logic .....	607	G
SIDE RADAR : DTC Logic .....	592	Diagnosis Procedure .....	607	
SIDE RADAR : Diagnosis Procedure .....	592	<b>U1508 LOST COMM(SIDE RDR L)</b> .....	<b>608</b>	
		DTC Logic .....	608	H
<b>LANE CAMERA UNIT</b> .....	<b>592</b>	Diagnosis Procedure .....	608	
LANE CAMERA UNIT : DTC Logic .....	592	<b>U1512 HVAC CAN 3</b> .....	<b>609</b>	
LANE CAMERA UNIT : Diagnosis Procedure .....	593	DTC Logic .....	609	I
		Diagnosis Procedure .....	609	
<b>U0415 VDC CAN 1</b> .....	<b>594</b>	<b>U1513 METER CAN 3</b> .....	<b>610</b>	
DTC Logic .....	594	DTC Logic .....	610	J
Diagnosis Procedure .....	594	Diagnosis Procedure .....	610	
<b>U0428 STRG SEN CAN 2</b> .....	<b>595</b>	<b>U1514 STRG SEN CAN 3</b> .....	<b>611</b>	
<b>ADAS CONTROL UNIT</b> .....	<b>595</b>	DTC Logic .....	611	K
ADAS CONTROL UNIT : DTC Logic .....	595	Diagnosis Procedure .....	611	
ADAS CONTROL UNIT : Diagnosis Procedure ...	595	<b>U1516 CAM CAN 3</b> .....	<b>612</b>	
		DTC Logic .....	612	L
<b>LANE CAMERA UNIT</b> .....	<b>595</b>	Diagnosis Procedure .....	612	
LANE CAMERA UNIT : DTC Logic .....	595	<b>U1518 SIDE RDR L CAN 3</b> .....	<b>613</b>	
LANE CAMERA UNIT : Diagnosis Procedure .....	596	DTC Logic .....	613	M
		Diagnosis Procedure .....	613	
<b>U150B ECM CAN 3</b> .....	<b>597</b>	<b>U1519 SIDE RDR R CAN 3</b> .....	<b>614</b>	
DTC Logic .....	597	DTC Logic .....	614	N
Diagnosis Procedure .....	597	Diagnosis Procedure .....	614	
<b>U150C VDC CAN 3</b> .....	<b>598</b>	<b>POWER SUPPLY AND GROUND CIRCUIT</b> ..	<b>615</b>	
DTC Logic .....	598	<b>ADAS CONTROL UNIT</b> .....	<b>615</b>	
Diagnosis Procedure .....	598	ADAS CONTROL UNIT : Diagnosis Procedure ...	615	
<b>U150D TCM CAN 3</b> .....	<b>599</b>	<b>SIDE RADAR LH</b> .....	<b>615</b>	
DTC Logic .....	599	SIDE RADAR LH : Diagnosis Procedure .....	615	
Diagnosis Procedure .....	599			P
<b>U150E BCM CAN 3</b> .....	<b>600</b>			
DTC Logic .....	600			
Diagnosis Procedure .....	600			
<b>U1500 CAM CAN 2</b> .....	<b>601</b>			

<b>SIDE RADAR RH</b> .....	<b>616</b>	<b>DYNAMIC DRIVER ASSISTANCE SWITCH</b> ..	<b>637</b>
SIDE RADAR RH : Diagnosis Procedure .....	616	Removal and Installation .....	637
<b>LANE CAMERA UNIT</b> .....	<b>617</b>	<b>WARNING BUZZER</b> .....	<b>638</b>
LANE CAMERA UNIT : Diagnosis Procedure .....	617	Removal and Installation .....	638
<b>RIGHT/LEFT SWITCHING SIGNAL CIRCUIT.</b>	<b>618</b>	<b>BCI</b>	
Diagnosis Procedure .....	618	<b>PRECAUTION</b> .....	<b>639</b>
<b>WARNING SYSTEMS SWITCH CIRCUIT</b> .....	<b>619</b>	<b>PRECAUTIONS</b> .....	<b>639</b>
Component Function Check .....	619	Precaution for Supplemental Restraint System (SRS) "AIR BAG" and "SEAT BELT PRE-TENSIONER" .....	639
Diagnosis Procedure .....	619	Precautions For Harness Repair .....	639
Component Inspection .....	620	Precaution for Backup Collision Intervention .....	640
<b>WARNING SYSTEMS ON INDICATOR CIRCUIT</b> .....	<b>621</b>	<b>SYSTEM DESCRIPTION</b> .....	<b>641</b>
Component Function Check .....	621	<b>COMPONENT PARTS</b> .....	<b>641</b>
Diagnosis Procedure .....	621	Component Parts Location .....	641
Component Inspection .....	622	Component Description .....	642
<b>WARNING BUZZER CIRCUIT</b> .....	<b>623</b>	<b>SYSTEM</b> .....	<b>644</b>
Component Function Check .....	623	System Description .....	644
Diagnosis Procedure .....	623	Fail-safe (ADAS Control Unit) .....	648
<b>SYMPTOM DIAGNOSIS</b> .....	<b>625</b>	Fail-safe (Side Radar) .....	648
<b>BLIND SPOT WARNING &amp; BLIND SPOT INTERVENTION SYSTEM SYMPTOMS</b> .....	<b>625</b>	<b>OPERATION</b> .....	<b>650</b>
Symptom Table .....	625	Switch Name and Function .....	650
<b>SWITCH DOES NOT TURN ON / SWITCH DOES NOT TURN OFF</b> .....	<b>627</b>	System Display and Warning .....	650
Description .....	627	<b>HANDLING PRECAUTION</b> .....	<b>652</b>
Diagnosis Procedure .....	627	Precautions for Blind Spot Warning/Blind Spot Intervention .....	652
<b>BSW/BSI SYSTEM SETTINGS CANNOT BE TURNED ON/OFF IN VEHICLE INFORMATION DISPLAY</b> .....	<b>629</b>	<b>DIAGNOSIS SYSTEM (ADAS CONTROL UNIT)</b> .....	<b>653</b>
Description .....	629	On Board Diagnosis Function .....	653
Diagnosis Procedure .....	629	CONSULT Function (ICC/ADAS) .....	654
<b>NORMAL OPERATING CONDITION</b> .....	<b>630</b>	<b>DIAGNOSIS SYSTEM (SIDE RADAR LH)</b> .....	<b>667</b>
Description .....	630	CONSULT Function (SIDE RADAR LEFT) .....	667
<b>REMOVAL AND INSTALLATION</b> .....	<b>632</b>	<b>DIAGNOSIS SYSTEM (SIDE RADAR RH)</b> .....	<b>668</b>
<b>SIDE RADAR</b> .....	<b>632</b>	CONSULT Function (SIDE RADAR RIGHT) .....	668
Exploded View .....	632	<b>ECU DIAGNOSIS INFORMATION</b> .....	<b>669</b>
Removal and Installation .....	632	<b>ADAS CONTROL UNIT</b> .....	<b>669</b>
<b>BLIND SPOT WARNING/BLIND SPOT INTERVENTION INDICATOR</b> .....	<b>634</b>	Reference Value .....	669
Exploded View .....	634	Fail-safe .....	674
Removal and Installation .....	634	DTC Inspection Priority Chart .....	675
<b>LANE CAMERA UNIT</b> .....	<b>635</b>	DTC Index .....	677
Exploded View .....	635	<b>SIDE RADAR LH</b> .....	<b>682</b>
Removal and Installation .....	635	Reference Value .....	682
<b>WARNING SYSTEMS SWITCH</b> .....	<b>636</b>	Fail-safe .....	682
Removal and Installation .....	636	DTC Inspection Priority Chart .....	683
		DTC Index .....	683
		<b>SIDE RADAR RH</b> .....	<b>684</b>
		Reference Value .....	684



Fail-safe .....	684	Diagnosis Procedure .....	728
DTC Inspection Priority Chart .....	685	<b>C1A39 STEERING ANGLE SENSOR .....</b>	<b>730</b>
DTC Index .....	685	DTC Logic .....	730
<b>WIRING DIAGRAM .....</b>	<b>686</b>	Diagnosis Procedure .....	730
<b>DRIVER ASSISTANCE SYSTEMS .....</b>	<b>686</b>	<b>C1A50 ADAS CONTROL UNIT .....</b>	<b>731</b>
Wiring Diagram .....	686	DTC Logic .....	731
<b>BASIC INSPECTION .....</b>	<b>707</b>	Diagnosis Procedure .....	731
<b>DIAGNOSIS AND REPAIR WORK FLOW .....</b>	<b>707</b>	<b>C1B00 CAMERA UNIT MALF .....</b>	<b>732</b>
Work Flow .....	707	<b>ADAS CONTROL UNIT .....</b>	<b>732</b>
<b>PRE-INSPECTION FOR DIAGNOSIS .....</b>	<b>710</b>	ADAS CONTROL UNIT : DTC Logic .....	732
Inspection Procedure .....	710	ADAS CONTROL UNIT : Diagnosis Procedure .....	732
<b>ACTION TEST .....</b>	<b>711</b>	<b>LANE CAMERA UNIT .....</b>	<b>732</b>
Description .....	711	LANE CAMERA UNIT : DTC Logic .....	732
Work Procedure .....	711	LANE CAMERA UNIT : Diagnosis Procedure .....	732
<b>DTC/CIRCUIT DIAGNOSIS .....</b>	<b>714</b>	<b>C1B01 CAM AIMING INCOMP .....</b>	<b>734</b>
<b>C1A00 CONTROL UNIT .....</b>	<b>714</b>	<b>ADAS CONTROL UNIT .....</b>	<b>734</b>
DTC Logic .....	714	ADAS CONTROL UNIT : DTC Logic .....	734
Diagnosis Procedure .....	714	ADAS CONTROL UNIT : Diagnosis Procedure .....	734
<b>C1A01 POWER SUPPLY CIRCUIT 1, C1A02 POWER SUPPLY CIRCUIT 2 .....</b>	<b>715</b>	<b>LANE CAMERA UNIT .....</b>	<b>734</b>
DTC Logic .....	715	LANE CAMERA UNIT : DTC Logic .....	734
Diagnosis Procedure .....	715	LANE CAMERA UNIT : Diagnosis Procedure .....	735
<b>C1A03 VEHICLE SPEED SENSOR .....</b>	<b>716</b>	<b>C1B03 ABNRML TEMP DETECT .....</b>	<b>736</b>
DTC Logic .....	716	<b>ADAS CONTROL UNIT .....</b>	<b>736</b>
Diagnosis Procedure .....	716	ADAS CONTROL UNIT : DTC Logic .....	736
<b>C1A04 ABS/TCS/VDC SYSTEM .....</b>	<b>717</b>	ADAS CONTROL UNIT : Diagnosis Procedure .....	736
DTC Logic .....	717	<b>LANE CAMERA UNIT .....</b>	<b>736</b>
Diagnosis Procedure .....	717	LANE CAMERA UNIT : DTC Logic .....	736
<b>C1A05 BRAKE SW/STOP LAMP SW .....</b>	<b>718</b>	LANE CAMERA UNIT : Diagnosis Procedure .....	736
DTC Logic .....	718	<b>C1B50 SIDE RADAR MALFUNCTION .....</b>	<b>737</b>
Diagnosis Procedure .....	718	DTC LOGIC .....	737
Component Inspection (ICC Brake Switch) .....	721	Diagnosis Procedure .....	737
Component Inspection (Stop Lamp Switch) .....	721	<b>C1B51 BLIND SPOT WARNING/BLIND SPOT INTERVENTION INDICATOR SHORT CIRCUIT .....</b>	<b>738</b>
<b>C1A06 OPERATION SW .....</b>	<b>722</b>	DTC Logic .....	738
DTC Logic .....	722	Diagnosis Procedure .....	738
Diagnosis Procedure .....	722	<b>C1B52 BLIND SPOT WARNING/BLIND SPOT INTERVENTION INDICATOR OPEN CIRCUIT .....</b>	<b>739</b>
Component Inspection .....	723	DTC Logic .....	739
<b>C1A14 ECM .....</b>	<b>725</b>	Diagnosis Procedure .....	739
DTC Logic .....	725	<b>C1B53 SIDE RADAR RIGHT MALFUNCTION.</b>	<b>741</b>
Diagnosis Procedure .....	725	DTC Logic .....	741
<b>C1A15 GEAR POSITION .....</b>	<b>726</b>	Diagnosis Procedure .....	741
Description .....	726	<b>C1B54 SIDE RADAR LEFT MALFUNCTION .</b>	<b>742</b>
DTC Logic .....	726	DTC Logic .....	742
Diagnosis Procedure .....	726	Diagnosis Procedure .....	742
<b>C1A24 NP RANGE .....</b>	<b>728</b>		
DTC Logic .....	728		

A  
B  
C  
D  
E  
F  
G  
H  
I  
J  
K  
L  
M  
N  
P

DAS

<b>C1B55 RADAR BLOCKAGE</b> .....	<b>743</b>	LANE CAMERA UNIT : DTC Logic .....	751
DTC Logic .....	743	LANE CAMERA UNIT : Diagnosis Procedure .....	752
Diagnosis Procedure .....	743	<b>U0121 VDC CAN 2</b> .....	<b>753</b>
<b>C1B56 SONAR CIRCUIT</b> .....	<b>744</b>	DTC Logic .....	753
DTC Logic .....	744	Diagnosis Procedure .....	753
Diagnosis Procedure .....	744	<b>U0126 STRG SEN CAN 1</b> .....	<b>754</b>
<b>C1B57 AVM CIRCUIT</b> .....	<b>745</b>	<b>ADAS CONTROL UNIT</b> .....	<b>754</b>
DTC Logic .....	745	ADAS CONTROL UNIT : DTC Logic .....	754
Diagnosis Procedure .....	745	ADAS CONTROL UNIT : Diagnosis Procedure .....	754
<b>U1000 CAN COMM CIRCUIT</b> .....	<b>746</b>	<b>LANE CAMERA UNIT</b> .....	<b>754</b>
<b>SIDE RADAR LH</b> .....	<b>746</b>	LANE CAMERA UNIT : DTC Logic .....	754
SIDE RADAR LH : Description .....	746	LANE CAMERA UNIT : Diagnosis Procedure .....	755
SIDE RADAR LH : DTC Logic .....	746	<b>U0401 ECM CAN 1</b> .....	<b>756</b>
SIDE RADAR LH : Diagnosis Procedure .....	746	DTC Logic .....	756
<b>SIDE RADAR RH</b> .....	<b>746</b>	Diagnosis Procedure .....	756
SIDE RADAR RH : Description .....	746	<b>U0402 TCM CAN 1</b> .....	<b>757</b>
SIDE RADAR RH : DTC Logic .....	747	DTC Logic .....	757
SIDE RADAR RH : Diagnosis Procedure .....	747	Diagnosis Procedure .....	757
<b>ADAS CONTROL UNIT</b> .....	<b>747</b>	<b>U0405 ADAS CAN 2</b> .....	<b>758</b>
ADAS CONTROL UNIT : Description .....	747	<b>SIDE RADAR</b> .....	<b>758</b>
ADAS CONTROL UNIT : DTC Logic .....	747	SIDE RADAR : DTC Logic .....	758
ADAS CONTROL UNIT : Diagnosis Procedure .....	747	SIDE RADAR : Diagnosis Procedure .....	758
<b>LANE CAMERA UNIT</b> .....	<b>748</b>	<b>LANE CAMERA UNIT</b> .....	<b>758</b>
LANE CAMERA UNIT : Description .....	748	LANE CAMERA UNIT : DTC Logic .....	758
LANE CAMERA UNIT : DTC Logic .....	748	LANE CAMERA UNIT : Diagnosis Procedure .....	759
LANE CAMERA UNIT : Diagnosis Procedure .....	748	<b>U0415 VDC CAN 1</b> .....	<b>760</b>
<b>U1010 CONTROL UNIT (CAN)</b> .....	<b>749</b>	DTC Logic .....	760
<b>SIDE RADAR LH</b> .....	<b>749</b>	Diagnosis Procedure .....	760
SIDE RADAR LH : Description .....	749	<b>U0428 STRG SEN CAN 2</b> .....	<b>761</b>
SIDE RADAR LH : DTC Logic .....	749	<b>ADAS CONTROL UNIT</b> .....	<b>761</b>
SIDE RADAR LH : Diagnosis Procedure .....	749	ADAS CONTROL UNIT : DTC Logic .....	761
<b>SIDE RADAR RH</b> .....	<b>749</b>	ADAS CONTROL UNIT : Diagnosis Procedure .....	761
SIDE RADAR RH : Description .....	749	<b>LANE CAMERA UNIT</b> .....	<b>761</b>
SIDE RADAR RH : DTC Logic .....	749	LANE CAMERA UNIT : DTC Logic .....	761
SIDE RADAR RH : Diagnosis Procedure .....	749	LANE CAMERA UNIT : Diagnosis Procedure .....	762
<b>ADAS CONTROL UNIT</b> .....	<b>749</b>	<b>U150B ECM CAN 3</b> .....	<b>763</b>
ADAS CONTROL UNIT : Description .....	749	DTC Logic .....	763
ADAS CONTROL UNIT : DTC Logic .....	750	Diagnosis Procedure .....	763
ADAS CONTROL UNIT : Diagnosis Procedure .....	750	<b>U150C VDC CAN 3</b> .....	<b>764</b>
<b>LANE CAMERA UNIT</b> .....	<b>750</b>	DTC Logic .....	764
LANE CAMERA UNIT : Description .....	750	Diagnosis Procedure .....	764
LANE CAMERA UNIT : DTC Logic .....	750	<b>U150D TCM CAN 3</b> .....	<b>765</b>
LANE CAMERA UNIT : Diagnosis Procedure .....	750	DTC Logic .....	765
<b>U0104 ADAS CAN 1</b> .....	<b>751</b>	Diagnosis Procedure .....	765
<b>SIDE RADAR</b> .....	<b>751</b>	<b>U150E BCM CAN 3</b> .....	<b>766</b>
SIDE RADAR : DTC Logic .....	751	DTC Logic .....	766
SIDE RADAR : Diagnosis Procedure .....	751		
<b>LANE CAMERA UNIT</b> .....	<b>751</b>		

Diagnosis Procedure .....	766	DTC Logic .....	782	
<b>U1500 CAM CAN 2 .....</b>	<b>767</b>	Diagnosis Procedure .....	782	A
DTC Logic .....	767	<b>U1523 SONAR CAN DLC .....</b>	<b>783</b>	
Diagnosis Procedure .....	767	DTC Logic .....	783	B
<b>U1501 CAM CAN 1 .....</b>	<b>768</b>	Diagnosis Procedure .....	783	
DTC Logic .....	768	<b>U1524 AVM CAN DLC .....</b>	<b>784</b>	C
Diagnosis Procedure .....	768	DTC Logic .....	784	
<b>U1503 SIDE RDR L CAN 2 .....</b>	<b>769</b>	Diagnosis Procedure .....	784	
DTC Logic .....	769	<b>U1525 AVM MESSAGE .....</b>	<b>785</b>	D
Diagnosis Procedure .....	769	DTC Logic .....	785	
<b>U1504 SIDE RDR L CAN 1 .....</b>	<b>770</b>	Diagnosis Procedure .....	785	
DTC Logic .....	770	<b>POWER SUPPLY AND GROUND CIRCUIT ..</b>	<b>786</b>	E
Diagnosis Procedure .....	770	<b>ADAS CONTROL UNIT .....</b>	<b>786</b>	
<b>U1505 SIDE RDR R CAN 2 .....</b>	<b>771</b>	ADAS CONTROL UNIT : Diagnosis Procedure ..	786	F
DTC Logic .....	771	<b>SIDE RADAR LH .....</b>	<b>786</b>	
Diagnosis Procedure .....	771	SIDE RADAR LH : Diagnosis Procedure .....	786	
<b>U1506 SIDE RDR R CAN 1 .....</b>	<b>772</b>	<b>SIDE RADAR RH .....</b>	<b>787</b>	G
DTC Logic .....	772	SIDE RADAR RH : Diagnosis Procedure .....	787	
Diagnosis Procedure .....	772	<b>LANE CAMERA UNIT .....</b>	<b>788</b>	H
<b>U1507 LOST COMM(SIDE RDR R) .....</b>	<b>773</b>	LANE CAMERA UNIT : Diagnosis Procedure .....	788	
DTC Logic .....	773	<b>RIGHT/LEFT SWITCHING SIGNAL CIRCUIT .</b>	<b>789</b>	I
Diagnosis Procedure .....	773	Diagnosis Procedure .....	789	
<b>U1508 LOST COMM(SIDE RDR L) .....</b>	<b>774</b>	<b>WARNING SYSTEMS SWITCH CIRCUIT .....</b>	<b>790</b>	J
DTC Logic .....	774	Component Function Check .....	790	
Diagnosis Procedure .....	774	Diagnosis Procedure .....	790	
<b>U1512 HVAC CAN 3 .....</b>	<b>775</b>	Component Inspection .....	791	
DTC Logic .....	775	<b>SYMPTOM DIAGNOSIS .....</b>	<b>792</b>	K
Diagnosis Procedure .....	775	<b>BACKUP COLLISION INTERVENTION SYS-</b>		
<b>U1513 METER CAN 3 .....</b>	<b>776</b>	<b>TEM SYMPTOMS .....</b>	<b>792</b>	L
DTC Logic .....	776	Symptom Table .....	792	
Diagnosis Procedure .....	776	<b>BCI SYSTEM DOES NOT ACTIVATE .....</b>	<b>793</b>	M
<b>U1514 STRG SEN CAN 3 .....</b>	<b>777</b>	Description .....	793	
DTC Logic .....	777	Diagnosis Procedure .....	793	
Diagnosis Procedure .....	777	<b>BCI SYSTEM SETTING CANNOT BE</b>		
<b>U1516 CAM CAN 3 .....</b>	<b>778</b>	<b>TURNUED ON/OFF .....</b>	<b>795</b>	N
DTC Logic .....	778	Description .....	795	
Diagnosis Procedure .....	778	Diagnosis Procedure .....	795	
<b>U1518 SIDE RDR L CAN 3 .....</b>	<b>779</b>	<b>NORMAL OPERATING CONDITION .....</b>	<b>796</b>	
DTC Logic .....	779	Description .....	796	
Diagnosis Procedure .....	779	<b>REMOVAL AND INSTALLATION .....</b>	<b>797</b>	P
<b>U1519 SIDE RDR R CAN 3 .....</b>	<b>780</b>	<b>LANE CAMERA UNIT .....</b>	<b>797</b>	
DTC Logic .....	780	Exploded View .....	797	
Diagnosis Procedure .....	780	Removal and Installation .....	797	
<b>U1521 SONAR CHECKSUM .....</b>	<b>781</b>	<b>SIDE RADAR .....</b>	<b>798</b>	
DTC Logic .....	781	Exploded View .....	798	
Diagnosis Procedure .....	781			
<b>U1522 SONAR MESSAGE .....</b>	<b>782</b>			

---

Removal and Installation .....	798	<b>BLIND SPOT WARNING/BLIND SPOT IN-</b>	
<b>SONAR SENSOR .....</b>	<b>800</b>	<b>TERVENTION INDICATOR .....</b>	<b>803</b>
Removal and Installation .....	800	Exploded View .....	803
<b>REAR CAMERA .....</b>	<b>802</b>	Removal and Installation .....	803
Removal and Installation .....	802	<b>METER CONTROL SWITCH .....</b>	<b>804</b>
		Removal and Installation .....	804

PRECAUTION

PRECAUTIONS

Precaution for Supplemental Restraint System (SRS) "AIR BAG" and "SEAT BELT PRE-TENSIONER"

INFOID:000000009730865

The Supplemental Restraint System such as "AIR BAG" and "SEAT BELT PRE-TENSIONER", used along with a front seat belt, helps to reduce the risk or severity of injury to the driver and front passenger for certain types of collision. This system includes dual stage front air bag modules. The SRS system may only deploy one front air bag, depending on the severity of a collision and whether the front passenger seat is occupied. Information necessary to service the system safely is included in the SR and SB section of this Service Manual.

**WARNING:**

- To avoid rendering the SRS inoperative, which could increase the risk of personal injury or death in the event of a collision which would result in air bag inflation, all maintenance must be performed by an authorized NISSAN/INFINITI dealer.
- Improper maintenance, including incorrect removal and installation of the SRS, can lead to personal injury caused by unintentional activation of the system. For removal of Spiral Cable and Air Bag Module, see the SR section.
- Do not use electrical test equipment on any circuit related to the SRS unless instructed to in this Service Manual. SRS wiring harnesses can be identified by yellow and/or orange harnesses or harness connectors.

PRECAUTIONS WHEN USING POWER TOOLS (AIR OR ELECTRIC) AND HAMMERS

**WARNING:**

- When working near the Airbag Diagnosis Sensor Unit or other Airbag System sensors with the Ignition ON or engine running, DO NOT use air or electric power tools or strike near the sensor(s) with a hammer. Heavy vibration could activate the sensor(s) and deploy the air bag(s), possibly causing serious injury.
- When using air or electric power tools or hammers, always switch the Ignition OFF, disconnect the battery and wait at least three minutes before performing any service.

Precautions For Harness Repair

INFOID:000000009716364

ITS communication uses a twisted pair line. Be careful when repairing it.

- Solder the repaired area and wrap tape around the soldered area.

**NOTE:**

A fray of twisted lines must be within 110 mm (4.33 in).

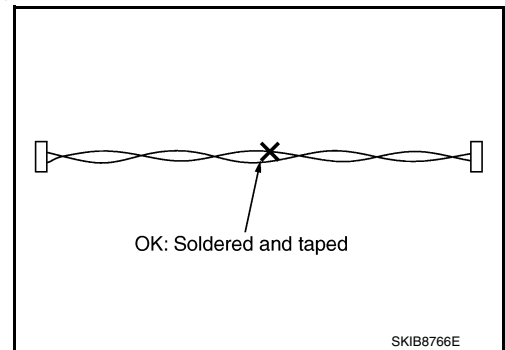

- Bypass connection is never allowed at the repaired area.

**NOTE:**

Bypass connection may cause ITS communication error. The spliced wire becomes separated and the characteristics of twisted line are lost.

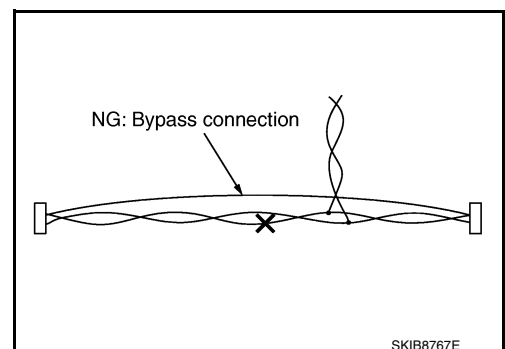

A  
B  
C  
D  
E  
F  
G  
H  
I  
J  
K  
L  
M  
N  
DAS  
P

SYSTEM DESCRIPTION

COMPONENT PARTS

Component Parts Location

INFOID:000000009716365

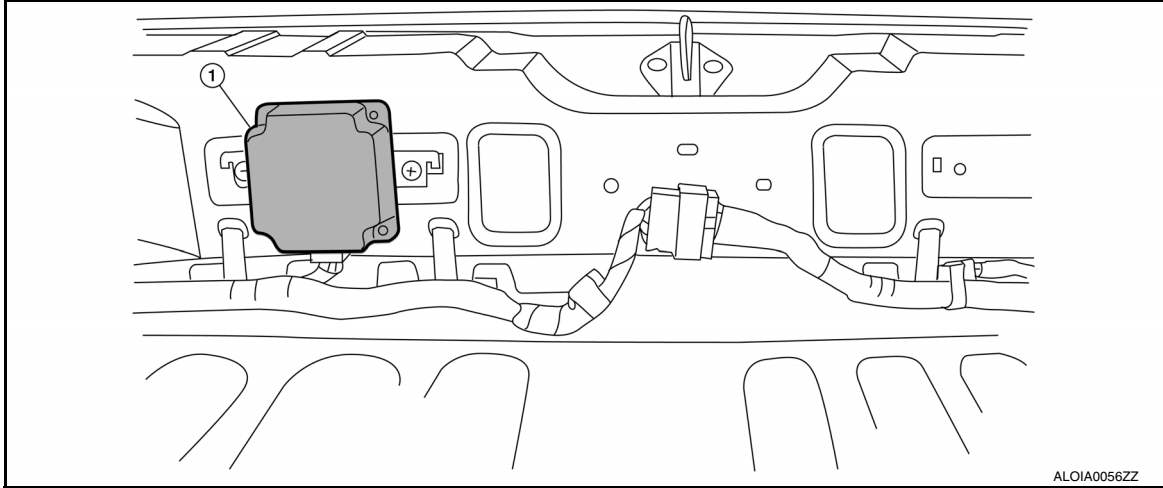

1. ADAS control unit (view of rear luggage room area with rear panel assembly removed)  
Refer to [DAS-18.](#) "Component Description".

Component Description

INFOID:000000009716366

Component	Description
ADAS control unit	<ul style="list-style-type: none"> <li>• Controls each system, based on ITS communication signals received from the ICC sensor, the accelerator pedal actuator, the lane camera unit, and the side radar LH/RH and CAN communication signals received from each control unit</li> <li>• Transmits signals necessary for control between CAN communication and ITS communication</li> </ul>

SYSTEM

System Diagram

INFOID:000000009716367

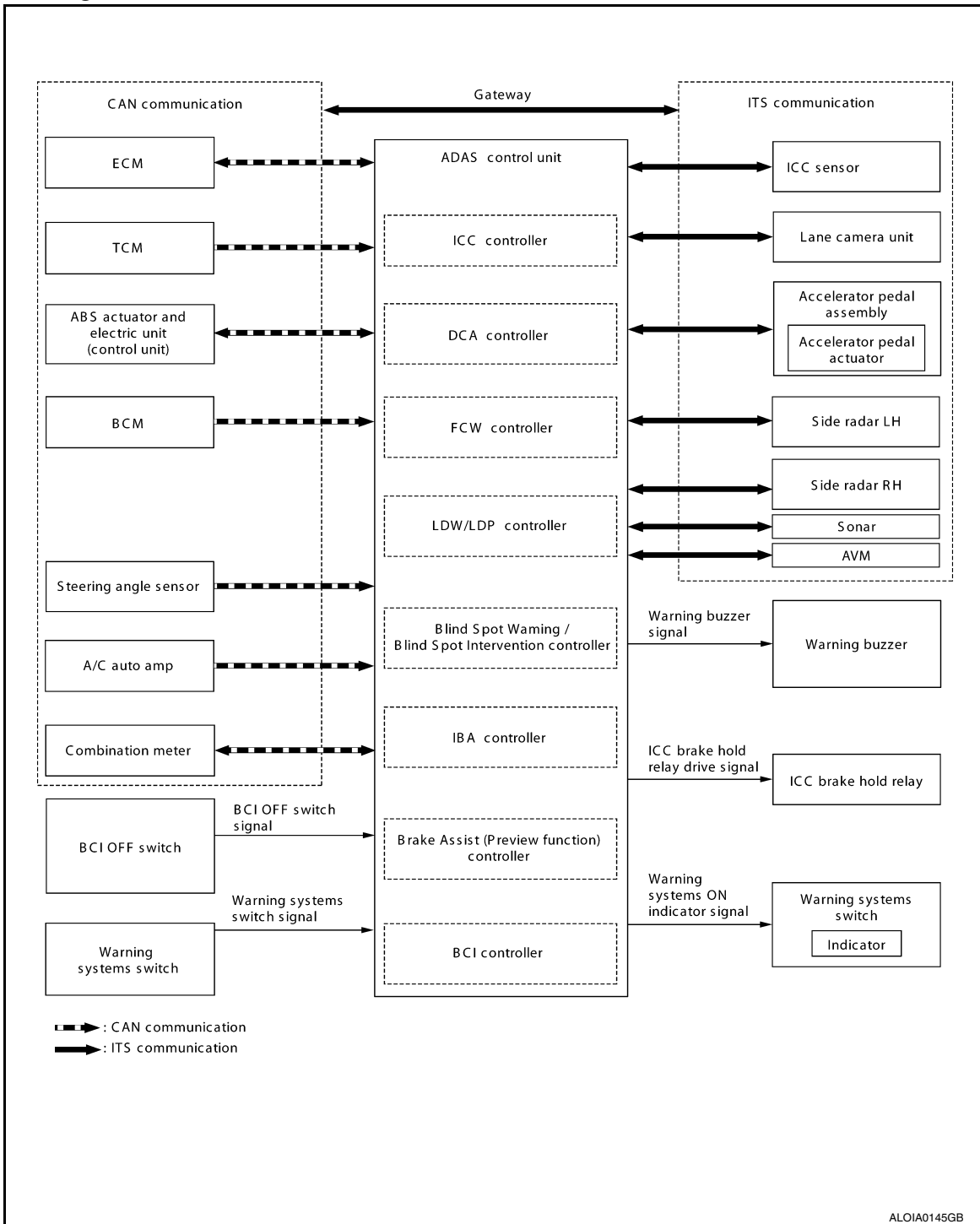

A  
B  
C  
D  
E  
F  
G  
H  
I  
J  
K  
L  
M  
N

DAS

System Function

INFOID:000000009716368

ADAS CONTROL UNIT INPUT/OUTPUT SIGNAL ITEM

Input Signal Item

P

# SYSTEM

< SYSTEM DESCRIPTION >

[ADAS CONTROL UNIT]

Transmit unit	Signal name		Description	
ECM	CAN communication	Closed throttle position signal	Receives idle position state (ON/OFF)	
		Accelerator pedal position signal	Receives accelerator pedal position (angle)	
		ICC prohibition signal	Receives an operable/inoperable state of the ICC system	
		ICC steering switch signal	Main switch signal	Receives the operational state of the ICC steering switch
			SET/COAST switch signal	
			CANCEL switch signal	
			RESUME/ACCELERATE switch signal	
			DISTANCE switch signal	
			Dynamic driver assistance switch signal	
		Engine speed signal	Receives engine speed	
		Stop lamp switch signal	Receives an operational state of the brake pedal	
		ICC brake switch signal	Receives an operational state of the brake pedal	
Snow mode switch signal	Receives an operational state of the snow mode			
TCM	CAN communication	Input speed signal	Receives the number of revolutions of input shaft	
		Current gear position signal	Receives a current gear position	
		Shift position signal	Receives a selector lever position	
		Output shaft revolution signal	Receives the number of revolutions of output shaft	
ABS actuator and electric unit (control unit)	CAN communication	ABS malfunction signal	Receives a malfunction state of ABS	
		ABS operation signal	Receives an operational state of ABS	
		ABS warning lamp signal	Receives an ON/OFF state of ABS warning lamp	
		TCS malfunction signal	Receives a malfunction state of TCS	
		TCS operation signal	Receives an operational state of TCS	
		VDC OFF switch signal	Receives an ON/OFF state of VDC	
		VDC malfunction signal	Receives a malfunction state of VDC	
		VDC operation signal	Receives an operational state of VDC	
		Vehicle speed signal (ABS)	Receives wheel speeds of four wheels	
		Stop lamp switch signal	Receives an operational state of the brake pedal	
		Yaw rate signal	Receives yaw rate acting on the vehicle	
Side G sensor signal	Receives lateral G acting on the vehicle			
Combination meter	CAN communication	Parking brake switch signal	Receives an operational state of the parking brake	
BCM	CAN communication	Front wiper request signal	Receives an operational state of front wiper(s)	
		Turn indicator signal	Receives an operational state of the turn signal lamp and the hazard lamp	
		Dimmer signal	Receives ON/OFF state of dimmer signal	
Steering angle sensor	CAN communication	Steering angle sensor malfunction signal	Receives a malfunction state of steering angle sensor	
		Steering angle sensor signal	Receives the number of revolutions, turning direction of the steering wheel	
		Steering angle speed signal	Receives the turning angle speed of the steering wheel	



# SYSTEM

< SYSTEM DESCRIPTION >

[ADAS CONTROL UNIT]

Transmit unit	Signal name		Description
Combination meter	CAN communication	System selection signal	Receives a selection state of each item in "Driving Aids" selected with the vehicle information display
A/C auto amp.	CAN communication	Ambient temperature signal	Receives ambient temperature signal
ICC sensor	ITS communication	ICC sensor signal	Receives detection results, such as the presence or absence of a vehicle ahead and distance from the vehicle
Lane camera unit	ITS communication	Detected lane condition signal	Receives detection results of lane marker
Accelerator pedal actuator	ITS communication	Accelerator pedal actuator operation status signal	Receives an operational state of accelerator pedal actuator
Side radar LH, RH	ITS communication	Vehicle detection signal	Receives vehicle detection condition of detection zone
BCI OFF Switch	Hard wire	BCI OFF switch signal	Receives the state of the BCI OFF switch request
Sonar control unit	ITS communication	Rear object detection signal	Receives objects detection result of rear area behind vehicle
Warning systems switch	Warning systems switch signal		Receives an ON/OFF state of the warning systems switch

Output Signal Item

Reception unit	Signal name		Description
ECM	CAN communication	ICC operation signal	Transmits an ICC operation signal necessary for intelligent cruise control
TCM	CAN communication	ICC operation signal	Transmits an ICC operation signal necessary for intelligent cruise control via ECM
ABS actuator and electric unit (control unit)	CAN communication	Brake fluid pressure control signal	Transmits a brake fluid pressure control signal to activate the brake
		Target yaw moment signal	Transmits a target yaw moment signal to generate yaw moment to the vehicle

A  
B  
C  
D  
E  
F  
G  
H  
I  
J  
K  
L  
M  
N  
P

DAS

# SYSTEM

< SYSTEM DESCRIPTION >

[ADAS CONTROL UNIT]

Reception unit	Signal name		Description
Combination meter	CAN communication	Own vehicle indicator signal	Transmits a signal to display a state of the system on the information display
		Vehicle ahead detection indicator signal	
		Set vehicle speed indicator signal	
		Set distance indicator signal	
		SET switch indicator signal	
		MAIN switch indicator signal	
		DCA system switch indicator signal	
	Blind Spot Warning/Blind Spot Intervention warning lamp signal	Blind Spot Warning/Blind Spot Intervention warning lamp signal to turn ON the Blind Spot Warning/Blind Spot Intervention warning lamp	
	Blind Spot Intervention ON indicator lamp signal	Transmits a Blind Spot Intervention ON indicator lamp signal to turn ON the Blind Spot Intervention ON indicator lamp	
	LDP ON indicator lamp signal	Transmits an LDP ON indicator lamp signal to turn ON the LDP ON indicator lamp	
Lane departure warning lamp signal	Transmits a lane departure warning lamp signal to turn ON the lane departure warning lamp		
ICC warning lamp signal	Transmits an ICC warning lamp signal to turn ON the ICC system warning lamp		
IBA OFF indicator lamp signal	<ul style="list-style-type: none"> <li>• Transmits a signal to turn ON the IBA OFF indicator lamp</li> <li>• Transmits an ON/OFF state of the intelligent brake assist</li> </ul>		
Buzzer output signal	Transmits a buzzer output signal to turn ON the buzzer of the following systems: <ul style="list-style-type: none"> <li>• Intelligent Cruise Control (ICC)</li> <li>• Distance Control Assist (DCA)</li> <li>• Intelligent Brake Assist (IBA)</li> <li>• Forward Collision Warning (FCW)</li> </ul>		
ICC sensor	ITS communication	Vehicle speed signal	Transmits a vehicle speed calculated by the ADAS control unit
		Steering angle sensor signal	Transmits a steering angle sensor signal received from the steering angle sensor
Lane camera unit	ITS communication	Vehicle speed signal	Transmits a vehicle speed calculated by the ADAS control unit
		Turn indicator signal	Transmits a turn indicator signal received from BCM
Accelerator pedal actuator	ITS communication	Accelerator pedal position signal	Transmits an accelerator pedal angle calculated by the ADAS control unit
		Accelerator pedal feedback force control signal	Transmits a target reaction force value calculated by the ADAS control unit
Side radar LH, RH	ITS communication	Vehicle speed signal	Transmits a vehicle speed calculated by the ADAS control unit
		Blind Spot Warning/Blind Spot Intervention indicator signal	Transmits a Blind Spot Warning/Blind Spot Intervention indicator signal to turn ON the Blind Spot Warning/Blind Spot Intervention indicator
		Blind Spot Warning/Blind Spot Intervention indicator dimmer signal	Transmits a Blind Spot Warning/Blind Spot Intervention indicator dimmer signal to dimmer Blind Spot Warning/Blind Spot Intervention indicator

# SYSTEM

< SYSTEM DESCRIPTION >

[ADAS CONTROL UNIT]

Reception unit	Signal name		Description
ICC brake hold relay	ICC brake hold relay drive signal		Activates the brake hold relay and turns ON the stop lamp
Warning buzzer	Warning buzzer signal		Activates the warning buzzer of the following systems: <ul style="list-style-type: none"> <li>• Lane Departure Warning (LDW)</li> <li>• Lane Departure Prevention (LDP)</li> <li>• Blind Spot Warning (BSW)</li> <li>• Blind Spot Intervention</li> </ul>
Warning systems ON indicator	Warning systems ON indicator signal		Turns ON the warning systems ON indicator
Sonar control unit	ITS communication	Warning buzzer signal	While the shifter is in reverse and backing up, transmits a request for a variable warning buzzer signal related to distance whenever an obstacle exists
Around view monitor control unit	ITS communication	Visual signal request	Transmits a visual signal request by the ADAS control unit to center display to override other signals and display rear view while the shift lever is in reverse

- ADAS\* control unit controls the following systems, based on ITS communication signals from the ICC sensor, the accelerator pedal actuator, the lane camera unit and side radar LH/RH and a CAN communication signal from each control unit.

**NOTE:**

\*: Advanced Driver Assistance Systems

- Intelligent Cruise Control (ICC)
- Distance Control Assist (DCA)
- Intelligent Brake Assist (IBA)
- Brake Assist (with preview function)
- Forward Collision Warning (FCW)
- Lane Departure Warning (LDW)/Lane Departure Prevention (LDP)
- Blind Spot Warning (BSW)/Blind Spot Intervention (BSI)
- Backup Collision Intervention (BCI)

System	Reference
Intelligent Cruise Control (ICC)	<a href="#">CCS-14. "System Description"</a>
Distance Control Assist (DCA)	<a href="#">DAS-85. "System Diagram"</a>
Intelligent Brake Assist (IBA)	<a href="#">BRC-145. "INTELLIGENT BRAKE ASSIST : System Description"</a>
Brake Assist (with preview function)	<a href="#">BRC-138. "BRAKE ASSIST (WITH PREVIEW FUNCTION) : System Description"</a>
Forward Collision Warning (FCW)	<a href="#">DAS-250. "System Description"</a>
Lane Departure Warning (LDW)/Lane Departure Prevention (LDP)	<ul style="list-style-type: none"> <li>• Lane Departure Warning: <a href="#">DAS-322. "LANE DEPARTURE WARNING (LDW) SYSTEM : System Description"</a></li> <li>• Lane Departure Prevention: <a href="#">DAS-325. "LANE DEPARTURE PREVENTION (LDP) SYSTEM : System Description"</a></li> </ul>
Blind Spot Warning (BSW)/Blind Spot Intervention (BSI)	<ul style="list-style-type: none"> <li>• Blind Spot Warning: <a href="#">DAS-468. "BLIND SPOT WARNING (BSW) SYSTEM : System Description"</a></li> <li>• Blind Spot Intervention: <a href="#">DAS-472. "BLIND SPOT INTERVENTION SYSTEM : System Description"</a></li> </ul>
Backup Collision Intervention (BCI)	<ul style="list-style-type: none"> <li>• Backup Collision Intervention: <a href="#">DAS-644. "System Description"</a></li> </ul>

## Fail-safe (ADAS Control Unit)

INFOID:000000009716369

If a malfunction occurs in any system, ADAS control unit cancels each control, sounds a beep, and turns ON the warning lamp or indicator lamp or warning message will display.

# SYSTEM

< SYSTEM DESCRIPTION >

[ADAS CONTROL UNIT]

System	Buzzer	Warning lamp/Indicator lamp	Description
Vehicle-to-vehicle distance control mode	High-pitched tone	ICC system warning lamp	Cancel
Conventional (fixed speed) cruise control mode	High-pitched tone	ICC system warning lamp	Cancel
Intelligent Brake Assist (IBA)	High-pitched tone	IBA OFF indicator lamp	Cancel
Forward Collision Warning (FCW)	High-pitched tone	Warning message	Cancel
Distance Control Assist (DCA)	High-pitched tone	ICC system warning lamp	Cancel
Lane Departure Warning (LDW)	—	Lane Departure Warning lamp	Cancel
Lane Departure Prevention (LDP)	Low-pitched tone	Lane Departure Warning lamp	Cancel
Blind Spot Warning (BSW)	—	Blind Spot Warning/Blind Spot Intervention warning lamp	Cancel
Blind Spot Intervention (BSI)	Low-pitched tone	Blind Spot Warning/Blind Spot Intervention warning lamp	Cancel
Backup Collision Intervention (BCI)	High-pitched tone	Backup Collision Intervention warning indicator	Cancel

# DIAGNOSIS SYSTEM (ADAS CONTROL UNIT)

< SYSTEM DESCRIPTION >

[ADAS CONTROL UNIT]

## DIAGNOSIS SYSTEM (ADAS CONTROL UNIT)

### On Board Diagnosis Function

INFOID:00000009716370

#### DESCRIPTION

The DTC is displayed on the information display by operating the ICC steering switch.

#### On Board Self-diagnosis System Diagram

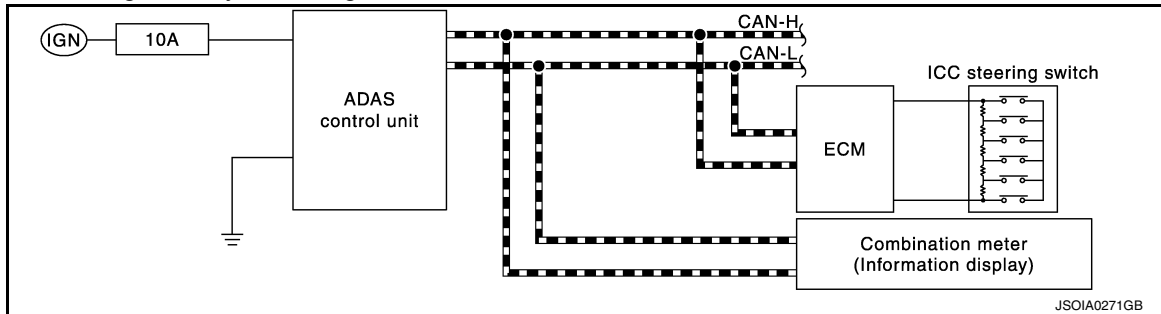

#### METHOD OF STARTING

##### CAUTION:

##### Start condition of on board self-diagnosis

- ICC system OFF
- DCA system OFF
- Vehicle speed 0 km/h (0 MPH)

1. Turn the ignition switch OFF.
2. Start the engine.
3. Wait for 5 seconds after starting the engine. Push up the RESUME/ACCELERATE switch 5 times and push down the SET/COAST switch 5 times within 10 seconds.

##### NOTE:

If the above operation cannot be performed within 10 seconds after waiting for 5 seconds after starting the engine, repeat the procedure from step 1.

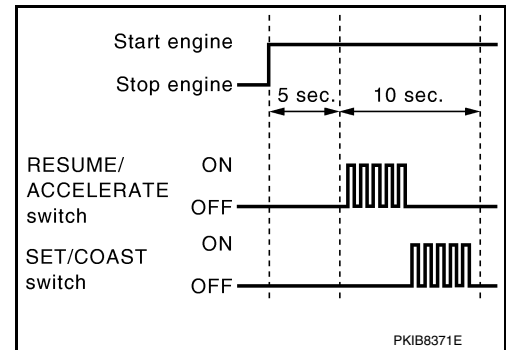

4. The DTC is displayed on the set vehicle speed indicator (1) on the ICC system display on the information display when the on board self-diagnosis starts. Refer to [DAS-47, "DTC Index"](#).

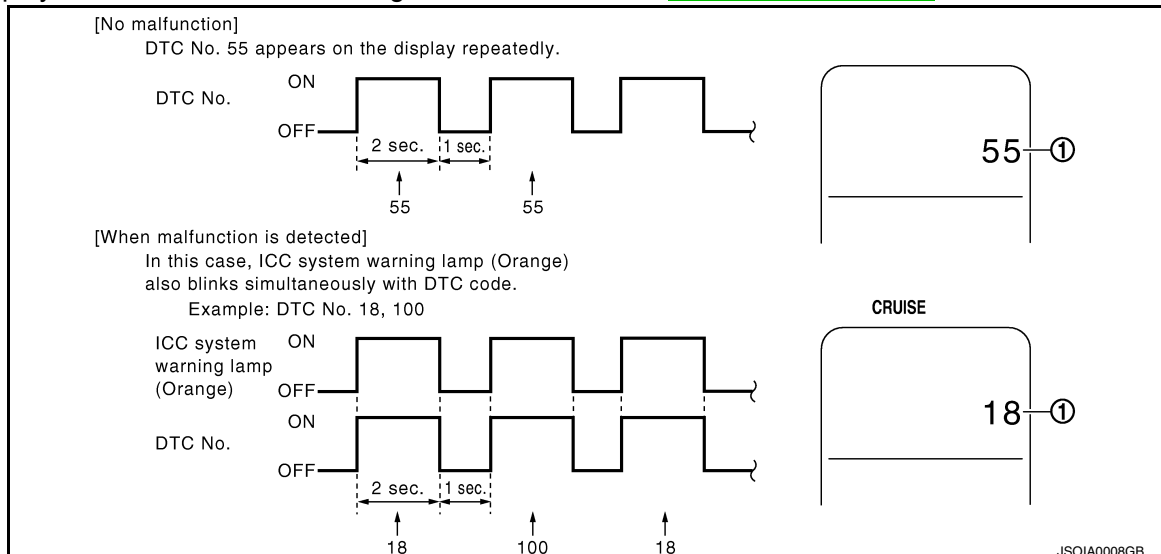

##### NOTE:

A  
B  
C  
D  
E  
F  
G  
H  
I  
J  
K  
L  
M  
N  
P

DAS

# DIAGNOSIS SYSTEM (ADAS CONTROL UNIT)

< SYSTEM DESCRIPTION >

[ADAS CONTROL UNIT]

- It displays for up to 5 minutes and then stops.
- If multiple malfunctions exist, up to 6 DTCs can be stored in memory at the most, and the most recent one is displayed first.

## WHEN THE ON BOARD SELF-DIAGNOSIS DOES NOT START

If the on board self-diagnosis does not start, check the following items.

Assumed abnormal part		Inspection item
Information display	Combination meter malfunction	Check that the self-diagnosis function of the combination meter operates. Refer to <a href="#">MWI-15, "INFORMATION DISPLAY : System Description"</a>
ICC steering switch malfunction		Perform the inspection for DTC"C1A06". Refer to <a href="#">DAS-167, "Diagnosis Procedure"</a>
Harness malfunction between ICC steering switch and ECM		
ECM malfunction		
ADAS control unit malfunction		<ul style="list-style-type: none"> <li>• Check power supply and ground circuit of ADAS control unit. Refer to <a href="#">DAS-78, "Diagnosis Procedure"</a>.</li> <li>• Perform SELF-DIAGNOSIS for "ICC/ADAS"with CONSULT, and then check the malfunctioning parts. Refer to <a href="#">DAS-47, "DTC Index"</a>.</li> </ul>

## HOW TO ERASE ON BOARD SELF-DIAGNOSIS

1. Turn the ignition switch OFF.
2. Start the engine, and then start the on board self-diagnosis.
3. Press the CANCEL switch 5 times, and then press the DISTANCE switch 5 times under the condition that the on board self-diagnosis starts.

### NOTE:

- Complete the operation within 10 seconds after pressing the CANCEL switch first.
- If the operation is not completed within 10 seconds, repeat the procedure from step 1.

4. DTC 55 is displayed after erasing.

### NOTE:

DTCs for existing malfunction can not be erased.

5. Turn ignition switch OFF, and finish the diagnosis.

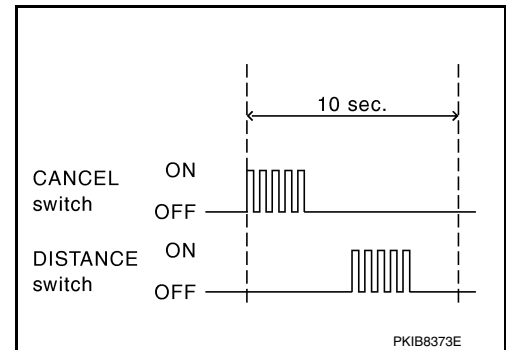

## CONSULT Function (ICC/ADAS)

INFOID:000000009716371

### CAUTION:

After disconnecting the CONSULT vehicle interface (VI) from the data link connector, the ignition must be cycled OFF → ON (for at least 5 seconds) → OFF. If this step is not performed, the BCM may not go to "sleep mode", potentially causing a discharged battery and a no-start condition.

## APPLICATION ITEMS

CONSULT performs the following functions via CAN communication using ADAS control unit.

Diagnosis mode	Description
Self Diagnostic Result	Displays the name of a malfunctioning system stored in the ADAS control unit.
Data Monitor	Displays ADAS control unit input/output data in real time.
Work support	Displays causes of automatic system cancellation occurred during system control.
Active Test	Enables an operational check of a load by transmitting a driving signal from the ADAS control unit to the load.
ECU identification	Displays ADAS control unit part number.
CAN Diag Support Mntr	Displays a reception/transmission state of CAN communication and ITS communication.

## SELF DIAGNOSTIC RESULT

Refer to [DAS-47, "DTC Index"](#).

# DIAGNOSIS SYSTEM (ADAS CONTROL UNIT)

< SYSTEM DESCRIPTION >

[ADAS CONTROL UNIT]

## DATA MONITOR

Monitored item [Unit]	ALL SIG (ICC)	MAIN SIG (ICC)	MAIN SIG (LDW/LDP)	MAIN SIG (BSW/BSI)	BCI MAIN	Description
MAIN SW [On/Off]	×	×	×	×		Indicates [On/Off] status as judged from ICC steering switch signal (ECM transmits ICC steering switch signal through CAN communication)
SET/COAST SW [On/Off]	×	×				Indicates [On/Off] status as judged from ICC steering switch signal (ECM transmits ICC steering switch signal through CAN communication)
CANCEL SW [On/Off]	×	×				Indicates [On/Off] status as judged from ICC steering switch signal (ECM transmits ICC steering switch signal through CAN communication)
RESUME/ACC SW [On/Off]	×	×				Indicates [On/Off] status as judged from ICC steering switch signal (ECM transmits ICC steering switch signal through CAN communication)
DISTANCE SW [On/Off]	×					Indicates [On/Off] status as judged from ICC steering switch signal (ECM transmits ICC steering switch signal through CAN communication)
CRUISE OPE [On/Off]	×	×				Indicates whether controlling or not (ON means "controlling")
BRAKE SW [On/Off]	×	×	×	×	×	Indicates [On/Off] status as judged from ICC brake switch signal (ECM transmits ICC brake switch signal through CAN communication)
STOP LAMP SW [On/Off]	×	×	×	×	×	Indicates [On/Off] status as judged from stop lamp switch signal (ECM transmits stop lamp switch signal through CAN communication)
IDLE SW [On/Off]	×				×	Indicates [On/Off] status of idle switch read from ADAS control unit through CAN communication (ECM transmits On/Off status through CAN communication)
SET DISTANCE [Short/Mid/Long]	×	×				Indicates set distance memorized in ADAS control unit
CRUISE LAMP [On/Off]	×	×				Indicates [On/Off] status of MAIN switch indicator output
OWN VHCL [On/Off]	×					Indicates [On/Off] status of own vehicle indicator output
VHCL AHEAD [On/Off]	×					Indicates [On/Off] status of vehicle ahead detection indicator output
ICC WARNING [On/Off]	×					Indicates [On/Off] status of ICC system warning lamp output
VHCL SPEED SE [km/h] or [mph]	×	×	×	×	×	Indicates vehicle speed calculated from ADAS control unit through CAN communication [ABS actuator and electric unit (control unit) transmits vehicle speed signal (wheel speed) through CAN communication]
SET VHCL SPD [km/h] or [mph]	×	×				Indicates set vehicle speed memorized in ADAS control unit
BUZZER O/P [On/Off]	×				×	Indicates [On/Off] status of ICC warning chime output
THRTL SENSOR [deg]	×	×				<b>NOTE:</b> The item is displayed, but it is not monitored
ENGINE RPM [rpm]	×					Indicates engine speed read from ADAS control unit through CAN communication (ECM transmits engine speed signal through CAN communication)
WIPER SW [OFF/LOW/HIGH]	×					Indicates wiper [OFF/LOW/HIGH] status (BCM transmits front wiper request signal through CAN communication)
BA WARNING [On/Off]	×					Indicates [On/Off] status of IBA OFF indicator lamp output
STP LMP DRIVE [On/Off]	×	×			×	Indicates [On/Off] status of ICC brake hold relay drive output

A

B

C

D

E

F

G

H

I

J

K

L

M

N

DAS

P

# DIAGNOSIS SYSTEM (ADAS CONTROL UNIT)

< SYSTEM DESCRIPTION >

[ADAS CONTROL UNIT]

Monitored item [Unit]	ALL SIG (ICC)	MAIN SIG (ICC)	MAIN SIG (LDW/LDP)	MAIN SIG (BSW/BSI)	BCI MAIN	Description
D RANGE SW [On/Off]	×					Indicates [On/Off] status of "D" or "M" positions read from ADAS control unit through CAN communication; ON when position "D" or "M" (TCM transmits shift position signal through CAN communication).
NP RANGE SW [On/Off]	×					Indicates shift position signal read from ADAS control unit through CAN communication (TCM transmits shift position signal through CAN communication)
PKB SW [On/Off]	×					Parking brake switch status [On/Off] judged from the parking brake switch signal that ADAS control unit readout via CAN communication is displayed (Combination meter transmits the parking brake switch signal via CAN communication)
PWR SUP MONI [V]	×	×				Indicates IGN voltage input by ADAS control unit
VHCL SPD AT [km/h] or [mph]	×					Indicates vehicle speed calculated from CVT vehicle speed sensor read from ADAS control unit through CAN communication (TCM transmits CVT vehicle speed sensor signal through CAN communication)
THRTL OPENING [%]	×	×			×	Indicates throttle position read from ADAS control unit through CAN communication (ECM transmits accelerator pedal position signal through CAN communication).
GEAR [1, 2, 3, 4, 5, 6]	×					Indicates CVT gear position read from ADAS control unit through CAN communication (TCM transmits current gear position signal through CAN communication)
MODE SIG [OFF, ICC, ASCD]	×					Indicates the active mode from ICC or ASCD [conventional (fixed speed) cruise control mode]
SET DISP IND [On/Off]	×					Indicates [On/Off] status of SET switch indicator output
DISTANCE [m]	×					Indicates the distance from the vehicle ahead
RELATIVE SPD [m/s]	×					Indicates the relative speed of the vehicle ahead
Camera lost [Detect/Deviate/Both]			×	×		Indicates a lane marker detection state judged from a lane marker detection signal read by the ADAS control unit via ITS communication (Lane camera unit transmits a lane marker signal via ITS communication)
Lane unclear [On/Off]			×	×		Indicates an ON/OFF state of the lane marker. The ON/OFF state is judged from a detected lane condition signal read by the ADAS control unit via ITS communication (The lane camera unit transmits a detected lane condition signal via ITS communication)
STATUS signal [Stnby/Warn/Cancl/Off]			×			Indicates a control state of LDP system
DYNA ASIST SW [On/Off]	×	×		×		Indicates [On/Off] status as judged from ICC steering switch signal (ECM transmits ICC steering switch signal through CAN communication)
DCA ON IND [On/Off]	×					The status [ON/OFF] of DCA system switch indicator output is displayed
DCA VHL AHED [On/Off]	×					The status [ON/OFF] of vehicle ahead detection indicator output in DCA system is displayed
IBA SW [On/Off]	×	×				Indicates [On/Off] status of IBA OFF switch
APA TEMP [°C]	×				×	Accelerator pedal actuator integrated motor temperature that the ADAS control unit readout via ITS communication is displayed (Accelerator pedal actuator transmits the integrated motor temperature via ITS communication)



# DIAGNOSIS SYSTEM (ADAS CONTROL UNIT)

< SYSTEM DESCRIPTION >

[ADAS CONTROL UNIT]

Monitored item [Unit]	ALL SIG (ICC)	MAIN SIG (ICC)	MAIN SIG (LDW/LDP)	MAIN SIG (BSW/BSI)	BCI MAIN	Description
APA PWR [V]	×				×	Accelerator pedal actuator power supply voltage that the ADAS control unit read-out via ITS communication is displayed (Accelerator pedal actuator transmits the power supply voltage via ITS communication)
FCW SYSTEM ON [On/Off]	×	×				Indicates [On/Off] status of FCW system
LDW SYSTEM ON [On/Off]			×			Indicates [On/Off] status of LDW system
LDW ON LAMP [On/Off]			×			Indicates [On/Off] status of warning systems ON indicator output
LDP ON IND [On/Off]			×			Indicates [On/Off] status of LDP ON indicator lamp (Green) output
LANE DPRT W/L [On/Off]			×			Indicates [On/Off] status of lane departure warning lamp (Yellow) output
LDW BUZER OUTPUT [On/Off]			×			Indicates [On/Off] status of warning buzzer output
LDP SYSTEM ON [On/Off]			×			Indicates [On/Off] status of LDP system
READY signal [On/Off]			×			Indicates LDP system settings
Shift position [Off, P, R, N, D, M/T1 - 7]			×	×	×	Indicates shift position read from ADAS control unit through CAN communication (TCM transmits shift position signal through CAN communication)
Turn signal [OFF/LH/RH/LH&RH]			×	×		Indicates turn signal operation status read from ADAS control unit through CAN communication (BCM transmits turn indicator signal through CAN communication)
SIDE G [G]			×	×		Indicates lateral G acting on the vehicle. This lateral G is judged from a side G sensor signal read by ADAS control unit via CAN communication (The ABS actuator and electric unit (control unit) transmits a side G sensor signal via CAN communication)
FUNC ITEM(FCW)	×	×	×	×		Indicates systems which can be set to ON/OFF by selecting "Driver Assistance"⇒ "Driving aids" of the navigation system FCW: Distance Control Assist (DCA), Lane Departure Prevention (LDP) and Blind Spot Intervention
FUNC ITEM(LDW)	×	×	×	×		Indicates systems which can be set to ON/OFF by selecting "Driver Assistance"⇒ "Driving aids" of the navigation system LDW: Distance Control Assist (DCA), Lane Departure Prevention (LDP) and Blind Spot Intervention
FUNC ITEM(BSW)	×	×	×	×		Indicates systems which can be set to ON/OFF by selecting "Driver Assistance"⇒ "Driving aids" of the navigation system BSW: Distance Control Assist (DCA), Lane Departure Prevention (LDP) and Blind Spot Intervention
FUNC ITEM (NV-ICC) [Off]	×	×	×	×		<b>NOTE:</b> The item is displayed, but it is not monitored
FUNC ITEM (NV-DCA) [Off]	×	×	×	×		<b>NOTE:</b> The item is displayed, but it is not monitored
DCA SELECT [On/Off]	×	×	×	×		Indicates an ON/OFF state of DCA system. DCA system can be set to ON/OFF by selecting "Driver Assistance"⇒ "Driving aids" of the navigation system
LDP SELECT [On/Off]	×	×	×	×		Indicates an ON/OFF state of LDP system. LDP system can be set to ON/OFF by selecting "Driver Assistance"⇒ "Driving aids" of the navigation system

A  
B  
C  
D  
E  
F  
G  
H  
I  
J  
K  
L  
M  
N  
P

DAS

# DIAGNOSIS SYSTEM (ADAS CONTROL UNIT)

< SYSTEM DESCRIPTION >

[ADAS CONTROL UNIT]

Monitored item [Unit]	ALL SIG (ICC)	MAIN SIG (ICC)	MAIN SIG (LDW/LDP)	MAIN SIG (BSW/BSI)	BCI MAIN	Description
BSI SELECT [On/Off]	×	×	×	×		Indicates an ON/OFF state of Blind Spot Intervention system. Blind Spot Intervention system can be set to ON/OFF by selecting "Driver Assistance"⇒"Driving aids" of the navigation system
DRIVE MODE STATS [SNO/ECO/STD/SPT]	×	×	×	×		Indicates [On/Off] status of warning systems switch
WARN SYS SW [On/Off]	×	×	×	×		Indicates [On/Off] status of warning systems switch
BSW/BSI WARN LMP [On/Off]				×		Indicates [On/Off] status of Blind Spot Warning/Blind Spot Intervention warning lamp output
BSI ON IND [On/Off]				×		Indicates [On/Off] status of Blind Spot Intervention ON indicator output
BSW SYSTEM ON [On/Off]				×		Indicates [On/Off] status of BSW system
BSI SYSTEM ON [On/Off]				×		Indicates [On/Off] status of Blind Spot Intervention system
BCI SYSTEM ON [On/Off]					×	Indicates [On/Off] status of Backup Collision Intervention system
BCI SWITCH [On/Off]					×	Indicates [On/Off] status of Backup Collision Intervention system switch
LDP WARNING INDICA- TOR [On/Off]			×			Indicates [On/Off] status of Lane Departure Prevention system failure lamp
LDW ON INDICATOR [On/Off]			×			Indicates [On/Off] status of LDW system
LDW WARNING INDICA- TOR [On/Off]			×			Indicates [On/Off] status of Lane Departure Warning system failure lamp
SYSTEM CANCEL MES- SAGE [Request/No Request]	×	×	×	×		Indicates system cancel message request
CAMERA HI TEMP MSG [On/Off]			×	×		Indicates high temperature message has been received
ITS Setting Item(DCA) [On/Off]	×	×	×	×		Indicates [On/Off] status of Distance Control Assist warning lamp output
ITS Setting Item(LDP) [On/Off]	×	×	×	×		Indicates [On/Off] status of Lane Departure Prevention warning lamp output
ITS Setting Item(BSI) [On/Off]	×	×	×	×		Indicates [On/Off] status of Blind Spot Intervention system
BSI WARNING INDICA- TOR [On/Off]				×		Indicates [On/Off] status of Blind Spot Intervention warning lamp indicator
BSW ON INDICATOR [On/Off]				×		Indicates [On/Off] status of BSW system
BSW IND BRIGHTNESS [Bright/Not Bright]				×		Indicates BSW warning lamp indicator brightness level
WARN REQ [On/Off]			×			Indicates an ADAS control unit judged warning state (ON/OFF) of LDP system

# DIAGNOSIS SYSTEM (ADAS CONTROL UNIT)

< SYSTEM DESCRIPTION >

[ADAS CONTROL UNIT]

## WORK SUPPORT

Work support items	Description
CAUSE OF AUTO-CANCEL 1	Displays causes of automatic system cancellation occurred during control of the following systems <ul style="list-style-type: none"> <li>• Vehicle-to-vehicle distance control mode</li> <li>• Conventional (fixed speed) cruise control mode</li> <li>• Distance Control Assist (DCA)</li> </ul>
CAUSE OF AUTO-CANCEL 2	Displays causes of automatic system cancellation occurred during control of the following systems <ul style="list-style-type: none"> <li>• Lane Departure Prevention (LDP)</li> <li>• Blind Spot Intervention</li> </ul>
CAUSE OF AUTO-CANCEL 3	Displays causes of automatic system cancellation occurred during control of the following system <ul style="list-style-type: none"> <li>• Backup Collision Intervention</li> </ul>

**NOTE:**

- Causes of the maximum five cancellations (system cancel) are displayed.
- The displayed cancellation causes display the number of the ignition switch ON/OFF up to 254. It is fixed to 254 if it is over 254. It returns to 0 when the same cancellation cause is detected again.

### Display Items for The Cause of Automatic Cancellation 1

Cause of cancellation	Vehicle-to-vehicle distance control mode	Conventional (fixed speed) cruise control mode	Distance Control Assist	Description
OPERATING ABS	×		×	ABS function was operated
OPERATING TCS	×	×	×	TCS function was operated
OPERATING VDC	×	×	×	VDC function was operated
ECM CIRCUIT	×	×		ECM did not permit ICC operation
OPE SW VOLT CIRC	×	×	×	The ICC steering switch input voltage is not within standard range
LASER TEMP	×		×	Temperature around ICC sensor became low
SNOW MODE SW	×		×	SNOW mode switch was pressed
OP SW DOUBLE TOUCH	×	×		ICC steering switches were pressed at the same time
VHCL SPD DOWN	×	×	×	Vehicle speed lower than the speed as follows <ul style="list-style-type: none"> <li>• Vehicle-to-vehicle distance control mode is 24 km/h (15 MPH)</li> <li>• Conventional (fixed speed) cruise control mode is 22 km/h (14 MPH)</li> </ul>
WHL SPD ELEC NOISE	×	×	×	Wheel speed sensor signal caught electromagnetic noise
VDC/TCS OFF SW	×		×	VDC OFF switch was pressed
VHCL SPD UNMATCH	×	×	×	Wheel speed became different from CVT vehicle speed
FR RADAR BLOCKED	×		×	The front bumper near the ICC sensor is blocked or dirty
TIRE SLIP	×	×		Wheel slipped

## DIAGNOSIS SYSTEM (ADAS CONTROL UNIT)

< SYSTEM DESCRIPTION >

[ADAS CONTROL UNIT]

IGN LOW VOLT	×	×	×	Decrease in ADAS control unit IGN voltage
PARKING BRAKE ON	×	×		The parking brake is engaged
WHEEL SPD UNMATCH	×	×	×	The wheel speeds of 4 wheels are out of the specified values
INCHING LOST	×			A vehicle ahead is not detected during the following driving when the vehicle speed is approximately 24 km/h (15 MPH) or less
CAN COMM ERROR	×	×	×	ADAS control unit received an abnormal signal with CAN communication
ABS/TCS/VDC CIRC	×	×	×	An abnormal condition occurs in VDC/TCS/ABS system
ECD CIRCUIT	×	×	×	An abnormal condition occurs in ECD system
ASCD VHCL SPD DTAC		×		Vehicle speed is detached from set vehicle speed
ASCD DOUBLE COMD		×		Cancel switch and operation switch are detected simultaneously
APA HI TEMP			×	The accelerator pedal actuator integrated motor temperature is high
ICC SENSOR CAN COMM ERR	×		×	Communication error between ADAS control unit and the ICC sensor
ABS WARNING LAMP	×		×	ABS warning lamp ON
NO RECORD	×	×	×	—

### Display Items for The Cause of Automatic Cancellation 2

Cause of cancellation	Lane departure prevention	Blind spot intervention	Description
OPE VDC/TCS/ABS 1	×		The activation of VDC, TCS, or ABS during LDP system control
Vehicle dynamics	×		Vehicle behavior exceeds specified value
Steering speed	×		Steering speed was more than the specified value in evasive direction
End by yaw angle	×		Yaw angle was the end of LDP control
Departure yaw large	×		Detected more than the specified value of yaw angle in departure direction
ICC WARNING	×		Target approach warning of ICC system, IBA system, or FCW system was activated
CURVATURE	×		Road curve was more than the specified value
Steering angle large	×		Steering angle was more than the specified value
Brake is operated	×		Brake pedal was operated
IGN LOW VOLT	×		Decrease in ADAS control unit IGN voltage
Lateral offset	×		Distance of vehicle and lane was detached in lateral direction more than the specified value
Lane marker lost	×		Lane camera unit lost the trace of lane marker
Lane marker unclear	×		Detected lane marker was unclear
Yaw acceleration	×		Detected yawing speed was more than the specified value
Deceleration large	×		Deceleration in a longitudinal direction was more than the specified value
Accel is operated	×		Accelerator pedal was depressed
Departure steering	×		Steering wheel was steered more than the specified value in departure direction
Evasive steering	×		Steering wheel was steered more than the specified value in the evasive direction
R range	×		Selector lever was operated to R range
Parking brake drift	×		Rear wheels lock was detected

# DIAGNOSIS SYSTEM (ADAS CONTROL UNIT)

< SYSTEM DESCRIPTION >

[ADAS CONTROL UNIT]

Cause of cancellation	Lane departure prevention	Blind spot intervention	Description
Not operating condition	×		Did not meet the operating condition (vehicle speed, turn signal operation, etc.)
SNOW MODE SW	×		SNOW mode switch was pressed
VDC OFF SW	×		VDC OFF switch was pressed
OPE VDC/ABS 2	×		The activation of VDC or ABS during a standby time of LDP system control
BSI WARNING	×		Blind Spot Intervention system was activated
BSI) OPE VDC/TCS/ABS 1		×	The activation of VDC, TCS, or ABS during Blind Spot Intervention system control
BSI) Vehicle dynamics		×	Vehicle behavior exceeds specified value
BSI) Steering speed		×	Steering speed was more than the specified value in evasive direction
BSI) End by yaw angle		×	Yaw angle was the end of Blind Spot Intervention control
BSI) Departure yaw large		×	Detected more than the specified value of yaw angle in departure direction
BSI) ICC WARNING		×	Target approach warning of ICC system, IBA system or FCW system was activated
BSI) CURVATURE		×	Road curve was more than the specified value
BSI) Steering angle large		×	Steering angle was more than the specified value
BSI) Brake is operated		×	Brake pedal was operated
BSI) IGN LOW VOLT		×	Decrease in ADAS control unit IGN voltage
BSI) Lateral offset		×	Distance of vehicle and lane was detached in lateral direction more than the specified
BSI) Lane marker lost		×	Lane camera unit lost the trace of lane marker
BSI) Lane marker unclear		×	Detected lane marker was unclear
BSI) Yaw acceleration		×	Detected yawing speed was more than the specified value
BSI) Deceleration large		×	Deceleration in a longitudinal direction was more than the specified value
BSI) Accel is operated		×	Accelerator pedal was depressed
BSI) Departure steering		×	Steering wheel was steered more than the specified value in departure direction
BSI) Evasive steering		×	Steering wheel was steered more than the specified value in the evasive direction
BSI) R range		×	Selector lever was operated to R range
BSI) Parking brake drift		×	Rear wheels lock was detected
BSI) SNOW MODE SW		×	SNOW mode switch was pressed
BSI) VDC OFF SW		×	VDC OFF switch was pressed
BSI) OPE VDC/ABS 2		×	The activation of VDC or ABS during a standby time of Blind Spot Intervention system control
BSI) Not operating condition		×	Did not meet the operating condition (vehicle speed, turn signal operation, etc.)
Side Radar Lost		×	Unrecognized side radar LH or RH by the ADAS control unit
NO RECORD	×	×	—

A  
B  
C  
D  
E  
F  
G  
H  
I  
J  
K  
L  
M  
N  
P

DAS

Display Items for The Cause of Automatic Cancellation 3

# DIAGNOSIS SYSTEM (ADAS CONTROL UNIT)

< SYSTEM DESCRIPTION >

[ADAS CONTROL UNIT]

Cause of cancellation	Backup Collision Intervention	Description
OPERATING WIPER	×	The wiper operates at HI (it includes when the wiper is operated at HI with the wiper switch AUTO position)
OPERATING ABS	×	ABS function was operated
OPERATING TCS	×	TCS function was operated
OPERATING VDC	×	VDC function was operated
ECM CIRCUIT	×	ECM did not permit ICC operation
SNOW MODE SW	×	SNOW mode switch was pressed
VDC/TCS OFF SW	×	VDC OFF switch was pressed
VHCL SPD UNMATCH	×	Wheel speed became different from CVT vehicle speed
TIRE SLIP	×	Wheel slipped
IGN LOW VOLT	×	Decrease in ADAS control unit IGN voltage
PARKING BRAKE ON	×	The parking brake is engaged
WHEEL SPD UNMATCH	×	The wheel speeds of 4 wheels are out of the specified values
CAN COMM ERROR	×	ADAS control unit received an abnormal signal with CAN communication
ABS/TCS/VDC CIRC	×	An abnormal condition occurs in VDC/TCS/ABS system
ECD CIRCUIT	×	An abnormal condition occurs in ECD system
APA HI TEMP		The accelerator pedal actuator integrated motor temperature is high
ABS WARNING LAMP	×	ABS warning lamp ON
Brake is operated	×	Brake pedal was operated
Accel is operated	×	Accelerator pedal was depressed
SNOW MODE SW	×	DMS switch SNOW mode was selected
VDC OFF SW	×	VDC OFF switch was pressed
Side Radar Lost	×	Unrecognized side radar LH or RH by the ADAS control unit
NO RECORD	×	—

## ACTIVE TEST

### CAUTION:

- Never perform “Active Test” while driving the vehicle.
- The “Active Test” cannot be performed when the following systems warning lamp is illuminated.
  - ICC system warning lamp
  - Lane departure warning lamp
  - Blind Spot Warning/Blind Spot Intervention warning lamp
  - IBA OFF indicator lamp (IBA system ON)
- Shift the selector lever to “P” position, and then perform the test.

Test item	Description
BRAKE ACTUATOR	Activates the brake by an arbitrary operation
ICC BUZZER	Sounds a buzzer used for following systems by arbitrarily operating ON/OFF <ul style="list-style-type: none"> <li>• Intelligent Cruise Control (ICC)</li> <li>• Distance Control Assist (DCA)</li> <li>• Forward Collision Warning (FCW)</li> <li>• Intelligent Brake Assist (IBA)</li> </ul>

# DIAGNOSIS SYSTEM (ADAS CONTROL UNIT)

< SYSTEM DESCRIPTION >

[ADAS CONTROL UNIT]

Test item	Description
METER LAMP	The ICC system warning lamp, MAIN switch indicator and IBA OFF indicator lamp can be illuminated by ON/OFF operations as necessary
STOP LAMP	The ICC brake hold relay can be operated by ON/OFF operations as necessary, and the stop lamp can be illuminated
ACTIVE PEDAL	The accelerator pedal actuator can be operated as necessary
DCA INDICATOR	The DCA system switch indicator can be illuminated by ON/OFF operations as necessary
LDP BUZZER	Sounds a buzzer used for following systems by arbitrarily operating ON/OFF <ul style="list-style-type: none"> <li>• Lane Departure Warning (LDW)</li> <li>• Lane Departure Prevention (LDP)</li> <li>• Blind Spot Warning (BSW)</li> <li>• Blind Spot Intervention</li> </ul>
WARNING SYSTEM IND	Warning systems ON indicator (on warning systems switch) can be illuminated by ON/OFF operations as necessary
LDP ON IND	The LDP ON indicator lamp can be illuminated by ON/OFF operations as necessary
LANE DEPARTURE W/L	The Lane departure warning lamp can be illuminated by ON/OFF operations as necessary
BSW/BSI WARNING LAMP	The Blind Spot Warning/Blind Spot Intervention warning lamp can be illuminated by ON/OFF operations as necessary
BSI ON INDICATOR	The Blind Spot Intervention ON indicator can be illuminated by ON/OFF operations as necessary
LDW ON INDICATOR	The LDW ON indicator lamp can be illuminated by ON/OFF operations as necessary
BSW ON INDICATOR	The BSW ON indicator lamp can be illuminated by ON/OFF operations as necessary

## BRAKE ACTUATOR

### NOTE:

The test can be performed only when the engine is running.

Test item	Operation	Description	"PRESS SENS" value
BRAKE ACTUATOR	MODE1	Transmits the brake fluid pressure control signal to the ABS actuator and electric unit (control unit) via CAN communication	10 bar
	MODE2		20 bar
	MODE3		30 bar
	Test start	Starts the tests of "MODE1", "MODE2" and "MODE3"	—
	Reset	Stops transmitting the brake fluid pressure control signal below to end the test	—
	End	Returns to the "SELECT TEST ITEM" screen	—

### NOTE:

The test is finished in 10 seconds after starting

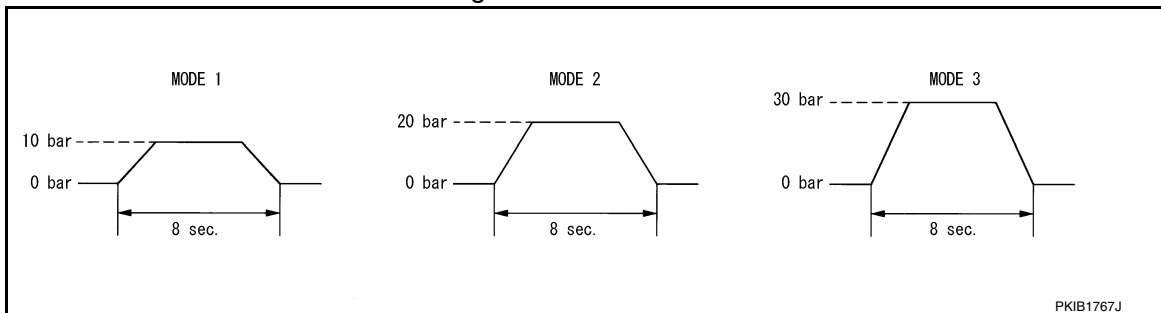

## ICC BUZZER

A  
B  
C  
D  
E  
F  
G  
H  
I  
J  
K  
L  
M  
N  
P



# DIAGNOSIS SYSTEM (ADAS CONTROL UNIT)

< SYSTEM DESCRIPTION >

[ADAS CONTROL UNIT]

Test item	Operation	Description	ICC warning chime operation sound
ICC BUZZER	MODE1	Transmits the buzzer output signals to the combination meter via CAN communication	Intermittent beep sound
	Test start	Starts the tests of "MODE1"	—
	Reset	Stops transmitting the buzzer output signal below to end the test	—
	End	Returns to the "SELECT TEST ITEM" screen	—

## METER LAMP

### NOTE:

The test can be performed only when the engine is running.

Test item	Operation	Description	<ul style="list-style-type: none"> <li>• MAIN switch indicator</li> <li>• ICC system warning lamp</li> <li>• IBA OFF indicator lamp</li> </ul>
METER LAMP	Off	Stops sending the following signals to exit from the test <ul style="list-style-type: none"> <li>• Meter display signal</li> <li>• ICC warning lamp signal</li> <li>• IBA OFF indicator lamp signal</li> </ul>	OFF
	On	Transmits the following signals to the combination meter via CAN communication <ul style="list-style-type: none"> <li>• Meter display signal</li> <li>• ICC warning lamp signal</li> <li>• IBA OFF indicator lamp signal</li> </ul>	ON

## STOP LAMP

Test item	Operation	Description	Stop lamp
STOP LAMP	Off	Stops transmitting the ICC brake hold relay drive signal below to end the test	OFF
	On	Transmits the ICC brake hold relay drive signal	ON

## ACTIVE PEDAL

### CAUTION:

- Shift the selector lever to "P" position, and then perform the test.
- Never depress the accelerator pedal excessively. (The engine speed may rise unexpectedly when finishing the test.)

### NOTE:

- Depress the accelerator pedal to check when performing the test.
- The test can be performed only when the engine is running.

Test item	Operation	Description	Accelerator pedal operation
Active Pedal	MODE1	Transmit the accelerator pedal feedback force control signal to the accelerator pedal actuator via ITS communication.	Constant with a force of 25 N for 8 seconds
	MODE2		Constant with a force of 15 N for 8 seconds
	MODE3		Change up to a force of 25 N for 8 seconds
	MODE4		Change up to a force of 15 N for 8 seconds
	Test start	Starts the tests of "MODE1", "MODE2", "MODE3" and "MODE4"	—
	Reset	Stops transmitting the accelerator pedal feedback force control signal below to end the test.	—
	End	Returns to the "SELECT TEST ITEM" screen	—



# DIAGNOSIS SYSTEM (ADAS CONTROL UNIT)

< SYSTEM DESCRIPTION >

[ADAS CONTROL UNIT]

**NOTE:**

The test is finished in 10 seconds after starting

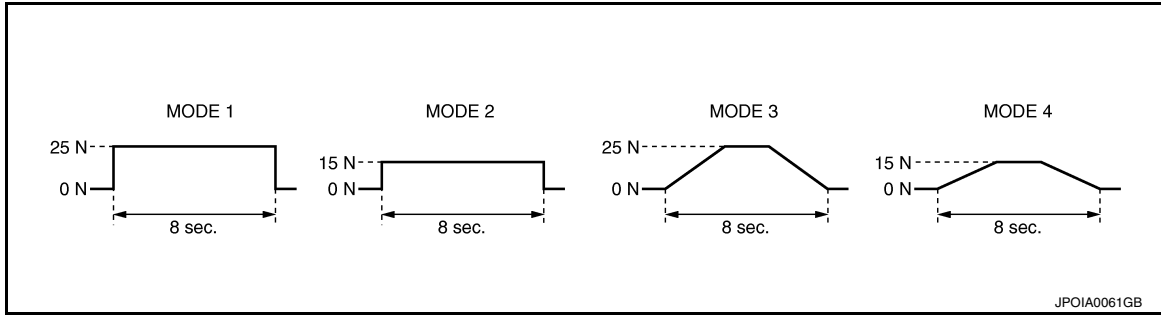

**DCA INDICATOR**

**NOTE:**

The test can be performed only when the engine is running.

Test item	Operation	Description	DCA system switch indicator
DCA INDICATOR	Off	Stops transmitting the DCA system switch indicator signal below to end the test	—
	On	Transmits the DCA system switch indicator signal to the combination meter via CAN communication	ON

**LDP BUZZER**

Test item	Operation	Description	Warning buzzer
LDP BUZZER	Off	Stops transmitting the warning buzzer signal below to end the test	—
	On	Transmits the warning buzzer signal to the warning buzzer	ON

**WARNING SYSTEM IND**

Test item	Operation	Description	Warning systems ON indicator
WARNING SYSTEM IND	Off	Stops transmitting the warning systems ON indicator signal below to end the test	—
	On	Transmits the warning systems ON indicator signal to the warning systems ON indicator	ON

**LDP ON IND**

Test item	Operation	Description	LDP ON indicator lamp (Green)
LDP ON IND	Off	Stops transmitting the LDP ON indicator lamp signal below to end the test	—
	On	Transmits the LDP ON indicator lamp signal to the combination meter via CAN communication	ON

**LANE DEPARTURE W/L**

Test item	Operation	Description	Lane departure warning lamp (Yellow)
LANE DEPARTURE W/L	Off	Stops transmitting the lane departure warning lamp signal below to end the test	—
	On	Transmits the lane departure warning lamp signal to the combination meter via CAN communication	ON

A  
B  
C  
D  
E  
F  
G  
H  
I  
J  
K  
L  
M  
N  
P

DAS

# DIAGNOSIS SYSTEM (ADAS CONTROL UNIT)

< SYSTEM DESCRIPTION >

[ADAS CONTROL UNIT]

## BSW/BSI WARNING LAMP

Test item	Operation	Description	Blind Spot Warning/Blind Spot Intervention warning lamp (Yellow)
BSW/BSI WARNING LAMP	Off	Stops transmitting the Blind Spot Warning/Blind Spot Intervention warning lamp signal below to end the test	—
	On	Transmits the Blind Spot Warning/Blind Spot Intervention warning lamp signal to the combination meter via CAN communication	ON

## BSI ON INDICATOR

Test item	Operation	Description	Blind Spot Intervention ON indicator lamp (Green)
BSI ON INDICATOR	Off	Stops transmitting the Blind Spot Intervention ON indicator signal below to end the test	—
	On	Transmits the Blind Spot Intervention ON indicator signal to the combination meter via CAN communication	ON

## LDW ON INDICATOR

Test item	Operation	Description	Lane Departure Warning ON indicator lamp (Yellow)
LDW ON INDICATOR	Off	Stops transmitting the Lane Departure Warning ON indicator signal below to end the test	—
	On	Transmits the Lane Departure Warning ON indicator signal to the combination meter via CAN communication	ON

## BSW ON INDICATOR

Test item	Operation	Description	Blind Spot Warning ON indicator lamp (Yellow)
BSW ON INDICATOR	Off	Stops transmitting the Blind Spot Warning ON indicator signal below to end the test	—
	On	Transmits the Blind Spot Warning ON indicator signal to the warning lamp on the door	ON

## ECU IDENTIFICATION

ADAS control unit part number is displayed.

# ADAS CONTROL UNIT

< ECU DIAGNOSIS INFORMATION >

[ADAS CONTROL UNIT]

## ECU DIAGNOSIS INFORMATION

### ADAS CONTROL UNIT

Reference Value

INFOID:000000009716372

#### VALUES ON THE DIAGNOSIS TOOL

Monitor item	Condition	Value/Status	
MAIN SW	Ignition switch ON	When MAIN switch is pressed	On
		When MAIN switch is not pressed	Off
SET/COAST SW	Ignition switch ON	When SET/COAST switch is pressed	On
		When SET/COAST switch is not pressed	Off
CANCEL SW	Ignition switch ON	When CANCEL switch is pressed	On
		When CANCEL switch is not pressed	Off
RESUME/ACC SW	Ignition switch ON	When RESUME/ACCELERATE switch is pressed	On
		When RESUME/ACCELERATE switch is not pressed	Off
DISTANCE SW	Ignition switch ON	When DISTANCE switch is pressed	On
		When DISTANCE switch is not pressed	Off
CRUISE OPE	Drive the vehicle and activate the vehicle-to-vehicle distance control mode	When ICC system is controlling	On
		When ICC system is not controlling	Off
BRAKE SW	Ignition switch ON	When brake pedal is depressed	Off
		When brake pedal is not depressed	On
STOP LAMP SW	Ignition switch ON	When brake pedal is depressed	On
		When brake pedal is not depressed	Off
IDLE SW	Engine running	Idling	On
		Except idling (depress accelerator pedal)	Off
SET DISTANCE	<ul style="list-style-type: none"> <li>• Start the engine and turn the ICC system ON</li> <li>• Press the DISTANCE switch to change the vehicle-to-vehicle distance setting</li> </ul>	When set to "long"	Long
		When set to "middle"	Mid
		When set to "short"	Short
CRUISE LAMP	Start the engine and press MAIN switch	ICC system ON (MAIN switch indicator ON)	On
		ICC system OFF (MAIN switch indicator OFF)	Off
OWN VHCL	Start the engine and press MAIN switch	ICC system ON (Own vehicle indicator ON)	On
		ICC system OFF (Own vehicle indicator OFF)	Off
VHCL AHEAD	Drive the vehicle and activate the vehicle-to-vehicle distance control mode	When a vehicle ahead is detected (vehicle ahead detection indicator ON)	On
		When a vehicle ahead is not detected (vehicle ahead detection indicator OFF)	Off
ICC WARNING	Start the engine and press MAIN switch	When ICC system is malfunctioning (ICC system warning lamp ON)	On
		When ICC system is normal (ICC system warning lamp OFF)	Off

A  
B  
C  
D  
E  
F  
G  
H  
I  
J  
K  
L  
M  
N  
P

DAS

# ADAS CONTROL UNIT

< ECU DIAGNOSIS INFORMATION >

[ADAS CONTROL UNIT]

Monitor item	Condition		Value/Status
VHCL SPEED SE	While driving		Displays a vehicle speed calculated by the ADAS control unit
SET VHCL SPD	While driving	When vehicle speed is set	Displays the set vehicle speed
BUZZER O/P	Engine running	When the buzzer of the following system operates <ul style="list-style-type: none"> <li>• Vehicle-to-vehicle distance control mode</li> <li>• DCA system</li> <li>• FCW system</li> <li>• IBA system</li> </ul>	On
		When the buzzer of the following system not operates <ul style="list-style-type: none"> <li>• Vehicle-to-vehicle distance control mode</li> <li>• DCA system</li> <li>• FCW system</li> <li>• IBA system</li> </ul>	Off
THRTL SENSOR	<b>NOTE:</b> The item is indicated, but not monitored		0.0
ENGINE RPM	Engine running		Equivalent to tachometer reading
WIPER SW	Ignition switch ON	Wiper not operating	Off
		Wiper LO operation	Low
		Wiper HI operation	High
BA WARNING	Engine running	IBA OFF indicator lamp ON <ul style="list-style-type: none"> <li>• When IBA system is malfunctioning</li> <li>• When IBA system is turned to OFF</li> </ul>	On
		IBA OFF indicator lamp OFF <ul style="list-style-type: none"> <li>• When IBA system is normal</li> <li>• When IBA system is turned to ON</li> </ul>	Off
STP LMP DRIVE	Drive the vehicle and activate the vehicle-to-vehicle distance control mode	When ICC brake hold relay is activated	On
		When ICC brake hold relay is not activated	Off
D RANGE SW	Engine running	When the selector lever is in "D" position or manual mode	On
		When the selector lever is in any position other than "D" or manual mode	Off
NP RANGE SW	Engine running	When the selector lever is in "N", "P" position	On
		When the selector lever is in any position other than "N", "P"	Off
PKB SW	Ignition switch ON	When the parking brake is applied	On
		When the parking brake is released	Off
PWR SUP MONI	Engine running		Power supply voltage value of ADAS control unit
VHCL SPD AT	While driving		Value of CVT vehicle speed sensor signal
THRTL OPENING	Engine running	Depress accelerator pedal	Displays the throttle position

# ADAS CONTROL UNIT

< ECU DIAGNOSIS INFORMATION >

[ADAS CONTROL UNIT]

Monitor item	Condition		Value/Status
GEAR	While driving		Displays the gear position
MODE SIG	Start the engine and press MAIN switch	When ICC system is deactivated	Off
		When vehicle-to-vehicle distance control mode is activated	ICC
		When conventional (fixed speed) cruise control mode is activated	ASCD
SET DISP IND	<ul style="list-style-type: none"> <li>• Drive the vehicle and activate the conventional (fixed speed) cruise control mode</li> <li>• Press SET/COAST switch</li> </ul>	SET switch indicator ON	On
		SET switch indicator OFF	Off
DISTANCE	Drive the vehicle and activate the vehicle-to-vehicle distance control mode	When a vehicle ahead is detected	Displays the distance from the preceding vehicle
		When a vehicle ahead is not detected	0.0
RELATIVE SPD	Drive the vehicle and activate the vehicle-to-vehicle distance control mode	When a vehicle ahead is detected	Displays the relative speed.
		When a vehicle ahead is not detected	0.0
Camera lost	Drive the vehicle and activate the LDW system, LDP system or Blind Spot Intervention system	Both side lane markers are detected	Detect
		Deviate side lane marker is lost	Deviate
		Both side lane markers are lost	Both
Lane unclear	While driving	Lane marker is unclear	On
		Lane marker is clear	Off
STATUS signal	Drive the vehicle with the LDP system turned ON	When the LDP system is ON	Stnby
		When the LDP system is operating	Warn
		When the LDP system is canceled	Cancl
		When the LDP system is OFF	Off
DYNA ASIST SW	Ignition switch ON	When dynamic driver assistance switch is pressed	On
		When dynamic driver assistance switch is not pressed	Off
DCA ON IND	Start the engine and press dynamic driver assistance switch (When DCA system setting is ON)	DCA system OFF (DCA system switch indicator OFF)	Off
		DCA system ON (DCA system switch indicator ON)	On
DCA VHL AHED	Drive the vehicle and activate the DCA system	When a vehicle ahead is not detected (vehicle ahead detection indicator OFF)	Off
		When a vehicle ahead is detected (vehicle ahead detection indicator ON)	On
IBA SW	Ignition switch ON	When the IBA OFF switch is pressed	On
		When the IBA OFF switch is not pressed	Off
APA TEMP	Engine running		Display the accelerator pedal actuator integrated motor temperature
APA PWR	Ignition switch ON		Power supply voltage value of accelerator pedal actuator

A

B

C

D

E

F

G

H

I

J

K

L

M

N

DAS

P

# ADAS CONTROL UNIT

< ECU DIAGNOSIS INFORMATION >

[ADAS CONTROL UNIT]

Monitor item	Condition		Value/Status
FCW SYSTEM ON	Ignition switch ON	When the FCW system is ON (Warning systems ON indicator ON)	On
		When the FCW system is OFF (Warning systems ON indicator OFF)	Off
LDW SYSTEM ON	Ignition switch ON	When the LDW system is ON (Warning systems ON indicator ON)	On
		When the LDW system is OFF (Warning systems ON indicator OFF)	Off
LDW ON LAMP	Ignition switch ON	Warning systems ON indicator ON	On
		Warning systems ON indicator OFF	Off
LDP ON IND	Start the engine and press dynamic driver assistance switch (When LDP system setting is ON)	LDP ON indicator lamp ON	On
		LDP ON indicator lamp OFF	Off
LANE DPRT W/L	Drive the vehicle and activate the LDW system or LDP system	Lane departure warning lamp ON	On
		Lane departure warning lamp OFF	Off
LDW BUZER OUTPUT	Drive the vehicle and activate the LDW/LDP system or Blind Spot Warning/Blind Spot Intervention system	When the buzzer of the following system operates • LDW/LDP system • Blind Spot Warning/Blind Spot Intervention system	On
		When the buzzer of the following system does not operate • LDW/LDP system • Blind Spot Warning/Blind Spot Intervention system	Off
LDP SYSTEM ON	Start the engine and press dynamic driver assistance switch (When LDP system setting is ON)	When the LDP system is ON	On
		When the LDP system is OFF	Off
READY signal	Start the engine and press dynamic driver assistance switch (When LDP system setting is ON)	When the LDP system is ON	On
		When the LDP system is OFF	Off
Shift position	<ul style="list-style-type: none"> <li>• Engine running</li> <li>• While driving</li> </ul>		Displays the shift position
Turn signal	Turn signal lamps OFF		Off
	Turn signal lamp LH blinking		LH
	Turn signal lamp RH blinking		RH
	Turn signal lamp LH and RH blinking		LH&RH
SIDE G	While driving	Vehicle turning right	Negative value
		Vehicle turning left	Positive value
FUNC ITEM (FCW)	Ignition switch ON		FCW
FUNC ITEM (LDW)	Ignition switch ON		LDW
FUNC ITEM (BSW)	Ignition switch ON		BSW
FUNC ITEM (NV-ICC)	<b>NOTE:</b> The item is indicated, but not monitored		Off
FUNC ITEM (NV-DCA)	<b>NOTE:</b> The item is indicated, but not monitored		Off
DCA SELECT	Ignition switch ON	"Distance Control Assist" set with the navigation system is ON	On
		"Distance Control Assist" set with the navigation system is OFF	Off

# ADAS CONTROL UNIT

< ECU DIAGNOSIS INFORMATION >

[ADAS CONTROL UNIT]

Monitor item	Condition	Value/Status	
LDP SELECT	Ignition switch ON	"Lane Departure Prevention" set with the navigation system is ON	On
		"Lane Departure Prevention" set with the navigation system is OFF	Off
BSI SELECT	Ignition switch ON	"Blind Spot Intervention" set with the navigation system is ON	On
		"Blind Spot Intervention" set with the navigation system is OFF	Off
DRIVE MODE STATS	Ignition switch ON	When the DMS switch is in normal position	Std
		When the DMS switch is in SNOW position	SNO
		When the DMS switch is in ECO position	ECO
		When the DMS switch is in SPORT position	SPT
WARN SYS SW	Ignition switch ON	When warning systems switch is pressed	On
		When warning systems switch is not pressed	Off
BSW/BSI WARN LMP	Ignition switch ON	Blind Spot Warning/Blind Spot Intervention warning lamp ON	On
		Blind Spot Warning/Blind Spot Intervention warning lamp OFF	Off
BSI ON IND	Ignition switch ON	Blind Spot Intervention ON indicator ON	On
		Blind Spot Intervention ON indicator OFF	Off
BSW SYSTEM ON	Ignition switch ON	When the BSW system is ON (Warning systems ON indicator ON)	On
		When the BSW system is OFF (Warning systems ON indicator OFF)	Off
BSI SYSTEM ON	Start the engine and press dynamic driver assistance switch (When Blind Spot Intervention system setting is ON)	When the Blind Spot Intervention system is ON	On
		When the Blind Spot Intervention system is OFF	Off
BCI SYSTEM ON	Ignition switch ON	Back-up Collision Intervention system ON	On
		Back-up Collision Intervention system OFF	Off
BCI SWITCH	Ignition switch ON	Back-up Collision Intervention switch ON	On
		Back-up Collision Intervention switch OFF	Off
LDP WARNING INDICATOR	Ignition switch ON	When the LDP fail lamp is ON (Warning systems ON indicator ON)	On
		When the LDP fail lamp is OFF	Off
LDW ON LAMP	Ignition switch ON	When LDW indicator lamp is ON	On
		When LDW indicator lamp is OFF	Off
LDW WARNING INDICATOR	Ignition switch ON	When LDW FAIL lamp is ON	On
		When LDW FAIL lamp is OFF	Off
SYSTEM CANCEL MESSAGE	Ignition switch ON	When a system cancel message is sent	Request
		When a system cancel message is not sent	No Request
CAMERA HI TEMP MSG	Ignition switch ON	When camera high temperature message is sent	On
		When camera high temperature message is not sent	Off
ITS Setting Item(DCA)	Ignition switch ON	When the DCA is set	On
		When the DCA is not set	Off
ITS Setting Item(LDP)	Ignition switch ON	When the LDP is set	On
		When the LDP is not set	Off

A

B

C

D

E

F

G

H

I

J

K

L

M

N

DAS

P

# ADAS CONTROL UNIT

< ECU DIAGNOSIS INFORMATION >

[ADAS CONTROL UNIT]

Monitor item	Condition		Value/Status
ITS Setting Item(BSI)	Ignition switch ON	When the BSI is set	On
		When the BSI is not set	Off
BSI WARNING INDICATOR	Ignition switch ON	When BSI FAIL indicator warning lamp is ON	On
		When BSI FAIL indicator warning lamp is OFF	Off
BSW ON INDICATOR	Ignition switch ON	When BSW ON indicator lamp is ON	On
		When BSW ON indicator lamp is OFF	Off
BSW IND BRIGHTNESS	Ignition switch ON	When BSW indicator brightness is selected	On
		When BSW indicator brightness is not selected	Off
WARN REQ	Drive the vehicle and activate the LDP system	Lane departure warning is operating	On
		Lane departure warning is not operating	Off

## TERMINAL LAYOUT

## PHYSICAL VALUES

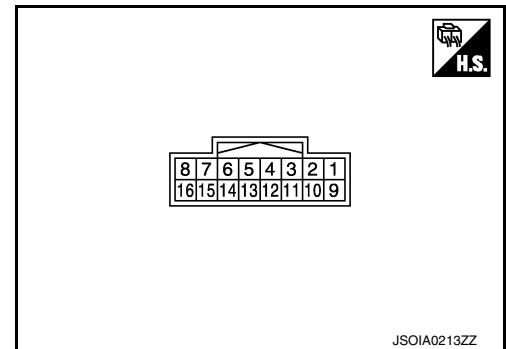

Terminal No. (Wire color)		Description		Condition	Value (Approx.)
+	-	Signal name	Input/ Output		
5 (G)	Ground	ICC brake hold relay drive signal	Output	Ignition switch ON	12 V
				At "STOP LAMP" test of "Active test"	0 V
6 (B)		Ground	Input	—	0 V
7 (L)		ITS communication-H	—	—	—
8 (Y)		ITS communication-L	—	—	—
14 (B)		CAN -H	—	—	—
15 (W)		CAN -L	—	—	—
16 (R)	Ignition power supply	Input	Ignition switch ON	Battery Voltage	

## Fail-safe

INFOID:000000009716373

If a malfunction occurs in each system, ADAS control unit cancels each control, sounds a beep, and turns ON the warning lamp or indicator lamp.

System	Buzzer	Warning lamp/Indicator lamp	Description
Vehicle-to-vehicle distance control mode	High-pitched tone	ICC system warning lamp	Cancel
Conventional (fixed speed) cruise control mode	High-pitched tone	ICC system warning lamp	Cancel



# ADAS CONTROL UNIT

< ECU DIAGNOSIS INFORMATION >

[ADAS CONTROL UNIT]

System	Buzzer	Warning lamp/Indicator lamp	Description
Intelligent Brake Assist (IBA)	High-pitched tone	IBA OFF indicator lamp	Cancel
Forward Collision Warning (FCW)	High-pitched tone	Warning message	Cancel
Distance Control Assist (DCA)	High-pitched tone	DCA system warning	Cancel
Lane Departure Warning (LDW)	—	Lane departure warning lamp	Cancel
Lane Departure Prevention (LDP)	Low-pitched tone	Lane departure warning lamp	Cancel
Blind Spot Warning (BSW)	—	Blind Spot Warning/Blind Spot Intervention warning lamp	Cancel
Blind Spot Intervention	Low-pitched tone	Blind Spot Warning/Blind Spot Intervention warning lamp	Cancel
Backup Collision Intervention (BCI)	High-pitched tone	Backup Collision Intervention warning indicator	Cancel

## DTC Inspection Priority Chart

INFOID:000000009716374

If multiple DTCs are detected simultaneously, check them one by one depending on the following DTC inspection priority chart.

Priority	Detected items (DTC)
1	<ul style="list-style-type: none"> <li>• C1A0A: CONFIG UNFINISHED</li> <li>• U1507: LOST COMM (SIDE RDR R)</li> <li>• U1508: LOST COMM (SIDE RDR L)</li> </ul>
2	<ul style="list-style-type: none"> <li>• U1000: CAN COMM CIRCUIT</li> <li>• U1010: CONTROL UNIT (CAN)</li> </ul>
3	<ul style="list-style-type: none"> <li>• C1B00: CAMERA UNIT MALF</li> <li>• C1F02: APA C/U MALF</li> <li>• C1A17: ICC SENSOR MALF</li> <li>• C1B53: SIDE RDR R MALF</li> <li>• C1B54: SIDE RDR L MALF</li> </ul>

DAS

# ADAS CONTROL UNIT

< ECU DIAGNOSIS INFORMATION >

[ADAS CONTROL UNIT]

Priority	Detected items (DTC)
4	<ul style="list-style-type: none"> <li>• C1A01: POWER SUPPLY CIR</li> <li>• C1A02: POWER SUPPLY CIR 2</li> <li>• C1A04: ABS/TCS/VDC CIRC</li> <li>• C1A05: BRAKE SW/STOP L SW</li> <li>• C1A06: OPERATION SW CIRC</li> <li>• C1A12: LASER BEAM OFFCNTR</li> <li>• C1A13: STOP LAMP RLY FIX</li> <li>• C1A14: ECM CIRCUIT</li> <li>• C1A16: RADAR STAIN</li> <li>• C1A18: LASER AIMING INCOMP</li> <li>• C1A2A: ICC SEN PWR SUP CIR</li> <li>• C1A21: ICC SENSOR HIGH TEMP</li> <li>• C1A24: NP RANGE</li> <li>• C1A26: ECD MODE MALF</li> <li>• C1A27: ECD PWR SUPPLY CIR</li> <li>• C1A33: CAN TRANSMISSION ERR</li> <li>• C1A34: COMMAND ERROR</li> <li>• C1A35: APA CIR</li> <li>• C1A36: APA CAN COMM CIR</li> <li>• C1A37: APA CAN CIR 2</li> <li>• C1A38: APA CAN CIR 1</li> <li>• C1A39: STRG SEN CIR</li> <li>• C1A40: SYSTEM SW CIRC</li> <li>• C1B01: CAM AIMING INCOMP</li> <li>• C1B03: CAM ABNRML TMP DETCT</li> <li>• C1B56: SONAR CIRCUIT</li> <li>• C1B57: AVM CIRCUIT</li> <li>• C1F01: APA MOTOR MALF</li> <li>• C1F05: APA PWR SUPPLY CIR</li> <li>• U0121: VDC CAN CIR 2</li> <li>• U0126: STRG SEN CAN CIR 1</li> <li>• U0235: ICC SENSOR CAN CIRC 1</li> <li>• U0401: ECM CAN CIR 1</li> <li>• U0402: TCM CAN CIR 1</li> <li>• U0415: VDC CAN CIR 1</li> <li>• U0428: STRG SEN CAN CIR 2</li> <li>• U1500: CAM CAN CIR 2</li> <li>• U1501: CAM CAN CIR 1</li> <li>• U1502: ICC SEN CAN COMM CIR</li> <li>• U1503: SIDE RDR L CAN CIR 2</li> <li>• U1504: SIDE RDR L CAN CIR 1</li> <li>• U1505: SIDE RDR R CAN CIR 2</li> <li>• U1506: SIDE RDR R CAN CIR 1</li> <li>• U1521: SONAR CAN COMMUNICATION</li> <li>• U1522: SONAR CAN COMMUNICATION</li> <li>• U1523: SONAR CAN COMMUNICATION</li> <li>• U1524: AVM CAN COMMUNICATION</li> <li>• U1525: AVM CAN COMMUNICATION</li> <li>• U150B: ECM CAN CIRC 3</li> <li>• U150C: VDC CAN CIRC 3</li> <li>• U150D: TCM CAN CIRC 3</li> <li>• U150E: BCM CAN CIRC 3</li> <li>• U150F: AV CAN CIRC 3</li> <li>• U1512: HVAC CAN CIRC3</li> <li>• U1513: METER CAN CIRC 3</li> <li>• U1514: STRG SEN CAN CIRC 3</li> <li>• U1515: ICC SENSOR CAN CIRC 3</li> <li>• U1516: CAM CAN CIRC 3</li> <li>• U1517: APA CAN CIRC 3</li> <li>• U1518: SIDE RDR L CAN CIRC 3</li> <li>• U1519: SIDE RDR R CAN CIRC 3</li> </ul>
5	<ul style="list-style-type: none"> <li>• C1A03: VHCL SPEED SE CIRC</li> </ul>
6	<ul style="list-style-type: none"> <li>• C1A15: GEAR POSITION</li> </ul>
7	<ul style="list-style-type: none"> <li>• C1A00: CONTROL UNIT</li> </ul>

# ADAS CONTROL UNIT

< ECU DIAGNOSIS INFORMATION >

[ADAS CONTROL UNIT]

## DTC Index

INFOID:000000009716375

**NOTE:**

- The details of time display are as per the following.
- CRNT: A malfunction is detected now
- PAST: A malfunction was detected in the past
- IGN counter is displayed on FFD (Freeze Frame Data).
- 0: The malfunctions that are detected now  
CAN communication system (U1000, U1010)
- 1 - 39: It increases like 0 → 1 → 2 ... 38 → 39 after returning to the normal condition whenever the ignition switch OFF → ON. It returns to 0 when a malfunction is detected again in the process.
- If it is over 39, it is fixed to 39 until the self-diagnosis results are erased.  
Other than CAN communication system (Other than U1000, U1010)
- 1 - 49: It increases like 0 → 1 → 2 ... 38 → 49 after returning to the normal condition whenever the ignition switch OFF → ON. It returns to 0 when a malfunction is detected again in the process.
- If it is over 49, it is fixed to 49 until the self-diagnosis results are erased.

Systems for fail-safe

- A: Vehicle-to-vehicle distance control mode
- B: Conventional (fixed speed) cruise control mode
- C: Intelligent Brake Assist (IBA)
- D: Forward Collision Warning (FCW)
- E: Distance Control Assist (DCA)
- F: Lane Departure Warning (LDW)/Lane Departure Prevention (LDP)
- G: Blind Spot Warning (BSW)/Blind Spot Intervention
- H: Backup Collision Intervention (BCI)

DTC			Warning lamp					Fail-safe	Reference
CONSULT	On board display		CONSULT display	ICC system warning lamp	IBA OFF indicator lamp	Lane departure warning lamp	Blind Spot Warning/Blind Spot Intervention warning lamp	Backup Collision Intervention	
C1A00	0	CONTROL UNIT	ON	ON	ON	ON	ON	A, B, C, D, E, F, G, H	<a href="#">DAS-73</a>
C1A01	1	POWER SUPPLY CIR	ON	ON	ON	ON	ON	A, B, C, D, E, F, G, H	<a href="#">DAS-74</a>
C1A02	2	POWER SUPPLY CIR 2	ON	ON	ON	ON	ON	A, B, C, D, E, F, G, H	<a href="#">DAS-74</a>
C1A03	3	VHCL SPEED SE CIRC	ON	ON	ON	ON	ON	A, B, C, D, E, F, G, H	<a href="#">DAS-160</a>
C1A04	4	ABS/TCS/VDC CIRC	ON	ON	ON	ON	ON	A, B, C, D, E, F, G, H	<a href="#">DAS-162</a>
C1A05	5	BRAKE SW/STOP L SW	ON	ON	ON	ON	ON	A, B, C, D, E, F, G, H	<a href="#">DAS-163</a>
C1A06	6	OPERATION SW CIRC	ON		ON	ON		A, B, E, F, G	<a href="#">DAS-167</a>
C1A12	12	LASER BEAM OFFCN-TR	ON	ON				A, C, D, E	<a href="#">DAS-170</a>
C1A13	13	STOP LAMP RLY FIX	ON	ON			ON	A, B, C, D, E, H	<a href="#">DAS-171</a>
C1A14	14	ECM CIRCUIT	ON		ON	ON	ON	A, B, E, F, G, H	<a href="#">DAS-177</a>

A  
B  
C  
D  
E  
F  
G  
H  
I  
J  
K  
L  
M  
N

DAS

P

# ADAS CONTROL UNIT

< ECU DIAGNOSIS INFORMATION >

[ADAS CONTROL UNIT]

Systems for fail-safe

- A: Vehicle-to-vehicle distance control mode
- B: Conventional (fixed speed) cruise control mode
- C: Intelligent Brake Assist (IBA)
- D: Forward Collision Warning (FCW)
- E: Distance Control Assist (DCA)
- F: Lane Departure Warning (LDW)/Lane Departure Prevention (LDP)
- G: Blind Spot Warning (BSW)/Blind Spot Intervention
- H: Backup Collision Intervention (BCI)

DTC		CONSULT display	Warning lamp					Fail-safe	Reference
CONSULT	On board display		ICC system warning lamp	IBA OFF indicator lamp	Lane departure warning lamp	Blind Spot Warning/Blind Spot Intervention warning lamp	Backup Collision Intervention	System	
C1A15	15	GEAR POSITION	ON	ON	ON	ON	ON	A, B, C, D, E, F, G, H	<a href="#">DAS-178</a>
C1A16	16	RADAR STAIN	ON	ON				A, C, D, E	<a href="#">DAS-180</a>
C1A17	17	ICC SENSOR MALF	ON	ON				A, B, C, D, E	<a href="#">DAS-181</a>
C1A18	18	LASER AIMING INCOMP	ON	ON				A, C, D, E	<a href="#">DAS-182</a>
C1A21	21	ICC SENSOR HIGH TEMP	ON	ON				A, B, C, D, E	<a href="#">DAS-183</a>
C1A24	24	NP RANGE	ON	ON	ON	ON	ON	A, B, C, D, E, F, G, H	<a href="#">DAS-184</a>
C1A26	26	ECD MODE MALF	ON	ON				A, B, C, D, E	<a href="#">DAS-186</a>
C1A27	27	ECD PWR SUPPLY CIR	ON	ON				A, B, C, D, E	<a href="#">DAS-187</a>
C1A33	33	CAN TRANSMISSION ERR	ON					A, B, E	<a href="#">DAS-189</a>
C1A34	34	COMMAND ERROR	ON					A, B, E	<a href="#">DAS-190</a>
C1A35	35	APA CIR	ON				ON	A, E, H	<a href="#">DAS-191</a>
C1A36	36	APA CAN COMM CIR	ON				ON	A, E, H	<a href="#">DAS-192</a>
C1A37	133	APA CAN CIR 2	ON				ON	A, B, E, H	<a href="#">DAS-193</a>
C1A38	132	APA CAN CIR 1	ON				ON	A, B, E, H	<a href="#">DAS-194</a>
C1A39	39	STRG SEN CIR	ON	ON		ON	ON	A, B, C, D, E, G, H	<a href="#">DAS-195</a>
C1A2A	80	ICC SEN PWR SUP CIR	ON	ON				A, C, D, E	<a href="#">DAS-188</a>
C1B00	81	CAMERA UNIT MALF			ON	ON		F, G	<a href="#">DAS-418</a>
C1B01	82	CAM AIMING INCOMP			ON	ON		F, G	<a href="#">DAS-420</a>
C1B03	83	CAM ABNRML TMP DETECT							<a href="#">DAS-422</a>
C1B53	84	SIDE RDR R MALF				ON	ON	G, H	<a href="#">DAS-577</a>
C1B54	85	SIDE RDR L MALF				ON	ON	G, H	<a href="#">DAS-578</a>
C1B56	87	SONAR CIRCUIT					ON	H	<a href="#">DAS-744</a>

# ADAS CONTROL UNIT

< ECU DIAGNOSIS INFORMATION >

[ADAS CONTROL UNIT]

A  
B  
C  
D  
E  
F  
G  
H  
I  
J  
K  
L  
M  
N  
P

- Systems for fail-safe
- A: Vehicle-to-vehicle distance control mode
  - B: Conventional (fixed speed) cruise control mode
  - C: Intelligent Brake Assist (IBA)
  - D: Forward Collision Warning (FCW)
  - E: Distance Control Assist (DCA)
  - F: Lane Departure Warning (LDW)/Lane Departure Prevention (LDP)
  - G: Blind Spot Warning (BSW)/Blind Spot Intervention
  - H: Backup Collision Intervention (BCI)

DTC		CONSULT display	Warning lamp					Fail-safe	Reference
CONSULT	On board display		ICC system warning lamp	IBA OFF indicator lamp	Lane departure warning lamp	Blind Spot Warning/Blind Spot Intervention warning lamp	Backup Collision Intervention	System	
C1B57	88	AVM CIRCUIT					ON	H	<a href="#">DAS-745</a>
C1F01	91	APA MOTOR MALF	ON				ON	A, E, H	<a href="#">DAS-196</a>
C1F02	92	APA C/U MALF	ON				ON	A, E, H	<a href="#">DAS-198</a>
C1F05	95	APA PWR SUPPLY CIR	ON				ON	A, E, H	<a href="#">DAS-201</a>
NO DTC IS DETECTED. FURTHER TESTING MAY BE REQUIRED	55	NO DTC IS DETECTED. FURTHER TESTING MAY BE REQUIRED	—	—	—	—	—	—	—
U0121	127	VDC CAN CIR 2	ON	ON	ON	ON	ON	A, B, C, D, E, F, G, H	<a href="#">DAS-205</a>
U0126	130	STRG SEN CAN CIR 1	ON	ON		ON	ON	A, B, C, D, E, G, H	<a href="#">DAS-206</a>
U0235	144	ICC SENSOR CAN CIRC 1	ON	ON				A, B, C, D, E	<a href="#">DAS-207</a>
U0401	120	ECM CAN CIR 1	ON		ON	ON	ON	A, B, E, F, G, H	<a href="#">DAS-208</a>
U0402	122	TCM CAN CIR 1	ON	ON	ON	ON	ON	A, B, C, D, E, F, G, H	<a href="#">DAS-209</a>
U0415	126	VDC CAN CIR 1	ON	ON	ON	ON	ON	A, B, C, D, E, F, G, H	<a href="#">DAS-210</a>
U0428	131	STRG SEN CAN CIR 2	ON	ON		ON	ON	A, B, C, D, E, G, H	<a href="#">DAS-211</a>
U1000 <sup>NOTE</sup>	100	CAN COMM CIRCUIT	ON	ON	ON	ON	ON	A, B, C, D, E, F, G, H	<a href="#">DAS-75</a>
U1010	110	CONTROL UNIT (CAN)	ON	ON	ON	ON	ON	A, B, C, D, E, F, G, H	<a href="#">DAS-76</a>
U1500	145	CAM CAN CIR 2			ON	ON		F, G	<a href="#">DAS-438</a>
U1501	146	CAM CAN CIR 1			ON	ON		F, G	<a href="#">DAS-439</a>
U1502	147	ICC SEN CAN COMM CIR	ON	ON				A, B, C, D, E	<a href="#">DAS-219</a>
U1503	150	SIDE RDR L CAN CIR 2				ON	ON	G, H	<a href="#">DAS-603</a>

DAS

# ADAS CONTROL UNIT

< ECU DIAGNOSIS INFORMATION >

[ADAS CONTROL UNIT]

Systems for fail-safe

- A: Vehicle-to-vehicle distance control mode
- B: Conventional (fixed speed) cruise control mode
- C: Intelligent Brake Assist (IBA)
- D: Forward Collision Warning (FCW)
- E: Distance Control Assist (DCA)
- F: Lane Departure Warning (LDW)/Lane Departure Prevention (LDP)
- G: Blind Spot Warning (BSW)/Blind Spot Intervention
- H: Backup Collision Intervention (BCI)

DTC		CONSULT display	Warning lamp					Fail-safe	Reference
CONSULT	On board display		ICC system warning lamp	IBA OFF indicator lamp	Lane departure warning lamp	Blind Spot Warning/Blind Spot Intervention warning lamp	Backup Collision Intervention	System	
U1504	151	SIDE RDR L CAN CIRC 1				ON	ON	G, H	<a href="#">DAS-604</a>
U1505	152	SIDE RDR R CAN CIRC 2				ON	ON	G, H	<a href="#">DAS-605</a>
U1506	153	SIDE RDR R CAN CIRC 1				ON	ON	G, H	<a href="#">DAS-606</a>
U1507	154	LOST COMM (SIDE RDR R)				ON	ON	G, H	<a href="#">DAS-607</a>
U1508	155	LOST COMM (SIDE RDR L)				ON	ON	G, H	<a href="#">DAS-608</a>
U150B	157	ECM CAN CIRC 3	ON		ON	ON	ON	A, B, E, F, G, H	<a href="#">DAS-215</a>
U150C	158	VDC CAN CIRC 3	ON	ON	ON	ON	ON	A, B, C, D, E, F, G, H	<a href="#">DAS-216</a>
U150D	159	TCM CAN CIRC 3	ON	ON	ON	ON	ON	A, B, C, D, E, F, G, H	<a href="#">DAS-217</a>
U150E	160	BCM CAN CIRC 3	ON		ON	ON	ON	A, B, E, F, G, H	<a href="#">DAS-218</a>
U150F	161	AV CAN CIRC 3							<a href="#">DAS-77</a>
U1512	162	HVAC CAN CIRC3			ON	ON		F, G	<a href="#">DAS-440</a>
U1513	163	METER CAN CIRC 3	ON	ON	ON	ON	ON	A, B, C, D, E, F, G, H	<a href="#">DAS-220</a>
U1514	164	STRG SEN CAN CIRC 3	ON	ON		ON	ON	A, B, C, D, E, G, H	<a href="#">DAS-221</a>
U1515	165	ICC SENSOR CAN CIRC 3	ON	ON				A, B, C, D, E	<a href="#">DAS-222</a>
U1516	166	CAM CAN CIRC 3			ON	ON		F, G	<a href="#">DAS-442</a>
U1517	167	APA CAN CIRC 3	ON				ON	A, B, E, H	<a href="#">DAS-223</a>
U1518	168	SIDE RDR L CAN CIRC 3				ON	ON	G, H	<a href="#">DAS-613</a>
U1519	169	SIDE RDR R CAN CIRC 3				ON	ON	G, H	<a href="#">DAS-614</a>
U1521	177	SONAR CHECKSUM					ON	H	<a href="#">DAS-781</a>
U1522	178	SONAR MESSAGE					ON	H	<a href="#">DAS-782</a>
U1523	179	SONAR CAN DLC					ON	H	<a href="#">DAS-783</a>

# ADAS CONTROL UNIT

< ECU DIAGNOSIS INFORMATION >

[ADAS CONTROL UNIT]

Systems for fail-safe

- A: Vehicle-to-vehicle distance control mode
- B: Conventional (fixed speed) cruise control mode
- C: Intelligent Brake Assist (IBA)
- D: Forward Collision Warning (FCW)
- E: Distance Control Assist (DCA)
- F: Lane Departure Warning (LDW)/Lane Departure Prevention (LDP)
- G: Blind Spot Warning (BSW)/Blind Spot Intervention
- H: Backup Collision Intervention (BCI)

DTC			Warning lamp					Fail-safe		
			ICC system warning lamp	IBA OFF indicator lamp	Lane departure warning lamp	Blind Spot Warning/Blind Spot Intervention warning lamp	Backup Collision Intervention			
CONSULT	On board display	CONSULT display						System	Reference	
U1524	180	SONAR CAN DLC					ON	H	<a href="#">DAS-784</a>	
U1525	181	AVM MESSAGE					ON	H	<a href="#">DAS-785</a>	

**NOTE:**

With the detection of “U1000” some systems do not perform the fail-safe operation.

A system controlling based on a signal received from the control unit performs fail-safe operation when the communication with the ADAS control unit becomes inoperable.

A  
B  
C  
D  
E  
F  
G  
H  
I  
J  
K  
L  
M  
N  
P

DAS

# WIRING DIAGRAM

## DRIVER ASSISTANCE SYSTEMS

### Wiring Diagram

INFOID:000000009716376

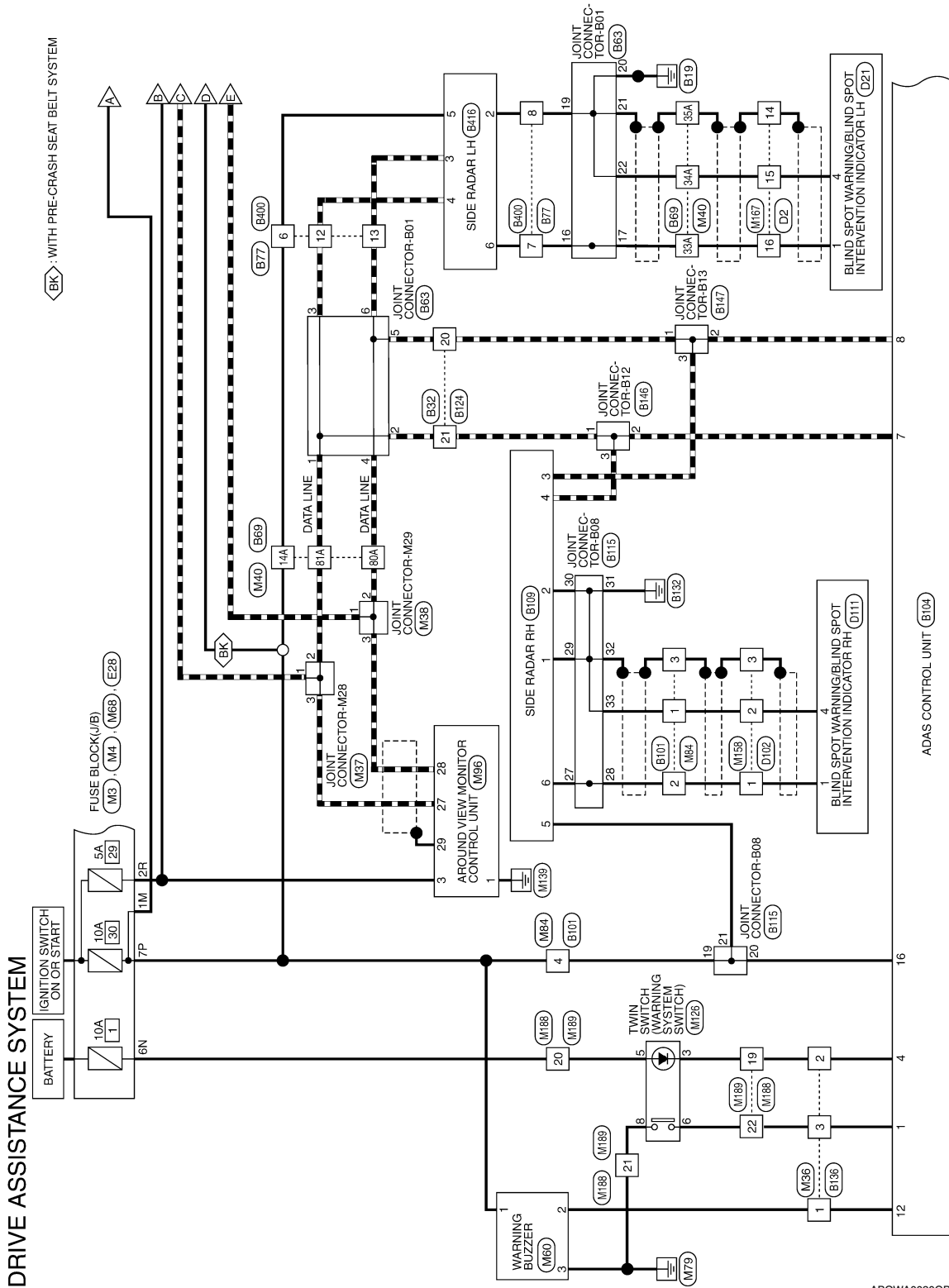

ABOWA0030GB



# DRIVER ASSISTANCE SYSTEMS

< WIRING DIAGRAM >

[ADAS CONTROL UNIT]

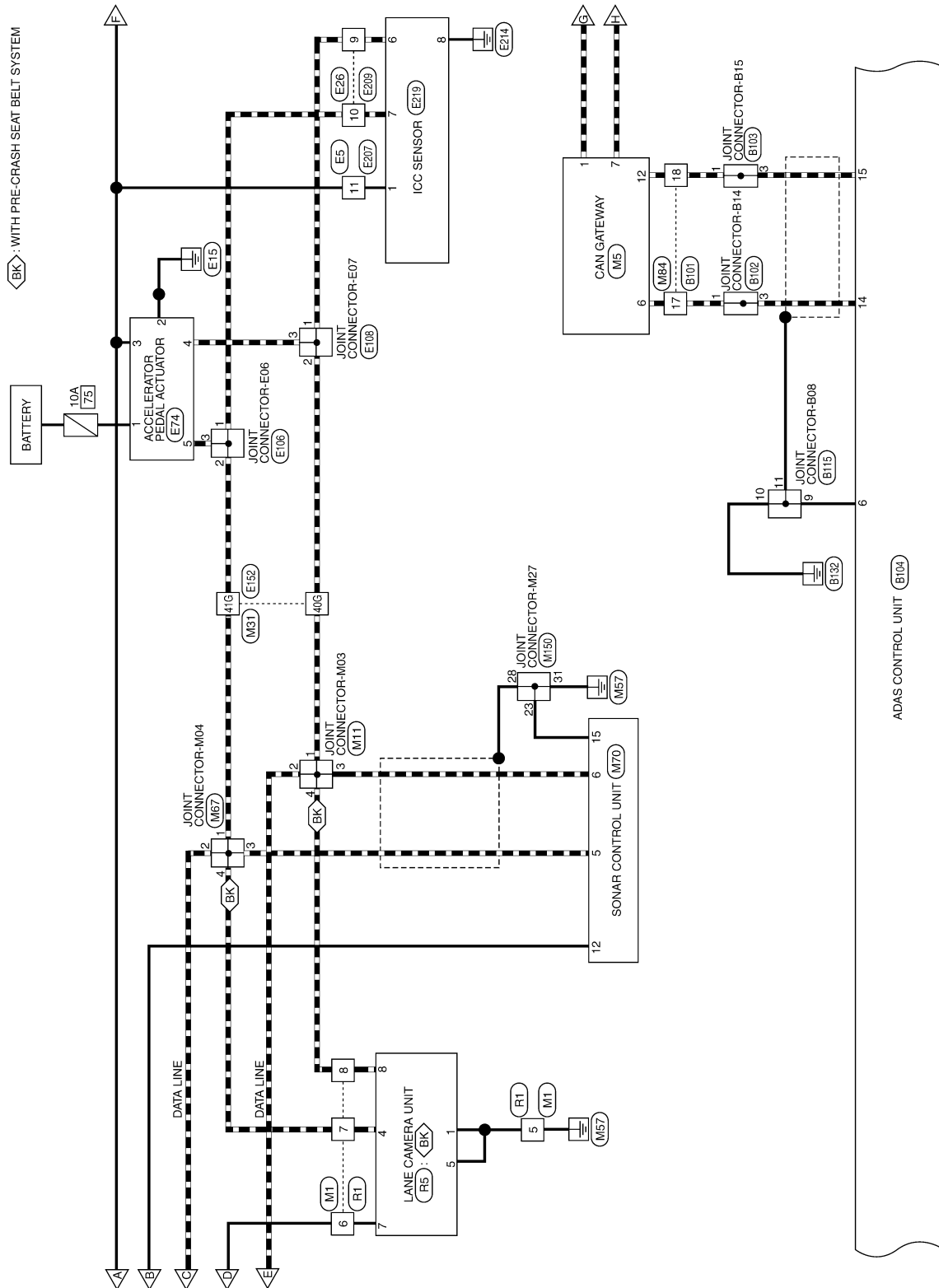

ABOWA0031GB

A  
B  
C  
D  
E  
F  
G  
H  
I  
J  
K  
L  
M  
N  
P

DAS

# DRIVER ASSISTANCE SYSTEMS

< WIRING DIAGRAM >

[ADAS CONTROL UNIT]

(ZD) : WITH BOSE AUDIO SYSTEM - WITH NAVIGATION SYSTEM WITHOUT SURROUND SOUND SYSTEM  
 (ZF) : WITH BOSE AUDIO SYSTEM - WITH NAVIGATION SYSTEM AND SURROUND SOUND SYSTEM

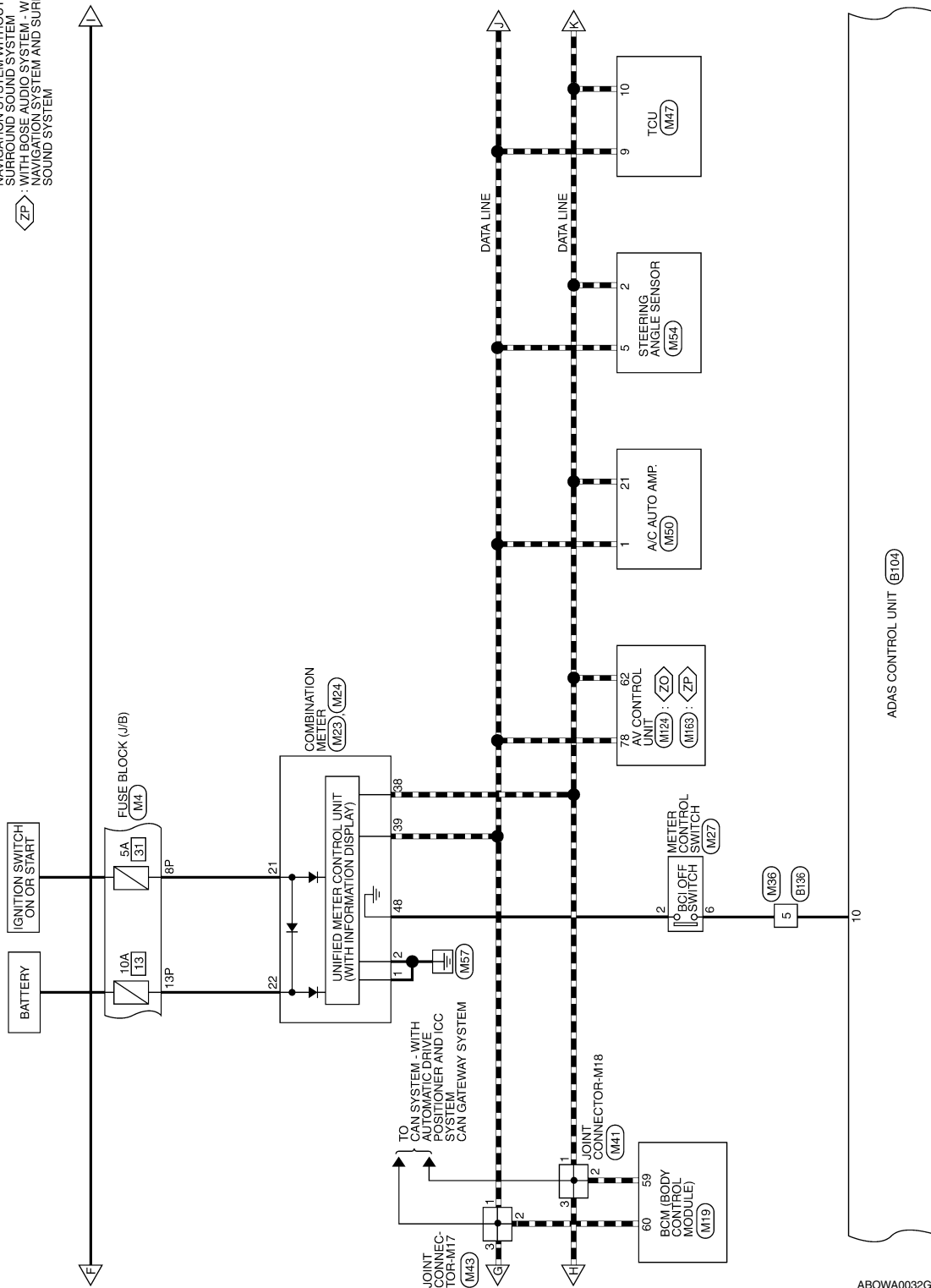

ABOWA0032GB

# DRIVER ASSISTANCE SYSTEMS

< WIRING DIAGRAM >

[ADAS CONTROL UNIT]

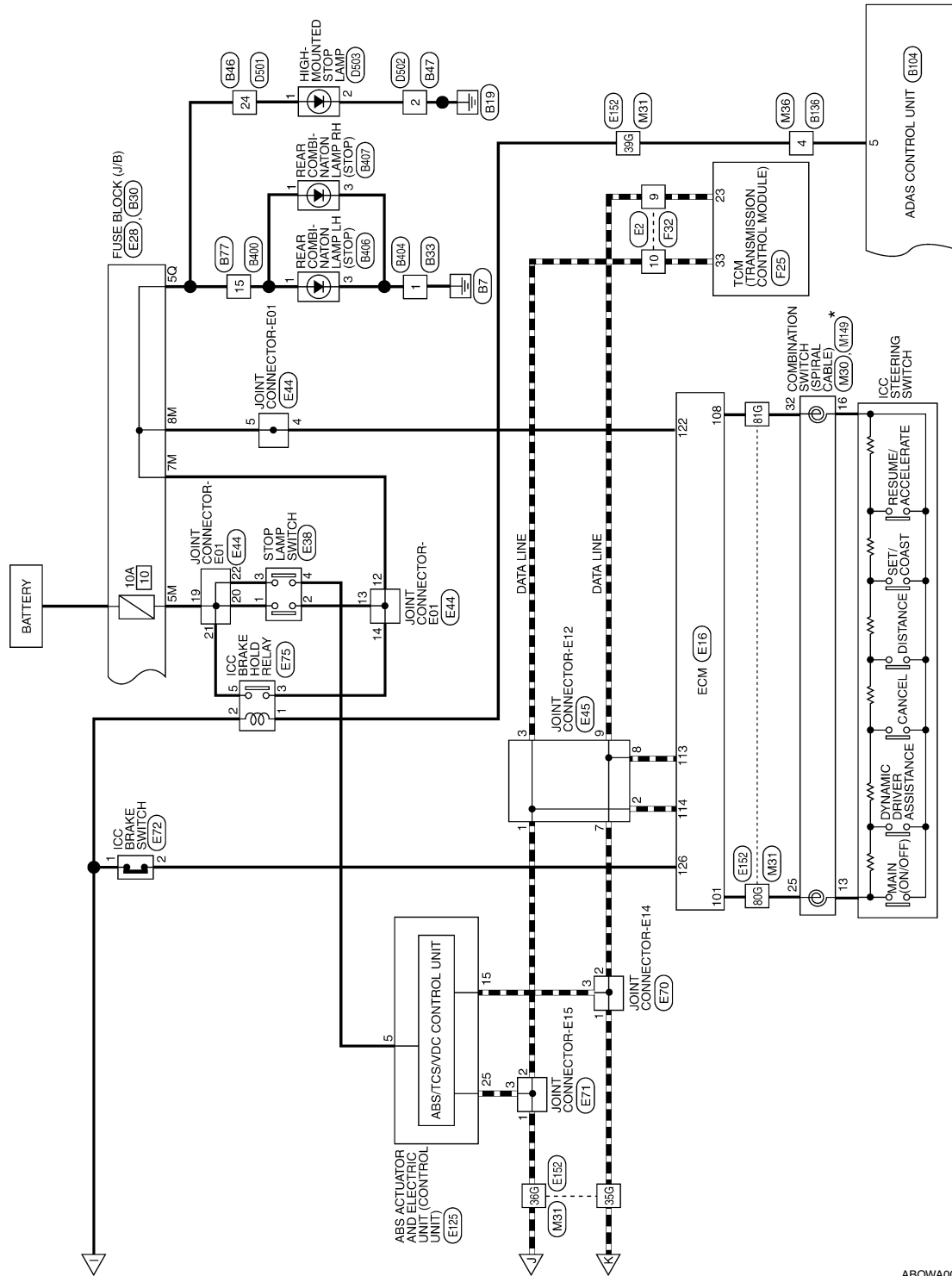

\* : THIS CONNECTOR IS NOT SHOWN IN "HARNES LAYOUT" OF PG SECTION.

ABOWA0033GB

A  
B  
C  
D  
E  
F  
G  
H  
I  
J  
K  
L  
M  
N  
P

DAS

DRIVE ASSISTANCE SYSTEM CONNECTORS

Connector No.	M1
Connector Name	WIRE TO WIRE
Connector Color	WHITE

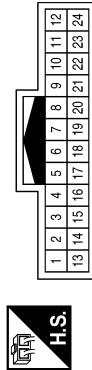

Terminal No.	Color of Wire	Signal Name
5	GR	-
6	LG	-
7	L	-
8	Y	-

Connector No.	M3
Connector Name	FUSE BLOCK (J/B)
Connector Color	WHITE

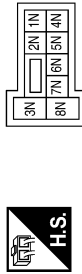

Terminal No.	Color of Wire	Signal Name
6N	W	-

Connector No.	M4
Connector Name	FUSE BLOCK (J/B)
Connector Color	WHITE

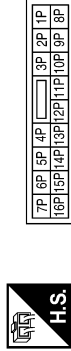

Terminal No.	Color of Wire	Signal Name
7P	LG	-
8P	BG	-
13P	W	-

Connector No.	M5
Connector Name	CAN GATEWAY
Connector Color	WHITE

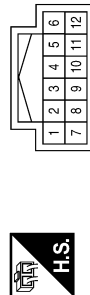

Terminal No.	Color of Wire	Signal Name
1	L	CAN-H
6	L	CAN-H
7	P	CAN-L
12	P	CAN-L

Connector No.	M11
Connector Name	JOINT CONNECTOR-M03
Connector Color	WHITE



Terminal No.	Color of Wire	Signal Name
1	Y	-
2	Y	-
3	W	-
4	Y	-

Connector No.	M19
Connector Name	BCM (BODY CONTROL MODULE)
Connector Color	BLACK

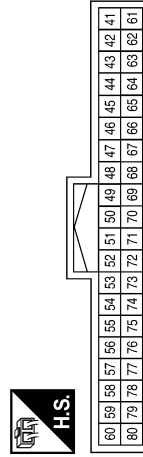

Terminal No.	Color of Wire	Signal Name
59	P	CAN-L
60	L	CAN-H

ABOIA0114GB

# DRIVER ASSISTANCE SYSTEMS

< WIRING DIAGRAM >

[ADAS CONTROL UNIT]

Terminal No.	Color of Wire	Signal Name
1	B	GND1
2	B	GND2
21	BG	IGN
22	W	BAT
38	P	CAN-L
39	L	CAN-H

Connector No.	M24
Connector Name	COMBINATION METER
Connector Color	WHITE

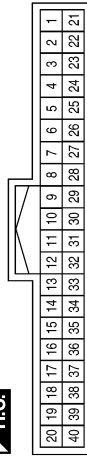

# DRIVER ASSISTANCE SYSTEMS

< WIRING DIAGRAM >

[ADAS CONTROL UNIT]

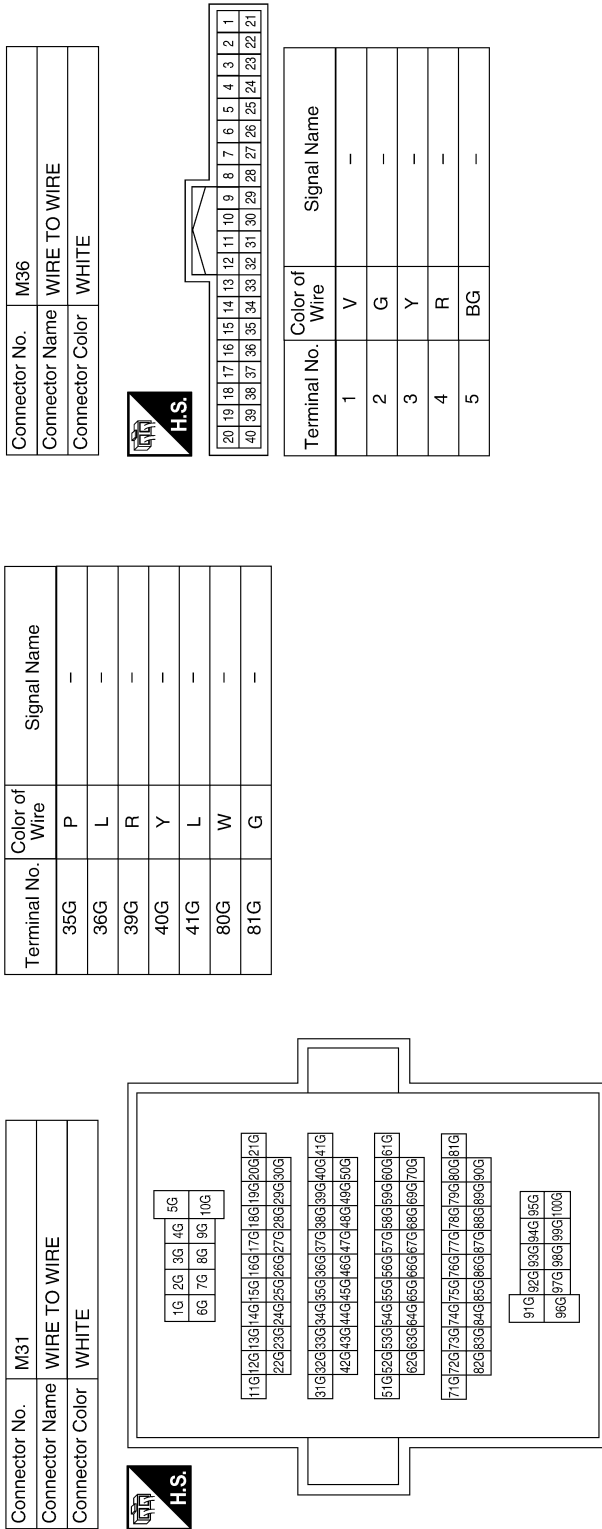

Terminal No.	Color of Wire	Signal Name
35G	P	-
36G	L	-
39G	R	-
40G	Y	-
41G	L	-
80G	W	-
81G	G	-

Terminal No.	Color of Wire	Signal Name
1	Y	-
2	Y	-
3	W	-

Terminal No.	Color of Wire	Signal Name
1	L	-
2	L	-
3	B	-

Terminal No.	Color of Wire	Signal Name
1	Y	-
2	Y	-
3	W	-

Terminal No.	Color of Wire	Signal Name
1	L	-
2	L	-
3	B	-

# DRIVER ASSISTANCE SYSTEMS

< WIRING DIAGRAM >

[ADAS CONTROL UNIT]

Connector No.	M41
Connector Name	JOINT CONNECTOR-M18
Connector Color	WHITE



Terminal No.	Color of Wire	Signal Name
1	P	-
2	P	-
3	P	-

Terminal No.	Color of Wire	Signal Name
14A	LG	-
33A	W	-
34A	B	-
35A	SHIELD	-
80A	Y	-
81A	L	-

Connector No.	M40
Connector Name	WIRE TO WIRE
Connector Color	GRAY

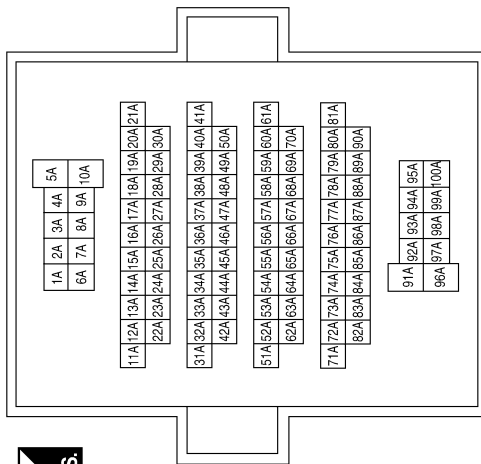

Connector No.	M50
Connector Name	A/C AUTO AMP.
Connector Color	WHITE

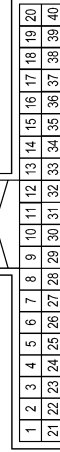

Terminal No.	Color of Wire	Signal Name
1	L	CAN-H
21	P	CAN-L

Connector No.	M47
Connector Name	TCU
Connector Color	WHITE

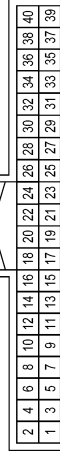

Terminal No.	Color of Wire	Signal Name
9	L	CAN-H
10	P	CAN-L

Connector No.	M43
Connector Name	JOINT CONNECTOR-M17
Connector Color	WHITE

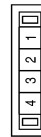

Terminal No.	Color of Wire	Signal Name
1	L	-
2	L	-
3	L	-

ABOIA0113GB

A  
B  
C  
D  
E  
F  
G  
H  
I  
J  
K  
L  
M  
N  
P

DAS

# DRIVER ASSISTANCE SYSTEMS

< WIRING DIAGRAM >

[ADAS CONTROL UNIT]

Connector No.	M67
Connector Name	JOINT CONNECTOR-M04
Connector Color	WHITE



Terminal No.	Color of Wire	Signal Name
1	L	-
2	L	-
3	B	-
4	L	-

Connector No.	M60
Connector Name	WARNING BUZZER
Connector Color	BROWN



Terminal No.	Color of Wire	Signal Name
1	LG	-
2	V	-
3	GR	-
4	-	-

Connector No.	M54
Connector Name	STEERING ANGLE SENSOR
Connector Color	WHITE

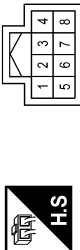

Terminal No.	Color of Wire	Signal Name
2	P	-
5	L	-

Connector No.	M84
Connector Name	WIRE TO WIRE
Connector Color	WHITE

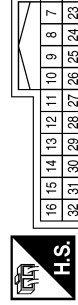

Terminal No.	Color of Wire	Signal Name
1	B	-
2	W	-
3	SHIELD	-
4	LG	-
17	L	-
18	P	-

Connector No.	M70
Connector Name	SONAR CONTROL UNIT
Connector Color	WHITE

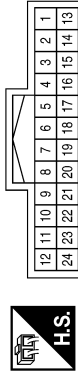

Terminal No.	Color of Wire	Signal Name
5	B	CAN-H
6	W	CAN-L
12	LG	IGN
15	GR	GND

Connector No.	M68
Connector Name	FUSE BLOCK (J/B)
Connector Color	BROWN

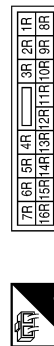

Terminal No.	Color of Wire	Signal Name
2R	LG	-

A010A100GB



# DRIVER ASSISTANCE SYSTEMS

< WIRING DIAGRAM >

[ADAS CONTROL UNIT]

Connector No.	M126
Connector Name	TWIN SWITCH (WARNING SYSTEM SWITCH)
Connector Color	BLACK

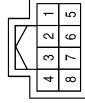

Terminal No.	Color of Wire	Signal Name
1	-	-
2	-	-
3	G	-
4	-	-
5	W	-
6	Y	-
7	-	-
8	B	-

Connector No.	M124
Connector Name	AV CONTROL UNIT (WITH BOSE AUDIO SYSTEM - WITH NAVI WITHOUT SURROUND SOUND SYSTEM)
Connector Color	WHITE

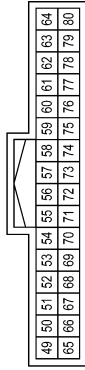

Terminal No.	Color of Wire	Signal Name
62	P	CAN-L
78	L	CAN-H

Connector No.	M96
Connector Name	AROUND VIEW MONITOR CONTROL UNIT
Connector Color	WHITE

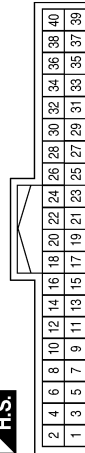

Terminal No.	Color of Wire	Signal Name
1	B	GND
3	LG	IGN
27	B	CAN-H
28	W	CAN-L
29	SHIELD	CAN GND

Connector No.	M158
Connector Name	WIRE TO WIRE
Connector Color	WHITE

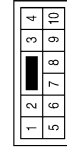

Terminal No.	Color of Wire	Signal Name
1	W	-
2	B	-
3	SHIELD	-

Connector No.	M150
Connector Name	JOINT CONNECTOR-M27
Connector Color	WHITE

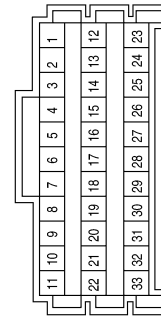

Terminal No.	Color of Wire	Signal Name
23	GR	-
28	SHIELD	-
31	GR	-

Connector No.	M149
Connector Name	COMBINATION SWITCH (SPIRAL CABLE)
Connector Color	GRAY

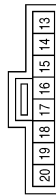

Terminal No.	Color of Wire	Signal Name
13	R	-
16	L	-

ABOIA0101GB

A  
B  
C  
D  
E  
F  
G  
H  
I  
J  
K  
L  
M  
N  
P



# DRIVER ASSISTANCE SYSTEMS

< WIRING DIAGRAM >

[ADAS CONTROL UNIT]

Connector No.	M188
Connector Name	WIRE TO WIRE
Connector Color	WHITE

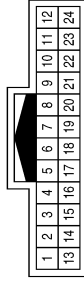

Terminal No.	Color of Wire	Signal Name
19	G	-
20	W	-
21	B	-
22	Y	-

Connector No.	M167
Connector Name	WIRE TO WIRE
Connector Color	WHITE

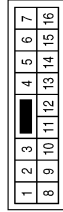

Terminal No.	Color of Wire	Signal Name
14	SHIELD	-
15	B	-
16	W	-

Connector No.	M163
Connector Name	AV CONTROL UNIT (WITH BOSE AUDIO SYSTEM - WITH NAVI AND SURROUND SOUND SYSTEM)
Connector Color	WHITE

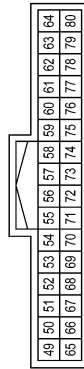

Terminal No.	Color of Wire	Signal Name
62	P	CAN-L
78	L	CAN-H

Connector No.	E5
Connector Name	WIRE TO WIRE
Connector Color	WHITE

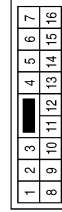

Terminal No.	Color of Wire	Signal Name
11	R	-

Connector No.	E2
Connector Name	WIRE TO WIRE
Connector Color	WHITE



Terminal No.	Color of Wire	Signal Name
9	P	-
10	L	-

Connector No.	M189
Connector Name	WIRE TO WIRE
Connector Color	WHITE

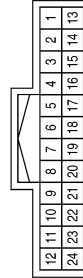

Terminal No.	Color of Wire	Signal Name
19	G	-
20	W	-
21	B	-
22	Y	-

ABOIA0102GB

# DRIVER ASSISTANCE SYSTEMS

< WIRING DIAGRAM >

[ADAS CONTROL UNIT]

Connector No.	E16
Connector Name	ECM
Connector Color	GRAY

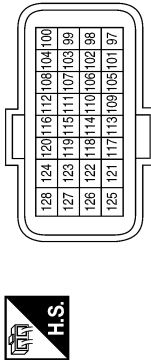

Terminal No.	Color of Wire	Signal Name
101	G	ASC D STEERING SWITCH/ICC STEERING SWITCH
108	R	SENSOR GROUND (ASC D STEERING SWITCH)
113	P	CAN-L
114	L	CAN-H
122	R	STOP LAMP SWITCH
126	LG	ASC D BRAKE SWITCH

Connector No.	E38
Connector Name	STOP LAMP SWITCH
Connector Color	WHITE



Terminal No.	Color of Wire	Signal Name
1	Y	-
2	P	-
3	Y	-
4	G	-

Connector No.	E26
Connector Name	WIRE TO WIRE
Connector Color	WHITE

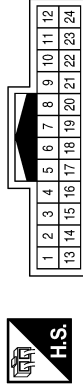

Terminal No.	Color of Wire	Signal Name
9	Y	-
10	BG	-

Connector No.	E44
Connector Name	JOINT CONNECTOR-E01
Connector Color	WHITE

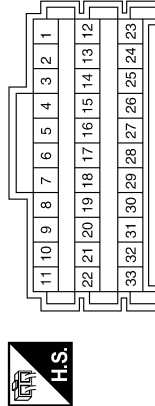

Terminal No.	Color of Wire	Signal Name
4	R	-
5	R	-
12	P	-
13	P	-

Connector No.	E28
Connector Name	FUSE BLOCK (J/B)
Connector Color	WHITE

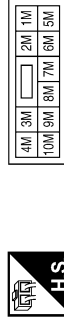

Terminal No.	Color of Wire	Signal Name
1M	R	-
5M	Y	-
7M	P	-
8M	R	-

Terminal No.	Color of Wire	Signal Name
14	P	-
19	Y	-
20	Y	-
21	Y	-
22	Y	-

A  
B  
C  
D  
E  
F  
G  
H  
I  
J  
K  
L  
M  
N  
P



# DRIVER ASSISTANCE SYSTEMS

< WIRING DIAGRAM >

[ADAS CONTROL UNIT]

Connector No.	E45
Connector Name	JOINT CONNECTOR-E12
Connector Color	BLUE

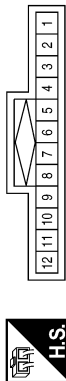

Terminal No.	Color of Wire	Signal Name
1	L	-
2	L	-
3	L	-
7	P	-
8	P	-
9	P	-

Connector No.	E70
Connector Name	JOINT CONNECTOR-E14
Connector Color	BLACK



Terminal No.	Color of Wire	Signal Name
1	P	-
2	P	-
3	P	-

Connector No.	E71
Connector Name	JOINT CONNECTOR-E15
Connector Color	BLACK



Terminal No.	Color of Wire	Signal Name
1	L	-
2	L	-
3	L	-

Connector No.	E72
Connector Name	ICC BRAKE SWITCH
Connector Color	BROWN



Terminal No.	Color of Wire	Signal Name
1	R	-
2	LG	-

Connector No.	E74
Connector Name	ACCELERATOR PEDAL ACTUATOR
Connector Color	GRAY



Terminal No.	Color of Wire	Signal Name
1	BG	-
2	GR	-
3	G	-
4	Y	-
5	BG	-
6	-	-

Connector No.	E75
Connector Name	ICC BRAKE HOLD RELAY
Connector Color	BLUE



Terminal No.	Color of Wire	Signal Name
1	W	-
2	R	-
3	P	-
5	Y	-

ABOIA0104GB

# DRIVER ASSISTANCE SYSTEMS

< WIRING DIAGRAM >

[ADAS CONTROL UNIT]

Connector No.	E106
Connector Name	JOINT CONNECTOR-E06
Connector Color	WHITE



Terminal No.	Color of Wire	Signal Name
1	BG	-
2	BG	-
3	BG	-

Connector No.	E108
Connector Name	JOINT CONNECTOR-E07
Connector Color	WHITE



Terminal No.	Color of Wire	Signal Name
1	Y	-
2	Y	-
3	Y	-

Connector No.	E125
Connector Name	ABS ACTUATOR AND ELECTRIC UNIT (CONTROL UNIT)
Connector Color	BLACK

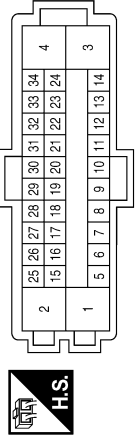

Terminal No.	Color of Wire	Signal Name
5	G	STOP LAMP SW (WITH ICC)
15	P	CAN-L
25	L	CAN-H

Connector No.	E152
Connector Name	WIRE TO WIRE
Connector Color	WHITE

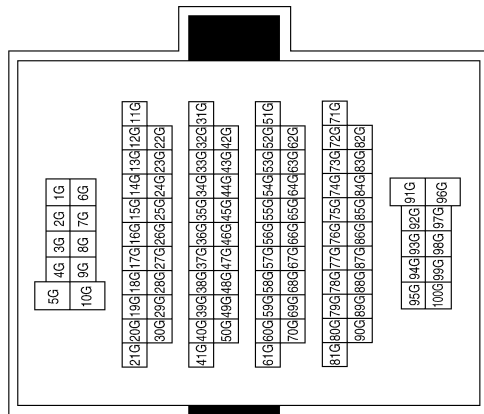

Connector No.	E207
Connector Name	WIRE TO WIRE
Connector Color	WHITE



Terminal No.	Color of Wire	Signal Name
11	P	-

A  
B  
C  
D  
E  
F  
G  
H  
I  
J  
K  
L  
M  
N  
P

DAS

# DRIVER ASSISTANCE SYSTEMS

< WIRING DIAGRAM >

[ADAS CONTROL UNIT]

Connector No.	F25
Connector Name	TCM (TRANSMISSION CONTROL MODULE)
Connector Color	BLACK

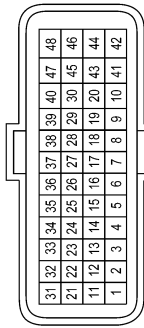

Terminal No.	Color of Wire	Signal Name
23	P	CAN-L
33	L	CAN-H

Connector No.	E219
Connector Name	ICC SENSOR
Connector Color	BLACK

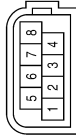

Terminal No.	Color of Wire	Signal Name
1	P	-
6	Y	-
7	L	-
8	B	-

Connector No.	E209
Connector Name	WIRE TO WIRE
Connector Color	WHITE

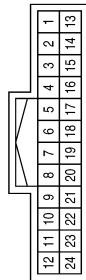

Terminal No.	Color of Wire	Signal Name
9	Y	-
10	L	-

Connector No.	B32
Connector Name	WIRE TO WIRE
Connector Color	WHITE

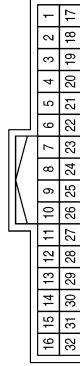

Terminal No.	Color of Wire	Signal Name
20	Y	-
21	L	-

Connector No.	B30
Connector Name	FUSE BLOCK (J/B)
Connector Color	WHITE



Terminal No.	Color of Wire	Signal Name
5Q	G	-

Connector No.	F32
Connector Name	WIRE TO WIRE
Connector Color	WHITE

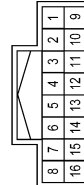

Terminal No.	Color of Wire	Signal Name
9	P	-
10	L	-

A01A0106GB

# DRIVER ASSISTANCE SYSTEMS

< WIRING DIAGRAM >

[ADAS CONTROL UNIT]

Connector No.	B33
Connector Name	WIRE TO WIRE
Connector Color	BLACK



Terminal No.	1	Color of Wire	B	Signal Name	-
--------------	---	---------------	---	-------------	---

Connector No.	B63
Connector Name	JOINT CONNECTOR-B01
Connector Color	WHITE

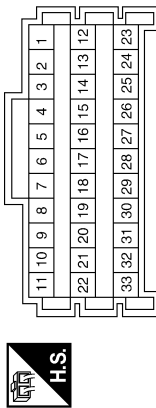

Terminal No.	Color of Wire	Signal Name
1	L	-
2	L	-
3	L	-
4	Y	-
5	Y	-
6	Y	-
16	W	-
17	W	-
19	B	-
20	B	-
21	SHIELD	-
22	B	-

Connector No.	B46
Connector Name	WIRE TO WIRE
Connector Color	WHITE

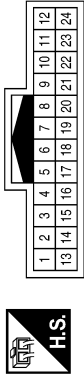

Terminal No.	24	Color of Wire	G	Signal Name	-
--------------	----	---------------	---	-------------	---

Connector No.	B69
Connector Name	WIRE TO WIRE
Connector Color	GRAY

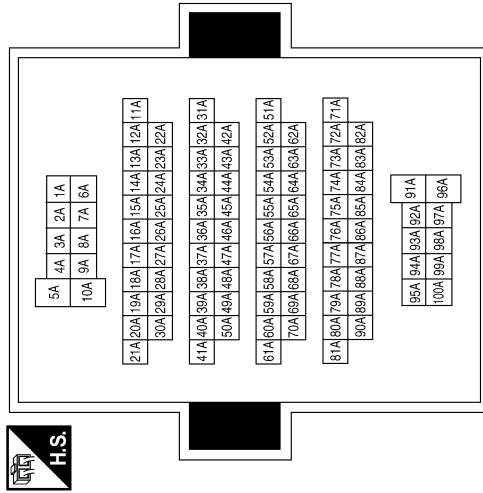

Connector No.	B47
Connector Name	WIRE TO WIRE
Connector Color	GRAY



Terminal No.	2	Color of Wire	B	Signal Name	-
--------------	---	---------------	---	-------------	---

Terminal No.	Color of Wire	Signal Name
14A	R	-
33A	W	-
34A	B	-
35A	SHIELD	-
80A	Y	-
81A	L	-

ABOIA0107GB

A  
B  
C  
D  
E  
F  
G  
H  
I  
J  
K  
L  
M  
N  
P



# DRIVER ASSISTANCE SYSTEMS

< WIRING DIAGRAM >

[ADAS CONTROL UNIT]

Connector No.	B102
Connector Name	JOINT CONNECTOR-B14
Connector Color	WHITE



Terminal No.	Color of Wire	Signal Name
1	L	-
3	B	-

Connector No.	B101
Connector Name	WIRE TO WIRE
Connector Color	WHITE

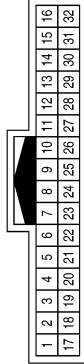

Terminal No.	Color of Wire	Signal Name
1	B	-
2	W	-
3	SHIELD	-
4	R	-
17	L	-
18	P	-

Connector No.	B77
Connector Name	WIRE TO WIRE
Connector Color	WHITE

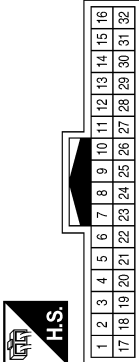

Terminal No.	Color of Wire	Signal Name
6	R	-
7	W	-
8	B	-
12	L	-
13	Y	-
15	G	-

Terminal No.	Color of Wire	Signal Name
7	L	ITS COMM-H
8	Y	ITS COMM-L
9	-	-
10	BG	BCP OFF SW
11	-	-
12	G	WARNING BUZZER
13	-	-
14	B	CAN-H
15	W	CAN-L
16	R	IGNITION

Connector No.	B104
Connector Name	ADAS CONTROL UNIT
Connector Color	WHITE

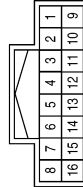

Terminal No.	Color of Wire	Signal Name
1	BR	WARNING SYSTEM SW
2	-	-
3	-	-
4	W	WARNING SYSTEM ON IND
5	G	BRAKE HOLD RLY DRIVE SIGNAL
6	B	GND

Connector No.	B103
Connector Name	JOINT CONNECTOR-B15
Connector Color	WHITE

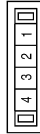

Terminal No.	Color of Wire	Signal Name
1	P	-
3	W	-

ABOIA0108GB



# DRIVER ASSISTANCE SYSTEMS

< WIRING DIAGRAM >

[ADAS CONTROL UNIT]

Terminal No.	Color of Wire	Signal Name
9	B	-
10	GR	-
11	SHIELD	-
19	R	-
20	R	-
21	R	-
27	W	-
28	W	-
29	B	-
30	B	-
31	GR	-
32	SHIELD	-
33	B	-

Connector No.	B115
Connector Name	JOINT CONNECTOR-B08
Connector Color	WHITE

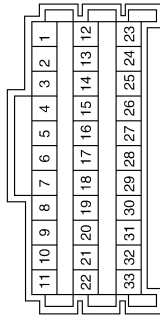

Connector No.	B109
Connector Name	SIDE RADAR RH
Connector Color	BLACK

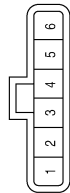

Terminal No.	Color of Wire	Signal Name
1	B	-
2	B	-
3	Y	-
4	L	-
5	R	-
6	W	-

Connector No.	B146
Connector Name	JOINT CONNECTOR-B12
Connector Color	WHITE



Connector No.	B136
Connector Name	WIRE TO WIRE
Connector Color	WHITE

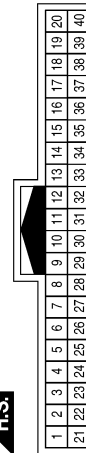

Terminal No.	Color of Wire	Signal Name
1	L	-
2	L	-
3	L	-

Connector No.	B124
Connector Name	WIRE TO WIRE
Connector Color	WHITE

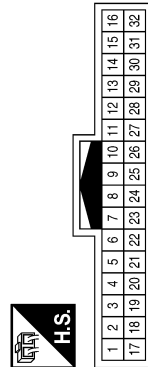

Terminal No.	Color of Wire	Signal Name
20	Y	-
21	L	-

ABOIA0109GB

A  
B  
C  
D  
E  
F  
G  
H  
I  
J  
K  
L  
M  
N  
P

DAS

# DRIVER ASSISTANCE SYSTEMS

< WIRING DIAGRAM >

[ADAS CONTROL UNIT]

Connector No.	B147
Connector Name	JOINT CONNECTOR-B13
Connector Color	WHITE



Terminal No.	Color of Wire	Signal Name
1	Y	-
2	Y	-
3	Y	-

Connector No.	B400
Connector Name	WIRE TO WIRE
Connector Color	WHITE

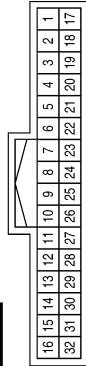

Terminal No.	Color of Wire	Signal Name
6	R	-
7	W	-
8	B	-
12	L	-
13	Y	-
15	G	-

Connector No.	B404
Connector Name	WIRE TO WIRE
Connector Color	BLACK



Terminal No.	Color of Wire	Signal Name
1	B	-

Connector No.	B406
Connector Name	REAR COMBINATION LAMP LH
Connector Color	GRAY



Terminal No.	Color of Wire	Signal Name
1	G	-
3	B	-

Connector No.	B407
Connector Name	REAR COMBINATION LAMP RH
Connector Color	GRAY



Terminal No.	Color of Wire	Signal Name
1	G	-
3	GR	-

Connector No.	B416
Connector Name	SIDE RADAR LH
Connector Color	BLACK

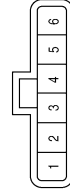

Terminal No.	Color of Wire	Signal Name
1	-	-
2	B	-
3	Y	-
4	L	-
5	R	-
6	W	-

ABOIA0110GB

# DRIVER ASSISTANCE SYSTEMS

< WIRING DIAGRAM >

[ADAS CONTROL UNIT]

Connector No.	D2
Connector Name	WIRE TO WIRE
Connector Color	WHITE

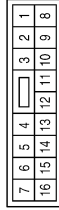

Terminal No.	Color of Wire	Signal Name
14	SHIELD	-
15	B	-
16	W	-

Connector No.	R5
Connector Name	LANE CAMERA UNIT
Connector Color	WHITE

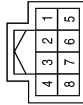

Terminal No.	Color of Wire	Signal Name
1	B	-
2	-	-
3	-	-
4	BR	-
5	B	-
6	-	-
7	LG	-
8	Y	-

Connector No.	R1
Connector Name	WIRE TO WIRE
Connector Color	WHITE

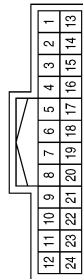

Terminal No.	Color of Wire	Signal Name
5	B	-
6	LG	-
7	BR	-
8	Y	-

Connector No.	D111
Connector Name	BLIND SPOT WARNING/ BLIND SPOT INTERVEN- TION INDICATOR RH
Connector Color	WHITE

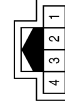

Terminal No.	Color of Wire	Signal Name
1	W	-
2	-	-
3	-	-
4	B	-

Connector No.	D102
Connector Name	WIRE TO WIRE
Connector Color	WHITE

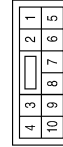

Terminal No.	Color of Wire	Signal Name
1	W	-
2	B	-
3	SHIELD	-

Connector No.	D21
Connector Name	BLIND SPOT WARNING/ BLIND SPOT INTERVEN- TION INDICATOR LH
Connector Color	WHITE

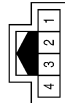

Terminal No.	Color of Wire	Signal Name
1	W	-
2	-	-
3	-	-
4	B	-

ABOIA0111GB

A  
B  
C  
D  
E  
F  
G  
H  
I  
J  
K  
L  
M  
N  
P

DAS

# DRIVER ASSISTANCE SYSTEMS

< WIRING DIAGRAM >

[ADAS CONTROL UNIT]

Connector No.	D503
Connector Name	HIGH-MOUNTED STOP LAMP
Connector Color	BROWN



Terminal No.	Color of Wire	Signal Name
1	LG	-
2	B	-

Connector No.	D502
Connector Name	WIRE TO WIRE
Connector Color	GRAY

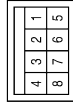

Terminal No.	Color of Wire	Signal Name
2	B	-

Connector No.	D501
Connector Name	WIRE TO WIRE
Connector Color	WHITE

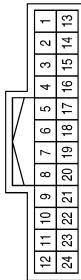

Terminal No.	Color of Wire	Signal Name
24	LG	-

A010A0112GB

**DTC/CIRCUIT DIAGNOSIS**

C1A00 CONTROL UNIT

DTC Logic

INFOID:000000009716377

DTC DETECTION LOGIC

DTC (On board display)	Trouble diagnosis name	DTC detecting condition	Possible causes
C1A00 (0)	CONTROL UNIT	ADAS control unit internal malfunction	ADAS control unit

DTC CONFIRMATION PROCEDURE

**1. PERFORM DTC CONFIRMATION PROCEDURE**

1. Start the engine.
2. Perform "All DTC Reading" with CONSULT.
3. Check if the "C1A00" is detected as the current malfunction in "Self Diagnostic Result" of "ICC/ADAS".

Is "C1A00" detected as the current malfunction?

- YES >> Refer to [DAS-73, "Diagnosis Procedure"](#).
- NO >> INSPECTION END

Diagnosis Procedure

INFOID:000000009716378

**1. CHECK SELF-DIAGNOSIS RESULTS**

Check if any DTC other than "C1A00" is detected in "Self Diagnostic Result" of "ICC/ADAS".

Is any DTC detected?

- YES >> Perform diagnosis on the detected DTC and repair or replace the malfunctioning parts. Refer to [DAS-47, "DTC Index"](#).
- NO >> Replace the ADAS control unit. Refer to [DAS-79, "Removal and Installation"](#).

A  
B  
C  
D  
E  
F  
G  
H  
I  
J  
K  
L  
M  
N  
P

DAS

# C1A01 POWER SUPPLY CIRCUIT 1, C1A02 POWER SUPPLY CIRCUIT 2

< DTC/CIRCUIT DIAGNOSIS >

[ADAS CONTROL UNIT]

## C1A01 POWER SUPPLY CIRCUIT 1, C1A02 POWER SUPPLY CIRCUIT 2

### DTC Logic

INFOID:000000009716379

### DTC DETECTION LOGIC

DTC (On board display)	Trouble diagnosis name	DTC detecting condition	Possible causes
C1A01 (1)	POWER SUPPLY CIR	The battery voltage sent to ADAS control unit remains less than 7.9 V for 5 seconds	<ul style="list-style-type: none"><li>• Connector, harness, fuse</li><li>• ADAS control unit</li></ul>
C1A02 (2)	POWER SUPPLY CIR 2	The battery voltage sent to ADAS control unit remains more than 19.3 V for 5 seconds	

### DTC CONFIRMATION PROCEDURE

#### 1.PERFORM DTC CONFIRMATION PROCEDURE

1. Start the engine.
2. Turn the MAIN switch of ICC system ON.
3. Perform "All DTC Reading" with CONSULT.
4. Check if the "C1A01" or "C1A02" is detected as the current malfunction in "Self Diagnostic Result" of "ICC/ADAS".

Is "C1A01" or "C1A02" detected as the current malfunction?

- YES >> Refer to [DAS-74. "Diagnosis Procedure"](#).  
NO >> Refer to [GI-53. "Intermittent Incident"](#).

### Diagnosis Procedure

INFOID:000000009716380

#### 1.CHECK ADAS CONTROL UNIT POWER SUPPLY AND GROUND CIRCUIT

Check power supply and ground circuit of ADAS control unit. Refer to [DAS-78. "Diagnosis Procedure"](#).

Is the inspection result normal?

- YES >> Replace the ADAS control unit. Refer to [DAS-79. "Removal and Installation"](#).  
NO >> Repair or replace the malfunctioning parts.

## U1000 CAN COMM CIRCUIT

### Description

INFOID:000000009716381

#### CAN COMMUNICATION

CAN (Controller Area Network) is a serial communication line for real time applications. It is an on-vehicle multiplex communication line with high data communication speed and excellent error detection ability. Modern vehicle is equipped with many electronic control units, and each control unit shares information and links with other control units during operation (not independent). In CAN communication, control units are connected with 2 communication lines (CAN-H, CAN-L) allowing a high rate of information transmission with less wiring. Each control unit transmits/receives data but selectively reads the required data only.

CAN communication signal chart. Refer to [LAN-43, "CAN COMMUNICATION SYSTEM : CAN Communication Signal Chart"](#).

#### ITS COMMUNICATION

- ITS communication is a multiplex communication system. This enables the system to transmit and receive large quantities of data at high speed by connecting control units with 2 communication lines.
- ITS communication lines adopt twisted-pair line style (two lines twisted) for noise immunity.

### DTC Logic

INFOID:000000009716382

#### DTC DETECTION LOGIC

DTC (On board display)	Trouble diagnosis name	DTC detecting condition	Possible causes
U1000 (100)	CAN COMM CIRCUIT	If ADAS control unit is not transmitting or receiving CAN communication signal or ITS communication signal for 2 seconds or more	<ul style="list-style-type: none"> <li>• CAN communication system</li> <li>• ITS communication system</li> </ul>

#### NOTE:

If "U1000" is detected, first diagnose the CAN communication system.

### Diagnosis Procedure

INFOID:000000009716383

#### 1. PERFORM THE SELF-DIAGNOSIS

1. Turn the ignition switch ON.
2. Turn the MAIN switch of ICC system ON, and then wait for 30 seconds or more.
3. Perform "All DTC Reading" with CONSULT.
4. Check if the "U1000" is detected as the current malfunction in "Self Diagnostic Result" of "ICC/ADAS".

Is "U1000" detected as the current malfunction?

- YES >> Refer to [DAS-212, "ADAS CONTROL UNIT : Diagnosis Procedure"](#).  
 NO >> Refer to [GI-53, "Intermittent Incident"](#).



# U1010 CONTROL UNIT (CAN)

< DTC/CIRCUIT DIAGNOSIS >

[ADAS CONTROL UNIT]

## U1010 CONTROL UNIT (CAN)

### Description

INFOID:000000009716384

CAN controller controls the communication of CAN communication signal and ITS communication signal, and the error detection.

### DTC Logic

INFOID:000000009716385

### DTC DETECTION LOGIC

DTC (On board display)	Trouble diagnosis name	DTC detecting condition	Possible causes
U1010 (110)	CONTROL UNIT (CAN)	If ADAS control unit detects malfunction by CAN controller initial diagnosis	ADAS control unit

### Diagnosis Procedure

INFOID:000000009716386

#### 1. PERFORM DTC CONFIRMATION PROCEDURE

1. Turn the MAIN switch of ICC system ON.
2. Perform "All DTC Reading" with CONSULT.
3. Check if the "U1010" is detected as the current malfunction in "Self Diagnostic Result" of "ICC/ADAS".

#### Is "U1010" detected as the current malfunction?

- YES >> Replace the ADAS control unit. Refer to [DAS-79, "Removal and Installation"](#).
- NO >> INSPECTION END



U150F AV CAN 3

DTC Logic

INFOID:000000009716387

DTC DETECTION LOGIC

DTC (On board display)	Trouble diagnosis name	DTC detecting condition	Possible causes
U150F (161)	AV CAN CIRC 3	ADAS control unit detects an error signal that is received from AV control unit via CAN communication	AV control unit

**NOTE:**

If DTC "U150F" is detected along with DTC "U1000", first diagnose the DTC "U1000". Refer to [DAS-75, "DTC Logic"](#).

DTC CONFIRMATION PROCEDURE

**1**.PERFORM DTC CONFIRMATION PROCEDURE

1. Start the engine.
2. Turn the DCA or LDP or Blind Spot Intervention system ON.
3. Perform "All DTC Reading" with CONSULT.
4. Check if the "U150F" is detected as the current malfunction in "Self Diagnostic Result" of "ICC/ADAS".

Is "U150F" detected as the current malfunction?

- YES >> Refer to [DAS-77, "Diagnosis Procedure"](#).
- NO >> Refer to [GI-53, "Intermittent Incident"](#).

Diagnosis Procedure

INFOID:000000009716388

**1**.CHECK SELF-DIAGNOSIS RESULTS

Check if "U1000" is detected other than "U150F" in "Self Diagnostic Result" of "ICC/ADAS".

Is "U1000" detected?

- YES >> Perform the CAN communication system inspection. Repair or replace the malfunctioning parts. Refer to [DAS-75, "DTC Logic"](#).
- NO >> GO TO 2.

**2**.CHECK AV CONTROL UNIT SELF-DIAGNOSIS RESULTS

Check if any DTC is detected in "Self Diagnostic Result" of "MULTI AV".

Is any DTC detected?

- YES >> Perform diagnosis on the detected DTC and repair or replace the malfunctioning parts. Refer to [AV-42, "DTC Index"](#).
- NO >> Replace the ADAS control unit. Refer to [DAS-79, "Removal and Installation"](#).

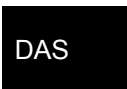

# POWER SUPPLY AND GROUND CIRCUIT

< DTC/CIRCUIT DIAGNOSIS >

[ADAS CONTROL UNIT]

## POWER SUPPLY AND GROUND CIRCUIT

### Diagnosis Procedure

INFOID:000000009716389

Regarding Wiring Diagram information, refer to [DAS-52. "Wiring Diagram"](#).

### 1. CHECK ADAS CONTROL UNIT POWER SUPPLY CIRCUIT

Check voltage between ADAS control unit harness connector and ground.

Terminal		Condition	Voltage (Approx.)
(+)	(-)		
ADAS control unit		Ignition switch	0 V
Connector	Terminal		
B104	16	OFF	0 V
		ON	Battery voltage

Is the inspection result normal?

YES >> GO TO 2.

NO >> Repair the ADAS control unit power supply circuit.

### 2. CHECK ADAS CONTROL UNIT GROUND CIRCUIT

1. Turn the ignition switch OFF.
2. Disconnect the ADAS control unit connector.
3. Check for continuity between ADAS control unit harness connector and ground.

ADAS control unit		Ground	Continuity
Connector	Terminal		
B104	6		Yes

Is the inspection result normal?

YES >> INSPECTION END

NO >> Repair the ADAS control unit ground circuit.

## REMOVAL AND INSTALLATION

### ADAS CONTROL UNIT

#### Removal and Installation

INFOID:000000009716390

#### REMOVAL

1. Disconnect the battery negative terminal. Refer to [PG-93. "Removal and Installation"](#).
2. Remove the storage box. Refer to [INT-33. "STORAGE BOX : Removal and Installation"](#).
3. Disconnect the harness connector (A) from the ADAS control unit (1).  
 ↳ Front
4. Remove bolts (←).
5. Lift upward to remove ADAS control unit (1).

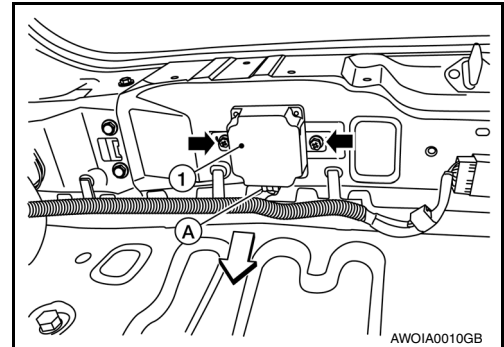

#### INSTALLATION

- Installation is in the reverse order of removal.
- Tighten ADAS control unit bolts to specification.

**ADAS control unit bolts : 8.3 N·m (0.85 kg-m, 73 in-lb)**

A  
B  
C  
D  
E  
F  
G  
H  
I  
J  
K  
L  
M  
N  
P

DAS

# PRECAUTION

## PRECAUTIONS

### Precaution for Supplemental Restraint System (SRS) "AIR BAG" and "SEAT BELT PRE-TENSIONER"

INFOID:000000009730866

The Supplemental Restraint System such as "AIR BAG" and "SEAT BELT PRE-TENSIONER", used along with a front seat belt, helps to reduce the risk or severity of injury to the driver and front passenger for certain types of collision. This system includes dual stage front air bag modules. The SRS system may only deploy one front air bag, depending on the severity of a collision and whether the front passenger seat is occupied. Information necessary to service the system safely is included in the SR and SB section of this Service Manual.

**WARNING:**

- To avoid rendering the SRS inoperative, which could increase the risk of personal injury or death in the event of a collision which would result in air bag inflation, all maintenance must be performed by an authorized NISSAN/INFINITI dealer.
- Improper maintenance, including incorrect removal and installation of the SRS, can lead to personal injury caused by unintentional activation of the system. For removal of Spiral Cable and Air Bag Module, see the SR section.
- Do not use electrical test equipment on any circuit related to the SRS unless instructed to in this Service Manual. SRS wiring harnesses can be identified by yellow and/or orange harnesses or harness connectors.

### PRECAUTIONS WHEN USING POWER TOOLS (AIR OR ELECTRIC) AND HAMMERS

**WARNING:**

- When working near the Airbag Diagnosis Sensor Unit or other Airbag System sensors with the Ignition ON or engine running, DO NOT use air or electric power tools or strike near the sensor(s) with a hammer. Heavy vibration could activate the sensor(s) and deploy the air bag(s), possibly causing serious injury.
- When using air or electric power tools or hammers, always switch the Ignition OFF, disconnect the battery and wait at least three minutes before performing any service.

### Precautions For Harness Repair

INFOID:000000009716392

ITS communication uses a twisted pair line. Be careful when repairing it.

- Solder the repaired area and wrap tape around the soldered area.

**NOTE:**

A fray of twisted lines must be within 110 mm (4.33 in).

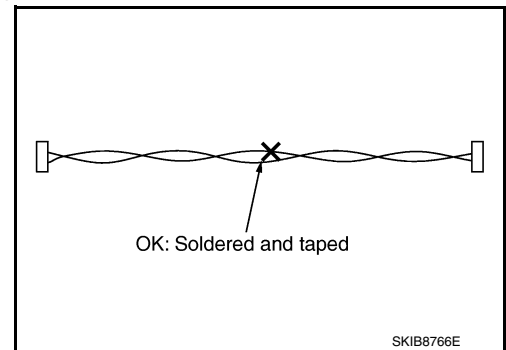

- Bypass connection is never allowed at the repaired area.

**NOTE:**

Bypass connection may cause ITS communication error. The spliced wire becomes separated and the characteristics of twisted line are lost.

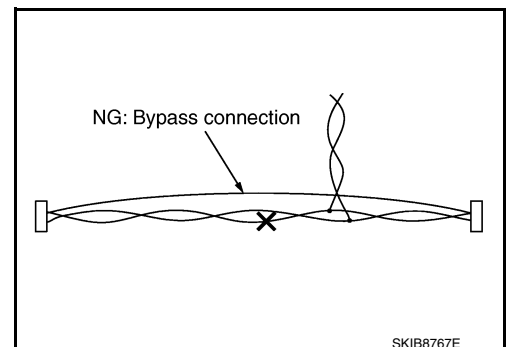

# PRECAUTIONS

< PRECAUTION >

[DCA]

## DCA System Service

INFOID:000000009716393

### CAUTION:

- Turn the MAIN switch OFF in conditions similar to driving, such as free rollers or a chassis dynamometer.
- Do not use or disassemble the ICC sensor removed from the vehicle.
- Erase DTC when replacing parts of DCA system, then check the operation of DCA system after performing radar beam alignment, if necessary.

A

B

C

D

E

F

G

H

I

J

K

L

M

N

DAS

P

# COMPONENT PARTS

< SYSTEM DESCRIPTION >

[DCA]

## SYSTEM DESCRIPTION

### COMPONENT PARTS

#### Component Parts Location

INFOID:000000009716394

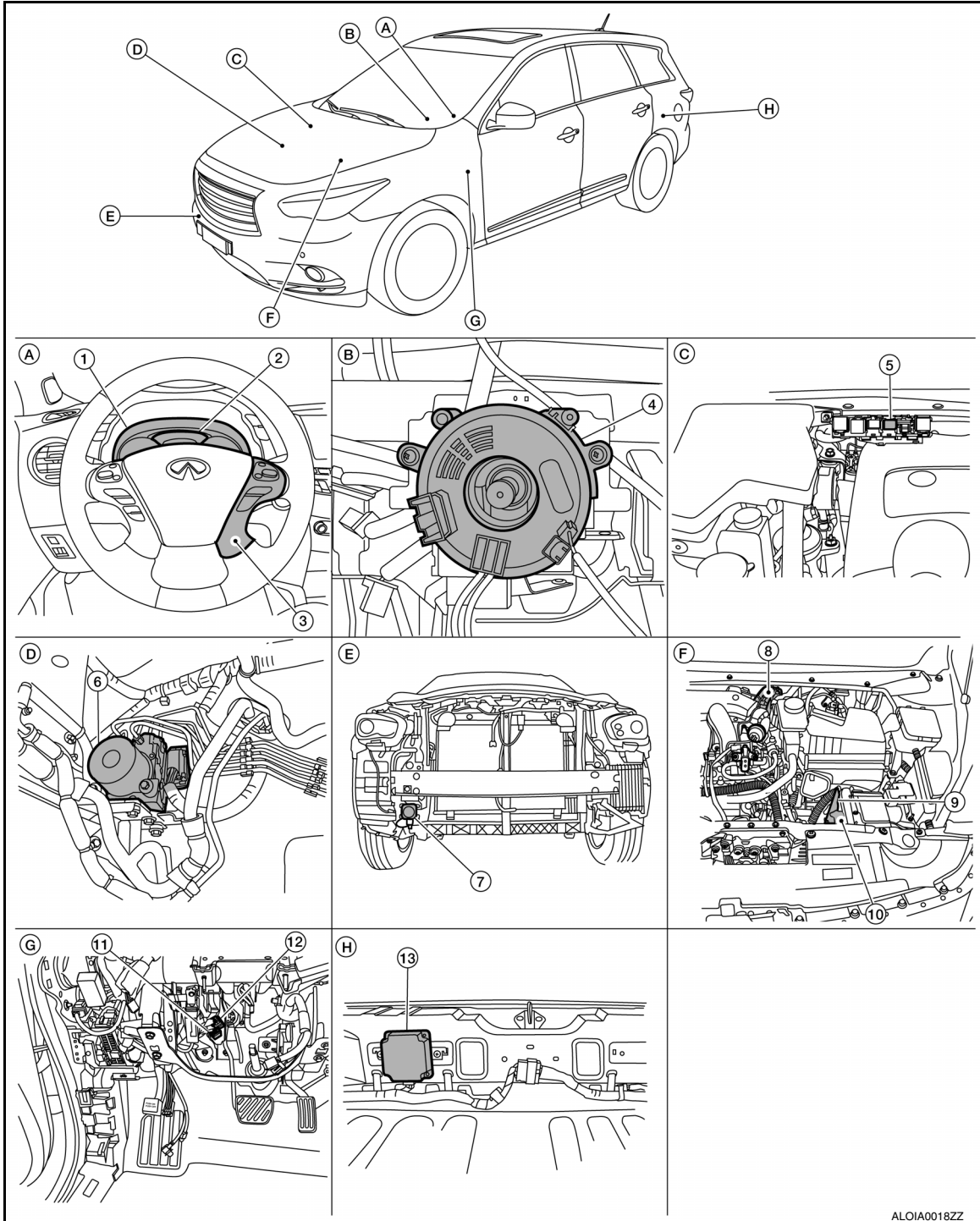

# COMPONENT PARTS

< SYSTEM DESCRIPTION >

[DCA]

- |   |   |  |   |
|---|---|--|---|
| 1. Combination meter<br>Refer to <a href="#">DAS-83, "Component Description"</a> .  | 2. Vehicle information display, ICC system warning lamp, buzzer<br>(On the combination meter) | 3. ICC steering switch   | A |
| 4. Steering angle sensor (view with steering wheel removed)<br>Refer to <a href="#">DAS-83, "Component Description"</a> .                             | 5. ICC brake hold relay   | 6. ABS actuator and electric unit (control unit)<br>Refer to <a href="#">DAS-83, "Component Description"</a> . | B |
| 7. ICC sensor (view with front fascia removed)<br>Refer to <a href="#">DAS-83, "Component Description"</a> .  | 8. Accelerator pedal actuator   | 9. ECM<br>Refer to <a href="#">DAS-83, "Component Description"</a> .   | C |
| 10. TCM<br>Refer to <a href="#">DAS-83, "Component Description"</a> .   | 11. ICC brake switch  | 12. Stop lamp switch   | D |
| 13. ADAS control unit (view of rear luggage room area with rear panel assembly removed)<br>Refer to <a href="#">DAS-83, "Component Description"</a> . |   |  | E |

## Component Description

INFOID:000000009716395

Component	Description
ADAS control unit	<ul style="list-style-type: none"> <li>• ADAS control unit calculates a target distance between vehicles and a target speed, based on signals received from each sensor and switch to transmit a brake fluid pressure control signal to ABS actuator and electric unit (control unit) via CAN communication</li> <li>• ADAS control unit transmits the buzzer output signal to the combination meter via CAN communication</li> <li>• ADAS control unit transmits an accelerator pedal feedback force control signal to the accelerator pedal actuator via ITS communication</li> </ul>
ICC sensor	<ul style="list-style-type: none"> <li>• ICC sensor detects light reflected from a vehicle ahead by emitting millimeter waves forward and calculates a distance from the vehicle ahead and a relative speed, based on the detected signal</li> <li>• ICC sensor transmits the presence/absence of vehicle ahead and the distance from the vehicle to ADAS control unit via ITS communication</li> </ul>
ECM	ECM transmits the accelerator pedal position signal, ICC brake switch signal, stop lamp switch signal, ICC steering switch signal, etc. to ADAS control unit via CAN communication
ABS actuator and electric unit (control unit)	<ul style="list-style-type: none"> <li>• ABS actuator and electric unit (control unit) transmits the vehicle speed signal (wheel speed), stop lamp signal and VDC/TCS/ABS system operation condition to ADAS control unit via CAN communication</li> <li>• ABS actuator and electric unit (control unit) controls the brake, based on a brake fluid pressure control signal received from ADAS control unit via CAN communication</li> </ul>
TCM	TCM transmits the signal related to CVT control to ADAS control unit via CAN communication
Combination meter	Performs the following operations using the signals received from the ADAS control unit via the CAN communication <ul style="list-style-type: none"> <li>• Displays the DCA system operation status using the meter display signal</li> <li>• Illuminates the ICC system warning lamp using the ICC warning lamp signal</li> <li>• Operates the buzzer (ICC warning chime) using the buzzer output signal</li> </ul>
Dynamic driver assistance switch (On the ICC steering switch)	ECM receives an ICC steering switch (dynamic driver assistance switch) signal and transmits the signal to ADAS control unit via CAN communication
ICC brake hold relay	ICC brake hold relay activates the stop lamp by ICC brake hold relay drive signal (stop lamp drive signal) outputted by the ADAS control unit

## COMPONENT PARTS

< SYSTEM DESCRIPTION >

[DCA]

Component	Description
ICC brake switch	<ul style="list-style-type: none"><li>• ICC brake switch is turned OFF and stop lamp switch is turned ON, when depressing the brake pedal</li><li>• ICC brake switch signal is input to ECM. These signals are transmitted from ECM to ADAS control unit via CAN communication</li><li>• Stop lamp switch signal is input to ECM and ABS actuator and electric unit (control unit). These signals are transmitted from ECM and ABS actuator and electric unit (control unit) to ADAS control unit via CAN communication</li></ul>
Stop lamp switch	
AV control unit	AV control unit transmits the system selection signal to the ADAS control unit via CAN communication
Steering angle sensor	Measures the rotation amount, rotation speed, and rotation direction of steering wheel, and then transmits them to ADAS control unit via CAN communication
Accelerator pedal actuator	Accelerator pedal actuator receives an accelerator pedal feedback force control signal from the ADAS control unit via ITS communication and pushes back the accelerator pedal



SYSTEM

System Diagram

INFOID:000000009716396

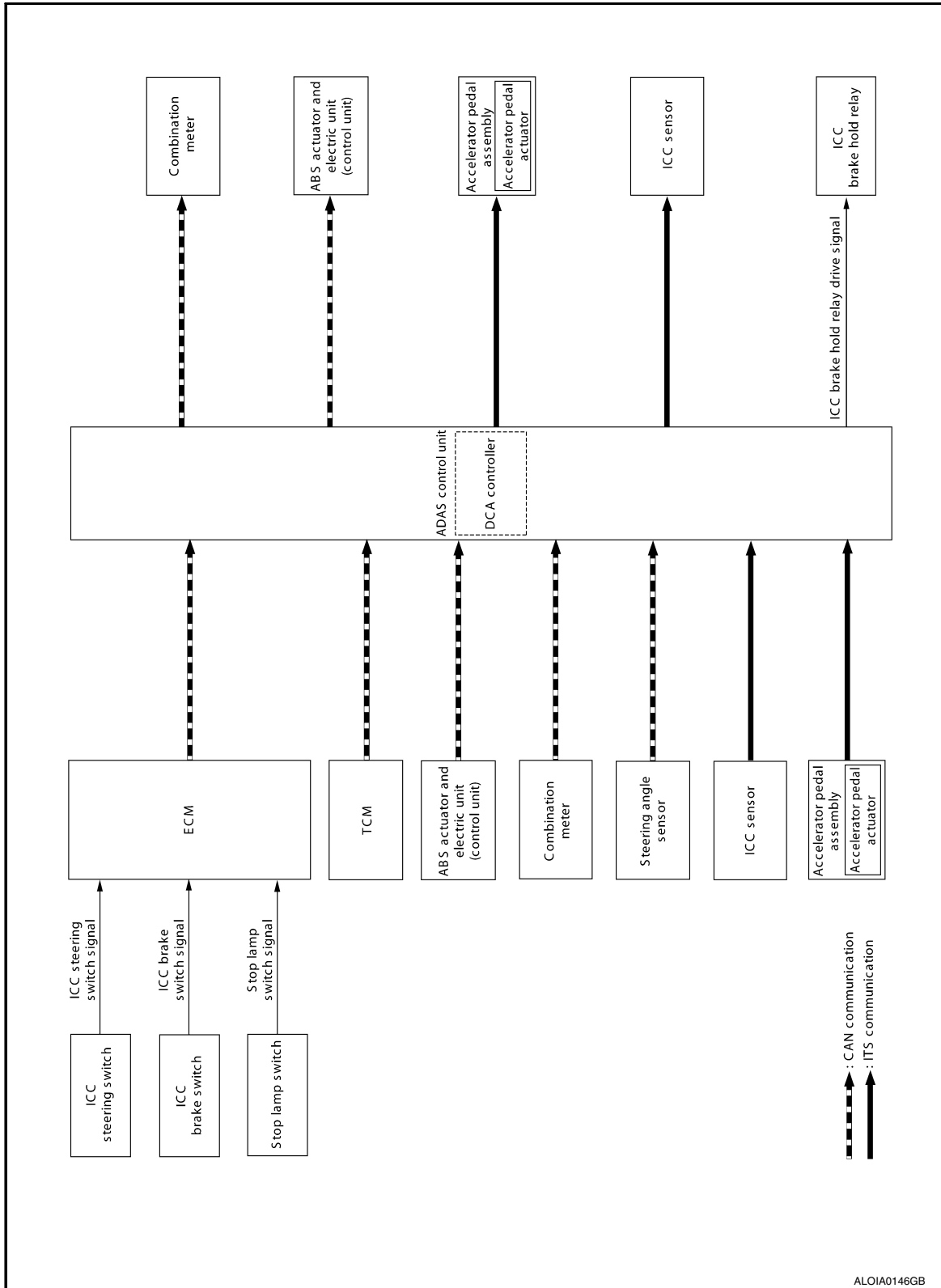

A  
B  
C  
D  
E  
F  
G  
H  
I  
J  
K  
L  
M  
N  
P

DAS

System Function

INFOID:000000009716397

ADAS CONTROL UNIT INPUT/OUTPUT SIGNAL ITEM

Input Signal Item

# SYSTEM

< SYSTEM DESCRIPTION >

[DCA]

Transmit unit	Signal name		Description	
ECM	CAN communication	Closed throttle position signal	Receives idle position state (ON/OFF)	
		Accelerator pedal position signal	Receives accelerator pedal position (angle)	
		ICC steering switch signal	Dynamic driver assistance switch signal	Receives the operational state of the ICC steering switch
		Engine speed signal		Receives engine speed
		Stop lamp switch signal		Receives an operational state of the brake pedal
		Snow mode switch signal		Receives an operational state of the snow mode
TCM	CAN communication	Input speed signal	Receives the number of revolutions of input shaft	
		Current gear position signal	Receives a current gear position	
		Shift position signal	Receives a selector lever position	
		Output shaft revolution signal	Receives the number of revolutions of output shaft	
ABS actuator and electric unit (control unit)	CAN communication	ABS malfunction signal	Receives a malfunction state of ABS	
		ABS operation signal	Receives an operational state of ABS	
		ABS warning lamp signal	Receives an ON/OFF state of ABS warning lamp	
		TCS malfunction signal	Receives a malfunction state of TCS	
		TCS operation signal	Receives an operational state of TCS	
		VDC OFF switch signal	Receives an ON/OFF state of VDC	
		VDC malfunction signal	Receives a malfunction state of VDC	
		VDC operation signal	Receives an operational state of VDC	
		Vehicle speed signal (ABS)	Receives wheel speeds of four wheels	
		Stop lamp switch signal	Receives an operational state of the brake pedal	
Yaw rate signal	Receives yaw rate acting on the vehicle			
Steering angle sensor	CAN communication	Steering angle sensor malfunction signal	Receives a malfunction state of steering angle sensor	
		Steering angle sensor signal	Receives the number of revolutions, turning direction of the steering wheel	
		Steering angle speed signal	Receives the turning angle speed of the steering wheel	
Combination meter	CAN communication	System selection signal	Receives a selection state of each item in "Driving Aids" selected with the vehicle information display	
ICC sensor	ITS communication	ICC sensor signal	Receives detection results, such as the presence or absence of a vehicle ahead and distance from the vehicle	
Accelerator pedal actuator	ITS communication	Accelerator pedal actuator operation status signal	Receives an operational state of accelerator pedal actuator	

## Output Signal Item

Reception unit	Signal name		Description
ABS actuator and electric unit (control unit)	CAN communication	Brake fluid pressure control signal	Transmits a brake fluid pressure control signal to activates the brake

# SYSTEM

< SYSTEM DESCRIPTION >

[DCA]

Reception unit	Signal name		Description
Combination meter	CAN communication	Meter display signal	Transmits a signal to display a state of the system on the information display
		DCA system switch indicator signal	
	ICC warning lamp signal	Transmits an ICC warning lamp signal to turn ON the ICC system warning lamp	
ICC sensor	ITS communication	Buzzer output signal	Transmits a buzzer output signal to activate the buzzer
		Vehicle speed signal	Transmits a vehicle speed calculated by the ADAS control unit
Accelerator pedal actuator	ITS communication	Steering angle sensor signal	Transmits a steering angle sensor signal received from the steering angle sensor
		Accelerator pedal position signal	Transmits an accelerator pedal angle calculated by the ADAS control unit
ICC brake hold relay	ICC brake hold relay drive signal	Accelerator pedal feedback force control signal	Transmits a target actuation force value calculated by the ADAS control unit
			Activates the brake hold relay and turns ON the stop lamp

## FUNCTION DESCRIPTION

When a vehicle is detected ahead

- The vehicle ahead detection indicator comes ON.

When vehicle approaches a vehicle ahead

- If the driver is not depressing the accelerator pedal, the system activates the brakes to decelerate smoothly as necessary. If the vehicle ahead comes to a stop, the vehicle decelerates to a standstill within the limitations of the system.
- If the driver is depressing the accelerator pedal, the system moves the accelerator pedal upward to assist the driver to release the accelerator pedal.

When brake operation by driver is required

- The system alerts the driver by a warning chime and blinking the vehicle ahead detection indicator. If the driver is depressing the accelerator pedal after the warning, the system moves the accelerator pedal upward to assist the driver to switch to the brake pedal.

### CAUTION:

**If the vehicle ahead comes to a standstill, the vehicle decelerates to a standstill within the limitations of the system. The system will release brake control with a warning chime once it judges the vehicle is at a standstill. To prevent the vehicle from moving, the driver must depress the brake pedal. [The system will resume control automatically once the system reaches 5 km/h (3 MPH)].**

### NOTE:

- Depending on the position of the accelerator pedal, the system may not be able to assist the driver to release the accelerator pedal appropriately.
- When the driver depresses the accelerator pedal even further while the system is moving the accelerator pedal upward, the accelerator pedal control will be canceled.
- When the driver is depressing the accelerator pedal, the brake control by the system is not operated.
- When the driver is depressing the brake pedal, neither the brake control nor the alert by the system operates.
- When the ICC system is set, the DCA system will be canceled.

## OPERATION DESCRIPTION

ICC sensor calculates a distance from a vehicle ahead and a relative speed to transmit the ICC sensor signal to the ADAS control unit via ITS communication. Based on the received signal, the ADAS control unit transmits a control signal to the accelerator pedal actuator via ITS communication and to the ABS actuator control unit (control unit) via CAN communication.

A  
B  
C  
D  
E  
F  
G  
H  
I  
J  
K  
L  
M  
N  
P

DAS

# SYSTEM

< SYSTEM DESCRIPTION >

[DCA]

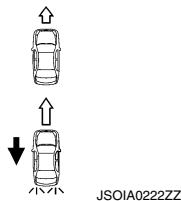
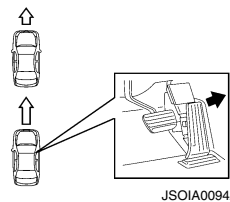
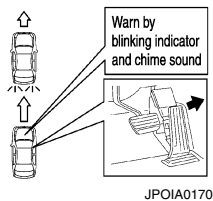
<p>When vehicle approaches a vehicle ahead</p>	<p>If the driver is not depressing the accelerator pedal, the system activates the brakes to decelerate smoothly as necessary</p>	
	<p>If the driver is depressing the accelerator pedal, the system moves the accelerator pedal upward to assist the driver to release the accelerator pedal</p>	
<p>When brake operation by driver is required</p>	<p>The system alerts the driver by a warning chime and blinking the vehicle ahead detection indicator. If the driver is depressing the accelerator pedal after the warning, the system moves the accelerator pedal upward to assist the driver to switch to the brake pedal</p>	
<p>Deceleration control</p>	<p>It transmits the brake fluid pressure control signal to the ABS actuator and electric unit (control unit) via CAN communication and performs the brake control</p>	
<p>Accelerator pedal actuation control</p>	<p>It transmits the accelerator pedal feedback force control signal to the accelerator pedal actuator via ITS communication and controls the accelerator pedal in the upward direction</p>	

**Operation Condition**

ADAS control unit performs the control when the following conditions are satisfied.

- When the DCA system setting on the navigation screen is ON.
- When the dynamic driver assistance switch is turned to ON.
- When the brake pedal is not depressed.
- When the vehicle speed is above approximately 5 km/h (3 MPH).
- When the vehicle ahead is detected.
- When the ICC system is not set.

**No Operation Condition**

The ADAS control unit is not operate when the system is under any conditions of the no operation condition.

- When the brake pedal depressed.
- When the ICC system is set.
- When the system judges that the vehicle comes to a standstill by the system control.
- When the vehicle ahead is not detected.

**Operation Cancellation Condition**

The ADAS control unit cancels the operation when the system is under any conditions of the operation cancellation condition.

- When the dynamic driver assistance switch is turned to OFF.
- When the system malfunction occurs.
- When ABS or VDC (including the TCS) operates.
- When the VDC is turned OFF.
- When the SNOW mode switch is turned ON.
- When the sensor area of the front bumper is dirty and the measurement of the distance between the vehicles becomes difficult.

**Operation At The Driver Operation**

Give priority to the driver operation in the following situation.

- When the accelerator pedal is depressed again.
- When the brake pedal is depressed.

# SYSTEM

< SYSTEM DESCRIPTION >

[DCA]

## Fail-safe (ADAS Control Unit)

INFOID:000000009716398

If a malfunction occurs in any system, ADAS control unit cancels each control, sounds a beep, and turns ON the warning lamp or indicator lamp or warning message will display.

System	Buzzer	Warning lamp/Indicator lamp	Description
Vehicle-to-vehicle distance control mode	High-pitched tone	ICC system warning lamp	Cancel
Conventional (fixed speed) cruise control mode	High-pitched tone	ICC system warning lamp	Cancel
Intelligent Brake Assist (IBA)	High-pitched tone	IBA OFF indicator lamp	Cancel
Forward Collision Warning (FCW)	High-pitched tone	Warning message	Cancel
Distance Control Assist (DCA)	High-pitched tone	ICC system warning lamp	Cancel
Lane Departure Warning (LDW)	—	Lane Departure Warning lamp	Cancel
Lane Departure Prevention (LDP)	Low-pitched tone	Lane Departure Warning lamp	Cancel
Blind Spot Warning (BSW)	—	Blind Spot Warning/Blind Spot Intervention warning lamp	Cancel
Blind Spot Intervention (BSI)	Low-pitched tone	Blind Spot Warning/Blind Spot Intervention warning lamp	Cancel
Backup Collision Intervention (BCI)	High-pitched tone	Backup Collision Intervention warning indicator	Cancel

## Fail-safe (ICC Sensor)

INFOID:000000009716399

If a malfunction occurs in the ICC sensor, ADAS control unit cancels control, sounds a beep, and turns ON the ICC system warning lamp in the combination meter.

A  
B  
C  
D  
E  
F  
G  
H  
I  
J  
K  
L  
M  
N  
P

DAS

OPERATION

Switch Name and Function

INFOID:000000009716400

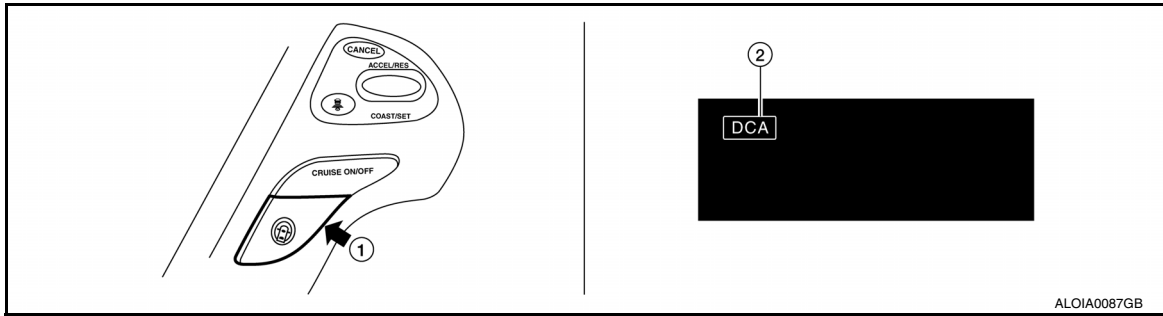

ALOIA0087GB

No.	Switch name	Description
1	Dynamic driver assistance switch	Turns the DCA system ON/OFF (When the setting of the DCA system in the vehicle information display is ON)
2	DCA system setting screen (in the vehicle information display)	DCA system settings can be switched between ON and OFF

Menu Displayed by Pressing Each Switch

INFOID:000000009716401

SYSTEM DISPLAY

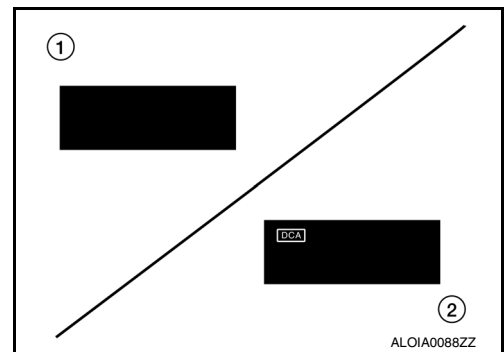

ALOIA0088ZZ

No.	Switch name	Description
1	Dynamic driver assistance switch OFF	Indicates that DCA system is OFF.
2	Dynamic driver assistance switch ON (DCA set)	Indicates that DCA system is ON with no vehicle ahead

DISPLAY AND WARNING LAMP



System Control Condition Display

The DCA system indicator on the vehicle information display illuminates when the system is turned ON by pressing the dynamic driver assistance switch.

# OPERATION

< SYSTEM DESCRIPTION >

[DCA]

	Condition	Display on combination meter	
Operation status	System set display with vehicle ahead	 <small>ALOIA0089ZZ</small>	A B C
	System set display with out vehicle ahead	 <small>ALOIA0090ZZ</small>	D E F

**Approach Warning Display**

- If own vehicle comes closer to the vehicle ahead due to rapid deceleration of that vehicle or if another vehicle cuts in, the system warns the driver with the chime and DCA system display. Decelerate by depressing the brake pedal to maintain a safe vehicle distance if:
  - The chime sounds.
  - The vehicle ahead detection indicator blinks.
- The warning chime may not sound in some cases when there is a short distance between vehicles. Some examples are:
  - When the vehicles are traveling at the same speed and the distance between vehicles is not changing
  - When the vehicle ahead is traveling faster and the distance between vehicles is increasing
  - When a vehicle cuts in near own vehicle
- The warning chime will not sound when own vehicle approaches vehicles that are parked or moving slowly.

**Warning Lamp Display**

A  
B  
C  
D  
E  
F  
G  
H  
I  
J  
K  
L  
M  
N  
P

DAS

# OPERATION

< SYSTEM DESCRIPTION >

[DCA]

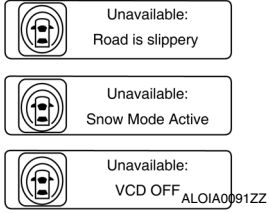
	Condition	Description	Display on combination meter
Warning display	When the dynamic driver assistance switch is turned ON with settings of DCA system, LDP system and Blind Spot Intervention system OFF	The DCA system is not activated. The DCA system switch indicator blinks.	
	<ul style="list-style-type: none"> <li>• When the road is slippery and VDC or ABS (including the TCS) operates</li> <li>• When the VDC is turned OFF</li> <li>• When the SNOW mode switch is turned ON</li> </ul>	The DCA system is automatically canceled. The chime will sound and the DCA system switch indicator will blink. <b>NOTE:</b> The system operates if the dynamic driver assistance switch is turned OFF⇒ON after the condition improves.	
	When the sensor window is dirty, making it impossible to detect a vehicle ahead	The DCA system is automatically canceled. The chime sounds and the ICC system warning lamp will come on and the “Sensor Blocked” indicator will appear. <b>NOTE:</b> Stop the vehicle in a safe location and turn the ignition switch OFF. Clean the dirty area. The system returns to normal condition when turning the ignition switch ON again.	<h2 style="margin: 0;">SENSOR BLOCKED</h2> <p style="font-size: small; margin: 0;">ALOIA0092ZZ</p>
	When the DCA system is not operating properly	The chime sounds and the DCA system warning indicator (orange) will come on. <b>NOTE:</b> Turn the ignition switch OFF, and then turn the ignition switch ON again. If there is no malfunction, the system returns to the normal condition.	<div style="border: 1px solid black; border-radius: 15px; padding: 10px; width: 100px; margin: 0 auto;"> <h1 style="margin: 0;">DCA</h1> </div> <p style="font-size: small; margin: 0;">ALOIA0093ZZ</p>

**NOTE:**

When the DCA system is automatically canceled, the cancellation condition can be displayed on “WORK SUPPORT” of CONSULT (ICC/ADAS).



## HANDLING PRECAUTION

## Precautions for Distance Control Assist

INFOID:000000009716402

- If the vehicle ahead comes to a stop, the vehicle decelerates to a standstill within the limitations of the system. The system will cancel once it judges that the vehicle has come to a standstill with a warning chime. To prevent the vehicle from moving, the driver must depress the brake pedal.
- The DCA system will not apply brake control while the driver is depressing the accelerator pedal.
- This system is only an aid to assist the driver and is not a collision warning or avoidance device. It is the driver's responsibility to stay alert, drive safely and be in control of the vehicle at all times.
- This system will not adapt automatically to road conditions. Do not use the system on roads with sharp curves, or on icy roads, in heavy rain or in fog.
- The distance sensor will not detect under most conditions.
  - Stationary and slow moving vehicles
  - Pedestrians or objects in the roadway
  - Oncoming vehicles in the same lane
  - Motorcycles traveling offset in the travel lane
- As there is a performance limit to the distance control function, never rely solely on the DCA system. This system does not correct careless, inattentive or absent-minded driving, or overcome poor visibility in rain, fog, or other bad weather. Decelerate the vehicle speed by depressing the brake pedal, depending on the distance to the vehicle ahead and the surrounding circumstances in order to maintain a safe distance between vehicles.
- The system may not detect the vehicle in front of own vehicle in certain road or weather conditions. To avoid accidents, never use the DCA system under the following conditions.
  - On roads with sharp curves
  - On slippery road surfaces such as on ice or snow, etc.
  - On off-road surfaces such as on sand or rock, etc.
  - During bad weather (rain, fog, snow, etc.)
  - When rain, snow or dirt adhere to the system sensor
  - On steep downhill roads (frequent braking may result in overheating the brakes)
  - On repeated uphill and downhill roads
  - When towing a trailer or other vehicle
- In some road or traffic conditions, a vehicle or object can unexpectedly come into the sensor detection zone and cause automatic braking. Driver may need to control the distance from other vehicles using the accelerator pedal. Always stay alert and avoid using the DCA system when it is not recommended in this section.
- The following are some conditions in which the sensor cannot detect the signals.
  - When the snow or road spray from traveling vehicles reduces the sensor's visibility
  - When excessively heavy baggage is loaded in the rear seat or the luggage room of own vehicle
- The DCA system is designed to automatically check the sensor's operation. When the front bumper area of the distance sensor is covered with dirt or is obstructed, the system will automatically be cancelled. If the front bumper area of the distance sensor is covered with ice, a transparent or translucent vinyl bag, etc., the DCA system may not detect them. In these instances, the DCA system may not be able to decelerate the vehicle properly. Be sure to check and clean the sensor regularly.
- The DCA system is designed to help assist the driver to maintain a following distance from the vehicle ahead. The system will decelerate as necessary and if the vehicle ahead comes to a stop, the vehicle decelerates to standstill. However, the DCA system can only apply up to 25% of the vehicles total braking power. If a vehicle moves into the traveling lane ahead or if a vehicle traveling ahead rapidly decelerates, the distance between vehicles may become closer because the DCA system cannot decelerate the vehicle quickly enough. If this occurs, the DCA system will sound a warning chime and blink the system display to notify the driver to take necessary action.
- The DCA system does not control vehicle speed or warn when driver approach stationary and slow moving vehicles. Driver must pay attention to vehicle operation to maintain proper distance from vehicles ahead.

A

B

C

D

E

F

G

H

I

J

K

L

M

N

DAS

P

## HANDLING PRECAUTION

[DCA]

### < SYSTEM DESCRIPTION >

- The detection zone of the sensor is limited. A vehicle ahead must be in the detection zone for the system to operate.
- A vehicle ahead may move outside of the detection zone due to its position within the same lane of travel. Motorcycles may not be detected in the same lane ahead if they are traveling offset from the center line of the lane. A vehicle that is entering the lane ahead may not be detected until the vehicle has completely moved into the lane. If this occurs, the system may warn driver by blinking the system indicator and sounding the chime. The driver may have to manually control the proper distance away from vehicle traveling ahead.

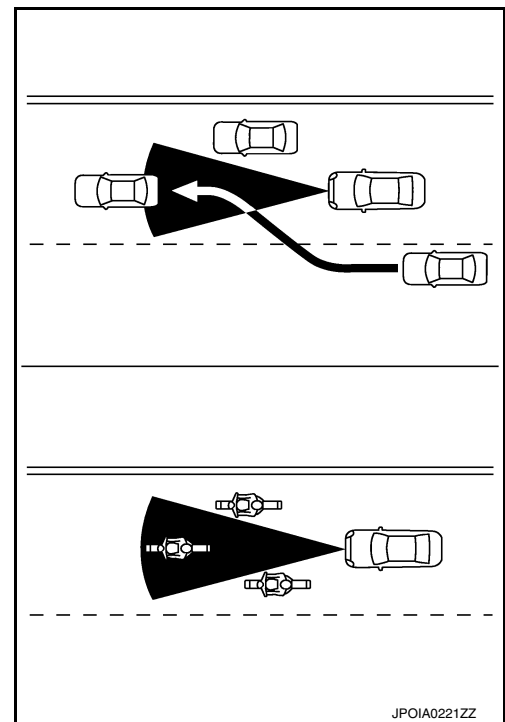

- When driving on some roads, such as winding, hilly, curved, narrow roads, or roads which are under construction, the sensor may detect vehicles in a different lane, or may temporarily not detect a vehicle traveling ahead. This may cause the system to work inappropriately. The detection of vehicles may also be affected by vehicle operation (steering maneuver or traveling position in the lane, etc.) or vehicle condition. If this occurs, the system may warn driver by blinking the system indicator and sounding the chime unexpectedly. The driver will have to manually control the proper distance away from the vehicle traveling ahead.

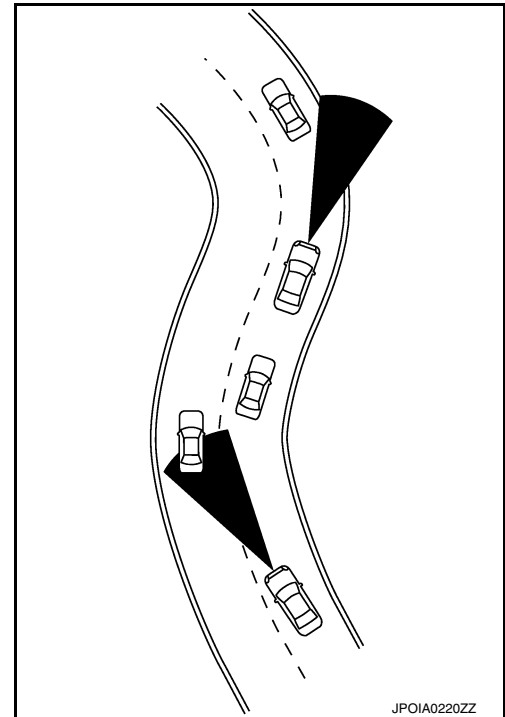

- The approach warning chime may sound and the system display may blink when the sensor detects some reflectors which are fitted on vehicles in other lanes or on the side of the road. This may cause the DCA system to operate inappropriately. The sensor may detect these reflectors when the vehicle is driven on winding roads, hilly roads or when entering or exiting a curve. The sensor may also detect reflectors on narrow roads or in road construction zones. In these cases driver will have to manually control the proper distance ahead of own vehicle. Also, the sensor sensitivity can be affected by vehicle operation (steering maneuver or driving position in the lane) or traffic or vehicle condition (for example, if a vehicle is being driven with some damage).
- The DCA system automatically decelerates own vehicle to help assist the driver to maintain a following distance from the vehicle ahead. Manually brake when deceleration is required to maintain a safe distance upon sudden braking by the vehicle ahead or when a vehicle suddenly appears in front of own vehicle. Always stay alert when using the DCA system.
- When the vehicle ahead detection indicator lamp is not illuminated, system will not control or warn the driver.
- Depending on the position of the accelerator pedal, the system may not be able to assist the driver to release the accelerator pedal appropriately.
- If the vehicle ahead comes to a standstill, the vehicle decelerates to a standstill within the limitations of the system. The system will release brake control with a warning chime once it judges the vehicle is at a standstill. To prevent the vehicle from moving, the driver must depress the brake pedal. [The system will resume control automatically once the system reaches 5 km/h (3 MPH)].

# DIAGNOSIS SYSTEM (ADAS CONTROL UNIT)

< SYSTEM DESCRIPTION >

[DCA]

## DIAGNOSIS SYSTEM (ADAS CONTROL UNIT)

### On Board Diagnosis Function

INFOID:00000009716403

#### DESCRIPTION

The DTC is displayed on the information display by operating the ICC steering switch.

#### On Board Self-diagnosis System Diagram

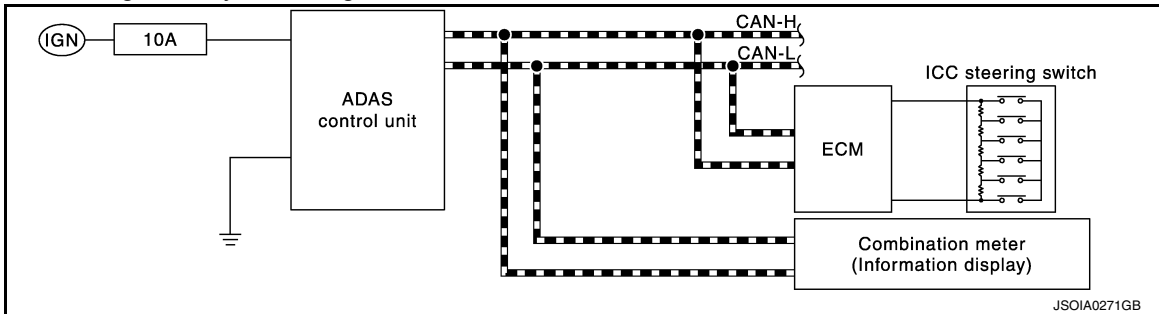

#### METHOD OF STARTING

##### CAUTION:

##### Start condition of on board self-diagnosis

- ICC system OFF
- DCA system OFF
- Vehicle speed 0 km/h (0 MPH)

1. Turn the ignition switch OFF.
2. Start the engine.
3. Wait for 5 seconds after starting the engine. Push up the RESUME/ACCELERATE switch 5 times and push down the SET/COAST switch 5 times within 10 seconds.

##### NOTE:

If the above operation cannot be performed within 10 seconds after waiting for 5 seconds after starting the engine, repeat the procedure from step 1.

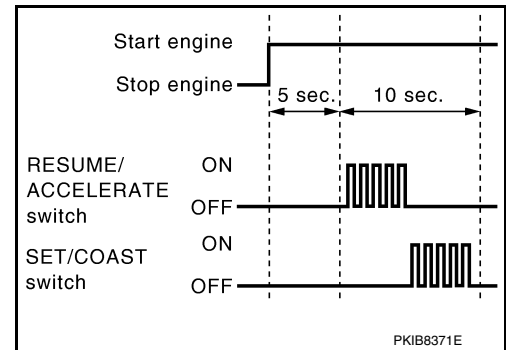

4. The DTC is displayed on the set vehicle speed indicator (1) on the ICC system display on the information display when the on board self-diagnosis starts. Refer to [DAS-122, "DTC Index"](#).

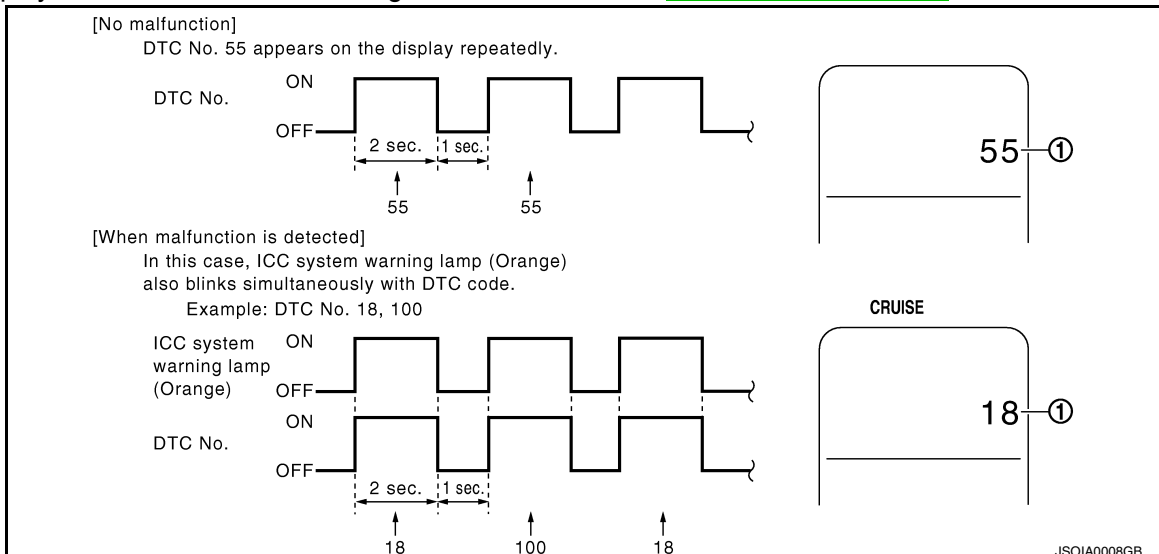

##### NOTE:

A  
B  
C  
D  
E  
F  
G  
H  
I  
J  
K  
L  
M  
N  
P

DAS

# DIAGNOSIS SYSTEM (ADAS CONTROL UNIT)

[DCA]

## < SYSTEM DESCRIPTION >

- It displays for up to 5 minutes and then stops.
- If multiple malfunctions exist, up to 6 DTCs can be stored in memory at the most, and the most recent one is displayed first.

## WHEN THE ON BOARD SELF-DIAGNOSIS DOES NOT START

If the on board self-diagnosis does not start, check the following items.

Assumed abnormal part		Inspection item
Information display	Combination meter malfunction	Check that the self-diagnosis function of the combination meter operates. Refer to <a href="#">MWI-15, "INFORMATION DISPLAY : System Description"</a>
ICC steering switch malfunction		Perform the inspection for DTC"C1A06". Refer to <a href="#">DAS-167, "Diagnosis Procedure"</a>
Harness malfunction between ICC steering switch and ECM		
ECM malfunction		
ADAS control unit malfunction		<ul style="list-style-type: none"> <li>• Check power supply and ground circuit of ADAS control unit. Refer to <a href="#">DAS-224, "ADAS CONTROL UNIT : Diagnosis Procedure"</a>.</li> <li>• Perform SELF-DIAGNOSIS for "ICC/ADAS"with CONSULT, and then check the malfunctioning parts. Refer to <a href="#">DAS-122, "DTC Index"</a>.</li> </ul>

## HOW TO ERASE ON BOARD SELF-DIAGNOSIS

1. Turn the ignition switch OFF.
2. Start the engine, and then start the on board self-diagnosis.
3. Press the CANCEL switch 5 times, and then press the DISTANCE switch 5 times under the condition that the on board self-diagnosis starts.

### NOTE:

- Complete the operation within 10 seconds after pressing the CANCEL switch first.
- If the operation is not completed within 10 seconds, repeat the procedure from step 1.

4. DTC 55 is displayed after erasing.

### NOTE:

DTCs for existing malfunction can not be erased.

5. Turn ignition switch OFF, and finish the diagnosis.

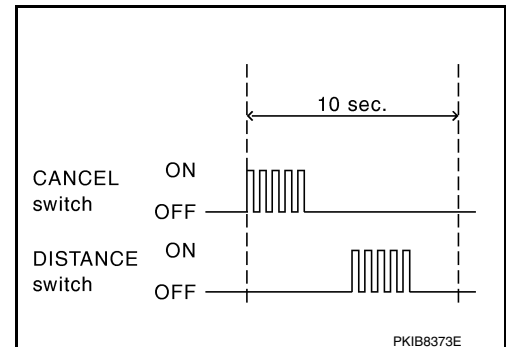

## CONSULT Function (ICC/ADAS)

INFOID:000000009716404

### CAUTION:

After disconnecting the CONSULT vehicle interface (VI) from the data link connector, the ignition must be cycled OFF → ON (for at least 5 seconds) → OFF. If this step is not performed, the BCM may not go to "sleep mode", potentially causing a discharged battery and a no-start condition.

## APPLICATION ITEMS

CONSULT performs the following functions via CAN communication using ADAS control unit.

Diagnosis mode	Description
Self Diagnostic Result	Displays the name of a malfunctioning system stored in the ADAS control unit.
Data Monitor	Displays ADAS control unit input/output data in real time.
Work support	Displays causes of automatic system cancellation occurred during system control.
Active Test	Enables an operational check of a load by transmitting a driving signal from the ADAS control unit to the load.
ECU identification	Displays ADAS control unit part number.
CAN Diag Support Mntr	Displays a reception/transmission state of CAN communication and ITS communication.

## SELF DIAGNOSTIC RESULT

Refer to [DAS-47, "DTC Index"](#).

# DIAGNOSIS SYSTEM (ADAS CONTROL UNIT)

< SYSTEM DESCRIPTION >

[DCA]

## DATA MONITOR

Monitored item [Unit]	ALL SIG (ICC)	MAIN SIG (ICC)	MAIN SIG (LDW/LDP)	MAIN SIG (BSW/BSI)	BCI MAIN	Description
MAIN SW [On/Off]	×	×	×	×		Indicates [On/Off] status as judged from ICC steering switch signal (ECM transmits ICC steering switch signal through CAN communication)
SET/COAST SW [On/Off]	×	×				Indicates [On/Off] status as judged from ICC steering switch signal (ECM transmits ICC steering switch signal through CAN communication)
CANCEL SW [On/Off]	×	×				Indicates [On/Off] status as judged from ICC steering switch signal (ECM transmits ICC steering switch signal through CAN communication)
RESUME/ACC SW [On/Off]	×	×				Indicates [On/Off] status as judged from ICC steering switch signal (ECM transmits ICC steering switch signal through CAN communication)
DISTANCE SW [On/Off]	×					Indicates [On/Off] status as judged from ICC steering switch signal (ECM transmits ICC steering switch signal through CAN communication)
CRUISE OPE [On/Off]	×	×				Indicates whether controlling or not (ON means "controlling")
BRAKE SW [On/Off]	×	×	×	×	×	Indicates [On/Off] status as judged from ICC brake switch signal (ECM transmits ICC brake switch signal through CAN communication)
STOP LAMP SW [On/Off]	×	×	×	×	×	Indicates [On/Off] status as judged from stop lamp switch signal (ECM transmits stop lamp switch signal through CAN communication)
IDLE SW [On/Off]	×				×	Indicates [On/Off] status of idle switch read from ADAS control unit through CAN communication (ECM transmits On/Off status through CAN communication)
SET DISTANCE [Short/Mid/Long]	×	×				Indicates set distance memorized in ADAS control unit
CRUISE LAMP [On/Off]	×	×				Indicates [On/Off] status of MAIN switch indicator output
OWN VHCL [On/Off]	×					Indicates [On/Off] status of own vehicle indicator output
VHCL AHEAD [On/Off]	×					Indicates [On/Off] status of vehicle ahead detection indicator output
ICC WARNING [On/Off]	×					Indicates [On/Off] status of ICC system warning lamp output
VHCL SPEED SE [km/h] or [mph]	×	×	×	×	×	Indicates vehicle speed calculated from ADAS control unit through CAN communication [ABS actuator and electric unit (control unit) transmits vehicle speed signal (wheel speed) through CAN communication]
SET VHCL SPD [km/h] or [mph]	×	×				Indicates set vehicle speed memorized in ADAS control unit
BUZZER O/P [On/Off]	×				×	Indicates [On/Off] status of ICC warning chime output
THRTL SENSOR [deg]	×	×				<b>NOTE:</b> The item is displayed, but it is not monitored
ENGINE RPM [rpm]	×					Indicates engine speed read from ADAS control unit through CAN communication (ECM transmits engine speed signal through CAN communication)
WIPER SW [OFF/LOW/HIGH]	×					Indicates wiper [OFF/LOW/HIGH] status (BCM transmits front wiper request signal through CAN communication)
BA WARNING [On/Off]	×					Indicates [On/Off] status of IBA OFF indicator lamp output
STP LMP DRIVE [On/Off]	×	×			×	Indicates [On/Off] status of ICC brake hold relay drive output

A

B

C

D

E

F

G

H

I

J

K

L

M

N

DAS

P

# DIAGNOSIS SYSTEM (ADAS CONTROL UNIT)

< SYSTEM DESCRIPTION >

[DCA]

Monitored item [Unit]	ALL SIG (ICC)	MAIN SIG (ICC)	MAIN SIG (LDW/LDP)	MAIN SIG (BSW/BSI)	BCI MAIN	Description
D RANGE SW [On/Off]	×					Indicates [On/Off] status of "D" or "M" positions read from ADAS control unit through CAN communication; ON when position "D" or "M" (TCM transmits shift position signal through CAN communication).
NP RANGE SW [On/Off]	×					Indicates shift position signal read from ADAS control unit through CAN communication (TCM transmits shift position signal through CAN communication)
PKB SW [On/Off]	×					Parking brake switch status [On/Off] judged from the parking brake switch signal that ADAS control unit readout via CAN communication is displayed (Combination meter transmits the parking brake switch signal via CAN communication)
PWR SUP MONI [V]	×	×				Indicates IGN voltage input by ADAS control unit
VHCL SPD AT [km/h] or [mph]	×					Indicates vehicle speed calculated from CVT vehicle speed sensor read from ADAS control unit through CAN communication (TCM transmits CVT vehicle speed sensor signal through CAN communication)
THRTL OPENING [%]	×	×			×	Indicates throttle position read from ADAS control unit through CAN communication (ECM transmits accelerator pedal position signal through CAN communication).
GEAR [1, 2, 3, 4, 5, 6]	×					Indicates CVT gear position read from ADAS control unit through CAN communication (TCM transmits current gear position signal through CAN communication)
MODE SIG [OFF, ICC, ASCD]	×					Indicates the active mode from ICC or ASCD [conventional (fixed speed) cruise control mode]
SET DISP IND [On/Off]	×					Indicates [On/Off] status of SET switch indicator output
DISTANCE [m]	×					Indicates the distance from the vehicle ahead
RELATIVE SPD [m/s]	×					Indicates the relative speed of the vehicle ahead
Camera lost [Detect/Deviate/Both]			×	×		Indicates a lane marker detection state judged from a lane marker detection signal read by the ADAS control unit via ITS communication (Lane camera unit transmits a lane marker signal via ITS communication)
Lane unclear [On/Off]			×	×		Indicates an ON/OFF state of the lane marker. The ON/OFF state is judged from a detected lane condition signal read by the ADAS control unit via ITS communication (The lane camera unit transmits a detected lane condition signal via ITS communication)
STATUS signal [Stnby/Warn/Cancl/Off]			×			Indicates a control state of LDP system
DYNA ASIST SW [On/Off]	×	×		×		Indicates [On/Off] status as judged from ICC steering switch signal (ECM transmits ICC steering switch signal through CAN communication)
DCA ON IND [On/Off]	×					The status [ON/OFF] of DCA system switch indicator output is displayed
DCA VHL AHED [On/Off]	×					The status [ON/OFF] of vehicle ahead detection indicator output in DCA system is displayed
IBA SW [On/Off]	×	×				Indicates [On/Off] status of IBA OFF switch
APA TEMP [°C]	×				×	Accelerator pedal actuator integrated motor temperature that the ADAS control unit readout via ITS communication is displayed (Accelerator pedal actuator transmits the integrated motor temperature via ITS communication)

# DIAGNOSIS SYSTEM (ADAS CONTROL UNIT)

< SYSTEM DESCRIPTION >

[DCA]

Monitored item [Unit]	ALL SIG (ICC)	MAIN SIG (ICC)	MAIN SIG (LDW/LDP)	MAIN SIG (BSW/BSI)	BCI MAIN	Description
APA PWR [V]	×				×	Accelerator pedal actuator power supply voltage that the ADAS control unit read-out via ITS communication is displayed (Accelerator pedal actuator transmits the power supply voltage via ITS communication)
FCW SYSTEM ON [On/Off]	×	×				Indicates [On/Off] status of FCW system
LDW SYSTEM ON [On/Off]			×			Indicates [On/Off] status of LDW system
LDW ON LAMP [On/Off]			×			Indicates [On/Off] status of warning systems ON indicator output
LDP ON IND [On/Off]			×			Indicates [On/Off] status of LDP ON indicator lamp (Green) output
LANE DPRT W/L [On/Off]			×			Indicates [On/Off] status of lane departure warning lamp (Yellow) output
LDW BUZER OUTPUT [On/Off]			×			Indicates [On/Off] status of warning buzzer output
LDP SYSTEM ON [On/Off]			×			Indicates [On/Off] status of LDP system
READY signal [On/Off]			×			Indicates LDP system settings
Shift position [Off, P, R, N, D, M/T1 - 7]			×	×	×	Indicates shift position read from ADAS control unit through CAN communication (TCM transmits shift position signal through CAN communication)
Turn signal [OFF/LH/RH/LH&RH]			×	×		Indicates turn signal operation status read from ADAS control unit through CAN communication (BCM transmits turn indicator signal through CAN communication)
SIDE G [G]			×	×		Indicates lateral G acting on the vehicle. This lateral G is judged from a side G sensor signal read by ADAS control unit via CAN communication (The ABS actuator and electric unit (control unit) transmits a side G sensor signal via CAN communication)
FUNC ITEM(FCW)	×	×	×	×		Indicates systems which can be set to ON/OFF by selecting "Driver Assistance"⇒ "Driving aids" of the navigation system FCW: Distance Control Assist (DCA), Lane Departure Prevention (LDP) and Blind Spot Intervention
FUNC ITEM(LDW)	×	×	×	×		Indicates systems which can be set to ON/OFF by selecting "Driver Assistance"⇒ "Driving aids" of the navigation system LDW: Distance Control Assist (DCA), Lane Departure Prevention (LDP) and Blind Spot Intervention
FUNC ITEM(BSW)	×	×	×	×		Indicates systems which can be set to ON/OFF by selecting "Driver Assistance"⇒ "Driving aids" of the navigation system BSW: Distance Control Assist (DCA), Lane Departure Prevention (LDP) and Blind Spot Intervention
FUNC ITEM (NV-ICC) [Off]	×	×	×	×		<b>NOTE:</b> The item is displayed, but it is not monitored
FUNC ITEM (NV-DCA) [Off]	×	×	×	×		<b>NOTE:</b> The item is displayed, but it is not monitored
DCA SELECT [On/Off]	×	×	×	×		Indicates an ON/OFF state of DCA system. DCA system can be set to ON/OFF by selecting "Driver Assistance"⇒"Driving aids" of the navigation system
LDP SELECT [On/Off]	×	×	×	×		Indicates an ON/OFF state of LDP system. LDP system can be set to ON/OFF by selecting "Driver Assistance"⇒"Driving aids" of the navigation system

A  
B  
C  
D  
E  
F  
G  
H  
I  
J  
K  
L  
M  
N  
P

DAS

# DIAGNOSIS SYSTEM (ADAS CONTROL UNIT)

< SYSTEM DESCRIPTION >

[DCA]

Monitored item [Unit]	ALL SIG (ICC)	MAIN SIG (ICC)	MAIN SIG (LDW/LDP)	MAIN SIG (BSW/BSI)	BCI MAIN	Description
BSI SELECT [On/Off]	×	×	×	×		Indicates an ON/OFF state of Blind Spot Intervention system. Blind Spot Intervention system can be set to ON/OFF by selecting "Driver Assistance"⇒"Driving aids" of the navigation system
DRIVE MODE STATS [SNO/ECO/STD/SPT]	×	×	×	×		Indicates [On/Off] status of warning systems switch
WARN SYS SW [On/Off]	×	×	×	×		Indicates [On/Off] status of warning systems switch
BSW/BSI WARN LMP [On/Off]				×		Indicates [On/Off] status of Blind Spot Warning/Blind Spot Intervention warning lamp output
BSI ON IND [On/Off]				×		Indicates [On/Off] status of Blind Spot Intervention ON indicator output
BSW SYSTEM ON [On/Off]				×		Indicates [On/Off] status of BSW system
BSI SYSTEM ON [On/Off]				×		Indicates [On/Off] status of Blind Spot Intervention system
BCI SYSTEM ON [On/Off]					×	Indicates [On/Off] status of Backup Collision Intervention system
BCI SWITCH [On/Off]					×	Indicates [On/Off] status of Backup Collision Intervention system switch
LDP WARNING INDICA- TOR [On/Off]			×			Indicates [On/Off] status of Lane Departure Prevention system failure lamp
LDW ON INDICATOR [On/Off]			×			Indicates [On/Off] status of LDW system
LDW WARNING INDICA- TOR [On/Off]			×			Indicates [On/Off] status of Lane Departure Warning system failure lamp
SYSTEM CANCEL MES- SAGE [Request/No Request]	×	×	×	×		Indicates system cancel message request
CAMERA HI TEMP MSG [On/Off]			×	×		Indicates high temperature message has been received
ITS Setting Item(DCA) [On/Off]	×	×	×	×		Indicates [On/Off] status of Distance Control Assist warning lamp output
ITS Setting Item(LDP) [On/Off]	×	×	×	×		Indicates [On/Off] status of Lane Departure Prevention warning lamp output
ITS Setting Item(BSI) [On/Off]	×	×	×	×		Indicates [On/Off] status of Blind Spot Intervention system
BSI WARNING INDICA- TOR [On/Off]				×		Indicates [On/Off] status of Blind Spot Intervention warning lamp indicator
BSW ON INDICATOR [On/Off]				×		Indicates [On/Off] status of BSW system
BSW IND BRIGHTNESS [Bright/Not Bright]				×		Indicates BSW warning lamp indicator brightness level
WARN REQ [On/Off]			×			Indicates an ADAS control unit judged warning state (ON/OFF) of LDP system



# DIAGNOSIS SYSTEM (ADAS CONTROL UNIT)

< SYSTEM DESCRIPTION >

[DCA]

## WORK SUPPORT

Work support items	Description
CAUSE OF AUTO-CANCEL 1	Displays causes of automatic system cancellation occurred during control of the following systems <ul style="list-style-type: none"> <li>• Vehicle-to-vehicle distance control mode</li> <li>• Conventional (fixed speed) cruise control mode</li> <li>• Distance Control Assist (DCA)</li> </ul>
CAUSE OF AUTO-CANCEL 2	Displays causes of automatic system cancellation occurred during control of the following systems <ul style="list-style-type: none"> <li>• Lane Departure Prevention (LDP)</li> <li>• Blind Spot Intervention</li> </ul>
CAUSE OF AUTO-CANCEL 3	Displays causes of automatic system cancellation occurred during control of the following system <ul style="list-style-type: none"> <li>• Backup Collision Intervention</li> </ul>

**NOTE:**

- Causes of the maximum five cancellations (system cancel) are displayed.
- The displayed cancellation causes display the number of the ignition switch ON/OFF up to 254. It is fixed to 254 if it is over 254. It returns to 0 when the same cancellation cause is detected again.

### Display Items for The Cause of Automatic Cancellation 1

Cause of cancellation	Vehicle-to-vehicle distance control mode	Conventional (fixed speed) cruise control mode	Distance Control Assist	Description
OPERATING ABS	×		×	ABS function was operated
OPERATING TCS	×	×	×	TCS function was operated
OPERATING VDC	×	×	×	VDC function was operated
ECM CIRCUIT	×	×		ECM did not permit ICC operation
OPE SW VOLT CIRC	×	×	×	The ICC steering switch input voltage is not within standard range
LASER TEMP	×		×	Temperature around ICC sensor became low
SNOW MODE SW	×		×	SNOW mode switch was pressed
OP SW DOUBLE TOUCH	×	×		ICC steering switches were pressed at the same time
VHCL SPD DOWN	×	×	×	Vehicle speed lower than the speed as follows <ul style="list-style-type: none"> <li>• Vehicle-to-vehicle distance control mode is 24 km/h (15 MPH)</li> <li>• Conventional (fixed speed) cruise control mode is 22 km/h (14 MPH)</li> </ul>
WHL SPD ELEC NOISE	×	×	×	Wheel speed sensor signal caught electromagnetic noise
VDC/TCS OFF SW	×		×	VDC OFF switch was pressed
VHCL SPD UNMATCH	×	×	×	Wheel speed became different from CVT vehicle speed
FR RADAR BLOCKED	×		×	The front bumper near the ICC sensor is blocked or dirty
TIRE SLIP	×	×		Wheel slipped

# DIAGNOSIS SYSTEM (ADAS CONTROL UNIT)

[DCA]

## < SYSTEM DESCRIPTION >

IGN LOW VOLT	×	×	×	Decrease in ADAS control unit IGN voltage
PARKING BRAKE ON	×	×		The parking brake is engaged
WHEEL SPD UNMATCH	×	×	×	The wheel speeds of 4 wheels are out of the specified values
INCHING LOST	×			A vehicle ahead is not detected during the following driving when the vehicle speed is approximately 24 km/h (15 MPH) or less
CAN COMM ERROR	×	×	×	ADAS control unit received an abnormal signal with CAN communication
ABS/TCS/VDC CIRC	×	×	×	An abnormal condition occurs in VDC/TCS/ABS system
ECD CIRCUIT	×	×	×	An abnormal condition occurs in ECD system
ASCD VHCL SPD DTAC		×		Vehicle speed is detached from set vehicle speed
ASCD DOUBLE COMD		×		Cancel switch and operation switch are detected simultaneously
APA HI TEMP			×	The accelerator pedal actuator integrated motor temperature is high
ICC SENSOR CAN COMM ERR	×		×	Communication error between ADAS control unit and the ICC sensor
ABS WARNING LAMP	×		×	ABS warning lamp ON
NO RECORD	×	×	×	—

## Display Items for The Cause of Automatic Cancellation 2

Cause of cancellation	Lane departure prevention	Blind spot intervention	Description
OPE VDC/TCS/ABS 1	×		The activation of VDC, TCS, or ABS during LDP system control
Vehicle dynamics	×		Vehicle behavior exceeds specified value
Steering speed	×		Steering speed was more than the specified value in evasive direction
End by yaw angle	×		Yaw angle was the end of LDP control
Departure yaw large	×		Detected more than the specified value of yaw angle in departure direction
ICC WARNING	×		Target approach warning of ICC system, IBA system, or FCW system was activated
CURVATURE	×		Road curve was more than the specified value
Steering angle large	×		Steering angle was more than the specified value
Brake is operated	×		Brake pedal was operated
IGN LOW VOLT	×		Decrease in ADAS control unit IGN voltage
Lateral offset	×		Distance of vehicle and lane was detached in lateral direction more than the specified value
Lane marker lost	×		Lane camera unit lost the trace of lane marker
Lane marker unclear	×		Detected lane marker was unclear
Yaw acceleration	×		Detected yawing speed was more than the specified value
Deceleration large	×		Deceleration in a longitudinal direction was more than the specified value
Accel is operated	×		Accelerator pedal was depressed
Departure steering	×		Steering wheel was steered more than the specified value in departure direction
Evasive steering	×		Steering wheel was steered more than the specified value in the evasive direction
R range	×		Selector lever was operated to R range
Parking brake drift	×		Rear wheels lock was detected

# DIAGNOSIS SYSTEM (ADAS CONTROL UNIT)

< SYSTEM DESCRIPTION >

[DCA]

Cause of cancellation	Lane departure prevention	Blind spot intervention	Description
Not operating condition	×		Did not meet the operating condition (vehicle speed, turn signal operation, etc.)
SNOW MODE SW	×		SNOW mode switch was pressed
VDC OFF SW	×		VDC OFF switch was pressed
OPE VDC/ABS 2	×		The activation of VDC or ABS during a standby time of LDP system control
BSI WARNING	×		Blind Spot Intervention system was activated
BSI) OPE VDC/TCS/ ABS 1		×	The activation of VDC, TCS, or ABS during Blind Spot Intervention system control
BSI) Vehicle dynamics		×	Vehicle behavior exceeds specified value
BSI) Steering speed		×	Steering speed was more than the specified value in evasive direction
BSI) End by yaw angle		×	Yaw angle was the end of Blind Spot Intervention control
BSI) Departure yaw large		×	Detected more than the specified value of yaw angle in departure direction
BSI) ICC WARNING		×	Target approach warning of ICC system, IBA system or FCW system was activated
BSI) CURVATURE		×	Road curve was more than the specified value
BSI) Steering angle large		×	Steering angle was more than the specified value
BSI) Brake is operated		×	Brake pedal was operated
BSI) IGN LOW VOLT		×	Decrease in ADAS control unit IGN voltage
BSI) Lateral offset		×	Distance of vehicle and lane was detached in lateral direction more than the specified
BSI) Lane marker lost		×	Lane camera unit lost the trace of lane marker
BSI) Lane marker unclear		×	Detected lane marker was unclear
BSI) Yaw acceleration		×	Detected yawing speed was more than the specified value
BSI) Deceleration large		×	Deceleration in a longitudinal direction was more than the specified value
BSI) Accel is operated		×	Accelerator pedal was depressed
BSI) Departure steering		×	Steering wheel was steered more than the specified value in departure direction
BSI) Evasive steering		×	Steering wheel was steered more than the specified value in the evasive direction
BSI) R range		×	Selector lever was operated to R range
BSI) Parking brake drift		×	Rear wheels lock was detected
BSI) SNOW MODE SW		×	SNOW mode switch was pressed
BSI) VDC OFF SW		×	VDC OFF switch was pressed
BSI) OPE VDC/ABS 2		×	The activation of VDC or ABS during a standby time of Blind Spot Intervention system control
BSI) Not operating condition		×	Did not meet the operating condition (vehicle speed, turn signal operation, etc.)
Side Radar Lost		×	Unrecognized side radar LH or RH by the ADAS control unit
NO RECORD	×	×	—

A  
B  
C  
D  
E  
F  
G  
H  
I  
J  
K  
L  
M  
N  
P

DAS

Display Items for The Cause of Automatic Cancellation 3

# DIAGNOSIS SYSTEM (ADAS CONTROL UNIT)

< SYSTEM DESCRIPTION >

[DCA]

Cause of cancellation	Backup Collision Intervention	Description
OPERATING WIPER	×	The wiper operates at HI (it includes when the wiper is operated at HI with the wiper switch AUTO position)
OPERATING ABS	×	ABS function was operated
OPERATING TCS	×	TCS function was operated
OPERATING VDC	×	VDC function was operated
ECM CIRCUIT	×	ECM did not permit ICC operation
SNOW MODE SW	×	SNOW mode switch was pressed
VDC/TCS OFF SW	×	VDC OFF switch was pressed
VHCL SPD UNMATCH	×	Wheel speed became different from CVT vehicle speed
TIRE SLIP	×	Wheel slipped
IGN LOW VOLT	×	Decrease in ADAS control unit IGN voltage
PARKING BRAKE ON	×	The parking brake is engaged
WHEEL SPD UNMATCH	×	The wheel speeds of 4 wheels are out of the specified values
CAN COMM ERROR	×	ADAS control unit received an abnormal signal with CAN communication
ABS/TCS/VDC CIRC	×	An abnormal condition occurs in VDC/TCS/ABS system
ECD CIRCUIT	×	An abnormal condition occurs in ECD system
APA HI TEMP		The accelerator pedal actuator integrated motor temperature is high
ABS WARNING LAMP	×	ABS warning lamp ON
Brake is operated	×	Brake pedal was operated
Accel is operated	×	Accelerator pedal was depressed
SNOW MODE SW	×	DMS switch SNOW mode was selected
VDC OFF SW	×	VDC OFF switch was pressed
Side Radar Lost	×	Unrecognized side radar LH or RH by the ADAS control unit
NO RECORD	×	—

## ACTIVE TEST

### CAUTION:

- Never perform “Active Test” while driving the vehicle.
- The “Active Test” cannot be performed when the following systems warning lamp is illuminated.
  - ICC system warning lamp
  - Lane departure warning lamp
  - Blind Spot Warning/Blind Spot Intervention warning lamp
  - IBA OFF indicator lamp (IBA system ON)
- Shift the selector lever to “P” position, and then perform the test.

Test item	Description
BRAKE ACTUATOR	Activates the brake by an arbitrary operation
ICC BUZZER	Sounds a buzzer used for following systems by arbitrarily operating ON/OFF <ul style="list-style-type: none"> <li>• Intelligent Cruise Control (ICC)</li> <li>• Distance Control Assist (DCA)</li> <li>• Forward Collision Warning (FCW)</li> <li>• Intelligent Brake Assist (IBA)</li> </ul>

# DIAGNOSIS SYSTEM (ADAS CONTROL UNIT)

< SYSTEM DESCRIPTION >

[DCA]

Test item	Description
METER LAMP	The ICC system warning lamp, MAIN switch indicator and IBA OFF indicator lamp can be illuminated by ON/OFF operations as necessary
STOP LAMP	The ICC brake hold relay can be operated by ON/OFF operations as necessary, and the stop lamp can be illuminated
ACTIVE PEDAL	The accelerator pedal actuator can be operated as necessary
DCA INDICATOR	The DCA system switch indicator can be illuminated by ON/OFF operations as necessary
LDP BUZZER	Sounds a buzzer used for following systems by arbitrarily operating ON/OFF <ul style="list-style-type: none"> <li>• Lane Departure Warning (LDW)</li> <li>• Lane Departure Prevention (LDP)</li> <li>• Blind Spot Warning (BSW)</li> <li>• Blind Spot Intervention</li> </ul>
WARNING SYSTEM IND	Warning systems ON indicator (on warning systems switch) can be illuminated by ON/OFF operations as necessary
LDP ON IND	The LDP ON indicator lamp can be illuminated by ON/OFF operations as necessary
LANE DEPARTURE W/L	The Lane departure warning lamp can be illuminated by ON/OFF operations as necessary
BSW/BSI WARNING LAMP	The Blind Spot Warning/Blind Spot Intervention warning lamp can be illuminated by ON/OFF operations as necessary
BSI ON INDICATOR	The Blind Spot Intervention ON indicator can be illuminated by ON/OFF operations as necessary
LDW ON INDICATOR	The LDW ON indicator lamp can be illuminated by ON/OFF operations as necessary
BSW ON INDICATOR	The BSW ON indicator lamp can be illuminated by ON/OFF operations as necessary

## BRAKE ACTUATOR

### NOTE:

The test can be performed only when the engine is running.

Test item	Operation	Description	"PRESS SENS" value
BRAKE ACTUATOR	MODE1	Transmits the brake fluid pressure control signal to the ABS actuator and electric unit (control unit) via CAN communication	10 bar
	MODE2		20 bar
	MODE3		30 bar
	Test start	Starts the tests of "MODE1", "MODE2" and "MODE3"	—
	Reset	Stops transmitting the brake fluid pressure control signal below to end the test	—
	End	Returns to the "SELECT TEST ITEM" screen	—

### NOTE:

The test is finished in 10 seconds after starting

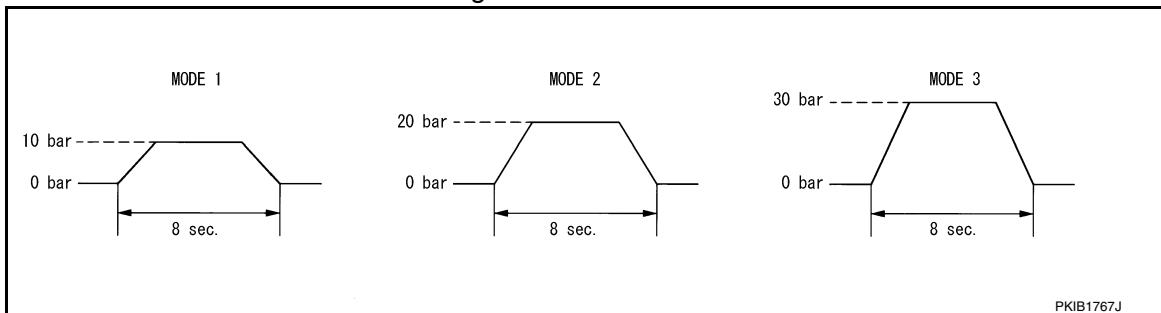

## ICC BUZZER

A  
B  
C  
D  
E  
F  
G  
H  
I  
J  
K  
L  
M  
N  
P

DAS

# DIAGNOSIS SYSTEM (ADAS CONTROL UNIT)

< SYSTEM DESCRIPTION >

[DCA]

Test item	Operation	Description	ICC warning chime operation sound
ICC BUZZER	MODE1	Transmits the buzzer output signals to the combination meter via CAN communication	Intermittent beep sound
	Test start	Starts the tests of "MODE1"	—
	Reset	Stops transmitting the buzzer output signal below to end the test	—
	End	Returns to the "SELECT TEST ITEM" screen	—

## METER LAMP

### NOTE:

The test can be performed only when the engine is running.

Test item	Operation	Description	<ul style="list-style-type: none"> <li>• MAIN switch indicator</li> <li>• ICC system warning lamp</li> <li>• IBA OFF indicator lamp</li> </ul>
METER LAMP	Off	Stops sending the following signals to exit from the test <ul style="list-style-type: none"> <li>• Meter display signal</li> <li>• ICC warning lamp signal</li> <li>• IBA OFF indicator lamp signal</li> </ul>	OFF
	On	Transmits the following signals to the combination meter via CAN communication <ul style="list-style-type: none"> <li>• Meter display signal</li> <li>• ICC warning lamp signal</li> <li>• IBA OFF indicator lamp signal</li> </ul>	ON

## STOP LAMP

Test item	Operation	Description	Stop lamp
STOP LAMP	Off	Stops transmitting the ICC brake hold relay drive signal below to end the test	OFF
	On	Transmits the ICC brake hold relay drive signal	ON

## ACTIVE PEDAL

### CAUTION:

- Shift the selector lever to "P" position, and then perform the test.
- Never depress the accelerator pedal excessively. (The engine speed may rise unexpectedly when finishing the test.)

### NOTE:

- Depress the accelerator pedal to check when performing the test.
- The test can be performed only when the engine is running.

Test item	Operation	Description	Accelerator pedal operation
Active Pedal	MODE1	Transmit the accelerator pedal feedback force control signal to the accelerator pedal actuator via ITS communication.	Constant with a force of 25 N for 8 seconds
	MODE2		Constant with a force of 15 N for 8 seconds
	MODE3		Change up to a force of 25 N for 8 seconds
	MODE4		Change up to a force of 15 N for 8 seconds
	Test start	Starts the tests of "MODE1", "MODE2", "MODE3" and "MODE4"	—
	Reset	Stops transmitting the accelerator pedal feedback force control signal below to end the test.	—
	End	Returns to the "SELECT TEST ITEM" screen	—

# DIAGNOSIS SYSTEM (ADAS CONTROL UNIT)

[DCA]

## < SYSTEM DESCRIPTION >

### NOTE:

The test is finished in 10 seconds after starting

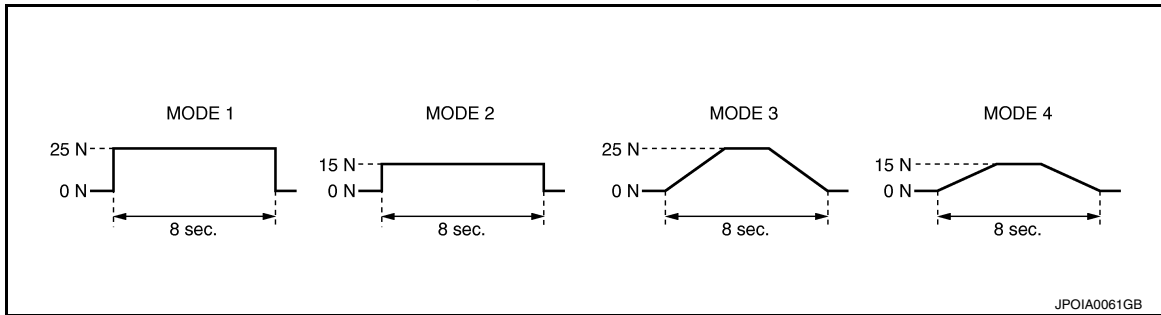

### DCA INDICATOR

#### NOTE:

The test can be performed only when the engine is running.

Test item	Operation	Description	DCA system switch indicator
DCA INDICATOR	Off	Stops transmitting the DCA system switch indicator signal below to end the test	—
	On	Transmits the DCA system switch indicator signal to the combination meter via CAN communication	ON

### LDP BUZZER

Test item	Operation	Description	Warning buzzer
LDP BUZZER	Off	Stops transmitting the warning buzzer signal below to end the test	—
	On	Transmits the warning buzzer signal to the warning buzzer	ON

### WARNING SYSTEM IND

Test item	Operation	Description	Warning systems ON indicator
WARNING SYSTEM IND	Off	Stops transmitting the warning systems ON indicator signal below to end the test	—
	On	Transmits the warning systems ON indicator signal to the warning systems ON indicator	ON

### LDP ON IND

Test item	Operation	Description	LDP ON indicator lamp (Green)
LDP ON IND	Off	Stops transmitting the LDP ON indicator lamp signal below to end the test	—
	On	Transmits the LDP ON indicator lamp signal to the combination meter via CAN communication	ON

### LANE DEPARTURE W/L

Test item	Operation	Description	Lane departure warning lamp (Yellow)
LANE DEPARTURE W/L	Off	Stops transmitting the lane departure warning lamp signal below to end the test	—
	On	Transmits the lane departure warning lamp signal to the combination meter via CAN communication	ON

A  
B  
C  
D  
E  
F  
G  
H  
I  
J  
K  
L  
M  
N  
P

DAS

# DIAGNOSIS SYSTEM (ADAS CONTROL UNIT)

< SYSTEM DESCRIPTION >

[DCA]

## BSW/BSI WARNING LAMP

Test item	Operation	Description	Blind Spot Warning/Blind Spot Intervention warning lamp (Yellow)
BSW/BSI WARNING LAMP	Off	Stops transmitting the Blind Spot Warning/Blind Spot Intervention warning lamp signal below to end the test	—
	On	Transmits the Blind Spot Warning/Blind Spot Intervention warning lamp signal to the combination meter via CAN communication	ON

## BSI ON INDICATOR

Test item	Operation	Description	Blind Spot Intervention ON indicator lamp (Green)
BSI ON INDICATOR	Off	Stops transmitting the Blind Spot Intervention ON indicator signal below to end the test	—
	On	Transmits the Blind Spot Intervention ON indicator signal to the combination meter via CAN communication	ON

## LDW ON INDICATOR

Test item	Operation	Description	Lane Departure Warning ON indicator lamp (Yellow)
LDW ON INDICATOR	Off	Stops transmitting the Lane Departure Warning ON indicator signal below to end the test	—
	On	Transmits the Lane Departure Warning ON indicator signal to the combination meter via CAN communication	ON

## BSW ON INDICATOR

Test item	Operation	Description	Blind Spot Warning ON indicator lamp (Yellow)
BSW ON INDICATOR	Off	Stops transmitting the Blind Spot Warning ON indicator signal below to end the test	—
	On	Transmits the Blind Spot Warning ON indicator signal to the warning lamp on the door	ON

## ECU IDENTIFICATION

ADAS control unit part number is displayed.



# DIAGNOSIS SYSTEM (ICC SENSOR)

[DCA]

< SYSTEM DESCRIPTION >

## DIAGNOSIS SYSTEM (ICC SENSOR)

### CONSULT Function (LASER/RADAR)

INFOID:000000009716405

#### CAUTION:

After disconnecting the CONSULT vehicle interface (VI) from the data link connector, the ignition must be cycled OFF → ON (for at least 5 seconds) → OFF. If this step is not performed, the BCM may not go to “sleep mode”, potentially causing a discharged battery and a no-start condition.

#### APPLICATION ITEMS

CONSULT performs the following functions via CAN communication with ADAS control unit and the communication with ICC sensor.

Diagnosis mode	Description
Self Diagnostic Result	Displays malfunctioning system memorized in ICC sensor
Data Monitor	Displays real-time input/output data of ICC sensor
Work support	It can monitor the adjustment direction indication in order to perform the radar adjustment operation smoothly
ECU identification	Displays ICC sensor part number
CAN Diag Support Monitor	The results of transmit/receive diagnosis of ITS communication can be read

#### SELF DIAGNOSTIC RESULT

Refer to [DAS-128, "DTC Index"](#).

#### DATA MONITOR

Monitored item [Unit]	Description
VHCL SPEED SE [km/h] or [mph]	Vehicle speed judged from a vehicle speed signal read by the ICC sensor via ITS communication is displayed [ADAS control unit receives a vehicle speed signal from ABS actuator and electric unit (control unit) via CAN communication and transmits the calculated vehicle speed to ICC sensor via ITS communication]
YAW RATE [deg/s]	Indicates yaw rate read from ADAS control unit through ITS communication (ADAS control unit receives yaw rate signal from ABS actuator and electric unit (control unit) via CAN communication and transmits yaw rate calculated by the ADAS control unit) Yaw rate judged from a yaw rate signal read by ICC sensor via ITS communication is displayed [ADAS control unit receives a yaw rate signal from ABS actuator and electric unit (control unit) via CAN communication and transmits the calculated yaw rate to ICC sensor via ITS communication]
PWR SUP MONI [V]	Indicates IGN voltage input by ICC sensor
DISTANCE [m]	Indicates the distance from the vehicle ahead
RELATIVE SPD [m/s]	Indicates the relative speed of the vehicle ahead
RADAR OFFSET [m]	<b>NOTE:</b> The item is indicated, but not used
RADAR HEIGHT [m]	<b>NOTE:</b> The item is indicated, but not used
STEERING ANGLE [deg]	The steering angle is displayed
STRG ANGLE SPEED [deg/s]	The steering angle speed is displayed
L/R ADJUST [deg]	Indicates a horizontal correction value of the radar
U/D ADJUST [deg]	Indicates a vertical correction value of the radar

A  
B  
C  
D  
E  
F  
G  
H  
I  
J  
K  
L  
M  
N  
P

DAS

# DIAGNOSIS SYSTEM (ICC SENSOR)

< SYSTEM DESCRIPTION >

[DCA]

## WORK SUPPORT

Work support items	Description
MILLIWAVE RADAR ADJUST	Outputs ICC sensor waves, calculates the displacement in radar direction, and indicates an adjustment direction

ICC sensor Adjust

Refer to [CCS-87, "Description"](#).

## ECU IDENTIFICATION

ICC sensor part number is displayed.

# DIAGNOSIS SYSTEM (ACCELERATOR PEDAL ACTUATOR)

< SYSTEM DESCRIPTION >

[DCA]

## DIAGNOSIS SYSTEM (ACCELERATOR PEDAL ACTUATOR)

### CONSULT Function (ACCELERATOR PEDAL ACT)

INFOID:000000009716406

#### CAUTION:

After disconnecting the CONSULT vehicle interface (VI) from the data link connector, the ignition must be cycled OFF → ON (for at least 5 seconds) → OFF. If this step is not performed, the BCM may not go to "sleep mode", potentially causing a discharged battery and a no-start condition.

#### DESCRIPTION

CONSULT performs the following functions via CAN communication with ADAS control unit and the communication with accelerator pedal actuator.

Test mode	Function
Self Diagnostic Result	<ul style="list-style-type: none"><li>Displays malfunctioning system memorized in accelerator pedal actuator</li><li>Displays the Freeze Frame Data when the malfunction is detected</li></ul>
DATA MONITOR	Displays real-time input/output data of accelerator pedal actuator
ACTIVE TEST	Enables operation check of electrical loads by sending driving signal to them
ECU Identification	Displays accelerator pedal actuator parts number
CAN Diag Support Monitor	The results of transmit/receive diagnosis of ITS communication can be read

### SELF DIAGNOSTIC RESULT

#### Self Diagnostic Result

Refer to [DAS-131. "DTC Index"](#).

#### FFD (Freeze Frame Data)

The accelerator pedal actuator records the following data when the malfunction is detected.

Freeze Frame Data item [Unit]	Description
TGT FBK FRC [N]	It displays the target accelerator pedal actuation force that the accelerator pedal actuator read out from the accelerator pedal feedback force control signal received via ITS communication at the time when the malfunction is detected
TGT MOT POSI [%]	It displays the target motor position that the accelerator pedal actuator read out from the accelerator pedal feedback force control signal received via ITS communication at the time when the malfunction is detected
ACT MOT POSI [%]	It displays the integrated motor position that the accelerator pedal actuator read out at the time when the malfunction is detected
AP OPEN [%]	It displays the accelerator pedal position signal that the accelerator pedal actuator read out via ITS communication at the time when the malfunction is detected
APA TEMP [°C]	It displays the integrated motor temperature that the accelerator pedal actuator read out at the time when the malfunction is detected
APA CURRENT [A]	It displays the integrated motor consumption current that the accelerator pedal actuator read out at the time when the malfunction is detected
APA PWR [V]	It displays the power supply voltage that the accelerator pedal actuator read out at the time when the malfunction is detected
APA OPE STATS [On/Off]	It displays the activation permission status of accelerator pedal actuator at the time when the malfunction is detected
APA STATS [READY/NG/TP NG/INIT]	It displays the condition of accelerator pedal actuator at the time when the malfunction is detected
IGN Counter <sup>Note</sup>	It displays number of ignition switch OFF → ON after the malfunction is detected

#### NOTE:

- The number is 0 when is detected now.
- The number increases like 1 → 2 ... 38 → 39 after returning to the normal condition whenever IGN OFF → ON.
- The number is fixed to 39 until the self-diagnosis results are erased if it is over 39.

# DIAGNOSIS SYSTEM (ACCELERATOR PEDAL ACTUATOR)

< SYSTEM DESCRIPTION >

[DCA]

## DATA MONITOR

Monitor item [Unit]	FUNCTION DESCRIPTION
TGT FBK FRC [N]	It displays the target accelerator pedal actuation force that the accelerator pedal actuator read out from the accelerator pedal feedback force control signal received via ITS communication (The ADAS control unit transmits the accelerator pedal feedback force control signal via ITS communication)
TGT MOT POSI [%]	It displays the target motor position that the accelerator pedal actuator read out from the accelerator pedal feedback force control signal received via ITS communication (The ADAS control unit transmits the accelerator pedal feedback force control signal via ITS communication)
ACT MOT POSI [%]	It displays the integrated motor position that the accelerator pedal actuator read out
AP OPEN [%]	It displays the accelerator pedal position signal that the accelerator pedal actuator read out via ITS communication (The ADAS control unit transmits with ITS communication the accelerator pedal position signal that is received from ECM via CAN communication)
APA TEMP [°C]	It displays the accelerator pedal actuator integrated motor temperature
APA CURRENT [A]	It displays the accelerator pedal actuator integrated motor consumption current
APA PWR [V]	It displays the power supply voltage that the accelerator pedal actuator read out
APA OPE STATS [On/Off]	It displays the activation permission status of accelerator pedal actuator
APA STATS [READY/NG/TP NG/INIT]	It displays the condition of accelerator pedal actuator

## ACTIVE TEST

### CAUTION:

**Never perform ACTIVE TEST while driving the vehicle.**

### NOTE:

The active test cannot be performed when the ICC system warning lamp is illuminated.

### Item list

Active test item	Description
ACCELERATOR PEDAL ACTUATOR TEST1	Drive the accelerator pedal actuator and generate the constant accelerator pedal actuation force
ACCELERATOR PEDAL ACTUATOR TEST2	Drive the accelerator pedal actuator and generate the vibration

### ACCELERATOR PEDAL ACTUATOR TEST 1

#### NOTE:

Check the accelerator pedal by depressing when performing the test.

Active test item	Operation	Description
ACCELERATOR PEDAL ACTUATOR TEST1	STOP	Finish the test
	START	Generate the constant accelerator pedal actuation force for accelerator pedal

### ACCELERATOR PEDAL ACTUATOR TEST 2

#### NOTE:

Check the accelerator pedal by depressing when performing the test.

Active test item	Operation	Description
ACCELERATOR PEDAL ACTUATOR TEST 2	STOP	Finish the test
	START	Generate the vibration for accelerator pedal

## ECU IDENTIFICATION

# DIAGNOSIS SYSTEM (ACCELERATOR PEDAL ACTUATOR)

< SYSTEM DESCRIPTION >

[DCA]

Displays accelerator pedal assembly parts number.

A

B

C

D

E

F

G

H

I

J

K

L

M

N

DAS

P

# ADAS CONTROL UNIT

< ECU DIAGNOSIS INFORMATION >

[DCA]

## ECU DIAGNOSIS INFORMATION

### ADAS CONTROL UNIT

Reference Value

INFOID:000000009716407

#### VALUES ON THE DIAGNOSIS TOOL

Monitor item	Condition		Value/Status
MAIN SW	Ignition switch ON	When MAIN switch is pressed	On
		When MAIN switch is not pressed	Off
SET/COAST SW	Ignition switch ON	When SET/COAST switch is pressed	On
		When SET/COAST switch is not pressed	Off
CANCEL SW	Ignition switch ON	When CANCEL switch is pressed	On
		When CANCEL switch is not pressed	Off
RESUME/ACC SW	Ignition switch ON	When RESUME/ACCELERATE switch is pressed	On
		When RESUME/ACCELERATE switch is not pressed	Off
DISTANCE SW	Ignition switch ON	When DISTANCE switch is pressed	On
		When DISTANCE switch is not pressed	Off
CRUISE OPE	Drive the vehicle and activate the vehicle-to-vehicle distance control mode	When ICC system is controlling	On
		When ICC system is not controlling	Off
BRAKE SW	Ignition switch ON	When brake pedal is depressed	Off
		When brake pedal is not depressed	On
STOP LAMP SW	Ignition switch ON	When brake pedal is depressed	On
		When brake pedal is not depressed	Off
IDLE SW	Engine running	Idling	On
		Except idling (depress accelerator pedal)	Off
SET DISTANCE	<ul style="list-style-type: none"> <li>• Start the engine and turn the ICC system ON</li> <li>• Press the DISTANCE switch to change the vehicle-to-vehicle distance setting</li> </ul>	When set to "long"	Long
		When set to "middle"	Mid
		When set to "short"	Short
CRUISE LAMP	Start the engine and press MAIN switch	ICC system ON (MAIN switch indicator ON)	On
		ICC system OFF (MAIN switch indicator OFF)	Off
OWN VHCL	Start the engine and press MAIN switch	ICC system ON (Own vehicle indicator ON)	On
		ICC system OFF (Own vehicle indicator OFF)	Off
VHCL AHEAD	Drive the vehicle and activate the vehicle-to-vehicle distance control mode	When a vehicle ahead is detected (vehicle ahead detection indicator ON)	On
		When a vehicle ahead is not detected (vehicle ahead detection indicator OFF)	Off
ICC WARNING	Start the engine and press MAIN switch	When ICC system is malfunctioning (ICC system warning lamp ON)	On
		When ICC system is normal (ICC system warning lamp OFF)	Off

# ADAS CONTROL UNIT

< ECU DIAGNOSIS INFORMATION >

[DCA]

Monitor item	Condition		Value/Status
VHCL SPEED SE	While driving		Displays a vehicle speed calculated by the ADAS control unit
SET VHCL SPD	While driving	When vehicle speed is set	Displays the set vehicle speed
BUZZER O/P	Engine running	When the buzzer of the following system operates • Vehicle-to-vehicle distance control mode • DCA system • FCW system • IBA system	On
		When the buzzer of the following system not operates • Vehicle-to-vehicle distance control mode • DCA system • FCW system • IBA system	Off
THRTL SENSOR	<b>NOTE:</b> The item is indicated, but not monitored		0.0
ENGINE RPM	Engine running		Equivalent to tachometer reading
WIPER SW	Ignition switch ON	Wiper not operating	Off
		Wiper LO operation	Low
		Wiper HI operation	High
BA WARNING	Engine running	IBA OFF indicator lamp ON • When IBA system is malfunctioning • When IBA system is turned to OFF	On
		IBA OFF indicator lamp OFF • When IBA system is normal • When IBA system is turned to ON	Off
STP LMP DRIVE	Drive the vehicle and activate the vehicle-to-vehicle distance control mode	When ICC brake hold relay is activated	On
		When ICC brake hold relay is not activated	Off
D RANGE SW	Engine running	When the selector lever is in "D" position or manual mode	On
		When the selector lever is in any position other than "D" or manual mode	Off
NP RANGE SW	Engine running	When the selector lever is in "N", "P" position	On
		When the selector lever is in any position other than "N", "P"	Off
PKB SW	Ignition switch ON	When the parking brake is applied	On
		When the parking brake is released	Off
PWR SUP MONI	Engine running		Power supply voltage value of ADAS control unit
VHCL SPD AT	While driving		Value of CVT vehicle speed sensor signal
THRTL OPENING	Engine running	Depress accelerator pedal	Displays the throttle position

A

B

C

D

E

F

G

H

I

J

K

L

M

N

DAS

P

# ADAS CONTROL UNIT

< ECU DIAGNOSIS INFORMATION >

[DCA]

Monitor item	Condition		Value/Status
GEAR	While driving		Displays the gear position
MODE SIG	Start the engine and press MAIN switch	When ICC system is deactivated	Off
		When vehicle-to-vehicle distance control mode is activated	ICC
		When conventional (fixed speed) cruise control mode is activated	ASCD
SET DISP IND	<ul style="list-style-type: none"> <li>• Drive the vehicle and activate the conventional (fixed speed) cruise control mode</li> <li>• Press SET/COAST switch</li> </ul>	SET switch indicator ON	On
		SET switch indicator OFF	Off
DISTANCE	Drive the vehicle and activate the vehicle-to-vehicle distance control mode	When a vehicle ahead is detected	Displays the distance from the preceding vehicle
		When a vehicle ahead is not detected	0.0
RELATIVE SPD	Drive the vehicle and activate the vehicle-to-vehicle distance control mode	When a vehicle ahead is detected	Displays the relative speed.
		When a vehicle ahead is not detected	0.0
Camera lost	Drive the vehicle and activate the LDW system, LDP system or Blind Spot Intervention system	Both side lane markers are detected	Detect
		Deviate side lane marker is lost	Deviate
		Both side lane markers are lost	Both
Lane unclear	While driving	Lane marker is unclear	On
		Lane marker is clear	Off
STATUS signal	Drive the vehicle with the LDP system turned ON	When the LDP system is ON	Stnby
		When the LDP system is operating	Warn
		When the LDP system is canceled	Cancl
		When the LDP system is OFF	Off
DYNA ASIST SW	Ignition switch ON	When dynamic driver assistance switch is pressed	On
		When dynamic driver assistance switch is not pressed	Off
DCA ON IND	Start the engine and press dynamic driver assistance switch (When DCA system setting is ON)	DCA system OFF (DCA system switch indicator OFF)	Off
		DCA system ON (DCA system switch indicator ON)	On
DCA VHL AHED	Drive the vehicle and activate the DCA system	When a vehicle ahead is not detected (vehicle ahead detection indicator OFF)	Off
		When a vehicle ahead is detected (vehicle ahead detection indicator ON)	On
IBA SW	Ignition switch ON	When the IBA OFF switch is pressed	On
		When the IBA OFF switch is not pressed	Off
APA TEMP	Engine running		Display the accelerator pedal actuator integrated motor temperature
APA PWR	Ignition switch ON		Power supply voltage value of accelerator pedal actuator



# ADAS CONTROL UNIT

< ECU DIAGNOSIS INFORMATION >

[DCA]

Monitor item	Condition		Value/Status
FCW SYSTEM ON	Ignition switch ON	When the FCW system is ON (Warning systems ON indicator ON)	On
		When the FCW system is OFF (Warning systems ON indicator OFF)	Off
LDW SYSTEM ON	Ignition switch ON	When the LDW system is ON (Warning systems ON indicator ON)	On
		When the LDW system is OFF (Warning systems ON indicator OFF)	Off
LDW ON LAMP	Ignition switch ON	Warning systems ON indicator ON	On
		Warning systems ON indicator OFF	Off
LDP ON IND	Start the engine and press dynamic driver assistance switch (When LDP system setting is ON)	LDP ON indicator lamp ON	On
		LDP ON indicator lamp OFF	Off
LANE DPRT W/L	Drive the vehicle and activate the LDW system or LDP system	Lane departure warning lamp ON	On
		Lane departure warning lamp OFF	Off
LDW BUZER OUTPUT	Drive the vehicle and activate the LDW/LDP system or Blind Spot Warning/Blind Spot Intervention system	When the buzzer of the following system operates • LDW/LDP system • Blind Spot Warning/Blind Spot Intervention system	On
		When the buzzer of the following system does not operate • LDW/LDP system • Blind Spot Warning/Blind Spot Intervention system	Off
LDP SYSTEM ON	Start the engine and press dynamic driver assistance switch (When LDP system setting is ON)	When the LDP system is ON	On
		When the LDP system is OFF	Off
READY signal	Start the engine and press dynamic driver assistance switch (When LDP system setting is ON)	When the LDP system is ON	On
		When the LDP system is OFF	Off
Shift position	<ul style="list-style-type: none"> <li>• Engine running</li> <li>• While driving</li> </ul>		Displays the shift position
Turn signal	Turn signal lamps OFF		Off
	Turn signal lamp LH blinking		LH
	Turn signal lamp RH blinking		RH
	Turn signal lamp LH and RH blinking		LH&RH
SIDE G	While driving	Vehicle turning right	Negative value
		Vehicle turning left	Positive value
FUNC ITEM (FCW)	Ignition switch ON		FCW
FUNC ITEM (LDW)	Ignition switch ON		LDW
FUNC ITEM (BSW)	Ignition switch ON		BSW
FUNC ITEM (NV-ICC)	<b>NOTE:</b> The item is indicated, but not monitored		Off
FUNC ITEM (NV-DCA)	<b>NOTE:</b> The item is indicated, but not monitored		Off
DCA SELECT	Ignition switch ON	"Distance Control Assist" set with the navigation system is ON	On
		"Distance Control Assist" set with the navigation system is OFF	Off

A  
B  
C  
D  
E  
F  
G  
H  
I  
J  
K  
L  
M  
N  
P

DAS

# ADAS CONTROL UNIT

< ECU DIAGNOSIS INFORMATION >

[DCA]

Monitor item		Condition	Value/Status
LDP SELECT	Ignition switch ON	"Lane Departure Prevention" set with the navigation system is ON	On
		"Lane Departure Prevention" set with the navigation system is OFF	Off
BSI SELECT	Ignition switch ON	"Blind Spot Intervention" set with the navigation system is ON	On
		"Blind Spot Intervention" set with the navigation system is OFF	Off
DRIVE MODE STATS	Ignition switch ON	When the DMS switch is in normal position	Std
		When the DMS switch is in SNOW position	SNO
		When the DMS switch is in ECO position	ECO
		When the DMS switch is in SPORT position	SPT
WARN SYS SW	Ignition switch ON	When warning systems switch is pressed	On
		When warning systems switch is not pressed	Off
BSW/BSI WARN LMP	Ignition switch ON	Blind Spot Warning/Blind Spot Intervention warning lamp ON	On
		Blind Spot Warning/Blind Spot Intervention warning lamp OFF	Off
BSI ON IND	Ignition switch ON	Blind Spot Intervention ON indicator ON	On
		Blind Spot Intervention ON indicator OFF	Off
BSW SYSTEM ON	Ignition switch ON	When the BSW system is ON (Warning systems ON indicator ON)	On
		When the BSW system is OFF (Warning systems ON indicator OFF)	Off
BSI SYSTEM ON	Start the engine and press dynamic driver assistance switch (When Blind Spot Intervention system setting is ON)	When the Blind Spot Intervention system is ON	On
		When the Blind Spot Intervention system is OFF	Off
BCI SYSTEM ON	Ignition switch ON	Back-up Collision Intervention system ON	On
		Back-up Collision Intervention system OFF	Off
BCI SWITCH	Ignition switch ON	Back-up Collision Intervention switch ON	On
		Back-up Collision Intervention switch OFF	Off
LDP WARNING INDICATOR	Ignition switch ON	When the LDP fail lamp is ON (Warning systems ON indicator ON)	On
		When the LDP fail lamp is OFF	Off
LDW ON LAMP	Ignition switch ON	When LDW indicator lamp is ON	On
		When LDW indicator lamp is OFF	Off
LDW WARNING INDICATOR	Ignition switch ON	When LDW FAIL lamp is ON	On
		When LDW FAIL lamp is OFF	Off
SYSTEM CANCEL MESSAGE	Ignition switch ON	When a system cancel message is sent	Request
		When a system cancel message is not sent	No Request
CAMERA HI TEMP MSG	Ignition switch ON	When camera high temperature message is sent	On
		When camera high temperature message is not sent	Off
ITS Setting Item(DCA)	Ignition switch ON	When the DCA is set	On
		When the DCA is not set	Off
ITS Setting Item(LDP)	Ignition switch ON	When the LDP is set	On
		When the LDP is not set	Off

# ADAS CONTROL UNIT

< ECU DIAGNOSIS INFORMATION >

[DCA]

Monitor item	Condition	Value/Status	
ITS Setting Item(BSI)	Ignition switch ON	When the BSI is set	On
		When the BSI is not set	Off
BSI WARNING INDICATOR	Ignition switch ON	When BSI FAIL indicator warning lamp is ON	On
		When BSI FAIL indicator warning lamp is OFF	Off
BSW ON INDICATOR	Ignition switch ON	When BSW ON indicator lamp is ON	On
		When BSW ON indicator lamp is OFF	Off
BSW IND BRIGHTNESS	Ignition switch ON	When BSW indicator brightness is selected	On
		When BSW indicator brightness is not selected	Off
WARN REQ	Drive the vehicle and activate the LDP system	Lane departure warning is operating	On
		Lane departure warning is not operating	Off

TERMINAL LAYOUT  
PHYSICAL VALUES

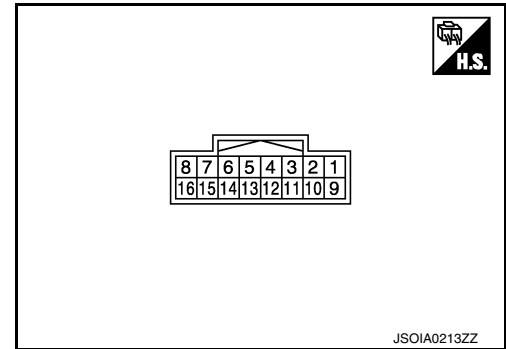

Terminal No. (Wire color)		Description		Condition	Value (Approx.)
+	-	Signal name	Input/ Output		
5 (G)	Ground	ICC brake hold relay drive signal	Output	Ignition switch ON	12 V
				At "STOP LAMP" test of "Active test"	0 V
6 (B)		Ground	Input	—	0 V
7 (L)		ITS communication-H	—	—	—
8 (Y)		ITS communication-L	—	—	—
14 (B)		CAN -H	—	—	—
15 (W)		CAN -L	—	—	—
16 (R)	Ignition power supply	Input	Ignition switch ON	Battery Voltage	

## Fail-safe

INFOID:000000009716408

If a malfunction occurs in each system, ADAS control unit cancels each control, sounds a beep, and turns ON the warning lamp or indicator lamp.

System	Buzzer	Warning lamp/Indicator lamp	Description
Vehicle-to-vehicle distance control mode	High-pitched tone	ICC system warning lamp	Cancel
Conventional (fixed speed) cruise control mode	High-pitched tone	ICC system warning lamp	Cancel

# ADAS CONTROL UNIT

< ECU DIAGNOSIS INFORMATION >

[DCA]

System	Buzzer	Warning lamp/Indicator lamp	Description
Intelligent Brake Assist (IBA)	High-pitched tone	IBA OFF indicator lamp	Cancel
Forward Collision Warning (FCW)	High-pitched tone	Warning message	Cancel
Distance Control Assist (DCA)	High-pitched tone	DCA system warning	Cancel
Lane Departure Warning (LDW)	—	Lane departure warning lamp	Cancel
Lane Departure Prevention (LDP)	Low-pitched tone	Lane departure warning lamp	Cancel
Blind Spot Warning (BSW)	—	Blind Spot Warning/Blind Spot Intervention warning lamp	Cancel
Blind Spot Intervention	Low-pitched tone	Blind Spot Warning/Blind Spot Intervention warning lamp	Cancel
Backup Collision Intervention (BCI)	High-pitched tone	Backup Collision Intervention warning indicator	Cancel

## DTC Inspection Priority Chart

INFOID:000000009716409

If multiple DTCs are detected simultaneously, check them one by one depending on the following DTC inspection priority chart.

Priority	Detected items (DTC)
1	<ul style="list-style-type: none"> <li>• C1A0A: CONFIG UNFINISHED</li> <li>• U1507: LOST COMM (SIDE RDR R)</li> <li>• U1508: LOST COMM (SIDE RDR L)</li> </ul>
2	<ul style="list-style-type: none"> <li>• U1000: CAN COMM CIRCUIT</li> <li>• U1010: CONTROL UNIT (CAN)</li> </ul>
3	<ul style="list-style-type: none"> <li>• C1B00: CAMERA UNIT MALF</li> <li>• C1F02: APA C/U MALF</li> <li>• C1A17: ICC SENSOR MALF</li> <li>• C1B53: SIDE RDR R MALF</li> <li>• C1B54: SIDE RDR L MALF</li> </ul>

# ADAS CONTROL UNIT

< ECU DIAGNOSIS INFORMATION >

[DCA]

Priority	Detected items (DTC)		
4	<ul style="list-style-type: none"> <li>• C1A01: POWER SUPPLY CIR</li> <li>• C1A02: POWER SUPPLY CIR 2</li> <li>• C1A04: ABS/TCS/VDC CIRC</li> <li>• C1A05: BRAKE SW/STOP L SW</li> <li>• C1A06: OPERATION SW CIRC</li> <li>• C1A12: LASER BEAM OFFCNTR</li> <li>• C1A13: STOP LAMP RLY FIX</li> <li>• C1A14: ECM CIRCUIT</li> <li>• C1A16: RADAR STAIN</li> <li>• C1A18: LASER AIMING INCOMP</li> <li>• C1A2A: ICC SEN PWR SUP CIR</li> <li>• C1A21: ICC SENSOR HIGH TEMP</li> <li>• C1A24: NP RANGE</li> <li>• C1A26: ECD MODE MALF</li> <li>• C1A27: ECD PWR SUPPLY CIR</li> <li>• C1A33: CAN TRANSMISSION ERR</li> <li>• C1A34: COMMAND ERROR</li> <li>• C1A35: APA CIR</li> <li>• C1A36: APA CAN COMM CIR</li> <li>• C1A37: APA CAN CIR 2</li> <li>• C1A38: APA CAN CIR 1</li> <li>• C1A39: STRG SEN CIR</li> <li>• C1A40: SYSTEM SW CIRC</li> <li>• C1B01: CAM AIMING INCOMP</li> <li>• C1B03: CAM ABNRML TMP DETCT</li> <li>• C1B56: SONAR CIRCUIT</li> <li>• C1B57: AVM CIRCUIT</li> <li>• C1F01: APA MOTOR MALF</li> <li>• C1F05: APA PWR SUPPLY CIR</li> <li>• U0121: VDC CAN CIR 2</li> <li>• U0126: STRG SEN CAN CIR 1</li> <li>• U0235: ICC SENSOR CAN CIRC 1</li> <li>• U0401: ECM CAN CIR 1</li> <li>• U0402: TCM CAN CIR 1</li> <li>• U0415: VDC CAN CIR 1</li> <li>• U0428: STRG SEN CAN CIR 2</li> <li>• U1500: CAM CAN CIR 2</li> <li>• U1501: CAM CAN CIR 1</li> <li>• U1502: ICC SEN CAN COMM CIR</li> <li>• U1503: SIDE RDR L CAN CIR 2</li> <li>• U1504: SIDE RDR L CAN CIR 1</li> <li>• U1505: SIDE RDR R CAN CIR 2</li> <li>• U1506: SIDE RDR R CAN CIR 1</li> <li>• U1521: SONAR CAN COMMUNICATION</li> <li>• U1522: SONAR CAN COMMUNICATION</li> <li>• U1523: SONAR CAN COMMUNICATION</li> <li>• U1524: AVM CAN COMMUNICATION</li> <li>• U1525: AVM CAN COMMUNICATION</li> <li>• U150B: ECM CAN CIRC 3</li> <li>• U150C: VDC CAN CIRC 3</li> <li>• U150D: TCM CAN CIRC 3</li> <li>• U150E: BCM CAN CIRC 3</li> <li>• U150F: AV CAN CIRC 3</li> <li>• U1512: HVAC CAN CIRC3</li> <li>• U1513: METER CAN CIRC 3</li> <li>• U1514: STRG SEN CAN CIRC 3</li> <li>• U1515: ICC SENSOR CAN CIRC 3</li> <li>• U1516: CAM CAN CIRC 3</li> <li>• U1517: APA CAN CIRC 3</li> <li>• U1518: SIDE RDR L CAN CIRC 3</li> <li>• U1519: SIDE RDR R CAN CIRC 3</li> </ul>	<p>A</p> <p>B</p> <p>C</p> <p>D</p> <p>E</p> <p>F</p> <p>G</p> <p>H</p> <p>I</p> <p>J</p> <p>K</p> <p>L</p> <p>M</p> <p>N</p> <p>P</p>	
	5	<ul style="list-style-type: none"> <li>• C1A03: VHCL SPEED SE CIRC</li> </ul>	
	6	<ul style="list-style-type: none"> <li>• C1A15: GEAR POSITION</li> </ul>	
	7	<ul style="list-style-type: none"> <li>• C1A00: CONTROL UNIT</li> </ul>	

DAS

# ADAS CONTROL UNIT

< ECU DIAGNOSIS INFORMATION >

[DCA]

## DTC Index

INFOID:000000009716410

**NOTE:**

- The details of time display are as per the following.
- CRNT: A malfunction is detected now
- PAST: A malfunction was detected in the past
- IGN counter is displayed on FFD (Freeze Frame Data).
- 0: The malfunctions that are detected now  
CAN communication system (U1000, U1010)
- 1 - 39: It increases like 0 → 1 → 2 ... 38 → 39 after returning to the normal condition whenever the ignition switch OFF → ON. It returns to 0 when a malfunction is detected again in the process.
- If it is over 39, it is fixed to 39 until the self-diagnosis results are erased.  
Other than CAN communication system (Other than U1000, U1010)
- 1 - 49: It increases like 0 → 1 → 2 ... 38 → 49 after returning to the normal condition whenever the ignition switch OFF → ON. It returns to 0 when a malfunction is detected again in the process.
- If it is over 49, it is fixed to 49 until the self-diagnosis results are erased.

Systems for fail-safe

- A: Vehicle-to-vehicle distance control mode
- B: Conventional (fixed speed) cruise control mode
- C: Intelligent Brake Assist (IBA)
- D: Forward Collision Warning (FCW)
- E: Distance Control Assist (DCA)
- F: Lane Departure Warning (LDW)/Lane Departure Prevention (LDP)
- G: Blind Spot Warning (BSW)/Blind Spot Intervention
- H: Backup Collision Intervention (BCI)

DTC		CONSULT display	Warning lamp					Fail-safe	Reference
CONSULT	On board display		ICC system warning lamp	IBA OFF indicator lamp	Lane departure warning lamp	Blind Spot Warning/Blind Spot Intervention warning lamp	Backup Collision Intervention	System	
C1A00	0	CONTROL UNIT	ON	ON	ON	ON	ON	A, B, C, D, E, F, G, H	<a href="#">DAS-73</a>
C1A01	1	POWER SUPPLY CIR	ON	ON	ON	ON	ON	A, B, C, D, E, F, G, H	<a href="#">DAS-74</a>
C1A02	2	POWER SUPPLY CIR 2	ON	ON	ON	ON	ON	A, B, C, D, E, F, G, H	<a href="#">DAS-74</a>
C1A03	3	VHCL SPEED SE CIRC	ON	ON	ON	ON	ON	A, B, C, D, E, F, G, H	<a href="#">DAS-160</a>
C1A04	4	ABS/TCS/VDC CIRC	ON	ON	ON	ON	ON	A, B, C, D, E, F, G, H	<a href="#">DAS-162</a>
C1A05	5	BRAKE SW/STOP L SW	ON	ON	ON	ON	ON	A, B, C, D, E, F, G, H	<a href="#">DAS-163</a>
C1A06	6	OPERATION SW CIRC	ON		ON	ON		A, B, E, F, G	<a href="#">DAS-167</a>
C1A12	12	LASER BEAM OFFCN-TR	ON	ON				A, C, D, E	<a href="#">DAS-170</a>
C1A13	13	STOP LAMP RLY FIX	ON	ON			ON	A, B, C, D, E, H	<a href="#">DAS-171</a>
C1A14	14	ECM CIRCUIT	ON		ON	ON	ON	A, B, E, F, G, H	<a href="#">DAS-177</a>

# ADAS CONTROL UNIT

< ECU DIAGNOSIS INFORMATION >

[DCA]

Systems for fail-safe

- A: Vehicle-to-vehicle distance control mode
- B: Conventional (fixed speed) cruise control mode
- C: Intelligent Brake Assist (IBA)
- D: Forward Collision Warning (FCW)
- E: Distance Control Assist (DCA)
- F: Lane Departure Warning (LDW)/Lane Departure Prevention (LDP)
- G: Blind Spot Warning (BSW)/Blind Spot Intervention
- H: Backup Collision Intervention (BCI)

DTC		CONSULT display	Warning lamp					Fail-safe	Reference
CONSULT	On board display		ICC system warning lamp	IBA OFF indicator lamp	Lane departure warning lamp	Blind Spot Warning/Blind Spot Intervention warning lamp	Backup Collision Intervention	System	
C1A15	15	GEAR POSITION	ON	ON	ON	ON	ON	A, B, C, D, E, F, G, H	<a href="#">DAS-178</a>
C1A16	16	RADAR STAIN	ON	ON				A, C, D, E	<a href="#">DAS-180</a>
C1A17	17	ICC SENSOR MALF	ON	ON				A, B, C, D, E	<a href="#">DAS-181</a>
C1A18	18	LASER AIMING INCOMP	ON	ON				A, C, D, E	<a href="#">DAS-182</a>
C1A21	21	ICC SENSOR HIGH TEMP	ON	ON				A, B, C, D, E	<a href="#">DAS-183</a>
C1A24	24	NP RANGE	ON	ON	ON	ON	ON	A, B, C, D, E, F, G, H	<a href="#">DAS-184</a>
C1A26	26	ECD MODE MALF	ON	ON				A, B, C, D, E	<a href="#">DAS-186</a>
C1A27	27	ECD PWR SUPPLY CIR	ON	ON				A, B, C, D, E	<a href="#">DAS-187</a>
C1A33	33	CAN TRANSMISSION ERR	ON					A, B, E	<a href="#">DAS-189</a>
C1A34	34	COMMAND ERROR	ON					A, B, E	<a href="#">DAS-190</a>
C1A35	35	APA CIR	ON				ON	A, E, H	<a href="#">DAS-191</a>
C1A36	36	APA CAN COMM CIR	ON				ON	A, E, H	<a href="#">DAS-192</a>
C1A37	133	APA CAN CIR 2	ON				ON	A, B, E, H	<a href="#">DAS-193</a>
C1A38	132	APA CAN CIR 1	ON				ON	A, B, E, H	<a href="#">DAS-194</a>
C1A39	39	STRG SEN CIR	ON	ON		ON	ON	A, B, C, D, E, G, H	<a href="#">DAS-195</a>
C1A2A	80	ICC SEN PWR SUP CIR	ON	ON				A, C, D, E	<a href="#">DAS-188</a>
C1B00	81	CAMERA UNIT MALF			ON	ON		F, G	<a href="#">DAS-418</a>
C1B01	82	CAM AIMING INCOMP			ON	ON		F, G	<a href="#">DAS-420</a>
C1B03	83	CAM ABRML TMP DETECT							<a href="#">DAS-422</a>
C1B53	84	SIDE RDR R MALF				ON	ON	G, H	<a href="#">DAS-577</a>
C1B54	85	SIDE RDR L MALF				ON	ON	G, H	<a href="#">DAS-578</a>
C1B56	87	SONAR CIRCUIT					ON	H	<a href="#">DAS-744</a>

A  
B  
C  
D  
E  
F  
G  
H  
I  
J  
K  
L  
M  
N  
P

DAS

# ADAS CONTROL UNIT

< ECU DIAGNOSIS INFORMATION >

[DCA]

Systems for fail-safe

- A: Vehicle-to-vehicle distance control mode
- B: Conventional (fixed speed) cruise control mode
- C: Intelligent Brake Assist (IBA)
- D: Forward Collision Warning (FCW)
- E: Distance Control Assist (DCA)
- F: Lane Departure Warning (LDW)/Lane Departure Prevention (LDP)
- G: Blind Spot Warning (BSW)/Blind Spot Intervention
- H: Backup Collision Intervention (BCI)

DTC		CONSULT display	Warning lamp					Fail-safe	Reference
CONSULT	On board display		ICC system warning lamp	IBA OFF indicator lamp	Lane departure warning lamp	Blind Spot Warning/Blind Spot Intervention warning lamp	Backup Collision Intervention	System	
C1B57	88	AVM CIRCUIT					ON	H	<a href="#">DAS-745</a>
C1F01	91	APA MOTOR MALF	ON				ON	A, E, H	<a href="#">DAS-196</a>
C1F02	92	APA C/U MALF	ON				ON	A, E, H	<a href="#">DAS-198</a>
C1F05	95	APA PWR SUPPLY CIR	ON				ON	A, E, H	<a href="#">DAS-201</a>
NO DTC IS DETECTED. FURTHER TESTING MAY BE REQUIRED	55	NO DTC IS DETECTED. FURTHER TESTING MAY BE REQUIRED	—	—	—	—	—	—	—
U0121	127	VDC CAN CIR 2	ON	ON	ON	ON	ON	A, B, C, D, E, F, G, H	<a href="#">DAS-205</a>
U0126	130	STRG SEN CAN CIR 1	ON	ON		ON	ON	A, B, C, D, E, G, H	<a href="#">DAS-206</a>
U0235	144	ICC SENSOR CAN CIRC 1	ON	ON				A, B, C, D, E	<a href="#">DAS-207</a>
U0401	120	ECM CAN CIR 1	ON		ON	ON	ON	A, B, E, F, G, H	<a href="#">DAS-208</a>
U0402	122	TCM CAN CIR 1	ON	ON	ON	ON	ON	A, B, C, D, E, F, G, H	<a href="#">DAS-209</a>
U0415	126	VDC CAN CIR 1	ON	ON	ON	ON	ON	A, B, C, D, E, F, G, H	<a href="#">DAS-210</a>
U0428	131	STRG SEN CAN CIR 2	ON	ON		ON	ON	A, B, C, D, E, G, H	<a href="#">DAS-211</a>
U1000 <sup>NOTE</sup>	100	CAN COMM CIRCUIT	ON	ON	ON	ON	ON	A, B, C, D, E, F, G, H	<a href="#">DAS-75</a>
U1010	110	CONTROL UNIT (CAN)	ON	ON	ON	ON	ON	A, B, C, D, E, F, G, H	<a href="#">DAS-76</a>
U1500	145	CAM CAN CIR 2			ON	ON		F, G	<a href="#">DAS-438</a>
U1501	146	CAM CAN CIR 1			ON	ON		F, G	<a href="#">DAS-439</a>
U1502	147	ICC SEN CAN COMM CIR	ON	ON				A, B, C, D, E	<a href="#">DAS-219</a>
U1503	150	SIDE RDR L CAN CIR 2				ON	ON	G, H	<a href="#">DAS-603</a>



# ADAS CONTROL UNIT

< ECU DIAGNOSIS INFORMATION >

[DCA]

Systems for fail-safe

- A: Vehicle-to-vehicle distance control mode
- B: Conventional (fixed speed) cruise control mode
- C: Intelligent Brake Assist (IBA)
- D: Forward Collision Warning (FCW)
- E: Distance Control Assist (DCA)
- F: Lane Departure Warning (LDW)/Lane Departure Prevention (LDP)
- G: Blind Spot Warning (BSW)/Blind Spot Intervention
- H: Backup Collision Intervention (BCI)

DTC		CONSULT display	Warning lamp					Fail-safe	Reference
CONSULT	On board display		ICC system warning lamp	IBA OFF indicator lamp	Lane departure warning lamp	Blind Spot Warning/Blind Spot Intervention warning lamp	Backup Collision Intervention	System	
U1504	151	SIDE RDR L CAN CIR 1				ON	ON	G, H	<a href="#">DAS-604</a>
U1505	152	SIDE RDR R CAN CIR 2				ON	ON	G, H	<a href="#">DAS-605</a>
U1506	153	SIDE RDR R CAN CIR 1				ON	ON	G, H	<a href="#">DAS-606</a>
U1507	154	LOST COMM (SIDE RDR R)				ON	ON	G, H	<a href="#">DAS-607</a>
U1508	155	LOST COMM (SIDE RDR L)				ON	ON	G, H	<a href="#">DAS-608</a>
U150B	157	ECM CAN CIRC 3	ON		ON	ON	ON	A, B, E, F, G, H	<a href="#">DAS-215</a>
U150C	158	VDC CAN CIRC 3	ON	ON	ON	ON	ON	A, B, C, D, E, F, G, H	<a href="#">DAS-216</a>
U150D	159	TCM CAN CIRC 3	ON	ON	ON	ON	ON	A, B, C, D, E, F, G, H	<a href="#">DAS-217</a>
U150E	160	BCM CAN CIRC 3	ON		ON	ON	ON	A, B, E, F, G, H	<a href="#">DAS-218</a>
U150F	161	AV CAN CIRC 3							<a href="#">DAS-77</a>
U1512	162	HVAC CAN CIRC3			ON	ON		F, G	<a href="#">DAS-440</a>
U1513	163	METER CAN CIRC 3	ON	ON	ON	ON	ON	A, B, C, D, E, F, G, H	<a href="#">DAS-220</a>
U1514	164	STRG SEN CAN CIRC 3	ON	ON		ON	ON	A, B, C, D, E, G, H	<a href="#">DAS-221</a>
U1515	165	ICC SENSOR CAN CIRC 3	ON	ON				A, B, C, D, E	<a href="#">DAS-222</a>
U1516	166	CAM CAN CIRC 3			ON	ON		F, G	<a href="#">DAS-442</a>
U1517	167	APA CAN CIRC 3	ON				ON	A, B, E, H	<a href="#">DAS-223</a>
U1518	168	SIDE RDR L CAN CIRC 3				ON	ON	G, H	<a href="#">DAS-613</a>
U1519	169	SIDE RDR R CAN CIRC 3				ON	ON	G, H	<a href="#">DAS-614</a>
U1521	177	SONAR CHECKSUM					ON	H	<a href="#">DAS-781</a>
U1522	178	SONAR MESSAGE					ON	H	<a href="#">DAS-782</a>
U1523	179	SONAR CAN DLC					ON	H	<a href="#">DAS-783</a>

A  
B  
C  
D  
E  
F  
G  
H  
I  
J  
K  
L  
M  
N  
P

DAS

# ADAS CONTROL UNIT

< ECU DIAGNOSIS INFORMATION >

[DCA]

Systems for fail-safe

- A: Vehicle-to-vehicle distance control mode
- B: Conventional (fixed speed) cruise control mode
- C: Intelligent Brake Assist (IBA)
- D: Forward Collision Warning (FCW)
- E: Distance Control Assist (DCA)
- F: Lane Departure Warning (LDW)/Lane Departure Prevention (LDP)
- G: Blind Spot Warning (BSW)/Blind Spot Intervention
- H: Backup Collision Intervention (BCI)

DTC			Warning lamp					Fail-safe	Reference
	On board display		ICC system warning lamp	IBA OFF indicator lamp	Lane departure warning lamp	Blind Spot Warning/Blind Spot Intervention warning lamp	Backup Collision Intervention	System	
U1524	180	SONAR CAN DLC					ON	H	<a href="#">DAS-784</a>
U1525	181	AVM MESSAGE					ON	H	<a href="#">DAS-785</a>

**NOTE:**

With the detection of “U1000” some systems do not perform the fail-safe operation.

A system controlling based on a signal received from the control unit performs fail-safe operation when the communication with the ADAS control unit becomes inoperable.

# ICC SENSOR

< ECU DIAGNOSIS INFORMATION >

[DCA]

## ICC SENSOR

### Reference Value

INFOID:000000009716411

### VALUES ON THE DIAGNOSIS TOOL

Monitor item	Condition		Value/Status
VHCL SPEED SE	While driving		Value of vehicle speed signal (wheel speed)
YAW RATE	While driving	Vehicle stopped	0.0
		Vehicle turning right	Positive value
		Vehicle turning left	Negative value
PWR SUP MONI	Ignition switch ON		Power supply voltage value of ICC sensor
DISTANCE	Drive the vehicle and activate the vehicle-to-vehicle distance control mode	When a vehicle ahead is detected	Displays the distance from the preceding vehicle
		When a vehicle ahead is not detected	0.0
RELATIVE SPD	Drive the vehicle and activate the vehicle-to-vehicle distance control mode	When a vehicle ahead is detected	Displays the relative speed
		When a vehicle ahead is not detected	0.0
RADAR OFFSET	<b>NOTE:</b> The item is indicated, but not used		—
RADAR HEIGHT	<b>NOTE:</b> The item is indicated, but not used		—
STEERING ANGLE	Ignition switch ON	When setting the steering wheel in straight-ahead position	0.0
		When turning the steering wheel 90° rightward	+90
		When turning the steering wheel 90° leftward	-90
STRG ANGLE SPEED	Ignition switch ON	At the time of turning the steering wheel	Steering wheel turning speed is displayed
L/R ADJUST	Ignition switch ON	At the completion of radar alignment adjustment	Horizontal correction value is displayed
U/D ADJUST	Ignition switch ON	At the completion of radar alignment adjustment	Vertical correction value is displayed

### TERMINAL LAYOUT

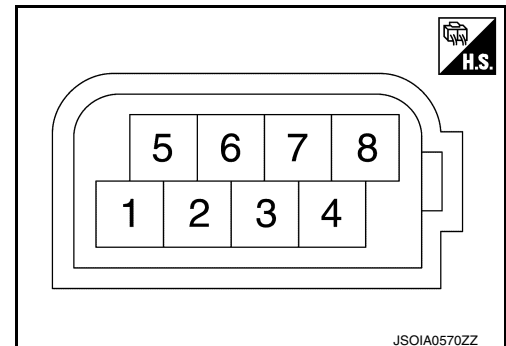

### PHYSICAL VALUES

A  
B  
C  
D  
E  
F  
G  
H  
I  
J  
K  
L  
M  
N

DAS

P

# ICC SENSOR

< ECU DIAGNOSIS INFORMATION >

[DCA]

Terminal No. (Wire color)		Description		Condition	Standard value	Reference value (Approx.)
+	-	Signal name	Input/ Output			
1 (P)	8 (B)	Ignition power supply	Input	Ignition switch ON	9.5 - 16 V	Battery voltage
6 (Y)	—	ITS communication-L	—	—	—	—
7 (L)		ITS communication-H	—	—	—	—
8 (B)	Ground	Ground	—	Ignition switch ON	0 - 0.1 V	0 V

## Fail-safe

INFOID:000000009716412

If a malfunction occurs in the ICC sensor, ADAS control unit cancels control, sounds a beep, and turns ON the ICC system warning lamp in the combination meter.

## DTC Inspection Priority Chart

INFOID:000000009716413

If multiple DTCs are detected simultaneously, check them one by one depending on the following DTC inspection priority chart.

Priority	Detected items (DTC)
1	<ul style="list-style-type: none"> <li>U1000: CAN COMM CIRCUIT</li> <li>U1010: CONTROL UNIT (CAN)</li> </ul>
2	<ul style="list-style-type: none"> <li>C1A50: ADAS MALFUNCTION</li> </ul>
3	<ul style="list-style-type: none"> <li>C1A01: POWER SUPPLY CIR</li> <li>C1A02: POWER SUPPLY CIR 2</li> <li>C1A12 :RADAR OFF-CENTER</li> <li>C1A16: RADAR BLOCKED</li> <li>C1A18: RADAR ALIGNMENT INCOMPLETE</li> <li>C1A21: UNIT HIGH TEMP</li> <li>C1A39: STRG SEN CIR</li> <li>U0104: ADAS CAN CIR1</li> <li>U0121: VDC CAN CIR2</li> <li>U0126: STRG SEN CAN CIR1</li> <li>U0405: ADAS CAN CIR2</li> <li>U0415: VDC CAN CIR1</li> <li>U0428: STRG SEN CAN CIR2</li> </ul>
4	<ul style="list-style-type: none"> <li>C1A00: CONTROL UNIT</li> </ul>

## DTC Index

INFOID:000000009716414

### NOTE:

- The details of time display are as per the following.
- 0: The malfunctions that are detected now  
CAN communication system (U1000, U1010)
- 1 - 39: It increases like 0 → 1 → 2 ... 38 → 39 after returning to the normal condition whenever the ignition switch OFF → ON. It returns to 0 when a malfunction is detected again in the process.
- If it is over 39, it is fixed to 39 until the self-diagnosis results are erased.  
Other than CAN communication system (Other than U1000, U1010)
- 1 - 49: It increases like 0 → 1 → 2 ... 38 → 49 after returning to the normal condition whenever the ignition switch OFF → ON. It returns to 0 when a malfunction is detected again in the process.
- If it is over 49, it is fixed to 49 until the self-diagnosis results are erased.

# ICC SENSOR

< ECU DIAGNOSIS INFORMATION >

[DCA]

×: Applicable

DTC	CONSULT display	ICC system warning lamp	Fail-safe function						Reference
			Vehicle-to-vehicle distance control mode	Conventional (fixed speed) cruise control mode	Distance Control Assist (DCA)	Forward Collision Warning (FCW)	Intelligent Brake Assist (IBA)	Brake Assist (with preview function)	
C1A00	CONTROL UNIT	ON	×	×	×	×	×	×	<a href="#">DAS-158</a>
C1A01	POWER SUPPLY CIR	ON	×	×	×	×	×	×	<a href="#">DAS-159</a>
C1A02	POWER SUPPLY CIR2	ON	×	×	×	×	×	×	<a href="#">DAS-74</a>
C1A12	RADAR OFF-CENTER	ON	×		×	×	×	×	<a href="#">DAS-170</a>
C1A16	RADAR BLOCKED	ON	×		×	×	×	×	<a href="#">DAS-180</a>
C1A18	RADAR ALIGNMENT INCOMPLETE	ON	×		×	×	×	×	<a href="#">DAS-182</a>
C1A21	UNIT HIGH TEMP	ON	×	×	×	×	×	×	<a href="#">DAS-183</a>
C1A39	STRG SEN CIR	ON	×	×	×	×	×	×	<a href="#">DAS-195</a>
C1A50	ADAS MALFUNCTION	ON	×	×	×	×	×	×	<a href="#">DAS-417</a>
U0104	ADAS CAN CIR1	ON	×	×	×	×	×	×	<a href="#">DAS-423</a>
U0121	VDC CAN CIR2	ON	×	×	×	×	×	×	<a href="#">DAS-205</a>
U0126	STRG SEN CAN CIR1	ON	×	×	×	×	×	×	<a href="#">DAS-206</a>
U0405	ADAS CAN CIR2	ON	×	×	×	×	×	×	<a href="#">DAS-428</a>
U0415	VDC CAN CIR1	ON	×	×	×	×	×	×	<a href="#">DAS-211</a>
U0428	STRG SEN CAN CIR2	ON	×	×	×	×	×	×	<a href="#">DAS-430</a>
U1000	CAN COMM CIRCUIT	ON	×	×	×	×	×	×	<a href="#">DAS-212</a>
U1010	CONTROL UNIT (CAN)	ON	×	×	×	×	×	×	<a href="#">DAS-214</a>

A  
B  
C  
D  
E  
F  
G  
H  
I  
J  
K  
L  
M  
N  
P

DAS

# ACCELERATOR PEDAL ACTUATOR

< ECU DIAGNOSIS INFORMATION >

[DCA]

## ACCELERATOR PEDAL ACTUATOR

### Reference Value

INFOID:000000009716415

### VALUES ON THE DIAGNOSIS TOOL

Monitor item	Condition		Value/Status
TGT FBK FRC	Drive the vehicle and operate the DCA system	When the ADAS control unit is controlling the accelerator pedal actuator	It changes with the demand from the ADAS control unit
ACT MOT POSI	Engine running	Depress accelerator pedal	It changes according to the depressed amount of accelerator pedal
AP OPEN	Engine running	Depress accelerator pedal	It changes according to the depressed amount of accelerator pedal
APA TEMP	Engine running		Display the accelerator pedal actuator integrated motor temperature
APA CURRENT	Drive the vehicle and operate the DCA system	When the ADAS control unit is controlling the accelerator pedal actuator	Display the accelerator pedal actuator motor operation consumption current
APA PWR	Ignition switch ON		Battery voltage
APA OPE STATS	Engine running	When the accelerator pedal actuator control is permitted	On
		When the accelerator pedal actuator control is invalid	Off
APA STATS	Engine running	When the accelerator pedal actuator is normal	Ready
		When the accelerator pedal actuator is temporarily malfunctioning	TP NG
		When the accelerator pedal actuator is malfunctioning	NG
		During the accelerator pedal actuator operation preparations	Init

### TERMINAL LAYOUT

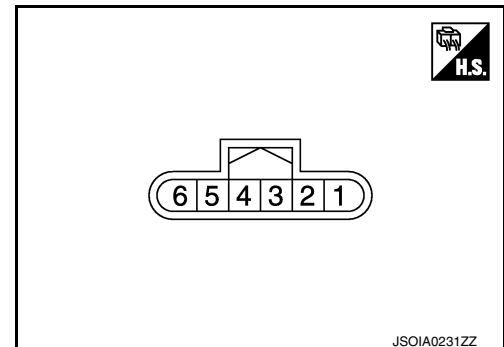

### PHYSICAL VALUES

# ACCELERATOR PEDAL ACTUATOR

< ECU DIAGNOSIS INFORMATION >

[DCA]

Terminal No. (Wire color)		Description		Condition	Value (Approx.)
+	-	Signal name	Input/ Output		
1 (BG)	Ground	Battery power supply	Input	Ignition switch OFF	Battery voltage
2 (GR)		Ground	—	Ignition switch ON	0 V
3 (G)		Ignition power supply	Input	Ignition switch ON	Battery voltage
4 (Y)		ITS communication-L	—	—	—
5 (BG)		ITS communication-H	—	—	—

## DTC Inspection Priority Chart

INFOID:000000009716416

If multiple DTCs are detected simultaneously, check them one by one depending on the following DTC inspection priority chart.

Priority	Detected items (DTC)
1	<ul style="list-style-type: none"> <li>U1000: CAN COMM CIRCUIT</li> <li>U1010: CONTROL UNIT (CAN)</li> </ul>
2	<ul style="list-style-type: none"> <li>C1F02: APA C/U MALF</li> </ul>
3	<ul style="list-style-type: none"> <li>C1F01: APA MOTOR MALF</li> <li>C1F03: APA HI TEMP</li> <li>C1F05: APA PWR SUPPLY CIR</li> <li>C1F06: CAN CIR2</li> <li>C1F07: CAN CIR1</li> </ul>

## DTC Index

INFOID:000000009716417

### NOTE:

- The details of time display are as per the following.
  - CRNT: A malfunction is detected now
  - PAST: A malfunction was detected in the past
- IGN counter is displayed in FFD (Freeze Frame Data).
  - 0: The malfunctions that are detected now
  - 1 - 39: It increases like 0 → 1 → 2 ... 38 → 39 after returning to the normal condition whenever the ignition switch OFF → ON. It returns to 0 when a malfunction is detected again in the process.
  - If it is over 39, it is fixed to 39 until the self-diagnosis results are erased.

x: Applicable

CONSULT display	ICC system warning lamp	Fail-safe function	Reference
C1F01: APA MOTOR MALF	ON	×	<a href="#">DAS-196</a>
C1F02: APA C/U MALF	ON	×	<a href="#">DAS-198</a>
C1F03: APA HI TEMP	—	—	<a href="#">DAS-200</a>
C1F05: APA PWR SUPPLY CIR	ON	×	<a href="#">DAS-201</a>
C1F06: CAN CIR2	ON	×	<a href="#">DAS-203</a>
C1F07: CAN CIR1	ON	×	<a href="#">DAS-204</a>
U1000: CAN COMM CIRCUIT	ON	×	<a href="#">DAS-212</a>
U1010: CONTROL UNIT (CAN)	ON	×	<a href="#">DAS-214</a>

< WIRING DIAGRAM >

# WIRING DIAGRAM

## DRIVER ASSISTANCE SYSTEMS

### Wiring Diagram

INFOID:000000009716418

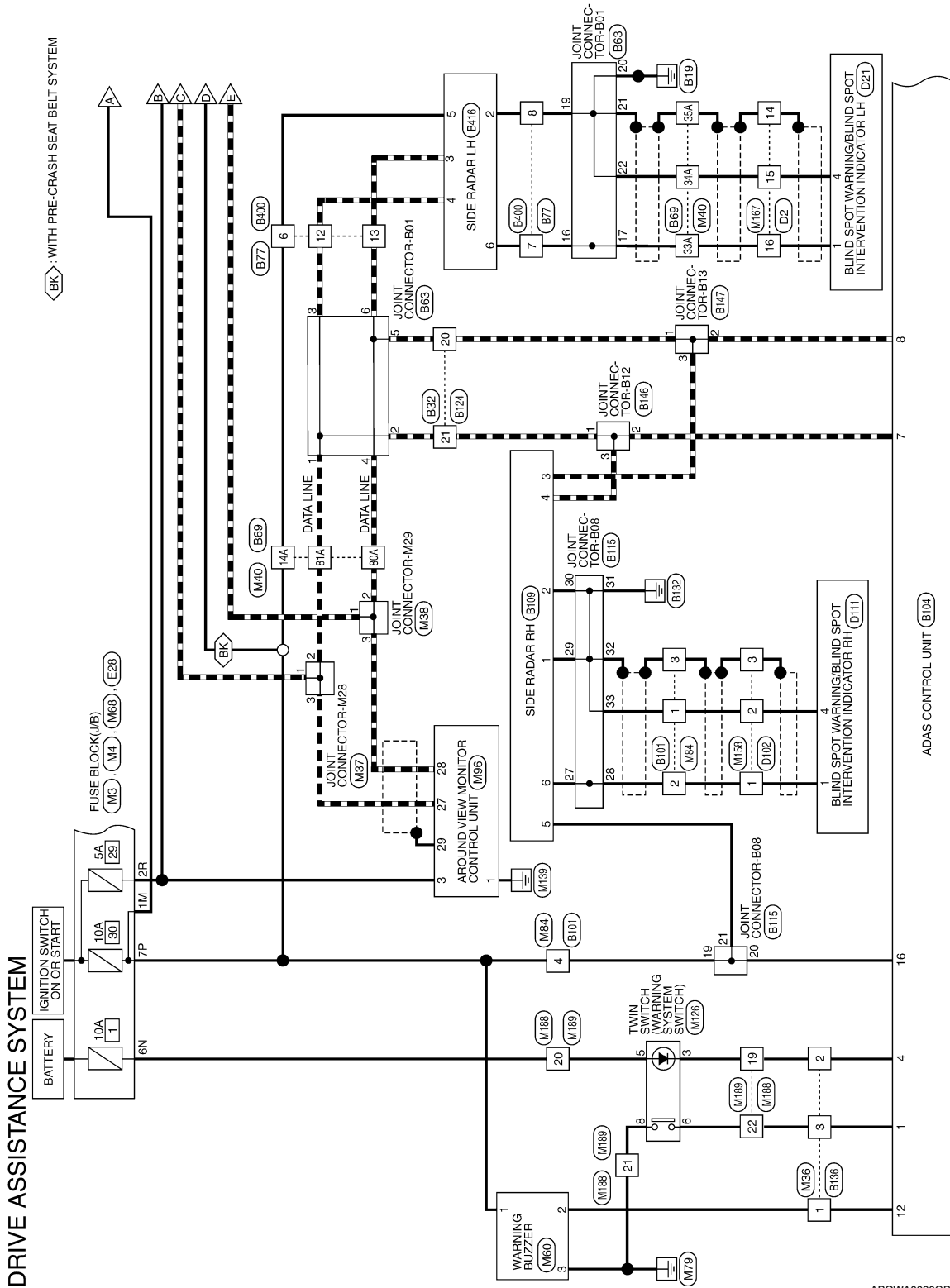

ABOWA0030GB







# DRIVER ASSISTANCE SYSTEMS

< WIRING DIAGRAM >

[DCA]

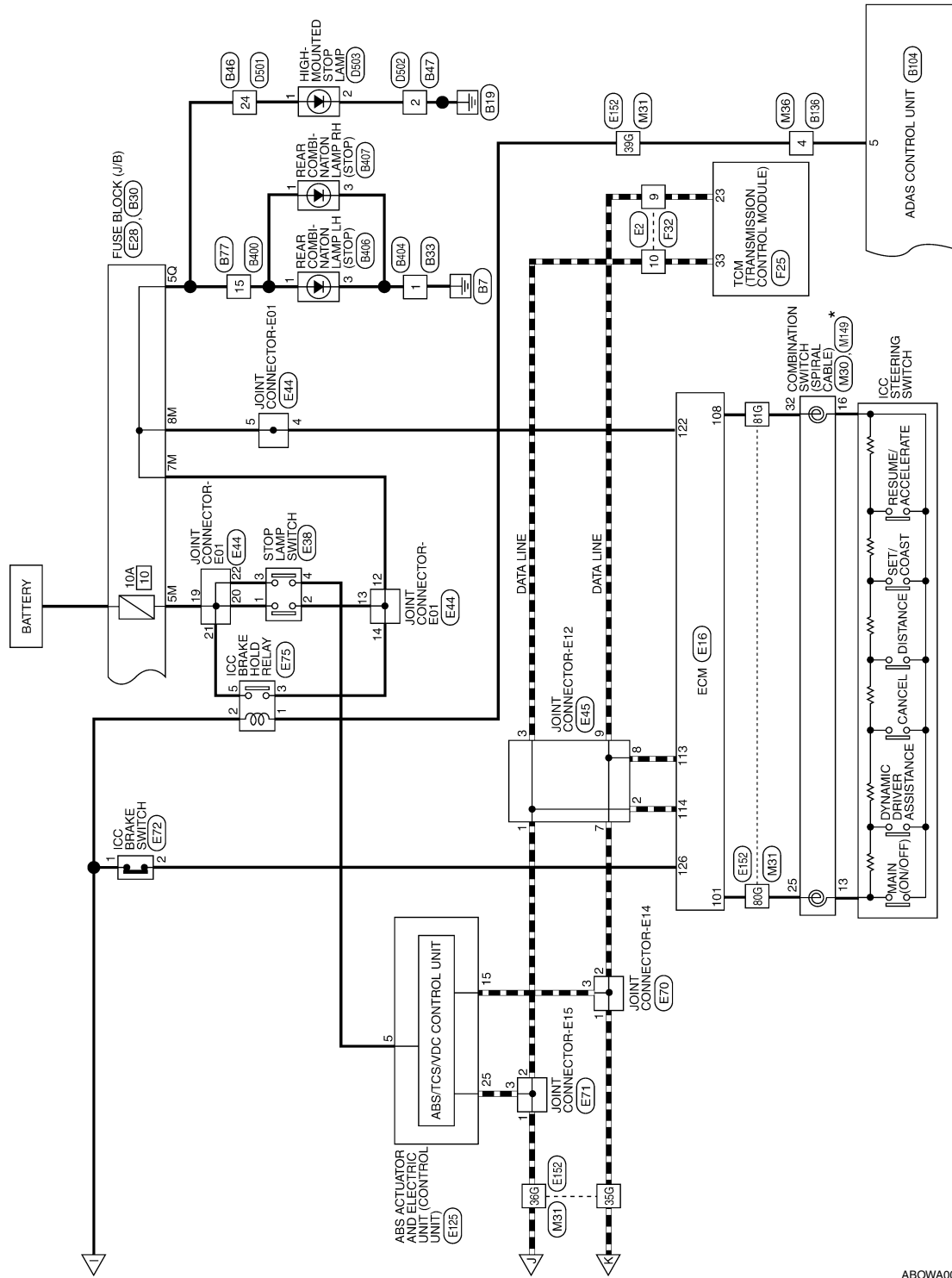

\* : THIS CONNECTOR IS NOT SHOWN IN "HARNES LAYOUT" OF PG SECTION.

ABOWA0033GB

A  
B  
C  
D  
E  
F  
G  
H  
I  
J  
K  
L  
M  
N  
P

DAS

DRIVE ASSISTANCE SYSTEM CONNECTORS

Connector No.	M1
Connector Name	WIRE TO WIRE
Connector Color	WHITE

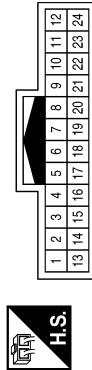

Terminal No.	Color of Wire	Signal Name
5	GR	-
6	LG	-
7	L	-
8	Y	-

Connector No.	M3
Connector Name	FUSE BLOCK (J/B)
Connector Color	WHITE

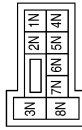

Terminal No.	Color of Wire	Signal Name
6N	W	-

Connector No.	M4
Connector Name	FUSE BLOCK (J/B)
Connector Color	WHITE



Terminal No.	Color of Wire	Signal Name
7P	LG	-
8P	BG	-
13P	W	-

Connector No.	M5
Connector Name	CAN GATEWAY
Connector Color	WHITE

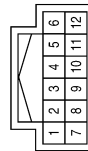

Terminal No.	Color of Wire	Signal Name
1	L	CAN-H
6	L	CAN-H
7	P	CAN-L
12	P	CAN-L

Connector No.	M11
Connector Name	JOINT CONNECTOR-M03
Connector Color	WHITE

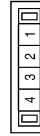

Terminal No.	Color of Wire	Signal Name
1	Y	-
2	Y	-
3	W	-
4	Y	-

Connector No.	M19
Connector Name	BCM (BODY CONTROL MODULE)
Connector Color	BLACK

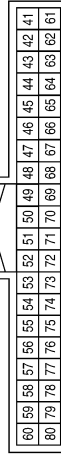

Terminal No.	Color of Wire	Signal Name
59	P	CAN-L
60	L	CAN-H

ABOIA0114GB

# DRIVER ASSISTANCE SYSTEMS

< WIRING DIAGRAM >

[DCA]

Terminal No.	Color of Wire	Signal Name
1	B	GND1
2	B	GND2
21	BG	IGN
22	W	BAT
38	P	CAN-L
39	L	CAN-H

Connector No.	M24
Connector Name	COMBINATION METER
Connector Color	WHITE

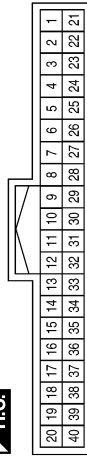

# DRIVER ASSISTANCE SYSTEMS

< WIRING DIAGRAM >

[DCA]

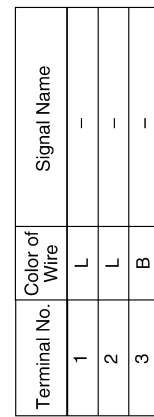
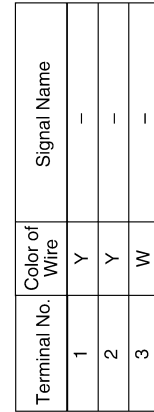
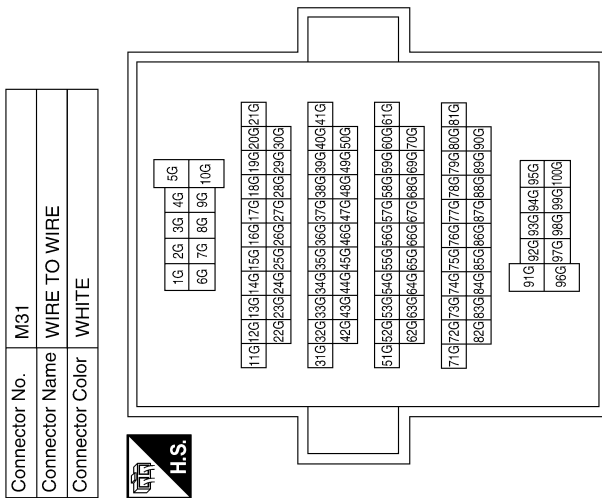
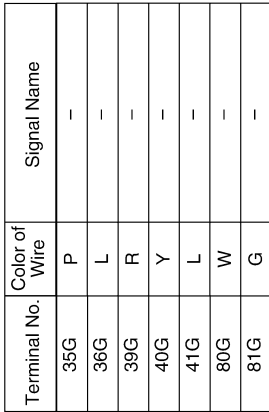
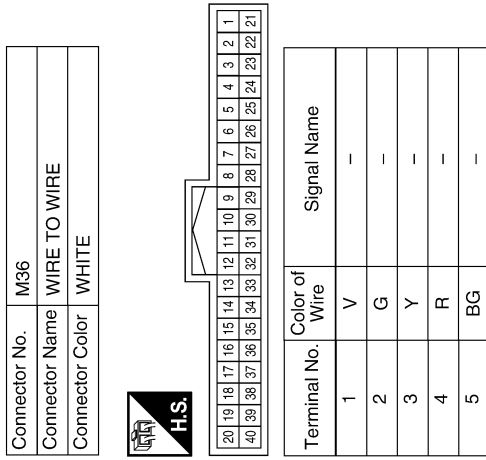

ABOIA0099GB

# DRIVER ASSISTANCE SYSTEMS

< WIRING DIAGRAM >

[DCA]

Connector No.	M41
Connector Name	JOINT CONNECTOR-M18
Connector Color	WHITE



Terminal No.	Color of Wire	Signal Name
1	P	-
2	P	-
3	P	-

Terminal No.	Color of Wire	Signal Name
14A	LG	-
33A	W	-
34A	B	-
35A	SHIELD	-
80A	Y	-
81A	L	-

Connector No.	M40
Connector Name	WIRE TO WIRE
Connector Color	GRAY

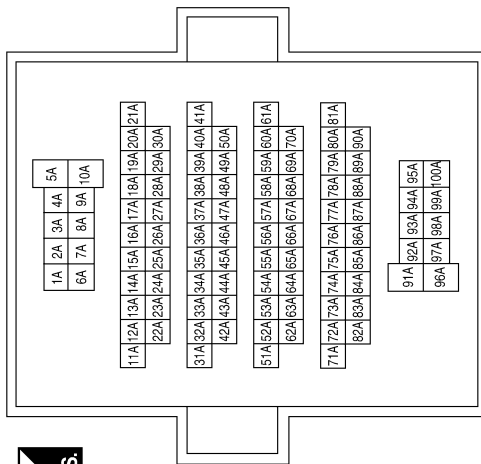

Connector No.	M50
Connector Name	A/C AUTO AMP.
Connector Color	WHITE

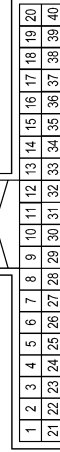

Terminal No.	Color of Wire	Signal Name
1	L	CAN-H
21	P	CAN-L

Connector No.	M47
Connector Name	TCU
Connector Color	WHITE

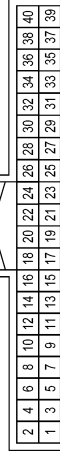

Terminal No.	Color of Wire	Signal Name
9	L	CAN-H
10	P	CAN-L

Connector No.	M43
Connector Name	JOINT CONNECTOR-M17
Connector Color	WHITE

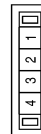

Terminal No.	Color of Wire	Signal Name
1	L	-
2	L	-
3	L	-

ABOIA0113GB

A  
B  
C  
D  
E  
F  
G  
H  
I  
J  
K  
L  
M  
N  
P

DAS

# DRIVER ASSISTANCE SYSTEMS

< WIRING DIAGRAM >

[DCA]

Connector No.	M67
Connector Name	JOINT CONNECTOR-M04
Connector Color	WHITE



Terminal No.	Color of Wire	Signal Name
1	L	-
2	L	-
3	B	-
4	L	-

Connector No.	M60
Connector Name	WARNING BUZZER
Connector Color	BROWN



Terminal No.	Color of Wire	Signal Name
1	LG	-
2	V	-
3	GR	-
4	-	-

Connector No.	M54
Connector Name	STEERING ANGLE SENSOR
Connector Color	WHITE

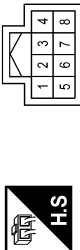

Terminal No.	Color of Wire	Signal Name
2	P	-
5	L	-

Connector No.	M84
Connector Name	WIRE TO WIRE
Connector Color	WHITE



Terminal No.	Color of Wire	Signal Name
1	B	-
2	W	-
3	SHIELD	-
4	LG	-
17	L	-
18	P	-

Connector No.	M70
Connector Name	SONAR CONTROL UNIT
Connector Color	WHITE

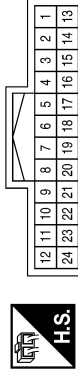

Terminal No.	Color of Wire	Signal Name
5	B	CAN-H
6	W	CAN-L
12	LG	IGN
15	GR	GND

Connector No.	M68
Connector Name	FUSE BLOCK (J/B)
Connector Color	BROWN

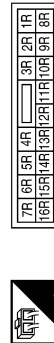

Terminal No.	Color of Wire	Signal Name
2R	LG	-

A010A100GB



# DRIVER ASSISTANCE SYSTEMS

< WIRING DIAGRAM >

[DCA]

Connector No.	M126
Connector Name	TWIN SWITCH (WARNING SYSTEM SWITCH)
Connector Color	BLACK

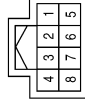

Terminal No.	Color of Wire	Signal Name
1	-	-
2	-	-
3	G	-
4	-	-
5	W	-
6	Y	-
7	-	-
8	B	-

Connector No.	M124
Connector Name	AV CONTROL UNIT (WITH BOSE AUDIO SYSTEM - WITH NAVI WITHOUT SURROUND SOUND SYSTEM)
Connector Color	WHITE

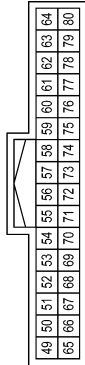

Terminal No.	Color of Wire	Signal Name
62	P	CAN-L
78	L	CAN-H

Connector No.	M96
Connector Name	AROUND VIEW MONITOR CONTROL UNIT
Connector Color	WHITE

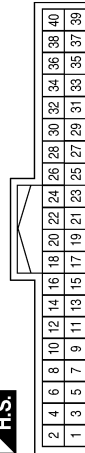

Terminal No.	Color of Wire	Signal Name
1	B	GND
3	LG	IGN
27	B	CAN-H
28	W	CAN-L
29	SHIELD	CAN GND

Connector No.	M158
Connector Name	WIRE TO WIRE
Connector Color	WHITE

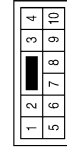

Terminal No.	Color of Wire	Signal Name
1	W	-
2	B	-
3	SHIELD	-

Connector No.	M150
Connector Name	JOINT CONNECTOR-M27
Connector Color	WHITE

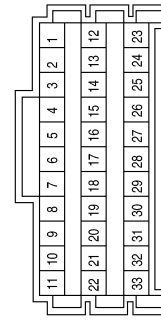

Terminal No.	Color of Wire	Signal Name
23	GR	-
28	SHIELD	-
31	GR	-

Connector No.	M149
Connector Name	COMBINATION SWITCH (SPIRAL CABLE)
Connector Color	GRAY

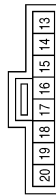

Terminal No.	Color of Wire	Signal Name
13	R	-
16	L	-

ABOIA0101GB

A  
B  
C  
D  
E  
F  
G  
H  
I  
J  
K  
L  
M  
N  
P

DAS

# DRIVER ASSISTANCE SYSTEMS

< WIRING DIAGRAM >

[DCA]

Connector No.	M188
Connector Name	WIRE TO WIRE
Connector Color	WHITE



Terminal No.	Color of Wire	Signal Name
19	G	-
20	W	-
21	B	-
22	Y	-

Connector No.	M167
Connector Name	WIRE TO WIRE
Connector Color	WHITE

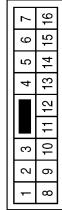

Terminal No.	Color of Wire	Signal Name
14	SHIELD	-
15	B	-
16	W	-

Connector No.	M163
Connector Name	AV CONTROL UNIT (WITH BOSE AUDIO SYSTEM - WITH NAVI AND SURROUND SOUND SYSTEM)
Connector Color	WHITE

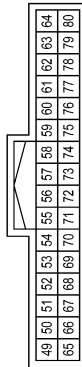

Terminal No.	Color of Wire	Signal Name
62	P	CAN-L
78	L	CAN-H

Connector No.	E5
Connector Name	WIRE TO WIRE
Connector Color	WHITE



Terminal No.	Color of Wire	Signal Name
11	R	-

Connector No.	E2
Connector Name	WIRE TO WIRE
Connector Color	WHITE



Terminal No.	Color of Wire	Signal Name
9	P	-
10	L	-

Connector No.	M189
Connector Name	WIRE TO WIRE
Connector Color	WHITE

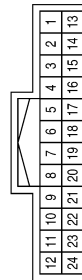

Terminal No.	Color of Wire	Signal Name
19	G	-
20	W	-
21	B	-
22	Y	-

ABOIA0102GB

# DRIVER ASSISTANCE SYSTEMS

< WIRING DIAGRAM >

[DCA]

Connector No.	E16
Connector Name	ECM
Connector Color	GRAY

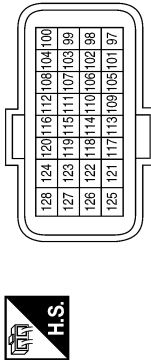

Terminal No.	Color of Wire	Signal Name
101	G	ASC D STEERING SWITCH/ICC STEERING SWITCH
108	R	SENSOR GROUND (ASC D STEERING SWITCH)
113	P	CAN-L
114	L	CAN-H
122	R	STOP LAMP SWITCH
126	LG	ASC D BRAKE SWITCH

Connector No.	E38
Connector Name	STOP LAMP SWITCH
Connector Color	WHITE



Terminal No.	Color of Wire	Signal Name
1	Y	-
2	P	-
3	Y	-
4	G	-

Connector No.	E26
Connector Name	WIRE TO WIRE
Connector Color	WHITE

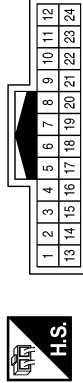

Terminal No.	Color of Wire	Signal Name
9	Y	-
10	BG	-

Connector No.	E44
Connector Name	JOINT CONNECTOR-E01
Connector Color	WHITE

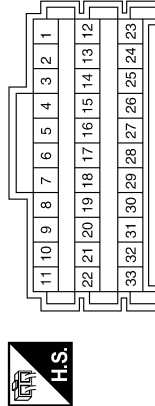

Terminal No.	Color of Wire	Signal Name
4	R	-
5	R	-
12	P	-
13	P	-

Connector No.	E28
Connector Name	FUSE BLOCK (J/B)
Connector Color	WHITE

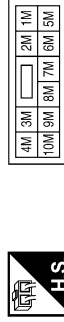

Terminal No.	Color of Wire	Signal Name
1M	R	-
5M	Y	-
7M	P	-
8M	R	-

Terminal No.	Color of Wire	Signal Name
14	P	-
19	Y	-
20	Y	-
21	Y	-
22	Y	-

A  
B  
C  
D  
E  
F  
G  
H  
I  
J  
K  
L  
M  
N  
P

DAS

A01A0103GB

# DRIVER ASSISTANCE SYSTEMS

< WIRING DIAGRAM >

[DCA]

Connector No.	E45
Connector Name	JOINT CONNECTOR-E12
Connector Color	BLUE

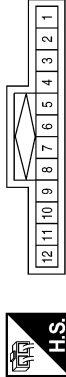

Terminal No.	Color of Wire	Signal Name
1	L	-
2	L	-
3	L	-
7	P	-
8	P	-
9	P	-

Connector No.	E70
Connector Name	JOINT CONNECTOR-E14
Connector Color	BLACK



Terminal No.	Color of Wire	Signal Name
1	P	-
2	P	-
3	P	-

Connector No.	E71
Connector Name	JOINT CONNECTOR-E15
Connector Color	BLACK



Terminal No.	Color of Wire	Signal Name
1	L	-
2	L	-
3	L	-

Connector No.	E72
Connector Name	ICC BRAKE SWITCH
Connector Color	BROWN



Terminal No.	Color of Wire	Signal Name
1	R	-
2	LG	-

Connector No.	E74
Connector Name	ACCELERATOR PEDAL ACTUATOR
Connector Color	GRAY



Terminal No.	Color of Wire	Signal Name
1	BG	-
2	GR	-
3	G	-
4	Y	-
5	BG	-
6	-	-

Connector No.	E75
Connector Name	ICC BRAKE HOLD RELAY
Connector Color	BLUE



Terminal No.	Color of Wire	Signal Name
1	W	-
2	R	-
3	P	-
5	Y	-

ABOIA0104GB

# DRIVER ASSISTANCE SYSTEMS

< WIRING DIAGRAM >

[DCA]

Connector No.	E106
Connector Name	JOINT CONNECTOR-E06
Connector Color	WHITE

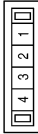

Terminal No.	Color of Wire	Signal Name
1	BG	-
2	BG	-
3	BG	-

Connector No.	E108
Connector Name	JOINT CONNECTOR-E07
Connector Color	WHITE



Terminal No.	Color of Wire	Signal Name
1	Y	-
2	Y	-
3	Y	-

Connector No.	E125
Connector Name	ABS ACTUATOR AND ELECTRIC UNIT (CONTROL UNIT)
Connector Color	BLACK

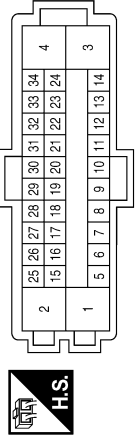

Terminal No.	Color of Wire	Signal Name
5	G	STOP LAMP SW (WITH ICC)
15	P	CAN-L
25	L	CAN-H

Connector No.	E152
Connector Name	WIRE TO WIRE
Connector Color	WHITE

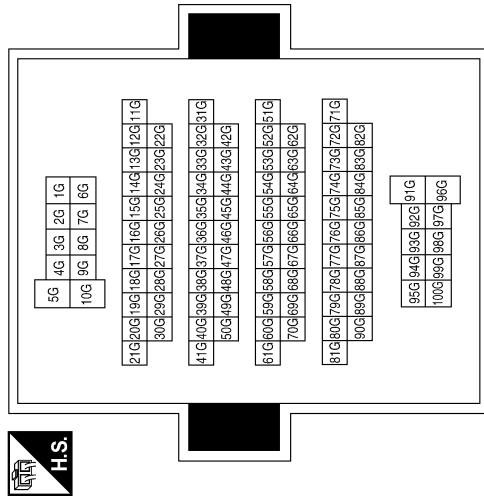

Connector No.	E207
Connector Name	WIRE TO WIRE
Connector Color	WHITE

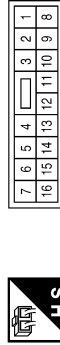

Terminal No.	Color of Wire	Signal Name
11	P	-

ABOIA0105GB

A  
B  
C  
D  
E  
F  
G  
H  
I  
J  
K  
L  
M  
N  
P

DAS

# DRIVER ASSISTANCE SYSTEMS

< WIRING DIAGRAM >

[DCA]

Connector No.	F25
Connector Name	TCM (TRANSMISSION CONTROL MODULE)
Connector Color	BLACK

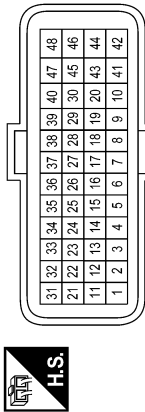

Terminal No.	Color of Wire	Signal Name
23	P	CAN-L
33	L	CAN-H

Connector No.	E219
Connector Name	ICC SENSOR
Connector Color	BLACK



Terminal No.	Color of Wire	Signal Name
1	P	-
6	Y	-
7	L	-
8	B	-

Connector No.	E209
Connector Name	WIRE TO WIRE
Connector Color	WHITE

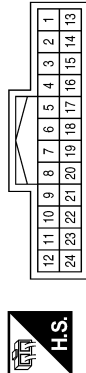

Terminal No.	Color of Wire	Signal Name
9	Y	-
10	L	-

Connector No.	B32
Connector Name	WIRE TO WIRE
Connector Color	WHITE

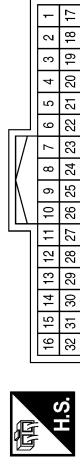

Terminal No.	Color of Wire	Signal Name
20	Y	-
21	L	-

Connector No.	B30
Connector Name	FUSE BLOCK (J/B)
Connector Color	WHITE

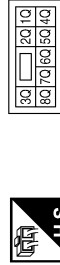

Terminal No.	Color of Wire	Signal Name
5Q	G	-

Connector No.	F32
Connector Name	WIRE TO WIRE
Connector Color	WHITE

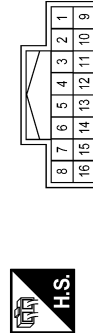

Terminal No.	Color of Wire	Signal Name
9	P	-
10	L	-

A01A106GB

# DRIVER ASSISTANCE SYSTEMS

< WIRING DIAGRAM >

[DCA]

Connector No.	B47
Connector Name	WIRE TO WIRE
Connector Color	GRAY

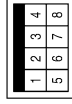

Terminal No.	2	Color of Wire	B	Signal Name	-
--------------	---	---------------	---	-------------	---

Connector No.	B46
Connector Name	WIRE TO WIRE
Connector Color	WHITE

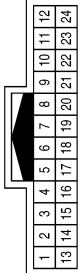

Terminal No.	24	Color of Wire	G	Signal Name	-
--------------	----	---------------	---	-------------	---

Connector No.	B33
Connector Name	WIRE TO WIRE
Connector Color	BLACK



Terminal No.	1	Color of Wire	B	Signal Name	-
--------------	---	---------------	---	-------------	---

Terminal No.	14A	Color of Wire	R	Signal Name	-
	33A	Color of Wire	W	Signal Name	-
	34A	Color of Wire	B	Signal Name	-
	35A	Color of Wire	SHIELD	Signal Name	-
	80A	Color of Wire	Y	Signal Name	-
	81A	Color of Wire	L	Signal Name	-

Connector No.	B69
Connector Name	WIRE TO WIRE
Connector Color	GRAY

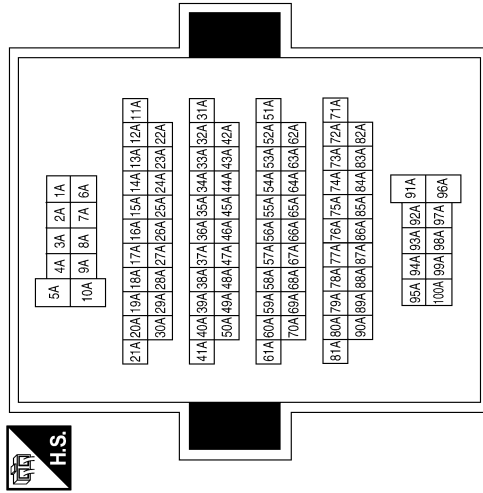

Connector No.	B63
Connector Name	JOINT CONNECTOR-B01
Connector Color	WHITE

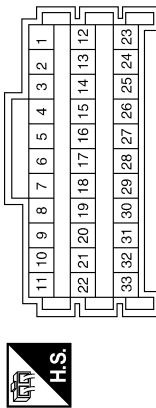

Terminal No.	1	Color of Wire	L	Signal Name	-
	2	Color of Wire	L	Signal Name	-
	3	Color of Wire	L	Signal Name	-
	4	Color of Wire	Y	Signal Name	-
	5	Color of Wire	Y	Signal Name	-
	6	Color of Wire	Y	Signal Name	-
	16	Color of Wire	W	Signal Name	-
	17	Color of Wire	W	Signal Name	-
	19	Color of Wire	B	Signal Name	-
	20	Color of Wire	B	Signal Name	-
	21	Color of Wire	SHIELD	Signal Name	-
	22	Color of Wire	B	Signal Name	-

ABOIA0107GB

A  
B  
C  
D  
E  
F  
G  
H  
I  
J  
K  
L  
M  
N  
P

DAS

# DRIVER ASSISTANCE SYSTEMS

< WIRING DIAGRAM >

[DCA]

Connector No.	B102
Connector Name	JOINT CONNECTOR-B14
Connector Color	WHITE



Terminal No.	Color of Wire	Signal Name
1	L	-
3	B	-

Connector No.	B101
Connector Name	WIRE TO WIRE
Connector Color	WHITE

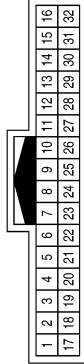

Terminal No.	Color of Wire	Signal Name
1	B	-
2	W	-
3	SHIELD	-
4	R	-
17	L	-
18	P	-

Connector No.	B77
Connector Name	WIRE TO WIRE
Connector Color	WHITE

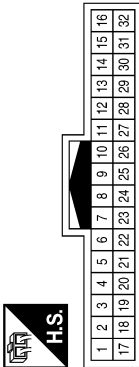

Terminal No.	Color of Wire	Signal Name
6	R	-
7	W	-
8	B	-
12	L	-
13	Y	-
15	G	-

Terminal No.	Color of Wire	Signal Name
7	L	ITS COMM-H
8	Y	ITS COMM-L
9	-	-
10	BG	BCP OFF SW
11	-	-
12	G	WARNING BUZZER
13	-	-
14	B	CAN-H
15	W	CAN-L
16	R	IGNITION

Connector No.	B104
Connector Name	ADAS CONTROL UNIT
Connector Color	WHITE

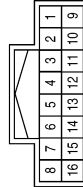

Terminal No.	Color of Wire	Signal Name
1	BR	WARNING SYSTEM SW
2	-	-
3	-	-
4	W	WARNING SYSTEM ON IND
5	G	BRAKE HOLD RLY DRIVE SIGNAL
6	B	GND

Connector No.	B103
Connector Name	JOINT CONNECTOR-B15
Connector Color	WHITE



Terminal No.	Color of Wire	Signal Name
1	P	-
3	W	-

ABOIA0108GB



# DRIVER ASSISTANCE SYSTEMS

< WIRING DIAGRAM >

[DCA]

Terminal No.	Color of Wire	Signal Name
9	B	-
10	GR	-
11	SHIELD	-
19	R	-
20	R	-
21	R	-
27	W	-
28	W	-
29	B	-
30	B	-
31	GR	-
32	SHIELD	-
33	B	-

Connector No.	B115
Connector Name	JOINT CONNECTOR-B08
Connector Color	WHITE

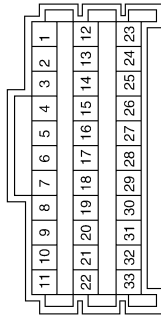

Connector No.	B109
Connector Name	SIDE RADAR RH
Connector Color	BLACK

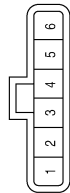

Terminal No.	Color of Wire	Signal Name
1	B	-
2	B	-
3	Y	-
4	L	-
5	R	-
6	W	-

Connector No.	B146
Connector Name	JOINT CONNECTOR-B12
Connector Color	WHITE



Connector No.	B136
Connector Name	WIRE TO WIRE
Connector Color	WHITE

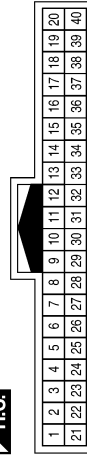

Terminal No.	Color of Wire	Signal Name
1	L	-
2	L	-
3	L	-

Connector No.	B124
Connector Name	WIRE TO WIRE
Connector Color	WHITE

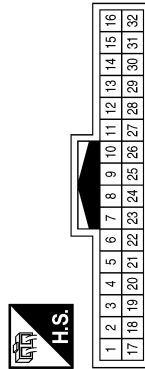

Terminal No.	Color of Wire	Signal Name
20	Y	-
21	L	-

ABOIA0109GB

A  
B  
C  
D  
E  
F  
G  
H  
I  
J  
K  
L  
M  
N  
P

DAS

# DRIVER ASSISTANCE SYSTEMS

< WIRING DIAGRAM >

[DCA]

Connector No.	B404
Connector Name	WIRE TO WIRE
Connector Color	BLACK



Terminal No.	Color of Wire	Signal Name
1	B	-

Connector No.	B400
Connector Name	WIRE TO WIRE
Connector Color	WHITE

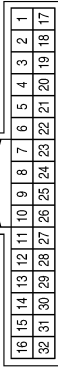

Terminal No.	Color of Wire	Signal Name
6	R	-
7	W	-
8	B	-
12	L	-
13	Y	-
15	G	-

Connector No.	B147
Connector Name	JOINT CONNECTOR-B13
Connector Color	WHITE



Terminal No.	Color of Wire	Signal Name
1	Y	-
2	Y	-
3	Y	-

Connector No.	B416
Connector Name	SIDE RADAR LH
Connector Color	BLACK

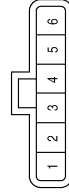

Terminal No.	Color of Wire	Signal Name
1	-	-
2	B	-
3	Y	-
4	L	-
5	R	-
6	W	-

Connector No.	B407
Connector Name	REAR COMBINATION LAMP RH
Connector Color	GRAY



Terminal No.	Color of Wire	Signal Name
1	G	-
3	GR	-

Connector No.	B406
Connector Name	REAR COMBINATION LAMP LH
Connector Color	GRAY



Terminal No.	Color of Wire	Signal Name
1	G	-
3	B	-

ABOIA0110GB

# DRIVER ASSISTANCE SYSTEMS

< WIRING DIAGRAM >

[DCA]

Connector No.	D2
Connector Name	WIRE TO WIRE
Connector Color	WHITE

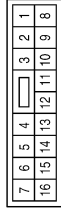

Terminal No.	Color of Wire	Signal Name
14	SHIELD	-
15	B	-
16	W	-

Connector No.	R5
Connector Name	LANE CAMERA UNIT
Connector Color	WHITE



Terminal No.	Color of Wire	Signal Name
1	B	-
2	-	-
3	-	-
4	BR	-
5	B	-
6	-	-
7	LG	-
8	Y	-

Connector No.	R1
Connector Name	WIRE TO WIRE
Connector Color	WHITE

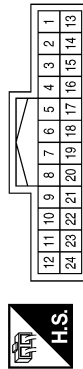

Terminal No.	Color of Wire	Signal Name
5	B	-
6	LG	-
7	BR	-
8	Y	-

Connector No.	D111
Connector Name	BLIND SPOT WARNING/ BLIND SPOT INTERVEN- TION INDICATOR RH
Connector Color	WHITE



Terminal No.	Color of Wire	Signal Name
1	W	-
2	-	-
3	-	-
4	B	-

Connector No.	D102
Connector Name	WIRE TO WIRE
Connector Color	WHITE



Terminal No.	Color of Wire	Signal Name
1	W	-
2	B	-
3	SHIELD	-

Connector No.	D21
Connector Name	BLIND SPOT WARNING/ BLIND SPOT INTERVEN- TION INDICATOR LH
Connector Color	WHITE



Terminal No.	Color of Wire	Signal Name
1	W	-
2	-	-
3	-	-
4	B	-

ABOIA0111GB

A  
B  
C  
D  
E  
F  
G  
H  
I  
J  
K  
L  
M  
N  
P



# DRIVER ASSISTANCE SYSTEMS

< WIRING DIAGRAM >

[DCA]

Connector No.	D503
Connector Name	HIGH-MOUNTED STOP LAMP
Connector Color	BROWN



Terminal No.	Color of Wire	Signal Name
1	LG	-
2	B	-

Connector No.	D502
Connector Name	WIRE TO WIRE
Connector Color	GRAY

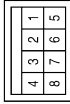

Terminal No.	Color of Wire	Signal Name
2	B	-

Connector No.	D501
Connector Name	WIRE TO WIRE
Connector Color	WHITE

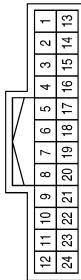

Terminal No.	Color of Wire	Signal Name
24	LG	-

ABOIA0112GB

# DIAGNOSIS AND REPAIR WORK FLOW

< BASIC INSPECTION >

[DCA]

## BASIC INSPECTION

### DIAGNOSIS AND REPAIR WORK FLOW

Work Flow

INFOID:000000009716419

#### OVERALL SEQUENCE

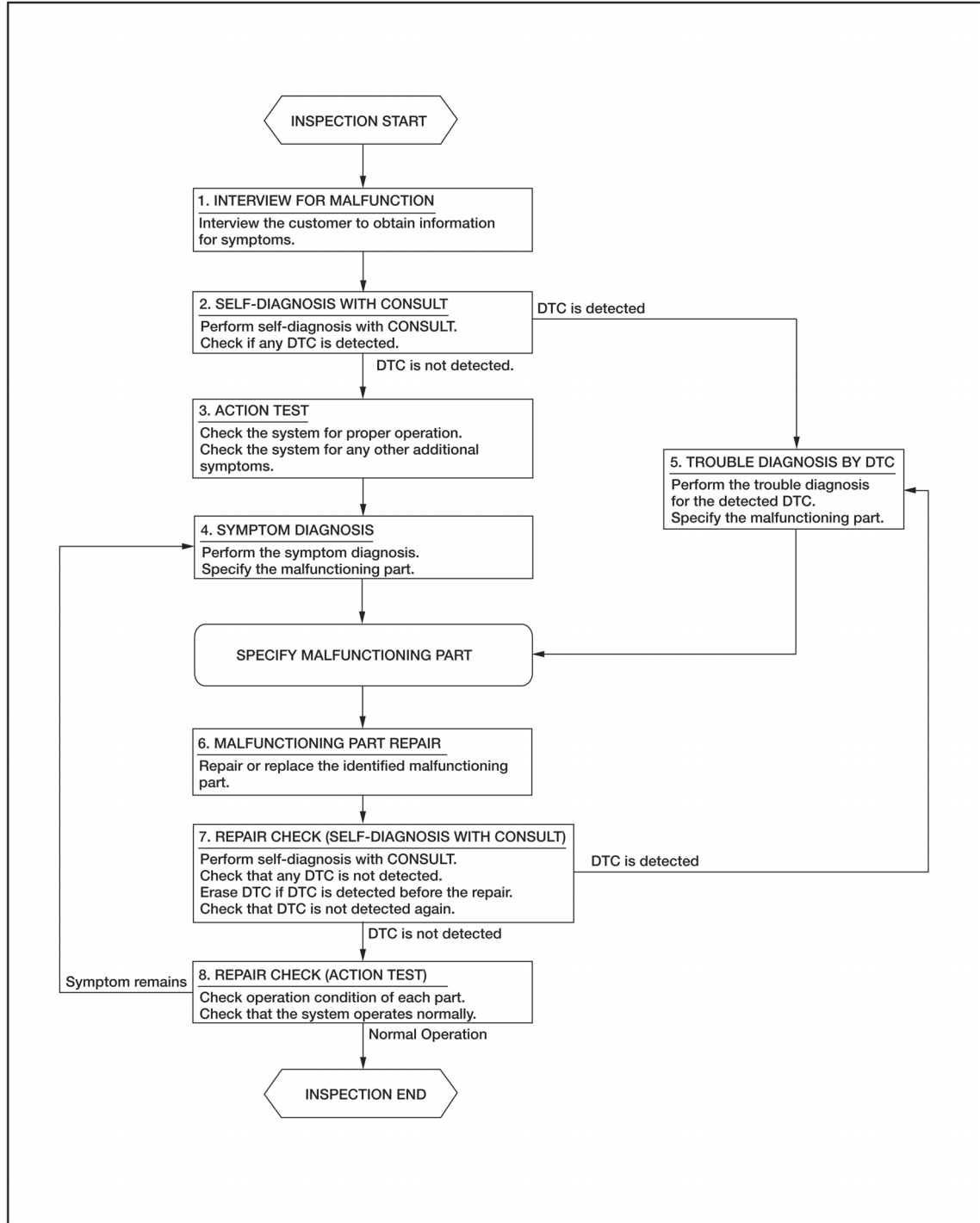

#### DETAILED FLOW

##### 1. INTERVIEW FOR MALFUNCTION

It is also important to clarify the customer concerns before starting the inspection. Interview the customer about the concerns carefully and understand the symptoms fully.

A  
B  
C  
D  
E  
F  
G  
H  
I  
J  
K  
L  
M  
N  
P

DAS

# DIAGNOSIS AND REPAIR WORK FLOW

[DCA]

< BASIC INSPECTION >

**NOTE:**

The customers are not professionals. Never assume that “maybe the customer means…” or “maybe the customer mentioned this symptom”.

>> GO TO 2.

## 2. SELF-DIAGNOSIS WITH CONSULT

---

1. Perform “All DTC Reading” with CONSULT.
2. Check if the DTC is detected on the self-diagnosis results of “ICC/ADAS” and/or “ACCELE PEDAL ACT”.

Is any DTC detected?

- YES >> GO TO 5.  
NO >> GO TO 3.

## 3. ACTION TEST

---

Perform DCA system action test to check the operation status. Refer to [DAS-157, "Description"](#).  
Check if any other malfunctions occur.

>> GO TO 4.

## 4. SYMPTOM DIAGNOSIS

---

Perform the applicable diagnosis according to the diagnosis chart by symptom. Refer to [DAS-226, "Symptom Table"](#).

>> GO TO 6.

## 5. TROUBLE DIAGNOSIS BY DTC

---

1. Check the DTC in the self-diagnosis results.
2. Perform trouble diagnosis for the detected DTC. Refer to [DAS-47, "DTC Index"](#) (ICC/ADAS) and/or [DAS-131, "DTC Index"](#) (ACCELE PEDAL ACT).

**NOTE:**

If “DTC: U1000” is detected, first diagnose the CAN communication system or ITS communication system.

>> GO TO 6.

## 6. MALFUNCTIONING PART REPAIR

---

Repair or replace the identified malfunctioning parts.

>> GO TO 7.

## 7. REPAIR CHECK (SELF-DIAGNOSIS WITH CONSULT)

---

1. Erases self-diagnosis results.
2. Perform “All DTC Reading” again after repairing or replacing the specific items.
3. Check if any DTC is detected in self-diagnosis results of “ICC/ADAS” and “ACCELE PEDAL ACT”.

Is any DTC detected?

- YES >> GO TO 5.  
NO >> GO TO 8.

## 8. REPAIR CHECK (ACTION TEST)

---

Perform the DCA system action test. Check that the malfunction symptom is solved or no other symptoms occur.

Is there a malfunction symptom?

- YES >> GO TO 4.  
NO >> INSPECTION END

# ADDITIONAL SERVICE WHEN REPLACING ICC SENSOR

< BASIC INSPECTION >

[DCA]

## ADDITIONAL SERVICE WHEN REPLACING ICC SENSOR

### Description

INFOID:000000009716420

- Always perform the ICC sensor aiming adjustment after removing and installing or replacing the ICC sensor.  
**CAUTION:**  
**The system does not operate normally unless the ICC sensor aiming adjustment is performed. Always perform it.**
- Perform the DCA system action test check that the DCA system operates normally.

### Work Procedure

INFOID:000000009716421

#### 1. ICC SENSOR AIMING ADJUSTMENT

Adjust the ICC sensor aiming. Refer to [CCS-87. "Description"](#).

>> GO TO 2.

#### 2. DCA SYSTEM ACTION TEST

1. Perform the DCA system action test. Refer to [DAS-157. "Description"](#).
2. Check that the DCA system operates normally.

>> INSPECTION END

A  
B  
C  
D  
E  
F  
G  
H  
I  
J  
K  
L  
M  
N  
P

DAS

# ADDITIONAL SERVICE WHEN REPLACING ACCELERATOR PEDAL ASSEMBLY

< BASIC INSPECTION >

[DCA]

## ADDITIONAL SERVICE WHEN REPLACING ACCELERATOR PEDAL ASSEMBLY

### Description

INFOID:000000009716422

- Always perform accelerator pedal released position learning when replacing the accelerator pedal assembly or disconnecting the accelerator pedal position sensor connector.
- Perform the DCA system action test check that the DCA system operates normally.

### Work Procedure

INFOID:000000009716423

#### 1.ACCELERATOR PEDAL RELEASED POSITION LEARNING

Perform accelerator pedal released position learning. Refer to [DAS-156. "Description"](#).

>> GO TO 2.

#### 2.DCA SYSTEM ACTION TEST

1. Perform the DCA system action test. Refer to [DAS-157. "Description"](#).
2. Check that the DCA system operates normally.

>> INSPECTION END



# ACTION TEST

< BASIC INSPECTION >

[DCA]

## ACTION TEST

### Description

INFOID:000000009716424

Always perform the DCA system action test to check that the system operates normally after replacing the ICC sensor, replacing the accelerator pedal assembly, or repairing any DCA system malfunction.

#### CAUTION:

**Perform the DCA system action test after checking that the ICC system operates normally because the DCA system shares components with the ICC system.**

### Work Procedure

INFOID:000000009716425

#### NOTE:

When the ICC system is set, the information display changes to the ICC system display.

#### 1. ICC SYSTEM ACTION TEST

Perform the ICC system action test. Refer to [DAS-157. "Description"](#).

>> GO TO 2.

#### 2. CHECK DCA SYSTEM SETTING

1. Start the engine.
2. After starting the engine wait for 30 seconds or more.
3. Check that the DCA system setting can be enabled/disabled on the navigation screen.
4. Turn OFF the ignition switch and wait for 5 seconds or more.
5. Check that the previous setting is saved when the engine starts again.

>> GO TO 3.

#### 3. CHECK DYNAMIC DRIVER ASSISTANCE SWITCH

1. Start the engine.
2. After starting the engine wait for 30 seconds or more.
3. Enable the setting of the DCA system on the navigation screen.
4. Press the dynamic driver assistance switch (1).
5. Check that the DCA system switch indicator (2) on the information display illuminates.
6. Check that the DCA system switch indicator turns OFF when the system is turned OFF by pressing the dynamic driver assistance switch.
7. Check that the DCA system switch indicator turns OFF when the engine starts again.

#### NOTE:

The DCA system switch indicator does not illuminate even when the dynamic driver assistance switch is turned ON within approximately 5 seconds after starting the engine.

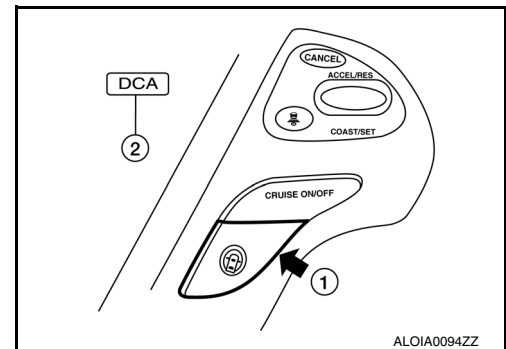

If the accelerator pedal assembly is not replaced >> INSPECTION END

If the accelerator pedal assembly is replaced >> GO TO 4.

#### 4. CHECK DCA SYSTEM OPERATION

Check that the accelerator pedal actuator operates by the "Active Test" items "ACCELERATOR PEDAL ACTUATOR TEST1" and "ACCELERATOR PEDAL ACTUATOR TEST2" of "ACCELE PEDAL ACT" with CONSULT.

>> INSPECTION END

A  
B  
C  
D  
E  
F  
G  
H  
I  
J  
K  
L  
M  
N  
P

DAS

# DTC/CIRCUIT DIAGNOSIS

## C1A00 CONTROL UNIT

### DTC Logic

INFOID:000000009716426

### DTC DETECTION LOGIC

DTC (On board display)	Trouble diagnosis name	DTC detecting condition	Possible causes
C1A00 (0)	CONTROL UNIT	ADAS control unit internal malfunction	ADAS control unit

### DTC CONFIRMATION PROCEDURE

#### 1. PERFORM DTC CONFIRMATION PROCEDURE

1. Start the engine.
2. Perform "All DTC Reading" with CONSULT.
3. Check if the "C1A00" is detected as the current malfunction in "Self Diagnostic Result" of "ICC/ADAS".

Is "C1A00" detected as the current malfunction?

- YES >> Refer to [DAS-158, "Diagnosis Procedure"](#).  
 NO >> INSPECTION END

### Diagnosis Procedure

INFOID:000000009716427

#### 1. CHECK SELF-DIAGNOSIS RESULTS

Check if any DTC other than "C1A00" is detected in "Self Diagnostic Result" of "ICC/ADAS".

Is any DTC detected?

- YES >> Perform diagnosis on the detected DTC and repair or replace the malfunctioning parts. Refer to [DAS-122, "DTC Index"](#).  
 NO >> Replace the ADAS control unit. Refer to [DAS-79, "Removal and Installation"](#).

# C1A01 POWER SUPPLY CIRCUIT 1, C1A02 POWER SUPPLY CIRCUIT 2

< DTC/CIRCUIT DIAGNOSIS >

[DCA]

## C1A01 POWER SUPPLY CIRCUIT 1, C1A02 POWER SUPPLY CIRCUIT 2

### DTC Logic

INFOID:000000009716428

### DTC DETECTION LOGIC

DTC (On board display)	Trouble diagnosis name	DTC detecting condition	Possible causes
C1A01 (1)	POWER SUPPLY CIR	The battery voltage sent to ADAS control unit remains less than 7.9 V for 5 seconds	• Connector, harness, fuse • ADAS control unit
C1A02 (2)	POWER SUPPLY CIR 2	The battery voltage sent to ADAS control unit remains more than 19.3 V for 5 seconds	

### DTC CONFIRMATION PROCEDURE

#### 1.PERFORM DTC CONFIRMATION PROCEDURE

1. Start the engine.
2. Turn the DCA system ON.
3. Perform "All DTC Reading" with CONSULT.
4. Check if the "C1A01" or "C1A02" is detected as the current malfunction in "Self Diagnostic Result" of "ICC/ADAS".

Is "C1A01" or "C1A02" detected as the current malfunction?

- YES >> Refer to [DAS-159, "Diagnosis Procedure"](#).  
NO >> Refer to [GI-53, "Intermittent Incident"](#).

### Diagnosis Procedure

INFOID:000000009716429

#### 1.CHECK ADAS CONTROL UNIT POWER SUPPLY AND GROUND CIRCUIT

Check power supply and ground circuit of ADAS control unit. Refer to [DAS-224, "ADAS CONTROL UNIT : Diagnosis Procedure"](#).

Is the inspection result normal?

- YES >> Replace the ADAS control unit. Refer to [DAS-79, "Removal and Installation"](#).  
NO >> Repair or replace the malfunctioning parts.

DAS

# C1A03 VEHICLE SPEED SENSOR

< DTC/CIRCUIT DIAGNOSIS >

[DCA]

## C1A03 VEHICLE SPEED SENSOR

### DTC Logic

INFOID:000000009716430

### DTC DETECTION LOGIC

DTC (On board display)	Trouble diagnosis name	DTC detecting condition	Possible causes
C1A03 (3)	VHCL SPEED SE CIRC	If the vehicle speed signal (wheel speed) from ABS actuator and electric unit (control unit) and the CVT vehicle speed sensor signal (output shaft revolution signal) from TCM, received by the ADAS control unit via CAN communication, are inconsistent	<ul style="list-style-type: none"><li>• Wheel speed sensor</li><li>• ABS actuator and electric unit (control unit)</li><li>• Vehicle speed sensor CVT (output speed sensor)</li><li>• TCM</li><li>• ADAS control unit</li></ul>

#### NOTE:

If DTC "C1A03" is detected along with DTC "U1000" or "C1A04", first diagnose the DTC "U1000" or "C1A04".

- Refer to [DAS-212, "ADAS CONTROL UNIT : DTC Logic"](#) for DTC "U1000".
- Refer to [DAS-162, "DTC Logic"](#) for DTC "C1A04".

### DTC CONFIRMATION PROCEDURE

#### 1. PERFORM DTC CONFIRMATION PROCEDURE

1. Start the engine.
2. Turn the DCA system ON.
3. Drive the vehicle at 30 km/h (19 MPH) or more.

#### CAUTION:

**Always drive safely.**

4. Stop the vehicle.
5. Perform "All DTC Reading" with CONSULT.
6. Check if the "C1A03" is detected as the current malfunction in "Self Diagnostic Result" of "ICC/ADAS".

#### Is "C1A03" detected as the current malfunction?

- YES >> Refer to [DAS-160, "Diagnosis Procedure"](#).  
NO >> Refer to [GI-53, "Intermittent Incident"](#).

### Diagnosis Procedure

INFOID:000000009716431

#### 1. CHECK SELF-DIAGNOSIS RESULTS

Check if "C1A04" or "U1000" is detected other than "C1A03" in "Self Diagnostic Result" of "ICC/ADAS".

#### Is any DTC detected?

- YES >> Perform diagnosis on the detected DTC and repair or replace the malfunctioning parts. Refer to [DAS-122, "DTC Index"](#).  
NO >> GO TO 2.

#### 2. CHECK DATA MONITOR

1. Start the engine.
2. Drive the vehicle.
3. Check that the value of "VHCL SPD AT" is almost the same as the value of "VHCL SPEED SE" in "DATA MONITOR" of "ICC/ADAS".

#### CAUTION:

**Be careful of the vehicle speed.**

#### Is the inspection result normal?

- YES >> Replace the ADAS control unit. Refer to [DAS-79, "Removal and Installation"](#).  
NO >> GO TO 3.

#### 3. CHECK TCM SELF-DIAGNOSIS RESULTS

1. Perform "All DTC Reading".
2. Check if any DTC is detected in "Self Diagnostic Result" of "TRANSMISSION".

## C1A03 VEHICLE SPEED SENSOR

[DCA]

< DTC/CIRCUIT DIAGNOSIS >

Is any DTC detected?

YES >> Perform diagnosis on the detected DTC and repair or replace the malfunctioning parts. Refer to [TM-61, "DTC Index"](#).

NO >> GO TO 4.

### 4. CHECK ABS ACTUATOR AND ELECTRIC UNIT (CONTROL UNIT) SELF-DIAGNOSIS RESULTS

Check if any DTC is detected in "Self Diagnostic Result" of "ABS".

Is any DTC detected?

YES >> Perform diagnosis on the detected DTC and repair or replace the malfunctioning parts. Refer to [BRC-46, "DTC Index"](#).

NO >> Replace the ADAS control unit. Refer to [DAS-79, "Removal and Installation"](#).

A  
B  
C  
D  
E  
F  
G  
H  
I  
J  
K  
L  
M  
N  
P

DAS

# C1A04 ABS/TCS/VDC SYSTEM

< DTC/CIRCUIT DIAGNOSIS >

[DCA]

## C1A04 ABS/TCS/VDC SYSTEM

### DTC Logic

INFOID:000000009716432

### DTC DETECTION LOGIC

DTC (On board display)	Trouble diagnosis name	DTC detecting condition	Possible causes
C1A04 (4)	ABS/TCS/VDC CIRC	If a malfunction occurs in the VDC/TCS/ABS system	ABS actuator and electric unit (control unit)

#### NOTE:

If DTC "C1A04" is detected along with DTC "U1000", first diagnose the DTC "U1000". Refer to [DAS-212, "ADAS CONTROL UNIT : DTC Logic"](#).

### Diagnosis Procedure

INFOID:000000009716433

#### 1. CHECK SELF-DIAGNOSIS RESULTS

1. Perform "All DTC Reading" with CONSULT.
2. Check if the "U1000" is detected other than "C1A04" in "Self Diagnostic Result" of "ICC/ADAS".

##### Is "U1000" detected?

- YES >> Perform the CAN communication system inspection. Repair or replace the malfunctioning parts.  
Refer to [DAS-212, "ADAS CONTROL UNIT : DTC Logic"](#).
- NO >> GO TO 2.

#### 2. CHECK ABS ACTUATOR AND ELECTRIC UNIT (CONTROL UNIT) SELF-DIAGNOSIS RESULTS

Check if any DTC is detected in "Self Diagnostic Result" of "ABS".

##### Is any DTC detected?

- YES >> Perform diagnosis on the detected DTC and repair or replace the malfunctioning parts. Refer to [BRC-46, "DTC Index"](#).
- NO >> Replace the ADAS control unit. Refer to [DAS-79, "Removal and Installation"](#).

# C1A05 BRAKE SW/STOP LAMP SW

[DCA]

< DTC/CIRCUIT DIAGNOSIS >

## C1A05 BRAKE SW/STOP LAMP SW

### DTC Logic

INFOID:000000009716434

### DTC DETECTION LOGIC

DTC (On board display)	Trouble diagnosis name	DTC detecting condition	Possible causes
C1A05 (5)	BRAKE SW/STOP L SW	A mismatch between a stop lamp switch signal and a ICC brake switch signal received from ECM and a stop lamp signal received from the ABS actuator and electric unit (control unit) continues for 10 seconds or more with vehicle speeds at approximately 40 km/h or more	<ul style="list-style-type: none"><li>• Stop lamp switch circuit</li><li>• ICC brake switch circuit</li><li>• Stop lamp switch</li><li>• ICC brake switch</li><li>• Incorrect stop lamp switch installation</li><li>• Incorrect ICC brake switch installation</li><li>• ECM</li><li>• ABS actuator and electric unit (control unit)</li></ul>

#### NOTE:

If DTC "C1A05" is detected along with DTC "U1000", first diagnose the DTC "U1000". Refer to [DAS-212, "ADAS CONTROL UNIT : DTC Logic"](#).

### Diagnosis Procedure

INFOID:000000009716435

Regarding Wiring Diagram information, refer to [DAS-132, "Wiring Diagram"](#).

## 1. CHECK SELF-DIAGNOSIS RESULTS

1. Perform "All DTC Reading" with CONSULT.
2. Check if the "U1000" is detected other than "C1A05" in "Self Diagnostic Result" of "ICC/ADAS".

Is "U1000" detected?

YES >> Perform the CAN communication system inspection. Repair or replace the malfunctioning parts.  
Refer to [DAS-212, "ADAS CONTROL UNIT : DTC Logic"](#).

NO >> GO TO 2.

## 2. CHECK STOP LAMP SWITCH AND ICC BRAKE SWITCH

Check that "STOP LAMP SW" and "BRAKE SW" operate normally in "DATA MONITOR" of "ICC/ADAS".

Is the inspection result normal?

YES >> GO TO 3.

NO-1 >> When "BRAKE SW" operation is malfunctioning: GO TO 4.

NO-2 >> When "STOP LAMP SW" operation is malfunctioning: GO TO 9.

## 3. CHECK STOP LAMP SWITCH

Check that "STOP LAMP SW" operate normally in "DATA MONITOR" of "ABS".

Is the inspection result normal?

YES >> GO TO 14.

NO >> GO TO 9.

## 4. CHECK ICC BRAKE SWITCH INSTALLATION

1. Turn ignition switch OFF.
2. Check ICC brake switch for correct installation. Refer to [BR-15, "Adjustment"](#).

Is the inspection result normal?

YES >> GO TO 5.

NO >> Adjust ICC brake switch installation. Refer to [BR-15, "Adjustment"](#).

# C1A05 BRAKE SW/STOP LAMP SW

[DCA]

< DTC/CIRCUIT DIAGNOSIS >

## 5. ICC BRAKE SWITCH INSPECTION

1. Disconnect ICC brake switch connector.
2. Check ICC brake switch. Refer to [DAS-166, "Component Inspection \(ICC Brake Switch\)"](#).

Is the inspection result normal?

- YES >> GO TO 6.  
NO >> Replace ICC brake switch.

## 6. CHECK ICC BRAKE SWITCH POWER SUPPLY CIRCUIT

1. Turn the ignition switch ON.
2. Check voltage between ICC brake switch harness connector and ground.

Terminals		Voltage (Approx.)
(+)	(-)	
ICC brake switch		Ground
Connector	Terminal	
E72	1	
		Battery voltage

Is the inspection result normal?

- YES >> GO TO 7.  
NO >> Repair the harnesses or connectors.

## 7. CHECK HARNESS BETWEEN ICC BRAKE SWITCH AND ECM

1. Turn ignition switch OFF
2. Disconnect ECM connector.
3. Check for continuity between ICC brake switch harness connector and ECM harness connector.

ICC brake switch		ECM		Continuity
Connector	Terminal	Connector	Terminal	
E72	2	E16	126	Yes

4. Check for continuity between ICC brake switch harness connector and ground.

ICC brake switch		Ground	Continuity
Connector	Terminal		
E72	2		No

Is the inspection result normal?

- YES >> GO TO 8.  
NO >> Repair the harnesses or connectors.

## 8. PERFORM SELF-DIAGNOSIS OF ECM

1. Connect all connectors again if the connectors are disconnected.
2. Turn ignition switch ON.
3. Perform "All DTC Reading".
4. Check if any DTC is detected in "Self Diagnostic Result" of "ENGINE". Refer to [EC-97, "DTC Index"](#).

Is any DTC detected?

- YES >> Repair or replace the malfunctioning parts identified by the self-diagnosis result.  
NO >> Replace the ADAS control unit. Refer to [DAS-79, "Removal and Installation"](#).

## 9. CHECK STOP LAMP SWITCH INSTALLATION

1. Turn ignition switch OFF.
2. Check stop lamp switch for correct installation. Refer to [BR-15, "Adjustment"](#).

Is the inspection result normal?

- YES >> GO TO 10.  
NO >> Adjust stop lamp switch installation. Refer to [BR-15, "Adjustment"](#).



# C1A05 BRAKE SW/STOP LAMP SW

[DCA]

< DTC/CIRCUIT DIAGNOSIS >

## 10. STOP LAMP SWITCH INSPECTION

1. Disconnect stop lamp switch connector.
2. Check stop lamp switch. Refer to [DAS-166, "Component Inspection \(Stop Lamp Switch\)"](#).

Is the inspection result normal?

- YES >> GO TO 11.  
NO >> Replace stop lamp switch.

## 11. CHECK STOP LAMP SWITCH POWER SUPPLY CIRCUIT

1. Turn the ignition switch ON.
2. Check voltage between stop lamp switch harness connector and ground.

Terminals		Voltage (Approx.)
(+)	(-)	
Stop lamp switch		Ground
Connector	Terminal	
E38	1	
	3	
		Battery voltage

Is the inspection result normal?

- YES >> GO TO 12.  
NO >> Repair the harnesses or connectors.

## 12. CHECK HARNESS BETWEEN STOP LAMP SWITCH AND ECM

1. Turn ignition switch OFF
2. Disconnect ECM, rear combination lamp and high-mounted stop lamp connectors.
3. Check for continuity between stop lamp switch harness connector and ECM harness connector.

Stop lamp switch		ECM		Continuity
Connector	Terminal	Connector	Terminal	
E38	2	E16	122	Yes

4. Check for continuity between stop lamp switch harness connector and ground.

Stop lamp switch		Ground	Continuity
Connector	Terminal		
E38	2		No

Is the inspection result normal?

- YES >> GO TO 13.  
NO >> Repair the harnesses or connectors.

## 13. CHECK HARNESS BETWEEN STOP LAMP SWITCH AND ABS ACTUATOR AND ELECTRIC UNIT (CONTROL UNIT)

1. Disconnect ABS actuator and electric unit (control unit) connector.
2. Check for continuity between stop lamp switch harness connector and ABS actuator and electric unit (control unit) harness connector.

Stop lamp switch		ABS actuator and electric unit (control unit)		Continuity
Connector	Terminal	Connector	Terminal	
E38	4	E125	5	Yes

3. Check for continuity between stop lamp switch harness connector and ground.

A  
B  
C  
D  
E  
F  
G  
H  
I  
J  
K  
L  
M  
N

DAS

P

# C1A05 BRAKE SW/STOP LAMP SW

< DTC/CIRCUIT DIAGNOSIS >

[DCA]

Stop lamp switch		Ground	Continuity
Connector	Terminal		
E38	4		No

Is the inspection result normal?

YES >> GO TO 14.

NO >> Repair the harnesses or connectors.

## 14.PERFORM SELF-DIAGNOSIS OF ECM

1. Connect all connectors again if the connectors are disconnected.
2. Turn ignition switch ON.
3. Perform "All DTC Reading".
4. Check if any DTC is detected in "Self Diagnostic Result" of "ENGINE". Refer to [EC-97, "DTC Index"](#).

Is any DTC detected?

YES >> Repair or replace the malfunctioning parts identified by the self-diagnosis result.

NO >> GO TO 15.

## 15.PERFORM SELF-DIAGNOSIS OF ABS ACTUATOR AND ELECTRIC UNIT (CONTROL UNIT)

Check if any DTC is detected in "Self Diagnostic Result" of "ABS". Refer to [BRC-46, "DTC Index"](#).

Is any DTC detected?

YES >> Repair or replace the malfunctioning parts identified by the self-diagnosis result.

NO >> Replace the ADAS control unit. Refer to [DAS-79, "Removal and Installation"](#).

## Component Inspection (ICC Brake Switch)

INFOID:000000009716436

### 1.CHECK ICC BRAKE SWITCH

Check for continuity between ICC brake switch terminals.

Terminal		Condition	Continuity
1	2	When brake pedal is depressed	No
		When brake pedal is released	Yes

Is the inspection result normal?

YES >> INSPECTION END

NO >> Replace ICC brake switch.

## Component Inspection (Stop Lamp Switch)

INFOID:000000009716437

### 1.CHECK STOP LAMP SWITCH

Check for continuity between stop lamp switch terminals.

Terminal		Condition	Continuity
1	2	When brake pedal is depressed	Yes
		When brake pedal is released	No
3	4	When brake pedal is depressed	Yes
		When brake pedal is released	No

Is the inspection result normal?

YES >> INSPECTION END

NO >> Replace stop lamp switch.

C1A06 OPERATION SW

DTC Logic

INFOID:000000009716438

DTC DETECTION LOGIC

DTC (On board display)	Trouble diagnosis name	DTC detecting condition	Possible causes
C1A06 (6)	OPERATION SW CIRC	<ul style="list-style-type: none"> <li>Any switch of the ICC steering switch is detected as "ON" continuously for 60 seconds</li> <li>An ON/OFF state judgment of the ICC differs between ECM and ADAS control unit, and the state continues for 2 seconds or more</li> </ul>	<ul style="list-style-type: none"> <li>ICC steering switch circuit</li> <li>ICC steering switch</li> <li>ECM</li> </ul>

**NOTE:**

If DTC "C1A06" is detected along with DTC "U1000", first diagnose the DTC "U1000". Refer to [DAS-212, "ADAS CONTROL UNIT : DTC Logic"](#).

DTC CONFIRMATION PROCEDURE

**1. PERFORM DTC CONFIRMATION PROCEDURE**

- Start the engine.
- Wait for approximately 10 minutes after turning the DCA system ON.
- Perform "All DTC Reading" with CONSULT.
- Check if the "C1A06" is detected as the current malfunction in "Self Diagnostic Result" of "ICC/ADAS".

Is "C1A06" detected as the current malfunction?

- YES >> Refer to [DAS-167, "Diagnosis Procedure"](#).
- NO >> Refer to [GI-53, "Intermittent Incident"](#).

Diagnosis Procedure

INFOID:000000009716439

Regarding Wiring Diagram information, refer to [DAS-132, "Wiring Diagram"](#).

**1. CHECK SELF-DIAGNOSIS RESULTS**

Check if "U1000" is detected other than "C1A06" in "Self Diagnostic Result" of "ICC/ADAS".

Is "U1000" detected?

- YES >> Perform the CAN communication system inspection. Repair or replace the malfunctioning parts. Refer to [DAS-212, "ADAS CONTROL UNIT : DTC Logic"](#).
- NO >> GO TO 2.

**2. CHECK ICC STEERING SWITCH**

- Turn the ignition switch OFF.
- Disconnect the ICC steering switch connector.
- Check the ICC steering switch. Refer to [DAS-168, "Component Inspection"](#).

Is the inspection result normal?

- YES >> GO TO 3.
- NO >> Replace the steering wheel.

**3. CHECK HARNESS BETWEEN SPIRAL CABLE AND ECM**

- Disconnect the ECM connector.
- Check for continuity between the spiral cable harness connector and ECM harness connector.

Spiral cable		ECM		Continuity
Connector	Terminal	Connector	Terminal	

A  
B  
C  
D  
E  
F  
G  
H  
I  
J  
K  
L  
M  
N  
P



< DTC/CIRCUIT DIAGNOSIS >

M30	25	E16	101	Yes
	32		108	

3. Check for continuity between spiral cable harness connector and ground.

Spiral cable		Ground	Continuity
Connector	Terminal		
M30	25		No
	32		

Is the inspection result normal?

- YES >> GO TO 4.
- NO >> Repair the harnesses or connectors.

## 4. CHECK SPIRAL CABLE

Check for continuity between spiral cable terminals.

Spiral cable		Continuity
Terminal		
13	25	Yes
16	32	

Is the inspection result normal?

- YES >> GO TO 5.
- NO >> Replace the spiral cable.

## 5. PERFORM SELF-DIAGNOSIS OF ECM

1. Connect the connectors of ICC steering switch and ECM connector.
2. Turn the ignition switch ON.
3. Perform "All DTC Reading".
4. Check if any DTC is detected in "Self Diagnostic Result" of "ENGINE".

Is any DTC detected?

- YES >> Perform self-diagnosis on the detected DTC and repair or replace the malfunctioning parts. Refer to [EC-97, "DTC Index"](#).
- NO >> Replace the ADAS control unit. Refer to [DAS-79, "Removal and Installation"](#).

## Component Inspection

INFOID:000000009716440

### 1. CHECK ICC STEERING SWITCH

Check resistance between ICC steering switch terminals.

Terminal	Switch operation	Resistance [Ω]
13      16	When pressing MAIN switch	Approx. 0
	When pressing dynamic driver assistance switch	Approx. 267
	When pressing CANCEL switch	Approx. 615
	When pressing DISTANCE switch	Approx. 1090
	When pressing SET/COAST switch	Approx. 1805
	When pressing RESUME/ACCELERATE switch	Approx. 2985
	When all switches are not pressed	Approx. 5415

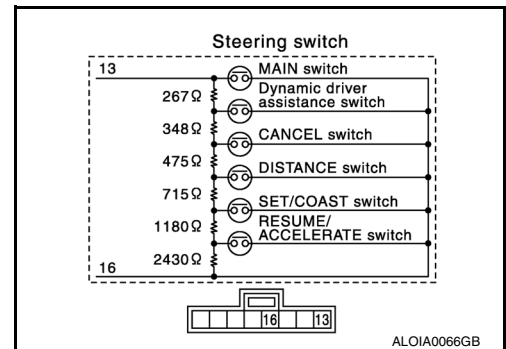

# C1A06 OPERATION SW

< DTC/CIRCUIT DIAGNOSIS >

[DCA]

Is the inspection result normal?

- YES >> INSPECTION END
- NO >> Replace the steering wheel.

A  
B  
C  
D  
E  
F  
G  
H  
I  
J  
K  
L  
M  
N  
P

DAS

# C1A12 LASER BEAM OFF CENTER

< DTC/CIRCUIT DIAGNOSIS >

[DCA]

## C1A12 LASER BEAM OFF CENTER

### DTC Logic

INFOID:000000009716441

### DTC DETECTION LOGIC

DTC (On board display)	Trouble diagnosis name	DTC detecting condition	Possible causes
C1A12 (12)	LASER BEAM OFFCNTR	ICC sensor is off the aiming point	ICC sensor is off the aiming point

### Diagnosis Procedure

INFOID:000000009716442

#### 1. CHECK ICC SENSOR SELF-DIAGNOSIS RESULTS

1. Perform "All DTC Reading" with CONSULT.
2. Check if the "C1A12" is detected as the current malfunction in "Self Diagnostic Result" of "LASER".

Is "C1A12" detected?

YES >> Refer to [DAS-170, "DTC Logic"](#).

NO >> GO TO 2.

#### 2. CHECK ADAS CONTROL SELF-DIAGNOSIS RESULTS

Check if the "C1A12" is detected as the current malfunction in "Self Diagnostic Result" of "ICC/ADAS".

Is "C1A12" detected?

YES >> Replace ADAS control unit. Refer to [DAS-79, "Removal and Installation"](#).

NO >> INSPECTION END

# C1A13 STOP LAMP RELAY

< DTC/CIRCUIT DIAGNOSIS >

[DCA]

## C1A13 STOP LAMP RELAY

### DTC Logic

INFOID:000000009716443

### DTC DETECTION LOGIC

DTC (On board display)	Trouble diagnosis name	DTC detecting condition	Possible causes
C1A13 (13)	STOP LAMP RLY FIX	<ul style="list-style-type: none"><li>Stop lamp inactive state continues for 0.3 seconds or more despite the outputting of an ICC sensor ICC brake hold relay drive signal</li><li>The stop lamp remains ON for 60 seconds or more under the following conditions:<ul style="list-style-type: none"><li>Driving at 40 km/h or more</li><li>No stop lamp drive signal output from ICC sensor</li><li>No brake operation</li></ul></li></ul>	<ul style="list-style-type: none"><li>Stop lamp switch circuit</li><li>ICC brake switch circuit</li><li>ICC brake hold relay circuit</li><li>Stop lamp switch</li><li>ICC brake switch</li><li>ICC brake hold relay</li><li>Incorrect stop lamp switch installation</li><li>Incorrect ICC brake switch installation</li><li>ECM</li><li>ABS actuator and electric unit (control unit)</li></ul>

#### NOTE:

If DTC "C1A13" is detected along with DTC "U1000", first diagnose the DTC "U1000". Refer to [DAS-212, "ADAS CONTROL UNIT : DTC Logic"](#).

### DTC CONFIRMATION PROCEDURE

#### 1. PERFORM DTC CONFIRMATION PROCEDURE (1)

- Start the engine.
- Perform the active test item "STOP LAMP" with CONSULT.
- Perform "All DTC Reading".
- Check if the "C1A13" is detected as the current malfunction in the "Self Diagnostic Result" of "ICC/ADAS".

Is "C1A13" detected as the current malfunction?

- YES >> Refer to [DAS-171, "Diagnosis Procedure"](#).  
NO >> GO TO 2.

#### 2. PERFORM DTC CONFIRMATION PROCEDURE (2)

- Drive at the vehicle speed of 40 km/h (25 MPH) or more for approximately 60 seconds or more without the brake pedal depressed.

#### CAUTION:

**Always drive safely.**

#### NOTE:

If it is outside the above condition, repeat step 1.

- Perform "All DTC Reading".
- Check if the "C1A13" is detected as the current malfunction in the "Self Diagnostic Result" of "ICC/ADAS".

Is "C1A13" detected as the current malfunction?

- YES >> Refer to [DAS-171, "Diagnosis Procedure"](#).  
NO >> Refer to [GI-53, "Intermittent Incident"](#).

### Diagnosis Procedure

INFOID:000000009716444

DAS

Regarding Wiring Diagram information, refer to [DAS-132, "Wiring Diagram"](#).

#### 1. CHECK SELF-DIAGNOSIS RESULTS

Check if "U1000" is detected other than "C1A13" in "Self Diagnostic Result" of "ICC/ADAS".

Is "U1000" detected?

- YES >> Perform the CAN communication system inspection. Repair or replace the malfunctioning parts.  
Refer to [DAS-212, "ADAS CONTROL UNIT : DTC Logic"](#).

# C1A13 STOP LAMP RELAY

[DCA]

< DTC/CIRCUIT DIAGNOSIS >

NO >> GO TO 2.

## 2.CHECK STOP LAMP SWITCH

Check that "STOP LAMP SW" operate normally in "DATA MONITOR" of "ICC/ADAS".

Is the inspection result normal?

YES >> GO TO 10.

NO >> GO TO 3.

## 3.CHECK STOP LAMP SWITCH INSTALLATION

1. Turn ignition switch OFF.

2. Check stop lamp switch for correct installation. Refer to [BR-15. "Adjustment"](#).

Is the inspection result normal?

YES >> GO TO 4.

NO >> Adjust stop lamp switch installation. Refer to [BR-15. "Adjustment"](#).

## 4.CHECK STOP LAMP SWITCH

1. Disconnect stop lamp switch connector.

2. Check stop lamp switch. Refer to [DAS-166. "Component Inspection \(Stop Lamp Switch\)"](#).

Is the inspection result normal?

YES >> GO TO 5.

NO >> Replace stop lamp switch.

## 5.CHECK STOP LAMP FOR ILLUMINATION

1. Turn the ignition switch OFF.

2. Remove ICC brake hold relay.

3. Check that the stop lamp is illuminated by depressing the brake pedal to turn the stop lamp ON.

Is the inspection result normal?

YES >> GO TO 6.

NO >> Check the stop lamp circuit, and repair or replace the malfunctioning parts.

## 6.CHECK HARNESS BETWEEN STOP LAMP SWITCH AND ECM

1. Turn the ignition switch OFF.

2. Disconnect stop lamp switch, ECM, rear combination lamp, and high-mounted stop lamp connectors.

3. Check for continuity between the stop lamp switch harness connector and the ECM harness connector.

Stop lamp switch		ECM		Continuity
Connector	Terminal	Connector	Terminal	
E38	2	E16	122	Yes

4. Check for continuity between stop lamp switch harness connector and ground.

Stop lamp switch		Ground	Continuity
Connector	Terminal		
E38	2		No

Is the inspection result normal?

YES >> GO TO 7.

NO >> Repair the harnesses or connectors.

## 7.CHECK ICC BRAKE HOLD RELAY CIRCUIT

1. Disconnect ECM, rear combination lamp, and high-mounted stop lamp connectors.

2. Check that the stop lamp does not illuminate when brake pedal is not depressed.

Is the inspection result normal?

YES >> GO TO 9.

NO >> GO TO 8.

## 8.CHECK ICC BRAKE HOLD RELAY



# C1A13 STOP LAMP RELAY

[DCA]

## < DTC/CIRCUIT DIAGNOSIS >

1. Remove ICC brake hold relay
2. Check ICC brake hold relay. Refer to [DAS-176, "Component Inspection"](#).

Is the inspection result normal?

- YES >> GO TO 9.  
NO >> Replace ICC brake hold relay.

## 9.PERFORM SELF-DIAGNOSIS OF ECM

1. Connect all connectors again if the connectors are disconnected.
2. Turn ignition switch ON.
3. Perform "All DTC Reading".
4. Check if any DTC is detected in "Self Diagnostic Result" of "ENGINE". Refer to [EC-97, "DTC Index"](#).

Is any DTC detected?

- YES >> Repair or replace the malfunctioning parts identified by the self-diagnosis result.  
NO >> Replace ADAS control unit. Refer to [DAS-79, "Removal and Installation"](#).

## 10.CHECK ICC BRAKE HOLD RELAY POWER SUPPLY CIRCUIT

1. Turn ignition switch OFF.
2. Remove ICC brake hold relay.
3. Check the voltage between ICC brake hold relay harness connector and ground.

Terminal		Voltage (Approx.)
(+)	(-)	
ICC brake hold relay		Ground
Connector	Terminal	
E75	2	
		Battery voltage

Is the inspection result normal?

- YES >> GO TO 11.  
NO >> Repair or replace ICC brake hold relay power supply circuit.

## 11.CHECK HARNESS BETWEEN AND ICC BRAKE HOLD RELAY AND ADAS CONTROL UNIT

1. Disconnect ADAS control unit connectors.
2. Check for continuity between ICC brake hold relay harness connector and ECM harness connector.

ICC brake hold relay		ADAS control unit		Continuity
Connector	Terminal	Connector	Terminal	
E75	1	B104	5	Yes

3. Check for continuity between ADAS control unit harness connector and ground.

ICC brake hold relay		Ground	Continuity
Connector	Terminal		
E75	1		No

Is the inspection result normal?

- YES >> GO TO 12.  
NO >> Repair the harnesses or connectors.

## 12.CHECK ADAS CONTROL UNIT STANDARD VOLTAGE

1. Connect all connectors again if the connectors are disconnected.
2. Turn ignition switch ON.
3. Perform "STOP LAMP" on "Active Test" of "ICC/ADAS", and then check the voltage between ADAS control unit harness connector and ground.

# C1A13 STOP LAMP RELAY

< DTC/CIRCUIT DIAGNOSIS >

[DCA]

Terminal		Condition	Voltage (Approx.)
(+)	(-)		
ADAS control unit		Active Test item "STOP LAMP"	Battery voltage
Connector	Terminal		
B104	5	Off	Battery voltage
		On	0 V

Is the inspection result normal?

YES >> GO TO 13.

NO >> Replace ADAS control unit. Refer to [DAS-79, "Removal and Installation"](#).

## 13. CHECK ICC BRAKE HOLD RELAY POWER SUPPLY CIRCUIT

1. Turn ignition switch OFF.
2. Check the voltage between ICC brake hold relay harness connector and ground.

Terminal		Condition	Voltage (Approx.)
(+)	(-)		
ICC brake hold relay		Ground	Battery voltage
Connector	Terminal		
E75	5		

Is the inspection result normal?

YES >> GO TO 14.

NO >> Repair or replace ICC brake hold relay power supply circuit.

## 14. CHECK HARNESS BETWEEN ICC BRAKE HOLD RELAY AND ECM

1. Disconnect ECM, rear combination lamp, and high-mounted stop lamp connectors and remove ICC brake hold relay.
2. Check for continuity between ICC brake hold relay harness connector and ECM harness connector.

ICC brake hold relay		ECM		Continuity
Connector	Terminal	Connector	Terminal	
E75	3	M16	122	Yes

3. Check for continuity between ICC brake hold relay harness connector and ground.

ICC brake hold relay		Ground	Continuity
Connector	Terminal		
E75	3		No

Is the inspection result normal?

YES >> GO TO 15.

NO >> Repair the harnesses or connectors.

## 15. CHECK ICC BRAKE HOLD RELAY

1. Remove ICC brake hold relay.
2. Check ICC brake hold relay. Refer to [DAS-176, "Component Inspection"](#).

Is the inspection result normal?

YES >> GO TO 16.

NO >> Replace ICC brake hold relay.

## 16. CHECK STOP LAMP SWITCH

Check that "STOP LAMP SW" operate normally in "DATA MONITOR" of "ABS".

# C1A13 STOP LAMP RELAY

[DCA]

< DTC/CIRCUIT DIAGNOSIS >

Is the inspection result normal?

- YES >> GO TO 21.
- NO >> GO TO 17.

## 17. CHECK STOP LAMP SWITCH INSTALLATION

1. Turn ignition switch OFF.
2. Check stop lamp switch for correct installation. Refer to [BR-15, "Adjustment"](#).

Is the inspection result normal?

- YES >> GO TO 18.
- NO >> Adjust stop lamp switch installation. Refer to [BR-15, "Adjustment"](#).

## 18. CHECK STOP LAMP SWITCH

1. Disconnect stop lamp switch connector.
2. Check stop lamp switch. Refer to [DAS-166, "Component Inspection \(Stop Lamp Switch\)"](#).

Is the inspection result normal?

- YES >> GO TO 19.
- NO >> Replace stop lamp switch.

## 19. CHECK STOP LAMP SWITCH POWER SUPPLY CIRCUIT

1. Connect stop lamp switch connector.
2. Check the voltage between stop lamp switch harness connector and ground.

Terminal		Voltage (Approx.)
(+)	(-)	
Stop lamp switch		Ground
Connector	Terminal	
E38	3	
		Battery voltage

Is the inspection result normal?

- YES >> GO TO 20.
- NO >> Repair or replace stop lamp switch power supply circuit.

## 20. CHECK HARNESS BETWEEN STOP LAMP SWITCH AND ABS ACTUATOR AND ELECTRIC UNIT (CONTROL UNIT)

1. Turn the ignition switch OFF.
2. Disconnect stop lamp switch, ABS actuator and electric unit (control unit) connectors.
3. Check for continuity between the stop lamp switch harness connector and the ABS actuator and electric unit (control unit) harness connector.

Stop lamp switch		ABS actuator and electric unit (control unit)		Continuity
Connector	Terminal	Connector	Terminal	
E38	4	E125	5	Yes

4. Check for continuity between stop lamp switch harness connector and ground.

Stop lamp switch		Ground	Continuity
Connector	Terminal		
E38	4		No

Is the inspection result normal?

- YES >> GO TO 21.
- NO >> Repair the harnesses or connectors.

## 21. PERFORM SELF-DIAGNOSIS OF ECM

1. Connect all connectors again if the connectors are disconnected.

A  
B  
C  
D  
E  
F  
G  
H  
I  
J  
K  
L  
M  
N  
P

DAS

# C1A13 STOP LAMP RELAY

[DCA]

## < DTC/CIRCUIT DIAGNOSIS >

2. Turn ignition switch ON.
3. Perform "All DTC Reading".
4. Check if any DTC is detected in "Self Diagnostic Result" of "ENGINE". Refer to [EC-97. "DTC Index"](#).

### Is any DTC detected?

- YES >> Repair or replace the malfunctioning parts identified by the self-diagnosis result.  
NO >> GO TO 22.

## 22.PERFORM SELF-DIAGNOSIS OF ABS ACTUATOR AND ELECTRIC UNIT (CONTROL UNIT)

1. Connect all connectors again if the connectors are disconnected.
2. Turn ignition switch ON.
3. Perform "All DTC Reading".
4. Check if any DTC is detected in "Self Diagnostic Result" of "ABS". Refer to [BRC-46. "DTC Index"](#).

### Is any DTC detected?

- YES >> Repair or replace the malfunctioning parts identified by the self-diagnosis result.  
NO >> Replace ADAS control unit. Refer to [DAS-79. "Removal and Installation"](#).

## Component Inspection

INFOID:000000009716445

### 1.CHECK ICC BRAKE HOLD RELAY

Apply battery voltage to ICC brake hold relay terminals 1 and 2, and then check for continuity under the following conditions.

Terminal	Condition	Continuity	
3	5	When the battery voltage is applied	Yes
		When the battery voltage is not applied	No

### Is the inspection result normal?

- YES >> INSPECTION END  
NO >> Replace ICC brake hold relay.

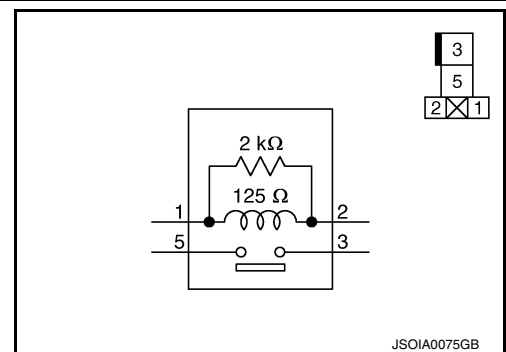

C1A14 ECM

DTC Logic

INFOID:000000009716446

DTC DETECTION LOGIC

DTC (On board display)	Trouble diagnosis name	DTC detecting condition	Possible causes
C1A14 (14)	ECM CIRCUIT	If ECM is malfunctioning	<ul style="list-style-type: none"> <li>Accelerator pedal position sensor</li> <li>ECM</li> <li>ADAS control unit</li> </ul>

**NOTE:**

If DTC "C1A14" is detected along with DTC "U1000", first diagnose the DTC "U1000". Refer to [DAS-212, "ADAS CONTROL UNIT : DTC Logic"](#).

**1. PERFORM DTC CONFIRMATION PROCEDURE**

- Start the engine.
- Operate the ICC system and drive.  
**CAUTION:**  
**Always drive safely.**
- Stop the vehicle.
- Perform "All DTC Reading" with CONSULT.
- Check if the "C1A14" is detected as the current malfunction in "Self Diagnostic Result" of "ICC/ADAS".

Is "C1A14" detected as the current malfunction?

- YES >> Refer to [DAS-177, "Diagnosis Procedure"](#).
- NO >> Refer to [GI-53, "Intermittent Incident"](#).

Diagnosis Procedure

INFOID:000000009716447

**1. CHECK SELF-DIAGNOSIS RESULTS**

Check if "U1000" is detected other than "C1A14" in "Self Diagnostic Result" of "ICC/ADAS".

Is "U1000" detected?

- YES >> Perform the CAN communication system inspection. Repair or replace the malfunctioning parts. Refer to [DAS-212, "ADAS CONTROL UNIT : DTC Logic"](#).
- NO >> GO TO 2.

**2. PERFORM SELF-DIAGNOSIS OF ECM**

Check if any DTC is detected in "Self Diagnostic Result" of "ENGINE".

Is any DTC detected?

- YES >> Perform diagnosis on the detected DTC and repair or replace the malfunctioning parts. Refer to [EC-97, "DTC Index"](#).
- NO >> Replace the ADAS control unit. Refer to [DAS-79, "Removal and Installation"](#).



# C1A15 GEAR POSITION

< DTC/CIRCUIT DIAGNOSIS >

[DCA]

## C1A15 GEAR POSITION

### Description

INFOID:000000009716448

ADAS control unit judges the gear position based on the following signals.

- Current gear position signal transmitted from TCM via CAN communication.
- Value of gear ratio calculated from input speed signal transmitted from TCM via CAN communication.
- Value of gear ratio calculated from the vehicle speed signal transmitted from ABS actuator and electric unit (control unit) via CAN communication.

### DTC Logic

INFOID:000000009716449

### DTC DETECTION LOGIC

DTC (On board display)	Trouble diagnosis name	DTC detecting condition	Possible causes
C1A15 (15)	GEAR POSITION	A mismatch between a current gear position signal transmitted from TCM via CAN communication and a gear position calculated by the ADAS control unit continues for approximately 11 minutes or more	<ul style="list-style-type: none"><li>• Input speed sensor</li><li>• Vehicle speed sensor CVT (output speed sensor)</li><li>• TCM</li></ul>

#### NOTE:

If DTC "C1A15" is detected along with DTC "U1000", "C1A03", or "C1A04", first diagnose the DTC "U1000", "C1A03", or "C1A04".

- Refer to [DAS-212, "ADAS CONTROL UNIT : DTC Logic"](#) for DTC "U1000".
- Refer to [DAS-160, "DTC Logic"](#) for DTC "C1A03".
- Refer to [DAS-162, "DTC Logic"](#) for DTC "C1A04".

### DTC CONFIRMATION PROCEDURE

#### 1. PERFORM DTC CONFIRMATION PROCEDURE

1. Start the engine.
2. Turn the DCA system ON.
3. Drive the vehicle at 10 km/h (6 MPH) or faster for approximately 15 minutes or more.

#### CAUTION:

**Always drive safely.**

4. Stop the vehicle.
5. Perform "All DTC Reading" with CONSULT.
6. Check if "C1A15" is detected as the current malfunction in the "Self Diagnostic Result" of "ICC/ADAS".

Is "C1A15" detected as the current malfunction?

YES >> Refer to [DAS-178, "Diagnosis Procedure"](#).

NO >> Refer to [GI-53, "Intermittent Incident"](#).

### Diagnosis Procedure

INFOID:000000009716450

#### 1. CHECK SELF-DIAGNOSIS RESULTS

Check if "C1A03", "C1A04", or "U1000" is detected other than "C1A15" in "Self Diagnostic Result" of "ICC/ADAS".

Is any DTC detected?

YES >> Perform diagnosis on the detected DTC and repair or replace the malfunctioning parts. Refer to [DAS-212, "ADAS CONTROL UNIT : DTC Logic"](#).

NO >> GO TO 2.

#### 2. CHECK VEHICLE SPEED SIGNAL

Check that "VHCL SPEED SE" operates normally in "DATA MONITOR" of "ICC/ADAS".

#### CAUTION:

**Be careful of the vehicle speed.**

Is the inspection result normal?

# C1A15 GEAR POSITION

[DCA]

< DTC/CIRCUIT DIAGNOSIS >

- YES >> GO TO 3.
- NO >> GO TO 7.

## 3.CHECK GEAR POSITION

Check that "GEAR" operates normally in "DATA MONITOR" of "ICC/ADAS".

### CAUTION:

**Be careful of the vehicle speed.**

Is the inspection result normal?

- YES >> GO TO 5.
- NO >> GO TO 4.

## 4.CHECK GEAR POSITION SIGNAL

Check that "GEAR" operates normally in "DATA MONITOR" of "TRANSMISSION".

Is the inspection result normal?

- YES >> GO TO 5.
- NO >> GO TO 6.

## 5.CHECK INPUT SPEED SENSOR SIGNAL

Check that "INPUT SPEED" operates normally in "DATA MONITOR" of "TRANSMISSION".

Is the inspection result normal?

- YES >> Replace the ADAS control unit. Refer to [DAS-79. "Removal and Installation"](#).
- NO >> GO TO 6.

## 6.CHECK TCM SELF-DIAGNOSIS RESULTS

1. Perform "All DTC Reading".
2. Check if any DTC is detected in "Self Diagnostic Result" of "TRANSMISSION".

Is any DTC detected?

- YES >> Perform diagnosis on the detected DTC and repair or replace the malfunctioning parts. Refer to [TM-61. "DTC Index"](#).
- NO >> Replace the ADAS control unit. Refer to [DAS-79. "Removal and Installation"](#).

## 7.CHECK ABS ACTUATOR AND ELECTRIC UNIT (CONTROL UNIT) SELF-DIAGNOSIS RESULTS

1. Perform "All DTC Reading".
2. Check if any DTC is detected in "Self Diagnostic Result" of "ABS".

Is any DTC detected?

- YES >> Perform diagnosis on the detected DTC and repair or replace the malfunctioning parts. Refer to [BRC-46. "DTC Index"](#).
- NO >> Replace the ADAS control unit. Refer to [DAS-79. "Removal and Installation"](#).

A  
B  
C  
D  
E  
F  
G  
H  
I  
J  
K  
L  
M  
N  
P

DAS

# C1A16 RADAR BLOCKED

< DTC/CIRCUIT DIAGNOSIS >

[DCA]

## C1A16 RADAR BLOCKED

### DTC Logic

INFOID:000000009716451

### DTC DETECTION LOGIC

DTC (On board display)	Trouble diagnosis name	DTC detecting condition	Possible causes
C1A16 (16)	RADAR BLOCKED	If any stain occurs to ICC sensor body window	<ul style="list-style-type: none"><li>• Stain or foreign materials is deposited</li><li>• Cracks or scratches exist</li></ul>

#### NOTE:

DTC "C1A16" may be detected under the following conditions. (Explain to the customer about the difference between the contamination detection function and the indication when the malfunction is detected and tell them "This is not malfunction".)

- When contamination or foreign materials adhere to the ICC sensor area of the front bumper
- When driving while it is snowing or when frost forms on the ICC sensor area of the front bumper
- When ICC sensor area of the front bumper is temporarily fogged

### Diagnosis Procedure

INFOID:000000009716452

#### 1.VISUAL CHECK 1

Check for contamination and foreign material on the ICC sensor area of the front bumper.

Does contamination or foreign material exist?

- YES >> Clean the contamination and foreign material from the ICC sensor area of the front bumper.  
NO >> GO TO 2.

#### 2.VISUAL CHECK 2

1. Remove the front bumper. Refer to [EXT-17, "Removal and Installation"](#).
2. Check ICC sensor for contamination and foreign materials.

Does contamination or foreign material exist?

- YES >> Clean the contamination and foreign material from the ICC sensor.  
NO >> GO TO 3.

#### 3.VISUAL CHECK 3

Check ICC sensor for cracks and scratches.

Are there any cracks or scratches found?

- YES >> Replace the ICC sensor. Refer to [DAS-241, "Removal and Installation"](#).  
NO >> GO TO 4.

#### 4.INTERVIEW

1. Ask if there is any trace of contamination or foreign material adhering to the ICC sensor area of the front bumper.
2. Ask if the ICC sensor area of the front bumper was frosted during driving or if vehicle was driven in snow.
3. Ask if ICC sensor area of the front bumper was temporarily fogged (windshield glass may also tend to fog, etc.)

Are any of the above conditions seen?

- YES >> Explain to customer about the difference between contamination detection and an actual malfunction. Inform them that "this is not malfunction".  
NO >> Replace the ICC sensor. Refer to [DAS-241, "Removal and Installation"](#).



# C1A17 ICC SENSOR

< DTC/CIRCUIT DIAGNOSIS >

[DCA]

## C1A17 ICC SENSOR

### DTC Logic

INFOID:000000009716453

### DTC DETECTION LOGIC

DTC (On board display)	Trouble diagnosis name	DTC detecting condition	Possible causes
C1A17 (17)	ICC SENSOR MALF	If ICC sensor is malfunctioning	ICC sensor

#### NOTE:

If DTC "C1A17" is detected along with DTC "U1000", first diagnose the DTC "U1000". Refer to [DAS-212, "ADAS CONTROL UNIT : DTC Logic"](#).

### Diagnosis Procedure

INFOID:000000009716454

#### 1. CHECK ADAS CONTROL UNIT SELF-DIAGNOSIS RESULTS

1. Perform "All DTC Reading" with CONSULT.
2. Check if "U1000" is detected other than "C1A17" in "Self Diagnostic Result" of "ICC/ADAS".

##### Is "U1000" detected?

- YES >> Perform diagnosis on the detected DTC and repair or replace the malfunctioning parts. Refer to [DAS-181, "DTC Logic"](#).
- NO >> GO TO 2.

#### 2. CHECK ICC SENSOR SELF-DIAGNOSIS RESULTS

Check if any DTC is detected in "Self Diagnostic Result" of "LASER".

##### Is any DTC detected?

- YES >> Perform diagnosis on the detected DTC and repair or replace the malfunctioning parts. Refer to [DAS-128, "DTC Index"](#).
- NO >> Replace ADAS control unit. Refer to [DAS-79, "Removal and Installation"](#).

A  
B  
C  
D  
E  
F  
G  
H  
I  
J  
K  
L  
M  
N  
P

DAS

# C1A18 RADAR AIMING INCOMP

< DTC/CIRCUIT DIAGNOSIS >

[DCA]

## C1A18 RADAR AIMING INCOMP

### DTC Logic

INFOID:000000009716455

### DTC DETECTION LOGIC

DTC (On board display)	Trouble diagnosis name	DTC detecting condition	Possible causes
C1A18 (18)	RADAR AIMING INCOMP	ICC sensor is not adjusted	<ul style="list-style-type: none"><li>• No ICC sensor aiming adjustment is performed</li><li>• ICC sensor aiming adjustment has been interrupted</li></ul>

### DTC CONFIRMATION PROCEDURE

#### 1.PERFORM DTC CONFIRMATION PROCEDURE

1. Start the engine.
2. Turn the DCA system ON.
3. Perform "All DTC Reading" with CONSULT.
4. Check if the "C1A18" is detected as the current malfunction in "Self Diagnostic Result" of "ICC/ADAS".

Is "C1A18" detected as the current malfunction?

- YES >> Refer to [DAS-182, "Diagnosis Procedure"](#).  
NO >> INSPECTION END

### Diagnosis Procedure

INFOID:000000009716456

#### 1.AJUST ICC SENSOR AIMING

Check if the "C1A18" is detected in "Self Diagnostic Result" of "RADAR".

Is "C1A18" detected?

- YES >> Refer to [DAS-182, "DTC Logic"](#).  
NO >> Replace the ADAS control unit. Refer to [DAS-79, "Removal and Installation"](#).

# C1A21 UNIT HIGH TEMP

[DCA]

< DTC/CIRCUIT DIAGNOSIS >

## C1A21 UNIT HIGH TEMP

### DTC Logic

INFOID:000000009716457

### DTC DETECTION LOGIC

DTC (On board display)	Trouble diagnosis name	DTC detecting condition	Possible causes
C1A21 (21)	ICC SENSOR HIGH TEMP	ICC sensor judges high temperature abnormality	Temperature around the ICC sensor becomes high

### 1. PERFORM DTC CONFIRMATION PROCEDURE

1. Turn the ignition switch OFF.
2. Wait for 10 minutes or more to cool the ICC sensor.
3. Start the engine.
4. Turn the DCA system ON.
5. Perform "All DTC Reading" with CONSULT.
6. Check if the "C1A21" is detected as the current malfunction in "Self Diagnostic Result" of "ICC/ADAS".

Is "C1A21" detected as the current malfunction?

- YES >> Refer to [DAS-183, "Diagnosis Procedure"](#).  
NO >> Refer to [GI-53, "Intermittent Incident"](#).

### Diagnosis Procedure

INFOID:000000009716458

### 1. CHECK SELF-DIAGNOSIS RESULTS

Check if "C1A21" is detected in "Self Diagnostic Result" of "LASER".

Is "C1A21" detected?

- YES >> Perform diagnosis on the detected DTC and repair or replace the malfunctioning parts. Refer to [DAS-183, "DTC Logic"](#).  
NO >> Replace the ADAS control unit. Refer to [DAS-79, "Removal and Installation"](#).

A  
B  
C  
D  
E  
F  
G  
H  
I  
J  
K  
L  
M  
N  
P

DAS

## C1A24 NP RANGE

### DTC Logic

INFOID:000000009716459

#### DTC DETECTION LOGIC

DTC (On board display)	Trouble diagnosis name	DTC detecting condition	Possible causes
C1A24 (24)	NP RANGE	A mismatch between a shift position signal transmitted from TCM via CAN communication and a current gear position signal continues for 60 seconds or more	<ul style="list-style-type: none"> <li>• TCM</li> <li>• Transmission range switch</li> </ul>

**NOTE:**

If DTC "C1A24" is detected along with DTC "U1000", first diagnose the DTC "U1000". Refer to [DAS-212, "ADAS CONTROL UNIT : DTC Logic"](#).

#### DTC CONFIRMATION PROCEDURE

##### 1. CHECK DTC REPRODUCE (1)

1. Start the engine.
2. Turn the DCA system ON.
3. Wait for approximately 5 minutes or more after shifting the selector lever to "P" position.
4. Perform "All DTC Reading" with CONSULT.
5. Check if the "C1A24" is detected as the current malfunction in "Self Diagnostic Result" of "ICC/ADAS".

Is "C1A24" detected as the current malfunction?

- YES >> Refer to [DAS-184, "Diagnosis Procedure"](#).  
 NO >> GO TO 2.

##### 2. CHECK DTC REPRODUCE (2)

1. Wait for approximately 5 minutes or more after shifting the selector lever to "N" position.
2. Perform "All DTC Reading".
3. Check if the "C1A24" is detected as the current malfunction in "Self Diagnostic Result" of "ICC/ADAS".

Is "C1A24" detected as the current malfunction?

- YES >> Refer to [DAS-184, "Diagnosis Procedure"](#).  
 NO >> Refer to [GI-53, "Intermittent Incident"](#).

### Diagnosis Procedure

INFOID:000000009716460

##### 1. CHECK SELF-DIAGNOSIS RESULTS

Check if "U1000" is detected other than "C1A24" in "Self Diagnostic Result" of "ICC/ADAS".

Is "U1000" detected?

- YES >> Perform the CAN communication system inspection. Repair or replace the malfunctioning parts.  
 Refer to [DAS-212, "ADAS CONTROL UNIT : DTC Logic"](#).  
 NO >> GO TO 2.

##### 2. CHECK TCM DATA MONITOR

Check that "SLCT LVR POSI" operates normally in "DATA MONITOR" of "TRANSMISSION".

Is the inspection result normal?

- YES >> GO TO 3.  
 NO >> Perform diagnosis for transmission range switch circuit and repair or replace the malfunctioning parts. Refer to [TM-61, "DTC Index"](#).

##### 3. PERFORM TCM SELF-DIAGNOSIS

1. Perform "All DTC Reading".
2. Check if any DTC is detected in "Self Diagnostic Result" of "TRANSMISSION".

Is any DTC detected?

## C1A24 NP RANGE

< DTC/CIRCUIT DIAGNOSIS >

[DCA]

- 
- YES >> Perform diagnosis on the detected DTC and repair or replace the malfunctioning parts. Refer to [TM-61, "DTC Index"](#).
- NO >> Replace the ADAS control unit. Refer to [DAS-79, "Removal and Installation"](#).

A  
B  
C  
D  
E  
F  
G  
H  
I  
J  
K  
L  
M  
N  
P

DAS

# C1A26 ECD MODE MALFUNCTION

< DTC/CIRCUIT DIAGNOSIS >

[DCA]

## C1A26 ECD MODE MALFUNCTION

### DTC Logic

INFOID:000000009716461

### DTC DETECTION LOGIC

DTC (On board display)	Trouble diagnosis name	DTC detecting condition	Possible cause
C1A26 (26)	ECD MODE MALF	If an abnormal condition occurs with ECD system	ABS actuator and electric unit (control unit)

#### NOTE:

If DTC "C1A26" is detected along with DTC "U1000", "U0415" or "U0121" first diagnose the DTC "U1000", "U0415" or "U0121".

- DTC "U1000": Refer to [DAS-212, "ADAS CONTROL UNIT : DTC Logic"](#).
- DTC "U0415": Refer to [DAS-210, "DTC Logic"](#).
- DTC "U0121": Refer to [DAS-205, "DTC Logic"](#).

### DTC CONFIRMATION PROCEDURE

#### 1. PERFORM DTC CONFIRMATION PROCEDURE

1. Start the engine.
2. Wait for approximately 1 minute after turning the DCA system ON.
3. Perform "All DTC Reading" with CONSULT.
4. Check if the "C1A26" is detected as the current malfunction in "Self Diagnostic Result" of "ICC/ADAS".

Is "C1A26" detected as the current malfunction?

- YES >> Refer to [DAS-186, "Diagnosis Procedure"](#).
- NO >> Refer to [GI-53, "Intermittent Incident"](#).

### Diagnosis Procedure

INFOID:000000009716462

#### 1. CHECK SELF-DIAGNOSIS RESULTS

Check if "U1000", "U0415" or "U0121" is detected other than "C1A26" in "Self Diagnostic Result" of "ICC/ADAS".

Is any DTC detected?

- YES >> Perform diagnosis on the detected DTC and repair or replace the malfunctioning parts. Refer to [DAS-212, "ADAS CONTROL UNIT : DTC Logic"](#).
- NO >> GO TO 2.

#### 2. PERFORM SELF-DIAGNOSIS OF ABS ACTUATOR AND ELECTRIC UNIT (CONTROL UNIT)

Check if any DTC is detected in "Self Diagnostic Result" of "ABS".

Is any DTC detected?

- YES >> Perform diagnosis on the detected DTC and repair or replace the malfunctioning parts. Refer to [BRC-46, "DTC Index"](#).
- NO >> Replace ADAS control unit. Refer to [DAS-79, "Removal and Installation"](#).

# C1A27 ECD POWER SUPPLY CIRCUIT

< DTC/CIRCUIT DIAGNOSIS >

[DCA]

## C1A27 ECD POWER SUPPLY CIRCUIT

### DTC Logic

INFOID:000000009716463

### DTC DETECTION LOGIC

DTC (On board display)	Trouble diagnosis name	DTC detecting condition	Possible cause
C1A27 (27)	ECD PWR SUPPLY CIR	ECD system power supply voltage is excessively low	<ul style="list-style-type: none"><li>• ABS actuator and electric unit (control unit) power supply circuit</li><li>• ABS actuator and electric unit (control unit)</li></ul>

#### NOTE:

If DTC "C1A27" is detected along with DTC "U1000", "U0415" or "U0121" first diagnose the DTC "U1000", "U0415" or "U0121".

- DTC "U1000": Refer to [DAS-212, "ADAS CONTROL UNIT : DTC Logic"](#).
- DTC "U0415": Refer to [DAS-210, "DTC Logic"](#).
- DTC "U0121": Refer to [DAS-205, "DTC Logic"](#).

### DTC CONFIRMATION PROCEDURE

#### 1. PERFORM DTC CONFIRMATION PROCEDURE

1. Start the engine.
2. Wait for approximately 1 minute after turning the DCA system ON.
3. Perform "All DTC Reading" with CONSULT.
4. Check if the "C1A27" is detected as the current malfunction in "Self Diagnostic Result" of "ICC/ADAS".

Is "C1A27" detected as the current malfunction?

- YES >> Refer to [DAS-187, "Diagnosis Procedure"](#).  
NO >> Refer to [GI-53, "Intermittent Incident"](#).

### Diagnosis Procedure

INFOID:000000009716464

#### 1. CHECK SELF-DIAGNOSIS RESULTS

Check if "U1000", "U0415" or "U0121" is detected other than "C1A27" in "Self Diagnostic Result" of "ICC/ADAS".

Is any DTC detected?

- YES >> Perform diagnosis on the detected DTC and repair or replace the malfunctioning parts. Refer to [DAS-122, "DTC Index"](#).  
NO >> GO TO 2.

#### 2. CHECK POWER SUPPLY CIRCUIT OF ABS ACTUATOR AND ELECTRIC UNIT (CONTROL UNIT)

Check power supply circuit of ABS actuator and electric unit (control unit). Refer to [BRC-70, "Diagnosis Procedure"](#).

Is the inspection result normal?

- YES >> Perform self-diagnosis of ABS actuator and electric unit (control unit). Refer to [BRC-46, "DTC Index"](#).  
NO >> Repair the harnesses or connectors.

A  
B  
C  
D  
E  
F  
G  
H  
I  
J  
K  
L  
M  
N  
P

DAS

# C1A2A ICC SENSOR POWER SUPPLY CIRCUIT

< DTC/CIRCUIT DIAGNOSIS >

[DCA]

## C1A2A ICC SENSOR POWER SUPPLY CIRCUIT

### DTC Logic

INFOID:000000009716465

### DTC DETECTION LOGIC

DTC (On board display)	Trouble diagnosis name	DTC detecting condition	Possible cause
C1A2A (80)	ICC SEN PWR SUP CIR	Abnormal power supply voltage in ICC sensor	<ul style="list-style-type: none"><li>• Harness, connector, fuse</li><li>• ICC sensor</li></ul>

### DTC CONFIRMATION PROCEDURE

#### 1.PERFORM DTC CONFIRMATION PROCEDURE

1. Start the engine.
2. Turn the DCA system ON.
3. Perform "All DTC Reading" with CONSULT.
4. Check if the "C1A2A" is detected as the current malfunction in "Self Diagnostic Result" of "ICC/ADAS".

Is "C1A2A" detected as the current malfunction?

- YES >> Refer to [DAS-188, "Diagnosis Procedure"](#).  
NO >> Refer to [GI-53, "Intermittent Incident"](#).

### Diagnosis Procedure

INFOID:000000009716466

#### 1.CHECK SELF-DIAGNOSIS RESULTS

Check if "U1000" is detected other than "C1A2A" in "Self Diagnostic Result" of "ICC/ADAS".

Is any DTC detected?

- YES >> Perform diagnosis on the detected DTC and repair or replace the malfunctioning parts. Refer to [DAS-212, "ADAS CONTROL UNIT : DTC Logic"](#).  
NO >> GO TO 2.

#### 2.CHECK ICC SENSOR SELF-DIAGNOSIS

Check if any DTC is detected in "Self Diagnostic Result" of "LASER".

Is any DTC detected?

- YES >> Perform diagnosis on the detected DTC and repair or replace the malfunctioning parts. Refer to [DAS-128, "DTC Index"](#).  
NO >> Replace ADAS control unit. Refer to [DAS-79, "Removal and Installation"](#).



# C1A33 CAN TRANSMISSION ERROR

< DTC/CIRCUIT DIAGNOSIS >

[DCA]

## C1A33 CAN TRANSMISSION ERROR

### DTC Logic

INFOID:000000009716467

### DTC DETECTION LOGIC

DTC (On board display)	Trouble diagnosis name	DTC detecting condition	Possible causes
C1A33 (33)	CAN TRANSMISSION ERR	If an error occurs in the CAN communication signal that ADAS control unit transmits to ECM	ADAS control unit

#### NOTE:

If DTC "C1A33" is detected along with DTC "U1000", first diagnose the DTC "U1000". Refer to [DAS-212, "ADAS CONTROL UNIT : DTC Logic"](#).

### DTC CONFIRMATION PROCEDURE

#### 1. PERFORM DTC CONFIRMATION PROCEDURE

1. Start the engine.
2. Turn the DCA system ON.
3. Perform "All DTC Reading" with CONSULT.
4. Check if the "C1A33" is detected as the current malfunction in "Self Diagnostic Result" of "ICC/ADAS".

#### Is "C1A33" detected as the current malfunction?

- YES >> Refer to [DAS-189, "Diagnosis Procedure"](#).  
NO >> Refer to [GI-53, "Intermittent Incident"](#).

### Diagnosis Procedure

INFOID:000000009716468

#### 1. CHECK SELF-DIAGNOSIS RESULTS

Check if "U1000" is detected other than "C1A33" in "Self Diagnostic Result" of "ICC/ADAS".

#### Is "U1000" detected?

- YES >> Perform the CAN communication system inspection. Repair or replace the malfunctioning parts.  
Refer to [DAS-212, "ADAS CONTROL UNIT : DTC Logic"](#).  
NO >> Replace the ADAS control unit. Refer to [DAS-79, "Removal and Installation"](#).

DAS

# C1A34 COMMAND ERROR

< DTC/CIRCUIT DIAGNOSIS >

[DCA]

## C1A34 COMMAND ERROR

### DTC Logic

INFOID:000000009716469

### DTC DETECTION LOGIC

DTC (On board display)	Trouble diagnosis name	DTC detecting condition	Possible causes
C1A34 (34)	COMMAND ERROR	If an error occurs in the command signal that ADAS control unit transmits to ECM via CAN communication	ADAS control unit

#### NOTE:

If DTC "C1A34" is detected along with DTC "U1000", first diagnose the DTC "U1000". Refer to [DAS-212, "ADAS CONTROL UNIT : DTC Logic"](#).

### DTC CONFIRMATION PROCEDURE

#### 1. PERFORM DTC CONFIRMATION PROCEDURE

1. Start the engine.
2. Operate the ICC system and drive.  
**CAUTION:**  
**Always drive safely.**
3. Stop the vehicle.
4. Perform "All DTC Reading" with CONSULT.
5. Check if the "C1A34" is detected as the current malfunction in "Self Diagnostic Result" of "ICC/ADAS".

Is "C1A34" detected as the current malfunction?

YES >> Refer to [DAS-190, "Diagnosis Procedure"](#).

NO >> Refer to [GI-53, "Intermittent Incident"](#).

### Diagnosis Procedure

INFOID:000000009716470

#### 1. CHECK SELF-DIAGNOSIS RESULTS

Check if "U1000" is detected other than "C1A34" in "Self Diagnostic Result" of "ICC/ADAS".

Is "U1000" detected?

YES >> Perform the CAN communication system inspection. Repair or replace the malfunctioning parts.  
Refer to [DAS-212, "ADAS CONTROL UNIT : DTC Logic"](#).

NO >> Replace the ADAS control unit. Refer to [DAS-79, "Removal and Installation"](#).

# C1A35 ACCELERATOR PEDAL ACTUATOR

< DTC/CIRCUIT DIAGNOSIS >

[DCA]

## C1A35 ACCELERATOR PEDAL ACTUATOR

### DTC Logic

INFOID:000000009716471

### DTC DETECTION LOGIC

DTC (On board display)	Trouble diagnosis name	DTC detecting condition	Possible causes
C1A35 (35)	APA CIR	If the accelerator pedal actuator is malfunctioning	Accelerator pedal actuator

#### NOTE:

If DTC "C1A35" is detected along with DTC "U1000", first diagnose the DTC "U1000". Refer to [DAS-212, "ADAS CONTROL UNIT : DTC Logic"](#).

### Diagnosis Procedure

INFOID:000000009716472

#### 1. PERFORM DTC CONFIRMATION PROCEDURE

1. Start the engine.
2. Turn the DCA system ON.
3. Perform "All DTC Reading" with CONSULT.
4. Check if the "C1A35" is detected as the current malfunction in self-diagnosis results of "ICC/ADAS".

Is "C1A35" detected as the current malfunction?

YES >> GO TO 2.

NO >> INSPECTION END

#### 2. CHECK SELF-DIAGNOSIS RESULTS

Check if "U1000" is detected other than "C1A35" in "Self Diagnostic Result" of "ICC/ADAS".

Is "U1000" detected?

YES >> Perform the CAN communication system inspection. Repair or replace the malfunctioning parts.  
Refer to [DAS-212, "ADAS CONTROL UNIT : DTC Logic"](#).

NO >> GO TO 3.

#### 3. CHECK ACCELERATOR PEDAL ACTUATOR SELF-DIAGNOSIS RESULTS

Check if the DTC is detected in "Self Diagnostic Result" of "ACCELE PEDAL ACT".

Is any DTC detected?

YES >> Perform diagnosis on the detected DTC and repair or replace the malfunctioning parts. Refer to [DAS-131, "DTC Index"](#).

NO >> Replace the ADAS control unit. Refer to [DAS-79, "Removal and Installation"](#).

# C1A36 ACCELERATOR PEDAL ACTUATOR CAN COMM

< DTC/CIRCUIT DIAGNOSIS >

[DCA]

## C1A36 ACCELERATOR PEDAL ACTUATOR CAN COMM

### DTC Logic

INFOID:000000009716473

### DTC DETECTION LOGIC

DTC (On board display)	Trouble diagnosis name	DTC detecting condition	Possible causes
C1A36 (36)	APA CAN COMM CIR	If an error occurs in the signal that the accelerator pedal actuator transmits via ITS communication	<ul style="list-style-type: none"><li>• ADAS control unit</li><li>• Accelerator pedal actuator</li><li>• ITS communication system</li></ul>

#### NOTE:

If DTC "C1A36" is detected along with DTC "U1000", first diagnose the DTC "U1000". Refer to [DAS-212, "ADAS CONTROL UNIT : DTC Logic"](#).

### DTC CONFIRMATION PROCEDURE

#### 1. PERFORM DTC CONFIRMATION PROCEDURE

1. Start the engine.
2. Turn the DCA system ON.
3. Perform "All DTC Reading" with CONSULT.
4. Check if the "C1A36" is detected as the current malfunction in self-diagnosis results of "ICC/ADAS".

Is "C1A36" detected as the current malfunction?

- YES >> Refer to [DAS-192, "Diagnosis Procedure"](#).  
NO >> Refer to [GI-53, "Intermittent Incident"](#).

### Diagnosis Procedure

INFOID:000000009716474

#### 1. CHECK ADAS CONTROL UNIT SELF-DIAGNOSIS RESULTS

Check if "U1000" is detected other than "C1A36" in "Self Diagnostic Result" of "ICC/ADAS".

Is "U1000" detected?

- YES >> Perform the CAN communication system inspection. Repair or replace the malfunctioning parts.  
Refer to [DAS-212, "ADAS CONTROL UNIT : DTC Logic"](#).  
NO >> GO TO 2.

#### 2. CHECK ACCELERATOR PEDAL ACTUATOR SELF-DIAGNOSIS RESULTS

Check if the DTC is detected in "Self Diagnostic Result" of "ACCELE PEDAL ACT".

Is any DTC detected?

- YES >> Perform diagnosis on the detected DTC and repair or replace the malfunctioning parts. Refer to [DAS-131, "DTC Index"](#).  
NO >> Replace the ADAS control unit. Refer to [DAS-79, "Removal and Installation"](#).

# C1A37 ACCELERATOR PEDAL ACTUATOR CAN 2

< DTC/CIRCUIT DIAGNOSIS >

[DCA]

## C1A37 ACCELERATOR PEDAL ACTUATOR CAN 2

### DTC Logic

INFOID:000000009716475

### DTC DETECTION LOGIC

DTC (On board display)	Trouble diagnosis name	DTC detecting condition	Possible causes
C1A37 (133)	APA CAN CIR2	If ADAS control unit detects an error signal that is received from accelerator pedal actuator via ITS communication	Accelerator pedal actuator malfunction

#### NOTE:

If DTC "C1A37" is detected along with DTC "U1000", first diagnose the DTC "U1000". Refer to [DAS-212, "ADAS CONTROL UNIT : DTC Logic"](#).

### DTC CONFIRMATION PROCEDURE

#### 1. PERFORM DTC CONFIRMATION PROCEDURE

1. Start the engine.
2. Turn the DCA system ON.
3. Perform "All DTC Reading" with CONSULT.
4. Check if the "C1A37" is detected as the current malfunction in self-diagnosis results of "ICC/ADAS".

Is "C1A37" detected as the current malfunction?

- YES >> Refer to [DAS-193, "Diagnosis Procedure"](#).  
NO >> Refer to [GI-53, "Intermittent Incident"](#).

### Diagnosis Procedure

INFOID:000000009716476

#### 1. CHECK ADAS CONTROL UNIT SELF-DIAGNOSIS RESULTS

Check if "U1000" is detected other than "C1A37" in "Self Diagnostic Result" of "ICC/ADAS".

Is "U1000" detected?

- YES >> Perform the CAN communication system inspection. Repair or replace the malfunctioning parts.  
Refer to [DAS-212, "ADAS CONTROL UNIT : DTC Logic"](#).  
NO >> GO TO 2.

#### 2. REPLACE ACCELERATOR PEDAL ASSEMBLY

1. Turn the ignition switch OFF.
2. Replace the accelerator pedal assembly.
3. Turn the ignition switch ON.
4. Erases all self-diagnosis results.
5. Perform "All DTC Reading" again.
6. Check if the DTC "C1A37" is detected in self-diagnosis results of "ICC/ADAS".

Is "C1A37" detected?

- YES >> Replace the ADAS control unit. Refer to [DAS-79, "Removal and Installation"](#).  
NO >> INSPECTION END

DAS

# C1A38 ACCELERATOR PEDAL ACTUATOR CAN 1

< DTC/CIRCUIT DIAGNOSIS >

[DCA]

## C1A38 ACCELERATOR PEDAL ACTUATOR CAN 1

### DTC Logic

INFOID:000000009716477

### DTC DETECTION LOGIC

DTC (On board display)	Trouble diagnosis name	DTC detecting condition	Possible causes
C1A38 (132)	APA CAN CIR1	If ADAS control unit detects an error signal that is received from accelerator pedal actuator via ITS communication	Accelerator pedal actuator malfunction

#### NOTE:

If DTC "C1A38" is detected along with DTC "U1000", first diagnose the DTC "U1000". Refer to [DAS-212, "ADAS CONTROL UNIT : DTC Logic"](#).

### DTC CONFIRMATION PROCEDURE

#### 1. PERFORM DTC CONFIRMATION PROCEDURE

1. Start the engine.
2. Turn the DCA system ON.
3. Perform "All DTC Reading" with CONSULT.
4. Check if the "C1A38" is detected as the current malfunction in self-diagnosis results of "ICC/ADAS".

Is "C1A38" detected as the current malfunction?

- YES >> Refer to [DAS-194, "Diagnosis Procedure"](#).  
NO >> Refer to [GI-53, "Intermittent Incident"](#).

### Diagnosis Procedure

INFOID:000000009716478

#### 1. CHECK ADAS CONTROL UNIT SELF-DIAGNOSIS RESULTS

Check if "U1000" is detected other than "C1A38" in "Self Diagnostic Result" of "ICC/ADAS".

Is "U1000" detected?

- YES >> Perform the CAN communication system inspection. Repair or replace the malfunctioning parts.  
Refer to [DAS-212, "ADAS CONTROL UNIT : DTC Logic"](#).  
NO >> GO TO 2.

#### 2. REPLACE ACCELERATOR PEDAL ASSEMBLY

1. Turn the ignition switch OFF.
2. Replace the accelerator pedal assembly.
3. Erases All self-diagnosis results.
4. Perform "All DTC Reading" again.
5. Check if the "C1A38" is detected in self-diagnosis results of "ICC/ADAS".

Is "C1A38" detected?

- YES >> Replace the ADAS control unit. Refer to [DAS-79, "Removal and Installation"](#).  
NO >> INSPECTION END

# C1A39 STEERING ANGLE SENSOR

< DTC/CIRCUIT DIAGNOSIS >

[DCA]

## C1A39 STEERING ANGLE SENSOR

### DTC Logic

INFOID:000000009716479

### DTC DETECTION LOGIC

DTC (On board display)	Trouble diagnosis name	DTC detecting condition	Possible causes
C1A39 (39)	STRG SEN CIR	If the steering angle sensor is malfunction	Steering angle sensor

#### NOTE:

If DTC "C1A39" is detected along with DTC "U1000", first diagnose the DTC "U1000". Refer to [DAS-212, "ADAS CONTROL UNIT : DTC Logic"](#).

### DTC CONFIRMATION PROCEDURE

#### 1. PERFORM DTC CONFIRMATION PROCEDURE

1. Start the engine.
2. Turn the DCA system ON.
3. Perform "All DTC Reading" with CONSULT.
4. Check if the "C1A39" is detected as the current malfunction in self-diagnosis results of "ICC/ADAS".

Is "C1A39" detected as the current malfunction?

- YES >> Refer to [DAS-195, "Diagnosis Procedure"](#).  
NO >> Refer to [GI-53, "Intermittent Incident"](#).

### Diagnosis Procedure

INFOID:000000009716480

#### 1. CHECK SELF-DIAGNOSIS RESULTS

Check if "U1000" is detected other than "C1A39" in "Self Diagnostic Result" of "ICC/ADAS".

Is "U1000" detected?

- YES >> Perform the CAN communication system inspection. Repair or replace the malfunctioning parts.  
Refer to [DAS-212, "ADAS CONTROL UNIT : DTC Logic"](#).  
NO >> GO TO 2.

#### 2. CHECK ABS ACTUATOR AND ELECTRIC UNIT (CONTROL UNIT) SELF-DIAGNOSIS RESULTS

Check if any DTC is detected in "Self Diagnostic Result" of "ABS".

Is any DTC detected?

- YES >> Perform diagnosis on the detected DTC and repair or replace the malfunctioning parts. Refer to [BRC-46, "DTC Index"](#).  
NO >> Replace the ADAS control unit. Refer to [DAS-79, "Removal and Installation"](#).

# C1F01 ACCELERATOR PEDAL ACTUATOR

< DTC/CIRCUIT DIAGNOSIS >

[DCA]

## C1F01 ACCELERATOR PEDAL ACTUATOR ADAS CONTROL UNIT

ADAS CONTROL UNIT : DTC Logic

INFOID:000000009716481

### DTC DETECTION LOGIC

DTC (On board display)	Trouble diagnosis name	DTC detecting condition	Possible causes
C1F01 (91)	APA MOTOR MALF	If the accelerator pedal actuator motor error is detected	Accelerator pedal actuator integrated motor malfunction

### DTC CONFIRMATION PROCEDURE

#### 1. PERFORM DTC CONFIRMATION PROCEDURE

1. Turn the ignition switch OFF.
2. Turn the ignition switch ON.
3. Slowly depress the accelerator pedal completely, and then release it.
4. Repeat step 3 several times.
5. Perform "All DTC Reading" with CONSULT.
6. Check if the DTC "C1F01" is detected as the current malfunction on the self-diagnosis results of "ICC/ADAS".

Is "C1F01" detected as the current malfunction?

- YES >> Refer to [DAS-196, "ADAS CONTROL UNIT : Diagnosis Procedure"](#).  
NO >> Refer to [GI-53, "Intermittent Incident"](#).

### ADAS CONTROL UNIT : Diagnosis Procedure

INFOID:000000009716482

#### 1. CHECK ADAS CONTROL UNIT SELF-DIAGNOSIS RESULTS

Check if "U1000" is detected other than "C1F01" in "Self Diagnostic Result" of "ICC/ADAS".

Is "U1000" detected?

- YES >> Perform the CAN communication system inspection. Repair or replace the malfunctioning parts.  
Refer to [DAS-212, "ADAS CONTROL UNIT : DTC Logic"](#).  
NO >> GO TO 2.

#### 2. CHECK ACCELERATOR PEDAL ACTUATOR SELF-DIAGNOSIS RESULTS

Check if "C1F01" is detected in "Self Diagnostic Result" of "ACCELE PEDAL ACT".

Is "C1F01" detected?

- YES >> Refer to [DAS-196, "ACCELERATOR PEDAL ACTUATOR : DTC Logic"](#).  
NO >> Replace the ADAS control unit. Refer to [DAS-79, "Removal and Installation"](#).

## ACCELERATOR PEDAL ACTUATOR

ACCELERATOR PEDAL ACTUATOR : DTC Logic

INFOID:000000009716483

### DTC DETECTION LOGIC

DTC	Trouble diagnosis name	DTC detecting condition	Possible causes
C1F01	APA MOTOR MALF	If the accelerator pedal actuator motor error is detected	Accelerator pedal actuator integrated motor malfunction

### DTC CONFIRMATION PROCEDURE

#### 1. PERFORM DTC CONFIRMATION PROCEDURE

1. Turn the ignition switch OFF.
2. Turn the ignition switch ON.
3. Slowly depress the accelerator pedal completely, and then release it.



# C1F01 ACCELERATOR PEDAL ACTUATOR

[DCA]

< DTC/CIRCUIT DIAGNOSIS >

4. Repeat step 3 several times.
5. Perform "All DTC Reading" with CONSULT.
6. Check if the DTC "C1F01" is detected as the current malfunction on the self-diagnosis results of "ICC/ADAS" or "ACCELE PEDAL ACT".

Is "C1F01" detected as the current malfunction?

YES >> Refer to [DAS-197, "ACCELERATOR PEDAL ACTUATOR : Diagnosis Procedure"](#).

NO >> Refer to [GI-53, "Intermittent Incident"](#).

## ACCELERATOR PEDAL ACTUATOR : Diagnosis Procedure

INFOID:000000009716484

### 1. REPLACE ACCELERATOR PEDAL ASSEMBLY

Perform DTC confirmation procedure. If "C1F01" is detected, replace the accelerator pedal assembly. Refer to [DAS-243, "MODELS WITH DISTANCE CONTROL ASSIST SYSTEM : Removal and Installation"](#).

>> INSPECTION END

A  
B  
C  
D  
E  
F  
G  
H  
I  
J  
K  
L  
M  
N  
P

DAS

# C1F02 ACCELERATOR PEDAL ACTUATOR

< DTC/CIRCUIT DIAGNOSIS >

[DCA]

## C1F02 ACCELERATOR PEDAL ACTUATOR ADAS CONTROL UNIT

ADAS CONTROL UNIT : DTC Logic

INFOID:000000009716485

### DTC DETECTION LOGIC

DTC (On board display)	Trouble diagnosis name	DTC detecting condition	Possible causes
C1F02 (92)	APA C/U MALF	If the accelerator pedal actuator integrated control unit error is detected	Accelerator pedal actuator integrated control unit malfunction

### 1. PERFORM DTC CONFIRMATION PROCEDURE

1. Start the engine.
2. Turn the DCA system ON.
3. Perform "All DTC Reading" with CONSULT.
4. Check if the "C1F02" is detected as the current malfunction on the self-diagnosis results of "ICC/ADAS".

Is "C1F02" detected as the current malfunction?

YES >> Refer to [DAS-198, "ADAS CONTROL UNIT : Diagnosis Procedure"](#).

NO >> Refer to [GI-53, "Intermittent Incident"](#).

### ADAS CONTROL UNIT : Diagnosis Procedure

INFOID:000000009716486

### 1. CHECK ADAS CONTROL UNIT SELF-DIAGNOSIS RESULTS

Check if "U1000" is detected other than "C1F02" in "Self Diagnostic Result" of "ICC/ADAS".

Is "U1000" detected?

YES >> Perform the CAN communication system inspection. Repair or replace the malfunctioning parts.  
Refer to [DAS-212, "ADAS CONTROL UNIT : DTC Logic"](#).

NO >> GO TO 2.

### 2. CHECK ACCELERATOR PEDAL ACTUATOR SELF-DIAGNOSIS RESULTS

Check if "C1F02" is detected in "Self Diagnostic Result" of "ACCELE PEDAL ACT".

Is "C1F02" detected?

YES >> Refer to [DAS-198, "ACCELERATOR PEDAL ACTUATOR : DTC Logic"](#).

NO >> Replace the ADAS control unit. Refer to [DAS-79, "Removal and Installation"](#).

## ACCELERATOR PEDAL ACTUATOR

ACCELERATOR PEDAL ACTUATOR : DTC Logic

INFOID:000000009716487

### DTC DETECTION LOGIC

DTC	Trouble diagnosis name	DTC detecting condition	Possible causes
C1F02	APA C/U MALF	If the accelerator pedal actuator integrated control unit error is detected	Accelerator pedal actuator integrated control unit malfunction

### ACCELERATOR PEDAL ACTUATOR : Diagnosis Procedure

INFOID:000000009716488

### 1. PERFORM DTC CONFIRMATION PROCEDURE

1. Start the engine.
2. Turn the DCA system ON.
3. Perform "All DTC Reading" with CONSULT.
4. Check if the "C1F02" is detected as the current malfunction on the self-diagnosis results of "ACCELE PEDAL ACT" or "ICC/ADAS"

Is "C1F02" detected as the current malfunction?

## C1F02 ACCELERATOR PEDAL ACTUATOR

< DTC/CIRCUIT DIAGNOSIS >

[DCA]

- YES >> Replace the accelerator pedal assembly. Refer to [DAS-243. "MODELS WITH DISTANCE CONTROL ASSIST SYSTEM : Removal and Installation"](#) (models with distance control assist system).
- NO >> INSPECTION END

A

B

C

D

E

F

G

H

I

J

K

L

M

N

DAS

P

# C1F03 ACCELERATOR PEDAL ACTUATOR

< DTC/CIRCUIT DIAGNOSIS >

[DCA]

## C1F03 ACCELERATOR PEDAL ACTUATOR

### DTC Logic

INFOID:000000009716489

### DTC DETECTION LOGIC

DTC	Trouble diagnosis name	DTC detecting condition	Possible causes
C1F03	APA HI TEMP	<ul style="list-style-type: none"><li>The temperature of the motor integrated in the accelerator pedal actuator remains 100°C (212°F) or more for 0.4 seconds or more</li><li>The temperature of the motor drive circuit integrated in the accelerator pedal actuator remains 120°C (248°F) or more for 0.4 seconds or more</li></ul>	Accelerator pedal actuator integrated motor malfunction

#### NOTE:

When the accelerator pedal actuator operates excessively, "C1F03" may be detected temporarily.

### DTC CONFIRMATION PROCEDURE

#### 1. PERFORM DTC CONFIRMATION PROCEDURE

- Turn the ignition switch OFF.
- Wait for 10 minutes or more and cool the accelerator pedal actuator integrated motor.
- Drive the vehicle with DCA system ON and operate the system.  
**CAUTION:**  
**Always drive safely.**
- Stop the vehicle.
- Perform "All DTC Reading" with CONSULT.
- Check if the DTC "C1F03" is detected as the current malfunction in self-diagnosis results of "ACCELERATOR PEDAL ACT".

Is "C1F03" detected as the current malfunction?

- YES >> Refer to [DAS-200. "Diagnosis Procedure"](#).  
NO >> Refer to [GI-53. "Intermittent Incident"](#).

### Diagnosis Procedure

INFOID:000000009716490

#### 1. REPLACE ACCELERATOR PEDAL ASSEMBLY

Perform DTC confirmation procedure. If "C1F03" is detected, replace the accelerator pedal assembly. Refer to [DAS-243. "MODELS WITH DISTANCE CONTROL ASSIST SYSTEM : Removal and Installation"](#).

>> INSPECTION END

# C1F05 ACCELERATOR PEDAL ACTUATOR POWER SUPPLY CIRCUIT

< DTC/CIRCUIT DIAGNOSIS >

[DCA]

## C1F05 ACCELERATOR PEDAL ACTUATOR POWER SUPPLY CIRCUIT ADAS CONTROL UNIT

ADAS CONTROL UNIT : DTC Logic

INFOID:000000009716491

### DTC DETECTION LOGIC

DTC (On board display)	Trouble diagnosis name	DTC detecting condition	Possible causes
C1F05 (95)	APA PWR SUPPLY CIR	The battery voltage sent to accelerator pedal actuator remains less than 7.9 V or more than 19.3 V for 5 seconds	<ul style="list-style-type: none"><li>• Harness, connector, or fuse</li><li>• Accelerator pedal actuator</li></ul>

### DTC CONFIRMATION PROCEDURE

#### 1. PERFORM DTC CONFIRMATION PROCEDURE

1. Start the engine.
2. Turn the DCA system ON.
3. Perform "All DTC Reading" with CONSULT.
4. Check if the "C1F05" is detected as the current malfunction on the self-diagnosis results of "ICC/ADAS".

#### Is "C1F05" detected as the current malfunction?

YES >> Refer to [DAS-201, "ADAS CONTROL UNIT : Diagnosis Procedure"](#).

NO >> Refer to [GI-53, "Intermittent Incident"](#).

### ADAS CONTROL UNIT : Diagnosis Procedure

INFOID:000000009716492

#### 1. CHECK ADAS CONTROL UNIT SELF-DIAGNOSIS RESULTS

Check if "U1000" is detected other than "C1F05" in "Self Diagnostic Result" of "ICC/ADAS".

#### Is "U1000" detected?

YES >> Perform the CAN communication system inspection. Repair or replace the malfunctioning parts. Refer to [DAS-212, "ADAS CONTROL UNIT : DTC Logic"](#).

NO >> GO TO 2.

#### 2. CHECK ACCELERATOR PEDAL ACTUATOR SELF-DIAGNOSIS RESULTS

Check if "C1F05" is detected in "Self Diagnostic Result" of "ACCELE PEDAL ACT".

#### Is "C1F05" detected?

YES >> Refer to [DAS-201, "ACCELERATOR PEDAL ACTUATOR : DTC Logic"](#).

NO >> Replace the ADAS control unit. Refer to [DAS-79, "Removal and Installation"](#).

### ACCELERATOR PEDAL ACTUATOR

ACCELERATOR PEDAL ACTUATOR : DTC Logic

INFOID:000000009716493

### DTC DETECTION LOGIC

DTC	Trouble diagnosis name	DTC detecting condition	Possible causes
C1F05	APA PWR SUPPLY CIR	The battery voltage sent to accelerator pedal actuator remains less than 7.9 V or more than 19.3 V for 5 seconds	<ul style="list-style-type: none"><li>• Harness, connector, or fuse</li><li>• Accelerator pedal actuator</li></ul>

### DTC CONFIRMATION PROCEDURE

#### 1. PERFORM DTC CONFIRMATION PROCEDURE

1. Start the engine.
2. Turn the DCA system ON.
3. Perform "All DTC Reading" with CONSULT.

# C1F05 ACCELERATOR PEDAL ACTUATOR POWER SUPPLY CIRCUIT

< DTC/CIRCUIT DIAGNOSIS >

[DCA]

4. Check if the "C1F05" is detected as the current malfunction on the self-diagnosis results of "ACCELERATOR PEDAL ACT".

Is "C1F05" detected as the current malfunction?

YES >> Refer to [DAS-202, "ACCELERATOR PEDAL ACTUATOR : Diagnosis Procedure"](#).

NO >> Refer to [GI-53, "Intermittent Incident"](#).

## ACCELERATOR PEDAL ACTUATOR : Diagnosis Procedure

INFOID:000000009716494

### 1. CHECK POWER SUPPLY CIRCUIT

Check the accelerator pedal actuator power supply circuit. Refer to [DAS-224, "ACCELERATOR PEDAL ACTUATOR : Diagnosis Procedure"](#).

Is the inspection result normal?

YES >> Replace the accelerator pedal assembly. Refer to [DAS-243, "MODELS WITH DISTANCE CONTROL ASSIST SYSTEM : Removal and Installation"](#).

NO >> Repair or replace the malfunctioning parts.

# C1F06 CAN CIRCUIT2

< DTC/CIRCUIT DIAGNOSIS >

[DCA]

## C1F06 CAN CIRCUIT2

### DTC Logic

INFOID:000000009716495

### DTC DETECTION LOGIC

DTC	Trouble diagnosis name	DTC detecting condition	Possible causes
C1F06	CAN CIR 2	If accelerator pedal actuator detects an error signal that is received from ADAS control unit via ITS communication	ADAS control unit

#### NOTE:

If DTC "C1F06" is detected along with DTC "U1000", first diagnose the DTC "U1000". Refer to [DAS-212, "ACCELERATOR PEDAL ACTUATOR : DTC Logic"](#).

### DTC CONFIRMATION PROCEDURE

#### 1.PERFORM DTC CONFIRMATION PROCEDURE

1. Start the engine.
2. Turn the DCA system ON.
3. Perform "All DTC Reading" with CONSULT.
4. Check if the "C1F06" is detected as the current malfunction in "Self Diagnostic Result" of "ACCELE PEDAL ACT".

Is "C1F06" detected as the current malfunction?

- YES >> Refer to [DAS-203, "Diagnosis Procedure"](#).  
NO >> Refer to [GI-53, "Intermittent Incident"](#).

### Diagnosis Procedure

INFOID:000000009716496

#### 1.CHECK SELF-DIAGNOSIS RESULTS

Check if "U1000" is detected other than "C1F06" in "Self Diagnostic Result" of "ACCELE PEDAL ACT".

Is "U1000" detected?

- YES >> Perform the CAN communication system inspection. Repair or replace the malfunctioning parts.  
Refer to [DAS-212, "ACCELERATOR PEDAL ACTUATOR : DTC Logic"](#).  
NO >> GO TO 2.

#### 2.REPLACE ADAS CONTROL UNIT

1. Turn the ignition switch OFF.
2. Replace the ADAS control unit. Refer to [DAS-79, "Removal and Installation"](#).
3. Erases All self-diagnosis results.
4. Perform "All DTC Reading" again.
5. Check if the "C1F06" is detected in self-diagnosis results of "ACCELE PEDAL ACT".

Is "C1F06" detected?

- YES >> Replace the accelerator pedal assembly. Refer to [DAS-243, "MODELS WITH DISTANCE CONTROL ASSIST SYSTEM : Removal and Installation"](#).  
NO >> INSPECTION END

A  
B  
C  
D  
E  
F  
G  
H  
I  
J  
K  
L  
M  
N  
P

DAS

# C1F07 CAN CIRCUIT1

< DTC/CIRCUIT DIAGNOSIS >

[DCA]

## C1F07 CAN CIRCUIT1

### DTC Logic

INFOID:000000009716497

### DTC DETECTION LOGIC

DTC	Trouble diagnosis name	DTC detecting condition	Possible causes
C1F07	CAN CIR 1	If accelerator pedal actuator detects an error signal that is received from ADAS control unit via ITS communication	ADAS control unit

#### NOTE:

If DTC "C1F07" is detected along with DTC "U1000", first diagnose the DTC "U1000". Refer to [DAS-212, "ADAS CONTROL UNIT : DTC Logic"](#).

### DTC CONFIRMATION PROCEDURE

#### 1.PERFORM DTC CONFIRMATION PROCEDURE

1. Start the engine.
2. Turn the DCA system ON.
3. Perform "All DTC Reading" with CONSULT.
4. Check if the "C1F07" is detected as the current malfunction in "Self Diagnostic Result" of "ACCELE PEDAL ACT".

Is "C1F07" detected as the current malfunction?

- YES >> Refer to [DAS-203, "Diagnosis Procedure"](#).  
NO >> Refer to [GI-53, "Intermittent Incident"](#).

### Diagnosis Procedure

INFOID:000000009716498

#### 1.CHECK SELF-DIAGNOSIS RESULTS

Check if "U1000" is detected other than "C1F07" in "Self Diagnostic Result" of "ACCELE PEDAL ACT".

Is "U1000" detected?

- YES >> Perform the CAN communication system inspection. Repair or replace the malfunctioning parts.  
Refer to [DAS-212, "ACCELERATOR PEDAL ACTUATOR : DTC Logic"](#).  
NO >> GO TO 2.

#### 2.REPLACE ADAS CONTROL UNIT

1. Turn the ignition switch OFF.
2. Replace the ADAS control unit. Refer to [DAS-79, "Removal and Installation"](#).
3. Erases All self-diagnosis results.
4. Perform "All DTC Reading" again.
5. Check if the "C1F07" is detected in self-diagnosis results of "ACCELE PEDAL ACT".

Is "C1F07" detected?

- YES >> Replace the accelerator pedal assembly. Refer to [DAS-243, "MODELS WITH DISTANCE CONTROL ASSIST SYSTEM : Removal and Installation"](#).  
NO >> INSPECTION END



# U0121 VDC CAN 2

< DTC/CIRCUIT DIAGNOSIS >

[DCA]

## U0121 VDC CAN 2

### DTC Logic

INFOID:000000009716499

### DTC DETECTION LOGIC

DTC (On board display)	Trouble diagnosis name	DTC detecting condition	Possible causes
U0121 (127)	VDC CAN CIR2	If ADAS control unit detects an error signal that is received from ABS actuator and electric unit (control unit) via CAN communication	ABS actuator and electric unit (control unit)

#### NOTE:

If DTC "U0121" is detected along with DTC "U1000", first diagnose the DTC "U1000". Refer to [DAS-212, "ADAS CONTROL UNIT : DTC Logic"](#).

### DTC CONFIRMATION PROCEDURE

#### 1. PERFORM DTC CONFIRMATION PROCEDURE

1. Start the engine.
2. Turn the DCA system ON.
3. Perform "All DTC Reading" with CONSULT.
4. Check if the "U0121" is detected as the current malfunction in "Self Diagnostic Result" of "ICC/ADAS".

Is "U0121" detected as the current malfunction?

- YES >> Refer to [DAS-205, "Diagnosis Procedure"](#).  
NO >> Refer to [GI-53, "Intermittent Incident"](#).

### Diagnosis Procedure

INFOID:000000009716500

#### 1. CHECK SELF-DIAGNOSIS RESULTS

Check if "U1000" is detected other than "U0121" in "Self Diagnostic Result" of "ICC/ADAS".

Is "U1000" detected?

- YES >> Perform the CAN communication system inspection. Repair or replace the malfunctioning parts. Refer to [DAS-212, "ADAS CONTROL UNIT : DTC Logic"](#).  
NO >> GO TO 2.

#### 2. CHECK ABS ACTUATOR AND ELECTRIC UNIT (CONTROL UNIT) SELF-DIAGNOSIS RESULTS

Check if any DTC is detected in "Self Diagnostic Result" of "ABS".

Is any DTC detected?

- YES >> Perform diagnosis on the detected DTC and repair or replace the malfunctioning parts. Refer to [BRC-46, "DTC Index"](#).  
NO >> Replace the ADAS control unit. Refer to [DAS-79, "Removal and Installation"](#).

A  
B  
C  
D  
E  
F  
G  
H  
I  
J  
K  
L  
M  
N  
P

DAS

U0126 STRG SEN CAN 1

DTC Logic

INFOID:000000009716501

DTC DETECTION LOGIC

DTC (On board display)	Trouble diagnosis name	DTC detecting condition	Possible causes
U0126 (130)	STRG SEN CAN CIR1	If ADAS control unit detects an error signal that is received from steering angle sensor via CAN communication	Steering angle sensor

**NOTE:**

If DTC "U0126" is detected along with DTC "U1000", first diagnose the DTC "U1000". Refer to [DAS-212, "ADAS CONTROL UNIT : DTC Logic"](#).

DTC CONFIRMATION PROCEDURE

**1**.PERFORM DTC CONFIRMATION PROCEDURE

1. Start the engine.
2. Turn the DCA system ON.
3. Perform "All DTC Reading" with CONSULT.
4. Check if the "U0126" is detected as the current malfunction in "Self Diagnostic Result" of "ICC/ADAS".

Is "U0126" detected as the current malfunction?

- YES >> Refer to [DAS-206, "Diagnosis Procedure"](#).
- NO >> Refer to [GI-53, "Intermittent Incident"](#).

Diagnosis Procedure

INFOID:000000009716502

**1**.CHECK SELF-DIAGNOSIS RESULTS

Check if "U1000" is detected other than "U0126" in "Self Diagnostic Result" of "ICC/ADAS".

Is "U1000" detected?

- YES >> Perform the CAN communication system inspection. Repair or replace the malfunctioning parts. Refer to [DAS-212, "ADAS CONTROL UNIT : DTC Logic"](#).
- NO >> GO TO 2.

**2**.CHECK ABS ACTUATOR AND ELECTRIC UNIT (CONTROL UNIT) SELF-DIAGNOSIS RESULTS

Check if any DTC is detected in "Self Diagnostic Result" of "ABS".

Is any DTC detected?

- YES >> Perform diagnosis on the detected DTC and repair or replace the malfunctioning parts. Refer to [BRC-46, "DTC Index"](#).
- NO >> Replace the ADAS control unit. Refer to [DAS-79, "Removal and Installation"](#).

# U0235 ICC SENSOR CAN 1

< DTC/CIRCUIT DIAGNOSIS >

[DCA]

## U0235 ICC SENSOR CAN 1

### DTC Logic

INFOID:000000009716503

### DTC DETECTION LOGIC

DTC (On board display)	Trouble diagnosis name	DTC detecting condition	Possible causes
U0235 (144)	ICC SENSOR CAN CIR1	If ADAS control unit detects an error signal that is received from ICC sensor via ITS communication	ICC sensor

#### NOTE:

If DTC "U0235" is detected along with DTC "U1000", first diagnose the DTC "U1000". Refer to [DAS-212, "ADAS CONTROL UNIT : DTC Logic"](#).

### DTC CONFIRMATION PROCEDURE

#### 1. PERFORM DTC CONFIRMATION PROCEDURE

1. Start the engine.
2. Turn the DCA system ON.
3. Perform "All DTC Reading" with CONSULT.
4. Check if the "U0235" is detected as the current malfunction in "Self Diagnostic Result" of "ICC/ADAS".

Is "U0235" detected as the current malfunction?

- YES >> Refer to [DAS-207, "Diagnosis Procedure"](#).  
NO >> Refer to [GI-53, "Intermittent Incident"](#).

### Diagnosis Procedure

INFOID:000000009716504

#### 1. CHECK ADAS CONTROL UNIT SELF-DIAGNOSIS RESULTS

Check if "U1000" is detected other than "U0235" in "Self Diagnostic Result" of "ICC/ADAS".

Is "U1000" detected?

- YES >> Perform the CAN communication system inspection. Repair or replace the malfunctioning parts. Refer to [DAS-212, "ADAS CONTROL UNIT : DTC Logic"](#).  
NO >> GO TO 2.

#### 2. CHECK ICC SENSOR SELF-DIAGNOSIS RESULTS

Check if any DTC is detected in "Self Diagnostic Result" of "LASER".

Is any DTC detected?

- YES >> Perform diagnosis on the detected DTC and repair or replace the malfunctioning parts. Refer to [DAS-128, "DTC Index"](#).  
NO >> Replace the ADAS control unit. Refer to [DAS-79, "Removal and Installation"](#).

A  
B  
C  
D  
E  
F  
G  
H  
I  
J  
K  
L  
M  
N  
P

DAS

U0401 ECM CAN 1

DTC Logic

INFOID:000000009716505

DTC DETECTION LOGIC

DTC (On board display)	Trouble diagnosis name	DTC detecting condition	Possible causes
U0401 (120)	ECM CAN CIR1	If ADAS control unit detects an error signal that is received from ECM via CAN communication	ECM

**NOTE:**

If DTC "U0401" is detected along with DTC "U1000", first diagnose the DTC "U1000". Refer to [DAS-212, "ADAS CONTROL UNIT : DTC Logic"](#).

DTC CONFIRMATION PROCEDURE

**1**.PERFORM DTC CONFIRMATION PROCEDURE

1. Start the engine.
2. Turn the DCA system ON.
3. Perform "All DTC Reading" with CONSULT.
4. Check if the "U0401" is detected as the current malfunction in "Self Diagnostic Result" of "ICC/ADAS".

Is "U0401" detected as the current malfunction?

- YES >> Refer to [DAS-208, "Diagnosis Procedure"](#).
- NO >> Refer to [GI-53, "Intermittent Incident"](#).

Diagnosis Procedure

INFOID:000000009716506

**1**.CHECK SELF-DIAGNOSIS RESULTS

Check if "U1000" is detected other than "U0401" in "Self Diagnostic Result" of "ICC/ADAS".

Is "U1000" detected?

- YES >> Perform the CAN communication system inspection. Repair or replace the malfunctioning parts. Refer to [DAS-212, "ADAS CONTROL UNIT : DTC Logic"](#).
- NO >> GO TO 2.

**2**.CHECK ECM SELF-DIAGNOSIS RESULTS

Check if any DTC is detected in "Self Diagnostic Result" of "ENGINE".

Is any DTC detected?

- YES >> Perform diagnosis on the detected DTC and repair or replace the malfunctioning parts. Refer to [EC-97, "DTC Index"](#).
- NO >> Replace the ADAS control unit. Refer to [DAS-79, "Removal and Installation"](#).

# U0402 TCM CAN 1

< DTC/CIRCUIT DIAGNOSIS >

[DCA]

## U0402 TCM CAN 1

### DTC Logic

INFOID:000000009716507

### DTC DETECTION LOGIC

DTC (On board display)	Trouble diagnosis name	DTC detecting condition	Possible causes
U0402 (122)	TCM CAN CIRC1	If ADAS control unit detects an error signal that is received from TCM via CAN communication	TCM

#### NOTE:

If DTC "U0402" is detected along with DTC "U1000", first diagnose the DTC "U1000". Refer to [DAS-212, "ADAS CONTROL UNIT : DTC Logic"](#).

### DTC CONFIRMATION PROCEDURE

#### 1. PERFORM DTC CONFIRMATION PROCEDURE

1. Start the engine.
2. Turn the DCA system ON.
3. Perform "All DTC Reading" with CONSULT.
4. Check if the "U0402" is detected as the current malfunction in "Self Diagnostic Result" of "ICC/ADAS".

Is "U0402" detected as the current malfunction?

- YES >> Refer to [DAS-209, "Diagnosis Procedure"](#).  
NO >> Refer to [GI-53, "Intermittent Incident"](#).

### Diagnosis Procedure

INFOID:000000009716508

#### 1. CHECK SELF-DIAGNOSIS RESULTS

Check if "U1000" is detected other than "U0402" in "Self Diagnostic Result" of "ICC/ADAS".

Is "U1000" detected?

- YES >> Perform the CAN communication system inspection. Repair or replace the malfunctioning parts. Refer to [DAS-212, "ADAS CONTROL UNIT : DTC Logic"](#).  
NO >> GO TO 2.

#### 2. CHECK TCM SELF-DIAGNOSIS RESULTS

Check if any DTC is detected in "Self Diagnostic Result" of "TRANSMISSION".

Is any DTC detected?

- YES >> Perform diagnosis on the detected DTC and repair or replace the malfunctioning parts. Refer to [TM-61, "DTC Index"](#).  
NO >> Replace the ADAS control unit. Refer to [DAS-79, "Removal and Installation"](#).

A  
B  
C  
D  
E  
F  
G  
H  
I  
J  
K  
L  
M  
N  
P

DAS

**U0415 VDC CAN 1**

**DTC Logic**

INFOID:000000009716509

**DTC DETECTION LOGIC**

DTC (On board display)	Trouble diagnosis name	DTC detecting condition	Possible causes
U0415 (126)	VDC CAN CIR1	If ADAS control unit detects an error signal that is received from ABS actuator and electric unit (control unit) via CAN communication	ABS actuator and electric unit (control unit)

**NOTE:**

If DTC "U0415" is detected along with DTC "U1000", first diagnose the DTC "U1000". Refer to [DAS-212, "ADAS CONTROL UNIT : DTC Logic"](#).

**DTC CONFIRMATION PROCEDURE**

**1. PERFORM DTC CONFIRMATION PROCEDURE**

1. Start the engine.
2. Turn the DCA system ON.
3. Perform "All DTC Reading" with CONSULT.
4. Check if the "U0415" is detected as the current malfunction in "Self Diagnostic Result" of "ICC/ADAS".

Is "U0415" detected as the current malfunction?

- YES >> Refer to [DAS-210, "Diagnosis Procedure"](#).
- NO >> Refer to [GI-53, "Intermittent Incident"](#).

**Diagnosis Procedure**

INFOID:000000009716510

**1. CHECK SELF-DIAGNOSIS RESULTS**

Check if "U1000" is detected other than "U0415" in "Self Diagnostic Result" of "ICC/ADAS".

Is "U1000" detected?

- YES >> Perform the CAN communication system inspection. Repair or replace the malfunctioning parts. Refer to [DAS-212, "ADAS CONTROL UNIT : DTC Logic"](#).
- NO >> GO TO 2.

**2. CHECK ABS ACTUATOR AND ELECTRIC UNIT (CONTROL UNIT) SELF-DIAGNOSIS RESULTS**

Check if any DTC is detected in "Self Diagnostic Result" of "ABS".

Is any DTC detected?

- YES >> Perform diagnosis on the detected DTC and repair or replace the malfunctioning parts. Refer to [BRC-46, "DTC Index"](#).
- NO >> Replace the ADAS control unit. Refer to [DAS-79, "Removal and Installation"](#).

# U0428 STRG SEN CAN 2

< DTC/CIRCUIT DIAGNOSIS >

[DCA]

## U0428 STRG SEN CAN 2

### DTC Logic

INFOID:000000009716511

### DTC DETECTION LOGIC

DTC (On board display)	Trouble diagnosis name	DTC detecting condition	Possible causes
U0428 (131)	STRG SEN CAN CIR2	If ADAS control unit detects an error signal that is received from steering angle sensor via CAN communication	Steering angle sensor

#### NOTE:

If DTC "U0428" is detected along with DTC "U1000", first diagnose the DTC "U1000". Refer to [DAS-212, "ADAS CONTROL UNIT : DTC Logic"](#).

### DTC CONFIRMATION PROCEDURE

#### 1. PERFORM DTC CONFIRMATION PROCEDURE

1. Start the engine.
2. Turn the DCA system ON.
3. Perform "All DTC Reading" with CONSULT.
4. Check if the "U0428" is detected as the current malfunction in "Self Diagnostic Result" of "ICC/ADAS".

Is "U0428" detected as the current malfunction?

- YES >> Refer to [DAS-211, "Diagnosis Procedure"](#).  
NO >> Refer to [GI-53, "Intermittent Incident"](#).

### Diagnosis Procedure

INFOID:000000009716512

#### 1. CHECK SELF-DIAGNOSIS RESULTS

Check if "U1000" is detected other than "U0428" in "Self Diagnostic Result" of "ICC/ADAS".

Is "U1000" detected?

- YES >> Perform the CAN communication system inspection. Repair or replace the malfunctioning parts. Refer to [DAS-212, "ADAS CONTROL UNIT : DTC Logic"](#).  
NO >> GO TO 2.

#### 2. CHECK ABS ACTUATOR AND ELECTRIC UNIT (CONTROL UNIT) SELF-DIAGNOSIS RESULTS

Check if any DTC is detected in "Self Diagnostic Result" of "ABS".

Is any DTC detected?

- YES >> Perform diagnosis on the detected DTC and repair or replace the malfunctioning parts. Refer to [BRC-46, "DTC Index"](#).  
NO >> Replace the ADAS control unit. Refer to [DAS-79, "Removal and Installation"](#).

DAS

# U1000 CAN COMM CIRCUIT

< DTC/CIRCUIT DIAGNOSIS >

[DCA]

## U1000 CAN COMM CIRCUIT ADAS CONTROL UNIT

### ADAS CONTROL UNIT : Description

INFOID:000000009716513

#### CAN COMMUNICATION

CAN (Controller Area Network) is a serial communication line for real time applications. It is an on-vehicle multiplex communication line with high data communication speed and excellent error detection ability. Modern vehicle is equipped with many electronic control units, and each control unit shares information and links with other control units during operation (not independent). In CAN communication, control units are connected with 2 communication lines (CAN-H, CAN-L) allowing a high rate of information transmission with less wiring. Each control unit transmits/receives data but selectively reads the required data only.

CAN communication signal chart. Refer to [LAN-43. "CAN COMMUNICATION SYSTEM : CAN Communication Signal Chart"](#).

#### ITS COMMUNICATION

- ITS communication is a multiplex communication system. This enables the system to transmit and receive large quantities of data at high speed by connecting control units with 2 communication lines.
- ITS communication lines adopt twisted-pair line style (two lines twisted) for noise immunity.

### ADAS CONTROL UNIT : DTC Logic

INFOID:000000009716514

#### DTC DETECTION LOGIC

DTC (On board display)	Trouble diagnosis name	DTC detecting condition	Possible causes
U1000 (100)	CAN COMM CIRCUIT	If ADAS control unit is not transmitting or receiving CAN communication signal or ITS communication signal for 2 seconds or more	<ul style="list-style-type: none"><li>• CAN communication system</li><li>• ITS communication system</li></ul>

#### NOTE:

If "U1000" is detected, first diagnose the CAN communication system.

### ADAS CONTROL UNIT : Diagnosis Procedure

INFOID:000000009716515

#### 1. PERFORM THE SELF-DIAGNOSIS

1. Turn the ignition switch ON.
2. Turn the DCA system ON, and then wait for 30 seconds or more.
3. Perform "All DTC Reading" with CONSULT.
4. Check if the "U1000" is detected as the current malfunction in "Self Diagnostic Result" of "ICC/ADAS".

Is "U1000" detected as the current malfunction?

YES >> Refer to [LAN-26. "Trouble Diagnosis Flow Chart"](#).

NO >> Refer to [GI-53. "Intermittent Incident"](#).

## ACCELERATOR PEDAL ACTUATOR

### ACCELERATOR PEDAL ACTUATOR : Description

INFOID:000000009716516

#### ITS COMMUNICATION

- ITS communication is a multiplex communication system. This enables the system to transmit and receive large quantities of data at high speed by connecting control units with 2 communication lines
- ITS communication lines adopt twisted-pair line style (two lines twisted) for noise immunity.

### ACCELERATOR PEDAL ACTUATOR : DTC Logic

INFOID:000000009716517

#### DTC DETECTION LOGIC



# U1000 CAN COMM CIRCUIT

< DTC/CIRCUIT DIAGNOSIS >

[DCA]

DTC	Trouble diagnosis name	DTC detecting condition	Possible causes
U1000	CAN COMM CIRCUIT	If accelerator pedal actuator is not transmitting or receiving ITS communication signal for 2 seconds or more	ITS communication system

A  
B  
C  
D  
E  
F  
G  
H  
I  
J  
K  
L  
M  
N  
P

## ACCELERATOR PEDAL ACTUATOR : Diagnosis Procedure

INFOID:000000009716518

### 1. PERFORM THE SELF-DIAGNOSIS

1. Turn the ignition switch ON.
2. Turn the DCA system ON, and then wait for 2 seconds or more.
3. Perform "All DTC Reading" with CONSULT.
4. Check if the "U1000" is detected as the current malfunction in "Self Diagnostic Result" of "ACCELERATOR PEDAL ACT".

Is "U1000" detected as the current malfunction?

- YES >> Refer to [LAN-26. "Trouble Diagnosis Flow Chart"](#).  
NO >> Refer to [GI-53. "Intermittent Incident"](#).

DAS

# U1010 CONTROL UNIT (CAN)

< DTC/CIRCUIT DIAGNOSIS >

[DCA]

## U1010 CONTROL UNIT (CAN)

### ADAS CONTROL UNIT

#### ADAS CONTROL UNIT : Description

INFOID:000000009716519

CAN controller controls the communication of CAN communication signal and ITS communication signal, and the error detection.

#### ADAS CONTROL UNIT : DTC Logic

INFOID:000000009716520

#### DTC DETECTION LOGIC

DTC (On board display)	Trouble diagnosis name	DTC detecting condition	Possible causes
U1010 (110)	CONTROL UNIT (CAN)	If ADAS control unit detects malfunction by CAN controller initial diagnosis	ADAS control unit

#### ADAS CONTROL UNIT : Diagnosis Procedure

INFOID:000000009716521

##### 1. PERFORM DTC CONFIRMATION PROCEDURE

1. Turn the DCA system ON.
2. Perform "All DTC Reading" with CONSULT.
3. Check if the "U1010" is detected as the current malfunction in "Self Diagnostic Result" of "ICC/ADAS".

Is "U1010" detected as the current malfunction?

YES >> Replace the ADAS control unit. Refer to [DAS-79, "Removal and Installation"](#).

NO >> INSPECTION END

### ACCELERATOR PEDAL ACTUATOR

#### ACCELERATOR PEDAL ACTUATOR : Description

INFOID:000000009716522

CAN controller controls the communication of ITS communication signal and the error detection.

#### ACCELERATOR PEDAL ACTUATOR : DTC Logic

INFOID:000000009716523

#### DTC DETECTION LOGIC

DTC	Trouble diagnosis name	DTC detecting condition	Possible causes
U1010	CONTROL UNIT (CAN)	If accelerator pedal actuator detects malfunction by CAN controller initial diagnosis	Accelerator pedal actuator

#### ACCELERATOR PEDAL ACTUATOR : Diagnosis Procedure

INFOID:000000009716524

##### 1. PERFORM DTC CONFIRMATION PROCEDURE

1. Turn the DCA system ON.
2. Perform "All DTC Reading" with CONSULT.
3. Check if the "U1010" is detected as the current malfunction in "Self Diagnostic Result" of "ACCELERATOR PEDAL ACT".

Is "U1010" detected as the current malfunction?

YES >> Replace the accelerator pedal actuator. Refer to [DAS-243, "MODELS WITH DISTANCE CONTROL ASSIST SYSTEM : Removal and Installation"](#).

NO >> INSPECTION END

# U150B ECM CAN 3

< DTC/CIRCUIT DIAGNOSIS >

[DCA]

## U150B ECM CAN 3

### DTC Logic

INFOID:000000009716525

### DTC DETECTION LOGIC

DTC (On board display)	Trouble diagnosis name	DTC detecting condition	Possible causes
U150B (157)	ECM CAN CIRC 3	ADAS control unit detects an error signal that is received from ECM via CAN communication	ECM

#### NOTE:

If DTC "U150B" is detected along with DTC "U1000", first diagnose the DTC "U1000". Refer to [DAS-212, "ADAS CONTROL UNIT : DTC Logic"](#).

### DTC CONFIRMATION PROCEDURE

#### 1. PERFORM DTC CONFIRMATION PROCEDURE

1. Start the engine.
2. Turn the DCA system ON.
3. Perform "All DTC Reading" with CONSULT.
4. Check if the "U150B" is detected as the current malfunction in "Self Diagnostic Result" of "ICC/ADAS".

Is "U150B" detected as the current malfunction?

- YES >> Refer to [DAS-215, "Diagnosis Procedure"](#).  
NO >> Refer to [GI-53, "Intermittent Incident"](#).

### Diagnosis Procedure

INFOID:000000009716526

#### 1. CHECK SELF-DIAGNOSIS RESULTS

Check if "U1000" is detected other than "U150B" in "Self Diagnostic Result" of "ICC/ADAS".

Is "U1000" detected?

- YES >> Perform the CAN communication system inspection. Repair or replace the malfunctioning parts.  
Refer to [DAS-212, "ADAS CONTROL UNIT : DTC Logic"](#).  
NO >> GO TO 2.

#### 2. CHECK ECM SELF-DIAGNOSIS RESULTS

Check if any DTC is detected in "Self Diagnostic Result" of "ENGINE".

Is any DTC detected?

- YES >> Perform diagnosis on the detected DTC and repair or replace the malfunctioning parts. Refer to [EC-97, "DTC Index"](#).  
NO >> Replace the ADAS control unit. Refer to [DAS-79, "Removal and Installation"](#).

**U150C VDC CAN 3**

**DTC Logic**

INFOID:000000009716527

**DTC DETECTION LOGIC**

DTC (On board display)	Trouble diagnosis name	DTC detecting condition	Possible causes
U150C (158)	VDC CAN CIRC 3	ADAS control unit detects an error signal that is received from ABS actuator and electric unit (control unit) via CAN communication	ABS actuator and electric unit (control unit)

**NOTE:**

If DTC "U150C" is detected along with DTC "U1000", first diagnose the DTC "U1000". Refer to [DAS-212, "ADAS CONTROL UNIT : DTC Logic"](#).

**DTC CONFIRMATION PROCEDURE**

**1. PERFORM DTC CONFIRMATION PROCEDURE**

1. Start the engine.
2. Turn the DCA system ON.
3. Perform "All DTC Reading" with CONSULT.
4. Check if the "U150C" is detected as the current malfunction in "Self Diagnostic Result" of "ICC/ADAS".

Is "U150C" detected as the current malfunction?

- YES >> Refer to [DAS-216, "Diagnosis Procedure"](#).
- NO >> Refer to [GI-53, "Intermittent Incident"](#).

**Diagnosis Procedure**

INFOID:000000009716528

**1. CHECK SELF-DIAGNOSIS RESULTS**

Check if "U1000" is detected other than "U150C" in "Self Diagnostic Result" of "ICC/ADAS".

Is "U1000" detected?

- YES >> Perform the CAN communication system inspection. Repair or replace the malfunctioning parts. Refer to [DAS-212, "ADAS CONTROL UNIT : DTC Logic"](#).
- NO >> GO TO 2.

**2. CHECK ABS ACTUATOR AND ELECTRIC UNIT (CONTROL UNIT) SELF-DIAGNOSIS RESULTS**

Check if any DTC is detected in "Self Diagnostic Result" of "ABS".

Is any DTC detected?

- YES >> Perform diagnosis on the detected DTC and repair or replace the malfunctioning parts. Refer to [BRC-46, "DTC Index"](#).
- NO >> Replace the ADAS control unit. Refer to [DAS-79, "Removal and Installation"](#).

# U150D TCM CAN 3

< DTC/CIRCUIT DIAGNOSIS >

[DCA]

## U150D TCM CAN 3

### DTC Logic

INFOID:000000009716529

### DTC DETECTION LOGIC

DTC (On board display)	Trouble diagnosis name	DTC detecting condition	Possible causes
U150D (159)	TCM CAN CIRC 3	ADAS control unit detects an error signal that is received from TCM via CAN communication	TCM

#### NOTE:

If DTC "U150D" is detected along with DTC "U1000", first diagnose the DTC "U1000". Refer to [DAS-212, "ADAS CONTROL UNIT : DTC Logic"](#).

### DTC CONFIRMATION PROCEDURE

#### 1. PERFORM DTC CONFIRMATION PROCEDURE

1. Start the engine.
2. Turn the DCA system ON.
3. Perform "All DTC Reading" with CONSULT.
4. Check if the "U150D" is detected as the current malfunction in "Self Diagnostic Result" of "ICC/ADAS".

Is "U150D" detected as the current malfunction?

- YES >> Refer to [DAS-217, "Diagnosis Procedure"](#).  
NO >> Refer to [GI-53, "Intermittent Incident"](#).

### Diagnosis Procedure

INFOID:000000009716530

#### 1. CHECK SELF-DIAGNOSIS RESULTS

Check if "U1000" is detected other than "U150D" in "Self Diagnostic Result" of "ICC/ADAS".

Is "U1000" detected?

- YES >> Perform the CAN communication system inspection. Repair or replace the malfunctioning parts.  
Refer to [DAS-212, "ADAS CONTROL UNIT : DTC Logic"](#).  
NO >> GO TO 2.

#### 2. CHECK TCM SELF-DIAGNOSIS RESULTS

Check if any DTC is detected in "Self Diagnostic Result" of "TRANSMISSION".

Is any DTC detected?

- YES >> Perform diagnosis on the detected DTC and repair or replace the malfunctioning parts. Refer to [TM-61, "DTC Index"](#).  
NO >> Replace the ADAS control unit. Refer to [DAS-79, "Removal and Installation"](#).

# U150E BCM CAN 3

< DTC/CIRCUIT DIAGNOSIS >

[DCA]

## U150E BCM CAN 3

### DTC Logic

INFOID:000000009716531

### DTC DETECTION LOGIC

DTC (On board display)	Trouble diagnosis name	DTC detecting condition	Possible causes
U150E (160)	BCM CAN CIRC 3	ADAS control unit detects an error signal that is received from BCM via CAN communication	BCM

#### NOTE:

If DTC "U150E" is detected along with DTC "U1000", first diagnose the DTC "U1000". Refer to [DAS-212, "ADAS CONTROL UNIT : DTC Logic"](#).

### DTC CONFIRMATION PROCEDURE

#### 1. PERFORM DTC CONFIRMATION PROCEDURE

1. Start the engine.
2. Turn the DCA system ON.
3. Perform "All DTC Reading" with CONSULT.
4. Check if the "U150E" is detected as the current malfunction in "Self Diagnostic Result" of "ICC/ADAS".

Is "U150E" detected as the current malfunction?

- YES >> Refer to [DAS-218, "Diagnosis Procedure"](#).  
NO >> Refer to [GI-53, "Intermittent Incident"](#).

### Diagnosis Procedure

INFOID:000000009716532

#### 1. CHECK SELF-DIAGNOSIS RESULTS

Check if "U1000" is detected other than "U150E" in "Self Diagnostic Result" of "ICC/ADAS".

Is "U1000" detected?

- YES >> Perform the CAN communication system inspection. Repair or replace the malfunctioning parts.  
Refer to [DAS-212, "ADAS CONTROL UNIT : DTC Logic"](#).  
NO >> GO TO 2.

#### 2. CHECK BCM SELF-DIAGNOSIS RESULTS

Check if any DTC is detected in "Self Diagnostic Result" of "BCM".

Is any DTC detected?

- YES >> Perform diagnosis on the detected DTC and repair or replace the malfunctioning parts. Refer to [BCS-51, "DTC Index"](#).  
NO >> Replace the ADAS control unit. Refer to [DAS-79, "Removal and Installation"](#).

# U1502 ICC SENSOR CAN COMM CIRC

< DTC/CIRCUIT DIAGNOSIS >

[DCA]

## U1502 ICC SENSOR CAN COMM CIRC

### DTC Logic

INFOID:000000009716533

### DTC DETECTION LOGIC

DTC (On board display)	Trouble diagnosis name	DTC detecting condition	Possible causes
U1502 (147)	ICC SEN CAN COMM CIR	ADAS control unit detects an error signal that is received from ICC sensor via CAN communication	ICC sensor

#### NOTE:

If DTC "U1502" is detected along with DTC "U1000", first diagnose the DTC "U1000". Refer to [DAS-212, "ADAS CONTROL UNIT : DTC Logic"](#).

### DTC CONFIRMATION PROCEDURE

#### 1. PERFORM DTC CONFIRMATION PROCEDURE

1. Start the engine.
2. Turn the DCA system ON.
3. Perform "All DTC Reading" with CONSULT.
4. Check if the "U1502" is detected as the current malfunction in "Self Diagnostic Result" of "ICC/ADAS".

Is "U1502" detected as the current malfunction?

- YES >> Refer to [DAS-219, "Diagnosis Procedure"](#).  
NO >> Refer to [GI-53, "Intermittent Incident"](#).

### Diagnosis Procedure

INFOID:000000009716534

#### 1. CHECK SELF-DIAGNOSIS RESULTS

Check if "U1000" is detected other than "U1502" in "Self Diagnostic Result" of "ICC/ADAS".

Is "U1000" detected?

- YES >> Perform the CAN communication system inspection. Repair or replace the malfunctioning parts. Refer to [DAS-212, "ADAS CONTROL UNIT : DTC Logic"](#).  
NO >> GO TO 2.

#### 2. CHECK ICC SENSOR SELF-DIAGNOSIS RESULTS

Check if any DTC is detected in "Self Diagnostic Result" of "LASER".

Is any DTC detected?

- YES >> Perform diagnosis on the detected DTC and repair or replace the malfunctioning parts. Refer to [DAS-128, "DTC Index"](#).  
NO >> Replace the ADAS control unit. Refer to [DAS-79, "Removal and Installation"](#).

A  
B  
C  
D  
E  
F  
G  
H  
I  
J  
K  
L  
M  
N  
P

DAS

# U1513 METER CAN 3

< DTC/CIRCUIT DIAGNOSIS >

[DCA]

## U1513 METER CAN 3

### DTC Logic

INFOID:000000009716535

### DTC DETECTION LOGIC

DTC (On board display)	Trouble diagnosis name	DTC detecting condition	Possible causes
U1513 (163)	METER CAN CIRC 3	ADAS control unit detects an error signal that is received from combination meter via CAN communication	Combination meter

#### NOTE:

If DTC "U1513" is detected along with DTC "U1000", first diagnose the DTC "U1000". Refer to [DAS-212, "ADAS CONTROL UNIT : DTC Logic"](#).

### DTC CONFIRMATION PROCEDURE

#### 1. PERFORM DTC CONFIRMATION PROCEDURE

1. Start the engine.
2. Turn the DCA system ON.
3. Perform "All DTC Reading" with CONSULT.
4. Check if the "U1513" is detected as the current malfunction in "Self Diagnostic Result" of "ICC/ADAS".

Is "U1513" detected as the current malfunction?

- YES >> Refer to [DAS-220, "Diagnosis Procedure"](#).  
NO >> Refer to [GI-53, "Intermittent Incident"](#).

### Diagnosis Procedure

INFOID:000000009716536

#### 1. CHECK SELF-DIAGNOSIS RESULTS

Check if "U1000" is detected other than "U1513" in "Self Diagnostic Result" of "ICC/ADAS".

Is "U1000" detected?

- YES >> Perform the CAN communication system inspection. Repair or replace the malfunctioning parts.  
Refer to [DAS-212, "ADAS CONTROL UNIT : DTC Logic"](#).  
NO >> GO TO 2.

#### 2. CHECK COMBINATION METER SELF-DIAGNOSIS RESULTS

Check if any DTC is detected in "Self Diagnostic Result" of "METER/M&A".

Is any DTC detected?

- YES >> Perform diagnosis on the detected DTC and repair or replace the malfunctioning parts. Refer to [MWI-26, "DTC Index"](#).  
NO >> Replace the ADAS control unit. Refer to [DAS-79, "Removal and Installation"](#).



# U1514 STRG SEN CAN 3

< DTC/CIRCUIT DIAGNOSIS >

[DCA]

## U1514 STRG SEN CAN 3

### DTC Logic

INFOID:000000009716537

### DTC DETECTION LOGIC

DTC (On board display)	Trouble diagnosis name	DTC detecting condition	Possible causes
U1514 (165)	STRG SEN CAN CIRC 3	ADAS control unit detects an error signal that is received from steering angle sensor via CAN communication	Steering angle sensor

#### NOTE:

If DTC "U1514" is detected along with DTC "U1000", first diagnose the DTC "U1000". Refer to [DAS-212, "ADAS CONTROL UNIT : DTC Logic"](#).

### DTC CONFIRMATION PROCEDURE

#### 1. PERFORM DTC CONFIRMATION PROCEDURE

1. Start the engine.
2. Turn the DCA system ON.
3. Perform "All DTC Reading" with CONSULT.
4. Check if the "U1514" is detected as the current malfunction in "Self Diagnostic Result" of "ICC/ADAS".

Is "U1514" detected as the current malfunction?

- YES >> Refer to [DAS-221, "Diagnosis Procedure"](#).  
NO >> Refer to [GI-53, "Intermittent Incident"](#).

### Diagnosis Procedure

INFOID:000000009716538

#### 1. CHECK SELF-DIAGNOSIS RESULTS

Check if "U1000" is detected other than "U1514" in "Self Diagnostic Result" of "ICC/ADAS".

Is "U1000" detected?

- YES >> Perform the CAN communication system inspection. Repair or replace the malfunctioning parts. Refer to [DAS-212, "ADAS CONTROL UNIT : DTC Logic"](#).  
NO >> GO TO 2.

#### 2. CHECK ABS ACTUATOR AND ELECTRIC UNIT (CONTROL UNIT) SELF-DIAGNOSIS RESULTS

Check if any DTC is detected in "Self Diagnostic Result" of "ABS".

Is any DTC detected?

- YES >> Perform diagnosis on the detected DTC and repair or replace the malfunctioning parts. Refer to [BRC-46, "DTC Index"](#).  
NO >> Replace the ADAS control unit. Refer to [DAS-79, "Removal and Installation"](#).

# U1515 ICC SENSOR CAN 3

< DTC/CIRCUIT DIAGNOSIS >

[DCA]

## U1515 ICC SENSOR CAN 3

### DTC Logic

INFOID:000000009716539

### DTC DETECTION LOGIC

DTC (On board display)	Trouble diagnosis name	DTC detecting condition	Possible causes
U1515 (165)	ICC SENSOR CAN CIRC 3	ADAS control unit detects an error signal that is received from ICC sensor via CAN communication	ICC sensor

#### NOTE:

If DTC "U1515" is detected along with DTC "U1000", first diagnose the DTC "U1000". Refer to [DAS-212, "ADAS CONTROL UNIT : DTC Logic"](#).

### DTC CONFIRMATION PROCEDURE

#### 1. PERFORM DTC CONFIRMATION PROCEDURE

1. Start the engine.
2. Turn the DCA system ON.
3. Perform "All DTC Reading" with CONSULT.
4. Check if the "U1515" is detected as the current malfunction in "Self Diagnostic Result" of "ICC/ADAS".

Is "U1515" detected as the current malfunction?

- YES >> Refer to [DAS-222, "Diagnosis Procedure"](#).  
NO >> Refer to [GI-53, "Intermittent Incident"](#).

### Diagnosis Procedure

INFOID:000000009716540

#### 1. CHECK SELF-DIAGNOSIS RESULTS

Check if "U1000" is detected other than "U1515" in "Self Diagnostic Result" of "ICC/ADAS".

Is "U1000" detected?

- YES >> Perform the CAN communication system inspection. Repair or replace the malfunctioning parts.  
Refer to [DAS-212, "ADAS CONTROL UNIT : DTC Logic"](#).  
NO >> GO TO 2.

#### 2. CHECK ICC SENSOR SELF-DIAGNOSIS RESULTS

Check if any DTC is detected in "Self Diagnostic Result" of "LASER".

Is any DTC detected?

- YES >> Perform diagnosis on the detected DTC and repair or replace the malfunctioning parts. Refer to [DAS-128, "DTC Index"](#).  
NO >> Replace the ADAS control unit. Refer to [DAS-79, "Removal and Installation"](#).

# U1517 ACCELERATOR PEDAL ACTUATOR CAN 3

< DTC/CIRCUIT DIAGNOSIS >

[DCA]

## U1517 ACCELERATOR PEDAL ACTUATOR CAN 3

### DTC Logic

INFOID:000000009716541

### DTC DETECTION LOGIC

DTC (On board display)	Trouble diagnosis name	DTC detecting condition	Possible causes
U1517 (167)	APA CAN CIRC 3	ADAS control unit detects an error signal that is received from accelerator pedal actuator via CAN communication	Accelerator pedal actuator

#### NOTE:

If DTC "U1517" is detected along with DTC "U1000", first diagnose the DTC "U1000". Refer to [DAS-212, "ADAS CONTROL UNIT : DTC Logic"](#).

### DTC CONFIRMATION PROCEDURE

#### 1. PERFORM DTC CONFIRMATION PROCEDURE

1. Start the engine.
2. Turn the DCA system ON.
3. Perform "All DTC Reading" with CONSULT.
4. Check if the "U1517" is detected as the current malfunction in "Self Diagnostic Result" of "ICC/ADAS".

Is "U1517" detected as the current malfunction?

- YES >> Refer to [DAS-223, "Diagnosis Procedure"](#).  
NO >> Refer to [GI-53, "Intermittent Incident"](#).

### Diagnosis Procedure

INFOID:000000009716542

#### 1. CHECK SELF-DIAGNOSIS RESULTS

Check if "U1000" is detected other than "U1517" in "Self Diagnostic Result" of "ICC/ADAS".

Is "U1000" detected?

- YES >> Perform the CAN communication system inspection. Repair or replace the malfunctioning parts. Refer to [DAS-212, "ADAS CONTROL UNIT : DTC Logic"](#).  
NO >> GO TO 2.

#### 2. CHECK ACCELERATOR PEDAL ACTUATOR SELF-DIAGNOSIS RESULTS

Check if any DTC is detected in "Self Diagnostic Result" of "ACCELE PEDAL ACT".

Is any DTC detected?

- YES >> Perform diagnosis on the detected DTC and repair or replace the malfunctioning parts. Refer to [DAS-131, "DTC Index"](#).  
NO >> Replace the ADAS control unit. Refer to [DAS-79, "Removal and Installation"](#).

A  
B  
C  
D  
E  
F  
G  
H  
I  
J  
K  
L  
M  
N  
P

DAS

# POWER SUPPLY AND GROUND CIRCUIT

< DTC/CIRCUIT DIAGNOSIS >

[DCA]

## POWER SUPPLY AND GROUND CIRCUIT ADAS CONTROL UNIT

### ADAS CONTROL UNIT : Diagnosis Procedure

INFOID:000000009716543

Regarding Wiring Diagram information, refer to [DAS-132. "Wiring Diagram"](#).

#### 1. CHECK ADAS CONTROL UNIT POWER SUPPLY CIRCUIT

Check voltage between ADAS control unit harness connector and ground.

Terminal		Condition	Voltage (Approx.)
(+)	(-)		
ADAS control unit		Ignition switch	0 V
Connector	Terminal		
B104	16	OFF	Battery voltage
		ON	

Is the inspection result normal?

YES >> GO TO 2.

NO >> Repair the ADAS control unit power supply circuit.

#### 2. CHECK ADAS CONTROL UNIT GROUND CIRCUIT

1. Turn the ignition switch OFF.
2. Disconnect the ADAS control unit connector.
3. Check for continuity between ADAS control unit harness connector and ground.

ADAS control unit		Ground	Continuity
Connector	Terminal		
B104	6		Yes

Is the inspection result normal?

YES >> INSPECTION END

NO >> Repair the ADAS control unit ground circuit.

## ACCELERATOR PEDAL ACTUATOR

### ACCELERATOR PEDAL ACTUATOR : Diagnosis Procedure

INFOID:000000009716544

Regarding Wiring Diagram information, refer to [DAS-132. "Wiring Diagram"](#).

#### 1. CHECK FUSES

Check if any of the following fuses are blown:

Signal name	Fuse No.
Battery power supply	75

Is the inspection result normal?

YES >> GO TO 2.

NO >> Replace the blown fuse after repairing the affected circuit if a fuse is blown.

#### 2. CHECK ACCELERATOR PEDAL ACTUATOR POWER SUPPLY CIRCUIT

# POWER SUPPLY AND GROUND CIRCUIT

[DCA]

< DTC/CIRCUIT DIAGNOSIS >

Check voltage between accelerator pedal actuator harness connector and ground.

Terminal		Condition	Voltage (Approx.)
(+)	(-)		
Accelerator pedal actuator		Ignition switch	Battery volt- age
Connector	Terminal		
E74	1	OFF	
	3	ON	

Is the inspection result normal?

YES >> GO TO 3.

NO >> Repair the accelerator pedal actuator power supply circuit.

### 3.CHECK ACCELERATOR PEDAL ACTUATOR GROUND CIRCUIT

1. Turn the ignition switch OFF.
2. Disconnect the accelerator pedal actuator connector.
3. Check for continuity between accelerator pedal actuator harness connector and ground.

Accelerator pedal actuator		Ground	Continuity
Connector	Terminal		
E74	2		Yes

Is the inspection result normal?

YES >> INSPECTION END

NO >> Repair the accelerator pedal actuator ground circuit.

A  
B  
C  
D  
E  
F  
G  
H  
I  
J  
K  
L  
M  
N  
P

DAS

# DISTANCE CONTROL ASSIST SYSTEM SYMPTOMS

< SYMPTOM DIAGNOSIS >

[DCA]

## SYMPTOM DIAGNOSIS

### DISTANCE CONTROL ASSIST SYSTEM SYMPTOMS

#### Symptom Table

INFOID:000000009716545

	Symptoms	Reference page
Operation	Switch does not turn ON	Refer to <a href="#">DAS-227, "Description"</a> .
	Switch does not turn OFF	
	DCA system setting cannot be turned ON on the navigation screen	Refer to <a href="#">DAS-229, "Description"</a> .
	DCA system setting cannot be turned OFF on the navigation screen	
	DCA system not activated (switch is ON)	Refer to <a href="#">DAS-230, "Description"</a> .
Display/Chime	Information display is not illuminated (vehicle ahead indicator)	Refer to <a href="#">MWI-17, "Description"</a> .
	Chime does not sound	Refer to <a href="#">DAS-232, "Description"</a> .
Control	No force generated for putting back the accelerator pedal	Refer to <a href="#">DAS-234, "Description"</a> .
Detection of lead vehicle	Frequently cannot detect the vehicle ahead	Refer to <a href="#">DAS-235, "Description"</a> .
	Detection zone is short	
	System misidentifies a vehicle even though there is no vehicle ahead	<ul style="list-style-type: none"> <li>• Adjust ICC sensor aiming: Refer to <a href="#">CCS-87, "Description"</a>.</li> <li>• Perform action test. Refer to <a href="#">DAS-157, "Description"</a>.</li> </ul>
	System misidentifies a vehicle in the next lane	
	System does not detect the vehicle ahead at all	Refer to <a href="#">DAS-237, "Description"</a> .

# SWITCH DOES NOT TURN ON / SWITCH DOES NOT TURN OFF

< SYMPTOM DIAGNOSIS >

[DCA]

## SWITCH DOES NOT TURN ON / SWITCH DOES NOT TURN OFF

### Description

INFOID:000000009716546

The switch does not turn ON

- When the DCA system setting is ON, the DCA system switch indicator does not illuminate even if the dynamic driver assistance switch is depressed.

The switch does not turn OFF

- The DCA system switch indicator does not turn OFF even if the dynamic driver assistance switch is pressed when the DCA system switch indicator illuminates.

#### NOTE:

The system cannot be operated when setting conventional (fixed speed) cruise control mode.

### Diagnosis Procedure

INFOID:000000009716547

#### 1. CHECK DCA SYSTEM SETTING

1. Start the engine.
2. After starting the engine wait for 5 seconds or more.
3. Check that DCA system setting on the navigation screen is ON.

##### Is DCA system setting ON?

- YES >> GO TO 2.  
NO >> Enable the DCA system setting.

#### 2. DYNAMIC DRIVER ASSISTANCE SWITCH INSPECTION

1. Start the engine.
2. Check that "DYNA ASIST SW" operates normally in "DATA MONITOR" of "ICC/ADAS" with CONSULT.

##### Is the inspection result normal?

- YES >> GO TO 3.  
NO >> GO TO 5.

#### 3. CHECK DCA SYSTEM SWITCH INDICATOR CIRCUIT

1. Start the engine.
2. Select the active test item "DCA INDICATOR" of "ICC/ADAS" with CONSULT.
3. Check if the DCA system switch indicator illuminates when the test item is operated.

##### Is the inspection result normal?

- YES >> GO TO 6.  
NO >> GO TO 4.

#### 4. PERFORM THE SELF-DIAGNOSIS OF COMBINATION METER

1. Perform "All DTC Reading" with CONSULT.
2. Check if the DTC is detected in self-diagnosis results of "METER/M&A". Refer to [MWI-26. "DTC Index"](#).

##### Is the inspection result normal?

- YES >> GO TO 7.  
NO >> GO TO 6.

#### 5. CHECK STEERING SWITCH CIRCUIT

Check the steering switch circuit. Refer to [DAS-167. "Diagnosis Procedure"](#).

##### Is the inspection result normal?

- YES >> GO TO 6.  
NO >> GO TO 7.

#### 6. PERFORM THE SELF-DIAGNOSIS

1. Perform "All DTC Reading" with CONSULT.
2. Check if the DTC is detected in self-diagnosis results of "ICC/ADAS". Refer to [DAS-122. "DTC Index"](#).

##### Is any DTC detected?

- YES >> GO TO 7.

## SWITCH DOES NOT TURN ON / SWITCH DOES NOT TURN OFF

< SYMPTOM DIAGNOSIS >

[DCA]

---

NO >> GO TO 8.

### 7.REPAIR OR REPLACE MALFUNCTIONING PARTS.

---

Repair or replace malfunctioning parts.

>> GO TO 8.

### 8.CHECK DCA SYSTEM

---

1. Erase "self-diagnosis result", and then perform "All DTC Reading" again after performing the action test.  
(Refer to [DAS-157. "Description"](#) for action test.)
2. Check that the DCA system is normal.

>> INSPECTION END



# DCA SYSTEM SETTINGS CANNOT BE TURNED ON/OFF IN VEHICLE INFORMATION DISPLAY

< SYMPTOM DIAGNOSIS >

[DCA]

## DCA SYSTEM SETTINGS CANNOT BE TURNED ON/OFF IN VEHICLE INFORMATION DISPLAY

### Description

INFOID:000000009716548

- DCA system setting is not selectable on the navigation screen.  
**NOTE:**  
When the ignition switch is in ACC position, DCA system settings cannot be changed.
- "Distance Control Assist" is not indicated on the navigation screen.
- The switching between ON and OFF cannot be performed by operating the navigation system.
- The item of "Distance Control Assist" on the navigation screen is not active.
- After turning ON the ignition switch or starting the engine, DCA settings of the navigation system cannot be selected for several tens of seconds under the following conditions:
  - After replacing AV control unit.
  - After erasing connection history of the navigation system.
  - After erasing self-diagnosis results.
- The DCA system setting differs from the one set at the previous driving.  
**NOTE:**  
Turn OFF the ignition switch and wait for 5 seconds or more.

### Diagnosis Procedure

INFOID:000000009716549

#### 1. CHECK DCA SYSTEM SETTING

1. Start the engine.
2. Check that the DCA system settings is selectable on the navigation screen.

Is the inspection result normal?

- YES >> GO TO 3.
- NO >> GO TO 2.

#### 2. PERFORM THE SELF-DIAGNOSIS

1. Perform "All DTC Reading" with CONSULT.
2. Check if the DTC is detected in self-diagnosis results of "ICC/ADAS", "MULTI AV" and "METER/M&A". Refer to the following.
  - ICC/ADAS: [DAS-122. "DTC Index"](#)
  - MULTI AV: [AV-660. "DTC Index"](#)
  - METER/M&A: [MWI-26. "DTC Index"](#)

Is any DTC detected?

- YES >> Repair or replace malfunctioning parts.
- NO >> INSPECTION END

#### 3. CHECK DATA MONITOR OF ADAS CONTROL UNIT

Check that "DCA SELECT" operates normally in "DATA MONITOR" of "ICC/ADAS" with CONSULT.

Is the inspection result normal?

- YES >> Refer to [AV-633. "Description"](#).
- NO >> GO TO 4.

#### 4. CHECK MULTIFUNCTION SWITCH

Operate the multifunction switch to check that the audio, navigation system, and air conditioner operate properly.

Is the inspection result normal?

- YES >> Replace the ADAS control unit. Refer to [DAS-79. "Removal and Installation"](#).
- NO >> Repair or replace malfunctioning parts.

# DCA SYSTEM NOT ACTIVATED (SWITCH IS ON)

< SYMPTOM DIAGNOSIS >

[DCA]

## DCA SYSTEM NOT ACTIVATED (SWITCH IS ON)

### Description

INFOID:000000009716550

The dynamic driver assistance switch can be turned ON/OFF, but the DCA system does not operate.

#### NOTE:

Never start the operation under the following conditions.

- No operation condition
- When the brake pedal depressed
- When the ICC system is set
- When the system judges that the vehicle comes to a standstill by the system control
- When the vehicle ahead is not detected
- Operation cancellation condition
- When the dynamic driver assistance switch is turned to OFF
- When the system malfunction occurs
- When ABS or VDC (including the TCS) operates
- When the VDC is turned OFF
- When the sensor area of the front bumper is dirty and the measurement of the distance between the vehicles becomes difficult
- When ABS warning lamp is ON
- When the SNOW mode switch is turned ON

### Diagnosis Procedure

INFOID:000000009716551

#### 1. CHECK CAUSE OF AUTOMATIC CANCELLATION

Check if there is any cancellation cause in the "CAUSE OF AUTO-CANCEL" on "WORK SUPPORT" of "ICC/ADAS" with CONSULT.

##### Is it displayed?

Not displayed >> GO TO 2.

"OPE SW VOLT CIRC" >> Refer to [DAS-167, "DTC Logic"](#).

"VHCL SPD UNMATCH" >> Refer to [DAS-160, "DTC Logic"](#).

"IGN LOW VOLT" >> Refer to [DAS-159, "DTC Logic"](#).

"CAN COMM ERROR" >> Refer to [DAS-212, "ADAS CONTROL UNIT : DTC Logic"](#).

"ICC SENSOR CAN COMM ERR" >> Refer to [DAS-207, "DTC Logic"](#).

"ABS/TCS/VDC CIRC" >> Refer to [DAS-162, "DTC Logic"](#).

"APA HI TEMP" >> Refer to [DAS-200, "DTC Logic"](#).

"ECD CIRCUIT" >> Refer to [DAS-186, "DTC Logic"](#).

#### 2. PERFORM ALL OF THE SELF-DIAGNOSIS

1. Perform "All DTC Reading".
2. Check if any DTC is detected in self-diagnosis results of "ICC/ADAS". Refer to [DAS-122, "DTC Index"](#).

##### Is any DTC detected?

YES >> GO TO 3.

NO >> GO TO 4.

#### 3. REPAIR OR REPLACE MALFUNCTIONING PARTS

Repair or replace malfunctioning parts identified by the self-diagnosis result.

>> GO TO 6.

#### 4. CHECK EACH SWITCH AND VEHICLE SPEED SIGNAL

1. Start the engine.
2. Check that the following items operate normally in "DATA MONITOR" of "ICC/ADAS".
  - "VHCL SPEED SE"
  - "BRAKE SW"
  - "DYNA ASIST SW"

##### Is there a malfunctioning item?

All items are normal >> GO TO 5.

"VHCL SPEED SE" >> Refer to [DAS-160, "DTC Logic"](#).

## DCA SYSTEM NOT ACTIVATED (SWITCH IS ON)

< SYMPTOM DIAGNOSIS >

[DCA]

"BRAKE SW">>Refer to [DAS-163, "DTC Logic"](#).

"DYNA ASIST SW">>Refer to [DAS-167, "DTC Logic"](#).

A

### 5.REPLACE ADAS CONTROL UNIT

Replace the ADAS control unit. Refer to [DAS-79, "Removal and Installation"](#).

B

>> GO TO 6.

### 6.CHECK DCA SYSTEM

C

1. Erase "self-diagnosis result", and then perform "All DTC Reading" again after performing the action test.  
(Refer to [DAS-157, "Description"](#) for action test.)
2. Check that the DCA system is normal.

D

>> INSPECTION END

E

F

G

H

I

J

K

L

M

N

DAS

P

# CHIME DOES NOT SOUND

< SYMPTOM DIAGNOSIS >

[DCA]

## CHIME DOES NOT SOUND

### Description

INFOID:000000009716552

The warning chime may not sound in some cases when there is a short distance between vehicles. Some examples are:

- When the vehicles are traveling at the same speed and the distance between vehicles is not changing
- When the vehicle ahead is traveling faster and the distance between vehicles is increasing
- When a vehicle cuts in near own vehicle
- The warning chime will not sound when own vehicle approaches vehicles that are parked or moving slowly.
- The warning chime does not sound when the system does not detect any vehicle ahead. (Diagnose the conditions under which the system is detecting the vehicle ahead and when the system is malfunctioning. If there is any malfunction in detecting the vehicle ahead, check the system following the [DAS-235, "Description".](#))

### Diagnosis Procedure

INFOID:000000009716553

#### 1.PERFORM ACTIVE TEST

Check if the warning chime sounds on the active test item "ICC BUZZER" of "ICC/ADAS" with CONSULT.

Does the warning chime sound?

- YES >> GO TO 2.
- NO >> GO TO 3.

#### 2.CHECK THE MALFUNCTION SYMPTOM DURING WARNING CHIME OPERATION

Understand the vehicle ahead detection condition when the malfunction occurred. If the warning chime should have sounded, replace the ADAS control unit. Refer to [DAS-79, "Removal and Installation".](#)

>> GO TO 9.

#### 3.PERFORM THE SELF-DIAGNOSIS

1. Perform "All DTC Reading" with CONSULT.
2. Check if the "U1000" is detected in self-diagnosis results of "ICC/ADAS".

Is "U1000" detected?

- YES >> GO TO 4.
- NO >> GO TO 5.

#### 4.CAN COMMUNICATIONS INSPECTION

Check the CAN communication and repair or replace malfunctioning parts. Refer to [DAS-212, "ADAS CONTROL UNIT : DTC Logic".](#)

>> GO TO 9.

#### 5.PERFORM THE SELF-DIAGNOSIS OF COMBINATION METER

1. Perform "All DTC Reading" with CONSULT.
2. Check if any DTC is detected in self-diagnosis results of "METER/M&A".

Is any DTC detected?

- YES >> Repair or replace malfunctioning parts. Refer to [MWI-26, "DTC Index".](#)
- NO >> GO TO 6.

#### 6.CHECK ICC WARNING CHIME CIRCUIT

Check meter buzzer. Refer to [WCS-29, "Component Function Check".](#)

Is the inspection result normal?

- YES >> GO TO 8.
- NO >> GO TO 7.

#### 7.REPAIR OR REPLACE MALFUNCTIONING PARTS

Repair or replace malfunctioning parts.

# CHIME DOES NOT SOUND

< SYMPTOM DIAGNOSIS >

[DCA]

>> GO TO 9.

## 8. REPLACE ADAS CONTROL UNIT

Replace the ADAS control unit. Refer to [DAS-79. "Removal and Installation"](#).

>> GO TO 9.

## 9. CHECK DCA SYSTEM

1. Erase "self-diagnosis result", and then perform "All DTC Reading" again after performing the action test. (Refer to [DAS-157. "Description"](#) for action test.)
2. Check if the DCA system is normal.

>> INSPECTION END

A  
B  
C  
D  
E  
F  
G  
H  
I  
J  
K  
L  
M  
N  
P

DAS

# NO FORCE GENERATED FOR PUTTING BACK THE ACCELERATOR PEDAL

< SYMPTOM DIAGNOSIS >

[DCA]

## NO FORCE GENERATED FOR PUTTING BACK THE ACCELERATOR PEDAL

### Description

INFOID:000000009716554

The dynamic driver assistance switch can be turned ON/OFF but the actuation force of accelerator pedal is not generated.

#### NOTE:

- When the vehicle ahead detection indicator does not illuminate, the control and warning with the system are not performed.
- The actuation force of accelerator pedal may not be generated sufficiently depending on depressing method or depressing amount of accelerator pedal.

### Diagnosis Procedure

INFOID:000000009716555

#### 1.PERFORM THE SELF-DIAGNOSIS

1. Perform "All DTC Reading" with CONSULT.
2. Check if any DTC is detected in self-diagnosis results of "ICC/ADAS" or "ACCELE PEDAL ACT".

##### Is any DTC detected?

- YES >> GO TO 2.  
NO >> GO TO 3.

#### 2.REPAIR OR REPLACE THE MALFUNCTIONING PARTS

Repair or replace malfunctioning parts. Refer to [DAS-122. "DTC Index"](#) (ICC/ADAS) or [DAS-131. "DTC Index"](#) (ACCELE PEDAL ACT).

>> GO TO 5.

#### 3.PERFORM ACTIVE TEST

Check if the accelerator pedal actuator operates by the active test items "ACCELERATOR PEDAL ACTUATOR TEST1" and "ACCELERATOR PEDAL ACTUATOR TEST2" of "ACCELE PEDAL ACT" with CONSULT.

##### Does it operate?

- YES >> GO TO 4.  
NO >> Replace the accelerator pedal assembly.

#### 4.CHECK VEHICLE AHEAD DETECTION PERFORMANCE

Understand the vehicle ahead detection condition when the malfunction occurred. If the detecting function is malfunctioning, check according to [DAS-235. "Description"](#).

>> INSPECTION END

#### 5.CHECK DCA SYSTEM

1. Erase "self-diagnosis result", and then perform "All DTC Reading" again after performing the action test. (Refer to [DAS-157. "Description"](#) for action test.)
2. Check if the DCA system is normal.

>> INSPECTION END

# FREQUENTLY CANNOT DETECT THE VEHICLE AHEAD / DETECTION ZONE IS SHORT

< SYMPTOM DIAGNOSIS >

[DCA]

## FREQUENTLY CANNOT DETECT THE VEHICLE AHEAD / DETECTION ZONE IS SHORT

### Description

INFOID:000000009716556

The detection function may become unstable in the following cases.

- When radar reflections from the vehicle is interrupted.
- When driving a road with extremely sharp corners.
- When the sensor cannot detect a vehicle ahead while the vehicle ahead passes a hill or valley.

### Diagnosis Procedure

INFOID:000000009716557

#### 1.VISUAL CHECK (1)

Check the contamination and foreign matter on the ICC sensor area of the front bumper.

Does foreign material exist?

- YES >> GO TO 3.
- NO >> GO TO 2.

#### 2.VISUAL CHECK (2)

1. Remove for front bumper. Refer to [EXT-17, "Removal and Installation"](#).
2. Check ICC sensor for contamination and foreign material.

Does foreign material exist?

- YES >> GO TO 3.
- NO >> GO TO 4.

#### 3.CLEAN DIRT AND FOREIGN MATERIALS

Clean the contamination and foreign material from the area around the ICC sensor body window.

>> GO TO 8.

#### 4.VISUAL CHECK (3)

Check ICC sensor for cracks and scratches.

Are there any cracks or scratches?

- YES >> GO TO 6.
- NO >> GO TO 5.

#### 5.AJUST ICC SENSOR ALIGNMENT

1. Install the front bumper. Refer to [EXT-17, "Removal and Installation"](#).
2. Adjust the ICC sensor alignment. Refer to [CCS-87, "Description"](#).
3. Perform ICC system action test. Refer to [DAS-157, "Description"](#).
4. Check that the vehicle ahead detection performance improves.

Does it improve?

- YES >> INSPECTION END
- NO >> GO TO 6.

#### 6.REPLACE ICC SENSOR

1. Replace the ICC sensor. Refer to [DAS-241, "Removal and Installation"](#).
2. Install the front bumper. Refer to [EXT-17, "Removal and Installation"](#).
3. Adjust the ICC sensor alignment. Refer to [CCS-87, "Description"](#).
4. Perform ICC system action test. Refer to [DAS-157, "Description"](#).
5. Check that the vehicle ahead detection performance improves.

Does it improve?

- YES >> INSPECTION END
- NO >> GO TO 7.

#### 7.REPLACE ADAS CONTROL UNIT

Replace the ADAS control unit. Refer to [DAS-79, "Removal and Installation"](#).

A  
B  
C  
D  
E  
F  
G  
H  
I  
J  
K  
L  
M  
N  
P

DAS

# FREQUENTLY CANNOT DETECT THE VEHICLE AHEAD / DETECTION ZONE IS SHORT

< SYMPTOM DIAGNOSIS >

[DCA]

>> GO TO 8.

## 8. CHECK ICC SYSTEM

1. Erase "self-diagnosis result", and then perform "All DTC Reading" again after performing the action test.  
(Refer to [DAS-157. "Description"](#) for action test.)
2. Check that the ICC system is normal.

>> INSPECTION END



# THE SYSTEM DOES NOT DETECT THE VEHICLE AHEAD AT ALL

< SYMPTOM DIAGNOSIS >

[DCA]

## THE SYSTEM DOES NOT DETECT THE VEHICLE AHEAD AT ALL

### Description

INFOID:000000009716558

When ICC system is active, the ICC system does not perform any control even though there is a vehicle ahead.

### Diagnosis Procedure

INFOID:000000009716559

#### 1. CHECK ICC SYSTEM DISPLAY ON INFORMATION DISPLAY

1. Start the self-diagnosis mode of combination meter. Refer to [MWI-17, "Description"](#).
2. Check that the information display turns ON normally.

Is the inspection result normal?

- YES >> GO TO 2.  
NO >> Replace the combination meter.

#### 2. VISUAL CHECK (1)

Check for contamination and foreign material on the ICC sensor area of the front bumper.

Do foreign material exist?

- YES >> GO TO 4.  
NO >> GO TO 3.

#### 3. VISUAL CHECK (2)

1. Remove the front bumper. Refer to [EXT-17, "Removal and Installation"](#).
2. Check ICC sensor for contamination and foreign material.

Does foreign material exist?

- YES >> GO TO 4.  
NO >> GO TO 5.

#### 4. CLEAN DIRT AND FOREIGN MATERIAL

Clean the contamination and foreign material from the area around from the ICC sensor.

>> GO TO 9.

#### 5. VISUAL CHECK (3)

Check ICC sensor for cracks and/or scratches.

Are there cracks?

- YES >> GO TO 7.  
NO >> GO TO 6.

#### 6. ICC SENSOR ALIGNMENT ADJUSTMENT

1. Install the front bumper. Refer to [EXT-17, "Removal and Installation"](#).
2. Adjust the ICC sensor alignment. Refer to [CCS-87, "Description"](#).
3. Perform ICC system action test. Refer to [DAS-157, "Description"](#).
4. Check that the vehicle ahead detection performance improves.

Does it improve?

- YES >> INSPECTION END  
NO >> GO TO 8.

#### 7. REPLACE ICC SENSOR

1. Replace the ICC sensor. Refer to [DAS-241, "Removal and Installation"](#).
2. Adjust the ICC sensor alignment. Refer to [CCS-87, "Description"](#).
3. Perform ICC system action test. Refer to [DAS-157, "Description"](#).
4. Check that the vehicle ahead detection performance improves.

Does it improve?

- YES >> Inspection End.  
NO >> GO TO 8.

A  
B  
C  
D  
E  
F  
G  
H  
I  
J  
K  
L  
M  
N  
P

DAS

# THE SYSTEM DOES NOT DETECT THE VEHICLE AHEAD AT ALL

< SYMPTOM DIAGNOSIS >

[DCA]

---

## 8. REPLACE ADAS CONTROL UNIT

---

Replace the ADAS control unit. Refer to [DAS-79. "Removal and Installation"](#).

>> GO TO 9.

## 9. CHECK DCA SYSTEM

---

1. Erase "self-diagnosis result", and then perform "All DTC Reading" again after performing the action test. (Refer to [DAS-157. "Description"](#) for action test.)
2. Check that the ICC system is normal.

>> INSPECTION END

# NORMAL OPERATING CONDITION

< SYMPTOM DIAGNOSIS >

[DCA]

## NORMAL OPERATING CONDITION

### Description

INFOID:000000009716560

#### PRECAUTIONS FOR DISTANCE CONTROL ASSIST (DCA) SYSTEM

- If the vehicle ahead comes to a stop, the vehicle decelerates to a standstill within the limitations of the system. The system will cancel once it judges that the vehicle has come to a standstill with a warning chime. To prevent the vehicle from moving, the driver must depress the brake pedal.
- The DCA system will not apply brake control while the driver is depressing the accelerator pedal.
- This system is only an aid to assist the driver and is not a collision warning or avoidance device. It is the driver's responsibility to stay alert, drive safely and be in control of the vehicle at all times.
- This system will not adapt automatically to road conditions. Do not use the system on roads with sharp curves, or on icy roads, in heavy rain or in fog.
- The distance sensor will not detect under most conditions.
  - Stationary and slow moving vehicles
  - Pedestrians or objects in the roadway
  - Oncoming vehicles in the same lane
  - Motorcycles traveling offset in the travel lane
- As there is a performance limit to the distance control function, never rely solely on the DCA system. This system does not correct careless, inattentive or absent-minded driving, or overcome poor visibility in rain, fog, or other bad weather. Decelerate the vehicle speed by depressing the brake pedal, depending on the distance to the vehicle ahead and the surrounding circumstances in order to maintain a safe distance between vehicles.
- The system may not detect the vehicle in front of own vehicle in certain road or weather conditions. To avoid accidents, never use the DCA system under the following conditions.
  - On roads with sharp curves
  - On slippery road surfaces such as on ice or snow, etc.
  - On off-road surfaces such as on sand or rock, etc.
  - During bad weather (rain, fog, snow, etc.)
  - When rain, snow or dirt adhere to the system sensor
  - On steep downhill roads (frequent braking may result in overheating the brakes)
  - On repeated uphill and downhill roads
  - When towing a trailer or other vehicle
- In some road or traffic conditions, a vehicle or object can unexpectedly come into the sensor detection zone and cause automatic braking. Driver may need to control the distance from other vehicles using the accelerator pedal. Always stay alert and avoid using the DCA system when it is not recommended in this section.
- The following are some conditions in which the sensor cannot detect the signals.
  - When the snow or road spray from traveling vehicles reduces the sensor's visibility
  - When excessively heavy baggage is loaded in the rear seat or the luggage room of own vehicle
- The DCA system is designed to automatically check the sensor's operation. When the front bumper area of the distance sensor is covered with dirt or is obstructed, the system will automatically be cancelled. If the front bumper area of the distance sensor is covered with ice, a transparent or translucent vinyl bag, etc., the DCA system may not detect them. In these instances, the DCA system may not be able to decelerate the vehicle properly. Be sure to check and clean the sensor regularly.
- The DCA system is designed to help assist the driver to maintain a following distance from the vehicle ahead. The system will decelerate as necessary and if the vehicle ahead comes to a stop, the vehicle decelerates to standstill. However, the DCA system can only apply up to 25% of the vehicles total braking power. If a vehicle moves into the traveling lane ahead or if a vehicle traveling ahead rapidly decelerates, the distance between vehicles may become closer because the DCA system cannot decelerate the vehicle quickly enough. If this occurs, the DCA system will sound a warning chime and blink the system display to notify the driver to take necessary action.
- The DCA system does not control vehicle speed or warn when driver approach stationary and slow moving vehicles. Driver must pay attention to vehicle operation to maintain proper distance from vehicles ahead.

A  
B  
C  
D  
E  
F  
G  
H  
I  
J  
K  
L  
M  
N  
DAS  
P

## NORMAL OPERATING CONDITION

[DCA]

### < SYMPTOM DIAGNOSIS >

- The detection zone of the sensor is limited. A vehicle ahead must be in the detection zone for the system to operate.
- A vehicle ahead may move outside of the detection zone due to its position within the same lane of travel. Motorcycles may not be detected in the same lane ahead if they are traveling offset from the center line of the lane. A vehicle that is entering the lane ahead may not be detected until the vehicle has completely moved into the lane. If this occurs, the system may warn driver by blinking the system indicator and sounding the chime. The driver may have to manually control the proper distance away from vehicle traveling ahead.

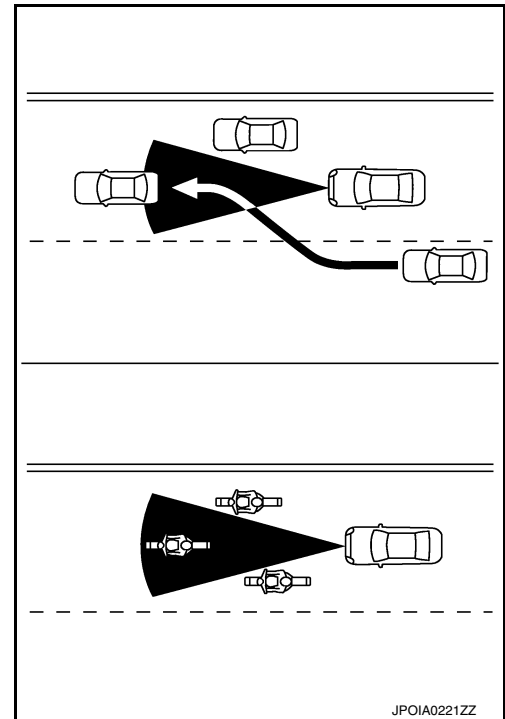

- When driving on some roads, such as winding, hilly, curved, narrow roads, or roads which are under construction, the sensor may detect vehicles in a different lane, or may temporarily not detect a vehicle traveling ahead. This may cause the system to work inappropriately. The detection of vehicles may also be affected by vehicle operation (steering maneuver or traveling position in the lane, etc.) or vehicle condition. If this occurs, the system may warn driver by blinking the system indicator and sounding the chime unexpectedly. The driver will have to manually control the proper distance away from the vehicle traveling ahead.

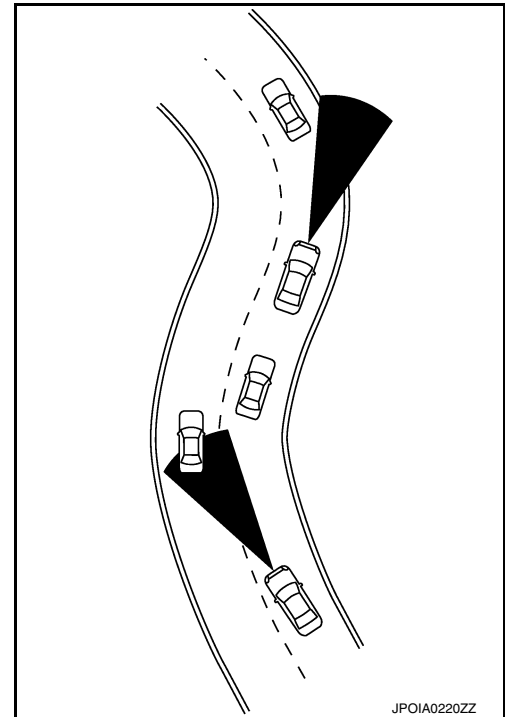

- The approach warning chime may sound and the system display may blink when the sensor detects some reflectors which are fitted on vehicles in other lanes or on the side of the road. This may cause the DCA system to operate inappropriately. The sensor may detect these reflectors when the vehicle is driven on winding roads, hilly roads or when entering or exiting a curve. The sensor may also detect reflectors on narrow roads or in road construction zones. In these cases driver will have to manually control the proper distance ahead of own vehicle. Also, the sensor sensitivity can be affected by vehicle operation (steering maneuver or driving position in the lane) or traffic or vehicle condition (for example, if a vehicle is being driven with some damage).
- The DCA system automatically decelerates own vehicle to help assist the driver to maintain a following distance from the vehicle ahead. Manually brake when deceleration is required to maintain a safe distance upon sudden braking by the vehicle ahead or when a vehicle suddenly appears in front of own vehicle. Always stay alert when using the DCA system.
- When the vehicle ahead detection indicator lamp is not illuminated, system will not control or warn the driver.
- Depending on the position of the accelerator pedal, the system may not be able to assist the driver to release the accelerator pedal appropriately.
- If the vehicle ahead comes to a standstill, the vehicle decelerates to a standstill within the limitations of the system. The system will release brake control with a warning chime once it judges the vehicle is at a standstill. To prevent the vehicle from moving, the driver must depress the brake pedal. [The system will resume control automatically once the system reaches 5 km/h (3 MPH)].

# ICC SENSOR

< REMOVAL AND INSTALLATION >

[DCA]

## REMOVAL AND INSTALLATION

### ICC SENSOR

#### Exploded View

INFOID:000000009716561

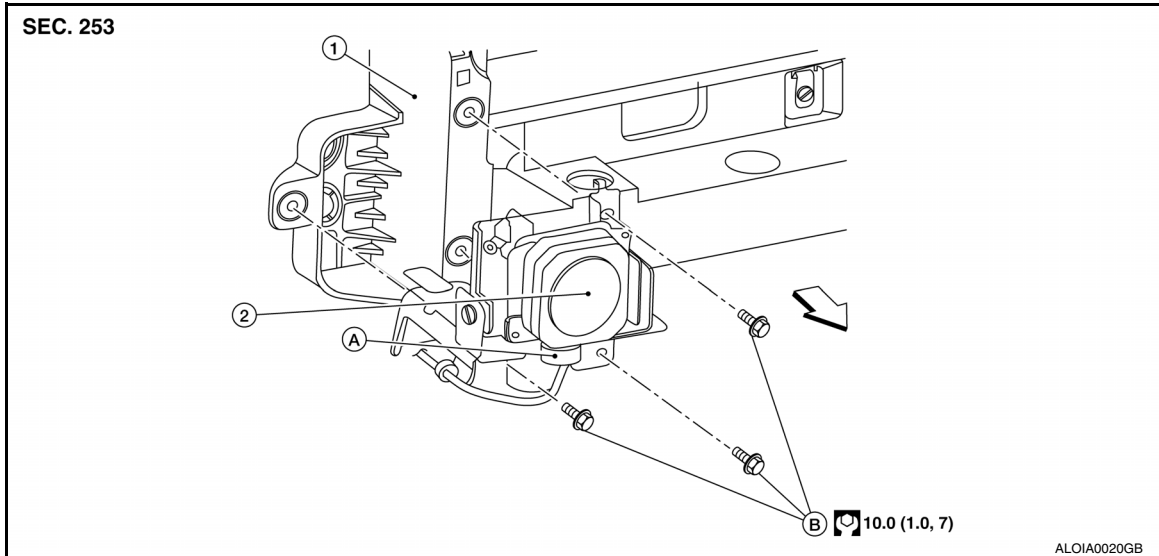

1. Radiator core support assembly    2. ICC sensor    ← Front
- A. ICC sensor harness connector    B. For tightening sequence, refer to [DAS-241. "Removal and Installation"](#).

### Removal and Installation

INFOID:000000009716562

#### REMOVAL

1. Remove front bumper fascia. Refer to [EXT-17. "Removal and Installation"](#).
2. Disconnect the harness connector from the ICC sensor.
3. Release the harness clip from the ICC sensor.
4. Remove ICC sensor bolts.
5. Remove ICC sensor.

#### INSTALLATION

Installation is in the reverse order of removal.

- Install ICC sensor bolts (←) loosely, then tighten in sequence shown.

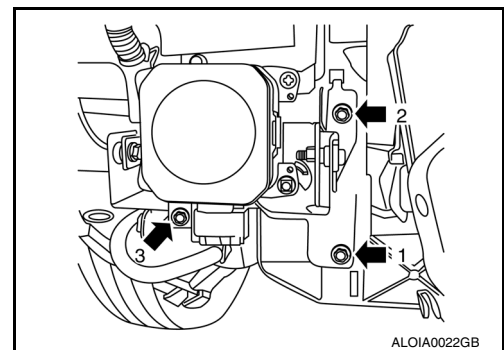

#### CAUTION:

- Always perform the ICC sensor alignment and check the operation after removal, installation or replacement of ICC sensor. Refer to [CCS-87. "Description"](#).
- Do not drop or shock ICC sensor.

## ICC SENSOR

< REMOVAL AND INSTALLATION >

[DCA]

---

- **Make sure ICC sensor harness is installed without any twists.**

# ACCELERATOR PEDAL ASSEMBLY

< REMOVAL AND INSTALLATION >

[DCA]

## ACCELERATOR PEDAL ASSEMBLY

MODELS WITH DISTANCE CONTROL ASSIST SYSTEM

MODELS WITH DISTANCE CONTROL ASSIST SYSTEM : Exploded View

INFOID:000000009716563

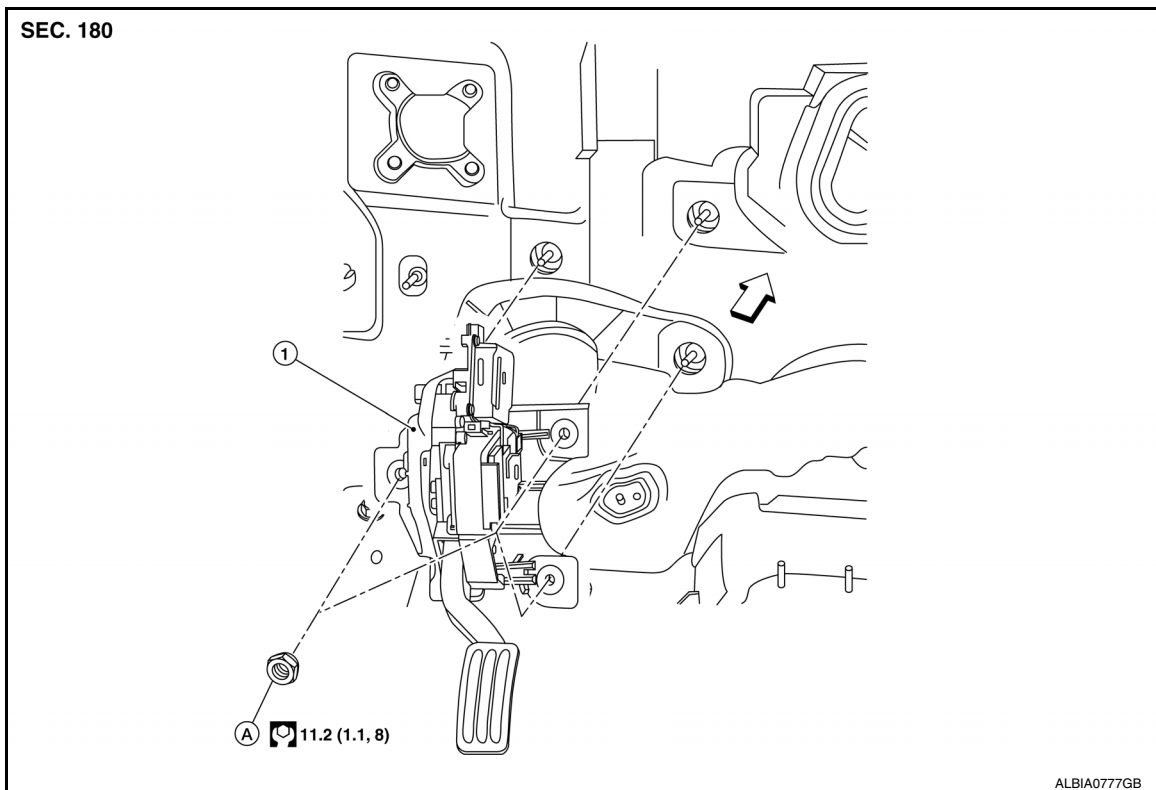

1. Accelerator pedal assembly

A. Nut

⇨ Front

## MODELS WITH DISTANCE CONTROL ASSIST SYSTEM : Removal and Installation

INFOID:000000009716564

### REMOVAL

1. Remove three accelerator pedal assembly nuts.
2. Disconnect the two harness connectors (A, B) from the accelerator pedal assembly.  
⇨: Front
3. Remove the accelerator pedal assembly from vehicle.

### CAUTION:

- Do not disassemble accelerator pedal assembly.
- Do not drop or impact accelerator pedal assembly.
- Do not expose accelerator pedal assembly to water.

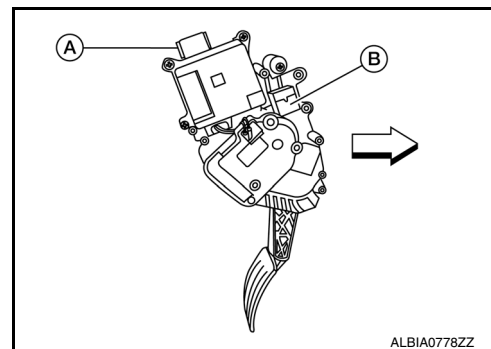

### INSTALLATION

Installation is in the reverse order of removal.

### NOTE:

For inspection, refer to [DAS-244, "MODELS WITH DISTANCE CONTROL ASSIST SYSTEM : Inspection"](#).

# ACCELERATOR PEDAL ASSEMBLY

< REMOVAL AND INSTALLATION >

[DCA]

MODELS WITH DISTANCE CONTROL ASSIST SYSTEM : Inspection

INFOID:000000009716565

## INSPECTION AFTER INSTALLATION

- Check that the accelerator pedal moves smoothly within the specified range.

⇐: Front

**Accelerator pedal stroke (A)** : Refer to [ACC-7, "Accelerator Control"](#)

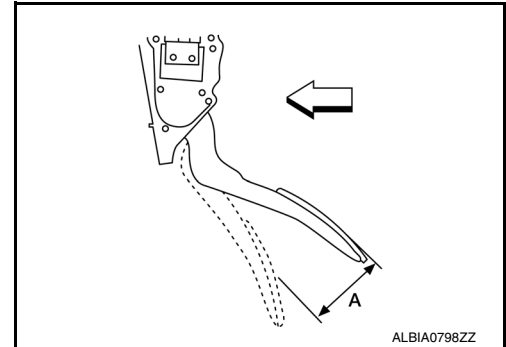

- Check the accelerator pedal height.

**Accelerator pedal height** : Refer to [ACC-7, "Accelerator Control"](#)

- Depress and release the accelerator pedal to check that it returns quickly and smoothly to the original released position.

### CAUTION:

- Whenever the harness connector of the accelerator pedal position sensor has been disconnected, perform "Accelerator Pedal Released Position Learning". Refer to [EC-151, "Work Procedure"](#).
- The accelerator pedal should operate smoothly without catching when the pedal operating force is released. The pedal should return smoothly to the fully raised position. The spring should be free from damage.



# DYNAMIC DRIVER ASSISTANCE SWITCH

< REMOVAL AND INSTALLATION >

[DCA]

## DYNAMIC DRIVER ASSISTANCE SWITCH

### Removal and Installation

INFOID:000000009716566

The dynamic driver assistance switch and ICC steering switch are serviced as an assembly. Refer to [AV-885](#), "[Removal and Installation](#)".

#### **CAUTION:**

Always perform the DCA system action test to check that the system operates normally after replacing the ICC sensor, replacing the accelerator pedal or repairing any DCA system malfunction. Refer to [DAS-155](#), "[Work Procedure](#)".

A  
B  
C  
D  
E  
F  
G  
H  
I  
J  
K  
L  
M  
N  
P

DAS

PRECAUTION

PRECAUTIONS

Precaution for Supplemental Restraint System (SRS) "AIR BAG" and "SEAT BELT PRE-TENSIONER"

INFOID:000000009730867

The Supplemental Restraint System such as "AIR BAG" and "SEAT BELT PRE-TENSIONER", used along with a front seat belt, helps to reduce the risk or severity of injury to the driver and front passenger for certain types of collision. This system includes dual stage front air bag modules. The SRS system may only deploy one front air bag, depending on the severity of a collision and whether the front passenger seat is occupied. Information necessary to service the system safely is included in the SR and SB section of this Service Manual.

**WARNING:**

- To avoid rendering the SRS inoperative, which could increase the risk of personal injury or death in the event of a collision which would result in air bag inflation, all maintenance must be performed by an authorized NISSAN/INFINITI dealer.
- Improper maintenance, including incorrect removal and installation of the SRS, can lead to personal injury caused by unintentional activation of the system. For removal of Spiral Cable and Air Bag Module, see the SR section.
- Do not use electrical test equipment on any circuit related to the SRS unless instructed to in this Service Manual. SRS wiring harnesses can be identified by yellow and/or orange harnesses or harness connectors.

PRECAUTIONS WHEN USING POWER TOOLS (AIR OR ELECTRIC) AND HAMMERS

**WARNING:**

- When working near the Airbag Diagnosis Sensor Unit or other Airbag System sensors with the Ignition ON or engine running, DO NOT use air or electric power tools or strike near the sensor(s) with a hammer. Heavy vibration could activate the sensor(s) and deploy the air bag(s), possibly causing serious injury.
- When using air or electric power tools or hammers, always switch the Ignition OFF, disconnect the battery and wait at least three minutes before performing any service.

Precautions For Harness Repair

INFOID:000000009716568

ITS communication uses a twisted pair line. Be careful when repairing it.

- Solder the repaired area and wrap tape around the soldered area.

**NOTE:**

A fray of twisted lines must be within 110 mm (4.33 in).

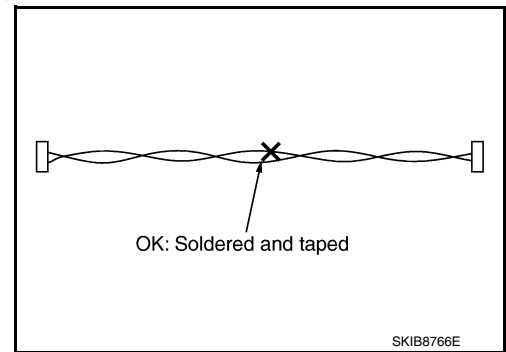

- Bypass connection is never allowed at the repaired area.

**NOTE:**

Bypass connection may cause ITS communication error. The spliced wire becomes separated and the characteristics of twisted line are lost.

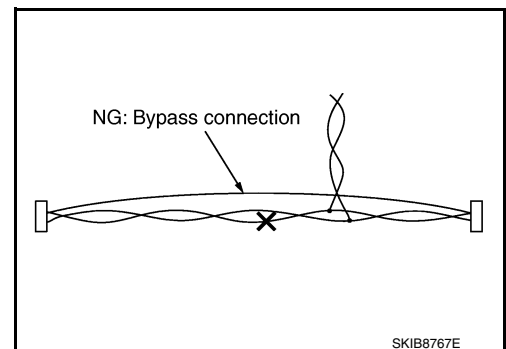

# PRECAUTIONS

< PRECAUTION >

[FCW]

## Precaution for FCW System Service

INFOID:000000009716569

### CAUTION:

- Turn the FCW system OFF in conditions similar to driving, such as free rollers or a chassis dynamometer.
- Do not use or disassemble the ICC sensor removed from the vehicle.
- Erase DTC when replacing parts of FCW system, then check the operation of FCW system after performing radar beam alignment, if necessary.
- Never change FCW initial state ON ⇒ OFF without the consent of the customer.

A

B

C

D

E

F

G

H

I

J

K

L

M

N

DAS

P

## SYSTEM DESCRIPTION

### COMPONENT PARTS

#### Component Parts Location

INFOID:000000009716570

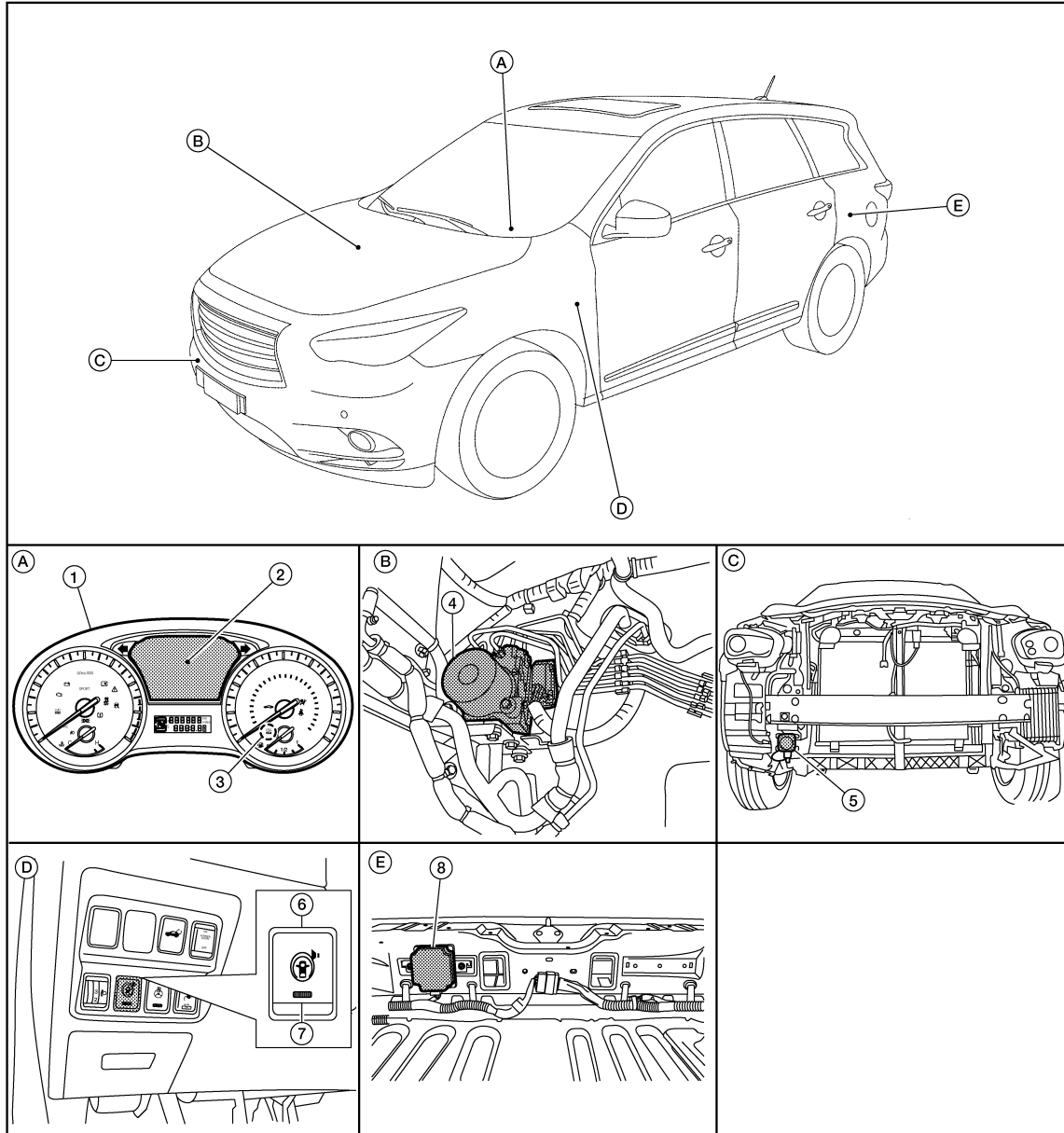

AWOIA0022ZZ

- |   |  |  |
|---|--|--|
| <p>1. Combination meter<br/>Refer to <a href="#">DAS-249, "Component Description"</a>.</p> <p>4. ABS actuator and electric unit (control unit)<br/>Refer to <a href="#">DAS-249, "Component Description"</a>.</p> <p>7. Warning system ON indicator</p> | <p>2. Vehicle information display, buzzer (On the combination meter)</p> <p>5. ICC sensor (view with front fascia removed)<br/>Refer to <a href="#">DAS-249, "Component Description"</a>.</p> <p>8. ADAS control unit (view of rear luggage room area with rear panel assembly removed)<br/>Refer to <a href="#">DAS-249, "Component Description"</a>.</p> | <p>3. IBA OFF indicator lamp</p> <p>6. Warning system switch</p> |
|---|--|--|

# COMPONENT PARTS

< SYSTEM DESCRIPTION >

[FCW]

## Component Description

INFOID:000000009716571

Component	Description
ADAS control unit	<ul style="list-style-type: none"> <li>• ADAS control unit turns ON warning systems ON indicator</li> <li>• ADAS control unit transmits a buzzer output signal to combination meter via CAN communication</li> </ul>
ICC sensor	<ul style="list-style-type: none"> <li>• ICC sensor detects light reflected from a vehicle ahead by irradiating a wave forward and calculates a distance from the vehicle ahead and a relative speed, based on the detected signal</li> <li>• ICC sensor transmits the presence/absence of a vehicle ahead and a distance from the vehicle ahead to the ADAS control unit via ITS communication</li> </ul>
ABS actuator and electric unit (control unit)	ABS actuator and electric unit (control unit) transmits the vehicle speed signal (wheel speed), to ADAS control unit via CAN communication
Warning systems switch	Inputs the warning systems switch signal to ADAS control unit.
Warning systems ON indicator (On the warning systems switch)	Turns warning systems ON indicator ON/OFF according to the signals from the ADAS control unit
Combination meter	<p>Performs the following operations using the signals received from the ADAS control unit via the CAN communication</p> <ul style="list-style-type: none"> <li>• Blinks the vehicle ahead detection indicator according to a meter display signal</li> <li>• Illuminates the IBA OFF indicator lamp using the IBA OFF indicator lamp signal</li> <li>• Operates the buzzer (ICC warning chime) using the buzzer output signal</li> </ul>
AV control unit	AV control unit transmits the system selection signal to the ADAS control unit via CAN communication

A  
B  
C  
D  
E  
F  
G  
H  
I  
J  
K  
L  
M  
N  
P

DAS

SYSTEM

System Description

INFOID:000000009716572

SYSTEM DIAGRAM

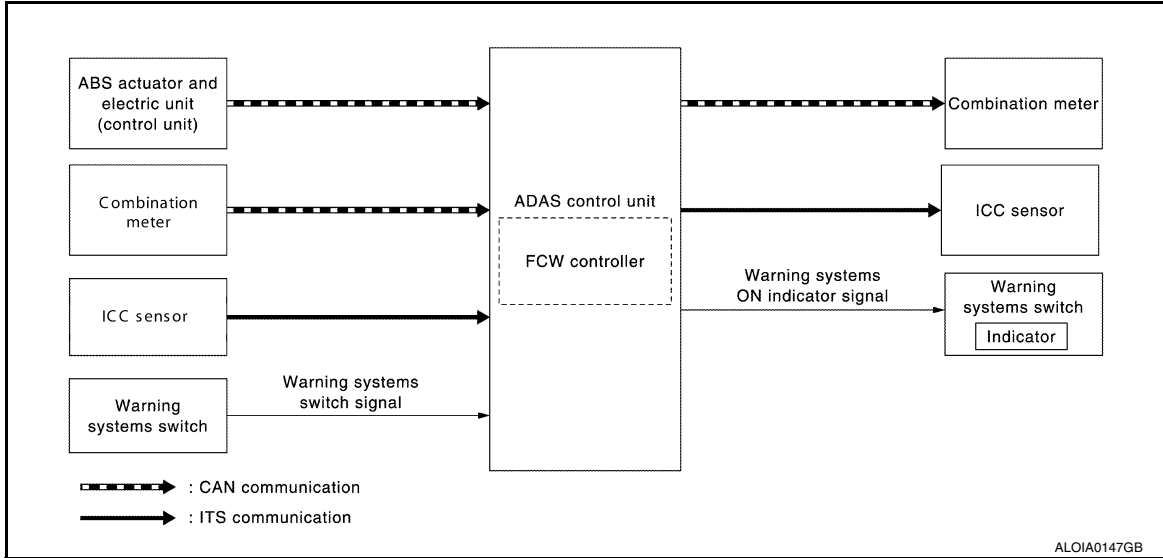

ADAS CONTROL UNIT INPUT/OUTPUT SIGNAL ITEM

Input Signal Item

Transmit unit	Signal name		Description
ABS actuator and electric unit (control unit)	CAN communication	Vehicle speed signal (ABS)	Receives wheel speeds of four wheels
Combination meter	CAN communication	System selection signal	Receives a selection state of each item in "Driving Aids" selected with the vehicle information display
ICC sensor	ITS communication	ICC sensor signal	Receives detection results, such as the presence or absence of a leading vehicle and distance from the vehicle
Warning systems switch	Warning systems switch signal		Receives an ON/OFF state of the warning systems switch

Output Signal Item

Reception unit	Signal name		Description
Combination meter	CAN communication	Meter display signal	Transmits a signal to display a state of the system on the information display
		Vehicle ahead detection indicator signal	
		IBA OFF indicator lamp signal	<ul style="list-style-type: none"> <li>Transmits a signal to turn ON the IBA OFF indicator lamp</li> <li>Transmits an ON/OFF state of the intelligent brake assist</li> </ul>
		Buzzer output signal	Transmits a buzzer output signal to activate the buzzer
ICC sensor	ITS communication	Vehicle speed signal	Transmits a vehicle speed calculated by the ADAS control unit
Warning systems ON indicator	Warning systems ON indicator signal		Turns ON the warning systems ON indicator

DESCRIPTION

# SYSTEM

[FCW]

## < SYSTEM DESCRIPTION >

- The Forward Collision Warning (FCW) system will warn the driver by a warning lamp (vehicle ahead detection indicator) and chime when own vehicle is getting close to the vehicle ahead in the traveling lane.
- The FCW system will function when own vehicle is driven at speeds of approximately 10 MPH (15 km/h) and above.

**NOTE:**

The FCW system shares the diagnosis function with ICC system.

### FUNCTION DESCRIPTION

The distance from the vehicle ahead and a relative speed are calculated by using the ICC sensor and a ICC sensor signal is transmitted to the ADAS control unit via ITS communication. When judging the necessity of warning according to the received ICC sensor signal, the ADAS control unit transmits a buzzer output signal and meter display signal to the combination meter via CAN communication.

### FCW Operating Condition

- Warning systems ON indicator: ON
- Vehicle speed: Approximately 10 MPH (15 km/h) and above.

**NOTE:**

When the FCW system setting on the navigation screen is ON.

### Fail-safe Indication

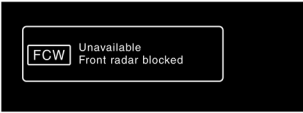
Vehicle condition	Indication on the combination meter
When the FCW system malfunctions	 <p>ALOIA0124GB</p>
When the sensor area of the front bumper is dirty	 <p>ALOIA0125GB</p>

### Fail-safe (ADAS Control Unit)

INFOID:000000009716573

If a malfunction occurs in any system, ADAS control unit cancels each control, sounds a beep, and turns ON the warning lamp or indicator lamp or warning message will display.

System	Buzzer	Warning lamp/Indicator lamp	Description
Vehicle-to-vehicle distance control mode	High-pitched tone	ICC system warning lamp	Cancel
Conventional (fixed speed) cruise control mode	High-pitched tone	ICC system warning lamp	Cancel
Intelligent Brake Assist (IBA)	High-pitched tone	IBA OFF indicator lamp	Cancel
Forward Collision Warning (FCW)	High-pitched tone	Warning message	Cancel
Distance Control Assist (DCA)	High-pitched tone	ICC system warning lamp	Cancel
Lane Departure Warning (LDW)	—	Lane Departure Warning lamp	Cancel
Lane Departure Prevention (LDP)	Low-pitched tone	Lane Departure Warning lamp	Cancel

# SYSTEM

< SYSTEM DESCRIPTION >

[FCW]

System	Buzzer	Warning lamp/Indicator lamp	Description
Blind Spot Warning (BSW)	—	Blind Spot Warning/Blind Spot Intervention warning lamp	Cancel
Blind Spot Intervention (BSI)	Low-pitched tone	Blind Spot Warning/Blind Spot Intervention warning lamp	Cancel
Backup Collision Intervention (BCI)	High-pitched tone	Backup Collision Intervention warning indicator	Cancel

## Fail-safe (ICC Sensor)

INFOID:000000009716574

If a malfunction occurs in the ICC sensor, ADAS control unit cancels control, sounds a beep, and turns ON the ICC system warning lamp in the combination meter.



OPERATION

Switch Name and Function

INFOID:000000009716575

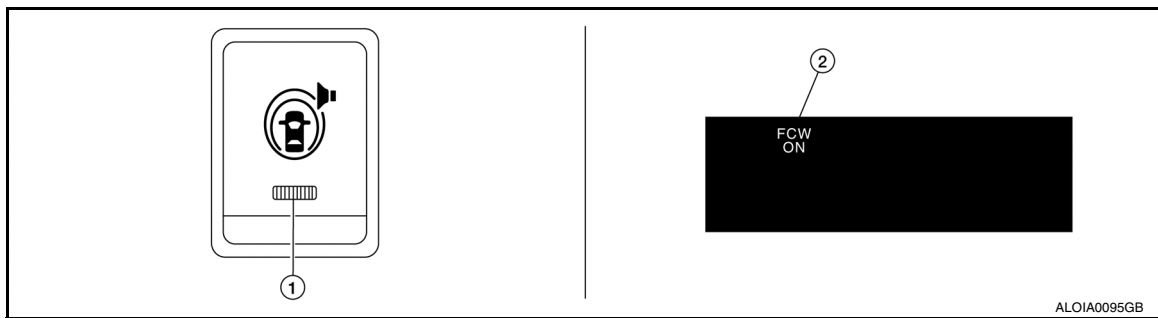

No.	Switch name	Description
1	Warning systems switch	Turns FCW system ON/OFF (When the setting of FCW system in the vehicle information display is ON)
2	FCW system setting screen (the vehicle information display)	The setting of FCW system can be switched between ON and OFF

Menu Displayed by Pressing Each Switch

INFOID:000000009716576

DISPLAY AND WARNING LAMP

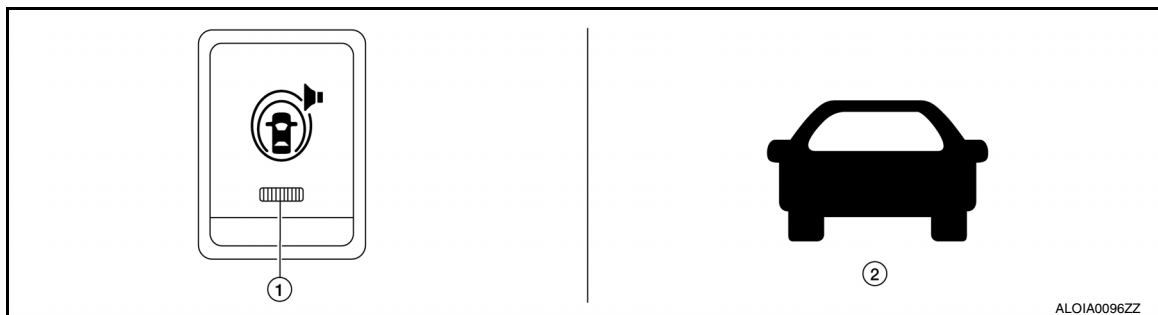

No.	Display item	Description
1	Warning systems ON indicator	<ul style="list-style-type: none"> <li>Indicates that the FCW system, LDW system, and/or BSW system is ON.</li> <li>Blinks when the setting of LDW, FCW, and BSW are "OFF" and the warning systems switch is pressed.</li> </ul>
2	Vehicle ahead detection indicator	Vehicle ahead detection indicator blinks when the FCW system is activated

SYSTEM CONTROL CONDITION DISPLAY

Condition	Warning systems ON indicator	Vehicle ahead detection indicator (In the combination meter)	Buzzer
Set condition	ON	OFF	—

# OPERATION

< SYSTEM DESCRIPTION >

[FCW]

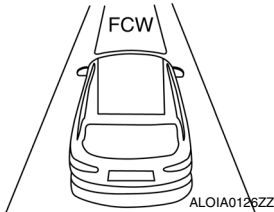
Condition	Warning systems ON indicator	Vehicle ahead detection indicator (In the combination meter)	Buzzer
When the warning systems switch is turned ON with settings of FCW system, LDW system and BSW system OFF	Blink	OFF	—
When own vehicle comes close to the vehicle ahead and it is judged that the distance between the vehicles is not sufficient	ON		Beep

## HANDLING PRECAUTION

### Precautions for Forward Collision Warning

INFOID:000000009716577

#### FORWARD COLLISION WARNING (FCW)

- FCW system is intended to warn the driver before a collision but will not avoid a collision. It is the driver's responsibility to stay alert, drive safely and be in control of the vehicle at all times.
- As there is a performance limit, the FCW system may not provide a warning in certain conditions.
- The FCW system will not detect the following objects.
  - Pedestrians, animals, or obstacles in the roadway.
  - Oncoming vehicles in the same lane
- FCW system will not detect under the following conditions.
  - When the sensor gets dirty, it is impossible to detect the distance from the vehicle ahead.
- The sensor generally detects signals returned from the reflectors on a vehicle ahead. Therefore, the FCW system may not warn properly under the following conditions:
  - When the sensor area of the front bumper gets dirty or it is impossible to detect the distance to the vehicle ahead.
  - When visibility is low (such as rain, fog, snow, etc.).
  - When snow or road spray from traveling vehicles are splashed.
  - When excessively heavy baggage is loaded in the rear seat or the luggage room of own vehicle.
  - When abruptly accelerating or decelerating.
  - On steep downhill or roads with sharp curves.
  - When there is a highly reflective object near the vehicle ahead.
    - i.e.) very close to other vehicle, signboard, etc.
  - When own vehicle are towing a trailer.
- Depending on certain road conditions (curved, beginning of a curve), vehicle conditions (steering position, vehicle position), or preceding vehicle's conditions (position in lane, etc.), the FCW system may not function properly. The FCW system may detect highly reflective objects such as signs and other stationary objects on the road or near the traveling lane, and provide unnecessary warning.
- The FCW system may not function in offset conditions.
- The FCW system may not function when the distance to the vehicle ahead is extremely close.
- The FCW system is designed to automatically check the sensor's functionality. If the sensor area of the front bumper is covered with ice, a transparent or translucent bag, etc., the system may not detect them. In these instances, the system may not be able to warn the driver properly. Be sure to check and clean the sensor area of the front bumper regularly.
- Excessive noise will interfere with the warning chime sound, and the chime may not be heard.
- A sudden appearance of the vehicle in front (i.e.: when a vehicle abruptly cuts in) may not be detected and the system may not warn soon enough.
- The FCW system will be canceled automatically with a chime sound and a warning message will appear under the following conditions:
  - When the sensor area of the front bumper is dirty
  - When the FCW system malfunctions

A  
B  
C  
D  
E  
F  
G  
H  
I  
J  
K  
L  
M  
N  
P

DAS

# DIAGNOSIS SYSTEM (ADAS CONTROL UNIT)

[FCW]

< SYSTEM DESCRIPTION >

## DIAGNOSIS SYSTEM (ADAS CONTROL UNIT)

### On Board Diagnosis Function

INFOID:00000009716578

#### DESCRIPTION

The DTC is displayed on the information display by operating the ICC steering switch.

#### On Board Self-diagnosis System Diagram

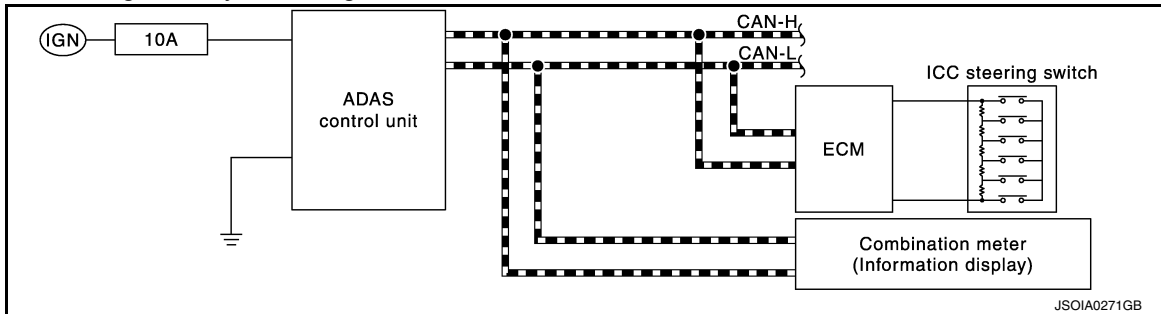

#### METHOD OF STARTING

##### CAUTION:

##### Start condition of on board self-diagnosis

- ICC system OFF
- DCA system OFF
- Vehicle speed 0 km/h (0 MPH)

1. Turn the ignition switch OFF.
2. Start the engine.
3. Wait for 5 seconds after starting the engine. Push up the RESUME/ACCELERATE switch 5 times and push down the SET/COAST switch 5 times within 10 seconds.

##### NOTE:

If the above operation cannot be performed within 10 seconds after waiting for 5 seconds after starting the engine, repeat the procedure from step 1.

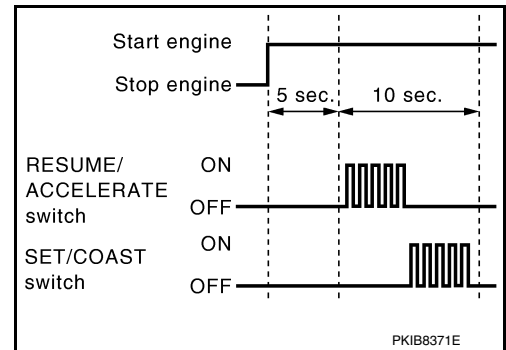

4. The DTC is displayed on the set vehicle speed indicator (1) on the ICC system display on the information display when the on board self-diagnosis starts. Refer to [DAS-280, "DTC Index"](#).

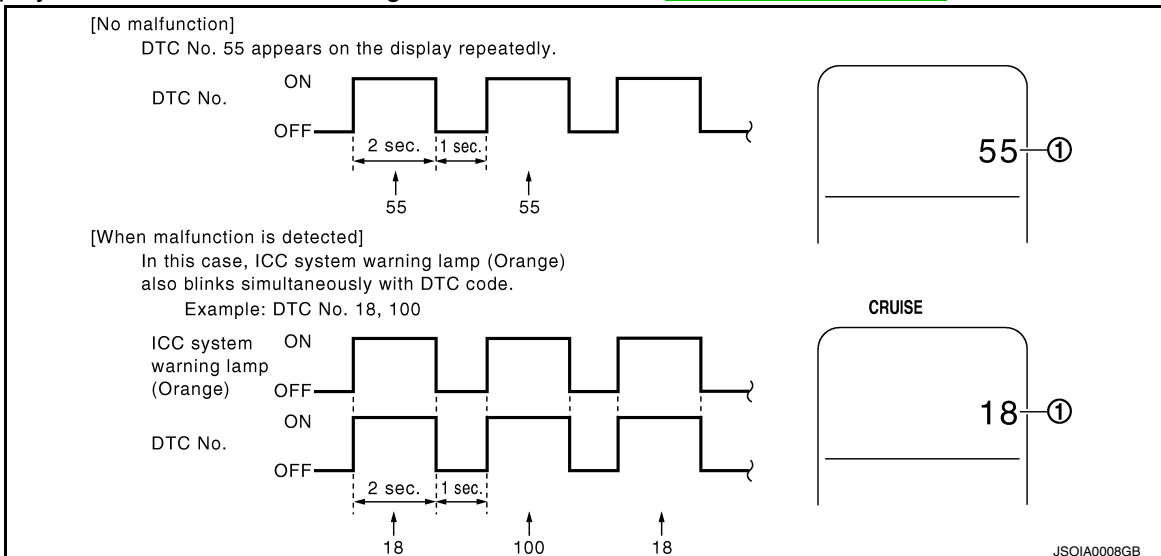

##### NOTE:

# DIAGNOSIS SYSTEM (ADAS CONTROL UNIT)

[FCW]

## < SYSTEM DESCRIPTION >

- It displays for up to 5 minutes and then stops.
- If multiple malfunctions exist, up to 6 DTCs can be stored in memory at the most, and the most recent one is displayed first.

## WHEN THE ON BOARD SELF-DIAGNOSIS DOES NOT START

If the on board self-diagnosis does not start, check the following items.

Assumed abnormal part		Inspection item
Information display	Combination meter malfunction	Check that the self-diagnosis function of the combination meter operates. Refer to <a href="#">MWI-15, "INFORMATION DISPLAY : System Description"</a>
ICC steering switch malfunction		Perform the inspection for DTC "C1A06". Refer to <a href="#">DAS-167, "Diagnosis Procedure"</a>
Harness malfunction between ICC steering switch and ECM		
ECM malfunction		
ADAS control unit malfunction		<ul style="list-style-type: none"> <li>• Check power supply and ground circuit of ADAS control unit. Refer to <a href="#">DAS-78, "Diagnosis Procedure"</a>.</li> <li>• Perform SELF-DIAGNOSIS for "ICC/ADAS" with CONSULT, and then check the malfunctioning parts. Refer to <a href="#">DAS-280, "DTC Index"</a>.</li> </ul>

## HOW TO ERASE ON BOARD SELF-DIAGNOSIS

1. Turn the ignition switch OFF.
2. Start the engine, and then start the on board self-diagnosis.
3. Press the CANCEL switch 5 times, and then press the DISTANCE switch 5 times under the condition that the on board self-diagnosis starts.

### NOTE:

- Complete the operation within 10 seconds after pressing the CANCEL switch first.
- If the operation is not completed within 10 seconds, repeat the procedure from step 1.

4. DTC 55 is displayed after erasing.

### NOTE:

DTCs for existing malfunction can not be erased.

5. Turn ignition switch OFF, and finish the diagnosis.

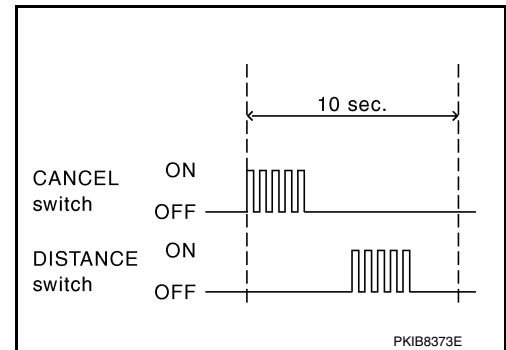

## CONSULT Function (ICC/ADAS)

INFOID:000000009716579

### CAUTION:

After disconnecting the CONSULT vehicle interface (VI) from the data link connector, the ignition must be cycled OFF → ON (for at least 5 seconds) → OFF. If this step is not performed, the BCM may not go to "sleep mode", potentially causing a discharged battery and a no-start condition.

## APPLICATION ITEMS

CONSULT performs the following functions via CAN communication using ADAS control unit.

Diagnosis mode	Description
Self Diagnostic Result	Displays the name of a malfunctioning system stored in the ADAS control unit.
Data Monitor	Displays ADAS control unit input/output data in real time.
Work support	Displays causes of automatic system cancellation occurred during system control.
Active Test	Enables an operational check of a load by transmitting a driving signal from the ADAS control unit to the load.
ECU identification	Displays ADAS control unit part number.
CAN Diag Support Mntr	Displays a reception/transmission state of CAN communication and ITS communication.

## SELF DIAGNOSTIC RESULT

Refer to [DAS-47, "DTC Index"](#).

# DIAGNOSIS SYSTEM (ADAS CONTROL UNIT)

< SYSTEM DESCRIPTION >

[FCW]

## DATA MONITOR

Monitored item [Unit]	ALL SIG (ICC)	MAIN SIG (ICC)	MAIN SIG (LDW/LDP)	MAIN SIG (BSW/BSI)	BCI MAIN	Description
MAIN SW [On/Off]	×	×	×	×		Indicates [On/Off] status as judged from ICC steering switch signal (ECM transmits ICC steering switch signal through CAN communication)
SET/COAST SW [On/Off]	×	×				Indicates [On/Off] status as judged from ICC steering switch signal (ECM transmits ICC steering switch signal through CAN communication)
CANCEL SW [On/Off]	×	×				Indicates [On/Off] status as judged from ICC steering switch signal (ECM transmits ICC steering switch signal through CAN communication)
RESUME/ACC SW [On/Off]	×	×				Indicates [On/Off] status as judged from ICC steering switch signal (ECM transmits ICC steering switch signal through CAN communication)
DISTANCE SW [On/Off]	×					Indicates [On/Off] status as judged from ICC steering switch signal (ECM transmits ICC steering switch signal through CAN communication)
CRUISE OPE [On/Off]	×	×				Indicates whether controlling or not (ON means "controlling")
BRAKE SW [On/Off]	×	×	×	×	×	Indicates [On/Off] status as judged from ICC brake switch signal (ECM transmits ICC brake switch signal through CAN communication)
STOP LAMP SW [On/Off]	×	×	×	×	×	Indicates [On/Off] status as judged from stop lamp switch signal (ECM transmits stop lamp switch signal through CAN communication)
IDLE SW [On/Off]	×				×	Indicates [On/Off] status of idle switch read from ADAS control unit through CAN communication (ECM transmits On/Off status through CAN communication)
SET DISTANCE [Short/Mid/Long]	×	×				Indicates set distance memorized in ADAS control unit
CRUISE LAMP [On/Off]	×	×				Indicates [On/Off] status of MAIN switch indicator output
OWN VHCL [On/Off]	×					Indicates [On/Off] status of own vehicle indicator output
VHCL AHEAD [On/Off]	×					Indicates [On/Off] status of vehicle ahead detection indicator output
ICC WARNING [On/Off]	×					Indicates [On/Off] status of ICC system warning lamp output
VHCL SPEED SE [km/h] or [mph]	×	×	×	×	×	Indicates vehicle speed calculated from ADAS control unit through CAN communication [ABS actuator and electric unit (control unit) transmits vehicle speed signal (wheel speed) through CAN communication]
SET VHCL SPD [km/h] or [mph]	×	×				Indicates set vehicle speed memorized in ADAS control unit
BUZZER O/P [On/Off]	×				×	Indicates [On/Off] status of ICC warning chime output
THRSL SENSOR [deg]	×	×				<b>NOTE:</b> The item is displayed, but it is not monitored
ENGINE RPM [rpm]	×					Indicates engine speed read from ADAS control unit through CAN communication (ECM transmits engine speed signal through CAN communication)
WIPER SW [OFF/LOW/HIGH]	×					Indicates wiper [OFF/LOW/HIGH] status (BCM transmits front wiper request signal through CAN communication)
BA WARNING [On/Off]	×					Indicates [On/Off] status of IBA OFF indicator lamp output
STP LMP DRIVE [On/Off]	×	×			×	Indicates [On/Off] status of ICC brake hold relay drive output

# DIAGNOSIS SYSTEM (ADAS CONTROL UNIT)

< SYSTEM DESCRIPTION >

[FCW]

Monitored item [Unit]	ALL SIG (ICC)	MAIN SIG (ICC)	MAIN SIG (LDW/LDP)	MAIN SIG (BSW/BSI)	BCI MAIN	Description
D RANGE SW [On/Off]	×					Indicates [On/Off] status of "D" or "M" positions read from ADAS control unit through CAN communication; ON when position "D" or "M" (TCM transmits shift position signal through CAN communication).
NP RANGE SW [On/Off]	×					Indicates shift position signal read from ADAS control unit through CAN communication (TCM transmits shift position signal through CAN communication)
PKB SW [On/Off]	×					Parking brake switch status [On/Off] judged from the parking brake switch signal that ADAS control unit readout via CAN communication is displayed (Combination meter transmits the parking brake switch signal via CAN communication)
PWR SUP MONI [V]	×	×				Indicates IGN voltage input by ADAS control unit
VHCL SPD AT [km/h] or [mph]	×					Indicates vehicle speed calculated from CVT vehicle speed sensor read from ADAS control unit through CAN communication (TCM transmits CVT vehicle speed sensor signal through CAN communication)
THRTL OPENING [%]	×	×			×	Indicates throttle position read from ADAS control unit through CAN communication (ECM transmits accelerator pedal position signal through CAN communication).
GEAR [1, 2, 3, 4, 5, 6]	×					Indicates CVT gear position read from ADAS control unit through CAN communication (TCM transmits current gear position signal through CAN communication)
MODE SIG [OFF, ICC, ASCD]	×					Indicates the active mode from ICC or ASCD [conventional (fixed speed) cruise control mode]
SET DISP IND [On/Off]	×					Indicates [On/Off] status of SET switch indicator output
DISTANCE [m]	×					Indicates the distance from the vehicle ahead
RELATIVE SPD [m/s]	×					Indicates the relative speed of the vehicle ahead
Camera lost [Detect/Deviate/Both]			×	×		Indicates a lane marker detection state judged from a lane marker detection signal read by the ADAS control unit via ITS communication (Lane camera unit transmits a lane marker signal via ITS communication)
Lane unclear [On/Off]			×	×		Indicates an ON/OFF state of the lane marker. The ON/OFF state is judged from a detected lane condition signal read by the ADAS control unit via ITS communication (The lane camera unit transmits a detected lane condition signal via ITS communication)
STATUS signal [Stnby/Warn/Cancl/Off]			×			Indicates a control state of LDP system
DYNA ASIST SW [On/Off]	×	×		×		Indicates [On/Off] status as judged from ICC steering switch signal (ECM transmits ICC steering switch signal through CAN communication)
DCA ON IND [On/Off]	×					The status [ON/OFF] of DCA system switch indicator output is displayed
DCA VHL AHED [On/Off]	×					The status [ON/OFF] of vehicle ahead detection indicator output in DCA system is displayed
IBA SW [On/Off]	×	×				Indicates [On/Off] status of IBA OFF switch
APA TEMP [°C]	×				×	Accelerator pedal actuator integrated motor temperature that the ADAS control unit readout via ITS communication is displayed (Accelerator pedal actuator transmits the integrated motor temperature via ITS communication)

A  
B  
C  
D  
E  
F  
G  
H  
I  
J  
K  
L  
M  
N  
P

DAS

# DIAGNOSIS SYSTEM (ADAS CONTROL UNIT)

[FCW]

< SYSTEM DESCRIPTION >

Monitored item [Unit]	ALL SIG (ICC)	MAIN SIG (ICC)	MAIN SIG (LDW/LDP)	MAIN SIG (BSW/BSI)	BCI MAIN	Description
APA PWR [V]	×				×	Accelerator pedal actuator power supply voltage that the ADAS control unit read-out via ITS communication is displayed (Accelerator pedal actuator transmits the power supply voltage via ITS communication)
FCW SYSTEM ON [On/Off]	×	×				Indicates [On/Off] status of FCW system
LDW SYSTEM ON [On/Off]			×			Indicates [On/Off] status of LDW system
LDW ON LAMP [On/Off]			×			Indicates [On/Off] status of warning systems ON indicator output
LDP ON IND [On/Off]			×			Indicates [On/Off] status of LDP ON indicator lamp (Green) output
LANE DPRT W/L [On/Off]			×			Indicates [On/Off] status of lane departure warning lamp (Yellow) output
LDW BUZER OUTPUT [On/Off]			×			Indicates [On/Off] status of warning buzzer output
LDP SYSTEM ON [On/Off]			×			Indicates [On/Off] status of LDP system
READY signal [On/Off]			×			Indicates LDP system settings
Shift position [Off, P, R, N, D, M/T1 - 7]			×	×	×	Indicates shift position read from ADAS control unit through CAN communication (TCM transmits shift position signal through CAN communication)
Turn signal [OFF/LH/RH/LH&RH]			×	×		Indicates turn signal operation status read from ADAS control unit through CAN communication (BCM transmits turn indicator signal through CAN communication)
SIDE G [G]			×	×		Indicates lateral G acting on the vehicle. This lateral G is judged from a side G sensor signal read by ADAS control unit via CAN communication (The ABS actuator and electric unit (control unit) transmits a side G sensor signal via CAN communication)
FUNC ITEM(FCW)	×	×	×	×		Indicates systems which can be set to ON/OFF by selecting "Driver Assistance"⇒ "Driving aids" of the navigation system FCW: Distance Control Assist (DCA), Lane Departure Prevention (LDP) and Blind Spot Intervention
FUNC ITEM(LDW)	×	×	×	×		Indicates systems which can be set to ON/OFF by selecting "Driver Assistance"⇒ "Driving aids" of the navigation system LDW: Distance Control Assist (DCA), Lane Departure Prevention (LDP) and Blind Spot Intervention
FUNC ITEM(BSW)	×	×	×	×		Indicates systems which can be set to ON/OFF by selecting "Driver Assistance"⇒ "Driving aids" of the navigation system BSW: Distance Control Assist (DCA), Lane Departure Prevention (LDP) and Blind Spot Intervention
FUNC ITEM (NV-ICC) [Off]	×	×	×	×		<b>NOTE:</b> The item is displayed, but it is not monitored
FUNC ITEM (NV-DCA) [Off]	×	×	×	×		<b>NOTE:</b> The item is displayed, but it is not monitored
DCA SELECT [On/Off]	×	×	×	×		Indicates an ON/OFF state of DCA system. DCA system can be set to ON/OFF by selecting "Driver Assistance"⇒ "Driving aids" of the navigation system
LDP SELECT [On/Off]	×	×	×	×		Indicates an ON/OFF state of LDP system. LDP system can be set to ON/OFF by selecting "Driver Assistance"⇒ "Driving aids" of the navigation system



# DIAGNOSIS SYSTEM (ADAS CONTROL UNIT)

< SYSTEM DESCRIPTION >

[FCW]

Monitored item [Unit]	ALL SIG (ICC)	MAIN SIG (ICC)	MAIN SIG (LDW/LDP)	MAIN SIG (BSW/BSI)	BCI MAIN	Description
BSI SELECT [On/Off]	×	×	×	×		Indicates an ON/OFF state of Blind Spot Intervention system. Blind Spot Intervention system can be set to ON/OFF by selecting "Driver Assistance"⇒"Driving aids" of the navigation system
DRIVE MODE STATS [SNO/ECO/STD/SPT]	×	×	×	×		Indicates [On/Off] status of warning systems switch
WARN SYS SW [On/Off]	×	×	×	×		Indicates [On/Off] status of warning systems switch
BSW/BSI WARN LMP [On/Off]				×		Indicates [On/Off] status of Blind Spot Warning/Blind Spot Intervention warning lamp output
BSI ON IND [On/Off]				×		Indicates [On/Off] status of Blind Spot Intervention ON indicator output
BSW SYSTEM ON [On/Off]				×		Indicates [On/Off] status of BSW system
BSI SYSTEM ON [On/Off]				×		Indicates [On/Off] status of Blind Spot Intervention system
BCI SYSTEM ON [On/Off]					×	Indicates [On/Off] status of Backup Collision Intervention system
BCI SWITCH [On/Off]					×	Indicates [On/Off] status of Backup Collision Intervention system switch
LDP WARNING INDICA- TOR [On/Off]			×			Indicates [On/Off] status of Lane Departure Prevention system failure lamp
LDW ON INDICATOR [On/Off]			×			Indicates [On/Off] status of LDW system
LDW WARNING INDICA- TOR [On/Off]			×			Indicates [On/Off] status of Lane Departure Warning system failure lamp
SYSTEM CANCEL MES- SAGE [Request/No Request]	×	×	×	×		Indicates system cancel message request
CAMERA HI TEMP MSG [On/Off]			×	×		Indicates high temperature message has been received
ITS Setting Item(DCA) [On/Off]	×	×	×	×		Indicates [On/Off] status of Distance Control Assist warning lamp output
ITS Setting Item(LDP) [On/Off]	×	×	×	×		Indicates [On/Off] status of Lane Departure Prevention warning lamp output
ITS Setting Item(BSI) [On/Off]	×	×	×	×		Indicates [On/Off] status of Blind Spot Intervention system
BSI WARNING INDICA- TOR [On/Off]				×		Indicates [On/Off] status of Blind Spot Intervention warning lamp indicator
BSW ON INDICATOR [On/Off]				×		Indicates [On/Off] status of BSW system
BSW IND BRIGHTNESS [Bright/Not Bright]				×		Indicates BSW warning lamp indicator brightness level
WARN REQ [On/Off]			×			Indicates an ADAS control unit judged warning state (ON/OFF) of LDP system

A

B

C

D

E

F

G

H

I

J

K

L

M

DAS

P

# DIAGNOSIS SYSTEM (ADAS CONTROL UNIT)

[FCW]

< SYSTEM DESCRIPTION >

## WORK SUPPORT

Work support items	Description
CAUSE OF AUTO-CANCEL 1	Displays causes of automatic system cancellation occurred during control of the following systems <ul style="list-style-type: none"> <li>• Vehicle-to-vehicle distance control mode</li> <li>• Conventional (fixed speed) cruise control mode</li> <li>• Distance Control Assist (DCA)</li> </ul>
CAUSE OF AUTO-CANCEL 2	Displays causes of automatic system cancellation occurred during control of the following systems <ul style="list-style-type: none"> <li>• Lane Departure Prevention (LDP)</li> <li>• Blind Spot Intervention</li> </ul>
CAUSE OF AUTO-CANCEL 3	Displays causes of automatic system cancellation occurred during control of the following system <ul style="list-style-type: none"> <li>• Backup Collision Intervention</li> </ul>

**NOTE:**

- Causes of the maximum five cancellations (system cancel) are displayed.
- The displayed cancellation causes display the number of the ignition switch ON/OFF up to 254. It is fixed to 254 if it is over 254. It returns to 0 when the same cancellation cause is detected again.

Display Items for The Cause of Automatic Cancellation 1

Cause of cancellation	Vehicle-to-vehicle distance control mode	Conventional (fixed speed) cruise control mode	Distance Control Assist	Description
OPERATING ABS	×		×	ABS function was operated
OPERATING TCS	×	×	×	TCS function was operated
OPERATING VDC	×	×	×	VDC function was operated
ECM CIRCUIT	×	×		ECM did not permit ICC operation
OPE SW VOLT CIRC	×	×	×	The ICC steering switch input voltage is not within standard range
LASER TEMP	×		×	Temperature around ICC sensor became low
SNOW MODE SW	×		×	SNOW mode switch was pressed
OP SW DOUBLE TOUCH	×	×		ICC steering switches were pressed at the same time
VHCL SPD DOWN	×	×	×	Vehicle speed lower than the speed as follows <ul style="list-style-type: none"> <li>• Vehicle-to-vehicle distance control mode is 24 km/h (15 MPH)</li> <li>• Conventional (fixed speed) cruise control mode is 22 km/h (14 MPH)</li> </ul>
WHL SPD ELEC NOISE	×	×	×	Wheel speed sensor signal caught electromagnetic noise
VDC/TCS OFF SW	×		×	VDC OFF switch was pressed
VHCL SPD UNMATCH	×	×	×	Wheel speed became different from CVT vehicle speed
FR RADAR BLOCKED	×		×	The front bumper near the ICC sensor is blocked or dirty
TIRE SLIP	×	×		Wheel slipped

# DIAGNOSIS SYSTEM (ADAS CONTROL UNIT)

< SYSTEM DESCRIPTION >

[FCW]

IGN LOW VOLT	×	×	×	Decrease in ADAS control unit IGN voltage	A
PARKING BRAKE ON	×	×		The parking brake is engaged	B
WHEEL SPD UNMATCH	×	×	×	The wheel speeds of 4 wheels are out of the specified values	C
INCHING LOST	×			A vehicle ahead is not detected during the following driving when the vehicle speed is approximately 24 km/h (15 MPH) or less	D
CAN COMM ERROR	×	×	×	ADAS control unit received an abnormal signal with CAN communication	E
ABS/TCS/VDC CIRC	×	×	×	An abnormal condition occurs in VDC/TCS/ABS system	F
ECD CIRCUIT	×	×	×	An abnormal condition occurs in ECD system	G
ASCD VHCL SPD DTAC		×		Vehicle speed is detached from set vehicle speed	H
ASCD DOUBLE COMD		×		Cancel switch and operation switch are detected simultaneously	I
APA HI TEMP			×	The accelerator pedal actuator integrated motor temperature is high	J
ICC SENSOR CAN COMM ERR	×		×	Communication error between ADAS control unit and the ICC sensor	K
ABS WARNING LAMP	×		×	ABS warning lamp ON	L
NO RECORD	×	×	×	—	M

## Display Items for The Cause of Automatic Cancellation 2

Cause of cancellation	Lane departure prevention	Blind spot intervention	Description	
OPE VDC/TCS/ABS 1	×		The activation of VDC, TCS, or ABS during LDP system control	N
Vehicle dynamics	×		Vehicle behavior exceeds specified value	O
Steering speed	×		Steering speed was more than the specified value in evasive direction	P
End by yaw angle	×		Yaw angle was the end of LDP control	Q
Departure yaw large	×		Detected more than the specified value of yaw angle in departure direction	R
ICC WARNING	×		Target approach warning of ICC system, IBA system, or FCW system was activated	S
CURVATURE	×		Road curve was more than the specified value	T
Steering angle large	×		Steering angle was more than the specified value	U
Brake is operated	×		Brake pedal was operated	V
IGN LOW VOLT	×		Decrease in ADAS control unit IGN voltage	W
Lateral offset	×		Distance of vehicle and lane was detached in lateral direction more than the specified value	X
Lane marker lost	×		Lane camera unit lost the trace of lane marker	Y
Lane marker unclear	×		Detected lane marker was unclear	Z
Yaw acceleration	×		Detected yawing speed was more than the specified value	AA
Deceleration large	×		Deceleration in a longitudinal direction was more than the specified value	AB
Accel is operated	×		Accelerator pedal was depressed	AC
Departure steering	×		Steering wheel was steered more than the specified value in departure direction	AD
Evasive steering	×		Steering wheel was steered more than the specified value in the evasive direction	AE
R range	×		Selector lever was operated to R range	AF
Parking brake drift	×		Rear wheels lock was detected	AG

# DIAGNOSIS SYSTEM (ADAS CONTROL UNIT)

< SYSTEM DESCRIPTION >

[FCW]

Cause of cancellation	Lane departure prevention	Blind spot intervention	Description
Not operating condition	×		Did not meet the operating condition (vehicle speed, turn signal operation, etc.)
SNOW MODE SW	×		SNOW mode switch was pressed
VDC OFF SW	×		VDC OFF switch was pressed
OPE VDC/ABS 2	×		The activation of VDC or ABS during a standby time of LDP system control
BSI WARNING	×		Blind Spot Intervention system was activated
BSI) OPE VDC/TCS/ABS 1		×	The activation of VDC, TCS, or ABS during Blind Spot Intervention system control
BSI) Vehicle dynamics		×	Vehicle behavior exceeds specified value
BSI) Steering speed		×	Steering speed was more than the specified value in evasive direction
BSI) End by yaw angle		×	Yaw angle was the end of Blind Spot Intervention control
BSI) Departure yaw large		×	Detected more than the specified value of yaw angle in departure direction
BSI) ICC WARNING		×	Target approach warning of ICC system, IBA system or FCW system was activated
BSI) CURVATURE		×	Road curve was more than the specified value
BSI) Steering angle large		×	Steering angle was more than the specified value
BSI) Brake is operated		×	Brake pedal was operated
BSI) IGN LOW VOLT		×	Decrease in ADAS control unit IGN voltage
BSI) Lateral offset		×	Distance of vehicle and lane was detached in lateral direction more than the specified
BSI) Lane marker lost		×	Lane camera unit lost the trace of lane marker
BSI) Lane marker unclear		×	Detected lane marker was unclear
BSI) Yaw acceleration		×	Detected yawing speed was more than the specified value
BSI) Deceleration large		×	Deceleration in a longitudinal direction was more than the specified value
BSI) Accel is operated		×	Accelerator pedal was depressed
BSI) Departure steering		×	Steering wheel was steered more than the specified value in departure direction
BSI) Evasive steering		×	Steering wheel was steered more than the specified value in the evasive direction
BSI) R range		×	Selector lever was operated to R range
BSI) Parking brake drift		×	Rear wheels lock was detected
BSI) SNOW MODE SW		×	SNOW mode switch was pressed
BSI) VDC OFF SW		×	VDC OFF switch was pressed
BSI) OPE VDC/ABS 2		×	The activation of VDC or ABS during a standby time of Blind Spot Intervention system control
BSI) Not operating condition		×	Did not meet the operating condition (vehicle speed, turn signal operation, etc.)
Side Radar Lost		×	Unrecognized side radar LH or RH by the ADAS control unit
NO RECORD	×	×	—

Display Items for The Cause of Automatic Cancellation 3

# DIAGNOSIS SYSTEM (ADAS CONTROL UNIT)

< SYSTEM DESCRIPTION >

[FCW]

Cause of cancellation	Backup Collision Intervention	Description
OPERATING WIPER	×	The wiper operates at HI (it includes when the wiper is operated at HI with the wiper switch AUTO position)
OPERATING ABS	×	ABS function was operated
OPERATING TCS	×	TCS function was operated
OPERATING VDC	×	VDC function was operated
ECM CIRCUIT	×	ECM did not permit ICC operation
SNOW MODE SW	×	SNOW mode switch was pressed
VDC/TCS OFF SW	×	VDC OFF switch was pressed
VHCL SPD UNMATCH	×	Wheel speed became different from CVT vehicle speed
TIRE SLIP	×	Wheel slipped
IGN LOW VOLT	×	Decrease in ADAS control unit IGN voltage
PARKING BRAKE ON	×	The parking brake is engaged
WHEEL SPD UNMATCH	×	The wheel speeds of 4 wheels are out of the specified values
CAN COMM ERROR	×	ADAS control unit received an abnormal signal with CAN communication
ABS/TCS/VDC CIRC	×	An abnormal condition occurs in VDC/TCS/ABS system
ECD CIRCUIT	×	An abnormal condition occurs in ECD system
APA HI TEMP		The accelerator pedal actuator integrated motor temperature is high
ABS WARNING LAMP	×	ABS warning lamp ON
Brake is operated	×	Brake pedal was operated
Accel is operated	×	Accelerator pedal was depressed
SNOW MODE SW	×	DMS switch SNOW mode was selected
VDC OFF SW	×	VDC OFF switch was pressed
Side Radar Lost	×	Unrecognized side radar LH or RH by the ADAS control unit
NO RECORD	×	—

## ACTIVE TEST

### CAUTION:

- Never perform “Active Test” while driving the vehicle.
- The “Active Test” cannot be performed when the following systems warning lamp is illuminated.
  - ICC system warning lamp
  - Lane departure warning lamp
  - Blind Spot Warning/Blind Spot Intervention warning lamp
  - IBA OFF indicator lamp (IBA system ON)
- Shift the selector lever to “P” position, and then perform the test.

Test item	Description
BRAKE ACTUATOR	Activates the brake by an arbitrary operation
ICC BUZZER	Sounds a buzzer used for following systems by arbitrarily operating ON/OFF <ul style="list-style-type: none"> <li>• Intelligent Cruise Control (ICC)</li> <li>• Distance Control Assist (DCA)</li> <li>• Forward Collision Warning (FCW)</li> <li>• Intelligent Brake Assist (IBA)</li> </ul>

A  
B  
C  
D  
E  
F  
G  
H  
I  
J  
K  
L  
M  
N  
P

DAS

# DIAGNOSIS SYSTEM (ADAS CONTROL UNIT)

[FCW]

## < SYSTEM DESCRIPTION >

Test item	Description
METER LAMP	The ICC system warning lamp, MAIN switch indicator and IBA OFF indicator lamp can be illuminated by ON/OFF operations as necessary
STOP LAMP	The ICC brake hold relay can be operated by ON/OFF operations as necessary, and the stop lamp can be illuminated
ACTIVE PEDAL	The accelerator pedal actuator can be operated as necessary
DCA INDICATOR	The DCA system switch indicator can be illuminated by ON/OFF operations as necessary
LDP BUZZER	Sounds a buzzer used for following systems by arbitrarily operating ON/OFF <ul style="list-style-type: none"> <li>• Lane Departure Warning (LDW)</li> <li>• Lane Departure Prevention (LDP)</li> <li>• Blind Spot Warning (BSW)</li> <li>• Blind Spot Intervention</li> </ul>
WARNING SYSTEM IND	Warning systems ON indicator (on warning systems switch) can be illuminated by ON/OFF operations as necessary
LDP ON IND	The LDP ON indicator lamp can be illuminated by ON/OFF operations as necessary
LANE DEPARTURE W/L	The Lane departure warning lamp can be illuminated by ON/OFF operations as necessary
BSW/BSI WARNING LAMP	The Blind Spot Warning/Blind Spot Intervention warning lamp can be illuminated by ON/OFF operations as necessary
BSI ON INDICATOR	The Blind Spot Intervention ON indicator can be illuminated by ON/OFF operations as necessary
LDW ON INDICATOR	The LDW ON indicator lamp can be illuminated by ON/OFF operations as necessary
BSW ON INDICATOR	The BSW ON indicator lamp can be illuminated by ON/OFF operations as necessary

### BRAKE ACTUATOR

**NOTE:**

The test can be performed only when the engine is running.

Test item	Operation	Description	"PRESS SENS" value
BRAKE ACTUATOR	MODE1	Transmits the brake fluid pressure control signal to the ABS actuator and electric unit (control unit) via CAN communication	10 bar
	MODE2		20 bar
	MODE3		30 bar
	Test start	Starts the tests of "MODE1", "MODE2" and "MODE3"	—
	Reset	Stops transmitting the brake fluid pressure control signal below to end the test	—
	End	Returns to the "SELECT TEST ITEM" screen	—

**NOTE:**

The test is finished in 10 seconds after starting

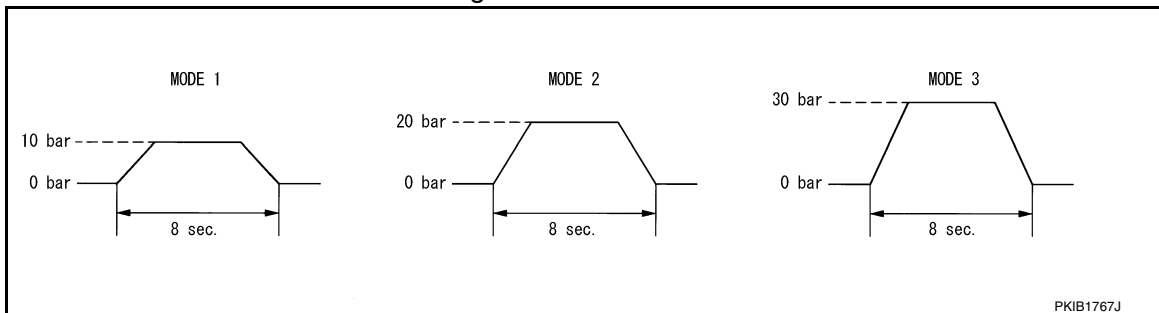

### ICC BUZZER

# DIAGNOSIS SYSTEM (ADAS CONTROL UNIT)

< SYSTEM DESCRIPTION >

[FCW]

Test item	Operation	Description	ICC warning chime operation sound
ICC BUZZER	MODE1	Transmits the buzzer output signals to the combination meter via CAN communication	Intermittent beep sound
	Test start	Starts the tests of "MODE1"	—
	Reset	Stops transmitting the buzzer output signal below to end the test	—
	End	Returns to the "SELECT TEST ITEM" screen	—

## METER LAMP

### NOTE:

The test can be performed only when the engine is running.

Test item	Operation	Description	<ul style="list-style-type: none"> <li>• MAIN switch indicator</li> <li>• ICC system warning lamp</li> <li>• IBA OFF indicator lamp</li> </ul>
METER LAMP	Off	Stops sending the following signals to exit from the test <ul style="list-style-type: none"> <li>• Meter display signal</li> <li>• ICC warning lamp signal</li> <li>• IBA OFF indicator lamp signal</li> </ul>	OFF
	On	Transmits the following signals to the combination meter via CAN communication <ul style="list-style-type: none"> <li>• Meter display signal</li> <li>• ICC warning lamp signal</li> <li>• IBA OFF indicator lamp signal</li> </ul>	ON

## STOP LAMP

Test item	Operation	Description	Stop lamp
STOP LAMP	Off	Stops transmitting the ICC brake hold relay drive signal below to end the test	OFF
	On	Transmits the ICC brake hold relay drive signal	ON

## ACTIVE PEDAL

### CAUTION:

- Shift the selector lever to "P" position, and then perform the test.
- Never depress the accelerator pedal excessively. (The engine speed may rise unexpectedly when finishing the test.)

### NOTE:

- Depress the accelerator pedal to check when performing the test.
- The test can be performed only when the engine is running.

Test item	Operation	Description	Accelerator pedal operation
Active Pedal	MODE1	Transmit the accelerator pedal feedback force control signal to the accelerator pedal actuator via ITS communication.	Constant with a force of 25 N for 8 seconds
	MODE2		Constant with a force of 15 N for 8 seconds
	MODE3		Change up to a force of 25 N for 8 seconds
	MODE4		Change up to a force of 15 N for 8 seconds
	Test start	Starts the tests of "MODE1", "MODE2", "MODE3" and "MODE4"	—
	Reset	Stops transmitting the accelerator pedal feedback force control signal below to end the test.	—
	End	Returns to the "SELECT TEST ITEM" screen	—

# DIAGNOSIS SYSTEM (ADAS CONTROL UNIT)

[FCW]

## < SYSTEM DESCRIPTION >

### NOTE:

The test is finished in 10 seconds after starting

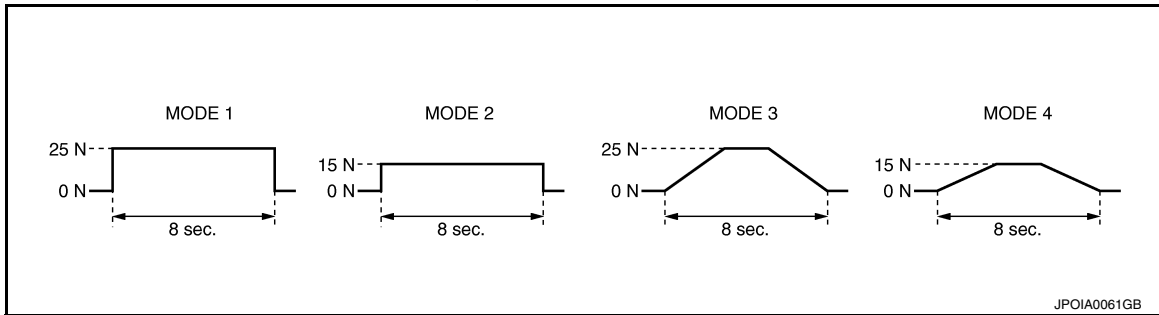

### DCA INDICATOR

#### NOTE:

The test can be performed only when the engine is running.

Test item	Operation	Description	DCA system switch indicator
DCA INDICATOR	Off	Stops transmitting the DCA system switch indicator signal below to end the test	—
	On	Transmits the DCA system switch indicator signal to the combination meter via CAN communication	ON

### LDP BUZZER

Test item	Operation	Description	Warning buzzer
LDP BUZZER	Off	Stops transmitting the warning buzzer signal below to end the test	—
	On	Transmits the warning buzzer signal to the warning buzzer	ON

### WARNING SYSTEM IND

Test item	Operation	Description	Warning systems ON indicator
WARNING SYSTEM IND	Off	Stops transmitting the warning systems ON indicator signal below to end the test	—
	On	Transmits the warning systems ON indicator signal to the warning systems ON indicator	ON

### LDP ON IND

Test item	Operation	Description	LDP ON indicator lamp (Green)
LDP ON IND	Off	Stops transmitting the LDP ON indicator lamp signal below to end the test	—
	On	Transmits the LDP ON indicator lamp signal to the combination meter via CAN communication	ON

### LANE DEPARTURE W/L

Test item	Operation	Description	Lane departure warning lamp (Yellow)
LANE DEPARTURE W/L	Off	Stops transmitting the lane departure warning lamp signal below to end the test	—
	On	Transmits the lane departure warning lamp signal to the combination meter via CAN communication	ON



# DIAGNOSIS SYSTEM (ADAS CONTROL UNIT)

< SYSTEM DESCRIPTION >

[FCW]

## BSW/BSI WARNING LAMP

Test item	Operation	Description	Blind Spot Warning/Blind Spot Intervention warning lamp (Yellow)
BSW/BSI WARNING LAMP	Off	Stops transmitting the Blind Spot Warning/Blind Spot Intervention warning lamp signal below to end the test	—
	On	Transmits the Blind Spot Warning/Blind Spot Intervention warning lamp signal to the combination meter via CAN communication	ON

## BSI ON INDICATOR

Test item	Operation	Description	Blind Spot Intervention ON indicator lamp (Green)
BSI ON INDICATOR	Off	Stops transmitting the Blind Spot Intervention ON indicator signal below to end the test	—
	On	Transmits the Blind Spot Intervention ON indicator signal to the combination meter via CAN communication	ON

## LDW ON INDICATOR

Test item	Operation	Description	Lane Departure Warning ON indicator lamp (Yellow)
LDW ON INDICATOR	Off	Stops transmitting the Lane Departure Warning ON indicator signal below to end the test	—
	On	Transmits the Lane Departure Warning ON indicator signal to the combination meter via CAN communication	ON

## BSW ON INDICATOR

Test item	Operation	Description	Blind Spot Warning ON indicator lamp (Yellow)
BSW ON INDICATOR	Off	Stops transmitting the Blind Spot Warning ON indicator signal below to end the test	—
	On	Transmits the Blind Spot Warning ON indicator signal to the warning lamp on the door	ON

## ECU IDENTIFICATION

ADAS control unit part number is displayed.

A  
B  
C  
D  
E  
F  
G  
H  
I  
J  
K  
L  
M  
N  
P

DAS

# DIAGNOSIS SYSTEM (ICC SENSOR)

< SYSTEM DESCRIPTION >

[FCW]

## DIAGNOSIS SYSTEM (ICC SENSOR)

### CONSULT Function (LASER/RADAR)

INFOID:000000009716580

#### CAUTION:

After disconnecting the CONSULT vehicle interface (VI) from the data link connector, the ignition must be cycled OFF → ON (for at least 5 seconds) → OFF. If this step is not performed, the BCM may not go to “sleep mode”, potentially causing a discharged battery and a no-start condition.

#### APPLICATION ITEMS

CONSULT performs the following functions via CAN communication with ADAS control unit and the communication with ICC sensor.

Diagnosis mode	Description
Self Diagnostic Result	Displays malfunctioning system memorized in ICC sensor
Data Monitor	Displays real-time input/output data of ICC sensor
Work support	It can monitor the adjustment direction indication in order to perform the radar adjustment operation smoothly
ECU identification	Displays ICC sensor part number
CAN Diag Support Monitor	The results of transmit/receive diagnosis of ITS communication can be read

#### SELF DIAGNOSTIC RESULT

Refer to [DAS-128. "DTC Index"](#).

#### DATA MONITOR

Monitored item [Unit]	Description
VHCL SPEED SE [km/h] or [mph]	Vehicle speed judged from a vehicle speed signal read by the ICC sensor via ITS communication is displayed [ADAS control unit receives a vehicle speed signal from ABS actuator and electric unit (control unit) via CAN communication and transmits the calculated vehicle speed to ICC sensor via ITS communication]
YAW RATE [deg/s]	Indicates yaw rate read from ADAS control unit through ITS communication (ADAS control unit receives yaw rate signal from ABS actuator and electric unit (control unit) via CAN communication and transmits yaw rate calculated by the ADAS control unit) Yaw rate judged from a yaw rate signal read by ICC sensor via ITS communication is displayed [ADAS control unit receives a yaw rate signal from ABS actuator and electric unit (control unit) via CAN communication and transmits the calculated yaw rate to ICC sensor via ITS communication]
PWR SUP MONI [V]	Indicates IGN voltage input by ICC sensor
DISTANCE [m]	Indicates the distance from the vehicle ahead
RELATIVE SPD [m/s]	Indicates the relative speed of the vehicle ahead
RADAR OFFSET [m]	<b>NOTE:</b> The item is indicated, but not used
RADAR HEIGHT [m]	<b>NOTE:</b> The item is indicated, but not used
STEERING ANGLE [deg]	The steering angle is displayed
STRG ANGLE SPEED [deg/s]	The steering angle speed is displayed
L/R ADJUST [deg]	Indicates a horizontal correction value of the radar
U/D ADJUST [deg]	Indicates a vertical correction value of the radar

# DIAGNOSIS SYSTEM (ICC SENSOR)

< SYSTEM DESCRIPTION >

[FCW]

## WORK SUPPORT

Work support items	Description
MILLIWAVE RADAR ADJUST	Outputs ICC sensor waves, calculates the displacement in radar direction, and indicates an adjustment direction

ICC sensor Adjust

Refer to [CCS-87, "Description"](#).

## ECU IDENTIFICATION

ICC sensor part number is displayed.

A  
B  
C  
D  
E  
F  
G  
H  
I  
J  
K  
L  
M  
N  
P

DAS

# ADAS CONTROL UNIT

< ECU DIAGNOSIS INFORMATION >

[FCW]

## ECU DIAGNOSIS INFORMATION

### ADAS CONTROL UNIT

Reference Value

INFOID:000000009716581

#### VALUES ON THE DIAGNOSIS TOOL

Monitor item	Condition		Value/Status
MAIN SW	Ignition switch ON	When MAIN switch is pressed	On
		When MAIN switch is not pressed	Off
SET/COAST SW	Ignition switch ON	When SET/COAST switch is pressed	On
		When SET/COAST switch is not pressed	Off
CANCEL SW	Ignition switch ON	When CANCEL switch is pressed	On
		When CANCEL switch is not pressed	Off
RESUME/ACC SW	Ignition switch ON	When RESUME/ACCELERATE switch is pressed	On
		When RESUME/ACCELERATE switch is not pressed	Off
DISTANCE SW	Ignition switch ON	When DISTANCE switch is pressed	On
		When DISTANCE switch is not pressed	Off
CRUISE OPE	Drive the vehicle and activate the vehicle-to-vehicle distance control mode	When ICC system is controlling	On
		When ICC system is not controlling	Off
BRAKE SW	Ignition switch ON	When brake pedal is depressed	Off
		When brake pedal is not depressed	On
STOP LAMP SW	Ignition switch ON	When brake pedal is depressed	On
		When brake pedal is not depressed	Off
IDLE SW	Engine running	Idling	On
		Except idling (depress accelerator pedal)	Off
SET DISTANCE	<ul style="list-style-type: none"> <li>• Start the engine and turn the ICC system ON</li> <li>• Press the DISTANCE switch to change the vehicle-to-vehicle distance setting</li> </ul>	When set to "long"	Long
		When set to "middle"	Mid
		When set to "short"	Short
CRUISE LAMP	Start the engine and press MAIN switch	ICC system ON (MAIN switch indicator ON)	On
		ICC system OFF (MAIN switch indicator OFF)	Off
OWN VHCL	Start the engine and press MAIN switch	ICC system ON (Own vehicle indicator ON)	On
		ICC system OFF (Own vehicle indicator OFF)	Off
VHCL AHEAD	Drive the vehicle and activate the vehicle-to-vehicle distance control mode	When a vehicle ahead is detected (vehicle ahead detection indicator ON)	On
		When a vehicle ahead is not detected (vehicle ahead detection indicator OFF)	Off
ICC WARNING	Start the engine and press MAIN switch	When ICC system is malfunctioning (ICC system warning lamp ON)	On
		When ICC system is normal (ICC system warning lamp OFF)	Off

# ADAS CONTROL UNIT

< ECU DIAGNOSIS INFORMATION >

[FCW]

Monitor item	Condition		Value/Status
VHCL SPEED SE	While driving		Displays a vehicle speed calculated by the ADAS control unit
SET VHCL SPD	While driving	When vehicle speed is set	Displays the set vehicle speed
BUZZER O/P	Engine running	When the buzzer of the following system operates • Vehicle-to-vehicle distance control mode • DCA system • FCW system • IBA system	On
		When the buzzer of the following system not operates • Vehicle-to-vehicle distance control mode • DCA system • FCW system • IBA system	Off
THRTL SENSOR	<b>NOTE:</b> The item is indicated, but not monitored		0.0
ENGINE RPM	Engine running		Equivalent to tachometer reading
WIPER SW	Ignition switch ON	Wiper not operating	Off
		Wiper LO operation	Low
		Wiper HI operation	High
BA WARNING	Engine running	IBA OFF indicator lamp ON • When IBA system is malfunctioning • When IBA system is turned to OFF	On
		IBA OFF indicator lamp OFF • When IBA system is normal • When IBA system is turned to ON	Off
STP LMP DRIVE	Drive the vehicle and activate the vehicle-to-vehicle distance control mode	When ICC brake hold relay is activated	On
		When ICC brake hold relay is not activated	Off
D RANGE SW	Engine running	When the selector lever is in "D" position or manual mode	On
		When the selector lever is in any position other than "D" or manual mode	Off
NP RANGE SW	Engine running	When the selector lever is in "N", "P" position	On
		When the selector lever is in any position other than "N", "P"	Off
PKB SW	Ignition switch ON	When the parking brake is applied	On
		When the parking brake is released	Off
PWR SUP MONI	Engine running		Power supply voltage value of ADAS control unit
VHCL SPD AT	While driving		Value of CVT vehicle speed sensor signal
THRTL OPENING	Engine running	Depress accelerator pedal	Displays the throttle position

A  
B  
C  
D  
E  
F  
G  
H  
I  
J  
K  
L  
M  
N  
DAS  
P

# ADAS CONTROL UNIT

< ECU DIAGNOSIS INFORMATION >

[FCW]

Monitor item	Condition		Value/Status
GEAR	While driving		Displays the gear position
MODE SIG	Start the engine and press MAIN switch	When ICC system is deactivated	Off
		When vehicle-to-vehicle distance control mode is activated	ICC
		When conventional (fixed speed) cruise control mode is activated	ASCD
SET DISP IND	<ul style="list-style-type: none"> <li>• Drive the vehicle and activate the conventional (fixed speed) cruise control mode</li> <li>• Press SET/COAST switch</li> </ul>	SET switch indicator ON	On
		SET switch indicator OFF	Off
DISTANCE	Drive the vehicle and activate the vehicle-to-vehicle distance control mode	When a vehicle ahead is detected	Displays the distance from the preceding vehicle
		When a vehicle ahead is not detected	0.0
RELATIVE SPD	Drive the vehicle and activate the vehicle-to-vehicle distance control mode	When a vehicle ahead is detected	Displays the relative speed.
		When a vehicle ahead is not detected	0.0
Camera lost	Drive the vehicle and activate the LDW system, LDP system or Blind Spot Intervention system	Both side lane markers are detected	Detect
		Deviate side lane marker is lost	Deviate
		Both side lane markers are lost	Both
Lane unclear	While driving	Lane marker is unclear	On
		Lane marker is clear	Off
STATUS signal	Drive the vehicle with the LDP system turned ON	When the LDP system is ON	Stnby
		When the LDP system is operating	Warn
		When the LDP system is canceled	Cancl
		When the LDP system is OFF	Off
DYNA ASIST SW	Ignition switch ON	When dynamic driver assistance switch is pressed	On
		When dynamic driver assistance switch is not pressed	Off
DCA ON IND	Start the engine and press dynamic driver assistance switch (When DCA system setting is ON)	DCA system OFF (DCA system switch indicator OFF)	Off
		DCA system ON (DCA system switch indicator ON)	On
DCA VHL AHED	Drive the vehicle and activate the DCA system	When a vehicle ahead is not detected (vehicle ahead detection indicator OFF)	Off
		When a vehicle ahead is detected (vehicle ahead detection indicator ON)	On
IBA SW	Ignition switch ON	When the IBA OFF switch is pressed	On
		When the IBA OFF switch is not pressed	Off
APA TEMP	Engine running		Display the accelerator pedal actuator integrated motor temperature
APA PWR	Ignition switch ON		Power supply voltage value of accelerator pedal actuator

# ADAS CONTROL UNIT

< ECU DIAGNOSIS INFORMATION >

[FCW]

Monitor item	Condition		Value/Status
FCW SYSTEM ON	Ignition switch ON	When the FCW system is ON (Warning systems ON indicator ON)	On
		When the FCW system is OFF (Warning systems ON indicator OFF)	Off
LDW SYSTEM ON	Ignition switch ON	When the LDW system is ON (Warning systems ON indicator ON)	On
		When the LDW system is OFF (Warning systems ON indicator OFF)	Off
LDW ON LAMP	Ignition switch ON	Warning systems ON indicator ON	On
		Warning systems ON indicator OFF	Off
LDP ON IND	Start the engine and press dynamic driver assistance switch (When LDP system setting is ON)	LDP ON indicator lamp ON	On
		LDP ON indicator lamp OFF	Off
LANE DPRT W/L	Drive the vehicle and activate the LDW system or LDP system	Lane departure warning lamp ON	On
		Lane departure warning lamp OFF	Off
LDW BUZER OUTPUT	Drive the vehicle and activate the LDW/LDP system or Blind Spot Warning/Blind Spot Intervention system	When the buzzer of the following system operates • LDW/LDP system • Blind Spot Warning/Blind Spot Intervention system	On
		When the buzzer of the following system does not operate • LDW/LDP system • Blind Spot Warning/Blind Spot Intervention system	Off
LDP SYSTEM ON	Start the engine and press dynamic driver assistance switch (When LDP system setting is ON)	When the LDP system is ON	On
		When the LDP system is OFF	Off
READY signal	Start the engine and press dynamic driver assistance switch (When LDP system setting is ON)	When the LDP system is ON	On
		When the LDP system is OFF	Off
Shift position	<ul style="list-style-type: none"> <li>• Engine running</li> <li>• While driving</li> </ul>		Displays the shift position
Turn signal	Turn signal lamps OFF		Off
	Turn signal lamp LH blinking		LH
	Turn signal lamp RH blinking		RH
	Turn signal lamp LH and RH blinking		LH&RH
SIDE G	While driving	Vehicle turning right	Negative value
		Vehicle turning left	Positive value
FUNC ITEM (FCW)	Ignition switch ON		FCW
FUNC ITEM (LDW)	Ignition switch ON		LDW
FUNC ITEM (BSW)	Ignition switch ON		BSW
FUNC ITEM (NV-ICC)	<b>NOTE:</b> The item is indicated, but not monitored		Off
FUNC ITEM (NV-DCA)	<b>NOTE:</b> The item is indicated, but not monitored		Off
DCA SELECT	Ignition switch ON	"Distance Control Assist" set with the navigation system is ON	On
		"Distance Control Assist" set with the navigation system is OFF	Off

A  
B  
C  
D  
E  
F  
G  
H  
I  
J  
K  
L  
M  
N  
P

DAS

# ADAS CONTROL UNIT

< ECU DIAGNOSIS INFORMATION >

[FCW]

Monitor item		Condition	Value/Status
LDP SELECT	Ignition switch ON	"Lane Departure Prevention" set with the navigation system is ON	On
		"Lane Departure Prevention" set with the navigation system is OFF	Off
BSI SELECT	Ignition switch ON	"Blind Spot Intervention" set with the navigation system is ON	On
		"Blind Spot Intervention" set with the navigation system is OFF	Off
DRIVE MODE STATS	Ignition switch ON	When the DMS switch is in normal position	Std
		When the DMS switch is in SNOW position	SNO
		When the DMS switch is in ECO position	ECO
		When the DMS switch is in SPORT position	SPT
WARN SYS SW	Ignition switch ON	When warning systems switch is pressed	On
		When warning systems switch is not pressed	Off
BSW/BSI WARN LMP	Ignition switch ON	Blind Spot Warning/Blind Spot Intervention warning lamp ON	On
		Blind Spot Warning/Blind Spot Intervention warning lamp OFF	Off
BSI ON IND	Ignition switch ON	Blind Spot Intervention ON indicator ON	On
		Blind Spot Intervention ON indicator OFF	Off
BSW SYSTEM ON	Ignition switch ON	When the BSW system is ON (Warning systems ON indicator ON)	On
		When the BSW system is OFF (Warning systems ON indicator OFF)	Off
BSI SYSTEM ON	Start the engine and press dynamic driver assistance switch (When Blind Spot Intervention system setting is ON)	When the Blind Spot Intervention system is ON	On
		When the Blind Spot Intervention system is OFF	Off
BCI SYSTEM ON	Ignition switch ON	Back-up Collision Intervention system ON	On
		Back-up Collision Intervention system OFF	Off
BCI SWITCH	Ignition switch ON	Back-up Collision Intervention switch ON	On
		Back-up Collision Intervention switch OFF	Off
LDP WARNING INDICATOR	Ignition switch ON	When the LDP fail lamp is ON (Warning systems ON indicator ON)	On
		When the LDP fail lamp is OFF	Off
LDW ON LAMP	Ignition switch ON	When LDW indicator lamp is ON	On
		When LDW indicator lamp is OFF	Off
LDW WARNING INDICATOR	Ignition switch ON	When LDW FAIL lamp is ON	On
		When LDW FAIL lamp is OFF	Off
SYSTEM CANCEL MESSAGE	Ignition switch ON	When a system cancel message is sent	Request
		When a system cancel message is not sent	No Request
CAMERA HI TEMP MSG	Ignition switch ON	When camera high temperature message is sent	On
		When camera high temperature message is not sent	Off
ITS Setting Item(DCA)	Ignition switch ON	When the DCA is set	On
		When the DCA is not set	Off
ITS Setting Item(LDP)	Ignition switch ON	When the LDP is set	On
		When the LDP is not set	Off



# ADAS CONTROL UNIT

< ECU DIAGNOSIS INFORMATION >

[FCW]

Monitor item	Condition	Value/Status	
ITS Setting Item(BSI)	Ignition switch ON	When the BSI is set	On
		When the BSI is not set	Off
BSI WARNING INDICATOR	Ignition switch ON	When BSI FAIL indicator warning lamp is ON	On
		When BSI FAIL indicator warning lamp is OFF	Off
BSW ON INDICATOR	Ignition switch ON	When BSW ON indicator lamp is ON	On
		When BSW ON indicator lamp is OFF	Off
BSW IND BRIGHTNESS	Ignition switch ON	When BSW indicator brightness is selected	On
		When BSW indicator brightness is not selected	Off
WARN REQ	Drive the vehicle and activate the LDP system	Lane departure warning is operating	On
		Lane departure warning is not operating	Off

TERMINAL LAYOUT  
PHYSICAL VALUES

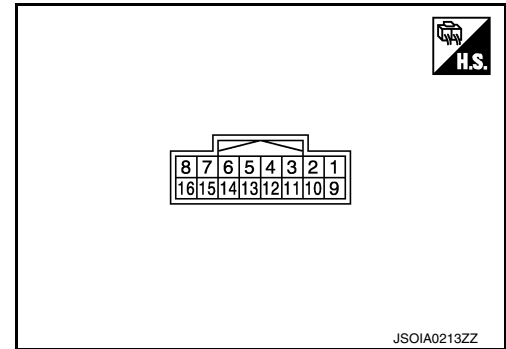

Terminal No. (Wire color)		Description		Condition	Value (Approx.)
+	-	Signal name	Input/ Output		
5 (G)	Ground	ICC brake hold relay drive signal	Output	Ignition switch ON	12 V
				At "STOP LAMP" test of "Active test"	0 V
6 (B)		Ground	Input	—	0 V
7 (L)		ITS communication-H	—	—	—
8 (Y)		ITS communication-L	—	—	—
14 (B)		CAN -H	—	—	—
15 (W)		CAN -L	—	—	—
16 (R)	Ignition power supply	Input	Ignition switch ON	Battery Voltage	

## Fail-safe

INFOID:000000009716582

If a malfunction occurs in each system, ADAS control unit cancels each control, sounds a beep, and turns ON the warning lamp or indicator lamp.

System	Buzzer	Warning lamp/Indicator lamp	Description
Vehicle-to-vehicle distance control mode	High-pitched tone	ICC system warning lamp	Cancel
Conventional (fixed speed) cruise control mode	High-pitched tone	ICC system warning lamp	Cancel

# ADAS CONTROL UNIT

< ECU DIAGNOSIS INFORMATION >

[FCW]

System	Buzzer	Warning lamp/Indicator lamp	Description
Intelligent Brake Assist (IBA)	High-pitched tone	IBA OFF indicator lamp	Cancel
Forward Collision Warning (FCW)	High-pitched tone	Warning message	Cancel
Distance Control Assist (DCA)	High-pitched tone	DCA system warning	Cancel
Lane Departure Warning (LDW)	—	Lane departure warning lamp	Cancel
Lane Departure Prevention (LDP)	Low-pitched tone	Lane departure warning lamp	Cancel
Blind Spot Warning (BSW)	—	Blind Spot Warning/Blind Spot Intervention warning lamp	Cancel
Blind Spot Intervention	Low-pitched tone	Blind Spot Warning/Blind Spot Intervention warning lamp	Cancel
Backup Collision Intervention (BCI)	High-pitched tone	Backup Collision Intervention warning indicator	Cancel

## DTC Inspection Priority Chart

INFOID:000000009716583

If multiple DTCs are detected simultaneously, check them one by one depending on the following DTC inspection priority chart.

Priority	Detected items (DTC)
1	<ul style="list-style-type: none"> <li>• C1A0A: CONFIG UNFINISHED</li> <li>• U1507: LOST COMM (SIDE RDR R)</li> <li>• U1508: LOST COMM (SIDE RDR L)</li> </ul>
2	<ul style="list-style-type: none"> <li>• U1000: CAN COMM CIRCUIT</li> <li>• U1010: CONTROL UNIT (CAN)</li> </ul>
3	<ul style="list-style-type: none"> <li>• C1B00: CAMERA UNIT MALF</li> <li>• C1F02: APA C/U MALF</li> <li>• C1A17: ICC SENSOR MALF</li> <li>• C1B53: SIDE RDR R MALF</li> <li>• C1B54: SIDE RDR L MALF</li> </ul>

# ADAS CONTROL UNIT

< ECU DIAGNOSIS INFORMATION >

[FCW]

Priority	Detected items (DTC)		
4	<ul style="list-style-type: none"> <li>• C1A01: POWER SUPPLY CIR</li> <li>• C1A02: POWER SUPPLY CIR 2</li> <li>• C1A04: ABS/TCS/VDC CIRC</li> <li>• C1A05: BRAKE SW/STOP L SW</li> <li>• C1A06: OPERATION SW CIRC</li> <li>• C1A12: LASER BEAM OFFCNTR</li> <li>• C1A13: STOP LAMP RLY FIX</li> <li>• C1A14: ECM CIRCUIT</li> <li>• C1A16: RADAR STAIN</li> <li>• C1A18: LASER AIMING INCOMP</li> <li>• C1A2A: ICC SEN PWR SUP CIR</li> <li>• C1A21: ICC SENSOR HIGH TEMP</li> <li>• C1A24: NP RANGE</li> <li>• C1A26: ECD MODE MALF</li> <li>• C1A27: ECD PWR SUPPLY CIR</li> <li>• C1A33: CAN TRANSMISSION ERR</li> <li>• C1A34: COMMAND ERROR</li> <li>• C1A35: APA CIR</li> <li>• C1A36: APA CAN COMM CIR</li> <li>• C1A37: APA CAN CIR 2</li> <li>• C1A38: APA CAN CIR 1</li> <li>• C1A39: STRG SEN CIR</li> <li>• C1A40: SYSTEM SW CIRC</li> <li>• C1B01: CAM AIMING INCOMP</li> <li>• C1B03: CAM ABNRML TMP DETCT</li> <li>• C1B56: SONAR CIRCUIT</li> <li>• C1B57: AVM CIRCUIT</li> <li>• C1F01: APA MOTOR MALF</li> <li>• C1F05: APA PWR SUPPLY CIR</li> <li>• U0121: VDC CAN CIR 2</li> <li>• U0126: STRG SEN CAN CIR 1</li> <li>• U0235: ICC SENSOR CAN CIRC 1</li> <li>• U0401: ECM CAN CIR 1</li> <li>• U0402: TCM CAN CIR 1</li> <li>• U0415: VDC CAN CIR 1</li> <li>• U0428: STRG SEN CAN CIR 2</li> <li>• U1500: CAM CAN CIR 2</li> <li>• U1501: CAM CAN CIR 1</li> <li>• U1502: ICC SEN CAN COMM CIR</li> <li>• U1503: SIDE RDR L CAN CIR 2</li> <li>• U1504: SIDE RDR L CAN CIR 1</li> <li>• U1505: SIDE RDR R CAN CIR 2</li> <li>• U1506: SIDE RDR R CAN CIR 1</li> <li>• U1521: SONAR CAN COMMUNICATION</li> <li>• U1522: SONAR CAN COMMUNICATION</li> <li>• U1523: SONAR CAN COMMUNICATION</li> <li>• U1524: AVM CAN COMMUNICATION</li> <li>• U1525: AVM CAN COMMUNICATION</li> <li>• U150B: ECM CAN CIRC 3</li> <li>• U150C: VDC CAN CIRC 3</li> <li>• U150D: TCM CAN CIRC 3</li> <li>• U150E: BCM CAN CIRC 3</li> <li>• U150F: AV CAN CIRC 3</li> <li>• U1512: HVAC CAN CIRC3</li> <li>• U1513: METER CAN CIRC 3</li> <li>• U1514: STRG SEN CAN CIRC 3</li> <li>• U1515: ICC SENSOR CAN CIRC 3</li> <li>• U1516: CAM CAN CIRC 3</li> <li>• U1517: APA CAN CIRC 3</li> <li>• U1518: SIDE RDR L CAN CIRC 3</li> <li>• U1519: SIDE RDR R CAN CIRC 3</li> </ul>	<p>A</p> <p>B</p> <p>C</p> <p>D</p> <p>E</p> <p>F</p> <p>G</p> <p>H</p> <p>I</p> <p>J</p> <p>K</p> <p>L</p> <p>M</p> <p>N</p> <p>P</p>	
	5	<ul style="list-style-type: none"> <li>• C1A03: VHCL SPEED SE CIRC</li> </ul>	
	6	<ul style="list-style-type: none"> <li>• C1A15: GEAR POSITION</li> </ul>	
	7	<ul style="list-style-type: none"> <li>• C1A00: CONTROL UNIT</li> </ul>	

DAS

# ADAS CONTROL UNIT

< ECU DIAGNOSIS INFORMATION >

[FCW]

## DTC Index

INFOID:000000009716584

### NOTE:

- The details of time display are as per the following.
- CRNT: A malfunction is detected now
- PAST: A malfunction was detected in the past
- IGN counter is displayed on FFD (Freeze Frame Data).
- 0: The malfunctions that are detected now  
CAN communication system (U1000, U1010)
- 1 - 39: It increases like 0 → 1 → 2 ... 38 → 39 after returning to the normal condition whenever the ignition switch OFF → ON. It returns to 0 when a malfunction is detected again in the process.
- If it is over 39, it is fixed to 39 until the self-diagnosis results are erased.  
Other than CAN communication system (Other than U1000, U1010)
- 1 - 49: It increases like 0 → 1 → 2 ... 38 → 49 after returning to the normal condition whenever the ignition switch OFF → ON. It returns to 0 when a malfunction is detected again in the process.
- If it is over 49, it is fixed to 49 until the self-diagnosis results are erased.

### Systems for fail-safe

- A: Vehicle-to-vehicle distance control mode
- B: Conventional (fixed speed) cruise control mode
- C: Intelligent Brake Assist (IBA)
- D: Forward Collision Warning (FCW)
- E: Distance Control Assist (DCA)
- F: Lane Departure Warning (LDW)/Lane Departure Prevention (LDP)
- G: Blind Spot Warning (BSW)/Blind Spot Intervention
- H: Backup Collision Intervention (BCI)

DTC		CONSULT display	Warning lamp					Fail-safe	Reference
CONSULT	On board display		ICC system warning lamp	IBA OFF indicator lamp	Lane departure warning lamp	Blind Spot Warning/Blind Spot Intervention warning lamp	Backup Collision Intervention	System	
C1A00	0	CONTROL UNIT	ON	ON	ON	ON	ON	A, B, C, D, E, F, G, H	<a href="#">DAS-73</a>
C1A01	1	POWER SUPPLY CIR	ON	ON	ON	ON	ON	A, B, C, D, E, F, G, H	<a href="#">DAS-74</a>
C1A02	2	POWER SUPPLY CIR 2	ON	ON	ON	ON	ON	A, B, C, D, E, F, G, H	<a href="#">DAS-74</a>
C1A03	3	VHCL SPEED SE CIRC	ON	ON	ON	ON	ON	A, B, C, D, E, F, G, H	<a href="#">DAS-160</a>
C1A04	4	ABS/TCS/VDC CIRC	ON	ON	ON	ON	ON	A, B, C, D, E, F, G, H	<a href="#">DAS-162</a>
C1A05	5	BRAKE SW/STOP L SW	ON	ON	ON	ON	ON	A, B, C, D, E, F, G, H	<a href="#">DAS-163</a>
C1A06	6	OPERATION SW CIRC	ON		ON	ON		A, B, E, F, G	<a href="#">DAS-167</a>
C1A12	12	LASER BEAM OFFCN-TR	ON	ON				A, C, D, E	<a href="#">DAS-170</a>
C1A13	13	STOP LAMP RLY FIX	ON	ON			ON	A, B, C, D, E, H	<a href="#">DAS-171</a>
C1A14	14	ECM CIRCUIT	ON		ON	ON	ON	A, B, E, F, G, H	<a href="#">DAS-177</a>

# ADAS CONTROL UNIT

< ECU DIAGNOSIS INFORMATION >

[FCW]

A  
B  
C  
D  
E  
F  
G  
H  
I  
J  
K  
L  
M  
N  
DAS  
P

- Systems for fail-safe
- A: Vehicle-to-vehicle distance control mode
  - B: Conventional (fixed speed) cruise control mode
  - C: Intelligent Brake Assist (IBA)
  - D: Forward Collision Warning (FCW)
  - E: Distance Control Assist (DCA)
  - F: Lane Departure Warning (LDW)/Lane Departure Prevention (LDP)
  - G: Blind Spot Warning (BSW)/Blind Spot Intervention
  - H: Backup Collision Intervention (BCI)

DTC		CONSULT display	Warning lamp					Fail-safe	Reference
CONSULT	On board display		ICC system warning lamp	IBA OFF indicator lamp	Lane departure warning lamp	Blind Spot Warning/Blind Spot Intervention warning lamp	Backup Collision Intervention	System	
C1A15	15	GEAR POSITION	ON	ON	ON	ON	ON	A, B, C, D, E, F, G, H	<a href="#">DAS-178</a>
C1A16	16	RADAR STAIN	ON	ON				A, C, D, E	<a href="#">DAS-180</a>
C1A17	17	ICC SENSOR MALF	ON	ON				A, B, C, D, E	<a href="#">DAS-181</a>
C1A18	18	LASER AIMING INCOMP	ON	ON				A, C, D, E	<a href="#">DAS-182</a>
C1A21	21	ICC SENSOR HIGH TEMP	ON	ON				A, B, C, D, E	<a href="#">DAS-183</a>
C1A24	24	NP RANGE	ON	ON	ON	ON	ON	A, B, C, D, E, F, G, H	<a href="#">DAS-184</a>
C1A26	26	ECD MODE MALF	ON	ON				A, B, C, D, E	<a href="#">DAS-186</a>
C1A27	27	ECD PWR SUPPLY CIR	ON	ON				A, B, C, D, E	<a href="#">DAS-187</a>
C1A33	33	CAN TRANSMISSION ERR	ON					A, B, E	<a href="#">DAS-189</a>
C1A34	34	COMMAND ERROR	ON					A, B, E	<a href="#">DAS-190</a>
C1A35	35	APA CIR	ON				ON	A, E, H	<a href="#">DAS-191</a>
C1A36	36	APA CAN COMM CIR	ON				ON	A, E, H	<a href="#">DAS-192</a>
C1A37	133	APA CAN CIR 2	ON				ON	A, B, E, H	<a href="#">DAS-193</a>
C1A38	132	APA CAN CIR 1	ON				ON	A, B, E, H	<a href="#">DAS-194</a>
C1A39	39	STRG SEN CIR	ON	ON		ON	ON	A, B, C, D, E, G, H	<a href="#">DAS-195</a>
C1A2A	80	ICC SEN PWR SUP CIR	ON	ON				A, C, D, E	<a href="#">DAS-188</a>
C1B00	81	CAMERA UNIT MALF			ON	ON		F, G	<a href="#">DAS-418</a>
C1B01	82	CAM AIMING INCOMP			ON	ON		F, G	<a href="#">DAS-420</a>
C1B03	83	CAM ABRML TMP DETECT							<a href="#">DAS-422</a>
C1B53	84	SIDE RDR R MALF				ON	ON	G, H	<a href="#">DAS-577</a>
C1B54	85	SIDE RDR L MALF				ON	ON	G, H	<a href="#">DAS-578</a>
C1B56	87	SONAR CIRCUIT					ON	H	<a href="#">DAS-744</a>

# ADAS CONTROL UNIT

< ECU DIAGNOSIS INFORMATION >

[FCW]

Systems for fail-safe

- A: Vehicle-to-vehicle distance control mode
- B: Conventional (fixed speed) cruise control mode
- C: Intelligent Brake Assist (IBA)
- D: Forward Collision Warning (FCW)
- E: Distance Control Assist (DCA)
- F: Lane Departure Warning (LDW)/Lane Departure Prevention (LDP)
- G: Blind Spot Warning (BSW)/Blind Spot Intervention
- H: Backup Collision Intervention (BCI)

DTC		CONSULT display	Warning lamp					Fail-safe	Reference
CONSULT	On board display		ICC system warning lamp	IBA OFF indicator lamp	Lane departure warning lamp	Blind Spot Warning/Blind Spot Intervention warning lamp	Backup Collision Intervention	System	
C1B57	88	AVM CIRCUIT					ON	H	<a href="#">DAS-745</a>
C1F01	91	APA MOTOR MALF	ON				ON	A, E, H	<a href="#">DAS-196</a>
C1F02	92	APA C/U MALF	ON				ON	A, E, H	<a href="#">DAS-198</a>
C1F05	95	APA PWR SUPPLY CIR	ON				ON	A, E, H	<a href="#">DAS-201</a>
NO DTC IS DETECTED. FURTHER TESTING MAY BE REQUIRED	55	NO DTC IS DETECTED. FURTHER TESTING MAY BE REQUIRED	—	—	—	—	—	—	—
U0121	127	VDC CAN CIR 2	ON	ON	ON	ON	ON	A, B, C, D, E, F, G, H	<a href="#">DAS-205</a>
U0126	130	STRG SEN CAN CIR 1	ON	ON		ON	ON	A, B, C, D, E, G, H	<a href="#">DAS-206</a>
U0235	144	ICC SENSOR CAN CIRC 1	ON	ON				A, B, C, D, E	<a href="#">DAS-207</a>
U0401	120	ECM CAN CIR 1	ON		ON	ON	ON	A, B, E, F, G, H	<a href="#">DAS-208</a>
U0402	122	TCM CAN CIR 1	ON	ON	ON	ON	ON	A, B, C, D, E, F, G, H	<a href="#">DAS-209</a>
U0415	126	VDC CAN CIR 1	ON	ON	ON	ON	ON	A, B, C, D, E, F, G, H	<a href="#">DAS-210</a>
U0428	131	STRG SEN CAN CIR 2	ON	ON		ON	ON	A, B, C, D, E, G, H	<a href="#">DAS-211</a>
U1000 <sup>NOTE</sup>	100	CAN COMM CIRCUIT	ON	ON	ON	ON	ON	A, B, C, D, E, F, G, H	<a href="#">DAS-75</a>
U1010	110	CONTROL UNIT (CAN)	ON	ON	ON	ON	ON	A, B, C, D, E, F, G, H	<a href="#">DAS-76</a>
U1500	145	CAM CAN CIR 2			ON	ON		F, G	<a href="#">DAS-438</a>
U1501	146	CAM CAN CIR 1			ON	ON		F, G	<a href="#">DAS-439</a>
U1502	147	ICC SEN CAN COMM CIR	ON	ON				A, B, C, D, E	<a href="#">DAS-219</a>
U1503	150	SIDE RDR L CAN CIR 2				ON	ON	G, H	<a href="#">DAS-603</a>

# ADAS CONTROL UNIT

< ECU DIAGNOSIS INFORMATION >

[FCW]

Systems for fail-safe

- A: Vehicle-to-vehicle distance control mode
- B: Conventional (fixed speed) cruise control mode
- C: Intelligent Brake Assist (IBA)
- D: Forward Collision Warning (FCW)
- E: Distance Control Assist (DCA)
- F: Lane Departure Warning (LDW)/Lane Departure Prevention (LDP)
- G: Blind Spot Warning (BSW)/Blind Spot Intervention
- H: Backup Collision Intervention (BCI)

DTC		CONSULT display	Warning lamp					Fail-safe	Reference
CONSULT	On board display		ICC system warning lamp	IBA OFF indicator lamp	Lane departure warning lamp	Blind Spot Warning/Blind Spot Intervention warning lamp	Backup Collision Intervention	System	
U1504	151	SIDE RDR L CAN CIR 1				ON	ON	G, H	<a href="#">DAS-604</a>
U1505	152	SIDE RDR R CAN CIR 2				ON	ON	G, H	<a href="#">DAS-605</a>
U1506	153	SIDE RDR R CAN CIR 1				ON	ON	G, H	<a href="#">DAS-606</a>
U1507	154	LOST COMM (SIDE RDR R)				ON	ON	G, H	<a href="#">DAS-607</a>
U1508	155	LOST COMM (SIDE RDR L)				ON	ON	G, H	<a href="#">DAS-608</a>
U150B	157	ECM CAN CIRC 3	ON		ON	ON	ON	A, B, E, F, G, H	<a href="#">DAS-215</a>
U150C	158	VDC CAN CIRC 3	ON	ON	ON	ON	ON	A, B, C, D, E, F, G, H	<a href="#">DAS-216</a>
U150D	159	TCM CAN CIRC 3	ON	ON	ON	ON	ON	A, B, C, D, E, F, G, H	<a href="#">DAS-217</a>
U150E	160	BCM CAN CIRC 3	ON		ON	ON	ON	A, B, E, F, G, H	<a href="#">DAS-218</a>
U150F	161	AV CAN CIRC 3							<a href="#">DAS-77</a>
U1512	162	HVAC CAN CIRC3			ON	ON		F, G	<a href="#">DAS-440</a>
U1513	163	METER CAN CIRC 3	ON	ON	ON	ON	ON	A, B, C, D, E, F, G, H	<a href="#">DAS-220</a>
U1514	164	STRG SEN CAN CIRC 3	ON	ON		ON	ON	A, B, C, D, E, G, H	<a href="#">DAS-221</a>
U1515	165	ICC SENSOR CAN CIRC 3	ON	ON				A, B, C, D, E	<a href="#">DAS-222</a>
U1516	166	CAM CAN CIRC 3			ON	ON		F, G	<a href="#">DAS-442</a>
U1517	167	APA CAN CIRC 3	ON				ON	A, B, E, H	<a href="#">DAS-223</a>
U1518	168	SIDE RDR L CAN CIRC 3				ON	ON	G, H	<a href="#">DAS-613</a>
U1519	169	SIDE RDR R CAN CIRC 3				ON	ON	G, H	<a href="#">DAS-614</a>
U1521	177	SONAR CHECKSUM					ON	H	<a href="#">DAS-781</a>
U1522	178	SONAR MESSAGE					ON	H	<a href="#">DAS-782</a>
U1523	179	SONAR CAN DLC					ON	H	<a href="#">DAS-783</a>

A  
B  
C  
D  
E  
F  
G  
H  
I  
J  
K  
L  
M  
N  
P

DAS

# ADAS CONTROL UNIT

< ECU DIAGNOSIS INFORMATION >

[FCW]

Systems for fail-safe

- A: Vehicle-to-vehicle distance control mode
- B: Conventional (fixed speed) cruise control mode
- C: Intelligent Brake Assist (IBA)
- D: Forward Collision Warning (FCW)
- E: Distance Control Assist (DCA)
- F: Lane Departure Warning (LDW)/Lane Departure Prevention (LDP)
- G: Blind Spot Warning (BSW)/Blind Spot Intervention
- H: Backup Collision Intervention (BCI)

DTC		CONSULT display	Warning lamp					Fail-safe	Reference
	On board display		ICC system warning lamp	IBA OFF indicator lamp	Lane departure warning lamp	Blind Spot Warning/Blind Spot Intervention warning lamp	Backup Collision Intervention	System	
U1524	180	SONAR CAN DLC					ON	H	<a href="#">DAS-784</a>
U1525	181	AVM MESSAGE					ON	H	<a href="#">DAS-785</a>

**NOTE:**

With the detection of “U1000” some systems do not perform the fail-safe operation.

A system controlling based on a signal received from the control unit performs fail-safe operation when the communication with the ADAS control unit becomes inoperable.



# ICC SENSOR

< ECU DIAGNOSIS INFORMATION >

[FCW]

## ICC SENSOR

### Reference Value

INFOID:000000009716585

### VALUES ON THE DIAGNOSIS TOOL

A  
B  
C  
D  
E  
F  
G  
H  
I  
J  
K  
L  
M  
N

Monitor item	Condition		Value/Status
VHCL SPEED SE	While driving		Value of vehicle speed signal (wheel speed)
YAW RATE	While driving	Vehicle stopped	0.0
		Vehicle turning right	Positive value
		Vehicle turning left	Negative value
PWR SUP MONI	Ignition switch ON		Power supply voltage value of ICC sensor
DISTANCE	Drive the vehicle and activate the vehicle-to-vehicle distance control mode	When a vehicle ahead is detected	Displays the distance from the preceding vehicle
		When a vehicle ahead is not detected	0.0
RELATIVE SPD	Drive the vehicle and activate the vehicle-to-vehicle distance control mode	When a vehicle ahead is detected	Displays the relative speed
		When a vehicle ahead is not detected	0.0
RADAR OFFSET	<b>NOTE:</b> The item is indicated, but not used		—
RADAR HEIGHT	<b>NOTE:</b> The item is indicated, but not used		—
STEERING ANGLE	Ignition switch ON	When setting the steering wheel in straight-ahead position	0.0
		When turning the steering wheel 90° rightward	+90
		When turning the steering wheel 90° leftward	-90
STRG ANGLE SPEED	Ignition switch ON	At the time of turning the steering wheel	Steering wheel turning speed is displayed
L/R ADJUST	Ignition switch ON	At the completion of radar alignment adjustment	Horizontal correction value is displayed
U/D ADJUST	Ignition switch ON	At the completion of radar alignment adjustment	Vertical correction value is displayed

### TERMINAL LAYOUT

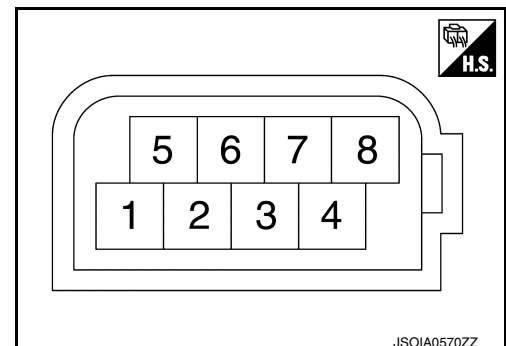

DAS

P

### PHYSICAL VALUES

# ICC SENSOR

< ECU DIAGNOSIS INFORMATION >

[FCW]

Terminal No. (Wire color)		Description		Condition	Standard value	Reference value (Approx.)
+	-	Signal name	Input/ Output			
1 (P)	8 (B)	Ignition power supply	Input	Ignition switch ON	9.5 - 16 V	Battery voltage
6 (Y)	—	ITS communication-L	—	—	—	—
7 (L)		ITS communication-H	—	—	—	—
8 (B)	Ground	Ground	—	Ignition switch ON	0 - 0.1 V	0 V

## Fail-safe

INFOID:000000009716586

If a malfunction occurs in the ICC sensor, ADAS control unit cancels control, sounds a beep, and turns ON the ICC system warning lamp in the combination meter.

## DTC Inspection Priority Chart

INFOID:000000009716587

If multiple DTCs are detected simultaneously, check them one by one depending on the following DTC inspection priority chart.

Priority	Detected items (DTC)
1	<ul style="list-style-type: none"> <li>U1000: CAN COMM CIRCUIT</li> <li>U1010: CONTROL UNIT (CAN)</li> </ul>
2	<ul style="list-style-type: none"> <li>C1A50: ADAS MALFUNCTION</li> </ul>
3	<ul style="list-style-type: none"> <li>C1A01: POWER SUPPLY CIR</li> <li>C1A02: POWER SUPPLY CIR 2</li> <li>C1A12 :RADAR OFF-CENTER</li> <li>C1A16: RADAR BLOCKED</li> <li>C1A18: RADAR ALIGNMENT INCOMPLETE</li> <li>C1A21: UNIT HIGH TEMP</li> <li>C1A39: STRG SEN CIR</li> <li>U0104: ADAS CAN CIR1</li> <li>U0121: VDC CAN CIR2</li> <li>U0126: STRG SEN CAN CIR1</li> <li>U0405: ADAS CAN CIR2</li> <li>U0415: VDC CAN CIR1</li> <li>U0428: STRG SEN CAN CIR2</li> </ul>
4	<ul style="list-style-type: none"> <li>C1A00: CONTROL UNIT</li> </ul>

## DTC Index

INFOID:000000009716588

### NOTE:

- The details of time display are as per the following.
- 0: The malfunctions that are detected now  
CAN communication system (U1000, U1010)
- 1 - 39: It increases like 0 → 1 → 2 ... 38 → 39 after returning to the normal condition whenever the ignition switch OFF → ON. It returns to 0 when a malfunction is detected again in the process.
- If it is over 39, it is fixed to 39 until the self-diagnosis results are erased.  
Other than CAN communication system (Other than U1000, U1010)
- 1 - 49: It increases like 0 → 1 → 2 ... 38 → 49 after returning to the normal condition whenever the ignition switch OFF → ON. It returns to 0 when a malfunction is detected again in the process.
- If it is over 49, it is fixed to 49 until the self-diagnosis results are erased.

# ICC SENSOR

< ECU DIAGNOSIS INFORMATION >

[FCW]

×: Applicable

DTC	CONSULT display	ICC system warning lamp	Fail-safe function						Reference
			Vehicle-to-vehicle distance control mode	Conventional (fixed speed) cruise control mode	Distance Control Assist (DCA)	Forward Collision Warning (FCW)	Intelligent Brake Assist (IBA)	Brake Assist (with preview function)	
C1A00	CONTROL UNIT	ON	×	×	×	×	×	×	<a href="#">DAS-158</a>
C1A01	POWER SUPPLY CIR	ON	×	×	×	×	×	×	<a href="#">DAS-159</a>
C1A02	POWER SUPPLY CIR2	ON	×	×	×	×	×	×	<a href="#">DAS-74</a>
C1A12	RADAR OFF-CENTER	ON	×		×	×	×	×	<a href="#">DAS-170</a>
C1A16	RADAR BLOCKED	ON	×		×	×	×	×	<a href="#">DAS-180</a>
C1A18	RADAR ALIGNMENT INCOMPLETE	ON	×		×	×	×	×	<a href="#">DAS-182</a>
C1A21	UNIT HIGH TEMP	ON	×	×	×	×	×	×	<a href="#">DAS-183</a>
C1A39	STRG SEN CIR	ON	×	×	×	×	×	×	<a href="#">DAS-195</a>
C1A50	ADAS MALFUNCTION	ON	×	×	×	×	×	×	<a href="#">DAS-417</a>
U0104	ADAS CAN CIR1	ON	×	×	×	×	×	×	<a href="#">DAS-423</a>
U0121	VDC CAN CIR2	ON	×	×	×	×	×	×	<a href="#">DAS-205</a>
U0126	STRG SEN CAN CIR1	ON	×	×	×	×	×	×	<a href="#">DAS-206</a>
U0405	ADAS CAN CIR2	ON	×	×	×	×	×	×	<a href="#">DAS-428</a>
U0415	VDC CAN CIR1	ON	×	×	×	×	×	×	<a href="#">DAS-211</a>
U0428	STRG SEN CAN CIR2	ON	×	×	×	×	×	×	<a href="#">DAS-430</a>
U1000	CAN COMM CIRCUIT	ON	×	×	×	×	×	×	<a href="#">DAS-212</a>
U1010	CONTROL UNIT (CAN)	ON	×	×	×	×	×	×	<a href="#">DAS-214</a>

A  
B  
C  
D  
E  
F  
G  
H  
I  
J  
K  
L  
M  
N  
P

DAS



# DRIVER ASSISTANCE SYSTEMS

[FCW]

< WIRING DIAGRAM >

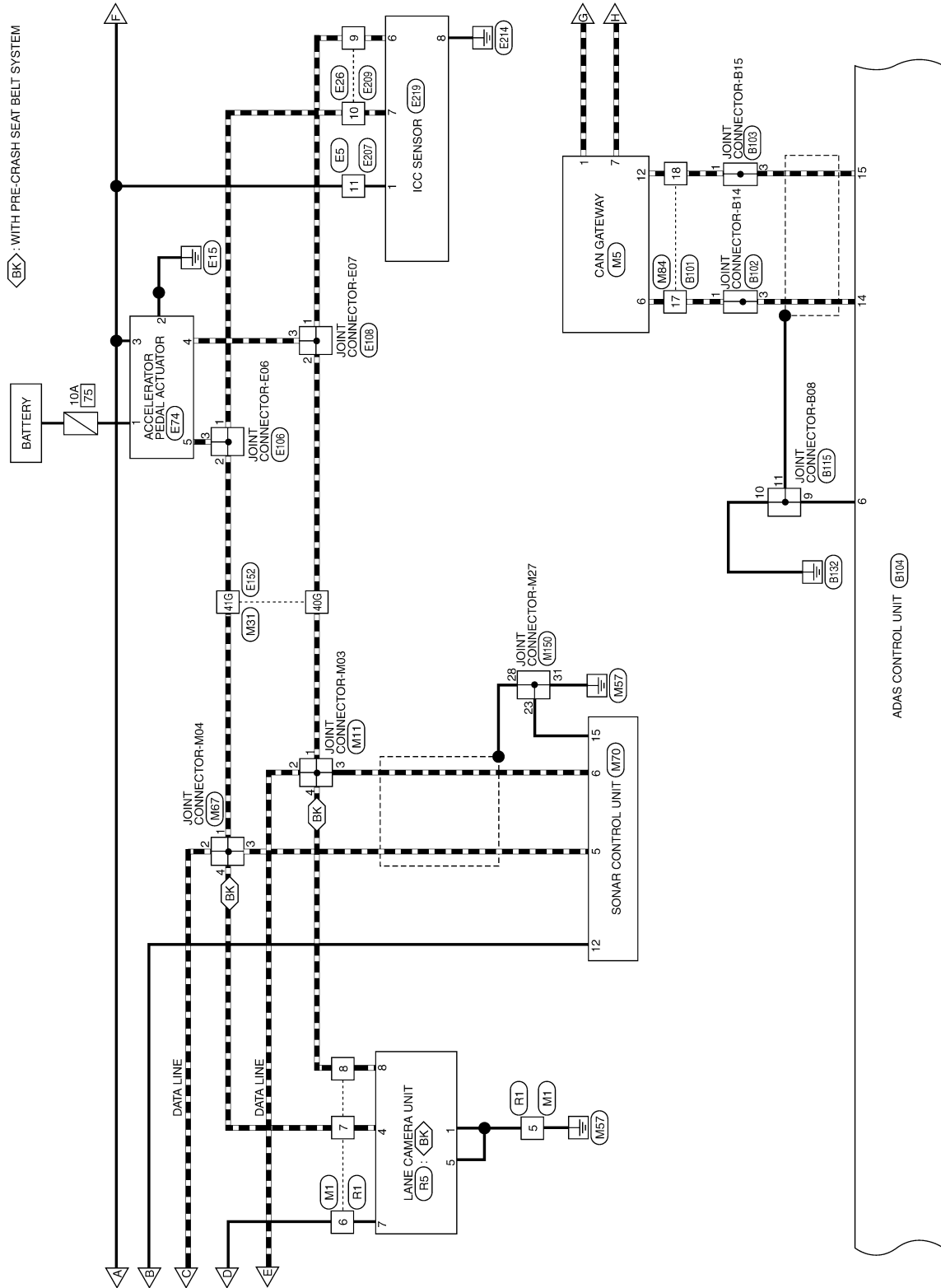

ABOWA0031GB

A  
B  
C  
D  
E  
F  
G  
H  
I  
J  
K  
L  
M  
N  
P

DAS



# DRIVER ASSISTANCE SYSTEMS

< WIRING DIAGRAM >

[FCW]

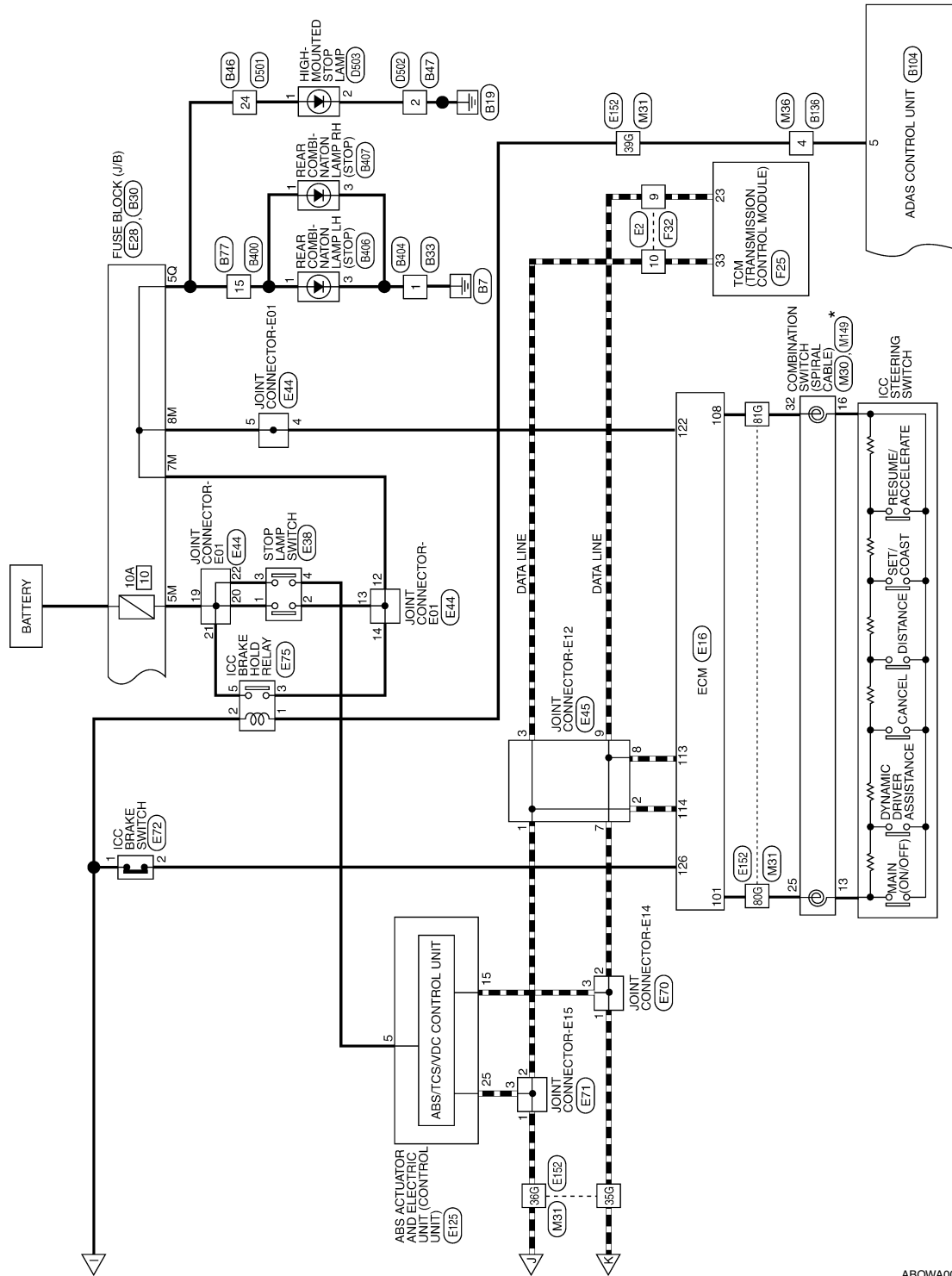

\* : THIS CONNECTOR IS NOT SHOWN IN "HARNES LAYOUT" OF PG SECTION.

ABOWA0033GB

A  
B  
C  
D  
E  
F  
G  
H  
I  
J  
K  
L  
M  
N  
P

DAS

DRIVE ASSISTANCE SYSTEM CONNECTORS

Connector No.	M1
Connector Name	WIRE TO WIRE
Connector Color	WHITE

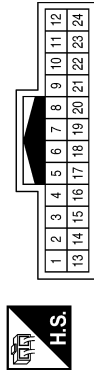

Terminal No.	Color of Wire	Signal Name
5	GR	-
6	LG	-
7	L	-
8	Y	-

Connector No.	M3
Connector Name	FUSE BLOCK (J/B)
Connector Color	WHITE

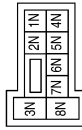

Terminal No.	Color of Wire	Signal Name
6N	W	-

Connector No.	M4
Connector Name	FUSE BLOCK (J/B)
Connector Color	WHITE

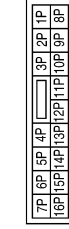

Terminal No.	Color of Wire	Signal Name
7P	LG	-
8P	BG	-
13P	W	-

Connector No.	M5
Connector Name	CAN GATEWAY
Connector Color	WHITE

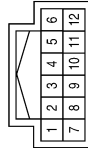

Terminal No.	Color of Wire	Signal Name
1	L	CAN-H
6	L	CAN-H
7	P	CAN-L
12	P	CAN-L

Connector No.	M11
Connector Name	JOINT CONNECTOR-M03
Connector Color	WHITE



Terminal No.	Color of Wire	Signal Name
1	Y	-
2	Y	-
3	W	-
4	Y	-

Connector No.	M19
Connector Name	BCM (BODY CONTROL MODULE)
Connector Color	BLACK

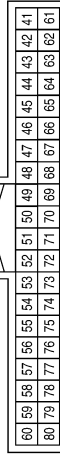

Terminal No.	Color of Wire	Signal Name
59	P	CAN-L
60	L	CAN-H

ABOIA0114GB



# DRIVER ASSISTANCE SYSTEMS

< WIRING DIAGRAM >

[FCW]

Terminal No.	Color of Wire	Signal Name
1	B	GND1
2	B	GND2
21	BG	IGN
22	W	BAT
38	P	CAN-L
39	L	CAN-H

Connector No.	M24
Connector Name	COMBINATION METER
Connector Color	WHITE

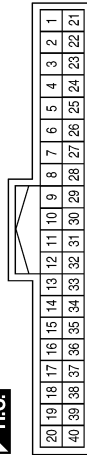

Connector No.	M23
Connector Name	COMBINATION METER
Connector Color	WHITE

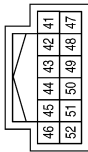

Terminal No.	Color of Wire	Signal Name
48	G	SW GND

Connector No.	M30
Connector Name	COMBINATION SWITCH (SPIRAL CABLE)
Connector Color	GRAY

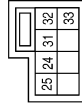

Connector No.	M27
Connector Name	METER CONTROL SWITCH
Connector Color	WHITE

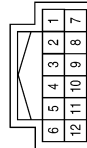

Terminal No.	Color of Wire	Signal Name
25	W	-
32	G	-

Terminal No.	Color of Wire	Signal Name
2	G	-
6	BG	-

ABOIA0098GB

A  
B  
C  
D  
E  
F  
G  
H  
I  
J  
K  
L  
M  
N  
P

DAS

# DRIVER ASSISTANCE SYSTEMS

< WIRING DIAGRAM >

[FCW]

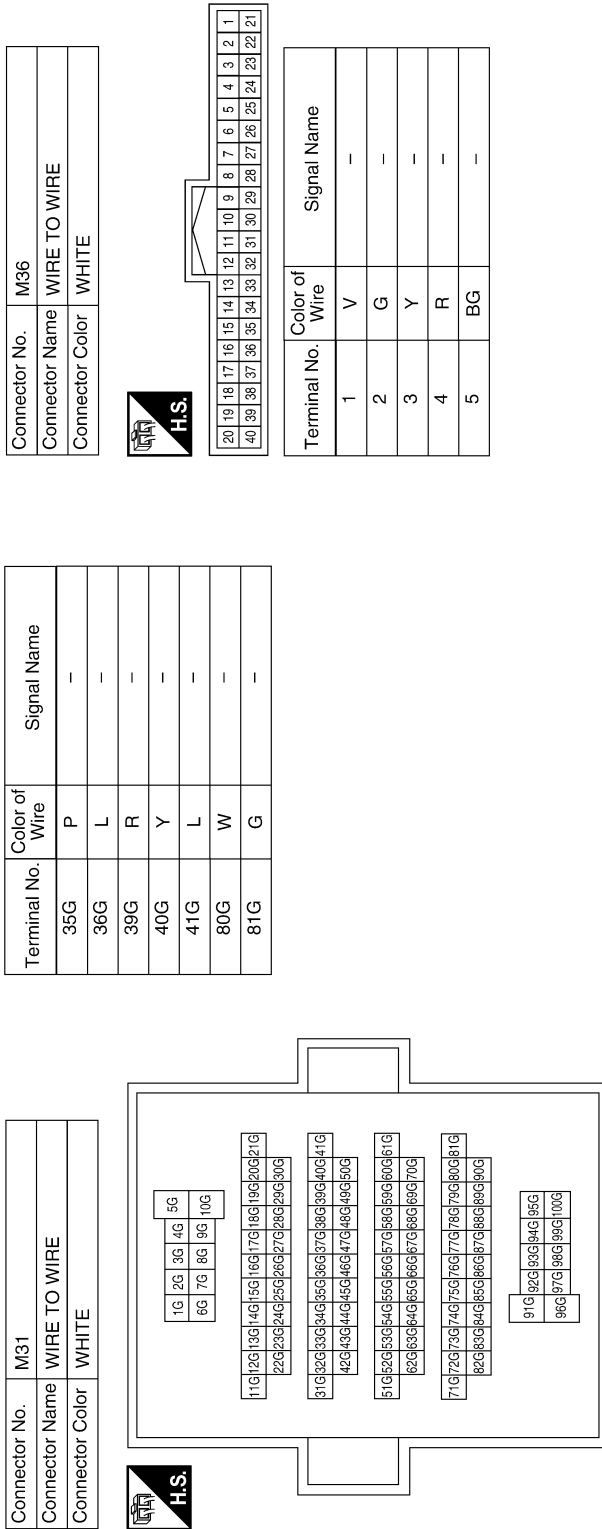

Terminal No.	Color of Wire	Signal Name
35G	P	-
36G	L	-
39G	R	-
40G	Y	-
41G	L	-
80G	W	-
81G	G	-

Connector No.	M36
Connector Name	WIRE TO WIRE
Connector Color	WHITE



20	19	18	17	16	15	14	13	12	11	10	9	8	7	6	5	4	3	2	1
40	39	38	37	36	35	34	33	32	31	30	29	28	27	26	25	24	23	22	21

Terminal No.	Color of Wire	Signal Name
1	V	-
2	G	-
3	Y	-
4	R	-
5	BG	-

Terminal No.	Color of Wire	Signal Name
1	Y	-
2	Y	-
3	W	-

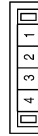

Terminal No.	Color of Wire	Signal Name
1	L	-
2	L	-
3	B	-

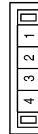

Terminal No.	Color of Wire	Signal Name
1	Y	-
2	Y	-
3	W	-

Terminal No.	Color of Wire	Signal Name
1	L	-
2	L	-
3	B	-

ABOIA0099GB

# DRIVER ASSISTANCE SYSTEMS

< WIRING DIAGRAM >

[FCW]

Connector No.	M41
Connector Name	JOINT CONNECTOR-M18
Connector Color	WHITE

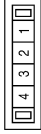

Terminal No.	Color of Wire	Signal Name
1	P	-
2	P	-
3	P	-

Terminal No.	Color of Wire	Signal Name
14A	LG	-
33A	W	-
34A	B	-
35A	SHIELD	-
80A	Y	-
81A	L	-

Connector No.	M40
Connector Name	WIRE TO WIRE
Connector Color	GRAY

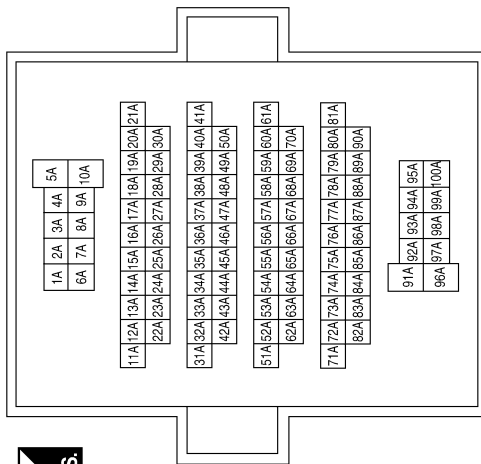

Connector No.	M50
Connector Name	A/C AUTO AMP.
Connector Color	WHITE

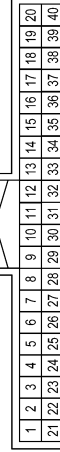

Terminal No.	Color of Wire	Signal Name
1	L	CAN-H
21	P	CAN-L

Connector No.	M47
Connector Name	TCU
Connector Color	WHITE

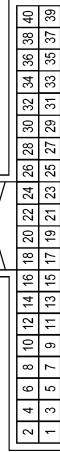

Terminal No.	Color of Wire	Signal Name
9	L	CAN-H
10	P	CAN-L

Connector No.	M43
Connector Name	JOINT CONNECTOR-M17
Connector Color	WHITE

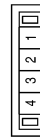

Terminal No.	Color of Wire	Signal Name
1	L	-
2	L	-
3	L	-

ABOIA0113GB

A  
B  
C  
D  
E  
F  
G  
H  
I  
J  
K  
L  
M  
N  
P

DAS

# DRIVER ASSISTANCE SYSTEMS

< WIRING DIAGRAM >

[FCW]

Connector No.	M67
Connector Name	JOINT CONNECTOR-M04
Connector Color	WHITE



Terminal No.	Color of Wire	Signal Name
1	L	-
2	L	-
3	B	-
4	L	-

Connector No.	M60
Connector Name	WARNING BUZZER
Connector Color	BROWN



Terminal No.	Color of Wire	Signal Name
1	LG	-
2	V	-
3	GR	-
4	-	-

Connector No.	M54
Connector Name	STEERING ANGLE SENSOR
Connector Color	WHITE

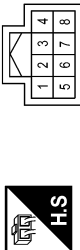

Terminal No.	Color of Wire	Signal Name
2	P	-
5	L	-

Connector No.	M84
Connector Name	WIRE TO WIRE
Connector Color	WHITE

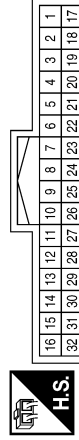

Terminal No.	Color of Wire	Signal Name
1	B	-
2	W	-
3	SHIELD	-
4	LG	-
17	L	-
18	P	-

Connector No.	M70
Connector Name	SONAR CONTROL UNIT
Connector Color	WHITE

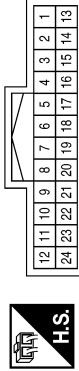

Terminal No.	Color of Wire	Signal Name
5	B	CAN-H
6	W	CAN-L
12	LG	IGN
15	GR	GND

Connector No.	M68
Connector Name	FUSE BLOCK (J/B)
Connector Color	BROWN

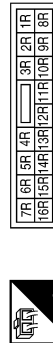

Terminal No.	Color of Wire	Signal Name
2R	LG	-

A010A100GB

# DRIVER ASSISTANCE SYSTEMS

[FCW]

< WIRING DIAGRAM >

Connector No.	M126
Connector Name	TWIN SWITCH (WARNING SYSTEM SWITCH)
Connector Color	BLACK

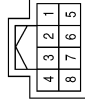

Terminal No.	Color of Wire	Signal Name
1	-	-
2	-	-
3	G	-
4	-	-
5	W	-
6	Y	-
7	-	-
8	B	-

Connector No.	M124
Connector Name	AV CONTROL UNIT (WITH BOSE AUDIO SYSTEM - WITH NAVI WITHOUT SURROUND SOUND SYSTEM)
Connector Color	WHITE

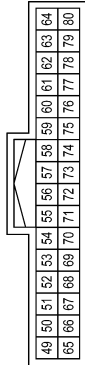

Terminal No.	Color of Wire	Signal Name
62	P	CAN-L
78	L	CAN-H

Connector No.	M96
Connector Name	AROUND VIEW MONITOR CONTROL UNIT
Connector Color	WHITE

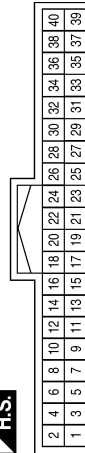

Terminal No.	Color of Wire	Signal Name
1	B	GND
3	LG	IGN
27	B	CAN-H
28	W	CAN-L
29	SHIELD	CAN GND

Connector No.	M158
Connector Name	WIRE TO WIRE
Connector Color	WHITE

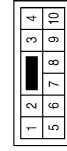

Terminal No.	Color of Wire	Signal Name
1	W	-
2	B	-
3	SHIELD	-

Connector No.	M150
Connector Name	JOINT CONNECTOR-M27
Connector Color	WHITE

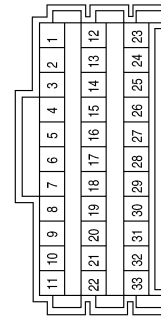

Terminal No.	Color of Wire	Signal Name
23	GR	-
28	SHIELD	-
31	GR	-

Connector No.	M149
Connector Name	COMBINATION SWITCH (SPIRAL CABLE)
Connector Color	GRAY

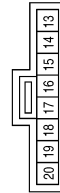

Terminal No.	Color of Wire	Signal Name
13	R	-
16	L	-

ABOIA0101GB

A B C D E F G H I J K L M N P

DAS

# DRIVER ASSISTANCE SYSTEMS

< WIRING DIAGRAM >

[FCW]

Connector No.	M188
Connector Name	WIRE TO WIRE
Connector Color	WHITE

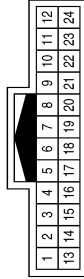

Terminal No.	Color of Wire	Signal Name
19	G	-
20	W	-
21	B	-
22	Y	-

Connector No.	M167
Connector Name	WIRE TO WIRE
Connector Color	WHITE

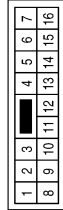

Terminal No.	Color of Wire	Signal Name
14	SHIELD	-
15	B	-
16	W	-

Connector No.	M163
Connector Name	AV CONTROL UNIT (WITH BOSE AUDIO SYSTEM - WITH NAVI AND SURROUND SOUND SYSTEM)
Connector Color	WHITE

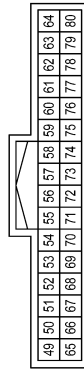

Terminal No.	Color of Wire	Signal Name
62	P	CAN-L
78	L	CAN-H

Connector No.	E5
Connector Name	WIRE TO WIRE
Connector Color	WHITE

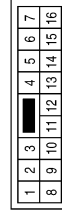

Terminal No.	Color of Wire	Signal Name
11	R	-

Connector No.	E2
Connector Name	WIRE TO WIRE
Connector Color	WHITE



Terminal No.	Color of Wire	Signal Name
9	P	-
10	L	-

Connector No.	M189
Connector Name	WIRE TO WIRE
Connector Color	WHITE

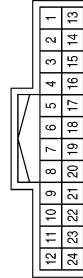

Terminal No.	Color of Wire	Signal Name
19	G	-
20	W	-
21	B	-
22	Y	-

ABOIA0102GB

# DRIVER ASSISTANCE SYSTEMS

[FCW]

< WIRING DIAGRAM >

Connector No.	E16
Connector Name	ECM
Connector Color	GRAY

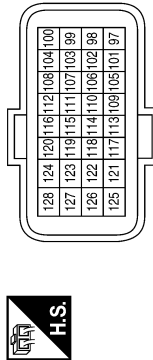

Terminal No.	Color of Wire	Signal Name
101	G	ASC D STEERING SWITCH/ICC STEERING SWITCH
108	R	SENSOR GROUND (ASC D STEERING SWITCH)
113	P	CAN-L
114	L	CAN-H
122	R	STOP LAMP SWITCH
126	LG	ASC D BRAKE SWITCH

Connector No.	E38
Connector Name	STOP LAMP SWITCH
Connector Color	WHITE



Terminal No.	Color of Wire	Signal Name
1	Y	-
2	P	-
3	Y	-
4	G	-

Connector No.	E26
Connector Name	WIRE TO WIRE
Connector Color	WHITE

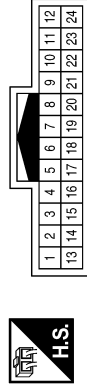

Terminal No.	Color of Wire	Signal Name
9	Y	-
10	BG	-

Connector No.	E44
Connector Name	JOINT CONNECTOR-E01
Connector Color	WHITE

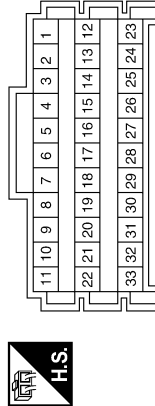

Terminal No.	Color of Wire	Signal Name
4	R	-
5	R	-
12	P	-
13	P	-

Connector No.	E28
Connector Name	FUSE BLOCK (J/B)
Connector Color	WHITE

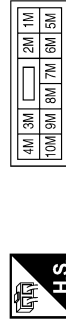

Terminal No.	Color of Wire	Signal Name
1M	R	-
5M	Y	-
7M	P	-
8M	R	-

Terminal No.	Color of Wire	Signal Name
14	P	-
19	Y	-
20	Y	-
21	Y	-
22	Y	-

A  
B  
C  
D  
E  
F  
G  
H  
I  
J  
K  
L  
M  
N  
P

DAS

A01A0103GB

# DRIVER ASSISTANCE SYSTEMS

< WIRING DIAGRAM >

[FCW]

Connector No.	E45
Connector Name	JOINT CONNECTOR-E12
Connector Color	BLUE



Terminal No.	Color of Wire	Signal Name
1	L	-
2	L	-
3	L	-
7	P	-
8	P	-
9	P	-

Connector No.	E70
Connector Name	JOINT CONNECTOR-E14
Connector Color	BLACK



Terminal No.	Color of Wire	Signal Name
1	P	-
2	P	-
3	P	-

Connector No.	E71
Connector Name	JOINT CONNECTOR-E15
Connector Color	BLACK



Terminal No.	Color of Wire	Signal Name
1	L	-
2	L	-
3	L	-

Connector No.	E72
Connector Name	ICC BRAKE SWITCH
Connector Color	BROWN



Terminal No.	Color of Wire	Signal Name
1	R	-
2	LG	-

Connector No.	E74
Connector Name	ACCELERATOR PEDAL ACTUATOR
Connector Color	GRAY



Terminal No.	Color of Wire	Signal Name
1	BG	-
2	GR	-
3	G	-
4	Y	-
5	BG	-
6	-	-

Connector No.	E75
Connector Name	ICC BRAKE HOLD RELAY
Connector Color	BLUE



Terminal No.	Color of Wire	Signal Name
1	W	-
2	R	-
3	P	-
5	Y	-

ABOIA0104GB



# DRIVER ASSISTANCE SYSTEMS

< WIRING DIAGRAM >

[FCW]

Connector No.	E106
Connector Name	JOINT CONNECTOR-E06
Connector Color	WHITE

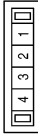

Terminal No.	Color of Wire	Signal Name
1	BG	-
2	BG	-
3	BG	-

Connector No.	E108
Connector Name	JOINT CONNECTOR-E07
Connector Color	WHITE



Terminal No.	Color of Wire	Signal Name
1	Y	-
2	Y	-
3	Y	-

Connector No.	E125
Connector Name	ABS ACTUATOR AND ELECTRIC UNIT (CONTROL UNIT)
Connector Color	BLACK

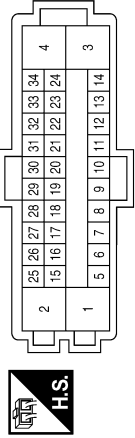

Terminal No.	Color of Wire	Signal Name
5	G	STOP LAMP SW (WITH ICC)
15	P	CAN-L
25	L	CAN-H

Connector No.	E152
Connector Name	WIRE TO WIRE
Connector Color	WHITE

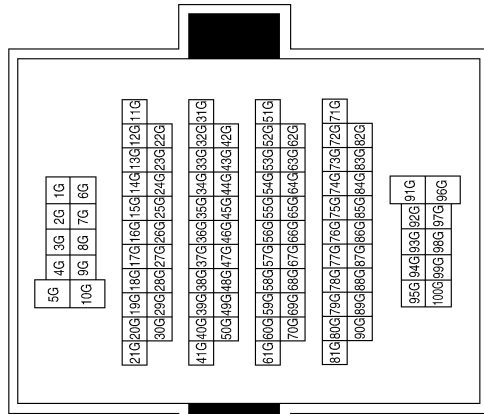

Terminal No.	Color of Wire	Signal Name
35G	P	-
36G	L	-
39G	W	-
40G	Y	-
41G	BG	-
80G	G	-
81G	R	-

Connector No.	E207
Connector Name	WIRE TO WIRE
Connector Color	WHITE



Terminal No.	Color of Wire	Signal Name
11	P	-

A B C D E F G H I J K L M N P

DAS

ABOIA0105GB

# DRIVER ASSISTANCE SYSTEMS

< WIRING DIAGRAM >

[FCW]

Connector No.	F25
Connector Name	TCM (TRANSMISSION CONTROL MODULE)
Connector Color	BLACK

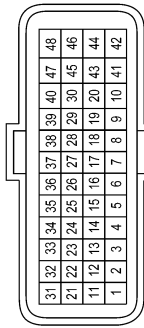

Terminal No.	Color of Wire	Signal Name
23	P	CAN-L
33	L	CAN-H

Connector No.	E219
Connector Name	ICC SENSOR
Connector Color	BLACK

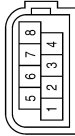

Terminal No.	Color of Wire	Signal Name
1	P	-
6	Y	-
7	L	-
8	B	-

Connector No.	E209
Connector Name	WIRE TO WIRE
Connector Color	WHITE

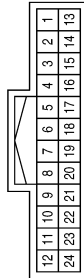

Terminal No.	Color of Wire	Signal Name
9	Y	-
10	L	-

Connector No.	B32
Connector Name	WIRE TO WIRE
Connector Color	WHITE

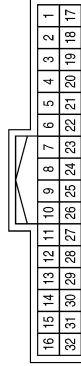

Terminal No.	Color of Wire	Signal Name
20	Y	-
21	L	-

Connector No.	B30
Connector Name	FUSE BLOCK (J/B)
Connector Color	WHITE



Terminal No.	Color of Wire	Signal Name
5Q	G	-

Connector No.	F32
Connector Name	WIRE TO WIRE
Connector Color	WHITE

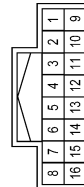

Terminal No.	Color of Wire	Signal Name
9	P	-
10	L	-

A01A106GB

# DRIVER ASSISTANCE SYSTEMS

[FCW]

< WIRING DIAGRAM >

Connector No.	B33
Connector Name	WIRE TO WIRE
Connector Color	BLACK



Terminal No.	1	Color of Wire	B	Signal Name	-
--------------	---	---------------	---	-------------	---

Connector No.	B63
Connector Name	JOINT CONNECTOR-B01
Connector Color	WHITE

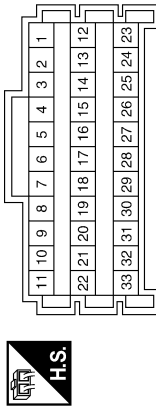

Terminal No.	Color of Wire	Signal Name
1	L	-
2	L	-
3	L	-
4	Y	-
5	Y	-
6	Y	-
16	W	-
17	W	-
19	B	-
20	B	-
21	SHIELD	-
22	B	-

Connector No.	B46
Connector Name	WIRE TO WIRE
Connector Color	WHITE

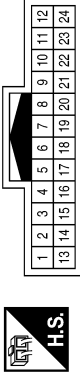

Terminal No.	24	Color of Wire	G	Signal Name	-
--------------	----	---------------	---	-------------	---

Connector No.	B69
Connector Name	WIRE TO WIRE
Connector Color	GRAY

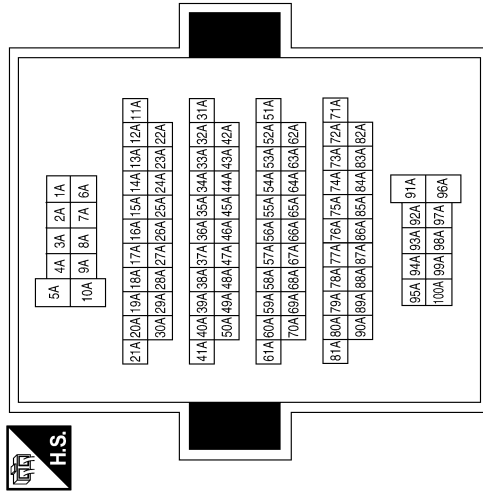

Connector No.	B47
Connector Name	WIRE TO WIRE
Connector Color	GRAY



Terminal No.	2	Color of Wire	B	Signal Name	-
--------------	---	---------------	---	-------------	---

Terminal No.	14A	Color of Wire	R	Signal Name	-
	33A	Color of Wire	W	Signal Name	-
	34A	Color of Wire	B	Signal Name	-
	35A	Color of Wire	SHIELD	Signal Name	-
	80A	Color of Wire	Y	Signal Name	-
	81A	Color of Wire	L	Signal Name	-

ABOIA0107GB

A  
B  
C  
D  
E  
F  
G  
H  
I  
J  
K  
L  
M  
N  
P

DAS

# DRIVER ASSISTANCE SYSTEMS

< WIRING DIAGRAM >

[FCW]

Connector No.	B102
Connector Name	JOINT CONNECTOR-B14
Connector Color	WHITE



Terminal No.	Color of Wire	Signal Name
1	L	-
3	B	-

Connector No.	B101
Connector Name	WIRE TO WIRE
Connector Color	WHITE

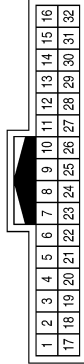

Terminal No.	Color of Wire	Signal Name
1	B	-
2	W	-
3	SHIELD	-
4	R	-
17	L	-
18	P	-

Connector No.	B77
Connector Name	WIRE TO WIRE
Connector Color	WHITE

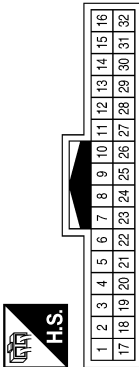

Terminal No.	Color of Wire	Signal Name
6	R	-
7	W	-
8	B	-
12	L	-
13	Y	-
15	G	-

Terminal No.	Color of Wire	Signal Name
7	L	ITS COMM-H
8	Y	ITS COMM-L
9	-	-
10	BG	BCP OFF SW
11	-	-
12	G	WARNING BUZZER
13	-	-
14	B	CAN-H
15	W	CAN-L
16	R	IGNITION

Connector No.	B104
Connector Name	ADAS CONTROL UNIT
Connector Color	WHITE

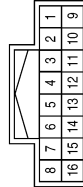

Terminal No.	Color of Wire	Signal Name
1	BR	WARNING SYSTEM SW
2	-	-
3	-	-
4	W	WARNING SYSTEM ON IND
5	G	BRAKE HOLD RLY DRIVE SIGNAL
6	B	GND

Connector No.	B103
Connector Name	JOINT CONNECTOR-B15
Connector Color	WHITE



Terminal No.	Color of Wire	Signal Name
1	P	-
3	W	-

A010A108GB

# DRIVER ASSISTANCE SYSTEMS

< WIRING DIAGRAM >

[FCW]

Terminal No.	Color of Wire	Signal Name
9	B	-
10	GR	-
11	SHIELD	-
19	R	-
20	R	-
21	R	-
27	W	-
28	W	-
29	B	-
30	B	-
31	GR	-
32	SHIELD	-
33	B	-

Connector No.	B115
Connector Name	JOINT CONNECTOR-B08
Connector Color	WHITE

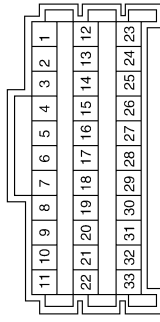

Connector No.	B109
Connector Name	SIDE RADAR RH
Connector Color	BLACK

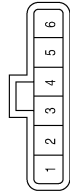

Terminal No.	Color of Wire	Signal Name
1	B	-
2	B	-
3	Y	-
4	L	-
5	R	-
6	W	-

Connector No.	B146
Connector Name	JOINT CONNECTOR-B12
Connector Color	WHITE



Connector No.	B136
Connector Name	WIRE TO WIRE
Connector Color	WHITE

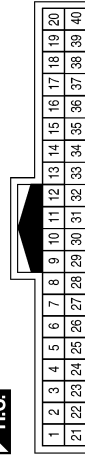

Terminal No.	Color of Wire	Signal Name
1	L	-
2	L	-
3	L	-

Terminal No.	Color of Wire	Signal Name
1	G	-
2	W	-
3	BR	-
4	G	-
5	BG	-

Connector No.	B124
Connector Name	WIRE TO WIRE
Connector Color	WHITE

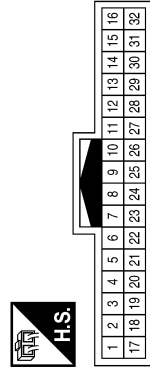

Terminal No.	Color of Wire	Signal Name
20	Y	-
21	L	-

ABOIA0109GB

A B C D E F G H I J K L M N P

DAS

# DRIVER ASSISTANCE SYSTEMS

< WIRING DIAGRAM >

[FCW]

Connector No.	B147
Connector Name	JOINT CONNECTOR-B13
Connector Color	WHITE



Terminal No.	Color of Wire	Signal Name
1	Y	-
2	Y	-
3	Y	-

Connector No.	B400
Connector Name	WIRE TO WIRE
Connector Color	WHITE

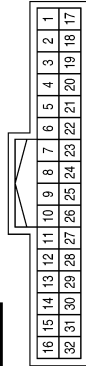

Terminal No.	Color of Wire	Signal Name
6	R	-
7	W	-
8	B	-
12	L	-
13	Y	-
15	G	-

Connector No.	B404
Connector Name	WIRE TO WIRE
Connector Color	BLACK



Terminal No.	Color of Wire	Signal Name
1	B	-

Connector No.	B406
Connector Name	REAR COMBINATION LAMP LH
Connector Color	GRAY



Terminal No.	Color of Wire	Signal Name
1	G	-
3	B	-

Connector No.	B407
Connector Name	REAR COMBINATION LAMP RH
Connector Color	GRAY



Terminal No.	Color of Wire	Signal Name
1	G	-
3	GR	-

Connector No.	B416
Connector Name	SIDE RADAR LH
Connector Color	BLACK

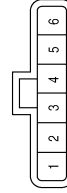

Terminal No.	Color of Wire	Signal Name
1	-	-
2	B	-
3	Y	-
4	L	-
5	R	-
6	W	-

ABOIA0110GB

# DRIVER ASSISTANCE SYSTEMS

[FCW]

< WIRING DIAGRAM >

Connector No.	D2
Connector Name	WIRE TO WIRE
Connector Color	WHITE

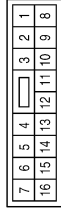

Terminal No.	Color of Wire	Signal Name
14	SHIELD	-
15	B	-
16	W	-

Connector No.	R5
Connector Name	LANE CAMERA UNIT
Connector Color	WHITE

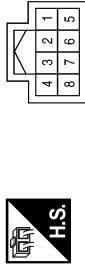

Terminal No.	Color of Wire	Signal Name
1	B	-
2	-	-
3	-	-
4	BR	-
5	B	-
6	-	-
7	LG	-
8	Y	-

Connector No.	R1
Connector Name	WIRE TO WIRE
Connector Color	WHITE

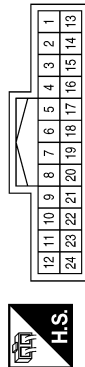

Terminal No.	Color of Wire	Signal Name
5	B	-
6	LG	-
7	BR	-
8	Y	-

Connector No.	D111
Connector Name	BLIND SPOT WARNING/ BLIND SPOT INTERVEN- TION INDICATOR RH
Connector Color	WHITE



Terminal No.	Color of Wire	Signal Name
1	W	-
2	-	-
3	-	-
4	B	-

Connector No.	D102
Connector Name	WIRE TO WIRE
Connector Color	WHITE

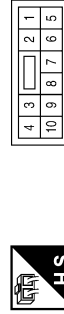

Terminal No.	Color of Wire	Signal Name
1	W	-
2	B	-
3	SHIELD	-

Connector No.	D21
Connector Name	BLIND SPOT WARNING/ BLIND SPOT INTERVEN- TION INDICATOR LH
Connector Color	WHITE

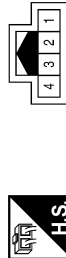

Terminal No.	Color of Wire	Signal Name
1	W	-
2	-	-
3	-	-
4	B	-

ABOIA0111GB

A  
B  
C  
D  
E  
F  
G  
H  
I  
J  
K  
L  
M  
N  
P

DAS

# DRIVER ASSISTANCE SYSTEMS

< WIRING DIAGRAM >

[FCW]

Connector No.	D503
Connector Name	HIGH-MOUNTED STOP LAMP
Connector Color	BROWN



Terminal No.	Color of Wire	Signal Name
1	LG	-
2	B	-

Connector No.	D502
Connector Name	WIRE TO WIRE
Connector Color	GRAY

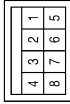

Terminal No.	Color of Wire	Signal Name
2	B	-

Connector No.	D501
Connector Name	WIRE TO WIRE
Connector Color	WHITE

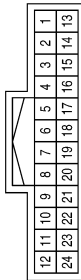

Terminal No.	Color of Wire	Signal Name
24	LG	-

ABOIA0112GB



# DIAGNOSIS AND REPAIR WORK FLOW

[FCW]

< BASIC INSPECTION >

## BASIC INSPECTION

### DIAGNOSIS AND REPAIR WORK FLOW

Work Flow

INFOID:000000009716590

#### OVERALL SEQUENCE

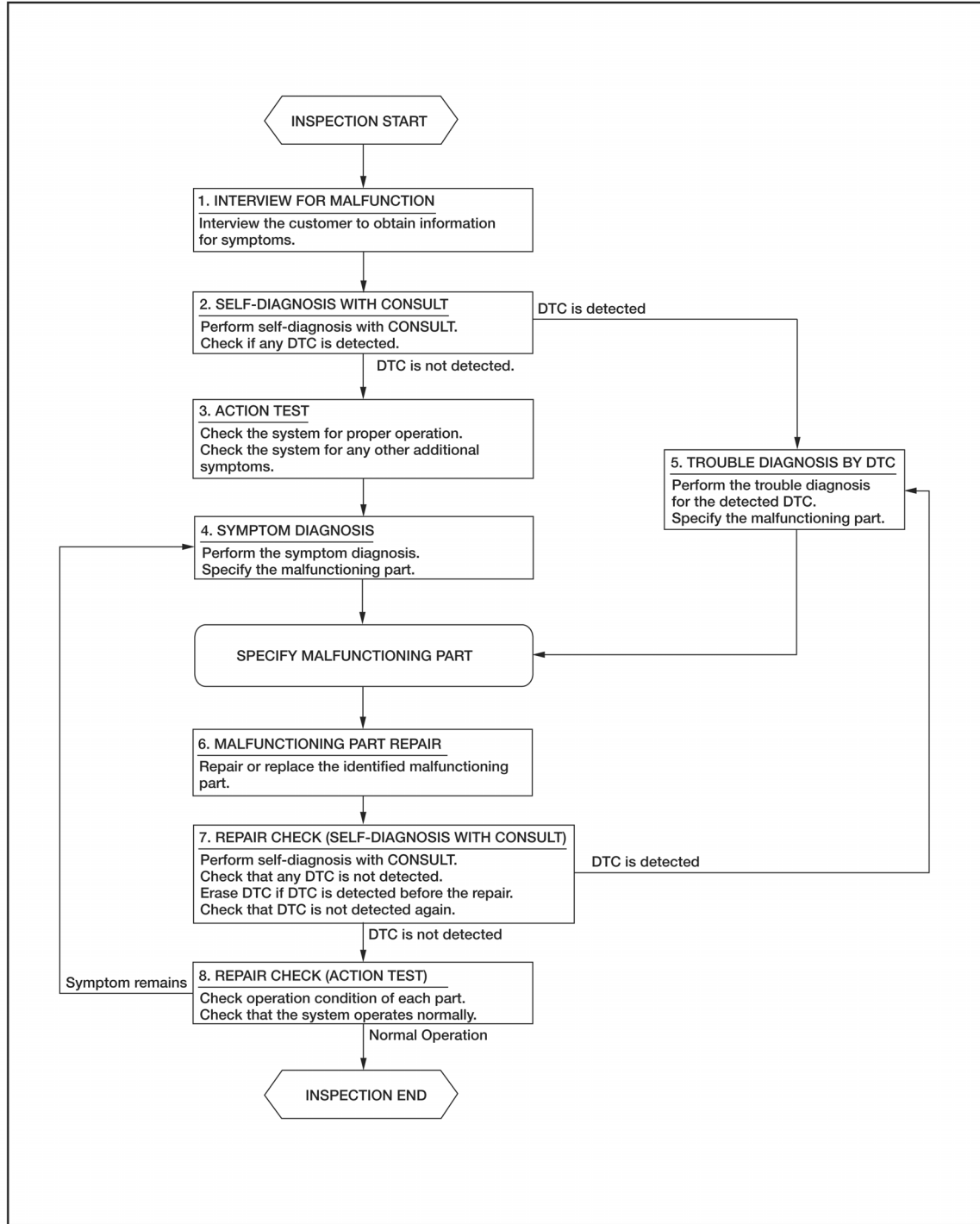

#### DETAILED FLOW

##### NOTE:

The FCW system shares component parts with the ICC system. If the FCW system has a malfunction perform diagnosis for the ICC system.

#### 1. INTERVIEW FOR MALFUNCTION

A  
B  
C  
D  
E  
F  
G  
H  
I  
J  
K  
L  
M  
N  
P

DAS

# DIAGNOSIS AND REPAIR WORK FLOW

[FCW]

< BASIC INSPECTION >

It is also important to clarify the customer concerns before starting the inspection. Interview the customer about the concerns carefully and understand the symptoms fully.

**NOTE:**

The customers are not professionals. Never assume that “maybe the customer means…” or “maybe the customer mentioned this symptom”.

>> GO TO 2.

## 2.SELF-DIAGNOSIS WITH CONSULT

---

1. Perform “All DTC Reading” with CONSULT.
2. Check if the DTC is detected on the self-diagnosis results of “ICC/ADAS”.

Is any DTC detected?

- YES >> GO TO 5.  
NO >> GO TO 3.

## 3.ACTION TEST

---

Perform the ICC system action test to check the operation status. Refer to [CCS-95, "Description"](#).

>> GO TO 4.

## 4.SYMPTOM DIAGNOSIS

---

Perform the applicable diagnosis according to the diagnosis chart by symptom. Refer to [DAS-311, "Symptom Table"](#).

>> GO TO 6.

## 5.TROUBLE DIAGNOSIS BY DTC

---

1. Check the DTC in the self-diagnosis results.
2. Perform trouble diagnosis for the detected DTC. Refer to [DAS-286, "DTC Index"](#).

>> GO TO 6.

## 6.MALFUNCTIONING PART REPAIR

---

Repair or replace the identified malfunctioning parts.

>> GO TO 7.

## 7.REPAIR CHECK (SELF-DIAGNOSIS WITH CONSULT)

---

1. Erases self-diagnosis results.
2. Perform “All DTC Reading” again after repairing or replacing the specific items.
3. Check if the DTC is detected on the self-diagnosis results of “ICC/ADAS”.

Is any DTC detected?

- YES >> GO TO 5.  
NO >> GO TO 8.

## 8.REPAIR CHECK (ACTION TEST)

---

Perform the ICC system action test. Check that the malfunction symptom is solved or no other symptoms occur.

Is there any malfunction symptom?

- YES >> GO TO 4.  
NO >> Inspection End.

# FORWARD COLLISION WARNING SYSTEM SYMPTOMS

< SYMPTOM DIAGNOSIS >

[FCW]

## SYMPTOM DIAGNOSIS

### FORWARD COLLISION WARNING SYSTEM SYMPTOMS

#### Symptom Table

INFOID:000000009716591

**NOTE:**

Perform the self-diagnosis with CONSULT before the symptom diagnosis. Perform the trouble diagnosis if any DTC is detected.

Symptoms		Reference page
Operation	FCW system is not activated	Refer to <a href="#">DAS-312, "Description"</a>
	FCW system setting cannot be turned ON on the navigation screen	Refer to <a href="#">DAS-313, "Description"</a>
	FCW system setting cannot be turned OFF on the navigation screen	

A  
B  
C  
D  
E  
F  
G  
H  
I  
J  
K  
L  
M  
N  
P

DAS

# FCW SYSTEM IS NOT ACTIVATED

[FCW]

< SYMPTOM DIAGNOSIS >

---

## FCW SYSTEM IS NOT ACTIVATED

### Description

INFOID:000000009716592

FCW system does not operate by pressing the warning systems switch.

**NOTE:**

Warning systems switch is shared with LDW system and BSW system.

### Diagnosis Procedure

INFOID:000000009716593

#### 1.PERFORM THE SELF-DIAGNOSIS

---

1. Perform "All DTC Reading" with CONSULT.
2. Check if the DTC is detected in self-diagnosis results of "ICC/ADAS". Refer to [DAS-286, "DTC Index"](#).

Is any DTC detected?

- YES >> GO TO 3.
- NO >> GO TO 2.

#### 2.CHECK WARNING SYSTEMS SWITCH CIRCUIT

---

Check warning systems switch circuit. Refer to [DAS-445, "Component Function Check"](#).

**NOTE:**

Warning systems switch is shared with LDW system and BSW system.

Is the inspection result normal?

- YES >> Replace the ADAS control unit. Refer to [DAS-79, "Removal and Installation"](#).
- NO >> GO TO 3.

#### 3.REPAIR OR REPLACE THE SPECIFIC ITEMS

---

Repair or replace malfunctioning items.

>> Inspection End.

# FCW SYSTEM SETTINGS CANNOT BE TURNED ON/OFF IN VEHICLE INFORMATION DISPLAY

[FCW]

< SYMPTOM DIAGNOSIS >

## FCW SYSTEM SETTINGS CANNOT BE TURNED ON/OFF IN VEHICLE INFORMATION DISPLAY

### Description

INFOID:000000009716594

- FCW system setting is not selectable on the navigation screen.

#### NOTE:

- When the ignition switch is in ACC position, FCW system settings cannot be changed.
- "Forward Collision Warning" is not indicated on the navigation screen.
- The switching between ON and OFF cannot be performed by operating the navigation system.
- The item of "Forward Collision Warning" on the navigation screen is not active.
- After turning ON the ignition switch or starting the engine, FCW settings of the navigation system cannot be selected for several tens of seconds under the following conditions:
  - After replacing AV control unit.
  - After erasing connection history of the navigation system.
  - After erasing self-diagnosis results of AV control unit.
- The FCW system setting differs from the one set at the previous driving.

#### NOTE:

- Turn OFF the ignition switch and wait for 5 seconds or more.

### Diagnosis Procedure

INFOID:000000009716595

#### 1. CHECK FCW SYSTEM SETTING

1. Start the engine.
2. Check that the FCW system settings is selectable on the navigation screen.

Is the inspection result normal?

YES >> GO TO 3.

NO >> GO TO 2.

#### 2. PERFORM THE SELF-DIAGNOSIS

1. Perform self-diagnosis with CONSULT.
2. Check if the DTC is detected in self-diagnosis results of "ICC/ADAS", "MULTI AV" and "METER/M&A". Refer to the following.
  - ICC/ADAS: [DAS-286. "DTC Index"](#)
  - MULTI AV: [AV-660. "DTC Index"](#)
  - METER/M&A: [MWI-26. "DTC Index"](#)

Is any DTC detected?

YES >> Repair or replace malfunctioning parts.

NO >> INSPECTION END

#### 3. CHECK DATA MONITOR OF ADAS CONTROL UNIT

Check that "DCA SELECT" operates normally in "DATA MONITOR" of "ICC/ADAS" with CONSULT.

Is the inspection result normal?

YES >> Refer to [DAS-256. "On Board Diagnosis Function"](#).

NO >> GO TO 4.

#### 4. CHECK MULTIFUNCTION SWITCH

Operate the multifunction switch to check that the audio, navigation system, and air conditioner operate properly.

Is the inspection result normal?

YES >> Replace the ADAS control unit. Refer to [DAS-79. "Removal and Installation"](#).

NO >> Repair or replace malfunctioning parts.

# NORMAL OPERATING CONDITION

< SYMPTOM DIAGNOSIS >

[FCW]

## NORMAL OPERATING CONDITION

### Description

INFOID:000000009716596

#### PRECAUTIONS FOR FORWARD COLLISION WARNING (FCW)

- FCW system is intended to warn the driver before a collision but will not avoid a collision. It is the driver's responsibility to stay alert, drive safely and be in control of the vehicle at all times.
- As there is a performance limit, the FCW system may not provide a warning in certain conditions.
- The FCW system will not detect the following objects.
  - Pedestrians, animals, or obstacles in the roadway.
  - Oncoming vehicles in the same lane
- FCW system will not detect under the following conditions.
  - When the sensor gets dirty, it is impossible to detect the distance from the vehicle ahead.
  - The sensor generally detects signals returned from the reflectors on a vehicle ahead. Therefore, the FCW system may not warn properly under the following conditions:
    - When the sensor area of the front bumper gets dirty or it is impossible to detect the distance to the vehicle ahead.
    - When visibility is low (such as rain, fog, snow, etc.).
    - When snow or road spray from traveling vehicles are splashed.
    - When excessively heavy baggage is loaded in the rear seat or the luggage room.
    - When abruptly accelerating or decelerating.
    - On steep downhill or roads with sharp curves.
    - When there is a highly reflective object near the vehicle ahead.  
i.e.) very close to other vehicle, signboard, etc.
- Depending on certain road conditions (curved, beginning of a curve), vehicle conditions (steering position, vehicle position), or preceding vehicle's conditions (position in lane, etc.), the FCW system may not function properly. The FCW system may detect highly reflective objects such as signs and other stationary objects on the road or near the traveling lane, and provide unnecessary warning.
- The FCW system may not function in offset conditions.
- The FCW system may not function when the distance to the vehicle ahead is extremely close.
- The FCW system is designed to automatically check the sensor's functionality. If the sensor area of the front bumper is covered with ice, a transparent or translucent bag, etc., the system may not detect them. In these instances, the system may not be able to warn the driver properly. Be sure to check and clean the sensor area of the front bumper regularly.
- Excessive noise will interfere with the warning chime sound, and the chime may not be heard.
- A sudden appearance of the vehicle in front (i.e.: when a vehicle abruptly cuts in) may not be detected and the system may not warn soon enough.
- The FCW system will be canceled automatically with a chime sound and a warning message will be displayed under the following conditions:
  - When the sensor area of the front bumper is dirty
  - When the FCW system malfunctions

# WARNING SYSTEMS SWITCH

< REMOVAL AND INSTALLATION >

[FCW]

## REMOVAL AND INSTALLATION

### WARNING SYSTEMS SWITCH

#### Removal and Installation

INFOID:000000009716597

#### REMOVAL

1. Remove the instrument lower panel LH. Refer to [IP-25. "Removal and Installation"](#).
2. Remove three screws (A, B) that retain the lower switch carrier (2).  
(1): Upper switch carrier  
(2): Upper switch carrier screws
3. Release upper (B) and lower (C) tab using a suitable tool (A), then remove the warning system switch (1) from the lower switch carrier.  
(2): Headlamp aiming switch  
(3): AC 120V outlet main switch (if equipped)  
(4): Heated steering wheel switch

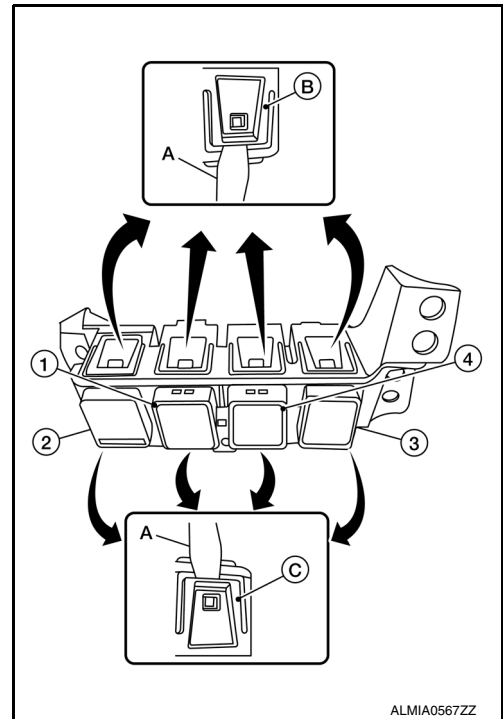
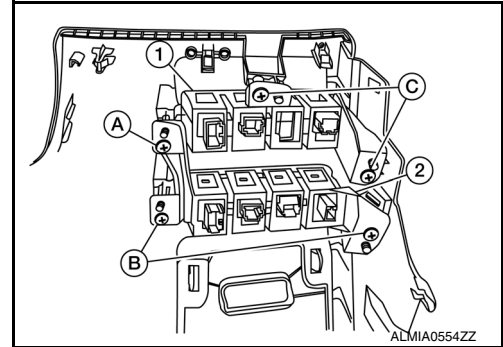

#### INSTALLATION

Installation is in the reverse order of removal.

A  
B  
C  
D  
E  
F  
G  
H  
I  
J  
K  
L  
M  
N

DAS

P

# PRECAUTION

## PRECAUTIONS

### Precaution for Supplemental Restraint System (SRS) "AIR BAG" and "SEAT BELT PRE-TENSIONER"

INFOID:000000009730868

The Supplemental Restraint System such as "AIR BAG" and "SEAT BELT PRE-TENSIONER", used along with a front seat belt, helps to reduce the risk or severity of injury to the driver and front passenger for certain types of collision. This system includes dual stage front air bag modules. The SRS system may only deploy one front air bag, depending on the severity of a collision and whether the front passenger seat is occupied. Information necessary to service the system safely is included in the SR and SB section of this Service Manual.

**WARNING:**

- To avoid rendering the SRS inoperative, which could increase the risk of personal injury or death in the event of a collision which would result in air bag inflation, all maintenance must be performed by an authorized NISSAN/INFINITI dealer.
- Improper maintenance, including incorrect removal and installation of the SRS, can lead to personal injury caused by unintentional activation of the system. For removal of Spiral Cable and Air Bag Module, see the SR section.
- Do not use electrical test equipment on any circuit related to the SRS unless instructed to in this Service Manual. SRS wiring harnesses can be identified by yellow and/or orange harnesses or harness connectors.

### PRECAUTIONS WHEN USING POWER TOOLS (AIR OR ELECTRIC) AND HAMMERS

**WARNING:**

- When working near the Airbag Diagnosis Sensor Unit or other Airbag System sensors with the Ignition ON or engine running, DO NOT use air or electric power tools or strike near the sensor(s) with a hammer. Heavy vibration could activate the sensor(s) and deploy the air bag(s), possibly causing serious injury.
- When using air or electric power tools or hammers, always switch the Ignition OFF, disconnect the battery and wait at least three minutes before performing any service.

### Precautions For Harness Repair

INFOID:000000009716599

ITS communication uses a twisted pair line. Be careful when repairing it.

- Solder the repaired area and wrap tape around the soldered area.

**NOTE:**

A fray of twisted lines must be within 110 mm (4.33 in).

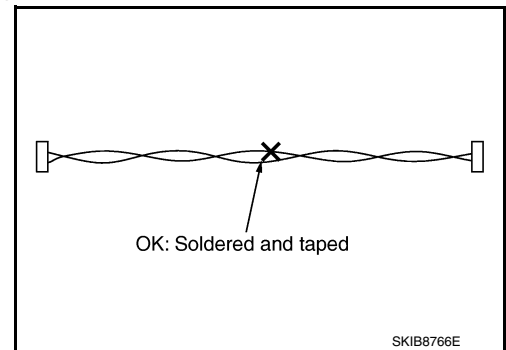

- Bypass connection is never allowed at the repaired area.

**NOTE:**

Bypass connection may cause ITS communication error. The spliced wire becomes separated and the characteristics of twisted line are lost.

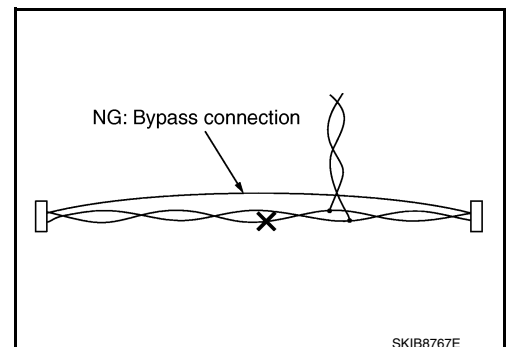



# PRECAUTIONS

< PRECAUTION >

[LDW & LDP]

## Precaution for LDW/LDP System Service

INFOID:000000009716600

### **WARNING:**

Be careful of traffic conditions and safety around the vehicle when performing road test.

### **CAUTION:**

- Do not use the LDP system when driving with free rollers or a chassis dynamometer.
- Do not perform the active test while driving.
- Do not disassemble the lane camera unit.
- Do not use the lane camera unit that is removed from the vehicle.
- Do not change LDW initial state ON ⇒ OFF without the consent of the customer.

A

B

C

D

E

F

G

H

I

J

K

L

M

N

DAS

P

# COMPONENT PARTS

< SYSTEM DESCRIPTION >

[LDW & LDP]

## SYSTEM DESCRIPTION

### COMPONENT PARTS

#### LANE DEPARTURE WARNING (LDW) SYSTEM

#### LANE DEPARTURE WARNING (LDW) SYSTEM : Component Parts Location

INFOID:000000009716601

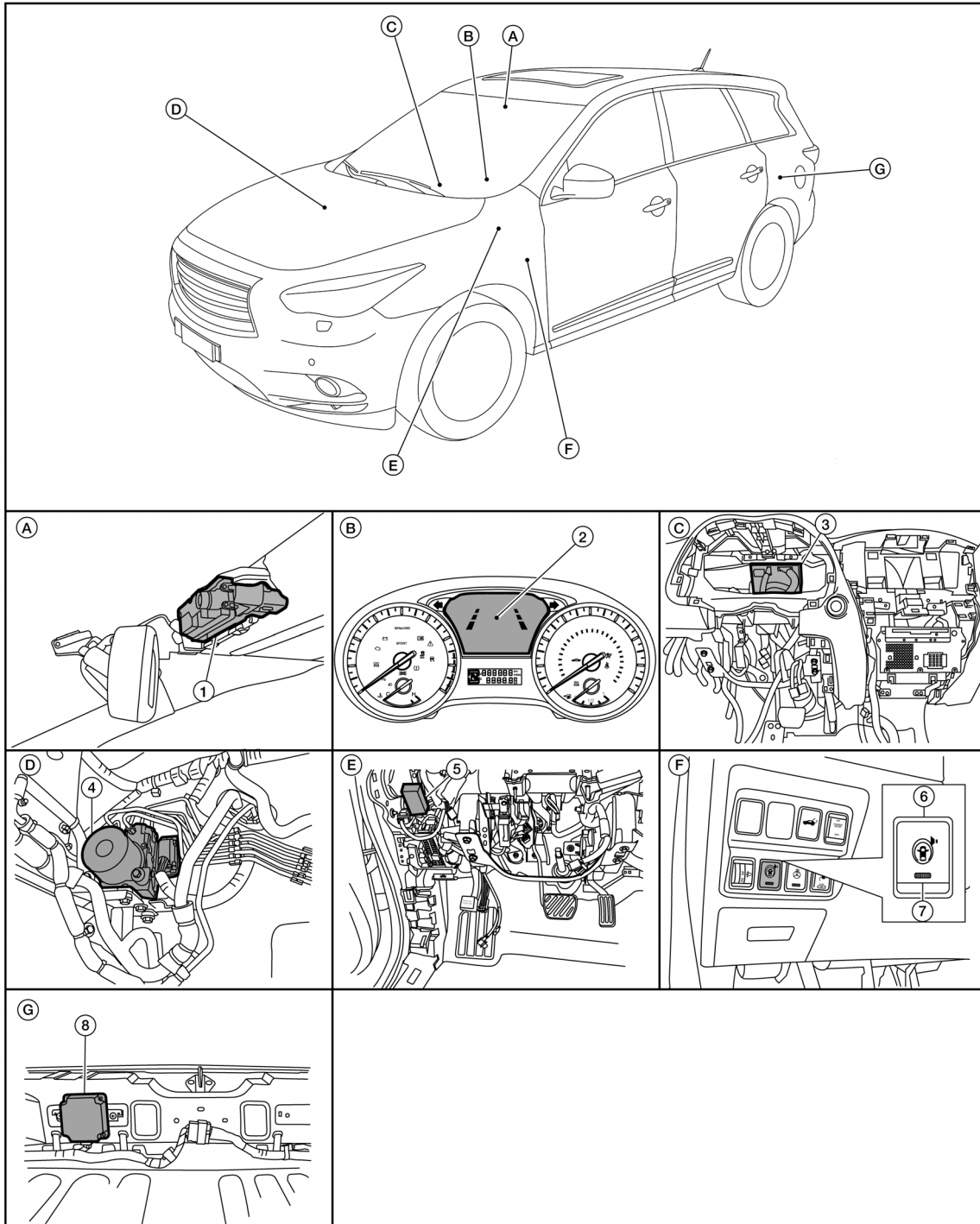

ALOIA0062ZZ

# COMPONENT PARTS

< SYSTEM DESCRIPTION >

[LDW & LDP]

- |   |  |  |   |
|---|--|--|---|
| 1. Lane camera unit   | 2. Vehicle information display   | 3. BCM (with the combination meter removed)<br>Refer to <a href="#">DAS-319. "LANE DEPARTURE WARNING (LDW) SYSTEM : Component Description"</a> | A |
| 4. ABS actuator and electric unit (control unit)<br>Refer to <a href="#">DAS-319. "LANE DEPARTURE WARNING (LDW) SYSTEM : Component Description"</a> . | 5. Warning buzzer<br>(view with instrument panel LH removed)   | 6. Warning systems switch  | B |
| 7. Warning systems ON indicator   | 8. ADAS control unit<br>(view of rear luggage room area with rear panel assembly removed)<br>Refer to <a href="#">DAS-319. "LANE DEPARTURE WARNING (LDW) SYSTEM : Component Description"</a> . |  | C |
|   |  |  | D |
|   |  |  | E |

## LANE DEPARTURE WARNING (LDW) SYSTEM : Component Description INFOID:000000009716602

Component	Description
ADAS control unit	<ul style="list-style-type: none"> <li>Judges the lane departure depending on the lane detection result and each signals</li> <li>Controls the warning buzzer and the warning systems ON indicator</li> <li>Transmits lane departure warning lamp signal to combination meter via CAN communication</li> </ul>
Lane camera unit	<ul style="list-style-type: none"> <li>Detects the lane marker in travel lane</li> <li>Transmits the detected lane condition signal to ADAS control unit via ITS communication</li> </ul>
ABS actuator and electric unit (control unit)	Transmits the vehicle speed signal (wheel speed) to ADAS control unit via CAN communication
Warning systems switch	Inputs the warning systems switch signal to ADAS control unit
Warning systems ON indicator (On the warning systems switch)	Turns on the warning systems ON indicator, according to a warning systems ON indicator signal received from the ADAS control unit
Warning buzzer	Activates the warning buzzer, according to a warning buzzer signal received from the ADAS control unit
Combination meter	<ul style="list-style-type: none"> <li>Turns the lane departure indicator lamp ON/OFF according to the signals from ADAS control unit via CAN communication</li> <li>Transmits the system selection signal to ADAS control unit via CAN communication</li> </ul>
BCM	Transmits the turn indicator signal to ADAS control unit via CAN communication

## LANE DEPARTURE PREVENTION (LDP) SYSTEM

DAS

# COMPONENT PARTS

< SYSTEM DESCRIPTION >

[LDW & LDP]

## LANE DEPARTURE PREVENTION (LDP) SYSTEM : Component Parts Location

INFOID:000000009716603

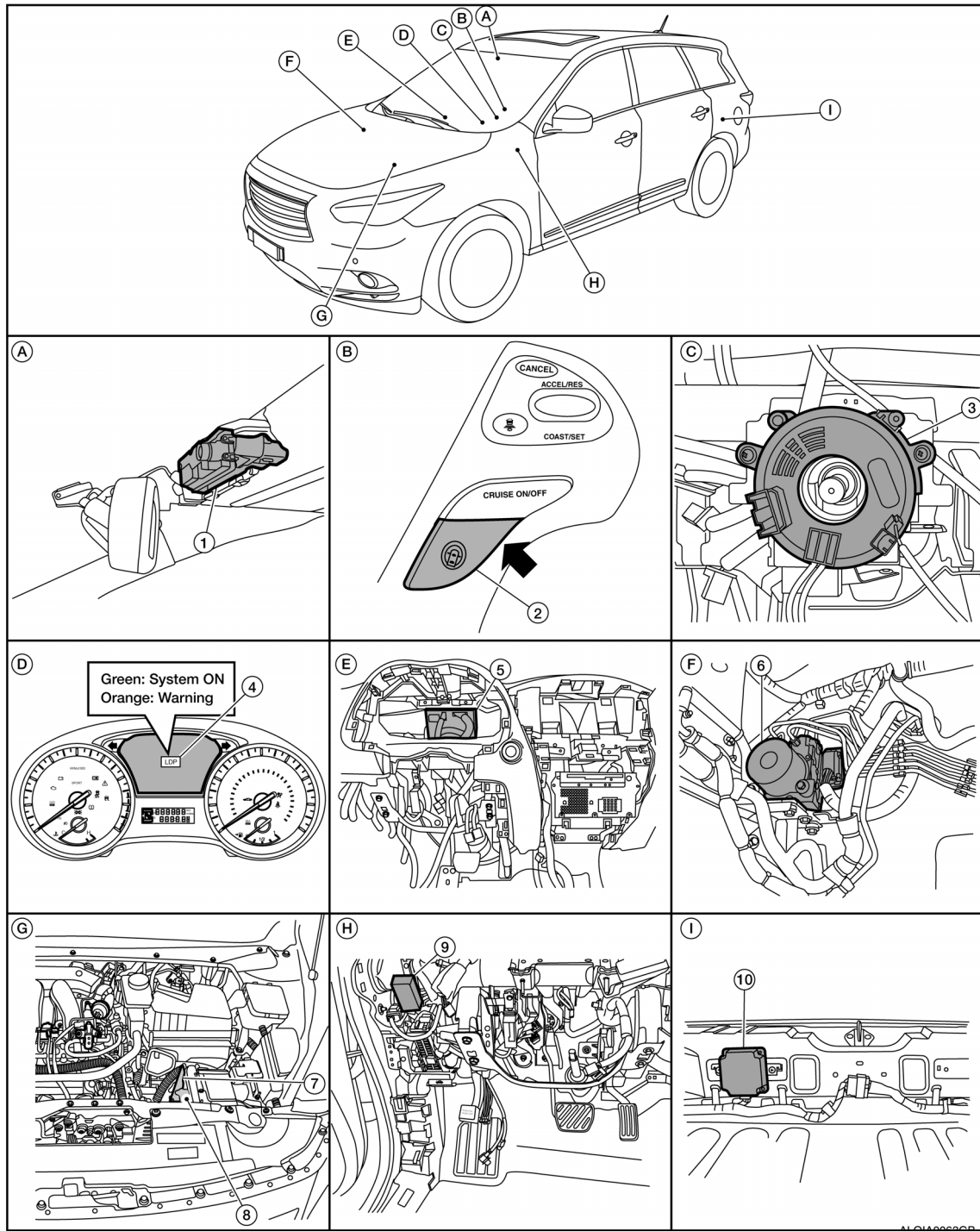

- |                                      |  |   |
|--------------------------------------|--|---|
| 1. Lane camera unit                  | 2. Dynamic driver assistance switch<br>(On the ICC steering switch)  | 3. Steering angle sensor (view with steering wheel removed)<br>Refer to <a href="#">DAS-321, "LANE DEPARTURE PREVENTION (LDP) SYSTEM : Component Description"</a> . |
| 4. Vehicle information display (LDP) | 5. BCM (with the combination meter removed) Refer to <a href="#">DAS-321, "LANE DEPARTURE PREVENTION (LDP) SYSTEM : Component Description"</a> . | 6. ABS actuator and electric unit (control unit)<br>Refer to <a href="#">DAS-321, "LANE DEPARTURE PREVENTION (LDP) SYSTEM : Component Description"</a> .            |

# COMPONENT PARTS

< SYSTEM DESCRIPTION >

[LDW & LDP]

- |  |   |                          |
|--|---|--------------------------|
| <p>7. ECM<br/>Refer to <a href="#">DAS-321, "LANE DEPARTURE PREVENTION (LDP) SYSTEM : Component Description"</a>.</p>  | <p>8. TCM<br/>Refer to <a href="#">DAS-321, "LANE DEPARTURE PREVENTION (LDP) SYSTEM : Component Description"</a>.</p> | <p>9. Warning buzzer</p> |
| <p>10. ADAS control unit<br/>(view of rear luggage room area with rear panel assembly removed)<br/>Refer to <a href="#">DAS-321, "LANE DEPARTURE PREVENTION (LDP) SYSTEM : Component Description"</a>.</p> |   |                          |

A  
B  
C  
D

## LANE DEPARTURE PREVENTION (LDP) SYSTEM : Component Description

INFOID:000000009716604

D

Component	Description
ADAS control unit	<ul style="list-style-type: none"> <li>Judges lane departure based on each signal and calculates yaw moment necessary to generate force toward the direction to recover the vehicle from the lane departure</li> <li>Outputs the warning buzzer signal to the warning buzzer</li> <li>Transmits a target yaw moment signal to the ABS actuator and electric unit (control unit) via CAN communication</li> <li>Transmits the lane departure warning lamp signal and LDP ON indicator lamp signal to combination meter via CAN communication</li> </ul>
Lane camera unit	<ul style="list-style-type: none"> <li>Detects the lane marker in travel lane</li> <li>Transmits the detected lane condition signal to ADAS control unit via ITS communication</li> </ul>
ABS actuator and electric unit (control unit)	<ul style="list-style-type: none"> <li>Transmits the vehicle speed signal (wheel speed) to ADAS control unit via CAN communication</li> <li>Transmits the yaw rate signal and side G sensor signal to ADAS control unit via CAN communication</li> <li>Receives a target yaw moment signal from the ADAS control unit via CAN communication and controls brake pressure of four wheels, respectively</li> </ul>
Warning buzzer	Activates the warning buzzer, according to a warning buzzer signal received from the ADAS control unit
Dynamic driver assistance switch (On the ICC steering switch)	ECM receives an ICC steering switch (dynamic driver assistance switch) signal and transmits the signal to ADAS control unit via CAN communication
Combination meter	Turns on the following indicator/warning lamp, according to a signal received for the ADAS control unit via CAN communication <ul style="list-style-type: none"> <li>LDP ON indicator lamp (Green)</li> <li>Lane departure warning indicator light (Yellow)</li> <li>Transmits the system selection signal to ADAS control unit via CAN communication</li> </ul>
BCM	Transmits the turn indicator signal to ADAS control unit via CAN communication
ECM	Transmits the accelerator pedal position signal, engine speed signal and ICC steering switch signal (dynamic driver assistance switch signal) to ADAS control unit via CAN communication
Steering angle sensor	Transmits the steering angle sensor signal to ADAS control unit via CAN communication
TCM	Transmits the output shaft revolution signal, input speed signal, current gear position signal and shift position signal to ADAS control unit via CAN communication

E  
F  
G  
H  
I  
J  
K  
L  
M  
N

DAS

P

SYSTEM

LANE DEPARTURE WARNING (LDW) SYSTEM

LANE DEPARTURE WARNING (LDW) SYSTEM : System Description

INFOID:000000009716605

SYSTEM DIAGRAM

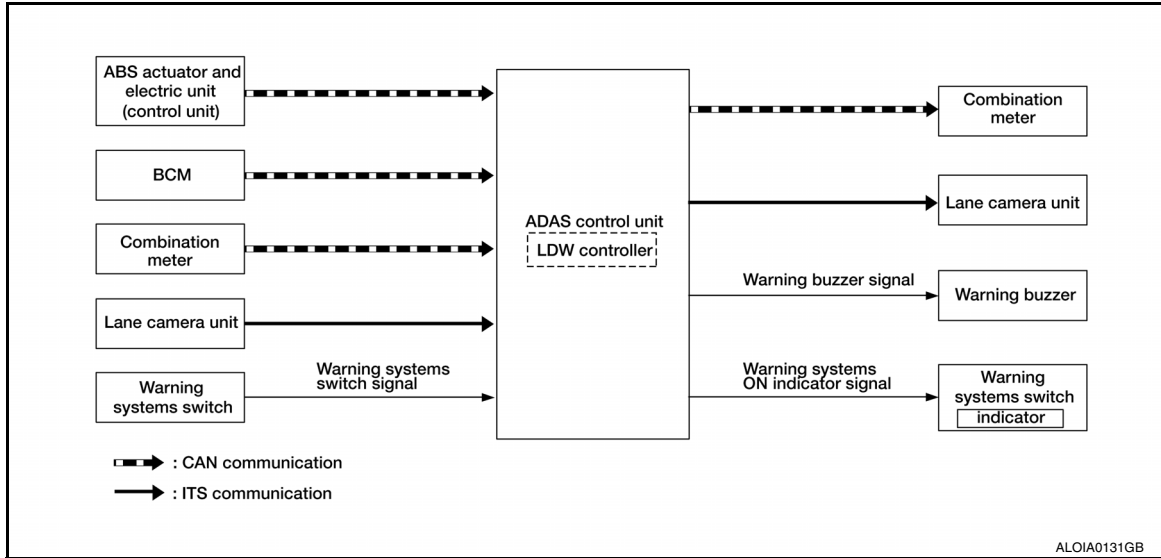

ADAS CONTROL UNIT INPUT/OUTPUT SIGNAL ITEM

Input Signal Item

Transmit unit	Signal name		Description
ABS actuator and electric unit (control unit)	CAN communication	Vehicle speed signal (ABS)	Receives wheel speeds of four wheels
BCM	CAN communication	Turn indicator signal	Receives an operational state of the turn signal lamp and the hazard lamp
Combination meter	CAN communication	System selection signal	Receives a selection state of each item in "Driving Aids" selected with the vehicle information display
Lane camera unit	ITS communication	Detected lane condition signal	Receives detection results of lane marker
Warning systems switch	Warning systems switch signal		Receives an ON/OFF state of the warning systems switch

Output Signal Item

Reception unit	Signal name		Description
Combination meter	CAN communication	Lane departure warning lamp signal	Transmits a lane departure warning lamp signal to turn ON the lane departure warning lamp
Lane camera unit	ITS communication	Vehicle speed signal	Transmits a vehicle speed calculated by the ADAS control unit
		Turn indicator signal	Transmits a turn indicator signal received from BCM
Warning buzzer	Warning buzzer signal		Activates the warning buzzer
Warning systems ON indicator	Warning systems ON indicator signal		Turns ON the warning systems ON indicator



# SYSTEM

< SYSTEM DESCRIPTION >

[LDW & LDP]

## FUNCTION DESCRIPTION

- Lane Departure Warning (LDW) system provides a lane departure warning function when the vehicle is driven at speeds of approximately 70 km/h (45 MPH) or more.
- When the vehicle approaches either the left or the right side of the traveling lane, a warning will sound and the lane departure warning lamp (yellow) on the combination meter will blink to alert the driver.
- The warning does not occur during turn signal operation (Lane change side).
- The warning function will stop when the vehicle returns inside of the lane markers.

## EXAMPLE

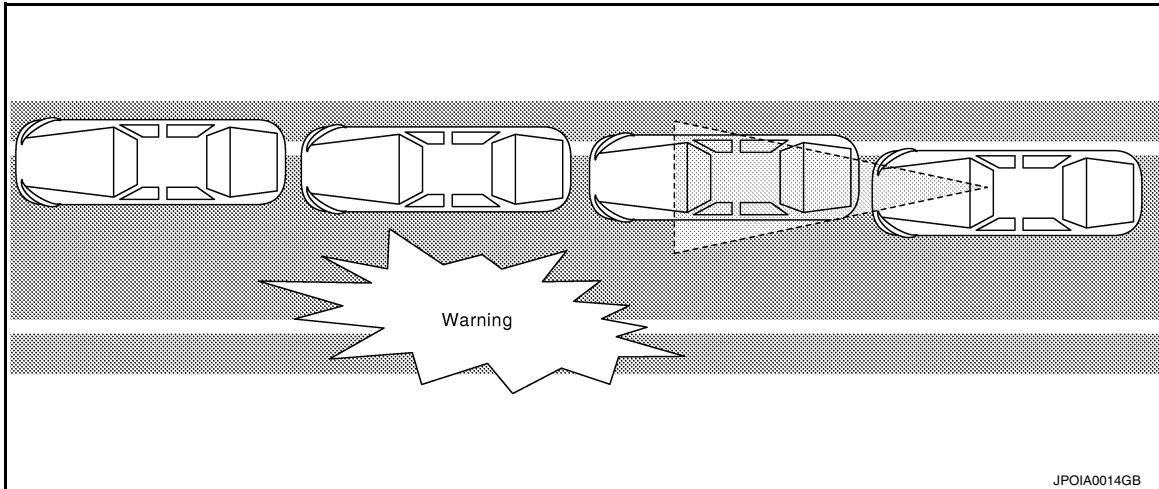

When the vehicle approaches the right lane marker, the driver is alerted by the buzzer and the blinking of lane departure warning lamp (yellow).

## OPERATION DESCRIPTION

- When the system is turned ON by operating the warning systems switch, ADAS control unit turns ON the warning systems ON indicator.
- Lane camera unit monitors lane markers of the traveling lane. It transmits the detected lane condition signal to ADAS control unit via ITS communication.
- When judging from a lane marker detection signal that the vehicle is approaching the lane marker, the ADAS control unit controls the following item to alert the driver.
  - Activates warning buzzer
  - ADAS control unit transmits a lane departure warning lamp signal to combination meter via CAN communication and turns ON/OFF the lane departure warning lamp (yellow).

## OPERATING CONDITION

- Warning systems ON indicator: ON
- Vehicle speed: approximately 70 km/h (45 MPH) or more
- Turn indicator signal: After 2 seconds or more from turned OFF

### NOTE:

- When the LDW system setting on the vehicle information display is ON.
- After the operating conditions of warning are satisfied, the warning continues until the vehicle speed reaches approximately 60 km/h (40 MPH)
- LDP ON indicator lamp is OFF
- The LDW system may not function properly, depending on the situation. Refer to [DAS-333. "Precautions for Lane Departure Warning/Lane Departure Prevention"](#).

Fail-safe Indication

A  
B  
C  
D  
E  
F  
G  
H  
I  
J  
K  
L  
M  
N  
P

DAS

# SYSTEM

< SYSTEM DESCRIPTION >

[LDW & LDP]

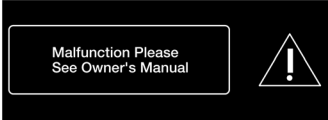
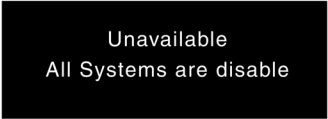
Vehicle condition/ Driver's operation	Warning systems ON indicator	Indication on the combination meter
When DTC is detected (Except "C1B01" and "C1B03")	ON	 <small>ALOIA0133GB</small>
Camera aiming is not completed ("C1B01" is detected) <b>NOTE:</b> This is detected while driving the vehicle and the indication remains ON until the ignition switch is turned OFF	ON	
When DTC is detected (Except "C1B01" and "C1B03")	ON	 <small>ALOIA0099GB</small>
Camera aiming is not completed ("C1B01" is detected) <b>NOTE:</b> This is detected while driving the vehicle and the indication remains ON until the ignition switch is turned OFF	ON	
Temporary disabled status at high temperature ("C1B03" is detected)	OFF	Unavailable: High Cabin Temp
When the warning systems switch is pressed (When the settings of LDW system, FCW system, and BSW system on the vehicle information display are "OFF")	Blink	 <small>ALOIA0132GB</small>

## LANE DEPARTURE WARNING (LDW) SYSTEM : Fail-safe (ADAS Control Unit)

INFOID:000000009716606

If a malfunction occurs in any system, ADAS control unit cancels each control, sounds a beep, and turns ON the warning lamp or indicator lamp or warning message will display.

System	Buzzer	Warning lamp/Indicator lamp	Description
Vehicle-to-vehicle distance control mode	High-pitched tone	ICC system warning lamp	Cancel
Conventional (fixed speed) cruise control mode	High-pitched tone	ICC system warning lamp	Cancel
Intelligent Brake Assist (IBA)	High-pitched tone	IBA OFF indicator lamp	Cancel
Forward Collision Warning (FCW)	High-pitched tone	Warning message	Cancel
Distance Control Assist (DCA)	High-pitched tone	ICC system warning lamp	Cancel
Lane Departure Warning (LDW)	—	Lane Departure Warning lamp	Cancel
Lane Departure Prevention (LDP)	Low-pitched tone	Lane Departure Warning lamp	Cancel
Blind Spot Warning (BSW)	—	Blind Spot Warning/Blind Spot Intervention warning lamp	Cancel
Blind Spot Intervention (BSI)	Low-pitched tone	Blind Spot Warning/Blind Spot Intervention warning lamp	Cancel
Backup Collision Intervention (BCI)	High-pitched tone	Backup Collision Intervention warning indicator	Cancel



# SYSTEM

< SYSTEM DESCRIPTION >

[LDW & LDP]

## LANE DEPARTURE WARNING (LDW) SYSTEM : Fail-safe (Lane Camera Unit)

INFOID:000000009716607

### FAIL-SAFE CONTROL BY DTC

If a malfunction occurs in the lane camera unit, ADAS control unit cancels control, and turns ON the lane departure warning lamp in the combination meter.

### TEMPORARY DISABLED STATUS AT HIGH TEMPERATURE

- If the vehicle is parked in direct sunlight under high temperature conditions, the system may be deactivated automatically. The warning systems ON indicator on the switch will blink and the following message appears on the vehicle information display "Unavailable High Cabin Temp."
- When interior temperature is reduced, the system will resume operation automatically and the warning systems ON indicator on the switch will stop blinking.

## LANE DEPARTURE PREVENTION (LDP) SYSTEM

### LANE DEPARTURE PREVENTION (LDP) SYSTEM : System Description

INFOID:000000009716608

### SYSTEM DIAGRAM

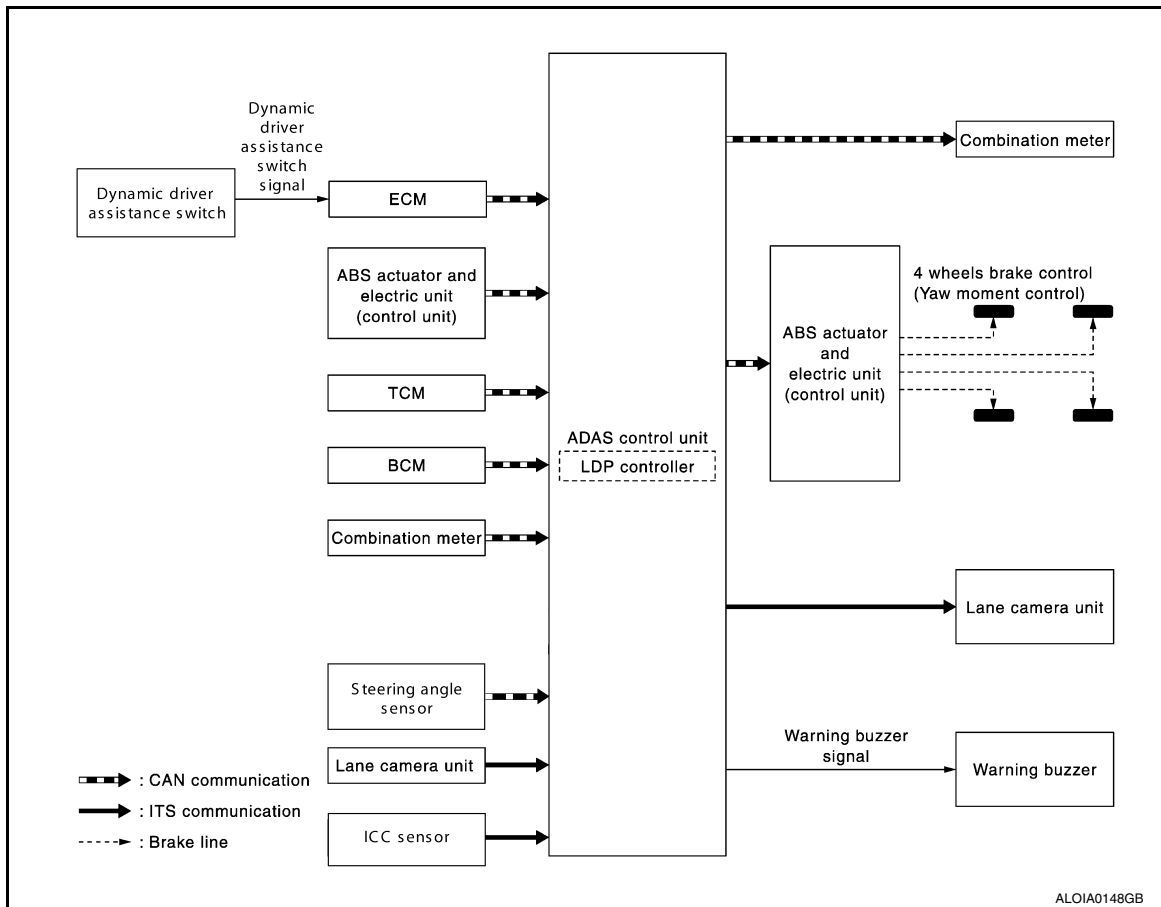

### ADAS CONTROL UNIT INPUT/OUTPUT SIGNAL ITEM

#### Input Signal Item

Transmit unit	Signal name		Description
ECM	CAN communication	Accelerator pedal position signal	Receives accelerator pedal position (angle)
		ICC steering switch signal	Receives the operational state of the ICC steering switch
		Engine speed signal	Receives engine speed
		Snow mode switch signal	Receives an operational state of the snow mode

A  
B  
C  
D  
E  
F  
G  
H  
I  
J  
K  
L  
M  
N

DAS

P

# SYSTEM

## < SYSTEM DESCRIPTION >

[LDW & LDP]

Transmit unit		Signal name	Description
TCM	CAN communication	Input speed signal	Receives the number of revolutions of input shaft
		Current gear position signal	Receives a current gear position
		Shift position signal	Receives a selector lever position
		Output shaft revolution signal	Receives the number of revolutions of output shaft
ABS actuator and electric unit (control unit)	CAN communication	ABS malfunction signal	Receives a malfunction state of ABS
		ABS operation signal	Receives an operational state of ABS
		TCS malfunction signal	Receives a malfunction state of TCS
		TCS operation signal	Receives an operational state of TCS
		VDC OFF switch signal	Receives an ON/OFF state of VDC
		VDC malfunction signal	Receives a malfunction state of VDC
		VDC operation signal	Receives an operational state of VDC
		Vehicle speed signal (ABS)	Receives wheel speeds of four wheels
		Yaw rate signal	Receives yaw rate acting on the vehicle
Side G sensor signal	Receives lateral G acting on the vehicle		
Combination meter	CAN communication	Parking brake switch signal	Receives an operational state of the parking brake
		System selection signal	Receives a selection state of each item in "Driver Aids"
BCM	CAN communication	Turn indicator signal	Receives an operational state of the turn signal lamp and the hazard lamp
Steering angle sensor	CAN communication	Steering angle sensor malfunction signal	Receives a malfunction state of steering angle sensor
		Steering angle sensor signal	Receives the number of revolutions, turning direction of the steering wheel
		Steering angle speed signal	Receives the turning angle speed of the steering wheel
ICC sensor	ITS communication	ICC sensor signal	Receives detection results, such as the presence or absence of a vehicle ahead and distance from the vehicle
Lane camera unit	ITS communication	Detected lane condition signal	Receives detection results of lane marker

### Output Signal Item

Reception unit		Signal name	Description
ABS actuator and electric unit (control unit)	CAN communication	Target yaw moment signal	Transmits a target yaw moment signal to generate yaw moment to the vehicle
Combination meter	CAN communication	LDP ON indicator lamp signal	Transmits an LDP ON indicator lamp signal to turn ON the LDP ON indicator lamp
		Lane departure warning lamp signal	Transmits an lane departure warning lamp signal to turn ON the lane departure warning lamp
Lane camera unit	ITS communication	Vehicle speed signal	Transmits a vehicle speed calculated by the ADAS control unit
		Turn indicator signal	Transmits a turn indicator signal received from BCM
Warning buzzer	Warning buzzer signal		Activates the warning buzzer

### FUNCTION DESCRIPTION

- Lane Departure Prevention (LDP) system provides a lane departure warning and brake control assistance when the vehicle is driven at speeds of approximately 70 km/h (45 MPH) or more.

# SYSTEM

## < SYSTEM DESCRIPTION >

[LDW & LDP]

- When the vehicle approaches either the left or the right side of the traveling lane, a warning sounds and the lane departure warning lamp (yellow) on the combination meter blinks to alert the driver. Then, the LDP system automatically applies the brakes for a short period of time to help assist the driver to return the vehicle to the center of the traveling lane.
- Warning and brake control are not performed during turn signal operation (lane change side).
- The warning and assist functions stop when the vehicle returns to a position inside of the lane marker.

### EXAMPLE

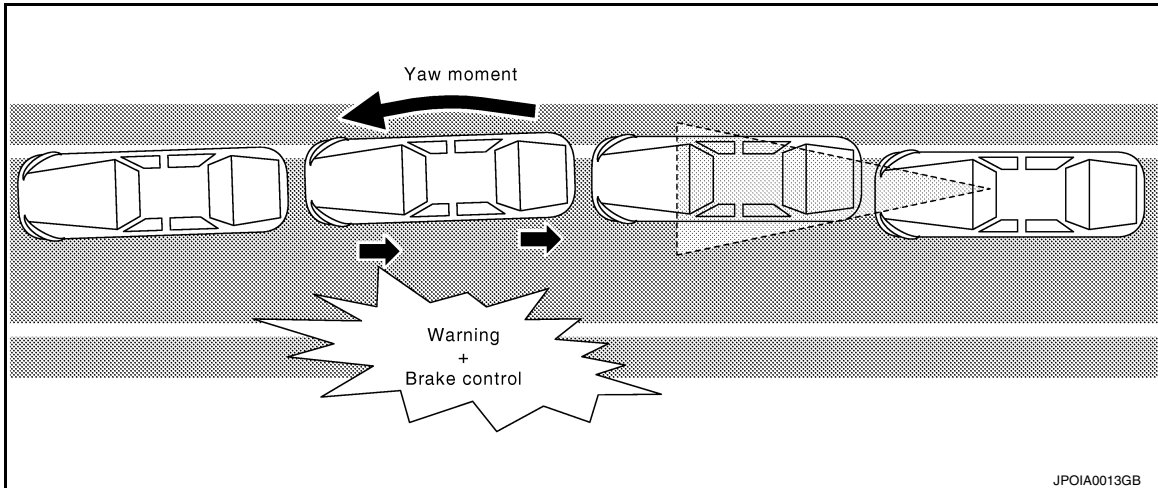

When the vehicle approaches the right lane marker, the driver is alerted by the buzzer and the blinking of lane departure warning lamp (yellow). Simultaneously, the left brake is controlled independently to generate force toward the direction to recover the vehicle from the lane departure.

### OPERATION DESCRIPTION

- When the system is turned ON by dynamic driver assistance switch, ADAS control unit transmits LDP ON indicator signal to combination meter via CAN communication.
- Lane camera unit monitors lane markers of the traveling lane. It transmits the detected lane condition signal to ADAS control unit via ITS communication.
- When judging from a lane marker detection signal that the vehicle is approaching the lane marker, ADAS control unit controls the following items.
  - Activates warning buzzer.
  - Transmits a lane departure warning lamp signal to combination meter via CAN communication.
  - Calculates necessary yaw moment to transmit a target yaw moment signal to ABS actuator and electric unit (control unit) via CAN communication.
- When receiving the target yaw moment signal, ABS actuator and electric unit (control unit) controls brake pressure of four wheels, respectively.
- When receiving the signal from ADAS control unit, combination meter turns ON/OFF the lane departure warning lamp (yellow) and the LDP ON indicator lamp (green).

### OPERATING CONDITION

- LDP ON indicator lamp: ON
- Vehicle speed: approximately 70 km/h (45 MPH) or more
- Turn indicator signal: After 2 seconds or more from turned OFF

### NOTE:

- When the LDP system setting in the vehicle information display is ON.
- After the operating conditions are satisfied, the control continues until the vehicle speed reaches approximately 60 km/h (40 MPH).
- The LDP system may not function properly, depending on the situation. Refer to [DAS-333. "Precautions for Lane Departure Warning/Lane Departure Prevention"](#).

Fail-safe Indication

# SYSTEM

< SYSTEM DESCRIPTION >

[LDW & LDP]

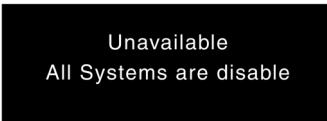
Vehicle condition/ Driver's operation	Indication on the combination meter	Buzzer
When DTC is detected (Except "C1B01" and "C1B03")	 <p style="text-align: center;">ALOIA0133GB</p>	Beep
Camera aiming is not completed ("C1B01" is detected) <b>NOTE:</b> This is detected while driving the vehicle and the indication remains ON until the ignition switch is turned OFF		
Temporary disabled status at high temperature ("C1B03" is detected)	Unavailable High Cabin Temp	Beep
Temporary disabled status during rain	Unavailable Road is slippery	Beep
Temporary disabled status when the VDC system is turned OFF	Unavailable VDC OFF	Beep
Temporary disabled status when drive mode select switch is in SNOW mode	Unavailable Snow mode active	Beep
When the dynamic driver assistance switch is pressed (When the settings of LDP system, DCA system and Blind Spot Intervention system in the vehicle information display are "OFF")	<p style="text-align: center;">LDP OFF (green)</p>  <p style="text-align: center;">ALOIA0132GB</p>	—

## LANE DEPARTURE PREVENTION (LDP) SYSTEM : Fail-safe (ADAS Control Unit)

INFOID:000000009716609

If a malfunction occurs in any system, ADAS control unit cancels each control, sounds a beep, and turns ON the warning lamp or indicator lamp or warning message will display.

System	Buzzer	Warning lamp/Indicator lamp	Description
Vehicle-to-vehicle distance control mode	High-pitched tone	ICC system warning lamp	Cancel
Conventional (fixed speed) cruise control mode	High-pitched tone	ICC system warning lamp	Cancel
Intelligent Brake Assist (IBA)	High-pitched tone	IBA OFF indicator lamp	Cancel
Forward Collision Warning (FCW)	High-pitched tone	Warning message	Cancel
Distance Control Assist (DCA)	High-pitched tone	ICC system warning lamp	Cancel
Lane Departure Warning (LDW)	—	Lane Departure Warning lamp	Cancel
Lane Departure Prevention (LDP)	Low-pitched tone	Lane Departure Warning lamp	Cancel
Blind Spot Warning (BSW)	—	Blind Spot Warning/Blind Spot Intervention warning lamp	Cancel
Blind Spot Intervention (BSI)	Low-pitched tone	Blind Spot Warning/Blind Spot Intervention warning lamp	Cancel
Backup Collision Intervention (BCI)	High-pitched tone	Backup Collision Intervention warning indicator	Cancel

## LANE DEPARTURE PREVENTION (LDP) SYSTEM : Fail-safe (Lane Camera Unit)

INFOID:000000009716610

### FAIL-SAFE CONTROL BY DTC

If a malfunction occurs in the lane camera unit, ADAS control unit cancels control, and turns ON the lane departure warning lamp in the combination meter.

# SYSTEM

< SYSTEM DESCRIPTION >

[LDW & LDP]

## TEMPORARY DISABLED STATUS AT HIGH TEMPERATURE

- If the vehicle is parked in direct sunlight under high temperature conditions, the system may be deactivated automatically. The warning systems ON indicator on the switch will blink and the following message appears on the vehicle information display "Unavailable High Cabin Temp."
- When interior temperature is reduced, the system will resume operation automatically and the warning systems ON indicator on the switch will stop blinking.

A  
B  
C  
D  
E  
F  
G  
H  
I  
J  
K  
L  
M  
N  
P

DAS

OPERATION

LANE DEPARTURE WARNING (LDW) SYSTEM

LANE DEPARTURE WARNING (LDW) SYSTEM : Switch Name and Function

INFOID:000000009716611

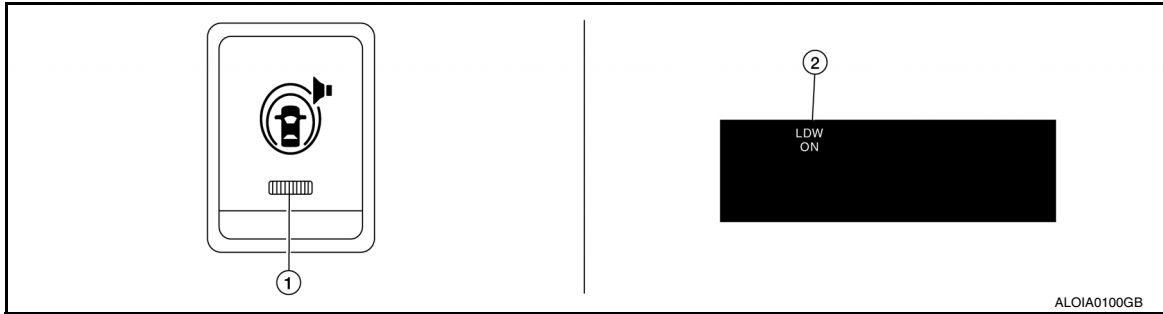

No.	Switch name	Description
1	Warning systems switch	Turns LDW system ON/OFF (When the setting of LDW system in the vehicle information display is ON)
2	LDW system setting screen (The vehicle information display)	Turns setting of LDW system can be switched between ON and OFF

LANE DEPARTURE WARNING (LDW) SYSTEM : Menu Displayed by Pressing Each Switch

INFOID:000000009716612

INDICATOR LAMP AND WARNING LAMP

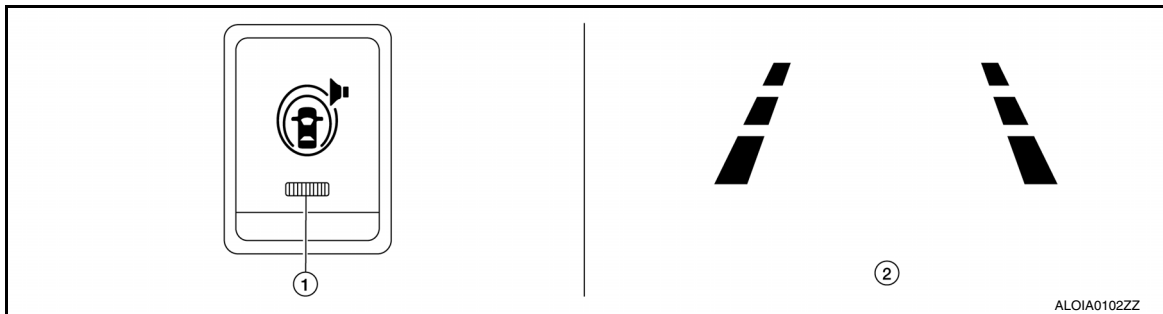

No.	Display item	Description
1	Warning systems ON indicator	<ul style="list-style-type: none"> <li>Indicates that the LDW, FCW, and/or BSW system is ON</li> <li>Blinks when the setting of LDW, FCW, and BSW are "OFF" and the warning systems switch is pressed</li> <li>Blinks when the temperature of the lane camera unit becomes high</li> </ul>
2	Lane departure warning indicator light	<ul style="list-style-type: none"> <li>Blinks when LDW system is activated</li> </ul>

DISPLAY AND WARNING

# OPERATION

< SYSTEM DESCRIPTION >

[LDW & LDP]

Vehicle condition/ Driver's operation	Action	Warning systems ON indicator	Indication on the combination meter	Buzzer
Less than Approx. 60 km/h (40 MPH)	Close to lane marker	No action	OFF	—
Approx. 70 km/h (45 MPH) or more	Close to lane marker	Warning <ul style="list-style-type: none"> <li>• Buzzer sounds</li> <li>• Warning lamp blinks (orange)</li> </ul>		Short continuous beeps
	<ul style="list-style-type: none"> <li>• Close to lane marker</li> <li>• Turn signal ON (Deviate side)</li> </ul>	No action	ON	OFF

**NOTE:**

After the operating conditions of warning are satisfied, the warning continues until the vehicle speed reaches approximately 60 km/h (40 MPH). Refer to [DAS-322. "LANE DEPARTURE WARNING \(LDW\) SYSTEM : System Description"](#).

## LANE DEPARTURE PREVENTION (LDP) SYSTEM

### LANE DEPARTURE PREVENTION (LDP) SYSTEM : Switch Name and Function

INFOID:000000009716613

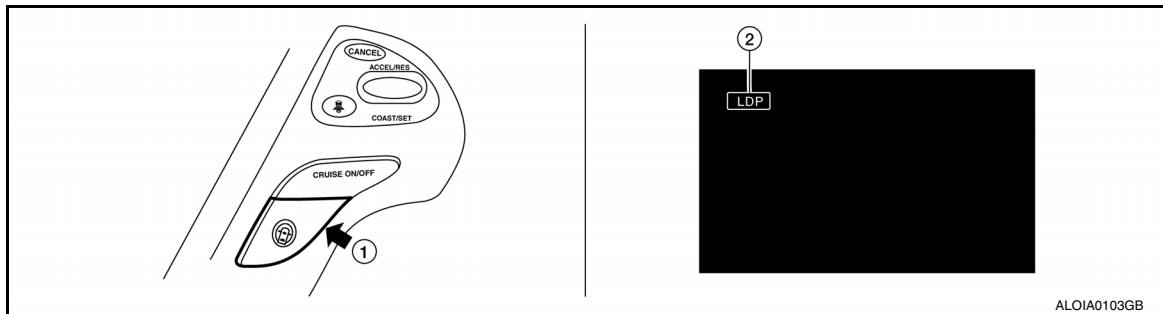

No.	Switch name	Description
1	Dynamic driver assistance switch	Turns LDP system ON/OFF (When the setting of LDP system in the vehicle information display)
2	LDP system settings screen (the vehicle information display)	The setting of LDP system can be switched between ON and OFF

### LANE DEPARTURE PREVENTION (LDP) SYSTEM : Menu Displayed by Pressing Each Switch

INFOID:000000009716614

#### INDICATOR LAMP AND WARNING LAMP

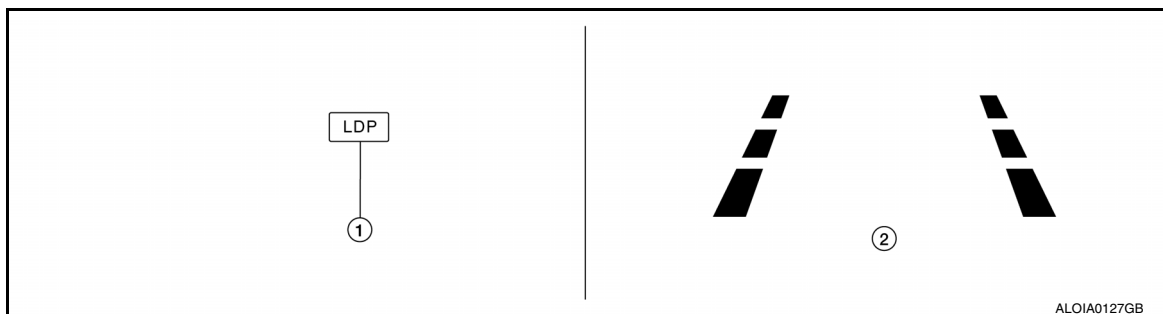

A  
B  
C  
D  
E  
F  
G  
H  
I  
J  
K  
L  
M  
N  
P

DAS



# OPERATION

< SYSTEM DESCRIPTION >

[LDW & LDP]

No.	Display item	Description
1	LDP ON indicator (green)	Indicates that LDP system is ON
	Lane departure warning lamp (yellow)	Turns ON when LDP system has a malfunction
2	Lane departure warning indicator light (yellow)	Blinks when the warning of LDP system occurs

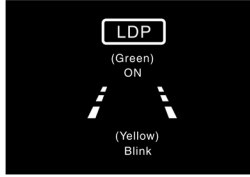
## DISPLAY AND WARNING

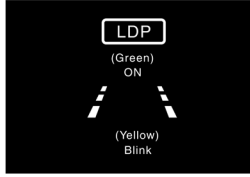
Vehicle condition/ Driver's operation	Action	Indication on the combination meter	Buzzer	
Less than Approx. 60 km/h (40 MPH)	Close to lane marker	No action	ON (green)	—
Approx. 70 km/h (45 MPH) or more	Close to lane marker	Warning and yawing <ul style="list-style-type: none"> <li>• Buzzer sounds</li> <li>• Warning lamp blinks</li> <li>• Brake control</li> </ul>	Green →→  ALOIA0135GB	Short continuous beeps
	<ul style="list-style-type: none"> <li>• Close to lane marker</li> <li>• Turn signal ON (Deviate side)</li> </ul>	No action	 ALOIA0134GB	—
	Close to lane with soft braking	Warning <ul style="list-style-type: none"> <li>• Buzzer sounds</li> <li>• Warning lamp blinks</li> </ul>	Green (ON)  ALOIA0135GB	Short continuous beeps
	<ul style="list-style-type: none"> <li>• VDC OFF Switch OFF ⇒ ON (VDC system ON ⇒ OFF)</li> <li>• SNOW mode switch OFF ⇒ ON</li> <li>• Road is slippery</li> <li>• Camera temperature high</li> </ul>	Cancellation <ul style="list-style-type: none"> <li>• Buzzer sounds</li> <li>• Each message is displayed</li> </ul> <b>NOTE:</b> When dynamic driver assistance switch is ON ⇒ OFF, message is turned OFF	Each message is displayed	Beep

**NOTE:**

After the operating conditions are satisfied, the control continues until the vehicle speed reaches approximately 60 km/h (40 MPH). Refer to [DAS-325, "LANE DEPARTURE PREVENTION \(LDP\) SYSTEM : System Description"](#).



## HANDLING PRECAUTION

### Precautions for Lane Departure Warning/Lane Departure Prevention

INFOID:00000009716615

#### LANE CAMERA UNIT HANDLING

To keep the proper operation of the LDW/LDP systems and prevent a system malfunction, be sure to observe the following:

- Always keep the windshield clean.
- Do not attach a sticker (including transparent material) or install an accessory near the lane camera unit.
- Do not place reflective materials, such as white paper or a mirror, on the instrument panel. The reflection of sunlight may adversely affect the lane camera unit capability of detecting the lane markers.
- Do not strike or damage the areas around the lane camera unit.
- Do not touch the camera lens.
- Do not remove the screw located on the lane camera unit.

#### LANE DEPARTURE WARNING (LDW)

- LDW system is only a warning device to inform the driver of a potential unintended lane departure. It will not steer the vehicle or prevent loss of control. It is the driver's responsibility to stay alert, drive safely, keep the vehicle in the traveling lane, and be in control of the vehicle at all times.
- LDW system will not operate at speeds below approximately 70 km/h (45 MPH) or if it cannot detect lane markers.
- Excessive noise will interfere with the warning chime sound, and the chime may not be heard.
- LDW system may not function properly under the following conditions:
  - On roads where there are multiple parallel lane markers; lane markers that are faded or not painted clearly; yellow painted lane markers; non-standard lane markers; or lane markers covered with water, dirt or snow, etc.
  - On roads where the discontinued lane markers are still detectable.
  - On roads where there are sharp curves.
  - On roads where there are sharply contrasting objects, such as shadows, snow, water, wheel ruts, seams or lines remaining after road repairs. (The LDW system could detect these items as lane markers.)
  - On roads where the traveling lane merges or separates.
  - When the vehicle's traveling direction does not align with the lane marker.
  - When traveling close to other vehicle in front of the vehicle, which obstructs the lane camera unit detection range.
  - When rain, snow or dirt adheres to the windshield in front of the lane camera unit.
  - When the headlights are not bright due to dirt on the lens or if the aiming is not adjusted properly.
  - When strong light enters the lane camera unit. (For example, the light directly shines on the front of the vehicle at sunrise or sunset.)
  - When a sudden change in brightness occurs. (For example, when the vehicle enters or exits a tunnel or under a bridge.)

#### LANE DEPARTURE PREVENTION (LDP)

- LDP system will not steer the vehicle or prevent loss of control. It is the driver's responsibility to stay alert, drive safely, keep the vehicle in the traveling lane, and be in control of vehicle at all times.
- LDP system is primarily intended for use on well-developed freeways or highways. It may not detect the lane markers in certain roads, weather or driving conditions.
- Using the LDP system under some conditions of road, lane marker or weather, or when driver change lanes without using the turn signal could lead to an unexpected system operation. In such conditions, driver needs to correct the vehicle's direction with driver's steering operation to avoid accidents.
- When the LDP system is operating, avoid excessive or sudden steering maneuvers. Otherwise, driver could lose control of the vehicle.
- The LDP system will not operate at speeds below approximately 70 km/h (45 MPH) or if it cannot detect lane markers.
- The LDP system may not function properly under the following conditions, and do not use the LDP system:
  - During bad weather (rain, fog, snow, wind, etc.).
  - When driving on slippery roads, such as on ice or snow, etc.
  - When driving off-road such as on sand or rock, etc.
  - When driving on winding or uneven roads.
  - When there is a lane closure due to road repairs.
  - When driving in a makeshift lane.
  - When driving on roads where the lane width is too narrow.

A  
B  
C  
D  
E  
F  
G  
H  
I  
J  
K  
L  
M  
N  
P

DAS

## HANDLING PRECAUTION

[LDW & LDP]

### < SYSTEM DESCRIPTION >

- When driving without normal tire conditions (for example, tire wear, low tire pressure, installation of spare tire, tire chains, non-standard wheels).
- When the vehicle is equipped with non-original brake parts or suspension parts.
- When towing a trailer or other vehicle.
- Excessive noise will interfere with the warning chime sound, and the chime may not be heard.
- The functions of the LDP system (warning and brake control assist) may or may not operate properly under the following conditions:
  - On roads where there are multiple parallel lane markers; lane markers that are faded or not painted clearly; yellow painted lane markers; non-standard lane markers or lane markers covered with water, dirt or snow, etc.
  - On roads where discontinued lane markers are still detectable.
  - On roads where there are sharp curves.
  - On roads where there are sharply contrasting objects, such as shadows, snow, water, wheel ruts, seams or lines remaining after road repairs (The LDP system could detect these items as lane markers.).
  - On roads where the traveling lane merges or separates.
  - When the vehicle's traveling direction does not align with the lane marker.
  - When traveling close to other vehicle in front of the vehicle, which obstructs the lane camera unit detection range.
  - When rain, snow or dirt adheres to the windshield in front of the lane camera unit.
  - When the headlights are not bright due to dirt on the lens or if the aiming is not adjusted properly.
  - When strong light enters the lane camera unit (For example, the light directly shines on the front of the vehicle at sunrise or sunset.)
  - When a sudden change in brightness occurs (For example, when the vehicle enters or exits a tunnel or under a bridge.)
- While the LDP system is operating, driver may hear a sound of brake operation. This is normal and indicates that the LDP system is operating properly.

# DIAGNOSIS SYSTEM (ADAS CONTROL UNIT)

< SYSTEM DESCRIPTION >

[LDW & LDP]

## DIAGNOSIS SYSTEM (ADAS CONTROL UNIT)

### On Board Diagnosis Function

INFOID:00000009716616

#### DESCRIPTION

The DTC is displayed on the information display by operating the ICC steering switch.

#### On Board Self-diagnosis System Diagram

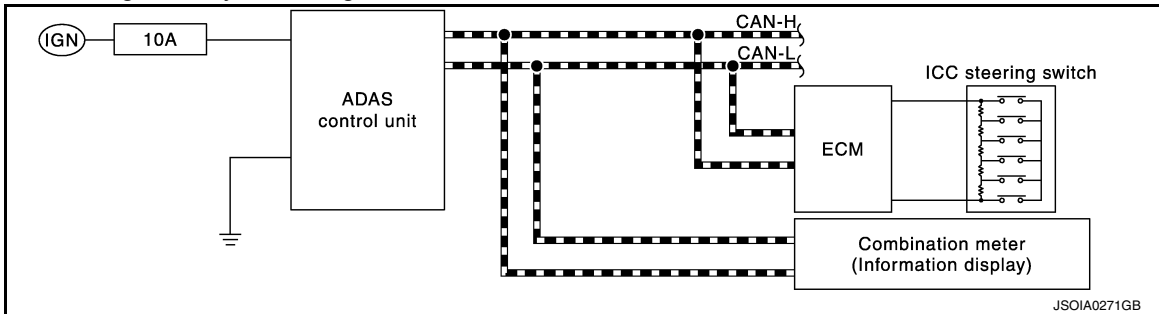

#### METHOD OF STARTING

##### CAUTION:

##### Start condition of on board self-diagnosis

- ICC system OFF
- DCA system OFF
- Vehicle speed 0 km/h (0 MPH)

1. Turn the ignition switch OFF.
2. Start the engine.
3. Wait for 5 seconds after starting the engine. Push up the RESUME/ACCELERATE switch 5 times and push down the SET/COAST switch 5 times within 10 seconds.

##### NOTE:

If the above operation cannot be performed within 10 seconds after waiting for 5 seconds after starting the engine, repeat the procedure from step 1.

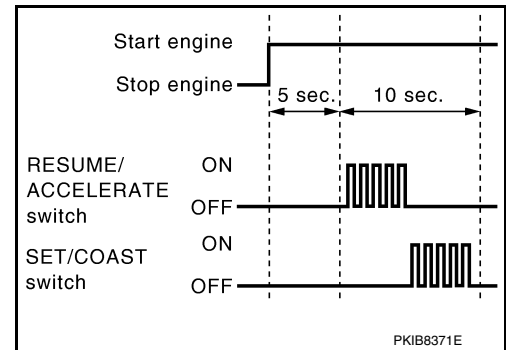

4. The DTC is displayed on the set vehicle speed indicator (1) on the ICC system display on the information display when the on board self-diagnosis starts. Refer to [DAS-359, "DTC Index"](#).

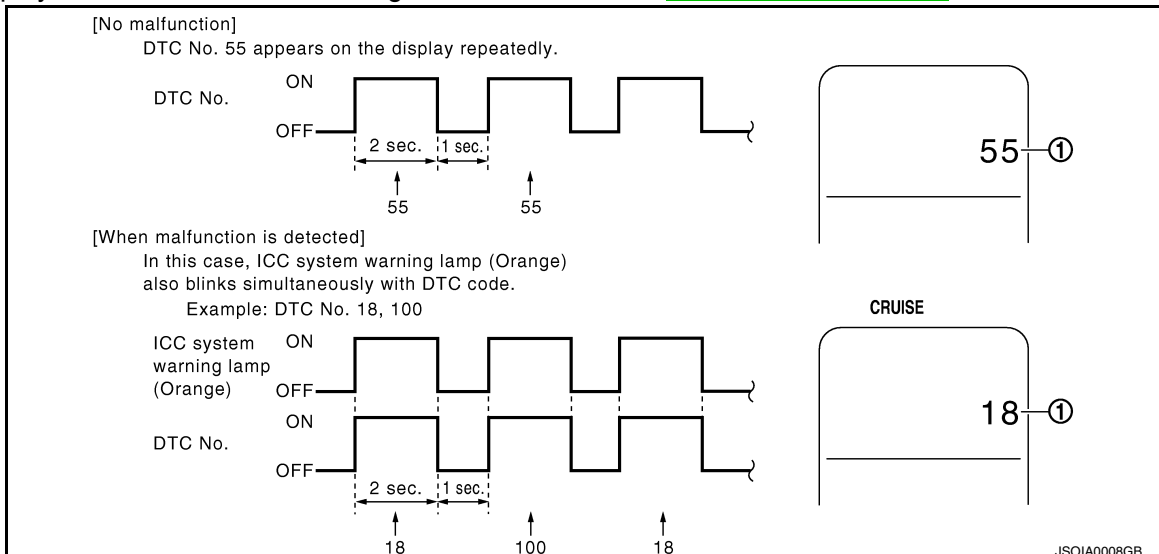

##### NOTE:

A  
B  
C  
D  
E  
F  
G  
H  
I  
J  
K  
L  
M  
N  
P

DAS

# DIAGNOSIS SYSTEM (ADAS CONTROL UNIT)

[LDW & LDP]

## < SYSTEM DESCRIPTION >

- It displays for up to 5 minutes and then stops.
- If multiple malfunctions exist, up to 6 DTCs can be stored in memory at the most, and the most recent one is displayed first.

## WHEN THE ON BOARD SELF-DIAGNOSIS DOES NOT START

If the on board self-diagnosis does not start, check the following items.

Assumed abnormal part		Inspection item
Information display	Combination meter malfunction	Check that the self-diagnosis function of the combination meter operates. Refer to <a href="#">MWI-15, "INFORMATION DISPLAY : System Description"</a>
ICC steering switch malfunction		Perform the inspection for DTC"C1A06". Refer to <a href="#">DAS-167, "Diagnosis Procedure"</a>
Harness malfunction between ICC steering switch and ECM		
ECM malfunction		
ADAS control unit malfunction		<ul style="list-style-type: none"> <li>• Check power supply and ground circuit of ADAS control unit. Refer to <a href="#">DAS-443, "ADAS CONTROL UNIT : Diagnosis Procedure"</a>.</li> <li>• Perform SELF-DIAGNOSIS for "ICC/ADAS"with CONSULT, and then check the malfunctioning parts. Refer to <a href="#">DAS-359, "DTC Index"</a>.</li> </ul>

## HOW TO ERASE ON BOARD SELF-DIAGNOSIS

1. Turn the ignition switch OFF.
2. Start the engine, and then start the on board self-diagnosis.
3. Press the CANCEL switch 5 times, and then press the DISTANCE switch 5 times under the condition that the on board self-diagnosis starts.

### NOTE:

- Complete the operation within 10 seconds after pressing the CANCEL switch first.
- If the operation is not completed within 10 seconds, repeat the procedure from step 1.

4. DTC 55 is displayed after erasing.

### NOTE:

DTCs for existing malfunction can not be erased.

5. Turn ignition switch OFF, and finish the diagnosis.

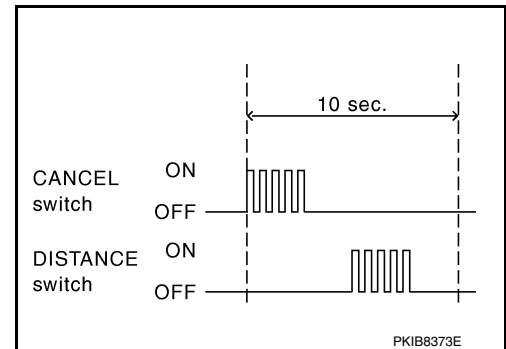

## CONSULT Function (ICC/ADAS)

INFOID:000000009716617

### CAUTION:

After disconnecting the CONSULT vehicle interface (VI) from the data link connector, the ignition must be cycled OFF → ON (for at least 5 seconds) → OFF. If this step is not performed, the BCM may not go to "sleep mode", potentially causing a discharged battery and a no-start condition.

## APPLICATION ITEMS

CONSULT performs the following functions via CAN communication using ADAS control unit.

Diagnosis mode	Description
Self Diagnostic Result	Displays the name of a malfunctioning system stored in the ADAS control unit.
Data Monitor	Displays ADAS control unit input/output data in real time.
Work support	Displays causes of automatic system cancellation occurred during system control.
Active Test	Enables an operational check of a load by transmitting a driving signal from the ADAS control unit to the load.
ECU identification	Displays ADAS control unit part number.
CAN Diag Support Mntr	Displays a reception/transmission state of CAN communication and ITS communication.

## SELF DIAGNOSTIC RESULT

Refer to [DAS-47, "DTC Index"](#).

# DIAGNOSIS SYSTEM (ADAS CONTROL UNIT)

< SYSTEM DESCRIPTION >

[LDW & LDP]

## DATA MONITOR

Monitored item [Unit]	ALL SIG (ICC)	MAIN SIG (ICC)	MAIN SIG (LDW/LDP)	MAIN SIG (BSW/BSI)	BCI MAIN	Description
MAIN SW [On/Off]	×	×	×	×		Indicates [On/Off] status as judged from ICC steering switch signal (ECM transmits ICC steering switch signal through CAN communication)
SET/COAST SW [On/Off]	×	×				Indicates [On/Off] status as judged from ICC steering switch signal (ECM transmits ICC steering switch signal through CAN communication)
CANCEL SW [On/Off]	×	×				Indicates [On/Off] status as judged from ICC steering switch signal (ECM transmits ICC steering switch signal through CAN communication)
RESUME/ACC SW [On/Off]	×	×				Indicates [On/Off] status as judged from ICC steering switch signal (ECM transmits ICC steering switch signal through CAN communication)
DISTANCE SW [On/Off]	×					Indicates [On/Off] status as judged from ICC steering switch signal (ECM transmits ICC steering switch signal through CAN communication)
CRUISE OPE [On/Off]	×	×				Indicates whether controlling or not (ON means "controlling")
BRAKE SW [On/Off]	×	×	×	×	×	Indicates [On/Off] status as judged from ICC brake switch signal (ECM transmits ICC brake switch signal through CAN communication)
STOP LAMP SW [On/Off]	×	×	×	×	×	Indicates [On/Off] status as judged from stop lamp switch signal (ECM transmits stop lamp switch signal through CAN communication)
IDLE SW [On/Off]	×				×	Indicates [On/Off] status of idle switch read from ADAS control unit through CAN communication (ECM transmits On/Off status through CAN communication)
SET DISTANCE [Short/Mid/Long]	×	×				Indicates set distance memorized in ADAS control unit
CRUISE LAMP [On/Off]	×	×				Indicates [On/Off] status of MAIN switch indicator output
OWN VHCL [On/Off]	×					Indicates [On/Off] status of own vehicle indicator output
VHCL AHEAD [On/Off]	×					Indicates [On/Off] status of vehicle ahead detection indicator output
ICC WARNING [On/Off]	×					Indicates [On/Off] status of ICC system warning lamp output
VHCL SPEED SE [km/h] or [mph]	×	×	×	×	×	Indicates vehicle speed calculated from ADAS control unit through CAN communication [ABS actuator and electric unit (control unit) transmits vehicle speed signal (wheel speed) through CAN communication]
SET VHCL SPD [km/h] or [mph]	×	×				Indicates set vehicle speed memorized in ADAS control unit
BUZZER O/P [On/Off]	×				×	Indicates [On/Off] status of ICC warning chime output
THRTL SENSOR [deg]	×	×				<b>NOTE:</b> The item is displayed, but it is not monitored
ENGINE RPM [rpm]	×					Indicates engine speed read from ADAS control unit through CAN communication (ECM transmits engine speed signal through CAN communication)
WIPER SW [OFF/LOW/HIGH]	×					Indicates wiper [OFF/LOW/HIGH] status (BCM transmits front wiper request signal through CAN communication)
BA WARNING [On/Off]	×					Indicates [On/Off] status of IBA OFF indicator lamp output
STP LMP DRIVE [On/Off]	×	×			×	Indicates [On/Off] status of ICC brake hold relay drive output

A

B

C

D

E

F

G

H

I

J

K

L

M

N

DAS

P

# DIAGNOSIS SYSTEM (ADAS CONTROL UNIT)

< SYSTEM DESCRIPTION >

[LDW & LDP]

Monitored item [Unit]	ALL SIG (ICC)	MAIN SIG (ICC)	MAIN SIG (LDW/LDP)	MAIN SIG (BSW/BSI)	BCI MAIN	Description
D RANGE SW [On/Off]	×					Indicates [On/Off] status of "D" or "M" positions read from ADAS control unit through CAN communication; ON when position "D" or "M" (TCM transmits shift position signal through CAN communication).
NP RANGE SW [On/Off]	×					Indicates shift position signal read from ADAS control unit through CAN communication (TCM transmits shift position signal through CAN communication)
PKB SW [On/Off]	×					Parking brake switch status [On/Off] judged from the parking brake switch signal that ADAS control unit readout via CAN communication is displayed (Combination meter transmits the parking brake switch signal via CAN communication)
PWR SUP MONI [V]	×	×				Indicates IGN voltage input by ADAS control unit
VHCL SPD AT [km/h] or [mph]	×					Indicates vehicle speed calculated from CVT vehicle speed sensor read from ADAS control unit through CAN communication (TCM transmits CVT vehicle speed sensor signal through CAN communication)
THRTL OPENING [%]	×	×			×	Indicates throttle position read from ADAS control unit through CAN communication (ECM transmits accelerator pedal position signal through CAN communication).
GEAR [1, 2, 3, 4, 5, 6]	×					Indicates CVT gear position read from ADAS control unit through CAN communication (TCM transmits current gear position signal through CAN communication)
MODE SIG [OFF, ICC, ASCD]	×					Indicates the active mode from ICC or ASCD [conventional (fixed speed) cruise control mode]
SET DISP IND [On/Off]	×					Indicates [On/Off] status of SET switch indicator output
DISTANCE [m]	×					Indicates the distance from the vehicle ahead
RELATIVE SPD [m/s]	×					Indicates the relative speed of the vehicle ahead
Camera lost [Detect/Deviate/Both]			×	×		Indicates a lane marker detection state judged from a lane marker detection signal read by the ADAS control unit via ITS communication (Lane camera unit transmits a lane marker signal via ITS communication)
Lane unclear [On/Off]			×	×		Indicates an ON/OFF state of the lane marker. The ON/OFF state is judged from a detected lane condition signal read by the ADAS control unit via ITS communication (The lane camera unit transmits a detected lane condition signal via ITS communication)
STATUS signal [Stnby/Warn/Cancl/Off]			×			Indicates a control state of LDP system
DYNA ASIST SW [On/Off]	×	×		×		Indicates [On/Off] status as judged from ICC steering switch signal (ECM transmits ICC steering switch signal through CAN communication)
DCA ON IND [On/Off]	×					The status [ON/OFF] of DCA system switch indicator output is displayed
DCA VHL AHED [On/Off]	×					The status [ON/OFF] of vehicle ahead detection indicator output in DCA system is displayed
IBA SW [On/Off]	×	×				Indicates [On/Off] status of IBA OFF switch
APA TEMP [°C]	×				×	Accelerator pedal actuator integrated motor temperature that the ADAS control unit readout via ITS communication is displayed (Accelerator pedal actuator transmits the integrated motor temperature via ITS communication)

# DIAGNOSIS SYSTEM (ADAS CONTROL UNIT)

< SYSTEM DESCRIPTION >

[LDW & LDP]

Monitored item [Unit]	ALL SIG (ICC)	MAIN SIG (ICC)	MAIN SIG (LDW/LDP)	MAIN SIG (BSW/BSI)	BCI MAIN	Description
APA PWR [V]	×				×	Accelerator pedal actuator power supply voltage that the ADAS control unit read-out via ITS communication is displayed (Accelerator pedal actuator transmits the power supply voltage via ITS communication)
FCW SYSTEM ON [On/Off]	×	×				Indicates [On/Off] status of FCW system
LDW SYSTEM ON [On/Off]			×			Indicates [On/Off] status of LDW system
LDW ON LAMP [On/Off]			×			Indicates [On/Off] status of warning systems ON indicator output
LDP ON IND [On/Off]			×			Indicates [On/Off] status of LDP ON indicator lamp (Green) output
LANE DPRT W/L [On/Off]			×			Indicates [On/Off] status of lane departure warning lamp (Yellow) output
LDW BUZER OUTPUT [On/Off]			×			Indicates [On/Off] status of warning buzzer output
LDP SYSTEM ON [On/Off]			×			Indicates [On/Off] status of LDP system
READY signal [On/Off]			×			Indicates LDP system settings
Shift position [Off, P, R, N, D, M/T1 - 7]			×	×	×	Indicates shift position read from ADAS control unit through CAN communication (TCM transmits shift position signal through CAN communication)
Turn signal [OFF/LH/RH/LH&RH]			×	×		Indicates turn signal operation status read from ADAS control unit through CAN communication (BCM transmits turn indicator signal through CAN communication)
SIDE G [G]			×	×		Indicates lateral G acting on the vehicle. This lateral G is judged from a side G sensor signal read by ADAS control unit via CAN communication (The ABS actuator and electric unit (control unit) transmits a side G sensor signal via CAN communication)
FUNC ITEM(FCW)	×	×	×	×		Indicates systems which can be set to ON/OFF by selecting "Driver Assistance"⇒ "Driving aids" of the navigation system FCW: Distance Control Assist (DCA), Lane Departure Prevention (LDP) and Blind Spot Intervention
FUNC ITEM(LDW)	×	×	×	×		Indicates systems which can be set to ON/OFF by selecting "Driver Assistance"⇒ "Driving aids" of the navigation system LDW: Distance Control Assist (DCA), Lane Departure Prevention (LDP) and Blind Spot Intervention
FUNC ITEM(BSW)	×	×	×	×		Indicates systems which can be set to ON/OFF by selecting "Driver Assistance"⇒ "Driving aids" of the navigation system BSW: Distance Control Assist (DCA), Lane Departure Prevention (LDP) and Blind Spot Intervention
FUNC ITEM (NV-ICC) [Off]	×	×	×	×		<b>NOTE:</b> The item is displayed, but it is not monitored
FUNC ITEM (NV-DCA) [Off]	×	×	×	×		<b>NOTE:</b> The item is displayed, but it is not monitored
DCA SELECT [On/Off]	×	×	×	×		Indicates an ON/OFF state of DCA system. DCA system can be set to ON/OFF by selecting "Driver Assistance"⇒ "Driving aids" of the navigation system
LDP SELECT [On/Off]	×	×	×	×		Indicates an ON/OFF state of LDP system. LDP system can be set to ON/OFF by selecting "Driver Assistance"⇒ "Driving aids" of the navigation system

A  
B  
C  
D  
E  
F  
G  
H  
I  
J  
K  
L  
M  
N  
P

DAS

# DIAGNOSIS SYSTEM (ADAS CONTROL UNIT)

< SYSTEM DESCRIPTION >

[LDW & LDP]

Monitored item [Unit]	ALL SIG (ICC)	MAIN SIG (ICC)	MAIN SIG (LDW/LDP)	MAIN SIG (BSW/BSI)	BCI MAIN	Description
BSI SELECT [On/Off]	×	×	×	×		Indicates an ON/OFF state of Blind Spot Intervention system. Blind Spot Intervention system can be set to ON/OFF by selecting "Driver Assistance"⇒"Driving aids" of the navigation system
DRIVE MODE STATS [SNO/ECO/STD/SPT]	×	×	×	×		Indicates [On/Off] status of warning systems switch
WARN SYS SW [On/Off]	×	×	×	×		Indicates [On/Off] status of warning systems switch
BSW/BSI WARN LMP [On/Off]				×		Indicates [On/Off] status of Blind Spot Warning/Blind Spot Intervention warning lamp output
BSI ON IND [On/Off]				×		Indicates [On/Off] status of Blind Spot Intervention ON indicator output
BSW SYSTEM ON [On/Off]				×		Indicates [On/Off] status of BSW system
BSI SYSTEM ON [On/Off]				×		Indicates [On/Off] status of Blind Spot Intervention system
BCI SYSTEM ON [On/Off]					×	Indicates [On/Off] status of Backup Collision Intervention system
BCI SWITCH [On/Off]					×	Indicates [On/Off] status of Backup Collision Intervention system switch
LDP WARNING INDICA- TOR [On/Off]			×			Indicates [On/Off] status of Lane Departure Prevention system failure lamp
LDW ON INDICATOR [On/Off]			×			Indicates [On/Off] status of LDW system
LDW WARNING INDICA- TOR [On/Off]			×			Indicates [On/Off] status of Lane Departure Warning system failure lamp
SYSTEM CANCEL MES- SAGE [Request/No Request]	×	×	×	×		Indicates system cancel message request
CAMERA HI TEMP MSG [On/Off]			×	×		Indicates high temperature message has been received
ITS Setting Item(DCA) [On/Off]	×	×	×	×		Indicates [On/Off] status of Distance Control Assist warning lamp output
ITS Setting Item(LDP) [On/Off]	×	×	×	×		Indicates [On/Off] status of Lane Departure Prevention warning lamp output
ITS Setting Item(BSI) [On/Off]	×	×	×	×		Indicates [On/Off] status of Blind Spot Intervention system
BSI WARNING INDICA- TOR [On/Off]				×		Indicates [On/Off] status of Blind Spot Intervention warning lamp indicator
BSW ON INDICATOR [On/Off]				×		Indicates [On/Off] status of BSW system
BSW IND BRIGHTNESS [Bright/Not Bright]				×		Indicates BSW warning lamp indicator brightness level
WARN REQ [On/Off]			×			Indicates an ADAS control unit judged warning state (ON/OFF) of LDP system



# DIAGNOSIS SYSTEM (ADAS CONTROL UNIT)

< SYSTEM DESCRIPTION >

[LDW & LDP]

## WORK SUPPORT

Work support items	Description
CAUSE OF AUTO-CANCEL 1	Displays causes of automatic system cancellation occurred during control of the following systems <ul style="list-style-type: none"> <li>• Vehicle-to-vehicle distance control mode</li> <li>• Conventional (fixed speed) cruise control mode</li> <li>• Distance Control Assist (DCA)</li> </ul>
CAUSE OF AUTO-CANCEL 2	Displays causes of automatic system cancellation occurred during control of the following systems <ul style="list-style-type: none"> <li>• Lane Departure Prevention (LDP)</li> <li>• Blind Spot Intervention</li> </ul>
CAUSE OF AUTO-CANCEL 3	Displays causes of automatic system cancellation occurred during control of the following system <ul style="list-style-type: none"> <li>• Backup Collision Intervention</li> </ul>

**NOTE:**

- Causes of the maximum five cancellations (system cancel) are displayed.
- The displayed cancellation causes display the number of the ignition switch ON/OFF up to 254. It is fixed to 254 if it is over 254. It returns to 0 when the same cancellation cause is detected again.

### Display Items for The Cause of Automatic Cancellation 1

Cause of cancellation	Vehicle-to-vehicle distance control mode	Conventional (fixed speed) cruise control mode	Distance Control Assist	Description
OPERATING ABS	×		×	ABS function was operated
OPERATING TCS	×	×	×	TCS function was operated
OPERATING VDC	×	×	×	VDC function was operated
ECM CIRCUIT	×	×		ECM did not permit ICC operation
OPE SW VOLT CIRC	×	×	×	The ICC steering switch input voltage is not within standard range
LASER TEMP	×		×	Temperature around ICC sensor became low
SNOW MODE SW	×		×	SNOW mode switch was pressed
OP SW DOUBLE TOUCH	×	×		ICC steering switches were pressed at the same time
VHCL SPD DOWN	×	×	×	Vehicle speed lower than the speed as follows <ul style="list-style-type: none"> <li>• Vehicle-to-vehicle distance control mode is 24 km/h (15 MPH)</li> <li>• Conventional (fixed speed) cruise control mode is 22 km/h (14 MPH)</li> </ul>
WHL SPD ELEC NOISE	×	×	×	Wheel speed sensor signal caught electromagnetic noise
VDC/TCS OFF SW	×		×	VDC OFF switch was pressed
VHCL SPD UNMATCH	×	×	×	Wheel speed became different from CVT vehicle speed
FR RADAR BLOCKED	×		×	The front bumper near the ICC sensor is blocked or dirty
TIRE SLIP	×	×		Wheel slipped

# DIAGNOSIS SYSTEM (ADAS CONTROL UNIT)

< SYSTEM DESCRIPTION >

[LDW & LDP]

IGN LOW VOLT	×	×	×	Decrease in ADAS control unit IGN voltage
PARKING BRAKE ON	×	×		The parking brake is engaged
WHEEL SPD UNMATCH	×	×	×	The wheel speeds of 4 wheels are out of the specified values
INCHING LOST	×			A vehicle ahead is not detected during the following driving when the vehicle speed is approximately 24 km/h (15 MPH) or less
CAN COMM ERROR	×	×	×	ADAS control unit received an abnormal signal with CAN communication
ABS/TCS/VDC CIRC	×	×	×	An abnormal condition occurs in VDC/TCS/ABS system
ECD CIRCUIT	×	×	×	An abnormal condition occurs in ECD system
ASCD VHCL SPD DTAC		×		Vehicle speed is detached from set vehicle speed
ASCD DOUBLE COMD		×		Cancel switch and operation switch are detected simultaneously
APA HI TEMP			×	The accelerator pedal actuator integrated motor temperature is high
ICC SENSOR CAN COMM ERR	×		×	Communication error between ADAS control unit and the ICC sensor
ABS WARNING LAMP	×		×	ABS warning lamp ON
NO RECORD	×	×	×	—

## Display Items for The Cause of Automatic Cancellation 2

Cause of cancellation	Lane departure prevention	Blind spot intervention	Description
OPE VDC/TCS/ABS 1	×		The activation of VDC, TCS, or ABS during LDP system control
Vehicle dynamics	×		Vehicle behavior exceeds specified value
Steering speed	×		Steering speed was more than the specified value in evasive direction
End by yaw angle	×		Yaw angle was the end of LDP control
Departure yaw large	×		Detected more than the specified value of yaw angle in departure direction
ICC WARNING	×		Target approach warning of ICC system, IBA system, or FCW system was activated
CURVATURE	×		Road curve was more than the specified value
Steering angle large	×		Steering angle was more than the specified value
Brake is operated	×		Brake pedal was operated
IGN LOW VOLT	×		Decrease in ADAS control unit IGN voltage
Lateral offset	×		Distance of vehicle and lane was detached in lateral direction more than the specified value
Lane marker lost	×		Lane camera unit lost the trace of lane marker
Lane marker unclear	×		Detected lane marker was unclear
Yaw acceleration	×		Detected yawing speed was more than the specified value
Deceleration large	×		Deceleration in a longitudinal direction was more than the specified value
Accel is operated	×		Accelerator pedal was depressed
Departure steering	×		Steering wheel was steered more than the specified value in departure direction
Evasive steering	×		Steering wheel was steered more than the specified value in the evasive direction
R range	×		Selector lever was operated to R range
Parking brake drift	×		Rear wheels lock was detected

# DIAGNOSIS SYSTEM (ADAS CONTROL UNIT)

< SYSTEM DESCRIPTION >

[LDW & LDP]

Cause of cancellation	Lane departure prevention	Blind spot intervention	Description
Not operating condition	×		Did not meet the operating condition (vehicle speed, turn signal operation, etc.)
SNOW MODE SW	×		SNOW mode switch was pressed
VDC OFF SW	×		VDC OFF switch was pressed
OPE VDC/ABS 2	×		The activation of VDC or ABS during a standby time of LDP system control
BSI WARNING	×		Blind Spot Intervention system was activated
BSI) OPE VDC/TCS/ABS 1		×	The activation of VDC, TCS, or ABS during Blind Spot Intervention system control
BSI) Vehicle dynamics		×	Vehicle behavior exceeds specified value
BSI) Steering speed		×	Steering speed was more than the specified value in evasive direction
BSI) End by yaw angle		×	Yaw angle was the end of Blind Spot Intervention control
BSI) Departure yaw large		×	Detected more than the specified value of yaw angle in departure direction
BSI) ICC WARNING		×	Target approach warning of ICC system, IBA system or FCW system was activated
BSI) CURVATURE		×	Road curve was more than the specified value
BSI) Steering angle large		×	Steering angle was more than the specified value
BSI) Brake is operated		×	Brake pedal was operated
BSI) IGN LOW VOLT		×	Decrease in ADAS control unit IGN voltage
BSI) Lateral offset		×	Distance of vehicle and lane was detached in lateral direction more than the specified
BSI) Lane marker lost		×	Lane camera unit lost the trace of lane marker
BSI) Lane marker unclear		×	Detected lane marker was unclear
BSI) Yaw acceleration		×	Detected yawing speed was more than the specified value
BSI) Deceleration large		×	Deceleration in a longitudinal direction was more than the specified value
BSI) Accel is operated		×	Accelerator pedal was depressed
BSI) Departure steering		×	Steering wheel was steered more than the specified value in departure direction
BSI) Evasive steering		×	Steering wheel was steered more than the specified value in the evasive direction
BSI) R range		×	Selector lever was operated to R range
BSI) Parking brake drift		×	Rear wheels lock was detected
BSI) SNOW MODE SW		×	SNOW mode switch was pressed
BSI) VDC OFF SW		×	VDC OFF switch was pressed
BSI) OPE VDC/ABS 2		×	The activation of VDC or ABS during a standby time of Blind Spot Intervention system control
BSI) Not operating condition		×	Did not meet the operating condition (vehicle speed, turn signal operation, etc.)
Side Radar Lost		×	Unrecognized side radar LH or RH by the ADAS control unit
NO RECORD	×	×	—

A  
B  
C  
D  
E  
F  
G  
H  
I  
J  
K  
L  
M  
N  
P

DAS

Display Items for The Cause of Automatic Cancellation 3

# DIAGNOSIS SYSTEM (ADAS CONTROL UNIT)

< SYSTEM DESCRIPTION >

[LDW & LDP]

Cause of cancellation	Backup Collision Intervention	Description
OPERATING WIPER	×	The wiper operates at HI (it includes when the wiper is operated at HI with the wiper switch AUTO position)
OPERATING ABS	×	ABS function was operated
OPERATING TCS	×	TCS function was operated
OPERATING VDC	×	VDC function was operated
ECM CIRCUIT	×	ECM did not permit ICC operation
SNOW MODE SW	×	SNOW mode switch was pressed
VDC/TCS OFF SW	×	VDC OFF switch was pressed
VHCL SPD UNMATCH	×	Wheel speed became different from CVT vehicle speed
TIRE SLIP	×	Wheel slipped
IGN LOW VOLT	×	Decrease in ADAS control unit IGN voltage
PARKING BRAKE ON	×	The parking brake is engaged
WHEEL SPD UNMATCH	×	The wheel speeds of 4 wheels are out of the specified values
CAN COMM ERROR	×	ADAS control unit received an abnormal signal with CAN communication
ABS/TCS/VDC CIRC	×	An abnormal condition occurs in VDC/TCS/ABS system
ECD CIRCUIT	×	An abnormal condition occurs in ECD system
APA HI TEMP		The accelerator pedal actuator integrated motor temperature is high
ABS WARNING LAMP	×	ABS warning lamp ON
Brake is operated	×	Brake pedal was operated
Accel is operated	×	Accelerator pedal was depressed
SNOW MODE SW	×	DMS switch SNOW mode was selected
VDC OFF SW	×	VDC OFF switch was pressed
Side Radar Lost	×	Unrecognized side radar LH or RH by the ADAS control unit
NO RECORD	×	—

## ACTIVE TEST

### CAUTION:

- Never perform “Active Test” while driving the vehicle.
- The “Active Test” cannot be performed when the following systems warning lamp is illuminated.
  - ICC system warning lamp
  - Lane departure warning lamp
  - Blind Spot Warning/Blind Spot Intervention warning lamp
  - IBA OFF indicator lamp (IBA system ON)
- Shift the selector lever to “P” position, and then perform the test.

Test item	Description
BRAKE ACTUATOR	Activates the brake by an arbitrary operation
ICC BUZZER	Sounds a buzzer used for following systems by arbitrarily operating ON/OFF <ul style="list-style-type: none"> <li>• Intelligent Cruise Control (ICC)</li> <li>• Distance Control Assist (DCA)</li> <li>• Forward Collision Warning (FCW)</li> <li>• Intelligent Brake Assist (IBA)</li> </ul>

# DIAGNOSIS SYSTEM (ADAS CONTROL UNIT)

< SYSTEM DESCRIPTION >

[LDW & LDP]

Test item	Description
METER LAMP	The ICC system warning lamp, MAIN switch indicator and IBA OFF indicator lamp can be illuminated by ON/OFF operations as necessary
STOP LAMP	The ICC brake hold relay can be operated by ON/OFF operations as necessary, and the stop lamp can be illuminated
ACTIVE PEDAL	The accelerator pedal actuator can be operated as necessary
DCA INDICATOR	The DCA system switch indicator can be illuminated by ON/OFF operations as necessary
LDP BUZZER	Sounds a buzzer used for following systems by arbitrarily operating ON/OFF <ul style="list-style-type: none"> <li>• Lane Departure Warning (LDW)</li> <li>• Lane Departure Prevention (LDP)</li> <li>• Blind Spot Warning (BSW)</li> <li>• Blind Spot Intervention</li> </ul>
WARNING SYSTEM IND	Warning systems ON indicator (on warning systems switch) can be illuminated by ON/OFF operations as necessary
LDP ON IND	The LDP ON indicator lamp can be illuminated by ON/OFF operations as necessary
LANE DEPARTURE W/L	The Lane departure warning lamp can be illuminated by ON/OFF operations as necessary
BSW/BSI WARNING LAMP	The Blind Spot Warning/Blind Spot Intervention warning lamp can be illuminated by ON/OFF operations as necessary
BSI ON INDICATOR	The Blind Spot Intervention ON indicator can be illuminated by ON/OFF operations as necessary
LDW ON INDICATOR	The LDW ON indicator lamp can be illuminated by ON/OFF operations as necessary
BSW ON INDICATOR	The BSW ON indicator lamp can be illuminated by ON/OFF operations as necessary

## BRAKE ACTUATOR

**NOTE:**

The test can be performed only when the engine is running.

Test item	Operation	Description	"PRESS SENS" value
BRAKE ACTUATOR	MODE1	Transmits the brake fluid pressure control signal to the ABS actuator and electric unit (control unit) via CAN communication	10 bar
	MODE2		20 bar
	MODE3		30 bar
	Test start	Starts the tests of "MODE1", "MODE2" and "MODE3"	—
	Reset	Stops transmitting the brake fluid pressure control signal below to end the test	—
	End	Returns to the "SELECT TEST ITEM" screen	—

**NOTE:**

The test is finished in 10 seconds after starting

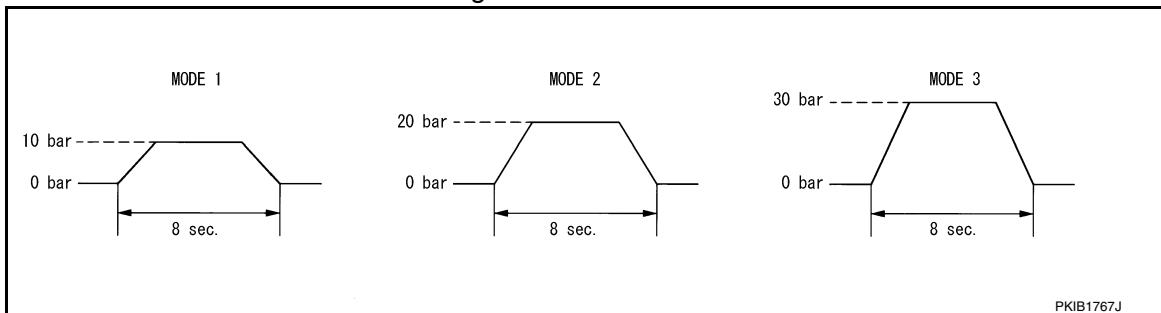

## ICC BUZZER

A  
B  
C  
D  
E  
F  
G  
H  
I  
J  
K  
L  
M  
N  
P



# DIAGNOSIS SYSTEM (ADAS CONTROL UNIT)

< SYSTEM DESCRIPTION >

[LDW & LDP]

Test item	Operation	Description	ICC warning chime operation sound
ICC BUZZER	MODE1	Transmits the buzzer output signals to the combination meter via CAN communication	Intermittent beep sound
	Test start	Starts the tests of "MODE1"	—
	Reset	Stops transmitting the buzzer output signal below to end the test	—
	End	Returns to the "SELECT TEST ITEM" screen	—

## METER LAMP

### NOTE:

The test can be performed only when the engine is running.

Test item	Operation	Description	<ul style="list-style-type: none"> <li>• MAIN switch indicator</li> <li>• ICC system warning lamp</li> <li>• IBA OFF indicator lamp</li> </ul>
METER LAMP	Off	Stops sending the following signals to exit from the test <ul style="list-style-type: none"> <li>• Meter display signal</li> <li>• ICC warning lamp signal</li> <li>• IBA OFF indicator lamp signal</li> </ul>	OFF
	On	Transmits the following signals to the combination meter via CAN communication <ul style="list-style-type: none"> <li>• Meter display signal</li> <li>• ICC warning lamp signal</li> <li>• IBA OFF indicator lamp signal</li> </ul>	ON

## STOP LAMP

Test item	Operation	Description	Stop lamp
STOP LAMP	Off	Stops transmitting the ICC brake hold relay drive signal below to end the test	OFF
	On	Transmits the ICC brake hold relay drive signal	ON

## ACTIVE PEDAL

### CAUTION:

- Shift the selector lever to "P" position, and then perform the test.
- Never depress the accelerator pedal excessively. (The engine speed may rise unexpectedly when finishing the test.)

### NOTE:

- Depress the accelerator pedal to check when performing the test.
- The test can be performed only when the engine is running.

Test item	Operation	Description	Accelerator pedal operation
Active Pedal	MODE1	Transmit the accelerator pedal feedback force control signal to the accelerator pedal actuator via ITS communication.	Constant with a force of 25 N for 8 seconds
	MODE2		Constant with a force of 15 N for 8 seconds
	MODE3		Change up to a force of 25 N for 8 seconds
	MODE4		Change up to a force of 15 N for 8 seconds
	Test start	Starts the tests of "MODE1", "MODE2", "MODE3" and "MODE4"	—
	Reset	Stops transmitting the accelerator pedal feedback force control signal below to end the test.	—
	End	Returns to the "SELECT TEST ITEM" screen	—

# DIAGNOSIS SYSTEM (ADAS CONTROL UNIT)

< SYSTEM DESCRIPTION >

[LDW & LDP]

**NOTE:**

The test is finished in 10 seconds after starting

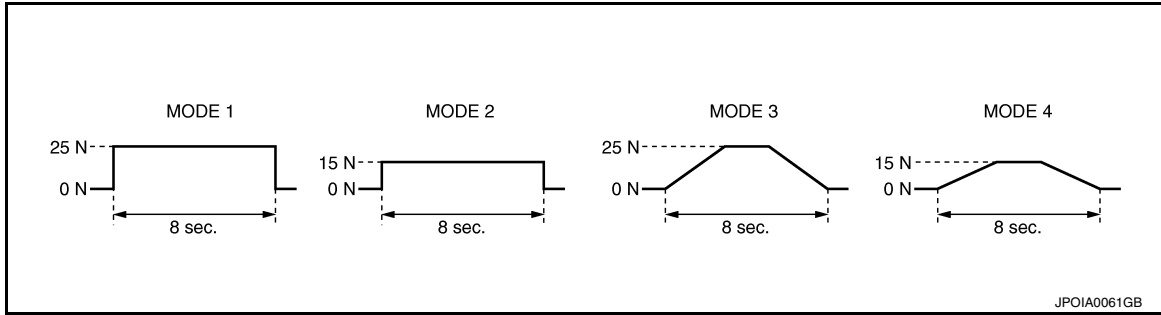

**DCA INDICATOR**

**NOTE:**

The test can be performed only when the engine is running.

Test item	Operation	Description	DCA system switch indicator
DCA INDICATOR	Off	Stops transmitting the DCA system switch indicator signal below to end the test	—
	On	Transmits the DCA system switch indicator signal to the combination meter via CAN communication	ON

**LDP BUZZER**

Test item	Operation	Description	Warning buzzer
LDP BUZZER	Off	Stops transmitting the warning buzzer signal below to end the test	—
	On	Transmits the warning buzzer signal to the warning buzzer	ON

**WARNING SYSTEM IND**

Test item	Operation	Description	Warning systems ON indicator
WARNING SYSTEM IND	Off	Stops transmitting the warning systems ON indicator signal below to end the test	—
	On	Transmits the warning systems ON indicator signal to the warning systems ON indicator	ON

**LDP ON IND**

Test item	Operation	Description	LDP ON indicator lamp (Green)
LDP ON IND	Off	Stops transmitting the LDP ON indicator lamp signal below to end the test	—
	On	Transmits the LDP ON indicator lamp signal to the combination meter via CAN communication	ON

**LANE DEPARTURE W/L**

Test item	Operation	Description	Lane departure warning lamp (Yellow)
LANE DEPARTURE W/L	Off	Stops transmitting the lane departure warning lamp signal below to end the test	—
	On	Transmits the lane departure warning lamp signal to the combination meter via CAN communication	ON

A  
B  
C  
D  
E  
F  
G  
H  
I  
J  
K  
L  
M  
N  
P

DAS

# DIAGNOSIS SYSTEM (ADAS CONTROL UNIT)

< SYSTEM DESCRIPTION >

[LDW & LDP]

## BSW/BSI WARNING LAMP

Test item	Operation	Description	Blind Spot Warning/Blind Spot Intervention warning lamp (Yellow)
BSW/BSI WARNING LAMP	Off	Stops transmitting the Blind Spot Warning/Blind Spot Intervention warning lamp signal below to end the test	—
	On	Transmits the Blind Spot Warning/Blind Spot Intervention warning lamp signal to the combination meter via CAN communication	ON

## BSI ON INDICATOR

Test item	Operation	Description	Blind Spot Intervention ON indicator lamp (Green)
BSI ON INDICATOR	Off	Stops transmitting the Blind Spot Intervention ON indicator signal below to end the test	—
	On	Transmits the Blind Spot Intervention ON indicator signal to the combination meter via CAN communication	ON

## LDW ON INDICATOR

Test item	Operation	Description	Lane Departure Warning ON indicator lamp (Yellow)
LDW ON INDICATOR	Off	Stops transmitting the Lane Departure Warning ON indicator signal below to end the test	—
	On	Transmits the Lane Departure Warning ON indicator signal to the combination meter via CAN communication	ON

## BSW ON INDICATOR

Test item	Operation	Description	Blind Spot Warning ON indicator lamp (Yellow)
BSW ON INDICATOR	Off	Stops transmitting the Blind Spot Warning ON indicator signal below to end the test	—
	On	Transmits the Blind Spot Warning ON indicator signal to the warning lamp on the door	ON

## ECU IDENTIFICATION

ADAS control unit part number is displayed.



# DIAGNOSIS SYSTEM (LANE CAMERA UNIT)

< SYSTEM DESCRIPTION >

[LDW & LDP]

## DIAGNOSIS SYSTEM (LANE CAMERA UNIT)

### CONSULT Function (LANE CAMERA)

INFOID:000000009716618

#### CAUTION:

After disconnecting the CONSULT vehicle interface (VI) from the data link connector, the ignition must be cycled OFF → ON (for at least 5 seconds) → OFF. If this step is not performed, the BCM may not go to “sleep mode”, potentially causing a discharged battery and a no-start condition.

#### APPLICATION ITEMS

CONSULT performs the following functions by communicating with the lane camera unit.

Diagnosis mode	Description
Self Diagnostic Result	Displays the name of a malfunctioning system stored in the lane camera unit
Data Monitor	Displays lane camera unit input/output data in real time
Work support	Performs the camera aiming
ECU identification	Displays lane camera unit part number

#### WORK SUPPORT

Work support items	Description
AUTO AIM	Outputs camera unit, calculates dislocation of the camera, and displays adjustment direction.

#### SELF DIAGNOSTIC RESULT

Refer to [DAS-366, "DTC Index"](#).

#### DATA MONITOR

Monitored item [Unit]	Description
LC INACCURAT [On/Off]	Lane camera unit status
AIMING RESULT [OK/NOK]	Result of camera aiming
AIMING DONE [OK/NG]	Status that camera aiming is done
CAM HIGH TEMP [NORMAL/High]	Status of lane camera unit high temperature judgment
VHCL SPD SE [km/h] or [mph]	Vehicle speed received from ADAS control unit via ITS communication
TURN SIGNAL [Off, LH, RH, LH/RH]	Status of “Turn signal” determined from ADAS control unit via ITS communication
LANE DETCT LH [On/Off]	Left side lane marker detection
LANE DETCT RH [On/Off]	Right side lane marker detection
CROSS LANE LH [On/Off]	Condition that the vehicle is crossing left lane marker
CROSS LANE RH [On/Off]	Condition that the vehicle is crossing right lane marker
WARN LANE LH [On/Off]	Warning for left lane marker
WARN LANE RH [On/Off]	Warning for right lane marker
VALID POS LH [VLD/INVLD]	Lateral position for left lane marker is valid
VALID POS RH [VLD/INVLD]	Lateral position for right lane marker is valid
XOFFSET [pixel]	Lane camera unit installation condition
AIM CHECK YAW [deg]	Check result of camera aiming
AIM CHECK ROLL [deg]	Check result of camera aiming
AIM CHECK PITCH [deg]	Check result of camera aiming
FCTRY AIM YAW [deg]	Lane camera unit installation condition

# DIAGNOSIS SYSTEM (LANE CAMERA UNIT)

< SYSTEM DESCRIPTION >

[LDW & LDP]

Monitored item [Unit]	Description
FCTRY AIM ROL [deg]	Lane camera unit installation condition
FCTRY AIM PIT [deg]	Lane camera unit installation condition
ADAS MALF [On/Off]	ADAS control unit status

## ECU identification

Lane camera part number is displayed.

# ADAS CONTROL UNIT

< ECU DIAGNOSIS INFORMATION >

[LDW & LDP]

## ECU DIAGNOSIS INFORMATION

### ADAS CONTROL UNIT

Reference Value

INFOID:000000009716619

#### VALUES ON THE DIAGNOSIS TOOL

Monitor item	Condition		Value/Status
MAIN SW	Ignition switch ON	When MAIN switch is pressed	On
		When MAIN switch is not pressed	Off
SET/COAST SW	Ignition switch ON	When SET/COAST switch is pressed	On
		When SET/COAST switch is not pressed	Off
CANCEL SW	Ignition switch ON	When CANCEL switch is pressed	On
		When CANCEL switch is not pressed	Off
RESUME/ACC SW	Ignition switch ON	When RESUME/ACCELERATE switch is pressed	On
		When RESUME/ACCELERATE switch is not pressed	Off
DISTANCE SW	Ignition switch ON	When DISTANCE switch is pressed	On
		When DISTANCE switch is not pressed	Off
CRUISE OPE	Drive the vehicle and activate the vehicle-to-vehicle distance control mode	When ICC system is controlling	On
		When ICC system is not controlling	Off
BRAKE SW	Ignition switch ON	When brake pedal is depressed	Off
		When brake pedal is not depressed	On
STOP LAMP SW	Ignition switch ON	When brake pedal is depressed	On
		When brake pedal is not depressed	Off
IDLE SW	Engine running	Idling	On
		Except idling (depress accelerator pedal)	Off
SET DISTANCE	<ul style="list-style-type: none"> <li>• Start the engine and turn the ICC system ON</li> <li>• Press the DISTANCE switch to change the vehicle-to-vehicle distance setting</li> </ul>	When set to "long"	Long
		When set to "middle"	Mid
		When set to "short"	Short
CRUISE LAMP	Start the engine and press MAIN switch	ICC system ON (MAIN switch indicator ON)	On
		ICC system OFF (MAIN switch indicator OFF)	Off
OWN VHCL	Start the engine and press MAIN switch	ICC system ON (Own vehicle indicator ON)	On
		ICC system OFF (Own vehicle indicator OFF)	Off
VHCL AHEAD	Drive the vehicle and activate the vehicle-to-vehicle distance control mode	When a vehicle ahead is detected (vehicle ahead detection indicator ON)	On
		When a vehicle ahead is not detected (vehicle ahead detection indicator OFF)	Off
ICC WARNING	Start the engine and press MAIN switch	When ICC system is malfunctioning (ICC system warning lamp ON)	On
		When ICC system is normal (ICC system warning lamp OFF)	Off

# ADAS CONTROL UNIT

< ECU DIAGNOSIS INFORMATION >

[LDW & LDP]

Monitor item	Condition		Value/Status
VHCL SPEED SE	While driving		Displays a vehicle speed calculated by the ADAS control unit
SET VHCL SPD	While driving	When vehicle speed is set	Displays the set vehicle speed
BUZZER O/P	Engine running	When the buzzer of the following system operates <ul style="list-style-type: none"> <li>• Vehicle-to-vehicle distance control mode</li> <li>• DCA system</li> <li>• FCW system</li> <li>• IBA system</li> </ul>	On
		When the buzzer of the following system not operates <ul style="list-style-type: none"> <li>• Vehicle-to-vehicle distance control mode</li> <li>• DCA system</li> <li>• FCW system</li> <li>• IBA system</li> </ul>	Off
THRTL SENSOR	<b>NOTE:</b> The item is indicated, but not monitored		0.0
ENGINE RPM	Engine running		Equivalent to tachometer reading
WIPER SW	Ignition switch ON	Wiper not operating	Off
		Wiper LO operation	Low
		Wiper HI operation	High
BA WARNING	Engine running	IBA OFF indicator lamp ON <ul style="list-style-type: none"> <li>• When IBA system is malfunctioning</li> <li>• When IBA system is turned to OFF</li> </ul>	On
		IBA OFF indicator lamp OFF <ul style="list-style-type: none"> <li>• When IBA system is normal</li> <li>• When IBA system is turned to ON</li> </ul>	Off
STP LMP DRIVE	Drive the vehicle and activate the vehicle-to-vehicle distance control mode	When ICC brake hold relay is activated	On
		When ICC brake hold relay is not activated	Off
D RANGE SW	Engine running	When the selector lever is in "D" position or manual mode	On
		When the selector lever is in any position other than "D" or manual mode	Off
NP RANGE SW	Engine running	When the selector lever is in "N", "P" position	On
		When the selector lever is in any position other than "N", "P"	Off
PKB SW	Ignition switch ON	When the parking brake is applied	On
		When the parking brake is released	Off
PWR SUP MONI	Engine running		Power supply voltage value of ADAS control unit
VHCL SPD AT	While driving		Value of CVT vehicle speed sensor signal
THRTL OPENING	Engine running	Depress accelerator pedal	Displays the throttle position

# ADAS CONTROL UNIT

< ECU DIAGNOSIS INFORMATION >

[LDW & LDP]

Monitor item	Condition		Value/Status
GEAR	While driving		Displays the gear position
MODE SIG	Start the engine and press MAIN switch	When ICC system is deactivated	Off
		When vehicle-to-vehicle distance control mode is activated	ICC
		When conventional (fixed speed) cruise control mode is activated	ASCD
SET DISP IND	<ul style="list-style-type: none"> <li>• Drive the vehicle and activate the conventional (fixed speed) cruise control mode</li> <li>• Press SET/COAST switch</li> </ul>	SET switch indicator ON	On
		SET switch indicator OFF	Off
DISTANCE	Drive the vehicle and activate the vehicle-to-vehicle distance control mode	When a vehicle ahead is detected	Displays the distance from the preceding vehicle
		When a vehicle ahead is not detected	0.0
RELATIVE SPD	Drive the vehicle and activate the vehicle-to-vehicle distance control mode	When a vehicle ahead is detected	Displays the relative speed.
		When a vehicle ahead is not detected	0.0
Camera lost	Drive the vehicle and activate the LDW system, LDP system or Blind Spot Intervention system	Both side lane markers are detected	Detect
		Deviate side lane marker is lost	Deviate
		Both side lane markers are lost	Both
Lane unclear	While driving	Lane marker is unclear	On
		Lane marker is clear	Off
STATUS signal	Drive the vehicle with the LDP system turned ON	When the LDP system is ON	Stnby
		When the LDP system is operating	Warn
		When the LDP system is canceled	Cancl
		When the LDP system is OFF	Off
DYNA ASIST SW	Ignition switch ON	When dynamic driver assistance switch is pressed	On
		When dynamic driver assistance switch is not pressed	Off
DCA ON IND	Start the engine and press dynamic driver assistance switch (When DCA system setting is ON)	DCA system OFF (DCA system switch indicator OFF)	Off
		DCA system ON (DCA system switch indicator ON)	On
DCA VHL AHED	Drive the vehicle and activate the DCA system	When a vehicle ahead is not detected (vehicle ahead detection indicator OFF)	Off
		When a vehicle ahead is detected (vehicle ahead detection indicator ON)	On
IBA SW	Ignition switch ON	When the IBA OFF switch is pressed	On
		When the IBA OFF switch is not pressed	Off
APA TEMP	Engine running		Display the accelerator pedal actuator integrated motor temperature
APA PWR	Ignition switch ON		Power supply voltage value of accelerator pedal actuator

A

B

C

D

E

F

G

H

I

J

K

L

M

N

DAS

P

# ADAS CONTROL UNIT

< ECU DIAGNOSIS INFORMATION >

[LDW & LDP]

Monitor item	Condition		Value/Status
FCW SYSTEM ON	Ignition switch ON	When the FCW system is ON (Warning systems ON indicator ON)	On
		When the FCW system is OFF (Warning systems ON indicator OFF)	Off
LDW SYSTEM ON	Ignition switch ON	When the LDW system is ON (Warning systems ON indicator ON)	On
		When the LDW system is OFF (Warning systems ON indicator OFF)	Off
LDW ON LAMP	Ignition switch ON	Warning systems ON indicator ON	On
		Warning systems ON indicator OFF	Off
LDP ON IND	Start the engine and press dynamic driver assistance switch (When LDP system setting is ON)	LDP ON indicator lamp ON	On
		LDP ON indicator lamp OFF	Off
LANE DPRT W/L	Drive the vehicle and activate the LDW system or LDP system	Lane departure warning lamp ON	On
		Lane departure warning lamp OFF	Off
LDW BUZER OUTPUT	Drive the vehicle and activate the LDW/LDP system or Blind Spot Warning/Blind Spot Intervention system	When the buzzer of the following system operates • LDW/LDP system • Blind Spot Warning/Blind Spot Intervention system	On
		When the buzzer of the following system does not operate • LDW/LDP system • Blind Spot Warning/Blind Spot Intervention system	Off
LDP SYSTEM ON	Start the engine and press dynamic driver assistance switch (When LDP system setting is ON)	When the LDP system is ON	On
		When the LDP system is OFF	Off
READY signal	Start the engine and press dynamic driver assistance switch (When LDP system setting is ON)	When the LDP system is ON	On
		When the LDP system is OFF	Off
Shift position	<ul style="list-style-type: none"> <li>• Engine running</li> <li>• While driving</li> </ul>		Displays the shift position
Turn signal	Turn signal lamps OFF		Off
	Turn signal lamp LH blinking		LH
	Turn signal lamp RH blinking		RH
	Turn signal lamp LH and RH blinking		LH&RH
SIDE G	While driving	Vehicle turning right	Negative value
		Vehicle turning left	Positive value
FUNC ITEM (FCW)	Ignition switch ON		FCW
FUNC ITEM (LDW)	Ignition switch ON		LDW
FUNC ITEM (BSW)	Ignition switch ON		BSW
FUNC ITEM (NV-ICC)	<b>NOTE:</b> The item is indicated, but not monitored		Off
FUNC ITEM (NV-DCA)	<b>NOTE:</b> The item is indicated, but not monitored		Off
DCA SELECT	Ignition switch ON	"Distance Control Assist" set with the navigation system is ON	On
		"Distance Control Assist" set with the navigation system is OFF	Off

# ADAS CONTROL UNIT

< ECU DIAGNOSIS INFORMATION >

[LDW & LDP]

Monitor item	Condition	Value/Status	
LDP SELECT	Ignition switch ON	"Lane Departure Prevention" set with the navigation system is ON	On
		"Lane Departure Prevention" set with the navigation system is OFF	Off
BSI SELECT	Ignition switch ON	"Blind Spot Intervention" set with the navigation system is ON	On
		"Blind Spot Intervention" set with the navigation system is OFF	Off
DRIVE MODE STATS	Ignition switch ON	When the DMS switch is in normal position	Std
		When the DMS switch is in SNOW position	SNO
		When the DMS switch is in ECO position	ECO
		When the DMS switch is in SPORT position	SPT
WARN SYS SW	Ignition switch ON	When warning systems switch is pressed	On
		When warning systems switch is not pressed	Off
BSW/BSI WARN LMP	Ignition switch ON	Blind Spot Warning/Blind Spot Intervention warning lamp ON	On
		Blind Spot Warning/Blind Spot Intervention warning lamp OFF	Off
BSI ON IND	Ignition switch ON	Blind Spot Intervention ON indicator ON	On
		Blind Spot Intervention ON indicator OFF	Off
BSW SYSTEM ON	Ignition switch ON	When the BSW system is ON (Warning systems ON indicator ON)	On
		When the BSW system is OFF (Warning systems ON indicator OFF)	Off
BSI SYSTEM ON	Start the engine and press dynamic driver assistance switch (When Blind Spot Intervention system setting is ON)	When the Blind Spot Intervention system is ON	On
		When the Blind Spot Intervention system is OFF	Off
BCI SYSTEM ON	Ignition switch ON	Back-up Collision Intervention system ON	On
		Back-up Collision Intervention system OFF	Off
BCI SWITCH	Ignition switch ON	Back-up Collision Intervention switch ON	On
		Back-up Collision Intervention switch OFF	Off
LDP WARNING INDICATOR	Ignition switch ON	When the LDP fail lamp is ON (Warning systems ON indicator ON)	On
		When the LDP fail lamp is OFF	Off
LDW ON LAMP	Ignition switch ON	When LDW indicator lamp is ON	On
		When LDW indicator lamp is OFF	Off
LDW WARNING INDICATOR	Ignition switch ON	When LDW FAIL lamp is ON	On
		When LDW FAIL lamp is OFF	Off
SYSTEM CANCEL MESSAGE	Ignition switch ON	When a system cancel message is sent	Request
		When a system cancel message is not sent	No Request
CAMERA HI TEMP MSG	Ignition switch ON	When camera high temperature message is sent	On
		When camera high temperature message is not sent	Off
ITS Setting Item(DCA)	Ignition switch ON	When the DCA is set	On
		When the DCA is not set	Off
ITS Setting Item(LDP)	Ignition switch ON	When the LDP is set	On
		When the LDP is not set	Off

A  
B  
C  
D  
E  
F  
G  
H  
I  
J  
K  
L  
M  
N  
P

DAS

# ADAS CONTROL UNIT

< ECU DIAGNOSIS INFORMATION >

[LDW & LDP]

Monitor item	Condition		Value/Status
ITS Setting Item(BSI)	Ignition switch ON	When the BSI is set	On
		When the BSI is not set	Off
BSI WARNING INDICATOR	Ignition switch ON	When BSI FAIL indicator warning lamp is ON	On
		When BSI FAIL indicator warning lamp is OFF	Off
BSW ON INDICATOR	Ignition switch ON	When BSW ON indicator lamp is ON	On
		When BSW ON indicator lamp is OFF	Off
BSW IND BRIGHTNESS	Ignition switch ON	When BSW indicator brightness is selected	On
		When BSW indicator brightness is not selected	Off
WARN REQ	Drive the vehicle and activate the LDP system	Lane departure warning is operating	On
		Lane departure warning is not operating	Off

TERMINAL LAYOUT  
PHYSICAL VALUES

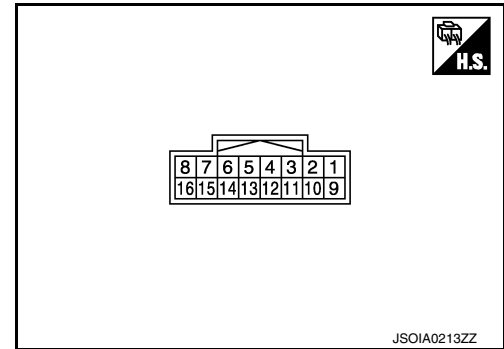

Terminal No. (Wire color)		Description		Condition	Value (Approx.)
+	-	Signal name	Input/ Output		
5 (G)	Ground	ICC brake hold relay drive signal	Output	Ignition switch ON	12 V
				At "STOP LAMP" test of "Active test"	0 V
6 (B)		Ground	Input	—	0 V
7 (L)		ITS communication-H	—	—	—
8 (Y)		ITS communication-L	—	—	—
14 (B)		CAN -H	—	—	—
15 (W)		CAN -L	—	—	—
16 (R)	Ignition power supply	Input	Ignition switch ON	Battery Voltage	

## Fail-safe

INFOID:000000009716620

If a malfunction occurs in each system, ADAS control unit cancels each control, sounds a beep, and turns ON the warning lamp or indicator lamp.

System	Buzzer	Warning lamp/Indicator lamp	Description
Vehicle-to-vehicle distance control mode	High-pitched tone	ICC system warning lamp	Cancel
Conventional (fixed speed) cruise control mode	High-pitched tone	ICC system warning lamp	Cancel



# ADAS CONTROL UNIT

< ECU DIAGNOSIS INFORMATION >

[LDW & LDP]

System	Buzzer	Warning lamp/Indicator lamp	Description
Intelligent Brake Assist (IBA)	High-pitched tone	IBA OFF indicator lamp	Cancel
Forward Collision Warning (FCW)	High-pitched tone	Warning message	Cancel
Distance Control Assist (DCA)	High-pitched tone	DCA system warning	Cancel
Lane Departure Warning (LDW)	—	Lane departure warning lamp	Cancel
Lane Departure Prevention (LDP)	Low-pitched tone	Lane departure warning lamp	Cancel
Blind Spot Warning (BSW)	—	Blind Spot Warning/Blind Spot Intervention warning lamp	Cancel
Blind Spot Intervention	Low-pitched tone	Blind Spot Warning/Blind Spot Intervention warning lamp	Cancel
Backup Collision Intervention (BCI)	High-pitched tone	Backup Collision Intervention warning indicator	Cancel

## DTC Inspection Priority Chart

INFOID:000000009716621

If multiple DTCs are detected simultaneously, check them one by one depending on the following DTC inspection priority chart.

Priority	Detected items (DTC)
1	<ul style="list-style-type: none"> <li>• C1A0A: CONFIG UNFINISHED</li> <li>• U1507: LOST COMM (SIDE RDR R)</li> <li>• U1508: LOST COMM (SIDE RDR L)</li> </ul>
2	<ul style="list-style-type: none"> <li>• U1000: CAN COMM CIRCUIT</li> <li>• U1010: CONTROL UNIT (CAN)</li> </ul>
3	<ul style="list-style-type: none"> <li>• C1B00: CAMERA UNIT MALF</li> <li>• C1F02: APA C/U MALF</li> <li>• C1A17: ICC SENSOR MALF</li> <li>• C1B53: SIDE RDR R MALF</li> <li>• C1B54: SIDE RDR L MALF</li> </ul>

DAS

# ADAS CONTROL UNIT

< ECU DIAGNOSIS INFORMATION >

[LDW & LDP]

Priority	Detected items (DTC)
4	<ul style="list-style-type: none"> <li>• C1A01: POWER SUPPLY CIR</li> <li>• C1A02: POWER SUPPLY CIR 2</li> <li>• C1A04: ABS/TCS/VDC CIRC</li> <li>• C1A05: BRAKE SW/STOP L SW</li> <li>• C1A06: OPERATION SW CIRC</li> <li>• C1A12: LASER BEAM OFFCNTR</li> <li>• C1A13: STOP LAMP RLY FIX</li> <li>• C1A14: ECM CIRCUIT</li> <li>• C1A16: RADAR STAIN</li> <li>• C1A18: LASER AIMING INCOMP</li> <li>• C1A2A: ICC SEN PWR SUP CIR</li> <li>• C1A21: ICC SENSOR HIGH TEMP</li> <li>• C1A24: NP RANGE</li> <li>• C1A26: ECD MODE MALF</li> <li>• C1A27: ECD PWR SUPPLY CIR</li> <li>• C1A33: CAN TRANSMISSION ERR</li> <li>• C1A34: COMMAND ERROR</li> <li>• C1A35: APA CIR</li> <li>• C1A36: APA CAN COMM CIR</li> <li>• C1A37: APA CAN CIR 2</li> <li>• C1A38: APA CAN CIR 1</li> <li>• C1A39: STRG SEN CIR</li> <li>• C1A40: SYSTEM SW CIRC</li> <li>• C1B01: CAM AIMING INCOMP</li> <li>• C1B03: CAM ABNRML TMP DETCT</li> <li>• C1B56: SONAR CIRCUIT</li> <li>• C1B57: AVM CIRCUIT</li> <li>• C1F01: APA MOTOR MALF</li> <li>• C1F05: APA PWR SUPPLY CIR</li> <li>• U0121: VDC CAN CIR 2</li> <li>• U0126: STRG SEN CAN CIR 1</li> <li>• U0235: ICC SENSOR CAN CIRC 1</li> <li>• U0401: ECM CAN CIR 1</li> <li>• U0402: TCM CAN CIR 1</li> <li>• U0415: VDC CAN CIR 1</li> <li>• U0428: STRG SEN CAN CIR 2</li> <li>• U1500: CAM CAN CIR 2</li> <li>• U1501: CAM CAN CIR 1</li> <li>• U1502: ICC SEN CAN COMM CIR</li> <li>• U1503: SIDE RDR L CAN CIR 2</li> <li>• U1504: SIDE RDR L CAN CIR 1</li> <li>• U1505: SIDE RDR R CAN CIR 2</li> <li>• U1506: SIDE RDR R CAN CIR 1</li> <li>• U1521: SONAR CAN COMMUNICATION</li> <li>• U1522: SONAR CAN COMMUNICATION</li> <li>• U1523: SONAR CAN COMMUNICATION</li> <li>• U1524: AVM CAN COMMUNICATION</li> <li>• U1525: AVM CAN COMMUNICATION</li> <li>• U150B: ECM CAN CIRC 3</li> <li>• U150C: VDC CAN CIRC 3</li> <li>• U150D: TCM CAN CIRC 3</li> <li>• U150E: BCM CAN CIRC 3</li> <li>• U150F: AV CAN CIRC 3</li> <li>• U1512: HVAC CAN CIRC3</li> <li>• U1513: METER CAN CIRC 3</li> <li>• U1514: STRG SEN CAN CIRC 3</li> <li>• U1515: ICC SENSOR CAN CIRC 3</li> <li>• U1516: CAM CAN CIRC 3</li> <li>• U1517: APA CAN CIRC 3</li> <li>• U1518: SIDE RDR L CAN CIRC 3</li> <li>• U1519: SIDE RDR R CAN CIRC 3</li> </ul>
5	<ul style="list-style-type: none"> <li>• C1A03: VHCL SPEED SE CIRC</li> </ul>
6	<ul style="list-style-type: none"> <li>• C1A15: GEAR POSITION</li> </ul>
7	<ul style="list-style-type: none"> <li>• C1A00: CONTROL UNIT</li> </ul>

# ADAS CONTROL UNIT

< ECU DIAGNOSIS INFORMATION >

[LDW & LDP]

## DTC Index

INFOID:000000009716622

### NOTE:

- The details of time display are as per the following.
  - CRNT: A malfunction is detected now
  - PAST: A malfunction was detected in the past
- IGN counter is displayed on FFD (Freeze Frame Data).
- 0: The malfunctions that are detected now
  - CAN communication system (U1000, U1010)
  - 1 - 39: It increases like 0 → 1 → 2 ... 38 → 39 after returning to the normal condition whenever the ignition switch OFF → ON. It returns to 0 when a malfunction is detected again in the process.
  - If it is over 39, it is fixed to 39 until the self-diagnosis results are erased.
  - Other than CAN communication system (Other than U1000, U1010)
  - 1 - 49: It increases like 0 → 1 → 2 ... 38 → 49 after returning to the normal condition whenever the ignition switch OFF → ON. It returns to 0 when a malfunction is detected again in the process.
  - If it is over 49, it is fixed to 49 until the self-diagnosis results are erased.

### Systems for fail-safe

- A: Vehicle-to-vehicle distance control mode
- B: Conventional (fixed speed) cruise control mode
- C: Intelligent Brake Assist (IBA)
- D: Forward Collision Warning (FCW)
- E: Distance Control Assist (DCA)
- F: Lane Departure Warning (LDW)/Lane Departure Prevention (LDP)
- G: Blind Spot Warning (BSW)/Blind Spot Intervention
- H: Backup Collision Intervention (BCI)

DTC		CONSULT display	Warning lamp					Fail-safe	Reference
CONSULT	On board display		ICC system warning lamp	IBA OFF indicator lamp	Lane departure warning lamp	Blind Spot Warning/Blind Spot Intervention warning lamp	Backup Collision Intervention	System	
C1A00	0	CONTROL UNIT	ON	ON	ON	ON	ON	A, B, C, D, E, F, G, H	<a href="#">DAS-73</a>
C1A01	1	POWER SUPPLY CIR	ON	ON	ON	ON	ON	A, B, C, D, E, F, G, H	<a href="#">DAS-74</a>
C1A02	2	POWER SUPPLY CIR 2	ON	ON	ON	ON	ON	A, B, C, D, E, F, G, H	<a href="#">DAS-74</a>
C1A03	3	VHCL SPEED SE CIRC	ON	ON	ON	ON	ON	A, B, C, D, E, F, G, H	<a href="#">DAS-160</a>
C1A04	4	ABS/TCS/VDC CIRC	ON	ON	ON	ON	ON	A, B, C, D, E, F, G, H	<a href="#">DAS-162</a>
C1A05	5	BRAKE SW/STOP L SW	ON	ON	ON	ON	ON	A, B, C, D, E, F, G, H	<a href="#">DAS-163</a>
C1A06	6	OPERATION SW CIRC	ON		ON	ON		A, B, E, F, G	<a href="#">DAS-167</a>
C1A12	12	LASER BEAM OFFCN-TR	ON	ON				A, C, D, E	<a href="#">DAS-170</a>
C1A13	13	STOP LAMP RLY FIX	ON	ON			ON	A, B, C, D, E, H	<a href="#">DAS-171</a>
C1A14	14	ECM CIRCUIT	ON		ON	ON	ON	A, B, E, F, G, H	<a href="#">DAS-177</a>

A  
B  
C  
D  
E  
F  
G  
H  
I  
J  
K  
L  
M  
N  
P

DAS

# ADAS CONTROL UNIT

< ECU DIAGNOSIS INFORMATION >

[LDW & LDP]

Systems for fail-safe

- A: Vehicle-to-vehicle distance control mode
- B: Conventional (fixed speed) cruise control mode
- C: Intelligent Brake Assist (IBA)
- D: Forward Collision Warning (FCW)
- E: Distance Control Assist (DCA)
- F: Lane Departure Warning (LDW)/Lane Departure Prevention (LDP)
- G: Blind Spot Warning (BSW)/Blind Spot Intervention
- H: Backup Collision Intervention (BCI)

DTC		CONSULT display	Warning lamp					Fail-safe	Reference
CONSULT	On board display		ICC system warning lamp	IBA OFF indicator lamp	Lane departure warning lamp	Blind Spot Warning/Blind Spot Intervention warning lamp	Backup Collision Intervention	System	
C1A15	15	GEAR POSITION	ON	ON	ON	ON	ON	A, B, C, D, E, F, G, H	<a href="#">DAS-178</a>
C1A16	16	RADAR STAIN	ON	ON				A, C, D, E	<a href="#">DAS-180</a>
C1A17	17	ICC SENSOR MALF	ON	ON				A, B, C, D, E	<a href="#">DAS-181</a>
C1A18	18	LASER AIMING INCOMP	ON	ON				A, C, D, E	<a href="#">DAS-182</a>
C1A21	21	ICC SENSOR HIGH TEMP	ON	ON				A, B, C, D, E	<a href="#">DAS-183</a>
C1A24	24	NP RANGE	ON	ON	ON	ON	ON	A, B, C, D, E, F, G, H	<a href="#">DAS-184</a>
C1A26	26	ECD MODE MALF	ON	ON				A, B, C, D, E	<a href="#">DAS-186</a>
C1A27	27	ECD PWR SUPPLY CIR	ON	ON				A, B, C, D, E	<a href="#">DAS-187</a>
C1A33	33	CAN TRANSMISSION ERR	ON					A, B, E	<a href="#">DAS-189</a>
C1A34	34	COMMAND ERROR	ON					A, B, E	<a href="#">DAS-190</a>
C1A35	35	APA CIR	ON				ON	A, E, H	<a href="#">DAS-191</a>
C1A36	36	APA CAN COMM CIR	ON				ON	A, E, H	<a href="#">DAS-192</a>
C1A37	133	APA CAN CIR 2	ON				ON	A, B, E, H	<a href="#">DAS-193</a>
C1A38	132	APA CAN CIR 1	ON				ON	A, B, E, H	<a href="#">DAS-194</a>
C1A39	39	STRG SEN CIR	ON	ON		ON	ON	A, B, C, D, E, G, H	<a href="#">DAS-195</a>
C1A2A	80	ICC SEN PWR SUP CIR	ON	ON				A, C, D, E	<a href="#">DAS-188</a>
C1B00	81	CAMERA UNIT MALF			ON	ON		F, G	<a href="#">DAS-418</a>
C1B01	82	CAM AIMING INCOMP			ON	ON		F, G	<a href="#">DAS-420</a>
C1B03	83	CAM ABNRML TMP DETECT							<a href="#">DAS-422</a>
C1B53	84	SIDE RDR R MALF				ON	ON	G, H	<a href="#">DAS-577</a>
C1B54	85	SIDE RDR L MALF				ON	ON	G, H	<a href="#">DAS-578</a>
C1B56	87	SONAR CIRCUIT					ON	H	<a href="#">DAS-744</a>

# ADAS CONTROL UNIT

< ECU DIAGNOSIS INFORMATION >

[LDW & LDP]

A  
B  
C  
D  
E  
F  
G  
H  
I  
J  
K  
L  
M  
N  
P

- Systems for fail-safe
- A: Vehicle-to-vehicle distance control mode
  - B: Conventional (fixed speed) cruise control mode
  - C: Intelligent Brake Assist (IBA)
  - D: Forward Collision Warning (FCW)
  - E: Distance Control Assist (DCA)
  - F: Lane Departure Warning (LDW)/Lane Departure Prevention (LDP)
  - G: Blind Spot Warning (BSW)/Blind Spot Intervention
  - H: Backup Collision Intervention (BCI)

DTC		CONSULT display	Warning lamp					Fail-safe	Reference
CONSULT	On board display		ICC system warning lamp	IBA OFF indicator lamp	Lane departure warning lamp	Blind Spot Warning/Blind Spot Intervention warning lamp	Backup Collision Intervention	System	
C1B57	88	AVM CIRCUIT					ON	H	<a href="#">DAS-745</a>
C1F01	91	APA MOTOR MALF	ON				ON	A, E, H	<a href="#">DAS-196</a>
C1F02	92	APA C/U MALF	ON				ON	A, E, H	<a href="#">DAS-198</a>
C1F05	95	APA PWR SUPPLY CIR	ON				ON	A, E, H	<a href="#">DAS-201</a>
NO DTC IS DETECTED. FURTHER TESTING MAY BE REQUIRED	55	NO DTC IS DETECTED. FURTHER TESTING MAY BE REQUIRED	—	—	—	—	—	—	—
U0121	127	VDC CAN CIR 2	ON	ON	ON	ON	ON	A, B, C, D, E, F, G, H	<a href="#">DAS-205</a>
U0126	130	STRG SEN CAN CIR 1	ON	ON		ON	ON	A, B, C, D, E, G, H	<a href="#">DAS-206</a>
U0235	144	ICC SENSOR CAN CIRC 1	ON	ON				A, B, C, D, E	<a href="#">DAS-207</a>
U0401	120	ECM CAN CIR 1	ON		ON	ON	ON	A, B, E, F, G, H	<a href="#">DAS-208</a>
U0402	122	TCM CAN CIR 1	ON	ON	ON	ON	ON	A, B, C, D, E, F, G, H	<a href="#">DAS-209</a>
U0415	126	VDC CAN CIR 1	ON	ON	ON	ON	ON	A, B, C, D, E, F, G, H	<a href="#">DAS-210</a>
U0428	131	STRG SEN CAN CIR 2	ON	ON		ON	ON	A, B, C, D, E, G, H	<a href="#">DAS-211</a>
U1000 <sup>NOTE</sup>	100	CAN COMM CIRCUIT	ON	ON	ON	ON	ON	A, B, C, D, E, F, G, H	<a href="#">DAS-75</a>
U1010	110	CONTROL UNIT (CAN)	ON	ON	ON	ON	ON	A, B, C, D, E, F, G, H	<a href="#">DAS-76</a>
U1500	145	CAM CAN CIR 2			ON	ON		F, G	<a href="#">DAS-438</a>
U1501	146	CAM CAN CIR 1			ON	ON		F, G	<a href="#">DAS-439</a>
U1502	147	ICC SEN CAN COMM CIR	ON	ON				A, B, C, D, E	<a href="#">DAS-219</a>
U1503	150	SIDE RDR L CAN CIR 2				ON	ON	G, H	<a href="#">DAS-603</a>

# ADAS CONTROL UNIT

< ECU DIAGNOSIS INFORMATION >

[LDW & LDP]

Systems for fail-safe

- A: Vehicle-to-vehicle distance control mode
- B: Conventional (fixed speed) cruise control mode
- C: Intelligent Brake Assist (IBA)
- D: Forward Collision Warning (FCW)
- E: Distance Control Assist (DCA)
- F: Lane Departure Warning (LDW)/Lane Departure Prevention (LDP)
- G: Blind Spot Warning (BSW)/Blind Spot Intervention
- H: Backup Collision Intervention (BCI)

DTC		CONSULT display	Warning lamp					Fail-safe	Reference
CONSULT	On board display		ICC system warning lamp	IBA OFF indicator lamp	Lane departure warning lamp	Blind Spot Warning/Blind Spot Intervention warning lamp	Backup Collision Intervention	System	
U1504	151	SIDE RDR L CAN CIRC 1				ON	ON	G, H	<a href="#">DAS-604</a>
U1505	152	SIDE RDR R CAN CIRC 2				ON	ON	G, H	<a href="#">DAS-605</a>
U1506	153	SIDE RDR R CAN CIRC 1				ON	ON	G, H	<a href="#">DAS-606</a>
U1507	154	LOST COMM (SIDE RDR R)				ON	ON	G, H	<a href="#">DAS-607</a>
U1508	155	LOST COMM (SIDE RDR L)				ON	ON	G, H	<a href="#">DAS-608</a>
U150B	157	ECM CAN CIRC 3	ON		ON	ON	ON	A, B, E, F, G, H	<a href="#">DAS-215</a>
U150C	158	VDC CAN CIRC 3	ON	ON	ON	ON	ON	A, B, C, D, E, F, G, H	<a href="#">DAS-216</a>
U150D	159	TCM CAN CIRC 3	ON	ON	ON	ON	ON	A, B, C, D, E, F, G, H	<a href="#">DAS-217</a>
U150E	160	BCM CAN CIRC 3	ON		ON	ON	ON	A, B, E, F, G, H	<a href="#">DAS-218</a>
U150F	161	AV CAN CIRC 3							<a href="#">DAS-77</a>
U1512	162	HVAC CAN CIRC3			ON	ON		F, G	<a href="#">DAS-440</a>
U1513	163	METER CAN CIRC 3	ON	ON	ON	ON	ON	A, B, C, D, E, F, G, H	<a href="#">DAS-220</a>
U1514	164	STRG SEN CAN CIRC 3	ON	ON		ON	ON	A, B, C, D, E, G, H	<a href="#">DAS-221</a>
U1515	165	ICC SENSOR CAN CIRC 3	ON	ON				A, B, C, D, E	<a href="#">DAS-222</a>
U1516	166	CAM CAN CIRC 3			ON	ON		F, G	<a href="#">DAS-442</a>
U1517	167	APA CAN CIRC 3	ON				ON	A, B, E, H	<a href="#">DAS-223</a>
U1518	168	SIDE RDR L CAN CIRC 3				ON	ON	G, H	<a href="#">DAS-613</a>
U1519	169	SIDE RDR R CAN CIRC 3				ON	ON	G, H	<a href="#">DAS-614</a>
U1521	177	SONAR CHECKSUM					ON	H	<a href="#">DAS-781</a>
U1522	178	SONAR MESSAGE					ON	H	<a href="#">DAS-782</a>
U1523	179	SONAR CAN DLC					ON	H	<a href="#">DAS-783</a>

# ADAS CONTROL UNIT

< ECU DIAGNOSIS INFORMATION >

[LDW & LDP]

Systems for fail-safe

- A: Vehicle-to-vehicle distance control mode
- B: Conventional (fixed speed) cruise control mode
- C: Intelligent Brake Assist (IBA)
- D: Forward Collision Warning (FCW)
- E: Distance Control Assist (DCA)
- F: Lane Departure Warning (LDW)/Lane Departure Prevention (LDP)
- G: Blind Spot Warning (BSW)/Blind Spot Intervention
- H: Backup Collision Intervention (BCI)

DTC			Warning lamp					Fail-safe		Reference
			ICC system warning lamp	IBA OFF indicator lamp	Lane departure warning lamp	Blind Spot Warning/Blind Spot Intervention warning lamp	Backup Collision Intervention			
CONSULT	On board display	CONSULT display						System		
U1524	180	SONAR CAN DLC					ON	H	<a href="#">DAS-784</a>	
U1525	181	AVM MESSAGE					ON	H	<a href="#">DAS-785</a>	

**NOTE:**

With the detection of “U1000” some systems do not perform the fail-safe operation.

A system controlling based on a signal received from the control unit performs fail-safe operation when the communication with the ADAS control unit becomes inoperable.

A  
B  
C  
D  
E  
F  
G  
H  
I  
J  
K  
L  
M  
N  
P

DAS

# LANE CAMERA UNIT

< ECU DIAGNOSIS INFORMATION >

[LDW & LDP]

## LANE CAMERA UNIT

### Reference Value

INFOID:000000009716623

### VALUES ON THE DIAGNOSIS TOOL

Monitor Item	Condition	Value/Status
LC INACCURAT	Lane camera unit malfunction	On
	Lane camera unit normal	Off
AIMING DONE	Camera aiming is completed	OK
	Camera aiming is not adjusted	NG
AIMING RESULT	Camera aiming is completed	OK
	Camera aiming is not completed	NOK
CAM HIGH TEMP	When the temperature around lane camera unit is adequate	NORMAL
	When the temperature around the lane camera unit is high	High
VHCL SPD SE	While driving	Approximately equivalent to speedometer reading
TURN SIGNAL	Turn signal lamp LH and RH blinking	LH/RH
	Turn signal lamp LH blinking	LH
	Turn signal lamp RH blinking	RH
	Turn signal lamps OFF	Off
LANE DETCT LH	Left side lane marker is detected	On
	Left side lane marker is not detected	Off
LANE DETCT RH	Right side lane marker is detected	On
	Right side lane marker is not detected	Off
CROSS LANE LH	The vehicle is crossing left side lane marker	On
	The vehicle is not crossing left side lane marker	Off
CROSS LANE RH	The vehicle is crossing right side lane marker	On
	The vehicle is not crossing right side lane marker	Off
WARN LANE LH	Warning for left side lane	On
	Not warning for left side lane	Off
WARN LANE RH	Warning for right side lane	On
	Not warning for right side lane	Off
VALID POS LH	Lateral position for left side lane marker is valid	VLD
	Lateral position for left side lane marker is invalid	INVLD
VALID POS RH	Lateral position for right side lane marker is valid	VLD
	Lateral position for right side lane marker is invalid	INVLD
XOFFSET	Camera aiming is completed	Approx. 180 pixel
FCTRY AIM YAW	Camera aiming is not completed	0.0 deg
	Camera aiming is completed	0 ± 5.0 deg
FCTRY AIM ROL	Camera aiming is not completed	0.0 deg
	Camera aiming is completed	0 ± 5.0 deg
FCTRY AIM PIT	Camera aiming is not completed	0.0 deg
	Camera aiming is completed	0 ± 5.0 deg
ADAS MALF	ADAS control unit malfunction	On
	ADAS control unit normal	Off



# LANE CAMERA UNIT

< ECU DIAGNOSIS INFORMATION >

[LDW & LDP]

## TERMINAL LAYOUT

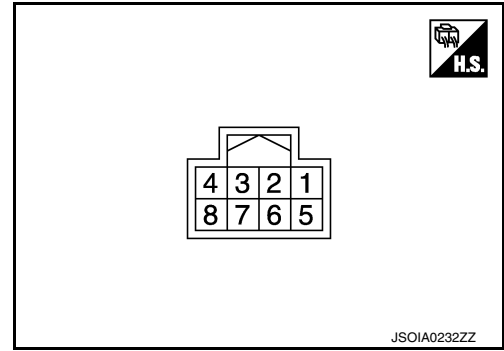

## PHYSICAL VALUES

Terminal No. (Wire color)		Description		Condition	Value (Approx.)
+	-	Signal name	Input/ Output		
1 (B)	Ground	Ground	—	—	0 V
4 (BR)		ITS communication-H	—	—	—
5 (B)		Ground	—	—	0 V
7 (LG)		Ignition power supply	Input	Ignition switch ON	Battery voltage
8 (Y)		ITS communication-L	—	—	—

## Fail-safe

INFOID:000000009716624

### FAIL-SAFE CONTROL BY DTC

#### Lane Departure Warning (LDW)

If a malfunction occurs in the lane camera unit, ADAS control unit cancels control, and turns ON the lane departure warning lamp in the combination meter.

#### Lane Departure Prevention (LDP)

If a malfunction occurs in the lane camera unit, ADAS control unit cancels control, sounds a beep, and turns ON the lane departure warning lamp in the combination meter.

### TEMPORARY DISABLED STATUS AT HIGH TEMPERATURE

#### Lane Departure Warning (LDW)

- If the vehicle is parked in direct sunlight under high temperature conditions, the system may be deactivated automatically. And the lane departure warning lamp (yellow) in the combination meter will blink.
- When interior temperature is reduced, the system will resume operation automatically and the lane departure warning lamp (yellow) in the combination meter will stop blinking.

#### Lane Departure Prevention (LDP)

- If the vehicle is parked in direct sunlight under high temperature conditions, the system may be deactivated automatically. And the buzzer sounds and lane departure warning lamp (yellow) in the combination meter will blink.
- When interior temperature is reduced, the system will resume when dynamic driver assistance switch is turned OFF and turned ON and the lane departure warning lamp (yellow) in the combination meter will stop blinking.

### DTC Inspection Priority Chart

INFOID:000000009716625

If multiple DTCs are detected simultaneously, check them one by one depending on the following DTC inspection priority chart.

A  
B  
C  
D  
E  
F  
G  
H  
I  
J  
K  
L  
M  
N  
P

DAS

# LANE CAMERA UNIT

< ECU DIAGNOSIS INFORMATION >

[LDW & LDP]

Priority	Detected items (DTC)
1	<ul style="list-style-type: none"> <li>• U1000: CAN COMM CIRCUIT</li> <li>• U1010: CONTROL UNIT (CAN)</li> </ul>
2	C1A50: ADAS MALFUNCTION
3	<ul style="list-style-type: none"> <li>• C1B01: CAM AIMING INCMP</li> <li>• C1B03: ABNRML TEMP DETECT</li> <li>• U0104: ADAS CAN CIR1</li> <li>• U0126: STRG SEN CAN CIR1</li> <li>• U0405: ADAS CAN CIR2</li> <li>• U0428: STRG SEN CAN CIR2</li> </ul>
4	C1B00: CAMERA UNIT MALF

## DTC Index

INFOID:000000009716626

×: Applicable

DTC		Warning indicator lamp (orange / Message)	Fail-safe	Reference
C1A50	ADAS MALFUNCTION	ON	—	<a href="#">DAS-417</a>
C1B00	CAMERA UNIT MALF	ON	×	<a href="#">DAS-418</a>
C1B01	CAM AIMING INCMP	ON	×	<a href="#">DAS-420</a>
C1B03	ABNRML TEMP DETECT	Message	×	<a href="#">DAS-422</a>
U0104	ADAS CAN CIR1	ON	×	<a href="#">DAS-423</a>
U0126	STRG SEN CAN CIR1	ON	×	<a href="#">DAS-425</a>
U0405	ADAS CAN CIR2	ON	×	<a href="#">DAS-428</a>
U0428	STRG SEN CAN CIR2	ON	×	<a href="#">DAS-430</a>
U1000	CAN COMM CIRCUIT	ON	×	<a href="#">DAS-431</a>
U1010	CONTROL UNIT (CAN)	ON	×	<a href="#">DAS-433</a>

# WIRING DIAGRAM

## DRIVER ASSISTANCE SYSTEMS

### Wiring Diagram

INFOID:000000009716627

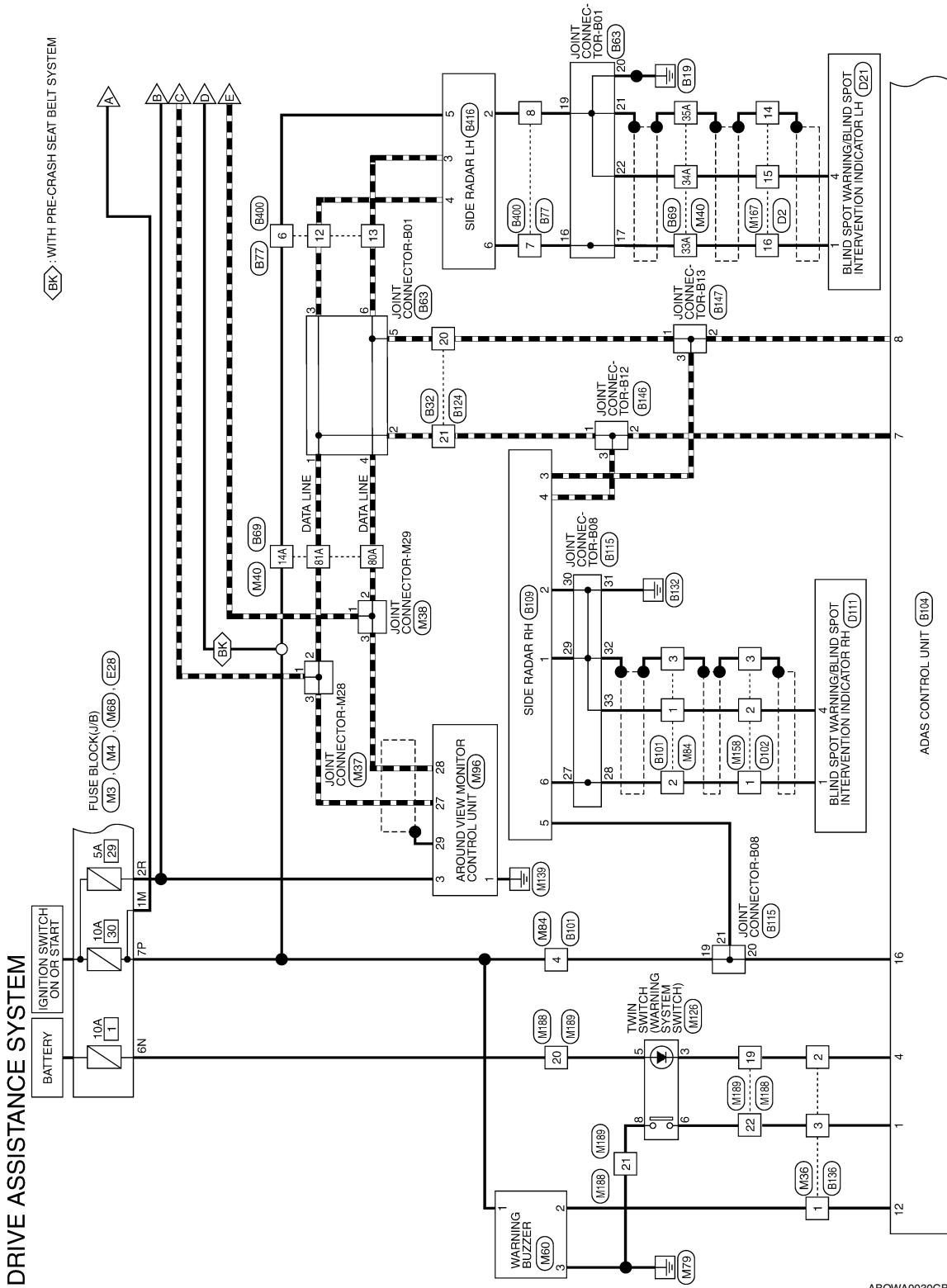

ABOWA0030GB

A  
B  
C  
D  
E  
F  
G  
H  
I  
J  
K  
L  
M  
N  
P

DAS

# DRIVER ASSISTANCE SYSTEMS

< WIRING DIAGRAM >

[LDW & LDP]

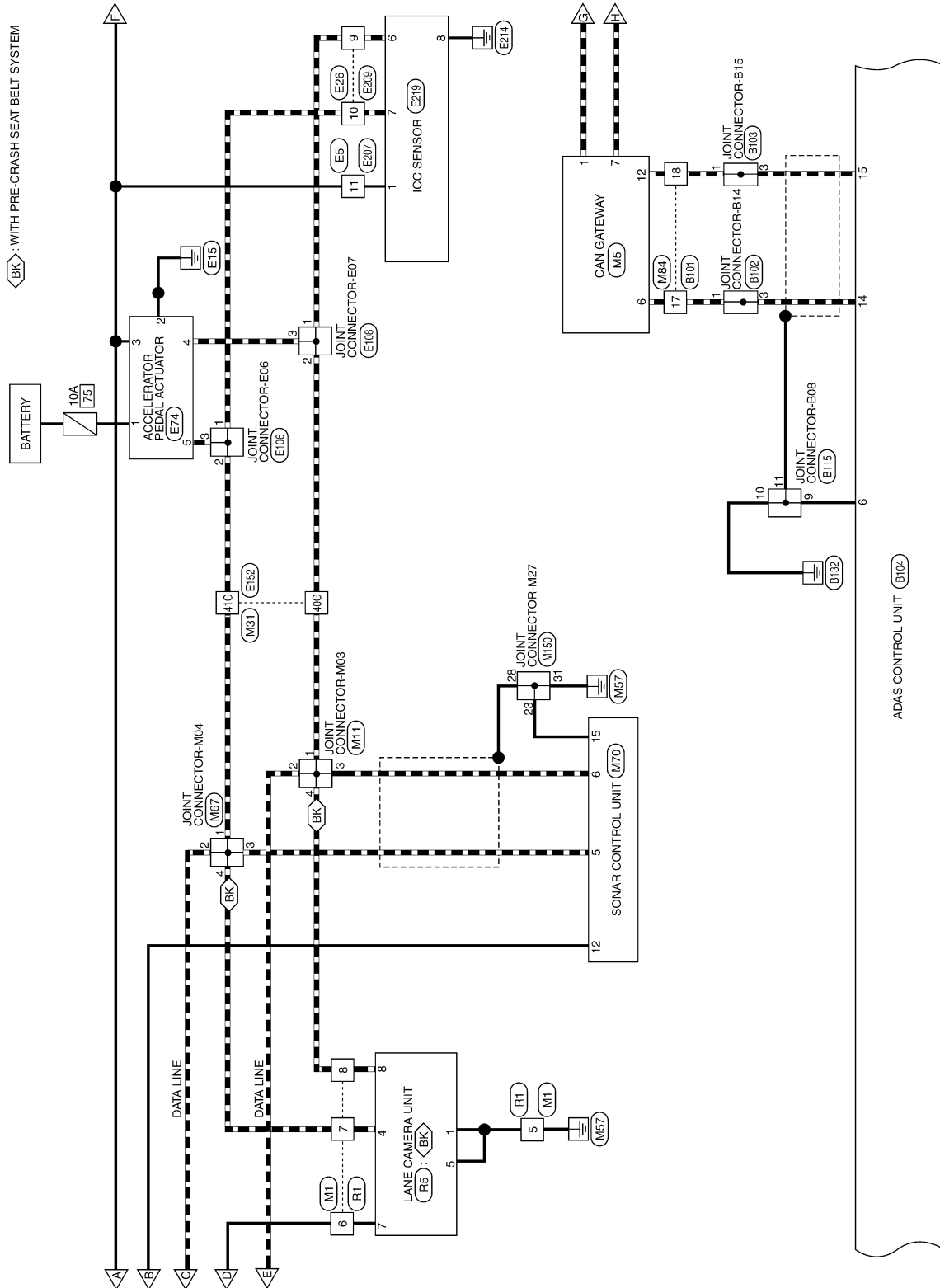

ABOWA0031GB

# DRIVER ASSISTANCE SYSTEMS

< WIRING DIAGRAM >

[LDW & LDP]

(ZD) : WITH BOSE AUDIO SYSTEM - WITH NAVIGATION SYSTEM WITHOUT SURROUND SOUND SYSTEM  
 (ZF) : WITH BOSE AUDIO SYSTEM - WITH NAVIGATION SYSTEM AND SURROUND SOUND SYSTEM

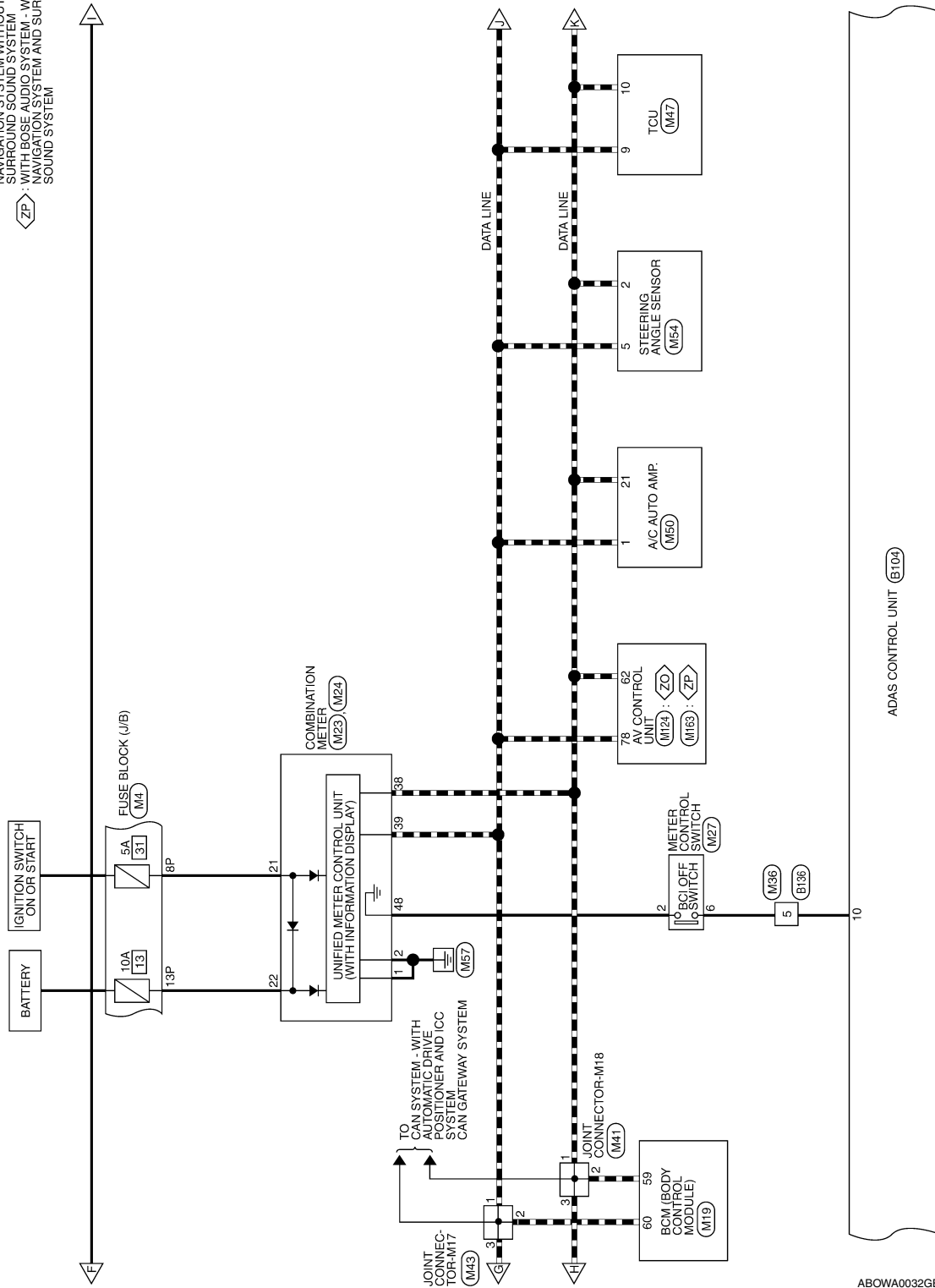

A  
B  
C  
D  
E  
F  
G  
H  
I  
J  
K  
L  
M  
N  
P

DAS

# DRIVER ASSISTANCE SYSTEMS

< WIRING DIAGRAM >

[LDW & LDP]

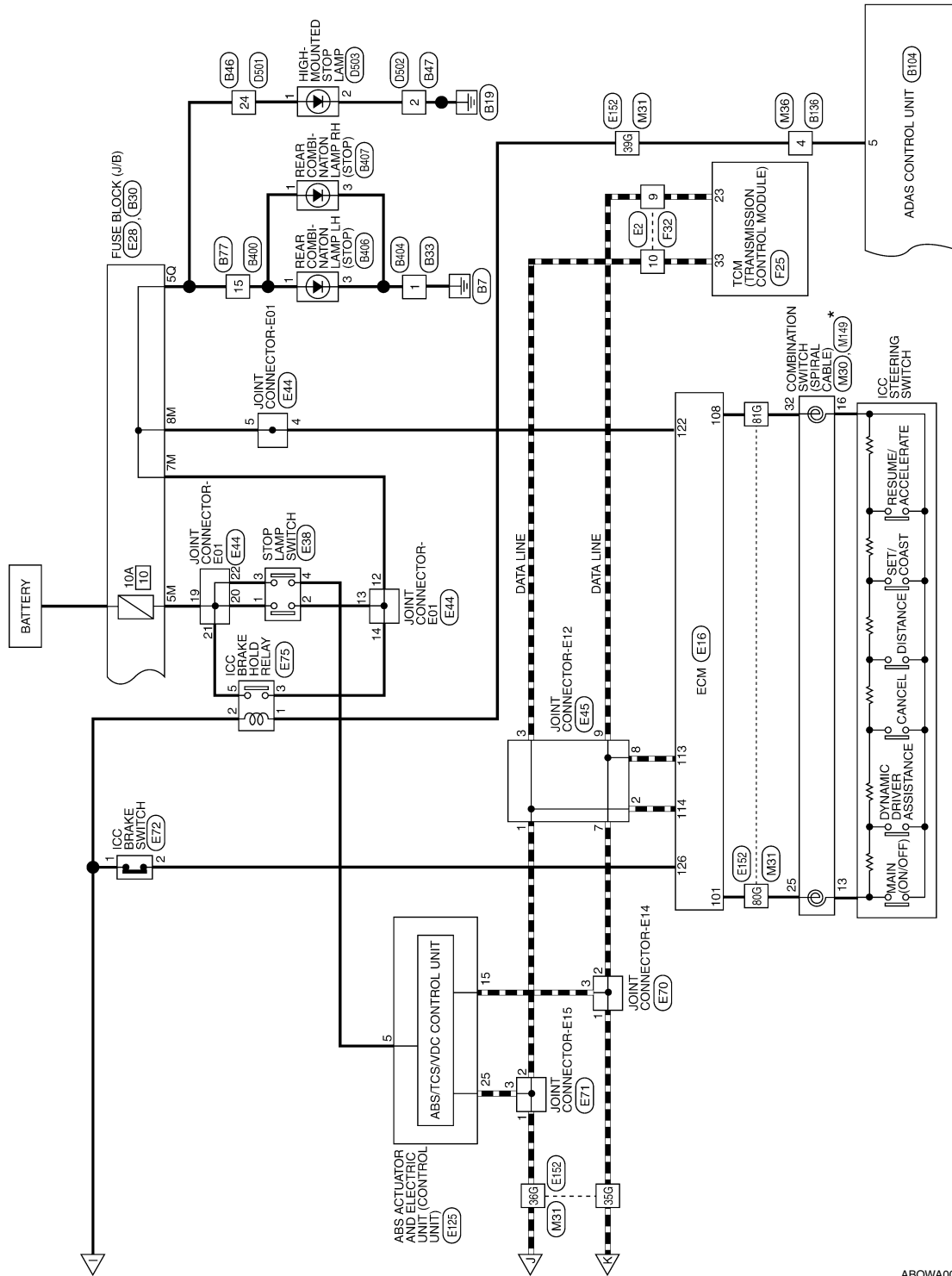

\* : THIS CONNECTOR IS NOT SHOWN IN "HARNES LAYOUT" OF PG SECTION.

ABOWA0033GB

DRIVE ASSISTANCE SYSTEM CONNECTORS

Connector No.	M1
Connector Name	WIRE TO WIRE
Connector Color	WHITE

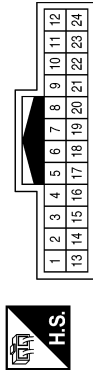

Terminal No.	Color of Wire	Signal Name
5	GR	-
6	LG	-
7	L	-
8	Y	-

Connector No.	M3
Connector Name	FUSE BLOCK (J/B)
Connector Color	WHITE

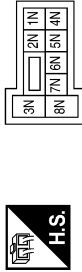

Terminal No.	Color of Wire	Signal Name
6N	W	-

Connector No.	M4
Connector Name	FUSE BLOCK (J/B)
Connector Color	WHITE



Terminal No.	Color of Wire	Signal Name
7P	LG	-
8P	BG	-
13P	W	-

Connector No.	M5
Connector Name	CAN GATEWAY
Connector Color	WHITE

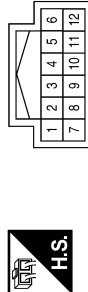

Terminal No.	Color of Wire	Signal Name
1	L	CAN-H
6	L	CAN-H
7	P	CAN-L
12	P	CAN-L

Connector No.	M11
Connector Name	JOINT CONNECTOR-M03
Connector Color	WHITE



Terminal No.	Color of Wire	Signal Name
1	Y	-
2	Y	-
3	W	-
4	Y	-

Connector No.	M19
Connector Name	BCM (BODY CONTROL MODULE)
Connector Color	BLACK



Terminal No.	Color of Wire	Signal Name
59	P	CAN-L
60	L	CAN-H

ABOIA0114GB

A B C D E F G H I J K L M N P

DAS

# DRIVER ASSISTANCE SYSTEMS

< WIRING DIAGRAM >

[LDW & LDP]

Terminal No.	Color of Wire	Signal Name
1	B	GND1
2	B	GND2
21	BG	IGN
22	W	BAT
38	P	CAN-L
39	L	CAN-H

Connector No.	M24
Connector Name	COMBINATION METER
Connector Color	WHITE

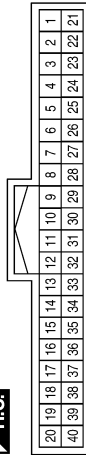

Connector No.	M23
Connector Name	COMBINATION METER
Connector Color	WHITE

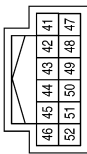

Terminal No.	Color of Wire	Signal Name
48	G	SW GND

Connector No.	M30
Connector Name	COMBINATION SWITCH (SPIRAL CABLE)
Connector Color	GRAY

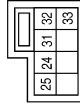

Terminal No.	Color of Wire	Signal Name
25	W	-
32	G	-

Connector No.	M27
Connector Name	METER CONTROL SWITCH
Connector Color	WHITE

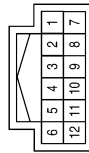

Terminal No.	Color of Wire	Signal Name
2	G	-
6	BG	-

A010A0098GB



# DRIVER ASSISTANCE SYSTEMS

< WIRING DIAGRAM >

[LDW & LDP]

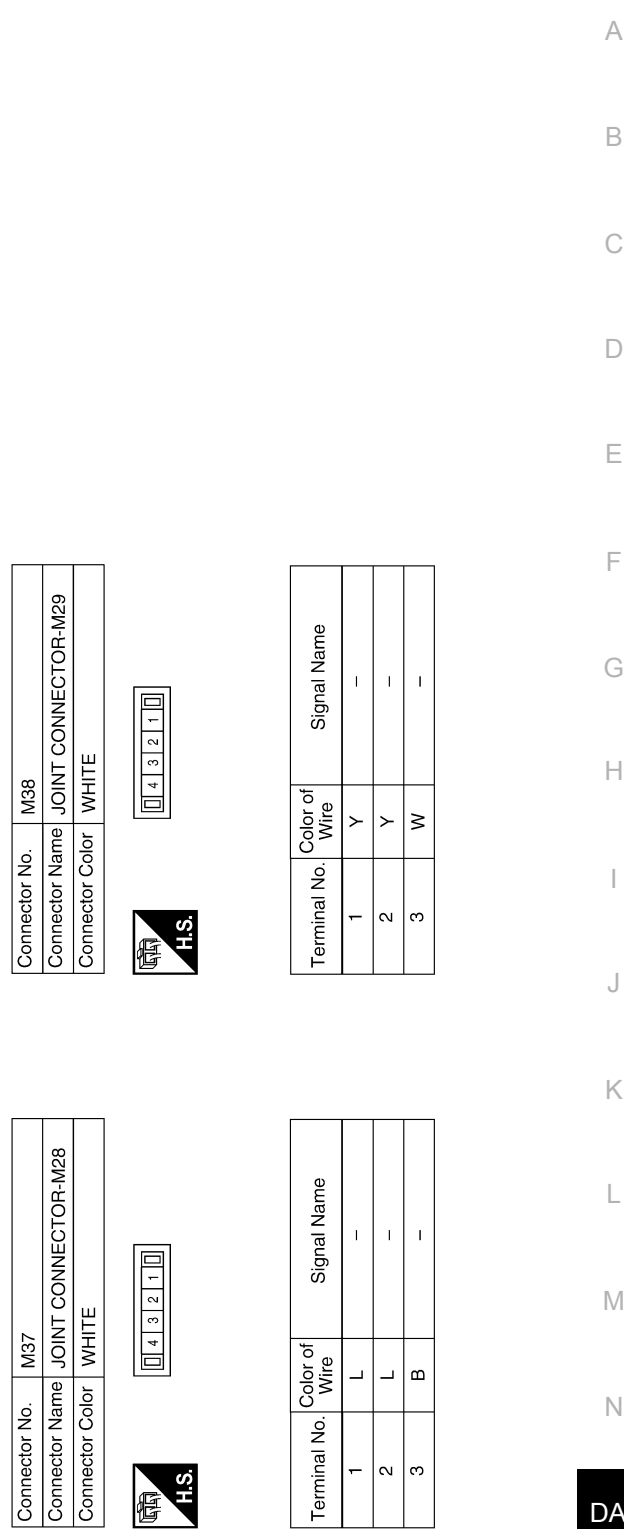
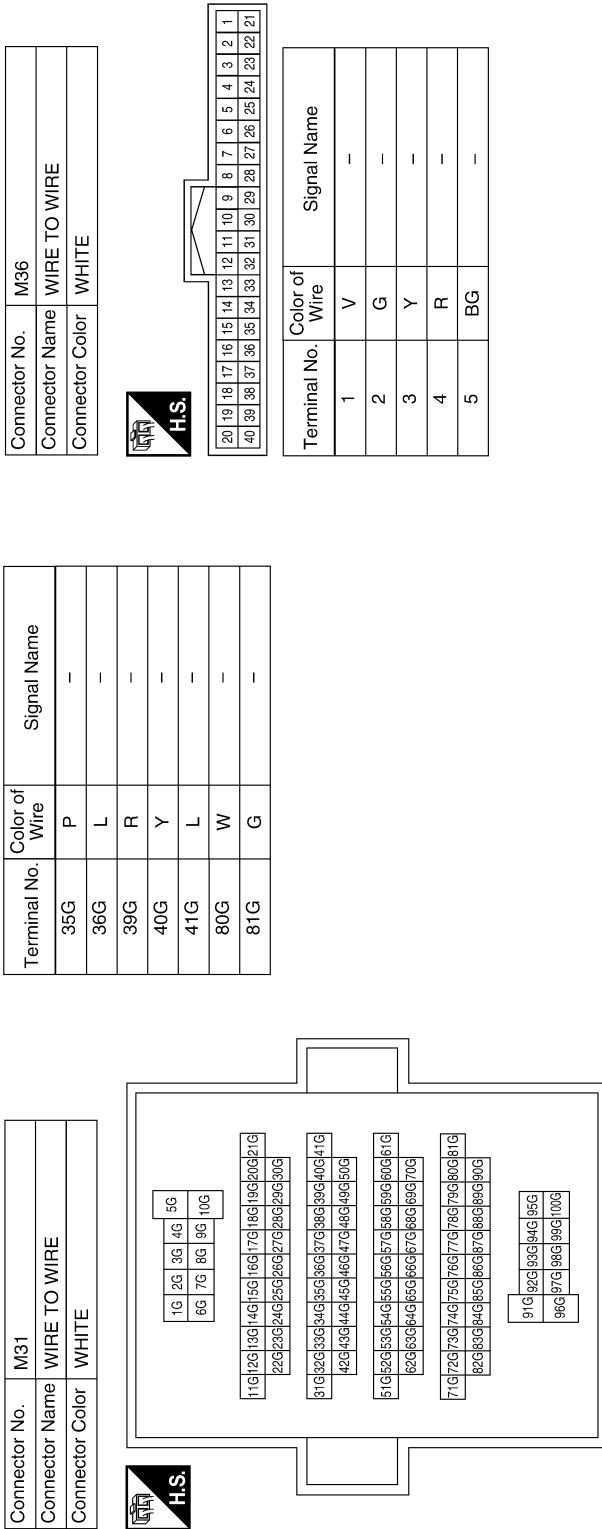

A  
B  
C  
D  
E  
F  
G  
H  
I  
J  
K  
L  
M  
N  
P



A010A0099GB

# DRIVER ASSISTANCE SYSTEMS

< WIRING DIAGRAM >

[LDW & LDP]

Connector No.	M41
Connector Name	JOINT CONNECTOR-M18
Connector Color	WHITE



Terminal No.	Color of Wire	Signal Name
1	P	-
2	P	-
3	P	-

Terminal No.	Color of Wire	Signal Name
14A	LG	-
33A	W	-
34A	B	-
35A	SHIELD	-
80A	Y	-
81A	L	-

Connector No.	M40
Connector Name	WIRE TO WIRE
Connector Color	GRAY

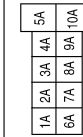

11A	12A	13A	14A	15A	16A	17A	18A	19A	20A	21A
22A	23A	24A	25A	26A	27A	28A	29A	30A		
31A	32A	33A	34A	35A	36A	37A	38A	39A	40A	41A
42A	43A	44A	45A	46A	47A	48A	49A	50A		
51A	52A	53A	54A	55A	56A	57A	58A	59A	60A	61A
62A	63A	64A	65A	66A	67A	68A	69A	70A		
71A	72A	73A	74A	75A	76A	77A	78A	79A	80A	81A
82A	83A	84A	85A	86A	87A	88A	89A	90A		

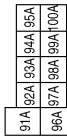

Connector No.	M50
Connector Name	A/C AUTO AMP.
Connector Color	WHITE



Terminal No.	Color of Wire	Signal Name
1	L	CAN-H
21	P	CAN-L

Connector No.	M47
Connector Name	TCU
Connector Color	WHITE

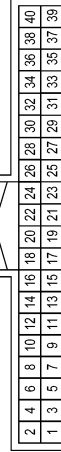

Terminal No.	Color of Wire	Signal Name
9	L	CAN-H
10	P	CAN-L

Connector No.	M43
Connector Name	JOINT CONNECTOR-M17
Connector Color	WHITE

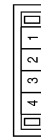

Terminal No.	Color of Wire	Signal Name
1	L	-
2	L	-
3	L	-

ABOIA0113GB

# DRIVER ASSISTANCE SYSTEMS

< WIRING DIAGRAM >

[LDW & LDP]

Connector No.	M67
Connector Name	JOINT CONNECTOR-M04
Connector Color	WHITE



Terminal No.	Color of Wire	Signal Name
1	L	-
2	L	-
3	B	-
4	L	-

Connector No.	M60
Connector Name	WARNING BUZZER
Connector Color	BROWN

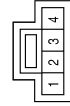

Terminal No.	Color of Wire	Signal Name
1	LG	-
2	V	-
3	GR	-
4	-	-

Connector No.	M54
Connector Name	STEERING ANGLE SENSOR
Connector Color	WHITE

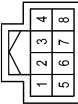

Terminal No.	Color of Wire	Signal Name
2	P	-
5	L	-

Connector No.	M84
Connector Name	WIRE TO WIRE
Connector Color	WHITE

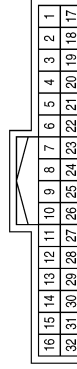

Terminal No.	Color of Wire	Signal Name
1	B	-
2	W	-
3	SHIELD	-
4	LG	-
17	L	-
18	P	-

Connector No.	M70
Connector Name	SONAR CONTROL UNIT
Connector Color	WHITE

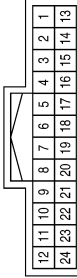

Terminal No.	Color of Wire	Signal Name
5	B	CAN-H
6	W	CAN-L
12	LG	IGN
15	GR	GND

Connector No.	M68
Connector Name	FUSE BLOCK (J/B)
Connector Color	BROWN



Terminal No.	Color of Wire	Signal Name
2R	LG	-

A010A100GB

A  
B  
C  
D  
E  
F  
G  
H  
I  
J  
K  
L  
M  
N  
P

DAS

# DRIVER ASSISTANCE SYSTEMS

< WIRING DIAGRAM >

[LDW & LDP]

Connector No.	M126
Connector Name	TWIN SWITCH (WARNING SYSTEM SWITCH)
Connector Color	BLACK

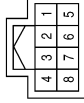

Terminal No.	Color of Wire	Signal Name
1	-	-
2	-	-
3	G	-
4	-	-
5	W	-
6	Y	-
7	-	-
8	B	-

Connector No.	M124
Connector Name	AV CONTROL UNIT (WITH BOSE AUDIO SYSTEM - WITH NAVI WITHOUT SURROUND SOUND SYSTEM)
Connector Color	WHITE

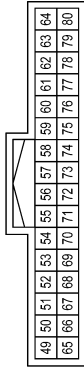

Terminal No.	Color of Wire	Signal Name
62	P	CAN-L
78	L	CAN-H

Connector No.	M96
Connector Name	AROUND VIEW MONITOR CONTROL UNIT
Connector Color	WHITE

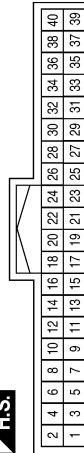

Terminal No.	Color of Wire	Signal Name
1	B	GND
3	LG	IGN
27	B	CAN-H
28	W	CAN-L
29	SHIELD	CAN GND

Connector No.	M158
Connector Name	WIRE TO WIRE
Connector Color	WHITE

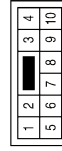

Terminal No.	Color of Wire	Signal Name
1	W	-
2	B	-
3	SHIELD	-

Connector No.	M150
Connector Name	JOINT CONNECTOR-M27
Connector Color	WHITE

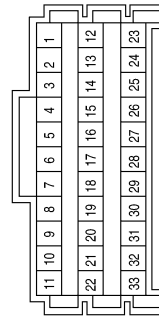

Terminal No.	Color of Wire	Signal Name
23	GR	-
28	SHIELD	-
31	GR	-

Connector No.	M149
Connector Name	COMBINATION SWITCH (SPIRAL CABLE)
Connector Color	GRAY

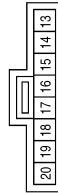

Terminal No.	Color of Wire	Signal Name
13	R	-
16	L	-

ABOIA0101GB

# DRIVER ASSISTANCE SYSTEMS

< WIRING DIAGRAM >

[LDW & LDP]

Connector No.	M188
Connector Name	WIRE TO WIRE
Connector Color	WHITE



1	2	3	4	5	6	7	8	9	10	11	12
13	14	15	16	17	18	19	20	21	22	23	24

Terminal No.	Color of Wire	Signal Name
19	G	-
20	W	-
21	B	-
22	Y	-

Connector No.	M167
Connector Name	WIRE TO WIRE
Connector Color	WHITE



1	2	3	4	5	6	7
8	9	10	11	12	13	14
15	16					

Terminal No.	Color of Wire	Signal Name
14	SHIELD	-
15	B	-
16	W	-

Connector No.	M163
Connector Name	AV CONTROL UNIT (WITH BOSE AUDIO SYSTEM - WITH NAVI AND SURROUND SOUND SYSTEM)
Connector Color	WHITE



49	50	51	52	53	54	55	56	57	58	59	60	61	62	63	64
65	66	67	68	69	70	71	72	73	74	75	76	77	78	79	80

Terminal No.	Color of Wire	Signal Name
62	P	CAN-L
78	L	CAN-H

Connector No.	E5
Connector Name	WIRE TO WIRE
Connector Color	WHITE



1	2	3	4	5	6	7
8	9	10	11	12	13	14
15	16					

Terminal No.	Color of Wire	Signal Name
11	R	-

Connector No.	E2
Connector Name	WIRE TO WIRE
Connector Color	WHITE



1	2	3	4	5	6	7	8
9	10	11	12	13	14	15	16

Terminal No.	Color of Wire	Signal Name
9	P	-
10	L	-

Connector No.	M189
Connector Name	WIRE TO WIRE
Connector Color	WHITE



12	11	10	9	8	7	6	5	4	3	2	1
24	23	22	21	20	19	18	17	16	15	14	13

Terminal No.	Color of Wire	Signal Name
19	G	-
20	W	-
21	B	-
22	Y	-

ABOIA0102GB

A  
B  
C  
D  
E  
F  
G  
H  
I  
J  
K  
L  
M  
N  
P

DAS

# DRIVER ASSISTANCE SYSTEMS

< WIRING DIAGRAM >

[LDW & LDP]

Connector No.	E28
Connector Name	FUSE BLOCK (J/B)
Connector Color	WHITE

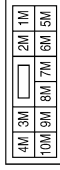

Terminal No.	Color of Wire	Signal Name
1M	R	-
5M	Y	-
7M	P	-
8M	R	-

Connector No.	E26
Connector Name	WIRE TO WIRE
Connector Color	WHITE

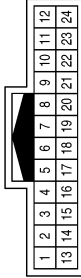

Terminal No.	Color of Wire	Signal Name
9	Y	-
10	BG	-

Connector No.	E16
Connector Name	ECM
Connector Color	GRAY

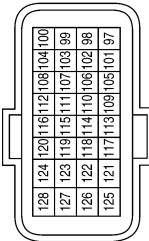

Terminal No.	Color of Wire	Signal Name
101	G	ASCD STEERING SWITCH/ICC STEERING SWITCH
108	R	SENSOR GROUND (ASCD STEERING SWITCH)
113	P	CAN-L
114	L	CAN-H
122	R	STOP LAMP SWITCH
126	LG	ASCD BRAKE SWITCH

Terminal No.	Color of Wire	Signal Name
14	P	-
19	Y	-
20	Y	-
21	Y	-
22	Y	-

Connector No.	E44
Connector Name	JOINT CONNECTOR-E01
Connector Color	WHITE

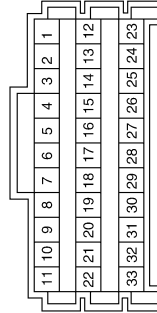

Terminal No.	Color of Wire	Signal Name
4	R	-
5	R	-
12	P	-
13	P	-

Connector No.	E38
Connector Name	STOP LAMP SWITCH
Connector Color	WHITE



Terminal No.	Color of Wire	Signal Name
1	Y	-
2	P	-
3	Y	-
4	G	-

ABOIA0103GB

# DRIVER ASSISTANCE SYSTEMS

< WIRING DIAGRAM >

[LDW & LDP]

Connector No.	E71
Connector Name	JOINT CONNECTOR-E15
Connector Color	BLACK



Terminal No.	Color of Wire	Signal Name
1	L	-
2	L	-
3	L	-

Connector No.	E70
Connector Name	JOINT CONNECTOR-E14
Connector Color	BLACK



Terminal No.	Color of Wire	Signal Name
1	P	-
2	P	-
3	P	-

Connector No.	E45
Connector Name	JOINT CONNECTOR-E12
Connector Color	BLUE



Terminal No.	Color of Wire	Signal Name
1	L	-
2	L	-
3	L	-
7	P	-
8	P	-
9	P	-

Connector No.	E75
Connector Name	ICC BRAKE HOLD RELAY
Connector Color	BLUE



Terminal No.	Color of Wire	Signal Name
1	W	-
2	R	-
3	P	-
5	Y	-

Connector No.	E74
Connector Name	ACCELERATOR PEDAL ACTUATOR
Connector Color	GRAY



Terminal No.	Color of Wire	Signal Name
1	BG	-
2	GR	-
3	G	-
4	Y	-
5	BG	-
6	-	-

Connector No.	E72
Connector Name	ICC BRAKE SWITCH
Connector Color	BROWN



Terminal No.	Color of Wire	Signal Name
1	R	-
2	LG	-

ABOIA0104GB

A  
B  
C  
D  
E  
F  
G  
H  
I  
J  
K  
L  
M  
N  
P

DAS

# DRIVER ASSISTANCE SYSTEMS

< WIRING DIAGRAM >

[LDW & LDP]

Connector No.	E106
Connector Name	JOINT CONNECTOR-E06
Connector Color	WHITE



Terminal No.	Color of Wire	Signal Name
1	BG	-
2	BG	-
3	BG	-

Connector No.	E108
Connector Name	JOINT CONNECTOR-E07
Connector Color	WHITE



Terminal No.	Color of Wire	Signal Name
1	Y	-
2	Y	-
3	Y	-

Connector No.	E125
Connector Name	ABS ACTUATOR AND ELECTRIC UNIT (CONTROL UNIT)
Connector Color	BLACK

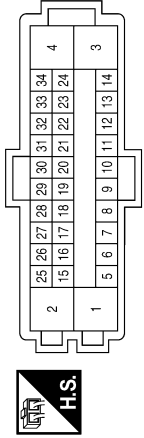

Terminal No.	Color of Wire	Signal Name
5	G	STOP LAMP SW (WITH ICC)
15	P	CAN-L
25	L	CAN-H

Connector No.	E152
Connector Name	WIRE TO WIRE
Connector Color	WHITE

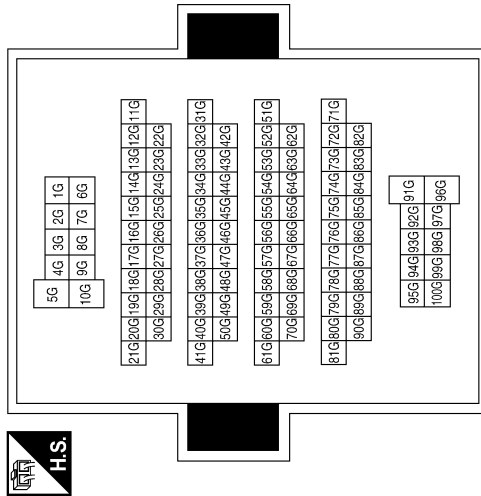

Terminal No.	Color of Wire	Signal Name
35G	P	-
36G	L	-
39G	W	-
40G	Y	-
41G	BG	-
80G	G	-
81G	R	-

Connector No.	E207
Connector Name	WIRE TO WIRE
Connector Color	WHITE

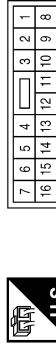

Terminal No.	Color of Wire	Signal Name
11	P	-

A010A105GB



# DRIVER ASSISTANCE SYSTEMS

< WIRING DIAGRAM >

[LDW & LDP]

Connector No.	F25
Connector Name	TCM (TRANSMISSION CONTROL MODULE)
Connector Color	BLACK

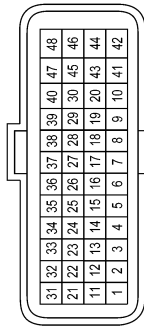

Terminal No.	Color of Wire	Signal Name
23	P	CAN-L
33	L	CAN-H

Connector No.	E219
Connector Name	ICC SENSOR
Connector Color	BLACK

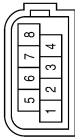

Terminal No.	Color of Wire	Signal Name
1	P	-
6	Y	-
7	L	-
8	B	-

Connector No.	E209
Connector Name	WIRE TO WIRE
Connector Color	WHITE

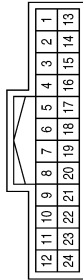

Terminal No.	Color of Wire	Signal Name
9	Y	-
10	L	-

Connector No.	B32
Connector Name	WIRE TO WIRE
Connector Color	WHITE

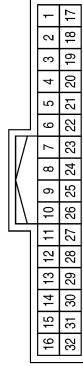

Terminal No.	Color of Wire	Signal Name
20	Y	-
21	L	-

Connector No.	B30
Connector Name	FUSE BLOCK (J/B)
Connector Color	WHITE

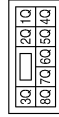

Terminal No.	Color of Wire	Signal Name
5Q	G	-

Connector No.	F32
Connector Name	WIRE TO WIRE
Connector Color	WHITE

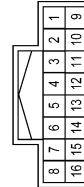

Terminal No.	Color of Wire	Signal Name
9	P	-
10	L	-

A01A0106GB

A  
B  
C  
D  
E  
F  
G  
H  
I  
J  
K  
L  
M  
N  
P

DAS

# DRIVER ASSISTANCE SYSTEMS

< WIRING DIAGRAM >

[LDW & LDP]

Connector No.	B33
Connector Name	WIRE TO WIRE
Connector Color	BLACK



Terminal No.	1	Color of Wire	B	Signal Name	-
--------------	---	---------------	---	-------------	---

Connector No.	B63
Connector Name	JOINT CONNECTOR-B01
Connector Color	WHITE

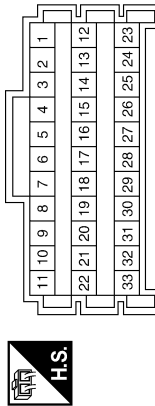

Terminal No.	Color of Wire	Signal Name
1	L	-
2	L	-
3	L	-
4	Y	-
5	Y	-
6	Y	-
16	W	-
17	W	-
19	B	-
20	B	-
21	SHIELD	-
22	B	-

Connector No.	B46
Connector Name	WIRE TO WIRE
Connector Color	WHITE

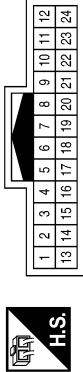

Terminal No.	24	Color of Wire	G	Signal Name	-
--------------	----	---------------	---	-------------	---

Connector No.	B69
Connector Name	WIRE TO WIRE
Connector Color	GRAY

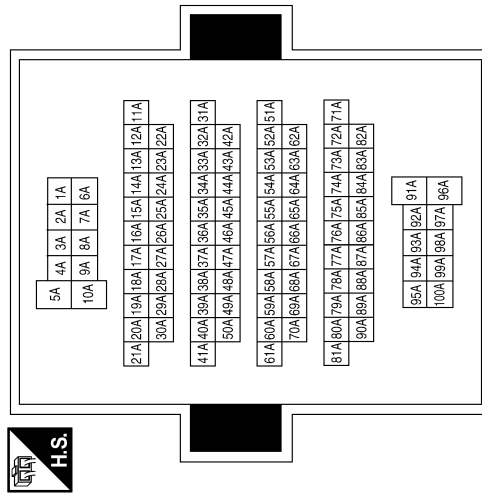

Connector No.	B47
Connector Name	WIRE TO WIRE
Connector Color	GRAY



Terminal No.	2	Color of Wire	B	Signal Name	-
--------------	---	---------------	---	-------------	---

Terminal No.	14A	Color of Wire	R	Signal Name	-
	33A	Color of Wire	W	Signal Name	-
	34A	Color of Wire	B	Signal Name	-
	35A	Color of Wire	SHIELD	Signal Name	-
	80A	Color of Wire	Y	Signal Name	-
	81A	Color of Wire	L	Signal Name	-

A010A107GB

# DRIVER ASSISTANCE SYSTEMS

< WIRING DIAGRAM >

[LDW & LDP]

Connector No.	B102
Connector Name	JOINT CONNECTOR-B14
Connector Color	WHITE



Terminal No.	Color of Wire	Signal Name
1	L	-
3	B	-

Connector No.	B101
Connector Name	WIRE TO WIRE
Connector Color	WHITE

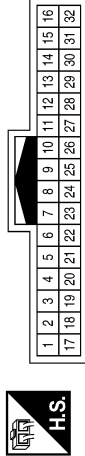

Terminal No.	Color of Wire	Signal Name
1	B	-
2	W	-
3	SHIELD	-
4	R	-
17	L	-
18	P	-

Connector No.	B77
Connector Name	WIRE TO WIRE
Connector Color	WHITE

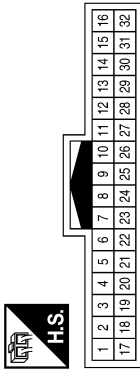

Terminal No.	Color of Wire	Signal Name
6	R	-
7	W	-
8	B	-
12	L	-
13	Y	-
15	G	-

Terminal No.	Color of Wire	Signal Name
7	L	ITS COMM-H
8	Y	ITS COMM-L
9	-	-
10	BG	BCP OFF SW
11	-	-
12	G	WARNING BUZZER
13	-	-
14	B	CAN-H
15	W	CAN-L
16	R	IGNITION

Connector No.	B104
Connector Name	ADAS CONTROL UNIT
Connector Color	WHITE

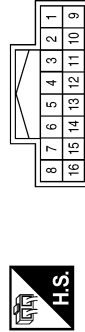

Terminal No.	Color of Wire	Signal Name
1	BR	WARNING SYSTEM SW
2	-	-
3	-	-
4	W	WARNING SYSTEM ON IND
5	G	BRAKE HOLD RLY DRIVE SIGNAL
6	B	GND

Connector No.	B103
Connector Name	JOINT CONNECTOR-B15
Connector Color	WHITE



Terminal No.	Color of Wire	Signal Name
1	P	-
3	W	-

ABOIA0108GB

A  
B  
C  
D  
E  
F  
G  
H  
I  
J  
K  
L  
M  
N  
P

DAS

# DRIVER ASSISTANCE SYSTEMS

< WIRING DIAGRAM >

[LDW & LDP]

Terminal No.	Color of Wire	Signal Name
9	B	-
10	GR	-
11	SHIELD	-
19	R	-
20	R	-
21	R	-
27	W	-
28	W	-
29	B	-
30	B	-
31	GR	-
32	SHIELD	-
33	B	-

Connector No.	B115
Connector Name	JOINT CONNECTOR-B08
Connector Color	WHITE

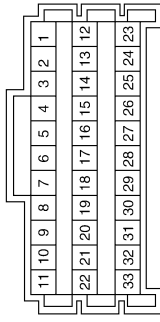

Connector No.	B109
Connector Name	SIDE RADAR RH
Connector Color	BLACK

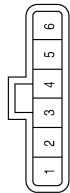

Terminal No.	Color of Wire	Signal Name
1	B	-
2	B	-
3	Y	-
4	L	-
5	R	-
6	W	-

Connector No.	B146
Connector Name	JOINT CONNECTOR-B12
Connector Color	WHITE



Connector No.	B136
Connector Name	WIRE TO WIRE
Connector Color	WHITE

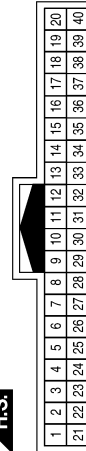

Terminal No.	Color of Wire	Signal Name
1	L	-
2	L	-
3	L	-

Connector No.	B124
Connector Name	WIRE TO WIRE
Connector Color	WHITE

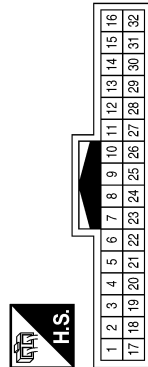

Terminal No.	Color of Wire	Signal Name
20	Y	-
21	L	-

ABOIA0109GB

# DRIVER ASSISTANCE SYSTEMS

< WIRING DIAGRAM >

[LDW & LDP]

Connector No.	B404
Connector Name	WIRE TO WIRE
Connector Color	BLACK



Terminal No.	Color of Wire	Signal Name
1	B	-

Connector No.	B400
Connector Name	WIRE TO WIRE
Connector Color	WHITE

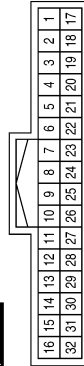

Terminal No.	Color of Wire	Signal Name
6	R	-
7	W	-
8	B	-
12	L	-
13	Y	-
15	G	-

Connector No.	B147
Connector Name	JOINT CONNECTOR-B13
Connector Color	WHITE



Terminal No.	Color of Wire	Signal Name
1	Y	-
2	Y	-
3	Y	-

Connector No.	B416
Connector Name	SIDE RADAR LH
Connector Color	BLACK

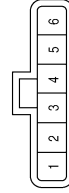

Terminal No.	Color of Wire	Signal Name
1	-	-
2	B	-
3	Y	-
4	L	-
5	R	-
6	W	-

Connector No.	B407
Connector Name	REAR COMBINATION LAMP RH
Connector Color	GRAY



Terminal No.	Color of Wire	Signal Name
1	G	-
3	GR	-

Connector No.	B406
Connector Name	REAR COMBINATION LAMP LH
Connector Color	GRAY



Terminal No.	Color of Wire	Signal Name
1	G	-
3	B	-

ABOIA0110GB

A  
B  
C  
D  
E  
F  
G  
H  
I  
J  
K  
L  
M  
N  
P

DAS

# DRIVER ASSISTANCE SYSTEMS

< WIRING DIAGRAM >

[LDW & LDP]

Connector No.	D2
Connector Name	WIRE TO WIRE
Connector Color	WHITE

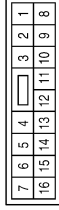

Terminal No.	Color of Wire	Signal Name
14	SHIELD	-
15	B	-
16	W	-

Connector No.	R5
Connector Name	LANE CAMERA UNIT
Connector Color	WHITE



Terminal No.	Color of Wire	Signal Name
1	B	-
2	-	-
3	-	-
4	BR	-
5	B	-
6	-	-
7	LG	-
8	Y	-

Connector No.	R1
Connector Name	WIRE TO WIRE
Connector Color	WHITE

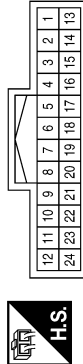

Terminal No.	Color of Wire	Signal Name
5	B	-
6	LG	-
7	BR	-
8	Y	-

Connector No.	D111
Connector Name	BLIND SPOT WARNING/ BLIND SPOT INTERVEN- TION INDICATOR RH
Connector Color	WHITE



Terminal No.	Color of Wire	Signal Name
1	W	-
2	-	-
3	-	-
4	B	-

Connector No.	D102
Connector Name	WIRE TO WIRE
Connector Color	WHITE

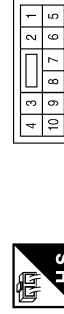

Terminal No.	Color of Wire	Signal Name
1	W	-
2	B	-
3	SHIELD	-

Connector No.	D21
Connector Name	BLIND SPOT WARNING/ BLIND SPOT INTERVEN- TION INDICATOR LH
Connector Color	WHITE



Terminal No.	Color of Wire	Signal Name
1	W	-
2	-	-
3	-	-
4	B	-

ABOIA0111GB

# DRIVER ASSISTANCE SYSTEMS

< WIRING DIAGRAM >

[LDW & LDP]

A  
B  
C  
D  
E  
F  
G  
H  
I  
J  
K  
L  
M  
N  
P

Connector No.	D503
Connector Name	HIGH-MOUNTED STOP LAMP
Connector Color	BROWN



Terminal No.	Color of Wire	Signal Name
1	LG	-
2	B	-

Connector No.	D502
Connector Name	WIRE TO WIRE
Connector Color	GRAY

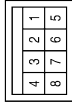

Terminal No.	Color of Wire	Signal Name
2	B	-

Connector No.	D501
Connector Name	WIRE TO WIRE
Connector Color	WHITE

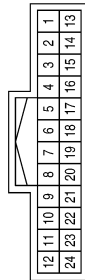

Terminal No.	Color of Wire	Signal Name
24	LG	-

ABOIA0112GB

DAS

# DIAGNOSIS AND REPAIR WORK FLOW

< BASIC INSPECTION >

[LDW & LDP]

## BASIC INSPECTION

### DIAGNOSIS AND REPAIR WORK FLOW

Work Flow

INFOID:000000009716628

#### OVERALL SEQUENCE

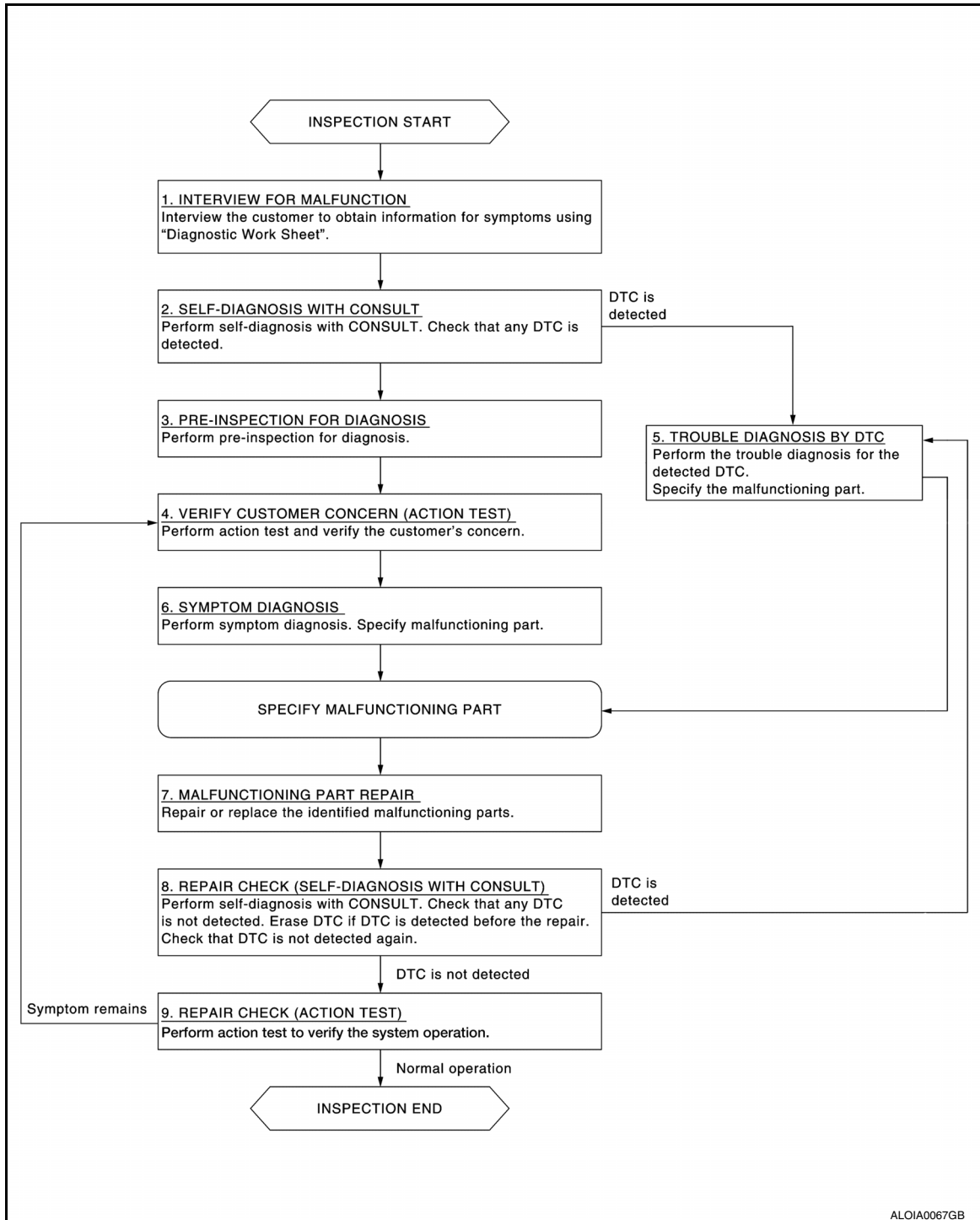

#### DETAILED FLOW

##### 1. INTERVIEW FOR MALFUNCTION

Interview the customer to obtain information about symptoms using "Diagnostic Work Sheet". (Refer to [DAS-389, "Diagnostic Work Sheet"](#).)



# DIAGNOSIS AND REPAIR WORK FLOW

< BASIC INSPECTION >

[LDW & LDP]

>> GO TO 2.

## 2. SELF-DIAGNOSIS WITH CONSULT

1. Perform "All DTC Reading" with CONSULT.
2. Check if the DTC is detected on the self-diagnosis results of "ICC/ADAS" and/or "LANE CAMERA".

Is any DTC detected?

- YES >> GO TO 5.  
NO >> GO TO 3.

## 3. PRE-INSPECTION FOR DIAGNOSIS

Perform pre-inspection for diagnosis. Refer to [DAS-391, "Inspection Procedure"](#).

>> GO TO 4.

## 4. ACTION TEST

Perform LDW/LDP system action test to check the operation status. Refer to [DAS-392, "Description"](#).

>> GO TO 6.

## 5. TROUBLE DIAGNOSIS BY DTC

Perform trouble diagnosis for the detected DTC. Specify a malfunctioning part. Refer to [DAS-359, "DTC Index"](#) (ICC/ADAS) and/or [DAS-366, "DTC Index"](#) (LANE CAMERA).

>> GO TO 7.

## 6. SYMPTOM DIAGNOSIS

Perform symptom diagnosis. Specify malfunctioning part. Refer to [DAS-451, "Symptom Table"](#).

>> GO TO 7.

## 7. MALFUNCTION PART REPAIR

Repair or replace the identified malfunctioning parts.

>> GO TO 8.

## 8. REPAIR CHECK (SELF-DIAGNOSIS WITH CONSULT)

Perform self-diagnosis with CONSULT. Check that any DTC is not detected. Erase DTC if DTC is detected before the repair. Check that DTC is not detected again.

Is any DTC detected?

- YES >> GO TO 5.  
NO >> GO TO 9.

## 9. REPAIR CHECK (ACTION TEST)

Perform LDW/LDP system action test. Also check the system operation.

Does it operate normally?

- YES >> INSPECTION END  
NO >> GO TO 4.

## Diagnostic Work Sheet

INFOID:000000009716629

### DESCRIPTION

In general, each customer feels differently about an incident. It is important to fully understand the symptoms or conditions for a customer complaint.

There are many operating conditions that lead to the malfunction. A good grasp of such conditions can make troubleshooting faster and more accurate.

Some conditions may cause the lane departure warning lamp to stay ON.

A  
B  
C  
D  
E  
F  
G  
H  
I  
J  
K  
L  
M  
N  
P

# DIAGNOSIS AND REPAIR WORK FLOW

< BASIC INSPECTION >

[LDW & LDP]

Utilize a work sheet sample to organize all of the information for troubleshooting.

**KEY POINTS**

- WHAT..... System and functions
- WHEN..... Date, Frequencies
- WHERE..... Road conditions
- HOW..... Operating conditions, Symptoms

**WORK SHEET SAMPLE**

Customer name MR/MS		Model and Year		VIN	
Engine #		Trans.		Mileage	
Incident Date		Manuf. Date		In Service Date	
<b>Symptoms</b>					
Indicator/Warning lamps	<input type="checkbox"/> Lane departure warning lamp	<input type="checkbox"/> Stays ON <input type="checkbox"/> Turned ON occasionally	<input type="checkbox"/> Stays OFF <input type="checkbox"/> Others ( )	<input type="checkbox"/> Blinks	
	<input type="checkbox"/> Warning systems ON indicator	<input type="checkbox"/> Stays ON	<input type="checkbox"/> Stays OFF <input type="checkbox"/> Others ( )	<input type="checkbox"/> Blinks	
	<input type="checkbox"/> LDP ON indicator lamp	<input type="checkbox"/> Stays ON <input type="checkbox"/> Turned ON occasionally	<input type="checkbox"/> Stays OFF <input type="checkbox"/> Others ( )	<input type="checkbox"/> Blinks	
	<input type="checkbox"/> Other lamps ( )	<input type="checkbox"/> Stays ON <input type="checkbox"/> Turned ON occasionally	<input type="checkbox"/> Stays OFF <input type="checkbox"/> Others ( )	<input type="checkbox"/> Blinks	
Functions	<input type="checkbox"/> When using LDW <input type="checkbox"/> When using LDP				
	<input type="checkbox"/> All functions do not operate. <input type="checkbox"/> Warning function does not operate. ( <input type="checkbox"/> No sound <input type="checkbox"/> No indicator ) <input type="checkbox"/> Yawing function does not operate. (Warning function is operated.)				
	<input type="checkbox"/> Functions when changing the course in the turn signal direction. <input type="checkbox"/> Functions are untimely. <ul style="list-style-type: none"> <li><input type="checkbox"/> Does not function when driving on lane markers.</li> <li><input type="checkbox"/> Functions when driving in a lane.</li> <li><input type="checkbox"/> Functions in a different position from the actual position.</li> </ul> <input type="checkbox"/> Others ( )				
<b>Conditions</b>					
Frequency	<input type="checkbox"/> Continuously		<input type="checkbox"/> Intermittently		
Light conditions	<input type="checkbox"/> Not affected <input type="checkbox"/> In the daytime <input type="checkbox"/> Direct light	<input type="checkbox"/> At night <input type="checkbox"/> Backlight	<input type="checkbox"/> Sunrise/sunset (Strong light) <input type="checkbox"/> Others ( )		
Driving conditions	<input type="checkbox"/> Not affected <input type="checkbox"/> Vehicle speed	MPH (      km/h)	<input type="checkbox"/> Vehicle is stopped		
Weather conditions	<input type="checkbox"/> Not affected <input type="checkbox"/> Fine <input type="checkbox"/> Clouding	<input type="checkbox"/> Raining	<input type="checkbox"/> Snowing <input type="checkbox"/> Others ( )		
Road conditions	<input type="checkbox"/> Not affected <input type="checkbox"/> Highway <input type="checkbox"/> Uneven roads	<input type="checkbox"/> In town <input type="checkbox"/> Winding roads	<input type="checkbox"/> Others ( )		
Lane maker conditions	<input type="checkbox"/> Not affected <input type="checkbox"/> Clear	<input type="checkbox"/> Unclear	<input type="checkbox"/> Others ( )		
Other conditions					

JSOIA0287GB

# PRE-INSPECTION FOR DIAGNOSIS

< BASIC INSPECTION >

[LDW & LDP]

## PRE-INSPECTION FOR DIAGNOSIS

### Inspection Procedure

INFOID:000000009716630

#### 1.CHECK CAMERA LENS AND WINDSHIELD

Are camera lens and windshield contaminated with foreign materials?

- YES >> Clean camera lens and windshield.
- NO >> GO TO 2.

#### 2.CHECK LANE CAMERA UNIT INSTALLATION CONDITION

Check lane camera unit installation condition (installation position, properly tightened, a bent bracket).

Is it properly installed?

- YES >> GO TO 3.
- NO >> Install lane camera unit properly, and perform camera aiming. Refer to [DAS-396. "Description"](#).

#### 3.CHECK VEHICLE HEIGHT

Check vehicle height. Refer to [DAS-398. "Work Procedure \(Camera Aiming Adjustment\)"](#).

Is vehicle height appropriate?

- YES >> INSPECTION END
- NO >> Repair vehicle to appropriate height.

A  
B  
C  
D  
E  
F  
G  
H  
I  
J  
K  
L  
M  
N  
P

DAS

## ACTION TEST

## Description

INFOID:000000009716631

- Perform action test to verify the customer's concern.
- Perform action test and check the system operation after system diagnosis.

**WARNING:**

Be careful of traffic conditions and safety around the vehicle when performing road test.

**CAUTION:**

- Fully understand the following items well before the road test;
- Precautions: Refer to [DAS-317, "Precaution for LDW/LDP System Service"](#).
- System description for LDW: Refer to [DAS-322, "LANE DEPARTURE WARNING \(LDW\) SYSTEM : System Description"](#).
- System description for LDP: Refer to [DAS-325, "LANE DEPARTURE PREVENTION \(LDP\) SYSTEM : System Description"](#).
- Handling precaution: Refer to [DAS-333, "Precautions for Lane Departure Warning/Lane Departure Prevention"](#).

## Inspection Procedure

INFOID:000000009716632

**WARNING:**

Be careful of traffic conditions and safety around the vehicle when performing road test.

**CAUTION:**

- Fully understand the following items well before the road test;
- Precautions: Refer to [DAS-317, "Precaution for LDW/LDP System Service"](#).
- System description for LDW: Refer to [DAS-322, "LANE DEPARTURE WARNING \(LDW\) SYSTEM : System Description"](#).
- System description for LDP: Refer to [DAS-325, "LANE DEPARTURE PREVENTION \(LDP\) SYSTEM : System Description"](#).
- Handling precaution: Refer to [DAS-333, "Precautions for Lane Departure Warning/Lane Departure Prevention"](#).

**1**.CHECK LDW SYSTEM SETTING

1. Start the engine.
2. Check that the LDW system setting can be enabled/disabled in the vehicle information display.
3. Turn OFF the ignition switch and wait for 30 seconds or more.
4. Check that the previous setting is saved when the engine starts again.

>> GO TO 2.

**2**.ACTION TEST FOR LDW

1. Enable the setting of the LDW system in the vehicle information display.
2. Turn warning systems switch ON (warning systems ON indicator is ON).

**NOTE:**

LDP system is OFF.

3. Check the LDW operation according to the following table.

# ACTION TEST

< BASIC INSPECTION >

[LDW & LDP]

Vehicle condition/ Driver's operation		Action	Warning systems ON indicator	Indication on the combination meter	Buzzer
Less than Approx. 60 km/h (40 MPH)	Close to lane marker	No action	ON	OFF	—
Approx. 70 km/h (45 MPH) or more	Close to lane marker	Warning <ul style="list-style-type: none"> <li>• Buzzer sounds</li> <li>• Warning lamp blinks</li> </ul>	ON	Orange (Blink) <div style="text-align: center; margin-top: 10px;">  </div>	Short continuous beeps
	<ul style="list-style-type: none"> <li>• Close to lane marker</li> <li>• Turn signal ON (Deviate side)</li> </ul>	No action	ON	OFF	—

**NOTE:**

After the operating conditions of warning are satisfied, the warning continues until the vehicle speed reaches approximately 60 km/h (40 MPH). Refer to [DAS-322. "LANE DEPARTURE WARNING \(LDW\) SYSTEM : System Description"](#).

>> GO TO 3.

### 3. CHECK LDP SYSTEM SETTING

1. Start the engine.
2. Check that the LDP system setting can be enabled/disabled in the vehicle information display.
3. Turn OFF the ignition switch and wait for 30 seconds or more.
4. Check that the previous setting is saved when the engine starts again.

>> GO TO 4.

### 4. ACTION TEST FOR LDP

1. Enable the setting of the LDP system in the vehicle information display.
2. Turn dynamic driver assistance switch ON (LDP ON indicator lamp is ON).

**NOTE:**

LDW system is OFF.



3. Check the LDP operation according to the following table.

Vehicle condition/ Driver's operation		Action	Indication on the combination meter	Buzzer
Less than Approx. 60 km/h (40 MPH)	Close to lane marker	No action	<div style="text-align: center; margin-top: 10px;">  </div>	—

# ACTION TEST

< BASIC INSPECTION >

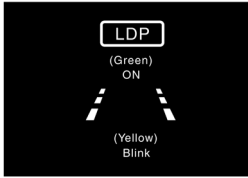
[LDW & LDP]

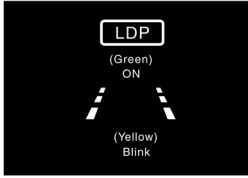
Vehicle condition/ Driver's operation	Action	Indication on the combination meter	Buzzer	
Approx. 70 km/h (45 MPH) or more	Close to lane marker	Warning and yawing <ul style="list-style-type: none"> <li>• Buzzer sounds</li> <li>• Warning lamp blinks</li> <li>• Brake control</li> </ul>	 <p style="text-align: center; font-size: small;">ALOIA0135GB</p>	Short continuous beeps
	<ul style="list-style-type: none"> <li>• Close to lane marker</li> <li>• Turn signal ON (Deviate side)</li> </ul>	No action	 <p style="text-align: center; font-size: small;">ALOIA0136GB</p>	—
	Close to lane marker with soft braking	Warning <ul style="list-style-type: none"> <li>• Buzzer sounds</li> <li>• Warning lamp blinks</li> </ul>	 <p style="text-align: center; font-size: small;">ALOIA0135GB</p>	Short continuous beeps
	<ul style="list-style-type: none"> <li>• VDC OFF Switch OFF ⇒ ON (VDC system ON ⇒ OFF)</li> <li>• SNOW mode switch OFF ⇒ ON</li> <li>• Road condition is wet</li> <li>• Lane camera temperature is high</li> </ul>	Cancellation <ul style="list-style-type: none"> <li>• Buzzer sounds</li> <li>• Each message is displayed</li> </ul> <b>NOTE:</b> When dynamic driver assistance switch is ON ⇒ OFF, message is turned OFF.	Each message is displayed	Beep

**NOTE:**

After the operating conditions are satisfied, the control continues until the vehicle speed reaches approximately 60 km/h (40 MPH). Refer to [DAS-325. "LANE DEPARTURE PREVENTION \(LDP\) SYSTEM : System Description"](#).

>> INSPECTION END

# ADDITIONAL SERVICE WHEN REPLACING LANE CAMERA UNIT

< BASIC INSPECTION >

[LDW & LDP]

## ADDITIONAL SERVICE WHEN REPLACING LANE CAMERA UNIT

### Description

INFOID:000000009716633

Always adjust the camera aiming after removing and installing or replacing the lane camera unit.

#### **CAUTION:**

**The system does not operate normally unless the camera aiming adjustment is performed. Always perform it.**

### Work Procedure

INFOID:000000009716634

#### 1. CAMERA AIMING ADJUSTMENT

Perform the camera aiming adjustment with CONSULT. Refer to [DAS-396, "Description"](#).

>> GO TO 2.

#### 2. PERFORM SELF-DIAGNOSIS

Perform the self-diagnosis of lane camera unit with CONSULT. Check if any DTC is detected.

##### Is any DTC detected?

YES >> Perform the trouble diagnosis for the detected DTC. Refer to [DAS-366, "DTC Index"](#).

NO >> GO TO 3.

#### 3. LDW/LDP SYSTEM ACTION TEST

1. Perform the LDW/LDP system action test. Refer to [DAS-392, "Description"](#).
2. Check that the LDW/LDP system operates normally.

>> WORK END

A  
B  
C  
D  
E  
F  
G  
H  
I  
J  
K  
L  
M  
N  
P

DAS

# CAMERA AIMING ADJUSTMENT

< BASIC INSPECTION >

[LDW & LDP]

## CAMERA AIMING ADJUSTMENT

### Description

INFOID:000000009716635

Always adjust the camera aiming after removing and installing or replacing the lane camera unit.

#### CAUTION:

- Place the vehicle on level ground when the camera aiming adjustment is operated.
- Follow the CONSULT when performing the camera aiming. (Camera aiming adjustment cannot be operated without CONSULT.)

### Work Procedure (Preparation)

INFOID:000000009716636

#### 1. PERFORM SELF-DIAGNOSIS

Perform self-diagnosis of ADAS control unit and lane camera unit.

##### Is any DTC detected?

Except "C1B01">>Perform diagnosis on the detected DTC and repair or replace the applicable item. Refer to [DAS-359, "DTC Index"](#) (ICC/ADAS) or [DAS-366, "DTC Index"](#) (LANE CAMERA).

"C1B01" or no DTC>>GO TO 2.

#### 2. PREPARATION BEFORE CAMERA AIMING ADJUSTMENT

1. Perform pre-inspection for diagnosis. Refer to [DAS-391, "Inspection Procedure"](#).
2. Adjust the tire pressure to the specified pressure value.
3. Maintain no-load in vehicle.
4. Check if coolant and engine oil are filled up to correct level and fuel tank is full.
5. Shift the selector lever to "P" position and release the parking brake.
6. Clean the windshield.
7. Completely clear off the instrument panel.

>> GO TO 3.

#### 3. PREPARATION OF AIMING ADJUSTMENT JIG

Prepare the aiming adjustment jig according to the following procedure and the figure.

1. Print out the target mark attached in this service manual. Refer to [DAS-399, "Work Procedure \(Target Mark Sample\)"](#).
2. Stick a printed target mark on the board with a scotch tape or a piece of double-sided tape.

##### NOTE:

- Use the board that peripheral area of the target is monochrome such as a white-board.
- Notice that the cross of the target is horizontal and vertical.

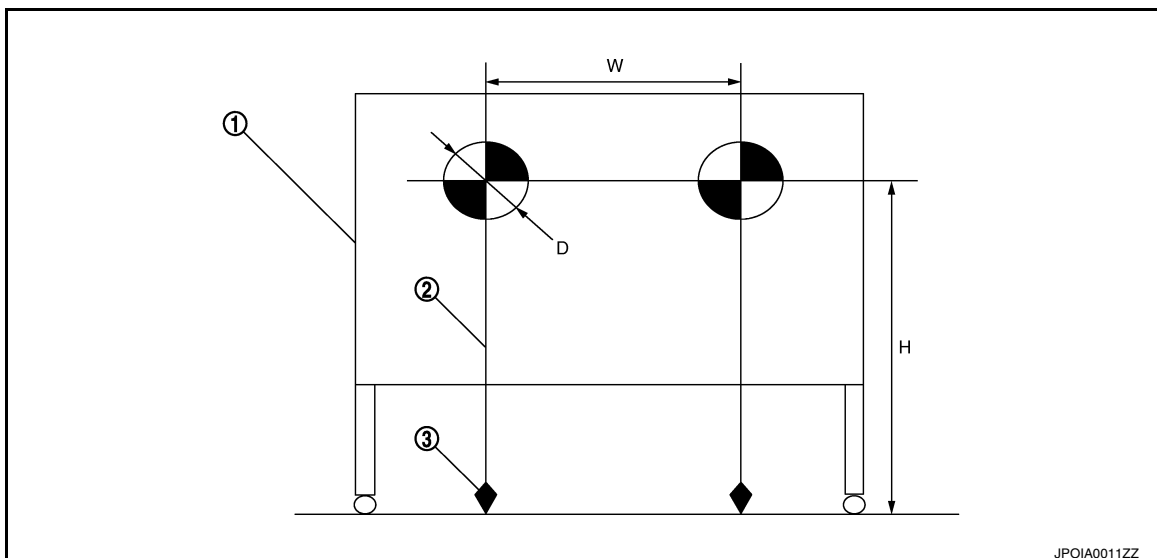



# CAMERA AIMING ADJUSTMENT

< BASIC INSPECTION >

[LDW & LDP]

1. Board
2. String
3. Cone

 : Target mark

- Diameter of a target (D) : 200 mm (7.87 in)**
- Height of a target center (H) : 1450 mm (57.09 in)**
- Width between a right target center from a left target center (W) : 600 mm (23.62 in)**

>> Go to [DAS-397, "Work Procedure \(Target Setting\)"](#).

## Work Procedure (Target Setting)

INFOID:000000009716637

### CAUTION:

- Perform this operation in a horizontal position where there is a clear view for 5 m (16.4 ft) forward and 3 m (9.84 ft) wide.
- Place the target in a well-lighted location. (Poor lighting may make it hard to adjust.)
- The target may not be detected when there is a light source within 1.5 m (4.92 ft) from either side and within 1 m (3.28 ft) upward/downward from the target.
- Check the location of the sun. (Sunlight should not shine directly on the front of the vehicle.)
- The target may not be detected when there is the same pattern of black and white as the target when the pattern is within 1 m (3.28 ft) from either side and upward/downward position from the target. (It is desirable that the vehicle is positioned on the opposite side of a single-color wall.)

### 1. TARGET SETTING

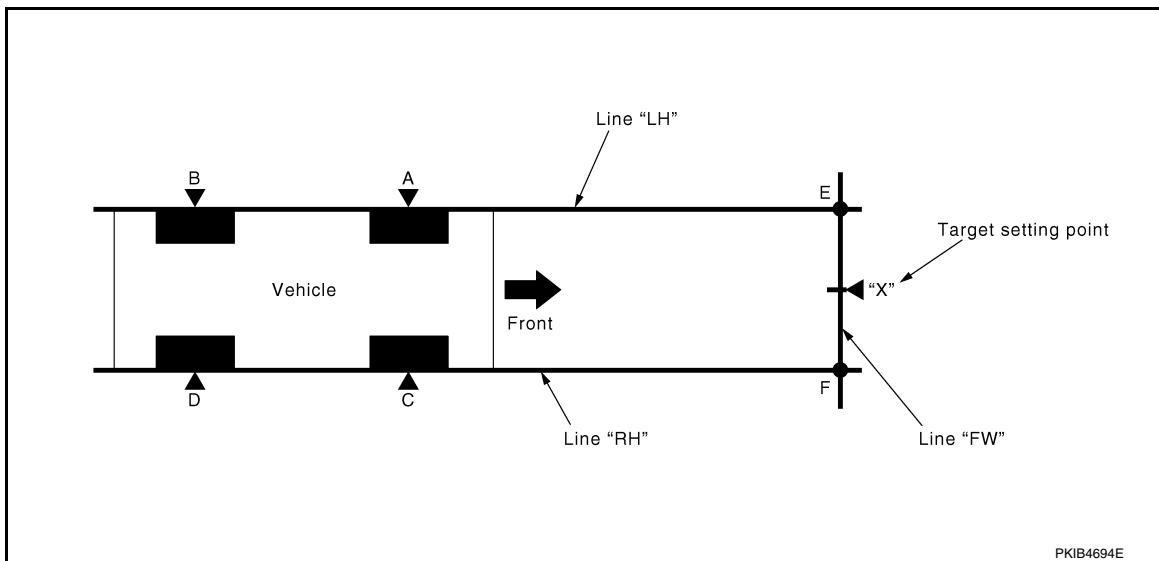

**"A" – "E" ("C" – "F") : 3850 mm (151.57 in)**

1. Mark points "A", "B", "C" and "D" at the center of the lateral surface of each wheels.

#### NOTE:

Hang a string with a cone from the fender so as to pass through the center of wheel, and then mark a point at the center of the lateral surface of the wheel.

2. Draw line "LH" passing through points "A" and "B" on the left side of vehicle.

#### NOTE:

Approximately 4 m (13.12 ft) or more from the front end of vehicle.

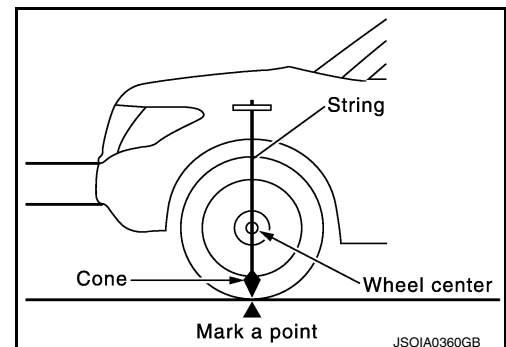

A  
B  
C  
D  
E  
F  
G  
H  
I  
J  
K  
L  
M  
N

DAS

P

# CAMERA AIMING ADJUSTMENT

[LDW & LDP]

## < BASIC INSPECTION >

3. Mark point "E" on the line "LH" at the positions 3850 mm (151.57 in) from point "A".
4. Draw line "RH" passing through points "C" and "D" on the right side of vehicle in the same way as step 2.  
**NOTE:**  
Approximately 4 m (13.12 ft) or more from the front end of vehicle.
5. Mark point "F" on the line "RH" at the positions 3850 mm (151.57 in) from point "C".
6. Draw line "FW" passing through the points "E" and "F" on the front side of vehicle.
7. Mark point "X" at the center of point "E" and "F" on the line "FW".  
**CAUTION:**  
**Make sure that "E" to "X" is equal to "F" to "X".**
8. Position the center of the right target to point of "X".

>> Go to [DAS-398, "Work Procedure \(Camera Aiming Adjustment\)"](#).

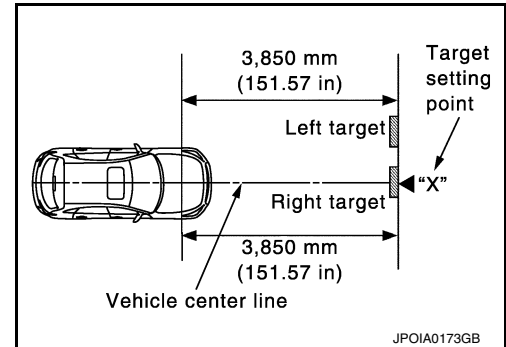

## Work Procedure (Camera Aiming Adjustment)

INFOID:000000009716638

### **CAUTION:**

Perform the adjustment under unloaded vehicle condition.

### 1. CHECK VEHICLE HEIGHT

Measure the wheel arch height. Calculate "Dh".

$$Dh [mm] = (Hfl + Hfr) \div 2 - 820$$

where,

**Hfl: Front left wheel arch height [mm]**

**Hfr: Front right wheel arch height [mm]**

### **NOTE:**

"Dh" may be calculated as a minus value.

>> GO TO 2.

### 2. CAMERA AIMING ADJUSTMENT

#### **CAUTION:**

Operate CONSULT outside the vehicle, and close all the doors. (To retain vehicle attitude appropriately)

1. Select "Work Support" on "LANE CAMERA" with CONSULT.
2. Select "AUTO AIM".
3. Confirm the following items;
  - The target should be accurately placed.
  - The vehicle should be stopped.
4. Select "Start" to perform camera aiming.

#### **CAUTION:**

- Never select "Start" when the target is not accurately placed.
- Wait 5 seconds or more after selecting "Start".

5. Input "Dh", and then select "Start".

#### **CAUTION:**

Never change "Ht" and "Dt".

6. Confirm the displayed item.
  - "Normally Completed": Select "Completion".
  - "SUSPENSION", "X AIMING NG Y", "ABNORMALLY COMPLETED": Perform the following services.

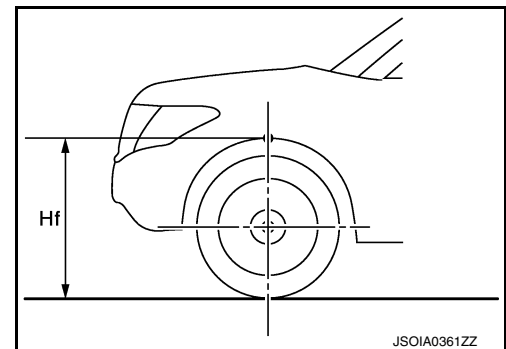

# CAMERA AIMING ADJUSTMENT

< BASIC INSPECTION >

[LDW & LDP]

Displayed item		Possible cause	Service procedure
SUSPENSION	—	Temporary malfunction in internal processing of the lane camera unit.	Go back to Step 1
	00H Routine not activated	Lane camera unit malfunction.	Position the target appropriately again. Perform the aiming again. Refer to <a href="#">DAS-397. "Work Procedure (Target Setting)"</a>
	10H Writing error	<ul style="list-style-type: none"> <li>• Temporary malfunction in internal processing of the lane camera unit.</li> <li>• Lane camera unit malfunction.</li> </ul>	
X AIMING NG Y (X: 0 - 7, Y: 1 - 8)	—	<ul style="list-style-type: none"> <li>• A target is not-yet-placed. (The lane camera unit cannot detect a target.)</li> <li>• The position of the lane camera unit is not correct.</li> </ul>	Position the target appropriately again. Perform the aiming again. Refer to <a href="#">DAS-396. "Work Procedure (Preparation)"</a> .
ABNORMALLY COMPLETED	—	<ul style="list-style-type: none"> <li>• Inappropriate work environment.</li> <li>• Inappropriate vehicle condition.</li> </ul>	

**NOTE:**

Replace camera unit if "00H Routine not activated" or "10H Writing error" are repeatedly indicated during the above two services are performed.

7. Confirm that "Normally Completed" is displayed and then select "End" to close the aiming adjustment procedure.

>> GO TO 3.

### 3. PERFORM SELF-DIAGNOSIS

Perform self-diagnosis of lane camera unit with CONSULT.

Is any DTC detected?

YES >> Perform diagnosis on the detected DTC and repair or replace the applicable item. Refer to [DAS-366. "DTC Index"](#).

NO >> GO TO 4.

### 4. ACTION TEST

Test the LDW/LDP system operation by action test. Refer to [DAS-392. "Description"](#).

>> WORK END

Work Procedure (Target Mark Sample)

INFOID:000000009716639

**NOTE:**

DAS

# CAMERA AIMING ADJUSTMENT

< BASIC INSPECTION >

[LDW & LDP]

Print this illustration so that the diameter of the circle is 200 mm (7.87 in).

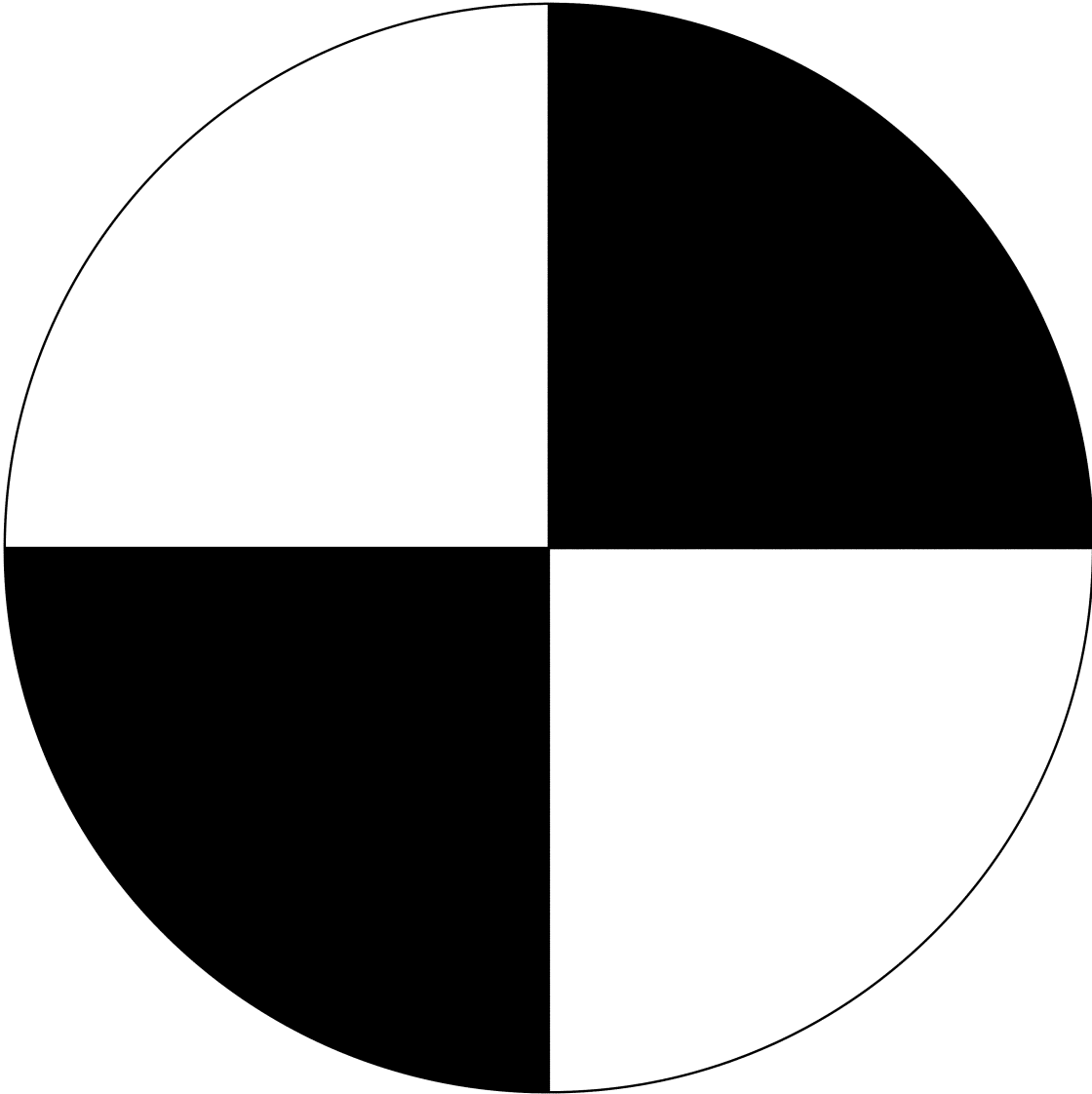

PGIA0105J

**DTC/CIRCUIT DIAGNOSIS**

C1A00 CONTROL UNIT

DTC Logic

INFOID:000000009716640

DTC DETECTION LOGIC

DTC (On board display)	Trouble diagnosis name	DTC detecting condition	Possible causes
C1A00 (0)	CONTROL UNIT	ADAS control unit internal malfunction	ADAS control unit

DTC CONFIRMATION PROCEDURE

**1**.PERFORM DTC CONFIRMATION PROCEDURE

1. Start the engine.
2. Perform "All DTC Reading" with CONSULT.
3. Check if the "C1A00" is detected as the current malfunction in "Self Diagnostic Result" of "ICC/ADAS".

Is "C1A00" detected as the current malfunction?

- YES >> Refer to [DAS-401, "Diagnosis Procedure"](#).
- NO >> Inspection End.

Diagnosis Procedure

INFOID:000000009716641

**1**.CHECK SELF-DIAGNOSIS RESULTS

Check if any DTC other than "C1A00" is detected in "Self Diagnostic Result" of "ICC/ADAS".

Is any DTC detected?

- YES >> Perform diagnosis on the detected DTC and repair or replace the malfunctioning parts. Refer to [DAS-359, "DTC Index"](#).
- NO >> Replace the ADAS control unit. Refer to [DAS-79, "Removal and Installation"](#).

A  
B  
C  
D  
E  
F  
G  
H  
I  
J  
K  
L  
M  
N  
P



# C1A01 POWER SUPPLY CIRCUIT 1, C1A02 POWER SUPPLY CIRCUIT 2

< DTC/CIRCUIT DIAGNOSIS >

[LDW & LDP]

## C1A01 POWER SUPPLY CIRCUIT 1, C1A02 POWER SUPPLY CIRCUIT 2

### DTC Logic

INFOID:000000009716642

### DTC DETECTION LOGIC

DTC (On board display)	Trouble diagnosis name	DTC detecting condition	Possible causes
C1A01 (1)	POWER SUPPLY CIR	The battery voltage sent to ADAS control unit remains less than 7.9 V for 5 seconds	<ul style="list-style-type: none"><li>• Connector, harness, fuse</li><li>• ADAS control unit</li></ul>
C1A02 (2)	POWER SUPPLY CIR 2	The battery voltage sent to ADAS control unit remains more than 19.3 V for 5 seconds	

### DTC CONFIRMATION PROCEDURE

#### 1.PERFORM DTC CONFIRMATION PROCEDURE

1. Start the engine.
2. Turn the LDP system ON.
3. Perform "All DTC Reading" with CONSULT.
4. Check if the "C1A01" or "C1A02" is detected as the current malfunction in "Self Diagnostic Result" of "ICC/ADAS".

Is "C1A01" or "C1A02" detected as the current malfunction?

YES >> Refer to [DAS-402. "Diagnosis Procedure"](#).

NO >> Refer to [GI-53. "Intermittent Incident"](#).

### Diagnosis Procedure

INFOID:000000009716643

#### 1.CHECK ADAS CONTROL UNIT POWER SUPPLY AND GROUND CIRCUIT

Check power supply and ground circuit of ADAS control unit. Refer to [DAS-443. "ADAS CONTROL UNIT : Diagnosis Procedure"](#).

Is the inspection result normal?

YES >> Replace the ADAS control unit. Refer to [DAS-79. "Removal and Installation"](#).

NO >> Repair or replace the malfunctioning parts.

# C1A03 VEHICLE SPEED SENSOR

< DTC/CIRCUIT DIAGNOSIS >

[LDW & LDP]

## C1A03 VEHICLE SPEED SENSOR

### DTC Logic

INFOID:000000009716644

### DTC DETECTION LOGIC

DTC (On board display)	Trouble diagnosis name	DTC detecting condition	Possible causes
C1A03 (3)	VHCL SPEED SE CIRC	If the vehicle speed signal (wheel speed) from ABS actuator and electric unit (control unit) received by the ADAS control unit via CAN communication, are inconsistent	<ul style="list-style-type: none"><li>Wheel speed sensor</li><li>ABS actuator and electric unit (control unit)</li><li>ADAS control unit</li></ul>

#### NOTE:

If DTC "C1A03" is detected along with DTC "U1000" or "C1A04", first diagnose the DTC "U1000" or "C1A04".

- Refer to [DAS-431, "ADAS CONTROL UNIT : DTC Logic"](#) for DTC "U1000".
- Refer to [DAS-404, "DTC Logic"](#) for DTC "C1A04".

### DTC CONFIRMATION PROCEDURE

#### 1. PERFORM DTC CONFIRMATION PROCEDURE

- Start the engine.
- Turn the LDP system ON.
- Drive the vehicle at 30 km/h (19 MPH) or more.

#### CAUTION:

**Always drive safely.**

- Stop the vehicle.
- Perform "All DTC Reading" with CONSULT.
- Check if the "C1A03" is detected as the current malfunction in "Self Diagnostic Result" of "ICC/ADAS".

Is "C1A03" detected as the current malfunction?

YES-1 (Lane departure warning lamp: ON)>>Refer to [DAS-403, "Diagnosis Procedure"](#).

YES-2 (Lane departure warning lamp: OFF)>>Refer to [CCS-105, "Diagnosis Procedure"](#).

NO >> Refer to [GI-53, "Intermittent Incident"](#).

### Diagnosis Procedure

INFOID:000000009716645

#### 1. CHECK SELF-DIAGNOSIS RESULTS

Check if "C1A04" or "U1000" is detected other than "C1A03" in "Self Diagnostic Result" of "ICC/ADAS".

Is any DTC detected?

YES >> Perform diagnosis on the detected DTC and repair or replace the malfunctioning parts. Refer to [DAS-359, "DTC Index"](#).

NO >> GO TO 2.

#### 2. CHECK ABS ACTUATOR AND ELECTRIC UNIT (CONTROL UNIT) SELF-DIAGNOSIS RESULTS

Check if any DTC is detected in "Self Diagnostic Result" of "ABS".

Is any DTC detected?

YES >> Perform diagnosis on the detected DTC and repair or replace the malfunctioning parts. Refer to [BRC-46, "DTC Index"](#).

NO >> Replace the ADAS control unit. Refer to [DAS-79, "Removal and Installation"](#).

A  
B  
C  
D  
E  
F  
G  
H  
I  
J  
K  
L  
M  
N  
P

DAS

# C1A04 ABS/TCS/VDC SYSTEM

< DTC/CIRCUIT DIAGNOSIS >

[LDW & LDP]

## C1A04 ABS/TCS/VDC SYSTEM

### DTC Logic

INFOID:000000009716646

### DTC DETECTION LOGIC

DTC (On board display)	Trouble diagnosis name	DTC detecting condition	Possible causes
C1A04 (4)	ABS/TCS/VDC CIRC	If a malfunction occurs in the VDC/TCS/ABS system	ABS actuator and electric unit (control unit)

#### NOTE:

If DTC "C1A04" is detected along with DTC "U1000", first diagnose the DTC "U1000". Refer to [DAS-431, "ADAS CONTROL UNIT : DTC Logic"](#).

### Diagnosis Procedure

INFOID:000000009716647

#### 1. CHECK SELF-DIAGNOSIS RESULTS

1. Perform "All DTC Reading" with CONSULT.
2. Check if the "U1000" is detected other than "C1A04" in "Self Diagnostic Result" of "ICC/ADAS".

##### Is "U1000" detected?

- YES >> Perform the CAN communication system inspection. Repair or replace the malfunctioning parts. Refer to [DAS-431, "ADAS CONTROL UNIT : DTC Logic"](#).
- NO >> GO TO 2.

#### 2. CHECK ABS ACTUATOR AND ELECTRIC UNIT (CONTROL UNIT) SELF-DIAGNOSIS RESULTS

Check if any DTC is detected in "Self Diagnostic Result" of "ABS".

##### Is any DTC detected?

- YES >> Perform diagnosis on the detected DTC and repair or replace the malfunctioning parts. Refer to [BRC-46, "DTC Index"](#).
- NO >> Replace the ADAS control unit. Refer to [DAS-79, "Removal and Installation"](#).



# C1A05 BRAKE SW/STOP LAMP SW

< DTC/CIRCUIT DIAGNOSIS >

[LDW & LDP]

## C1A05 BRAKE SW/STOP LAMP SW

### DTC Logic

INFOID:000000009716648

### DTC DETECTION LOGIC

DTC (On board display)	Trouble diagnosis name	DTC detecting condition	Possible causes
C1A05 (5)	BRAKE SW/STOP L SW	A mismatch between a stop lamp switch signal and a ICC brake switch signal received from ECM and a stop lamp signal received from the ABS actuator and electric unit (control unit) continues for 10 seconds or more with vehicle speeds at approximately 40 km/h or more	<ul style="list-style-type: none"><li>• Stop lamp switch circuit</li><li>• ICC brake switch circuit</li><li>• Stop lamp switch</li><li>• ICC brake switch</li><li>• Incorrect stop lamp switch installation</li><li>• Incorrect ICC brake switch installation</li><li>• ECM</li><li>• ABS actuator and electric unit (control unit)</li></ul>

#### NOTE:

If DTC "C1A05" is detected along with DTC "U1000", first diagnose the DTC "U1000". Refer to [DAS-431, "ADAS CONTROL UNIT : DTC Logic"](#).

### Diagnosis Procedure

INFOID:000000009716649

Regarding Wiring Diagram information, refer to [DAS-367, "Wiring Diagram"](#).

### 1. CHECK SELF-DIAGNOSIS RESULTS

1. Perform "All DTC Reading" with CONSULT.
2. Check if the "U1000" is detected other than "C1A05" in "Self Diagnostic Result" of "ICC/ADAS".

Is "U1000" detected?

YES >> Perform the CAN communication system inspection. Repair or replace the malfunctioning parts.  
Refer to [DAS-431, "ADAS CONTROL UNIT : DTC Logic"](#).

NO >> GO TO 2.

### 2. CHECK STOP LAMP SWITCH AND ICC BRAKE SWITCH

Check that "STOP LAMP SW" and "BRAKE SW" operate normally in "DATA MONITOR" of "ICC/ADAS".

Is the inspection result normal?

YES >> GO TO 3.

NO-1 >> When "BRAKE SW" operation is malfunctioning: GO TO 4.

NO-2 >> When "STOP LAMP SW" operation is malfunctioning: GO TO 9.

### 3. CHECK STOP LAMP SWITCH

Check that "STOP LAMP SW" operate normally in "DATA MONITOR" of "ABS".

Is the inspection result normal?

YES >> GO TO 14.

NO >> GO TO 9.

### 4. CHECK ICC BRAKE SWITCH INSTALLATION

1. Turn ignition switch OFF.
2. Check ICC brake switch for correct installation. Refer to [BR-15, "Adjustment"](#).

Is the inspection result normal?

YES >> GO TO 5.

NO >> Adjust ICC brake switch installation. Refer to [BR-15, "Adjustment"](#).

# C1A05 BRAKE SW/STOP LAMP SW

< DTC/CIRCUIT DIAGNOSIS >

[LDW & LDP]

## 5. ICC BRAKE SWITCH INSPECTION

1. Disconnect ICC brake switch connector.
2. Check ICC brake switch. Refer to [DAS-408, "Component Inspection \(ICC Brake Switch\)"](#).

Is the inspection result normal?

- YES >> GO TO 6.  
NO >> Replace ICC brake switch.

## 6. CHECK ICC BRAKE SWITCH POWER SUPPLY CIRCUIT

1. Turn the ignition switch ON.
2. Check voltage between ICC brake switch harness connector and ground.

Terminals		Voltage (Approx.)
(+)	(-)	
ICC brake switch		Ground
Connector	Terminal	
E72	1	
		Battery voltage

Is the inspection result normal?

- YES >> GO TO 7.  
NO >> Repair the harnesses or connectors.

## 7. CHECK HARNESS BETWEEN ICC BRAKE SWITCH AND ECM

1. Turn ignition switch OFF
2. Disconnect ECM connector.
3. Check for continuity between ICC brake switch harness connector and ECM harness connector.

ICC brake switch		ECM		Continuity
Connector	Terminal	Connector	Terminal	
E72	2	E16	126	Yes

4. Check for continuity between ICC brake switch harness connector and ground.

ICC brake switch		Ground	Continuity
Connector	Terminal		
E72	2		No

Is the inspection result normal?

- YES >> GO TO 8.  
NO >> Repair the harnesses or connectors.

## 8. PERFORM SELF-DIAGNOSIS OF ECM

1. Connect all connectors again if the connectors are disconnected.
2. Turn ignition switch ON.
3. Perform "All DTC Reading".
4. Check if any DTC is detected in "Self Diagnostic Result" of "ENGINE". Refer to [EC-97, "DTC Index"](#).

Is any DTC detected?

- YES >> Repair or replace the malfunctioning parts identified by the self-diagnosis result.  
NO >> Replace the ADAS control unit. Refer to [DAS-79, "Removal and Installation"](#).

## 9. CHECK STOP LAMP SWITCH INSTALLATION

1. Turn ignition switch OFF.
2. Check stop lamp switch for correct installation. Refer to [BR-15, "Adjustment"](#).

Is the inspection result normal?

- YES >> GO TO 10.  
NO >> Adjust stop lamp switch installation. Refer to [BR-15, "Adjustment"](#).

# C1A05 BRAKE SW/STOP LAMP SW

< DTC/CIRCUIT DIAGNOSIS >

[LDW & LDP]

## 10. STOP LAMP SWITCH INSPECTION

1. Disconnect stop lamp switch connector.
2. Check stop lamp switch. Refer to [DAS-408, "Component Inspection \(Stop Lamp Switch\)"](#).

Is the inspection result normal?

YES >> GO TO 11.

NO >> Replace stop lamp switch.

## 11. CHECK STOP LAMP SWITCH POWER SUPPLY CIRCUIT

1. Turn the ignition switch ON.
2. Check voltage between stop lamp switch harness connector and ground.

Terminals		Voltage (Approx.)
(+)	(-)	
Stop lamp switch		Ground
Connector	Terminal	
E38	1	
	3	Battery voltage

Is the inspection result normal?

YES >> GO TO 12.

NO >> Repair the harnesses or connectors.

## 12. CHECK HARNESS BETWEEN STOP LAMP SWITCH AND ECM

1. Turn ignition switch OFF
2. Disconnect ECM, rear combination lamp and high-mounted stop lamp connectors.
3. Check for continuity between stop lamp switch harness connector and ECM harness connector.

Stop lamp switch		ECM		Continuity
Connector	Terminal	Connector	Terminal	
E38	2	E16	122	Yes

4. Check for continuity between stop lamp switch harness connector and ground.

Stop lamp switch		Ground	Continuity
Connector	Terminal		
E38	2		No

Is the inspection result normal?

YES >> GO TO 13.

NO >> Repair the harnesses or connectors.

## 13. CHECK HARNESS BETWEEN STOP LAMP SWITCH AND ABS ACTUATOR AND ELECTRIC UNIT (CONTROL UNIT)

1. Disconnect ABS actuator and electric unit (control unit) connector.
2. Check for continuity between stop lamp switch harness connector and ABS actuator and electric unit (control unit) harness connector.

Stop lamp switch		ABS actuator and electric unit (control unit)		Continuity
Connector	Terminal	Connector	Terminal	
E38	4	E125	5	Yes

3. Check for continuity between stop lamp switch harness connector and ground.

A  
B  
C  
D  
E  
F  
G  
H  
I  
J  
K  
L  
M  
N  
P

# C1A05 BRAKE SW/STOP LAMP SW

< DTC/CIRCUIT DIAGNOSIS >

[LDW & LDP]

Stop lamp switch		Ground	Continuity
Connector	Terminal		
E38	4		No

Is the inspection result normal?

YES >> GO TO 14.

NO >> Repair the harnesses or connectors.

## 14.PERFORM SELF-DIAGNOSIS OF ECM

1. Connect all connectors again if the connectors are disconnected.
2. Turn ignition switch ON.
3. Perform "All DTC Reading".
4. Check if any DTC is detected in "Self Diagnostic Result" of "ENGINE". Refer to [EC-97, "DTC Index"](#).

Is any DTC detected?

YES >> Repair or replace the malfunctioning parts identified by the self-diagnosis result.

NO >> GO TO 15.

## 15.PERFORM SELF-DIAGNOSIS OF ABS ACTUATOR AND ELECTRIC UNIT (CONTROL UNIT)

Check if any DTC is detected in "Self Diagnostic Result" of "ABS". Refer to [BRC-46, "DTC Index"](#).

Is any DTC detected?

YES >> Repair or replace the malfunctioning parts identified by the self-diagnosis result.

NO >> Replace the ADAS control unit. Refer to [DAS-79, "Removal and Installation"](#).

## Component Inspection (ICC Brake Switch)

INFOID:000000009716650

### 1.CHECK ICC BRAKE SWITCH

Check for continuity between ICC brake switch terminals.

Terminal		Condition	Continuity
1	2	When brake pedal is depressed	No
		When brake pedal is released	Yes

Is the inspection result normal?

YES >> Inspection End.

NO >> Replace ICC brake switch.

## Component Inspection (Stop Lamp Switch)

INFOID:000000009716651

### 1.CHECK STOP LAMP SWITCH

Check for continuity between stop lamp switch terminals.

Terminal		Condition	Continuity
1	2	When brake pedal is depressed	Yes
		When brake pedal is released	No
3	4	When brake pedal is depressed	Yes
		When brake pedal is released	No

Is the inspection result normal?

YES >> Inspection End.

NO >> Replace stop lamp switch.

C1A06 OPERATION SW

DTC Logic

INFOID:000000009716652

DTC DETECTION LOGIC

DTC (On board display)	Trouble diagnosis name	DTC detecting condition	Possible causes
C1A06 (6)	OPERATION SW CIRC	<ul style="list-style-type: none"> <li>Any switch of the ICC steering switch is detected as "ON" continuously for 60 seconds</li> <li>An ON/OFF state judgment of the ICC differs between ECM and ADAS control unit, and the state continues for 2 seconds or more</li> </ul>	<ul style="list-style-type: none"> <li>ICC steering switch circuit</li> <li>ICC steering switch</li> <li>ECM</li> </ul>

**NOTE:**

If DTC "C1A06" is detected along with DTC "U1000", first diagnose the DTC "U1000". Refer to [DAS-431, "ADAS CONTROL UNIT : DTC Logic"](#).

DTC CONFIRMATION PROCEDURE

**1. PERFORM DTC CONFIRMATION PROCEDURE**

- Start the engine.
- Wait for approximately 5 minutes after turning the LDP system ON.
- Perform "All DTC Reading" with CONSULT.
- Check if the "C1A06" is detected as the current malfunction in "Self Diagnostic Result" of "ICC/ADAS".

Is "C1A06" detected as the current malfunction?

- YES >> Refer to [DAS-409, "Diagnosis Procedure"](#).
- NO >> Refer to [GI-53, "Intermittent Incident"](#).

Diagnosis Procedure

INFOID:000000009716653

Regarding Wiring Diagram information, refer to [DAS-367, "Wiring Diagram"](#).

**1. CHECK SELF-DIAGNOSIS RESULTS**

Check if "U1000" is detected other than "C1A06" in "Self Diagnostic Result" of "ICC/ADAS".

Is "U1000" detected?

- YES >> Perform the CAN communication system inspection. Repair or replace the malfunctioning parts. Refer to [DAS-431, "ADAS CONTROL UNIT : DTC Logic"](#).
- NO >> GO TO 2.

**2. CHECK ICC STEERING SWITCH**

- Turn the ignition switch OFF.
- Disconnect the ICC steering switch connector.
- Check the ICC steering switch. Refer to [DAS-410, "Component Inspection"](#).

Is the inspection result normal?

- YES >> GO TO 3.
- NO >> Replace the steering wheel.

**3. CHECK HARNESS BETWEEN SPIRAL CABLE AND ECM**

- Disconnect the ECM connector.
- Check for continuity between the spiral cable harness connector and ECM harness connector.

Spiral cable		ECM		Continuity
Connector	Terminal	Connector	Terminal	

A  
B  
C  
D  
E  
F  
G  
H  
I  
J  
K  
L  
M  
N  
P



M30	25	E16	101	Yes
	32		108	

3. Check for continuity between spiral cable harness connector and ground.

Spiral cable		Ground	Continuity
Connector	Terminal		
M30	25		No
	32		

Is the inspection result normal?

- YES >> GO TO 4.
- NO >> Repair the harnesses or connectors.

## 4. CHECK SPIRAL CABLE

Check for continuity between spiral cable terminals.

Spiral cable		Continuity
Terminal		
13	25	Yes
16	32	

Is the inspection result normal?

- YES >> GO TO 5.
- NO >> Replace the spiral cable.

## 5. PERFORM SELF-DIAGNOSIS OF ECM

1. Connect the connectors of ICC steering switch and ECM connector.
2. Turn the ignition switch ON.
3. Perform "All DTC Reading".
4. Check if any DTC is detected in "Self Diagnostic Result" of "ENGINE".

Is any DTC detected?

- YES >> Perform self-diagnosis on the detected DTC and repair or replace the malfunctioning parts. Refer to [EC-97, "DTC Index"](#).
- NO >> Replace the ADAS control unit. Refer to [DAS-79, "Removal and Installation"](#).

## Component Inspection

INFOID:000000009716654

### 1. CHECK ICC STEERING SWITCH

Check resistance between ICC steering switch terminals.

Terminal	Switch operation	Resistance [Ω]
13    16	When pressing MAIN switch	Approx. 0
	When pressing dynamic driver assistance switch	Approx. 267
	When pressing CANCEL switch	Approx. 615
	When pressing DISTANCE switch	Approx. 1090
	When pressing SET/COAST switch	Approx. 1805
	When pressing RESUME/ACCELERATE switch	Approx. 2985
	When all switches are not pressed	Approx. 5415

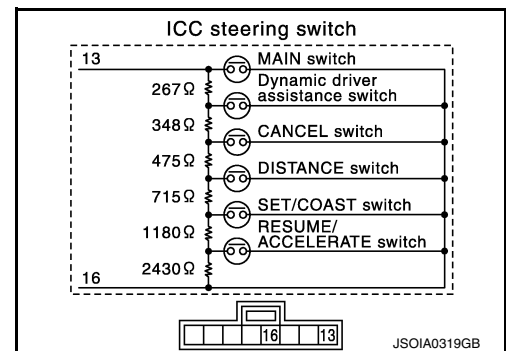

# C1A06 OPERATION SW

< DTC/CIRCUIT DIAGNOSIS >

[LDW & LDP]

Is the inspection result normal?

- YES >> Inspection End.
- NO >> Replace the ICC steering switch.

A  
B  
C  
D  
E  
F  
G  
H  
I  
J  
K  
L  
M  
N  
P

DAS

## C1A14 ECM

## DTC Logic

INFOID:000000009716655

## DTC DETECTION LOGIC

DTC (On board display)	Trouble diagnosis name	DTC detecting condition	Possible causes
C1A14 (14)	ECM CIRCUIT	If ECM is malfunctioning	<ul style="list-style-type: none"> <li>• Accelerator pedal position sensor</li> <li>• ECM</li> <li>• ADAS control unit</li> </ul>

**NOTE:**

If DTC "C1A14" is detected along with DTC "U1000", first diagnose the DTC "U1000". Refer to [DAS-431, "ADAS CONTROL UNIT : DTC Logic"](#).

**1. PERFORM DTC CONFIRMATION PROCEDURE**

1. Start the engine.
2. Operate the ICC system and drive.  
**CAUTION:**  
**Always drive safely.**
3. Stop the vehicle.
4. Perform "All DTC Reading" with CONSULT.
5. Check if the "C1A14" is detected as the current malfunction in "Self Diagnostic Result" of "ICC/ADAS".

Is "C1A14" detected as the current malfunction?

- YES >> Refer to [DAS-412, "Diagnosis Procedure"](#).  
NO >> Refer to [GI-53, "Intermittent Incident"](#).

## Diagnosis Procedure

INFOID:000000009716656

**1. CHECK SELF-DIAGNOSIS RESULTS**

Check if "U1000" is detected other than "C1A14" in "Self Diagnostic Result" of "ICC/ADAS".

Is "U1000" detected?

- YES >> Perform the CAN communication system inspection. Repair or replace the malfunctioning parts.  
Refer to [DAS-431, "ADAS CONTROL UNIT : DTC Logic"](#).  
NO >> GO TO 2.

**2. PERFORM SELF-DIAGNOSIS OF ECM**

Check if any DTC is detected in "Self Diagnostic Result" of "ENGINE".

Is any DTC detected?

- YES >> Perform diagnosis on the detected DTC and repair or replace the malfunctioning parts. Refer to [EC-97, "DTC Index"](#).  
NO >> Replace the ADAS control unit. Refer to [DAS-79, "Removal and Installation"](#).



# C1A15 GEAR POSITION

< DTC/CIRCUIT DIAGNOSIS >

[LDW & LDP]

## C1A15 GEAR POSITION

### Description

INFOID:000000009716657

ADAS control unit judges the gear position based on the following signals.

- Current gear position signal transmitted from TCM via CAN communication.
- Value of gear ratio calculated from input speed signal transmitted from TCM via CAN communication.
- Value of gear ratio calculated from the vehicle speed signal transmitted from ABS actuator and electric unit (control unit) via CAN communication.

### DTC Logic

INFOID:000000009716658

### DTC DETECTION LOGIC

DTC (On board display)	Trouble diagnosis name	DTC detecting condition	Possible causes
C1A15 (15)	GEAR POSITION	A mismatch between a current gear position signal transmitted from TCM via CAN communication and a gear position calculated by the ADAS control unit continues for approximately 11 minutes or more	<ul style="list-style-type: none"><li>• Input speed sensor</li><li>• Vehicle speed sensor CVT (output speed sensor)</li><li>• TCM</li></ul>

#### NOTE:

If DTC "C1A15" is detected along with DTC "U1000", "C1A03", or "C1A04", first diagnose the DTC "U1000", "C1A03", or "C1A04".

- Refer to [DAS-431, "ADAS CONTROL UNIT : DTC Logic"](#) for DTC "U1000".
- Refer to [DAS-403, "DTC Logic"](#) for DTC "C1A03".
- Refer to [DAS-404, "DTC Logic"](#) for DTC "C1A04".

### DTC CONFIRMATION PROCEDURE

#### 1. PERFORM DTC CONFIRMATION PROCEDURE

1. Start the engine.
2. Turn the LDP system ON.
3. Drive the vehicle at 10 km/h (6 MPH) or faster for approximately 15 minutes or more.

**CAUTION:**

**Always drive safely.**

4. Stop the vehicle.
5. Perform "All DTC Reading" with CONSULT.
6. Check if "C1A15" is detected as the current malfunction in the "Self Diagnostic Result" of "ICC/ADAS".

Is "C1A15" detected as the current malfunction?

YES >> Refer to [DAS-413, "Diagnosis Procedure"](#).

NO >> Refer to [GI-53, "Intermittent Incident"](#).

### Diagnosis Procedure

INFOID:000000009716659

#### 1. CHECK SELF-DIAGNOSIS RESULTS

Check if "C1A03", "C1A04", or "U1000" is detected other than "C1A15" in "Self Diagnostic Result" of "ICC/ADAS".

Is any DTC detected?

YES >> Perform diagnosis on the detected DTC and repair or replace the malfunctioning parts. Refer to [DAS-359, "DTC Index"](#).

NO >> GO TO 2.

#### 2. CHECK VEHICLE SPEED SIGNAL

Check that "VHCL SPEED SE" operates normally in "DATA MONITOR" of "ICC/ADAS".

**CAUTION:**

**Be careful of the vehicle speed.**

Is the inspection result normal?

< DTC/CIRCUIT DIAGNOSIS >

---

- YES >> GO TO 3.
- NO >> GO TO 7.

## 3. CHECK GEAR POSITION

---

Check that "GEAR" operates normally in "DATA MONITOR" of "ICC/ADAS".

### **CAUTION:**

**Be careful of the vehicle speed.**

Is the inspection result normal?

- YES >> GO TO 5.
- NO >> GO TO 4.

## 4. CHECK GEAR POSITION SIGNAL

---

Check that "GEAR" operates normally in "DATA MONITOR" of "TRANSMISSION".

Is the inspection result normal?

- YES >> GO TO 5.
- NO >> GO TO 6.

## 5. CHECK INPUT SPEED SENSOR SIGNAL

---

Check that "INPUT SPEED" operates normally in "DATA MONITOR" of "TRANSMISSION".

Is the inspection result normal?

- YES >> Replace the ADAS control unit. Refer to [DAS-79, "Removal and Installation"](#).
- NO >> GO TO 6.

## 6. CHECK TCM SELF-DIAGNOSIS RESULTS

---

1. Perform "All DTC Reading".
2. Check if any DTC is detected in "Self Diagnostic Result" of "TRANSMISSION".

Is any DTC detected?

- YES >> Perform diagnosis on the detected DTC and repair or replace the malfunctioning parts. Refer to [TM-61, "DTC Index"](#).
- NO >> Replace the ADAS control unit. Refer to [DAS-79, "Removal and Installation"](#).

## 7. CHECK ABS ACTUATOR AND ELECTRIC UNIT (CONTROL UNIT) SELF-DIAGNOSIS RESULTS

---

1. Perform "All DTC Reading".
2. Check if any DTC is detected in "Self Diagnostic Result" of "ABS".

Is any DTC detected?

- YES >> Perform diagnosis on the detected DTC and repair or replace the malfunctioning parts. Refer to [BRC-46, "DTC Index"](#).
- NO >> Replace the ADAS control unit. Refer to [DAS-79, "Removal and Installation"](#).

# C1A24 NP RANGE

< DTC/CIRCUIT DIAGNOSIS >

[LDW & LDP]

## C1A24 NP RANGE

### DTC Logic

INFOID:000000009716660

### DTC DETECTION LOGIC

DTC (On board display)	Trouble diagnosis name	DTC detecting condition	Possible causes
C1A24 (24)	NP RANGE	A mismatch between a shift position signal transmitted from TCM via CAN communication and a current gear position signal continues for 60 seconds or more	<ul style="list-style-type: none"><li>• TCM</li><li>• Transmission range switch</li></ul>

#### NOTE:

If DTC "C1A24" is detected along with DTC "U1000", first diagnose the DTC "U1000". Refer to [DAS-431. "ADAS CONTROL UNIT : DTC Logic"](#).

### DTC CONFIRMATION PROCEDURE

#### 1. CHECK DTC REPRODUCE (1)

1. Start the engine.
2. Turn the LDP system ON.
3. Wait for approximately 5 minutes or more after shifting the selector lever to "P" position.
4. Perform "All DTC Reading" with CONSULT.
5. Check if the "C1A24" is detected as the current malfunction in "Self Diagnostic Result" of "ICC/ADAS".

Is "C1A24" detected as the current malfunction?

- YES >> Refer to [DAS-415. "Diagnosis Procedure"](#).  
NO >> GO TO 2.

#### 2. CHECK DTC REPRODUCE (2)

1. Wait for approximately 5 minutes or more after shifting the selector lever to "N" position.
2. Perform "All DTC Reading".
3. Check if the "C1A24" is detected as the current malfunction in "Self Diagnostic Result" of "ICC/ADAS".

Is "C1A24" detected as the current malfunction?

- YES >> Refer to [DAS-415. "Diagnosis Procedure"](#).  
NO >> Refer to [GI-53. "Intermittent Incident"](#).

### Diagnosis Procedure

INFOID:000000009716661

#### 1. CHECK SELF-DIAGNOSIS RESULTS

Check if "U1000" is detected other than "C1A24" in "Self Diagnostic Result" of "ICC/ADAS".

Is "U1000" detected?

- YES >> Perform the CAN communication system inspection. Repair or replace the malfunctioning parts.  
Refer to [DAS-431. "ADAS CONTROL UNIT : DTC Logic"](#).  
NO >> GO TO 2.

#### 2. CHECK NP POSITION SWITCH SIGNAL

Check that "NP RANGE SW" operates normally in "DATA MONITOR" of "ICC/ADAS".

Is the inspection result normal?

- YES >> GO TO 3.  
NO >> GO TO 4.

#### 3. CHECK TCM DATA MONITOR

Check that "SLCT LVR POSI" operates normally in "DATA MONITOR" of "TRANSMISSION".

Is the inspection result normal?

- YES >> Replace the ADAS control unit. Refer to [DAS-79. "Removal and Installation"](#).  
NO >> GO TO 4.

A

B

C

D

E

F

G

H

I

J

K

L

M

N

DAS

P

---

## 4.PERFORM TCM SELF-DIAGNOSIS

---

1. Perform "All DTC Reading".
2. Check if any DTC is detected in "Self Diagnostic Result" of "TRANSMISSION".

### Is any DTC detected?

- YES >> Perform diagnosis on the detected DTC and repair or replace the malfunctioning parts. Refer to [TM-61, "DTC Index"](#).
- NO >> Replace the ADAS control unit. Refer to [DAS-79, "Removal and Installation"](#).

# C1A50 ADAS CONTROL UNIT

< DTC/CIRCUIT DIAGNOSIS >

[LDW & LDP]

## C1A50 ADAS CONTROL UNIT

### DTC Logic

INFOID:000000009716662

### DTC DETECTION LOGIC

DTC	Trouble diagnosis name	DTC detecting condition	Possible cause
C1A50	ADAS MALFUNCTION	If ADAS control unit is malfunctioning	ADAS control unit

#### NOTE:

If DTC "C1A50" is detected along with DTC "U1000", first diagnose the DTC "U1000". Refer to [DAS-431. "ADAS CONTROL UNIT : DTC Logic"](#).

#### 1.PERFORM DTC CONFIRMATION PROCEDURE

1. Start the engine.
2. Turn the LDP system ON.
3. Perform "All DTC Reading" with CONSULT.
4. Check if the "C1A50" is detected as the current malfunction in "Self Diagnostic Result" of "LANE CAMERA".

Is "C1A50" detected as the current malfunction?

- YES >> Refer to [DAS-417. "Diagnosis Procedure"](#).  
NO >> Refer to [GI-53. "Intermittent Incident"](#).

### Diagnosis Procedure

INFOID:000000009716663

#### 1.CHECK LANE CAMERA UNIT SELF-DIAGNOSIS RESULTS

Check if "U1000" is detected other than "C1A50" in "Self Diagnostic Result" of "LANE CAMERA".

Is "U1000" detected?

- YES >> Perform the CAN communication system inspection. Repair or replace the malfunctioning parts.  
Refer to [DAS-431. "LANE CAMERA UNIT : DTC Logic"](#).  
NO >> GO TO 2.

#### 2.CHECK ADAS CONTROL UNIT SELF-DIAGNOSIS RESULTS

Check if any DTC is detected in "Self Diagnostic Result" of "ICC/ADAS".

Is any DTC detected?

- YES >> Perform diagnosis on the detected DTC and repair or replace the malfunctioning parts. Refer to [DAS-359. "DTC Index"](#).  
NO >> Replace the lane camera unit. Refer to [DAS-459. "Removal and Installation"](#).

# C1B00 CAMERA UNIT MALF

< DTC/CIRCUIT DIAGNOSIS >

[LDW & LDP]

## C1B00 CAMERA UNIT MALF ADAS CONTROL UNIT

ADAS CONTROL UNIT : DTC Logic

INFOID:000000009716664

### DTC DETECTION LOGIC

DTC (On board display)	Trouble diagnosis name	DTC detecting condition	Possible causes
C1B00 (81)	CAMERA UNIT MALF	If lane camera unit is malfunctioning	Lane camera unit

### DTC CONFIRMATION PROCEDURE

#### 1. PERFORM DTC CONFIRMATION PROCEDURE

1. Start the engine.
2. Perform "All DTC Reading" with CONSULT.
3. Check if the "C1B00" is detected as the current malfunction in "Self Diagnostic Result" of "ICC/ADAS".

Is "C1B00" detected as the current malfunction?

- YES >> Refer to [DAS-418, "ADAS CONTROL UNIT : Diagnosis Procedure"](#).  
NO >> INSPECTION END

### ADAS CONTROL UNIT : Diagnosis Procedure

INFOID:000000009716665

#### 1. CHECK SELF-DIAGNOSIS RESULTS

Check if "C1B00" is detected in "Self Diagnostic Result" of "LANE CAMERA".

Is "C1B00" detected?

- YES >> Refer to [DAS-418, "LANE CAMERA UNIT : DTC Logic"](#)  
NO >> Replace the ADAS control unit. Refer to [DAS-79, "Removal and Installation"](#).

## LANE CAMERA UNIT

LANE CAMERA UNIT : DTC Logic

INFOID:000000009716666

### DTC DETECTION LOGIC

DTC	Trouble diagnosis name	DTC detecting condition	Possible causes
C1B00	CAMERA UNIT MALF	If lane camera unit is malfunctioning	Lane camera unit

### DTC CONFIRMATION PROCEDURE

#### 1. PERFORM DTC CONFIRMATION PROCEDURE

1. Start the engine.
2. Perform "All DTC Reading" with CONSULT.
3. Check if the "C1B00" is detected as the current malfunction in "Self Diagnostic Result" of "LANE CAMERA".

Is "C1B00" detected as the current malfunction?

- YES >> Refer to [DAS-418, "ADAS CONTROL UNIT : Diagnosis Procedure"](#).  
NO >> INSPECTION END

### LANE CAMERA UNIT : Diagnosis Procedure

INFOID:000000009716667

#### 1. CHECK SELF-DIAGNOSIS RESULTS

Check if any DTC other than "C1B00" is detected in "Self Diagnostic Result" of "LANE CAMERA".

Is any DTC detected?

## C1B00 CAMERA UNIT MALF

< DTC/CIRCUIT DIAGNOSIS >

[LDW & LDP]

- YES >> Perform diagnosis on the detected DTC and repair or replace the malfunctioning parts. Refer to [DAS-366. "DTC Index"](#).
- NO >> Replace the lane camera unit. Refer to [DAS-459. "Removal and Installation"](#).

A

B

C

D

E

F

G

H

I

J

K

L

M

N

DAS

P

< DTC/CIRCUIT DIAGNOSIS >

## C1B01 CAM AIMING INCMP

### ADAS CONTROL UNIT

#### ADAS CONTROL UNIT : DTC Logic

INFOID:000000009716668

#### DTC DETECTION LOGIC

DTC (On board display)	Trouble diagnosis name	DTC detecting condition	Possible causes
C1B01 (82)	CAM AIMING INCMP	Camera aiming is not completed	<ul style="list-style-type: none"> <li>Lane camera aiming is not adjusted</li> <li>Lane camera aiming adjustment has been interrupted</li> </ul>

#### DTC CONFIRMATION PROCEDURE

##### 1. PERFORM DTC CONFIRMATION PROCEDURE

- Start the engine.
- Operate the LDP system and drive.  
**CAUTION:**  
**Always drive safely.**
- Perform "All DTC Reading" with CONSULT.
- Check if the "C1B01" is detected as the current malfunction in "Self Diagnostic Result" of "ICC/ADAS".

Is "C1B01" detected as the current malfunction?

- YES >> Refer to [DAS-420, "ADAS CONTROL UNIT : Diagnosis Procedure"](#).  
NO >> Refer to [GI-53, "Intermittent Incident"](#).

#### ADAS CONTROL UNIT : Diagnosis Procedure

INFOID:000000009716669

##### 1. CHECK SELF-DIAGNOSIS RESULTS

Check if "C1B01" is detected in "Self Diagnostic Result" of "LANE CAMERA".

Is "C1B01" detected?

- YES >> Refer to [DAS-420, "LANE CAMERA UNIT : DTC Logic"](#).  
NO >> GO TO 2.

##### 2. CHECK DATA MONITOR

- Start the engine.
- Check that "OK" is indicated for the value of "AIMING RESULT" in "DATA MONITOR" of "LANE CAMERA".

Is "OK" indicated?

- YES >> Replace the ADAS control unit. Refer to [DAS-79, "Removal and Installation"](#).  
NO >> Replace the lane camera unit. Refer to [DAS-459, "Removal and Installation"](#).

## LANE CAMERA UNIT

#### LANE CAMERA UNIT : DTC Logic

INFOID:000000009716670

#### DTC DETECTION LOGIC

DTC	Trouble diagnosis name	DTC detecting condition	Possible causes
C1B01	CAM AIMING INCMP	Camera aiming is not completed	<ul style="list-style-type: none"> <li>Lane camera aiming is not adjusted</li> <li>Lane camera aiming adjustment has been interrupted</li> </ul>

#### DTC CONFIRMATION PROCEDURE



# C1B01 CAM AIMING INCOMP

< DTC/CIRCUIT DIAGNOSIS >

[LDW & LDP]

## 1. PERFORM DTC CONFIRMATION PROCEDURE

1. Start the engine.
2. Perform "All DTC Reading" with CONSULT.
3. Check if the "C1B01" is detected as the current malfunction in "Self Diagnostic Result" of "LANE CAMERA".

Is "C1B01" detected as the current malfunction?

- YES >> Refer to [DAS-421, "LANE CAMERA UNIT : Diagnosis Procedure"](#).  
NO >> Refer to [GI-53, "Intermittent Incident"](#).

## LANE CAMERA UNIT : Diagnosis Procedure

INFOID:000000009716671

## 1. CAMERA AIMING ADJUSTMENT

1. Perform the camera aiming. Refer to [DAS-396, "Description"](#).
2. Erase all self-diagnosis results with CONSULT.
3. Perform "All DTC Reading".
4. Check if the "C1B01" is detected in "Self Diagnostic Result" of "LANE CAMERA".

Is "C1B01" detected?

- YES >> Replace the lane camera unit. Refer to [DAS-459, "Removal and Installation"](#).  
NO >> INSPECTION END

A  
B  
C  
D  
E  
F  
G  
H  
I  
J  
K  
L  
M  
N  
P

DAS

# C1B03 ABNRML TEMP DETECT

< DTC/CIRCUIT DIAGNOSIS >

[LDW & LDP]

## C1B03 ABNRML TEMP DETECT

### ADAS CONTROL UNIT

#### ADAS CONTROL UNIT : DTC Logic

INFOID:000000009716672

#### DTC DETECTION LOGIC

DTC (On board display)	Trouble diagnosis name	DTC detecting condition	Possible causes
C1B03 (83)	CAM ABNRML TMP DETCT	Temperature around lane camera unit is excessively high	Interior room temperature is excessively high

#### ADAS CONTROL UNIT : Diagnosis Procedure

INFOID:000000009716673

### 1. CHECK LANE CAMERA UNIT SELF-DIAGNOSIS RESULTS

1. Perform "All DTC Reading" with CONSULT.
2. Check if the "C1B03" is detected in "Self Diagnostic Result" of "LANE CAMERA"

#### Is "C1B03" detected?

- YES >> Refer to [DAS-422. "LANE CAMERA UNIT : DTC Logic"](#).  
NO >> GO TO 2.

### 2. CHECK ADAS CONTROL UNIT SELF-DIAGNOSIS RESULTS

1. Erase all self-diagnosis results with CONSULT.
2. Perform "All DTC Reading".
3. Check if the "C1B03" is detected in "Self Diagnostic Result" of "ICC/ADAS"

#### Is "C1B03" detected?

- YES >> Replace the ADAS control unit. Refer to [DAS-79. "Removal and Installation"](#).  
NO >> INSPECTION END

### LANE CAMERA UNIT

#### LANE CAMERA UNIT : DTC Logic

INFOID:000000009716674

#### DTC DETECTION LOGIC

DTC	Trouble diagnosis name	DTC detecting condition	Possible causes
C1B03	ABNRML TEMP DETECT	Temperature around lane camera unit is excessively high	Interior room temperature is excessively high

#### LANE CAMERA UNIT : Diagnosis Procedure

INFOID:000000009716675

### 1. COOLING LANE CAMERA UNIT

1. Wait for 10 minutes or more to cool the lane camera unit.
2. Erase All self-diagnosis results with CONSULT.
3. Perform "All DTC Reading".
4. Check if the "C1B03" is detected in "Self Diagnostic Result" of "LANE CAMERA".

#### Is "C1B03" detected?

- YES >> Replace the lane camera unit. Refer to [DAS-459. "Removal and Installation"](#).  
NO >> Inspection End.

# U0104 ADAS CAN 1

< DTC/CIRCUIT DIAGNOSIS >

[LDW & LDP]

## U0104 ADAS CAN 1

### DTC Logic

INFOID:000000009716676

### DTC DETECTION LOGIC

DTC	Trouble diagnosis name	DTC detecting condition	Possible causes
U0104	ADAS CAN CIR 1	If lane camera unit detects an error signal that is received from ADAS control unit via ITS communication	ADAS control unit

#### NOTE:

If DTC "U0104" is detected along with DTC "U1000", first diagnose the DTC "U1000". Refer to [DAS-431, "LANE CAMERA UNIT : DTC Logic"](#).

### DTC CONFIRMATION PROCEDURE

#### 1. PERFORM DTC CONFIRMATION PROCEDURE

1. Start the engine.
2. Turn the LDP system ON.
3. Perform "All DTC Reading" with CONSULT.
4. Check if the "U0104" is detected as the current malfunction in "Self Diagnostic Result" of "LANE CAMERA".

Is "U0104" detected as the current malfunction?

- YES >> Refer to [DAS-423, "Diagnosis Procedure"](#).
- NO >> Refer to [GI-53, "Intermittent Incident"](#).

### Diagnosis Procedure

INFOID:000000009716677

#### 1. CHECK LANE CAMERA UNIT SELF-DIAGNOSIS RESULTS

Check if "U1000" is detected other than "U0104" in "Self Diagnostic Result" of "LANE CAMERA".

Is "U1000" detected?

- YES >> Perform the CAN communication system inspection. Repair or replace the malfunctioning parts. Refer to [DAS-431, "LANE CAMERA UNIT : DTC Logic"](#).
- NO >> GO TO 2.

#### 2. CHECK ADAS CONTROL UNIT SELF-DIAGNOSIS RESULTS

Check if any DTC is detected in "Self Diagnostic Result" of "ICC/ADAS".

Is any DTC detected?

- YES >> Perform diagnosis on the detected DTC and repair or replace the malfunctioning parts. Refer to [DAS-359, "DTC Index"](#).
- NO >> Replace the lane camera unit. Refer to [DAS-459, "Removal and Installation"](#).

A  
B  
C  
D  
E  
F  
G  
H  
I  
J  
K  
L  
M  
N  
P

DAS

**U0121 VDC CAN 2**

**DTC Logic**

INFOID:000000009716678

**DTC DETECTION LOGIC**

DTC (On board display)	Trouble diagnosis name	DTC detecting condition	Possible causes
U0121 (127)	VDC CAN CIR2	If ADAS control unit detects an error signal that is received from ABS actuator and electric unit (control unit) via CAN communication	ABS actuator and electric unit (control unit)

**NOTE:**

If DTC "U0121" is detected along with DTC "U1000", first diagnose the DTC "U1000". Refer to [DAS-431, "ADAS CONTROL UNIT : DTC Logic"](#).

**DTC CONFIRMATION PROCEDURE**

**1. PERFORM DTC CONFIRMATION PROCEDURE**

1. Start the engine.
2. Turn the LDP system ON.
3. Perform "All DTC Reading" with CONSULT.
4. Check if the "U0121" is detected as the current malfunction in "Self Diagnostic Result" of "ICC/ADAS".

Is "U0121" detected as the current malfunction?

- YES >> Refer to [DAS-424, "Diagnosis Procedure"](#).
- NO >> Refer to [GI-53, "Intermittent Incident"](#).

**Diagnosis Procedure**

INFOID:000000009716679

**1. CHECK SELF-DIAGNOSIS RESULTS**

Check if "U1000" is detected other than "U0121" in "Self Diagnostic Result" of "ICC/ADAS".

Is "U1000" detected?

- YES >> Perform the CAN communication system inspection. Repair or replace the malfunctioning parts. Refer to [DAS-431, "ADAS CONTROL UNIT : DTC Logic"](#).
- NO >> GO TO 2.

**2. CHECK ABS ACTUATOR AND ELECTRIC UNIT (CONTROL UNIT) SELF-DIAGNOSIS RESULTS**

Check if any DTC is detected in "Self Diagnostic Result" of "ABS".

Is any DTC detected?

- YES >> Perform diagnosis on the detected DTC and repair or replace the malfunctioning parts. Refer to [BRC-46, "DTC Index"](#).
- NO >> Replace the ADAS control unit. Refer to [DAS-79, "Removal and Installation"](#).

# U0126 STRG SEN CAN 1

< DTC/CIRCUIT DIAGNOSIS >

[LDW & LDP]

## U0126 STRG SEN CAN 1

### DTC Logic

INFOID:000000009716680

### DTC DETECTION LOGIC

DTC	Trouble diagnosis name	DTC detecting condition	Possible causes
U0126	STRG SEN CAN CIR1	If lane camera unit detects an error signal that is received from steering angle sensor via ADAS control unit	Steering angle sensor

#### NOTE:

If DTC "U0126" is detected along with DTC "U1000", first diagnose the DTC "U1000". Refer to [DAS-431, "ADAS CONTROL UNIT : DTC Logic"](#).

### DTC CONFIRMATION PROCEDURE

#### 1.PERFORM DTC CONFIRMATION PROCEDURE

1. Start the engine.
2. Turn the LDP system ON.
3. Perform "All DTC Reading" with CONSULT.
4. Check if the "U0126" is detected as the current malfunction in "Self Diagnostic Result" of "LANE CAMERA".

Is "U0126" detected as the current malfunction?

- YES >> Refer to [DAS-425, "Diagnosis Procedure"](#).  
NO >> Refer to [GI-53, "Intermittent Incident"](#).

### Diagnosis Procedure

INFOID:000000009716681

#### 1.CHECK SELF-DIAGNOSIS RESULTS

Check if "U1000" is detected other than "U0126" in "Self Diagnostic Result" of "LANE CAMERA".

Is "U1000" detected?

- YES >> Perform the CAN communication system inspection. Repair or replace the malfunctioning parts.  
Refer to [DAS-431, "LANE CAMERA UNIT : DTC Logic"](#).  
NO >> GO TO 2.

#### 2.CHECK ADAS CONTROL UNIT SELF-DIAGNOSIS RESULTS

Check if any DTC is detected in "Self Diagnostic Result" of "ICC/ADAS".

Is any DTC detected?

- YES >> Perform diagnosis on the detected DTC and repair or replace the malfunctioning parts. Refer to [DAS-359, "DTC Index"](#).  
NO >> Replace the lane camera unit. Refer to [DAS-459, "Removal and Installation"](#).

## U0401 ECM CAN 1

### DTC Logic

INFOID:000000009716682

#### DTC DETECTION LOGIC

DTC (On board display)	Trouble diagnosis name	DTC detecting condition	Possible causes
U0401 (120)	ECM CAN CIR1	If ADAS control unit detects an error signal that is received from ECM via CAN communication	ECM

**NOTE:**

If DTC "U0401" is detected along with DTC "U1000", first diagnose the DTC "U1000". Refer to [DAS-431, "ADAS CONTROL UNIT : DTC Logic"](#).

#### DTC CONFIRMATION PROCEDURE

##### 1. PERFORM DTC CONFIRMATION PROCEDURE

1. Start the engine.
2. Turn the LDP system ON.
3. Perform "All DTC Reading" with CONSULT.
4. Check if the "U0401" is detected as the current malfunction in "Self Diagnostic Result" of "ICC/ADAS".

Is "U0401" detected as the current malfunction?

- YES >> Refer to [DAS-426, "Diagnosis Procedure"](#).  
 NO >> Refer to [GI-53, "Intermittent Incident"](#).

#### Diagnosis Procedure

INFOID:000000009716683

##### 1. CHECK SELF-DIAGNOSIS RESULTS

Check if "U1000" is detected other than "U0401" in "Self Diagnostic Result" of "ICC/ADAS".

Is "U1000" detected?

- YES >> Perform the CAN communication system inspection. Repair or replace the malfunctioning parts. Refer to [DAS-431, "ADAS CONTROL UNIT : DTC Logic"](#).  
 NO >> GO TO 2.

##### 2. CHECK ECM SELF-DIAGNOSIS RESULTS

Check if any DTC is detected in "Self Diagnostic Result" of "ENGINE".

Is any DTC detected?

- YES >> Perform diagnosis on the detected DTC and repair or replace the malfunctioning parts. Refer to [EC-97, "DTC Index"](#).  
 NO >> Replace the ADAS control unit. Refer to [DAS-79, "Removal and Installation"](#).

# U0402 TCM CAN 1

< DTC/CIRCUIT DIAGNOSIS >

[LDW & LDP]

## U0402 TCM CAN 1

### DTC Logic

INFOID:000000009716684

### DTC DETECTION LOGIC

DTC (On board display)	Trouble diagnosis name	DTC detecting condition	Possible causes
U0402 (122)	TCM CAN CIRC1	If ADAS control unit detects an error signal that is received from TCM via CAN communication	TCM

#### NOTE:

If DTC "U0402" is detected along with DTC "U1000", first diagnose the DTC "U1000". Refer to [DAS-431, "ADAS CONTROL UNIT : DTC Logic"](#).

### DTC CONFIRMATION PROCEDURE

#### 1. PERFORM DTC CONFIRMATION PROCEDURE

1. Start the engine.
2. Turn the LDP system ON.
3. Perform "All DTC Reading" with CONSULT.
4. Check if the "U0402" is detected as the current malfunction in "Self Diagnostic Result" of "ICC/ADAS".

Is "U0402" detected as the current malfunction?

- YES >> Refer to [DAS-427, "Diagnosis Procedure"](#).  
NO >> Refer to [GI-53, "Intermittent Incident"](#).

### Diagnosis Procedure

INFOID:000000009716685

#### 1. CHECK SELF-DIAGNOSIS RESULTS

Check if "U1000" is detected other than "U0402" in "Self Diagnostic Result" of "ICC/ADAS".

Is "U1000" detected?

- YES >> Perform the CAN communication system inspection. Repair or replace the malfunctioning parts. Refer to [DAS-431, "ADAS CONTROL UNIT : DTC Logic"](#).  
NO >> GO TO 2.

#### 2. CHECK TCM SELF-DIAGNOSIS RESULTS

Check if any DTC is detected in "Self Diagnostic Result" of "TRANSMISSION".

Is any DTC detected?

- YES >> Perform diagnosis on the detected DTC and repair or replace the malfunctioning parts. Refer to [TM-61, "DTC Index"](#).  
NO >> Replace the ADAS control unit. Refer to [DAS-79, "Removal and Installation"](#).

A  
B  
C  
D  
E  
F  
G  
H  
I  
J  
K  
L  
M  
N  
P

DAS

# U0405 ADAS CAN 2

< DTC/CIRCUIT DIAGNOSIS >

[LDW & LDP]

## U0405 ADAS CAN 2

### DTC Logic

INFOID:000000009716686

### DTC DETECTION LOGIC

DTC	Trouble diagnosis name	DTC detecting condition	Possible causes
U0405	ADAS CAN CIR 2	If lane camera unit detects an error signal that is received from ADAS control unit via ITS communication	ADAS control unit

#### NOTE:

If DTC "U0405" is detected along with DTC "U1000", first diagnose the DTC "U1000". Refer to [DAS-431, "ADAS CONTROL UNIT : DTC Logic"](#).

### DTC CONFIRMATION PROCEDURE

#### 1. PERFORM DTC CONFIRMATION PROCEDURE

1. Start the engine.
2. Turn the LDP system ON.
3. Perform "All DTC Reading" with CONSULT.
4. Check if the "U0405" is detected as the current malfunction in "Self Diagnostic Result" of "LANE CAMERA".

Is "U0405" detected as the current malfunction?

- YES >> Refer to [DAS-428, "Diagnosis Procedure"](#).  
NO >> Refer to [GI-53, "Intermittent Incident"](#).

### Diagnosis Procedure

INFOID:000000009716687

#### 1. CHECK LANE CAMERA UNIT SELF-DIAGNOSIS RESULTS

Check if "U1000" is detected other than "U0405" in "Self Diagnostic Result" of "LANE CAMERA".

Is "U1000" detected?

- YES >> Perform the CAN communication system inspection. Repair or replace the malfunctioning parts.  
Refer to [DAS-431, "LANE CAMERA UNIT : DTC Logic"](#).  
NO >> GO TO 2.

#### 2. CHECK ADAS CONTROL UNIT SELF-DIAGNOSIS RESULTS

Check if any DTC is detected in "Self Diagnostic Result" of "ICC/ADAS".

Is any DTC detected?

- YES >> Perform diagnosis on the detected DTC and repair or replace the malfunctioning parts. Refer to [DAS-359, "DTC Index"](#).  
NO >> Replace the lane camera unit. Refer to [DAS-459, "Removal and Installation"](#).



# U0415 VDC CAN 1

< DTC/CIRCUIT DIAGNOSIS >

[LDW & LDP]

## U0415 VDC CAN 1

### DTC Logic

INFOID:000000009716688

### DTC DETECTION LOGIC

DTC (On board display)	Trouble diagnosis name	DTC detecting condition	Possible causes
U0415 (126)	VDC CAN CIR1	If ADAS control unit detects an error signal that is received from ABS actuator and electric unit (control unit) via CAN communication	ABS actuator and electric unit (control unit)

#### NOTE:

If DTC "U0415" is detected along with DTC "U1000", first diagnose the DTC "U1000". Refer to [DAS-431, "ADAS CONTROL UNIT : DTC Logic"](#).

### DTC CONFIRMATION PROCEDURE

#### 1. PERFORM DTC CONFIRMATION PROCEDURE

1. Start the engine.
2. Turn the LDP system ON.
3. Perform "All DTC Reading" with CONSULT.
4. Check if the "U0415" is detected as the current malfunction in "Self Diagnostic Result" of "ICC/ADAS".

Is "U0415" detected as the current malfunction?

- YES >> Refer to [DAS-429, "Diagnosis Procedure"](#).  
NO >> Refer to [GI-53, "Intermittent Incident"](#).

### Diagnosis Procedure

INFOID:000000009716689

#### 1. CHECK SELF-DIAGNOSIS RESULTS

Check if "U1000" is detected other than "U0415" in "Self Diagnostic Result" of "ICC/ADAS".

Is "U1000" detected?

- YES >> Perform the CAN communication system inspection. Repair or replace the malfunctioning parts. Refer to [DAS-431, "ADAS CONTROL UNIT : DTC Logic"](#).  
NO >> GO TO 2.

#### 2. CHECK ABS ACTUATOR AND ELECTRIC UNIT (CONTROL UNIT) SELF-DIAGNOSIS RESULTS

Check if any DTC is detected in "Self Diagnostic Result" of "ABS".

Is any DTC detected?

- YES >> Perform diagnosis on the detected DTC and repair or replace the malfunctioning parts. Refer to [BRC-46, "DTC Index"](#).  
NO >> Replace the ADAS control unit. Refer to [DAS-79, "Removal and Installation"](#).

A  
B  
C  
D  
E  
F  
G  
H  
I  
J  
K  
L  
M  
N  
P

DAS

# U0428 STRG SEN CAN 2

< DTC/CIRCUIT DIAGNOSIS >

[LDW & LDP]

## U0428 STRG SEN CAN 2

### DTC Logic

INFOID:000000009716690

### DTC DETECTION LOGIC

DTC	Trouble diagnosis name	DTC detecting condition	Possible causes
U0428	STRG SEN CAN CIR2	If lane camera unit detects an error signal that is received from steering angle sensor via ADAS control unit	Steering angle sensor

#### NOTE:

If DTC "U0428" is detected along with DTC "U1000", first diagnose the DTC "U1000". Refer to [DAS-431, "LANE CAMERA UNIT : DTC Logic"](#).

### DTC CONFIRMATION PROCEDURE

#### 1. PERFORM DTC CONFIRMATION PROCEDURE

1. Start the engine.
2. Turn the LDP system ON.
3. Perform "All DTC Reading" with CONSULT.
4. Check if the "U0428" is detected as the current malfunction in "Self Diagnostic Result" of "LANE CAMERA".

Is "U0428" detected as the current malfunction?

- YES >> Refer to [DAS-430, "Diagnosis Procedure"](#).
- NO >> Refer to [GI-53, "Intermittent Incident"](#).

### Diagnosis Procedure

INFOID:000000009716691

#### 1. CHECK SELF-DIAGNOSIS RESULTS

Check if "U1000" is detected other than "U0428" in "Self Diagnostic Result" of "LANE CAMERA".

Is "U1000" detected?

- YES >> Perform the CAN communication system inspection. Repair or replace the malfunctioning parts. Refer to [DAS-431, "LANE CAMERA UNIT : DTC Logic"](#).
- NO >> GO TO 2.

#### 2. CHECK ADAS CONTROL UNIT SELF-DIAGNOSIS RESULTS

Check if any DTC is detected in "Self Diagnostic Result" of "ICC/ADAS".

Is any DTC detected?

- YES >> Perform diagnosis on the detected DTC and repair or replace the malfunctioning parts. Refer to [DAS-359, "DTC Index"](#).
- NO >> Replace the lane camera unit. Refer to [DAS-459, "Removal and Installation"](#).

# U1000 CAN COMM CIRCUIT

< DTC/CIRCUIT DIAGNOSIS >

[LDW & LDP]

## U1000 CAN COMM CIRCUIT ADAS CONTROL UNIT

### ADAS CONTROL UNIT : Description

INFOID:000000009716692

#### CAN COMMUNICATION

CAN (Controller Area Network) is a serial communication line for real time applications. It is an on-vehicle multiplex communication line with high data communication speed and excellent error detection ability. Modern vehicle is equipped with many electronic control units, and each control unit shares information and links with other control units during operation (not independent). In CAN communication, control units are connected with 2 communication lines (CAN-H, CAN-L) allowing a high rate of information transmission with less wiring. Each control unit transmits/receives data but selectively reads the required data only.

CAN communication signal chart. Refer to [LAN-43, "CAN COMMUNICATION SYSTEM : CAN Communication Signal Chart"](#).

#### ITS COMMUNICATION

- ITS communication is a multiplex communication system. This enables the system to transmit and receive large quantities of data at high speed by connecting control units with 2 communication lines.
- ITS communication lines adopt twisted-pair line style (two lines twisted) for noise immunity.

### ADAS CONTROL UNIT : DTC Logic

INFOID:000000009716693

#### DTC DETECTION LOGIC

DTC (On board display)	Trouble diagnosis name	DTC detecting condition	Possible causes
U1000 (100)	CAN COMM CIRCUIT	If ADAS control unit is not transmitting or receiving CAN communication signal or ITS communication signal for 2 seconds or more	<ul style="list-style-type: none"><li>• CAN communication system</li><li>• ITS communication system</li></ul>

#### NOTE:

If "U1000" is detected, first diagnose the CAN communication system.

### ADAS CONTROL UNIT : Diagnosis Procedure

INFOID:000000009716694

#### 1. PERFORM THE SELF-DIAGNOSIS

1. Turn the ignition switch ON.
2. Turn the LDP system ON, and then wait for 30 seconds or more.
3. Perform "All DTC Reading" with CONSULT.
4. Check if the "U1000" is detected as the current malfunction in "Self Diagnostic Result" of "ICC/ADAS".

Is "U1000" detected as the current malfunction?

YES >> Refer to [LAN-26, "Trouble Diagnosis Flow Chart"](#).

NO >> Refer to [GI-53, "Intermittent Incident"](#).

## LANE CAMERA UNIT

### LANE CAMERA UNIT : Description

INFOID:000000009716695

#### ITS COMMUNICATION

- ITS communication is a multiplex communication system. This enables the system to transmit and receive large quantities of data at high speed by connecting control units with 2 communication lines
- ITS communication lines adopt twisted-pair line style (two lines twisted) for noise immunity.

### LANE CAMERA UNIT : DTC Logic

INFOID:000000009716696

#### DTC DETECTION LOGIC

A  
B  
C  
D  
E  
F  
G  
H  
I  
J  
K  
L  
M  
N  
P

DAS

# U1000 CAN COMM CIRCUIT

< DTC/CIRCUIT DIAGNOSIS >

[LDW & LDP]

DTC	Trouble diagnosis name	DTC detecting condition	Possible causes
U1000	CAN COMM CIRCUIT	If lane camera unit is not transmitting or receiving ITS communication signal for 2 seconds or more	ITS communication system

## LANE CAMERA UNIT : Diagnosis Procedure

INFOID:000000009716697

### 1. PERFORM THE SELF-DIAGNOSIS

1. Turn the ignition switch ON.
2. Turn the LDP system ON, and then wait for 2 seconds or more.
3. Perform "All DTC Reading" with CONSULT.
4. Check if the "U1000" is detected as the current malfunction in "Self Diagnostic Result" of "LANE CAMERA".

Is "U1000" detected as the current malfunction?

- YES >> Refer to [LAN-26. "Trouble Diagnosis Flow Chart"](#).  
NO >> Refer to [GI-53. "Intermittent Incident"](#).

# U1010 CONTROL UNIT (CAN)

< DTC/CIRCUIT DIAGNOSIS >

[LDW & LDP]

## U1010 CONTROL UNIT (CAN)

### ADAS CONTROL UNIT

#### ADAS CONTROL UNIT : Description

INFOID:000000009716698

CAN controller controls the communication of CAN communication signal and ITS communication signal, and the error detection.

#### ADAS CONTROL UNIT : DTC Logic

INFOID:000000009716699

#### DTC DETECTION LOGIC

DTC (On board display)	Trouble diagnosis name	DTC detecting condition	Possible causes
U1010 (110)	CONTROL UNIT (CAN)	If ADAS control unit detects malfunction by CAN controller initial diagnosis	ADAS control unit

#### ADAS CONTROL UNIT : Diagnosis Procedure

INFOID:000000009716700

##### 1.PERFORM DTC CONFIRMATION PROCEDURE

1. Turn the LDP system ON.
2. Perform "All DTC Reading" with CONSULT.
3. Check if the "U1010" is detected as the current malfunction in "Self Diagnostic Result" of "ICC/ADAS".

Is "U1010" detected as the current malfunction?

- YES >> Replace the ADAS control unit. Refer to [DAS-79, "Removal and Installation"](#).  
NO >> INSPECTION END

### LANE CAMERA UNIT

#### LANE CAMERA UNIT : Description

INFOID:000000009716701

CAN controller controls the communication of ITS communication signal and the error detection.

#### LANE CAMERA UNIT : DTC Logic

INFOID:000000009716702

#### DTC DETECTION LOGIC

DTC	Trouble diagnosis name	DTC detecting condition	Possible causes
U1010	CONTROL UNIT (CAN)	If lane camera unit detects malfunction by CAN controller initial diagnosis	Lane camera unit

#### LANE CAMERA UNIT : Diagnosis Procedure

INFOID:000000009716703

##### 1.PERFORM DTC CONFIRMATION PROCEDURE

1. Turn the LDP system ON.
2. Perform "All DTC Reading" with CONSULT.
3. Check if the "U1010" is detected as the current malfunction in "Self Diagnostic Result" of "LANE CAMERA".

Is "U1010" detected as the current malfunction?

- YES >> Replace the lane camera unit. Refer to [DAS-459, "Removal and Installation"](#).  
NO >> INSPECTION END

A  
B  
C  
D  
E  
F  
G  
H  
I  
J  
K  
L  
M  
N  
P

DAS

# U150B ECM CAN 3

< DTC/CIRCUIT DIAGNOSIS >

[LDW & LDP]

## U150B ECM CAN 3

### DTC Logic

INFOID:000000009716704

### DTC DETECTION LOGIC

DTC (On board display)	Trouble diagnosis name	DTC detecting condition	Possible causes
U150B (157)	ECM CAN CIRC 3	ADAS control unit detects an error signal that is received from ECM via CAN communication	ECM

#### NOTE:

If DTC "U150B" is detected along with DTC "U1000", first diagnose the DTC "U1000". Refer to [DAS-431, "ADAS CONTROL UNIT : DTC Logic"](#).

### DTC CONFIRMATION PROCEDURE

#### 1. PERFORM DTC CONFIRMATION PROCEDURE

1. Start the engine.
2. Turn the LDP system ON.
3. Perform "All DTC Reading" with CONSULT.
4. Check if the "U150B" is detected as the current malfunction in "Self Diagnostic Result" of "ICC/ADAS".

Is "U150B" detected as the current malfunction?

- YES >> Refer to [DAS-434, "Diagnosis Procedure"](#).  
NO >> Refer to [GI-53, "Intermittent Incident"](#).

### Diagnosis Procedure

INFOID:000000009716705

#### 1. CHECK SELF-DIAGNOSIS RESULTS

Check if "U1000" is detected other than "U150B" in "Self Diagnostic Result" of "ICC/ADAS".

Is "U1000" detected?

- YES >> Perform the CAN communication system inspection. Repair or replace the malfunctioning parts.  
Refer to [DAS-431, "ADAS CONTROL UNIT : DTC Logic"](#).  
NO >> GO TO 2.

#### 2. CHECK ECM SELF-DIAGNOSIS RESULTS

Check if any DTC is detected in "Self Diagnostic Result" of "ENGINE".

Is any DTC detected?

- YES >> Perform diagnosis on the detected DTC and repair or replace the malfunctioning parts. Refer to [EC-97, "DTC Index"](#).  
NO >> Replace the ADAS control unit. Refer to [DAS-79, "Removal and Installation"](#).

U150C VDC CAN 3

DTC Logic

INFOID:000000009716706

DTC DETECTION LOGIC

DTC (On board display)	Trouble diagnosis name	DTC detecting condition	Possible causes
U150C (158)	VDC CAN CIRC 3	ADAS control unit detects an error signal that is received from ABS actuator and electric unit (control unit) via CAN communication	ABS actuator and electric unit (control unit)

**NOTE:**

If DTC "U150C" is detected along with DTC "U1000", first diagnose the DTC "U1000". Refer to [DAS-431, "ADAS CONTROL UNIT : DTC Logic"](#).

DTC CONFIRMATION PROCEDURE

**1**.PERFORM DTC CONFIRMATION PROCEDURE

1. Start the engine.
2. Turn the LDP system ON.
3. Perform "All DTC Reading" with CONSULT.
4. Check if the "U150C" is detected as the current malfunction in "Self Diagnostic Result" of "ICC/ADAS".

Is "U150C" detected as the current malfunction?

- YES >> Refer to [DAS-435, "Diagnosis Procedure"](#).
- NO >> Refer to [GI-53, "Intermittent Incident"](#).

Diagnosis Procedure

INFOID:000000009716707

**1**.CHECK SELF-DIAGNOSIS RESULTS

Check if "U1000" is detected other than "U150C" in "Self Diagnostic Result" of "ICC/ADAS".

Is "U1000" detected?

- YES >> Perform the CAN communication system inspection. Repair or replace the malfunctioning parts. Refer to [DAS-431, "ADAS CONTROL UNIT : DTC Logic"](#).
- NO >> GO TO 2.

**2**.CHECK ABS ACTUATOR AND ELECTRIC UNIT (CONTROL UNIT) SELF-DIAGNOSIS RESULTS

Check if any DTC is detected in "Self Diagnostic Result" of "ABS".

Is any DTC detected?

- YES >> Perform diagnosis on the detected DTC and repair or replace the malfunctioning parts. Refer to [BRC-46, "DTC Index"](#).
- NO >> Replace the ADAS control unit. Refer to [DAS-79, "Removal and Installation"](#).

## U150D TCM CAN 3

### DTC Logic

INFOID:000000009716708

#### DTC DETECTION LOGIC

DTC (On board display)	Trouble diagnosis name	DTC detecting condition	Possible causes
U150D (159)	TCM CAN CIRC 3	ADAS control unit detects an error signal that is received from TCM via CAN communication	TCM

**NOTE:**

If DTC "U150D" is detected along with DTC "U1000", first diagnose the DTC "U1000". Refer to [DAS-431, "ADAS CONTROL UNIT : DTC Logic"](#).

#### DTC CONFIRMATION PROCEDURE

##### 1. PERFORM DTC CONFIRMATION PROCEDURE

1. Start the engine.
2. Turn the LDP system ON.
3. Perform "All DTC Reading" with CONSULT.
4. Check if the "U150D" is detected as the current malfunction in "Self Diagnostic Result" of "ICC/ADAS".

Is "U150D" detected as the current malfunction?

- YES >> Refer to [DAS-436, "Diagnosis Procedure"](#).  
 NO >> Refer to [GI-53, "Intermittent Incident"](#).

#### Diagnosis Procedure

INFOID:000000009716709

##### 1. CHECK SELF-DIAGNOSIS RESULTS

Check if "U1000" is detected other than "U150D" in "Self Diagnostic Result" of "ICC/ADAS".

Is "U1000" detected?

- YES >> Perform the CAN communication system inspection. Repair or replace the malfunctioning parts. Refer to [DAS-431, "ADAS CONTROL UNIT : DTC Logic"](#).  
 NO >> GO TO 2.

##### 2. CHECK TCM SELF-DIAGNOSIS RESULTS

Check if any DTC is detected in "Self Diagnostic Result" of "TRANSMISSION".

Is any DTC detected?

- YES >> Perform diagnosis on the detected DTC and repair or replace the malfunctioning parts. Refer to [TM-61, "DTC Index"](#).  
 NO >> Replace the ADAS control unit. Refer to [DAS-79, "Removal and Installation"](#).



# U150E BCM CAN 3

< DTC/CIRCUIT DIAGNOSIS >

[LDW & LDP]

## U150E BCM CAN 3

### DTC Logic

INFOID:000000009716710

### DTC DETECTION LOGIC

DTC (On board display)	Trouble diagnosis name	DTC detecting condition	Possible causes
U150E (160)	BCM CAN CIRC 3	ADAS control unit detects an error signal that is received from BCM via CAN communication	BCM

#### NOTE:

If DTC "U150E" is detected along with DTC "U1000", first diagnose the DTC "U1000". Refer to [DAS-431, "ADAS CONTROL UNIT : DTC Logic"](#).

### DTC CONFIRMATION PROCEDURE

#### 1. PERFORM DTC CONFIRMATION PROCEDURE

1. Start the engine.
2. Turn the LDP system ON.
3. Perform "All DTC Reading" with CONSULT.
4. Check if the "U150E" is detected as the current malfunction in "Self Diagnostic Result" of "ICC/ADAS".

Is "U150E" detected as the current malfunction?

- YES >> Refer to [DAS-437, "Diagnosis Procedure"](#).  
NO >> Refer to [GI-53, "Intermittent Incident"](#).

### Diagnosis Procedure

INFOID:000000009716711

#### 1. CHECK SELF-DIAGNOSIS RESULTS

Check if "U1000" is detected other than "U150E" in "Self Diagnostic Result" of "ICC/ADAS".

Is "U1000" detected?

- YES >> Perform the CAN communication system inspection. Repair or replace the malfunctioning parts.  
Refer to [DAS-431, "ADAS CONTROL UNIT : DTC Logic"](#).  
NO >> GO TO 2.

#### 2. CHECK BCM SELF-DIAGNOSIS RESULTS

Check if any DTC is detected in "Self Diagnostic Result" of "BCM".

Is any DTC detected?

- YES >> Perform diagnosis on the detected DTC and repair or replace the malfunctioning parts. Refer to [BCS-51, "DTC Index"](#).  
NO >> Replace the ADAS control unit. Refer to [DAS-79, "Removal and Installation"](#).

**U1500 CAM CAN 2**

**DTC Logic**

INFOID:000000009716712

**DTC DETECTION LOGIC**

DTC (On board display)	Trouble diagnosis name	DTC detecting condition	Possible causes
U1500 (145)	CAM CAN CIRC 2	ADAS control unit detects an error signal that is received from lane camera unit via ITS communication	Lane camera unit

**NOTE:**

If DTC “U1500” is detected along with DTC “U1000”, first diagnose the DTC “U1000”. Refer to [DAS-431, "ADAS CONTROL UNIT : DTC Logic"](#).

**DTC CONFIRMATION PROCEDURE**

**1. PERFORM DTC CONFIRMATION PROCEDURE**

1. Start the engine.
2. Turn the LDP system ON.
3. Perform “All DTC Reading” with CONSULT.
4. Check if the “U1500” is detected as the current malfunction in “Self Diagnostic Result” of “ICC/ADAS”.

Is “U1500” detected as the current malfunction?

- YES >> Refer to [DAS-438, "Diagnosis Procedure"](#).
- NO >> Refer to [GI-53, "Intermittent Incident"](#).

**Diagnosis Procedure**

INFOID:000000009716713

**1. CHECK SELF-DIAGNOSIS RESULTS**

Check if “U1000” is detected other than “U1500” in “Self Diagnostic Result” of “ICC/ADAS”.

Is “U1000” detected?

- YES >> Perform the CAN communication system inspection. Repair or replace the malfunctioning parts. Refer to [DAS-431, "ADAS CONTROL UNIT : DTC Logic"](#).
- NO >> GO TO 2.

**2. CHECK LANE CAMERA UNIT SELF-DIAGNOSIS RESULTS**

Check if any DTC is detected in “Self Diagnostic Result” of “LANE CAMERA”.

Is any DTC detected?

- YES >> Perform diagnosis on the detected DTC and repair or replace the malfunctioning parts. Refer to [DAS-366, "DTC Index"](#).
- NO >> Replace the ADAS control unit. Refer to [DAS-79, "Removal and Installation"](#).

# U1501 CAM CAN 1

< DTC/CIRCUIT DIAGNOSIS >

[LDW & LDP]

## U1501 CAM CAN 1

### DTC Logic

INFOID:000000009716714

### DTC DETECTION LOGIC

DTC (On board display)	Trouble diagnosis name	DTC detecting condition	Possible causes
U1501 (145)	CAM CAN CIRC 1	ADAS control unit detects an error signal that is received from lane camera unit via ITS communication	Lane camera unit

#### NOTE:

If DTC "U1501" is detected along with DTC "U1000", first diagnose the DTC "U1000". Refer to [DAS-431, "ADAS CONTROL UNIT : DTC Logic"](#).

### DTC CONFIRMATION PROCEDURE

#### 1. PERFORM DTC CONFIRMATION PROCEDURE

1. Start the engine.
2. Turn the LDP system ON.
3. Perform "All DTC Reading" with CONSULT.
4. Check if the "U1501" is detected as the current malfunction in "Self Diagnostic Result" of "ICC/ADAS".

Is "U1501" detected as the current malfunction?

- YES >> Refer to [DAS-439, "Diagnosis Procedure"](#).  
NO >> Refer to [GI-53, "Intermittent Incident"](#).

### Diagnosis Procedure

INFOID:000000009716715

#### 1. CHECK SELF-DIAGNOSIS RESULTS

Check if "U1000" is detected other than "U1501" in "Self Diagnostic Result" of "ICC/ADAS".

Is "U1000" detected?

- YES >> Perform the CAN communication system inspection. Repair or replace the malfunctioning parts. Refer to [DAS-431, "ADAS CONTROL UNIT : DTC Logic"](#).  
NO >> GO TO 2.

#### 2. CHECK LANE CAMERA UNIT SELF-DIAGNOSIS RESULTS

Check if any DTC is detected in "Self Diagnostic Result" of "LANE CAMERA".

Is any DTC detected?

- YES >> Perform diagnosis on the detected DTC and repair or replace the malfunctioning parts. Refer to [DAS-366, "DTC Index"](#).  
NO >> Replace the ADAS control unit. Refer to [DAS-79, "Removal and Installation"](#).

A  
B  
C  
D  
E  
F  
G  
H  
I  
J  
K  
L  
M  
N  
P

DAS

# U1512 HVAC CAN 3

< DTC/CIRCUIT DIAGNOSIS >

[LDW & LDP]

## U1512 HVAC CAN 3

### DTC Logic

INFOID:000000009716716

### DTC DETECTION LOGIC

DTC (On board display)	Trouble diagnosis name	DTC detecting condition	Possible causes
U1512 (162)	HVAC CAN CIRC 3	ADAS control unit detects an error signal that is received from A/C auto amp. via CAN communication	A/C auto amp.

#### NOTE:

If DTC "U1512" is detected along with DTC "U1000", first diagnose the DTC "U1000". Refer to [DAS-431, "ADAS CONTROL UNIT : DTC Logic"](#).

### DTC CONFIRMATION PROCEDURE

#### 1. PERFORM DTC CONFIRMATION PROCEDURE

1. Start the engine.
2. Turn the LDP system ON.
3. Perform "All DTC Reading" with CONSULT.
4. Check if the "U1512" is detected as the current malfunction in "Self Diagnostic Result" of "ICC/ADAS".

Is "U1512" detected as the current malfunction?

- YES >> Refer to [DAS-440, "Diagnosis Procedure"](#).  
NO >> Refer to [GI-53, "Intermittent Incident"](#).

### Diagnosis Procedure

INFOID:000000009716717

#### 1. CHECK SELF-DIAGNOSIS RESULTS

Check if "U1000" is detected other than "U1512" in "Self Diagnostic Result" of "ICC/ADAS".

Is "U1000" detected?

- YES >> Perform the CAN communication system inspection. Repair or replace the malfunctioning parts.  
Refer to [DAS-431, "ADAS CONTROL UNIT : DTC Logic"](#).  
NO >> GO TO 2.

#### 2. CHECK A/C AUTO AMP. SELF-DIAGNOSIS RESULTS

Check if any DTC is detected in "Self Diagnostic Result" of "HVAC".

Is any DTC detected?

- YES >> Perform diagnosis on the detected DTC and repair or replace the malfunctioning parts. Refer to [HAC-49, "DTC Index"](#).  
NO >> Replace the ADAS control unit. Refer to [DAS-79, "Removal and Installation"](#).

# U1513 METER CAN 3

< DTC/CIRCUIT DIAGNOSIS >

[LDW & LDP]

## U1513 METER CAN 3

### DTC Logic

INFOID:000000009716718

### DTC DETECTION LOGIC

DTC (On board display)	Trouble diagnosis name	DTC detecting condition	Possible causes
U1513 (163)	METER CAN CIRC 3	ADAS control unit detects an error signal that is received from combination meter via CAN communication	Combination meter

#### NOTE:

If DTC "U1513" is detected along with DTC "U1000", first diagnose the DTC "U1000". Refer to [DAS-431, "ADAS CONTROL UNIT : DTC Logic"](#).

### DTC CONFIRMATION PROCEDURE

#### 1. PERFORM DTC CONFIRMATION PROCEDURE

1. Start the engine.
2. Turn the LDP system ON.
3. Perform "All DTC Reading" with CONSULT.
4. Check if the "U1513" is detected as the current malfunction in "Self Diagnostic Result" of "ICC/ADAS".

Is "U1513" detected as the current malfunction?

- YES >> Refer to [DAS-441, "Diagnosis Procedure"](#).  
NO >> Refer to [GI-53, "Intermittent Incident"](#).

### Diagnosis Procedure

INFOID:000000009716719

#### 1. CHECK SELF-DIAGNOSIS RESULTS

Check if "U1000" is detected other than "U1513" in "Self Diagnostic Result" of "ICC/ADAS".

Is "U1000" detected?

- YES >> Perform the CAN communication system inspection. Repair or replace the malfunctioning parts. Refer to [DAS-431, "ADAS CONTROL UNIT : DTC Logic"](#).  
NO >> GO TO 2.

#### 2. CHECK COMBINATION METER SELF-DIAGNOSIS RESULTS

Check if any DTC is detected in "Self Diagnostic Result" of "METER/M&A".

Is any DTC detected?

- YES >> Perform diagnosis on the detected DTC and repair or replace the malfunctioning parts. Refer to [MWI-26, "DTC Index"](#).  
NO >> Replace the ADAS control unit. Refer to [DAS-79, "Removal and Installation"](#).

A  
B  
C  
D  
E  
F  
G  
H  
I  
J  
K  
L  
M  
N  
P

DAS

**U1516 CAM CAN 3**

**DTC Logic**

INFOID:000000009716720

**DTC DETECTION LOGIC**

DTC (On board display)	Trouble diagnosis name	DTC detecting condition	Possible causes
U1516 (166)	CAM CAN CIRC 3	ADAS control unit detects an error signal that is received from lane camera unit via ITS communication	Lane camera unit

**NOTE:**

If DTC "U1516" is detected along with DTC "U1000", first diagnose the DTC "U1000". Refer to [DAS-431, "ADAS CONTROL UNIT : DTC Logic"](#).

**DTC CONFIRMATION PROCEDURE**

**1. PERFORM DTC CONFIRMATION PROCEDURE**

1. Start the engine.
2. Turn the LDP system ON.
3. Perform "All DTC Reading" with CONSULT.
4. Check if the "U1516" is detected as the current malfunction in "Self Diagnostic Result" of "ICC/ADAS".

Is "U1516" detected as the current malfunction?

- YES >> Refer to [DAS-442, "Diagnosis Procedure"](#).
- NO >> Refer to [GI-53, "Intermittent Incident"](#).

**Diagnosis Procedure**

INFOID:000000009716721

**1. CHECK SELF-DIAGNOSIS RESULTS**

Check if "U1000" is detected other than "U1516" in "Self Diagnostic Result" of "ICC/ADAS".

Is "U1000" detected?

- YES >> Perform the CAN communication system inspection. Repair or replace the malfunctioning parts. Refer to [DAS-431, "ADAS CONTROL UNIT : DTC Logic"](#).
- NO >> GO TO 2.

**2. CHECK LANE CAMERA UNIT SELF-DIAGNOSIS RESULTS**

Check if any DTC is detected in "Self Diagnostic Result" of "LANE CAMERA".

Is any DTC detected?

- YES >> Perform diagnosis on the detected DTC and repair or replace the malfunctioning parts. Refer to [DAS-366, "DTC Index"](#).
- NO >> Replace the ADAS control unit. Refer to [DAS-79, "Removal and Installation"](#).

# POWER SUPPLY AND GROUND CIRCUIT

< DTC/CIRCUIT DIAGNOSIS >

[LDW & LDP]

## POWER SUPPLY AND GROUND CIRCUIT ADAS CONTROL UNIT

### ADAS CONTROL UNIT : Diagnosis Procedure

INFOID:000000009716722

Regarding Wiring Diagram information, refer to [DAS-367, "Wiring Diagram"](#).

#### 1. CHECK ADAS CONTROL UNIT POWER SUPPLY CIRCUIT

Check voltage between ADAS control unit harness connector and ground.

Terminal		Condition	Voltage (Approx.)
(+)	(-)		
ADAS control unit		Ignition switch	0 V
Connector	Terminal		
B104	16	OFF	0 V
		ON	Battery voltage

Is the inspection result normal?

YES >> GO TO 2.

NO >> Repair the ADAS control unit power supply circuit.

#### 2. CHECK ADAS CONTROL UNIT GROUND CIRCUIT

1. Turn the ignition switch OFF.
2. Disconnect the ADAS control unit connector.
3. Check for continuity between ADAS control unit harness connector and ground.

ADAS control unit		Ground	Continuity
Connector	Terminal		
B104	6		Yes

Is the inspection result normal?

YES >> INSPECTION END

NO >> Repair the ADAS control unit ground circuit.

## LANE CAMERA UNIT

### LANE CAMERA UNIT : Diagnosis Procedure

INFOID:000000009716723

Regarding Wiring Diagram information, refer to [DAS-367, "Wiring Diagram"](#).

#### 1. CHECK LANE CAMERA UNIT POWER SUPPLY CIRCUIT

Check voltage between lane camera unit harness connector and ground.

# POWER SUPPLY AND GROUND CIRCUIT

< DTC/CIRCUIT DIAGNOSIS >

[LDW & LDP]

Terminal		Condition	Voltage (Approx.)
(+)	(-)		
Lane camera unit		Ignition switch	0 V
Connector	Terminal		
R5	7	OFF	
		ON	

Is the inspection result normal?

YES >> GO TO 2.

NO >> Repair the lane camera unit power supply circuit.

## 2. CHECK LANE CAMERA UNIT GROUND CIRCUIT

1. Turn the ignition switch OFF.
2. Disconnect the lane camera unit connector.
3. Check for continuity between lane camera unit harness connector and ground.

Lane camera unit		Ground	Continuity
Connector	Terminal		
R5	1		Yes
	5		

Is the inspection result normal?

YES >> Inspection End.

NO >> Repair the lane camera unit ground circuit.



# WARNING SYSTEMS SWITCH CIRCUIT

< DTC/CIRCUIT DIAGNOSIS >

[LDW & LDP]

## WARNING SYSTEMS SWITCH CIRCUIT

### Component Function Check

INFOID:000000009716724

#### 1.CHECK WARNING SYSTEMS SWITCH INPUT SIGNAL

1. Turn the ignition switch ON.
2. Select the DATA MONITOR item "WARN SYS SW" of "ICC/ADAS" with CONSULT.
3. With operating the warning systems switch, check the monitor status.

Monitor item	Condition	Monitor status
WARN SYS SW	Warning systems switch is pressed	On
	Warning systems switch is not pressed	OFF

Is the inspection result normal?

- YES >> Warning systems switch circuit is normal.  
NO >> Refer to [DAS-445. "Diagnosis Procedure"](#).

### Diagnosis Procedure

INFOID:000000009716725

Regarding Wiring Diagram information, refer to [DAS-367. "Wiring Diagram"](#).

#### 1.CHECK WARNING SYSTEMS SWITCH SIGNAL INPUT

1. Turn the ignition switch ON.
2. Check voltage between ADAS control unit harness connector and ground.

Terminals		Condition	Voltage (Approx.)
(+)	(-)		
ADAS control unit		Warning systems switch	
Connector	Terminal		
B104	1	Pressed	
		Released	12 V

Is the inspection result normal?

- YES >> Replace the ADAS control unit. Refer to [DAS-79. "Removal and Installation"](#).  
NO >> GO TO 2.

#### 2.CHECK WARNING SYSTEMS SWITCH

1. Turn ignition switch OFF.
2. Remove warning systems switch.
3. Check warning systems switch. Refer to [DAS-446. "Component Inspection"](#).

Is the inspection result normal?

- YES >> GO TO 3.  
NO >> Replace the warning systems switch. Refer to [DAS-460. "Removal and Installation"](#).

#### 3.CHECK WARNING SYSTEMS SWITCH GROUND CIRCUIT

Check continuity between warning systems switch harness connector terminal and the ground.

Warning systems switch		Ground	Continuity
Connector	Terminal		
M126	8		Yes

Is the inspection result normal?

- YES >> GO TO 4.

A  
B  
C  
D  
E  
F  
G  
H  
I  
J  
K  
L  
M  
N  
P

DAS

# WARNING SYSTEMS SWITCH CIRCUIT

[LDW & LDP]

< DTC/CIRCUIT DIAGNOSIS >

NO >> Repair harness or connector.

## 4. CHECK WARNING SYSTEMS SWITCH SIGNAL INPUT CIRCUIT FOR OPEN

1. Disconnect the ADAS control unit connector.
2. Check continuity between the ADAS control unit harness connector and warning systems switch harness connector.

ADAS control unit		Warning systems switch		Continuity
Connector	Terminal	Connector	Terminal	
B104	1	M126	6	Yes

Is the inspection result normal?

YES >> GO TO 5.

NO >> Repair the harnesses or connectors.

## 5. CHECK WARNING SYSTEMS SWITCH SIGNAL INPUT CIRCUIT FOR SHORT

Check continuity between the ADAS control unit harness connector and ground.

ADAS control unit		Ground	Continuity
Connector	Terminal		
B104	1		No

Is the inspection result normal?

YES >> Replace the ADAS control unit. Refer to [DAS-79, "Removal and Installation"](#).

NO >> Repair the harnesses or connectors.

## Component Inspection

INFOID:000000009716726

## 1. CHECK WARNING SYSTEMS SWITCH

Check continuity of warning systems switch.

Terminal		Condition	Continuity
6	8	When warning systems switch is pressed	Yes
		When warning systems switch is released	No

Is the inspection result normal?

YES >> Inspection End.

NO >> Replace warning systems switch.

# WARNING SYSTEMS ON INDICATOR CIRCUIT

< DTC/CIRCUIT DIAGNOSIS >

[LDW & LDP]

## WARNING SYSTEMS ON INDICATOR CIRCUIT

### Component Function Check

INFOID:000000009716727

#### 1. CHECK WARNING SYSTEMS ON INDICATOR

1. Turn the ignition switch ON.
2. Select the active test item "WARNING SYSTEM IND" of "ICC/ADAS" with CONSULT.
3. With operating the test item, check the operation.

**On** : Warning systems ON indicator illuminates

**Off** : Warning systems ON indicator is turned OFF

Is the inspection result normal?

YES >> Inspection End.

NO >> Refer to [DAS-447, "Diagnosis Procedure"](#).

### Diagnosis Procedure

INFOID:000000009716728

Regarding Wiring Diagram information, refer to [DAS-367, "Wiring Diagram"](#).

#### 1. CHECK WARNING ON INDICATOR POWER SUPPLY CIRCUIT

1. Turn ignition switch OFF.
2. Disconnect warning systems switch connector.
3. Turn ignition switch ON.
4. Check voltage between warning systems switch harness connector and ground.

Terminals		Voltage (Approx.)
(+)	(-)	
Warning systems switch		Ground Battery voltage
Connector	Terminal	
M126	5	

Is the inspection result normal?

YES >> GO TO 2.

NO >> Repair the warning systems ON indicator power supply circuit.

#### 2. CHECK WARNING SYSTEMS ON INDICATOR SIGNAL FOR OPEN

1. Turn ignition switch OFF.
2. Disconnect the ADAS control unit harness connector.
3. Check continuity between the ADAS control unit harness connector and warning systems switch harness connector.

ADAS control unit		Warning systems switch		Continuity
Connector	Terminal	Connector	Terminal	
B104	4	M126	3	Yes

Is the inspection result normal?

YES >> GO TO 3.

NO >> Repair the harnesses or connectors.

#### 3. CHECK WARNING SYSTEMS ON INDICATOR SIGNAL CIRCUIT FOR SHORT

Check continuity between the ADAS control unit harness connector and ground.

A  
B  
C  
D  
E  
F  
G  
H  
I  
J  
K  
L  
M  
N  
P

# WARNING SYSTEMS ON INDICATOR CIRCUIT

< DTC/CIRCUIT DIAGNOSIS >

[LDW & LDP]

ADAS control unit		Ground	Continuity
Connector	Terminal		
B104	4		No

Is the inspection result normal?

YES >> GO TO 4.

NO >> Repair the harnesses or connectors.

## 4.CHECK WARNING SYSTEMS ON INDICATOR

Check the warning systems ON indicator. Refer to [DAS-448, "Component Inspection"](#).

Is the inspection result normal?

YES >> Replace the ADAS control unit. Refer to [DAS-79, "Removal and Installation"](#).

NO >> Replace warning systems switch. [DAS-460, "Removal and Installation"](#).

## Component Inspection

INFOID:000000009716729

## 1.CHECK WARNING SYSTEMS ON INDICATOR

Apply battery voltage to warning systems switch terminals 5 and 3, and then check if the warning systems ON indicator illuminates.

Terminals		Condition	Warning systems ON indicator
(+)	(-)		
5	3	When the battery voltage is applied	On
		When the battery voltage is not applied	Off

Is the inspection result normal?

YES >> Inspection End.

NO >> Replace the warning systems switch. Refer to [DAS-460, "Removal and Installation"](#).

# WARNING BUZZER CIRCUIT

< DTC/CIRCUIT DIAGNOSIS >

[LDW & LDP]

## WARNING BUZZER CIRCUIT

### Component Function Check

INFOID:000000009716730

#### 1. CHECK WARNING BUZZER

1. Turn the ignition switch ON.
2. Select the active test item "LDP BUZZER" of "ICC/ADAS" with CONSULT.
3. With operating the test item, check the operation.

**On** : Warning buzzer is activated.

**Off** : Warning buzzer is not activated.

Is the inspection result normal?

YES >> Inspection End.

NO >> Refer to [DAS-449, "Diagnosis Procedure"](#).

### Diagnosis Procedure

INFOID:000000009716731

Regarding Wiring Diagram information, refer to [DAS-367, "Wiring Diagram"](#).

#### 1. CHECK WARNING BUZZER POWER SUPPLY CIRCUIT

1. Turn ignition switch OFF.
2. Disconnect the warning buzzer connector.
3. Turn ignition switch ON.
4. Check voltage between the warning buzzer harness connector and ground.

Terminals		Voltage (Approx.)
(+)	(-)	
Warning buzzer		Ground
Connector	Terminal	
M60	1	
		Battery voltage

Is the inspection result normal?

YES >> GO TO 2.

NO >> Repair the warning buzzer power supply circuit.

#### 2. CHECK WARNING BUZZER GROUND CIRCUIT

1. Turn ignition switch OFF.
2. Check continuity between the warning buzzer harness connector and ground.

Warning buzzer		Ground	Continuity
Connector	Terminal		
M60	3		Yes

Is the inspection result normal?

YES >> GO TO 3.

NO >> Repair the harnesses or connectors.

#### 3. CHECK WARNING BUZZER SIGNAL CIRCUIT FOR OPEN

1. Disconnect the ADAS control unit connector.
2. Check continuity between the ADAS control unit harness connector and warning buzzer harness connector.

# WARNING BUZZER CIRCUIT

< DTC/CIRCUIT DIAGNOSIS >

[LDW & LDP]

ADAS control unit		Warning buzzer		Continuity
Connector	Terminal	Connector	Terminal	
B104	12	M60	2	Yes

Is the inspection result normal?

YES >> GO TO 4.

NO >> Repair the harnesses or connectors.

## 4.CHECK WARNING BUZZER SIGNAL CIRCUIT FOR SHORT

Check continuity between the ADAS control unit harness connector and ground.

ADAS control unit		Ground	Continuity
Connector	Terminal		
B104	12		No

Is the inspection result normal?

YES >> GO TO 5.

NO >> Repair the harnesses or connectors.

## 5.CHECK WARNING BUZZER OPERATION

1. Connect the warning buzzer connector.
2. Turn ignition switch ON.
3. Apply ground to warning buzzer terminal 2.
4. Check condition of the warning buzzer.

Does warning buzzer sound?

YES >> Replace the ADAS control unit. Refer to [DAS-79. "Removal and Installation"](#).

NO >> Replace the warning buzzer.

# LDW & LDP SYSTEM SYMPTOMS

< SYMPTOM DIAGNOSIS >

[LDW & LDP]

## SYMPTOM DIAGNOSIS

### LDW & LDP SYSTEM SYMPTOMS

#### Symptom Table

INFOID:000000009716732

**NOTE:**

For the operational conditions of Lane Departure Warning (LDW) and Lane Departure Prevention (LDP), refer to the following descriptions.

- LDW: [DAS-322. "LANE DEPARTURE WARNING \(LDW\) SYSTEM : System Description"](#)
- LDP: [DAS-325. "LANE DEPARTURE PREVENTION \(LDP\) SYSTEM : System Description"](#)

Symptom	Possible cause	Inspection item/Reference page	
Indicator/warning lamps do not illuminate when ignition switch OFF ⇒ ON	Lane departure warning indicator light (Yellow) does not illuminate.	<ul style="list-style-type: none"> <li>• Combination meter</li> <li>• ADAS control unit</li> </ul>	Lane departure warning indicator light does not turned ON Refer to <a href="#">DAS-453. "Description"</a>
	LDP ON indicator lamp (Green) does not illuminate.	<ul style="list-style-type: none"> <li>• Combination meter</li> <li>• ADAS control unit</li> </ul>	LDP ON indicator lamp does not turned ON Refer to <a href="#">DAS-454. "Description"</a>
	Warning systems ON indicator does not illuminate.	<ul style="list-style-type: none"> <li>• Harness between ADAS control unit and warning systems switch</li> <li>• Warning systems switch</li> <li>• ADAS control unit</li> </ul>	Warning systems ON indicator circuit Refer to <a href="#">DAS-447. "Component Function Check"</a>
	Lane departure warning indicator light (Yellow) and LDP ON indicator lamp (Green) does not illuminate.	<ul style="list-style-type: none"> <li>• Combination meter</li> <li>• ADAS control unit</li> </ul>	<ul style="list-style-type: none"> <li>• Lane departure warning indicator light does not turned ON Refer to <a href="#">DAS-453. "Description"</a></li> <li>• LDP ON indicator lamp does not turned ON Refer to <a href="#">DAS-454. "Description"</a></li> </ul>
	All of indicator/warning lamps does not illuminate; <ul style="list-style-type: none"> <li>• Lane departure warning indicator light (Yellow)</li> <li>• LDP ON indicator lamp (Green)</li> <li>• Warning systems ON indicator</li> </ul>	<ul style="list-style-type: none"> <li>• Power supply and ground circuit of ADAS control unit</li> <li>• ADAS control unit</li> </ul>	Power supply and ground circuit of ADAS control unit Refer to <a href="#">DAS-443. "ADAS CONTROL UNIT : Diagnosis Procedure"</a>
LDW system is not activated. (Indicator/warning lamps illuminate when ignition switch OFF ⇒ ON)	Warning systems ON indicator is not turned ON ⇔ OFF when operating warning systems switch	<ul style="list-style-type: none"> <li>• Harness between ADAS control unit and warning systems switch</li> <li>• Harness between warning systems switch and ground</li> <li>• Warning systems switch</li> <li>• ADAS control unit</li> </ul>	<ul style="list-style-type: none"> <li>• Warning systems switch circuit Refer to <a href="#">DAS-445. "Component Function Check"</a></li> <li>• LDW system setting can not be turned ON/OFF on the navigation screen Refer to <a href="#">DAS-456. "Diagnosis Procedure"</a></li> </ul>
	Warning buzzer is not sounding. (Lane departure warning indicator light is activated.)	<ul style="list-style-type: none"> <li>• Harness between the IPDM E/R and warning buzzer</li> <li>• Harness between ADAS control unit and warning buzzer</li> <li>• Harness between warning buzzer and ground</li> <li>• Warning buzzer</li> <li>• ADAS control unit</li> </ul>	Warning buzzer circuit Refer to <a href="#">DAS-449. "Component Function Check"</a>

A  
B  
C  
D  
E  
F  
G  
H  
I  
J  
K  
L  
M  
N  
P

DAS

# LDW & LDP SYSTEM SYMPTOMS

< SYMPTOM DIAGNOSIS >

[LDW & LDP]

Symptom	Possible cause	Inspection item/Reference page
LDP system is not activated. (LDW system is functioning normally)	<ul style="list-style-type: none"> <li>• Dynamic driver assistance switch</li> <li>• Combination meter</li> <li>• ADAS control unit</li> <li>• AV control unit</li> </ul>	<ul style="list-style-type: none"> <li>• Dynamic driver assistance switch (ICC steering switch) Refer to <a href="#">DAS-410, "Component Inspection"</a></li> <li>• LDP system setting can not be turned ON/OFF in the vehicle information display Refer to <a href="#">DAS-456, "Description"</a></li> </ul>
	—	<ul style="list-style-type: none"> <li>• Cause of auto-cancel 2 Refer to <a href="#">DAS-336, "CONSULT Function (ICC/ADAS)"</a></li> <li>• Normal operating condition Refer to <a href="#">DAS-457, "Description"</a></li> </ul>
Warning functions are not timely (Example) <ul style="list-style-type: none"> <li>• Does not function when driving on lane markers</li> <li>• Functions when driving in a lane</li> <li>• Functions in a different position from the actual position.</li> </ul>	<ul style="list-style-type: none"> <li>• Camera aiming adjustment</li> <li>• Lane camera unit</li> <li>• ADAS control unit</li> </ul>	Camera aiming adjustment <a href="#">DAS-396, "Description"</a>
Functions when changing the course in direction of the turn signal	Turn indicator signal (CAN) <ul style="list-style-type: none"> <li>• BCM</li> <li>• ADAS control unit</li> </ul>	System operates even when using turn signal Refer to <a href="#">DAS-455, "Description"</a>



# LANE DEPARTURE WARNING LAMP DOES NOT TURNED ON

< SYMPTOM DIAGNOSIS >

[LDW & LDP]

## LANE DEPARTURE WARNING LAMP DOES NOT TURNED ON

### Description

INFOID:000000009716733

The lane departure warning lamp in the combination meter does not turn ON when turning on the ignition switch

### Diagnosis Procedure

INFOID:000000009716734

#### 1. CHECK LANE DEPARTURE WARNING LAMP

1. Check that "LANE DEPARTURE W/L" operate normally in "ACTIVE TEST" of "ICC/ADAS".
2. Operate the test items to check that the lane departure warning lamp blinks

Is the inspection result normal?

- YES >> GO TO 4.
- NO >> GO TO 2.

#### 2. CHECK COMBINATION METER

Turn the ignition switch from OFF to ON to check that "LANE W/L" included in "DATA MONITOR" in "METER/M&A" operates normally.

Is the inspection result normal?

- YES >> Replace the combination meter. Refer to [MWI-95, "Removal and Installation"](#).
- NO >> GO TO 3.

#### 3. CHECK SELF-DIAGNOSIS RESULTS OF COMBINATION METER

1. Perform "All DTC Reading" with CONSULT.
2. Check if the DTC is detected in self-diagnosis results of "METER/M&A". Refer to [MWI-26, "DTC Index"](#).

Is any DTC detected?

- YES >> Repair or replace malfunctioning parts.
- NO >> GO TO 4.

#### 4. CHECK SELF-DIAGNOSIS RESULTS OF ADAS CONTROL UNIT

Check if the DTC is detected in self-diagnosis results of "ICC/ADAS" Refer to [DAS-359, "DTC Index"](#).

Is any DTC detected?

- YES >> Repair or replace malfunctioning parts.
- NO >> Replace the ADAS control unit. Refer to [DAS-79, "Removal and Installation"](#).

A  
B  
C  
D  
E  
F  
G  
H  
I  
J  
K  
L  
M  
N  
P

DAS

# LDP ON INDICATOR LAMP DOES NOT TURNED ON

< SYMPTOM DIAGNOSIS >

[LDW & LDP]

## LDP ON INDICATOR LAMP DOES NOT TURNED ON

### Description

INFOID:000000009716735

The LDP ON indicator lamp in the combination meter does not turn ON when turning on the ignition switch

### Diagnosis Procedure

INFOID:000000009716736

#### 1. CHECK LDP ON INDICATOR LAMP

1. Check that "LDP ON IND" operate normally in "ACTIVE TEST" of "ICC/ADAS".
2. Check if the LDP ON indicator lamp illuminates when operates each test item.

Is the inspection result normal?

- YES >> GO TO 4.
- NO >> GO TO 2.

#### 2. CHECK COMBINATION METER

Turn the ignition switch from OFF to ON to check that "LDP IND" included in "DATA MONITOR" in "METER/M&A" operates normally.

Is the inspection result normal?

- YES >> Replace the combination meter. Refer to [MWI-95. "Removal and Installation"](#).
- NO >> GO TO 3.

#### 3. CHECK SELF-DIAGNOSIS RESULTS OF COMBINATION METER

1. Perform "All DTC Reading" with CONSULT.
2. Check if the DTC is detected in self-diagnosis results of "METER/M&A" Refer to [MWI-26. "DTC Index"](#).

Is any DTC detected?

- YES >> Repair or replace malfunctioning parts.
- NO >> GO TO 4.

#### 4. CHECK SELF-DIAGNOSIS RESULTS OF ADAS CONTROL UNIT

Check if the DTC is detected in self-diagnosis results of "ICC/ADAS" Refer to [DAS-359. "DTC Index"](#).

Is any DTC detected?

- YES >> Repair or replace malfunctioning parts.
- NO >> Replace the ADAS control unit. Refer to [DAS-79. "Removal and Installation"](#).

# THE SYSTEM OPERATES EVEN WHEN USING TURN SIGNAL

< SYMPTOM DIAGNOSIS >

[LDW & LDP]

## THE SYSTEM OPERATES EVEN WHEN USING TURN SIGNAL

### Description

INFOID:000000009716737

The warning of Lane Departure Warning (LDW) and Lane Departure Prevention (LDP) and the yaw moment control are activated during the use of a turn signal.

#### NOTE:

For the operational conditions of Lane Departure Warning (LDW) and Lane Departure Prevention (LDP), refer to the following descriptions.

- LDW: [DAS-322. "LANE DEPARTURE WARNING \(LDW\) SYSTEM : System Description"](#)
- LDP: [DAS-325. "LANE DEPARTURE PREVENTION \(LDP\) SYSTEM : System Description"](#)

### Diagnosis Procedure

INFOID:000000009716738

#### 1. CHECK TURN SIGNAL OPERATION

Check that both right and left turn signals are normal.

Is the inspection result normal?

YES >> GO TO 2.

NO >> Repair or replace malfunctioning parts. Refer to [DAS-451. "Symptom Table"](#).

#### 2. CHECK SELF-DIAGNOSIS RESULTS

1. Perform "All DTC Reading" with CONSULT.

2. Check if the DTC is detected in self-diagnosis results of "ICC/ADAS" Refer to [DAS-359. "DTC Index"](#).

Is any DTC detected?

YES >> Perform diagnosis on the detected DTC and repair or replace the malfunctioning parts.

NO >> Replace ADAS control unit. Refer to [DAS-79. "Removal and Installation"](#).

A  
B  
C  
D  
E  
F  
G  
H  
I  
J  
K  
L  
M  
N  
P

DAS

# LDW/LDP SYSTEM SETTINGS CANNOT BE TURNED ON/OFF IN VEHICLE INFORMATION DISPLAY

< SYMPTOM DIAGNOSIS >

[LDW & LDP]

## LDW/LDP SYSTEM SETTINGS CANNOT BE TURNED ON/OFF IN VEHICLE INFORMATION DISPLAY

### Description

INFOID:000000009716739

- LDW system setting is not selectable in the vehicle information display.
- LDP system setting is not selectable in the vehicle information display.

#### NOTE:

When the ignition switch is in ACC position, LDW or LDP system settings cannot be changed.

- "Lane Departure Warning" or "Lane Departure Prevention" is not indicated in the vehicle information display.
- The switching between ON and OFF cannot be performed by operating the vehicle information display.
- The item of "Lane Departure Warning" or "Lane Departure Prevention" in the vehicle information display is not active.
- After turning ON the ignition switch or starting the engine, LDW or LDP settings of the vehicle information display cannot be selected for several tens of seconds under the following conditions:
  - After replacing AV control unit.
  - After erasing connection history of the vehicle information display.
  - After erasing self-diagnosis results of the meter unit.
- The LDW or LDP system setting differs from the one set at the previous driving.

#### NOTE:

Turn OFF the ignition switch and wait for 5 seconds or more.

### Diagnosis Procedure

INFOID:000000009716740

#### 1. CHECK LDP SYSTEM SETTING

1. Start the engine.
2. Check that the LDP system settings is selectable in the vehicle information display.

Is the inspection result normal?

- YES >> GO TO 3.
- NO >> GO TO 2.

#### 2. PERFORM THE SELF-DIAGNOSIS

1. Perform "All DTC Reading" with CONSULT.
2. Check if the DTC is detected in self-diagnosis results of "ICC/ADAS" and "METER/M&A". Refer to the following.
  - ICC/ADAS: [DAS-359, "DTC Index"](#).
  - METER/M&A: [MWI-26, "DTC Index"](#).

Is any DTC detected?

- YES >> Repair or replace malfunctioning parts.
- NO >> INSPECTION END

#### 3. CHECK DATA MONITOR OF ADAS CONTROL UNIT

Check that "LDP SELECT" operates normally in "DATA MONITOR" of "ICC/ADAS" with CONSULT.

Is the inspection result normal?

- YES >> Refer to [DAS-325, "LANE DEPARTURE PREVENTION \(LDP\) SYSTEM : System Description"](#).
- NO >> GO TO 4.

#### 4. CHECK THE VEHICLE INFORMATION DISPLAY SWITCH

Operate the vehicle information display switch to check that the vehicle information display operates properly.

Is the inspection result normal?

- YES >> Replace the ADAS control unit. Refer to [DAS-79, "Removal and Installation"](#).
- NO >> Repair or replace malfunctioning parts.

# NORMAL OPERATING CONDITION

< SYMPTOM DIAGNOSIS >

[LDW & LDP]

## NORMAL OPERATING CONDITION

### Description

INFOID:000000009716741

#### PRECAUTIONS FOR LANE DEPARTURE WARNING (LDW)

- LDW system is only a warning device to inform the driver of a potential unintended lane departure. It will not steer the vehicle or prevent loss of control. It is the driver's responsibility to stay alert, drive safely, keep the vehicle in the traveling lane, and be in control of the vehicle at all times.
- LDW system will not operate at speeds below approximately 70 km/h (45 MPH) or if it cannot detect lane markers.
- Excessive noise will interfere with the warning chime sound, and the chime may not be heard.
- LDW system may not function properly under the following conditions:
  - On roads where there are multiple parallel lane markers; lane markers that are faded or not painted clearly; yellow painted lane markers; non-standard lane markers; or lane markers covered with water, dirt or snow, etc.
  - On roads where the discontinued lane markers are still detectable.
  - On roads where there are sharp curves.
  - On roads where there are sharply contrasting objects, such as shadows, snow, water, wheel ruts, seams or lines remaining after road repairs. (The LDW system could detect these items as lane markers.)
  - On roads where the traveling lane merges or separates.
  - When the vehicle's traveling direction does not align with the lane marker.
  - When traveling close to other vehicle in front of the vehicle, which obstructs the lane camera unit detection range.
  - When rain, snow or dirt adheres to the windshield in front of the lane camera unit.
  - When the headlights are not bright due to dirt on the lens or if the aiming is not adjusted properly.
  - When strong light enters the lane camera unit. (For example, the light directly shines on the front of the vehicle at sunrise or sunset.)
  - When a sudden change in brightness occurs. (For example, when the vehicle enters or exits a tunnel or under a bridge.)

#### PRECAUTIONS FOR LANE DEPARTURE PREVENTION (LDP)

- LDP system will not steer the vehicle or prevent loss of control. It is the driver's responsibility to stay alert, drive safely, keep the vehicle in the traveling lane, and be in control of vehicle at all times.
- LDP system is primarily intended for use on well-developed freeways or highways. It may not detect the lane markers in certain roads, weather or driving conditions.
- Using the LDP system under some conditions of road, lane marker or weather, or when driver change lanes without using the turn signal could lead to an unexpected system operation. In such conditions, driver needs to correct the vehicle's direction with driver's steering operation to avoid accidents.
- When the LDP system is operating, avoid excessive or sudden steering maneuvers. Otherwise, driver could lose control of the vehicle.
- The LDP system will not operate at speeds below approximately 70 km/h (45 MPH) or if it cannot detect lane markers.
- The LDP system may not function properly under the following conditions, and do not use the LDP system:
  - During bad weather (rain, fog, snow, wind, etc.).
  - When driving on slippery roads, such as on ice or snow, etc.
  - When driving on winding or uneven roads.
  - When there is a lane closure due to road repairs.
  - When driving in a makeshift lane.
  - When driving on roads where the lane width is too narrow.
  - When driving with a tire that is not within normal tire conditions (for example, tire wear, low tire pressure, installation of spare tire, tire chains, non-standard wheels).
  - When the vehicle is equipped with non-original brake parts or suspension parts.
- Excessive noise will interfere with the warning chime sound, and the chime may not be heard.
- The functions of the LDP system (warning and brake control assist) may or may not operate properly under the following conditions:
  - On roads where there are multiple parallel lane markers; lane markers that are faded or not painted clearly; yellow painted lane markers; non-standard lane markers or lane markers covered with water, dirt or snow, etc.
  - On roads where discontinued lane markers are still detectable.
  - On roads where there are sharp curves.

A

B

C

D

E

F

G

H

I

J

K

L

M

N

DAS

P

## NORMAL OPERATING CONDITION

< SYMPTOM DIAGNOSIS >

[LDW & LDP]

- On roads where there are sharply contrasting objects, such as shadows, snow, water, wheel ruts, seams or lines remaining after road repairs (The LDP system could detect these items as lane markers.).
- On roads where the traveling lane merges or separates.
- When the vehicle's traveling direction does not align with the lane marker.
- When traveling close to other vehicle in front of the vehicle, which obstructs the lane camera unit detection range.
- When rain, snow or dirt adheres to the windshield in front of the lane camera unit.
- When the headlights are not bright due to dirt on the lens or if the aiming is not adjusted properly.
- When strong light enters the lane camera unit (For example, the light directly shines on the front of the vehicle at sunrise or sunset.)
- When a sudden change in brightness occurs (For example, when the vehicle enters or exits a tunnel or under a bridge.)
- While the LDP system is operating, driver may hear a sound of brake operation. This is normal and indicates that the LDP system is operating properly.

# LANE CAMERA UNIT

< REMOVAL AND INSTALLATION >

[LDW & LDP]

## REMOVAL AND INSTALLATION

### LANE CAMERA UNIT

Exploded View

INFOID:000000009716742

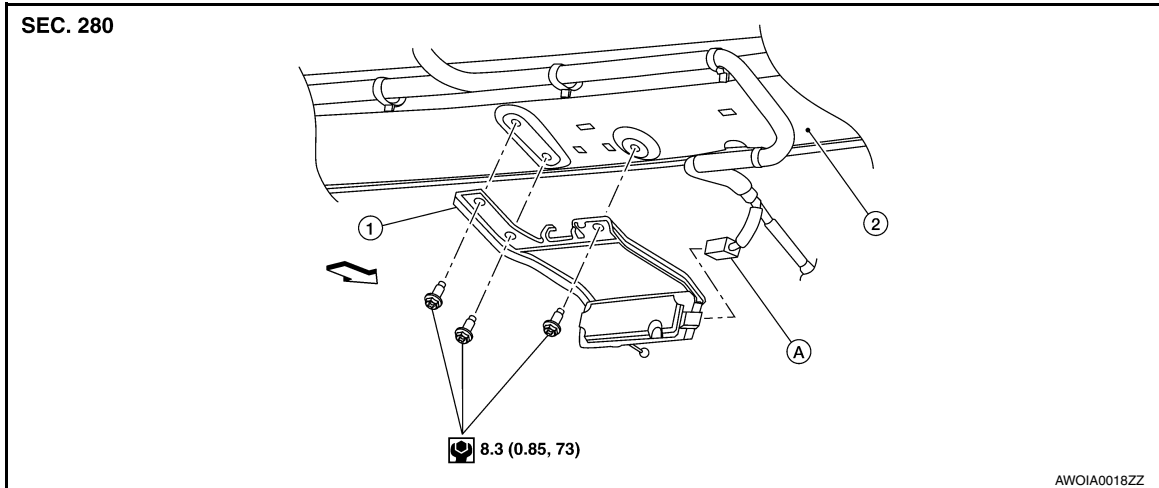

1. Lane camera unit

2. Roof rail

A. Lane camera unit harness connector

⇐ Front

### Removal and Installation

INFOID:000000009716743

#### REMOVAL

1. Partially remove the headlining. Refer to [INT-27, "Removal and Installation"](#).
2. Disconnect the lane camera unit harness connector from the lane camera unit.
3. Remove three lane camera bolts.
4. Remove lane camera unit.

#### INSTALLATION

Installation is in the reverse order of removal.

#### CAUTION:

- Remove the camera lens cover from the replacement lane camera unit before aiming.
- Do not drop or impact the lane camera unit.
- Perform additional service when replacing lane camera unit. Refer to [DAS-395, "Description"](#).

A  
B  
C  
D  
E  
F  
G  
H  
I  
J  
K  
L  
M  
N  
P

DAS

# WARNING SYSTEMS SWITCH

< REMOVAL AND INSTALLATION >

[LDW & LDP]

## WARNING SYSTEMS SWITCH

### Removal and Installation

INFOID:000000009730871

#### REMOVAL

1. Remove the instrument lower panel LH. Refer to [IP-25. "Removal and Installation"](#).
2. Remove three screws (A, B) that retain the lower switch carrier (2).  
(1): Upper switch carrier  
(2): Upper switch carrier screws
3. Release upper (B) and lower (C) tab using a suitable tool (A), then remove the warning system switch (1) from the lower switch carrier.  
(2): Headlamp aiming switch  
(3): AC 120V outlet main switch (if equipped)  
(4): Heated steering wheel switch

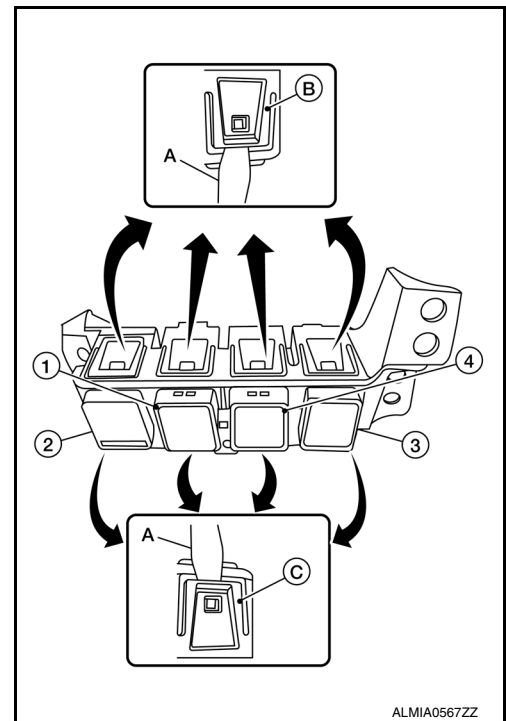
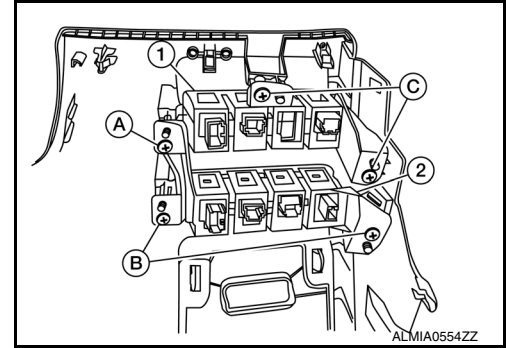

#### INSTALLATION

Installation is in the reverse order of removal.



# DYNAMIC DRIVER ASSISTANCE SWITCH

< REMOVAL AND INSTALLATION >

[LDW & LDP]

## DYNAMIC DRIVER ASSISTANCE SWITCH

### Removal and Installation

INFOID:000000009716745

The dynamic driver assistance switch and ICC steering switch are serviced as an assembly. Refer to [AV-885, "Removal and Installation"](#).

#### **CAUTION:**

Always perform the DCA system action test to check that the system operates normally after replacing the ICC sensor, replacing the accelerator pedal or repairing any DCA system malfunction. Refer to [DAS-155, "Work Procedure"](#).

A  
B  
C  
D  
E  
F  
G  
H  
I  
J  
K  
L  
M  
N  
P

DAS

# WARNING BUZZER

< REMOVAL AND INSTALLATION >

[LDW & LDP]

## WARNING BUZZER

### Removal and Installation

INFOID:000000009716746

#### REMOVAL

1. Remove the instrument lower panel LH. Refer to [IP-25. "Removal and Installation"](#).
2. Remove screw (←).
3. Disconnect the harness connector (A) from the warning buzzer (1).
4. Remove the warning buzzer (1).

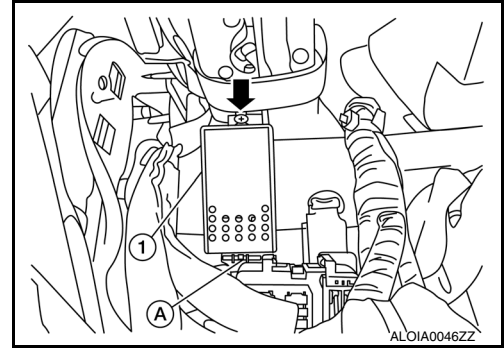

#### INSTALLATION

Installation is in the reverse order of removal.

# PRECAUTIONS

## [BLIND SPOT WARNING & BLIND SPOT INTERVENTION]

< PRECAUTION >

### PRECAUTION

#### PRECAUTIONS

##### Precaution for Supplemental Restraint System (SRS) "AIR BAG" and "SEAT BELT PRE-TENSIONER"

INFOID:000000009730869

The Supplemental Restraint System such as "AIR BAG" and "SEAT BELT PRE-TENSIONER", used along with a front seat belt, helps to reduce the risk or severity of injury to the driver and front passenger for certain types of collision. This system includes dual stage front air bag modules. The SRS system may only deploy one front air bag, depending on the severity of a collision and whether the front passenger seat is occupied. Information necessary to service the system safely is included in the SR and SB section of this Service Manual.

#### **WARNING:**

- To avoid rendering the SRS inoperative, which could increase the risk of personal injury or death in the event of a collision which would result in air bag inflation, all maintenance must be performed by an authorized NISSAN/INFINITI dealer.
- Improper maintenance, including incorrect removal and installation of the SRS, can lead to personal injury caused by unintentional activation of the system. For removal of Spiral Cable and Air Bag Module, see the SR section.
- Do not use electrical test equipment on any circuit related to the SRS unless instructed to in this Service Manual. SRS wiring harnesses can be identified by yellow and/or orange harnesses or harness connectors.

#### PRECAUTIONS WHEN USING POWER TOOLS (AIR OR ELECTRIC) AND HAMMERS

#### **WARNING:**

- When working near the Airbag Diagnosis Sensor Unit or other Airbag System sensors with the Ignition ON or engine running, DO NOT use air or electric power tools or strike near the sensor(s) with a hammer. Heavy vibration could activate the sensor(s) and deploy the air bag(s), possibly causing serious injury.
- When using air or electric power tools or hammers, always switch the Ignition OFF, disconnect the battery and wait at least three minutes before performing any service.

#### Precautions For Harness Repair

INFOID:000000009716748

ITS communication uses a twisted pair line. Be careful when repairing it.

- Solder the repaired area and wrap tape around the soldered area.

#### **NOTE:**

A fray of twisted lines must be within 110 mm (4.33 in).

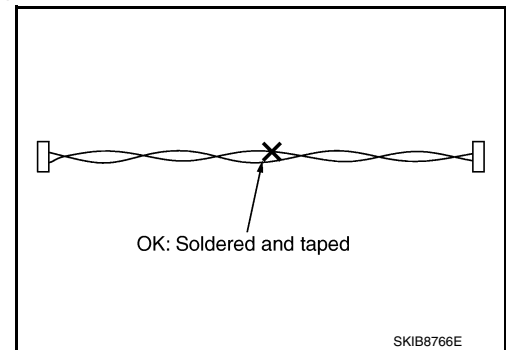

- Bypass connection is never allowed at the repaired area.

#### **NOTE:**

Bypass connection may cause ITS communication error. The spliced wire becomes separated and the characteristics of twisted line are lost.

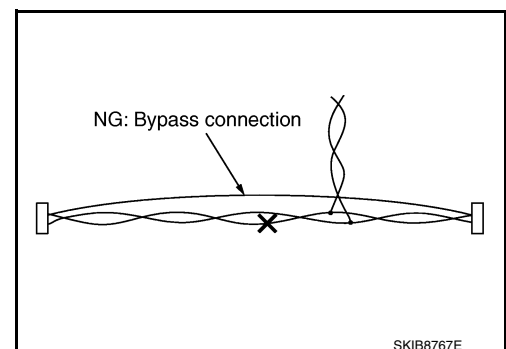

A  
B  
C  
D  
E  
F  
G  
H  
I  
J  
K  
L  
M  
N  
DAS  
P

## PRECAUTIONS

### [BLIND SPOT WARNING & BLIND SPOT INTERVENTION]

< PRECAUTION >

Precaution for Blind Spot Warning/Blind Spot Intervention System Service INFOID:000000009716749

#### **WARNING:**

Be careful of traffic conditions and safety around the vehicle when performing road test.

#### **CAUTION:**

- Do not use the Blind Spot Intervention system when driving with free rollers or a chassis dynamometer.
- Do not perform the active test while driving.
- Do not disassemble the lane camera unit.
- Do not use the lane camera unit that is removed from the vehicle.
- Do not change BSW initial state ON ⇒ OFF without the consent of the customer.

TO KEEP THE BLIND SPOT WARNING/BLIND SPOT INTERVENTION SYSTEM OPERATING PROPERLY, BE SURE TO OBSERVE THE FOLLOWING ITEMS:

#### Lane Camera Unit Maintenance

The lane camera unit for the LDW/LDP system is located above the inside mirror. To keep the proper operation of the LDW/LDP systems and prevent a system malfunction, be sure to observe the following:

- Always keep the windshield clean.
- Do not attach a sticker (including transparent material) or install an accessory near the camera unit.
- Do not place reflective materials, such as white paper or a mirror, on the instrument panel. The reflection of sunlight may adversely affect the camera unit capability of detecting the lane markers.
- Do not strike or damage the areas around the camera unit.
- Do not touch the camera lens or remove the screw located on the camera unit.

#### System Maintenance

The two side radar for the Blind Spot Warning and Blind Spot Intervention systems are located near the rear bumper.

- Always keep the area near the side radar clean.
- Do not attach stickers (including transparent material), install accessories or apply additional paint near the side radar.
- Do not strike or damage the area around the side radar.

# COMPONENT PARTS

[BLIND SPOT WARNING & BLIND SPOT INTERVENTION]

< SYSTEM DESCRIPTION >

## SYSTEM DESCRIPTION

### COMPONENT PARTS

#### Component Parts Location

INFOID:000000009716750

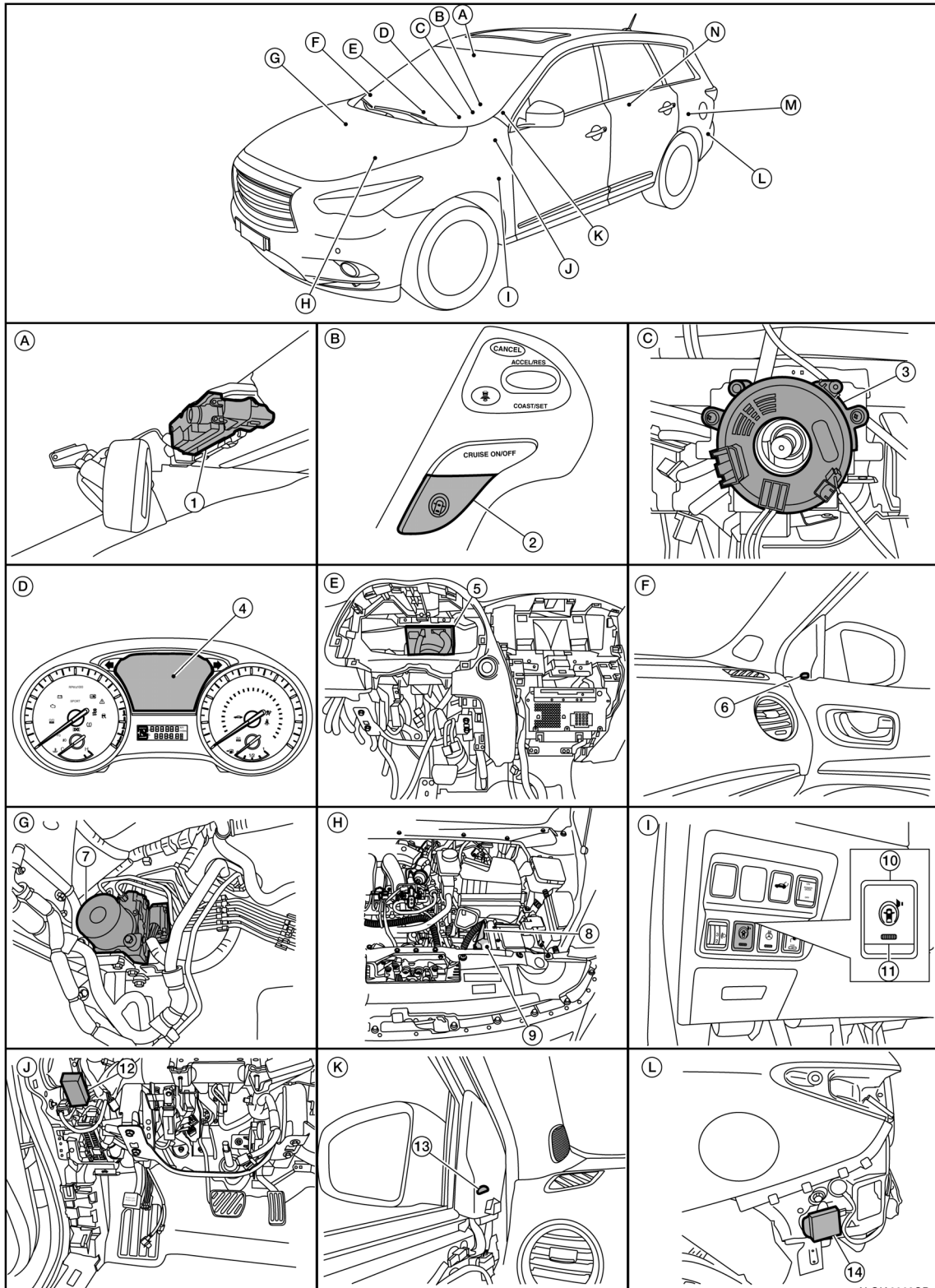

A  
B  
C  
D  
E  
F  
G  
H  
I  
J  
K  
L  
M  
N  
P

DAS

# COMPONENT PARTS

< SYSTEM DESCRIPTION >

[BLIND SPOT WARNING & BLIND SPOT INTERVENTION]

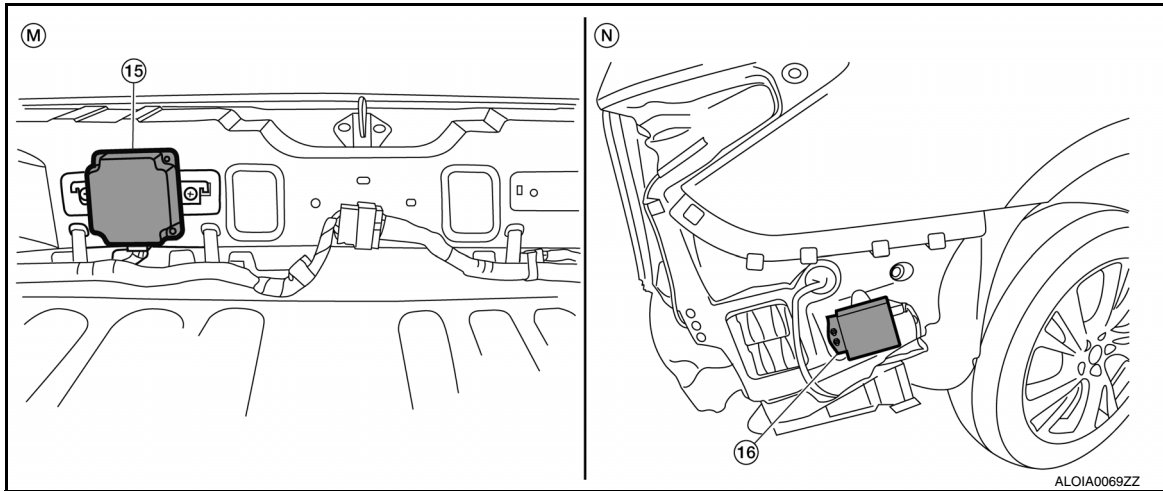

- |   |  |   |
|---|--|---|
| 1. Lane camera unit   | 2. ICC steering switch                                     | 3. Steering angle sensor<br>(view with steering wheel removed).                             |
| 4. Vehicle information display                              | 5. BCM (with the combination meter removed).               | 6. Blind Spot Warning/Blind Spot Intervention indicator RH                                  |
| 7. ABS actuator and electric unit (control unit).           | 8. ECM.  | 9. TCM.   |
| 10. Warning systems switch                                  | 11. Warning systems ON indicator                           | 12. Warning buzzer<br>(view with instrument panel LH removed)                               |
| 13. Blind Spot Warning/Blind Spot Intervention indicator LH | 14. Side radar LH<br>(view with rear bumper cover removed) | 15. ADAS control unit<br>(view of rear luggage room area with rear panel assembly removed). |
| 16. Side radar RH<br>(view with rear bumper cover removed)  |  |   |

## Component Description

INFOID:000000009716751

Component	Description
ADAS control unit	<ul style="list-style-type: none"> <li>• Being connected with side radar (LH and RH) via ITS communication, receives vehicle detection signal and transmits Blind Spot Warning/Blind Spot Intervention indicator signal and Blind Spot Warning/Blind Spot Intervention indicator dimmer signal to side radar</li> <li>• Being connected with lane camera unit via ITS communication, receives detected lane condition signal</li> <li>• Receives steering angle sensor signal from steering angle sensor via CAN communication</li> <li>• Judges a Blind Spot Warning/Blind Spot Intervention indicator ON/OFF state and an approach state to the lane marker, based on each signal and calculates yaw moment to help return the vehicle back to the center of the lane.</li> <li>• Transmits target yaw moment signal to ABS actuator and electric unit (control unit)</li> <li>• Activates the warning buzzer and warning systems ON indicator</li> <li>• Transmits Blind Spot Intervention ON indicator signal and Blind Spot Intervention warning lamp signal to combination meter via CAN communication</li> </ul>
Side radar LH/ RH	<ul style="list-style-type: none"> <li>• Being connected with ADAS control unit via ITS communication, transmits vehicle detection signal</li> <li>• Receives Blind Spot Intervention indicator signal and Blind Spot Intervention indicator dimmer signal from ADAS control unit and transmits an indicator operation signal to Blind Spot Intervention indicator LH/RH</li> <li>• RH side radar equips right/left switching signal circuit for identifying LH or RH because the parts of side radar are common for right and left</li> </ul>
Blind Spot Warning/Blind Spot Intervention indicator LH/ RH	Receives Blind Spot Warning/Blind Spot Intervention indicator operation signal from side radar LH/ RH and turns OFF, turns ON or blinks
Lane camera unit	<ul style="list-style-type: none"> <li>• Detects the lane marker by the built-in camera</li> <li>• Transmits detected lane condition signal to ADAS control unit</li> </ul>

## COMPONENT PARTS

### [BLIND SPOT WARNING & BLIND SPOT INTERVENTION]

< SYSTEM DESCRIPTION >

Component	Description
ABS actuator and electric unit (control unit)	<ul style="list-style-type: none"> <li>• Transmits vehicle speed signal to ADAS control unit via CAN communication</li> <li>• Transmits yaw rate signal/side G sensor signal to ADAS control unit via CAN communication</li> <li>• Receives a target yaw moment signal from the ADAS control unit via CAN communication and controls brake pressure of four wheels, respectively</li> </ul>
Warning systems switch	Inputs the switch signal to ADAS control unit
Dynamic driver assistance switch	Inputs the switch signal to ECM
Warning systems ON indicator (On the warning systems switch)	Indicates BSW system status
Warning buzzer	Receives buzzer signal from ADAS control unit and sounds buzzer.
Combination meter	<ul style="list-style-type: none"> <li>• Turns the Blind Spot Warning/Blind Spot Intervention warning lamp and Blind Spot Intervention ON indicator ON/OFF according to the signals from the ADAS control unit via CAN communication</li> <li>• Receives Blind Spot Intervention ON indicator signal, and Blind Spot Warning/Blind Spot Intervention warning lamp signal via CAN communication.</li> <li>• Transmits the system selection signal to ADAS control unit via CAN communication.</li> </ul>
Steering angle sensor	Transmits steering angle sensor signal to ADAS control unit via CAN communication
BCM	<ul style="list-style-type: none"> <li>• Transmits turn indicator signal to ADAS control unit via CAN communication</li> <li>• Transmits dimmer signal to ADAS control unit via CAN communication</li> </ul>
ECM	Transmits the accelerator pedal position signal, engine speed signal and ICC steering switch signal (dynamic driver assistance switch signal) to ADAS control unit via CAN communication
TCM	Transmits the output shaft speed signal, input speed signal, current gear position signal and shift position signal to ADAS control unit via CAN communication

A  
B  
C  
D  
E  
F  
G  
H  
I  
J  
K  
L  
M  
N  
P

DAS

# SYSTEM [BLIND SPOT WARNING & BLIND SPOT INTERVENTION]

< SYSTEM DESCRIPTION >

## SYSTEM

### BLIND SPOT WARNING (BSW) SYSTEM

### BLIND SPOT WARNING (BSW) SYSTEM : System Description

INFOID:000000009716752

#### SYSTEM DIAGRAM

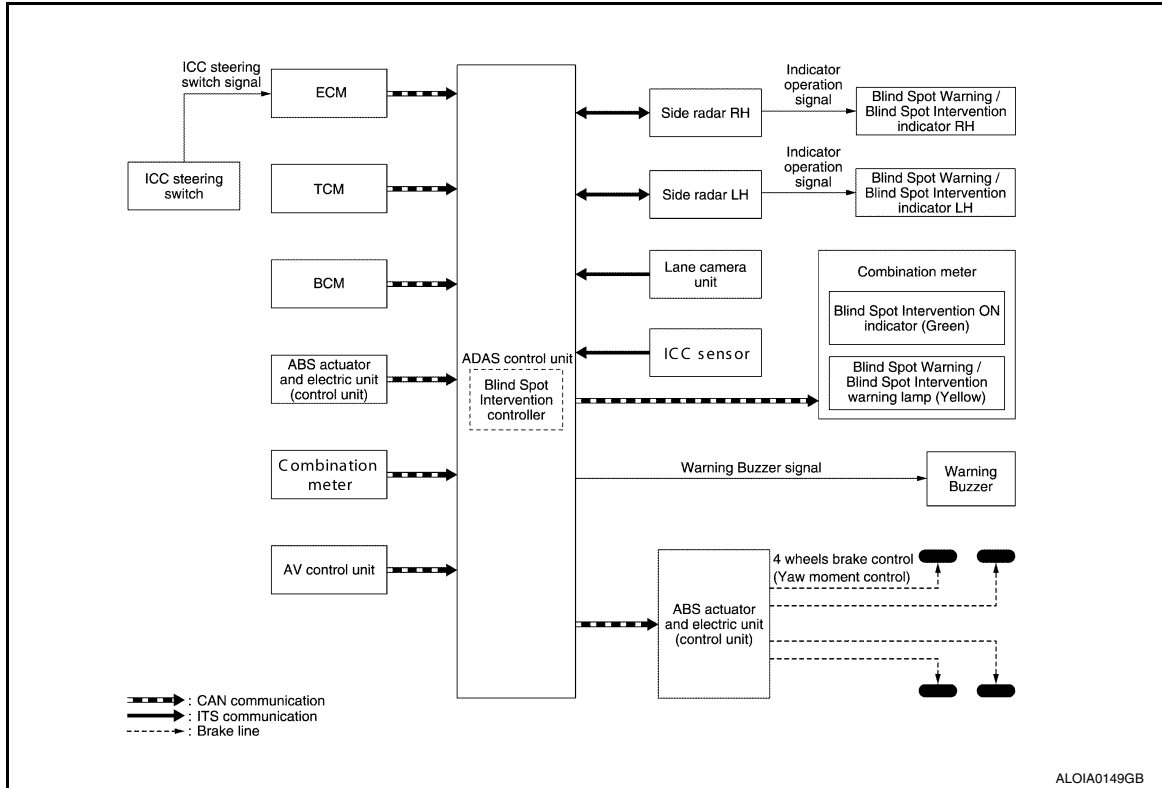

#### ADAS CONTROL UNIT INPUT/OUTPUT SIGNAL ITEM

ADAS control unit receives signals via CAN communication. It also detects vehicle conditions that are necessary for BSW control.

##### Input Signal Item

Transmit unit	Signal name	Description
TCM	CAN communication Shift position signal	Receives a selector lever position
ABS actuator and electric unit (control unit)	CAN communication Vehicle speed signal (ABS)	Receives wheel speeds of four wheels
BCM	CAN communication Turn indicator signal	Receives an operational state of the turn signal lamp and the hazard lamp
	Dimmer signal	Receives ON/OFF state of dimmer signal
Combination meter	CAN communication System selection signal	Receives a selection state of each item in "Driving Aids" selected with the vehicle information display
Side radar LH, RH	ITS communication Vehicle detection signal	Receives vehicle detection condition of detection zone.
Warning systems switch	Warning systems switch signal	Receives an ON/OFF state of the warning systems switch

##### Output Signal Item



# SYSTEM

## [BLIND SPOT WARNING & BLIND SPOT INTERVENTION]

< SYSTEM DESCRIPTION >

Reception unit	Signal name		Description
Combination meter	CAN communication	Blind Spot Warning/Blind Spot Intervention warning lamp signal	Transmits a Blind Spot Warning/Blind Spot Intervention warning lamp signal to turn ON the Blind Spot Warning/Blind Spot Intervention warning lamp
		Blind Spot Intervention ON indicator signal	Transmits a Blind Spot Intervention ON indicator lamp signal to turn ON the Blind Spot Intervention ON indicator lamp
Side radar LH, RH	ITS communication	Blind Spot Warning/Blind Spot Intervention indicator signal	Transmits a Blind Spot Warning/Blind Spot Intervention indicator signal to turn ON the Blind Spot Warning/Blind Spot Intervention indicator
		Blind Spot Warning/Blind Spot Intervention indicator dimmer signal	Transmits a Blind Spot Warning/Blind Spot Intervention indicator dimmer signal to dimmer Blind Spot Warning/Blind Spot Intervention indicator
		Vehicle speed signal	Transmits a vehicle speed calculated by the ADAS control unit
Warning systems ON indicator	Warning systems ON indicator signal		Turns ON the warning systems ON indicator
Warning buzzer	Warning buzzer operation signal		Activates the warning buzzer

### FUNCTION DESCRIPTION

- The BSW system can help alert the driver of other vehicles in adjacent lanes when changing lanes.
- The BSW system uses side radar installed near the rear bumper to detect vehicles in an adjacent lane.
- The side radar can detect vehicles on either side of vehicle within the detection zone shown as illustrated.
- This detection zone starts from the outside mirror of vehicle and extends approximately 10 ft (3.0 m) behind the rear bumper, and approximately 10 ft (3.0 m) sideways.
- The BSW system operates above approximately 32 km/h (20 MPH).
- If the side radar detects vehicles in the detection zone, the Blind Spot Warning/Blind Spot Intervention indicator illuminates.

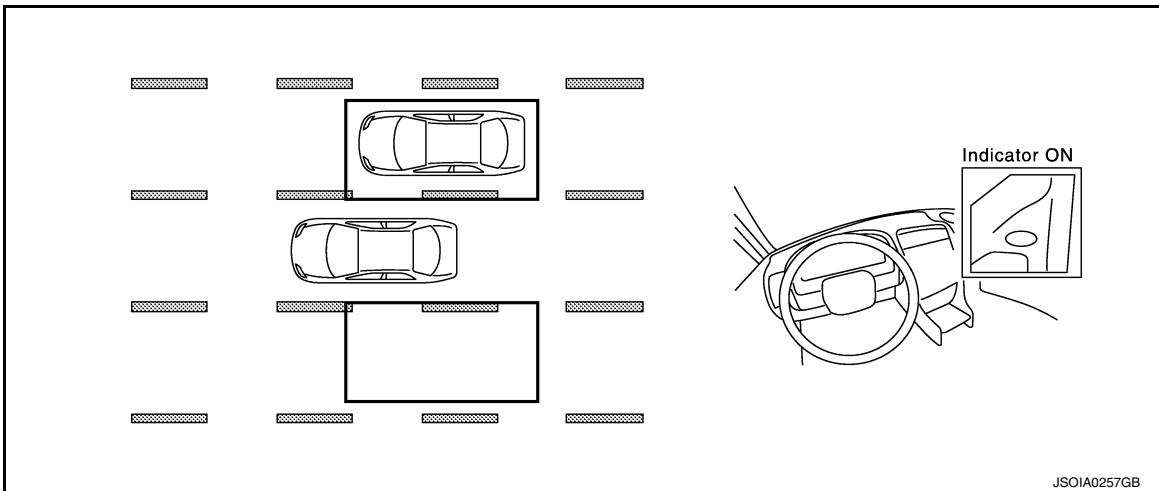

- If the driver then activates the turn signal, a buzzer will sound twice and the Blind Spot Warning/Blind Spot Intervention indicator will blink.

**NOTE:**

DAS

# SYSTEM [BLIND SPOT WARNING & BLIND SPOT INTERVENTION]

## < SYSTEM DESCRIPTION >

A buzzer sounds if the side radar have already detected vehicles when the driver activates the turn signal. If a vehicle comes into the detection zone after the driver activates the turn signal, then only the Blind Spot Warning/Blind Spot Intervention indicator blinks and no buzzer sounds.

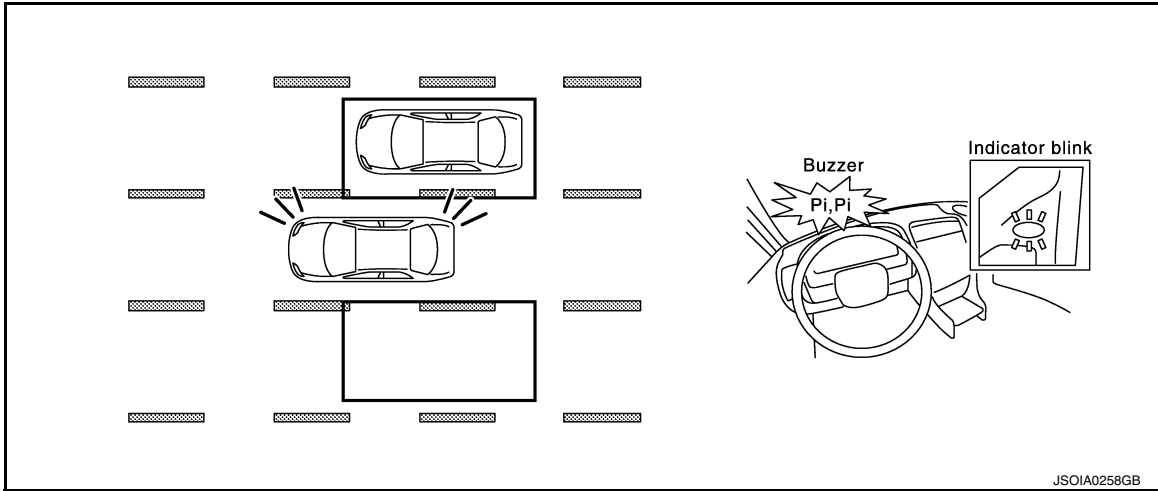

### BSW SYSTEM OPERATION DESCRIPTION

- ADAS control unit enables BSW system.
- The ADAS control unit turns on the BSW system when the warning systems switch is turned ON.
- Side radar detects a vehicle in the adjacent lane, and transmits the vehicle detection signal to ADAS control unit via ITS communication.
- ADAS control unit starts the control as follows, based on a vehicle detection signal, turn signal and dimmer signal transmitted from BCM via CAN communication:
  - Blind Spot Warning/Blind Spot Intervention indicator signal and Blind Spot Warning/Blind Spot Intervention indicator dimmer signal transmission to side radar.
  - Buzzer signal transmission to warning buzzer.
- Side radar transmits an indicator operation signal to the Blind Spot Warning/Blind Spot Intervention indicator according to Blind Spot Warning/Blind Spot Intervention indicator signal and Blind Spot Warning/Blind Spot Intervention indicator dimmer signal.

### Operation Condition of BSW System

ADAS control unit performs the control when the following conditions are satisfied.

- When the warning systems switch is turned ON\* or Blind Spot Intervention system turned ON.
- When the vehicle drives at 32 km/h (20 MPH) or more to the forward direction.

### NOTE:

- \*: When the BSW system setting in the vehicle information display is ON.
- After the operating conditions of warning are satisfied, the warning continues until the vehicle speed is reduced below approximately 29 km/h (18 MPH)
- The BSW system may not function properly, depending on the situation. Refer to [DAS-481, "Precautions for Blind Spot Warning/Blind Spot Intervention"](#).

### BULB CHECK ACTION AND FAIL-SAFE INDICATION

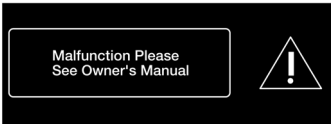
Vehicle condition/Driver's operation	Blind Spot Warning/ Blind Spot Intervention indicator	Warning systems ON indicator	Indication on the combination meter
When DTC is detected	OFF	ON	<p>OFF → Orange</p> 

ALOIA0099GB

# SYSTEM [BLIND SPOT WARNING & BLIND SPOT INTERVENTION]

## < SYSTEM DESCRIPTION >

Vehicle condition/Driver's operation	Blind Spot Warning/ Blind Spot Intervention indicator	Warning systems ON indicator	Indication on the combination meter
When radar blockage is detected	OFF	ON	Unavailable: Side Radar Obstruction
When the warning systems switch is pressed (When the settings of LDW system, FCW system, and BSW system in the vehicle information display are "OFF")	OFF	Blink	<div style="background-color: black; color: white; padding: 10px; width: fit-content; margin: 0 auto;">                     Unavailable All Systems are disable                 </div>

ALOIA0132GB

\*: Blinking cycle when the side radar blockage condition

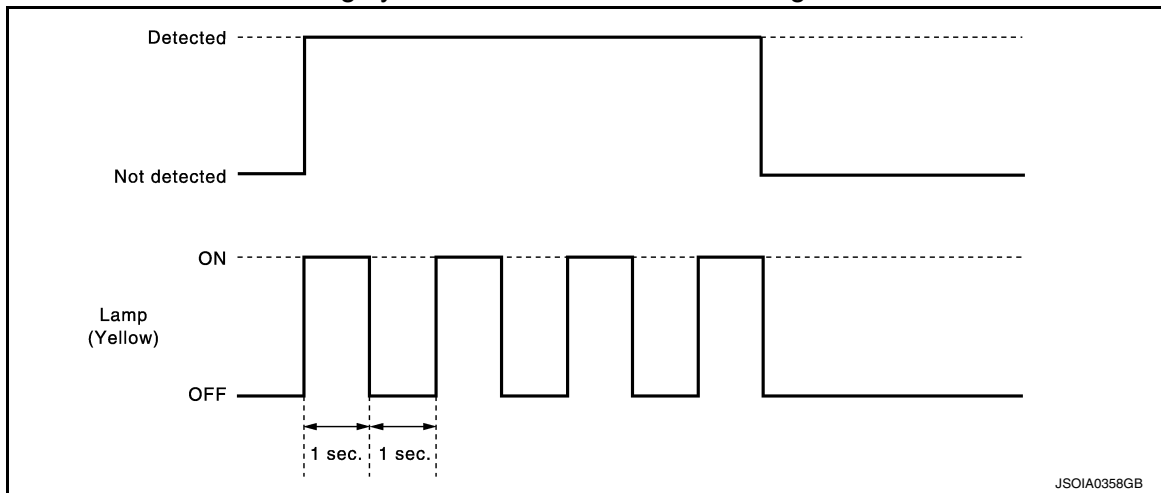

**NOTE:**

Time shown in the figure is approximate time.

### BLIND SPOT WARNING (BSW) SYSTEM : Fail-safe (ADAS Control Unit) INFOID:000000009716753

If a malfunction occurs in any system, ADAS control unit cancels each control, sounds a beep, and turns ON the warning lamp or indicator lamp or warning message will display.

System	Buzzer	Warning lamp/Indicator lamp	Description
Vehicle-to-vehicle distance control mode	High-pitched tone	ICC system warning lamp	Cancel
Conventional (fixed speed) cruise control mode	High-pitched tone	ICC system warning lamp	Cancel
Intelligent Brake Assist (IBA)	High-pitched tone	IBA OFF indicator lamp	Cancel
Forward Collision Warning (FCW)	High-pitched tone	Warning message	Cancel
Distance Control Assist (DCA)	High-pitched tone	ICC system warning lamp	Cancel
Lane Departure Warning (LDW)	—	Lane Departure Warning lamp	Cancel
Lane Departure Prevention (LDP)	Low-pitched tone	Lane Departure Warning lamp	Cancel
Blind Spot Warning (BSW)	—	Blind Spot Warning/Blind Spot Intervention warning lamp	Cancel
Blind Spot Intervention (BSI)	Low-pitched tone	Blind Spot Warning/Blind Spot Intervention warning lamp	Cancel
Backup Collision Intervention (BCI)	High-pitched tone	Backup Collision Intervention warning indicator	Cancel

A  
B  
C  
D  
E  
F  
G  
H  
I  
J  
K  
L  
M  
N  
P

DAS

# SYSTEM [BLIND SPOT WARNING & BLIND SPOT INTERVENTION]

< SYSTEM DESCRIPTION >

## BLIND SPOT WARNING (BSW) SYSTEM : Fail-safe (Side Radar)

INFOID:000000009716754

### FAIL-SAFE CONTROL BY DTC

If a malfunction occurs in the side radar, ADAS control unit cancels control, and a chime will sound and the "Please see owner's manual" message appears in the vehicle information display.

### TEMPORARY DISABLED STATUS AT BLOCKAGE

When the side radar is blocked, the operation is temporarily cancelled. Then the "Unavailable Side Radar Obstruction" message appears in the vehicle information display and the warning systems ON indicator will blink. Also, under the following conditions, the operation may be temporarily cancelled.

- The side radar may be blocked by temporary ambient conditions such as splashing water, mist or fog.
- The blocked condition may also be caused by objects such as ice, frost or dirt obstructing the side radar.

## BLIND SPOT INTERVENTION SYSTEM

### BLIND SPOT INTERVENTION SYSTEM : System Description

INFOID:000000009716755

### SYSTEM DIAGRAM

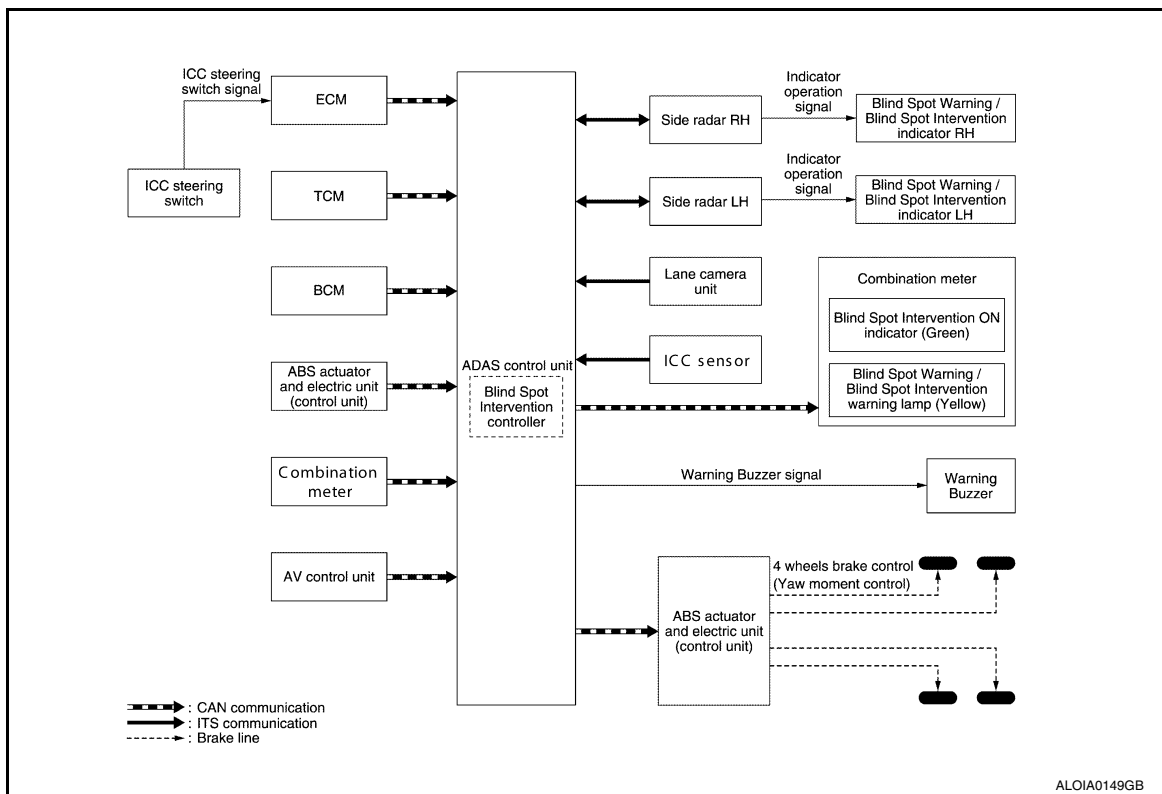

### ADAS CONTROL UNIT INPUT/OUTPUT SIGNAL ITEM

#### Input Signal Item

Transmit unit	Signal name		Description
ECM	CAN communication	Accelerator pedal position signal	Receives accelerator pedal position (angle)
		ICC steering switch signal	Receives the operational state of the ICC steering switch
		Engine speed signal	Receives engine speed
TCM	CAN communication	Input speed signal	Receives the number of revolutions of input shaft
		Current gear position signal	Receives a current gear position
		Shift position signal	Receives a select lever position
		Output shaft revolution signal	Receives the number of revolutions of output shaft

# SYSTEM [BLIND SPOT WARNING & BLIND SPOT INTERVENTION]

## < SYSTEM DESCRIPTION >

Transmit unit	Signal name	Description	
ABS actuator and electric unit (control unit)	CAN communication	ABS malfunction signal	Receives a malfunction state of ABS
		ABS operation signal	Receives an operational state of ABS
		TCS malfunction signal	Receives a malfunction state of TCS
		TCS operation signal	Receives an operational state of TCS
		VDC OFF switch signal	Receives an ON/OFF state of VDC
		VDC malfunction signal	Receives a malfunction state of VDC
		VDC operation signal	Receives an operational state of VDC
		Vehicle speed signal (ABS)	Receives wheel speeds of four wheels
		Yaw rate signal	Receives yaw rate acting on the vehicle
		Side G sensor signal	Receives lateral G acting on the vehicle
Combination meter	CAN communication	Parking brake switch signal	Receives an operational state of the parking brake
		System selection signal	Receives a selection state of each item in "Driving Aids" selected with the vehicle information display
BCM	CAN communication	Turn indicator signal	Receives an operational state of the turn signal lamp and the hazard lamp
		Dimmer signal	Receives ON/OFF state of dimmer signal
Steering angle sensor	CAN communication	Steering angle sensor malfunction signal	Receives a malfunction state of steering angle sensor
		Steering angle sensor signal	Receives the number of revolutions, turning direction of the steering wheel
		Steering angle speed signal	Receives the turning angle speed of the steering wheel
ICC sensor	ITS communication	ICC sensor signal	Receives detection results, such as the presence or absence of a leading vehicle and distance from the vehicle
Lane camera unit	ITS communication	Detection lane condition signal	Receives detection results of lane marker
Side radar LH, RH	ITS communication	Vehicle detection signal	Receives vehicle detection condition of detection zone.

## Output Signal Item

Reception unit	Signal name	Description	
ABS actuator and electric unit (control unit)	CAN communication	Target yaw moment signal	Transmits a target yaw moment signal to generate yaw moment to the vehicle
Combination meter	CAN communication	Blind Spot Warning/Blind Spot Intervention warning lamp signal	Transmits a Blind Spot Warning/Blind Spot Intervention warning lamp signal to turn ON the Blind Spot Warning/Blind Spot Intervention warning lamp
		Blind Spot Intervention ON indicator lamp signal	Transmits a Blind Spot Intervention ON indicator lamp signal to turn ON the Blind Spot Intervention ON indicator lamp
Lane camera unit	ITS communication	Vehicle speed signal	Transmits a vehicle speed calculated by the ADAS control unit
		Turn indicator signal	Transmits a turn indicator signal received from BCM

# SYSTEM [BLIND SPOT WARNING & BLIND SPOT INTERVENTION]

## < SYSTEM DESCRIPTION >

Reception unit	Signal name	Description
Side radar LH, RH	Blind Spot Warning/Blind Spot Intervention indicator signal	Transmits a Blind Spot Warning/Blind Spot Intervention indicator signal to turn ON the Blind Spot Warning/Blind Spot Intervention indicator
	Blind Spot Warning/Blind Spot Intervention indicator dimmer signal	Transmits a Blind Spot Warning/Blind Spot Intervention indicator dimmer signal to dimmer Blind Spot Warning/Blind Spot Intervention indicator
	Vehicle speed signal	Transmits a vehicle speed calculated by the ADAS control unit
Warning buzzer	Warning buzzer operation signal	Activates the warning buzzer

## FUNCTION DESCRIPTION

- The Blind Spot Intervention system can help alert the driver of other vehicles in adjacent lanes when changing lanes. Blind Spot Intervention always operates together with BSW.
- The Blind Spot Intervention system operates above approximately 60 km/h (37 MPH).
- The Blind Spot Intervention system uses side radar installed near the rear bumper to detect other vehicles beside vehicle in an adjacent lane.
- The side radar can detect vehicles on either side of vehicle within the detection zone shown as illustrated.
- This detection zone starts from the outside mirror of vehicle and extends approximately 10 ft (3.0 m) behind the rear bumper, and approximately 10 ft (3.0 m) sideways.
- If the Blind Spot Warning/Blind Spot Intervention indicator is illuminated while vehicle is approaching a lane marker, the Blind Spot Warning/Blind Spot Intervention indicator blinks and an audible warning will sound three times. Then the system applies the brakes on one side of the vehicle for a short period of time to help return the vehicle back to the center of the lane.

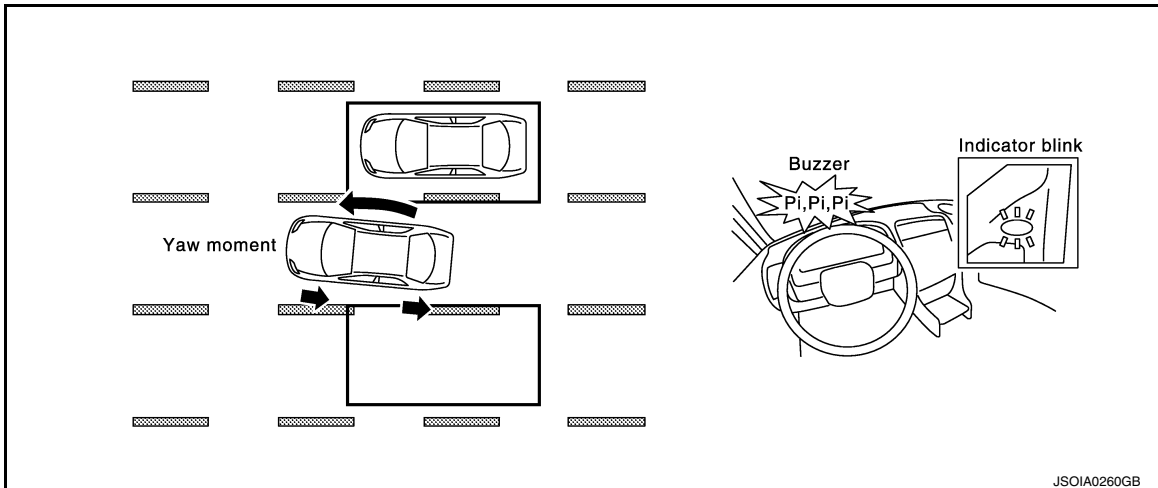

- Blind Spot Intervention operates regardless of turn signal usage.
- The brightness of Blind Spot Warning/Blind Spot Intervention indicator lights is adjusted automatically depending on the brightness of the ambient light.

### NOTE:

- Blind Spot Intervention is typically activated earlier than LDP when getting closer to the lane marker.
- Warning and brake control will only be activated if the Blind Spot Warning/Blind Spot Intervention indicator is already illuminated when vehicle approaches a lane marker.
- If another vehicle comes into the detection zone after vehicle has crossed a lane marker, no warning or brake control will be activated.

## BLIND SPOT INTERVENTION SYSTEM OPERATION DESCRIPTION

- ADAS control unit enables Blind Spot Intervention system.
- Turn ON the dynamic driver assistance switch, and Blind Spot Intervention system setting in the vehicle information display. Then Blind Spot Intervention ON indicator comes on.
- Combination meter turns Blind Spot Intervention ON indicator lamp ON/OFF according to the signals from ADAS control unit via CAN communication.
- Side radar detects a vehicle in the adjacent lane, and transmits the vehicle detection signal to ADAS control unit via ITS communication.
- Side radar receives vehicle speed signal from ADAS control unit and changes its detecting function.

# SYSTEM

## [BLIND SPOT WARNING & BLIND SPOT INTERVENTION]

### < SYSTEM DESCRIPTION >

- Lane camera unit monitors lane markers of the traveling lane and transmits the detected lane condition signal to ADAS control unit via ITS communication.
- ADAS control unit starts the control as follows, based on a vehicle detection signal, lane condition signal, turn signal and dimmer signal transmitted from BCM via CAN communication:
  - Blind Spot Warning/Blind Spot Intervention indicator signal and Blind Spot Warning/Blind Spot Intervention indicator dimmer signal transmission to side radar.
  - Buzzer signal transmission to warning buzzer.
  - Calculation of necessary yaw moment and transmission of the target yaw moment signal to ABS actuator and electric unit (control unit).
- Side radar transmits an indicator operation signal to the Blind Spot Warning/Blind Spot Intervention indicator according to Blind Spot Warning/Blind Spot Intervention indicator operation signal and Blind Spot Warning/Blind Spot Intervention indicator dimmer signal.
- ABS actuator and electric unit (control unit) controls brake pressure of four wheels respectively according to the target yaw moment signal.

#### Operation Condition of Blind Spot Intervention System

ADAS control unit performs the control when the following conditions are satisfied.

- Blind Spot Intervention ON indicator: ON
- When the vehicle drives at 60 km/h (37 MPH) or more to the forward direction.

#### NOTE:

- When the Blind Spot Intervention system setting in the vehicle information display is ON.
- The Blind Spot Intervention system may not function properly, depending on the situation. Refer to [DAS-481, "Precautions for Blind Spot Warning/Blind Spot Intervention"](#).
- Blind Spot Intervention braking will not operate or will stop operating and only a warning chime will sound under the following conditions.
  - When the brake pedal is depressed.
  - When the accelerator pedal is depressed while brake control assist is provided.
  - When steering quickly.
  - When the ICC, DCA, FCW or IBA warnings sound.
  - When the hazard warning flashers are operated.
  - When driving on a curve at a high speed.
- Under the following conditions, the Blind Spot Intervention system will be turned off automatically, a beep will sound and the Blind Spot Intervention ON indicator will blink. The BSW system is still available, but the Blind Spot Intervention system will not be available until the conditions no longer exist.
  - When the VDC system (except TCS function) or ABS operates.
  - When the VDC system is turned OFF.
  - When the SNOW mode switch is turned ON.

#### BULB CHECK ACTION AND FAIL-SAFE INDICATION.

Vehicle condition/Driver's operation	Blind Spot Warning/Blind Spot Intervention indicator	Warning buzzer	Indication on the combination meter
When DTC is detected	OFF	Beep	 <small>AL0IA0137GB</small>
When radar blockage is detected	OFF	Beep	Unavailable: Side Radar Obstruction

# SYSTEM [BLIND SPOT WARNING & BLIND SPOT INTERVENTION]

< SYSTEM DESCRIPTION >

Vehicle condition/Driver's operation	Blind Spot Warning/Blind Spot Intervention indicator	Warning buzzer	Indication on the combination meter
When the camera detects that the interior temperature is high	OFF	Beep	Unavailable: High Cabin Temp.
When the dynamic driver assistance switch is turned ON with settings of DCA system, LDP system and Blind Spot Intervention system OFF	OFF	—	Blink (Approx. 3 sec.) <div style="background-color: black; color: white; padding: 5px; text-align: center;">                         Unavailable All Systems are disable                     </div>

ALOIA0132GB

\*: Blinking cycle when the side radar blockage condition or lane camera unit high temperature condition

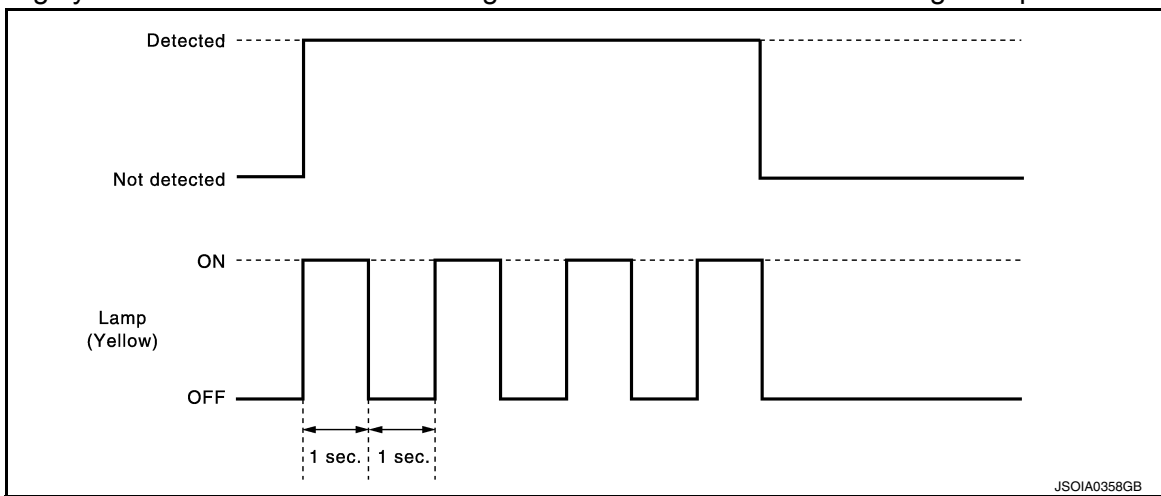

JSOIA0358GB

**NOTE:**

Time shown in the figure is approximate time.

**BLIND SPOT INTERVENTION SYSTEM : Fail-safe (ADAS Control Unit)**

INFOID:000000009716756

If a malfunction occurs in any system, ADAS control unit cancels each control, sounds a beep, and turns ON the warning lamp or indicator lamp or warning message will display.

System	Buzzer	Warning lamp/Indicator lamp	Description
Vehicle-to-vehicle distance control mode	High-pitched tone	ICC system warning lamp	Cancel
Conventional (fixed speed) cruise control mode	High-pitched tone	ICC system warning lamp	Cancel
Intelligent Brake Assist (IBA)	High-pitched tone	IBA OFF indicator lamp	Cancel
Forward Collision Warning (FCW)	High-pitched tone	Warning message	Cancel
Distance Control Assist (DCA)	High-pitched tone	ICC system warning lamp	Cancel
Lane Departure Warning (LDW)	—	Lane Departure Warning lamp	Cancel
Lane Departure Prevention (LDP)	Low-pitched tone	Lane Departure Warning lamp	Cancel
Blind Spot Warning (BSW)	—	Blind Spot Warning/Blind Spot Intervention warning lamp	Cancel



**SYSTEM**  
**[BLIND SPOT WARNING & BLIND SPOT INTERVENTION]**

< SYSTEM DESCRIPTION >

System	Buzzer	Warning lamp/Indicator lamp	Description
Blind Spot Intervention (BSI)	Low-pitched tone	Blind Spot Warning/Blind Spot Intervention warning lamp	Cancel
Backup Collision Intervention (BCI)	High-pitched tone	Backup Collision Intervention warning indicator	Cancel

**BLIND SPOT INTERVENTION SYSTEM : Fail-safe (Lane Camera Unit)** INFOID:000000009716757

**FAIL-SAFE CONTROL BY DTC**

If a malfunction occurs in the lane camera unit, ADAS control unit cancels control, and turns ON the lane departure warning lamp in the combination meter.

**TEMPORARY DISABLED STATUS AT HIGH TEMPERATURE**

- If the vehicle is parked in direct sunlight under high temperature conditions, the system may be deactivated automatically. The warning systems ON indicator on the switch will blink and the following message appears on the vehicle information display "Unavailable High Cabin Temp."
- When interior temperature is reduced, the system will resume operation automatically and the warning systems ON indicator on the switch will stop blinking.

**BLIND SPOT INTERVENTION SYSTEM : Fail-safe (Side Radar)** INFOID:000000009716758

**FAIL-SAFE CONTROL BY DTC**

If a malfunction occurs in the side radar, ADAS control unit cancels control, and a chime will sound and the "Please see owner's manual" message appears in the vehicle information display.

**TEMPORARY DISABLED STATUS AT BLOCKAGE**

When the side radar is blocked, the operation is temporarily cancelled. Then the "Unavailable Side Radar Obstruction" message appears in the vehicle information display and the warning systems ON indicator will blink. Also, under the following conditions, the operation may be temporarily cancelled.

- The side radar may be blocked by temporary ambient conditions such as splashing water, mist or fog.
- The blocked condition may also be caused by objects such as ice, frost or dirt obstructing the side radar.

A  
B  
C  
D  
E  
F  
G  
H  
I  
J  
K  
L  
M  
N  
P

DAS

# OPERATION

## [BLIND SPOT WARNING & BLIND SPOT INTERVENTION]

< SYSTEM DESCRIPTION >

### OPERATION

#### BLIND SPOT WARNING (BSW) SYSTEM

#### BLIND SPOT WARNING (BSW) SYSTEM : Switch Name and Function

INFOID:000000009716759

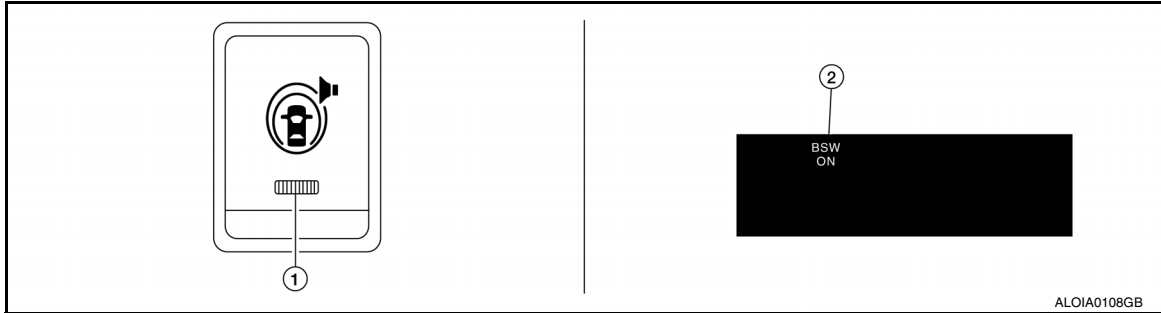

No.	Name	Function
1	Warning systems switch	Turns BSW system ON/OFF (When the setting of BSW system in the vehicle information display is ON)
2	BSW setting screen (the vehicle information display)	Changes setting of BSW system (ON/OFF)

#### BLIND SPOT WARNING (BSW) SYSTEM : System Display and Warning

INFOID:000000009716760

#### INDICATOR AND WARNING LAMP

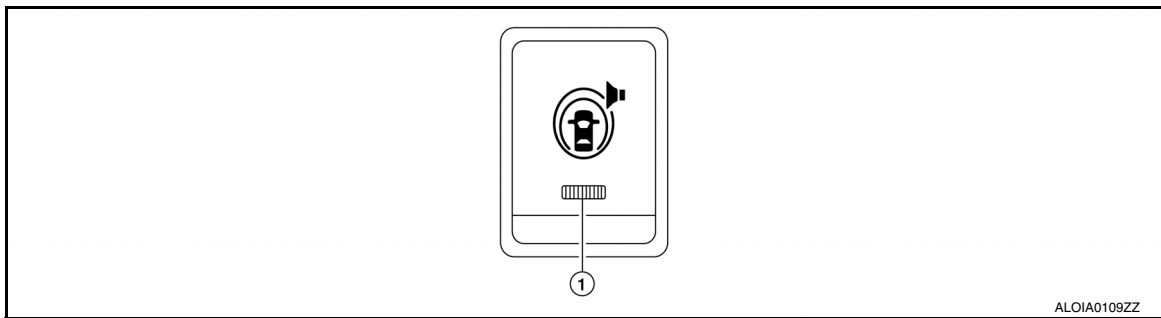

No.	Name	Description
1	Warning systems ON indicator	<ul style="list-style-type: none"> <li>Indicates that the FCW system, LDW system, and/or BSW system is ON</li> <li>Blinks when the setting of LDW, FCW, and BSW are "OFF" and the warning systems switch is pressed</li> </ul>

#### DISPLAY AND WARNING OPERATION

Vehicle condition/ Driver's operation				Action	
Warning systems ON indicator	Vehicle speed (Approx.) [km/h (MPH)]	Turn signal condition	Status of vehicle detection within detection area	Indication on the Blind Spot Warning/Blind Spot Intervention indicator	Buzzer
OFF	—	—	—	OFF	OFF

# OPERATION

## [BLIND SPOT WARNING & BLIND SPOT INTERVENTION]

< SYSTEM DESCRIPTION >

Vehicle condition/ Driver's operation				Action	
Warning systems ON indicator	Vehicle speed (Approx.) [km/h (MPH)]	Turn signal condition	Status of vehicle detection within detection area	Indication on the Blind Spot Warning/Blind Spot Intervention indicator	Buzzer
ON	Less than approx. 29 (18)	—	—	OFF	OFF
	Approx. 32 (20) or more	—	Vehicle is absent	OFF	OFF
		OFF	Vehicle is detected	ON	OFF
		ON (vehicle detected direction)	Before turn signal operates Vehicle is detected	Blink	
ON (vehicle detected direction)	Vehicle is detected after turn signal operates	Blink		OFF	

**NOTE:**

- If vehicle speed exceeds approximately 32 km/h (20MPH), BSW function operates until the vehicle speed becomes lower than approximately 29km/h (18MPH).
- Time shown in the figure is approximate time.
- Always Blind Spot Intervention system operates together with BSW system. Whenever Blind Spot Intervention system is turned on by pushing the dynamic driver assistance switch, BSW system also be turned on even if the BSW system is turned off. However, at this time the warning systems ON indicator remains OFF.

### BLIND SPOT INTERVENTION SYSTEM

#### BLIND SPOT INTERVENTION SYSTEM : Switch Name and Function

INFOID:000000009716761

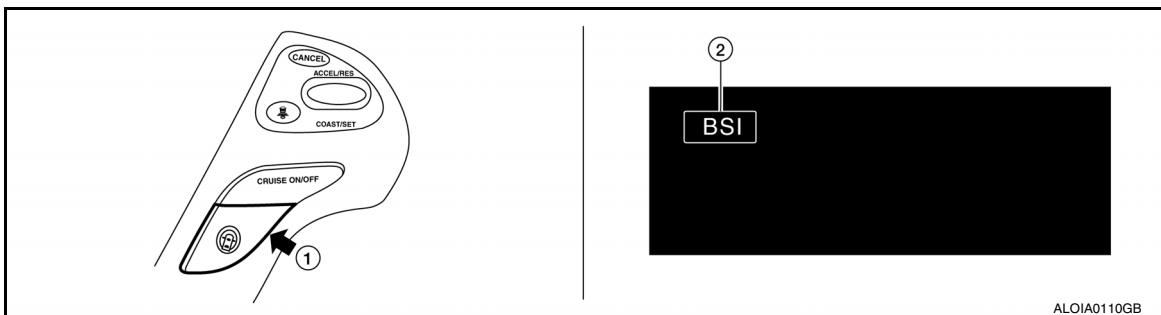

No.	Name	Function
1	Dynamic driver assistance switch	Turns Blind Spot Intervention, LDP, and DCA systems ON/OFF
2	Blind Spot Intervention setting screen (The vehicle information display)	Changes setting of Blind Spot Intervention system (ON/OFF)

# OPERATION

## [BLIND SPOT WARNING & BLIND SPOT INTERVENTION]

< SYSTEM DESCRIPTION >

### BLIND SPOT INTERVENTION SYSTEM : System Display and Warning

INFOID:00000009716762

#### INDICATOR AND WARNING LAMP

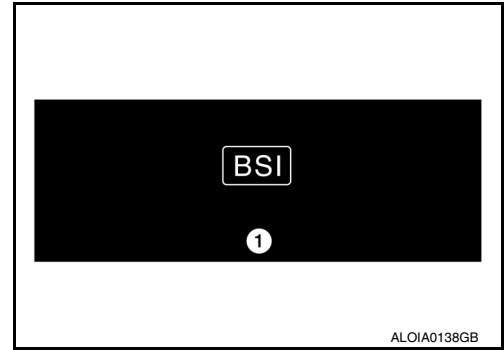

No.	Name	Description
1	Blind Spot Intervention ON indicator (green)	<ul style="list-style-type: none"> <li>Turns ON when Blind Spot Warning/Blind Spot Intervention system is malfunctioning</li> </ul>

#### DISPLAY AND WARNING OPERATION

Whenever the Blind Spot Intervention system is turned on, the BSW system will also be on.

Vehicle condition/Driver's operation				Action		
Blind Spot Intervention ON indicator	Vehicle speed (Approx.) [km/h (MPH)]	Status of vehicle detection within detection area	Status of approach to adjacent lane	Indication on the Blind Spot Warning/Blind Spot Intervention indicator	Brake control	Buzzer
OFF	—	—	—	OFF	OFF	OFF
Green	Less than approx. 60 (37)	—	—	OFF	OFF	OFF
		Vehicle is absent	—	OFF	OFF	OFF
	Approx. 60 (37) or more	Vehicle is detected	Not approaching	ON	OFF	OFF
Vehicle is detected		Approaching	<p style="text-align: center;">Blink</p> <p style="text-align: center;">Time shown in the figure is approximate time.</p>	ON	<p style="text-align: center;">Time shown in the figure is approximate time.</p>	

BSI system warning light (orange)

# HANDLING PRECAUTION

< SYSTEM DESCRIPTION >

[BLIND SPOT WARNING & BLIND SPOT INTERVENTION]

## HANDLING PRECAUTION

### Precautions for Blind Spot Warning/Blind Spot Intervention

INFOID:00000009716763

#### LANE CAMERA UNIT HANDLING

Refer to [DAS-481, "Precautions for Blind Spot Warning/Blind Spot Intervention"](#).

#### SIDE RADAR HANDLING

- Side radar for Blind Spot Warning/Blind Spot Intervention system is located inside the rear bumper.
- Always keep the rear bumper near the side radar clean.
- Do not attach a sticker (including transparent material), install an accessory or paintwork near the side radar.
- Do not strike or damage the areas around the side radar.
- Do not strike, damage, and scratch the side radar, especially the vent seal (gray circular) area, under repair.

#### BLIND SPOT WARNING & BLIND SPOT INTERVENTION

- The Blind Spot Warning and Blind Spot Intervention systems are not a replacement for proper driving procedure and are not designed to prevent contact with vehicles or objects. When changing lanes, always use the side and rear mirrors and turn and look in the direction driver will move to ensure it is safe to change lanes. Never rely solely on the Blind Spot Warning and Blind Spot Intervention system.
- Using the Blind Spot Intervention system under some road, lane marker or weather conditions could lead to improper system operation. Always rely on driver's own steering and braking operation to avoid accidents.
- The Blind Spot Warning and Blind Spot Intervention systems may not provide a warning or brake control for vehicles that pass through the detection zone quickly.
- Do not use the Blind Spot Warning or Blind Spot Intervention systems when towing a trailer.
- Excessive noise (e.g. audio system volume, open vehicle window) will interfere with the chime sound, and it may not be heard.
- The side radar may not be able to detect and activate Blind Spot Warning/Blind Spot Intervention when certain objects are present such as:
  - Pedestrians, bicycles, animals.
  - Several types of vehicles such as motorcycles.
  - Oncoming vehicles.
  - Vehicles remaining in the detection zone when driver accelerate from a stop.
  - A vehicle merging into an adjacent lane at a speed approximately the same as vehicle.
  - A vehicle approaching rapidly from behind.
  - A vehicle which vehicle overtakes rapidly.
- Severe weather or road spray conditions may reduce the ability of the radar to detect other vehicles.
- The side radar detection zone is designed based on a standard lane width. When driving in a wider lane, the side radar may not detect vehicles in an adjacent lane. When driving in a narrow lane, the side radar may detect vehicles driving two lanes away.
- The side radar are designed to ignore most stationary objects, however objects such as guardrails, walls, foliage and parked vehicles may occasionally be detected. This is a normal operating condition.

#### BLIND SPOT INTERVENTION

- Do not use the Blind Spot Intervention system under the following conditions because the system may not function properly.
  - During bad weather (e.g. rain, fog, snow, wind, etc.)
  - When driving on slippery roads, such as on ice or snow, etc.
  - When driving on winding or uneven roads.
  - When there is a lane closure due to road repairs.
  - When driving in a makeshift lane.
  - When driving on roads where the lane width is too narrow.
  - When driving with a tire that is not within normal tire conditions (e.g. tire wear, low tire pressure, installation of spare tire, tire chains, non-standard wheels).
  - When the vehicle is equipped with non-original brake parts or suspension parts.
- The camera may not detect lane markers in the following situations and the Blind Spot Intervention system may not operate properly.
  - On roads where there are multiple parallel lane markers; lane markers that are faded or not painted clearly; yellow painted lane markers; nonstandard lane markers; lane markers covered with water, dirt, snow, etc.
  - On roads where discontinued lane markers are still detectable.
  - On roads where there are sharp curves.

A

B

C

D

E

F

G

H

I

J

K

L

M

N

DAS

P

## HANDLING PRECAUTION

< SYSTEM DESCRIPTION >

### [BLIND SPOT WARNING & BLIND SPOT INTERVENTION]

- On roads where there are sharply contrasting objects, such as shadows, snow, water, wheel ruts, seams or lines remaining after road repairs.
- On roads where the traveling lane merges or separates.
- When the vehicle is traveling direction does not align with the lane markers.
- When traveling close to the vehicle in front of driver, which obstructs the lane camera unit detection range.
- When rain, snow or dirt adheres to the windshield in front of a lane camera unit.
- When the headlights are not bright due to dirt on the lens or if aiming is not adjusted properly.
- When strong light enters a lane camera unit. (e.g. light directly shines on the front of the vehicle at sunrise or sunset.)
- When a sudden change in brightness occurs. (e.g. when the vehicle enters or exits a tunnel or under a bridge.)
- The Blind Spot Intervention system will not operate if your vehicle is on a lane marker when another vehicle enters the detection zone. In this case only the BSW system operates.
- Blind Spot Intervention braking will not operate or will stop operating and only a warning chime will sound under the following conditions.
  - When the brake pedal is depressed.
  - When the accelerator pedal is depressed while brake control assist is provided.
  - When steering quickly.
  - When the ICC, DCA, FCW or IBA warnings sound.
  - When the hazard warning flashers are operated.
  - When driving on a curve at a high speed.

# DIAGNOSIS SYSTEM (ADAS CONTROL UNIT)

< SYSTEM DESCRIPTION >

[BLIND SPOT WARNING & BLIND SPOT INTERVENTION]

## DIAGNOSIS SYSTEM (ADAS CONTROL UNIT)

### On Board Diagnosis Function

INFOID:00000009716764

#### DESCRIPTION

The DTC is displayed on the information display by operating the ICC steering switch.

#### On Board Self-diagnosis System Diagram

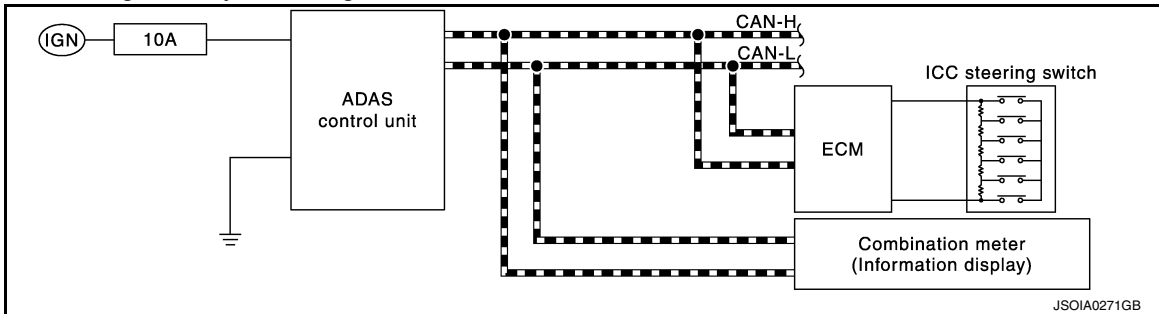

#### METHOD OF STARTING

##### CAUTION:

##### Start condition of on board self-diagnosis

- ICC system OFF
- DCA system OFF
- Vehicle speed 0 km/h (0 MPH)

1. Turn the ignition switch OFF.
2. Start the engine.
3. Wait for 5 seconds after starting the engine. Push up the RESUME/ACCELERATE switch 5 times and push down the SET/COAST switch 5 times within 10 seconds.

##### NOTE:

If the above operation cannot be performed within 10 seconds after waiting for 5 seconds after starting the engine, repeat the procedure from step 1.

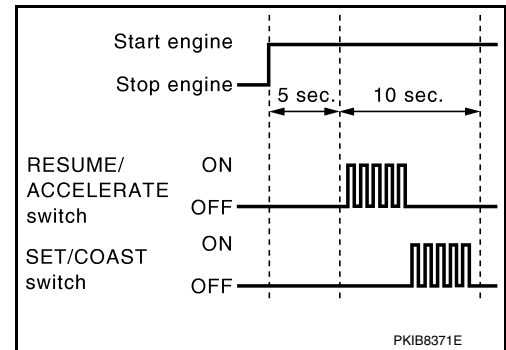

4. The DTC is displayed on the set vehicle speed indicator (1) on the ICC system display on the information display when the on board self-diagnosis starts. Refer to [DAS-509, "DTC Index"](#).

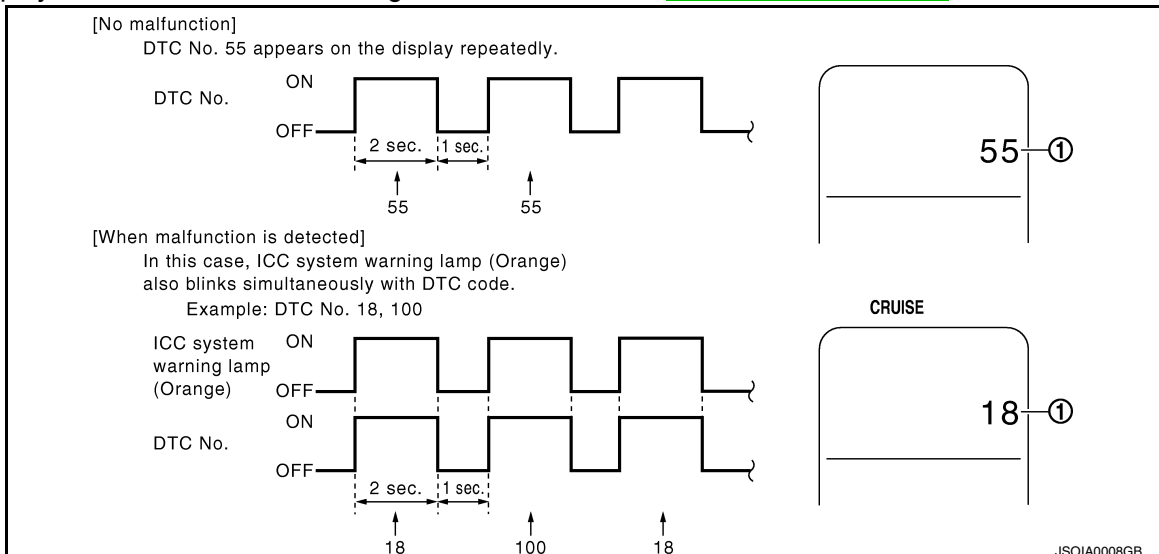

##### NOTE:

A  
B  
C  
D  
E  
F  
G  
H  
I  
J  
K  
L  
M  
N  
P

DAS

# DIAGNOSIS SYSTEM (ADAS CONTROL UNIT)

< SYSTEM DESCRIPTION >

[BLIND SPOT WARNING & BLIND SPOT INTERVENTION]

- It displays for up to 5 minutes and then stops.
- If multiple malfunctions exist, up to 6 DTCs can be stored in memory at the most, and the most recent one is displayed first.

## WHEN THE ON BOARD SELF-DIAGNOSIS DOES NOT START

If the on board self-diagnosis does not start, check the following items.

Assumed abnormal part		Inspection item
Information display	Combination meter malfunction	Check that the self-diagnosis function of the combination meter operates. Refer to <a href="#">MWI-15, "INFORMATION DISPLAY : System Description"</a>
ICC steering switch malfunction		Perform the inspection for DTC"C1A06". Refer to <a href="#">DAS-167, "Diagnosis Procedure"</a>
Harness malfunction between ICC steering switch and ECM		
ECM malfunction		
ADAS control unit malfunction		<ul style="list-style-type: none"> <li>• Check power supply and ground circuit of ADAS control unit. Refer to <a href="#">DAS-615, "ADAS CONTROL UNIT : Diagnosis Procedure"</a>.</li> <li>• Perform SELF-DIAGNOSIS for "ICC/ADAS" with CONSULT, and then check the malfunctioning parts. Refer to <a href="#">DAS-509, "DTC Index"</a>.</li> </ul>

## HOW TO ERASE ON BOARD SELF-DIAGNOSIS

1. Turn the ignition switch OFF.
2. Start the engine, and then start the on board self-diagnosis.
3. Press the CANCEL switch 5 times, and then press the DISTANCE switch 5 times under the condition that the on board self-diagnosis starts.

### NOTE:

- Complete the operation within 10 seconds after pressing the CANCEL switch first.
- If the operation is not completed within 10 seconds, repeat the procedure from step 1.

4. DTC 55 is displayed after erasing.

### NOTE:

DTCs for existing malfunction can not be erased.

5. Turn ignition switch OFF, and finish the diagnosis.

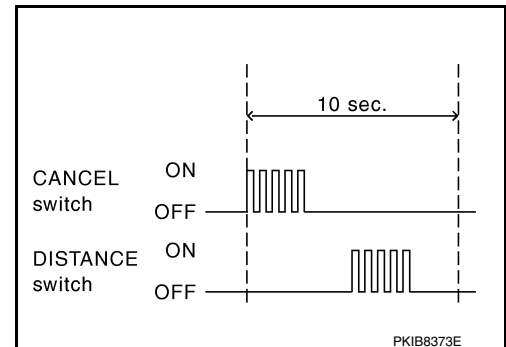

## CONSULT Function (ICC/ADAS)

INFOID:000000009716765

### CAUTION:

After disconnecting the CONSULT vehicle interface (VI) from the data link connector, the ignition must be cycled OFF → ON (for at least 5 seconds) → OFF. If this step is not performed, the BCM may not go to "sleep mode", potentially causing a discharged battery and a no-start condition.

## APPLICATION ITEMS

CONSULT performs the following functions via CAN communication using ADAS control unit.

Diagnosis mode	Description
Self Diagnostic Result	Displays the name of a malfunctioning system stored in the ADAS control unit.
Data Monitor	Displays ADAS control unit input/output data in real time.
Work support	Displays causes of automatic system cancellation occurred during system control.
Active Test	Enables an operational check of a load by transmitting a driving signal from the ADAS control unit to the load.
ECU identification	Displays ADAS control unit part number.
CAN Diag Support Mntr	Displays a reception/transmission state of CAN communication and ITS communication.

## SELF DIAGNOSTIC RESULT

Refer to [DAS-47, "DTC Index"](#).



# DIAGNOSIS SYSTEM (ADAS CONTROL UNIT)

< SYSTEM DESCRIPTION >

[BLIND SPOT WARNING & BLIND SPOT INTERVENTION]

## DATA MONITOR

Monitored item [Unit]	ALL SIG (ICC)	MAIN SIG (ICC)	MAIN SIG (LDW/LDP)	MAIN SIG (BSW/BSI)	BCI MAIN	Description
MAIN SW [On/Off]	×	×	×	×		Indicates [On/Off] status as judged from ICC steering switch signal (ECM transmits ICC steering switch signal through CAN communication)
SET/COAST SW [On/Off]	×	×				Indicates [On/Off] status as judged from ICC steering switch signal (ECM transmits ICC steering switch signal through CAN communication)
CANCEL SW [On/Off]	×	×				Indicates [On/Off] status as judged from ICC steering switch signal (ECM transmits ICC steering switch signal through CAN communication)
RESUME/ACC SW [On/Off]	×	×				Indicates [On/Off] status as judged from ICC steering switch signal (ECM transmits ICC steering switch signal through CAN communication)
DISTANCE SW [On/Off]	×					Indicates [On/Off] status as judged from ICC steering switch signal (ECM transmits ICC steering switch signal through CAN communication)
CRUISE OPE [On/Off]	×	×				Indicates whether controlling or not (ON means "controlling")
BRAKE SW [On/Off]	×	×	×	×	×	Indicates [On/Off] status as judged from ICC brake switch signal (ECM transmits ICC brake switch signal through CAN communication)
STOP LAMP SW [On/Off]	×	×	×	×	×	Indicates [On/Off] status as judged from stop lamp switch signal (ECM transmits stop lamp switch signal through CAN communication)
IDLE SW [On/Off]	×				×	Indicates [On/Off] status of idle switch read from ADAS control unit through CAN communication (ECM transmits On/Off status through CAN communication)
SET DISTANCE [Short/Mid/Long]	×	×				Indicates set distance memorized in ADAS control unit
CRUISE LAMP [On/Off]	×	×				Indicates [On/Off] status of MAIN switch indicator output
OWN VHCL [On/Off]	×					Indicates [On/Off] status of own vehicle indicator output
VHCL AHEAD [On/Off]	×					Indicates [On/Off] status of vehicle ahead detection indicator output
ICC WARNING [On/Off]	×					Indicates [On/Off] status of ICC system warning lamp output
VHCL SPEED SE [km/h] or [mph]	×	×	×	×	×	Indicates vehicle speed calculated from ADAS control unit through CAN communication [ABS actuator and electric unit (control unit) transmits vehicle speed signal (wheel speed) through CAN communication]
SET VHCL SPD [km/h] or [mph]	×	×				Indicates set vehicle speed memorized in ADAS control unit
BUZZER O/P [On/Off]	×				×	Indicates [On/Off] status of ICC warning chime output
THRTL SENSOR [deg]	×	×				<b>NOTE:</b> The item is displayed, but it is not monitored
ENGINE RPM [rpm]	×					Indicates engine speed read from ADAS control unit through CAN communication (ECM transmits engine speed signal through CAN communication)
WIPER SW [OFF/LOW/HIGH]	×					Indicates wiper [OFF/LOW/HIGH] status (BCM transmits front wiper request signal through CAN communication)
BA WARNING [On/Off]	×					Indicates [On/Off] status of IBA OFF indicator lamp output
STP LMP DRIVE [On/Off]	×	×			×	Indicates [On/Off] status of ICC brake hold relay drive output

A

B

C

D

E

F

G

H

I

J

K

L

M

N

DAS

P

# DIAGNOSIS SYSTEM (ADAS CONTROL UNIT)

< SYSTEM DESCRIPTION >

[BLIND SPOT WARNING & BLIND SPOT INTERVENTION]

Monitored item [Unit]	ALL SIG (ICC)	MAIN SIG (ICC)	MAIN SIG (LDW/LDP)	MAIN SIG (BSW/BSI)	BCI MAIN	Description
D RANGE SW [On/Off]	×					Indicates [On/Off] status of “D” or “M” positions read from ADAS control unit through CAN communication; ON when position “D” or “M” (TCM transmits shift position signal through CAN communication).
NP RANGE SW [On/Off]	×					Indicates shift position signal read from ADAS control unit through CAN communication (TCM transmits shift position signal through CAN communication)
PKB SW [On/Off]	×					Parking brake switch status [On/Off] judged from the parking brake switch signal that ADAS control unit readout via CAN communication is displayed (Combination meter transmits the parking brake switch signal via CAN communication)
PWR SUP MONI [V]	×	×				Indicates IGN voltage input by ADAS control unit
VHCL SPD AT [km/h] or [mph]	×					Indicates vehicle speed calculated from CVT vehicle speed sensor read from ADAS control unit through CAN communication (TCM transmits CVT vehicle speed sensor signal through CAN communication)
THRTL OPENING [%]	×	×			×	Indicates throttle position read from ADAS control unit through CAN communication (ECM transmits accelerator pedal position signal through CAN communication).
GEAR [1, 2, 3, 4, 5, 6]	×					Indicates CVT gear position read from ADAS control unit through CAN communication (TCM transmits current gear position signal through CAN communication)
MODE SIG [OFF, ICC, ASCD]	×					Indicates the active mode from ICC or ASCD [conventional (fixed speed) cruise control mode]
SET DISP IND [On/Off]	×					Indicates [On/Off] status of SET switch indicator output
DISTANCE [m]	×					Indicates the distance from the vehicle ahead
RELATIVE SPD [m/s]	×					Indicates the relative speed of the vehicle ahead
Camera lost [Detect/Deviate/Both]			×	×		Indicates a lane marker detection state judged from a lane marker detection signal read by the ADAS control unit via ITS communication (Lane camera unit transmits a lane marker signal via ITS communication)
Lane unclear [On/Off]			×	×		Indicates an ON/OFF state of the lane marker. The ON/OFF state is judged from a detected lane condition signal read by the ADAS control unit via ITS communication (The lane camera unit transmits a detected lane condition signal via ITS communication)
STATUS signal [Stnby/Warn/Cancl/Off]			×			Indicates a control state of LDP system
DYNA ASIST SW [On/Off]	×	×		×		Indicates [On/Off] status as judged from ICC steering switch signal (ECM transmits ICC steering switch signal through CAN communication)
DCA ON IND [On/Off]	×					The status [ON/OFF] of DCA system switch indicator output is displayed
DCA VHL AHED [On/Off]	×					The status [ON/OFF] of vehicle ahead detection indicator output in DCA system is displayed
IBA SW [On/Off]	×	×				Indicates [On/Off] status of IBA OFF switch
APA TEMP [°C]	×				×	Accelerator pedal actuator integrated motor temperature that the ADAS control unit readout via ITS communication is displayed (Accelerator pedal actuator transmits the integrated motor temperature via ITS communication)

# DIAGNOSIS SYSTEM (ADAS CONTROL UNIT)

< SYSTEM DESCRIPTION >

## [BLIND SPOT WARNING & BLIND SPOT INTERVENTION]

Monitored item [Unit]	ALL SIG (ICC)	MAIN SIG (ICC)	MAIN SIG (LDW/LDP)	MAIN SIG (BSW/BSI)	BCI MAIN	Description
APA PWR [V]	×				×	Accelerator pedal actuator power supply voltage that the ADAS control unit read-out via ITS communication is displayed (Accelerator pedal actuator transmits the power supply voltage via ITS communication)
FCW SYSTEM ON [On/Off]	×	×				Indicates [On/Off] status of FCW system
LDW SYSTEM ON [On/Off]			×			Indicates [On/Off] status of LDW system
LDW ON LAMP [On/Off]			×			Indicates [On/Off] status of warning systems ON indicator output
LDP ON IND [On/Off]			×			Indicates [On/Off] status of LDP ON indicator lamp (Green) output
LANE DPRT W/L [On/Off]			×			Indicates [On/Off] status of lane departure warning lamp (Yellow) output
LDW BUZER OUTPUT [On/Off]			×			Indicates [On/Off] status of warning buzzer output
LDP SYSTEM ON [On/Off]			×			Indicates [On/Off] status of LDP system
READY signal [On/Off]			×			Indicates LDP system settings
Shift position [Off, P, R, N, D, M/T1 - 7]			×	×	×	Indicates shift position read from ADAS control unit through CAN communication (TCM transmits shift position signal through CAN communication)
Turn signal [OFF/LH/RH/LH&RH]			×	×		Indicates turn signal operation status read from ADAS control unit through CAN communication (BCM transmits turn indicator signal through CAN communication)
SIDE G [G]			×	×		Indicates lateral G acting on the vehicle. This lateral G is judged from a side G sensor signal read by ADAS control unit via CAN communication (The ABS actuator and electric unit (control unit) transmits a side G sensor signal via CAN communication)
FUNC ITEM(FCW)	×	×	×	×		Indicates systems which can be set to ON/OFF by selecting "Driver Assistance"⇒ "Driving aids" of the navigation system FCW: Distance Control Assist (DCA), Lane Departure Prevention (LDP) and Blind Spot Intervention
FUNC ITEM(LDW)	×	×	×	×		Indicates systems which can be set to ON/OFF by selecting "Driver Assistance"⇒ "Driving aids" of the navigation system LDW: Distance Control Assist (DCA), Lane Departure Prevention (LDP) and Blind Spot Intervention
FUNC ITEM(BSW)	×	×	×	×		Indicates systems which can be set to ON/OFF by selecting "Driver Assistance"⇒ "Driving aids" of the navigation system BSW: Distance Control Assist (DCA), Lane Departure Prevention (LDP) and Blind Spot Intervention
FUNC ITEM (NV-ICC) [Off]	×	×	×	×		<b>NOTE:</b> The item is displayed, but it is not monitored
FUNC ITEM (NV-DCA) [Off]	×	×	×	×		<b>NOTE:</b> The item is displayed, but it is not monitored
DCA SELECT [On/Off]	×	×	×	×		Indicates an ON/OFF state of DCA system. DCA system can be set to ON/OFF by selecting "Driver Assistance"⇒"Driving aids" of the navigation system
LDP SELECT [On/Off]	×	×	×	×		Indicates an ON/OFF state of LDP system. LDP system can be set to ON/OFF by selecting "Driver Assistance"⇒"Driving aids" of the navigation system

A  
B  
C  
D  
E  
F  
G  
H  
I  
J  
K  
L  
M  
N  
P

DAS

# DIAGNOSIS SYSTEM (ADAS CONTROL UNIT)

< SYSTEM DESCRIPTION >

[BLIND SPOT WARNING & BLIND SPOT INTERVENTION]

Monitored item [Unit]	ALL SIG (ICC)	MAIN SIG (ICC)	MAIN SIG (LDW/LDP)	MAIN SIG (BSW/BSI)	BCI MAIN	Description
BSI SELECT [On/Off]	×	×	×	×		Indicates an ON/OFF state of Blind Spot Intervention system. Blind Spot Intervention system can be set to ON/OFF by selecting "Driver Assistance"⇒"Driving aids" of the navigation system
DRIVE MODE STATS [SNO/ECO/STD/SPT]	×	×	×	×		Indicates [On/Off] status of warning systems switch
WARN SYS SW [On/Off]	×	×	×	×		Indicates [On/Off] status of warning systems switch
BSW/BSI WARN LMP [On/Off]				×		Indicates [On/Off] status of Blind Spot Warning/Blind Spot Intervention warning lamp output
BSI ON IND [On/Off]				×		Indicates [On/Off] status of Blind Spot Intervention ON indicator output
BSW SYSTEM ON [On/Off]				×		Indicates [On/Off] status of BSW system
BSI SYSTEM ON [On/Off]				×		Indicates [On/Off] status of Blind Spot Intervention system
BCI SYSTEM ON [On/Off]					×	Indicates [On/Off] status of Backup Collision Intervention system
BCI SWITCH [On/Off]					×	Indicates [On/Off] status of Backup Collision Intervention system switch
LDP WARNING INDICA- TOR [On/Off]			×			Indicates [On/Off] status of Lane Departure Prevention system failure lamp
LDW ON INDICATOR [On/Off]			×			Indicates [On/Off] status of LDW system
LDW WARNING INDICA- TOR [On/Off]			×			Indicates [On/Off] status of Lane Departure Warning system failure lamp
SYSTEM CANCEL MES- SAGE [Request/No Request]	×	×	×	×		Indicates system cancel message request
CAMERA HI TEMP MSG [On/Off]			×	×		Indicates high temperature message has been received
ITS Setting Item(DCA) [On/Off]	×	×	×	×		Indicates [On/Off] status of Distance Control Assist warning lamp output
ITS Setting Item(LDP) [On/Off]	×	×	×	×		Indicates [On/Off] status of Lane Departure Prevention warning lamp output
ITS Setting Item(BSI) [On/Off]	×	×	×	×		Indicates [On/Off] status of Blind Spot Intervention system
BSI WARNING INDICA- TOR [On/Off]				×		Indicates [On/Off] status of Blind Spot Intervention warning lamp indicator
BSW ON INDICATOR [On/Off]				×		Indicates [On/Off] status of BSW system
BSW IND BRIGHTNESS [Bright/Not Bright]				×		Indicates BSW warning lamp indicator brightness level
WARN REQ [On/Off]			×			Indicates an ADAS control unit judged warning state (ON/OFF) of LDP system

# DIAGNOSIS SYSTEM (ADAS CONTROL UNIT)

< SYSTEM DESCRIPTION >

[BLIND SPOT WARNING & BLIND SPOT INTERVENTION]

## WORK SUPPORT

Work support items	Description
CAUSE OF AUTO-CANCEL 1	Displays causes of automatic system cancellation occurred during control of the following systems <ul style="list-style-type: none"> <li>• Vehicle-to-vehicle distance control mode</li> <li>• Conventional (fixed speed) cruise control mode</li> <li>• Distance Control Assist (DCA)</li> </ul>
CAUSE OF AUTO-CANCEL 2	Displays causes of automatic system cancellation occurred during control of the following systems <ul style="list-style-type: none"> <li>• Lane Departure Prevention (LDP)</li> <li>• Blind Spot Intervention</li> </ul>
CAUSE OF AUTO-CANCEL 3	Displays causes of automatic system cancellation occurred during control of the following system <ul style="list-style-type: none"> <li>• Backup Collision Intervention</li> </ul>

**NOTE:**

- Causes of the maximum five cancellations (system cancel) are displayed.
- The displayed cancellation causes display the number of the ignition switch ON/OFF up to 254. It is fixed to 254 if it is over 254. It returns to 0 when the same cancellation cause is detected again.

### Display Items for The Cause of Automatic Cancellation 1

Cause of cancellation	Vehicle-to-vehicle distance control mode	Conventional (fixed speed) cruise control mode	Distance Control Assist	Description
OPERATING ABS	×		×	ABS function was operated
OPERATING TCS	×	×	×	TCS function was operated
OPERATING VDC	×	×	×	VDC function was operated
ECM CIRCUIT	×	×		ECM did not permit ICC operation
OPE SW VOLT CIRC	×	×	×	The ICC steering switch input voltage is not within standard range
LASER TEMP	×		×	Temperature around ICC sensor became low
SNOW MODE SW	×		×	SNOW mode switch was pressed
OP SW DOUBLE TOUCH	×	×		ICC steering switches were pressed at the same time
VHCL SPD DOWN	×	×	×	Vehicle speed lower than the speed as follows <ul style="list-style-type: none"> <li>• Vehicle-to-vehicle distance control mode is 24 km/h (15 MPH)</li> <li>• Conventional (fixed speed) cruise control mode is 22 km/h (14 MPH)</li> </ul>
WHL SPD ELEC NOISE	×	×	×	Wheel speed sensor signal caught electromagnetic noise
VDC/TCS OFF SW	×		×	VDC OFF switch was pressed
VHCL SPD UNMATCH	×	×	×	Wheel speed became different from CVT vehicle speed
FR RADAR BLOCKED	×		×	The front bumper near the ICC sensor is blocked or dirty
TIRE SLIP	×	×		Wheel slipped

A  
B  
C  
D  
E  
F  
G  
H  
I  
J  
K  
L  
M  
N  
P

DAS

# DIAGNOSIS SYSTEM (ADAS CONTROL UNIT)

< SYSTEM DESCRIPTION >

[BLIND SPOT WARNING & BLIND SPOT INTERVENTION]

IGN LOW VOLT	×	×	×	Decrease in ADAS control unit IGN voltage
PARKING BRAKE ON	×	×		The parking brake is engaged
WHEEL SPD UNMATCH	×	×	×	The wheel speeds of 4 wheels are out of the specified values
INCHING LOST	×			A vehicle ahead is not detected during the following driving when the vehicle speed is approximately 24 km/h (15 MPH) or less
CAN COMM ERROR	×	×	×	ADAS control unit received an abnormal signal with CAN communication
ABS/TCS/VDC CIRC	×	×	×	An abnormal condition occurs in VDC/TCS/ABS system
ECD CIRCUIT	×	×	×	An abnormal condition occurs in ECD system
ASCD VHCL SPD DTAC		×		Vehicle speed is detached from set vehicle speed
ASCD DOUBLE COMD		×		Cancel switch and operation switch are detected simultaneously
APA HI TEMP			×	The accelerator pedal actuator integrated motor temperature is high
ICC SENSOR CAN COMM ERR	×		×	Communication error between ADAS control unit and the ICC sensor
ABS WARNING LAMP	×		×	ABS warning lamp ON
NO RECORD	×	×	×	—

## Display Items for The Cause of Automatic Cancellation 2

Cause of cancellation	Lane departure prevention	Blind spot intervention	Description
OPE VDC/TCS/ABS 1	×		The activation of VDC, TCS, or ABS during LDP system control
Vehicle dynamics	×		Vehicle behavior exceeds specified value
Steering speed	×		Steering speed was more than the specified value in evasive direction
End by yaw angle	×		Yaw angle was the end of LDP control
Departure yaw large	×		Detected more than the specified value of yaw angle in departure direction
ICC WARNING	×		Target approach warning of ICC system, IBA system, or FCW system was activated
CURVATURE	×		Road curve was more than the specified value
Steering angle large	×		Steering angle was more than the specified value
Brake is operated	×		Brake pedal was operated
IGN LOW VOLT	×		Decrease in ADAS control unit IGN voltage
Lateral offset	×		Distance of vehicle and lane was detached in lateral direction more than the specified value
Lane marker lost	×		Lane camera unit lost the trace of lane marker
Lane marker unclear	×		Detected lane marker was unclear
Yaw acceleration	×		Detected yawing speed was more than the specified value
Deceleration large	×		Deceleration in a longitudinal direction was more than the specified value
Accel is operated	×		Accelerator pedal was depressed
Departure steering	×		Steering wheel was steered more than the specified value in departure direction
Evasive steering	×		Steering wheel was steered more than the specified value in the evasive direction
R range	×		Selector lever was operated to R range
Parking brake drift	×		Rear wheels lock was detected

# DIAGNOSIS SYSTEM (ADAS CONTROL UNIT)

< SYSTEM DESCRIPTION >

[BLIND SPOT WARNING & BLIND SPOT INTERVENTION]

Cause of cancellation	Lane departure prevention	Blind spot intervention	Description
Not operating condition	×		Did not meet the operating condition (vehicle speed, turn signal operation, etc.)
SNOW MODE SW	×		SNOW mode switch was pressed
VDC OFF SW	×		VDC OFF switch was pressed
OPE VDC/ABS 2	×		The activation of VDC or ABS during a standby time of LDP system control
BSI WARNING	×		Blind Spot Intervention system was activated
BSI) OPE VDC/TCS/ABS 1		×	The activation of VDC, TCS, or ABS during Blind Spot Intervention system control
BSI) Vehicle dynamics		×	Vehicle behavior exceeds specified value
BSI) Steering speed		×	Steering speed was more than the specified value in evasive direction
BSI) End by yaw angle		×	Yaw angle was the end of Blind Spot Intervention control
BSI) Departure yaw large		×	Detected more than the specified value of yaw angle in departure direction
BSI) ICC WARNING		×	Target approach warning of ICC system, IBA system or FCW system was activated
BSI) CURVATURE		×	Road curve was more than the specified value
BSI) Steering angle large		×	Steering angle was more than the specified value
BSI) Brake is operated		×	Brake pedal was operated
BSI) IGN LOW VOLT		×	Decrease in ADAS control unit IGN voltage
BSI) Lateral offset		×	Distance of vehicle and lane was detached in lateral direction more than the specified
BSI) Lane marker lost		×	Lane camera unit lost the trace of lane marker
BSI) Lane marker unclear		×	Detected lane marker was unclear
BSI) Yaw acceleration		×	Detected yawing speed was more than the specified value
BSI) Deceleration large		×	Deceleration in a longitudinal direction was more than the specified value
BSI) Accel is operated		×	Accelerator pedal was depressed
BSI) Departure steering		×	Steering wheel was steered more than the specified value in departure direction
BSI) Evasive steering		×	Steering wheel was steered more than the specified value in the evasive direction
BSI) R range		×	Selector lever was operated to R range
BSI) Parking brake drift		×	Rear wheels lock was detected
BSI) SNOW MODE SW		×	SNOW mode switch was pressed
BSI) VDC OFF SW		×	VDC OFF switch was pressed
BSI) OPE VDC/ABS 2		×	The activation of VDC or ABS during a standby time of Blind Spot Intervention system control
BSI) Not operating condition		×	Did not meet the operating condition (vehicle speed, turn signal operation, etc.)
Side Radar Lost		×	Unrecognized side radar LH or RH by the ADAS control unit
NO RECORD	×	×	—

Display Items for The Cause of Automatic Cancellation 3

A  
B  
C  
D  
E  
F  
G  
H  
I  
J  
K  
L  
M  
N  
P

DAS

# DIAGNOSIS SYSTEM (ADAS CONTROL UNIT)

< SYSTEM DESCRIPTION >

[BLIND SPOT WARNING & BLIND SPOT INTERVENTION]

Cause of cancellation	Backup Collision Intervention	Description
OPERATING WIPER	×	The wiper operates at HI (it includes when the wiper is operated at HI with the wiper switch AUTO position)
OPERATING ABS	×	ABS function was operated
OPERATING TCS	×	TCS function was operated
OPERATING VDC	×	VDC function was operated
ECM CIRCUIT	×	ECM did not permit ICC operation
SNOW MODE SW	×	SNOW mode switch was pressed
VDC/TCS OFF SW	×	VDC OFF switch was pressed
VHCL SPD UNMATCH	×	Wheel speed became different from CVT vehicle speed
TIRE SLIP	×	Wheel slipped
IGN LOW VOLT	×	Decrease in ADAS control unit IGN voltage
PARKING BRAKE ON	×	The parking brake is engaged
WHEEL SPD UNMATCH	×	The wheel speeds of 4 wheels are out of the specified values
CAN COMM ERROR	×	ADAS control unit received an abnormal signal with CAN communication
ABS/TCS/VDC CIRC	×	An abnormal condition occurs in VDC/TCS/ABS system
ECD CIRCUIT	×	An abnormal condition occurs in ECD system
APA HI TEMP		The accelerator pedal actuator integrated motor temperature is high
ABS WARNING LAMP	×	ABS warning lamp ON
Brake is operated	×	Brake pedal was operated
Accel is operated	×	Accelerator pedal was depressed
SNOW MODE SW	×	DMS switch SNOW mode was selected
VDC OFF SW	×	VDC OFF switch was pressed
Side Radar Lost	×	Unrecognized side radar LH or RH by the ADAS control unit
NO RECORD	×	—

## ACTIVE TEST

### CAUTION:

- Never perform “Active Test” while driving the vehicle.
- The “Active Test” cannot be performed when the following systems warning lamp is illuminated.
  - ICC system warning lamp
  - Lane departure warning lamp
  - Blind Spot Warning/Blind Spot Intervention warning lamp
  - IBA OFF indicator lamp (IBA system ON)
- Shift the selector lever to “P” position, and then perform the test.

Test item	Description
BRAKE ACTUATOR	Activates the brake by an arbitrary operation
ICC BUZZER	Sounds a buzzer used for following systems by arbitrarily operating ON/OFF <ul style="list-style-type: none"> <li>• Intelligent Cruise Control (ICC)</li> <li>• Distance Control Assist (DCA)</li> <li>• Forward Collision Warning (FCW)</li> <li>• Intelligent Brake Assist (IBA)</li> </ul>



# DIAGNOSIS SYSTEM (ADAS CONTROL UNIT)

< SYSTEM DESCRIPTION >

## [BLIND SPOT WARNING & BLIND SPOT INTERVENTION]

Test item	Description
METER LAMP	The ICC system warning lamp, MAIN switch indicator and IBA OFF indicator lamp can be illuminated by ON/OFF operations as necessary
STOP LAMP	The ICC brake hold relay can be operated by ON/OFF operations as necessary, and the stop lamp can be illuminated
ACTIVE PEDAL	The accelerator pedal actuator can be operated as necessary
DCA INDICATOR	The DCA system switch indicator can be illuminated by ON/OFF operations as necessary
LDP BUZZER	Sounds a buzzer used for following systems by arbitrarily operating ON/OFF <ul style="list-style-type: none"> <li>• Lane Departure Warning (LDW)</li> <li>• Lane Departure Prevention (LDP)</li> <li>• Blind Spot Warning (BSW)</li> <li>• Blind Spot Intervention</li> </ul>
WARNING SYSTEM IND	Warning systems ON indicator (on warning systems switch) can be illuminated by ON/OFF operations as necessary
LDP ON IND	The LDP ON indicator lamp can be illuminated by ON/OFF operations as necessary
LANE DEPARTURE W/L	The Lane departure warning lamp can be illuminated by ON/OFF operations as necessary
BSW/BSI WARNING LAMP	The Blind Spot Warning/Blind Spot Intervention warning lamp can be illuminated by ON/OFF operations as necessary
BSI ON INDICATOR	The Blind Spot Intervention ON indicator can be illuminated by ON/OFF operations as necessary
LDW ON INDICATOR	The LDW ON indicator lamp can be illuminated by ON/OFF operations as necessary
BSW ON INDICATOR	The BSW ON indicator lamp can be illuminated by ON/OFF operations as necessary

### BRAKE ACTUATOR

**NOTE:**

The test can be performed only when the engine is running.

Test item	Operation	Description	"PRESS SENS" value
BRAKE ACTUATOR	MODE1	Transmits the brake fluid pressure control signal to the ABS actuator and electric unit (control unit) via CAN communication	10 bar
	MODE2		20 bar
	MODE3		30 bar
	Test start	Starts the tests of "MODE1", "MODE2" and "MODE3"	—
	Reset	Stops transmitting the brake fluid pressure control signal below to end the test	—
	End	Returns to the "SELECT TEST ITEM" screen	—

**NOTE:**

The test is finished in 10 seconds after starting

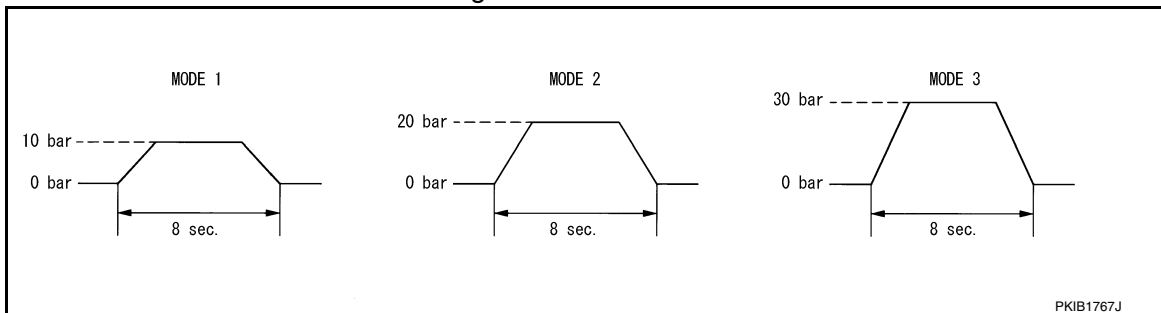

### ICC BUZZER

A  
B  
C  
D  
E  
F  
G  
H  
I  
J  
K  
L  
M  
N  
P



# DIAGNOSIS SYSTEM (ADAS CONTROL UNIT)

< SYSTEM DESCRIPTION >

[BLIND SPOT WARNING & BLIND SPOT INTERVENTION]

Test item	Operation	Description	ICC warning chime operation sound
ICC BUZZER	MODE1	Transmits the buzzer output signals to the combination meter via CAN communication	Intermittent beep sound
	Test start	Starts the tests of "MODE1"	—
	Reset	Stops transmitting the buzzer output signal below to end the test	—
	End	Returns to the "SELECT TEST ITEM" screen	—

## METER LAMP

### NOTE:

The test can be performed only when the engine is running.

Test item	Operation	Description	<ul style="list-style-type: none"> <li>• MAIN switch indicator</li> <li>• ICC system warning lamp</li> <li>• IBA OFF indicator lamp</li> </ul>
METER LAMP	Off	Stops sending the following signals to exit from the test <ul style="list-style-type: none"> <li>• Meter display signal</li> <li>• ICC warning lamp signal</li> <li>• IBA OFF indicator lamp signal</li> </ul>	OFF
	On	Transmits the following signals to the combination meter via CAN communication <ul style="list-style-type: none"> <li>• Meter display signal</li> <li>• ICC warning lamp signal</li> <li>• IBA OFF indicator lamp signal</li> </ul>	ON

## STOP LAMP

Test item	Operation	Description	Stop lamp
STOP LAMP	Off	Stops transmitting the ICC brake hold relay drive signal below to end the test	OFF
	On	Transmits the ICC brake hold relay drive signal	ON

## ACTIVE PEDAL

### CAUTION:

- Shift the selector lever to "P" position, and then perform the test.
- Never depress the accelerator pedal excessively. (The engine speed may rise unexpectedly when finishing the test.)

### NOTE:

- Depress the accelerator pedal to check when performing the test.
- The test can be performed only when the engine is running.

Test item	Operation	Description	Accelerator pedal operation
Active Pedal	MODE1	Transmit the accelerator pedal feedback force control signal to the accelerator pedal actuator via ITS communication.	Constant with a force of 25 N for 8 seconds
	MODE2		Constant with a force of 15 N for 8 seconds
	MODE3		Change up to a force of 25 N for 8 seconds
	MODE4		Change up to a force of 15 N for 8 seconds
	Test start	Starts the tests of "MODE1", "MODE2", "MODE3" and "MODE4"	—
	Reset	Stops transmitting the accelerator pedal feedback force control signal below to end the test.	—
	End	Returns to the "SELECT TEST ITEM" screen	—

# DIAGNOSIS SYSTEM (ADAS CONTROL UNIT)

< SYSTEM DESCRIPTION >

[BLIND SPOT WARNING & BLIND SPOT INTERVENTION]

**NOTE:**

The test is finished in 10 seconds after starting

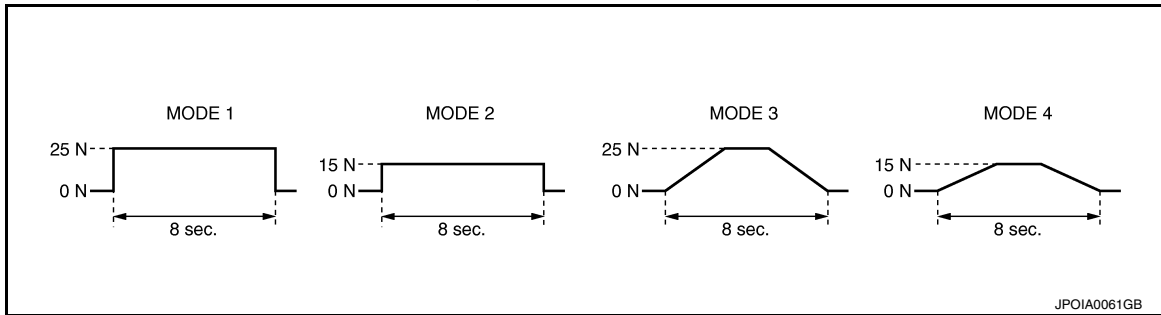

**DCA INDICATOR**

**NOTE:**

The test can be performed only when the engine is running.

Test item	Operation	Description	DCA system switch indicator
DCA INDICATOR	Off	Stops transmitting the DCA system switch indicator signal below to end the test	—
	On	Transmits the DCA system switch indicator signal to the combination meter via CAN communication	ON

**LDP BUZZER**

Test item	Operation	Description	Warning buzzer
LDP BUZZER	Off	Stops transmitting the warning buzzer signal below to end the test	—
	On	Transmits the warning buzzer signal to the warning buzzer	ON

**WARNING SYSTEM IND**

Test item	Operation	Description	Warning systems ON indicator
WARNING SYSTEM IND	Off	Stops transmitting the warning systems ON indicator signal below to end the test	—
	On	Transmits the warning systems ON indicator signal to the warning systems ON indicator	ON

**LDP ON IND**

Test item	Operation	Description	LDP ON indicator lamp (Green)
LDP ON IND	Off	Stops transmitting the LDP ON indicator lamp signal below to end the test	—
	On	Transmits the LDP ON indicator lamp signal to the combination meter via CAN communication	ON

**LANE DEPARTURE W/L**

Test item	Operation	Description	Lane departure warning lamp (Yellow)
LANE DEPARTURE W/L	Off	Stops transmitting the lane departure warning lamp signal below to end the test	—
	On	Transmits the lane departure warning lamp signal to the combination meter via CAN communication	ON

A  
B  
C  
D  
E  
F  
G  
H  
I  
J  
K  
L  
M  
N  
P

DAS

# DIAGNOSIS SYSTEM (ADAS CONTROL UNIT)

< SYSTEM DESCRIPTION >

[BLIND SPOT WARNING & BLIND SPOT INTERVENTION]

## BSW/BSI WARNING LAMP

Test item	Operation	Description	Blind Spot Warning/Blind Spot Intervention warning lamp (Yellow)
BSW/BSI WARNING LAMP	Off	Stops transmitting the Blind Spot Warning/Blind Spot Intervention warning lamp signal below to end the test	—
	On	Transmits the Blind Spot Warning/Blind Spot Intervention warning lamp signal to the combination meter via CAN communication	ON

## BSI ON INDICATOR

Test item	Operation	Description	Blind Spot Intervention ON indicator lamp (Green)
BSI ON INDICATOR	Off	Stops transmitting the Blind Spot Intervention ON indicator signal below to end the test	—
	On	Transmits the Blind Spot Intervention ON indicator signal to the combination meter via CAN communication	ON

## LDW ON INDICATOR

Test item	Operation	Description	Lane Departure Warning ON indicator lamp (Yellow)
LDW ON INDICATOR	Off	Stops transmitting the Lane Departure Warning ON indicator signal below to end the test	—
	On	Transmits the Lane Departure Warning ON indicator signal to the combination meter via CAN communication	ON

## BSW ON INDICATOR

Test item	Operation	Description	Blind Spot Warning ON indicator lamp (Yellow)
BSW ON INDICATOR	Off	Stops transmitting the Blind Spot Warning ON indicator signal below to end the test	—
	On	Transmits the Blind Spot Warning ON indicator signal to the warning lamp on the door	ON

## ECU IDENTIFICATION

ADAS control unit part number is displayed.

# DIAGNOSIS SYSTEM (SIDE RADAR LH)

< SYSTEM DESCRIPTION >

[BLIND SPOT WARNING & BLIND SPOT INTERVENTION]

## DIAGNOSIS SYSTEM (SIDE RADAR LH)

### CONSULT Function (SIDE RADAR LEFT)

INFOID:000000009716766

#### CAUTION:

After disconnecting the CONSULT vehicle interface (VI) from the data link connector, the ignition must be cycled OFF → ON (for at least 5 seconds) → OFF. If this step is not performed, the BCM may not go to “sleep mode”, potentially causing a discharged battery and a no-start condition.

#### DESCRIPTION

CONSULT performs the following functions by communicating with the side radar LH.

Select diag mode	Function
Self Diagnostic Result	Displays memorized DTC in the side radar.
Data Monitor	Displays real-time data of side radar.
Active Test	Enables operation check of electrical loads by sending driving signal to them.
ECU identification	Displays part number of side radar.

#### SELF DIAGNOSTIC RESULT

##### Self Diagnostic Result

Displays memorized DTC in side radar LH. Refer to [DAS-515. "DTC Index"](#).

##### FFD (Freeze Frame Data)

The side radar records the following data when the malfunction is detected.

Freeze Frame Data item	Description
VHCL SP from ADAS	The vehicle speed (from ADAS control unit) at the moment a malfunction is detected is displayed
TURN SIG STATUS	Turn signal status at the moment a malfunction is detected is displayed

#### DATA MONITOR

Monitored Item [unit]	Description	
SIDE RADAR MALF	Off	Side radar is normal.
	On	Side radar is malfunctioning.
BLOCKAGE COND	Off	Side radar is not blocked.
	On	Side radar is blocked.
VEHICLE DETECT	Off	Does not detect a vehicle within detection area.
	On	Detects a vehicle within detection area.

#### ACTIVE TEST

##### CAUTION:

- Never perform the active test while driving.
- Active test cannot be started while the Blind Spot Warning/Blind Spot Intervention indicator is illuminated.

Active test item	Operation	Description
BSW/BSI INDICATOR DRIVE	On	Outputs the voltage to illuminate the Blind Spot Warning/Blind Spot Intervention indicator.
	Off	Stops the voltage to illuminate the Blind Spot Warning/Blind Spot Intervention indicator.

#### ECU IDENTIFICATION

Side radar part number is displayed.

A  
B  
C  
D  
E  
F  
G  
H  
I  
J  
K  
L  
M  
N  
P

DAS

# DIAGNOSIS SYSTEM (SIDE RADAR RH)

< SYSTEM DESCRIPTION >

[BLIND SPOT WARNING & BLIND SPOT INTERVENTION]

## DIAGNOSIS SYSTEM (SIDE RADAR RH)

### CONSULT Function (SIDE RADAR RIGHT)

INFOID:000000009716767

#### CAUTION:

After disconnecting the CONSULT vehicle interface (VI) from the data link connector, the ignition must be cycled OFF → ON (for at least 5 seconds) → OFF. If this step is not performed, the BCM may not go to "sleep mode", potentially causing a discharged battery and a no-start condition.

#### DESCRIPTION

CONSULT performs the following functions by communicating with the side radar RH.

Select diag mode	Function
Self Diagnostic Result	Displays memorized DTC in the side radar.
Data Monitor	Displays real-time data of side radar.
Active Test	Enables operation check of electrical loads by sending driving signal to them.
ECU identification	Displays part number of side radar.

#### SELF DIAGNOSTIC RESULT

##### Self Diagnostic Result

Displays memorized DTC in side radar RH. Refer to [DAS-517, "DTC Index"](#).

##### FFD (Freeze Frame Data)

The side radar records the following data when the malfunction is detected.

Freeze Frame Data item	Description
VHCL SP from ADAS	The vehicle speed (from ADAS control unit) at the moment a malfunction is detected is displayed
TURN SIG STATUS	Turn signal status at the moment a malfunction is detected is displayed

#### DATA MONITOR

Monitored Item [unit]	Description	
SIDE RADAR MALF	Off	Side radar is normal.
	On	Side radar is malfunctioning.
BLOCKAGE COND	Off	Side radar is not blocked.
	On	Side radar is blocked.
VEHICLE DETECT	Off	Does not detect a vehicle within detection area.
	On	Detects a vehicle within detection area.

#### ACTIVE TEST

##### CAUTION:

- Never perform the active test while driving.
- Active test cannot be started while the Blind Spot Warning/Blind Spot Intervention indicator is illuminated.

Active test item	Operation	Description
BSW/BSI INDICATOR DRIVE	On	Outputs the voltage to illuminate the Blind Spot Warning/Blind Spot Intervention indicator.
	Off	Stops the voltage to illuminate the Blind Spot Warning/Blind Spot Intervention indicator.

#### ECU IDENTIFICATION

Side radar part number is displayed.

# DIAGNOSIS SYSTEM (LANE CAMERA UNIT)

< SYSTEM DESCRIPTION >

[BLIND SPOT WARNING & BLIND SPOT INTERVENTION]

## DIAGNOSIS SYSTEM (LANE CAMERA UNIT)

### CONSULT Function (LANE CAMERA)

INFOID:000000009716768

#### CAUTION:

After disconnecting the CONSULT vehicle interface (VI) from the data link connector, the ignition must be cycled OFF → ON (for at least 5 seconds) → OFF. If this step is not performed, the BCM may not go to “sleep mode”, potentially causing a discharged battery and a no-start condition.

#### APPLICATION ITEMS

CONSULT performs the following functions by communicating with the lane camera unit.

Diagnosis mode	Description
Self Diagnostic Result	Displays the name of a malfunctioning system stored in the lane camera unit
Data Monitor	Displays lane camera unit input/output data in real time
Work support	Performs the camera aiming
ECU identification	Displays lane camera unit part number

#### WORK SUPPORT

Work support items	Description
AUTO AIM	Outputs camera unit, calculates dislocation of the camera, and displays adjustment direction.

#### SELF DIAGNOSTIC RESULT

Refer to [DAS-366, "DTC Index"](#).

#### DATA MONITOR

Monitored item [Unit]	Description
LC INACCURAT [On/Off]	Lane camera unit status
AIMING RESULT [OK/NOK]	Result of camera aiming
AIMING DONE [OK/NG]	Status that camera aiming is done
CAM HIGH TEMP [NORMAL/High]	Status of lane camera unit high temperature judgment
VHCL SPD SE [km/h] or [mph]	Vehicle speed received from ADAS control unit via ITS communication
TURN SIGNAL [Off, LH, RH, LH/RH]	Status of “Turn signal” determined from ADAS control unit via ITS communication
LANE DETCT LH [On/Off]	Left side lane marker detection
LANE DETCT RH [On/Off]	Right side lane marker detection
CROSS LANE LH [On/Off]	Condition that the vehicle is crossing left lane marker
CROSS LANE RH [On/Off]	Condition that the vehicle is crossing right lane marker
WARN LANE LH [On/Off]	Warning for left lane marker
WARN LANE RH [On/Off]	Warning for right lane marker
VALID POS LH [VLD/INVLD]	Lateral position for left lane marker is valid
VALID POS RH [VLD/INVLD]	Lateral position for right lane marker is valid
XOFFSET [pixel]	Lane camera unit installation condition
AIM CHECK YAW [deg]	Check result of camera aiming
AIM CHECK ROLL [deg]	Check result of camera aiming
AIM CHECK PITCH [deg]	Check result of camera aiming
FCTRY AIM YAW [deg]	Lane camera unit installation condition

## DIAGNOSIS SYSTEM (LANE CAMERA UNIT)

< SYSTEM DESCRIPTION >

[BLIND SPOT WARNING & BLIND SPOT INTERVENTION]

Monitored item [Unit]	Description
FCTRY AIM ROL [deg]	Lane camera unit installation condition
FCTRY AIM PIT [deg]	Lane camera unit installation condition
ADAS MALF [On/Off]	ADAS control unit status

### ECU identification

Lane camera part number is displayed.



# ADAS CONTROL UNIT

< ECU DIAGNOSIS INFORMATION > **[BLIND SPOT WARNING & BLIND SPOT INTERVENTION]**

## ECU DIAGNOSIS INFORMATION

### ADAS CONTROL UNIT

Reference Value

INFOID:000000009716769

#### VALUES ON THE DIAGNOSIS TOOL

Monitor item	Condition		Value/Status
MAIN SW	Ignition switch ON	When MAIN switch is pressed	On
		When MAIN switch is not pressed	Off
SET/COAST SW	Ignition switch ON	When SET/COAST switch is pressed	On
		When SET/COAST switch is not pressed	Off
CANCEL SW	Ignition switch ON	When CANCEL switch is pressed	On
		When CANCEL switch is not pressed	Off
RESUME/ACC SW	Ignition switch ON	When RESUME/ACCELERATE switch is pressed	On
		When RESUME/ACCELERATE switch is not pressed	Off
DISTANCE SW	Ignition switch ON	When DISTANCE switch is pressed	On
		When DISTANCE switch is not pressed	Off
CRUISE OPE	Drive the vehicle and activate the vehicle-to-vehicle distance control mode	When ICC system is controlling	On
		When ICC system is not controlling	Off
BRAKE SW	Ignition switch ON	When brake pedal is depressed	Off
		When brake pedal is not depressed	On
STOP LAMP SW	Ignition switch ON	When brake pedal is depressed	On
		When brake pedal is not depressed	Off
IDLE SW	Engine running	Idling	On
		Except idling (depress accelerator pedal)	Off
SET DISTANCE	<ul style="list-style-type: none"> <li>• Start the engine and turn the ICC system ON</li> <li>• Press the DISTANCE switch to change the vehicle-to-vehicle distance setting</li> </ul>	When set to "long"	Long
		When set to "middle"	Mid
		When set to "short"	Short
CRUISE LAMP	Start the engine and press MAIN switch	ICC system ON (MAIN switch indicator ON)	On
		ICC system OFF (MAIN switch indicator OFF)	Off
OWN VHCL	Start the engine and press MAIN switch	ICC system ON (Own vehicle indicator ON)	On
		ICC system OFF (Own vehicle indicator OFF)	Off
VHCL AHEAD	Drive the vehicle and activate the vehicle-to-vehicle distance control mode	When a vehicle ahead is detected (vehicle ahead detection indicator ON)	On
		When a vehicle ahead is not detected (vehicle ahead detection indicator OFF)	Off
ICC WARNING	Start the engine and press MAIN switch	When ICC system is malfunctioning (ICC system warning lamp ON)	On
		When ICC system is normal (ICC system warning lamp OFF)	Off

A  
B  
C  
D  
E  
F  
G  
H  
I  
J  
K  
L  
M  
N  
P

DAS

## ADAS CONTROL UNIT

### < ECU DIAGNOSIS INFORMATION > [BLIND SPOT WARNING & BLIND SPOT INTERVENTION]

Monitor item	Condition		Value/Status
VHCL SPEED SE	While driving		Displays a vehicle speed calculated by the ADAS control unit
SET VHCL SPD	While driving	When vehicle speed is set	Displays the set vehicle speed
BUZZER O/P	Engine running	When the buzzer of the following system operates <ul style="list-style-type: none"> <li>• Vehicle-to-vehicle distance control mode</li> <li>• DCA system</li> <li>• FCW system</li> <li>• IBA system</li> </ul>	On
		When the buzzer of the following system not operates <ul style="list-style-type: none"> <li>• Vehicle-to-vehicle distance control mode</li> <li>• DCA system</li> <li>• FCW system</li> <li>• IBA system</li> </ul>	Off
THRTL SENSOR	<b>NOTE:</b> The item is indicated, but not monitored		0.0
ENGINE RPM	Engine running		Equivalent to tachometer reading
WIPER SW	Ignition switch ON	Wiper not operating	Off
		Wiper LO operation	Low
		Wiper HI operation	High
BA WARNING	Engine running	IBA OFF indicator lamp ON <ul style="list-style-type: none"> <li>• When IBA system is malfunctioning</li> <li>• When IBA system is turned to OFF</li> </ul>	On
		IBA OFF indicator lamp OFF <ul style="list-style-type: none"> <li>• When IBA system is normal</li> <li>• When IBA system is turned to ON</li> </ul>	Off
STP LMP DRIVE	Drive the vehicle and activate the vehicle-to-vehicle distance control mode	When ICC brake hold relay is activated	On
		When ICC brake hold relay is not activated	Off
D RANGE SW	Engine running	When the selector lever is in "D" position or manual mode	On
		When the selector lever is in any position other than "D" or manual mode	Off
NP RANGE SW	Engine running	When the selector lever is in "N", "P" position	On
		When the selector lever is in any position other than "N", "P"	Off
PKB SW	Ignition switch ON	When the parking brake is applied	On
		When the parking brake is released	Off
PWR SUP MONI	Engine running		Power supply voltage value of ADAS control unit
VHCL SPD AT	While driving		Value of CVT vehicle speed sensor signal
THRTL OPENING	Engine running	Depress accelerator pedal	Displays the throttle position

# ADAS CONTROL UNIT

## < ECU DIAGNOSIS INFORMATION > [BLIND SPOT WARNING & BLIND SPOT INTERVENTION]

Monitor item	Condition		Value/Status
GEAR	While driving		Displays the gear position
MODE SIG	Start the engine and press MAIN switch	When ICC system is deactivated	Off
		When vehicle-to-vehicle distance control mode is activated	ICC
		When conventional (fixed speed) cruise control mode is activated	ASCD
SET DISP IND	<ul style="list-style-type: none"> <li>• Drive the vehicle and activate the conventional (fixed speed) cruise control mode</li> <li>• Press SET/COAST switch</li> </ul>	SET switch indicator ON	On
		SET switch indicator OFF	Off
DISTANCE	Drive the vehicle and activate the vehicle-to-vehicle distance control mode	When a vehicle ahead is detected	Displays the distance from the preceding vehicle
		When a vehicle ahead is not detected	0.0
RELATIVE SPD	Drive the vehicle and activate the vehicle-to-vehicle distance control mode	When a vehicle ahead is detected	Displays the relative speed.
		When a vehicle ahead is not detected	0.0
Camera lost	Drive the vehicle and activate the LDW system, LDP system or Blind Spot Intervention system	Both side lane markers are detected	Detect
		Deviate side lane marker is lost	Deviate
		Both side lane markers are lost	Both
Lane unclear	While driving	Lane marker is unclear	On
		Lane marker is clear	Off
STATUS signal	Drive the vehicle with the LDP system turned ON	When the LDP system is ON	Stnby
		When the LDP system is operating	Warn
		When the LDP system is canceled	Cancl
		When the LDP system is OFF	Off
DYNA ASIST SW	Ignition switch ON	When dynamic driver assistance switch is pressed	On
		When dynamic driver assistance switch is not pressed	Off
DCA ON IND	Start the engine and press dynamic driver assistance switch (When DCA system setting is ON)	DCA system OFF (DCA system switch indicator OFF)	Off
		DCA system ON (DCA system switch indicator ON)	On
DCA VHL AHED	Drive the vehicle and activate the DCA system	When a vehicle ahead is not detected (vehicle ahead detection indicator OFF)	Off
		When a vehicle ahead is detected (vehicle ahead detection indicator ON)	On
IBA SW	Ignition switch ON	When the IBA OFF switch is pressed	On
		When the IBA OFF switch is not pressed	Off
APA TEMP	Engine running		Display the accelerator pedal actuator integrated motor temperature
APA PWR	Ignition switch ON		Power supply voltage value of accelerator pedal actuator

A

B

C

D

E

F

G

H

I

J

K

L

M

N

DAS

P

# ADAS CONTROL UNIT

## < ECU DIAGNOSIS INFORMATION > [BLIND SPOT WARNING & BLIND SPOT INTERVENTION]

Monitor item	Condition		Value/Status
FCW SYSTEM ON	Ignition switch ON	When the FCW system is ON (Warning systems ON indicator ON)	On
		When the FCW system is OFF (Warning systems ON indicator OFF)	Off
LDW SYSTEM ON	Ignition switch ON	When the LDW system is ON (Warning systems ON indicator ON)	On
		When the LDW system is OFF (Warning systems ON indicator OFF)	Off
LDW ON LAMP	Ignition switch ON	Warning systems ON indicator ON	On
		Warning systems ON indicator OFF	Off
LDP ON IND	Start the engine and press dynamic driver assistance switch (When LDP system setting is ON)	LDP ON indicator lamp ON	On
		LDP ON indicator lamp OFF	Off
LANE DPRT W/L	Drive the vehicle and activate the LDW system or LDP system	Lane departure warning lamp ON	On
		Lane departure warning lamp OFF	Off
LDW BUZER OUTPUT	Drive the vehicle and activate the LDW/LDP system or Blind Spot Warning/Blind Spot Intervention system	When the buzzer of the following system operates • LDW/LDP system • Blind Spot Warning/Blind Spot Intervention system	On
		When the buzzer of the following system does not operate • LDW/LDP system • Blind Spot Warning/Blind Spot Intervention system	Off
LDP SYSTEM ON	Start the engine and press dynamic driver assistance switch (When LDP system setting is ON)	When the LDP system is ON	On
		When the LDP system is OFF	Off
READY signal	Start the engine and press dynamic driver assistance switch (When LDP system setting is ON)	When the LDP system is ON	On
		When the LDP system is OFF	Off
Shift position	<ul style="list-style-type: none"> <li>• Engine running</li> <li>• While driving</li> </ul>		Displays the shift position
Turn signal	Turn signal lamps OFF		Off
	Turn signal lamp LH blinking		LH
	Turn signal lamp RH blinking		RH
	Turn signal lamp LH and RH blinking		LH&RH
SIDE G	While driving	Vehicle turning right	Negative value
		Vehicle turning left	Positive value
FUNC ITEM (FCW)	Ignition switch ON		FCW
FUNC ITEM (LDW)	Ignition switch ON		LDW
FUNC ITEM (BSW)	Ignition switch ON		BSW
FUNC ITEM (NV-ICC)	<b>NOTE:</b> The item is indicated, but not monitored		Off
FUNC ITEM (NV-DCA)	<b>NOTE:</b> The item is indicated, but not monitored		Off
DCA SELECT	Ignition switch ON	"Distance Control Assist" set with the navigation system is ON	On
		"Distance Control Assist" set with the navigation system is OFF	Off

# ADAS CONTROL UNIT

< ECU DIAGNOSIS INFORMATION >

## [BLIND SPOT WARNING & BLIND SPOT INTERVENTION]

Monitor item	Condition	Value/Status	
LDP SELECT	Ignition switch ON	"Lane Departure Prevention" set with the navigation system is ON	On
		"Lane Departure Prevention" set with the navigation system is OFF	Off
BSI SELECT	Ignition switch ON	"Blind Spot Intervention" set with the navigation system is ON	On
		"Blind Spot Intervention" set with the navigation system is OFF	Off
DRIVE MODE STATS	Ignition switch ON	When the DMS switch is in normal position	Std
		When the DMS switch is in SNOW position	SNO
		When the DMS switch is in ECO position	ECO
		When the DMS switch is in SPORT position	SPT
WARN SYS SW	Ignition switch ON	When warning systems switch is pressed	On
		When warning systems switch is not pressed	Off
BSW/BSI WARN LMP	Ignition switch ON	Blind Spot Warning/Blind Spot Intervention warning lamp ON	On
		Blind Spot Warning/Blind Spot Intervention warning lamp OFF	Off
BSI ON IND	Ignition switch ON	Blind Spot Intervention ON indicator ON	On
		Blind Spot Intervention ON indicator OFF	Off
BSW SYSTEM ON	Ignition switch ON	When the BSW system is ON (Warning systems ON indicator ON)	On
		When the BSW system is OFF (Warning systems ON indicator OFF)	Off
BSI SYSTEM ON	Start the engine and press dynamic driver assistance switch (When Blind Spot Intervention system setting is ON)	When the Blind Spot Intervention system is ON	On
		When the Blind Spot Intervention system is OFF	Off
BCI SYSTEM ON	Ignition switch ON	Back-up Collision Intervention system ON	On
		Back-up Collision Intervention system OFF	Off
BCI SWITCH	Ignition switch ON	Back-up Collision Intervention switch ON	On
		Back-up Collision Intervention switch OFF	Off
LDP WARNING INDICATOR	Ignition switch ON	When the LDP fail lamp is ON (Warning systems ON indicator ON)	On
		When the LDP fail lamp is OFF	Off
LDW ON LAMP	Ignition switch ON	When LDW indicator lamp is ON	On
		When LDW indicator lamp is OFF	Off
LDW WARNING INDICATOR	Ignition switch ON	When LDW FAIL lamp is ON	On
		When LDW FAIL lamp is OFF	Off
SYSTEM CANCEL MESSAGE	Ignition switch ON	When a system cancel message is sent	Request
		When a system cancel message is not sent	No Request
CAMERA HI TEMP MSG	Ignition switch ON	When camera high temperature message is sent	On
		When camera high temperature message is not sent	Off
ITS Setting Item(DCA)	Ignition switch ON	When the DCA is set	On
		When the DCA is not set	Off
ITS Setting Item(LDP)	Ignition switch ON	When the LDP is set	On
		When the LDP is not set	Off

A

B

C

D

E

F

G

H

I

J

K

L

M

N

DAS

P

# ADAS CONTROL UNIT

## < ECU DIAGNOSIS INFORMATION > [BLIND SPOT WARNING & BLIND SPOT INTERVENTION]

Monitor item	Condition		Value/Status
ITS Setting Item(BSI)	Ignition switch ON	When the BSI is set	On
		When the BSI is not set	Off
BSI WARNING INDICATOR	Ignition switch ON	When BSI FAIL indicator warning lamp is ON	On
		When BSI FAIL indicator warning lamp is OFF	Off
BSW ON INDICATOR	Ignition switch ON	When BSW ON indicator lamp is ON	On
		When BSW ON indicator lamp is OFF	Off
BSW IND BRIGHTNESS	Ignition switch ON	When BSW indicator brightness is selected	On
		When BSW indicator brightness is not selected	Off
WARN REQ	Drive the vehicle and activate the LDP system	Lane departure warning is operating	On
		Lane departure warning is not operating	Off

### TERMINAL LAYOUT PHYSICAL VALUES

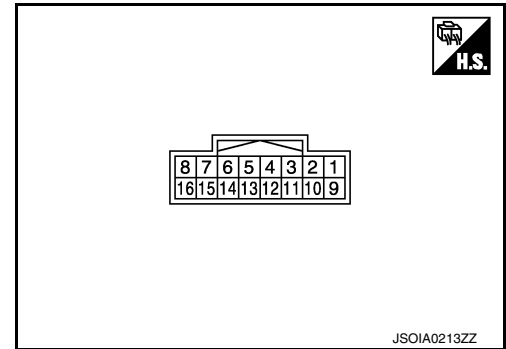

Terminal No. (Wire color)		Description		Condition	Value (Approx.)
+	-	Signal name	Input/ Output		
5 (G)	Ground	ICC brake hold relay drive signal	Output	Ignition switch ON	12 V
				At "STOP LAMP" test of "Active test"	0 V
6 (B)		Ground	Input	—	0 V
7 (L)		ITS communication-H	—	—	—
8 (Y)		ITS communication-L	—	—	—
14 (B)		CAN -H	—	—	—
15 (W)		CAN -L	—	—	—
16 (R)	Ignition power supply	Input	Ignition switch ON	Battery Voltage	

### Fail-safe

INFOID:000000009716770

If a malfunction occurs in each system, ADAS control unit cancels each control, sounds a beep, and turns ON the warning lamp or indicator lamp.

System	Buzzer	Warning lamp/Indicator lamp	Description
Vehicle-to-vehicle distance control mode	High-pitched tone	ICC system warning lamp	Cancel
Conventional (fixed speed) cruise control mode	High-pitched tone	ICC system warning lamp	Cancel

# ADAS CONTROL UNIT

## < ECU DIAGNOSIS INFORMATION > [BLIND SPOT WARNING & BLIND SPOT INTERVENTION]

System	Buzzer	Warning lamp/Indicator lamp	Description
Intelligent Brake Assist (IBA)	High-pitched tone	IBA OFF indicator lamp	Cancel
Forward Collision Warning (FCW)	High-pitched tone	Warning message	Cancel
Distance Control Assist (DCA)	High-pitched tone	DCA system warning	Cancel
Lane Departure Warning (LDW)	—	Lane departure warning lamp	Cancel
Lane Departure Prevention (LDP)	Low-pitched tone	Lane departure warning lamp	Cancel
Blind Spot Warning (BSW)	—	Blind Spot Warning/Blind Spot Intervention warning lamp	Cancel
Blind Spot Intervention	Low-pitched tone	Blind Spot Warning/Blind Spot Intervention warning lamp	Cancel
Backup Collision Intervention (BCI)	High-pitched tone	Backup Collision Intervention warning indicator	Cancel

### DTC Inspection Priority Chart

INFOID:000000009716771

If multiple DTCs are detected simultaneously, check them one by one depending on the following DTC inspection priority chart.

Priority	Detected items (DTC)
1	<ul style="list-style-type: none"> <li>• C1A0A: CONFIG UNFINISHED</li> <li>• U1507: LOST COMM (SIDE RDR R)</li> <li>• U1508: LOST COMM (SIDE RDR L)</li> </ul>
2	<ul style="list-style-type: none"> <li>• U1000: CAN COMM CIRCUIT</li> <li>• U1010: CONTROL UNIT (CAN)</li> </ul>
3	<ul style="list-style-type: none"> <li>• C1B00: CAMERA UNIT MALF</li> <li>• C1F02: APA C/U MALF</li> <li>• C1A17: ICC SENSOR MALF</li> <li>• C1B53: SIDE RDR R MALF</li> <li>• C1B54: SIDE RDR L MALF</li> </ul>

DAS

# ADAS CONTROL UNIT

## < ECU DIAGNOSIS INFORMATION > [BLIND SPOT WARNING & BLIND SPOT INTERVENTION]

Priority	Detected items (DTC)
4	<ul style="list-style-type: none"> <li>• C1A01: POWER SUPPLY CIR</li> <li>• C1A02: POWER SUPPLY CIR 2</li> <li>• C1A04: ABS/TCS/VDC CIRC</li> <li>• C1A05: BRAKE SW/STOP L SW</li> <li>• C1A06: OPERATION SW CIRC</li> <li>• C1A12: LASER BEAM OFFCNTR</li> <li>• C1A13: STOP LAMP RLY FIX</li> <li>• C1A14: ECM CIRCUIT</li> <li>• C1A16: RADAR STAIN</li> <li>• C1A18: LASER AIMING INCOMP</li> <li>• C1A2A: ICC SEN PWR SUP CIR</li> <li>• C1A21: ICC SENSOR HIGH TEMP</li> <li>• C1A24: NP RANGE</li> <li>• C1A26: ECD MODE MALF</li> <li>• C1A27: ECD PWR SUPPLY CIR</li> <li>• C1A33: CAN TRANSMISSION ERR</li> <li>• C1A34: COMMAND ERROR</li> <li>• C1A35: APA CIR</li> <li>• C1A36: APA CAN COMM CIR</li> <li>• C1A37: APA CAN CIR 2</li> <li>• C1A38: APA CAN CIR 1</li> <li>• C1A39: STRG SEN CIR</li> <li>• C1A40: SYSTEM SW CIRC</li> <li>• C1B01: CAM AIMING INCOMP</li> <li>• C1B03: CAM ABNRML TMP DETCT</li> <li>• C1B56: SONAR CIRCUIT</li> <li>• C1B57: AVM CIRCUIT</li> <li>• C1F01: APA MOTOR MALF</li> <li>• C1F05: APA PWR SUPPLY CIR</li> <li>• U0121: VDC CAN CIR 2</li> <li>• U0126: STRG SEN CAN CIR 1</li> <li>• U0235: ICC SENSOR CAN CIRC 1</li> <li>• U0401: ECM CAN CIR 1</li> <li>• U0402: TCM CAN CIR 1</li> <li>• U0415: VDC CAN CIR 1</li> <li>• U0428: STRG SEN CAN CIR 2</li> <li>• U1500: CAM CAN CIR 2</li> <li>• U1501: CAM CAN CIR 1</li> <li>• U1502: ICC SEN CAN COMM CIR</li> <li>• U1503: SIDE RDR L CAN CIR 2</li> <li>• U1504: SIDE RDR L CAN CIR 1</li> <li>• U1505: SIDE RDR R CAN CIR 2</li> <li>• U1506: SIDE RDR R CAN CIR 1</li> <li>• U1521: SONAR CAN COMMUNICATION</li> <li>• U1522: SONAR CAN COMMUNICATION</li> <li>• U1523: SONAR CAN COMMUNICATION</li> <li>• U1524: AVM CAN COMMUNICATION</li> <li>• U1525: AVM CAN COMMUNICATION</li> <li>• U150B: ECM CAN CIRC 3</li> <li>• U150C: VDC CAN CIRC 3</li> <li>• U150D: TCM CAN CIRC 3</li> <li>• U150E: BCM CAN CIRC 3</li> <li>• U150F: AV CAN CIRC 3</li> <li>• U1512: HVAC CAN CIRC3</li> <li>• U1513: METER CAN CIRC 3</li> <li>• U1514: STRG SEN CAN CIRC 3</li> <li>• U1515: ICC SENSOR CAN CIRC 3</li> <li>• U1516: CAM CAN CIRC 3</li> <li>• U1517: APA CAN CIRC 3</li> <li>• U1518: SIDE RDR L CAN CIRC 3</li> <li>• U1519: SIDE RDR R CAN CIRC 3</li> </ul>
5	<ul style="list-style-type: none"> <li>• C1A03: VHCL SPEED SE CIRC</li> </ul>
6	<ul style="list-style-type: none"> <li>• C1A15: GEAR POSITION</li> </ul>
7	<ul style="list-style-type: none"> <li>• C1A00: CONTROL UNIT</li> </ul>



# ADAS CONTROL UNIT

< ECU DIAGNOSIS INFORMATION > **[BLIND SPOT WARNING & BLIND SPOT INTERVENTION]**

## DTC Index

INFOID:000000009716772

**NOTE:**

- The details of time display are as per the following.
- CRNT: A malfunction is detected now
- PAST: A malfunction was detected in the past
- IGN counter is displayed on FFD (Freeze Frame Data).
- 0: The malfunctions that are detected now  
CAN communication system (U1000, U1010)
- 1 - 39: It increases like 0 → 1 → 2 ... 38 → 39 after returning to the normal condition whenever the ignition switch OFF → ON. It returns to 0 when a malfunction is detected again in the process.
- If it is over 39, it is fixed to 39 until the self-diagnosis results are erased.  
Other than CAN communication system (Other than U1000, U1010)
- 1 - 49: It increases like 0 → 1 → 2 ... 38 → 49 after returning to the normal condition whenever the ignition switch OFF → ON. It returns to 0 when a malfunction is detected again in the process.
- If it is over 49, it is fixed to 49 until the self-diagnosis results are erased.

Systems for fail-safe

- A: Vehicle-to-vehicle distance control mode
- B: Conventional (fixed speed) cruise control mode
- C: Intelligent Brake Assist (IBA)
- D: Forward Collision Warning (FCW)
- E: Distance Control Assist (DCA)
- F: Lane Departure Warning (LDW)/Lane Departure Prevention (LDP)
- G: Blind Spot Warning (BSW)/Blind Spot Intervention
- H: Backup Collision Intervention (BCI)

DTC		CONSULT display	Warning lamp					Fail-safe	Reference
CONSULT	On board display		ICC system warning lamp	IBA OFF indicator lamp	Lane departure warning lamp	Blind Spot Warning/Blind Spot Intervention warning lamp	Backup Collision Intervention	System	
C1A00	0	CONTROL UNIT	ON	ON	ON	ON	ON	A, B, C, D, E, F, G, H	<a href="#">DAS-73</a>
C1A01	1	POWER SUPPLY CIR	ON	ON	ON	ON	ON	A, B, C, D, E, F, G, H	<a href="#">DAS-74</a>
C1A02	2	POWER SUPPLY CIR 2	ON	ON	ON	ON	ON	A, B, C, D, E, F, G, H	<a href="#">DAS-74</a>
C1A03	3	VHCL SPEED SE CIRC	ON	ON	ON	ON	ON	A, B, C, D, E, F, G, H	<a href="#">DAS-160</a>
C1A04	4	ABS/TCS/VDC CIRC	ON	ON	ON	ON	ON	A, B, C, D, E, F, G, H	<a href="#">DAS-162</a>
C1A05	5	BRAKE SW/STOP L SW	ON	ON	ON	ON	ON	A, B, C, D, E, F, G, H	<a href="#">DAS-163</a>
C1A06	6	OPERATION SW CIRC	ON		ON	ON		A, B, E, F, G	<a href="#">DAS-167</a>
C1A12	12	LASER BEAM OFFCN-TR	ON	ON				A, C, D, E	<a href="#">DAS-170</a>
C1A13	13	STOP LAMP RLY FIX	ON	ON			ON	A, B, C, D, E, H	<a href="#">DAS-171</a>
C1A14	14	ECM CIRCUIT	ON		ON	ON	ON	A, B, E, F, G, H	<a href="#">DAS-177</a>

A  
B  
C  
D  
E  
F  
G  
H  
I  
J  
K  
L  
M  
N

DAS

P

# ADAS CONTROL UNIT

## < ECU DIAGNOSIS INFORMATION > [BLIND SPOT WARNING & BLIND SPOT INTERVENTION]

Systems for fail-safe

- A: Vehicle-to-vehicle distance control mode
- B: Conventional (fixed speed) cruise control mode
- C: Intelligent Brake Assist (IBA)
- D: Forward Collision Warning (FCW)
- E: Distance Control Assist (DCA)
- F: Lane Departure Warning (LDW)/Lane Departure Prevention (LDP)
- G: Blind Spot Warning (BSW)/Blind Spot Intervention
- H: Backup Collision Intervention (BCI)

DTC		CONSULT display	Warning lamp					Fail-safe	Reference
CONSULT	On board display		ICC system warning lamp	IBA OFF indicator lamp	Lane departure warning lamp	Blind Spot Warning/Blind Spot Intervention warning lamp	Backup Collision Intervention	System	
C1A15	15	GEAR POSITION	ON	ON	ON	ON	ON	A, B, C, D, E, F, G, H	<a href="#">DAS-178</a>
C1A16	16	RADAR STAIN	ON	ON				A, C, D, E	<a href="#">DAS-180</a>
C1A17	17	ICC SENSOR MALF	ON	ON				A, B, C, D, E	<a href="#">DAS-181</a>
C1A18	18	LASER AIMING INCMP	ON	ON				A, C, D, E	<a href="#">DAS-182</a>
C1A21	21	ICC SENSOR HIGH TEMP	ON	ON				A, B, C, D, E	<a href="#">DAS-183</a>
C1A24	24	NP RANGE	ON	ON	ON	ON	ON	A, B, C, D, E, F, G, H	<a href="#">DAS-184</a>
C1A26	26	ECD MODE MALF	ON	ON				A, B, C, D, E	<a href="#">DAS-186</a>
C1A27	27	ECD PWR SUPPLY CIR	ON	ON				A, B, C, D, E	<a href="#">DAS-187</a>
C1A33	33	CAN TRANSMISSION ERR	ON					A, B, E	<a href="#">DAS-189</a>
C1A34	34	COMMAND ERROR	ON					A, B, E	<a href="#">DAS-190</a>
C1A35	35	APA CIR	ON				ON	A, E, H	<a href="#">DAS-191</a>
C1A36	36	APA CAN COMM CIR	ON				ON	A, E, H	<a href="#">DAS-192</a>
C1A37	133	APA CAN CIR 2	ON				ON	A, B, E, H	<a href="#">DAS-193</a>
C1A38	132	APA CAN CIR 1	ON				ON	A, B, E, H	<a href="#">DAS-194</a>
C1A39	39	STRG SEN CIR	ON	ON		ON	ON	A, B, C, D, E, G, H	<a href="#">DAS-195</a>
C1A2A	80	ICC SEN PWR SUP CIR	ON	ON				A, C, D, E	<a href="#">DAS-188</a>
C1B00	81	CAMERA UNIT MALF			ON	ON		F, G	<a href="#">DAS-418</a>
C1B01	82	CAM AIMING INCMP			ON	ON		F, G	<a href="#">DAS-420</a>
C1B03	83	CAM ABNRML TMP DETCT							<a href="#">DAS-422</a>
C1B53	84	SIDE RDR R MALF				ON	ON	G, H	<a href="#">DAS-577</a>
C1B54	85	SIDE RDR L MALF				ON	ON	G, H	<a href="#">DAS-578</a>
C1B56	87	SONAR CIRCUIT					ON	H	<a href="#">DAS-744</a>

# ADAS CONTROL UNIT

## < ECU DIAGNOSIS INFORMATION > [BLIND SPOT WARNING & BLIND SPOT INTERVENTION]

Systems for fail-safe

- A: Vehicle-to-vehicle distance control mode
- B: Conventional (fixed speed) cruise control mode
- C: Intelligent Brake Assist (IBA)
- D: Forward Collision Warning (FCW)
- E: Distance Control Assist (DCA)
- F: Lane Departure Warning (LDW)/Lane Departure Prevention (LDP)
- G: Blind Spot Warning (BSW)/Blind Spot Intervention
- H: Backup Collision Intervention (BCI)

DTC		CONSULT display	Warning lamp					Fail-safe	Reference
CONSULT	On board display		ICC system warning lamp	IBA OFF indicator lamp	Lane departure warning lamp	Blind Spot Warning/Blind Spot Intervention warning lamp	Backup Collision Intervention	System	
C1B57	88	AVM CIRCUIT					ON	H	<a href="#">DAS-745</a>
C1F01	91	APA MOTOR MALF	ON				ON	A, E, H	<a href="#">DAS-196</a>
C1F02	92	APA C/U MALF	ON				ON	A, E, H	<a href="#">DAS-198</a>
C1F05	95	APA PWR SUPPLY CIR	ON				ON	A, E, H	<a href="#">DAS-201</a>
NO DTC IS DETECTED. FURTHER TESTING MAY BE REQUIRED	55	NO DTC IS DETECTED. FURTHER TESTING MAY BE REQUIRED	—	—	—	—	—	—	—
U0121	127	VDC CAN CIR 2	ON	ON	ON	ON	ON	A, B, C, D, E, F, G, H	<a href="#">DAS-205</a>
U0126	130	STRG SEN CAN CIR 1	ON	ON		ON	ON	A, B, C, D, E, G, H	<a href="#">DAS-206</a>
U0235	144	ICC SENSOR CAN CIRC 1	ON	ON				A, B, C, D, E	<a href="#">DAS-207</a>
U0401	120	ECM CAN CIR 1	ON		ON	ON	ON	A, B, E, F, G, H	<a href="#">DAS-208</a>
U0402	122	TCM CAN CIR 1	ON	ON	ON	ON	ON	A, B, C, D, E, F, G, H	<a href="#">DAS-209</a>
U0415	126	VDC CAN CIR 1	ON	ON	ON	ON	ON	A, B, C, D, E, F, G, H	<a href="#">DAS-210</a>
U0428	131	STRG SEN CAN CIR 2	ON	ON		ON	ON	A, B, C, D, E, G, H	<a href="#">DAS-211</a>
U1000 <sup>NOTE</sup>	100	CAN COMM CIRCUIT	ON	ON	ON	ON	ON	A, B, C, D, E, F, G, H	<a href="#">DAS-75</a>
U1010	110	CONTROL UNIT (CAN)	ON	ON	ON	ON	ON	A, B, C, D, E, F, G, H	<a href="#">DAS-76</a>
U1500	145	CAM CAN CIR 2			ON	ON		F, G	<a href="#">DAS-438</a>
U1501	146	CAM CAN CIR 1			ON	ON		F, G	<a href="#">DAS-439</a>
U1502	147	ICC SEN CAN COMM CIR	ON	ON				A, B, C, D, E	<a href="#">DAS-219</a>
U1503	150	SIDE RDR L CAN CIR 2				ON	ON	G, H	<a href="#">DAS-603</a>

A  
B  
C  
D  
E  
F  
G  
H  
I  
J  
K  
L  
M  
N  
P



# ADAS CONTROL UNIT

## < ECU DIAGNOSIS INFORMATION > [BLIND SPOT WARNING & BLIND SPOT INTERVENTION]

Systems for fail-safe

- A: Vehicle-to-vehicle distance control mode
- B: Conventional (fixed speed) cruise control mode
- C: Intelligent Brake Assist (IBA)
- D: Forward Collision Warning (FCW)
- E: Distance Control Assist (DCA)
- F: Lane Departure Warning (LDW)/Lane Departure Prevention (LDP)
- G: Blind Spot Warning (BSW)/Blind Spot Intervention
- H: Backup Collision Intervention (BCI)

DTC		CONSULT display	Warning lamp					Fail-safe	Reference
CONSULT	On board display		ICC system warning lamp	IBA OFF indicator lamp	Lane departure warning lamp	Blind Spot Warning/Blind Spot Intervention warning lamp	Backup Collision Intervention	System	
U1504	151	SIDE RDR L CAN CIRC 1				ON	ON	G, H	<a href="#">DAS-604</a>
U1505	152	SIDE RDR R CAN CIRC 2				ON	ON	G, H	<a href="#">DAS-605</a>
U1506	153	SIDE RDR R CAN CIRC 1				ON	ON	G, H	<a href="#">DAS-606</a>
U1507	154	LOST COMM (SIDE RDR R)				ON	ON	G, H	<a href="#">DAS-607</a>
U1508	155	LOST COMM (SIDE RDR L)				ON	ON	G, H	<a href="#">DAS-608</a>
U150B	157	ECM CAN CIRC 3	ON		ON	ON	ON	A, B, E, F, G, H	<a href="#">DAS-215</a>
U150C	158	VDC CAN CIRC 3	ON	ON	ON	ON	ON	A, B, C, D, E, F, G, H	<a href="#">DAS-216</a>
U150D	159	TCM CAN CIRC 3	ON	ON	ON	ON	ON	A, B, C, D, E, F, G, H	<a href="#">DAS-217</a>
U150E	160	BCM CAN CIRC 3	ON		ON	ON	ON	A, B, E, F, G, H	<a href="#">DAS-218</a>
U150F	161	AV CAN CIRC 3							<a href="#">DAS-77</a>
U1512	162	HVAC CAN CIRC3			ON	ON		F, G	<a href="#">DAS-440</a>
U1513	163	METER CAN CIRC 3	ON	ON	ON	ON	ON	A, B, C, D, E, F, G, H	<a href="#">DAS-220</a>
U1514	164	STRG SEN CAN CIRC 3	ON	ON		ON	ON	A, B, C, D, E, G, H	<a href="#">DAS-221</a>
U1515	165	ICC SENSOR CAN CIRC 3	ON	ON				A, B, C, D, E	<a href="#">DAS-222</a>
U1516	166	CAM CAN CIRC 3			ON	ON		F, G	<a href="#">DAS-442</a>
U1517	167	APA CAN CIRC 3	ON				ON	A, B, E, H	<a href="#">DAS-223</a>
U1518	168	SIDE RDR L CAN CIRC 3				ON	ON	G, H	<a href="#">DAS-613</a>
U1519	169	SIDE RDR R CAN CIRC 3				ON	ON	G, H	<a href="#">DAS-614</a>
U1521	177	SONAR CHECKSUM					ON	H	<a href="#">DAS-781</a>
U1522	178	SONAR MESSAGE					ON	H	<a href="#">DAS-782</a>
U1523	179	SONAR CAN DLC					ON	H	<a href="#">DAS-783</a>

# ADAS CONTROL UNIT

## < ECU DIAGNOSIS INFORMATION > [BLIND SPOT WARNING & BLIND SPOT INTERVENTION]

Systems for fail-safe

- A: Vehicle-to-vehicle distance control mode
- B: Conventional (fixed speed) cruise control mode
- C: Intelligent Brake Assist (IBA)
- D: Forward Collision Warning (FCW)
- E: Distance Control Assist (DCA)
- F: Lane Departure Warning (LDW)/Lane Departure Prevention (LDP)
- G: Blind Spot Warning (BSW)/Blind Spot Intervention
- H: Backup Collision Intervention (BCI)

DTC			Warning lamp					Fail-safe		
CONSULT	On board display	CONSULT display	ICC system warning lamp	IBA OFF indicator lamp	Lane departure warning lamp	Blind Spot Warning/Blind Spot Intervention warning lamp	Backup Collision Intervention	System	Reference	
U1524	180	SONAR CAN DLC					ON	H	<a href="#">DAS-784</a>	
U1525	181	AVM MESSAGE					ON	H	<a href="#">DAS-785</a>	

**NOTE:**

With the detection of “U1000” some systems do not perform the fail-safe operation.

A system controlling based on a signal received from the control unit performs fail-safe operation when the communication with the ADAS control unit becomes inoperable.

A  
B  
C  
D  
E  
F  
G  
H  
I  
J  
K  
L  
M  
N  
P

DAS

# SIDE RADAR LH

< ECU DIAGNOSIS INFORMATION >

[BLIND SPOT WARNING & BLIND SPOT INTERVENTION]

## SIDE RADAR LH

### Reference Value

INFOID:000000009716773

### VALUES ON THE DIAGNOSIS TOOL

#### CONSULT MONITOR ITEM

Monitor Item	Condition	Value/Status
SIDE RADAR MALF	Side radar is normal.	Off
	Side radar is malfunctioning.	On
BLOCKAGE COND	Side radar is not blocked.	Off
	Side radar is blocked.	On
VEHICLE DETECT	Radar does not detect a vehicle.	Off
	Radar detects a vehicle.	On

### TERMINAL LAYOUT

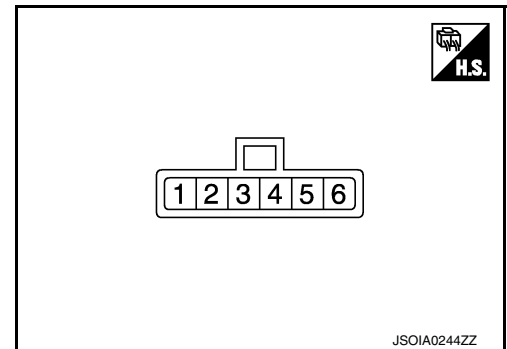

### PHYSICAL VALUES

Terminal No. (Wire color)		Description		Condition	Value (Approx.)
+	-	Signal name	Input/ Output		
2 (B)	Ground	Ground	—	—	0 V
3 (Y)	—	ITS communication-L	—	—	—
4 (L)	—	ITS communication-H	—	—	—
5 (R)	Ground	Ignition power supply	Input	Ignition switch ON	Battery voltage
6 (W)	Ground	Blind Spot Warning/Blind Spot Intervention indicator	Output	Approx. 2 sec. after ignition switch OFF ⇒ ON (bulb check)	6 V

### Fail-safe

INFOID:000000009716774

#### FAIL-SAFE CONTROL BY DTC

##### Blind Spot Warning (BSW)

If a malfunction occurs in the side radar, ADAS control unit cancels control, and turns ON the "Please see owner's manual" message in the vehicle information display.

##### Blind Spot Intervention

If a malfunction occurs in the side radar, ADAS control unit cancels control, sounds a beep, and turns ON the BSI system warning light (orange) in the vehicle information display.

#### TEMPORARY DISABLED STATUS AT BLOCKAGE

# SIDE RADAR LH

< ECU DIAGNOSIS INFORMATION >

## [BLIND SPOT WARNING & BLIND SPOT INTERVENTION]

### Blind Spot Warning (BSW)

When the side radar is blocked, the operation is temporarily cancelled. Then the "Unavailable Side Radar Obstruction" message appears in the vehicle information display and the warning systems ON indicator will blink. Also, under the following conditions, the operation may be temporarily cancelled.

- The side radar may be blocked by temporary ambient conditions such as splashing water, mist or fog.
- The blocked condition may also be caused by objects such as ice, frost or dirt obstructing the side radar.

### Blind Spot Intervention

When the side radar is blocked, the operation is temporarily cancelled. Then the buzzer sounds and the "Unavailable Side Radar Obstruction" message appears in the vehicle information display. Also, under the following conditions, the operation may be temporarily cancelled.

- The side radar may be blocked by temporary ambient conditions such as splashing water, mist or fog.
- The blocked condition may also be caused by objects such as ice, frost or dirt obstructing the side radar.

## DTC Inspection Priority Chart

INFOID:000000009716775

If some DTCs are displayed at the same time, perform inspections one by one based on the following priority chart.

Priority	Detected items (DTC)
1	<ul style="list-style-type: none"> <li>• U1000: CAN COMM CIRCUIT</li> <li>• U1010: CONTROL UNIT (CAN)</li> </ul>
2	<ul style="list-style-type: none"> <li>• U0104: ADAS CAN CIR 1</li> <li>• U0405: ADAS CAN CIR 2</li> </ul>
3	C1B50: SIDE RDR MALFUNCTION
4	<ul style="list-style-type: none"> <li>• C1B51: BSW/BSI IND SHORT CIR</li> <li>• C1B52: BSW/BSI IND OPEN CIR</li> <li>• C1B55: RADAR BLOCKAGE</li> </ul>

## DTC Index

INFOID:000000009716776

×: Applicable

DTC	Blind Spot Warning/Blind Spot Intervention warning lamp	Fail-safe	Reference page	
C1B50	SIDE RDR MALFUNCTION	ON	×	<a href="#">DAS-573</a>
C1B51	BSW/BSI IND SHORT CIR	ON	×	<a href="#">DAS-574</a>
C1B52	BSW/BSI IND OPEN CIR	ON	×	<a href="#">DAS-575</a>
C1B55	RADAR BLOCKAGE	Blink	×	<a href="#">DAS-579</a>
U1000	CAN COMM CIRCUIT	ON	×	<a href="#">DAS-580</a>
U1010	CONTROL UNIT (CAN)	ON	×	<a href="#">DAS-583</a>
U0104	ADAS CAN CIR1	ON	×	<a href="#">DAS-585</a>
U0405	ADAS CAN CIR2	ON	×	<a href="#">DAS-592</a>

DAS

# SIDE RADAR RH

< ECU DIAGNOSIS INFORMATION >

[BLIND SPOT WARNING & BLIND SPOT INTERVENTION]

## SIDE RADAR RH

### Reference Value

INFOID:000000009716777

### VALUES ON THE DIAGNOSIS TOOL

#### CONSULT MONITOR ITEM

Monitor Item	Condition	Value/Status
SIDE RADAR MALF	Side radar is normal.	Off
	Side radar is malfunctioning.	On
BLOCKAGE COND	Side radar is not blocked.	Off
	Side radar is blocked.	On
VEHICLE DETECT	Radar does not detect a vehicle.	Off
	Radar detects a vehicle.	On

### TERMINAL LAYOUT

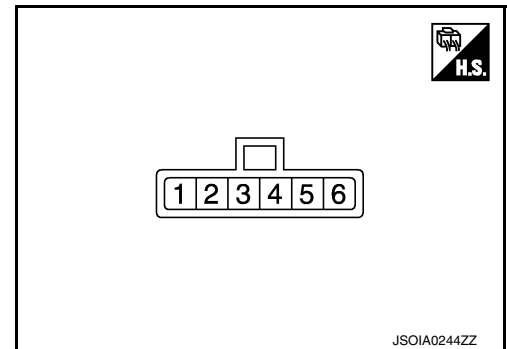

### PHYSICAL VALUES

Terminal No. (Wire color)		Description		Condition	Value (Approx.)
+	-	Signal name	Input/ Output		
1 (B)	Ground	Right/Left switching signal	Input	—	0 V
2 (B)	Ground	Ground	—	—	0 V
3 (Y)	—	ITS communication-L	—	—	—
4 (L)	—	ITS communication-H	—	—	—
5 (R)	Ground	Ignition power supply	Input	Ignition switch ON	Battery voltage
6 (W)	Ground	Blind Spot Warning/Blind Spot Intervention indicator	Output	Approx. 2 sec. after ignition switch OFF ⇒ ON (bulb check)	6 V

### Fail-safe

INFOID:000000009716778

### FAIL-SAFE CONTROL BY DTC

#### Blind Spot Warning (BSW)

If a malfunction occurs in the side radar, ADAS control unit cancels control, and turns ON the "Please see owner's manual" appears in the vehicle information display.

#### Blind Spot Intervention

If a malfunction occurs in the side radar, ADAS control unit cancels control, sounds a beep, and turns ON the BSI system warning light (orange) in the vehicle information display.



# SIDE RADAR RH

## < ECU DIAGNOSIS INFORMATION > [BLIND SPOT WARNING & BLIND SPOT INTERVENTION]

### TEMPORARY DISABLED STATUS AT BLOCKAGE

#### Blind Spot Warning (BSW)

When the side radar is blocked, the operation is temporarily cancelled. Then the "Unavailable Side Radar Obstruction" message appears in the vehicle information display and the warning systems ON indicator will blink. Also, under the following conditions, the operation may be temporarily cancelled.

- The side radar may be blocked by temporary ambient conditions such as splashing water, mist or fog.
- The blocked condition may also be caused by objects such as ice, frost or dirt obstructing the side radar.

#### Blind Spot Intervention

When the side radar is blocked, the operation is temporarily cancelled. Then the buzzer sounds and the "Unavailable Side Radar Obstruction" message appears in the vehicle information display. Also, under the following conditions, the operation may be temporarily cancelled.

- The side radar may be blocked by temporary ambient conditions such as splashing water, mist or fog.
- The blocked condition may also be caused by objects such as ice, frost or dirt obstructing the side radar.

### DTC Inspection Priority Chart

INFOID:000000009716779

If some DTCs are displayed at the same time, perform inspections one by one based on the following priority chart.

Priority	Detected items (DTC)
1	<ul style="list-style-type: none"> <li>• U1000: CAN COMM CIRCUIT</li> <li>• U1010: CONTROL UNIT (CAN)</li> </ul>
2	<ul style="list-style-type: none"> <li>• U0104: ADAS CAN CIR 1</li> <li>• U0405: ADAS CAN CIR 2</li> </ul>
3	C1B50: SIDE RDR MALFUNCTION
4	<ul style="list-style-type: none"> <li>• C1B51: BSW/BSI IND SHORT CIR</li> <li>• C1B52: BSW/BSI IND OPEN CIR</li> <li>• C1B55: RADAR BLOCKAGE</li> </ul>

### DTC Index

INFOID:000000009716780

×: Applicable

DTC	Blind Spot Warning/Blind Spot Intervention warning lamp	Fail-safe	Reference page	
C1B50	SIDE RDR MALFUNCTION	ON	×	<a href="#">DAS-573</a>
C1B51	BSW/BSI IND SHORT CIR	ON	×	<a href="#">DAS-574</a>
C1B52	BSW/BSI IND OPEN CIR	ON	×	<a href="#">DAS-575</a>
C1B55	RADAR BLOCKAGE	Blink	×	<a href="#">DAS-579</a>
U1000	CAN COMM CIRCUIT	ON	×	<a href="#">DAS-580</a>
U1010	CONTROL UNIT (CAN)	ON	×	<a href="#">DAS-583</a>
U0104	ADAS CAN CIR1	ON	×	<a href="#">DAS-585</a>
U0405	ADAS CAN CIR2	ON	×	<a href="#">DAS-592</a>

A  
B  
C  
D  
E  
F  
G  
H  
I  
J  
K  
L  
M  
N  
P



# LANE CAMERA UNIT

< ECU DIAGNOSIS INFORMATION >

[BLIND SPOT WARNING & BLIND SPOT INTERVENTION]

## LANE CAMERA UNIT

### Reference Value

INFOID:000000009716781

### VALUES ON THE DIAGNOSIS TOOL

Monitor Item	Condition	Value/Status
LC INACCURAT	Lane camera unit malfunction	On
	Lane camera unit normal	Off
AIMING DONE	Camera aiming is completed	OK
	Camera aiming is not adjusted	NG
AIMING RESULT	Camera aiming is completed	OK
	Camera aiming is not completed	NOK
CAM HIGH TEMP	When the temperature around lane camera unit is adequate	NORMAL
	When the temperature around the lane camera unit is high	High
VHCL SPD SE	While driving	Approximately equivalent to speedometer reading
TURN SIGNAL	Turn signal lamp LH and RH blinking	LH/RH
	Turn signal lamp LH blinking	LH
	Turn signal lamp RH blinking	RH
	Turn signal lamps OFF	Off
LANE DETCT LH	Left side lane marker is detected	On
	Left side lane marker is not detected	Off
LANE DETCT RH	Right side lane marker is detected	On
	Right side lane marker is not detected	Off
CROSS LANE LH	The vehicle is crossing left side lane marker	On
	The vehicle is not crossing left side lane marker	Off
CROSS LANE RH	The vehicle is crossing right side lane marker	On
	The vehicle is not crossing right side lane marker	Off
WARN LANE LH	Warning for left side lane	On
	Not warning for left side lane	Off
WARN LANE RH	Warning for right side lane	On
	Not warning for right side lane	Off
VALID POS LH	Lateral position for left side lane marker is valid	VLD
	Lateral position for left side lane marker is invalid	INVLD
VALID POS RH	Lateral position for right side lane marker is valid	VLD
	Lateral position for right side lane marker is invalid	INVLD
XOFFSET	Camera aiming is completed	Approx. 180 pixel
FCTRY AIM YAW	Camera aiming is not completed	0.0 deg
	Camera aiming is completed	0 ± 5.0 deg
FCTRY AIM ROL	Camera aiming is not completed	0.0 deg
	Camera aiming is completed	0 ± 5.0 deg
FCTRY AIM PIT	Camera aiming is not completed	0.0 deg
	Camera aiming is completed	0 ± 5.0 deg
ADAS MALF	ADAS control unit malfunction	On
	ADAS control unit normal	Off

# LANE CAMERA UNIT

< ECU DIAGNOSIS INFORMATION >

[BLIND SPOT WARNING & BLIND SPOT INTERVENTION]

## TERMINAL LAYOUT

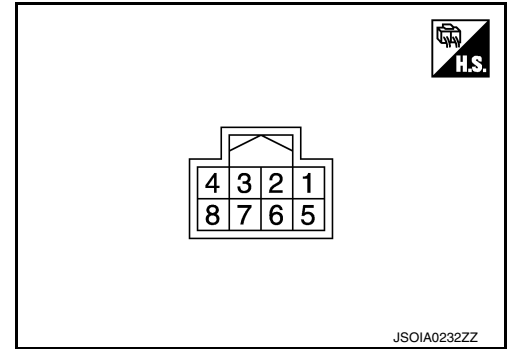

## PHYSICAL VALUES

Terminal No. (Wire color)		Description		Condition	Value (Approx.)
+	-	Signal name	Input/ Output		
1 (B)	Ground	Ground	—	—	0 V
4 (BR)		ITS communication-H	—	—	—
5 (B)		Ground	—	—	0 V
7 (LG)		Ignition power supply	Input	Ignition switch ON	Battery voltage
8 (Y)		ITS communication-L	—	—	—

## Fail-safe

INFOID:000000009716782

### FAIL-SAFE CONTROL BY DTC

#### Lane Departure Warning (LDW)

If a malfunction occurs in the lane camera unit, ADAS control unit cancels control, and turns ON the lane departure warning lamp in the combination meter.

#### Lane Departure Prevention (LDP)

If a malfunction occurs in the lane camera unit, ADAS control unit cancels control, sounds a beep, and turns ON the lane departure warning lamp in the combination meter.

### TEMPORARY DISABLED STATUS AT HIGH TEMPERATURE

#### Lane Departure Warning (LDW)

- If the vehicle is parked in direct sunlight under high temperature conditions, the system may be deactivated automatically. And the lane departure warning lamp (yellow) in the combination meter will blink.
- When interior temperature is reduced, the system will resume operation automatically and the lane departure warning lamp (yellow) in the combination meter will stop blinking.

#### Lane Departure Prevention (LDP)

- If the vehicle is parked in direct sunlight under high temperature conditions, the system may be deactivated automatically. And the buzzer sounds and lane departure warning lamp (yellow) in the combination meter will blink.
- When interior temperature is reduced, the system will resume when dynamic driver assistance switch is turned OFF and turned ON and the lane departure warning lamp (yellow) in the combination meter will stop blinking.

### DTC Inspection Priority Chart

INFOID:000000009716783

If multiple DTCs are detected simultaneously, check them one by one depending on the following DTC inspection priority chart.

A  
B  
C  
D  
E  
F  
G  
H  
I  
J  
K  
L  
M  
N  
P

DAS

# LANE CAMERA UNIT

< ECU DIAGNOSIS INFORMATION > **[BLIND SPOT WARNING & BLIND SPOT INTERVENTION]**

Priority	Detected items (DTC)
1	<ul style="list-style-type: none"> <li>• U1000: CAN COMM CIRCUIT</li> <li>• U1010: CONTROL UNIT (CAN)</li> </ul>
2	C1A50: ADAS MALFUNCTION
3	<ul style="list-style-type: none"> <li>• C1B01: CAM AIMING INCOMP</li> <li>• C1B03: ABNRML TEMP DETECT</li> <li>• U0104: ADAS CAN CIR1</li> <li>• U0126: STRG SEN CAN CIR1</li> <li>• U0405: ADAS CAN CIR2</li> <li>• U0428: STRG SEN CAN CIR2</li> </ul>
4	C1B00: CAMERA UNIT MALF

## DTC Index

INFOID:000000009716784

×: Applicable

DTC		Warning indicator lamp (orange / Message)	Fail-safe	Reference
C1A50	ADAS MALFUNCTION	ON	—	<a href="#">DAS-417</a>
C1B00	CAMERA UNIT MALF	ON	×	<a href="#">DAS-418</a>
C1B01	CAM AIMING INCOMP	ON	×	<a href="#">DAS-420</a>
C1B03	ABNRML TEMP DETECT	Message	×	<a href="#">DAS-422</a>
U0104	ADAS CAN CIR1	ON	×	<a href="#">DAS-423</a>
U0126	STRG SEN CAN CIR1	ON	×	<a href="#">DAS-425</a>
U0405	ADAS CAN CIR2	ON	×	<a href="#">DAS-428</a>
U0428	STRG SEN CAN CIR2	ON	×	<a href="#">DAS-430</a>
U1000	CAN COMM CIRCUIT	ON	×	<a href="#">DAS-431</a>
U1010	CONTROL UNIT (CAN)	ON	×	<a href="#">DAS-433</a>

# DRIVER ASSISTANCE SYSTEMS

## [BLIND SPOT WARNING & BLIND SPOT INTERVENTION]

< WIRING DIAGRAM >

# WIRING DIAGRAM

## DRIVER ASSISTANCE SYSTEMS

### Wiring Diagram

INFOID:000000009716785

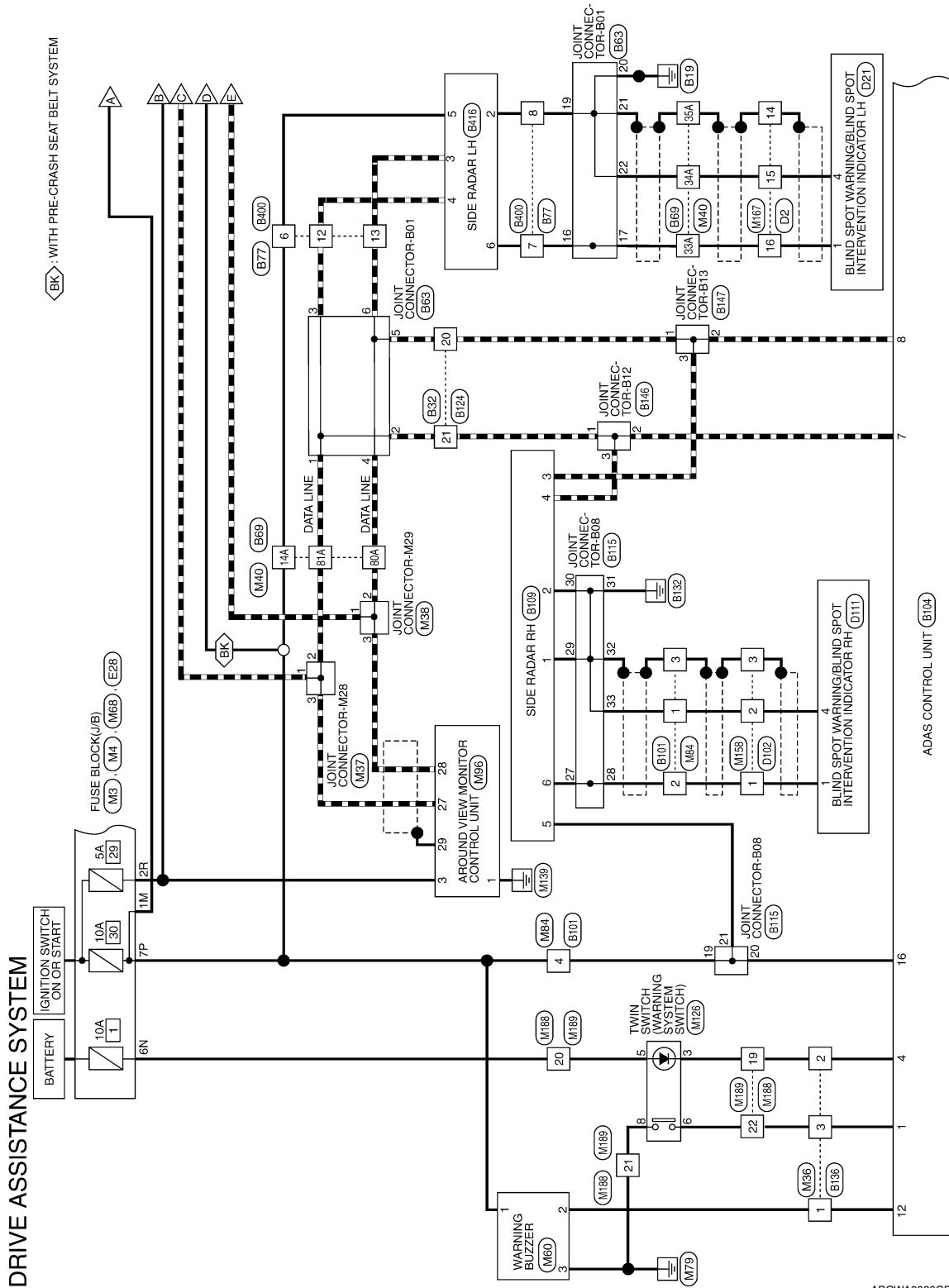

ABOWA0030GB

A  
B  
C  
D  
E  
F  
G  
H  
I  
J  
K  
L  
M  
N  
P

DAS

# DRIVER ASSISTANCE SYSTEMS

## [BLIND SPOT WARNING & BLIND SPOT INTERVENTION]

< WIRING DIAGRAM >

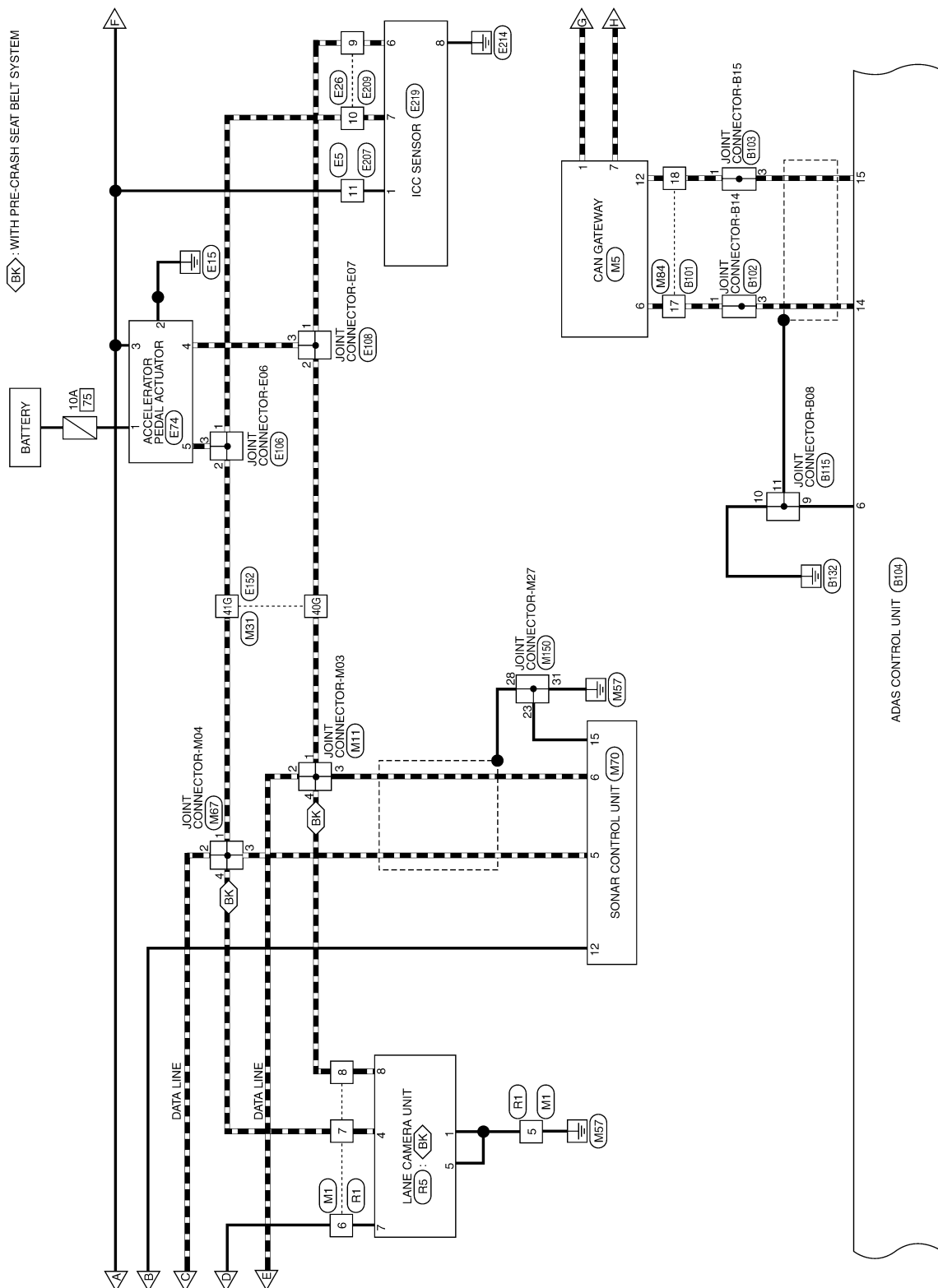

ABOWA0031GB

# DRIVER ASSISTANCE SYSTEMS

## [BLIND SPOT WARNING & BLIND SPOT INTERVENTION]

< WIRING DIAGRAM >

◊ZD◊ : WITH BOSE AUDIO SYSTEM - WITH NAVIGATION SYSTEM AND SURROUND SOUND SYSTEM  
 ◊ZF◊ : WITH BOSE AUDIO SYSTEM - WITH NAVIGATION SYSTEM AND SURROUND SOUND SYSTEM

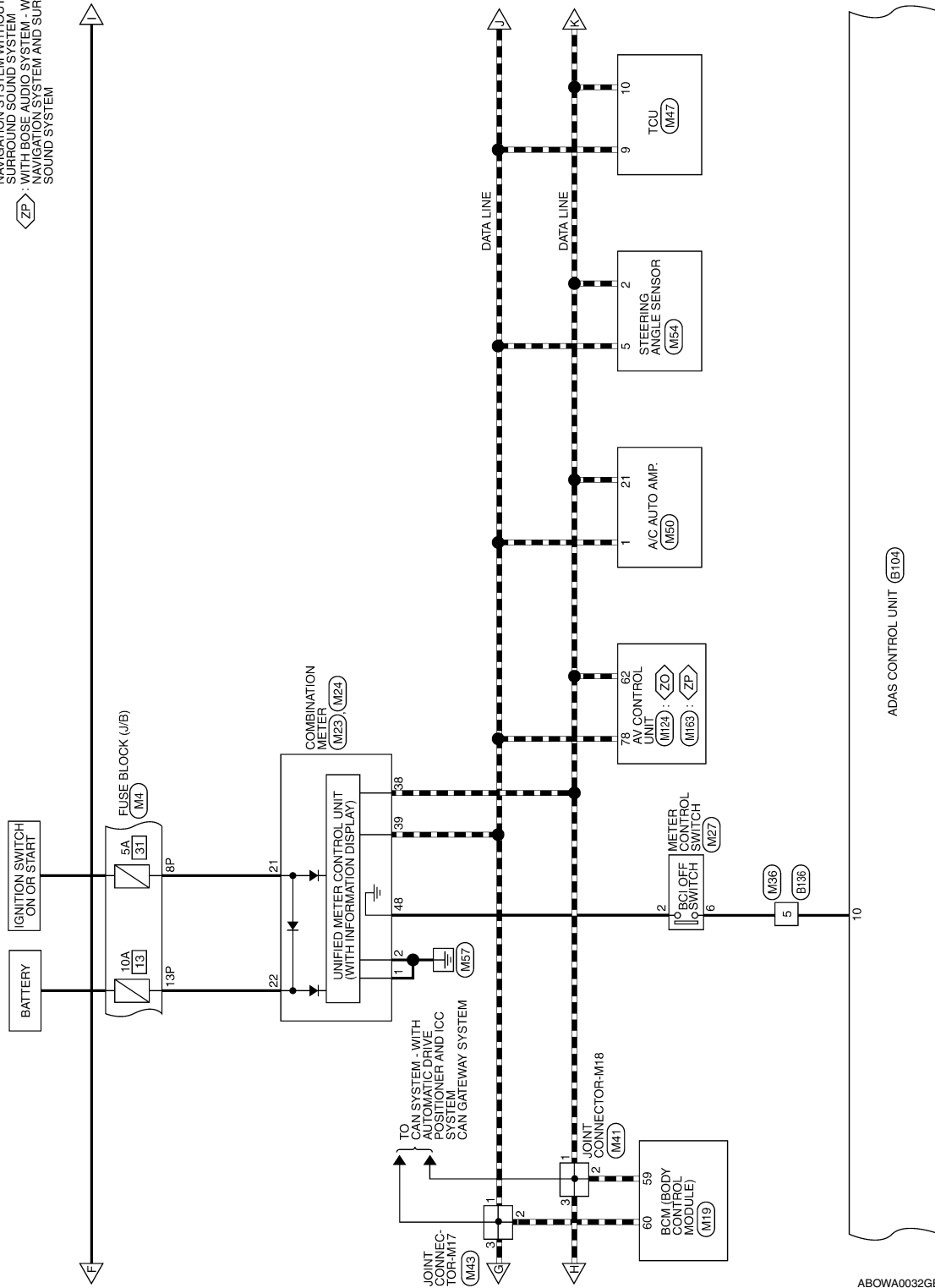

ABOWA0032GB

A  
B  
C  
D  
E  
F  
G  
H  
I  
J  
K  
L  
M  
N  
P

DAS

# DRIVER ASSISTANCE SYSTEMS

## [BLIND SPOT WARNING & BLIND SPOT INTERVENTION]

< WIRING DIAGRAM >

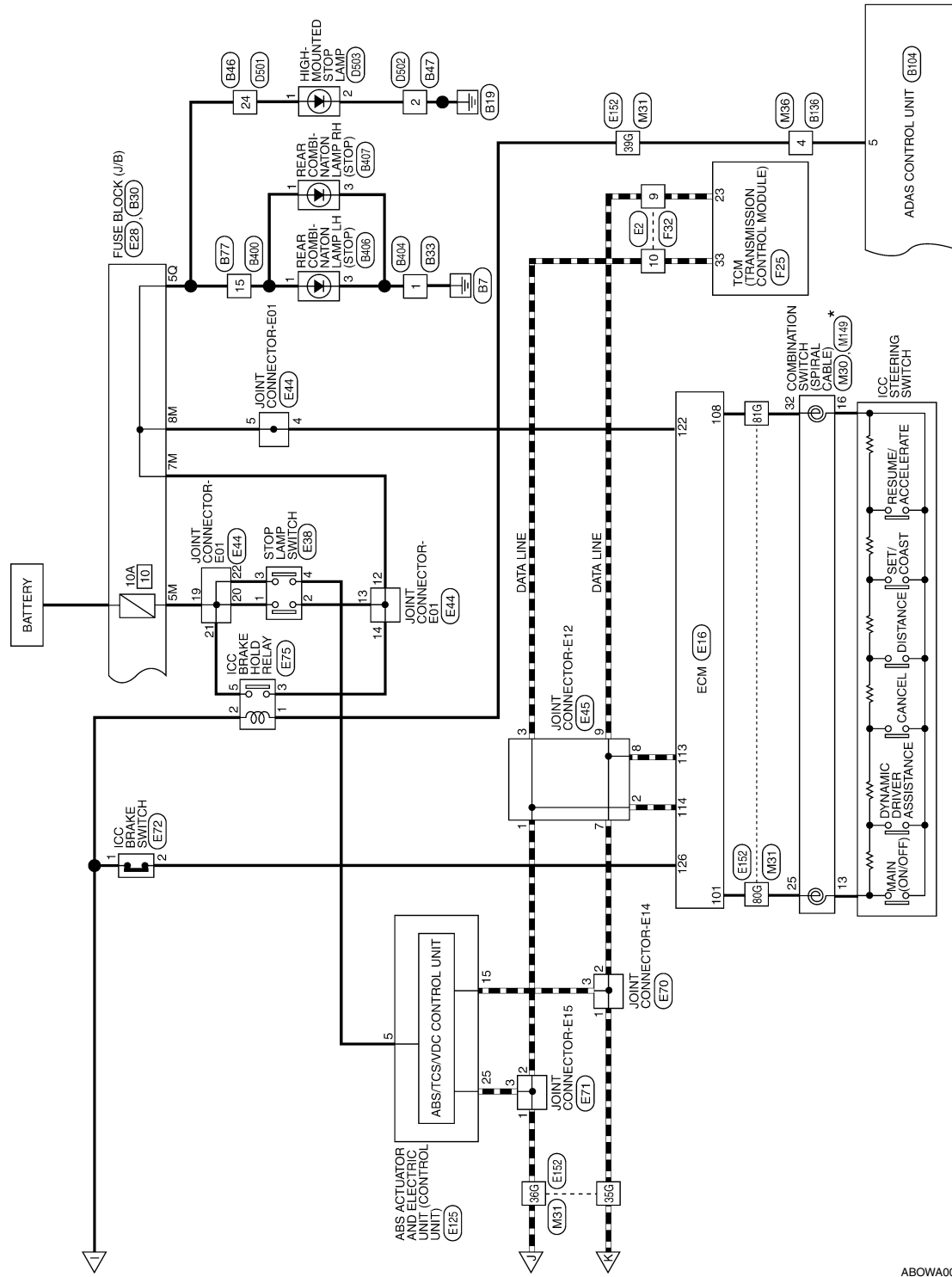

\* : THIS CONNECTOR IS NOT SHOWN IN "HARNES LAYOUT" OF PG SECTION.

ABOWA0033GB



# DRIVER ASSISTANCE SYSTEMS

## [BLIND SPOT WARNING & BLIND SPOT INTERVENTION]

< WIRING DIAGRAM >

### DRIVE ASSISTANCE SYSTEM CONNECTORS

Connector No.	M1
Connector Name	WIRE TO WIRE
Connector Color	WHITE

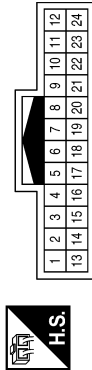

Terminal No.	Color of Wire	Signal Name
5	GR	-
6	LG	-
7	L	-
8	Y	-

Connector No.	M3
Connector Name	FUSE BLOCK (J/B)
Connector Color	WHITE

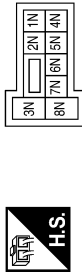

Terminal No.	Color of Wire	Signal Name
6N	W	-

Connector No.	M4
Connector Name	FUSE BLOCK (J/B)
Connector Color	WHITE



Terminal No.	Color of Wire	Signal Name
7P	LG	-
8P	BG	-
13P	W	-

Connector No.	M5
Connector Name	CAN GATEWAY
Connector Color	WHITE

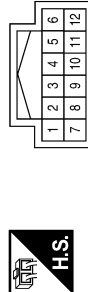

Terminal No.	Color of Wire	Signal Name
1	L	CAN-H
6	L	CAN-H
7	P	CAN-L
12	P	CAN-L

Connector No.	M11
Connector Name	JOINT CONNECTOR-M03
Connector Color	WHITE

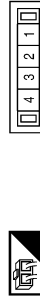

Terminal No.	Color of Wire	Signal Name
1	Y	-
2	Y	-
3	W	-
4	Y	-

Connector No.	M19
Connector Name	BCM (BODY CONTROL MODULE)
Connector Color	BLACK

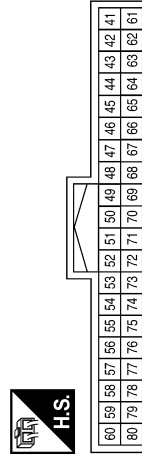

Terminal No.	Color of Wire	Signal Name
59	P	CAN-L
60	L	CAN-H

ABOIA0114GB

# DRIVER ASSISTANCE SYSTEMS

## [BLIND SPOT WARNING & BLIND SPOT INTERVENTION]

< WIRING DIAGRAM >

Terminal No.	Color of Wire	Signal Name
1	B	GND1
2	B	GND2
21	BG	IGN
22	W	BAT
38	P	CAN-L
39	L	CAN-H

Connector No.	M24
Connector Name	COMBINATION METER
Connector Color	WHITE

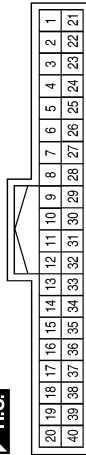

Connector No.	M23
Connector Name	COMBINATION METER
Connector Color	WHITE

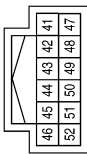

Terminal No.	Color of Wire	Signal Name
48	G	SW GND

Connector No.	M30
Connector Name	COMBINATION SWITCH (SPIRAL CABLE)
Connector Color	GRAY

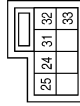

Connector No.	M27
Connector Name	METER CONTROL SWITCH
Connector Color	WHITE

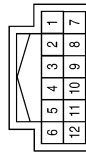

Terminal No.	Color of Wire	Signal Name
25	W	-
32	G	-

Terminal No.	Color of Wire	Signal Name
2	G	-
6	BG	-

A010A0098GB

# DRIVER ASSISTANCE SYSTEMS

## [BLIND SPOT WARNING & BLIND SPOT INTERVENTION]

< WIRING DIAGRAM >

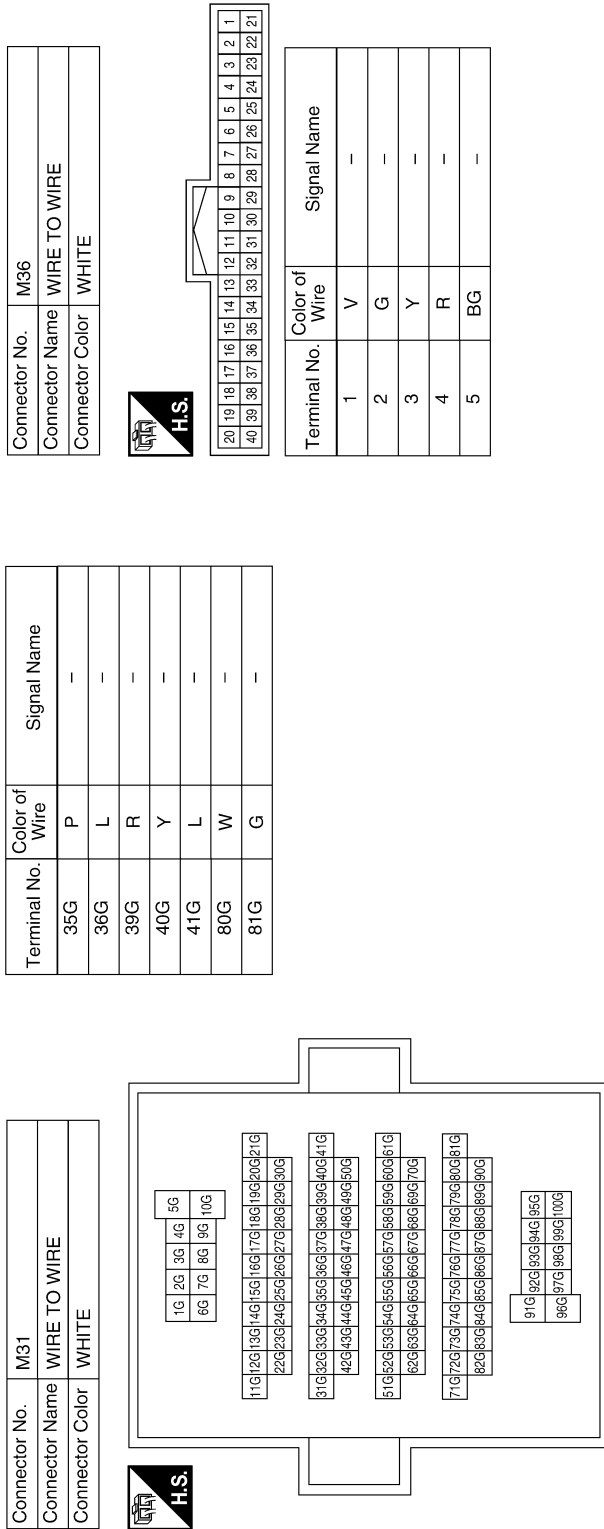

Terminal No.	Color of Wire	Signal Name
35G	P	-
36G	L	-
39G	R	-
40G	Y	-
41G	L	-
80G	W	-
81G	G	-

Connector No.	M36
Connector Name	WIRE TO WIRE
Connector Color	WHITE



20	19	18	17	16	15	14	13	12	11	10	9	8	7	6	5	4	3	2	1
40	39	38	37	36	35	34	33	32	31	30	29	28	27	26	25	24	23	22	21

Terminal No.	Color of Wire	Signal Name
1	V	-
2	G	-
3	Y	-
4	R	-
5	BG	-

Connector No.	M38
Connector Name	JOINT CONNECTOR-M29
Connector Color	WHITE



4	3	2	1
---	---	---	---

Terminal No.	Color of Wire	Signal Name
1	Y	-
2	Y	-
3	W	-

Connector No.	M37
Connector Name	JOINT CONNECTOR-M28
Connector Color	WHITE



4	3	2	1
---	---	---	---

Terminal No.	Color of Wire	Signal Name
1	L	-
2	L	-
3	B	-

A010A0099GB

A  
B  
C  
D  
E  
F  
G  
H  
I  
J  
K  
L  
M  
N  
P



# DRIVER ASSISTANCE SYSTEMS

## [BLIND SPOT WARNING & BLIND SPOT INTERVENTION]

< WIRING DIAGRAM >

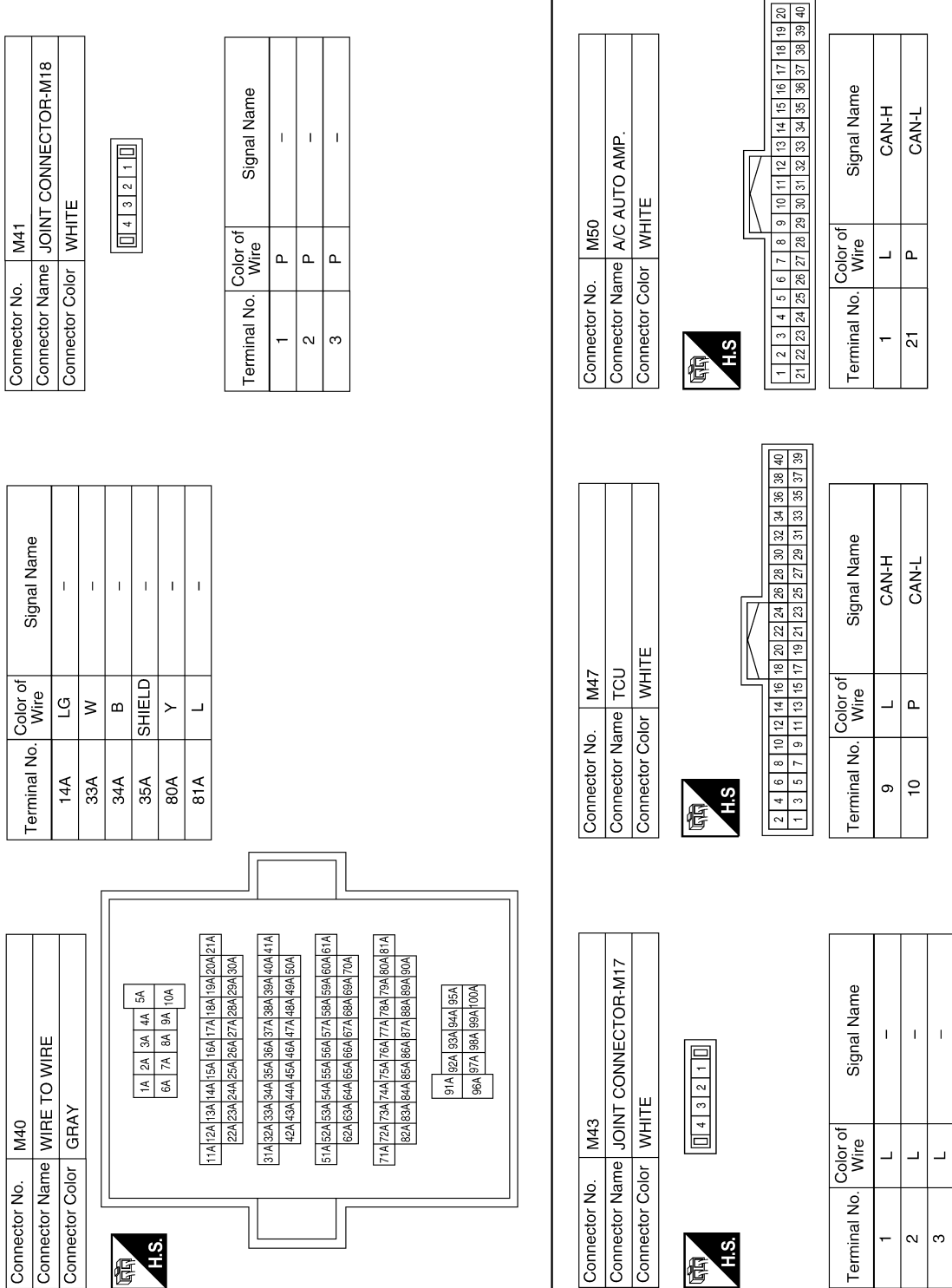

ABOIA0113GB

# DRIVER ASSISTANCE SYSTEMS

## [BLIND SPOT WARNING & BLIND SPOT INTERVENTION]

< WIRING DIAGRAM >

Connector No.	M67
Connector Name	JOINT CONNECTOR-M04
Connector Color	WHITE



Terminal No.	Color of Wire	Signal Name
1	L	-
2	L	-
3	B	-
4	L	-

Connector No.	M60
Connector Name	WARNING BUZZER
Connector Color	BROWN

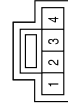

Terminal No.	Color of Wire	Signal Name
1	LG	-
2	V	-
3	GR	-
4	-	-

Connector No.	M54
Connector Name	STEERING ANGLE SENSOR
Connector Color	WHITE

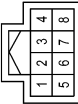

Terminal No.	Color of Wire	Signal Name
2	P	-
5	L	-

Connector No.	M84
Connector Name	WIRE TO WIRE
Connector Color	WHITE

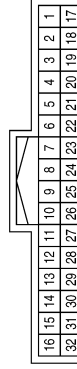

Terminal No.	Color of Wire	Signal Name
1	B	-
2	W	-
3	SHIELD	-
4	LG	-
17	L	-
18	P	-

Connector No.	M70
Connector Name	SONAR CONTROL UNIT
Connector Color	WHITE

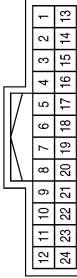

Terminal No.	Color of Wire	Signal Name
5	B	CAN-H
6	W	CAN-L
12	LG	IGN
15	GR	GND

Connector No.	M68
Connector Name	FUSE BLOCK (J/B)
Connector Color	BROWN



Terminal No.	Color of Wire	Signal Name
2R	LG	-

A010A100GB

A  
B  
C  
D  
E  
F  
G  
H  
I  
J  
K  
L  
M  
N  
P

DAS

# DRIVER ASSISTANCE SYSTEMS

## [BLIND SPOT WARNING & BLIND SPOT INTERVENTION]

< WIRING DIAGRAM >

Connector No.	M126
Connector Name	TWIN SWITCH (WARNING SYSTEM SWITCH)
Connector Color	BLACK

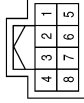

Terminal No.	Color of Wire	Signal Name
1	-	-
2	-	-
3	G	-
4	-	-
5	W	-
6	Y	-
7	-	-
8	B	-

Connector No.	M124
Connector Name	AV CONTROL UNIT (WITH BOSE AUDIO SYSTEM - WITH NAVI WITHOUT SURROUND SOUND SYSTEM)
Connector Color	WHITE

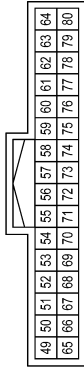

Terminal No.	Color of Wire	Signal Name
62	P	CAN-L
78	L	CAN-H

Connector No.	M96
Connector Name	AROUND VIEW MONITOR CONTROL UNIT
Connector Color	WHITE

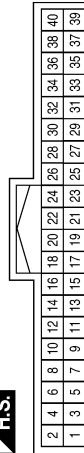

Terminal No.	Color of Wire	Signal Name
1	B	GND
3	LG	IGN
27	B	CAN-H
28	W	CAN-L
29	SHIELD	CAN GND

Connector No.	M158
Connector Name	WIRE TO WIRE
Connector Color	WHITE

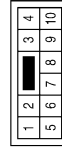

Connector No.	M150
Connector Name	JOINT CONNECTOR-M27
Connector Color	WHITE

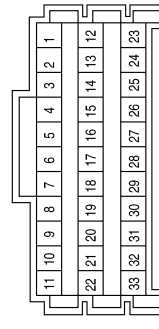

Terminal No.	Color of Wire	Signal Name
1	W	-
2	B	-
3	SHIELD	-

Connector No.	M149
Connector Name	COMBINATION SWITCH (SPIRAL CABLE)
Connector Color	GRAY

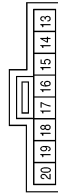

Terminal No.	Color of Wire	Signal Name
13	R	-
16	L	-

ABOIA0101GB

# DRIVER ASSISTANCE SYSTEMS

## [BLIND SPOT WARNING & BLIND SPOT INTERVENTION]

< WIRING DIAGRAM >

Connector No.	M188
Connector Name	WIRE TO WIRE
Connector Color	WHITE



1	2	3	4	5	6	7	8	9	10	11	12
13	14	15	16	17	18	19	20	21	22	23	24

Terminal No.	Color of Wire	Signal Name
19	G	-
20	W	-
21	B	-
22	Y	-

Connector No.	M167
Connector Name	WIRE TO WIRE
Connector Color	WHITE



1	2	3	4	5	6	7
8	9	10	11	12	13	14
15	16					

Terminal No.	Color of Wire	Signal Name
14	SHIELD	-
15	B	-
16	W	-

Connector No.	M163
Connector Name	AV CONTROL UNIT (WITH BOSE AUDIO SYSTEM - WITH NAVI AND SURROUND SOUND SYSTEM)
Connector Color	WHITE



49	50	51	52	53	54	55	56	57	58	59	60	61	62	63	64
65	66	67	68	69	70	71	72	73	74	75	76	77	78	79	80

Terminal No.	Color of Wire	Signal Name
62	P	CAN-L
78	L	CAN-H

Connector No.	E5
Connector Name	WIRE TO WIRE
Connector Color	WHITE



1	2	3	4	5	6	7
8	9	10	11	12	13	14
15	16					

Terminal No.	Color of Wire	Signal Name
11	R	-

Connector No.	E2
Connector Name	WIRE TO WIRE
Connector Color	WHITE



1	2	3	4	5	6	7	8
9	10	11	12	13	14	15	16

Terminal No.	Color of Wire	Signal Name
9	P	-
10	L	-

Connector No.	M189
Connector Name	WIRE TO WIRE
Connector Color	WHITE



12	11	10	9	8	7	6	5	4	3	2	1
24	23	22	21	20	19	18	17	16	15	14	13

Terminal No.	Color of Wire	Signal Name
19	G	-
20	W	-
21	B	-
22	Y	-

ABOIA0102GB

A  
B  
C  
D  
E  
F  
G  
H  
I  
J  
K  
L  
M  
N  
P

DAS

# DRIVER ASSISTANCE SYSTEMS

## [BLIND SPOT WARNING & BLIND SPOT INTERVENTION]

< WIRING DIAGRAM >

Connector No.	E16
Connector Name	ECM
Connector Color	GRAY

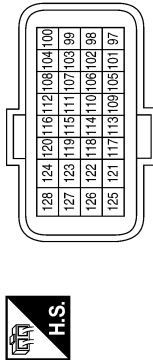

Terminal No.	Color of Wire	Signal Name
101	G	ASCSD STEERING SWITCH/ICC STEERING SWITCH
108	R	SENSOR GROUND (ASCSD STEERING SWITCH)
113	P	CAN-L
114	L	CAN-H
122	R	STOP LAMP SWITCH
126	LG	ASCSD BRAKE SWITCH



Connector No.	E38
Connector Name	STOP LAMP SWITCH
Connector Color	WHITE

Terminal No.	Color of Wire	Signal Name
1	Y	-
2	P	-
3	Y	-
4	G	-

Connector No.	E26
Connector Name	WIRE TO WIRE
Connector Color	WHITE

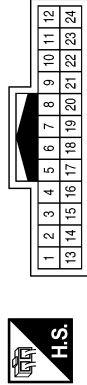

Terminal No.	Color of Wire	Signal Name
9	Y	-
10	BG	-

Connector No.	E44
Connector Name	JOINT CONNECTOR-E01
Connector Color	WHITE

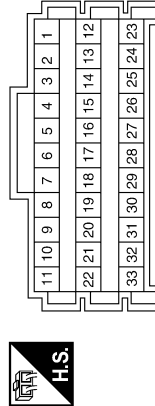

Terminal No.	Color of Wire	Signal Name
4	R	-
5	R	-
12	P	-
13	P	-

Connector No.	E28
Connector Name	FUSE BLOCK (J/B)
Connector Color	WHITE

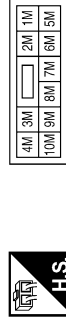

Terminal No.	Color of Wire	Signal Name
1M	R	-
5M	Y	-
7M	P	-
8M	R	-

Terminal No.	Color of Wire	Signal Name
14	P	-
19	Y	-
20	Y	-
21	Y	-
22	Y	-



# DRIVER ASSISTANCE SYSTEMS

## [BLIND SPOT WARNING & BLIND SPOT INTERVENTION]

< WIRING DIAGRAM >

Connector No.	E71
Connector Name	JOINT CONNECTOR-E15
Connector Color	BLACK



Terminal No.	Color of Wire	Signal Name
1	L	-
2	L	-
3	L	-

Connector No.	E70
Connector Name	JOINT CONNECTOR-E14
Connector Color	BLACK



Terminal No.	Color of Wire	Signal Name
1	P	-
2	P	-
3	P	-

Connector No.	E45
Connector Name	JOINT CONNECTOR-E12
Connector Color	BLUE



Terminal No.	Color of Wire	Signal Name
1	L	-
2	L	-
3	L	-
7	P	-
8	P	-
9	P	-

Connector No.	E75
Connector Name	ICC BRAKE HOLD RELAY
Connector Color	BLUE



Terminal No.	Color of Wire	Signal Name
1	W	-
2	R	-
3	P	-
5	Y	-

Connector No.	E74
Connector Name	ACCELERATOR PEDAL ACTUATOR
Connector Color	GRAY



Terminal No.	Color of Wire	Signal Name
1	BG	-
2	GR	-
3	G	-
4	Y	-
5	BG	-
6	-	-

Connector No.	E72
Connector Name	ICC BRAKE SWITCH
Connector Color	BROWN



Terminal No.	Color of Wire	Signal Name
1	R	-
2	LG	-

ABOIA0104GB

A  
B  
C  
D  
E  
F  
G  
H  
I  
J  
K  
L  
M  
N  
P



# DRIVER ASSISTANCE SYSTEMS

## [BLIND SPOT WARNING & BLIND SPOT INTERVENTION]

< WIRING DIAGRAM >

Connector No.	E106
Connector Name	JOINT CONNECTOR-E06
Connector Color	WHITE

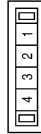

Terminal No.	Color of Wire	Signal Name
1	BG	-
2	BG	-
3	BG	-

Connector No.	E108
Connector Name	JOINT CONNECTOR-E07
Connector Color	WHITE



Terminal No.	Color of Wire	Signal Name
1	Y	-
2	Y	-
3	Y	-

Connector No.	E125
Connector Name	ABS ACTUATOR AND ELECTRIC UNIT (CONTROL UNIT)
Connector Color	BLACK

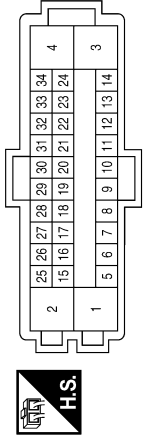

Terminal No.	Color of Wire	Signal Name
5	G	STOP LAMP SW (WITH ICC)
15	P	CAN-L
25	L	CAN-H

Connector No.	E152
Connector Name	WIRE TO WIRE
Connector Color	WHITE

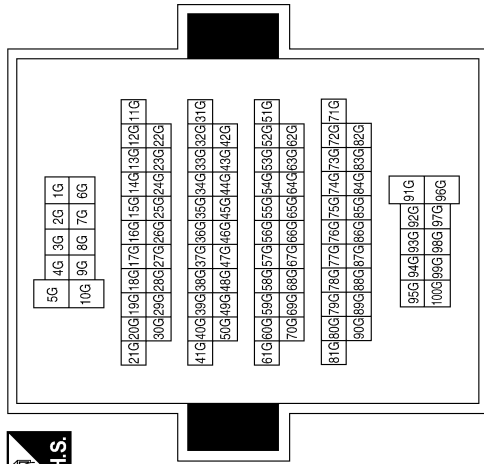

Terminal No.	Color of Wire	Signal Name
35G	P	-
36G	L	-
39G	W	-
40G	Y	-
41G	BG	-
80G	G	-
81G	R	-

Connector No.	E207
Connector Name	WIRE TO WIRE
Connector Color	WHITE

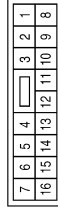

Terminal No.	Color of Wire	Signal Name
11	P	-

A010A105GB

# DRIVER ASSISTANCE SYSTEMS

## [BLIND SPOT WARNING & BLIND SPOT INTERVENTION]

< WIRING DIAGRAM >

Connector No.	F25
Connector Name	TCM (TRANSMISSION CONTROL MODULE)
Connector Color	BLACK

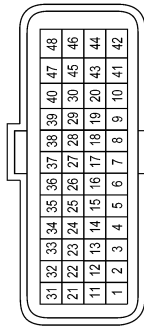

Terminal No.	Color of Wire	Signal Name
23	P	CAN-L
33	L	CAN-H

Connector No.	E219
Connector Name	ICC SENSOR
Connector Color	BLACK

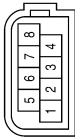

Terminal No.	Color of Wire	Signal Name
1	P	-
6	Y	-
7	L	-
8	B	-

Connector No.	E209
Connector Name	WIRE TO WIRE
Connector Color	WHITE

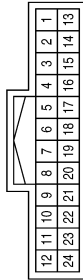

Terminal No.	Color of Wire	Signal Name
9	Y	-
10	L	-

Connector No.	B32
Connector Name	WIRE TO WIRE
Connector Color	WHITE

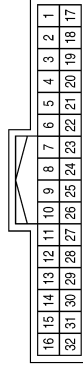

Terminal No.	Color of Wire	Signal Name
20	Y	-
21	L	-

Connector No.	B30
Connector Name	FUSE BLOCK (J/B)
Connector Color	WHITE

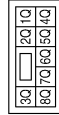

Terminal No.	Color of Wire	Signal Name
5Q	G	-

Connector No.	F32
Connector Name	WIRE TO WIRE
Connector Color	WHITE

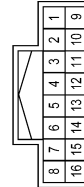

Terminal No.	Color of Wire	Signal Name
9	P	-
10	L	-

ABOIA0106GB

A  
B  
C  
D  
E  
F  
G  
H  
I  
J  
K  
L  
M  
N  
P



# DRIVER ASSISTANCE SYSTEMS

## [BLIND SPOT WARNING & BLIND SPOT INTERVENTION]

< WIRING DIAGRAM >

Connector No.	B33
Connector Name	WIRE TO WIRE
Connector Color	BLACK



Terminal No.	1	Color of Wire	B	Signal Name	-
--------------	---	---------------	---	-------------	---

Connector No.	B63
Connector Name	JOINT CONNECTOR-B01
Connector Color	WHITE

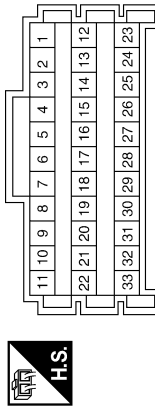

Terminal No.	Color of Wire	Signal Name
1	L	-
2	L	-
3	L	-
4	Y	-
5	Y	-
6	Y	-
16	W	-
17	W	-
19	B	-
20	B	-
21	SHIELD	-
22	B	-

Connector No.	B46
Connector Name	WIRE TO WIRE
Connector Color	WHITE

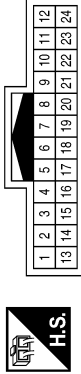

Terminal No.	24	Color of Wire	G	Signal Name	-
--------------	----	---------------	---	-------------	---

Connector No.	B69
Connector Name	WIRE TO WIRE
Connector Color	GRAY

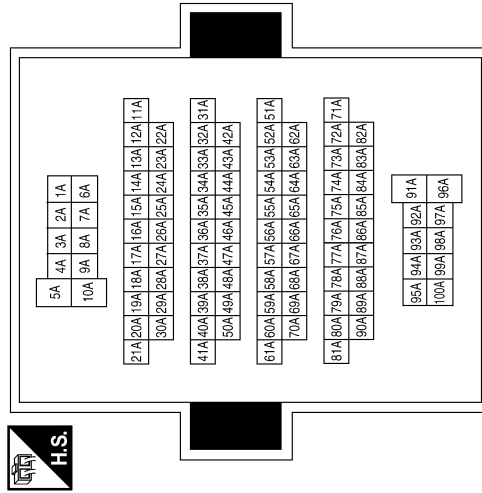

Connector No.	B47
Connector Name	WIRE TO WIRE
Connector Color	GRAY



Terminal No.	2	Color of Wire	B	Signal Name	-
--------------	---	---------------	---	-------------	---

Terminal No.	Color of Wire	Signal Name
14A	R	-
33A	W	-
34A	B	-
35A	SHIELD	-
80A	Y	-
81A	L	-

A01A0107GB

# DRIVER ASSISTANCE SYSTEMS

## [BLIND SPOT WARNING & BLIND SPOT INTERVENTION]

< WIRING DIAGRAM >

Connector No.	B102
Connector Name	JOINT CONNECTOR-B14
Connector Color	WHITE



Terminal No.	Color of Wire	Signal Name
1	L	-
3	B	-

Connector No.	B101
Connector Name	WIRE TO WIRE
Connector Color	WHITE

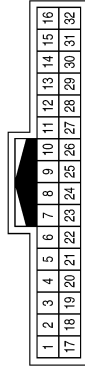

Terminal No.	Color of Wire	Signal Name
1	B	-
2	W	-
3	SHIELD	-
4	R	-
17	L	-
18	P	-

Connector No.	B77
Connector Name	WIRE TO WIRE
Connector Color	WHITE

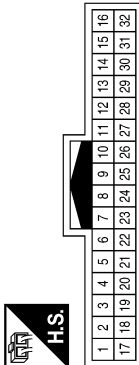

Terminal No.	Color of Wire	Signal Name
6	R	-
7	W	-
8	B	-
12	L	-
13	Y	-
15	G	-

Terminal No.	Color of Wire	Signal Name
7	L	ITS COMM-H
8	Y	ITS COMM-L
9	-	-
10	BG	BCP OFF SW
11	-	-
12	G	WARNING BUZZER
13	-	-
14	B	CAN-H
15	W	CAN-L
16	R	IGNITION

Connector No.	B104
Connector Name	ADAS CONTROL UNIT
Connector Color	WHITE

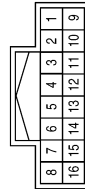

Terminal No.	Color of Wire	Signal Name
1	BR	WARNING SYSTEM SW
2	-	-
3	-	-
4	W	WARNING SYSTEM ON IND
5	G	BRAKE HOLD RLY DRIVE SIGNAL
6	B	GND

Connector No.	B103
Connector Name	JOINT CONNECTOR-B15
Connector Color	WHITE

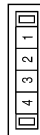

Terminal No.	Color of Wire	Signal Name
1	P	-
3	W	-

ABOIA0108GB

A  
B  
C  
D  
E  
F  
G  
H  
I  
J  
K  
L  
M  
N  
P



# DRIVER ASSISTANCE SYSTEMS

## [BLIND SPOT WARNING & BLIND SPOT INTERVENTION]

< WIRING DIAGRAM >

Terminal No.	Color of Wire	Signal Name
9	B	-
10	GR	-
11	SHIELD	-
19	R	-
20	R	-
21	R	-
27	W	-
28	W	-
29	B	-
30	B	-
31	GR	-
32	SHIELD	-
33	B	-

Connector No.	B115
Connector Name	JOINT CONNECTOR-B08
Connector Color	WHITE

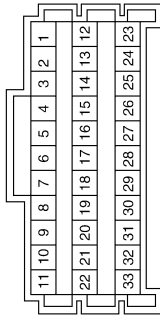

Connector No.	B109
Connector Name	SIDE RADAR RH
Connector Color	BLACK

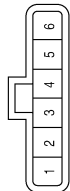

Terminal No.	Color of Wire	Signal Name
1	B	-
2	B	-
3	Y	-
4	L	-
5	R	-
6	W	-

Connector No.	B146
Connector Name	JOINT CONNECTOR-B12
Connector Color	WHITE



Connector No.	B136
Connector Name	WIRE TO WIRE
Connector Color	WHITE

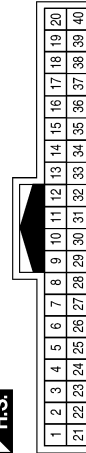

Terminal No.	Color of Wire	Signal Name
1	L	-
2	L	-
3	L	-

Connector No.	B124
Connector Name	WIRE TO WIRE
Connector Color	WHITE

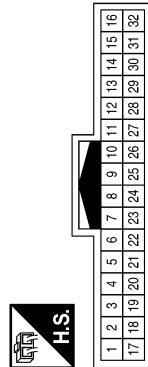

Terminal No.	Color of Wire	Signal Name
20	Y	-
21	L	-

ABOIA0109GB

# DRIVER ASSISTANCE SYSTEMS

## [BLIND SPOT WARNING & BLIND SPOT INTERVENTION]

< WIRING DIAGRAM >

Connector No.	B404
Connector Name	WIRE TO WIRE
Connector Color	BLACK



Terminal No.	Color of Wire	Signal Name
1	B	-

Connector No.	B400
Connector Name	WIRE TO WIRE
Connector Color	WHITE

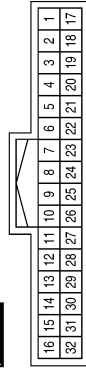

Terminal No.	Color of Wire	Signal Name
6	R	-
7	W	-
8	B	-
12	L	-
13	Y	-
15	G	-

Connector No.	B147
Connector Name	JOINT CONNECTOR-B13
Connector Color	WHITE



Terminal No.	Color of Wire	Signal Name
1	Y	-
2	Y	-
3	Y	-

Connector No.	B416
Connector Name	SIDE RADAR LH
Connector Color	BLACK

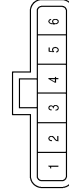

Terminal No.	Color of Wire	Signal Name
1	-	-
2	B	-
3	Y	-
4	L	-
5	R	-
6	W	-

Connector No.	B407
Connector Name	REAR COMBINATION LAMP RH
Connector Color	GRAY



Terminal No.	Color of Wire	Signal Name
1	G	-
3	GR	-

Connector No.	B406
Connector Name	REAR COMBINATION LAMP LH
Connector Color	GRAY



Terminal No.	Color of Wire	Signal Name
1	G	-
3	B	-

ABOIA0110GB

A  
B  
C  
D  
E  
F  
G  
H  
I  
J  
K  
L  
M  
N  
P

DAS

# DRIVER ASSISTANCE SYSTEMS

## [BLIND SPOT WARNING & BLIND SPOT INTERVENTION]

< WIRING DIAGRAM >

Connector No.	D2
Connector Name	WIRE TO WIRE
Connector Color	WHITE

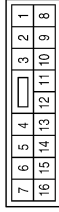

Terminal No.	Color of Wire	Signal Name
14	SHIELD	-
15	B	-
16	W	-

Connector No.	R5
Connector Name	LANE CAMERA UNIT
Connector Color	WHITE



Terminal No.	Color of Wire	Signal Name
1	B	-
2	-	-
3	-	-
4	BR	-
5	B	-
6	-	-
7	LG	-
8	Y	-

Connector No.	R1
Connector Name	WIRE TO WIRE
Connector Color	WHITE

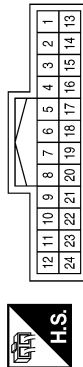

Terminal No.	Color of Wire	Signal Name
5	B	-
6	LG	-
7	BR	-
8	Y	-

Connector No.	D111
Connector Name	BLIND SPOT WARNING/ BLIND SPOT INTERVEN- TION INDICATOR RH
Connector Color	WHITE



Terminal No.	Color of Wire	Signal Name
1	W	-
2	-	-
3	-	-
4	B	-

Connector No.	D102
Connector Name	WIRE TO WIRE
Connector Color	WHITE



Terminal No.	Color of Wire	Signal Name
1	W	-
2	B	-
3	SHIELD	-

Connector No.	D21
Connector Name	BLIND SPOT WARNING/ BLIND SPOT INTERVEN- TION INDICATOR LH
Connector Color	WHITE

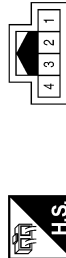

Terminal No.	Color of Wire	Signal Name
1	W	-
2	-	-
3	-	-
4	B	-

ABOIA0111GB



# DRIVER ASSISTANCE SYSTEMS

## [BLIND SPOT WARNING & BLIND SPOT INTERVENTION]

< WIRING DIAGRAM >

Connector No.	D503
Connector Name	HIGH-MOUNTED STOP LAMP
Connector Color	BROWN



Terminal No.	Color of Wire	Signal Name
1	LG	-
2	B	-

Connector No.	D502
Connector Name	WIRE TO WIRE
Connector Color	GRAY

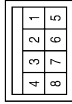

Terminal No.	Color of Wire	Signal Name
2	B	-

Connector No.	D501
Connector Name	WIRE TO WIRE
Connector Color	WHITE

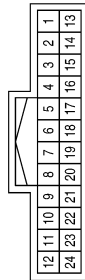

Terminal No.	Color of Wire	Signal Name
24	LG	-

A  
B  
C  
D  
E  
F  
G  
H  
I  
J  
K  
L  
M  
N  
P

DAS

ABOIA0112GB

# DIAGNOSIS AND REPAIR WORK FLOW

< BASIC INSPECTION >

[BLIND SPOT WARNING & BLIND SPOT INTERVENTION]

## BASIC INSPECTION

### DIAGNOSIS AND REPAIR WORK FLOW

Work Flow

INFOID:000000009716786

#### OVERALL SEQUENCE

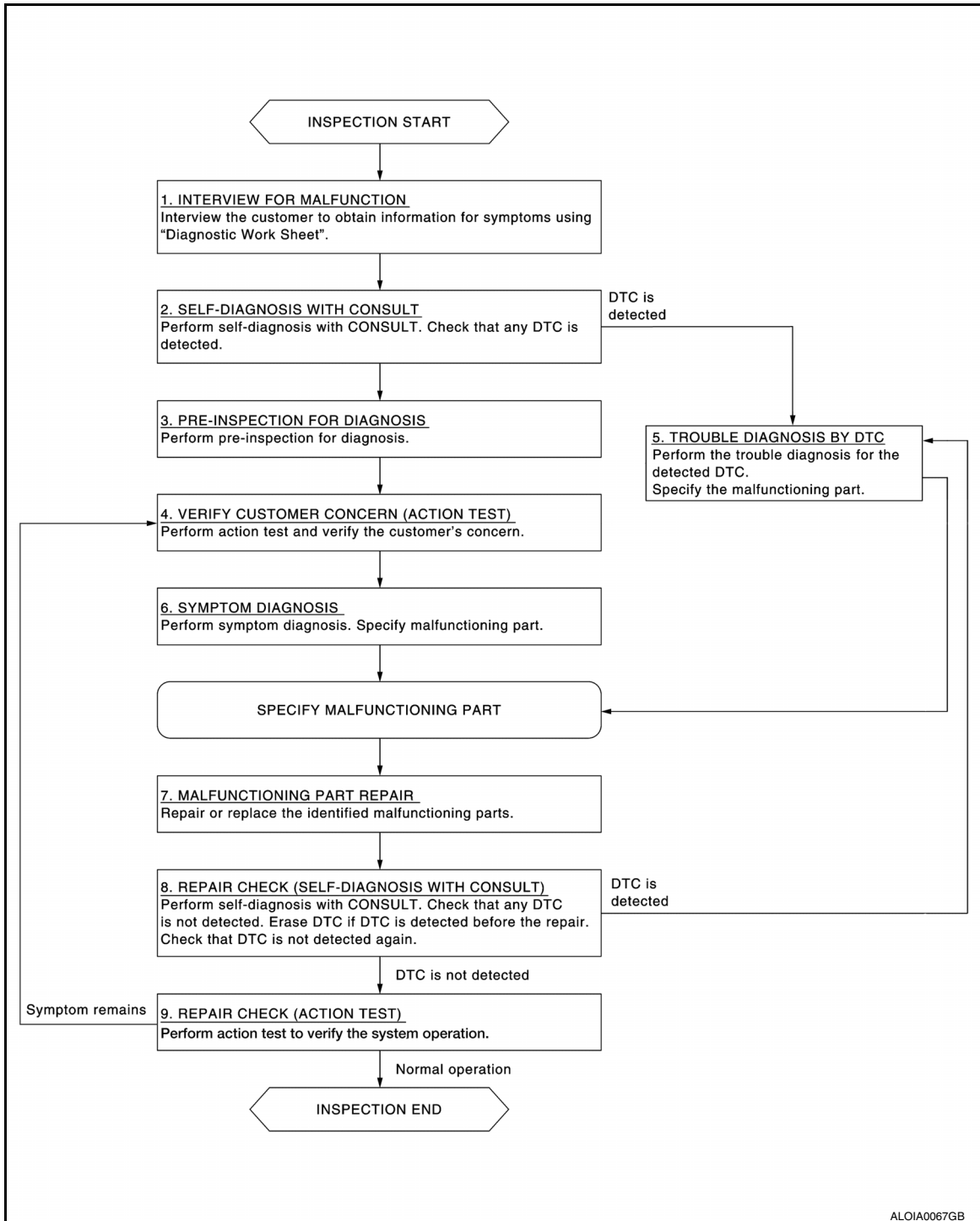

#### DETAILED FLOW

##### 1. INTERVIEW FOR MALFUNCTION

It is also important to clarify the customer concerns before starting the inspection. Interview the customer about the concerns carefully and understand the symptoms fully.

**NOTE:**

# DIAGNOSIS AND REPAIR WORK FLOW

< BASIC INSPECTION >

[BLIND SPOT WARNING & BLIND SPOT INTERVENTION]

The customers are not professionals. Never assume that “maybe the customer means…” or “maybe the customer mentioned this symptom”.

>> GO TO 2.

## 2. SELF-DIAGNOSIS WITH CONSULT

1. Perform “All DTC Reading” with CONSULT.
2. Check if the DTC is detected on the self-diagnosis results of “SIDE RADAR LEFT/RIGHT” and/or “ICC/ADAS”.

Is any DTC detected?

YES >> GO TO 5.

NO >> GO TO 3.

## 3. PRE-INSPECTION FOR DIAGNOSIS

Perform pre-inspection for diagnosis. Refer to [DAS-545, "Inspection Procedure"](#).

>> GO TO 4.

## 4. ACTION TEST

Perform Blind Spot Warning and Blind Spot Intervention system action test to check the operation status. Refer to [DAS-547, "Work Procedure"](#). Check if any other malfunctions occur.

>> GO TO 6.

## 5. TROUBLE DIAGNOSIS BY DTC

1. Check the DTC in the self-diagnosis results.
2. Perform trouble diagnosis for the detected DTC. Refer to [DAS-515, "DTC Index"](#) or [DAS-517, "DTC Index"](#) (SIDE RADAR LEFT/RIGHT), [DAS-520, "DTC Index"](#) (LANE CAMERA UNIT) and/or [DAS-509, "DTC Index"](#) (ICC/ADAS).

### NOTE:

If “DTC: U1000” is detected, first diagnose the CAN communication system or ITS communication system.

>> GO TO 7.

## 6. SYMPTOM DIAGNOSIS

Perform the applicable diagnosis according to the diagnosis chart by symptom. Refer to [DAS-625, "Symptom Table"](#).

>> GO TO 7.

## 7. MALFUNCTIONING PART REPAIR

Repair or replace the identified malfunctioning parts.

>> GO TO 8.

## 8. REPAIR CHECK (SELF-DIAGNOSIS WITH CONSULT)

1. Erases self-diagnosis results.
2. Perform “All DTC Reading” again after repairing or replacing the specific items.
3. Check if any DTC is detected in self-diagnosis results of “SIDE RADAR LEFT/RIGHT”, “LANE CAMERA UNIT” and “ICC/ADAS”.

Is any DTC detected?

YES >> GO TO 5.

NO >> GO TO 9.

## 9. REPAIR CHECK (ACTION TEST)

A  
B  
C  
D  
E  
F  
G  
H  
I  
J  
K  
L  
M  
N  
P

## DIAGNOSIS AND REPAIR WORK FLOW

< BASIC INSPECTION >

[BLIND SPOT WARNING & BLIND SPOT INTERVENTION]

---

Perform the Blind Spot Warning and Blind Spot Intervention system action test. Check that the malfunction symptom is solved or no other symptoms occur.

Is there a malfunction symptom?

YES >> GO TO 4.

NO >> Inspection End.

# PRE-INSPECTION FOR DIAGNOSIS

< BASIC INSPECTION >

[BLIND SPOT WARNING & BLIND SPOT INTERVENTION]

## PRE-INSPECTION FOR DIAGNOSIS

### Inspection Procedure

INFOID:000000009716787

#### 1. PERFORM PRE-INSPECTION OF LANE CAMERA UNIT

Perform pre-inspection of lane camera unit. Refer to [DAS-545, "Inspection Procedure"](#).

>> GO TO 2.

#### 2. CHECK REAR BUMPER NEAR THE SIDE RADAR

Are rear bumper near the side radar contaminated with foreign materials?

YES >> Clean the rear bumper.

NO >> GO TO 3.

#### 3. CHECK SIDE RADAR AND THE SIDE RADAR OUTSKIRTS

Are side radar and the side radar outskirts contaminated with foreign materials?

YES >> Clean the side radar or side radar outskirts.

NO >> GO TO 4.

#### 4. CHECK SIDE RADAR INSTALLATION CONDITION

Check side radar installation condition (installation position, properly tightened, a bent bracket).

Is it properly installed?

YES >> Inspection End.

NO >> Install side radar properly.

A  
B  
C  
D  
E  
F  
G  
H  
I  
J  
K  
L  
M  
N  
P

DAS

## ADDITIONAL SERVICE WHEN REPLACING LANE CAMERA UNIT

< BASIC INSPECTION >

[BLIND SPOT WARNING & BLIND SPOT INTERVENTION]

---

## ADDITIONAL SERVICE WHEN REPLACING LANE CAMERA UNIT

### Description

INFOID:000000009716788

Always adjust the camera aiming after removing and installing or replacing the lane camera unit.

#### **CAUTION:**

**The system does not operate normally unless the camera aiming adjustment is performed. Always perform it.**

### Work Procedure

INFOID:000000009716789

#### 1. CAMERA AIMING ADJUSTMENT

---

Perform the camera aiming adjustment. Refer to [DAS-396, "Description"](#).

>> GO TO 2.

#### 2. BLIND SPOT WARNING/BLIND SPOT INTERVENTION SYSTEM ACTION TEST

---

1. Perform the Blind Spot Warning/Blind Spot Intervention system action test. Refer to [DAS-547, "Work Procedure"](#).
2. Check that the Blind Spot Warning/Blind Spot Intervention system operates normally.

>> WORK END

## ACTION TEST

### Description

INFOID:000000009716790

Always perform the Blind Spot Warning and Blind Spot Intervention system action test to check that the system operates normally after replacing the lane camera unit, replacing the side radar left (right), or repairing any Blind Spot Intervention system malfunction.

**NOTE:**

Perform the Blind Spot Intervention system action test after checking that the LDP system operates normally because the Blind Spot Intervention system shares components with the LDP system.

**WARNING:**

Be careful of traffic conditions and safety around the vehicle when performing road test.

**CAUTION:**

Fully understand the following items well before the road test;

- Precautions: Refer to [DAS-464, "Precaution for Blind Spot Warning/Blind Spot Intervention System Service"](#).
- System description for Blind Spot Warning: Refer to [DAS-468, "BLIND SPOT WARNING \(BSW\) SYSTEM : System Description"](#).
- System description for Blind Spot Intervention: Refer to [DAS-472, "BLIND SPOT INTERVENTION SYSTEM : System Description"](#).
- Normal operating condition: Refer to [DAS-630, "Description"](#).

### Work Procedure

INFOID:000000009716791

**WARNING:**

Be careful of traffic conditions and safety around the vehicle when performing road test.

**CAUTION:**

Fully understand the following items well before the road test;

- Precautions: Refer to [DAS-464, "Precaution for Blind Spot Warning/Blind Spot Intervention System Service"](#).
- System description for Blind Spot Warning: Refer to [DAS-468, "BLIND SPOT WARNING \(BSW\) SYSTEM : System Description"](#).
- System description for Blind Spot Intervention: Refer to [DAS-472, "BLIND SPOT INTERVENTION SYSTEM : System Description"](#).
- Normal operating condition: Refer to [DAS-630, "Description"](#).

#### 1. LDW/LDP SYSTEM ACTION TEST

Perform the LDW/LDP system action test. Refer to [DAS-392, "Inspection Procedure"](#).

>> GO TO 2.

#### 2. CHECK BSW SYSTEM SETTING

1. Start the engine.
2. Check that the BSW system setting can be enabled/disabled in the vehicle information display.
3. Turn OFF the ignition switch and wait for 5 seconds or more.
4. Check that the previous setting is saved when the engine starts again.

>> GO TO 3.

#### 3. BSW SYSTEM ACTION TEST

1. Enable the setting of the BSW system in the vehicle information display.
2. Turn warning systems switch ON (warning systems ON indicator is ON).

**NOTE:**

Blind Spot Intervention system is OFF.

3. Check BSW operation according to the following table.

A  
B  
C  
D  
E  
F  
G  
H  
I  
J  
K  
L  
M  
N  
P

# ACTION TEST

## [BLIND SPOT WARNING & BLIND SPOT INTERVENTION]

< BASIC INSPECTION >

Vehicle condition/ Driver's operation				Action	
Warning systems ON indicator	Vehicle speed (Approx.) [km/h (MPH)]	Turn signal condition	Status of vehicle detection within detection area	Indication on the Blind Spot Warning/Blind Spot Intervention indicator	Buzzer
OFF	—	—	—	OFF	OFF
ON	Less than approx. 29 (18)	—	—	OFF	OFF
		—	Vehicle is absent	OFF	OFF
	Approx. 32 (20) or more	OFF	Vehicle is detected	ON	OFF
		ON (vehicle detected direction)	Before turn signal operates Vehicle is detected	Blink Indicator ON Indicator OFF 200 ms 200 ms JSOIA0251GB	Short continuous beep Buzzer ON Buzzer OFF 80 ms 550 ms JSOIA0252GB
Vehicle is detected after turn signal operates	Blink Indicator ON Indicator OFF 200 ms 200 ms JSOIA0251GB		OFF		

**NOTE:**

- If vehicle speed exceeds approximately 32 km/h (20MPH), BSW function operates until the vehicle speed becomes lower than approximately 29km/h (18MPH).
- Time shown in the figure is approximate time.
- Always Blind Spot Intervention system operates together with BSW system. Whenever Blind Spot Intervention system is turned on by pushing the dynamic driver assistance switch, BSW system also be turned on even if the BSW system is turned off. However, at this time the warning systems ON indicator remains OFF.

>> GO TO 4.

### 4. CHECK BLIND SPOT INTERVENTION SYSTEM SETTING

1. Start the engine.
2. Check that the Blind Spot Intervention system setting can be enabled/disabled in the vehicle information display.
3. Turn OFF the ignition switch and wait for 5 seconds or more.
4. Check that the previous setting is saved when the engine starts again.

>> GO TO 5.

### 5. CHECK DYNAMIC DRIVER ASSISTANCE SWITCH

1. Start the engine.
2. After starting the engine wait for 5 seconds or more.
3. Enable the setting of the Blind Spot Intervention system in the vehicle information display.
4. Press the dynamic driver assistance switch.
5. Check that the Blind Spot Intervention ON indicator on the combination meter illuminates.
6. Check that the Blind Spot Intervention ON indicator turns OFF when the system is turned OFF by pressing the dynamic driver assistance switch.



## ACTION TEST

### [BLIND SPOT WARNING & BLIND SPOT INTERVENTION]

< BASIC INSPECTION >

7. Check that the Blind Spot Intervention ON indicator turns OFF when the engine starts again.

**NOTE:**

- The Blind Spot Intervention ON indicator does not illuminate even when the dynamic driver assistance switch is turned ON within approximately 5 seconds after starting the engine.

>> Inspection End.

A

B

C

D

E

F

G

H

I

J

K

L

M

N

DAS

P

# C1A00 CONTROL UNIT

[BLIND SPOT WARNING & BLIND SPOT INTERVENTION]

< DTC/CIRCUIT DIAGNOSIS >

## DTC/CIRCUIT DIAGNOSIS

### C1A00 CONTROL UNIT

#### DTC Logic

INFOID:000000009716792

#### DTC DETECTION LOGIC

DTC (On board display)	Trouble diagnosis name	DTC detecting condition	Possible causes
C1A00 (0)	CONTROL UNIT	ADAS control unit internal malfunction	ADAS control unit

#### DTC CONFIRMATION PROCEDURE

##### 1. PERFORM DTC CONFIRMATION PROCEDURE

1. Start the engine.
2. Perform "All DTC Reading" with CONSULT.
3. Check if the "C1A00" is detected as the current malfunction in "Self Diagnostic Result" of "ICC/ADAS".

Is "C1A00" detected as the current malfunction?

- YES >> Refer to [DAS-550, "Diagnosis Procedure"](#).  
NO >> Inspection End.

#### Diagnosis Procedure

INFOID:000000009716793

##### 1. CHECK SELF-DIAGNOSIS RESULTS

Check if any DTC other than "C1A00" is detected in "Self Diagnostic Result" of "ICC/ADAS".

Is any DTC detected?

- YES >> Perform diagnosis on the detected DTC and repair or replace the malfunctioning parts. Refer to [DAS-509, "DTC Index"](#).  
NO >> Replace the ADAS control unit. Refer to [DAS-79, "Removal and Installation"](#).

# C1A01 POWER SUPPLY CIRCUIT 1, C1A02 POWER SUPPLY CIRCUIT 2

< DTC/CIRCUIT DIAGNOSIS >

[BLIND SPOT WARNING & BLIND SPOT INTERVENTION]

## C1A01 POWER SUPPLY CIRCUIT 1, C1A02 POWER SUPPLY CIRCUIT 2

### DTC Logic

INFOID:000000009716794

### DTC DETECTION LOGIC

DTC (On board display)	Trouble diagnosis name	DTC detecting condition	Possible causes
C1A01 (1)	POWER SUPPLY CIR	The battery voltage sent to ADAS control unit remains less than 7.9 V for 5 seconds	<ul style="list-style-type: none"><li>• Connector, harness, fuse</li><li>• ADAS control unit</li></ul>
C1A02 (2)	POWER SUPPLY CIR 2	The battery voltage sent to ADAS control unit remains more than 19.3 V for 5 seconds	

### DTC CONFIRMATION PROCEDURE

#### 1.PERFORM DTC CONFIRMATION PROCEDURE

1. Start the engine.
2. Turn the Blind Spot Intervention system ON.
3. Perform "All DTC Reading" with CONSULT.
4. Check if the "C1A01" or "C1A02" is detected as the current malfunction in "Self Diagnostic Result" of "ICC/ADAS".

Is "C1A01" or "C1A02" detected as the current malfunction?

- YES >> Refer to [DAS-551, "Diagnosis Procedure"](#).  
NO >> Refer to [GI-53, "Intermittent Incident"](#).

### Diagnosis Procedure

INFOID:000000009716795

#### 1.CHECK ADAS CONTROL UNIT POWER SUPPLY AND GROUND CIRCUIT

Check power supply and ground circuit of ADAS control unit. Refer to [DAS-615, "ADAS CONTROL UNIT : Diagnosis Procedure"](#).

Is the inspection result normal?

- YES >> Replace the ADAS control unit. Refer to [DAS-79, "Removal and Installation"](#).  
NO >> Repair or replace the malfunctioning parts.

A  
B  
C  
D  
E  
F  
G  
H  
I  
J  
K  
L  
M  
N  
P

DAS

# C1A03 VEHICLE SPEED SENSOR

< DTC/CIRCUIT DIAGNOSIS >

[BLIND SPOT WARNING & BLIND SPOT INTERVENTION]

## C1A03 VEHICLE SPEED SENSOR

### DTC Logic

INFOID:000000009716796

### DTC DETECTION LOGIC

DTC (On board display)	Trouble diagnosis name	DTC detecting condition	Possible causes
C1A03 (3)	VHCL SPEED SE CIRC	If the vehicle speed signal (wheel speed) from ABS actuator and electric unit (control unit) received by the ADAS control unit via CAN communication, are inconsistent	<ul style="list-style-type: none"><li>• Wheel speed sensor</li><li>• ABS actuator and electric unit (control unit)</li><li>• ADAS control unit</li></ul>

#### NOTE:

If DTC "C1A03" is detected along with DTC "U1000" or "C1A04", first diagnose the DTC "U1000" or "C1A04".

- Refer to [DAS-581, "ADAS CONTROL UNIT : DTC Logic"](#) for DTC "U1000".
- Refer to [DAS-553, "DTC Logic"](#) for DTC "C1A04".

### DTC CONFIRMATION PROCEDURE

#### 1. PERFORM DTC CONFIRMATION PROCEDURE

1. Start the engine.
2. Turn the Blind Spot Intervention system ON.
3. Drive the vehicle at 30 km/h (19 MPH) or more.

#### CAUTION:

**Always drive safely.**

4. Stop the vehicle.
5. Perform "All DTC Reading" with CONSULT.
6. Check if the "C1A03" is detected as the current malfunction in "Self Diagnostic Result" of "ICC/ADAS".

Is "C1A03" detected as the current malfunction?

YES-1 (Blind Spot Warning/Blind Spot Intervention warning lamp: ON)>>Refer to [DAS-552, "Diagnosis Procedure"](#).

YES-2 (Blind Spot Warning/Blind Spot Intervention warning lamp: OFF)>>Refer to [CCS-107, "DTC Logic"](#).

NO >> Refer to [GI-53, "Intermittent Incident"](#).

### Diagnosis Procedure

INFOID:000000009716797

#### 1. CHECK SELF-DIAGNOSIS RESULTS

Check if "C1A04" or "U1000" is detected other than "C1A03" in "Self Diagnostic Result" of "ICC/ADAS".

Is any DTC detected?

YES >> Perform diagnosis on the detected DTC and repair or replace the malfunctioning parts. Refer to [DAS-509, "DTC Index"](#).

NO >> GO TO 2.

#### 2. CHECK ABS ACTUATOR AND ELECTRIC UNIT (CONTROL UNIT) SELF-DIAGNOSIS RESULTS

Check if any DTC is detected in "Self Diagnostic Result" of "ABS".

Is any DTC detected?

YES >> Perform diagnosis on the detected DTC and repair or replace the malfunctioning parts. Refer to [BRC-46, "DTC Index"](#).

NO >> Replace the ADAS control unit. Refer to [DAS-79, "Removal and Installation"](#).

# C1A04 ABS/TCS/VDC SYSTEM

< DTC/CIRCUIT DIAGNOSIS >

[BLIND SPOT WARNING & BLIND SPOT INTERVENTION]

## C1A04 ABS/TCS/VDC SYSTEM

### DTC Logic

INFOID:000000009716798

### DTC DETECTION LOGIC

DTC (On board display)	Trouble diagnosis name	DTC detecting condition	Possible causes
C1A04 (4)	ABS/TCS/VDC CIRC	If a malfunction occurs in the VDC/TCS/ABS system	ABS actuator and electric unit (control unit)

#### NOTE:

If DTC "C1A04" is detected along with DTC "U1000", first diagnose the DTC "U1000". Refer to [DAS-581, "ADAS CONTROL UNIT : DTC Logic"](#).

### Diagnosis Procedure

INFOID:000000009716799

#### 1. CHECK SELF-DIAGNOSIS RESULTS

1. Perform "All DTC Reading" with CONSULT.
2. Check if the "U1000" is detected other than "C1A04" in "Self Diagnostic Result" of "ICC/ADAS".

##### Is "U1000" detected?

- YES >> Perform the CAN communication system inspection. Repair or replace the malfunctioning parts. Refer to [DAS-581, "ADAS CONTROL UNIT : DTC Logic"](#).
- NO >> GO TO 2.

#### 2. CHECK ABS ACTUATOR AND ELECTRIC UNIT (CONTROL UNIT) SELF-DIAGNOSIS RESULTS

Check if any DTC is detected in "Self Diagnostic Result" of "ABS".

##### Is any DTC detected?

- YES >> Perform diagnosis on the detected DTC and repair or replace the malfunctioning parts. Refer to [BRC-46, "DTC Index"](#).
- NO >> Replace the ADAS control unit. Refer to [DAS-79, "Removal and Installation"](#).

A  
B  
C  
D  
E  
F  
G  
H  
I  
J  
K  
L  
M  
N  
P

DAS

# C1A05 BRAKE SW/STOP LAMP SW

< DTC/CIRCUIT DIAGNOSIS >

[BLIND SPOT WARNING & BLIND SPOT INTERVENTION]

## C1A05 BRAKE SW/STOP LAMP SW

### DTC Logic

INFOID:000000009716800

### DTC DETECTION LOGIC

DTC (On board display)	Trouble diagnosis name	DTC detecting condition	Possible causes
C1A05 (5)	BRAKE SW/STOP L SW	A mismatch between a stop lamp switch signal and a ICC brake switch signal received from ECM and a stop lamp signal received from the ABS actuator and electric unit (control unit) continues for 10 seconds or more with vehicle speeds at approximately 40 km/h or more	<ul style="list-style-type: none"><li>• Stop lamp switch circuit</li><li>• ICC brake switch circuit</li><li>• Stop lamp switch</li><li>• ICC brake switch</li><li>• Incorrect stop lamp switch installation</li><li>• Incorrect ICC brake switch installation</li><li>• ECM</li><li>• ABS actuator and electric unit (control unit)</li></ul>

#### NOTE:

If DTC "C1A05" is detected along with DTC "U1000", first diagnose the DTC "U1000". Refer to [DAS-581, "ADAS CONTROL UNIT : DTC Logic"](#).

### Diagnosis Procedure

INFOID:000000009716801

Regarding Wiring Diagram information, refer to [DAS-521, "Wiring Diagram"](#).

## 1. CHECK SELF-DIAGNOSIS RESULTS

1. Perform "All DTC Reading" with CONSULT.
2. Check if the "U1000" is detected other than "C1A05" in "Self Diagnostic Result" of "ICC/ADAS".

#### Is "U1000" detected?

YES >> Perform the CAN communication system inspection. Repair or replace the malfunctioning parts.  
Refer to [LAN-26, "Trouble Diagnosis Flow Chart"](#).

NO >> GO TO 2.

## 2. CHECK STOP LAMP SWITCH AND ICC BRAKE SWITCH

Check that "STOP LAMP SW" and "BRAKE SW" operate normally in "DATA MONITOR" of "ICC/ADAS".

#### Is the inspection result normal?

YES >> GO TO 3.

NO-1 >> When "BRAKE SW" operation is malfunctioning: GO TO 4.

NO-2 >> When "STOP LAMP SW" operation is malfunctioning: GO TO 9.

## 3. CHECK STOP LAMP SWITCH

Check that "STOP LAMP SW" operate normally in "DATA MONITOR" of "ABS".

#### Is the inspection result normal?

YES >> GO TO 14.

NO >> GO TO 9.

## 4. CHECK ICC BRAKE SWITCH INSTALLATION

1. Turn ignition switch OFF.
2. Check ICC brake switch for correct installation. Refer to [BR-15, "Adjustment"](#).

#### Is the inspection result normal?

YES >> GO TO 5.

NO >> Adjust ICC brake switch installation. Refer to [BR-15, "Adjustment"](#).

# C1A05 BRAKE SW/STOP LAMP SW

< DTC/CIRCUIT DIAGNOSIS >

[BLIND SPOT WARNING & BLIND SPOT INTERVENTION]

## 5. ICC BRAKE SWITCH INSPECTION

1. Disconnect ICC brake switch connector.
2. Check ICC brake switch. Refer to [DAS-557, "Component Inspection \(ICC Brake Switch\)"](#).

Is the inspection result normal?

- YES >> GO TO 6.  
NO >> Replace ICC brake switch.

## 6. CHECK ICC BRAKE SWITCH POWER SUPPLY CIRCUIT

1. Turn the ignition switch ON.
2. Check voltage between ICC brake switch harness connector and ground.

Terminals		Voltage (Approx.)
(+)	(-)	
ICC brake switch		Ground
Connector	Terminal	
E72	1	
		Battery voltage

Is the inspection result normal?

- YES >> GO TO 7.  
NO >> Repair the harnesses or connectors.

## 7. CHECK HARNESS BETWEEN ICC BRAKE SWITCH AND ECM

1. Turn ignition switch OFF
2. Disconnect ECM connector.
3. Check for continuity between ICC brake switch harness connector and ECM harness connector.

ICC brake switch		ECM		Continuity
Connector	Terminal	Connector	Terminal	
E72	2	E16	126	Yes

4. Check for continuity between ICC brake switch harness connector and ground.

ICC brake switch		Ground	Continuity
Connector	Terminal		
E72	2		No

Is the inspection result normal?

- YES >> GO TO 8.  
NO >> Repair the harnesses or connectors.

## 8. PERFORM SELF-DIAGNOSIS OF ECM

1. Connect all connectors again if the connectors are disconnected.
2. Turn ignition switch ON.
3. Perform "All DTC Reading".
4. Check if any DTC is detected in "Self Diagnostic Result" of "ENGINE". Refer to [EC-97, "DTC Index"](#).

Is any DTC detected?

- YES >> Repair or replace the malfunctioning parts identified by the self-diagnosis result.  
NO >> Replace the ADAS control unit. Refer to [DAS-79, "Removal and Installation"](#).

## 9. CHECK STOP LAMP SWITCH INSTALLATION

1. Turn ignition switch OFF.
2. Check stop lamp switch for correct installation. Refer to [BR-15, "Adjustment"](#).

Is the inspection result normal?

- YES >> GO TO 10.  
NO >> Adjust stop lamp switch installation. Refer to [BR-15, "Adjustment"](#).

A  
B  
C  
D  
E  
F  
G  
H  
I  
J  
K  
L  
M  
N  
P

DAS

# C1A05 BRAKE SW/STOP LAMP SW

< DTC/CIRCUIT DIAGNOSIS >

[BLIND SPOT WARNING & BLIND SPOT INTERVENTION]

## 10. STOP LAMP SWITCH INSPECTION

1. Disconnect stop lamp switch connector.
2. Check stop lamp switch. Refer to [DAS-557, "Component Inspection \(Stop Lamp Switch\)"](#).

Is the inspection result normal?

YES >> GO TO 11.

NO >> Replace stop lamp switch.

## 11. CHECK STOP LAMP SWITCH POWER SUPPLY CIRCUIT

1. Turn the ignition switch ON.
2. Check voltage between stop lamp switch harness connector and ground.

Terminals		Voltage (Approx.)
(+)	(-)	
Stop lamp switch		Ground
Connector	Terminal	
E38	1	
	3	Battery voltage

Is the inspection result normal?

YES >> GO TO 12.

NO >> Repair the harnesses or connectors.

## 12. CHECK HARNESS BETWEEN STOP LAMP SWITCH AND ECM

1. Turn ignition switch OFF
2. Disconnect ECM, rear combination lamp and high-mounted stop lamp connectors.
3. Check for continuity between stop lamp switch harness connector and ECM harness connector.

Stop lamp switch		ECM		Continuity
Connector	Terminal	Connector	Terminal	
E38	2	E16	122	Yes

4. Check for continuity between stop lamp switch harness connector and ground.

Stop lamp switch		Ground	Continuity
Connector	Terminal		
E38	2		No

Is the inspection result normal?

YES >> GO TO 13.

NO >> Repair the harnesses or connectors.

## 13. CHECK HARNESS BETWEEN STOP LAMP SWITCH AND ABS ACTUATOR AND ELECTRIC UNIT (CONTROL UNIT)

1. Disconnect ABS actuator and electric unit (control unit) connector.
2. Check for continuity between stop lamp switch harness connector and ABS actuator and electric unit (control unit) harness connector.

Stop lamp switch		ABS actuator and electric unit (control unit)		Continuity
Connector	Terminal	Connector	Terminal	
E38	4	E125	5	Yes

3. Check for continuity between stop lamp switch harness connector and ground.



# C1A05 BRAKE SW/STOP LAMP SW

< DTC/CIRCUIT DIAGNOSIS >

[BLIND SPOT WARNING & BLIND SPOT INTERVENTION]

Stop lamp switch		Ground	Continuity
Connector	Terminal		
E38	4		No

Is the inspection result normal?

YES >> GO TO 14.

NO >> Repair the harnesses or connectors.

## 14.PERFORM SELF-DIAGNOSIS OF ECM

1. Connect all connectors again if the connectors are disconnected.
2. Turn ignition switch ON.
3. Perform "All DTC Reading".
4. Check if any DTC is detected in "Self Diagnostic Result" of "ENGINE". Refer to [EC-97. "DTC Index"](#).

Is any DTC detected?

YES >> Repair or replace the malfunctioning parts identified by the self-diagnosis result.

NO >> GO TO 15.

## 15.PERFORM SELF-DIAGNOSIS OF ABS ACTUATOR AND ELECTRIC UNIT (CONTROL UNIT)

Check if any DTC is detected in "Self Diagnostic Result" of "ABS". Refer to [BRC-46. "DTC Index"](#).

Is any DTC detected?

YES >> Repair or replace the malfunctioning parts identified by the self-diagnosis result.

NO >> Replace the ADAS control unit. Refer to [DAS-79. "Removal and Installation"](#).

## Component Inspection (ICC Brake Switch)

INFOID:000000009716802

### 1.CHECK ICC BRAKE SWITCH

Check for continuity between ICC brake switch terminals.

Terminal		Condition	Continuity
1	2	When brake pedal is depressed	No
		When brake pedal is released	Yes

Is the inspection result normal?

YES >> Inspection End.

NO >> Replace ICC brake switch.

## Component Inspection (Stop Lamp Switch)

INFOID:000000009716803

### 1.CHECK STOP LAMP SWITCH

Check for continuity between stop lamp switch terminals.

Terminal		Condition	Continuity
1	2	When brake pedal is depressed	Yes
		When brake pedal is released	No
3	4	When brake pedal is depressed	Yes
		When brake pedal is released	No

Is the inspection result normal?

YES >> Inspection End.

NO >> Replace stop lamp switch.

# C1A06 OPERATION SW

[BLIND SPOT WARNING & BLIND SPOT INTERVENTION]

< DTC/CIRCUIT DIAGNOSIS >

## C1A06 OPERATION SW

### DTC Logic

INFOID:000000009716804

### DTC DETECTION LOGIC

DTC (On board display)	Trouble diagnosis name	DTC detecting condition	Possible causes
C1A06 (6)	OPERATION SW CIRC	<ul style="list-style-type: none"><li>Any switch of the ICC steering switch is detected as "ON" continuously for 60 seconds</li><li>An ON/OFF state judgment of the ICC differs between ECM and ADAS control unit, and the state continues for 2 seconds or more</li></ul>	<ul style="list-style-type: none"><li>ICC steering switch circuit</li><li>ICC steering switch</li><li>ECM</li></ul>

#### NOTE:

If DTC "C1A06" is detected along with DTC "U1000", first diagnose the DTC "U1000". Refer to [CCS-163, "ADAS CONTROL UNIT : DTC Logic"](#).

### DTC CONFIRMATION PROCEDURE

#### 1. PERFORM DTC CONFIRMATION PROCEDURE

- Start the engine.
- Wait for approximately 5 minutes after turning the LDP system ON.
- Perform "All DTC Reading" with CONSULT.
- Check if the "C1A06" is detected as the current malfunction in "Self Diagnostic Result" of "ICC/ADAS".

Is "C1A06" detected as the current malfunction?

- YES >> Refer to [DAS-558, "Diagnosis Procedure"](#).  
NO >> Refer to [GI-53, "Intermittent Incident"](#).

### Diagnosis Procedure

INFOID:000000009716805

Regarding Wiring Diagram information, refer to [DAS-521, "Wiring Diagram"](#).

#### 1. CHECK SELF-DIAGNOSIS RESULTS

Check if "U1000" is detected other than "C1A06" in "Self Diagnostic Result" of "ICC/ADAS".

Is "U1000" detected?

- YES >> Perform the CAN communication system inspection. Repair or replace the malfunctioning parts.  
Refer to [CCS-163, "ADAS CONTROL UNIT : DTC Logic"](#).  
NO >> GO TO 2.

#### 2. CHECK ICC STEERING SWITCH

- Turn the ignition switch OFF.
- Disconnect the ICC steering switch connector.
- Check the ICC steering switch. Refer to [DAS-559, "Component Inspection"](#).

Is the inspection result normal?

- YES >> GO TO 3.  
NO >> Replace the steering wheel.

#### 3. CHECK HARNESS BETWEEN SPIRAL CABLE AND ECM

- Disconnect the ECM connector.
- Check for continuity between the spiral cable harness connector and ECM harness connector.

Spiral cable		ECM		Continuity
Connector	Terminal	Connector	Terminal	

# C1A06 OPERATION SW

## [BLIND SPOT WARNING & BLIND SPOT INTERVENTION]

< DTC/CIRCUIT DIAGNOSIS >

M30	25	E16	101	Yes
	32		108	

3. Check for continuity between spiral cable harness connector and ground.

Spiral cable		Ground	Continuity
Connector	Terminal		
M30	25		No
	32		

Is the inspection result normal?

YES >> GO TO 4.

NO >> Repair the harnesses or connectors.

### 4.CHECK SPIRAL CABLE

Check for continuity between spiral cable terminals.

Spiral cable		Continuity
Terminal		
13	25	Yes
16	32	

Is the inspection result normal?

YES >> GO TO 5.

NO >> Replace the spiral cable.

### 5.PERFORM SELF-DIAGNOSIS OF ECM

1. Connect the connectors of ICC steering switch and ECM connector.
2. Turn the ignition switch ON.
3. Perform "All DTC Reading".
4. Check if any DTC is detected in "Self Diagnostic Result" of "ENGINE".

Is any DTC detected?

YES >> Perform self-diagnosis on the detected DTC and repair or replace the malfunctioning parts. Refer to [EC-97, "DTC Index"](#).

NO >> Replace the ADAS control unit. Refer to [DAS-79, "Removal and Installation"](#).

## Component Inspection

INFOID:000000009716806

### 1.CHECK ICC STEERING SWITCH

Check resistance between ICC steering switch terminals.

Terminal	Switch operation	Resistance [Ω]
13 16	When pressing MAIN switch	Approx. 0
	When pressing dynamic driver assistance switch	Approx. 267
	When pressing CANCEL switch	Approx. 615
	When pressing DISTANCE switch	Approx. 1090
	When pressing SET/COAST switch	Approx. 1805
	When pressing RESUME/ACCELERATE switch	Approx. 2985
	When all switches are not pressed	Approx. 5415

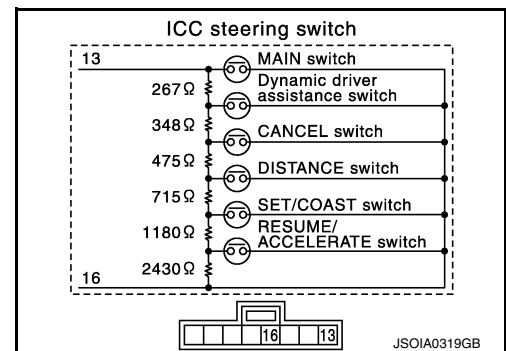

## C1A06 OPERATION SW

[BLIND SPOT WARNING & BLIND SPOT INTERVENTION]

---

< DTC/CIRCUIT DIAGNOSIS >

Is the inspection result normal?

YES >> Inspection End.

NO >> Replace the ICC steering switch.

## C1A14 ECM

### DTC Logic

INFOID:000000009716807

### DTC DETECTION LOGIC

DTC (On board display)	Trouble diagnosis name	DTC detecting condition	Possible causes
C1A14 (14)	ECM CIRCUIT	If ECM is malfunctioning	<ul style="list-style-type: none"> <li>• Accelerator pedal position sensor</li> <li>• ECM</li> <li>• ADAS control unit</li> </ul>

**NOTE:**

If DTC “C1A14” is detected along with DTC “U1000”, first diagnose the DTC “U1000”. Refer to [DAS-581, "ADAS CONTROL UNIT : DTC Logic"](#).

#### 1. PERFORM DTC CONFIRMATION PROCEDURE

1. Start the engine.
2. Operate the Blind Spot Intervention system and drive.  
**CAUTION:**  
**Always drive safely.**
3. Stop the vehicle.
4. Perform “All DTC Reading” with CONSULT.
5. Check if the “C1A14” is detected as the current malfunction in “Self Diagnostic Result” of “ICC/ADAS”.

Is “C1A14” detected as the current malfunction?

- YES >> Refer to [DAS-561, "Diagnosis Procedure"](#).  
 NO >> Refer to [GI-53, "Intermittent Incident"](#).

### Diagnosis Procedure

INFOID:000000009716808

#### 1. CHECK SELF-DIAGNOSIS RESULTS

Check if “U1000” is detected other than “C1A14” in “Self Diagnostic Result” of “ICC/ADAS”.

Is “U1000” detected?

- YES >> Perform the CAN communication system inspection. Repair or replace the malfunctioning parts.  
 Refer to [DAS-581, "ADAS CONTROL UNIT : DTC Logic"](#).  
 NO >> GO TO 2.

#### 2. PERFORM SELF-DIAGNOSIS OF ECM

Check if any DTC is detected in “Self Diagnostic Result” of “ENGINE”.

Is any DTC detected?

- YES >> Perform diagnosis on the detected DTC and repair or replace the malfunctioning parts. Refer to [EC-97, "DTC Index"](#).  
 NO >> Replace the ADAS control unit. Refer to [DAS-79, "Removal and Installation"](#).

# C1A15 GEAR POSITION

< DTC/CIRCUIT DIAGNOSIS >

[BLIND SPOT WARNING & BLIND SPOT INTERVENTION]

## C1A15 GEAR POSITION

### Description

INFOID:000000009716809

ADAS control unit judges the gear position based on the following signals.

- Current gear position signal transmitted from TCM via CAN communication.
- Value of gear ratio calculated from input speed signal transmitted from TCM via CAN communication.
- Value of gear ratio calculated from the vehicle speed signal transmitted from ABS actuator and electric unit (control unit) via CAN communication.

### DTC Logic

INFOID:000000009716810

### DTC DETECTION LOGIC

DTC (On board display)	Trouble diagnosis name	DTC detecting condition	Possible causes
C1A15 (15)	GEAR POSITION	A mismatch between a current gear position signal transmitted from TCM via CAN communication and a gear position calculated by the ADAS control unit continues for approximately 11 minutes or more	<ul style="list-style-type: none"><li>• Input speed sensor</li><li>• Vehicle speed sensor CVT (output speed sensor)</li><li>• TCM</li></ul>

#### NOTE:

If DTC "C1A15" is detected along with DTC "U1000", "C1A03", or "C1A04", first diagnose the DTC "U1000", "C1A03", or "C1A04".

- Refer to [DAS-581, "ADAS CONTROL UNIT : DTC Logic"](#) for DTC "U1000".
- Refer to [DAS-552, "DTC Logic"](#) for DTC "C1A03".
- Refer to [DAS-553, "DTC Logic"](#) for DTC "C1A04".

### DTC CONFIRMATION PROCEDURE

#### 1. PERFORM DTC CONFIRMATION PROCEDURE

1. Start the engine.
2. Turn the Blind Spot Intervention system ON.
3. Drive the vehicle at 10 km/h (6 MPH) or faster for approximately 15 minutes or more.

#### CAUTION:

**Always drive safely.**

4. Stop the vehicle.
5. Perform "All DTC Reading" with CONSULT.
6. Check if "C1A15" is detected as the current malfunction in the "Self Diagnostic Result" of "ICC/ADAS".

Is "C1A15" detected as the current malfunction?

YES >> Refer to [DAS-562, "Diagnosis Procedure"](#).

NO >> Refer to [GI-53, "Intermittent Incident"](#).

### Diagnosis Procedure

INFOID:000000009716811

#### 1. CHECK SELF-DIAGNOSIS RESULTS

Check if "C1A03", "C1A04", or "U1000" is detected other than "C1A15" in "Self Diagnostic Result" of "ICC/ADAS".

Is any DTC detected?

YES >> Perform diagnosis on the detected DTC and repair or replace the malfunctioning parts. Refer to [DAS-509, "DTC Index"](#).

NO >> GO TO 2.

#### 2. CHECK VEHICLE SPEED SIGNAL

Check that "VHCL SPEED SE" operates normally in "DATA MONITOR" of "ICC/ADAS".

#### CAUTION:

**Be careful of the vehicle speed.**

Is the inspection result normal?

## C1A15 GEAR POSITION

### [BLIND SPOT WARNING & BLIND SPOT INTERVENTION]

< DTC/CIRCUIT DIAGNOSIS >

- YES >> GO TO 3.  
NO >> GO TO 7.

### 3.CHECK GEAR POSITION

Check that "GEAR" operates normally in "DATA MONITOR" of "ICC/ADAS".

#### **CAUTION:**

**Be careful of the vehicle speed.**

Is the inspection result normal?

- YES >> GO TO 5.  
NO >> GO TO 4.

### 4.CHECK GEAR POSITION SIGNAL

Check that "GEAR" operates normally in "DATA MONITOR" of "TRANSMISSION".

Is the inspection result normal?

- YES >> GO TO 5.  
NO >> GO TO 6.

### 5.CHECK INPUT SPEED SENSOR SIGNAL

Check that "INPUT SPEED" operates normally in "DATA MONITOR" of "TRANSMISSION".

Is the inspection result normal?

- YES >> Replace the ADAS control unit. Refer to [DAS-79. "Removal and Installation"](#).  
NO >> GO TO 6.

### 6.CHECK TCM SELF-DIAGNOSIS RESULTS

1. Perform "All DTC Reading".
2. Check if any DTC is detected in "Self Diagnostic Result" of "TRANSMISSION".

Is any DTC detected?

- YES >> Perform diagnosis on the detected DTC and repair or replace the malfunctioning parts. Refer to [TM-61. "DTC Index"](#).  
NO >> Replace the ADAS control unit. Refer to [DAS-79. "Removal and Installation"](#).

### 7.CHECK ABS ACTUATOR AND ELECTRIC UNIT (CONTROL UNIT) SELF-DIAGNOSIS RESULTS

1. Perform "All DTC Reading".
2. Check if any DTC is detected in "Self Diagnostic Result" of "ABS".

Is any DTC detected?

- YES >> Perform diagnosis on the detected DTC and repair or replace the malfunctioning parts. Refer to [BRC-46. "DTC Index"](#).  
NO >> Replace the ADAS control unit. Refer to [DAS-79. "Removal and Installation"](#).

A  
B  
C  
D  
E  
F  
G  
H  
I  
J  
K  
L  
M  
N  
P

DAS

# C1A24 NP RANGE

## [BLIND SPOT WARNING & BLIND SPOT INTERVENTION]

< DTC/CIRCUIT DIAGNOSIS >

### C1A24 NP RANGE

#### DTC Logic

INFOID:000000009716812

#### DTC DETECTION LOGIC

DTC (On board display)	Trouble diagnosis name	DTC detecting condition	Possible causes
C1A24 (24)	NP RANGE	A mismatch between a shift position signal transmitted from TCM via CAN communication and a current gear position signal continues for 60 seconds or more	<ul style="list-style-type: none"><li>• TCM</li><li>• Transmission range switch</li></ul>

#### NOTE:

If DTC "C1A24" is detected along with DTC "U1000", first diagnose the DTC "U1000". Refer to [DAS-581, "ADAS CONTROL UNIT : DTC Logic"](#).

#### DTC CONFIRMATION PROCEDURE

##### 1. CHECK DTC REPRODUCE (1)

1. Start the engine.
2. Turn the Blind Spot Intervention system ON.
3. Wait for approximately 5 minutes or more after shifting the selector lever to "P" position.
4. Perform "All DTC Reading" with CONSULT.
5. Check if the "C1A24" is detected as the current malfunction in "Self Diagnostic Result" of "ICC/ADAS".

Is "C1A24" detected as the current malfunction?

- YES >> Refer to [DAS-564, "Diagnosis Procedure"](#).  
NO >> GO TO 2.

##### 2. CHECK DTC REPRODUCE (2)

1. Wait for approximately 5 minutes or more after shifting the selector lever to "N" position.
2. Perform "All DTC Reading".
3. Check if the "C1A24" is detected as the current malfunction in "Self Diagnostic Result" of "ICC/ADAS".

Is "C1A24" detected as the current malfunction?

- YES >> Refer to [DAS-564, "Diagnosis Procedure"](#).  
NO >> Refer to [GI-53, "Intermittent Incident"](#).

#### Diagnosis Procedure

INFOID:000000009716813

##### 1. CHECK SELF-DIAGNOSIS RESULTS

Check if "U1000" is detected other than "C1A24" in "Self Diagnostic Result" of "ICC/ADAS".

Is "U1000" detected?

- YES >> Perform the CAN communication system inspection. Repair or replace the malfunctioning parts.  
Refer to [DAS-581, "ADAS CONTROL UNIT : DTC Logic"](#).  
NO >> GO TO 2.

##### 2. CHECK NP POSITION SWITCH SIGNAL

Check that "NP RANGE SW" operates normally in "DATA MONITOR" of "ICC/ADAS".

Is the inspection result normal?

- YES >> GO TO 3.  
NO >> GO TO 4.

##### 3. CHECK TCM DATA MONITOR

Check that "SLCT LVR POSI" operates normally in "DATA MONITOR" of "TRANSMISSION".

Is the inspection result normal?

- YES >> Replace the ADAS control unit. Refer to [DAS-79, "Removal and Installation"](#).  
NO >> GO TO 4.



## C1A24 NP RANGE

### [BLIND SPOT WARNING & BLIND SPOT INTERVENTION]

< DTC/CIRCUIT DIAGNOSIS >

#### 4. PERFORM TCM SELF-DIAGNOSIS

1. Perform "All DTC Reading".
2. Check if any DTC is detected in "Self Diagnostic Result" of "TRANSMISSION".

##### Is any DTC detected?

- YES >> Perform diagnosis on the detected DTC and repair or replace the malfunctioning parts. Refer to [TM-61, "DTC Index"](#).
- NO >> Replace the ADAS control unit. Refer to [DAS-79, "Removal and Installation"](#).

A  
B  
C  
D  
E  
F  
G  
H  
I  
J  
K  
L  
M  
N  
P

DAS

# C1A39 STEERING ANGLE SENSOR

< DTC/CIRCUIT DIAGNOSIS >

[BLIND SPOT WARNING & BLIND SPOT INTERVENTION]

## C1A39 STEERING ANGLE SENSOR

### DTC Logic

INFOID:000000009716814

### DTC DETECTION LOGIC

DTC (On board display)	Trouble diagnosis name	DTC detecting condition	Possible causes
C1A39 (39)	STRG SEN CIR	If the steering angle sensor is malfunction	Steering angle sensor

#### NOTE:

If DTC "C1A39" is detected along with DTC "U1000", first diagnose the DTC "U1000". Refer to [DAS-581, "ADAS CONTROL UNIT : DTC Logic"](#).

### DTC CONFIRMATION PROCEDURE

#### 1. PERFORM DTC CONFIRMATION PROCEDURE

1. Start the engine.
2. Turn the Blind Spot Intervention system ON.
3. Perform "All DTC Reading" with CONSULT.
4. Check if the "C1A39" is detected as the current malfunction in self-diagnosis results of "ICC/ADAS".

Is "C1A39" detected as the current malfunction?

- YES >> Refer to [DAS-566, "Diagnosis Procedure"](#).  
NO >> Refer to [GI-53, "Intermittent Incident"](#).

### Diagnosis Procedure

INFOID:000000009716815

#### 1. CHECK SELF-DIAGNOSIS RESULTS

Check if "U1000" is detected other than "C1A39" in "Self Diagnostic Result" of "ICC/ADAS".

Is "U1000" detected?

- YES >> Perform the CAN communication system inspection. Repair or replace the malfunctioning parts.  
Refer to [DAS-581, "ADAS CONTROL UNIT : DTC Logic"](#).  
NO >> GO TO 2.

#### 2. CHECK ABS ACTUATOR AND ELECTRIC UNIT (CONTROL UNIT) SELF-DIAGNOSIS RESULTS

Check if any DTC is detected in "Self Diagnostic Result" of "ABS".

Is any DTC detected?

- YES >> Perform diagnosis on the detected DTC and repair or replace the malfunctioning parts. Refer to [BRC-46, "DTC Index"](#).  
NO >> Replace the ADAS control unit. Refer to [DAS-79, "Removal and Installation"](#).

# C1A50 ADAS CONTROL UNIT

< DTC/CIRCUIT DIAGNOSIS >

[BLIND SPOT WARNING & BLIND SPOT INTERVENTION]

## C1A50 ADAS CONTROL UNIT

### DTC Logic

INFOID:000000009716816

### DTC DETECTION LOGIC

DTC	Trouble diagnosis name	DTC detecting condition	Possible cause
C1A50	ADAS MALFUNCTION	If ADAS control unit is malfunctioning	ADAS control unit

#### NOTE:

If DTC "C1A50" is detected along with DTC "U1000", first diagnose the DTC "U1000". Refer to [DAS-581, "ADAS CONTROL UNIT : DTC Logic"](#).

#### 1.PERFORM DTC CONFIRMATION PROCEDURE

1. Start the engine.
2. Turn the Blind Spot Intervention system ON.
3. Perform "All DTC Reading" with CONSULT.
4. Check if the "C1A50" is detected as the current malfunction in "Self Diagnostic Result" of "LANE CAMERA".

Is "C1A50" detected as the current malfunction?

- YES >> Refer to [DAS-567, "Diagnosis Procedure"](#).  
NO >> Refer to [GI-53, "Intermittent Incident"](#).

### Diagnosis Procedure

INFOID:000000009716817

#### 1.CHECK LANE CAMERA UNIT SELF-DIAGNOSIS RESULTS

Check if "U1000" is detected other than "C1A50" in "Self Diagnostic Result" of "LANE CAMERA".

Is "U1000" detected?

- YES >> Perform the CAN communication system inspection. Repair or replace the malfunctioning parts.  
Refer to [DAS-582, "LANE CAMERA UNIT : DTC Logic"](#).  
NO >> GO TO 2.

#### 2.CHECK ADAS CONTROL UNIT SELF-DIAGNOSIS RESULTS

Check if any DTC is detected in "Self Diagnostic Result" of "ICC/ADAS".

Is any DTC detected?

- YES >> Perform diagnosis on the detected DTC and repair or replace the malfunctioning parts. Refer to [DAS-509, "DTC Index"](#).  
NO >> Replace the lane camera unit. Refer to [DAS-635, "Removal and Installation"](#).

# C1B00 CAMERA UNIT MALF

< DTC/CIRCUIT DIAGNOSIS >

[BLIND SPOT WARNING & BLIND SPOT INTERVENTION]

## C1B00 CAMERA UNIT MALF

### ADAS CONTROL UNIT

#### ADAS CONTROL UNIT : DTC Logic

INFOID:000000009716818

#### DTC DETECTION LOGIC

DTC (On board display)	Trouble diagnosis name	DTC detecting condition	Possible causes
C1B00 (81)	CAMERA UNIT MALF	If lane camera unit is malfunctioning	Lane camera unit

#### DTC CONFIRMATION PROCEDURE

##### 1.PERFORM DTC CONFIRMATION PROCEDURE

1. Start the engine.
2. Perform "All DTC Reading" with CONSULT.
3. Check if the "C1B00" is detected as the current malfunction in "Self Diagnostic Result" of "ICC/ADAS".

Is "C1B00" detected as the current malfunction?

YES >> Refer to [DAS-568, "ADAS CONTROL UNIT : Diagnosis Procedure"](#).

NO >> INSPECTION END

#### ADAS CONTROL UNIT : Diagnosis Procedure

INFOID:000000009716819

##### 1.CHECK SELF-DIAGNOSIS RESULTS

Check if "C1B00" is detected in "Self Diagnostic Result" of "LANE CAMERA".

Is "C1B00" detected?

YES >> Refer to [DAS-568, "LANE CAMERA UNIT : DTC Logic"](#)

NO >> Replace the ADAS control unit. Refer to [DAS-79, "Removal and Installation"](#).

### LANE CAMERA UNIT

#### LANE CAMERA UNIT : DTC Logic

INFOID:000000009716820

#### DTC DETECTION LOGIC

DTC	Trouble diagnosis name	DTC detecting condition	Possible causes
C1B00	CAMERA UNIT MALF	If lane camera unit is malfunctioning	Lane camera unit

#### DTC CONFIRMATION PROCEDURE

##### 1.PERFORM DTC CONFIRMATION PROCEDURE

1. Start the engine.
2. Perform "All DTC Reading" with CONSULT.
3. Check if the "C1B00" is detected as the current malfunction in "Self Diagnostic Result" of "LANE CAMERA".

Is "C1B00" detected as the current malfunction?

YES >> Refer to [DAS-568, "LANE CAMERA UNIT : Diagnosis Procedure"](#).

NO >> Inspection End.

#### LANE CAMERA UNIT : Diagnosis Procedure

INFOID:000000009716821

##### 1.CHECK SELF-DIAGNOSIS RESULTS

Check if any DTC other than "C1B00" is detected in "Self Diagnostic Result" of "LANE CAMERA".

Is any DTC detected?

## C1B00 CAMERA UNIT MALF

### [BLIND SPOT WARNING & BLIND SPOT INTERVENTION]

< DTC/CIRCUIT DIAGNOSIS >

- YES >> Perform diagnosis on the detected DTC and repair or replace the malfunctioning parts. Refer to [DAS-520, "DTC Index"](#).
- NO >> Replace the lane camera unit. Refer to [DAS-635, "Removal and Installation"](#).

A  
B  
C  
D  
E  
F  
G  
H  
I  
J  
K  
L  
M  
N  
P

DAS

# C1B01 CAM AIMING INCMP

< DTC/CIRCUIT DIAGNOSIS >

[BLIND SPOT WARNING & BLIND SPOT INTERVENTION]

## C1B01 CAM AIMING INCMP

### ADAS CONTROL UNIT

#### ADAS CONTROL UNIT : DTC Logic

INFOID:000000009716822

#### DTC DETECTION LOGIC

DTC (On board display)	Trouble diagnosis name	DTC detecting condition	Possible causes
C1B01 (82)	CAM AIMING INCMP	Camera aiming is not completed	<ul style="list-style-type: none"><li>• Lane camera aiming is not adjusted</li><li>• Lane camera aiming adjustment has been interrupted</li></ul>

#### DTC CONFIRMATION PROCEDURE

##### 1. PERFORM DTC CONFIRMATION PROCEDURE

1. Start the engine.
2. Operate the Blind Spot Intervention system and drive.  
**CAUTION:**  
**Always drive safely.**
3. Perform "All DTC Reading" with CONSULT.
4. Check if the "C1B01" is detected as the current malfunction in "Self Diagnostic Result" of "ICC/ADAS".

Is "C1B01" detected as the current malfunction?

- YES >> Refer to [DAS-570, "ADAS CONTROL UNIT : Diagnosis Procedure"](#).  
NO >> Refer to [GI-53, "Intermittent Incident"](#).

#### ADAS CONTROL UNIT : Diagnosis Procedure

INFOID:000000009716823

##### 1. CHECK SELF-DIAGNOSIS RESULTS

Check if "C1B01" is detected in "Self Diagnostic Result" of "LANE CAMERA".

Is "C1B01" detected?

- YES >> Refer to [DAS-570, "LANE CAMERA UNIT : DTC Logic"](#).  
NO >> GO TO 2.

##### 2. CHECK DATA MONITOR

1. Start the engine.
2. Check that "OK" is indicated for the value of "AIMING RESULT" in "DATA MONITOR" of "LANE CAMERA".

Is "OK" indicated?

- YES >> Replace the ADAS control unit. Refer to [DAS-79, "Removal and Installation"](#).  
NO >> Replace the lane camera unit. Refer to [DAS-635, "Removal and Installation"](#).

## LANE CAMERA UNIT

#### LANE CAMERA UNIT : DTC Logic

INFOID:000000009716824

#### DTC DETECTION LOGIC

DTC	Trouble diagnosis name	DTC detecting condition	Possible causes
C1B01	CAM AIMING INCMP	Camera aiming is not completed	<ul style="list-style-type: none"><li>• Lane camera aiming is not adjusted</li><li>• Lane camera aiming adjustment has been interrupted</li></ul>

#### DTC CONFIRMATION PROCEDURE

# C1B01 CAM AIMING INCOMP

< DTC/CIRCUIT DIAGNOSIS >

[BLIND SPOT WARNING & BLIND SPOT INTERVENTION]

## 1. PERFORM DTC CONFIRMATION PROCEDURE

1. Start the engine.
2. Perform "All DTC Reading" with CONSULT.
3. Check if the "C1B01" is detected as the current malfunction in "Self Diagnostic Result" of "LANE CAMERA".

Is "C1B01" detected as the current malfunction?

YES >> Refer to [DAS-571, "LANE CAMERA UNIT : Diagnosis Procedure"](#).

NO >> Refer to [GI-53, "Intermittent Incident"](#).

## LANE CAMERA UNIT : Diagnosis Procedure

INFOID:000000009716825

## 1. CAMERA AIMING ADJUSTMENT

1. Perform the camera aiming. Refer to [DAS-396, "Description"](#).
2. Erase all self-diagnosis results with CONSULT.
3. Perform "All DTC Reading".
4. Check if the "C1B01" is detected in "Self Diagnostic Result" of "LANE CAMERA".

Is "C1B01" detected?

YES >> Replace the lane camera unit. Refer to [DAS-635, "Removal and Installation"](#).

NO >> Inspection End.

A  
B  
C  
D  
E  
F  
G  
H  
I  
J  
K  
L  
M  
N  
P

DAS

# C1B03 ABNRML TEMP DETECT

< DTC/CIRCUIT DIAGNOSIS >

[BLIND SPOT WARNING & BLIND SPOT INTERVENTION]

## C1B03 ABNRML TEMP DETECT

### ADAS CONTROL UNIT

#### ADAS CONTROL UNIT : DTC Logic

INFOID:000000009716826

#### DTC DETECTION LOGIC

DTC (On board display)	Trouble diagnosis name	DTC detecting condition	Possible causes
C1B03 (83)	CAM ABNRML TMP DETCT	Temperature around lane camera unit is excessively high	Interior room temperature is excessively high

#### ADAS CONTROL UNIT : Diagnosis Procedure

INFOID:000000009716827

### 1. CHECK LANE CAMERA UNIT SELF-DIAGNOSIS RESULTS

1. Perform "All DTC Reading" with CONSULT.
2. Check if the "C1B03" is detected in "Self Diagnostic Result" of "LANE CAMERA"

Is "C1B03" detected?

- YES >> Refer to [DAS-572. "LANE CAMERA UNIT : DTC Logic"](#)  
NO >> GO TO 2.

### 2. CHECK ADAS CONTROL UNIT SELF-DIAGNOSIS RESULTS

1. Erase all self-diagnosis results with CONSULT.
2. Perform "All DTC Reading".
3. Check if the "C1B03" is detected in "Self Diagnostic Result" of "ICC/ADAS"

Is "C1B03" detected?

- YES >> Replace the ADAS control unit. Refer to [DAS-79. "Removal and Installation"](#).  
NO >> INSPECTION END

### LANE CAMERA UNIT

#### LANE CAMERA UNIT : DTC Logic

INFOID:000000009716828

#### DTC DETECTION LOGIC

DTC	Trouble diagnosis name	DTC detecting condition	Possible causes
C1B03	ABNRML TEMP DETECT	Temperature around lane camera unit is excessively high	Interior room temperature is excessively high

#### LANE CAMERA UNIT : Diagnosis Procedure

INFOID:000000009716829

### 1. COOLING LANE CAMERA UNIT

1. Wait for 10 minutes or more to cool the lane camera unit.
2. Erase all self-diagnosis results with CONSULT.
3. Perform "All DTC Reading".
4. Check if the "C1B03" is detected in "Self Diagnostic Result" of "LANE CAMERA".

Is "C1B03" detected?

- YES >> Replace the lane camera unit. Refer to [DAS-635. "Removal and Installation"](#).  
NO >> Inspection End.



# C1B50 SIDE RADAR MALFUNCTION

< DTC/CIRCUIT DIAGNOSIS >

[BLIND SPOT WARNING & BLIND SPOT INTERVENTION]

## C1B50 SIDE RADAR MALFUNCTION

### DTC LOGIC

INFOID:000000009716830

### DTC DETECTION LOGIC

DTC	Trouble diagnosis name	DTC detecting condition	Possible causes
C1B50	SIDE RDR MALFUNCTION	Side radar malfunction	Side radar

### DTC CONFIRMATION PROCEDURE

#### 1. PERFORM DTC CONFIRMATION PROCEDURE

1. Start the engine.
2. Perform "All DTC Reading" with CONSULT.
3. Check if the "C1B50" is detected as the current malfunction in "Self Diagnostic Result" of "SIDE RADAR RIGHT/LEFT".

Is the "C1B50" detected as the current malfunction?

- YES >> Refer to [DAS-573, "Diagnosis Procedure"](#).  
NO >> Inspection End.

### Diagnosis Procedure

INFOID:000000009716831

#### 1. CHECK SELF-DIAGNOSIS RESULT

Check if any DTC other than "C1B50" is detected in "Self Diagnostic Result" of "SIDE RADAR LEFT/RIGHT"

Is any DTC detected?

- YES >> Perform diagnosis on the detected DTC and repair or replace the malfunction part. Refer to [DAS-517, "DTC Index"](#) (SIDE RADAR RIGHT) or [DAS-515, "DTC Index"](#) (SIDE RADAR LEFT).  
NO >> Replace the side radar. Refer to [DAS-632, "Removal and Installation"](#).

A  
B  
C  
D  
E  
F  
G  
H  
I  
J  
K  
L  
M  
N  
P

DAS

# C1B51 BLIND SPOT WARNING/BLIND SPOT INTERVENTION INDICATOR SHORT CIRCUIT

< DTC/CIRCUIT DIAGNOSIS >

[BLIND SPOT WARNING & BLIND SPOT INTERVENTION]

## C1B51 BLIND SPOT WARNING/BLIND SPOT INTERVENTION INDICATOR SHORT CIRCUIT

### DTC Logic

INFOID:000000009716832

### DTC DETECTION LOGIC

DTC	Trouble diagnosis name	DTC detecting condition	Possible cause
C1B51	BSW/BSI IND SHORT CIR	Short circuit in Blind Spot Warning/Blind Spot Intervention indicator circuit is detected. (Over current is detected)	<ul style="list-style-type: none"> <li>Blind Spot Warning/Blind Spot Intervention indicator circuit.</li> <li>Blind Spot Warning/Blind Spot Intervention indicator.</li> <li>Side radar.</li> </ul>

### DTC CONFIRMATION PROCEDURE

#### 1. PERFORM DTC CONFIRMATION PROCEDURE

- Start the engine.
- Perform "All DTC Reading" with CONSULT.
- Check if the "C1B51" is detected as the current malfunction in "Self Diagnostic Result" of "SIDE RADAR RIGHT/LEFT".

Is the "C1B51" detected as the current malfunction?

- YES >> Refer to [DAS-573, "Diagnosis Procedure"](#).  
 NO >> Inspection End.

### Diagnosis Procedure

INFOID:000000009716833

Regarding Wiring Diagram information, refer to [DAS-521, "Wiring Diagram"](#).

#### 1. CHECK BLIND SPOT WARNING/BLIND SPOT INTERVENTION INDICATOR CIRCUIT FOR SHORT

- Turn ignition switch OFF.
- Disconnect side radar harness connector and Blind Spot Warning/Blind Spot Intervention indicator harness connector.
- Check continuity between side radar harness connector and ground.

Side radar		Ground	Continuity
Connector	Terminal		
B416 (LH)	6		No
B109 (RH)			

Is the inspection result normal?

- YES >> GO TO 2.  
 NO >> Repair the harnesses or connectors.

#### 2. REPLACE THE SIDE RADAR

- Replace the side radar.
- Perform "All DTC Reading" with CONSULT.
- Check if the "C1B51" is detected in "Self Diagnostic Result" of "SIDE RADAR RIGHT/LEFT"

Is the DTC "C1B51" detected?

- YES >> Replace the side radar. Refer to [DAS-632, "Removal and Installation"](#).  
 NO >> Inspection End.

# C1B52 BLIND SPOT WARNING/BLIND SPOT INTERVENTION INDICATOR OPEN CIRCUIT

< DTC/CIRCUIT DIAGNOSIS >

[BLIND SPOT WARNING & BLIND SPOT INTERVENTION]

## C1B52 BLIND SPOT WARNING/BLIND SPOT INTERVENTION INDICATOR OPEN CIRCUIT

### DTC Logic

INFOID:000000009716834

### DTC DETECTION LOGIC

DTC	Trouble diagnosis name	DTC detecting condition	Possible cause
C1B52	BSW/BSI IND OPEN CIR	Open circuit in Blind Spot Warning/Blind Spot Intervention indicator circuit is detected.	<ul style="list-style-type: none"> <li>Blind Spot Warning/Blind Spot Intervention indicator circuit.</li> <li>Blind Spot Warning/Blind Spot Intervention indicator.</li> <li>Side radar.</li> </ul>

### DTC CONFIRMATION PROCEDURE

#### 1. PERFORM DTC CONFIRMATION PROCEDURE

- Start the engine.
- Perform "All DTC Reading" with CONSULT.
- Check if the "C1B52" is detected as the current malfunction in "Self Diagnostic Result" of "SIDE RADAR RIGHT/LEFT".

Is the "C1B52" detected as the current malfunction?

- YES >> Refer to [DAS-573, "Diagnosis Procedure"](#).  
NO >> Inspection End.

### Diagnosis Procedure

INFOID:000000009716835

Regarding Wiring Diagram information, refer to [DAS-521, "Wiring Diagram"](#).

#### 1. CHECK BLIND SPOT WARNING/BLIND SPOT INTERVENTION INDICATOR CIRCUIT FOR OPEN 1

- Turn ignition switch OFF.
- Disconnect side radar harness connector and Blind Spot Warning/Blind Spot Intervention indicator harness connector.
- Check continuity between side radar harness connector and Blind Spot Warning/Blind Spot Intervention indicator harness connector.

Side radar		Blind Spot Warning/Blind Spot Intervention indicator		Continuity
Connector	Terminal	Connector	Terminal	
B416 (LH)	6	D21 (LH)	1	Yes
B109 (RH)		D111 (RH)		

Is the inspection result normal?

- YES >> GO TO 2.  
NO >> Repair the harnesses or connectors.

#### 2. CHECK BLIND SPOT WARNING/BLIND SPOT INTERVENTION INDICATOR CIRCUIT FOR OPEN 2

Check continuity between Blind Spot Warning/Blind Spot Intervention indicator harness connector and ground.

# C1B52 BLIND SPOT WARNING/BLIND SPOT INTERVENTION INDICATOR OPEN CIRCUIT

< DTC/CIRCUIT DIAGNOSIS >

[BLIND SPOT WARNING & BLIND SPOT INTERVENTION]

Blind Spot Warning/Blind Spot Intervention indicator		Ground	Continuity
Connector	Terminal		
D21 (LH)	4		Yes
D111 (RH)			

Is the inspection result normal?

YES >> GO TO 3.

NO >> Repair the harnesses or connectors.

### 3. CHECK SIDE RADAR VOLTAGE OUTPUT

1. Connect side radar harness connector.
2. Check voltage between Blind Spot Warning/Blind Spot Intervention indicator harness connector and ground.

Blind Spot Warning/Blind Spot Intervention indicator		Ground	Condition	Voltage (Approx.)
Connector	Terminal			
D21 (LH)	1		Ignition switch OFF ⇒ ON (Approx. 2 sec.)	6 V
D111 (RH)				

Is the inspection result normal?

YES >> Replace Blind Spot Warning/Blind Spot Intervention indicator.

NO >> Replace side radar. Refer to [DAS-632. "Removal and Installation"](#).

# C1B53 SIDE RADAR RIGHT MALFUNCTION

< DTC/CIRCUIT DIAGNOSIS >

[BLIND SPOT WARNING & BLIND SPOT INTERVENTION]

## C1B53 SIDE RADAR RIGHT MALFUNCTION

### DTC Logic

INFOID:000000009716836

### DTC DETECTION LOGIC

DTC (On board display)	Trouble diagnosis name	DTC detecting condition	Possible cause
C1B53 (84)	SIDE RDR R MALF	ADAS control unit detects that side radar RH has a malfunction.	Side radar RH

### DTC CONFIRMATION PROCEDURE

#### 1. PERFORM DTC CONFIRMATION PROCEDURE

1. Start the engine.
2. Perform "All DTC Reading" with CONSULT.
3. Check if the "C1B53" is detected as the current malfunction in "Self Diagnostic Result" of "ICC/ADAS".

#### Is "C1B53" detected as the current malfunction?

- YES >> Refer to [DAS-577, "Diagnosis Procedure"](#).  
NO >> Refer to [GI-53, "Intermittent Incident"](#).

### Diagnosis Procedure

INFOID:000000009716837

#### 1. CHECK SELF-DIAGNOSIS RESULTS

Check if "U1000" is detected other than "C1B53" in "Self Diagnostic Result" of "ICC/ADAS".

#### Is "U1000" detected?

- YES >> Perform the CAN communication system inspection. Repair or replace the malfunctioning parts.  
Refer to [DAS-581, "ADAS CONTROL UNIT : DTC Logic"](#).  
NO >> GO TO 2.

#### 2. CHECK SELF-DIAGNOSIS RESULTS

Check if any DTC is detected in "Self Diagnostic Result" of "SIDE RADAR RIGHT".

#### Is any DTC detected?

- YES >> Perform diagnosis on the detected DTC and repair or replace the malfunctioning parts. Refer to [DAS-515, "DTC Index"](#) (SIDE RADAR LH), [DAS-517, "DTC Index"](#) (SIDE RADAR RH).  
NO >> Replace the ADAS control unit. Refer to [DAS-79, "Removal and Installation"](#).

A  
B  
C  
D  
E  
F  
G  
H  
I  
J  
K  
L  
M  
N  
P

DAS

# C1B54 SIDE RADAR LEFT MALFUNCTION

< DTC/CIRCUIT DIAGNOSIS >

[BLIND SPOT WARNING & BLIND SPOT INTERVENTION]

## C1B54 SIDE RADAR LEFT MALFUNCTION

### DTC Logic

INFOID:000000009716838

### DTC DETECTION LOGIC

DTC (On board display)	Trouble diagnosis name	DTC detecting condition	Possible cause
C1B54 (85)	SIDE RDR L MALF	ADAS control unit detects that side radar LH has a malfunction.	Side radar LH

### DTC CONFIRMATION PROCEDURE

#### 1. PERFORM DTC CONFIRMATION PROCEDURE

1. Start the engine.
2. Perform "All DTC Reading" with CONSULT.
3. Check if the "C1B54" is detected as the current malfunction in "Self Diagnostic Result" of "ICC/ADAS".

Is "C1B54" detected as the current malfunction?

- YES >> Refer to [DAS-577, "Diagnosis Procedure"](#).  
NO >> Refer to [GI-53, "Intermittent Incident"](#).

### Diagnosis Procedure

INFOID:000000009716839

#### 1. CHECK SELF-DIAGNOSIS RESULTS

Check if "U1000" is detected other than "C1B54" in "Self Diagnostic Result" of "ICC/ADAS".

Is "U1000" detected?

- YES >> Perform the CAN communication system inspection. Repair or replace the malfunctioning parts.  
Refer to [DAS-581, "ADAS CONTROL UNIT : DTC Logic"](#).  
NO >> GO TO 2.

#### 2. CHECK SELF-DIAGNOSIS RESULTS

Check if any DTC is detected in "Self Diagnostic Result" of "SIDE RADAR LEFT".

Is any DTC detected?

- YES >> Perform diagnosis on the detected DTC and repair or replace the malfunctioning parts. Refer to [DAS-515, "DTC Index"](#) (SIDE RADAR LH), [DAS-517, "DTC Index"](#) (SIDE RADAR RH).  
NO >> Replace the ADAS control unit. Refer to [DAS-79, "Removal and Installation"](#).

# C1B55 RADAR BLOCKAGE

< DTC/CIRCUIT DIAGNOSIS >

[BLIND SPOT WARNING & BLIND SPOT INTERVENTION]

## C1B55 RADAR BLOCKAGE

### DTC Logic

INFOID:000000009716840

### DTC DETECTION LOGIC

DTC No.	Trouble diagnosis name	DTC detecting condition	Possible cause
C1B55	RADAR BLOCKAGE	Side radar is blocked.	Stain or foreign materials is deposited.

#### NOTE:

DTC "C1B55" may be detected under the following conditions except for possible cause. (Explain to the customer about the difference between the contamination detection function and the indication when the malfunction is detected and tell them "This is not malfunction".)

- The side radar may be blocked by temporary ambient conditions such as splashing water, mist or fog.
- The blocked condition may also be caused by objects such as ice, frost or dirt obstructing the side radar.
- Due to the nature of radar technology it is possible to get a blockage warning and not actually be blocked. This is rare and is known as a false blockage warning. A false blocked condition either self-clears or clears after an ignition cycle.

### Diagnosis Procedure

INFOID:000000009716841

#### 1.CHECK THE REAR BUMPER

Check rear bumper near the side radar contaminated with foreign materials.

>> GO TO 2.

#### 2.CHECK THE SIDE RADAR

Check side radar and the side radar outskirts contaminated with foreign materials.

>> GO TO 3.

#### 3.CHECK THE SIDE RADAR INSTALL CONDITION

Check side radar installation condition (installation position, properly tightened, a bent bracket).

>> GO TO 4.

#### 4.INTERVIEW

1. Ask if there is stain or foreign materials.
2. Ask if there is any temporary ambient condition such as splashing water, mist or fog.
3. Ask if there is any object such as ice, frost or dirt obstructing the side radar.

#### Is any of above conditions seen?

- YES >> Explain to the customer about the difference between the blockage detection function and the indication when the malfunction is detected and tell them "This is not malfunction".
- NO >> Inspection End.

A  
B  
C  
D  
E  
F  
G  
H  
I  
J  
K  
L  
M  
N  
P

DAS

# U1000 CAN COMM CIRCUIT

< DTC/CIRCUIT DIAGNOSIS >

[BLIND SPOT WARNING & BLIND SPOT INTERVENTION]

## U1000 CAN COMM CIRCUIT

### SIDE RADAR LH

#### SIDE RADAR LH : Description

INFOID:000000009716842

#### CAN COMMUNICATION

CAN (Controller Area Network) is a serial communication line for real time applications. It is an on-vehicle multiplex communication line with high data communication speed and excellent error detection ability. Modern vehicle is equipped with many electronic control units, and each control unit shares information and links with other control units during operation (not independent). In CAN communication, control units are connected with 2 communication lines (CAN-H, CAN-L) allowing a high rate of information transmission with less wiring. Each control unit transmits/receives data but selectively reads the required data only.

CAN communication signal chart. Refer to [LAN-43. "CAN COMMUNICATION SYSTEM : CAN Communication Signal Chart"](#).

#### ITS COMMUNICATION

- ITS communication is a multiplex communication system. This enables the system to transmit and receive large quantities of data at high speed by connecting plural units with 2 communication lines.
- ITS communication lines adopt twisted-pair line style (two lines twisted) for noise immunity.

#### SIDE RADAR LH : DTC Logic

INFOID:000000009716843

#### DTC DETECTION LOGIC

DTC	Trouble diagnosis name	DTC detecting condition	Possible causes
U1000	CAN COMM CIRCUIT	If Side radar LH is not transmitting or receiving ITS communication signal for 2 seconds or more	ITS communication system

#### SIDE RADAR LH : Diagnosis Procedure

INFOID:000000009716844

#### 1. PERFORM THE SELF-DIAGNOSIS

1. Start the engine.
2. Turn the Blind Spot Intervention system ON, and then wait for 30 seconds or more.
3. Perform "All DTC Reading" with CONSULT.
4. Check if the "U1000" is detected as the current malfunction in "Self Diagnostic Result" of "SIDE RADAR LEFT".

Is "U1000" detected as the current malfunction?

YES >> Refer to [LAN-26. "Trouble Diagnosis Flow Chart"](#).

NO >> Refer to [GI-53. "Intermittent Incident"](#).

### SIDE RADAR RH

#### SIDE RADAR RH : Description

INFOID:000000009716845

#### CAN COMMUNICATION

CAN (Controller Area Network) is a serial communication line for real time applications. It is an on-vehicle multiplex communication line with high data communication speed and excellent error detection ability. Modern vehicle is equipped with many electronic control units, and each control unit shares information and links with other control units during operation (not independent). In CAN communication, control units are connected with 2 communication lines (CAN-H, CAN-L) allowing a high rate of information transmission with less wiring. Each control unit transmits/receives data but selectively reads the required data only.

CAN communication signal chart. Refer to [LAN-43. "CAN COMMUNICATION SYSTEM : CAN Communication Signal Chart"](#).

#### ITS COMMUNICATION

- ITS communication is a multiplex communication system. This enables the system to transmit and receive large quantities of data at high speed by connecting plural units with 2 communication lines.
- ITS communication lines adopt twisted-pair line style (two lines twisted) for noise immunity.



# U1000 CAN COMM CIRCUIT

< DTC/CIRCUIT DIAGNOSIS >

[BLIND SPOT WARNING & BLIND SPOT INTERVENTION]

## SIDE RADAR RH : DTC Logic

INFOID:000000009716846

### DTC DETECTION LOGIC

DTC	Trouble diagnosis name	DTC detecting condition	Possible causes
U1000	CAN COMM CIRCUIT	If Side radar RH is not transmitting or receiving ITS communication signal for 2 seconds or more	ITS communication system

## SIDE RADAR RH : Diagnosis Procedure

INFOID:000000009716847

### 1. PERFORM THE SELF-DIAGNOSIS

1. Start the engine.
2. Turn the Blind Spot Intervention system ON, and then wait for 30 seconds or more.
3. Perform "All DTC Reading" with CONSULT.
4. Check if the "U1000" is detected as the current malfunction in "Self Diagnostic Result" of "SIDE RADAR RIGHT".

Is "U1000" detected as the current malfunction?

YES >> Refer to [LAN-26, "Trouble Diagnosis Flow Chart"](#).

NO >> Refer to [GI-53, "Intermittent Incident"](#).

## ADAS CONTROL UNIT

### ADAS CONTROL UNIT : Description

INFOID:000000009716848

#### CAN COMMUNICATION

CAN (Controller Area Network) is a serial communication line for real time applications. It is an on-vehicle multiplex communication line with high data communication speed and excellent error detection ability. Modern vehicle is equipped with many electronic control units, and each control unit shares information and links with other control units during operation (not independent). In CAN communication, control units are connected with 2 communication lines (CAN-H, CAN-L) allowing a high rate of information transmission with less wiring. Each control unit transmits/receives data but selectively reads the required data only.

CAN communication signal chart. Refer to [LAN-43, "CAN COMMUNICATION SYSTEM : CAN Communication Signal Chart"](#).

#### ITS COMMUNICATION

- ITS communication is a multiplex communication system. This enables the system to transmit and receive large quantities of data at high speed by connecting control units with 2 communication lines.
- ITS communication lines adopt twisted-pair line style (two lines twisted) for noise immunity.

### ADAS CONTROL UNIT : DTC Logic

INFOID:000000009716849

### DTC DETECTION LOGIC

DTC (On board display)	Trouble diagnosis name	DTC detecting condition	Possible causes
U1000 (100)	CAN COMM CIRCUIT	If ADAS control unit is not transmitting or receiving CAN communication signal or ITS communication signal for 2 seconds or more	<ul style="list-style-type: none"><li>• CAN communication system</li><li>• ITS communication system</li></ul>

#### NOTE:

If "U1000" is detected, first diagnose the CAN communication system.

## ADAS CONTROL UNIT : Diagnosis Procedure

INFOID:000000009716850

### 1. PERFORM THE SELF-DIAGNOSIS

1. Turn the ignition switch ON.
2. Turn the Blind Spot Intervention system ON, and then wait for 30 seconds or more.
3. Perform "All DTC Reading" with CONSULT.
4. Check if the "U1000" is detected as the current malfunction in "Self Diagnostic Result" of "ICC/ADAS".

# U1000 CAN COMM CIRCUIT

< DTC/CIRCUIT DIAGNOSIS >

[BLIND SPOT WARNING & BLIND SPOT INTERVENTION]

Is "U1000" detected as the current malfunction?

YES >> Refer to [LAN-26, "Trouble Diagnosis Flow Chart"](#).

NO >> Refer to [GI-53, "Intermittent Incident"](#).

## LANE CAMERA UNIT

### LANE CAMERA UNIT : Description

INFOID:000000009716851

#### ITS COMMUNICATION

- ITS communication is a multiplex communication system. This enables the system to transmit and receive large quantities of data at high speed by connecting control units with 2 communication lines.
- ITS communication lines adopt twisted-pair line style (two lines twisted) for noise immunity.

### LANE CAMERA UNIT : DTC Logic

INFOID:000000009716852

#### DTC DETECTION LOGIC

DTC	Trouble diagnosis name	DTC detecting condition	Possible causes
U1000	CAN COMM CIRCUIT	If lane camera unit is not transmitting or receiving ITS communication signal for 2 seconds or more	ITS communication system

### LANE CAMERA UNIT : Diagnosis Procedure

INFOID:000000009716853

#### 1. PERFORM THE SELF-DIAGNOSIS

1. Turn the ignition switch ON.
2. Turn the Blind Spot Intervention system ON, and then wait for 2 seconds or more.
3. Perform "All DTC Reading" with CONSULT.
4. Check if the "U1000" is detected as the current malfunction in "Self Diagnostic Result" of "LANE CAMERA".

Is "U1000" detected as the current malfunction?

YES >> Refer to [LAN-26, "Trouble Diagnosis Flow Chart"](#).

NO >> Refer to [GI-53, "Intermittent Incident"](#).

# U1010 CONTROL UNIT (CAN)

< DTC/CIRCUIT DIAGNOSIS >

[BLIND SPOT WARNING & BLIND SPOT INTERVENTION]

## U1010 CONTROL UNIT (CAN)

### SIDE RADAR LH

#### SIDE RADAR LH : Description

INFOID:000000009716854

CAN controller controls the communication of ITS communication signal and the error detection.

#### SIDE RADAR LH : DTC Logic

INFOID:000000009716855

#### DTC DETECTION LOGIC

DTC	Trouble diagnosis name	DTC detecting condition	Possible cause
U1010	CONTROL UNIT (CAN)	If side radar LH detects malfunction by CAN controller initial diagnosis.	Side radar LH

#### SIDE RADAR LH : Diagnosis Procedure

INFOID:000000009716856

##### 1. CHECK SELF-DIAGNOSIS RESULT

1. Turn the Blind Spot Intervention system ON.
2. Perform "All DTC Reading" with CONSULT.
3. Check if the "U1010" is detected as the current malfunction in "Self Diagnostic Result" of "SIDE RADAR LEFT".

Is "U1010" detected as the current malfunction?

YES >> Replace the side radar LH. Refer to [DAS-632, "Removal and Installation"](#).

NO >> INSPECTION END

### SIDE RADAR RH

#### SIDE RADAR RH : Description

INFOID:000000009716857

CAN controller controls the communication of ITS communication signal and the error detection.

#### SIDE RADAR RH : DTC Logic

INFOID:000000009716858

#### DTC DETECTION LOGIC

DTC	Trouble diagnosis name	DTC detecting condition	Possible cause
U1010	CONTROL UNIT (CAN)	If Side radar RH detects malfunction by CAN controller initial diagnosis.	Side radar RH

#### SIDE RADAR RH : Diagnosis Procedure

INFOID:000000009716859

##### 1. CHECK SELF-DIAGNOSIS RESULT

1. Turn the Blind Spot Intervention system ON.
2. Perform "All DTC Reading" with CONSULT.
3. Check if the "U1010" is detected as the current malfunction in "Self Diagnostic Result" of "SIDE RADAR RIGHT".

Is "U1010" detected as the current malfunction?

YES >> Replace the side radar RH. Refer to [DAS-632, "Removal and Installation"](#).

NO >> INSPECTION END

### ADAS CONTROL UNIT

#### ADAS CONTROL UNIT : Description

INFOID:000000009716860

CAN controller controls the communication of CAN communication signal and ITS communication signal, and the error detection.

A  
B  
C  
D  
E  
F  
G  
H  
I  
J  
K  
L  
M  
N  
P

DAS

# U1010 CONTROL UNIT (CAN)

< DTC/CIRCUIT DIAGNOSIS >

[BLIND SPOT WARNING & BLIND SPOT INTERVENTION]

## ADAS CONTROL UNIT : DTC Logic

INFOID:000000009716861

### DTC DETECTION LOGIC

DTC (On board display)	Trouble diagnosis name	DTC detecting condition	Possible causes
U1010 (110)	CONTROL UNIT (CAN)	If ADAS control unit detects malfunction by CAN controller initial diagnosis	ADAS control unit

## ADAS CONTROL UNIT : Diagnosis Procedure

INFOID:000000009716862

### 1.PERFORM DTC CONFIRMATION PROCEDURE

1. Turn the Blind Spot Intervention system ON.
2. Perform "All DTC Reading" with CONSULT.
3. Check if the "U1010" is detected as the current malfunction in "Self Diagnostic Result" of "ICC/ADAS".

Is "U1010" detected as the current malfunction?

- YES >> Replace the ADAS control unit. Refer to [DAS-79. "Removal and Installation"](#).  
NO >> INSPECTION END

## LANE CAMERA UNIT

### LANE CAMERA UNIT : Description

INFOID:000000009716863

CAN controller controls the communication of ITS communication signal and the error detection.

### LANE CAMERA UNIT : DTC Logic

INFOID:000000009716864

### DTC DETECTION LOGIC

DTC	Trouble diagnosis name	DTC detecting condition	Possible causes
U1010	CONTROL UNIT (CAN)	If lane camera unit detects malfunction by CAN controller initial diagnosis	Lane camera unit

## LANE CAMERA UNIT : Diagnosis Procedure

INFOID:000000009716865

### 1.PERFORM DTC CONFIRMATION PROCEDURE

1. Turn the Blind Spot Intervention system ON.
2. Perform "All DTC Reading" with CONSULT.
3. Check if the "U1010" is detected as the current malfunction in "Self Diagnostic Result" of "LANE CAMERA".

Is "U1010" detected as the current malfunction?

- YES >> Replace the lane camera unit. Refer to [DAS-635. "Removal and Installation"](#).  
NO >> INSPECTION END

# U0104 ADAS CAN 1

## [BLIND SPOT WARNING & BLIND SPOT INTERVENTION]

< DTC/CIRCUIT DIAGNOSIS >

### U0104 ADAS CAN 1

#### SIDE RADAR

#### SIDE RADAR : DTC Logic

INFOID:000000009716866

#### DTC DETECTION LOGIC

DTC	Trouble diagnosis name	DTC detecting condition	Possible cause
U0104	ADAS CAN CIR1	Side radar detected an error of ITS communication signal that was received from ADAS control unit.	ADAS control unit

#### NOTE:

If DTC "U0104" is detected along with DTC "U1000", first diagnose the DTC "U1000". Refer to [DAS-580, "SIDE RADAR LH : DTC Logic"](#) (SIDE RADAR LH), [DAS-581, "SIDE RADAR RH : DTC Logic"](#) (SIDE RADAR RH).

#### DTC CONFIRMATION PROCEDURE

##### 1. PERFORM DTC CONFIRMATION PROCEDURE

1. Start the engine.
2. Turn the Blind Spot Intervention system ON.
3. Perform "All DTC Reading" with CONSULT
4. Check if the U0104 is detected as the current malfunction in "Self Diagnostic Result" of "SIDE RADAR RIGHT/LEFT".

#### Is the DTC "U0104" detected?

- YES >> Refer to [DAS-585, "SIDE RADAR : Diagnosis Procedure"](#).  
NO >> Refer to [GI-53, "Intermittent Incident"](#).

#### SIDE RADAR : Diagnosis Procedure

INFOID:000000009716867

##### 1. CHECK SELF-DIAGNOSIS RESULTS

Check if "U1000" is detected other than "U0104" in "Self Diagnostic Result" of "SIDE RADAR RIGHT/LEFT".

#### Is "U1000" detected?

- YES >> Perform the CAN communication system inspection. Repair or replace the malfunctioning parts. Refer to [DAS-580, "SIDE RADAR LH : DTC Logic"](#) (SIDE RADAR LH), [DAS-581, "SIDE RADAR RH : DTC Logic"](#) (SIDE RADAR RH).  
NO >> GO TO 2.

##### 2. CHECK ADAS CONTROL UNIT SELF-DIAGNOSIS RESULTS

Check if any DTC is detected in "Self Diagnostic Result" of "ICC/ADAS".

#### Is any DTC detected?

- YES >> Perform diagnosis on the detected DTC and repair or replace the malfunctioning parts. Refer to [DAS-509, "DTC Index"](#).  
NO >> Replace side radar LH or RH. Refer to [DAS-632, "Removal and Installation"](#).

#### LANE CAMERA UNIT

#### LANE CAMERA UNIT : DTC Logic

INFOID:000000009716868

#### DTC DETECTION LOGIC

DTC	Trouble diagnosis name	DTC detecting condition	Possible causes
U0104	ADAS CAN CIR 1	If lane camera unit detects an error signal that is received from ADAS control unit via ITS communication	ADAS control unit

#### NOTE:

If DTC "U0104" is detected along with DTC "U1000", first diagnose the DTC "U1000". Refer to [DAS-582, "LANE CAMERA UNIT : DTC Logic"](#).

A  
B  
C  
D  
E  
F  
G  
H  
I  
J  
K  
L  
M  
N  
P

DAS

# U0104 ADAS CAN 1

[BLIND SPOT WARNING & BLIND SPOT INTERVENTION]

< DTC/CIRCUIT DIAGNOSIS >

## DTC CONFIRMATION PROCEDURE

### 1. PERFORM DTC CONFIRMATION PROCEDURE

1. Start the engine.
2. Turn the Blind Spot Intervention system ON.
3. Perform "All DTC Reading" with CONSULT.
4. Check if the "U0104" is detected as the current malfunction in "Self Diagnostic Result" of "LANE CAMERA".

Is "U0104" detected as the current malfunction?

YES >> Refer to [DAS-586, "LANE CAMERA UNIT : Diagnosis Procedure"](#).

NO >> Refer to [GI-53, "Intermittent Incident"](#).

## LANE CAMERA UNIT : Diagnosis Procedure

INFOID:000000009716869

### 1. CHECK LANE CAMERA UNIT SELF-DIAGNOSIS RESULTS

Check if "U1000" is detected other than "U0104" in "Self Diagnostic Result" of "LANE CAMERA".

Is "U1000" detected?

YES >> Perform the CAN communication system inspection. Repair or replace the malfunctioning parts.  
Refer to [DAS-582, "LANE CAMERA UNIT : DTC Logic"](#).

NO >> GO TO 2.

### 2. CHECK ADAS CONTROL UNIT SELF-DIAGNOSIS RESULTS

Check if any DTC is detected in "Self Diagnostic Result" of "ICC/ADAS".

Is any DTC detected?

YES >> Perform diagnosis on the detected DTC and repair or replace the malfunctioning parts. Refer to [DAS-509, "DTC Index"](#).

NO >> Replace the lane camera unit. Refer to [DAS-635, "Removal and Installation"](#).

# U0121 VDC CAN 2

## [BLIND SPOT WARNING & BLIND SPOT INTERVENTION]

< DTC/CIRCUIT DIAGNOSIS >

### U0121 VDC CAN 2

#### DTC Logic

INFOID:000000009716870

#### DTC DETECTION LOGIC

DTC (On board display)	Trouble diagnosis name	DTC detecting condition	Possible causes
U0121 (127)	VDC CAN CIR2	If ADAS control unit detects an error signal that is received from ABS actuator and electric unit (control unit) via CAN communication	ABS actuator and electric unit (control unit)

#### NOTE:

If DTC "U0121" is detected along with DTC "U1000", first diagnose the DTC "U1000". Refer to [DAS-581, "ADAS CONTROL UNIT : DTC Logic"](#).

#### DTC CONFIRMATION PROCEDURE

##### 1. PERFORM DTC CONFIRMATION PROCEDURE

1. Start the engine.
2. Turn the Blind Spot Intervention system ON.
3. Perform "All DTC Reading" with CONSULT.
4. Check if the "U0121" is detected as the current malfunction in "Self Diagnostic Result" of "ICC/ADAS".

Is "U0121" detected as the current malfunction?

- YES >> Refer to [DAS-587, "Diagnosis Procedure"](#).  
NO >> Refer to [GI-53, "Intermittent Incident"](#).

#### Diagnosis Procedure

INFOID:000000009716871

##### 1. CHECK SELF-DIAGNOSIS RESULTS

Check if "U1000" is detected other than "U0121" in "Self Diagnostic Result" of "ICC/ADAS".

Is "U1000" detected?

- YES >> Perform the CAN communication system inspection. Repair or replace the malfunctioning parts. Refer to [DAS-581, "ADAS CONTROL UNIT : DTC Logic"](#).  
NO >> GO TO 2.

##### 2. CHECK ABS ACTUATOR AND ELECTRIC UNIT (CONTROL UNIT) SELF-DIAGNOSIS RESULTS

Check if any DTC is detected in "Self Diagnostic Result" of "ABS".

Is any DTC detected?

- YES >> Perform diagnosis on the detected DTC and repair or replace the malfunctioning parts. Refer to [BRC-46, "DTC Index"](#).  
NO >> Replace the ADAS control unit. Refer to [DAS-79, "Removal and Installation"](#).

A  
B  
C  
D  
E  
F  
G  
H  
I  
J  
K  
L  
M  
N  
P

DAS

# U0126 STRG SEN CAN 1

[BLIND SPOT WARNING & BLIND SPOT INTERVENTION]

< DTC/CIRCUIT DIAGNOSIS >

## U0126 STRG SEN CAN 1

### ADAS CONTROL UNIT

#### ADAS CONTROL UNIT : DTC Logic

INFOID:000000009716872

#### DTC DETECTION LOGIC

DTC (On board display)	Trouble diagnosis name	DTC detecting condition	Possible causes
U0126 (130)	STRG SEN CAN CIR1	If ADAS control unit detects an error signal that is received from steering angle sensor via CAN communication	Steering angle sensor

#### NOTE:

If DTC "U0126" is detected along with DTC "U1000", first diagnose the DTC "U1000". Refer to [DAS-581, "ADAS CONTROL UNIT : DTC Logic"](#).

#### DTC CONFIRMATION PROCEDURE

##### 1. PERFORM DTC CONFIRMATION PROCEDURE

1. Start the engine.
2. Turn the Blind Spot Intervention system ON.
3. Perform "All DTC Reading" with CONSULT.
4. Check if the "U0126" is detected as the current malfunction in "Self Diagnostic Result" of "ICC/ADAS".

#### Is "U0126" detected as the current malfunction?

- YES >> Refer to [DAS-588, "ADAS CONTROL UNIT : Diagnosis Procedure"](#).  
NO >> Refer to [GI-53, "Intermittent Incident"](#).

#### ADAS CONTROL UNIT : Diagnosis Procedure

INFOID:000000009716873

##### 1. CHECK SELF-DIAGNOSIS RESULTS

Check if "U1000" is detected other than "U0126" in "Self Diagnostic Result" of "ICC/ADAS".

#### Is "U1000" detected?

- YES >> Perform the CAN communication system inspection. Repair or replace the malfunctioning parts. Refer to [DAS-581, "ADAS CONTROL UNIT : DTC Logic"](#).  
NO >> GO TO 2.

##### 2. CHECK ABS ACTUATOR AND ELECTRIC UNIT (CONTROL UNIT) SELF-DIAGNOSIS RESULTS

Check if any DTC is detected in "Self Diagnostic Result" of "ABS".

#### Is any DTC detected?

- YES >> Perform diagnosis on the detected DTC and repair or replace the malfunctioning parts. Refer to [BRC-46, "DTC Index"](#).  
NO >> Replace the ADAS control unit. Refer to [DAS-79, "Removal and Installation"](#).

## LANE CAMERA UNIT

#### LANE CAMERA UNIT : DTC Logic

INFOID:000000009716874

#### DTC DETECTION LOGIC

DTC	Trouble diagnosis name	DTC detecting condition	Possible causes
U0126	STRG SEN CAN CIR1	If lane camera unit detects an error signal that is received from steering angle sensor via ADAS control unit	Steering angle sensor

#### NOTE:

If DTC "U0126" is detected along with DTC "U1000", first diagnose the DTC "U1000". Refer to [DAS-582, "LANE CAMERA UNIT : DTC Logic"](#).



# U0126 STRG SEN CAN 1

< DTC/CIRCUIT DIAGNOSIS >

[BLIND SPOT WARNING & BLIND SPOT INTERVENTION]

## DTC CONFIRMATION PROCEDURE

### 1. PERFORM DTC CONFIRMATION PROCEDURE

1. Start the engine.
2. Turn the Blind Spot Intervention system ON.
3. Perform "All DTC Reading" with CONSULT.
4. Check if the "U0126" is detected as the current malfunction in "Self Diagnostic Result" of "LANE CAMERA".

Is "U0126" detected as the current malfunction?

YES >> Refer to [DAS-589, "LANE CAMERA UNIT : Diagnosis Procedure"](#).

NO >> Refer to [GI-53, "Intermittent Incident"](#).

## LANE CAMERA UNIT : Diagnosis Procedure

INFOID:000000009716875

### 1. CHECK SELF-DIAGNOSIS RESULTS

Check if "U1000" is detected other than "U0126" in "Self Diagnostic Result" of "LANE CAMERA".

Is "U1000" detected?

YES >> Perform the CAN communication system inspection. Repair or replace the malfunctioning parts.  
Refer to [DAS-582, "LANE CAMERA UNIT : DTC Logic"](#).

NO >> GO TO 2.

### 2. CHECK ADAS CONTROL UNIT SELF-DIAGNOSIS RESULTS

Check if any DTC is detected in "Self Diagnostic Result" of "ICC/ADAS".

Is any DTC detected?

YES >> Perform diagnosis on the detected DTC and repair or replace the malfunctioning parts. Refer to [DAS-509, "DTC Index"](#).

NO >> Replace the lane camera unit. Refer to [DAS-635, "Removal and Installation"](#).

A  
B  
C  
D  
E  
F  
G  
H  
I  
J  
K  
L  
M  
N  
P

DAS

# U0401 ECM CAN 1

[BLIND SPOT WARNING & BLIND SPOT INTERVENTION]

< DTC/CIRCUIT DIAGNOSIS >

## U0401 ECM CAN 1

### DTC Logic

INFOID:000000009716876

### DTC DETECTION LOGIC

DTC (On board display)	Trouble diagnosis name	DTC detecting condition	Possible causes
U0401 (120)	ECM CAN CIR1	If ADAS control unit detects an error signal that is received from ECM via CAN communication	ECM

#### NOTE:

If DTC "U0401" is detected along with DTC "U1000", first diagnose the DTC "U1000". Refer to [DAS-581, "ADAS CONTROL UNIT : DTC Logic"](#).

### DTC CONFIRMATION PROCEDURE

#### 1. PERFORM DTC CONFIRMATION PROCEDURE

1. Start the engine.
2. Turn the Blind Spot Intervention system ON.
3. Perform "All DTC Reading" with CONSULT.
4. Check if the "U0401" is detected as the current malfunction in "Self Diagnostic Result" of "ICC/ADAS".

Is "U0401" detected as the current malfunction?

- YES >> Refer to [DAS-590, "Diagnosis Procedure"](#).  
NO >> Refer to [GI-53, "Intermittent Incident"](#).

### Diagnosis Procedure

INFOID:000000009716877

#### 1. CHECK SELF-DIAGNOSIS RESULTS

Check if "U1000" is detected other than "U0401" in "Self Diagnostic Result" of "ICC/ADAS".

Is "U1000" detected?

- YES >> Perform the CAN communication system inspection. Repair or replace the malfunctioning parts.  
Refer to [DAS-581, "ADAS CONTROL UNIT : DTC Logic"](#).  
NO >> GO TO 2.

#### 2. CHECK ECM SELF-DIAGNOSIS RESULTS

Check if any DTC is detected in "Self Diagnostic Result" of "ENGINE".

Is any DTC detected?

- YES >> Perform diagnosis on the detected DTC and repair or replace the malfunctioning parts. Refer to [EC-97, "DTC Index"](#).  
NO >> Replace the ADAS control unit. Refer to [DAS-79, "Removal and Installation"](#).

# U0402 TCM CAN 1

## [BLIND SPOT WARNING & BLIND SPOT INTERVENTION]

< DTC/CIRCUIT DIAGNOSIS >

### U0402 TCM CAN 1

#### DTC Logic

INFOID:000000009716878

#### DTC DETECTION LOGIC

DTC (On board display)	Trouble diagnosis name	DTC detecting condition	Possible causes
U0402 (122)	TCM CAN CIRC1	If ADAS control unit detects an error signal that is received from TCM via CAN communication	TCM

#### NOTE:

If DTC "U0402" is detected along with DTC "U1000", first diagnose the DTC "U1000". Refer to [DAS-581, "ADAS CONTROL UNIT : DTC Logic"](#).

#### DTC CONFIRMATION PROCEDURE

##### 1. PERFORM DTC CONFIRMATION PROCEDURE

1. Start the engine.
2. Turn the Blind Spot Intervention system ON.
3. Perform "All DTC Reading" with CONSULT.
4. Check if the "U0402" is detected as the current malfunction in "Self Diagnostic Result" of "ICC/ADAS".

Is "U0402" detected as the current malfunction?

- YES >> Refer to [DAS-591, "Diagnosis Procedure"](#).  
NO >> Refer to [GI-53, "Intermittent Incident"](#).

#### Diagnosis Procedure

INFOID:000000009716879

##### 1. CHECK SELF-DIAGNOSIS RESULTS

Check if "U1000" is detected other than "U0402" in "Self Diagnostic Result" of "ICC/ADAS".

Is "U1000" detected?

- YES >> Perform the CAN communication system inspection. Repair or replace the malfunctioning parts. Refer to [DAS-581, "ADAS CONTROL UNIT : DTC Logic"](#).  
NO >> GO TO 2.

##### 2. CHECK TCM SELF-DIAGNOSIS RESULTS

Check if any DTC is detected in "Self Diagnostic Result" of "TRANSMISSION".

Is any DTC detected?

- YES >> Perform diagnosis on the detected DTC and repair or replace the malfunctioning parts. Refer to [TM-61, "DTC Index"](#).  
NO >> Replace the ADAS control unit. Refer to [DAS-79, "Removal and Installation"](#).

DAS

# U0405 ADAS CAN 2

## [BLIND SPOT WARNING & BLIND SPOT INTERVENTION]

< DTC/CIRCUIT DIAGNOSIS >

### U0405 ADAS CAN 2

#### SIDE RADAR

#### SIDE RADAR : DTC Logic

INFOID:000000009716880

#### DTC DETECTION LOGIC

DTC	Trouble diagnosis name	DTC detecting condition	Possible cause
U0405	ADAS CAN CIR2	Side radar detected an error of ITS communication signal that was received from ADAS control unit.	ADAS control unit.

#### NOTE:

If DTC "U0405" is detected along with DTC "U1000", first diagnose the DTC "U1000". Refer to [DAS-580, "SIDE RADAR LH : DTC Logic"](#) (SIDE RADAR LH), [DAS-581, "SIDE RADAR RH : DTC Logic"](#) (SIDE RADAR RH).

#### DTC CONFIRMATION PROCEDURE

##### 1. PERFORM DTC CONFIRMATION PROCEDURE

1. Start the engine.
2. Turn the Blind Spot Intervention system ON.
3. Perform "All DTC Reading" with CONSULT
4. Check if the "U0405" is detected as the current malfunction in "Self Diagnostic Result" of "SIDE RADAR RIGHT/LEFT".

#### Is the DTC "U0405" detected?

- YES >> Refer to [DAS-592, "SIDE RADAR : Diagnosis Procedure"](#).  
NO >> Refer to [GI-53, "Intermittent Incident"](#).

#### SIDE RADAR : Diagnosis Procedure

INFOID:000000009716881

##### 1. CHECK SELF-DIAGNOSIS RESULTS

Check if "U1000" is detected other than "U0405" in "Self Diagnostic Result" of "SIDE RADAR RIGHT/LEFT".

#### Is "U1000" detected?

- YES >> Perform the CAN communication system inspection. Repair or replace the malfunctioning parts. Refer to [DAS-580, "SIDE RADAR LH : DTC Logic"](#) (SIDE RADAR LH), [DAS-581, "SIDE RADAR RH : DTC Logic"](#) (SIDE RADAR RH).  
NO >> GO TO 2.

##### 2. CHECK ADAS CONTROL UNIT SELF-DIAGNOSIS RESULTS

Check if any DTC is detected in "Self Diagnostic Result" of "ICC/ADAS".

#### Is any DTC detected?

- YES >> Perform diagnosis on the detected DTC and repair or replace the malfunctioning parts. Refer to [DAS-509, "DTC Index"](#).  
NO >> Replace side radar LH or RH. Refer to [DAS-632, "Removal and Installation"](#).

#### LANE CAMERA UNIT

#### LANE CAMERA UNIT : DTC Logic

INFOID:000000009716882

#### DTC DETECTION LOGIC

DTC	Trouble diagnosis name	DTC detecting condition	Possible causes
U0405	ADAS CAN CIR 2	If lane camera unit detects an error signal that is received from ADAS control unit via ITS communication	ADAS control unit

#### NOTE:

If DTC "U0405" is detected along with DTC "U1000", first diagnose the DTC "U1000". Refer to [DAS-582, "LANE CAMERA UNIT : DTC Logic"](#).

## U0405 ADAS CAN 2

### [BLIND SPOT WARNING & BLIND SPOT INTERVENTION]

< DTC/CIRCUIT DIAGNOSIS >

#### DTC CONFIRMATION PROCEDURE

##### 1. PERFORM DTC CONFIRMATION PROCEDURE

1. Start the engine.
2. Turn the Blind Spot Intervention system ON.
3. Perform "All DTC Reading" with CONSULT.
4. Check if the "U0405" is detected as the current malfunction in "Self Diagnostic Result" of "LANE CAMERA".

Is "U0405" detected as the current malfunction?

YES >> Refer to [DAS-593, "LANE CAMERA UNIT : Diagnosis Procedure"](#).

NO >> Refer to [GI-53, "Intermittent Incident"](#).

#### LANE CAMERA UNIT : Diagnosis Procedure

INFOID:000000009716883

##### 1. CHECK LANE CAMERA UNIT SELF-DIAGNOSIS RESULTS

Check if "U1000" is detected other than "U0405" in "Self Diagnostic Result" of "LANE CAMERA".

Is "U1000" detected?

YES >> Perform the CAN communication system inspection. Repair or replace the malfunctioning parts.

Refer to [DAS-582, "LANE CAMERA UNIT : DTC Logic"](#).

NO >> GO TO 2.

##### 2. CHECK ADAS CONTROL UNIT SELF-DIAGNOSIS RESULTS

Check if any DTC is detected in "Self Diagnostic Result" of "ICC/ADAS".

Is any DTC detected?

YES >> Perform diagnosis on the detected DTC and repair or replace the malfunctioning parts. Refer to [DAS-509, "DTC Index"](#).

NO >> Replace the lane camera unit. Refer to [DAS-635, "Removal and Installation"](#).

A  
B  
C  
D  
E  
F  
G  
H  
I  
J  
K  
L  
M  
N  
P

DAS

# U0415 VDC CAN 1

[BLIND SPOT WARNING & BLIND SPOT INTERVENTION]

< DTC/CIRCUIT DIAGNOSIS >

## U0415 VDC CAN 1

### DTC Logic

INFOID:000000009716884

### DTC DETECTION LOGIC

DTC (On board display)	Trouble diagnosis name	DTC detecting condition	Possible causes
U0415 (126)	VDC CAN CIR1	If ADAS control unit detects an error signal that is received from ABS actuator and electric unit (control unit) via CAN communication	ABS actuator and electric unit (control unit)

#### NOTE:

If DTC "U0415" is detected along with DTC "U1000", first diagnose the DTC "U1000". Refer to [DAS-581, "ADAS CONTROL UNIT : DTC Logic"](#).

### DTC CONFIRMATION PROCEDURE

#### 1. PERFORM DTC CONFIRMATION PROCEDURE

1. Start the engine.
2. Turn the Blind Spot Intervention system ON.
3. Perform "All DTC Reading" with CONSULT.
4. Check if the "U0415" is detected as the current malfunction in "Self Diagnostic Result" of "ICC/ADAS".

Is "U0415" detected as the current malfunction?

- YES >> Refer to [DAS-594, "Diagnosis Procedure"](#).  
NO >> Refer to [GI-53, "Intermittent Incident"](#).

### Diagnosis Procedure

INFOID:000000009716885

#### 1. CHECK SELF-DIAGNOSIS RESULTS

Check if "U1000" is detected other than "U0415" in "Self Diagnostic Result" of "ICC/ADAS".

Is "U1000" detected?

- YES >> Perform the CAN communication system inspection. Repair or replace the malfunctioning parts.  
Refer to [DAS-581, "ADAS CONTROL UNIT : DTC Logic"](#).  
NO >> GO TO 2.

#### 2. CHECK ABS ACTUATOR AND ELECTRIC UNIT (CONTROL UNIT) SELF-DIAGNOSIS RESULTS

Check if any DTC is detected in "Self Diagnostic Result" of "ABS".

Is any DTC detected?

- YES >> Perform diagnosis on the detected DTC and repair or replace the malfunctioning parts. Refer to [BRC-46, "DTC Index"](#).  
NO >> Replace the ADAS control unit. Refer to [DAS-79, "Removal and Installation"](#).

## U0428 STRG SEN CAN 2

[BLIND SPOT WARNING & BLIND SPOT INTERVENTION]

< DTC/CIRCUIT DIAGNOSIS >

### U0428 STRG SEN CAN 2

#### ADAS CONTROL UNIT

#### ADAS CONTROL UNIT : DTC Logic

INFOID:000000009716886

#### DTC DETECTION LOGIC

DTC (On board display)	Trouble diagnosis name	DTC detecting condition	Possible causes
U0428 (131)	STRG SEN CAN CIR2	If ADAS control unit detects an error signal that is received from steering angle sensor via CAN communication	Steering angle sensor

#### NOTE:

If DTC "U0428" is detected along with DTC "U1000", first diagnose the DTC "U1000". Refer to [DAS-581, "ADAS CONTROL UNIT : DTC Logic"](#).

#### DTC CONFIRMATION PROCEDURE

##### 1. PERFORM DTC CONFIRMATION PROCEDURE

1. Start the engine.
2. Turn the Blind Spot Intervention system ON.
3. Perform "All DTC Reading" with CONSULT.
4. Check if the "U0428" is detected as the current malfunction in "Self Diagnostic Result" of "ICC/ADAS".

##### Is "U0428" detected as the current malfunction?

- YES >> Refer to [DAS-595, "ADAS CONTROL UNIT : Diagnosis Procedure"](#).  
NO >> Refer to [GI-53, "Intermittent Incident"](#).

#### ADAS CONTROL UNIT : Diagnosis Procedure

INFOID:000000009716887

##### 1. CHECK SELF-DIAGNOSIS RESULTS

Check if "U1000" is detected other than "U0428" in "Self Diagnostic Result" of "ICC/ADAS".

##### Is "U1000" detected?

- YES >> Perform the CAN communication system inspection. Repair or replace the malfunctioning parts. Refer to [DAS-581, "ADAS CONTROL UNIT : DTC Logic"](#).  
NO >> GO TO 2.

##### 2. CHECK ABS ACTUATOR AND ELECTRIC UNIT (CONTROL UNIT) SELF-DIAGNOSIS RESULTS

Check if any DTC is detected in "Self Diagnostic Result" of "ABS".

##### Is any DTC detected?

- YES >> Perform diagnosis on the detected DTC and repair or replace the malfunctioning parts. Refer to [BRC-46, "DTC Index"](#).  
NO >> Replace the ADAS control unit. Refer to [DAS-79, "Removal and Installation"](#).

#### LANE CAMERA UNIT

#### LANE CAMERA UNIT : DTC Logic

INFOID:000000009716888

#### DTC DETECTION LOGIC

DTC	Trouble diagnosis name	DTC detecting condition	Possible causes
U0428	STRG SEN CAN CIR2	If lane camera unit detects an error signal that is received from steering angle sensor via ADAS control unit	Steering angle sensor

#### NOTE:

If DTC "U0428" is detected along with DTC "U1000", first diagnose the DTC "U1000". Refer to [DAS-582, "LANE CAMERA UNIT : DTC Logic"](#).

## U0428 STRG SEN CAN 2

< DTC/CIRCUIT DIAGNOSIS >

[BLIND SPOT WARNING & BLIND SPOT INTERVENTION]

### DTC CONFIRMATION PROCEDURE

#### 1. PERFORM DTC CONFIRMATION PROCEDURE

1. Start the engine.
2. Turn the Blind Spot Intervention system ON.
3. Perform "All DTC Reading" with CONSULT.
4. Check if the "U0428" is detected as the current malfunction in "Self Diagnostic Result" of "LANE CAMERA".

Is "U0428" detected as the current malfunction?

YES >> Refer to [DAS-596, "LANE CAMERA UNIT : Diagnosis Procedure"](#).

NO >> Refer to [GI-53, "Intermittent Incident"](#).

### LANE CAMERA UNIT : Diagnosis Procedure

INFOID:000000009716889

#### 1. CHECK SELF-DIAGNOSIS RESULTS

Check if "U1000" is detected other than "U0428" in "Self Diagnostic Result" of "LANE CAMERA".

Is "U1000" detected?

YES >> Perform the CAN communication system inspection. Repair or replace the malfunctioning parts.

Refer to [DAS-582, "LANE CAMERA UNIT : DTC Logic"](#).

NO >> GO TO 2.

#### 2. CHECK ADAS CONTROL UNIT SELF-DIAGNOSIS RESULTS

Check if any DTC is detected in "Self Diagnostic Result" of "ICC/ADAS".

Is any DTC detected?

YES >> Perform diagnosis on the detected DTC and repair or replace the malfunctioning parts. Refer to

[DAS-509, "DTC Index"](#).

NO >> Replace the lane camera unit. Refer to [DAS-635, "Removal and Installation"](#).



# U150B ECM CAN 3

## [BLIND SPOT WARNING & BLIND SPOT INTERVENTION]

< DTC/CIRCUIT DIAGNOSIS >

### U150B ECM CAN 3

#### DTC Logic

INFOID:000000009716890

#### DTC DETECTION LOGIC

DTC (On board display)	Trouble diagnosis name	DTC detecting condition	Possible causes
U150B (157)	ECM CAN CIRC 3	ADAS control unit detects an error signal that is received from ECM via CAN communication	ECM

#### NOTE:

If DTC "U150B" is detected along with DTC "U1000", first diagnose the DTC "U1000". Refer to [DAS-581, "ADAS CONTROL UNIT : DTC Logic"](#).

#### DTC CONFIRMATION PROCEDURE

##### 1. PERFORM DTC CONFIRMATION PROCEDURE

1. Start the engine.
2. Turn the Blind Spot Intervention system ON.
3. Perform "All DTC Reading" with CONSULT.
4. Check if the "U150B" is detected as the current malfunction in "Self Diagnostic Result" of "ICC/ADAS".

Is "U150B" detected as the current malfunction?

- YES >> Refer to [DAS-597, "Diagnosis Procedure"](#).  
NO >> Refer to [GI-53, "Intermittent Incident"](#).

#### Diagnosis Procedure

INFOID:000000009716891

##### 1. CHECK SELF-DIAGNOSIS RESULTS

Check if "U1000" is detected other than "U150B" in "Self Diagnostic Result" of "ICC/ADAS".

Is "U1000" detected?

- YES >> Perform the CAN communication system inspection. Repair or replace the malfunctioning parts.  
Refer to [DAS-581, "ADAS CONTROL UNIT : DTC Logic"](#).  
NO >> GO TO 2.

##### 2. CHECK ECM SELF-DIAGNOSIS RESULTS

Check if any DTC is detected in "Self Diagnostic Result" of "ENGINE".

Is any DTC detected?

- YES >> Perform diagnosis on the detected DTC and repair or replace the malfunctioning parts. Refer to [EC-97, "DTC Index"](#).  
NO >> Replace the ADAS control unit. Refer to [DAS-79, "Removal and Installation"](#).

# U150C VDC CAN 3

## [BLIND SPOT WARNING & BLIND SPOT INTERVENTION]

< DTC/CIRCUIT DIAGNOSIS >

### U150C VDC CAN 3

#### DTC Logic

INFOID:000000009716892

#### DTC DETECTION LOGIC

DTC (On board display)	Trouble diagnosis name	DTC detecting condition	Possible causes
U150C (158)	VDC CAN CIRC 3	ADAS control unit detects an error signal that is received from ABS actuator and electric unit (control unit) via CAN communication	ABS actuator and electric unit (control unit)

#### NOTE:

If DTC "U150C" is detected along with DTC "U1000", first diagnose the DTC "U1000". Refer to [DAS-581, "ADAS CONTROL UNIT : DTC Logic"](#).

#### DTC CONFIRMATION PROCEDURE

##### 1. PERFORM DTC CONFIRMATION PROCEDURE

1. Start the engine.
2. Turn the Blind Spot Intervention system ON.
3. Perform "All DTC Reading" with CONSULT.
4. Check if the "U150C" is detected as the current malfunction in "Self Diagnostic Result" of "ICC/ADAS".

Is "U150C" detected as the current malfunction?

- YES >> Refer to [DAS-598, "Diagnosis Procedure"](#).  
NO >> Refer to [GI-53, "Intermittent Incident"](#).

#### Diagnosis Procedure

INFOID:000000009716893

##### 1. CHECK SELF-DIAGNOSIS RESULTS

Check if "U1000" is detected other than "U150C" in "Self Diagnostic Result" of "ICC/ADAS".

Is "U1000" detected?

- YES >> Perform the CAN communication system inspection. Repair or replace the malfunctioning parts.  
Refer to [DAS-581, "ADAS CONTROL UNIT : DTC Logic"](#).  
NO >> GO TO 2.

##### 2. CHECK ABS ACTUATOR AND ELECTRIC UNIT (CONTROL UNIT) SELF-DIAGNOSIS RESULTS

Check if any DTC is detected in "Self Diagnostic Result" of "ABS".

Is any DTC detected?

- YES >> Perform diagnosis on the detected DTC and repair or replace the malfunctioning parts. Refer to [BRC-46, "DTC Index"](#).  
NO >> Replace the ADAS control unit. Refer to [DAS-79, "Removal and Installation"](#).

# U150D TCM CAN 3

## [BLIND SPOT WARNING & BLIND SPOT INTERVENTION]

< DTC/CIRCUIT DIAGNOSIS >

### U150D TCM CAN 3

#### DTC Logic

INFOID:000000009716894

#### DTC DETECTION LOGIC

DTC (On board display)	Trouble diagnosis name	DTC detecting condition	Possible causes
U150D (159)	TCM CAN CIRC 3	ADAS control unit detects an error signal that is received from TCM via CAN communication	TCM

#### NOTE:

If DTC "U150D" is detected along with DTC "U1000", first diagnose the DTC "U1000". Refer to [DAS-581, "ADAS CONTROL UNIT : DTC Logic"](#).

#### DTC CONFIRMATION PROCEDURE

##### 1. PERFORM DTC CONFIRMATION PROCEDURE

1. Start the engine.
2. Turn the Blind Spot Intervention system ON.
3. Perform "All DTC Reading" with CONSULT.
4. Check if the "U150D" is detected as the current malfunction in "Self Diagnostic Result" of "ICC/ADAS".

Is "U150D" detected as the current malfunction?

- YES >> Refer to [DAS-599, "Diagnosis Procedure"](#).  
NO >> Refer to [GI-53, "Intermittent Incident"](#).

#### Diagnosis Procedure

INFOID:000000009716895

##### 1. CHECK SELF-DIAGNOSIS RESULTS

Check if "U1000" is detected other than "U150D" in "Self Diagnostic Result" of "ICC/ADAS".

Is "U1000" detected?

- YES >> Perform the CAN communication system inspection. Repair or replace the malfunctioning parts.  
Refer to [DAS-581, "ADAS CONTROL UNIT : DTC Logic"](#).  
NO >> GO TO 2.

##### 2. CHECK TCM SELF-DIAGNOSIS RESULTS

Check if any DTC is detected in "Self Diagnostic Result" of "TRANSMISSION".

Is any DTC detected?

- YES >> Perform diagnosis on the detected DTC and repair or replace the malfunctioning parts. Refer to [TM-61, "DTC Index"](#).  
NO >> Replace the ADAS control unit. Refer to [DAS-79, "Removal and Installation"](#).

# U150E BCM CAN 3

[BLIND SPOT WARNING & BLIND SPOT INTERVENTION]

< DTC/CIRCUIT DIAGNOSIS >

## U150E BCM CAN 3

### DTC Logic

INFOID:000000009716896

### DTC DETECTION LOGIC

DTC (On board display)	Trouble diagnosis name	DTC detecting condition	Possible causes
U150E (160)	BCM CAN CIRC 3	ADAS control unit detects an error signal that is received from BCM via CAN communication	BCM

#### NOTE:

If DTC "U150E" is detected along with DTC "U1000", first diagnose the DTC "U1000". Refer to [DAS-581, "ADAS CONTROL UNIT : DTC Logic"](#).

### DTC CONFIRMATION PROCEDURE

#### 1. PERFORM DTC CONFIRMATION PROCEDURE

1. Start the engine.
2. Turn the Blind Spot Intervention system ON.
3. Perform "All DTC Reading" with CONSULT.
4. Check if the "U150E" is detected as the current malfunction in "Self Diagnostic Result" of "ICC/ADAS".

Is "U150E" detected as the current malfunction?

- YES >> Refer to [DAS-600, "Diagnosis Procedure"](#).  
NO >> Refer to [GI-53, "Intermittent Incident"](#).

### Diagnosis Procedure

INFOID:000000009716897

#### 1. CHECK SELF-DIAGNOSIS RESULTS

Check if "U1000" is detected other than "U150E" in "Self Diagnostic Result" of "ICC/ADAS".

Is "U1000" detected?

- YES >> Perform the CAN communication system inspection. Repair or replace the malfunctioning parts.  
Refer to [DAS-581, "ADAS CONTROL UNIT : DTC Logic"](#).  
NO >> GO TO 2.

#### 2. CHECK BCM SELF-DIAGNOSIS RESULTS

Check if any DTC is detected in "Self Diagnostic Result" of "BCM".

Is any DTC detected?

- YES >> Perform diagnosis on the detected DTC and repair or replace the malfunctioning parts. Refer to [BCS-51, "DTC Index"](#).  
NO >> Replace the ADAS control unit. Refer to [DAS-79, "Removal and Installation"](#).

# U1500 CAM CAN 2

## [BLIND SPOT WARNING & BLIND SPOT INTERVENTION]

< DTC/CIRCUIT DIAGNOSIS >

### U1500 CAM CAN 2

#### DTC Logic

INFOID:000000009716898

#### DTC DETECTION LOGIC

DTC (On board display)	Trouble diagnosis name	DTC detecting condition	Possible causes
U1500 (145)	CAM CAN CIRC 2	ADAS control unit detects an error signal that is received from lane camera unit via ITS communication	Lane camera unit

#### NOTE:

If DTC "U1500" is detected along with DTC "U1000", first diagnose the DTC "U1000". Refer to [DAS-581, "ADAS CONTROL UNIT : DTC Logic"](#).

#### DTC CONFIRMATION PROCEDURE

##### 1. PERFORM DTC CONFIRMATION PROCEDURE

1. Start the engine.
2. Turn the Blind Spot Intervention system ON.
3. Perform "All DTC Reading" with CONSULT.
4. Check if the "U1500" is detected as the current malfunction in "Self Diagnostic Result" of "ICC/ADAS".

Is "U1500" detected as the current malfunction?

- YES >> Refer to [DAS-601, "Diagnosis Procedure"](#).  
NO >> Refer to [GI-53, "Intermittent Incident"](#).

#### Diagnosis Procedure

INFOID:000000009716899

##### 1. CHECK SELF-DIAGNOSIS RESULTS

Check if "U1000" is detected other than "U1500" in "Self Diagnostic Result" of "ICC/ADAS".

Is "U1000" detected?

- YES >> Perform the CAN communication system inspection. Repair or replace the malfunctioning parts. Refer to [DAS-581, "ADAS CONTROL UNIT : DTC Logic"](#).  
NO >> GO TO 2.

##### 2. CHECK LANE CAMERA UNIT SELF-DIAGNOSIS RESULTS

Check if any DTC is detected in "Self Diagnostic Result" of "LANE CAMERA".

Is any DTC detected?

- YES >> Perform diagnosis on the detected DTC and repair or replace the malfunctioning parts. Refer to [DAS-520, "DTC Index"](#).  
NO >> Replace the ADAS control unit. Refer to [DAS-79, "Removal and Installation"](#).

DAS

# U1501 CAM CAN 1

[BLIND SPOT WARNING & BLIND SPOT INTERVENTION]

< DTC/CIRCUIT DIAGNOSIS >

## U1501 CAM CAN 1

### DTC Logic

INFOID:000000009716900

### DTC DETECTION LOGIC

DTC (On board display)	Trouble diagnosis name	DTC detecting condition	Possible causes
U1501 (145)	CAM CAN CIRC 1	ADAS control unit detects an error signal that is received from lane camera unit via ITS communication	Lane camera unit

#### NOTE:

If DTC "U1501" is detected along with DTC "U1000", first diagnose the DTC "U1000". Refer to [DAS-581, "ADAS CONTROL UNIT : DTC Logic"](#).

### DTC CONFIRMATION PROCEDURE

#### 1. PERFORM DTC CONFIRMATION PROCEDURE

1. Start the engine.
2. Turn the Blind Spot Intervention system ON.
3. Perform "All DTC Reading" with CONSULT.
4. Check if the "U1501" is detected as the current malfunction in "Self Diagnostic Result" of "ICC/ADAS".

Is "U1501" detected as the current malfunction?

- YES >> Refer to [DAS-602, "Diagnosis Procedure"](#).  
NO >> Refer to [GI-53, "Intermittent Incident"](#).

### Diagnosis Procedure

INFOID:000000009716901

#### 1. CHECK SELF-DIAGNOSIS RESULTS

Check if "U1000" is detected other than "U1501" in "Self Diagnostic Result" of "ICC/ADAS".

Is "U1000" detected?

- YES >> Perform the CAN communication system inspection. Repair or replace the malfunctioning parts.  
Refer to [DAS-581, "ADAS CONTROL UNIT : DTC Logic"](#).  
NO >> GO TO 2.

#### 2. CHECK LANE CAMERA UNIT SELF-DIAGNOSIS RESULTS

Check if any DTC is detected in "Self Diagnostic Result" of "LANE CAMERA".

Is any DTC detected?

- YES >> Perform diagnosis on the detected DTC and repair or replace the malfunctioning parts. Refer to [DAS-520, "DTC Index"](#).  
NO >> Replace the ADAS control unit. Refer to [DAS-79, "Removal and Installation"](#).

# U1503 SIDE RDR L CAN 2

< DTC/CIRCUIT DIAGNOSIS >

[BLIND SPOT WARNING & BLIND SPOT INTERVENTION]

## U1503 SIDE RDR L CAN 2

### DTC Logic

INFOID:000000009716902

### DTC DETECTION LOGIC

DTC (On board display)	Trouble diagnosis name	DTC detecting condition	Possible causes
U1503 (150)	SIDE RDR L CAN CIR 2	ADAS control unit detects an error signal that is received from side radar LH via ITS communication	Side radar LH

#### NOTE:

If DTC "U1503" is detected along with DTC "U1000", or "U1508", first diagnose the DTC "U1000" or "U1508".

- Refer to [DAS-581, "ADAS CONTROL UNIT : DTC Logic"](#) for DTC "U1000".
- Refer to [DAS-608, "DTC Logic"](#) for DTC "U1508".

### DTC CONFIRMATION PROCEDURE

#### 1. PERFORM DTC CONFIRMATION PROCEDURE

1. Start the engine.
2. Turn the Blind Spot Intervention system ON.
3. Perform "All DTC Reading" with CONSULT.
4. Check if the "U1503" is detected as the current malfunction in "Self Diagnostic Result" of "ICC/ADAS".

Is "U1503" detected as the current malfunction?

- YES >> Refer to [DAS-603, "Diagnosis Procedure"](#).
- NO >> Refer to [GI-53, "Intermittent Incident"](#).

### Diagnosis Procedure

INFOID:000000009716903

#### 1. CHECK SELF-DIAGNOSIS RESULTS

Check if "U1000" or "U1508" is detected other than "U1503" in "Self Diagnostic Result" of "ICC/ADAS".

Is "U1000" or "U1508" detected?

- YES-1 >> U1000 detected: Perform the CAN communication system inspection. Repair or replace the malfunctioning parts. Refer to [DAS-581, "ADAS CONTROL UNIT : DTC Logic"](#).
- YES-2 >> U1508 detected: Refer to [DAS-608, "DTC Logic"](#).
- NO >> GO TO 2.

#### 2. CHECK SIDE RADAR LH SELF-DIAGNOSIS RESULTS

Check if any DTC is detected in "Self Diagnostic Result" of "SIDE RADAR LEFT".

Is any DTC detected?

- YES >> Perform diagnosis on the detected DTC and repair or replace the malfunctioning parts. Refer to [DAS-517, "DTC Index"](#).
- NO >> Replace the ADAS control unit. Refer to [DAS-79, "Removal and Installation"](#).

A  
B  
C  
D  
E  
F  
G  
H  
I  
J  
K  
L  
M  
N  
P

# U1504 SIDE RDR L CAN 1

< DTC/CIRCUIT DIAGNOSIS >

[BLIND SPOT WARNING & BLIND SPOT INTERVENTION]

## U1504 SIDE RDR L CAN 1

### DTC Logic

INFOID:000000009716904

### DTC DETECTION LOGIC

DTC (On board display)	Trouble diagnosis name	DTC detecting condition	Possible causes
U1504 (151)	SIDE RDR L CAN CIR 1	ADAS control unit detects an error signal that is received from side radar LH via ITS communication	Side radar LH

#### NOTE:

If DTC "U1504" is detected along with DTC "U1000", or "U1508", first diagnose the DTC "U1000" or "U1508".

- Refer to [DAS-581, "ADAS CONTROL UNIT : DTC Logic"](#) for DTC "U1000".
- Refer to [DAS-608, "DTC Logic"](#) for DTC "U1508".

### DTC CONFIRMATION PROCEDURE

#### 1. PERFORM DTC CONFIRMATION PROCEDURE

1. Start the engine.
2. Turn the Blind Spot Intervention system ON.
3. Perform "All DTC Reading" with CONSULT.
4. Check if the "U1504" is detected as the current malfunction in "Self Diagnostic Result" of "ICC/ADAS".

Is "U1504" detected as the current malfunction?

- YES >> Refer to [DAS-604, "Diagnosis Procedure"](#).  
NO >> Refer to [GI-53, "Intermittent Incident"](#).

### Diagnosis Procedure

INFOID:000000009716905

#### 1. CHECK SELF-DIAGNOSIS RESULTS

Check if "U1000" or "U1508" is detected other than "U1504" in "Self Diagnostic Result" of "ICC/ADAS".

Is "U1000" or "U1508" detected?

- YES-1 >> U1000 detected: Perform the CAN communication system inspection. Repair or replace the malfunctioning parts. Refer to [DAS-581, "ADAS CONTROL UNIT : DTC Logic"](#).  
YES-2 >> U1508 detected: Refer to [DAS-608, "DTC Logic"](#).  
NO >> GO TO 2.

#### 2. CHECK SIDE RADAR LH SELF-DIAGNOSIS RESULTS

Check if any DTC is detected in "Self Diagnostic Result" of "SIDE RADAR LEFT".

Is any DTC detected?

- YES >> Perform diagnosis on the detected DTC and repair or replace the malfunctioning parts. Refer to [DAS-515, "DTC Index"](#).  
NO >> Replace the ADAS control unit. Refer to [DAS-79, "Removal and Installation"](#).



# U1505 SIDE RDR R CAN 2

< DTC/CIRCUIT DIAGNOSIS >

[BLIND SPOT WARNING & BLIND SPOT INTERVENTION]

## U1505 SIDE RDR R CAN 2

### DTC Logic

INFOID:000000009716906

### DTC DETECTION LOGIC

DTC (On board display)	Trouble diagnosis name	DTC detecting condition	Possible causes
U1505 (152)	SIDE RDR R CAN CIR 2	ADAS control unit detects an error signal that is received from side radar RH via ITS communication	Side radar RH

#### NOTE:

If DTC "U1505" is detected along with DTC "U1000", or "U1507", first diagnose the DTC "U1000" or "U1507".

- Refer to [DAS-581, "ADAS CONTROL UNIT : DTC Logic"](#) for DTC "U1000".
- Refer to [DAS-607, "DTC Logic"](#) for DTC "U1507".

### DTC CONFIRMATION PROCEDURE

#### 1. PERFORM DTC CONFIRMATION PROCEDURE

1. Start the engine.
2. Turn the Blind Spot Intervention system ON.
3. Perform "All DTC Reading" with CONSULT.
4. Check if the "U1505" is detected as the current malfunction in "Self Diagnostic Result" of "ICC/ADAS".

Is "U1505" detected as the current malfunction?

- YES >> Refer to [DAS-605, "Diagnosis Procedure"](#).  
NO >> Refer to [GI-53, "Intermittent Incident"](#).

### Diagnosis Procedure

INFOID:000000009716907

#### 1. CHECK SELF-DIAGNOSIS RESULTS

Check if "U1000" or "U1507" is detected other than "U1505" in "Self Diagnostic Result" of "ICC/ADAS".

Is "U1000" or "U1507" detected?

- YES-1 >> U1000 detected: Perform the CAN communication system inspection. Repair or replace the malfunctioning parts. Refer to [DAS-581, "ADAS CONTROL UNIT : DTC Logic"](#).  
YES-2 >> U1507 detected: Refer to [DAS-608, "DTC Logic"](#).  
NO >> GO TO 2.

#### 2. CHECK SIDE RADAR RH SELF-DIAGNOSIS RESULTS

Check if any DTC is detected in "Self Diagnostic Result" of "SIDE RADAR RIGHT".

Is any DTC detected?

- YES >> Perform diagnosis on the detected DTC and repair or replace the malfunctioning parts. Refer to [DAS-517, "DTC Index"](#).  
NO >> Replace the ADAS control unit. Refer to [DAS-79, "Removal and Installation"](#).

# U1506 SIDE RDR R CAN 1

< DTC/CIRCUIT DIAGNOSIS >

[BLIND SPOT WARNING & BLIND SPOT INTERVENTION]

## U1506 SIDE RDR R CAN 1

### DTC Logic

INFOID:000000009716908

### DTC DETECTION LOGIC

DTC (On board display)	Trouble diagnosis name	DTC detecting condition	Possible causes
U1506 (153)	SIDE RDR R CAN CIR 1	ADAS control unit detects an error signal that is received from side radar RH via ITS communication	Side radar RH

#### NOTE:

If DTC "U1506" is detected along with DTC "U1000", or "U1507", first diagnose the DTC "U1000" or "U1507".

- Refer to [DAS-581, "ADAS CONTROL UNIT : DTC Logic"](#) for DTC "U1000".
- Refer to [DAS-608, "DTC Logic"](#) for DTC "U1507".

### DTC CONFIRMATION PROCEDURE

#### 1. PERFORM DTC CONFIRMATION PROCEDURE

1. Start the engine.
2. Turn the Blind Spot Intervention system ON.
3. Perform "All DTC Reading" with CONSULT.
4. Check if the "U1506" is detected as the current malfunction in "Self Diagnostic Result" of "ICC/ADAS".

Is "U1506" detected as the current malfunction?

- YES >> Refer to [DAS-604, "Diagnosis Procedure"](#).  
NO >> Refer to [GI-53, "Intermittent Incident"](#).

### Diagnosis Procedure

INFOID:000000009716909

#### 1. CHECK SELF-DIAGNOSIS RESULTS

Check if "U1000" or "U1507" is detected other than "U1506" in "Self Diagnostic Result" of "ICC/ADAS".

Is "U1000" or "U1507" detected?

- YES-1 >> U1000 detected: Perform the CAN communication system inspection. Repair or replace the malfunctioning parts. Refer to [DAS-581, "ADAS CONTROL UNIT : DTC Logic"](#).  
YES-2 >> U1507 detected: Refer to [DAS-608, "DTC Logic"](#).  
NO >> GO TO 2.

#### 2. CHECK SIDE RADAR RH SELF-DIAGNOSIS RESULTS

Check if any DTC is detected in "Self Diagnostic Result" of "SIDE RADAR RIGHT".

Is any DTC detected?

- YES >> Perform diagnosis on the detected DTC and repair or replace the malfunctioning parts. Refer to [DAS-517, "DTC Index"](#).  
NO >> Replace the ADAS control unit. Refer to [DAS-79, "Removal and Installation"](#).

# U1507 LOST COMM(SIDE RDR R)

< DTC/CIRCUIT DIAGNOSIS >

[BLIND SPOT WARNING & BLIND SPOT INTERVENTION]

## U1507 LOST COMM(SIDE RDR R)

### DTC Logic

INFOID:000000009716910

### DTC DETECTION LOGIC

DTC (On board display)	Trouble diagnosis name	DTC detecting condition	Possible causes
U1507 (154)	LOST COMM(SIDE RDR R)	ADAS control unit cannot receive ITS communication signal from side radar RH for 2 seconds or more	<ul style="list-style-type: none"><li>• Side radar RH right/left switching signal circuit</li><li>• ITS communication system</li><li>• Side radar RH</li></ul>

#### NOTE:

DTC "U1507" is detected along with DTC "U1000", first diagnose the DTC "U1507".

### DTC CONFIRMATION PROCEDURE

#### 1. PERFORM DTC CONFIRMATION PROCEDURE

1. Start the engine.
2. Turn the Blind Spot Intervention system ON.
3. Perform "All DTC Reading" with CONSULT.
4. Check if the "U1507" is detected as the current malfunction in "Self Diagnostic Result" of "ICC/ADAS".

#### Is "U1507" detected as the current malfunction?

- YES >> Refer to [DAS-607, "Diagnosis Procedure"](#).  
NO >> Refer to [GI-53, "Intermittent Incident"](#).

### Diagnosis Procedure

INFOID:000000009716911

#### 1. CHECK RIGHT/LEFT SWITCHING SIGNAL CIRCUIT

Check right/left switching signal circuit. Refer to [DAS-618, "Diagnosis Procedure"](#).

#### Is the inspection result normal?

- YES >> Perform the CAN communication system inspection. Repair or replace the malfunctioning parts.  
Refer to [LAN-43, "CAN COMMUNICATION SYSTEM : CAN Communication Signal Chart"](#).  
NO >> Repair right/left switching signal circuit.

A  
B  
C  
D  
E  
F  
G  
H  
I  
J  
K  
L  
M  
N  
P

DAS

# U1508 LOST COMM(SIDE RDR L)

< DTC/CIRCUIT DIAGNOSIS >

[BLIND SPOT WARNING & BLIND SPOT INTERVENTION]

## U1508 LOST COMM(SIDE RDR L)

### DTC Logic

INFOID:000000009716912

### DTC DETECTION LOGIC

DTC (On board display)	Trouble diagnosis name	DTC detecting condition	Possible causes
U1508 (155)	LOST COMM(SIDE RDR L)	ADAS control unit cannot receive ITS communication signal from side radar LH for 2 seconds or more	<ul style="list-style-type: none"><li>• Side radar LH harness connector</li><li>• ITS communication system</li><li>• Side radar LH</li></ul>

#### NOTE:

DTC "U1508" is detected along with DTC "U1000", first diagnose the DTC "U1508".

### DTC CONFIRMATION PROCEDURE

#### 1. PERFORM DTC CONFIRMATION PROCEDURE

1. Start the engine.
2. Turn the Blind Spot Intervention system ON.
3. Perform "All DTC Reading" with CONSULT.
4. Check if the "U1508" is detected as the current malfunction in "Self Diagnostic Result" of "ICC/ADAS".

#### Is "U1508" detected as the current malfunction?

YES >> Refer to [DAS-608, "Diagnosis Procedure"](#).

NO >> Refer to [GI-53, "Intermittent Incident"](#).

### Diagnosis Procedure

INFOID:000000009716913

#### 1. CHECK SIDE RADAR HARNESS CONNECTOR

1. Turn the ignition switch OFF.
2. Check the terminals and connectors of the side radar LH for damage, bend and short (unit side and connector side).

#### Is the inspection result normal?

YES >> Perform the CAN communication system inspection. Repair or replace the malfunctioning parts.  
Refer to [LAN-26, "Trouble Diagnosis Flow Chart"](#).

NO >> Repair the terminal or connector.

# U1512 HVAC CAN 3

## [BLIND SPOT WARNING & BLIND SPOT INTERVENTION]

< DTC/CIRCUIT DIAGNOSIS >

### U1512 HVAC CAN 3

#### DTC Logic

INFOID:000000009716914

#### DTC DETECTION LOGIC

DTC (On board display)	Trouble diagnosis name	DTC detecting condition	Possible causes
U1512 (162)	HVAC CAN CIRC 3	ADAS control unit detects an error signal that is received from A/C auto amp. via CAN communication	A/C auto amp.

#### NOTE:

If DTC "U1512" is detected along with DTC "U1000", first diagnose the DTC "U1000". Refer to [DAS-581, "ADAS CONTROL UNIT : DTC Logic"](#).

#### DTC CONFIRMATION PROCEDURE

##### 1. PERFORM DTC CONFIRMATION PROCEDURE

1. Start the engine.
2. Turn the Blind Spot Intervention system ON.
3. Perform "All DTC Reading" with CONSULT.
4. Check if the "U1512" is detected as the current malfunction in "Self Diagnostic Result" of "ICC/ADAS".

Is "U1512" detected as the current malfunction?

- YES >> Refer to [DAS-609, "Diagnosis Procedure"](#).  
NO >> Refer to [GI-53, "Intermittent Incident"](#).

#### Diagnosis Procedure

INFOID:000000009716915

##### 1. CHECK SELF-DIAGNOSIS RESULTS

Check if "U1000" is detected other than "U1512" in "Self Diagnostic Result" of "ICC/ADAS".

Is "U1000" detected?

- YES >> Perform the CAN communication system inspection. Repair or replace the malfunctioning parts. Refer to [DAS-581, "ADAS CONTROL UNIT : DTC Logic"](#).  
NO >> GO TO 2.

##### 2. CHECK A/C AUTO AMP. SELF-DIAGNOSIS RESULTS

Check if any DTC is detected in "Self Diagnostic Result" of "HVAC".

Is any DTC detected?

- YES >> Perform diagnosis on the detected DTC and repair or replace the malfunctioning parts. Refer to [HAC-49, "DTC Index"](#).  
NO >> Replace the ADAS control unit. Refer to [DAS-79, "Removal and Installation"](#).

A  
B  
C  
D  
E  
F  
G  
H  
I  
J  
K  
L  
M  
N  
P

DAS

# U1513 METER CAN 3

[BLIND SPOT WARNING & BLIND SPOT INTERVENTION]

< DTC/CIRCUIT DIAGNOSIS >

## U1513 METER CAN 3

### DTC Logic

INFOID:000000009716916

### DTC DETECTION LOGIC

DTC (On board display)	Trouble diagnosis name	DTC detecting condition	Possible causes
U1513 (163)	METER CAN CIRC 3	ADAS control unit detects an error signal that is received from combination meter via CAN communication	Combination meter

#### NOTE:

If DTC "U1513" is detected along with DTC "U1000", first diagnose the DTC "U1000". Refer to [DAS-581, "ADAS CONTROL UNIT : DTC Logic"](#).

### DTC CONFIRMATION PROCEDURE

#### 1. PERFORM DTC CONFIRMATION PROCEDURE

1. Start the engine.
2. Turn the Blind Spot Intervention system ON.
3. Perform "All DTC Reading" with CONSULT.
4. Check if the "U1513" is detected as the current malfunction in "Self Diagnostic Result" of "ICC/ADAS".

Is "U1513" detected as the current malfunction?

- YES >> Refer to [DAS-610, "Diagnosis Procedure"](#).  
NO >> Refer to [GI-53, "Intermittent Incident"](#).

### Diagnosis Procedure

INFOID:000000009716917

#### 1. CHECK SELF-DIAGNOSIS RESULTS

Check if "U1000" is detected other than "U1513" in "Self Diagnostic Result" of "ICC/ADAS".

Is "U1000" detected?

- YES >> Perform the CAN communication system inspection. Repair or replace the malfunctioning parts.  
Refer to [DAS-581, "ADAS CONTROL UNIT : DTC Logic"](#).  
NO >> GO TO 2.

#### 2. CHECK COMBINATION METER SELF-DIAGNOSIS RESULTS

Check if any DTC is detected in "Self Diagnostic Result" of "METER/M&A".

Is any DTC detected?

- YES >> Perform diagnosis on the detected DTC and repair or replace the malfunctioning parts. Refer to [MWI-26, "DTC Index"](#).  
NO >> Replace the ADAS control unit. Refer to [DAS-79, "Removal and Installation"](#).

# U1514 STRG SEN CAN 3

[BLIND SPOT WARNING & BLIND SPOT INTERVENTION]

< DTC/CIRCUIT DIAGNOSIS >

## U1514 STRG SEN CAN 3

### DTC Logic

INFOID:000000009716918

### DTC DETECTION LOGIC

DTC (On board display)	Trouble diagnosis name	DTC detecting condition	Possible causes
U1514 (164)	STRG SEN CAN CIRC 3	ADAS control unit detects an error signal that is received from steering angle sensor via CAN communication	Steering angle sensor

#### NOTE:

If DTC "U1514" is detected along with DTC "U1000", first diagnose the DTC "U1000". Refer to [DAS-581, "ADAS CONTROL UNIT : DTC Logic"](#).

### DTC CONFIRMATION PROCEDURE

#### 1. PERFORM DTC CONFIRMATION PROCEDURE

1. Start the engine.
2. Turn the Blind Spot Intervention system ON.
3. Perform "All DTC Reading" with CONSULT.
4. Check if the "U1514" is detected as the current malfunction in "Self Diagnostic Result" of "ICC/ADAS".

Is "U1514" detected as the current malfunction?

- YES >> Refer to [DAS-611, "Diagnosis Procedure"](#).  
NO >> Refer to [GI-53, "Intermittent Incident"](#).

### Diagnosis Procedure

INFOID:000000009716919

#### 1. CHECK SELF-DIAGNOSIS RESULTS

Check if "U1000" is detected other than "U1514" in "Self Diagnostic Result" of "ICC/ADAS".

Is "U1000" detected?

- YES >> Perform the CAN communication system inspection. Repair or replace the malfunctioning parts. Refer to [DAS-581, "ADAS CONTROL UNIT : DTC Logic"](#).  
NO >> GO TO 2.

#### 2. CHECK ABS ACTUATOR AND ELECTRIC UNIT (CONTROL UNIT) SELF-DIAGNOSIS RESULTS

Check if any DTC is detected in "Self Diagnostic Result" of "ABS".

Is any DTC detected?

- YES >> Perform diagnosis on the detected DTC and repair or replace the malfunctioning parts. Refer to [BRC-46, "DTC Index"](#).  
NO >> Replace the ADAS control unit. Refer to [DAS-79, "Removal and Installation"](#).

# U1516 CAM CAN 3

[BLIND SPOT WARNING & BLIND SPOT INTERVENTION]

< DTC/CIRCUIT DIAGNOSIS >

## U1516 CAM CAN 3

### DTC Logic

INFOID:000000009716920

### DTC DETECTION LOGIC

DTC (On board display)	Trouble diagnosis name	DTC detecting condition	Possible causes
U1516 (166)	CAM CAN CIRC 3	ADAS control unit detects an error signal that is received from lane camera unit via ITS communication	Lane camera unit

#### NOTE:

If DTC "U1516" is detected along with DTC "U1000", first diagnose the DTC "U1000". Refer to [DAS-581, "ADAS CONTROL UNIT : DTC Logic"](#).

### DTC CONFIRMATION PROCEDURE

#### 1. PERFORM DTC CONFIRMATION PROCEDURE

1. Start the engine.
2. Turn the Blind Spot Intervention system ON.
3. Perform "All DTC Reading" with CONSULT.
4. Check if the "U1516" is detected as the current malfunction in "Self Diagnostic Result" of "ICC/ADAS".

Is "U1516" detected as the current malfunction?

- YES >> Refer to [DAS-612, "Diagnosis Procedure"](#).  
NO >> Refer to [GI-53, "Intermittent Incident"](#).

### Diagnosis Procedure

INFOID:000000009716921

#### 1. CHECK SELF-DIAGNOSIS RESULTS

Check if "U1000" is detected other than "U1516" in "Self Diagnostic Result" of "ICC/ADAS".

Is "U1000" detected?

- YES >> Perform the CAN communication system inspection. Repair or replace the malfunctioning parts.  
Refer to [DAS-581, "ADAS CONTROL UNIT : DTC Logic"](#).  
NO >> GO TO 2.

#### 2. CHECK LANE CAMERA UNIT SELF-DIAGNOSIS RESULTS

Check if any DTC is detected in "Self Diagnostic Result" of "LANE CAMERA".

Is any DTC detected?

- YES >> Perform diagnosis on the detected DTC and repair or replace the malfunctioning parts. Refer to [DAS-520, "DTC Index"](#).  
NO >> Replace the ADAS control unit. Refer to [DAS-79, "Removal and Installation"](#).



# U1518 SIDE RDR L CAN 3

< DTC/CIRCUIT DIAGNOSIS >

[BLIND SPOT WARNING & BLIND SPOT INTERVENTION]

## U1518 SIDE RDR L CAN 3

### DTC Logic

INFOID:000000009716922

### DTC DETECTION LOGIC

DTC (On board display)	Trouble diagnosis name	DTC detecting condition	Possible causes
U1518 (168)	SIDE RDR L CAN CIRC 3	ADAS control unit detects an error signal that is received from side radar LH via ITS communication	Side radar LH

#### NOTE:

If DTC "U1518" is detected along with DTC "U1000", or "U1508", first diagnose the DTC "U1000" or "U1508".

- Refer to [DAS-581, "ADAS CONTROL UNIT : DTC Logic"](#) for DTC "U1000".
- Refer to [DAS-608, "DTC Logic"](#) for DTC "U1508".

### DTC CONFIRMATION PROCEDURE

#### 1. PERFORM DTC CONFIRMATION PROCEDURE

1. Start the engine.
2. Turn the Blind Spot Intervention system ON.
3. Perform "All DTC Reading" with CONSULT.
4. Check if the "U1518" is detected as the current malfunction in "Self Diagnostic Result" of "ICC/ADAS".

Is "U1518" detected as the current malfunction?

- YES >> Refer to [DAS-613, "Diagnosis Procedure"](#).  
NO >> Refer to [GI-53, "Intermittent Incident"](#).

### Diagnosis Procedure

INFOID:000000009716923

#### 1. CHECK SELF-DIAGNOSIS RESULTS

Check if "U1000" or "U1508" is detected other than "U1518" in "Self Diagnostic Result" of "ICC/ADAS".

Is "U1000" or "U1508" detected?

- YES-1 >> U1000 detected: Perform the CAN communication system inspection. Repair or replace the malfunctioning parts. Refer to [DAS-581, "ADAS CONTROL UNIT : DTC Logic"](#).  
YES-2 >> U1508 detected: Refer to [DAS-613, "DTC Logic"](#).  
NO >> GO TO 2.

#### 2. CHECK SIDE RADAR LH SELF-DIAGNOSIS RESULTS

Check if any DTC is detected in "Self Diagnostic Result" of "SIDE RADAR LEFT".

Is any DTC detected?

- YES >> Perform diagnosis on the detected DTC and repair or replace the malfunctioning parts. Refer to [DAS-515, "DTC Index"](#).  
NO >> Replace the ADAS control unit. Refer to [DAS-79, "Removal and Installation"](#).

# U1519 SIDE RDR R CAN 3

< DTC/CIRCUIT DIAGNOSIS >

[BLIND SPOT WARNING & BLIND SPOT INTERVENTION]

## U1519 SIDE RDR R CAN 3

### DTC Logic

INFOID:000000009716924

#### DTC DETECTION LOGIC

DTC (On board display)	Trouble diagnosis name	DTC detecting condition	Possible causes
U1519 (169)	SIDE RDR R CAN CIRC 3	ADAS control unit detects an error signal that is received from side radar RH via ITS communication	Side radar RH

#### NOTE:

If DTC "U1519" is detected along with DTC "U1000", or "U1507", first diagnose the DTC "U1000" or "U1507".

- Refer to [DAS-581, "ADAS CONTROL UNIT : DTC Logic"](#) for DTC "U1000".
- Refer to [DAS-607, "DTC Logic"](#) for DTC "U1507".

#### DTC CONFIRMATION PROCEDURE

##### 1. PERFORM DTC CONFIRMATION PROCEDURE

1. Start the engine.
2. Turn the Blind Spot Intervention system ON.
3. Perform "All DTC Reading" with CONSULT.
4. Check if the "U1519" is detected as the current malfunction in "Self Diagnostic Result" of "ICC/ADAS".

Is "U1519" detected as the current malfunction?

- YES >> Refer to [DAS-614, "Diagnosis Procedure"](#).  
NO >> Refer to [GI-53, "Intermittent Incident"](#).

#### Diagnosis Procedure

INFOID:000000009716925

##### 1. CHECK SELF-DIAGNOSIS RESULTS

Check if "U1000" or "U1507" is detected other than "U1519" in "Self Diagnostic Result" of "ICC/ADAS".

Is "U1000" or "U1507" detected?

- YES-1 >> U1000 detected: Perform the CAN communication system inspection. Repair or replace the malfunctioning parts. Refer to [DAS-581, "ADAS CONTROL UNIT : DTC Logic"](#).  
YES-2 >> U1507 detected: Refer to [DAS-607, "DTC Logic"](#).  
NO >> GO TO 2.

##### 2. CHECK SIDE RADAR RH SELF-DIAGNOSIS RESULTS

Check if any DTC is detected in "Self Diagnostic Result" of "SIDE RADAR RIGHT".

Is any DTC detected?

- YES >> Perform diagnosis on the detected DTC and repair or replace the malfunctioning parts. Refer to [DAS-517, "DTC Index"](#).  
NO >> Replace the ADAS control unit. Refer to [DAS-79, "Removal and Installation"](#).

# POWER SUPPLY AND GROUND CIRCUIT

< DTC/CIRCUIT DIAGNOSIS >

[BLIND SPOT WARNING & BLIND SPOT INTERVENTION]

## POWER SUPPLY AND GROUND CIRCUIT

### ADAS CONTROL UNIT

#### ADAS CONTROL UNIT : Diagnosis Procedure

INFOID:000000009716926

Regarding Wiring Diagram information, refer to [DAS-521, "Wiring Diagram"](#).

#### 1. CHECK ADAS CONTROL UNIT POWER SUPPLY CIRCUIT

Check voltage between ADAS control unit harness connector and ground.

Terminal		Condition	Voltage (Approx.)
(+)	(-)		
ADAS control unit		Ignition switch	0 V
Connector	Terminal		
B104	16	OFF	0 V
		ON	Battery voltage

Is the inspection result normal?

YES >> GO TO 2.

NO >> Repair the ADAS control unit power supply circuit.

#### 2. CHECK ADAS CONTROL UNIT GROUND CIRCUIT

1. Turn the ignition switch OFF.
2. Disconnect the ADAS control unit connector.
3. Check for continuity between ADAS control unit harness connector and ground.

ADAS control unit		Ground	Continuity
Connector	Terminal		
B104	6		Yes

Is the inspection result normal?

YES >> INSPECTION END

NO >> Repair the ADAS control unit ground circuit.

### SIDE RADAR LH

#### SIDE RADAR LH : Diagnosis Procedure

INFOID:000000009716927

Regarding Wiring Diagram information, refer to [DAS-521, "Wiring Diagram"](#).

#### 1. CHECK POWER SUPPLY CIRCUIT

1. Turn ignition switch OFF.
2. Disconnect the side radar LH connector.
3. Check voltage between side radar LH harness connector and ground.

DAS

# POWER SUPPLY AND GROUND CIRCUIT

< DTC/CIRCUIT DIAGNOSIS >

[BLIND SPOT WARNING & BLIND SPOT INTERVENTION]

Terminals		Condition	Voltage (Approx.)
(+)	(-)		
Side radar LH		Ignition switch	0 V
Connector	Terminal		
B416	5	Ground	OFF
		ON	Battery voltage

Is the inspection result normal?

YES >> GO TO 2.

NO >> Repair the side radar LH power supply circuit.

## 2.CHECK GROUND CIRCUIT

Check continuity between side radar LH harness connectors and ground.

Side radar LH		Ground	Continuity
Connector	Terminal		
B416	2		Yes

Is the inspection result normal?

YES >> Inspection End.

NO >> Repair the side radar LH ground circuit.

## SIDE RADAR RH

### SIDE RADAR RH : Diagnosis Procedure

INFOID:000000009716928

Regarding Wiring Diagram information, refer to [DAS-521. "Wiring Diagram"](#).

## 1.CHECK POWER SUPPLY CIRCUIT

1. Turn ignition switch OFF.
2. Disconnect the side radar RH connector.
3. Check voltage between side radar RH harness connector and ground.

Terminals		Condition	Voltage (Approx.)
(+)	(-)		
Side radar RH		Ignition switch	0 V
Connector	Terminal		
B109	5	Ground	OFF
		ON	Battery voltage

Is the inspection result normal?

YES >> GO TO 2.

NO >> Repair the side radar RH power supply circuit.

## 2.CHECK GROUND CIRCUIT

Check continuity between side radar RH harness connectors and ground.

Side radar RH		Ground	Continuity
Connector	Terminal		
B109	2		Yes

Is the inspection result normal?

YES >> Inspection End.

# POWER SUPPLY AND GROUND CIRCUIT

< DTC/CIRCUIT DIAGNOSIS >

[BLIND SPOT WARNING & BLIND SPOT INTERVENTION]

NO >> Repair the side radar RH ground circuit.

## LANE CAMERA UNIT

### LANE CAMERA UNIT : Diagnosis Procedure

INFOID:000000009716929

Regarding Wiring Diagram information, refer to [DAS-367. "Wiring Diagram"](#).

## 1. CHECK LANE CAMERA UNIT POWER SUPPLY CIRCUIT

Check voltage between lane camera unit harness connector and ground.

Terminal		Condition	Voltage (Approx.)
(+)	(-)		
Lane camera unit		Ignition switch	0 V
Connector	Terminal		
R5	7	OFF	0 V
		ON	Battery volt- age

Is the inspection result normal?

YES >> GO TO 2.

NO >> Repair the lane camera unit power supply circuit.

## 2. CHECK LANE CAMERA UNIT GROUND CIRCUIT

1. Turn the ignition switch OFF.
2. Disconnect the lane camera unit connector.
3. Check for continuity between lane camera unit harness connector and ground.

Lane camera unit		Ground	Continuity
Connector	Terminal		
R5	1		Yes
	5		

Is the inspection result normal?

YES >> Inspection End.

NO >> Repair the lane camera unit ground circuit.

A  
B  
C  
D  
E  
F  
G  
H  
I  
J  
K  
L  
M  
N  
P

DAS

# RIGHT/LEFT SWITCHING SIGNAL CIRCUIT

< DTC/CIRCUIT DIAGNOSIS >

[BLIND SPOT WARNING & BLIND SPOT INTERVENTION]

## RIGHT/LEFT SWITCHING SIGNAL CIRCUIT

### Diagnosis Procedure

INFOID:000000009716930

Regarding Wiring Diagram information, refer to [DAS-521. "Wiring Diagram"](#).

#### 1. CHECK CONNECTOR

1. Turn the ignition switch OFF.
2. Check the terminals and connectors of the side radar RH for damage, bend and short (unit side and connector side).

Is the inspection result normal?

YES >> GO TO 2.

NO >> Repair the terminal or connector.

#### 2. CHECK CONTINUITY RIGHT/LEFT SWITCHING SIGNAL CIRCUIT

1. Disconnect side radar RH connector.
2. Check continuity between side radar RH harness connectors and ground.

Side radar RH		Ground	Continuity
Connector	Terminal		
B109	1		Yes

Is the inspection result normal?

YES >> Inspection End.

NO >> Repair harness or connector.

# WARNING SYSTEMS SWITCH CIRCUIT

< DTC/CIRCUIT DIAGNOSIS >

[BLIND SPOT WARNING & BLIND SPOT INTERVENTION]

## WARNING SYSTEMS SWITCH CIRCUIT

### Component Function Check

INFOID:000000009716931

#### 1.CHECK WARNING SYSTEMS SWITCH INPUT SIGNAL

1. Turn the ignition switch ON.
2. Select the DATA MONITOR item "WARN SYS SW" of "ICC/ADAS" with CONSULT.
3. With operating the warning systems switch, check the monitor status.

Monitor item	Condition	Monitor status
WARN SYS SW	Warning systems switch is pressed	On
	Warning systems switch is not pressed	OFF

Is the inspection result normal?

- YES >> Warning systems switch circuit is normal.  
NO >> Refer to [DAS-619. "Diagnosis Procedure"](#).

### Diagnosis Procedure

INFOID:000000009716932

Regarding Wiring Diagram information, refer to [DAS-521. "Wiring Diagram"](#).

#### 1.CHECK WARNING SYSTEMS SWITCH SIGNAL INPUT

1. Turn the ignition switch ON.
2. Check voltage between ADAS control unit harness connector and ground.

Terminals		Condition	Voltage (Approx.)
(+)	(-)		
ADAS control unit		Warning systems switch	
Connector	Terminal		
B104	1	Pressed	
		Released	12 V

Is the inspection result normal?

- YES >> Replace the ADAS control unit. Refer to [DAS-79. "Removal and Installation"](#).  
NO >> GO TO 2.

#### 2.CHECK WARNING SYSTEMS SWITCH

1. Turn ignition switch OFF.
2. Remove warning systems switch.
3. Check warning systems switch. Refer to [DAS-620. "Component Inspection"](#).

Is the inspection result normal?

- YES >> GO TO 3.  
NO >> Replace the warning systems switch. Refer to [DAS-460. "Removal and Installation"](#).

#### 3.CHECK WARNING SYSTEMS SWITCH GROUND CIRCUIT

Check continuity between warning systems switch harness connector terminal and the ground.

Warning systems switch		Ground	Continuity
Connector	Terminal		
M126	8		Yes

Is the inspection result normal?

- YES >> GO TO 4.

# WARNING SYSTEMS SWITCH CIRCUIT

< DTC/CIRCUIT DIAGNOSIS >

[BLIND SPOT WARNING & BLIND SPOT INTERVENTION]

NO >> Repair harness or connector.

## 4. CHECK WARNING SYSTEMS SWITCH SIGNAL INPUT CIRCUIT FOR OPEN

1. Disconnect the ADAS control unit connector.
2. Check continuity between the ADAS control unit harness connector and warning systems switch harness connector.

ADAS control unit		Warning systems switch		Continuity
Connector	Terminal	Connector	Terminal	
B104	1	M126	6	Yes

Is the inspection result normal?

YES >> GO TO 5.

NO >> Repair the harnesses or connectors.

## 5. CHECK WARNING SYSTEMS SWITCH SIGNAL INPUT CIRCUIT FOR SHORT

Check continuity between the ADAS control unit harness connector and ground.

ADAS control unit		Ground	Continuity
Connector	Terminal		
B104	1		No

Is the inspection result normal?

YES >> Replace the ADAS control unit. Refer to [DAS-79, "Removal and Installation"](#).

NO >> Repair the harnesses or connectors.

## Component Inspection

INFOID:000000009716933

## 1. CHECK WARNING SYSTEMS SWITCH

Check continuity of warning systems switch.

Terminal		Condition	Continuity
6	8	When warning systems switch is pressed	Yes
		When warning systems switch is released	No

Is the inspection result normal?

YES >> Inspection End.

NO >> Replace warning systems switch.



# WARNING SYSTEMS ON INDICATOR CIRCUIT

< DTC/CIRCUIT DIAGNOSIS >

[BLIND SPOT WARNING & BLIND SPOT INTERVENTION]

## WARNING SYSTEMS ON INDICATOR CIRCUIT

### Component Function Check

INFOID:000000009716934

#### 1. CHECK WARNING SYSTEMS ON INDICATOR

1. Turn the ignition switch ON.
2. Select the active test item "WARNING SYSTEM IND" of "ICC/ADAS" with CONSULT.
3. With operating the test item, check the operation.

**On** : Warning systems ON indicator illuminates

**Off** : Warning systems ON indicator is turned OFF

Is the inspection result normal?

YES >> Inspection End.

NO >> Refer to [DAS-621, "Diagnosis Procedure"](#).

### Diagnosis Procedure

INFOID:000000009716935

Regarding Wiring Diagram information, refer to [DAS-521, "Wiring Diagram"](#).

#### 1. CHECK WARNING ON INDICATOR POWER SUPPLY CIRCUIT

1. Turn ignition switch OFF.
2. Disconnect warning systems switch connector.
3. Turn ignition switch ON.
4. Check voltage between warning systems switch harness connector and ground.

Terminals		Voltage (Approx.)
(+)	(-)	
Warning systems switch		Ground Battery voltage
Connector	Terminal	
M126	5	

Is the inspection result normal?

YES >> GO TO 2.

NO >> Repair the warning systems ON indicator power supply circuit.

#### 2. CHECK WARNING SYSTEMS ON INDICATOR SIGNAL FOR OPEN

1. Turn ignition switch OFF.
2. Disconnect the ADAS control unit harness connector.
3. Check continuity between the ADAS control unit harness connector and warning systems switch harness connector.

ADAS control unit		Warning systems switch		Continuity
Connector	Terminal	Connector	Terminal	
B104	4	M126	3	Yes

Is the inspection result normal?

YES >> GO TO 3.

NO >> Repair the harnesses or connectors.

#### 3. CHECK WARNING SYSTEMS ON INDICATOR SIGNAL CIRCUIT FOR SHORT

Check continuity between the ADAS control unit harness connector and ground.

A  
B  
C  
D  
E  
F  
G  
H  
I  
J  
K  
L  
M  
N  
P

# WARNING SYSTEMS ON INDICATOR CIRCUIT

< DTC/CIRCUIT DIAGNOSIS >

[BLIND SPOT WARNING & BLIND SPOT INTERVENTION]

ADAS control unit		Ground	Continuity
Connector	Terminal		
B104	4		No

Is the inspection result normal?

YES >> GO TO 4.

NO >> Repair the harnesses or connectors.

## 4.CHECK WARNING SYSTEMS ON INDICATOR

Check the warning systems ON indicator. Refer to [DAS-622, "Component Inspection"](#).

Is the inspection result normal?

YES >> Replace the ADAS control unit. Refer to [DAS-79, "Removal and Installation"](#).

NO >> Replace warning systems switch. [DAS-460, "Removal and Installation"](#).

## Component Inspection

INFOID:000000009716936

## 1.CHECK WARNING SYSTEMS ON INDICATOR

Apply battery voltage to warning systems switch terminals 5 and 3, and then check if the warning systems ON indicator illuminates.

Terminals		Condition	Warning systems ON indicator
(+)	(-)		
5	3	When the battery voltage is applied	On
		When the battery voltage is not applied	Off

Is the inspection result normal?

YES >> Inspection End.

NO >> Replace the warning systems switch. Refer to [DAS-460, "Removal and Installation"](#).

# WARNING BUZZER CIRCUIT

< DTC/CIRCUIT DIAGNOSIS >

[BLIND SPOT WARNING & BLIND SPOT INTERVENTION]

## WARNING BUZZER CIRCUIT

### Component Function Check

INFOID:000000009716937

#### 1. CHECK WARNING BUZZER

1. Turn the ignition switch ON.
2. Select the active test item "LDP BUZZER" of "ICC/ADAS" with CONSULT.
3. With operating the test item, check the operation.

**On** : Warning buzzer is activated.

**Off** : Warning buzzer is not activated.

Is the inspection result normal?

YES >> Inspection End.

NO >> Refer to [DAS-623, "Diagnosis Procedure"](#).

### Diagnosis Procedure

INFOID:000000009716938

Regarding Wiring Diagram information, refer to [DAS-521, "Wiring Diagram"](#).

#### 1. CHECK WARNING BUZZER POWER SUPPLY CIRCUIT

1. Turn ignition switch OFF.
2. Disconnect the warning buzzer connector.
3. Turn ignition switch ON.
4. Check voltage between the warning buzzer harness connector and ground.

Terminals		Voltage (Approx.)
(+)	(-)	
Warning buzzer		Ground Battery voltage
Connector	Terminal	
M60	1	

Is the inspection result normal?

YES >> GO TO 2.

NO >> Repair the warning buzzer power supply circuit.

#### 2. CHECK WARNING BUZZER GROUND CIRCUIT

1. Turn ignition switch OFF.
2. Check continuity between the warning buzzer harness connector and ground.

Warning buzzer		Ground	Continuity
Connector	Terminal		
M60	3		Yes

Is the inspection result normal?

YES >> GO TO 3.

NO >> Repair the harnesses or connectors.

#### 3. CHECK WARNING BUZZER SIGNAL CIRCUIT FOR OPEN

1. Disconnect the ADAS control unit connector.
2. Check continuity between the ADAS control unit harness connector and warning buzzer harness connector.

## WARNING BUZZER CIRCUIT

< DTC/CIRCUIT DIAGNOSIS >

[BLIND SPOT WARNING & BLIND SPOT INTERVENTION]

ADAS control unit		Warning buzzer		Continuity
Connector	Terminal	Connector	Terminal	
B104	12	M60	2	Yes

Is the inspection result normal?

YES >> GO TO 4.

NO >> Repair the harnesses or connectors.

### 4.CHECK WARNING BUZZER SIGNAL CIRCUIT FOR SHORT

Check continuity between the ADAS control unit harness connector and ground.

ADAS control unit		Ground	Continuity
Connector	Terminal		
B104	12		No

Is the inspection result normal?

YES >> GO TO 5.

NO >> Repair the harnesses or connectors.

### 5.CHECK WARNING BUZZER OPERATION

1. Connect the warning buzzer connector.
2. Turn ignition switch ON.
3. Apply ground to warning buzzer terminal 2.
4. Check condition of the warning buzzer.

Does warning buzzer sound?

YES >> Replace the ADAS control unit. Refer to [DAS-79. "Removal and Installation"](#).

NO >> Replace the warning buzzer.

## SYMPTOM DIAGNOSIS

### BLIND SPOT WARNING & BLIND SPOT INTERVENTION SYSTEM SYMPTOMS

#### Symptom Table

INFOID:000000009716939

**CAUTION:**

Perform the self-diagnosis with **CONSULT** before the symptom diagnosis. Perform the trouble diagnosis if any DTC is detected.

**NOTE:**

Refer to the following the operation condition of the Blind Spot Warning/Blind Spot Intervention system.

- Blind Spot Warning system: [DAS-468, "BLIND SPOT WARNING \(BSW\) SYSTEM : System Description"](#).
- Blind Spot Intervention system: [DAS-472, "BLIND SPOT INTERVENTION SYSTEM : System Description"](#).

Symptom	Possible cause	Inspection item/Reference page	
Indicator/warning lamps do not illuminate when ignition switch OFF ⇒ ON.	Blind Spot Warning/Blind Spot Intervention warning lamp (orange) does not illuminate	<ul style="list-style-type: none"> <li>• Blind Spot Warning/Blind Spot Intervention warning lamp signal (CAN)</li> <li>- Combination meter</li> <li>- ADAS control unit</li> <li>• Blind Spot Warning/Blind Spot Intervention warning lamp (combination meter)</li> </ul>	<ul style="list-style-type: none"> <li>• ADAS control unit Active test "BSW/BSI WARNING LAMP" and "BSI ON INDICATOR". Refer to <a href="#">DAS-484, "CONSULT Function (ICC/ADAS)"</a>.</li> <li>• ADAS control unit Data monitor "BSW/BSI WARN LMP" and "BSI ON IND". Refer to <a href="#">DAS-484, "CONSULT Function (ICC/ADAS)"</a>.</li> <li>• Combination meter Data monitor "BSW W/L" and "BSI IND". Refer to <a href="#">DAS-484, "CONSULT Function (ICC/ADAS)"</a>.</li> </ul>
	Blind Spot Intervention ON indicator (Green) does not illuminate	<ul style="list-style-type: none"> <li>• Blind Spot Intervention ON indicator lamp signal (CAN)</li> <li>- Combination meter</li> <li>- ADAS control unit</li> <li>• Blind Spot Intervention ON indicator (combination meter)</li> </ul>	
	Blind Spot Intervention ON indicator (Green) and Blind Spot Warning/Blind Spot Intervention warning lamp (orange) do not illuminate	<ul style="list-style-type: none"> <li>• Combination meter</li> <li>• ADAS control unit</li> </ul>	
	All of indicator/warning lamps do not illuminate; <ul style="list-style-type: none"> <li>• Blind Spot Warning/Blind Spot Intervention warning lamp</li> <li>• Blind Spot Intervention ON indicator</li> <li>• Warning systems ON indicator</li> </ul>	<ul style="list-style-type: none"> <li>• Power supply and ground circuit of ADAS control unit</li> <li>• ADAS control unit</li> <li>• Combination meter</li> </ul>	Power supply and ground circuit of ADAS control unit. Refer to <a href="#">DAS-567, "Diagnosis Procedure"</a>
	Warning systems ON indicator (on the warning systems switch) does not illuminate	<ul style="list-style-type: none"> <li>• Harness between ADAS control unit and warning systems switch</li> <li>• Warning systems switch</li> <li>• ADAS control unit</li> </ul>	Warning systems ON indicator circuit. Refer to <a href="#">DAS-567, "Diagnosis Procedure"</a>
	Blind Spot Warning/Blind Spot Intervention indicator does not turn ON	<ul style="list-style-type: none"> <li>• Harness between side radar and Blind Spot Warning/Blind Spot Intervention indicator</li> <li>• Side radar LH/RH</li> <li>• Blind Spot Warning/Blind Spot Intervention indicator</li> </ul>	Perform self-diagnosis of side radar. Refer to <a href="#">DAS-497, "CONSULT Function (SIDE RADAR LEFT)"</a> or <a href="#">DAS-498, "CONSULT Function (SIDE RADAR RIGHT)"</a> .

# BLIND SPOT WARNING & BLIND SPOT INTERVENTION SYSTEM SYMPTOMS

< SYMPTOM DIAGNOSIS >

[BLIND SPOT WARNING & BLIND SPOT INTERVENTION]

Symptom		Possible cause	Inspection item/Reference page
BSW system is not activated. (Indicator/warning lamps illuminate when ignition switch OFF ⇒ ON.)	Warning systems ON indicator is not turned ON ⇔ OFF when operating warning systems switch	<ul style="list-style-type: none"> <li>• Harness between ADAS control unit and warning systems switch</li> <li>• Harness between warning systems switch and ground</li> <li>• ADAS control unit</li> <li>• Warning systems switch</li> </ul>	<ul style="list-style-type: none"> <li>• Warning systems switch circuit. Refer to <a href="#">DAS-574. "Diagnosis Procedure"</a>.</li> <li>• BSW system setting cannot be turned ON/OFF on the navigation screen. Refer to <a href="#">DAS-629. "Description"</a></li> </ul>
	Buzzer is not sounding	<ul style="list-style-type: none"> <li>• Buzzer power supply circuit.</li> <li>• Harness between ADAS control unit and warning buzzer</li> <li>• Harness between warning buzzer and ground.</li> <li>• Warning buzzer</li> <li>• ADAS control unit</li> </ul>	Warning buzzer circuit. Refer to <a href="#">DAS-623. "Diagnosis Procedure"</a>
Blind Spot Intervention system is not activated. (BSW system is functioning normally)	Blind Spot Intervention ON indicator is not turned ON ⇔ OFF when operating dynamic driver assistance switch.	<ul style="list-style-type: none"> <li>• Dynamic driver assistance switch</li> <li>• Combination meter</li> <li>• ADAS control unit</li> </ul>	<ul style="list-style-type: none"> <li>• Dynamic driver assistance switch does not turn ON/OFF. Refer to <a href="#">DAS-627. "Description"</a></li> <li>• Blind Spot Intervention system setting cannot be turned ON/OFF on the navigation screen. Refer to <a href="#">DAS-629. "Description"</a></li> </ul>
	Warning is functioning but yawing is not functioning.	—	<ul style="list-style-type: none"> <li>• Check "Cause of auto-cancel 2". Refer to <a href="#">DAS-484. "CONSULT Function (ICC/ADAS)"</a></li> <li>• Check normal operating condition. Refer to <a href="#">DAS-630. "Description"</a></li> </ul>
Blind Spot Intervention functions are not timely.(BSW system is functioning normally.) (Example)	<ul style="list-style-type: none"> <li>• Does not function when approaching a lane marker while Blind Spot Warning/Blind Spot Intervention indicator lamp is illuminated.</li> <li>• Functions when driving in the middle of lane.</li> </ul>	<ul style="list-style-type: none"> <li>• Camera aiming adjustment</li> <li>• Lane camera unit</li> </ul>	Camera aiming adjustment. Refer to <a href="#">DAS-546. "Work Procedure"</a> .

# SWITCH DOES NOT TURN ON / SWITCH DOES NOT TURN OFF

< SYMPTOM DIAGNOSIS >

[BLIND SPOT WARNING & BLIND SPOT INTERVENTION]

## SWITCH DOES NOT TURN ON / SWITCH DOES NOT TURN OFF

### Description

INFOID:000000009716940

The switch does not turn ON

- When the Blind Spot Intervention system setting is ON, the Blind Spot Intervention ON indicator does not illuminate even if the dynamic driver assistance switch is depressed.

The switch does not turn OFF

- The Blind Spot Intervention ON indicator does not turn off even if the dynamic driver assistance switch is pressed when the Blind Spot Intervention ON indicator illuminates.

### Diagnosis Procedure

INFOID:000000009716941

#### 1. CHECK BLIND SPOT INTERVENTION SYSTEM SETTING

1. Start the engine.
2. After starting the engine wait for 5 seconds or more.
3. Check that Blind Spot Intervention system setting on the navigation screen is ON.

Is Blind Spot Intervention system setting ON?

YES >> GO TO 2.

NO >> Enable the Blind Spot Intervention system setting.

#### 2. DYNAMIC DRIVER ASSISTANCE SWITCH INSPECTION

1. Start the engine.
2. Check that "DYNA ASIST SW" operates normally in "DATA MONITOR" of "ICC/ADAS" with CONSULT.

Is the inspection result normal?

YES >> GO TO 3.

NO >> GO TO 5.

#### 3. CHECK BLIND SPOT INTERVENTION ON INDICATOR CIRCUIT

1. Start the engine.
2. Select the active test item "BSI ON IND" of "ICC/ADAS" with CONSULT.
3. Check if the Blind Spot Intervention ON indicator illuminates when the test item is operated.

Is the inspection result normal?

YES >> GO TO 6.

NO >> GO TO 4.

#### 4. PERFORM THE SELF-DIAGNOSIS OF COMBINATION METER

1. Perform "All DTC Reading" with CONSULT.
2. Check if the DTC is detected in self-diagnosis results of "METER/M&A". Refer to [MWI-26, "DTC Index"](#).

Is the inspection result normal?

YES >> GO TO 7.

NO >> GO TO 6.

#### 5. CHECK STEERING SWITCH CIRCUIT

Check the steering switch circuit. Refer to [DAS-558, "Diagnosis Procedure"](#).

Is the inspection result normal?

YES >> GO TO 6.

NO >> GO TO 7.

#### 6. PERFORM THE SELF-DIAGNOSIS

1. Perform "All DTC Reading" with CONSULT.
2. Check if the DTC is detected in self-diagnosis results of "ICC/ADAS". Refer to [DAS-509, "DTC Index"](#).

Is any DTC detected?

YES >> GO TO 7.

NO >> GO TO 8.

A  
B  
C  
D  
E  
F  
G  
H  
I  
J  
K  
L  
M  
N  
P

DAS

## SWITCH DOES NOT TURN ON / SWITCH DOES NOT TURN OFF

< SYMPTOM DIAGNOSIS >

[BLIND SPOT WARNING & BLIND SPOT INTERVENTION]

---

### 7. REPAIR OR REPLACE MALFUNCTIONING PARTS.

---

Repair or replace malfunctioning parts.

>> GO TO 8.

### 8. CHECK BLIND SPOT INTERVENTION SYSTEM

---

1. Erase "self-diagnosis result", and then perform "All DTC Reading" again after performing the action test. (Refer to [DAS-547, "Description"](#) for action test.)
2. Check that the Blind Spot Intervention system is normal.

>> Inspection End.



# BSW/BSI SYSTEM SETTINGS CANNOT BE TURNED ON/OFF IN VEHICLE INFORMATION DISPLAY

< SYMPTOM DIAGNOSIS >

[BLIND SPOT WARNING & BLIND SPOT INTERVENTION]

## BSW/BSI SYSTEM SETTINGS CANNOT BE TURNED ON/OFF IN VEHICLE INFORMATION DISPLAY

### Description

INFOID:000000009716942

- BSW system setting is not selectable in the vehicle information display.
- Blind Spot Intervention system setting is not selectable in the vehicle information display.

#### NOTE:

When the ignition switch is in ACC position, Blind Spot Warning or Blind Spot Intervention system settings cannot be changed.

- "Blind Spot Warning" or "Blind Spot Intervention" is not indicated in the vehicle information display.
- The switching between ON and OFF cannot be performed by operating the vehicle information display.
- The item "Blind Spot Warning" or "Blind Spot Intervention" in the vehicle information display.
- The Blind Spot Warning or Blind Spot Intervention system setting differs from the one set at the previous driving.

#### NOTE:

Turn OFF the ignition switch and wait for 5 seconds or more.

### Diagnosis Procedure

INFOID:000000009716943

#### 1. CHECK BLIND SPOT INTERVENTION SYSTEM SETTING

1. Start the engine.
2. Check that the Blind Spot Intervention system settings is selectable in the vehicle information display.

Is the inspection result normal?

YES >> GO TO 3.

NO >> GO TO 2.

#### 2. PERFORM THE SELF-DIAGNOSIS

1. Perform self-diagnosis with CONSULT.
2. Check if the DTC is detected in self-diagnosis results of "ICC/ADAS" and "METER/M&A". Refer to the following.
  - ICC/ADAS: [DAS-509. "DTC Index"](#).
  - METER/M&A: [MWI-26. "DTC Index"](#).

Is any DTC detected?

YES >> Repair or replace malfunctioning parts.

NO >> INSPECTION END

#### 3. CHECK DATA MONITOR OF ADAS CONTROL UNIT

Check that "BSI SELECT" operates normally in "DATA MONITOR" of "ICC/ADAS" with CONSULT.

Is the inspection result normal?

YES >> Refer to [DAS-472. "BLIND SPOT INTERVENTION SYSTEM : System Description"](#).

NO >> GO TO 4.

#### 4. CHECK THE VEHICLE INFORMATION DISPLAY SWITCH

Operate the vehicle information display switch to check that the vehicle information display operates properly.

Is the inspection result normal?

YES >> Replace the ADAS control unit. Refer to [DAS-79. "Removal and Installation"](#).

NO >> Repair or replace malfunctioning parts.

A  
B  
C  
D  
E  
F  
G  
H  
I  
J  
K  
L  
M  
N  
P

## NORMAL OPERATING CONDITION

< SYMPTOM DIAGNOSIS >

[BLIND SPOT WARNING & BLIND SPOT INTERVENTION]

### NORMAL OPERATING CONDITION

#### Description

INFOID:000000009716944

#### PRECAUTIONS FOR BLIND SPOT WARNING (BSW) & BLIND SPOT INTERVENTION

- The Blind Spot Warning and Blind Spot Intervention systems are not a replacement for proper driving procedure and are not designed to prevent contact with vehicles or objects. When changing lanes, always use the side and rear mirrors and turn and look in the direction driver will move to ensure it is safe to change lanes. Never rely solely on the Blind Spot Warning or Blind Spot Intervention system.
- Using the Blind Spot Intervention system under some road, lane marker or weather conditions could lead to improper system operation. Always rely on driver's own steering and braking operation to avoid accidents.
- The Blind Spot Warning and Blind Spot Intervention systems may not provide a warning or brake control for vehicles that pass through the detection zone quickly.
- Do not use the Blind Spot Warning or Blind Spot Intervention systems when towing a trailer.
- Excessive noise (e.g. audio system volume, open vehicle window) will interfere with the chime sound, and it may not be heard.
- The side radar may not be able to detect and activate Blind Spot Warning/Blind Spot Intervention when certain objects are present such as:
  - Pedestrians, bicycles, animals.
  - Several types of vehicles such as motorcycles.
  - Oncoming vehicles.
  - Vehicles remaining in the detection zone when driver accelerate from a stop.
  - A vehicle merging into an adjacent lane at a speed approximately the same as vehicle.
  - A vehicle approaching rapidly from behind.
  - A vehicle which vehicle overtakes rapidly.
- Severe weather or road spray conditions may reduce the ability of the radar to detect other vehicles.
- The side radar detection zone is designed based on a standard lane width. When driving in a wider lane, the side radar may not detect vehicles in an adjacent lane. When driving in a narrow lane, the side radar may detect vehicles driving two lanes away.
- The side radar are designed to ignore most stationary objects, however objects such as guardrails, walls, foliage and parked vehicles may occasionally be detected. This is a normal operating condition.

#### PRECAUTIONS FOR BLIND SPOT INTERVENTION

- Do not use the Blind Spot Intervention system under the following conditions because the system may not function properly.
  - During bad weather (e.g. rain, fog, snow, wind, etc.)
  - When driving on slippery roads, such as on ice or snow, etc.
  - When driving on winding or uneven roads.
  - When there is a lane closure due to road repairs.
  - When driving in a makeshift lane.
  - When driving on roads where the lane width is too narrow.
  - When driving with a tire that is not within normal tire conditions (e.g. tire wear, low tire pressure, installation of spare tire, tire chains, non-standard wheels).
  - When the vehicle is equipped with non-original brake parts or suspension parts.
- The camera may not detect lane markers in the following situations and the Blind Spot Intervention system may not operate properly.
  - On roads where there are multiple parallel lane markers; lane markers that are faded or not painted clearly; yellow painted lane markers; nonstandard lane markers; lane markers covered with water, dirt, snow, etc.
  - On roads where discontinued lane markers are still detectable.
  - On roads where there are sharp curves.
  - On roads where there are sharply contrasting objects, such as shadows, snow, water, wheel ruts, seams or lines remaining after road repairs.
  - On roads where the traveling lane merges or separates.
  - When the vehicle is traveling direction does not align with the lane markers.
  - When traveling close to the vehicle in front of driver, which obstructs the lane camera unit detection range.
  - When rain, snow or dirt adheres to the windshield in front of a lane camera unit.
  - When the headlights are not bright due to dirt on the lens or if aiming is not adjusted properly.
  - When strong light enters a lane camera unit. (e.g. light directly shines on the front of the vehicle at sunrise or sunset.)
  - When a sudden change in brightness occurs. (e.g. when the vehicle enters or exits a tunnel or under a bridge.)

## NORMAL OPERATING CONDITION

< SYMPTOM DIAGNOSIS >

[BLIND SPOT WARNING & BLIND SPOT INTERVENTION]

- The Blind Spot Intervention system will not operate if your vehicle is on a lane marker when another vehicle enters the detection zone. In this case only the BSW system operates.
- Blind Spot Intervention braking will not operate or will stop operating and only a warning chime will sound under the following conditions.
  - When the brake pedal is depressed.
  - When the accelerator pedal is depressed while brake control assist is provided.
  - When steering quickly.
  - When the ICC, DCA, FCW or IBA warnings sound.
  - When the hazard warning flashers are operated.
  - When driving on a curve at a high speed.

A

B

C

D

E

F

G

H

I

J

K

L

M

N

DAS

P

# SIDE RADAR

[BLIND SPOT WARNING & BLIND SPOT INTERVENTION]

< REMOVAL AND INSTALLATION >

## REMOVAL AND INSTALLATION

### SIDE RADAR

#### Exploded View

INFOID:000000009730873

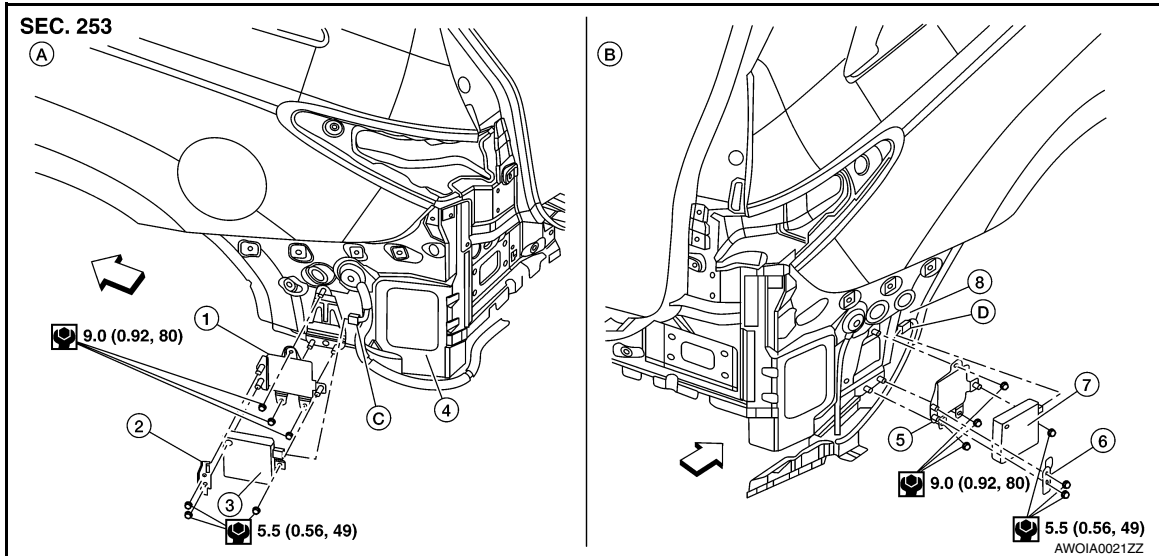

- |                                 |                                 |                                 |
|---------------------------------|---------------------------------|---------------------------------|
| 1. Retaining inner bracket (LH) | 2. Retaining outer bracket (LH) | 3. Side radar (LH)              |
| 4. Body side (LH)               | 5. Retaining inner bracket (RH) | 6. Retaining outer bracket (RH) |
| 7. Side radar (RH)              | 8. Body side (RH)               | A. LH side                      |
| B. RH side                      | C. Harness connector (LH)       | D. Harness connector (RH)       |

⇐ Front

### Removal and Installation

INFOID:000000009716946

#### REMOVAL AND INSTALLATION

##### Removal

1. Remove the rear bumper fascia. Refer to [EXT-20. "Removal and Installation"](#).
2. Disconnect the harness connector (1) (3) from the side radar (LH/RH) as shown.

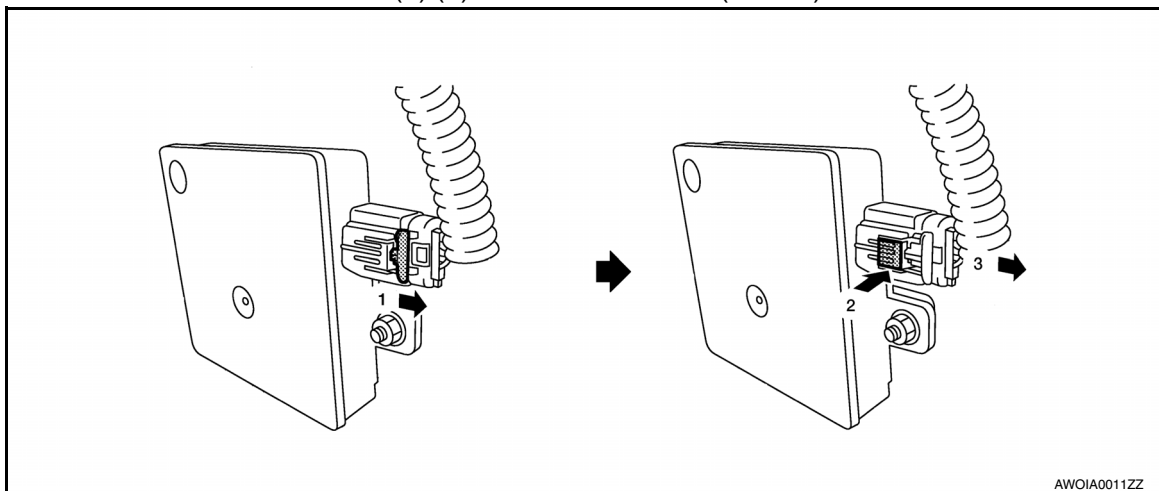

3. Remove nuts to remove the side radar (LH/RH) as necessary.

##### Installation

Installation is in the reverse order of removal.

**CAUTION:**

## SIDE RADAR

< REMOVAL AND INSTALLATION >

[BLIND SPOT WARNING & BLIND SPOT INTERVENTION]

---

**Do not use the side radar if the lens has flaws.**

**NOTE:**

- Always lock the side radar connector (2).
- Do not touch the side radar lens and keep lens area clean.

A

B

C

D

E

F

G

H

I

J

K

L

M

N

DAS

P

# BLIND SPOT WARNING/BLIND SPOT INTERVENTION INDICATOR

< REMOVAL AND INSTALLATION >

[BLIND SPOT WARNING & BLIND SPOT INTERVENTION]

## BLIND SPOT WARNING/BLIND SPOT INTERVENTION INDICATOR

Exploded View

INFOID:000000009716947

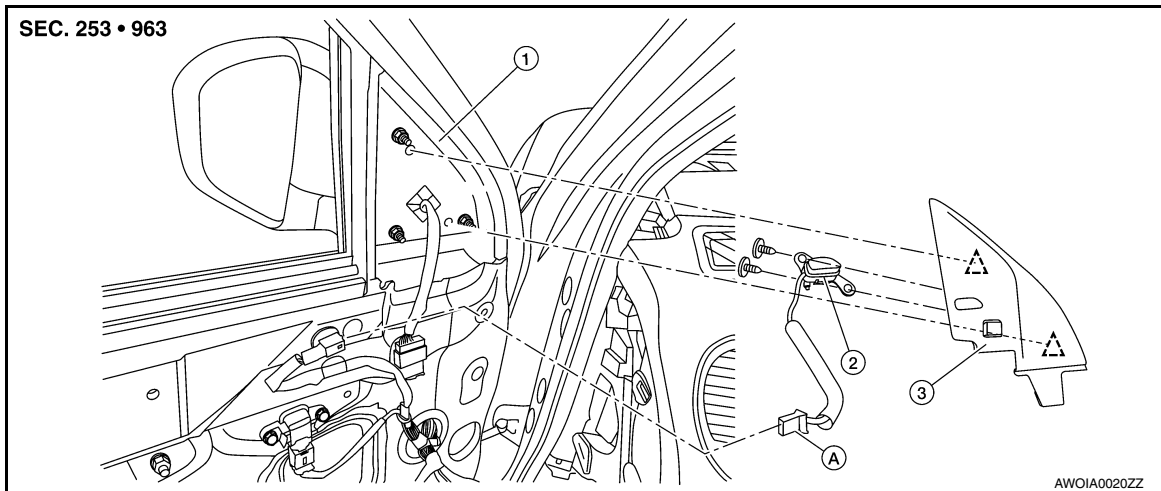

- 1. Front door
- 2. Blind spot warning/blind spot intervention indicator
- 3. Door mirror corner finisher
- A. Blind spot warning/blind spot intervention indicator harness connector
- △ Clip

### Removal and Installation

INFOID:000000009716948

#### REMOVAL AND INSTALLATION

##### Removal

1. Remove front door finisher. Refer to [INT-15, "Removal and Installation"](#).
2. Remove the door mirror corner finisher (LH/RH) as necessary. Refer to [MIR-29, "Removal and Installation"](#).
3. Remove the blind spot warning/blind spot intervention indicator screws.
4. Remove the blind spot warning/blind spot intervention indicator.

##### Installation

Installation is in the reverse order of removal.

# LANE CAMERA UNIT

< REMOVAL AND INSTALLATION >

[BLIND SPOT WARNING & BLIND SPOT INTERVENTION]

## LANE CAMERA UNIT

Exploded View

INFOID:000000009730897

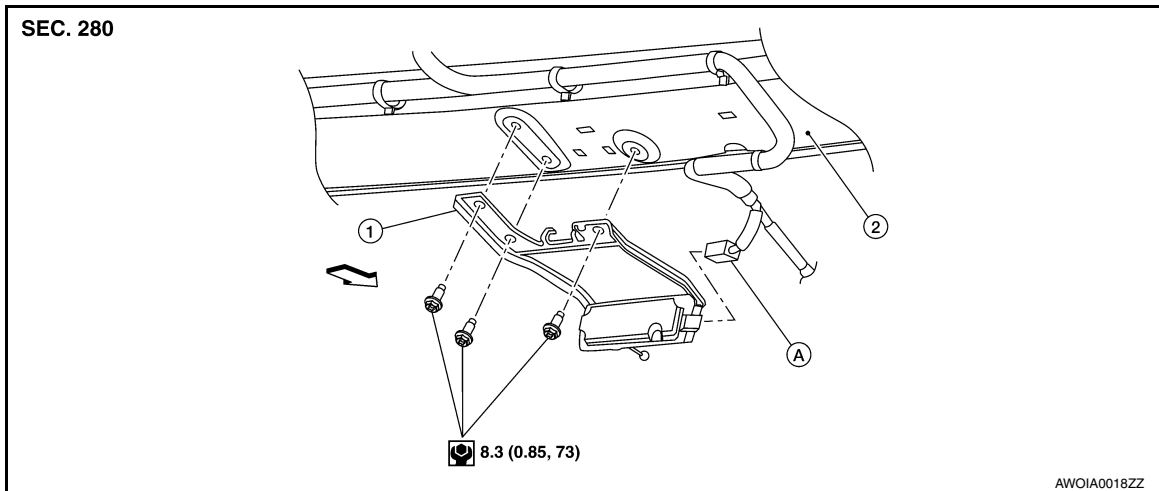

1. Lane camera unit

2. Roof rail

A. Lane camera unit harness connector

⇐ Front

## Removal and Installation

INFOID:000000009730898

### REMOVAL

1. Partially remove the headlining. Refer to [INT-27, "Removal and Installation"](#).
2. Disconnect the lane camera unit harness connector from the lane camera unit.
3. Remove three lane camera bolts.
4. Remove lane camera unit.

### INSTALLATION

Installation is in the reverse order of removal.

#### CAUTION:

- Remove the camera lens cover from the replacement lane camera unit before aiming.
- Do not drop or impact the lane camera unit.
- Perform additional service when replacing lane camera unit. Refer to [DAS-395, "Description"](#).

A  
B  
C  
D  
E  
F  
G  
H  
I  
J  
K  
L  
M  
N  
P

DAS

# WARNING SYSTEMS SWITCH

< REMOVAL AND INSTALLATION > [BLIND SPOT WARNING & BLIND SPOT INTERVENTION]

## WARNING SYSTEMS SWITCH

### Removal and Installation

INFOID:000000009730872

#### REMOVAL

1. Remove the instrument lower panel LH. Refer to [IP-25. "Removal and Installation"](#).

2. Remove three screws (A, B) that retain the lower switch carrier (2).

(1): Upper switch carrier

(2): Upper switch carrier screws

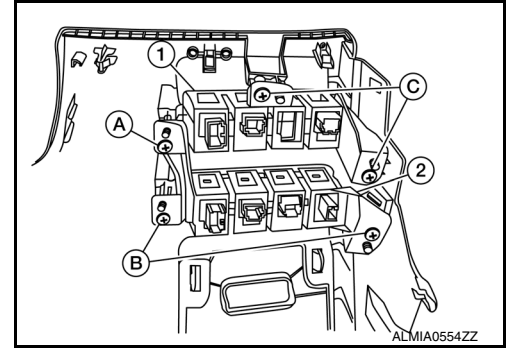

3. Release upper (B) and lower (C) tab using a suitable tool (A), then remove the warning system switch (1) from the lower switch carrier.

(2): Headlamp aiming switch

(3): AC 120V outlet main switch (if equipped)

(4): Heated steering wheel switch

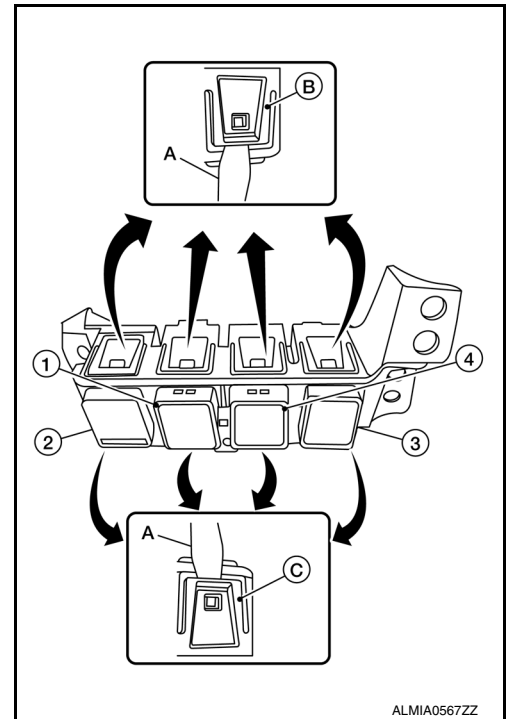

#### INSTALLATION

Installation is in the reverse order of removal.



# DYNAMIC DRIVER ASSISTANCE SWITCH

< REMOVAL AND INSTALLATION > [BLIND SPOT WARNING & BLIND SPOT INTERVENTION]

## DYNAMIC DRIVER ASSISTANCE SWITCH

### Removal and Installation

INFOID:000000009730901

The dynamic driver assistance switch and ICC steering switch are serviced as an assembly. Refer to [AV-885](#), "[Removal and Installation](#)".

#### **CAUTION:**

Always perform the DCA system action test to check that the system operates normally after replacing the ICC sensor, replacing the accelerator pedal or repairing any DCA system malfunction. Refer to [DAS-155](#), "[Work Procedure](#)".

A  
B  
C  
D  
E  
F  
G  
H  
I  
J  
K  
L  
M  
N  
P

DAS

## WARNING BUZZER

< REMOVAL AND INSTALLATION >

[BLIND SPOT WARNING & BLIND SPOT INTERVENTION]

### WARNING BUZZER

#### Removal and Installation

INFOID:000000009730902

#### REMOVAL

1. Remove the instrument lower panel LH. Refer to [IP-25. "Removal and Installation"](#).
2. Remove screw (←).
3. Disconnect the harness connector (A) from the warning buzzer (1).
4. Remove the warning buzzer (1).

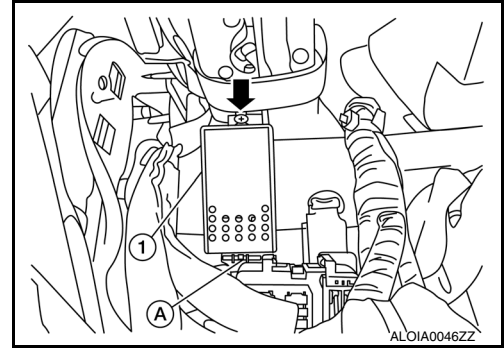

#### INSTALLATION

Installation is in the reverse order of removal.

# PRECAUTION

## PRECAUTIONS

### Precaution for Supplemental Restraint System (SRS) "AIR BAG" and "SEAT BELT PRE-TENSIONER"

INFOID:000000009730870

The Supplemental Restraint System such as "AIR BAG" and "SEAT BELT PRE-TENSIONER", used along with a front seat belt, helps to reduce the risk or severity of injury to the driver and front passenger for certain types of collision. This system includes dual stage front air bag modules. The SRS system may only deploy one front air bag, depending on the severity of a collision and whether the front passenger seat is occupied. Information necessary to service the system safely is included in the SR and SB section of this Service Manual.

**WARNING:**

- To avoid rendering the SRS inoperative, which could increase the risk of personal injury or death in the event of a collision which would result in air bag inflation, all maintenance must be performed by an authorized NISSAN/INFINITI dealer.
- Improper maintenance, including incorrect removal and installation of the SRS, can lead to personal injury caused by unintentional activation of the system. For removal of Spiral Cable and Air Bag Module, see the SR section.
- Do not use electrical test equipment on any circuit related to the SRS unless instructed to in this Service Manual. SRS wiring harnesses can be identified by yellow and/or orange harnesses or harness connectors.

### PRECAUTIONS WHEN USING POWER TOOLS (AIR OR ELECTRIC) AND HAMMERS

**WARNING:**

- When working near the Airbag Diagnosis Sensor Unit or other Airbag System sensors with the Ignition ON or engine running, DO NOT use air or electric power tools or strike near the sensor(s) with a hammer. Heavy vibration could activate the sensor(s) and deploy the air bag(s), possibly causing serious injury.
- When using air or electric power tools or hammers, always switch the Ignition OFF, disconnect the battery and wait at least three minutes before performing any service.

### Precautions For Harness Repair

INFOID:000000009716955

ITS communication uses a twisted pair line. Be careful when repairing it.

- Solder the repaired area and wrap tape around the soldered area.

**NOTE:**

A fray of twisted lines must be within 110 mm (4.33 in).

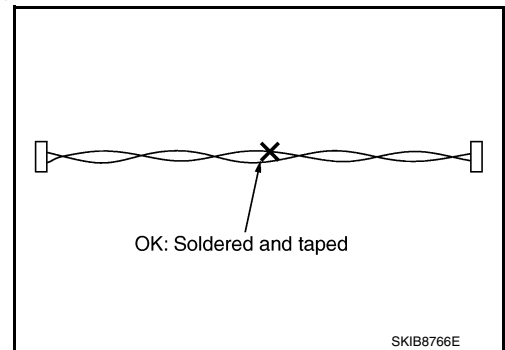

- Bypass connection is never allowed at the repaired area.

**NOTE:**

Bypass connection may cause ITS communication error. The spliced wire becomes separated and the characteristics of twisted line are lost.

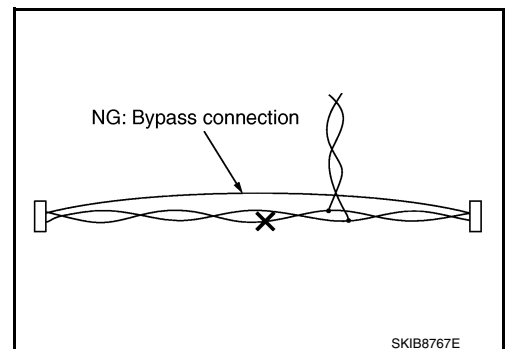

A  
B  
C  
D  
E  
F  
G  
H  
I  
J  
K  
L  
M  
N  
DAS  
P

# PRECAUTIONS

< PRECAUTION >

[BCI]

## Precaution for Backup Collision Intervention

INFOID:000000009716956

### **WARNING:**

**Be careful of traffic conditions and safety around the vehicle when performing road test.**

### **CAUTION:**

- Do not use the Backup Collision Intervention system when driving with free rollers or a chassis dynamometer.
- Do not perform the active test while driving.
- Do not change BCI initial state ON ⇒ OFF without the consent of the customer.

TO KEEP THE BACKUP COLLISION INTERVENTION SYSTEM OPERATING PROPERLY, BE SURE TO OBSERVE THE FOLLOWING ITEMS:

#### System Maintenance

The two side radars for the Backup Collision Intervention system are located near the rear bumper.

- Always keep the area near the side radars clean.
- Do not attach stickers (including transparent material), install accessories or apply additional paint near the side radars.
- Do not strike or damage the area around the side radars.

#### System Maintenance

The four rear sonars for the Backup Collision Intervention system are located in the rear bumper.

- Always keep the area near the rear sonars clean.
- Do not attach stickers (including transparent material), install accessories or apply additional paint near the rear sonars.
- Do not strike or damage the area around the rear sonars.

# COMPONENT PARTS

< SYSTEM DESCRIPTION >

[BCI]

## SYSTEM DESCRIPTION

### COMPONENT PARTS

#### Component Parts Location

INFOID:000000009716957

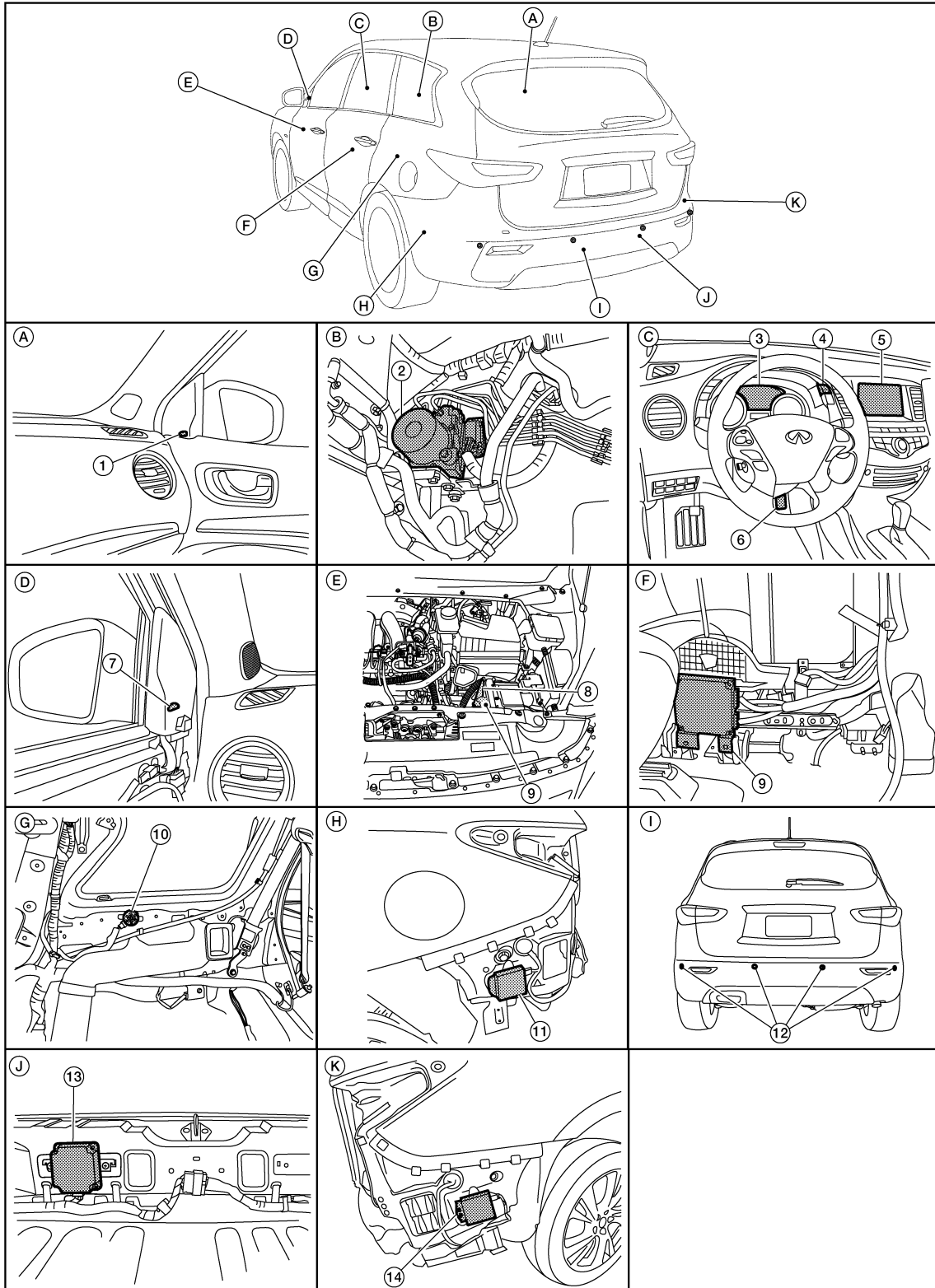

A  
B  
C  
D  
E  
F  
G  
H  
I  
J  
K  
L  
M  
N  
P

DAS

AWOIA0023ZZ

# COMPONENT PARTS

< SYSTEM DESCRIPTION >

[BCI]

- |   |   |   |
|---|---|---|
| 1. Blind Spot Warning/Blind Spot Intervention indicator RH  | 2. ABS actuator and electric unit (control unit)<br>Refer to <a href="#">DAS-642, "Component Description"</a> . | 3. Vehicle information display  |
| 4. BCI switch   | 5. Display unit   | 6. Accelerator pedal actuator   |
| 7. Blind Spot Warning/Blind Spot Intervention indicator LH  | 8. ECM<br>Refer to <a href="#">DAS-642, "Component Description"</a> .   | 9. Around View Monitor control unit (view with center console removed)<br>Refer to <a href="#">DAS-642, "Component Description"</a> . |
| 10. Warning buzzer (view with LH quarter panel finisher removed)  | 11. Side radar LH (view with rear bumper cover removed)   | 12. Rear sonar sensors  |
| 13. ADAS control unit (view of rear luggage room area)<br>Refer to <a href="#">DAS-642, "Component Description"</a> . | 14. Side radar RH (view with rear bumper cover removed)   |   |

## Component Description

INFOID:000000009716958

Component	Description
ADAS control unit	<ul style="list-style-type: none"> <li>Being connected with side radar (LH and RH) via ITS communication, receives vehicle detection signal and transmits Blind Spot Warning/Blind Spot Intervention indicator signal and Blind Spot Warning/Blind Spot Intervention indicator dimmer signal to side radar</li> <li>Receives steering angle sensor signal from steering angle sensor via CAN communication</li> <li>Calculates the approach with the object by the signal from a sensor.</li> <li>Transmits a brake fluid pressure control signal to ABS actuator and electric unit (control unit) via CAN communication.</li> <li>Transmits the buzzer output signal to the sonar control unit via CAN communication.</li> <li>Transmits BCI ON/OFF display signal and BCI system warning lamp signal to combination meter via CAN communication.</li> </ul>
Side radar LH/ RH	<ul style="list-style-type: none"> <li>Being connected with ADAS control unit via ITS communication, transmits vehicle detection signal</li> <li>Receives Blind Spot Intervention indicator signal and Blind Spot Intervention indicator dimmer signal from ADAS control unit and transmits an indicator operation signal to Blind Spot Intervention indicator LH/RH</li> <li>RH side radar equips right/left switching signal circuit for identifying LH or RH because the parts of side radar are common for right and left</li> </ul>
Blind Spot Warning/Blind Spot Intervention indicator LH/ RH	Receives Blind Spot Warning/Blind Spot Intervention indicator operation signal from side radar LH/ RH and turns OFF, turns ON or blinks
ABS actuator and electric unit (control unit)	<ul style="list-style-type: none"> <li>Transmits vehicle speed signal to ADAS control unit via CAN communication</li> <li>Receives a brake fluid pressure control signal from the ADAS control unit via CAN communication and controls brake pressure.</li> </ul>
BCI OFF switch	Inputs the switch signal to ADAS control unit
Rear sonar sensors (4)	Monitors the near rear surrounding area of the vehicle and transmits the signal to the sonar control unit which passes it to the ADAS control unit for BCI purposes.
Sonar buzzer	Receives buzzer signal from ADAS control unit via sonar control unit and sounds buzzer.
Combination meter (vehicle information display)	<ul style="list-style-type: none"> <li>Turns the BCI ON/OFF display and BCI system warning lamp according to the signals from the ADAS control unit via CAN communication.</li> <li>Receives BCI ON/OFF display signal and BCI system warning lamp signal via CAN communication.</li> </ul>
ECM	Transmits the accelerator pedal position signal, engine speed signal to ADAS control unit via CAN communication
TCM	Transmits the current gear position signal and shift position signal to ADAS control unit via CAN communication
AVM control unit	Receives the various systems and camera signals and routes them to the center display via CAN communication

# COMPONENT PARTS

< SYSTEM DESCRIPTION >

[BCI]

Component	Description
Center display	Displays the various system screen signals according to the priority level received via CAN communication
Accelerator pedal actuator	Receives signal from ADAS control unit to push up accelerator via ITS communication.

A  
B  
C  
D  
E  
F  
G  
H  
I  
J  
K  
L  
M  
N  
P

DAS

SYSTEM

System Description

INFOID:000000009716959

SYSTEM DIAGRAM

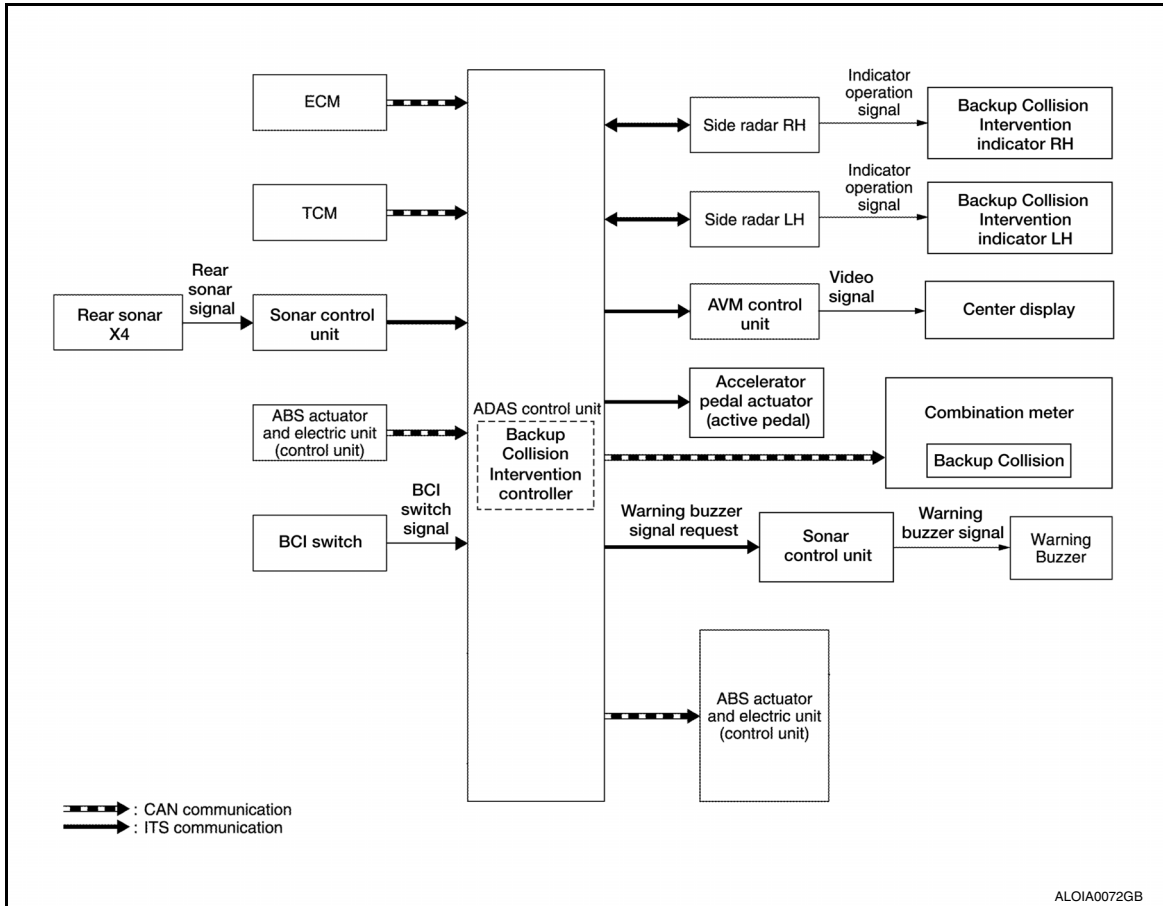

ADAS CONTROL UNIT INPUT/OUTPUT SIGNAL ITEM

Input Signal Item

Transmit unit	Signal name		Description
ECM	CAN communication	Accelerator pedal position signal	Receives accelerator pedal position (angle)
		Engine speed signal	Receives engine speed
TCM	CAN communication	Current gear position signal	Receives a current gear position
		Shift position signal	Receives a select lever position
ABS actuator and electric unit (control unit)	CAN communication	ABS malfunction signal	Receives a malfunction state of ABS
		VDC malfunction signal	Receives a malfunction state of VDC
		Vehicle speed signal (ABS)	Receives wheel speeds of four wheels
BCI OFF switch	Hard wire	BCI OFF switch signal	Receives the state of the BCI OFF switch request
Sonar control unit	ITS communication	Rear object detection signal	Receives objects detection result of rear area behind vehicle
Side radar LH, RH	ITS communication	Vehicle detection signal	Receives vehicle detection condition of detection zone.

Output Signal Item



# SYSTEM

## < SYSTEM DESCRIPTION >

[BCI]

Reception unit	Signal name		Description
ABS actuator and electric unit (control unit)	CAN communication	Brake fluid pressure control signal.	Transmits a brake fluid pressure control signal to activate the brake.
Combination meter	CAN communication	Turns the BCI ON/OFF display and BCI system warning lamp.	Turns the BCI ON/OFF display and BCI system warning lamp to display a state of the system on the information display.
Sonar control unit	ITS communication	Warning buzzer signal	While the shifter is in reverse and backing up, transmits a request for a variable warning buzzer signal to alert the driver.
Around view monitor control unit	ITS communication	Visual signal request	Transmits a visual signal request by the ADAS control unit to center display to override other signals and display rear view while the shift lever is in reverse.
Accelerator pedal actuator	ITS communication	Push up accelerator signal	While backing up and obstacle appears, transmits a signal to push up the accelerator pedal
Side radar LH, RH	ITS communication	Blind Spot Warning/Blind Spot Intervention indicator signal	Transmits a Blind Spot Warning/Blind Spot Intervention indicator signal to turn ON the Blind Spot Warning/Blind Spot Intervention indicator
		Blind Spot Warning/Blind Spot Intervention indicator dimmer signal	Transmits a Blind Spot Warning/Blind Spot Intervention indicator dimmer signal to dimmer Blind Spot Warning/Blind Spot Intervention indicator
		Vehicle speed signal	Transmits a vehicle speed calculated by the ADAS control unit

## FUNCTION DESCRIPTION

- The Backup Collision Intervention system can help alert the driver of approaching vehicles or rear objects when the driver is backing out of a parking space.
- The BCI system comprise of to main detection systems. The side radars (1), and the four sonar sensors (2) mounted on the rear bumper cover as illustrated.
- The BCI system operates at speeds below 5 MPH (8 km/h) whenever the vehicle is in reverse.

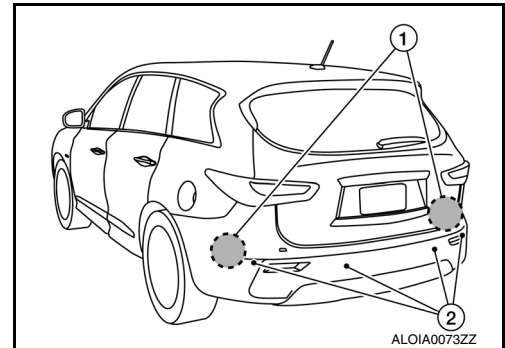

- The BCI system uses the two side radars installed near the rear bumper to detect approaching vehicles and rear obstacles.
- The side radar can detect vehicles on either side of vehicle within the detection zone shown as illustrated.
- The radar sensors detect the approaching vehicle from up to approximately 49 feet (15 m) away.

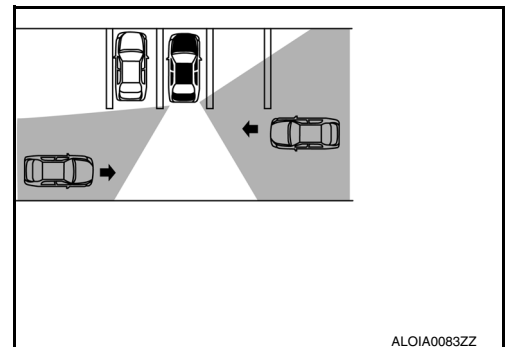

A  
B  
C  
D  
E  
F  
G  
H  
I  
J  
K  
L  
M  
N  
P

DAS

# SYSTEM

[BCI]

## < SYSTEM DESCRIPTION >

- The sonar sensors can detect rear obstacles of up to approximately 4.9 feet (1.5 m).
- If the radar detects a vehicle approaching from the side or the sonar detects close objects in the rear, the system gives visual and audible warnings, and applies the brake for a moment when the vehicle is moving backwards. If the driver's foot is on the accelerator pedal, the system pushes the accelerator upward before applying the brake. If the driver continues to press the accelerator, the system will not engage the brake.

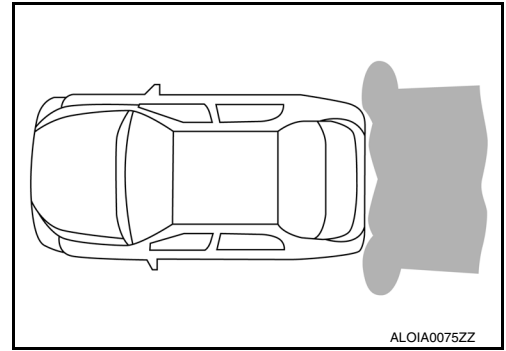

The radar sensors may not be able to detect certain objects such as:

- Pedestrians, bicycles, animals
- A vehicle that is passing at a speed greater than approximately 15 MPH (24 km/h)
- The radar sensors may not detect approaching vehicles in certain situations:

Examples of certain situations	Illustration of certain situations
When the vehicle parked aside obstruct the beam of the radar sensor	<p>ALOIA0076ZZ</p>
When the vehicle is parked in an angled parking space	<p>ALOIA0077ZZ</p>
When the vehicle is parked on an inclined ground	<p>ALOIA0078ZZ</p>
When the vehicle turns around into your vehicle's aisle	<p>ALOIA0079ZZ</p>
When the angle formed by your vehicle and approaching vehicle is small	<p>ALOIA0080ZZ</p>

# SYSTEM

< SYSTEM DESCRIPTION >

[BCI]

## BACKUP COLLISION INTERVENTION SYSTEM OPERATION DESCRIPTION

- ADAS control unit enables Backup Collision Intervention system.
- The BCI system is automatically turned ON every time the engine is started. Then BCI ON indicator comes on.
- Combination meter turns Backup Collision Intervention ON indicator lamp ON/OFF according to the signals from ADAS control unit via CAN communication.
- Side radar detects a vehicle approaching, and transmits the vehicle detection signal to ADAS control unit via ITS communication.
- Side radar receives vehicle speed signal from ADAS control unit and changes its detecting function.
- ADAS control unit starts the control as follows, based on a vehicle detection signal.

### Operation Condition of Backup Collision Intervention System



ADAS control unit performs the control when the following conditions are satisfied.

- Backup Collision Intervention ON indicator: ON
- When the vehicle is moving in reverse at 5 MPH (8 km/h) or less.

### NOTE:

- When the Backup Collision Intervention system setting is ON in the meter display.
- Backup Collision Intervention braking will not function properly under the following conditions:
  - When driving with a tire that is not within normal tire conditions (pressure, wear, chain, spare, etc...)
  - When the vehicle is equipped with non-original brake parts or suspension parts.
- Do not use the BCI system when towing a trailer.
- Excessive noise such as the audio system will interfere with the chime sound, and it may not be heard.

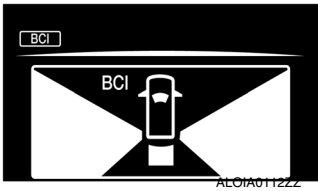
### BULB CHECK ACTION AND FAIL-SAFE INDICATION.

Vehicle condition/Driver's operation	Backup Collision Intervention indicator	Warning buzzer	Indication on the combination meter
Engine running and shift lever in reverse	ON	OFF	 OFF (orange) <small>ALC01A0112ZZ</small>
When DTC is detected	OFF	OFF	 OFF (orange) <small>ALC01A0081ZZ</small>
When radar blockage is detected	ON	Beep	Unavailable: Side Radar Obstruction
When the accelerator pedal actuator detects that the internal motor temperature is high.	ON	Beep	Unavailable: High Accelerator Temp.

DAS

# SYSTEM

## < SYSTEM DESCRIPTION >

[BCI]

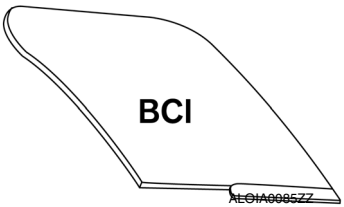
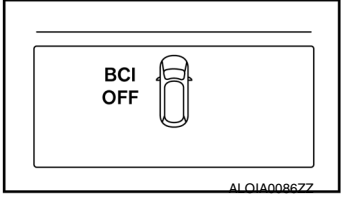
Vehicle condition/Driver's operation	Backup Collision Intervention indicator	Warning buzzer	Indication on the combination meter
Unless the driver overrides it and turns it off, the BCI system is always set to ON every time the engine is started and the shifter placed in reverse.	OFF	—	
The BCI system is turned off temporarily by pushing the BCI switch. The BCI OFF display appears on the meter display. When the selector lever is shifted into R again the BCI system is turned ON.	OFF	—	

### Fail-safe (ADAS Control Unit)

INFOID:000000009716960

If a malfunction occurs in any system, ADAS control unit cancels each control, sounds a beep, and turns ON the warning lamp or indicator lamp or warning message will display.

System	Buzzer	Warning lamp/Indicator lamp	Description
Vehicle-to-vehicle distance control mode	High-pitched tone	ICC system warning lamp	Cancel
Conventional (fixed speed) cruise control mode	High-pitched tone	ICC system warning lamp	Cancel
Intelligent Brake Assist (IBA)	High-pitched tone	IBA OFF indicator lamp	Cancel
Forward Collision Warning (FCW)	High-pitched tone	Warning message	Cancel
Distance Control Assist (DCA)	High-pitched tone	ICC system warning lamp	Cancel
Lane Departure Warning (LDW)	—	Lane Departure Warning lamp	Cancel
Lane Departure Prevention (LDP)	Low-pitched tone	Lane Departure Warning lamp	Cancel
Blind Spot Warning (BSW)	—	Blind Spot Warning/Blind Spot Intervention warning lamp	Cancel
Blind Spot Intervention (BSI)	Low-pitched tone	Blind Spot Warning/Blind Spot Intervention warning lamp	Cancel
Backup Collision Intervention (BCI)	High-pitched tone	Backup Collision Intervention warning indicator	Cancel

### Fail-safe (Side Radar)

INFOID:000000009716961

#### FAIL-SAFE CONTROL BY DTC

If a malfunction occurs in the side radar, ADAS control unit cancels control, and a chime will sound and the "Please see owner's manual" message appears in the vehicle information display.

#### TEMPORARY DISABLED STATUS AT BLOCKAGE

When the side radar is blocked, the operation is temporarily cancelled. Then the "Unavailable Side Radar Obstruction" message appears in the vehicle information display and the warning systems ON indicator will blink. Also, under the following conditions, the operation may be temporarily cancelled.

- The side radar may be blocked by temporary ambient conditions such as splashing water, mist or fog.

**SYSTEM**

< SYSTEM DESCRIPTION >

**[BCI]**

- The blocked condition may also be caused by objects such as ice, frost or dirt obstructing the side radar.

A  
B  
C  
D  
E  
F  
G  
H  
I  
J  
K  
L  
M  
N  
P

**DAS**

# OPERATION

< SYSTEM DESCRIPTION >

[BCI]

## OPERATION

### Switch Name and Function

INFOID:000000009716962

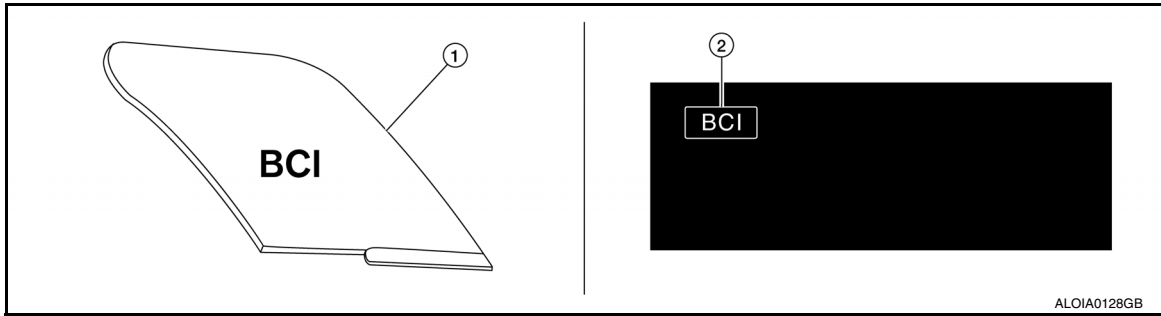

No.	Name	Function
1	BCI switch	Turns Backup Collision Intervention system ON/OFF

### System Display and Warning

INFOID:000000009716963

#### INDICATOR AND WARNING LAMP

Press the BCI switch to toggle between ON and OFF. "BCI" will appear on the left side of the vehicle information display screen.

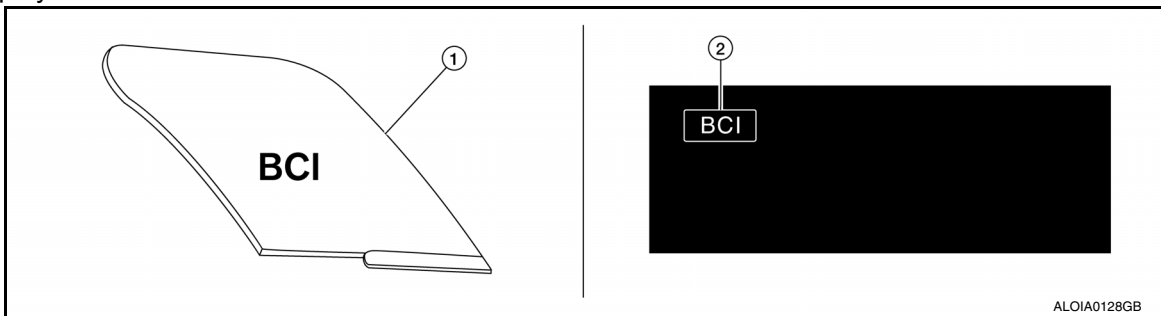

No.	Name	Description
2	BCI indicator	Turns ON while Backup Collision Intervention system is ON
	Backup Collision Intervention warning lamp (orange)	Turns ON when Backup Collision Intervention system is malfunctioning

### DISPLAY AND WARNING OPERATION

Vehicle condition/Driver's operation			Action		
Backup Collision Intervention ON indicator	Vehicle speed (Approx.) [km/h (MPH)]	Status of vehicle detection within detection area	Indication on the Backup Collision Intervention indicator	Brake control	Buzzer
OFF	—	—	OFF	OFF	OFF

# OPERATION

< SYSTEM DESCRIPTION >

[BCI]

Vehicle condition/Driver's operation			Action		
Backup Collision Intervention ON indicator	Vehicle speed (Approx.) [km/h (MPH)]	Status of vehicle detection within detection area	Indication on the Backup Collision Intervention indicator	Brake control	Buzzer
ON	Less than approx. 5 MPH (8 km/h)	Vehicle is detected	ON	ON	ON
		Vehicle is absent	ON	OFF	OFF
	Approx. 5 MPH (8 km/h) or more	Vehicle is detected	ON	ON	ON
		Vehicle is not detected	ON	OFF	OFF

Under the following conditions, the Backup Collision Intervention system will be turned off automatically, a beep will sound. The Backup Collision Intervention system will not be available until the conditions no longer exist.

- When the accelerator pedal actuator detects that the internal motor temperature is high.
- When side radar blockage is detected.

A  
B  
C  
D  
E  
F  
G  
H  
I  
J  
K  
L  
M  
N  
P

DAS

## HANDLING PRECAUTION

### Precautions for Blind Spot Warning/Blind Spot Intervention

INFOID:000000009716964

#### SONAR HANDLING

- The four sonar sensors for Backup Collision Intervention system are located on the rear bumper cover.
- Always keep the sonar sensors clean.
- Do not attach a sticker (including transparent material), install an accessory or paintwork over any of the sonar sensors.
- Do not strike or scratch any of the sonar sensors causing physical damage. to a sensor or the surrounding area

#### SIDE RADAR HANDLING

- Side radar for Backup Collision Intervention system is located inside the rear bumper.
- Always keep the rear bumper near the side radar clean.
- Do not attach a sticker (including transparent material), install an accessory or paintwork near the side radar.
- Do not strike or damage the areas around the side radar.
- Do not strike, damage, and scratch the side radar, especially the vent seal (gray circular) area, under repair.

#### BACKUP COLLISION INTERVENTION

- The Backup Collision Intervention system is not a replacement for proper driving procedure and is not designed to prevent contact with vehicles or objects. When backing up, always look in the direction driver will move to ensure it is safe to proceed. Never rely solely on the Backup Collision Intervention system.
- Using the Backup Collision Intervention system under some road or weather condition could lead to improper system operation. Always rely on driver's own steering and braking operation to avoid accidents.
- The Backup Collision Intervention system may not provide a warning or brake control for vehicles that pass through the detection zone quickly.
- Do not use the Backup Collision Intervention system when towing a trailer.
- Excessive noise (e.g. audio system volume, open vehicle window) will interfere with the chime sound, and it may not be heard.
- The side radar may not be able to detect and activate Backup Collision Intervention when certain objects are present such as:
  - Pedestrians, bicycles, animals.
  - A vehicle passing at a speed greater than approximately 15 MPH (24km/h).
- A radar sensor may not detect approaching vehicles in certain situations:
  - When the vehicle parked aside obstruct the beam of the radar sensor.
  - When the vehicle is parked in an angled parking space.
  - When the vehicle is parked on an inclined ground.
  - When the vehicle turns around into your vehicle's aisle.
  - When the angle formed by your vehicle and approaching vehicle is small.
- Severe weather or road spray conditions may reduce the ability of the radar to detect other vehicles.
- The sonar system may not detect:
  - Small or moving object.
  - Wedge-shaped objects.
  - Object closer to the bumper than 10 inch (30 cm).
  - Thin objects such as rope, wire, chain, etc...
- The brakes engaged by the BCI system is relatively weaker on a slope than flat ground. On a steep slope, the system may not function properly.
- Do not use the BCI system under the following conditions because the system may not function properly:
  - When driving with a tire that is not the within normal tire condition (example: tire wear, low pressure, spare tire, chain, non-standard wheels).
  - When the vehicle is equipped with non-original brake parts or suspension parts.



# DIAGNOSIS SYSTEM (ADAS CONTROL UNIT)

< SYSTEM DESCRIPTION >

[BCI]

## DIAGNOSIS SYSTEM (ADAS CONTROL UNIT)

### On Board Diagnosis Function

INFOID:00000009716965

#### DESCRIPTION

The DTC is displayed on the information display by operating the ICC steering switch.

#### On Board Self-diagnosis System Diagram

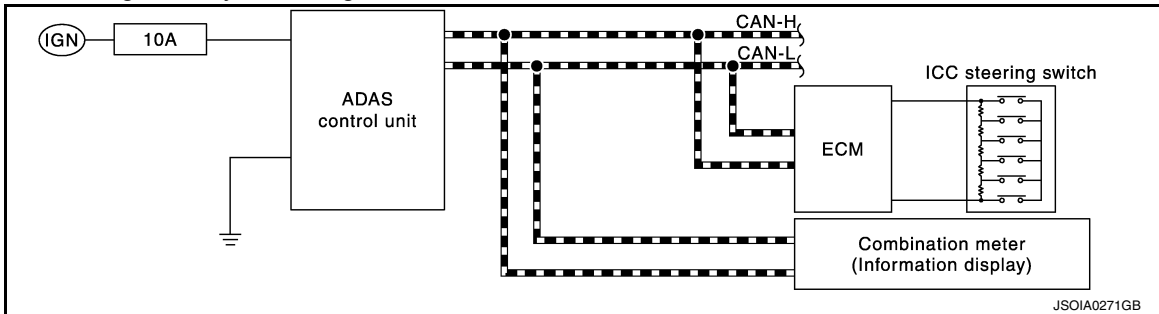

#### METHOD OF STARTING

##### CAUTION:

##### Start condition of on board self-diagnosis

- ICC system OFF
- DCA system OFF
- Vehicle speed 0 km/h (0 MPH)

1. Turn the ignition switch OFF.
2. Start the engine.
3. Wait for 5 seconds after starting the engine. Push up the RESUME/ACCELERATE switch 5 times and push down the SET/COAST switch 5 times within 10 seconds.

##### NOTE:

If the above operation cannot be performed within 10 seconds after waiting for 5 seconds after starting the engine, repeat the procedure from step 1.

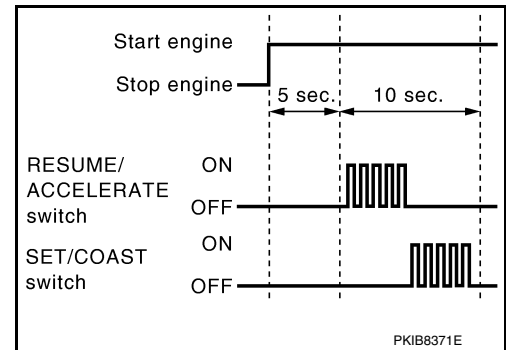

4. The DTC is displayed on the set vehicle speed indicator (1) on the ICC system display on the information display when the on board self-diagnosis starts. Refer to [DAS-677, "DTC Index"](#).

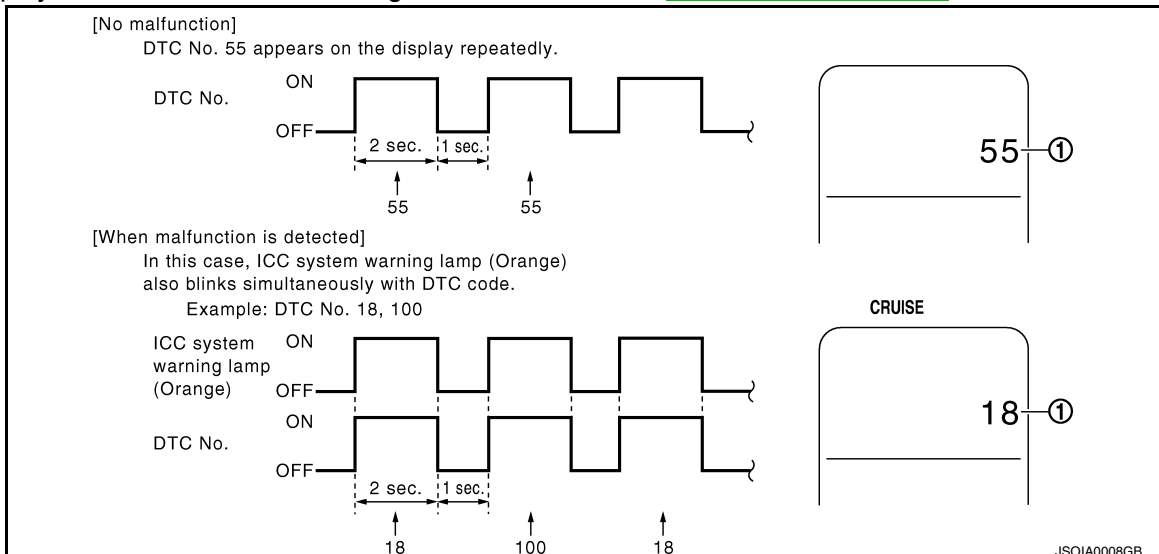

##### NOTE:

A  
B  
C  
D  
E  
F  
G  
H  
I  
J  
K  
L  
M  
N  
P

DAS

# DIAGNOSIS SYSTEM (ADAS CONTROL UNIT)

[BCI]

## < SYSTEM DESCRIPTION >

- It displays for up to 5 minutes and then stops.
- If multiple malfunctions exist, up to 6 DTCs can be stored in memory at the most, and the most recent one is displayed first.

## WHEN THE ON BOARD SELF-DIAGNOSIS DOES NOT START

If the on board self-diagnosis does not start, check the following items.

Assumed abnormal part		Inspection item
Information display	Combination meter malfunction	Check that the self-diagnosis function of the combination meter operates. Refer to <a href="#">MWI-15, "INFORMATION DISPLAY : System Description"</a>
ICC steering switch malfunction		Perform the inspection for DTC"C1A06". Refer to <a href="#">DAS-167, "Diagnosis Procedure"</a>
Harness malfunction between ICC steering switch and ECM		
ECM malfunction		
ADAS control unit malfunction		<ul style="list-style-type: none"> <li>• Check power supply and ground circuit of ADAS control unit. Refer to <a href="#">DAS-786, "ADAS CONTROL UNIT : Diagnosis Procedure"</a>.</li> <li>• Perform SELF-DIAGNOSIS for "ICC/ADAS" with CONSULT, and then check the malfunctioning parts. Refer to <a href="#">DAS-677, "DTC Index"</a>.</li> </ul>

## HOW TO ERASE ON BOARD SELF-DIAGNOSIS

1. Turn the ignition switch OFF.
2. Start the engine, and then start the on board self-diagnosis.
3. Press the CANCEL switch 5 times, and then press the DISTANCE switch 5 times under the condition that the on board self-diagnosis starts.

### NOTE:

- Complete the operation within 10 seconds after pressing the CANCEL switch first.
- If the operation is not completed within 10 seconds, repeat the procedure from step 1.

4. DTC 55 is displayed after erasing.

### NOTE:

DTCs for existing malfunction can not be erased.

5. Turn ignition switch OFF, and finish the diagnosis.

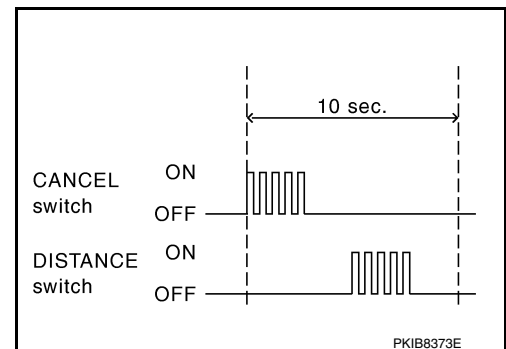

## CONSULT Function (ICC/ADAS)

INFOID:000000009716966

### CAUTION:

After disconnecting the CONSULT vehicle interface (VI) from the data link connector, the ignition must be cycled OFF → ON (for at least 5 seconds) → OFF. If this step is not performed, the BCM may not go to "sleep mode", potentially causing a discharged battery and a no-start condition.

## APPLICATION ITEMS

CONSULT performs the following functions via CAN communication using ADAS control unit.

Diagnosis mode	Description
Self Diagnostic Result	Displays the name of a malfunctioning system stored in the ADAS control unit.
Data Monitor	Displays ADAS control unit input/output data in real time.
Work support	Displays causes of automatic system cancellation occurred during system control.
Active Test	Enables an operational check of a load by transmitting a driving signal from the ADAS control unit to the load.
ECU identification	Displays ADAS control unit part number.
CAN Diag Support Mntr	Displays a reception/transmission state of CAN communication and ITS communication.

## SELF DIAGNOSTIC RESULT

Refer to [DAS-47, "DTC Index"](#).

# DIAGNOSIS SYSTEM (ADAS CONTROL UNIT)

< SYSTEM DESCRIPTION >

[BCI]

## DATA MONITOR

Monitored item [Unit]	ALL SIG (ICC)	MAIN SIG (ICC)	MAIN SIG (LDW/LDP)	MAIN SIG (BSW/BSI)	BCI MAIN	Description
MAIN SW [On/Off]	×	×	×	×		Indicates [On/Off] status as judged from ICC steering switch signal (ECM transmits ICC steering switch signal through CAN communication)
SET/COAST SW [On/Off]	×	×				Indicates [On/Off] status as judged from ICC steering switch signal (ECM transmits ICC steering switch signal through CAN communication)
CANCEL SW [On/Off]	×	×				Indicates [On/Off] status as judged from ICC steering switch signal (ECM transmits ICC steering switch signal through CAN communication)
RESUME/ACC SW [On/Off]	×	×				Indicates [On/Off] status as judged from ICC steering switch signal (ECM transmits ICC steering switch signal through CAN communication)
DISTANCE SW [On/Off]	×					Indicates [On/Off] status as judged from ICC steering switch signal (ECM transmits ICC steering switch signal through CAN communication)
CRUISE OPE [On/Off]	×	×				Indicates whether controlling or not (ON means "controlling")
BRAKE SW [On/Off]	×	×	×	×	×	Indicates [On/Off] status as judged from ICC brake switch signal (ECM transmits ICC brake switch signal through CAN communication)
STOP LAMP SW [On/Off]	×	×	×	×	×	Indicates [On/Off] status as judged from stop lamp switch signal (ECM transmits stop lamp switch signal through CAN communication)
IDLE SW [On/Off]	×				×	Indicates [On/Off] status of idle switch read from ADAS control unit through CAN communication (ECM transmits On/Off status through CAN communication)
SET DISTANCE [Short/Mid/Long]	×	×				Indicates set distance memorized in ADAS control unit
CRUISE LAMP [On/Off]	×	×				Indicates [On/Off] status of MAIN switch indicator output
OWN VHCL [On/Off]	×					Indicates [On/Off] status of own vehicle indicator output
VHCL AHEAD [On/Off]	×					Indicates [On/Off] status of vehicle ahead detection indicator output
ICC WARNING [On/Off]	×					Indicates [On/Off] status of ICC system warning lamp output
VHCL SPEED SE [km/h] or [mph]	×	×	×	×	×	Indicates vehicle speed calculated from ADAS control unit through CAN communication [ABS actuator and electric unit (control unit) transmits vehicle speed signal (wheel speed) through CAN communication]
SET VHCL SPD [km/h] or [mph]	×	×				Indicates set vehicle speed memorized in ADAS control unit
BUZZER O/P [On/Off]	×				×	Indicates [On/Off] status of ICC warning chime output
THRTL SENSOR [deg]	×	×				<b>NOTE:</b> The item is displayed, but it is not monitored
ENGINE RPM [rpm]	×					Indicates engine speed read from ADAS control unit through CAN communication (ECM transmits engine speed signal through CAN communication)
WIPER SW [OFF/LOW/HIGH]	×					Indicates wiper [OFF/LOW/HIGH] status (BCM transmits front wiper request signal through CAN communication)
BA WARNING [On/Off]	×					Indicates [On/Off] status of IBA OFF indicator lamp output
STP LMP DRIVE [On/Off]	×	×			×	Indicates [On/Off] status of ICC brake hold relay drive output

A

B

C

D

E

F

G

H

I

J

K

L

M

N

DAS

P

# DIAGNOSIS SYSTEM (ADAS CONTROL UNIT)

< SYSTEM DESCRIPTION >

[BCI]

Monitored item [Unit]	ALL SIG (ICC)	MAIN SIG (ICC)	MAIN SIG (LDW/LDP)	MAIN SIG (BSW/BSI)	BCI MAIN	Description
D RANGE SW [On/Off]	×					Indicates [On/Off] status of "D" or "M" positions read from ADAS control unit through CAN communication; ON when position "D" or "M" (TCM transmits shift position signal through CAN communication).
NP RANGE SW [On/Off]	×					Indicates shift position signal read from ADAS control unit through CAN communication (TCM transmits shift position signal through CAN communication)
PKB SW [On/Off]	×					Parking brake switch status [On/Off] judged from the parking brake switch signal that ADAS control unit readout via CAN communication is displayed (Combination meter transmits the parking brake switch signal via CAN communication)
PWR SUP MONI [V]	×	×				Indicates IGN voltage input by ADAS control unit
VHCL SPD AT [km/h] or [mph]	×					Indicates vehicle speed calculated from CVT vehicle speed sensor read from ADAS control unit through CAN communication (TCM transmits CVT vehicle speed sensor signal through CAN communication)
THRTL OPENING [%]	×	×			×	Indicates throttle position read from ADAS control unit through CAN communication (ECM transmits accelerator pedal position signal through CAN communication).
GEAR [1, 2, 3, 4, 5, 6]	×					Indicates CVT gear position read from ADAS control unit through CAN communication (TCM transmits current gear position signal through CAN communication)
MODE SIG [OFF, ICC, ASCD]	×					Indicates the active mode from ICC or ASCD [conventional (fixed speed) cruise control mode]
SET DISP IND [On/Off]	×					Indicates [On/Off] status of SET switch indicator output
DISTANCE [m]	×					Indicates the distance from the vehicle ahead
RELATIVE SPD [m/s]	×					Indicates the relative speed of the vehicle ahead
Camera lost [Detect/Deviate/Both]			×	×		Indicates a lane marker detection state judged from a lane marker detection signal read by the ADAS control unit via ITS communication (Lane camera unit transmits a lane marker signal via ITS communication)
Lane unclear [On/Off]			×	×		Indicates an ON/OFF state of the lane marker. The ON/OFF state is judged from a detected lane condition signal read by the ADAS control unit via ITS communication (The lane camera unit transmits a detected lane condition signal via ITS communication)
STATUS signal [Stnby/Warn/Cancl/Off]			×			Indicates a control state of LDP system
DYNA ASIST SW [On/Off]	×	×		×		Indicates [On/Off] status as judged from ICC steering switch signal (ECM transmits ICC steering switch signal through CAN communication)
DCA ON IND [On/Off]	×					The status [ON/OFF] of DCA system switch indicator output is displayed
DCA VHL AHED [On/Off]	×					The status [ON/OFF] of vehicle ahead detection indicator output in DCA system is displayed
IBA SW [On/Off]	×	×				Indicates [On/Off] status of IBA OFF switch
APA TEMP [°C]	×				×	Accelerator pedal actuator integrated motor temperature that the ADAS control unit readout via ITS communication is displayed (Accelerator pedal actuator transmits the integrated motor temperature via ITS communication)

# DIAGNOSIS SYSTEM (ADAS CONTROL UNIT)

< SYSTEM DESCRIPTION >

[BCI]

Monitored item [Unit]	ALL SIG (ICC)	MAIN SIG (ICC)	MAIN SIG (LDW/LDP)	MAIN SIG (BSW/BSI)	BCI MAIN	Description
APA PWR [V]	×				×	Accelerator pedal actuator power supply voltage that the ADAS control unit read-out via ITS communication is displayed (Accelerator pedal actuator transmits the power supply voltage via ITS communication)
FCW SYSTEM ON [On/Off]	×	×				Indicates [On/Off] status of FCW system
LDW SYSTEM ON [On/Off]			×			Indicates [On/Off] status of LDW system
LDW ON LAMP [On/Off]			×			Indicates [On/Off] status of warning systems ON indicator output
LDP ON IND [On/Off]			×			Indicates [On/Off] status of LDP ON indicator lamp (Green) output
LANE DPRT W/L [On/Off]			×			Indicates [On/Off] status of lane departure warning lamp (Yellow) output
LDW BUZER OUTPUT [On/Off]			×			Indicates [On/Off] status of warning buzzer output
LDP SYSTEM ON [On/Off]			×			Indicates [On/Off] status of LDP system
READY signal [On/Off]			×			Indicates LDP system settings
Shift position [Off, P, R, N, D, M/T1 - 7]			×	×	×	Indicates shift position read from ADAS control unit through CAN communication (TCM transmits shift position signal through CAN communication)
Turn signal [OFF/LH/RH/LH&RH]			×	×		Indicates turn signal operation status read from ADAS control unit through CAN communication (BCM transmits turn indicator signal through CAN communication)
SIDE G [G]			×	×		Indicates lateral G acting on the vehicle. This lateral G is judged from a side G sensor signal read by ADAS control unit via CAN communication (The ABS actuator and electric unit (control unit) transmits a side G sensor signal via CAN communication)
FUNC ITEM(FCW)	×	×	×	×		Indicates systems which can be set to ON/OFF by selecting "Driver Assistance"⇒ "Driving aids" of the navigation system FCW: Distance Control Assist (DCA), Lane Departure Prevention (LDP) and Blind Spot Intervention
FUNC ITEM(LDW)	×	×	×	×		Indicates systems which can be set to ON/OFF by selecting "Driver Assistance"⇒ "Driving aids" of the navigation system LDW: Distance Control Assist (DCA), Lane Departure Prevention (LDP) and Blind Spot Intervention
FUNC ITEM(BSW)	×	×	×	×		Indicates systems which can be set to ON/OFF by selecting "Driver Assistance"⇒ "Driving aids" of the navigation system BSW: Distance Control Assist (DCA), Lane Departure Prevention (LDP) and Blind Spot Intervention
FUNC ITEM (NV-ICC) [Off]	×	×	×	×		<b>NOTE:</b> The item is displayed, but it is not monitored
FUNC ITEM (NV-DCA) [Off]	×	×	×	×		<b>NOTE:</b> The item is displayed, but it is not monitored
DCA SELECT [On/Off]	×	×	×	×		Indicates an ON/OFF state of DCA system. DCA system can be set to ON/OFF by selecting "Driver Assistance"⇒ "Driving aids" of the navigation system
LDP SELECT [On/Off]	×	×	×	×		Indicates an ON/OFF state of LDP system. LDP system can be set to ON/OFF by selecting "Driver Assistance"⇒ "Driving aids" of the navigation system

A  
B  
C  
D  
E  
F  
G  
H  
I  
J  
K  
L  
M  
N  
P

DAS

# DIAGNOSIS SYSTEM (ADAS CONTROL UNIT)

< SYSTEM DESCRIPTION >

[BCI]

Monitored item [Unit]	ALL SIG (ICC)	MAIN SIG (ICC)	MAIN SIG (LDW/LDP)	MAIN SIG (BSW/BSI)	BCI MAIN	Description
BSI SELECT [On/Off]	×	×	×	×		Indicates an ON/OFF state of Blind Spot Intervention system. Blind Spot Intervention system can be set to ON/OFF by selecting "Driver Assistance"⇒"Driving aids" of the navigation system
DRIVE MODE STATS [SNO/ECO/STD/SPT]	×	×	×	×		Indicates [On/Off] status of warning systems switch
WARN SYS SW [On/Off]	×	×	×	×		Indicates [On/Off] status of warning systems switch
BSW/BSI WARN LMP [On/Off]				×		Indicates [On/Off] status of Blind Spot Warning/Blind Spot Intervention warning lamp output
BSI ON IND [On/Off]				×		Indicates [On/Off] status of Blind Spot Intervention ON indicator output
BSW SYSTEM ON [On/Off]				×		Indicates [On/Off] status of BSW system
BSI SYSTEM ON [On/Off]				×		Indicates [On/Off] status of Blind Spot Intervention system
BCI SYSTEM ON [On/Off]					×	Indicates [On/Off] status of Backup Collision Intervention system
BCI SWITCH [On/Off]					×	Indicates [On/Off] status of Backup Collision Intervention system switch
LDP WARNING INDICA- TOR [On/Off]			×			Indicates [On/Off] status of Lane Departure Prevention system failure lamp
LDW ON INDICATOR [On/Off]			×			Indicates [On/Off] status of LDW system
LDW WARNING INDICA- TOR [On/Off]			×			Indicates [On/Off] status of Lane Departure Warning system failure lamp
SYSTEM CANCEL MES- SAGE [Request/No Request]	×	×	×	×		Indicates system cancel message request
CAMERA HI TEMP MSG [On/Off]			×	×		Indicates high temperature message has been received
ITS Setting Item(DCA) [On/Off]	×	×	×	×		Indicates [On/Off] status of Distance Control Assist warning lamp output
ITS Setting Item(LDP) [On/Off]	×	×	×	×		Indicates [On/Off] status of Lane Departure Prevention warning lamp output
ITS Setting Item(BSI) [On/Off]	×	×	×	×		Indicates [On/Off] status of Blind Spot Intervention system
BSI WARNING INDICA- TOR [On/Off]				×		Indicates [On/Off] status of Blind Spot Intervention warning lamp indicator
BSW ON INDICATOR [On/Off]				×		Indicates [On/Off] status of BSW system
BSW IND BRIGHTNESS [Bright/Not Bright]				×		Indicates BSW warning lamp indicator brightness level
WARN REQ [On/Off]			×			Indicates an ADAS control unit judged warning state (ON/OFF) of LDP system

# DIAGNOSIS SYSTEM (ADAS CONTROL UNIT)

< SYSTEM DESCRIPTION >

[BCI]

## WORK SUPPORT

A  
B  
C  
D  
E

Work support items	Description
CAUSE OF AUTO-CANCEL 1	Displays causes of automatic system cancellation occurred during control of the following systems <ul style="list-style-type: none"> <li>• Vehicle-to-vehicle distance control mode</li> <li>• Conventional (fixed speed) cruise control mode</li> <li>• Distance Control Assist (DCA)</li> </ul>
CAUSE OF AUTO-CANCEL 2	Displays causes of automatic system cancellation occurred during control of the following systems <ul style="list-style-type: none"> <li>• Lane Departure Prevention (LDP)</li> <li>• Blind Spot Intervention</li> </ul>
CAUSE OF AUTO-CANCEL 3	Displays causes of automatic system cancellation occurred during control of the following system <ul style="list-style-type: none"> <li>• Backup Collision Intervention</li> </ul>

**NOTE:**

- Causes of the maximum five cancellations (system cancel) are displayed.
- The displayed cancellation causes display the number of the ignition switch ON/OFF up to 254. It is fixed to 254 if it is over 254. It returns to 0 when the same cancellation cause is detected again.

F

Display Items for The Cause of Automatic Cancellation 1

G

Cause of cancellation	Vehicle-to-vehicle distance control mode	Conventional (fixed speed) cruise control mode	Distance Control Assist	Description
OPERATING ABS	×		×	ABS function was operated
OPERATING TCS	×	×	×	TCS function was operated
OPERATING VDC	×	×	×	VDC function was operated
ECM CIRCUIT	×	×		ECM did not permit ICC operation
OPE SW VOLT CIRC	×	×	×	The ICC steering switch input voltage is not within standard range
LASER TEMP	×		×	Temperature around ICC sensor became low
SNOW MODE SW	×		×	SNOW mode switch was pressed
OP SW DOUBLE TOUCH	×	×		ICC steering switches were pressed at the same time
VHCL SPD DOWN	×	×	×	Vehicle speed lower than the speed as follows <ul style="list-style-type: none"> <li>• Vehicle-to-vehicle distance control mode is 24 km/h (15 MPH)</li> <li>• Conventional (fixed speed) cruise control mode is 22 km/h (14 MPH)</li> </ul>
WHL SPD ELEC NOISE	×	×	×	Wheel speed sensor signal caught electromagnetic noise
VDC/TCS OFF SW	×		×	VDC OFF switch was pressed
VHCL SPD UNMATCH	×	×	×	Wheel speed became different from CVT vehicle speed
FR RADAR BLOCKED	×		×	The front bumper near the ICC sensor is blocked or dirty
TIRE SLIP	×	×		Wheel slipped

H

I

J

K

L

M

N

DAS

P

# DIAGNOSIS SYSTEM (ADAS CONTROL UNIT)

< SYSTEM DESCRIPTION >

[BCI]

IGN LOW VOLT	×	×	×	Decrease in ADAS control unit IGN voltage
PARKING BRAKE ON	×	×		The parking brake is engaged
WHEEL SPD UNMATCH	×	×	×	The wheel speeds of 4 wheels are out of the specified values
INCHING LOST	×			A vehicle ahead is not detected during the following driving when the vehicle speed is approximately 24 km/h (15 MPH) or less
CAN COMM ERROR	×	×	×	ADAS control unit received an abnormal signal with CAN communication
ABS/TCS/VDC CIRC	×	×	×	An abnormal condition occurs in VDC/TCS/ABS system
ECD CIRCUIT	×	×	×	An abnormal condition occurs in ECD system
ASCD VHCL SPD DTAC		×		Vehicle speed is detached from set vehicle speed
ASCD DOUBLE COMD		×		Cancel switch and operation switch are detected simultaneously
APA HI TEMP			×	The accelerator pedal actuator integrated motor temperature is high
ICC SENSOR CAN COMM ERR	×		×	Communication error between ADAS control unit and the ICC sensor
ABS WARNING LAMP	×		×	ABS warning lamp ON
NO RECORD	×	×	×	—

## Display Items for The Cause of Automatic Cancellation 2

Cause of cancellation	Lane departure prevention	Blind spot intervention	Description
OPE VDC/TCS/ABS 1	×		The activation of VDC, TCS, or ABS during LDP system control
Vehicle dynamics	×		Vehicle behavior exceeds specified value
Steering speed	×		Steering speed was more than the specified value in evasive direction
End by yaw angle	×		Yaw angle was the end of LDP control
Departure yaw large	×		Detected more than the specified value of yaw angle in departure direction
ICC WARNING	×		Target approach warning of ICC system, IBA system, or FCW system was activated
CURVATURE	×		Road curve was more than the specified value
Steering angle large	×		Steering angle was more than the specified value
Brake is operated	×		Brake pedal was operated
IGN LOW VOLT	×		Decrease in ADAS control unit IGN voltage
Lateral offset	×		Distance of vehicle and lane was detached in lateral direction more than the specified value
Lane marker lost	×		Lane camera unit lost the trace of lane marker
Lane marker unclear	×		Detected lane marker was unclear
Yaw acceleration	×		Detected yawing speed was more than the specified value
Deceleration large	×		Deceleration in a longitudinal direction was more than the specified value
Accel is operated	×		Accelerator pedal was depressed
Departure steering	×		Steering wheel was steered more than the specified value in departure direction
Evasive steering	×		Steering wheel was steered more than the specified value in the evasive direction
R range	×		Selector lever was operated to R range
Parking brake drift	×		Rear wheels lock was detected



# DIAGNOSIS SYSTEM (ADAS CONTROL UNIT)

< SYSTEM DESCRIPTION >

[BCI]

Cause of cancellation	Lane departure prevention	Blind spot intervention	Description	A B C D E F G H I J K L M N P
Not operating condition	×		Did not meet the operating condition (vehicle speed, turn signal operation, etc.)	
SNOW MODE SW	×		SNOW mode switch was pressed	
VDC OFF SW	×		VDC OFF switch was pressed	
OPE VDC/ABS 2	×		The activation of VDC or ABS during a standby time of LDP system control	
BSI WARNING	×		Blind Spot Intervention system was activated	
BSI) OPE VDC/TCS/ ABS 1		×	The activation of VDC, TCS, or ABS during Blind Spot Intervention system control	
BSI) Vehicle dynamics		×	Vehicle behavior exceeds specified value	
BSI) Steering speed		×	Steering speed was more than the specified value in evasive direction	
BSI) End by yaw angle		×	Yaw angle was the end of Blind Spot Intervention control	
BSI) Departure yaw large		×	Detected more than the specified value of yaw angle in departure direction	
BSI) ICC WARNING		×	Target approach warning of ICC system, IBA system or FCW system was activated	
BSI) CURVATURE		×	Road curve was more than the specified value	
BSI) Steering angle large		×	Steering angle was more than the specified value	
BSI) Brake is operated		×	Brake pedal was operated	
BSI) IGN LOW VOLT		×	Decrease in ADAS control unit IGN voltage	
BSI) Lateral offset		×	Distance of vehicle and lane was detached in lateral direction more than the specified	
BSI) Lane marker lost		×	Lane camera unit lost the trace of lane marker	
BSI) Lane marker unclear		×	Detected lane marker was unclear	
BSI) Yaw acceleration		×	Detected yawing speed was more than the specified value	
BSI) Deceleration large		×	Deceleration in a longitudinal direction was more than the specified value	
BSI) Accel is operated		×	Accelerator pedal was depressed	
BSI) Departure steering		×	Steering wheel was steered more than the specified value in departure direction	
BSI) Evasive steering		×	Steering wheel was steered more than the specified value in the evasive direction	
BSI) R range		×	Selector lever was operated to R range	
BSI) Parking brake drift		×	Rear wheels lock was detected	
BSI) SNOW MODE SW		×	SNOW mode switch was pressed	
BSI) VDC OFF SW		×	VDC OFF switch was pressed	
BSI) OPE VDC/ABS 2		×	The activation of VDC or ABS during a standby time of Blind Spot Intervention system control	DAS
BSI) Not operating condition		×	Did not meet the operating condition (vehicle speed, turn signal operation, etc.)	
Side Radar Lost		×	Unrecognized side radar LH or RH by the ADAS control unit	
NO RECORD	×	×	—	

Display Items for The Cause of Automatic Cancellation 3

# DIAGNOSIS SYSTEM (ADAS CONTROL UNIT)

< SYSTEM DESCRIPTION >

[BCI]

Cause of cancellation	Backup Collision Intervention	Description
OPERATING WIPER	×	The wiper operates at HI (it includes when the wiper is operated at HI with the wiper switch AUTO position)
OPERATING ABS	×	ABS function was operated
OPERATING TCS	×	TCS function was operated
OPERATING VDC	×	VDC function was operated
ECM CIRCUIT	×	ECM did not permit ICC operation
SNOW MODE SW	×	SNOW mode switch was pressed
VDC/TCS OFF SW	×	VDC OFF switch was pressed
VHCL SPD UNMATCH	×	Wheel speed became different from CVT vehicle speed
TIRE SLIP	×	Wheel slipped
IGN LOW VOLT	×	Decrease in ADAS control unit IGN voltage
PARKING BRAKE ON	×	The parking brake is engaged
WHEEL SPD UNMATCH	×	The wheel speeds of 4 wheels are out of the specified values
CAN COMM ERROR	×	ADAS control unit received an abnormal signal with CAN communication
ABS/TCS/VDC CIRC	×	An abnormal condition occurs in VDC/TCS/ABS system
ECD CIRCUIT	×	An abnormal condition occurs in ECD system
APA HI TEMP		The accelerator pedal actuator integrated motor temperature is high
ABS WARNING LAMP	×	ABS warning lamp ON
Brake is operated	×	Brake pedal was operated
Accel is operated	×	Accelerator pedal was depressed
SNOW MODE SW	×	DMS switch SNOW mode was selected
VDC OFF SW	×	VDC OFF switch was pressed
Side Radar Lost	×	Unrecognized side radar LH or RH by the ADAS control unit
NO RECORD	×	—

## ACTIVE TEST

### CAUTION:

- Never perform “Active Test” while driving the vehicle.
- The “Active Test” cannot be performed when the following systems warning lamp is illuminated.
  - ICC system warning lamp
  - Lane departure warning lamp
  - Blind Spot Warning/Blind Spot Intervention warning lamp
  - IBA OFF indicator lamp (IBA system ON)
- Shift the selector lever to “P” position, and then perform the test.

Test item	Description
BRAKE ACTUATOR	Activates the brake by an arbitrary operation
ICC BUZZER	Sounds a buzzer used for following systems by arbitrarily operating ON/OFF <ul style="list-style-type: none"> <li>• Intelligent Cruise Control (ICC)</li> <li>• Distance Control Assist (DCA)</li> <li>• Forward Collision Warning (FCW)</li> <li>• Intelligent Brake Assist (IBA)</li> </ul>

# DIAGNOSIS SYSTEM (ADAS CONTROL UNIT)

< SYSTEM DESCRIPTION >

[BCI]

Test item	Description
METER LAMP	The ICC system warning lamp, MAIN switch indicator and IBA OFF indicator lamp can be illuminated by ON/OFF operations as necessary
STOP LAMP	The ICC brake hold relay can be operated by ON/OFF operations as necessary, and the stop lamp can be illuminated
ACTIVE PEDAL	The accelerator pedal actuator can be operated as necessary
DCA INDICATOR	The DCA system switch indicator can be illuminated by ON/OFF operations as necessary
LDP BUZZER	Sounds a buzzer used for following systems by arbitrarily operating ON/OFF <ul style="list-style-type: none"> <li>• Lane Departure Warning (LDW)</li> <li>• Lane Departure Prevention (LDP)</li> <li>• Blind Spot Warning (BSW)</li> <li>• Blind Spot Intervention</li> </ul>
WARNING SYSTEM IND	Warning systems ON indicator (on warning systems switch) can be illuminated by ON/OFF operations as necessary
LDP ON IND	The LDP ON indicator lamp can be illuminated by ON/OFF operations as necessary
LANE DEPARTURE W/L	The Lane departure warning lamp can be illuminated by ON/OFF operations as necessary
BSW/BSI WARNING LAMP	The Blind Spot Warning/Blind Spot Intervention warning lamp can be illuminated by ON/OFF operations as necessary
BSI ON INDICATOR	The Blind Spot Intervention ON indicator can be illuminated by ON/OFF operations as necessary
LDW ON INDICATOR	The LDW ON indicator lamp can be illuminated by ON/OFF operations as necessary
BSW ON INDICATOR	The BSW ON indicator lamp can be illuminated by ON/OFF operations as necessary

## BRAKE ACTUATOR

### NOTE:

The test can be performed only when the engine is running.

Test item	Operation	Description	"PRESS SENS" value
BRAKE ACTUATOR	MODE1	Transmits the brake fluid pressure control signal to the ABS actuator and electric unit (control unit) via CAN communication	10 bar
	MODE2		20 bar
	MODE3		30 bar
	Test start	Starts the tests of "MODE1", "MODE2" and "MODE3"	—
	Reset	Stops transmitting the brake fluid pressure control signal below to end the test	—
	End	Returns to the "SELECT TEST ITEM" screen	—

### NOTE:

The test is finished in 10 seconds after starting

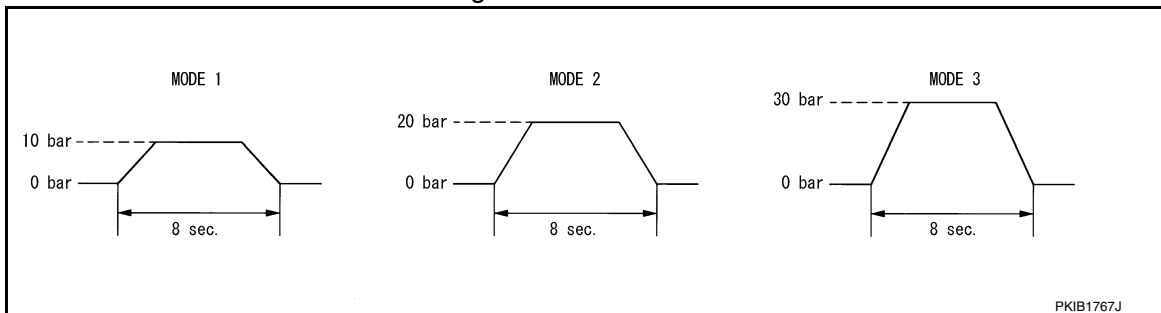

## ICC BUZZER

A  
B  
C  
D  
E  
F  
G  
H  
I  
J  
K  
L  
M  
N  
P

DAS

# DIAGNOSIS SYSTEM (ADAS CONTROL UNIT)

< SYSTEM DESCRIPTION >

[BCI]

Test item	Operation	Description	ICC warning chime operation sound
ICC BUZZER	MODE1	Transmits the buzzer output signals to the combination meter via CAN communication	Intermittent beep sound
	Test start	Starts the tests of "MODE1"	—
	Reset	Stops transmitting the buzzer output signal below to end the test	—
	End	Returns to the "SELECT TEST ITEM" screen	—

## METER LAMP

### NOTE:

The test can be performed only when the engine is running.

Test item	Operation	Description	<ul style="list-style-type: none"> <li>• MAIN switch indicator</li> <li>• ICC system warning lamp</li> <li>• IBA OFF indicator lamp</li> </ul>
METER LAMP	Off	Stops sending the following signals to exit from the test <ul style="list-style-type: none"> <li>• Meter display signal</li> <li>• ICC warning lamp signal</li> <li>• IBA OFF indicator lamp signal</li> </ul>	OFF
	On	Transmits the following signals to the combination meter via CAN communication <ul style="list-style-type: none"> <li>• Meter display signal</li> <li>• ICC warning lamp signal</li> <li>• IBA OFF indicator lamp signal</li> </ul>	ON

## STOP LAMP

Test item	Operation	Description	Stop lamp
STOP LAMP	Off	Stops transmitting the ICC brake hold relay drive signal below to end the test	OFF
	On	Transmits the ICC brake hold relay drive signal	ON

## ACTIVE PEDAL

### CAUTION:

- Shift the selector lever to "P" position, and then perform the test.
- Never depress the accelerator pedal excessively. (The engine speed may rise unexpectedly when finishing the test.)

### NOTE:

- Depress the accelerator pedal to check when performing the test.
- The test can be performed only when the engine is running.

Test item	Operation	Description	Accelerator pedal operation
Active Pedal	MODE1	Transmit the accelerator pedal feedback force control signal to the accelerator pedal actuator via ITS communication.	Constant with a force of 25 N for 8 seconds
	MODE2		Constant with a force of 15 N for 8 seconds
	MODE3		Change up to a force of 25 N for 8 seconds
	MODE4		Change up to a force of 15 N for 8 seconds
	Test start	Starts the tests of "MODE1", "MODE2", "MODE3" and "MODE4"	—
	Reset	Stops transmitting the accelerator pedal feedback force control signal below to end the test.	—
	End	Returns to the "SELECT TEST ITEM" screen	—

# DIAGNOSIS SYSTEM (ADAS CONTROL UNIT)

< SYSTEM DESCRIPTION >

[BCI]

**NOTE:**

The test is finished in 10 seconds after starting

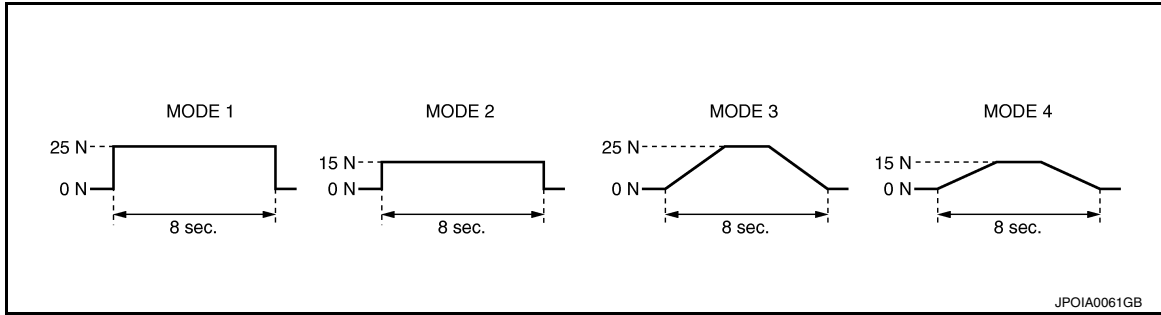

**DCA INDICATOR**

**NOTE:**

The test can be performed only when the engine is running.

Test item	Operation	Description	DCA system switch indicator
DCA INDICATOR	Off	Stops transmitting the DCA system switch indicator signal below to end the test	—
	On	Transmits the DCA system switch indicator signal to the combination meter via CAN communication	ON

**LDP BUZZER**

Test item	Operation	Description	Warning buzzer
LDP BUZZER	Off	Stops transmitting the warning buzzer signal below to end the test	—
	On	Transmits the warning buzzer signal to the warning buzzer	ON

**WARNING SYSTEM IND**

Test item	Operation	Description	Warning systems ON indicator
WARNING SYSTEM IND	Off	Stops transmitting the warning systems ON indicator signal below to end the test	—
	On	Transmits the warning systems ON indicator signal to the warning systems ON indicator	ON

**LDP ON IND**

Test item	Operation	Description	LDP ON indicator lamp (Green)
LDP ON IND	Off	Stops transmitting the LDP ON indicator lamp signal below to end the test	—
	On	Transmits the LDP ON indicator lamp signal to the combination meter via CAN communication	ON

**LANE DEPARTURE W/L**

Test item	Operation	Description	Lane departure warning lamp (Yellow)
LANE DEPARTURE W/L	Off	Stops transmitting the lane departure warning lamp signal below to end the test	—
	On	Transmits the lane departure warning lamp signal to the combination meter via CAN communication	ON

A  
B  
C  
D  
E  
F  
G  
H  
I  
J  
K  
L  
M  
N  
P

DAS

# DIAGNOSIS SYSTEM (ADAS CONTROL UNIT)

< SYSTEM DESCRIPTION >

[BCI]

## BSW/BSI WARNING LAMP

Test item	Operation	Description	Blind Spot Warning/Blind Spot Intervention warning lamp (Yellow)
BSW/BSI WARNING LAMP	Off	Stops transmitting the Blind Spot Warning/Blind Spot Intervention warning lamp signal below to end the test	—
	On	Transmits the Blind Spot Warning/Blind Spot Intervention warning lamp signal to the combination meter via CAN communication	ON

## BSI ON INDICATOR

Test item	Operation	Description	Blind Spot Intervention ON indicator lamp (Green)
BSI ON INDICATOR	Off	Stops transmitting the Blind Spot Intervention ON indicator signal below to end the test	—
	On	Transmits the Blind Spot Intervention ON indicator signal to the combination meter via CAN communication	ON

## LDW ON INDICATOR

Test item	Operation	Description	Lane Departure Warning ON indicator lamp (Yellow)
LDW ON INDICATOR	Off	Stops transmitting the Lane Departure Warning ON indicator signal below to end the test	—
	On	Transmits the Lane Departure Warning ON indicator signal to the combination meter via CAN communication	ON

## BSW ON INDICATOR

Test item	Operation	Description	Blind Spot Warning ON indicator lamp (Yellow)
BSW ON INDICATOR	Off	Stops transmitting the Blind Spot Warning ON indicator signal below to end the test	—
	On	Transmits the Blind Spot Warning ON indicator signal to the warning lamp on the door	ON

## ECU IDENTIFICATION

ADAS control unit part number is displayed.

# DIAGNOSIS SYSTEM (SIDE RADAR LH)

< SYSTEM DESCRIPTION >

[BCI]

## DIAGNOSIS SYSTEM (SIDE RADAR LH)

### CONSULT Function (SIDE RADAR LEFT)

INFOID:000000009716967

#### CAUTION:

After disconnecting the CONSULT vehicle interface (VI) from the data link connector, the ignition must be cycled OFF → ON (for at least 5 seconds) → OFF. If this step is not performed, the BCM may not go to “sleep mode”, potentially causing a discharged battery and a no-start condition.

#### DESCRIPTION

CONSULT performs the following functions by communicating with the side radar LH.

Select diag mode	Function
Self Diagnostic Result	Displays memorized DTC in the side radar.
Data Monitor	Displays real-time data of side radar.
Active Test	Enables operation check of electrical loads by sending driving signal to them.
ECU identification	Displays part number of side radar.

#### SELF DIAGNOSTIC RESULT

##### Self Diagnostic Result

Displays memorized DTC in side radar LH. Refer to [DAS-683, "DTC Index"](#).

##### FFD (Freeze Frame Data)

The side radar records the following data when the malfunction is detected.

Freeze Frame Data item	Description
VHCL SP from ADAS	The vehicle speed (from ADAS control unit) at the moment a malfunction is detected is displayed
TURN SIG STATUS	Turn signal status at the moment a malfunction is detected is displayed

#### DATA MONITOR

Monitored Item [unit]	Description	
SIDE RADAR MALF	Off	Side radar is normal.
	On	Side radar is malfunctioning.
BLOCKAGE COND	Off	Side radar is not blocked.
	On	Side radar is blocked.
VEHICLE DETECT	Off	Does not detect a vehicle within detection area.
	On	Detects a vehicle within detection area.

#### ACTIVE TEST

##### CAUTION:

- Never perform the active test while driving.
- Active test cannot be started while the Blind Spot Warning/Blind Spot Intervention indicator is illuminated.

Active test item	Operation	Description
BSW/BSI INDICATOR DRIVE	On	Outputs the voltage to illuminate the Blind Spot Warning/Blind Spot Intervention indicator.
	Off	Stops the voltage to illuminate the Blind Spot Warning/Blind Spot Intervention indicator.

#### ECU IDENTIFICATION

Side radar part number is displayed.

# DIAGNOSIS SYSTEM (SIDE RADAR RH)

< SYSTEM DESCRIPTION >

[BCI]

## DIAGNOSIS SYSTEM (SIDE RADAR RH)

### CONSULT Function (SIDE RADAR RIGHT)

INFOID:000000009716968

#### CAUTION:

After disconnecting the CONSULT vehicle interface (VI) from the data link connector, the ignition must be cycled OFF → ON (for at least 5 seconds) → OFF. If this step is not performed, the BCM may not go to “sleep mode”, potentially causing a discharged battery and a no-start condition.

#### DESCRIPTION

CONSULT performs the following functions by communicating with the side radar RH.

Select diag mode	Function
Self Diagnostic Result	Displays memorized DTC in the side radar.
Data Monitor	Displays real-time data of side radar.
Active Test	Enables operation check of electrical loads by sending driving signal to them.
ECU identification	Displays part number of side radar.

#### SELF DIAGNOSTIC RESULT

##### Self Diagnostic Result

Displays memorized DTC in side radar RH. Refer to [DAS-685, "DTC Index"](#).

##### FFD (Freeze Frame Data)

The side radar records the following data when the malfunction is detected.

Freeze Frame Data item	Description
VHCL SP from ADAS	The vehicle speed (from ADAS control unit) at the moment a malfunction is detected is displayed
TURN SIG STATUS	Turn signal status at the moment a malfunction is detected is displayed

#### DATA MONITOR

Monitored Item [unit]	Description	
SIDE RADAR MALF	Off	Side radar is normal.
	On	Side radar is malfunctioning.
BLOCKAGE COND	Off	Side radar is not blocked.
	On	Side radar is blocked.
VEHICLE DETECT	Off	Does not detect a vehicle within detection area.
	On	Detects a vehicle within detection area.

#### ACTIVE TEST

##### CAUTION:

- Never perform the active test while driving.
- Active test cannot be started while the Blind Spot Warning/Blind Spot Intervention indicator is illuminated.

Active test item	Operation	Description
BSW/BSI INDICATOR DRIVE	On	Outputs the voltage to illuminate the Blind Spot Warning/Blind Spot Intervention indicator.
	Off	Stops the voltage to illuminate the Blind Spot Warning/Blind Spot Intervention indicator.

#### ECU IDENTIFICATION

Side radar part number is displayed.



# ADAS CONTROL UNIT

< ECU DIAGNOSIS INFORMATION >

[BCI]

## ECU DIAGNOSIS INFORMATION

### ADAS CONTROL UNIT

Reference Value

INFOID:000000009716969

#### VALUES ON THE DIAGNOSIS TOOL

Monitor item	Condition	Value/Status	
MAIN SW	Ignition switch ON	When MAIN switch is pressed	On
		When MAIN switch is not pressed	Off
SET/COAST SW	Ignition switch ON	When SET/COAST switch is pressed	On
		When SET/COAST switch is not pressed	Off
CANCEL SW	Ignition switch ON	When CANCEL switch is pressed	On
		When CANCEL switch is not pressed	Off
RESUME/ACC SW	Ignition switch ON	When RESUME/ACCELERATE switch is pressed	On
		When RESUME/ACCELERATE switch is not pressed	Off
DISTANCE SW	Ignition switch ON	When DISTANCE switch is pressed	On
		When DISTANCE switch is not pressed	Off
CRUISE OPE	Drive the vehicle and activate the vehicle-to-vehicle distance control mode	When ICC system is controlling	On
		When ICC system is not controlling	Off
BRAKE SW	Ignition switch ON	When brake pedal is depressed	Off
		When brake pedal is not depressed	On
STOP LAMP SW	Ignition switch ON	When brake pedal is depressed	On
		When brake pedal is not depressed	Off
IDLE SW	Engine running	Idling	On
		Except idling (depress accelerator pedal)	Off
SET DISTANCE	<ul style="list-style-type: none"> <li>• Start the engine and turn the ICC system ON</li> <li>• Press the DISTANCE switch to change the vehicle-to-vehicle distance setting</li> </ul>	When set to "long"	Long
		When set to "middle"	Mid
		When set to "short"	Short
CRUISE LAMP	Start the engine and press MAIN switch	ICC system ON (MAIN switch indicator ON)	On
		ICC system OFF (MAIN switch indicator OFF)	Off
OWN VHCL	Start the engine and press MAIN switch	ICC system ON (Own vehicle indicator ON)	On
		ICC system OFF (Own vehicle indicator OFF)	Off
VHCL AHEAD	Drive the vehicle and activate the vehicle-to-vehicle distance control mode	When a vehicle ahead is detected (vehicle ahead detection indicator ON)	On
		When a vehicle ahead is not detected (vehicle ahead detection indicator OFF)	Off
ICC WARNING	Start the engine and press MAIN switch	When ICC system is malfunctioning (ICC system warning lamp ON)	On
		When ICC system is normal (ICC system warning lamp OFF)	Off

A  
B  
C  
D  
E  
F  
G  
H  
I  
J  
K  
L  
M  
N  
P

DAS

# ADAS CONTROL UNIT

< ECU DIAGNOSIS INFORMATION >

[BCI]

Monitor item	Condition		Value/Status
VHCL SPEED SE	While driving		Displays a vehicle speed calculated by the ADAS control unit
SET VHCL SPD	While driving	When vehicle speed is set	Displays the set vehicle speed
BUZZER O/P	Engine running	When the buzzer of the following system operates <ul style="list-style-type: none"> <li>• Vehicle-to-vehicle distance control mode</li> <li>• DCA system</li> <li>• FCW system</li> <li>• IBA system</li> </ul>	On
		When the buzzer of the following system not operates <ul style="list-style-type: none"> <li>• Vehicle-to-vehicle distance control mode</li> <li>• DCA system</li> <li>• FCW system</li> <li>• IBA system</li> </ul>	Off
THRTL SENSOR	<b>NOTE:</b> The item is indicated, but not monitored		0.0
ENGINE RPM	Engine running		Equivalent to tachometer reading
WIPER SW	Ignition switch ON	Wiper not operating	Off
		Wiper LO operation	Low
		Wiper HI operation	High
BA WARNING	Engine running	IBA OFF indicator lamp ON <ul style="list-style-type: none"> <li>• When IBA system is malfunctioning</li> <li>• When IBA system is turned to OFF</li> </ul>	On
		IBA OFF indicator lamp OFF <ul style="list-style-type: none"> <li>• When IBA system is normal</li> <li>• When IBA system is turned to ON</li> </ul>	Off
STP LMP DRIVE	Drive the vehicle and activate the vehicle-to-vehicle distance control mode	When ICC brake hold relay is activated	On
		When ICC brake hold relay is not activated	Off
D RANGE SW	Engine running	When the selector lever is in "D" position or manual mode	On
		When the selector lever is in any position other than "D" or manual mode	Off
NP RANGE SW	Engine running	When the selector lever is in "N", "P" position	On
		When the selector lever is in any position other than "N", "P"	Off
PKB SW	Ignition switch ON	When the parking brake is applied	On
		When the parking brake is released	Off
PWR SUP MONI	Engine running		Power supply voltage value of ADAS control unit
VHCL SPD AT	While driving		Value of CVT vehicle speed sensor signal
THRTL OPENING	Engine running	Depress accelerator pedal	Displays the throttle position

# ADAS CONTROL UNIT

< ECU DIAGNOSIS INFORMATION >

[BCI]

Monitor item	Condition		Value/Status
GEAR	While driving		Displays the gear position
MODE SIG	Start the engine and press MAIN switch	When ICC system is deactivated	Off
		When vehicle-to-vehicle distance control mode is activated	ICC
		When conventional (fixed speed) cruise control mode is activated	ASCD
SET DISP IND	<ul style="list-style-type: none"> <li>• Drive the vehicle and activate the conventional (fixed speed) cruise control mode</li> <li>• Press SET/COAST switch</li> </ul>	SET switch indicator ON	On
		SET switch indicator OFF	Off
DISTANCE	Drive the vehicle and activate the vehicle-to-vehicle distance control mode	When a vehicle ahead is detected	Displays the distance from the preceding vehicle
		When a vehicle ahead is not detected	0.0
RELATIVE SPD	Drive the vehicle and activate the vehicle-to-vehicle distance control mode	When a vehicle ahead is detected	Displays the relative speed.
		When a vehicle ahead is not detected	0.0
Camera lost	Drive the vehicle and activate the LDW system, LDP system or Blind Spot Intervention system	Both side lane markers are detected	Detect
		Deviate side lane marker is lost	Deviate
		Both side lane markers are lost	Both
Lane unclear	While driving	Lane marker is unclear	On
		Lane marker is clear	Off
STATUS signal	Drive the vehicle with the LDP system turned ON	When the LDP system is ON	Stnby
		When the LDP system is operating	Warn
		When the LDP system is canceled	Cancl
		When the LDP system is OFF	Off
DYNA ASIST SW	Ignition switch ON	When dynamic driver assistance switch is pressed	On
		When dynamic driver assistance switch is not pressed	Off
DCA ON IND	Start the engine and press dynamic driver assistance switch (When DCA system setting is ON)	DCA system OFF (DCA system switch indicator OFF)	Off
		DCA system ON (DCA system switch indicator ON)	On
DCA VHL AHED	Drive the vehicle and activate the DCA system	When a vehicle ahead is not detected (vehicle ahead detection indicator OFF)	Off
		When a vehicle ahead is detected (vehicle ahead detection indicator ON)	On
IBA SW	Ignition switch ON	When the IBA OFF switch is pressed	On
		When the IBA OFF switch is not pressed	Off
APA TEMP	Engine running		Display the accelerator pedal actuator integrated motor temperature
APA PWR	Ignition switch ON		Power supply voltage value of accelerator pedal actuator

A  
B  
C  
D  
E  
F  
G  
H  
I  
J  
K  
L  
M  
N  
DAS  
P

# ADAS CONTROL UNIT

< ECU DIAGNOSIS INFORMATION >

[BCI]

Monitor item	Condition		Value/Status
FCW SYSTEM ON	Ignition switch ON	When the FCW system is ON (Warning systems ON indicator ON)	On
		When the FCW system is OFF (Warning systems ON indicator OFF)	Off
LDW SYSTEM ON	Ignition switch ON	When the LDW system is ON (Warning systems ON indicator ON)	On
		When the LDW system is OFF (Warning systems ON indicator OFF)	Off
LDW ON LAMP	Ignition switch ON	Warning systems ON indicator ON	On
		Warning systems ON indicator OFF	Off
LDP ON IND	Start the engine and press dynamic driver assistance switch (When LDP system setting is ON)	LDP ON indicator lamp ON	On
		LDP ON indicator lamp OFF	Off
LANE DPRT W/L	Drive the vehicle and activate the LDW system or LDP system	Lane departure warning lamp ON	On
		Lane departure warning lamp OFF	Off
LDW BUZER OUTPUT	Drive the vehicle and activate the LDW/LDP system or Blind Spot Warning/Blind Spot Intervention system	When the buzzer of the following system operates • LDW/LDP system • Blind Spot Warning/Blind Spot Intervention system	On
		When the buzzer of the following system does not operate • LDW/LDP system • Blind Spot Warning/Blind Spot Intervention system	Off
LDP SYSTEM ON	Start the engine and press dynamic driver assistance switch (When LDP system setting is ON)	When the LDP system is ON	On
		When the LDP system is OFF	Off
READY signal	Start the engine and press dynamic driver assistance switch (When LDP system setting is ON)	When the LDP system is ON	On
		When the LDP system is OFF	Off
Shift position	<ul style="list-style-type: none"> <li>• Engine running</li> <li>• While driving</li> </ul>		Displays the shift position
Turn signal	Turn signal lamps OFF		Off
	Turn signal lamp LH blinking		LH
	Turn signal lamp RH blinking		RH
	Turn signal lamp LH and RH blinking		LH&RH
SIDE G	While driving	Vehicle turning right	Negative value
		Vehicle turning left	Positive value
FUNC ITEM (FCW)	Ignition switch ON		FCW
FUNC ITEM (LDW)	Ignition switch ON		LDW
FUNC ITEM (BSW)	Ignition switch ON		BSW
FUNC ITEM (NV-ICC)	<b>NOTE:</b> The item is indicated, but not monitored		Off
FUNC ITEM (NV-DCA)	<b>NOTE:</b> The item is indicated, but not monitored		Off
DCA SELECT	Ignition switch ON	"Distance Control Assist" set with the navigation system is ON	On
		"Distance Control Assist" set with the navigation system is OFF	Off

# ADAS CONTROL UNIT

< ECU DIAGNOSIS INFORMATION >

[BCI]

Monitor item	Condition	Value/Status	
LDP SELECT	Ignition switch ON	"Lane Departure Prevention" set with the navigation system is ON	On
		"Lane Departure Prevention" set with the navigation system is OFF	Off
BSI SELECT	Ignition switch ON	"Blind Spot Intervention" set with the navigation system is ON	On
		"Blind Spot Intervention" set with the navigation system is OFF	Off
DRIVE MODE STATS	Ignition switch ON	When the DMS switch is in normal position	Std
		When the DMS switch is in SNOW position	SNO
		When the DMS switch is in ECO position	ECO
		When the DMS switch is in SPORT position	SPT
WARN SYS SW	Ignition switch ON	When warning systems switch is pressed	On
		When warning systems switch is not pressed	Off
BSW/BSI WARN LMP	Ignition switch ON	Blind Spot Warning/Blind Spot Intervention warning lamp ON	On
		Blind Spot Warning/Blind Spot Intervention warning lamp OFF	Off
BSI ON IND	Ignition switch ON	Blind Spot Intervention ON indicator ON	On
		Blind Spot Intervention ON indicator OFF	Off
BSW SYSTEM ON	Ignition switch ON	When the BSW system is ON (Warning systems ON indicator ON)	On
		When the BSW system is OFF (Warning systems ON indicator OFF)	Off
BSI SYSTEM ON	Start the engine and press dynamic driver assistance switch (When Blind Spot Intervention system setting is ON)	When the Blind Spot Intervention system is ON	On
		When the Blind Spot Intervention system is OFF	Off
BCI SYSTEM ON	Ignition switch ON	Back-up Collision Intervention system ON	On
		Back-up Collision Intervention system OFF	Off
BCI SWITCH	Ignition switch ON	Back-up Collision Intervention switch ON	On
		Back-up Collision Intervention switch OFF	Off
LDP WARNING INDICATOR	Ignition switch ON	When the LDP fail lamp is ON (Warning systems ON indicator ON)	On
		When the LDP fail lamp is OFF	Off
LDW ON LAMP	Ignition switch ON	When LDW indicator lamp is ON	On
		When LDW indicator lamp is OFF	Off
LDW WARNING INDICATOR	Ignition switch ON	When LDW FAIL lamp is ON	On
		When LDW FAIL lamp is OFF	Off
SYSTEM CANCEL MESSAGE	Ignition switch ON	When a system cancel message is sent	Request
		When a system cancel message is not sent	No Request
CAMERA HI TEMP MSG	Ignition switch ON	When camera high temperature message is sent	On
		When camera high temperature message is not sent	Off
ITS Setting Item(DCA)	Ignition switch ON	When the DCA is set	On
		When the DCA is not set	Off
ITS Setting Item(LDP)	Ignition switch ON	When the LDP is set	On
		When the LDP is not set	Off

A  
B  
C  
D  
E  
F  
G  
H  
I  
J  
K  
L  
M  
N  
P

DAS

# ADAS CONTROL UNIT

< ECU DIAGNOSIS INFORMATION >

[BCI]

Monitor item	Condition		Value/Status
ITS Setting Item(BSI)	Ignition switch ON	When the BSI is set	On
		When the BSI is not set	Off
BSI WARNING INDICATOR	Ignition switch ON	When BSI FAIL indicator warning lamp is ON	On
		When BSI FAIL indicator warning lamp is OFF	Off
BSW ON INDICATOR	Ignition switch ON	When BSW ON indicator lamp is ON	On
		When BSW ON indicator lamp is OFF	Off
BSW IND BRIGHTNESS	Ignition switch ON	When BSW indicator brightness is selected	On
		When BSW indicator brightness is not selected	Off
WARN REQ	Drive the vehicle and activate the LDP system	Lane departure warning is operating	On
		Lane departure warning is not operating	Off

TERMINAL LAYOUT  
PHYSICAL VALUES

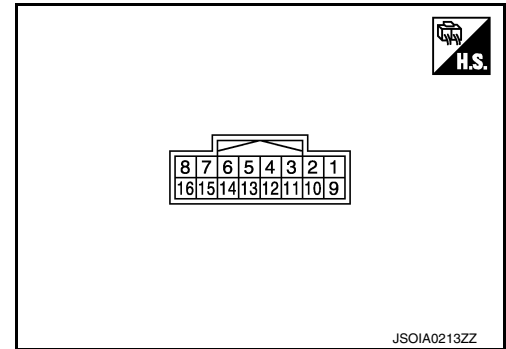

Terminal No. (Wire color)		Description		Condition	Value (Approx.)
+	-	Signal name	Input/ Output		
5 (G)	Ground	ICC brake hold relay drive signal	Output	Ignition switch ON	12 V
				At "STOP LAMP" test of "Active test"	0 V
6 (B)		Ground	Input	—	0 V
7 (L)		ITS communication-H	—	—	—
8 (Y)		ITS communication-L	—	—	—
14 (B)		CAN -H	—	—	—
15 (W)		CAN -L	—	—	—
16 (R)	Ignition power supply	Input	Ignition switch ON	Battery Voltage	

## Fail-safe

INFOID:000000009716970

If a malfunction occurs in each system, ADAS control unit cancels each control, sounds a beep, and turns ON the warning lamp or indicator lamp.

System	Buzzer	Warning lamp/Indicator lamp	Description
Vehicle-to-vehicle distance control mode	High-pitched tone	ICC system warning lamp	Cancel
Conventional (fixed speed) cruise control mode	High-pitched tone	ICC system warning lamp	Cancel

# ADAS CONTROL UNIT

< ECU DIAGNOSIS INFORMATION >

[BCI]

System	Buzzer	Warning lamp/Indicator lamp	Description
Intelligent Brake Assist (IBA)	High-pitched tone	IBA OFF indicator lamp	Cancel
Forward Collision Warning (FCW)	High-pitched tone	Warning message	Cancel
Distance Control Assist (DCA)	High-pitched tone	DCA system warning	Cancel
Lane Departure Warning (LDW)	—	Lane departure warning lamp	Cancel
Lane Departure Prevention (LDP)	Low-pitched tone	Lane departure warning lamp	Cancel
Blind Spot Warning (BSW)	—	Blind Spot Warning/Blind Spot Intervention warning lamp	Cancel
Blind Spot Intervention	Low-pitched tone	Blind Spot Warning/Blind Spot Intervention warning lamp	Cancel
Backup Collision Intervention (BCI)	High-pitched tone	Backup Collision Intervention warning indicator	Cancel

## DTC Inspection Priority Chart

INFOID:000000009716971

If multiple DTCs are detected simultaneously, check them one by one depending on the following DTC inspection priority chart.

Priority	Detected items (DTC)
1	<ul style="list-style-type: none"> <li>• C1A0A: CONFIG UNFINISHED</li> <li>• U1507: LOST COMM (SIDE RDR R)</li> <li>• U1508: LOST COMM (SIDE RDR L)</li> </ul>
2	<ul style="list-style-type: none"> <li>• U1000: CAN COMM CIRCUIT</li> <li>• U1010: CONTROL UNIT (CAN)</li> </ul>
3	<ul style="list-style-type: none"> <li>• C1B00: CAMERA UNIT MALF</li> <li>• C1F02: APA C/U MALF</li> <li>• C1A17: ICC SENSOR MALF</li> <li>• C1B53: SIDE RDR R MALF</li> <li>• C1B54: SIDE RDR L MALF</li> </ul>

DAS

# ADAS CONTROL UNIT

< ECU DIAGNOSIS INFORMATION >

[BCI]

Priority	Detected items (DTC)
4	<ul style="list-style-type: none"> <li>• C1A01: POWER SUPPLY CIR</li> <li>• C1A02: POWER SUPPLY CIR 2</li> <li>• C1A04: ABS/TCS/VDC CIRC</li> <li>• C1A05: BRAKE SW/STOP L SW</li> <li>• C1A06: OPERATION SW CIRC</li> <li>• C1A12: LASER BEAM OFFCNTR</li> <li>• C1A13: STOP LAMP RLY FIX</li> <li>• C1A14: ECM CIRCUIT</li> <li>• C1A16: RADAR STAIN</li> <li>• C1A18: LASER AIMING INCOMP</li> <li>• C1A2A: ICC SEN PWR SUP CIR</li> <li>• C1A21: ICC SENSOR HIGH TEMP</li> <li>• C1A24: NP RANGE</li> <li>• C1A26: ECD MODE MALF</li> <li>• C1A27: ECD PWR SUPPLY CIR</li> <li>• C1A33: CAN TRANSMISSION ERR</li> <li>• C1A34: COMMAND ERROR</li> <li>• C1A35: APA CIR</li> <li>• C1A36: APA CAN COMM CIR</li> <li>• C1A37: APA CAN CIR 2</li> <li>• C1A38: APA CAN CIR 1</li> <li>• C1A39: STRG SEN CIR</li> <li>• C1A40: SYSTEM SW CIRC</li> <li>• C1B01: CAM AIMING INCOMP</li> <li>• C1B03: CAM ABNRML TMP DETCT</li> <li>• C1B56: SONAR CIRCUIT</li> <li>• C1B57: AVM CIRCUIT</li> <li>• C1F01: APA MOTOR MALF</li> <li>• C1F05: APA PWR SUPPLY CIR</li> <li>• U0121: VDC CAN CIR 2</li> <li>• U0126: STRG SEN CAN CIR 1</li> <li>• U0235: ICC SENSOR CAN CIRC 1</li> <li>• U0401: ECM CAN CIR 1</li> <li>• U0402: TCM CAN CIR 1</li> <li>• U0415: VDC CAN CIR 1</li> <li>• U0428: STRG SEN CAN CIR 2</li> <li>• U1500: CAM CAN CIR 2</li> <li>• U1501: CAM CAN CIR 1</li> <li>• U1502: ICC SEN CAN COMM CIR</li> <li>• U1503: SIDE RDR L CAN CIR 2</li> <li>• U1504: SIDE RDR L CAN CIR 1</li> <li>• U1505: SIDE RDR R CAN CIR 2</li> <li>• U1506: SIDE RDR R CAN CIR 1</li> <li>• U1521: SONAR CAN COMMUNICATION</li> <li>• U1522: SONAR CAN COMMUNICATION</li> <li>• U1523: SONAR CAN COMMUNICATION</li> <li>• U1524: AVM CAN COMMUNICATION</li> <li>• U1525: AVM CAN COMMUNICATION</li> <li>• U150B: ECM CAN CIRC 3</li> <li>• U150C: VDC CAN CIRC 3</li> <li>• U150D: TCM CAN CIRC 3</li> <li>• U150E: BCM CAN CIRC 3</li> <li>• U150F: AV CAN CIRC 3</li> <li>• U1512: HVAC CAN CIRC3</li> <li>• U1513: METER CAN CIRC 3</li> <li>• U1514: STRG SEN CAN CIRC 3</li> <li>• U1515: ICC SENSOR CAN CIRC 3</li> <li>• U1516: CAM CAN CIRC 3</li> <li>• U1517: APA CAN CIRC 3</li> <li>• U1518: SIDE RDR L CAN CIRC 3</li> <li>• U1519: SIDE RDR R CAN CIRC 3</li> </ul>
5	<ul style="list-style-type: none"> <li>• C1A03: VHCL SPEED SE CIRC</li> </ul>
6	<ul style="list-style-type: none"> <li>• C1A15: GEAR POSITION</li> </ul>
7	<ul style="list-style-type: none"> <li>• C1A00: CONTROL UNIT</li> </ul>



# ADAS CONTROL UNIT

< ECU DIAGNOSIS INFORMATION >

[BCI]

## DTC Index

INFOID:000000009716972

**NOTE:**

- The details of time display are as per the following.
- CRNT: A malfunction is detected now
- PAST: A malfunction was detected in the past
- IGN counter is displayed on FFD (Freeze Frame Data).
- 0: The malfunctions that are detected now  
CAN communication system (U1000, U1010)
- 1 - 39: It increases like 0 → 1 → 2 ... 38 → 39 after returning to the normal condition whenever the ignition switch OFF → ON. It returns to 0 when a malfunction is detected again in the process.
- If it is over 39, it is fixed to 39 until the self-diagnosis results are erased.  
Other than CAN communication system (Other than U1000, U1010)
- 1 - 49: It increases like 0 → 1 → 2 ... 38 → 49 after returning to the normal condition whenever the ignition switch OFF → ON. It returns to 0 when a malfunction is detected again in the process.
- If it is over 49, it is fixed to 49 until the self-diagnosis results are erased.

Systems for fail-safe

- A: Vehicle-to-vehicle distance control mode
- B: Conventional (fixed speed) cruise control mode
- C: Intelligent Brake Assist (IBA)
- D: Forward Collision Warning (FCW)
- E: Distance Control Assist (DCA)
- F: Lane Departure Warning (LDW)/Lane Departure Prevention (LDP)
- G: Blind Spot Warning (BSW)/Blind Spot Intervention
- H: Backup Collision Intervention (BCI)

DTC			Warning lamp					Fail-safe	Reference
CONSULT	On board display		CONSULT display	ICC system warning lamp	IBA OFF indicator lamp	Lane departure warning lamp	Blind Spot Warning/Blind Spot Intervention warning lamp	Backup Collision Intervention	
C1A00	0	CONTROL UNIT	ON	ON	ON	ON	ON	A, B, C, D, E, F, G, H	<a href="#">DAS-73</a>
C1A01	1	POWER SUPPLY CIR	ON	ON	ON	ON	ON	A, B, C, D, E, F, G, H	<a href="#">DAS-74</a>
C1A02	2	POWER SUPPLY CIR 2	ON	ON	ON	ON	ON	A, B, C, D, E, F, G, H	<a href="#">DAS-74</a>
C1A03	3	VHCL SPEED SE CIRC	ON	ON	ON	ON	ON	A, B, C, D, E, F, G, H	<a href="#">DAS-160</a>
C1A04	4	ABS/TCS/VDC CIRC	ON	ON	ON	ON	ON	A, B, C, D, E, F, G, H	<a href="#">DAS-162</a>
C1A05	5	BRAKE SW/STOP L SW	ON	ON	ON	ON	ON	A, B, C, D, E, F, G, H	<a href="#">DAS-163</a>
C1A06	6	OPERATION SW CIRC	ON		ON	ON		A, B, E, F, G	<a href="#">DAS-167</a>
C1A12	12	LASER BEAM OFFCN-TR	ON	ON				A, C, D, E	<a href="#">DAS-170</a>
C1A13	13	STOP LAMP RLY FIX	ON	ON			ON	A, B, C, D, E, H	<a href="#">DAS-171</a>
C1A14	14	ECM CIRCUIT	ON		ON	ON	ON	A, B, E, F, G, H	<a href="#">DAS-177</a>

A  
B  
C  
D  
E  
F  
G  
H  
I  
J  
K  
L  
M  
N

DAS

P

# ADAS CONTROL UNIT

< ECU DIAGNOSIS INFORMATION >

[BCI]

Systems for fail-safe

- A: Vehicle-to-vehicle distance control mode
- B: Conventional (fixed speed) cruise control mode
- C: Intelligent Brake Assist (IBA)
- D: Forward Collision Warning (FCW)
- E: Distance Control Assist (DCA)
- F: Lane Departure Warning (LDW)/Lane Departure Prevention (LDP)
- G: Blind Spot Warning (BSW)/Blind Spot Intervention
- H: Backup Collision Intervention (BCI)

DTC		CONSULT display	Warning lamp					Fail-safe	Reference
CONSULT	On board display		ICC system warning lamp	IBA OFF indicator lamp	Lane departure warning lamp	Blind Spot Warning/Blind Spot Intervention warning lamp	Backup Collision Intervention	System	
C1A15	15	GEAR POSITION	ON	ON	ON	ON	ON	A, B, C, D, E, F, G, H	<a href="#">DAS-178</a>
C1A16	16	RADAR STAIN	ON	ON				A, C, D, E	<a href="#">DAS-180</a>
C1A17	17	ICC SENSOR MALF	ON	ON				A, B, C, D, E	<a href="#">DAS-181</a>
C1A18	18	LASER AIMING INCOMP	ON	ON				A, C, D, E	<a href="#">DAS-182</a>
C1A21	21	ICC SENSOR HIGH TEMP	ON	ON				A, B, C, D, E	<a href="#">DAS-183</a>
C1A24	24	NP RANGE	ON	ON	ON	ON	ON	A, B, C, D, E, F, G, H	<a href="#">DAS-184</a>
C1A26	26	ECD MODE MALF	ON	ON				A, B, C, D, E	<a href="#">DAS-186</a>
C1A27	27	ECD PWR SUPPLY CIR	ON	ON				A, B, C, D, E	<a href="#">DAS-187</a>
C1A33	33	CAN TRANSMISSION ERR	ON					A, B, E	<a href="#">DAS-189</a>
C1A34	34	COMMAND ERROR	ON					A, B, E	<a href="#">DAS-190</a>
C1A35	35	APA CIR	ON				ON	A, E, H	<a href="#">DAS-191</a>
C1A36	36	APA CAN COMM CIR	ON				ON	A, E, H	<a href="#">DAS-192</a>
C1A37	133	APA CAN CIR 2	ON				ON	A, B, E, H	<a href="#">DAS-193</a>
C1A38	132	APA CAN CIR 1	ON				ON	A, B, E, H	<a href="#">DAS-194</a>
C1A39	39	STRG SEN CIR	ON	ON		ON	ON	A, B, C, D, E, G, H	<a href="#">DAS-195</a>
C1A2A	80	ICC SEN PWR SUP CIR	ON	ON				A, C, D, E	<a href="#">DAS-188</a>
C1B00	81	CAMERA UNIT MALF			ON	ON		F, G	<a href="#">DAS-418</a>
C1B01	82	CAM AIMING INCOMP			ON	ON		F, G	<a href="#">DAS-420</a>
C1B03	83	CAM ABNRML TMP DETECT							<a href="#">DAS-422</a>
C1B53	84	SIDE RDR R MALF				ON	ON	G, H	<a href="#">DAS-577</a>
C1B54	85	SIDE RDR L MALF				ON	ON	G, H	<a href="#">DAS-578</a>
C1B56	87	SONAR CIRCUIT					ON	H	<a href="#">DAS-744</a>

# ADAS CONTROL UNIT

< ECU DIAGNOSIS INFORMATION >

[BCI]

A  
B  
C  
D  
E  
F  
G  
H  
I  
J  
K  
L  
M  
N  
P

- Systems for fail-safe
- A: Vehicle-to-vehicle distance control mode
  - B: Conventional (fixed speed) cruise control mode
  - C: Intelligent Brake Assist (IBA)
  - D: Forward Collision Warning (FCW)
  - E: Distance Control Assist (DCA)
  - F: Lane Departure Warning (LDW)/Lane Departure Prevention (LDP)
  - G: Blind Spot Warning (BSW)/Blind Spot Intervention
  - H: Backup Collision Intervention (BCI)

DTC		CONSULT display	Warning lamp					Fail-safe	Reference
CONSULT	On board display		ICC system warning lamp	IBA OFF indicator lamp	Lane departure warning lamp	Blind Spot Warning/Blind Spot Intervention warning lamp	Backup Collision Intervention	System	
C1B57	88	AVM CIRCUIT					ON	H	<a href="#">DAS-745</a>
C1F01	91	APA MOTOR MALF	ON				ON	A, E, H	<a href="#">DAS-196</a>
C1F02	92	APA C/U MALF	ON				ON	A, E, H	<a href="#">DAS-198</a>
C1F05	95	APA PWR SUPPLY CIR	ON				ON	A, E, H	<a href="#">DAS-201</a>
NO DTC IS DETECTED. FURTHER TESTING MAY BE REQUIRED	55	NO DTC IS DETECTED. FURTHER TESTING MAY BE REQUIRED	—	—	—	—	—	—	—
U0121	127	VDC CAN CIR 2	ON	ON	ON	ON	ON	A, B, C, D, E, F, G, H	<a href="#">DAS-205</a>
U0126	130	STRG SEN CAN CIR 1	ON	ON		ON	ON	A, B, C, D, E, G, H	<a href="#">DAS-206</a>
U0235	144	ICC SENSOR CAN CIRC 1	ON	ON				A, B, C, D, E	<a href="#">DAS-207</a>
U0401	120	ECM CAN CIR 1	ON		ON	ON	ON	A, B, E, F, G, H	<a href="#">DAS-208</a>
U0402	122	TCM CAN CIR 1	ON	ON	ON	ON	ON	A, B, C, D, E, F, G, H	<a href="#">DAS-209</a>
U0415	126	VDC CAN CIR 1	ON	ON	ON	ON	ON	A, B, C, D, E, F, G, H	<a href="#">DAS-210</a>
U0428	131	STRG SEN CAN CIR 2	ON	ON		ON	ON	A, B, C, D, E, G, H	<a href="#">DAS-211</a>
U1000 <sup>NOTE</sup>	100	CAN COMM CIRCUIT	ON	ON	ON	ON	ON	A, B, C, D, E, F, G, H	<a href="#">DAS-75</a>
U1010	110	CONTROL UNIT (CAN)	ON	ON	ON	ON	ON	A, B, C, D, E, F, G, H	<a href="#">DAS-76</a>
U1500	145	CAM CAN CIR 2			ON	ON		F, G	<a href="#">DAS-438</a>
U1501	146	CAM CAN CIR 1			ON	ON		F, G	<a href="#">DAS-439</a>
U1502	147	ICC SEN CAN COMM CIR	ON	ON				A, B, C, D, E	<a href="#">DAS-219</a>
U1503	150	SIDE RDR L CAN CIR 2				ON	ON	G, H	<a href="#">DAS-603</a>

DAS

# ADAS CONTROL UNIT

< ECU DIAGNOSIS INFORMATION >

[BCI]

Systems for fail-safe

- A: Vehicle-to-vehicle distance control mode
- B: Conventional (fixed speed) cruise control mode
- C: Intelligent Brake Assist (IBA)
- D: Forward Collision Warning (FCW)
- E: Distance Control Assist (DCA)
- F: Lane Departure Warning (LDW)/Lane Departure Prevention (LDP)
- G: Blind Spot Warning (BSW)/Blind Spot Intervention
- H: Backup Collision Intervention (BCI)

DTC		CONSULT display	Warning lamp					Fail-safe	Reference
CONSULT	On board display		ICC system warning lamp	IBA OFF indicator lamp	Lane departure warning lamp	Blind Spot Warning/Blind Spot Intervention warning lamp	Backup Collision Intervention	System	
U1504	151	SIDE RDR L CAN CIRC 1				ON	ON	G, H	<a href="#">DAS-604</a>
U1505	152	SIDE RDR R CAN CIRC 2				ON	ON	G, H	<a href="#">DAS-605</a>
U1506	153	SIDE RDR R CAN CIRC 1				ON	ON	G, H	<a href="#">DAS-606</a>
U1507	154	LOST COMM (SIDE RDR R)				ON	ON	G, H	<a href="#">DAS-607</a>
U1508	155	LOST COMM (SIDE RDR L)				ON	ON	G, H	<a href="#">DAS-608</a>
U150B	157	ECM CAN CIRC 3	ON		ON	ON	ON	A, B, E, F, G, H	<a href="#">DAS-215</a>
U150C	158	VDC CAN CIRC 3	ON	ON	ON	ON	ON	A, B, C, D, E, F, G, H	<a href="#">DAS-216</a>
U150D	159	TCM CAN CIRC 3	ON	ON	ON	ON	ON	A, B, C, D, E, F, G, H	<a href="#">DAS-217</a>
U150E	160	BCM CAN CIRC 3	ON		ON	ON	ON	A, B, E, F, G, H	<a href="#">DAS-218</a>
U150F	161	AV CAN CIRC 3							<a href="#">DAS-77</a>
U1512	162	HVAC CAN CIRC3			ON	ON		F, G	<a href="#">DAS-440</a>
U1513	163	METER CAN CIRC 3	ON	ON	ON	ON	ON	A, B, C, D, E, F, G, H	<a href="#">DAS-220</a>
U1514	164	STRG SEN CAN CIRC 3	ON	ON		ON	ON	A, B, C, D, E, G, H	<a href="#">DAS-221</a>
U1515	165	ICC SENSOR CAN CIRC 3	ON	ON				A, B, C, D, E	<a href="#">DAS-222</a>
U1516	166	CAM CAN CIRC 3			ON	ON		F, G	<a href="#">DAS-442</a>
U1517	167	APA CAN CIRC 3	ON				ON	A, B, E, H	<a href="#">DAS-223</a>
U1518	168	SIDE RDR L CAN CIRC 3				ON	ON	G, H	<a href="#">DAS-613</a>
U1519	169	SIDE RDR R CAN CIRC 3				ON	ON	G, H	<a href="#">DAS-614</a>
U1521	177	SONAR CHECKSUM					ON	H	<a href="#">DAS-781</a>
U1522	178	SONAR MESSAGE					ON	H	<a href="#">DAS-782</a>
U1523	179	SONAR CAN DLC					ON	H	<a href="#">DAS-783</a>

# ADAS CONTROL UNIT

< ECU DIAGNOSIS INFORMATION >

[BCI]

Systems for fail-safe

- A: Vehicle-to-vehicle distance control mode
- B: Conventional (fixed speed) cruise control mode
- C: Intelligent Brake Assist (IBA)
- D: Forward Collision Warning (FCW)
- E: Distance Control Assist (DCA)
- F: Lane Departure Warning (LDW)/Lane Departure Prevention (LDP)
- G: Blind Spot Warning (BSW)/Blind Spot Intervention
- H: Backup Collision Intervention (BCI)

DTC			Warning lamp					Fail-safe		Reference
			ICC system warning lamp	IBA OFF indicator lamp	Lane departure warning lamp	Blind Spot Warning/Blind Spot Intervention warning lamp	Backup Collision Intervention			
CONSULT	On board display	CONSULT display						System		
U1524	180	SONAR CAN DLC					ON	H	<a href="#">DAS-784</a>	
U1525	181	AVM MESSAGE					ON	H	<a href="#">DAS-785</a>	

**NOTE:**

With the detection of “U1000” some systems do not perform the fail-safe operation.

A system controlling based on a signal received from the control unit performs fail-safe operation when the communication with the ADAS control unit becomes inoperable.

A  
B  
C  
D  
E  
F  
G  
H  
I  
J  
K  
L  
M  
N  
P

DAS

# SIDE RADAR LH

< ECU DIAGNOSIS INFORMATION >

[BCI]

## SIDE RADAR LH

### Reference Value

INFOID:000000009716973

### VALUES ON THE DIAGNOSIS TOOL

#### CONSULT MONITOR ITEM

Monitor Item	Condition	Value/Status
SIDE RADAR MALF	Side radar is normal.	Off
	Side radar is malfunctioning.	On
BLOCKAGE COND	Side radar is not blocked.	Off
	Side radar is blocked.	On
VEHICLE DETECT	Radar does not detect a vehicle.	Off
	Radar detects a vehicle.	On

### TERMINAL LAYOUT

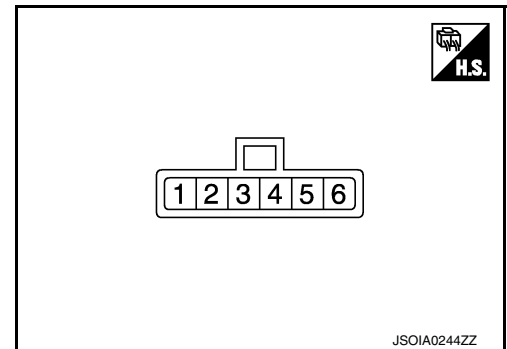

### PHYSICAL VALUES

Terminal No. (Wire color)		Description		Condition	Value (Approx.)
+	-	Signal name	Input/ Output		
2 (B)	Ground	Ground	—	—	0 V
3 (Y)	—	ITS communication-L	—	—	—
4 (L)	—	ITS communication-H	—	—	—
5 (R)	Ground	Ignition power supply	Input	Ignition switch ON	Battery voltage
6 (W)	Ground	Blind Spot Warning/Blind Spot Intervention indicator	Output	Approx. 2 sec. after ignition switch OFF ⇒ ON (bulb check)	6 V

### Fail-safe

INFOID:000000009716974

#### FAIL-SAFE CONTROL BY DTC

##### Blind Spot Warning (BSW)

If a malfunction occurs in the side radar, ADAS control unit cancels control, and turns ON the "Please see owner's manual" message in the vehicle information display.

##### Blind Spot Intervention

If a malfunction occurs in the side radar, ADAS control unit cancels control, sounds a beep, and turns ON the BSI system warning light (orange) in the vehicle information display.

#### TEMPORARY DISABLED STATUS AT BLOCKAGE

# SIDE RADAR LH

< ECU DIAGNOSIS INFORMATION >

[BCI]

## Blind Spot Warning (BSW)

When the side radar is blocked, the operation is temporarily cancelled. Then the "Unavailable Side Radar Obstruction" message appears in the vehicle information display and the warning systems ON indicator will blink. Also, under the following conditions, the operation may be temporarily cancelled.

- The side radar may be blocked by temporary ambient conditions such as splashing water, mist or fog.
- The blocked condition may also be caused by objects such as ice, frost or dirt obstructing the side radar.

## Blind Spot Intervention

When the side radar is blocked, the operation is temporarily cancelled. Then the buzzer sounds and the "Unavailable Side Radar Obstruction" message appears in the vehicle information display. Also, under the following conditions, the operation may be temporarily cancelled.

- The side radar may be blocked by temporary ambient conditions such as splashing water, mist or fog.
- The blocked condition may also be caused by objects such as ice, frost or dirt obstructing the side radar.

## DTC Inspection Priority Chart

INFOID:000000009716975

If some DTCs are displayed at the same time, perform inspections one by one based on the following priority chart.

Priority	Detected items (DTC)
1	<ul style="list-style-type: none"> <li>• U1000: CAN COMM CIRCUIT</li> <li>• U1010: CONTROL UNIT (CAN)</li> </ul>
2	<ul style="list-style-type: none"> <li>• U0104: ADAS CAN CIR 1</li> <li>• U0405: ADAS CAN CIR 2</li> </ul>
3	C1B50: SIDE RDR MALFUNCTION
4	<ul style="list-style-type: none"> <li>• C1B51: BSW/BSI IND SHORT CIR</li> <li>• C1B52: BSW/BSI IND OPEN CIR</li> <li>• C1B55: RADAR BLOCKAGE</li> </ul>

## DTC Index

INFOID:000000009716976

×: Applicable

DTC	Blind Spot Warning/Blind Spot Intervention warning lamp	Fail-safe	Reference page	
C1B50	SIDE RDR MALFUNCTION	ON	×	<a href="#">DAS-573</a>
C1B51	BSW/BSI IND SHORT CIR	ON	×	<a href="#">DAS-574</a>
C1B52	BSW/BSI IND OPEN CIR	ON	×	<a href="#">DAS-575</a>
C1B55	RADAR BLOCKAGE	Blink	×	<a href="#">DAS-579</a>
U1000	CAN COMM CIRCUIT	ON	×	<a href="#">DAS-580</a>
U1010	CONTROL UNIT (CAN)	ON	×	<a href="#">DAS-583</a>
U0104	ADAS CAN CIR1	ON	×	<a href="#">DAS-585</a>
U0405	ADAS CAN CIR2	ON	×	<a href="#">DAS-592</a>

DAS

# SIDE RADAR RH

< ECU DIAGNOSIS INFORMATION >

[BCI]

## SIDE RADAR RH

### Reference Value

INFOID:000000009716977

### VALUES ON THE DIAGNOSIS TOOL

#### CONSULT MONITOR ITEM

Monitor Item	Condition	Value/Status
SIDE RADAR MALF	Side radar is normal.	Off
	Side radar is malfunctioning.	On
BLOCKAGE COND	Side radar is not blocked.	Off
	Side radar is blocked.	On
VEHICLE DETECT	Radar does not detect a vehicle.	Off
	Radar detects a vehicle.	On

### TERMINAL LAYOUT

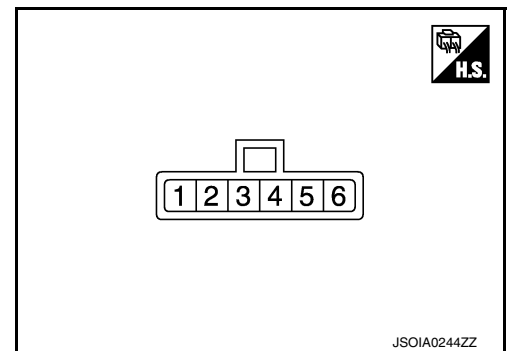

### PHYSICAL VALUES

Terminal No. (Wire color)		Description		Condition	Value (Approx.)
+	-	Signal name	Input/ Output		
1 (B)	Ground	Right/Left switching signal	Input	—	0 V
2 (B)	Ground	Ground	—	—	0 V
3 (Y)	—	ITS communication-L	—	—	—
4 (L)	—	ITS communication-H	—	—	—
5 (R)	Ground	Ignition power supply	Input	Ignition switch ON	Battery voltage
6 (W)	Ground	Blind Spot Warning/Blind Spot Intervention indicator	Output	Approx. 2 sec. after ignition switch OFF ⇒ ON (bulb check)	6 V

### Fail-safe

INFOID:000000009716978

### FAIL-SAFE CONTROL BY DTC

#### Blind Spot Warning (BSW)

If a malfunction occurs in the side radar, ADAS control unit cancels control, and turns ON the "Please see owner's manual" appears in the vehicle information display.

#### Blind Spot Intervention

If a malfunction occurs in the side radar, ADAS control unit cancels control, sounds a beep, and turns ON the BSI system warning light (orange) in the vehicle information display.



# SIDE RADAR RH

< ECU DIAGNOSIS INFORMATION >

[BCI]

## TEMPORARY DISABLED STATUS AT BLOCKAGE

### Blind Spot Warning (BSW)

When the side radar is blocked, the operation is temporarily cancelled. Then the "Unavailable Side Radar Obstruction" message appears in the vehicle information display and the warning systems ON indicator will blink. Also, under the following conditions, the operation may be temporarily cancelled.

- The side radar may be blocked by temporary ambient conditions such as splashing water, mist or fog.
- The blocked condition may also be caused by objects such as ice, frost or dirt obstructing the side radar.

### Blind Spot Intervention

When the side radar is blocked, the operation is temporarily cancelled. Then the buzzer sounds and the "Unavailable Side Radar Obstruction" message appears in the vehicle information display. Also, under the following conditions, the operation may be temporarily cancelled.

- The side radar may be blocked by temporary ambient conditions such as splashing water, mist or fog.
- The blocked condition may also be caused by objects such as ice, frost or dirt obstructing the side radar.

## DTC Inspection Priority Chart

INFOID:000000009716979

If some DTCs are displayed at the same time, perform inspections one by one based on the following priority chart.

Priority	Detected items (DTC)
1	<ul style="list-style-type: none"> <li>• U1000: CAN COMM CIRCUIT</li> <li>• U1010: CONTROL UNIT (CAN)</li> </ul>
2	<ul style="list-style-type: none"> <li>• U0104: ADAS CAN CIR 1</li> <li>• U0405: ADAS CAN CIR 2</li> </ul>
3	C1B50: SIDE RDR MALFUNCTION
4	<ul style="list-style-type: none"> <li>• C1B51: BSW/BSI IND SHORT CIR</li> <li>• C1B52: BSW/BSI IND OPEN CIR</li> <li>• C1B55: RADAR BLOCKAGE</li> </ul>

## DTC Index

INFOID:000000009716980

×: Applicable

DTC		Blind Spot Warning/Blind Spot Intervention warning lamp	Fail-safe	Reference page
C1B50	SIDE RDR MALFUNCTION	ON	×	<a href="#">DAS-573</a>
C1B51	BSW/BSI IND SHORT CIR	ON	×	<a href="#">DAS-574</a>
C1B52	BSW/BSI IND OPEN CIR	ON	×	<a href="#">DAS-575</a>
C1B55	RADAR BLOCKAGE	Blink	×	<a href="#">DAS-579</a>
U1000	CAN COMM CIRCUIT	ON	×	<a href="#">DAS-580</a>
U1010	CONTROL UNIT (CAN)	ON	×	<a href="#">DAS-583</a>
U0104	ADAS CAN CIR1	ON	×	<a href="#">DAS-585</a>
U0405	ADAS CAN CIR2	ON	×	<a href="#">DAS-592</a>

A  
B  
C  
D  
E  
F  
G  
H  
I  
J  
K  
L  
M  
N  
P

DAS

< WIRING DIAGRAM >

# WIRING DIAGRAM

## DRIVER ASSISTANCE SYSTEMS

### Wiring Diagram

INFOID:000000009716981

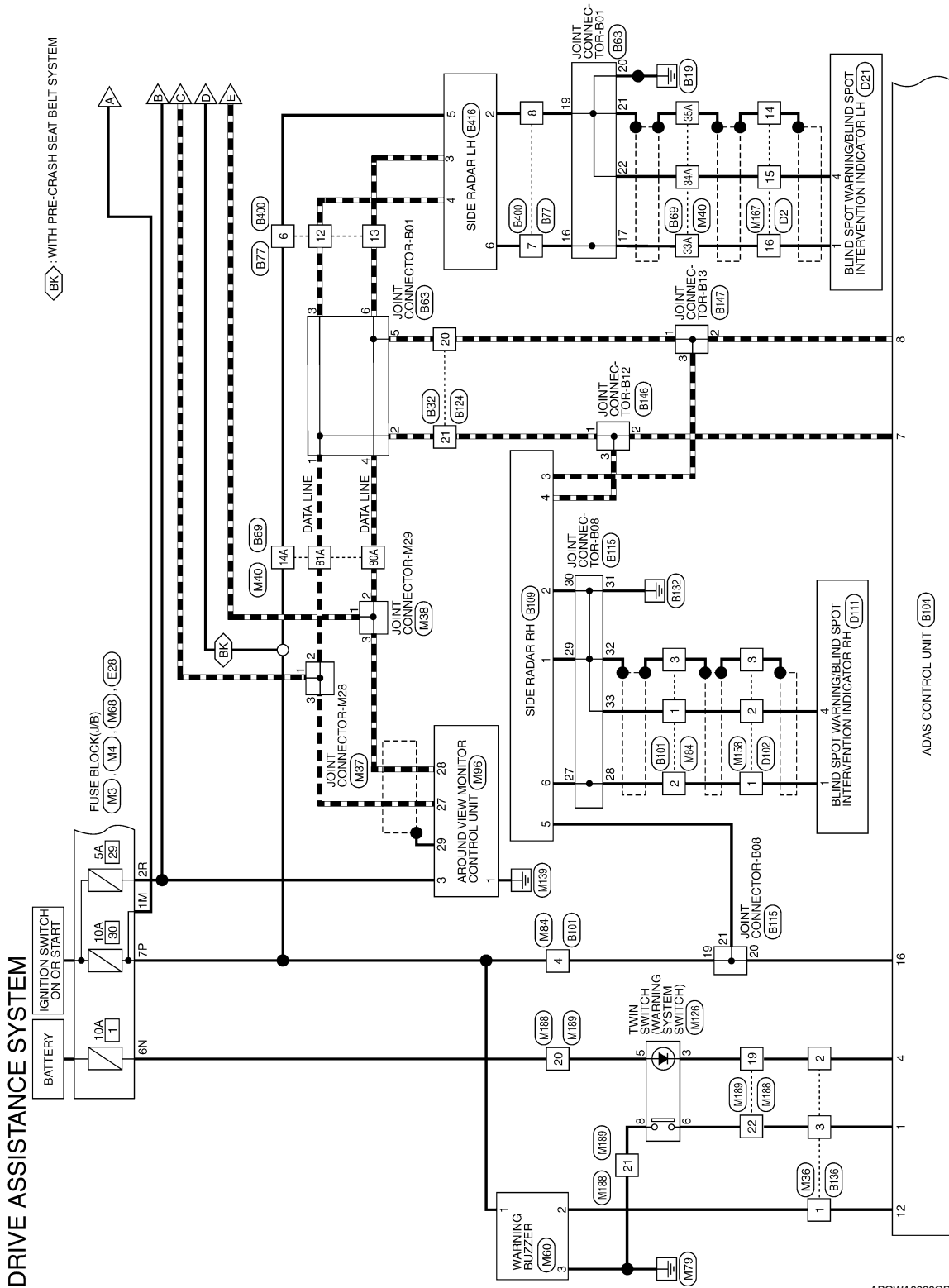

ABOWA0030GB

# DRIVER ASSISTANCE SYSTEMS

< WIRING DIAGRAM >

[BCI]

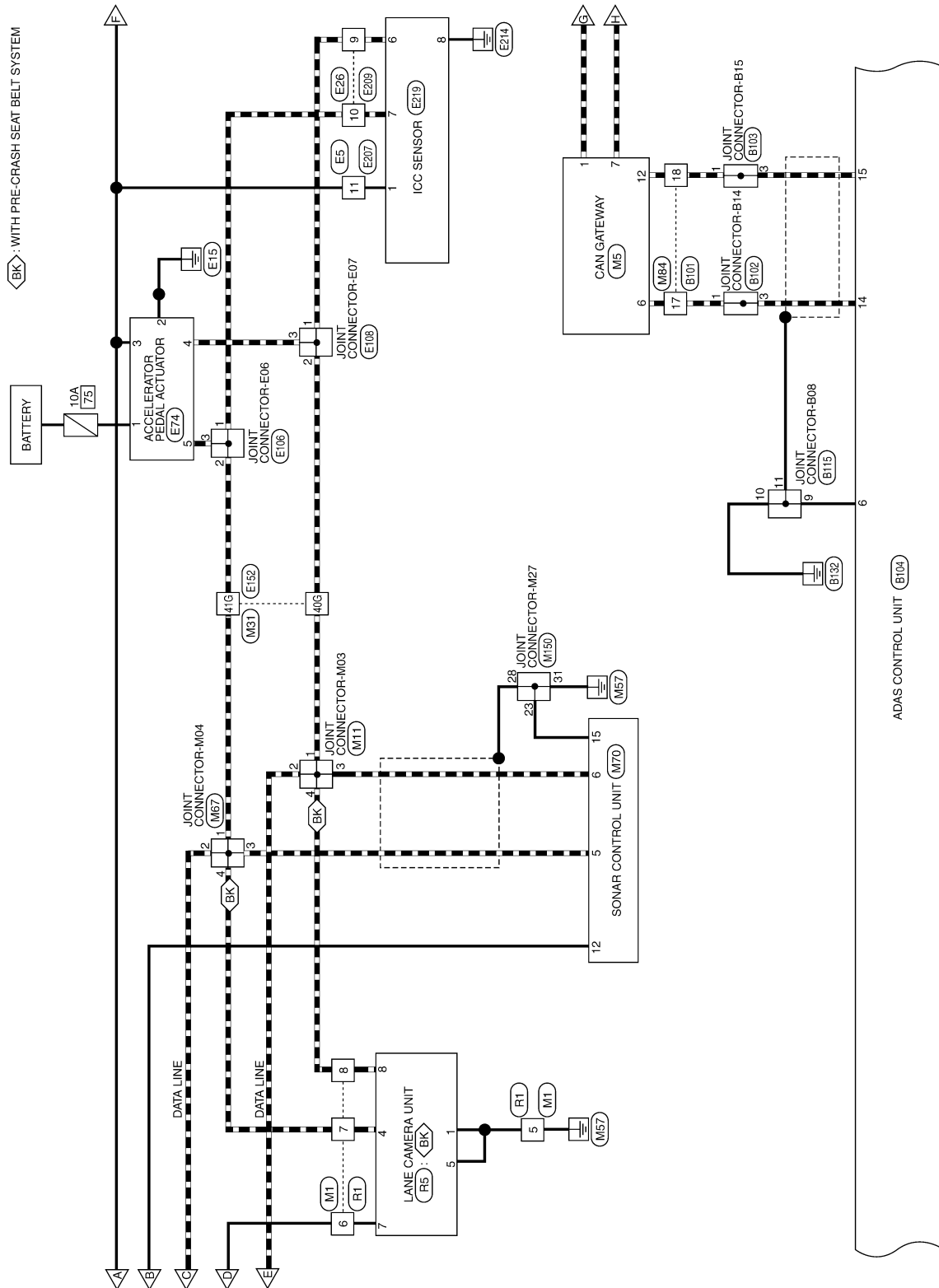

ABOWA0031GB

A  
B  
C  
D  
E  
F  
G  
H  
I  
J  
K  
L  
M  
N  
P

DAS

# DRIVER ASSISTANCE SYSTEMS

< WIRING DIAGRAM >

[BCI]

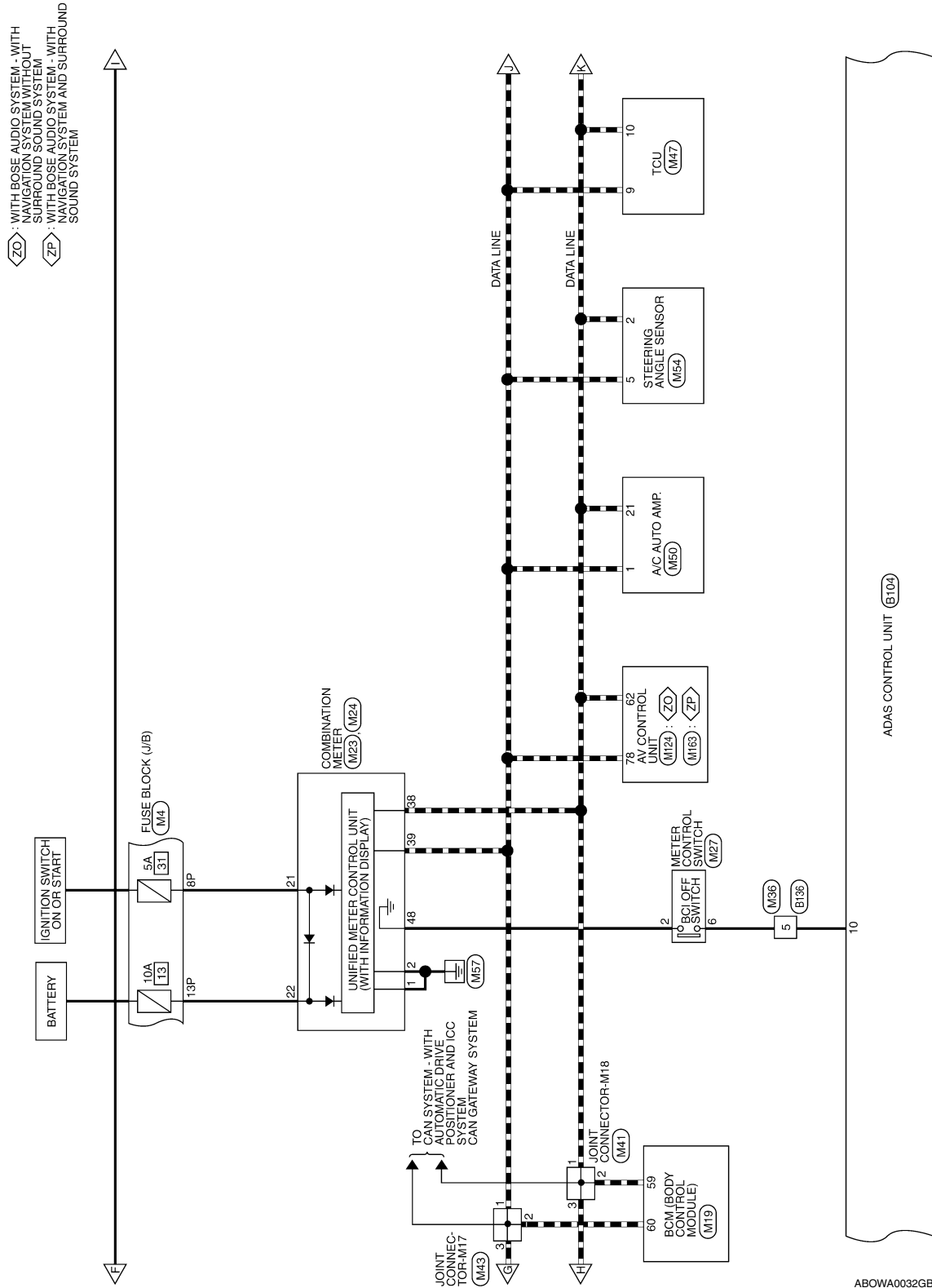

ABOWA0032GB

# DRIVER ASSISTANCE SYSTEMS

< WIRING DIAGRAM >

[BCI]

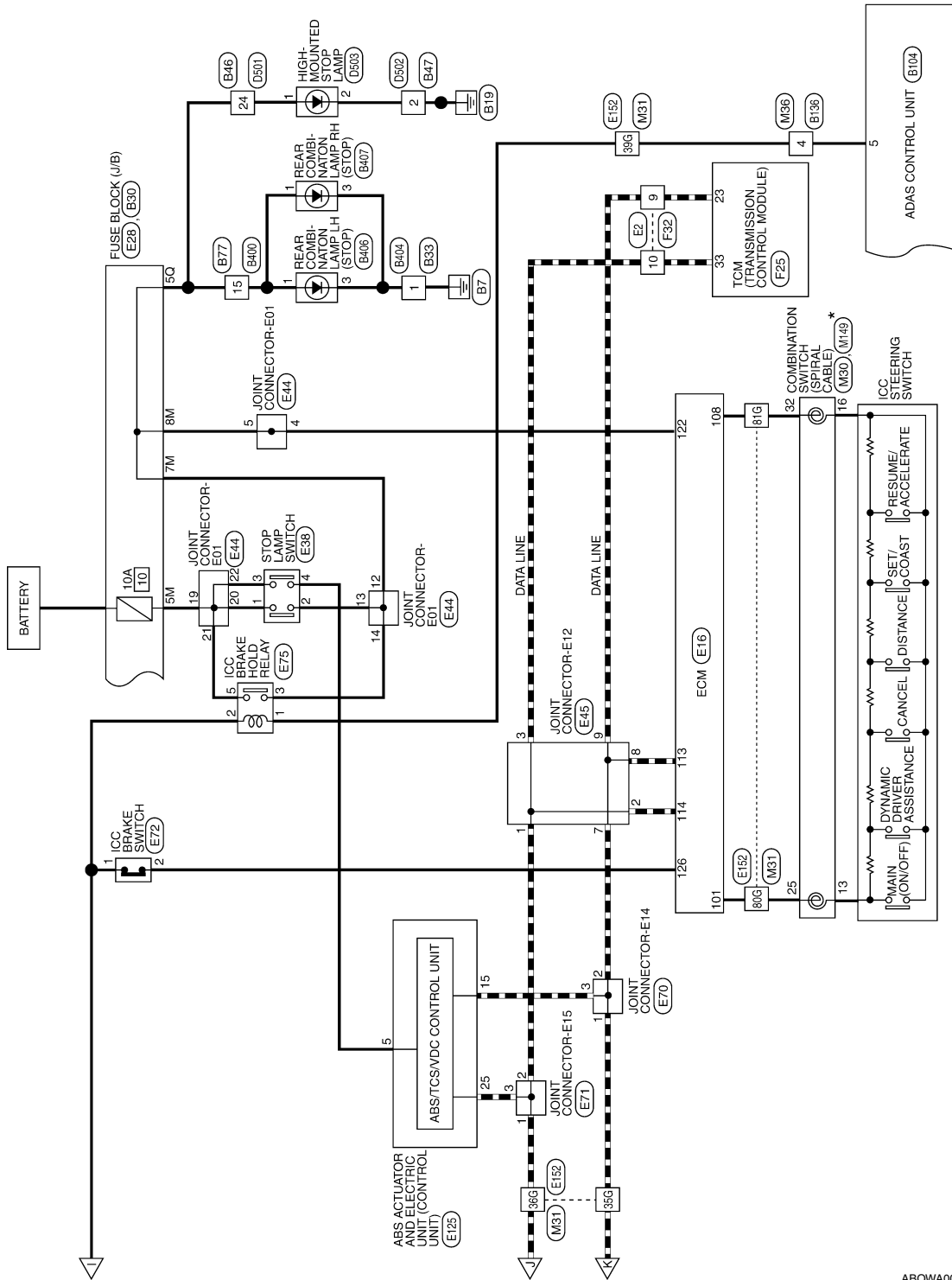

\* : THIS CONNECTOR IS NOT SHOWN IN "HARNES LAYOUT" OF PG SECTION.

ABOWA0033GB

A  
B  
C  
D  
E  
F  
G  
H  
I  
J  
K  
L  
M  
N  
P

DAS

DRIVE ASSISTANCE SYSTEM CONNECTORS

Connector No.	M1
Connector Name	WIRE TO WIRE
Connector Color	WHITE

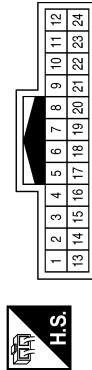

Terminal No.	Color of Wire	Signal Name
5	GR	-
6	LG	-
7	L	-
8	Y	-

Connector No.	M3
Connector Name	FUSE BLOCK (J/B)
Connector Color	WHITE

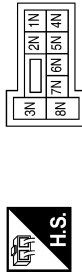

Terminal No.	Color of Wire	Signal Name
6N	W	-

Connector No.	M4
Connector Name	FUSE BLOCK (J/B)
Connector Color	WHITE

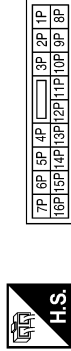

Terminal No.	Color of Wire	Signal Name
7P	LG	-
8P	BG	-
13P	W	-

Connector No.	M5
Connector Name	CAN GATEWAY
Connector Color	WHITE

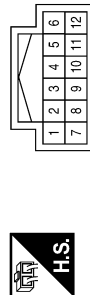

Terminal No.	Color of Wire	Signal Name
1	L	CAN-H
6	L	CAN-H
7	P	CAN-L
12	P	CAN-L

Connector No.	M11
Connector Name	JOINT CONNECTOR-M03
Connector Color	WHITE



Terminal No.	Color of Wire	Signal Name
1	Y	-
2	Y	-
3	W	-
4	Y	-

Connector No.	M19
Connector Name	BCM (BODY CONTROL MODULE)
Connector Color	BLACK

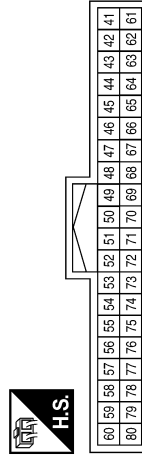

Terminal No.	Color of Wire	Signal Name
59	P	CAN-L
60	L	CAN-H

ABOIA0114GB

# DRIVER ASSISTANCE SYSTEMS

< WIRING DIAGRAM >

[BCI]

Terminal No.	Color of Wire	Signal Name
1	B	GND1
2	B	GND2
21	BG	IGN
22	W	BAT
38	P	CAN-L
39	L	CAN-H

Connector No.	M24
Connector Name	COMBINATION METER
Connector Color	WHITE

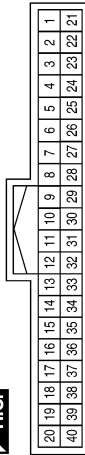

Connector No.	M23
Connector Name	COMBINATION METER
Connector Color	WHITE

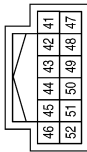

Terminal No.	Color of Wire	Signal Name
48	G	SW GND

Connector No.	M30
Connector Name	COMBINATION SWITCH (SPIRAL CABLE)
Connector Color	GRAY

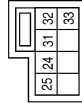

Terminal No.	Color of Wire	Signal Name
25	W	-
32	G	-

Connector No.	M27
Connector Name	METER CONTROL SWITCH
Connector Color	WHITE

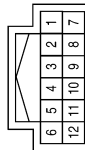

Terminal No.	Color of Wire	Signal Name
2	G	-
6	BG	-

ABOIA0098GB

A  
B  
C  
D  
E  
F  
G  
H  
I  
J  
K  
L  
M  
N  
P

DAS

# DRIVER ASSISTANCE SYSTEMS

< WIRING DIAGRAM >

[BCI]

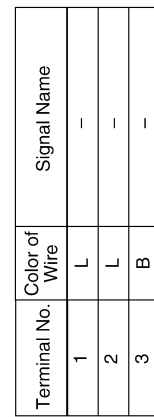
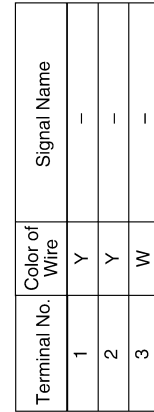
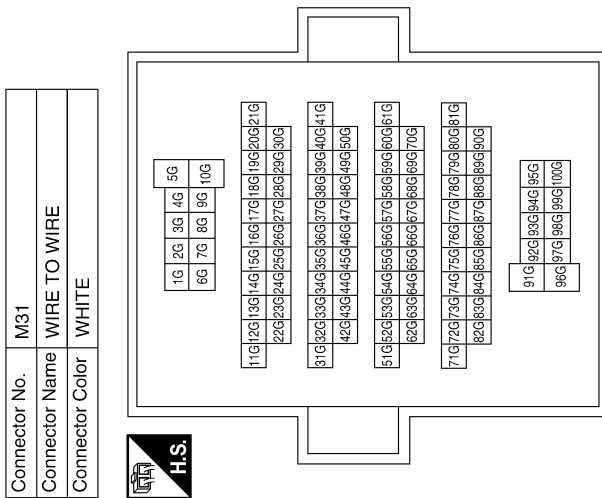
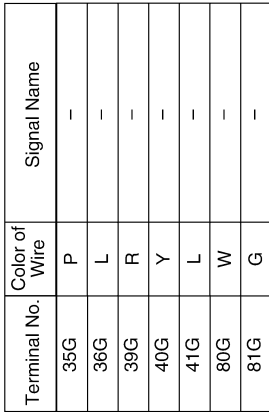
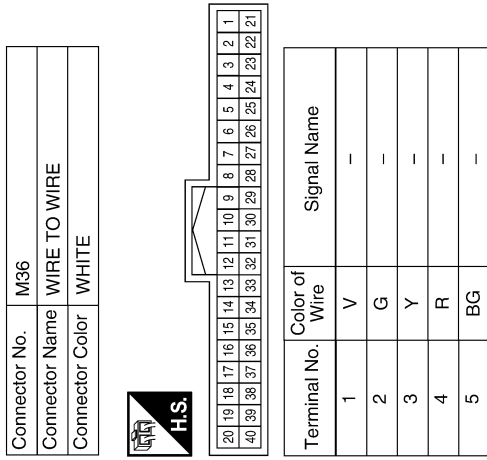

ABOIA0099GB



# DRIVER ASSISTANCE SYSTEMS

< WIRING DIAGRAM >

[BCI]

Connector No.	M41
Connector Name	JOINT CONNECTOR-M18
Connector Color	WHITE

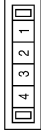

Terminal No.	Color of Wire	Signal Name
1	P	-
2	P	-
3	P	-

Terminal No.	Color of Wire	Signal Name
14A	LG	-
33A	W	-
34A	B	-
35A	SHIELD	-
80A	Y	-
81A	L	-

Connector No.	M40
Connector Name	WIRE TO WIRE
Connector Color	GRAY

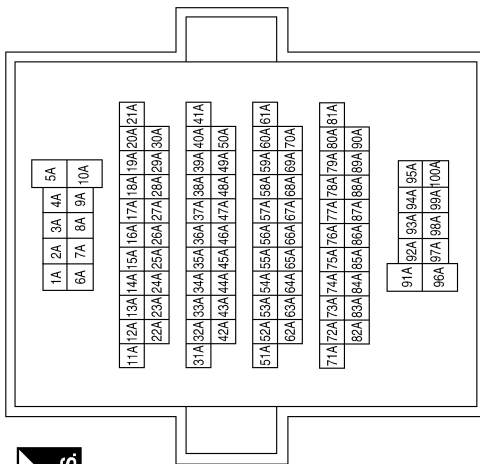

Connector No.	M50
Connector Name	A/C AUTO AMP.
Connector Color	WHITE

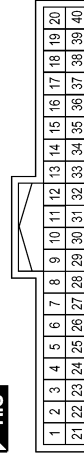

Terminal No.	Color of Wire	Signal Name
1	L	CAN-H
21	P	CAN-L

Connector No.	M47
Connector Name	TCU
Connector Color	WHITE



Terminal No.	Color of Wire	Signal Name
9	L	CAN-H
10	P	CAN-L

Connector No.	M43
Connector Name	JOINT CONNECTOR-M17
Connector Color	WHITE

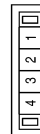

Terminal No.	Color of Wire	Signal Name
1	L	-
2	L	-
3	L	-

ABOIA0113GB

A  
B  
C  
D  
E  
F  
G  
H  
I  
J  
K  
L  
M  
N  
P

DAS

# DRIVER ASSISTANCE SYSTEMS

< WIRING DIAGRAM >

[BCI]

Connector No.	M67
Connector Name	JOINT CONNECTOR-M04
Connector Color	WHITE



Terminal No.	Color of Wire	Signal Name
1	L	-
2	L	-
3	B	-
4	L	-

Connector No.	M60
Connector Name	WARNING BUZZER
Connector Color	BROWN

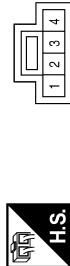

Terminal No.	Color of Wire	Signal Name
1	LG	-
2	V	-
3	GR	-
4	-	-

Connector No.	M54
Connector Name	STEERING ANGLE SENSOR
Connector Color	WHITE

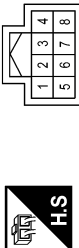

Terminal No.	Color of Wire	Signal Name
2	P	-
5	L	-

Connector No.	M84
Connector Name	WIRE TO WIRE
Connector Color	WHITE

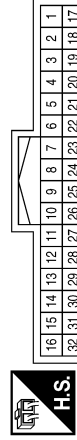

Terminal No.	Color of Wire	Signal Name
1	B	-
2	W	-
3	SHIELD	-
4	LG	-
17	L	-
18	P	-

Connector No.	M70
Connector Name	SONAR CONTROL UNIT
Connector Color	WHITE

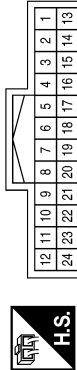

Terminal No.	Color of Wire	Signal Name
5	B	CAN-H
6	W	CAN-L
12	LG	IGN
15	GR	GND

Connector No.	M68
Connector Name	FUSE BLOCK (J/B)
Connector Color	BROWN

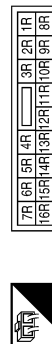

Terminal No.	Color of Wire	Signal Name
2R	LG	-

A010A100GB

# DRIVER ASSISTANCE SYSTEMS

< WIRING DIAGRAM >

[BCI]

Connector No.	M126
Connector Name	TWIN SWITCH (WARNING SYSTEM SWITCH)
Connector Color	BLACK

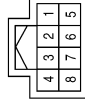

Terminal No.	Color of Wire	Signal Name
1	-	-
2	-	-
3	G	-
4	-	-
5	W	-
6	Y	-
7	-	-
8	B	-

Connector No.	M124
Connector Name	AV CONTROL UNIT (WITH BOSE AUDIO SYSTEM - WITH NAVI WITHOUT SURROUND SOUND SYSTEM)
Connector Color	WHITE

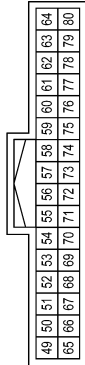

Terminal No.	Color of Wire	Signal Name
62	P	CAN-L
78	L	CAN-H

Connector No.	M96
Connector Name	AROUND VIEW MONITOR CONTROL UNIT
Connector Color	WHITE

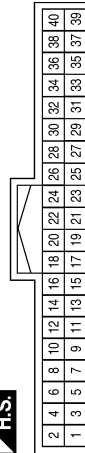

Terminal No.	Color of Wire	Signal Name
1	B	GND
3	LG	IGN
27	B	CAN-H
28	W	CAN-L
29	SHIELD	CAN GND

Connector No.	M158
Connector Name	WIRE TO WIRE
Connector Color	WHITE

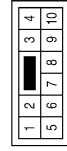

Terminal No.	Color of Wire	Signal Name
1	W	-
2	B	-
3	SHIELD	-

Connector No.	M150
Connector Name	JOINT CONNECTOR-M27
Connector Color	WHITE

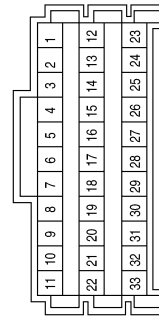

Terminal No.	Color of Wire	Signal Name
23	GR	-
28	SHIELD	-
31	GR	-

Connector No.	M149
Connector Name	COMBINATION SWITCH (SPIRAL CABLE)
Connector Color	GRAY

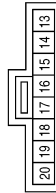

Terminal No.	Color of Wire	Signal Name
13	R	-
16	L	-

ABOIA0101GB

A  
B  
C  
D  
E  
F  
G  
H  
I  
J  
K  
L  
M  
N  
P

DAS

# DRIVER ASSISTANCE SYSTEMS

< WIRING DIAGRAM >

[BCI]

Connector No.	M188
Connector Name	WIRE TO WIRE
Connector Color	WHITE

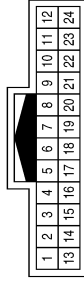

Terminal No.	Color of Wire	Signal Name
19	G	-
20	W	-
21	B	-
22	Y	-

Connector No.	M167
Connector Name	WIRE TO WIRE
Connector Color	WHITE

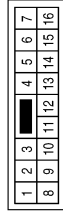

Terminal No.	Color of Wire	Signal Name
14	SHIELD	-
15	B	-
16	W	-

Connector No.	M163
Connector Name	AV CONTROL UNIT (WITH BOSE AUDIO SYSTEM - WITH NAVI AND SURROUND SOUND SYSTEM)
Connector Color	WHITE

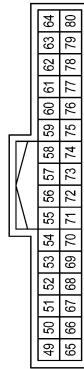

Terminal No.	Color of Wire	Signal Name
62	P	CAN-L
78	L	CAN-H

Connector No.	E5
Connector Name	WIRE TO WIRE
Connector Color	WHITE



Terminal No.	Color of Wire	Signal Name
11	R	-

Connector No.	E2
Connector Name	WIRE TO WIRE
Connector Color	WHITE



Terminal No.	Color of Wire	Signal Name
9	P	-
10	L	-

Connector No.	M189
Connector Name	WIRE TO WIRE
Connector Color	WHITE

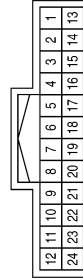

Terminal No.	Color of Wire	Signal Name
19	G	-
20	W	-
21	B	-
22	Y	-

A010A102GB

# DRIVER ASSISTANCE SYSTEMS

< WIRING DIAGRAM >

[BCI]

Connector No.	E16
Connector Name	ECM
Connector Color	GRAY

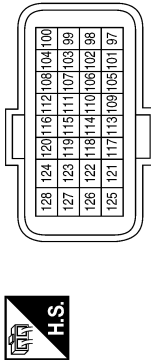

Terminal No.	Color of Wire	Signal Name
101	G	ASC D STEERING SWITCH/ICC STEERING SWITCH
108	R	SENSOR GROUND (ASC D STEERING SWITCH)
113	P	CAN-L
114	L	CAN-H
122	R	STOP LAMP SWITCH
126	LG	ASC D BRAKE SWITCH

Connector No.	E38
Connector Name	STOP LAMP SWITCH
Connector Color	WHITE



Terminal No.	Color of Wire	Signal Name
1	Y	-
2	P	-
3	Y	-
4	G	-

Connector No.	E26
Connector Name	WIRE TO WIRE
Connector Color	WHITE

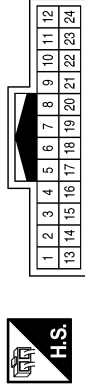

Terminal No.	Color of Wire	Signal Name
9	Y	-
10	BG	-

Connector No.	E44
Connector Name	JOINT CONNECTOR-E01
Connector Color	WHITE

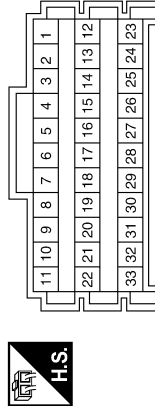

Terminal No.	Color of Wire	Signal Name
4	R	-
5	R	-
12	P	-
13	P	-

Connector No.	E28
Connector Name	FUSE BLOCK (J/B)
Connector Color	WHITE

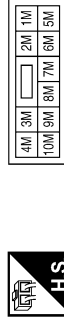

Terminal No.	Color of Wire	Signal Name
1M	R	-
5M	Y	-
7M	P	-
8M	R	-

Terminal No.	Color of Wire	Signal Name
14	P	-
19	Y	-
20	Y	-
21	Y	-
22	Y	-

A  
B  
C  
D  
E  
F  
G  
H  
I  
J  
K  
L  
M  
N  
P

DAS

A01A0103GB

# DRIVER ASSISTANCE SYSTEMS

< WIRING DIAGRAM >

[BCI]

Connector No.	E45
Connector Name	JOINT CONNECTOR-E12
Connector Color	BLUE



Terminal No.	Color of Wire	Signal Name
1	L	-
2	L	-
3	L	-
7	P	-
8	P	-
9	P	-

Connector No.	E70
Connector Name	JOINT CONNECTOR-E14
Connector Color	BLACK



Terminal No.	Color of Wire	Signal Name
1	P	-
2	P	-
3	P	-

Connector No.	E71
Connector Name	JOINT CONNECTOR-E15
Connector Color	BLACK



Terminal No.	Color of Wire	Signal Name
1	L	-
2	L	-
3	L	-

Connector No.	E72
Connector Name	ICC BRAKE SWITCH
Connector Color	BROWN



Terminal No.	Color of Wire	Signal Name
1	R	-
2	LG	-

Connector No.	E74
Connector Name	ACCELERATOR PEDAL ACTUATOR
Connector Color	GRAY



Terminal No.	Color of Wire	Signal Name
1	BG	-
2	GR	-
3	G	-
4	Y	-
5	BG	-
6	-	-

Connector No.	E75
Connector Name	ICC BRAKE HOLD RELAY
Connector Color	BLUE



Terminal No.	Color of Wire	Signal Name
1	W	-
2	R	-
3	P	-
5	Y	-

ABOIA0104GB

# DRIVER ASSISTANCE SYSTEMS

< WIRING DIAGRAM >

[BCI]

Connector No.	E106
Connector Name	JOINT CONNECTOR-E06
Connector Color	WHITE

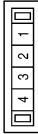

Terminal No.	Color of Wire	Signal Name
1	BG	-
2	BG	-
3	BG	-

Connector No.	E108
Connector Name	JOINT CONNECTOR-E07
Connector Color	WHITE



Terminal No.	Color of Wire	Signal Name
1	Y	-
2	Y	-
3	Y	-

Connector No.	E125
Connector Name	ABS ACTUATOR AND ELECTRIC UNIT (CONTROL UNIT)
Connector Color	BLACK

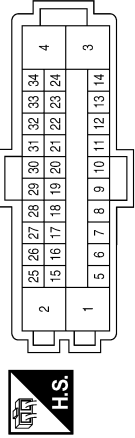

Terminal No.	Color of Wire	Signal Name
5	G	STOP LAMP SW (WITH ICC)
15	P	CAN-L
25	L	CAN-H

Connector No.	E152
Connector Name	WIRE TO WIRE
Connector Color	WHITE

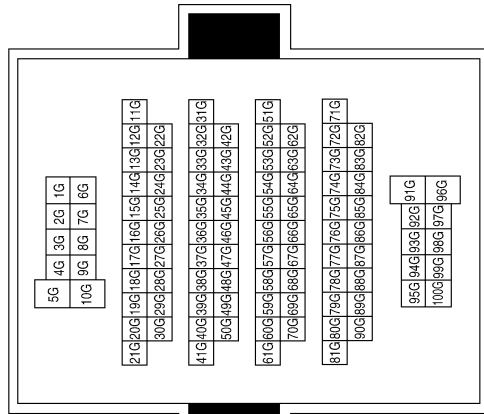

Terminal No.	Color of Wire	Signal Name
35G	P	-
36G	L	-
39G	W	-
40G	Y	-
41G	BG	-
80G	G	-
81G	R	-

Connector No.	E207
Connector Name	WIRE TO WIRE
Connector Color	WHITE



Terminal No.	Color of Wire	Signal Name
11	P	-

ABOIA0105GB

A  
B  
C  
D  
E  
F  
G  
H  
I  
J  
K  
L  
M  
N  
P

DAS

# DRIVER ASSISTANCE SYSTEMS

< WIRING DIAGRAM >

[BCI]

Connector No.	F25
Connector Name	TCM (TRANSMISSION CONTROL MODULE)
Connector Color	BLACK

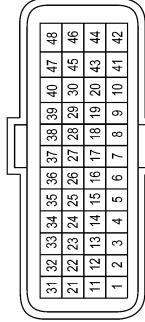

Terminal No.	Color of Wire	Signal Name
23	P	CAN-L
33	L	CAN-H

Connector No.	E219
Connector Name	ICC SENSOR
Connector Color	BLACK

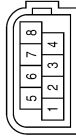

Terminal No.	Color of Wire	Signal Name
1	P	-
6	Y	-
7	L	-
8	B	-

Connector No.	E209
Connector Name	WIRE TO WIRE
Connector Color	WHITE

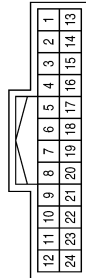

Terminal No.	Color of Wire	Signal Name
9	Y	-
10	L	-

Connector No.	B32
Connector Name	WIRE TO WIRE
Connector Color	WHITE

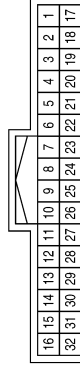

Terminal No.	Color of Wire	Signal Name
20	Y	-
21	L	-

Connector No.	B30
Connector Name	FUSE BLOCK (J/B)
Connector Color	WHITE



Terminal No.	Color of Wire	Signal Name
5Q	G	-

Connector No.	F32
Connector Name	WIRE TO WIRE
Connector Color	WHITE

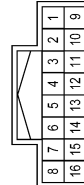

Terminal No.	Color of Wire	Signal Name
9	P	-
10	L	-

A01A106GB



# DRIVER ASSISTANCE SYSTEMS

< WIRING DIAGRAM >

[BCI]

Connector No.	B47
Connector Name	WIRE TO WIRE
Connector Color	GRAY

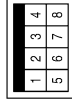

Terminal No.	Color of Wire	Signal Name
2	B	-

Connector No.	B46
Connector Name	WIRE TO WIRE
Connector Color	WHITE

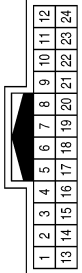

Terminal No.	Color of Wire	Signal Name
24	G	-

Connector No.	B33
Connector Name	WIRE TO WIRE
Connector Color	BLACK



Terminal No.	Color of Wire	Signal Name
1	B	-

Terminal No.	Color of Wire	Signal Name
14A	R	-
33A	W	-
34A	B	-
35A	SHIELD	-
80A	Y	-
81A	L	-

Connector No.	B69
Connector Name	WIRE TO WIRE
Connector Color	GRAY

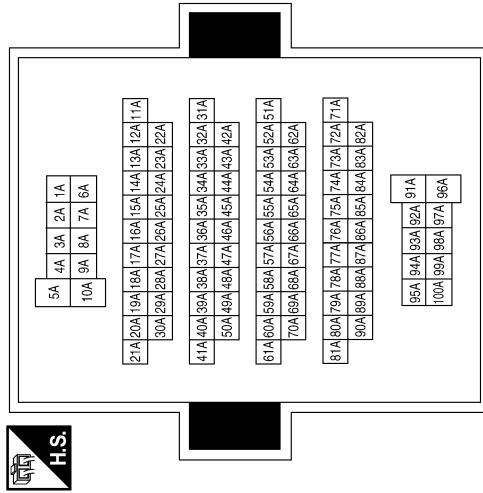

Connector No.	B63
Connector Name	JOINT CONNECTOR-B01
Connector Color	WHITE

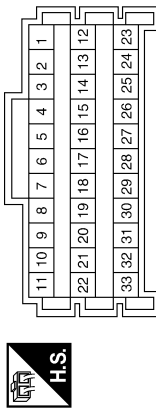

Terminal No.	Color of Wire	Signal Name
1	L	-
2	L	-
3	L	-
4	Y	-
5	Y	-
6	Y	-
16	W	-
17	W	-
19	B	-
20	B	-
21	SHIELD	-
22	B	-

ABOIA0107GB

A  
B  
C  
D  
E  
F  
G  
H  
I  
J  
K  
L  
M  
N  
P

DAS

# DRIVER ASSISTANCE SYSTEMS

< WIRING DIAGRAM >

[BCI]

Connector No.	B102
Connector Name	JOINT CONNECTOR-B14
Connector Color	WHITE



Terminal No.	Color of Wire	Signal Name
1	L	-
3	B	-

Connector No.	B101
Connector Name	WIRE TO WIRE
Connector Color	WHITE

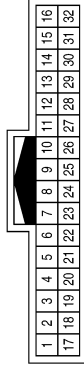

Terminal No.	Color of Wire	Signal Name
1	B	-
2	W	-
3	SHIELD	-
4	R	-
17	L	-
18	P	-

Connector No.	B77
Connector Name	WIRE TO WIRE
Connector Color	WHITE

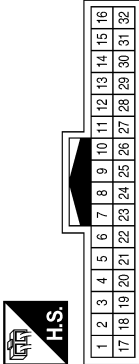

Terminal No.	Color of Wire	Signal Name
6	R	-
7	W	-
8	B	-
12	L	-
13	Y	-
15	G	-

Terminal No.	Color of Wire	Signal Name
7	L	ITS COMM-H
8	Y	ITS COMM-L
9	-	-
10	BG	BCP OFF SW
11	-	-
12	G	WARNING BUZZER
13	-	-
14	B	CAN-H
15	W	CAN-L
16	R	IGNITION

Connector No.	B104
Connector Name	ADAS CONTROL UNIT
Connector Color	WHITE

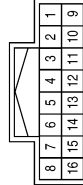

Terminal No.	Color of Wire	Signal Name
1	BR	WARNING SYSTEM SW
2	-	-
3	-	-
4	W	WARNING SYSTEM ON IND
5	G	BRAKE HOLD RLY DRIVE SIGNAL
6	B	GND

Connector No.	B103
Connector Name	JOINT CONNECTOR-B15
Connector Color	WHITE

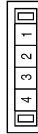

Terminal No.	Color of Wire	Signal Name
1	P	-
3	W	-

ABOIA0108GB

# DRIVER ASSISTANCE SYSTEMS

< WIRING DIAGRAM >

[BCI]

Terminal No.	Color of Wire	Signal Name
9	B	-
10	GR	-
11	SHIELD	-
19	R	-
20	R	-
21	R	-
27	W	-
28	W	-
29	B	-
30	B	-
31	GR	-
32	SHIELD	-
33	B	-

Connector No.	B115
Connector Name	JOINT CONNECTOR-B08
Connector Color	WHITE

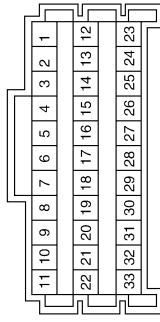

Connector No.	B109
Connector Name	SIDE RADAR RH
Connector Color	BLACK

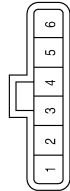

Terminal No.	Color of Wire	Signal Name
1	B	-
2	B	-
3	Y	-
4	L	-
5	R	-
6	W	-

Connector No.	B146
Connector Name	JOINT CONNECTOR-B12
Connector Color	WHITE



Connector No.	B136
Connector Name	WIRE TO WIRE
Connector Color	WHITE

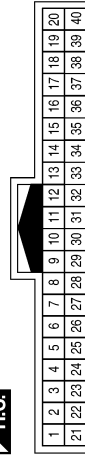

Terminal No.	Color of Wire	Signal Name
1	L	-
2	L	-
3	L	-

Connector No.	B124
Connector Name	WIRE TO WIRE
Connector Color	WHITE

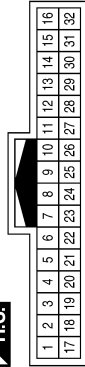

Terminal No.	Color of Wire	Signal Name
20	Y	-
21	L	-

A010A0109GB

A  
B  
C  
D  
E  
F  
G  
H  
I  
J  
K  
L  
M  
N  
P

DAS

# DRIVER ASSISTANCE SYSTEMS

< WIRING DIAGRAM >

[BCI]

Connector No.	B404
Connector Name	WIRE TO WIRE
Connector Color	BLACK



Terminal No.	Color of Wire	Signal Name
1	B	-

Connector No.	B400
Connector Name	WIRE TO WIRE
Connector Color	WHITE

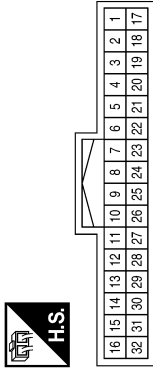

Terminal No.	Color of Wire	Signal Name
6	R	-
7	W	-
8	B	-
12	L	-
13	Y	-
15	G	-

Connector No.	B147
Connector Name	JOINT CONNECTOR-B13
Connector Color	WHITE

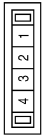

Terminal No.	Color of Wire	Signal Name
1	Y	-
2	Y	-
3	Y	-

Connector No.	B416
Connector Name	SIDE RADAR LH
Connector Color	BLACK

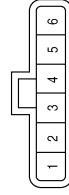

Terminal No.	Color of Wire	Signal Name
1	-	-
2	B	-
3	Y	-
4	L	-
5	R	-
6	W	-

Connector No.	B407
Connector Name	REAR COMBINATION LAMP RH
Connector Color	GRAY



Terminal No.	Color of Wire	Signal Name
1	G	-
3	GR	-

Connector No.	B406
Connector Name	REAR COMBINATION LAMP LH
Connector Color	GRAY



Terminal No.	Color of Wire	Signal Name
1	G	-
3	B	-

ABOIA0110GB

# DRIVER ASSISTANCE SYSTEMS

< WIRING DIAGRAM >

[BCI]

Connector No.	D2
Connector Name	WIRE TO WIRE
Connector Color	WHITE

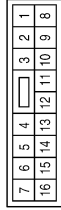

Terminal No.	Color of Wire	Signal Name
14	SHIELD	-
15	B	-
16	W	-

Connector No.	R5
Connector Name	LANE CAMERA UNIT
Connector Color	WHITE

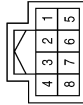

Terminal No.	Color of Wire	Signal Name
1	B	-
2	-	-
3	-	-
4	BR	-
5	B	-
6	-	-
7	LG	-
8	Y	-

Connector No.	R1
Connector Name	WIRE TO WIRE
Connector Color	WHITE

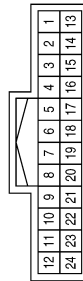

Terminal No.	Color of Wire	Signal Name
5	B	-
6	LG	-
7	BR	-
8	Y	-

Connector No.	D111
Connector Name	BLIND SPOT WARNING/ BLIND SPOT INTERVEN- TION INDICATOR RH
Connector Color	WHITE



Terminal No.	Color of Wire	Signal Name
1	W	-
2	-	-
3	-	-
4	B	-

Connector No.	D102
Connector Name	WIRE TO WIRE
Connector Color	WHITE

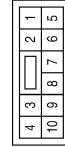

Terminal No.	Color of Wire	Signal Name
1	W	-
2	B	-
3	SHIELD	-

Connector No.	D21
Connector Name	BLIND SPOT WARNING/ BLIND SPOT INTERVEN- TION INDICATOR LH
Connector Color	WHITE

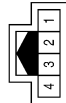

Terminal No.	Color of Wire	Signal Name
1	W	-
2	-	-
3	-	-
4	B	-

ABOIA0111GB

A  
B  
C  
D  
E  
F  
G  
H  
I  
J  
K  
L  
M  
N  
P

DAS

# DRIVER ASSISTANCE SYSTEMS

< WIRING DIAGRAM >

[BCI]

Connector No.	D503
Connector Name	HIGH-MOUNTED STOP LAMP
Connector Color	BROWN



Terminal No.	Color of Wire	Signal Name
1	LG	-
2	B	-

Connector No.	D502
Connector Name	WIRE TO WIRE
Connector Color	GRAY

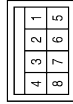

Terminal No.	Color of Wire	Signal Name
2	B	-

Connector No.	D501
Connector Name	WIRE TO WIRE
Connector Color	WHITE

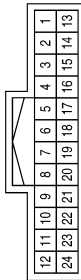

Terminal No.	Color of Wire	Signal Name
24	LG	-

ABOIA0112GB

# DIAGNOSIS AND REPAIR WORK FLOW

< BASIC INSPECTION >

[BCI]

## BASIC INSPECTION

### DIAGNOSIS AND REPAIR WORK FLOW

Work Flow

INFOID:000000009716982

#### OVERALL SEQUENCE

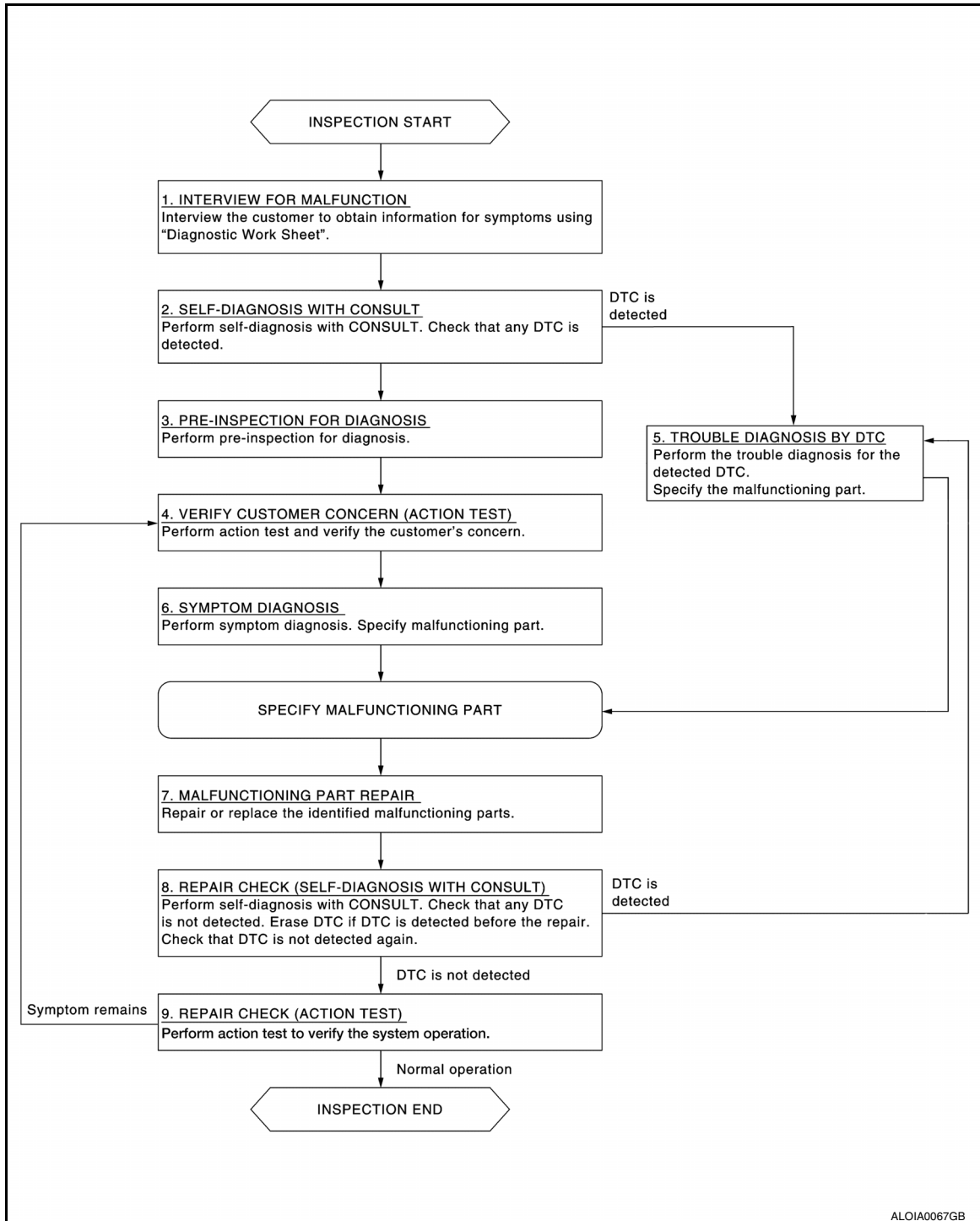

#### DETAILED FLOW

##### 1. INTERVIEW FOR MALFUNCTION

It is also important to clarify the customer concerns before starting the inspection. Interview the customer about the concerns carefully and understand the symptoms fully.

**NOTE:**

A  
B  
C  
D  
E  
F  
G  
H  
I  
J  
K  
L  
M  
N  
P

DAS

# DIAGNOSIS AND REPAIR WORK FLOW

< BASIC INSPECTION >

[BCI]

The customers are not professionals. Never assume that “maybe the customer means…” or “maybe the customer mentioned this symptom”.

>> GO TO 2.

## 2. SELF-DIAGNOSIS WITH CONSULT

---

1. Perform “All DTC Reading” with CONSULT.
2. Check if the DTC is detected on the self-diagnosis results of “SIDE RADAR LEFT/RIGHT”, “SONAR”, and/or “ICC/ADAS”.

Is any DTC detected?

YES >> GO TO 5.

NO >> GO TO 3.

## 3. PRE-INSPECTION FOR DIAGNOSIS

---

Perform pre-inspection for diagnosis. Refer to [DAS-710, "Inspection Procedure"](#).

>> GO TO 4.

## 4. ACTION TEST

---

Perform Backup Collision Intervention system action test to check the operation status. Refer to [DAS-711, "Work Procedure"](#).

Check if any other malfunctions occur.

>> GO TO 6.

## 5. TROUBLE DIAGNOSIS BY DTC

---

1. Check the DTC in the self-diagnosis results.
2. Perform trouble diagnosis for the detected DTC. Refer to [DAS-683, "DTC Index"](#) or [DAS-685, "DTC Index"](#) (SIDE RADAR LEFT/RIGHT), [AV-682, "DTC Index"](#) (SONAR) and/or [DAS-677, "DTC Index"](#) (ICC/ADAS).

### NOTE:

If “DTC: U1000” is detected, first diagnose the CAN communication system or ITS communication system.

>> GO TO 7.

## 6. SYMPTOM DIAGNOSIS

---

Perform the applicable diagnosis according to the diagnosis chart by symptom. Refer to [DAS-792, "Symptom Table"](#).

>> GO TO 7.

## 7. MALFUNCTIONING PART REPAIR

---

Repair or replace the identified malfunctioning parts.

>> GO TO 8.

## 8. REPAIR CHECK (SELF-DIAGNOSIS WITH CONSULT)

---

1. Erases self-diagnosis results.
2. Perform “All DTC Reading” again after repairing or replacing the specific items.
3. Check if any DTC is detected in self-diagnosis results of “SIDE RADAR LEFT/RIGHT”, “SONAR” and “ICC/ADAS”.

Is any DTC detected?

YES >> GO TO 5.

NO >> GO TO 9.

## 9. REPAIR CHECK (ACTION TEST)

---



# DIAGNOSIS AND REPAIR WORK FLOW

< BASIC INSPECTION >

[BCI]

Perform the Backup Collision Intervention system action test. Check that the malfunction symptom is solved or no other symptoms occur.

Is there a malfunction symptom?

YES >> GO TO 4.

NO >> Inspection End.

A  
B  
C  
D  
E  
F  
G  
H  
I  
J  
K  
L  
M  
N  
P

DAS

# PRE-INSPECTION FOR DIAGNOSIS

< BASIC INSPECTION >

[BCI]

## PRE-INSPECTION FOR DIAGNOSIS

### Inspection Procedure

INFOID:000000009716983

#### 1.CHECK SONAR SENSORS INSTALLATION ON THE REAR BUMPER COVER

---

Are there any foreign materials obstructing the view of any sonar sensor?

- YES >> Clean the rear bumper and the sonar detection window.
- NO >> GO TO 2.

#### 2.CHECK REAR BUMPER NEAR THE SIDE RADAR

---

Are rear bumper near the side radar contaminated with foreign materials?

- YES >> Clean the rear bumper.
- NO >> GO TO 3.

#### 3.CHECK SIDE RADAR AND THE SIDE RADAR OUTSKIRTS

---

Are side radar and the side radar outskirts contaminated with foreign materials?

- YES >> Clean the side radar or side radar outskirts.
- NO >> GO TO 4.

#### 4.CHECK SIDE RADAR INSTALLATION CONDITION

---

Check side radar installation condition (installation position, properly tightened, a bent bracket).

Is it properly installed?

- YES >> Inspection End.
- NO >> Install side radar properly.

# ACTION TEST

< BASIC INSPECTION >

[BCI]

## ACTION TEST

### Description

INFOID:000000009716984

Always perform the Backup Collision Intervention system action test to check that the system operates normally after replacing the side radar (left or right), or repairing any Backup Collision Intervention system malfunction.

**WARNING:**

Be careful of traffic conditions and safety around the vehicle when performing road test.

**CAUTION:**

Fully understand the following items well before the road test;

- Precautions: Refer to [DAS-640, "Precaution for Backup Collision Intervention"](#).
- System description for Backup Collision Intervention: Refer to [DAS-644, "System Description"](#).
- Normal operating condition: Refer to [DAS-796, "Description"](#).

### Work Procedure

INFOID:000000009716985

**WARNING:**

Be careful of traffic conditions and safety around the vehicle when performing road test.

**CAUTION:**

Fully understand the following items well before the road test;

- Precautions: Refer to [DAS-640, "Precaution for Backup Collision Intervention"](#).
- System description for Backup Collision Intervention: Refer to [DAS-644, "System Description"](#).
- Normal operating condition: Refer to [DAS-796, "Description"](#).

#### 1. CHECK BCI SYSTEM SETTING

1. Start the engine.
2. Check that the BCI system setting can be enabled/disabled in the meter setting.
3. Turn OFF the ignition switch and wait for 30 seconds or more.
4. Check that the previous setting is saved when the engine starts again.

>> GO TO 2.

#### 2. ACTION TEST FOR BCI

1. Enable the setting of the BCI system in the meter setting.
2. Turn BCI OFF switch OFF (Backup Collision Intervention system ON indicator is ON).
3. Check the BCI operation according to the following table.

A  
B  
C  
D  
E  
F  
G  
H  
I  
J  
K  
L  
M  
N  
P

DAS

# ACTION TEST

< BASIC INSPECTION >

[BCI]

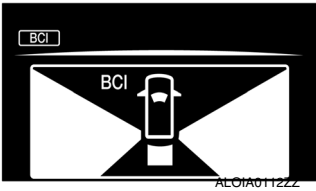
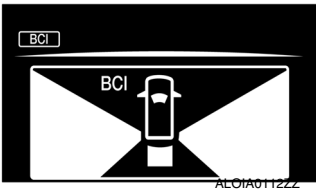
Vehicle condition		Action	Indication on the combination meter	Buzzer
0 MPH (0 km/h) R range	If the radar detects an approaching vehicle from the side.	<ul style="list-style-type: none"> <li>• Chime sound (single beep)</li> <li>• Flashes Blind spot warning indicator light on the side the approaching vehicle is detected.</li> <li>• Yellow rectangular frame appears in the display.</li> </ul>		single beep
	No approaching vehicle	No action		—

**NOTE:**

After the operating conditions of warning are satisfied, the warning continues until the vehicle speed reaches a speed above 5 MPH (8 km/h). Refer to [DAS-644. "System Description"](#).

>> GO TO 3.

### 3. CHECK BCI SYSTEM SETTING

1. Start the engine.
2. Check that the BCI system setting can be enabled/disabled on the navigation screen.
3. Turn OFF the ignition switch and wait for 30 seconds or more.
4. Check that the previous setting is saved when the engine starts again.

>> GO TO 4.



### 4. ACTION TEST FOR BCI

1. Enable the setting of the BCI system on the navigation screen.
2. Turn BCI OFF switch OFF (BCI ON indicator lamp is ON).
3. Check the BCI operation according to the following table.

# ACTION TEST

< BASIC INSPECTION >

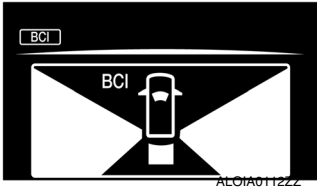
[BCI]

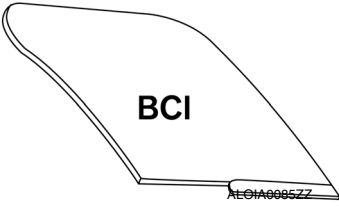
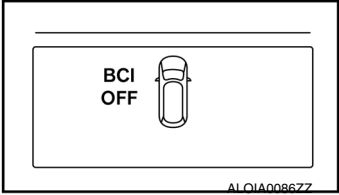
Vehicle condition	Backup Collision Intervention indicator	Warning buzzer	Indication on the combination meter
Shift lever in reverse	ON	OFF	
When DTC is detected	OFF	Beep	<p style="text-align: center;">OFF (orange)</p> 
When radar blockage is detected	ON	Beep	Unavailable: Side Radar Obstruction
When the accelerator pedal actuator detects that the internal motor temperature is high	ON	Beep	Unavailable: High Accelerator Temp.
Unless the driver overrides it and turns it off, the BCI system is always set to ON every time the engine is started and the shifter placed in reverse.	OFF	—	
The BCI system is turned off temporarily by pushing the BCI switch. The BCI OFF display appears on the meter display. When the selector lever is switched into R again the BCI system is turned on.	OFF	—	

**NOTE:**

After the operating conditions are satisfied, the control continues until the vehicle reaches a speed above approximately 5 MPH (8 km/h). Refer to [DAS-644, "System Description"](#).

>> Inspection End.

A  
B  
C  
D  
E  
F  
G  
H  
I  
J  
K  
L  
M  
N  
P

DAS

## DTC/CIRCUIT DIAGNOSIS

### C1A00 CONTROL UNIT

#### DTC Logic

INFOID:000000009716986

#### DTC DETECTION LOGIC

DTC (On board display)	Trouble diagnosis name	DTC detecting condition	Possible causes
C1A00 (0)	CONTROL UNIT	ADAS control unit internal malfunction	ADAS control unit

#### DTC CONFIRMATION PROCEDURE

##### 1. PERFORM DTC CONFIRMATION PROCEDURE

1. Start the engine.
2. Perform "All DTC Reading" with CONSULT.
3. Check if the "C1A00" is detected as the current malfunction in "Self Diagnostic Result" of "ICC/ADAS".

##### Is "C1A00" detected as the current malfunction?

- YES >> Refer to [DAS-714, "Diagnosis Procedure"](#).  
NO >> INSPECTION END

#### Diagnosis Procedure

INFOID:000000009716987

##### 1. CHECK SELF-DIAGNOSIS RESULTS

Check if any DTC other than "C1A00" is detected in "Self Diagnostic Result" of "ICC/ADAS".

##### Is any DTC detected?

- YES >> Perform diagnosis on the detected DTC and repair or replace the malfunctioning parts. Refer to [DAS-677, "DTC Index"](#).  
NO >> Replace the ADAS control unit. Refer to [DAS-79, "Removal and Installation"](#).

# C1A01 POWER SUPPLY CIRCUIT 1, C1A02 POWER SUPPLY CIRCUIT 2

< DTC/CIRCUIT DIAGNOSIS >

[BCI]

## C1A01 POWER SUPPLY CIRCUIT 1, C1A02 POWER SUPPLY CIRCUIT 2

### DTC Logic

INFOID:000000009716988

### DTC DETECTION LOGIC

DTC (On board display)	Trouble diagnosis name	DTC detecting condition	Possible causes
C1A01 (1)	POWER SUPPLY CIR	The battery voltage sent to ADAS control unit remains less than 7.9 V for 5 seconds	<ul style="list-style-type: none"><li>• Connector, harness, fuse</li><li>• ADAS control unit</li></ul>
C1A02 (2)	POWER SUPPLY CIR 2	The battery voltage sent to ADAS control unit remains more than 19.3 V for 5 seconds	

### DTC CONFIRMATION PROCEDURE

#### 1.PERFORM DTC CONFIRMATION PROCEDURE

1. Start the engine.
2. Turn the Blind Spot Intervention system ON.
3. Perform "All DTC Reading" with CONSULT.
4. Check if the "C1A01" or "C1A02" is detected as the current malfunction in "Self Diagnostic Result" of "ICC/ADAS".

Is "C1A01" or "C1A02" detected as the current malfunction?

- YES >> Refer to [DAS-715, "Diagnosis Procedure"](#).  
NO >> Refer to [GI-53, "Intermittent Incident"](#).

### Diagnosis Procedure

INFOID:000000009716989

#### 1.CHECK ADAS CONTROL UNIT POWER SUPPLY AND GROUND CIRCUIT

Check power supply and ground circuit of ADAS control unit. Refer to [DAS-786, "ADAS CONTROL UNIT : Diagnosis Procedure"](#).

Is the inspection result normal?

- YES >> Replace the ADAS control unit. Refer to [DAS-79, "Removal and Installation"](#).  
NO >> Repair or replace the malfunctioning parts.

DAS

# C1A03 VEHICLE SPEED SENSOR

< DTC/CIRCUIT DIAGNOSIS >

[BCI]

## C1A03 VEHICLE SPEED SENSOR

### DTC Logic

INFOID:000000009716990

### DTC DETECTION LOGIC

DTC (On board display)	Trouble diagnosis name	DTC detecting condition	Possible causes
C1A03 (3)	VHCL SPEED SE CIRC	If the vehicle speed signal (wheel speed) from ABS actuator and electric unit (control unit) received by the ADAS control unit via CAN communication, are inconsistent	<ul style="list-style-type: none"><li>• Wheel speed sensor</li><li>• ABS actuator and electric unit (control unit)</li><li>• ADAS control unit</li></ul>

#### NOTE:

If DTC "C1A03" is detected along with DTC "U1000" or "C1A04", first diagnose the DTC "U1000" or "C1A04".

- Refer to [DAS-747, "ADAS CONTROL UNIT : DTC Logic"](#) for DTC "U1000".
- Refer to [DAS-717, "DTC Logic"](#) for DTC "C1A04".

### DTC CONFIRMATION PROCEDURE

#### 1. PERFORM DTC CONFIRMATION PROCEDURE

1. Start the engine.
2. Turn the Blind Spot Intervention system ON.
3. Drive the vehicle at 30 km/h (19 MPH) or more.

#### CAUTION:

**Always drive safely.**

4. Stop the vehicle.
5. Perform "All DTC Reading" with CONSULT.
6. Check if the "C1A03" is detected as the current malfunction in "Self Diagnostic Result" of "ICC/ADAS".

Is "C1A03" detected as the current malfunction?

YES-1 (Blind Spot Warning/Blind Spot Intervention warning lamp: ON)>>Refer to [DAS-716, "Diagnosis Procedure"](#).

YES-2 (Blind Spot Warning/Blind Spot Intervention warning lamp: OFF)>>Refer to [CCS-105, "DTC Logic"](#).

NO >> Refer to [GI-53, "Intermittent Incident"](#).

### Diagnosis Procedure

INFOID:000000009716991

#### 1. CHECK SELF-DIAGNOSIS RESULTS

Check if "C1A04" or "U1000" is detected other than "C1A03" in "Self Diagnostic Result" of "ICC/ADAS".

Is any DTC detected?

YES >> Perform diagnosis on the detected DTC and repair or replace the malfunctioning parts. Refer to [DAS-677, "DTC Index"](#).

NO >> GO TO 2.

#### 2. CHECK ABS ACTUATOR AND ELECTRIC UNIT (CONTROL UNIT) SELF-DIAGNOSIS RESULTS

Check if any DTC is detected in "Self Diagnostic Result" of "ABS".

Is any DTC detected?

YES >> Perform diagnosis on the detected DTC and repair or replace the malfunctioning parts. Refer to [BRC-46, "DTC Index"](#).

NO >> Replace the ADAS control unit. Refer to [DAS-79, "Removal and Installation"](#).



# C1A04 ABS/TCS/VDC SYSTEM

< DTC/CIRCUIT DIAGNOSIS >

[BCI]

## C1A04 ABS/TCS/VDC SYSTEM

### DTC Logic

INFOID:000000009716992

### DTC DETECTION LOGIC

DTC (On board display)	Trouble diagnosis name	DTC detecting condition	Possible causes
C1A04 (4)	ABS/TCS/VDC CIRC	If a malfunction occurs in the VDC/TCS/ABS system	ABS actuator and electric unit (control unit)

#### NOTE:

If DTC "C1A04" is detected along with DTC "U1000", first diagnose the DTC "U1000". Refer to [DAS-747, "ADAS CONTROL UNIT : DTC Logic"](#).

### Diagnosis Procedure

INFOID:000000009716993

#### 1. CHECK SELF-DIAGNOSIS RESULTS

1. Perform "All DTC Reading" with CONSULT.
2. Check if the "U1000" is detected other than "C1A04" in "Self Diagnostic Result" of "ICC/ADAS".

##### Is "U1000" detected?

- YES >> Perform the CAN communication system inspection. Repair or replace the malfunctioning parts. Refer to [DAS-747, "ADAS CONTROL UNIT : DTC Logic"](#).
- NO >> GO TO 2.

#### 2. CHECK ABS ACTUATOR AND ELECTRIC UNIT (CONTROL UNIT) SELF-DIAGNOSIS RESULTS

Check if any DTC is detected in "Self Diagnostic Result" of "ABS".

##### Is any DTC detected?

- YES >> Perform diagnosis on the detected DTC and repair or replace the malfunctioning parts. Refer to [BRC-46, "DTC Index"](#).
- NO >> Replace the ADAS control unit. Refer to [DAS-79, "Removal and Installation"](#).

A  
B  
C  
D  
E  
F  
G  
H  
I  
J  
K  
L  
M  
N  
P

DAS

# C1A05 BRAKE SW/STOP LAMP SW

< DTC/CIRCUIT DIAGNOSIS >

[BCI]

## C1A05 BRAKE SW/STOP LAMP SW

### DTC Logic

INFOID:000000009716994

### DTC DETECTION LOGIC

DTC (On board display)	Trouble diagnosis name	DTC detecting condition	Possible causes
C1A05 (5)	BRAKE SW/STOP L SW	A mismatch between a stop lamp switch signal and a ICC brake switch signal received from ECM and a stop lamp signal received from the ABS actuator and electric unit (control unit) continues for 10 seconds or more with vehicle speeds at approximately 40 km/h or more	<ul style="list-style-type: none"><li>• Stop lamp switch circuit</li><li>• ICC brake switch circuit</li><li>• Stop lamp switch</li><li>• ICC brake switch</li><li>• Incorrect stop lamp switch installation</li><li>• Incorrect ICC brake switch installation</li><li>• ECM</li><li>• ABS actuator and electric unit (control unit)</li></ul>

#### NOTE:

If DTC "C1A05" is detected along with DTC "U1000", first diagnose the DTC "U1000". Refer to [CCS-163, "ADAS CONTROL UNIT : DTC Logic"](#).

### Diagnosis Procedure

INFOID:000000009716995

Regarding Wiring Diagram information, refer to [DAS-686, "Wiring Diagram"](#).

## 1. CHECK SELF-DIAGNOSIS RESULTS

1. Perform "All DTC Reading" with CONSULT.
2. Check if the "U1000" is detected other than "C1A05" in "Self Diagnostic Result" of "ICC/ADAS".

#### Is "U1000" detected?

YES >> Perform the CAN communication system inspection. Repair or replace the malfunctioning parts.  
Refer to [CCS-163, "ADAS CONTROL UNIT : DTC Logic"](#).

NO >> GO TO 2.

## 2. CHECK STOP LAMP SWITCH AND ICC BRAKE SWITCH

Check that "STOP LAMP SW" and "BRAKE SW" operate normally in "DATA MONITOR" of "ICC/ADAS".

#### Is the inspection result normal?

YES >> GO TO 3.

NO-1 >> When "BRAKE SW" operation is malfunctioning: GO TO 4.

NO-2 >> When "STOP LAMP SW" operation is malfunctioning: GO TO 9.

## 3. CHECK STOP LAMP SWITCH

Check that "STOP LAMP SW" operate normally in "DATA MONITOR" of "ABS".

#### Is the inspection result normal?

YES >> GO TO 14.

NO >> GO TO 9.

## 4. CHECK ICC BRAKE SWITCH INSTALLATION

1. Turn ignition switch OFF.
2. Check ICC brake switch for correct installation. Refer to [BR-15, "Adjustment"](#).

#### Is the inspection result normal?

YES >> GO TO 5.

NO >> Adjust ICC brake switch installation. Refer to [BR-15, "Adjustment"](#).

# C1A05 BRAKE SW/STOP LAMP SW

< DTC/CIRCUIT DIAGNOSIS >

[BCI]

## 5. ICC BRAKE SWITCH INSPECTION

1. Disconnect ICC brake switch connector.
2. Check ICC brake switch. Refer to [DAS-721, "Component Inspection \(ICC Brake Switch\)"](#).

Is the inspection result normal?

- YES >> GO TO 6.  
NO >> Replace ICC brake switch.

## 6. CHECK ICC BRAKE SWITCH POWER SUPPLY CIRCUIT

1. Turn the ignition switch ON.
2. Check voltage between ICC brake switch harness connector and ground.

Terminals		Voltage (Approx.)
(+)	(-)	
ICC brake switch		Ground
Connector	Terminal	
E72	1	
		Battery voltage

Is the inspection result normal?

- YES >> GO TO 7.  
NO >> Repair the harnesses or connectors.

## 7. CHECK HARNESS BETWEEN ICC BRAKE SWITCH AND ECM

1. Turn ignition switch OFF
2. Disconnect ECM connector.
3. Check for continuity between ICC brake switch harness connector and ECM harness connector.

ICC brake switch		ECM		Continuity
Connector	Terminal	Connector	Terminal	
E72	2	E16	126	Yes

4. Check for continuity between ICC brake switch harness connector and ground.

ICC brake switch		Ground	Continuity
Connector	Terminal		
E72	2		No

Is the inspection result normal?

- YES >> GO TO 8.  
NO >> Repair the harnesses or connectors.

## 8. PERFORM SELF-DIAGNOSIS OF ECM

1. Connect all connectors again if the connectors are disconnected.
2. Turn ignition switch ON.
3. Perform "All DTC Reading".
4. Check if any DTC is detected in "Self Diagnostic Result" of "ENGINE". Refer to [EC-97, "DTC Index"](#).

Is any DTC detected?

- YES >> Repair or replace the malfunctioning parts identified by the self-diagnosis result.  
NO >> Replace the ADAS control unit. Refer to [DAS-79, "Removal and Installation"](#).

## 9. CHECK STOP LAMP SWITCH INSTALLATION

1. Turn ignition switch OFF.
2. Check stop lamp switch for correct installation. Refer to [BR-15, "Adjustment"](#).

Is the inspection result normal?

- YES >> GO TO 10.  
NO >> Adjust stop lamp switch installation. Refer to [BR-15, "Adjustment"](#).

A  
B  
C  
D  
E  
F  
G  
H  
I  
J  
K  
L  
M  
N  
P

DAS

# C1A05 BRAKE SW/STOP LAMP SW

< DTC/CIRCUIT DIAGNOSIS >

[BCI]

## 10. STOP LAMP SWITCH INSPECTION

1. Disconnect stop lamp switch connector.
2. Check stop lamp switch. Refer to [DAS-721, "Component Inspection \(Stop Lamp Switch\)"](#).

Is the inspection result normal?

YES >> GO TO 11.

NO >> Replace stop lamp switch.

## 11. CHECK STOP LAMP SWITCH POWER SUPPLY CIRCUIT

1. Turn the ignition switch ON.
2. Check voltage between stop lamp switch harness connector and ground.

Terminals		Voltage (Approx.)
(+)	(-)	
Stop lamp switch		Ground
Connector	Terminal	
E38	1	
	3	

Is the inspection result normal?

YES >> GO TO 12.

NO >> Repair the harnesses or connectors.

## 12. CHECK HARNESS BETWEEN STOP LAMP SWITCH AND ECM

1. Turn ignition switch OFF
2. Disconnect ECM, rear combination lamp and high-mounted stop lamp connectors.
3. Check for continuity between stop lamp switch harness connector and ECM harness connector.

Stop lamp switch		ECM		Continuity
Connector	Terminal	Connector	Terminal	
E38	2	E16	122	Yes

4. Check for continuity between stop lamp switch harness connector and ground.

Stop lamp switch		Ground	Continuity
Connector	Terminal		
E38	2		No

Is the inspection result normal?

YES >> GO TO 13.

NO >> Repair the harnesses or connectors.

## 13. CHECK HARNESS BETWEEN STOP LAMP SWITCH AND ABS ACTUATOR AND ELECTRIC UNIT (CONTROL UNIT)

1. Disconnect ABS actuator and electric unit (control unit) connector.
2. Check for continuity between stop lamp switch harness connector and ABS actuator and electric unit (control unit) harness connector.

Stop lamp switch		ABS actuator and electric unit (control unit)		Continuity
Connector	Terminal	Connector	Terminal	
E38	4	E125	5	Yes

3. Check for continuity between stop lamp switch harness connector and ground.

# C1A05 BRAKE SW/STOP LAMP SW

< DTC/CIRCUIT DIAGNOSIS >

[BCI]

Stop lamp switch		Ground	Continuity
Connector	Terminal		
E38	4		No

Is the inspection result normal?

- YES >> GO TO 14.
- NO >> Repair the harnesses or connectors.

## 14.PERFORM SELF-DIAGNOSIS OF ECM

1. Connect all connectors again if the connectors are disconnected.
2. Turn ignition switch ON.
3. Perform "All DTC Reading".
4. Check if any DTC is detected in "Self Diagnostic Result" of "ENGINE". Refer to [EC-97. "DTC Index"](#).

Is any DTC detected?

- YES >> Repair or replace the malfunctioning parts identified by the self-diagnosis result.
- NO >> GO TO 15.

## 15.PERFORM SELF-DIAGNOSIS OF ABS ACTUATOR AND ELECTRIC UNIT (CONTROL UNIT)

Check if any DTC is detected in "Self Diagnostic Result" of "ABS". Refer to [BRC-46. "DTC Index"](#).

Is any DTC detected?

- YES >> Repair or replace the malfunctioning parts identified by the self-diagnosis result.
- NO >> Replace the ADAS control unit. Refer to [DAS-79. "Removal and Installation"](#).

## Component Inspection (ICC Brake Switch)

INFOID:000000009716996

### 1.CHECK ICC BRAKE SWITCH

Check for continuity between ICC brake switch terminals.

Terminal		Condition	Continuity
1	2	When brake pedal is depressed	No
		When brake pedal is released	Yes

Is the inspection result normal?

- YES >> Inspection End.
- NO >> Replace ICC brake switch.

## Component Inspection (Stop Lamp Switch)

INFOID:000000009716997

### 1.CHECK STOP LAMP SWITCH

Check for continuity between stop lamp switch terminals.

Terminal		Condition	Continuity
1	2	When brake pedal is depressed	Yes
		When brake pedal is released	No
3	4	When brake pedal is depressed	Yes
		When brake pedal is released	No

Is the inspection result normal?

- YES >> Inspection End.
- NO >> Replace stop lamp switch.

C1A06 OPERATION SW

DTC Logic

INFOID:000000009716998

DTC DETECTION LOGIC

DTC (On board display)	Trouble diagnosis name	DTC detecting condition	Possible causes
C1A06 (6)	OPERATION SW CIRC	<ul style="list-style-type: none"> <li>Any switch of the ICC steering switch is detected as "ON" continuously for 60 seconds</li> <li>An ON/OFF state judgment of the ICC differs between ECM and ADAS control unit, and the state continues for 2 seconds or more</li> </ul>	<ul style="list-style-type: none"> <li>ICC steering switch circuit</li> <li>ICC steering switch</li> <li>ECM</li> </ul>

**NOTE:**

If DTC "C1A06" is detected along with DTC "U1000", first diagnose the DTC "U1000". Refer to [CCS-163, "ADAS CONTROL UNIT : DTC Logic"](#).

DTC CONFIRMATION PROCEDURE

**1.**PERFORM DTC CONFIRMATION PROCEDURE

1. Start the engine.
2. Wait for approximately 5 minutes after turning the LDP system ON.
3. Perform "All DTC Reading" with CONSULT.
4. Check if the "C1A06" is detected as the current malfunction in "Self Diagnostic Result" of "ICC/ADAS".

Is "C1A06" detected as the current malfunction?

- YES >> Refer to [DAS-722, "Diagnosis Procedure"](#).  
 NO >> Refer to [GI-53, "Intermittent Incident"](#).

Diagnosis Procedure

INFOID:000000009716999

Regarding Wiring Diagram information, refer to [DAS-686, "Wiring Diagram"](#).

**1.**CHECK SELF-DIAGNOSIS RESULTS

Check if "U1000" is detected other than "C1A06" in "Self Diagnostic Result" of "ICC/ADAS".

Is "U1000" detected?

- YES >> Perform the CAN communication system inspection. Repair or replace the malfunctioning parts.  
 Refer to [CCS-163, "ADAS CONTROL UNIT : DTC Logic"](#).  
 NO >> GO TO 2.

**2.**CHECK ICC STEERING SWITCH

1. Turn the ignition switch OFF.
2. Disconnect the ICC steering switch connector.
3. Check the ICC steering switch. Refer to [DAS-723, "Component Inspection"](#).

Is the inspection result normal?

- YES >> GO TO 3.  
 NO >> Replace the steering wheel.

**3.**CHECK HARNESS BETWEEN SPIRAL CABLE AND ECM

1. Disconnect the ECM connector.
2. Check for continuity between the spiral cable harness connector and ECM harness connector.

Spiral cable		ECM		Continuity
Connector	Terminal	Connector	Terminal	

< DTC/CIRCUIT DIAGNOSIS >

M30	25	E16	101	Yes
	32		108	

3. Check for continuity between spiral cable harness connector and ground.

Spiral cable		Ground	Continuity
Connector	Terminal		
M30	25		No
	32		

Is the inspection result normal?

- YES >> GO TO 4.
- NO >> Repair the harnesses or connectors.

4. CHECK SPIRAL CABLE

Check for continuity between spiral cable terminals.

Spiral cable		Continuity
Terminal		
13	25	Yes
16	32	

Is the inspection result normal?

- YES >> GO TO 5.
- NO >> Replace the spiral cable.

5. PERFORM SELF-DIAGNOSIS OF ECM

1. Connect the connectors of ICC steering switch and ECM connector.
2. Turn the ignition switch ON.
3. Perform "All DTC Reading".
4. Check if any DTC is detected in "Self Diagnostic Result" of "ENGINE".

Is any DTC detected?

- YES >> Perform self-diagnosis on the detected DTC and repair or replace the malfunctioning parts. Refer to [EC-97, "DTC Index"](#).
- NO >> Replace the ADAS control unit. Refer to [DAS-79, "Removal and Installation"](#).

Component Inspection

INFOID:000000009717000

1. CHECK ICC STEERING SWITCH

Check resistance between ICC steering switch terminals.

Terminal	Switch operation	Resistance [Ω]
13 16	When pressing MAIN switch	Approx. 0
	When pressing dynamic driver assistance switch	Approx. 267
	When pressing CANCEL switch	Approx. 615
	When pressing DISTANCE switch	Approx. 1090
	When pressing SET/COAST switch	Approx. 1805
	When pressing RESUME/ACCELERATE switch	Approx. 2985
	When all switches are not pressed	Approx. 5415

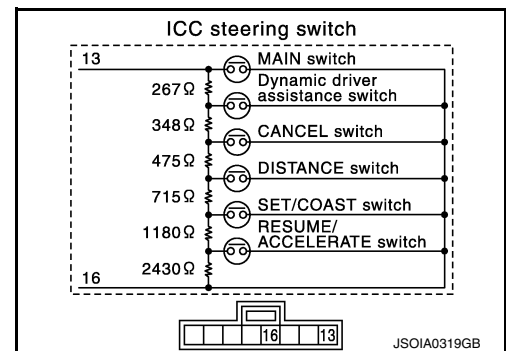

A  
B  
C  
D  
E  
F  
G  
H  
I  
J  
K  
L  
M  
N  
P

DAS

## C1A06 OPERATION SW

< DTC/CIRCUIT DIAGNOSIS >

[BCI]

---

Is the inspection result normal?

- YES >> Inspection End.
- NO >> Replace the ICC steering switch.



C1A14 ECM

DTC Logic

INFOID:000000009717001

DTC DETECTION LOGIC

DTC (On board display)	Trouble diagnosis name	DTC detecting condition	Possible causes
C1A14 (14)	ECM CIRCUIT	If ECM is malfunctioning	<ul style="list-style-type: none"> <li>• Accelerator pedal position sensor</li> <li>• ECM</li> <li>• ADAS control unit</li> </ul>

**NOTE:**

If DTC “C1A14” is detected along with DTC “U1000”, first diagnose the DTC “U1000”. Refer to [DAS-747, "ADAS CONTROL UNIT : DTC Logic"](#).

**1. PERFORM DTC CONFIRMATION PROCEDURE**

1. Start the engine.
2. Operate the Blind Spot Intervention system and drive.  
**CAUTION:**  
**Always drive safely.**
3. Stop the vehicle.
4. Perform “All DTC Reading” with CONSULT.
5. Check if the “C1A14” is detected as the current malfunction in “Self Diagnostic Result” of “ICC/ADAS”.

Is “C1A14” detected as the current malfunction?

- YES >> Refer to [DAS-725, "Diagnosis Procedure"](#).
- NO >> Refer to [GI-53, "Intermittent Incident"](#).

Diagnosis Procedure

INFOID:000000009717002

**1. CHECK SELF-DIAGNOSIS RESULTS**

Check if “U1000” is detected other than “C1A14” in “Self Diagnostic Result” of “ICC/ADAS”.

Is “U1000” detected?

- YES >> Perform the CAN communication system inspection. Repair or replace the malfunctioning parts. Refer to [DAS-747, "ADAS CONTROL UNIT : DTC Logic"](#).
- NO >> GO TO 2.

**2. PERFORM SELF-DIAGNOSIS OF ECM**

Check if any DTC is detected in “Self Diagnostic Result” of “ENGINE”.

Is any DTC detected?

- YES >> Perform diagnosis on the detected DTC and repair or replace the malfunctioning parts. Refer to [EC-97, "DTC Index"](#).
- NO >> Replace the ADAS control unit. Refer to [DAS-79, "Removal and Installation"](#).

# C1A15 GEAR POSITION

< DTC/CIRCUIT DIAGNOSIS >

[BCI]

## C1A15 GEAR POSITION

### Description

INFOID:000000009717003

ADAS control unit judges the gear position based on the following signals.

- Current gear position signal transmitted from TCM via CAN communication.
- Value of gear ratio calculated from input speed signal transmitted from TCM via CAN communication.
- Value of gear ratio calculated from the vehicle speed signal transmitted from ABS actuator and electric unit (control unit) via CAN communication.

### DTC Logic

INFOID:000000009717004

### DTC DETECTION LOGIC

DTC (On board display)	Trouble diagnosis name	DTC detecting condition	Possible causes
C1A15 (15)	GEAR POSITION	A mismatch between a current gear position signal transmitted from TCM via CAN communication and a gear position calculated by the ADAS control unit continues for approximately 11 minutes or more	<ul style="list-style-type: none"><li>• Input speed sensor</li><li>• Vehicle speed sensor CVT (output speed sensor)</li><li>• TCM</li></ul>

#### NOTE:

If DTC "C1A15" is detected along with DTC "U1000", "C1A03", or "C1A04", first diagnose the DTC "U1000", "C1A03", or "C1A04".

- Refer to [DAS-747, "ADAS CONTROL UNIT : DTC Logic"](#) for DTC "U1000".
- Refer to [DAS-716, "DTC Logic"](#) for DTC "C1A03".
- Refer to [DAS-717, "DTC Logic"](#) for DTC "C1A04".

### DTC CONFIRMATION PROCEDURE

#### 1. PERFORM DTC CONFIRMATION PROCEDURE

1. Start the engine.
2. Turn the Blind Spot Intervention system ON.
3. Drive the vehicle at 10 km/h (6 MPH) or faster for approximately 15 minutes or more.

#### CAUTION:

**Always drive safely.**

4. Stop the vehicle.
5. Perform "All DTC Reading" with CONSULT.
6. Check if "C1A15" is detected as the current malfunction in the "Self Diagnostic Result" of "ICC/ADAS".

Is "C1A15" detected as the current malfunction?

YES >> Refer to [DAS-726, "Diagnosis Procedure"](#).

NO >> Refer to [GI-53, "Intermittent Incident"](#).

### Diagnosis Procedure

INFOID:000000009717005

#### 1. CHECK SELF-DIAGNOSIS RESULTS

Check if "C1A03", "C1A04", or "U1000" is detected other than "C1A15" in "Self Diagnostic Result" of "ICC/ADAS".

Is any DTC detected?

YES >> Perform diagnosis on the detected DTC and repair or replace the malfunctioning parts. Refer to [DAS-677, "DTC Index"](#).

NO >> GO TO 2.

#### 2. CHECK VEHICLE SPEED SIGNAL

Check that "VHCL SPEED SE" operates normally in "DATA MONITOR" of "ICC/ADAS".

#### CAUTION:

**Be careful of the vehicle speed.**

Is the inspection result normal?

# C1A15 GEAR POSITION

[BCI]

< DTC/CIRCUIT DIAGNOSIS >

- YES >> GO TO 3.
- NO >> GO TO 7.

## 3.CHECK GEAR POSITION

Check that "GEAR" operates normally in "DATA MONITOR" of "ICC/ADAS".

### **CAUTION:**

**Be careful of the vehicle speed.**

Is the inspection result normal?

- YES >> GO TO 5.
- NO >> GO TO 4.

## 4.CHECK GEAR POSITION SIGNAL

Check that "GEAR" operates normally in "DATA MONITOR" of "TRANSMISSION".

Is the inspection result normal?

- YES >> GO TO 5.
- NO >> GO TO 6.

## 5.CHECK INPUT SPEED SENSOR SIGNAL

Check that "INPUT SPEED" operates normally in "DATA MONITOR" of "TRANSMISSION".

Is the inspection result normal?

- YES >> Replace the ADAS control unit. Refer to [DAS-79. "Removal and Installation"](#).
- NO >> GO TO 6.

## 6.CHECK TCM SELF-DIAGNOSIS RESULTS

1. Perform "All DTC Reading".
2. Check if any DTC is detected in "Self Diagnostic Result" of "TRANSMISSION".

Is any DTC detected?

- YES >> Perform diagnosis on the detected DTC and repair or replace the malfunctioning parts. Refer to [TM-61. "DTC Index"](#).
- NO >> Replace the ADAS control unit. Refer to [DAS-79. "Removal and Installation"](#).

## 7.CHECK ABS ACTUATOR AND ELECTRIC UNIT (CONTROL UNIT) SELF-DIAGNOSIS RESULTS

1. Perform "All DTC Reading".
2. Check if any DTC is detected in "Self Diagnostic Result" of "ABS".

Is any DTC detected?

- YES >> Perform diagnosis on the detected DTC and repair or replace the malfunctioning parts. Refer to [BRC-46. "DTC Index"](#).
- NO >> Replace the ADAS control unit. Refer to [DAS-79. "Removal and Installation"](#).

A  
B  
C  
D  
E  
F  
G  
H  
I  
J  
K  
L  
M  
N  
P

DAS

# C1A24 NP RANGE

< DTC/CIRCUIT DIAGNOSIS >

[BCI]

## C1A24 NP RANGE

### DTC Logic

INFOID:000000009717006

### DTC DETECTION LOGIC

DTC (On board display)	Trouble diagnosis name	DTC detecting condition	Possible causes
C1A24 (24)	NP RANGE	A mismatch between a shift position signal transmitted from TCM via CAN communication and a current gear position signal continues for 60 seconds or more	<ul style="list-style-type: none"><li>• TCM</li><li>• Transmission range switch</li></ul>

#### NOTE:

If DTC "C1A24" is detected along with DTC "U1000", first diagnose the DTC "U1000". Refer to [DAS-747, "ADAS CONTROL UNIT : DTC Logic"](#).

### DTC CONFIRMATION PROCEDURE

#### 1. CHECK DTC REPRODUCE (1)

1. Start the engine.
2. Turn the Blind Spot Intervention system ON.
3. Wait for approximately 5 minutes or more after shifting the selector lever to "P" position.
4. Perform "All DTC Reading" with CONSULT.
5. Check if the "C1A24" is detected as the current malfunction in "Self Diagnostic Result" of "ICC/ADAS".

Is "C1A24" detected as the current malfunction?

- YES >> Refer to [DAS-728, "Diagnosis Procedure"](#).  
NO >> GO TO 2.

#### 2. CHECK DTC REPRODUCE (2)

1. Wait for approximately 5 minutes or more after shifting the selector lever to "N" position.
2. Perform "All DTC Reading".
3. Check if the "C1A24" is detected as the current malfunction in "Self Diagnostic Result" of "ICC/ADAS".

Is "C1A24" detected as the current malfunction?

- YES >> Refer to [DAS-728, "Diagnosis Procedure"](#).  
NO >> Refer to [GI-53, "Intermittent Incident"](#).

### Diagnosis Procedure

INFOID:000000009717007

#### 1. CHECK SELF-DIAGNOSIS RESULTS

Check if "U1000" is detected other than "C1A24" in "Self Diagnostic Result" of "ICC/ADAS".

Is "U1000" detected?

- YES >> Perform the CAN communication system inspection. Repair or replace the malfunctioning parts.  
Refer to [DAS-747, "ADAS CONTROL UNIT : DTC Logic"](#).  
NO >> GO TO 2.

#### 2. CHECK NP POSITION SWITCH SIGNAL

Check that "NP RANGE SW" operates normally in "DATA MONITOR" of "ICC/ADAS".

Is the inspection result normal?

- YES >> GO TO 3.  
NO >> GO TO 4.

#### 3. CHECK TCM DATA MONITOR

Check that "SLCT LVR POSI" operates normally in "DATA MONITOR" of "TRANSMISSION".

Is the inspection result normal?

- YES >> Replace the ADAS control unit. Refer to [DAS-79, "Removal and Installation"](#).  
NO >> GO TO 4.

## C1A24 NP RANGE

< DTC/CIRCUIT DIAGNOSIS >

[BCI]

### 4.PERFORM TCM SELF-DIAGNOSIS

1. Perform "All DTC Reading".
2. Check if any DTC is detected in "Self Diagnostic Result" of "TRANSMISSION".

#### Is any DTC detected?

- YES >> Perform diagnosis on the detected DTC and repair or replace the malfunctioning parts. Refer to [TM-61, "DTC Index"](#).
- NO >> Replace the ADAS control unit. Refer to [DAS-79, "Removal and Installation"](#).

A  
B  
C  
D  
E  
F  
G  
H  
I  
J  
K  
L  
M  
N  
P

DAS

# C1A39 STEERING ANGLE SENSOR

< DTC/CIRCUIT DIAGNOSIS >

[BCI]

## C1A39 STEERING ANGLE SENSOR

### DTC Logic

INFOID:000000009717008

### DTC DETECTION LOGIC

DTC (On board display)	Trouble diagnosis name	DTC detecting condition	Possible causes
C1A39 (39)	STRG SEN CIR	If the steering angle sensor is malfunction	Steering angle sensor

#### NOTE:

If DTC "C1A39" is detected along with DTC "U1000", first diagnose the DTC "U1000". Refer to [DAS-747, "ADAS CONTROL UNIT : DTC Logic"](#).

### DTC CONFIRMATION PROCEDURE

#### 1. PERFORM DTC CONFIRMATION PROCEDURE

1. Start the engine.
2. Turn the Blind Spot Intervention system ON.
3. Perform "All DTC Reading" with CONSULT.
4. Check if the "C1A39" is detected as the current malfunction in self-diagnosis results of "ICC/ADAS".

Is "C1A39" detected as the current malfunction?

- YES >> Refer to [DAS-730, "Diagnosis Procedure"](#).  
NO >> Refer to [GI-53, "Intermittent Incident"](#).

### Diagnosis Procedure

INFOID:000000009717009

#### 1. CHECK SELF-DIAGNOSIS RESULTS

Check if "U1000" is detected other than "C1A39" in "Self Diagnostic Result" of "ICC/ADAS".

Is "U1000" detected?

- YES >> Perform the CAN communication system inspection. Repair or replace the malfunctioning parts.  
Refer to [DAS-747, "ADAS CONTROL UNIT : DTC Logic"](#).  
NO >> GO TO 2.

#### 2. CHECK ABS ACTUATOR AND ELECTRIC UNIT (CONTROL UNIT) SELF-DIAGNOSIS RESULTS

Check if any DTC is detected in "Self Diagnostic Result" of "ABS".

Is any DTC detected?

- YES >> Perform diagnosis on the detected DTC and repair or replace the malfunctioning parts. Refer to [BRC-46, "DTC Index"](#).  
NO >> Replace the ADAS control unit. Refer to [DAS-79, "Removal and Installation"](#).

# C1A50 ADAS CONTROL UNIT

< DTC/CIRCUIT DIAGNOSIS >

[BCI]

## C1A50 ADAS CONTROL UNIT

### DTC Logic

INFOID:000000009717010

### DTC DETECTION LOGIC

DTC	Trouble diagnosis name	DTC detecting condition	Possible cause
C1A50	ADAS MALFUNCTION	If ADAS control unit is malfunctioning	ADAS control unit

#### NOTE:

If DTC "C1A50" is detected along with DTC "U1000", first diagnose the DTC "U1000". Refer to [DAS-747. "ADAS CONTROL UNIT : DTC Logic"](#).

#### 1.PERFORM DTC CONFIRMATION PROCEDURE

1. Start the engine.
2. Turn the Blind Spot Intervention system ON.
3. Perform "All DTC Reading" with CONSULT.
4. Check if the "C1A50" is detected as the current malfunction in "Self Diagnostic Result" of "LANE CAMERA".

Is "C1A50" detected as the current malfunction?

- YES >> Refer to [DAS-731. "Diagnosis Procedure"](#).  
NO >> Refer to [GI-53. "Intermittent Incident"](#).

### Diagnosis Procedure

INFOID:000000009717011

#### 1.CHECK LANE CAMERA UNIT SELF-DIAGNOSIS RESULTS

Check if "U1000" is detected other than "C1A50" in "Self Diagnostic Result" of "LANE CAMERA".

Is "U1000" detected?

- YES >> Perform the CAN communication system inspection. Repair or replace the malfunctioning parts.  
Refer to [DAS-748. "LANE CAMERA UNIT : DTC Logic"](#).  
NO >> GO TO 2.

#### 2.CHECK ADAS CONTROL UNIT SELF-DIAGNOSIS RESULTS

Check if any DTC is detected in "Self Diagnostic Result" of "ICC/ADAS".

Is any DTC detected?

- YES >> Perform diagnosis on the detected DTC and repair or replace the malfunctioning parts. Refer to [DAS-677. "DTC Index"](#).  
NO >> Replace the lane camera unit. Refer to [DAS-635. "Removal and Installation"](#).

A  
B  
C  
D  
E  
F  
G  
H  
I  
J  
K  
L  
M  
N  
P

DAS

# C1B00 CAMERA UNIT MALF

< DTC/CIRCUIT DIAGNOSIS >

[BCI]

## C1B00 CAMERA UNIT MALF

### ADAS CONTROL UNIT

#### ADAS CONTROL UNIT : DTC Logic

INFOID:000000009717012

#### DTC DETECTION LOGIC

DTC (On board display)	Trouble diagnosis name	DTC detecting condition	Possible causes
C1B00 (81)	CAMERA UNIT MALF	If lane camera unit is malfunctioning	Lane camera unit

#### DTC CONFIRMATION PROCEDURE

##### 1.PERFORM DTC CONFIRMATION PROCEDURE

1. Start the engine.
2. Perform "All DTC Reading" with CONSULT.
3. Check if the "C1B00" is detected as the current malfunction in "Self Diagnostic Result" of "ICC/ADAS".

Is "C1B00" detected as the current malfunction?

YES >> Refer to [DAS-732, "ADAS CONTROL UNIT : Diagnosis Procedure"](#).

NO >> INSPECTION END

#### ADAS CONTROL UNIT : Diagnosis Procedure

INFOID:000000009717013

##### 1.CHECK SELF-DIAGNOSIS RESULTS

Check if "C1B00" is detected in "Self Diagnostic Result" of "LANE CAMERA".

Is "C1B00" detected?

YES >> Refer to [DAS-732, "LANE CAMERA UNIT : DTC Logic"](#)

NO >> Replace the ADAS control unit. Refer to [DAS-79, "Removal and Installation"](#).

### LANE CAMERA UNIT

#### LANE CAMERA UNIT : DTC Logic

INFOID:000000009717014

#### DTC DETECTION LOGIC

DTC	Trouble diagnosis name	DTC detecting condition	Possible causes
C1B00	CAMERA UNIT MALF	If lane camera unit is malfunctioning	Lane camera unit

#### DTC CONFIRMATION PROCEDURE

##### 1.PERFORM DTC CONFIRMATION PROCEDURE

1. Start the engine.
2. Perform "All DTC Reading" with CONSULT.
3. Check if the "C1B00" is detected as the current malfunction in "Self Diagnostic Result" of "LANE CAMERA".

Is "C1B00" detected as the current malfunction?

YES >> Refer to [DAS-732, "LANE CAMERA UNIT : Diagnosis Procedure"](#).

NO >> INSPECTION END

#### LANE CAMERA UNIT : Diagnosis Procedure

INFOID:000000009717015

##### 1.CHECK SELF-DIAGNOSIS RESULTS

Check if any DTC other than "C1B00" is detected in "Self Diagnostic Result" of "LANE CAMERA".

Is any DTC detected?



## C1B00 CAMERA UNIT MALF

< DTC/CIRCUIT DIAGNOSIS >

[BCI]

- YES >> Perform diagnosis on the detected DTC and repair or replace the malfunctioning parts. Refer to [DAS-520, "DTC Index"](#).
- NO >> Replace the lane camera unit. Refer to [DAS-635, "Removal and Installation"](#).

A  
B  
C  
D  
E  
F  
G  
H  
I  
J  
K  
L  
M  
N  
P

DAS

# C1B01 CAM AIMING INCOMP

< DTC/CIRCUIT DIAGNOSIS >

[BCI]

## C1B01 CAM AIMING INCOMP

### ADAS CONTROL UNIT

#### ADAS CONTROL UNIT : DTC Logic

INFOID:000000009717016

#### DTC DETECTION LOGIC

DTC (On board display)	Trouble diagnosis name	DTC detecting condition	Possible causes
C1B01 (82)	CAM AIMING INCOMP	Camera aiming is not completed	<ul style="list-style-type: none"><li>Lane camera aiming is not adjusted</li><li>Lane camera aiming adjustment has been interrupted</li></ul>

#### DTC CONFIRMATION PROCEDURE

##### 1. PERFORM DTC CONFIRMATION PROCEDURE

- Start the engine.
- Operate the Blind Spot Intervention system and drive.  
**CAUTION:**  
**Always drive safely.**
- Perform "All DTC Reading" with CONSULT.
- Check if the "C1B01" is detected as the current malfunction in "Self Diagnostic Result" of "ICC/ADAS".

Is "C1B01" detected as the current malfunction?

- YES >> Refer to [DAS-734, "ADAS CONTROL UNIT : Diagnosis Procedure"](#).  
NO >> Refer to [GI-53, "Intermittent Incident"](#).

#### ADAS CONTROL UNIT : Diagnosis Procedure

INFOID:000000009717017

##### 1. CHECK SELF-DIAGNOSIS RESULTS

Check if "C1B01" is detected in "Self Diagnostic Result" of "LANE CAMERA".

Is "C1B01" detected?

- YES >> Refer to [DAS-734, "LANE CAMERA UNIT : DTC Logic"](#).  
NO >> GO TO 2.

##### 2. CHECK DATA MONITOR

- Start the engine.
- Check that "OK" is indicated for the value of "AIMING RESULT" in "DATA MONITOR" of "LANE CAMERA".

Is "OK" indicated?

- YES >> Replace the ADAS control unit. Refer to [DAS-79, "Removal and Installation"](#).  
NO >> Replace the lane camera unit. Refer to [DAS-635, "Removal and Installation"](#).

## LANE CAMERA UNIT

#### LANE CAMERA UNIT : DTC Logic

INFOID:000000009717018

#### DTC DETECTION LOGIC

DTC	Trouble diagnosis name	DTC detecting condition	Possible causes
C1B01	CAM AIMING INCOMP	Camera aiming is not completed	<ul style="list-style-type: none"><li>Lane camera aiming is not adjusted</li><li>Lane camera aiming adjustment has been interrupted</li></ul>

#### DTC CONFIRMATION PROCEDURE

# C1B01 CAM AIMING INCOMP

< DTC/CIRCUIT DIAGNOSIS >

[BCI]

## 1. PERFORM DTC CONFIRMATION PROCEDURE

1. Start the engine.
2. Perform "All DTC Reading" with CONSULT.
3. Check if the "C1B01" is detected as the current malfunction in "Self Diagnostic Result" of "LANE CAMERA".

Is "C1B01" detected as the current malfunction?

- YES >> Refer to [DAS-735, "LANE CAMERA UNIT : Diagnosis Procedure"](#).  
NO >> Refer to [GI-53, "Intermittent Incident"](#).

## LANE CAMERA UNIT : Diagnosis Procedure

INFOID:000000009717019

## 1. CAMERA AIMING ADJUSTMENT

1. Perform the camera aiming. Refer to [DAS-396, "Description"](#).
2. Erase all self-diagnosis results with CONSULT.
3. Perform "All DTC Reading".
4. Check if the "C1B01" is detected in "Self Diagnostic Result" of "LANE CAMERA".

Is "C1B01" detected?

- YES >> Replace the lane camera unit. Refer to [DAS-635, "Removal and Installation"](#).  
NO >> INSPECTION END

A  
B  
C  
D  
E  
F  
G  
H  
I  
J  
K  
L  
M  
N  
P

DAS

# C1B03 ABNRML TEMP DETECT

< DTC/CIRCUIT DIAGNOSIS >

[BCI]

## C1B03 ABNRML TEMP DETECT ADAS CONTROL UNIT

ADAS CONTROL UNIT : DTC Logic

INFOID:000000009717020

### DTC DETECTION LOGIC

DTC (On board display)	Trouble diagnosis name	DTC detecting condition	Possible causes
C1B03 (83)	CAM ABNRML TMP DETCT	Temperature around lane camera unit is excessively high	Interior room temperature is excessively high

### ADAS CONTROL UNIT : Diagnosis Procedure

INFOID:000000009717021

#### 1. CHECK LANE CAMERA UNIT SELF-DIAGNOSIS RESULTS

1. Perform "All DTC Reading" with CONSULT.
2. Check if the "C1B03" is detected in "Self Diagnostic Result" of "LANE CAMERA"

Is "C1B03" detected?

- YES >> Refer to [DAS-736. "LANE CAMERA UNIT : DTC Logic"](#)  
NO >> GO TO 2.

#### 2. CHECK ADAS CONTROL UNIT SELF-DIAGNOSIS RESULTS

1. Erase all self-diagnosis results with CONSULT.
2. Perform "All DTC Reading".
3. Check if the "C1B03" is detected in "Self Diagnostic Result" of "ICC/ADAS"

Is "C1B03" detected?

- YES >> Replace the ADAS control unit. Refer to [DAS-79. "Removal and Installation"](#).  
NO >> INSPECTION END

## LANE CAMERA UNIT

LANE CAMERA UNIT : DTC Logic

INFOID:000000009717022

### DTC DETECTION LOGIC

DTC	Trouble diagnosis name	DTC detecting condition	Possible causes
C1B03	ABNRML TEMP DETECT	Temperature around lane camera unit is excessively high	Interior room temperature is excessively high

### LANE CAMERA UNIT : Diagnosis Procedure

INFOID:000000009717023

#### 1. COOLING LANE CAMERA UNIT

1. Wait for 10 minutes or more to cool the lane camera unit.
2. Erase all self-diagnosis results with CONSULT.
3. Perform "All DTC Reading".
4. Check if the "C1B03" is detected in "Self Diagnostic Result" of "LANE CAMERA".

Is "C1B03" detected?

- YES >> Replace the lane camera unit. Refer to [DAS-635. "Removal and Installation"](#).  
NO >> INSPECTION END

# C1B50 SIDE RADAR MALFUNCTION

< DTC/CIRCUIT DIAGNOSIS >

[BCI]

## C1B50 SIDE RADAR MALFUNCTION

### DTC LOGIC

INFOID:000000009717024

### DTC DETECTION LOGIC

DTC	Trouble diagnosis name	DTC detecting condition	Possible causes
C1B50	SIDE RDR MALFUNCTION	Side radar malfunction	Side radar

### DTC CONFIRMATION PROCEDURE

#### 1. PERFORM DTC CONFIRMATION PROCEDURE

1. Start the engine.
2. Perform "All DTC Reading" with CONSULT.
3. Check if the "C1B50" is detected as the current malfunction in "Self Diagnostic Result" of "SIDE RADAR RIGHT/LEFT".

Is the "C1B50" detected as the current malfunction?

- YES >> Refer to [DAS-737, "Diagnosis Procedure"](#).  
NO >> INSPECTION END

### Diagnosis Procedure

INFOID:000000009717025

#### 1. CHECK SELF-DIAGNOSIS RESULT

Check if any DTC other than "C1B50" is detected in "Self Diagnostic Result" of "SIDE RADAR LEFT/RIGHT"

Is any DTC detected?

- YES >> Perform diagnosis on the detected DTC and repair or replace the malfunction part. Refer to [DAS-685, "DTC Index"](#) (SIDE RADAR RIGHT) or [DAS-683, "DTC Index"](#) (SIDE RADAR LEFT).  
NO >> Replace the side radar. Refer to [DAS-632, "Removal and Installation"](#).

A  
B  
C  
D  
E  
F  
G  
H  
I  
J  
K  
L  
M  
N  
P

DAS

# C1B51 BLIND SPOT WARNING/BLIND SPOT INTERVENTION INDICATOR SHORT CIRCUIT

< DTC/CIRCUIT DIAGNOSIS >

[BCI]

## C1B51 BLIND SPOT WARNING/BLIND SPOT INTERVENTION INDICATOR SHORT CIRCUIT

### DTC Logic

INFOID:000000009717026

### DTC DETECTION LOGIC

DTC	Trouble diagnosis name	DTC detecting condition	Possible cause
C1B51	BSW/BSI IND SHORT CIR	Short circuit in Blind Spot Warning/Blind Spot Intervention indicator circuit is detected. (Over current is detected)	<ul style="list-style-type: none"><li>Blind Spot Warning/Blind Spot Intervention indicator circuit.</li><li>Blind Spot Warning/Blind Spot Intervention indicator.</li><li>Side radar.</li></ul>

### DTC CONFIRMATION PROCEDURE

#### 1. PERFORM DTC CONFIRMATION PROCEDURE

- Start the engine.
- Perform "All DTC Reading" with CONSULT.
- Check if the "C1B51" is detected as the current malfunction in "Self Diagnostic Result" of "SIDE RADAR RIGHT/LEFT".

Is the "C1B51" detected as the current malfunction?

- YES >> Refer to [DAS-737, "Diagnosis Procedure"](#).  
NO >> INSPECTION END

### Diagnosis Procedure

INFOID:000000009717027

#### 1. CHECK BLIND SPOT WARNING/BLIND SPOT INTERVENTION INDICATOR CIRCUIT FOR SHORT

- Turn ignition switch OFF.
- Disconnect side radar harness connector and Blind Spot Warning/Blind Spot Intervention indicator harness connector.
- Check continuity between side radar harness connector and ground.

Side radar		Ground	Continuity
Connector	Terminal		
B416 (LH)	6		Not existed
B81 (RH)			

Is the inspection result normal?

- YES >> GO TO 2.  
NO >> Repair the harnesses or connectors.

#### 2. REPLACE THE SIDE RADAR

- Replace the side radar.
- Perform "All DTC Reading" with CONSULT.
- Check if the "C1B51" is detected in "Self Diagnostic Result" of "SIDE RADAR RIGHT/LEFT"

Is the DTC "C1B51" detected?

- YES >> Replace the side radar. Refer to [DAS-632, "Removal and Installation"](#).  
NO >> INSPECTION END

# C1B52 BLIND SPOT WARNING/BLIND SPOT INTERVENTION INDICATOR OPEN CIRCUIT

< DTC/CIRCUIT DIAGNOSIS >

[BCI]

## C1B52 BLIND SPOT WARNING/BLIND SPOT INTERVENTION INDICATOR OPEN CIRCUIT

### DTC Logic

INFOID:000000009717028

### DTC DETECTION LOGIC

DTC	Trouble diagnosis name	DTC detecting condition	Possible cause
C1B52	BSW/BSI IND OPEN CIR	Open circuit in Blind Spot Warning/Blind Spot Intervention indicator circuit is detected.	<ul style="list-style-type: none"> <li>• Blind Spot Warning/Blind Spot Intervention indicator circuit.</li> <li>• Blind Spot Warning/Blind Spot Intervention indicator.</li> <li>• Side radar.</li> </ul>

### DTC CONFIRMATION PROCEDURE

#### 1. PERFORM DTC CONFIRMATION PROCEDURE

1. Start the engine.
2. Perform "All DTC Reading" with CONSULT.
3. Check if the "C1B52" is detected as the current malfunction in "Self Diagnostic Result" of "SIDE RADAR RIGHT/LEFT".

Is the "C1B52" detected as the current malfunction?

- YES >> Refer to [DAS-737, "Diagnosis Procedure"](#).  
 NO >> INSPECTION END

### Diagnosis Procedure

INFOID:000000009717029

#### 1. CHECK BLIND SPOT WARNING/BLIND SPOT INTERVENTION INDICATOR CIRCUIT FOR OPEN 1

1. Turn ignition switch OFF.
2. Disconnect side radar harness connector and Blind Spot Warning/Blind Spot Intervention indicator harness connector.
3. Check continuity between side radar harness connector and Blind Spot Warning/Blind Spot Intervention indicator harness connector.

Side radar		Blind Spot Warning/Blind Spot Intervention indicator		Continuity
Connector	Terminal	Connector	Terminal	
B416 (LH)	6	D21 (LH)	1	Existed
B109 (RH)		D111 (RH)		

Is the inspection result normal?

- YES >> GO TO 2.  
 NO >> Repair the harnesses or connectors.

#### 2. CHECK BLIND SPOT WARNING/BLIND SPOT INTERVENTION INDICATOR CIRCUIT FOR OPEN 2

Check continuity between Blind Spot Warning/Blind Spot Intervention indicator harness connector and ground.

Blind Spot Warning/Blind Spot Intervention indicator		Ground	Continuity
Connector	Terminal		
D21 (LH)	4		Existed
D111 (RH)			



# C1B52 BLIND SPOT WARNING/BLIND SPOT INTERVENTION INDICATOR OPEN CIRCUIT

< DTC/CIRCUIT DIAGNOSIS >

[BCI]

Is the inspection result normal?

- YES >> GO TO 3.  
NO >> Repair the harnesses or connectors.

## 3. CHECK SIDE RADAR VOLTAGE OUTPUT

1. Connect side radar harness connector.
2. Check voltage between Blind Spot Warning/Blind Spot Intervention indicator harness connector and ground.

Blind Spot Warning/Blind Spot Intervention indicator		Ground	Condition	Voltage (Approx.)
Connector	Terminal			
D21 (LH)	1		Ignition switch OFF ⇒ ON (Approx. 2 sec.)	6 V
D111 (RH)				

Is the inspection result normal?

- YES >> Replace Blind Spot Warning/Blind Spot Intervention indicator.  
NO >> Replace side radar. Refer to [DAS-632. "Removal and Installation"](#).



# C1B53 SIDE RADAR RIGHT MALFUNCTION

< DTC/CIRCUIT DIAGNOSIS >

[BCI]

## C1B53 SIDE RADAR RIGHT MALFUNCTION

### DTC Logic

INFOID:000000009717030

### DTC DETECTION LOGIC

DTC (On board display)	Trouble diagnosis name	DTC detecting condition	Possible cause
C1B53 (84)	SIDE RDR R MALF	ADAS control unit detects that side radar RH has a malfunction.	Side radar RH

### DTC CONFIRMATION PROCEDURE

#### 1. PERFORM DTC CONFIRMATION PROCEDURE

1. Start the engine.
2. Perform "All DTC Reading" with CONSULT.
3. Check if the "C1B53" is detected as the current malfunction in "Self Diagnostic Result" of "ICC/ADAS".

#### Is "C1B53" detected as the current malfunction?

- YES >> Refer to [DAS-741, "Diagnosis Procedure"](#).  
NO >> Refer to [GI-53, "Intermittent Incident"](#).

### Diagnosis Procedure

INFOID:000000009717031

#### 1. CHECK SELF-DIAGNOSIS RESULTS

Check if "U1000" is detected other than "C1B53" in "Self Diagnostic Result" of "ICC/ADAS".

#### Is "U1000" detected?

- YES >> Perform the CAN communication system inspection. Repair or replace the malfunctioning parts.  
Refer to [DAS-747, "ADAS CONTROL UNIT : DTC Logic"](#).  
NO >> GO TO 2.

#### 2. CHECK SELF-DIAGNOSIS RESULTS

Check if any DTC is detected in "Self Diagnostic Result" of "SIDE RADAR RIGHT".

#### Is any DTC detected?

- YES >> Perform diagnosis on the detected DTC and repair or replace the malfunctioning parts. Refer to [DAS-683, "DTC Index"](#) (SIDE RADAR LH), [DAS-685, "DTC Index"](#) (SIDE RADAR RH).  
NO >> Replace the ADAS control unit. Refer to [DAS-79, "Removal and Installation"](#).

DAS

# C1B54 SIDE RADAR LEFT MALFUNCTION

< DTC/CIRCUIT DIAGNOSIS >

[BCI]

## C1B54 SIDE RADAR LEFT MALFUNCTION

### DTC Logic

INFOID:000000009717032

### DTC DETECTION LOGIC

DTC (On board display)	Trouble diagnosis name	DTC detecting condition	Possible cause
C1B54 (85)	SIDE RDR L MALF	ADAS control unit detects that side radar LH has a malfunction.	Side radar LH

### DTC CONFIRMATION PROCEDURE

#### 1. PERFORM DTC CONFIRMATION PROCEDURE

1. Start the engine.
2. Perform "All DTC Reading" with CONSULT.
3. Check if the "C1B54" is detected as the current malfunction in "Self Diagnostic Result" of "ICC/ADAS".

Is "C1B54" detected as the current malfunction?

- YES >> Refer to [DAS-741, "Diagnosis Procedure"](#).  
NO >> Refer to [GI-53, "Intermittent Incident"](#).

### Diagnosis Procedure

INFOID:000000009717033

#### 1. CHECK SELF-DIAGNOSIS RESULTS

Check if "U1000" is detected other than "C1B54" in "Self Diagnostic Result" of "ICC/ADAS".

Is "U1000" detected?

- YES >> Perform the CAN communication system inspection. Repair or replace the malfunctioning parts.  
Refer to [DAS-747, "ADAS CONTROL UNIT : DTC Logic"](#).  
NO >> GO TO 2.

#### 2. CHECK SELF-DIAGNOSIS RESULTS

Check if any DTC is detected in "Self Diagnostic Result" of "SIDE RADAR LEFT".

Is any DTC detected?

- YES >> Perform diagnosis on the detected DTC and repair or replace the malfunctioning parts. Refer to [DAS-683, "DTC Index"](#) (SIDE RADAR LH), [DAS-685, "DTC Index"](#) (SIDE RADAR RH).  
NO >> Replace the ADAS control unit. Refer to [DAS-79, "Removal and Installation"](#).

# C1B55 RADAR BLOCKAGE

< DTC/CIRCUIT DIAGNOSIS >

[BCI]

## C1B55 RADAR BLOCKAGE

### DTC Logic

INFOID:000000009717034

### DTC DETECTION LOGIC

DTC No.	Trouble diagnosis name	DTC detecting condition	Possible cause
C1B55	RADAR BLOCKAGE	Side radar is blocked.	Stain or foreign materials is deposited.

#### NOTE:

DTC "C1B55" may be detected under the following conditions except for possible cause. (Explain to the customer about the difference between the contamination detection function and the indication when the malfunction is detected and tell them "This is not malfunction".)

- The side radar may be blocked by temporary ambient conditions such as splashing water, mist or fog.
- The blocked condition may also be caused by objects such as ice, frost or dirt obstructing the side radar.
- Due to the nature of radar technology it is possible to get a blockage warning and not actually be blocked. This is rare and is known as a false blockage warning. A false blocked condition either self-clears or clears after an ignition cycle.

### Diagnosis Procedure

INFOID:000000009717035

#### 1.CHECK THE REAR BUMPER

Check rear bumper near the side radar contaminated with foreign materials.

>> GO TO 2.

#### 2.CHECK THE SIDE RADAR

Check side radar and the side radar outskirts contaminated with foreign materials.

>> GO TO 3.

#### 3.CHECK THE SIDE RADAR INSTALL CONDITION

Check side radar installation condition (installation position, properly tightened, a bent bracket).

>> GO TO 4.

#### 4.INTERVIEW

1. Ask if there is stain or foreign materials.
2. Ask if there is any temporary ambient condition such as splashing water, mist or fog.
3. Ask if there is any object such as ice, frost or dirt obstructing the side radar.

#### Is any of above conditions seen?

- YES >> Explain to the customer about the difference between the blockage detection function and the indication when the malfunction is detected and tell them "This is not malfunction".
- NO >> INSPECTION END

# C1B56 SONAR CIRCUIT

< DTC/CIRCUIT DIAGNOSIS >

[BCI]

## C1B56 SONAR CIRCUIT

### DTC Logic

INFOID:000000009717036

### DTC DETECTION LOGIC

DTC (On board display)	Trouble diagnosis name	DTC detecting condition	Possible cause
C1B56 (87)	SONAR CIRCUIT MALF	ADAS control unit detects that rear sonar circuit has a malfunction.	Sonar control unit

### DTC CONFIRMATION PROCEDURE

#### 1. PERFORM DTC CONFIRMATION PROCEDURE

1. Start the engine.
2. Perform "All DTC Reading" with CONSULT.
3. Check if the "C1B56" is detected as the current malfunction in "Self Diagnostic Result" of "ICC/ADAS".

Is "C1B56" detected as the current malfunction?

- YES >> Refer to [DAS-744, "Diagnosis Procedure"](#).  
NO >> Refer to [GI-53, "Intermittent Incident"](#).

### Diagnosis Procedure

INFOID:000000009717037

#### 1. CHECK SELF-DIAGNOSIS RESULTS

Check if "U1000" is detected other than "C1B56" in "Self Diagnostic Result" of "ICC/ADAS".

Is "U1000" detected?

- YES >> Perform the CAN communication system inspection. Repair or replace the malfunctioning parts.  
Refer to [DAS-747, "ADAS CONTROL UNIT : DTC Logic"](#).  
NO >> GO TO 2.

#### 2. CHECK SELF-DIAGNOSIS RESULTS

Check if any DTC is detected in "Self Diagnostic Result" of "SONAR".

Is any DTC detected?

- YES >> Perform diagnosis on the detected DTC and repair or replace the malfunctioning parts. Refer to [AV-682, "DTC Index"](#).  
NO >> Replace the ADAS control unit. Refer to [DAS-79, "Removal and Installation"](#).

# C1B57 AVM CIRCUIT

< DTC/CIRCUIT DIAGNOSIS >

[BCI]

## C1B57 AVM CIRCUIT

### DTC Logic

INFOID:000000009717038

### DTC DETECTION LOGIC

DTC (On board display)	Trouble diagnosis name	DTC detecting condition	Possible cause
C1B57 (88)	AVM CIRCUIT MALF	ADAS control unit detects that AVM has a mal- function.	AVM control unit

### DTC CONFIRMATION PROCEDURE

#### 1. PERFORM DTC CONFIRMATION PROCEDURE

1. Start the engine.
2. Perform "All DTC Reading" with CONSULT.
3. Check if the "C1B57" is detected as the current malfunction in "Self Diagnostic Result" of "ICC/ADAS".

#### Is "C1B57" detected as the current malfunction?

- YES >> Refer to [DAS-745, "Diagnosis Procedure"](#).  
NO >> Refer to [GI-53, "Intermittent Incident"](#).

### Diagnosis Procedure

INFOID:000000009717039

#### 1. CHECK SELF-DIAGNOSIS RESULTS

Check if "U1000" is detected other than "C1B57" in "Self Diagnostic Result" of "ICC/ADAS".

#### Is "U1000" detected?

- YES >> Perform the CAN communication system inspection. Repair or replace the malfunctioning parts.  
Refer to [DAS-747, "ADAS CONTROL UNIT : DTC Logic"](#).  
NO >> GO TO 2.

#### 2. CHECK SELF-DIAGNOSIS RESULTS

Check if any DTC is detected in "Self Diagnostic Result" of "AVM".

#### Is any DTC detected?

- YES >> Perform diagnosis on the detected DTC and repair or replace the malfunctioning parts. Refer to  
[AV-660, "DTC Index"](#).  
NO >> Replace the ADAS control unit. Refer to [DAS-79, "Removal and Installation"](#).

A  
B  
C  
D  
E  
F  
G  
H  
I  
J  
K  
L  
M  
N  
P

DAS

# U1000 CAN COMM CIRCUIT

< DTC/CIRCUIT DIAGNOSIS >

[BCI]

## U1000 CAN COMM CIRCUIT

### SIDE RADAR LH

#### SIDE RADAR LH : Description

INFOID:000000009717040

#### CAN COMMUNICATION

CAN (Controller Area Network) is a serial communication line for real time applications. It is an on-vehicle multiplex communication line with high data communication speed and excellent error detection ability. Modern vehicle is equipped with many electronic control units, and each control unit shares information and links with other control units during operation (not independent). In CAN communication, control units are connected with 2 communication lines (CAN-H, CAN-L) allowing a high rate of information transmission with less wiring. Each control unit transmits/receives data but selectively reads the required data only.

CAN communication signal chart. Refer to [LAN-43. "CAN COMMUNICATION SYSTEM : CAN Communication Signal Chart"](#).

#### ITS COMMUNICATION

- ITS communication is a multiplex communication system. This enables the system to transmit and receive large quantities of data at high speed by connecting plural units with 2 communication lines.
- ITS communication lines adopt twisted-pair line style (two lines twisted) for noise immunity.

#### SIDE RADAR LH : DTC Logic

INFOID:000000009717041

#### DTC DETECTION LOGIC

DTC	Trouble diagnosis name	DTC detecting condition	Possible causes
U1000	CAN COMM CIRCUIT	If Side radar LH is not transmitting or receiving ITS communication signal for 2 seconds or more	ITS communication system

#### SIDE RADAR LH : Diagnosis Procedure

INFOID:000000009717042

#### 1. PERFORM THE SELF-DIAGNOSIS

1. Start the engine.
2. Turn the Blind Spot Intervention system ON, and then wait for 30 seconds or more.
3. Perform "All DTC Reading" with CONSULT.
4. Check if the "U1000" is detected as the current malfunction in "Self Diagnostic Result" of "SIDE RADAR LEFT".

Is "U1000" detected as the current malfunction?

YES >> Refer to [LAN-26. "Trouble Diagnosis Flow Chart"](#).

NO >> Refer to [GI-53. "Intermittent Incident"](#).

### SIDE RADAR RH

#### SIDE RADAR RH : Description

INFOID:000000009717043

#### CAN COMMUNICATION

CAN (Controller Area Network) is a serial communication line for real time applications. It is an on-vehicle multiplex communication line with high data communication speed and excellent error detection ability. Modern vehicle is equipped with many electronic control units, and each control unit shares information and links with other control units during operation (not independent). In CAN communication, control units are connected with 2 communication lines (CAN-H, CAN-L) allowing a high rate of information transmission with less wiring. Each control unit transmits/receives data but selectively reads the required data only.

CAN communication signal chart. Refer to [LAN-43. "CAN COMMUNICATION SYSTEM : CAN Communication Signal Chart"](#).

#### ITS COMMUNICATION

- ITS communication is a multiplex communication system. This enables the system to transmit and receive large quantities of data at high speed by connecting plural units with 2 communication lines.
- ITS communication lines adopt twisted-pair line style (two lines twisted) for noise immunity.

# U1000 CAN COMM CIRCUIT

< DTC/CIRCUIT DIAGNOSIS >

[BCI]

## SIDE RADAR RH : DTC Logic

INFOID:000000009717044

### DTC DETECTION LOGIC

DTC	Trouble diagnosis name	DTC detecting condition	Possible causes
U1000	CAN COMM CIRCUIT	If Side radar RH is not transmitting or receiving ITS communication signal for 2 seconds or more	ITS communication system

## SIDE RADAR RH : Diagnosis Procedure

INFOID:000000009717045

### 1. PERFORM THE SELF-DIAGNOSIS

1. Start the engine.
2. Turn the Blind Spot Intervention system ON, and then wait for 30 seconds or more.
3. Perform "All DTC Reading" with CONSULT.
4. Check if the "U1000" is detected as the current malfunction in "Self Diagnostic Result" of "SIDE RADAR RIGHT".

Is "U1000" detected as the current malfunction?

YES >> Refer to [LAN-26, "Trouble Diagnosis Flow Chart"](#).

NO >> Refer to [GI-53, "Intermittent Incident"](#).

## ADAS CONTROL UNIT

### ADAS CONTROL UNIT : Description

INFOID:000000009717046

#### CAN COMMUNICATION

CAN (Controller Area Network) is a serial communication line for real time applications. It is an on-vehicle multiplex communication line with high data communication speed and excellent error detection ability. Modern vehicle is equipped with many electronic control units, and each control unit shares information and links with other control units during operation (not independent). In CAN communication, control units are connected with 2 communication lines (CAN-H, CAN-L) allowing a high rate of information transmission with less wiring. Each control unit transmits/receives data but selectively reads the required data only.

CAN communication signal chart. Refer to [LAN-43, "CAN COMMUNICATION SYSTEM : CAN Communication Signal Chart"](#).

#### ITS COMMUNICATION

- ITS communication is a multiplex communication system. This enables the system to transmit and receive large quantities of data at high speed by connecting control units with 2 communication lines.
- ITS communication lines adopt twisted-pair line style (two lines twisted) for noise immunity.

### ADAS CONTROL UNIT : DTC Logic

INFOID:000000009717047

### DTC DETECTION LOGIC

DTC (On board display)	Trouble diagnosis name	DTC detecting condition	Possible causes
U1000 (100)	CAN COMM CIRCUIT	If ADAS control unit is not transmitting or receiving CAN communication signal or ITS communication signal for 2 seconds or more	<ul style="list-style-type: none"><li>• CAN communication system</li><li>• ITS communication system</li></ul>

#### NOTE:

If "U1000" is detected, first diagnose the CAN communication system.

## ADAS CONTROL UNIT : Diagnosis Procedure

INFOID:000000009717048

### 1. PERFORM THE SELF-DIAGNOSIS

1. Turn the ignition switch ON.
2. Turn the Blind Spot Intervention system ON, and then wait for 30 seconds or more.
3. Perform "All DTC Reading" with CONSULT.
4. Check if the "U1000" is detected as the current malfunction in "Self Diagnostic Result" of "ICC/ADAS".

A  
B  
C  
D  
E  
F  
G  
H  
I  
J  
K  
L  
M  
N  
P

# U1000 CAN COMM CIRCUIT

[BCI]

< DTC/CIRCUIT DIAGNOSIS >

Is "U1000" detected as the current malfunction?

YES >> Refer to [LAN-26, "Trouble Diagnosis Flow Chart"](#).

NO >> Refer to [GI-53, "Intermittent Incident"](#).

## LANE CAMERA UNIT

### LANE CAMERA UNIT : Description

INFOID:000000009717049

#### ITS COMMUNICATION

- ITS communication is a multiplex communication system. This enables the system to transmit and receive large quantities of data at high speed by connecting control units with 2 communication lines.
- ITS communication lines adopt twisted-pair line style (two lines twisted) for noise immunity.

### LANE CAMERA UNIT : DTC Logic

INFOID:000000009717050

#### DTC DETECTION LOGIC

DTC	Trouble diagnosis name	DTC detecting condition	Possible causes
U1000	CAN COMM CIRCUIT	If lane camera unit is not transmitting or receiving ITS communication signal for 2 seconds or more	ITS communication system

### LANE CAMERA UNIT : Diagnosis Procedure

INFOID:000000009717051

#### 1. PERFORM THE SELF-DIAGNOSIS

1. Turn the ignition switch ON.
2. Turn the Blind Spot Intervention system ON, and then wait for 2 seconds or more.
3. Perform "All DTC Reading" with CONSULT.
4. Check if the "U1000" is detected as the current malfunction in "Self Diagnostic Result" of "LANE CAMERA".

Is "U1000" detected as the current malfunction?

YES >> Refer to [LAN-26, "Trouble Diagnosis Flow Chart"](#).

NO >> Refer to [GI-53, "Intermittent Incident"](#).



# U1010 CONTROL UNIT (CAN)

< DTC/CIRCUIT DIAGNOSIS >

[BCI]

## U1010 CONTROL UNIT (CAN)

### SIDE RADAR LH

#### SIDE RADAR LH : Description

INFOID:000000009717052

CAN controller controls the communication of ITS communication signal and the error detection.

#### SIDE RADAR LH : DTC Logic

INFOID:000000009717053

#### DTC DETECTION LOGIC

DTC	Trouble diagnosis name	DTC detecting condition	Possible cause
U1010	CONTROL UNIT (CAN)	If side radar LH detects malfunction by CAN controller initial diagnosis.	Side radar LH

#### SIDE RADAR LH : Diagnosis Procedure

INFOID:000000009717054

##### 1. CHECK SELF-DIAGNOSIS RESULT

1. Turn the Blind Spot Intervention system ON.
2. Perform "All DTC Reading" with CONSULT.
3. Check if the "U1010" is detected as the current malfunction in "Self Diagnostic Result" of "SIDE RADAR LEFT".

Is "U1010" detected as the current malfunction?

YES >> Replace the side radar LH. Refer to [DAS-798, "Removal and Installation"](#).

NO >> INSPECTION END

### SIDE RADAR RH

#### SIDE RADAR RH : Description

INFOID:000000009717055

CAN controller controls the communication of ITS communication signal and the error detection.

#### SIDE RADAR RH : DTC Logic

INFOID:000000009717056

#### DTC DETECTION LOGIC

DTC	Trouble diagnosis name	DTC detecting condition	Possible cause
U1010	CONTROL UNIT (CAN)	If Side radar RH detects malfunction by CAN controller initial diagnosis.	Side radar RH

#### SIDE RADAR RH : Diagnosis Procedure

INFOID:000000009717057

##### 1. CHECK SELF-DIAGNOSIS RESULT

1. Turn the Blind Spot Intervention system ON.
2. Perform "All DTC Reading" with CONSULT.
3. Check if the "U1010" is detected as the current malfunction in "Self Diagnostic Result" of "SIDE RADAR RIGHT".

Is "U1010" detected as the current malfunction?

YES >> Replace the side radar RH. Refer to [DAS-798, "Removal and Installation"](#).

NO >> INSPECTION END

### ADAS CONTROL UNIT

#### ADAS CONTROL UNIT : Description

INFOID:000000009717058

CAN controller controls the communication of CAN communication signal and ITS communication signal, and the error detection.

A  
B  
C  
D  
E  
F  
G  
H  
I  
J  
K  
L  
M  
N  
P

DAS

# U1010 CONTROL UNIT (CAN)

< DTC/CIRCUIT DIAGNOSIS >

[BCI]

## ADAS CONTROL UNIT : DTC Logic

INFOID:000000009717059

### DTC DETECTION LOGIC

DTC (On board display)	Trouble diagnosis name	DTC detecting condition	Possible causes
U1010 (110)	CONTROL UNIT (CAN)	If ADAS control unit detects malfunction by CAN controller initial diagnosis	ADAS control unit

## ADAS CONTROL UNIT : Diagnosis Procedure

INFOID:000000009717060

### 1.PERFORM DTC CONFIRMATION PROCEDURE

1. Turn the Blind Spot Intervention system ON.
2. Perform "All DTC Reading" with CONSULT.
3. Check if the "U1010" is detected as the current malfunction in "Self Diagnostic Result" of "ICC/ADAS".

Is "U1010" detected as the current malfunction?

- YES >> Replace the ADAS control unit. Refer to [DAS-79. "Removal and Installation"](#).  
NO >> INSPECTION END

## LANE CAMERA UNIT

### LANE CAMERA UNIT : Description

INFOID:000000009717061

CAN controller controls the communication of ITS communication signal and the error detection.

### LANE CAMERA UNIT : DTC Logic

INFOID:000000009717062

### DTC DETECTION LOGIC

DTC	Trouble diagnosis name	DTC detecting condition	Possible causes
U1010	CONTROL UNIT (CAN)	If lane camera unit detects malfunction by CAN controller initial diagnosis	Lane camera unit

## LANE CAMERA UNIT : Diagnosis Procedure

INFOID:000000009717063

### 1.PERFORM DTC CONFIRMATION PROCEDURE

1. Turn the Blind Spot Intervention system ON.
2. Perform "All DTC Reading" with CONSULT.
3. Check if the "U1010" is detected as the current malfunction in "Self Diagnostic Result" of "LANE CAMERA".

Is "U1010" detected as the current malfunction?

- YES >> Replace the lane camera unit. Refer to [DAS-797. "Removal and Installation"](#).  
NO >> INSPECTION END

# U0104 ADAS CAN 1

< DTC/CIRCUIT DIAGNOSIS >

[BCI]

## U0104 ADAS CAN 1

### SIDE RADAR

#### SIDE RADAR : DTC Logic

INFOID:000000009717064

#### DTC DETECTION LOGIC

DTC	Trouble diagnosis name	DTC detecting condition	Possible cause
U0104	ADAS CAN CIR1	Side radar detected an error of ITS communication signal that was received from ADAS control unit.	ADAS control unit

#### NOTE:

If DTC "U0104" is detected along with DTC "U1000", first diagnose the DTC "U1000". Refer to [DAS-746, "SIDE RADAR LH : DTC Logic"](#) (SIDE RADAR LH), [DAS-747, "SIDE RADAR RH : DTC Logic"](#) (SIDE RADAR RH).

#### DTC CONFIRMATION PROCEDURE

##### 1.PERFORM DTC CONFIRMATION PROCEDURE

1. Start the engine.
2. Turn the Blind Spot Intervention system ON.
3. Perform "All DTC Reading" with CONSULT
4. Check if the U0104 is detected as the current malfunction in "Self Diagnostic Result" of "SIDE RADAR RIGHT/LEFT".

#### Is the DTC "U0104" detected?

- YES >> Refer to [DAS-751, "SIDE RADAR : Diagnosis Procedure"](#).  
 NO >> Refer to [GI-53, "Intermittent Incident"](#).

#### SIDE RADAR : Diagnosis Procedure

INFOID:000000009717065

##### 1.CHECK SELF-DIAGNOSIS RESULTS

Check if "U1000" is detected other than "U0104" in "Self Diagnostic Result" of "SIDE RADAR RIGHT/LEFT".

#### Is "U1000" detected?

- YES >> Perform the CAN communication system inspection. Repair or replace the malfunctioning parts. Refer to [DAS-746, "SIDE RADAR LH : DTC Logic"](#) (SIDE RADAR LH), [DAS-747, "SIDE RADAR RH : DTC Logic"](#) (SIDE RADAR RH).  
 NO >> GO TO 2.

##### 2.CHECK ADAS CONTROL UNIT SELF-DIAGNOSIS RESULTS

Check if any DTC is detected in "Self Diagnostic Result" of "ICC/ADAS".

#### Is any DTC detected?

- YES >> Perform diagnosis on the detected DTC and repair or replace the malfunctioning parts. Refer to [DAS-677, "DTC Index"](#).  
 NO >> Replace side radar LH or RH. Refer to [DAS-798, "Removal and Installation"](#).

### LANE CAMERA UNIT

#### LANE CAMERA UNIT : DTC Logic

INFOID:000000009717066

#### DTC DETECTION LOGIC

DTC	Trouble diagnosis name	DTC detecting condition	Possible causes
U0104	ADAS CAN CIR 1	If lane camera unit detects an error signal that is received from ADAS control unit via ITS communication	ADAS control unit

#### NOTE:

If DTC "U0104" is detected along with DTC "U1000", first diagnose the DTC "U1000". Refer to [DAS-748, "LANE CAMERA UNIT : DTC Logic"](#).

A  
B  
C  
D  
E  
F  
G  
H  
I  
J  
K  
L  
M  
N  
P

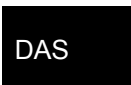

---

## DTC CONFIRMATION PROCEDURE

### 1. PERFORM DTC CONFIRMATION PROCEDURE

---

1. Start the engine.
2. Turn the Blind Spot Intervention system ON.
3. Perform "All DTC Reading" with CONSULT.
4. Check if the "U0104" is detected as the current malfunction in "Self Diagnostic Result" of "LANE CAMERA".

Is "U0104" detected as the current malfunction?

YES >> Refer to [DAS-752, "LANE CAMERA UNIT : Diagnosis Procedure"](#).

NO >> Refer to [GI-53, "Intermittent Incident"](#).

## LANE CAMERA UNIT : Diagnosis Procedure

INFOID:000000009717067

### 1. CHECK LANE CAMERA UNIT SELF-DIAGNOSIS RESULTS

---

Check if "U1000" is detected other than "U0104" in "Self Diagnostic Result" of "LANE CAMERA".

Is "U1000" detected?

YES >> Perform the CAN communication system inspection. Repair or replace the malfunctioning parts.  
Refer to [DAS-748, "LANE CAMERA UNIT : DTC Logic"](#).

NO >> GO TO 2.

### 2. CHECK ADAS CONTROL UNIT SELF-DIAGNOSIS RESULTS

---

Check if any DTC is detected in "Self Diagnostic Result" of "ICC/ADAS".

Is any DTC detected?

YES >> Perform diagnosis on the detected DTC and repair or replace the malfunctioning parts. Refer to [DAS-677, "DTC Index"](#).

NO >> Replace the lane camera unit. Refer to [DAS-797, "Removal and Installation"](#).

# U0121 VDC CAN 2

< DTC/CIRCUIT DIAGNOSIS >

[BCI]

## U0121 VDC CAN 2

### DTC Logic

INFOID:000000009717068

### DTC DETECTION LOGIC

DTC (On board display)	Trouble diagnosis name	DTC detecting condition	Possible causes
U0121 (127)	VDC CAN CIR2	If ADAS control unit detects an error signal that is received from ABS actuator and electric unit (control unit) via CAN communication	ABS actuator and electric unit (control unit)

#### NOTE:

If DTC "U0121" is detected along with DTC "U1000", first diagnose the DTC "U1000". Refer to [DAS-747, "ADAS CONTROL UNIT : DTC Logic"](#).

### DTC CONFIRMATION PROCEDURE

#### 1. PERFORM DTC CONFIRMATION PROCEDURE

1. Start the engine.
2. Turn the Blind Spot Intervention system ON.
3. Perform "All DTC Reading" with CONSULT.
4. Check if the "U0121" is detected as the current malfunction in "Self Diagnostic Result" of "ICC/ADAS".

Is "U0121" detected as the current malfunction?

- YES >> Refer to [DAS-753, "Diagnosis Procedure"](#).  
NO >> Refer to [GI-53, "Intermittent Incident"](#).

### Diagnosis Procedure

INFOID:000000009717069

#### 1. CHECK SELF-DIAGNOSIS RESULTS

Check if "U1000" is detected other than "U0121" in "Self Diagnostic Result" of "ICC/ADAS".

Is "U1000" detected?

- YES >> Perform the CAN communication system inspection. Repair or replace the malfunctioning parts. Refer to [DAS-747, "ADAS CONTROL UNIT : DTC Logic"](#).  
NO >> GO TO 2.

#### 2. CHECK ABS ACTUATOR AND ELECTRIC UNIT (CONTROL UNIT) SELF-DIAGNOSIS RESULTS

Check if any DTC is detected in "Self Diagnostic Result" of "ABS".

Is any DTC detected?

- YES >> Perform diagnosis on the detected DTC and repair or replace the malfunctioning parts. Refer to [BRC-46, "DTC Index"](#).  
NO >> Replace the ADAS control unit. Refer to [DAS-79, "Removal and Installation"](#).

A  
B  
C  
D  
E  
F  
G  
H  
I  
J  
K  
L  
M  
N  
P

DAS

# U0126 STRG SEN CAN 1

< DTC/CIRCUIT DIAGNOSIS >

[BCI]

## U0126 STRG SEN CAN 1

### ADAS CONTROL UNIT

#### ADAS CONTROL UNIT : DTC Logic

INFOID:000000009717070

#### DTC DETECTION LOGIC

DTC (On board display)	Trouble diagnosis name	DTC detecting condition	Possible causes
U0126 (130)	STRG SEN CAN CIR1	If ADAS control unit detects an error signal that is received from steering angle sensor via CAN communication	Steering angle sensor

#### NOTE:

If DTC "U0126" is detected along with DTC "U1000", first diagnose the DTC "U1000". Refer to [DAS-747, "ADAS CONTROL UNIT : DTC Logic"](#).

#### DTC CONFIRMATION PROCEDURE

##### 1. PERFORM DTC CONFIRMATION PROCEDURE

1. Start the engine.
2. Turn the Blind Spot Intervention system ON.
3. Perform "All DTC Reading" with CONSULT.
4. Check if the "U0126" is detected as the current malfunction in "Self Diagnostic Result" of "ICC/ADAS".

##### Is "U0126" detected as the current malfunction?

- YES >> Refer to [DAS-754, "ADAS CONTROL UNIT : Diagnosis Procedure"](#).  
NO >> Refer to [GI-53, "Intermittent Incident"](#).

#### ADAS CONTROL UNIT : Diagnosis Procedure

INFOID:000000009717071

##### 1. CHECK SELF-DIAGNOSIS RESULTS

Check if "U1000" is detected other than "U0126" in "Self Diagnostic Result" of "ICC/ADAS".

##### Is "U1000" detected?

- YES >> Perform the CAN communication system inspection. Repair or replace the malfunctioning parts. Refer to [DAS-747, "ADAS CONTROL UNIT : DTC Logic"](#).  
NO >> GO TO 2.

##### 2. CHECK ABS ACTUATOR AND ELECTRIC UNIT (CONTROL UNIT) SELF-DIAGNOSIS RESULTS

Check if any DTC is detected in "Self Diagnostic Result" of "ABS".

##### Is any DTC detected?

- YES >> Perform diagnosis on the detected DTC and repair or replace the malfunctioning parts. Refer to [BRC-46, "DTC Index"](#).  
NO >> Replace the ADAS control unit. Refer to [DAS-79, "Removal and Installation"](#).

### LANE CAMERA UNIT

#### LANE CAMERA UNIT : DTC Logic

INFOID:000000009717072

#### DTC DETECTION LOGIC

DTC	Trouble diagnosis name	DTC detecting condition	Possible causes
U0126	STRG SEN CAN CIR1	If lane camera unit detects an error signal that is received from steering angle sensor via ADAS control unit	Steering angle sensor

#### NOTE:

If DTC "U0126" is detected along with DTC "U1000", first diagnose the DTC "U1000". Refer to [DAS-748, "LANE CAMERA UNIT : DTC Logic"](#).

# U0126 STRG SEN CAN 1

< DTC/CIRCUIT DIAGNOSIS >

[BCI]

## DTC CONFIRMATION PROCEDURE

### 1. PERFORM DTC CONFIRMATION PROCEDURE

1. Start the engine.
2. Turn the Blind Spot Intervention system ON.
3. Perform "All DTC Reading" with CONSULT.
4. Check if the "U0126" is detected as the current malfunction in "Self Diagnostic Result" of "LANE CAMERA".

Is "U0126" detected as the current malfunction?

- YES >> Refer to [DAS-755, "LANE CAMERA UNIT : Diagnosis Procedure"](#).  
NO >> Refer to [GI-53, "Intermittent Incident"](#).

## LANE CAMERA UNIT : Diagnosis Procedure

INFOID:000000009717073

### 1. CHECK SELF-DIAGNOSIS RESULTS

Check if "U1000" is detected other than "U0126" in "Self Diagnostic Result" of "LANE CAMERA".

Is "U1000" detected?

- YES >> Perform the CAN communication system inspection. Repair or replace the malfunctioning parts.  
Refer to [DAS-748, "LANE CAMERA UNIT : DTC Logic"](#).  
NO >> GO TO 2.

### 2. CHECK ADAS CONTROL UNIT SELF-DIAGNOSIS RESULTS

Check if any DTC is detected in "Self Diagnostic Result" of "ICC/ADAS".

Is any DTC detected?

- YES >> Perform diagnosis on the detected DTC and repair or replace the malfunctioning parts. Refer to [DAS-677, "DTC Index"](#).  
NO >> Replace the lane camera unit. Refer to [DAS-797, "Removal and Installation"](#).

A  
B  
C  
D  
E  
F  
G  
H  
I  
J  
K  
L  
M  
N  
P

DAS

# U0401 ECM CAN 1

< DTC/CIRCUIT DIAGNOSIS >

[BCI]

## U0401 ECM CAN 1

### DTC Logic

INFOID:000000009717074

### DTC DETECTION LOGIC

DTC (On board display)	Trouble diagnosis name	DTC detecting condition	Possible causes
U0401 (120)	ECM CAN CIR1	If ADAS control unit detects an error signal that is received from ECM via CAN communication	ECM

#### NOTE:

If DTC "U0401" is detected along with DTC "U1000", first diagnose the DTC "U1000". Refer to [DAS-747, "ADAS CONTROL UNIT : DTC Logic"](#).

### DTC CONFIRMATION PROCEDURE

#### 1. PERFORM DTC CONFIRMATION PROCEDURE

1. Start the engine.
2. Turn the Blind Spot Intervention system ON.
3. Perform "All DTC Reading" with CONSULT.
4. Check if the "U0401" is detected as the current malfunction in "Self Diagnostic Result" of "ICC/ADAS".

Is "U0401" detected as the current malfunction?

- YES >> Refer to [DAS-756, "Diagnosis Procedure"](#).  
NO >> Refer to [GI-53, "Intermittent Incident"](#).

### Diagnosis Procedure

INFOID:000000009717075

#### 1. CHECK SELF-DIAGNOSIS RESULTS

Check if "U1000" is detected other than "U0401" in "Self Diagnostic Result" of "ICC/ADAS".

Is "U1000" detected?

- YES >> Perform the CAN communication system inspection. Repair or replace the malfunctioning parts.  
Refer to [DAS-747, "ADAS CONTROL UNIT : DTC Logic"](#).  
NO >> GO TO 2.

#### 2. CHECK ECM SELF-DIAGNOSIS RESULTS

Check if any DTC is detected in "Self Diagnostic Result" of "ENGINE".

Is any DTC detected?

- YES >> Perform diagnosis on the detected DTC and repair or replace the malfunctioning parts. Refer to [EC-97, "DTC Index"](#).  
NO >> Replace the ADAS control unit. Refer to [DAS-79, "Removal and Installation"](#).



# U0402 TCM CAN 1

< DTC/CIRCUIT DIAGNOSIS >

[BCI]

## U0402 TCM CAN 1

### DTC Logic

INFOID:000000009717076

### DTC DETECTION LOGIC

DTC (On board display)	Trouble diagnosis name	DTC detecting condition	Possible causes
U0402 (122)	TCM CAN CIRC1	If ADAS control unit detects an error signal that is received from TCM via CAN communication	TCM

#### NOTE:

If DTC "U0402" is detected along with DTC "U1000", first diagnose the DTC "U1000". Refer to [DAS-747, "ADAS CONTROL UNIT : DTC Logic"](#).

### DTC CONFIRMATION PROCEDURE

#### 1. PERFORM DTC CONFIRMATION PROCEDURE

1. Start the engine.
2. Turn the Blind Spot Intervention system ON.
3. Perform "All DTC Reading" with CONSULT.
4. Check if the "U0402" is detected as the current malfunction in "Self Diagnostic Result" of "ICC/ADAS".

Is "U0402" detected as the current malfunction?

- YES >> Refer to [DAS-757, "Diagnosis Procedure"](#).  
 NO >> Refer to [GI-53, "Intermittent Incident"](#).

### Diagnosis Procedure

INFOID:000000009717077

#### 1. CHECK SELF-DIAGNOSIS RESULTS

Check if "U1000" is detected other than "U0402" in "Self Diagnostic Result" of "ICC/ADAS".

Is "U1000" detected?

- YES >> Perform the CAN communication system inspection. Repair or replace the malfunctioning parts. Refer to [DAS-747, "ADAS CONTROL UNIT : DTC Logic"](#).  
 NO >> GO TO 2.

#### 2. CHECK TCM SELF-DIAGNOSIS RESULTS

Check if any DTC is detected in "Self Diagnostic Result" of "TRANSMISSION".

Is any DTC detected?

- YES >> Perform diagnosis on the detected DTC and repair or replace the malfunctioning parts. Refer to [TM-61, "DTC Index"](#).  
 NO >> Replace the ADAS control unit. Refer to [DAS-79, "Removal and Installation"](#).

A  
B  
C  
D  
E  
F  
G  
H  
I  
J  
K  
L  
M  
N  
P

DAS

# U0405 ADAS CAN 2

< DTC/CIRCUIT DIAGNOSIS >

[BCI]

## U0405 ADAS CAN 2 SIDE RADAR

### SIDE RADAR : DTC Logic

INFOID:000000009717078

#### DTC DETECTION LOGIC

DTC	Trouble diagnosis name	DTC detecting condition	Possible cause
U0405	ADAS CAN CIR2	Side radar detected an error of ITS communication signal that was received from ADAS control unit.	ADAS control unit.

#### NOTE:

If DTC "U0405" is detected along with DTC "U1000", first diagnose the DTC "U1000". Refer to [DAS-746, "SIDE RADAR LH : DTC Logic"](#) (SIDE RADAR LH), [DAS-747, "SIDE RADAR RH : DTC Logic"](#) (SIDE RADAR RH).

#### DTC CONFIRMATION PROCEDURE

##### 1. PERFORM DTC CONFIRMATION PROCEDURE

1. Start the engine.
2. Turn the Blind Spot Intervention system ON.
3. Perform "All DTC Reading" with CONSULT
4. Check if the "U0405" is detected as the current malfunction in "Self Diagnostic Result" of "SIDE RADAR RIGHT/LEFT".

#### Is the DTC "U0405" detected?

- YES >> Refer to [DAS-758, "SIDE RADAR : Diagnosis Procedure"](#).  
NO >> Refer to [GI-53, "Intermittent Incident"](#).

### SIDE RADAR : Diagnosis Procedure

INFOID:000000009717079

##### 1. CHECK SELF-DIAGNOSIS RESULTS

Check if "U1000" is detected other than "U0405" in "Self Diagnostic Result" of "SIDE RADAR RIGHT/LEFT".

#### Is "U1000" detected?

- YES >> Perform the CAN communication system inspection. Repair or replace the malfunctioning parts. Refer to [DAS-746, "SIDE RADAR LH : DTC Logic"](#) (SIDE RADAR LH), [DAS-747, "SIDE RADAR RH : DTC Logic"](#) (SIDE RADAR RH).  
NO >> GO TO 2.

##### 2. CHECK ADAS CONTROL UNIT SELF-DIAGNOSIS RESULTS

Check if any DTC is detected in "Self Diagnostic Result" of "ICC/ADAS".

#### Is any DTC detected?

- YES >> Perform diagnosis on the detected DTC and repair or replace the malfunctioning parts. Refer to [DAS-677, "DTC Index"](#).  
NO >> Replace side radar LH or RH. Refer to [DAS-798, "Removal and Installation"](#).

## LANE CAMERA UNIT

### LANE CAMERA UNIT : DTC Logic

INFOID:000000009717080

#### DTC DETECTION LOGIC

DTC	Trouble diagnosis name	DTC detecting condition	Possible causes
U0405	ADAS CAN CIR 2	If lane camera unit detects an error signal that is received from ADAS control unit via ITS communication	ADAS control unit

#### NOTE:

If DTC "U0405" is detected along with DTC "U1000", first diagnose the DTC "U1000". Refer to [DAS-748, "LANE CAMERA UNIT : DTC Logic"](#).

# U0405 ADAS CAN 2

< DTC/CIRCUIT DIAGNOSIS >

[BCI]

## DTC CONFIRMATION PROCEDURE

### 1. PERFORM DTC CONFIRMATION PROCEDURE

1. Start the engine.
2. Turn the Blind Spot Intervention system ON.
3. Perform "All DTC Reading" with CONSULT.
4. Check if the "U0405" is detected as the current malfunction in "Self Diagnostic Result" of "LANE CAMERA".

Is "U0405" detected as the current malfunction?

- YES >> Refer to [DAS-759, "LANE CAMERA UNIT : Diagnosis Procedure"](#).  
NO >> Refer to [GI-53, "Intermittent Incident"](#).

## LANE CAMERA UNIT : Diagnosis Procedure

INFOID:000000009717081

### 1. CHECK LANE CAMERA UNIT SELF-DIAGNOSIS RESULTS

Check if "U1000" is detected other than "U0405" in "Self Diagnostic Result" of "LANE CAMERA".

Is "U1000" detected?

- YES >> Perform the CAN communication system inspection. Repair or replace the malfunctioning parts.  
Refer to [DAS-748, "LANE CAMERA UNIT : DTC Logic"](#).  
NO >> GO TO 2.

### 2. CHECK ADAS CONTROL UNIT SELF-DIAGNOSIS RESULTS

Check if any DTC is detected in "Self Diagnostic Result" of "ICC/ADAS".

Is any DTC detected?

- YES >> Perform diagnosis on the detected DTC and repair or replace the malfunctioning parts. Refer to [DAS-677, "DTC Index"](#).  
NO >> Replace the lane camera unit. Refer to [DAS-797, "Removal and Installation"](#).

A  
B  
C  
D  
E  
F  
G  
H  
I  
J  
K  
L  
M  
N  
P

DAS

# U0415 VDC CAN 1

< DTC/CIRCUIT DIAGNOSIS >

[BCI]

## U0415 VDC CAN 1

### DTC Logic

INFOID:000000009717082

### DTC DETECTION LOGIC

DTC (On board display)	Trouble diagnosis name	DTC detecting condition	Possible causes
U0415 (126)	VDC CAN CIR1	If ADAS control unit detects an error signal that is received from ABS actuator and electric unit (control unit) via CAN communication	ABS actuator and electric unit (control unit)

#### NOTE:

If DTC "U0415" is detected along with DTC "U1000", first diagnose the DTC "U1000". Refer to [DAS-747, "ADAS CONTROL UNIT : DTC Logic"](#).

### DTC CONFIRMATION PROCEDURE

#### 1. PERFORM DTC CONFIRMATION PROCEDURE

1. Start the engine.
2. Turn the Blind Spot Intervention system ON.
3. Perform "All DTC Reading" with CONSULT.
4. Check if the "U0415" is detected as the current malfunction in "Self Diagnostic Result" of "ICC/ADAS".

Is "U0415" detected as the current malfunction?

- YES >> Refer to [DAS-760, "Diagnosis Procedure"](#).  
NO >> Refer to [GI-53, "Intermittent Incident"](#).

### Diagnosis Procedure

INFOID:000000009717083

#### 1. CHECK SELF-DIAGNOSIS RESULTS

Check if "U1000" is detected other than "U0415" in "Self Diagnostic Result" of "ICC/ADAS".

Is "U1000" detected?

- YES >> Perform the CAN communication system inspection. Repair or replace the malfunctioning parts.  
Refer to [DAS-747, "ADAS CONTROL UNIT : DTC Logic"](#).  
NO >> GO TO 2.

#### 2. CHECK ABS ACTUATOR AND ELECTRIC UNIT (CONTROL UNIT) SELF-DIAGNOSIS RESULTS

Check if any DTC is detected in "Self Diagnostic Result" of "ABS".

Is any DTC detected?

- YES >> Perform diagnosis on the detected DTC and repair or replace the malfunctioning parts. Refer to [BRC-46, "DTC Index"](#).  
NO >> Replace the ADAS control unit. Refer to [DAS-79, "Removal and Installation"](#).

# U0428 STRG SEN CAN 2

< DTC/CIRCUIT DIAGNOSIS >

[BCI]

## U0428 STRG SEN CAN 2

### ADAS CONTROL UNIT

#### ADAS CONTROL UNIT : DTC Logic

INFOID:000000009717084

#### DTC DETECTION LOGIC

DTC (On board display)	Trouble diagnosis name	DTC detecting condition	Possible causes
U0428 (131)	STRG SEN CAN CIR2	If ADAS control unit detects an error signal that is received from steering angle sensor via CAN communication	Steering angle sensor

#### NOTE:

If DTC "U0428" is detected along with DTC "U1000", first diagnose the DTC "U1000". Refer to [DAS-747, "ADAS CONTROL UNIT : DTC Logic"](#).

#### DTC CONFIRMATION PROCEDURE

##### 1. PERFORM DTC CONFIRMATION PROCEDURE

1. Start the engine.
2. Turn the Blind Spot Intervention system ON.
3. Perform "All DTC Reading" with CONSULT.
4. Check if the "U0428" is detected as the current malfunction in "Self Diagnostic Result" of "ICC/ADAS".

##### Is "U0428" detected as the current malfunction?

- YES >> Refer to [DAS-761, "ADAS CONTROL UNIT : Diagnosis Procedure"](#).  
NO >> Refer to [GI-53, "Intermittent Incident"](#).

#### ADAS CONTROL UNIT : Diagnosis Procedure

INFOID:000000009717085

##### 1. CHECK SELF-DIAGNOSIS RESULTS

Check if "U1000" is detected other than "U0428" in "Self Diagnostic Result" of "ICC/ADAS".

##### Is "U1000" detected?

- YES >> Perform the CAN communication system inspection. Repair or replace the malfunctioning parts. Refer to [DAS-747, "ADAS CONTROL UNIT : DTC Logic"](#).  
NO >> GO TO 2.

##### 2. CHECK ABS ACTUATOR AND ELECTRIC UNIT (CONTROL UNIT) SELF-DIAGNOSIS RESULTS

Check if any DTC is detected in "Self Diagnostic Result" of "ABS".

##### Is any DTC detected?

- YES >> Perform diagnosis on the detected DTC and repair or replace the malfunctioning parts. Refer to [BRC-46, "DTC Index"](#).  
NO >> Replace the ADAS control unit. Refer to [DAS-79, "Removal and Installation"](#).

### LANE CAMERA UNIT

#### LANE CAMERA UNIT : DTC Logic

INFOID:000000009717086

#### DTC DETECTION LOGIC

DTC	Trouble diagnosis name	DTC detecting condition	Possible causes
U0428	STRG SEN CAN CIR2	If lane camera unit detects an error signal that is received from steering angle sensor via ADAS control unit	Steering angle sensor

#### NOTE:

If DTC "U0428" is detected along with DTC "U1000", first diagnose the DTC "U1000". Refer to [DAS-748, "LANE CAMERA UNIT : DTC Logic"](#).

## DTC CONFIRMATION PROCEDURE

**1**.PERFORM DTC CONFIRMATION PROCEDURE

1. Start the engine.
2. Turn the Blind Spot Intervention system ON.
3. Perform "All DTC Reading" with CONSULT.
4. Check if the "U0428" is detected as the current malfunction in "Self Diagnostic Result" of "LANE CAMERA".

Is "U0428" detected as the current malfunction?

YES >> Refer to [DAS-762, "LANE CAMERA UNIT : Diagnosis Procedure"](#).

NO >> Refer to [GI-53, "Intermittent Incident"](#).

## LANE CAMERA UNIT : Diagnosis Procedure

INFOID:000000009717087

**1**.CHECK SELF-DIAGNOSIS RESULTS

Check if "U1000" is detected other than "U0428" in "Self Diagnostic Result" of "LANE CAMERA".

Is "U1000" detected?

YES >> Perform the CAN communication system inspection. Repair or replace the malfunctioning parts.  
Refer to [DAS-748, "LANE CAMERA UNIT : DTC Logic"](#).

NO >> GO TO 2.

**2**.CHECK ADAS CONTROL UNIT SELF-DIAGNOSIS RESULTS

Check if any DTC is detected in "Self Diagnostic Result" of "ICC/ADAS".

Is any DTC detected?

YES >> Perform diagnosis on the detected DTC and repair or replace the malfunctioning parts. Refer to [DAS-677, "DTC Index"](#).

NO >> Replace the lane camera unit. Refer to [DAS-797, "Removal and Installation"](#).

# U150B ECM CAN 3

< DTC/CIRCUIT DIAGNOSIS >

[BCI]

## U150B ECM CAN 3

### DTC Logic

INFOID:000000009717088

### DTC DETECTION LOGIC

DTC (On board display)	Trouble diagnosis name	DTC detecting condition	Possible causes
U150B (157)	ECM CAN CIRC 3	ADAS control unit detects an error signal that is received from ECM via CAN communication	ECM

#### NOTE:

If DTC "U150B" is detected along with DTC "U1000", first diagnose the DTC "U1000". Refer to [DAS-747, "ADAS CONTROL UNIT : DTC Logic"](#).

### DTC CONFIRMATION PROCEDURE

#### 1. PERFORM DTC CONFIRMATION PROCEDURE

1. Start the engine.
2. Turn the Blind Spot Intervention system ON.
3. Perform "All DTC Reading" with CONSULT.
4. Check if the "U150B" is detected as the current malfunction in "Self Diagnostic Result" of "ICC/ADAS".

#### Is "U150B" detected as the current malfunction?

- YES >> Refer to [DAS-763, "Diagnosis Procedure"](#).  
NO >> Refer to [GI-53, "Intermittent Incident"](#).

### Diagnosis Procedure

INFOID:000000009717089

#### 1. CHECK SELF-DIAGNOSIS RESULTS

Check if "U1000" is detected other than "U150B" in "Self Diagnostic Result" of "ICC/ADAS".

#### Is "U1000" detected?

- YES >> Perform the CAN communication system inspection. Repair or replace the malfunctioning parts.  
Refer to [DAS-747, "ADAS CONTROL UNIT : DTC Logic"](#).  
NO >> GO TO 2.

#### 2. CHECK ECM SELF-DIAGNOSIS RESULTS

Check if any DTC is detected in "Self Diagnostic Result" of "ENGINE".

#### Is any DTC detected?

- YES >> Perform diagnosis on the detected DTC and repair or replace the malfunctioning parts. Refer to [EC-97, "DTC Index"](#).  
NO >> Replace the ADAS control unit. Refer to [DAS-79, "Removal and Installation"](#).

DAS

## U150C VDC CAN 3

### DTC Logic

INFOID:000000009717090

#### DTC DETECTION LOGIC

DTC (On board display)	Trouble diagnosis name	DTC detecting condition	Possible causes
U150C (158)	VDC CAN CIRC 3	ADAS control unit detects an error signal that is received from ABS actuator and electric unit (control unit) via CAN communication	ABS actuator and electric unit (control unit)

**NOTE:**

If DTC "U150C" is detected along with DTC "U1000", first diagnose the DTC "U1000". Refer to [DAS-747, "ADAS CONTROL UNIT : DTC Logic"](#).

#### DTC CONFIRMATION PROCEDURE

##### 1. PERFORM DTC CONFIRMATION PROCEDURE

1. Start the engine.
2. Turn the Blind Spot Intervention system ON.
3. Perform "All DTC Reading" with CONSULT.
4. Check if the "U150C" is detected as the current malfunction in "Self Diagnostic Result" of "ICC/ADAS".

Is "U150C" detected as the current malfunction?

- YES >> Refer to [DAS-764, "Diagnosis Procedure"](#).  
 NO >> Refer to [GI-53, "Intermittent Incident"](#).

#### Diagnosis Procedure

INFOID:000000009717091

##### 1. CHECK SELF-DIAGNOSIS RESULTS

Check if "U1000" is detected other than "U150C" in "Self Diagnostic Result" of "ICC/ADAS".

Is "U1000" detected?

- YES >> Perform the CAN communication system inspection. Repair or replace the malfunctioning parts. Refer to [DAS-747, "ADAS CONTROL UNIT : DTC Logic"](#).  
 NO >> GO TO 2.

##### 2. CHECK ABS ACTUATOR AND ELECTRIC UNIT (CONTROL UNIT) SELF-DIAGNOSIS RESULTS

Check if any DTC is detected in "Self Diagnostic Result" of "ABS".

Is any DTC detected?

- YES >> Perform diagnosis on the detected DTC and repair or replace the malfunctioning parts. Refer to [BRC-46, "DTC Index"](#).  
 NO >> Replace the ADAS control unit. Refer to [DAS-79, "Removal and Installation"](#).



# U150D TCM CAN 3

< DTC/CIRCUIT DIAGNOSIS >

[BCI]

## U150D TCM CAN 3

### DTC Logic

INFOID:000000009717092

### DTC DETECTION LOGIC

DTC (On board display)	Trouble diagnosis name	DTC detecting condition	Possible causes
U150D (159)	TCM CAN CIRC 3	ADAS control unit detects an error signal that is received from TCM via CAN communication	TCM

#### NOTE:

If DTC "U150D" is detected along with DTC "U1000", first diagnose the DTC "U1000". Refer to [DAS-747, "ADAS CONTROL UNIT : DTC Logic"](#).

### DTC CONFIRMATION PROCEDURE

#### 1. PERFORM DTC CONFIRMATION PROCEDURE

1. Start the engine.
2. Turn the Blind Spot Intervention system ON.
3. Perform "All DTC Reading" with CONSULT.
4. Check if the "U150D" is detected as the current malfunction in "Self Diagnostic Result" of "ICC/ADAS".

Is "U150D" detected as the current malfunction?

- YES >> Refer to [DAS-765, "Diagnosis Procedure"](#).  
NO >> Refer to [GI-53, "Intermittent Incident"](#).

### Diagnosis Procedure

INFOID:000000009717093

#### 1. CHECK SELF-DIAGNOSIS RESULTS

Check if "U1000" is detected other than "U150D" in "Self Diagnostic Result" of "ICC/ADAS".

Is "U1000" detected?

- YES >> Perform the CAN communication system inspection. Repair or replace the malfunctioning parts.  
Refer to [DAS-747, "ADAS CONTROL UNIT : DTC Logic"](#).  
NO >> GO TO 2.

#### 2. CHECK TCM SELF-DIAGNOSIS RESULTS

Check if any DTC is detected in "Self Diagnostic Result" of "TRANSMISSION".

Is any DTC detected?

- YES >> Perform diagnosis on the detected DTC and repair or replace the malfunctioning parts. Refer to [TM-61, "DTC Index"](#).  
NO >> Replace the ADAS control unit. Refer to [DAS-79, "Removal and Installation"](#).

A  
B  
C  
D  
E  
F  
G  
H  
I  
J  
K  
L  
M  
N  
P

DAS

# U150E BCM CAN 3

< DTC/CIRCUIT DIAGNOSIS >

[BCI]

## U150E BCM CAN 3

### DTC Logic

INFOID:000000009717094

### DTC DETECTION LOGIC

DTC (On board display)	Trouble diagnosis name	DTC detecting condition	Possible causes
U150E (160)	BCM CAN CIRC 3	ADAS control unit detects an error signal that is received from BCM via CAN communication	BCM

#### NOTE:

If DTC "U150E" is detected along with DTC "U1000", first diagnose the DTC "U1000". Refer to [DAS-747, "ADAS CONTROL UNIT : DTC Logic"](#).

### DTC CONFIRMATION PROCEDURE

#### 1. PERFORM DTC CONFIRMATION PROCEDURE

1. Start the engine.
2. Turn the Blind Spot Intervention system ON.
3. Perform "All DTC Reading" with CONSULT.
4. Check if the "U150E" is detected as the current malfunction in "Self Diagnostic Result" of "ICC/ADAS".

Is "U150E" detected as the current malfunction?

- YES >> Refer to [DAS-766, "Diagnosis Procedure"](#).  
NO >> Refer to [GI-53, "Intermittent Incident"](#).

### Diagnosis Procedure

INFOID:000000009717095

#### 1. CHECK SELF-DIAGNOSIS RESULTS

Check if "U1000" is detected other than "U150E" in "Self Diagnostic Result" of "ICC/ADAS".

Is "U1000" detected?

- YES >> Perform the CAN communication system inspection. Repair or replace the malfunctioning parts.  
Refer to [DAS-747, "ADAS CONTROL UNIT : DTC Logic"](#).  
NO >> GO TO 2.

#### 2. CHECK BCM SELF-DIAGNOSIS RESULTS

Check if any DTC is detected in "Self Diagnostic Result" of "BCM".

Is any DTC detected?

- YES >> Perform diagnosis on the detected DTC and repair or replace the malfunctioning parts. Refer to [BCS-51, "DTC Index"](#).  
NO >> Replace the ADAS control unit. Refer to [DAS-79, "Removal and Installation"](#).

# U1500 CAM CAN 2

< DTC/CIRCUIT DIAGNOSIS >

[BCI]

## U1500 CAM CAN 2

### DTC Logic

INFOID:000000009717096

### DTC DETECTION LOGIC

DTC (On board display)	Trouble diagnosis name	DTC detecting condition	Possible causes
U1500 (145)	CAM CAN CIRC 2	ADAS control unit detects an error signal that is received from lane camera unit via ITS communication	Lane camera unit

#### NOTE:

If DTC "U1500" is detected along with DTC "U1000", first diagnose the DTC "U1000". Refer to [DAS-747, "ADAS CONTROL UNIT : DTC Logic"](#).

### DTC CONFIRMATION PROCEDURE

#### 1. PERFORM DTC CONFIRMATION PROCEDURE

1. Start the engine.
2. Turn the Blind Spot Intervention system ON.
3. Perform "All DTC Reading" with CONSULT.
4. Check if the "U1500" is detected as the current malfunction in "Self Diagnostic Result" of "ICC/ADAS".

Is "U1500" detected as the current malfunction?

- YES >> Refer to [DAS-767, "Diagnosis Procedure"](#).  
NO >> Refer to [GI-53, "Intermittent Incident"](#).

### Diagnosis Procedure

INFOID:000000009717097

#### 1. CHECK SELF-DIAGNOSIS RESULTS

Check if "U1000" is detected other than "U1500" in "Self Diagnostic Result" of "ICC/ADAS".

Is "U1000" detected?

- YES >> Perform the CAN communication system inspection. Repair or replace the malfunctioning parts. Refer to [DAS-747, "ADAS CONTROL UNIT : DTC Logic"](#).  
NO >> GO TO 2.

#### 2. CHECK LANE CAMERA UNIT SELF-DIAGNOSIS RESULTS

Check if any DTC is detected in "Self Diagnostic Result" of "LANE CAMERA".

Is any DTC detected?

- YES >> Perform diagnosis on the detected DTC and repair or replace the malfunctioning parts. Refer to [DAS-520, "DTC Index"](#).  
NO >> Replace the ADAS control unit. Refer to [DAS-79, "Removal and Installation"](#).

A  
B  
C  
D  
E  
F  
G  
H  
I  
J  
K  
L  
M  
N  
P

DAS

# U1501 CAM CAN 1

< DTC/CIRCUIT DIAGNOSIS >

[BCI]

## U1501 CAM CAN 1

### DTC Logic

INFOID:000000009717098

### DTC DETECTION LOGIC

DTC (On board display)	Trouble diagnosis name	DTC detecting condition	Possible causes
U1501 (145)	CAM CAN CIRC 1	ADAS control unit detects an error signal that is received from lane camera unit via ITS communication	Lane camera unit

#### NOTE:

If DTC "U1501" is detected along with DTC "U1000", first diagnose the DTC "U1000". Refer to [DAS-747, "ADAS CONTROL UNIT : DTC Logic"](#).

### DTC CONFIRMATION PROCEDURE

#### 1. PERFORM DTC CONFIRMATION PROCEDURE

1. Start the engine.
2. Turn the Blind Spot Intervention system ON.
3. Perform "All DTC Reading" with CONSULT.
4. Check if the "U1501" is detected as the current malfunction in "Self Diagnostic Result" of "ICC/ADAS".

Is "U1501" detected as the current malfunction?

- YES >> Refer to [DAS-768, "Diagnosis Procedure"](#).  
NO >> Refer to [GI-53, "Intermittent Incident"](#).

### Diagnosis Procedure

INFOID:000000009717099

#### 1. CHECK SELF-DIAGNOSIS RESULTS

Check if "U1000" is detected other than "U1501" in "Self Diagnostic Result" of "ICC/ADAS".

Is "U1000" detected?

- YES >> Perform the CAN communication system inspection. Repair or replace the malfunctioning parts.  
Refer to [DAS-747, "ADAS CONTROL UNIT : DTC Logic"](#).  
NO >> GO TO 2.

#### 2. CHECK LANE CAMERA UNIT SELF-DIAGNOSIS RESULTS

Check if any DTC is detected in "Self Diagnostic Result" of "LANE CAMERA".

Is any DTC detected?

- YES >> Perform diagnosis on the detected DTC and repair or replace the malfunctioning parts. Refer to [DAS-520, "DTC Index"](#).  
NO >> Replace the ADAS control unit. Refer to [DAS-79, "Removal and Installation"](#).

# U1503 SIDE RDR L CAN 2

< DTC/CIRCUIT DIAGNOSIS >

[BCI]

## U1503 SIDE RDR L CAN 2

### DTC Logic

INFOID:000000009717100

### DTC DETECTION LOGIC

DTC (On board display)	Trouble diagnosis name	DTC detecting condition	Possible causes
U1503 (150)	SIDE RDR L CAN CIR 2	ADAS control unit detects an error signal that is received from side radar LH via ITS communication	Side radar LH

#### NOTE:

If DTC "U1503" is detected along with DTC "U1000", or "U1508", first diagnose the DTC "U1000" or "U1508".

- Refer to [DAS-747, "ADAS CONTROL UNIT : DTC Logic"](#) for DTC "U1000".
- Refer to [DAS-774, "DTC Logic"](#) for DTC "U1508".

### DTC CONFIRMATION PROCEDURE

#### 1. PERFORM DTC CONFIRMATION PROCEDURE

1. Start the engine.
2. Turn the Blind Spot Intervention system ON.
3. Perform "All DTC Reading" with CONSULT.
4. Check if the "U1503" is detected as the current malfunction in "Self Diagnostic Result" of "ICC/ADAS".

Is "U1503" detected as the current malfunction?

- YES >> Refer to [DAS-769, "Diagnosis Procedure"](#).  
NO >> Refer to [GI-53, "Intermittent Incident"](#).

### Diagnosis Procedure

INFOID:000000009717101

#### 1. CHECK SELF-DIAGNOSIS RESULTS

Check if "U1000" or "U1508" is detected other than "U1503" in "Self Diagnostic Result" of "ICC/ADAS".

Is "U1000" or "U1508" detected?

- YES-1 >> U1000 detected: Perform the CAN communication system inspection. Repair or replace the malfunctioning parts. Refer to [DAS-747, "ADAS CONTROL UNIT : DTC Logic"](#).  
YES-2 >> U1508 detected: Refer to [DAS-774, "DTC Logic"](#).  
NO >> GO TO 2.

#### 2. CHECK SIDE RADAR LH SELF-DIAGNOSIS RESULTS

Check if any DTC is detected in "Self Diagnostic Result" of "SIDE RADAR LEFT".

Is any DTC detected?

- YES >> Perform diagnosis on the detected DTC and repair or replace the malfunctioning parts. Refer to [DAS-683, "DTC Index"](#).  
NO >> Replace the ADAS control unit. Refer to [DAS-79, "Removal and Installation"](#).

# U1504 SIDE RDR L CAN 1

< DTC/CIRCUIT DIAGNOSIS >

[BCI]

## U1504 SIDE RDR L CAN 1

### DTC Logic

INFOID:000000009717102

### DTC DETECTION LOGIC

DTC (On board display)	Trouble diagnosis name	DTC detecting condition	Possible causes
U1504 (151)	SIDE RDR L CAN CIR 1	ADAS control unit detects an error signal that is received from side radar LH via ITS communication	Side radar LH

#### NOTE:

If DTC "U1504" is detected along with DTC "U1000", or "U1508", first diagnose the DTC "U1000" or "U1508".

- Refer to [DAS-747, "ADAS CONTROL UNIT : DTC Logic"](#) for DTC "U1000".
- Refer to [DAS-774, "DTC Logic"](#) for DTC "U1508".

### DTC CONFIRMATION PROCEDURE

#### 1. PERFORM DTC CONFIRMATION PROCEDURE

1. Start the engine.
2. Turn the Blind Spot Intervention system ON.
3. Perform "All DTC Reading" with CONSULT.
4. Check if the "U1504" is detected as the current malfunction in "Self Diagnostic Result" of "ICC/ADAS".

Is "U1504" detected as the current malfunction?

- YES >> Refer to [DAS-770, "Diagnosis Procedure"](#).  
NO >> Refer to [GI-53, "Intermittent Incident"](#).

### Diagnosis Procedure

INFOID:000000009717103

#### 1. CHECK SELF-DIAGNOSIS RESULTS

Check if "U1000" or "U1508" is detected other than "U1504" in "Self Diagnostic Result" of "ICC/ADAS".

Is "U1000" or "U1508" detected?

- YES-1 >> U1000 detected: Perform the CAN communication system inspection. Repair or replace the malfunctioning parts. Refer to [DAS-747, "ADAS CONTROL UNIT : DTC Logic"](#).  
YES-2 >> U1508 detected: Refer to [DAS-774, "DTC Logic"](#).  
NO >> GO TO 2.

#### 2. CHECK SIDE RADAR LH SELF-DIAGNOSIS RESULTS

Check if any DTC is detected in "Self Diagnostic Result" of "SIDE RADAR LEFT".

Is any DTC detected?

- YES >> Perform diagnosis on the detected DTC and repair or replace the malfunctioning parts. Refer to [DAS-683, "DTC Index"](#).  
NO >> Replace the ADAS control unit. Refer to [DAS-79, "Removal and Installation"](#).

# U1505 SIDE RDR R CAN 2

< DTC/CIRCUIT DIAGNOSIS >

[BCI]

## U1505 SIDE RDR R CAN 2

### DTC Logic

INFOID:000000009717104

### DTC DETECTION LOGIC

DTC (On board display)	Trouble diagnosis name	DTC detecting condition	Possible causes
U1505 (152)	SIDE RDR R CAN CIR 2	ADAS control unit detects an error signal that is received from side radar RH via ITS communication	Side radar RH

#### NOTE:

If DTC "U1505" is detected along with DTC "U1000", or "U1507", first diagnose the DTC "U1000" or "U1507".

- Refer to [DAS-747, "ADAS CONTROL UNIT : DTC Logic"](#) for DTC "U1000".
- Refer to [DAS-773, "DTC Logic"](#) for DTC "U1507".

### DTC CONFIRMATION PROCEDURE

#### 1. PERFORM DTC CONFIRMATION PROCEDURE

1. Start the engine.
2. Turn the Blind Spot Intervention system ON.
3. Perform "All DTC Reading" with CONSULT.
4. Check if the "U1505" is detected as the current malfunction in "Self Diagnostic Result" of "ICC/ADAS".

Is "U1505" detected as the current malfunction?

- YES >> Refer to [DAS-771, "Diagnosis Procedure"](#).  
NO >> Refer to [GI-53, "Intermittent Incident"](#).

### Diagnosis Procedure

INFOID:000000009717105

#### 1. CHECK SELF-DIAGNOSIS RESULTS

Check if "U1000" or "U1507" is detected other than "U1505" in "Self Diagnostic Result" of "ICC/ADAS".

Is "U1000" or "U1507" detected?

- YES-1 >> U1000 detected: Perform the CAN communication system inspection. Repair or replace the malfunctioning parts. Refer to [DAS-747, "ADAS CONTROL UNIT : DTC Logic"](#).  
YES-2 >> U1507 detected: Refer to [DAS-774, "DTC Logic"](#).  
NO >> GO TO 2.

#### 2. CHECK SIDE RADAR RH SELF-DIAGNOSIS RESULTS

Check if any DTC is detected in "Self Diagnostic Result" of "SIDE RADAR RIGHT".

Is any DTC detected?

- YES >> Perform diagnosis on the detected DTC and repair or replace the malfunctioning parts. Refer to [DAS-685, "DTC Index"](#).  
NO >> Replace the ADAS control unit. Refer to [DAS-79, "Removal and Installation"](#).

## U1506 SIDE RDR R CAN 1

### DTC Logic

INFOID:000000009717106

### DTC DETECTION LOGIC

DTC (On board display)	Trouble diagnosis name	DTC detecting condition	Possible causes
U1506 (153)	SIDE RDR R CAN CIR 1	ADAS control unit detects an error signal that is received from side radar RH via ITS communication	Side radar RH

**NOTE:**

If DTC "U1506" is detected along with DTC "U1000", or "U1507", first diagnose the DTC "U1000" or "U1507".

- Refer to [DAS-747, "ADAS CONTROL UNIT : DTC Logic"](#) for DTC "U1000".
- Refer to [DAS-774, "DTC Logic"](#) for DTC "U1507".

### DTC CONFIRMATION PROCEDURE

#### 1. PERFORM DTC CONFIRMATION PROCEDURE

1. Start the engine.
2. Turn the Blind Spot Intervention system ON.
3. Perform "All DTC Reading" with CONSULT.
4. Check if the "U1506" is detected as the current malfunction in "Self Diagnostic Result" of "ICC/ADAS".

Is "U1506" detected as the current malfunction?

- YES >> Refer to [DAS-770, "Diagnosis Procedure"](#).  
 NO >> Refer to [GI-53, "Intermittent Incident"](#).

### Diagnosis Procedure

INFOID:000000009717107

#### 1. CHECK SELF-DIAGNOSIS RESULTS

Check if "U1000" or "U1507" is detected other than "U1506" in "Self Diagnostic Result" of "ICC/ADAS".

Is "U1000" or "U1507" detected?

- YES-1 >> U1000 detected: Perform the CAN communication system inspection. Repair or replace the malfunctioning parts. Refer to [DAS-747, "ADAS CONTROL UNIT : DTC Logic"](#).  
 YES-2 >> U1507 detected: Refer to [DAS-774, "DTC Logic"](#).  
 NO >> GO TO 2.

#### 2. CHECK SIDE RADAR RH SELF-DIAGNOSIS RESULTS

Check if any DTC is detected in "Self Diagnostic Result" of "SIDE RADAR RIGHT".

Is any DTC detected?

- YES >> Perform diagnosis on the detected DTC and repair or replace the malfunctioning parts. Refer to [DAS-685, "DTC Index"](#).  
 NO >> Replace the ADAS control unit. Refer to [DAS-79, "Removal and Installation"](#).



# U1507 LOST COMM(SIDE RDR R)

< DTC/CIRCUIT DIAGNOSIS >

[BCI]

## U1507 LOST COMM(SIDE RDR R)

### DTC Logic

INFOID:000000009717108

### DTC DETECTION LOGIC

DTC (On board display)	Trouble diagnosis name	DTC detecting condition	Possible causes
U1507 (154)	LOST COMM(SIDE RDR R)	ADAS control unit cannot receive ITS communication signal from side radar RH for 2 seconds or more	<ul style="list-style-type: none"><li>• Side radar RH right/left switching signal circuit</li><li>• ITS communication system</li><li>• Side radar RH</li></ul>

#### NOTE:

DTC "U1507" is detected along with DTC "U1000", first diagnose the DTC "U1507".

### DTC CONFIRMATION PROCEDURE

#### 1. PERFORM DTC CONFIRMATION PROCEDURE

1. Start the engine.
2. Turn the Blind Spot Intervention system ON.
3. Perform "All DTC Reading" with CONSULT.
4. Check if the "U1507" is detected as the current malfunction in "Self Diagnostic Result" of "ICC/ADAS".

#### Is "U1507" detected as the current malfunction?

- YES >> Refer to [DAS-773, "Diagnosis Procedure"](#).  
NO >> Refer to [GI-53, "Intermittent Incident"](#).

### Diagnosis Procedure

INFOID:000000009717109

#### 1. CHECK RIGHT/LEFT SWITCHING SIGNAL CIRCUIT

Check right/left switching signal circuit. Refer to [DAS-789, "Diagnosis Procedure"](#).

#### Is the inspection result normal?

- YES >> Perform the CAN communication system inspection. Repair or replace the malfunctioning parts.  
Refer to [LAN-26, "Trouble Diagnosis Flow Chart"](#).  
NO >> Repair right/left switching signal circuit.

A  
B  
C  
D  
E  
F  
G  
H  
I  
J  
K  
L  
M  
N  
P

DAS

# U1508 LOST COMM(SIDE RDR L)

< DTC/CIRCUIT DIAGNOSIS >

[BCI]

## U1508 LOST COMM(SIDE RDR L)

### DTC Logic

INFOID:000000009717110

### DTC DETECTION LOGIC

DTC (On board display)	Trouble diagnosis name	DTC detecting condition	Possible causes
U1508 (155)	LOST COMM(SIDE RDR L)	ADAS control unit cannot receive ITS communication signal from side radar LH for 2 seconds or more	<ul style="list-style-type: none"><li>• Side radar LH harness connector</li><li>• ITS communication system</li><li>• Side radar LH</li></ul>

#### NOTE:

DTC "U1508" is detected along with DTC "U1000", first diagnose the DTC "U1508".

### DTC CONFIRMATION PROCEDURE

#### 1. PERFORM DTC CONFIRMATION PROCEDURE

1. Start the engine.
2. Turn the Blind Spot Intervention system ON.
3. Perform "All DTC Reading" with CONSULT.
4. Check if the "U1508" is detected as the current malfunction in "Self Diagnostic Result" of "ICC/ADAS".

#### Is "U1508" detected as the current malfunction?

- YES >> Refer to [DAS-774, "Diagnosis Procedure"](#).  
NO >> Refer to [GI-53, "Intermittent Incident"](#).

### Diagnosis Procedure

INFOID:000000009717111

#### 1. CHECK SIDE RADAR HARNESS CONNECTOR

1. Turn the ignition switch OFF.
2. Check the terminals and connectors of the side radar LH for damage, bend and short (unit side and connector side).

#### Is the inspection result normal?

- YES >> Perform the CAN communication system inspection. Repair or replace the malfunctioning parts. Refer to [LAN-26, "Trouble Diagnosis Flow Chart"](#).  
NO >> Repair the terminal or connector.

# U1512 HVAC CAN 3

< DTC/CIRCUIT DIAGNOSIS >

[BCI]

## U1512 HVAC CAN 3

### DTC Logic

INFOID:000000009717112

### DTC DETECTION LOGIC

DTC (On board display)	Trouble diagnosis name	DTC detecting condition	Possible causes
U1512 (162)	HVAC CAN CIRC 3	ADAS control unit detects an error signal that is received from A/C auto amp. via CAN communication	A/C auto amp.

#### NOTE:

If DTC "U1512" is detected along with DTC "U1000", first diagnose the DTC "U1000". Refer to [DAS-747, "ADAS CONTROL UNIT : DTC Logic"](#).

### DTC CONFIRMATION PROCEDURE

#### 1. PERFORM DTC CONFIRMATION PROCEDURE

1. Start the engine.
2. Turn the Blind Spot Intervention system ON.
3. Perform "All DTC Reading" with CONSULT.
4. Check if the "U1512" is detected as the current malfunction in "Self Diagnostic Result" of "ICC/ADAS".

Is "U1512" detected as the current malfunction?

- YES >> Refer to [DAS-775, "Diagnosis Procedure"](#).  
NO >> Refer to [GI-53, "Intermittent Incident"](#).

### Diagnosis Procedure

INFOID:000000009717113

#### 1. CHECK SELF-DIAGNOSIS RESULTS

Check if "U1000" is detected other than "U1512" in "Self Diagnostic Result" of "ICC/ADAS".

Is "U1000" detected?

- YES >> Perform the CAN communication system inspection. Repair or replace the malfunctioning parts. Refer to [DAS-747, "ADAS CONTROL UNIT : DTC Logic"](#).  
NO >> GO TO 2.

#### 2. CHECK A/C AUTO AMP. SELF-DIAGNOSIS RESULTS

Check if any DTC is detected in "Self Diagnostic Result" of "HVAC".

Is any DTC detected?

- YES >> Perform diagnosis on the detected DTC and repair or replace the malfunctioning parts. Refer to [HAC-49, "DTC Index"](#).  
NO >> Replace the ADAS control unit. Refer to [DAS-79, "Removal and Installation"](#).

A  
B  
C  
D  
E  
F  
G  
H  
I  
J  
K  
L  
M  
N  
P

DAS

# U1513 METER CAN 3

< DTC/CIRCUIT DIAGNOSIS >

[BCI]

## U1513 METER CAN 3

### DTC Logic

INFOID:000000009717114

### DTC DETECTION LOGIC

DTC (On board display)	Trouble diagnosis name	DTC detecting condition	Possible causes
U1513 (163)	METER CAN CIRC 3	ADAS control unit detects an error signal that is received from combination meter via CAN communication	Combination meter

#### NOTE:

If DTC "U1513" is detected along with DTC "U1000", first diagnose the DTC "U1000". Refer to [DAS-747, "ADAS CONTROL UNIT : DTC Logic"](#).

### DTC CONFIRMATION PROCEDURE

#### 1. PERFORM DTC CONFIRMATION PROCEDURE

1. Start the engine.
2. Turn the Blind Spot Intervention system ON.
3. Perform "All DTC Reading" with CONSULT.
4. Check if the "U1513" is detected as the current malfunction in "Self Diagnostic Result" of "ICC/ADAS".

Is "U1513" detected as the current malfunction?

- YES >> Refer to [DAS-776, "Diagnosis Procedure"](#).  
NO >> Refer to [GI-53, "Intermittent Incident"](#).

### Diagnosis Procedure

INFOID:000000009717115

#### 1. CHECK SELF-DIAGNOSIS RESULTS

Check if "U1000" is detected other than "U1513" in "Self Diagnostic Result" of "ICC/ADAS".

Is "U1000" detected?

- YES >> Perform the CAN communication system inspection. Repair or replace the malfunctioning parts.  
Refer to [DAS-747, "ADAS CONTROL UNIT : DTC Logic"](#).  
NO >> GO TO 2.

#### 2. CHECK COMBINATION METER SELF-DIAGNOSIS RESULTS

Check if any DTC is detected in "Self Diagnostic Result" of "METER/M&A".

Is any DTC detected?

- YES >> Perform diagnosis on the detected DTC and repair or replace the malfunctioning parts. Refer to [MWI-26, "DTC Index"](#).  
NO >> Replace the ADAS control unit. Refer to [DAS-79, "Removal and Installation"](#).

# U1514 STRG SEN CAN 3

< DTC/CIRCUIT DIAGNOSIS >

[BCI]

## U1514 STRG SEN CAN 3

### DTC Logic

INFOID:000000009717116

### DTC DETECTION LOGIC

DTC (On board display)	Trouble diagnosis name	DTC detecting condition	Possible causes
U1514 (164)	STRG SEN CAN CIRC 3	ADAS control unit detects an error signal that is received from steering angle sensor via CAN communication	Steering angle sensor

#### NOTE:

If DTC "U1514" is detected along with DTC "U1000", first diagnose the DTC "U1000". Refer to [DAS-747, "ADAS CONTROL UNIT : DTC Logic"](#).

### DTC CONFIRMATION PROCEDURE

#### 1. PERFORM DTC CONFIRMATION PROCEDURE

1. Start the engine.
2. Turn the Blind Spot Intervention system ON.
3. Perform "All DTC Reading" with CONSULT.
4. Check if the "U1514" is detected as the current malfunction in "Self Diagnostic Result" of "ICC/ADAS".

Is "U1514" detected as the current malfunction?

- YES >> Refer to [DAS-777, "Diagnosis Procedure"](#).  
NO >> Refer to [GI-53, "Intermittent Incident"](#).

### Diagnosis Procedure

INFOID:000000009717117

#### 1. CHECK SELF-DIAGNOSIS RESULTS

Check if "U1000" is detected other than "U1514" in "Self Diagnostic Result" of "ICC/ADAS".

Is "U1000" detected?

- YES >> Perform the CAN communication system inspection. Repair or replace the malfunctioning parts. Refer to [DAS-747, "ADAS CONTROL UNIT : DTC Logic"](#).  
NO >> GO TO 2.

#### 2. CHECK ABS ACTUATOR AND ELECTRIC UNIT (CONTROL UNIT) SELF-DIAGNOSIS RESULTS

Check if any DTC is detected in "Self Diagnostic Result" of "ABS".

Is any DTC detected?

- YES >> Perform diagnosis on the detected DTC and repair or replace the malfunctioning parts. Refer to [BRC-46, "DTC Index"](#).  
NO >> Replace the ADAS control unit. Refer to [DAS-79, "Removal and Installation"](#).

# U1516 CAM CAN 3

< DTC/CIRCUIT DIAGNOSIS >

[BCI]

## U1516 CAM CAN 3

### DTC Logic

INFOID:000000009717118

### DTC DETECTION LOGIC

DTC (On board display)	Trouble diagnosis name	DTC detecting condition	Possible causes
U1516 (166)	CAM CAN CIRC 3	ADAS control unit detects an error signal that is received from lane camera unit via ITS communication	Lane camera unit

#### NOTE:

If DTC "U1516" is detected along with DTC "U1000", first diagnose the DTC "U1000". Refer to [DAS-747, "ADAS CONTROL UNIT : DTC Logic"](#).

### DTC CONFIRMATION PROCEDURE

#### 1. PERFORM DTC CONFIRMATION PROCEDURE

1. Start the engine.
2. Turn the Blind Spot Intervention system ON.
3. Perform "All DTC Reading" with CONSULT.
4. Check if the "U1516" is detected as the current malfunction in "Self Diagnostic Result" of "ICC/ADAS".

Is "U1516" detected as the current malfunction?

- YES >> Refer to [DAS-778, "Diagnosis Procedure"](#).  
NO >> Refer to [GI-53, "Intermittent Incident"](#).

### Diagnosis Procedure

INFOID:000000009717119

#### 1. CHECK SELF-DIAGNOSIS RESULTS

Check if "U1000" is detected other than "U1516" in "Self Diagnostic Result" of "ICC/ADAS".

Is "U1000" detected?

- YES >> Perform the CAN communication system inspection. Repair or replace the malfunctioning parts.  
Refer to [DAS-747, "ADAS CONTROL UNIT : DTC Logic"](#).  
NO >> GO TO 2.

#### 2. CHECK LANE CAMERA UNIT SELF-DIAGNOSIS RESULTS

Check if any DTC is detected in "Self Diagnostic Result" of "LANE CAMERA".

Is any DTC detected?

- YES >> Perform diagnosis on the detected DTC and repair or replace the malfunctioning parts. Refer to [DAS-520, "DTC Index"](#).  
NO >> Replace the ADAS control unit. Refer to [DAS-79, "Removal and Installation"](#).

# U1518 SIDE RDR L CAN 3

< DTC/CIRCUIT DIAGNOSIS >

[BCI]

## U1518 SIDE RDR L CAN 3

### DTC Logic

INFOID:000000009717120

### DTC DETECTION LOGIC

DTC (On board display)	Trouble diagnosis name	DTC detecting condition	Possible causes
U1518 (168)	SIDE RDR L CAN CIRC 3	ADAS control unit detects an error signal that is received from side radar LH via ITS communication	Side radar LH

#### NOTE:

If DTC "U1518" is detected along with DTC "U1000", or "U1508", first diagnose the DTC "U1000" or "U1508".

- Refer to [DAS-747, "ADAS CONTROL UNIT : DTC Logic"](#) for DTC "U1000".
- Refer to [DAS-774, "DTC Logic"](#) for DTC "U1508".

### DTC CONFIRMATION PROCEDURE

#### 1. PERFORM DTC CONFIRMATION PROCEDURE

1. Start the engine.
2. Turn the Blind Spot Intervention system ON.
3. Perform "All DTC Reading" with CONSULT.
4. Check if the "U1518" is detected as the current malfunction in "Self Diagnostic Result" of "ICC/ADAS".

Is "U1518" detected as the current malfunction?

- YES >> Refer to [DAS-779, "Diagnosis Procedure"](#).  
NO >> Refer to [GI-53, "Intermittent Incident"](#).

### Diagnosis Procedure

INFOID:000000009717121

#### 1. CHECK SELF-DIAGNOSIS RESULTS

Check if "U1000" or "U1508" is detected other than "U1518" in "Self Diagnostic Result" of "ICC/ADAS".

Is "U1000" or "U1508" detected?

- YES-1 >> U1000 detected: Perform the CAN communication system inspection. Repair or replace the malfunctioning parts. Refer to [DAS-747, "ADAS CONTROL UNIT : DTC Logic"](#).  
YES-2 >> U1508 detected: Refer to [DAS-779, "DTC Logic"](#).  
NO >> GO TO 2.

#### 2. CHECK SIDE RADAR LH SELF-DIAGNOSIS RESULTS

Check if any DTC is detected in "Self Diagnostic Result" of "SIDE RADAR LEFT".

Is any DTC detected?

- YES >> Perform diagnosis on the detected DTC and repair or replace the malfunctioning parts. Refer to [DAS-683, "DTC Index"](#).  
NO >> Replace the ADAS control unit. Refer to [DAS-79, "Removal and Installation"](#).

## U1519 SIDE RDR R CAN 3

### DTC Logic

INFOID:000000009717122

#### DTC DETECTION LOGIC

DTC (On board display)	Trouble diagnosis name	DTC detecting condition	Possible causes
U1519 (169)	SIDE RDR R CAN CIRC 3	ADAS control unit detects an error signal that is received from side radar RH via ITS communication	Side radar RH

**NOTE:**

If DTC "U1519" is detected along with DTC "U1000", or "U1507", first diagnose the DTC "U1000" or "U1507".

- Refer to [DAS-747, "ADAS CONTROL UNIT : DTC Logic"](#) for DTC "U1000".
- Refer to [DAS-773, "DTC Logic"](#) for DTC "U1507".

#### DTC CONFIRMATION PROCEDURE

##### 1. PERFORM DTC CONFIRMATION PROCEDURE

1. Start the engine.
2. Turn the Blind Spot Intervention system ON.
3. Perform "All DTC Reading" with CONSULT.
4. Check if the "U1519" is detected as the current malfunction in "Self Diagnostic Result" of "ICC/ADAS".

Is "U1519" detected as the current malfunction?

- YES >> Refer to [DAS-780, "Diagnosis Procedure"](#).  
 NO >> Refer to [GI-53, "Intermittent Incident"](#).

#### Diagnosis Procedure

INFOID:000000009717123

##### 1. CHECK SELF-DIAGNOSIS RESULTS

Check if "U1000" or "U1507" is detected other than "U1519" in "Self Diagnostic Result" of "ICC/ADAS".

Is "U1000" or "U1507" detected?

- YES-1 >> U1000 detected: Perform the CAN communication system inspection. Repair or replace the malfunctioning parts. Refer to [DAS-747, "ADAS CONTROL UNIT : DTC Logic"](#).  
 YES-2 >> U1507 detected: Refer to [DAS-773, "DTC Logic"](#).  
 NO >> GO TO 2.

##### 2. CHECK SIDE RADAR RH SELF-DIAGNOSIS RESULTS

Check if any DTC is detected in "Self Diagnostic Result" of "SIDE RADAR RIGHT".

Is any DTC detected?

- YES >> Perform diagnosis on the detected DTC and repair or replace the malfunctioning parts. Refer to [DAS-685, "DTC Index"](#).  
 NO >> Replace the ADAS control unit. Refer to [DAS-79, "Removal and Installation"](#).



# U1521 SONAR CHECKSUM

< DTC/CIRCUIT DIAGNOSIS >

[BCI]

## U1521 SONAR CHECKSUM

### DTC Logic

INFOID:000000009717124

### DTC DETECTION LOGIC

DTC (On board display)	Trouble diagnosis name	DTC detecting condition	Possible causes
U1521 (177)	SONAR CHECKSUM ABNORMALITY	ADAS control unit detects an error signal that is received from sonar control unit via CAN communication	Sonar control unit

#### NOTE:

If DTC "U1521" is detected along with DTC "U1000", first diagnose the DTC "U1000". Refer to [DAS-747, "ADAS CONTROL UNIT : DTC Logic"](#).

### DTC CONFIRMATION PROCEDURE

#### 1. PERFORM DTC CONFIRMATION PROCEDURE

1. Start the engine.
2. Turn the Backup Collision Intervention system ON.
3. Perform "All DTC Reading" with CONSULT.
4. Check if the "U1521" is detected as the current malfunction in "Self Diagnostic Result" of "ICC/ADAS".

Is "U1521" detected as the current malfunction?

- YES >> Refer to [DAS-781, "Diagnosis Procedure"](#).  
NO >> Refer to [GI-53, "Intermittent Incident"](#).

### Diagnosis Procedure

INFOID:000000009717125

#### 1. CHECK SELF-DIAGNOSIS RESULTS

Check if "U1000" is detected other than "U1521" in "Self Diagnostic Result" of "ICC/ADAS".

Is "U1000" detected?

- YES >> Perform the CAN communication system inspection. Repair or replace the malfunctioning parts. Refer to [DAS-747, "ADAS CONTROL UNIT : DTC Logic"](#).  
NO >> GO TO 2.

#### 2. CHECK SONAR SYSTEM SELF-DIAGNOSIS RESULTS

Check if any DTC is detected in "Self Diagnostic Result" of "SONAR".

Is any DTC detected?

- YES >> Perform diagnosis on the detected DTC and repair or replace the malfunctioning parts. Refer to [AV-682, "DTC Index"](#).  
NO >> Replace the ADAS control unit. Refer to [DAS-79, "Removal and Installation"](#).

A  
B  
C  
D  
E  
F  
G  
H  
I  
J  
K  
L  
M  
N  
P

DAS

# U1522 SONAR MESSAGE

< DTC/CIRCUIT DIAGNOSIS >

[BCI]

## U1522 SONAR MESSAGE

### DTC Logic

INFOID:000000009717126

### DTC DETECTION LOGIC

DTC (On board display)	Trouble diagnosis name	DTC detecting condition	Possible causes
U1522 (178)	SONAR MESSAGE AB-NORMALITY	ADAS control unit detects an error signal that is received from sonar control unit via CAN communication	Sonar control unit

#### NOTE:

If DTC "U1522" is detected along with DTC "U1000", first diagnose the DTC "U1000". Refer to [DAS-747, "ADAS CONTROL UNIT : DTC Logic"](#).

### DTC CONFIRMATION PROCEDURE

#### 1. PERFORM DTC CONFIRMATION PROCEDURE

1. Start the engine.
2. Turn the Backup Collision Intervention system ON.
3. Perform "All DTC Reading" with CONSULT.
4. Check if the "U1522" is detected as the current malfunction in "Self Diagnostic Result" of "ICC/ADAS".

Is "U1522" detected as the current malfunction?

- YES >> Refer to [DAS-782, "Diagnosis Procedure"](#).  
NO >> Refer to [GI-53, "Intermittent Incident"](#).

### Diagnosis Procedure

INFOID:000000009717127

#### 1. CHECK SELF-DIAGNOSIS RESULTS

Check if "U1000" is detected other than "U1522" in "Self Diagnostic Result" of "ICC/ADAS".

Is "U1000" detected?

- YES >> Perform the CAN communication system inspection. Repair or replace the malfunctioning parts.  
Refer to [DAS-747, "ADAS CONTROL UNIT : DTC Logic"](#).  
NO >> GO TO 2.

#### 2. CHECK SONAR SELF-DIAGNOSIS RESULTS

Check if any DTC is detected in "Self Diagnostic Result" of "SONAR".

Is any DTC detected?

- YES >> Perform diagnosis on the detected DTC and repair or replace the malfunctioning parts. Refer to [AV-682, "DTC Index"](#).  
NO >> Replace the ADAS control unit. Refer to [DAS-79, "Removal and Installation"](#).

# U1523 SONAR CAN DLC

< DTC/CIRCUIT DIAGNOSIS >

[BCI]

## U1523 SONAR CAN DLC

### DTC Logic

INFOID:000000009717128

### DTC DETECTION LOGIC

DTC (On board display)	Trouble diagnosis name	DTC detecting condition	Possible causes
U1523 (179)	SONAR CAN DLC AB-NORMALITY	ADAS control unit detects an error signal that is received from sonar control unit via CAN communication	Sonar control unit

#### NOTE:

If DTC "U1523" is detected along with DTC "U1000", first diagnose the DTC "U1000". Refer to [DAS-747, "ADAS CONTROL UNIT : DTC Logic"](#).

### DTC CONFIRMATION PROCEDURE

#### 1. PERFORM DTC CONFIRMATION PROCEDURE

1. Start the engine.
2. Turn the Backup Collision Intervention system ON.
3. Perform "All DTC Reading" with CONSULT.
4. Check if the "U1523" is detected as the current malfunction in "Self Diagnostic Result" of "ICC/ADAS".

Is "U1523" detected as the current malfunction?

- YES >> Refer to [DAS-783, "Diagnosis Procedure"](#).  
NO >> Refer to [GI-53, "Intermittent Incident"](#).

### Diagnosis Procedure

INFOID:000000009717129

#### 1. CHECK SELF-DIAGNOSIS RESULTS

Check if "U1000" is detected other than "U1523" in "Self Diagnostic Result" of "ICC/ADAS".

Is "U1000" detected?

- YES >> Perform the CAN communication system inspection. Repair or replace the malfunctioning parts. Refer to [DAS-747, "ADAS CONTROL UNIT : DTC Logic"](#).  
NO >> GO TO 2.

#### 2. CHECK SONAR SELF-DIAGNOSIS RESULTS

Check if any DTC is detected in "Self Diagnostic Result" of "SONAR".

Is any DTC detected?

- YES >> Perform diagnosis on the detected DTC and repair or replace the malfunctioning parts. Refer to [AV-682, "DTC Index"](#).  
NO >> Replace the ADAS control unit. Refer to [DAS-79, "Removal and Installation"](#).

# U1524 AVM CAN DLC

< DTC/CIRCUIT DIAGNOSIS >

[BCI]

## U1524 AVM CAN DLC

### DTC Logic

INFOID:000000009717130

### DTC DETECTION LOGIC

DTC (On board display)	Trouble diagnosis name	DTC detecting condition	Possible causes
U1524 (180)	AVM CAN DLC ABNORMALITY	ADAS control unit detects an error signal that is received from AVM via CAN communication	AVM control unit

#### NOTE:

If DTC "U1524" is detected along with DTC "U1000", first diagnose the DTC "U1000". Refer to [DAS-747, "ADAS CONTROL UNIT : DTC Logic"](#).

### DTC CONFIRMATION PROCEDURE

#### 1. PERFORM DTC CONFIRMATION PROCEDURE

1. Start the engine.
2. Turn the Blind Spot Intervention system ON.
3. Perform "All DTC Reading" with CONSULT.
4. Check if the "U1524" is detected as the current malfunction in "Self Diagnostic Result" of "ICC/ADAS".

Is "U1524" detected as the current malfunction?

- YES >> Refer to [DAS-784, "Diagnosis Procedure"](#).  
NO >> Refer to [GI-53, "Intermittent Incident"](#).

### Diagnosis Procedure

INFOID:000000009717131

#### 1. CHECK SELF-DIAGNOSIS RESULTS

Check if "U1000" is detected other than "U1524" in "Self Diagnostic Result" of "ICC/ADAS".

Is "U1000" detected?

- YES >> Perform the CAN communication system inspection. Repair or replace the malfunctioning parts.  
Refer to [DAS-747, "ADAS CONTROL UNIT : DTC Logic"](#).  
NO >> GO TO 2.

#### 2. CHECK SONAR SELF-DIAGNOSIS RESULTS

Check if any DTC is detected in "Self Diagnostic Result" of "AVM".

Is any DTC detected?

- YES >> Perform diagnosis on the detected DTC and repair or replace the malfunctioning parts. Refer to [AV-660, "DTC Index"](#).  
NO >> Replace the ADAS control unit. Refer to [DAS-79, "Removal and Installation"](#).

# U1525 AVM MESSAGE

< DTC/CIRCUIT DIAGNOSIS >

[BCI]

## U1525 AVM MESSAGE

### DTC Logic

INFOID:000000009717132

### DTC DETECTION LOGIC

DTC (On board display)	Trouble diagnosis name	DTC detecting condition	Possible causes
U1525 (181)	AVM MESSAGE AB-NORMALITY	ADAS control unit detects an error signal that is received from AVM via CAN communication	AVM control unit

#### NOTE:

If DTC "U1525" is detected along with DTC "U1000", first diagnose the DTC "U1000". Refer to [DAS-747, "ADAS CONTROL UNIT : DTC Logic"](#).

### DTC CONFIRMATION PROCEDURE

#### 1. PERFORM DTC CONFIRMATION PROCEDURE

1. Start the engine.
2. Turn the Backup Collision Intervention system ON.
3. Perform "All DTC Reading" with CONSULT.
4. Check if the "U1525" is detected as the current malfunction in "Self Diagnostic Result" of "ICC/ADAS".

#### Is "U1525" detected as the current malfunction?

- YES >> Refer to [DAS-785, "Diagnosis Procedure"](#).  
NO >> Refer to [GI-53, "Intermittent Incident"](#).

### Diagnosis Procedure

INFOID:000000009717133

#### 1. CHECK SELF-DIAGNOSIS RESULTS

Check if "U1000" is detected other than "U1525" in "Self Diagnostic Result" of "ICC/ADAS".

#### Is "U1000" detected?

- YES >> Perform the CAN communication system inspection. Repair or replace the malfunctioning parts.  
Refer to [DAS-747, "ADAS CONTROL UNIT : DTC Logic"](#).  
NO >> GO TO 2.

#### 2. CHECK SONAR SELF-DIAGNOSIS RESULTS

Check if any DTC is detected in "Self Diagnostic Result" of "AVM".

#### Is any DTC detected?

- YES >> Perform diagnosis on the detected DTC and repair or replace the malfunctioning parts. Refer to [AV-660, "DTC Index"](#).  
NO >> Replace the ADAS control unit. Refer to [DAS-79, "Removal and Installation"](#).

A  
B  
C  
D  
E  
F  
G  
H  
I  
J  
K  
L  
M  
N  
P

DAS

# POWER SUPPLY AND GROUND CIRCUIT

< DTC/CIRCUIT DIAGNOSIS >

[BCI]

## POWER SUPPLY AND GROUND CIRCUIT ADAS CONTROL UNIT

### ADAS CONTROL UNIT : Diagnosis Procedure

INFOID:000000009717134

Regarding Wiring Diagram information, refer to [DAS-686, "Wiring Diagram"](#).

#### 1. CHECK ADAS CONTROL UNIT POWER SUPPLY CIRCUIT

Check voltage between ADAS control unit harness connector and ground.

Terminal		Condition	Voltage (Approx.)
(+)	(-)		
ADAS control unit		Ignition switch	0 V
Connector	Terminal		
B104	16	OFF	0 V
		ON	Battery voltage

Is the inspection result normal?

YES >> GO TO 2.

NO >> Repair the ADAS control unit power supply circuit.

#### 2. CHECK ADAS CONTROL UNIT GROUND CIRCUIT

1. Turn the ignition switch OFF.
2. Disconnect the ADAS control unit connector.
3. Check for continuity between ADAS control unit harness connector and ground.

ADAS control unit		Ground	Continuity
Connector	Terminal		
B104	6		Yes

Is the inspection result normal?

YES >> INSPECTION END

NO >> Repair the ADAS control unit ground circuit.

## SIDE RADAR LH

### SIDE RADAR LH : Diagnosis Procedure

INFOID:000000009717135

Regarding Wiring Diagram information, refer to [DAS-521, "Wiring Diagram"](#).

#### 1. CHECK POWER SUPPLY CIRCUIT

1. Turn ignition switch OFF.
2. Disconnect the side radar LH connector.
3. Check voltage between side radar LH harness connector and ground.

# POWER SUPPLY AND GROUND CIRCUIT

< DTC/CIRCUIT DIAGNOSIS >

[BCI]

Terminals		Condition	Voltage (Approx.)
(+)	(-)		
Side radar LH		Ignition switch	0 V
Connector	Terminal		
B416	5	OFF	0 V
		ON	Battery voltage

Is the inspection result normal?

YES >> GO TO 2.

NO >> Repair the side radar LH power supply circuit.

## 2.CHECK GROUND CIRCUIT

Check continuity between side radar LH harness connectors and ground.

Side radar LH		Ground	Continuity
Connector	Terminal		
B416	2		Yes

Is the inspection result normal?

YES >> Inspection End.

NO >> Repair the side radar LH ground circuit.

## SIDE RADAR RH

### SIDE RADAR RH : Diagnosis Procedure

INFOID:000000009717136

Regarding Wiring Diagram information, refer to [DAS-521, "Wiring Diagram"](#).

## 1.CHECK POWER SUPPLY CIRCUIT

1. Turn ignition switch OFF.
2. Disconnect the side radar RH connector.
3. Check voltage between side radar RH harness connector and ground.

Terminals		Condition	Voltage (Approx.)
(+)	(-)		
Side radar RH		Ignition switch	0 V
Connector	Terminal		
B109	5	OFF	0 V
		ON	Battery voltage

Is the inspection result normal?

YES >> GO TO 2.

NO >> Repair the side radar RH power supply circuit.

## 2.CHECK GROUND CIRCUIT

Check continuity between side radar RH harness connectors and ground.

Side radar RH		Ground	Continuity
Connector	Terminal		
B109	2		Yes

Is the inspection result normal?

YES >> Inspection End.

A  
B  
C  
D  
E  
F  
G  
H  
I  
J  
K  
L  
M  
N  
P

DAS

# POWER SUPPLY AND GROUND CIRCUIT

[BCI]

< DTC/CIRCUIT DIAGNOSIS >

NO >> Repair the side radar RH ground circuit.

## LANE CAMERA UNIT

### LANE CAMERA UNIT : Diagnosis Procedure

INFOID:000000009717137

Regarding Wiring Diagram information, refer to [DAS-367. "Wiring Diagram"](#).

#### 1. CHECK LANE CAMERA UNIT POWER SUPPLY CIRCUIT

Check voltage between lane camera unit harness connector and ground.

Terminal		Condition	Voltage (Approx.)
(+)	(-)		
Lane camera unit		Ignition switch	0 V
Connector	Terminal		
R5	7	OFF	0 V
		ON	Battery volt- age

Is the inspection result normal?

YES >> GO TO 2.

NO >> Repair the lane camera unit power supply circuit.

#### 2. CHECK LANE CAMERA UNIT GROUND CIRCUIT

1. Turn the ignition switch OFF.
2. Disconnect the lane camera unit connector.
3. Check for continuity between lane camera unit harness connector and ground.

Lane camera unit		Ground	Continuity
Connector	Terminal		
R5	1		Yes
	5		

Is the inspection result normal?

YES >> Inspection End.

NO >> Repair the lane camera unit ground circuit.



# RIGHT/LEFT SWITCHING SIGNAL CIRCUIT

< DTC/CIRCUIT DIAGNOSIS >

[BCI]

## RIGHT/LEFT SWITCHING SIGNAL CIRCUIT

### Diagnosis Procedure

INFOID:000000009717138

Regarding Wiring Diagram information, refer to [DAS-686. "Wiring Diagram"](#).

#### 1. CHECK CONNECTOR

1. Turn the ignition switch OFF.
2. Check the terminals and connectors of the side radar RH for damage, bend and short (unit side and connector side).

Is the inspection result normal?

- YES >> GO TO 2.  
NO >> Repair the terminal or connector.

#### 2. CHECK CONTINUITY RIGHT/LEFT SWITCHING SIGNAL CIRCUIT

1. Disconnect side radar RH connector.
2. Check continuity between side radar RH harness connectors and ground.

Side radar RH		Ground	Continuity
Connector	Terminal		
B109	1		Yes

Is the inspection result normal?

- YES >> Inspection End.  
NO >> Repair harness or connector.

A  
B  
C  
D  
E  
F  
G  
H  
I  
J  
K  
L  
M  
N  
P

DAS

# WARNING SYSTEMS SWITCH CIRCUIT

< DTC/CIRCUIT DIAGNOSIS >

[BCI]

## WARNING SYSTEMS SWITCH CIRCUIT

### Component Function Check

INFOID:000000009717139

#### 1.CHECK BCI SYSTEM SWITCH INPUT SIGNAL

1. Turn the ignition switch ON.
2. Select the DATA MONITOR item "BCI SYS SW" of "ICC/ADAS" with CONSULT.
3. With operating the warning systems switch, check the monitor status.

Monitor item	Condition	Monitor status
BCI SW	BCI switch is pressed	On
	BCI switch is not pressed	OFF

Is the inspection result normal?

- YES >> Warning systems switch circuit is normal.  
NO >> Refer to [DAS-790. "Diagnosis Procedure"](#).

### Diagnosis Procedure

INFOID:000000009717140

Regarding Wiring Diagram information, refer to [DAS-686. "Wiring Diagram"](#).

#### 1.CHECK BCI OFF SWITCH SIGNAL INPUT

1. Turn the ignition switch ON.
2. Check voltage between ADAS control unit harness connector and ground.

Terminals		Condition	Voltage (Approx.)
(+)	(-)		
ADAS control unit		BCI OFF switch	0 V
Connector	Terminal		
B104	10	Released	

Is the inspection result normal?

- YES >> Replace the ADAS control unit. Refer to [DAS-79. "Removal and Installation"](#).  
NO >> GO TO 2.

#### 2.CHECK BCI OFF SWITCH

1. Turn ignition switch OFF.
2. Remove BCI OFF switch.
3. Check BCI OFF switch. Refer to [DAS-791. "Component Inspection"](#).

Is the inspection result normal?

- YES >> GO TO 3.  
NO >> Replace the BCI OFF switch.

#### 3.CHECK BCI OFF SWITCH GROUND CIRCUIT

Check continuity between BCI OFF switch harness connector terminal and the ground.

BCI OFF switch		Ground	Continuity
Connector	Terminal		
M27	2		Yes

Is the inspection result normal?

- YES >> GO TO 4.

# WARNING SYSTEMS SWITCH CIRCUIT

[BCI]

< DTC/CIRCUIT DIAGNOSIS >

NO >> Repair harness or connector.

## 4.CHECK BCI OFF SWITCH SIGNAL INPUT CIRCUIT FOR OPEN

1. Disconnect the ADAS control unit connector.
2. Check continuity between the ADAS control unit harness connector and BCI OFF switch harness connector.

ADAS control unit		BCI OFF switch		Continuity
Connector	Terminal	Connector	Terminal	
B104	10	M27	6	Yes

Is the inspection result normal?

YES >> GO TO 5.

NO >> Repair the harnesses or connectors.

## 5.CHECK BCI OFF SWITCH SIGNAL INPUT CIRCUIT FOR SHORT

Check continuity between the ADAS control unit harness connector and ground.

ADAS control unit		Ground	Continuity
Connector	Terminal		
B104	10		No

Is the inspection result normal?

YES >> Replace the ADAS control unit. Refer to [DAS-79, "Removal and Installation"](#).

NO >> Repair the harnesses or connectors.

## Component Inspection

INFOID:000000009717141

### 1.CHECK BCI OFF SWITCH

Check continuity of BCI OFF switch.

Terminal		Condition	Continuity
2	6	When BCI OFF switch is pressed	Yes
		When BCI OFF switch is released	No

Is the inspection result normal?

YES >> Inspection End.

NO >> Replace warning systems switch.

DAS

# BACKUP COLLISION INTERVENTION SYSTEM SYMPTOMS

< SYMPTOM DIAGNOSIS >

[BCI]

## SYMPTOM DIAGNOSIS

### BACKUP COLLISION INTERVENTION SYSTEM SYMPTOMS

#### Symptom Table

INFOID:000000009717142

**CAUTION:**

Perform the self-diagnosis with CONSULT before the symptom diagnosis. Perform the trouble diagnosis if any DTC is detected.

**NOTE:**

Refer to the following the operation condition of the Backup Collision Intervention system.

- Backup Collision Intervention system: [DAS-644. "System Description"](#).

Symptom	Possible cause	Inspection item/Reference page
Backup Collision Intervention ON indicator (Green) does not illuminate	<ul style="list-style-type: none"> <li>• Backup Collision Intervention ON indicator lamp signal (CAN)</li> <li>- Combination meter</li> <li>- ADAS control unit</li> <li>• Backup Collision Intervention ON indicator (combination meter)</li> </ul>	<ul style="list-style-type: none"> <li>• ADAS control unit Active test "BCI ON INDICATOR". Refer to <a href="#">DAS-654. "CONSULT Function (ICC/ADAS)"</a>.</li> <li>• ADAS control unit Data monitor "BCI WARN LMP". Refer to <a href="#">DAS-654. "CONSULT Function (ICC/ADAS)"</a>.</li> <li>• Combination meter Data monitor "BCI W/L". Refer to <a href="#">MWI-17. "CONSULT Function (METER/M&amp;A)"</a></li> </ul>
Indicator/warning lamps do not illuminate when ignition switch OFF ⇒ ON.	<ul style="list-style-type: none"> <li>• All of indicator/warning lamps do not illuminate;</li> <li>• Backup Collision Intervention warning lamp</li> <li>• Backup Collision Intervention ON indicator</li> <li>• Warning systems ON indicator</li> </ul>	<ul style="list-style-type: none"> <li>• Power supply and ground circuit of ADAS control unit</li> <li>• ADAS control unit</li> <li>• Combination meter</li> </ul> <p>Power supply and ground circuit of ADAS control unit. Refer to <a href="#">DAS-786. "ADAS CONTROL UNIT : Diagnosis Procedure"</a></p>
Backup Collision Intervention indicator does not turn ON	<ul style="list-style-type: none"> <li>• Harness between side radar and Backup Collision Intervention indicator</li> <li>• Side radar LH/RH</li> <li>• Backup Collision Intervention indicator</li> </ul>	<p>Perform self-diagnosis of side radar. Refer to <a href="#">DAS-667. "CONSULT Function (SIDE RADAR LEFT)"</a> or <a href="#">DAS-668. "CONSULT Function (SIDE RADAR RIGHT)"</a>.</p>
Buzzer is not sounding	<ul style="list-style-type: none"> <li>• Buzzer power supply circuit.</li> <li>• Harness between sonar control unit and sonar buzzer</li> <li>• Harness between sonar buzzer and ground.</li> <li>• Sonar buzzer</li> <li>• Sonar control unit</li> </ul>	<p>Refer to sonar buzzer for repair <a href="#">AV-811. "Diagnosis Procedure"</a></p>

# BCI SYSTEM DOES NOT ACTIVATE

< SYMPTOM DIAGNOSIS >

[BCI]

## BCI SYSTEM DOES NOT ACTIVATE

### Description

INFOID:000000009717143

The switch does not turn ON

- When the Backup Collision Intervention system setting is ON, the Backup Collision Intervention ON indicator does not illuminate even if the BCI OFF switch is depressed.

The switch does not turn OFF

- The Backup Collision Intervention ON indicator does not turn off even if the BCI OFF switch is pressed when the Backup Collision Intervention ON indicator illuminates.

### Diagnosis Procedure

INFOID:000000009717144

#### 1. CHECK BACKUP COLLISION INTERVENTION SYSTEM SETTING

1. Start the engine.
2. After starting the engine wait for 5 seconds or more.
3. Check that Backup Collision Intervention system setting on the navigation screen is ON.

Is Backup Collision Intervention system setting ON?

- YES >> GO TO 2.  
NO >> Enable the Backup Collision Intervention system setting.

#### 2. BCI OFF SWITCH INSPECTION

1. Start the engine.
2. Check that "BCI SW" operates normally in "DATA MONITOR" of "ICC/ADAS" with CONSULT.

Is the inspection result normal?

- YES >> GO TO 3.  
NO >> GO TO 5.

#### 3. CHECK BACKUP COLLISION INTERVENTION ON INDICATOR CIRCUIT

1. Start the engine.
2. Select the active test item "BSI ON IND" of "ICC/ADAS" with CONSULT.
3. Check if the Backup Collision Intervention ON indicator illuminates when the test item is operated.

Is the inspection result normal?

- YES >> GO TO 6.  
NO >> GO TO 4.

#### 4. PERFORM THE SELF-DIAGNOSIS OF COMBINATION METER

1. Perform "All DTC Reading" with CONSULT.
2. Check if the DTC is detected in self-diagnosis results of "METER/M&A". Refer to [MWI-26, "DTC Index"](#).

Is the inspection result normal?

- YES >> GO TO 7.  
NO >> GO TO 6.

#### 5. CHECK STEERING SWITCH CIRCUIT

Check the steering switch circuit. Refer to [DAS-722, "Diagnosis Procedure"](#).

Is the inspection result normal?

- YES >> GO TO 6.  
NO >> GO TO 7.

#### 6. PERFORM THE SELF-DIAGNOSIS

1. Perform "All DTC Reading" with CONSULT.
2. Check if the DTC is detected in self-diagnosis results of "ICC/ADAS". Refer to [DAS-677, "DTC Index"](#).

Is any DTC detected?

- YES >> GO TO 7.  
NO >> GO TO 8.

## BCI SYSTEM DOES NOT ACTIVATE

< SYMPTOM DIAGNOSIS >

[BCI]

---

### 7. REPAIR OR REPLACE MALFUNCTIONING PARTS.

---

Repair or replace malfunctioning parts.

>> GO TO 8.

### 8. CHECK BACKUP COLLISION INTERVENTION SYSTEM

---

1. Erase "self-diagnosis result", and then perform "All DTC Reading" again after performing the action test. (Refer to [DAS-711, "Description"](#) for action test.)
2. Check that the Backup Collision Intervention system is normal.

>> Inspection End.

# BCI SYSTEM SETTING CANNOT BE TURNED ON/OFF

< SYMPTOM DIAGNOSIS >

[BCI]

## BCI SYSTEM SETTING CANNOT BE TURNED ON/OFF

### Description

INFOID:000000009717145

- BCI system setting is not selectable on the navigation screen.
- Backup Collision Intervention system setting is not selectable on the navigation screen.

**NOTE:**

When the ignition switch is in ACC position, Backup Collision Intervention system settings cannot be changed.

- "Backup Collision Intervention" is not indicated on the navigation screen.
- The switching between ON and OFF cannot be performed by operating the navigation system.
- The item "Backup Collision Intervention" on the navigation screen is not active.
- The Backup Collision Intervention system setting differs from the one set at the previous driving.

**NOTE:**

Turn OFF the ignition switch and wait for 5 seconds or more.

### Diagnosis Procedure

INFOID:000000009717146

#### 1. CHECK BACKUP COLLISION INTERVENTION SYSTEM SETTING

1. Start the engine.
2. Check that the Backup Collision Intervention system settings is selectable on the navigation screen.

Is the inspection result normal?

- YES >> GO TO 3.
- NO >> GO TO 2.

#### 2. PERFORM THE SELF-DIAGNOSIS

1. Perform self-diagnosis with CONSULT.
2. Check if the DTC is detected in self-diagnosis results of "ICC/ADAS", "MULTI AV" and "METER/M&A". Refer to the following.
  - ICC/ADAS: [DAS-677](#), "DTC Index".
  - MULTI AV: [AV-42](#), "DTC Index".
  - METER/M&A: [MWI-26](#), "DTC Index".

Is any DTC detected?

- YES >> Repair or replace malfunctioning parts.
- NO >> Inspection End.

#### 3. CHECK DATA MONITOR OF ADAS CONTROL UNIT

Check that "BCI SELECT" operates normally in "DATA MONITOR" of "ICC/ADAS" with CONSULT.

Is the inspection result normal?

- YES >> Refer to [DAS-653](#), "On Board Diagnosis Function".
- NO >> GO TO 4.

#### 4. CHECK MULTIFUNCTION SWITCH

Operate the multifunction switch to check that the audio, navigation system, and air conditioner operate properly.

Is the inspection result normal?

- YES >> Replace the ADAS control unit. Refer to [DAS-79](#), "Removal and Installation".
- NO >> Repair or replace malfunctioning parts.

A  
B  
C  
D  
E  
F  
G  
H  
I  
J  
K  
L  
M  
N  
P

DAS

## NORMAL OPERATING CONDITION

### Description

INFOID:000000009717147

#### BACKUP COLLISION INTERVENTION

- The Backup Collision Intervention system is not a replacement for proper driving procedure and is not designed to prevent contact with vehicles or objects. When backing up, always look in the direction driver will move to ensure it is safe to proceed. Never rely solely on the Backup Collision Intervention system.
- Using the Backup Collision Intervention system under some road or weather condition could lead to improper system operation. Always rely on driver's own steering and braking operation to avoid accidents.
- The Backup Collision Intervention system may not provide a warning or brake control for vehicles that pass through the detection zone quickly.
- Do not use the Backup Collision Intervention system when towing a trailer.
- Excessive noise (e.g. audio system volume, open vehicle window) will interfere with the chime sound, and it may not be heard.
- The side radar may not be able to detect and activate Backup Collision Intervention when certain objects are present such as:
  - Pedestrians, bicycles, animals.
  - A vehicle passing at a speed greater than approximately 15 MPH (24km/h).
- A radar sensor may not detect approaching vehicles in certain situations:
  - When the vehicle parked aside obstruct the beam of the radar sensor.
  - When the vehicle is parked in an angled parking space.
  - When the vehicle is parked on an inclined ground.
  - When the vehicle turns around into your vehicle's aisle.
  - When the angle formed by your vehicle and approaching vehicle is small.
- Severe weather or road spray conditions may reduce the ability of the radar to detect other vehicles.
- The sonar system may not detect:
  - Small or moving object.
  - Wedge-shaped objects.
  - Object closer to the bumper than 10 inch (30 cm).
  - Thin objects such as rope, wire, chain, etc...
- The brakes engaged by the BCI system is relatively weaker on a slope than flat ground. On a steep slope, the system may not function properly.
- Do not use the BCI system under the following conditions because the system may not function properly:
  - When driving with a tire that is not the within normal tire condition (example: tire wear, low pressure, spare tire, chain, non-standard wheels).
  - When the vehicle is equipped with non-original brake parts or suspension parts.

#### SIDE RADAR HANDLING

- Side radar for Backup Collision Intervention system is located inside the rear bumper.
- Always keep the rear bumper near the side radar clean.
- Do not attach a sticker (including transparent material), install an accessory or paintwork near the side radar.
- Do not strike or damage the areas around the side radar.
- Do not strike, damage, and scratch the side radar, especially the vent seal (gray circular) area, under repair.

#### SONAR HANDLING

- The four sonar sensors for Backup Collision Intervention system are located on the rear bumper cover.
- Always keep the sonar sensors clean.
- Do not attach a sticker (including transparent material), install an accessory or paintwork over any of the sonar sensors.
- Do not strike or scratch any of the sonar sensors causing physical damage. to a sensor or the surrounding area



# LANE CAMERA UNIT

< REMOVAL AND INSTALLATION >

[BCI]

## REMOVAL AND INSTALLATION

### LANE CAMERA UNIT

Exploded View

INFOID:000000009730899

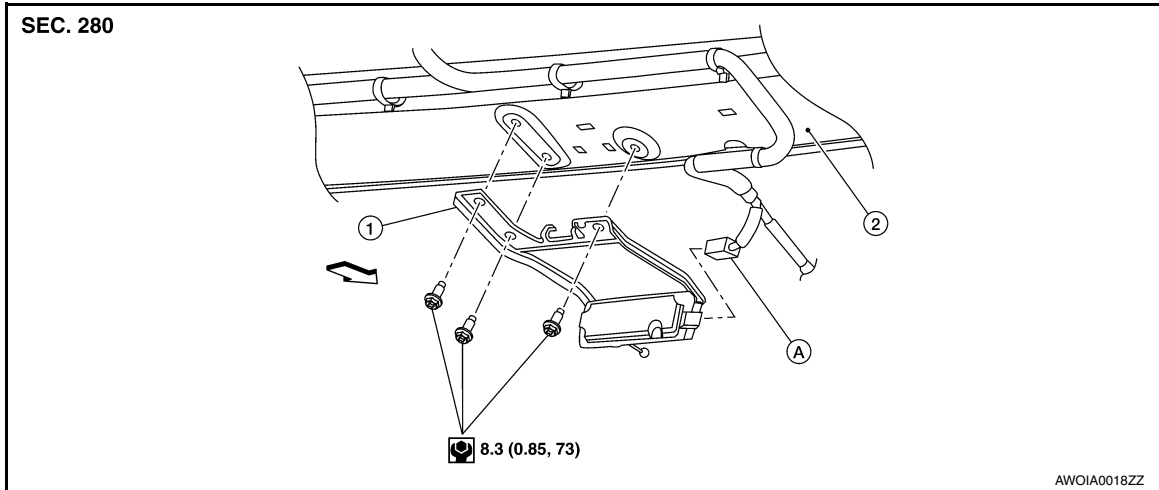

1. Lane camera unit

2. Roof rail

A. Lane camera unit harness connector

⇐ Front

### Removal and Installation

INFOID:000000009730900

#### REMOVAL

1. Partially remove the headlining. Refer to [INT-27, "Removal and Installation"](#).
2. Disconnect the lane camera unit harness connector from the lane camera unit.
3. Remove three lane camera bolts.
4. Remove lane camera unit.

#### INSTALLATION

Installation is in the reverse order of removal.

#### CAUTION:

- Remove the camera lens cover from the replacement lane camera unit before aiming.
- Do not drop or impact the lane camera unit.
- Perform additional service when replacing lane camera unit. Refer to [DAS-395, "Description"](#).

A  
B  
C  
D  
E  
F  
G  
H  
I  
J  
K  
L  
M  
N  
P

DAS

# SIDE RADAR

< REMOVAL AND INSTALLATION >

[BCI]

## SIDE RADAR

Exploded View

INFOID:000000009730905

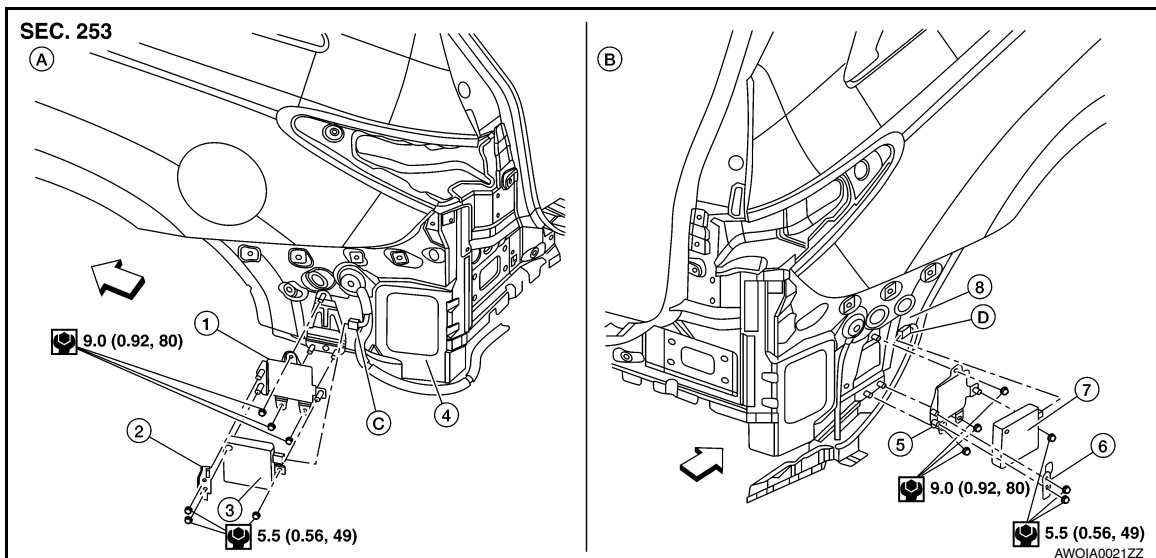

- |                                 |                                 |                                 |
|---------------------------------|---------------------------------|---------------------------------|
| 1. Retaining inner bracket (LH) | 2. Retaining outer bracket (LH) | 3. Side radar (LH)              |
| 4. Body side (LH)               | 5. Retaining inner bracket (RH) | 6. Retaining outer bracket (RH) |
| 7. Side radar (RH)              | 8. Body side (RH)               | A. LH side                      |
| B. RH side                      | C. Harness connector (LH)       | D. Harness connector (RH)       |

⇐ Front

## Removal and Installation

INFOID:000000009730907

### REMOVAL AND INSTALLATION

#### Removal

1. Remove the rear bumper fascia. Refer to [EXT-20, "Removal and Installation"](#).
2. Disconnect the harness connector (1) (3) from the side radar (LH/RH) as shown.

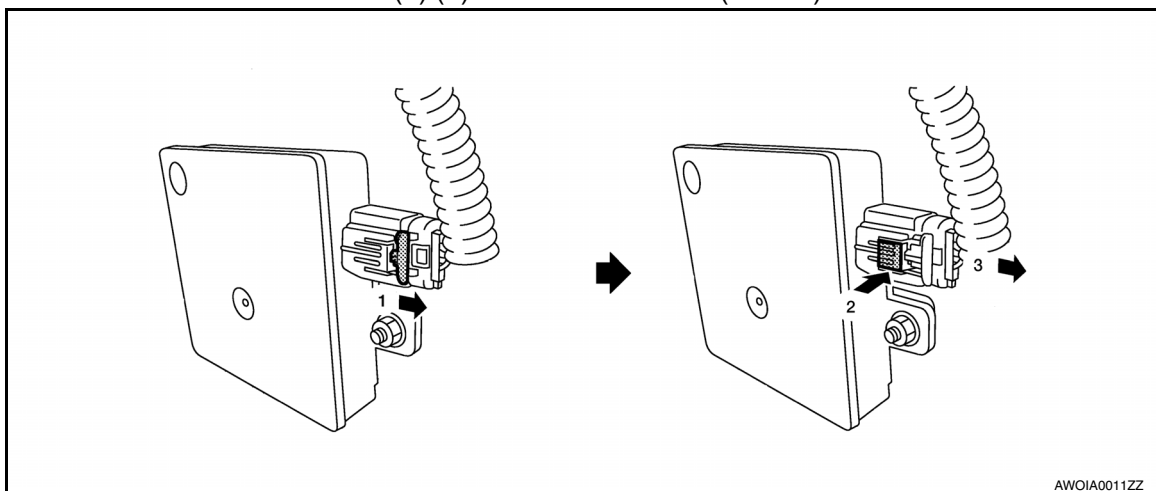

3. Remove nuts to remove the side radar (LH/RH) as necessary.

#### Installation

Installation is in the reverse order of removal.

#### CAUTION:

Do not use the side radar if the lens has flaws.

#### NOTE:

# SIDE RADAR

## < REMOVAL AND INSTALLATION >

[BCI]

- Always lock the side radar connector (2).
- Do not touch the side radar lens and keep lens area clean.

A

B

C

D

E

F

G

H

I

J

K

L

M

N

DAS

P

# SONAR SENSOR

< REMOVAL AND INSTALLATION >

[BCI]

## SONAR SENSOR

### Removal and Installation

INFOID:000000009730908

#### REAR SONAR SENSORS

##### Removal

1. Remove rear bumper fascia. Refer to [EXT-20. "Removal and Installation"](#).
2. Press sonar sensor spring (←).
3. Remove the sonar sensor (1) from rear bumper (2) as shown (↔).
4. Disconnect the harness connector from sonar sensor (1) and remove.

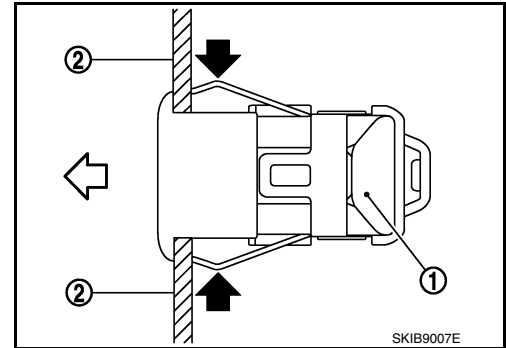

##### Installation

Installation is in the reverse order of removal.

##### CAUTION:

The connector direction is within  $\pm 10^\circ$  from the horizontal position when assembling the bumper.

(A) : Horizontal position

(a) :  $10^\circ$

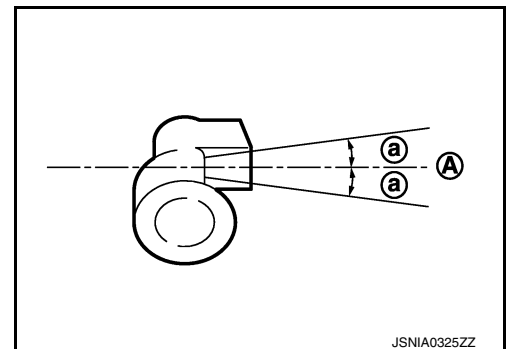

#### FRONT SONAR SENSORS

##### Removal

1. Remove front bumper fascia. Refer to [EXT-17. "Removal and Installation"](#).
2. Press sonar sensor spring (←).
3. Remove the sonar sensor (1) from front bumper (2) as shown (↔).
4. Disconnect harness connector from sonar sensor (1) and remove.

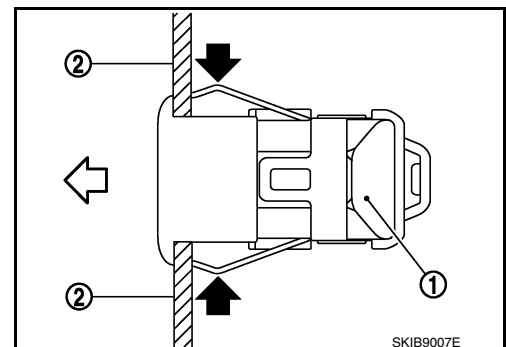

##### Installation

Installation is in the reverse order of removal.

##### CAUTION:

# SONAR SENSOR

< REMOVAL AND INSTALLATION >

[BCI]

The connector direction is within  $\pm 10^\circ$  from the horizontal position when assembling the bumper.

- (A) : Horizontal position
- (a) :  $10^\circ$

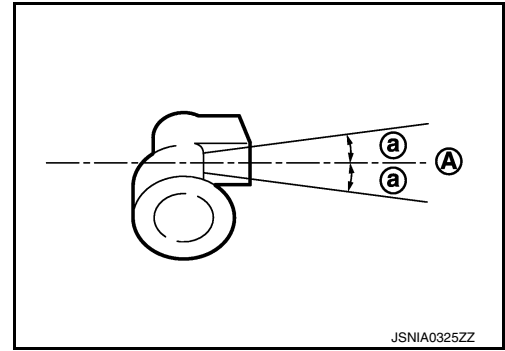

A  
B  
C  
D  
E  
F  
G  
H  
I  
J  
K  
L  
M  
N  
P

DAS

# REAR CAMERA

< REMOVAL AND INSTALLATION >

[BCI]

## REAR CAMERA

### Removal and Installation

INFOID:000000009717153

#### REMOVAL

1. Remove back door outer upper finisher. Refer to [EXT-44. "Removal and Installation"](#).
2. Remove rear camera screws (A), then remove rear camera (1) from the back door outer upper finisher (2).

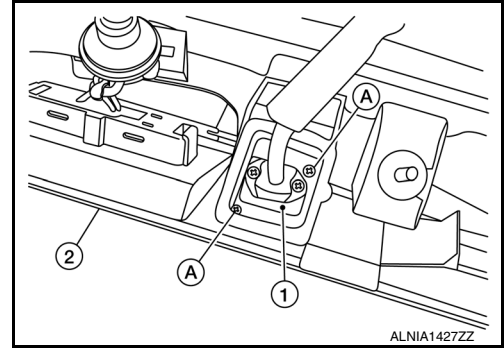

#### INSTALLATION

Installation is in the reverse order of removal.

**NOTE:**

Perform camera image calibration. Refer to [AV-749. "CALIBRATING CAMERA IMAGE \(AROUND VIEW MONITOR\) : Work Procedure"](#).

# BLIND SPOT WARNING/BLIND SPOT INTERVENTION INDICATOR

< REMOVAL AND INSTALLATION >

[BCI]

## BLIND SPOT WARNING/BLIND SPOT INTERVENTION INDICATOR

Exploded View

INFOID:000000009730909

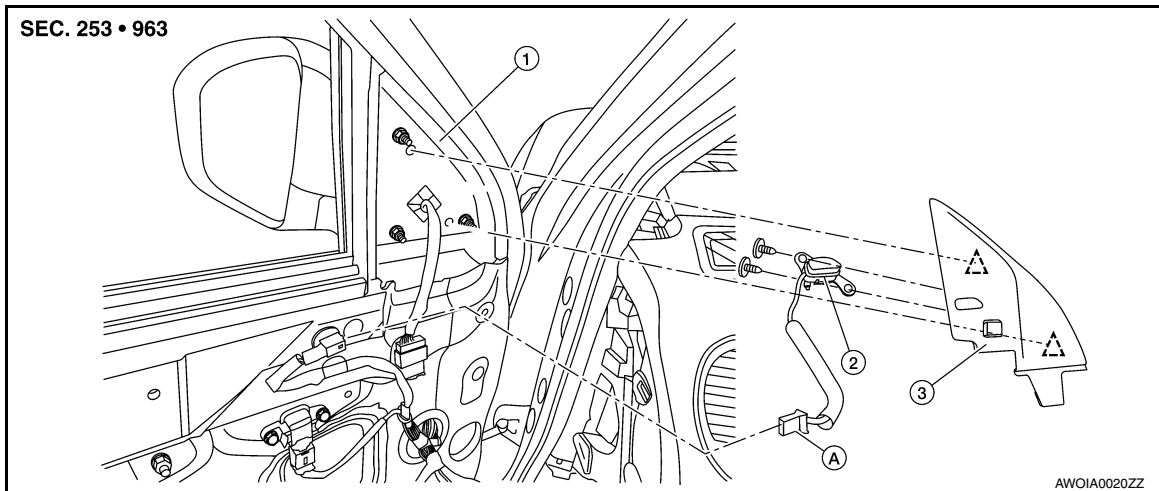

- 1. Front door
- 2. Blind spot warning/blind spot intervention indicator
- 3. Door mirror corner finisher
- A. Blind spot warning/blind spot intervention indicator harness connector
- Clip

### Removal and Installation

INFOID:000000009730910

#### REMOVAL AND INSTALLATION

##### Removal

1. Remove front door finisher. Refer to [INT-15, "Removal and Installation"](#).
2. Remove the door mirror corner finisher (LH/RH) as necessary. Refer to [MIR-29, "Removal and Installation"](#).
3. Remove the blind spot warning/blind spot intervention indicator screws.
4. Remove the blind spot warning/blind spot intervention indicator.

##### Installation

Installation is in the reverse order of removal.

A  
B  
C  
D  
E  
F  
G  
H  
I  
J  
K  
L  
M  
N  
P

DAS

## METER CONTROL SWITCH

< REMOVAL AND INSTALLATION >

[BCI]

---

### METER CONTROL SWITCH

#### Removal and Installation

INFOID:000000009717156

The backup collision intervention (BCI) switch is serviced as part of the meter control switch. Refer to [MWI-96](#), "[Removal and Installation](#)".