

SECTION **PWC**

POWER WINDOW CONTROL SYSTEM

A
B
C
D
E
F
G
H
I
J
L
M
N
O
P

CONTENTS

<p>PRECAUTION 4</p> <p>PRECAUTIONS 4</p> <p style="padding-left: 20px;">Precaution for Supplemental Restraint System (SRS) "AIR BAG" and "SEAT BELT PRE-TENSIONER"4</p> <p>SYSTEM DESCRIPTION 5</p> <p>COMPONENT PARTS 5</p> <p style="padding-left: 20px;">Component Parts Location5</p> <p style="padding-left: 20px;">Component Description6</p> <p>SYSTEM 7</p> <p style="padding-left: 20px;">System Diagram7</p> <p style="padding-left: 20px;">System Description7</p> <p style="padding-left: 20px;">Fail-safe9</p> <p>DIAGNOSIS SYSTEM (BCM)10</p> <p>COMMON ITEM 10</p> <p style="padding-left: 20px;">COMMON ITEM : CONSULT Function (BCM - COMMON ITEM) 10</p> <p>RETAINED PWR 11</p> <p style="padding-left: 20px;">RETAINED PWR : CONSULT Function (BCM - RETAINED PWR) 11</p> <p>ECU DIAGNOSIS INFORMATION12</p> <p>BCM (BODY CONTROL MODULE)12</p> <p style="padding-left: 20px;">List of ECU Reference 12</p> <p>MAIN POWER WINDOW AND DOOR LOCK/UNLOCK SWITCH13</p> <p style="padding-left: 20px;">Reference Value 13</p> <p>POWER WINDOW AND DOOR LOCK/UNLOCK SWITCH RH15</p> <p style="padding-left: 20px;">Reference Value 15</p> <p>REAR POWER WINDOW SWITCH LH17</p> <p style="padding-left: 20px;">Reference Value 17</p>	<p>REAR POWER WINDOW SWITCH RH19</p> <p style="padding-left: 20px;">Reference Value19</p> <p>WIRING DIAGRAM21</p> <p>POWER WINDOW SYSTEM21</p> <p style="padding-left: 20px;">Wiring Diagram21</p> <p>BASIC INSPECTION31</p> <p>DIAGNOSIS AND REPAIR WORKFLOW31</p> <p style="padding-left: 20px;">Work Flow31</p> <p>ADDITIONAL SERVICE WHEN REMOVING BATTERY NEGATIVE TERMINAL33</p> <p style="padding-left: 20px;">Description33</p> <p style="padding-left: 20px;">Work Procedure33</p> <p>ADDITIONAL SERVICE WHEN REPLACING CONTROL UNIT34</p> <p style="padding-left: 20px;">Description34</p> <p style="padding-left: 20px;">Work Procedure34</p> <p>SYSTEM INITIALIZATION35</p> <p style="padding-left: 20px;">Description35</p> <p style="padding-left: 20px;">Work Procedure35</p> <p>CHECK ANTI-PINCH FUNCTION36</p> <p style="padding-left: 20px;">Description36</p> <p style="padding-left: 20px;">Work Procedure36</p> <p>DTC/CIRCUIT DIAGNOSIS37</p> <p>POWER SUPPLY AND GROUND CIRCUIT37</p> <p>BCM37</p> <p style="padding-left: 20px;">BCM : Diagnosis Procedure37</p> <p>POWER WINDOW MAIN SWITCH37</p> <p style="padding-left: 20px;">POWER WINDOW MAIN SWITCH : Diagnosis Procedure37</p>
----------------------------------------------------------------------------------------------------------------------------------------------------------------------------------------------------------------------------------------------------------------------------------------------------------------------------------------------------------------------------------------------------------------------------------------------------------------------------------------------------------------------------------------------------------------------------------------------------------------------------------------------------------------------------------------------------------------------------------------------------------------------------------------------------------------------------------------------------------------------------------------------------------------------------------------------------------------------------------------------------------------------------------------------------------------------------------------------------------------------------------------------------------------------------------------------------------------------------------------------------------------------------------------------------------------------------------------------------------------------------------------------------------------------------------------------------------------------------------------------------	----------------------------------------------------------------------------------------------------------------------------------------------------------------------------------------------------------------------------------------------------------------------------------------------------------------------------------------------------------------------------------------------------------------------------------------------------------------------------------------------------------------------------------------------------------------------------------------------------------------------------------------------------------------------------------------------------------------------------------------------------------------------------------------------------------------------------------------------------------------------------------------------------------------------------------------------------------------------------------------------------------------------------------------------------------------------------------------------------------------------------------------------------------------------------------------------------------------------------------------------------------------------------------------------------------------------------------------------------------------------------------------------------------------------------------------------------------------------

PWC

FRONT POWER WINDOW SWITCH (PASSENGER SIDE)	38	FRONT POWER WINDOW SWITCH (PASSENGER SIDE) : Component Function Check	59
FRONT POWER WINDOW SWITCH (PASSENGER SIDE) : Diagnosis Procedure	38	FRONT POWER WINDOW SWITCH (PASSENGER SIDE) : Diagnosis Procedure	59
REAR POWER WINDOW SWITCH	39	REAR POWER WINDOW SWITCH LH	60
REAR POWER WINDOW SWITCH : Diagnosis Procedure	39	REAR POWER WINDOW SWITCH LH : Component Function Check	60
POWER WINDOW MOTOR	41	REAR POWER WINDOW SWITCH LH : Diagnosis Procedure	61
DRIVER SIDE	41	REAR POWER WINDOW SWITCH RH	62
DRIVER SIDE : Component Function Check	41	REAR POWER WINDOW SWITCH RH : Component Function Check	62
DRIVER SIDE : Diagnosis Procedure	41	REAR POWER WINDOW SWITCH RH : Diagnosis Procedure	62
PASSENGER SIDE	42	SYMPTOM DIAGNOSIS	64
PASSENGER SIDE : Component Function Check	42	POWER WINDOWS DO NOT OPERATE WITH POWER WINDOW MAIN SWITCH	64
PASSENGER SIDE : Diagnosis Procedure	42	Diagnosis Procedure	64
REAR LH	43	DRIVER SIDE POWER WINDOW ALONE DOES NOT OPERATE	65
REAR LH : Component Function Check	43	Diagnosis Procedure	65
REAR LH : Diagnosis Procedure	43	FRONT PASSENGER SIDE POWER WINDOW DOES NOT OPERATE	66
REAR RH	44	WHEN POWER WINDOW MAIN SWITCH IS OPERATED	66
REAR RH : Component Function Check	44	WHEN POWER WINDOW MAIN SWITCH IS OPERATED : Diagnosis Procedure	66
REAR RH : Diagnosis Procedure	44	WHEN FRONT POWER WINDOW SWITCH (PASSENGER SIDE) IS OPERATED	66
ENCODER	46	WHEN FRONT POWER WINDOW SWITCH (PASSENGER SIDE) IS OPERATED : Diagnosis Procedure	66
DRIVER SIDE	46	WHEN BOTH POWER WINDOW MAIN SWITCH AND FRONT POWER WINDOW SWITCH ARE OPERATED	66
DRIVER SIDE : Component Function Check	46	WHEN BOTH POWER WINDOW MAIN SWITCH AND FRONT POWER WINDOW SWITCH ARE OPERATED : Diagnosis Procedure	66
DRIVER SIDE : Diagnosis Procedure	46	REAR LH SIDE POWER WINDOW ALONE DOES NOT OPERATE	67
PASSENGER SIDE	48	WHEN POWER WINDOW MAIN SWITCH IS OPERATED	67
PASSENGER SIDE : Component Function Check	48	WHEN POWER WINDOW MAIN SWITCH IS OPERATED : Diagnosis Procedure	67
PASSENGER SIDE : Diagnosis Procedure	48	WHEN REAR POWER WINDOW SWITCH LH IS OPERATED	67
REAR LH	50	WHEN REAR POWER WINDOW SWITCH LH IS OPERATED : Diagnosis Procedure	67
REAR LH : Component Function Check	50		
REAR LH : Diagnosis Procedure	50		
REAR RH	52		
REAR RH : Component Function Check	52		
REAR RH : Diagnosis Procedure	53		
DOOR KEY CYLINDER SWITCH	56		
Component Function Check	56		
Diagnosis Procedure	56		
Component Inspection	57		
POWER WINDOW SERIAL LINK	58		
POWER WINDOW MAIN SWITCH	58		
POWER WINDOW MAIN SWITCH : Component Function Check	58		
POWER WINDOW MAIN SWITCH : Diagnosis Procedure	58		
FRONT POWER WINDOW SWITCH (PASSENGER SIDE)	59		

WHEN BOTH POWER WINDOW MAIN SWITCH AND REAR POWER WINDOW SWITCH LH ARE OPERATED	67	POWER WINDOW RETAINED POWER FUNCTION DOES NOT OPERATE NORMALLY	72	A
WHEN BOTH POWER WINDOW MAIN SWITCH AND REAR POWER WINDOW SWITCH LH ARE OPERATED : Diagnosis Procedure	67	Diagnosis Procedure	72	
REAR RH SIDE POWER WINDOW ALONE DOES NOT OPERATE	68	DOOR KEY CYLINDER SWITCH DOES NOT OPERATE POWER WINDOWS	73	B
WHEN POWER WINDOW MAIN SWITCH IS OPERATED	68	Diagnosis Procedure	73	C
WHEN POWER WINDOW MAIN SWITCH IS OPERATED : Diagnosis Procedure	68	KEYLESS POWER WINDOW DOWN DOES NOT OPERATE	74	D
WHEN REAR POWER WINDOW SWITCH RH IS OPERATED	68	Diagnosis Procedure	74	
WHEN REAR POWER WINDOW SWITCH RH IS OPERATED : Diagnosis Procedure	68	POWER WINDOW LOCK SWITCH DOES NOT FUNCTION	75	E
WHEN BOTH POWER WINDOW MAIN SWITCH AND REAR POWER WINDOW SWITCH RH ARE OPERATED	68	Diagnosis Procedure	75	
WHEN BOTH POWER WINDOW MAIN SWITCH AND REAR POWER WINDOW SWITCH RH ARE OPERATED : Diagnosis Procedure	68	POWER WINDOW SWITCH DOES NOT ILLUMINATE	76	F
AUTO OPERATION DOES NOT OPERATE BUT MANUAL OPERATE NORMALLY	69	DRIVER SIDE	76	G
DRIVER SIDE	69	DRIVER SIDE : Diagnosis Procedure	76	
DRIVER SIDE : Diagnosis Procedure	69	PASSENGER SIDE	76	H
PASSENGER SIDE	69	PASSENGER SIDE : Diagnosis Procedure	76	
PASSENGER SIDE : Diagnosis Procedure	69	REAR LH	76	I
REAR LH	69	REAR LH : Diagnosis Procedure	76	
REAR LH : Diagnosis Procedure	69	REAR RH	76	J
REAR RH	70	REAR RH : Diagnosis Procedure	76	
REAR RH : Diagnosis Procedure	70	REMOVAL AND INSTALLATION	77	
ANTI-PINCH FUNCTION DOES NOT OPERATE	71	MAIN POWER WINDOW AND DOOR LOCK/UNLOCK SWITCH	77	
Diagnosis Procedure	71	Removal and Installation	77	
		POWER WINDOW AND DOOR LOCK/UNLOCK SWITCH RH	78	L
		Removal and Installation	78	
		REAR POWER WINDOW SWITCH	79	M
		Removal and Installation	79	

PWC

PRECAUTIONS

< PRECAUTION >

PRECAUTION

PRECAUTIONS

Precaution for Supplemental Restraint System (SRS) "AIR BAG" and "SEAT BELT PRE-TENSIONER"

INFOID:000000009133421

The Supplemental Restraint System such as "AIR BAG" and "SEAT BELT PRE-TENSIONER", used along with a front seat belt, helps to reduce the risk or severity of injury to the driver and front passenger for certain types of collision. This system includes dual stage front air bag modules. The SRS system may only deploy one front air bag, depending on the severity of a collision and whether the front passenger seat is occupied. Information necessary to service the system safely is included in the SR and SB section of this Service Manual.

WARNING:

- To avoid rendering the SRS inoperative, which could increase the risk of personal injury or death in the event of a collision which would result in air bag inflation, all maintenance must be performed by an authorized NISSAN/INFINITI dealer.
- Improper maintenance, including incorrect removal and installation of the SRS, can lead to personal injury caused by unintentional activation of the system. For removal of Spiral Cable and Air Bag Module, see the SR section.
- Do not use electrical test equipment on any circuit related to the SRS unless instructed to in this Service Manual. SRS wiring harnesses can be identified by yellow and/or orange harnesses or harness connectors.

PRECAUTIONS WHEN USING POWER TOOLS (AIR OR ELECTRIC) AND HAMMERS

WARNING:

- When working near the Airbag Diagnosis Sensor Unit or other Airbag System sensors with the Ignition ON or engine running, DO NOT use air or electric power tools or strike near the sensor(s) with a hammer. Heavy vibration could activate the sensor(s) and deploy the air bag(s), possibly causing serious injury.
- When using air or electric power tools or hammers, always switch the Ignition OFF, disconnect the battery, and wait at least 3 minutes before performing any service.

COMPONENT PARTS

< SYSTEM DESCRIPTION >

SYSTEM DESCRIPTION

COMPONENT PARTS

Component Parts Location

INFOID:000000009133422

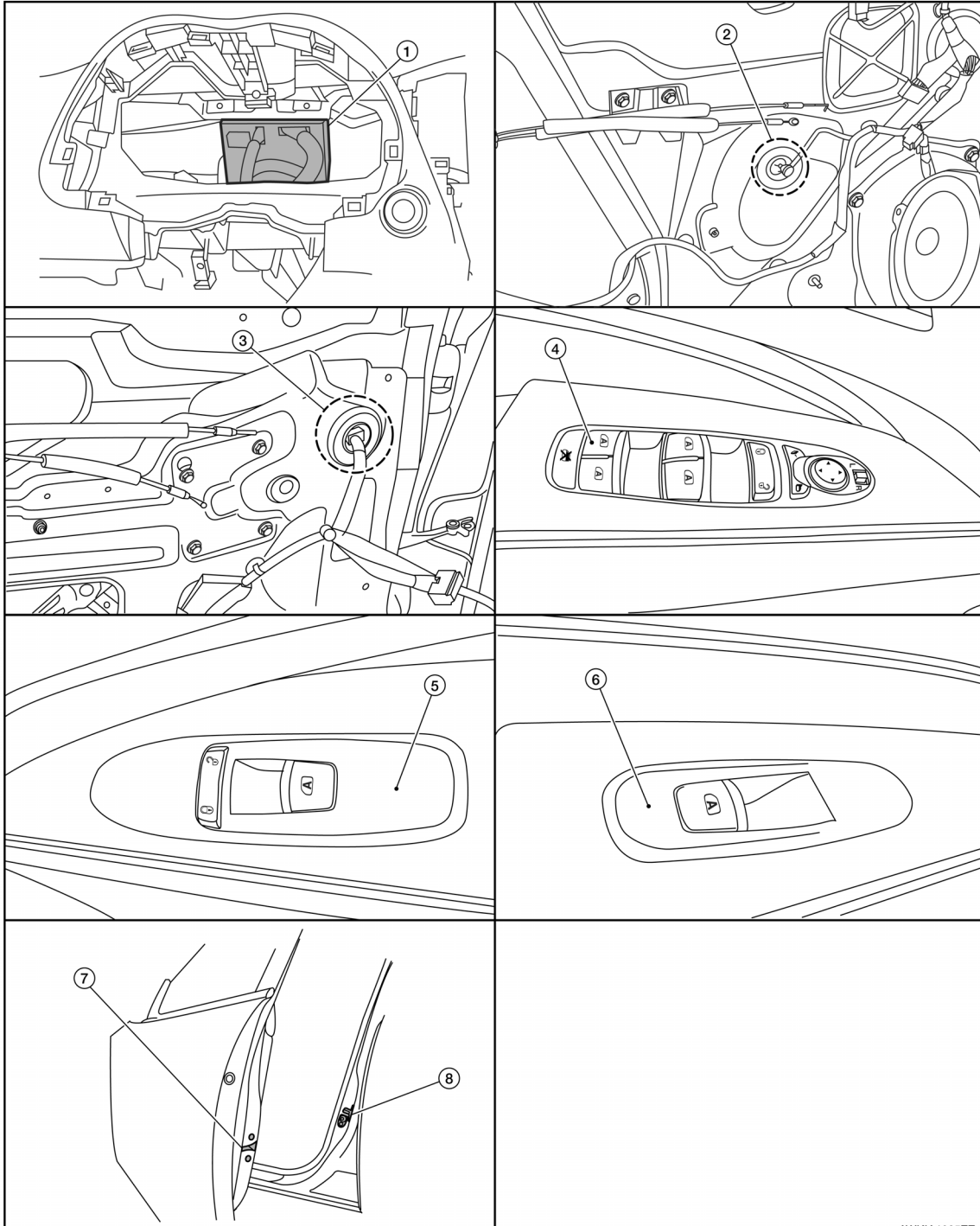

- | | | |
|------------------------------------------------------|------------------------------------------------|---------------------------------------------|
| 1. BCM (view with the combination meter removed) | 2. Front power window motor LH (RH similar) | 3. Rear power window motor LH (RH similar) |
| 4. Main power window and door lock/unlock switch | 5. Power window and door lock/unlock switch RH | 6. Rear power window switch LH (RH similar) |
| 7. Front door lock assembly LH (key cylinder switch) | 8. Front door switch LH (RH similar) | |

AWKIA1985ZZ

A
B
C
D
E
F
G
H
I
J
PWC
L
M
N
O
P

COMPONENT PARTS

< SYSTEM DESCRIPTION >

Component Description

INFOID:000000009133423

Component	Function
BCM	<ul style="list-style-type: none">• Supplies power to the window switches.• Controls retained power.
Main power window and door lock/unlock switch	Directly controls all power window motors.
Power window and door lock/unlock switch RH	Controls power window motor of passenger door.
Rear power window switch	<ul style="list-style-type: none">• Controls anti-pinch operation of power window.• Controls right and left power window motors for the rear doors.
Power window motor	<ul style="list-style-type: none">• Integrates the ENCODER and WINDOW MOTOR.• Starts operating with signals from each power window switch.• Transmits power window motor rotation as a pulse signal to power window switch.• Controls anti-pinch operation for all windows.
Front door lock assembly LH (key cylinder switch)	Transmits operation condition of door key cylinder switch to power window main switch.
Front door switch LH/RH	Detects door open/close condition and transmits it to the BCM.

SYSTEM

< SYSTEM DESCRIPTION >

SYSTEM

System Diagram

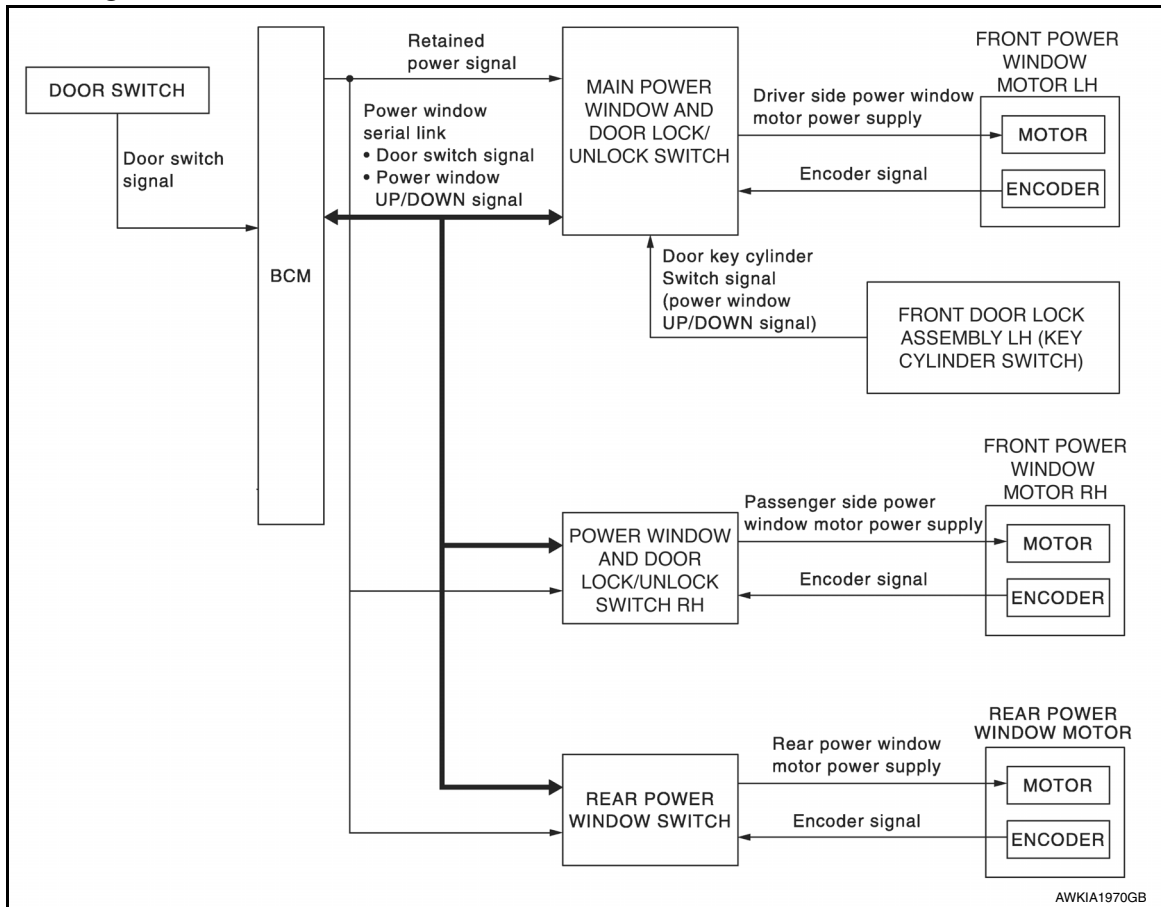

System Description

INFOID:000000009133425

PWC

POWER WINDOW OPERATION

- Power window system is activated by the power window switch when the ignition switch is in the ON position or during the retained power operation after ignition switch turns OFF.
- Power window main switch can open/close door glass.
- Front and rear power window switch can open/close the corresponding door glass.
- Power window lock switch can lock all power windows other than driver seat.
- All power windows open when pressing Intelligent Key unlock button for 3 seconds.
- If door glass receives resistance that is more than the specified value and the power window is in the AUTO-UP operation, power window will move in the reverse direction (Anti-Pinch Function).
- Power window serial link transmits the signals from power window main switch to each power window switch.

POWER WINDOW AUTO-OPERATION

- AUTO-UP/DOWN operation can be performed when each power window motor turns to AUTO.
- Encoder continues detecting the movement of power window motor and output the encoder pulse signal to power window switch while power window motor is operating.
- Power window switch reads the changes of encoder signal and stops AUTO operation when door glass is at fully opened/closed position.
- Power window motor is operable in case encoder is malfunctioning.
- AUTO function does not operate if encoder is malfunctioning.

POWER WINDOW SERIAL LINK

Power window main switch, front power window switch (passenger side), rear power window switch LH/RH and BCM transmit and receive the signal by power window serial link.

SYSTEM

< SYSTEM DESCRIPTION >

The signal mentioned below is transmitted from BCM to power window main switch, front power window switch (passenger side) and rear power window switch LH/RH.

- Keyless power window down signal
- Door switch signal

The signal mentioned below is transmitted from power window main switch to front power window switch (passenger side) and rear power window switch LH/RH.

- Front passenger side door window and rear door window operation signal
- Power window control by door key cylinder switch signal
- Power window lock switch signal
- Retained power operation signal

RETAINED POWER OPERATION

- Retained power operation is an additional power supply function that enables power window system to operate during the 45 seconds even when ignition switch is turned OFF.

Retained Power Function Cancel Conditions

- Front door CLOSE (door switch OFF)→OPEN (door switch ON).
- When ignition switch is ON again.
- When timer time passes. (45 seconds)

POWER WINDOW LOCK FUNCTION

Ground circuit inside power window main switch shuts off when power window lock switch is ON. This inhibits power window switch operation except with the power window main switch.

ANTI-PINCH OPERATION

- Pinch foreign material in the door glass during Auto-Up operation, and it is the anti-pinch that lowers the door glass 150 mm (5.9 in) or 2 seconds when detected.
- Encoder continues detecting the movement of power window motor and transmits to the power window switch as the encoder pulse signal while power window motor is operating.
- Resistance is applied to the power window motor rotation that changes the frequency of encoder pulse signal if foreign material is trapped in the door glass.
- Power window switch controls to lower the door glass for 150 mm (5.9 in) or 2 seconds after it detects encoder pulse signal frequency change.

Operation Condition

When all door glass AUTO-UP operation is performed (anti-pinch function does not operate just before the door glass closes and is fully closed)

NOTE:

Depending on environment and driving conditions, if a similar impact or load is applied to the door glass, it may lower.

DOOR KEY CYLINDER SWITCH OPERATION

Hold the door key cylinder to the LOCK or UNLOCK direction for 1 second or more to OPEN or CLOSE all power windows when ignition switch is OFF. In addition, it stops when key position is moved to N (NEUTRAL) when operating.

Operation Condition

- Ignition switch OFF.
- Hold door key cylinder to LOCK position for 1 second or more to perform CLOSE operation of the door glass.
- Hold door key cylinder to UNLOCK position for 1 second or more to perform OPEN operation of the door glass.

KEYLESS POWER WINDOW DOWN FUNCTION

All power windows open when the unlock button on Intelligent Key is activated and pressed for more than 3 seconds with the ignition switch OFF. The windows keep opening if the unlock button is continuously pressed. The power window opening stops when the following operations are performed.

- When the unlock button is pressed for more than 15 seconds.
- When the ignition switch is turned ON while the power window opening is operated.
- When the unlock button is released.

While retained power operation activate, keyless power window down function cannot be operated.

SYSTEM

< SYSTEM DESCRIPTION >

Fail-safe

INFOID:000000009133426

FAIL-SAFE CONTROL

Switches to fail-safe control when malfunction is detected in encoder signal that detects up/down speed and direction of door glass. Switches to fail-safe control when an error beyond the regulation value is detected between the fully closed position and the actual position of the glass.

Malfunction	Malfunction condition
Pulse sensor malfunction	When only one side of pulse signal is being detected for more than the specified value.
Both pulse sensors malfunction	When both pulse signals have not been detected for more than the specified value during glass open/close operation.
Pulse direction malfunction	When the pulse signal that is detected during glass open/close operation detects the opposite condition of power window motor operating direction.
Glass recognition position malfunction 1	When it detects the error between glass fully closed position in power window switch memory and actual fully closed position during glass open/close operation is more than the specified value.
Glass recognition position malfunction 2	When it detects pulse count more that the value of glass full stroke during glass open/close operation.
Malfunction of not yet updated closed position of glass	When glass open/close operation is continuously performed without fully closing more that the specified value (approximately 10 strokes).

It changes to condition before initialization and the following functions do not operate when switched to fail-safe control:

- Auto-up operation
- Anti-pinch function
- Retained power function

Perform initial operation to recover when switched to fail-safe mode. However, it switches back to fail-safe control when malfunction is found in power window switch or in motor.

A
B
C
D
E
F
G
H
I
J
L
M
N
O
P

PWC

DIAGNOSIS SYSTEM (BCM)

< SYSTEM DESCRIPTION >

DIAGNOSIS SYSTEM (BCM)

COMMON ITEM

COMMON ITEM : CONSULT Function (BCM - COMMON ITEM)

INFOID:000000009725726

CAUTION:

After disconnecting the CONSULT vehicle interface (VI) from the data link connector, the ignition must be cycled OFF → ON (for at least 5 seconds) → OFF. If this step is not performed, the BCM may not go to "sleep mode", potentially causing a discharged battery and no-start condition.

APPLICATION ITEM

CONSULT performs the following functions via CAN communication with BCM.

Direct Diagnostic Mode	Description
Ecu Identification	The BCM part number is displayed.
Self Diagnostic Result	The BCM self diagnostic results are displayed.
Data Monitor	The BCM input/output data is displayed in real time.
Active Test	The BCM activates outputs to test components.
Work support	The settings for BCM functions can be changed.
Configuration	<ul style="list-style-type: none"> The vehicle specification can be read and saved. The vehicle specification can be written when replacing BCM.
CAN Diag Support Mntr	The result of transmit/receive diagnosis of CAN communication is displayed.

SYSTEM APPLICATION

BCM can perform the following functions.

System	Sub System	Direct Diagnostic Mode						
		Ecu Identification	Self Diagnostic Result	Data Monitor	Active Test	Work support	Configuration	CAN Diag Support Mntr
Door lock	DOOR LOCK		×	×	×	×		
Rear window defogger	REAR DEFOGGER			×	×	×		
Warning chime	BUZZER			×	×			
Interior room lamp timer	INT LAMP			×	×	×		
Exterior lamp	HEADLAMP			×	×	×		
Wiper and washer	WIPER			×	×	×		
Turn signal and hazard warning lamps	FLASHER			×	×			
Air conditioner	AIR CONDITIONER			×				
Intelligent Key system	INTELLIGENT KEY		×	×	×	×		
Combination switch	COMB SW			×				
BCM	BCM	×	×			×	×	×
Immobilizer	IMMU		×	×	×			
Interior room lamp battery saver	BATTERY SAVER			×	×			
Back door open	TRUNK			×				
Vehicle security system	THEFT ALM			×	×	×		
RAP system	RETAINED PWR			×				

DIAGNOSIS SYSTEM (BCM)

< SYSTEM DESCRIPTION >

System	Sub System	Direct Diagnostic Mode						
		Ecu Identification	Self Diagnostic Result	Data Monitor	Active Test	Work support	Configuration	CAN Diag Support Mntr
Signal buffer system	SIGNAL BUFFER			×				
TPMS	AIR PRESSURE MONITOR		×	×	×	×		

RETAINED PWR

RETAINED PWR : CONSULT Function (BCM - RETAINED PWR)

INFOID:000000009725727

CAUTION:

After disconnecting the CONSULT vehicle interface (VI) from the data link connector, the ignition must be cycled OFF → ON (for at least 5 seconds) → OFF. If this step is not performed, the BCM may not go to "sleep mode", potentially causing a discharged battery and no-start condition.

DATA MONITOR

Monitor Item [Unit]	Description
DOOR SW-DR [On/Off]	Indicates condition of front door switch LH.
DOOR SW-AS [On/Off]	Indicates condition of front door switch RH.

A
B
C
D
E
F
G
H
I
J
L
M
N
O
P

PWC

BCM (BODY CONTROL MODULE)

< ECU DIAGNOSIS INFORMATION >

ECU DIAGNOSIS INFORMATION

BCM (BODY CONTROL MODULE)

List of ECU Reference

INFOID:000000009133429

ECU	Reference
BCM	BCS-29, "Reference Value"
	BCS-49, "Fail Safe"
	BCS-49, "DTC Inspection Priority Chart"
	BCS-51, "DTC Index"

MAIN POWER WINDOW AND DOOR LOCK/UNLOCK SWITCH

< ECU DIAGNOSIS INFORMATION >

MAIN POWER WINDOW AND DOOR LOCK/UNLOCK SWITCH

Reference Value

INFOID:000000009133430

TERMINAL LAYOUT

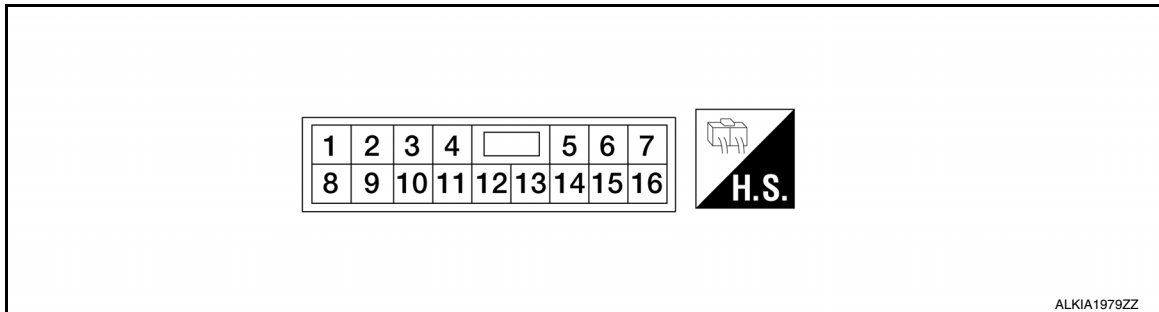

PHYSICAL VALUES

POWER WINDOW MAIN SWITCH

Terminal No. (wire color)		Description		Condition	Voltage (Approx.)
+	-	Signal name	Input/ Output		
3 (R)	Ground	Encoder power supply	Output	When ignition switch ON or power window timer op- erates	Battery voltage
4 (Y)	Ground	Battery power supply	Input	—	Battery voltage
5 (BR)	Ground	Front driver side power win- dow motor DOWN signal	Output	When front LH switch in power window main switch is operated DOWN	Battery voltage
6 (L)	Ground	Front driver side power win- dow motor UP signal	Output	When front LH switch in power window main switch is operated UP	Battery voltage
7 (B)	Ground	Ground	—	—	0
9 ¹ (BR)	Ground	Retained power signal	Input	IGN SW ON	Battery voltage
				Within 45 second after ig- nition switch is turned to OFF	Battery voltage
				When driver side or pas- senger side door is opened during retained power operation	0
9 ² (W)	Ground	Retained power signal	Input	IGN SW ON	Battery voltage
				Within 45 second after ig- nition switch is turned to OFF	Battery voltage
				When driver side or pas- senger side door is opened during retained power operation	0
10 (LG)	Ground	Encoder ground	—	—	0

A
B
C
D
E
F
G
H
I
J
L
M
N
O
P

PWC

MAIN POWER WINDOW AND DOOR LOCK/UNLOCK SWITCH

< ECU DIAGNOSIS INFORMATION >

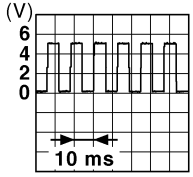
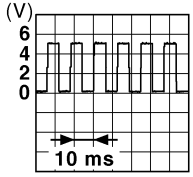
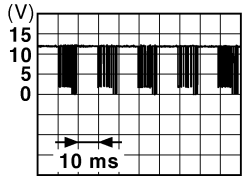
Terminal No. (wire color)		Description		Condition	Voltage (Approx.)
+	-	Signal name	Input/ Output		
11 (V)	Ground	Encoder pulse signal 1	Input	When power window motor operates	 <p style="text-align: right; font-size: small;">JMKIA0070GB</p>
12 (O)	Ground	Encoder pulse signal 2	Input	When power window motor operates	 <p style="text-align: right; font-size: small;">JMKIA0070GB</p>
13 (Y)	Ground	Power window serial link	Input/ Output	IGN SW ON or power window timer operating	 <p style="text-align: right; font-size: small;">JPMIA0013GB</p>
15 ¹ (W)	Ground	Door key cylinder switch LOCK signal	Input	Key position (Neutral →Locked)	5 → 0
15 ² (BR)	Ground	Door key cylinder switch LOCK signal	Input	Key position (Neutral →Locked)	5 → 0
16 (SB)	Ground	Door key cylinder switch UN-LOCK signal	Input	Key position (Neutral →Unlocked)	5 → 0

¹: with automatic drive positioner

²: without automatic drive positioner

POWER WINDOW AND DOOR LOCK/UNLOCK SWITCH RH

< ECU DIAGNOSIS INFORMATION >

POWER WINDOW AND DOOR LOCK/UNLOCK SWITCH RH

Reference Value

INFOID:000000009133431

TERMINAL LAYOUT

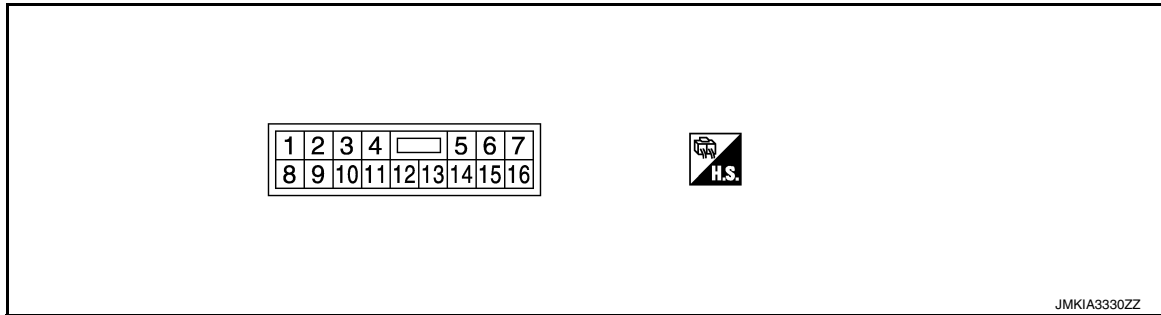

PHYSICAL VALUES

FRONT POWER WINDOW SWITCH

Terminal No. (wire color)		Description		Condition	Voltage (Approx.)
+	-	Signal name	Input/ Output		
3 (LG)	Ground	Encoder ground	—	—	0
4 (R)	Ground	Encoder power supply	Output	When ignition switch ON or power window timer operates	Battery voltage
8 (L)	Ground	Power window motor UP signal	Output	When power window motor is operated UP	Battery voltage
9 (BR)	Ground	Power window motor DOWN signal	Output	When power window motor is operated DOWN	Battery voltage
10 (Y)	Ground	Battery power supply	Input	—	Battery voltage
11 (B)	Ground	Ground	—	—	0
12 (V)	Ground	Encoder pulse signal 1	Input	When power window motor operates	

JMKIA0070GB

A
B
C
D
E
F
G
H
I
J
L
M
N
O
P

PWC

POWER WINDOW AND DOOR LOCK/UNLOCK SWITCH RH

< ECU DIAGNOSIS INFORMATION >

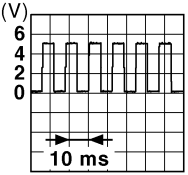
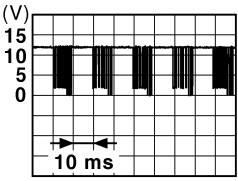
Terminal No. (wire color)		Description		Condition	Voltage (Approx.)
+	-	Signal name	Input/ Output		
15 (O)	Ground	Encoder pulse signal 2	Input	When power window motor operates	 <p style="text-align: right; font-size: small;">JMKIA0070GB</p>
16 (BR)	Ground	Power window serial link	Input/ Output	When ignition switch ON or power window timer operates	 <p style="text-align: right; font-size: small;">JPMIA0013GB</p>

REAR POWER WINDOW SWITCH LH

< ECU DIAGNOSIS INFORMATION >

REAR POWER WINDOW SWITCH LH

Reference Value

INFOID:000000009133432

TERMINAL LAYOUT

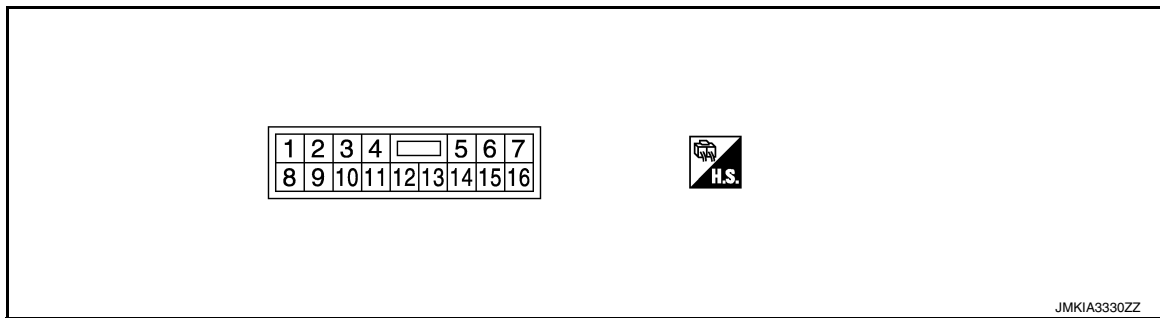

PHYSICAL VALUES

REAR POWER WINDOW SWITCH

Terminal No. (wire color)		Description		Condition	Voltage (Approx.)
+	-	Signal name	Input/ Output		
3 (LG)	Ground	Encoder ground	—	—	0
4 (R)	Ground	Encoder power supply	Output	When ignition switch ON or power window timer operates	Battery voltage
8 (L)	Ground	Power window motor UP signal	Output	When power window motor is operated UP	Battery voltage
9 (BR)	Ground	Power window motor DOWN signal	Output	When power window motor is operated DOWN	Battery voltage
10 (Y)	Ground	Battery power supply	Input	—	Battery voltage
11 (B)	Ground	Ground	—	—	0
12 (V)	Ground	Encoder pulse signal 1	Input	When power window motor operates	

JMKIA0070GB

A
B
C
D
E
F
G
H
I
J
L
M
N
O
P

PWC

REAR POWER WINDOW SWITCH LH

< ECU DIAGNOSIS INFORMATION >

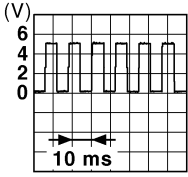
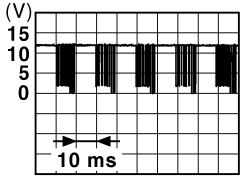
Terminal No. (wire color)		Description		Condition	Voltage (Approx.)
+	-	Signal name	Input/ Output		
15 (O)	Ground	Encoder pulse signal 2	Input	When power window motor operates	 <p style="text-align: right; font-size: small;">JMKIA0070GB</p>
16 (W)	Ground	Power window serial link	Input/ Output	When ignition switch ON or power window timer operates	 <p style="text-align: right; font-size: small;">JPMIA0013GB</p>

REAR POWER WINDOW SWITCH RH

< ECU DIAGNOSIS INFORMATION >

REAR POWER WINDOW SWITCH RH

Reference Value

INFOID:000000009133433

TERMINAL LAYOUT

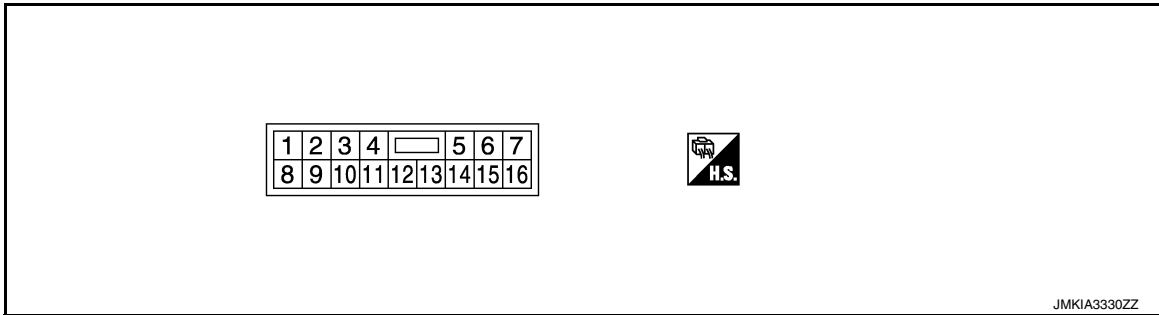

PHYSICAL VALUES

REAR POWER WINDOW SWITCH

Terminal No. (wire color)		Description		Condition	Voltage (Approx.)
+	-	Signal name	Input/ Output		
3 (LG)	Ground	Encoder ground	—	—	0
4 (BG)	Ground	Encoder power supply	Output	When ignition switch ON or power window timer operates	Battery voltage
8 (L)	Ground	Power window motor UP signal	Output	When power window motor is operated UP	Battery voltage
9 (BR)	Ground	Power window motor DOWN signal	Output	When power window motor is operated DOWN	Battery voltage
10 (Y)	Ground	Battery power supply	Input	—	Battery voltage
11 (B)	Ground	Ground	—	—	0
12 (V)	Ground	Encoder pulse signal 1	Input	When power window motor operates	

JMKIA0070GB

A
B
C
D
E
F
G
H
I
J
L
M
N
O
P

PWC

REAR POWER WINDOW SWITCH RH

< ECU DIAGNOSIS INFORMATION >

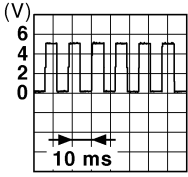
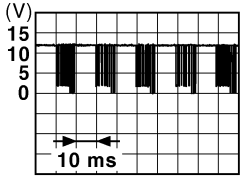
Terminal No. (wire color)		Description		Condition	Voltage (Approx.)
+	-	Signal name	Input/ Output		
15 (O)	Ground	Encoder pulse signal 2	Input	When power window motor operates	 <p style="text-align: right; font-size: small;">JMKIA0070GB</p>
16 (W)	Ground	Power window serial link	Input/ Output	When ignition switch ON or power window timer operates	 <p style="text-align: right; font-size: small;">JPMIA0013GB</p>

POWER WINDOW SYSTEM

< WIRING DIAGRAM >

WIRING DIAGRAM

POWER WINDOW SYSTEM

Wiring Diagram

INFOID:000000009133434

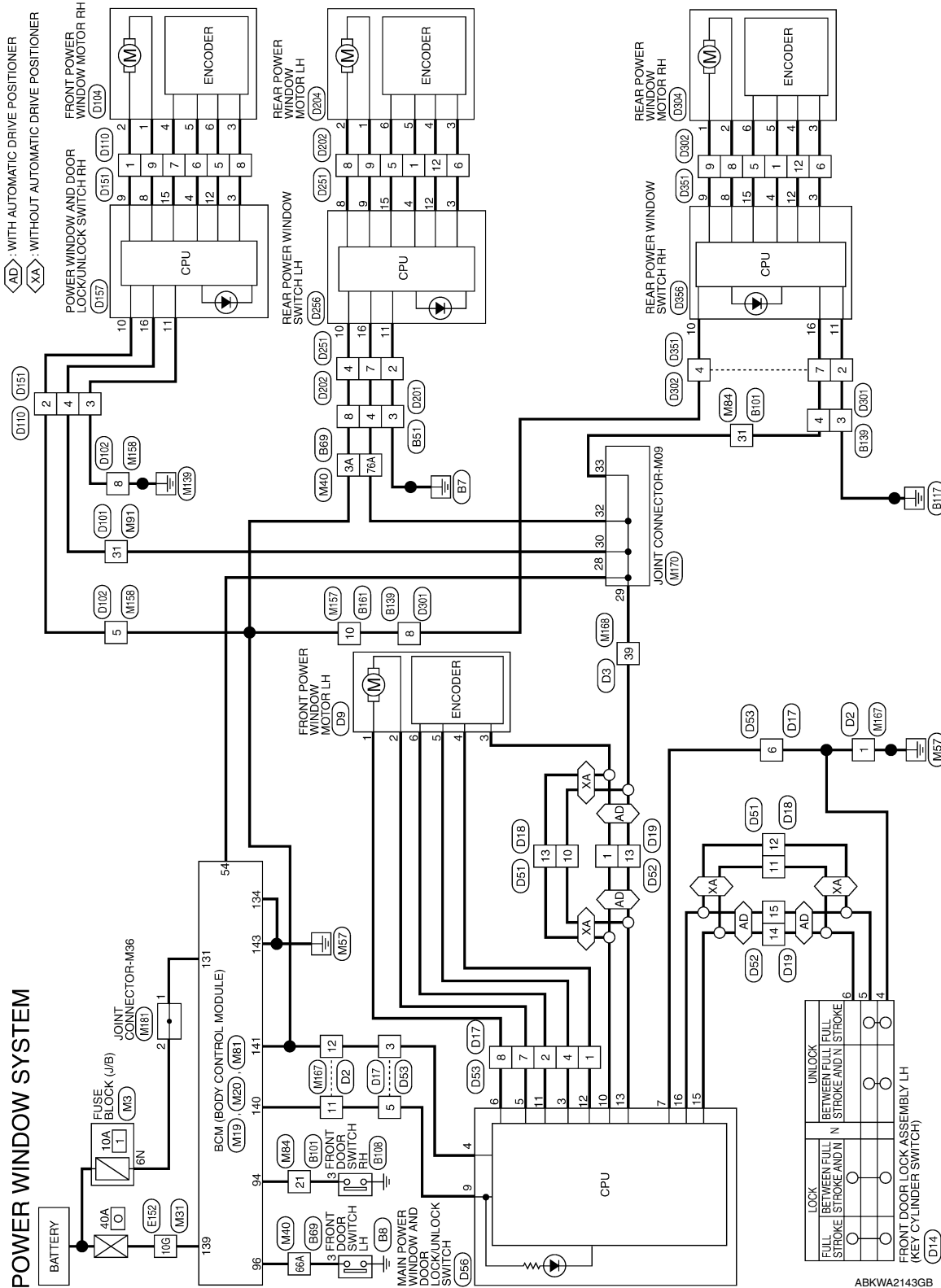

A
B
C
D
E
F
G
H
I
J
K
L
M
N
O
P



POWER WINDOW SYSTEM

< WIRING DIAGRAM >

POWER WINDOW SYSTEM CONNECTORS

Connector No.	M3
Connector Name	FUSE BLOCK (J/B)
Connector Color	WHITE

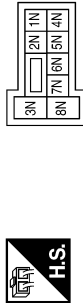

Terminal No.	Color of Wire	Signal Name
6N	W	-

Connector No.	M31
Connector Name	WIRE TO WIRE
Connector Color	WHITE

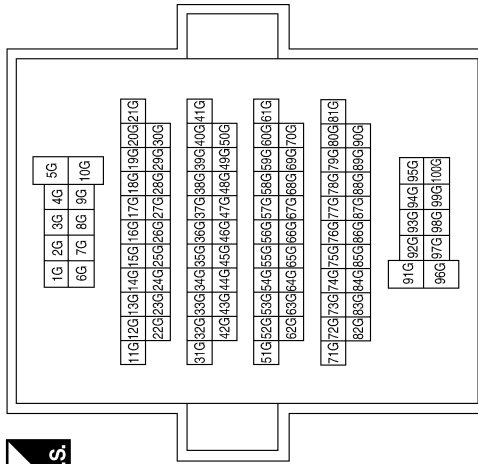

Terminal No.	Color of Wire	Signal Name
10G	W	-

Connector No.	M19
Connector Name	BCM (BODY CONTROL MODULE)
Connector Color	BLACK

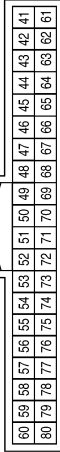

Terminal No.	Color of Wire	Signal Name
54	W	PW LIN/COM

Connector No.	M40
Connector Name	WIRE TO WIRE
Connector Color	GRAY

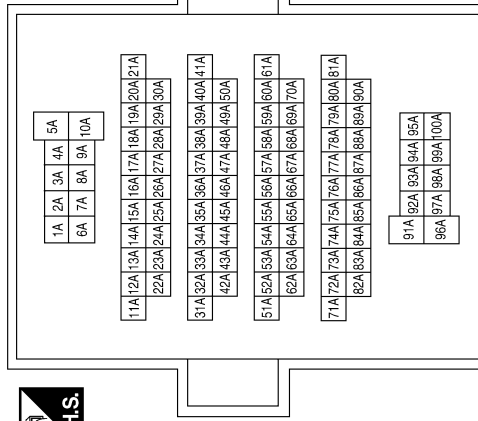

Terminal No.	Color of Wire	Signal Name
3A	Y	-
66A	BG	-
76A	W	-

Connector No.	M20
Connector Name	BCM (BODY CONTROL MODULE)
Connector Color	GRAY

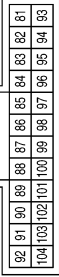

Terminal No.	Color of Wire	Signal Name
94	G	AS DOOR SW
96	BG	DR DOOR SW

Connector No.	M81
Connector Name	BCM (BODY CONTROL MODULE)
Connector Color	WHITE

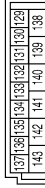

Terminal No.	Color of Wire	Signal Name
131	W	BAT BCM FUSE
134	B	GND 2
139	W	BAT POWER FIL
140	BR	P/W SUPPLY IGN
141	Y	P/W SUPPLY BAT
143	B	GND 1

POWER WINDOW SYSTEM

< WIRING DIAGRAM >

Connector No.	M157
Connector Name	WIRE TO WIRE
Connector Color	WHITE



7	6	5	4	3	2	1		
16	15	14	13	12	11	10	9	8

Terminal No.	Color of Wire	Signal Name
10	Y	-

Connector No.	M81
Connector Name	WIRE TO WIRE
Connector Color	WHITE



1	2	3	4	5	6	7	8	9	10	11	12	13	14	15	16
17	18	19	20	21	22	23	24	25	26	27	28	29	30	31	32

Terminal No.	Color of Wire	Signal Name
31	W	-

Connector No.	M84
Connector Name	WIRE TO WIRE
Connector Color	WHITE



16	15	14	13	12	11	10	9	8	7	6	5	4	3	2	1
32	31	30	29	28	27	26	25	24	23	22	21	20	19	18	17

Terminal No.	Color of Wire	Signal Name
21	G	-
31	W	-

Connector No.	M168
Connector Name	WIRE TO WIRE
Connector Color	WHITE



1	2	3	4	5	6	7	8	9	10	11	12	13	14	15	16	17	18	19	20
21	22	23	24	25	26	27	28	29	30	31	32	33	34	35	36	37	38	39	40

Terminal No.	Color of Wire	Signal Name
39	W	-

Connector No.	M167
Connector Name	WIRE TO WIRE
Connector Color	WHITE



1	2	3	4	5	6	7		
8	9	10	11	12	13	14	15	16

Terminal No.	Color of Wire	Signal Name
1	B	-
11	BR	-
12	Y	-

Connector No.	M158
Connector Name	WIRE TO WIRE
Connector Color	WHITE



1	2	3	4		
5	6	7	8	9	10

Terminal No.	Color of Wire	Signal Name
5	Y	-
8	GR	-

ABKIA4682GB

A
B
C
D
E
F
G
H
I
J
L
M
N
O
P

PWC

POWER WINDOW SYSTEM

< WIRING DIAGRAM >

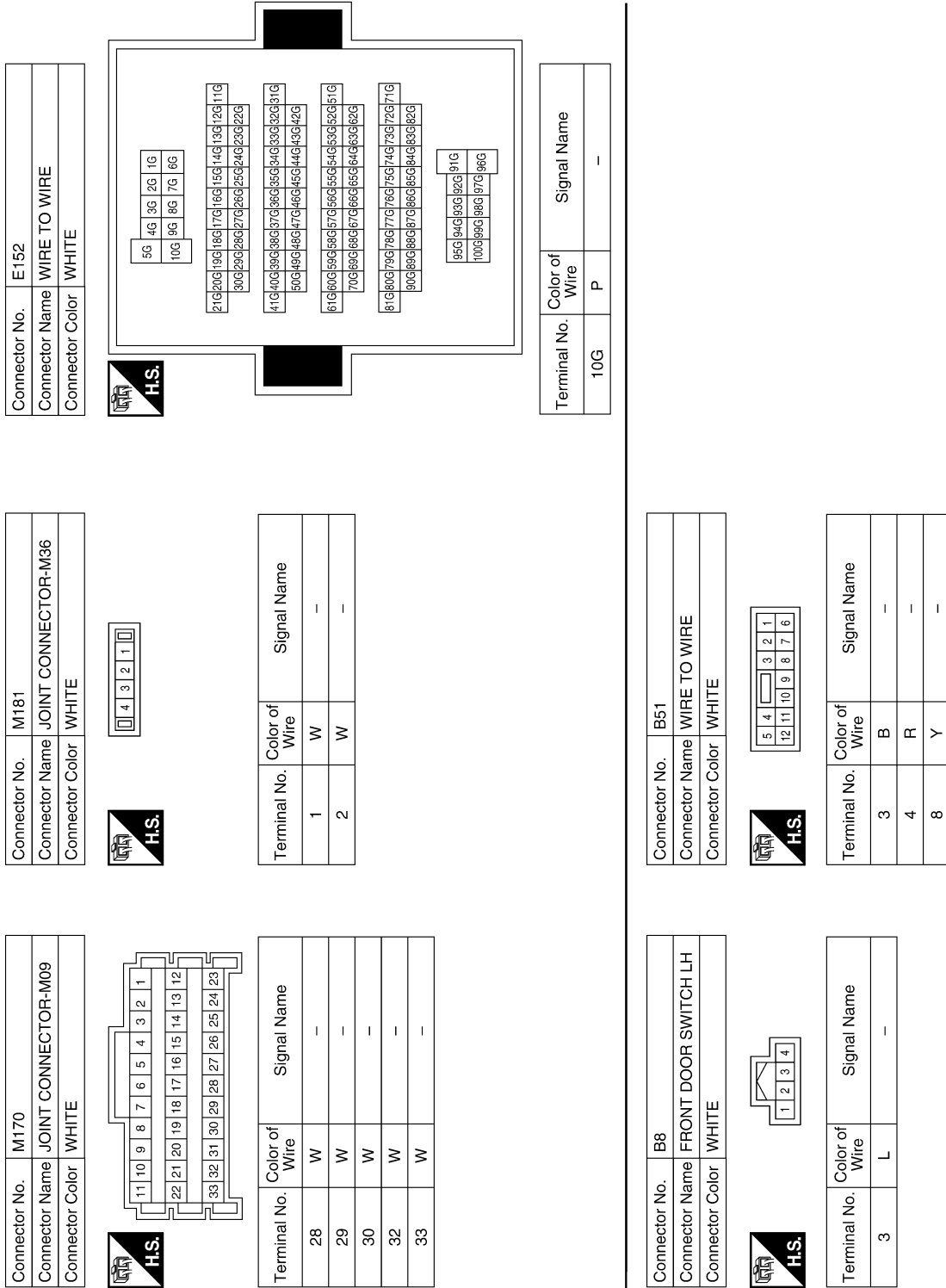

ABKIA4683GB

POWER WINDOW SYSTEM

< WIRING DIAGRAM >

Connector No.	B108
Connector Name	FRONT DOOR SWITCH RH
Connector Color	WHITE

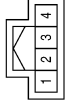

Terminal No.	Color of Wire	Signal Name
3	LG	-

Connector No.	B101
Connector Name	WIRE TO WIRE
Connector Color	WHITE

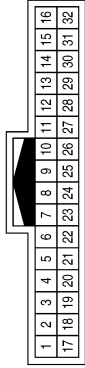

Terminal No.	Color of Wire	Signal Name
21	LG	-
31	G	-

Connector No.	B69
Connector Name	WIRE TO WIRE
Connector Color	GRAY

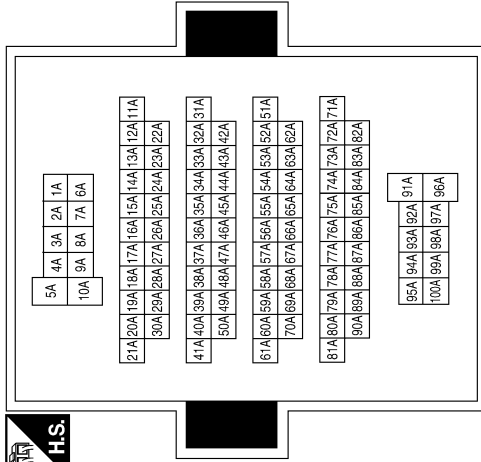

Terminal No.	Color of Wire	Signal Name
3A	Y	-
66A	L	-
76A	R	-

Connector No.	D2
Connector Name	WIRE TO WIRE
Connector Color	WHITE

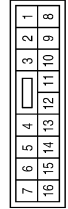

Terminal No.	Color of Wire	Signal Name
1	B	-
11	BR	-
12	LG	-

Connector No.	B161
Connector Name	WIRE TO WIRE
Connector Color	WHITE

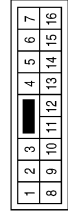

Terminal No.	Color of Wire	Signal Name
10	Y	-

Connector No.	B139
Connector Name	WIRE TO WIRE
Connector Color	WHITE

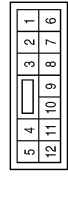

Terminal No.	Color of Wire	Signal Name
3	B	-
4	G	-
8	Y	-

ABKIA4684GB

A B C D E F G H I J L M N O P

PWC

POWER WINDOW SYSTEM

< WIRING DIAGRAM >

Connector No.	D14
Connector Name	FRONT DOOR LOCK ASSEMBLY LH
Connector Color	GRAY

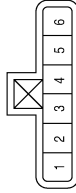

Terminal No.	Color of Wire	Signal Name
4	B	-
5	SB	-
6	BR	-

Connector No.	D9
Connector Name	FRONT POWER WINDOW MOTOR LH
Connector Color	WHITE

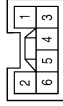

Terminal No.	Color of Wire	Signal Name
1	L	M1
2	BR	M2
3	LG	GND
4	W	HS-A (ULP)
5	BG	VCC
6	V	HS-B (DLP)

Connector No.	D3
Connector Name	WIRE TO WIRE
Connector Color	WHITE

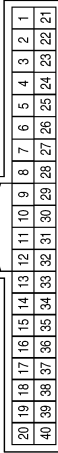

Terminal No.	Color of Wire	Signal Name
39	Y	-

Connector No.	D19
Connector Name	WIRE TO WIRE
Connector Color	WHITE

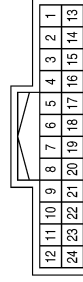

Terminal No.	Color of Wire	Signal Name
1	LG	-
13	Y	-
14	BR	-
15	SB	-

Connector No.	D18
Connector Name	WIRE TO WIRE
Connector Color	WHITE

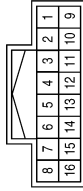

Terminal No.	Color of Wire	Signal Name
10	Y	-
11	BR	-
12	SB	-
13	LG	-

Connector No.	D17
Connector Name	WIRE TO WIRE
Connector Color	WHITE

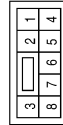

Terminal No.	Color of Wire	Signal Name
1	W	-
2	V	-
3	LG	-
4	BG	-
5	BR	-
6	B	-
7	BR	-
8	L	-

ABKIA4685GB

POWER WINDOW SYSTEM

< WIRING DIAGRAM >

Connector No.	D51
Connector Name	WIRE TO WIRE
Connector Color	WHITE

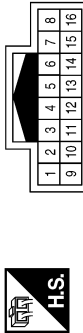

Terminal No.	Color of Wire	Signal Name
10	Y	-
11	BR	-
12	SB	-
13	LG	-

Connector No.	D52
Connector Name	WIRE TO WIRE
Connector Color	WHITE

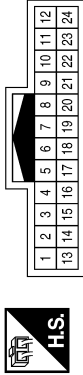

Terminal No.	Color of Wire	Signal Name
1	LG	-
13	Y	-
14	W	-
15	SB	-

Connector No.	D53
Connector Name	WIRE TO WIRE
Connector Color	WHITE



Terminal No.	Color of Wire	Signal Name
1	O	-
2	V	-
3	Y	-
4	R	-
5	W	-(WITHOUT AUTOMATIC DRIVE POSITIONER)
5	BR	-(WITH AUTOMATIC DRIVE POSITIONER)
6	B	-
7	BR	-
8	L	-

Connector No.	D56
Connector Name	MAIN POWER WINDOW AND DOOR LOCK/UNLOCK SWITCH
Connector Color	WHITE

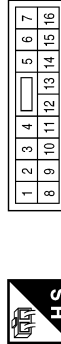

Terminal No.	Color of Wire	Signal Name
1	-	-
2	-	-
3	R	ENCODER +
4	Y	B +
5	BR	MOTOR DN DR
6	L	MOTOR UP DR
7	B	GND

Terminal No.	Color of Wire	Signal Name
8	-	-
9	W	IGN (RAP) (WITHOUT AUTOMATIC DRIVE POSITIONER)
9	BR	IGN (RAP) (WITH AUTOMATIC DRIVE POSITIONER)
10	LG	ENCODER GND
11	V	ENCODER SIG1 (DLP)
12	O	ENCODER SIG2 (ULP)
13	Y	COM
14	-	-
15	BR	LOCK SW (WITHOUT AUTOMATIC DRIVE POSITIONER)
15	W	LOCK SW (WITH AUTOMATIC DRIVE POSITIONER)
16	SB	UNLOCK SW

Connector No.	D101
Connector Name	WIRE TO WIRE
Connector Color	WHITE

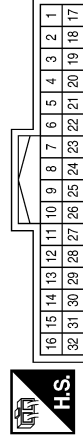

Terminal No.	Color of Wire	Signal Name
31	BR	-

ABKIA4686GB

A
B
C
D
E
F
G
H
I
J
K
L
M
N
O
P

PWC

POWER WINDOW SYSTEM

< WIRING DIAGRAM >

Connector No.	D102
Connector Name	WIRE TO WIRE
Connector Color	WHITE

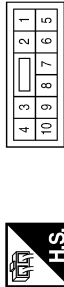

Terminal No.	Color of Wire	Signal Name
5	BR	-
8	B	-

Connector No.	D104
Connector Name	FRONT POWER WINDOW MOTOR RH
Connector Color	WHITE



Terminal No.	Color of Wire	Signal Name
1	L	M1
2	BR	M2
3	LG	GND
4	W	HS-A (ULP)
5	BG	VCC
6	V	HS-B (DLP)

Connector No.	D110
Connector Name	WIRE TO WIRE
Connector Color	WHITE



Terminal No.	Color of Wire	Signal Name
1	BR	-
2	BR	-
3	B	-
4	BR	-
5	V	-
6	BG	-
7	W	-
8	LG	-
9	L	-

Connector No.	D151
Connector Name	WIRE TO WIRE
Connector Color	WHITE



Terminal No.	Color of Wire	Signal Name
1	BR	-
2	Y	-
3	B	-
4	BR	-
5	V	-
6	R	-
7	O	-
8	LG	-
9	L	-

Connector No.	D157
Connector Name	POWER WINDOW AND DOOR LOCK/UNLOCK SWITCH RH
Connector Color	WHITE



Terminal No.	Color of Wire	Signal Name
1	-	-
2	-	-
3	LG	ENCODER GND
4	R	ENCODER +
5	-	-
6	-	-

Terminal No.	Color of Wire	Signal Name
7	-	-
8	L	MOTOR UP AS
9	BR	MOTOR DN AS
10	Y	B+
11	B	GND
12	V	(DLP) ENCODER SIG1
13	-	-
14	-	-
15	O	(ULP) ENCODER SIG2
16	BR	COM

ABKIA4687GB

POWER WINDOW SYSTEM

< WIRING DIAGRAM >

Connector No.	D201
Connector Name	WIRE TO WIRE
Connector Color	WHITE

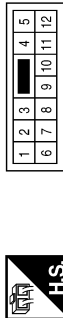

Terminal No.	Color of Wire	Signal Name
3	B	-
4	SB	-
8	V	-

Connector No.	D202
Connector Name	WIRE TO WIRE
Connector Color	WHITE

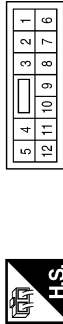

Terminal No.	Color of Wire	Signal Name
1	BG	-
2	B	-
4	V	-
5	P	-
6	W	-
7	SB	-
8	LG	-
9	Y	-
12	R	-

Connector No.	D204
Connector Name	REAR POWER WINDOW MOTOR LH
Connector Color	WHITE

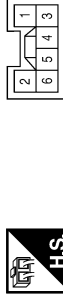

Terminal No.	Color of Wire	Signal Name
1	Y	M1
2	LG	M2
3	W	GND
4	R	HS-A (DLP)
5	BG	VCC
6	P	HS-B (ULP)

Connector No.	D251
Connector Name	WIRE TO WIRE
Connector Color	WHITE

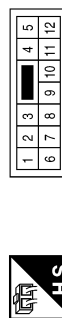

Terminal No.	Color of Wire	Signal Name
1	R	-
2	B	-
4	Y	-
5	O	-
6	LG	-
7	W	-
8	L	-
9	BR	-
12	V	-

Connector No.	D256
Connector Name	REAR POWER WINDOW SWITCH LH
Connector Color	WHITE



Terminal No.	Color of Wire	Signal Name
1	-	-
2	-	-
3	LG	ENCODER GND
4	R	ENCODER +
5	-	-
6	-	-
7	-	-

Terminal No.	Color of Wire	Signal Name
8	L	MOTOR UP RL
9	BR	MOTOR DN RL
10	Y	B +
11	B	GND
12	V	(DLP) ENCODER SIG1
13	-	-
14	-	-
15	O	(ULP) ENCODER SIG2
16	W	COM

A B C D E F G H I J L M N O P



POWER WINDOW SYSTEM

< WIRING DIAGRAM >

Connector No.	D301
Connector Name	WIRE TO WIRE
Connector Color	WHITE

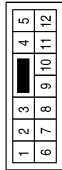

Terminal No.	Color of Wire	Signal Name
3	B	-
4	V	-
8	SB	-

Connector No.	D302
Connector Name	WIRE TO WIRE
Connector Color	WHITE

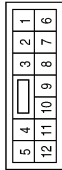

Terminal No.	Color of Wire	Signal Name
1	BG	-
2	B	-
4	SB	-
5	P	-
6	W	-
7	V	-
8	L	-
9	BR	-
12	R	-

Connector No.	D304
Connector Name	REAR POWER WINDOW MOTOR RH
Connector Color	WHITE

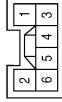

Terminal No.	Color of Wire	Signal Name
1	BR	M1
2	L	M2
3	W	GND
4	R	HS-A (DLP)
5	BG	VCC
6	P	HS-B (ULP)

Connector No.	D351
Connector Name	WIRE TO WIRE
Connector Color	WHITE

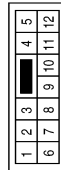

Terminal No.	Color of Wire	Signal Name
1	BG	-
2	B	-
4	Y	-
5	O	-
6	LG	-
7	W	-
8	L	-
9	BR	-
12	V	-

Connector No.	D356
Connector Name	REAR POWER WINDOW SWITCH RH
Connector Color	WHITE

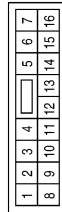

Terminal No.	Color of Wire	Signal Name
1	-	-
2	-	-
3	LG	ENCODER GND
4	BG	ENCODER +
5	-	-
6	-	-
7	-	-
8	L	MOTOR UP RR

Terminal No.	Color of Wire	Signal Name
9	BR	MOTOR DN RR
10	Y	B +
11	B	GND
12	V	(DLP) ENCODER SIG1
13	-	-
14	-	-
15	O	(ULP) ENCODER SIG2
16	W	COM

ABKIA4689GB

DIAGNOSIS AND REPAIR WORKFLOW

< BASIC INSPECTION >

BASIC INSPECTION

DIAGNOSIS AND REPAIR WORKFLOW

Work Flow

INFOID:000000009133435

OVERALL SEQUENCE

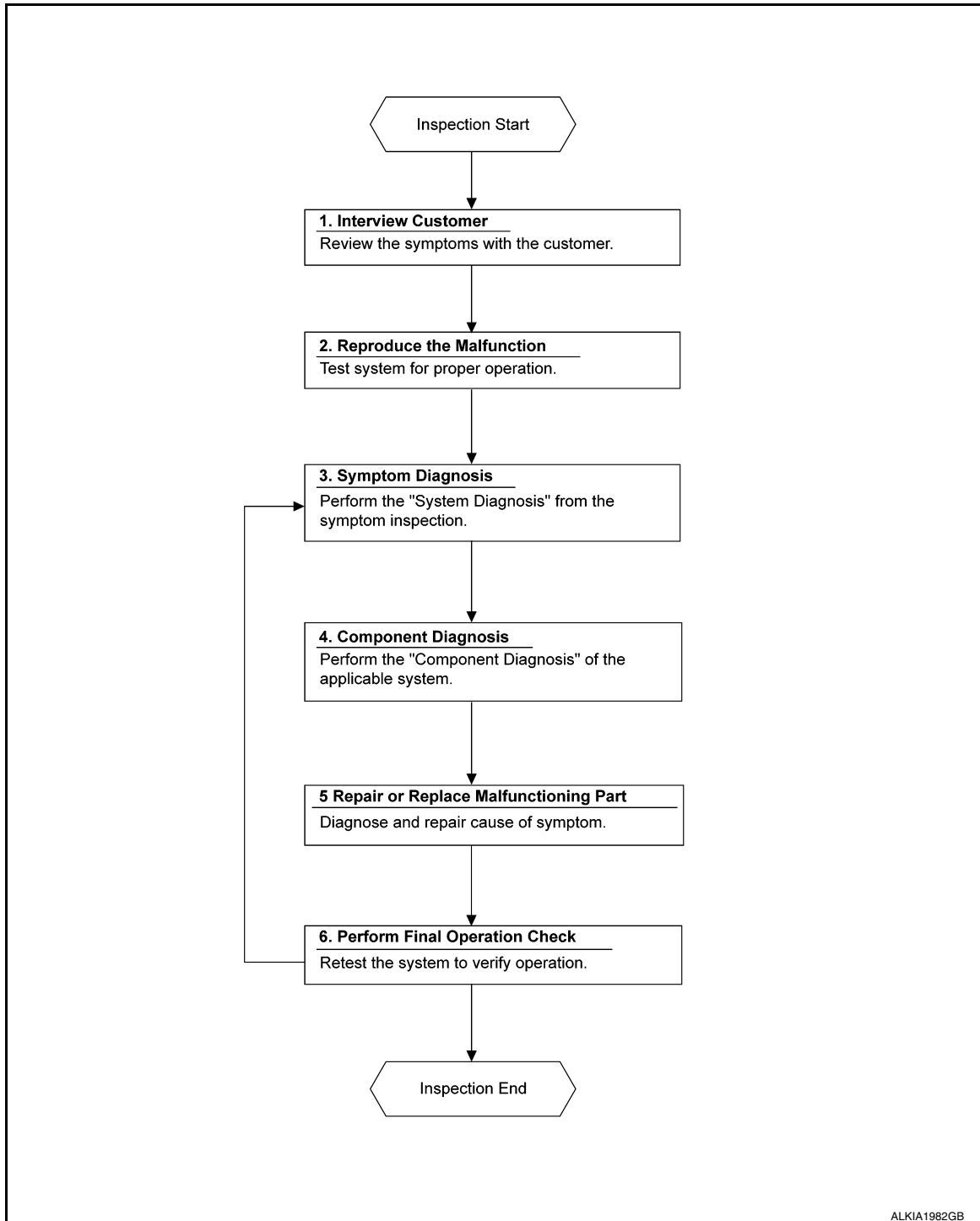

DETAILED FLOW

1. OBTAIN INFORMATION ABOUT SYMPTOM

Interview the customer to obtain as much information as possible about the conditions and environment under which the malfunction occurred.

A
B
C
D
E
F
G
H
I
J
L
M
N
O
P

PWC

DIAGNOSIS AND REPAIR WORKFLOW

< BASIC INSPECTION >

>> GO TO 2.

2. CONFIRM THE SYMPTOM

Check the malfunction on the vehicle that the customer describes.
Inspect the relation of the symptoms and the condition when the symptoms occur.

>> GO TO 3.

3. IDENTIFY THE MALFUNCTIONING SYSTEM WITH SYMPTOM DIAGNOSIS

Use Symptom diagnosis from the symptom inspection result in step 2 and then identify where to start performing the diagnosis based on possible causes and symptoms.

>> GO TO 4.

4. PERFORM THE COMPONENT DIAGNOSIS OF THE OF THE APPLICABLE SYSTEM

Perform the diagnosis with Component diagnosis of the applicable system.

>> GO TO 5.

5. REPAIR OR REPLACE THE MALFUNCTIONING PARTS

Repair or replace the specified malfunctioning parts.

>> GO TO 6.

6. FINAL CHECK

Check that malfunctions are not reproduced when obtaining the malfunction information from the customer, referring to the symptom inspection result in step 2.

Are the malfunctions corrected?

YES >> Inspection End.

NO >> GO TO 3.

ADDITIONAL SERVICE WHEN REMOVING BATTERY NEGATIVE TERMINAL

< BASIC INSPECTION >

ADDITIONAL SERVICE WHEN REMOVING BATTERY NEGATIVE TERMINAL

Description

INFOID:000000009133436

When the negative battery terminal is disconnected, the initialization is necessary for normal operation of power window system.

CAUTION:

The following specified operations can not be performed under the non-initialized condition.

- Auto-up operation
- Anti-pinch function

Work Procedure

INFOID:000000009133437

1.SYSTEM INITIALIZATION

Perform system initialization. Refer to [PWC-35. "Work Procedure"](#).

>> GO TO 2.

2.CHECK ANTI-PINCH FUNCTION

Check anti-pinch function. Refer to [PWC-36. "Work Procedure"](#).

>> Inspection End.

A
B
C
D
E
F
G
H
I
J
L
M
N
O
P

PWC

ADDITIONAL SERVICE WHEN REPLACING CONTROL UNIT

< BASIC INSPECTION >

ADDITIONAL SERVICE WHEN REPLACING CONTROL UNIT

Description

INFOID:000000009133438

When the negative battery terminal is disconnected, the initialization is necessary for normal operation of power window system.

CAUTION:

The following specified operations can not be performed under the non-initialized condition.

- Auto-up operation
- Anti-pinch function

Work Procedure

INFOID:000000009133439

1.SYSTEM INITIALIZATION

Perform system initialization. Refer to [PWC-35. "Work Procedure"](#).

>> GO TO 2.

2.CHECK ANTI-PINCH FUNCTION

Check anti-pinch function. Refer to [PWC-36. "Work Procedure"](#).

>> Inspection End.

SYSTEM INITIALIZATION

< BASIC INSPECTION >

SYSTEM INITIALIZATION

Description

INFOID:000000009133440

If any of the following operations are performed, the initialization is necessary for normal operation of power window system.

- When control unit replaced.
- Electric power supply to power window switch or motor is interrupted by blown fuse or disconnection and connection of the negative battery terminal.
- Removal and installation of regulator assembly.
- Power supply to the power window main switch or power window motor is cut off by the removal of battery terminal or if the battery fuse is blown.
- Disconnection and connection of power window main switch harness connector.
- Removal and installation of motor from regulator assembly.
- Operation of regulator assembly as an independent unit.
- Removal and installation of door glass.
- Removal and installation of door glass run.

The following specified operations can not be performed under the non-initialized condition.

- Auto-up operation
- Anti-pinch function

Work Procedure

INFOID:000000009133441

1.STEP 1

1. Turn ignition switch ON.
2. Operate power window switch to fully open the window.
3. Hold the window up switch UP until it completely closes. After the glass stops at fully closed position, keep pulling the switch for 2 seconds or more.
4. Check that AUTO-UP function operates normally.

>> GO TO 2.

2.STEP 2

Check anti-pinch function. Refer to [PWC-36. "Work Procedure"](#).

>> Inspection End.

A
B
C
D
E
F
G
H
I
J
L
M
N
O
P

PWC

CHECK ANTI-PINCH FUNCTION

< BASIC INSPECTION >

CHECK ANTI-PINCH FUNCTION

Description

INFOID:000000009133442

If any of the following operations are performed, the initialization is necessary for normal operation of power window system.

- When control unit is replaced.
- Electric power supply to power window switch or motor is interrupted by blown fuse or disconnection and connection of the negative battery terminal.
- Removal and installation of regulator assembly.
- Power supply to the power window main switch or power window motor is cut off by the removal of battery terminal or if the battery fuse is blown.
- Disconnection and connection of power window main switch harness connector.
- Removal and installation of motor from regulator assembly.
- Operation of regulator assembly as an independent unit.
- Removal and installation of door glass.
- Removal and installation of door glass run.

The following specified operations can not be performed under the non-initialized condition.

- Auto-up operation
- Anti-pinch function

Work Procedure

INFOID:000000009133443

1. CHECK ANTI-PINCH FUNCTION

- Fully open the door window.
- Place a piece of wood near fully closed position.
- Close door glass completely with AUTO-UP.
- Check the following conditions
- Check that glass lowers for approximately 150 mm (5.9 in) without pinching piece of wood and stops.
- Check that glass does not rise not when operating the power window main switch while lowering.

CAUTION:

- **Perform initial setting when AUTO-UP operation or anti-pinch function does not operate normally.**
- **Check that AUTO-UP operates before inspection when system initialization is performed.**
- **Do not check with hands and other body parts because they may be pinched. Do not get pinched.**

>> Inspection End.

POWER SUPPLY AND GROUND CIRCUIT

< DTC/CIRCUIT DIAGNOSIS >

DTC/CIRCUIT DIAGNOSIS

POWER SUPPLY AND GROUND CIRCUIT

BCM

BCM : Diagnosis Procedure

INFOID:000000009725728

Regarding Wiring Diagram information, refer to [BCS-54, "Wiring Diagram"](#).

1. CHECK FUSE AND FUSIBLE LINK

Check that the following fuse and fusible link are not blown.

Terminal No.	Signal name	Fuse and fusible link No.
139	Fusible link battery power	O (40A)
131	BCM battery fuse	1 (10A)

Is the fuse or fusible link blown?

- YES >> Replace the blown fuse or fusible link after repairing the affected circuit.
NO >> GO TO 2

2. CHECK POWER SUPPLY CIRCUIT

1. Disconnect BCM connector M81.
2. Check voltage between BCM connector M81 terminals 131, 139 and ground.

BCM		Ground	Voltage (Approx.)
Connector	Terminal		
M81	131	—	Battery voltage
	139		

Is the inspection result normal?

- YES >> GO TO 3
NO >> Repair or replace harness or connectors.

3. CHECK GROUND CIRCUIT

Check continuity between BCM connector M81 terminals 134, 143 and ground.

BCM		Ground	Continuity
Connector	Terminal		
M81	134	—	Yes
	143		

Is the inspection result normal?

- YES >> Inspection End.
NO >> Repair or replace harness or connectors.

POWER WINDOW MAIN SWITCH

POWER WINDOW MAIN SWITCH : Diagnosis Procedure

INFOID:000000009133445

Regarding Wiring Diagram information, refer to [PWC-21, "Wiring Diagram"](#).

1. CHECK POWER SUPPLY

POWER SUPPLY AND GROUND CIRCUIT

< DTC/CIRCUIT DIAGNOSIS >

1. Turn ignition switch OFF.
2. Disconnect power window main switch connector.
3. Turn ignition switch ON.
4. Check voltage between power window main switch harness connector and ground.

(+)		(-)	Voltage (Approx.)
Power window main switch			
Connector	Terminal	Ground	Battery voltage
D56	4		
	9		

Is the inspection result normal?

YES >> GO TO 3.

NO >> GO TO 2.

2. CHECK POWER SUPPLY CIRCUIT

1. Turn ignition switch OFF.
2. Disconnect BCM connector.
3. Check continuity between BCM harness connector and power window main switch harness connector.

BCM		Power window main switch		Continuity
Connector	Terminal	Connector	Terminal	
M81	140	D56	9	Yes
	141		4	

4. Check continuity between BCM harness connector and ground.

BCM		Ground	Continuity
Connector	Terminal		
M81	140		No

Is the inspection result normal?

YES >> Replace BCM. Refer to [BCS-79, "Removal and Installation"](#).

NO >> Repair or replace harness.

3. CHECK GROUND CIRCUIT

1. Turn ignition switch OFF.
2. Check continuity between power window main switch harness connector and ground.

Power window main switch		Ground	Continuity
Connector	Terminal		
D56	7		Yes

Is the inspection result normal?

YES >> GO TO 4.

NO >> Repair or replace harness.

4. CHECK INTERMITTENT INCIDENT

Refer to [GI-53, "Intermittent Incident"](#).

>> Inspection End.

FRONT POWER WINDOW SWITCH (PASSENGER SIDE)

FRONT POWER WINDOW SWITCH (PASSENGER SIDE) : Diagnosis Procedure

INFOID:000000009133446

POWER SUPPLY AND GROUND CIRCUIT

< DTC/CIRCUIT DIAGNOSIS >

Regarding Wiring Diagram information, refer to [PWC-21, "Wiring Diagram"](#).

1. CHECK POWER SUPPLY

1. Turn ignition switch OFF.
2. Disconnect power window and door lock/unlock switch RH connector.
3. Check voltage between power window and door lock/unlock switch RH harness connector and ground.

(+)		(-)	Voltage (Approx.)
Power window and door lock/unlock switch RH			
Connector	Terminal		
D157	10	Ground	Battery voltage

Is the inspection result normal?

YES >> GO TO 3.

NO >> GO TO 2.

2. CHECK POWER SUPPLY CIRCUIT

1. Disconnect BCM connector.
2. Check continuity between BCM harness connector and power window and door lock/unlock switch RH harness connector.

BCM		Power window and door lock/unlock switch RH		Continuity
Connector	Terminal	Connector	Terminal	
M81	141	D157	10	Yes

Is the inspection result normal?

YES >> Replace BCM. Refer to [BCS-79, "Removal and Installation"](#).

NO >> Repair or replace harness.

3. CHECK GROUND CIRCUIT

Check continuity between power window and door lock/unlock switch RH harness connector and ground.

Power window and door lock/unlock switch RH		Ground	Continuity
Connector	Terminal		
D157	11		Yes

Is the inspection result normal?

YES >> GO TO 4.

NO >> Repair or replace harness.

4. CHECK INTERMITTENT INCIDENT

Refer to [GI-53, "Intermittent Incident"](#).

>> Inspection End.

REAR POWER WINDOW SWITCH

REAR POWER WINDOW SWITCH : Diagnosis Procedure

INFOID:000000009133447

Regarding Wiring Diagram information, refer to [PWC-21, "Wiring Diagram"](#).

1. CHECK POWER SUPPLY

1. Turn ignition switch OFF.
2. Disconnect rear power window switch LH connector and rear power window switch RH connector.
3. Turn ignition switch ON.
4. Check voltage between rear power window switch harness connector and ground.

POWER SUPPLY AND GROUND CIRCUIT

< DTC/CIRCUIT DIAGNOSIS >

(+)		Terminal	(-)	Voltage (Approx.)
Rear power window switch				
Connector				
LH	D256	10	Ground	Battery voltage
RH	D356			

Is the inspection result normal?

YES >> GO TO 3.

NO >> GO TO 2.

2. CHECK POWER SUPPLY CIRCUIT

1. Turn ignition switch OFF.
2. Disconnect BCM connector.
3. Check continuity between BCM harness connector and rear power window switch harness connector.

BCM		Rear power window switch		Continuity	
Connector	Terminal	Connector	Terminal		
M81	141	LH	D256	10	Yes
		RH	D356		

Is the inspection result normal?

YES >> Replace BCM. Refer to [BCS-79, "Removal and Installation"](#).

NO >> Repair or replace harness.

3. CHECK GROUND CIRCUIT

1. Turn ignition switch OFF.
2. Check continuity between rear power window switch harness connector and ground.

Rear power window switch		Terminal	Ground	Continuity
Connector				
LH	D256	11		Yes
RH	D356			

Is the inspection result normal?

YES >> GO TO 4.

NO >> Repair or replace harness.

4. CHECK INTERMITTENT INCIDENT

Refer to [GI-53, "Intermittent Incident"](#).

>> Inspection End.

POWER WINDOW MOTOR

< DTC/CIRCUIT DIAGNOSIS >

POWER WINDOW MOTOR DRIVER SIDE

DRIVER SIDE : Component Function Check

INFOID:000000009133448

1.CHECK POWER WINDOW MOTOR CIRCUIT

Check front power window motor LH operation with power window main switch.

Is the inspection result normal?

- YES >> Front power window motor LH is OK.
 NO >> Refer to [PWC-41, "DRIVER SIDE : Diagnosis Procedure"](#).

DRIVER SIDE : Diagnosis Procedure

INFOID:000000009133449

Regarding Wiring Diagram information, refer to [PWC-21, "Wiring Diagram"](#).

1.CHECK FRONT POWER WINDOW MOTOR INPUT SIGNAL

1. Turn ignition switch OFF.
2. Disconnect front power window motor LH connector.
3. Turn ignition switch ON.
4. Check voltage between front power window motor LH harness connector and ground.

(+)		(-)	Condition	Voltage (Approx.)	
Connector	Terminal				
D9	1	Ground	Power window main switch	UP	Battery voltage
				DOWN	0
	2			UP	0
				DOWN	Battery voltage

Is the inspection result normal?

- YES >> Replace front power window motor LH. Refer to [GW-18, "Removal and Installation"](#).
 NO >> GO TO 2.

2.CHECK POWER WINDOW MOTOR CIRCUIT

1. Turn ignition switch OFF.
2. Disconnect power window main switch connector.
3. Check continuity between power window main switch harness connector and front power window motor LH harness connector.

Power window main switch		Front power window motor LH		Continuity
Connector	Terminal	Connector	Terminal	
D56	6	D9	1	Yes
	5		2	

4. Check continuity between power window main switch harness connector and ground.

Power window main switch		Ground	Continuity
Connector	Terminal		
D56	6		No
	5		

Is the inspection result normal?

- YES >> Replace power window main switch. Refer to [PWC-77, "Removal and Installation"](#).

A
B
C
D
E
F
G
H
I
J
L
M
N
O
P

PWC

POWER WINDOW MOTOR

< DTC/CIRCUIT DIAGNOSIS >

NO >> Repair or replace harness.

PASSENGER SIDE

PASSENGER SIDE : Component Function Check

INFOID:000000009133450

1. CHECK POWER WINDOW MOTOR CIRCUIT

Check front power window motor RH operation with power window main switch or power window and door lock/unlock switch RH.

Is the inspection result normal?

YES >> Front power window motor RH is OK.

NO >> Refer to [PWC-42, "PASSENGER SIDE : Diagnosis Procedure"](#).

PASSENGER SIDE : Diagnosis Procedure

INFOID:000000009133451

Regarding Wiring Diagram information, refer to [PWC-21, "Wiring Diagram"](#).

1. CHECK FRONT POWER WINDOW MOTOR INPUT SIGNAL

1. Turn ignition switch OFF.
2. Disconnect front power window motor RH connector.
3. Turn ignition switch ON.
4. Check voltage between front power window motor RH harness connector and ground.

(+)		(-)	Condition	Voltage (Approx.)
Connector	Terminal			
D104	1	Ground	Power window and door lock/unlock switch RH	UP Battery voltage
			DOWN 0	
	2		UP 0	
			DOWN Battery voltage	

Is the inspection result normal?

YES >> Replace front power window motor RH. Refer to [GW-18, "Removal and Installation"](#).

NO >> GO TO 2.

2. CHECK POWER WINDOW MOTOR CIRCUIT

1. Turn ignition switch OFF.
2. Disconnect power window and door lock/switch RH connector.
3. Check continuity between power window and door lock/unlock switch RH harness connector and front power window motor RH harness connector.

Power window and door lock/unlock switch RH		Front power window motor RH		Continuity
Connector	Terminal	Connector	Terminal	
D157	9	D104	2	Yes
	8		1	

4. Check continuity between power window and door lock/unlock switch RH connector and ground.

Power window and door lock/unlock switch RH		Ground	Continuity
Connector	Terminal		
D157	9		No
	8		

Is the inspection result normal?

POWER WINDOW MOTOR

< DTC/CIRCUIT DIAGNOSIS >

- YES >> Replace power window and door lock/unlock switch RH. Refer to [PWC-78. "Removal and Installation"](#).
 NO >> Repair or replace harness.

REAR LH

REAR LH : Component Function Check

INFOID:000000009133452

1. CHECK POWER WINDOW MOTOR CIRCUIT

Check rear power window motor LH operation with power window main switch or rear power window switch LH.

Is the inspection result normal?

- YES >> Rear power window motor LH is OK.
 NO >> Refer to [PWC-43. "REAR LH : Diagnosis Procedure"](#).

REAR LH : Diagnosis Procedure

INFOID:000000009133453

Regarding Wiring Diagram information, refer to [PWC-21. "Wiring Diagram"](#).

1. CHECK REAR POWER WINDOW MOTOR INPUT SIGNAL

- Turn ignition switch OFF.
- Disconnect rear power window motor LH connector.
- Turn ignition switch ON.
- Check voltage between rear power window motor LH harness connector and ground.

(+)		(-)	Condition	Voltage (Approx.)
Connector	Terminal			
D204	2	Ground	UP	Battery voltage
			DOWN	0
	1		UP	0
			DOWN	Battery voltage

Is the inspection result normal?

- YES >> Replace rear power window motor LH. Refer to [GW-23. "Removal and Installation"](#).
 NO >> GO TO 2.

2. CHECK POWER WINDOW MOTOR CIRCUIT

- Turn ignition switch OFF.
- Disconnect rear power window switch LH connector.
- Check continuity between rear power window switch LH harness connector and rear power window motor LH harness connector.

Rear power window switch LH		Rear power window motor LH		Continuity
Connector	Terminal	Connector	Terminal	
D256	8	D204	2	Yes
	9		1	

- Check continuity between rear power window switch LH harness connector and ground.

Rear power window switch LH		Ground	Continuity
Connector	Terminal		
D256	8		No
	9		

A
B
C
D
E
F
G
H
I
J
L
M
N
O
P



POWER WINDOW MOTOR

< DTC/CIRCUIT DIAGNOSIS >

Is the inspection result normal?

- YES >> Replace rear power window switch LH. Refer to [PWC-79, "Removal and Installation"](#).
 NO >> Repair or replace harness.

REAR RH

REAR RH : Component Function Check

INFOID:000000009133454

1. CHECK POWER WINDOW MOTOR CIRCUIT

Check rear power window motor RH operation with power window main switch or rear power window switch RH.

Is the inspection result normal?

- YES >> Rear power window motor RH is OK.
 NO >> Refer to [PWC-44, "REAR RH : Diagnosis Procedure"](#).

REAR RH : Diagnosis Procedure

INFOID:000000009133455

Regarding Wiring Diagram information, refer to [PWC-21, "Wiring Diagram"](#).

1. CHECK REAR POWER WINDOW MOTOR INPUT SIGNAL

- Turn ignition switch OFF.
- Disconnect rear power window motor RH connector.
- Turn ignition switch ON.
- Check voltage between rear power window motor RH harness connector and ground.

(+)		(-)	Condition	Voltage (Approx.)
Connector	Terminal			
D304	1	Ground	Rear power window switch RH UP	0
			Rear power window switch RH DOWN	Battery voltage
	2		Rear power window switch RH UP	Battery voltage
			Rear power window switch RH DOWN	0

Is the inspection result normal?

- YES >> Replace rear power window motor RH. Refer to [GW-23, "Removal and Installation"](#).
 NO >> GO TO 2.

2. CHECK POWER WINDOW MOTOR CIRCUIT

- Turn ignition switch OFF.
- Disconnect rear power window switch RH connector.
- Check continuity between rear power window switch RH harness connector and rear power window motor RH harness connector.

Rear power window switch RH		Rear power window motor RH		Continuity
Connector	Terminal	Connector	Terminal	
D356	9	D304	1	Yes
	8		2	

- Check continuity between rear power window switch RH harness connector and ground.

Rear power window switch RH		Ground	Continuity
Connector	Terminal		
D356	9		No
	8		

POWER WINDOW MOTOR

< DTC/CIRCUIT DIAGNOSIS >

Is the inspection result normal?

- YES >> Replace rear power window switch RH. Refer to [PWC-79, "Removal and Installation"](#).
- NO >> Repair or replace harness.

A

B

C

D

E

F

G

H

I

J

PWC

L

M

N

O

P

ENCODER

< DTC/CIRCUIT DIAGNOSIS >

ENCODER DRIVER SIDE

DRIVER SIDE : Component Function Check

INFOID:000000009133456

1. CHECK ENCODER

Check that driver side door glass performs AUTO open/close operation normally by power window main switch.

Is the inspection result normal?

- YES >> Encoder is OK.
NO >> Refer to [PWC-46, "DRIVER SIDE : Diagnosis Procedure"](#).

DRIVER SIDE : Diagnosis Procedure

INFOID:000000009133457

Regarding Wiring Diagram information, refer to [PWC-21, "Wiring Diagram"](#).

1. CHECK ENCODER SIGNAL

1. Turn ignition switch ON.
2. Check signal between power window main switch harness connector and ground with oscilloscope.

Signal name	(+)		(-)	Signal (Reference value)
	Power window main switch			
	Connector	Terminal		
Encoder signal 1	D56	11	Ground	Refer to following signal
Encoder signal 2		12		

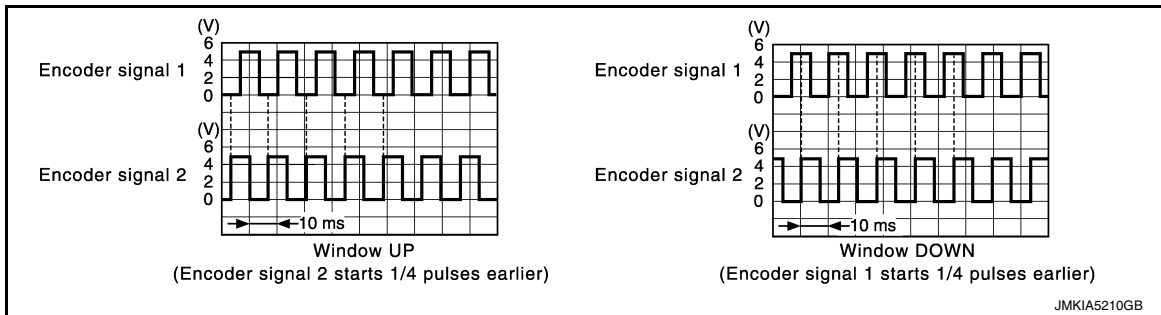

Is the inspection result normal?

- YES >> Replace power window main switch. Refer to [PWC-77, "Removal and Installation"](#).
NO >> GO TO 2.

2. CHECK ENCODER SIGNAL CIRCUIT

1. Turn ignition switch OFF.
2. Disconnect power window main switch connector and front power window motor LH connector.
3. Check continuity between power window main switch harness connector and front power window motor LH harness connector.

Power window main switch		Front power window motor LH		Continuity
Connector	Terminal	Connector	Terminal	
D56	11	D9	6	Yes
	12		4	

4. Check continuity between power window main switch harness connector and ground.

ENCODER

< DTC/CIRCUIT DIAGNOSIS >

Power window main switch		Ground	Continuity
Connector	Terminal		
D56	11		No
	12		

Is the inspection result normal?

YES >> GO TO 3.

NO >> Repair or replace harness.

3.CHECK ENCODER POWER SUPPLY

1. Connect power window main switch connector.
2. Turn ignition switch ON.
3. Check voltage between front power window motor LH harness connector and ground.

(+)		(-)	Voltage (Approx.)
Front power window motor LH			
Connector	Terminal		
D9	5	Ground	Battery voltage

Is the inspection result normal?

YES >> GO TO 5.

NO >> GO TO 4.

4.CHECK ENCODER POWER SUPPLY CIRCUIT

1. Turn ignition switch OFF.
2. Disconnect power window main switch connector.
3. Check continuity between power window main switch harness connector and front power window motor LH harness connector.

Power window main switch		Front power window motor LH		Continuity
Connector	Terminal	Connector	Terminal	
D56	3	D9	5	Yes

4. Check continuity between power window main switch harness connector and ground.

Power window main switch		Ground	Continuity
Connector	Terminal		
D56	3		No

Is the inspection result normal?

YES >> Replace power window main switch. Refer to [PWC-77. "Removal and Installation"](#).

NO >> Repair or replace harness.

5.CHECK GROUND CIRCUIT 1

1. Turn ignition switch OFF.
2. Check continuity between front power window motor LH harness connector and ground.

Front power window motor LH		Ground	Continuity
Connector	Terminal		
D9	3		Yes

Is the inspection result normal?

YES >> Replace front power window motor LH. Refer to [GW-18. "Removal and Installation"](#).

NO >> GO TO 6.

6.CHECK GROUND CIRCUIT 2

1. Disconnect power window main switch connector.

A
B
C
D
E
F
G
H
I
J
L
M
N
O
P

PWC

ENCODER

< DTC/CIRCUIT DIAGNOSIS >

- Check continuity between power window main switch harness connector and front power window motor LH harness connector.

Power window main switch		Front power window motor LH		Continuity
Connector	Terminal	Connector	Terminal	
D56	10	D9	3	Yes

- Check continuity between power window main switch harness connector and ground.

Power window main switch		Ground	Continuity
Connector	Terminal		
D56	10		No

Is the inspection result normal?

YES >> Replace power window main switch. Refer to [PWC-77. "Removal and Installation"](#).

NO >> Repair or replace harness.

PASSENGER SIDE

PASSENGER SIDE : Component Function Check

INFOID:000000009133458

1.CHECK ENCODER

Check that passenger side door glass performs AUTO open/close operation normally by power window main switch or power window and door lock/unlock switch RH.

Is the inspection result normal?

YES >> Encoder is OK.

NO >> Refer to [PWC-48. "PASSENGER SIDE : Diagnosis Procedure"](#).

PASSENGER SIDE : Diagnosis Procedure

INFOID:000000009133459

Regarding Wiring Diagram information, refer to [PWC-21. "Wiring Diagram"](#).

1.CHECK ENCODER SIGNAL

- Turn ignition switch ON.
- Check signal between power window and door lock/unlock switch RH harness connector and ground with oscilloscope.

Signal name	(+)		(-)	Signal (Reference value)
	Power window and door lock/unlock switch RH			
	Connector	Terminal		
Encoder signal 1	D157	12	Ground	Refer to following signal
Encoder signal 2		15		

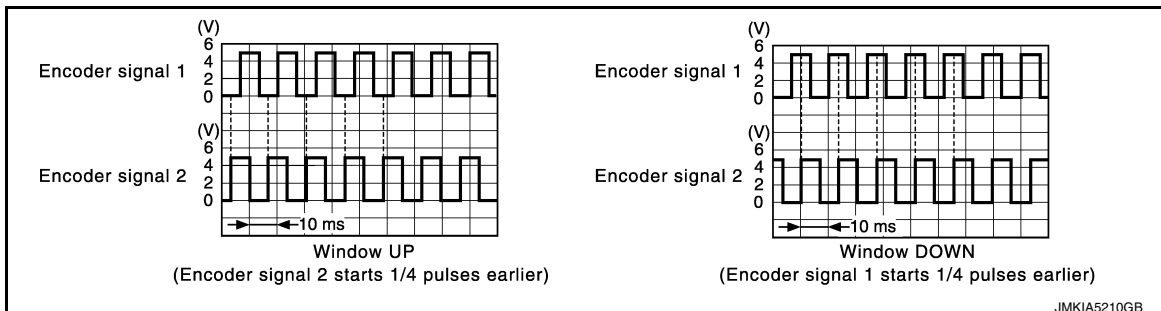

Is the inspection result normal?

ENCODER

< DTC/CIRCUIT DIAGNOSIS >

- YES >> Replace power window and door lock/unlock switch RH. Refer to [PWC-78. "Removal and Installation"](#).
- NO >> GO TO 2.

2.CHECK ENCODER SIGNAL CIRCUIT

- Turn ignition switch OFF.
- Disconnect power window and door lock/unlock switch RH connector and power window and door lock/unlock switch motor RH connector.
- Check continuity between power window and door lock/unlock switch RH harness connector and front power window motor RH harness connector.

Power window and door lock/unlock switch RH		Front power window motor RH		Continuity
Connector	Terminal	Connector	Terminal	
D157	12	D104	6	Yes
	15		4	

- Check continuity between power window and door lock/unlock switch RH harness connector and ground.

Power window and door lock/unlock switch RH		Ground	Continuity
Connector	Terminal		
D157	12		No
	15		

Is the inspection result normal?

- YES >> GO TO 3.
- NO >> Repair or replace harness.

3.CHECK ENCODER POWER SUPPLY

- Connect power window and door lock/unlock switch RH connector.
- Turn ignition switch ON.
- Check voltage between power window and door lock/unlock motor RH harness connector and ground.

(+)		(-)	Voltage (Approx.)
Power window and door lock/unlock motor RH			
Connector	Terminal		
D104	5	Ground	Battery voltage

Is the inspection result normal?

- YES >> GO TO 5.
- NO >> GO TO 4.

4.CHECK ENCODER POWER SUPPLY CIRCUIT

- Turn ignition switch OFF.
- Disconnect power window and door lock/unlock switch RH connector.
- Check continuity between power window and door lock/unlock switch RH harness connector and power window and door lock/unlock motor RH harness connector.

Power window and door lock/unlock switch RH		Front power window motor RH		Continuity
Connector	Terminal	Connector	Terminal	
D157	4	D104	5	Yes

- Check continuity between power window and door lock/unlock switch RH harness connector and ground.

Power window and door lock/unlock switch RH		Ground	Continuity
Connector	Terminal		
D157	4		No

Is the inspection result normal?

A
B
C
D
E
F
G
H
I
J
L
M
N
O
P

PWC

ENCODER

< DTC/CIRCUIT DIAGNOSIS >

- YES >> Replace power window and door lock/unlock switch RH. Refer to [PWC-78, "Removal and Installation"](#).
NO >> Repair or replace harness.

5.CHECK GROUND CIRCUIT 1

1. Turn ignition switch OFF.
2. Check continuity between front power window motor RH harness connector and ground.

Front power window motor RH		Ground	Continuity
Connector	Terminal		
D104	3		Yes

Is the inspection result normal?

- YES >> Replace front power window motor RH. Refer to [GW-18, "Removal and Installation"](#).
NO >> GO TO 6.

6.CHECK GROUND CIRCUIT 2

1. Disconnect power window and door lock/unlock switch RH connector.
2. Check continuity between power window and door lock/unlock switch RH harness connector and front power window motor RH harness connector.

Power window and door lock/unlock switch RH		Front power window motor RH		Continuity
Connector	Terminal	Connector	Terminal	
D157	3	D104	3	Yes

3. Check continuity between power window and door lock/unlock switch RH harness connector and ground.

Power window and door lock/unlock switch RH		Ground	Continuity
Connector	Terminal		
D157	3		No

Is the inspection result normal?

- YES >> Replace power window and door lock/unlock switch RH. Refer to [PWC-78, "Removal and Installation"](#).
NO >> Repair or replace harness.

REAR LH

REAR LH : Component Function Check

INFOID:000000009133460

1.CHECK ENCODER OPERATION

Check that rear door LH glass performs AUTO open/close operation normally by power window main switch or rear power window switch LH.

Is the inspection result normal?

- YES >> Encoder operation is OK.
NO >> Refer to [PWC-50, "REAR LH : Diagnosis Procedure"](#).

REAR LH : Diagnosis Procedure

INFOID:000000009133461

Regarding Wiring Diagram information, refer to [PWC-21, "Wiring Diagram"](#).

1.CHECK ENCODER SIGNAL

1. Turn ignition switch ON.
2. Check signal between rear power window switch LH harness connector and ground with oscilloscope.

ENCODER

< DTC/CIRCUIT DIAGNOSIS >

Signal name	(+)		(-)	Signal (Reference value)
	Rear power window switch LH			
	Connector	Terminal		
Encoder signal 1	D256	12	Ground	Refer to following signal
Encoder signal 2		15		

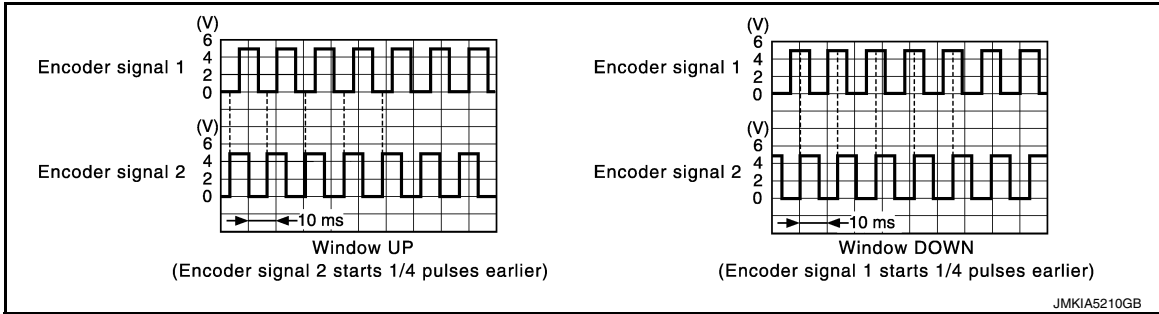

Is the inspection result normal?

- YES >> Replace rear power window switch LH. Refer to [PWC-79, "Removal and Installation"](#).
 NO >> GO TO 2.

2. CHECK ENCODER SIGNAL CIRCUIT

- Turn ignition switch OFF.
- Disconnect rear power window switch LH connector and rear power window motor LH connector.
- Check continuity between rear power window switch LH harness connector and rear power window motor LH harness connector.

Rear power window switch LH		Rear power window motor LH		Continuity
Connector	Terminal	Connector	Terminal	
D256	12	D204	4	Yes
	15		6	

- Check continuity rear power window switch LH harness connector and ground.

Rear power window switch LH		Ground	Continuity
Connector	Terminal		
D256	12		No
	15		

Is the inspection result normal?

- YES >> GO TO 3.
 NO >> Repair or replace harness.

3. CHECK ENCODER POWER SUPPLY

- Connect rear power window switch LH connector.
- Turn ignition switch ON.
- Check voltage between rear power window motor LH harness connector and ground.

(+)		(-)	Voltage (Approx.)
Rear power window motor LH			
Connector	Terminal		
D204	5	Ground	Battery voltage

Is the inspection result normal?

- YES >> GO TO 5.
 NO >> GO TO 4.

ENCODER

< DTC/CIRCUIT DIAGNOSIS >

4.CHECK ENCODER POWER SUPPLY CIRCUIT

1. Turn ignition switch OFF.
2. Disconnect rear power window switch LH connector.
3. Check continuity between rear power window switch LH harness connector and rear power window motor LH harness connector.

Rear power window switch LH		Rear power window motor LH		Continuity
Connector	Terminal	Connector	Terminal	
D256	4	D204	5	Yes

4. Check continuity between rear power window switch LH harness connector and ground.

Rear power window switch LH		Ground	Continuity
Connector	Terminal		
D256	4		No

Is the inspection result normal?

YES >> Replace rear power window switch LH. Refer to [PWC-79, "Removal and Installation"](#).

NO >> Repair or replace harness.

5.CHECK GROUND CIRCUIT 1

1. Turn ignition switch OFF.
2. Check continuity between rear power window motor LH harness connector and ground.

Rear power window motor LH		Ground	Continuity
Connector	Terminal		
D204	3		Yes

Is the inspection result normal?

YES >> Replace rear power window motor LH. Refer to [GW-23, "Removal and Installation"](#).

NO >> GO TO 6.

6.CHECK GROUND CIRCUIT 2

1. Disconnect rear power window switch LH harness connector.
2. Check continuity between rear power window switch LH harness connector and rear power window motor LH harness connector.

Rear power window switch LH		Rear power window motor LH		Continuity
Connector	Terminal	Connector	Terminal	
D256	3	D204	3	Yes

3. Check continuity between rear power window switch LH harness connector and ground.

Rear power window switch LH		Ground	Continuity
Connector	Terminal		
D256	3		No

Is the inspection result normal?

YES >> Replace rear power window switch LH. Refer to [PWC-79, "Removal and Installation"](#).

NO >> Repair or replace harness.

REAR RH

REAR RH : Component Function Check

INFOID:000000009133462

1.CHECK ENCODER OPERATION

Check that rear door RH glass performs AUTO open/close operation normally by power window main switch or rear power window switch RH.

ENCODER

< DTC/CIRCUIT DIAGNOSIS >

Is the inspection result normal?

- YES >> Encoder operation is OK.
 NO >> Refer to [PWC-53. "REAR RH : Diagnosis Procedure"](#).

REAR RH : Diagnosis Procedure

INFOID:000000009133463

Regarding Wiring Diagram information, refer to [PWC-21. "Wiring Diagram"](#).

1.CHECK ENCODER SIGNAL

- Turn ignition switch ON.
- Check signal between rear power window switch RH harness connector and ground with oscilloscope.

Signal name	(+)		(-)	Signal (Reference value)
	Rear power window switch RH			
	Connector	Terminal		
Encoder signal 1	D356	12	Ground	Refer to following signal
Encoder signal 2		15		

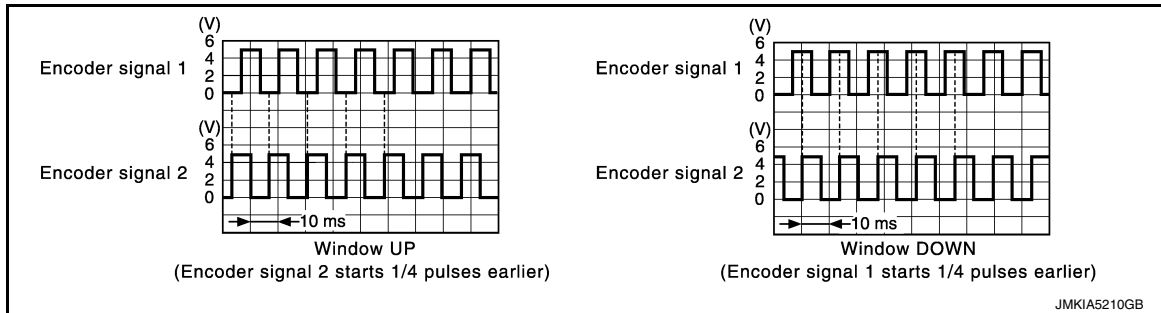

Is the inspection result normal?

- YES >> Replace rear power window switch RH. Refer to [PWC-79. "Removal and Installation"](#).
 NO >> GO TO 2.

2.CHECK ENCODER SIGNAL CIRCUIT

- Turn ignition switch OFF.
- Disconnect rear power window switch RH connector and rear power window motor RH connector.
- Check continuity between rear power window switch RH harness connector and rear power window motor RH harness connector.

Rear power window switch RH		Rear power window motor RH		Continuity
Connector	Terminal	Connector	Terminal	
D356	12	D304	4	Yes
	15		6	

- Check continuity rear power window switch RH harness connector and ground.

Rear power window switch RH		Ground	Continuity
Connector	Terminal		
D356	12		Ground
	15		

Is the inspection result normal?

- YES >> GO TO 3.
 NO >> Repair or replace harness.

3.CHECK ENCODER POWER SUPPLY

A
B
C
D
E
F
G
H
I
J
L
M
N
O
P

PWC

ENCODER

< DTC/CIRCUIT DIAGNOSIS >

1. Connect rear power window switch RH connector.
2. Turn ignition switch ON.
3. Check voltage between rear power window motor RH harness connector and ground.

(+)		(-)	Voltage (Approx.)
Rear power window motor RH			
Connector	Terminal	Ground	Battery voltage
D304	5		

Is the inspection result normal?

- YES >> GO TO 5.
NO >> GO TO 4.

4.CHECK ENCODER POWER SUPPLY CIRCUIT

1. Turn ignition switch OFF.
2. Disconnect rear power window switch RH connector.
3. Check continuity between rear power window switch RH harness connector and rear power window motor RH harness connector.

Rear power window switch RH		Rear power window motor RH		Continuity
Connector	Terminal	Connector	Terminal	
D356	4	D304	5	Yes

4. Check continuity between rear power window switch RH harness connector and ground.

Rear power window switch RH		Ground	Continuity
Connector	Terminal		
D356	4	No	

Is the inspection result normal?

- YES >> Replace rear power window switch RH. Refer to [PWC-79. "Removal and Installation"](#).
NO >> Repair or replace harness.

5.CHECK GROUND CIRCUIT 1

1. Turn ignition switch OFF.
2. Check continuity between rear power window motor RH harness connector and ground.

Rear power window motor RH		Ground	Continuity
Connector	Terminal		
D304	3	Yes	

Is the inspection result normal?

- YES >> Replace rear power window motor RH. Refer to [GW-23. "Removal and Installation"](#).
NO >> GO TO 6.

6.CHECK GROUND CIRCUIT 2

1. Disconnect rear power window switch RH harness connector.
2. Check continuity between rear power window switch RH harness connector and rear power window motor RH harness connector.

Rear power window switch RH		Rear power window motor RH		Continuity
Connector	Terminal	Connector	Terminal	
D356	3	D304	3	Yes

3. Check continuity between rear power window switch RH harness connector and ground.

ENCODER

< DTC/CIRCUIT DIAGNOSIS >

Rear power window switch RH		Ground	Continuity
Connector	Terminal		
D356	3		No

Is the inspection result normal?

- YES >> Replace rear power window switch RH. Refer to [PWC-79, "Removal and Installation"](#).
- NO >> Repair or replace harness.

A
B
C
D
E
F
G
H
I
J
L
M
N
O
P

PWC

DOOR KEY CYLINDER SWITCH

< DTC/CIRCUIT DIAGNOSIS >

DOOR KEY CYLINDER SWITCH

Component Function Check

INFOID:000000009133464

1. CHECK FUNCTION

1. Select DOOR LOCK of BCM using CONSULT.
2. Select KEY CYL LK-SW, KEY CYL UN-SW in DATA MONITOR mode.
3. Check that the function operates normally according to the following conditions.

Monitor item	Condition	Status
KEY CYL LK-SW	Lock	ON
	Neutral / Unlock	OFF
KEY CYL UN-SW	Unlock	ON
	Neutral / Lock	OFF

Is the inspection result normal?

- YES >> Door key cylinder switch is OK.
NO >> Refer to [PWC-56. "Diagnosis Procedure"](#).

Diagnosis Procedure

INFOID:000000009133465

Regarding Wiring Diagram information, refer to [DLK-61. "Wiring Diagram"](#).

1. CHECK DOOR KEY CYLINDER SWITCH INPUT SIGNAL

1. Turn ignition switch OFF.
2. Disconnect front door lock assembly LH connector.
3. Check voltage between front door lock assembly LH harness connector and ground.

(+)		(-)	Voltage (Approx.)
Front door lock assembly LH			
Connector	Terminal	Ground	5 V
D14	5		
	6		

Is the inspection result normal?

- YES >> GO TO 3.
NO >> GO TO 2.

2. CHECK DOOR KEY CYLINDER SWITCH SIGNAL CIRCUIT

1. Disconnect power window main switch connector.
2. Check continuity between main power window and door lock/unlock switch harness connector and front door lock assembly LH harness connector.

Main power window and door lock/unlock switch		Front door lock assembly LH		Continuity
Connector	Terminal	Connector	Terminal	
D402	15	D14	6	Yes
	16		5	

3. Check continuity between power window main switch harness connector and ground.

DOOR KEY CYLINDER SWITCH

< DTC/CIRCUIT DIAGNOSIS >

Main power window and door lock/unlock switch		Ground	Continuity
Connector	Terminal		
D402	15		No
	16		

Is the inspection result normal?

YES >> Replace main power window and door lock/unlock switch. Refer to [PWC-77, "Removal and Installation"](#).

NO >> Repair or replace harness.

3. CHECK DOOR KEY CYLINDER SWITCH GROUND CIRCUIT

Check continuity between front door lock assembly LH harness connector and ground.

Front door lock assembly LH		Ground	Continuity
Connector	Terminal		
D14	4		Yes

Is the inspection result normal?

YES >> GO TO 4.

NO >> Repair or replace harness.

4. CHECK DOOR KEY CYLINDER SWITCH

Refer to [PWC-57, "Component Inspection"](#).

Is the inspection result normal?

YES >> GO TO 5.

NO >> Replace front door lock assembly LH. Refer to [DLK-295, "DOOR LOCK : Removal and Installation"](#).

5. CHECK INTERMITTENT INCIDENT

Refer to [GI-53, "Intermittent Incident"](#).

>> Inspection End.

Component Inspection

INFOID:000000009133466

PWC

1. CHECK DOOR KEY CYLINDER SWITCH

1. Turn ignition switch OFF.
2. Disconnect front door lock assembly LH connector.
3. Check continuity between front door lock assembly LH terminals.

Front door lock assembly LH		Condition	Continuity
Terminal			
5	4	Driver side door key cylinder	Unlock Yes
		Neutral / Lock No	
6		Lock Yes	
		Neutral / Unlock No	

Is the inspection result normal?

YES >> Inspection End.

NO >> Replace front door lock assembly LH. Refer to [DLK-295, "DOOR LOCK : Removal and Installation"](#).

POWER WINDOW SERIAL LINK

< DTC/CIRCUIT DIAGNOSIS >

POWER WINDOW SERIAL LINK

POWER WINDOW MAIN SWITCH

POWER WINDOW MAIN SWITCH : Component Function Check

INFOID:000000009133467

1. CHECK POWER WINDOW SWITCH OUTPUT SIGNAL

With CONSULT

Check ("CDL LOCK SW", "CDL UNLOCK SW") in "DATA MONITOR" mode for "POWER DOOR LOCK SYSTEM" with CONSULT. Refer to [BCS-14, "DOOR LOCK : CONSULT Function \(BCM - DOOR LOCK\)"](#).

Monitor item	Condition
CDL LOCK SW	LOCK : ON
	UNLOCK : OFF
CDL UNLOCK SW	LOCK : OFF
	UNLOCK : ON

Is the inspection result normal?

YES >> Power window serial link is OK.

NO >> Refer to [PWC-58, "POWER WINDOW MAIN SWITCH : Diagnosis Procedure"](#).

POWER WINDOW MAIN SWITCH : Diagnosis Procedure

INFOID:000000009133468

Regarding Wiring Diagram information, refer to [PWC-21, "Wiring Diagram"](#).

1. CHECK POWER WINDOW SWITCH INPUT SIGNAL

1. Turn ignition switch ON.
2. Check signal between power window main switch harness connector and ground with oscilloscope.

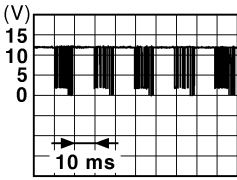
(+)		(-)	Signal (Reference value)
Connector	Terminal		
D56	13	Ground	 <p>JPMAI0013GB</p>

Is the inspection result normal?

YES >> GO TO 4.

NO >> GO TO 2.

2. CHECK POWER WINDOW SERIAL LINK SIGNAL

1. Turn ignition switch OFF.
2. Disconnect power window main switch connector.
3. Turn ignition switch ON.
4. Check voltage between power window main switch harness connector and ground.

POWER WINDOW SERIAL LINK

< DTC/CIRCUIT DIAGNOSIS >

(+)		(-)	Voltage (Approx.)
Power window main switch			
Connector	Terminal	Ground	Battery voltage
D56	13		

Is the inspection result normal?

- YES >> Replace power window main switch. Refer to [PWC-77. "Removal and Installation"](#).
 NO >> GO TO 3.

3.CHECK POWER WINDOW SERIAL LINK CIRCUIT

1. Disconnect BCM connector and power window main switch connector.
2. Check continuity between BCM harness connector and power window main switch harness connector.

BCM		Power window main switch		Continuity
Connector	Terminal	Connector	Terminal	
M19	54	D56	13	Yes

Is the inspection result normal?

- YES >> Replace BCM. Refer to [BCS-79. "Removal and Installation"](#).
 NO >> Repair or replace harness.

4.CHECK INTERMITTENT INCIDENT

Refer to [GI-53. "Intermittent Incident"](#).

>> Inspection End.

FRONT POWER WINDOW SWITCH (PASSENGER SIDE)

FRONT POWER WINDOW SWITCH (PASSENGER SIDE) : Component Function Check

INFOID:000000009133469

1.CHECK POWER WINDOW SWITCH OUTPUT SIGNAL

With CONSULT

Check ("CDL LOCK SW", "CDL UNLOCK SW") in "DATA MONITOR" mode for "POWER DOOR LOCK SYSTEM" with CONSULT. Refer to [BCS-14. "DOOR LOCK : CONSULT Function \(BCM - DOOR LOCK\)"](#).

Monitor item	Condition
CDL LOCK SW	LOCK : ON
	UNLOCK : OFF
CDL UNLOCK SW	LOCK : OFF
	UNLOCK : ON

Is the inspection result normal?

- YES >> Power window serial link is OK.
 NO >> Refer to [PWC-59. "FRONT POWER WINDOW SWITCH \(PASSENGER SIDE\) : Diagnosis Procedure"](#).

FRONT POWER WINDOW SWITCH (PASSENGER SIDE) : Diagnosis Procedure

INFOID:000000009133470

Regarding Wiring Diagram information, refer to [PWC-21. "Wiring Diagram"](#).

1.CHECK POWER WINDOW SWITCH INPUT SIGNAL

1. Turn ignition switch ON.

A
B
C
D
E
F
G
H
I
J
L
M
N
O
P

PWC

POWER WINDOW SERIAL LINK

< DTC/CIRCUIT DIAGNOSIS >

- Check signal between power window and door lock/unlock switch RH harness connector and ground with oscilloscope.

(+)		(-)	Signal (Reference value)
Connector	Terminal		
D157	16	Ground	

Is the inspection result normal?

YES >> Replace power window and door lock/unlock switch RH. Refer to [PWC-78, "Removal and Installation"](#).

NO >> GO TO 2.

2. CHECK POWER WINDOW SERIAL LINK SIGNAL

- Turn ignition switch OFF.
- Disconnect power window and door lock/unlock switch RH connector.
- Turn ignition switch ON.
- Check voltage between power window and door lock/unlock switch RH harness connector and ground.

(+)		(-)	Voltage (Approx.)
Connector	Terminal		
D157	16	Ground	Battery voltage

Is the inspection result normal?

YES >> Replace power window main switch. Refer to [PWC-77, "Removal and Installation"](#).

NO >> GO TO 3.

3. CHECK POWER WINDOW SERIAL LINK CIRCUIT

- Disconnect power window main switch connector.
- Check continuity between power window main switch harness connector and power window and door lock/unlock switch RH harness connector.

Power window main switch		Power window and door lock/unlock switch RH		Continuity
Connector	Terminal	Connector	Terminal	
D56	13	D157	16	Yes

Is the inspection result normal?

YES >> GO TO 4.

NO >> Repair or replace harness.

4. CHECK INTERMITTENT INCIDENT

Refer to [GI-53, "Intermittent Incident"](#).

>> Inspection End.

REAR POWER WINDOW SWITCH LH

REAR POWER WINDOW SWITCH LH : Component Function Check

INFOID:000000009133471

1. CHECK POWER WINDOW SWITCH OUTPUT SIGNAL

With CONSULT

POWER WINDOW SERIAL LINK

< DTC/CIRCUIT DIAGNOSIS >

Check ("CDL LOCK SW", "CDL UNLOCK SW") in "DATA MONITOR" mode for "POWER DOOR LOCK SYSTEM" with CONSULT. Refer to [BCS-14, "DOOR LOCK : CONSULT Function \(BCM - DOOR LOCK\)"](#).

Monitor item	Condition
CDL LOCK SW	LOCK : ON
	UNLOCK : OFF
CDL UNLOCK SW	LOCK : OFF
	UNLOCK : ON

Is the inspection result normal?

YES >> Power window serial link is OK.

NO >> Refer to [PWC-61, "REAR POWER WINDOW SWITCH LH : Diagnosis Procedure"](#).

REAR POWER WINDOW SWITCH LH : Diagnosis Procedure

INFOID:000000009133472

Regarding Wiring Diagram information, refer to [PWC-21, "Wiring Diagram"](#).

1. CHECK POWER WINDOW SWITCH INPUT SIGNAL

1. Turn ignition switch ON.
2. Check signal between rear power window switch LH harness connector and ground with oscilloscope.

(+) Rear power window switch LH		(-)	Signal (Reference value)
Connector	Terminal		
D256	16	Ground	

Is the inspection result normal?

YES >> Replace rear power window switch LH. Refer to [PWC-79, "Removal and Installation"](#).

NO >> GO TO 2.

2. CHECK POWER WINDOW SERIAL LINK SIGNAL

1. Turn ignition switch OFF.
2. Disconnect rear power window switch LH connector.
3. Turn ignition switch ON.
4. Check voltage between rear power window switch LH harness connector and ground.

(+) Rear power window switch LH		(-)	Voltage (Approx.)
Connector	Terminal		
D256	16	Ground	Battery voltage

Is the inspection result normal?

YES >> Replace power window main switch. Refer to [PWC-77, "Removal and Installation"](#).

NO >> GO TO 3.

3. CHECK POWER WINDOW SERIAL LINK CIRCUIT

1. Disconnect power window main switch connector.

A
B
C
D
E
F
G
H
I
J
L
M
N
O
P



POWER WINDOW SERIAL LINK

< DTC/CIRCUIT DIAGNOSIS >

- Check continuity between power window main switch harness connector and rear power window switch LH harness connector.

Power window main switch		Rear power window switch LH		Continuity
Connector	Terminal	Connector	Terminal	
D56	13	D256	16	Yes

Is the inspection result normal?

- YES >> GO TO 4.
 NO >> Repair or replace harness.

4. CHECK INTERMITTENT INCIDENT

Refer to [GI-53, "Intermittent Incident"](#).

>> Inspection End.

REAR POWER WINDOW SWITCH RH

REAR POWER WINDOW SWITCH RH : Component Function Check

INFOID:000000009133473

1. CHECK POWER WINDOW SWITCH OUTPUT SIGNAL

With CONSULT

Check ("CDL LOCK SW", "CDL UNLOCK SW") in "DATA MONITOR" mode for "POWER DOOR LOCK SYSTEM" with CONSULT. Refer to [BCS-14, "DOOR LOCK : CONSULT Function \(BCM - DOOR LOCK\)"](#).

Monitor item	Condition
CDL LOCK SW	LOCK : ON
	UNLOCK : OFF
CDL UNLOCK SW	LOCK : OFF
	UNLOCK : ON

Is the inspection result normal?

- YES >> Power window serial link is OK.
 NO >> Refer to [PWC-62, "REAR POWER WINDOW SWITCH RH : Diagnosis Procedure"](#).

REAR POWER WINDOW SWITCH RH : Diagnosis Procedure

INFOID:000000009133474

Regarding Wiring Diagram information, refer to [PWC-21, "Wiring Diagram"](#).

1. CHECK POWER WINDOW SWITCH INPUT SIGNAL

- Turn ignition switch ON.
- Check signal between rear power window switch RH harness connector and ground with oscilloscope.

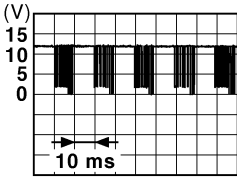
(+)		(-)	Signal (Reference value)
Connector	Terminal		
D356	16	Ground	 <p>JPMAI0013GB</p>

POWER WINDOW SERIAL LINK

< DTC/CIRCUIT DIAGNOSIS >

Is the inspection result normal?

- YES >> Replace rear power window switch RH. Refer to [PWC-79, "Removal and Installation"](#).
NO >> GO TO 2.

2.CHECK POWER WINDOW SERIAL LINK SIGNAL

1. Turn ignition switch OFF.
2. Disconnect rear power window switch RH connector.
3. Turn ignition switch ON.
4. Check voltage between rear power window switch RH harness connector and ground.

(+)		(-)	Voltage (Approx.)
Rear power window switch RH			
Connector	Terminal		
D356	16	Ground	Battery voltage

Is the inspection result normal?

- YES >> Replace power window main switch. Refer to [PWC-77, "Removal and Installation"](#).
NO >> GO TO 3.

3.CHECK POWER WINDOW SERIAL LINK CIRCUIT

1. Disconnect power window main switch connector.
2. Check continuity between power window main switch harness connector and rear power window switch RH harness connector.

Power window main switch		Rear power window switch RH		Continuity
Connector	Terminal	Connector	Terminal	
D56	13	D356	16	Yes

Is the inspection result normal?

- YES >> GO TO 4.
NO >> Repair or replace harness.

4.CHECK INTERMITTENT INCIDENT

Refer to [GI-53, "Intermittent Incident"](#).

>> Inspection End.

PWC

POWER WINDOWS DO NOT OPERATE WITH POWER WINDOW MAIN SWITCH

< SYMPTOM DIAGNOSIS >

SYMPTOM DIAGNOSIS

POWER WINDOWS DO NOT OPERATE WITH POWER WINDOW MAIN SWITCH

Diagnosis Procedure

INFOID:000000009133475

1. CHECK BCM POWER SUPPLY AND GROUND CIRCUIT

Check BCM power supply and ground circuit.

[BCS-79, "Removal and Installation"](#).

Is the inspection result normal?

YES >> GO TO 2.

NO >> Repair or replace the malfunctioning parts.

2. CHECK POWER WINDOW MAIN SWITCH POWER SUPPLY AND GROUND CIRCUIT

Check power window switch power supply and ground circuit.

Refer to [PWC-37, "POWER WINDOW MAIN SWITCH : Diagnosis Procedure"](#).

Is the inspection result normal?

YES >> GO TO 3.

NO >> Repair or replace the malfunctioning parts.

3. CHECK POWER WINDOW MAIN SWITCH SERIAL LINK CIRCUIT

Check power window serial link circuit.

Refer to [PWC-58, "POWER WINDOW MAIN SWITCH : Component Function Check"](#).

Is the inspection result normal?

YES >> GO TO 4.

NO >> Repair or replace the malfunctioning parts.

4. CONFIRM THE OPERATION

Confirm the operation again.

Is the inspection result normal?

YES >> Check intermittent incident. Refer to [GI-53, "Intermittent Incident"](#).

NO >> GO TO 1.

DRIVER SIDE POWER WINDOW ALONE DOES NOT OPERATE

< SYMPTOM DIAGNOSIS >

DRIVER SIDE POWER WINDOW ALONE DOES NOT OPERATE

Diagnosis Procedure

INFOID:000000009133476

1. CHECK DRIVER SIDE POWER WINDOW MOTOR

Check driver side power window motor.

Refer to [PWC-41, "DRIVER SIDE : Component Function Check"](#).

Is the inspection result normal?

YES >> GO TO 2.

NO >> Repair or replace the malfunctioning parts.

2. CONFIRM THE OPERATION

Confirm the operation again.

Is the inspection result normal?

YES >> Check intermittent incident. Refer to [GI-53, "Intermittent Incident"](#).

NO >> GO TO 1.

A
B
C
D
E
F
G
H
I
J
L
M
N
O
P

PWC

FRONT PASSENGER SIDE POWER WINDOW DOES NOT OPERATE

< SYMPTOM DIAGNOSIS >

FRONT PASSENGER SIDE POWER WINDOW DOES NOT OPERATE WHEN POWER WINDOW MAIN SWITCH IS OPERATED

WHEN POWER WINDOW MAIN SWITCH IS OPERATED : Diagnosis Procedure

INFOID:000000009133477

1. CHECK POWER WINDOW AND DOOR LOCK/UNLOCK SWITCH RH

Check power window and door lock/unlock switch RH serial link circuit.

Refer to [PWC-59. "FRONT POWER WINDOW SWITCH \(PASSENGER SIDE\) : Component Function Check"](#).

Is the inspection result normal?

YES >> GO TO 2.

NO >> Repair or replace the malfunctioning parts.

2. CONFIRM THE OPERATION

Confirm the operation again.

Is the inspection result normal?

YES >> Check intermittent incident. Refer to [GI-53. "Intermittent Incident"](#).

NO >> GO TO 1.

WHEN FRONT POWER WINDOW SWITCH (PASSENGER SIDE) IS OPERATED

WHEN FRONT POWER WINDOW SWITCH (PASSENGER SIDE) IS OPERATED :
Diagnosis Procedure

INFOID:000000009133478

1. REPLACE POWER WINDOW AND DOOR LOCK/UNLOCK SWITCH RH

Replace power window and door lock/unlock switch RH.

Refer to [PWC-78. "Removal and Installation"](#).

>> Inspection End.

WHEN BOTH POWER WINDOW MAIN SWITCH AND FRONT POWER WINDOW SWITCH ARE OPERATED

WHEN BOTH POWER WINDOW MAIN SWITCH AND FRONT POWER WINDOW
SWITCH ARE OPERATED : Diagnosis Procedure

INFOID:000000009133479

1. CHECK FRONT POWER WINDOW SWITCH (PASSENGER SIDE) POWER SUPPLY AND GROUND CIR- CUIT

Check power window and door lock/unlock switch RH power supply and ground circuit.

Refer to [PWC-38. "FRONT POWER WINDOW SWITCH \(PASSENGER SIDE\) : Diagnosis Procedure"](#).

Is the inspection result normal?

YES >> GO TO 2.

NO >> Repair or replace the malfunctioning parts.

2. CHECK FRONT POWER WINDOW MOTOR RH CIRCUIT

Check front power window motor RH circuit.

Refer to [PWC-42. "PASSENGER SIDE : Component Function Check"](#).

Is the inspection result normal?

YES >> GO TO 3.

NO >> Repair or replace the malfunctioning parts.

3. CONFIRM THE OPERATION

Confirm the operation again.

Is the inspection result normal?

YES >> Check intermittent incident. Refer to [GI-53. "Intermittent Incident"](#).

NO >> GO TO 1.

REAR LH SIDE POWER WINDOW ALONE DOES NOT OPERATE

< SYMPTOM DIAGNOSIS >

REAR LH SIDE POWER WINDOW ALONE DOES NOT OPERATE WHEN POWER WINDOW MAIN SWITCH IS OPERATED

WHEN POWER WINDOW MAIN SWITCH IS OPERATED : Diagnosis Procedure

INFOID:000000009133480

1. CHECK REAR POWER WINDOW SWITCH LH SERIAL LINK CIRCUIT

Check rear power window switch LH serial link circuit.

Refer to [PWC-60, "REAR POWER WINDOW SWITCH LH : Component Function Check"](#).

Is the inspection result normal?

YES >> GO TO 2.

NO >> Repair or replace the malfunctioning parts.

2. CONFIRM THE OPERATION

Confirm the operation again.

Is the inspection result normal?

YES >> Check intermittent incident. Refer to [GI-53, "Intermittent Incident"](#).

NO >> GO TO 1.

WHEN REAR POWER WINDOW SWITCH LH IS OPERATED

WHEN REAR POWER WINDOW SWITCH LH IS OPERATED : Diagnosis Procedure

INFOID:000000009133481

1. REPLACE REAR POWER WINDOW SWITCH LH

Replace rear power window switch LH.

Refer to [PWC-79, "Removal and Installation"](#).

>> Inspection End.

WHEN BOTH POWER WINDOW MAIN SWITCH AND REAR POWER WINDOW SWITCH LH ARE OPERATED

WHEN BOTH POWER WINDOW MAIN SWITCH AND REAR POWER WINDOW
SWITCH LH ARE OPERATED : Diagnosis Procedure

INFOID:000000009133482

PWC

1. CHECK REAR POWER WINDOW SWITCH POWER SUPPLY AND GROUND CIRCUIT

Check rear power window switch power supply and ground circuit.

Refer to [PWC-39, "REAR POWER WINDOW SWITCH : Diagnosis Procedure"](#).

Is the inspection result normal?

YES >> GO TO 2.

NO >> Repair or replace the malfunctioning parts.

2. CHECK REAR POWER WINDOW MOTOR LH

Check rear power window motor LH.

Refer to [PWC-43, "REAR LH : Component Function Check"](#).

Is the inspection result normal?

YES >> GO TO 3.

NO >> Repair or replace the malfunctioning parts.

3. CONFIRM THE OPERATION

Confirm the operation again.

Is the inspection result normal?

YES >> Check intermittent incident. Refer to [GI-53, "Intermittent Incident"](#).

NO >> GO TO 1.

REAR RH SIDE POWER WINDOW ALONE DOES NOT OPERATE

< SYMPTOM DIAGNOSIS >

REAR RH SIDE POWER WINDOW ALONE DOES NOT OPERATE WHEN POWER WINDOW MAIN SWITCH IS OPERATED

WHEN POWER WINDOW MAIN SWITCH IS OPERATED : Diagnosis Procedure

INFOID:000000009133483

1. CHECK REAR POWER WINDOW SWITCH RH SERIAL LINK CIRCUIT

Check rear power window switch RH serial link circuit.

Refer to [PWC-62. "REAR POWER WINDOW SWITCH RH : Component Function Check"](#).

Is the inspection result normal?

YES >> GO TO 2.

NO >> Repair or replace the malfunctioning parts.

2. CONFIRM THE OPERATION

Confirm the operation again.

Is the inspection result normal?

YES >> Check intermittent incident. Refer to [GI-53. "Intermittent Incident"](#).

NO >> GO TO 1.

WHEN REAR POWER WINDOW SWITCH RH IS OPERATED

WHEN REAR POWER WINDOW SWITCH RH IS OPERATED : Diagnosis Procedure

INFOID:000000009133484

1. REPLACE REAR POWER WINDOW SWITCH RH

Replace rear power window switch RH.

Refer to [PWC-79. "Removal and Installation"](#).

>> Inspection End.

WHEN BOTH POWER WINDOW MAIN SWITCH AND REAR POWER WINDOW
SWITCH RH ARE OPERATED

WHEN BOTH POWER WINDOW MAIN SWITCH AND REAR POWER WINDOW
SWITCH RH ARE OPERATED : Diagnosis Procedure

INFOID:000000009133485

1. CHECK REAR POWER WINDOW SWITCH POWER SUPPLY AND GROUND CIRCUIT

Check rear power window switch power supply and ground circuit.

Refer to [PWC-39. "REAR POWER WINDOW SWITCH : Diagnosis Procedure"](#).

Is the inspection result normal?

YES >> GO TO 2.

NO >> Repair or replace the malfunctioning parts.

2. CHECK REAR POWER WINDOW MOTOR RH

Check rear power window motor RH.

Refer to [PWC-44. "REAR RH : Component Function Check"](#).

Is the inspection result normal?

YES >> GO TO 3.

NO >> Repair or replace the malfunctioning parts.

3. CONFIRM THE OPERATION

Confirm the operation again.

Is the inspection result normal?

YES >> Check intermittent incident. Refer to [GI-53. "Intermittent Incident"](#).

NO >> GO TO 1.

AUTO OPERATION DOES NOT OPERATE BUT MANUAL OPERATE NORMALLY

< SYMPTOM DIAGNOSIS >

AUTO OPERATION DOES NOT OPERATE BUT MANUAL OPERATE NORMALLY

DRIVER SIDE

DRIVER SIDE : Diagnosis Procedure

INFOID:000000009133486

1.PERFORM INITIALIZATION PROCEDURE

Initialization procedure is performed and operation is confirmed.
Refer to [PWC-35, "Work Procedure"](#).

Is the inspection result normal?

YES >> Inspection End.
NO >> GO TO 2.

2.CHECK ENCODER (DRIVER SIDE) CIRCUIT

Check encoder (driver side) circuit.
Refer to [PWC-46, "DRIVER SIDE : Component Function Check"](#).

Is the inspection result normal?

YES >> GO TO 3.
NO >> Repair or replace the malfunctioning parts.

3.CONFIRM THE OPERATION

Confirm the operation again.

Is the inspection result normal?

YES >> Check intermittent incident. Refer to [GI-53, "Intermittent Incident"](#).
NO >> GO TO 1.

PASSENGER SIDE

PASSENGER SIDE : Diagnosis Procedure

INFOID:000000009133487

1.PERFORM INITIALIZATION PROCEDURE

Initialization procedure is performed and operation is confirmed.
Refer to [PWC-35, "Work Procedure"](#).

Is the inspection result normal?

YES >> Inspection End.
NO >> GO TO 2.

2.CHECK ENCODER (PASSENGER SIDE) CIRCUIT

Check encoder (passenger side) circuit.
Refer to [PWC-48, "PASSENGER SIDE : Component Function Check"](#).

Is the inspection result normal?

YES >> GO TO 3.
NO >> Repair or replace the malfunctioning parts.

3.CONFIRM THE OPERATION

Confirm the operation again.

Is the inspection result normal?

YES >> Check intermittent incident. Refer to [GI-53, "Intermittent Incident"](#).
NO >> GO TO 1.

REAR LH

REAR LH : Diagnosis Procedure

INFOID:000000009133488

1.PERFORM INITIALIZATION PROCEDURE

Initialization procedure is performed and operation is confirmed.

A
B
C
D
E
F
G
H
I
J
L
M
N
O
P

PWC

AUTO OPERATION DOES NOT OPERATE BUT MANUAL OPERATE NORMALLY

< SYMPTOM DIAGNOSIS >

Refer to [PWC-35. "Work Procedure"](#).

Is the inspection result normal?

- YES >> Inspection End.
- NO >> GO TO 2.

2.CHECK ENCODER (REAR LH) CIRCUIT

Check encoder (rear LH) circuit.

Refer to [PWC-50. "REAR LH : Component Function Check"](#).

Is the inspection result normal?

- YES >> GO TO 3.
- NO >> Repair or replace the malfunctioning parts.

3.CONFIRM THE OPERATION

Confirm the operation again.

Is the inspection result normal?

- YES >> Check intermittent incident. Refer to [GI-53. "Intermittent Incident"](#).
- NO >> GO TO 1.

REAR RH

REAR RH : Diagnosis Procedure

INFOID:000000009133489

1.PERFORM INITIALIZATION PROCEDURE

Initialization procedure is performed and operation is confirmed.

Refer to [PWC-35. "Work Procedure"](#).

Is the inspection result normal?

- YES >> Inspection End.
- NO >> GO TO 2.

2.CHECK ENCODER (REAR RH) CIRCUIT

Check encoder (rear RH) circuit.

Refer to [PWC-52. "REAR RH : Component Function Check"](#).

Is the inspection result normal?

- YES >> GO TO 3.
- NO >> Repair or replace the malfunctioning parts.

3.CONFIRM THE OPERATION

Confirm the operation again.

Is the inspection result normal?

- YES >> Check intermittent incident. Refer to [GI-53. "Intermittent Incident"](#).
- NO >> GO TO 1.

ANTI-PINCH FUNCTION DOES NOT OPERATE

< SYMPTOM DIAGNOSIS >

ANTI-PINCH FUNCTION DOES NOT OPERATE

Diagnosis Procedure

INFOID:000000009133490

1. CHECK POWER WINDOW AUTO OPERATION

Check AUTO operation of the door when anti-pinch function does not operate.

Is the inspection result normal?

YES >> GO TO 2.

NO >> Refer to [PWC-69, "DRIVER SIDE : Diagnosis Procedure"](#) (driver side), [PWC-69, "PASSENGER SIDE : Diagnosis Procedure"](#) (passenger side), [PWC-69, "REAR LH : Diagnosis Procedure"](#) (rear LH), [PWC-70, "REAR RH : Diagnosis Procedure"](#) (rear RH).

2. CONFIRM THE OPERATION

Confirm the operation again.

Is the inspection result normal?

YES >> Check intermittent incident. Refer to [GI-53, "Intermittent Incident"](#).

NO >> GO TO 1.

A
B
C
D
E
F
G
H
I
J
L
M
N
O
P

PWC

POWER WINDOW RETAINED POWER FUNCTION DOES NOT OPERATE NORMALLY

< SYMPTOM DIAGNOSIS >

POWER WINDOW RETAINED POWER FUNCTION DOES NOT OPERATE NORMALLY

Diagnosis Procedure

INFOID:000000009133491

1. CHECK DOOR SWITCH

Check door switch.

Refer to [DLK-170, "Component Function Check"](#).

Is the inspection result normal?

YES >> GO TO 2.

NO >> Repair or replace the malfunctioning parts.

2. CONFIRM THE OPERATION

Confirm the operation again.

Is the inspection result normal?

YES >> Check intermittent incident. Refer to [GI-53, "Intermittent Incident"](#).

NO >> GO TO 1.

DOOR KEY CYLINDER SWITCH DOES NOT OPERATE POWER WINDOWS

< SYMPTOM DIAGNOSIS >

DOOR KEY CYLINDER SWITCH DOES NOT OPERATE POWER WINDOWS

Diagnosis Procedure

INFOID:000000009133492

1.PERFORM INITIALIZATION PROCEDURE

Initialization procedure is performed and operation is confirmed.

Refer to [PWC-35, "Work Procedure"](#).

Is the inspection result normal?

YES >> Inspection End.

NO >> GO TO 2.

2.CHECK FRONT DOOR LOCK ASSEMBLY LH (DOOR KEY CYLINDER SWITCH)

Check front door lock assembly LH (door key cylinder switch).

Refer to [PWC-56, "Component Function Check"](#).

Is the inspection result normal?

YES >> GO TO 3.

NO >> Repair or replace the malfunctioning parts.

3.CONFIRM THE OPERATION

Confirm the operation again.

Is the inspection result normal?

YES >> Check intermittent incident. Refer to [GI-53, "Intermittent Incident"](#).

NO >> GO TO 1.

A
B
C
D
E
F
G
H
I
J
L
M
N
O
P

PWC

KEYLESS POWER WINDOW DOWN DOES NOT OPERATE

< SYMPTOM DIAGNOSIS >

KEYLESS POWER WINDOW DOWN DOES NOT OPERATE

Diagnosis Procedure

INFOID:000000009133493

1.CHECK REMOTE KEYLESS ENTRY FUNCTION

Check remote keyless entry function.

Is the inspection result normal?

YES >> GO TO 2.

NO >> Refer to [DLK-232, "Diagnosis Procedure"](#).

2.CHECK POWER WINDOW OPERATION

Check power window operation.

In the inspection result normal?

YES >> GO TO 3.

NO >> Refer to [PWC-37, "POWER WINDOW MAIN SWITCH : Diagnosis Procedure"](#).

3.CONFIRM THE OPERATION

Confirm the operation again.

Is the inspection result normal?

YES >> Check intermittent incident. Refer to [GI-53, "Intermittent Incident"](#).

NO >> GO TO 1.

POWER WINDOW LOCK SWITCH DOES NOT FUNCTION

< SYMPTOM DIAGNOSIS >

POWER WINDOW LOCK SWITCH DOES NOT FUNCTION

Diagnosis Procedure

INFOID:000000009133494

1. REPLACE POWER WINDOW MAIN SWITCH

Replace power window main switch. Refer to [PWC-77, "Removal and Installation"](#).

>> Inspection End.

A
B
C
D
E
F
G
H
I
J
L
M
N
O
P

PWC

POWER WINDOW SWITCH DOES NOT ILLUMINATE

< SYMPTOM DIAGNOSIS >

POWER WINDOW SWITCH DOES NOT ILLUMINATE

DRIVER SIDE

DRIVER SIDE : Diagnosis Procedure

INFOID:000000009133495

1.REPLACE POWER WINDOW MAIN SWITCH

Replace power window main switch.

Refer to [PWC-77. "Removal and Installation"](#).

>> Inspection End.

PASSENGER SIDE

PASSENGER SIDE : Diagnosis Procedure

INFOID:000000009133496

1.REPLACE POWER WINDOW AND DOOR LOCK/UNLOCK SWITCH RH

Replace power window and door lock/unlock switch RH.

Refer to [PWC-78. "Removal and Installation"](#).

>> Inspection End.

REAR LH

REAR LH : Diagnosis Procedure

INFOID:000000009133497

1.REPLACE REAR POWER WINDOW SWITCH LH

Replace rear power window switch LH.

Refer to [PWC-79. "Removal and Installation"](#).

>> Inspection End.

REAR RH

REAR RH : Diagnosis Procedure

INFOID:000000009133498

1.REPLACE REAR POWER WINDOW SWITCH RH

Replace rear power window switch RH.

Refer to [PWC-79. "Removal and Installation"](#).

>> Inspection End.

MAIN POWER WINDOW AND DOOR LOCK/UNLOCK SWITCH

< REMOVAL AND INSTALLATION >

REMOVAL AND INSTALLATION

MAIN POWER WINDOW AND DOOR LOCK/UNLOCK SWITCH

Removal and Installation

INFOID:000000009133499

REMOVAL

1. Remove the front door finisher. Refer to [INT-15. "Removal and Installation"](#).
2. Disconnect the harness connectors (A) from the main power window and door lock/unlock switch (1).
3. Remove two screws (B) and remove main power window and door lock/unlock switch (1) and finisher as an assembly.

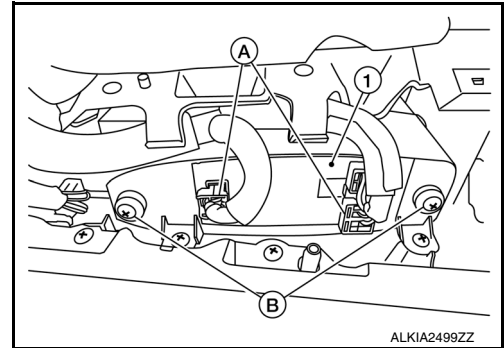

4. Release pawls then separate main power window and door lock/unlock switch from switch finisher.

INSTALLATION

Installation is in the reverse order of removal.

NOTE:

When main power window and door lock/unlock switch is removed or replaced, it is necessary to perform the initialization procedure. Refer to [PWC-35. "Work Procedure"](#).

A
B
C
D
E
F
G
H
I
J
L
M
N
O
P

PWC

POWER WINDOW AND DOOR LOCK/UNLOCK SWITCH RH

< REMOVAL AND INSTALLATION >

POWER WINDOW AND DOOR LOCK/UNLOCK SWITCH RH

Removal and Installation

INFOID:000000009133500

REMOVAL

1. Remove front door finisher. Refer to [INT-15, "Removal and Installation"](#).
2. Disconnect the harness connector from the power window and door lock/unlock switch (RH) (1).
3. Remove two screws (A) and the power window and door lock/unlock switch RH (1) and finisher as an assembly.

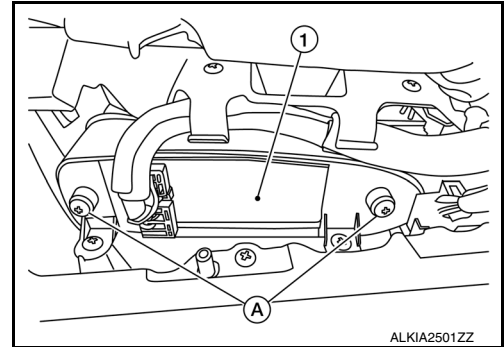

4. Release four pawls then separate power window and door lock/unlock switch (RH) (1) from switch finisher (2).

○: Pawl

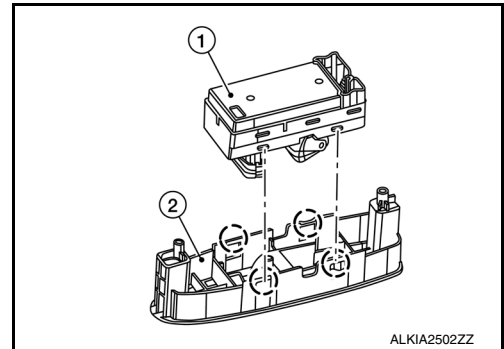

INSTALLATION

Installation is in the reverse order of removal.

NOTE:

When power window and door lock/unlock switch (RH) is removed or replaced, it is necessary to perform the initialization procedure. Refer to [PWC-35, "Work Procedure"](#).

REAR POWER WINDOW SWITCH

< REMOVAL AND INSTALLATION >

REAR POWER WINDOW SWITCH

Removal and Installation

INFOID:000000009133501

REMOVAL

1. Remove the rear door finisher. Refer to [INT-17. "Removal and Installation"](#).
2. Remove screws and the rear door armrest.
3. Disconnect the harness connector from the rear power window switch (1).
4. Remove two screws (A) and the rear power window switch (1) and finisher (2) as an assembly.

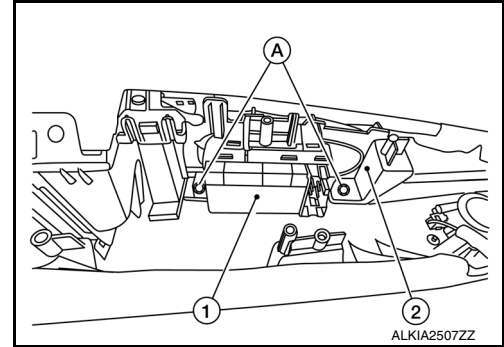

5. Release four pawls then separate rear power window switch (1) from switch finisher.

○: Pawl

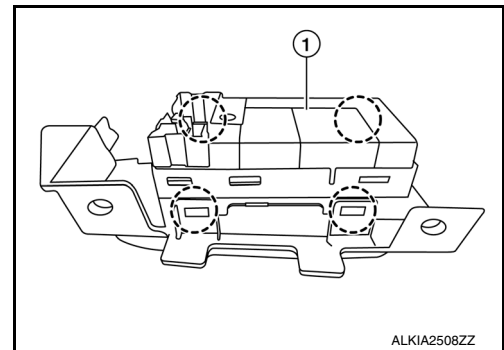

INSTALLATION

Installation is in the reverse order of removal.

NOTE:

When rear power window switch (LH/RH) is removed or replaced, it is necessary to perform the initialization procedure. Refer to [PWC-35. "Work Procedure"](#).

A
B
C
D
E
F
G
H
I
J
L
M
N
O
P

PWC