

SECTION **GI**
GENERAL INFORMATION

B
C

CONTENTS

| | | | | |
|--|-----------|--|-----------|---|
| HOW TO USE THIS MANUAL | 3 | PRECAUTION | 28 | F |
| HOW TO USE THIS MANUAL | 3 | PRECAUTIONS | 28 | G |
| Description | 3 | Description | 28 | |
| Terms | 3 | Precaution for Supplemental Restraint System (SRS) "AIR BAG" and "SEAT BELT PRE-TENSIONER" | 28 | H |
| Units | 3 | Precautions For Xenon Headlamp Service | 28 | I |
| Contents | 3 | Precaution for Procedure without Cowl Top Cover...29 | 29 | J |
| Relation between Illustrations and Descriptions | 4 | Cautions in Removing Battery Terminal and AV Control Unit (Models with AV Control Unit) | 29 | K |
| Components | 4 | Precautions for Removing of Battery Terminal | 29 | L |
| HOW TO FOLLOW TROUBLE DIAGNOSES | 6 | General Precautions | 29 | |
| Description | 6 | Three Way Catalyst | 31 | |
| How to Follow Test Groups in Trouble Diagnosis..... | 6 | Multipoint Fuel Injection System or Engine Control System | 31 | |
| Key to Symbols Signifying Measurements or Procedures | 7 | Hoses | 31 | |
| HOW TO READ WIRING DIAGRAMS | 9 | Engine Oils | 32 | |
| Connector Symbols | 9 | Air Conditioning | 33 | |
| Sample/Wiring Diagram -Example- | 10 | Fuel | 33 | |
| Connector Information | 12 | LIFTING POINT | 34 | |
| ABBREVIATIONS | 14 | Pantograph Jack | 34 | |
| Abbreviation List | 14 | Garage Jack and Safety Stand | 34 | |
| TIGHTENING TORQUE OF STANDARD BOLTS | 19 | 2-Pole Lift | 35 | M |
| Description | 19 | TOW TRUCK TOWING | 36 | |
| Tightening Torque Table (New Standard Included) | 19 | Tow Truck Towing | 36 | N |
| RECOMMENDED CHEMICAL PRODUCTS AND SEALANTS | 22 | Vehicle Recovery (Freeing a Stuck Vehicle) | 37 | |
| Recommended Chemical Products and Sealants...22 | 22 | BASIC INSPECTION | 39 | O |
| VEHICLE INFORMATION | 23 | SERVICE INFORMATION FOR ELECTRICAL INCIDENT | 39 | P |
| IDENTIFICATION INFORMATION | 23 | Work Flow | 39 | |
| Model Variation | 23 | Control Units and Electrical Parts | 39 | |
| Information About Identification or Model Code | 23 | How to Check Terminal | 40 | |
| Dimensions | 27 | Intermittent Incident | 43 | |
| Wheels & Tires | 27 | Circuit Inspection | 46 | |
| | | CONSULT/GST CHECKING SYSTEM | 51 | |
| | | Description | 51 | |

| | | | |
|--|-----------|---|-----------|
| CONSULT Function and System Application*1 | 51 | ADDITIONAL SERVICE WHEN REMOVING BATTERY NEGATIVE TERMINAL | 68 |
| CONSULT/GST Data Link Connector (DLC) Circuit | 52 | ADDITIONAL SERVICE WHEN REMOVING BATTERY NEGATIVE TERMINAL : Required | |
| Wiring Diagram - CONSULT/GST CHECKING SYSTEM - | 53 | Procedure After Battery Disconnection | 68 |
| INSPECTION AND ADJUSTMENT | 68 | | |

HOW TO USE THIS MANUAL

< HOW TO USE THIS MANUAL >

HOW TO USE THIS MANUAL

HOW TO USE THIS MANUAL

GI

Description

INFOID:000000009011013

This volume explains “Removal, Disassembly, Installation, Inspection and Adjustment” and “Trouble Diagnoses”.

Terms

INFOID:000000009011014

- The captions **WARNING** and **CAUTION** warn you of steps that must be followed to prevent personal injury and/or damage to some part of the vehicle.

WARNING indicates the possibility of personal injury if instructions are not followed.

CAUTION indicates the possibility of component damage if instructions are not followed.

BOLD TYPED STATEMENTS except **WARNING** and **CAUTION** give you helpful information.

Standard value: Tolerance at inspection and adjustment.

Limit value: The maximum or minimum limit value that should not be exceeded at inspection and adjustment.

Units

INFOID:000000009011015

- The **UNITS** given in this manual are primarily expressed as the SI UNIT (International System of Unit), and alternatively expressed in the metric system and in the yard/pound system. Also with regard to tightening torque of bolts and nuts, there are descriptions both about range and about the standard tightening torque.

“Example”

Range

Outer Socket Lock Nut : 59 - 78 N-m (6.0 - 8.0 kg-m, 43 - 58 ft-lb)

Standard

Drive Shaft Installation Bolt : 44.3 N-m (4.5 kg-m, 33 ft-lb)

Contents

INFOID:000000009011016

- A **QUICK REFERENCE INDEX**, a black tab (e.g. **BR**) is provided on the first page. You can quickly find the first page of each section by matching it to the section's black tab.
- **THE CONTENTS** are listed on the first page of each section.
- **THE TITLE** is indicated on the upper portion of each page and shows the part or system.
- **THE PAGE NUMBER** of each section consists of two or three letters which designate the particular section and a number (e.g. “BR-5”).
- **THE SMALL ILLUSTRATIONS** show the important steps such as inspection, use of special tools, knacks of work and hidden or tricky steps which are not shown in the previous large illustrations. Assembly, inspection and adjustment procedures for the complicated units such as the automatic transaxle or transmission, etc. are presented in a step-by-step format where necessary.

HOW TO USE THIS MANUAL

< HOW TO USE THIS MANUAL >

Relation between Illustrations and Descriptions

INFOID:000000009011017

The following sample explains the relationship between the part description in an illustration, the part name in the text and the service procedures.

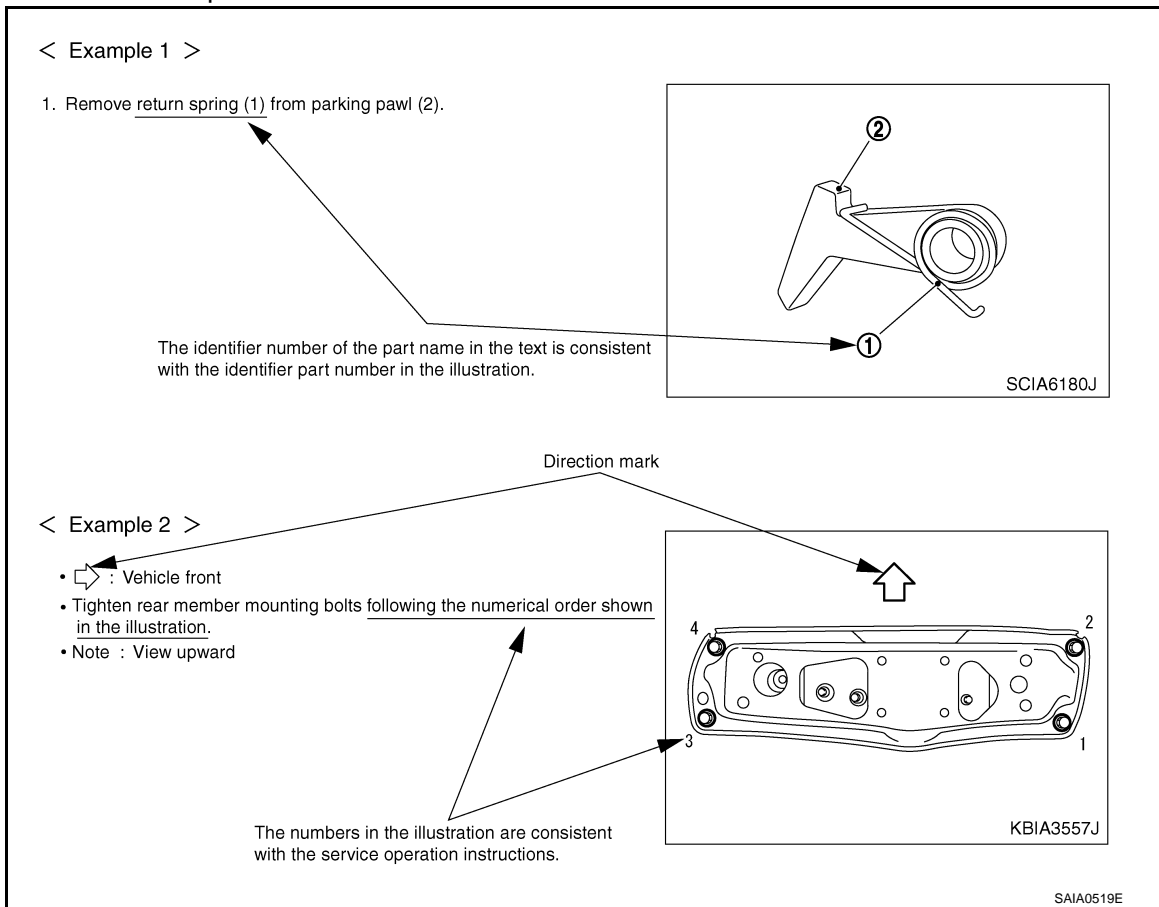

Components

INFOID:000000009011018

- **THE LARGE ILLUSTRATIONS** are exploded views (see the following) and contain tightening torques, lubrication points, section number of the **PARTS CATALOG** (e.g. SEC. 440) and other information necessary to perform repairs.

The illustrations should be used in reference to service matters only. When ordering parts, refer to the appropriate **PARTS CATALOG**.

Components shown in an illustration may be identified by a circled number. When this style of illustration is used, the text description of the components will follow the illustration.

HOW TO USE THIS MANUAL

< HOW TO USE THIS MANUAL >

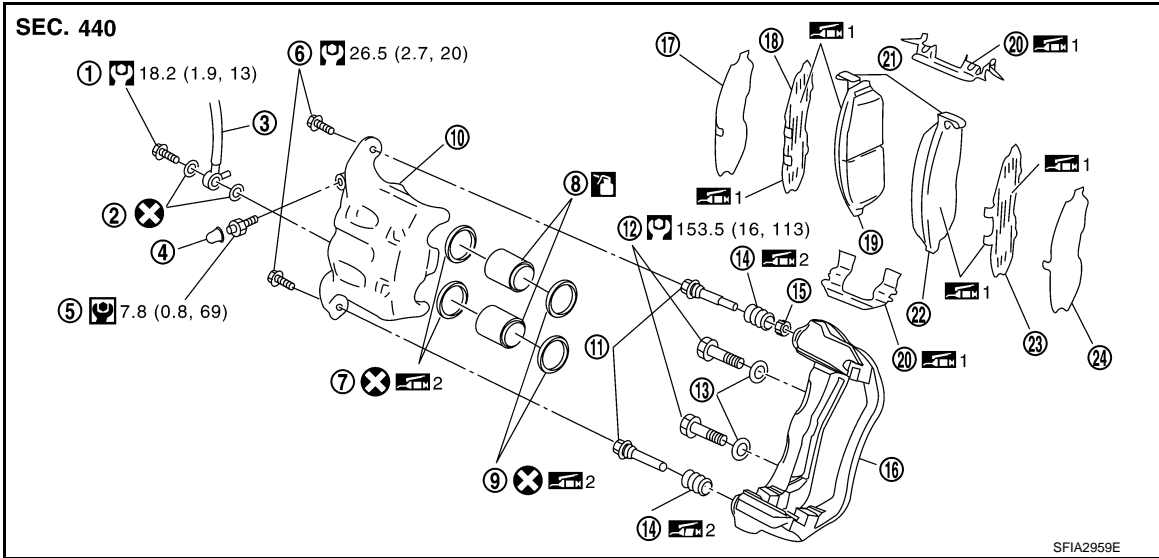

- | | | |
|-------------------|----------------------|---------------------------------|
| 1. Union bolt | 2. Copper washer | 3. Brake hose |
| 4. Cap | 5. Bleed valve | 6. Sliding pin bolt |
| 7. Piston seal | 8. Piston | 9. Piston boot |
| 10. Cylinder body | 11. Sliding pin | 12. Torque member mounting bolt |
| 13. Washer | 14. Sliding pin boot | 15. Bushing |
| 16. Torque member | 17. Inner shim cover | 18. Inner shim |
| 19. Inner pad | 20. Pad retainer | 21. Pad wear sensor |
| 22. Outer pad | 23. Outer shim | 24. Outer shim cover |
- 1: PBC (Poly Butyl Cuprysil) grease 2: Rubber grease or silicone-based grease : Brake fluid

Refer to GI section for additional symbol definitions.

SYMBOLS

| SYMBOL | DESCRIPTION | SYMBOL | DESCRIPTION |
|--------|---|---------------------|---|
| | Tightening torque The tightening torque specifications of bolts and nuts may be presented as either a range or a standard tightening torque. | : N•m (kg-m, ft-lb) | |
| | | : N•m (kg-m, in-lb) | |
| | Should be lubricated with grease. Unless otherwise indicated, use recommended multi-purpose grease. | | Apply molybdenum added petroleum jelly. |
| | Should be lubricated with oil. | | Apply ATF. |
| | Sealing point | | Select with proper thickness. |
| | Sealing point with locking sealant. | | Adjustment is required. |
| | Checking point | | |

SAIA0749E

HOW TO FOLLOW TROUBLE DIAGNOSES

< HOW TO USE THIS MANUAL >

HOW TO FOLLOW TROUBLE DIAGNOSES

Description

INFOID:000000009011019

NOTICE:

Trouble diagnoses indicate work procedures required to diagnose problems effectively. Observe the following instructions before diagnosing.

- Before performing trouble diagnoses, read the “Work Flow” in each section.
- After repairs, re-check that the problem has been completely eliminated.
- Refer to Component Parts and Harness Connector Location for the Systems described in each section for identification/location of components and harness connectors.
- When checking circuit continuity, ignition switch should be OFF.
- Refer to the Circuit Diagram for quick pinpoint check.

If you need to check circuit continuity between harness connectors in more detail, such as when a sub-harness is used, refer to Wiring Diagram in each individual section and Harness Layout in PG section for identification of harness connectors.

- Before checking voltage at connectors, check battery voltage.
- After accomplishing the Diagnosis Procedures and Electrical Components Inspection, check that all harness connectors are reconnected as they were.

How to Follow Test Groups in Trouble Diagnosis

INFOID:000000009011020

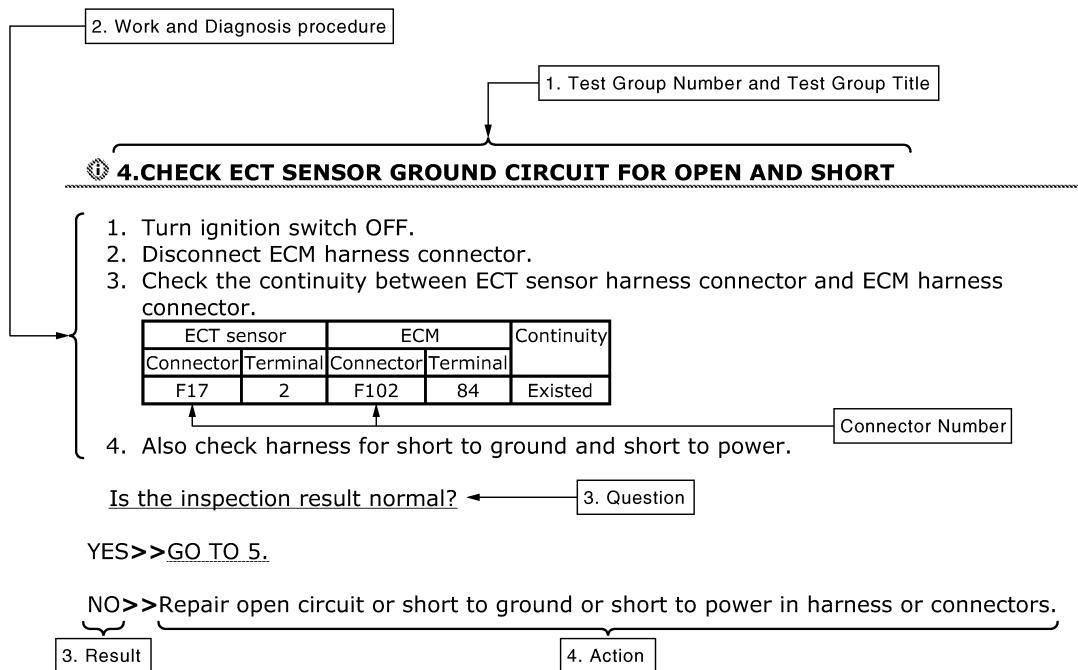

JPAIA0021GB

















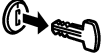

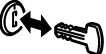

1. Test group number and test group title
 - Test group number and test group title are shown in the upper portion of each test group.
2. Work and diagnosis procedure
 - Start to diagnose a problem using procedures indicated in enclosed test groups.
3. Questions and results
 - Questions and required results are indicated in test group.
4. Action
 - Next action for each test group is indicated based on result of each question.

HOW TO FOLLOW TROUBLE DIAGNOSES

< HOW TO USE THIS MANUAL >

Key to Symbols Signifying Measurements or Procedures

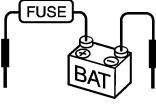
INFOID:000000009011021

| SYMBOL | DESCRIPTION | SYMBOL | DESCRIPTION |
|---|---|---|---|
|  | Check after disconnecting the connector to be measured. |  | Procedure with Generic Scan Tool. (GST, OBD-II scan tool) |
|  | Check after connecting the connector to be measured. |  | Procedure without CONSULT or GST |
|  | Insert key into ignition switch. |  | A/C switch is "OFF". |
|  | Remove key from ignition switch. |  | A/C switch is "ON". |
|  | Insert and remove key repeatedly. |  | REC switch is "ON". |
|  | Turn ignition switch to "OFF" position. |  | REC switch is "OFF". |
|  | Turn ignition switch to "ACC" position. |  | Fan switch is "ON". (At any position except for "OFF" position) |
|  | Turn ignition switch to "ON" position. |  | Fan switch is "OFF". |
|  | Turn ignition switch to "START" position. |  | Apply fuse. |
|  | Turn ignition switch from "OFF" to "ACC" position. |  | Apply positive voltage from battery with fuse directly to components. |
|  | Turn ignition switch from "ACC" to "ON" position. | | |
|  | Turn ignition switch from "ACC" to "OFF" position. | | |

JPAIA0982GB

GI

B

C

D

E

F

G

H

I

J

K

L

M

N

O

P

HOW TO FOLLOW TROUBLE DIAGNOSES

< HOW TO USE THIS MANUAL >

| SYMBOL | DESCRIPTION | SYMBOL | DESCRIPTION |
|--------|---|---|------------------------------------|
| | Turn ignition switch from "OFF" to "ON" position. | | Drive vehicle. |
| | Turn ignition switch from "ON" to "OFF" position. | | |
| | Do not start engine, or check with engine stopped. | | Disconnect battery negative cable. |
| | Start engine, or check with engine running. | | Depress brake pedal. |
| | Apply parking brake. | | Release brake pedal. |
| | Release parking brake. | | Depress accelerator pedal. |
| | Release accelerator pedal. | | Release accelerator pedal. |
| | Check after engine is warmed up sufficiently. | <p>Pin terminal check for SMJ type ECM or TCM connectors. For details regarding the terminal arrangement, refer to the "ELECTRICAL UNITS" electrical reference page at the end of the manual.</p> | |
| | Voltage should be measured with a voltmeter. | | |
| | Circuit resistance should be measured with an ohmmeter. | | |
| | Current should be measured with an ammeter. | | |
| | Pulse signal should be checked with an oscilloscope. | | |
| | Procedure with CONSULT | | |
| | Procedure without CONSULT | | |
| | Place selector lever in "P" position. | | |
| | Place selector lever in "N" position. | | |
| | Jack up front portion. | | |
| | Jack up rear portion. | | |
| | Inspect under engine room. | | |
| | Inspect under floor. | | |
| | Inspect rear under floor. | | |

JSAIA1461GB

HOW TO READ WIRING DIAGRAMS

< HOW TO USE THIS MANUAL >

HOW TO READ WIRING DIAGRAMS

GI

Connector Symbols

INFOID:000000009864120

Most of connector symbols in wiring diagrams are shown from the terminal side.

- Connector symbols shown from the terminal side are enclosed by a single line and followed by the direction mark.
- Connector symbols shown from the harness side are enclosed by a double line and followed by the direction mark.
- Certain systems and components, especially those related to OBD, may use a new style slide-locking type harness connector. For description and how to disconnect, refer to PG section, "Description", "HARNESS CONNECTOR".

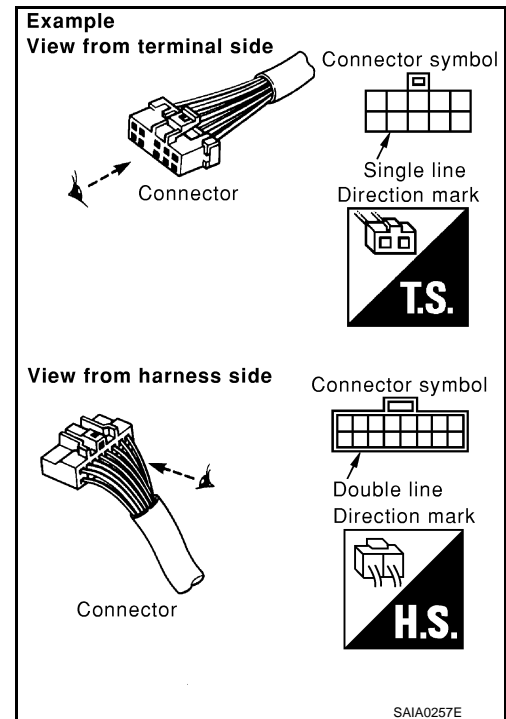

- Male and female terminals
Connector guides for male terminals are shown in black and female terminals in white in wiring diagrams.

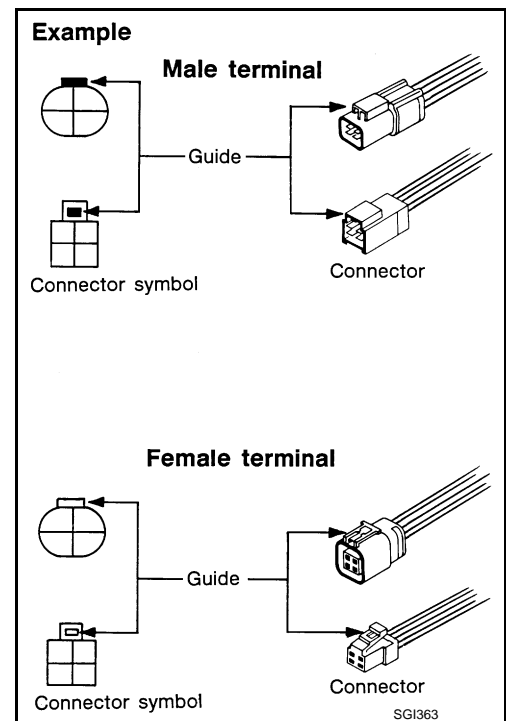

B
C
D
E
F
G
H
I
J
K
L
M
N
O
P

HOW TO READ WIRING DIAGRAMS

< HOW TO USE THIS MANUAL >

Sample/Wiring Diagram -Example-

INFOID:00000009864121

Each section includes wiring diagrams.

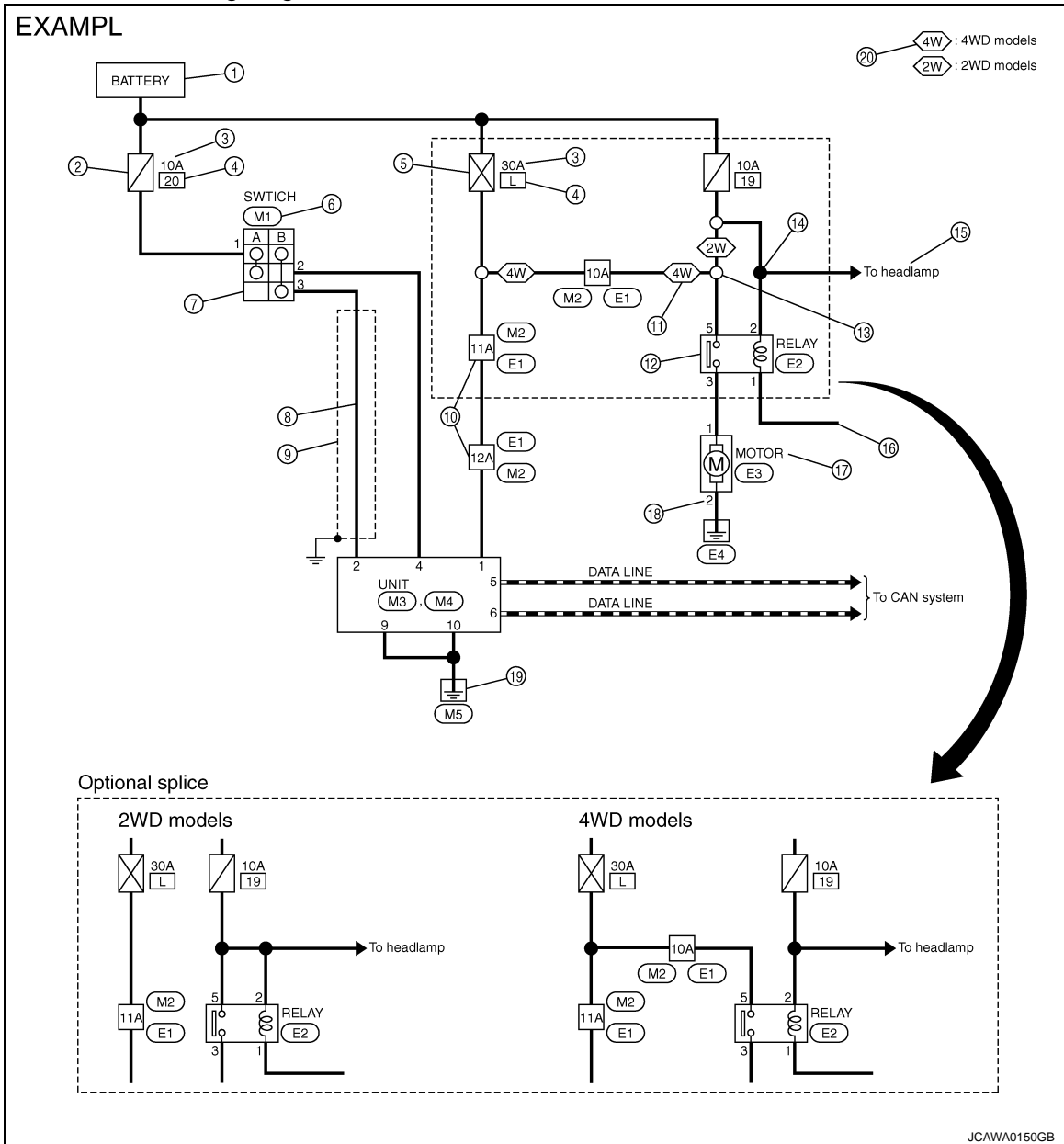

Description

| Number | Item | Description |
|--------|-------------------------------------|---|
| 1 | Power supply | • This means the power supply of fusible link or fuse. |
| 2 | Fuse | • “/” means the fuse. |
| 3 | Current rating of fusible link/fuse | • This means the current rating of the fusible link or fuse. |
| 4 | Number of fusible link/fuse | • This means the number of fusible link or fuse location. |
| 5 | Fusible link | • “X” means the fusible link. |
| 6 | Connector number | • Alphabetic characters show to which harness the connector is placed. • Numeric characters show the identification number of connectors. |
| 7 | Switch | • This shows that continuity exists between terminals 1 and 2 when the switch is in the A position. Continuity exists between terminals 1 and 3 when the switch is in the B position. |
| 8 | Circuit (Wiring) | • This means the wiring. |

HOW TO READ WIRING DIAGRAMS

< HOW TO USE THIS MANUAL >

| Number | Item | Description |
|--------|-----------------------------------|---|
| 9 | Shielded line | • The line enclosed by broken line circle shows shield wire. |
| 10 | Connectors | • This means that a transmission line bypasses two connectors or more. |
| 11 | Option abbreviation | • This means the vehicle specifications which layouts the circuit between “O”. |
| 12 | Relay | • This shows an internal representation of the relay. |
| 13 | Optional splice | • The open circle shows that the splice is optional depending on vehicle application. |
| 14 | Splice | • The shaded circle “●” means the splice. |
| 15 | System branch | • This shows that the circuit is branched to other systems. |
| 16 | Page crossing | • This circuit continues to an adjacent page. |
| 17 | Component name | • This shows the name of a component. |
| 18 | Terminal number | • This means the terminal number of a connector. |
| 19 | Ground (GND) | • This shows the ground connection. |
| 20 | Explanation of option description | • This shows a description of the option abbreviation used on the page. |

SWITCH POSITIONS

Switches are shown in wiring diagrams as if the vehicle is in the “normal” condition.

A vehicle is in the “normal” condition when:

- ignition switch is “OFF”
- doors, hood and trunk lid/back door are closed
- pedals are not depressed
- parking brake is released

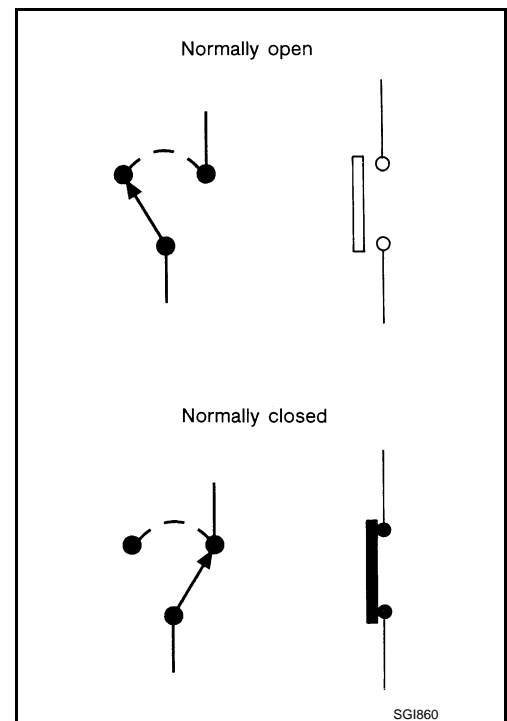

MULTIPLE SWITCH

The continuity of multiple switch is described in two ways as shown below.

- The switch chart is used in schematic diagrams.

HOW TO READ WIRING DIAGRAMS

< HOW TO USE THIS MANUAL >

- The switch diagram is used in wiring diagrams.

Example

(SWITCH CHART)

| WIPER SWITCH | | OFF | INT | LO | HI | WASH |
|--------------|---|-----|-----|----|----|------|
| 1 | | | | | | ○ |
| 2 | | | | | ○ | |
| 3 | ○ | ○ | ○ | | | |
| 4 | ○ | ○ | ○ | ○ | | |
| 5 | | ○ | | | | |
| 6 | | ○ | ○ | ○ | ○ | |

(SWITCH DIAGRAM)

Both switches are turned in combination.

Continuity circuit of wiper switch

| SWITCH POSITION | CONTINUITY CIRCUIT |
|-----------------|--------------------|
| OFF | 3-4 |
| INT | 3-4, 5-6 |
| LO | 3-6 |
| HI | 2-6 |
| WASH | 1-6 |

JSAIA0017GB

Connector Information

INFOID:000000009864122

HOW TO USE CONNECTOR INFORMATION

①

| | |
|----------------|-----------|
| Connector No. | M3 |
| Connector Name | UNIT |
| Connector Type | NS06FW-M2 |

②

| | |
|----------------|-----------|
| Connector No. | M4 |
| Connector Name | UNIT |
| Connector Type | NS10FW-CS |

H.S.

③

| Terminal No. | Color of Wire | Signal Name [Specification] |
|--------------|---------------|-----------------------------|
| 1 | W | BAT |
| 2 | G | SWITCH B |
| 4 | V | SWITCH A |
| 5 | L | CAN-H |
| 6 | P | CAN-L |

④

| Terminal No. | Color of Wire | Signal Name [Specification] |
|--------------|---------------|-----------------------------|
| 9 | B | GND |
| 10 | B | GND |

JCAWA0152GB

HOW TO READ WIRING DIAGRAMS

< HOW TO USE THIS MANUAL >

| Description | | | | |
|---|---|--|---|---|
| Number | Item | Description | | |
| 1 | Connector number | <ul style="list-style-type: none"> Alphabetic characters show to which harness the connector is placed. Numeric characters show the identification number of connectors. | | |
| 2 | Connector type | <p>1: Connector model 2: Cavity 3: Male (M) and female (F) terminals 4: Connector color 5: Special type</p> <div style="border: 1px solid black; padding: 5px; margin: 10px 0;"> <p>Example:</p> <p style="text-align: right; font-size: small;">JPMIA0113GB</p> </div> | | |
| 3 | Terminal number | <ul style="list-style-type: none"> This means the terminal number of a connector. | | |
| 4 | Wire color | <ul style="list-style-type: none"> This shows a code for the color of the wire. <table style="width: 100%; border: none;"> <tr> <td style="width: 50%; border: none;"> B = Black W = White R = Red G = Green L = Blue Y = Yellow LG = Light Green BG or BE = Beige LA = Lavender </td> <td style="width: 50%; border: none;"> BR = Brown OR or O = Orange P = Pink PU or V (Violet) = Purple GY or GR = Gray SB = Sky Blue CH = Dark Brown DG = Dark Green </td> </tr> </table> <ul style="list-style-type: none"> When the wire color is striped, the base color is given first, followed by the stripe color as shown below: Example: L/W = Blue with White Stripe | B = Black W = White R = Red G = Green L = Blue Y = Yellow LG = Light Green BG or BE = Beige LA = Lavender | BR = Brown OR or O = Orange P = Pink PU or V (Violet) = Purple GY or GR = Gray SB = Sky Blue CH = Dark Brown DG = Dark Green |
| B = Black W = White R = Red G = Green L = Blue Y = Yellow LG = Light Green BG or BE = Beige LA = Lavender | BR = Brown OR or O = Orange P = Pink PU or V (Violet) = Purple GY or GR = Gray SB = Sky Blue CH = Dark Brown DG = Dark Green | | | |
| 5 | Connector | <ul style="list-style-type: none"> This means the connector information. This unit-side is described by the connector symbols. | | |

GI

B

C

D

E

F

G

H

I

J

K

L

M

N

O

P

ABBREVIATIONS

< HOW TO USE THIS MANUAL >

ABBREVIATIONS

Abbreviation List

INFOID:000000009011025

The following **ABBREVIATIONS** are used:

A

| ABBREVIATION | DESCRIPTION |
|--------------|----------------------------------|
| A/C | Air conditioner |
| A/C | Air conditioning |
| A/F sensor | Air fuel ratio sensor |
| A/T | Automatic transaxle/transmission |
| ABS | Anti-lock braking system |
| ACCS | Advance climate control system |
| ACL | Air cleaner |
| AP | Accelerator pedal |
| APP | Accelerator pedal position |
| ATF | Automatic transmission fluid |
| AV | Audio visual |
| AWD | All wheel drive |

B

| ABBREVIATION | DESCRIPTION |
|--------------|---------------------------------|
| BARO | Barometric pressure |
| BCI | Back-up collision intervention |
| BCM | Body control module |
| BLSD | Brake limited slip differential |
| BPP | Brake pedal position |
| BSW | Blind spot warning |

C

| ABBREVIATION | DESCRIPTION |
|--------------|--|
| CKP | Crankshaft position |
| CL | Closed loop |
| CMP | Camshaft position |
| CPP | Clutch pedal position |
| CTP | Closed throttle position |
| CVT | Continuously variable transaxle/transmission |

D

| ABBREVIATION | DESCRIPTION |
|--------------|------------------------------|
| D1 | Drive range first gear |
| D2 | Drive range second gear |
| D3 | Drive range third gear |
| D4 | Drive range fourth gear |
| DCA | Distance control assist |
| DDS | Downhill drive support |
| DFI | Direct fuel injection system |
| DLC | Data link connector |
| DTC | Diagnostic trouble code |

ABBREVIATIONS

< HOW TO USE THIS MANUAL >

| E | | |
|---------------|---|----|
| ABBREVIATION | DESCRIPTION | |
| E/T | Exhaust temperature | GI |
| EBD | Electric brake force distribution | |
| EC | Engine control | B |
| ECL | Engine coolant level | |
| ECM | Engine control module | C |
| ECT | Engine coolant temperature | |
| ECV | Electrical control valve | |
| EEPROM | Electrically erasable programmable read only memory | D |
| EFT | Engine fuel temperature | |
| EGR | Exhaust gas recirculation | E |
| EGRT | Exhaust gas recirculation temperature | |
| EGT | Exhaust gas temperature | |
| EOP | Engine oil pressure | F |
| EP | Exhaust pressure | |
| EPR | Exhaust pressure regulator | G |
| EPS | Electronically controlled power steering | |
| ESP | Electronic stability program system | H |
| EVAP canister | Evaporative emission canister | |
| EVSE | Electric vehicle supply equipment | |
| EXC | Exhaust control | I |

| F | | |
|--------------|---------------------------|---|
| ABBREVIATION | DESCRIPTION | |
| FC | Fan control | J |
| FCW | Forward collision warning | |
| FEB | Forward emergency braking | |
| FIC | Fuel injector control | K |
| FP | Fuel pump | |
| FR | Front | L |
| FRP | Fuel rail pressure | |
| FRT | Fuel rail temperature | |
| FTP | Fuel tank pressure | M |
| FTT | Fuel tank temperature | |

| G | | |
|--------------|---------------------------|---|
| ABBREVIATION | DESCRIPTION | |
| GND | Ground | N |
| GPS | Global positioning system | O |
| GST | Generic scan tool | |

| H | | |
|--------------|--------------------------------------|---|
| ABBREVIATION | DESCRIPTION | |
| HBMC | Hydraulic body-motion control system | P |
| HDD | Hard disk drive | |
| HO2S | Heated oxygen sensor | |
| HOC | Heated oxidation catalyst | |
| HPCM | Hybrid power train control module | |

ABBREVIATIONS

< HOW TO USE THIS MANUAL >

| I | |
|--------------|---|
| ABBREVIATION | DESCRIPTION |
| I/M | Inspection and maintenance |
| IA | Intake air |
| IAC | Idle air control |
| IAT | Intake air temperature |
| IBA | Intelligent brake assist |
| IC | Ignition control |
| ICC | Intelligent cruise control |
| ICM | Ignition control module |
| IPDM E/R | Intelligent power distribution module engine room |
| ISC | Idle speed control |
| ISS | Input shaft speed |

| K | |
|--------------|--------------|
| ABBREVIATION | DESCRIPTION |
| KS | Knock sensor |

| L | |
|--------------|----------------------------|
| ABBREVIATION | DESCRIPTION |
| LBC | Li-ion battery controller |
| LCD | Liquid crystal display |
| LCU | Local control unit |
| LDP | Lane departure prevention |
| LDW | Lane departure warning |
| LED | Light emitting diode |
| LH | Left-hand |
| LIN | Local interconnect network |

| M | |
|--------------|-------------------------------|
| ABBREVIATION | DESCRIPTION |
| M/T | Manual transaxle/transmission |
| MAF | Mass airflow |
| MAP | Manifold absolute pressure |
| MDU | Multi display unit |
| MI | Malfunction indicator |
| MIL | Malfunction indicator lamp |

| N | |
|--------------|-----------------|
| ABBREVIATION | DESCRIPTION |
| NOX | Nitrogen oxides |

| O | |
|--------------|-------------------------------|
| ABBREVIATION | DESCRIPTION |
| O2 | Oxygen |
| O2S | Oxygen sensor |
| OBD | On board diagnostic |
| OC | Oxidation catalytic converter |
| OD | Overdrive |
| OL | Open loop |
| OSS | Output shaft speed |

ABBREVIATIONS

< HOW TO USE THIS MANUAL >

| P | | |
|--------------|---------------------------------------|----|
| ABBREVIATION | DESCRIPTION | |
| P/S | Power steering | GI |
| PBR | Potential balance resistor | |
| PCV | Positive crankcase ventilation | B |
| PFCW | Predictive forward collision warning | |
| PNP | Park/Neutral position | C |
| PSP | Power steering pressure | |
| PTC | Positive temperature coefficient | |
| PTO | Power takeoff | D |
| PWM | Pulse width modulation | |
| R | | |
| ABBREVIATION | DESCRIPTION | |
| RAM | Random access memory | E |
| RAS | Rear active steer | F |
| RH | Right-hand | |
| ROM | Read only memory | G |
| RPM | Engine speed | |
| RR | Rear | |
| S | | |
| ABBREVIATION | DESCRIPTION | |
| SAE | Society of Automotive Engineers, Inc. | H |
| SCK | Serial clock | I |
| SDS | Service Data and Specifications | |
| SRT | System readiness test | J |
| SST | Special Service Tools | |
| T | | |
| ABBREVIATION | DESCRIPTION | |
| TC | Turbocharger | K |
| TCM | Transmission control module | |
| TCS | Traction control system | L |
| TCU | Telematics communication unit | |
| TP | Throttle position | M |
| TPMS | Tire pressure monitoring system | |
| TSS | Turbine shaft speed | |
| TWC | Three way catalytic converter | N |
| U | | |
| ABBREVIATION | DESCRIPTION | |
| USS | Uphill start support | O |
| V | | |
| ABBREVIATION | DESCRIPTION | |
| VCM | Vehicle control module | P |
| VDC | Vehicle dynamics control system | |
| VIN | Vehicle identification number | |
| VSS | Vehicle speed sensor | |

ABBREVIATIONS

< HOW TO USE THIS MANUAL >

W

| ABBREVIATION | DESCRIPTION |
|--------------|--------------------|
| WOT | Wide open throttle |

1

| ABBREVIATION | DESCRIPTION |
|--------------|-----------------------|
| 11 | 1st range first gear |
| 12 | 1st range second gear |
| 1GR | First gear |

2

| ABBREVIATION | DESCRIPTION |
|--------------|-----------------------|
| 21 | 2nd range first gear |
| 22 | 2nd range second gear |
| 2GR | Second gear |
| 2WD | 2-wheel drive |

3

| ABBREVIATION | DESCRIPTION |
|--------------|-------------|
| 3GR | Third gear |

4

| ABBREVIATION | DESCRIPTION |
|--------------|-------------------------|
| 4GR | Fourth gear |
| 4WAS | Four wheel active steer |
| 4WD | Four wheel drive |

5

| ABBREVIATION | DESCRIPTION |
|--------------|-------------|
| 5GR | Fifth gear |

6

| ABBREVIATION | DESCRIPTION |
|--------------|-------------|
| 6GR | Sixth gear |

7

| ABBREVIATION | DESCRIPTION |
|--------------|--------------|
| 7GR | Seventh gear |

TIGHTENING TORQUE OF STANDARD BOLTS

< HOW TO USE THIS MANUAL >

TIGHTENING TORQUE OF STANDARD BOLTS

GI

Description

INFOID:000000009011026

This vehicle has both new standard based on ISO* and previous standard bolts/nuts. There are some differences between these two types of bolts/ nuts; shape of the head, grade of strength, hexagonal width across flats and the standard tightening torque.

- For guidance in discriminating, refer to [GI-19, "Tightening Torque Table \(New Standard Included\)"](#).
- The new standard machine screws and tapping screws have a head of ISO standard torx recess.
- If the tightening torque is not described in the description or figure, refer to [GI-19, "Tightening Torque Table \(New Standard Included\)"](#).

*ISO: International Organization for Standardization

Tightening Torque Table (New Standard Included)

INFOID:000000009011027

CAUTION:

- The special parts are excluded.
- The bolts/nuts in these tables have a strength (discrimination) number/symbol assigned to the head or the like. As to the relation between the strength grade in these tables and the strength (discrimination) number/symbol, refer to "DISCRIMINATION OF BOLTS AND NUTS".

PREVIOUS STANDARD

| Grade (Strength grade) | Bolt size | Bolt di- ameter mm | Hexagonal width across flats mm | Pitch mm | Tightening torque (Without lubricant) | | | | | | | |
|------------------------------|--------------|--------------------------|--|-------------|---------------------------------------|------|-------|-------|---------------------|------|-------|-------|
| | | | | | Hexagon head bolt | | | | Hexagon flange bolt | | | |
| | | | | | N-m | kg-m | ft-lb | in-lb | N-m | kg-m | ft-lb | in-lb |
| 4T | M6 | 6.0 | 10 | 1.0 | 5.5 | 0.56 | 4 | 49 | 7 | 0.71 | 5 | 62 |
| | M8 | 8.0 | 12 | 1.25 | 13.5 | 1.4 | 10 | — | 17 | 1.7 | 13 | — |
| | | | | 1.0 | 13.5 | 1.4 | 10 | — | 17 | 1.7 | 13 | — |
| | M10 | 10.0 | 14 | 1.5 | 28 | 2.9 | 21 | — | 35 | 3.6 | 26 | — |
| | | | | 1.25 | 28 | 2.9 | 21 | — | 35 | 3.6 | 26 | — |
| | M12 | 12.0 | 17 | 1.75 | 45 | 4.6 | 33 | — | 55 | 5.6 | 41 | — |
| 1.25 | | | | 45 | 4.6 | 33 | — | 65 | 6.6 | 48 | — | |
| M14 | 14.0 | 19 | 1.5 | 80 | 8.2 | 59 | — | 100 | 10 | 74 | — | |
| 7T | M6 | 6.0 | 10 | 1.0 | 9 | 0.92 | 7 | 80 | 11 | 1.1 | 8 | 97 |
| | M8 | 8.0 | 12 | 1.25 | 22 | 2.2 | 16 | — | 28 | 2.9 | 21 | — |
| | | | | 1.0 | 22 | 2.2 | 16 | — | 28 | 2.9 | 21 | — |
| | M10 | 10.0 | 14 | 1.5 | 45 | 4.6 | 33 | — | 55 | 5.6 | 41 | — |
| | | | | 1.25 | 45 | 4.6 | 33 | — | 55 | 5.6 | 41 | — |
| | M12 | 12.0 | 17 | 1.75 | 80 | 8.2 | 59 | — | 100 | 10 | 74 | — |
| 1.25 | | | | 80 | 8.2 | 59 | — | 100 | 10 | 74 | — | |
| M14 | 14.0 | 19 | 1.5 | 130 | 13 | 96 | — | 170 | 17 | 125 | — | |
| 9T | M6 | 6.0 | 10 | 1.0 | 11 | 1.1 | 8 | — | 13.5 | 1.4 | 10 | — |
| | M8 | 8.0 | 12 | 1.25 | 28 | 2.9 | 21 | — | 35 | 3.6 | 26 | — |
| | | | | 1.0 | 28 | 2.9 | 21 | — | 35 | 3.6 | 26 | — |
| | M10 | 10.0 | 14 | 1.5 | 55 | 5.6 | 41 | — | 80 | 8.2 | 59 | — |
| | | | | 1.25 | 55 | 5.6 | 41 | — | 80 | 8.2 | 59 | — |
| | M12 | 12.0 | 17 | 1.75 | 100 | 10 | 74 | — | 130 | 13 | 96 | — |
| 1.25 | | | | 100 | 10 | 74 | — | 130 | 13 | 96 | — | |
| M14 | 14.0 | 19 | 1.5 | 170 | 17 | 125 | — | 210 | 21 | 155 | — | |

CAUTION:

TIGHTENING TORQUE OF STANDARD BOLTS

< HOW TO USE THIS MANUAL >

The parts with aluminum or the cast iron washer surface/thread surface are excluded.

NEW STANDARD BASED ON ISO

| Grade (Strength grade) | Bolt size | Bolt di- ameter mm | Hexagonal width across flats mm | Pitch mm | Tightening torque | | | | | | | |
|-------------------------------|--------------|--------------------------|--|-------------|-------------------|------|-------|-------|---------------------|------|-------|-------|
| | | | | | Hexagon head bolt | | | | Hexagon flange bolt | | | |
| | | | | | N-m | kg-m | ft-lb | in-lb | N-m | kg-m | ft-lb | in-lb |
| 4.8 (Without lubricant) | M6 | 6.0 | 10 | 1.0 | 5.5 | 0.56 | 4 | 49 | 7 | 0.71 | 5 | 62 |
| | M8 | 8.0 | 13 | 1.25 | 13.5 | 1.4 | 10 | — | 17 | 1.7 | 13 | — |
| | | | | 1.0 | 13.5 | 1.4 | 10 | — | 17 | 1.7 | 13 | — |
| | M10 | 10.0 | 16 | 1.5 | 28 | 2.9 | 21 | — | 35 | 3.6 | 26 | — |
| | | | | 1.25 | 28 | 2.9 | 21 | — | 35 | 3.6 | 26 | — |
| | M12 | 12.0 | 18 | 1.75 | 45 | 4.6 | 33 | — | 55 | 5.6 | 41 | — |
| 1.25 | | | | 45 | 4.6 | 33 | — | 65 | 6.6 | 48 | — | |
| M14 | 14.0 | 21 | 1.5 | 80 | 8.2 | 59 | — | 100 | 10 | 74 | — | |
| 4.8 (With lu- bricant) | M6 | 6.0 | 10 | 1.0 | 4 | 0.41 | 3 | 35 | 5.5 | 0.56 | 4 | 49 |
| | M8 | 8.0 | 13 | 1.25 | 11 | 1.1 | 8 | — | 13.5 | 1.4 | 10 | — |
| | | | | 1.0 | 11 | 1.1 | 8 | — | 13.5 | 1.4 | 10 | — |
| | M10 | 10.0 | 16 | 1.5 | 22 | 2.2 | 16 | — | 28 | 2.9 | 21 | — |
| | | | | 1.25 | 22 | 2.2 | 16 | — | 28 | 2.9 | 21 | — |
| | M12 | 12.0 | 18 | 1.75 | 35 | 3.6 | 26 | — | 45 | 4.6 | 33 | — |
| 1.25 | | | | 35 | 3.6 | 26 | — | 45 | 4.6 | 33 | — | |
| M14 | 14.0 | 21 | 1.5 | 65 | 6.6 | 48 | — | 80 | 8.2 | 59 | — | |
| 8.8 (With lu- bricant) | M6 | 6.0 | 10 | 1.0 | 8 | 0.82 | 6 | 71 | 10 | 1.0 | 7 | 89 |
| | M8 | 8.0 | 13 | 1.25 | 21 | 2.1 | 15 | — | 25 | 2.6 | 18 | — |
| | | | | 1.0 | 21 | 2.1 | 15 | — | 25 | 2.6 | 18 | — |
| | M10 | 10.0 | 16 | 1.5 | 40 | 4.1 | 30 | — | 50 | 5.1 | 37 | — |
| | | | | 1.25 | 40 | 4.1 | 30 | — | 50 | 5.1 | 37 | — |
| | M12 | 12.0 | 18 | 1.75 | 70 | 7.1 | 52 | — | 85 | 8.7 | 63 | — |
| 1.25 | | | | 70 | 7.1 | 52 | — | 85 | 8.7 | 63 | — | |
| M14 | 14.0 | 21 | 1.5 | 120 | 12 | 89 | — | 140 | 14 | 103 | — | |
| 10.9 (With lu- bricant) | M6 | 6.0 | 10 | 1.0 | 10 | 1.0 | 7 | 89 | 12 | 1.2 | 9 | 106 |
| | M8 | 8.0 | 13 | 1.25 | 27 | 2.8 | 20 | — | 32 | 3.3 | 24 | — |
| | | | | 1.0 | 27 | 2.8 | 20 | — | 32 | 3.3 | 24 | — |
| | M10 | 10.0 | 16 | 1.5 | 55 | 5.6 | 41 | — | 65 | 6.6 | 48 | — |
| | | | | 1.25 | 55 | 5.6 | 41 | — | 65 | 6.6 | 48 | — |
| | M12 | 12.0 | 18 | 1.75 | 95 | 9.7 | 70 | — | 110 | 11 | 81 | — |
| 1.25 | | | | 95 | 9.7 | 70 | — | 110 | 11 | 81 | — | |
| M14 | 14.0 | 21 | 1.5 | 160 | 16 | 118 | — | 180 | 18 | 133 | — | |

CAUTION:

1. Use tightening torque with lubricant for the new standard bolts/nuts in principle. Friction coefficient stabilizer is applied to the new standard bolts/nuts.
2. However, use tightening torque without lubricant for the following cases. Friction coefficient stabilizer is not applied to the following bolts/nuts.
 - Grade 4.8, M6 size bolt, Conical spring washer installed
 - Paint removing nut (Size M6 and M8) for fixing with weld bolt

TIGHTENING TORQUE OF STANDARD BOLTS

< HOW TO USE THIS MANUAL >

DISCRIMINATION OF BOLTS AND NUTS

GI

BOLTS

| | Grade (Strength) | Discrimination | |
|----------------------|----------------------------------|----------------|----------------------------|
| Previous standard | 4T (392N/mm ²) | | (No number/ symbol) |
| | 7T (686N/mm ²) | | |
| | 9T (883N/mm ²) | | |
| New Standard | 4.8 (420N/mm ²) | | (No number/ symbol) |
| | 8.8 (800N/mm ²) | | |
| | 10.9 (1040N/mm ²) | | |

NUTS

| | Grade (Proof load stress) | Discrimination | | |
|----------------------|---------------------------------|----------------------------|--|----------------------------|
| Previous standard | 7N (686N/mm ²) | (No number/ symbol) | | |
| | 9N (883N/mm ²) | | | |
| New Standard | 8 (800N/mm ²) | | | (No number/ symbol) |
| | 10 (1040N/mm ²) | | | |

NOTICE:

- A number is assigned on the side of the nuts in some cases.
- A number or symbol is assigned on the upper surface of the flange for the nut with flange.

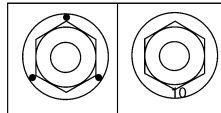

MACHINE SCREWS AND TAPPING SCREWS

Shape of the head :

Cross recess for the previous standard

Torx recess for the new standard

| Screw size | Screw diameter | Torx size |
|------------|----------------|-----------|
| M4 | 4.0 | T20 |
| M5 | 5.0 | T20 |
| M6 | 6.0 | T30 |

NOTICE:

Use torx size T20 (united with M4 screw) for M5 screw although ISO standard specifies T25.

SAIA0453E

B

C

D

E

F

G

H

I

J

K

L

M

N

O

P

RECOMMENDED CHEMICAL PRODUCTS AND SEALANTS

< HOW TO USE THIS MANUAL >

RECOMMENDED CHEMICAL PRODUCTS AND SEALANTS

Recommended Chemical Products and Sealants

INFOID:000000009011028

Refer to the following chart for help in selecting the appropriate chemical product or sealant.

| | Product Description | Purpose | Nissan North America Part No. (USA) | Nissan Canada Part No. (Canada) | Aftermarket Cross-reference Part Nos. |
|---|--|--|-------------------------------------|---------------------------------|---|
| 1 | Rear View Mirror Adhesive | Used to permanently re-mount rear view mirrors to windows. | 999MP-AM000P | 99998-50505 | Permatex 81844 |
| 2 | Anaerobic Liquid Gasket | For metal-to-metal flange sealing. Can fill a 0.38 mm (0.015 inch) gap and provide instant sealing for most powertrain applications. | 999MP-AM001P | 99998-50503 | Permatex 51813 and 51817 |
| 3 | High Performance Thread Sealant | Provides instant sealing on any threaded straight or parallel threaded fitting. (Thread sealant only, no locking ability.) • Do not use on plastic. | 999MP-AM002P | 999MP-AM002P | Permatex 56521 |
| 4 | Silicone RTV | Gasket Maker | 999MP-AM003P (Ultra Grey) | 99998-50506 (Ultra Grey) | Permatex Ultra Grey 82194; Three Bond 1207, 1215, 1216, 1217F, 1217G and 1217H Nissan RTV Part No. 999MP-A7007 |
| | | Gasket Maker for Maxima/Quest 5-speed automatic transmission (RE5F22A) | - | - | Three Bond 1281B or exact equivalent in its quality |
| 5 | High Temperature, High Strength Thread Locking Sealant (Red) | Threadlocker | 999MP-AM004P | 999MP-AM004P | Permatex 27200; Three Bond 1360, 1360N, 1305 N&P, 1307N, 1335, 1335B, 1363B, 1377C, 1386B, D&E and 1388 Loctite 648 |
| 6 | Medium Strength Thread Locking Sealant (Blue) | Threadlocker (service tool removable) | 999MP-AM005P | 999MP-AM005P | Permatex 24200, 24206, 24240, 24283 and 09178; Three Bond 1322, 1322N, 1324 D&N, 1333D, 1361C, 1364D, 1370C and 1374 |

IDENTIFICATION INFORMATION

< VEHICLE INFORMATION >

VEHICLE INFORMATION

IDENTIFICATION INFORMATION

Model Variation

INFOID:000000009011029

| Destination | Body | Engine | Axle | Handle | Transmission | Grade | Model |
|-------------|-------|--------|------|--------|--------------|---------|-------------|
| USA | Wagon | VK56VD | 4WD | LHD | 7A/T | Base | JPKNLHL-EU7 |
| | | | | | | Premium | JPKNLJL-EU7 |
| | | | | | | Base | JPKNLHL-EU8 |
| | | | | | | Premium | JPKNLJL-EU8 |
| | | | 2WD | | | Base | JPKALHL-EU7 |
| | | | | | | Premium | JPKALJL-EU7 |
| | | | | | | Base | JPKALHL-EU8 |
| | | | | | | Premium | JPKALJL-EU8 |
| Canada | | | 4WD | | | Base | JPKNLHL-EN7 |
| | | | | | | | JPKNLHL-EN8 |
| Mexico | | | | | | Premium | JPKNLJL-EJ7 |
| | | | | | | | JPKNLJL-EJ8 |

Model variation code (Prefix and suffix designations)

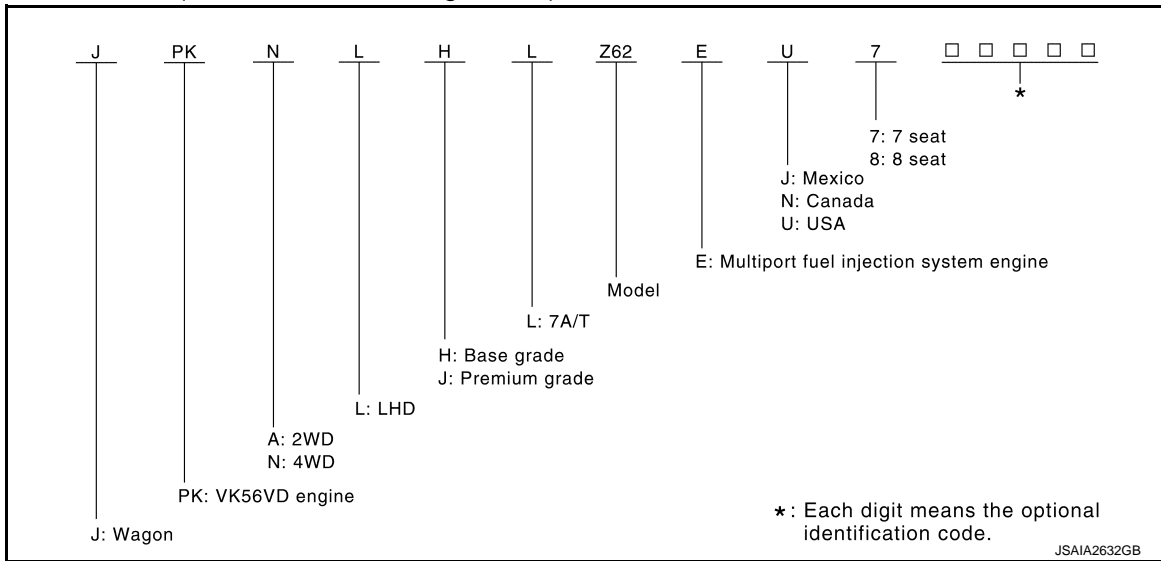

Information About Identification or Model Code

INFOID:000000009011030

IDENTIFICATION NUMBER

IDENTIFICATION INFORMATION

< VEHICLE INFORMATION >

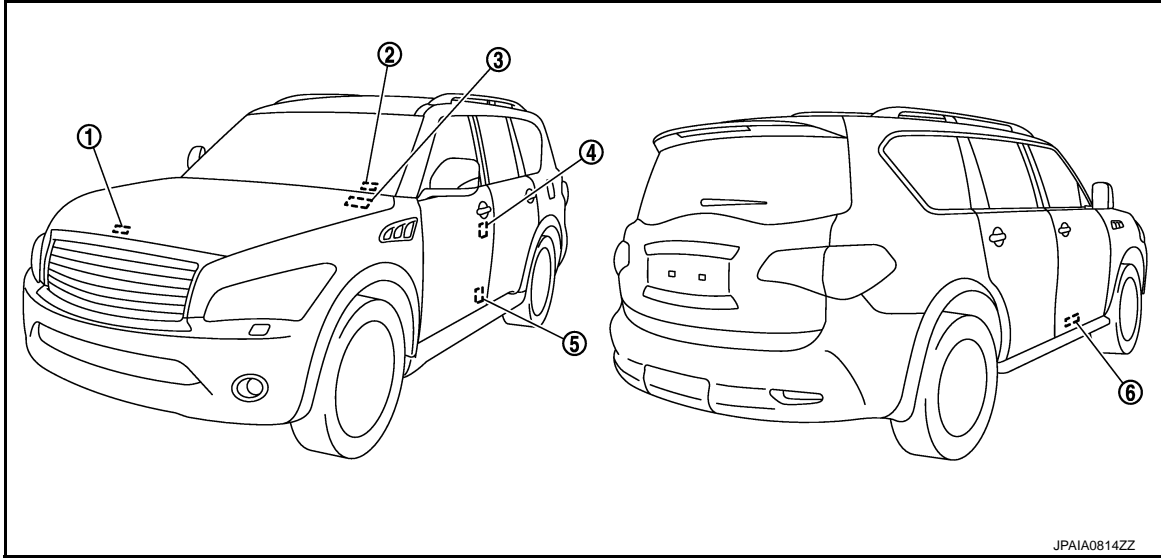

JPAIA0814ZZ

- | | | |
|---|--|---|
| 1. Air conditioner specification label | 2. Vehicle identification number plate | 3. Emission control information label (For USA and Canada) |
| 4. Tire and loading information label (For USA and Canada) Tire placard (For Mexico) | 5. FMVSS certification label (For USA) CMVSS certification label (For Canada) Vehicle identification label (For Mexico) | 6. Vehicle identification number (Chassis number) |

VEHICLE IDENTIFICATION NUMBER ARRANGEMENT

For USA and Canada

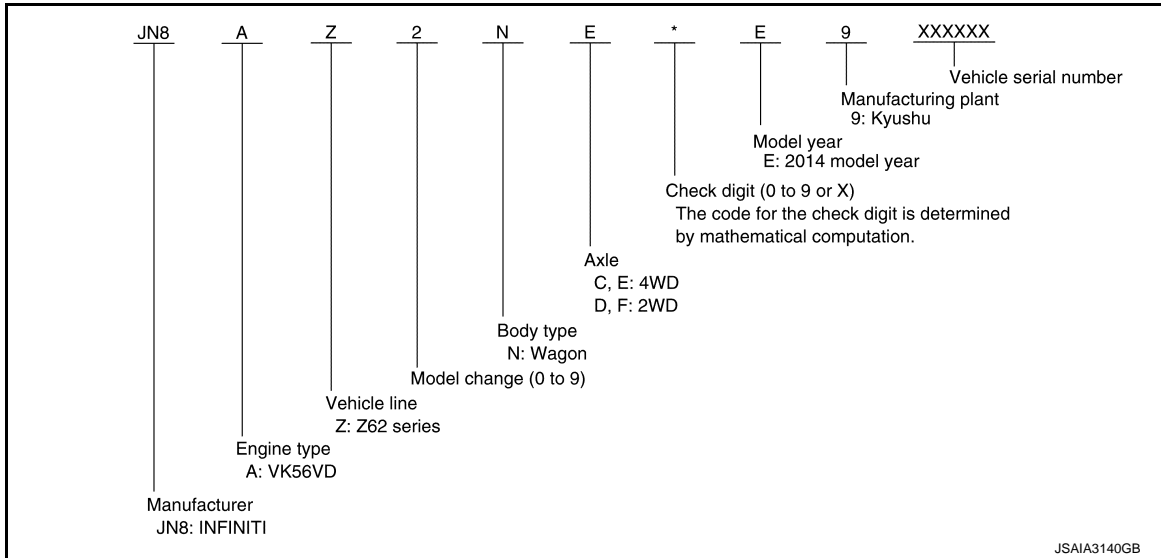

JSAIA3140GB

IDENTIFICATION INFORMATION

< VEHICLE INFORMATION >

For Mexico

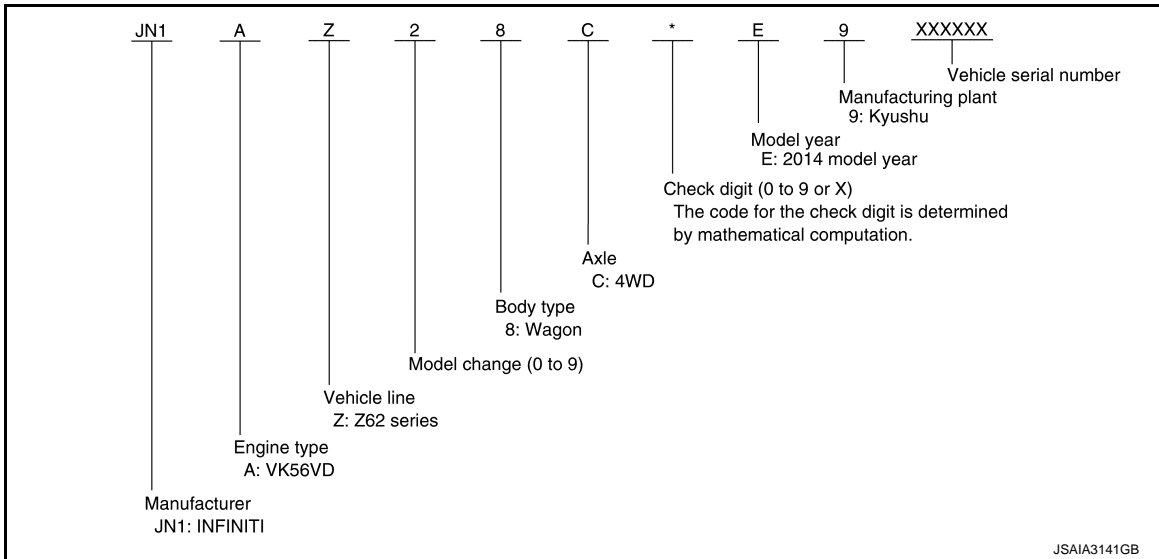

CERTIFICATION LABEL

FMVSS certification label

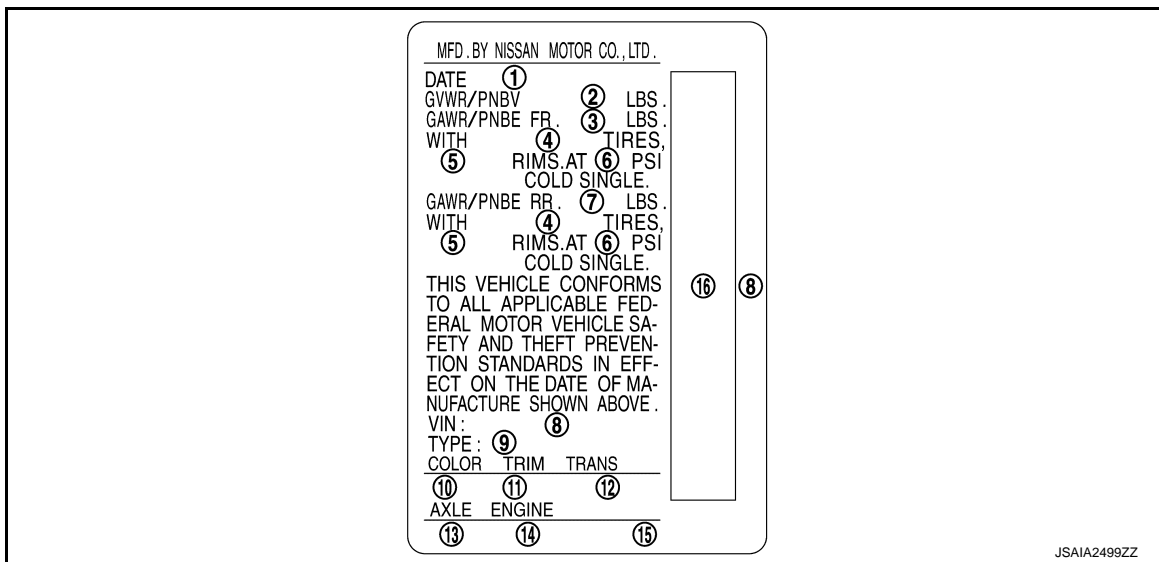

- | | | |
|------------------------------------|----------------------------------|-------------------------------------|
| 1. MFR Month / Year | 2. Gross vehicle weight rating | 3. Gross axle weight rating (Front) |
| 4. Tire size | 5. Wheel size | 6. Tire inflation pressure |
| 7. Gross axle weight rating (Rear) | 8. Vehicle identification number | 9. Verification model code |
| 10. Body color number | 11. Trim color number | 12. Transmission type |
| 13. Axle type | 14. Engine type | 15. Engine displacement |
| 16. VIN bar code | | |

CMVSS certification label

GI

B

C

D

E

F

G

H

I

J

K

L

M

N

O

P

IDENTIFICATION INFORMATION

< VEHICLE INFORMATION >

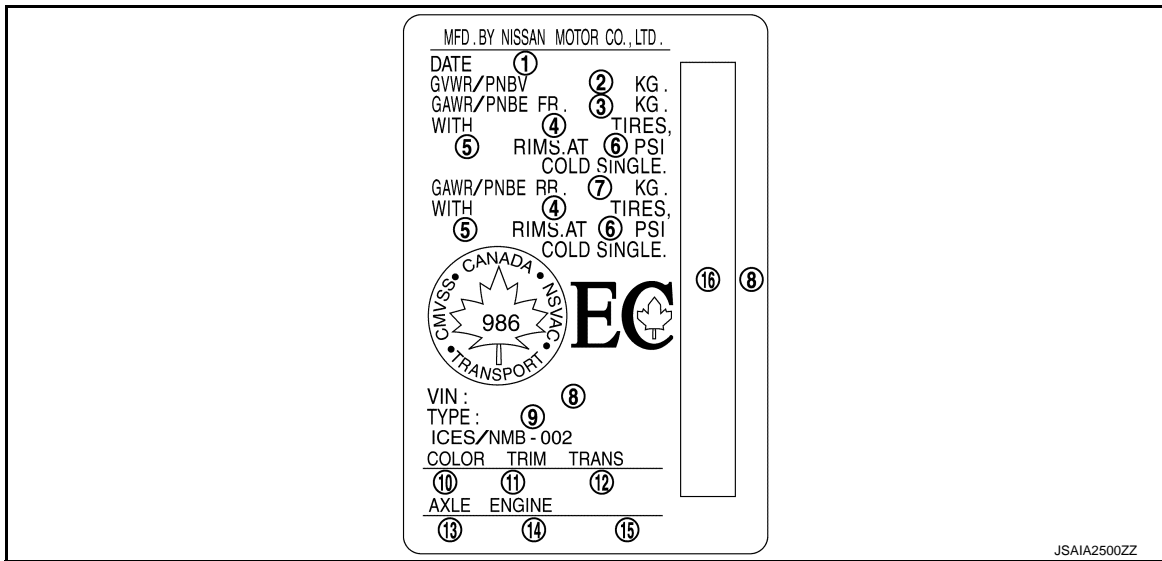

- | | | |
|------------------------------------|----------------------------------|-------------------------------------|
| 1. MFR Month / Year | 2. Gross vehicle weight rating | 3. Gross axle weight rating (Front) |
| 4. Tire size | 5. Wheel size | 6. Tire inflation pressure |
| 7. Gross axle weight rating (Rear) | 8. Vehicle identification number | 9. Verification model code |
| 10. Body color number | 11. Trim color number | 12. Transmission type |
| 13. Axle type | 14. Engine type | 15. Engine displacement |
| 16. VIN bar code | | |

IDENTIFICATION LABEL

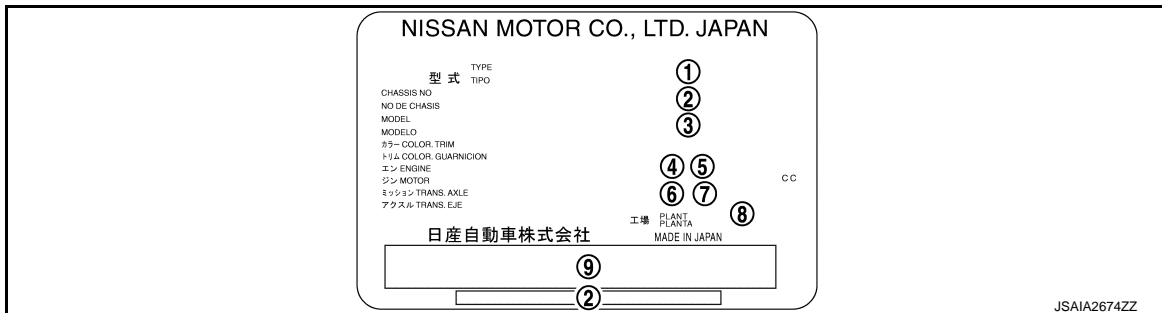

- | | | |
|-----------------|---|-------------------------|
| 1. Type | 2. Vehicle identification number (Chassis number) | 3. Model variation code |
| 4. Engine model | 5. Engine displacement | 6. Transmission model |
| 7. Axle model | 8. Manufacturing plant | 9. VIN bar code |

ENGINE SERIAL NUMBER

← : Vehicle front

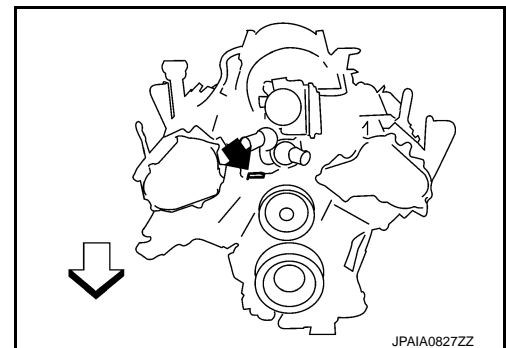

AUTOMATIC TRANSMISSION NUMBER

IDENTIFICATION INFORMATION

< VEHICLE INFORMATION >

← : Vehicle front

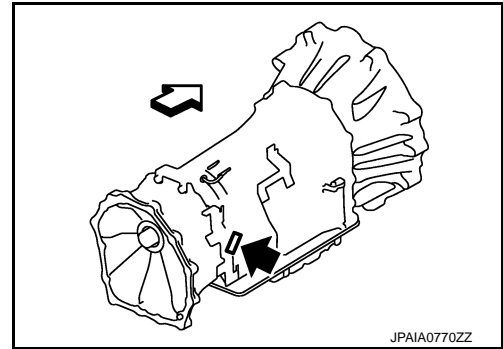

Dimensions

INFOID:000000009011031

Unit: mm (in)

| | |
|----------------|---------------|
| Overall length | 5,290 (208.3) |
| Overall width | 2,030 (79.9) |
| Overall height | 1,925 (75.8) |
| Front tread | 1,715 (67.5) |
| Rear tread | 1,725 (67.9) |
| Wheelbase | 3,075 (121.1) |

Wheels & Tires

INFOID:000000009011032

| | | Tire | | P275/60R20 114H |
|-----------------------|---------|-----------------------|-----------------|-----------------------------------|
| | | Road wheel (Aluminum) | Size | 20 × 8J |
| Conventional | 20 inch | Tire | | P275/60R20 114H |
| | | Road wheel (Aluminum) | Size | 20 × 8J |
| | Inset | | 30 mm (1.18 in) | |
| | 22 inch | Tire | | P275/50R22 111H |
| Road wheel (Aluminum) | | Size | 22 × 8J | |
| | Inset | 30 mm (1.18 in) | | |
| Spare | 20 inch | Tire | | P275/60R20 114H 275/60R20 115M |
| | | Road wheel (Aluminum) | Size | 20 × 8J |
| | | | Inset | 30 mm (1.18 in) |
| | 22 inch | Tire | | P275/50R22 111H |
| | | Road wheel (Aluminum) | Size | 22 × 8J |
| | | | Inset | 30 mm (1.18 in) |

PRECAUTIONS

< PRECAUTION >

PRECAUTION

PRECAUTIONS

Description

INFOID:000000009011033

Observe the following precautions to ensure safe and proper servicing. These precautions are not described in each individual section.

Precaution for Supplemental Restraint System (SRS) "AIR BAG" and "SEAT BELT PRE-TENSIONER"

INFOID:000000009011034

The Supplemental Restraint System such as "AIR BAG" and "SEAT BELT PRE-TENSIONER", used along with a front seat belt, helps to reduce the risk or severity of injury to the driver and front passenger for certain types of collision. Information necessary to service the system safely is included in the "SRS AIR BAG" and "SEAT BELT" of this Service Manual.

WARNING:

Always observe the following items for preventing accidental activation.

- To avoid rendering the SRS inoperative, which could increase the risk of personal injury or death in the event of a collision that would result in air bag inflation, all maintenance must be performed by an authorized NISSAN/INFINITI dealer.
- Improper maintenance, including incorrect removal and installation of the SRS, can lead to personal injury caused by unintentional activation of the system. For removal of Spiral Cable and Air Bag Module, see "SRS AIR BAG".
- Never use electrical test equipment on any circuit related to the SRS unless instructed to in this Service Manual. SRS wiring harnesses can be identified by yellow and/or orange harnesses or harness connectors.

PRECAUTIONS WHEN USING POWER TOOLS (AIR OR ELECTRIC) AND HAMMERS

WARNING:

Always observe the following items for preventing accidental activation.

- When working near the Air Bag Diagnosis Sensor Unit or other Air Bag System sensors with the ignition ON or engine running, never use air or electric power tools or strike near the sensor(s) with a hammer. Heavy vibration could activate the sensor(s) and deploy the air bag(s), possibly causing serious injury.
- When using air or electric power tools or hammers, always switch the ignition OFF, disconnect the battery, and wait at least 3 minutes before performing any service.

Precautions For Xenon Headlamp Service

INFOID:000000009011035

WARNING:

Comply with the following warnings to prevent any serious accident.

- Disconnect the battery cable (negative terminal) or the power supply fuse before installing, removing, or touching the xenon headlamp (bulb included). The xenon headlamp contains high-voltage generated parts.
- Never work with wet hands.
- Check the xenon headlamp ON-OFF status after assembling it to the vehicle. Never turn the xenon headlamp ON in other conditions. Connect the power supply to the vehicle-side connector. (Turning it ON outside the lamp case may cause fire or visual impairments.)
- Never touch the bulb glass immediately after turning it OFF. It is extremely hot.

CAUTION:

Comply with the following cautions to prevent any error and malfunction.

- Install the xenon bulb securely. (Insufficient bulb socket installation may melt the bulb, the connector, the housing, etc. by high-voltage leakage or corona discharge.)
- Never perform HID circuit inspection with a tester.
- Never touch the xenon bulb glass with hands. Never put oil and grease on it.
- Dispose of the used xenon bulb after packing it in thick vinyl without breaking it.
- Never wipe out dirt and contamination with organic solvent (thinner, gasoline, etc.).

PRECAUTIONS

< PRECAUTION >

Precaution for Procedure without Cowl Top Cover

INFOID:000000009011036

When performing the procedure after removing cowl top cover, cover the lower end of windshield with urethane, etc to prevent damage to windshield.

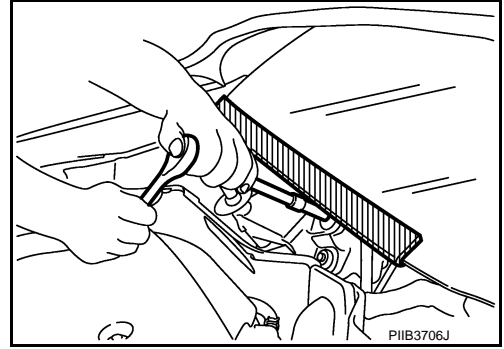

Cautions in Removing Battery Terminal and AV Control Unit (Models with AV Control Unit)

INFOID:000000009011037

CAUTION:

Remove battery terminal and AV control unit after a lapse of 30 seconds or more after turning the ignition switch OFF.

NOTE:

After the ignition switch is turned OFF, the AV control unit continues operating for approximately 30 seconds. Therefore, data corruption may occur if battery voltage is cut off within 30 seconds.

Precautions for Removing of Battery Terminal

INFOID:000000009864556

- When removing the 12V battery terminal, turn OFF the ignition switch and wait at least 30 seconds.

NOTE:

ECU may be active for several tens of seconds after the ignition switch is turned OFF. If the battery terminal is removed before ECU stops, then a DTC detection error or ECU data corruption may occur.

- For vehicles with the 2-batteries, be sure to connect the main battery and the sub battery before turning ON the ignition switch.

NOTE:

If the ignition switch is turned ON with any one of the terminals of main battery and sub battery disconnected, then DTC may be detected.

- After installing the 12V battery, always check "Self Diagnosis Result" of all ECUs and erase DTC.

NOTE:

The removal of 12V battery may cause a DTC detection error.

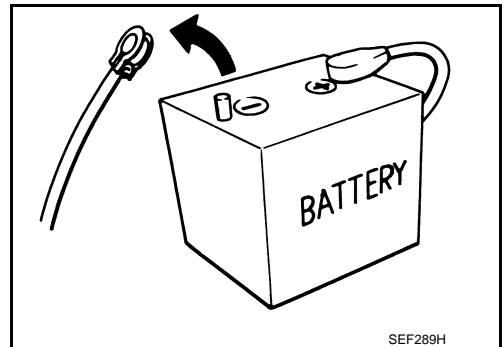

General Precautions

INFOID:000000009011038

- Do not operate the engine for an extended period of time without proper exhaust ventilation.

Keep the work area well ventilated and free of any inflammable materials. Special care should be taken when handling any inflammable or poisonous materials, such as gasoline, refrigerant gas, etc. When working in a pit or other enclosed area, be sure to properly ventilate the area before working with hazardous materials. Do not smoke while working on the vehicle.

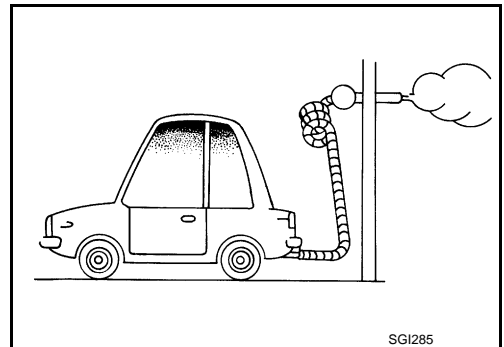

PRECAUTIONS

< PRECAUTION >

- Before jacking up the vehicle, apply wheel chocks or other tire blocks to the wheels to prevent the vehicle from moving. After jacking up the vehicle, support the vehicle weight with safety stands at the points designated for proper lifting before working on the vehicle.

These operations should be done on a level surface.

- When removing a heavy component such as the engine or transaxle/transmission, be careful not to lose your balance and drop them. Also, do not allow them to strike adjacent parts, especially the brake tubes and master cylinder.

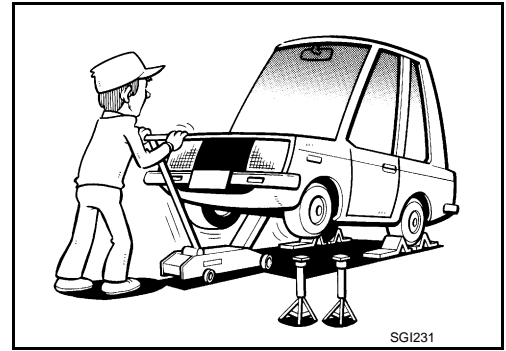

- Before starting repairs which do not require battery power:
Turn off ignition switch.
Disconnect the negative battery terminal.
- If the battery terminals are disconnected, recorded memory of radio and each control unit is erased.
- For vehicles with two batteries, be sure to remove both batteries when instructed to remove 12V battery in the service manual. If specified as main battery or sub battery, then do as instructed.

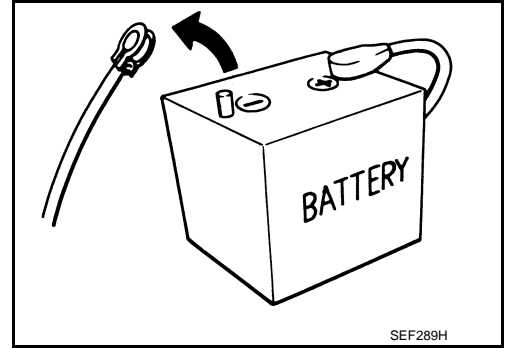

- To prevent serious burns:
Avoid contact with hot metal parts.
Do not remove the radiator cap when the engine is hot.
- Dispose of drained oil or the solvent used for cleaning parts in an appropriate manner.
- Do not attempt to top off the fuel tank after the fuel pump nozzle shuts off automatically.
Continued refueling may cause fuel overflow, resulting in fuel spray and possibly a fire.
- Clean all disassembled parts in the designated liquid or solvent prior to inspection or assembly.
- Replace oil seals, gaskets, packings, O-rings, locking washers, cotter pins, self-locking nuts, etc. with new ones.
- Replace inner and outer races of tapered roller bearings and needle bearings as a set.
- Arrange the disassembled parts in accordance with their assembled locations and sequence.
- Do not touch the terminals of electrical components which use microcomputers (such as ECM).
Static electricity may damage internal electronic components.
- After disconnecting vacuum or air hoses, attach a tag to indicate the proper connection.
- Use only the fluids and lubricants specified in this manual.
- Use approved bonding agent, sealants or their equivalents when required.
- Use hand tools, power tools (disassembly only) and recommended special tools where specified for safe and efficient service repairs.
- When repairing the fuel, oil, water, vacuum or exhaust systems, check all affected lines for leakage.

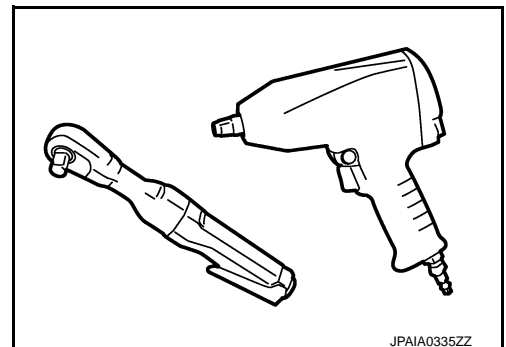

PRECAUTIONS

< PRECAUTION >

- Before servicing the vehicle:
Protect fenders, upholstery and carpeting with appropriate covers.
Take caution that keys, buckles or buttons do not scratch paint.

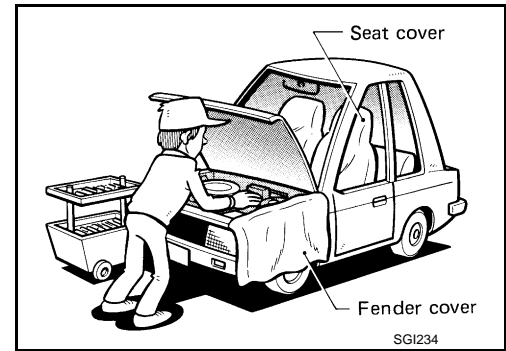

WARNING:

To prevent ECM from storing the diagnostic trouble codes, never carelessly disconnect the harness connectors which are related to the engine control system and TCM (transmission control module) system. The connectors should be disconnected only when working according to the WORK FLOW of TROUBLE DIAGNOSES in EC and TM sections.

Three Way Catalyst

INFOID:000000009011039

If a large amount of unburned fuel flows into the catalyst, the catalyst temperature will be excessively high. To prevent this, follow the instructions.

- Use unleaded gasoline only. Leaded gasoline will seriously damage the three way catalyst.
- When checking for ignition spark or measuring engine compression, make tests quickly and only when necessary.
- Do not run engine when the fuel tank level is low, otherwise the engine may misfire, causing damage to the catalyst.

Do not place the vehicle on flammable material. Keep flammable material off the exhaust pipe and the three way catalyst.

Multiport Fuel Injection System or Engine Control System

INFOID:000000009011040

- Before connecting or disconnecting any harness connector for the multiport fuel injection system or ECM:
Turn ignition switch to "OFF" position.
Disconnect negative battery terminal.
Otherwise, there may be damage to ECM.
- Before disconnecting pressurized fuel line from fuel pump to injectors, be sure to release fuel pressure.
- Be careful not to jar components such as ECM and mass air flow sensor.

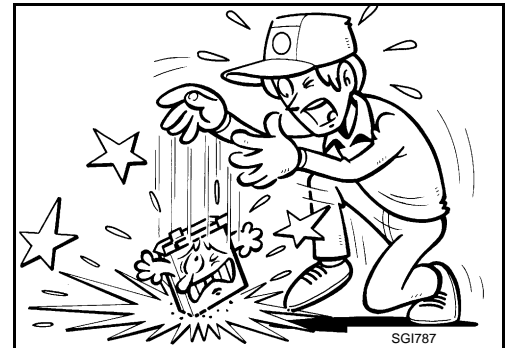

Hoses

INFOID:000000009011041

HOSE REMOVAL AND INSTALLATION

- To prevent damage to rubber hose, do not pry off rubber hose with tapered tool or screwdriver.

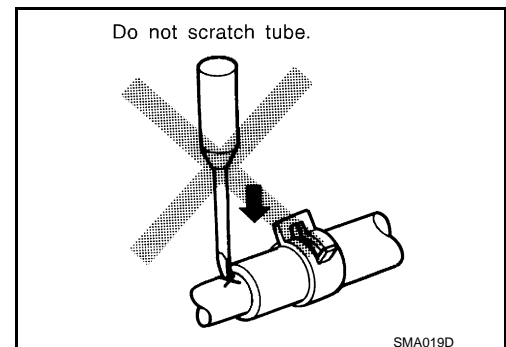

PRECAUTIONS

< PRECAUTION >

- To reinstall the rubber hose securely, check that hose insertion length and orientation is correct. (If tube is equipped with hose stopper, insert rubber hose into tube until it butts up against hose stopper.)

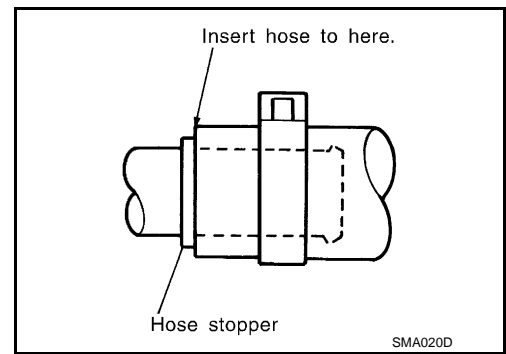

HOSE CLAMPING

- If old rubber hose is re-used, install hose clamp in its original position (at the indentation where the old clamp was). If there is a trace of tube bulging left on the old rubber hose, align rubber hose at that position.
- Discard old clamps; replace with new ones.

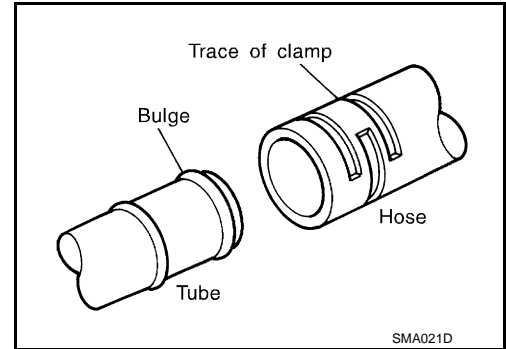

- After installing plate clamps, apply force to them in the direction of the arrow, tightening rubber hose equally all around.

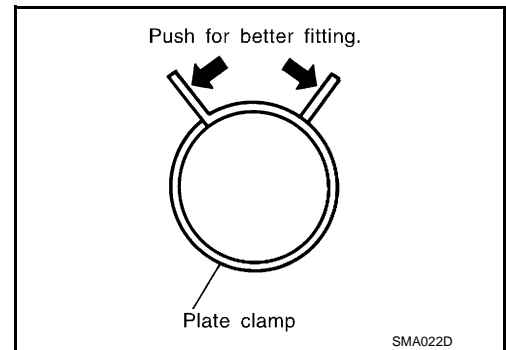

Engine Oils

INFOID:000000009011042

Prolonged and repeated contact with used engine oil may cause skin cancer. Try to avoid direct skin contact with used oil.

If skin contact is made, wash thoroughly with soap or hand cleaner as soon as possible.

HEALTH PROTECTION PRECAUTIONS

- Avoid prolonged and repeated contact with oils, particularly used engine oils.
- Wear protective clothing, including impervious gloves where practicable.
- Do not put oily rags in pockets.
- Avoid contaminating clothes, particularly underpants, with oil.
- Heavily soiled clothing and oil-impregnated footwear should not be worn. Overalls must be cleaned regularly.
- First aid treatment should be obtained immediately for open cuts and wounds.
- Use barrier creams, applying them before each work period, to help the removal of oil from the skin.
- Wash with soap and water to ensure all oil is removed (skin cleansers and nail brushes will help). Preparations containing lanolin replace the natural skin oils which have been removed.
- Do not use gasoline, kerosene, diesel fuel, gas oil, thinners or solvents for cleaning skin.
- If skin disorders develop, obtain medical advice without delay.
- Where practical, degrease components prior to handling.
- Where there is a risk of eye contact, eye protection should be worn, for example, chemical goggles or face shields; in addition an eye wash facility should be provided.

ENVIRONMENTAL PROTECTION PRECAUTIONS

PRECAUTIONS

< PRECAUTION >

Dispose of used oil and used oil filters through authorized waste disposal contractors to licensed waste disposal sites, or to the waste oil reclamation trade. If in doubt, contact the local authority for advice on disposal facilities.

It is illegal to pour used oil on to the ground, down sewers or drains, or into water sources. The regulations concerning pollution vary between regions.

Air Conditioning

INFOID:000000009011043

Use an approved refrigerant recovery unit any time the air conditioning system must be discharged. Refer to HA section "REFRIGERANT" for specific instructions.

Fuel

INFOID:000000009011044

FOR USA AND CANADA

INFINITI recommends the use of unleaded premium gasoline with an octane rating of at least 91 AKI (Anti-Knock Index) number (Research octane number 96).

If unleaded premium gasoline is not available, may use unleaded regular gasoline with an octane rating of at least 87 AKI number (Research octane number 91), can be used. In such case, engine performance may be decrease.

CAUTION:

- **Using a fuel other than that specified could adversely affect the emission control system, and may also affect warranty coverage.**
- **Under no circumstances should a leaded gasoline be used, because this will damage the three-way catalyst.**
- **Do not use E-15 or E-85 fuel in the vehicle. The vehicle is not designed to run on E-15 or E-85 fuel. Using E-15 or E-85 fuel in a vehicle not specifically designed for E-15 or E-85 fuel can adversely affect the emission control devices and systems of the vehicle. Damage caused by such fuel is not covered by the INFINITI new vehicle limited warranty.**
- **U.S government regulations require ethanol dispensing pumps to be identified by a small, square, orange and black label with the common abbreviation or the appropriate percentage for that region.**

FOR MEXICO

CAUTION:

Do not use leaded gasoline. Using leaded gasoline will damage the three-way catalyst.

Use unleaded premium gasoline with an octane rating of at least 91 AKI (Anti-knock index) number (Research octane number 96).

If unleaded premium gasoline is not used, unleaded regular gasoline with an octane rating of at least 87 AKI (Anti-knock Index) number (Research octane number 91) may be used at slightly reduced performance. However, for maximum vehicle performance and the best driveability, the use of unleaded premium gasoline is recommended.

GI

B

C

D

E

F

G

H

I

J

K

L

M

N

O

P

LIFTING POINT

< PRECAUTION >

LIFTING POINT

Pantograph Jack

INFOID:000000009011045

WARNING:

- Never get under the vehicle while it is supported only by the jack. Always use safety stands to support the frame when you have to get under the vehicle.
- Place wheel chocks at both front and back of the wheels on the ground.

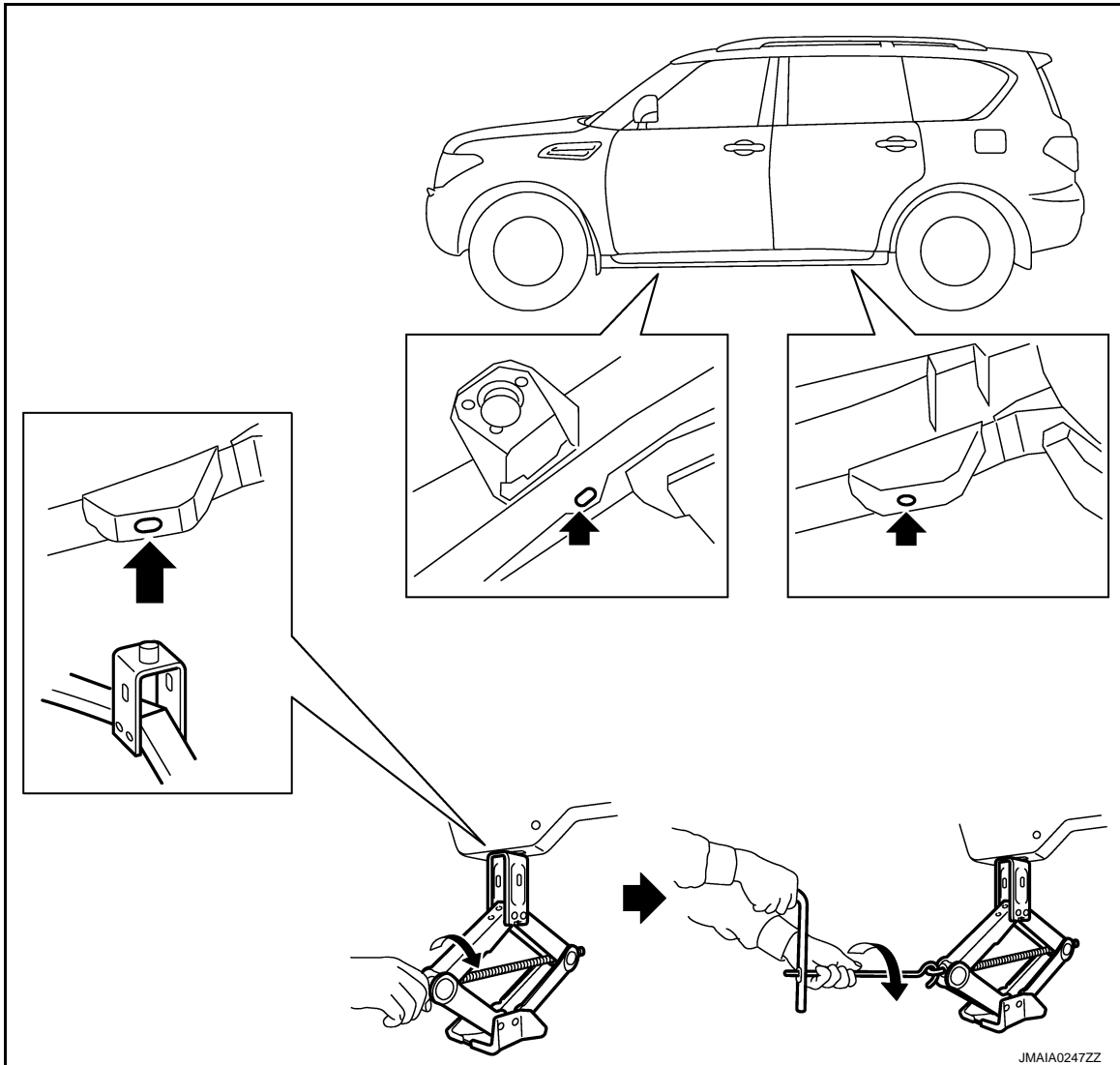

Garage Jack and Safety Stand

INFOID:000000009011046

CAUTION:

- Place a wooden or rubber block between safety stand and vehicle body when the supporting body is flat.
- Remove engine under cover before jacking up the front side of the vehicle with garage jack. Refer to [BRM-39, "Rear Fender"](#).

LIFTING POINT

< PRECAUTION >

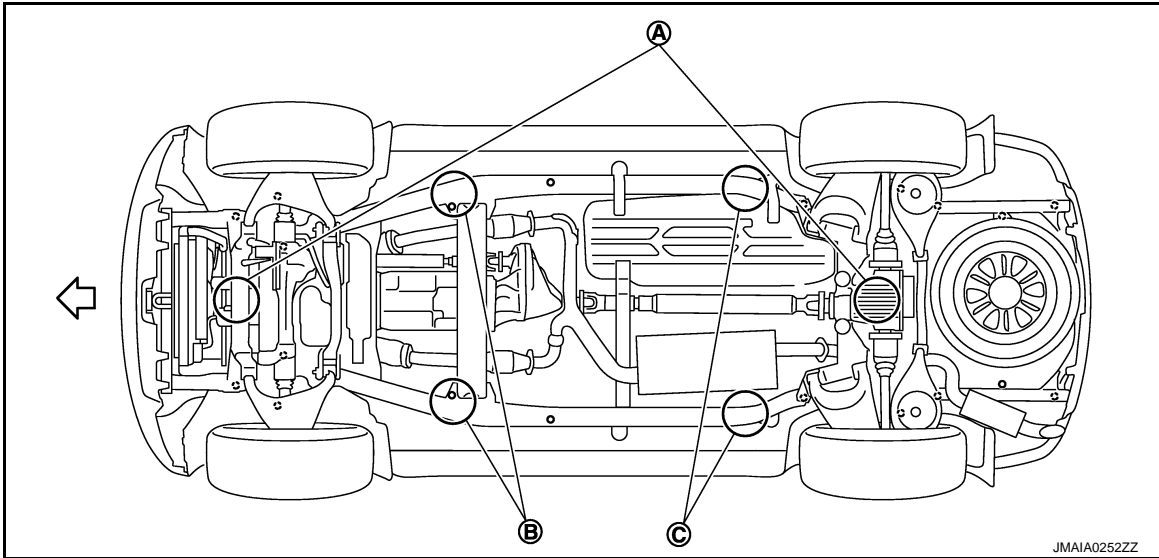

A : Garage jack point

B : Safety stand point

← : Vehicle front

2-Pole Lift

INFOID:000000009011047

WARNING:

- When lifting the vehicle, open the lift arms as wide as possible and ensure that the front and rear of the vehicle are well balanced.
- When setting the lift arm, never allow the arm to contact the brake tubes, brake cable, or fuel lines.

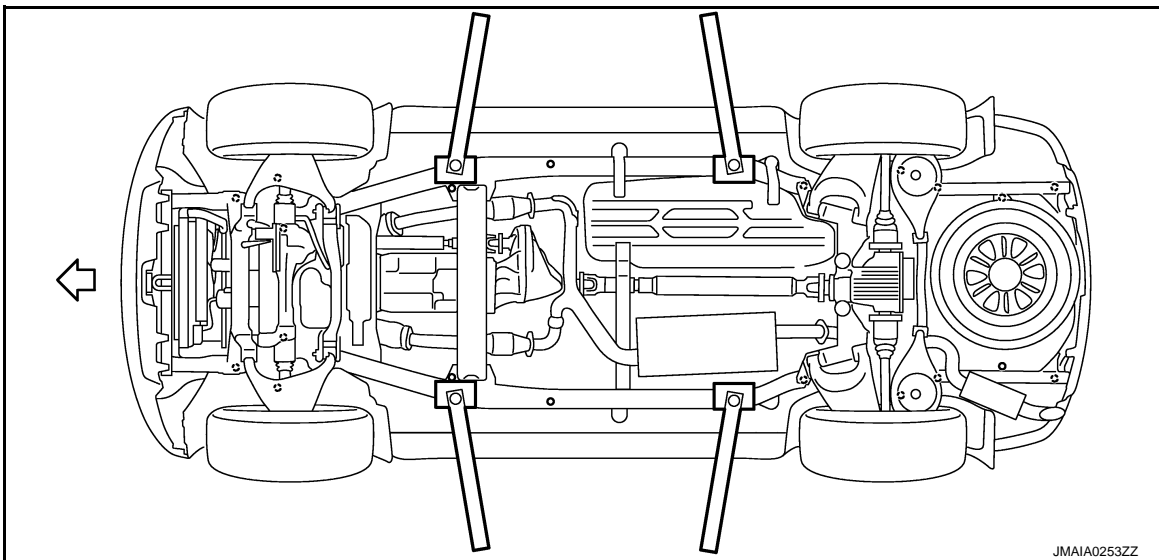

← : Vehicle front

GI

B

C

D

E

F

G

H

I

J

K

L

M

N

O

P

TOW TRUCK TOWING

< PRECAUTION >

TOW TRUCK TOWING

Tow Truck Towing

INFOID:000000009011048

CAUTION:

- All applicable state or Provincial (in Canada) laws and local laws regarding the towing operation must be obeyed.
- It is necessary to use proper towing equipment to avoid possible damage to the vehicle during towing operation. Towing is in accordance with Towing Procedure Manual at dealer.
- Always attach safety chains before towing.
- When towing, check that the transmission, steering system and powertrain are in good order. If any unit is damaged, dollies must be used.
- Never tow automatic transmission model from the rear (that is backward) with four wheels on the ground. This may cause serious and expensive damage to the transmission.

2WD MODELS

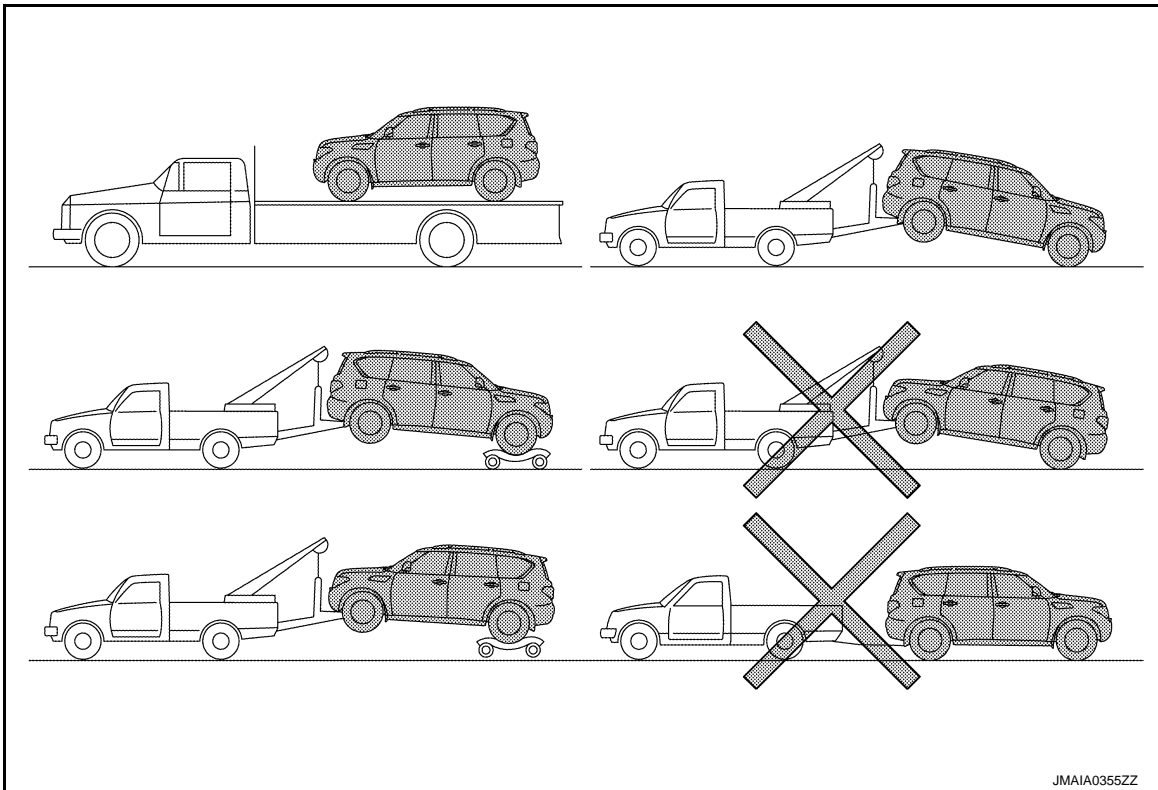

INFINITI recommends that vehicle be towed with the driving (rear) wheels off the ground or that a dolly be used as illustrated.

CAUTION:

- Never tow automatic transmission models with the rear wheels on the ground or four wheels on the ground (forward or backward), as this may cause serious and expensive damage to the transmission.
If it is necessary to tow the vehicle with the front wheels raised, always use towing dollies under the rear wheels.
- When towing rear wheel drive models with the front wheels on the ground or on towing dollies:
 - Turn the ignition switch to the OFF position, and secure the steering wheel in a straight ahead position with a rope or similar device. Never secure the steering wheel by turning the ignition switch to the LOCK position. This may damage the steering lock mechanism.
 - Move the selector lever to the N (Neutral) position.
- When the battery of vehicle equipped with the Intelligent Key system is discharged, your vehicle should be towed with the front wheels on towing dollies or place the vehicle on a flat bed truck.

If the speed or distance must necessarily be greater, remove the propeller shaft before towing to prevent damage to the transmission.

TOW TRUCK TOWING

< PRECAUTION >

4WD MODELS

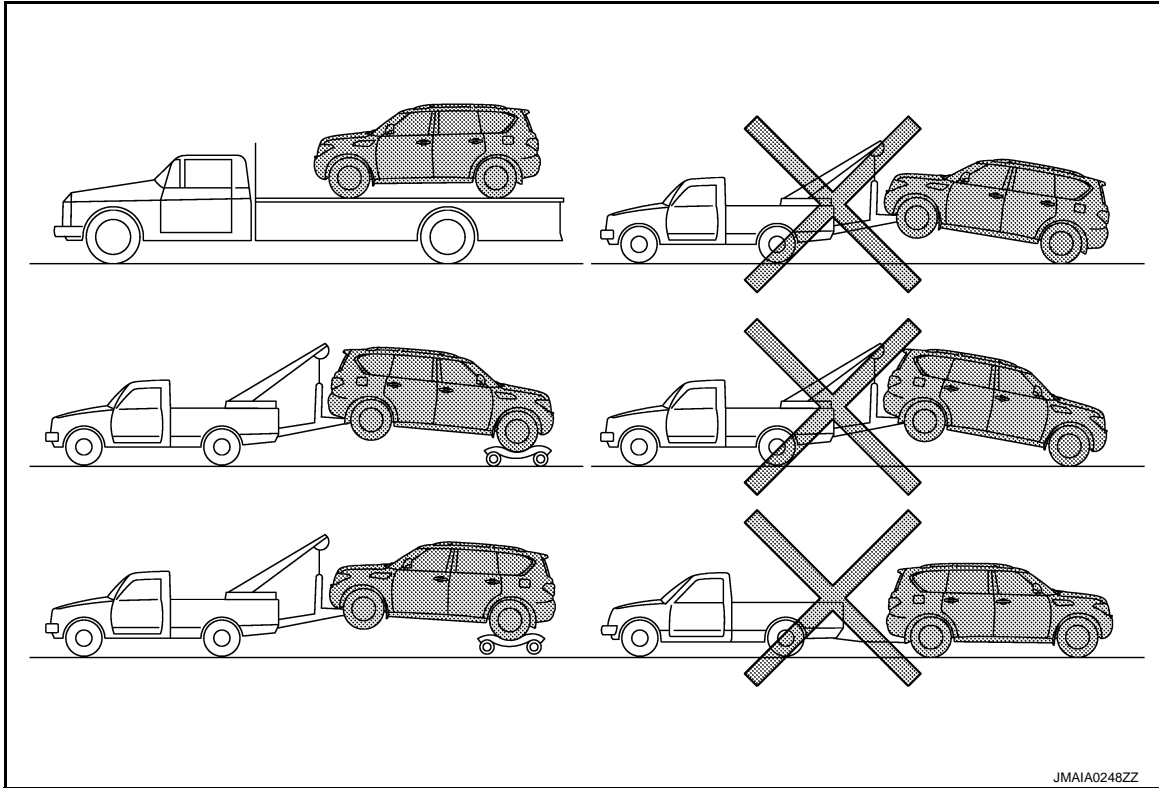

INFINITI recommends that a dolly be used as illustrated when towing 4WD models.

CAUTION:

Never tow 4WD models with any of the wheels on the ground as this may cause serious and expensive damage to the powertrain.

Vehicle Recovery (Freeing a Stuck Vehicle)

INFOID:000000009011049

FREEING TRAPPED VEHICLE

WARNING:

- Stand clear of a stuck vehicle.
- Never allow anyone to stand near the towing line during the pulling operation.
- Never spin your tires at high speed. This could cause them to explode and result in serious injury. Parts of your vehicle could also overheat and be damaged.

CAUTION:

- Tow chains or cables must be attached only to the vehicle recovery hooks or main structural members of the vehicle. Otherwise, the vehicle body will be damaged.
- Never use the vehicle tie downs to free a vehicle stuck in sand, snow, mud, etc. Never tow the vehicle using the vehicle tie downs or recovery hooks.
- Always pull the cable straight out from the front of the vehicle. Never pull on the hook at an angle.
- Pulling devices should be routed so they do not touch any part of the suspension, steering, brake or cooling systems.
- Pulling devices such as ropes or canvas straps are not recommended for use in vehicle towing or recovery.
- In order to not break the towing line, tension it slowly.

TOW TRUCK TOWING

< PRECAUTION >

FRONT

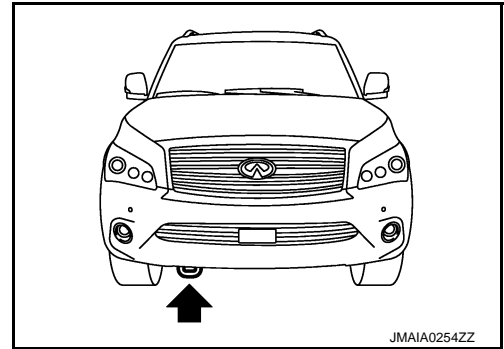

REAR

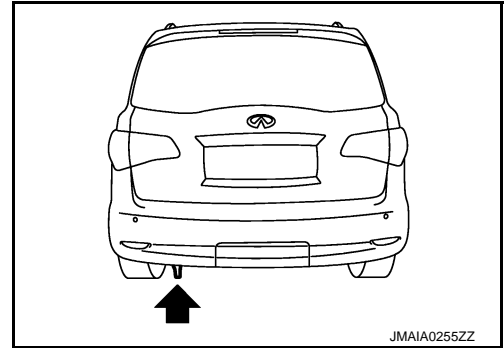

AUTOMATIC TRANSMISSION

To tow a vehicle equipped with an automatic transmission, an appropriate vehicle dolly **MUST** be placed under the towed vehicle's drive wheels. **Always** follow the dolly manufacturer's recommendations when using their product.

If the vehicle is stuck in sand, snow, mud, etc., use the following procedure:

1. Turn off the Vehicle Dynamic Control System. (if equipped)
2. Check the area in front and behind the vehicle is clear of obstructions.
3. Turn the steering wheel right and left to clear an area around the front tires.
4. Slowly rock the vehicle forward and backward.
Shift back and forth between R (reverse) and D (drive).
Apply the accelerator as little as possible to maintain the rocking motion.
Release the accelerator pedal before shifting between R and D.
Do not spin the tires above 35 mph (55 km/h).
5. If the vehicle can not be freed after a few tries, contact a professional towing service to remove the vehicle.

SERVICE INFORMATION FOR ELECTRICAL INCIDENT

< BASIC INSPECTION >

BASIC INSPECTION

SERVICE INFORMATION FOR ELECTRICAL INCIDENT

Work Flow

INFOID:000000009011050

WORK FLOW

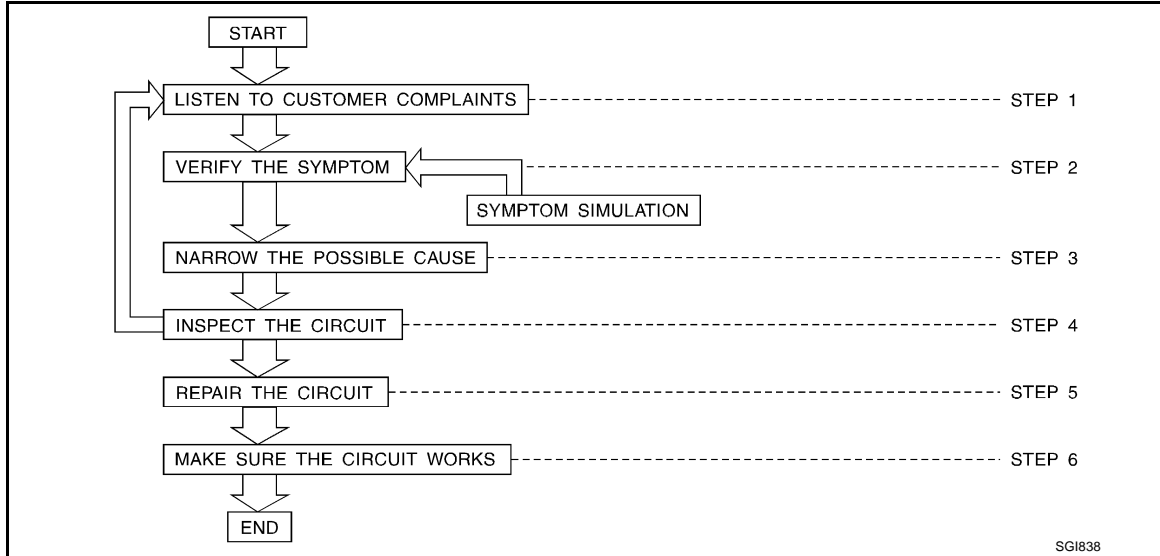

| STEP | DESCRIPTION | |
|--------|--|--|
| STEP 1 | Get detailed information about the conditions and the environment when the incident occurred. The following are key pieces of information required to make a good analysis: | |
| | WHAT | Vehicle Model, Engine, Transmission/Transaxle and the System (i.e. Radio). |
| | WHEN | Date, Time of Day, Weather Conditions, Frequency. |
| | WHERE | Road Conditions, Altitude and Traffic Situation. |
| STEP 2 | HOW | System Symptoms, Operating Conditions (Other Components Interaction). Service History and if any After Market Accessories have been installed. |
| | Operate the system, road test if necessary. Verify the parameter of the incident. If the problem cannot be duplicated, refer to "Incident Simulation Tests". | |
| STEP 3 | Get the proper diagnosis materials together including: <ul style="list-style-type: none"> • Power Supply Routing • System Operation Descriptions • Applicable Service Manual Sections • Check for any Service Bulletins Identify where to begin diagnosis based upon your knowledge of the system operation and the customer comments. | |
| STEP 4 | Inspect the system for mechanical binding, loose connectors or wiring damage. Determine which circuits and components are involved and diagnose using the Power Supply Routing and Harness Layouts. | |
| STEP 5 | Repair or replace the incident circuit or component. | |
| STEP 6 | Operate the system in all modes. Verify the system works properly under all conditions. check you have not inadvertently created a new incident during your diagnosis or repair steps. | |

Control Units and Electrical Parts

INFOID:000000009011051

PRECAUTIONS

- Never reverse polarity of battery terminals.
- Install only parts specified for a vehicle.
- Before replacing the control unit, check the input and output and functions of the component parts.
- Do not apply excessive force when disconnecting a connector.

SERVICE INFORMATION FOR ELECTRICAL INCIDENT

< BASIC INSPECTION >

- Do not apply excessive shock to the control unit by dropping or hitting it.
- Be careful to prevent condensation in the control unit due to rapid temperature changes and do not let water or rain get on it. If water is found in the control unit, dry it fully and then install it in the vehicle.
- Be careful not to let oil get on the control unit connector.
- Avoid cleaning the control unit with volatile oil.
- Do not disassemble the control unit, and do not remove the upper and lower covers.



- When using a DMM, be careful not to let test probes get close to each other to prevent the power transistor in the control unit from damaging battery voltage because of short circuiting.
- When checking input and output signals of the control unit, use the specified check adapter.

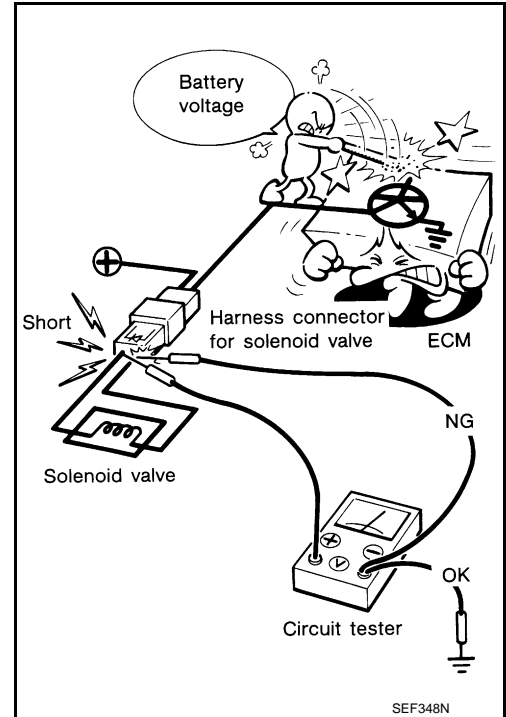

How to Check Terminal

INFOID:000000009011052

CONNECTOR AND TERMINAL PIN KIT

- Use the connector and terminal pin kits listed below when replacing connectors or terminals.
- The connector and terminal pin kits contain some of the most commonly used NISSAN/INFINITI connectors and terminals. For detailed connector and terminal pin replacement procedures, refer to the latest NISSAN/INFINITI CONNECTOR AND TERMINAL PIN SERVICE MANUAL.

SERVICE INFORMATION FOR ELECTRICAL INCIDENT

< BASIC INSPECTION >

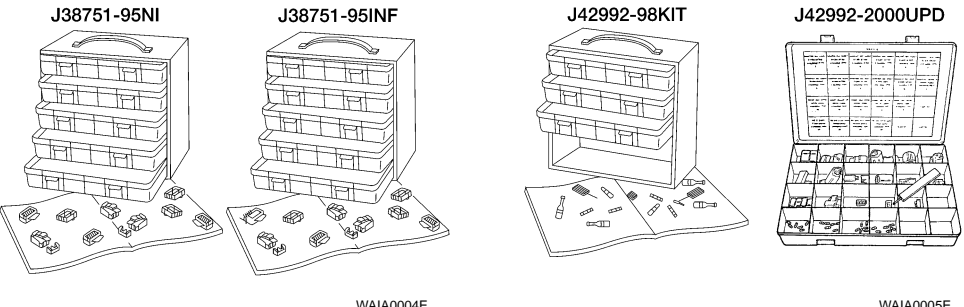
| Tool number (Kent-Moore No.) Tool name | Description |
|---|--|
| - (J38751-95NI) Connector and terminal pin kit (NISSAN) - (J38751-95INF) Connector and terminal pin kit (INFINITI) - (J42992-98KIT) OBD and terminal repair kit - (J42992-2000UPD) OBD-II Connector Kit Up- date |  |

GI

B

C

D

E

F

HOW TO PROBE CONNECTORS

- Connector damage and an intermittent connection can result from improperly probing of the connector during circuit checks.
- The probe of a digital multimeter (DMM) may not correctly fit the connector cavity. To correctly probe the connector, follow the procedures below using a "T" pin. For the best contact grasp the "T" pin using an alligator clip.

Probing from Harness Side

Standard type (not waterproof type) connector should be probed from harness side with "T" pin.

- If the connector has a rear cover such as a ECM connector, remove the rear cover before probing the terminal.
- Do not probe waterproof connector from harness side. Damage to the seal between wire and connector may result.

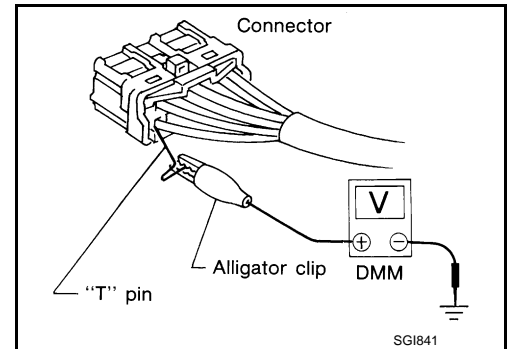

G

H

I

J

K

Probing from Terminal Side

FEMALE TERMINAL

- There is a small notch above each female terminal. Probe each terminal with the "T" pin through the notch. Do not insert any object other than the same type male terminal into female terminal.

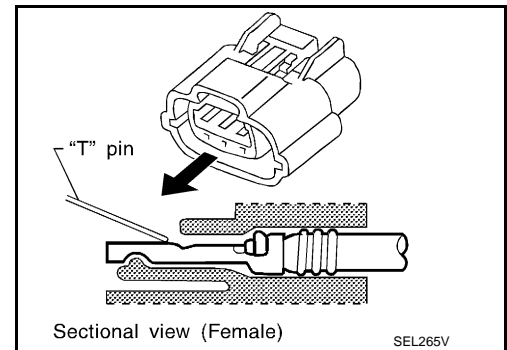

L

M

N

O

P

SERVICE INFORMATION FOR ELECTRICAL INCIDENT

< BASIC INSPECTION >

- Some connectors do not have a notch above each terminal. To probe each terminal, remove the connector retainer to make contact space for probing.

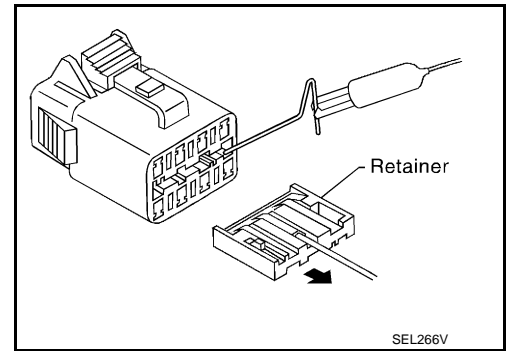

MALE TERMINAL

- Carefully probe the contact surface of each terminal using a "T" pin.

CAUTION:

Never bend terminal.

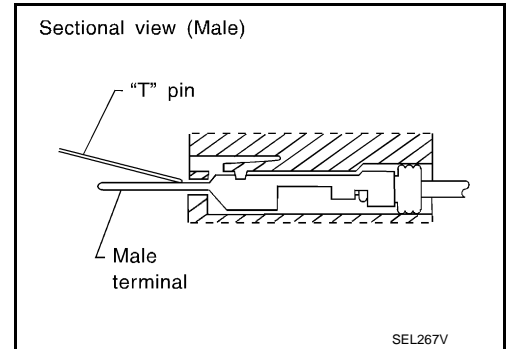

How to Check Enlarged Contact Spring of Terminal

- An enlarged contact spring of a terminal may create intermittent signals in the circuit.
- If the intermittent open circuit occurs, follow the procedure below to inspect for open wires and enlarged contact spring of female terminal.

1. Assemble a male terminal and approx. 10 cm (3.9 in) of wire.

NOTE:

Use a male terminal which matches the female terminal.

2. Disconnect the suspected faulty connector and hold it terminal side up.

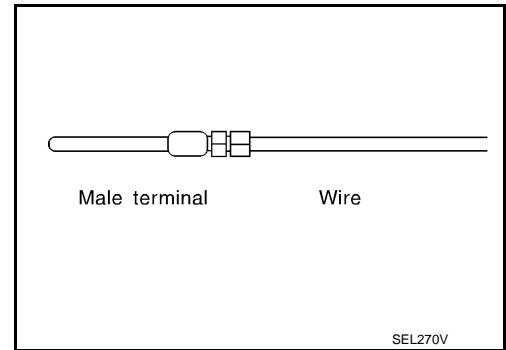

3. While holding the wire of the male terminal, try to insert the male terminal into the female terminal.

CAUTION:

Never force the male terminal into the female terminal with your hands.

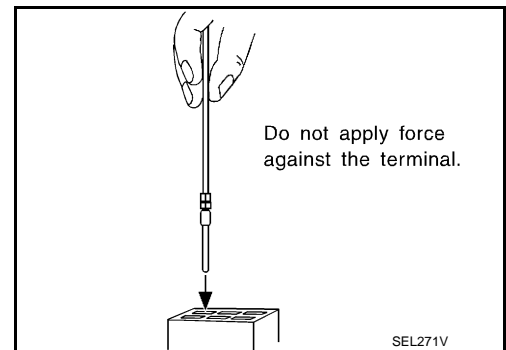

SERVICE INFORMATION FOR ELECTRICAL INCIDENT

< BASIC INSPECTION >

4. While moving the connector, check whether the male terminal can be easily inserted or not.

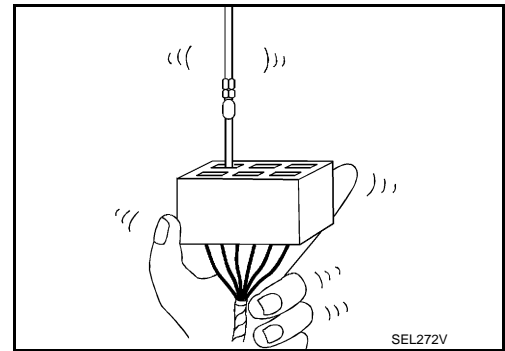

- If the male terminal can be easily inserted into the female terminal, replace the female terminal.

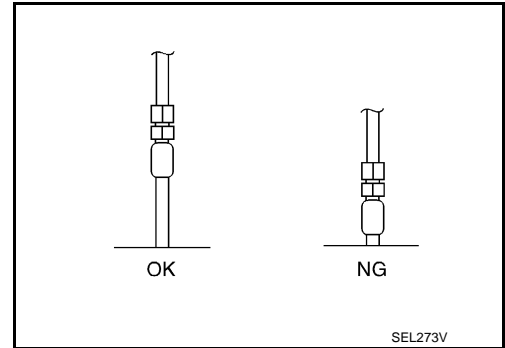

Waterproof Connector Inspection

If water enters the connector, it can short interior circuits. This may lead to intermittent problems. Check the following items to maintain the original waterproof characteristics.

RUBBER SEAL INSPECTION

- Most waterproof connectors are provided with a rubber seal between the male and female connectors. If the seal is missing, the waterproof performance may not meet specifications.
- The rubber seal may come off when connectors are disconnected. Whenever connectors are reconnected, check the rubber seal is properly installed on either side of male or female connector.

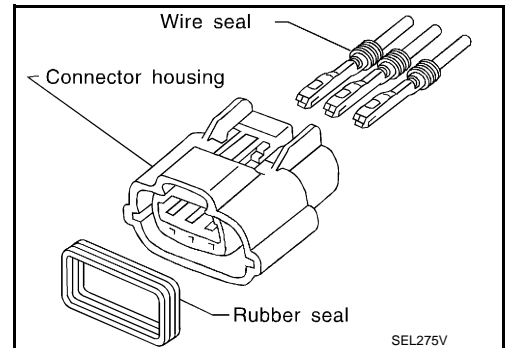

WIRE SEAL INSPECTION

- The wire seal must be installed on the wire insertion area of a waterproof connector. Be sure that the seal is installed properly.

Terminal Lock Inspection

Check for unlocked terminals by pulling wire at the end of connector. An unlocked terminal may create intermittent signals in the circuit.

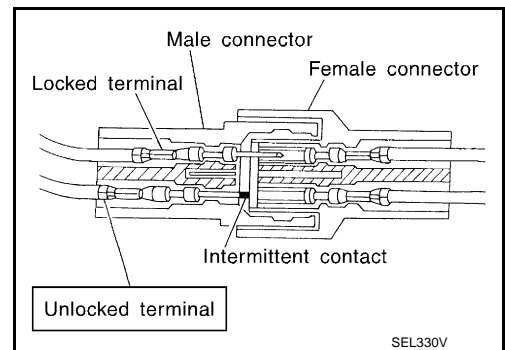

Intermittent Incident

INFOID:000000009011053

DESCRIPTION

Sometimes the symptom is not present when the vehicle is brought in for service. If possible, re-create the conditions present at the time of the incident. Doing so may help avoid a No Trouble Found Diagnosis. The fol-

GI
B
C
D
E
F
G
H
I
J
K
L
M
N
O
P

SERVICE INFORMATION FOR ELECTRICAL INCIDENT

< BASIC INSPECTION >

Following section illustrates ways to simulate the conditions/environment under which the owner experiences an electrical incident.

The section is broken into the six following topics:

- Vehicle vibration
- Heat sensitive
- Freezing
- Water intrusion
- Electrical load
- Cold or hot start up

Get a thorough description of the incident from the customer. It is important for simulating the conditions of the problem.

VEHICLE VIBRATION

The problem may occur or become worse while driving on a rough road or when engine is vibrating (idle with A/C on). In such a case, you will want to check for a vibration related condition. Refer to the following illustration.

Connector & Harness

Determine which connectors and wiring harness would affect the electrical system you are inspecting. Gently shake each connector and harness while monitoring the system for the incident you are trying to duplicate. This test may indicate a loose or poor electrical connection.

Hint

Connectors can be exposed to moisture. It is possible to get a thin film of corrosion on the connector terminals. A visual inspection may not reveal this without disconnecting the connector. If the problem occurs intermittently, perhaps the problem is caused by corrosion. It is a good idea to disconnect, inspect and clean the terminals on related connectors in the system.

Sensor & Relay

Gently apply a slight vibration to sensors and relays in the system you are inspecting. This test may indicate a loose or poorly mounted sensor or relay.

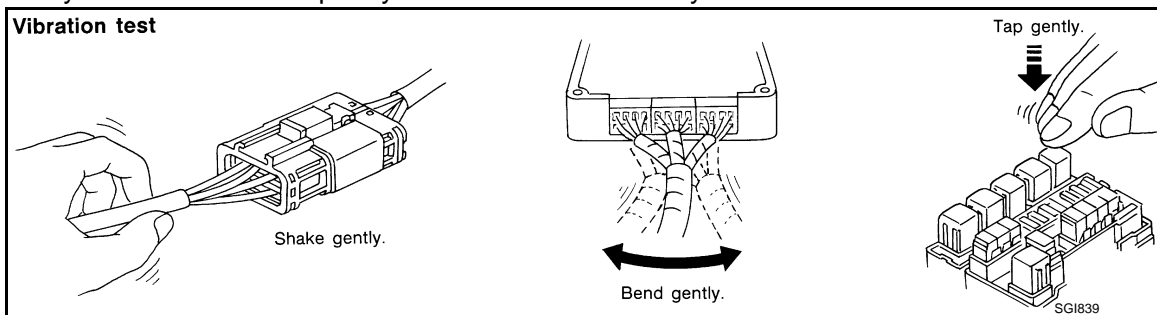

Engine Compartment

There are several reasons a vehicle or engine vibration could cause an electrical complaint. Some of the things to check for are:

- Connectors not fully seated.
- Wiring harness not long enough and is being stressed due to engine vibrations or rocking.
- Wires laying across brackets or moving components.
- Loose, dirty or corroded ground wires.
- Wires routed too close to hot components.

To inspect components under the hood, start by verifying the integrity of ground connections. (Refer to Ground Inspection described later.) First check that the system is properly grounded. Then check for loose connection by gently shaking the wiring or components as previously explained. Using the wiring diagrams inspect the wiring for continuity.

Behind the Instrument Panel

An improperly routed or improperly clamped harness can become pinched during accessory installation. Vehicle vibration can aggravate a harness which is routed along a bracket or near a screw.

Under Seating Areas

SERVICE INFORMATION FOR ELECTRICAL INCIDENT

< BASIC INSPECTION >

An unclamped or loose harness can cause wiring to be pinched by seat components (such as slide guides) during vehicle vibration. If the wiring runs under seating areas, inspect wire routing for possible damage or pinching.

HEAT SENSITIVE

- The customer's concern may occur during hot weather or after car has sat for a short time. In such cases you will want to check for a heat sensitive condition.
- To determine if an electrical component is heat sensitive, heat the component with a heat gun or equivalent.

CAUTION:

Never heat components above 60°C (140°F).

- If incident occurs while heating the unit, either replace or properly insulate the component.

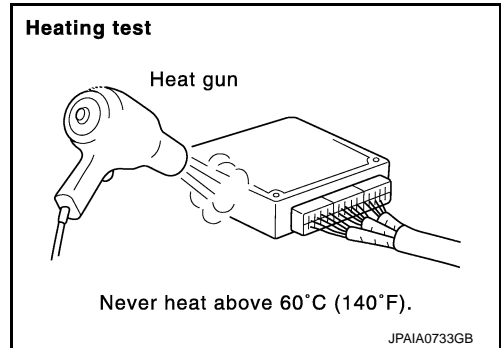

FREEZING

- The customer may indicate the incident goes away after the car warms up (winter time). The cause could be related to water freezing somewhere in the wiring/electrical system.
- There are two methods to check for this. The first is to arrange for the owner to leave his car overnight. Check it will get cold enough to demonstrate his complaint. Leave the car parked outside overnight. In the morning, do a quick and thorough diagnosis of those electrical components which could be affected.
- The second method is to put the suspect component into a freezer long enough for any water to freeze. Reinstall the part into the car and check for the reoccurrence of the incident. If it occurs, repair or replace the component.

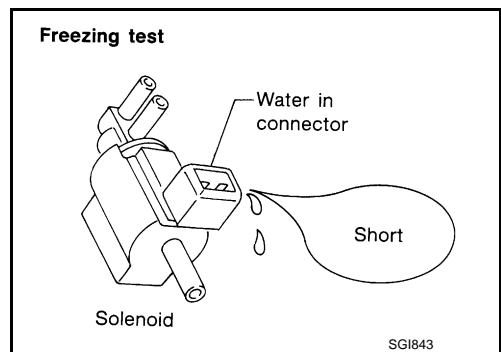

WATER INTRUSION

The incident may occur only during high humidity or in rainy/snowy weather. In such cases the incident could be caused by water intrusion on an electrical part. This can be simulated by soaking the car or running it through a car wash.

CAUTION:

Never spray water directly on any electrical components.

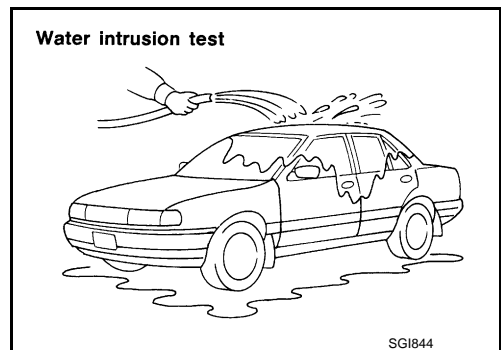

ELECTRICAL LOAD

The incident may be electrical load sensitive. Perform diagnosis with all accessories (including A/C, rear window defogger, radio, fog lamps) turned on.

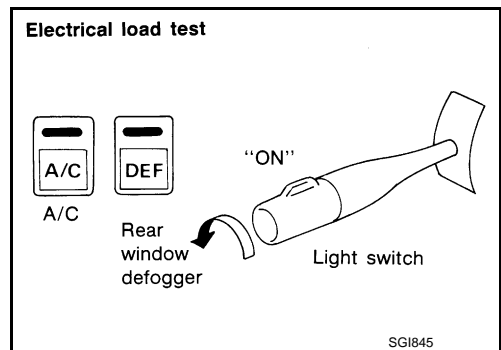

COLD OR HOT START UP

On some occasions an electrical incident may occur only when the car is started cold, or it may occur when the car is restarted hot shortly after being turned off. In these cases you may have to keep the car overnight to make a proper diagnosis.

GI

B

C

D

E

F

G

H

I

J

K

L

M

N

O

P

SERVICE INFORMATION FOR ELECTRICAL INCIDENT

< BASIC INSPECTION >

Circuit Inspection

INFOID:000000009011054

DESCRIPTION

- In general, testing electrical circuits is an easy task if it is approached in a logical and organized method. Before beginning it is important to have all available information on the system to be tested. Also, get a thorough understanding of system operation. Then you will be able to use the appropriate equipment and follow the correct test procedure.
- You may have to simulate vehicle vibrations while testing electrical components. Gently shake the wiring harness or electrical component to do this.

| | | |
|-------|---|---|
| OPEN | A circuit is open when there is no continuity through a section of the circuit. | |
| SHORT | There are two types of shorts. | |
| | • SHORT CIRCUIT | When a circuit contacts another circuit and causes the normal resistance to change. |
| | • SHORT TO GROUND | When a circuit contacts a ground source and grounds the circuit. |

NOTE:

Refer to [GI-40, "How to Check Terminal"](#) to probe or check terminal.

TESTING FOR "OPENS" IN THE CIRCUIT

Before you begin to diagnose and test the system, you should rough sketch a schematic of the system. This will help you to logically walk through the diagnosis process. Drawing the sketch will also reinforce your working knowledge of the system.

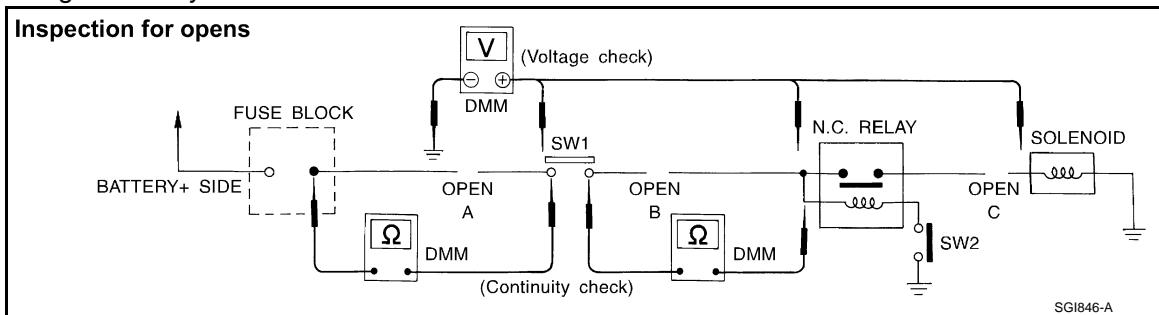

Continuity Check Method

The continuity check is used to find an open in the circuit. The digital multimeter (DMM) set on the resistance function will indicate an open circuit as over limit (no beep tone or no ohms symbol). Check to always start with the DMM at the highest resistance level.

To help in understanding the diagnosis of open circuits, please refer to the previous schematic.

- Disconnect the battery negative cable.
- Start at one end of the circuit and work your way to the other end. (At the fuse block in this example)
- Connect one probe of the DMM to the fuse block terminal on the load side.
- Connect the other probe to the fuse block (power) side of SW1. Little or no resistance will indicate that portion of the circuit has good continuity. If there were an open in the circuit, the DMM would indicate an over limit or infinite resistance condition. (point A)
- Connect the probes between SW1 and the relay. Little or no resistance will indicate that portion of the circuit has good continuity. If there were an open in the circuit, the DMM would indicate an over limit or infinite resistance condition. (point B)
- Connect the probes between the relay and the solenoid. Little or no resistance will indicate that portion of the circuit has good continuity. If there were an open in the circuit, the DMM would indicate an over limit or infinite resistance condition. (point C)

Any circuit can be diagnosed using the approach in the previous example.

Voltage Check Method

To help in understanding the diagnosis of open circuits please refer to the previous schematic.

In any powered circuit, an open can be found by methodically checking the system for the presence of voltage. This is done by switching the DMM to the voltage function.

- Connect one probe of the DMM to a known good ground.
- Begin probing at one end of the circuit and work your way to the other end.
- With SW1 open, probe at SW1 to check for voltage.
voltage: open is further down the circuit than SW1.

SERVICE INFORMATION FOR ELECTRICAL INCIDENT

< BASIC INSPECTION >

- no voltage: open is between fuse block and SW1 (point A).
 - Close SW1 and probe at relay.
 - voltage: open is further down the circuit than the relay.
 - no voltage: open is between SW1 and relay (point B).
 - Close the relay and probe at the solenoid.
 - voltage: open is further down the circuit than the solenoid.
 - no voltage: open is between relay and solenoid (point C).
- Any powered circuit can be diagnosed using the approach in the previous example.

TESTING FOR "SHORTS" IN THE CIRCUIT

To simplify the discussion of shorts in the system, please refer to the following schematic.

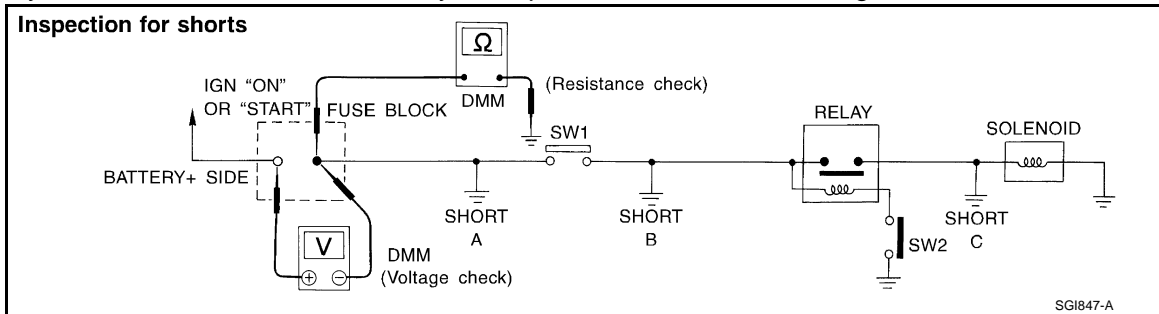

Resistance Check Method

- Disconnect the battery negative cable and remove the blown fuse.
- Disconnect all loads (SW1 open, relay disconnected and solenoid disconnected) powered through the fuse.
- Connect one probe of the DMM to the load side of the fuse terminal. Connect the other probe to a known good ground.
- With SW1 open, check for continuity.
 - continuity: short is between fuse terminal and SW1 (point A).
 - no continuity: short is further down the circuit than SW1.
- Close SW1 and disconnect the relay. Put probes at the load side of fuse terminal and a known good ground. Then, check for continuity.
 - continuity: short is between SW1 and the relay (point B).
 - no continuity: short is further down the circuit than the relay.
- Close SW1 and jump the relay contacts with jumper wire. Put probes at the load side of fuse terminal and a known good ground. Then, check for continuity.
 - continuity: short is between relay and solenoid (point C).
 - no continuity: check solenoid, retrace steps.

Voltage Check Method

- Remove the blown fuse and disconnect all loads (i.e. SW1 open, relay disconnected and solenoid disconnected) powered through the fuse.
- Turn the ignition switch to the ON or START position. Verify battery voltage at the battery + side of the fuse terminal (one lead on the battery + terminal side of the fuse block and one lead on a known good ground).
- With SW1 open and the DMM leads across both fuse terminals, check for voltage.
 - voltage: short is between fuse block and SW1 (point A).
 - no voltage: short is further down the circuit than SW1.
- With SW1 closed, relay and solenoid disconnected and the DMM leads across both fuse terminals, check for voltage.
 - voltage: short is between SW1 and the relay (point B).
 - no voltage: short is further down the circuit than the relay.
- With SW1 closed, relay contacts jumped with fused jumper wire check for voltage.
 - voltage: short is down the circuit of the relay or between the relay and the disconnected solenoid (point C).
 - no voltage: retrace steps and check power to fuse block.

GROUND INSPECTION

- Ground connections are very important to the proper operation of electrical and electronic circuits. Ground connections are often exposed to moisture, dirt and other corrosive elements. The corrosion (rust) can become an unwanted resistance. This unwanted resistance can change the way a circuit works.
- Electronically controlled circuits are very sensitive to proper grounding. A loose or corroded ground can drastically affect an electronically controlled circuit. A poor or corroded ground can easily affect the circuit. Even when the ground connection looks clean, there can be a thin film of rust on the surface.

SERVICE INFORMATION FOR ELECTRICAL INCIDENT

< BASIC INSPECTION >

- When inspecting a ground connection follow these rules:
 - Remove the ground bolt or screw.
 - Inspect all mating surfaces for tarnish, dirt, rust, etc.
 - Clean as required to assure good contact.
 - Reinstall bolt or screw securely.
- Inspect for “add-on” accessories which may be interfering with the ground circuit.
- If several wires are crimped into one ground eyelet terminal, check for proper crimps. Check all of the wires are clean, securely fastened and providing a good ground path. If multiple wires are cased in one eyelet check no ground wires have excess wire insulation.
- For detailed ground distribution information, refer to “Ground Distribution” in PG section.

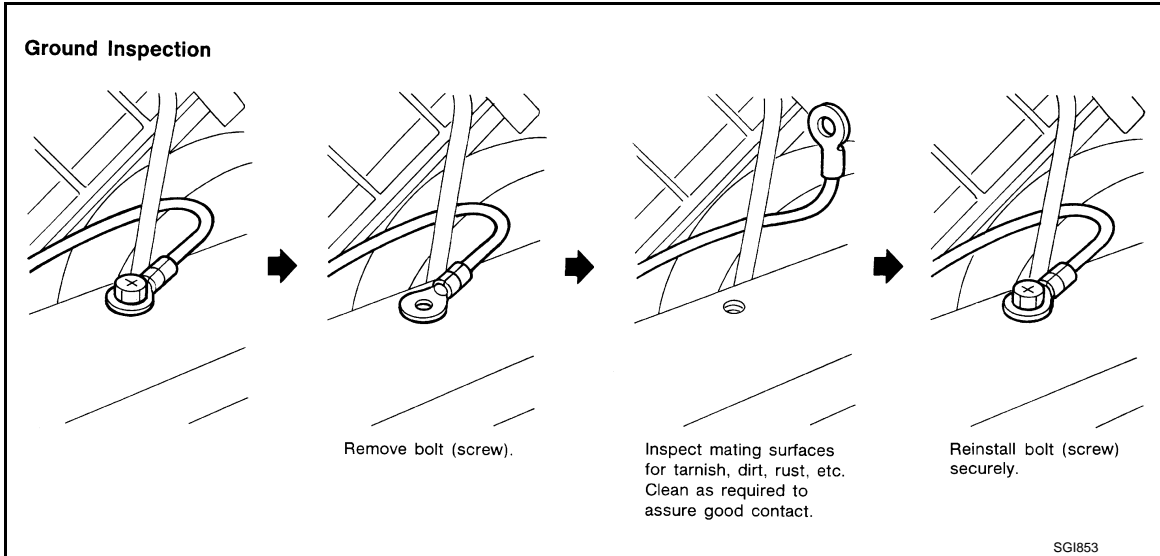

VOLTAGE DROP TESTS

- Voltage drop tests are often used to find components or circuits which have excessive resistance. A voltage drop in a circuit is caused by a resistance when the circuit is in operation.
- Check the wire in the illustration. When measuring resistance with DMM, contact by a single strand of wire will give reading of 0 ohms. This would indicate a good circuit. When the circuit operates, this single strand of wire is not able to carry the current. The single strand will have a high resistance to the current. This will be picked up as a slight voltage drop.
- Unwanted resistance can be caused by many situations as follows:
 - Undersized wiring (single strand example)
 - Corrosion on switch contacts
 - Loose wire connections or splices.
- If repairs are needed always use wire that is of the same or larger gauge.

Measuring Voltage Drop — Accumulated Method

- Connect the DMM across the connector or part of the circuit you want to check. The positive lead of the DMM should be closer to power and the negative lead closer to ground.
- Operate the circuit.
- The DMM will indicate how many volts are being used to “push” current through that part of the circuit.

SERVICE INFORMATION FOR ELECTRICAL INCIDENT

< BASIC INSPECTION >

Note in the illustration that there is an excessive 4.1 volt drop between the battery and the bulb.

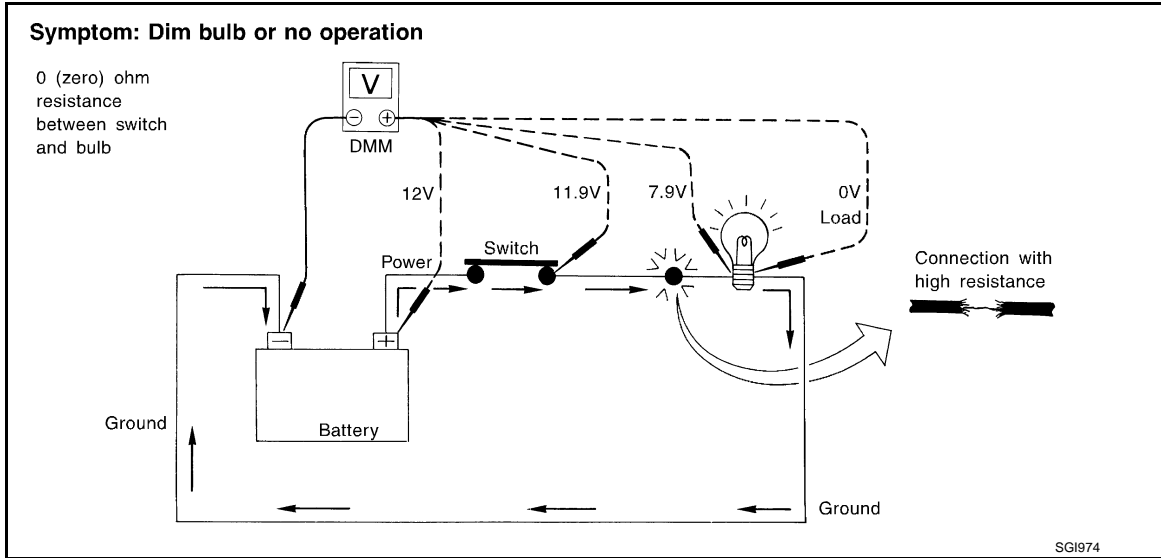

Measuring Voltage Drop — Step-by-Step

- The step-by-step method is most useful for isolating excessive drops in low voltage systems (such as those in “Computer Controlled Systems”).
- Circuits in the “Computer Controlled System” operate on very low amperage.
- The (Computer Controlled) system operations can be adversely affected by any variation in resistance in the system. Such resistance variation may be caused by poor connection, improper installation, improper wire gauge or corrosion.
- The step by step voltage drop test can identify a component or wire with too much resistance.

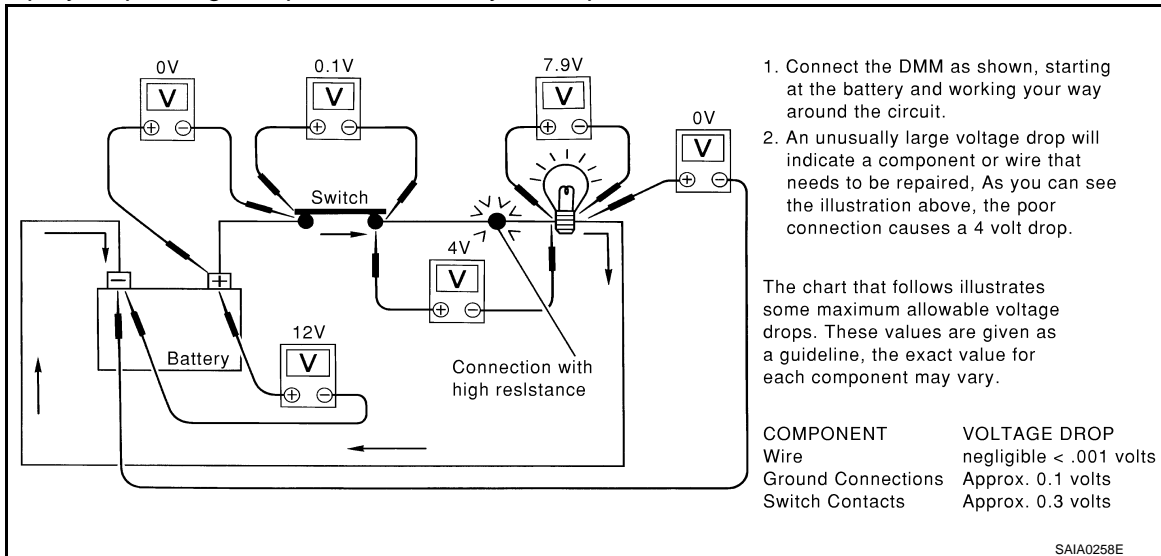

CONTROL UNIT CIRCUIT TEST

System Description

- When the switch is ON, the control unit lights up the lamp.

CASE 1

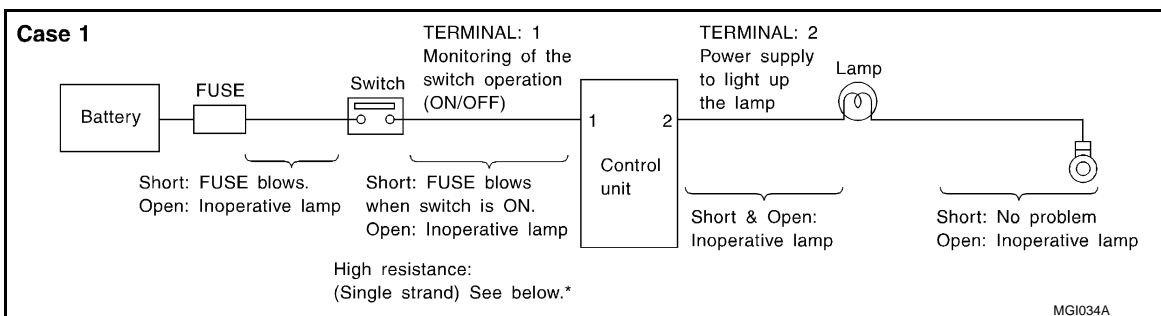

SERVICE INFORMATION FOR ELECTRICAL INCIDENT

< BASIC INSPECTION >

INPUT-OUTPUT VOLTAGE CHART

| Terminal No. | | Description | | Condition | Value (Approx.) | In case of high resistance such as single strand (V) * |
|--------------|-------------|-------------|--------------|------------|-----------------|--|
| + | - | Signal name | Input/Output | | | |
| 1 | Body ground | Switch | Input | Switch ON | Battery voltage | Lower than battery voltage Approx. 8 (Example) |
| | | | | Switch OFF | 0 V | Approx. 0 |
| 2 | Body ground | Lamp | Output | Switch ON | Battery voltage | Approx. 0 (Inoperative lamp) |
| | | | | Switch OFF | 0 V | Approx. 0 |

- The voltage value is based on the body ground.
- *: If high resistance exists in the switch side circuit (caused by a single strand), terminal 1 does not detect battery voltage. Control unit does not detect the switch is ON even if the switch does not turn ON. Therefore, the control unit does not supply power to light up the lamp.

CASE 2

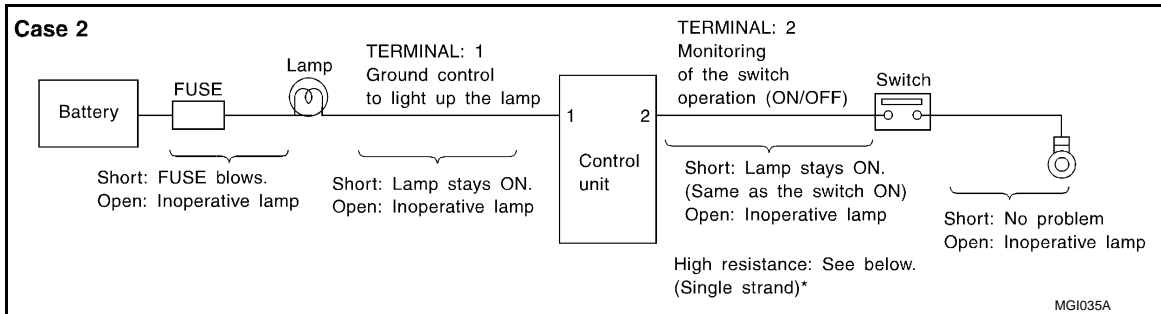

INPUT-OUTPUT VOLTAGE CHART

| Terminal No. | | Description | | Condition | Value (Approx.) | In case of high resistance such as single strand (V) * |
|--------------|-------------|-------------|--------------|------------|-----------------|--|
| + | - | Signal name | Input/Output | | | |
| 1 | Body ground | Lamp | Output | Switch ON | 0 V | Battery voltage (Inoperative lamp) |
| | | | | Switch OFF | Battery voltage | Battery voltage |
| 2 | Body ground | Switch | Input | Switch ON | 0 V | Higher than 0 Approx. 4 (Example) |
| | | | | Switch OFF | 5 V | Approx. 5 |

- The voltage value is based on the body ground.
- *: If high resistance exists in the switch side circuit (caused by a single strand), terminal 2 does not detect approx. 0 V. Control unit does not detect the switch is ON even if the switch does not turn ON. Therefore, the control unit does not control ground to light up the lamp.

CONSULT/GST CHECKING SYSTEM

< BASIC INSPECTION >

CONSULT/GST CHECKING SYSTEM

GI

Description

INFOID:000000009011055

- When CONSULT/GST is connected with a data link connector (A) equipped on the vehicle side, it will communicate with the control unit equipped in the vehicle and then enable various kinds of diagnostic tests.

1 : Instrument lower panel LH

- Refer to "CONSULT Software Operation Manual" for more information.

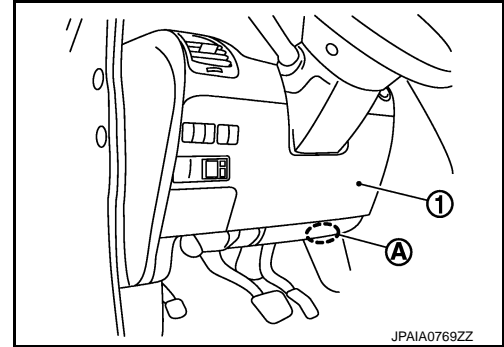

CONSULT Function and System Application*1

INFOID:000000009011056

FUNCTION

| Mode | Function |
|-------------------------------|---|
| All DTC Reading | Display all DTCs or diagnostic items that all ECUs are recording and judging. |
| Work Support | This mode enables a technician to adjust some devices faster and more accurately. |
| Self Diagnostic Results | Retrieve DTC from ECU and display diagnostic items. |
| Data Monitor | Monitor the input/output signal of the control unit in real time. |
| CAN Diagnosis | This mode displays a network diagnosis result about CAN by diagram. |
| CAN Diagnosis Support Monitor | It monitors the status of CAN communication. |
| Active Test | Send the drive signal from CONSULT to the actuator. The operation check can be performed. |
| ECU Identification | Display the ECU identification number (part number etc.) of the selected system. |
| Configuration | Function to READ/WRITE vehicle configuration. |
| SRT&P-DTC Confirmation | The state of System Readiness Test (SRT) items, the presence or absence of permanent DTC*, and driving conditions can be checked. |
| DTC work support | DTC reproduction procedure can be performed speedily and precisely. |
| Others | Other results or histories, etc. that are recorded in ECU are displayed. |

*: Permanent DTC is not applied for regions where it is not mandated.

SYSTEM APPLICATION*1

| System | All DTC Reading | Work Support | Self Diagnostic Results | Data Monitor | CAN Diagnosis | CAN Diagnosis Support Monitor | Active Test | ECU Identification | Configuration | SRT&P-DTC Confirmation | DTC work support | Others |
|--------------|-----------------|--------------|-------------------------|--------------|---------------|-------------------------------|-------------|--------------------|---------------|------------------------|------------------|--|
| ENGINE | x | x | x | x | x | x | x | x | - | x*2 | x | - |
| TRANSMISSION | x | x | x | x | x | x | - | x | x | - | x | • CALIB DATA |
| AIR BAG | x | - | x | - | x | - | - | x | - | - | - | • TROUBLE DIAG RECORD • SELF-DIAG RESULT [CAN] • Cause of Warning Lamp |

B

C

D

E

F

G

H

I

J

K

L

M

N

O

P

CONSULT/GST CHECKING SYSTEM

< BASIC INSPECTION >

| System | All DTC Reading | Work Support | Self Diagnostic Results | Data Monitor | CAN Diagnosis | CAN Diagnosis Support Monitor | Active Test | ECU Identification | Configuration | SRT&P-DTC Confirmation | DTC work support | Others |
|----------------------|-----------------|--------------|-------------------------|--------------|---------------|-------------------------------|-------------|--------------------|---------------|------------------------|------------------|-------------------|
| METER / M&A | x | x | x | x | x | x | - | - | - | - | - | • Warning History |
| AUTO BACK DOOR | x | - | x | x | x | x | - | x | - | - | - | - |
| BCM | x | x | x | x | x | x | x | x | x | - | - | - |
| AUTO DRIVE POS. | x | x | x | x | x | x | x | x | - | - | - | - |
| ABS | x | x | x | x | x | x | x | x | - | - | - | - |
| IPDM E/R | x | - | x | x | x | x | x | x | - | - | - | - |
| ALL MODE AWD/4WD | x | x | x | x | x | x | - | x | - | - | - | - |
| MULTI AV | - | x | x | x | x | x | - | x | x | - | - | - |
| ICC/ADAS | x | x | x | x | x | x | x | x | - | - | - | - |
| AVM | x | x | x | x | x | x | - | x | x | - | - | - |
| SONAR | x | x | x | x | x | x | x | x | x | - | - | - |
| AIR PRESSURE MONITOR | x | x | x | x | x | x | x | x | - | - | - | - |
| AFS (ADAPTIVE LIGHT) | x | x | x | x | x | x | x | x | - | - | - | - |
| PRECRASH SEAT BELT | x | x | x | x | x | x | - | x | - | - | - | - |
| HVAC | - | x | x | x | x | x | x | x | - | - | - | - |
| LASER | x | x | x | x | x | x | - | x | - | - | - | - |
| LANE CAMERA | x | x | x | x | x | x | - | x | - | - | - | - |
| ACCELE PEDAL ACT | x | - | x | x | x | x | x | x | - | - | - | - |
| E-SUS | x | x | x | x | x | x | x | x | - | - | - | - |
| SIDE RADAR LEFT | x | - | x | x | x | x | x | x | - | - | - | - |
| SIDE RADAR RIGHT | x | - | x | x | x | x | x | x | - | - | - | - |
| CAN GATEWAY | x | - | x | - | x | x | - | x | x | - | - | - |
| TCU | x | x | x | x | x | - | x | x | - | - | - | - |

x: Applicable

*1: If GST application is equipped, functions in accordance with SAE J1979 and ISO 15031-5 can be used.

*2: Permanent DTC is not applied for regions where it is not mandated.

CONSULT/GST Data Link Connector (DLC) Circuit

INFOID:000000009011057

INSPECTION PROCEDURE

If the CONSULT/GST cannot diagnose the system properly, check the following items.

| Symptom | Check item |
|---|--|
| CONSULT/GST cannot access any system. | <ul style="list-style-type: none"> CONSULT/GST DLC power supply circuit (Terminal 8 and 16) and ground circuit (Terminal 4 and 5) |
| CONSULT cannot access individual system. (Other systems can be accessed.) | <ul style="list-style-type: none"> Power supply and ground circuit for the control unit of the system (For detailed circuit, refer to wiring diagram for each system.) Open or short circuit between the system and CONSULT DLC (For detailed circuit, refer to wiring diagram for each system.) Open or short circuit CAN communication line. Refer to LAN-22, "Trouble Diagnosis Flow Chart". |

NOTE:

CONSULT/GST CHECKING SYSTEM

< BASIC INSPECTION >

The DDL1 and DDL2 circuits from DLC pins 12, 13, 14 and 15 may be connected to more than one system. A short in a DDL circuit connected to a control unit in one system may affect CONSULT access to other systems. If the GST cannot operate properly, check the circuit based on the information of SAE J1962 and ISO 15031-3.

GI

Wiring Diagram - CONSULT/GST CHECKING SYSTEM -

INFOID:000000009011058

WITH ICC

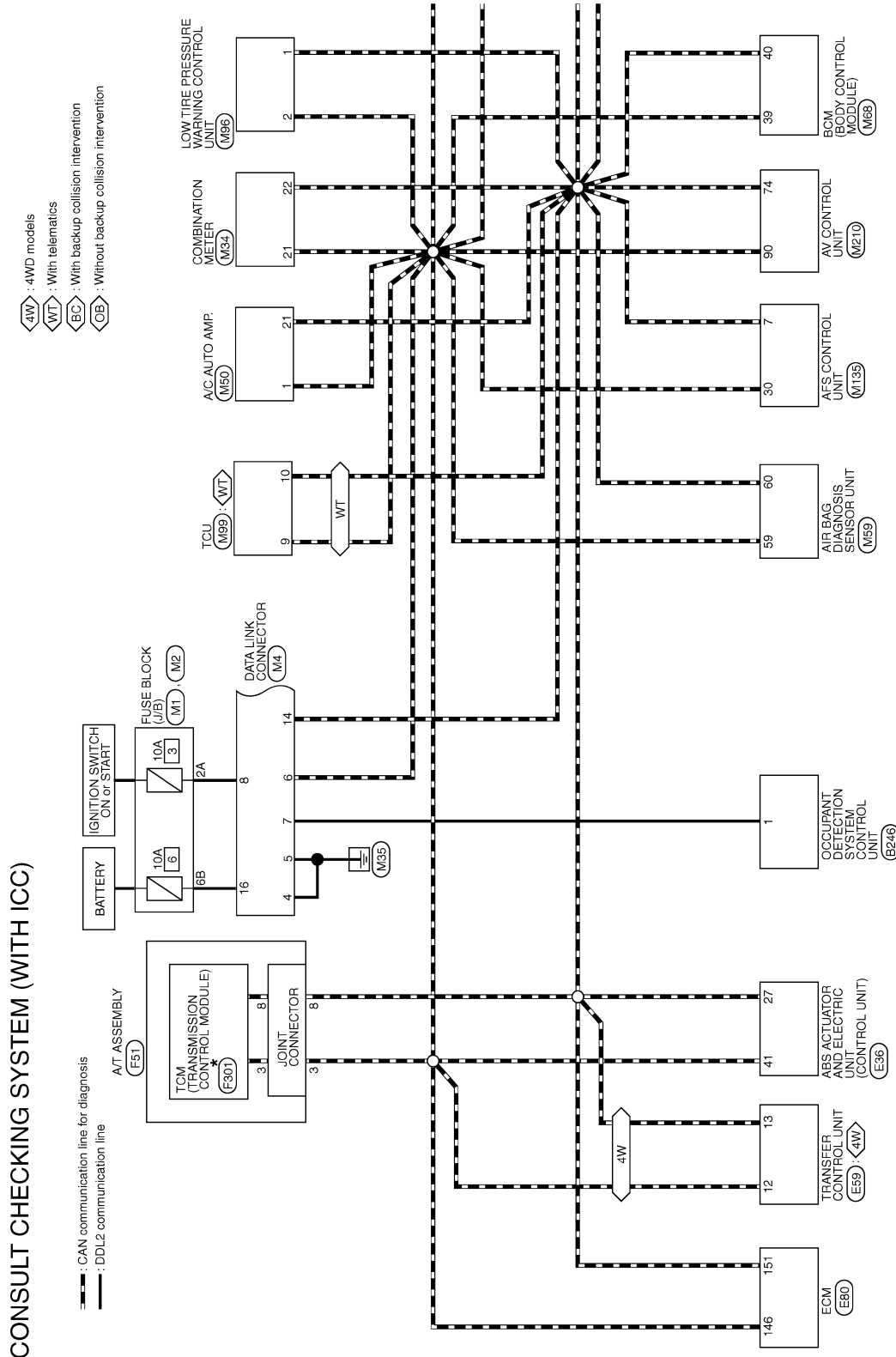

B
C
D
E
F
G
H
I
J
K
L
M
N
O
P

CONSULT/GST CHECKING SYSTEM

< BASIC INSPECTION >

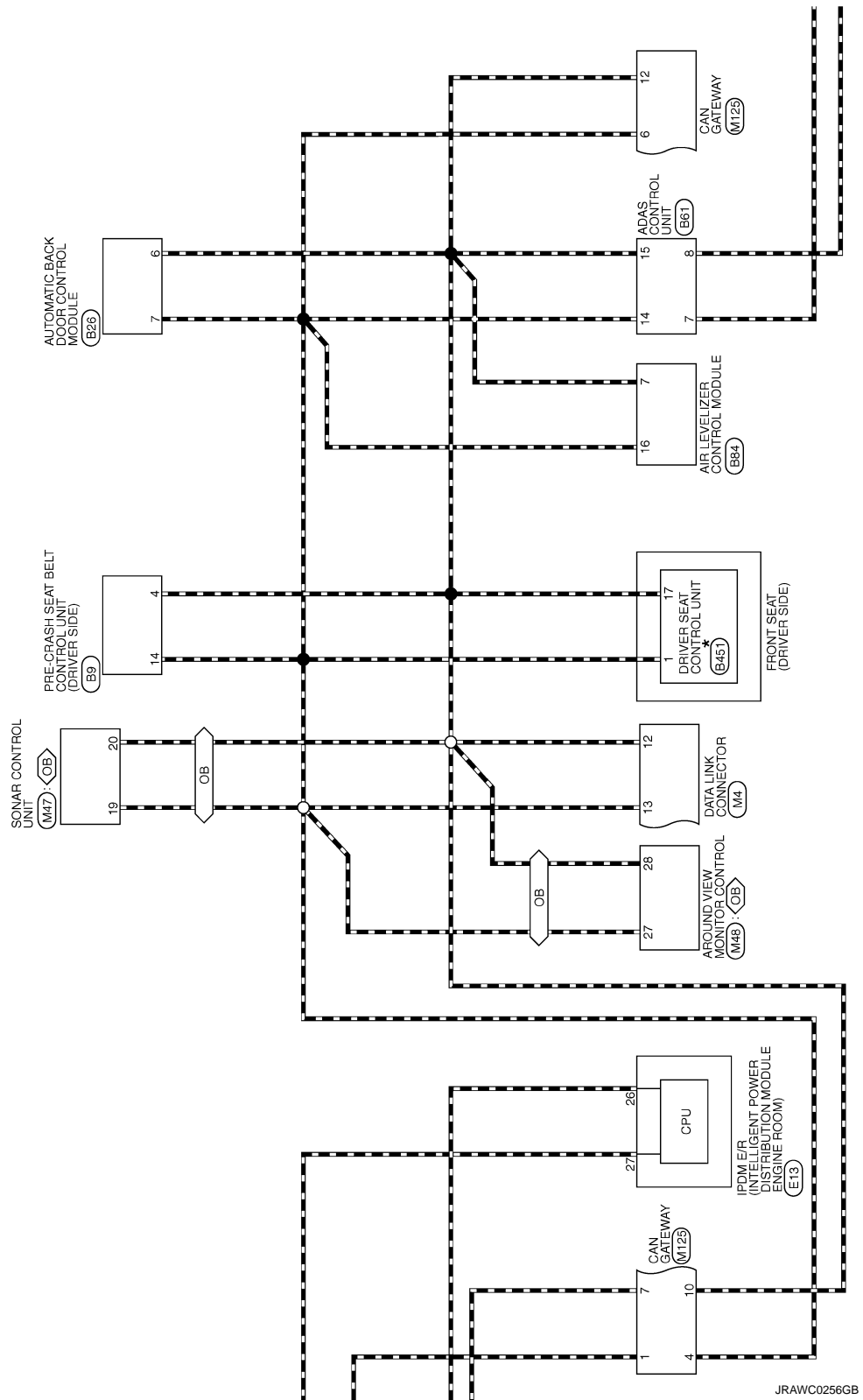

JRAWC0256GB

CONSULT/GST CHECKING SYSTEM

< BASIC INSPECTION >

GI

B
C
D
E
F
G
H
I
J
K
L
M
N
O
P

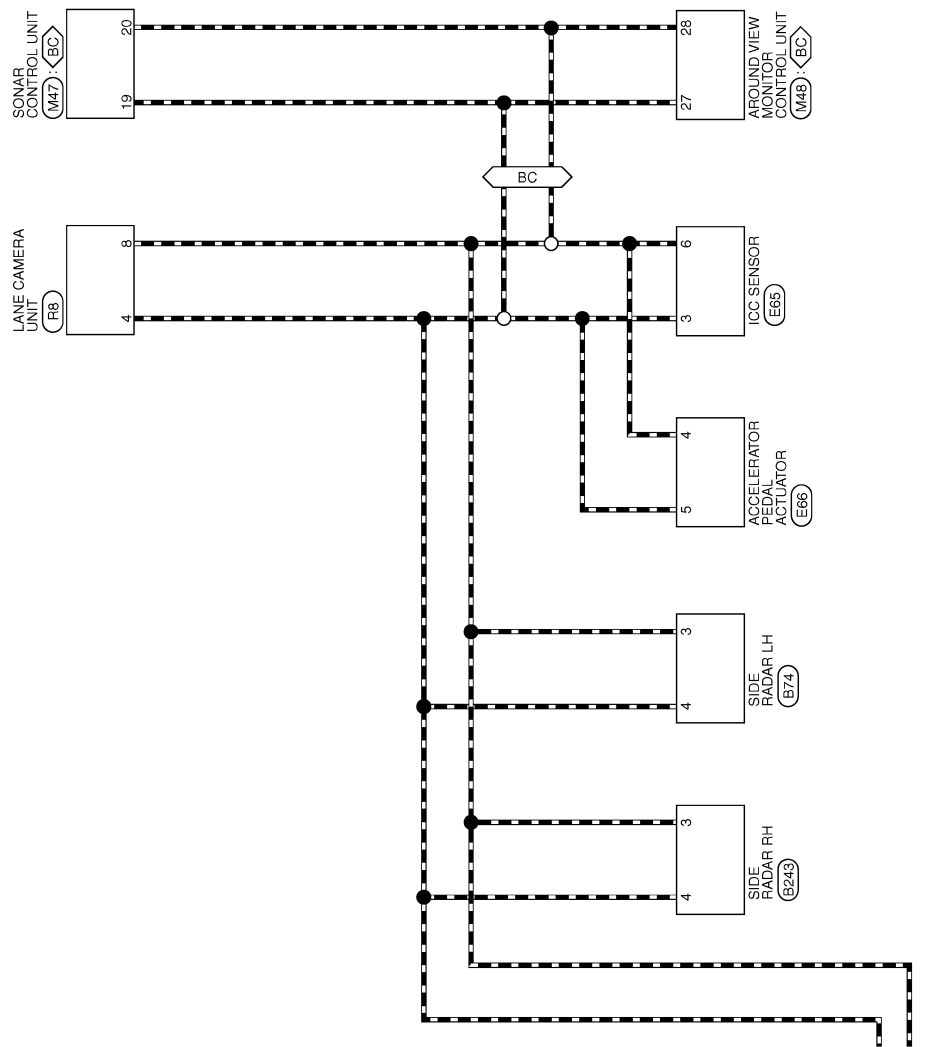

JRAWC0257GB

CONSULT/GST CHECKING SYSTEM

< BASIC INSPECTION >

CONSULT CHECKING SYSTEM (WITH ICC)

| | |
|----------------|---|
| Connector No. | B89 |
| Connector Name | PRE-CANSA SEAT BELT CONTROL UNIT (POWER SEAT) |
| Connector Type | TH86FW-CS2 |

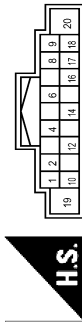

| Terminal No. | Color Of Wire | Signal Name [Specification] |
|--------------|---------------|-----------------------------|
| 1 | Y | SIG BAT |
| 2 | G | OUT 1 |
| 4 | P | CANL |
| 5 | LG/R | BUCKLE SW LH NO |
| 6 | G | LOCAL COMM 2 |
| 8 | SHIELD | SHIELD GND |
| 9 | R | SENS POWER 1 |
| 12 | B | OUT 2 |
| 14 | L | CANH |
| 16 | W | LOCAL COMM 1 |
| 17 | W | SENS GND 1 |
| 18 | B | SIG GND |
| 19 | W | MOTOR BAT |
| 20 | B | MOTOR GND |

| | |
|----------------|------------------------------------|
| Connector No. | B26 |
| Connector Name | AUTOMATIC BACK DOOR CONTROL MODULE |
| Connector Type | TH20FW-TB6 |

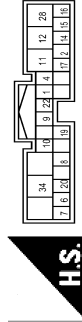

| Terminal No. | Color Of Wire | Signal Name [Specification] |
|--------------|---------------|-----------------------------|
| 1 | L | BUIZZER |
| 2 | Y/B | ABD SW |
| 4 | GR | ABD CLOSE SW |
| 6 | P | CANL |
| 7 | L | CANH |

| | | |
|----|------|---------------------|
| 8 | L/W | HALF LATCH SW |
| 9 | GR/L | IGN |
| 10 | Y | BAT |
| 11 | R | CLOSURE MTR (CLOSE) |
| 12 | V | CLOSURE MTR (OPEN) |
| 14 | GW | TOUCH SENS LH |
| 15 | L/R | TOUCH SENS GND |
| 16 | LG | TOUCH SENS RH |
| 17 | O | MAIN SW |
| 19 | L/Y | CLOSE SW |
| 20 | G/Y | OPEN SW |
| 22 | B | GND |
| 28 | R/W | BAT |
| 34 | B | GND |

| | |
|----------------|-------------------|
| Connector No. | B61 |
| Connector Name | ADAS CONTROL UNIT |
| Connector Type | TH86FW-NH |

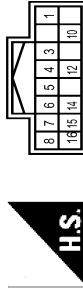

| Terminal No. | Color Of Wire | Signal Name [Specification] |
|--------------|---------------|-----------------------------|
| 1 | V/W | WARNING SYSTEMS SW |
| 3 | R/Y | IBA OFF SW |
| 4 | LG/B | WARNING SYSTEMS ON IND |
| 5 | R | BRAKE HOLD RLY DRIVE SIGNAL |
| 6 | B | GND |
| 7 | L | ITS COMM-L |
| 8 | Y | ITS COMM-H |
| 10 | O | BGI SW |
| 12 | G/R | WARNING BUZZER |
| 14 | L | CANL |
| 15 | P | CANH |
| 16 | W/G | IGNITION |

| | |
|----------------|---------------|
| Connector No. | B74 |
| Connector Name | SIDE RADAR LH |
| Connector Type | IAA06FB-VP-5P |



| Terminal No. | Color Of Wire | Signal Name [Specification] |
|--------------|---------------|-----------------------------|
| 2 | B | GND |
| 3 | Y | ITS COMM-L |
| 4 | L | ITS COMM-H |
| 5 | W/G | IGNITION |
| 6 | BR | BSW INDICATOR |

| | |
|----------------|------------------------------|
| Connector No. | B84 |
| Connector Name | AIR LEVELIZER CONTROL MODULE |
| Connector Type | TH86FW-NH |



| Terminal No. | Color Of Wire | Signal Name [Specification] |
|--------------|---------------|------------------------------------|
| 2 | B | GND |
| 3 | V | AIR COMPRESSOR RELAY |
| 4 | L/W | VEHICLE HEIGHT SENSOR GND |
| 5 | W | VEHICLE HEIGHT SENSOR SIGNAL |
| 7 | P | CANL |
| 9 | P/L | IGN |
| 11 | V/W | EXHAUST SOLENOID |
| 13 | R | VEHICLE HEIGHT SENSOR POWER SUPPLY |
| 16 | L | CANH |

| | |
|----------------|---------------|
| Connector No. | B243 |
| Connector Name | SIDE RADAR RH |
| Connector Type | IAA06FB-VP |



| Terminal No. | Color Of Wire | Signal Name [Specification] |
|--------------|---------------|-----------------------------|
| 1 | B/Y | RIGHT/LEFT SWITCHING SIGNAL |
| 2 | B | GND |
| 3 | Y | ITS COMM-L |
| 4 | L | ITS COMM-H |
| 5 | W/G | IGNITION |
| 6 | L/R | BSW INDICATOR |

| | |
|----------------|--|
| Connector No. | B246 |
| Connector Name | OCCUPANT DETECTION SYSTEM CONTROL UNIT |
| Connector Type | TH86FW-NH |



| Terminal No. | Color Of Wire | Signal Name [Specification] |
|--------------|---------------|-----------------------------|
| 1 | W | - |
| 2 | B | - |
| 3 | L/R | - |
| 4 | R/L | - |

CONSULT CHECKING SYSTEM (WITH ICC)

| | |
|----------------|--------------------------|
| Connector No. | B451 |
| Connector Name | DRIVER SEAT CONTROL UNIT |
| Connector Type | TH32FM-NH |

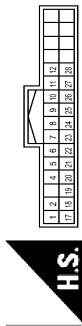

| | |
|----------------|---|
| Connector No. | E13 |
| Connector Name | POWER INTELLIGENT POWER DISTRIBUTION MODULE (ENGINE ROOM) |
| Connector Type | TH12FM-NH |



| | | | |
|--------------|----|-----|-----------------|
| Terminal No. | 21 | R/O | DS RR |
| Terminal No. | 22 | V | DP RL |
| Terminal No. | 27 | P | CAN-L |
| Terminal No. | 33 | LG | DP FR |
| Terminal No. | 34 | G | DS FL |
| Terminal No. | 35 | BR | DP RR |
| Terminal No. | 36 | P | DS RL |
| Terminal No. | 37 | R | STP |
| Terminal No. | 39 | L/W | VDC OFF SW |
| Terminal No. | 41 | L | CAN-H |
| Terminal No. | 46 | W | STOP LAMP SW ON |



| Terminal No. | Color Of Wire | Signal Name [Specification] |
|--------------|---------------|-----------------------------|
| 1 | R/Y | CAN-H |
| 2 | R | UART (TX/RX) |
| 4 | R/L | PULSE (RECLINER) |
| 5 | R/B | TELESCOPIC SENSOR |
| 6 | R/W | ADDRESS 2 |
| 7 | R/G | IND-2 |
| 8 | SB | SLIDE SW (BACKWARD) |
| 9 | L | RECLINER SW (BACKWARD) |
| 10 | L/B | FRONT LIFTER SW (DOWNWARD) |
| 11 | L/W | REAR LIFTER SW (DOWNWARD) |
| 12 | L/R | SENSOR POWER SUPPLY |
| 17 | V | CAN-L |
| 18 | B/W | PULSE (SLIDE) |
| 19 | B/R | PULSE (FRONT LIFTER) |
| 20 | B/L | PULSE (REAR LIFTER) |
| 21 | W/B | TILT SENSOR |
| 22 | W/L | ADDRESS 1 |
| 23 | W/R | IND-1 |
| 24 | W/W | SLIDE SW (FORWARD) |
| 25 | Y/B | RECLINER SW (FORWARD) |
| 26 | Y/R | FRONT LIFTER SW (UPWARD) |
| 27 | Y/L | REAR LIFTER SW (UPWARD) |
| 28 | G | SET SW |

| | |
|----------------|-----------------------|
| Connector No. | E59 |
| Connector Name | TRANSFER CONTROL UNIT |
| Connector Type | TH40FM-NH |



| | | | |
|--------------|---|-----|------------|
| Terminal No. | 1 | W/G | IGNITION |
| Terminal No. | 3 | L | ITS COMM-L |
| Terminal No. | 4 | B | GND |
| Terminal No. | 6 | Y | ITS COMM-H |

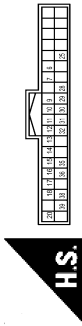

| | |
|----------------|---|
| Connector No. | E36 |
| Connector Name | ABS ACTUATOR AND ELECTRIC UNIT (CONTROL UNIT) |
| Connector Type | SA242FB-SJ24 |

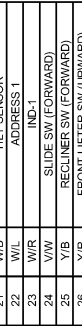

| | | | |
|--------------|----|------|------------------------------------|
| Terminal No. | 6 | BR | H-L0 POSITION SEN 1 |
| Terminal No. | 7 | Y | TRANSFER FLUID TEMP SEN PWR SUPPLY |
| Terminal No. | 9 | G | INTERNAL SPEED SEN GND |
| Terminal No. | 10 | Y/G | INTERNAL SPEED SEN IMP |
| Terminal No. | 11 | V | 4L SW |
| Terminal No. | 12 | L | CAN-H |
| Terminal No. | 13 | P | CAN-L |
| Terminal No. | 14 | W/R | AUTO SW |
| Terminal No. | 15 | P/B | ROTARY POSITION SEN PWM |
| Terminal No. | 16 | LG | ROTARY POSITION SEN GND |
| Terminal No. | 17 | W/L | LOCK POSITION SEN PWR SUPPLY |
| Terminal No. | 18 | B/R | ROTARY POSITION SEN PWR SUPPLY |
| Terminal No. | 20 | GR | TRANSFER FLUID PWR SUPPLY |
| Terminal No. | 25 | P/L | H-L0 POSITION SEN 3 |
| Terminal No. | 28 | W | MOTOR TEMP SEN PWR SUPPLY |
| Terminal No. | 29 | LG/R | H-L0 POSITION SEN 2 |
| Terminal No. | 30 | R/B | LOCK POSITION SEN GND |
| Terminal No. | 31 | L/O | INTERNAL SPEED SEN DIR |
| Terminal No. | 32 | B/R | IGN |
| Terminal No. | 35 | R | 4H SW |
| Terminal No. | 36 | L/R | TRANSFER FLUID TEMP SEN GND |
| Terminal No. | 38 | G/O | LOCK POSITION SEN SIGNAL |
| Terminal No. | 39 | R/W | INTERNAL SPEED SEN PWR SUPPLY |

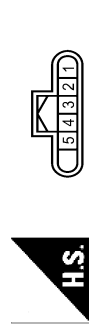

| | | | |
|--------------|----|-----|--|
| Terminal No. | 1 | G | BAT |
| Terminal No. | 2 | B | GND |
| Terminal No. | 3 | B | GND |
| Terminal No. | 4 | W | MOTOR SUPPLY |
| Terminal No. | 9 | R/B | YAW RATE (SKEW) SENSOR COMMUNICATIONAL |
| Terminal No. | 10 | P/B | YAW RATE (SKEW) SENSOR COMMUNICATIONAL |
| Terminal No. | 13 | GR | BRAKE FLUID LEVEL SW |
| Terminal No. | 17 | L/R | STP2 |
| Terminal No. | 18 | W/B | IGN |
| Terminal No. | 19 | O | DS FR |
| Terminal No. | 20 | SB | DP-FL |

| | |
|----------------|------------|
| Connector No. | E65 |
| Connector Name | ICC SENSOR |
| Connector Type | RS06FB-FR |



JRAWC0541GB

CONSULT/GST CHECKING SYSTEM

< BASIC INSPECTION >

CONSULT CHECKING SYSTEM (WITH ICC)

| | |
|----------------|-------------------|
| Connector No. | E60 |
| Connector Name | ECM |
| Connector Type | IMAB55FB-MEB10-LH |

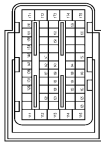

| Terminal No. | Color Of Wire | Signal Name [Specification] |
|--------------|---------------|---------------------------------------|
| 111 | R | FUEL INJECTOR DRIVER POWER SUPPLY |
| 112 | SB | FUEL INJECTOR DRIVER POWER SUPPLY |
| 113 | G | ECM GROUND |
| 114 | B | ECM GROUND |
| 115 | B | ECM GROUND |
| 120 | V | EVAP CANISTER VENT CONTROL VALVE |
| 122 | BR/W | EVAP CANISTER VENT CONTROL VALVE |
| 123 | W/R | THROTTLE CONTROL MOTOR RELAY |
| 125 | GR | FUEL PUMP CONTROL MODULE (FPDM) |
| 126 | O | ACCELERATOR PEDAL POSITION SENSOR 2 |
| 128 | Y | ASDC/ICC STEERING SWITCH |
| 129 | P/L | SENSOR GROUND |
| 130 | R | SENSOR GROUND |
| 131 | L/W | SENSOR POWER SUPPLY |
| 133 | SB | SENSOR POWER SUPPLY |
| 134 | V/W | FUEL TEMPERATURE SENSOR |
| 136 | W/R | ACCELERATOR PEDAL POSITION SENSOR 1 |
| 137 | W/G | SENSOR POWER SUPPLY |
| 138 | V | BATTERY CURRENT SENSOR |
| 139 | G | BATTERY TEMPERATURE SENSOR |
| 140 | R/Y | SENSOR GROUND |
| 141 | SB | IGNITION SWITCH |
| 142 | R/W | FUEL PUMP CONTROL MODULE (FPDM) CHECK |
| 143 | L/Y | EVAP CONTROL SYSTEM PRESSURE SENSOR |
| 144 | O/B | REFRIGERANT PRESSURE SENSOR |
| 146 | L | CAN COMMUNICATION LINE |
| 147 | G/Y | ASDC/ICC BRAKE SWITCH |
| 150 | R | SENSOR GROUND |
| 151 | P | CAN COMMUNICATION LINE |
| 156 | L | POWER SUPPLY FOR ECM (BACK-UP) |
| 158 | W/B | STOP LAMP SWITCH |
| 161 | R/W | ECM COMMUNICATION LINE |
| 163 | L/G | ECM RELAY (SELF SHUT-OFF) |
| 165 | GR/B | ECM RELAY (SELF SHUT-OFF) |
| 166 | W | ECM COMMUNICATION LINE |
| 169 | G/B | ENGINE SPEED SIGNAL OUTPUT |

| | | |
|-----|---|-------------------------------------|
| 171 | W | POWER SUPPLY FOR ECM |
| 172 | W | POWER SUPPLY FOR ECM |
| 173 | O | THROTTLE CONTROL MOTOR POWER SUPPLY |
| 174 | B | ECM GROUND |
| 175 | B | ECM GROUND |

| | |
|----------------|--------------|
| Connector No. | F51 |
| Connector Name | A/T ASSEMBLY |
| Connector Type | RK10FG |



| Terminal No. | Color Of Wire | Signal Name [Specification] |
|--------------|---------------|-----------------------------|
| 1 | V | IGNITION POWER SUPPLY |
| 2 | P | BATTERY POWER SUPPLY |
| 3 | L | CAN-H |
| 4 | SB | K-LINE |
| 5 | B | GROUND |
| 6 | V | IGNITION POWER SUPPLY |
| 7 | R | BACK-UP LAMP RELAY |
| 8 | P | CAN-L |
| 9 | BR | STARTER RELAY |
| 10 | B | GROUND |

| | |
|----------------|-----------------------------------|
| Connector No. | F301 |
| Connector Name | TCM (TRANSMISSION CONTROL MODULE) |
| Connector Type | SP10FG |



| Terminal No. | Color Of Wire | Signal Name [Specification] |
|--------------|---------------|-----------------------------|
| 1 | - | IGNITION POWER SUPPLY |
| 2 | - | BATTERY POWER SUPPLY |
| 3 | - | CAN-H |

| | | |
|----|---|-----------------------|
| 4 | - | K-LINE |
| 5 | - | GROUND |
| 6 | - | IGNITION POWER SUPPLY |
| 7 | - | BACK-UP LAMP RELAY |
| 8 | - | CAN-L |
| 9 | - | STARTER RELAY |
| 10 | - | GROUND |

| | |
|----------------|------------------|
| Connector No. | M1 |
| Connector Name | FUSE BLOCK (J/B) |
| Connector Type | NS08FM-M2 |

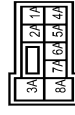

| Terminal No. | Color Of Wire | Signal Name [Specification] |
|--------------|---------------|-----------------------------|
| 1A | Y | - |
| 2A | GR | - |
| 3A | W | - |
| 4A | Y/G | - |
| 5A | V | - |
| 6A | L/W | - |
| 7A | LG | - |
| 8A | W | - |

| | |
|----------------|------------------|
| Connector No. | M2 |
| Connector Name | FUSE BLOCK (J/B) |
| Connector Type | NS10FM-GS |



| Terminal No. | Color Of Wire | Signal Name [Specification] |
|--------------|---------------|-----------------------------|
| 1B | R | - |
| 3B | R | - |
| 4B | B | - |

| | | |
|-----|-----|---|
| 5B | BR | - |
| 6B | Y | - |
| 8B | L/O | - |
| 10B | W/B | - |

| | |
|----------------|---------------------|
| Connector No. | M4 |
| Connector Name | DATA LINK CONNECTOR |
| Connector Type | BD16FW |

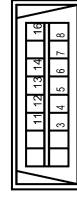

| Terminal No. | Color Of Wire | Signal Name [Specification] |
|--------------|---------------|-----------------------------|
| 3 | LG | - |
| 4 | B | - |
| 5 | B | - |
| 6 | L | - |
| 7 | SB | - |
| 8 | GR | - |
| 11 | SB | - |
| 12 | R | - |
| 13 | L | - |
| 14 | P | - |
| 16 | Y | - |

| | |
|----------------|-------------------|
| Connector No. | M34 |
| Connector Name | COMBINATION METER |
| Connector Type | TH40FW-NH |

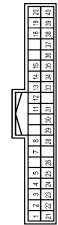

| Terminal No. | Color Of Wire | Signal Name [Specification] |
|--------------|---------------|-----------------------------|
| 1 | Y | BATTERY POWER SUPPLY |
| 2 | GR | IGNITION SIGNAL |
| 3 | B | GROUND |

JRAWC0542GB

CONSULT/GST CHECKING SYSTEM

< BASIC INSPECTION >

GI

CONSULT CHECKING SYSTEM (WITH ICC)

| Terminal No. | Color Of Wire | Signal Name [Specification] |
|--------------|---------------|--|
| 4 | B | ILL GND |
| 5 | B | ILL CONTROL OUTPUT |
| 6 | Y | TOW MODE SIGNAL |
| 7 | R | TRIP RESET SWITCH SIGNAL |
| 8 | P/L | ENTER SWITCH SIGNAL |
| 11 | G | SELECT SWITCH SIGNAL |
| 12 | O | ILLUMINATION CONTROL SWITCH SIGNAL (+) |
| 13 | W/R | ILLUMINATION CONTROL SWITCH SIGNAL (-) |
| 14 | R | AIR BAG SIGNAL |
| 15 | R/W | AMBIENT SENSOR SIGNAL |
| 18 | W/R | AC AUTO AMP CONNECTION SIGNAL |
| 19 | V/W | AC AUTO AMP CONNECTION SIGNAL |
| 20 | B | AMBIENT SENSOR GROUND |
| 21 | L | CANH |
| 22 | P | CANH |
| 23 | B | GROUND |
| 24 | V | FUEL LEVEL SENSOR GROUND |
| 25 | O/L | ALTERNATOR SIGNAL |
| 26 | W | PARKING BRAKE SWITCH SIGNAL |
| 28 | GR/R | SECURITY SIGNAL |
| 29 | BR | WASHER LEVEL SWITCH SIGNAL |
| 30 | SB | VEHICLE SPEED SIGNAL (2-PULSE) |
| 31 | BR/W | VEHICLE SPEED SIGNAL (8-PULSE) |
| 33 | W | SNOW MODE SIGNAL |
| 34 | BRY | FUEL LEVEL SENSOR SIGNAL |
| 35 | O/B | SEAT BELT BUCKLE SWITCH SIGNAL (DRIVER SIDE) |
| 36 | G/Y | PASSENGER SEAT BELT WARNING SIGNAL |
| 37 | R/Y | NON-MANUAL MODE SIGNAL |
| 38 | L/W | MANUAL MODE SHIFT DOWN SIGNAL |
| 39 | Y/B | MANUAL MODE SHIFT UP SIGNAL |
| 40 | G/W | MANUAL MODE SIGNAL |

| | |
|----------------|--------------------|
| Connector No. | M47 |
| Connector Name | SONAR CONTROL UNIT |
| Connector Type | TH24FM-NH |

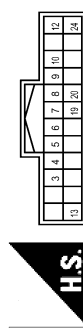

| Terminal No. | Color Of Wire | Signal Name [Specification] |
|--------------|---------------|-----------------------------|
| 3 | W | CORNER SENSOR FRONT LH |
| 4 | R | CORNER SENSOR FRONT RH |
| 5 | W | CORNER SENSOR REAR LH |
| 6 | R | CORNER SENSOR REAR RH |

| | | |
|----|------|-----------------------|
| 7 | G | SONAR RR INNER LH |
| 8 | Y | SONAR RR INNER RH |
| 9 | G | SONAR FR INNER LH |
| 10 | Y | SONAR FR INNER RH |
| 12 | B | SENSOR GND |
| 13 | GR/L | IGN |
| 19 | L | CANH [Without ADAS] |
| 19 | L | ITS-CAN L [With ADAS] |
| 20 | R | CANH [Without ADAS] |
| 20 | Y | ITS-CAN R [With ADAS] |
| 24 | B | GND |

| | |
|----------------|----------------------------------|
| Connector No. | M48 |
| Connector Name | AROUND VIEW MONITOR CONTROL UNIT |
| Connector Type | TH40FM-NH |

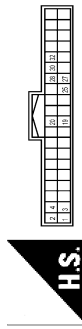

| Terminal No. | Color Of Wire | Signal Name [Specification] |
|--------------|---------------|--|
| 1 | B | GND |
| 2 | Y/G | BATTERY POWER SUPPLY |
| 3 | GR/L | IGNITION SIGNAL |
| 4 | V | ACC POWER SUPPLY |
| 19 | SB | AV COMM (H) |
| 20 | LG | AV COMM (L) |
| 25 | P | REV |
| 27 | L | CANH |
| 28 | R | CANH [Without ADAS] |
| 28 | Y | CANH [With ADAS] |
| 30 | LG | RETRACT MOTOR OPERATION SIGNAL (OPEN) |
| 32 | G/O | RETRACT MOTOR OPERATION SIGNAL (CLOSE) |

| | |
|----------------|-------------|
| Connector No. | M50 |
| Connector Name | AC AUTO AMP |
| Connector Type | ISAB40FW |

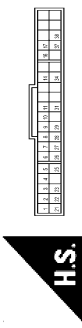

| Terminal No. | Color Of Wire | Signal Name [Specification] |
|--------------|---------------|--|
| 1 | L | CANH |
| 2 | B | GROUND |
| 3 | Y/G | BATTERY POWER SUPPLY |
| 4 | V | ACC POWER SUPPLY |
| 5 | W | IONIZER CONTROL SIGNAL |
| 6 | V/W | AC AUTO AMP CONNECTION SIGNAL |
| 7 | W/R | AMBIENT SENSOR SIGNAL |
| 8 | GR/L | RR IN-VEHICLE SENSOR SIGNAL |
| 9 | BR | SUNLOAD SENSOR (DRY SIGNAL) |
| 10 | V/W | Eye gaze/ outside look detecting sensor signal |
| 11 | W | COMM (AC AUTO AMP-RR AC CONT) |
| 14 | O/L | FR BLOWER MOTOR CONTROL SIGNAL |
| 16 | R/G | EACH DOOR MOTOR LIN SIGNAL |
| 17 | L/Y | EACH DOOR MOTOR POWER SUPPLY |
| 21 | P | CANH |
| 22 | B | GROUND |
| 23 | GR/L | IGNITION POWER SUPPLY |
| 25 | R | SENSOR GROUND |
| 26 | B | FR IN-VEHICLE SENSOR SIGNAL |
| 27 | GR | INTAKE SENSOR SIGNAL |
| 28 | R | SUNLOAD SENSOR (PASS) SIGNAL |
| 29 | O | COMM (RR AC CONT-AC AUTO AMP) |
| 31 | O/L | RR BLOWER MOTOR CONTROL SIGNAL |
| 34 | L/O | RR BLOWER MOTOR CONTROL SIGNAL |
| 37 | B | GROUND |
| 38 | G/W | RR A/C RELAY CONTROL SIGNAL |

| | |
|----------------|-------------------------------|
| Connector No. | M59 |
| Connector Name | AIR BAG DIAGNOSIS SENSOR UNIT |
| Connector Type | NH28FY-EX |



| Terminal No. | Color Of Wire | Signal Name [Specification] |
|--------------|---------------|-----------------------------|
| 1 | R/L | IGN |
| 2 | B | GND |
| 3 | Y | DS1 (+) |
| 4 | Y/R | DS1 (-) DPE (-) |
| 6 | Y/L | AS1 (+) |
| 7 | Y/B | AS1 (-) |
| 8 | B/Y | AS2 (+) |
| 9 | Y | AS2 (-) |
| 18 | O | ECZS (+) |
| 19 | W | ECZS (-) |
| 22 | SHIELD | GND |
| 23 | R/W | AIRBAG WIL |
| 24 | G/Y | SEATBELT WIL |
| 25 | R | CUTOFF TELLTALE |
| 57 | R/W | DEPLOYMENT INFORMATION |
| 59 | L | CANH |
| 60 | P | CANH |

| | |
|----------------|---------------------------|
| Connector No. | M68 |
| Connector Name | BCM (BODY CONTROL MODULE) |
| Connector Type | TH40FB-NH |

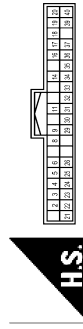

| Terminal No. | Color Of Wire | Signal Name [Specification] |
|--------------|---------------|-----------------------------|
| 2 | BRY | COMBI SW INPUT 5 |
| 3 | GR | COMBI SW INPUT 4 |
| 4 | L | COMBI SW INPUT 3 |

B
C
D
E
F
G
H
I
J
K
L
M
N
O
P

CONSULT/GST CHECKING SYSTEM

< BASIC INSPECTION >

CONSULT CHECKING SYSTEM (WITH ICC)

| | | |
|----|------|--------------------------------|
| 5 | G | COMBI SW INPUT 2 |
| 6 | V | COMBI SW INPUT 1 |
| 8 | V | POWER WINDOW SW COMM |
| 9 | R | STOP LAMP SW 1 |
| 11 | R | RAIN SENSOR SERIAL LINK |
| 14 | P/B | OPTICAL SENSOR |
| 16 | L/O | DIMMER SIGNAL |
| 17 | Y/G | SENSOR PWR SPLY |
| 18 | B/Y | RECEIVER SENSOR GND |
| 19 | BR | RECEIVER PWR SPLY |
| 20 | G/R | KYLS ENT RECEIVER COMM |
| 21 | P | NATS ANT AMP |
| 22 | W/B | KYLS ENT RECEIVER RSSI |
| 23 | GR/R | SECURITY IND CONT |
| 24 | SB | DONGLE LINK |
| 25 | LG/R | NATS ANT AMP |
| 26 | O | INTELLIGENT KEY IDENTIFICATION |
| 29 | W | HAZARD SW |
| 30 | W/L | BACK DOOR SW |
| 31 | W/G | DR DOOR UNLOCK SENSOR |
| 32 | G | COMBI SW OUTPUT 5 |
| 33 | Y | COMBI SW OUTPUT 4 |
| 34 | W | COMBI SW OUTPUT 3 |
| 35 | R/W | COMBI SW OUTPUT 2 |
| 36 | SB | COMBI SW OUTPUT 1 |
| 37 | G/Y | SHIFT P |
| 39 | L | CANL |
| 40 | P | CANL |

| | |
|----------------|--|
| Connector No. | M96 |
| Connector Name | LOW TIRE PRESSURE WARNING CONTROL UNIT |
| Connector Type | TH132FM-NH |



| Terminal No. | Color Of Wire | Signal Name [Specification] |
|--------------|---------------|----------------------------------|
| 1 | L | CANL |
| 2 | L | CANL |
| 3 | O/L | RR TIRE PRESSURE RECEIVER SIGNAL |
| 4 | L | RL TIRE PRESSURE RECEIVER SIGNAL |
| 5 | R/L | FR TIRE PRESSURE RECEIVER SIGNAL |
| 6 | W/G | FL TIRE PRESSURE RECEIVER SIGNAL |

| | | |
|----|------|--|
| 7 | SB | RR TIRE PRESSURE RECEIVER POWER SUPPLY |
| 8 | GR | RL TIRE PRESSURE RECEIVER POWER SUPPLY |
| 9 | R/W | FR TIRE PRESSURE RECEIVER POWER SUPPLY |
| 10 | LG | FL TIRE PRESSURE RECEIVER POWER SUPPLY |
| 15 | GR | IGN |
| 19 | L/R | RR TIRE PRESSURE RECEIVER SIGNAL (SENSITIVITY) |
| 20 | P | RL TIRE PRESSURE RECEIVER SIGNAL (SENSITIVITY) |
| 21 | G/R | FR TIRE PRESSURE RECEIVER SIGNAL (SENSITIVITY) |
| 22 | B/Y | FL TIRE PRESSURE RECEIVER SIGNAL (SENSITIVITY) |
| 23 | V/W | RR TIRE PRESSURE RECEIVER GND |
| 24 | R/B | RL TIRE PRESSURE RECEIVER GND |
| 25 | W/L | FR TIRE PRESSURE RECEIVER GND |
| 26 | BR/W | FL TIRE PRESSURE RECEIVER GND |
| 32 | B | GND |

| | |
|----------------|-----------|
| Connector No. | M99 |
| Connector Name | TCU |
| Connector Type | TH40FM-NH |

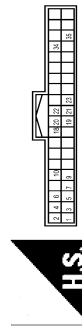

| Terminal No. | Color Of Wire | Signal Name [Specification] |
|--------------|---------------|-----------------------------|
| 1 | Y/R | BAT |
| 2 | B | GND |
| 3 | BR | ACC |
| 4 | GR/L | IGN |
| 5 | V | ACC OUT |
| 6 | BR | AV-ACC |
| 7 | B | GND |
| 9 | L | V-CANL |
| 10 | P | V-CANL |
| 18 | Y/G | MIC VCC |
| 19 | Y/L | MIC SIG |
| 20 | SHIELD | MIC GND |
| 21 | Y | DCM MIC VCC |
| 22 | BR | DCM MIC SIG |
| 23 | SHIELD | DCM MIC GND |
| 34 | G | ECALL SW |
| 35 | O | LED A |

| | |
|----------------|-------------|
| Connector No. | M125 |
| Connector Name | CAN GATEWAY |
| Connector Type | TH12FM-NH |

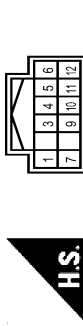

| Terminal No. | Color Of Wire | Signal Name [Specification] |
|--------------|---------------|-----------------------------|
| 1 | L | CANL |
| 3 | Y | BATTERY |
| 4 | L | GND |
| 5 | B | GND |
| 6 | L | CANL |
| 7 | P | CANL |
| 9 | GR | IGNITION |
| 10 | R | CANL |
| 11 | B | GND |
| 12 | R | CANL |

| | |
|----------------|------------------|
| Connector No. | M135 |
| Connector Name | AFS CONTROL UNIT |
| Connector Type | TH40FM-NH |

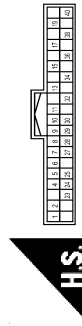

| Terminal No. | Color Of Wire | Signal Name [Specification] |
|--------------|---------------|-----------------------------|
| 1 | GR | IGN |
| 2 | LG/B | PSG-R |
| 4 | Y/R | PSV-R |
| 5 | L/Y | HSV-F |
| 6 | LG/R | HSV-R |
| 7 | P | CANL |
| 8 | B/O | HSG-R |
| 9 | GR | PS-R |
| 10 | B/W | HSG-F |
| 11 | R | SMR-2 (-) |

| | | |
|----|------|-----------|
| 13 | B | SMR-1 (-) |
| 15 | W | SM-L (+) |
| 17 | G | SM-L2 (+) |
| 19 | SB | AMDS-R |
| 23 | V | HS-F |
| 24 | L/O | PSV-L |
| 25 | B | GND |
| 27 | BR/Y | PSG-L |
| 28 | R/G | HS-R |
| 29 | BR/W | PS-L |
| 30 | L | CANL |
| 32 | G | SMR-1 (+) |
| 34 | W | SMR-2 (+) |
| 36 | R | SM-L2 (-) |
| 38 | B | SM-L1 (-) |
| 40 | GR/L | AMDS-L |

| | |
|----------------|-----------------|
| Connector No. | M210 |
| Connector Name | AV CONTROL UNIT |
| Connector Type | TH32FM-NH |

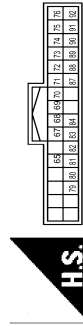

| Terminal No. | Color Of Wire | Signal Name [Specification] |
|--------------|---------------|---------------------------------------|
| 65 | W | PARKING BRAKE SIGNAL |
| 67 | R | COMPOSITE IMAGE SIGNAL GND |
| 68 | R | COMPOSITE IMAGE SIGNAL |
| 69 | O | INTELLIGENT KEY IDENTIFICATION SIGNAL |
| 70 | BR | REVERSE 12 |
| 71 | SHIELD | MICROPHONE SHIELD |
| 72 | Y | MICROPHONE VCC [With DCM] |
| 73 | Y/G | MICROPHONE VCC [Without DCM] |
| 74 | P | COMM. CONT. DISF. |
| 75 | LG | CANL |
| 76 | LG | AV COMM (L) |
| 79 | L/O | DIMMER SIGNAL |
| 80 | GR/L | IGNITION SIGNAL |
| 81 | R/Y | REVERSE SIGNAL |
| 82 | BR/W | VEHICLE SPEED SIGNAL (8-PULSE) |
| 83 | SHIELD | SHIELD |
| 84 | W/B | COMPOSITE IMAGE SYNC SIGNAL |

CONSULT/GST CHECKING SYSTEM

< BASIC INSPECTION >

GI

B

C

D

E

F

G

H

I

J

K

L

M

N

O

P

CONSULT CHECKING SYSTEM (WITH ICC)

| | | |
|----|--------|---------------------------------|
| 87 | BR | MICROPHONE SIGNAL (WITH DCM) |
| 87 | Y/L | MICROPHONE SIGNAL (WITHOUT DCM) |
| 88 | SHIELD | SHIELD |
| 89 | Y/L | COMM (DISP-CONT) |
| 90 | L | CAN-H |
| 91 | SB | AV COMM (H) |
| 92 | SB | AV COMM (H) |

| | |
|----------------|------------------|
| Connector No. | R8 |
| Connector Name | LANE CAMERA UNIT |
| Connector Type | TH08FW-NH |



| Terminal No. | Color Of Wire | Signal Name (Specification) |
|--------------|---------------|-----------------------------|
| 1 | B | GND |
| 4 | L | ITS COMM-H |
| 5 | B | GND |
| 7 | W/G | IGNITION |
| 8 | Y | ITS COMM-L |

JRAWC0545GB

CONSULT/GST CHECKING SYSTEM

< BASIC INSPECTION >
WITHOUT ICC

CONSULT CHECKING SYSTEM (WITHOUT ICC)

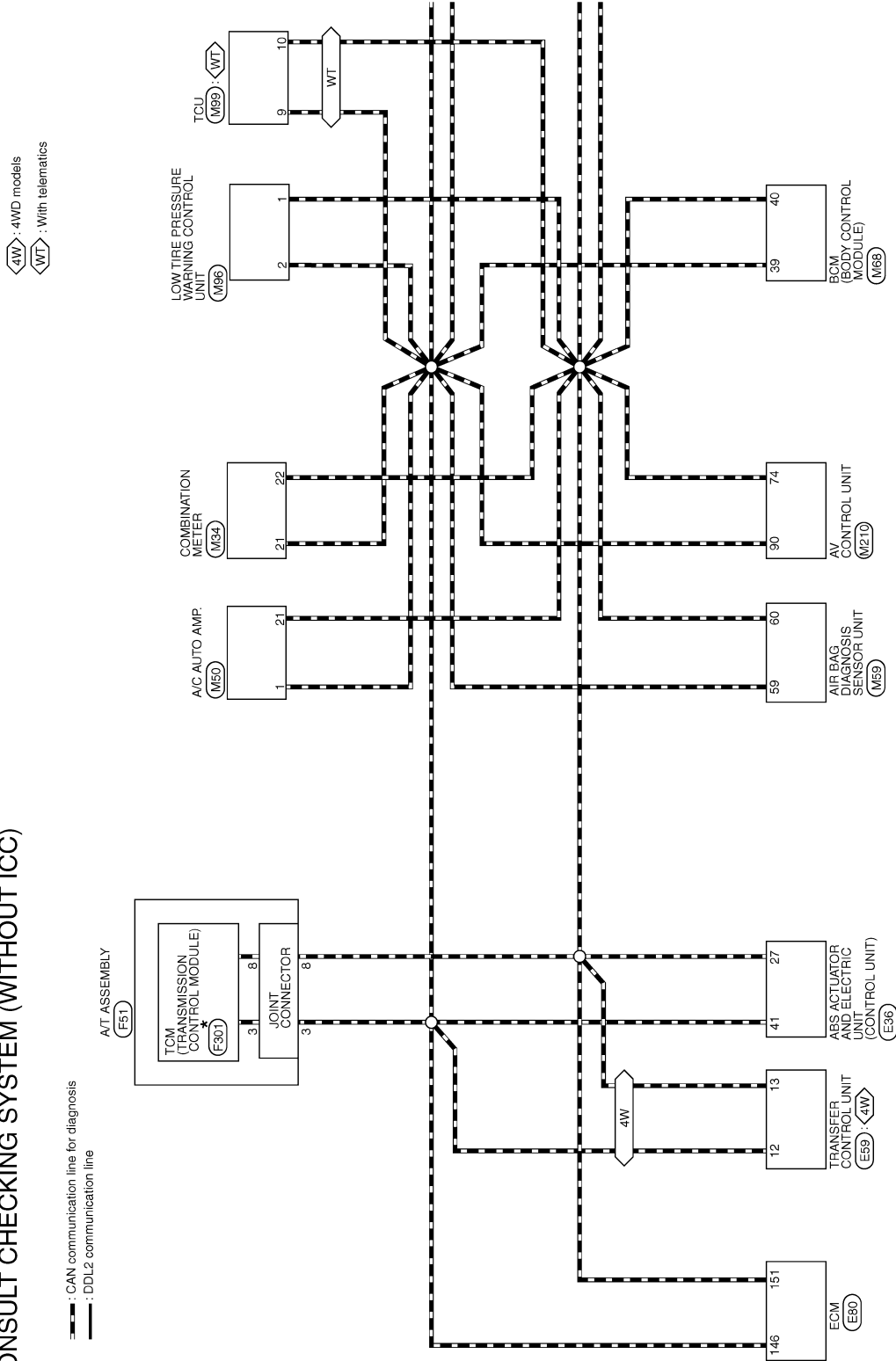

* : This connector is not shown in "Harness Layout".

2013/01/30

JRAWC0258GB

CONSULT/GST CHECKING SYSTEM

< BASIC INSPECTION >

GI

B

C

D

E

F

G

H

I

J

K

L

M

N

O

P

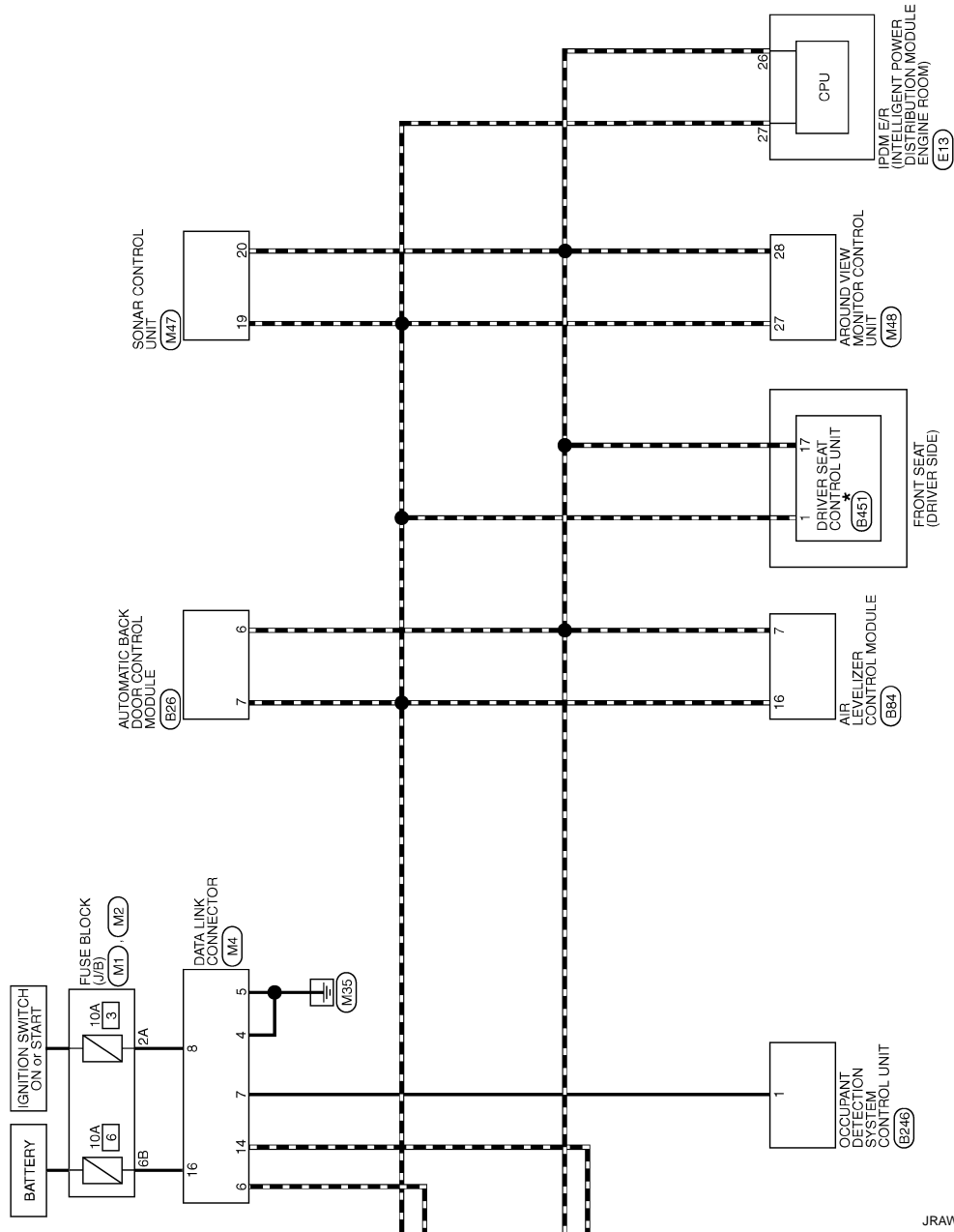

JRAWC0259GB

CONSULT/GST CHECKING SYSTEM

< BASIC INSPECTION >

CONSULT CHECKING SYSTEM (WITHOUT ICC)

| | |
|----------------|------------------------------------|
| Connector No. | B26 |
| Connector Name | AUTOMATIC BACK DOOR CONTROL MODULE |
| Connector Type | TH26FM-TB6 |

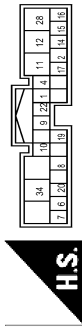

| Terminal No. | Color Of Wire | Signal Name [Specification] |
|--------------|---------------|-----------------------------|
| 1 | L | BUZZER |
| 2 | Y/B | ABD SW |
| 4 | GR | ABD CLOSE SW |
| 5 | P | CANL |
| 7 | L | CANRH |
| 8 | L/W | HALF LATCH SW |
| 9 | GR/L | IGN |
| 10 | Y | BAT |
| 11 | R | CLOSURE MTR (CLOSE) |
| 12 | V | CLOSURE MTR (OPEN) |
| 14 | G/W | TOUCH SENS LH |
| 15 | L/R | TOUCH SENS RH |
| 16 | LG | TOUCH SENS RH |
| 17 | O | MAIN SW |
| 19 | L/Y | CLOSE SW |
| 20 | G/Y | OPEN SW |
| 22 | B | GND |
| 28 | R/W | BAT |
| 34 | B | GND |

| | |
|----------------|------------------------------|
| Connector No. | B84 |
| Connector Name | AIR LEVELIZER CONTROL MODULE |
| Connector Type | TH18FM-NH |

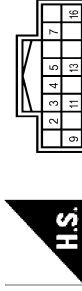

| Terminal No. | Color Of Wire | Signal Name [Specification] |
|--------------|---------------|------------------------------------|
| 2 | B | GND |
| 3 | V | AIR COMPRESSOR RELAY |
| 4 | L/W | VEHICLE HEIGHT SENSOR GND |
| 5 | W | VEHICLE HEIGHT SENSOR SIGNAL |
| 7 | P | CANL |
| 9 | P/L | IGN |
| 11 | V/W | EXHAUST SOLENOID |
| 13 | R | VEHICLE HEIGHT SENSOR POWER SUPPLY |
| 16 | L | CANRH |

| | |
|----------------|--|
| Connector No. | B246 |
| Connector Name | OCCUPANT DETECTION SYSTEM CONTROL UNIT |
| Connector Type | TH04FM-NH |



| Terminal No. | Color Of Wire | Signal Name [Specification] |
|--------------|---------------|-----------------------------|
| 1 | W | - |
| 2 | B | - |
| 3 | L/R | - |
| 4 | R/L | - |

| | |
|----------------|--------------------------|
| Connector No. | B451 |
| Connector Name | DRIVER SEAT CONTROL UNIT |
| Connector Type | TH32FM-NH |

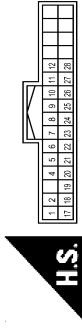

| Terminal No. | Color Of Wire | Signal Name [Specification] |
|--------------|---------------|-----------------------------|
| 1 | R/Y | CANRH |
| 2 | R | LIART (TX/RX) |
| 4 | R/L | PULSE (RECLINER) |
| 5 | R/B | TELESCOPIC SENSOR |
| 6 | R/W | ADDRESS 2 |
| 7 | R/W | IND-3 |
| 8 | SB | SLIDE SW (BACKWARD) |
| 9 | L | RECLINER SW (BACKWARD) |
| 10 | L/B | FRONT LIFTER SW (DOWNWARD) |
| 11 | L/W | REAR LIFTER SW (DOWNWARD) |
| 12 | L/R | SENSOR POWER SUPPLY |
| 17 | V | CANL |
| 18 | B/W | PULSE (SLIDE) |
| 19 | B/R | PULSE (FRONT LIFTER) |
| 20 | B/L | PULSE (REAR LIFTER) |
| 21 | W/B | TILT SENSOR ADDRESS 1 |
| 22 | W/L | IND-1 |
| 23 | W/R | IND-1 |
| 24 | V/W | SLIDE SW (FORWARD) |
| 25 | Y/B | RECLINER SW (FORWARD) |
| 26 | Y/R | FRONT LIFTER SW (UPWARD) |
| 27 | Y/L | REAR LIFTER SW (UPWARD) |
| 28 | G | SET SW |

| | |
|----------------|---|
| Connector No. | E13 |
| Connector Name | POWER INTELLIGENT POWER DISTRIBUTION MODULE (ENGINE ROOM) |
| Connector Type | TH12FM-NH |



| Terminal No. | Color Of Wire | Signal Name [Specification] |
|--------------|---------------|-----------------------------|
| 23 | GR/R | - |
| 24 | W/G | - |
| 25 | L/Y | - |
| 26 | P | - |
| 27 | L | - |
| 30 | R/W | - |
| 32 | LG | - |
| 33 | R | - |
| 34 | G | - |

| | |
|----------------|---|
| Connector No. | E36 |
| Connector Name | ABS ACTUATOR AND ELECTRIC UNIT (CONTROL UNIT) |
| Connector Type | SAZ42FB-SJ24 |

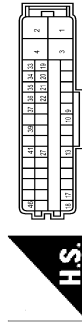

| Terminal No. | Color Of Wire | Signal Name [Specification] |
|--------------|---------------|--|
| 1 | G | BAT |
| 2 | B | GND |
| 3 | B | GND |
| 4 | W | MOTOR SUPPLY |
| 9 | R/B | YAW RATE / YAW / REEL / G SENSOR COMMUNICATION |
| 10 | P/B | YAW RATE / YAW / REEL / G SENSOR COMMUNICATION |
| 13 | GR | BRAKE FLUID LEVEL SW |
| 17 | L/R | STP2 |
| 18 | W/B | IGN |
| 19 | O | DS FR |

CONSULT/GST CHECKING SYSTEM

< BASIC INSPECTION >

GI

CONSULT CHECKING SYSTEM (WITHOUT ICC)

| | | |
|----|-----|-----------------|
| 20 | SB | DP FL |
| 21 | RIO | DS RR |
| 22 | V | DP RL |
| 27 | P | CANL |
| 33 | LG | DP FR |
| 34 | G | DS FL |
| 35 | BR | DP RR |
| 36 | P | DS RL |
| 37 | R | STP |
| 39 | L/W | VDC OFF SW |
| 41 | L | CANH |
| 46 | W | STOP LAMP SW ON |

| | |
|----------------|-----------------------|
| Connector No. | E59 |
| Connector Name | TRANSFER CONTROL UNIT |
| Connector Type | TH08FM-NH |

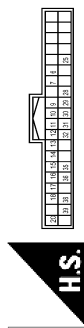

H.S.

| Terminal No. | Color Of Wire | Signal Name [Specification] |
|--------------|---------------|------------------------------------|
| 6 | BR | H-LO POSITION SEN 1 |
| 7 | Y | TRANSFER FLUID TEMP SEN PWR SUPPLY |
| 9 | G | INTERNAL SPEED SEN GND |
| 10 | Y/G | INTERNAL SPEED SEN IMP |
| 11 | V | 4L SW |
| 12 | L | CANH |
| 13 | P | CANL |
| 14 | W/R | AUTO SW |
| 15 | P/B | ROTALY POSITION SEN PWM |
| 16 | LG | ROTALY POSITION SEN GND |
| 17 | W/L | LOCK POSITION SEN PWR SUPPLY |
| 18 | B/R | ROTAY POSITION SEN PWR SUPPLY |
| 20 | GR | TRANSFER CU PWR SUPPLY |
| 25 | P/L | H-LO POSITION SEN 3 |
| 28 | W | MOTOR TEMP SEN PWR SUPPLY |
| 29 | LG/R | H-LO POSITION SEN 2 |
| 30 | R/B | LOCK POSITION SEN GND |
| 31 | L/O | INTERNAL SPEED SEN DIR |
| 32 | B/R | IGN 4P SW |
| 35 | R | TRANSFER FLUID TEMP SEN GND |
| 36 | L/R | LOCK POSITION SEN SIGNAL |
| 38 | G/O | LOCK POSITION SEN SIGNAL |

| | | |
|----|-----|-------------------------------|
| 39 | R/W | INTERNAL SPEED SEN PWR SUPPLY |
|----|-----|-------------------------------|

| | |
|----------------|------------------|
| Connector No. | E80 |
| Connector Name | ECM |
| Connector Type | MAB55FB-MEB10-LH |

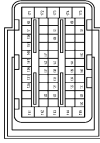

H.S.

| Terminal No. | Color Of Wire | Signal Name [Specification] |
|--------------|---------------|---------------------------------------|
| 111 | R | FUEL INJECTOR DRIVER POWER SUPPLY |
| 112 | SB | FUEL INJECTOR DRIVER POWER SUPPLY |
| 113 | G | ECM GROUND |
| 114 | B | ECM GROUND |
| 115 | B | ECM GROUND |
| 120 | Y | EVAP CANISTER VENT CONTROL VALVE |
| 122 | B/R | THROTTLE CONTROL MOTOR RELAY |
| 123 | W/R | FUEL PUMP CONTROL MODULE (FPCM) |
| 125 | O | ACCELERATOR PEDAL POSITION SENSOR 2 |
| 128 | Y | ASC/DCC STEERING SWITCH |
| 129 | P/L | SENSOR GROUND |
| 130 | R | SENSOR GROUND |
| 131 | L/W | SENSOR POWER SUPPLY |
| 133 | SB | SENSOR POWER SUPPLY |
| 134 | V/W | FUEL TEMPERATURE SENSOR |
| 136 | W/R | ACCELERATOR PEDAL POSITION SENSOR 1 |
| 137 | W/G | SENSOR POWER SUPPLY |
| 138 | V | BATTERY CURRENT SENSOR |
| 139 | G | BATTERY TEMPERATURE SENSOR |
| 140 | R/Y | SENSOR GROUND |
| 141 | SB | IGNITION SWITCH |
| 142 | R/W | FUEL PUMP CONTROL MODULE (FPCM) CHECK |
| 143 | L/Y | EVAP CONTROL SYSTEM PRESSURE SENSOR |
| 144 | O/B | REFRIGERANT PRESSURE SENSOR |
| 146 | L | CAN COMMUNICATION LINE |
| 147 | G/Y | ASC/DCC BRAKE SWITCH |
| 150 | R | SENSOR GROUND |
| 151 | P | CAN COMMUNICATION LINE |
| 156 | L | POWER SUPPLY FOR ECM (BACK-UP) |
| 158 | W/B | STOP LAMP SWITCH |
| 161 | R/W | ECM COMMUNICATION LINE |
| 163 | L/G | ECM RELAY (SELF SHUT-OFF) |

| | | |
|-----|------|-------------------------------------|
| 165 | GR/R | ECM COMMUNICATION LINE |
| 166 | W | ENGINE SPEED SIGNAL OUTPUT |
| 169 | G/B | POWER SUPPLY FOR ECM |
| 171 | W | POWER SUPPLY FOR ECM |
| 172 | W | POWER SUPPLY FOR ECM |
| 173 | O | THROTTLE CONTROL MOTOR POWER SUPPLY |
| 174 | B | ECM GROUND |
| 175 | B | ECM GROUND |

| | |
|----------------|-------------|
| Connector No. | F51 |
| Connector Name | AT ASSEMBLY |
| Connector Type | RK10FG |

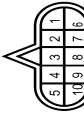

H.S.

| Terminal No. | Color Of Wire | Signal Name [Specification] |
|--------------|---------------|-----------------------------|
| 1 | V | IGNITION POWER SUPPLY |
| 2 | P | BATTERY POWER SUPPLY |
| 3 | L | CANH |
| 4 | SB | K-LINE |
| 5 | B | GROUND |
| 6 | V | IGNITION POWER SUPPLY |
| 7 | R | BACK-UP LAMP RELAY |
| 8 | P | CANL |
| 9 | BR | STARTER RELAY |
| 10 | B | GROUND |

| | |
|----------------|-----------------------------------|
| Connector No. | F301 |
| Connector Name | TCM (TRANSMISSION CONTROL MODULE) |
| Connector Type | SP10FG |

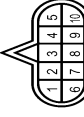

H.S.

| Terminal No. | Color Of Wire | Signal Name [Specification] |
|--------------|---------------|-----------------------------|
| 1 | - | IGNITION POWER SUPPLY |
| 2 | - | BATTERY POWER SUPPLY |
| 3 | - | CANH |
| 4 | - | K-LINE |
| 5 | - | GROUND |
| 6 | - | IGNITION POWER SUPPLY |
| 7 | - | BACK-UP LAMP RELAY |
| 8 | - | CANL |
| 9 | - | STARTER RELAY |
| 10 | - | GROUND |

| | |
|----------------|------------------|
| Connector No. | M1 |
| Connector Name | FUSE BLOCK (J/B) |
| Connector Type | NS08FM-M2 |



H.S.

| Terminal No. | Color Of Wire | Signal Name [Specification] |
|--------------|---------------|-----------------------------|
| 1A | Y | - |
| 2A | GR | - |
| 3A | W | - |
| 4A | Y/G | - |
| 5A | V | - |
| 6A | L/W | - |
| 7A | LG | - |
| 8A | W | - |

B
C
D
E
F
G
H
I
J
K
L
M
N
O
P

CONSULT/GST CHECKING SYSTEM

< BASIC INSPECTION >

CONSULT CHECKING SYSTEM (WITHOUT ICC)

| | |
|----------------|------------------|
| Connector No. | M42 |
| Connector Name | FUSE BLOCK (L/B) |
| Connector Type | NS10FW-CS |

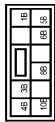

| Terminal No. | Wire | Signal Name [Specification] |
|--------------|------|-----------------------------|
| 1B | R | - |
| 3B | R | - |
| 4B | B | - |
| 5B | BR | - |
| 6B | Y | - |
| 8B | L/O | - |
| 10B | W/B | - |

| | |
|----------------|---------------------|
| Connector No. | M4 |
| Connector Name | DATA LINK CONNECTOR |
| Connector Type | BD16FW |

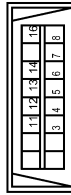

| Terminal No. | Wire | Signal Name [Specification] |
|--------------|------|-----------------------------|
| 3 | LG | - |
| 4 | B | - |
| 5 | B | - |
| 6 | L | - |
| 7 | SB | - |
| 8 | GR | - |
| 11 | SB | - |
| 12 | R | - |
| 13 | L | - |
| 14 | P | - |
| 16 | Y | - |

| | |
|----------------|-------------------|
| Connector No. | M34 |
| Connector Name | COMBINATION METER |
| Connector Type | TH40FW-NH |

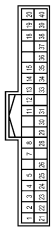

| Terminal No. | Wire | Signal Name [Specification] |
|--------------|------|--|
| 1 | Y | BATTERY POWER SUPPLY |
| 2 | GR | IGNITION SIGNAL |
| 3 | B | GROUND |
| 4 | B | ILL GND |
| 5 | B | ILL CONTROL OUTPUT |
| 7 | R | TOY MODE SIGNAL |
| 8 | PL | TRIP RESET SWITCH SIGNAL |
| 11 | G | ENTER SWITCH SIGNAL |
| 12 | O | SELECT SWITCH SIGNAL |
| 13 | WR | ILLUMINATION CONTROL SWITCH SIGNAL (+) |
| 14 | R | ILLUMINATION CONTROL SWITCH SIGNAL (-) |
| 15 | RW | AIR BAG SIGNAL |
| 16 | WR | AMBIENT SENSOR SIGNAL |
| 19 | V/W | AC AUTO AMP. CONNECTION SIGNAL |
| 20 | B | AMBIENT SENSOR GROUND |
| 21 | L | CANH |
| 22 | P | CANH |
| 23 | B | GROUND |
| 24 | V | FUEL LEVEL SENSOR GROUND |
| 25 | O/L | ALTERNATOR SIGNAL |
| 26 | W | PARKING BRAKE SWITCH SIGNAL |
| 28 | GR | SECURITY SIGNAL |
| 29 | BR | WASHER LEVEL SWITCH SIGNAL |
| 30 | SB | VEHICLE SPEED SIGNAL (2-PULSE) |
| 31 | BRW | VEHICLE SPEED SIGNAL (8-PULSE) |
| 33 | W | SNOW MODE SIGNAL |
| 34 | BRY | FUEL LEVEL SENSOR SIGNAL |
| 35 | O/B | SEAT BELT BUCKLE SWITCH SIGNAL (DRIVER SEAT) |
| 36 | G/Y | PASSENGER SEAT BELT WARNING SIGNAL |
| 37 | R/Y | NON-MANUAL MODE SIGNAL |
| 38 | L/W | MANUAL MODE SHIFT DOWN SIGNAL |
| 39 | Y/B | MANUAL MODE SHIFT UP SIGNAL |
| 40 | GW | MANUAL MODE SIGNAL |

| | |
|----------------|--------------------|
| Connector No. | M47 |
| Connector Name | SONAR CONTROL UNIT |
| Connector Type | TH24FW-NH |



| Terminal No. | Wire | Signal Name [Specification] |
|--------------|------|-----------------------------|
| 3 | W | CORNER SENSOR FRONT LH |
| 4 | R | CORNER SENSOR FRONT RH |
| 5 | W | CORNER SENSOR REAR LH |
| 6 | R | CORNER SENSOR REAR RH |
| 7 | O | SONAR FR INNER LH |
| 8 | Y | SONAR FR INNER RH |
| 9 | G | SONAR FR INNER LH |
| 10 | Y | SONAR FR INNER RH |
| 12 | B | SENSOR GND |
| 13 | GR/L | IGN |
| 19 | L | CANH [Without ADAS] |
| 19 | L | ITS-CANH [With ADAS] |
| 20 | R | CANH [Without ADAS] |
| 20 | Y | ITS-CANH [With ADAS] |
| 24 | B | GND |

| | |
|----------------|----------------------------------|
| Connector No. | M48 |
| Connector Name | AROUND VIEW MONITOR CONTROL UNIT |
| Connector Type | TH40FW-NH |



| Terminal No. | Wire | Signal Name [Specification] |
|--------------|------|-----------------------------|
| 1 | B | GND |
| 2 | Y/G | BATTERY POWER SUPPLY |
| 3 | GR/L | IGNITION SIGNAL |
| 4 | V | ACC POWER SUPPLY |
| 19 | SB | AV COMM (H) |

| | | |
|----|-----|--|
| 20 | LG | AV COMM (L) |
| 25 | P | REV |
| 27 | L | CANH |
| 28 | R | CANH [Without ADAS] |
| 28 | Y | CANH [With ADAS] |
| 30 | LG | RETRACT MOTOR OPERATION SIGNAL (OPEN) |
| 32 | G/O | RETRACT MOTOR OPERATION SIGNAL (CLOSE) |

| | |
|----------------|--------------|
| Connector No. | M50 |
| Connector Name | AC AUTO AMP. |
| Connector Type | SAB40FW |



| Terminal No. | Wire | Signal Name [Specification] |
|--------------|------|---|
| 1 | L | CANH |
| 2 | B | GROUND |
| 3 | Y/G | BATTERY POWER SUPPLY |
| 4 | V | ACC POWER SUPPLY |
| 5 | W | IONIZER CONTROL SIGNAL |
| 6 | V/W | AC AUTO AMP. CONNECTION SIGNAL |
| 7 | W/R | AMBIENT SENSOR SIGNAL |
| 8 | GR/L | RR IN-VEHICLE SENSOR SIGNAL |
| 9 | BR | SUNLOAD SENSOR (DR) SIGNAL |
| 10 | V/W | SUNLOAD SENSOR (DR) SIGNAL (HEADS / OUTSIDE DOOR DETECTING SENSOR SIGNAL) |
| 11 | W | COMM (AC AUTO AMP.-RR AC CONT) |
| 14 | O/L | FR BLOWER MOTOR CONTROL SIGNAL |
| 16 | R/G | EACH DOOR MOTOR LIN SIGNAL |
| 17 | L/Y | EACH DOOR MOTOR POWER SUPPLY |
| 21 | P | CANH |
| 22 | B | GROUND |
| 23 | GR/L | IGNITION POWER SUPPLY |
| 25 | R | - |
| 26 | B | SENSOR GROUND |
| 27 | GR | FR IN-VEHICLE SENSOR SIGNAL |
| 28 | R | INTAKE SENSOR SIGNAL |
| 29 | O | SUNLOAD SENSOR (PASS) SIGNAL |
| 31 | O/L | COMM (RR AC CONT. AC AUTO AMP.) |
| 34 | L/O | RR BLOWER MOTOR CONTROL SIGNAL |
| 37 | B | GROUND |
| 38 | GW | RR AC RELAY CONTROL SIGNAL |

CONSULT/GST CHECKING SYSTEM

< BASIC INSPECTION >

GI

B

C

D

E

F

G

H

I

J

K

L

M

N

O

P

CONSULT CHECKING SYSTEM (WITHOUT ICC)

| | |
|----------------|-------------------------------|
| Connector No. | M659 |
| Connector Name | AIR BAG DIAGNOSIS SENSOR UNIT |
| Connector Type | NH28FY-EX |

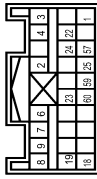

H.S.

| Terminal No. | Color Of Wire | Signal Name [Specification] |
|--------------|---------------|-----------------------------|
| 1 | R/L | IGN |
| 2 | B | GND |
| 3 | Y | DR1 (+) |
| 4 | Y/R | DR1 (-) DR2 (+) |
| 5 | Y/B | AS1 (+) |
| 6 | B/Y | AS1 (-) |
| 7 | Y | AS2 (+) |
| 8 | O | AS2 (-) |
| 9 | Y | ECZS (+) |
| 10 | W | ECZS (-) |
| 11 | SHIELD | GND |
| 12 | R/W | AIRBAG W/L |
| 13 | G/Y | SEATBELT W/L |
| 14 | R | CUTOFF TELLTALE |
| 15 | R/W | DEPLOYMENT INFORMATION |
| 16 | L | CANH |
| 17 | P | CANL |

| | |
|----------------|---------------------------|
| Connector No. | M668 |
| Connector Name | BCM (BODY CONTROL MODULE) |
| Connector Type | TH40FB-NH |

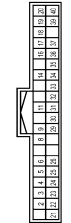

H.S.

| Terminal No. | Color Of Wire | Signal Name [Specification] |
|--------------|---------------|-----------------------------|
| 2 | B/Y | COMBI SW INPUT 5 |
| 3 | GR | COMBI SW INPUT 4 |
| 4 | L | COMBI SW INPUT 3 |

| | | |
|----|------|--------------------------------|
| 5 | G | COMBI SW INPUT 2 |
| 6 | V | COMBI SW INPUT 1 |
| 7 | R/W | POWER WINDOW SW COMM |
| 8 | R | STOP LAMP SW 1 |
| 9 | R | RAIN SENSOR SERIAL LINK |
| 10 | R | OPTICAL SENSOR |
| 11 | P/B | DIMMER SIGNAL |
| 12 | L/O | SENSOR PWR SPL |
| 13 | Y/G | RECEIVER SENSOR GND |
| 14 | B/Y | RECEIVER PWR SPL |
| 15 | BR | KYLS ENT RECEIVER COMM |
| 16 | G/R | KYLS ENT AMP |
| 17 | P | KYLS ENT RECEIVER RSSI |
| 18 | W/B | SECURITY INDICONT |
| 19 | GR | SECURITY LINK |
| 20 | SB | WAS ANT AMP |
| 21 | LG/R | WAS ANT LINK |
| 22 | W | INTELLIGENT KEY IDENTIFICATION |
| 23 | O | HAZARD SW |
| 24 | W | BR DOOR OPNR SW |
| 25 | W/L | DR DOOR UNLOCK SENSOR |
| 26 | W/G | COMBI SW OUTPUT 5 |
| 27 | Y | COMBI SW OUTPUT 4 |
| 28 | W | COMBI SW OUTPUT 3 |
| 29 | R/W | COMBI SW OUTPUT 2 |
| 30 | SB | COMBI SW OUTPUT 1 |
| 31 | G/Y | SHIFT P |
| 32 | L | CANH |
| 33 | P | CANL |

| | |
|----------------|--|
| Connector No. | M666 |
| Connector Name | LOW TIRE PRESSURE WARNING CONTROL UNIT |
| Connector Type | TH32FM-NH |



H.S.

| Terminal No. | Color Of Wire | Signal Name [Specification] |
|--------------|---------------|----------------------------------|
| 1 | P | CANL |
| 2 | L | CANH |
| 3 | O/L | RR TIRE PRESSURE RECEIVER SIGNAL |
| 4 | L | RL TIRE PRESSURE RECEIVER SIGNAL |
| 5 | R/L | FR TIRE PRESSURE RECEIVER SIGNAL |
| 6 | W/G | FL TIRE PRESSURE RECEIVER SIGNAL |

| | | |
|----|------|--|
| 7 | SB | RR TIRE PRESSURE RECEIVER POWER SUPPLY |
| 8 | GR | RL TIRE PRESSURE RECEIVER POWER SUPPLY |
| 9 | R/W | FR TIRE PRESSURE RECEIVER POWER SUPPLY |
| 10 | LG | FL TIRE PRESSURE RECEIVER POWER SUPPLY |
| 11 | GR | IGN |
| 12 | L/R | RR TIRE PRESSURE RECEIVER SIGNAL (SENSITIVITY) |
| 13 | P | RL TIRE PRESSURE RECEIVER SIGNAL (SENSITIVITY) |
| 14 | G/R | FR TIRE PRESSURE RECEIVER SIGNAL (SENSITIVITY) |
| 15 | B/Y | FL TIRE PRESSURE RECEIVER SIGNAL (SENSITIVITY) |
| 16 | V/W | RR TIRE PRESSURE RECEIVER GND |
| 17 | R/B | RL TIRE PRESSURE RECEIVER GND |
| 18 | W/L | FR TIRE PRESSURE RECEIVER GND |
| 19 | BR/W | FL TIRE PRESSURE RECEIVER GND |
| 20 | B | GND |

| | |
|----------------|-----------|
| Connector No. | M699 |
| Connector Name | TCU |
| Connector Type | TH40FM-NH |

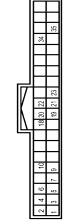

H.S.

| Terminal No. | Color Of Wire | Signal Name [Specification] |
|--------------|---------------|-----------------------------|
| 1 | Y/R | BAT |
| 2 | B | GND |
| 3 | BR | ACC |
| 4 | GR/L | IGN |
| 5 | V | ACC OUT |
| 6 | BR | AV-ACC |
| 7 | B | GND |
| 8 | L | V-CANH |
| 9 | P | V-CANL |
| 10 | Y/G | MIC VCC |
| 11 | Y/L | MIC SIG |
| 12 | SHIELD | MIC GND |
| 13 | Y | DCM MIC VCC |
| 14 | Y | DCM MIC SIG |
| 15 | SHIELD | DCM MIC GND |
| 16 | G | ECALL SW |
| 17 | O | LED A |

| | |
|----------------|-----------------|
| Connector No. | M210 |
| Connector Name | AV CONTROL UNIT |
| Connector Type | TH32FM-NH |

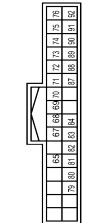

H.S.

| Terminal No. | Color Of Wire | Signal Name [Specification] |
|--------------|---------------|---------------------------------------|
| 65 | W | PARKING BRAKE SIGNAL |
| 66 | W | COMPOSITE IMAGE SIGNAL GND |
| 67 | R | COMPOSITE IMAGE SIGNAL |
| 68 | O | INTELLIGENT KEY IDENTIFICATION SIGNAL |
| 69 | BR | REVERSE IZ |
| 70 | SHIELD | MICROPHONE SHIELD |
| 71 | Y | MICROPHONE VCC (WITH DCM) |
| 72 | Y/G | MICROPHONE VCC (WITHOUT DCM) |
| 73 | Y/G | COMM (CONT-DISP) |
| 74 | P | CANL |
| 75 | LG | AV COMM (L) |
| 76 | LG | DIMMER SIGNAL |
| 77 | L/O | IGNITION SIGNAL |
| 78 | GR/L | REVERSE SIGNAL |
| 79 | R/Y | VEHICLE SPEED SIGNAL (8-PULSE) |
| 80 | SHIELD | SHIELD |
| 81 | W/B | COMPOSITE IMAGE SYNC SIGNAL |
| 82 | BR | MICROPHONE SIGNAL (WITH DCM) |
| 83 | Y/L | MICROPHONE SIGNAL (WITHOUT DCM) |
| 84 | SHIELD | SHIELD |
| 85 | Y/L | COMM (DISP-COMT) |
| 86 | L | CANH |
| 87 | SB | AV COMM (H) |
| 88 | SB | AV COMM (FH) |

JRAWC0549GB

INSPECTION AND ADJUSTMENT

< BASIC INSPECTION >

INSPECTION AND ADJUSTMENT

ADDITIONAL SERVICE WHEN REMOVING BATTERY NEGATIVE TERMINAL

ADDITIONAL SERVICE WHEN REMOVING BATTERY NEGATIVE TERMINAL : Re- quired Procedure After Battery Disconnection

INFOID:000000009011059

| SYSTEM | ITEM | REFERENCE |
|---|---|--|
| Front automatic air conditioning system | Temperature setting trimmer (Front) | HAC-73. "FRONT AUTOMATIC AIR CONDITIONING SYSTEM : Temperature Setting Trimmer (Front)" |
| | Foot position setting trimmer | HAC-73. "FRONT AUTOMATIC AIR CONDITIONING SYSTEM : Foot Position Setting Trimmer" |
| | Inlet port memory function* | — |
| | Inlet port memory function (FRE) | HAC-74. "FRONT AUTOMATIC AIR CONDITIONING SYSTEM : Inlet Port Memory Function (FRE)" |
| | Inlet port memory function (REC) | HAC-74. "FRONT AUTOMATIC AIR CONDITIONING SYSTEM : Inlet Port Memory Function (REC)" |
| ACCS (Advanced Climate Control System) | Exhaust gas / outside odor detecting sensor sensitivity adjustment function | HAC-75. "ACCS (ADVANCED CLIMATE CONTROL SYSTEM) : Exhaust Gas / Outside Odor Detecting Sensor Sensitivity Adjustment Function" |
| | Auto intake switch interlocking movement change function | HAC-75. "ACCS (ADVANCED CLIMATE CONTROL SYSTEM) : Auto Intake Switch Interlocking Movement Change Function" |
| | Clean switch interlocking movement change function* | — |
| Rear automatic air conditioning system | Temperature setting trimmer (Rear) | HAC-74. "REAR AUTOMATIC AIR CONDITIONING SYSTEM : Temperature Setting Trimmer (Rear)" |
| Automatic drive positioner | Automatic drive positioner system | ADP-52. "ADDITIONAL SERVICE WHEN REMOVING BATTERY NEGATIVE TERMINAL : Description" |
| Power window control | Power window control system | PWC-32. "Description" |
| Sunroof system | Sunroof system | — |
| Sunshade system | Sunshade system | — |
| Rear view monitor* | Rear view monitor predictive course line center position adjustment | — |
| Around view monitor | Predictive course line center position adjustment | — |
| Automatic back door system | Automatic back door system | DLK-82. "ADDITIONAL SERVICE WHEN REMOVING BATTERY NEGATIVE TERMINAL : Description" |
| Engine oil level read* | Engine oil level read | — |

*: Not equipped.