

SECTION **INT**  
INTERIOR

A  
B  
C

CONTENTS

D  
E

<b>PRECAUTION</b> .....	3	<b>FRONT PILLAR GARNISH</b> .....	19	F
<b>PRECAUTIONS</b> .....	3	FRONT PILLAR GARNISH : Removal and Installation .....	19	G
Precaution for Supplemental Restraint System (SRS) "AIR BAG" and "SEAT BELT PRE-TENSIONER" .....	3	<b>BODY SIDE WELT</b> .....	20	H
Precaution for Procedure without Cowl Top Cover.....	3	BODY SIDE WELT : Removal and Installation .....	20	I
Precautions for Removing of Battery Terminal .....	3	<b>KICKING PLATE INNER</b> .....	20	INT
Precaution for Work .....	4	KICKING PLATE INNER : Removal and Installation .....	20	K
<b>PREPARATION</b> .....	5	<b>KICKING PLATE OUTER</b> .....	21	L
<b>PREPARATION</b> .....	5	KICKING PLATE OUTER : Removal and Installation .....	21	M
Special Service Tools .....	5	<b>CENTER PILLAR LOWER GARNISH</b> .....	22	N
Commercial Service Tools .....	5	CENTER PILLAR LOWER GARNISH : Removal and Installation .....	22	O
<b>CLIP LIST</b> .....	6	<b>CENTER PILLAR UPPER GARNISH</b> .....	22	P
Clip List .....	6	CENTER PILLAR UPPER GARNISH : Removal and Installation .....	22	
<b>SYMPTOM DIAGNOSIS</b> .....	7	<b>FLOOR TRIM</b> .....	24	
<b>SQUEAK AND RATTLE TROUBLE DIAGNOSES</b> .....	7	Exploded View .....	24	
Work Flow .....	7	<b>FRONT FLOOR CARPET</b> .....	25	
Inspection Procedure .....	9	FRONT FLOOR CARPET : Removal and Installation .....	25	
Diagnostic Worksheet .....	11	<b>REAR FLOOR CARPET</b> .....	27	
<b>REMOVAL AND INSTALLATION</b> .....	13	REAR FLOOR CARPET : Removal and Installation .....	27	
<b>FRONT DOOR FINISHER</b> .....	13	<b>HEADLINING</b> .....	28	
Exploded View .....	13	Exploded View .....	28	
Removal and Installation .....	14	Removal and Installation .....	29	
<b>REAR DOOR FINISHER</b> .....	16	<b>LUGGAGE FLOOR TRIM</b> .....	33	
Exploded View .....	16	Exploded View .....	33	
Removal and Installation .....	16	<b>LUGGAGE FLOOR REAR BOARD</b> .....	34	
<b>BODY SIDE TRIM</b> .....	18	LUGGAGE FLOOR REAR BOARD : Removal and Installation .....	34	
Exploded View .....	18			
<b>DASH SIDE FINISHER</b> .....	18			
DASH SIDE FINISHER : Removal and Installation .....	18			

<b>LUGGAGE REAR PLATE</b> .....	<b>35</b>	<b>BACK PILLAR GARNISH</b> .....	<b>37</b>
LUGGAGE REAR PLATE : Removal and Installation .....	35	BACK PILLAR GARNISH : Removal and Installation .....	37
<b>LUGGAGE SIDE LOWER FINISHER</b> .....	<b>36</b>	<b>LUGGAGE SIDE UPPER FINISHER</b> .....	<b>38</b>
LUGGAGE SIDE LOWER FINISHER : Removal and Installation .....	36	LUGGAGE SIDE UPPER FINISHER : Removal and Installation .....	38
<b>REAR PILLAR FINISHER</b> .....	<b>37</b>	<b>BACK DOOR TRIM</b> .....	<b>39</b>
REAR PILLAR FINISHER : Removal and Installation .....	37	Exploded View .....	39
		Removal and Installation .....	39

# PRECAUTIONS

< PRECAUTION >

## PRECAUTION

### PRECAUTIONS

#### Precaution for Supplemental Restraint System (SRS) "AIR BAG" and "SEAT BELT PRE-TENSIONER"

INFOID:000000009011134

The Supplemental Restraint System such as "AIR BAG" and "SEAT BELT PRE-TENSIONER", used along with a front seat belt, helps to reduce the risk or severity of injury to the driver and front passenger for certain types of collision. Information necessary to service the system safely is included in the "SRS AIR BAG" and "SEAT BELT" of this Service Manual.

#### **WARNING:**

Always observe the following items for preventing accidental activation.

- To avoid rendering the SRS inoperative, which could increase the risk of personal injury or death in the event of a collision that would result in air bag inflation, all maintenance must be performed by an authorized NISSAN/INFINITI dealer.
- Improper maintenance, including incorrect removal and installation of the SRS, can lead to personal injury caused by unintentional activation of the system. For removal of Spiral Cable and Air Bag Module, see "SRS AIR BAG".
- Never use electrical test equipment on any circuit related to the SRS unless instructed to in this Service Manual. SRS wiring harnesses can be identified by yellow and/or orange harnesses or harness connectors.

#### PRECAUTIONS WHEN USING POWER TOOLS (AIR OR ELECTRIC) AND HAMMERS

#### **WARNING:**

Always observe the following items for preventing accidental activation.

- When working near the Air Bag Diagnosis Sensor Unit or other Air Bag System sensors with the ignition ON or engine running, never use air or electric power tools or strike near the sensor(s) with a hammer. Heavy vibration could activate the sensor(s) and deploy the air bag(s), possibly causing serious injury.
- When using air or electric power tools or hammers, always switch the ignition OFF, disconnect the battery, and wait at least 3 minutes before performing any service.

#### Precaution for Procedure without Cowl Top Cover

INFOID:000000009011135

When performing the procedure after removing cowl top cover, cover the lower end of windshield with urethane, etc to prevent damage to windshield.

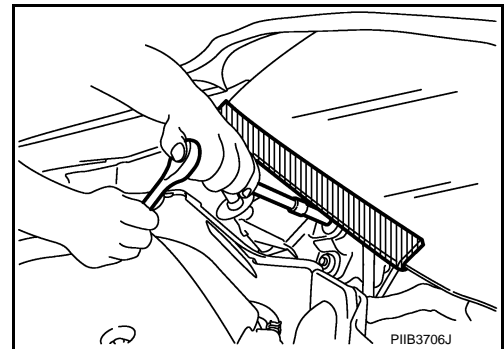

#### Precautions for Removing of Battery Terminal

INFOID:000000009871426

- When removing the 12V battery terminal, turn OFF the ignition switch and wait at least 30 seconds.

#### **NOTE:**

ECU may be active for several tens of seconds after the ignition switch is turned OFF. If the battery terminal is removed before ECU stops, then a DTC detection error or ECU data corruption may occur.

- For vehicles with the 2-batteries, be sure to connect the main battery and the sub battery before turning ON the ignition switch.

#### **NOTE:**

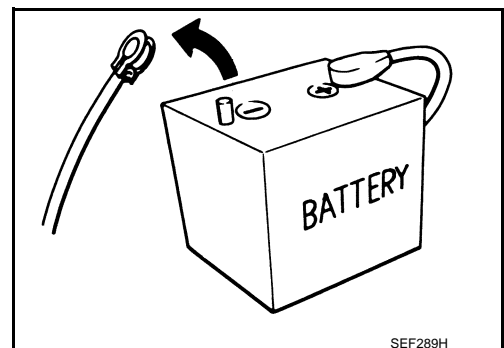

A  
B  
C  
D  
E  
F  
G  
H  
I  
INT  
K  
L  
M  
N  
O  
P

## PRECAUTIONS

### < PRECAUTION >

---

If the ignition switch is turned ON with any one of the terminals of main battery and sub battery disconnected, then DTC may be detected.

- After installing the 12V battery, always check "Self Diagnosis Result" of all ECUs and erase DTC.

**NOTE:**

The removal of 12V battery may cause a DTC detection error.

### Precaution for Work

INFOID:000000009011136

- After removing and installing the opening/closing parts, be sure to carry out fitting adjustments to check their operation.
- Check the lubrication level, damage, and wear of each part. If necessary, grease or replace it.

# PREPARATION

< PREPARATION >

## PREPARATION

### PREPARATION

#### Special Service Tools

INFOID:000000009011137

The actual shapes of Kent-Moore tools may differ from those of special service tools illustrated here.

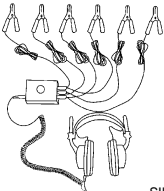
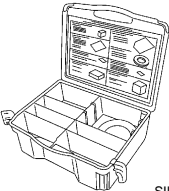
Tool number (Kent-Moore No.) Tool name	Description
(J-39570) Chassis ear   SIIA0993E	Locates the noise
(J-50397) NISSAN Squeak and Rattle Kit   SIIA0994E	Repairs the cause of noise

#### Commercial Service Tools

INFOID:000000009011138

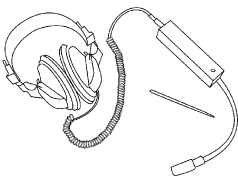
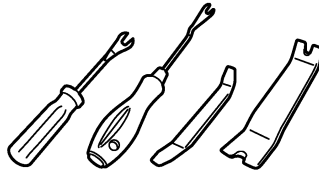
Tool name	Description
Engine ear   SIIA0995E	Locates the noise
Remover tool   JMKIA3050ZZ	Removes clips, pawls and metal clips

# CLIP LIST

< PREPARATION >

## CLIP LIST

### Clip List

INFOID:000000009011139

Shapes	Removal & Installation	Shapes	Removal & Installation
	<p><b>Removal:</b> Remove by bending up with flat-bladed screwdrivers or clip remover.</p>		<p><b>Removal:</b></p>
	<p><b>Removal:</b> Remove with a clip remover.</p>		<p><b>Removal:</b></p>
	<p><b>Removal:</b> Push center pin to catching position. (Do not remove center pin by hitting it.)</p> <p><b>Installation:</b></p>		<p><b>Removal:</b> Holder portion of clip must be spread out to remove rod.</p>
	<p><b>Removal:</b> Remove by bending up with flat-bladed screwdrivers or clip remover.</p>		<p><b>Removal:</b></p> <ol style="list-style-type: none"> <li>Screw out with a Phillips screwdriver.</li> <li>Remove female portion with flat-bladed screwdriver.</li> </ol>
	<p><b>Removal:</b></p>		<p><b>Removal:</b></p> <p>Rotate 45° to remove.</p> <p><b>Installation:</b></p>
	<p><b>Removal:</b></p>		<p><b>Removal:</b></p>

JMJIA3734GB

# SQUEAK AND RATTLE TROUBLE DIAGNOSES

< SYMPTOM DIAGNOSIS >

## SYMPTOM DIAGNOSIS

### SQUEAK AND RATTLE TROUBLE DIAGNOSES

#### Work Flow

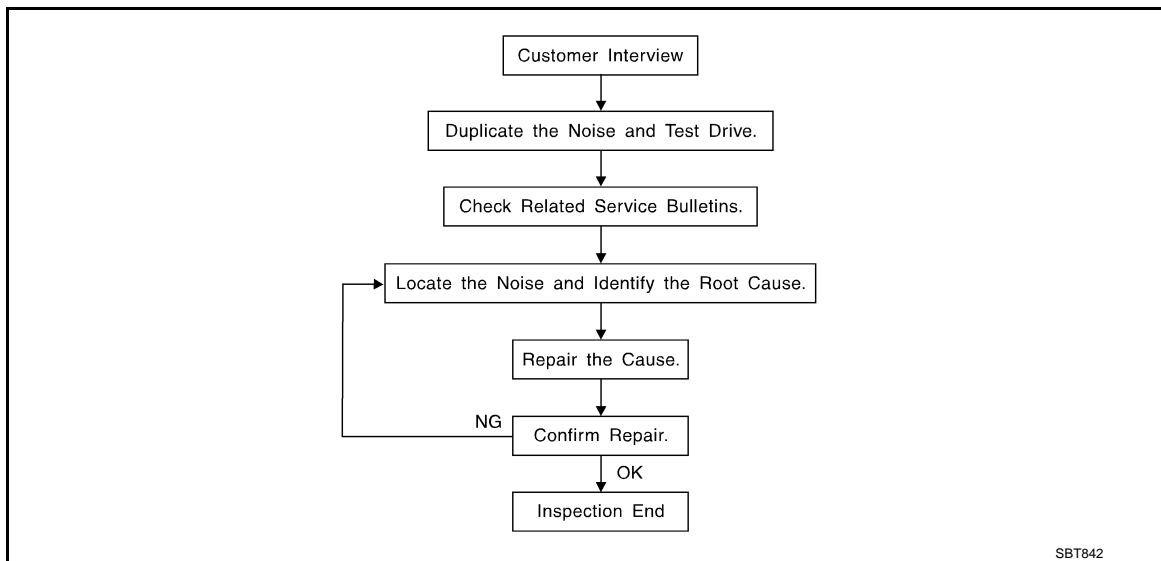

#### CUSTOMER INTERVIEW

Interview the customer if possible, to determine the conditions that exist when the noise occurs. Use the Diagnostic Worksheet during the interview to document the facts and conditions when the noise occurs and any customer comments. Refer to [INT-11, "Diagnostic Worksheet"](#). This information is necessary to duplicate the conditions that exist when the noise occurs.

- The customer may not be able to provide a detailed description or the location of the noise. Attempt to obtain all the facts and conditions that exist when the noise occurs (or does not occur).
- If there is more than one noise in the vehicle, perform a diagnosis and repair the noise that the customer is concerned about. This can be accomplished by performing a test drive with the customer.
- After identifying the type of noise, isolate the noise in terms of its characteristics. The noise characteristics are provided so that the customer, service adviser, and technician use the same language when describing the noise.
- Squeak – (Like tennis shoes on a clean floor)  
Squeak characteristics include the light contact / fast movement / brought on by road conditions / hard surfaces = high-pitched noise / softer surfaces = low-pitched noises / edge to surface = chirping
- Creak – (Like walking on an old wooden floor)  
Creak characteristics include firm contact / slow movement/twisting with a rotational movement / pitch dependent on materials / often brought on by activity.
- Rattle – (Like shaking a baby rattle)  
Rattle characteristics include fast repeated contact / vibration or similar movement / loose parts/missing clip or fastener / incorrect clearance.
- Knock – (Like a knock on a door)  
Knock characteristics include hollow sounds / sometimes repeating / often brought on by driver action.
- Tick – (Like a clock second hand)  
Tick characteristics include gentle contacting of light materials / loose components / can be caused by driver action or road conditions.
- Thump – (Heavy, muffled knock noise)  
Thump characteristics include softer knock / dull sounds often brought on by activity.
- Buzz – (Like a bumblebee)  
Buzz characteristics include high frequency rattle / firm contact.
- Often the degree of acceptable noise level varies depending upon the person. A noise that a technician may judge as acceptable may be very irritating to a customer.
- Weather conditions, especially humidity and temperature, may have a great effect on noise level.

#### DUPLICATE THE NOISE AND TEST DRIVE

# SQUEAK AND RATTLE TROUBLE DIAGNOSES

## < SYMPTOM DIAGNOSIS >

If possible, drive the vehicle with the customer until the noise is duplicated. Note any additional information on the Diagnostic Worksheet regarding the conditions or location of the noise. This information can be used to duplicate the same conditions when the repair is reconfirmed.

If the noise can be duplicated easily during the test drive, do the following with the vehicle stopped to help identify the source of the noise.

- 1) Close a door.
  - 2) Tap or push/pull around the area where the noise appears to be coming from.
  - 3) Rev the engine.
  - 4) Use a floor jack to recreate vehicle "twist".
  - 5) At idle, apply engine load (electrical load, half-clutch on M/T models, drive position on A/T models).
  - 6) Raise the vehicle on a hoist and hit a tire with a rubber hammer.
- Drive the vehicle and attempt to duplicate the conditions the customer states exist when the noise occurs.
  - If it is difficult to duplicate the noise, drive the vehicle slowly on an undulating or rough road to stress the vehicle body.

## CHECK RELATED SERVICE BULLETINS

After verifying the customer concern or symptom, check ASIST for Technical Service Bulletins (TSBs) related to the concern or symptom.

If a TSB relates to the symptom, follow the procedure to repair the noise.

## LOCATE THE NOISE AND IDENTIFY THE ROOT CAUSE

1. Narrow down the noise to a general area. To help pinpoint the source of the noise, use a listening tool (Chassis ear: J-39570, engine ear, and mechanics stethoscope).
2. Narrow down the noise to a more specific area and identify the cause of the noise by:
  - Removing the component(s) in the area(s) that is / are suspected to be the cause of the noise. Do not use too much force when removing clips and fasteners, otherwise clips and fasteners can be broken or lost during the repair, creating a new noise.
  - Tapping or pushing/pulling the component(s) that is / are suspected to be the cause of the noise. Do not tap or push/pull the component(s) with excessive force, otherwise the noise is eliminated only temporarily.
  - Feeling for a vibration by hand by touching the component(s) that is / are suspected to be the cause of the noise.
  - Placing a piece of paper between components that are suspected to be the cause of the noise.
  - Looking for loose components and contact marks.  
Refer to [INT-9, "Inspection Procedure"](#).

## REPAIR THE CAUSE

- If the cause is a loose component, tighten the component securely.
- If the cause is insufficient clearance between components:
  - Separate components by repositioning or loosening and retightening the components, if possible.
  - Insulate components with a suitable insulator such as urethane pads, foam blocks, felt cloth tape, or urethane tape. A NISSAN Squeak and Rattle Kit (J-50397) is available through the authorized NISSAN Parts Department.

### **CAUTION:**

**Never use excessive force as many components are constructed of plastic and may be damaged.**

### **NOTE:**

Always check with the Parts Department for the latest parts information.

The following materials are contained in the NISSAN Squeak and Rattle Kit (J-50397) are listed on the inside cover of the kit; and can each be ordered separately as needed.

URETHANE PADS [1.5 mm (0.059 in) thick]

Insulates connectors, harness, etc.

- 76268-9E005: 100 × 135 mm (3.937 × 5.315 in)
- 76884-71L01: 60 × 85 mm (2.362 × 3.346 in)
- 76884-71L02: 15 × 25 mm (0.591 × 0.984 in)

INSULATOR (Foam blocks)

Insulates components from contact. Can be used to fill space behind a panel.

- 73982-9E000: 45 mm (1.772 in) thick, 50 × 50 mm (1.969 × 1.969 in)
- 73982-50Y00: 10 mm (0.394 in) thick, 50 × 50 mm (1.969 × 1.969 in)

INSULATOR (Light foam block)

80845-71L00: 30 mm (1.18 in) thick, 30 × 50 mm (1.181 × 1.969in)

FELT CLOTHTAPE



# SQUEAK AND RATTLE TROUBLE DIAGNOSES

## < SYMPTOM DIAGNOSIS >

Used to insulate where movement does not occur. Ideal for instrument panel applications.

- 68370-4B000: 15 × 25 mm (0.591 × 0.984 in) pad
- 68239-13E00: 5 mm (0.197 in) wide tape roll

The following materials, not found in the kit, can also be used to repair squeaks and rattles.

### UHMW (TEFLON) TAPE

Insulates where slight movement is present. Ideal for instrument panel applications.

### SILICONE GREASE

Used in place of UHMW tape that is visible or does not fit. Only lasts a few months.

### SILICONE SPRAY

Used when grease cannot be applied.

### DUCT TAPE

Used to eliminate movement.

## CONFIRM THE REPAIR

After repair is complete, test drive the vehicle to confirm that the cause of noise is repaired by test driving the vehicle. Operate the vehicle under the same conditions as when the noise originally occurred. Refer to the notes on the Diagnostic Worksheet.

## Inspection Procedure

INFOID:000000009011141

Refer to Table of Contents for specific component removal and installation information.

## INSTRUMENT PANEL

Most incidents are caused by contact and movement between:

1. The cluster lid A and instrument panel
2. Acrylic lens and combination meter housing
3. Instrument panel to front pillar garnish
4. Instrument panel to windshield
5. Instrument panel mounting pins
6. Wiring harnesses behind the combination meter
7. A/C defroster duct and duct joint

These incidents can usually be located by tapping or moving the components to duplicate the noise or by pressing on the components while driving to stop the noise. Most of these incidents can be repaired by applying felt cloth tape or silicon spray (in hard to reach areas). Urethane pads can be used to insulate wiring harness.

### **CAUTION:**

**Never use silicone spray to isolate a squeak or rattle. If the area is saturated with silicone, the recheck of repair becomes impossible.**

## CENTER CONSOLE

Components to check include:

1. Shifter assembly cover to finisher
2. A/C control unit and cluster lid C
3. Wiring harnesses behind audio and A/C control unit

The instrument panel repair and isolation procedures also apply to the center console.

## DOORS

Check the following items:

1. Finisher and inner panel making a slapping noise
2. Inside handle escutcheon connection to door finisher
3. Wiring harnesses tapping
4. Door striker out of alignment causing a popping noise on starts and stops

Tapping, moving the components, or pressing on them while driving to duplicate the conditions can isolate many of these incidents. The areas can usually be insulated with felt cloth tape or insulator foam blocks from the NISSAN Squeak and Rattle Kit (J-50397) to repair the noise.

## TRUNK

Trunk noises are often caused by a loose jack or loose items put into the trunk by the customer.

In addition check for the following items:

A

B

C

D

E

F

G

H

I

INT

K

L

M

N

O

P

# SQUEAK AND RATTLE TROUBLE DIAGNOSES

## < SYMPTOM DIAGNOSIS >

---

1. Trunk lid dumpers out of adjustment
2. Trunk lid striker out of adjustment
3. Trunk lid torsion bars knocking together
4. A loose license plate or bracket

Most of these incidents can be repaired by adjusting, securing, or insulating the item(s) or component(s) causing the noise.

## SUNROOF/HEADLINING

Noises in the sunroof / headlining area can often be traced to one of the following items:

1. Sunroof lid, rail, linkage, or seals making a rattle or light knocking noise
2. Sunvisor shaft shaking in the holder
3. Front or rear windshield touching headlining and squeaking

Again, pressing on the components to stop the noise while duplicating the conditions can isolate most of these incidents. Repairs usually consist of insulating with felt cloth tape.

## SEATS

When isolating seat noise it is important to note the position the seat is in and the load placed on the seat when the noise occurs. These conditions should be duplicated when verifying and isolating the cause of the noise.

Causes of seat noise include:

1. Headrest rods and holder
2. A squeak between the seat pad cushion and frame
3. The rear seatback lock and bracket

These noises can be isolated by moving or pressing on the suspected components while duplicating the conditions under which the noise occurs. Most of these incidents can be repaired by repositioning the component or applying urethane tape to the contact area.

## UNDERHOOD

Some interior noise may be caused by components under the hood or on the engine wall. The noise is then transmitted into the passenger compartment.

Causes of transmitted underhood noise include:

1. Any component mounted to the engine wall
2. Components that pass through the engine wall
3. Engine wall mounts and connectors
4. Loose radiator mounting pins
5. Hood bumpers out of adjustment
6. Hood striker out of adjustment

These noises can be difficult to isolate since they cannot be reached from the interior of the vehicle. The best method is to secure, move, or insulate one component at a time and test drive the vehicle. Also, engine RPM or load can be changed to isolate the noise. Repairs can usually be made by moving, adjusting, securing, or insulating the component causing the noise.

# SQUEAK AND RATTLE TROUBLE DIAGNOSES

< SYMPTOM DIAGNOSIS >

## Diagnostic Worksheet

INFOID:000000009011142



### SQUEAK & RATTLE DIAGNOSTIC WORKSHEET

Dear Infiniti Customer:

We are concerned about your satisfaction with your Infiniti vehicle. Repairing a squeak or rattle sometimes can be very difficult. To help us fix your Infiniti right the first time, please take a moment to note the area of the vehicle where the squeak or rattle occurs and under what conditions. You may be asked to take a test drive with a service consultant or technician to ensure we confirm the noise you are hearing.

#### I. WHERE DOES THE NOISE COME FROM? (circle the area of the vehicle)

The illustrations are for reference only, and may not reflect the actual configuration of your vehicle.

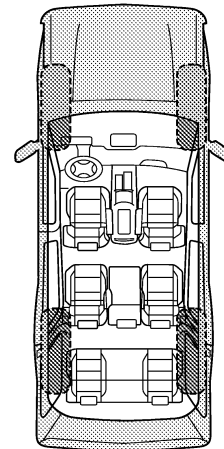
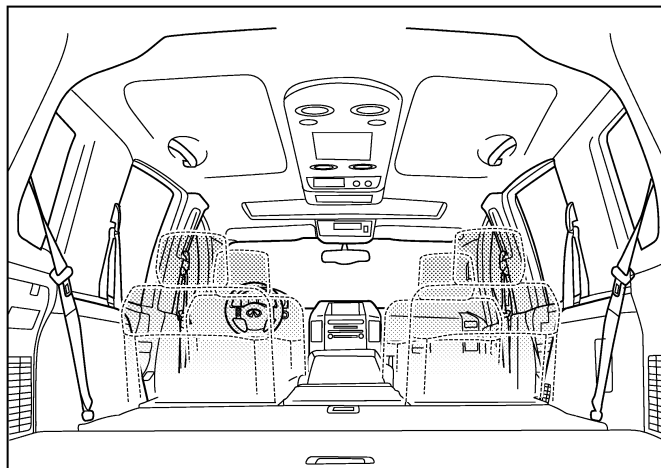
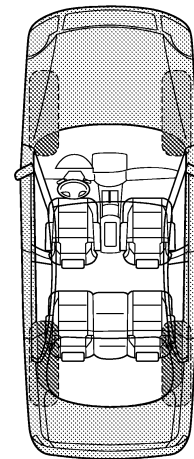
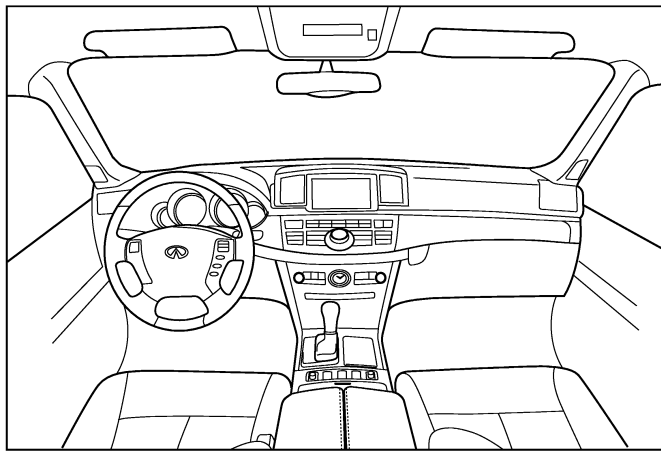

Continue to page 2 of the worksheet and briefly describe the location of the noise or rattle. In addition, please indicate the conditions which are present when the noise occurs.

PIIB8741E

A  
B  
C  
D  
E  
F  
G  
H  
I  
INT  
K  
L  
M  
N  
O  
P

# SQUEAK AND RATTLE TROUBLE DIAGNOSES

< SYMPTOM DIAGNOSIS >

## SQUEAK & RATTLE DIAGNOSTIC WORKSHEET - page 2

Briefly describe the location where the noise occurs:

---

---

### II. WHEN DOES IT OCCUR? (please check the boxes that apply)

- |   |  |
|---|--|
| <input type="checkbox"/> anytime                      | <input type="checkbox"/> after sitting out in the rain |
| <input type="checkbox"/> 1st time in the morning      | <input type="checkbox"/> when it is raining or wet     |
| <input type="checkbox"/> only when it is cold outside | <input type="checkbox"/> dry or dusty conditions       |
| <input type="checkbox"/> only when it is hot outside  | <input type="checkbox"/> other:                        |

### III. WHEN DRIVING:

- through driveways
- over rough roads
- over speed bumps
- only about \_\_\_\_ mph
- on acceleration
- coming to a stop
- on turns: left, right or either (circle)
- with passengers or cargo
- other: \_\_\_\_\_
- after driving \_\_\_\_ miles or \_\_\_\_ minutes

### IV. WHAT TYPE OF NOISE

- squeak (like tennis shoes on a clean floor)
- creak (like walking on an old wooden floor)
- rattle (like shaking a baby rattle)
- knock (like a knock at the door)
- tick (like a clock second hand)
- thump (heavy, muffled knock noise)
- buzz (like a bumble bee)

## TO BE COMPLETED BY DEALERSHIP PERSONNEL

### Test Drive Notes:

---

---

---

	YES	NO	Initials of person performing
Vehicle test driven with customer	<input type="checkbox"/>	<input type="checkbox"/>	_____
- Noise verified on test drive	<input type="checkbox"/>	<input type="checkbox"/>	_____
- Noise source located and repaired	<input type="checkbox"/>	<input type="checkbox"/>	_____
- Follow up test drive performed to confirm repair	<input type="checkbox"/>	<input type="checkbox"/>	_____

VIN: \_\_\_\_\_ Customer Name: \_\_\_\_\_  
W.O.# \_\_\_\_\_ Date: \_\_\_\_\_

This form must be attached to Work Order

PIIB8742E

# FRONT DOOR FINISHER

< REMOVAL AND INSTALLATION >

## REMOVAL AND INSTALLATION

### FRONT DOOR FINISHER

Exploded View

INFOID:000000009011143

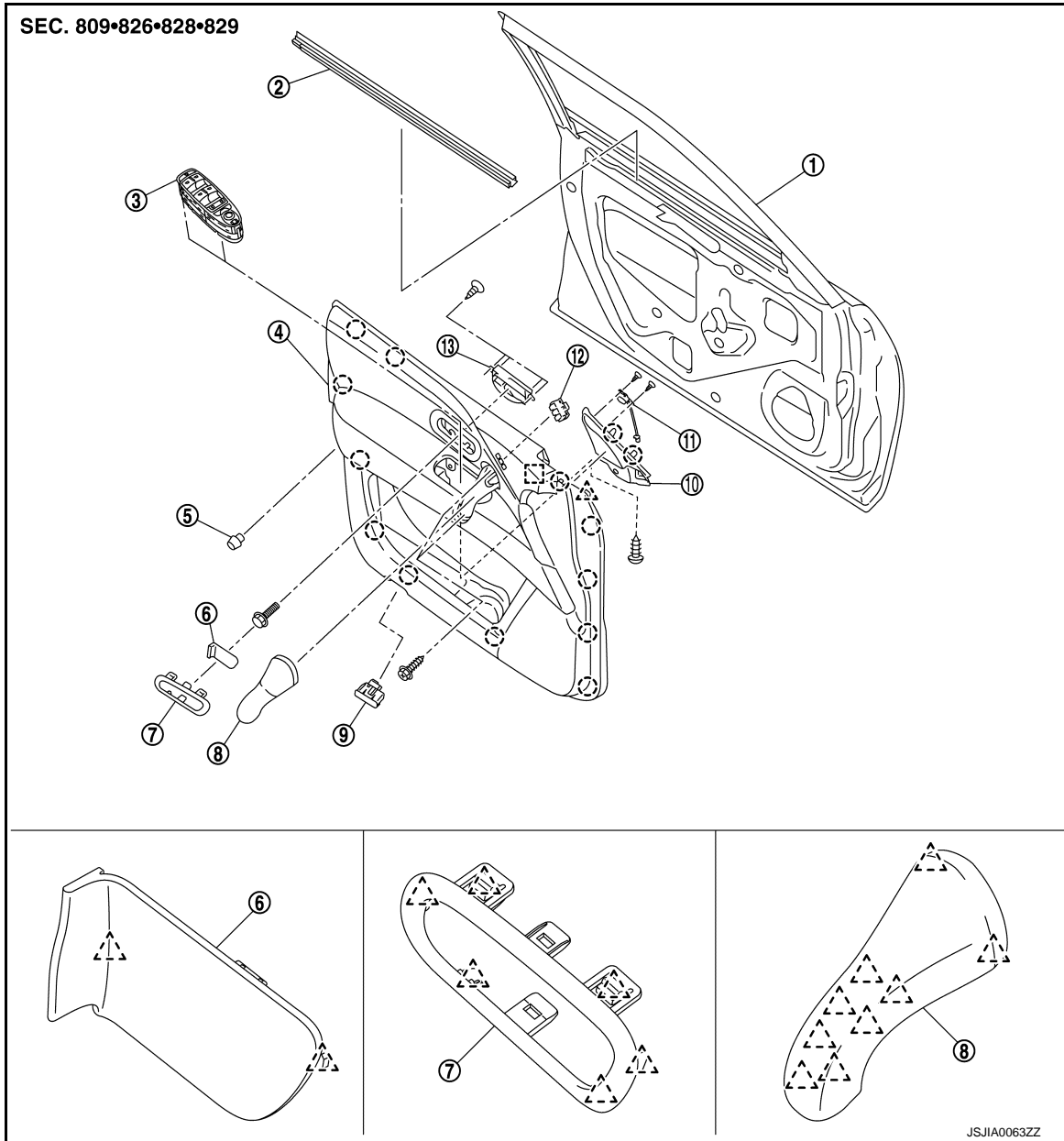

- |                              |                           |                        |
|------------------------------|---------------------------|------------------------|
| 1. Front door panel          | 2. Front inside door seal | 3. Power window switch |
| 4. Front door finisher       | 5. Bumper rubber          | 6. Door finisher cap   |
| 7. Inside handle escutcheon  | 8. Front door grip cap    | 9. Step lamp           |
| 10. Door mirror corner cover | 11. BSW/BSI indicator     | 12. Seat memory switch |
| 13. Front door inside handle |                           |                        |

○ : Clip

△ : Pawl

□ : Metal clip

A  
B  
C  
D  
E  
F  
G  
H  
I  
INT  
K  
L  
M  
N  
O  
P

# FRONT DOOR FINISHER

## < REMOVAL AND INSTALLATION >

### Removal and Installation

INFOID:000000009011144

#### CAUTION:

- When removing, always use a remover tool that is made of plastic.
- Never damage the body.

#### REMOVAL

1. Fully open door window.
2. Remove door finisher cap (1) using a small flat-bladed screwdriver (A) as shown by the arrow in the figure, and then remove front door finisher mounting bolt.

#### CAUTION:

Use a small flat-bladed screwdriver wrapped in tape (B).

 : Pawl

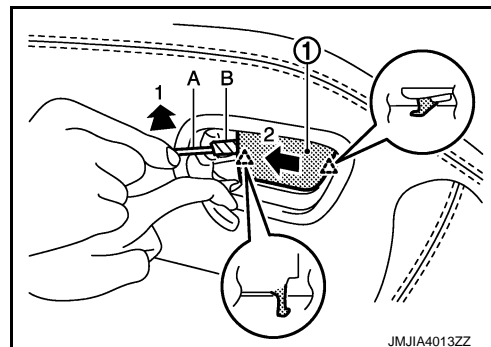

3. Insert a remover tool (A) between front door grip cap (1) and front door grip to disengage front door grip cap fixing pawls as shown by the arrow in the figure, and then remove fixing screws

 : Pawl

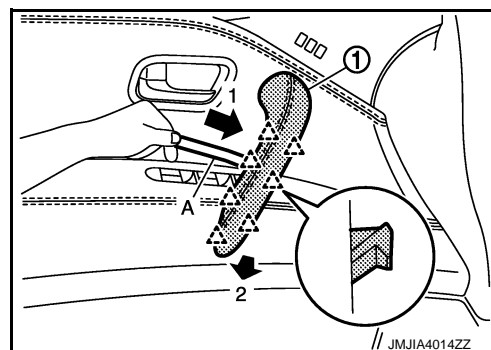

4. Remove step lamp, and then disconnect step lamp harness connector. Refer to [INL-75, "Removal and Installation"](#).
5. Remove bumper rubber.
6. Insert a remover tool (A) between door finisher and door panel to disengage fixing clips and metal clip as shown by the arrow in the figure.

 : Clip

 : Metal clip

#### CAUTION:

Insert a remover tool into the part shown in the figure (between the clips and the door panel).

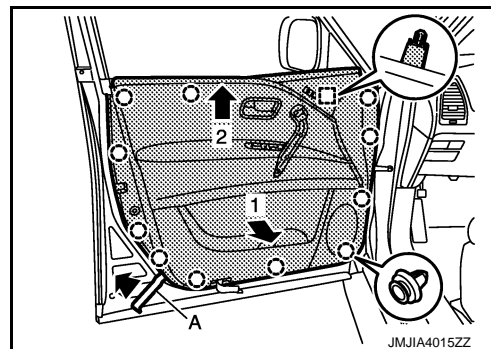

7. Disconnect BSW/BSI indicator harness connector.
8. Disconnect seat memory switch harness connector.
9. Disconnect mood lamp harness connector.
10. Disconnect power window switch harness connector and clamp.
11. Disconnect lock knob cable and inside handle cable from front door inside handle.
12. Remove front door finisher from front door panel.
13. Remove the following parts after removing front door finisher.
  - Mood lamp.
  - Door mirror corner cover.
  - Power window switch. Refer to [PWC-75, "Removal and Installation"](#).
  - BSW/BSI indicator. Refer to [DAS-602, "Removal and Installation"](#).

# FRONT DOOR FINISHER

## < REMOVAL AND INSTALLATION >

---

- Seat memory switch. Refer to [ADP-138, "Removal and Installation"](#).
- Front door inside handle. Refer to [DLK-247, "INSIDE HANDLE : Removal and Installation"](#).

## INSTALLATION

Note the following items, and install in the reverse order of removal.

### **CAUTION:**

- **Visually check the clips, pawls and metal clip for deformation and damage during installation. Replace with new ones if necessary.**
- **When installing front door finisher, check that clips, pawls and metal clip are securely fitted in body panel holes, and press them in.**

A

B

C

D

E

F

G

H

I

INT

K

L

M

N

O

P

# REAR DOOR FINISHER

< REMOVAL AND INSTALLATION >

## REAR DOOR FINISHER

Exploded View

INFOID:000000009011145

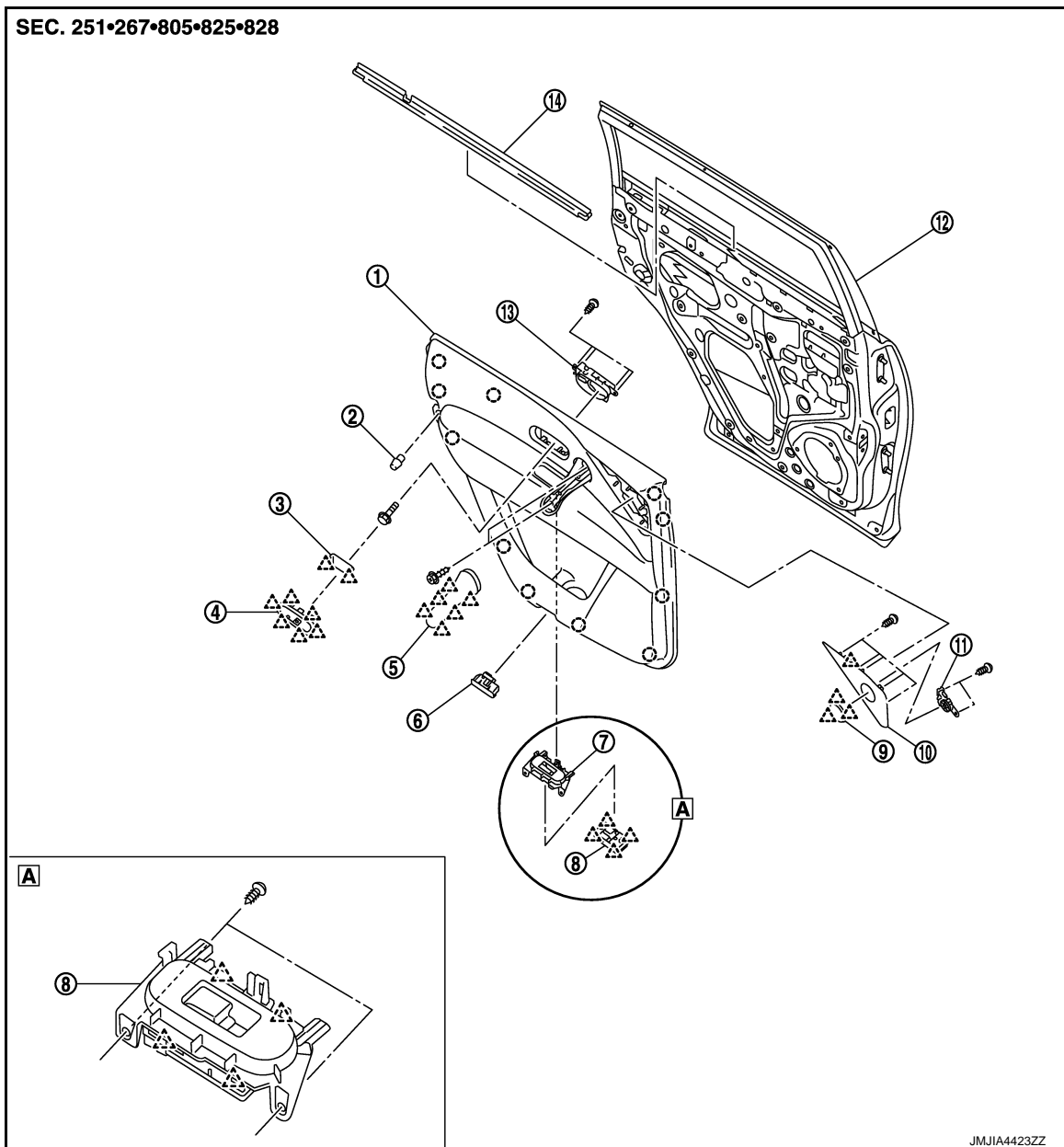

- |                                 |                           |                      |
|---------------------------------|---------------------------|----------------------|
| 1. Rear door finisher           | 2. Bumper rubber          | 3. Door finisher cap |
| 4. Inside handle escutcheon     | 5. Rear door grip cap     | 6. Step lamp         |
| 7. Power window switch finisher | 8. Power window switch    | 9. Tweeter grille    |
| 10. Rear door garnish           | 11. Rear door tweeter     | 12. Rear door panel  |
| 13. Rear door inside handle     | 14. Rear door inside seal |                      |

- : Clip  
 △ : Pawl

### Removal and Installation

INFOID:000000009011146

#### CAUTION:

- When removing, always use a remover tool that is made of plastic.
- Never damage the body.



# REAR DOOR FINISHER

## < REMOVAL AND INSTALLATION >

### REMOVAL

1. Fully open door window.
2. Remove door finisher cap (1) using a small flat-bladed screwdriver (A) as shown by the arrow in the figure, and then remove rear door finisher mounting bolt.

**CAUTION:**

Use a small flat-bladed screwdriver wrapped in tape (B).

 : Pawl

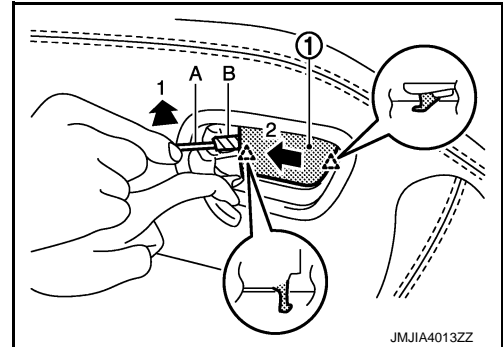

3. Insert a remover tool (A) between rear door grip cap (1) and rear door grip to disengage rear door grip cap fixing pawls as shown by the arrow in the figure, and then remove fixing screws.

 : Pawl

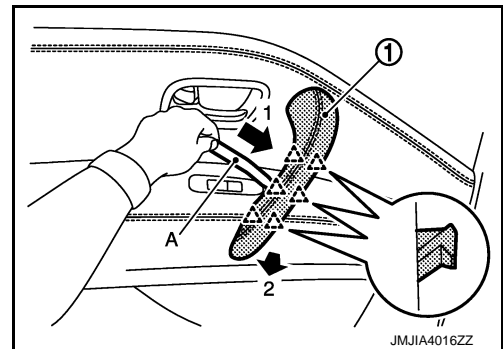

4. Remove step lamp, and then disconnect step lamp harness connector. Refer to [INL-75, "Removal and Installation"](#).
5. Remove bumper rubber.
6. Insert a remover tool (A) between rear door finisher and rear door panel to disengage the clips as shown by the arrow in the figure.

 : Clip

**CAUTION:**

Insert a remover tool into the part shown in the figure (between the clips and the door panel).

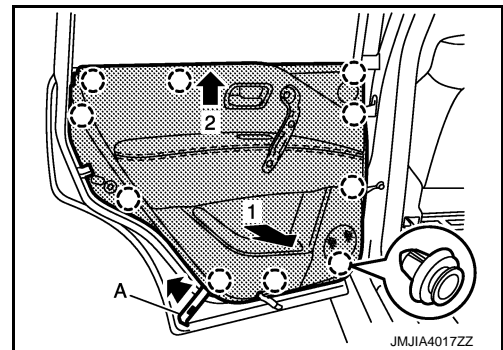

7. Disconnect mood lamp harness connector.
8. Disconnect power window switch harness connector and clamp.
9. Disconnect lock knob cable and inside handle cable from rear inside handle.
10. Remove rear door finisher from rear door panel.
11. Remove the following parts after removing rear door finisher.
  - Mood lamp.
  - Power window switch. Refer to [PWC-75, "Removal and Installation"](#).
  - Rear door inside handle. Refer to [DLK-250, "INSIDE HANDLE : Removal and Installation"](#).
  - Rear door tweeter. Refer to [AV-288, "Removal and Installation"](#).

### INSTALLATION

Note the following items, and install in the reverse order of removal.

**CAUTION:**

- Visually check the clips and pawls for deformation and damage during installation. Replace with new ones if necessary.
- When installing rear door finisher, check that clips and pawls are securely fitted in body panel holes, and press them in.

# BODY SIDE TRIM

< REMOVAL AND INSTALLATION >

## BODY SIDE TRIM

Exploded View

INFOID:000000009011147

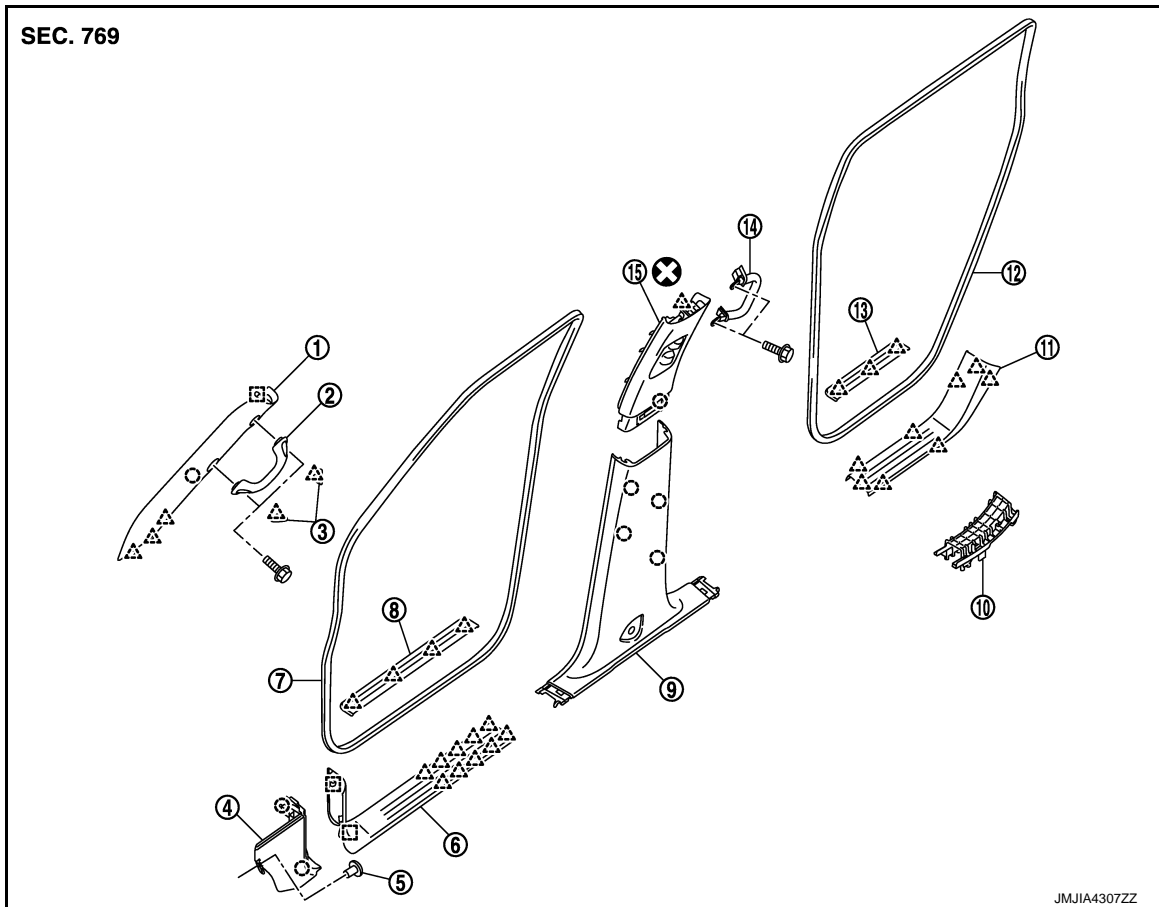

- |                              |                              |                                 |
|------------------------------|------------------------------|---------------------------------|
| 1. Front pillar garnish      | 2. Assist grip               | 3. Assist grip cap              |
| 4. Dash side finisher        | 5. Clip                      | 6. Front kicking plate inner    |
| 7. Front body side welt      | 8. Front kicking plate outer | 9. Center pillar lower garnish  |
| 10. Rear side bracket        | 11. Rear kicking plate inner | 12. Rear body side welt         |
| 13. Rear kicking plate outer | 14. Assist grip              | 15. Center pillar upper garnish |

○ : Clip

△ : Pawl

□ : Metal clip

⊗ : Always replace after every disassembly.

## DASH SIDE FINISHER

### DASH SIDE FINISHER : Removal and Installation

INFOID:000000009011148

#### CAUTION:

- When removing, always use a remover tool that is made of plastic.
- Never damage the body.

#### REMOVAL

1. Remove front kicking plate inner. Refer to [INT-20, "KICKING PLATE INNER : Removal and Installation"](#).
2. Remove dash side finisher fixing clip (A).

## BODY SIDE TRIM

### < REMOVAL AND INSTALLATION >

- Disengage dash side finisher (1) fixing clips using a remover tool (B) as shown by the arrow in the figure, and then remove dash side finisher.

○ : Clip

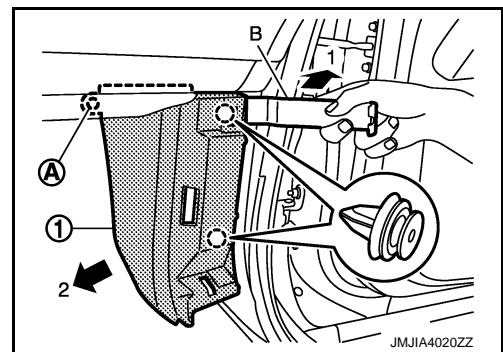

### INSTALLATION

Note the following items, and install in the reverse order of removal.

#### CAUTION:

- Visually check the clips for deformation and damage during installation. Replace with new ones if necessary.
- When installing dash side finisher, check that clips are securely fitted in body panel holes, and press clips in.

### FRONT PILLAR GARNISH

#### FRONT PILLAR GARNISH : Removal and Installation

INFOID:000000009011149

#### CAUTION:

- When removing, always use a remover tool that is made of plastic.
- Never damage the body.

### REMOVAL

- Release front pillar garnish portion of front body side welt.
- Disengage assist grip cap (1) fixing pawls using a flat-bladed screwdriver (A) as shown in the figure, and then remove assist grip mounting bolts and assist grip (2).

#### CAUTION:

Apply protective tape (B) to the assist grip to protect from damage.

△ : Pawl

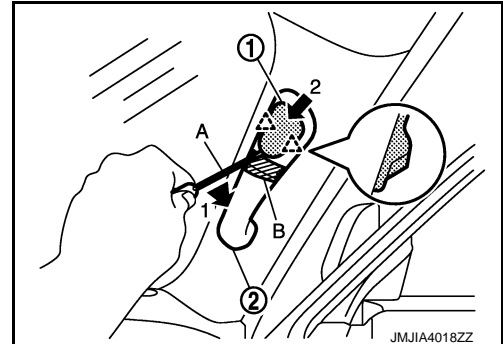

- Disengage front pillar garnish (1) fixing clip and metal clip using a remover tool (A) as shown by the arrow in the figure, and then remove front pillar garnish.

○ : Clip

□ : Metal clip

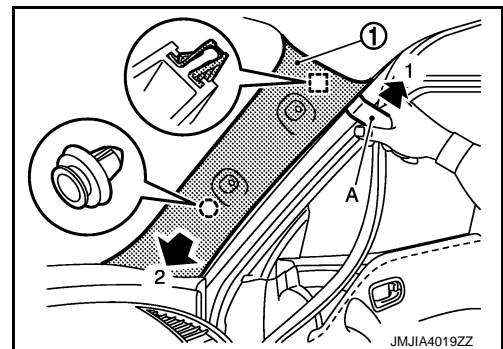

### INSTALLATION

Note the following items, and install in the reverse order of removal.

#### CAUTION:

- Visually check the clip, pawls and metal clip for deformation and damage during installation. Replace with new ones if necessary.
- When installing front pillar garnish, check that clip and metal clip are securely fitted in body panel holes, and press them in.

# BODY SIDE TRIM

< REMOVAL AND INSTALLATION >

## BODY SIDE WELT

### BODY SIDE WELT : Removal and Installation

INFOID:000000009011150

#### CAUTION:

Never damage the body.

#### REMOVAL

Front body side welt

1. Remove front kicking plate inner and rear kicking plate inner. Refer to [INT-20, "KICKING PLATE INNER : Removal and Installation"](#).
2. Remove dash side finisher. Refer to [INT-18, "DASH SIDE FINISHER : Removal and Installation"](#).
3. Slide front seat assembly to the frontmost position.
4. Remove center pillar lower garnish. Refer to [INT-22, "CENTER PILLAR LOWER GARNISH : Removal and Installation"](#).
5. Remove front body side welt.

Rear body side welt

1. Remove front kicking plate inner and rear kicking plate inner. Refer to [INT-20, "KICKING PLATE INNER : Removal and Installation"](#).
2. Slide front seat assembly to the frontmost position.
3. Remove center pillar lower garnish. Refer to [INT-22, "CENTER PILLAR LOWER GARNISH : Removal and Installation"](#).
4. Remove luggage side lower finisher. Refer to [INT-36, "LUGGAGE SIDE LOWER FINISHER : Removal and Installation"](#).
5. Remove rear body side welt.

#### INSTALLATION

Install in the reverse order of removal.

## KICKING PLATE INNER

### KICKING PLATE INNER : Removal and Installation

INFOID:000000009011151

#### CAUTION:

- When removing, always use a remover tool that is made of plastic.
- Never damage the body.

#### REMOVAL

Front kicking plate inner

Disengage front kicking plate inner fixing pawls and metal clips using a remover tool (A) as shown by the arrow in the figure, and then remove front kicking plate inner.

#### CAUTION:

Apply protective tape (B) to the body panel to protect from damage.

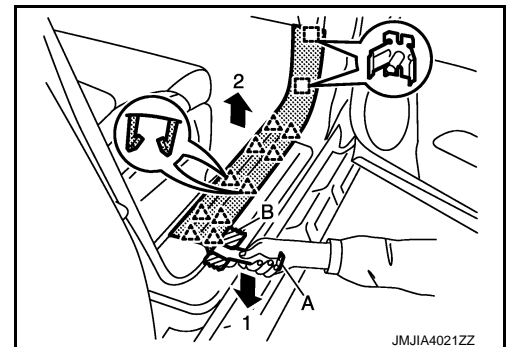
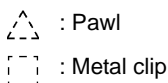

Rear kicking plate inner

1. Disengage rear kicking plate inner fixing pawls using a remover tool (A) as shown by the arrow in the figure, and then remove rear kicking plate inner (1).

#### CAUTION:

# BODY SIDE TRIM

## < REMOVAL AND INSTALLATION >

Apply protective tape (B) to the body panel to protect from damage.

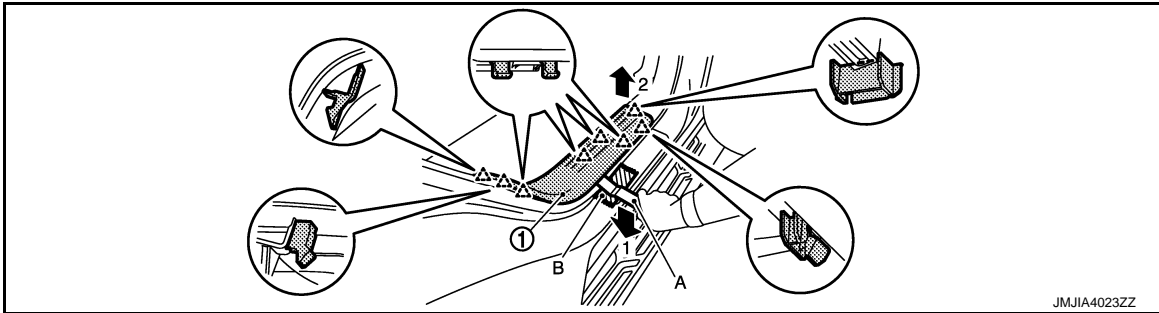

 : Pawl

2. Remove rear side bracket.

### INSTALLATION

Note the following items, and install in the reverse order of removal.

#### CAUTION:

- Visually check the pawls and metal clips for deformation and damage during installation. Replace with new ones if necessary.
- When installing front kicking plate inner and rear kicking plate inner, check that pawls and metal clips are securely fitted in body panel holes, and press them in.

### KICKING PLATE OUTER

#### KICKING PLATE OUTER : Removal and Installation

INFOID:000000009011152

#### CAUTION:

- When removing, always use a remover tool that is made of plastic.
- Never damage the body.

### REMOVAL

Front kicking plate outer

Disengage front kicking plate outer fixing pawls using a remover tool (A) as shown by the arrow in the figure, and then remove front kicking plate outer (1).

#### CAUTION:

Apply protective tape (B) to the body panel to protect from damage.

 : Pawl

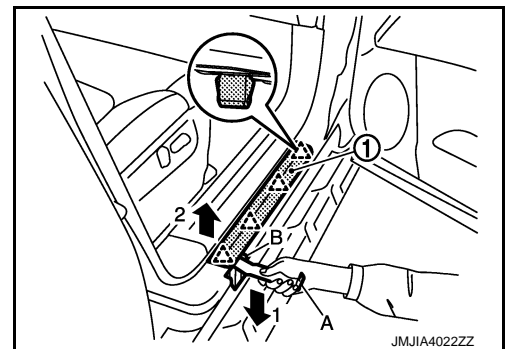

Rear kicking plate outer

Disengage rear kicking plate outer fixing pawls using a remover tool (A) as shown by the arrow in the figure, and then remove rear kicking plate outer (1).

#### CAUTION:

Apply protective tape (B) to the body panel to protect from damage.

 : Pawl

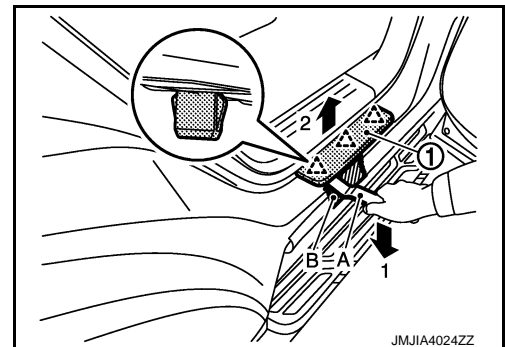

### INSTALLATION

Note the following items, and then install in the reverse order of removal.

A  
B  
C  
D  
E  
F  
G  
H  
I  
INT  
K  
L  
M  
N  
O  
P

# BODY SIDE TRIM

## < REMOVAL AND INSTALLATION >

### CAUTION:

- Visually check the pawls for deformation and damage during installation. Replace with new ones if necessary.
- When installing front kicking plate outer and rear kicking plate outer, check that pawls are securely fitted in body panel holes, and press them in.

## CENTER PILLAR LOWER GARNISH

### CENTER PILLAR LOWER GARNISH : Removal and Installation

INFOID:000000009011153

### CAUTION:

Never damage the body.

#### REMOVAL

1. Remove front kicking plate inner and rear kicking plate inner. Refer to [INT-20, "KICKING PLATE INNER : Removal and Installation"](#).
2. Slide front seat assembly to the frontmost position.
3. Remove seat belt outer anchor. Refer to [SB-6, "SEAT BELT RETRACTOR : Removal and Installation"](#).
4. Disengage center pillar lower garnish fixing clips.
5. Remove center pillar lower garnish (1) according to the order of the arrows shown in the figure.

 : Clip

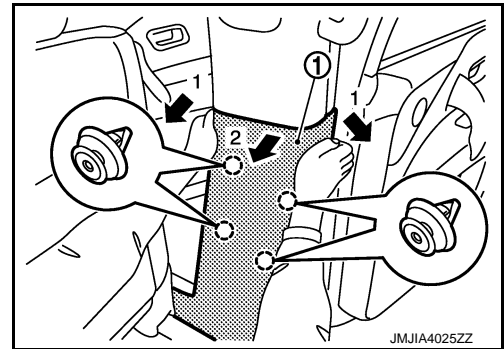

#### INSTALLATION

Note the following items, and install in the reverse order of removal.

### CAUTION:

- Visually check the clips for deformation and damage during installation. Replace with new ones if necessary.
- When installing center pillar lower garnish, check that clips are securely fitted in body panel holes, and press them in.

## CENTER PILLAR UPPER GARNISH

### CENTER PILLAR UPPER GARNISH : Removal and Installation

INFOID:000000009011154

### CAUTION:

- When removing, always use a remover tool that is made of plastic.
- Never damage the body.

#### REMOVAL

1. Remove front kicking plate inner and rear kicking plate inner. Refer to [INT-20, "KICKING PLATE INNER : Removal and Installation"](#).
2. Slide front seat assembly to the frontmost position.
3. Remove center pillar lower garnish. Refer to [INT-22, "CENTER PILLAR LOWER GARNISH : Removal and Installation"](#).

## BODY SIDE TRIM

### < REMOVAL AND INSTALLATION >

4. Disengage center pillar upper garnish (1) lower side fixing clip using a remover tool (A).

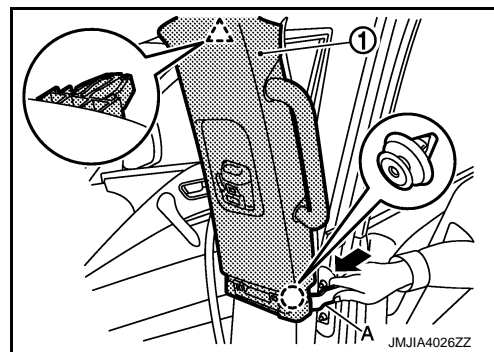
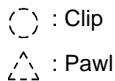

5. Pull center pillar upper garnish (1) from inside passenger room, disengage center pillar upper garnish upper side fixing pawl as shown in the following figure, and then remove center pillar upper garnish from center pillar panel (2).

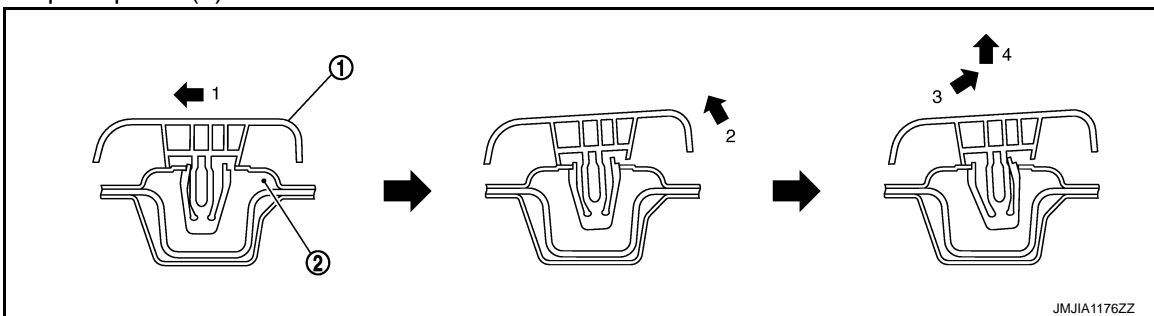

#### **CAUTION:**

Be careful not to apply excessive force when removing center pillar upper garnish. Otherwise, pawl may be damaged and fragments may drop in panel holes on body.

6. Remove assist grip mounting bolts, and then remove assist grip.

### INSTALLATION

Note the following items, and install in the reverse order of removal.

#### **CAUTION:**

- Replace center pillar upper garnish with a new part after removal. Never reuse center pillar upper garnish.
- Visually check the clip and pawl for deformation and damage during installation. Replace with new ones if necessary.
- When installing center pillar upper garnish, check that clip and pawl are securely fitted in body panel holes, and press them in.

# FLOOR TRIM

< REMOVAL AND INSTALLATION >

## FLOOR TRIM

Exploded View

INFOID:000000009011155

FOR SECOND BENCH SEAT

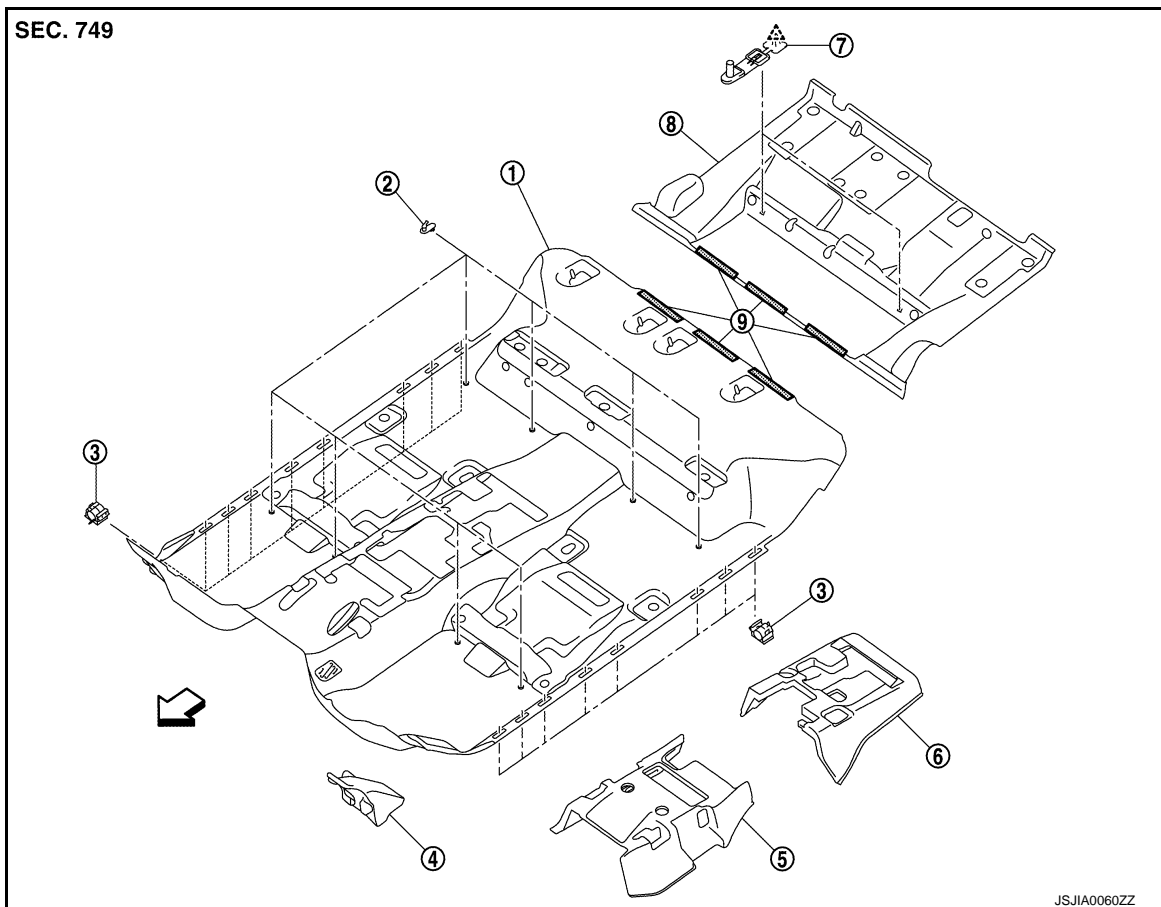

- |                       |                             |                            |
|-----------------------|-----------------------------|----------------------------|
| 1. Front floor carpet | 2. Carpet hook              | 3. Fixing clip             |
| 4. Footrest           | 5. Front floor spacer front | 6. Front floor spacer rear |
| 7. Floor hook         | 8. Rear floor carpet        | 9. Dual lock fastener      |

△ : Pawl

← : Vehicle front



# FLOOR TRIM

< REMOVAL AND INSTALLATION >

FOR SECOND CAPTAIN SEAT

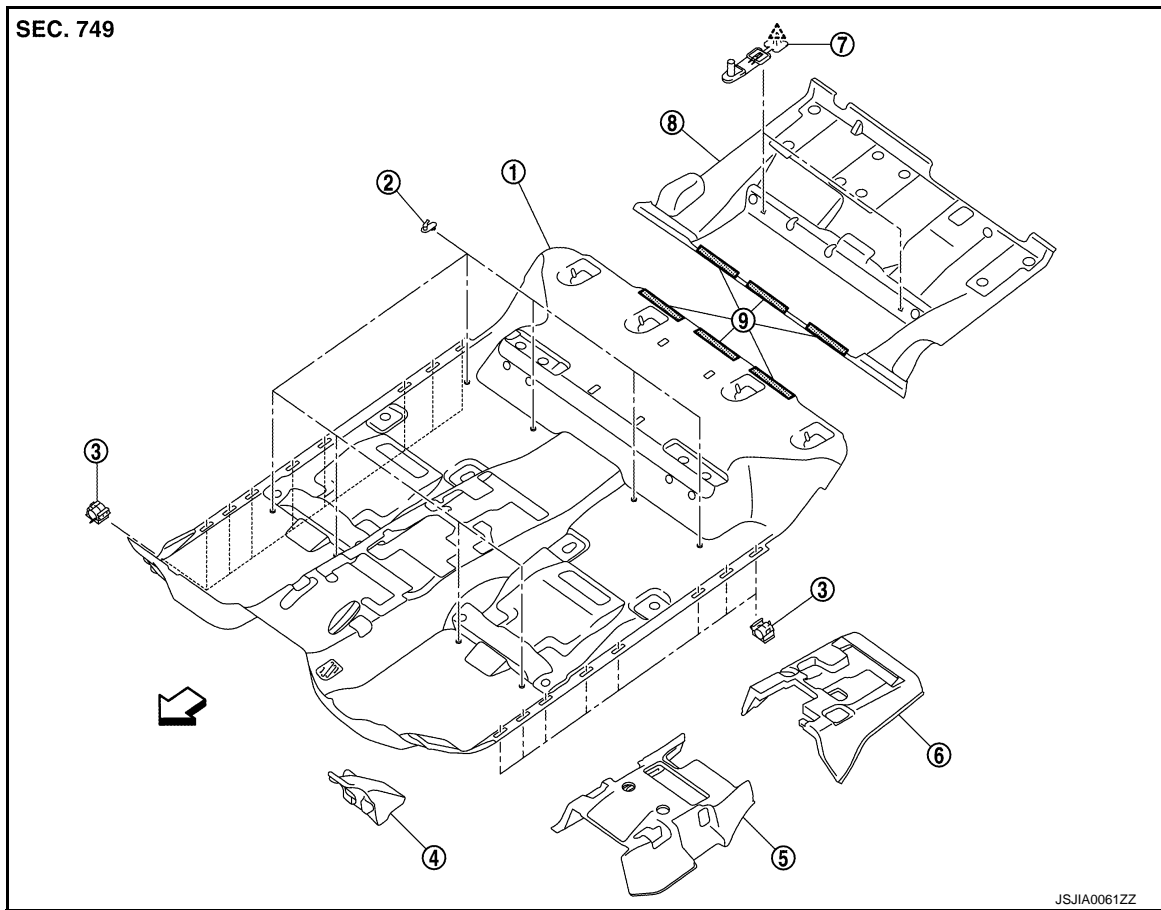



A  
B  
C  
D  
E  
F  
G  
H  
I

INT

K  
L  
M  
N  
O  
P

- |                       |                             |                            |
|-----------------------|-----------------------------|----------------------------|
| 1. Front floor carpet | 2. Carpet hook              | 3. Fixing clip             |
| 4. Footrest           | 5. Front floor spacer front | 6. Front floor spacer rear |
| 7. Floor hook         | 8. Rear floor carpet        | 9. Dual lock fastener      |

-  : Pawl
-  : Vehicle front

## FRONT FLOOR CARPET

### FRONT FLOOR CARPET : Removal and Installation

INFOID:000000009011156

#### REMOVAL

1. Remove front seat assembly (driver and passenger). Refer to [SE-113, "Removal and Installation"](#).
2. Remove second seat assembly (LH and RH). Refer to [SE-126, "Removal and Installation"](#).
3. Remove floor grille (LH and RH). Refer to [VTL-12, "REAR FLOOR GRILLE : Removal and Installation"](#).
4. Remove front kicking plate inner and rear kicking plate inner (LH and RH). Refer to [INT-20, "KICKING PLATE INNER : Removal and Installation"](#).
5. Remove dash side finisher (LH and RH). Refer to [INT-18, "DASH SIDE FINISHER : Removal and Installation"](#).
6. Remove center pillar lower garnish (LH and RH). Refer to [INT-22, "CENTER PILLAR LOWER GARNISH : Removal and Installation"](#).
7. Remove instrument lower panel LH. Refer to [IP-14, "Removal and Installation"](#).
8. Remove center console assembly. Refer to [IP-25, "Removal and Installation"](#).
9. Remove adjusting nut and front cable mounting bolts and nuts, and then remove front cable. Refer to [TM-185, "Removal and Installation"](#).

## FLOOR TRIM

### < REMOVAL AND INSTALLATION >

10. Remove the following parts after removing the center console assembly.

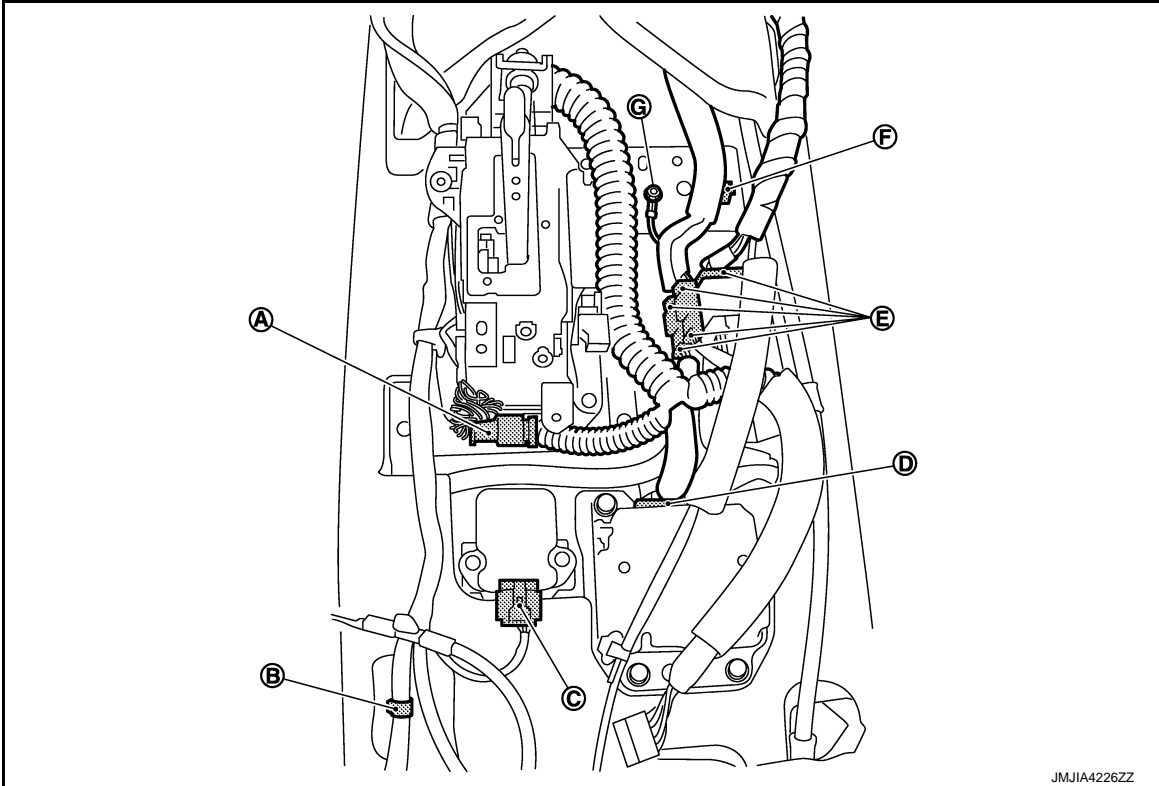

- Remove ground bolt (G).
- Disconnect floor harness connectors (A) and (E).
- Disconnect yaw rate/side/decel G sensor harness connector (C). Refer to [BRC-147, "Exploded View"](#).
- Disconnect diagnosis sensor unit harness connector (D). Refer to [SR-27, "Exploded View"](#).
- Remove floor harness clamps (B) and (F).

11. Remove A/T shift selector assembly mounting bolts. Refer to [TM-185, "Removal and Installation"](#).

12. Remove floor duct 1 (LH and RH). Refer to [VTL-11, "FLOOR DUCT 1 : Removal and Installation"](#).

13. Disconnect drain hose (1) and remove instrument stay mounting nuts (A), and then remove instrument stay (2) (LH and RH).

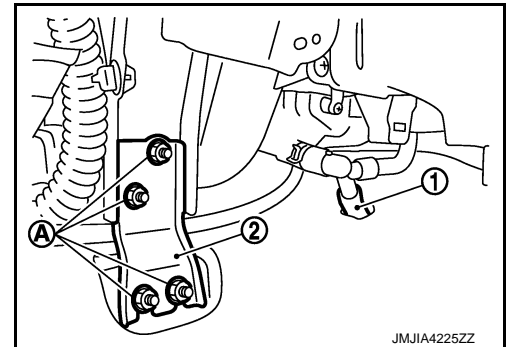

14. Disengage front floor carpet from front floor carpet fixing clips (A).

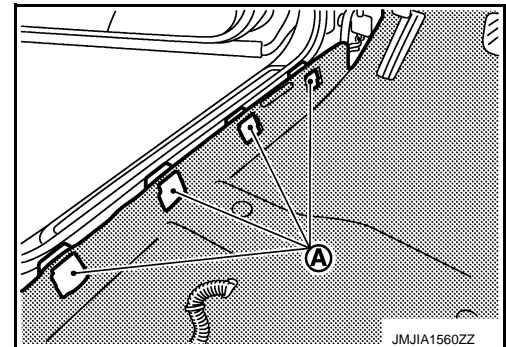

# FLOOR TRIM

## < REMOVAL AND INSTALLATION >

15. Peel off dual lock fastener between front floor carpet and rear floor carpet, and then remove front floor carpet.

### INSTALLATION

Install in the reverse order of removal.

### REAR FLOOR CARPET

#### REAR FLOOR CARPET : Removal and Installation

INFOID:000000009011157

### REMOVAL

1. Remove third seat assembly. Refer to [SE-139, "Removal and Installation"](#).
2. Remove luggage floor rear board. Refer to [INT-34, "LUGGAGE FLOOR REAR BOARD : Removal and Installation"](#).
3. Remove luggage rear plate. Refer to [INT-35, "LUGGAGE REAR PLATE : Removal and Installation"](#).
4. Remove luggage floor bracket. Refer to [INT-33, "Exploded View"](#).
5. Remove luggage side lower finisher. Refer to [INT-36, "LUGGAGE SIDE LOWER FINISHER : Removal and Installation"](#).
6. Disengage clip of each floor hook (1) using a remover tool (A), and then remove each floor hook.

 : Clip

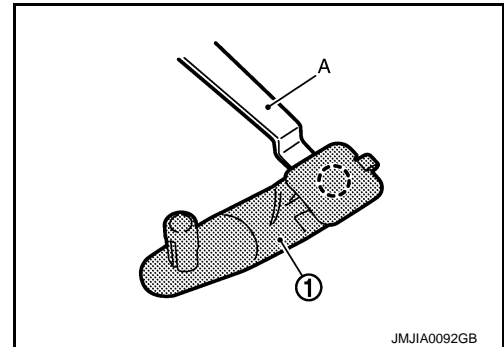

7. Peel off dual lock fastener between front floor carpet and rear floor carpet, and then remove rear floor carpet.

### INSTALLATION

Install in the reverse order of removal.

# HEADLINING

< REMOVAL AND INSTALLATION >

## HEADLINING

Exploded View

INFOID:000000009011158

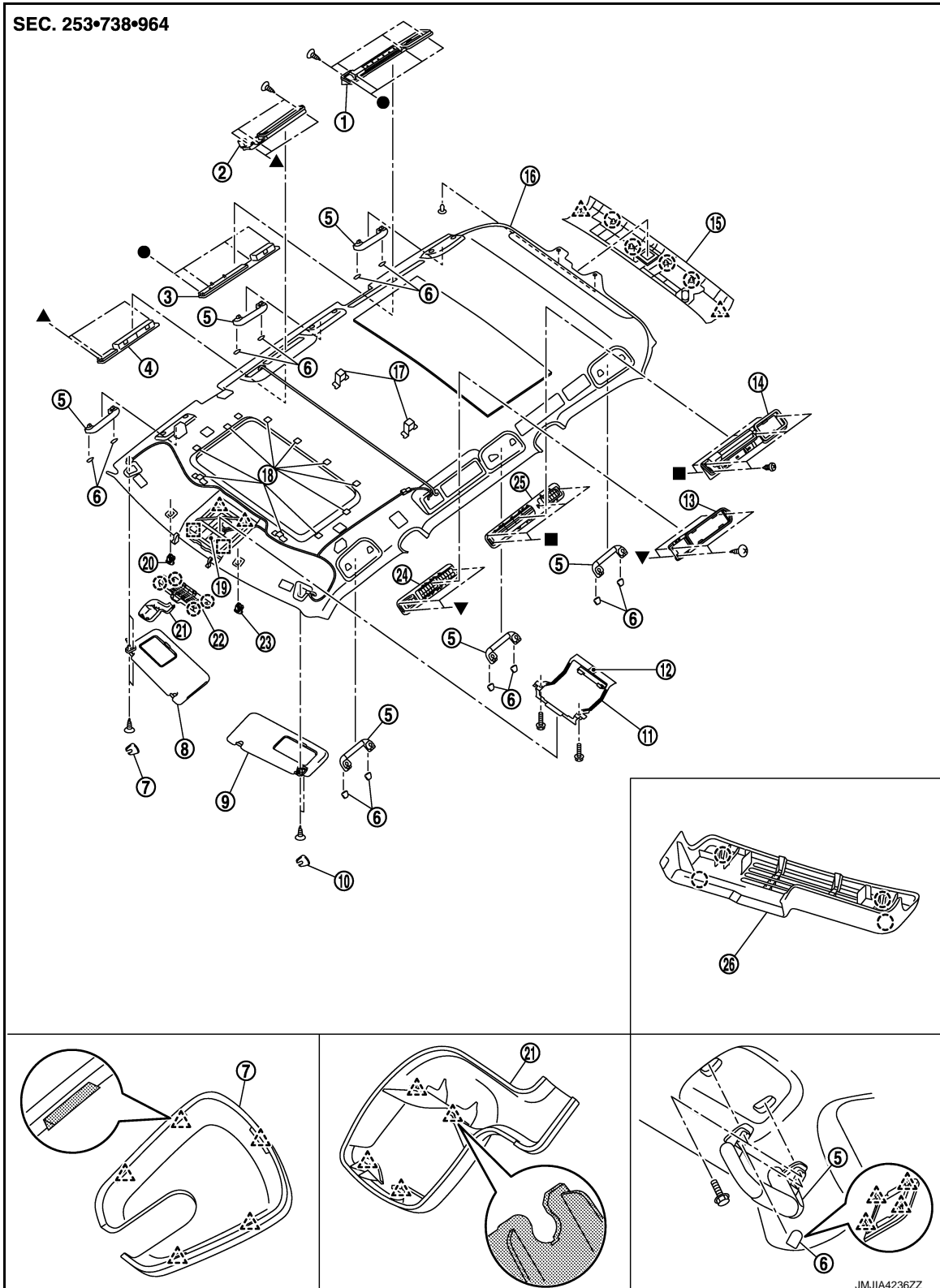

- |                                 |                            |                                 |
|---------------------------------|----------------------------|---------------------------------|
| 1. Rear ventilator grille RH    | 2. Rear ventilator base RH | 3. Rear ventilator garnish B RH |
| 4. Rear ventilator garnish A RH | 5. Assist grip             | 6. Assist grip cap              |
| 7. Sun visor cover RH           | 8. Sun visor assembly RH   | 9. Sun visor assembly LH        |

JMJIA4236ZZ

# HEADLINING

## < REMOVAL AND INSTALLATION >

- |                                  |  |                                  |
|----------------------------------|--|----------------------------------|
| 10. Sun visor cover LH           | 11. Map lamp bracket                     | 12. Dual lock fastener           |
| 13. Rear ventilator base LH      | 14. Rear ventilator grille LH            | 15. Roof garnish                 |
| 16. Headlining assembly          | 17. Dual lock fastener                   | 18. Dual lock fastener           |
| 19. Map lamp assembly            | 20. Sun visor holder RH                  | 21. Rain sensor cover            |
| 22. Front camera finisher        | 23. Sun visor holder LH                  | 24. Rear ventilator garnish A LH |
| 25. Rear ventilator garnish B LH | 26. Front camera finisher (with LDP/LDW) |                                  |

 : Clip

 : Pawl

 : Metal clip

●, ▲, ■, ▼ : Indicates that the part is connected at points with same symbol in actual vehicle.

## Removal and Installation

INFOID:000000009011159

### REMOVAL

1. Remove sun visor cap (1) using a remover tool (A), and then remove sunvisor assembly fixing TORX screws.

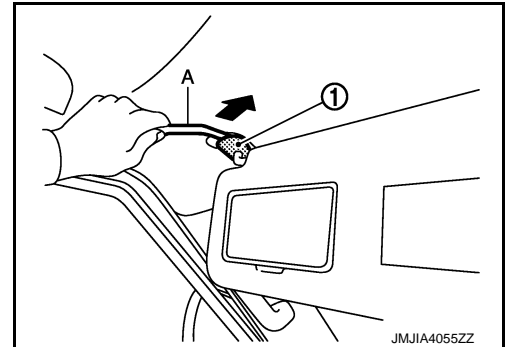

2. Disconnect vanity mirror lamp harness connector, and then remove sun visor assembly (LH and RH).
3. Rotate sun visor holder (1) (LH and RH) at approximately 90 degrees, and then pull it out to remove.

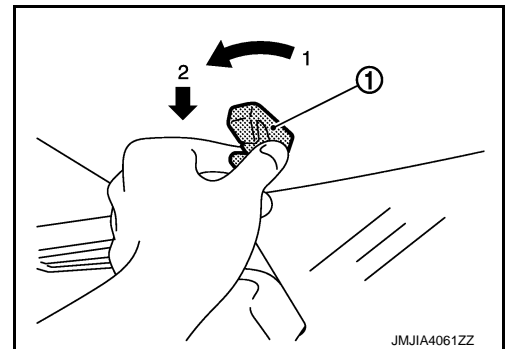

4. Insert a remover tool (A) into the gap between lane camera finisher (1), and then remove lane camera finisher (if equipped).

 : Pawl

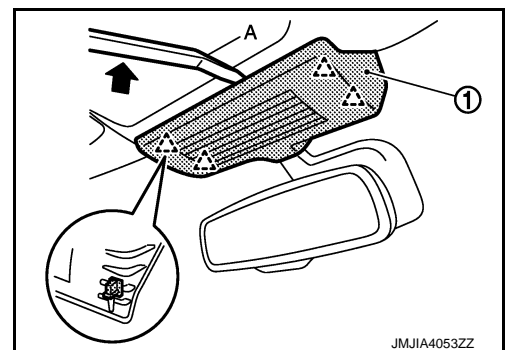

5. Remove light & rain sensor cover / rain sensor cover. Refer to [WW-71. "Removal and Installation"](#).

# HEADLINING

## < REMOVAL AND INSTALLATION >

6. Disconnect harness connectors.
- Lane camera unit harness connector (1) (if equipped).
  - Inside mirror harness connector (2).
  - Light & rain sensor harness connector / rain sensor harness connector (3).

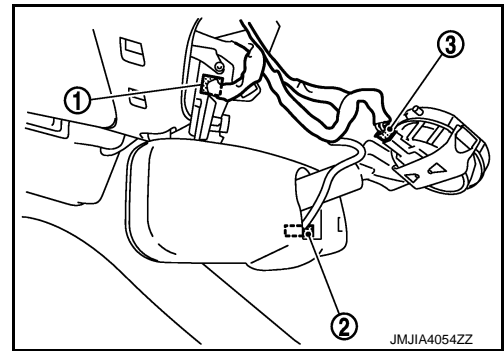

7. Remove assist grips
- Insert a small flat-bladed screwdriver (A) into the gap between assist grip cap (1), and then remove assist grip cap.
  - Remove assist grip mounting bolts, and then remove assist grips (2).

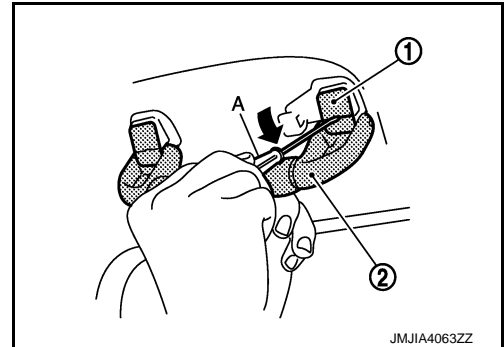

8. Insert a remover tool (A) between luggage room lamp (1) and roof garnish to disengage the fixing metal clips, and then disconnect luggage room lamp harness connector.

**CAUTION:**

**Apply protective tape (B) to the roof garnish to protect from damage.**

□ : Metal clip

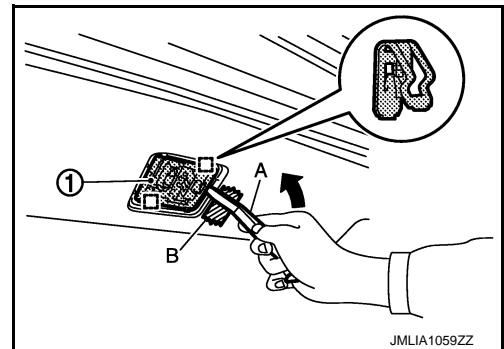

9. Insert a remover tool (A) between roof garnish (1) and body panel to disengage the fixing clips and pawls, and then remove roof garnish.

○ : Clip

△ : Pawl

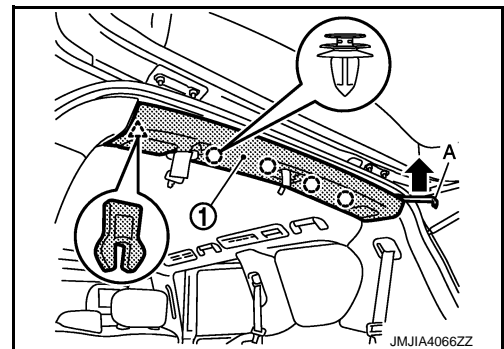

10. Remove front pillar garnish (LH and RH). Refer to [INT-19. "FRONT PILLAR GARNISH : Removal and Installation"](#).
11. Remove front kicking plate inner (LH and RH) and rear kicking plate inner (LH and RH). Refer to [INT-20. "KICKING PLATE INNER : Removal and Installation"](#).
12. Remove dash side finisher (LH and RH). Refer to [INT-18. "DASH SIDE FINISHER : Removal and Installation"](#).
13. Remove center pillar lower garnish (LH and RH). Refer to [INT-22. "CENTER PILLAR LOWER GARNISH : Removal and Installation"](#).

# HEADLINING

## < REMOVAL AND INSTALLATION >

14. Remove luggage side lower finisher (LH and RH). Refer to [INT-36. "LUGGAGE SIDE LOWER FINISHER : Removal and Installation"](#).
15. Remove front body side welt (LH and RH) and rear body side welt (LH and RH). Refer to [INT-20. "BODY SIDE WELT : Removal and Installation"](#).
16. Remove center pillar upper garnish (LH and RH). Refer to [INT-22. "CENTER PILLAR UPPER GARNISH : Removal and Installation"](#).
17. Remove rear pillar finisher (LH and RH). Refer to [INT-37. "REAR PILLAR FINISHER : Removal and Installation"](#).
18. Remove back pillar garnish (LH and RH). Refer to [INT-37. "BACK PILLAR GARNISH : Removal and Installation"](#).
19. Remove luggage side upper finisher (LH and RH). Refer to [INT-38. "LUGGAGE SIDE UPPER FINISHER : Removal and Installation"](#).
20. Insert a remover tool between map lamp assembly (1) and headlining assembly to disengage the fixing metal clips, and then remove map lamp assembly.

 : Metal clip

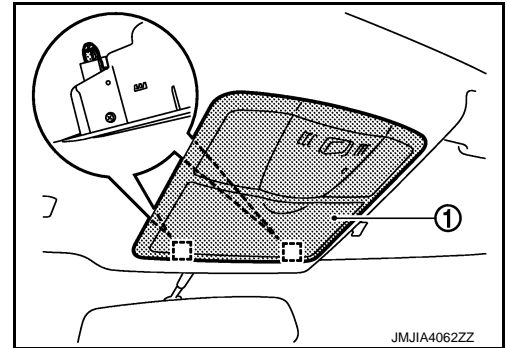

21. Peel off dual lock fastener between headlining assembly and roof panel.
22. Remove headlining clips located at the rear side
23. Remove headlining assembly (1) through the back door.

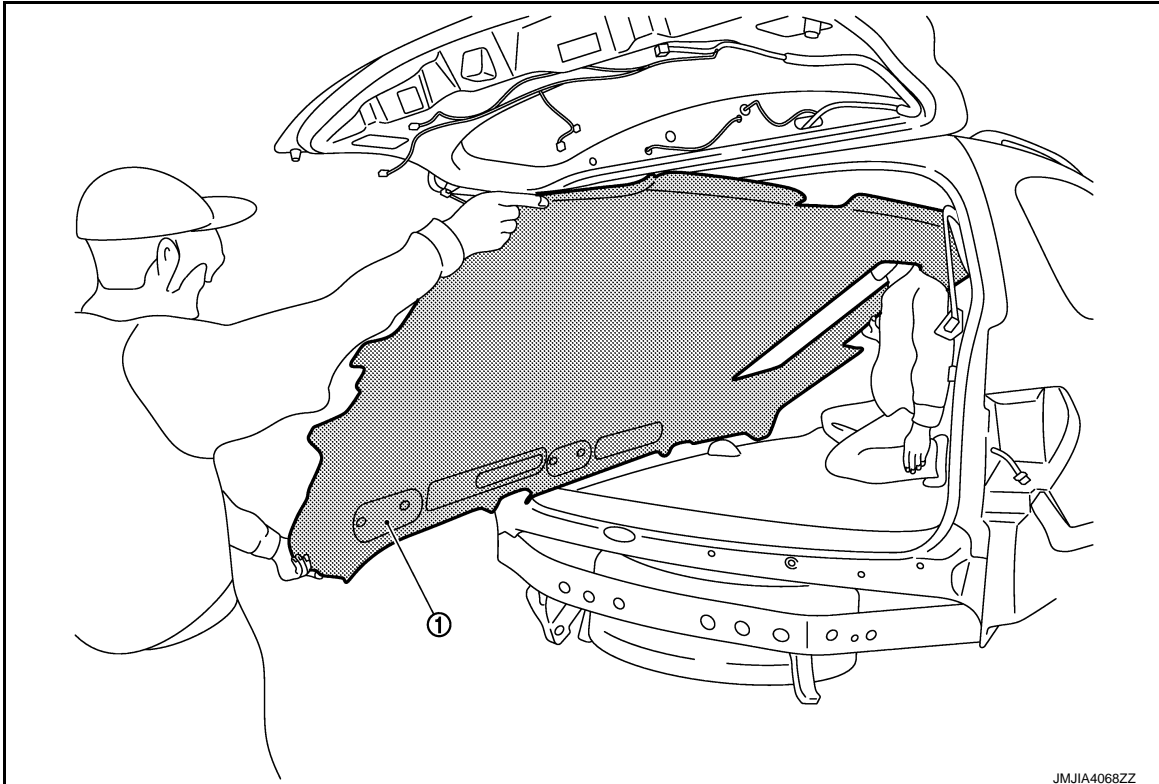

### CAUTION:

- When removing, 2 workers are required.
- Never bend headlining when removing.
- Be careful not to scratch or damage any part of the body while taking out the headlining.

24. Remove the following parts after removing headlining assembly.

## HEADLINING

### < REMOVAL AND INSTALLATION >

---

- Personal lamp assembly. Refer to [INL-78, "Removal and Installation"](#).
- Rear ventilator grille assembly. Refer to [VTL-13, "REAR VENTILATOR GRILLE : Removal and Installation"](#).
- Headlining harness.

### INSTALLATION

Note the following items, and install in the reverse order of removal.

#### **CAUTION:**

- **Be careful not to bend headlining when installing.**
- **First install metal clips of map lamp assembly and clips of the rear end of headlining for positioning.**







# LUGGAGE FLOOR TRIM

## < REMOVAL AND INSTALLATION >

- |                                    |                               |                               |
|------------------------------------|-------------------------------|-------------------------------|
| 10. Luggage floor board center     | 11. Tool box                  | 12. Luggage rear plate        |
| 13. Luggage rear plate mask        | 14. Child anchor cover        | 15. Luggage floor finisher RH |
| 16. Luggage lower board RH         | 17. Fold down switch          | 18. Back pillar garnish RH    |
| 19. Luggage side lower finisher RH | 20. Luggage upper finisher RH | 21. Rear pillar finisher RH   |
| 22. Reclining switch*              |                               |                               |

 : Clip

 : Pawl

 : Always replace after every disassembly.

\*: Reclining switch (22) is also installed on luggage side lower finisher LH (3).

## LUGGAGE FLOOR REAR BOARD

### LUGGAGE FLOOR REAR BOARD : Removal and Installation

INFOID:000000009011161

#### REMOVAL

1. Open luggage floor board center (1).
2. Remove both bolts shown by the arrows in the figure, and then remove luggage floor board center.

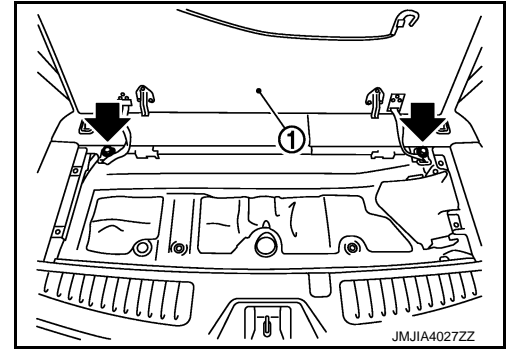

3. Remove luggage floor finishers (LH/RH).
  1. Remove bolts shown by the arrows in the figure.
  2. Disengage luggage floor finisher (1) fixing pawl and clip using a remover tool (A), and then remove luggage side finisher.

 : Clip

 : Pawl

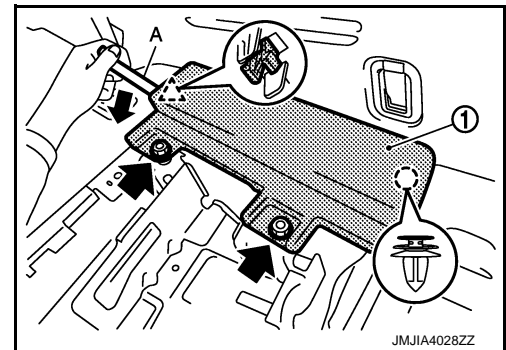

4. Remove both luggage floor rear boards.
  1. Fold down the third seat forward.
  2. Remove rope hook (1) mounting bolt using a socket wrench (A), and then remove rope hook.

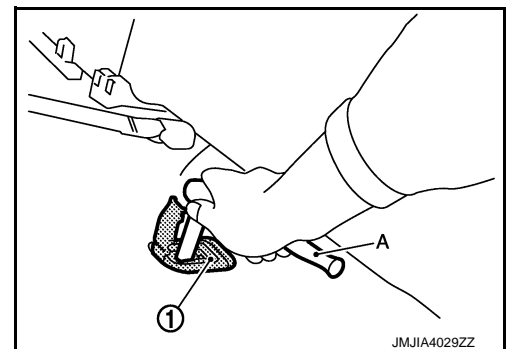

# LUGGAGE FLOOR TRIM

## < REMOVAL AND INSTALLATION >

3. Disengage luggage floor board RH (1) fixing pawls and clips, and then remove luggage side finisher.
4. Disengage luggage floor board LH (2) fixing pawls and clips, and then remove luggage side finisher.

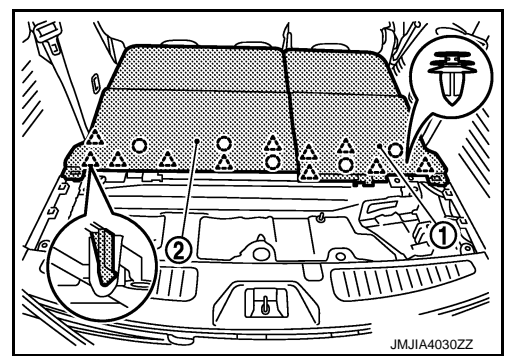
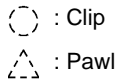

## INSTALLATION

Note the following items, and install in the reverse order of removal.

### CAUTION:

- Visually check the clips and pawls for deformation and damage during installation. Replace with new ones if necessary.
- When installing luggage floor rear board, check that clips and pawls are securely fitted in body panel holes, and press them in.

## LUGGAGE REAR PLATE

### LUGGAGE REAR PLATE : Removal and Installation

INFOID:000000009011162

## REMOVAL

1. Open luggage floor board center.
2. Remove luggage floor finishers (LH and RH).
  1. Remove nuts shown by the arrows in the figure.
  2. Disengage luggage floor finisher (1) fixing clip and pawl using a remover tool (A), and then remove luggage side finisher.

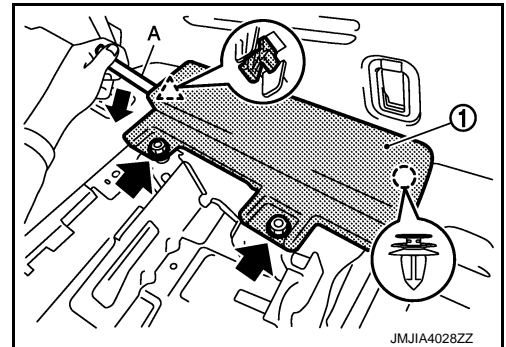
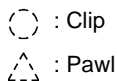

3. Disengage luggage rear plate (1) fixing clips and pawls using a remover tool (A), and then remove luggage rear plate.

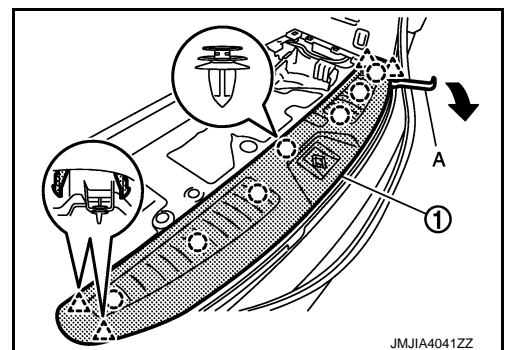
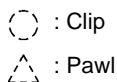

4. Remove luggage rear plate mask from luggage rear plate.

## INSTALLATION

Note the following items, and install in the reverse order of removal.

### CAUTION:

- Visually check the clips and pawls for deformation and damage during installation. Replace with new ones if necessary.
- When installing luggage rear plate, check that clips and pawls are securely fitted in body panel holes, and press them in.

# LUGGAGE FLOOR TRIM

< REMOVAL AND INSTALLATION >

## LUGGAGE SIDE LOWER FINISHER

### LUGGAGE SIDE LOWER FINISHER : Removal and Installation

INFOID:000000009011163

#### REMOVAL

1. Lift up the seat base, tilt seatback forward, and fold down second seat forward.
2. Remove second seat belt anchor. Refer to [SB-12. "SEAT BELT RETRACTOR : Removal and Installation"](#).
3. Remove third seat. Refer to [SE-139. "Removal and Installation"](#).
4. Remove third seat belt anchor. Refer to [SB-18. "SEAT BELT RETRACTOR : Removal and Installation"](#).
5. Remove luggage floor board center and both luggage lower boards. Refer to [INT-34. "LUGGAGE FLOOR REAR BOARD : Removal and Installation"](#).
6. Remove luggage rear plate. Refer to [INT-35. "LUGGAGE REAR PLATE : Removal and Installation"](#).
7. Remove rope hook (1) mounting bolt using a socket wrench (A), and then remove rope hook.

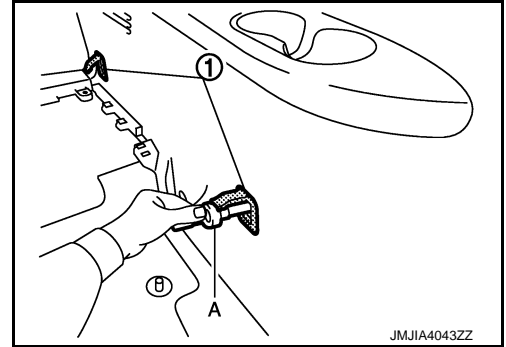

8. Disengage luggage side lower finisher fixing clip (1) using a small flat-bladed screwdriver (A) as shown by the arrow in the figure, and then remove clip.

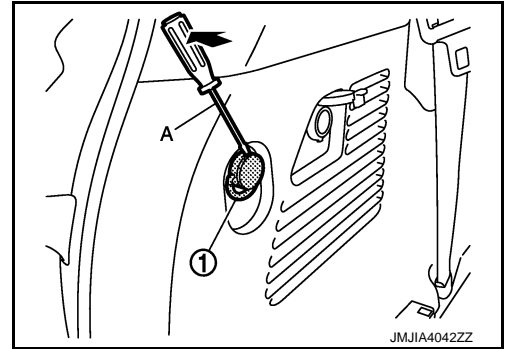

9. Remove luggage side lower finisher.
  1. Disengage luggage side lower finisher (1) fixing clips and pawls.

○ : Clip

△ : Pawl

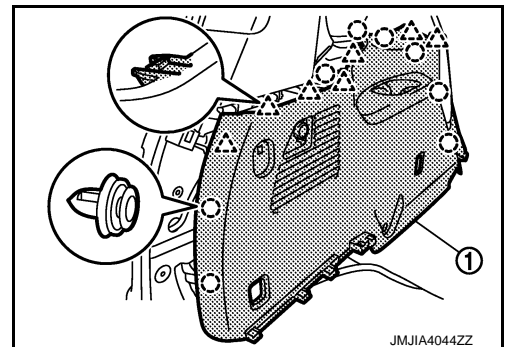

2. Disconnect luggage room power socket harness connector (LH side only).
3. Disconnect fold down switch harness connector (RH side only).
4. Disconnect reclining switch harness connector (LH and RH).
5. Remove luggage side lower finisher.

#### INSTALLATION

Note the following items, and install in the reverse order of removal.

**CAUTION:**

# LUGGAGE FLOOR TRIM

## < REMOVAL AND INSTALLATION >

- Visually check the clips and pawls for deformation and damage during installation. Replace with new ones if necessary.
- When installing luggage side lower finisher, check that clips and pawls are securely fitted in body panel holes, and press them in.

### REAR PILLAR FINISHER

#### REAR PILLAR FINISHER : Removal and Installation

INFOID:000000009011164

##### REMOVAL

1. Remove luggage side lower finisher. [INT-36, "LUGGAGE SIDE LOWER FINISHER : Removal and Installation"](#).
2. Disengage lower side of rear pillar finisher fixing clip.
3. Pull rear pillar upper garnish (1) from inside passenger room, disengage rear pillar upper garnish upper side fixing pawl as shown in the following figure, and then remove rear pillar upper garnish from body panel (2).

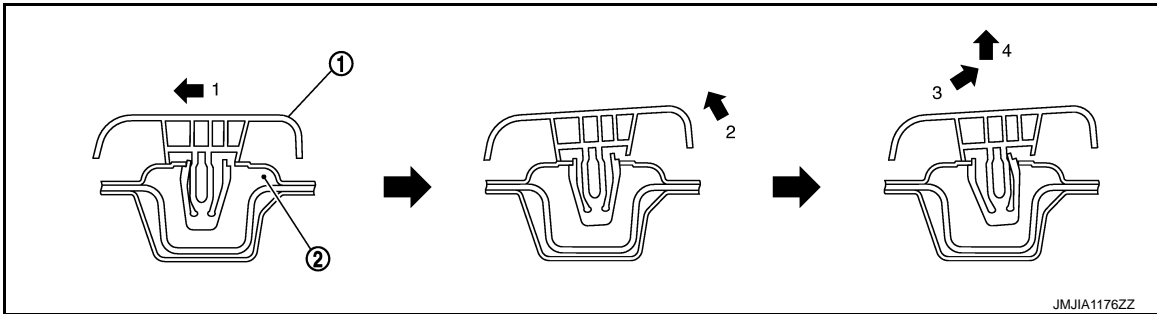

##### CAUTION:

Be careful not to apply excessive force when removing rear pillar finisher. Otherwise, pawl may be damaged and fragments may drop in body panel holes on body.

##### INSTALLATION

Note the following items, and install in the reverse order of removal.

##### CAUTION:

- Replace rear pillar finisher with a new part after removal. Never reuse rear pillar finisher.
- Visually check the clip and pawl for deformation and damage during installation. Replace with new ones if necessary.
- When installing rear pillar finisher, check that clip and pawl are securely fitted in body panel holes, and press them in.

### BACK PILLAR GARNISH

#### BACK PILLAR GARNISH : Removal and Installation

INFOID:000000009011165

##### REMOVAL

1. Remove luggage side lower finisher. [INT-36, "LUGGAGE SIDE LOWER FINISHER : Removal and Installation"](#).
2. Remove cap of back door finisher side (LH), and then remove stud ball. Refer to [DLK-253, "BACK DOOR SUPPORT ROD : Removal and Installation"](#) (LH side only).
3. Disengage back pillar garnish (1) fixing clips and pawl using a remover tool (A), and then remove back pillar garnish.

○ : Clip

△ : Pawl

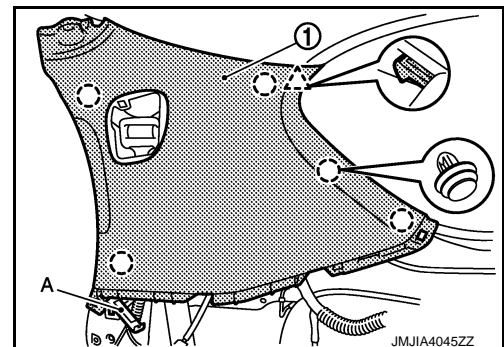

# LUGGAGE FLOOR TRIM

## < REMOVAL AND INSTALLATION >

### INSTALLATION

Note the following items, and install in the reverse order of removal.

#### CAUTION:

- Visually check the clips and pawl for deformation and damage during installation. Replace with new ones if necessary.
- When installing back pillar garnish, check that clips and pawl are securely fitted in body panel holes, and press them in.

### LUGGAGE SIDE UPPER FINISHER

#### LUGGAGE SIDE UPPER FINISHER : Removal and Installation

INFOID:000000009011166

#### REMOVAL

1. Remove luggage side lower finisher. Refer to [INT-36. "LUGGAGE SIDE LOWER FINISHER : Removal and Installation"](#).
2. Remove rear pillar finisher. Refer to [INT-37. "REAR PILLAR FINISHER : Removal and Installation"](#).
3. Remove back pillar garnish. Refer to [INT-37. "BACK PILLAR GARNISH : Removal and Installation"](#).
4. Remove luggage side upper finisher.
  1. Remove mounting bolts (1).
  2. Disengage luggage side upper finisher (2) fixing clips using a remover tool (A), and then remove luggage side upper finisher (3).

○ : Clip

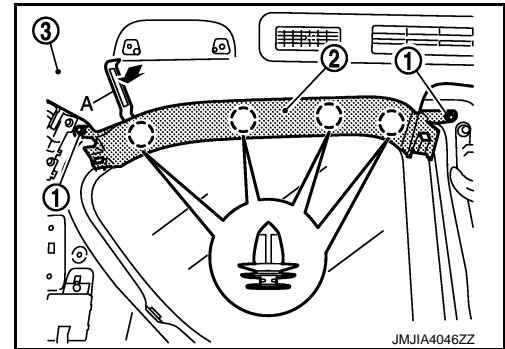

#### INSTALLATION

Note the following items, and install in the reverse order of removal.

#### CAUTION:

- Visually check the clips for deformation and damage during installation. Replace with new ones if necessary.
- When installing luggage side upper finisher, check that clips are securely fitted in body panel holes, and press them in.

# BACK DOOR TRIM

< REMOVAL AND INSTALLATION >

## BACK DOOR TRIM

Exploded View

INFOID:000000009011167

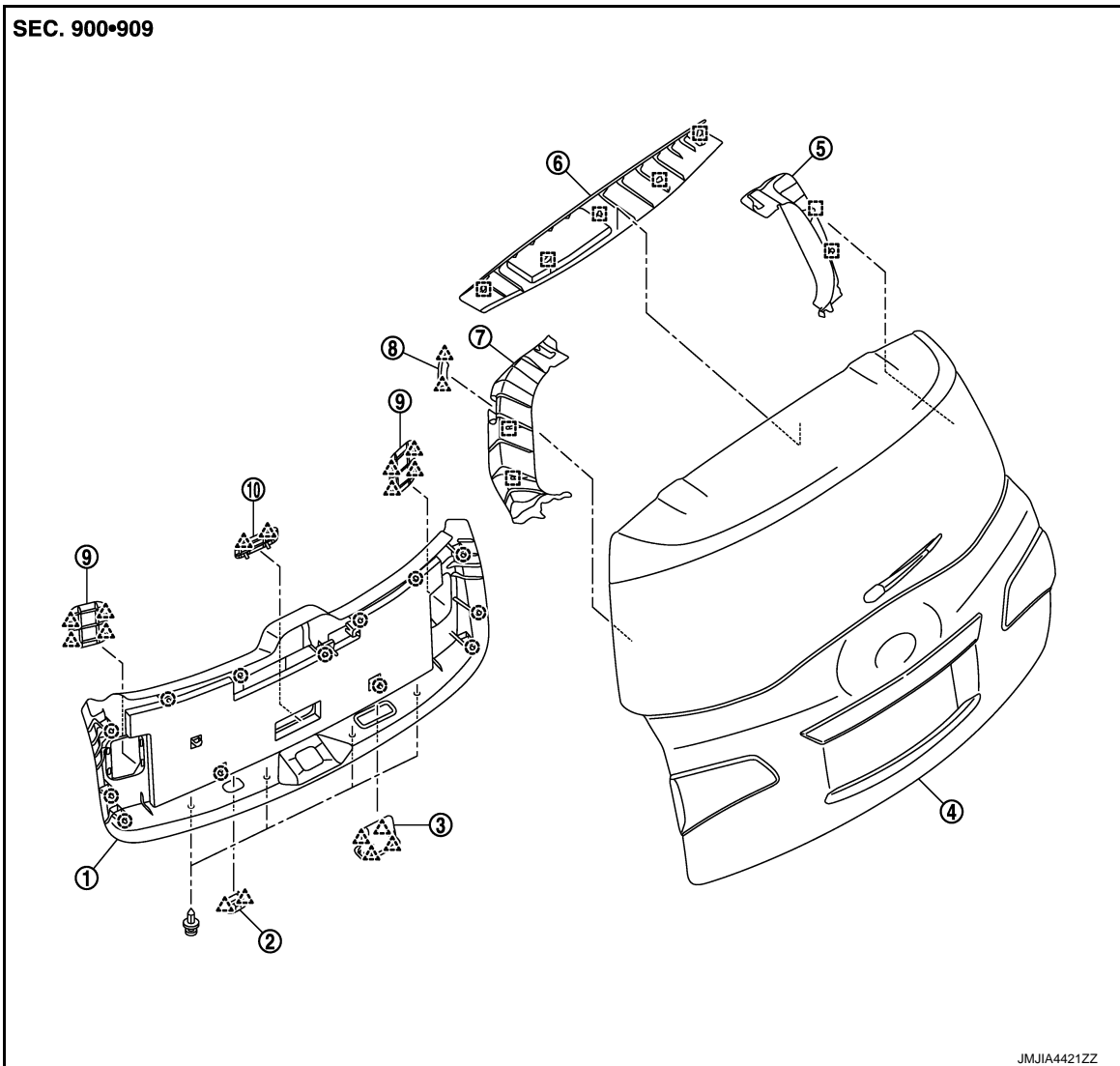

- |                               |                                   |                             |
|-------------------------------|-----------------------------------|-----------------------------|
| 1. Back door finisher lower   | 2. Auto back door switch finisher | 3. Pull handle              |
| 4. Back door assembly         | 5. Back door finisher side RH     | 6. Back door finisher upper |
| 7. Back door finisher side LH | 8. Cap                            | 9. Lamp mask                |
| 10. Emergency handle mask     |                                   |                             |

○ : Clip

△ : Pawl

□ : Metal clip

### Removal and Installation

INFOID:000000009011168

#### REMOVAL

1. Fully open back door.

A  
B  
C  
D  
E  
F  
G  
H  
I  
INT  
K  
L  
M  
N  
O  
P

# BACK DOOR TRIM

## < REMOVAL AND INSTALLATION >

- Disengage pull handle finisher (1) fixing pawls using a remover tool (A), and then remove pull handle finisher.

 : Pawl

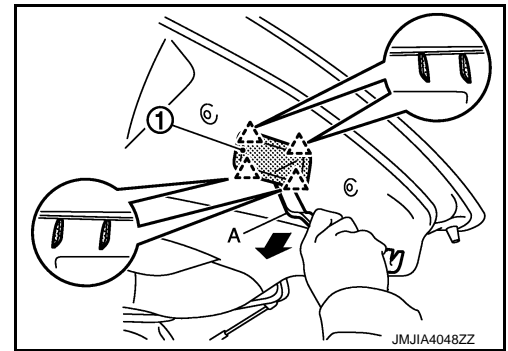

- Disengage auto back door switch finisher (1) fixing pawls using a remover tool (A), and then disconnect auto back door switch harness connector.

 : Pawl

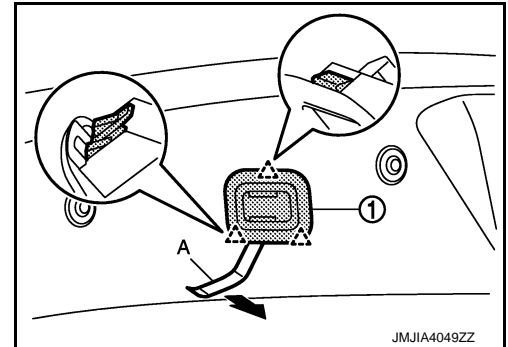

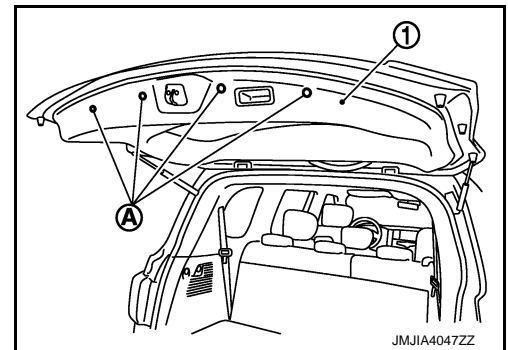

- Remove back door finisher inner lower (1) fixing clips (A).

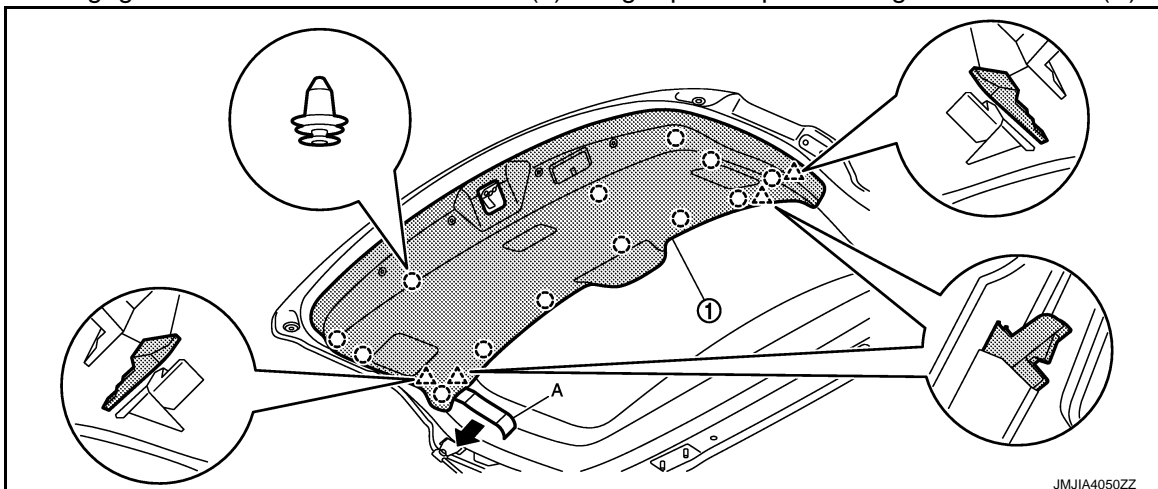

- Remove the back door finisher inner lower.

- Disengage back door finisher inner lower (1) fixing clips and pawls using a remover tool (A).



 : Clip

 : Pawl

**NOTE:**

Start disengaging from the position where pawls are located as shown in the figure.



# BACK DOOR TRIM

## < REMOVAL AND INSTALLATION >

2. Remove back door finisher inner lower.

6. Disengage back door finisher side (1) fixing metal clips using a remover tool (A), and then remove back door finisher side.

 : Metal clip

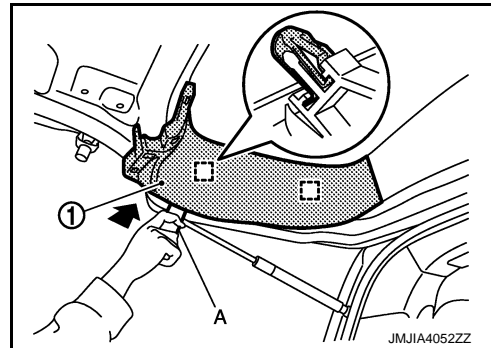

7. Disengage back door finisher upper (1) fixing metal clips using a remover tool (A), and then remove back door finisher upper.

 : Metal clip

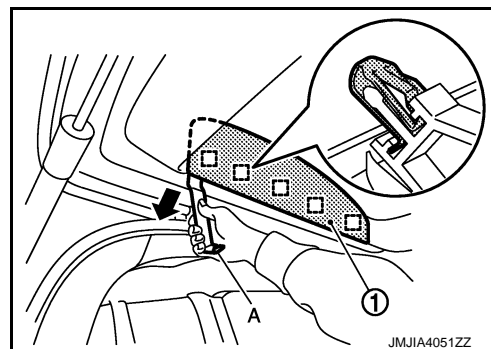

## INSTALLATION

Note the following items, and install in the reverse order of removal.

### CAUTION:

- Visually check the clips, pawls and metal clips for deformation and damage during installation. Replace with new ones if necessary.
- When installing back door trims, check that clips, pawls, and metal clips are securely fitted in body panel holes, and press them in.

A  
B  
C  
D  
E  
F  
G  
H  
I  
INT  
K  
L  
M  
N  
O  
P