

WCS

SECTION

WARNING CHIME SYSTEM

A
B
C
D
E
F
G
H
I
J
K
L
M
O
P

CONTENTS

<p>PRECAUTION 3</p> <p>PRECAUTIONS 3</p> <p style="padding-left: 20px;">Precaution for Supplemental Restraint System (SRS) "AIR BAG" and "SEAT BELT PRE-TENSIONER"3</p> <p style="padding-left: 20px;">Precautions for Removing Battery Terminal3</p> <p>SYSTEM DESCRIPTION 4</p> <p>COMPONENT PARTS 4</p> <p style="padding-left: 20px;">Component Parts Location4</p> <p style="padding-left: 20px;">Component Description4</p> <p style="padding-left: 20px;">Combination Meter5</p> <p>SYSTEM 6</p> <p>WARNING CHIME SYSTEM6</p> <p style="padding-left: 20px;">WARNING CHIME SYSTEM : System Diagram6</p> <p style="padding-left: 20px;">WARNING CHIME SYSTEM : System Description6</p> <p style="padding-left: 40px;">WARNING CHIME SYSTEM : Fail-Safe7</p> <p>LIGHT REMINDER WARNING CHIME8</p> <p style="padding-left: 20px;">LIGHT REMINDER WARNING CHIME : System Diagram8</p> <p style="padding-left: 20px;">LIGHT REMINDER WARNING CHIME : System Description8</p> <p>FRONT FOG LIGHT REMINDER WARNING CHIME9</p> <p style="padding-left: 20px;">FRONT FOG LIGHT REMINDER WARNING CHIME : System Diagram 10</p> <p style="padding-left: 20px;">FRONT FOG LIGHT REMINDER WARNING CHIME : System Description 10</p> <p>SEAT BELT WARNING CHIME 10</p> <p style="padding-left: 20px;">SEAT BELT WARNING CHIME : System Diagram 11</p> <p style="padding-left: 20px;">SEAT BELT WARNING CHIME : System Description 11</p> <p>PARKING BRAKE RELEASE WARNING CHIME.... 12</p>	<p style="padding-left: 20px;">PARKING BRAKE RELEASE WARNING CHIME : System Diagram12</p> <p style="padding-left: 20px;">PARKING BRAKE RELEASE WARNING CHIME : System Description12</p> <p>DIAGNOSIS SYSTEM (COMBINATION METER)14</p> <p style="padding-left: 20px;">CONSULT Function14</p> <p>DIAGNOSIS SYSTEM (BCM)19</p> <p>COMMON ITEM19</p> <p style="padding-left: 20px;">COMMON ITEM : CONSULT Function (BCM - COMMON ITEM)19</p> <p>BUZZER20</p> <p style="padding-left: 20px;">BUZZER : CONSULT Function (BCM - BUZZER)....20</p> <p>ECU DIAGNOSIS INFORMATION22</p> <p>COMBINATION METER22</p> <p style="padding-left: 20px;">Reference Value22</p> <p style="padding-left: 20px;">Fail-Safe30</p> <p style="padding-left: 20px;">DTC Index31</p> <p>BCM (BODY CONTROL MODULE)32</p> <p style="padding-left: 20px;">List of ECU Reference32</p> <p>WIRING DIAGRAM33</p> <p>WARNING CHIME SYSTEM33</p> <p style="padding-left: 20px;">Wiring Diagram33</p> <p>BASIC INSPECTION38</p> <p>DIAGNOSIS AND REPAIR WORKFLOW38</p> <p style="padding-left: 20px;">Work Flow38</p> <p>DTC/CIRCUIT DIAGNOSIS40</p> <p>POWER SUPPLY AND GROUND CIRCUIT40</p> <p>COMBINATION METER40</p> <p style="padding-left: 20px;">COMBINATION METER : Diagnosis Procedure40</p>
---	---

WCS

METER BUZZER CIRCUIT	41	THE LIGHT REMINDER WARNING DOES NOT SOUND	45
Component Function Check	41	Description	45
Diagnosis Procedure	41	Diagnosis Procedure	45
SEAT BELT BUCKLE SWITCH SIGNAL CIRCUIT	42	THE SEAT BELT WARNING CONTINUES SOUNDING, OR DOES NOT SOUND	46
Component Function Check	42	Description	46
Diagnosis Procedure	42	Diagnosis Procedure	46
Component Inspection	43	THE PARKING BRAKE RELEASE WARNING CONTINUES SOUNDING, OR DOES NOT SOUND	47
PARKING BRAKE SWITCH SIGNAL CIRCUIT	44	Description	47
Diagnosis Procedure	44	Diagnosis Procedure	47
Component Inspection	44		
SYMPTOM DIAGNOSIS	45		

PRECAUTIONS

< PRECAUTION >

PRECAUTION

PRECAUTIONS

Precaution for Supplemental Restraint System (SRS) "AIR BAG" and "SEAT BELT PRE-TENSIONER"

INFOID:000000010261620

The Supplemental Restraint System such as "AIR BAG" and "SEAT BELT PRE-TENSIONER", used along with a front seat belt, helps to reduce the risk or severity of injury to the driver and front passenger for certain types of collision. Information necessary to service the system safely is included in the "SRS AIR BAG" and "SEAT BELT" of this Service Manual.

WARNING:

Always observe the following items for preventing accidental activation.

- To avoid rendering the SRS inoperative, which could increase the risk of personal injury or death in the event of a collision that would result in air bag inflation, all maintenance must be performed by an authorized NISSAN/INFINITI dealer.
- Improper maintenance, including incorrect removal and installation of the SRS, can lead to personal injury caused by unintentional activation of the system. For removal of Spiral Cable and Air Bag Module, see "SRS AIR BAG".
- Never use electrical test equipment on any circuit related to the SRS unless instructed to in this Service Manual. SRS wiring harnesses can be identified by yellow and/or orange harnesses or harness connectors.

PRECAUTIONS WHEN USING POWER TOOLS (AIR OR ELECTRIC) AND HAMMERS

WARNING:

Always observe the following items for preventing accidental activation.

- When working near the Air Bag Diagnosis Sensor Unit or other Air Bag System sensors with the ignition ON or engine running, never use air or electric power tools or strike near the sensor(s) with a hammer. Heavy vibration could activate the sensor(s) and deploy the air bag(s), possibly causing serious injury.
- When using air or electric power tools or hammers, always switch the ignition OFF, disconnect the battery, and wait at least 3 minutes before performing any service.

Precautions for Removing Battery Terminal

INFOID:000000010261621

- When removing the 12V battery terminal, turn OFF the ignition switch and wait at least 30 seconds.

NOTE:

ECU may be active for several tens of seconds after the ignition switch is turned OFF. If the battery terminal is removed before ECU stops, then a DTC detection error or ECU data corruption may occur.

- For vehicles with the 2-batteries, be sure to connect the main battery and the sub battery before turning ON the ignition switch.

NOTE:

If the ignition switch is turned ON with any one of the terminals of main battery and sub battery disconnected, then DTC may be detected.

- After installing the 12V battery, always check "Self Diagnosis Result" of all ECUs and erase DTC.

NOTE:

The removal of 12V battery may cause a DTC detection error.

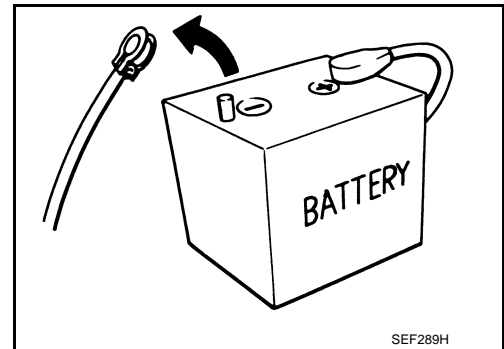

A
B
C
D
E
F
G
H
I
J
K
L
M
WCS
O
P

COMPONENT PARTS

< SYSTEM DESCRIPTION >

SYSTEM DESCRIPTION

COMPONENT PARTS

Component Parts Location

INFOID:0000000010261622

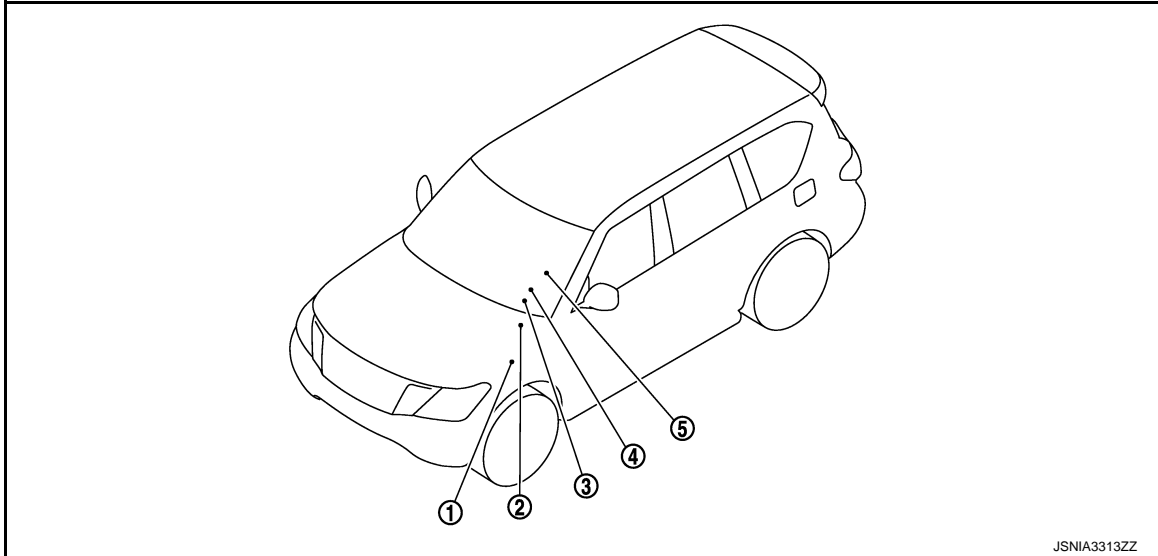

- | | | |
|-------------------------|--|--|
| 1. Parking brake switch | 2. ABS actuator and electric unit (control unit)
Refer to BRC-9, "Component Parts Location" . | 3. BCM
Refer to BCS-4, "BODY CONTROL SYSTEM : Component Parts Location" . |
| 4. Combination meter | 5. Seat belt buckle switch (driver side) | |

Component Description

INFOID:0000000010261623

Unit	Description
Combination meter	<ul style="list-style-type: none"> Receives a buzzer output signal from the BCM with CAN communication line and sounds the buzzer. Judges whether the parking brake is released from the vehicle speed signal received from the ABS actuator and electric unit (control unit) with CAN communication line and the parking brake switch signal from the parking brake switch, and sounds the buzzer if necessary.
BCM	Based on the signals received from various units and switches, transmits the buzzer output signal to the combination meter via CAN communication.
ABS actuator and electric unit (control unit)	Transmits the vehicle speed signal to the combination meter via CAN communication.
Parking brake switch	Transmits the parking brake switch signal to the combination meter.
Seat belt buckle switch (driver side)	Transmits the seat belt buckle switch signal (driver side) to the combination meter.

COMPONENT PARTS

< SYSTEM DESCRIPTION >

Combination Meter

INFOID:000000010261624

The buzzer (1) for the warning chime system is integrated in the combination meter.

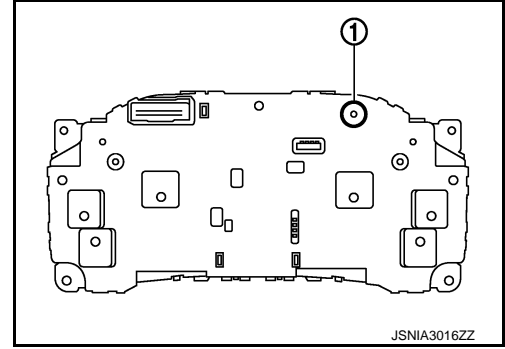

A
B
C
D
E
F
G
H
I
J
K
L
M
O
P

WCS

SYSTEM

< SYSTEM DESCRIPTION >

SYSTEM

WARNING CHIME SYSTEM

WARNING CHIME SYSTEM : System Diagram

INFOID:0000000010261625

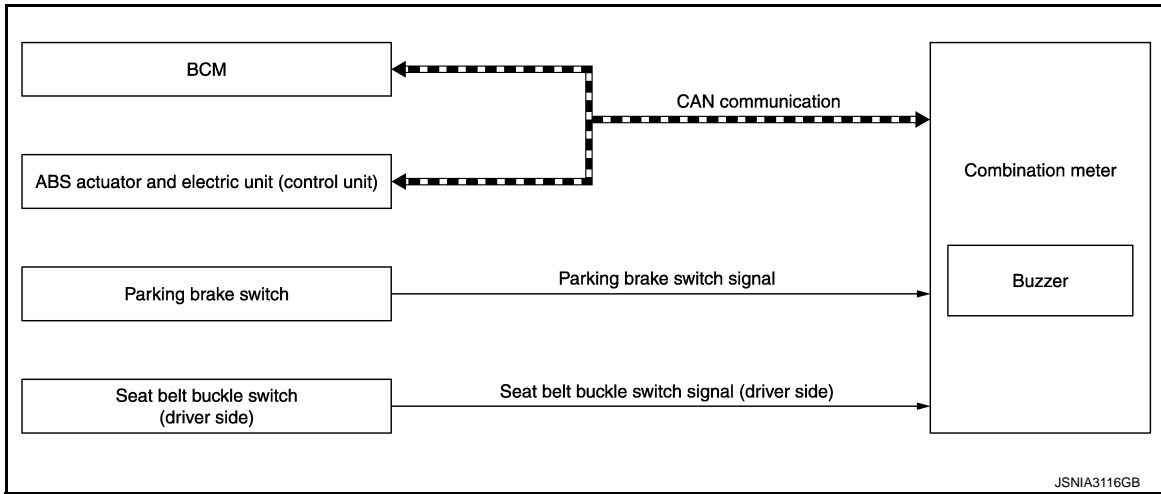

WARNING CHIME SYSTEM : System Description

INFOID:0000000010261626

COMBINATION METER

The combination meter sounds the alarm buzzer installed in the combination meter when receiving the buzzer output signal transmitted from each unit.

BCM

BCM receives signals from various units and transmits a buzzer output signal to the combination meter via CAN communication if it judges that the warning buzzer should be activated.

WARNING CHIME FUNCTION LIST

Warning functions	Out line	Warning judgment unit	Refer to
Light reminder warning chime	The warning chime sounds when the ignition switch is in OFF or ACC position with the combination switch (lighting switch) in the 1st or 2nd position and the driver side door open.	BCM	WCS-8. "LIGHT REMINDER WARNING CHIME : System Description"
Front fog light reminder warning chime	The warning chime sounds when the ignition switch is turned to LOCK, OFF or ACC position from ON position, with combination switch (lighting switch) is in AUTO position and the front fog lamp switch in ON position.	BCM	WCS-10. "FRONT FOG LIGHT REMINDER WARNING CHIME : System Description"

SYSTEM

< SYSTEM DESCRIPTION >

Warning functions	Out line	Warning judgment unit	Refer to
Seat belt warning chime	The warning chime sounds when the driver seat belt is unfastened with the ignition switch in ON position.	BCM	WCS-11. "SEAT BELT WARNING CHIME : System Description"
Parking brake release warning chime	The warning chime sounds when the ignition switch is in ON position with the parking brake in operation and the vehicle speed 7 km/h (4.3 MPH) or more.	Combination meter	WCS-12. "PARKING BRAKE RELEASE WARNING CHIME : System Description"

WARNING CHIME SYSTEM : Fail-Safe

INFOID:000000011515859

FAIL-SAFE

The combination meter activates the fail-safe control if CAN communication with each unit is malfunctioning.

Function	Specifications	
Speedometer	Reset to zero by suspending communication.	
Tachometer		
Engine coolant temperature gauge		
Engine oil pressure gauge		
Illumination control	When suspending communication, changes to nighttime mode.	
Information display	Odo/trip meter	An indicated value is maintained at communications blackout.
	Shift position indicator	The display turns OFF by suspending communication.
	Door open warning	The display turns OFF by suspending communication.
	Fuel filler cap warning	
	Low tire pressure warning	
Buzzer	The buzzer turns OFF by suspending communication.	

WCS

SYSTEM

< SYSTEM DESCRIPTION >

	Function	Specifications
Warning lamp/indicator lamp	ABS warning lamp	The lamp turns ON by suspending communication.
	VDC warning lamp	
	Brake warning lamp	
	FEB indicator lamp	
	4WD warning lamp	
	Malfunction indicator lamp	
	CRUISE warning lamp	
	AFS OFF indicator lamp	The lamp blinking caused by suspending communication.
	Low tire pressure warning lamp	After blinking for 1 minute, the lamp remains ON.
	High beam indicator lamp	The lamp turns OFF by suspending communication.
	Turn signal indicator lamp	
	Position lamp indicator lamp	
	A/T CHECK indicator lamp	
	Key warning lamp	
	ATP warning lamp	
	Lane departure warning lamp	
	LDP ON indicator lamp	
	CRUISE indicator lamp	
	Oil pressure warning lamp	
	TOW mode indicator lamp	
	CK SUSP indicator lamp	
	Blind Spot Intervention ON indicator	
	Blind Spot Warning/Blind Spot Intervention warning lamp	
	High beam assist indicator lamp	
	VDC OFF indicator lamp	

LIGHT REMINDER WARNING CHIME

LIGHT REMINDER WARNING CHIME : System Diagram

INFOID:000000010261628

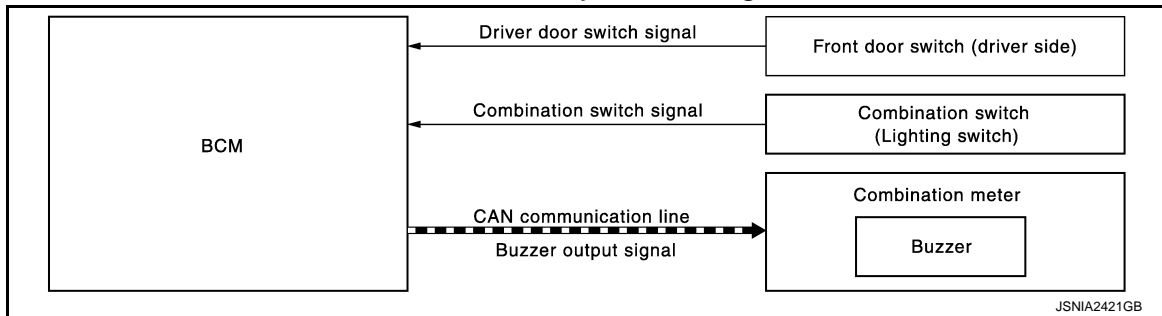

LIGHT REMINDER WARNING CHIME : System Description

INFOID:000000010261629

WARNING CHIME OPERATION CONDITIONS

If all of the following conditions are fulfilled.

SYSTEM

< SYSTEM DESCRIPTION >

Operation conditions	
Ignition switch	OFF or ACC position
Combination switch (Lighting switch)	1st or 2nd position
Driver door	Open [front door switch (driver side) ON]

WARNING CHIME CANCEL CONDITIONS

Warning is canceled if any of the following conditions is fulfilled.

Operation conditions	
Ignition switch	ON
Combination switch (Lighting switch)	OFF or AUTO position
Driver door	Close [front door switch (driver side) OFF]

SIGNAL PATH

1. BCM requires warning chime output to combination meter when it judges light reminder warning chime is necessary from signals below.

Signal name	Signal path
Ignition switch signal	—
Combination switch signal	Combination switch (Lighting switch) → BCM
Driver door switch signal	Front door switch (driver side) → BCM

2. Combination meter sounds integrated buzzer, following the warning chime output requirement (below signal) from BCM.

Signal name	Signal path
Buzzer output signal	BCM  → Combination meter

TIMING CHART

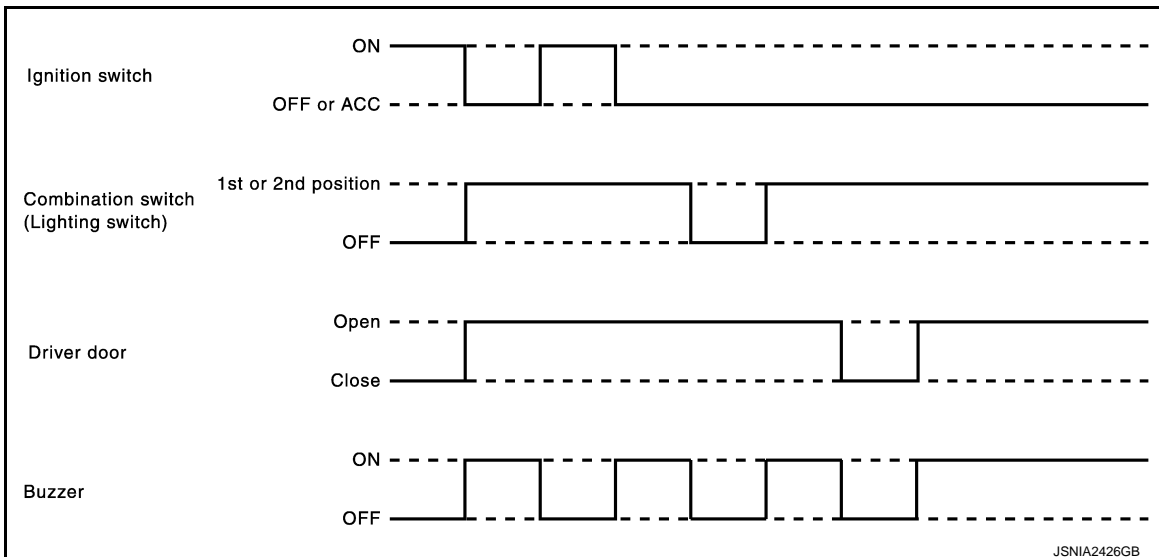

FRONT FOG LIGHT REMINDER WARNING CHIME

JSNIA2426GB

A
B
C
D
E
F
G
H
I
J
K
L
M
O
P

WCS

SYSTEM

< SYSTEM DESCRIPTION >

FRONT FOG LIGHT REMINDER WARNING CHIME : System Diagram

INFOID:000000010261631

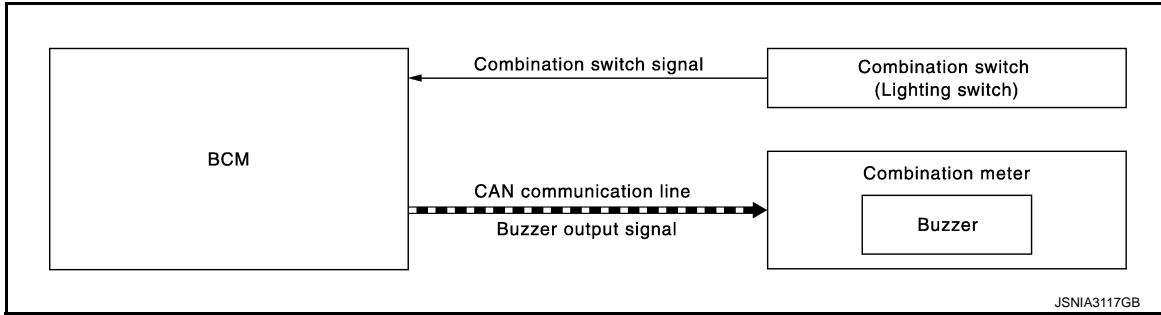

JSNIA3117GB

FRONT FOG LIGHT REMINDER WARNING CHIME : System Description

INFOID:000000010261631

WARNING CHIME OPERATION CONDITIONS

Warning chime sounds during 2 seconds when the ignition switch is in LOCK, OFF or ACC position, if all of below operation conditions is met.

Operation conditions	
Ignition switch	ON position
Combination switch (Lighting switch)	AUTO position and front fog lamp switch ON position

SIGNAL PATH

1. BCM requires warning chime output to combination meter when it judges front fog light reminder warning chime is necessary from signals below.

Signal name	Signal path
Ignition switch signal	—
Combination switch signal	Combination switch (Lighting switch) → BCM

2. Combination meter sounds integrated buzzer, following the warning chime output requirement (below signal) from BCM.

Signal name	Signal path
Buzzer output signal	BCM $\xrightarrow{\text{CAN}}$ Combination meter

TIMING CHART

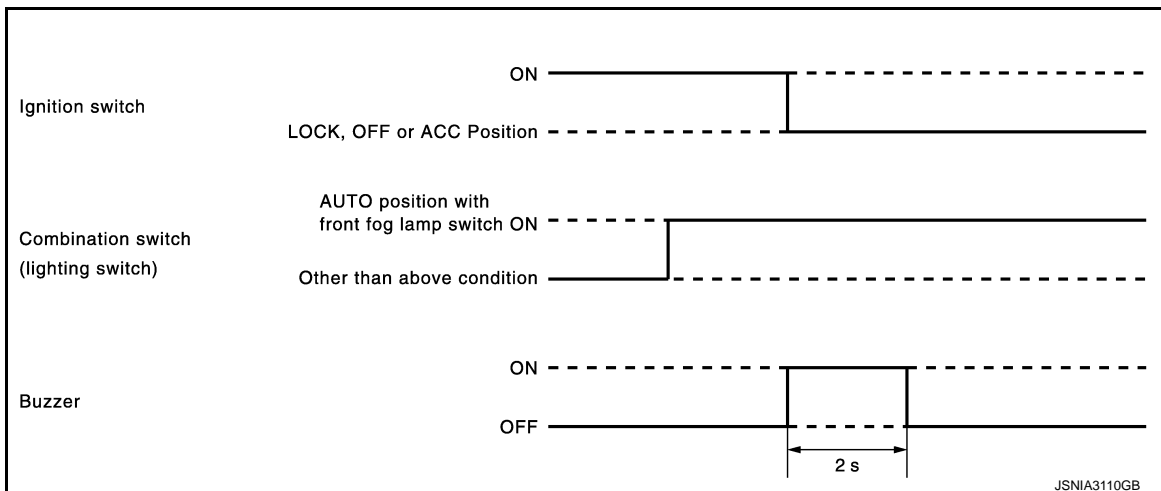

JSNIA3110GB

SEAT BELT WARNING CHIME

SYSTEM

< SYSTEM DESCRIPTION >

SEAT BELT WARNING CHIME : System Diagram

INFOID:000000010261632

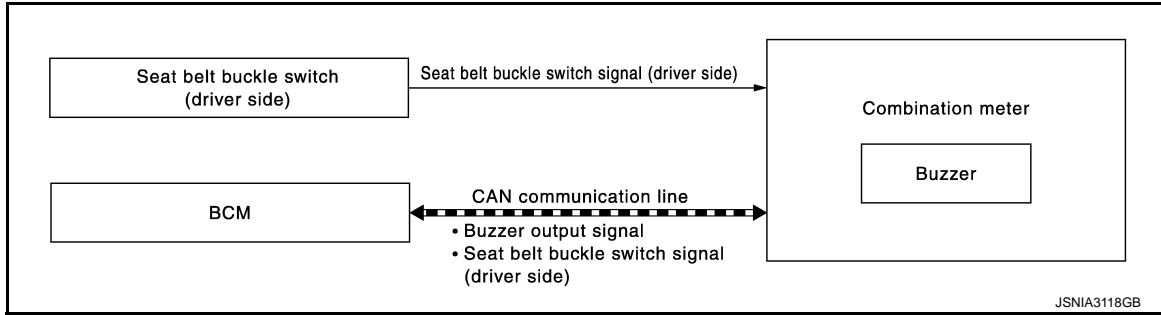

JSNIA3118GB

SEAT BELT WARNING CHIME : System Description

INFOID:000000010261632

WARNING OPERATION CONDITIONS

If all of the following conditions are fulfilled.

Operation conditions	
Ignition switch	ON
Seat belt	Unfastened [seat belt buckle switch (driver side) ON]

WARNING CANCEL CONDITIONS

Warning is canceled if any of the following conditions is fulfilled.

Operation conditions	
Ignition switch	OFF
Seat belt	Fastened [seat belt buckle switch (driver side) OFF]

6 seconds after the start of warning sound

SIGNAL PATH

1. BCM requires warning chime output to combination meter when it judges seat belt warning chime is necessary from signals below.

Signal name	Signal path
Ignition switch signal	—
Seat belt buckle switch signal (driver side)	Seat belt buckle switch (driver side) → Combination meter CAN → BCM

2. Combination meter sounds integrated buzzer, following the warning chime output requirement (below signal) from BCM.

Signal name	Signal path
Buzzer output signal	BCM → CAN → Combination meter

A
B
C
D
E
F
G
H
I
J
K
L
M
O
P

WCS

SYSTEM

< SYSTEM DESCRIPTION >

TIMING CHART

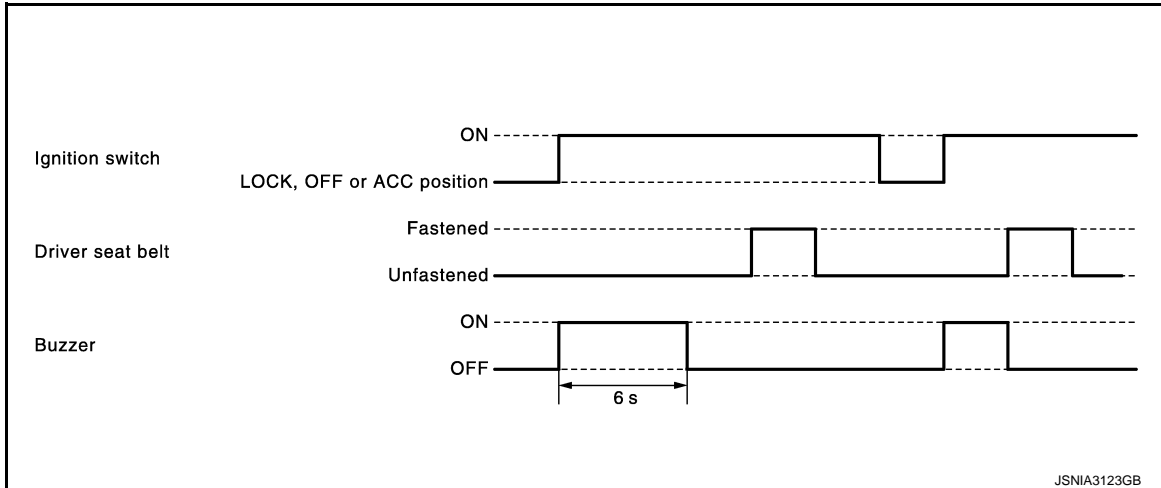

SOUND SPECIFICATION

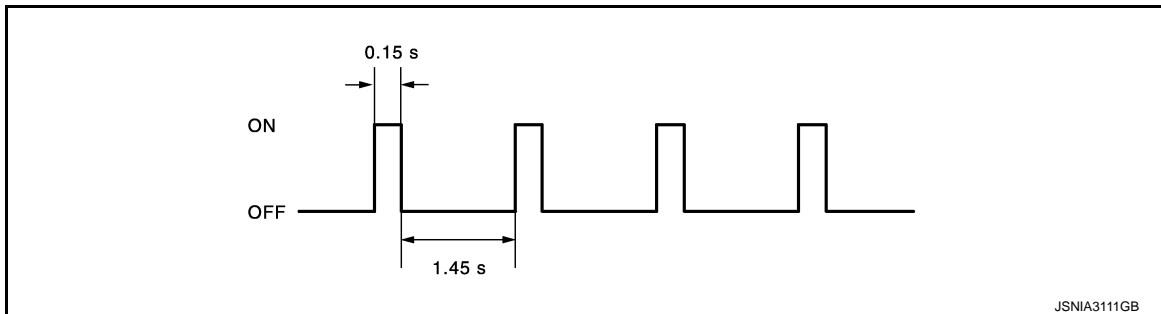

PARKING BRAKE RELEASE WARNING CHIME

PARKING BRAKE RELEASE WARNING CHIME : System Diagram

INFOID:000000010261634

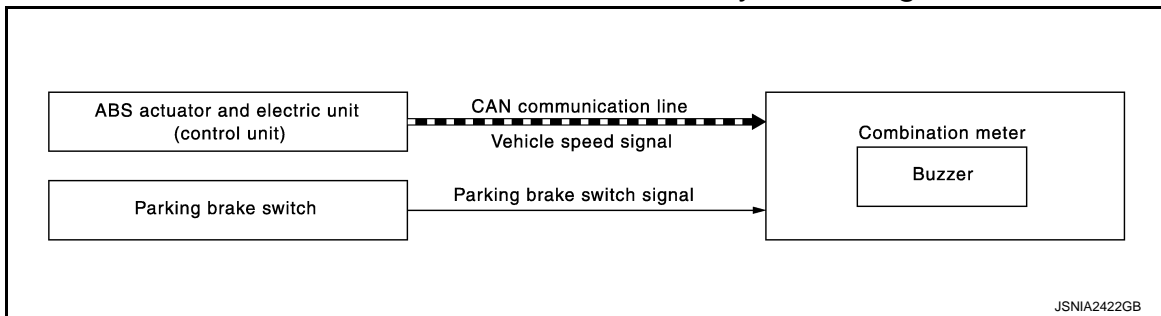

PARKING BRAKE RELEASE WARNING CHIME : System Description

INFOID:000000010261635

WARNING OPERATION CONDITIONS

If all of the following conditions are fulfilled.

Operation conditions	
Ignition switch	ON
Parking brake	During the operation (parking brake switch ON)
Vehicle speed	Approximately 7 km/h (4.3 MPH) or more

WARNING CANCEL CONDITIONS

Warning is canceled if any of the following conditions are fulfilled.

SYSTEM

< SYSTEM DESCRIPTION >

Operation conditions	
Ignition switch	OFF
Parking brake	Release condition (parking brake switch OFF)
Vehicle speed	Approximately 3 km/h (1.9 MPH) or less

SIGNAL PATH

Combination meter sounds integrated buzzer when it judges that parking brake release warning chime is necessary from signals below.

Signal name	Signal path
Ignition switch signal	—
Parking brake switch signal	Parking brake switch → Combination meter
Vehicle speed signal	ABS actuator and electric unit (control unit) ^{CAN} → Combination meter

TIMING CHART

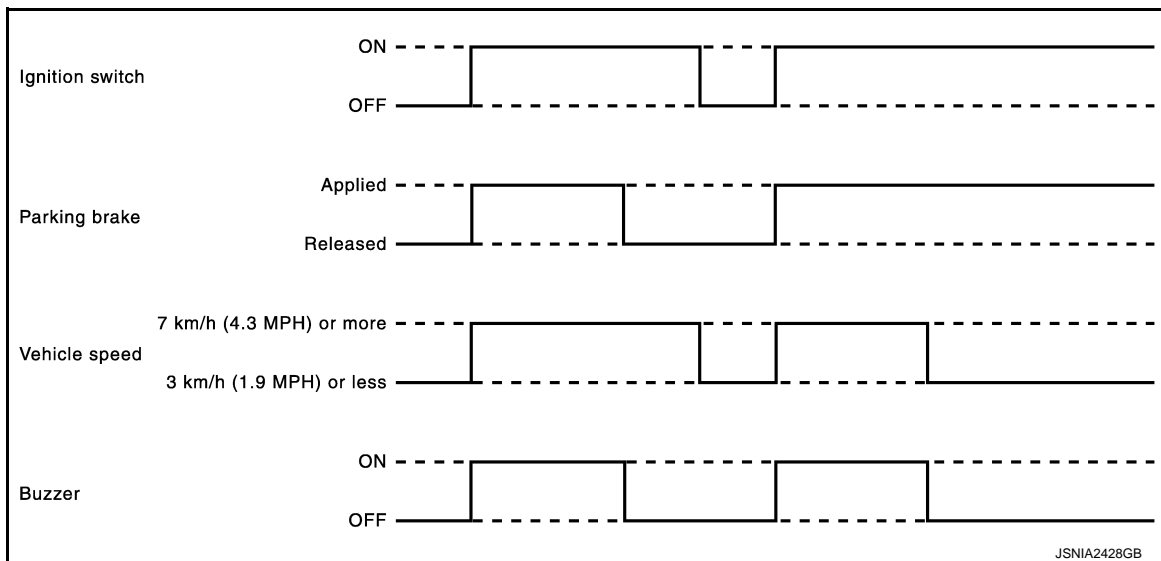

SOUND SPECIFICATION

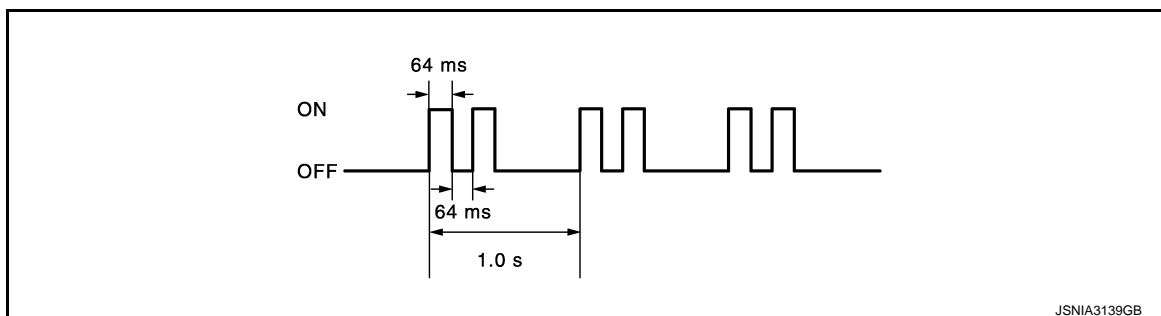

A
B
C
D
E
F
G
H
I
J
K
L
M
O
P

WCS

DIAGNOSIS SYSTEM (COMBINATION METER)

< SYSTEM DESCRIPTION >

DIAGNOSIS SYSTEM (COMBINATION METER)

CONSULT Function

INFOID:000000011515860

CONSULT APPLICATION ITEMS

CONSULT can perform the following diagnosis modes via CAN communication and the combination meter.

System	Diagnosis mode	Description
METER/M&A	Self Diagnostic Result	The combination meter checks the conditions and displays memorized errors.
	Data Monitor	Displays the combination meter input/output data in real time.
	Warning History	Lighting history of the warning lamp and indicator lamp can be checked.

SELF DIAG RESULT

Refer to [WCS-31. "DTC Index"](#).

DATA MONITOR

NOTE:

The following table includes information (items) inapplicable to this vehicle. For information (items) applicable to this vehicle, refer to CONSULT display items.

Display Item List

X: Applicable

Display item [Unit]	MAIN SIGNALS	Description
SPEED METER [km/h]	X	Value of vehicle speed signal received from ABS actuator and electric unit (control unit) via CAN communication. NOTE: 655.35 is displayed when the malfunction signal is received.
SPEED OUTPUT [km/h]	X	Vehicle speed signal value transmitted to other units via CAN communication. NOTE: 655.35 is displayed when the malfunction signal is received.
ODO OUTPUT [km/h or mph]		Odometer signal value transmitted to other units via CAN communication.
TACHO METER [rpm]	X	Value of the engine speed signal received from ECM via CAN communication. NOTE: 8191.875 is displayed when the malfunction signal is received.
FUEL METER [L]	X	Fuel level indicated on combination meter.
W TEMP METER [°C]	X	Value of engine coolant temperature signal is received from ECM via CAN communication. NOTE: 215 is displayed when the malfunction signal is input.
ABS W/L [On/Off]		Status of ABS warning lamp detected from ABS warning lamp signal is received from ABS actuator and electric unit (control unit) via CAN communication.
VDC/TCS IND [On/Off]		Status of VDC OFF indicator lamp detected from VDC OFF indicator lamp signal is received from ABS actuator and electric unit (control unit) via CAN communication.
SLIP IND [On/Off]		Status of VDC warning lamp detected from VDC warning lamp signal received from ABS actuator and electric unit (control unit) via CAN communication.
BRAKE W/L [On/Off]		Status of brake warning lamp detected from brake warning lamp signal is received from ABS actuator and electric unit (control unit) via CAN communication. NOTE: Displays "Off" if the brake warning lamp is illuminated when the valve check starts, the parking brake switch is turned ON or the brake fluid level switch is turned ON.
DOOR W/L [On/Off]		Status of door open warning detected from door switch signal received from BCM via CAN communication.
HI-BEAM IND [On/Off]		Status of high beam indicator lamp detected from high beam request signal is received from BCM via CAN communication.

DIAGNOSIS SYSTEM (COMBINATION METER)

< SYSTEM DESCRIPTION >

Display item [Unit]	MAIN SIGNALS	Description	
TURN IND [On/Off]		Status of turn indicator lamp detected from turn indicator signal is received from BCM via CAN communication.	A
FR FOG IND [Off]		This item is displayed, but cannot be monitored.	B
RR FOG IND [Off]		This item is displayed, but cannot be monitored.	C
LIGHT IND [On/Off]		Status of light indicator lamp detected from position light request signal is received from BCM via CAN communication.	
OIL W/L [On/Off]		Status of oil pressure warning lamp detected from oil pressure switch signal is received from BCM via CAN communication.	D
MIL [On/Off]		Status of malfunction indicator lamp detected from malfunctioning indicator lamp signal is received from ECM via CAN communication.	E
GLOW IND [Off]		This item is displayed, but cannot be monitored.	
CRUISE IND [On/Off]		<ul style="list-style-type: none"> • Status of CRUISE indicator detected from ASCD status signal is received from ECM via CAN communication. (ASCD models) • Status of CRUISE indicator detected from meter display signal is received from ADAS control unit via CAN communication. (ICC models) 	F
SET IND [On/Off]		Status of SET indicator detected from meter display signal is received from ADAS control unit via CAN communication.	G
CRUISE W/L [On/Off]		Status of CRUISE warning lamp judged from ICC warning lamp signal received from ADAS control unit with CAN communication line.	H
BA W/L [Off]		This item is displayed, but cannot be monitored.	
ATC/T-AMT W/L [On/Off]		Status of A/T CHECK warning lamp judged from A/T CHECK indicator lamp signal received from TCM with CAN communication line.	I
ATF TEMP W/L [Off]		This item is displayed, but cannot be monitored.	J
4WD W/L [On/Off]		Status of 4WD warning lamp judged from 4WD warning lamp signal received from 4WD control unit with CAN communication line.	
FUEL W/L [On/Off]		Low-fuel warning lamp status detected by the identified fuel level.	K
WASHER W/L [On/Off]		Status of low washer fluid warning judged from washer level switch input to combination meter.	L
AIR PRES W/L [On/Off]		Status of low tire pressure warning lamp judged from low tire pressure warning lamp signal received from BCM with CAN communication line.	
KEY G/Y W/L [On/Off]		Status of KEY warning lamp (Green/Yellow) detected from KEY warning lamp signal is received from BCM via CAN communication.	M
KEY KNOB W/L [Off]		This item is displayed, but cannot be monitored.	WCS
AFS OFF IND [On/Off]		Status of AFS OFF indicator lamp judged from AFS OFF indicator lamp signal received from AFS control unit with CAN communication line.	
DDS* W/L [Off]		This item is displayed, but cannot be monitored.	O
LANE W/L [On/Off]		Status of lane departure warning lamp judged from lane departure warning lamp signal received from ADAS control unit with CAN communication line.	P
LDP IND [On/Off]		Status of LDP ON indicator lamp judged from LDP ON indicator lamp signal received from ADAS control unit with CAN communication line.	
ATP W/L [On/Off]		Status of ATP warning lamp judged from ATP warning lamp signal received from 4WD control unit with CAN communication line.	
DCA IND [Off]		This item is displayed, but cannot be monitored.	

DIAGNOSIS SYSTEM (COMBINATION METER)

< SYSTEM DESCRIPTION >

Display item [Unit]	MAIN SIGNALS	Description
CHECK SUS IND [On/Off]		Status of CK SUSP indicator lamp judged from CK SUSP indicator lamp signal received from E-SUS control unit with CAN communication line.
LCD [B&P N, B&P I, ID NG, ROTAT, SFT P, INSRT, BATT, NO KY, OUTKY, LK WN]		Displays status of Intelligent Key system warning judged from meter display signal received from BCM with CAN communication line.
ACC TARGET [On/Off]		Status of vehicle ahead detection indicator judged from meter display signal received from ADAS control unit with CAN communication line.
ACC DISTANCE [Off, Short, Middle, Long]		Status of set distance indicator judged from meter display signal received from ADAS control unit with CAN communication line.
ACC OWN VHL [On/Off]		Status of own vehicle indicator judged from meter display signal received from ADAS control unit with CAN communication line.
ACC SET SPEED [Off, km/h]		Status of set vehicle speed indicator judged from meter display signal received from ADAS control unit with CAN communication line.
ACC UNIT [On/Off]		Status of display unit judged from meter display signal received from ADAS control unit with CAN communication line.
SHIFT IND [P, R, N, D, M1, M2, M3, M4, M5, M6, M7]		Status of shift position indicator judged from shift position signal and manual mode indicator signal received from TCM with CAN communication line.
4WD IND [AUTO, LOCK, 2W, 4Lo, HL1, HL2, MALF]		Status of 4WD indicator judged from 4WD indicator signal received from 4WD control unit with CAN communication line.
BSW IND [On/Off]		Status of Blind Spot Intervention ON indicator (green) judged from Blind Spot Intervention ON indicator signal received from ADAS control unit with CAN communication line.
BSW W/L [On/Off]		Status of Blind spot Warning/Blind Spot Intervention warning lamp (yellow) judged from Blind spot Warning/Blind Spot Intervention warning lamp signal received from ADAS control unit with CAN communication line.
FUEL CAP W/L [On/Off]		Status of fuel filler cap warning display detected from fuel filler cap warning display signal received from ECM via CAN communication.
AT S MODE SW [On/Off]		Status of snow mode switch.
M RANGE SW [On/Off]		Status of manual mode switch.
NM RANGE SW [On/Off]		Status of non-manual mode switch.
AT SFT UP SW [On/Off]		Status of manual mode shift up switch.
AT SFT DWN SW [On/Off]		Status of manual mode shift down switch.
PKB SW [On/Off]		Status of parking brake switch.
BUCKLE SW [On/Off]		Status of seat belt buckle switch (driver side).
BRAKE OIL SW [On/Off]		Status of brake fluid level switch.
A/C AMP CONN [Off]		This item is displayed, but cannot be monitored.
ENTER SW [On/Off]		Status of  (ENTER) switch.
SELECT SW [On/Off]		Status of  (SELECT) switch.

DIAGNOSIS SYSTEM (COMBINATION METER)

< SYSTEM DESCRIPTION >

Display item [Unit]	MAIN SIGNALS	Description
LED LMP R OPEN [On/Off]		Status of front combination lamp RH judged based on LED headlamp (RH) warning signal input from front combination lamp RH.
LED LMP L OPEN [On/Off]		Status of front combination lamp LH judged based on LED headlamp (LH) warning signal input from front combination lamp LH.
DISTANCE [km]		Value of distance to empty calculated by combination meter.
OUTSIDE TEMP [°C or °F]		Ambient temperature value converted from ambient sensor signal received from ambient sensor. NOTE: This may not match with the temperature value indicated on the information display. (Because the information display value is a corrected value from the ambient sensor input value.)
FUEL LOW SIG [On/Off]		Status of fuel level low warning signal to output to AV control unit via CAN communication.
TOW MODE IND [On/Off]		Status of TOW mode indicator lamp judged from TOW mode indicator lamp signal received from TCM with CAN communication line.
FR RADAR WARN [On/Off]		Status of front radar warning judged from front radar warning signal received from ADAS control unit with CAN communication line.
BUZZER [On/Off]	X	Buzzer status (in the combination meter) is detected from the buzzer output signal received from each unit via CAN communication and the warning output condition of the combination meter.
HI-BEAM ASST IND [km/h/Off]		Status of high beam assist indicator lamp from high beam assist indicator lamp signal is received from BCM via CAN communication.
BCI ON IND [On/Off]		Status of BCI ON indicator judged from meter display signal received from ADAS control unit with CAN communication line.
BCI OFF IND [On/Off]		Status of BCI OFF indicator judged from meter display signal received from ADAS control unit with CAN communication line.
BCI WARNING IND [On/Off]		Status of BCI malfunction indicator judged from meter display signal received from ADAS control unit with CAN communication line.
BCI HI TEMP WARN IND [On/Off]		Status of BCI not available indicator judged from meter display signal received from ADAS control unit with CAN communication line.
FEB W/L [On/Off]		Status of FEB indicator lamp judged from FEB warning lamp signal received from ADAS control unit with CAN communication line.
FEB WARN [On/Off]		Status of FEB warning judged from meter display signal received from ADAS control unit with CAN communication line.

*: DDS (hill descent control)

NOTE:

Some items are not available according to vehicle specification.

WARNING HISTORY

- Stores histories when warning/indicator lamp is turned on.
- “Warning History” indicates the “TIME” when the warning/ indicator lamp is turned on.
- The “TIME” above is:
 - 0: The condition that the warning/indicator lamp has been turned on 1 or more times after starting the engine and waiting for 30 seconds.
 - 1 - 39: The number of times the engine was restarted after the 0 condition.
 - NO Warning History: Stores NO (0) turning on history of warning/indicator lamp.

NOTE:

- Warning History is not stored for approximately 30 seconds after the engine starts.
- Brake warning lamp does not store any history when the parking brake is applied or the brake fluid level gets low.

Display Item

A
B
C
D
E
F
G
H
I
J
K
L
M
O
P

WCS

DIAGNOSIS SYSTEM (COMBINATION METER)

< SYSTEM DESCRIPTION >

Display item	Description
ABS W/L	Lighting history of ABS warning lamp.
VDC/TCS IND	Lighting history of VDC OFF indicator lamp.
SLIP IND	Lighting history of VDC warning lamp.
BRAKE W/L	Lighting history of brake warning lamp.
DOOR W/L	Lighting history of door open warning.
OIL W/L	Lighting history of oil pressure warning lamp.
C-ENG W/L	Lighting history of malfunction indicator lamp.
CRUISE IND	Lighting history of CRUISE indicator lamp.
SET IND	Lighting history of SET indicator lamp.
CRUISE W/L	Lighting history of CRUISE warning lamp.
ATC/T-AMT W/L	Lighting history of A/T CHECK warning lamp.
4WD W/L	Lighting history of 4WD warning lamp.
FUEL W/L	Lighting history of low fuel level warning.
WASHER W/L	Lighting history of low washer fluid warning.
AIR PRES W/L	Lighting history of low tire pressure warning lamp.
KEY G/Y W/L	Lighting history of KEY warning lamp.
LANE W/L	Lighting history of lane departure warning lamp.

NOTE:

In items displayed on the CONSULT screen, only those listed in the above table are used.

DIAGNOSIS SYSTEM (BCM)

< SYSTEM DESCRIPTION >

DIAGNOSIS SYSTEM (BCM)

COMMON ITEM

COMMON ITEM : CONSULT Function (BCM - COMMON ITEM)

INFOID:0000000011515861

APPLICATION ITEM

CONSULT performs the following functions via CAN communication with BCM.

Diagnosis mode	Function Description
Work Support	Changes the setting for each system function.
Self Diagnostic Result	Displays the diagnosis results judged by BCM. Refer to BCS-58. "DTC Index" .
CAN Diag Support Monitor	Monitors the reception status of CAN communication viewed from BCM.
Data Monitor	The BCM input/output signals are displayed.
Active Test	The signals used to activate each device are forcibly supplied from BCM.
Ecu Identification	The BCM part number is displayed.
Configuration	<ul style="list-style-type: none"> Read and save the vehicle specification. Write the vehicle specification when replacing BCM.

SYSTEM APPLICATION

BCM can perform the following functions for each system.

NOTE:

It can perform the diagnosis modes except the following for all sub system selection items.

x: Applicable item

System	Sub system selection item	Diagnosis mode		
		Work Support	Data Monitor	Active Test
Door lock	DOOR LOCK	x	x	x
Rear window defogger	REAR DEFOGGER		x	x
Warning chime	BUZZER		x	x
Interior room lamp timer	INT LAMP	x	x	x
Exterior lamp	HEAD LAMP	x	x	x
Wiper and washer	WIPER	x	x	x
Turn signal and hazard warning lamps	FLASHER	x	x	x
—	AIR CONDITONER*		x	x
<ul style="list-style-type: none"> Intelligent Key system Engine start system 	INTELLIGENT KEY	x	x	x
Combination switch	COMB SW		x	
Body control system	BCM	x		
IVIS	IMMU	x	x	x
Interior room lamp battery saver	BATTERY SAVER	x	x	x
Back door	TRUNK		x	
Vehicle security system	THEFT ALM	x	x	x
RAP system	RETAINED PWR		x	
Signal buffer system	SIGNAL BUFFER		x	x
—	AIR PRESSURE MONITOR*	x	x	x

*: This item is indicated, but not used.

FREEZE FRAME DATA (FFD)

The BCM records the following vehicle condition at the time a particular DTC is detected, and displays on CONSULT.

DIAGNOSIS SYSTEM (BCM)

< SYSTEM DESCRIPTION >

CONSULT screen item	Indication/Unit	Description	
Vehicle Speed	km/h	Vehicle speed of the moment a particular DTC is detected	
Odo/Trip Meter	km	Total mileage (Odometer value) of the moment a particular DTC is detected	
Vehicle Condition	SLEEP>LOCK	Power position status of the moment a particular DTC is detected	While turning BCM status from low power consumption mode to normal mode (Power supply position is "LOCK")
	SLEEP>OFF		While turning BCM status from low power consumption mode to normal mode (Power supply position is "OFF".)
	LOCK>ACC		While turning power supply position from "LOCK" to "ACC"
	ACC>ON		While turning power supply position from "ACC" to "IGN"
	RUN>ACC		While turning power supply position from "RUN" to "ACC" (Vehicle is stopping and selector lever is except P position.)
	CRANK>RUN		While turning power supply position from "CRANKING" to "RUN" (From cranking up the engine to run it)
	RUN>URGENT		While turning power supply position from "RUN" to "ACC" (Emergency stop operation)
	ACC>OFF		While turning power supply position from "ACC" to "OFF"
	OFF>LOCK		While turning power supply position from "OFF" to "LOCK"
	OFF>ACC		While turning power supply position from "OFF" to "ACC"
	ON>CRANK		While turning power supply position from "IGN" to "CRANKING"
	OFF>SLEEP		While turning BCM status from normal mode (Power supply position is "OFF".) to low power consumption mode
	LOCK>SLEEP		While turning BCM status from normal mode (Power supply position is "LOCK".) to low power consumption mode
	LOCK		Power supply position is "LOCK" (Ignition switch OFF with steering is locked.)
	OFF		Power supply position is "OFF" (Ignition switch OFF with steering is unlocked.)
	ACC		Power supply position is "ACC" (Ignition switch ACC)
	ON		Power supply position is "IGN" (Ignition switch ON with engine stopped)
	ENGINE RUN		Power supply position is "RUN" (Ignition switch ON with engine running)
CRANKING	Power supply position is "CRANKING" (At engine cranking)		
IGN Counter	0 - 39	The number of times that ignition switch is turned ON after DTC is detected <ul style="list-style-type: none"> • The number is 0 when a malfunction is detected now. • The number increases like 1 → 2 → 3...38 → 39 after returning to the normal condition whenever ignition switch OFF → ON. • The number is fixed to 39 until the self-diagnosis results are erased if it is over 39. 	

BUZZER

BUZZER : CONSULT Function (BCM - BUZZER)

INFOID:000000010261638

CONSULT APPLICATION ITEMS

Test item	Diagnosis mode	Description
BUZZER	Data Monitor	Displays BCM input data in real time.
	Active Test	Operation of electrical loads can be checked by sending driving signal to them.

DATA MONITOR

NOTE:

The following table includes information (items) inapplicable to this vehicle. For information (items) applicable to this vehicle, refer to CONSULT display items.

DIAGNOSIS SYSTEM (BCM)

< SYSTEM DESCRIPTION >

Display item [Unit]	Description	
PUSH SW [On/Off]	Status of push-button ignition switch judged by BCM.	A
UNLK SEN-DR [On/Off]	Status of unlock sensor judged by BCM.	B
VEH SPEED 1 [km/h]	Value of vehicle speed signal received from combination meter with CAN communication line.	C
TAIL LAMP SW [On/Off]	Status of lighting switch judged by BCM using the combination switch readout function.	D
FR FOG SW [On/Off]	Status of front fog lamp switch judged by BCM using the combination switch readout function.	E
DOOR SW-DR [On/Off]	Status of driver side door switch judged by BCM.	F
CDL LOCK SW [On/Off]	Status of door lock unlock switch judged by BCM.	F

ACTIVE TEST

Display item [Unit]	Description	
SEAT BELT WARN TEST	The seat belt warning chime operation can be checked by operating the relevant function (On/Off).	G
LIGHT WARN ALM	The light warning chime operation can be checked by operating the relevant function (On/Off).	H

WCS

COMBINATION METER

< ECU DIAGNOSIS INFORMATION >

ECU DIAGNOSIS INFORMATION

COMBINATION METER

Reference Value

INFOID:000000011515862

VALUES ON THE DIAGNOSIS TOOL

NOTE:

The following table includes information (items) inapplicable to this vehicle. For information (items) applicable to this vehicle, refer to CONSULT display items.

Monitor Item	Condition		Value/Status
SPEED METER [km/h]	Ignition switch ON	While driving	Input value of vehicle speed signal (CAN communication signal) NOTE: 655.35 is displayed when the malfunction signal is received
SPEED OUTPUT [km/h]	Ignition switch ON	While driving	Output value of vehicle speed signal (CAN communication signal) NOTE: 655.35 is displayed when the malfunction signal is received
ODO OUTPUT [km/h or mph]	Ignition switch ON	—	Output value of odometer signal (CAN communication signal)
TACHO METER [rpm]	Ignition switch ON	Engine running	Input value of engine speed signal (CAN communication signal) NOTE: 8191.875 is displayed when the malfunction signal is received
FUEL METER [L]	Ignition switch ON	—	Input value of fuel level sensor signal
W TEMP METER [°C]	Ignition switch ON	—	Input value of engine coolant temperature signal (CAN communication signal) NOTE: 215 is displayed when the malfunction signal is input
ABS W/L	Ignition switch ON	ABS warning lamp ON	On
		ABS warning lamp OFF	Off
VDC/TCS IND	Ignition switch ON	VDC OFF indicator lamp ON	On
		VDC OFF indicator lamp OFF	Off
SLIP IND	Ignition switch ON	VDC warning lamp ON	On
		VDC warning lamp OFF	Off
BRAKE W/L	Ignition switch ON	Brake warning lamp ON	On
		Brake warning lamp OFF	Off
DOOR W/L	Ignition switch ON	Door open warning ON	On
		Other than the above	Off
HI-BEAM IND	Ignition switch ON	High-beam indicator lamp ON	On
		High-beam indicator lamp OFF	Off
TURN IND	Ignition switch ON	Turn signal indicator lamp ON	On
		Turn signal indicator lamp OFF	Off
FR FOG IND	Ignition switch ON	NOTE: This item is displayed, but cannot be monitored.	Off

COMBINATION METER

< ECU DIAGNOSIS INFORMATION >

Monitor Item	Condition		Value/Status	
RR FOG IND	Ignition switch ON	NOTE: This item is displayed, but cannot be monitored.	Off	A
LIGHT IND	Ignition switch ON	Position lamp indicator lamp ON	On	B
		Position lamp indicator lamp OFF	Off	
OIL W/L	Ignition switch ON	Oil pressure warning lamp ON	On	C
		Oil pressure warning lamp OFF	Off	
MIL	Ignition switch ON	Malfunction indicator lamp ON	On	D
		Malfunction indicator lamp OFF	Off	
GLOW IND	Ignition switch ON	NOTE: This item is displayed, but cannot be monitored.	Off	E
CRUISE IND	Ignition switch ON	CRUISE indicator ON	On	F
		CRUISE indicator OFF	Off	
SET IND	Ignition switch ON	SET indicator ON	On	G
		SET indicator OFF	Off	
CRUISE W/L	Ignition switch ON	CRUISE warning lamp ON	On	H
		CRUISE warning lamp OFF	Off	
BA W/L	Ignition switch ON	NOTE: This item is displayed, but cannot be monitored.	Off	I
ATC/T-AMT W/L	Ignition switch ON	A/T check warning lamp ON	On	J
		A/T check warning lamp OFF	Off	
ATF TEMP W/L	Ignition switch ON	NOTE: This item is displayed, but cannot be monitored.	Off	K
4WD W/L	Ignition switch ON	4WD warning lamp ON	On	L
		4WD warning lamp OFF	Off	
FUEL W/L	Ignition switch ON	During low fuel warning indication	On	M
		Other than the above	Off	
WASHER W/L	Ignition switch ON	During low washer fluid warning indication	On	WCS
		Other than the above	Off	
AIR PRES W/L	Ignition switch ON	Low tire pressure warning lamp ON	On	O
		Low tire pressure warning lamp OFF	Off	
KEY G/Y W/L	Ignition switch ON	KEY warning lamp (Green/Yellow) ON	On	P
		KEY warning lamp (Green/Yellow) OFF	Off	
KEY KNOB W/L	Ignition switch ON	NOTE: This item is displayed, but cannot be monitored.	Off	
AFS OFF IND	Ignition switch ON	AFS OFF indicator lamp ON	On	
		AFS OFF indicator lamp OFF	Off	
DDS W/L	Ignition switch ON	NOTE: This item is displayed, but cannot be monitored.	Off	
LANE W/L	Ignition switch ON	Lane departure warning lamp ON	On	
		Lane departure warning lamp OFF	Off	
LDP IND	Ignition switch ON	LDP ON indicator lamp ON	On	
		LDP ON indicator lamp OFF	Off	

COMBINATION METER

< ECU DIAGNOSIS INFORMATION >

Monitor Item	Condition		Value/Status
ATP W/L	Ignition switch ON	ATP warning lamp ON	On
		ATP warning lamp OFF	Off
DCA IND	Ignition switch ON	NOTE: This item is displayed, but cannot be monitored.	Off
CHECK SUS IND	Ignition switch ON	CK SUSP indicator lamp ON	On
		CK SUSP indicator lamp OFF	Off
LCD	Ignition switch ON	During engine start information indication	B&P I
	Ignition switch ACC	During engine start information indication	B&P N
	Ignition switch LOCK	During key ID warning indication	ID NG
	Ignition switch LOCK	During steering lock information indication	ROTAT
	Ignition switch LOCK	During P position warning indication	SFT P
	Ignition switch LOCK	During Intelligent Key insert information indication	INSRT
	Ignition switch LOCK	During Intelligent Key low battery warning indication	BATT
	Ignition switch ON	During take away warning indication	NO KY
	Ignition switch LOCK	During key warning indication	OUTKY
	Ignition switch ON	During ACC warning indication	LK WN
ACC TARGET	Ignition switch ON	During vehicle ahead detection indicator indication	On
		Other than the above	Off
ACC DISTANCE	Ignition switch ON	When following distance set to "LONG"	LONG
		When following distance set to "MIDDLE"	MID
		When following distance set to "SHORT"	SHORT
		Set distance indicator not displayed	Off
ACC OWN VHL	Ignition switch ON	During own vehicle indicator indication	On
		Other than the above	Off
ACC SET SPEED	Ignition switch ON	During set vehicle speed indicator not displayed	Off
		During set vehicle speed indicator displayed	Indicates the set vehicle speed
ACC UNIT	Ignition switch ON	Set vehicle speed indicator unit display ON	On
		Set vehicle speed indicator unit display OFF	Off

COMBINATION METER



< ECU DIAGNOSIS INFORMATION >

Monitor Item	Condition		Value/Status	
SHIFT IND	Ignition switch ON	During the indication of "P" by shift position indicator	P	A
		During the indication of "R" by shift position indicator	R	B
		During the indication of "N" by shift position indicator	N	C
		During the indication of "D" by shift position indicator	D	D
		During the indication of "M1" by shift position indicator	M1	E
		During the indication of "M2" by shift position indicator	M2	F
		During the indication of "M3" by shift position indicator	M3	G
		During the indication of "M4" by shift position indicator	M4	H
		During the indication of "M5" by shift position indicator	M5	I
		During the indication of "M6" by shift position indicator	M6	J
		During the indication of "M7" by shift position indicator	M7	K
4WD IND	Ignition switch ON	4WD shift switch in AUTO position	AUTO	L
		4WD shift switch in 4H position	LOCK	M
		4WD shift switch in 4L position	LOCK/4Lo	
BSW IND	Ignition switch ON	Blind Spot Intervention ON indicator (green) ON	On	
		Blind Spot Intervention ON indicator (green) OFF	Off	
BSW W/L	Ignition switch ON	Blind Spot Warning/Blind Spot Intervention warning lamp (yellow) ON	On	
		Blind Spot Warning/Blind Spot Intervention warning lamp (yellow) OFF	Off	
FUEL CAP W/L	Ignition switch ON	Fuel filler cap warning display ON	On	
		Fuel filler cap warning display OFF	Off	
AT S MODE SW	Ignition switch ON	Snow mode switch ON	On	
		Snow mode switch OFF	Off	
M RANGE SW	Ignition switch ON	Selector lever in manual mode position	On	
		Other than the above	Off	
NM RANGE SW	Ignition switch ON	Selector lever in manual mode position	Off	
		Other than the above	On	
AT SFT UP SW	Ignition switch ON	Selector lever in + position	On	
		Other than the above	Off	
AT SFT DWN SW	Ignition switch ON	Selector lever in - position	On	
		Other than the above	Off	
PKB SW	Ignition switch ON	Parking brake switch ON	On	
		Parking brake switch OFF	Off	
BUCKLE SW	Ignition switch ON	Driver seat belt not fastened	On	
		Driver seat belt fastened	Off	

WCS

COMBINATION METER

< ECU DIAGNOSIS INFORMATION >

Monitor Item	Condition		Value/Status
BRAKE OIL SW	Ignition switch ON	Brake fluid level switch ON	On
		Brake fluid level switch OFF	Off
A/C AMP CONN	Ignition switch ON	NOTE: This item is displayed, but cannot be monitored.	Off
TOW MODE IND	Ignition switch ON	TOW mode indicator lamp ON	On
		TOW mode indicator lamp OFF	Off
ENTER SW	Ignition switch ON	When  switch (enter switch) is pressed	On
		Other than above	Off
SELECT SW	Ignition switch ON	When  switch (select switch) is pressed	On
		Other than above	Off
LED LMP R OPEN	Power switch ON	Front combination lamp RH malfunction	On
		Front combination lamp RH normal	Off
LED LMP L OPEN	Power switch ON	Front combination lamp LH malfunction	On
		Front combination lamp LH normal	Off
DISTANCE [km]	Ignition switch ON	—	Distance to empty calculated by combination meter
OUTSIDE TEMP [°C or °F]	Ignition switch ON	—	Equivalent to ambient temperature NOTE: This may not match the indicated value on the information display.
FUEL LOW SIG	Ignition switch ON	During low fuel warning indication	On
		Other than above	Off
FR RADAR WARN	Ignition switch ON	During front radar warning indication	On
		Other than above	Off
BUZZER	Ignition switch ON	Buzzer ON	On
		Buzzer OFF	Off
HI-BEAM ASST IND	Ignition switch ON	High beam assist indicator lamp ON	On
		High beam assist indicator lamp OFF	Off
BCI ON IND	Ignition switch ON	During BCI ON indicator indication	On
		Other than above	Off
BCI OFF IND	Ignition switch ON	During BCI OFF indicator indication	On
		Other than above	Off
BCI WARNING IND	Ignition switch ON	During BCI malfunction indicator indication	On
		Other than above	Off
BCI HI TEMP WARN IND	Ignition switch ON	During BCI not available indicator indication	On
		Other than above	Off
FEB W/L	Ignition switch ON	FEB indicator lamp ON	On
		FEB indicator lamp OFF	Off
FEB WARN	Ignition switch ON	During FEB warning indication	On
		Other than above	Off

NOTE:

Some items are not available according to vehicle specification.

COMBINATION METER

< ECU DIAGNOSIS INFORMATION >

TERMINAL LAYOUT

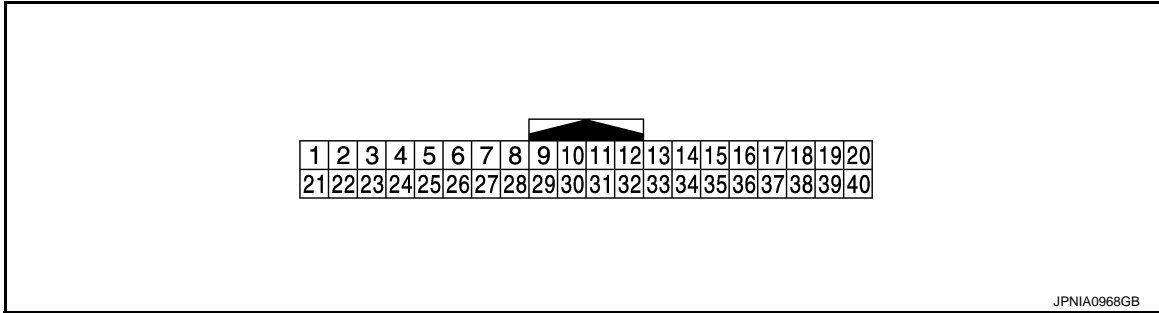

PHYSICAL VALUES

Terminal No. (Wire color)		Description		Condition		Value (Approx.)
+	-	Signal name	Input/ Output			
1 (Y)	Ground	Battery power supply	Input	Ignition switch OFF	—	Battery voltage
2 (GR)	Ground	Ignition signal	Input	Ignition switch ON	—	Battery voltage
3 (B)	Ground	Ground	—	Ignition switch ON	—	0 V
6 (GR)	Ground	LED headlamp (RH) warn- ing signal	Input	Ignition switch ON	Front combination lamp (RH) malfunction	1.0 V
					Front combination lamp (RH) normal	12 V
7 (R)	Ground	TOW mode signal	Input	Ignition switch ON	When TOW mode switch is pressed	0 V
					Other than the above	12 V
8 (P/L)	Ground	Trip reset switch signal	Input	Ignition switch ON	When trip reset switch is pressed	0 V
					Other than the above	5 V
9 (O)	Ground	LED headlamp (LH) warn- ing signal	Input	Ignition switch ON	Front combination lamp (LH) malfunction	1.0 V
					Front combination lamp (LH) normal	12 V
11 (G)	Ground	Enter switch signal	Input	Ignition switch ON	When switch (enter switch) is pressed	0 V
					Other than the above	5 V
12 (O)	Ground	Select switch signal	Input	Ignition switch ON	When switch (select switch) is pressed	0 V
					Other than the above	5 V
13 (W/R)	Ground	Illumination control switch signal (+)	Input	Ignition switch ON	When + switch [illumi- nation control switch (+)] is pressed	0 V
					Other than the above	5 V

A
B
C
D
E
F
G
H
I
J
K
L
M
P

WCS

COMBINATION METER

< ECU DIAGNOSIS INFORMATION >

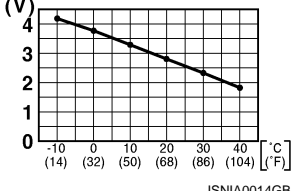
Terminal No. (Wire color)		Description		Condition		Value (Approx.)
+	-	Signal name	Input/ Output			
14 (R)	Ground	Illumination control switch signal (-)	Input	Ignition switch ON	When  switch [illumination control switch (-)] is pressed	0 V
					Other than the above	5 V
15 (R/W)	Ground	Air bag signal	Input	Ignition switch ON	Air bag warning lamp ON	4 V
					Air bag warning lamp OFF	0 V
18 (W/R)	Ground	Ambient sensor signal	Input	—	—	 <p style="text-align: center; font-size: small;">JSNIA0014GB</p>
19 (V/W)	Ground	A/C auto amp. connection recognition signal	Input	—	When A/C auto amp. is connected	5 V
					Other than the above	0 V
20 (B)	Ground	Ambient sensor ground	—	Ignition switch ON	—	0 V
21 (L)	—	CAN-H	—	—	—	—
22 (P)	—	CAN-L	—	—	—	—
23 (B)	Ground	Ground	—	Ignition switch ON	—	0 V
24 (V)	Ground	Fuel level sensor ground	—	Ignition switch ON	—	0 V
25 (O/L)	Ground	Alternator signal	Input	Ignition switch ON	Charge warning lamp ON	2 V
					Charge warning lamp OFF	Battery voltage
26 (W)	Ground	Parking brake switch signal	Input	Ignition switch ON	Parking brake applied	0 V
					Parking brake released	12 V
28 (GR/R)	Ground	Security signal	Input	Ignition switch ON	Security indicator lamp ON	0 V
					Security indicator lamp OFF	12 V
29 (BR)	Ground	Washer level switch signal	Input	Ignition switch ON	Washer level switch ON	0 V
					Washer level switch OFF	5 V

COMBINATION METER

< ECU DIAGNOSIS INFORMATION >

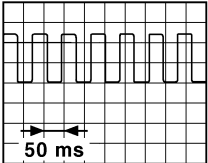
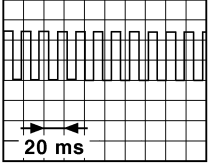
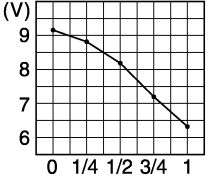
Terminal No. (Wire color)		Description		Condition	Value (Approx.)
+	-	Signal name	Input/ Output		
30 (SB)	Ground	Vehicle speed signal (2-pulse)	Output	Ignition switch ON Speedometer operated [When vehicle speed is ap- prox. 40 km/h (25 MPH)]	NOTE: The maximum voltage varies de- pending on the specification (destination unit).  <small>JSNIA0015GB</small>
31 (BR/W)	Ground	Vehicle speed signal (8-pulse)	Output	Ignition switch ON Speedometer operated [When vehicle speed is ap- prox. 40 km/h (25 MPH)]	NOTE: The maximum voltage varies de- pending on the specification (destination unit).  <small>JSNIA0012GB</small>
33 (W)	Ground	SNOW mode signal	Input	Ignition switch ON	12 V
				Other than the above	0 V
34 (BR/Y)	Ground	Fuel level sensor signal	Input	Ignition switch ON —	 <small>JSNIA3013ZZ</small>
35 (O/B)	Ground	Seat belt buckle switch sig- nal (driver side)	Input	Ignition switch ON	12 V
				Other than the above	0 V
36 (G/Y)	Ground	Passenger seat belt warn- ing signal	Input	<ul style="list-style-type: none"> • When driver side seat belt fastened • When getting in the pas- senger seat • When passenger seat belt fastened 	12 V
				<ul style="list-style-type: none"> • When driver side seat belt fastened • When getting in the pas- senger seat • When passenger seat belt unfastened 	0 V
37 (R/Y)	Ground	Non-manual mode signal	Input	Ignition switch ON	12 V
				Other than the above	0 V

A
B
C
D
E
F
G
H
I
J
K
L
M
O
P

WCS

COMBINATION METER

< ECU DIAGNOSIS INFORMATION >

Terminal No. (Wire color)		Description		Condition		Value (Approx.)
+	-	Signal name	Input/ Output			
38 (L/W)	Ground	Manual mode shift down signal	Input	Ignition switch ON	Selector lever DOWN operation	0 V
					Other than the above	12 V
39 (Y/B)	Ground	Manual mode shift up signal	Input	Ignition switch ON	Selector lever UP operation	0 V
					Other than the above	12 V
40 (G/W)	Ground	Manual mode signal	Input	Ignition switch ON	Selector manual mode position	0 V
					Other than the above	12 V

Fail-Safe

INFOID:000000011515863

FAIL-SAFE

The combination meter activates the fail-safe control if CAN communication with each unit is malfunctioning.

Function		Specifications
Speedometer		Reset to zero by suspending communication.
Tachometer		
Engine coolant temperature gauge		
Engine oil pressure gauge		
Illumination control		When suspending communication, changes to nighttime mode.
Information display	Odo/trip meter	An indicated value is maintained at communications blackout.
	Shift position indicator	The display turns OFF by suspending communication.
	Door open warning	The display turns OFF by suspending communication.
	Fuel filler cap warning	
	Low tire pressure warning	
Buzzer		The buzzer turns OFF by suspending communication.

COMBINATION METER

< ECU DIAGNOSIS INFORMATION >

Function	Specifications		
Warning lamp/indicator lamp	ABS warning lamp	The lamp turns ON by suspending communication.	A
	VDC warning lamp		B
	Brake warning lamp		C
	FEB indicator lamp		D
	4WD warning lamp		E
	Malfunction indicator lamp		F
	CRUISE warning lamp		G
	AFS OFF indicator lamp	The lamp blinking caused by suspending communication.	H
	Low tire pressure warning lamp		I
	High beam indicator lamp	The lamp turns OFF by suspending communication.	J
	Turn signal indicator lamp		K
	Position lamp indicator lamp		L
	A/T CHECK indicator lamp		M
	Key warning lamp		
	ATP warning lamp		
	Lane departure warning lamp		
	LDP ON indicator lamp		
	CRUISE indicator lamp		
	Oil pressure warning lamp		
	TOW mode indicator lamp		
CK SUSP indicator lamp			
Blind Spot Intervention ON indicator			
Blind Spot Warning/Blind Spot Intervention warning lamp			
High beam assist indicator lamp			
VDC OFF indicator lamp			

DTC Index

INFOID:000000011515864

Display contents of CONSULT	Diagnostic item is detected when...	Refer to	
CAN COMM CIRCUIT [U1000]	When combination meter is not transmitting or receiving CAN communication signal for 2 seconds or more.	MWI-62. "Diagnosis Procedure"	M
CONTROL UNIT (CAN) [U1010]	When detecting error during the initial diagnosis of the CAN controller of combination meter.	MWI-63. "Diagnosis Procedure"	WCS
VEHICLE SPEED [B2205]	The abnormal vehicle speed signal is input from the ABS actuator and electric unit (control unit) for 2 seconds or more.	MWI-64. "Diagnosis Procedure"	O
ENGINE SPEED [B2267]	If ECM continuously transmits abnormal engine speed signals for 2 seconds or more.	MWI-65. "Diagnosis Procedure"	P
WATER TEMP [B2268]	If ECM continuously transmits abnormal engine coolant temperature signals for 60 seconds or more.	MWI-66. "Diagnosis Procedure"	

BCM (BODY CONTROL MODULE)

< ECU DIAGNOSIS INFORMATION >

BCM (BODY CONTROL MODULE)

List of ECU Reference

INFOID:000000010261642

ECU	Reference
BCM	BCS-35, "Reference Value"
	BCS-56, "Fail-safe"
	BCS-57, "DTC Inspection Priority Chart"
	BCS-58, "DTC Index"

WARNING CHIME SYSTEM

< WIRING DIAGRAM >

WARNING CHIME

Connector No.	B2
Connector Name	WIRE TO WIRE
Connector Type	TH80MW-CS16-TM4

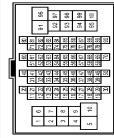

Terminal No.	Color Of Wire	Signal Name [Specification]
1	L	
2	BR	
3	R/W	
4	L	
5	V	
6	W/B	
7	G	
8	W/B	
9	BR	
10	G/R	
11	B/Y	
12	W/R	
13	GR/R	
14	G/W	
15	V	
16	W/G	
17	B/W	
18	G	
19	O	
20	Y	
21	L/O	
22	W/R	
23	O	
24	Y	
25	L/O	
26	Y/R	
27	L	
28	R	
29	G/Y	
30	B/SB	
31	LG/R	
32	BR/W	
33	GR/R	
34	SB	
35	LG	
36	L	
37	P	
38	L	
39	P	
40	W/G	
41	O	

Connector No.	B60
Connector Name	SEAT BELT BUCKLE SWITCH(DRIVER SIDE)
Connector Type	A03FW

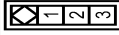

Terminal No.	Color Of Wire	Signal Name [Specification]
1	O/B	
2	B	
3	LG/R	

Connector No.	B83
Connector Name	FRONT DOOR SWITCH (DRIVER SIDE)
Connector Type	TH04FW-NH



Terminal No.	Color Of Wire	Signal Name [Specification]
3	GR/R	DOOR SW DR

Connector No.	E66
Connector Name	ABS ACTUATOR AND ELECTRIC UNIT (CONTROL UNIT)
Connector Type	SAZ42FB-SJZ4

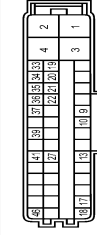

Terminal No.	Color Of Wire	Signal Name [Specification]
1	G	BAT
2	B	GND
3	B	GND
4	W	MOTOR SUPPLY
9	R/B	V/W RATE / SBE / DECEL G SENSOR COMMUNICATION-H
10	P/B	V/W RATE / SBE / DECEL G SENSOR COMMUNICATION-L
13	GR	IGN
17	L/R	STP2
18	W/B	IGN
19	O	DS FR
20	SB	DP FL
21	R/O	DS RR
22	V	DP RL
27	P	CAN-L
33	LG	DP FR
34	G	DS FL
35	BR	DP RR
36	P	DS RL
37	R	STP
39	L/W	VDC OFF SW
41	L	CAN-H
46	W	STOP LAMP SW ON

43	V/W	
44	LG/B	
46	B	
47	GR	
49	GR	
50	R/B	
51	W/R	
52	BR/Y	
53	O/B	
54	G/O	
55	R/B	
56	LG/R	
57	GR/R	
58	Y/G	
59	V/W	
60	R	
63	B	
64	R	
65	W	
66	G	
67	SHIELD	
69	LG/B	
70	P/L	
71	L	
72	R	
77	Y/B	
78	Y/L	
79	Y	
80	W/R	
81	Y/L	
84	L/O	
86	O	
87	W/R	
88	O	
89	W/L	
90	GR/L	
91	W	
92	G	
94	W/R	
96	L/W	
97	R	
98	V	
99	L/W	
100	P/B	

JRNWD8038GB

WARNING CHIME SYSTEM

< WIRING DIAGRAM >

WARNING CHIME

Connector No.	E105
Connector Name	WIRE TO WIRE
Connector Type	TH80MW-CS16-TM4

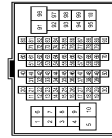

Terminal No.	Color Of Wire	Signal Name [Specification]
1	L	-
2	L/W	-
3	R/B	-
4	L	-
5	Y	-
7	W/G	-
8	P/B	-
9	W/B	-
10	G	-
11	L	-
12	P	-
13	P/B	-
14	BR	-
15	L/B	-
16	SB	-
18	BR	-
19	Y/G	-
20	BR/Y	-
21	Y/V	-
22	L	-
23	Y	-
24	L/W	-
28	O	-
29	R/W	-
30	L/B	-
31	L	-
32	GR/R	-
34	Y	-
35	R	-
36	B/R	-
37	G/Y	-
38	G	-
40	SB	-
41	W/R	-
42	R	-
43	V	-

54	GR/L	-
91	BR	-
92	L/W	-
94	Y/B	-
95	G/R	-
97	R	-
98	G/B	-
100	W/R	-

Connector No.	M1
Connector Name	FUSE BLOCK (J/B)
Connector Type	NS00FW-M2

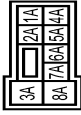

Terminal No.	Color Of Wire	Signal Name [Specification]
1A	Y	-
2A	GR	-
3A	W	-
4A	Y/G	-
5A	V	-
6A	L/W	-
7A	LG	-
8A	W	-

Connector No.	M2
Connector Name	FUSE BLOCK (J/B)
Connector Type	NS10FW-CS

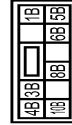

Terminal No.	Color Of Wire	Signal Name [Specification]
10E	W/B	-
1B	R	-
3B	R	-
4B	B	-
5B	BR	-
6B	Y	-
8B	L/O	-

Connector No.	M4
Connector Name	DATA LINK CONNECTOR
Connector Type	BD1EFW

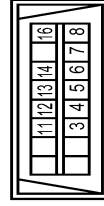

Terminal No.	Color Of Wire	Signal Name [Specification]
3	LG	-
4	B	-
5	B	-
6	L	-
7	SB	-
8	GR	-
11	SB	-
12	R	-
13	L	-
14	P	-
16	Y	-

Connector No.	M11
Connector Name	PARKING BRAKE SWITCH
Connector Type	PO1FB-A



Terminal No.	Color Of Wire	Signal Name [Specification]
1	W	-

Connector No.	M19
Connector Name	WIRE TO WIRE
Connector Type	TH80FW-CS16-TM4

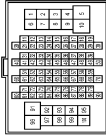

Terminal No.	Color Of Wire	Signal Name [Specification]
2	L	-
3	BR	-
5	R/W	-
6	L	-
7	V	-
9	G	-
11	W/B	-
12	BR	-
13	G/R	-
14	B/Y	-
15	W/R	-
16	GR/R	-
18	G/W	-
19	V	-
20	W/G	-
21	B/W	-
22	V	-
24	G	-
25	O	-

JRNWD8039GB

A
B
C
D
E
F
G
H
I
J
K
L
M
N
O
P

WCS

WARNING CHIME SYSTEM

< WIRING DIAGRAM >

WARNING CHIME

26	Y	-	-
27	L	-	-
28	Y	-	-
29	L	-	-
30	R	-	-
31	G/Y	-	-
32	B/SB	-	-
33	LG/R	-	-
34	BR/W	-	-
35	GR/R	-	-
36	SB	-	-
37	LG	-	-
38	L	-	-
39	P	-	-
40	W/G	-	-
41	O	-	-
43	V/W	-	-
44	LG/B	-	-
46	B	-	-
47	BR/W	-	-
49	GR	-	-
50	R/B	-	-
51	W/R	-	-
52	BR/Y	-	-
53	O/B	-	-
54	G/O	-	-
55	R/B	-	-
56	LG/R	-	-
57	GR/R	-	-
58	Y/G	-	-
59	V/W	-	-
60	R	-	-
63	B	-	-
64	R	-	-
65	W	-	-
66	G	-	-
67	SHIELD	-	-
69	LG/B	-	-
70	P/L	-	-
71	R	-	-
72	R	-	-
77	Y/B	-	-
78	Y/L	-	-
79	Y	-	-
80	W/R	-	-
81	Y/L	-	-
84	L/O	-	-
86	O	-	-
87	W/R	-	-
88	O	-	-

89	W/L	-	-
90	GR/L	-	-
91	W	-	-
92	G	-	-
94	W/R	-	-
96	L/W	-	-
97	R	-	-
98	V	-	-
99	L/W	-	-
100	P/B	-	-

Connector No.	M27
Connector Name	COMBINATION SWITCH
Connector Type	TH15FW-NH

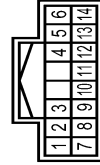

Terminal No.	Color Of Wire	Signal Name [Specification]
1	W/B	-
2	GR	OUTPUT 4
3	L/R	-
4	W	IGN
5	L	OUTPUT 3
6	B	GND
7	W	INPUT 3
8	BR/Y	OUTPUT 5
9	R/W	INPUT 2
10	Y	INPUT 4
11	SB	INPUT 1
12	V	OUTPUT 1
13	LG	INPUT 5
14	G	OUTPUT 2

Connector No.	M34
Connector Name	COMBINATION METER
Connector Type	TH40FW-NH

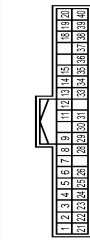

Terminal No.	Color Of Wire	Signal Name [Specification]
1	Y	BATTERY POWER SUPPLY
2	GR	IGNITION SIGNAL
3	B	GROUND
4	B	ILL GND
5	B	ILL CONTROL OUTPUT
6	GR	LED HEADLAMP (RH) WARNING SIGNAL
7	R	TOW MODE SIGNAL
8	P/L	TRIP RESET SWITCH SIGNAL
9	O	LED HEADLAMP (LH) WARNING SIGNAL
10	G	ENTER SWITCH SIGNAL
11	G	SELECT SWITCH SIGNAL
12	O	ILLUMINATION CONTROL SWITCH SIGNAL (+)
13	W/R	ILLUMINATION CONTROL SWITCH SIGNAL (-)
14	R	ILLUMINATION CONTROL SWITCH SIGNAL (+)
15	R/W	AIR BAG SIGNAL
16	W/R	AMBIENT SENSOR SIGNAL
17	V/W	A/C AUTO AMP. CONNECTION RECOGNITION SIGNAL
18	B	AMBIENT SENSOR GROUND
19	L	CAN-H
20	B	CAN-L
21	P	GROUND
22	B	FUEL LEVEL SENSOR GROUND
23	V	FUEL LEVEL SENSOR SIGNAL
24	O/L	ALTERNATOR SIGNAL
25	W	PARKING BRAKE SWITCH SIGNAL
26	W	SECURITY SIGNAL
27	GR/R	WASHER LEVEL SWITCH SIGNAL
28	BR	VEHICLE SPEED SIGNAL (2-PULSE)
29	SR	VEHICLE SPEED SIGNAL (3-PULSE)
30	BR/W	SHOW MODE SIGNAL
31	W	FUEL LEVEL SENSOR SIGNAL
32	BR/Y	SEAT BELT BUCKLE SWITCH SIGNAL (DRIVER SIDE)
33	O/B	SEAT BELT BUCKLE SWITCH SIGNAL (PASSENGER SIDE)
34	G/Y	NON-MANUAL MODE SIGNAL
35	R/Y	MANUAL MODE SHIFT DOWN SIGNAL
36	L/W	MANUAL MODE SHIFT UP SIGNAL
37	Y/B	MANUAL MODE SIGNAL
38	G/W	MANUAL MODE SIGNAL

Connector No.	M68
Connector Name	BCM (BODY CONTROL MODULE)
Connector Type	TH40FB-NH

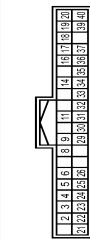

Terminal No.	Color Of Wire	Signal Name [Specification]
1	BR/Y	COMBI SW INPUT 5
2	GR	COMBI SW INPUT 4
3	GR	COMBI SW INPUT 4
4	L	COMBI SW INPUT 3
5	G	COMBI SW INPUT 2
6	V	COMBI SW INPUT 1
7	V	POWER WINDOW SW COMM
8	V	STOP LAMP SW 1
9	R	RAIN SENSOR SERIAL LINK
10	R	OPTICAL SENSOR
11	R	DIMMER SIGNAL
12	P/B	SENSOR PWR SPLY
13	L/O	RECEIVER/SENSOR GND
14	Y/G	TURN SIG RH OUTPUT (FRONT)
15	B/Y	TURN SIG LH OUTPUT (FRONT)
16	G/Y	NATS ANT AMP.
17	G/Y	KYLS ENT RECEIVER RSSI
18	P	SECURITY IND CONT
19	GR/R	DOUBLE LINK
20	SB	NATS ANT AMP.
21	LG/R	INTELLIGENT KEY IDENTIFICATION
22	O	HAZARD SW
23	W	BK DOOR OPNR SW
24	W	DR DOOR LOCK SENSOR
25	W/L	DR DOOR LOCK SENSOR
26	W/L	COMBI SW OUTPUT 3
27	W/G	COMBI SW OUTPUT 2
28	LG	COMBI SW OUTPUT 1
29	Y	COMBI SW OUTPUT 2
30	Y	COMBI SW OUTPUT 3
31	W	COMBI SW OUTPUT 1
32	R/W	COMBI SW OUTPUT 2
33	SB	COMBI SW OUTPUT 1
34	G/Y	CAN-H
35	L	CAN-L
36	P	P

JRNWD8040GB

WARNING CHIME SYSTEM

< WIRING DIAGRAM >

WARNING CHIME

Connector No.	M69
Connector Name	BCM (BODY CONTROL MODULE)
Connector Type	FEA09FB-FH46-SA



43	44	45	46	47	48	49	50	51	54	55
----	----	----	----	----	----	----	----	----	----	----

Terminal No.	Color Of Wire	Signal Name [Specification]
43	Y/L	BR. DOOR SW
44	G/W	REAR WIPER STOP POSITION
45	W	PASSENGER DOOR SW
46	GR	REAR RH DOOR SW
47	GR/R	DRIVER DOOR SW
48	O	REAR LH DOOR SW
49	BR/Y	LUGGAGE ROOM LAMP CONT.
50	B/Y	REMOTE ENGINE START
51	W/R	BACK DOOR REQ SW
54	L	REAR WIPER OUTPUT
55	G	REAR DOOR UNLK OUTPUT



56	57	58	60	61	62	63	64
----	----	----	----	----	----	----	----

Terminal No.	Color Of Wire	Signal Name [Specification]
56	W/R	INT ROOM LAMP PWR SPLY
57	LG	BAT (FUSE)
58	R/W	SHOCK DETECT SENS
59	G	PASSENGER DOOR UNLK OUTPUT
60	G	TURN SIG LH OUTPUT (SIDE REAR)
61	G/Y	TURN SIG RH OUTPUT (SIDE REAR)
62	R	STEP LAMP CONT.
63	BR	ROOM LAMP TIMER CONT
64	GR/R	CRANKING REQUEST

65	R	ALL DOOR LOCK OUTPUT
66	V	DR DOOR FUEL LID UNLK OUTPUT
67	B	GND
68	Y	PW PWR SPLY (IGN)
69	W	PW PWR SPLY (BAT)
70	Y	BAT (F/L)

Connector No.	M77
Connector Name	WIRE TO WIRE
Connector Type	TH80PW-CS (S-TM4)



1	2	3	4	5	6	7	8	9	10	11	12	13	14	15	16	17	18	19	20	21	22	23	24	25	26	27	28	29	30	31	32	33	34
---	---	---	---	---	---	---	---	---	----	----	----	----	----	----	----	----	----	----	----	----	----	----	----	----	----	----	----	----	----	----	----	----	----

Terminal No.	Color Of Wire	Signal Name [Specification]
1	W	-
2	L/W	-
3	R/B	-
4	L	-
5	Y	-
7	W/G	-
8	P/B	-
9	W/B	-
10	G	-
11	L	-
12	P	-
13	P/B	-
14	BR	-
15	O/L	-
16	SB	-
18	Y/R	-
19	Y/G	-
20	BR/Y	-
21	V	-
22	L	-
23	Y	-
24	L/W	-
28	O	-
29	R/W	-
30	O/L	-
31	Y	-
32	GR/R	-
34	Y	-

35	R	-
36	B/O	-
37	G/Y	-
38	G	-
40	SR	-
41	W/R	-
42	R	-
43	V	-
54	GR/L	-
51	BR	-
52	L/W	-
54	Y	-
55	L/R	-
57	R	-
58	O/L	-
100	W/B	-

A
B
C
D
E
F
G
H
I
J
K
L
M
N
O
P



DIAGNOSIS AND REPAIR WORKFLOW

< BASIC INSPECTION >

BASIC INSPECTION

DIAGNOSIS AND REPAIR WORKFLOW

Work Flow

INFOID:000000010261644

OVERALL SEQUENCE

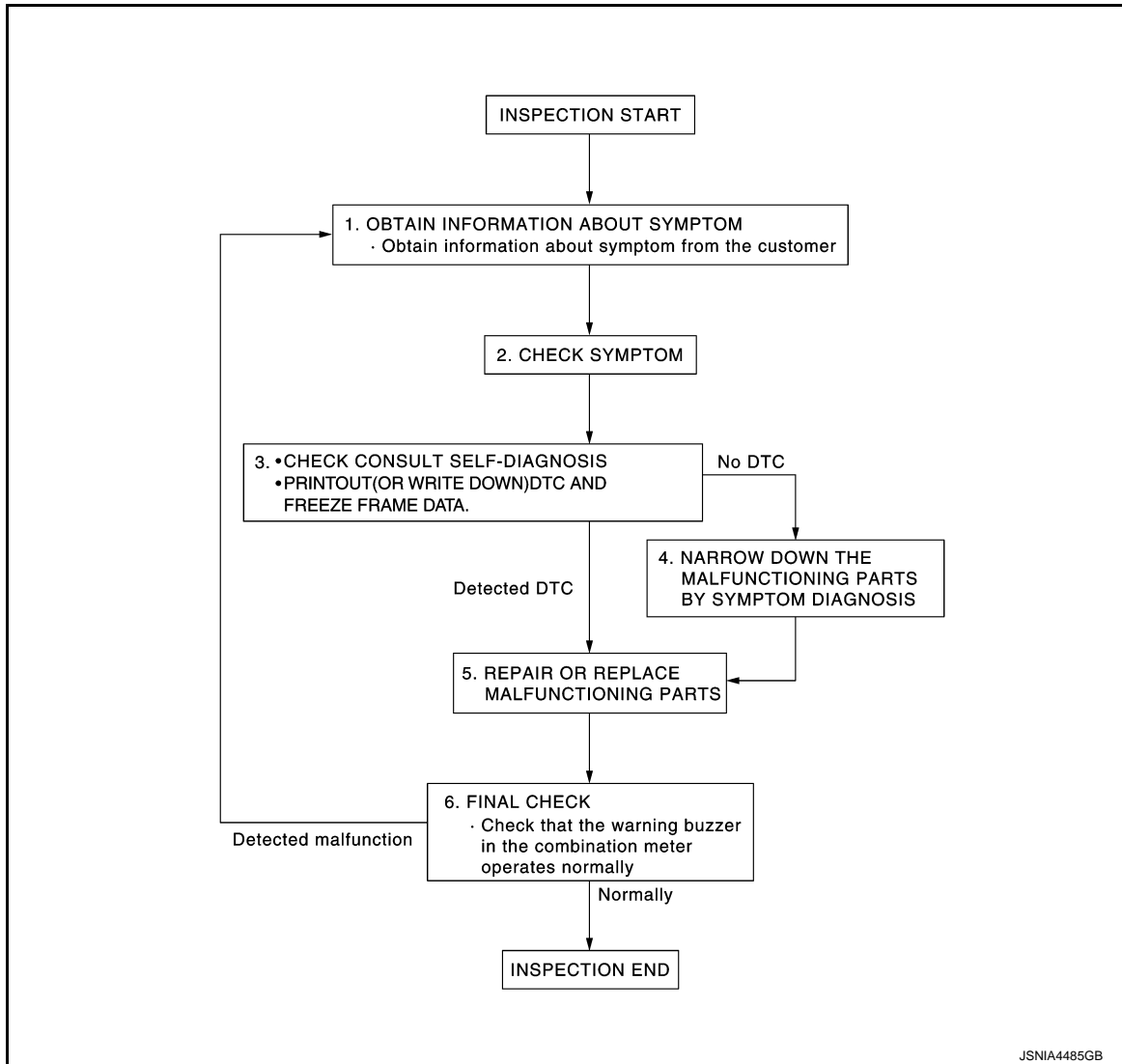

JSNIA4485GB

DETAILED FLOW

1. OBTAIN INFORMATION ABOUT SYMPTOM

Interview the customer to obtain as much information as possible about the conditions and environment under which the malfunction occurred.

>> GO TO 2.

2. CHECK SYMPTOM

- Check the symptom based on the information obtained from the customer.
- Check if any other malfunctions are present.

>> GO TO 3.

3. CHECK CONSULT SELF-DIAGNOSIS RESULTS

1. Connect CONSULT and perform self-diagnosis. Refer to [MWI-45, "DTC Index"](#).

DIAGNOSIS AND REPAIR WORKFLOW

< BASIC INSPECTION >

2. When DTC is detected, follow the instructions below:

- Record DTC and Freeze Frame Data.

Are self-diagnosis results normal?

YES >> GO TO 4.

NO >> GO TO 5.

4.NARROW DOWN MALFUNCTIONING PARTS BY SYMPTOM DIAGNOSIS

Perform symptom diagnosis and narrow down the malfunctioning parts.

>> GO TO 5.

5.REPAIR OR REPLACE MALFUNCTIONING PARTS

Repair or replace malfunctioning parts.

NOTE:

If DTC is displayed, erase DTC after repairing or replacing malfunctioning parts.

>> GO TO 6.

6.FINAL CHECK

Check that the warning buzzer in the combination meter operates normally.

Does it operate normally?

YES >> INSPECTION END

NO >> GO TO 1.

A
B
C
D
E
F
G
H
I
J
K
L
M
O
P

WCS

POWER SUPPLY AND GROUND CIRCUIT

< DTC/CIRCUIT DIAGNOSIS >

DTC/CIRCUIT DIAGNOSIS

POWER SUPPLY AND GROUND CIRCUIT COMBINATION METER

COMBINATION METER : Diagnosis Procedure

INFOID:000000011515875

1. CHECK FUSE

Check for blown fuses.

Power source	Fuse No.
Battery	6
Ignition switch ON or START	3

Is the inspection result normal?

YES >> GO TO 2.

NO >> Be sure to eliminate cause of malfunction before installing new fuse.

2. CHECK POWER SUPPLY CIRCUIT

Check voltage between combination meter harness connector and ground.

Terminals		Ignition switch position	Voltage (Approx.)
(+)	(-)		
Combination meter		OFF	Battery voltage
Connector	Terminal		
M34	1		
	2		
Ground		ON	

Is the inspection result normal?

YES >> GO TO 3.

NO >> Check harness between combination meter and fuse.

3. CHECK GROUND CIRCUIT

1. Turn ignition switch OFF.
2. Disconnect combination meter connector.
3. Check continuity between combination meter harness connector and ground.

Combination meter		Ground	Continuity
Connector	Terminal		
M34	3		Existed
	23		

Is the inspection result normal?

YES >> INSPECTION END

NO >> Repair harness or connector.

METER BUZZER CIRCUIT

< DTC/CIRCUIT DIAGNOSIS >

METER BUZZER CIRCUIT

Component Function Check

INFOID:000000010261646

1.CHECK OPERATION OF METER BUZZER

1. Select "BUZZER" of "BCM" on CONSULT.
2. Perform "LIGHT WARN ALM" of "Active Test".

Does meter buzzer beep?

- YES >> INSPECTION END
NO >> GO TO 2.

2.CHECK COMBINATION METER INPUT SIGNAL

Select the "Data Monitor" for the "METER/M&A" and check the "BUZZER" monitor value.

BUZZER
Under the condition of buzzer input : On
Except above : Off

Is the inspection result normal?

- YES >> Replace combination meter.
NO >> Replace BCM. Refer to [BCS-95, "Removal and Installation"](#).

Diagnosis Procedure

INFOID:000000010261647

1.CHECK POWER SUPPLY OF COMBINATION METER

Check power supply of combination meter. Refer to [MWI-67, "COMBINATION METER : Diagnosis Procedure"](#).

Is the inspection result normal?

- YES >> INSPECTION END
NO >> Repair power supply circuit of combination meter.

A
B
C
D
E
F
G
H
I
J
K
L
M
O
P

WCS

SEAT BELT BUCKLE SWITCH SIGNAL CIRCUIT

< DTC/CIRCUIT DIAGNOSIS >

SEAT BELT BUCKLE SWITCH SIGNAL CIRCUIT

Component Function Check

INFOID:000000010261648

1.CHECK COMBINATION METER INPUT SIGNAL

Select the "Data Monitor" for the "METER/M&A" and check the "BUCKLE SW" monitor value.

BUCKLE SW
When seat belt is fastened : Off
When seat belt is unfastened : On

>> INSPECTION END

Diagnosis Procedure

INFOID:000000010261649

1.CHECK COMBINATION METER INPUT SIGNAL

1. Turn ignition switch ON.
2. Check voltage between combination meter harness connector and ground.

Terminals		Condition	Voltage (Approx.)
(+)	(-)		
Combination meter			
Connector	Terminal	When driver seat belt is fastened	12 V
M34	35		
		When driver seat belt is unfastened	0 V

Is the inspection result normal?

- YES >> Replace combination meter. Refer to [MWI-88. "Removal and Installation"](#).
NO >> GO TO 2.

2.CHECK SEAT BELT BUCKLE SWITCH CIRCUIT

1. Turn ignition switch OFF.
2. Disconnect combination meter connector and seat belt buckle switch (driver side) connector.
3. Check continuity between combination meter harness connector and seat belt buckle switch (driver side) harness connector.

Combination meter		Seat belt buckle switch (driver side)		Continuity
Connector	Terminal	Connector	Terminal	
M34	35	B90	1	Existed

4. Check harness continuity between combination meter harness connector and ground.

Combination meter		Ground	Continuity
Connector	Terminal		
M34	35		Not existed

Is the inspection result normal?

- YES >> GO TO 3.
NO >> Repair harness or connector.

3.CHECK SEAT BELT BUCKLE SWITCH GROUND CIRCUIT

Check harness continuity between seat belt buckle switch (driver side) harness connector and ground.

SEAT BELT BUCKLE SWITCH SIGNAL CIRCUIT

< DTC/CIRCUIT DIAGNOSIS >

Seat belt buckle switch (driver side)		Ground	Continuity
Connector	Terminal		
B90	2		Existed

Is the inspection result normal?

YES >> INSPECTION END

NO >> Repair harness or connector.

Component Inspection

INFOID:000000010261650

1. CHECK SEAT BELT BUCKLE SWITCH (DRIVER SIDE)

1. Turn ignition switch OFF.
2. Disconnect the seat belt buckle switch (driver side) connector.
3. Check continuity between terminals.

Terminal		Condition	Continuity
1	2	When seat belt is fastened	Not existed
		When seat belt is unfastened	Existed

Is the inspection result normal?

YES >> INSPECTION END

NO >> Replace seat belt buckle (driver side). Refer to [SB-8, "SEAT BELT BUCKLE : Removal and Installation"](#).

A
B
C
D
E
F
G
H
I
J
K
L
M
O
P

WCS

PARKING BRAKE SWITCH SIGNAL CIRCUIT

< DTC/CIRCUIT DIAGNOSIS >

PARKING BRAKE SWITCH SIGNAL CIRCUIT

Diagnosis Procedure

INFOID:000000010261651

1. CHECK COMBINATION METER INPUT SIGNAL

1. Turn ignition switch ON.
2. Check the voltage between combination meter harness connector and ground.

(+)		(-)	Condition		Voltage (Approx.)
Combination meter		Ground			
Connector	Terminal		Ignition switch ON	When parking brake is applied	0 V
M34	26	When parking brake is released		12 V	

Is the inspection result normal?

- YES >> INSPECTION END
NO >> GO TO 2.

2. CHECK PARKING BRAKE SWITCH SIGNAL CIRCUIT

1. Turn ignition switch OFF.
2. Disconnect combination meter connector and parking brake switch connector.
3. Check continuity between combination meter harness connector and parking brake switch harness connector.

Terminals				Continuity
Combination meter		Parking brake switch		
Connector	Terminal	Connector	Terminal	
M34	26	M11	1	Existed

4. Check continuity between combination meter harness connector and ground.

Terminals			Continuity
Combination meter		Ground	
Connector	Terminal		
M34	26	Not existed	

Is the inspection result normal?

- YES >> INSPECTION END
NO >> Repair harness or connector.

Component Inspection

INFOID:000000010261652

1. CHECK PARKING BRAKE SWITCH

Check parking brake switch. Refer to [BRC-127, "Component Inspection"](#).

Is the inspection result normal?

- YES >> INSPECTION END.
NO >> Replace parking brake switch. Refer to [PB-6, "Exploded View"](#).

THE LIGHT REMINDER WARNING DOES NOT SOUND

< SYMPTOM DIAGNOSIS >

SYMPTOM DIAGNOSIS

THE LIGHT REMINDER WARNING DOES NOT SOUND

Description

INFOID:0000000010261653

Light reminder warning chime does not sound even though headlamp is illuminated.

Diagnosis Procedure

INFOID:0000000010261654

1. CHECK COMBINATION SWITCH (LIGHTING SWITCH) OPERATION

Check that the headlamps operate normally by operating the combination switch (lighting switch).

Do they operate normally?

YES >> GO TO 2.

NO >> Refer to [EXL-142, "Symptom Table"](#).

2. CHECK DRIVER SIDE DOOR SWITCH SIGNAL CIRCUIT

Perform the check for the driver side door switch signal circuit. Refer to [DLK-121, "Diagnosis Procedure"](#).

Is the inspection result normal?

YES >> GO TO 3.

NO >> Repair harness or connector.

3. CHECK DRIVER SIDE DOOR SWITCH

Perform a unit check for the driver side door switch. Refer to [DLK-122, "Component Inspection"](#).

Is the inspection result normal?

YES >> Replace BCM. Refer to [BCS-95, "Removal and Installation"](#).

NO >> Replace driver side door switch. Refer to [DLK-260, "Removal and Installation"](#).

A
B
C
D
E
F
G
H
I
J
K
L
M
O
P

WCS

THE SEAT BELT WARNING CONTINUES SOUNDING, OR DOES NOT SOUND

< SYMPTOM DIAGNOSIS >

THE SEAT BELT WARNING CONTINUES SOUNDING, OR DOES NOT SOUND

Description

INFOID:000000010261655

- Seat belt warning chime does not sound.
- Seat belt warning chime sounds continuously.

Diagnosis Procedure

INFOID:000000010261656

1. CHECK SEAT BELT WARNING LAMP

1. Turn ignition switch ON.
2. Check the operation of the seat belt warning lamp in the combination meter.

Seat belt fastened	: OFF
Seat belt not fastened	: ON

Is the inspection result normal?

- YES >> GO TO 2.
NO >> GO TO 4.

2. CHECK BCM OUTPUT SIGNAL

Check if the seat belt warning chime is activated by performing BCM active test. Refer to [WCS-20, "BUZZER : CONSULT Function \(BCM - BUZZER\)"](#).

Is the inspection result normal?

- YES >> INSPECTION END
NO >> GO TO 3.

3. CHECK COMBINATION METER INPUT SIGNAL

Check if buzzer switches to proper condition (On/Off) on data monitor of combination meter. Refer to [WCS-14, "CONSULT Function"](#).

Buzzer active condition	: On
Buzzer non-active condition	: Off

Is the inspection result normal?

- YES >> Replace combination meter. Refer to [MWI-88, "Removal and Installation"](#).
NO >> Replace BCM. Refer to [BCS-95, "Removal and Installation"](#).

4. CHECK SEAT BELT BUCKLE SWITCH (DRIVER SIDE) CIRCUIT

Perform the check for the seat belt buckle switch (driver side) circuit. Refer to [WCS-42, "Diagnosis Procedure"](#).

Is the inspection result normal?

- YES >> GO TO 5.
NO >> Repair harness or connector.

5. CHECK SEAT BELT BUCKLE SWITCH (DRIVER SIDE)

Perform a unit check for the seat belt buckle switch (driver side). Refer to [WCS-43, "Component Inspection"](#).

Is the inspection result normal?

- YES >> Replace combination meter. Refer to [MWI-88, "Removal and Installation"](#).
NO >> Replace seat belt buckle (driver side). Refer to [SB-8, "SEAT BELT BUCKLE : Removal and Installation"](#).

THE PARKING BRAKE RELEASE WARNING CONTINUES SOUNDING, OR DOES NOT SOUND

< SYMPTOM DIAGNOSIS >

THE PARKING BRAKE RELEASE WARNING CONTINUES SOUNDING, OR DOES NOT SOUND

Description

INFOID:0000000010261657

- The parking brake warning buzzer sounds continuously during vehicle travel though the parking brake is released.
- The parking brake warning buzzer does not sound at all even though driving the vehicle with the parking brake applied.

Diagnosis Procedure

INFOID:0000000010261658

1. CHECK PARKING BRAKE WARNING LAMP

1. Start the engine.
2. Check the operation of the brake warning lamp by operating the parking brake.

When parking brake is applied : ON

When parking brake is released : OFF

Is the inspection result normal?

YES >> Replace combination meter. Refer to [MWI-88, "Removal and Installation"](#)

NO >> GO TO 2.

2. CHECK PARKING BRAKE SWITCH SIGNAL CIRCUIT

Perform check for the parking brake switch signal circuit. Refer to [WCS-44, "Diagnosis Procedure"](#).

Is the inspection result normal?

YES >> GO TO 3.

NO >> Repair harness or connector.

3. CHECK PARKING BRAKE SWITCH

Perform a unit check for the parking brake switch. Refer to [WCS-44, "Component Inspection"](#).

Is the inspection result normal?

YES >> Replace combination meter. Refer to [MWI-88, "Removal and Installation"](#)

NO >> Replace parking brake switch. Refer to [PB-6, "Exploded View"](#).

A
B
C
D
E
F
G
H
I
J
K
L
M
O
P

WCS