

SECTION **PWC**

POWER WINDOW CONTROL SYSTEM

A
B
C
D
E
F
G
H
I
J
L
M
N
O
P

CONTENTS

<p>BASIC INSPECTION 4</p> <p>DIAGNOSIS AND REPAIR WORK FLOW 4</p> <p style="padding-left: 20px;">WorkFlow4</p> <p>INSPECTION AND ADJUSTMENT 5</p> <p>ADDITIONAL SERVICE WHEN REMOVING BATTERY NEGATIVE TERMINAL5</p> <p style="padding-left: 20px;">ADDITIONAL SERVICE WHEN REMOVING BATTERY NEGATIVE TERMINAL : Description5</p> <p style="padding-left: 20px;">ADDITIONAL SERVICE WHEN REMOVING BATTERY NEGATIVE TERMINAL : Special Repair Requirement5</p> <p>ADDITIONAL SERVICE WHEN REPLACING CONTROL UNIT5</p> <p style="padding-left: 20px;">ADDITIONAL SERVICE WHEN REPLACING CONTROL UNIT : Description6</p> <p style="padding-left: 20px;">ADDITIONAL SERVICE WHEN REPLACING CONTROL UNIT : Special Repair Requirement6</p> <p>SYSTEM DESCRIPTION 7</p> <p>POWER WINDOW SYSTEM 7</p> <p style="padding-left: 20px;">System Diagram7</p> <p style="padding-left: 20px;">System Description7</p> <p style="padding-left: 20px;">Component Parts Location9</p> <p style="padding-left: 20px;">Component Description9</p> <p>DIAGNOSIS SYSTEM (BCM)10</p> <p>COMMON ITEM10</p> <p style="padding-left: 20px;">COMMON ITEM : CONSULT-III Function (BCM - COMMON ITEM)10</p> <p>RETAIND PWR11</p> <p style="padding-left: 20px;">RETAIND PWR : CONSULT-III Function (BCM - RETAINED PWR)11</p> <p>DTC/CIRCUIT DIAGNOSIS12</p> <p>POWER SUPPLY AND GROUND CIRCUIT12</p>	<p>BCM12</p> <p style="padding-left: 20px;">BCM : Diagnosis Procedure12</p> <p>POWER WINDOW MAIN SWITCH12</p> <p style="padding-left: 20px;">POWER WINDOW MAIN SWITCH : Diagnosis Procedure13</p> <p>FRONT POWER WINDOW SWITCH (PASSENGER SIDE)13</p> <p style="padding-left: 20px;">FRONT POWER WINDOW SWITCH (PASSENGER SIDE) : Diagnosis Procedure14</p> <p>REAR POWER WINDOW SWITCH14</p> <p style="padding-left: 20px;">REAR POWER WINDOW SWITCH : Diagnosis Procedure14</p> <p>FRONT POWER WINDOW SWITCH (PASSENGER SIDE)16</p> <p style="padding-left: 20px;">Description16</p> <p style="padding-left: 20px;">Component Function Check16</p> <p style="padding-left: 20px;">Diagnosis Procedure16</p> <p style="padding-left: 20px;">Component Inspection17</p> <p>REAR POWER WINDOW SWITCH18</p> <p style="padding-left: 20px;">Description18</p> <p style="padding-left: 20px;">Component Function Check18</p> <p style="padding-left: 20px;">Diagnosis Procedure18</p> <p style="padding-left: 20px;">Component Inspection19</p> <p>POWER WINDOW MOTOR20</p> <p>DRIVER SIDE20</p> <p style="padding-left: 20px;">DRIVER SIDE : Description20</p> <p style="padding-left: 20px;">DRIVER SIDE : Component Function Check20</p> <p style="padding-left: 20px;">DRIVER SIDE : Diagnosis Procedure20</p> <p style="padding-left: 20px;">DRIVER SIDE : Component Inspection21</p> <p>PASSENGER SIDE21</p> <p style="padding-left: 20px;">PASSENGER SIDE : Description21</p> <p style="padding-left: 20px;">PASSENGER SIDE : Component Function Check21</p> <p style="padding-left: 20px;">PASSENGER SIDE : Diagnosis Procedure21</p> <p style="padding-left: 20px;">PASSENGER SIDE : Component Inspection22</p>
--	---



REAR LH	23	WITH FRONT POWER WINDOW SWITCH ONLY ...	73
REAR LH : Description	23	WITH FRONT POWER WINDOW SWITCH	
REAR LH : Component Function Check	23	ONLY : Diagnosis Procedure	73
REAR LH : Diagnosis Procedure	23		
REAR LH : Component Inspection	24		
REAR RH	24	REAR LH SIDE POWER WINDOW DOES	
REAR RH : Description	24	NOT OPERATE	74
REAR RH : Component Function Check	24		
REAR RH : Diagnosis Procedure	25	WITH BOTH POWER WINDOW MAIN SWITCH	
REAR RH : Component Inspection	26	AND REAR POWER WINDOW SWITCH LH	74
		WITH BOTH POWER WINDOW MAIN SWITCH	
		AND REAR POWER WINDOW SWITCH LH : Di-	
		agnosis Procedure	74
DOOR SWITCH	27	WITH REAR POWER WINDOW SWITCH LH	
Description	27	ONLY	74
Component Function Check	27	WITH REAR POWER WINDOW SWITCH LH	
Diagnosis Procedure	27	ONLY : Diagnosis Procedure	74
Component Inspection	29		
ENCODER CIRCUIT	30	REAR RH SIDE POWER WINDOW DOES	
Description	30	NOT OPERATE	75
Component Function Check	30		
Diagnosis Procedure	30	WITH BOTH POWER WINDOW MAIN SWITCH	
		AND REAR POWER WINDOW SWITCH RH	75
		WITH BOTH POWER WINDOW MAIN SWITCH	
		AND REAR POWER WINDOW SWITCH RH : Di-	
		agnosis Procedure	75
ECU DIAGNOSIS INFORMATION	33	WITH REAR POWER WINDOW SWITCH RH	
		ONLY	75
BCM (BODY CONTROL MODULE)	33	WITH REAR POWER WINDOW SWITCH RH	
Reference Value	33	ONLY : Diagnosis Procedure	75
Wiring Diagram - BCM -	48		
Fail-safe	52	ANTI-PINCH SYSTEM DOES NOT OPERATE	
DTC Inspection Priority Chart	53	NORMALLY (DRIVER SIDE)	76
DTC Index	53	Diagnosis Procedure	76
POWER WINDOW MAIN SWITCH	54		
Reference Value	54	POWER WINDOW RETAINED POWER OP-	
Wiring Diagram - POWER WINDOW CONTROL		ERATION DOES NOT OPERATE PROPERLY	
SYSTEM (WHIT POWER WINDOW ANTI-PINCH		77
SYSTEM) -	55	Diagnosis Procedure	77
Wiring Diagram - POWER WINDOW CONTROL			
SYSTEM (WITHOUT POWER WINDOW ANTI-		AUTO OPERATION DOES NOT OPERATE	
PINCH SYSTEM) -	62	BUT MANUAL OPERATE NORMALLY	
Fail Safe	69	(DRIVER SIDE)	78
		Diagnosis Procedure	78
SYMPTOM DIAGNOSIS	71		
NONE OF THE POWER WINDOWS CAN BE		POWER WINDOW LOCK SWITCH DOES	
OPERATED USING ANY SWITCH	71	NOT FUNCTION	79
Diagnosis Procedure	71	Diagnosis Procedure	79
DRIVER SIDE POWER WINDOW DOES NOT		PRECAUTION	80
OPERATE	72	PRECAUTIONS	80
Diagnosis Procedure	72	FOR MEXICO	80
FRONT PASSENGER SIDE POWER WIN-		FOR MEXICO : Precaution for Supplemental Re-	
DOW DOES NOT OPERATE	73	straint System (SRS) "AIR BAG" and "SEAT BELT	
WITH BOTH POWER WINDOW MAIN SWITCH		PRE-TENSIONER"	80
AND FRONT PASSENGER SIDE POWER WIN-		FOR USA AND CANADA	80
DOW SWITCH	73		
WITH BOTH POWER WINDOW MAIN SWITCH			
AND FRONT PASSENGER SIDE POWER WIN-			
DOW SWITCH : Diagnosis Procedure	73		

FOR USA AND CANADA : Precaution for Supplemental Restraint System (SRS) "AIR BAG" and "SEAT BELT PRE-TENSIONER"80

REMOVAL AND INSTALLATION82

POWER WINDOW MAIN SWITCH82
Exploded View82
Removal and Installation82

A

B

C

D

E

F

G

H

I

J

PWC

L

M

N

O

P

DIAGNOSIS AND REPAIR WORK FLOW

< BASIC INSPECTION >

BASIC INSPECTION

DIAGNOSIS AND REPAIR WORK FLOW

WorkFlow

INFOID:000000006199647

DETAILED FLOW

1.OBTAIN INFORMATION ABOUT SYMPTOM

Interview the customer to obtain the malfunction information (conditions and environment when the malfunction occurred) as much as possible when the customer brings the vehicle in.

>> GO TO 2.

2.REPRODUCE THE MALFUNCTION INFORMATION

Check the malfunction on the vehicle that the customer describes.
Inspect the relation of the symptoms and the condition when the symptoms occur.

>> GO TO 3.

3.IDENTIFY THE MALFUNCTIONING SYSTEM WITH "SYMPTOM DIAGNOSIS"

Use "Symptom diagnosis" from the symptom inspection result in step 2 and then identify where to start performing the diagnosis based on possible causes and symptoms.

>> GO TO 4.

4.IDENTIFY THE MALFUNCTIONING PARTS WITH "COMPONENT DIAGNOSIS"

Perform the diagnosis with "Component diagnosis" of the applicable system.

>> GO TO 5.

5.REPAIR OR REPLACE THE MALFUNCTIONING PARTS

Repair or replace the specified malfunctioning parts.

>> GO TO 6.

6.FINAL CHECK

Check that malfunctions are not reproduced when obtaining the malfunction information from the customer, referring to the symptom inspection result in step 2.

Are the malfunctions corrected?

YES >> INSPECTION END

NO >> GO TO 3.

INSPECTION AND ADJUSTMENT

< BASIC INSPECTION >

INSPECTION AND ADJUSTMENT

ADDITIONAL SERVICE WHEN REMOVING BATTERY NEGATIVE TERMINAL

ADDITIONAL SERVICE WHEN REMOVING BATTERY NEGATIVE TERMINAL : Description

INFOID:000000006199648

NOTE:

ANTI-PINCH SYSTEM

If any of the following work has been done Initial setting is necessary.

- Power supply to the power window main switch or power window motor is cut off by the removal of battery terminal or the battery fuse is blown.
- Disconnection and connection of power window main switch harness connector.
- Removal and installation of motor from regulator assembly.
- Operation of regulator assembly as an independent unit.
- Removal and installation of glass.
- Removal and installation of door glass run.

NOTE:

The following specified operations can not be performed under the non-initialized condition.

- Auto-up operation
- Anti-pinch function

Refer to [PWC-5, "ADDITIONAL SERVICE WHEN REMOVING BATTERY NEGATIVE TERMINAL : Special Repair Requirement"](#).

ADDITIONAL SERVICE WHEN REMOVING BATTERY NEGATIVE TERMINAL : Special Repair Requirement

INFOID:000000006199649

NOTE:

ANTI-PINCH SYSTEM

INITIALIZATION PROCEDURE

1. Disconnect battery minus terminal or power window main switch connector. Reconnect it after a minute or more.
2. Turn ignition switch ON.
3. Operate power window switch to fully open the window. (This operation is unnecessary if the window is already fully open)
4. Continue pulling the power window switch UP (AUTO-UP operation). Even after glass stops at fully closed position, keep pulling the switch for 2 seconds or more.
5. Initializing procedure is completely.
6. Inspect anti-pinch function.

CHECK ANTI-PINCH FUNCTION

1. Fully open the door window.
 2. Place a piece of wood near fully closed position.
 3. Close door glass completely with AUTO-UP.
- Check that glass lowers for approximately 150 mm (5.9 in) or 2 seconds without pinching piece of wood and stops.
 - Check that glass does not rise when operating the power window main switch while lowering.

CAUTION:

- Perform initial setting when auto-up operation or anti-pinch function does not operate normally.
- Check that AUTO-UP operates before inspection when system initialization is performed.
- Do not check with hands and other body parts because they may be pinched. Do not get pinched.
- It may switch to fail-safe mode if open/close operation is performed continuously without full close. Perform initial setting in that situation. Refer to [PWC-69, "Fail Safe"](#)
- Finish initial setting. Otherwise, next operation cannot be done.

1. Auto-up operation

2. Anti-pinch function

ADDITIONAL SERVICE WHEN REPLACING CONTROL UNIT

A
B
C
D
E
F
G
H
I
J
L
M
N
O
P

PWC

INSPECTION AND ADJUSTMENT

< BASIC INSPECTION >

ADDITIONAL SERVICE WHEN REPLACING CONTROL UNIT : Description

INFOID:000000006199650

Refer to [PWC-5. "ADDITIONAL SERVICE WHEN REMOVING BATTERY NEGATIVE TERMINAL : Description"](#).

ADDITIONAL SERVICE WHEN REPLACING CONTROL UNIT : Special Repair Requirement

INFOID:000000006199651

Refer to [PWC-5. "ADDITIONAL SERVICE WHEN REMOVING BATTERY NEGATIVE TERMINAL : Special Repair Requirement"](#) for initialization procedure and check anti-pinch function.

POWER WINDOW SYSTEM

< SYSTEM DESCRIPTION >

SYSTEM DESCRIPTION

POWER WINDOW SYSTEM

System Diagram

INFOID:000000006199652

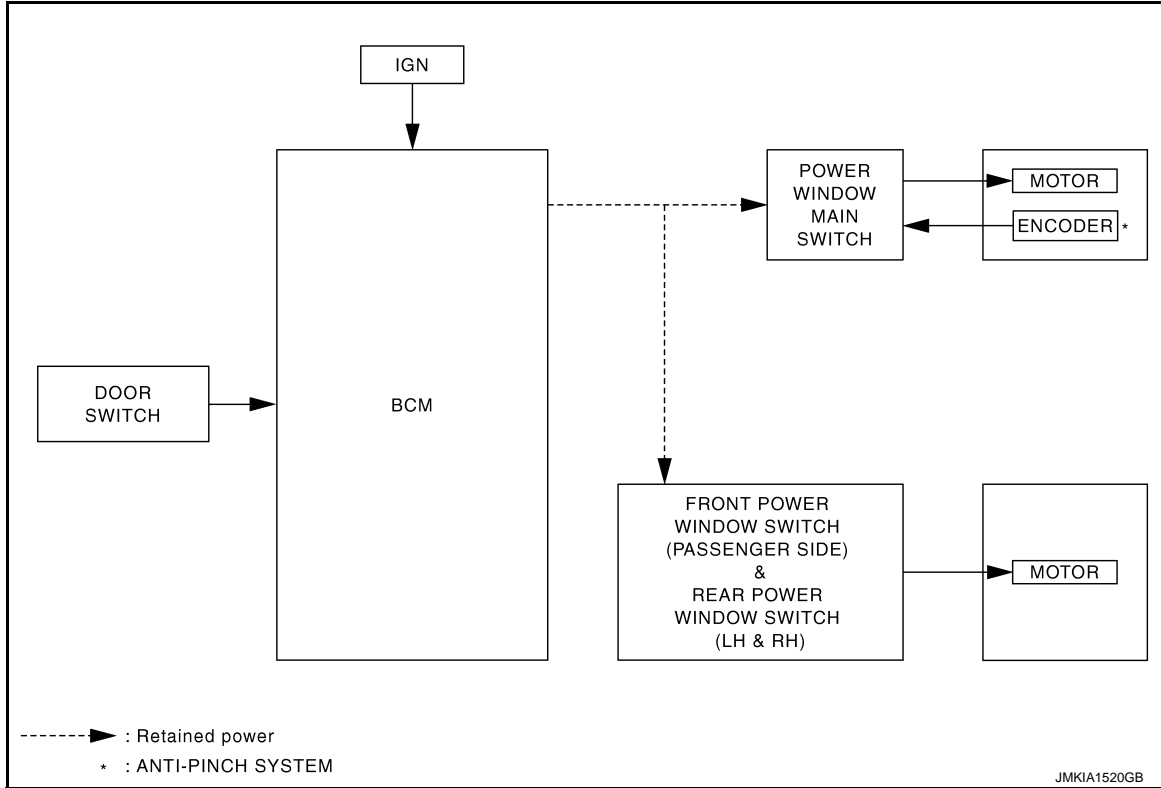

System Description

INFOID:000000006199653

POWER WINDOW MAIN SWITCH INPUT/OUTPUT SIGNAL CHART

PWC

Item	Input signal to power window main switch	Power window main switch function	Actuator
Encoder	Encoder pulse signal	Power window control	Front power window motor (driver side)
Power window main switch	Front power window motor (driver side) UP/DOWN signal		
Front power window switch (passenger side)	Front power window motor (passenger side) UP/DOWN signal		Front power window motor (passenger side)
Rear power window switch	Rear power window motor UP/DOWN signal		Rear power window motor (LH & RH)
BCM	Retained power signal		Each power window motor

FRONT POWER WINDOW SWITCH (PASSENGER SIDE) & REAR POWER WINDOW SWITCH (LH & RH)

INPUT/OUTPUT SIGNAL CHART

POWER WINDOW SYSTEM

< SYSTEM DESCRIPTION >

Item	Input signal to front power window switch (passenger side) & rear power window switch (LH & RH)	Front power window switch (passenger side) & rear power window switch (LH & RH) function	Actuator
Front power window switch (passenger side)	Front power window motor (passenger side) UP/DOWN signal	Power window control	Front power window motor (passenger side)
Rear power window switch (LH & RH)	Rear power window motor (LH & RH) UP/DOWN signal		Rear power window motor (LH & RH)

POWER WINDOW OPERATION

- Power window main switch (driver side) can open/close all windows.
- Front & rear power window switch can open/close the corresponding windows.
- Power window system is operable during the retained power operation timer after turning ignition switch ON and OFF.

POWER WINDOW AUTO-OPERATION (FRONT DRIVER SIDE)/WITH ANTI-PINCH SYSTEM

- AUTO UP/DOWN operation can be performed when power window main switch turns to AUTO.
- Encoder continues detecting the movement of power window motor and transmits to power window switch as the encoder pulse signal while power window motor is operating.
- Power window switch reads the changes of encoder signal and stops AUTO operation when door glass is at fully opened/closed position.
- Power window motor is operable in case encoder is malfunctioning.

RETAINED POWER OPERATION

Retained power operation is an additional power supply function that enables sunroof system to operate for 45 seconds even when ignition switch is turned OFF.

RETAINED POWER FUNCTION CANCEL CONDITIONS

- Front door CLOSE (door switch OFF) → OPEN (door switch ON).
- When ignition switch is ON again.
- When timer time passes. (45 seconds)

POWER WINDOW AUTO-OPERATION (FRONT DRIVER SIDE)/WITHOUT ANTI-PINCH SYSTEM

DOWN operation can be performed when power window main switch turns to AUTO.

POWER WINDOW LOCK

Ground circuit inside power window main switch shuts off when power window lock switch is ON. This inhibits power window switch operation except with the power window main switch.

ANTI-PINCH SYSTEM (FRONT DRIVER SIDE)/WITH ANTI-PINCH SYSTEM

- Pinch foreign material in the door glass during AUTO-UP operation, and it is the anti-pinch function that lowers the door glass 150 mm (5.9 in) or 2 seconds when detected.
- Encoder continues detecting the movement of front power window motor (driver side) and transmits to power window main switch as the encoder pulse signal while front power window motor (driver side) is operating.
- Resistance is applied to the front power window motor (driver side) rotation that changes the frequency of encoder pulse signal if foreign material is trapped in the door glass.
- Power window main switch controls to lower the window glass for 150 mm (5.9 in) or 2 seconds after it detects encoder pulse signal frequency change.

OPERATION CONDITION

- When front door glass (driver side) AUTO-UP operation is performed (anti-pinch function does not operate just before the door glass closes and is fully closed)

NOTE:

Depending on environment and driving conditions, if a similar impact or load is applied to the door glass, it may lower.

POWER WINDOW SYSTEM

< SYSTEM DESCRIPTION >

Component Parts Location

INFOID:000000006199654

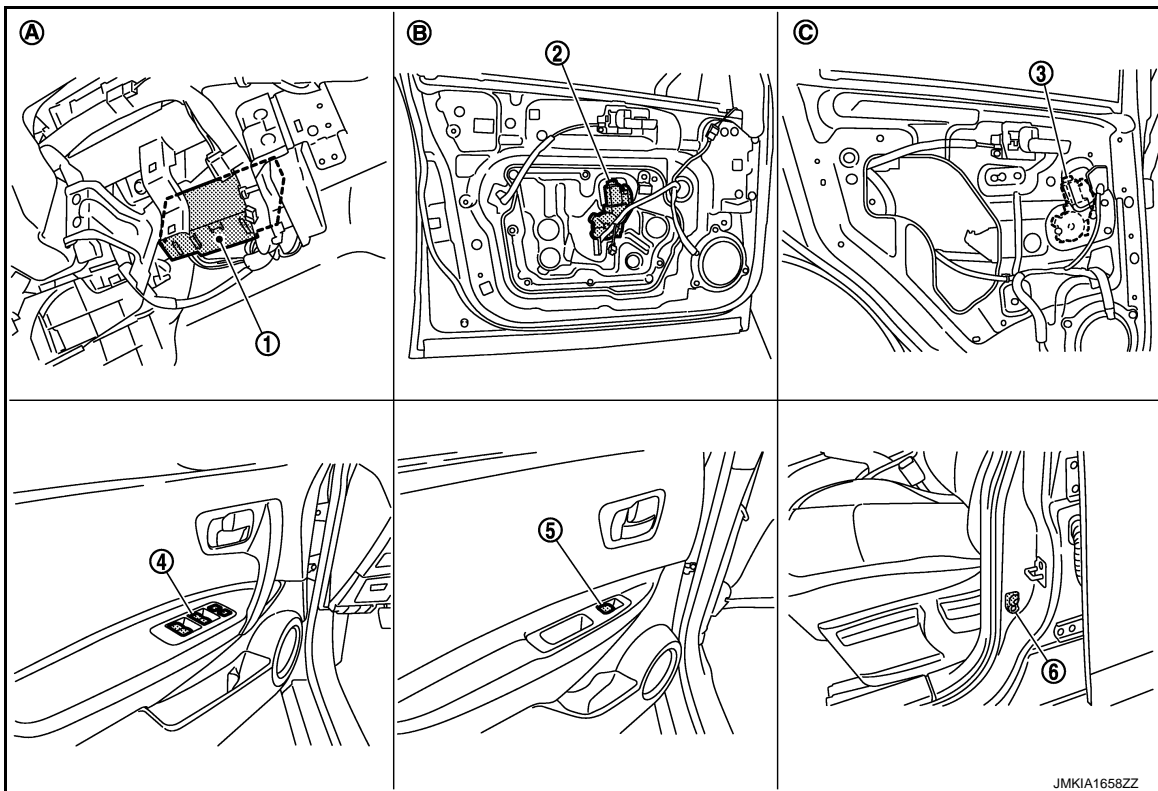

- | | | |
|---------------------------------------|---|---|
| 1. BCM
M65, M66, M67 | 2. Front power window motor (driver side)
D7 | 3. Rear power window motor LH
D82 |
| 4. Power window main switch
D5, D6 | 5. Rear power window switch LH
D83 | 6. Front door switch (driver side)
B34 |

A. Over the globe box

B. View with front door finisher removed.

C. View with rear door finisher removed.

Component Description

INFOID:000000006199655

Component	Function
BCM	<ul style="list-style-type: none"> Supplies power supply to power window switch. Controls retained power.
Power window main switch	<ul style="list-style-type: none"> Directly controls all power window motor of all doors. Controls anti-pinch operation of power window.
Front power window switch	Controls power window motor of front passenger side door.
Rear power window switch (LH & RH)	Controls power window motor of rear right and left doors.
Front power window motor (driver side)	<ul style="list-style-type: none"> Integrates the encoder and power window motor. Starts operating with signals from power window main switch. Transmits front power window motor (driver side) rotation as a pulse signal to power window main switch.
Front power window motor (passenger side)	Starts operating with signals from power window main switch & front power window switch (passenger side).
Rear power window motor (LH & RH)	Starts operating with signals from power window main switch & rear power window switch (LH & RH).
Front door switch (diver side)	Detects door open/close condition and transmits to BCM.

A
B
C
D
E
F
G
H
I
J

PWC

L
M
N
O
P

DIAGNOSIS SYSTEM (BCM)

< SYSTEM DESCRIPTION >

DIAGNOSIS SYSTEM (BCM)

COMMON ITEM

COMMON ITEM : CONSULT-III Function (BCM - COMMON ITEM)

INFOID:000000006484206

APPLICATION ITEM

CONSULT-III can display each diagnostic item using the diagnostic test modes shown following.

Diagnosis mode	Function description
ECU Identification	BCM part number is displayed.
Self-Diagnostic Result	Displays the diagnosis results judged by BCM. Refer to BCS-62, "DTC Index" .
Data Monitor	BCM input/output signals are displayed.
Active Test	The signals used to activate each device are forcibly supplied from BCM.
Work Support	Changes the setting for each system function.
Configuration	<ul style="list-style-type: none"> Read and save the vehicle specification. Write the vehicle specification when replacing BCM.
CAN Diag Support Monitor	Monitors the reception status of CAN communication viewed from BCM.

SYSTEM APPLICATION

BCM can perform the following functions for each system.

NOTE:

It can perform the diagnosis modes except the following for all sub system selection items.

×: Applicable item

System	CONSULT-III sub system selection item	Diagnosis mode		
		Work Support	Data Monitor	Active Test
Door lock	DOOR LOCK	×	×	×
Rear window defogger	REAR DEFOGGER		×	×
Warning chime	BUZZER		×	×
Interior room lamp control	INT LAMP	×	×	×
Remote keyless entry system	MULTI REMOTE ENT	×	×	×
Exterior lamp	HEAD LAMP	×	×	×
Wiper and washer	WIPER	×	×	×
Turn signal and hazard warning lamps	FLASHER		×	×
<ul style="list-style-type: none"> Auto air conditioning system Manual air conditioning system 	AIR CONDITONER		×	
Intelligent Key system	INTELLIGENT KEY		×	
Combination switch	COMB SW		×	
Body control system	BCM	×		
Immobilizer	IMMU		×	×
Interior room lamp battery saver	BATTERY SAVER	×	×	×
Back door open	TRUNK		×	×
Vehicle security system	THEFT ALM	×	×	×
RAP system	RETAINED PWR	×	×	×
Signal buffer system	SIGNAL BUFFER		×	×
—	FUEL LID*			
TPMS	TPMS (AIR PRESSURE MONITOR)	×	×	×
Panic alarm system	PANIC ALARM			×

*: This item is displayed, but is not function.

DIAGNOSIS SYSTEM (BCM)

< SYSTEM DESCRIPTION >

RETAINED PWR

RETAINED PWR : CONSULT-III Function (BCM - RETAINED PWR)

INFOID:000000006199657

Data monitor

Monitor Item	Description
DOOR SW-DR	Indicates [ON/OFF] condition of driver side door switch.
DOOR SW-AS	Indicates [ON/OFF] condition of passenger side door switch.

A
B
C
D
E
F
G
H
I
J
L
M
N
O
P

PWC

POWER SUPPLY AND GROUND CIRCUIT

< DTC/CIRCUIT DIAGNOSIS >

DTC/CIRCUIT DIAGNOSIS

POWER SUPPLY AND GROUND CIRCUIT

BCM

BCM : Diagnosis Procedure

INFOID:000000006485688

1. CHECK FUSES AND FUSIBLE LINK

Check that the following fuses and fusible link are not fusing.

Signal name	Fuses and fusible link No.
Battery power supply	10
	J
ACC power supply	20
Ignition power supply	1

Is the fuse fusing?

YES >> Replace the blown fuse or fusible link after repairing the affected circuit if a fuse or fusible link is blown.

NO >> GO TO 2.

2. CHECK POWER SUPPLY CIRCUIT

1. Turn the ignition switch OFF.
2. Disconnect BCM connectors.
3. Check voltage between BCM harness connector and the ground.

Terminals		(-)	Ignition switch position		
(+)			OFF	ACC	ON
BCM					
Connector	Terminal				
M67	70	Ground	Battery voltage	Battery voltage	Battery voltage
	57		Battery voltage	Battery voltage	Battery voltage
M65	11		Approx. 0 V	Battery voltage	Battery voltage
	38		Approx. 0 V	Approx. 0 V	Battery voltage

Is the measurement value normal?

YES >> GO TO 3.

NO >> Repair the harness or connector.

3. CHECK GROUND CIRCUIT

Check continuity between BCM harness connector and the ground.

BCM		Ground	Continuity
Connector	Terminal		
M67	67		Existed

Does continuity exist?

YES >> INSPECTION END

NO >> Repair the harness or connector.

POWER WINDOW MAIN SWITCH

POWER SUPPLY AND GROUND CIRCUIT

< DTC/CIRCUIT DIAGNOSIS >

POWER WINDOW MAIN SWITCH : Diagnosis Procedure

INFOID:000000006199659

1. CHECK POWER SUPPLY CIRCUIT

1. Turn ignition OFF.
2. Disconnect power window main switch connector.
3. Turn ignition switch ON.
4. Check voltage between power window main switch harness connector and ground.

(+)		(-)	Voltage (V) (Approx.)
Power window main switch			
Connector	Terminal	Ground	Battery voltage
D5	10		
D6	19*		

*: With ANTI-PINCH SYSTEM

Is the inspection result normal?

- YES >> GO TO 2.
NO >> GO TO 3.

2. CHECK GROUND CIRCUIT

1. Turn ignition switch OFF.
2. Check continuity between power window main switch harness connector and ground.

Power window main switch		Ground	Continuity
Connector	Terminal		
D6	17		Existed

Is the inspection result normal?

- YES >> INSPECTION END
NO >> Repair or replace harness.

3. CHECK HARNESS CONTINUITY

1. Turn ignition switch OFF.
2. Disconnect BCM connector.
3. Check continuity between BCM harness connector and power window main switch harness connector.

PWC

BCM		Power window main switch		Continuity
Connector	Terminal	Connector	Terminal	
M67	68	D5	10	Existed
	69*	D6	19*	

*: With ANTI-PINCH SYSTEM

4. Check continuity between BCM harness connector and ground.

BCM		Ground	Continuity
Connector	Terminal		
M67	68		Not existed
	69*		

*: With ANTI-PINCH SYSTEM

Is the inspection result normal?

- YES >> Replace BCM. Refer to [BCS-66, "Removal and Installation"](#).
NO >> Repair or replace harness.

FRONT POWER WINDOW SWITCH (PASSENGER SIDE)

POWER SUPPLY AND GROUND CIRCUIT

< DTC/CIRCUIT DIAGNOSIS >

FRONT POWER WINDOW SWITCH (PASSENGER SIDE) : Diagnosis Procedure

INFOID:000000006199660

1. CHECK POWER SUPPLY CIRCUIT

1. Turn ignition switch OFF.
2. Disconnect front power window switch (passenger side) connector.
3. Turn ignition switch ON.
4. Check voltage between front power window switch (passenger side) harness connector and ground.

(+)		(-)	Condition	Voltage (V) (Approx.)
Front power window switch (passenger side)				
Connector	Terminal			
D45	8	Ground	Ignition switch ON	Battery voltage

Is the inspection result normal?

YES >> INSPECTION END

NO >> GO TO 2.

2. CHECK HARNESS CONTINUITY

1. Turn ignition switch OFF.
2. Disconnect BCM connector.
3. Check continuity between BCM harness connector and front power window switch (passenger side) harness connector.

BCM		Front power window switch (passenger side)		Continuity
Connector	Terminal	Connector	Terminal	
M67	68	D45	8	Existed

4. Check continuity between BCM harness connector and ground.

BCM		Ground	Continuity
Connector	Terminal		
M67	68		Not existed

Is the inspection result normal?

YES >> Replace BCM. Refer to [BCS-66, "Removal and Installation"](#).

NO >> Repair or replace harness.

REAR POWER WINDOW SWITCH

REAR POWER WINDOW SWITCH : Diagnosis Procedure

INFOID:000000006199661

1. CHECK POWER SUPPLY CIRCUIT

1. Turn ignition switch OFF.
2. Disconnect rear power window switch connector.
3. Turn ignition switch ON.
4. Check voltage between rear power window switch harness connector and ground.

(+)		(-)	Condition	Voltage (V) (Approx.)
Rear power window switch				
Connector	Terminal			
LH	D83	Ground	Ignition switch ON	Battery voltage
RH	D103			

Is the inspection result normal?

YES >> INSPECTION END

NO >> GO TO 2.

POWER SUPPLY AND GROUND CIRCUIT

< DTC/CIRCUIT DIAGNOSIS >

2. CHECK HARNESS CONTINUITY

1. Turn ignition switch OFF.
2. Disconnect BCM connector.
3. Check continuity between BCM harness connector and rear power window switch harness connector.

BCM		Rear power window switch		Continuity
Connector	Terminal	Connector	Terminal	
M67	68	LH	D83	Existed
		RH	D103	

4. Check continuity between BCM harness connector and ground.

BCM		Ground	Continuity
Connector	Terminal		
M67	68		Not existed

Is the inspection result normal?

- YES >> Replace BCM. Refer to [BCS-66. "Removal and Installation"](#).
 NO >> Repair or replace harness.

A
B
C
D
E
F
G
H
I
J
L
M
N
O
P

PWC

FRONT POWER WINDOW SWITCH (PASSENGER SIDE)

< DTC/CIRCUIT DIAGNOSIS >

FRONT POWER WINDOW SWITCH (PASSENGER SIDE)

Description

INFOID:000000006199662

Front power window motor (passenger side) will be operated if front power window switch (passenger side) is operated.

Component Function Check

INFOID:000000006199663

1. CHECK FRONT POWER WINDOW SWITCH (PASSENGER SIDE) FUNCTION

Check front power window motor (passenger side) operation with front power window switch (passenger side).

Is the inspection result normal?

YES >> Front power window switch (passenger side) is OK.

NO >> Refer to [PWC-16. "Diagnosis Procedure"](#).

Diagnosis Procedure

INFOID:000000006199664

1. CHECK FRONT POWER WINDOW SWITCH (PASSENGER SIDE) INPUT SIGNAL

1. Turn ignition switch OFF.
2. Disconnect front power window switch (passenger side) connector.
3. Turn ignition switch ON.
4. Check voltage between front power window switch (passenger side) harness connector and ground.

(+)		(-)	Condition	Voltage (V) (Approx.)
Front power window switch (passenger side)				
Connector	Terminal			
D45	12	Ground	UP	Battery voltage
			DOWN	0
	11		UP	0
			DOWN	Battery voltage

Is the inspection result normal?

YES >> GO TO 2.

NO >> GO TO 3.

2. CHECK FRONT POWER WINDOW SWITCH (PASSENGER SIDE)

Check front power window switch (passenger side).

Refer to [PWC-17. "Component Inspection"](#).

Is the inspection result normal?

YES >> GO TO 4.

NO >> Replace front power window switch (passenger side). Refer to [PWC-82. "Removal and Installation"](#).

3. CHECK FRONT WINDOW SWITCH (PASSENGER SIDE) CIRCUIT

1. Turn ignition switch OFF.
2. Disconnect power window main switch connector.
3. Check continuity between power window main switch harness connector and front power window switch (passenger side) harness connector.

Power window main switch		Front power window switch (passenger side)		Continuity
Connector	Terminal	Connector	Terminal	
D5	16	D45	12	Existed
	12		11	

4. Check continuity between power window main switch harness connector and ground.

FRONT POWER WINDOW SWITCH (PASSENGER SIDE)

< DTC/CIRCUIT DIAGNOSIS >

Power window main switch		Ground	Continuity
Connector	Terminal		
D5	16		Not existed
	12		

Is the inspection result normal?

YES >> Replace power window main switch.

NO >> Repair or replace harness.

4.CHECK INTERMITTENT INCIDENT

Refer to [GI-45. "Intermittent Incident"](#).

>> INSPECTION END

Component Inspection

INFOID:000000006199665

1.CHECK FRONT POWER WINDOW SWITCH (PASSENGER SIDE)

1. Turn ignition OFF.
2. Disconnect front power window switch (passenger side) connector.
3. Check front power window switch (passenger side).

Front power window switch (passenger side)	Terminal		Front power window switch condition	Continuity
D45	8	7	UP	Existed
	11	6		
	11	6	NEUTRAL	
	12	7		
	8	6	DOWN	
	12	7		

Is the inspection result normal?

YES >> INSPECTION END

NO >> Replace front power window switch (passenger side). Refer to [PWC-82. "Removal and Installation"](#).

PWC

REAR POWER WINDOW SWITCH

< DTC/CIRCUIT DIAGNOSIS >

REAR POWER WINDOW SWITCH

Description

INFOID:000000006199666

Rear power window motor will be operated if rear power window switch is operated.

Component Function Check

INFOID:000000006199667

1. CHECK REAR POWER WINDOW SWITCH FUNCTION

Check rear power window motor operation with rear power window switch.

Is the inspection result normal?

- YES >> Rear power window switch is OK.
- NO >> Refer to [PWC-18, "Diagnosis Procedure"](#).

Diagnosis Procedure

INFOID:000000006199668

1. CHECK REAR POWER WINDOW SWITCH INPUT SIGNAL

1. Turn ignition switch OFF.
2. Disconnect rear power window switch connector.
3. Turn ignition switch ON.
4. Check voltage between rear power window switch harness connector and ground.

(+)		(-)	Condition	Voltage (V) (Approx.)	
Connector	Terminal				
LH: D83	2	Ground	Power window main switch: LH	UP	Battery voltage
			DOWN	0	
	3		UP	0	
			DOWN	Battery voltage	
RH: D103	2		Power window main switch: RH	UP	Battery voltage
				DOWN	0
	3			UP	0
				DOWN	Battery voltage

Is the inspection result normal?

- YES >> GO TO 2.
- NO >> GO TO 3.

2. CHECK REAR POWER WINDOW SWITCH

Check rear power window switch.

Refer to [PWC-19, "Component Inspection"](#).

Is the inspection result normal?

- YES >> GO TO 4.
- NO >> Replace rear power window switch. Refer to [PWC-82, "Removal and Installation"](#).

3. CHECK REAR POWER WINDOW SWITCH CIRCUIT

1. Turn ignition switch OFF.
2. Disconnect power window main switch connector.
3. Check continuity between power window main switch harness connector and rear power window switch harness connector.

REAR POWER WINDOW SWITCH

< DTC/CIRCUIT DIAGNOSIS >

Power window main switch		Rear power window switch			Continuity
Connector	Terminal	Connector		Terminal	
D5	1	LH	D83	2	Existed
	3			3	
	5	RH	D103	3	
	7			2	

4. Check continuity between power window main switch harness connector and ground.

Power window main switch		Ground	Continuity
Connector	Terminal		
D5	1	Ground	Not existed
	3		
	5		
	7		

Is the inspection result normal?

YES >> Replace power window main switch. Refer to [PWC-82, "Removal and Installation"](#).

NO >> Repair or replace harness.

4. CHECK INTERMITTENT INCIDENT

Refer to [GI-45, "Intermittent Incident"](#).

>> INSPECTION END

Component Inspection

INFOID:000000006199669

1. CHECK REAR POWER WINDOW SWITCH

- Turn ignition switch OFF.
- Disconnect rear power window switch connector.
- Check rear power window switch.

Rear power window switch	Terminal		Rear power window switch condition	Continuity
LH:D83 RH:D103	1	5	UP	Existed
	3	4		
	3	4	NEUTRAL	
	2	5		
	1	4	DOWN	
	2	5		

Is the inspection result normal?

YES >> INSPECTION END

NO >> Replace rear power window switch. Refer to [PWC-82, "Removal and Installation"](#).

PWC

A
B
C
D
E
F
G
H
I
J
L
M
N
O
P

POWER WINDOW MOTOR

< DTC/CIRCUIT DIAGNOSIS >

POWER WINDOW MOTOR DRIVER SIDE

DRIVER SIDE : Description

INFOID:000000006199670

Door glass moves UP/DOWN by receiving the signal from power window main switch.

DRIVER SIDE : Component Function Check

INFOID:000000006199671

1. CHECK FRONT POWER WINDOW MOTOR (DRIVER SIDE) OPERATION

Check front power window motor (driver side) operation with power window main switch.

Is the inspection result normal?

- YES >> Front power window motor (driver side) is OK.
 NO >> Refer to [PWC-20. "DRIVER SIDE : Diagnosis Procedure"](#).

DRIVER SIDE : Diagnosis Procedure

INFOID:000000006199672

1. CHECK POWER WINDOW MOTOR (DRIVER SIDE) INPUT SIGNAL

1. Turn ignition switch OFF.
2. Disconnect front power window motor (driver side) connector.
3. Turn ignition switch ON.
4. Check voltage between power window motor (driver side) harness connector and ground.

(+)		(-)	Condition	Voltage (V) (Approx.)
Connector	Terminal			
D7	1	Ground	UP	Battery voltage
			DOWN	0
	2		UP	0
			DOWN	Battery voltage

Is the inspection result normal?

- YES >> GO TO 3.
 NO >> GO TO 2.

2. CHECK POWER WINDOW MOTOR CIRCUIT

1. Turn ignition switch OFF.
2. Disconnect power window main switch connector.
3. Check continuity between power window main switch harness connector and front power window motor (driver side) harness connector.

Power window main switch		Front power window motor (driver side)		Continuity
Connector	Terminal	Connector	Terminal	
D5	8	D7	2	Existed
	11		1	

4. Check continuity between power window main switch harness connector and ground.

Power window main switch		Ground	Continuity
Connector	Terminal		
D5	8		Not existed
	11		

Is the inspection result normal?

- YES >> Replace power window main switch. Refer to [PWC-82. "Removal and Installation"](#).
 NO >> Repair or replace harness.

POWER WINDOW MOTOR

< DTC/CIRCUIT DIAGNOSIS >

3. CHECK FRONT POWER WINDOW MOTOR (DRIVER SIDE)

Check front power window motor (driver side).

Refer to [PWC-21, "DRIVER SIDE : Component Inspection"](#).

Is the inspection result normal?

YES >> GO TO 4.

NO >> Replace power window motor (driver side). Refer to [GW-23, "Removal and Installation"](#).

4. CHECK INTERMITTENT INCIDENT

Refer to [GI-45, "Intermittent Incident"](#).

>> INSPECTION END

DRIVER SIDE : Component Inspection

INFOID:000000006199673

1. CHECK FRONT POWER WINDOW MOTOR (DRIVER SIDE)

1. Turn ignition switch OFF.
2. Disconnect front power window motor (driver side) connector.
3. Check motor operate by connecting the battery voltage directly to front power window motor (driver side) connector.

Front power window motor (driver side) connector	Terminal		Motor condition
	(+)	(-)	
D7	1	2	DOWN
	2	1	UP

Is the inspection result normal?

YES >> INSPECTION END

NO >> Replace front power window motor (driver side). Refer to [GW-23, "Removal and Installation"](#).

PASSENGER SIDE

PASSENGER SIDE : Description

INFOID:000000006199674

Door glass moves UP/DOWN by receiving the signal from power window main switch or front power window switch (passenger side).

PASSENGER SIDE : Component Function Check

INFOID:000000006199675

1. CHECK FRONT POWER WINDOW MOTOR (PASSENGER SIDE) OPERATION

Check front power window motor (passenger side) operation with power window main switch or front power window switch (passenger side).

Is the inspection result normal?

YES >> Power window motor (passenger side) is OK.

NO >> Refer to [PWC-21, "PASSENGER SIDE : Diagnosis Procedure"](#).

PASSENGER SIDE : Diagnosis Procedure

INFOID:000000006199676

1. CHECK FRONT POWER WINDOW MOTOR (PASSENGER SIDE) INPUT SIGNAL

1. Turn ignition switch OFF.
2. Disconnect front power window motor (passenger side) connector.
3. Turn ignition switch ON.
4. Check voltage between front power window motor (passenger side) harness connector and ground.

A
B
C
D
E
F
G
H
I
J
L
M
N
O
P

PWC

POWER WINDOW MOTOR

< DTC/CIRCUIT DIAGNOSIS >

(+)		(-)	Condition	Voltage (V) (Approx.)
Front power window motor (passenger side)				
Connector	Terminal			
D46	2	Ground	UP	Battery voltage
			DOWN	0
	1		UP	0
			DOWN	Battery voltage

Is the inspection result normal?

YES >> GO TO 3.

NO >> GO TO 2.

2. CHECK FRONT POWER WINDOW MOTOR (PASSENGER SIDE) CIRCUIT

- Turn ignition switch OFF.
- Disconnect front power window switch (passenger side) connector.
- Check continuity between front power window switch (passenger side) harness connector and front power window motor (passenger side) harness connector.

Front power window switch (passenger side)		Front power window motor (passenger side)		Continuity
Connector	Terminal	Connector	Terminal	
D45	6	D46	1	Existed
	7		2	

- Check continuity between front power window switch (passenger side) harness connector and ground.

Front power window switch (passenger side)		Ground	Continuity
Connector	Terminal		
D45	6		Not existed
	7		

Is the inspection result normal?

YES >> Replace front power window switch (passenger side). [PWC-82. "Removal and Installation"](#).

NO >> Repair or replace harness.

3. CHECK FRONT POWER WINDOW MOTOR (PASSENGER SIDE)

Check front power window motor (passenger side).

Refer to [PWC-22. "PASSENGER SIDE : Component Inspection"](#).

Is the inspection result normal?

YES >> GO TO 4.

NO >> Replace front power window motor (passenger side). Refer to [GW-23. "Removal and Installation"](#).

4. CHECK INTERMITTENT INCIDENT

Refer to [GI-45. "Intermittent Incident"](#).

>> INSPECTION END

PASSENGER SIDE : Component Inspection

INFOID:000000006199677

1. CHECK FRONT POWER WINDOW MOTOR (PASSENGER SIDE)

- Turn ignition switch OFF.
- Disconnect front power window motor (passenger side) connector.
- Check motor operate by connecting the battery voltage directly to front power window motor (passenger side) connector.

POWER WINDOW MOTOR

< DTC/CIRCUIT DIAGNOSIS >

Front power window motor (passenger side) connector	Terminal		Motor condition
	(+)	(-)	
D46	1	2	DOWN
	2	1	UP

Is the inspection result normal?

YES >> INSPECTION END

NO >> Replace front power window motor (passenger side). Refer to [GW-23, "Removal and Installation"](#).

REAR LH

REAR LH : Description

INFOID:000000006199678

Door glass moves UP/DOWN by receiving the signal from power window main switch or rear power window switch LH.

REAR LH : Component Function Check

INFOID:000000006199679

1.CHECK REAR POWER WINDOW MOTOR LH OPERATION

Check rear power window motor LH operation with power window main switch or rear power window switch LH.

Is the inspection result normal?

YES >> Rear power window motor LH is OK.

NO >> Refer to [PWC-23, "REAR LH : Diagnosis Procedure"](#)

REAR LH : Diagnosis Procedure

INFOID:000000006199680

1.CHECK REAR POWER WINDOW MOTOR LH INPUT SIGNAL

1. Turn ignition switch OFF.
2. Disconnect rear power window motor LH connector.
3. Turn ignition switch ON.
4. Check voltage between rear power window motor LH harness connector and ground.

(+) Rear power window motor LH Connector		Terminal	(-) Ground	Condition	Voltage (V) (Approx.)
D82	1				
		DOWN	0		
	3	UP	0		
		DOWN	Battery voltage		

Is the inspection result normal?

YES >> GO TO 3.

NO >> GO TO 2.

2.CHECK REAR POWER WINDOW MOTOR LH CIRCUIT

1. Turn ignition switch OFF.
2. Disconnect rear power window switch LH connector.
3. Check continuity between rear power window switch LH harness connector and rear power window motor LH harness connector.

Rear power window switch LH Connector		Terminal	Rear power window motor LH Connector		Continuity
Connector	Terminal		Connector	Terminal	
D83	4	D82	3	Existed	
	5		1		

4. Check continuity between rear power window switch LH connector and ground.

POWER WINDOW MOTOR

< DTC/CIRCUIT DIAGNOSIS >

Rear power window switch LH		Ground	Continuity
Connector	Terminal		
D83	4		
	5		
			Not existed

Is the inspection result normal?

- YES >> Replace rear power window switch LH. Refer to [PWC-82, "Removal and Installation"](#).
NO >> Repair or replace harness.

3. CHECK REAR POWER WINDOW MOTOR LH

Check rear power window motor LH.

Refer to [PWC-24, "REAR LH : Component Inspection"](#).

Is the inspection result normal?

- YES >> GO TO 4.
NO >> Replace rear power window motor LH. Refer to [GW-28, "Removal and Installation"](#).

4. CHECK INTERMITTENT INCIDENT

Refer to [GI-45, "Intermittent Incident"](#).

>> INSPECTION END

REAR LH : Component Inspection

INFOID:000000006199681

COMPONENT INSPECTION

1. CHECK REAR POWER WINDOW MOTOR LH

1. Turn ignition switch OFF.
2. Disconnect rear power window motor LH connector.
3. Check motor operate by connecting the battery voltage directly to rear power window motor LH connector.

Rear power window motor LH connector	Terminal		Motor condition
	(+)	(-)	
D82	3	1	DOWN
	1	3	UP

Is the inspection result normal?

- YES >> INSPECTION END
NO >> Replace rear power window motor LH. Refer to [GW-28, "Removal and Installation"](#).

REAR RH

REAR RH : Description

INFOID:000000006199682

Door glass moves UP/DOWN by receiving the signal from power window main switch or rear power window switch RH.

REAR RH : Component Function Check

INFOID:000000006199683

1. CHECK REAR POWER WINDOW MOTOR RH OPERATION

Check rear power window motor RH operation with power window main switch or rear power window switch RH.

Is the inspection result normal?

- YES >> Rear power window motor RH is OK.
NO >> Refer to [PWC-25, "REAR RH : Diagnosis Procedure"](#).

POWER WINDOW MOTOR

< DTC/CIRCUIT DIAGNOSIS >

REAR RH : Diagnosis Procedure

INFOID:000000006199684

1. CHECK REAR POWER WINDOW MOTOR RH INPUT SIGNAL

1. Turn ignition switch OFF.
2. Disconnect rear power window motor RH connector.
3. Turn ignition switch ON.
4. Check voltage between rear power window motor RH harness connector and ground.

(+)		(-)	Condition	Voltage (V) (Approx.)
Connector	Terminal			
D102	1	Ground	UP	Battery voltage
			DOWN	0
	3		UP	0
			DOWN	Battery voltage

Is the inspection result normal?

- YES >> GO TO 3.
NO >> GO TO 2.

2. CHECK REAR POWER WINDOW MOTOR RH CIRCUIT

1. Turn ignition switch OFF.
2. Disconnect rear power window switch RH connector.
3. Check continuity between rear power window switch RH harness connector and rear power window motor RH harness connector.

Rear power window switch RH		Rear power window motor RH		Continuity
Connector	Terminal	Connector	Terminal	
D103	4	D102	3	Existed
	5		1	

4. Check continuity between rear power window switch RH harness connector and ground.

Rear power window switch RH		Ground	Continuity
Connector	Terminal		
D103	4		Not existed
	5		

Is the inspection result normal?

- YES >> Replace rear power window switch RH. Refer to [PWC-82, "Removal and Installation"](#).
NO >> Repair or replace harness.

3. CHECK REAR POWER WINDOW MOTOR RH

Check rear power window motor RH.
Refer to [PWC-26, "REAR RH : Component Inspection"](#).

Is the inspection result normal?

- YES >> GO TO 4.
NO >> Replace rear power window motor RH. Refer to [GW-28, "Removal and Installation"](#).

4. CHECK INTERMITTENT INCIDENT

Refer to [GI-45, "Intermittent Incident"](#).

>> INSPECTION END

A
B
C
D
E
F
G
H
I
J

PWC

L
M
N
O
P

POWER WINDOW MOTOR

< DTC/CIRCUIT DIAGNOSIS >

REAR RH : Component Inspection

INFOID:000000006199685

COMPONENT INSPECTION

1. CHECK REAR POWER WINDOW MOTOR RH

1. Turn ignition switch OFF.
2. Disconnect rear power window motor RH connector.
3. Check motor operation by connecting the battery voltage directly to rear power window motor RH connector.

Rear power window motor RH connector	Terminal		Motor condition
	(+)	(-)	
D102	3	1	DOWN
	1	3	UP

Is the inspection result normal?

YES >> INSPECTION END

NO >> Replace rear power window motor RH. Refer to [GW-28. "Removal and Installation"](#).

DOOR SWITCH

< DTC/CIRCUIT DIAGNOSIS >

DOOR SWITCH

Description

INFOID:000000006199686

Detects door open/closed condition.

Component Function Check

INFOID:000000006199687

1.CHECK FUNCTION

With CONSULT-III

Check door switches("DOOR SW-DR", "DOOR SW-AS", "DOOR SW-RL", "DOOR SW-RR", "BACK DOOR SW") in "Data Monitor" mode with CONSULT-III.

Monitor item	Door condition	Display
DOOR SW-DR	CLOSE → OPEN	OFF → ON
DOOR SW-AS		
DOOR SW-RL		
DOOR SW-RR		
BACK DOOR		

Is the inspection result normal?

YES >> Door switch is OK.

NO >> Refer to [PWC-27, "Diagnosis Procedure"](#).

Diagnosis Procedure

INFOID:000000006199688

1.CHECK DOOR SWITCH INPUT SIGNAL

1. Turn ignition switch OFF.
2. Disconnect door switch connector.
3. Check signal between door switch harness connector and ground with oscilloscope.

PWC

DOOR SWITCH

< DTC/CIRCUIT DIAGNOSIS >

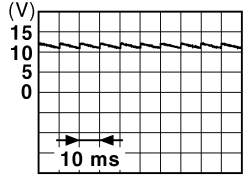
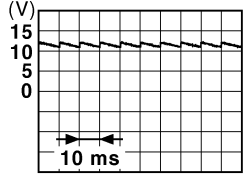
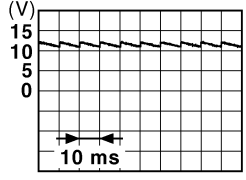
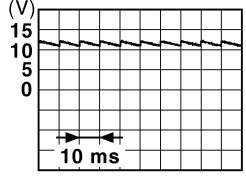
Door switch			(-)	Voltage (V) (Approx.)
(+)		Terminal		
connector				
Front door switch (passenger side)	B27	2	Ground	 <p style="text-align: right; font-size: small;">JPMIA0011GB</p>
Front door switch (driver side)	B34	2		 <p style="text-align: right; font-size: small;">JPMIA0011GB</p>
Rear door switch RH	B53	2		 <p style="text-align: right; font-size: small;">JPMIA0011GB</p>
Rear door switch LH	B71	2		 <p style="text-align: right; font-size: small;">JPMIA0011GB</p>
Back door lock assembly (back door switch)	D190	3		Battery voltage

Is the inspection result normal?

YES >> GO TO 3.

NO >> GO TO 2.

2. CHECK DOOR SWITCH CIRCUIT

1. Disconnect BCM connector .
2. Check continuity between BCM harness connector and door switch harness connector.

BCM		Door switch		Continuity
connector	Terminal	connector	Terminal	
M65	12	B27	2	Exists
	13	B53		
M66	43	D190	3	
	47	B34	2	
	48	B71		

3. Check continuity between BCM harness connector and ground.

DOOR SWITCH

< DTC/CIRCUIT DIAGNOSIS >

BCM connector	Terminal	Ground	Continuity	
M65	12		Ground	Does not exist
	13			
M66	43			
	47			
	48			

Is the inspection result normal?

YES >> Replace BCM. Refer to [BCS-66, "Removal and Installation"](#).

NO >> Repair or replace harness.

3.CHECK DOOR SWITCH

Check door switch.

Refer to [PWC-29, "Component Inspection"](#).

Is the inspection result normal?

YES >> GO TO 4.

NO >> Replace door switch. Refer to [DLK-265, "Removal and Installation"](#).

4.CHECK INTERMITTENT INCIDENT

Refer to [GI-45, "Intermittent Incident"](#).

>> INSPECTION END

Component Inspection

INFOID:000000006199689

1.CHECK DOOR SWITCH

1. Turn ignition switch OFF.
2. Disconnect door switch connector.
3. Check door switch .

Terminal		Ground	Condition	Continuity
Each door	2		Ground	Door switch pressed
		Door switch released		Does not exist
Back door	3	4	Back door open	Exists
			Back door close	Does not exist

Is the inspection result normal?

YES >> Door switch is OK.

NO >> Replace Door switch . Refer to [DLK-265, "Removal and Installation"](#).

PWC

ENCODER CIRCUIT

< DTC/CIRCUIT DIAGNOSIS >

ENCODER CIRCUIT

Description

INFOID:000000006199690

Detects condition of the front power window motor (driver side) operation and transmits to power window main switch as pulse signal.

Component Function Check

INFOID:000000006199691

1.CHECK ENCODER OPERATION

Check front driver side door glass perform AUTO open/close operation normally when power window main switch.

Is the inspection result normal?

- YES >> Encoder operation is OK.
- NO >> Refer to [PWC-30. "Diagnosis Procedure"](#)

Diagnosis Procedure

INFOID:000000006199692

Encoder Circuit Check

1.CHECK ENCODER OPERATION

1. Turn ignition switch ON.
2. Check signal between power window main switch harness connector and ground with oscilloscope.

(+)		(-)	Signal (Reference value)
Power window main switch			
Connector	Terminal	Ground	Refer to following signal
D5	9		
	13		

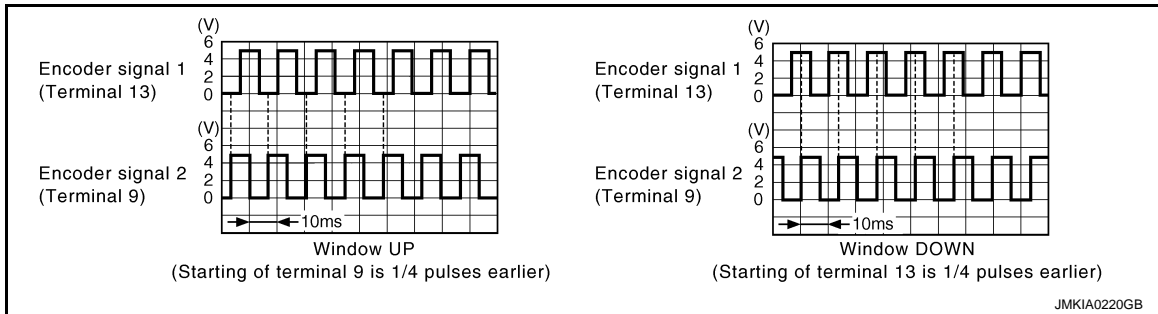

Is the inspection result normal?

- YES >> GO TO 7.
- NO >> GO TO 2.

2.CHECK ENCODER SIGNAL CIRCUIT

1. Turn ignition switch OFF.
2. Disconnect power window main switch connector and front power window motor (driver side) connector.
3. Check continuity between power window main switch harness connector and front power window motor (driver side) harness connector.

Power window main switch		Front power window motor (driver side)		Continuity
Connector	Terminal	Connector	Terminal	
D5	9	D7	3	Existed
	13		5	

4. Check continuity between power window main switch harness connector and ground.

ENCODER CIRCUIT

< DTC/CIRCUIT DIAGNOSIS >

Power window main switch		Ground	Continuity
Connector	Terminal		Not existed
D5	9		
	13		

Is the inspection result normal?

YES >> GO TO 3.

NO >> Repair or replace harness.

3.CHECK ENCODER POWER SUPPLY CIRCUIT

1. Connect power window main switch connector.
2. Turn ignition switch ON.
3. Check voltage between front power window motor (driver side) harness connector and ground.

(+)		(-)	Voltage (V) (Approx.)
Front power window motor (driver side)			
Connector	Terminal		
D7	4	Ground	Battery voltage

Is the inspection result normal?

YES >> GO TO 4.

NO >> GO TO 5.

4.CHECK GROUND CIRCUIT

1. Turn ignition switch OFF.
2. Check continuity between front power window motor (driver side) harness connector and ground.

Front power window motor (driver side)		Ground	Continuity
Connector	Terminal		Existed
D7	6		

Is the inspection result normal?

YES >> GO TO 7.

NO >> GO TO 6.

5.CHECK HARNESS CONTINUITY 1

1. Turn ignition switch OFF.
2. Check continuity between power window main switch harness connector and front power window motor (driver side) harness connector.

Power window main switch		Front power window motor (driver side)		Continuity
Connector	Terminal	Connector	Terminal	
D5	15	D7	4	

3. Check continuity between power window main switch harness connector and ground.

Power window main switch		Ground	Continuity
Connector	Terminal		Not existed
D5	15		

Is the inspection result normal?

YES >> Replace power window main switch. Refer to [PWC-82, "Removal and Installation"](#).

NO >> Repair or replace harness.

6.CHECK HARNESS CONTINUITY 2

1. Disconnect power window main switch connector.

A
B
C
D
E
F
G
H
I
J
L
M
N
O
P

PWC

ENCODER CIRCUIT

< DTC/CIRCUIT DIAGNOSIS >

2. Check continuity between power window main switch harness connector and front power window motor (driver side) harness connector.

Power window main switch		Front power window motor (driver side)		Continuity
Connector	Terminal	Connector	Terminal	
D5	2	D7	6	Existed

Is the inspection result normal?

- YES >> Replace power window main switch. Refer to [PWC-82, "Removal and Installation"](#).
NO >> Repair or replace harness.

7. CHECK INTERMITTENT INCIDENT

Refer to [GI-45, "Intermittent Incident"](#).

>> INSPECTION END

BCM (BODY CONTROL MODULE)

< ECU DIAGNOSIS INFORMATION >

ECU DIAGNOSIS INFORMATION

BCM (BODY CONTROL MODULE)

Reference Value

INFOID:000000006484207

VALUES ON THE DIAGNOSIS TOOL

Monitor Item	Condition	Value/Status
IGN ON SW	Ignition switch OFF or ACC	Off
	Ignition switch ON	On
KEY ON SW	Mechanical key is removed from key cylinder	Off
	Mechanical key is inserted to key cylinder	On
CDL LOCK SW	Door lock/unlock switch does not operate	Off
	Press door lock/unlock switch to the lock side	On
CDL UNLOCK SW	Door lock/unlock switch does not operate	Off
	Press door lock/unlock switch to the unlock side	On
DOOR SW-DR	Driver's door closed	Off
	Driver's door opened	On
DOOR SW-AS	Passenger door closed	Off
	Passenger door opened	On
DOOR SW-RR	Rear RH door closed	Off
	Rear RH door opened	On
DOOR SW-RL	Rear LH door closed	Off
	Rear LH door opened	On
BACK DOOR SW	Back door closed	Off
	Back door opened	On
KEY CYL LK-SW	Other than driver door key cylinder LOCK position	Off
	Driver door key cylinder LOCK position	On
KEY CYL UN-SW	Other than driver door key cylinder UNLOCK position	Off
	Driver door key cylinder UNLOCK position	On
KEYLESS LOCK	"LOCK" button of key fob is not pressed	Off
	"LOCK" button of key fob is pressed	On
KEYLESS UNLOCK	"UNLOCK" button of key fob is not pressed	Off
	"UNLOCK" button of key fob is pressed	On
I-KEY LOCK	"LOCK" button of Intelligent Key or door request switch are not pressed	Off
	"LOCK" button of Intelligent Key or door request switch are pressed	On
I-KEY UNLOCK	"UNLOCK" button of Intelligent Key or door request switch are not pressed	Off
	"UNLOCK" button of Intelligent Key or door request switch are pressed	On
ACC ON SW	Ignition switch OFF	Off
	Ignition switch ACC or ON	On
REAR DEF SW	Rear window defogger switch OFF	Off
	Rear window defogger switch ON	On
LIGHT SW 1ST	Lighting switch OFF	Off
	Lighting switch 1ST	On

A
B
C
D
E
F
G
H
I
J
L
M
N
O
P

PWC

BCM (BODY CONTROL MODULE)

< ECU DIAGNOSIS INFORMATION >

Monitor Item	Condition	Value/Status
BUCKLE SW	The seat belt (driver side) is unfastened. [Seat belt switch (driver side) OFF]	Off
	The seat belt (driver side) is fastened. [Seat belt switch (driver side) ON]	On
KEYLESS PANIC	PANIC button of key fob is not pressed	Off
	PANIC button of key fob is pressed	On
KEYLESS TRUNK	NOTE: The item is indicated, but not monitored.	Off
TRNK OPN MNTR	NOTE: The item is indicated, but not monitored.	Off
RKE LCK-UNLCK	LOCK/UNLOCK button of key fob is not pressed and held simultaneously	Off
	LOCK/UNLOCK button of key fob is pressed and held simultaneously	On
RKE KEEP UNLK	UNLOCK button of key fob is not pressed	Off
	UNLOCK button of key fob is pressed and held	On
HI BEAM SW	Lighting switch OFF	Off
	Lighting switch HI	On
HEAD LAMP SW 1	Lighting switch OFF	Off
	Lighting switch 2ND	On
HEAD LAMP SW 2	Lighting switch OFF	Off
	Lighting switch 2ND	On
AUTO LIGHT SW	Other than lighting switch AUTO	Off
	Lighting switch AUTO	On
PASSING SW	Other than lighting switch PASS	Off
	Lighting switch PASS	On
FR FOG SW	Front fog lamp switch OFF	Off
	Front fog lamp switch ON	On
RR FOG SW	NOTE: The item is indicated, but not monitored.	Off
TURN SIGNAL R	Turn signal switch OFF	Off
	Turn signal switch RH	On
TURN SIGNAL L	Turn signal switch OFF	Off
	Turn signal switch LH	On
ENGINE RUN	Engine stopped	Off
	Engine running	On
PKB SW	Parking brake switch is OFF	Off
	Parking brake switch is ON	On
CARGO LAMP SW	NOTE: The item is indicated, but not monitored.	Off
OPTICAL SENSOR	Bright outside of the vehicle	Close to 5 V
	Dark outside of the vehicle	Close to 0 V
IGN SW CAN	Ignition switch OFF or ACC	Off
	Ignition switch ON	On
FR WIPER HI	Front wiper switch OFF	Off
	Front wiper switch HI	On

BCM (BODY CONTROL MODULE)

< ECU DIAGNOSIS INFORMATION >

Monitor Item	Condition	Value/Status	
FR WIPER LOW	Front wiper switch OFF	Off	A
	Front wiper switch LO	On	
FR WIPER INT	Front wiper switch OFF	Off	B
	Front wiper switch INT	On	
FR WASHER SW	Front washer switch OFF	Off	C
	Front washer switch ON	On	
INT VOLUME	Wiper intermittent dial is in a dial position 1 - 7	1 - 7	
FR WIPER STOP	Any position other than front wiper stop position	Off	D
	Front wiper stop position	On	
VEHICLE SPEED	While driving	Equivalent to speedometer reading	
RR WIPER ON	Rear wiper switch OFF	Off	E
	Rear wiper switch ON	On	
RR WIPER INT	Rear wiper switch OFF	Off	F
	Rear wiper switch INT	On	
RR WASHER SW	Rear washer switch OFF	Off	G
	Rear washer switch ON	On	
RR WIPER STOP	Rear wiper stop position	Off	H
	Other than rear wiper stop position	On	
RR WIPER STP2	NOTE: The item is indicated, but not monitored.	Off	
H/L WASH SW	NOTE: The item is indicated, but not monitored.	Off	I
HAZARD SW	Hazard switch OFF	Off	J
	Hazard switch ON	On	
BRAKE SW	Brake pedal is not depressed	Off	
	Brake pedal is depressed	On	
FAN ON SIG	Blower fan motor switch OFF	Off	PWC
	Blower fan motor switch ON (other than OFF)	On	
AIR COND SW	<ul style="list-style-type: none"> • A/C conditioner OFF (A/C switch indicator OFF) (Automatic air conditioner) • A/C switch OFF (Manual air conditioner) 	Off	L
	<ul style="list-style-type: none"> • A/C conditioner ON (A/C switch indicator ON) (Automatic air conditioner) • A/C switch ON (Manual air conditioner) 	On	M
I-KEY TRUNK	NOTE: The item is indicated, but not monitored.	Off	N
I-KEY PW DWN	UNLOCK button of Intelligent Key is not pressed	Off	
	UNLOCK button of Intelligent Key is pressed and held	On	
I-KEY PANIC	PANIC button of Intelligent Key is not pressed	Off	O
	PANIC button of Intelligent Key is pressed	On	
PUSH SW	Return to ignition switch to "LOCK" position	Off	P
	Press ignition switch	On	
TRNK OPNR SW	When back door opener switch is not pressed	Off	
	When back door opener switch is pressed	On	
TRUNK CYL SW	NOTE: The item is indicated, but not monitored.	Off	

BCM (BODY CONTROL MODULE)

< ECU DIAGNOSIS INFORMATION >

Monitor Item	Condition	Value/Status
HOOD SW	Close the hood NOTE: Vehicles of except for Mexico are OFF-fixed	Off
	Open the hood	On
OIL PRESS SW	<ul style="list-style-type: none"> • Ignition switch OFF or ACC • Engine running 	Off
	Ignition switch ON	On
AIR PRESS FL	Ignition switch ON (Only when the signal from the transmitter is received)	Air pressure of front LH tire
AIR PRESS FR	Ignition switch ON (Only when the signal from the transmitter is received)	Air pressure of front RH tire
AIR PRESS RR	Ignition switch ON (Only when the signal from the transmitter is received)	Air pressure of rear RH tire
AIR PRESS RL	Ignition switch ON (Only when the signal from the transmitter is received)	Air pressure of rear LH tire
ID REGST FL1	ID of front LH tire transmitter is registered	Done
	ID of front LH tire transmitter is not registered	Yet
ID REGST FR1	ID of front RH tire transmitter is registered	Done
	ID of front RH tire transmitter is not registered	Yet
ID REGST RR1	ID of rear RH tire transmitter is registered	Done
	ID of rear RH tire transmitter is not registered	Yet
ID REGST RL1	ID of rear LH tire transmitter is registered	Done
	ID of rear LH tire transmitter is not registered	Yet
WARNING LAMP	Tire pressure indicator OFF	Off
	Tire pressure indicator ON	On
BUZZER	Tire pressure warning alarm is not sounding	Off
	Tire pressure warning alarm is sounding	On

BCM (BODY CONTROL MODULE)

< ECU DIAGNOSIS INFORMATION >

TERMINAL LAYOUT

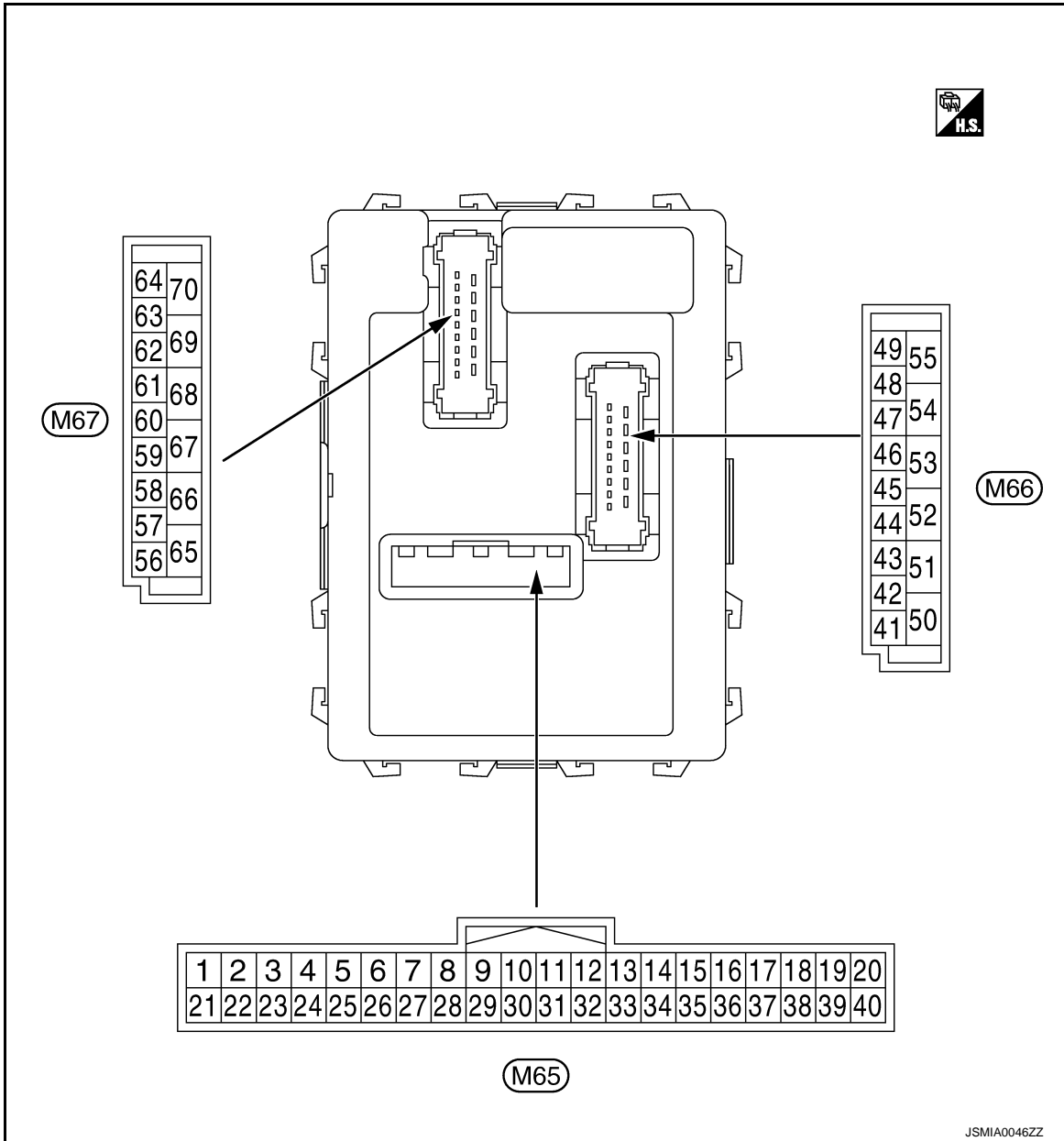

PHYSICAL VALUES

CAUTION:

- Check combination switch system terminal waveform under the loaded condition with lighting switch, turn signal switch and wiper switch OFF is not to be fluctuated by being overloaded.
- Turn wiper intermittent dial position to 4 except when checking waveform or voltage of wiper intermittent dial position. Wiper intermittent dial position can be confirmed on CONSULT-III. Refer to [BCS-27, "COMB SW : CONSULT-III Function \(BCM - COMB SW\)"](#).
- BCM reads the status of the combination switch at 10 ms internal normally. Refer to [BCS-9, "System Diagram"](#).

Terminal No. (Wire color)		Description		Condition		Value (Approx.)
+	-	Signal name	Input/ Output	Ignition key hole illumination	OFF	Battery voltage
1 (V)	Ground	Ignition key hole illumination control	Output		ON	

A
B
C
D
E
F
G
H
I
J
L
M
N
O
P

PWC

JSMIA0046ZZ

BCM (BODY CONTROL MODULE)

< ECU DIAGNOSIS INFORMATION >

Terminal No. (Wire color)		Description		Condition	Value (Approx.)	
+	-	Signal name	Input/ Output			
2 (G)	Ground	Combination switch INPUT 5	Input	Combination switch (Wiper intermit- tent dial 4)	All switch OFF	0 V
					Turn signal switch RH	
					Lighting switch HI	
					Lighting switch 1ST	
					1.0 V	
					2.0 V	
3 (Y)	Ground	Combination switch INPUT 4	Input	Combination switch (Wiper intermit- tent dial 4)	All switch OFF	0 V
					Turn signal switch LH	
					Lighting switch PASS	
					Lighting switch 2ND	
					1.0 V	
					0.8 V	
4 (W)	Ground	Combination switch INPUT 3	Input	Combination switch (Wiper intermit- tent dial 4)	All switch OFF	0 V
					Lighting switch AUTO	
					Front wiper switch LO	
					Front wiper switch MIST	
Front wiper switch INT						
					1.0 V	

BCM (BODY CONTROL MODULE)

< ECU DIAGNOSIS INFORMATION >

Terminal No. (Wire color)		Description		Condition	Value (Approx.)		
+	-	Signal name	Input/ Output				
5 (R)	Ground	Combination switch INPUT 2	Input	Combination switch	All switch OFF (Wiper intermittent dial 4)	0 V	A
					Front washer switch (Wiper intermittent dial 4)		B
					Rear washer ON (Wiper intermittent dial 4)		C
					Any of the condition below with all switch OFF <ul style="list-style-type: none"> • Wiper intermittent dial 1 • Wiper intermittent dial 5 • Wiper intermittent dial 6 		1.0 V
6 (P)	Ground	Combination switch INPUT 1	Input	Combination switch	Rear wiper switch ON (Wiper intermittent dial 4)		E
					0.8 V	F	
					All switch OFF (Wiper intermittent dial 4)	0 V	G
					Front wiper switch HI (Wiper intermittent dial 4)		H
Rear wiper switch INT (Wiper intermittent dial 4)	I						
Wiper intermittent dial 3 (All switch OFF)	1.0 V	J					
6 (P)	Ground	Combination switch INPUT 1	Input	Combination switch	Any of the condition below with all switch OFF <ul style="list-style-type: none"> • Wiper intermittent dial 1 • Wiper intermittent dial 2 		<div style="background-color: black; color: white; padding: 2px; display: inline-block;">PWC</div>
					1.7 V	L	
					Any of the condition below with all switch OFF <ul style="list-style-type: none"> • Wiper intermittent dial 6 • Wiper intermittent dial 7 		M
0.8 V	N						

BCM (BODY CONTROL MODULE)

< ECU DIAGNOSIS INFORMATION >

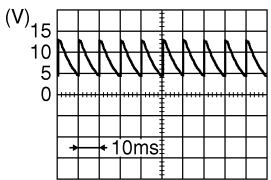
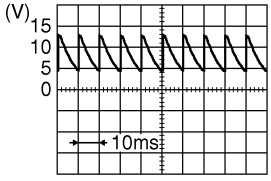
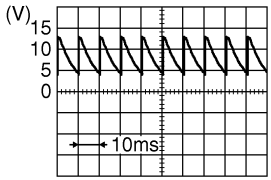
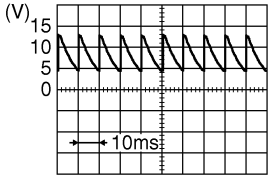
Terminal No. (Wire color)		Description		Condition		Value (Approx.)
+	-	Signal name	Input/ Output			
7 (L)	Ground	Door key cylinder switch UNLOCK signal	Input	Door key cylinder switch	NEUTRAL position	 <p style="text-align: right; font-size: small;">JPMIA0587GB</p> <p style="text-align: center;">8.0 - 8.5 V</p>
					UNLOCK position	0 V
8 (R)	Ground	Door key cylinder switch LOCK signal	Input	Door key cylinder switch	NEUTRAL position	 <p style="text-align: right; font-size: small;">JPMIA0587GB</p> <p style="text-align: center;">8.0 - 8.5 V</p>
					LOCK position	0 V
9 (R)	Ground	Stop lamp switch	Input	Stop lamp switch	OFF (Brake pedal is not depressed)	0 V
					ON (Brake pedal is de- pressed)	Battery voltage
10 (SB)	Ground	Rear window defog- ger switch	Input	Rear window defogger switch	Not pressed	Battery voltage
					Pressed	0 V
11 (SB)	Ground	Ignition switch ACC	Input	Ignition switch OFF	0 V	
				Ignition switch ACC or ON	Battery voltage	
12 (P)	Ground	Passenger door switch	Input	Passenger door switch	OFF (When passenger door closed)	 <p style="text-align: right; font-size: small;">JPMIA0586GB</p> <p style="text-align: center;">7.5 - 8.0 V</p>
					ON (When passenger door opened)	0 V
13 (LG)	Ground	Rear door switch RH	Input	Rear door switch RH	OFF (When rear door RH closed)	 <p style="text-align: right; font-size: small;">JPMIA0587GB</p> <p style="text-align: center;">8.0 - 8.5 V</p>
					ON (When rear door RH opened)	0 V

BCM (BODY CONTROL MODULE)

< ECU DIAGNOSIS INFORMATION >

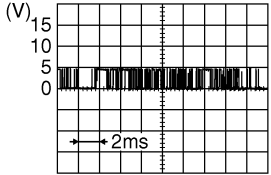
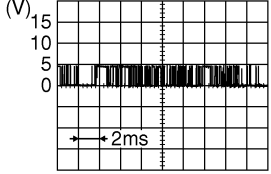
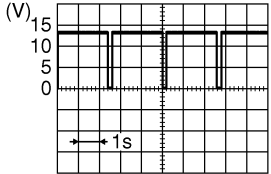
Terminal No. (Wire color)		Description		Condition		Value (Approx.)
		Signal name	Input/ Output			
+	-					
14 (G)	Ground	Optical sensor	Input	Ignition switch ON	When bright outside of the vehicle	Close to 5 V
					When dark outside of the vehicle	Close to 0 V
17 (W)	Ground	Optical sensor power supply	Output	Ignition switch	OFF, ACC	0 V
					ON	5 V
18* (O)	Ground	Remote keyless entry receiver ground	Input	Ignition switch ON		0 V
19* (V)	Ground	Remote keyless entry receiver power supply	Input	Without Intelligent Key system	At any condition	5 V
				With Intelligent Key system	• Ignition switch OFF • For 3 seconds after ignition switch OFF to ON	0 V
					3 seconds or later after ignition switch OFF to ON	5 V
20* (GR)	Ground	Remote keyless entry receiver signal	Input	Without Intelligent Key system	At any condition	 <p style="text-align: right; font-size: small;">JPMIA0589GB</p>
						<p>NOTE: The wave form changes according to signal-receiving condition.</p>
				With Intelligent Key system	• Ignition switch OFF • For 3 seconds after ignition switch OFF to ON	0 V
					3 seconds or later after ignition switch OFF to ON	 <p style="text-align: right; font-size: small;">JPMIA0589GB</p>
21 (G)	Ground	NATS antenna amp.	Input/ Output	Just after inserting ignition key in key cylinder		Pointer of tester should move
23 (B)	Ground	Security indicator signal	Input	Security indicator	ON	0 V
					Blinking (Ignition switch OFF)	 <p style="text-align: right; font-size: small;">JPMIA0590GB</p>
					OFF	12.0 V Battery voltage

A
B
C
D
E
F
G
H
I
J
L
M
N
O
P

PWC

BCM (BODY CONTROL MODULE)

< ECU DIAGNOSIS INFORMATION >

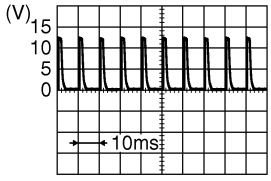
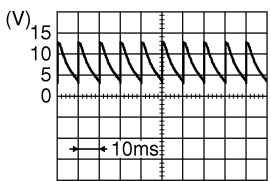
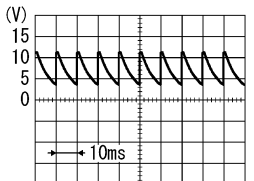
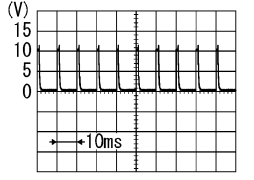
Terminal No. (Wire color)		Description		Condition	Value (Approx.)	
		Signal name	Input/ Output			
+	-					
25 (BR)	Ground	NATS antenna amp.	Input/ Output	Just after inserting ignition key in key cylinder	Pointer of tester should move	
27 (Y)	Ground	A/C switch	Input	Ignition switch OFF	 <p style="text-align: center;">1.6 V</p>	
				Ignition switch ON		A/C switch OFF
				A/C switch ON		0 V
28 (LG)	Ground	Blower fan switch	Input	Ignition switch OFF	 <p style="text-align: center;">7.0 - 7.5 V</p>	
				Ignition switch ON		Blower fan switch OFF
				Blower fan switch ON		0 V
29 (W)	Ground	Hazard switch	Input	Hazard switch	OFF	Battery voltage
				ON	0 V	
30 (G)	Ground	Back door opener switch	Input	Back door opener switch	Not pressed	Battery voltage
				Pressed	0 V	
32 (BR)	Ground	Combination switch OUTPUT 5	Output	Combination switch	All switch OFF (Wiper intermittent dial 4)	 <p style="text-align: center;">7.2 V</p>
					Front fog lamp switch ON (Wiper intermittent dial 4)	 <p style="text-align: center;">1.0 V</p>
					Rear wiper switch ON (Wiper intermittent dial 4)	
					Any of the condition below with all switch OFF <ul style="list-style-type: none"> • Wiper intermittent dial 1 • Wiper intermittent dial 2 • Wiper intermittent dial 6 • Wiper intermittent dial 7 	

BCM (BODY CONTROL MODULE)

< ECU DIAGNOSIS INFORMATION >

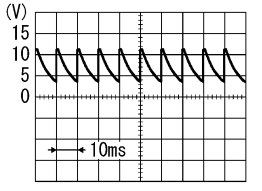
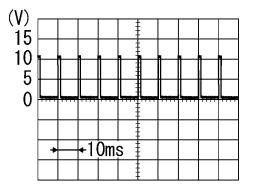
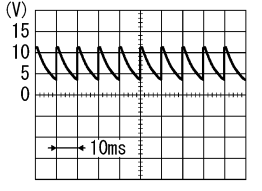
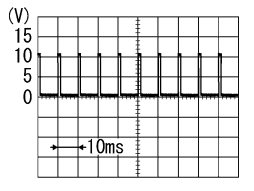
Terminal No. (Wire color)		Description		Condition	Value (Approx.)	
		Signal name	Input/ Output			
+	-					
33 (GR)	Ground	Combination switch OUTPUT 4	Output	Combination switch	All switch OFF (Wiper intermittent dial 4)	 <p style="text-align: center;">7.2 V</p>
					Lighting switch 1ST (Wiper intermittent dial 4)	 <p style="text-align: center;">1.2 V</p>
					Lighting switch AUTO (Wiper intermittent dial 4)	
					Rear wiper switch INT (Wiper intermittent dial 4)	
Any of the condition below with all switch OFF						
<ul style="list-style-type: none"> • Wiper intermittent dial 1 • Wiper intermittent dial 5 • Wiper intermittent dial 6 						
34 (L)	Ground	Combination switch OUTPUT 3	Output	Combination switch	All switch OFF (Wiper intermittent dial 4)	 <p style="text-align: center;">7.2 V</p>
					Lighting switch 2ND (Wiper intermittent dial 4)	 <p style="text-align: center;">1.2 V</p>
					Lighting switch HI (Wiper intermittent dial 4)	
					Rear washer switch ON (Wiper intermittent dial 4)	
Any of the condition below with all switch OFF						
<ul style="list-style-type: none"> • Wiper intermittent dial 1 • Wiper intermittent dial 2 • Wiper intermittent dial 3 						

A
B
C
D
E
F
G
H
I
J
L
M
N
O
P

PWC

BCM (BODY CONTROL MODULE)

< ECU DIAGNOSIS INFORMATION >

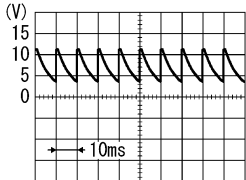
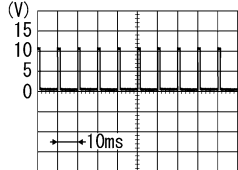
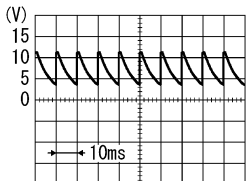
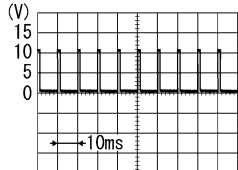
Terminal No. (Wire color)		Description		Condition	Value (Approx.)	
+	-	Signal name	Input/ Output			
35 (B)	Ground	Combination switch OUTPUT 2	Output	Combination switch (Wiper intermit- tent dial 4)	All switch OFF	 7.2 V
					Lighting switch 2ND	 1.2 V
					Lighting switch PASS	
					Front wiper switch INT	
Front wiper switch HI						
36 (V)	Ground	Combination switch OUTPUT 1	Output	Combination switch (Wiper intermit- tent dial 4)	All switch OFF	 7.2 V
					Turn signal switch RH	 1.2 V
					Turn signal switch LH	
					Front wiper switch LO (Front wiper switch MIST)	
Front washer switch ON						
37 (LG)	Ground	Key switch	Input	Insert mechanical key into ignition key cylinder	Battery voltage	
				Remove mechanical key from ignition key cylinder	0 V	
38 (G)	Ground	Ignition switch ON	Input	Ignition switch OFF or ACC	0 V	
				Ignition switch ON or START	Battery voltage	
39 (L)	Ground	CAN-H	Input/ Output	—	—	
40 (P)	Ground	CAN-L	Input/ Output	—	—	

BCM (BODY CONTROL MODULE)

< ECU DIAGNOSIS INFORMATION >

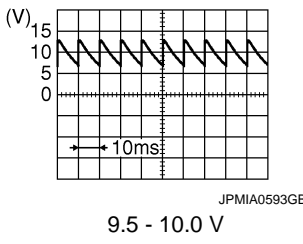
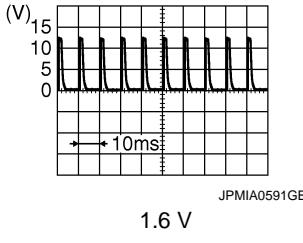
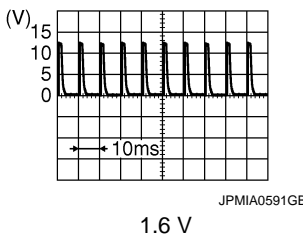
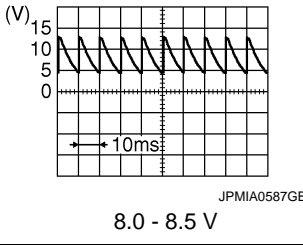
Terminal No. (Wire color)		Description		Condition	Value (Approx.)	
+	-	Signal name	Input/ Output			
43 (V)	Ground	Back door switch	Input	Back door switch	OFF (When back door closed)	
				ON (When back door opened)	0 V	
44 (B)	Ground	Rear wiper auto stop	Input	Ignition switch ON	Rear wiper stop position	0 V
				Any position other than rear wiper stop position	Battery voltage	
45 (P)	Ground	Door lock and unlock switch LOCK signal	Input	Door lock and unlock switch	NEUTRAL position	
				LOCK position	0 V	
46 (BR)	Ground	Door lock and unlock switch UNLOCK signal	Input	Door lock and unlock switch	NEUTRAL position	
				UNLOCK position	0 V	
47 (W)	Ground	Driver door switch	Input	Driver door switch	OFF (When driver door closed)	
				ON (When driver door opened)	0 V	

A
B
C
D
E
F
G
H
I
J
L
M
N
O
P

PWC

BCM (BODY CONTROL MODULE)

< ECU DIAGNOSIS INFORMATION >

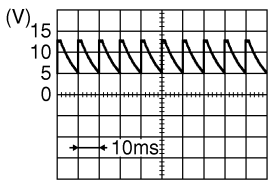
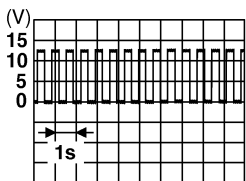
Terminal No. (Wire color)		Description		Condition		Value (Approx.)
+	-	Signal name	Input/ Output			
48 (GR)	Ground	Rear door switch LH	Input	Rear door switch LH	OFF (When rear door LH closed)	 <p style="text-align: right; font-size: small;">JPMIA0594GB</p>
					ON (When rear door LH opened)	0 V
49 (L)	Ground	Luggage room lamp control	Output	Luggage room lamp switch DOOR position	Back door is closed (Luggage room lamp turns OFF)	Battery voltage
					Back door is opened (Luggage room lamp turns ON)	0 V
53 (V)	Ground	Back door open	Output	Back door opener switch	Not pressed (Back door actuator is activated)	0 V
					Pressed (Back door actuator is activated)	Battery voltage
55 (SB)	Ground	Rear wiper motor	Output	Ignition switch ON	Rear wiper switch OFF	0 V
					Rear wiper switch ON	Battery voltage
56 (Y)	Ground	Interior room lamp power supply	Output		After passing the interior room lamp battery saver operation time	0 V
					Any other time after passing the interior room lamp battery saver operation time	Battery voltage
57 (G)	Ground	Battery power supply	Input	Ignition switch OFF		Battery voltage
59 (L)	Ground	Driver door UN-LOCK	Output	Driver door	UNLOCK (Actuator is activated)	Battery voltage
					Other than UNLOCK (Actuator is not activated)	0 V
60 (BR)	Ground	Turn signal LH	Output	Ignition switch ON	Turn signal switch OFF	0 V
					Turn signal switch LH	 <p style="text-align: right; font-size: small;">PKIC6370E</p>

BCM (BODY CONTROL MODULE)

< ECU DIAGNOSIS INFORMATION >

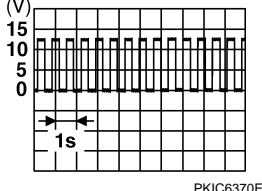
Terminal No. (Wire color)		Description		Condition	Value (Approx.)
+	-	Signal name	Input/ Output		
61 (GR)	Ground	Turn signal RH	Output	Ignition switch ON	Turn signal switch OFF 0 V
				Turn signal switch RH	
63 (R)	Ground	Interior room lamp timer control	Output	Interior room lamp	OFF Battery voltage
				ON	0 V
65 (V)	Ground	All doors LOCK	Output	All doors	LOCK (Actuator is activated) Battery voltage
				Other then LOCK (Actuator is not activated)	0 V
66 (G)	Ground	Passenger door and rear door UNLOCK	Output	Passenger door and rear door	UNLOCK (Actuator is activated) Battery voltage
				Other then UNLOCK (Actuator is not activated)	0 V
67 (B)	Ground	Ground	Output	Ignition switch ON	0 V
68 (L)	Ground	P/W power supply (RAP)	Output	Ignition switch ON	Battery voltage
69 (P)	Ground	P/W power supply (BAT)	Output	Ignition switch OFF	Battery voltage
70 (Y)	Ground	Battery power supply	Input	Ignition switch OFF	Battery voltage

*: Except for Mexico with Intelligent Key

PWC

L
M
N
O
P

BCM (BODY CONTROL MODULE)

< ECU DIAGNOSIS INFORMATION >

Wiring Diagram - BCM -

INFOID:000000006484208

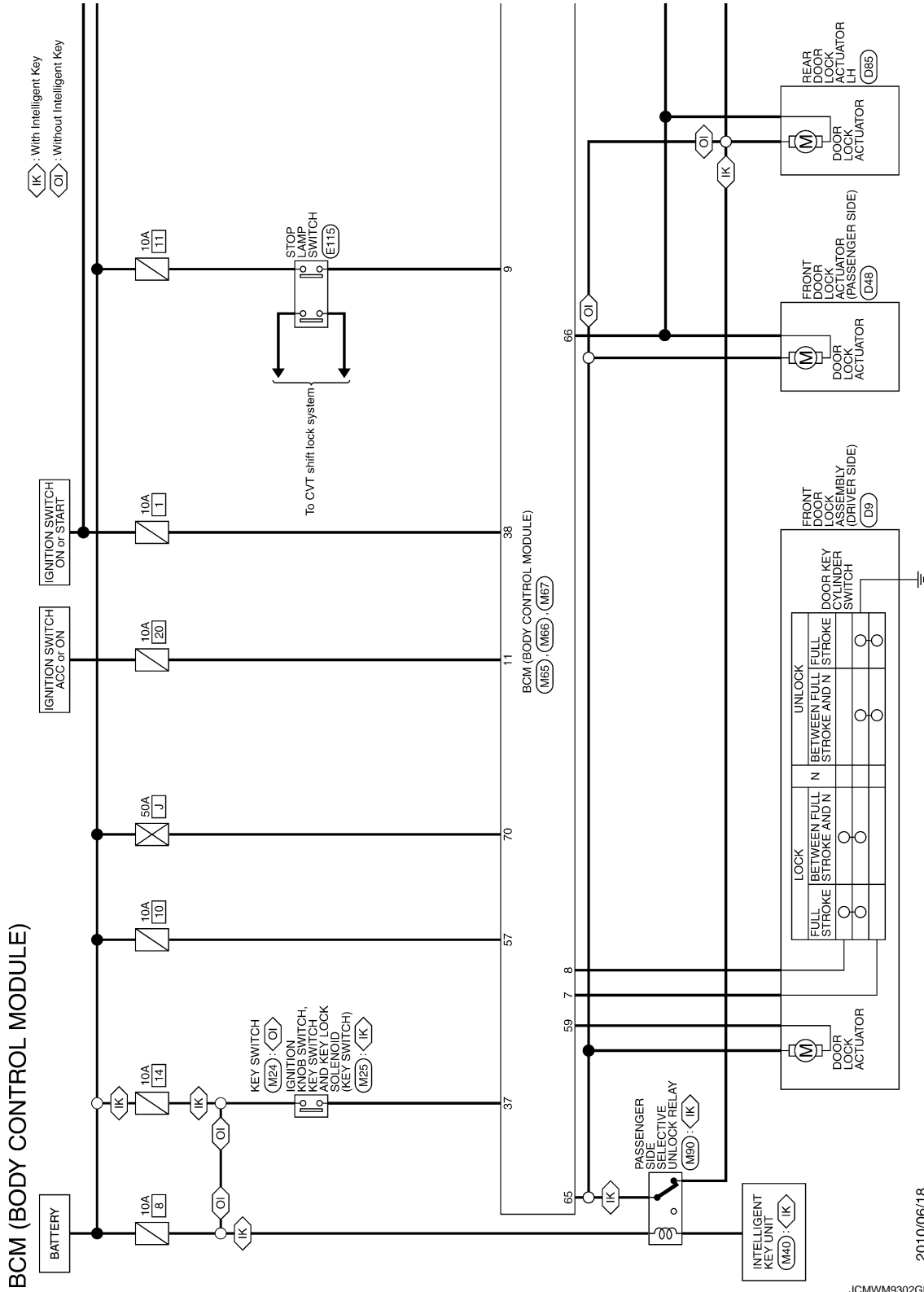

2010/06/18

JCMWM9302GB

BCM (BODY CONTROL MODULE)

< ECU DIAGNOSIS INFORMATION >

- ◊ AA : With auto A/C
- ◊ MA : With manual A/C
- ◊ IK : With Intelligent Key
- ◊ DI : Without Intelligent Key

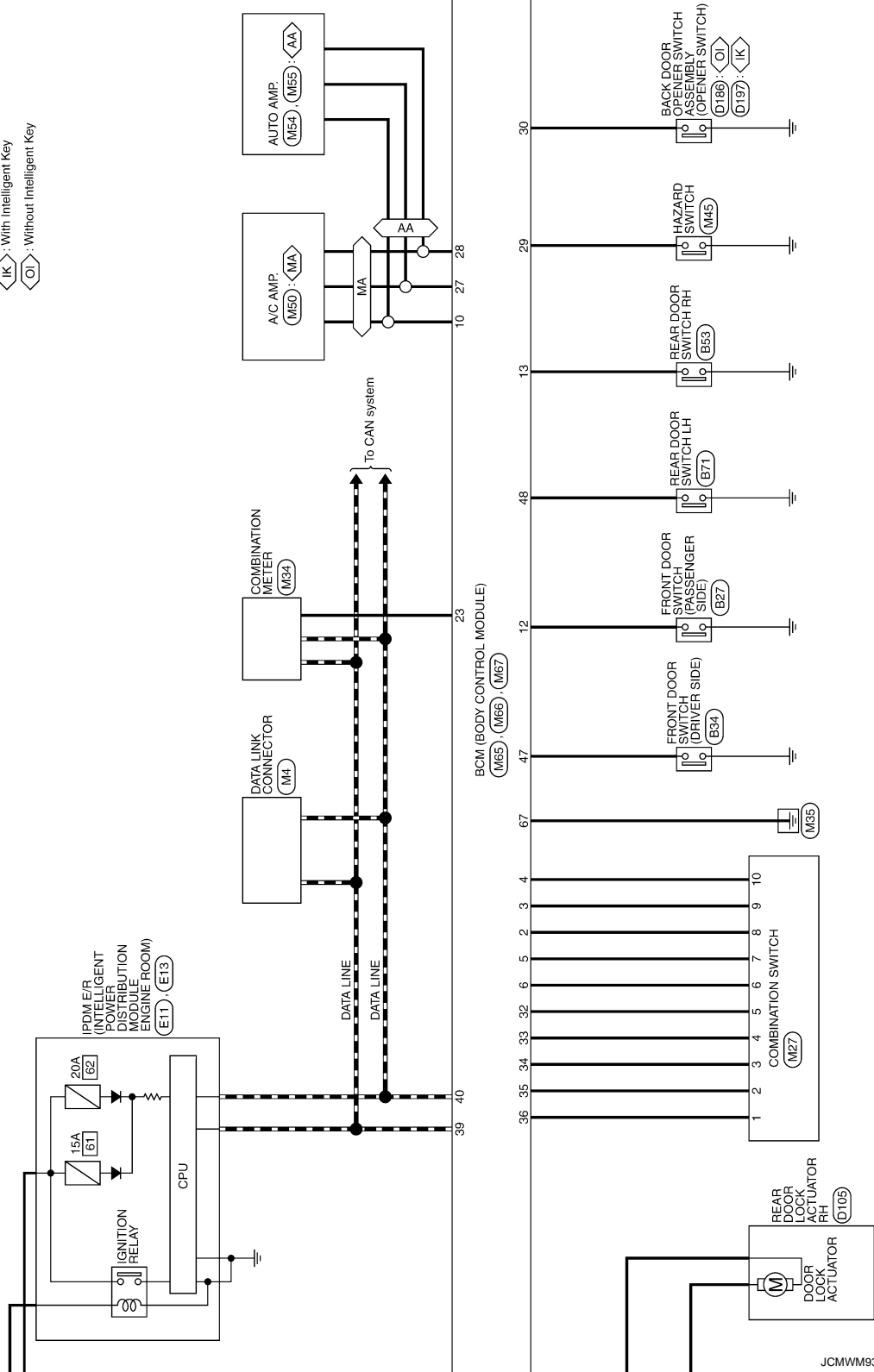

JCMWM9303GB

A
B
C
D
E
F
G
H
I
J
PWC
L
M
N
O
P

BCM (BODY CONTROL MODULE)

< ECU DIAGNOSIS INFORMATION >

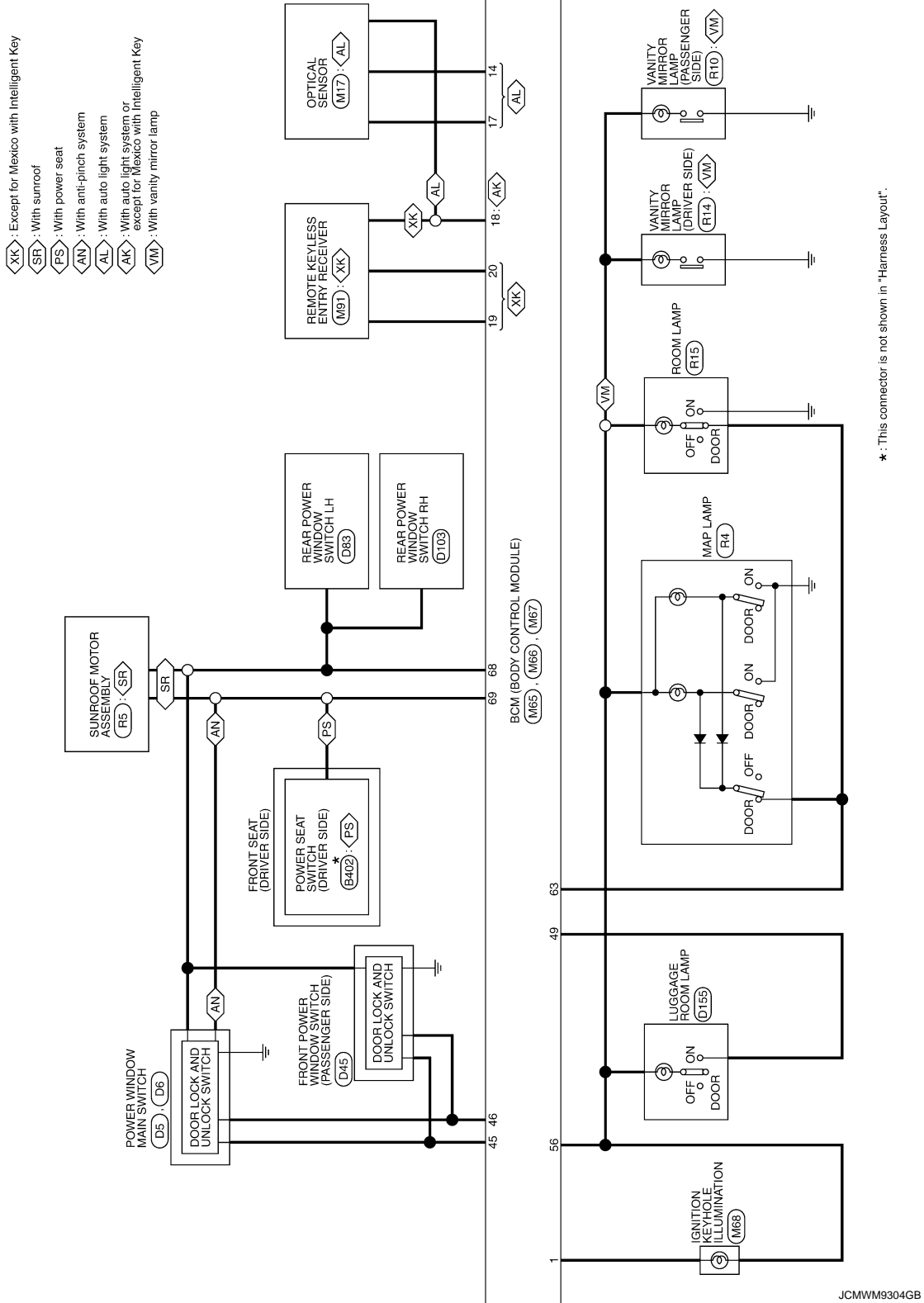

BCM (BODY CONTROL MODULE)

< ECU DIAGNOSIS INFORMATION >

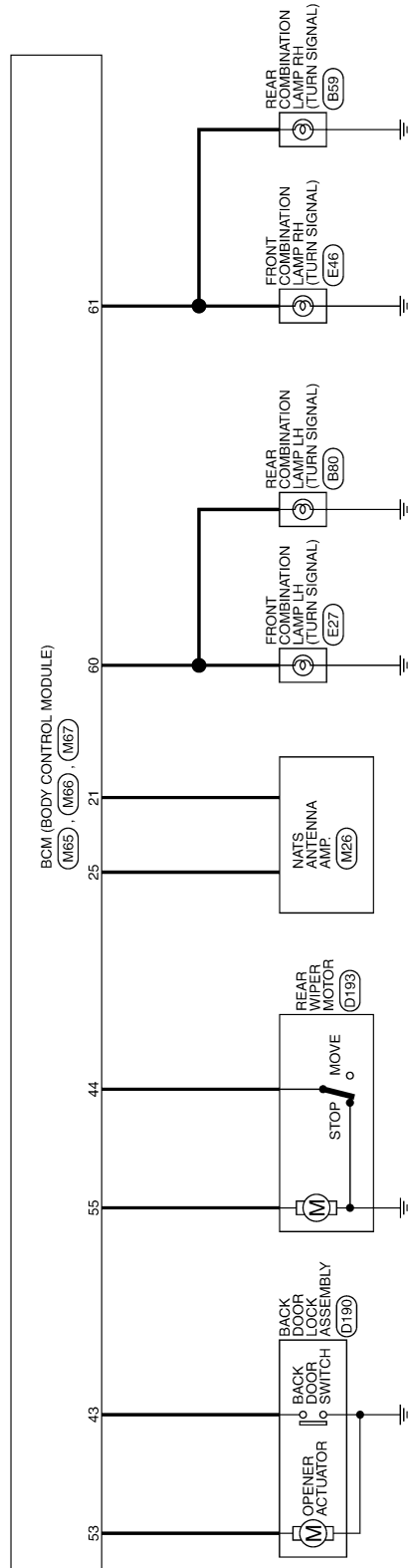

JCMWM9305GB

A
B
C
D
E
F
G
H
I
J
L
M
N
O
P

PWC

BCM (BODY CONTROL MODULE)

< ECU DIAGNOSIS INFORMATION >

BCM (BODY CONTROL MODULE)

Connector No.	M27
Connector Name	COMBINATION SWITCH
Connector Type	TK16FW



12	13	10	9	8	7		
14	11	1	2	3	4	5	6

Terminal No.	Color of Wire	Signal Name [Specification]
1	V	INPUT 1
2	B	INPUT 2
3	L	INPUT 3
4	GR	INPUT 4
5	BR	INPUT 5
6	P	OUTPUT 1
7	R	OUTPUT 2
8	G	OUTPUT 5
9	Y	OUTPUT 4
10	W	OUTPUT 3
11	LG	WASH FR (-) RR (+)
12	B	GND
13	O	WASH FR (+) RR (-)
14	BR	IGN

Connector No.	M65
Connector Name	BCM (BODY CONTROL MODULE)
Connector Type	TH40PW-NH



1	2	3	4	5	6	7	8	9	10	11	12	13	14	15	16	17	18	19	20	21	22	23	24	25	26	27	28	29	30	31	32	33	34	35	36	37	38	39	40
---	---	---	---	---	---	---	---	---	----	----	----	----	----	----	----	----	----	----	----	----	----	----	----	----	----	----	----	----	----	----	----	----	----	----	----	----	----	----	----

Terminal No.	Color of Wire	Signal Name [Specification]
1	V	KEY RING OUTPUT
2	G	INPUT 5
3	Y	INPUT 4
4	W	INPUT 3
5	R	INPUT 2
6	P	INPUT 1
7	L	KEY CYG UNLOCK
8	R	KEY CYL LOCK SW

Terminal No.	Color of Wire	Signal Name [Specification]
9	R	BRAKE SW
10	SR	RR DEF SW
11	SS	ACC
12	SP	DR SW AS
13	LG	DR SW RR
14	G	AUTO LIGHT SENS INPUT
17	W	SENS POWER SUPPLY
18	O	KEYLESS TUNER SENS GND
19	V	KEYLESS TUNER POWER
20	GR	KEYLESS TUNER SIGNAL
21	G	IMMOBILANT (CLOCK)
23	B	SECURITY IND OUT PUT
25	BR	IMMOBILANT (RX, TX)
27	Y	AIRCON SW
28	LG	BLOWER FAN SW
29	W	HAZARD SW
30	G	BACK DOOR OPEN SW
32	BR	OUTPUT 5
33	GR	OUTPUT 4
34	L	OUTPUT 3
35	B	OUTPUT 2
36	V	OUTPUT 1
37	LG	KEY SW
38	G	IGN
39	L	CAN-H
40	P	CAN-L

Connector No.	M66
Connector Name	BCM (BODY CONTROL MODULE)
Connector Type	FEA09FW-FHA6-SA



41	42	43	44	45	46	47	48	49
50	51	52	53	54	55			

Terminal No.	Color of Wire	Signal Name [Specification]
43	V	BACK DOOR SW
44	B	RR WIP AUTO STOP
45	P	ODLOCK SW
46	BR	CDUNLOCK SW
47	W	DR SW DR
48	GR	DR SW RL
49	L	LUGGAGE LAMP OUTPUT
53	V	BACK DOOR OPENER OUTPUT
55	SR	RR WIP MTR OUT

Connector No.	M67
Connector Name	BCM (BODY CONTROL MODULE)
Connector Type	FEA09FB-FHA6-SA



56	57	58	59	60	61	62	63	64
65	66	67	68	69	70			

Terminal No.	Color of Wire	Signal Name [Specification]
56	Y	BATTERY SAVER OUTPUT
57	G	BAT FUSE
59	L	D/L UNLOCK DR
60	BR	FLASHER OUT PUT (LEFT)
61	GR	FLASHER OUT PUT (RIGHT)
63	R	ROOM LAMP OUTPUT
65	V	D/L LOCK ALL
66	G	D/L UNLOCK OTHER
67	B	GND
68	L	POWER WDW OUTPUT (RAP)
69	P	POWER WDW OUTPUT (BAT)
70	Y	BAT FL

Fail-safe

REAR WIPER MOTOR PROTECTION

BCM detects the rear wiper stopping position according to the rear wiper stop position signal. When the rear wiper stop position signal does not change more than 5 seconds while driving the rear wiper, BCM stops power supply to protect the rear wiper motor.

Condition of cancellation

BCM (BODY CONTROL MODULE)

< ECU DIAGNOSIS INFORMATION >

1. Pass more than 1 minute after the rear wiper stop.
2. Turn the rear wiper switch OFF.
3. Operate the rear wiper switch or rear washer switch.

DTC Inspection Priority Chart

INFOID:000000006484210

If some DTCs are displayed at the same time, perform inspections one by one based on the following priority chart.

Priority	DTC
1	U1000: CAN COMM CIRCUIT
2	C1735: IGN CIRCUIT OPEN
3	<ul style="list-style-type: none"> • C1704: LOW PRESSURE FL • C1705: LOW PRESSURE FR • C1706: LOW PRESSURE RR • C1707: LOW PRESSURE RL • C1708: [NO DATA] FL • C1709: [NO DATA] FR • C1710: [NO DATA] RR • C1711: [NO DATA] RL • C1716: [PRESS DATA ERR] FL • C1717: [PRESS DATA ERR] FR • C1718: [PRESS DATA ERR] RR • C1719: [PRESS DATA ERR] RL • C1729: VHCL SPEED SIG ERR

DTC Index

INFOID:000000006484211

NOTE:

- Details of time display
- CRNT: Displays when there is a malfunction now or after returning to the normal condition until turning ignition switch OFF → ON again.
- 1 - 39: Displayed if any previous malfunction is present when current condition is normal. It increases like 1 → 2 → 3...38 → 39 after returning to the normal condition whenever ignition switch OFF → ON. The counter remains at 39 even if the number of cycles exceeds it. It is counted from 1 again when turning ignition switch OFF → ON after returning to the normal condition if the malfunction is detected again.

CONSULT display	Tire pressure monitor warning lamp ON	Reference
U1000: CAN COMM CIRCUIT	—	BCS-34
C1704: LOW PRESSURE FL	×	WT-13
C1705: LOW PRESSURE FR	×	
C1706: LOW PRESSURE RR	×	
C1707: LOW PRESSURE RL	×	WT-15
C1708: [NO DATA] FL	×	
C1709: [NO DATA] FR	×	
C1710: [NO DATA] RR	×	
C1711: [NO DATA] RL	×	WT-18
C1716: [PRESS DATA ERR] FL	×	
C1717: [PRESS DATA ERR] FR	×	
C1718: [PRESS DATA ERR] RR	×	
C1719: [PRESS DATA ERR] RL	×	WT-20
C1729: VHCL SPEED SIG ERR	×	
C1735: IGN CIRCUIT OPEN	—	BCS-35

POWER WINDOW MAIN SWITCH

< ECU DIAGNOSIS INFORMATION >

POWER WINDOW MAIN SWITCH

Reference Value

INFOID:000000006199698

TERMINAL LAYOUT

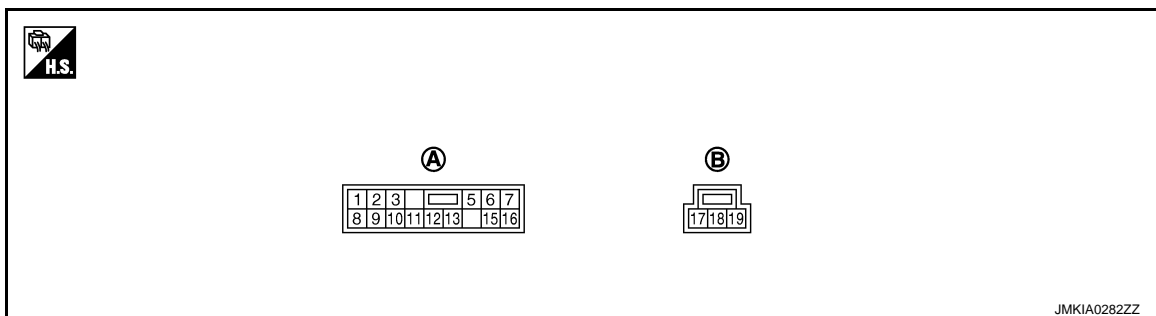

A. D5

B. D6

PHYSICAL VALUES

POWER WINDOW MAIN SWITCH

Terminal No. (Wire color)		Description		Condition	Voltage [V] (Approx.)
+	-	Signal name	Input/ Output		
1 (R)	Ground	Rear power window motor LH UP signal	Output	When rear LH switch in power window main switch is UP at operated.	Battery voltage
2 (Y)	Ground	Encoder ground*	—	—	0
3 (O)	Ground	Rear power window motor LH DOWN signal	Output	When rear LH switch in power window main switch is DOWN at operated.	Battery voltage
5 (Y)	Ground	Rear power window motor RH DOWN signal	Output	When rear RH switch in power window main switch is DOWN at operated.	Battery voltage
7 (LG)	Ground	Rear power window motor RH UP signal	Output	When rear RH switch in power window main switch is UP at operated.	Battery voltage
8 (BR)	11	Front power window motor (driver side) UP signal	Output	When front LH switch in power window main switch is UP at operated.	Battery voltage
9 (V)	2	Encoder pulse signal 2*	Input	When front power window motor (driver side) operates.	
10 (L)	Ground	Ignition switch power supply	Input	Ignition switch ON	Battery voltage
				Other than above	0
11 (GR)	8	Front power window motor (driver side) DOWN signal	Output	When front LH switch in power window main switch is DOWN at operated.	Battery voltage

JMKIA0070GB

POWER WINDOW MAIN SWITCH

< ECU DIAGNOSIS INFORMATION >

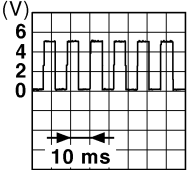
Terminal No. (Wire color)		Description		Condition	Voltage [V] (Approx.)
+	-	Signal name	Input/ Output		
12 (SB)	Ground	Front power window motor (passenger side) DOWN signal	Output	When front RH switch in power window main switch is DOWN at operated.	Battery voltage
13 (R)	2	Encoder pulse signal 1*	Input	When front power window motor (driver side) operates.	
15 (G)	Ground	Encoder power supply*	Output	Ignition switch ON.	Battery voltage
16 (W)	Ground	Front power window motor (passenger side) UP signal	Output	When front RH switch in power window main switch is UP at operated.	Battery voltage
17 (B)	Ground	Ground	—	—	0
19 (R)	Ground	Battery power supply	Input	Ignition switch OFF	Battery voltage

*: With ANTI-PINCH SYSTEM

Wiring Diagram - POWER WINDOW CONTROL SYSTEM (WHIT POWER WINDOW

A
B
C
D
E
F
G
H
I
J
L
M
N
O
P

PWC

POWER WINDOW MAIN SWITCH

< ECU DIAGNOSIS INFORMATION >

ANTI-PINCH SYSTEM) -

INFOID:000000006199699

POWER WINDOW SYSTEM (WITH POWER WINDOW ANTI-PINCH SYSTEM)

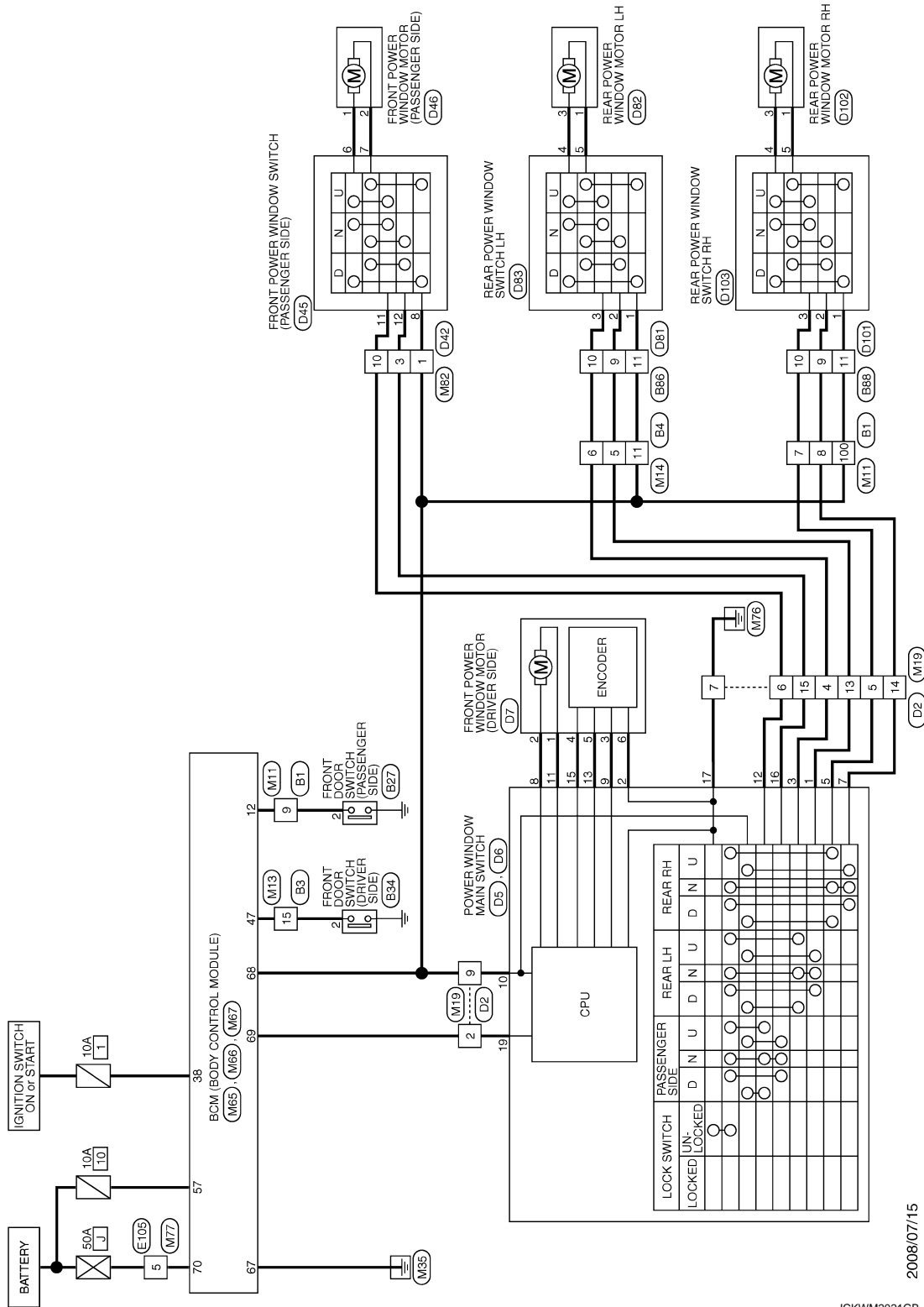

2008/07/15

JCKWM2021GB

POWER WINDOW MAIN SWITCH

< ECU DIAGNOSIS INFORMATION >

POWER WINDOW SYSTEM (WITH POWER WINDOW ANTI-PINCH SYSTEM)

Connector No.	B1
Connector Name	WIRE TO WIRE
Connector Type	TH80MW-CS (E-TM4)

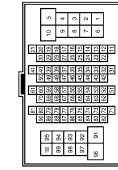

Terminal No.	Color of Wire	Signal Name [Specification]
1	W	
2	BR	
3	G	
4	L	
6	BR	
7	Y	
8	LG	
9	BR	
10	BR	
21	R	
35	SHIELD	
36	R	
37	LG	
38	SHIELD	
39	O	
40	G	
41	R	
45	L	
46	W	
47	SHIELD	
48	W	
48	W	
50	SHIELD	
52	L	
53	L	
53	L	- [With display audio]
54	G	- [With base audio or BOSE system]
54	O	
55	Y	
56	LG	
57	SB	
58	W	
59	B	
60	SB	
62	GR	
63	W	
65	SHIELD	
66	BR	
67	LG	

68	SB	
68	SHIELD	
70	W	
71	W	
72	Y	
77	L	
80	R	
81	W	
82	GR	
86	Y	
87	P	
91	GR	
92	R	
93	W	
94	G	
95	O	
96	Y	
97	SB	
98	Y	
99	Y	
100	L	

Connector No.	B3
Connector Name	WIRE TO WIRE
Connector Type	TH32MW-NH

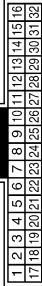

Terminal No.	Color of Wire	Signal Name [Specification]
1	L	
2	G	
4	R	
5	W	
6	G	
10	G	
13	Y	
14	BR	
15	P	
16	W	
17	LG	
18	R	
19	SB	
20	B	
21	SHIELD	

26	P	
28	L	
30	O	
31	GR	
32	LG	

Connector No.	B4
Connector Name	WIRE TO WIRE
Connector Type	NS18MW-CS



Terminal No.	Color of Wire	Signal Name [Specification]
1	R	
2	P	
3	V	
5	LG	
6	Y	
7	SB	
8	L	
9	W	
10	O	
11	L	
12	BR	
14	G	
15	BR	
16	W	

Connector No.	B27
Connector Name	FRONT DOOR SWITCH (PASSENGER SIDE)
Connector Type	AQ3FW

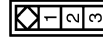

Terminal No.	2	Color of Wire	BR	Signal Name [Specification]	
--------------	---	---------------	----	-----------------------------	--

Connector No.	B34
Connector Name	FRONT DOOR SWITCH (DRIVER SIDE)
Connector Type	AQ3FW

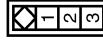

Terminal No.	2	Color of Wire	P	Signal Name [Specification]	
--------------	---	---------------	---	-----------------------------	--

Connector No.	B86
Connector Name	WIRE TO WIRE
Connector Type	NS12MW-CS

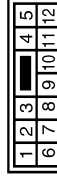

Terminal No.	Color of Wire	Signal Name [Specification]
1	V	
3	L	
6	G	
8	R	
9	LG	
10	Y	
11	L	

A
B
C
D
E
F
G
H
I
J
L
M
N
O
P



POWER WINDOW MAIN SWITCH

< ECU DIAGNOSIS INFORMATION >

POWER WINDOW SYSTEM (WITH POWER WINDOW ANTI-PINCH SYSTEM)

Connector No.	B88
Connector Name	WIRE TO WIRE
Connector Type	NS12MW-CS

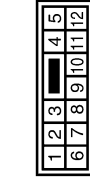

Terminal No.	Color of Wire	Signal Name [Specification]
1	V	-
3	GR	-
6	G	-
8	Y	-
9	LG	-
10	Y	-
11	L	-

Connector No.	D2
Connector Name	WIRE TO WIRE
Connector Type	NS16FW-CS

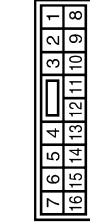

Terminal No.	Color of Wire	Signal Name [Specification]
1	GR	-
2	R	-
3	B	-
4	O	-
5	Y	-
6	SB	-
7	B	-
8	V	-
9	L	-
10	P	-
13	R	-
14	LG	-
15	W	-
16	BR	-

Connector No.	D5
Connector Name	POWER WINDOW MAIN SWITCH
Connector Type	NS16FW-CS

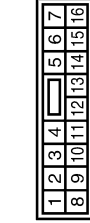

Terminal No.	Color of Wire	Signal Name [Specification]
1	R	-
2	Y	-
3	O	-
5	Y	-
6	BR	-
7	LG	-
8	BR	-
9	V	-
10	L	-
11	GR	-
12	SB	-
13	R	-
15	G	-
16	W	-

Connector No.	D6
Connector Name	POWER WINDOW MAIN SWITCH
Connector Type	NS03FW-CS



Terminal No.	Color of Wire	Signal Name [Specification]
17	B	-
18	P	-
19	R	-

Connector No.	D7
Connector Name	FRONT POWER WINDOW MOTOR (DRIVER SIDE)
Connector Type	NS08FW-CS

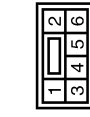

Terminal No.	Color of Wire	Signal Name [Specification]
1	GR	-
2	BR	-
3	V	-
4	G	-
5	R	-
6	Y	-

Connector No.	D42
Connector Name	WIRE TO WIRE
Connector Type	NS10FW-CS

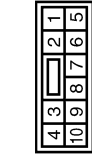

Terminal No.	Color of Wire	Signal Name [Specification]
1	L	-
2	G	-
3	W	-
4	Y	-
5	V	-
6	R	-
10	SB	-

Connector No.	D45
Connector Name	FRONT POWER WINDOW SWITCH (PASSENGER SIDE)
Connector Type	NS12FW-CS

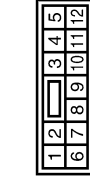

Terminal No.	Color of Wire	Signal Name [Specification]
1	P	-
2	BR	-
3	B	-
6	Y	-
7	R	-
8	L	-
11	SB	-
12	W	-

Connector No.	D46
Connector Name	FRONT POWER WINDOW MOTOR (PASSENGER SIDE)
Connector Type	NS06FW-CS



Terminal No.	Color of Wire	Signal Name [Specification]
1	Y	-
2	R	-

POWER WINDOW MAIN SWITCH

< ECU DIAGNOSIS INFORMATION >

POWER WINDOW SYSTEM (WITH POWER WINDOW ANTI-PINCH SYSTEM)

Connector No.	D81
Connector Name	WIRE TO WIRE
Connector Type	NS12PW-CS

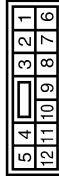

Terminal No.	Color of Wire	Signal Name [Specification]
1	V	-
3	L	-
6	G	-
8	R	-
9	LG	-
10	Y	-
11	L	-

Connector No.	D82
Connector Name	REAR POWER WINDOW MOTOR LH
Connector Type	RS08FG-DGY



Terminal No.	Color of Wire	Signal Name [Specification]
1	R	-
3	G	-

Connector No.	D83
Connector Name	REAR POWER WINDOW SWITCH LH
Connector Type	NS08PW-CS

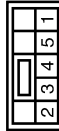

Terminal No.	Color of Wire	Signal Name [Specification]
1	L	-
2	LG	-
3	Y	-
4	G	-
5	R	-

Connector No.	D101
Connector Name	WIRE TO WIRE
Connector Type	NS12PW-CS



Terminal No.	Color of Wire	Signal Name [Specification]
1	V	-
3	GR	-
6	G	-
8	Y	-
9	LG	-
10	W	-
11	L	-

Connector No.	D102
Connector Name	REAR POWER WINDOW MOTOR RH
Connector Type	RS08FG-DGY



Terminal No.	Color of Wire	Signal Name [Specification]
1	R	-
3	G	-

Connector No.	D103
Connector Name	REAR POWER WINDOW SWITCH RH
Connector Type	MS08FW-CS



Terminal No.	Color of Wire	Signal Name [Specification]
1	L	-
2	LG	-
3	W	-
4	G	-
5	R	-

JCKWM4753GB

A
B
C
D
E
F
G
H
I
J
L
M
N
O
P

PWC

POWER WINDOW MAIN SWITCH

< ECU DIAGNOSIS INFORMATION >

POWER WINDOW SYSTEM (WITH POWER WINDOW ANTI-PINCH SYSTEM)

Connector No.	E105
Connector Name	WIRE TO WIRE
Connector Type	TH80PW-CS16-TM4



Terminal No.	Color of Wire	Signal Name [Specification]
1	W	-
2	O	-
3	LG	-
4	V	-
5	Y	-
6	G	-
7	R	-
8	GR	-
9	BR	-
10	L	-
11	GR	-
12	P	-
14	L	-
15	V	-
19	R	-
20	P	-
21	L	-
22	L	-
24	LG	-
25	SB	-
30	L	-
31	BR	-
42	V	-
45	SHIELD	-
51	L	-
52	W	-
53	BR	-
54	Y	-
60	O	-
61	BR	-
62	R	-
63	P	-
69	G	-
70	B	-
71	O	-
72	LG	-
78	L	-
79	V	-

Connector No.	M11
Connector Name	WIRE TO WIRE
Connector Type	TH80PW-CS16-TM4

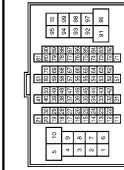

Terminal No.	Color of Wire	Signal Name [Specification]
1	W	-
2	BR	-
3	G	-
4	LG	-
6	P	-
7	Y	-
8	LG	-
9	P	-
10	Y	-
21	R	-
35	SHIELD	-
36	P	-
37	LG	-
38	SHIELD	-
39	O	-
40	G	-
41	R	-
45	BR	-
46	L	-
47	SHIELD	-
48	V	-

Terminal No.	Color of Wire	Signal Name [Specification]
49	W	-
50	SHIELD	-
52	O	-
53	L	-
54	V	-
55	Y	-
56	LG	-
57	SB	-
58	W	-
59	B	-
60	SB	-
62	GR	-
63	BR	-
65	SHIELD	-
66	BR	-
67	LG	-
68	SB	-
69	SHIELD	-
70	LG	-
71	O	-
72	BR	-
77	L	-
80	R	-
81	W	-
82	GR	-
86	Y	-
87	P	-
91	L	-
92	B	-
93	GR	-
94	G	-
95	O	-
96	P	-
97	SB	-
98	GR	-
99	R	-
100	L	-

Connector No.	M13
Connector Name	WIRE TO WIRE
Connector Type	TH52PW-NH

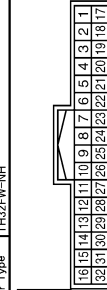

Terminal No.	Color of Wire	Signal Name [Specification]
16	L	-
15	L	-
14	L	-
13	L	-
12	L	-
11	L	-
10	O	-
9	W	-
8	V	-
7	SB	-
6	R	-
5	GR	-
3	V	-
2	P	-
1	LG	-

Terminal No.	Color of Wire	Signal Name [Specification]
1	G	-
2	Y	-
4	R	-
5	W	-
6	G	-
10	W	-
13	Y	-
14	O	-
15	W	-
16	V	-
17	LG	-
18	BR	-
19	SB	-
20	B	-
21	SHIELD	-
26	W	-
29	L	-
30	B	-
31	GR	-
32	G	-

Connector No.	M14
Connector Name	WIRE TO WIRE
Connector Type	NS16FW-CS



Terminal No.	Color of Wire	Signal Name [Specification]
7	L	-
6	L	-
5	L	-
4	L	-
3	L	-
2	L	-
1	L	-

POWER WINDOW MAIN SWITCH

< ECU DIAGNOSIS INFORMATION >

POWER WINDOW SYSTEM (WITH POWER WINDOW ANTI-PINCH SYSTEM)

Connector No.	M1B
Connector Name	WIRE TO WIRE
Connector Type	MS16MW-CS



1	2	3	4	5	6	7
8	9	10	11	12	13	14
15	16					

Terminal No.	Color of Wire	Signal Name [Specification]
1	GR	-
2	P	-
3	R	-
4	R	-
5	Y	-
6	SB	-
7	B	-
8	V	-
9	L	-
10	G	-
13	GR	-
14	LG	-
15	W	-
16	L	-

Connector No.	M65
Connector Name	BCM (BODY CONTROL MODULE)
Connector Type	TH40PW-NH



1	2	3	4	5	6	7	8	9	10	11	12	13	14	15	16	17	18	19	20	21	22	23	24	25	26	27	28	29	30	31	32	33	34	35	36	37	38	39	40
---	---	---	---	---	---	---	---	---	----	----	----	----	----	----	----	----	----	----	----	----	----	----	----	----	----	----	----	----	----	----	----	----	----	----	----	----	----	----	----

Terminal No.	Color of Wire	Signal Name [Specification]
1	V	KEY RING OUTPUT
2	G	INPUT 5
3	Y	INPUT 4
4	W	INPUT 3
5	R	INPUT 2
6	P	INPUT 1
7	L	KEY CYG UNLOCK
8	R	KEY CYL LOCK SW

9	R	BRAKE SW
10	SB	RR DEF SW
11	SB	ACC
12	P	DR SW RR
13	LG	DR SW RR
14	G	AUTO LIGHT SENS INPUT
17	W	SENS POWER SUPPLY
18	O	KEYLESS TUNER SENS GND
19	V	KEYLESS TUNER POWER
20	GR	KEYLESS TUNER SIGNAL
21	G	IMMOBILANT (CLOCK)
23	B	SECURITY IND OUT PUT
25	BR	IMMOBILANT (RX, TX)
27	Y	AIRCON SW
28	LG	BLOWER FAN SW
29	W	HAZARD SW
30	G	BACK DOOR OPEN SW
32	BR	OUTPUT 5
33	GR	OUTPUT 4
34	L	OUTPUT 3
35	B	OUTPUT 2
36	V	OUTPUT 1
37	LG	KEY SW
38	G	IGN
39	L	CAN-H
40	P	CAN-L

Connector No.	M66
Connector Name	BCM (BODY CONTROL MODULE)
Connector Type	FEA09FW-FHA6-SA



41	42	43	44	45	46	47	48	49
50	51	52	53	54	55			

Terminal No.	Color of Wire	Signal Name [Specification]
43	V	BACK DOOR SW
44	B	RR WIP AUTO STOP
45	P	ODL LOCK SW
46	BR	CDL UNLOCK SW
47	W	DR SW DR
48	GR	DR SW RL
49	L	LUGGAGE LAMP OUTPUT
53	V	BACK DOOR OPENER OUTPUT
55	SB	RR WIP MTR OUT

Connector No.	M67
Connector Name	BCM (BODY CONTROL MODULE)
Connector Type	FEA09FB-FHA6-SA



56	57	58	59	60	61	62	63	64
65	66	67	68	69	70			

Terminal No.	Color of Wire	Signal Name [Specification]
56	Y	BATTERY SAVER OUTPUT
57	G	BAT FUSE
59	L	D/L UNLOCK DR
60	BR	FLASHER OUT PUT (LEFT)
61	GR	FLASHER OUT PUT (RIGHT)
63	R	ROOM LAMP OUTPUT
65	G	D/L LOCK ALL
67	B	GND
68	L	POWER WDW OUTPUT (RAP)
69	P	POWER WDW OUTPUT (BAT)
70	Y	BAT FL

Connector No.	M77
Connector Name	WIRE TO WIRE
Connector Type	TH80MW-CS16-TM4

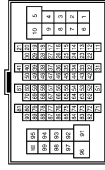

Terminal No.	Color of Wire	Signal Name [Specification]
1	BR	-
2	O	-
3	LG	-
4	Y	-
5	Y	-
6	G	-
7	R	-
8	GR	-
9	BR	-
10	L	-

11	GR	-
12	P	-
14	SB	-
15	V	-
19	R	-
20	P	-
21	O	-
22	L	-
24	BR	-
25	W	-
30	L	-
31	W	-
42	O	-
43	SHIELD	-
51	W	-
52	SB	-
53	L	-
54	Y	-
60	O	-
61	BR	-
62	G	-
63	P	-
69	W	-
70	B	-
71	P	-
72	O	-
78	SB	-
79	V	-
80	L	-
81	W	-
82	B	-
83	LG	-
88	BR	-
89	G	-
90	GR	-
91	R	-
92	L	-
93	P	-
94	W	-
96	BR	-
97	G	-
99	SB	-
100	Y	-

A
B
C
D
E
F
G
H
I
J
K
L
M
N
O
P



POWER WINDOW MAIN SWITCH

< ECU DIAGNOSIS INFORMATION >

POWER WINDOW SYSTEM (WITH POWER WINDOW ANTI-PINCH SYSTEM)

Connector No.	M82
Connector Name	WIRE TO WIRE
Connector Type	NS10MW-CS



1	2	3	4
5	6	7	8
9	10		

Terminal No.	Color of Wire	Signal Name [Specification]
1	L	-
2	O	-
3	W	-
4	G	-
5	V	-
6	W	-
10	SB	-

JCKWM4756GB

Wiring Diagram - POWER WINDOW CONTROL SYSTEM (WITHOUT POWER WIN-

POWER WINDOW MAIN SWITCH

< ECU DIAGNOSIS INFORMATION >

POWER WINDOW SYSTEM (WITHOUT POWER WINDOW ANTI-PINCH SYSTEM)

Connector No.	B1
Connector Name	WIRE TO WIRE
Connector Type	TH80MW-CS (F-TM4)



Terminal No.	Color of Wire	Signal Name [Specification]
1	W	
2	BR	
3	G	
4	L	
6	BR	
7	Y	
8	LG	
9	BR	
10	BR	
21	R	
35	SHIELD	
36	R	
37	LG	
38	SHIELD	
39	O	
40	G	
41	R	
45	L	
46	W	
47	SHIELD	
48	V	
49	W	
50	SHIELD	
52	L	
53	L	- [With display audio]
53	G	- [With base audio or EOSE system]
54	O	
55	Y	
56	LG	
57	SB	
58	W	
59	B	
60	SB	
62	GR	
63	W	
65	SHIELD	
66	BR	
67	LG	

68	SB	-
69	SHIELD	-
70	W	-
71	Y	-
72	Y	-
77	L	-
80	R	-
81	W	-
82	GR	-
86	Y	-
87	P	-
91	GR	-
92	R	-
93	G	-
94	G	-
95	O	-
96	Y	-
97	SB	-
98	Y	-
99	Y	-
100	L	-

Connector No.	B3
Connector Name	WIRE TO WIRE
Connector Type	TH32MW-NH

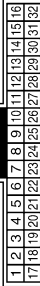

Terminal No.	Color of Wire	Signal Name [Specification]
1	L	
2	G	
4	R	
5	W	
6	G	
10	G	
13	Y	
14	BR	
15	P	
16	W	
17	LG	
18	R	
19	SB	
20	B	
21	SHIELD	

26	P	-
28	L	-
30	O	-
31	GR	-
32	LG	-

Connector No.	B4
Connector Name	WIRE TO WIRE
Connector Type	NS16MW-CS



Terminal No.	Color of Wire	Signal Name [Specification]
1	R	
2	P	
3	V	
5	LG	
6	Y	
7	SB	
8	L	
9	W	
10	O	
11	L	
12	BR	
14	G	
15	BR	
16	W	

Connector No.	B27
Connector Name	FRONT DOOR SWITCH (PASSENGER SIDE)
Connector Type	A03FW

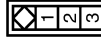

Terminal No.	2	BR	-	Signal Name [Specification]
--------------	---	----	---	-----------------------------

Connector No.	B34
Connector Name	FRONT DOOR SWITCH (DRIVER SIDE)
Connector Type	A03FW

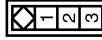

Terminal No.	2	P	-	Signal Name [Specification]
--------------	---	---	---	-----------------------------

Connector No.	B86
Connector Name	WIRE TO WIRE
Connector Type	NS12MW-CS

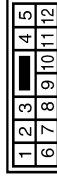

Terminal No.	Color of Wire	Signal Name [Specification]
1	V	
3	L	
6	G	
8	R	
9	LG	
10	Y	
11	L	

JCKWM4757GB

POWER WINDOW MAIN SWITCH

< ECU DIAGNOSIS INFORMATION >

POWER WINDOW SYSTEM (WITHOUT POWER WINDOW ANTI-PINCH SYSTEM)

Connector No.	B88
Connector Name	WIRE TO WIRE
Connector Type	NS12MW-CS



1	2	3	4	5
6	7	8	9	10
11	12			

Terminal No.	Color of Wire	Signal Name [Specification]
1	V	-
3	GR	-
6	G	-
8	Y	-
9	LG	-
10	Y	-
11	L	-

Connector No.	D2
Connector Name	WIRE TO WIRE
Connector Type	NS16FW-CS



7	6	5	4	3	2	1
16	15	14	13	12	11	10
9	8					

Terminal No.	Color of Wire	Signal Name [Specification]
1	GR	-
2	R	-
3	B	-
4	O	-
5	Y	-
6	SB	-
7	B	-
8	V	-
9	L	-
10	P	-
13	R	-
14	LG	-
15	W	-
16	BR	-

Connector No.	D5
Connector Name	POWER WINDOW MAIN SWITCH
Connector Type	NS16FW-CS



1	2	3	4	5	6	7
8	9	10	11	12	13	14
15	16					

Terminal No.	Color of Wire	Signal Name [Specification]
1	R	-
2	Y	-
3	O	-
5	G	-
6	BR	-
7	LG	-
8	BR	-
9	V	-
10	L	-
11	GR	-
12	SB	-
13	R	-
15	G	-
16	W	-

Connector No.	D6
Connector Name	POWER WINDOW MAIN SWITCH
Connector Type	NS30FW-CS



17	18	19
----	----	----

Terminal No.	Color of Wire	Signal Name [Specification]
17	B	-
18	P	-
19	R	-

Connector No.	D7
Connector Name	FRONT POWER WINDOW MOTOR (DRIVER SIDE)
Connector Type	NS8BFW-CS



1	2
3	4
5	6

Terminal No.	Color of Wire	Signal Name [Specification]
1	GR	-
2	BR	-
3	V	-
4	G	-
5	R	-
8	Y	-

Connector No.	D42
Connector Name	WIRE TO WIRE
Connector Type	NS10FW-CS



4	3	2	1
10	9	8	7
6	5		

Terminal No.	Color of Wire	Signal Name [Specification]
1	L	-
2	G	-
3	W	-
4	Y	-
5	V	-
6	R	-
10	SB	-

Connector No.	D45
Connector Name	FRONT POWER WINDOW SWITCH (PASSENGER SIDE)
Connector Type	NS12FW-CS



1	2	3	4	5
6	7	8	9	10
11	12			

Terminal No.	Color of Wire	Signal Name [Specification]
1	P	-
2	BR	-
3	B	-
6	Y	-
7	R	-
8	L	-
11	SB	-
12	W	-

Connector No.	D46
Connector Name	FRONT POWER WINDOW MOTOR (PASSENGER SIDE)
Connector Type	NS30FW-CS



1	2
3	4
5	6

Terminal No.	Color of Wire	Signal Name [Specification]
1	Y	-
2	R	-

JCKWM4758GB

A
B
C
D
E
F
G
H
I
J
PWC
L
M
N
O
P

POWER WINDOW MAIN SWITCH

< ECU DIAGNOSIS INFORMATION >

POWER WINDOW SYSTEM (WITHOUT POWER WINDOW ANTI-PINCH SYSTEM)

Connector No.	D81
Connector Name	WIRE TO WIRE
Connector Type	NS12FW-CS

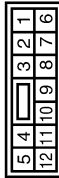

Terminal No.	Color of Wire	Signal Name [Specification]
1	V	-
3	L	-
6	G	-
8	R	-
9	LG	-
10	Y	-
11	L	-

Connector No.	D82
Connector Name	REAR POWER WINDOW MOTOR LH
Connector Type	RS08FG-DEY



Terminal No.	Color of Wire	Signal Name [Specification]
1	R	-
3	G	-

Connector No.	D83
Connector Name	REAR POWER WINDOW SWITCH LH
Connector Type	NS08FW-CS

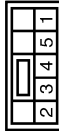

Terminal No.	Color of Wire	Signal Name [Specification]
1	L	-
2	LG	-
3	Y	-
4	G	-
5	R	-

Connector No.	D101
Connector Name	WIRE TO WIRE
Connector Type	NS12FW-CS



Terminal No.	Color of Wire	Signal Name [Specification]
1	V	-
3	GR	-
8	G	-
9	Y	-
10	W	-
11	L	-

Connector No.	D102
Connector Name	REAR POWER WINDOW MOTOR RH
Connector Type	RS08FG-DCY



Terminal No.	Color of Wire	Signal Name [Specification]
1	R	-
3	G	-

Connector No.	D103
Connector Name	REAR POWER WINDOW SWITCH RH
Connector Type	MS08FW-CS

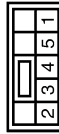

Terminal No.	Color of Wire	Signal Name [Specification]
1	L	-
2	LG	-
3	W	-
4	G	-
5	R	-

JCKWM4759GB

POWER WINDOW MAIN SWITCH

< ECU DIAGNOSIS INFORMATION >

POWER WINDOW SYSTEM (WITHOUT POWER WINDOW ANTI-PINCH SYSTEM)

Connector No.	E105
Connector Name	WIRE TO WIRE
Connector Type	TH80PW-CS16-TM4

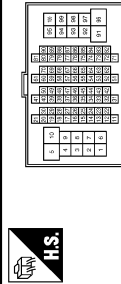

Terminal No.	Color of Wire	Signal Name [Specification]
1	W	
2	O	
3	LG	
4	V	
5	Y	
6	G	
7	R	
8	GR	
9	BR	
10	L	
11	GR	
12	P	
14	L	
15	V	
19	R	
20	P	
21	L	
22	L	
24	LG	
25	SB	
30	L	
31	BR	
42	Y	
43	SHIELD	
51	L	
52	W	
53	BR	
54	Y	
60	O	
61	BR	
62	R	
63	P	
69	G	
70	B	
71	O	
72	LG	
78	L	
79	V	

80	Y	
81	W	
82	R	
83	L	
88	BR	
89	R	
90	GR	
91	R	
92	O	
93	BR	
94	W	
96	BR	
97	G	
99	SB	
100	L	

Connector No.	M11
Connector Name	WIRE TO WIRE
Connector Type	TH80PW-CS16-TM4

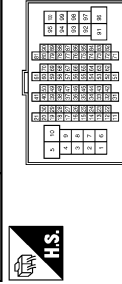

Terminal No.	Color of Wire	Signal Name [Specification]
1	W	
2	BR	
3	G	
4	LG	
6	P	
7	Y	
8	LG	
9	P	
10	Y	
21	R	
35	SHIELD	
36	P	
37	LG	
38	SHIELD	
39	O	
40	G	
41	R	
45	BR	
46	L	
47	SHIELD	
48	V	

Terminal No.	Color of Wire	Signal Name [Specification]
1	G	
2	Y	
4	R	
5	W	
6	G	
10	W	
13	Y	
14	O	
15	W	
16	V	
17	LG	
18	BR	
19	SB	
20	B	
21	SHIELD	
26	W	
29	L	
30	B	
31	GR	
32	G	

Connector No.	M14
Connector Name	WIRE TO WIRE
Connector Type	NS16FW-CS



Terminal No.	Color of Wire	Signal Name [Specification]
1	LG	
2	P	
3	V	
5	GR	
6	R	
7	SB	
8	V	
9	W	
10	O	
11	L	
12	Y	
14	G	
15	BR	
16	V	

49	W	
50	SHIELD	
52	O	
53	L	
54	V	
55	Y	
56	LG	
57	SB	
58	W	
59	B	
60	SB	
62	GR	
63	BR	
65	SHIELD	
66	BR	
67	LG	
68	SB	
69	SHIELD	
70	LG	
71	O	
72	BR	
77	L	
80	R	
81	W	
82	GR	
86	Y	
87	P	
91	L	
92	B	
93	GR	
94	G	
95	O	
96	P	
97	SB	
98	GR	
99	R	
100	L	

Connector No.	M13
Connector Name	WIRE TO WIRE
Connector Type	TH92FW-NH

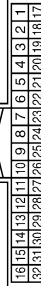

JCKWM4760GB

A
B
C
D
E
F
G
H
I
J
K
L
M
N
O
P



POWER WINDOW MAIN SWITCH

< ECU DIAGNOSIS INFORMATION >

POWER WINDOW SYSTEM (WITHOUT POWER WINDOW ANTI-PINCH SYSTEM)

Connector No.	M19
Connector Name	WIRE TO WIRE
Connector Type	NS16MW-CS



1	2	3	4	5	6	7
8	9	10	11	12	13	14
15	16					

Terminal No.	Color of Wire	Signal Name [Specification]
1	GR	-
2	P	-
3	R	-
4	R	-
5	Y	-
6	SB	-
7	B	-
8	V	-
9	L	-
10	G	-
13	GR	-
14	LG	-
15	W	-
16	L	-

Connector No.	M65
Connector Name	BCM (BODY CONTROL MODULE)
Connector Type	TH40PW-NH



1	2	3	4	5	6	7	8	9	10	11	12	13	14	15	16	17	18	19	20	21	22	23	24	25	26	27	28	29	30	31	32	33	34	35	36	37	38	39	40
---	---	---	---	---	---	---	---	---	----	----	----	----	----	----	----	----	----	----	----	----	----	----	----	----	----	----	----	----	----	----	----	----	----	----	----	----	----	----	----

Terminal No.	Color of Wire	Signal Name [Specification]
1	V	KEY RING OUTPUT
2	G	INPUT 5
3	Y	INPUT 4
4	W	INPUT 3
5	R	INPUT 2
6	P	INPUT 1
7	L	KEY CYG UNLOCK
8	R	KEY CYL LOCK SW

9	R	BRAKE SW
10	SB	RR DEF SW
11	SB	ACC
12	P	DR SW AS
13	LG	DR SW RR
14	G	AUTO LIGHT SENS INPUT
17	W	SENS POWER SUPPLY
18	O	KEYLESS TUNER SENS GND
19	V	KEYLESS TUNER POWER
20	GR	KEYLESS TUNER SIGNAL
21	G	IMMOBILANT (CLOCK)
23	B	SECURITY IN OUT PUT
25	BR	IMMOBILANT (RX, TX)
27	Y	AIRCORN SW
28	LG	BLOWER FAN SW
29	W	HAZARD SW
30	G	BACK DOOR OPEN SW
32	BR	OUTPUT 5
33	GR	OUTPUT 4
34	L	OUTPUT 3
35	B	OUTPUT 2
36	V	OUTPUT 1
37	LG	KEY SW
38	G	IGN
39	L	CAN-H
40	P	CAN-L



36	37	38	39	40	41	42	43	44	45	46	47	48	49
50	51	52	53	54	55	56	57	58	59	60	61	62	63
64	65	66	67	68	69	70							

Terminal No.	Color of Wire	Signal Name [Specification]
56	Y	BATTERY SAVER OUTPUT
57	G	BAT FUSE
59	L	D/L UNLOCK DR
60	BR	FLASHER OUT PUT (LEFT)
61	GR	FLASHER OUT PUT (RIGHT)
63	R	ROOM LAMP OUTPUT
65	V	D/L LOCK ALL
66	G	D/L UNLOCK OTHER
67	B	GND
68	L	POWER WDW OUTPUT (RAP)
69	P	POWER WDW OUTPUT (BAT)
70	Y	BAT FL

Connector No.	M66
Connector Name	BCM (BODY CONTROL MODULE)
Connector Type	FEA09FW-FHA6-SA



41	42	43	44	45	46	47	48	49
50	51	52	53	54	55			

Terminal No.	Color of Wire	Signal Name [Specification]
43	V	BACK DOOR SW
44	B	RR WIP AUTO STOP
45	P	GDLOCK SW
46	BR	CDUNLOCK SW
47	W	DR SW DR
48	GR	DR SW RL
49	L	LUGGAGE LAMP OUTPUT
53	V	BACK DOOR OPENER OUTPUT
55	SB	RR WIP MTR OUT

11	GR	-
12	P	-
14	SB	-
15	V	-
19	R	-
20	P	-
21	O	-
22	L	-
24	BR	-
25	W	-
30	L	-
31	W	-
42	O	-
43	SHIELD	-
51	W	-
52	SB	-
53	L	-
54	Y	-
60	O	-
61	BR	-
62	G	-
63	P	-
69	W	-
70	B	-
71	P	-
72	O	-
78	SS	-
79	V	-
80	L	-
81	W	-
82	B	-
83	LG	-
88	BR	-
89	G	-
90	GR	-
91	R	-
92	L	-
93	P	-
94	W	-
96	BR	-
97	G	-
99	SS	-
100	Y	-

Connector No.	M77
Connector Name	WIRE TO WIRE
Connector Type	TH80MW-CS16-TM4



1	2	3	4	5	6	7	8	9	10	11	12	13	14	15	16	17	18	19	20	21	22	23	24	25	26	27	28	29	30	31	32	33	34	35	36	37	38	39	40
---	---	---	---	---	---	---	---	---	----	----	----	----	----	----	----	----	----	----	----	----	----	----	----	----	----	----	----	----	----	----	----	----	----	----	----	----	----	----	----

Terminal No.	Color of Wire	Signal Name [Specification]
1	BR	-
2	O	-
3	LG	-
4	Y	-
5	Y	-
6	G	-
7	R	-
8	GR	-
9	BR	-
10	L	-

POWER WINDOW MAIN SWITCH

< ECU DIAGNOSIS INFORMATION >

A
B
C
D
E
F
G
H
I
J
L
M
N
O
P

PWC

POWER WINDOW SYSTEM (WITHOUT POWER WINDOW ANTI-PINCH SYSTEM)

Connector No.	M82
Connector Name	WIRE TO WIRE
Connector Type	MS10MW-CS



1	2	3	4
5	6	7	8
9	10		

Terminal No.	Color of Wire	Signal Name [Specification]
1	L	-
2	O	-
3	W	-
4	G	-
5	V	-
6	W	-
10	SB	-

JCKWM4762GB

Fail Safe

INFOID:000000006199701

FAIL-SAFE CONTROL

Switches to fail-safe control when malfunction is detected in encoder signal that detects up/down speed and direction of door glass. Switches to fail-safe control when error beyond regulation value is detected between the fully closed position and the actual position of the glass.

POWER WINDOW MAIN SWITCH

< ECU DIAGNOSIS INFORMATION >

Error	Error condition
Pulse sensor malfunction	When only one side of pulse signal is being detected for more than the specified value.
Both pulse sensors malfunction	When both pulse signals have not been detected for more than the specified value during glass open/close operation.
Pulse direction malfunction	When the pulse signal that is detected during glass open/close operation detects the opposite condition of power window motor operating direction.
Glass recognition position malfunction 1	When it detects the error between glass fully closed position in power window switch memory and actual fully closed position during glass open/close operation is more than the specified value.
Glass recognition position malfunction 2	When it detects pulse count more than the value of glass full stroke during glass open/close operation.
Malfunction of not yet updated closed position of glass	When glass open/close operation is continuously performed without fully closing more than the specified value (approximately 10 strokes).

It changes to condition before initialization and the following functions do not operate when switched to fail-safe control.

- Auto-up operation
- Anti-pinch function

Perform initial operation to recover when switched to fail-safe mode. However, it switches back to fail-safe control when malfunction is found in power window main switch or front power window motor (driver side).

NONE OF THE POWER WINDOWS CAN BE OPERATED USING ANY SWITCH

< SYMPTOM DIAGNOSIS >

SYMPTOM DIAGNOSIS

NONE OF THE POWER WINDOWS CAN BE OPERATED USING ANY SWITCH

Diagnosis Procedure

INFOID:000000006199702

1. CHECK BCM POWER SUPPLY AND GROUND CIRCUIT

Check BCM power supply and ground circuit.
Refer to [PWC-12, "BCM : Diagnosis Procedure"](#).

Is the inspection result normal?

YES >> GO TO 2.

NO >> Repair or replace the malfunctioning parts.

2. CHECK POWER WINDOW MAIN SWITCH POWER SUPPLY AND GROUND CIRCUIT

Check power window main switch power supply and ground circuit.
Refer to [PWC-13, "POWER WINDOW MAIN SWITCH : Diagnosis Procedure"](#).

Is the inspection result normal?

YES >> GO TO 3.

NO >> Repair or replace the malfunctioning parts.

3. CONFIRM THE OPERATION

Confirm the operation again.

Is the result normal?

YES >> Check intermittent incident. Refer to [GI-45, "Intermittent Incident"](#).

NO >> GO TO 1.

A
B
C
D
E
F
G
H
I
J
L
M
N
O
P

PWC

DRIVER SIDE POWER WINDOW DOES NOT OPERATE

< SYMPTOM DIAGNOSIS >

DRIVER SIDE POWER WINDOW DOES NOT OPERATE

Diagnosis Procedure

INFOID:000000006199703

1. CHECK FRONT POWER WINDOW MOTOR (DRIVER SIDE)

Check power window motor.

Refer to [PWC-20, "DRIVER SIDE : Component Function Check"](#).

Is the inspection result normal?

YES >> GO TO 2.

NO >> Repair or replace the malfunctioning parts.

2. CONFIRM THE OPERATION

Confirm the operation again.

Is the result normal?

YES >> Check intermittent incident. Refer to [GI-45, "Intermittent Incident"](#).

NO >> GO TO 1.

FRONT PASSENGER SIDE POWER WINDOW DOES NOT OPERATE

< SYMPTOM DIAGNOSIS >

FRONT PASSENGER SIDE POWER WINDOW DOES NOT OPERATE WITH BOTH POWER WINDOW MAIN SWITCH AND FRONT PASSENGER SIDE POWER WINDOW SWITCH

WITH BOTH POWER WINDOW MAIN SWITCH AND FRONT PASSENGER SIDE
POWER WINDOW SWITCH : Diagnosis Procedure

INFOID:000000006199704

1. CHECK FRONT POWER WINDOW SWITCH (PASSENGER SIDE)

Check front power window switch (passenger side).
Refer to [PWC-16, "Component Function Check"](#).

Is the inspection result normal?

YES >> GO TO 2.

NO >> Repair or replace the malfunctioning parts

2. CHECK FRONT POWER WINDOW MOTOR (PASSENGER SIDE)

Check front power window motor (passenger side).
Refer to [PWC-21, "PASSENGER SIDE : Component Function Check"](#).

Is the inspection result normal?

YES >> GO TO 3.

NO >> Repair or replace the malfunctioning parts.

3. CONFIRM THE OPERATION

Confirm the operation again.

Is the result normal?

YES >> Check intermittent incident. Refer to [GI-45, "Intermittent Incident"](#).

NO >> GO TO 1.

WITH FRONT POWER WINDOW SWITCH ONLY

WITH FRONT POWER WINDOW SWITCH ONLY : Diagnosis Procedure

INFOID:000000006199705

1. CHECK FRONT POWER WINDOW SWITCH (PASSENGER SIDE) POWER SUPPLY AND GROUND CIRCUIT

Check front power window switch (passenger side) power supply and ground circuit.
Refer to [PWC-14, "FRONT POWER WINDOW SWITCH \(PASSENGER SIDE\) : Diagnosis Procedure"](#).

Is the inspection result normal?

YES >> GO TO 2.

NO >> Repair or replace the malfunctioning parts.

2. CHECK FRONT POWER WINDOW SWITCH (PASSENGER SIDE)

Check front power window switch (passenger side).
Refer to [PWC-16, "Component Function Check"](#).

Is the inspection result normal?

YES >> GO TO 3.

NO >> Repair or replace the malfunctioning parts

3. CONFIRM THE OPERATION

Confirm the operation again.

Is the result normal?

YES >> Check intermittent incident. Refer to [GI-45, "Intermittent Incident"](#).

NO >> GO TO 1.

A
B
C
D
E
F
G
H
I
J
L
M
N
O
P

PWC

REAR LH SIDE POWER WINDOW DOES NOT OPERATE

< SYMPTOM DIAGNOSIS >

REAR LH SIDE POWER WINDOW DOES NOT OPERATE WITH BOTH POWER WINDOW MAIN SWITCH AND REAR POWER WINDOW SWITCH LH

WITH BOTH POWER WINDOW MAIN SWITCH AND REAR POWER WINDOW
SWITCH LH : Diagnosis Procedure

INFOID:000000006199706

1.CHECK REAR POWER WINDOW SWITCH

Check rear power window switch.

Refer to [PWC-18, "Component Function Check"](#).

Is the inspection result normal?

YES >> GO TO 2.

NO >> Repair or replace the malfunctioning parts.

2.CHECK REAR POWER WINDOW MOTOR LH

Check rear power window motor LH.

Refer to [PWC-23, "REAR LH : Component Function Check"](#).

Is the inspection result normal?

YES >> GO TO 3.

NO >> Repair or replace the malfunctioning parts.

3.CONFIRM THE OPERATION

Confirm the operation again.

Is the result normal?

YES >> Check intermittent incident. Refer to [GI-45, "Intermittent Incident"](#).

NO >> GO TO 1.

WITH REAR POWER WINDOW SWITCH LH ONLY

WITH REAR POWER WINDOW SWITCH LH ONLY : Diagnosis Procedure

INFOID:000000006199707

1.CHECK REAR POWER WINDOW SWITCH POWER SUPPLY AND GROUND CIRCUIT

Check rear power window switch power supply and ground circuit.

Refer to [PWC-14, "REAR POWER WINDOW SWITCH : Diagnosis Procedure"](#).

Is the inspection result normal?

YES >> GO TO 2.

NO >> Repair or replace the malfunctioning parts.

2.CHECK REAR POWER WINDOW SWITCH

Check rear power window switch.

Refer to [PWC-18, "Component Function Check"](#).

Is the inspection result normal?

YES >> GO TO 3.

NO >> Repair or replace the malfunctioning parts.

3.CONFIRM THE OPERATION

Confirm the operation again.

Is the result normal?

YES >> Check intermittent incident. Refer to [GI-45, "Intermittent Incident"](#).

NO >> GO TO 1.

REAR RH SIDE POWER WINDOW DOES NOT OPERATE

< SYMPTOM DIAGNOSIS >

REAR RH SIDE POWER WINDOW DOES NOT OPERATE
WITH BOTH POWER WINDOW MAIN SWITCH AND REAR POWER WINDOW SWITCH RH

WITH BOTH POWER WINDOW MAIN SWITCH AND REAR POWER WINDOW SWITCH RH : Diagnosis Procedure

INFOID:000000006199708

1.CHECK REAR POWER WINDOW SWITCH

Check rear power window switch.
Refer to [PWC-18, "Component Function Check"](#).

Is the inspection result normal?

- YES >> GO TO 2.
- NO >> Repair or replace the malfunctioning parts.

2.CHECK REAR POWER WINDOW MOTOR RH

Check rear power window motor RH.
Refer to [PWC-24, "REAR RH : Component Function Check"](#).

Is the inspection result normal?

- YES >> GO TO 3.
- NO >> Repair or replace the malfunctioning parts.

3.CONFIRM THE OPERATION

Confirm the operation again.

Is the result normal?

- YES >> Check intermittent incident. Refer to [GI-45, "Intermittent Incident"](#).
- NO >> GO TO 1.

WITH REAR POWER WINDOW SWITCH RH ONLY

WITH REAR POWER WINDOW SWITCH RH ONLY : Diagnosis Procedure

INFOID:000000006199709

1.CHECK REAR POWER WINDOW SWITCH POWER SUPPLY AND GROUND CIRCUIT

Check rear power window switch power supply and ground circuit.
Refer to [PWC-14, "REAR POWER WINDOW SWITCH : Diagnosis Procedure"](#).

Is the inspection result normal?

- YES >> GO TO 2.
- NO >> Repair or replace the malfunctioning parts.

2.CHECK REAR POWER WINDOW SWITCH

Check rear power window switch.
Refer to [PWC-18, "Component Function Check"](#).

Is the inspection result normal?

- YES >> GO TO 3.
- NO >> Repair or replace the malfunctioning parts.

3.CONFIRM THE OPERATION

Confirm the operation again.

Is the result normal?

- YES >> Check intermittent incident. Refer to [GI-45, "Intermittent Incident"](#).
- NO >> GO TO 1.

A
B
C
D
E
F
G
H
I
J
L
M
N
O
P

PWC

ANTI-PINCH SYSTEM DOES NOT OPERATE NORMALLY (DRIVER SIDE)

< SYMPTOM DIAGNOSIS >

ANTI-PINCH SYSTEM DOES NOT OPERATE NORMALLY (DRIVER SIDE)

Diagnosis Procedure

INFOID:000000006199710

1. PERFORM INITIALIZATION PROCEDURE

Initialization procedure is executed and operation is confirmed.

Refer to [PWC-5. "ADDITIONAL SERVICE WHEN REMOVING BATTERY NEGATIVE TERMINAL : Special Repair Requirement"](#).

Is the inspection result normal?

YES >> INSPECTION END

NO >> GO TO 2.

2. CHECK ENCODER CIRCUIT

Check encoder circuit.

Refer to [PWC-30. "Component Function Check"](#).

Is the inspection result normal?

YES >> GO TO 3.

NO >> Repair or replace the malfunctioning parts.

3. CONFIRM THE OPERATION

Confirm the operation again.

Is the result normal?

YES >> Check intermittent incident. Refer to [GI-45. "Intermittent Incident"](#).

NO >> GO TO 1.

POWER WINDOW RETAINED POWER OPERATION DOES NOT OPERATE PROPERLY

< SYMPTOM DIAGNOSIS >

POWER WINDOW RETAINED POWER OPERATION DOES NOT OPERATE PROPERLY

Diagnosis Procedure

INFOID:000000006199711

1.CHECK DOOR SWITCH

Check door switch.

Refer to [PWC-27, "Component Function Check"](#).

Is the inspection result normal?

YES >> GO TO 2.

NO >> Repair or replace the malfunctioning parts.

2.CONFIRM THE OPERATION

Confirm the operation again.

Is the result normal?

YES >> Check intermittent incident. Refer to [GI-45, "Intermittent Incident"](#).

NO >> GO TO 1.

A
B
C
D
E
F
G
H
I
J
L
M
N
O
P

PWC

AUTO OPERATION DOES NOT OPERATE BUT MANUAL OPERATE NORMALLY (DRIVER SIDE)

< SYMPTOM DIAGNOSIS >

AUTO OPERATION DOES NOT OPERATE BUT MANUAL OPERATE NORMALLY (DRIVER SIDE)

Diagnosis Procedure

INFOID:000000006199712

1.PERFORM INITIALIZATION PROCEDURE

Initialization procedure is executed and operation is confirmed.

Refer to [PWC-5. "ADDITIONAL SERVICE WHEN REMOVING BATTERY NEGATIVE TERMINAL : Special Repair Requirement"](#).

Is the inspection result normal?

YES >> INSPECTION END
NO >> GO TO 2.

2.CHECK ENCODER

Check encoder.

Refer to [PWC-30. "Component Function Check"](#).

Is the inspection result normal?

YES >> GO TO 3.
NO >> Repair or replace the malfunctioning parts.

3.CONFIRM THE OPERATION

Confirm the operation again.

Is the result normal?

YES >> Check intermittent incident. Refer to [GI-45. "Intermittent Incident"](#).
NO >> GO TO 1.

POWER WINDOW LOCK SWITCH DOES NOT FUNCTION

< SYMPTOM DIAGNOSIS >

POWER WINDOW LOCK SWITCH DOES NOT FUNCTION

Diagnosis Procedure

INFOID:000000006199713

1. REPLACE POWER WINDOW MAIN SWITCH

Replace power window main switch.

>> Refer to [PWC-82. "Removal and Installation"](#).

A
B
C
D
E
F
G
H
I
J
L
M
N
O
P

PWC

PRECAUTIONS

< PRECAUTION >

PRECAUTION

PRECAUTIONS FOR MEXICO

FOR MEXICO : Precaution for Supplemental Restraint System (SRS) "AIR BAG" and "SEAT BELT PRE-TENSIONER"

INFOID:000000006199714

The Supplemental Restraint System such as "AIR BAG" and "SEAT BELT PRE-TENSIONER", used along with a front seat belt, helps to reduce the risk or severity of injury to the driver and front passenger for certain types of collision. Information necessary to service the system safely is included in the "SRS AIR BAG" and "SEAT BELT" of this Service Manual.

WARNING:

- To avoid rendering the SRS inoperative, which could increase the risk of personal injury or death in the event of a collision which would result in air bag inflation, all maintenance must be performed by an authorized NISSAN/INFINITI dealer.
- Improper maintenance, including incorrect removal and installation of the SRS, can lead to personal injury caused by unintentional activation of the system. For removal of Spiral Cable and Air Bag Module, see "SRS AIR BAG".
- Never use electrical test equipment on any circuit related to the SRS unless instructed to in this Service Manual. SRS wiring harnesses can be identified by yellow and/or orange harnesses or harness connectors.

PRECAUTIONS WHEN USING POWER TOOLS (AIR OR ELECTRIC) AND HAMMERS

WARNING:

- When working near the Air Bag Diagnosis Sensor Unit or other Air Bag System sensors with the ignition ON or engine running, never use air or electric power tools or strike near the sensor(s) with a hammer. Heavy vibration could activate the sensor(s) and deploy the air bag(s), possibly causing serious injury.
- When using air or electric power tools or hammers, always switch the ignition OFF, disconnect the battery, and wait at least 3 minutes before performing any service.

FOR USA AND CANADA

FOR USA AND CANADA : Precaution for Supplemental Restraint System (SRS) "AIR BAG" and "SEAT BELT PRE-TENSIONER"

INFOID:000000006199715

The Supplemental Restraint System such as "AIR BAG" and "SEAT BELT PRE-TENSIONER", used along with a front seat belt, helps to reduce the risk or severity of injury to the driver and front passenger for certain types of collision. This system includes seat belt switch inputs and dual stage front air bag modules. The SRS system uses the seat belt switches to determine the front air bag deployment, and may only deploy one front air bag, depending on the severity of a collision and whether the front occupants are belted or unbelted. Information necessary to service the system safely is included in the "SRS AIR BAG" and "SEAT BELT" of this Service Manual.

WARNING:

- To avoid rendering the SRS inoperative, which could increase the risk of personal injury or death in the event of a collision that would result in air bag inflation, all maintenance must be performed by an authorized NISSAN/INFINITI dealer.
- Improper maintenance, including incorrect removal and installation of the SRS, can lead to personal injury caused by unintentional activation of the system. For removal of Spiral Cable and Air Bag Module, see "SRS AIR BAG".
- Never use electrical test equipment on any circuit related to the SRS unless instructed to in this Service Manual. SRS wiring harnesses can be identified by yellow and/or orange harnesses or harness connectors.

PRECAUTIONS WHEN USING POWER TOOLS (AIR OR ELECTRIC) AND HAMMERS

WARNING:

- When working near the Air Bag Diagnosis Sensor Unit or other Air Bag System sensors with the ignition ON or engine running, never use air or electric power tools or strike near the sensor(s) with

PRECAUTIONS

< PRECAUTION >

-
- a hammer. Heavy vibration could activate the sensor(s) and deploy the air bag(s), possibly causing serious injury.
 - When using air or electric power tools or hammers, always switch the ignition OFF, disconnect the battery, and wait at least 3 minutes before performing any service.

A

B

C

D

E

F

G

H

I

J

PWC

L

M

N

O

P

POWER WINDOW MAIN SWITCH

< REMOVAL AND INSTALLATION >

REMOVAL AND INSTALLATION

POWER WINDOW MAIN SWITCH

Exploded View

INFOID:000000006199716

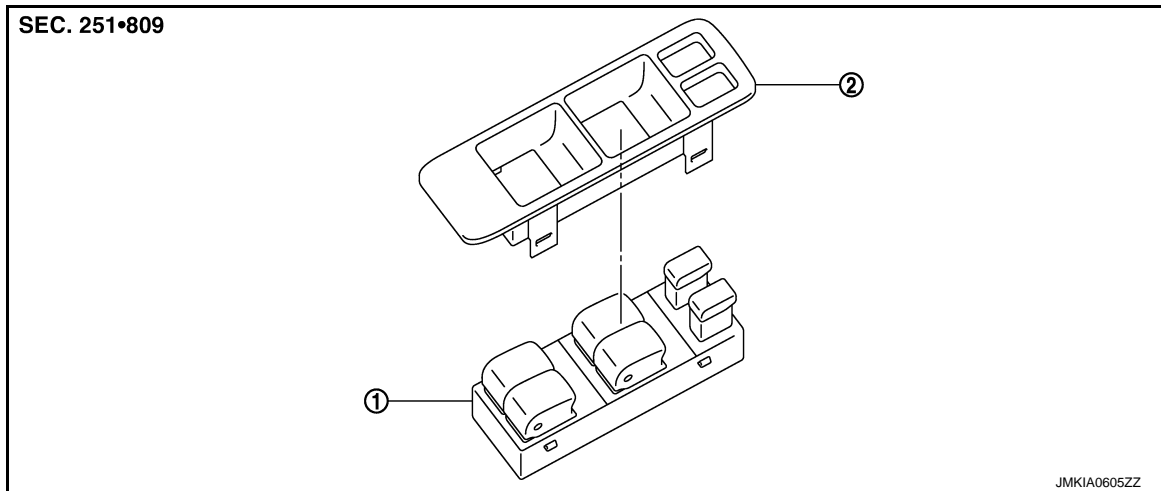

1. Power window main switch

2. Power window main switch finisher

NOTE:

The same procedure is also performed for front power window switch (passenger side) and rear power switch (LH & RH).

Refer to removal and installation procedure. Refer to [PWC-82. "Removal and Installation"](#).

Removal and Installation

INFOID:000000006199717

REMOVAL

1. Remove the power window main switch finisher (2).
Refer to [INT-13. "FRONT DOOR FINISHER : Exploded View"](#) and [INT-13. "FRONT DOOR FINISHER : Removal and Installation"](#).
2. Power window main switch (1) is removed from power window main switch finisher (2) using flat-head screw driver (A) etc.

 : Pawl

CAUTION:

Do not fold the pawl of power window main switch finisher.

NOTE:

The same procedure is also performed for front power window switch (passenger side) and rear power window switch (LH & RH).

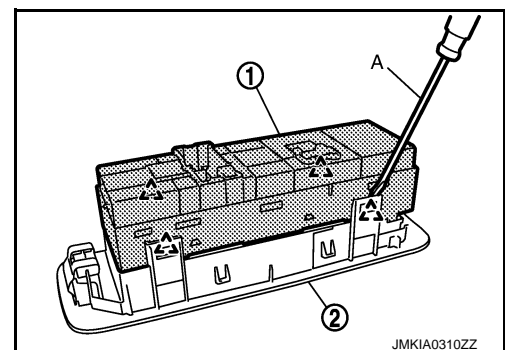

INSTALLATION

Install in the reverse order of removal.

NOTE:

Power window main switch is exchanged or is detached it is necessary to do the initialization procedure. Refer to [PWC-5. "ADDITIONAL SERVICE WHEN REMOVING BATTERY NEGATIVE TERMINAL : Special Repair Requirement"](#).