

SECTION **STC**

STEERING CONTROL SYSTEM

A
B
C
D
E

CONTENTS

<p>BASIC INSPECTION 3</p> <p>DIAGNOSIS AND REPAIR WORKFLOW 3</p> <p style="padding-left: 20px;">Work Flow3</p> <p>SYSTEM DESCRIPTION 4</p> <p>EPS SYSTEM 4</p> <p style="padding-left: 20px;">System Diagram4</p> <p style="padding-left: 20px;">System Description4</p> <p style="padding-left: 20px;">Component Parts Location5</p> <p style="padding-left: 20px;">Component Description5</p> <p>DIAGNOSIS SYSTEM (EPS CONTROL UNIT) 7</p> <p style="padding-left: 20px;">CONSULT-III Function7</p> <p>DTC/CIRCUIT DIAGNOSIS 8</p> <p>C1601 BATTERY POWER SUPPLY 8</p> <p style="padding-left: 20px;">Description8</p> <p style="padding-left: 20px;">DTC Logic8</p> <p style="padding-left: 20px;">Diagnosis Procedure8</p> <p style="padding-left: 20px;">Special Repair Requirement9</p> <p>C1604 TORQUE SENSOR10</p> <p style="padding-left: 20px;">Description 10</p> <p style="padding-left: 20px;">DTC Logic 10</p> <p style="padding-left: 20px;">Diagnosis Procedure 10</p> <p style="padding-left: 20px;">Special Repair Requirement 10</p> <p>C1606 EPS MOTOR11</p> <p style="padding-left: 20px;">Description 11</p> <p style="padding-left: 20px;">DTC Logic 11</p> <p style="padding-left: 20px;">Diagnosis Procedure 11</p> <p style="padding-left: 20px;">Special Repair Requirement 11</p> <p>C1607 EEPROM12</p> <p style="padding-left: 20px;">Description 12</p> <p style="padding-left: 20px;">DTC Logic 12</p> <p style="padding-left: 20px;">Diagnosis Procedure 12</p> <p style="padding-left: 20px;">Special Repair Requirement 12</p>	<p>C1608 CONTROL UNIT13</p> <p style="padding-left: 20px;">Description13</p> <p style="padding-left: 20px;">DTC Logic13</p> <p style="padding-left: 20px;">Diagnosis Procedure13</p> <p style="padding-left: 20px;">Special Repair Requirement14</p> <p>U1200 VEHICLE SPEED SIGNAL (ABS)15</p> <p style="padding-left: 20px;">Description15</p> <p style="padding-left: 20px;">DTC Logic15</p> <p style="padding-left: 20px;">Diagnosis Procedure15</p> <p style="padding-left: 20px;">Special Repair Requirement15</p> <p>U14FF VEHICLE SPEED SIGNAL (METER) ...17</p> <p style="padding-left: 20px;">Description17</p> <p style="padding-left: 20px;">DTC Logic17</p> <p style="padding-left: 20px;">Diagnosis Procedure17</p> <p style="padding-left: 20px;">Special Repair Requirement17</p> <p>U1000 CAN COMM CIRCUIT19</p> <p style="padding-left: 20px;">Description19</p> <p style="padding-left: 20px;">DTC Logic19</p> <p style="padding-left: 20px;">Diagnosis Procedure19</p> <p style="padding-left: 20px;">Special Repair Requirement19</p> <p>ECU DIAGNOSIS INFORMATION20</p> <p>EPS CONTROL UNIT20</p> <p style="padding-left: 20px;">Reference Value20</p> <p style="padding-left: 20px;">Wiring Diagram - ELECTRONICALLY CONTROLLED POWER STEERING SYSTEM -22</p> <p style="padding-left: 20px;">Fail-Safe24</p> <p style="padding-left: 20px;">DTC Index25</p> <p>SYMPTOM DIAGNOSIS26</p> <p>EPS WARNING LAMP DOES NOT TURN ON...26</p> <p style="padding-left: 20px;">Description26</p> <p style="padding-left: 20px;">Diagnosis Procedure26</p> <p>EPS WARNING LAMP DOES NOT TURN OFF27</p> <p style="padding-left: 20px;">Description27</p>
--	--

F
STC
H
I
J
K
L
M
N
O
P

Diagnosis Procedure	27	FOR USA AND CANADA : Precaution Necessary for Steering Wheel Rotation after Battery Disconnect	32
STEERING WHEEL TURNING FORCE IS HEAVY OR LIGHT	29	FOR USA AND CANADA : Service Notice or Precautions for EPS System	33
Diagnosis Procedure	29		
UNBALANCE STEERING WHEEL TURNING FORCE AND RETURN BETWEEN RIGHT AND LEFT	30	FOR MEXICO	33
Diagnosis Procedure	30	FOR MEXICO : Precaution for Supplemental Restraint System (SRS) "AIR BAG" and "SEAT BELT PRE-TENSIONER"	33
UNBALANCE STEERING WHEEL TURNING FORCE (TORQUE VARIATION)	31	FOR MEXICO : Precaution Necessary for Steering Wheel Rotation after Battery Disconnect	34
Diagnosis Procedure	31	FOR MEXICO : Service Notice or Precautions for EPS System	34
PRECAUTION	32	REMOVAL AND INSTALLATION	36
PRECAUTIONS	32	EPS CONTROL UNIT	36
FOR USA AND CANADA	32	Exploded View	36
FOR USA AND CANADA : Precaution for Supplemental Restraint System (SRS) "AIR BAG" and "SEAT BELT PRE-TENSIONER"	32	Removal and Installation	36

DIAGNOSIS AND REPAIR WORKFLOW

< BASIC INSPECTION >

BASIC INSPECTION

DIAGNOSIS AND REPAIR WORKFLOW

Work Flow

INFOID:000000005254050

DETAILED FLOW

1. COLLECT THE INFORMATION FROM THE CUSTOMER

Get the detailed information from the customer about the symptom (the condition and the environment when the incident/malfunction occurred) using the diagnosis worksheet.

>> GO TO 2.

2. PERFORM THE SELF-DIAGNOSIS

Check the DTC display with the self-diagnosis function. Refer to [STC-7, "CONSULT-III Function"](#).

Is there any DTC displayed?

YES >> GO TO 3.

NO >> GO TO 4.

3. PERFORM THE SYSTEM DIAGNOSIS

Perform the diagnosis applicable to the displayed DTC. Refer to [STC-25, "DTC Index"](#).

>> GO TO 6.

4. CHECK THE WARNING LAMP FOR ILLUMINATION

Check that the warning lamp illuminate.

Is ON/OFF timing normal?

YES >> GO TO 5.

NO >> GO TO 2.

5. PERFORM THE DIAGNOSIS BY SYMPTOM

Perform the diagnosis applicable to the symptom.

>> GO TO 6.

6. REPAIR OR REPLACE THE MALFUNCTIONING PARTS

Repair or replace the specified malfunctioning parts.

>> GO TO 7.

7. FINAL CHECK

Perform the self-diagnosis again, and check that the malfunction is repaired completely. After checking, erase the self-diagnosis memory. Refer to [STC-7, "CONSULT-III Function"](#).

Is no other DTC present and the repair completed?

YES >> INSPECTION END

NO >> GO TO 3.

A
B
C
D
E
F
STC
H
I
J
K
L
M
N
O
P

EPS SYSTEM

< SYSTEM DESCRIPTION >

SYSTEM DESCRIPTION

EPS SYSTEM

System Diagram

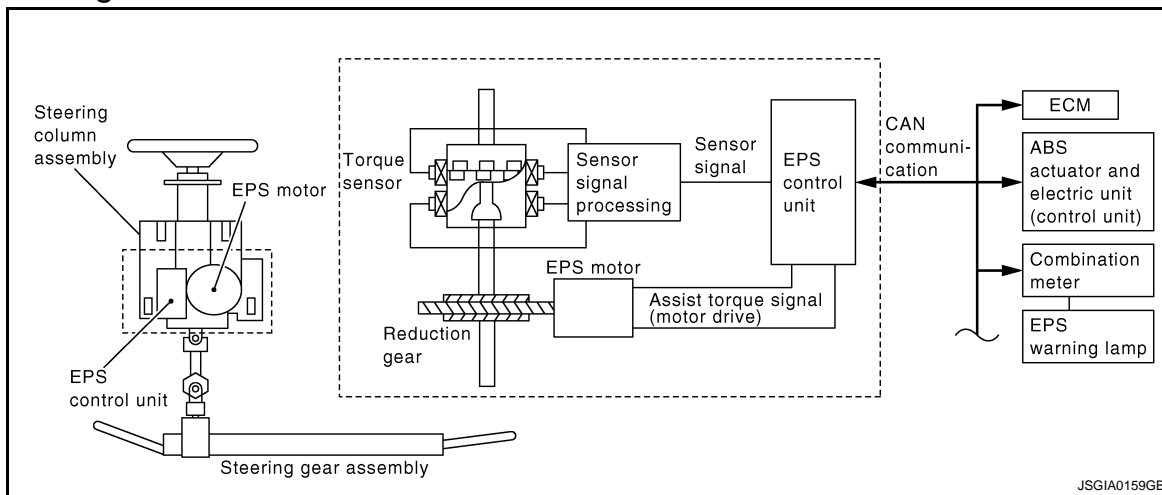

System Description

INFOID:000000005254052

- EPS control unit performs an arithmetical operation on data, such as steering wheel turning force (sensor signal) from the torque sensor, vehicle speed signal, etc. Then it generates an optimum assist torque signal to the EPS motor according to the driving condition.
- EPS control unit decreases the output signal to EPS motor while extremely using the power steering function (e.g., full steering) consecutively for protecting EPS motor and EPS control unit (Overload protection control). While activating overload protection control, the assist torque gradually decreases, and the steering wheel turning force becomes heavy. The normal assist torque reactivates by no steering.
- In case of an error in the electrical system, the fail-safe function stops output signals to the EPS motor. Then the previous state is changed to the manual steering state.
- Self-diagnosis can be done with CONSULT-III.
- EPS control unit will decrease assistance under the following 2 conditions.
 - Extensive steering at low speed will cause the ECU and MOTOR to heat up, once temperature reaches critical point ECU will reduce current to reduce heat up. System will recover as temperature lowers (reduced or no assistance).
 - Holding steering on rack-end (full lock) for 1 second will cause the system to engage rack-end protection. This reduces assistance down to 50% in order to prevent heat up. Assistance is immediately returned to 100% when steering released or turned away from rack-end.

EPS SYSTEM

< SYSTEM DESCRIPTION >

Component Parts Location

INFOID:000000005254053

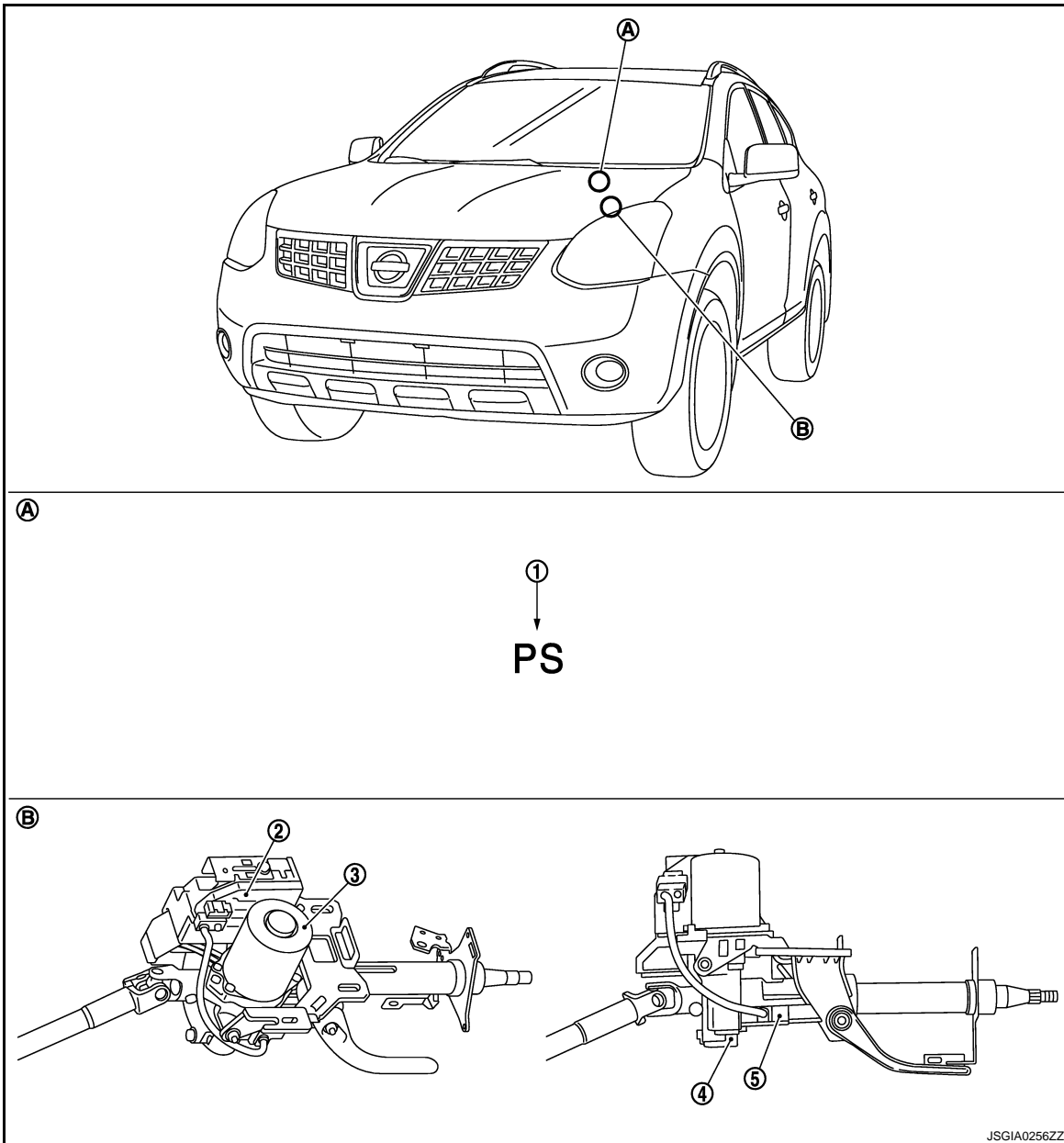

- 1. EPS warning lamp
- 2. EPS control unit
- 3. EPS motor
- 4. Reduction gear
- 5. Torque sensor
- A. Combination meter
- B. Steering column assembly

Component Description

INFOID:000000005254054

Components parts	Reference
EPS control unit	STC-13, "Description"
EPS motor	STC-11, "Description"
Torque sensor	STC-10, "Description"

EPS SYSTEM

< SYSTEM DESCRIPTION >

Components parts	Reference
Reduction gear	Reduction gear increases the assist torque provided from EPS motor with worm gears, and outputs to the column shaft.
EPS warning lamp	Turn on when a malfunction occurs in the EPS system, and tells the driver the malfunction.

DIAGNOSIS SYSTEM (EPS CONTROL UNIT)

< SYSTEM DESCRIPTION >

DIAGNOSIS SYSTEM (EPS CONTROL UNIT)

CONSULT-III Function

INFOID:000000005254055

FUNCTION

CONSULT-III can display each diagnostic item using the diagnostic test modes shown below.

Diagnostic test mode	Function
ECU identification	Steering column assembly number can be read.
Self-diagnostic results	Self-diagnostic results can be read and erased quickly.
Data monitor	Input/Output data in the EPS control unit can be read.

SELF-DIAG RESULTS MODE

Display Item List

Refer to [STC-25. "DTC Index"](#).

DATA MONITOR MODE

Display Item List

Monitor item (Unit)	Remarks
BATTERY VOLT (V)	Displays the power supply voltage for EPS control unit.
TORQUE SENSOR (Nm)	Displays steering wheel turning force detected by torque sensor.
MOTOR SIG (A)	Displays the current commanded value to EPS motor.
MOTOR CURRENT (A)	Displays the current value consumed by EPS motor.
ASSIST TORQUE (Nm)	Displays assist torque being output by the electric power steering.
C/U TEMP (°C)	Displays the temperature of the EPS control unit.
ASSIST LEVEL (%)	Normally displays 100%. In case of an excessive stationary steering, the assist curvature gradually falls. However, it return to 100% when left standing.
VEHICLE SPEED (km/h) or (MPH)	Vehicle speed is displayed from vehicle speed signal via CAN communication.
WARNING LAMP (On/Off)	EPS warning lamp control status is displayed.
ENGINE STATUS (STOP/RUN/STALL/CRANK)	Engine speed is displayed from engine status signal via CAN communication.
MOTOR TEMP (°C)	Displays the temperature of EPS motor.
VHCL SPD CALC (km/h) or (MPH)	Displays vehicle speeds used for controlling EPS.

A

B

C

D

E

F

STC

H

I

J

K

L

M

N

O

P

C1601 BATTERY POWER SUPPLY

< DTC/CIRCUIT DIAGNOSIS >

DTC/CIRCUIT DIAGNOSIS

C1601 BATTERY POWER SUPPLY

Description

INFOID:000000005254056

Power is supplied from the battery to EPS control unit.

DTC Logic

INFOID:000000005254057

DTC DETECTION LOGIC

DTC	Display item	Malfunction detected condition	Possible cause
C1601	BATTERY VOLT	When the EPS control unit power supply malfunction is detected.	<ul style="list-style-type: none">• Harness or connector• EPS control unit

DTC CONFIRMATION PROCEDURE

1.CHECK SELF-DIAGNOSIS RESULTS

With CONSULT-III

Perform self-diagnosis for "EPS" with CONSULT-III.

Self-diagnosis results

BATTERY VOLT

Is above displayed on the self-diagnosis display?

- YES >> Proceed to diagnosis procedure. Refer to [STC-8. "Diagnosis Procedure"](#).
NO >> INSPECTION END

Diagnosis Procedure

INFOID:000000005254058

1.CHECK CONNECTOR

With CONSULT-III

1. Turn ignition switch OFF.
2. Disconnect EPS control unit harness connector.
3. Check terminal for deformation, disconnection, looseness, and so on. If any malfunction is found, repair or replace terminal.
4. Reconnect connector and then perform self-diagnosis for "EPS" with CONSULT-III.

Is any item indicated on the self-diagnosis display?

- YES >> GO TO 2.
NO >> Poor connection of connector terminal. Repair or replace connector.

2.CHECK EPS CONTROL UNIT POWER SUPPLY CIRCUIT

1. Turn ignition switch OFF.
2. Disconnect EPS control unit harness connector.
3. Turn ignition switch ON. (Do not start engine.)
4. Check voltage between EPS control unit harness connector terminals and ground.

EPS control unit		—	Voltage
Connector	Terminal		
M38	1	Ground	Battery voltage
M37	3		

5. Turn ignition switch OFF.
6. Check voltage between EPS control unit harness connector terminals and ground.

C1601 BATTERY POWER SUPPLY

< DTC/CIRCUIT DIAGNOSIS >

EPS control unit		—	Voltage
Connector	Terminal		
M38	1	Ground	Battery voltage
M37	3		Approx. 0 V

Is the inspection result normal?

YES >> GO TO 3.

NO >> Repair or replace malfunctioning components.

3.CHECK EPS CONTROL UNIT GROUND CIRCUIT

1. Check continuity between EPS control unit harness connector terminal and ground.

EPS control unit		—	Continuity
Connector	Terminal		
M38	2	Ground	Existed

2. Connect EPS control unit harness connector.

Is the inspection result normal?

YES >> GO TO 4.

NO >> Repair open circuit or short to ground or short to power in harness or connectors.

4.CHECK EPS CONTROL UNIT

 **With CONSULT-III**

1. Turn ignition switch OFF.
2. Connect EPS control unit harness connector.
3. Start the engine.
CAUTION:
Stop the vehicle.
4. Select "EPS", "DATA MONITOR" and "BATTERY VOLT" and perform the battery voltage inspection.

Voltage : Almost same as battery voltage.

Is the inspection result normal?

YES >> GO TO 5.

NO >> Replace EPS control unit. Refer to [STC-36, "Exploded View"](#).

5.CHECK POWER SUPPLY CIRCUIT

 **With CONSULT-III**

1. Turn head lamp, A/C, blower fan and rear window defogger OFF.
2. Turn steering wheel until it stops.
3. At that time, "DATA MONITOR" and "BATTERY VOLT" and perform the battery voltage inspection

Voltage : Almost same as battery voltage.

Is the inspection result normal?

YES >> INSPECTION END

NO >> Power supply circuit is defective. Repair or replace any inoperative parts.

Special Repair Requirement

INFOID:000000005254059

1.AJUSTMENT OF STEERING ANGLE SENSOR NEUTRAL POSITION

Always perform the neutral position adjustment for the steering angle sensor, when replacing the steering column assembly. Refer to [BRC-76, "ADJUSTMENT OF STEERING ANGLE SENSOR NEUTRAL POSITION : Special Repair Requirement"](#). (VDC models)

>> END

C1604 TORQUE SENSOR

< DTC/CIRCUIT DIAGNOSIS >

C1604 TORQUE SENSOR

Description

INFOID:000000005254060

Torque sensor detects the steering torque, and transmit the signal to EPS control unit.

DTC Logic

INFOID:000000005254061

DTC DETECTION LOGIC

DTC	Display item	Malfunction detected condition	Possible cause
C1604	TORQUE SENSOR	Malfunction of the torque sensor in steering column assembly is detected.	<ul style="list-style-type: none">• Harness or connector• Torque sensor• EPS control unit

DTC CONFIRMATION PROCEDURE

1.CHECK SELF-DIAGNOSIS RESULTS

With CONSULT-III

Perform self-diagnosis for "EPS" with CONSULT-III.

Self-diagnosis results
TORQUE SENSOR

Is above displayed on the self-diagnosis display?

- YES >> Proceed to diagnosis procedure. Refer to [STC-10, "Diagnosis Procedure"](#).
NO >> INSPECTION END

Diagnosis Procedure

INFOID:000000005254062

1.CHECK CONNECTOR

With CONSULT-III

1. Turn ignition switch OFF.
2. Disconnect EPS control unit harness connector.
3. Check terminal for deformation, disconnection, looseness, and so on. If any malfunction is found, repair or replace terminal.
4. Reconnect connectors and then perform self-diagnosis for "EPS" with CONSULT-III.

Is the "TORQUE SENSOR" [C1604] displayed?

- YES >> Torque sensor is malfunction. Replace steering column assembly. Refer to [ST-12, "Exploded View"](#).
NO >> Poor connection of connector terminal. Repair or replace connector.

Special Repair Requirement

INFOID:000000005254063

1.AJUSTMENT OF STEERING ANGLE SENSOR NEUTRAL POSITION

Always perform the neutral position adjustment for the steering angle sensor, when replacing the steering column assembly. Refer to [BRC-76, "ADJUSTMENT OF STEERING ANGLE SENSOR NEUTRAL POSITION : Special Repair Requirement"](#). (VDC models)

>> END

C1606 EPS MOTOR

< DTC/CIRCUIT DIAGNOSIS >

C1606 EPS MOTOR

Description

INFOID:000000005254064

EPS motor provides the assist torque by the control signal from EPS control unit.

DTC Logic

INFOID:000000005254065

DTC DETECTION LOGIC

DTC	Display item	Malfunction detected condition	Possible cause
C1606	EPS MOTOR	When the motor driver malfunction of EPS control unit or EPS motor malfunction is detected.	<ul style="list-style-type: none">• Harness or connector• EPS motor• EPS control unit

DTC CONFIRMATION PROCEDURE

1.CHECK SELF-DIAGNOSIS RESULTS

With CONSULT-III

Perform self-diagnosis for "EPS" with CONSULT-III.

Self-diagnosis results
EPS MOTOR

Is above displayed on the self-diagnosis display?

- YES >> Proceed to diagnosis procedure. Refer to [STC-11, "Diagnosis Procedure"](#).
NO >> INSPECTION END

Diagnosis Procedure

INFOID:000000005254066

1.CHECK CONNECTOR

With CONSULT-III

1. Turn ignition switch OFF.
2. Disconnect EPS control unit harness connector.
3. Check terminal for deformation, disconnection, looseness, and so on. If any malfunction is found, repair or replace terminal.
4. Reconnect connectors and then perform self-diagnosis for "EPS" with CONSULT-III.

Is the "EPS MOTOR" [C1606] displayed?

- YES >> EPS motor malfunctions. Replace steering column assembly. Refer to [ST-12, "Exploded View"](#).
NO >> Poor connection of connector terminal. Repair or replace connector.

Special Repair Requirement

INFOID:000000005254067

1.AJUSTMENT OF STEERING ANGLE SENSOR NEUTRAL POSITION

Always perform the neutral position adjustment for the steering angle sensor, when replacing the steering column assembly. Refer to [BRC-76, "ADJUSTMENT OF STEERING ANGLE SENSOR NEUTRAL POSITION : Special Repair Requirement"](#). (VDC models)

>> END

C1607 EEPROM

< DTC/CIRCUIT DIAGNOSIS >

C1607 EEPROM

Description

INFOID:000000005254068

EPS control unit incorporates a memory function.

DTC Logic

INFOID:000000005254069

DTC DETECTION LOGIC

DTC	Display item	Malfunction detected condition	Possible cause
C1607	EEPROM	When the memory (EEPROM) system malfunction is detected in EPS control unit.	<ul style="list-style-type: none">• Harness or connector• EPS control unit

DTC CONFIRMATION PROCEDURE

1.CHECK SELF-DIAGNOSIS RESULTS

With CONSULT-III

Perform self-diagnosis for "EPS" with CONSULT-III.

Self-diagnosis results

EEPROM

Is above displayed on the self-diagnosis display?

- YES >> Proceed to diagnosis procedure. Refer to [STC-12, "Diagnosis Procedure"](#).
NO >> INSPECTION END

Diagnosis Procedure

INFOID:000000005254070

1.CHECK CONNECTOR

With CONSULT-III

1. Turn ignition switch OFF.
2. Disconnect EPS control unit harness connector.
3. Check terminal for deformation, disconnection, looseness, and so on. If any malfunction is found, repair or replace terminal.
4. Reconnect connectors and then perform self-diagnosis for "EPS" with CONSULT-III.

Is the "EEPROM" [C1607] displayed?

- YES >> Replace EPS control unit. Refer to [STC-36, "Exploded View"](#).
NO >> Poor connection of connector terminal. Repair or replace connector.

Special Repair Requirement

INFOID:000000005254071

1.AJUSTMENT OF STEERING ANGLE SENSOR NEUTRAL POSITION

Always perform the neutral position adjustment for the steering angle sensor, when replacing the steering column assembly. Refer to [BRC-76, "ADJUSTMENT OF STEERING ANGLE SENSOR NEUTRAL POSITION : Special Repair Requirement"](#). (VDC models)

>> END

C1608 CONTROL UNIT

< DTC/CIRCUIT DIAGNOSIS >

C1608 CONTROL UNIT

Description

INFOID:000000005254072

EPS control unit performs an arithmetical operation on data, such as steering wheel turning force (sensor signal) from the torque sensor, vehicle speed signal, etc. Then it generates an optimum assist torque signal to the EPS motor according to the driving condition.

DTC Logic

INFOID:000000005254073

DTC DETECTION LOGIC

DTC	Display item	Malfunction detected condition	Possible cause
C1608	CONTROL UNIT	When the internal malfunction is detected in EPS control unit.	<ul style="list-style-type: none">• Harness or connector• EPS control unit

DTC CONFIRMATION PROCEDURE

1.CHECK SELF-DIAGNOSIS RESULTS

With CONSULT-III

Perform self-diagnosis for "EPS" with CONSULT-III.

Self-diagnosis results
CONTROL UNIT

Is above displayed on the self-diagnosis display?

- YES >> Proceed to diagnosis procedure. Refer to [STC-13. "Diagnosis Procedure"](#).
NO >> INSPECTION END

Diagnosis Procedure

INFOID:000000005254074

1.CHECK CONNECTOR

With CONSULT-III

1. Turn ignition switch OFF.
2. Disconnect EPS control unit harness connector.
3. Check terminal for deformation, disconnection, looseness, and so on. If any malfunction is found, repair or replace terminal.
4. Reconnect connectors and then perform self-diagnosis for "EPS" with CONSULT-III.

Is any item indicated on the self-diagnosis display?

- YES >> GO TO 2.
NO >> Poor connection of connector terminal. Repair or replace connector.

2.CHECK EPS CONTROL UNIT POWER SUPPLY CIRCUIT

1. Turn ignition switch OFF.
2. Disconnect EPS control unit harness connector.
3. Turn ignition switch ON.
CAUTION:
Never start the engine.
4. Check voltage between EPS control unit harness connector terminals and ground.

EPS control unit		—	Voltage
Connector	Terminal		
M38	1	Ground	Battery voltage
M37	3		

5. Turn ignition switch OFF.
6. Check voltage between EPS control unit harness connector terminals and ground.

C1608 CONTROL UNIT

< DTC/CIRCUIT DIAGNOSIS >

EPS control unit		—	Voltage
Connector	Terminal		
M38	1	Ground	Battery voltage
M37	3		Approx. 0 V

Is the inspection result normal?

YES >> GO TO 3.

NO >> Repair or replace malfunctioning components.

3. CHECK EPS CONTROL UNIT GROUND CIRCUIT

1. Check continuity between EPS control unit harness connector terminal and ground.

EPS control unit		—	Continuity
Connector	Terminal		
M38	2	Ground	Existed

2. Connect EPS control unit harness connector.

Is the inspection result normal?

YES >> GO TO 4.

NO >> Repair open circuit or short to ground or short to power in harness or connectors.

4. CHECK DTC

With CONSULT-III

Perform self-diagnosis for "EPS" with CONSULT-III.

Is "C1608 CONTROL UNIT" indicated in self-diagnosis display?

YES >> Replace EPS control unit. Refer to [STC-36. "Exploded View"](#).

NO >> INSPECTION END

Special Repair Requirement

INFOID:000000005254075

1. ADJUSTMENT OF STEERING ANGLE SENSOR NEUTRAL POSITION

Always perform the neutral position adjustment for the steering angle sensor, when replacing the steering column assembly. Refer to [BRC-76. "ADJUSTMENT OF STEERING ANGLE SENSOR NEUTRAL POSITION : Special Repair Requirement"](#). (VDC models)

>> END

U1200 VEHICLE SPEED SIGNAL (ABS)

< DTC/CIRCUIT DIAGNOSIS >

U1200 VEHICLE SPEED SIGNAL (ABS)

Description

INFOID:000000005254076

EPS control unit receives the vehicle speed signal from ABS actuator and electric unit (control unit) via CAN communication line.

DTC Logic

INFOID:000000005254077

DTC DETECTION LOGIC

DTC	Display item	Malfunction detected condition	Possible cause
U1200	CAN VHCL SPEED (ABS)	Abnormal vehicle speed signals received via CAN communication are detected.	<ul style="list-style-type: none">• Harness or connector• CAN communication line• EPS control unit• ABS malfunction- Vehicle speed signal error

DTC CONFIRMATION PROCEDURE

1. CHECK SELF-DIAGNOSIS RESULTS

With CONSULT-III

Perform self-diagnosis for "EPS" with CONSULT-III.

Self-diagnosis results

CAN VHCL SPEED (ABS)

Is above displayed on the self-diagnosis display?

- YES >> Proceed to diagnosis procedure. Refer to [STC-15. "Diagnosis Procedure"](#).
NO >> INSPECTION END

Diagnosis Procedure

INFOID:000000005254078

1. CHECK ABS ACTUATOR AND ELECTRIC UNIT (CONTROL UNIT) SYSTEM

With CONSULT-III

Perform self-diagnosis for "ABS" with CONSULT-III. Repair or replace items indicated, then perform self-diagnosis again. Refer to [BRC-15. "CONSULT-III Function"](#) (ABS models), [BRC-94. "CONSULT-III Function"](#) (VDC models).

Is any item indicated on the self-diagnosis display?

- YES >> Repair or replace malfunctioning components.
NO >> GO TO 2.

2. CHECK CONNECTOR

With CONSULT-III

1. Turn ignition switch OFF.
2. Disconnect EPS control unit harness connector.
3. Check terminal for deformation, disconnection, looseness, and so on. If any malfunction is found, repair or replace terminal.
4. Reconnect connectors and then perform self-diagnosis for "EPS" with CONSULT-III.

Is any item indicated on the self-diagnosis display?

- YES >> Replace EPS control unit. Refer to [STC-36. "Exploded View"](#).
NO >> Poor connection of connector terminal. Repair or replace connector.

Special Repair Requirement

INFOID:000000005254079

1. ADJUSTMENT OF STEERING ANGLE SENSOR NEUTRAL POSITION

U1200 VEHICLE SPEED SIGNAL (ABS)

< DTC/CIRCUIT DIAGNOSIS >

Always perform the neutral position adjustment for the steering angle sensor, when replacing the steering column assembly. Refer to [BRC-76, "ADJUSTMENT OF STEERING ANGLE SENSOR NEUTRAL POSITION : Special Repair Requirement"](#). (VDC models)

>> END

U14FF VEHICLE SPEED SIGNAL (METER)

< DTC/CIRCUIT DIAGNOSIS >

U14FF VEHICLE SPEED SIGNAL (METER)

Description

INFOID:000000005254080

EPS control unit receives the vehicle speed signal from combination meter via CAN communication line.

DTC Logic

INFOID:000000005254081

DTC DETECTION LOGIC

DTC	Display item	Malfunction detected condition	Possible cause
U14FF	CAN VHCL SPEED (METER)	Abnormal vehicle speed signals received via CAN communication are detected.	<ul style="list-style-type: none">• Harness or connector• CAN communication line• EPS control unit• Combination meter malfunction- Vehicle speed signal error

DTC CONFIRMATION PROCEDURE

1. CHECK SELF-DIAGNOSIS RESULTS

With CONSULT-III

Perform self-diagnosis for "EPS" with CONSULT-III.

Self-diagnosis results

CAN VHCL SPEED (METER)

Is above displayed on the self-diagnosis display?

- YES >> Proceed to diagnosis procedure. Refer to [STC-17, "Diagnosis Procedure"](#).
NO >> INSPECTION END

Diagnosis Procedure

INFOID:000000005254082

1. CHECK COMBINATION METER SYSTEM

With CONSULT-III

Perform self-diagnosis for "METER/M&A". Repair or replace items indicated, then perform self-diagnosis again. Refer to [MWI-33, "CONSULT-III Function \(METER/M&A\)"](#).

Is any item indicated on the self-diagnosis display?

- YES >> Repair or replace malfunctioning components.
NO >> GO TO 2.

2. CHECK CONNECTOR

With CONSULT-III

1. Turn ignition switch OFF.
2. Disconnect EPS control unit harness connector.
3. Check terminal for deformation, disconnection, looseness, and so on. If any malfunction is found, repair or replace terminal.
4. Reconnect connectors and then perform self-diagnosis for "EPS" with CONSULT-III.

Is any item indicated on the self-diagnosis display?

- YES >> Replace EPS control unit. Refer to [STC-36, "Exploded View"](#).
NO >> Poor connection of connector terminal. Repair or replace connector.

Special Repair Requirement

INFOID:000000005254083

1. ADJUSTMENT OF STEERING ANGLE SENSOR NEUTRAL POSITION

Always perform the neutral position adjustment for the steering angle sensor, when replacing the steering column assembly. Refer to [BRC-76, "ADJUSTMENT OF STEERING ANGLE SENSOR NEUTRAL POSITION : Special Repair Requirement"](#). (VDC models)

U14FF VEHICLE SPEED SIGNAL (METER)

< DTC/CIRCUIT DIAGNOSIS >

>> END

U1000 CAN COMM CIRCUIT

< DTC/CIRCUIT DIAGNOSIS >

U1000 CAN COMM CIRCUIT

Description

INFOID:000000005254084

CAN (Controller Area Network) is a serial communication line for real time application. It is an on-vehicle multiplex communication line with high data communication speed and excellent error detection ability. Many electronic control units are equipped onto a vehicle, and each control unit shares information and links with other control units during operation (not independent). In CAN communication, control units are connected with 2 communication lines (CAN-H line, CAN-L line) allowing a high rate of information transmission with less wiring. Each control unit transmits/receives data but selectively reads required data only.

DTC Logic

INFOID:000000005254085

DTC DETECTION LOGIC

DTC	Display item	Malfunction detected condition	Possible cause
U1000	CAN COMM CIRCUIT	When EPS control unit is not transmitting or receiving CAN communication signal for 2 seconds or more.	<ul style="list-style-type: none">• Harness or connector• CAN communication line• EPS control unit

DTC CONFIRMATION PROCEDURE

1. CHECK SELF-DIAGNOSIS RESULTS

With CONSULT-III

Perform self-diagnosis for "EPS" with CONSULT-III.

Self-diagnosis results

CAN COMM CIRCUIT

Is above displayed on the self-diagnosis display?

- YES >> Proceed to diagnosis procedure. Refer to [STC-19, "Diagnosis Procedure"](#).
NO >> INSPECTION END

Diagnosis Procedure

INFOID:000000005254086

1. CHECK CONNECTOR

With CONSULT-III

1. Turn ignition switch OFF.
2. Disconnect EPS control unit harness connector.
3. Check terminal for deformation, disconnection, looseness, and so on. If any malfunction is found, repair or replace terminal.
4. Reconnect connector and perform self-diagnosis for "EPS" with CONSULT-III.

Is above displayed on the self-diagnosis display?

- YES >> Go to [LAN-26, "CAN System Specification Chart"](#).
NO >> INSPECTION END

Special Repair Requirement

INFOID:000000005254087

1. ADJUSTMENT OF STEERING ANGLE SENSOR NEUTRAL POSITION

Always perform the neutral position adjustment for the steering angle sensor, when replacing the steering column assembly. Refer to [BRC-76, "ADJUSTMENT OF STEERING ANGLE SENSOR NEUTRAL POSITION : Special Repair Requirement"](#). (VDC models)

>> END

EPS CONTROL UNIT

< ECU DIAGNOSIS INFORMATION >

ECU DIAGNOSIS INFORMATION

EPS CONTROL UNIT

Reference Value

INFOID:000000005254088

VALUES ON THE DIAGNOSIS TOOL

CAUTION:

The output signal indicates the EPS control unit calculation data. The normal values will be displayed even in the event that the output circuit (harness) is open.

Monitor item	Content	Condition	Display value	
BATTERY VOLT	Power supply voltage for EPS control unit	Ignition switch: ON	Battery voltage	
TORQUE SENSOR	Steering wheel turning force	Engine running	Steering wheel: Not steering (There is no steering force)	Approx. 0 Nm
			Steering wheel: Right turn	Negative value (Nm)
			Steering wheel: Left turn	Positive value (Nm)
MOTOR SIG	Command current to EPS motor	Engine running	Steering wheel: Not steering (There is no steering force)	Approx. 0 A
			Steering wheel: Right turn	Positive value (A)
			Steering wheel: Left turn	Negative value (A)
MOTOR CURRENT	Consumption current of EPS motor	Engine running	Steering wheel: Not steering (There is no steering force)	Approx. 0 A
			Steering wheel: Right turn	Positive value (A)
			Steering wheel: Left turn	Negative value (A)
ASSIST TORQUE	Displays assist torque being output by the EPS.	Engine running	Steering wheel: Not steering (There is no steering force)	Approx. 0 Nm
			Steering wheel: Right turn	Positive value (Nm)
			Steering wheel: Left turn	Negative value (Nm)
C/U TEMP	Displays temperature of the EPS control unit.	Ignition switch ON or engine running	Displays temperature of inside of EPS control unit (°C)	
ASSIST LEVEL	Assist available level	Engine running	100 % *2	
VEHICLE SPEED	Vehicle speed	Vehicle stopped	0 km/h (0 mph)	
		While driving	Approximately equal to the indication on speedometer (inside of ±10%)*3	
MOTOR TEMP	Displays temperature of EPS motor.	Engine running	Displays temperature of inside of EPS motor (°C)	
VHCL SPD CALC	Displays vehicle speeds used for controlling EPS.	Vehicle stopped	0 km/h (0 mph)	
		While driving	Approximately equal to the indication on speedometer (inside of ±10%)*3	
WARNING LAMP	EPS warning lamp condition	EPS warning lamp: ON	On	
		EPS warning lamp: OFF	Off	
ENGINE STATUS	Engine status	Engine not running	STOP, STALL, CRANK	
		Engine running	RUN	

*1: Almost in accordance with the value of MOTOR SIG. It is not a malfunction though these values are not accorded when steering quickly.

EPS CONTROL UNIT

< ECU DIAGNOSIS INFORMATION >

*2: Normally displays 100%. In case of an excessive stationary steering, the assist curvature gradually falls. However, it returns to 100% when left standing.

*3: It is not a malfunction, though it might not be corresponding just after ignition switch in turned ON.

TERMINAL LAYOUT

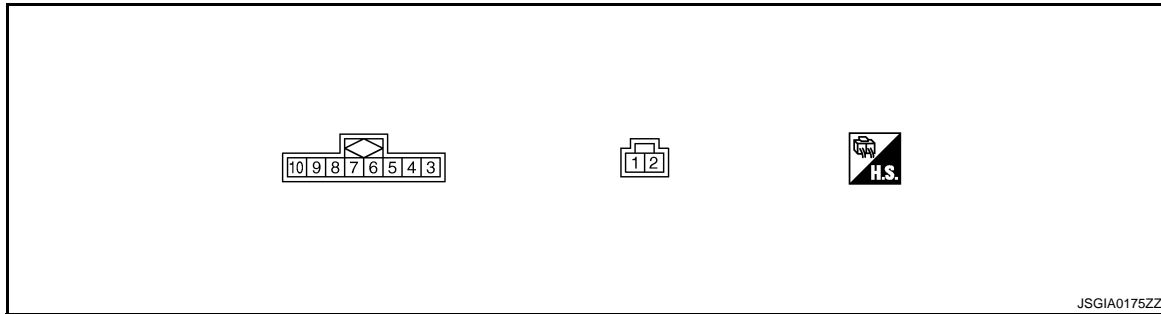

PHYSICAL VALUES

Terminal No. (Wire Color)		Description		Condition	Value (Approx.)
+	-	Signal name	Input/Output		
1 (R)	Ground	Battery power supply	Input	Always	Battery voltage
2 (B)	Ground	Ground	Output	Always	0 V
3 (W)	Ground	Ignition power supply	Input	Ignition switch: ON	Battery voltage
				Ignition switch: OFF	0 V
5 (L)	Ground	CAN-H	Input/Output	—	—
7 (P)	Ground	CAN-L	Input/Output	—	—

EPS CONTROL UNIT

< ECU DIAGNOSIS INFORMATION >

Wiring Diagram - ELECTRONICALLY CONTROLLED POWER STEERING SYSTEM -

INFOID:000000005254089

ELECTRONICALLY CONTROLLED POWER STEERING SYSTEM

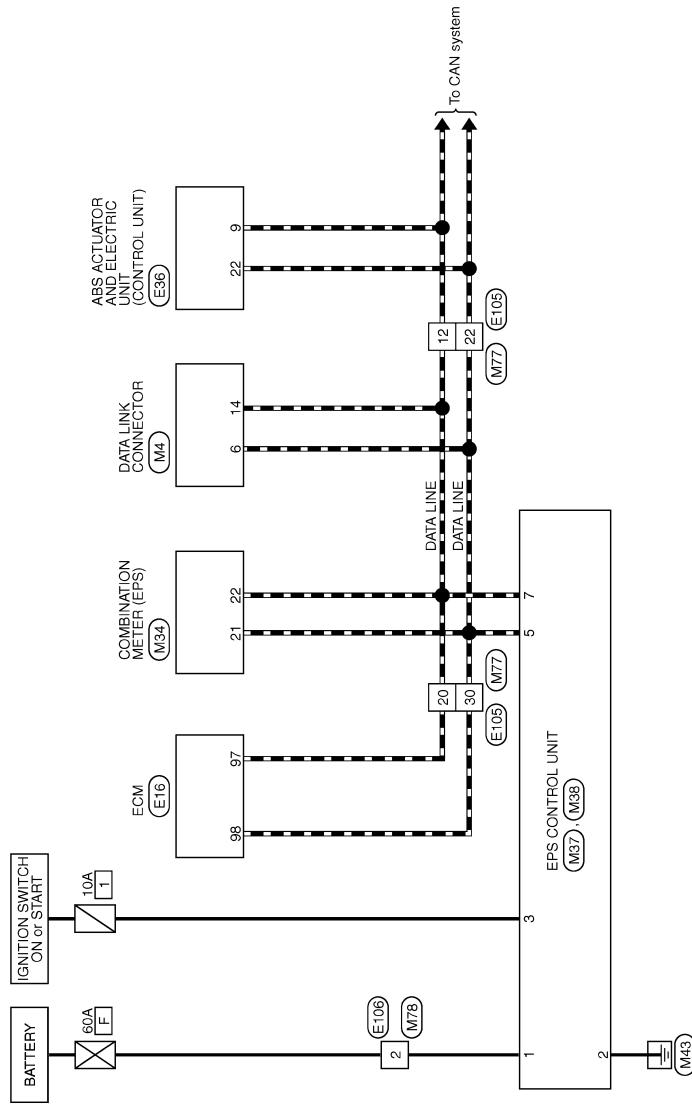

2008/07/15

JCGWM0158G1

EPS CONTROL UNIT

< ECU DIAGNOSIS INFORMATION >

ELECTRONICALLY CONTROLLED POWER STEERING SYSTEM

Connector No.	E16
Connector Name	ECM
Connector Type	RR24FB-R28-L-LH

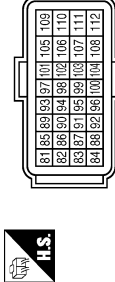

Terminal No.	Color of Wire	Signal Name [Specification]
97	P	VEHCAN-L
98	L	VEHCAN-H

Connector No.	E18
Connector Name	ABS ACTUATOR AND ELECTRIC UNIT (CONTROL UNIT)
Connector Type	RR28FB-T04-DH

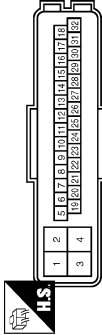

Terminal No.	Color of Wire	Signal Name [Specification]
9	P	CAN-L
22	L	CAN-H

Connector No.	E109
Connector Name	WIRE TO WIRE
Connector Type	TR60FW-C516-TM4



Terminal No.	Color of Wire	Signal Name [Specification]
12	P	-
20	P	-
22	L	-
30	L	-

Connector No.	E108
Connector Name	WIRE TO WIRE
Connector Type	L02FB-MC



Terminal No.	Color of Wire	Signal Name [Specification]
2	R	-

Connector No.	M4
Connector Name	DATA LINK CONNECTOR
Connector Type	BD18FW

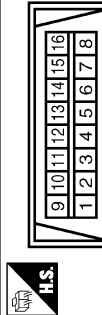

Terminal No.	Color of Wire	Signal Name [Specification]
6	L	-
14	P	-

Connector No.	M34
Connector Name	COMBINATION METER
Connector Type	SAB40FW



Terminal No.	Color of Wire	Signal Name [Specification]
21	L	CAN-H
22	P	CAN-L

Connector No.	M37
Connector Name	EPS CONTROL UNIT
Connector Type	MAA08FB



Terminal No.	Color of Wire	Signal Name [Specification]
3	W	-
5	L	-
7	P	-

Connector No.	M38
Connector Name	EPS CONTROL UNIT
Connector Type	ANA02FB



Terminal No.	Color of Wire	Signal Name [Specification]
1	R	-
2	B	-

A
B
C
D
E
F
STC
H
I
J
K
L
M
N
O
P

EPS CONTROL UNIT

< ECU DIAGNOSIS INFORMATION >

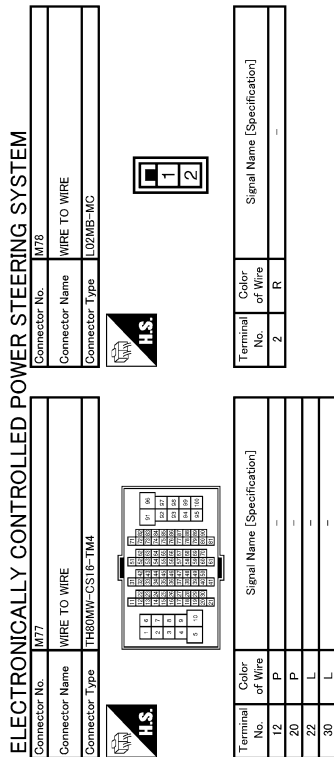

JCGWM0160Gi

INFOID:000000005254090

Fail-Safe

- If any malfunction occurs in the system, and control unit detects the malfunction, EPS warning lamp on combination meter turns ON to indicate system malfunction.
- When EPS warning lamp is ON, enters into a manual steering state. (Control turning force steering wheel becomes heavy.)

EPS CONTROL UNIT

< ECU DIAGNOSIS INFORMATION >

DTC Index

INFOID:000000005254091

DTC	Items (CONSULT screen terms)	Reference
C1601	BATTERY VOLT	STC-8, "DTC Logic"
C1604	TORQUE SENSOR	STC-10, "DTC Logic"
C1606	EPS MOTOR	STC-11, "DTC Logic"
C1607	EEPROM	STC-12, "DTC Logic"
C1608	CONTROL UNIT	STC-13, "DTC Logic"
U1200	CAN VHCL SPEED (ABS)	STC-15, "DTC Logic"
U14FF	CAN VHCL SPEED (METER)	STC-17, "DTC Logic"
U1000	CAN COMM CIRCUIT	STC-19, "DTC Logic"

A
B
C
D
E
F
H
I
J
K
L
M
N
O
P

STC

EPS WARNING LAMP DOES NOT TURN ON

< SYMPTOM DIAGNOSIS >

SYMPTOM DIAGNOSIS

EPS WARNING LAMP DOES NOT TURN ON

Description

INFOID:000000005254092

- EPS warning lamp does not turn ON when turning ignition switch ON from OFF.

Diagnosis Procedure

INFOID:000000005254093

1. CHECK SYSTEM FOR CAN COMMUNICATION LINE

With CONSULT-III

Perform self-diagnosis for "EPS" with CONSULT-III.

Is the "CAN COMM CIRCUIT [U1000]" displayed?

- YES >> Perform trouble diagnosis for CAN communication line.
- NO >> GO TO 2.

2. CHECK EPS CONTROL UNIT

Check EPS control unit input/output signal. Refer to [STC-20, "Reference Value"](#).

Is the inspection result normal?

- YES >> GO TO 3.
- NO >> Check EPS control unit pin terminals for damage or loose connection with harness connector. If any items are damaged, repair or replace damaged parts.

3. CHECK COMBINATION METER SELF-DIAGNOSIS RESULTS

With CONSULT-III

Perform self-diagnosis for "METER/M&A" with CONSULT-III. Refer to [MWI-33, "CONSULT-III Function \(METER/M&A\)"](#).

is self-diagnosis results indicated?

- YES >> Repair or replace malfunctioning components.
- NO >> GO TO 4.

4. SYMPTOM CHECK

Check again.

Is the inspection result normal?

- YES >> INSPECTION END
- NO >> Replace combination meter.

EPS WARNING LAMP DOES NOT TURN OFF

< SYMPTOM DIAGNOSIS >

EPS WARNING LAMP DOES NOT TURN OFF

Description

INFOID:000000005254094

- EPS warning lamp does not turn OFF several seconds after engine started.

Diagnosis Procedure

INFOID:000000005254095

1. CHECK SELF-DIAGNOSIS RESULTS

With CONSULT-III

Perform self-diagnosis for "EPS" with CONSULT-III.

Is any malfunction detected by self-diagnosis?

YES >> Check the malfunctioning system.

NO >> GO TO 2.

2. CHECK EPS CONTROL UNIT POWER SUPPLY CIRCUIT

1. Turn ignition switch OFF.
2. Disconnect EPS control unit harness connector.
3. Turn ignition switch ON. (Do not start engine.)
4. Check voltage between EPS control unit harness connector terminals and ground.

EPS control unit		—	Voltage
Connector	Terminal		
M38	1	Ground	Battery voltage
M37	3		

5. Turn ignition switch OFF.
6. Check voltage between EPS control unit harness connector terminals and ground.

EPS control unit		—	Voltage
Connector	Terminal		
M38	1	Ground	Battery voltage
M37	3		Approx. 0 V

Is the inspection result normal?

YES >> GO TO 3.

NO >> Repair or replace malfunctioning components.

3. CHECK EPS CONTROL UNIT GROUND CIRCUIT

1. Check continuity between EPS control unit harness connector terminal and ground.

EPS control unit		—	Continuity
Connector	Terminal		
M38	2	Ground	Existed

2. Connect EPS control unit harness connector.

Is the inspection result normal?

YES >> GO TO 4.

NO >> Repair open circuit or short to ground or short to power in harness or connectors.

4. CHECK EPS CONTROL UNIT PIN TERMINAL

Check EPS control unit pin terminals for damage or loose connection with harness connector.

Is the inspection result normal?

YES >> GO TO 5.

NO >> Repair or replace damaged parts.

A

B

C

D

E

F

STC

H

I

J

K

L

M

N

O

P

EPS WARNING LAMP DOES NOT TURN OFF

< SYMPTOM DIAGNOSIS >

5. CHECK COMBINATION METER SELF-DIAGNOSIS RESULTS

Ⓜ With CONSULT-III

Perform self-diagnosis for "METER/M&A" with CONSULT-III. Refer to [MWI-33, "CONSULT-III Function \(METER/M&A\)"](#).

is self-diagnosis results indicated?

- YES >> Repair or replace malfunctioning components.
- NO >> GO TO 6.

6. CHECK VEHICLE SPEED SIGNAL FROM ABS ACTUATOR AND ELECTRIC UNIT (CONTROL UNIT)

Ⓜ With CONSULT-III

Perform self-diagnosis for "ABS" with CONSULT-III.

- Without VDC: [BRC-15, "CONSULT-III Function"](#).
- With VDC: [BRC-94, "CONSULT-III Function"](#).

Is any malfunction detected by self-diagnosis?

- YES >> Check the malfunctioning system.
- NO >> GO TO 7.

7. CHECK ENGINE STATUS SIGNAL

Ⓜ With CONSULT-III

Perform self-diagnosis for "ENGINE" with CONSULT-III.

- For CALIFORNIA: [EC-107, "CONSULT-III Function"](#).
- For USA (FEDERAL) and CANADA: [EC-588, "CONSULT-III Function"](#).
- For MEXICO: [EC-1022, "CONSULT-III Function"](#).

Is the malfunction detected by self-diagnosis?

- YES >> Check the malfunctioning system.
- NO >> GO TO 8.

8. SYMPTOM CHECK

Check again.

Is the inspection result normal?

- YES >> INSPECTION END
- NO >> Replace combination meter. Refer to [MWI-87, "Exploded View"](#).

STEERING WHEEL TURNING FORCE IS HEAVY OR LIGHT

< SYMPTOM DIAGNOSIS >

STEERING WHEEL TURNING FORCE IS HEAVY OR LIGHT

Diagnosis Procedure

INFOID:000000005254096

1. CHECK SYSTEM FOR CAN COMMUNICATION LINE

With CONSULT-III

Perform self-diagnosis for "EPS" with CONSULT-III.

Is the "CAN COMM CIRCUIT [U1000]" displayed.

- YES >> Perform trouble diagnosis for CAN communication line. Refer to [STC-19, "Description"](#).
NO >> GO TO 2.

2. CHECK VEHICLE SPEED SIGNAL FROM ABS ACTUATOR AND ELECTRIC UNIT (CONTROL UNIT)

With CONSULT-III

Perform self-diagnosis for "ABS" with CONSULT-III.

- Without VDC: [BRC-15, "CONSULT-III Function"](#).
- With VDC: [BRC-94, "CONSULT-III Function"](#).

Is any malfunction detected by self-diagnosis?

- YES >> Check the malfunctioning system.
NO >> GO TO 3.

3. CHECK COMBINATION METER SIGNAL

With CONSULT-III

Perform self-diagnosis for "METER/M&A" with CONSULT-III. Refer to [MWI-33, "CONSULT-III Function \(METER/M&A\)"](#).

Is the malfunction detected by self-diagnosis?

- YES >> Check the malfunctioning system.
NO >> GO TO 4.

4. CHECK ENGINE STATUS SIGNAL

With CONSULT-III

Perform self-diagnosis for "ENGINE" with CONSULT-III.

- For CALIFORNIA: [EC-107, "CONSULT-III Function"](#).
- For USA (FEDERAL) and CANADA: [EC-588, "CONSULT-III Function"](#).
- For MEXICO: [EC-1022, "CONSULT-III Function"](#).

Is the malfunction detected by self-diagnosis?

- YES >> Check the malfunctioning system.
NO >> GO TO 5.

5. CHECK EPS CONTROL UNIT

Check EPS control unit input/output signal. Refer to [STC-20, "Reference Value"](#).

Is the inspection result normal?

- YES >> GO TO 6.
NO >> Check EPS control unit pin terminals for damage or loose connection with harness connector. If any items are damaged, repair or replace damaged parts.

6. CHECK STEERING WHEEL TURNING FORCE

Check steering wheel turning force. Refer to [ST-9, "Inspection"](#).

Is the inspection result normal?

- YES >> GO TO 7.
NO >> Repair or replace malfunctioning components.

7. SYMPTOM CHECK

Check again.

Is the inspection result normal?

- YES >> INSPECTION END
NO >> Check the steering wheel turning force for mechanical malfunction. Refer to [ST-9, "Inspection"](#).

A
B
C
D
E
F
H
I
J
K
L
M
N
O
P

STC

UNBALANCE STEERING WHEEL TURNING FORCE AND RETURN BETWEEN RIGHT AND LEFT

< SYMPTOM DIAGNOSIS >

UNBALANCE STEERING WHEEL TURNING FORCE AND RETURN BETWEEN RIGHT AND LEFT

Diagnosis Procedure

INFOID:000000005254097

1.CHECK EPS WARNING LAMP

Confirm EPS warning lamp during engine running.

Does EPS warning lamp turn OFF?

YES >> GO TO 2.

NO >> Go to [STC-27, "Diagnosis Procedure"](#).

2.CHECK WHEEL ALIGNMENT

Check wheel alignment. Refer to [FSU-8, "Inspection"](#).

Is the inspection result normal?

YES >> GO TO 3.

NO >> Adjust wheel alignment. Refer to [FSU-8, "Inspection"](#).

3.CHECK EPS CONTROL UNIT

Check EPS control unit input/output signal. Refer to [STC-20, "Reference Value"](#).

Is the inspection result normal?

YES >> GO TO 4.

NO >> Check EPS control unit pin terminals for damage or loose connection with harness connector. If any items are damaged, repair or replace damaged parts.

4.CHECK STEERING WHEEL TURNING FORCE

Check steering wheel turning force. Refer to [ST-9, "Inspection"](#).

Is the inspection result normal?

YES >> GO TO 5.

NO >> Repair or replace malfunctioning components.

5.SYMPTOM CHECK

Check again.

Is the inspection result normal?

YES >> INSPECTION END

NO >> Check the steering wheel turning force for mechanical malfunction. Refer to [ST-9, "Inspection"](#).

UNBALANCE STEERING WHEEL TURNING FORCE (TORQUE VARIATION)

< SYMPTOM DIAGNOSIS >

UNBALANCE STEERING WHEEL TURNING FORCE (TORQUE VARIATION)

Diagnosis Procedure

INFOID:000000005254098

1. CHECK EPS WARNING LAMP

Confirm EPS warning lamp during engine running.

Does EPS warning lamp turn OFF?

YES >> GO TO 2.

NO >> Go to [STC-27, "Diagnosis Procedure"](#).

2. CHECK STEERING COLUMN INTERMEDIATE SHAFT

Check the connection between intermediate shaft and the mounting part of steering column assembly and steering gear assembly. Refer to [ST-12, "Exploded View"](#).

Is the inspection result normal?

YES >> GO TO 3.

NO >> Repair or replace damaged parts.

3. CHECK EPS CONTROL UNIT

Check EPS control unit input/output signal. Refer to [STC-20, "Reference Value"](#).

Is the inspection result normal?

YES >> GO TO 4.

NO >> Check EPS control unit pin terminals for damage or loose connection with harness connector. If any items are damaged, repair or replace damaged parts.

4. SYMPTOM CHECK

Check again.

Is the inspection result normal?

YES >> INSPECTION END

NO >> Check the steering wheel turning force for mechanical malfunction. Refer to [ST-9, "Inspection"](#).

A
B
C
D
E
F
H
I
J
K
L
M
N
O
P

STC

PRECAUTIONS

< PRECAUTION >

PRECAUTION

PRECAUTIONS

FOR USA AND CANADA

FOR USA AND CANADA : Precaution for Supplemental Restraint System (SRS) "AIR BAG" and "SEAT BELT PRE-TENSIONER"

INFOID:000000005254099

The Supplemental Restraint System such as "AIR BAG" and "SEAT BELT PRE-TENSIONER", used along with a front seat belt, helps to reduce the risk or severity of injury to the driver and front passenger for certain types of collision. This system includes seat belt switch inputs and dual stage front air bag modules. The SRS system uses the seat belt switches to determine the front air bag deployment, and may only deploy one front air bag, depending on the severity of a collision and whether the front occupants are belted or unbelted. Information necessary to service the system safely is included in the "SRS AIR BAG" and "SEAT BELT" of this Service Manual.

WARNING:

- To avoid rendering the SRS inoperative, which could increase the risk of personal injury or death in the event of a collision which would result in air bag inflation, all maintenance must be performed by an authorized NISSAN/INFINITI dealer.
- Improper maintenance, including incorrect removal and installation of the SRS, can lead to personal injury caused by unintentional activation of the system. For removal of Spiral Cable and Air Bag Module, see the "SRS AIR BAG".
- Do not use electrical test equipment on any circuit related to the SRS unless instructed to in this Service Manual. SRS wiring harnesses can be identified by yellow and/or orange harnesses or harness connectors.

PRECAUTIONS WHEN USING POWER TOOLS (AIR OR ELECTRIC) AND HAMMERS

WARNING:

- When working near the Air Bag Diagnosis Sensor Unit or other Air Bag System sensors with the ignition ON or engine running, DO NOT use air or electric power tools or strike near the sensor(s) with a hammer. Heavy vibration could activate the sensor(s) and deploy the air bag(s), possibly causing serious injury.
- When using air or electric power tools or hammers, always switch the ignition OFF, disconnect the battery, and wait at least 3 minutes before performing any service.

FOR USA AND CANADA : Precaution Necessary for Steering Wheel Rotation after Battery Disconnect

INFOID:000000005588578

NOTE:

- Before removing and installing any control units, first turn the push-button ignition switch to the LOCK position, then disconnect both battery cables.
- After finishing work, confirm that all control unit connectors are connected properly, then re-connect both battery cables.
- Always use CONSULT-III to perform self-diagnosis as a part of each function inspection after finishing work. If a DTC is detected, perform trouble diagnosis according to self-diagnosis results.

For vehicle with steering lock unit, if the battery is disconnected or discharged, the steering wheel will lock and cannot be turned.

If turning the steering wheel is required with the battery disconnected or discharged, follow the operation procedure below before starting the repair operation.

OPERATION PROCEDURE

1. Connect both battery cables.

NOTE:

Supply power using jumper cables if battery is discharged.

2. Turn the push-button ignition switch to ACC position.
(At this time, the steering lock will be released.)
3. Disconnect both battery cables. The steering lock will remain released with both battery cables disconnected and the steering wheel can be turned.
4. Perform the necessary repair operation.

PRECAUTIONS

< PRECAUTION >

- When the repair work is completed, re-connect both battery cables. With the brake pedal released, turn the push-button ignition switch from ACC position to ON position, then to LOCK position. (The steering wheel will lock when the push-button ignition switch is turned to LOCK position.)
- Perform self-diagnosis check of all control units using CONSULT-III.

FOR USA AND CANADA : Service Notice or Precautions for EPS System INFOID:000000005254101

Check the following item when performing the trouble diagnosis.

- Check any possible causes by interviewing the symptom and it's condition from the customer if any malfunction, such as EPS warning lamp is turned ON, occurs.
- Check if air pressure and size of tires are proper, the specified part is used for the steering wheel, and control unit is genuine part.
- Check if the connection of steering column assembly and steering gear assembly is proper (there is no looseness of mounting bolts, damage of rods, boots or sealants, and leakage of grease, etc).
- Check if the wheel alignment is adjusted properly.
- Check if there is any damage or modification to suspension or body resulting in increased weight or altered ground clearance.
- Check if installation conditions of each link and suspension are proper.
- Check if the battery voltage is proper.
- Check connection conditions of each connector are proper.
- Before connecting or disconnecting the EPS control unit harness connector, turn ignition switch "OFF" and disconnect battery ground cable. Because battery voltage is applied to EPS control unit even if ignition switch is turned "OFF".

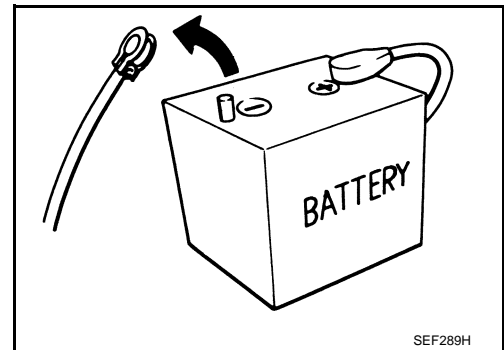

- When connecting or disconnecting pin connectors into or from EPS control unit, take care not to damage pin terminals (bend or break).
When connecting pin connectors, make sure that there are no bends or breaks on EPS control unit pin terminal.

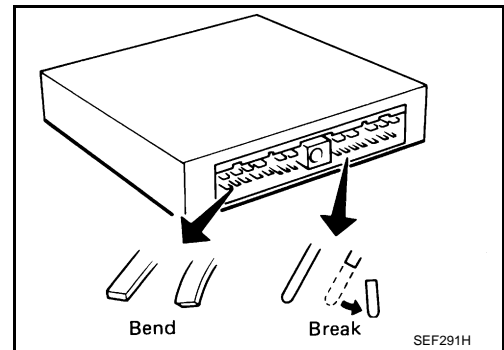

FOR MEXICO

FOR MEXICO : Precaution for Supplemental Restraint System (SRS) "AIR BAG" and "SEAT BELT PRE-TENSIONER"

INFOID:000000005254102

The Supplemental Restraint System such as "AIR BAG" and "SEAT BELT PRE-TENSIONER", used along with a front seat belt, helps to reduce the risk or severity of injury to the driver and front passenger for certain types of collision. Information necessary to service the system safely is included in the "SRS AIR BAG" and "SEAT BELT" of this Service Manual.

WARNING:

- To avoid rendering the SRS inoperative, which could increase the risk of personal injury or death in the event of a collision which would result in air bag inflation, all maintenance must be performed by an authorized NISSAN/INFINITI dealer.**

PRECAUTIONS

< PRECAUTION >

- **Improper maintenance, including incorrect removal and installation of the SRS, can lead to personal injury caused by unintentional activation of the system. For removal of Spiral Cable and Air Bag Module, see the “SRS AIR BAG”.**
- **Do not use electrical test equipment on any circuit related to the SRS unless instructed to in this Service Manual. SRS wiring harnesses can be identified by yellow and/or orange harnesses or harness connectors.**

PRECAUTIONS WHEN USING POWER TOOLS (AIR OR ELECTRIC) AND HAMMERS

WARNING:

- **When working near the Air Bag Diagnosis Sensor Unit or other Air Bag System sensors with the ignition ON or engine running, DO NOT use air or electric power tools or strike near the sensor(s) with a hammer. Heavy vibration could activate the sensor(s) and deploy the air bag(s), possibly causing serious injury.**
- **When using air or electric power tools or hammers, always switch the ignition OFF, disconnect the battery, and wait at least 3 minutes before performing any service.**

FOR MEXICO : Precaution Necessary for Steering Wheel Rotation after Battery Disconnect

INFOID:000000005588579

NOTE:

- Before removing and installing any control units, first turn the push-button ignition switch to the LOCK position, then disconnect both battery cables.
- After finishing work, confirm that all control unit connectors are connected properly, then re-connect both battery cables.
- Always use CONSULT-III to perform self-diagnosis as a part of each function inspection after finishing work. If a DTC is detected, perform trouble diagnosis according to self-diagnosis results.

For vehicle with steering lock unit, if the battery is disconnected or discharged, the steering wheel will lock and cannot be turned.

If turning the steering wheel is required with the battery disconnected or discharged, follow the operation procedure below before starting the repair operation.

OPERATION PROCEDURE

1. Connect both battery cables.

NOTE:

Supply power using jumper cables if battery is discharged.

2. Turn the push-button ignition switch to ACC position.
(At this time, the steering lock will be released.)
3. Disconnect both battery cables. The steering lock will remain released with both battery cables disconnected and the steering wheel can be turned.
4. Perform the necessary repair operation.
5. When the repair work is completed, re-connect both battery cables. With the brake pedal released, turn the push-button ignition switch from ACC position to ON position, then to LOCK position. (The steering wheel will lock when the push-button ignition switch is turned to LOCK position.)
6. Perform self-diagnosis check of all control units using CONSULT-III.

FOR MEXICO : Service Notice or Precautions for EPS System

INFOID:000000005254104

Check the following item when performing the trouble diagnosis.

- Check any possible causes by interviewing the symptom and it's condition from the customer if any malfunction, such as EPS warning lamp is turned ON, occurs.
- Check if air pressure and size of tires are proper, the specified part is used for the steering wheel, and control unit is genuine part.
- Check if the connection of steering column assembly and steering gear assembly is proper (there is no looseness of mounting bolts, damage of rods, boots or sealants, and leakage of grease, etc).
- Check if the wheel alignment is adjusted properly.
- Check if there is any damage or modification to suspension or body resulting in increased weight or altered ground clearance.
- Check if installation conditions of each link and suspension are proper.
- Check if the battery voltage is proper.
- Check connection conditions of each connector are proper.

PRECAUTIONS

< PRECAUTION >

- Before connecting or disconnecting the EPS control unit harness connector, turn ignition switch "OFF" and disconnect battery ground cable. Because battery voltage is applied to EPS control unit even if ignition switch is turned "OFF".

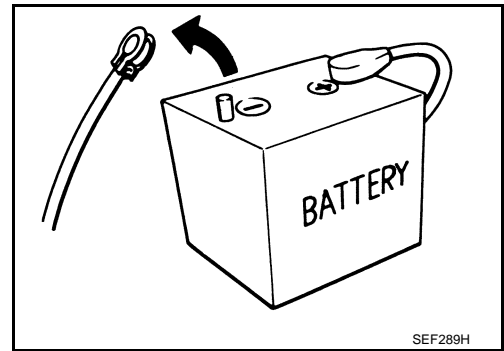

- When connecting or disconnecting pin connectors into or from EPS control unit, take care not to damage pin terminals (bend or break).
When connecting pin connectors, make sure that there are no bends or breaks on EPS control unit pin terminal.

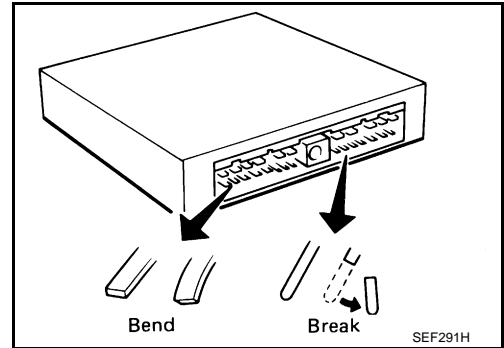

A
B
C
D
E
F
STC
H
I
J
K
L
M
N
O
P

EPS CONTROL UNIT

< REMOVAL AND INSTALLATION >

REMOVAL AND INSTALLATION

EPS CONTROL UNIT

Exploded View

INFOID:000000005254105

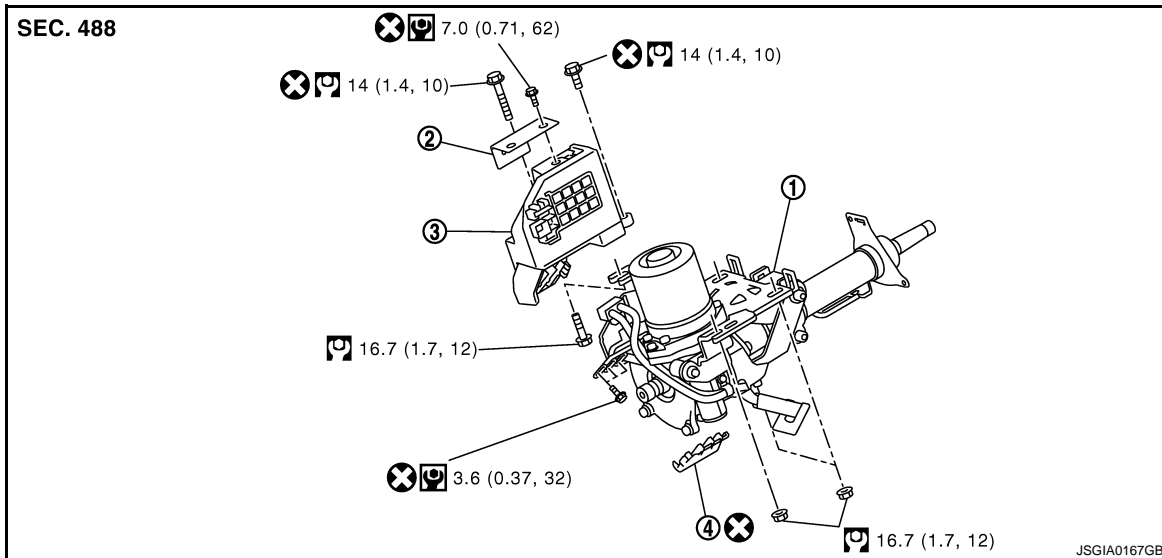

1. Steering column assembly
2. Harness bracket
3. EPS control unit
4. Harness cover

Refer to [GI-4, "Components"](#) for symbols in the figure.

Removal and Installation

INFOID:000000005254106

REMOVAL

CAUTION:

- Disconnect battery negative terminal before starting operations.
- Never shock EPS control unit, e.g. drop or hit.
- Never get EPS control unit wet with water or other liquid. Also, do not give EPS control unit a radical temperature change to avoid getting water drops.
- Never disassemble or remodel EPS control unit, EPS motor, torque sensor, harness and connectors.

1. Remove steering column assembly. Refer to [ST-12, "Exploded View"](#).
2. Remove harness bracket.
3. Disconnect EPS motor and torque sensor connectors.

CAUTION:

Hold and pull the connector housing, not pulling harness, when disconnecting connectors. Also, do not grip, collapse or apply excessive force to the connector.

4. Remove harness cover.
5. Disconnect EPS control unit connectors.
6. Remove EPS control unit.

INSTALLATION

Note the following, and install in the reverse order of removal.

EPS CONTROL UNIT

< REMOVAL AND INSTALLATION >

- Check the order of cable colors, red (A), black (B) and white (C), when connecting harness terminals.
- Check that harness is not damaged when installing EPS control unit. Also, check that EPS control unit is installed without trapping harness or foreign materials.
- Repeat the following operations three times without touching steering wheels (input torque = 0) after replacing EPS control unit:
Turn the key switch ON and wait for 3 seconds ⇒ Turn the key switch OFF and wait for 3 seconds.

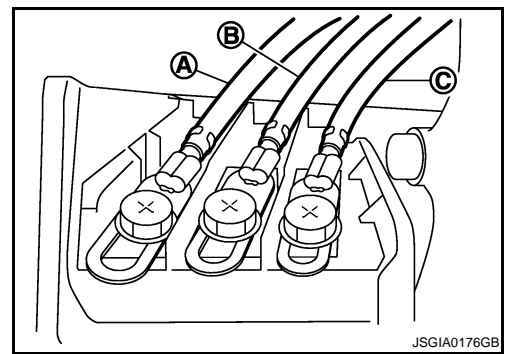

A

B

C

D

E

F

STC

H

I

J

K

L

M

N

O

P