

SECTION **PWO**
POWER OUTLET

A
B
C
D
E
F
G
H
I
J
K
L
N
O
P

CONTENTS

PRECAUTION	2	POWER SOCKET	4
PRECAUTIONS	2	Wiring Diagram	4
Precaution for Supplemental Restraint System (SRS) "AIR BAG" and "SEAT BELT PRE-TEN- SIONER"	2	REMOVAL AND INSTALLATION	7
SYSTEM DESCRIPTION	3	POWER SOCKET	7
COMPONENT PARTS	3	Removal and Installation	7
Component Parts Location	3	SERVICE DATA AND SPECIFICATIONS (SDS)	8
WIRING DIAGRAM	4	SERVICE DATA AND SPECIFICATIONS (SDS)	8
		Power Socket	8

PWO

PRECAUTIONS

< PRECAUTION >

PRECAUTION

PRECAUTIONS

Precaution for Supplemental Restraint System (SRS) "AIR BAG" and "SEAT BELT PRE-TENSIONER"

INFOID:000000012422453

The Supplemental Restraint System such as "AIR BAG" and "SEAT BELT PRE-TENSIONER", used along with a front seat belt, helps to reduce the risk or severity of injury to the driver and front passenger for certain types of collision. Information necessary to service the system safely is included in the SR and SB section of this Service Manual.

WARNING:

- To avoid rendering the SRS inoperative, which could increase the risk of personal injury or death in the event of a collision which would result in air bag inflation, all maintenance must be performed by an authorized NISSAN/INFINITI dealer.
- Improper maintenance, including incorrect removal and installation of the SRS, can lead to personal injury caused by unintentional activation of the system. For removal of Spiral Cable and Air Bag Module, see the SR section.
- Do not use electrical test equipment on any circuit related to the SRS unless instructed to in this Service Manual. SRS wiring harnesses can be identified by yellow and/or orange harnesses or harness connectors.

PRECAUTIONS WHEN USING POWER TOOLS (AIR OR ELECTRIC) AND HAMMERS

WARNING:

- When working near the Airbag Diagnosis Sensor Unit or other Airbag System sensors with the Ignition ON or engine running, DO NOT use air or electric power tools or strike near the sensor(s) with a hammer. Heavy vibration could activate the sensor(s) and deploy the air bag(s), possibly causing serious injury.
- When using air or electric power tools or hammers, always switch the Ignition OFF, disconnect the battery and wait at least three minutes before performing any service.

COMPONENT PARTS

< SYSTEM DESCRIPTION >

SYSTEM DESCRIPTION

COMPONENT PARTS

Component Parts Location

INFOID:0000000012422454

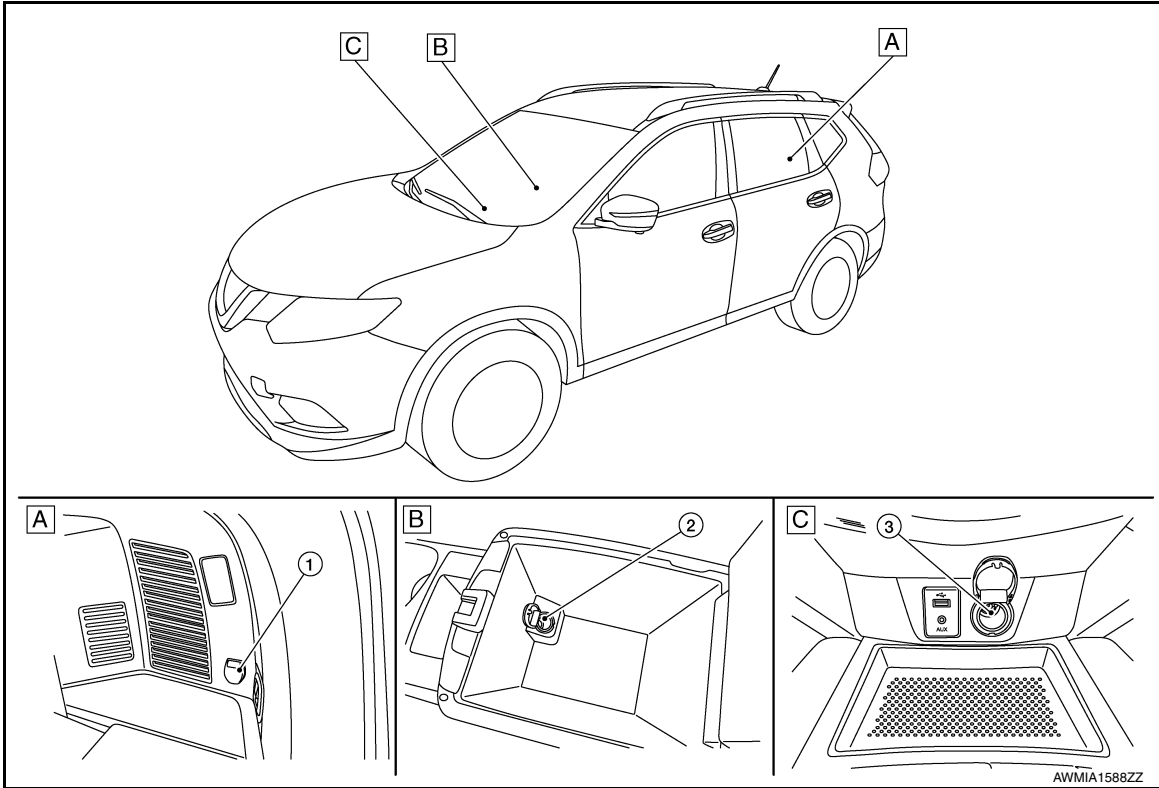

- A. Luggage side lower finisher RH
- 1. Rear cargo power socket

- B. Center console
- 2. Console power socket

- C. Cluster lid C
- 3. Front power socket

A
B
C
D
E
F
G
H
I
J
K
L
N
O
P

PWO

POWER SOCKET

< WIRING DIAGRAM >

WIRING DIAGRAM

POWER SOCKET

Wiring Diagram

INFOID:000000012422455

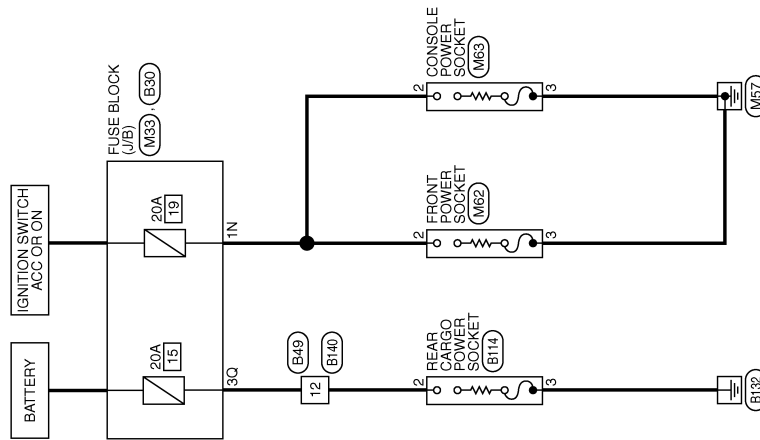

POWER SOCKET

AAMWA1408GB

POWER SOCKET

< WIRING DIAGRAM >

POWER SOCKET CONNECTORS

Connector No.	M33
Connector Name	FUSE BLOCK (J/B)
Connector Color	WHITE

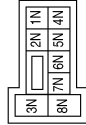

Terminal No.	1N	Color of Wire	L	Signal Name	-
--------------	----	---------------	---	-------------	---

Connector No.	M62
Connector Name	FRONT POWER SOCKET
Connector Color	BLACK

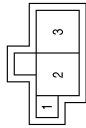

Terminal No.	2	Color of Wire	L	Signal Name	-
3	B	-	-	-	-

Connector No.	M63
Connector Name	CONSOLE POWER SOCKET
Connector Color	BLACK

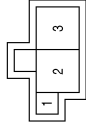

Terminal No.	2	Color of Wire	Y	Signal Name	-
3	B	-	-	-	-

Connector No.	B30
Connector Name	FUSE BLOCK (J/B)
Connector Color	WHITE

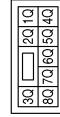

Terminal No.	3Q	Color of Wire	R	Signal Name	-
--------------	----	---------------	---	-------------	---

Connector No.	B49
Connector Name	WIRE TO WIRE
Connector Color	WHITE



Terminal No.	12	Color of Wire	R	Signal Name	-
--------------	----	---------------	---	-------------	---

Connector No.	B114
Connector Name	REAR CARGO POWER SOCKET
Connector Color	BLACK

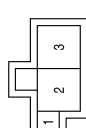

Terminal No.	2	Color of Wire	R	Signal Name	-
3	B	-	-	-	-

A
B
C
D
E
F
G
H
I
J
K
L
N
O
P

PWO

POWER SOCKET

< WIRING DIAGRAM >

Connector No.	B140
Connector Name	WIRE TO WIRE
Connector Color	WHITE



5	4	3	2	1		
12	11	10	9	8	7	6

Terminal No.	Color of Wire	Signal Name
12	R	-

AAMIA2114GB

POWER SOCKET

< REMOVAL AND INSTALLATION >

REMOVAL AND INSTALLATION

POWER SOCKET

Removal and Installation

INFOID:0000000012422456

FRONT POWER SOCKET

Removal

1. Remove cluster lid C. Refer to [IP-22. "Exploded View"](#).
2. Release the pawls on the power socket and remove from the cluster lid C.

Installation

Installation is in the reverse order of removal.

CONSOLE POWER SOCKET

Removal

1. Remove center console cup holder and position aside.
2. Release the pawls on the console power socket and remove from the center console.

Installation

Installation is in the reverse order of removal.

REAR CARGO POWER SOCKET

Removal

1. Remove luggage side lower finisher RH. Refer to [INT-34. "LUGGAGE SIDE LOWER FINISHER : Removal and Installation - With Third Row Seat"](#).
2. Release the pawls on the rear cargo power socket and remove from the luggage side lower finisher RH.

Installation

Installation is in the reverse order of removal.

A

B

C

D

E

F

G

H

I

J

K

L

PWO

N

O

P

SERVICE DATA AND SPECIFICATIONS (SDS)

< SERVICE DATA AND SPECIFICATIONS (SDS)

SERVICE DATA AND SPECIFICATIONS (SDS)

SERVICE DATA AND SPECIFICATIONS (SDS)

Power Socket

INFOID:0000000012422457

Rated voltage	DC 12 V
Maximum electric capacity	120 W or less (Total)
Maximum current	10 A or less (Total)