

# SECTION LAN

## LAN SYSTEM

### CONTENTS

<b>CAN FUNDAMENTAL</b>	
<b>PRECAUTION</b> .....	<b>5</b>
<b>PRECAUTIONS</b> .....	<b>5</b>
Precautions for Trouble Diagnosis .....	5
Precautions for Harness Repair .....	5
<b>FUNCTION DIAGNOSIS</b> .....	<b>6</b>
<b>CAN COMMUNICATION SYSTEM</b> .....	<b>6</b>
System Description .....	6
System Diagram .....	6
CAN Communication Control Circuit .....	7
<b>DIAG ON CAN</b> .....	<b>8</b>
Description .....	8
System Diagram .....	8
<b>TROUBLE DIAGNOSIS</b> .....	<b>9</b>
Condition of Error Detection .....	9
Symptom When Error Occurs in CAN Communi- cation System .....	9
CAN Diagnosis with CONSULT-III .....	12
Self-Diagnosis .....	12
CAN Diagnostic Support Monitor .....	13
How to Use CAN Communication Signal Chart .....	14
<b>BASIC INSPECTION</b> .....	<b>15</b>
<b>DIAGNOSIS AND REPAIR WORKFLOW</b> .....	<b>15</b>
Trouble Diagnosis Flow Chart .....	15
Trouble Diagnosis Procedure .....	15
<b>CAN</b>	
<b>HOW TO USE THIS MANUAL</b> .....	<b>20</b>
<b>HOW TO USE THIS SECTION</b> .....	<b>20</b>
Caution .....	20
Abbreviation List .....	20
<b>PRECAUTION</b> .....	<b>21</b>
<b>PRECAUTIONS</b> .....	<b>21</b>
Precaution for Supplemental Restraint System (SRS) "AIR BAG" and "SEAT BELT PRE-TEN- SIONER" .....	21
Precautions for Trouble Diagnosis .....	21
Precautions for Harness Repair .....	21
<b>BASIC INSPECTION</b> .....	<b>23</b>
<b>DIAGNOSIS AND REPAIR WORKFLOW</b> .....	<b>23</b>
Interview Sheet .....	23
<b>FUNCTION DIAGNOSIS</b> .....	<b>24</b>
<b>CAN COMMUNICATION SYSTEM</b> .....	<b>24</b>
CAN System Specification Chart .....	24
CAN Communication Signal Chart .....	25
<b>COMPONENT DIAGNOSIS</b> .....	<b>27</b>
<b>CAN COMMUNICATION SYSTEM</b> .....	<b>27</b>
Component Parts Location .....	27
Schematic .....	28
Wiring Diagram - CAN - .....	29
<b>MALFUNCTION AREA CHART</b> .....	<b>32</b>
Main Line .....	32
Branch Line .....	32
Short Circuit .....	32
<b>MAIN LINE BETWEEN ABS AND DLC CIR- CUIT</b> .....	<b>33</b>
Diagnosis Procedure .....	33
<b>MAIN LINE BETWEEN ABS AND TCM CIR- CUIT</b> .....	<b>34</b>
Diagnosis Procedure .....	34
<b>MAIN LINE BETWEEN TCM AND DLC CIR- CUIT</b> .....	<b>35</b>
Diagnosis Procedure .....	35
<b>ECM BRANCH LINE CIRCUIT</b> .....	<b>36</b>

Diagnosis Procedure .....	36
<b>ABS BRANCH LINE CIRCUIT .....</b>	<b>37</b>
Diagnosis Procedure .....	37
<b>TCM BRANCH LINE CIRCUIT .....</b>	<b>38</b>
Diagnosis Procedure .....	38
<b>AV BRANCH LINE CIRCUIT .....</b>	<b>39</b>
Diagnosis Procedure .....	39
<b>BCM BRANCH LINE CIRCUIT .....</b>	<b>40</b>
Diagnosis Procedure .....	40
<b>DLC BRANCH LINE CIRCUIT .....</b>	<b>41</b>
Diagnosis Procedure .....	41
<b>EPS BRANCH LINE CIRCUIT .....</b>	<b>42</b>
Diagnosis Procedure .....	42
<b>I-KEY BRANCH LINE CIRCUIT .....</b>	<b>43</b>
Diagnosis Procedure .....	43
<b>M&amp;A BRANCH LINE CIRCUIT .....</b>	<b>44</b>
Diagnosis Procedure .....	44
<b>M&amp;A2 BRANCH LINE CIRCUIT .....</b>	<b>45</b>
Diagnosis Procedure .....	45
<b>IPDM-E BRANCH LINE CIRCUIT .....</b>	<b>46</b>
Diagnosis Procedure .....	46
<b>CAN COMMUNICATION CIRCUIT .....</b>	<b>47</b>
Diagnosis Procedure .....	47
<b>CAN SYSTEM (TYPE 1)</b>	
<b>COMPONENT DIAGNOSIS .....</b>	<b>49</b>
<b>MAIN LINE BETWEEN ABS AND DLC CIR- CUIT .....</b>	<b>49</b>
Diagnosis Procedure .....	49
<b>ECM BRANCH LINE CIRCUIT .....</b>	<b>50</b>
Diagnosis Procedure .....	50
<b>ABS BRANCH LINE CIRCUIT .....</b>	<b>51</b>
Diagnosis Procedure .....	51
<b>BCM BRANCH LINE CIRCUIT .....</b>	<b>52</b>
Diagnosis Procedure .....	52
<b>DLC BRANCH LINE CIRCUIT .....</b>	<b>53</b>
Diagnosis Procedure .....	53
<b>EPS BRANCH LINE CIRCUIT .....</b>	<b>54</b>
Diagnosis Procedure .....	54
<b>M&amp;A BRANCH LINE CIRCUIT .....</b>	<b>55</b>
Diagnosis Procedure .....	55
<b>IPDM-E BRANCH LINE CIRCUIT .....</b>	<b>56</b>
Diagnosis Procedure .....	56
<b>CAN COMMUNICATION CIRCUIT .....</b>	<b>57</b>

Diagnosis Procedure .....	57
<b>CAN SYSTEM (TYPE 2)</b>	
<b>COMPONENT DIAGNOSIS .....</b>	<b>59</b>
<b>MAIN LINE BETWEEN ABS AND DLC CIR- CUIT .....</b>	<b>59</b>
Diagnosis Procedure .....	59
<b>ECM BRANCH LINE CIRCUIT .....</b>	<b>60</b>
Diagnosis Procedure .....	60
<b>ABS BRANCH LINE CIRCUIT .....</b>	<b>61</b>
Diagnosis Procedure .....	61
<b>AV BRANCH LINE CIRCUIT .....</b>	<b>62</b>
Diagnosis Procedure .....	62
<b>BCM BRANCH LINE CIRCUIT .....</b>	<b>63</b>
Diagnosis Procedure .....	63
<b>DLC BRANCH LINE CIRCUIT .....</b>	<b>64</b>
Diagnosis Procedure .....	64
<b>EPS BRANCH LINE CIRCUIT .....</b>	<b>65</b>
Diagnosis Procedure .....	65
<b>M&amp;A BRANCH LINE CIRCUIT .....</b>	<b>66</b>
Diagnosis Procedure .....	66
<b>IPDM-E BRANCH LINE CIRCUIT .....</b>	<b>67</b>
Diagnosis Procedure .....	67
<b>CAN COMMUNICATION CIRCUIT .....</b>	<b>68</b>
Diagnosis Procedure .....	68
<b>CAN SYSTEM (TYPE 3)</b>	
<b>COMPONENT DIAGNOSIS .....</b>	<b>70</b>
<b>MAIN LINE BETWEEN TCM AND DLC CIR- CUIT .....</b>	<b>70</b>
Diagnosis Procedure .....	70
<b>ECM BRANCH LINE CIRCUIT .....</b>	<b>71</b>
Diagnosis Procedure .....	71
<b>TCM BRANCH LINE CIRCUIT .....</b>	<b>72</b>
Diagnosis Procedure .....	72
<b>BCM BRANCH LINE CIRCUIT .....</b>	<b>73</b>
Diagnosis Procedure .....	73
<b>DLC BRANCH LINE CIRCUIT .....</b>	<b>74</b>
Diagnosis Procedure .....	74
<b>EPS BRANCH LINE CIRCUIT .....</b>	<b>75</b>
Diagnosis Procedure .....	75
<b>M&amp;A BRANCH LINE CIRCUIT .....</b>	<b>76</b>
Diagnosis Procedure .....	76
<b>IPDM-E BRANCH LINE CIRCUIT .....</b>	<b>77</b>
Diagnosis Procedure .....	77

<b>CAN COMMUNICATION CIRCUIT</b> .....	<b>78</b>	<b>BCM BRANCH LINE CIRCUIT</b> .....	<b>98</b>	
Diagnosis Procedure .....	78	Diagnosis Procedure .....	98	A
<b>CAN SYSTEM (TYPE 4)</b>				
<b>COMPONENT DIAGNOSIS</b> .....	<b>80</b>	<b>DLC BRANCH LINE CIRCUIT</b> .....	<b>99</b>	
		Diagnosis Procedure .....	99	B
<b>MAIN LINE BETWEEN ABS AND TCM CIR- CUIT</b> .....	<b>80</b>	<b>EPS BRANCH LINE CIRCUIT</b> .....	<b>100</b>	
Diagnosis Procedure .....	80	Diagnosis Procedure .....	100	C
<b>MAIN LINE BETWEEN TCM AND DLC CIR- CUIT</b> .....	<b>81</b>	<b>M&amp;A BRANCH LINE CIRCUIT</b> .....	<b>101</b>	
Diagnosis Procedure .....	81	Diagnosis Procedure .....	101	D
<b>ECM BRANCH LINE CIRCUIT</b> .....	<b>82</b>	<b>IPDM-E BRANCH LINE CIRCUIT</b> .....	<b>102</b>	
Diagnosis Procedure .....	82	Diagnosis Procedure .....	102	E
<b>ABS BRANCH LINE CIRCUIT</b> .....	<b>83</b>	<b>CAN COMMUNICATION CIRCUIT</b> .....	<b>103</b>	
Diagnosis Procedure .....	83	Diagnosis Procedure .....	103	F
<b>TCM BRANCH LINE CIRCUIT</b> .....	<b>84</b>	<b>CAN SYSTEM (TYPE 6)</b>		
Diagnosis Procedure .....	84	<b>COMPONENT DIAGNOSIS</b> .....	<b>105</b>	
<b>BCM BRANCH LINE CIRCUIT</b> .....	<b>85</b>	<b>MAIN LINE BETWEEN ABS AND TCM CIR- CUIT</b> .....	<b>105</b>	G
Diagnosis Procedure .....	85	Diagnosis Procedure .....	105	
<b>DLC BRANCH LINE CIRCUIT</b> .....	<b>86</b>	<b>MAIN LINE BETWEEN TCM AND DLC CIR- CUIT</b> .....	<b>106</b>	H
Diagnosis Procedure .....	86	Diagnosis Procedure .....	106	
<b>EPS BRANCH LINE CIRCUIT</b> .....	<b>87</b>	<b>ECM BRANCH LINE CIRCUIT</b> .....	<b>107</b>	I
Diagnosis Procedure .....	87	Diagnosis Procedure .....	107	
<b>M&amp;A BRANCH LINE CIRCUIT</b> .....	<b>88</b>	<b>ABS BRANCH LINE CIRCUIT</b> .....	<b>108</b>	J
Diagnosis Procedure .....	88	Diagnosis Procedure .....	108	
<b>IPDM-E BRANCH LINE CIRCUIT</b> .....	<b>89</b>	<b>TCM BRANCH LINE CIRCUIT</b> .....	<b>109</b>	
Diagnosis Procedure .....	89	Diagnosis Procedure .....	109	LAN
<b>CAN COMMUNICATION CIRCUIT</b> .....	<b>90</b>	<b>AV BRANCH LINE CIRCUIT</b> .....	<b>110</b>	
Diagnosis Procedure .....	90	Diagnosis Procedure .....	110	L
<b>CAN SYSTEM (TYPE 5)</b>				
<b>COMPONENT DIAGNOSIS</b> .....	<b>92</b>	<b>BCM BRANCH LINE CIRCUIT</b> .....	<b>111</b>	
		Diagnosis Procedure .....	111	M
<b>MAIN LINE BETWEEN ABS AND TCM CIR- CUIT</b> .....	<b>92</b>	<b>DLC BRANCH LINE CIRCUIT</b> .....	<b>112</b>	
Diagnosis Procedure .....	92	Diagnosis Procedure .....	112	N
<b>MAIN LINE BETWEEN TCM AND DLC CIR- CUIT</b> .....	<b>93</b>	<b>EPS BRANCH LINE CIRCUIT</b> .....	<b>113</b>	
Diagnosis Procedure .....	93	Diagnosis Procedure .....	113	O
<b>ECM BRANCH LINE CIRCUIT</b> .....	<b>94</b>	<b>I-KEY BRANCH LINE CIRCUIT</b> .....	<b>114</b>	
Diagnosis Procedure .....	94	Diagnosis Procedure .....	114	P
<b>ABS BRANCH LINE CIRCUIT</b> .....	<b>95</b>	<b>M&amp;A BRANCH LINE CIRCUIT</b> .....	<b>115</b>	
Diagnosis Procedure .....	95	Diagnosis Procedure .....	115	
<b>TCM BRANCH LINE CIRCUIT</b> .....	<b>96</b>	<b>IPDM-E BRANCH LINE CIRCUIT</b> .....	<b>116</b>	
Diagnosis Procedure .....	96	Diagnosis Procedure .....	116	
<b>AV BRANCH LINE CIRCUIT</b> .....	<b>97</b>	<b>CAN COMMUNICATION CIRCUIT</b> .....	<b>117</b>	
Diagnosis Procedure .....	97	Diagnosis Procedure .....	117	
		<b>CAN SYSTEM (TYPE 7)</b>		

<b>COMPONENT DIAGNOSIS</b> .....	119	Diagnosis Procedure .....	138
<b>MAIN LINE BETWEEN ABS AND DLC CIR- CUIT</b> .....	119	<b>EPS BRANCH LINE CIRCUIT</b> .....	139
Diagnosis Procedure .....	119	Diagnosis Procedure .....	139
<b>ECM BRANCH LINE CIRCUIT</b> .....	120	<b>M&amp;A BRANCH LINE CIRCUIT</b> .....	140
Diagnosis Procedure .....	120	Diagnosis Procedure .....	140
<b>ABS BRANCH LINE CIRCUIT</b> .....	121	<b>M&amp;A2 BRANCH LINE CIRCUIT</b> .....	141
Diagnosis Procedure .....	121	Diagnosis Procedure .....	141
<b>AV BRANCH LINE CIRCUIT</b> .....	122	<b>IPDM-E BRANCH LINE CIRCUIT</b> .....	142
Diagnosis Procedure .....	122	Diagnosis Procedure .....	142
<b>BCM BRANCH LINE CIRCUIT</b> .....	123	<b>CAN COMMUNICATION CIRCUIT</b> .....	143
Diagnosis Procedure .....	123	Diagnosis Procedure .....	143
<b>DLC BRANCH LINE CIRCUIT</b> .....	124	<b>CAN SYSTEM (TYPE 9)</b>	
Diagnosis Procedure .....	124	<b>COMPONENT DIAGNOSIS</b> .....	145
<b>EPS BRANCH LINE CIRCUIT</b> .....	125	<b>MAIN LINE BETWEEN ABS AND TCM CIR- CUIT</b> .....	145
Diagnosis Procedure .....	125	Diagnosis Procedure .....	145
<b>M&amp;A BRANCH LINE CIRCUIT</b> .....	126	<b>MAIN LINE BETWEEN TCM AND DLC CIR- CUIT</b> .....	146
Diagnosis Procedure .....	126	Diagnosis Procedure .....	146
<b>M&amp;A2 BRANCH LINE CIRCUIT</b> .....	127	<b>ECM BRANCH LINE CIRCUIT</b> .....	147
Diagnosis Procedure .....	127	Diagnosis Procedure .....	147
<b>IPDM-E BRANCH LINE CIRCUIT</b> .....	128	<b>ABS BRANCH LINE CIRCUIT</b> .....	148
Diagnosis Procedure .....	128	Diagnosis Procedure .....	148
<b>CAN COMMUNICATION CIRCUIT</b> .....	129	<b>TCM BRANCH LINE CIRCUIT</b> .....	149
Diagnosis Procedure .....	129	Diagnosis Procedure .....	149
<b>CAN SYSTEM (TYPE 8)</b>		<b>AV BRANCH LINE CIRCUIT</b> .....	150
<b>COMPONENT DIAGNOSIS</b> .....	131	Diagnosis Procedure .....	150
<b>MAIN LINE BETWEEN ABS AND TCM CIR- CUIT</b> .....	131	<b>BCM BRANCH LINE CIRCUIT</b> .....	151
Diagnosis Procedure .....	131	Diagnosis Procedure .....	151
<b>MAIN LINE BETWEEN TCM AND DLC CIR- CUIT</b> .....	132	<b>DLC BRANCH LINE CIRCUIT</b> .....	152
Diagnosis Procedure .....	132	Diagnosis Procedure .....	152
<b>ECM BRANCH LINE CIRCUIT</b> .....	133	<b>EPS BRANCH LINE CIRCUIT</b> .....	153
Diagnosis Procedure .....	133	Diagnosis Procedure .....	153
<b>ABS BRANCH LINE CIRCUIT</b> .....	134	<b>I-KEY BRANCH LINE CIRCUIT</b> .....	154
Diagnosis Procedure .....	134	Diagnosis Procedure .....	154
<b>TCM BRANCH LINE CIRCUIT</b> .....	135	<b>M&amp;A BRANCH LINE CIRCUIT</b> .....	155
Diagnosis Procedure .....	135	Diagnosis Procedure .....	155
<b>AV BRANCH LINE CIRCUIT</b> .....	136	<b>M&amp;A2 BRANCH LINE CIRCUIT</b> .....	156
Diagnosis Procedure .....	136	Diagnosis Procedure .....	156
<b>BCM BRANCH LINE CIRCUIT</b> .....	137	<b>IPDM-E BRANCH LINE CIRCUIT</b> .....	157
Diagnosis Procedure .....	137	Diagnosis Procedure .....	157
<b>DLC BRANCH LINE CIRCUIT</b> .....	138	<b>CAN COMMUNICATION CIRCUIT</b> .....	158
		Diagnosis Procedure .....	158

# PRECAUTION

## PRECAUTIONS

### Precautions for Trouble Diagnosis

INFOID:000000004501399

**CAUTION:**

- Never apply 7.0 V or more to the measurement terminal.
- Use a tester with open terminal voltage of 7.0 V or less.
- Turn the ignition switch OFF and disconnect the battery cable from the negative terminal when checking the harness.

### Precautions for Harness Repair

INFOID:000000004501400

- Solder the repaired area and wrap tape around the soldered area.

**NOTE:**

A fray of twisted lines must be within 110 mm (4.33 in).

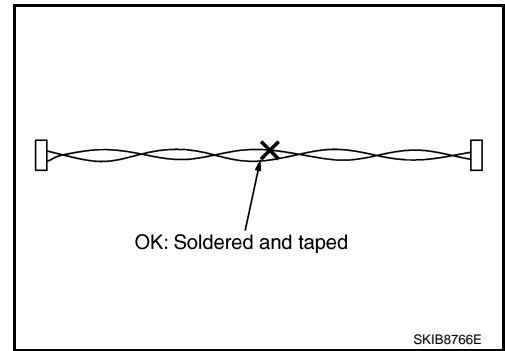

- Bypass connection is never allowed at the repaired area.

**NOTE:**

Bypass connection may cause CAN communication error. The spliced wire becomes separated and the characteristics of twisted line are lost.

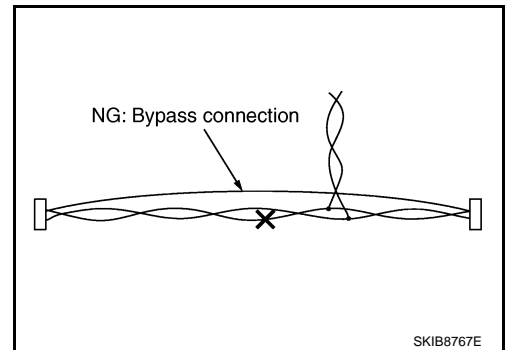

- Replace the applicable harness as an assembly if error is detected on the shield lines of CAN communication line.

A  
B  
C  
D  
E  
F  
G  
H  
I  
J  
L  
M  
N  
O  
P

LAN

## FUNCTION DIAGNOSIS

### CAN COMMUNICATION SYSTEM

#### System Description

INFOID:000000004501401

- CAN communication is a multiplex communication system. This enables the system to transmit and receive large quantities of data at high speed by connecting control units with two communication lines (CAN-H and CAN-L).
- Control units on the CAN network transmit signals using the CAN communication control circuit. They receive only necessary signals from other control units to operate various functions.
- CAN communication lines adopt twisted-pair line style (two lines twisted) for noise immunity.

#### System Diagram

INFOID:000000004501402

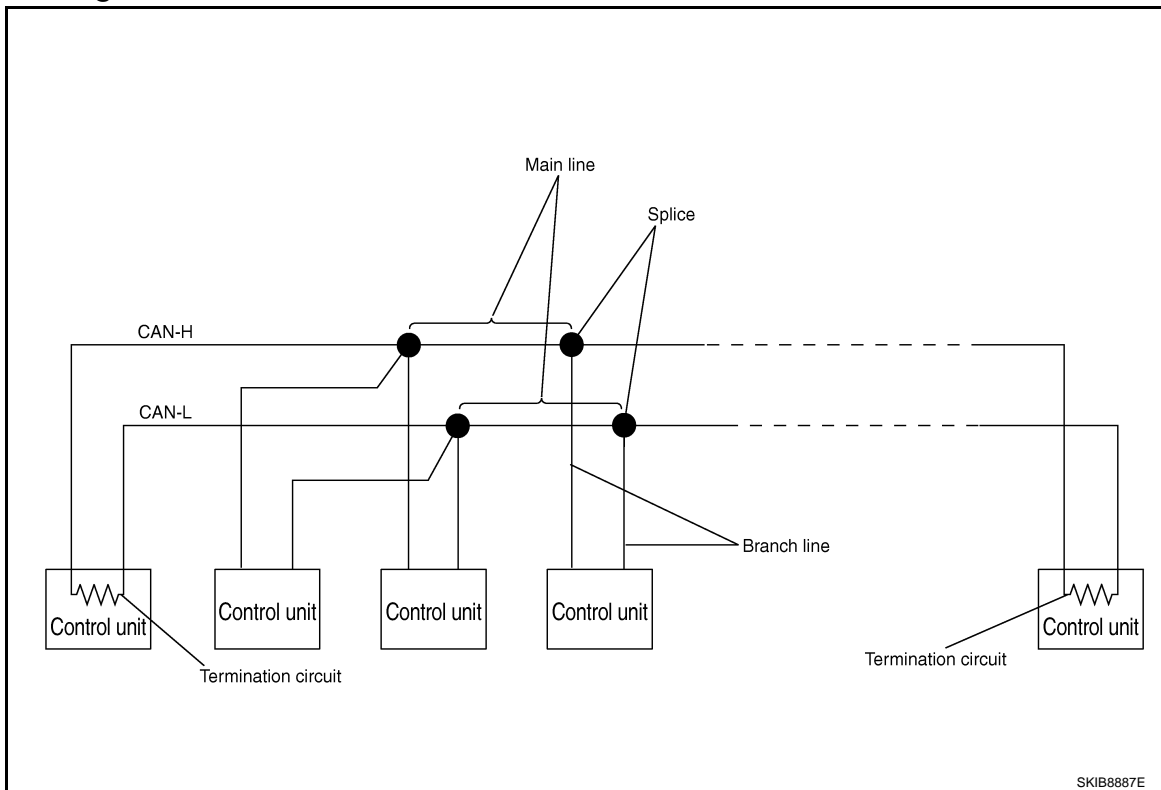

Each control unit passes an electric current to the termination circuits when transmitting CAN communication signal. The termination circuits produce an electrical potential difference between CAN-H and CAN-L. CAN communication system transmits and receives CAN communication signals by the potential difference.

Component	Description
Main line	CAN communication line between splices
Branch line	CAN communication line between splice and a control unit
Splice	A point connecting a branch line with a main line
Termination circuit	Refer to <a href="#">LAN-7, "CAN Communication Control Circuit"</a> .

# CAN COMMUNICATION SYSTEM

< FUNCTION DIAGNOSIS >

[CAN FUNDAMENTAL]

## CAN Communication Control Circuit

INFOID:000000004501403

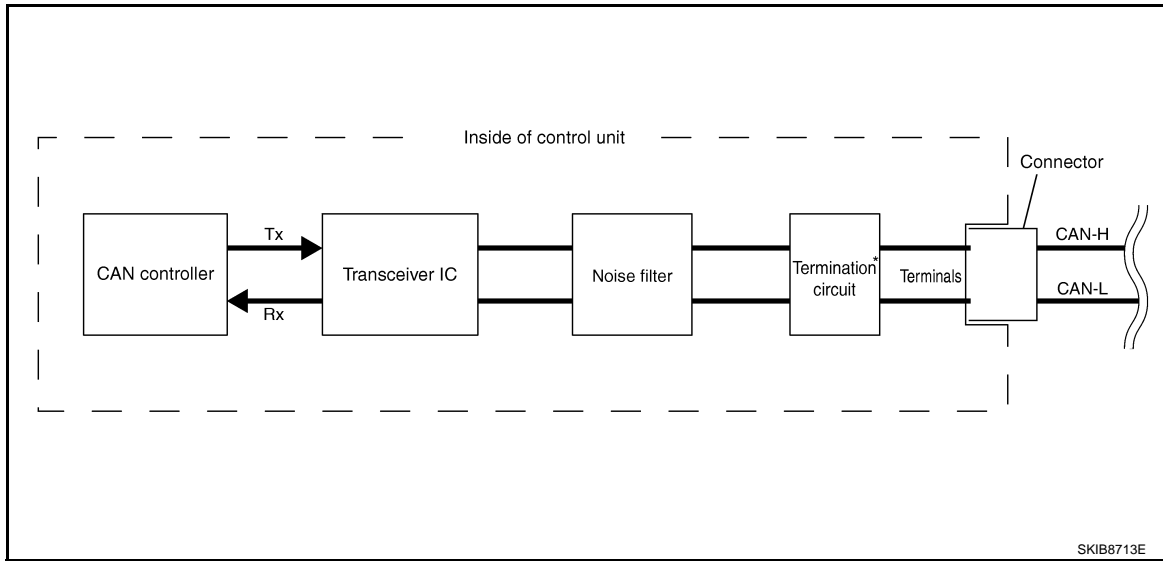

Component	System description
CAN controller	It controls CAN communication signal transmission and reception, error detection, etc.
Transceiver IC	It converts digital signal into CAN communication signal, and CAN communication signal into digital signal.
Noise filter	It eliminates noise of CAN communication signal.
Termination circuit* (Resistance of approx. 120 Ω)	It produces potential difference.

\*: These are the only control units wired with both ends of CAN communication system.

A  
B  
C  
D  
E  
F  
G  
H  
I  
J  
L  
M  
N  
O  
P

LAN

## DIAG ON CAN

### Description

INFOID:000000004501404

“Diag on CAN” is a diagnosis using CAN communication instead of previous DDL1 and DDL2 communication lines, between control units and diagnosis unit.

### System Diagram

INFOID:000000004501405

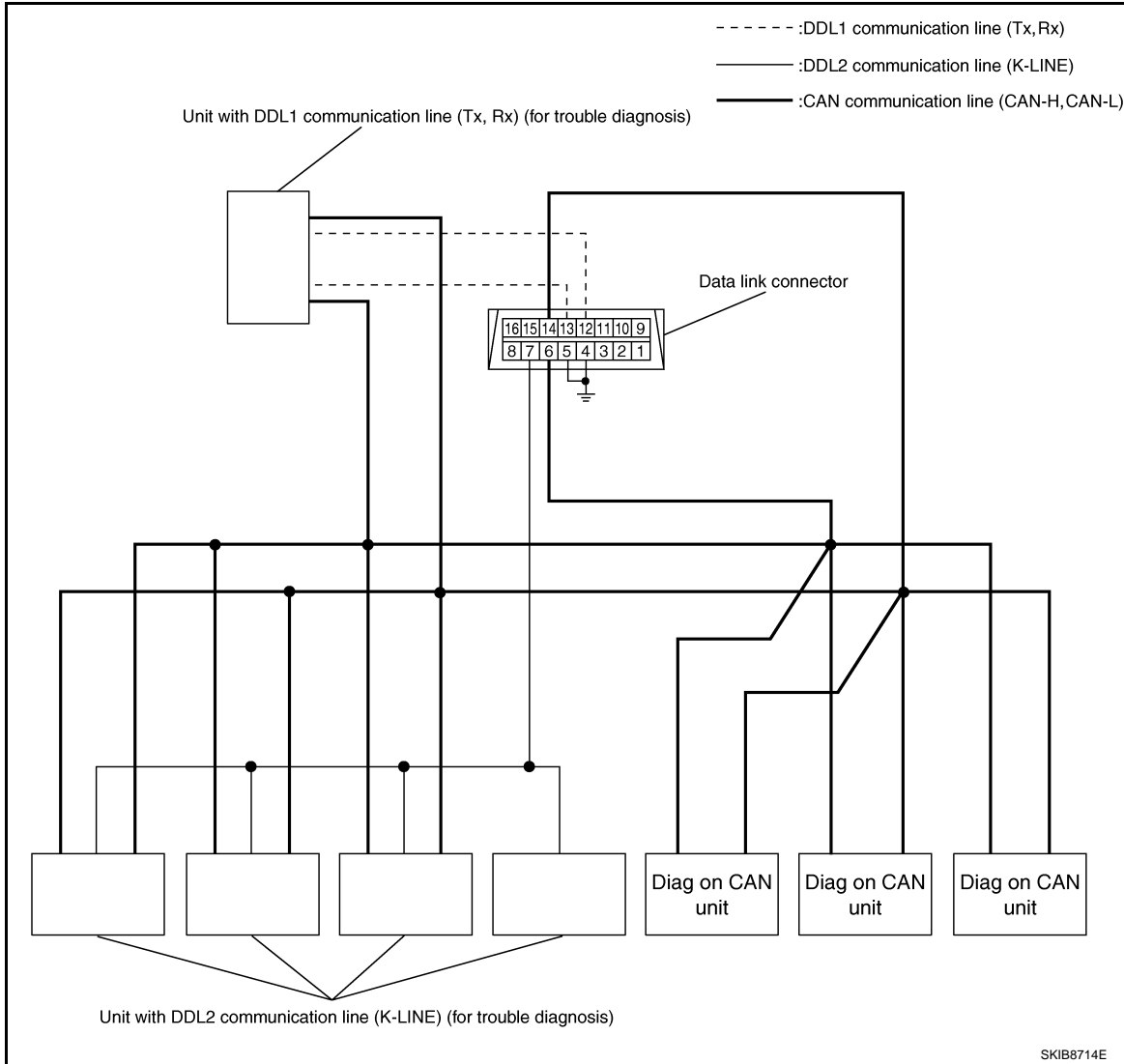

SKIB8714E

Name	Harness	Description
DDL1	Tx Rx	It is used for trouble diagnosis. (CAN-H and CAN-L are used for controlling)
DDL2	K-LINE	It is used for trouble diagnosis. (CAN-H and CAN-L are used for controlling)
Diag on CAN	CAN-H CAN-L	It is used for trouble diagnosis and control.



## TROUBLE DIAGNOSIS

### Condition of Error Detection

INFOID:000000004501406

“U1000” or “U1001” is indicated on SELF-DIAG RESULTS on CONSULT-III if CAN communication signal is not transmitted or received between units for 2 seconds or more.

#### CAN COMMUNICATION SYSTEM ERROR

- CAN communication line open (CAN-H, CAN-L, or both)
- CAN communication line short (ground, between CAN communication lines, other harnesses)
- Error of CAN communication control circuit of the unit connected to CAN communication line

#### WHEN “U1000” OR “U1001” IS INDICATED EVEN THOUGH CAN COMMUNICATION SYSTEM IS NORMAL

- Removal/installation of parts: Error may be detected when removing and installing CAN communication unit and related parts while turning the ignition switch ON. (A DTC except for CAN communication may be detected.)
- Fuse blown out (removed): CAN communication of the unit may cease.
- Voltage drop: Error may be detected if voltage drops due to discharged battery when turning the ignition switch ON (Depending on the control unit which carries out CAN communication).
- Error may be detected if the power supply circuit of the control unit, which carries out CAN communication, malfunctions (Depending on the control unit which carries out CAN communication).
- Error may be detected if reprogramming is not completed normally.

**NOTE:**

CAN communication system is normal if “U1000” or “U1001” is indicated on SELF-DIAG RESULTS of CONSULT-III under the above conditions. Erase the memory of the self-diagnosis of each unit.

### Symptom When Error Occurs in CAN Communication System

INFOID:000000004501407

In CAN communication system, multiple units mutually transmit and receive signals. Each unit cannot transmit and receive signals if any error occurs on CAN communication line. Under this condition, multiple control units related to the root cause malfunction or go into fail-safe mode.

#### ERROR EXAMPLE

**NOTE:**

- Each vehicle differs in symptom of each unit under fail-safe mode and CAN communication line wiring.
- Refer to [LAN-20. "Abbreviation List"](#) for the unit abbreviation.

Example: TCM branch line open circuit

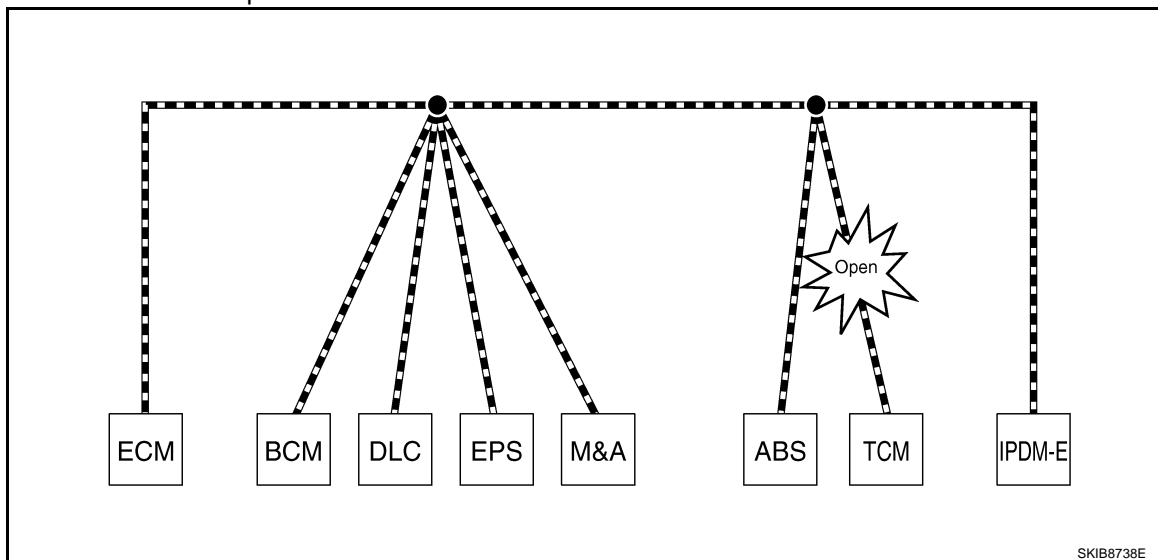

Unit name	Symptom
ECM	Engine torque limiting is affected, and shift harshness increases.
BCM	Reverse warning chime does not sound.

A  
B  
C  
D  
E  
F  
G  
H  
I  
J  
L  
M  
N  
O  
P

LAN

# TROUBLE DIAGNOSIS

< FUNCTION DIAGNOSIS >

[CAN FUNDAMENTAL]

Unit name	Symptom
EPS control unit	Normal operation.
Combination meter	<ul style="list-style-type: none"> <li>Shift position indicator and OD OFF indicator turn OFF.</li> <li>Warning lamps turn ON.</li> </ul>
ABS actuator and electric unit (control unit)	Normal operation.
TCM	No impact on operation.
IPDM E/R	Normal operation.

Example: Data link connector branch line open circuit

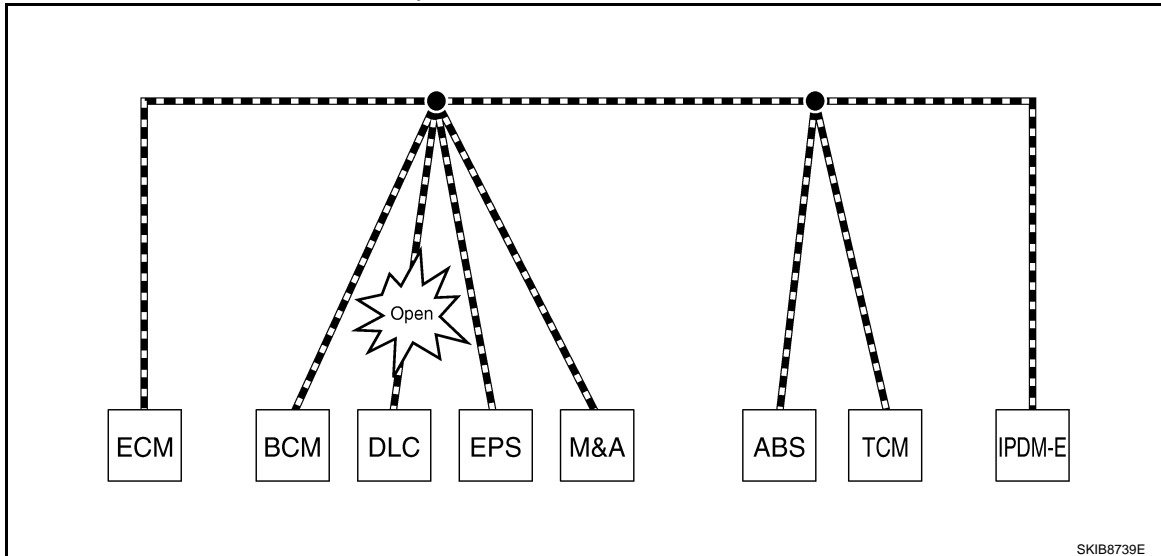

Unit name	Symptom
ECM	Normal operation.
BCM	
EPS control unit	
Combination meter	
ABS actuator and electric unit (control unit)	
TCM	
IPDM E/R	

**NOTE:**

- When data link connector branch line is open, transmission and reception of CAN communication signals are not affected. Therefore, no symptoms occur. However, be sure to repair malfunctioning circuit.
- The model (all units on CAN communication system are Diag on CAN) cannot perform CAN diagnosis with CONSULT-III if the following error occurs. The error is judged by the symptom.

Error	Difference of symptom
Data link connector branch line open circuit	Normal operation.
CAN-H, CAN-L harness short-circuit	Most of the units which are connected to the CAN communication system enter fail-safe mode or are deactivated.

# TROUBLE DIAGNOSIS

< FUNCTION DIAGNOSIS >

[CAN FUNDAMENTAL]

Example: Main Line Between Data Link Connector and ABS Actuator and Electric Unit (Control Unit) Open Circuit

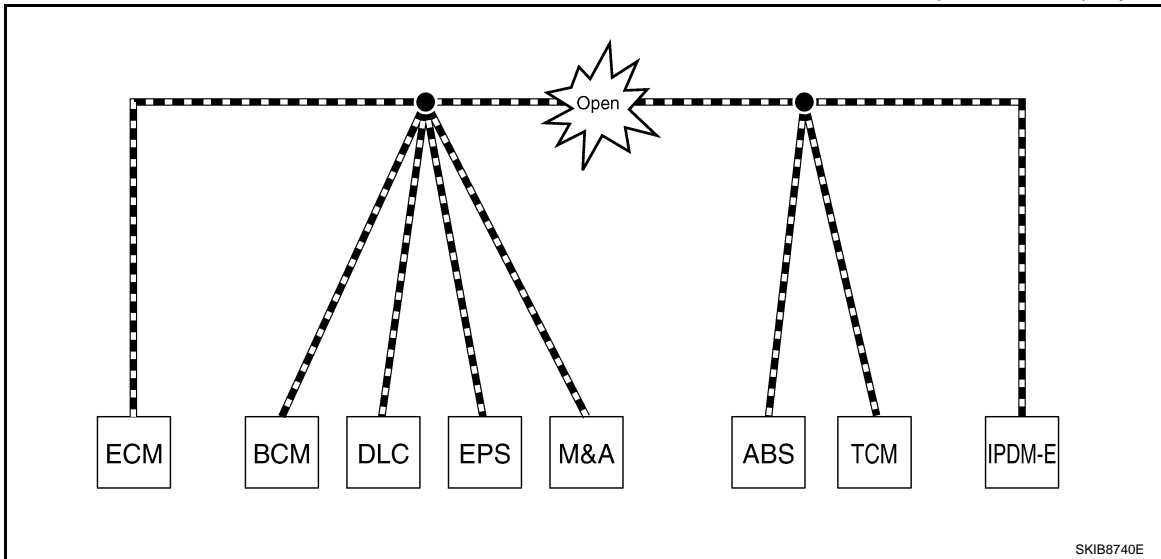

Unit name	Symptom
ECM	Engine torque limiting is affected, and shift harshness increases.
BCM	<ul style="list-style-type: none"> <li>• Reverse warning chime does not sound.</li> <li>• The front wiper moves under continuous operation mode even though the front wiper switch being in the intermittent position.</li> </ul>
EPS control unit	The steering effort increases.
Combination meter	<ul style="list-style-type: none"> <li>• The shift position indicator and OD OFF indicator turn OFF.</li> <li>• The speedometer is inoperative.</li> <li>• The odo/trip meter stops.</li> </ul>
ABS actuator and electric unit (control unit)	Normal operation.
TCM	No impact on operation.
IPDM E/R	When the ignition switch is ON, <ul style="list-style-type: none"> <li>• The headlamps (Lo) turn ON.</li> <li>• The cooling fan continues to rotate.</li> </ul>

Example: CAN-H, CAN-L Harness Short Circuit

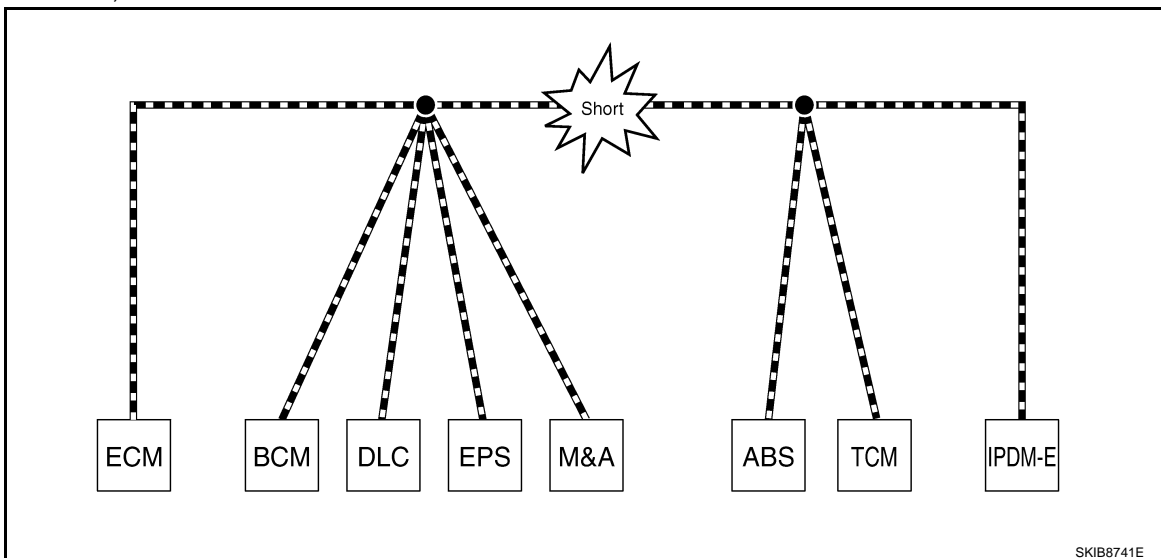

A  
B  
C  
D  
E  
F  
G  
H  
I  
J  
K  
L  
M  
N  
O  
P

LAN

# TROUBLE DIAGNOSIS

< FUNCTION DIAGNOSIS >

[CAN FUNDAMENTAL]

Unit name	Symptom
ECM	<ul style="list-style-type: none"> <li>• Engine torque limiting is affected, and shift harshness increases.</li> <li>• Engine speed drops.</li> </ul>
BCM	<ul style="list-style-type: none"> <li>• Reverse warning chime does not sound.</li> <li>• The front wiper moves under continuous operation mode even though the front wiper switch being in the intermittent position.</li> <li>• The room lamp does not turn ON.</li> <li>• The engine does not start (if an error or malfunction occurs while turning the ignition switch OFF.)</li> <li>• The steering lock does not release (if an error or malfunction occurs while turning the ignition switch OFF.)</li> </ul>
EPS control unit	The steering effort increases.
Combination meter	<ul style="list-style-type: none"> <li>• The tachometer and the speedometer do not move.</li> <li>• Warning lamps turn ON.</li> <li>• Indicator lamps do not turn ON.</li> </ul>
ABS actuator and electric unit (control unit)	Normal operation.
TCM	No impact on operation.
IPDM E/R	When the ignition switch is ON, <ul style="list-style-type: none"> <li>• The headlamps (Lo) turn ON.</li> <li>• The cooling fan continues to rotate.</li> </ul>

## CAN Diagnosis with CONSULT-III

INFOID:000000004501408

CAN diagnosis on CONSULT-III extracts the root cause by receiving the following information.

- Response to the system call
- Control unit diagnosis information
- Self-diagnosis
- CAN diagnostic support monitor

## Self-Diagnosis

INFOID:000000004501409

DTC	Self-diagnosis item (CONSULT-III indication)	DTC detection condition	Inspection/Action
U0101	LOST COMM (TCM)	When ECM is not transmitting or receiving CAN communication signal of OBD (emission-related diagnosis) from TCM for 2 seconds or more.	Start the inspection. Refer to the applicable section of the indicated control unit.
U0140	LOST COMM (BCM)	When ECM is not transmitting or receiving CAN communication signal of OBD (emission-related diagnosis) from BCM for 2 seconds or more.	
U1000	CAN COMM CIRCUIT	When ECM is not transmitting or receiving CAN communication signal of OBD (emission-related diagnosis) for 2 seconds or more.	
		When a control unit (except for ECM) is not transmitting or receiving CAN communication signal for 2 seconds or more.	
U1001	CAN COMM CIRCUIT	When ECM is not transmitting or receiving CAN communication signal other than OBD (emission-related diagnosis) for 2 seconds or more.	
U1002	SYSTEM COMM	When a control unit is not transmitting or receiving CAN communication signal for 2 seconds or less.	
U1010	CONTROL UNIT(CAN)	When an error is detected during the initial diagnosis for CAN controller of each control unit.	Replace the control unit indicating "U1010" or "P0607".
P0607	ECM		

# TROUBLE DIAGNOSIS

< FUNCTION DIAGNOSIS >

[CAN FUNDAMENTAL]

## CAN Diagnostic Support Monitor

INFOID:000000004501410

### MONITOR ITEM (CONSULT-III)

Example: CAN DIAG SUPPORT MNTR indication

Without PAST			With PAST		
ECM			ECM		
	PRSENT	PAST		PRSENT	PAST
INITIAL DIAG	OK		TRANSMIT DIAG	OK	OK
TRANSMIT DIAG	OK		VDC/TCS/ABS	-	-
TCM	OK		METER/M&A	OK	OK
VDC/TCS/ABS	UNKWN		BCM/SEC	OK	OK
METER/M&A	OK		ICC	-	-
ICC	UNKWN		HVAC	-	-
BCM/SEC	OK		TCM	OK	OK
IPDM E/R	OK		EPS	-	-
			IPDM E/R	OK	OK
			e4WD	-	-
			AWD/4WD	OK	OK

JSMIA0015GB

#### Without PAST

Item	PRSENT	Description
Initial diagnosis	OK	Normal at present
	NG	Control unit error (Except for some control units)
Transmission diagnosis	OK	Normal at present
	UNKWN	Unable to transmit signals for 2 seconds or more. Diagnosis not performed
Control unit name (Reception diagnosis)	OK	Normal at present
	UNKWN	Unable to receive signals for 2 seconds or more. Diagnosis not performed
		No control unit for receiving signals. (No applicable optional parts)

#### With PAST

Item	PRSENT	PAST	Description
Transmission diagnosis	OK	OK	Normal at present and in the past
		1 – 39	Normal at present, but unable to transmit signals for 2 seconds or more in the past. (The number indicates the number of ignition switch cycles from OFF to ON.)
	UNKWN	0	Unable to transmit signals for 2 seconds or more at present.
Control unit name (Reception diagnosis)	OK	OK	Normal at present and in the past
		1 – 39	Normal at present, but unable to receive signals for 2 seconds or more in the past. (The number indicates the number of ignition switch cycles from OFF to ON.)
	UNKWN	0	Unable to receive signals for 2 seconds or more at present.
	-	-	Diagnosis not performed. No control unit for receiving signals. (No applicable optional parts)

### MONITOR ITEM (ON-BOARD DIAGNOSIS)

#### NOTE:

For some models, CAN communication diagnosis result is received from the vehicle monitor.

A  
B  
C  
D  
E  
F  
G  
H  
I  
J  
L  
M  
N  
O  
P

LAN

# TROUBLE DIAGNOSIS

[CAN FUNDAMENTAL]

< FUNCTION DIAGNOSIS >

Example: Vehicle Display

Item	Result indicated	Error counter	Description
CAN_COMM (Initial diagnosis)	OK	0	Normal at present
	NG	1 – 50	Control unit error (The number indicates how many times diagnosis has been run.)
CAN_CIRC_1 (Transmission diagnosis)	OK	0	Normal at present
	UNKWN	1 – 50	Unable to transmit for 2 seconds or more at present. (The number indicates how many times diagnosis has been run.)
CAN_CIRC_2 – 9 (Reception diagnosis of each unit)	OK	0	Normal at present
	UNKWN	1 – 50	Unable to transmit for 2 seconds or more at present. (The number indicates how many times diagnosis has been run.)
			Diagnosis not performed.
			No control unit for receiving signals. (No applicable optional parts)

## How to Use CAN Communication Signal Chart

INFOID:000000004501411

The CAN communication signal chart lists the signals needed for trouble diagnosis. It is useful for detecting the root cause by finding a signal related to the symptom, and by checking transmission and reception unit.

Example: Tachometer does not move even though the engine rotates.

T: Transmit R: Receive

Signal name/Connecting unit	ECM	BCM	M&A	STRG	ABS	IPDM-E
A/C compressor feedback signal	T		R			
A/C compressor request signal	T					R
Accelerator pedal position signal	T				R	
Cooling fan motor operation signal	T					R
Engine coolant temperature signal	T		R			
Engine speed signal	T		R		R	
Fuel consumption monitor signal	T		R			
Malfunction indicator lamp signal	T		R			
A/C switch signal	R	T				
Ignition switch signal		T				R
Sleep/wake up signal		T	R			R

↓

It indicates that an error occurs between ECM and M&A (Shaded area).

SKIB8715E

## BASIC INSPECTION

### DIAGNOSIS AND REPAIR WORKFLOW

#### Trouble Diagnosis Flow Chart

INFOID:000000004501412

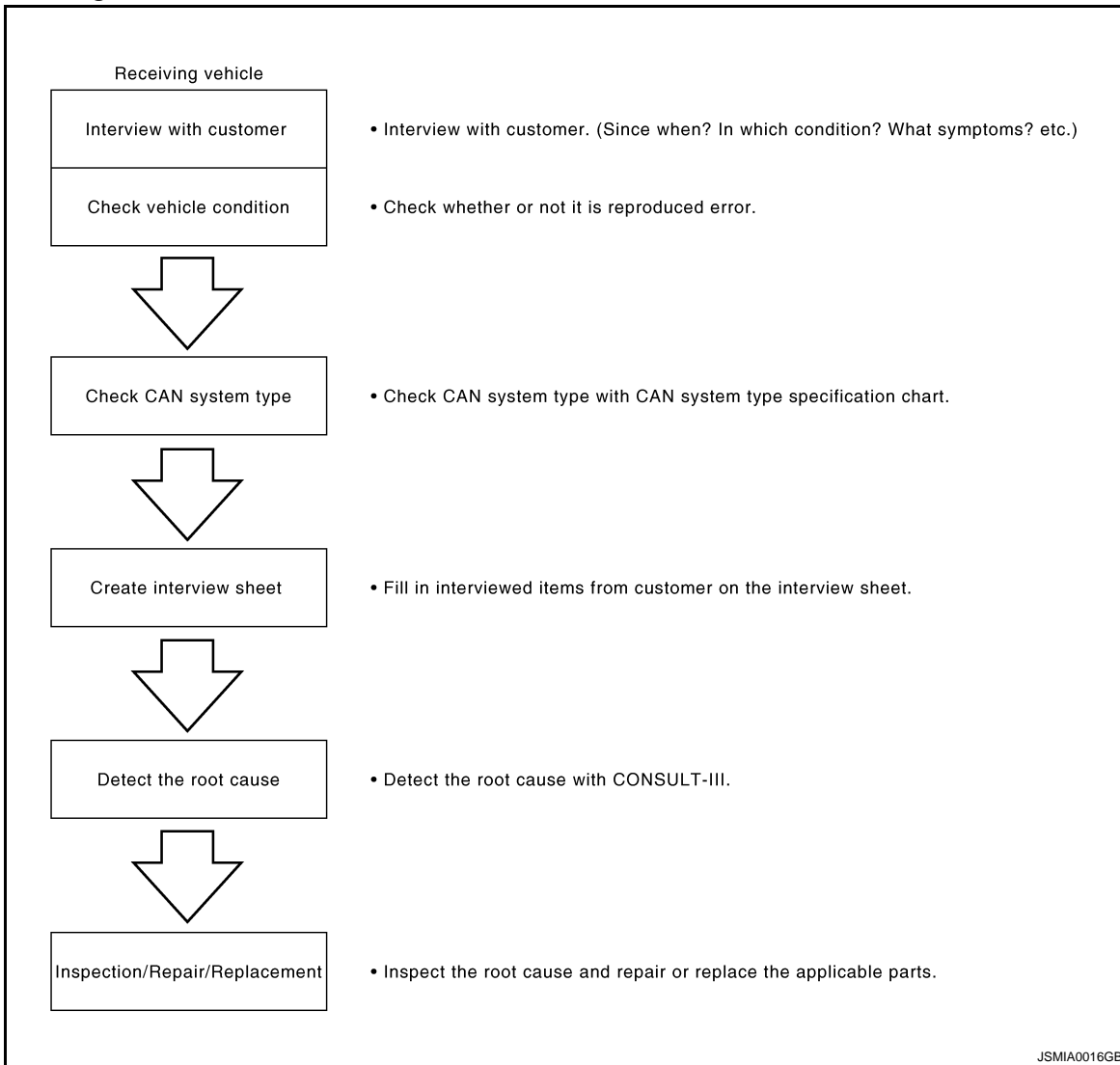

#### Trouble Diagnosis Procedure

INFOID:000000004501413

##### INTERVIEW WITH CUSTOMER

Interview with the customer is important to detect the root cause of CAN communication system errors and to understand vehicle condition and symptoms for proper trouble diagnosis.

##### Points in interview

- What: Parts name, system name
- When: Date, Frequency
- Where: Road condition, Place
- In what condition: Driving condition/environment
- Result: Symptom

##### NOTE:

- Check normal units as well as error symptoms.
- Example: Circuit between ECM and the combination meter is judged normal if the customer indicates tachometer functions normally.
- When a CAN communication system error is present, multiple control units may malfunction or go into fail-safe mode.

# DIAGNOSIS AND REPAIR WORKFLOW

< BASIC INSPECTION >

[CAN FUNDAMENTAL]

- Indication of the combination meter is important to detect the root cause because it is the most obvious to the customer, and it performs CAN communication with many units.

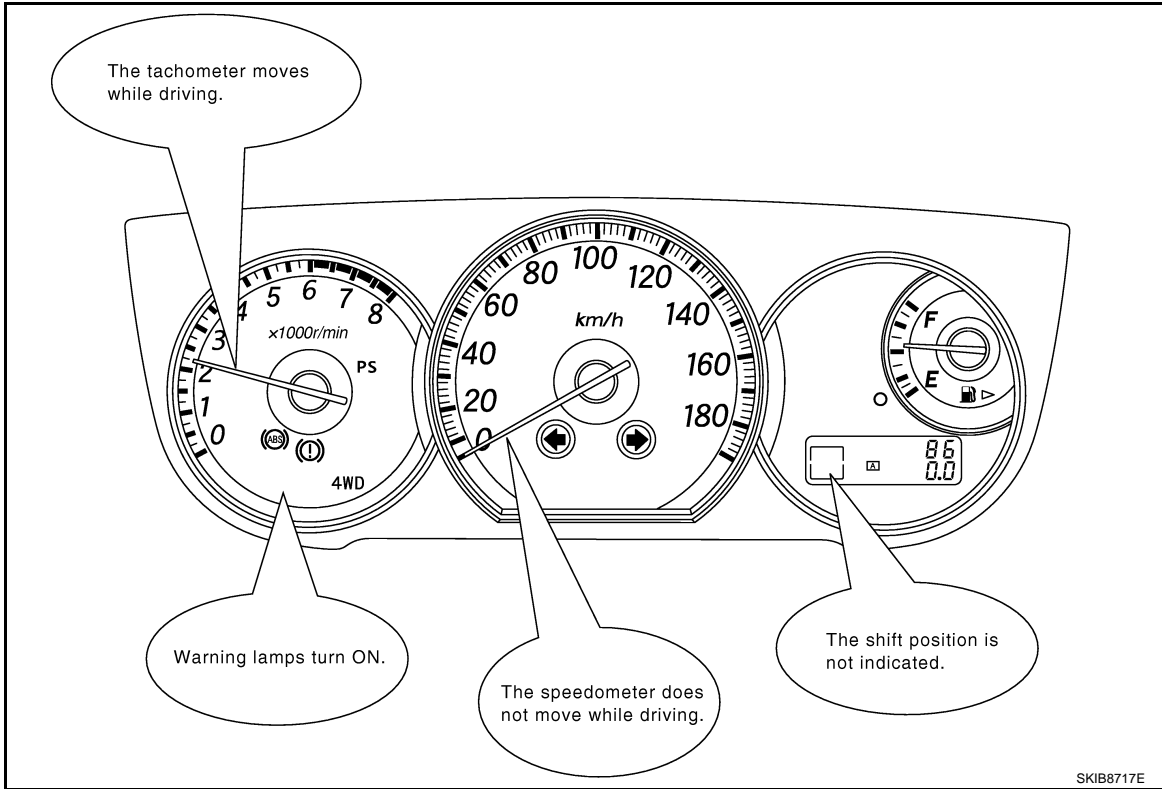

## INSPECTION OF VEHICLE CONDITION

Check whether the symptom is reproduced or not.

### NOTE:

Do not turn the ignition switch OFF or disconnect the battery cable while reproducing the error. The error may temporarily correct itself, making it difficult to determine the root cause.

## CHECK OF CAN SYSTEM TYPE (HOW TO USE CAN SYSTEM TYPE SPECIFICATION CHART)

Determine CAN system type based on vehicle equipment.

### NOTE:

- This chart is used if CONSULT-III does not automatically recognize CAN system type.
- There are two styles for CAN system type specification charts. Depending on the number of available system types, either style A or style B may be used.

CAN System Type Specification Chart (Style A)

### NOTE:



# DIAGNOSIS AND REPAIR WORKFLOW

< BASIC INSPECTION >

[CAN FUNDAMENTAL]

CAN system type is easily checked with the vehicle equipment identification information shown in the chart.

Example:  
Vehicle is equipped as follows: Wagon, AWD, VQ35DE, CVT, VDC, and Intelligent Key system. (○ shows an example of CAN system type.)

**CAN System Specification Chart**  
Determine CAN system type from the following specification chart.

Body type	Wagon					
Axle	2WD			AWD		
Engine	QR25DE		VQ35DE			
Transmission	A/T			CVT		
Brake control	ABS			VDC		
Intelligent Key system		X		X		X
CAN system type	1	2	3	4	5	6
CAN communication signal chart	XX-XX. "TYPE 1/TYPE 2"		XX-XX. "TYPE 3/TYPE 4"		XX-XX. "TYPE 5/TYPE 6"	

X : Applicable

**VEHICLE EQUIPMENT IDENTIFICATION INFORMATION**  
**NOTE:**  
Check CAN system type from the vehicle shape and equipment.

With VDC

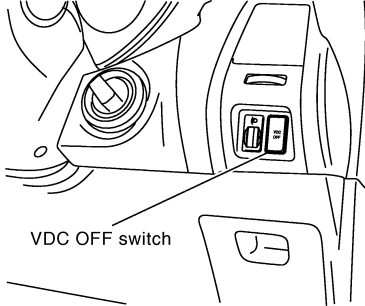

VDC OFF switch

With Intelligent Key system

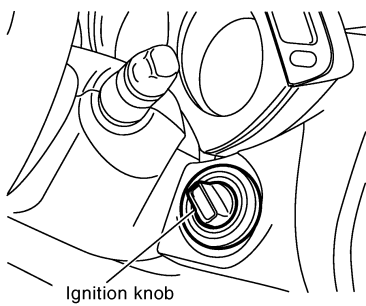

Ignition knob

[ For the above case, CAN system type is "6". ]

JSMIA0017GB

CAN System Type Specification Chart (Style B)

**NOTE:**

A  
B  
C  
D  
E  
F  
G  
H  
I  
J  
L  
M  
N  
O  
P

LAN

# DIAGNOSIS AND REPAIR WORKFLOW

< BASIC INSPECTION >

[CAN FUNDAMENTAL]

CAN system type is easily checked with the vehicle equipment identification information shown in the chart.

Example:

Vehicle is equipped as follows: Sedan, 2WD, MR20DE, CVT, ABS, Active AFS, Intelligent Key system, Navigation system and Automatic drive positioner. (○ shows an example of CAN system type.)

## CAN System Specification Chart

Refer to the specification as shown in the chart.

Body type	Sedan		
Axle	2WD		AWD
Engine	HR15DE	MR20DE	HR15DE
Transmission	AT	CVT	AT
Brake control	ABS		
Specification chart	XXX SPECIFICATION CHART A	YYY SPECIFICATION CHART B	XXX SPECIFICATION CHART C

x: Applicable

Check the vehicle equipment with the vehicle identification number plate.

Check the vehicle equipment.

Select the applicable vehicle equipment. Refer to the specification chart.

## SPECIFICATION CHART B

Determine CAN system type from the following specification chart.

Body type	Sedan											
Axle	2WD											
Engine	MR20DE											
Transmission	CVT											
Brake control	ABS											
Active AFS	x			x	x		x	x		x		
Intelligent Key system		x		x		x	x	x	x	x		
Navigation system			x			x	x		x			
Automatic drive positioner								x	x	x		
CAN system type	9	10	11	12	13	14	15	16	17	18	19	20
CAN communication signal chart	XXX TYPE W/PER ACTIVE AFS/INT KEY/NAV/DRIVE POS/TYPE W/PER INT KEY/INT KEY/NAV/DRIVE POS											

x: Applicable

Check the vehicle equipment.

The number indicates the CAN system type of the vehicle.

## VEHICLE EQUIPMENT IDENTIFICATION INFORMATION

### NOTE:

Check CAN system type from the vehicle shape and equipment.

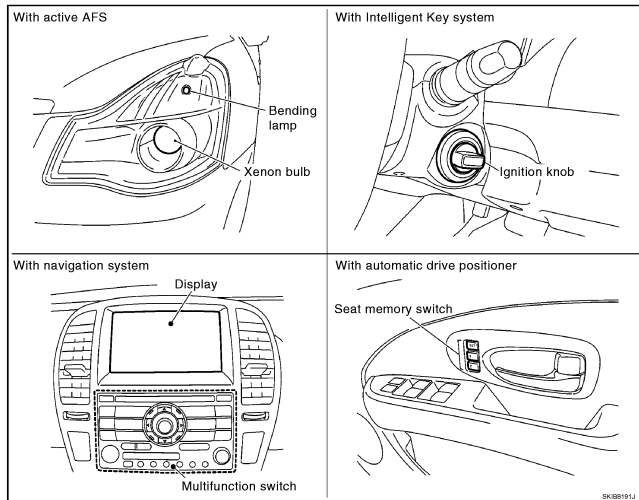

In the above example,

- Checking Xenon bulb and bending lamp lead to judge whether or not Active AFS is equipped.
- Checking the ignition knob leads to judge whether or not Intelligent Key system is equipped.
- Checking display and multifunction switch lead to judge whether or not Navigation system is equipped.
- Checking seat memory switch leads to judge whether or not Automatic drive positioner is equipped.

[ For the above case, CAN system type is "20". ]

JSMIA0018GB

## CREATE INTERVIEW SHEET

Fill out the symptom described by the customer, vehicle condition, and CAN system type on the interview sheet.

# DIAGNOSIS AND REPAIR WORKFLOW

< BASIC INSPECTION >

[CAN FUNDAMENTAL]

Interview Sheet (Example)

CAN Communication System Diagnosis Interview Sheet	
Date received:	3, Feb. 2006
Type: DBA-KG11	VIN No.: KG11-005040
Model: BDRARGZ397EDA-E-J-	
First registration: 10, Jan. 2001	Mileage: 62,140
CAN system type:	Type 19
Symptom (Results from interview with customer)	
<ul style="list-style-type: none"><li>• Headlamps suddenly turn ON while driving the vehicle.</li><li>• The engine does not restart after stopping the vehicle and turning the ignition switch OFF.</li><li>• The cooling fan continues rotating while turning the ignition switch ON.</li></ul>	
Condition at inspection	
Error Symptom: Present / Past	
<p>The engine does not start. While turning the ignition switch ON,</p> <ul style="list-style-type: none"><li>• The headlamps (Lo) turn ON, and the cooling fan continues rotating.</li><li>• The interior lamp does not turn ON.</li></ul>	
<small>JSMIA0019GB</small>	

A  
B  
C  
D  
E  
F  
G  
H  
I  
J  
L  
M  
N  
O  
P

LAN

DETECT THE ROOT CAUSE

CAN diagnosis function of CONSULT-III detects the root cause.

## HOW TO USE THIS SECTION

< HOW TO USE THIS MANUAL >

[CAN]

# HOW TO USE THIS MANUAL

## HOW TO USE THIS SECTION

### Caution

INFOID:000000004501414

- This section describes information peculiar to a vehicle and inspection procedures.
- For trouble diagnosis procedure, refer to [LAN-15, "Trouble Diagnosis Procedure"](#).

### Abbreviation List

INFOID:000000004501415

Unit name abbreviations in CONSULT-III CAN diagnosis and in this section are as per the following list.

Abbreviation	Unit name
A-BAG	Air bag diagnosis sensor unit
ABS	ABS actuator and electric unit (control unit)
AV	Audio unit
BCM	BCM
DLC	Data link connector
ECM	ECM
EPS	EPS control unit
I-KEY	Intelligent Key unit
IPDM-E	IPDM E/R
M&A	Combination meter
M&A2	Double meter
TCM	TCM

PRECAUTION

PRECAUTIONS

Precaution for Supplemental Restraint System (SRS) "AIR BAG" and "SEAT BELT PRE-TENSIONER"

INFOID:000000004779258

The Supplemental Restraint System such as "AIR BAG" and "SEAT BELT PRE-TENSIONER", used along with a front seat belt, helps to reduce the risk or severity of injury to the driver and front passenger for certain types of collision. This system includes seat belt switch inputs and dual stage front air bag modules. The SRS system uses the seat belt switches to determine the front air bag deployment, and may only deploy one front air bag, depending on the severity of a collision and whether the front occupants are belted or unbelted. Information necessary to service the system safely is included in the SRS and SB section of this Service Manual.

**WARNING:**

- To avoid rendering the SRS inoperative, which could increase the risk of personal injury or death in the event of a collision which would result in air bag inflation, all maintenance must be performed by an authorized NISSAN/INFINITI dealer.
- Improper maintenance, including incorrect removal and installation of the SRS can lead to personal injury caused by unintentional activation of the system. For removal of Spiral Cable and Air Bag Module, see the SRS section.
- Do not use electrical test equipment on any circuit related to the SRS unless instructed to in this Service Manual. SRS wiring harnesses can be identified by yellow and/or orange harnesses or harness connectors.
- When working near the Airbag Diagnosis Sensor Unit or other Airbag System sensors with the Ignition ON or engine running, DO NOT use air or electric power tools or strike near the sensor(s) with a hammer. Heavy vibration could activate the sensor(s) and deploy the air bag(s), possibly causing serious injury.
- When using air or electric power tools or hammers, always switch the Ignition OFF, disconnect the battery, and wait at least 3 minutes before performing any service.

Precautions for Trouble Diagnosis

INFOID:000000004501417

**CAUTION:**

- Never apply 7.0 V or more to the measurement terminal.
- Use a tester with open terminal voltage of 7.0 V or less.
- Turn the ignition switch OFF and disconnect the battery cable from the negative terminal when checking the harness.

Precautions for Harness Repair

INFOID:000000004501418

- Solder the repaired area and wrap tape around the soldered area.

**NOTE:**

A fray of twisted lines must be within 110 mm (4.33 in).

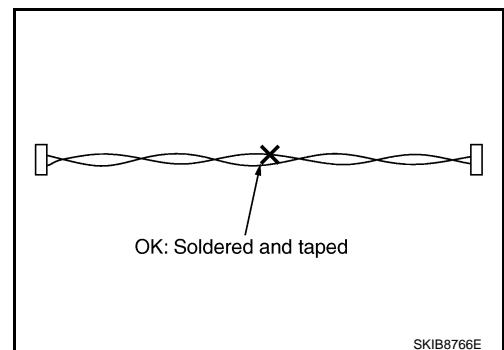

A  
B  
C  
D  
E  
F  
G  
H  
I  
J  
LAN  
L  
M  
N  
O  
P

## PRECAUTIONS

< PRECAUTION >

[CAN]

- Bypass connection is never allowed at the repaired area.

**NOTE:**

Bypass connection may cause CAN communication error. The spliced wire becomes separated and the characteristics of twisted line are lost.

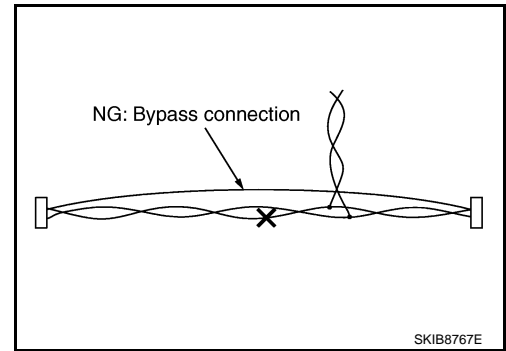

- Replace the applicable harness as an assembly if error is detected on the shield lines of CAN communication line.

# DIAGNOSIS AND REPAIR WORKFLOW

< BASIC INSPECTION >

[CAN]

## BASIC INSPECTION

### DIAGNOSIS AND REPAIR WORKFLOW

#### Interview Sheet

INFOID:000000004501419

#### CAN Communication System Diagnosis Interview Sheet

Date received:

Type:

VIN No.:

Model:

First registration:

Mileage:

CAN system type:

Symptom (Results from interview with customer)

Condition at inspection

Error symptom : Present / Past

SKIB8898E

A  
B  
C  
D  
E  
F  
G  
H  
I  
J  
LAN  
L  
M  
N  
O  
P

# CAN COMMUNICATION SYSTEM

[CAN]

< FUNCTION DIAGNOSIS >

## FUNCTION DIAGNOSIS

### CAN COMMUNICATION SYSTEM

#### CAN System Specification Chart

INFOID:000000004501420

Determine CAN system type from the following specification chart.

**NOTE:**

Refer to [LAN-15. "Trouble Diagnosis Procedure"](#) for how to use CAN system specification chart.

Body type	Sedan								
Axle	2WD								
Engine	MR20DE					QR25DE			
Transmission	M/T		CVT				M/T	CVT	
Brake control	ABS		—	ABS					
Mid/Premium audio system		×			×	×	×	×	×
Intelligent Key system						×			×
Double meter							×	×	×
CAN system type	1	2	3	4	5	6	7	8	9
Start CAN Diagnosis (CONSULT-III)	1	2	3	4	5	6	7	8	9

×: Applicable

#### VEHICLE EQUIPMENT IDENTIFICATION INFORMATION

**NOTE:**

Check CAN system type from the vehicle shape and equipment.

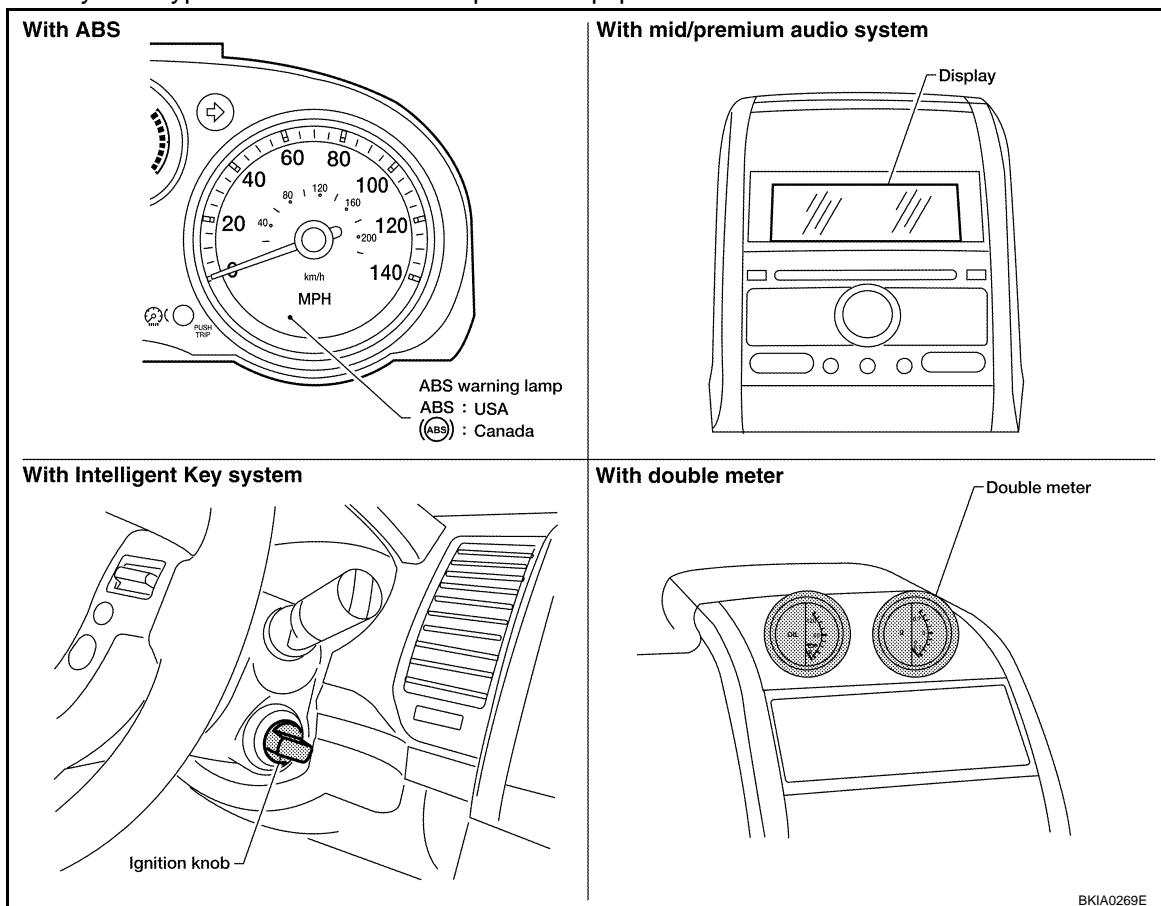



# CAN COMMUNICATION SYSTEM

< FUNCTION DIAGNOSIS >

[CAN]

## CAN Communication Signal Chart

INFOID:000000004501421

Refer to [LAN-14, "How to Use CAN Communication Signal Chart"](#) for how to use CAN communication signal chart.

**NOTE:**

Refer to [LAN-20, "Abbreviation List"](#) for the abbreviations of the connecting units.

T: Transmit R: Receive

Signal name/Connecting unit	ECM	ABS	TCM	AV	BCM	EPS	I-KEY	M&A	M&A2	IPDM-E
A/C compressor request signal	T									R
Accelerator pedal position signal	T		R							
ASCD CRUISE lamp signal	T							R		
ASCD SET lamp signal	T							R		
Closed throttle position signal	T		R							
Cooling fan speed request signal	T									R
Engine coolant temperature signal	T							R		
Engine speed signal	T		R					R		
Engine status signal	T					R				
Fuel consumption monitor signal	T			R				R		
Malfunction indicator lamp signal	T							R		
Wide open throttle position signal	T		R							
ABS warning lamp signal		T						R		
Brake warning lamp signal		T						R		
Vehicle speed signal	R			R	R	R		T	R	
	R	T	R			R		R		
			T <sup>*1</sup>					R <sup>*1</sup>		
CVT self-diagnosis signal	R		T							
Input shaft revolution signal	R		T							
OD OFF indicator signal			T					R		
Output shaft revolution signal	R		T							
Shift position indicator signal			T					R		
A/C switch signal	R				T					
Blower fan motor switch signal	R				T					
Buzzer output signal					T			R		
							T	R		
Day time running light request signal <sup>*2</sup>					T			R		R
Door lock/unlock status signal					T		R			
Door switch signal				R	T		R	R		R
Front wiper request signal					T					R
High beam request signal					T			R		R
Horn chirp signal					T					R
Ignition switch signal				R	T					R
Low beam request signal					T					R
Oil pressure switch signal					T			R		
Position lights request signal					T			R		R
Rear window defogger switch signal					T					R

A  
B  
C  
D  
E  
F  
G  
H  
I  
J  
LAN  
L  
M  
N  
O  
P

# CAN COMMUNICATION SYSTEM

< FUNCTION DIAGNOSIS >

[CAN]

Signal name/Connecting unit	ECM	ABS	TCM	AV	BCM	EPS	I-KEY	M&A	M&A2	IPDM-E
Sleep/wake up signal					R			T		
					T		R	R		R
Stop lamp switch signal			R		T					
Theft warning horn request signal					T					R
Tire pressure signal*3					T			R		
Trunk open/close status signal				R	T		R			
Turn indicator signal					T			R		
EPS operation signal	R					T				
EPS warning lamp signal						T		R		
Door lock/unlock/trunk open request signal					R		T			
Hazard request signal					R		T			
Ignition knob switch signal					R		T			
KEY warning lamp signal							T	R		
Panic alarm request signal					R		T			
Distance to empty signal				R				T		
Fuel level low warning signal				R				T		
Fuel level sensor signal	R							T		
Market information signal				R				T		
Overdrive control switch signal			R					T		
Front wiper stop position signal					R					T
High beam status signal	R									T
Low beam status signal	R									T
Rear window defogger control signal	R									T

\*1: Models without ABS

\*2: Models for Canada

\*3: Models for USA

**NOTE:**

CAN data of the air bag diagnosis sensor unit is not used by usual service work, thus it is omitted.

## COMPONENT DIAGNOSIS

### CAN COMMUNICATION SYSTEM

#### Component Parts Location

INFOID:000000004501422

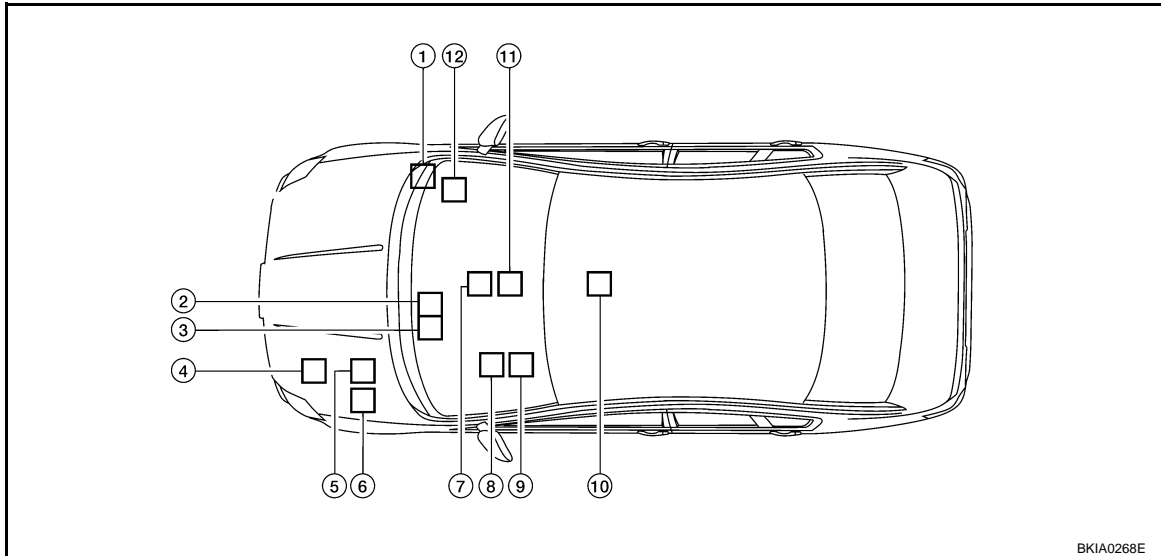

- |  |                          |                              |
|--|--------------------------|------------------------------|
| 1. ABS actuator and electric unit (control unit) E33 | 2. BCM M18               | 3. EPS control unit M37      |
| 4. TCM F23   | 5. ECM E16               | 6. IPDM E/R E46              |
| 7. Double meter M89                                  | 8. Combination meter M24 | 9. Data link connector M22   |
| 10. Air bag diagnosis sensor unit M35                | 11. Audio unit M53       | 12. Intelligent Key unit M42 |

A  
B  
C  
D  
E  
F  
G  
H  
I  
J  
L  
M  
N  
O  
P

LAN

# CAN COMMUNICATION SYSTEM

[CAN]

< COMPONENT DIAGNOSIS >

## Schematic

INFOID:000000004501423

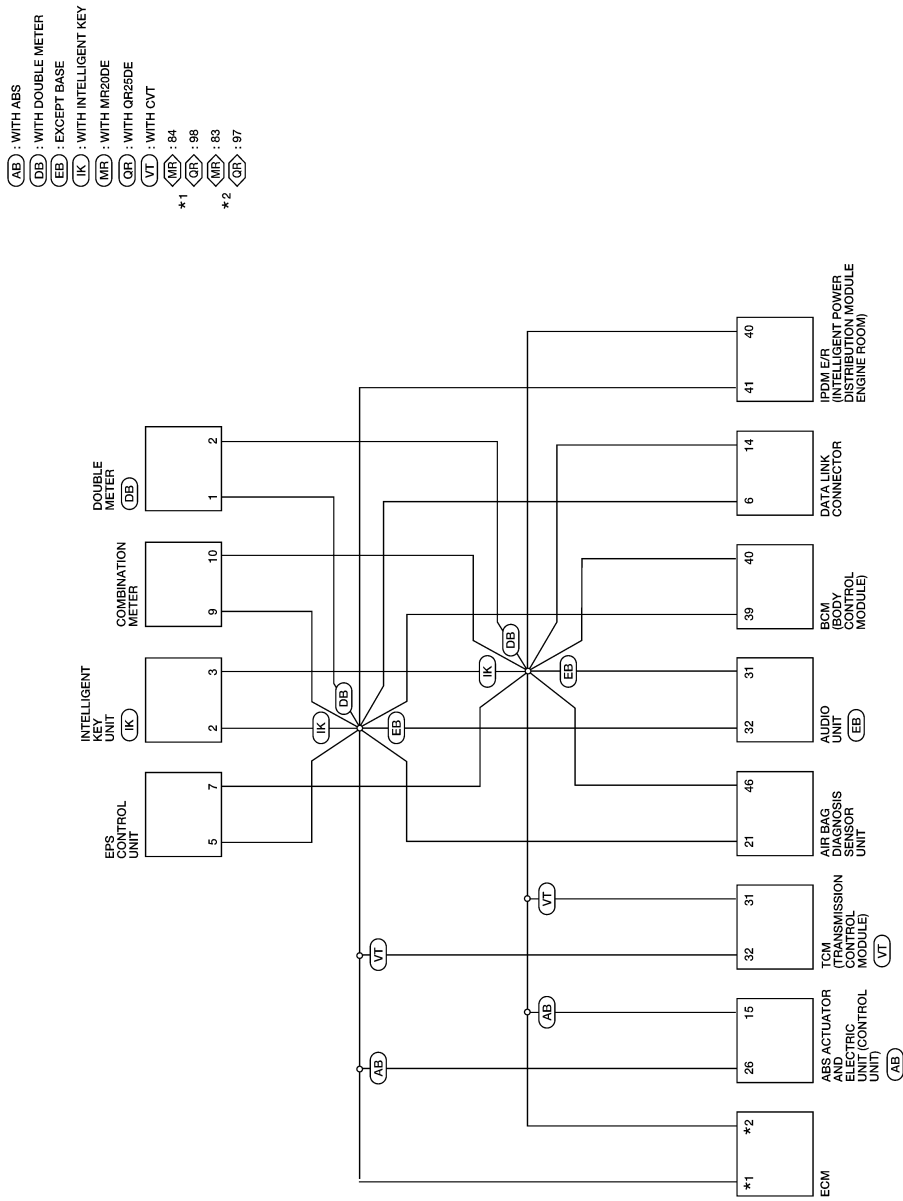

BKWA0822E

# CAN COMMUNICATION SYSTEM

< COMPONENT DIAGNOSIS >

[CAN]

## Wiring Diagram - CAN -

INFOID:000000004501424

### LAN-CAN-01

- : DATA LINE
- AB : WITH ABS
- MR : WITH MR20DE
- QR : WITH QR25DE
- VT : WITH CVT
- \*1 MR : 84  
QR : 98
- \*2 MR : 83  
QR : 97

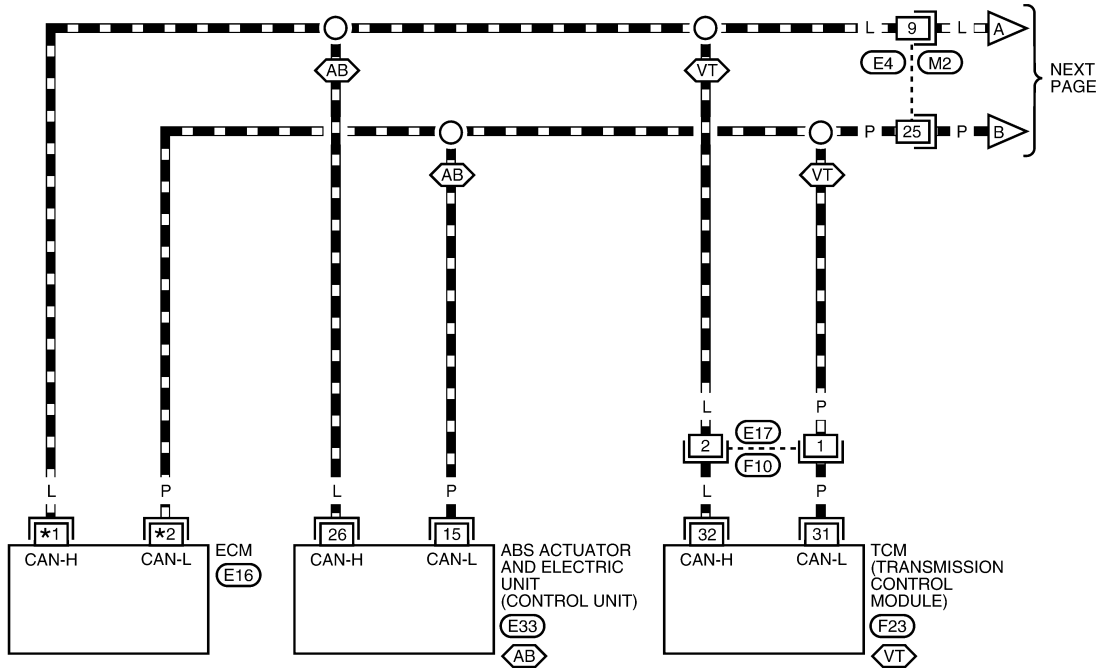

A  
B  
C  
D  
E  
F  
G  
H  
I  
J

LAN

L  
M  
N  
O  
P

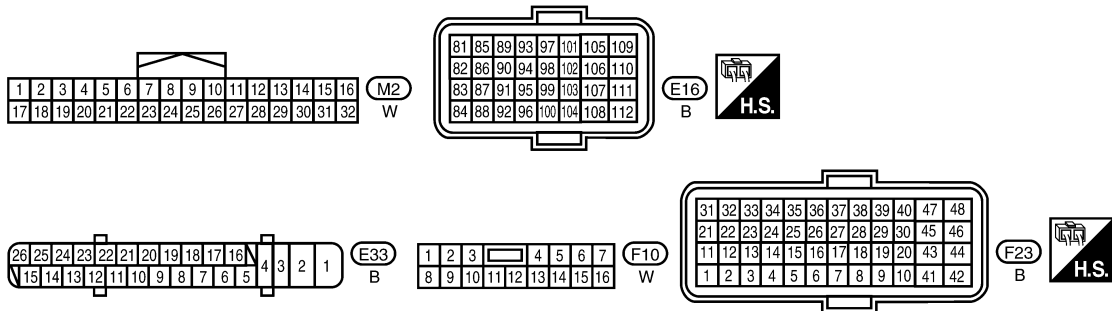

BKWA0823E

# CAN COMMUNICATION SYSTEM

< COMPONENT DIAGNOSIS >

[CAN]

## LAN-CAN-02

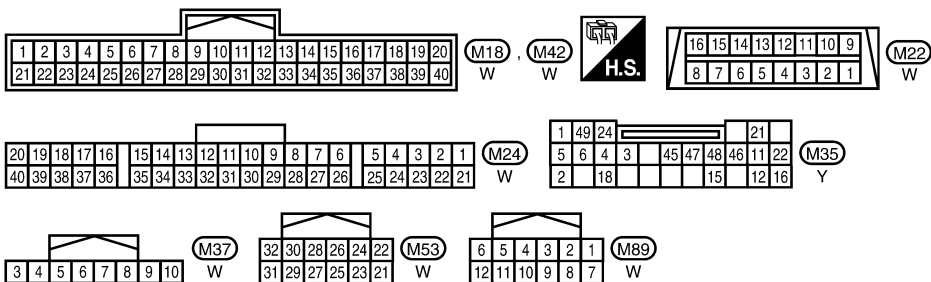
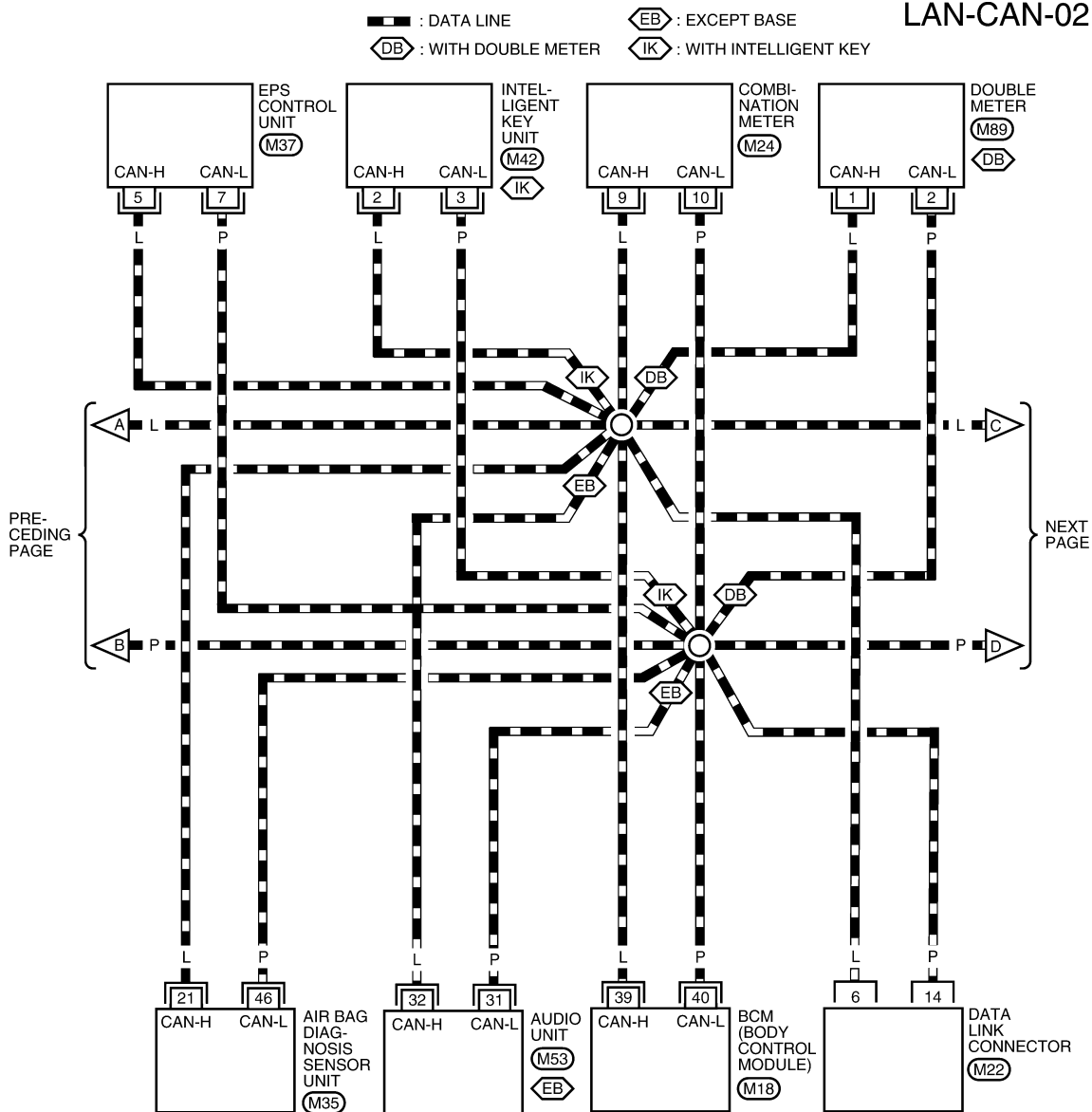

BKWA0824E

# CAN COMMUNICATION SYSTEM

< COMPONENT DIAGNOSIS >

[CAN]

LAN-CAN-03

— : DATA LINE

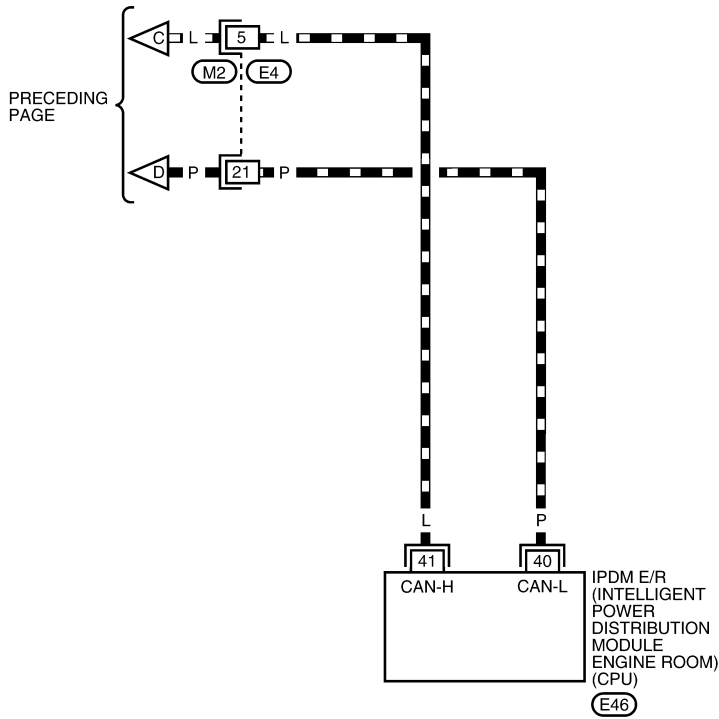

A  
B  
C  
D  
E  
F  
G  
H  
I  
J

LAN

L  
M  
N  
O  
P

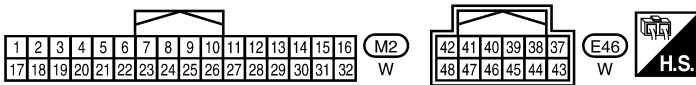

BKWA0737E

# MALFUNCTION AREA CHART

< COMPONENT DIAGNOSIS >

[CAN]

## MALFUNCTION AREA CHART

### Main Line

INFOID:000000004501425

Malfunction Area	Reference
Main line between ABS actuator and electric unit (control unit) and data link connector	<a href="#">LAN-33, "Diagnosis Procedure"</a>
Main line between ABS actuator and electric unit (control unit) and TCM	<a href="#">LAN-34, "Diagnosis Procedure"</a>
Main line between TCM and data link connector	<a href="#">LAN-35, "Diagnosis Procedure"</a>

### Branch Line

INFOID:000000004501426

Malfunction Area	Reference
ECM branch line circuit	<a href="#">LAN-36, "Diagnosis Procedure"</a>
ABS actuator and electric unit (control unit) branch line circuit	<a href="#">LAN-37, "Diagnosis Procedure"</a>
TCM branch line circuit	<a href="#">LAN-38, "Diagnosis Procedure"</a>
Audio unit branch line circuit	<a href="#">LAN-39, "Diagnosis Procedure"</a>
BCM branch line circuit	<a href="#">LAN-40, "Diagnosis Procedure"</a>
Data link connector branch line circuit	<a href="#">LAN-41, "Diagnosis Procedure"</a>
EPS control unit branch line circuit	<a href="#">LAN-42, "Diagnosis Procedure"</a>
Intelligent Key unit branch line circuit	<a href="#">LAN-43, "Diagnosis Procedure"</a>
Combination meter branch line circuit	<a href="#">LAN-44, "Diagnosis Procedure"</a>
Double meter branch line circuit	<a href="#">LAN-45, "Diagnosis Procedure"</a>
IPDM E/R branch line circuit	<a href="#">LAN-46, "Diagnosis Procedure"</a>

### Short Circuit

INFOID:000000004501427

Malfunction Area	Reference
CAN communication circuit	<a href="#">LAN-47, "Diagnosis Procedure"</a>



# MAIN LINE BETWEEN ABS AND DLC CIRCUIT

< COMPONENT DIAGNOSIS >

[CAN]

## MAIN LINE BETWEEN ABS AND DLC CIRCUIT

### Diagnosis Procedure

INFOID:000000004501428

#### 1.CHECK CONNECTOR

1. Turn the ignition switch OFF.
2. Disconnect the battery cable from the negative terminal.
3. Check the following terminals and connectors for damage, bend and loose connection (connector side and harness side).
  - Harness connector E4
  - Harness connector M2

Is the inspection result normal?

- YES >> GO TO 2.  
NO >> Repair the terminal and connector.

#### 2.CHECK HARNESS CONTINUITY (OPEN CIRCUIT)

1. Disconnect the following harness connectors.
  - ABS actuator and electric unit (control unit)
  - Harness connectors E4 and M2
2. Check the continuity between the ABS actuator and electric unit (control unit) harness connector and the harness connector.

ABS actuator and electric unit (control unit) harness connector		Harness connector		Continuity
Connector No.	Terminal No.	Connector No.	Terminal No.	
E33	26	E4	9	Existed
	15		25	Existed

Is the inspection result normal?

- YES >> GO TO 3.  
NO >> Repair the main line between the ABS actuator and electric unit (control unit) and the harness connector E4.

#### 3.CHECK HARNESS CONTINUITY (OPEN CIRCUIT)

Check the continuity between the harness connector and the data link connector.

Harness connector		Data link connector		Continuity
Connector No.	Terminal No.	Connector No.	Terminal No.	
M2	9	M22	6	Existed
	25		14	Existed

Is the inspection result normal?

- YES (Present error)>>Check CAN system type decision again.  
YES (Past error)>>Error was detected in the main line between the ABS actuator and electric unit (control unit) and the data link connector.  
NO >> Repair the main line between the harness connector M2 and the data link connector.

A  
B  
C  
D  
E  
F  
G  
H  
I  
J  
LAN  
L  
M  
N  
O  
P

# MAIN LINE BETWEEN ABS AND TCM CIRCUIT

< COMPONENT DIAGNOSIS >

[CAN]

## MAIN LINE BETWEEN ABS AND TCM CIRCUIT

### Diagnosis Procedure

INFOID:000000004501429

#### 1. CHECK HARNESS CONTINUITY (OPEN CIRCUIT)

1. Turn the ignition switch OFF.
2. Disconnect the battery cable from the negative terminal.
3. Disconnect the following harness connectors.
  - ECM
  - ABS actuator and electric unit (control unit)
  - Harness connectors E17 and F10
4. Check the continuity between the ABS actuator and electric unit (control unit) harness connector and the harness connector.

ABS actuator and electric unit (control unit) harness connector		Harness connector		Continuity
Connector No.	Terminal No.	Connector No.	Terminal No.	
E33	26	E17	2	Existed
	15		1	Existed

#### Is the inspection result normal?

YES (Present error)>>Check CAN system type decision again.

YES (Past error)>>Error was detected in the main line between the ABS actuator and electric unit (control unit) and the TCM.

NO >> Repair the main line between the ABS actuator and electric unit (control unit) and the harness connector E17.

# MAIN LINE BETWEEN TCM AND DLC CIRCUIT

< COMPONENT DIAGNOSIS >

[CAN]

## MAIN LINE BETWEEN TCM AND DLC CIRCUIT

### Diagnosis Procedure

INFOID:000000004501430

#### 1.CHECK CONNECTOR

1. Turn the ignition switch OFF.
2. Disconnect the battery cable from the negative terminal.
3. Check the following terminals and connectors for damage, bend and loose connection (connector side and harness side).
  - Harness connector E4
  - Harness connector M2

Is the inspection result normal?

YES >> GO TO 2.

NO >> Repair the terminal and connector.

#### 2.CHECK HARNESS CONTINUITY (OPEN CIRCUIT)

1. Disconnect the following harness connectors.
  - Harness connectors F10 and E17
  - Harness connectors E4 and M2
2. Check the continuity between the harness connectors.

Harness connector		Harness connector		Continuity
Connector No.	Terminal No.	Connector No.	Terminal No.	
E17	2	E4	9	Existed
	1		25	Existed

Is the inspection result normal?

YES >> GO TO 3.

NO >> Repair the main line between the harness connector E17 and the harness connector E4.

#### 3.CHECK HARNESS CONTINUITY (OPEN CIRCUIT)

Check the continuity between the harness connector and the data link connector.

Harness connector		Data link connector		Continuity
Connector No.	Terminal No.	Connector No.	Terminal No.	
M2	9	M22	6	Existed
	25		14	Existed

Is the inspection result normal?

YES (Present error)>>Check CAN system type decision again.

YES (Past error)>>Error was detected in the main line between the TCM and the data link connector.

NO >> Repair the main line between the harness connector M2 and the data link connector.

A  
B  
C  
D  
E  
F  
G  
H  
I  
J  
LAN  
L  
M  
N  
O  
P

# ECM BRANCH LINE CIRCUIT

< COMPONENT DIAGNOSIS >

[CAN]

## ECM BRANCH LINE CIRCUIT

### Diagnosis Procedure

INFOID:000000004501431

#### 1. CHECK CONNECTOR

1. Turn the ignition switch OFF.
2. Disconnect the battery cable from the negative terminal.
3. Check the following terminals and connectors for damage, bend and loose connection (unit side and connector side).
  - ECM
  - Harness connector E4 (M/T models without ABS)
  - Harness connector M2 (M/T models without ABS)

Is the inspection result normal?

YES >> GO TO 2.

NO >> Repair the terminal and connector.

#### 2. CHECK HARNESS FOR OPEN CIRCUIT

1. Disconnect the connector of ECM.
2. Check the resistance between the ECM harness connector terminals.
  - MR20DE

ECM harness connector			Resistance (Ω)
Connector No.	Terminal No.		
E16	84	83	Approx. 108 – 132

- QR25DE

ECM harness connector			Resistance (Ω)
Connector No.	Terminal No.		
E16	98	97	Approx. 108 – 132

Is the measurement value within the specification?

YES >> GO TO 3.

NO >> Repair the ECM branch line.

#### 3. CHECK POWER SUPPLY AND GROUND CIRCUIT

Check the power supply and the ground circuit of the ECM. Refer to the following.

- MR20DE (For California): [EC-147, "Diagnosis Procedure"](#)
- MR20DE (Except for California): [EC-693, "Diagnosis Procedure"](#)
- QR25DE: [EC-1214, "Diagnosis Procedure"](#)

Is the inspection result normal?

YES (Present error)>>Replace the ECM. Refer to the following.

- MR20DE (For California): [EC-90, "Procedure After Replacing ECM"](#)
- MR20DE (Except for California): [EC-636, "Procedure After Replacing ECM"](#)
- QR25DE: [EC-1158, "Procedure After Replacing ECM"](#)

YES (Past error)>>Error was detected in the ECM branch line.

NO >> Repair the power supply and the ground circuit.

# ABS BRANCH LINE CIRCUIT

< COMPONENT DIAGNOSIS >

[CAN]

## ABS BRANCH LINE CIRCUIT

### Diagnosis Procedure

INFOID:000000004501432

#### 1. CHECK CONNECTOR

1. Turn the ignition switch OFF.
2. Disconnect the battery cable from the negative terminal.
3. Check the terminals and connectors of the ABS actuator and electric unit (control unit) for damage, bend and loose connection (unit side and connector side).

Is the inspection result normal?

- YES >> GO TO 2.  
NO >> Repair the terminal and connector.

#### 2. CHECK HARNESS FOR OPEN CIRCUIT

1. Disconnect the connector of ABS actuator and electric unit (control unit).
2. Check the resistance between the ABS actuator and electric unit (control unit) harness connector terminals.

ABS actuator and electric unit (control unit) harness connector			Resistance (Ω)
Connector No.	Terminal No.		
E33	26	15	Approx. 54 – 66

Is the measurement value within the specification?

- YES >> GO TO 3.  
NO >> Repair the ABS actuator and electric unit (control unit) branch line.

#### 3. CHECK POWER SUPPLY AND GROUND CIRCUIT

Check the power supply and the ground circuit of the ABS actuator and electric unit (control unit). Refer to [BRC-26, "ABS Control Unit Power and Ground Systems Inspection"](#).

Is the inspection result normal?

- YES (Present error)>>Replace the ABS actuator and electric unit (control unit). Refer to [BRC-33, "Removal and Installation"](#).  
YES (Past error)>>Error was detected in the ABS actuator and electric unit (control unit) branch line.  
NO >> Repair the power supply and the ground circuit.

A  
B  
C  
D  
E  
F  
G  
H  
I  
J  
L  
M  
N  
O  
P

LAN

# TCM BRANCH LINE CIRCUIT

< COMPONENT DIAGNOSIS >

[CAN]

## TCM BRANCH LINE CIRCUIT

### Diagnosis Procedure

INFOID:000000004501433

#### 1. CHECK CONNECTOR

1. Turn the ignition switch OFF.
2. Disconnect the battery cable from the negative terminal.
3. Check the following terminals and connectors for damage, bend and loose connection (unit side and connector side).
  - TCM
  - Harness connector F10
  - Harness connector E17

Is the inspection result normal?

YES >> GO TO 2.

NO >> Repair the terminal and connector.

#### 2. CHECK HARNESS FOR OPEN CIRCUIT

1. Disconnect the connector of TCM.
2. Check the resistance between the TCM harness connector terminals.

TCM harness connector			Resistance (Ω)
Connector No.	Terminal No.		
F23	32	31	Approx. 54 – 66

Is the measurement value within the specification?

YES >> GO TO 3.

NO >> Repair the TCM branch line.

#### 3. CHECK POWER SUPPLY AND GROUND CIRCUIT

Check the power supply and the ground circuit of the TCM. Refer to [CVT-120, "Diagnosis Procedure"](#).

Is the inspection result normal?

YES (Present error)>>Replace the TCM. Refer to [CVT-162, "Removal and Installation"](#).

YES (Past error)>>Error was detected in the TCM branch line.

NO >> Repair the power supply and the ground circuit.

# AV BRANCH LINE CIRCUIT

< COMPONENT DIAGNOSIS >

[CAN]

## AV BRANCH LINE CIRCUIT

### Diagnosis Procedure

INFOID:000000004501434

#### 1. CHECK CONNECTOR

1. Turn the ignition switch OFF.
2. Disconnect the battery cable from the negative terminal.
3. Check the terminals and connectors of the audio unit for damage, bend and loose connection (unit side and connector side).

Is the inspection result normal?

- YES >> GO TO 2.  
NO >> Repair the terminal and connector.

#### 2. CHECK HARNESS FOR OPEN CIRCUIT

1. Disconnect the connector of audio unit.
2. Check the resistance between the audio unit harness connector terminals.

Audio unit harness connector			Resistance (Ω)
Connector No.	Terminal No.		
M53	32	31	Approx. 54 – 66

Is the measurement value within the specification?

- YES >> GO TO 3.  
NO >> Repair the audio unit branch line.

#### 3. CHECK POWER SUPPLY AND GROUND CIRCUIT

Check the power supply and the ground circuit of the audio unit. Refer to [AV-35, "Power Supply Circuit Inspection"](#).

Is the inspection result normal?

- YES (Present error)>>Replace the audio unit. Refer to [AV-51, "Removal and Installation"](#).  
YES (Past error)>>Error was detected in the audio unit branch line.  
NO >> Repair the power supply and the ground circuit.

A  
B  
C  
D  
E  
F  
G  
H  
I  
J  
L  
M  
N  
O  
P

LAN

# BCM BRANCH LINE CIRCUIT

< COMPONENT DIAGNOSIS >

[CAN]

## BCM BRANCH LINE CIRCUIT

### Diagnosis Procedure

INFOID:000000004501435

#### 1. CHECK CONNECTOR

1. Turn the ignition switch OFF.
2. Disconnect the battery cable from the negative terminal.
3. Check the terminals and connectors of the BCM for damage, bend and loose connection (unit side and connector side).

Is the inspection result normal?

- YES >> GO TO 2.  
NO >> Repair the terminal and connector.

#### 2. CHECK HARNESS FOR OPEN CIRCUIT

1. Disconnect the connector of BCM.
2. Check the resistance between the BCM harness connector terminals.

BCM harness connector			Resistance (Ω)
Connector No.	Terminal No.		
M18	39	40	Approx. 54 – 66

Is the measurement value within the specification?

- YES >> GO TO 3.  
NO >> Repair the BCM branch line.

#### 3. CHECK POWER SUPPLY AND GROUND CIRCUIT

Check the power supply and the ground circuit of the BCM. Refer to [BCS-14, "BCM Power Supply and Ground Circuit Inspection"](#).

Is the inspection result normal?

- YES (Present error)>>Replace the BCM. Refer to [BCS-17, "Removal and Installation of BCM"](#).  
YES (Past error)>>Error was detected in the BCM branch line.  
NO >> Repair the power supply and the ground circuit.



# DLC BRANCH LINE CIRCUIT

< COMPONENT DIAGNOSIS >

[CAN]

## DLC BRANCH LINE CIRCUIT

### Diagnosis Procedure

INFOID:000000004501436

#### 1. CHECK CONNECTOR

1. Turn the ignition switch OFF.
2. Disconnect the battery cable from the negative terminal.
3. Check the terminals and connectors of the data link connector for damage, bend and loose connection (connector side and harness side).

Is the inspection result normal?

- YES >> GO TO 2.  
NO >> Repair the terminal and connector.

#### 2. CHECK HARNESS FOR OPEN CIRCUIT

Check the resistance between the data link connector terminals.

Data link connector			Resistance (Ω)
Connector No.	Terminal No.		
M22	6	14	Approx. 54 – 66

Is the measurement value within the specification?

- YES (Present error)>>Check CAN system type decision again.  
YES (Past error)>>Error was detected in the data link connector branch line circuit.  
NO >> Repair the data link connector branch line.

A  
B  
C  
D  
E  
F  
G  
H  
I  
J  
L  
M  
N  
O  
P

LAN

# EPS BRANCH LINE CIRCUIT

< COMPONENT DIAGNOSIS >

[CAN]

## EPS BRANCH LINE CIRCUIT

### Diagnosis Procedure

INFOID:000000004501437

#### 1. CHECK CONNECTOR

1. Turn the ignition switch OFF.
2. Disconnect the battery cable from the negative terminal.
3. Check the terminals and connectors of the EPS control unit for damage, bend and loose connection (unit side and connector side).

Is the inspection result normal?

- YES >> GO TO 2.  
NO >> Repair the terminal and connector.

#### 2. CHECK HARNESS FOR OPEN CIRCUIT

1. Disconnect the connector of EPS control unit.
2. Check the resistance between the EPS control unit harness connector terminals.

EPS control unit harness connector			Resistance (Ω)
Connector No.	Terminal No.		
M37	5	7	Approx. 54 – 66

Is the measurement value within the specification?

- YES >> GO TO 3.  
NO >> Repair the EPS control unit branch line.

#### 3. CHECK POWER SUPPLY AND GROUND CIRCUIT

Check the power supply and the ground circuit of the EPS control unit. Refer to [STC-14, "DTC C1601 BATTERY VOLT"](#).

Is the inspection result normal?

- YES (Present error)>>Replace the EPS control unit. Refer to [STC-7, "Component Parts Location"](#).  
YES (Past error)>>Error was detected in the EPS control unit branch line.  
NO >> Repair the power supply and the ground circuit.

# I-KEY BRANCH LINE CIRCUIT

< COMPONENT DIAGNOSIS >

[CAN]

## I-KEY BRANCH LINE CIRCUIT

### Diagnosis Procedure

INFOID:000000004501438

#### 1. CHECK CONNECTOR

1. Turn the ignition switch OFF.
2. Disconnect the battery cable from the negative terminal.
3. Check the terminals and connectors of the Intelligent Key unit for damage, bend and loose connection (unit side and connector side).

Is the inspection result normal?

- YES >> GO TO 2.  
NO >> Repair the terminal and connector.

#### 2. CHECK HARNESS FOR OPEN CIRCUIT

1. Disconnect the connector of Intelligent Key unit.
2. Check the resistance between the Intelligent Key unit harness connector terminals.

Intelligent Key unit harness connector			Resistance (Ω)
Connector No.	Terminal No.		
M42	2	3	Approx. 54 – 66

Is the measurement value within the specification?

- YES >> GO TO 3.  
NO >> Repair the Intelligent Key unit branch line.

#### 3. CHECK POWER SUPPLY AND GROUND CIRCUIT

Check the power supply and the ground circuit of the Intelligent Key unit. Refer to [BL-106, "Power Supply and Ground Circuit Inspection"](#).

Is the inspection result normal?

- YES (Present error)>>Replace the Intelligent Key unit. Refer to [BL-129, "Removal and Installation of Intelligent Key Unit"](#).  
YES (Past error)>>Error was detected in the Intelligent Key unit branch line.  
NO >> Repair the power supply and the ground circuit.

A  
B  
C  
D  
E  
F  
G  
H  
I  
J  
L  
M  
N  
O  
P

LAN

# M&A BRANCH LINE CIRCUIT

< COMPONENT DIAGNOSIS >

[CAN]

## M&A BRANCH LINE CIRCUIT

### Diagnosis Procedure

INFOID:000000004501439

#### 1. CHECK CONNECTOR

1. Turn the ignition switch OFF.
2. Disconnect the battery cable from the negative terminal.
3. Check the terminals and connectors of the combination meter for damage, bend and loose connection (unit side and connector side).

Is the inspection result normal?

- YES >> GO TO 2.  
NO >> Repair the terminal and connector.

#### 2. CHECK HARNESS FOR OPEN CIRCUIT

1. Disconnect the connector of combination meter.
2. Check the resistance between the combination meter harness connector terminals.

Combination meter harness connector			Resistance ( $\Omega$ )
Connector No.	Terminal No.		
M24	9	10	Approx. 54 – 66

Is the measurement value within the specification?

- YES >> GO TO 3.  
NO >> Repair the combination meter branch line.

#### 3. CHECK POWER SUPPLY AND GROUND CIRCUIT

Check the power supply and the ground circuit of the combination meter. Refer to [DI-16, "Power Supply and Ground Circuit Inspection"](#).

Is the inspection result normal?

- YES (Present error)>>Replace the combination meter. Refer to [IP-11, "Component Parts"](#).  
YES (Past error)>>Error was detected in the combination meter branch line.  
NO >> Repair the power supply and the ground circuit.

# M&A2 BRANCH LINE CIRCUIT

< COMPONENT DIAGNOSIS >

[CAN]

## M&A2 BRANCH LINE CIRCUIT

### Diagnosis Procedure

INFOID:000000004501440

#### 1. CHECK CONNECTOR

1. Turn the ignition switch OFF.
2. Disconnect the battery cable from the negative terminal.
3. Check the terminals and connectors of the double meter for damage, bend and loose connection (unit side and connector side).

Is the inspection result normal?

- YES >> GO TO 2.  
NO >> Repair the terminal and connector.

#### 2. CHECK HARNESS FOR OPEN CIRCUIT

1. Disconnect the connector of double meter.
2. Check the resistance between the double meter harness connector terminals.

Double meter harness connector			Resistance (Ω)
Connector No.	Terminal No.		
M89	1	2	Approx. 54 – 66

Is the measurement value within the specification?

- YES >> GO TO 3.  
NO >> Repair the double meter branch line.

#### 3. CHECK POWER SUPPLY AND GROUND CIRCUIT

Check the power supply and the ground circuit of the double meter. Refer to [DI-27, "Power Supply and Ground Circuit Inspection"](#).

Is the inspection result normal?

- YES (Present error)>>Replace the double meter. Refer to [DI-29, "Removal and Installation"](#).  
YES (Past error)>>Error was detected in the double meter branch line.  
NO >> Repair the power supply and the ground circuit.

A  
B  
C  
D  
E  
F  
G  
H  
I  
J  
L  
M  
N  
O  
P

LAN

# IPDM-E BRANCH LINE CIRCUIT

< COMPONENT DIAGNOSIS >

[CAN]

## IPDM-E BRANCH LINE CIRCUIT

### Diagnosis Procedure

INFOID:000000004501441

#### 1. CHECK CONNECTOR

1. Turn the ignition switch OFF.
2. Disconnect the battery cable from the negative terminal.
3. Check the following terminals and connectors for damage, bend and loose connection (unit side and connector side).
  - IPDM E/R
  - Harness connector E4
  - Harness connector M2

Is the inspection result normal?

YES >> GO TO 2.

NO >> Repair the terminal and connector.

#### 2. CHECK HARNESS FOR OPEN CIRCUIT

1. Disconnect the connector of IPDM E/R.
2. Check the resistance between the IPDM E/R harness connector terminals.

IPDM E/R harness connector		Resistance (Ω)
Connector No.	Terminal No.	
E46	41                      40	Approx. 108 – 132

Is the measurement value within the specification?

YES >> GO TO 3.

NO >> Repair the IPDM E/R branch line.

#### 3. CHECK POWER SUPPLY AND GROUND CIRCUIT

Check the power supply and the ground circuit of the IPDM E/R. Refer to [PG-26, "IPDM E/R Power/Ground Circuit Inspection"](#).

Is the inspection result normal?

YES (Present error)>>Replace the IPDM E/R. Refer to [PG-27, "Removal and Installation of IPDM E/R"](#).

YES (Past error)>>Error was detected in the IPDM E/R branch line.

NO >> Repair the power supply and the ground circuit.

# CAN COMMUNICATION CIRCUIT

< COMPONENT DIAGNOSIS >

[CAN]

## CAN COMMUNICATION CIRCUIT

### Diagnosis Procedure

INFOID:000000004501442

#### 1. CONNECTOR INSPECTION

1. Turn the ignition switch OFF.
2. Disconnect the battery cable from the negative terminal.
3. Disconnect all the unit connectors on CAN communication system.
4. Check terminals and connectors for damage, bend and loose connection.

Is the inspection result normal?

- YES >> GO TO 2.  
 NO >> Repair the terminal and connector.

#### 2. CHECK HARNESS CONTINUITY (SHORT CIRCUIT)

Check the continuity between the data link connector terminals.

Data link connector		Continuity
Connector No.	Terminal No.	
M22	6 14	Not existed

Is the inspection result normal?

- YES >> GO TO 3.  
 NO >> Check the harness and repair the root cause.

#### 3. CHECK HARNESS CONTINUITY (SHORT CIRCUIT)

Check the continuity between the data link connector and the ground.

Data link connector		Ground	Continuity
Connector No.	Terminal No.		
M22	6		Not existed
	14		Not existed

Is the inspection result normal?

- YES >> GO TO 4.  
 NO >> Check the harness and repair the root cause.

#### 4. CHECK ECM AND IPDM E/R TERMINATION CIRCUIT

1. Remove the ECM and the IPDM E/R.
2. Check the resistance between the ECM terminals.
  - MR20DE

ECM		Resistance (Ω)
Terminal No.		
84	83	Approx. 108 – 132

- QR25DE

ECM		Resistance (Ω)
Terminal No.		
98	97	Approx. 108 – 132

3. Check the resistance between the IPDM E/R terminals.

IPDM E/R		Resistance (Ω)
Terminal No.		
41	40	Approx. 108 – 132

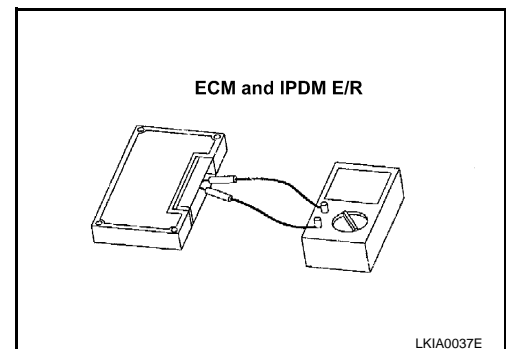

A  
B  
C  
D  
E  
F  
G  
H  
I  
J  
K  
L  
M  
N  
O  
P

LAN

# CAN COMMUNICATION CIRCUIT

[CAN]

## < COMPONENT DIAGNOSIS >

---

Is the measurement value within the specification?

YES >> GO TO 5.

NO >> Replace the ECM and/or the IPDM E/R.

## 5.CHECK SYMPTOM

---

Connect all the connectors. Check if the symptoms described in the “Symptom (Results from interview with customer)” are reproduced.

Inspection result

Reproduced>>GO TO 6.

Non-reproduced>>Start the diagnosis again. Follow the trouble diagnosis procedure when past error is detected.

## 6.CHECK UNIT REPRODUCTION

---

Perform the reproduction test as per the following procedure for each unit.

1. Turn the ignition switch OFF.
2. Disconnect the battery cable from the negative terminal.
3. Disconnect one of the unit connectors of CAN communication system.

**NOTE:**

ECM and IPDM E/R have a termination circuit. Check other units first.

4. Connect the battery cable to the negative terminal. Check if the symptoms described in the “Symptom (Results from interview with customer)” are reproduced.

**NOTE:**

Although unit-related error symptoms occur, do not confuse them with other symptoms.

Inspection result

Reproduced>>Connect the connector. Check other units as per the above procedure.

Non-reproduced>>Replace the unit whose connector was disconnected.



# MAIN LINE BETWEEN ABS AND DLC CIRCUIT

< COMPONENT DIAGNOSIS >

[CAN SYSTEM (TYPE 1)]

## COMPONENT DIAGNOSIS

### MAIN LINE BETWEEN ABS AND DLC CIRCUIT

#### Diagnosis Procedure

INFOID:000000004501450

#### 1. CHECK CONNECTOR

1. Turn the ignition switch OFF.
2. Disconnect the battery cable from the negative terminal.
3. Check the following terminals and connectors for damage, bend and loose connection (connector side and harness side).
  - Harness connector E4
  - Harness connector M2

Is the inspection result normal?

YES >> GO TO 2.

NO >> Repair the terminal and connector.

#### 2. CHECK HARNESS CONTINUITY (OPEN CIRCUIT)

1. Disconnect the following harness connectors.
  - ABS actuator and electric unit (control unit)
  - Harness connectors E4 and M2
2. Check the continuity between the ABS actuator and electric unit (control unit) harness connector and the harness connector.

ABS actuator and electric unit (control unit) harness connector		Harness connector		Continuity
Connector No.	Terminal No.	Connector No.	Terminal No.	
E33	26	E4	9	Existed
	15		25	Existed

Is the inspection result normal?

YES >> GO TO 3.

NO >> Repair the main line between the ABS actuator and electric unit (control unit) and the harness connector E4.

#### 3. CHECK HARNESS CONTINUITY (OPEN CIRCUIT)

Check the continuity between the harness connector and the data link connector.

Harness connector		Data link connector		Continuity
Connector No.	Terminal No.	Connector No.	Terminal No.	
M2	9	M22	6	Existed
	25		14	Existed

Is the inspection result normal?

YES (Present error)>>Check CAN system type decision again.

YES (Past error)>>Error was detected in the main line between the ABS actuator and electric unit (control unit) and the data link connector.

NO >> Repair the main line between the harness connector M2 and the data link connector.

# ECM BRANCH LINE CIRCUIT

< COMPONENT DIAGNOSIS >

[CAN SYSTEM (TYPE 1)]

## ECM BRANCH LINE CIRCUIT

### Diagnosis Procedure

INFOID:000000004501451

#### 1. CHECK CONNECTOR

1. Turn the ignition switch OFF.
2. Disconnect the battery cable from the negative terminal.
3. Check the following terminals and connectors for damage, bend and loose connection (unit side and connector side).
  - ECM
  - Harness connector E4 (M/T models without ABS)
  - Harness connector M2 (M/T models without ABS)

Is the inspection result normal?

YES >> GO TO 2.

NO >> Repair the terminal and connector.

#### 2. CHECK HARNESS FOR OPEN CIRCUIT

1. Disconnect the connector of ECM.
2. Check the resistance between the ECM harness connector terminals.
  - MR20DE

ECM harness connector			Resistance (Ω)
Connector No.	Terminal No.		
E16	84	83	Approx. 108 – 132

- QR25DE

ECM harness connector			Resistance (Ω)
Connector No.	Terminal No.		
E16	98	97	Approx. 108 – 132

Is the measurement value within the specification?

YES >> GO TO 3.

NO >> Repair the ECM branch line.

#### 3. CHECK POWER SUPPLY AND GROUND CIRCUIT

Check the power supply and the ground circuit of the ECM. Refer to the following.

- MR20DE (For California): [EC-147, "Diagnosis Procedure"](#)
- MR20DE (Except for California): [EC-693, "Diagnosis Procedure"](#)
- QR25DE: [EC-1214, "Diagnosis Procedure"](#)

Is the inspection result normal?

YES (Present error)>>Replace the ECM. Refer to the following.

- MR20DE (For California): [EC-90, "Procedure After Replacing ECM"](#)
- MR20DE (Except for California): [EC-636, "Procedure After Replacing ECM"](#)
- QR25DE: [EC-1158, "Procedure After Replacing ECM"](#)

YES (Past error)>>Error was detected in the ECM branch line.

NO >> Repair the power supply and the ground circuit.

# ABS BRANCH LINE CIRCUIT

< COMPONENT DIAGNOSIS >

[CAN SYSTEM (TYPE 1)]

## ABS BRANCH LINE CIRCUIT

### Diagnosis Procedure

INFOID:000000004501452

#### 1. CHECK CONNECTOR

1. Turn the ignition switch OFF.
2. Disconnect the battery cable from the negative terminal.
3. Check the terminals and connectors of the ABS actuator and electric unit (control unit) for damage, bend and loose connection (unit side and connector side).

Is the inspection result normal?

- YES >> GO TO 2.  
NO >> Repair the terminal and connector.

#### 2. CHECK HARNESS FOR OPEN CIRCUIT

1. Disconnect the connector of ABS actuator and electric unit (control unit).
2. Check the resistance between the ABS actuator and electric unit (control unit) harness connector terminals.

ABS actuator and electric unit (control unit) harness connector			Resistance (Ω)
Connector No.	Terminal No.		
E33	26	15	Approx. 54 – 66

Is the measurement value within the specification?

- YES >> GO TO 3.  
NO >> Repair the ABS actuator and electric unit (control unit) branch line.

#### 3. CHECK POWER SUPPLY AND GROUND CIRCUIT

Check the power supply and the ground circuit of the ABS actuator and electric unit (control unit). Refer to [BRC-26, "ABS Control Unit Power and Ground Systems Inspection"](#).

Is the inspection result normal?

- YES (Present error)>>Replace the ABS actuator and electric unit (control unit). Refer to [BRC-33, "Removal and Installation"](#).  
YES (Past error)>>Error was detected in the ABS actuator and electric unit (control unit) branch line.  
NO >> Repair the power supply and the ground circuit.

A  
B  
C  
D  
E  
F  
G  
H  
I  
J  
L  
M  
N  
O  
P

LAN

# BCM BRANCH LINE CIRCUIT

< COMPONENT DIAGNOSIS >

[CAN SYSTEM (TYPE 1)]

## BCM BRANCH LINE CIRCUIT

### Diagnosis Procedure

INFOID:000000004501453

#### 1. CHECK CONNECTOR

1. Turn the ignition switch OFF.
2. Disconnect the battery cable from the negative terminal.
3. Check the terminals and connectors of the BCM for damage, bend and loose connection (unit side and connector side).

Is the inspection result normal?

- YES >> GO TO 2.  
NO >> Repair the terminal and connector.

#### 2. CHECK HARNESS FOR OPEN CIRCUIT

1. Disconnect the connector of BCM.
2. Check the resistance between the BCM harness connector terminals.

BCM harness connector			Resistance (Ω)
Connector No.	Terminal No.		
M18	39	40	Approx. 54 – 66

Is the measurement value within the specification?

- YES >> GO TO 3.  
NO >> Repair the BCM branch line.

#### 3. CHECK POWER SUPPLY AND GROUND CIRCUIT

Check the power supply and the ground circuit of the BCM. Refer to [BCS-14, "BCM Power Supply and Ground Circuit Inspection"](#).

Is the inspection result normal?

- YES (Present error)>>Replace the BCM. Refer to [BCS-17, "Removal and Installation of BCM"](#).  
YES (Past error)>>Error was detected in the BCM branch line.  
NO >> Repair the power supply and the ground circuit.

# DLC BRANCH LINE CIRCUIT

< COMPONENT DIAGNOSIS >

[CAN SYSTEM (TYPE 1)]

## DLC BRANCH LINE CIRCUIT

### Diagnosis Procedure

INFOID:000000004501454

#### 1. CHECK CONNECTOR

1. Turn the ignition switch OFF.
2. Disconnect the battery cable from the negative terminal.
3. Check the terminals and connectors of the data link connector for damage, bend and loose connection (connector side and harness side).

Is the inspection result normal?

- YES >> GO TO 2.  
NO >> Repair the terminal and connector.

#### 2. CHECK HARNESS FOR OPEN CIRCUIT

Check the resistance between the data link connector terminals.

Data link connector			Resistance (Ω)
Connector No.	Terminal No.		
M22	6	14	Approx. 54 – 66

Is the measurement value within the specification?

- YES (Present error)>>Check CAN system type decision again.  
YES (Past error)>>Error was detected in the data link connector branch line circuit.  
NO >> Repair the data link connector branch line.

A  
B  
C  
D  
E  
F  
G  
H  
I  
J  
L  
M  
N  
O  
P

LAN

## EPS BRANCH LINE CIRCUIT

### Diagnosis Procedure

INFOID:000000004501455

#### 1. CHECK CONNECTOR

1. Turn the ignition switch OFF.
2. Disconnect the battery cable from the negative terminal.
3. Check the terminals and connectors of the EPS control unit for damage, bend and loose connection (unit side and connector side).

Is the inspection result normal?

- YES >> GO TO 2.  
 NO >> Repair the terminal and connector.

#### 2. CHECK HARNESS FOR OPEN CIRCUIT

1. Disconnect the connector of EPS control unit.
2. Check the resistance between the EPS control unit harness connector terminals.

EPS control unit harness connector			Resistance (Ω)
Connector No.	Terminal No.		
M37	5	7	Approx. 54 – 66

Is the measurement value within the specification?

- YES >> GO TO 3.  
 NO >> Repair the EPS control unit branch line.

#### 3. CHECK POWER SUPPLY AND GROUND CIRCUIT

Check the power supply and the ground circuit of the EPS control unit. Refer to [STC-14, "DTC C1601 BATTERY VOLT"](#).

Is the inspection result normal?

- YES (Present error)>>Replace the EPS control unit. Refer to [STC-7, "Component Parts Location"](#).  
 YES (Past error)>>Error was detected in the EPS control unit branch line.  
 NO >> Repair the power supply and the ground circuit.

# M&A BRANCH LINE CIRCUIT

< COMPONENT DIAGNOSIS >

[CAN SYSTEM (TYPE 1)]

## M&A BRANCH LINE CIRCUIT

### Diagnosis Procedure

INFOID:000000004501456

#### 1. CHECK CONNECTOR

1. Turn the ignition switch OFF.
2. Disconnect the battery cable from the negative terminal.
3. Check the terminals and connectors of the combination meter for damage, bend and loose connection (unit side and connector side).

Is the inspection result normal?

- YES >> GO TO 2.  
NO >> Repair the terminal and connector.

#### 2. CHECK HARNESS FOR OPEN CIRCUIT

1. Disconnect the connector of combination meter.
2. Check the resistance between the combination meter harness connector terminals.

Combination meter harness connector			Resistance ( $\Omega$ )
Connector No.	Terminal No.		
M24	9	10	Approx. 54 – 66

Is the measurement value within the specification?

- YES >> GO TO 3.  
NO >> Repair the combination meter branch line.

#### 3. CHECK POWER SUPPLY AND GROUND CIRCUIT

Check the power supply and the ground circuit of the combination meter. Refer to [DI-16, "Power Supply and Ground Circuit Inspection"](#).

Is the inspection result normal?

- YES (Present error)>>Replace the combination meter. Refer to [IP-11, "Component Parts"](#).  
YES (Past error)>>Error was detected in the combination meter branch line.  
NO >> Repair the power supply and the ground circuit.

A  
B  
C  
D  
E  
F  
G  
H  
I  
J  
L  
M  
N  
O  
P

LAN

# IPDM-E BRANCH LINE CIRCUIT

< COMPONENT DIAGNOSIS >

[CAN SYSTEM (TYPE 1)]

## IPDM-E BRANCH LINE CIRCUIT

### Diagnosis Procedure

INFOID:000000004501457

#### 1. CHECK CONNECTOR

1. Turn the ignition switch OFF.
2. Disconnect the battery cable from the negative terminal.
3. Check the following terminals and connectors for damage, bend and loose connection (unit side and connector side).
  - IPDM E/R
  - Harness connector E4
  - Harness connector M2

Is the inspection result normal?

YES >> GO TO 2.

NO >> Repair the terminal and connector.

#### 2. CHECK HARNESS FOR OPEN CIRCUIT

1. Disconnect the connector of IPDM E/R.
2. Check the resistance between the IPDM E/R harness connector terminals.

IPDM E/R harness connector		Resistance (Ω)
Connector No.	Terminal No.	
E46	41                      40	Approx. 108 – 132

Is the measurement value within the specification?

YES >> GO TO 3.

NO >> Repair the IPDM E/R branch line.

#### 3. CHECK POWER SUPPLY AND GROUND CIRCUIT

Check the power supply and the ground circuit of the IPDM E/R. Refer to [PG-26, "IPDM E/R Power/Ground Circuit Inspection"](#).

Is the inspection result normal?

YES (Present error)>>Replace the IPDM E/R. Refer to [PG-27, "Removal and Installation of IPDM E/R"](#).

YES (Past error)>>Error was detected in the IPDM E/R branch line.

NO >> Repair the power supply and the ground circuit.



# CAN COMMUNICATION CIRCUIT

< COMPONENT DIAGNOSIS >

[CAN SYSTEM (TYPE 1)]

## CAN COMMUNICATION CIRCUIT

### Diagnosis Procedure

INFOID:000000004501458

#### 1. CONNECTOR INSPECTION

1. Turn the ignition switch OFF.
2. Disconnect the battery cable from the negative terminal.
3. Disconnect all the unit connectors on CAN communication system.
4. Check terminals and connectors for damage, bend and loose connection.

Is the inspection result normal?

- YES >> GO TO 2.  
 NO >> Repair the terminal and connector.

#### 2. CHECK HARNESS CONTINUITY (SHORT CIRCUIT)

Check the continuity between the data link connector terminals.

Data link connector		Continuity
Connector No.	Terminal No.	
M22	6 14	Not existed

Is the inspection result normal?

- YES >> GO TO 3.  
 NO >> Check the harness and repair the root cause.

#### 3. CHECK HARNESS CONTINUITY (SHORT CIRCUIT)

Check the continuity between the data link connector and the ground.

Data link connector		Ground	Continuity
Connector No.	Terminal No.		
M22	6		Not existed
	14		Not existed

Is the inspection result normal?

- YES >> GO TO 4.  
 NO >> Check the harness and repair the root cause.

#### 4. CHECK ECM AND IPDM E/R TERMINATION CIRCUIT

1. Remove the ECM and the IPDM E/R.
2. Check the resistance between the ECM terminals.
  - MR20DE

ECM		Resistance (Ω)
Terminal No.		
84	83	Approx. 108 – 132

- QR25DE

ECM		Resistance (Ω)
Terminal No.		
98	97	Approx. 108 – 132

3. Check the resistance between the IPDM E/R terminals.

IPDM E/R		Resistance (Ω)
Terminal No.		
41	40	Approx. 108 – 132

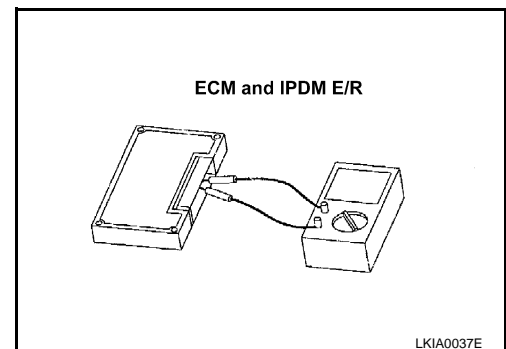

A  
B  
C  
D  
E  
F  
G  
H  
I  
J  
LAN  
L  
M  
N  
O  
P

# CAN COMMUNICATION CIRCUIT

< COMPONENT DIAGNOSIS >

[CAN SYSTEM (TYPE 1)]

---

Is the measurement value within the specification?

YES >> GO TO 5.

NO >> Replace the ECM and/or the IPDM E/R.

## 5.CHECK SYMPTOM

---

Connect all the connectors. Check if the symptoms described in the “Symptom (Results from interview with customer)” are reproduced.

Inspection result

Reproduced>>GO TO 6.

Non-reproduced>>Start the diagnosis again. Follow the trouble diagnosis procedure when past error is detected.

## 6.CHECK UNIT REPRODUCTION

---

Perform the reproduction test as per the following procedure for each unit.

1. Turn the ignition switch OFF.
2. Disconnect the battery cable from the negative terminal.
3. Disconnect one of the unit connectors of CAN communication system.

**NOTE:**

ECM and IPDM E/R have a termination circuit. Check other units first.

4. Connect the battery cable to the negative terminal. Check if the symptoms described in the “Symptom (Results from interview with customer)” are reproduced.

**NOTE:**

Although unit-related error symptoms occur, do not confuse them with other symptoms.

Inspection result

Reproduced>>Connect the connector. Check other units as per the above procedure.

Non-reproduced>>Replace the unit whose connector was disconnected.

# MAIN LINE BETWEEN ABS AND DLC CIRCUIT

< COMPONENT DIAGNOSIS >

[CAN SYSTEM (TYPE 2)]

## COMPONENT DIAGNOSIS

### MAIN LINE BETWEEN ABS AND DLC CIRCUIT

#### Diagnosis Procedure

INFOID:000000004501459

#### 1. CHECK CONNECTOR

1. Turn the ignition switch OFF.
2. Disconnect the battery cable from the negative terminal.
3. Check the following terminals and connectors for damage, bend and loose connection (connector side and harness side).
  - Harness connector E4
  - Harness connector M2

Is the inspection result normal?

YES >> GO TO 2.

NO >> Repair the terminal and connector.

#### 2. CHECK HARNESS CONTINUITY (OPEN CIRCUIT)

1. Disconnect the following harness connectors.
  - ABS actuator and electric unit (control unit)
  - Harness connectors E4 and M2
2. Check the continuity between the ABS actuator and electric unit (control unit) harness connector and the harness connector.

ABS actuator and electric unit (control unit) harness connector		Harness connector		Continuity
Connector No.	Terminal No.	Connector No.	Terminal No.	
E33	26	E4	9	Existed
	15		25	Existed

Is the inspection result normal?

YES >> GO TO 3.

NO >> Repair the main line between the ABS actuator and electric unit (control unit) and the harness connector E4.

#### 3. CHECK HARNESS CONTINUITY (OPEN CIRCUIT)

Check the continuity between the harness connector and the data link connector.

Harness connector		Data link connector		Continuity
Connector No.	Terminal No.	Connector No.	Terminal No.	
M2	9	M22	6	Existed
	25		14	Existed

Is the inspection result normal?

YES (Present error)>>Check CAN system type decision again.

YES (Past error)>>Error was detected in the main line between the ABS actuator and electric unit (control unit) and the data link connector.

NO >> Repair the main line between the harness connector M2 and the data link connector.

A  
B  
C  
D  
E  
F  
G  
H  
I  
J  
LAN  
L  
M  
N  
O  
P

# ECM BRANCH LINE CIRCUIT

< COMPONENT DIAGNOSIS >

[CAN SYSTEM (TYPE 2)]

## ECM BRANCH LINE CIRCUIT

### Diagnosis Procedure

INFOID:000000004501460

#### 1. CHECK CONNECTOR

1. Turn the ignition switch OFF.
2. Disconnect the battery cable from the negative terminal.
3. Check the following terminals and connectors for damage, bend and loose connection (unit side and connector side).
  - ECM
  - Harness connector E4 (M/T models without ABS)
  - Harness connector M2 (M/T models without ABS)

Is the inspection result normal?

YES >> GO TO 2.

NO >> Repair the terminal and connector.

#### 2. CHECK HARNESS FOR OPEN CIRCUIT

1. Disconnect the connector of ECM.
2. Check the resistance between the ECM harness connector terminals.
  - MR20DE

ECM harness connector			Resistance (Ω)
Connector No.	Terminal No.		
E16	84	83	Approx. 108 – 132

- QR25DE

ECM harness connector			Resistance (Ω)
Connector No.	Terminal No.		
E16	98	97	Approx. 108 – 132

Is the measurement value within the specification?

YES >> GO TO 3.

NO >> Repair the ECM branch line.

#### 3. CHECK POWER SUPPLY AND GROUND CIRCUIT

Check the power supply and the ground circuit of the ECM. Refer to the following.

- MR20DE (For California): [EC-147, "Diagnosis Procedure"](#)
- MR20DE (Except for California): [EC-693, "Diagnosis Procedure"](#)
- QR25DE: [EC-1214, "Diagnosis Procedure"](#)

Is the inspection result normal?

YES (Present error)>>Replace the ECM. Refer to the following.

- MR20DE (For California): [EC-90, "Procedure After Replacing ECM"](#)
- MR20DE (Except for California): [EC-636, "Procedure After Replacing ECM"](#)
- QR25DE: [EC-1158, "Procedure After Replacing ECM"](#)

YES (Past error)>>Error was detected in the ECM branch line.

NO >> Repair the power supply and the ground circuit.

# ABS BRANCH LINE CIRCUIT

< COMPONENT DIAGNOSIS >

[CAN SYSTEM (TYPE 2)]

## ABS BRANCH LINE CIRCUIT

### Diagnosis Procedure

INFOID:000000004501461

#### 1. CHECK CONNECTOR

1. Turn the ignition switch OFF.
2. Disconnect the battery cable from the negative terminal.
3. Check the terminals and connectors of the ABS actuator and electric unit (control unit) for damage, bend and loose connection (unit side and connector side).

Is the inspection result normal?

- YES >> GO TO 2.  
NO >> Repair the terminal and connector.

#### 2. CHECK HARNESS FOR OPEN CIRCUIT

1. Disconnect the connector of ABS actuator and electric unit (control unit).
2. Check the resistance between the ABS actuator and electric unit (control unit) harness connector terminals.

ABS actuator and electric unit (control unit) harness connector			Resistance (Ω)
Connector No.	Terminal No.		
E33	26	15	Approx. 54 – 66

Is the measurement value within the specification?

- YES >> GO TO 3.  
NO >> Repair the ABS actuator and electric unit (control unit) branch line.

#### 3. CHECK POWER SUPPLY AND GROUND CIRCUIT

Check the power supply and the ground circuit of the ABS actuator and electric unit (control unit). Refer to [BRC-26, "ABS Control Unit Power and Ground Systems Inspection"](#).

Is the inspection result normal?

- YES (Present error)>>Replace the ABS actuator and electric unit (control unit). Refer to [BRC-33, "Removal and Installation"](#).  
YES (Past error)>>Error was detected in the ABS actuator and electric unit (control unit) branch line.  
NO >> Repair the power supply and the ground circuit.

A  
B  
C  
D  
E  
F  
G  
H  
I  
J  
L  
M  
N  
O  
P

LAN

## AV BRANCH LINE CIRCUIT

### Diagnosis Procedure

INFOID:000000004501462

#### 1. CHECK CONNECTOR

1. Turn the ignition switch OFF.
2. Disconnect the battery cable from the negative terminal.
3. Check the terminals and connectors of the audio unit for damage, bend and loose connection (unit side and connector side).

Is the inspection result normal?

- YES >> GO TO 2.  
 NO >> Repair the terminal and connector.

#### 2. CHECK HARNESS FOR OPEN CIRCUIT

1. Disconnect the connector of audio unit.
2. Check the resistance between the audio unit harness connector terminals.

Audio unit harness connector			Resistance (Ω)
Connector No.	Terminal No.		
M53	32	31	Approx. 54 – 66

Is the measurement value within the specification?

- YES >> GO TO 3.  
 NO >> Repair the audio unit branch line.

#### 3. CHECK POWER SUPPLY AND GROUND CIRCUIT

Check the power supply and the ground circuit of the audio unit. Refer to [AV-35, "Power Supply Circuit Inspection"](#).

Is the inspection result normal?

- YES (Present error)>>Replace the audio unit. Refer to [AV-51, "Removal and Installation"](#).  
 YES (Past error)>>Error was detected in the audio unit branch line.  
 NO >> Repair the power supply and the ground circuit.

# BCM BRANCH LINE CIRCUIT

< COMPONENT DIAGNOSIS >

[CAN SYSTEM (TYPE 2)]

## BCM BRANCH LINE CIRCUIT

### Diagnosis Procedure

INFOID:000000004501463

#### 1.CHECK CONNECTOR

1. Turn the ignition switch OFF.
2. Disconnect the battery cable from the negative terminal.
3. Check the terminals and connectors of the BCM for damage, bend and loose connection (unit side and connector side).

Is the inspection result normal?

- YES >> GO TO 2.  
NO >> Repair the terminal and connector.

#### 2.CHECK HARNESS FOR OPEN CIRCUIT

1. Disconnect the connector of BCM.
2. Check the resistance between the BCM harness connector terminals.

BCM harness connector			Resistance (Ω)
Connector No.	Terminal No.		
M18	39	40	Approx. 54 – 66

Is the measurement value within the specification?

- YES >> GO TO 3.  
NO >> Repair the BCM branch line.

#### 3.CHECK POWER SUPPLY AND GROUND CIRCUIT

Check the power supply and the ground circuit of the BCM. Refer to [BCS-14, "BCM Power Supply and Ground Circuit Inspection"](#).

Is the inspection result normal?

- YES (Present error)>>Replace the BCM. Refer to [BCS-17, "Removal and Installation of BCM"](#).  
YES (Past error)>>Error was detected in the BCM branch line.  
NO >> Repair the power supply and the ground circuit.

A  
B  
C  
D  
E  
F  
G  
H  
I  
J  
LAN  
L  
M  
N  
O  
P

# DLC BRANCH LINE CIRCUIT

< COMPONENT DIAGNOSIS >

[CAN SYSTEM (TYPE 2)]

## DLC BRANCH LINE CIRCUIT

### Diagnosis Procedure

INFOID:000000004501464

#### 1. CHECK CONNECTOR

1. Turn the ignition switch OFF.
2. Disconnect the battery cable from the negative terminal.
3. Check the terminals and connectors of the data link connector for damage, bend and loose connection (connector side and harness side).

Is the inspection result normal?

- YES >> GO TO 2.  
NO >> Repair the terminal and connector.

#### 2. CHECK HARNESS FOR OPEN CIRCUIT

Check the resistance between the data link connector terminals.

Data link connector			Resistance (Ω)
Connector No.	Terminal No.		
M22	6	14	Approx. 54 – 66

Is the measurement value within the specification?

- YES (Present error)>>Check CAN system type decision again.  
YES (Past error)>>Error was detected in the data link connector branch line circuit.  
NO >> Repair the data link connector branch line.



# EPS BRANCH LINE CIRCUIT

< COMPONENT DIAGNOSIS >

[CAN SYSTEM (TYPE 2)]

## EPS BRANCH LINE CIRCUIT

### Diagnosis Procedure

INFOID:000000004501465

#### 1. CHECK CONNECTOR

1. Turn the ignition switch OFF.
2. Disconnect the battery cable from the negative terminal.
3. Check the terminals and connectors of the EPS control unit for damage, bend and loose connection (unit side and connector side).

Is the inspection result normal?

- YES >> GO TO 2.  
NO >> Repair the terminal and connector.

#### 2. CHECK HARNESS FOR OPEN CIRCUIT

1. Disconnect the connector of EPS control unit.
2. Check the resistance between the EPS control unit harness connector terminals.

EPS control unit harness connector			Resistance (Ω)
Connector No.	Terminal No.		
M37	5	7	Approx. 54 – 66

Is the measurement value within the specification?

- YES >> GO TO 3.  
NO >> Repair the EPS control unit branch line.

#### 3. CHECK POWER SUPPLY AND GROUND CIRCUIT

Check the power supply and the ground circuit of the EPS control unit. Refer to [STC-14, "DTC C1601 BATTERY VOLT"](#).

Is the inspection result normal?

- YES (Present error)>>Replace the EPS control unit. Refer to [STC-7, "Component Parts Location"](#).  
YES (Past error)>>Error was detected in the EPS control unit branch line.  
NO >> Repair the power supply and the ground circuit.

A  
B  
C  
D  
E  
F  
G  
H  
I  
J  
L  
M  
N  
O  
P

LAN

# M&A BRANCH LINE CIRCUIT

< COMPONENT DIAGNOSIS >

[CAN SYSTEM (TYPE 2)]

## M&A BRANCH LINE CIRCUIT

### Diagnosis Procedure

INFOID:000000004501466

#### 1. CHECK CONNECTOR

1. Turn the ignition switch OFF.
2. Disconnect the battery cable from the negative terminal.
3. Check the terminals and connectors of the combination meter for damage, bend and loose connection (unit side and connector side).

Is the inspection result normal?

- YES >> GO TO 2.  
NO >> Repair the terminal and connector.

#### 2. CHECK HARNESS FOR OPEN CIRCUIT

1. Disconnect the connector of combination meter.
2. Check the resistance between the combination meter harness connector terminals.

Combination meter harness connector			Resistance ( $\Omega$ )
Connector No.	Terminal No.		
M24	9	10	Approx. 54 – 66

Is the measurement value within the specification?

- YES >> GO TO 3.  
NO >> Repair the combination meter branch line.

#### 3. CHECK POWER SUPPLY AND GROUND CIRCUIT

Check the power supply and the ground circuit of the combination meter. Refer to [DI-16, "Power Supply and Ground Circuit Inspection"](#).

Is the inspection result normal?

- YES (Present error)>>Replace the combination meter. Refer to [IP-11, "Component Parts"](#).  
YES (Past error)>>Error was detected in the combination meter branch line.  
NO >> Repair the power supply and the ground circuit.

# IPDM-E BRANCH LINE CIRCUIT

< COMPONENT DIAGNOSIS >

[CAN SYSTEM (TYPE 2)]

## IPDM-E BRANCH LINE CIRCUIT

### Diagnosis Procedure

INFOID:000000004501467

#### 1. CHECK CONNECTOR

1. Turn the ignition switch OFF.
2. Disconnect the battery cable from the negative terminal.
3. Check the following terminals and connectors for damage, bend and loose connection (unit side and connector side).
  - IPDM E/R
  - Harness connector E4
  - Harness connector M2

Is the inspection result normal?

YES >> GO TO 2.

NO >> Repair the terminal and connector.

#### 2. CHECK HARNESS FOR OPEN CIRCUIT

1. Disconnect the connector of IPDM E/R.
2. Check the resistance between the IPDM E/R harness connector terminals.

IPDM E/R harness connector			Resistance (Ω)
Connector No.	Terminal No.		
E46	41	40	Approx. 108 – 132

Is the measurement value within the specification?

YES >> GO TO 3.

NO >> Repair the IPDM E/R branch line.

#### 3. CHECK POWER SUPPLY AND GROUND CIRCUIT

Check the power supply and the ground circuit of the IPDM E/R. Refer to [PG-26, "IPDM E/R Power/Ground Circuit Inspection"](#).

Is the inspection result normal?

YES (Present error)>>Replace the IPDM E/R. Refer to [PG-27, "Removal and Installation of IPDM E/R"](#).

YES (Past error)>>Error was detected in the IPDM E/R branch line.

NO >> Repair the power supply and the ground circuit.

A  
B  
C  
D  
E  
F  
G  
H  
I  
J  
L  
M  
N  
O  
P

LAN

# CAN COMMUNICATION CIRCUIT

< COMPONENT DIAGNOSIS >

[CAN SYSTEM (TYPE 2)]

## CAN COMMUNICATION CIRCUIT

### Diagnosis Procedure

INFOID:000000004501468

#### 1. CONNECTOR INSPECTION

1. Turn the ignition switch OFF.
2. Disconnect the battery cable from the negative terminal.
3. Disconnect all the unit connectors on CAN communication system.
4. Check terminals and connectors for damage, bend and loose connection.

Is the inspection result normal?

- YES >> GO TO 2.  
 NO >> Repair the terminal and connector.

#### 2. CHECK HARNESS CONTINUITY (SHORT CIRCUIT)

Check the continuity between the data link connector terminals.

Data link connector			Continuity
Connector No.	Terminal No.		
M22	6	14	Not existed

Is the inspection result normal?

- YES >> GO TO 3.  
 NO >> Check the harness and repair the root cause.

#### 3. CHECK HARNESS CONTINUITY (SHORT CIRCUIT)

Check the continuity between the data link connector and the ground.

Data link connector		Ground	Continuity
Connector No.	Terminal No.		
M22	6		Not existed
	14		Not existed

Is the inspection result normal?

- YES >> GO TO 4.  
 NO >> Check the harness and repair the root cause.

#### 4. CHECK ECM AND IPDM E/R TERMINATION CIRCUIT

1. Remove the ECM and the IPDM E/R.
2. Check the resistance between the ECM terminals.
  - MR20DE

ECM		Resistance (Ω)
Terminal No.		
84	83	Approx. 108 – 132

- QR25DE

ECM		Resistance (Ω)
Terminal No.		
98	97	Approx. 108 – 132

3. Check the resistance between the IPDM E/R terminals.

IPDM E/R		Resistance (Ω)
Terminal No.		
41	40	Approx. 108 – 132

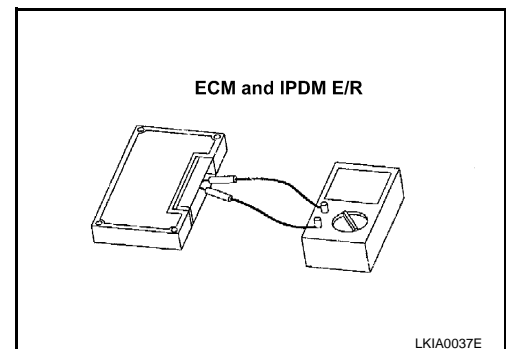

# CAN COMMUNICATION CIRCUIT

< COMPONENT DIAGNOSIS >

[CAN SYSTEM (TYPE 2)]

Is the measurement value within the specification?

YES >> GO TO 5.

NO >> Replace the ECM and/or the IPDM E/R.

## 5.CHECK SYMPTOM

Connect all the connectors. Check if the symptoms described in the “Symptom (Results from interview with customer)” are reproduced.

Inspection result

Reproduced>>GO TO 6.

Non-reproduced>>Start the diagnosis again. Follow the trouble diagnosis procedure when past error is detected.

## 6.CHECK UNIT REPRODUCTION

Perform the reproduction test as per the following procedure for each unit.

1. Turn the ignition switch OFF.
2. Disconnect the battery cable from the negative terminal.
3. Disconnect one of the unit connectors of CAN communication system.

**NOTE:**

ECM and IPDM E/R have a termination circuit. Check other units first.

4. Connect the battery cable to the negative terminal. Check if the symptoms described in the “Symptom (Results from interview with customer)” are reproduced.

**NOTE:**

Although unit-related error symptoms occur, do not confuse them with other symptoms.

Inspection result

Reproduced>>Connect the connector. Check other units as per the above procedure.

Non-reproduced>>Replace the unit whose connector was disconnected.

A  
B  
C  
D  
E  
F  
G  
H  
I  
J  
L  
M  
N  
O  
P

LAN

# MAIN LINE BETWEEN TCM AND DLC CIRCUIT

< COMPONENT DIAGNOSIS >

[CAN SYSTEM (TYPE 3)]

## COMPONENT DIAGNOSIS

### MAIN LINE BETWEEN TCM AND DLC CIRCUIT

#### Diagnosis Procedure

INFOID:000000004501469

#### 1. CHECK CONNECTOR

1. Turn the ignition switch OFF.
2. Disconnect the battery cable from the negative terminal.
3. Check the following terminals and connectors for damage, bend and loose connection (connector side and harness side).
  - Harness connector E4
  - Harness connector M2

Is the inspection result normal?

YES >> GO TO 2.

NO >> Repair the terminal and connector.

#### 2. CHECK HARNESS CONTINUITY (OPEN CIRCUIT)

1. Disconnect the following harness connectors.
  - Harness connectors F10 and E17
  - Harness connectors E4 and M2
2. Check the continuity between the harness connectors.

Harness connector		Harness connector		Continuity
Connector No.	Terminal No.	Connector No.	Terminal No.	
E17	2	E4	9	Existed
	1		25	Existed

Is the inspection result normal?

YES >> GO TO 3.

NO >> Repair the main line between the harness connector E17 and the harness connector E4.

#### 3. CHECK HARNESS CONTINUITY (OPEN CIRCUIT)

Check the continuity between the harness connector and the data link connector.

Harness connector		Data link connector		Continuity
Connector No.	Terminal No.	Connector No.	Terminal No.	
M2	9	M22	6	Existed
	25		14	Existed

Is the inspection result normal?

YES (Present error)>>Check CAN system type decision again.

YES (Past error)>>Error was detected in the main line between the TCM and the data link connector.

NO >> Repair the main line between the harness connector M2 and the data link connector.

# ECM BRANCH LINE CIRCUIT

< COMPONENT DIAGNOSIS >

[CAN SYSTEM (TYPE 3)]

## ECM BRANCH LINE CIRCUIT

### Diagnosis Procedure

INFOID:000000004501470

#### 1. CHECK CONNECTOR

1. Turn the ignition switch OFF.
2. Disconnect the battery cable from the negative terminal.
3. Check the following terminals and connectors for damage, bend and loose connection (unit side and connector side).
  - ECM
  - Harness connector E4 (M/T models without ABS)
  - Harness connector M2 (M/T models without ABS)

Is the inspection result normal?

- YES >> GO TO 2.  
NO >> Repair the terminal and connector.

#### 2. CHECK HARNESS FOR OPEN CIRCUIT

1. Disconnect the connector of ECM.
2. Check the resistance between the ECM harness connector terminals.
  - MR20DE

ECM harness connector			Resistance (Ω)
Connector No.	Terminal No.		
E16	84	83	Approx. 108 – 132

- QR25DE

ECM harness connector			Resistance (Ω)
Connector No.	Terminal No.		
E16	98	97	Approx. 108 – 132

Is the measurement value within the specification?

- YES >> GO TO 3.  
NO >> Repair the ECM branch line.

#### 3. CHECK POWER SUPPLY AND GROUND CIRCUIT

Check the power supply and the ground circuit of the ECM. Refer to the following.

- MR20DE (For California): [EC-147, "Diagnosis Procedure"](#)
- MR20DE (Except for California): [EC-693, "Diagnosis Procedure"](#)
- QR25DE: [EC-1214, "Diagnosis Procedure"](#)

Is the inspection result normal?

- YES (Present error)>>Replace the ECM. Refer to the following.
- MR20DE (For California): [EC-90, "Procedure After Replacing ECM"](#)
  - MR20DE (Except for California): [EC-636, "Procedure After Replacing ECM"](#)
  - QR25DE: [EC-1158, "Procedure After Replacing ECM"](#)

YES (Past error)>>Error was detected in the ECM branch line.

NO >> Repair the power supply and the ground circuit.

A  
B  
C  
D  
E  
F  
G  
H  
I  
J  
LAN  
L  
M  
N  
O  
P

# TCM BRANCH LINE CIRCUIT

< COMPONENT DIAGNOSIS >

[CAN SYSTEM (TYPE 3)]

## TCM BRANCH LINE CIRCUIT

### Diagnosis Procedure

INFOID:000000004501471

#### 1.CHECK CONNECTOR

1. Turn the ignition switch OFF.
2. Disconnect the battery cable from the negative terminal.
3. Check the following terminals and connectors for damage, bend and loose connection (unit side and connector side).
  - TCM
  - Harness connector F10
  - Harness connector E17

Is the inspection result normal?

YES >> GO TO 2.

NO >> Repair the terminal and connector.

#### 2.CHECK HARNESS FOR OPEN CIRCUIT

1. Disconnect the connector of TCM.
2. Check the resistance between the TCM harness connector terminals.

TCM harness connector			Resistance (Ω)
Connector No.	Terminal No.		
F23	32	31	Approx. 54 – 66

Is the measurement value within the specification?

YES >> GO TO 3.

NO >> Repair the TCM branch line.

#### 3.CHECK POWER SUPPLY AND GROUND CIRCUIT

Check the power supply and the ground circuit of the TCM. Refer to [CVT-120, "Diagnosis Procedure"](#).

Is the inspection result normal?

YES (Present error)>>Replace the TCM. Refer to [CVT-162, "Removal and Installation"](#).

YES (Past error)>>Error was detected in the TCM branch line.

NO >> Repair the power supply and the ground circuit.



# BCM BRANCH LINE CIRCUIT

< COMPONENT DIAGNOSIS >

[CAN SYSTEM (TYPE 3)]

## BCM BRANCH LINE CIRCUIT

### Diagnosis Procedure

INFOID:000000004501472

#### 1.CHECK CONNECTOR

1. Turn the ignition switch OFF.
2. Disconnect the battery cable from the negative terminal.
3. Check the terminals and connectors of the BCM for damage, bend and loose connection (unit side and connector side).

Is the inspection result normal?

- YES >> GO TO 2.  
NO >> Repair the terminal and connector.

#### 2.CHECK HARNESS FOR OPEN CIRCUIT

1. Disconnect the connector of BCM.
2. Check the resistance between the BCM harness connector terminals.

BCM harness connector			Resistance (Ω)
Connector No.	Terminal No.		
M18	39	40	Approx. 54 – 66

Is the measurement value within the specification?

- YES >> GO TO 3.  
NO >> Repair the BCM branch line.

#### 3.CHECK POWER SUPPLY AND GROUND CIRCUIT

Check the power supply and the ground circuit of the BCM. Refer to [BCS-14, "BCM Power Supply and Ground Circuit Inspection"](#).

Is the inspection result normal?

- YES (Present error)>>Replace the BCM. Refer to [BCS-17, "Removal and Installation of BCM"](#).  
YES (Past error)>>Error was detected in the BCM branch line.  
NO >> Repair the power supply and the ground circuit.

A  
B  
C  
D  
E  
F  
G  
H  
I  
J  
LAN  
L  
M  
N  
O  
P

# DLC BRANCH LINE CIRCUIT

< COMPONENT DIAGNOSIS >

[CAN SYSTEM (TYPE 3)]

## DLC BRANCH LINE CIRCUIT

### Diagnosis Procedure

INFOID:000000004501473

#### 1. CHECK CONNECTOR

1. Turn the ignition switch OFF.
2. Disconnect the battery cable from the negative terminal.
3. Check the terminals and connectors of the data link connector for damage, bend and loose connection (connector side and harness side).

Is the inspection result normal?

- YES >> GO TO 2.  
NO >> Repair the terminal and connector.

#### 2. CHECK HARNESS FOR OPEN CIRCUIT

Check the resistance between the data link connector terminals.

Data link connector			Resistance ( $\Omega$ )
Connector No.	Terminal No.		
M22	6	14	Approx. 54 – 66

Is the measurement value within the specification?

- YES (Present error)>>Check CAN system type decision again.  
YES (Past error)>>Error was detected in the data link connector branch line circuit.  
NO >> Repair the data link connector branch line.

# EPS BRANCH LINE CIRCUIT

< COMPONENT DIAGNOSIS >

[CAN SYSTEM (TYPE 3)]

## EPS BRANCH LINE CIRCUIT

### Diagnosis Procedure

INFOID:000000004501474

#### 1.CHECK CONNECTOR

1. Turn the ignition switch OFF.
2. Disconnect the battery cable from the negative terminal.
3. Check the terminals and connectors of the EPS control unit for damage, bend and loose connection (unit side and connector side).

Is the inspection result normal?

- YES >> GO TO 2.  
NO >> Repair the terminal and connector.

#### 2.CHECK HARNESS FOR OPEN CIRCUIT

1. Disconnect the connector of EPS control unit.
2. Check the resistance between the EPS control unit harness connector terminals.

EPS control unit harness connector			Resistance (Ω)
Connector No.	Terminal No.		
M37	5	7	Approx. 54 – 66

Is the measurement value within the specification?

- YES >> GO TO 3.  
NO >> Repair the EPS control unit branch line.

#### 3.CHECK POWER SUPPLY AND GROUND CIRCUIT

Check the power supply and the ground circuit of the EPS control unit. Refer to [STC-14, "DTC C1601 BATTERY VOLT"](#).

Is the inspection result normal?

- YES (Present error)>>Replace the EPS control unit. Refer to [STC-7, "Component Parts Location"](#).  
YES (Past error)>>Error was detected in the EPS control unit branch line.  
NO >> Repair the power supply and the ground circuit.

A  
B  
C  
D  
E  
F  
G  
H  
I  
J  
L  
M  
N  
O  
P

LAN

# M&A BRANCH LINE CIRCUIT

< COMPONENT DIAGNOSIS >

[CAN SYSTEM (TYPE 3)]

## M&A BRANCH LINE CIRCUIT

### Diagnosis Procedure

INFOID:000000004501475

#### 1. CHECK CONNECTOR

1. Turn the ignition switch OFF.
2. Disconnect the battery cable from the negative terminal.
3. Check the terminals and connectors of the combination meter for damage, bend and loose connection (unit side and connector side).

Is the inspection result normal?

- YES >> GO TO 2.  
NO >> Repair the terminal and connector.

#### 2. CHECK HARNESS FOR OPEN CIRCUIT

1. Disconnect the connector of combination meter.
2. Check the resistance between the combination meter harness connector terminals.

Combination meter harness connector			Resistance ( $\Omega$ )
Connector No.	Terminal No.		
M24	9	10	Approx. 54 – 66

Is the measurement value within the specification?

- YES >> GO TO 3.  
NO >> Repair the combination meter branch line.

#### 3. CHECK POWER SUPPLY AND GROUND CIRCUIT

Check the power supply and the ground circuit of the combination meter. Refer to [DI-16, "Power Supply and Ground Circuit Inspection"](#).

Is the inspection result normal?

- YES (Present error)>>Replace the combination meter. Refer to [IP-11, "Component Parts"](#).  
YES (Past error)>>Error was detected in the combination meter branch line.  
NO >> Repair the power supply and the ground circuit.

# IPDM-E BRANCH LINE CIRCUIT

< COMPONENT DIAGNOSIS >

[CAN SYSTEM (TYPE 3)]

## IPDM-E BRANCH LINE CIRCUIT

### Diagnosis Procedure

INFOID:000000004501476

#### 1. CHECK CONNECTOR

1. Turn the ignition switch OFF.
2. Disconnect the battery cable from the negative terminal.
3. Check the following terminals and connectors for damage, bend and loose connection (unit side and connector side).
  - IPDM E/R
  - Harness connector E4
  - Harness connector M2

Is the inspection result normal?

- YES >> GO TO 2.  
NO >> Repair the terminal and connector.

#### 2. CHECK HARNESS FOR OPEN CIRCUIT

1. Disconnect the connector of IPDM E/R.
2. Check the resistance between the IPDM E/R harness connector terminals.

IPDM E/R harness connector		Resistance (Ω)
Connector No.	Terminal No.	
E46	41                      40	Approx. 108 – 132

Is the measurement value within the specification?

- YES >> GO TO 3.  
NO >> Repair the IPDM E/R branch line.

#### 3. CHECK POWER SUPPLY AND GROUND CIRCUIT

Check the power supply and the ground circuit of the IPDM E/R. Refer to [PG-26, "IPDM E/R Power/Ground Circuit Inspection"](#).

Is the inspection result normal?

- YES (Present error)>>Replace the IPDM E/R. Refer to [PG-27, "Removal and Installation of IPDM E/R"](#).  
YES (Past error)>>Error was detected in the IPDM E/R branch line.  
NO >> Repair the power supply and the ground circuit.

A  
B  
C  
D  
E  
F  
G  
H  
I  
J  
L  
M  
N  
O  
P

LAN

# CAN COMMUNICATION CIRCUIT

< COMPONENT DIAGNOSIS >

[CAN SYSTEM (TYPE 3)]

## CAN COMMUNICATION CIRCUIT

### Diagnosis Procedure

INFOID:000000004501477

#### 1. CONNECTOR INSPECTION

1. Turn the ignition switch OFF.
2. Disconnect the battery cable from the negative terminal.
3. Disconnect all the unit connectors on CAN communication system.
4. Check terminals and connectors for damage, bend and loose connection.

Is the inspection result normal?

- YES >> GO TO 2.  
 NO >> Repair the terminal and connector.

#### 2. CHECK HARNESS CONTINUITY (SHORT CIRCUIT)

Check the continuity between the data link connector terminals.

Data link connector		Continuity
Connector No.	Terminal No.	
M22	6                      14	Not existed

Is the inspection result normal?

- YES >> GO TO 3.  
 NO >> Check the harness and repair the root cause.

#### 3. CHECK HARNESS CONTINUITY (SHORT CIRCUIT)

Check the continuity between the data link connector and the ground.

Data link connector		Ground	Continuity
Connector No.	Terminal No.		
M22	6		Not existed
	14		Not existed

Is the inspection result normal?

- YES >> GO TO 4.  
 NO >> Check the harness and repair the root cause.

#### 4. CHECK ECM AND IPDM E/R TERMINATION CIRCUIT

1. Remove the ECM and the IPDM E/R.
2. Check the resistance between the ECM terminals.
  - MR20DE

ECM		Resistance (Ω)
Terminal No.		
84	83	Approx. 108 – 132

- QR25DE

ECM		Resistance (Ω)
Terminal No.		
98	97	Approx. 108 – 132

3. Check the resistance between the IPDM E/R terminals.

IPDM E/R		Resistance (Ω)
Terminal No.		
41	40	Approx. 108 – 132

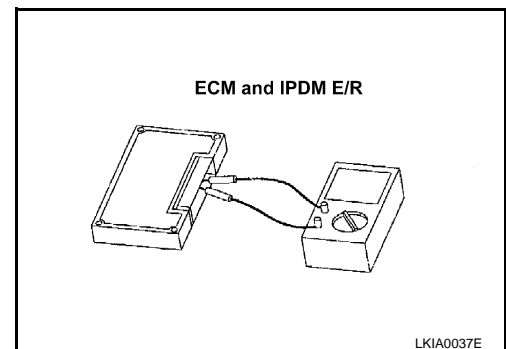

# CAN COMMUNICATION CIRCUIT

< COMPONENT DIAGNOSIS >

[CAN SYSTEM (TYPE 3)]

Is the measurement value within the specification?

YES >> GO TO 5.

NO >> Replace the ECM and/or the IPDM E/R.

## 5.CHECK SYMPTOM

Connect all the connectors. Check if the symptoms described in the “Symptom (Results from interview with customer)” are reproduced.

Inspection result

Reproduced>>GO TO 6.

Non-reproduced>>Start the diagnosis again. Follow the trouble diagnosis procedure when past error is detected.

## 6.CHECK UNIT REPRODUCTION

Perform the reproduction test as per the following procedure for each unit.

1. Turn the ignition switch OFF.
2. Disconnect the battery cable from the negative terminal.
3. Disconnect one of the unit connectors of CAN communication system.

**NOTE:**

ECM and IPDM E/R have a termination circuit. Check other units first.

4. Connect the battery cable to the negative terminal. Check if the symptoms described in the “Symptom (Results from interview with customer)” are reproduced.

**NOTE:**

Although unit-related error symptoms occur, do not confuse them with other symptoms.

Inspection result

Reproduced>>Connect the connector. Check other units as per the above procedure.

Non-reproduced>>Replace the unit whose connector was disconnected.

A  
B  
C  
D  
E  
F  
G  
H  
I  
J  
L  
M  
N  
O  
P

LAN

# MAIN LINE BETWEEN ABS AND TCM CIRCUIT

< COMPONENT DIAGNOSIS >

[CAN SYSTEM (TYPE 4)]

## COMPONENT DIAGNOSIS

### MAIN LINE BETWEEN ABS AND TCM CIRCUIT

#### Diagnosis Procedure

INFOID:000000004501478

#### 1. CHECK HARNESS CONTINUITY (OPEN CIRCUIT)

1. Turn the ignition switch OFF.
2. Disconnect the battery cable from the negative terminal.
3. Disconnect the following harness connectors.
  - ECM
  - ABS actuator and electric unit (control unit)
  - Harness connectors E17 and F10
4. Check the continuity between the ABS actuator and electric unit (control unit) harness connector and the harness connector.

ABS actuator and electric unit (control unit) harness connector		Harness connector		Continuity
Connector No.	Terminal No.	Connector No.	Terminal No.	
E33	26	E17	2	Existed
	15		1	Existed

#### Is the inspection result normal?

YES (Present error)>>Check CAN system type decision again.

YES (Past error)>>Error was detected in the main line between the ABS actuator and electric unit (control unit) and the TCM.

NO >> Repair the main line between the ABS actuator and electric unit (control unit) and the harness connector E17.



# MAIN LINE BETWEEN TCM AND DLC CIRCUIT

< COMPONENT DIAGNOSIS >

[CAN SYSTEM (TYPE 4)]

## MAIN LINE BETWEEN TCM AND DLC CIRCUIT

### Diagnosis Procedure

INFOID:000000004501479

#### 1.CHECK CONNECTOR

1. Turn the ignition switch OFF.
2. Disconnect the battery cable from the negative terminal.
3. Check the following terminals and connectors for damage, bend and loose connection (connector side and harness side).
  - Harness connector E4
  - Harness connector M2

Is the inspection result normal?

YES >> GO TO 2.

NO >> Repair the terminal and connector.

#### 2.CHECK HARNESS CONTINUITY (OPEN CIRCUIT)

1. Disconnect the following harness connectors.
  - Harness connectors F10 and E17
  - Harness connectors E4 and M2
2. Check the continuity between the harness connectors.

Harness connector		Harness connector		Continuity
Connector No.	Terminal No.	Connector No.	Terminal No.	
E17	2	E4	9	Existed
	1		25	Existed

Is the inspection result normal?

YES >> GO TO 3.

NO >> Repair the main line between the harness connector E17 and the harness connector E4.

#### 3.CHECK HARNESS CONTINUITY (OPEN CIRCUIT)

Check the continuity between the harness connector and the data link connector.

Harness connector		Data link connector		Continuity
Connector No.	Terminal No.	Connector No.	Terminal No.	
M2	9	M22	6	Existed
	25		14	Existed

Is the inspection result normal?

YES (Present error)>>Check CAN system type decision again.

YES (Past error)>>Error was detected in the main line between the TCM and the data link connector.

NO >> Repair the main line between the harness connector M2 and the data link connector.

A  
B  
C  
D  
E  
F  
G  
H  
I  
J  
LAN  
L  
M  
N  
O  
P

# ECM BRANCH LINE CIRCUIT

< COMPONENT DIAGNOSIS >

[CAN SYSTEM (TYPE 4)]

## ECM BRANCH LINE CIRCUIT

### Diagnosis Procedure

INFOID:000000004501480

#### 1. CHECK CONNECTOR

1. Turn the ignition switch OFF.
2. Disconnect the battery cable from the negative terminal.
3. Check the following terminals and connectors for damage, bend and loose connection (unit side and connector side).
  - ECM
  - Harness connector E4 (M/T models without ABS)
  - Harness connector M2 (M/T models without ABS)

Is the inspection result normal?

YES >> GO TO 2.

NO >> Repair the terminal and connector.

#### 2. CHECK HARNESS FOR OPEN CIRCUIT

1. Disconnect the connector of ECM.
2. Check the resistance between the ECM harness connector terminals.
  - MR20DE

ECM harness connector			Resistance (Ω)
Connector No.	Terminal No.		
E16	84	83	Approx. 108 – 132

- QR25DE

ECM harness connector			Resistance (Ω)
Connector No.	Terminal No.		
E16	98	97	Approx. 108 – 132

Is the measurement value within the specification?

YES >> GO TO 3.

NO >> Repair the ECM branch line.

#### 3. CHECK POWER SUPPLY AND GROUND CIRCUIT

Check the power supply and the ground circuit of the ECM. Refer to the following.

- MR20DE (For California): [EC-147, "Diagnosis Procedure"](#)
- MR20DE (Except for California): [EC-693, "Diagnosis Procedure"](#)
- QR25DE: [EC-1214, "Diagnosis Procedure"](#)

Is the inspection result normal?

YES (Present error)>>Replace the ECM. Refer to the following.

- MR20DE (For California): [EC-90, "Procedure After Replacing ECM"](#)
- MR20DE (Except for California): [EC-636, "Procedure After Replacing ECM"](#)
- QR25DE: [EC-1158, "Procedure After Replacing ECM"](#)

YES (Past error)>>Error was detected in the ECM branch line.

NO >> Repair the power supply and the ground circuit.

# ABS BRANCH LINE CIRCUIT

< COMPONENT DIAGNOSIS >

[CAN SYSTEM (TYPE 4)]

## ABS BRANCH LINE CIRCUIT

### Diagnosis Procedure

INFOID:000000004501481

#### 1. CHECK CONNECTOR

1. Turn the ignition switch OFF.
2. Disconnect the battery cable from the negative terminal.
3. Check the terminals and connectors of the ABS actuator and electric unit (control unit) for damage, bend and loose connection (unit side and connector side).

Is the inspection result normal?

- YES >> GO TO 2.  
NO >> Repair the terminal and connector.

#### 2. CHECK HARNESS FOR OPEN CIRCUIT

1. Disconnect the connector of ABS actuator and electric unit (control unit).
2. Check the resistance between the ABS actuator and electric unit (control unit) harness connector terminals.

ABS actuator and electric unit (control unit) harness connector			Resistance (Ω)
Connector No.	Terminal No.		
E33	26	15	Approx. 54 – 66

Is the measurement value within the specification?

- YES >> GO TO 3.  
NO >> Repair the ABS actuator and electric unit (control unit) branch line.

#### 3. CHECK POWER SUPPLY AND GROUND CIRCUIT

Check the power supply and the ground circuit of the ABS actuator and electric unit (control unit). Refer to [BRC-26, "ABS Control Unit Power and Ground Systems Inspection"](#).

Is the inspection result normal?

- YES (Present error)>>Replace the ABS actuator and electric unit (control unit). Refer to [BRC-33, "Removal and Installation"](#).  
YES (Past error)>>Error was detected in the ABS actuator and electric unit (control unit) branch line.  
NO >> Repair the power supply and the ground circuit.

A  
B  
C  
D  
E  
F  
G  
H  
I  
J  
L  
M  
N  
O  
P

LAN

# TCM BRANCH LINE CIRCUIT

< COMPONENT DIAGNOSIS >

[CAN SYSTEM (TYPE 4)]

## TCM BRANCH LINE CIRCUIT

### Diagnosis Procedure

INFOID:000000004501482

#### 1. CHECK CONNECTOR

1. Turn the ignition switch OFF.
2. Disconnect the battery cable from the negative terminal.
3. Check the following terminals and connectors for damage, bend and loose connection (unit side and connector side).
  - TCM
  - Harness connector F10
  - Harness connector E17

Is the inspection result normal?

YES >> GO TO 2.

NO >> Repair the terminal and connector.

#### 2. CHECK HARNESS FOR OPEN CIRCUIT

1. Disconnect the connector of TCM.
2. Check the resistance between the TCM harness connector terminals.

TCM harness connector			Resistance (Ω)
Connector No.	Terminal No.		
F23	32	31	Approx. 54 – 66

Is the measurement value within the specification?

YES >> GO TO 3.

NO >> Repair the TCM branch line.

#### 3. CHECK POWER SUPPLY AND GROUND CIRCUIT

Check the power supply and the ground circuit of the TCM. Refer to [CVT-120, "Diagnosis Procedure"](#).

Is the inspection result normal?

YES (Present error)>>Replace the TCM. Refer to [CVT-162, "Removal and Installation"](#).

YES (Past error)>>Error was detected in the TCM branch line.

NO >> Repair the power supply and the ground circuit.

# BCM BRANCH LINE CIRCUIT

< COMPONENT DIAGNOSIS >

[CAN SYSTEM (TYPE 4)]

## BCM BRANCH LINE CIRCUIT

### Diagnosis Procedure

INFOID:000000004501483

#### 1.CHECK CONNECTOR

1. Turn the ignition switch OFF.
2. Disconnect the battery cable from the negative terminal.
3. Check the terminals and connectors of the BCM for damage, bend and loose connection (unit side and connector side).

Is the inspection result normal?

- YES >> GO TO 2.  
NO >> Repair the terminal and connector.

#### 2.CHECK HARNESS FOR OPEN CIRCUIT

1. Disconnect the connector of BCM.
2. Check the resistance between the BCM harness connector terminals.

BCM harness connector			Resistance (Ω)
Connector No.	Terminal No.		
M18	39	40	Approx. 54 – 66

Is the measurement value within the specification?

- YES >> GO TO 3.  
NO >> Repair the BCM branch line.

#### 3.CHECK POWER SUPPLY AND GROUND CIRCUIT

Check the power supply and the ground circuit of the BCM. Refer to [BCS-14, "BCM Power Supply and Ground Circuit Inspection"](#).

Is the inspection result normal?

- YES (Present error)>>Replace the BCM. Refer to [BCS-17, "Removal and Installation of BCM"](#).  
YES (Past error)>>Error was detected in the BCM branch line.  
NO >> Repair the power supply and the ground circuit.

A  
B  
C  
D  
E  
F  
G  
H  
I  
J  
L  
M  
N  
O  
P

LAN

# DLC BRANCH LINE CIRCUIT

< COMPONENT DIAGNOSIS >

[CAN SYSTEM (TYPE 4)]

## DLC BRANCH LINE CIRCUIT

### Diagnosis Procedure

INFOID:000000004501484

#### 1. CHECK CONNECTOR

1. Turn the ignition switch OFF.
2. Disconnect the battery cable from the negative terminal.
3. Check the terminals and connectors of the data link connector for damage, bend and loose connection (connector side and harness side).

Is the inspection result normal?

- YES >> GO TO 2.  
NO >> Repair the terminal and connector.

#### 2. CHECK HARNESS FOR OPEN CIRCUIT

Check the resistance between the data link connector terminals.

Data link connector			Resistance ( $\Omega$ )
Connector No.	Terminal No.		
M22	6	14	Approx. 54 – 66

Is the measurement value within the specification?

- YES (Present error)>>Check CAN system type decision again.  
YES (Past error)>>Error was detected in the data link connector branch line circuit.  
NO >> Repair the data link connector branch line.

# EPS BRANCH LINE CIRCUIT

< COMPONENT DIAGNOSIS >

[CAN SYSTEM (TYPE 4)]

## EPS BRANCH LINE CIRCUIT

### Diagnosis Procedure

INFOID:000000004501485

#### 1.CHECK CONNECTOR

1. Turn the ignition switch OFF.
2. Disconnect the battery cable from the negative terminal.
3. Check the terminals and connectors of the EPS control unit for damage, bend and loose connection (unit side and connector side).

Is the inspection result normal?

- YES >> GO TO 2.  
NO >> Repair the terminal and connector.

#### 2.CHECK HARNESS FOR OPEN CIRCUIT

1. Disconnect the connector of EPS control unit.
2. Check the resistance between the EPS control unit harness connector terminals.

EPS control unit harness connector			Resistance (Ω)
Connector No.	Terminal No.		
M37	5	7	Approx. 54 – 66

Is the measurement value within the specification?

- YES >> GO TO 3.  
NO >> Repair the EPS control unit branch line.

#### 3.CHECK POWER SUPPLY AND GROUND CIRCUIT

Check the power supply and the ground circuit of the EPS control unit. Refer to [STC-14, "DTC C1601 BATTERY VOLT"](#).

Is the inspection result normal?

- YES (Present error)>>Replace the EPS control unit. Refer to [STC-7, "Component Parts Location"](#).  
YES (Past error)>>Error was detected in the EPS control unit branch line.  
NO >> Repair the power supply and the ground circuit.

A  
B  
C  
D  
E  
F  
G  
H  
I  
J  
L  
M  
N  
O  
P

LAN

# M&A BRANCH LINE CIRCUIT

< COMPONENT DIAGNOSIS >

[CAN SYSTEM (TYPE 4)]

## M&A BRANCH LINE CIRCUIT

### Diagnosis Procedure

INFOID:000000004501486

#### 1. CHECK CONNECTOR

1. Turn the ignition switch OFF.
2. Disconnect the battery cable from the negative terminal.
3. Check the terminals and connectors of the combination meter for damage, bend and loose connection (unit side and connector side).

Is the inspection result normal?

- YES >> GO TO 2.  
NO >> Repair the terminal and connector.

#### 2. CHECK HARNESS FOR OPEN CIRCUIT

1. Disconnect the connector of combination meter.
2. Check the resistance between the combination meter harness connector terminals.

Combination meter harness connector			Resistance ( $\Omega$ )
Connector No.	Terminal No.		
M24	9	10	Approx. 54 – 66

Is the measurement value within the specification?

- YES >> GO TO 3.  
NO >> Repair the combination meter branch line.

#### 3. CHECK POWER SUPPLY AND GROUND CIRCUIT

Check the power supply and the ground circuit of the combination meter. Refer to [DI-16, "Power Supply and Ground Circuit Inspection"](#).

Is the inspection result normal?

- YES (Present error)>>Replace the combination meter. Refer to [IP-11, "Component Parts"](#).  
YES (Past error)>>Error was detected in the combination meter branch line.  
NO >> Repair the power supply and the ground circuit.



# IPDM-E BRANCH LINE CIRCUIT

< COMPONENT DIAGNOSIS >

[CAN SYSTEM (TYPE 4)]

## IPDM-E BRANCH LINE CIRCUIT

### Diagnosis Procedure

INFOID:000000004501487

#### 1. CHECK CONNECTOR

1. Turn the ignition switch OFF.
2. Disconnect the battery cable from the negative terminal.
3. Check the following terminals and connectors for damage, bend and loose connection (unit side and connector side).
  - IPDM E/R
  - Harness connector E4
  - Harness connector M2

Is the inspection result normal?

- YES >> GO TO 2.  
NO >> Repair the terminal and connector.

#### 2. CHECK HARNESS FOR OPEN CIRCUIT

1. Disconnect the connector of IPDM E/R.
2. Check the resistance between the IPDM E/R harness connector terminals.

IPDM E/R harness connector		Resistance (Ω)
Connector No.	Terminal No.	
E46	41                      40	Approx. 108 – 132

Is the measurement value within the specification?

- YES >> GO TO 3.  
NO >> Repair the IPDM E/R branch line.

#### 3. CHECK POWER SUPPLY AND GROUND CIRCUIT

Check the power supply and the ground circuit of the IPDM E/R. Refer to [PG-26, "IPDM E/R Power/Ground Circuit Inspection"](#).

Is the inspection result normal?

- YES (Present error)>>Replace the IPDM E/R. Refer to [PG-27, "Removal and Installation of IPDM E/R"](#).  
YES (Past error)>>Error was detected in the IPDM E/R branch line.  
NO >> Repair the power supply and the ground circuit.

A  
B  
C  
D  
E  
F  
G  
H  
I  
J  
L  
M  
N  
O  
P

LAN

# CAN COMMUNICATION CIRCUIT

< COMPONENT DIAGNOSIS >

[CAN SYSTEM (TYPE 4)]

## CAN COMMUNICATION CIRCUIT

### Diagnosis Procedure

INFOID:000000004501488

#### 1. CONNECTOR INSPECTION

1. Turn the ignition switch OFF.
2. Disconnect the battery cable from the negative terminal.
3. Disconnect all the unit connectors on CAN communication system.
4. Check terminals and connectors for damage, bend and loose connection.

Is the inspection result normal?

- YES >> GO TO 2.  
NO >> Repair the terminal and connector.

#### 2. CHECK HARNESS CONTINUITY (SHORT CIRCUIT)

Check the continuity between the data link connector terminals.

Data link connector			Continuity
Connector No.	Terminal No.		
M22	6	14	Not existed

Is the inspection result normal?

- YES >> GO TO 3.  
NO >> Check the harness and repair the root cause.

#### 3. CHECK HARNESS CONTINUITY (SHORT CIRCUIT)

Check the continuity between the data link connector and the ground.

Data link connector		Ground	Continuity
Connector No.	Terminal No.		
M22	6		Not existed
	14		Not existed

Is the inspection result normal?

- YES >> GO TO 4.  
NO >> Check the harness and repair the root cause.

#### 4. CHECK ECM AND IPDM E/R TERMINATION CIRCUIT

1. Remove the ECM and the IPDM E/R.
2. Check the resistance between the ECM terminals.
  - MR20DE

ECM		Resistance ( $\Omega$ )
Terminal No.		
84	83	Approx. 108 – 132

- QR25DE

ECM		Resistance ( $\Omega$ )
Terminal No.		
98	97	Approx. 108 – 132

3. Check the resistance between the IPDM E/R terminals.

IPDM E/R		Resistance ( $\Omega$ )
Terminal No.		
41	40	Approx. 108 – 132

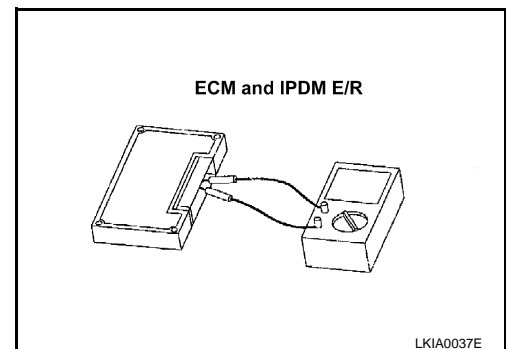

# CAN COMMUNICATION CIRCUIT

< COMPONENT DIAGNOSIS >

[CAN SYSTEM (TYPE 4)]

Is the measurement value within the specification?

YES >> GO TO 5.

NO >> Replace the ECM and/or the IPDM E/R.

## 5.CHECK SYMPTOM

Connect all the connectors. Check if the symptoms described in the “Symptom (Results from interview with customer)” are reproduced.

Inspection result

Reproduced>>GO TO 6.

Non-reproduced>>Start the diagnosis again. Follow the trouble diagnosis procedure when past error is detected.

## 6.CHECK UNIT REPRODUCTION

Perform the reproduction test as per the following procedure for each unit.

1. Turn the ignition switch OFF.
2. Disconnect the battery cable from the negative terminal.
3. Disconnect one of the unit connectors of CAN communication system.

**NOTE:**

ECM and IPDM E/R have a termination circuit. Check other units first.

4. Connect the battery cable to the negative terminal. Check if the symptoms described in the “Symptom (Results from interview with customer)” are reproduced.

**NOTE:**

Although unit-related error symptoms occur, do not confuse them with other symptoms.

Inspection result

Reproduced>>Connect the connector. Check other units as per the above procedure.

Non-reproduced>>Replace the unit whose connector was disconnected.

A  
B  
C  
D  
E  
F  
G  
H  
I  
J  
L  
M  
N  
O  
P

LAN

# MAIN LINE BETWEEN ABS AND TCM CIRCUIT

< COMPONENT DIAGNOSIS >

[CAN SYSTEM (TYPE 5)]

## COMPONENT DIAGNOSIS

### MAIN LINE BETWEEN ABS AND TCM CIRCUIT

#### Diagnosis Procedure

INFOID:000000004501489

#### 1. CHECK HARNESS CONTINUITY (OPEN CIRCUIT)

1. Turn the ignition switch OFF.
2. Disconnect the battery cable from the negative terminal.
3. Disconnect the following harness connectors.
  - ECM
  - ABS actuator and electric unit (control unit)
  - Harness connectors E17 and F10
4. Check the continuity between the ABS actuator and electric unit (control unit) harness connector and the harness connector.

ABS actuator and electric unit (control unit) harness connector		Harness connector		Continuity
Connector No.	Terminal No.	Connector No.	Terminal No.	
E33	26	E17	2	Existed
	15		1	Existed

#### Is the inspection result normal?

YES (Present error)>>Check CAN system type decision again.

YES (Past error)>>Error was detected in the main line between the ABS actuator and electric unit (control unit) and the TCM.

NO >> Repair the main line between the ABS actuator and electric unit (control unit) and the harness connector E17.

# MAIN LINE BETWEEN TCM AND DLC CIRCUIT

< COMPONENT DIAGNOSIS >

[CAN SYSTEM (TYPE 5)]

## MAIN LINE BETWEEN TCM AND DLC CIRCUIT

### Diagnosis Procedure

INFOID:000000004501490

#### 1. CHECK CONNECTOR

1. Turn the ignition switch OFF.
2. Disconnect the battery cable from the negative terminal.
3. Check the following terminals and connectors for damage, bend and loose connection (connector side and harness side).
  - Harness connector E4
  - Harness connector M2

Is the inspection result normal?

YES >> GO TO 2.

NO >> Repair the terminal and connector.

#### 2. CHECK HARNESS CONTINUITY (OPEN CIRCUIT)

1. Disconnect the following harness connectors.
  - Harness connectors F10 and E17
  - Harness connectors E4 and M2
2. Check the continuity between the harness connectors.

Harness connector		Harness connector		Continuity
Connector No.	Terminal No.	Connector No.	Terminal No.	
E17	2	E4	9	Existed
	1		25	Existed

Is the inspection result normal?

YES >> GO TO 3.

NO >> Repair the main line between the harness connector E17 and the harness connector E4.

#### 3. CHECK HARNESS CONTINUITY (OPEN CIRCUIT)

Check the continuity between the harness connector and the data link connector.

Harness connector		Data link connector		Continuity
Connector No.	Terminal No.	Connector No.	Terminal No.	
M2	9	M22	6	Existed
	25		14	Existed

Is the inspection result normal?

YES (Present error)>>Check CAN system type decision again.

YES (Past error)>>Error was detected in the main line between the TCM and the data link connector.

NO >> Repair the main line between the harness connector M2 and the data link connector.

A  
B  
C  
D  
E  
F  
G  
H  
I  
J  
LAN  
L  
M  
N  
O  
P

# ECM BRANCH LINE CIRCUIT

< COMPONENT DIAGNOSIS >

[CAN SYSTEM (TYPE 5)]

## ECM BRANCH LINE CIRCUIT

### Diagnosis Procedure

INFOID:000000004501491

#### 1. CHECK CONNECTOR

1. Turn the ignition switch OFF.
2. Disconnect the battery cable from the negative terminal.
3. Check the following terminals and connectors for damage, bend and loose connection (unit side and connector side).
  - ECM
  - Harness connector E4 (M/T models without ABS)
  - Harness connector M2 (M/T models without ABS)

Is the inspection result normal?

YES >> GO TO 2.

NO >> Repair the terminal and connector.

#### 2. CHECK HARNESS FOR OPEN CIRCUIT

1. Disconnect the connector of ECM.
2. Check the resistance between the ECM harness connector terminals.
  - MR20DE

ECM harness connector			Resistance (Ω)
Connector No.	Terminal No.		
E16	84	83	Approx. 108 – 132

- QR25DE

ECM harness connector			Resistance (Ω)
Connector No.	Terminal No.		
E16	98	97	Approx. 108 – 132

Is the measurement value within the specification?

YES >> GO TO 3.

NO >> Repair the ECM branch line.

#### 3. CHECK POWER SUPPLY AND GROUND CIRCUIT

Check the power supply and the ground circuit of the ECM. Refer to the following.

- MR20DE (For California): [EC-147, "Diagnosis Procedure"](#)
- MR20DE (Except for California): [EC-693, "Diagnosis Procedure"](#)
- QR25DE: [EC-1214, "Diagnosis Procedure"](#)

Is the inspection result normal?

YES (Present error)>>Replace the ECM. Refer to the following.

- MR20DE (For California): [EC-90, "Procedure After Replacing ECM"](#)
- MR20DE (Except for California): [EC-636, "Procedure After Replacing ECM"](#)
- QR25DE: [EC-1158, "Procedure After Replacing ECM"](#)

YES (Past error)>>Error was detected in the ECM branch line.

NO >> Repair the power supply and the ground circuit.

# ABS BRANCH LINE CIRCUIT

< COMPONENT DIAGNOSIS >

[CAN SYSTEM (TYPE 5)]

## ABS BRANCH LINE CIRCUIT

### Diagnosis Procedure

INFOID:000000004501492

#### 1. CHECK CONNECTOR

1. Turn the ignition switch OFF.
2. Disconnect the battery cable from the negative terminal.
3. Check the terminals and connectors of the ABS actuator and electric unit (control unit) for damage, bend and loose connection (unit side and connector side).

Is the inspection result normal?

- YES >> GO TO 2.  
NO >> Repair the terminal and connector.

#### 2. CHECK HARNESS FOR OPEN CIRCUIT

1. Disconnect the connector of ABS actuator and electric unit (control unit).
2. Check the resistance between the ABS actuator and electric unit (control unit) harness connector terminals.

ABS actuator and electric unit (control unit) harness connector			Resistance (Ω)
Connector No.	Terminal No.		
E33	26	15	Approx. 54 – 66

Is the measurement value within the specification?

- YES >> GO TO 3.  
NO >> Repair the ABS actuator and electric unit (control unit) branch line.

#### 3. CHECK POWER SUPPLY AND GROUND CIRCUIT

Check the power supply and the ground circuit of the ABS actuator and electric unit (control unit). Refer to [BRC-26, "ABS Control Unit Power and Ground Systems Inspection"](#).

Is the inspection result normal?

- YES (Present error)>>Replace the ABS actuator and electric unit (control unit). Refer to [BRC-33, "Removal and Installation"](#).  
YES (Past error)>>Error was detected in the ABS actuator and electric unit (control unit) branch line.  
NO >> Repair the power supply and the ground circuit.

A  
B  
C  
D  
E  
F  
G  
H  
I  
J  
L  
M  
N  
O  
P

LAN

# TCM BRANCH LINE CIRCUIT

< COMPONENT DIAGNOSIS >

[CAN SYSTEM (TYPE 5)]

## TCM BRANCH LINE CIRCUIT

### Diagnosis Procedure

INFOID:000000004501493

#### 1. CHECK CONNECTOR

1. Turn the ignition switch OFF.
2. Disconnect the battery cable from the negative terminal.
3. Check the following terminals and connectors for damage, bend and loose connection (unit side and connector side).
  - TCM
  - Harness connector F10
  - Harness connector E17

Is the inspection result normal?

YES >> GO TO 2.

NO >> Repair the terminal and connector.

#### 2. CHECK HARNESS FOR OPEN CIRCUIT

1. Disconnect the connector of TCM.
2. Check the resistance between the TCM harness connector terminals.

TCM harness connector			Resistance (Ω)
Connector No.	Terminal No.		
F23	32	31	Approx. 54 – 66

Is the measurement value within the specification?

YES >> GO TO 3.

NO >> Repair the TCM branch line.

#### 3. CHECK POWER SUPPLY AND GROUND CIRCUIT

Check the power supply and the ground circuit of the TCM. Refer to [CVT-120, "Diagnosis Procedure"](#).

Is the inspection result normal?

YES (Present error)>>Replace the TCM. Refer to [CVT-162, "Removal and Installation"](#).

YES (Past error)>>Error was detected in the TCM branch line.

NO >> Repair the power supply and the ground circuit.



# AV BRANCH LINE CIRCUIT

< COMPONENT DIAGNOSIS >

[CAN SYSTEM (TYPE 5)]

## AV BRANCH LINE CIRCUIT

### Diagnosis Procedure

INFOID:000000004501494

#### 1.CHECK CONNECTOR

1. Turn the ignition switch OFF.
2. Disconnect the battery cable from the negative terminal.
3. Check the terminals and connectors of the audio unit for damage, bend and loose connection (unit side and connector side).

Is the inspection result normal?

- YES >> GO TO 2.  
NO >> Repair the terminal and connector.

#### 2.CHECK HARNESS FOR OPEN CIRCUIT

1. Disconnect the connector of audio unit.
2. Check the resistance between the audio unit harness connector terminals.

Audio unit harness connector			Resistance (Ω)
Connector No.	Terminal No.		
M53	32	31	Approx. 54 – 66

Is the measurement value within the specification?

- YES >> GO TO 3.  
NO >> Repair the audio unit branch line.

#### 3.CHECK POWER SUPPLY AND GROUND CIRCUIT

Check the power supply and the ground circuit of the audio unit. Refer to [AV-35, "Power Supply Circuit Inspection"](#).

Is the inspection result normal?

- YES (Present error)>>Replace the audio unit. Refer to [AV-51, "Removal and Installation"](#).  
YES (Past error)>>Error was detected in the audio unit branch line.  
NO >> Repair the power supply and the ground circuit.

A  
B  
C  
D  
E  
F  
G  
H  
I  
J  
L  
M  
N  
O  
P

LAN

# BCM BRANCH LINE CIRCUIT

< COMPONENT DIAGNOSIS >

[CAN SYSTEM (TYPE 5)]

## BCM BRANCH LINE CIRCUIT

### Diagnosis Procedure

INFOID:000000004501495

#### 1. CHECK CONNECTOR

1. Turn the ignition switch OFF.
2. Disconnect the battery cable from the negative terminal.
3. Check the terminals and connectors of the BCM for damage, bend and loose connection (unit side and connector side).

Is the inspection result normal?

- YES >> GO TO 2.  
NO >> Repair the terminal and connector.

#### 2. CHECK HARNESS FOR OPEN CIRCUIT

1. Disconnect the connector of BCM.
2. Check the resistance between the BCM harness connector terminals.

BCM harness connector			Resistance (Ω)
Connector No.	Terminal No.		
M18	39	40	Approx. 54 – 66

Is the measurement value within the specification?

- YES >> GO TO 3.  
NO >> Repair the BCM branch line.

#### 3. CHECK POWER SUPPLY AND GROUND CIRCUIT

Check the power supply and the ground circuit of the BCM. Refer to [BCS-14, "BCM Power Supply and Ground Circuit Inspection"](#).

Is the inspection result normal?

- YES (Present error)>>Replace the BCM. Refer to [BCS-17, "Removal and Installation of BCM"](#).  
YES (Past error)>>Error was detected in the BCM branch line.  
NO >> Repair the power supply and the ground circuit.

# DLC BRANCH LINE CIRCUIT

< COMPONENT DIAGNOSIS >

[CAN SYSTEM (TYPE 5)]

## DLC BRANCH LINE CIRCUIT

### Diagnosis Procedure

INFOID:000000004501496

#### 1. CHECK CONNECTOR

1. Turn the ignition switch OFF.
2. Disconnect the battery cable from the negative terminal.
3. Check the terminals and connectors of the data link connector for damage, bend and loose connection (connector side and harness side).

Is the inspection result normal?

- YES >> GO TO 2.  
NO >> Repair the terminal and connector.

#### 2. CHECK HARNESS FOR OPEN CIRCUIT

Check the resistance between the data link connector terminals.

Data link connector			Resistance (Ω)
Connector No.	Terminal No.		
M22	6	14	Approx. 54 – 66

Is the measurement value within the specification?

- YES (Present error)>>Check CAN system type decision again.  
YES (Past error)>>Error was detected in the data link connector branch line circuit.  
NO >> Repair the data link connector branch line.

A  
B  
C  
D  
E  
F  
G  
H  
I  
J  
L  
M  
N  
O  
P

LAN

## EPS BRANCH LINE CIRCUIT

### Diagnosis Procedure

INFOID:000000004501497

#### 1. CHECK CONNECTOR

1. Turn the ignition switch OFF.
2. Disconnect the battery cable from the negative terminal.
3. Check the terminals and connectors of the EPS control unit for damage, bend and loose connection (unit side and connector side).

Is the inspection result normal?

- YES >> GO TO 2.  
 NO >> Repair the terminal and connector.

#### 2. CHECK HARNESS FOR OPEN CIRCUIT

1. Disconnect the connector of EPS control unit.
2. Check the resistance between the EPS control unit harness connector terminals.

EPS control unit harness connector			Resistance (Ω)
Connector No.	Terminal No.		
M37	5	7	Approx. 54 – 66

Is the measurement value within the specification?

- YES >> GO TO 3.  
 NO >> Repair the EPS control unit branch line.

#### 3. CHECK POWER SUPPLY AND GROUND CIRCUIT

Check the power supply and the ground circuit of the EPS control unit. Refer to [STC-14, "DTC C1601 BATTERY VOLT"](#).

Is the inspection result normal?

- YES (Present error)>>Replace the EPS control unit. Refer to [STC-7, "Component Parts Location"](#).  
 YES (Past error)>>Error was detected in the EPS control unit branch line.  
 NO >> Repair the power supply and the ground circuit.

# M&A BRANCH LINE CIRCUIT

< COMPONENT DIAGNOSIS >

[CAN SYSTEM (TYPE 5)]

## M&A BRANCH LINE CIRCUIT

### Diagnosis Procedure

INFOID:000000004501498

#### 1. CHECK CONNECTOR

1. Turn the ignition switch OFF.
2. Disconnect the battery cable from the negative terminal.
3. Check the terminals and connectors of the combination meter for damage, bend and loose connection (unit side and connector side).

Is the inspection result normal?

- YES >> GO TO 2.  
NO >> Repair the terminal and connector.

#### 2. CHECK HARNESS FOR OPEN CIRCUIT

1. Disconnect the connector of combination meter.
2. Check the resistance between the combination meter harness connector terminals.

Combination meter harness connector			Resistance (Ω)
Connector No.	Terminal No.		
M24	9	10	Approx. 54 – 66

Is the measurement value within the specification?

- YES >> GO TO 3.  
NO >> Repair the combination meter branch line.

#### 3. CHECK POWER SUPPLY AND GROUND CIRCUIT

Check the power supply and the ground circuit of the combination meter. Refer to [DI-16, "Power Supply and Ground Circuit Inspection"](#).

Is the inspection result normal?

- YES (Present error)>>Replace the combination meter. Refer to [IP-11, "Component Parts"](#).  
YES (Past error)>>Error was detected in the combination meter branch line.  
NO >> Repair the power supply and the ground circuit.

A  
B  
C  
D  
E  
F  
G  
H  
I  
J  
L  
M  
N  
O  
P

LAN

# IPDM-E BRANCH LINE CIRCUIT

< COMPONENT DIAGNOSIS >

[CAN SYSTEM (TYPE 5)]

## IPDM-E BRANCH LINE CIRCUIT

### Diagnosis Procedure

INFOID:000000004501499

#### 1. CHECK CONNECTOR

1. Turn the ignition switch OFF.
2. Disconnect the battery cable from the negative terminal.
3. Check the following terminals and connectors for damage, bend and loose connection (unit side and connector side).
  - IPDM E/R
  - Harness connector E4
  - Harness connector M2

Is the inspection result normal?

YES >> GO TO 2.

NO >> Repair the terminal and connector.

#### 2. CHECK HARNESS FOR OPEN CIRCUIT

1. Disconnect the connector of IPDM E/R.
2. Check the resistance between the IPDM E/R harness connector terminals.

IPDM E/R harness connector			Resistance (Ω)
Connector No.	Terminal No.		
E46	41	40	Approx. 108 – 132

Is the measurement value within the specification?

YES >> GO TO 3.

NO >> Repair the IPDM E/R branch line.

#### 3. CHECK POWER SUPPLY AND GROUND CIRCUIT

Check the power supply and the ground circuit of the IPDM E/R. Refer to [PG-26, "IPDM E/R Power/Ground Circuit Inspection"](#).

Is the inspection result normal?

YES (Present error)>>Replace the IPDM E/R. Refer to [PG-27, "Removal and Installation of IPDM E/R"](#).

YES (Past error)>>Error was detected in the IPDM E/R branch line.

NO >> Repair the power supply and the ground circuit.

# CAN COMMUNICATION CIRCUIT

< COMPONENT DIAGNOSIS >

[CAN SYSTEM (TYPE 5)]

## CAN COMMUNICATION CIRCUIT

### Diagnosis Procedure

INFOID:000000004501500

#### 1. CONNECTOR INSPECTION

1. Turn the ignition switch OFF.
2. Disconnect the battery cable from the negative terminal.
3. Disconnect all the unit connectors on CAN communication system.
4. Check terminals and connectors for damage, bend and loose connection.

Is the inspection result normal?

- YES >> GO TO 2.  
 NO >> Repair the terminal and connector.

#### 2. CHECK HARNESS CONTINUITY (SHORT CIRCUIT)

Check the continuity between the data link connector terminals.

Data link connector		Continuity
Connector No.	Terminal No.	
M22	6 14	Not existed

Is the inspection result normal?

- YES >> GO TO 3.  
 NO >> Check the harness and repair the root cause.

#### 3. CHECK HARNESS CONTINUITY (SHORT CIRCUIT)

Check the continuity between the data link connector and the ground.

Data link connector		Ground	Continuity
Connector No.	Terminal No.		
M22	6		Not existed
	14		Not existed

Is the inspection result normal?

- YES >> GO TO 4.  
 NO >> Check the harness and repair the root cause.

#### 4. CHECK ECM AND IPDM E/R TERMINATION CIRCUIT

1. Remove the ECM and the IPDM E/R.
2. Check the resistance between the ECM terminals.
  - MR20DE

ECM		Resistance (Ω)
Terminal No.		
84	83	Approx. 108 – 132

- QR25DE

ECM		Resistance (Ω)
Terminal No.		
98	97	Approx. 108 – 132

3. Check the resistance between the IPDM E/R terminals.

IPDM E/R		Resistance (Ω)
Terminal No.		
41	40	Approx. 108 – 132

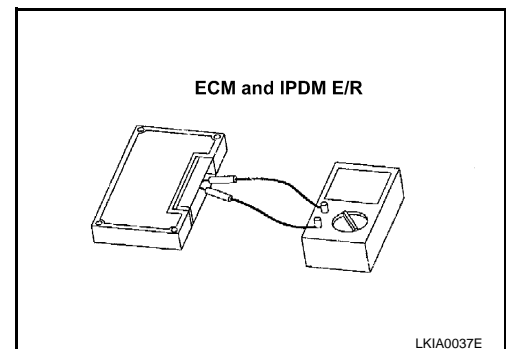

A  
B  
C  
D  
E  
F  
G  
H  
I  
J  
K  
L  
M  
N  
O  
P

LAN

# CAN COMMUNICATION CIRCUIT

< COMPONENT DIAGNOSIS >

[CAN SYSTEM (TYPE 5)]

---

Is the measurement value within the specification?

YES >> GO TO 5.

NO >> Replace the ECM and/or the IPDM E/R.

## 5.CHECK SYMPTOM

---

Connect all the connectors. Check if the symptoms described in the “Symptom (Results from interview with customer)” are reproduced.

Inspection result

Reproduced>>GO TO 6.

Non-reproduced>>Start the diagnosis again. Follow the trouble diagnosis procedure when past error is detected.

## 6.CHECK UNIT REPRODUCTION

---

Perform the reproduction test as per the following procedure for each unit.

1. Turn the ignition switch OFF.
2. Disconnect the battery cable from the negative terminal.
3. Disconnect one of the unit connectors of CAN communication system.

**NOTE:**

ECM and IPDM E/R have a termination circuit. Check other units first.

4. Connect the battery cable to the negative terminal. Check if the symptoms described in the “Symptom (Results from interview with customer)” are reproduced.

**NOTE:**

Although unit-related error symptoms occur, do not confuse them with other symptoms.

Inspection result

Reproduced>>Connect the connector. Check other units as per the above procedure.

Non-reproduced>>Replace the unit whose connector was disconnected.



# MAIN LINE BETWEEN ABS AND TCM CIRCUIT

< COMPONENT DIAGNOSIS >

[CAN SYSTEM (TYPE 6)]

## COMPONENT DIAGNOSIS

### MAIN LINE BETWEEN ABS AND TCM CIRCUIT

#### Diagnosis Procedure

INFOID:000000004501501

#### 1. CHECK HARNESS CONTINUITY (OPEN CIRCUIT)

1. Turn the ignition switch OFF.
2. Disconnect the battery cable from the negative terminal.
3. Disconnect the following harness connectors.
  - ECM
  - ABS actuator and electric unit (control unit)
  - Harness connectors E17 and F10
4. Check the continuity between the ABS actuator and electric unit (control unit) harness connector and the harness connector.

ABS actuator and electric unit (control unit) harness connector		Harness connector		Continuity
Connector No.	Terminal No.	Connector No.	Terminal No.	
E33	26	E17	2	Existed
	15		1	Existed

#### Is the inspection result normal?

YES (Present error)>>Check CAN system type decision again.

YES (Past error)>>Error was detected in the main line between the ABS actuator and electric unit (control unit) and the TCM.

NO >> Repair the main line between the ABS actuator and electric unit (control unit) and the harness connector E17.

A  
B  
C  
D  
E  
F  
G  
H  
I  
J  
L  
M  
N  
O  
P

LAN

# MAIN LINE BETWEEN TCM AND DLC CIRCUIT

< COMPONENT DIAGNOSIS >

[CAN SYSTEM (TYPE 6)]

## MAIN LINE BETWEEN TCM AND DLC CIRCUIT

### Diagnosis Procedure

INFOID:000000004501502

#### 1. CHECK CONNECTOR

1. Turn the ignition switch OFF.
2. Disconnect the battery cable from the negative terminal.
3. Check the following terminals and connectors for damage, bend and loose connection (connector side and harness side).
  - Harness connector E4
  - Harness connector M2

Is the inspection result normal?

YES >> GO TO 2.

NO >> Repair the terminal and connector.

#### 2. CHECK HARNESS CONTINUITY (OPEN CIRCUIT)

1. Disconnect the following harness connectors.
  - Harness connectors F10 and E17
  - Harness connectors E4 and M2
2. Check the continuity between the harness connectors.

Harness connector		Harness connector		Continuity
Connector No.	Terminal No.	Connector No.	Terminal No.	
E17	2	E4	9	Existed
	1		25	Existed

Is the inspection result normal?

YES >> GO TO 3.

NO >> Repair the main line between the harness connector E17 and the harness connector E4.

#### 3. CHECK HARNESS CONTINUITY (OPEN CIRCUIT)

Check the continuity between the harness connector and the data link connector.

Harness connector		Data link connector		Continuity
Connector No.	Terminal No.	Connector No.	Terminal No.	
M2	9	M22	6	Existed
	25		14	Existed

Is the inspection result normal?

YES (Present error)>>Check CAN system type decision again.

YES (Past error)>>Error was detected in the main line between the TCM and the data link connector.

NO >> Repair the main line between the harness connector M2 and the data link connector.

# ECM BRANCH LINE CIRCUIT

< COMPONENT DIAGNOSIS >

[CAN SYSTEM (TYPE 6)]

## ECM BRANCH LINE CIRCUIT

### Diagnosis Procedure

INFOID:000000004501503

#### 1. CHECK CONNECTOR

1. Turn the ignition switch OFF.
2. Disconnect the battery cable from the negative terminal.
3. Check the following terminals and connectors for damage, bend and loose connection (unit side and connector side).
  - ECM
  - Harness connector E4 (M/T models without ABS)
  - Harness connector M2 (M/T models without ABS)

Is the inspection result normal?

- YES >> GO TO 2.  
NO >> Repair the terminal and connector.

#### 2. CHECK HARNESS FOR OPEN CIRCUIT

1. Disconnect the connector of ECM.
2. Check the resistance between the ECM harness connector terminals.
  - MR20DE

ECM harness connector			Resistance (Ω)
Connector No.	Terminal No.		
E16	84	83	Approx. 108 – 132

- QR25DE

ECM harness connector			Resistance (Ω)
Connector No.	Terminal No.		
E16	98	97	Approx. 108 – 132

Is the measurement value within the specification?

- YES >> GO TO 3.  
NO >> Repair the ECM branch line.

#### 3. CHECK POWER SUPPLY AND GROUND CIRCUIT

Check the power supply and the ground circuit of the ECM. Refer to the following.

- MR20DE (For California): [EC-147, "Diagnosis Procedure"](#)
- MR20DE (Except for California): [EC-693, "Diagnosis Procedure"](#)
- QR25DE: [EC-1214, "Diagnosis Procedure"](#)

Is the inspection result normal?

- YES (Present error)>>Replace the ECM. Refer to the following.
- MR20DE (For California): [EC-90, "Procedure After Replacing ECM"](#)
  - MR20DE (Except for California): [EC-636, "Procedure After Replacing ECM"](#)
  - QR25DE: [EC-1158, "Procedure After Replacing ECM"](#)

YES (Past error)>>Error was detected in the ECM branch line.

NO >> Repair the power supply and the ground circuit.

A  
B  
C  
D  
E  
F  
G  
H  
I  
J  
LAN  
L  
M  
N  
O  
P

# ABS BRANCH LINE CIRCUIT

< COMPONENT DIAGNOSIS >

[CAN SYSTEM (TYPE 6)]

## ABS BRANCH LINE CIRCUIT

### Diagnosis Procedure

INFOID:000000004501504

#### 1. CHECK CONNECTOR

1. Turn the ignition switch OFF.
2. Disconnect the battery cable from the negative terminal.
3. Check the terminals and connectors of the ABS actuator and electric unit (control unit) for damage, bend and loose connection (unit side and connector side).

Is the inspection result normal?

- YES >> GO TO 2.  
NO >> Repair the terminal and connector.

#### 2. CHECK HARNESS FOR OPEN CIRCUIT

1. Disconnect the connector of ABS actuator and electric unit (control unit).
2. Check the resistance between the ABS actuator and electric unit (control unit) harness connector terminals.

ABS actuator and electric unit (control unit) harness connector			Resistance (Ω)
Connector No.	Terminal No.		
E33	26	15	Approx. 54 – 66

Is the measurement value within the specification?

- YES >> GO TO 3.  
NO >> Repair the ABS actuator and electric unit (control unit) branch line.

#### 3. CHECK POWER SUPPLY AND GROUND CIRCUIT

Check the power supply and the ground circuit of the ABS actuator and electric unit (control unit). Refer to [BRC-26. "ABS Control Unit Power and Ground Systems Inspection"](#).

Is the inspection result normal?

- YES (Present error)>>Replace the ABS actuator and electric unit (control unit). Refer to [BRC-33. "Removal and Installation"](#).  
YES (Past error)>>Error was detected in the ABS actuator and electric unit (control unit) branch line.  
NO >> Repair the power supply and the ground circuit.

# TCM BRANCH LINE CIRCUIT

< COMPONENT DIAGNOSIS >

[CAN SYSTEM (TYPE 6)]

## TCM BRANCH LINE CIRCUIT

### Diagnosis Procedure

INFOID:000000004501505

#### 1. CHECK CONNECTOR

1. Turn the ignition switch OFF.
2. Disconnect the battery cable from the negative terminal.
3. Check the following terminals and connectors for damage, bend and loose connection (unit side and connector side).
  - TCM
  - Harness connector F10
  - Harness connector E17

Is the inspection result normal?

- YES >> GO TO 2.  
NO >> Repair the terminal and connector.

#### 2. CHECK HARNESS FOR OPEN CIRCUIT

1. Disconnect the connector of TCM.
2. Check the resistance between the TCM harness connector terminals.

TCM harness connector			Resistance (Ω)
Connector No.	Terminal No.		
F23	32	31	Approx. 54 – 66

Is the measurement value within the specification?

- YES >> GO TO 3.  
NO >> Repair the TCM branch line.

#### 3. CHECK POWER SUPPLY AND GROUND CIRCUIT

Check the power supply and the ground circuit of the TCM. Refer to [CVT-120, "Diagnosis Procedure"](#).

Is the inspection result normal?

- YES (Present error)>>Replace the TCM. Refer to [CVT-162, "Removal and Installation"](#).  
YES (Past error)>>Error was detected in the TCM branch line.  
NO >> Repair the power supply and the ground circuit.

A  
B  
C  
D  
E  
F  
G  
H  
I  
J  
L  
M  
N  
O  
P

LAN

## AV BRANCH LINE CIRCUIT

### Diagnosis Procedure

INFOID:000000004501506

#### 1. CHECK CONNECTOR

1. Turn the ignition switch OFF.
2. Disconnect the battery cable from the negative terminal.
3. Check the terminals and connectors of the audio unit for damage, bend and loose connection (unit side and connector side).

Is the inspection result normal?

- YES >> GO TO 2.  
 NO >> Repair the terminal and connector.

#### 2. CHECK HARNESS FOR OPEN CIRCUIT

1. Disconnect the connector of audio unit.
2. Check the resistance between the audio unit harness connector terminals.

Audio unit harness connector			Resistance (Ω)
Connector No.	Terminal No.		
M53	32	31	Approx. 54 – 66

Is the measurement value within the specification?

- YES >> GO TO 3.  
 NO >> Repair the audio unit branch line.

#### 3. CHECK POWER SUPPLY AND GROUND CIRCUIT

Check the power supply and the ground circuit of the audio unit. Refer to [AV-35, "Power Supply Circuit Inspection"](#).

Is the inspection result normal?

- YES (Present error)>>Replace the audio unit. Refer to [AV-51, "Removal and Installation"](#).  
 YES (Past error)>>Error was detected in the audio unit branch line.  
 NO >> Repair the power supply and the ground circuit.

# BCM BRANCH LINE CIRCUIT

< COMPONENT DIAGNOSIS >

[CAN SYSTEM (TYPE 6)]

## BCM BRANCH LINE CIRCUIT

### Diagnosis Procedure

INFOID:000000004501507

#### 1.CHECK CONNECTOR

1. Turn the ignition switch OFF.
2. Disconnect the battery cable from the negative terminal.
3. Check the terminals and connectors of the BCM for damage, bend and loose connection (unit side and connector side).

Is the inspection result normal?

- YES >> GO TO 2.  
NO >> Repair the terminal and connector.

#### 2.CHECK HARNESS FOR OPEN CIRCUIT

1. Disconnect the connector of BCM.
2. Check the resistance between the BCM harness connector terminals.

BCM harness connector			Resistance (Ω)
Connector No.	Terminal No.		
M18	39	40	Approx. 54 – 66

Is the measurement value within the specification?

- YES >> GO TO 3.  
NO >> Repair the BCM branch line.

#### 3.CHECK POWER SUPPLY AND GROUND CIRCUIT

Check the power supply and the ground circuit of the BCM. Refer to [BCS-14, "BCM Power Supply and Ground Circuit Inspection"](#).

Is the inspection result normal?

- YES (Present error)>>Replace the BCM. Refer to [BCS-17, "Removal and Installation of BCM"](#).  
YES (Past error)>>Error was detected in the BCM branch line.  
NO >> Repair the power supply and the ground circuit.

A  
B  
C  
D  
E  
F  
G  
H  
I  
J  
L  
M  
N  
O  
P

LAN

# DLC BRANCH LINE CIRCUIT

< COMPONENT DIAGNOSIS >

[CAN SYSTEM (TYPE 6)]

## DLC BRANCH LINE CIRCUIT

### Diagnosis Procedure

INFOID:000000004501508

#### 1. CHECK CONNECTOR

1. Turn the ignition switch OFF.
2. Disconnect the battery cable from the negative terminal.
3. Check the terminals and connectors of the data link connector for damage, bend and loose connection (connector side and harness side).

Is the inspection result normal?

- YES >> GO TO 2.  
NO >> Repair the terminal and connector.

#### 2. CHECK HARNESS FOR OPEN CIRCUIT

Check the resistance between the data link connector terminals.

Data link connector			Resistance ( $\Omega$ )
Connector No.	Terminal No.		
M22	6	14	Approx. 54 – 66

Is the measurement value within the specification?

- YES (Present error)>>Check CAN system type decision again.  
YES (Past error)>>Error was detected in the data link connector branch line circuit.  
NO >> Repair the data link connector branch line.



# EPS BRANCH LINE CIRCUIT

< COMPONENT DIAGNOSIS >

[CAN SYSTEM (TYPE 6)]

## EPS BRANCH LINE CIRCUIT

### Diagnosis Procedure

INFOID:000000004501509

#### 1. CHECK CONNECTOR

1. Turn the ignition switch OFF.
2. Disconnect the battery cable from the negative terminal.
3. Check the terminals and connectors of the EPS control unit for damage, bend and loose connection (unit side and connector side).

Is the inspection result normal?

- YES >> GO TO 2.  
NO >> Repair the terminal and connector.

#### 2. CHECK HARNESS FOR OPEN CIRCUIT

1. Disconnect the connector of EPS control unit.
2. Check the resistance between the EPS control unit harness connector terminals.

EPS control unit harness connector			Resistance (Ω)
Connector No.	Terminal No.		
M37	5	7	Approx. 54 – 66

Is the measurement value within the specification?

- YES >> GO TO 3.  
NO >> Repair the EPS control unit branch line.

#### 3. CHECK POWER SUPPLY AND GROUND CIRCUIT

Check the power supply and the ground circuit of the EPS control unit. Refer to [STC-14, "DTC C1601 BATTERY VOLT"](#).

Is the inspection result normal?

- YES (Present error)>>Replace the EPS control unit. Refer to [STC-7, "Component Parts Location"](#).  
YES (Past error)>>Error was detected in the EPS control unit branch line.  
NO >> Repair the power supply and the ground circuit.

A  
B  
C  
D  
E  
F  
G  
H  
I  
J  
L  
M  
N  
O  
P

LAN

# I-KEY BRANCH LINE CIRCUIT

< COMPONENT DIAGNOSIS >

[CAN SYSTEM (TYPE 6)]

## I-KEY BRANCH LINE CIRCUIT

### Diagnosis Procedure

INFOID:000000004501510

#### 1. CHECK CONNECTOR

1. Turn the ignition switch OFF.
2. Disconnect the battery cable from the negative terminal.
3. Check the terminals and connectors of the Intelligent Key unit for damage, bend and loose connection (unit side and connector side).

Is the inspection result normal?

- YES >> GO TO 2.  
NO >> Repair the terminal and connector.

#### 2. CHECK HARNESS FOR OPEN CIRCUIT

1. Disconnect the connector of Intelligent Key unit.
2. Check the resistance between the Intelligent Key unit harness connector terminals.

Intelligent Key unit harness connector			Resistance (Ω)
Connector No.	Terminal No.		
M42	2	3	Approx. 54 – 66

Is the measurement value within the specification?

- YES >> GO TO 3.  
NO >> Repair the Intelligent Key unit branch line.

#### 3. CHECK POWER SUPPLY AND GROUND CIRCUIT

Check the power supply and the ground circuit of the Intelligent Key unit. Refer to [BL-106, "Power Supply and Ground Circuit Inspection"](#).

Is the inspection result normal?

- YES (Present error)>>Replace the Intelligent Key unit. Refer to [BL-129, "Removal and Installation of Intelligent Key Unit"](#).  
YES (Past error)>>Error was detected in the Intelligent Key unit branch line.  
NO >> Repair the power supply and the ground circuit.

# M&A BRANCH LINE CIRCUIT

< COMPONENT DIAGNOSIS >

[CAN SYSTEM (TYPE 6)]

## M&A BRANCH LINE CIRCUIT

### Diagnosis Procedure

INFOID:000000004501511

#### 1.CHECK CONNECTOR

1. Turn the ignition switch OFF.
2. Disconnect the battery cable from the negative terminal.
3. Check the terminals and connectors of the combination meter for damage, bend and loose connection (unit side and connector side).

Is the inspection result normal?

- YES >> GO TO 2.  
NO >> Repair the terminal and connector.

#### 2.CHECK HARNESS FOR OPEN CIRCUIT

1. Disconnect the connector of combination meter.
2. Check the resistance between the combination meter harness connector terminals.

Combination meter harness connector			Resistance (Ω)
Connector No.	Terminal No.		
M24	9	10	Approx. 54 – 66

Is the measurement value within the specification?

- YES >> GO TO 3.  
NO >> Repair the combination meter branch line.

#### 3.CHECK POWER SUPPLY AND GROUND CIRCUIT

Check the power supply and the ground circuit of the combination meter. Refer to [DI-16, "Power Supply and Ground Circuit Inspection"](#).

Is the inspection result normal?

- YES (Present error)>>Replace the combination meter. Refer to [IP-11, "Component Parts"](#).  
YES (Past error)>>Error was detected in the combination meter branch line.  
NO >> Repair the power supply and the ground circuit.

A  
B  
C  
D  
E  
F  
G  
H  
I  
J  
L  
M  
N  
O  
P

LAN

# IPDM-E BRANCH LINE CIRCUIT

< COMPONENT DIAGNOSIS >

[CAN SYSTEM (TYPE 6)]

## IPDM-E BRANCH LINE CIRCUIT

### Diagnosis Procedure

INFOID:000000004501512

#### 1. CHECK CONNECTOR

1. Turn the ignition switch OFF.
2. Disconnect the battery cable from the negative terminal.
3. Check the following terminals and connectors for damage, bend and loose connection (unit side and connector side).
  - IPDM E/R
  - Harness connector E4
  - Harness connector M2

Is the inspection result normal?

YES >> GO TO 2.

NO >> Repair the terminal and connector.

#### 2. CHECK HARNESS FOR OPEN CIRCUIT

1. Disconnect the connector of IPDM E/R.
2. Check the resistance between the IPDM E/R harness connector terminals.

IPDM E/R harness connector		Resistance (Ω)
Connector No.	Terminal No.	
E46	41                      40	Approx. 108 – 132

Is the measurement value within the specification?

YES >> GO TO 3.

NO >> Repair the IPDM E/R branch line.

#### 3. CHECK POWER SUPPLY AND GROUND CIRCUIT

Check the power supply and the ground circuit of the IPDM E/R. Refer to [PG-26, "IPDM E/R Power/Ground Circuit Inspection"](#).

Is the inspection result normal?

YES (Present error)>>Replace the IPDM E/R. Refer to [PG-27, "Removal and Installation of IPDM E/R"](#).

YES (Past error)>>Error was detected in the IPDM E/R branch line.

NO >> Repair the power supply and the ground circuit.

# CAN COMMUNICATION CIRCUIT

< COMPONENT DIAGNOSIS >

[CAN SYSTEM (TYPE 6)]

## CAN COMMUNICATION CIRCUIT

### Diagnosis Procedure

INFOID:000000004501513

#### 1. CONNECTOR INSPECTION

1. Turn the ignition switch OFF.
2. Disconnect the battery cable from the negative terminal.
3. Disconnect all the unit connectors on CAN communication system.
4. Check terminals and connectors for damage, bend and loose connection.

Is the inspection result normal?

- YES >> GO TO 2.  
 NO >> Repair the terminal and connector.

#### 2. CHECK HARNESS CONTINUITY (SHORT CIRCUIT)

Check the continuity between the data link connector terminals.

Data link connector		Continuity
Connector No.	Terminal No.	
M22	6 14	Not existed

Is the inspection result normal?

- YES >> GO TO 3.  
 NO >> Check the harness and repair the root cause.

#### 3. CHECK HARNESS CONTINUITY (SHORT CIRCUIT)

Check the continuity between the data link connector and the ground.

Data link connector		Ground	Continuity
Connector No.	Terminal No.		
M22	6		Not existed
	14		Not existed

Is the inspection result normal?

- YES >> GO TO 4.  
 NO >> Check the harness and repair the root cause.

#### 4. CHECK ECM AND IPDM E/R TERMINATION CIRCUIT

1. Remove the ECM and the IPDM E/R.
2. Check the resistance between the ECM terminals.
  - MR20DE

ECM		Resistance (Ω)
Terminal No.		
84	83	Approx. 108 – 132

- QR25DE

ECM		Resistance (Ω)
Terminal No.		
98	97	Approx. 108 – 132

3. Check the resistance between the IPDM E/R terminals.

IPDM E/R		Resistance (Ω)
Terminal No.		
41	40	Approx. 108 – 132

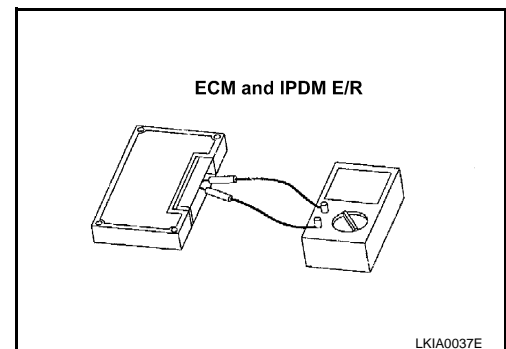

A  
B  
C  
D  
E  
F  
G  
H  
I  
J  
LAN  
L  
M  
N  
O  
P

# CAN COMMUNICATION CIRCUIT

< COMPONENT DIAGNOSIS >

[CAN SYSTEM (TYPE 6)]

---

Is the measurement value within the specification?

YES >> GO TO 5.

NO >> Replace the ECM and/or the IPDM E/R.

## 5.CHECK SYMPTOM

---

Connect all the connectors. Check if the symptoms described in the “Symptom (Results from interview with customer)” are reproduced.

Inspection result

Reproduced>>GO TO 6.

Non-reproduced>>Start the diagnosis again. Follow the trouble diagnosis procedure when past error is detected.

## 6.CHECK UNIT REPRODUCTION

---

Perform the reproduction test as per the following procedure for each unit.

1. Turn the ignition switch OFF.
2. Disconnect the battery cable from the negative terminal.
3. Disconnect one of the unit connectors of CAN communication system.

**NOTE:**

ECM and IPDM E/R have a termination circuit. Check other units first.

4. Connect the battery cable to the negative terminal. Check if the symptoms described in the “Symptom (Results from interview with customer)” are reproduced.

**NOTE:**

Although unit-related error symptoms occur, do not confuse them with other symptoms.

Inspection result

Reproduced>>Connect the connector. Check other units as per the above procedure.

Non-reproduced>>Replace the unit whose connector was disconnected.

# MAIN LINE BETWEEN ABS AND DLC CIRCUIT

< COMPONENT DIAGNOSIS >

[CAN SYSTEM (TYPE 7)]

## COMPONENT DIAGNOSIS

### MAIN LINE BETWEEN ABS AND DLC CIRCUIT

#### Diagnosis Procedure

INFOID:000000004501514

#### 1. CHECK CONNECTOR

1. Turn the ignition switch OFF.
2. Disconnect the battery cable from the negative terminal.
3. Check the following terminals and connectors for damage, bend and loose connection (connector side and harness side).
  - Harness connector E4
  - Harness connector M2

Is the inspection result normal?

YES >> GO TO 2.

NO >> Repair the terminal and connector.

#### 2. CHECK HARNESS CONTINUITY (OPEN CIRCUIT)

1. Disconnect the following harness connectors.
  - ABS actuator and electric unit (control unit)
  - Harness connectors E4 and M2
2. Check the continuity between the ABS actuator and electric unit (control unit) harness connector and the harness connector.

ABS actuator and electric unit (control unit) harness connector		Harness connector		Continuity
Connector No.	Terminal No.	Connector No.	Terminal No.	
E33	26	E4	9	Existed
	15		25	Existed

Is the inspection result normal?

YES >> GO TO 3.

NO >> Repair the main line between the ABS actuator and electric unit (control unit) and the harness connector E4.

#### 3. CHECK HARNESS CONTINUITY (OPEN CIRCUIT)

Check the continuity between the harness connector and the data link connector.

Harness connector		Data link connector		Continuity
Connector No.	Terminal No.	Connector No.	Terminal No.	
M2	9	M22	6	Existed
	25		14	Existed

Is the inspection result normal?

YES (Present error)>>Check CAN system type decision again.

YES (Past error)>>Error was detected in the main line between the ABS actuator and electric unit (control unit) and the data link connector.

NO >> Repair the main line between the harness connector M2 and the data link connector.

# ECM BRANCH LINE CIRCUIT

< COMPONENT DIAGNOSIS >

[CAN SYSTEM (TYPE 7)]

## ECM BRANCH LINE CIRCUIT

### Diagnosis Procedure

INFOID:000000004501515

#### 1. CHECK CONNECTOR

1. Turn the ignition switch OFF.
2. Disconnect the battery cable from the negative terminal.
3. Check the following terminals and connectors for damage, bend and loose connection (unit side and connector side).
  - ECM
  - Harness connector E4 (M/T models without ABS)
  - Harness connector M2 (M/T models without ABS)

Is the inspection result normal?

YES >> GO TO 2.

NO >> Repair the terminal and connector.

#### 2. CHECK HARNESS FOR OPEN CIRCUIT

1. Disconnect the connector of ECM.
2. Check the resistance between the ECM harness connector terminals.
  - MR20DE

ECM harness connector			Resistance (Ω)
Connector No.	Terminal No.		
E16	84	83	Approx. 108 – 132

- QR25DE

ECM harness connector			Resistance (Ω)
Connector No.	Terminal No.		
E16	98	97	Approx. 108 – 132

Is the measurement value within the specification?

YES >> GO TO 3.

NO >> Repair the ECM branch line.

#### 3. CHECK POWER SUPPLY AND GROUND CIRCUIT

Check the power supply and the ground circuit of the ECM. Refer to the following.

- MR20DE (For California): [EC-147, "Diagnosis Procedure"](#)
- MR20DE (Except for California): [EC-693, "Diagnosis Procedure"](#)
- QR25DE: [EC-1214, "Diagnosis Procedure"](#)

Is the inspection result normal?

YES (Present error)>>Replace the ECM. Refer to the following.

- MR20DE (For California): [EC-90, "Procedure After Replacing ECM"](#)
- MR20DE (Except for California): [EC-636, "Procedure After Replacing ECM"](#)
- QR25DE: [EC-1158, "Procedure After Replacing ECM"](#)

YES (Past error)>>Error was detected in the ECM branch line.

NO >> Repair the power supply and the ground circuit.



# ABS BRANCH LINE CIRCUIT

< COMPONENT DIAGNOSIS >

[CAN SYSTEM (TYPE 7)]

## ABS BRANCH LINE CIRCUIT

### Diagnosis Procedure

INFOID:000000004501516

#### 1. CHECK CONNECTOR

1. Turn the ignition switch OFF.
2. Disconnect the battery cable from the negative terminal.
3. Check the terminals and connectors of the ABS actuator and electric unit (control unit) for damage, bend and loose connection (unit side and connector side).

Is the inspection result normal?

- YES >> GO TO 2.  
NO >> Repair the terminal and connector.

#### 2. CHECK HARNESS FOR OPEN CIRCUIT

1. Disconnect the connector of ABS actuator and electric unit (control unit).
2. Check the resistance between the ABS actuator and electric unit (control unit) harness connector terminals.

ABS actuator and electric unit (control unit) harness connector			Resistance (Ω)
Connector No.	Terminal No.		
E33	26	15	Approx. 54 – 66

Is the measurement value within the specification?

- YES >> GO TO 3.  
NO >> Repair the ABS actuator and electric unit (control unit) branch line.

#### 3. CHECK POWER SUPPLY AND GROUND CIRCUIT

Check the power supply and the ground circuit of the ABS actuator and electric unit (control unit). Refer to [BRC-26, "ABS Control Unit Power and Ground Systems Inspection"](#).

Is the inspection result normal?

- YES (Present error)>>Replace the ABS actuator and electric unit (control unit). Refer to [BRC-33, "Removal and Installation"](#).  
YES (Past error)>>Error was detected in the ABS actuator and electric unit (control unit) branch line.  
NO >> Repair the power supply and the ground circuit.

A  
B  
C  
D  
E  
F  
G  
H  
I  
J  
L  
M  
N  
O  
P

LAN

# AV BRANCH LINE CIRCUIT

< COMPONENT DIAGNOSIS >

[CAN SYSTEM (TYPE 7)]

## AV BRANCH LINE CIRCUIT

### Diagnosis Procedure

INFOID:000000004501517

#### 1. CHECK CONNECTOR

1. Turn the ignition switch OFF.
2. Disconnect the battery cable from the negative terminal.
3. Check the terminals and connectors of the audio unit for damage, bend and loose connection (unit side and connector side).

Is the inspection result normal?

- YES >> GO TO 2.  
NO >> Repair the terminal and connector.

#### 2. CHECK HARNESS FOR OPEN CIRCUIT

1. Disconnect the connector of audio unit.
2. Check the resistance between the audio unit harness connector terminals.

Audio unit harness connector			Resistance ( $\Omega$ )
Connector No.	Terminal No.		
M53	32	31	Approx. 54 – 66

Is the measurement value within the specification?

- YES >> GO TO 3.  
NO >> Repair the audio unit branch line.

#### 3. CHECK POWER SUPPLY AND GROUND CIRCUIT

Check the power supply and the ground circuit of the audio unit. Refer to [AV-35, "Power Supply Circuit Inspection"](#).

Is the inspection result normal?

- YES (Present error)>>Replace the audio unit. Refer to [AV-51, "Removal and Installation"](#).  
YES (Past error)>>Error was detected in the audio unit branch line.  
NO >> Repair the power supply and the ground circuit.

# BCM BRANCH LINE CIRCUIT

< COMPONENT DIAGNOSIS >

[CAN SYSTEM (TYPE 7)]

## BCM BRANCH LINE CIRCUIT

### Diagnosis Procedure

INFOID:000000004501518

#### 1.CHECK CONNECTOR

1. Turn the ignition switch OFF.
2. Disconnect the battery cable from the negative terminal.
3. Check the terminals and connectors of the BCM for damage, bend and loose connection (unit side and connector side).

Is the inspection result normal?

- YES >> GO TO 2.  
NO >> Repair the terminal and connector.

#### 2.CHECK HARNESS FOR OPEN CIRCUIT

1. Disconnect the connector of BCM.
2. Check the resistance between the BCM harness connector terminals.

BCM harness connector			Resistance (Ω)
Connector No.	Terminal No.		
M18	39	40	Approx. 54 – 66

Is the measurement value within the specification?

- YES >> GO TO 3.  
NO >> Repair the BCM branch line.

#### 3.CHECK POWER SUPPLY AND GROUND CIRCUIT

Check the power supply and the ground circuit of the BCM. Refer to [BCS-14, "BCM Power Supply and Ground Circuit Inspection"](#).

Is the inspection result normal?

- YES (Present error)>>Replace the BCM. Refer to [BCS-17, "Removal and Installation of BCM"](#).  
YES (Past error)>>Error was detected in the BCM branch line.  
NO >> Repair the power supply and the ground circuit.

A  
B  
C  
D  
E  
F  
G  
H  
I  
J  
L  
M  
N  
O  
P

LAN

# DLC BRANCH LINE CIRCUIT

< COMPONENT DIAGNOSIS >

[CAN SYSTEM (TYPE 7)]

## DLC BRANCH LINE CIRCUIT

### Diagnosis Procedure

INFOID:000000004501519

#### 1. CHECK CONNECTOR

1. Turn the ignition switch OFF.
2. Disconnect the battery cable from the negative terminal.
3. Check the terminals and connectors of the data link connector for damage, bend and loose connection (connector side and harness side).

Is the inspection result normal?

- YES >> GO TO 2.  
NO >> Repair the terminal and connector.

#### 2. CHECK HARNESS FOR OPEN CIRCUIT

Check the resistance between the data link connector terminals.

Data link connector			Resistance ( $\Omega$ )
Connector No.	Terminal No.		
M22	6	14	Approx. 54 – 66

Is the measurement value within the specification?

- YES (Present error)>>Check CAN system type decision again.  
YES (Past error)>>Error was detected in the data link connector branch line circuit.  
NO >> Repair the data link connector branch line.

# EPS BRANCH LINE CIRCUIT

< COMPONENT DIAGNOSIS >

[CAN SYSTEM (TYPE 7)]

## EPS BRANCH LINE CIRCUIT

### Diagnosis Procedure

INFOID:000000004501520

#### 1.CHECK CONNECTOR

1. Turn the ignition switch OFF.
2. Disconnect the battery cable from the negative terminal.
3. Check the terminals and connectors of the EPS control unit for damage, bend and loose connection (unit side and connector side).

Is the inspection result normal?

- YES >> GO TO 2.  
NO >> Repair the terminal and connector.

#### 2.CHECK HARNESS FOR OPEN CIRCUIT

1. Disconnect the connector of EPS control unit.
2. Check the resistance between the EPS control unit harness connector terminals.

EPS control unit harness connector			Resistance (Ω)
Connector No.	Terminal No.		
M37	5	7	Approx. 54 – 66

Is the measurement value within the specification?

- YES >> GO TO 3.  
NO >> Repair the EPS control unit branch line.

#### 3.CHECK POWER SUPPLY AND GROUND CIRCUIT

Check the power supply and the ground circuit of the EPS control unit. Refer to [STC-14, "DTC C1601 BATTERY VOLT"](#).

Is the inspection result normal?

- YES (Present error)>>Replace the EPS control unit. Refer to [STC-7, "Component Parts Location"](#).  
YES (Past error)>>Error was detected in the EPS control unit branch line.  
NO >> Repair the power supply and the ground circuit.

A  
B  
C  
D  
E  
F  
G  
H  
I  
J  
L  
M  
N  
O  
P

LAN

# M&A BRANCH LINE CIRCUIT

< COMPONENT DIAGNOSIS >

[CAN SYSTEM (TYPE 7)]

## M&A BRANCH LINE CIRCUIT

### Diagnosis Procedure

INFOID:000000004501521

#### 1. CHECK CONNECTOR

1. Turn the ignition switch OFF.
2. Disconnect the battery cable from the negative terminal.
3. Check the terminals and connectors of the combination meter for damage, bend and loose connection (unit side and connector side).

Is the inspection result normal?

- YES >> GO TO 2.  
NO >> Repair the terminal and connector.

#### 2. CHECK HARNESS FOR OPEN CIRCUIT

1. Disconnect the connector of combination meter.
2. Check the resistance between the combination meter harness connector terminals.

Combination meter harness connector			Resistance ( $\Omega$ )
Connector No.	Terminal No.		
M24	9	10	Approx. 54 – 66

Is the measurement value within the specification?

- YES >> GO TO 3.  
NO >> Repair the combination meter branch line.

#### 3. CHECK POWER SUPPLY AND GROUND CIRCUIT

Check the power supply and the ground circuit of the combination meter. Refer to [DI-16, "Power Supply and Ground Circuit Inspection"](#).

Is the inspection result normal?

- YES (Present error)>>Replace the combination meter. Refer to [IP-11, "Component Parts"](#).  
YES (Past error)>>Error was detected in the combination meter branch line.  
NO >> Repair the power supply and the ground circuit.

# M&A2 BRANCH LINE CIRCUIT

< COMPONENT DIAGNOSIS >

[CAN SYSTEM (TYPE 7)]

## M&A2 BRANCH LINE CIRCUIT

### Diagnosis Procedure

INFOID:000000004501522

#### 1. CHECK CONNECTOR

1. Turn the ignition switch OFF.
2. Disconnect the battery cable from the negative terminal.
3. Check the terminals and connectors of the double meter for damage, bend and loose connection (unit side and connector side).

Is the inspection result normal?

- YES >> GO TO 2.  
NO >> Repair the terminal and connector.

#### 2. CHECK HARNESS FOR OPEN CIRCUIT

1. Disconnect the connector of double meter.
2. Check the resistance between the double meter harness connector terminals.

Double meter harness connector			Resistance (Ω)
Connector No.	Terminal No.		
M89	1	2	Approx. 54 – 66

Is the measurement value within the specification?

- YES >> GO TO 3.  
NO >> Repair the double meter branch line.

#### 3. CHECK POWER SUPPLY AND GROUND CIRCUIT

Check the power supply and the ground circuit of the double meter. Refer to [DI-27, "Power Supply and Ground Circuit Inspection"](#).

Is the inspection result normal?

- YES (Present error)>>Replace the double meter. Refer to [DI-29, "Removal and Installation"](#).  
YES (Past error)>>Error was detected in the double meter branch line.  
NO >> Repair the power supply and the ground circuit.

A  
B  
C  
D  
E  
F  
G  
H  
I  
J  
L  
M  
N  
O  
P

LAN

# IPDM-E BRANCH LINE CIRCUIT

< COMPONENT DIAGNOSIS >

[CAN SYSTEM (TYPE 7)]

## IPDM-E BRANCH LINE CIRCUIT

### Diagnosis Procedure

INFOID:000000004501523

#### 1. CHECK CONNECTOR

1. Turn the ignition switch OFF.
2. Disconnect the battery cable from the negative terminal.
3. Check the following terminals and connectors for damage, bend and loose connection (unit side and connector side).
  - IPDM E/R
  - Harness connector E4
  - Harness connector M2

Is the inspection result normal?

YES >> GO TO 2.

NO >> Repair the terminal and connector.

#### 2. CHECK HARNESS FOR OPEN CIRCUIT

1. Disconnect the connector of IPDM E/R.
2. Check the resistance between the IPDM E/R harness connector terminals.

IPDM E/R harness connector			Resistance (Ω)
Connector No.	Terminal No.		
E46	41	40	Approx. 108 – 132

Is the measurement value within the specification?

YES >> GO TO 3.

NO >> Repair the IPDM E/R branch line.

#### 3. CHECK POWER SUPPLY AND GROUND CIRCUIT

Check the power supply and the ground circuit of the IPDM E/R. Refer to [PG-26, "IPDM E/R Power/Ground Circuit Inspection"](#).

Is the inspection result normal?

YES (Present error)>>Replace the IPDM E/R. Refer to [PG-27, "Removal and Installation of IPDM E/R"](#).

YES (Past error)>>Error was detected in the IPDM E/R branch line.

NO >> Repair the power supply and the ground circuit.



# CAN COMMUNICATION CIRCUIT

< COMPONENT DIAGNOSIS >

[CAN SYSTEM (TYPE 7)]

## CAN COMMUNICATION CIRCUIT

### Diagnosis Procedure

INFOID:000000004501524

#### 1. CONNECTOR INSPECTION

1. Turn the ignition switch OFF.
2. Disconnect the battery cable from the negative terminal.
3. Disconnect all the unit connectors on CAN communication system.
4. Check terminals and connectors for damage, bend and loose connection.

Is the inspection result normal?

- YES >> GO TO 2.  
 NO >> Repair the terminal and connector.

#### 2. CHECK HARNESS CONTINUITY (SHORT CIRCUIT)

Check the continuity between the data link connector terminals.

Data link connector		Continuity
Connector No.	Terminal No.	
M22	6 14	Not existed

Is the inspection result normal?

- YES >> GO TO 3.  
 NO >> Check the harness and repair the root cause.

#### 3. CHECK HARNESS CONTINUITY (SHORT CIRCUIT)

Check the continuity between the data link connector and the ground.

Data link connector		Ground	Continuity
Connector No.	Terminal No.		
M22	6		Not existed
	14		Not existed

Is the inspection result normal?

- YES >> GO TO 4.  
 NO >> Check the harness and repair the root cause.

#### 4. CHECK ECM AND IPDM E/R TERMINATION CIRCUIT

1. Remove the ECM and the IPDM E/R.
2. Check the resistance between the ECM terminals.
  - MR20DE

ECM		Resistance (Ω)
Terminal No.		
84	83	Approx. 108 – 132

- QR25DE

ECM		Resistance (Ω)
Terminal No.		
98	97	Approx. 108 – 132

3. Check the resistance between the IPDM E/R terminals.

IPDM E/R		Resistance (Ω)
Terminal No.		
41	40	Approx. 108 – 132

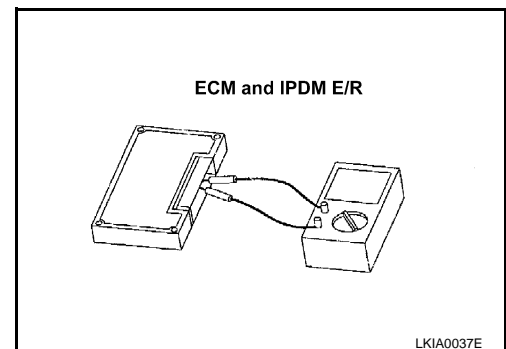

A  
B  
C  
D  
E  
F  
G  
H  
I  
J  
LAN  
L  
M  
N  
O  
P

# CAN COMMUNICATION CIRCUIT

< COMPONENT DIAGNOSIS >

[CAN SYSTEM (TYPE 7)]

---

Is the measurement value within the specification?

YES >> GO TO 5.

NO >> Replace the ECM and/or the IPDM E/R.

## 5.CHECK SYMPTOM

---

Connect all the connectors. Check if the symptoms described in the “Symptom (Results from interview with customer)” are reproduced.

Inspection result

Reproduced>>GO TO 6.

Non-reproduced>>Start the diagnosis again. Follow the trouble diagnosis procedure when past error is detected.

## 6.CHECK UNIT REPRODUCTION

---

Perform the reproduction test as per the following procedure for each unit.

1. Turn the ignition switch OFF.
2. Disconnect the battery cable from the negative terminal.
3. Disconnect one of the unit connectors of CAN communication system.

**NOTE:**

ECM and IPDM E/R have a termination circuit. Check other units first.

4. Connect the battery cable to the negative terminal. Check if the symptoms described in the “Symptom (Results from interview with customer)” are reproduced.

**NOTE:**

Although unit-related error symptoms occur, do not confuse them with other symptoms.

Inspection result

Reproduced>>Connect the connector. Check other units as per the above procedure.

Non-reproduced>>Replace the unit whose connector was disconnected.

# MAIN LINE BETWEEN ABS AND TCM CIRCUIT

< COMPONENT DIAGNOSIS >

[CAN SYSTEM (TYPE 8)]

## COMPONENT DIAGNOSIS

### MAIN LINE BETWEEN ABS AND TCM CIRCUIT

#### Diagnosis Procedure

INFOID:000000004501525

#### 1. CHECK HARNESS CONTINUITY (OPEN CIRCUIT)

1. Turn the ignition switch OFF.
2. Disconnect the battery cable from the negative terminal.
3. Disconnect the following harness connectors.
  - ECM
  - ABS actuator and electric unit (control unit)
  - Harness connectors E17 and F10
4. Check the continuity between the ABS actuator and electric unit (control unit) harness connector and the harness connector.

ABS actuator and electric unit (control unit) harness connector		Harness connector		Continuity
Connector No.	Terminal No.	Connector No.	Terminal No.	
E33	26	E17	2	Existed
	15		1	Existed

#### Is the inspection result normal?

YES (Present error)>>Check CAN system type decision again.

YES (Past error)>>Error was detected in the main line between the ABS actuator and electric unit (control unit) and the TCM.

NO >> Repair the main line between the ABS actuator and electric unit (control unit) and the harness connector E17.

A  
B  
C  
D  
E  
F  
G  
H  
I  
J  
L  
M  
N  
O  
P

LAN

# MAIN LINE BETWEEN TCM AND DLC CIRCUIT

< COMPONENT DIAGNOSIS >

[CAN SYSTEM (TYPE 8)]

## MAIN LINE BETWEEN TCM AND DLC CIRCUIT

### Diagnosis Procedure

INFOID:000000004501526

#### 1. CHECK CONNECTOR

1. Turn the ignition switch OFF.
2. Disconnect the battery cable from the negative terminal.
3. Check the following terminals and connectors for damage, bend and loose connection (connector side and harness side).
  - Harness connector E4
  - Harness connector M2

Is the inspection result normal?

YES >> GO TO 2.

NO >> Repair the terminal and connector.

#### 2. CHECK HARNESS CONTINUITY (OPEN CIRCUIT)

1. Disconnect the following harness connectors.
  - Harness connectors F10 and E17
  - Harness connectors E4 and M2
2. Check the continuity between the harness connectors.

Harness connector		Harness connector		Continuity
Connector No.	Terminal No.	Connector No.	Terminal No.	
E17	2	E4	9	Existed
	1		25	Existed

Is the inspection result normal?

YES >> GO TO 3.

NO >> Repair the main line between the harness connector E17 and the harness connector E4.

#### 3. CHECK HARNESS CONTINUITY (OPEN CIRCUIT)

Check the continuity between the harness connector and the data link connector.

Harness connector		Data link connector		Continuity
Connector No.	Terminal No.	Connector No.	Terminal No.	
M2	9	M22	6	Existed
	25		14	Existed

Is the inspection result normal?

YES (Present error)>>Check CAN system type decision again.

YES (Past error)>>Error was detected in the main line between the TCM and the data link connector.

NO >> Repair the main line between the harness connector M2 and the data link connector.

# ECM BRANCH LINE CIRCUIT

< COMPONENT DIAGNOSIS >

[CAN SYSTEM (TYPE 8)]

## ECM BRANCH LINE CIRCUIT

### Diagnosis Procedure

INFOID:000000004501527

#### 1. CHECK CONNECTOR

1. Turn the ignition switch OFF.
2. Disconnect the battery cable from the negative terminal.
3. Check the following terminals and connectors for damage, bend and loose connection (unit side and connector side).
  - ECM
  - Harness connector E4 (M/T models without ABS)
  - Harness connector M2 (M/T models without ABS)

Is the inspection result normal?

- YES >> GO TO 2.  
NO >> Repair the terminal and connector.

#### 2. CHECK HARNESS FOR OPEN CIRCUIT

1. Disconnect the connector of ECM.
2. Check the resistance between the ECM harness connector terminals.
  - MR20DE

ECM harness connector			Resistance (Ω)
Connector No.	Terminal No.		
E16	84	83	Approx. 108 – 132

- QR25DE

ECM harness connector			Resistance (Ω)
Connector No.	Terminal No.		
E16	98	97	Approx. 108 – 132

Is the measurement value within the specification?

- YES >> GO TO 3.  
NO >> Repair the ECM branch line.

#### 3. CHECK POWER SUPPLY AND GROUND CIRCUIT

Check the power supply and the ground circuit of the ECM. Refer to the following.

- MR20DE (For California): [EC-147, "Diagnosis Procedure"](#)
- MR20DE (Except for California): [EC-693, "Diagnosis Procedure"](#)
- QR25DE: [EC-1214, "Diagnosis Procedure"](#)

Is the inspection result normal?

- YES (Present error)>>Replace the ECM. Refer to the following.
- MR20DE (For California): [EC-90, "Procedure After Replacing ECM"](#)
  - MR20DE (Except for California): [EC-636, "Procedure After Replacing ECM"](#)
  - QR25DE: [EC-1158, "Procedure After Replacing ECM"](#)

YES (Past error)>>Error was detected in the ECM branch line.

- NO >> Repair the power supply and the ground circuit.

A  
B  
C  
D  
E  
F  
G  
H  
I  
J  
LAN  
L  
M  
N  
O  
P

# ABS BRANCH LINE CIRCUIT

< COMPONENT DIAGNOSIS >

[CAN SYSTEM (TYPE 8)]

## ABS BRANCH LINE CIRCUIT

### Diagnosis Procedure

INFOID:000000004501528

#### 1. CHECK CONNECTOR

1. Turn the ignition switch OFF.
2. Disconnect the battery cable from the negative terminal.
3. Check the terminals and connectors of the ABS actuator and electric unit (control unit) for damage, bend and loose connection (unit side and connector side).

Is the inspection result normal?

- YES >> GO TO 2.  
NO >> Repair the terminal and connector.

#### 2. CHECK HARNESS FOR OPEN CIRCUIT

1. Disconnect the connector of ABS actuator and electric unit (control unit).
2. Check the resistance between the ABS actuator and electric unit (control unit) harness connector terminals.

ABS actuator and electric unit (control unit) harness connector			Resistance (Ω)
Connector No.	Terminal No.		
E33	26	15	Approx. 54 – 66

Is the measurement value within the specification?

- YES >> GO TO 3.  
NO >> Repair the ABS actuator and electric unit (control unit) branch line.

#### 3. CHECK POWER SUPPLY AND GROUND CIRCUIT

Check the power supply and the ground circuit of the ABS actuator and electric unit (control unit). Refer to [BRC-26. "ABS Control Unit Power and Ground Systems Inspection"](#).

Is the inspection result normal?

- YES (Present error)>>Replace the ABS actuator and electric unit (control unit). Refer to [BRC-33. "Removal and Installation"](#).  
YES (Past error)>>Error was detected in the ABS actuator and electric unit (control unit) branch line.  
NO >> Repair the power supply and the ground circuit.

# TCM BRANCH LINE CIRCUIT

< COMPONENT DIAGNOSIS >

[CAN SYSTEM (TYPE 8)]

## TCM BRANCH LINE CIRCUIT

### Diagnosis Procedure

INFOID:000000004501529

#### 1. CHECK CONNECTOR

1. Turn the ignition switch OFF.
2. Disconnect the battery cable from the negative terminal.
3. Check the following terminals and connectors for damage, bend and loose connection (unit side and connector side).
  - TCM
  - Harness connector F10
  - Harness connector E17

Is the inspection result normal?

- YES >> GO TO 2.  
NO >> Repair the terminal and connector.

#### 2. CHECK HARNESS FOR OPEN CIRCUIT

1. Disconnect the connector of TCM.
2. Check the resistance between the TCM harness connector terminals.

TCM harness connector			Resistance (Ω)
Connector No.	Terminal No.		
F23	32	31	Approx. 54 – 66

Is the measurement value within the specification?

- YES >> GO TO 3.  
NO >> Repair the TCM branch line.

#### 3. CHECK POWER SUPPLY AND GROUND CIRCUIT

Check the power supply and the ground circuit of the TCM. Refer to [CVT-120, "Diagnosis Procedure"](#).

Is the inspection result normal?

- YES (Present error)>>Replace the TCM. Refer to [CVT-162, "Removal and Installation"](#).  
YES (Past error)>>Error was detected in the TCM branch line.  
NO >> Repair the power supply and the ground circuit.

A  
B  
C  
D  
E  
F  
G  
H  
I  
J  
L  
M  
N  
O  
P

LAN

## AV BRANCH LINE CIRCUIT

### Diagnosis Procedure

INFOID:000000004501530

#### 1. CHECK CONNECTOR

1. Turn the ignition switch OFF.
2. Disconnect the battery cable from the negative terminal.
3. Check the terminals and connectors of the audio unit for damage, bend and loose connection (unit side and connector side).

Is the inspection result normal?

- YES >> GO TO 2.  
 NO >> Repair the terminal and connector.

#### 2. CHECK HARNESS FOR OPEN CIRCUIT

1. Disconnect the connector of audio unit.
2. Check the resistance between the audio unit harness connector terminals.

Audio unit harness connector			Resistance (Ω)
Connector No.	Terminal No.		
M53	32	31	Approx. 54 – 66

Is the measurement value within the specification?

- YES >> GO TO 3.  
 NO >> Repair the audio unit branch line.

#### 3. CHECK POWER SUPPLY AND GROUND CIRCUIT

Check the power supply and the ground circuit of the audio unit. Refer to [AV-35, "Power Supply Circuit Inspection"](#).

Is the inspection result normal?

- YES (Present error)>>Replace the audio unit. Refer to [AV-51, "Removal and Installation"](#).  
 YES (Past error)>>Error was detected in the audio unit branch line.  
 NO >> Repair the power supply and the ground circuit.



# BCM BRANCH LINE CIRCUIT

< COMPONENT DIAGNOSIS >

[CAN SYSTEM (TYPE 8)]

## BCM BRANCH LINE CIRCUIT

### Diagnosis Procedure

INFOID:000000004501531

#### 1.CHECK CONNECTOR

1. Turn the ignition switch OFF.
2. Disconnect the battery cable from the negative terminal.
3. Check the terminals and connectors of the BCM for damage, bend and loose connection (unit side and connector side).

Is the inspection result normal?

- YES >> GO TO 2.  
NO >> Repair the terminal and connector.

#### 2.CHECK HARNESS FOR OPEN CIRCUIT

1. Disconnect the connector of BCM.
2. Check the resistance between the BCM harness connector terminals.

BCM harness connector			Resistance (Ω)
Connector No.	Terminal No.		
M18	39	40	Approx. 54 – 66

Is the measurement value within the specification?

- YES >> GO TO 3.  
NO >> Repair the BCM branch line.

#### 3.CHECK POWER SUPPLY AND GROUND CIRCUIT

Check the power supply and the ground circuit of the BCM. Refer to [BCS-14, "BCM Power Supply and Ground Circuit Inspection"](#).

Is the inspection result normal?

- YES (Present error)>>Replace the BCM. Refer to [BCS-17, "Removal and Installation of BCM"](#).  
YES (Past error)>>Error was detected in the BCM branch line.  
NO >> Repair the power supply and the ground circuit.

A  
B  
C  
D  
E  
F  
G  
H  
I  
J  
L  
M  
N  
O  
P

LAN

# DLC BRANCH LINE CIRCUIT

< COMPONENT DIAGNOSIS >

[CAN SYSTEM (TYPE 8)]

## DLC BRANCH LINE CIRCUIT

### Diagnosis Procedure

INFOID:000000004501532

#### 1. CHECK CONNECTOR

1. Turn the ignition switch OFF.
2. Disconnect the battery cable from the negative terminal.
3. Check the terminals and connectors of the data link connector for damage, bend and loose connection (connector side and harness side).

Is the inspection result normal?

- YES >> GO TO 2.  
NO >> Repair the terminal and connector.

#### 2. CHECK HARNESS FOR OPEN CIRCUIT

Check the resistance between the data link connector terminals.

Data link connector			Resistance ( $\Omega$ )
Connector No.	Terminal No.		
M22	6	14	Approx. 54 – 66

Is the measurement value within the specification?

- YES (Present error)>>Check CAN system type decision again.  
YES (Past error)>>Error was detected in the data link connector branch line circuit.  
NO >> Repair the data link connector branch line.

# EPS BRANCH LINE CIRCUIT

< COMPONENT DIAGNOSIS >

[CAN SYSTEM (TYPE 8)]

## EPS BRANCH LINE CIRCUIT

### Diagnosis Procedure

INFOID:000000004501533

#### 1.CHECK CONNECTOR

1. Turn the ignition switch OFF.
2. Disconnect the battery cable from the negative terminal.
3. Check the terminals and connectors of the EPS control unit for damage, bend and loose connection (unit side and connector side).

Is the inspection result normal?

- YES >> GO TO 2.  
NO >> Repair the terminal and connector.

#### 2.CHECK HARNESS FOR OPEN CIRCUIT

1. Disconnect the connector of EPS control unit.
2. Check the resistance between the EPS control unit harness connector terminals.

EPS control unit harness connector			Resistance (Ω)
Connector No.	Terminal No.		
M37	5	7	Approx. 54 – 66

Is the measurement value within the specification?

- YES >> GO TO 3.  
NO >> Repair the EPS control unit branch line.

#### 3.CHECK POWER SUPPLY AND GROUND CIRCUIT

Check the power supply and the ground circuit of the EPS control unit. Refer to [STC-14, "DTC C1601 BATTERY VOLT"](#).

Is the inspection result normal?

- YES (Present error)>>Replace the EPS control unit. Refer to [STC-7, "Component Parts Location"](#).  
YES (Past error)>>Error was detected in the EPS control unit branch line.  
NO >> Repair the power supply and the ground circuit.

A  
B  
C  
D  
E  
F  
G  
H  
I  
J  
L  
M  
N  
O  
P

LAN

# M&A BRANCH LINE CIRCUIT

< COMPONENT DIAGNOSIS >

[CAN SYSTEM (TYPE 8)]

## M&A BRANCH LINE CIRCUIT

### Diagnosis Procedure

INFOID:000000004501534

#### 1. CHECK CONNECTOR

1. Turn the ignition switch OFF.
2. Disconnect the battery cable from the negative terminal.
3. Check the terminals and connectors of the combination meter for damage, bend and loose connection (unit side and connector side).

Is the inspection result normal?

- YES >> GO TO 2.  
NO >> Repair the terminal and connector.

#### 2. CHECK HARNESS FOR OPEN CIRCUIT

1. Disconnect the connector of combination meter.
2. Check the resistance between the combination meter harness connector terminals.

Combination meter harness connector			Resistance ( $\Omega$ )
Connector No.	Terminal No.		
M24	9	10	Approx. 54 – 66

Is the measurement value within the specification?

- YES >> GO TO 3.  
NO >> Repair the combination meter branch line.

#### 3. CHECK POWER SUPPLY AND GROUND CIRCUIT

Check the power supply and the ground circuit of the combination meter. Refer to [DI-16, "Power Supply and Ground Circuit Inspection"](#).

Is the inspection result normal?

- YES (Present error)>>Replace the combination meter. Refer to [IP-11, "Component Parts"](#).  
YES (Past error)>>Error was detected in the combination meter branch line.  
NO >> Repair the power supply and the ground circuit.

# M&A2 BRANCH LINE CIRCUIT

< COMPONENT DIAGNOSIS >

[CAN SYSTEM (TYPE 8)]

## M&A2 BRANCH LINE CIRCUIT

### Diagnosis Procedure

INFOID:000000004501535

#### 1.CHECK CONNECTOR

1. Turn the ignition switch OFF.
2. Disconnect the battery cable from the negative terminal.
3. Check the terminals and connectors of the double meter for damage, bend and loose connection (unit side and connector side).

Is the inspection result normal?

- YES >> GO TO 2.  
NO >> Repair the terminal and connector.

#### 2.CHECK HARNESS FOR OPEN CIRCUIT

1. Disconnect the connector of double meter.
2. Check the resistance between the double meter harness connector terminals.

Double meter harness connector			Resistance (Ω)
Connector No.	Terminal No.		
M89	1	2	Approx. 54 – 66

Is the measurement value within the specification?

- YES >> GO TO 3.  
NO >> Repair the double meter branch line.

#### 3.CHECK POWER SUPPLY AND GROUND CIRCUIT

Check the power supply and the ground circuit of the double meter. Refer to [DI-27, "Power Supply and Ground Circuit Inspection"](#).

Is the inspection result normal?

- YES (Present error)>>Replace the double meter. Refer to [DI-29, "Removal and Installation"](#).  
YES (Past error)>>Error was detected in the double meter branch line.  
NO >> Repair the power supply and the ground circuit.

A  
B  
C  
D  
E  
F  
G  
H  
I  
J  
L  
M  
N  
O  
P

LAN

# IPDM-E BRANCH LINE CIRCUIT

< COMPONENT DIAGNOSIS >

[CAN SYSTEM (TYPE 8)]

## IPDM-E BRANCH LINE CIRCUIT

### Diagnosis Procedure

INFOID:000000004501536

#### 1. CHECK CONNECTOR

1. Turn the ignition switch OFF.
2. Disconnect the battery cable from the negative terminal.
3. Check the following terminals and connectors for damage, bend and loose connection (unit side and connector side).
  - IPDM E/R
  - Harness connector E4
  - Harness connector M2

Is the inspection result normal?

YES >> GO TO 2.

NO >> Repair the terminal and connector.

#### 2. CHECK HARNESS FOR OPEN CIRCUIT

1. Disconnect the connector of IPDM E/R.
2. Check the resistance between the IPDM E/R harness connector terminals.

IPDM E/R harness connector		Resistance (Ω)
Connector No.	Terminal No.	
E46	41                      40	Approx. 108 – 132

Is the measurement value within the specification?

YES >> GO TO 3.

NO >> Repair the IPDM E/R branch line.

#### 3. CHECK POWER SUPPLY AND GROUND CIRCUIT

Check the power supply and the ground circuit of the IPDM E/R. Refer to [PG-26, "IPDM E/R Power/Ground Circuit Inspection"](#).

Is the inspection result normal?

YES (Present error)>>Replace the IPDM E/R. Refer to [PG-27, "Removal and Installation of IPDM E/R"](#).

YES (Past error)>>Error was detected in the IPDM E/R branch line.

NO >> Repair the power supply and the ground circuit.

# CAN COMMUNICATION CIRCUIT

< COMPONENT DIAGNOSIS >

[CAN SYSTEM (TYPE 8)]

## CAN COMMUNICATION CIRCUIT

### Diagnosis Procedure

INFOID:000000004501537

#### 1. CONNECTOR INSPECTION

1. Turn the ignition switch OFF.
2. Disconnect the battery cable from the negative terminal.
3. Disconnect all the unit connectors on CAN communication system.
4. Check terminals and connectors for damage, bend and loose connection.

Is the inspection result normal?

- YES >> GO TO 2.  
 NO >> Repair the terminal and connector.

#### 2. CHECK HARNESS CONTINUITY (SHORT CIRCUIT)

Check the continuity between the data link connector terminals.

Data link connector		Continuity
Connector No.	Terminal No.	
M22	6 14	Not existed

Is the inspection result normal?

- YES >> GO TO 3.  
 NO >> Check the harness and repair the root cause.

#### 3. CHECK HARNESS CONTINUITY (SHORT CIRCUIT)

Check the continuity between the data link connector and the ground.

Data link connector		Ground	Continuity
Connector No.	Terminal No.		
M22	6		Not existed
	14		Not existed

Is the inspection result normal?

- YES >> GO TO 4.  
 NO >> Check the harness and repair the root cause.

#### 4. CHECK ECM AND IPDM E/R TERMINATION CIRCUIT

1. Remove the ECM and the IPDM E/R.
2. Check the resistance between the ECM terminals.
  - MR20DE

ECM		Resistance (Ω)
Terminal No.		
84	83	Approx. 108 – 132

- QR25DE

ECM		Resistance (Ω)
Terminal No.		
98	97	Approx. 108 – 132

3. Check the resistance between the IPDM E/R terminals.

IPDM E/R		Resistance (Ω)
Terminal No.		
41	40	Approx. 108 – 132

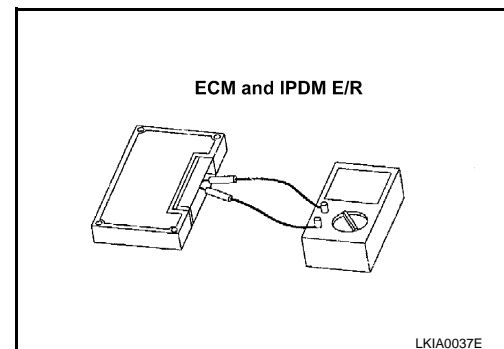

A  
B  
C  
D  
E  
F  
G  
H  
I  
J  
K  
L  
M  
N  
O  
P

LAN

# CAN COMMUNICATION CIRCUIT

< COMPONENT DIAGNOSIS >

[CAN SYSTEM (TYPE 8)]

---

Is the measurement value within the specification?

YES >> GO TO 5.

NO >> Replace the ECM and/or the IPDM E/R.

## 5.CHECK SYMPTOM

---

Connect all the connectors. Check if the symptoms described in the “Symptom (Results from interview with customer)” are reproduced.

Inspection result

Reproduced>>GO TO 6.

Non-reproduced>>Start the diagnosis again. Follow the trouble diagnosis procedure when past error is detected.

## 6.CHECK UNIT REPRODUCTION

---

Perform the reproduction test as per the following procedure for each unit.

1. Turn the ignition switch OFF.
2. Disconnect the battery cable from the negative terminal.
3. Disconnect one of the unit connectors of CAN communication system.

**NOTE:**

ECM and IPDM E/R have a termination circuit. Check other units first.

4. Connect the battery cable to the negative terminal. Check if the symptoms described in the “Symptom (Results from interview with customer)” are reproduced.

**NOTE:**

Although unit-related error symptoms occur, do not confuse them with other symptoms.

Inspection result

Reproduced>>Connect the connector. Check other units as per the above procedure.

Non-reproduced>>Replace the unit whose connector was disconnected.



# MAIN LINE BETWEEN ABS AND TCM CIRCUIT

< COMPONENT DIAGNOSIS >

[CAN SYSTEM (TYPE 9)]

## COMPONENT DIAGNOSIS

### MAIN LINE BETWEEN ABS AND TCM CIRCUIT

#### Diagnosis Procedure

INFOID:000000004501538

#### 1. CHECK HARNESS CONTINUITY (OPEN CIRCUIT)

1. Turn the ignition switch OFF.
2. Disconnect the battery cable from the negative terminal.
3. Disconnect the following harness connectors.
  - ECM
  - ABS actuator and electric unit (control unit)
  - Harness connectors E17 and F10
4. Check the continuity between the ABS actuator and electric unit (control unit) harness connector and the harness connector.

ABS actuator and electric unit (control unit) harness connector		Harness connector		Continuity
Connector No.	Terminal No.	Connector No.	Terminal No.	
E33	26	E17	2	Existed
	15		1	Existed

#### Is the inspection result normal?

YES (Present error)>>Check CAN system type decision again.

YES (Past error)>>Error was detected in the main line between the ABS actuator and electric unit (control unit) and the TCM.

NO >> Repair the main line between the ABS actuator and electric unit (control unit) and the harness connector E17.

A  
B  
C  
D  
E  
F  
G  
H  
I  
J  
L  
M  
N  
O  
P

LAN

# MAIN LINE BETWEEN TCM AND DLC CIRCUIT

< COMPONENT DIAGNOSIS >

[CAN SYSTEM (TYPE 9)]

## MAIN LINE BETWEEN TCM AND DLC CIRCUIT

### Diagnosis Procedure

INFOID:000000004501539

#### 1.CHECK CONNECTOR

1. Turn the ignition switch OFF.
2. Disconnect the battery cable from the negative terminal.
3. Check the following terminals and connectors for damage, bend and loose connection (connector side and harness side).
  - Harness connector E4
  - Harness connector M2

Is the inspection result normal?

YES >> GO TO 2.

NO >> Repair the terminal and connector.

#### 2.CHECK HARNESS CONTINUITY (OPEN CIRCUIT)

1. Disconnect the following harness connectors.
  - Harness connectors F10 and E17
  - Harness connectors E4 and M2
2. Check the continuity between the harness connectors.

Harness connector		Harness connector		Continuity
Connector No.	Terminal No.	Connector No.	Terminal No.	
E17	2	E4	9	Existed
	1		25	Existed

Is the inspection result normal?

YES >> GO TO 3.

NO >> Repair the main line between the harness connector E17 and the harness connector E4.

#### 3.CHECK HARNESS CONTINUITY (OPEN CIRCUIT)

Check the continuity between the harness connector and the data link connector.

Harness connector		Data link connector		Continuity
Connector No.	Terminal No.	Connector No.	Terminal No.	
M2	9	M22	6	Existed
	25		14	Existed

Is the inspection result normal?

YES (Present error)>>Check CAN system type decision again.

YES (Past error)>>Error was detected in the main line between the TCM and the data link connector.

NO >> Repair the main line between the harness connector M2 and the data link connector.

# ECM BRANCH LINE CIRCUIT

< COMPONENT DIAGNOSIS >

[CAN SYSTEM (TYPE 9)]

## ECM BRANCH LINE CIRCUIT

### Diagnosis Procedure

INFOID:000000004501540

#### 1. CHECK CONNECTOR

1. Turn the ignition switch OFF.
2. Disconnect the battery cable from the negative terminal.
3. Check the following terminals and connectors for damage, bend and loose connection (unit side and connector side).
  - ECM
  - Harness connector E4 (M/T models without ABS)
  - Harness connector M2 (M/T models without ABS)

Is the inspection result normal?

- YES >> GO TO 2.  
NO >> Repair the terminal and connector.

#### 2. CHECK HARNESS FOR OPEN CIRCUIT

1. Disconnect the connector of ECM.
2. Check the resistance between the ECM harness connector terminals.
  - MR20DE

ECM harness connector			Resistance (Ω)
Connector No.	Terminal No.		
E16	84	83	Approx. 108 – 132

- QR25DE

ECM harness connector			Resistance (Ω)
Connector No.	Terminal No.		
E16	98	97	Approx. 108 – 132

Is the measurement value within the specification?

- YES >> GO TO 3.  
NO >> Repair the ECM branch line.

#### 3. CHECK POWER SUPPLY AND GROUND CIRCUIT

Check the power supply and the ground circuit of the ECM. Refer to the following.

- MR20DE (For California): [EC-147, "Diagnosis Procedure"](#)
- MR20DE (Except for California): [EC-693, "Diagnosis Procedure"](#)
- QR25DE: [EC-1214, "Diagnosis Procedure"](#)

Is the inspection result normal?

- YES (Present error)>>Replace the ECM. Refer to the following.
- MR20DE (For California): [EC-90, "Procedure After Replacing ECM"](#)
  - MR20DE (Except for California): [EC-636, "Procedure After Replacing ECM"](#)
  - QR25DE: [EC-1158, "Procedure After Replacing ECM"](#)

YES (Past error)>>Error was detected in the ECM branch line.

- NO >> Repair the power supply and the ground circuit.

A  
B  
C  
D  
E  
F  
G  
H  
I  
J  
LAN  
L  
M  
N  
O  
P

# ABS BRANCH LINE CIRCUIT

< COMPONENT DIAGNOSIS >

[CAN SYSTEM (TYPE 9)]

## ABS BRANCH LINE CIRCUIT

### Diagnosis Procedure

INFOID:000000004501541

#### 1. CHECK CONNECTOR

1. Turn the ignition switch OFF.
2. Disconnect the battery cable from the negative terminal.
3. Check the terminals and connectors of the ABS actuator and electric unit (control unit) for damage, bend and loose connection (unit side and connector side).

Is the inspection result normal?

- YES >> GO TO 2.  
NO >> Repair the terminal and connector.

#### 2. CHECK HARNESS FOR OPEN CIRCUIT

1. Disconnect the connector of ABS actuator and electric unit (control unit).
2. Check the resistance between the ABS actuator and electric unit (control unit) harness connector terminals.

ABS actuator and electric unit (control unit) harness connector			Resistance (Ω)
Connector No.	Terminal No.		
E33	26	15	Approx. 54 – 66

Is the measurement value within the specification?

- YES >> GO TO 3.  
NO >> Repair the ABS actuator and electric unit (control unit) branch line.

#### 3. CHECK POWER SUPPLY AND GROUND CIRCUIT

Check the power supply and the ground circuit of the ABS actuator and electric unit (control unit). Refer to [BRC-26. "ABS Control Unit Power and Ground Systems Inspection"](#).

Is the inspection result normal?

- YES (Present error)>>Replace the ABS actuator and electric unit (control unit). Refer to [BRC-33. "Removal and Installation"](#).  
YES (Past error)>>Error was detected in the ABS actuator and electric unit (control unit) branch line.  
NO >> Repair the power supply and the ground circuit.

# TCM BRANCH LINE CIRCUIT

< COMPONENT DIAGNOSIS >

[CAN SYSTEM (TYPE 9)]

## TCM BRANCH LINE CIRCUIT

### Diagnosis Procedure

INFOID:000000004501542

#### 1.CHECK CONNECTOR

1. Turn the ignition switch OFF.
2. Disconnect the battery cable from the negative terminal.
3. Check the following terminals and connectors for damage, bend and loose connection (unit side and connector side).
  - TCM
  - Harness connector F10
  - Harness connector E17

Is the inspection result normal?

YES >> GO TO 2.

NO >> Repair the terminal and connector.

#### 2.CHECK HARNESS FOR OPEN CIRCUIT

1. Disconnect the connector of TCM.
2. Check the resistance between the TCM harness connector terminals.

TCM harness connector			Resistance (Ω)
Connector No.	Terminal No.		
F23	32	31	Approx. 54 – 66

Is the measurement value within the specification?

YES >> GO TO 3.

NO >> Repair the TCM branch line.

#### 3.CHECK POWER SUPPLY AND GROUND CIRCUIT

Check the power supply and the ground circuit of the TCM. Refer to [CVT-120, "Diagnosis Procedure"](#).

Is the inspection result normal?

YES (Present error)>>Replace the TCM. Refer to [CVT-162, "Removal and Installation"](#).

YES (Past error)>>Error was detected in the TCM branch line.

NO >> Repair the power supply and the ground circuit.

A  
B  
C  
D  
E  
F  
G  
H  
I  
J  
L  
M  
N  
O  
P

LAN

## AV BRANCH LINE CIRCUIT

### Diagnosis Procedure

INFOID:000000004501543

#### 1. CHECK CONNECTOR

1. Turn the ignition switch OFF.
2. Disconnect the battery cable from the negative terminal.
3. Check the terminals and connectors of the audio unit for damage, bend and loose connection (unit side and connector side).

Is the inspection result normal?

- YES >> GO TO 2.  
 NO >> Repair the terminal and connector.

#### 2. CHECK HARNESS FOR OPEN CIRCUIT

1. Disconnect the connector of audio unit.
2. Check the resistance between the audio unit harness connector terminals.

Audio unit harness connector			Resistance (Ω)
Connector No.	Terminal No.		
M53	32	31	Approx. 54 – 66

Is the measurement value within the specification?

- YES >> GO TO 3.  
 NO >> Repair the audio unit branch line.

#### 3. CHECK POWER SUPPLY AND GROUND CIRCUIT

Check the power supply and the ground circuit of the audio unit. Refer to [AV-35, "Power Supply Circuit Inspection"](#).

Is the inspection result normal?

- YES (Present error)>>Replace the audio unit. Refer to [AV-51, "Removal and Installation"](#).  
 YES (Past error)>>Error was detected in the audio unit branch line.  
 NO >> Repair the power supply and the ground circuit.

# BCM BRANCH LINE CIRCUIT

< COMPONENT DIAGNOSIS >

[CAN SYSTEM (TYPE 9)]

## BCM BRANCH LINE CIRCUIT

### Diagnosis Procedure

INFOID:000000004501544

#### 1. CHECK CONNECTOR

1. Turn the ignition switch OFF.
2. Disconnect the battery cable from the negative terminal.
3. Check the terminals and connectors of the BCM for damage, bend and loose connection (unit side and connector side).

Is the inspection result normal?

- YES >> GO TO 2.  
NO >> Repair the terminal and connector.

#### 2. CHECK HARNESS FOR OPEN CIRCUIT

1. Disconnect the connector of BCM.
2. Check the resistance between the BCM harness connector terminals.

BCM harness connector			Resistance (Ω)
Connector No.	Terminal No.		
M18	39	40	Approx. 54 – 66

Is the measurement value within the specification?

- YES >> GO TO 3.  
NO >> Repair the BCM branch line.

#### 3. CHECK POWER SUPPLY AND GROUND CIRCUIT

Check the power supply and the ground circuit of the BCM. Refer to [BCS-14, "BCM Power Supply and Ground Circuit Inspection"](#).

Is the inspection result normal?

- YES (Present error)>>Replace the BCM. Refer to [BCS-17, "Removal and Installation of BCM"](#).  
YES (Past error)>>Error was detected in the BCM branch line.  
NO >> Repair the power supply and the ground circuit.

A  
B  
C  
D  
E  
F  
G  
H  
I  
J  
LAN  
L  
M  
N  
O  
P

# DLC BRANCH LINE CIRCUIT

< COMPONENT DIAGNOSIS >

[CAN SYSTEM (TYPE 9)]

## DLC BRANCH LINE CIRCUIT

### Diagnosis Procedure

INFOID:000000004501545

#### 1. CHECK CONNECTOR

1. Turn the ignition switch OFF.
2. Disconnect the battery cable from the negative terminal.
3. Check the terminals and connectors of the data link connector for damage, bend and loose connection (connector side and harness side).

Is the inspection result normal?

- YES >> GO TO 2.  
NO >> Repair the terminal and connector.

#### 2. CHECK HARNESS FOR OPEN CIRCUIT

Check the resistance between the data link connector terminals.

Data link connector			Resistance ( $\Omega$ )
Connector No.	Terminal No.		
M22	6	14	Approx. 54 – 66

Is the measurement value within the specification?

- YES (Present error)>>Check CAN system type decision again.  
YES (Past error)>>Error was detected in the data link connector branch line circuit.  
NO >> Repair the data link connector branch line.



## EPS BRANCH LINE CIRCUIT

### Diagnosis Procedure

INFOID:000000004501546

#### 1. CHECK CONNECTOR

1. Turn the ignition switch OFF.
2. Disconnect the battery cable from the negative terminal.
3. Check the terminals and connectors of the EPS control unit for damage, bend and loose connection (unit side and connector side).

Is the inspection result normal?

- YES >> GO TO 2.  
 NO >> Repair the terminal and connector.

#### 2. CHECK HARNESS FOR OPEN CIRCUIT

1. Disconnect the connector of EPS control unit.
2. Check the resistance between the EPS control unit harness connector terminals.

EPS control unit harness connector			Resistance (Ω)
Connector No.	Terminal No.		
M37	5	7	Approx. 54 – 66

Is the measurement value within the specification?

- YES >> GO TO 3.  
 NO >> Repair the EPS control unit branch line.

#### 3. CHECK POWER SUPPLY AND GROUND CIRCUIT

Check the power supply and the ground circuit of the EPS control unit. Refer to [STC-14, "DTC C1601 BATTERY VOLT"](#).

Is the inspection result normal?

- YES (Present error)>>Replace the EPS control unit. Refer to [STC-7, "Component Parts Location"](#).  
 YES (Past error)>>Error was detected in the EPS control unit branch line.  
 NO >> Repair the power supply and the ground circuit.

A  
B  
C  
D  
E  
F  
G  
H  
I  
J  
L  
M  
N  
O  
P

LAN

# I-KEY BRANCH LINE CIRCUIT

< COMPONENT DIAGNOSIS >

[CAN SYSTEM (TYPE 9)]

## I-KEY BRANCH LINE CIRCUIT

### Diagnosis Procedure

INFOID:000000004501547

#### 1.CHECK CONNECTOR

1. Turn the ignition switch OFF.
2. Disconnect the battery cable from the negative terminal.
3. Check the terminals and connectors of the Intelligent Key unit for damage, bend and loose connection (unit side and connector side).

Is the inspection result normal?

- YES >> GO TO 2.  
NO >> Repair the terminal and connector.

#### 2.CHECK HARNESS FOR OPEN CIRCUIT

1. Disconnect the connector of Intelligent Key unit.
2. Check the resistance between the Intelligent Key unit harness connector terminals.

Intelligent Key unit harness connector			Resistance (Ω)
Connector No.	Terminal No.		
M42	2	3	Approx. 54 – 66

Is the measurement value within the specification?

- YES >> GO TO 3.  
NO >> Repair the Intelligent Key unit branch line.

#### 3.CHECK POWER SUPPLY AND GROUND CIRCUIT

Check the power supply and the ground circuit of the Intelligent Key unit. Refer to [BL-106, "Power Supply and Ground Circuit Inspection"](#).

Is the inspection result normal?

- YES (Present error)>>Replace the Intelligent Key unit. Refer to [BL-129, "Removal and Installation of Intelligent Key Unit"](#).  
YES (Past error)>>Error was detected in the Intelligent Key unit branch line.  
NO >> Repair the power supply and the ground circuit.

# M&A BRANCH LINE CIRCUIT

< COMPONENT DIAGNOSIS >

[CAN SYSTEM (TYPE 9)]

## M&A BRANCH LINE CIRCUIT

### Diagnosis Procedure

INFOID:000000004501548

#### 1. CHECK CONNECTOR

1. Turn the ignition switch OFF.
2. Disconnect the battery cable from the negative terminal.
3. Check the terminals and connectors of the combination meter for damage, bend and loose connection (unit side and connector side).

Is the inspection result normal?

- YES >> GO TO 2.  
NO >> Repair the terminal and connector.

#### 2. CHECK HARNESS FOR OPEN CIRCUIT

1. Disconnect the connector of combination meter.
2. Check the resistance between the combination meter harness connector terminals.

Combination meter harness connector			Resistance ( $\Omega$ )
Connector No.	Terminal No.		
M24	9	10	Approx. 54 – 66

Is the measurement value within the specification?

- YES >> GO TO 3.  
NO >> Repair the combination meter branch line.

#### 3. CHECK POWER SUPPLY AND GROUND CIRCUIT

Check the power supply and the ground circuit of the combination meter. Refer to [DI-16, "Power Supply and Ground Circuit Inspection"](#).

Is the inspection result normal?

- YES (Present error)>>Replace the combination meter. Refer to [IP-11, "Component Parts"](#).  
YES (Past error)>>Error was detected in the combination meter branch line.  
NO >> Repair the power supply and the ground circuit.

A  
B  
C  
D  
E  
F  
G  
H  
I  
J  
L  
M  
N  
O  
P

LAN

# M&A2 BRANCH LINE CIRCUIT

< COMPONENT DIAGNOSIS >

[CAN SYSTEM (TYPE 9)]

## M&A2 BRANCH LINE CIRCUIT

### Diagnosis Procedure

INFOID:000000004501549

#### 1. CHECK CONNECTOR

1. Turn the ignition switch OFF.
2. Disconnect the battery cable from the negative terminal.
3. Check the terminals and connectors of the double meter for damage, bend and loose connection (unit side and connector side).

Is the inspection result normal?

- YES >> GO TO 2.  
NO >> Repair the terminal and connector.

#### 2. CHECK HARNESS FOR OPEN CIRCUIT

1. Disconnect the connector of double meter.
2. Check the resistance between the double meter harness connector terminals.

Double meter harness connector			Resistance (Ω)
Connector No.	Terminal No.		
M89	1	2	Approx. 54 – 66

Is the measurement value within the specification?

- YES >> GO TO 3.  
NO >> Repair the double meter branch line.

#### 3. CHECK POWER SUPPLY AND GROUND CIRCUIT

Check the power supply and the ground circuit of the double meter. Refer to [DI-27, "Power Supply and Ground Circuit Inspection"](#).

Is the inspection result normal?

- YES (Present error)>>Replace the double meter. Refer to [DI-29, "Removal and Installation"](#).  
YES (Past error)>>Error was detected in the double meter branch line.  
NO >> Repair the power supply and the ground circuit.

# IPDM-E BRANCH LINE CIRCUIT

< COMPONENT DIAGNOSIS >

[CAN SYSTEM (TYPE 9)]

## IPDM-E BRANCH LINE CIRCUIT

### Diagnosis Procedure

INFOID:000000004501550

#### 1. CHECK CONNECTOR

1. Turn the ignition switch OFF.
2. Disconnect the battery cable from the negative terminal.
3. Check the following terminals and connectors for damage, bend and loose connection (unit side and connector side).
  - IPDM E/R
  - Harness connector E4
  - Harness connector M2

Is the inspection result normal?

YES >> GO TO 2.

NO >> Repair the terminal and connector.

#### 2. CHECK HARNESS FOR OPEN CIRCUIT

1. Disconnect the connector of IPDM E/R.
2. Check the resistance between the IPDM E/R harness connector terminals.

IPDM E/R harness connector			Resistance (Ω)
Connector No.	Terminal No.		
E46	41	40	Approx. 108 – 132

Is the measurement value within the specification?

YES >> GO TO 3.

NO >> Repair the IPDM E/R branch line.

#### 3. CHECK POWER SUPPLY AND GROUND CIRCUIT

Check the power supply and the ground circuit of the IPDM E/R. Refer to [PG-26, "IPDM E/R Power/Ground Circuit Inspection"](#).

Is the inspection result normal?

YES (Present error)>>Replace the IPDM E/R. Refer to [PG-27, "Removal and Installation of IPDM E/R"](#).

YES (Past error)>>Error was detected in the IPDM E/R branch line.

NO >> Repair the power supply and the ground circuit.

A  
B  
C  
D  
E  
F  
G  
H  
I  
J  
L  
M  
N  
O  
P

LAN

# CAN COMMUNICATION CIRCUIT

< COMPONENT DIAGNOSIS >

[CAN SYSTEM (TYPE 9)]

## CAN COMMUNICATION CIRCUIT

### Diagnosis Procedure

INFOID:000000004501551

#### 1. CONNECTOR INSPECTION

1. Turn the ignition switch OFF.
2. Disconnect the battery cable from the negative terminal.
3. Disconnect all the unit connectors on CAN communication system.
4. Check terminals and connectors for damage, bend and loose connection.

Is the inspection result normal?

- YES >> GO TO 2.  
NO >> Repair the terminal and connector.

#### 2. CHECK HARNESS CONTINUITY (SHORT CIRCUIT)

Check the continuity between the data link connector terminals.

Data link connector		Continuity
Connector No.	Terminal No.	
M22	6 14	Not existed

Is the inspection result normal?

- YES >> GO TO 3.  
NO >> Check the harness and repair the root cause.

#### 3. CHECK HARNESS CONTINUITY (SHORT CIRCUIT)

Check the continuity between the data link connector and the ground.

Data link connector		Ground	Continuity
Connector No.	Terminal No.		
M22	6		Not existed
	14		Not existed

Is the inspection result normal?

- YES >> GO TO 4.  
NO >> Check the harness and repair the root cause.

#### 4. CHECK ECM AND IPDM E/R TERMINATION CIRCUIT

1. Remove the ECM and the IPDM E/R.
2. Check the resistance between the ECM terminals.
  - MR20DE

ECM		Resistance ( $\Omega$ )
Terminal No.		
84	83	Approx. 108 – 132

- QR25DE

ECM		Resistance ( $\Omega$ )
Terminal No.		
98	97	Approx. 108 – 132

3. Check the resistance between the IPDM E/R terminals.

IPDM E/R		Resistance ( $\Omega$ )
Terminal No.		
41	40	Approx. 108 – 132

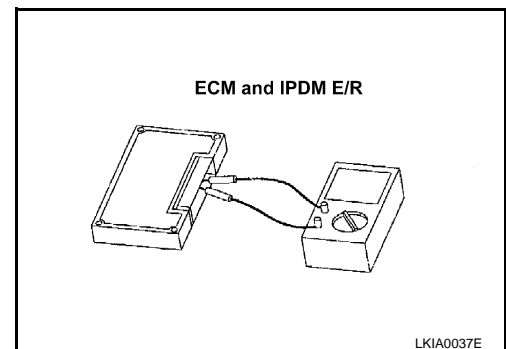

# CAN COMMUNICATION CIRCUIT

< COMPONENT DIAGNOSIS >

[CAN SYSTEM (TYPE 9)]

Is the measurement value within the specification?

YES >> GO TO 5.

NO >> Replace the ECM and/or the IPDM E/R.

## 5.CHECK SYMPTOM

Connect all the connectors. Check if the symptoms described in the “Symptom (Results from interview with customer)” are reproduced.

Inspection result

Reproduced>>GO TO 6.

Non-reproduced>>Start the diagnosis again. Follow the trouble diagnosis procedure when past error is detected.

## 6.CHECK UNIT REPRODUCTION

Perform the reproduction test as per the following procedure for each unit.

1. Turn the ignition switch OFF.
2. Disconnect the battery cable from the negative terminal.
3. Disconnect one of the unit connectors of CAN communication system.

**NOTE:**

ECM and IPDM E/R have a termination circuit. Check other units first.

4. Connect the battery cable to the negative terminal. Check if the symptoms described in the “Symptom (Results from interview with customer)” are reproduced.

**NOTE:**

Although unit-related error symptoms occur, do not confuse them with other symptoms.

Inspection result

Reproduced>>Connect the connector. Check other units as per the above procedure.

Non-reproduced>>Replace the unit whose connector was disconnected.

A  
B  
C  
D  
E  
F  
G  
H  
I  
J  
L  
M  
N  
O  
P

LAN