

A
STR
C

SECTION STR

STARTING SYSTEM

CONTENTS

PRECAUTION	STARTING SYSTEM (WITHOUT INTELLIGENT KEY) : System Description	F
3	9	
PRECAUTIONS	WIRING DIAGRAM	G
3	10	
Precaution for Supplemental Restraint System (SRS) "AIR BAG" and "SEAT BELT PRE-TENSIONER"	STARTING SYSTEM (WITH INTELLIGENT KEY)	H
3	10	
PREPARATION	Wiring Diagram	H
4	10	
PREPARATION	STARTING SYSTEM (WITHOUT INTELLIGENT KEY)	I
4	15	
Special Service Tool	Wiring Diagram	
4	15	
Commercial Service Tool	BASIC INSPECTION	J
4	20	
SYSTEM DESCRIPTION	DIAGNOSIS AND REPAIR WORKFLOW	K
5	20	
COMPONENT PARTS	Work Flow (With GR8-1200 NI)	
5	20	
STARTING SYSTEM (WITH INTELLIGENT KEY)	Work Flow (Without GR8-1200 NI)	K
5	23	
STARTING SYSTEM (WITH INTELLIGENT KEY)	DTC/CIRCUIT DIAGNOSIS	L
: Component Parts Location	26	
5		
STARTING SYSTEM (WITH INTELLIGENT KEY)	B TERMINAL CIRCUIT	L
: Component Description	26	
5		
STARTING SYSTEM (WITHOUT INTELLIGENT KEY)	Description	M
6	26	
STARTING SYSTEM (WITHOUT INTELLIGENT KEY) : Component Parts Location	Diagnosis Procedure	
6	26	
STARTING SYSTEM (WITHOUT INTELLIGENT KEY) : Component Description	S CONNECTOR CIRCUIT	N
6	28	
SYSTEM	Description	O
8	28	
STARTING SYSTEM (WITH INTELLIGENT KEY)	Diagnosis Procedure	O
8	28	
STARTING SYSTEM (WITH INTELLIGENT KEY)	SYMPTOM DIAGNOSIS	P
: System Diagram	29	
8		
STARTING SYSTEM (WITH INTELLIGENT KEY)	STARTING SYSTEM	P
: System Description	29	
8		
STARTING SYSTEM (WITHOUT INTELLIGENT KEY)	Symptom Table	P
8	29	
STARTING SYSTEM (WITHOUT INTELLIGENT KEY) : System Diagram	REMOVAL AND INSTALLATION	P
9	30	
	STARTER MOTOR	P
	30	
	Exploded View	
	30	
	Removal and Installation	
	30	
	SERVICE DATA AND SPECIFICATIONS (SDS)	P
	32	

SERVICE DATA AND SPECIFICATIONS

(SDS) 32

Starter Motor 32

PRECAUTIONS

< PRECAUTION >

PRECAUTION

PRECAUTIONS

Precaution for Supplemental Restraint System (SRS) "AIR BAG" and "SEAT BELT PRE-TENSIONER"

INFOID:000000008768555

The Supplemental Restraint System such as "AIR BAG" and "SEAT BELT PRE-TENSIONER", used along with a front seat belt, helps to reduce the risk or severity of injury to the driver and front passenger for certain types of collision. Information necessary to service the system safely is included in the SR and SB section of this Service Manual.

WARNING:

- To avoid rendering the SRS inoperative, which could increase the risk of personal injury or death in the event of a collision which would result in air bag inflation, all maintenance must be performed by an authorized NISSAN/INFINITI dealer.
- Improper maintenance, including incorrect removal and installation of the SRS, can lead to personal injury caused by unintentional activation of the system. For removal of Spiral Cable and Air Bag Module, see the SR section.
- Do not use electrical test equipment on any circuit related to the SRS unless instructed to in this Service Manual. SRS wiring harnesses can be identified by yellow and/or orange harnesses or harness connectors.

PRECAUTIONS WHEN USING POWER TOOLS (AIR OR ELECTRIC) AND HAMMERS

WARNING:

- When working near the Airbag Diagnosis Sensor Unit or other Airbag System sensors with the Ignition ON or engine running, DO NOT use air or electric power tools or strike near the sensor(s) with a hammer. Heavy vibration could activate the sensor(s) and deploy the air bag(s), possibly causing serious injury.
- When using air or electric power tools or hammers, always switch the Ignition OFF, disconnect the battery and wait at least 3 minutes before performing any service.

A

STR

C

D

E

F

G

H

I

J

K

L

M

N

O

P

PREPARATION

< PREPARATION >

PREPARATION

PREPARATION

Special Service Tool

INFOID:000000008832694

The actual shapes of Kent-Moore tools may differ from those of special service tools illustrated here.

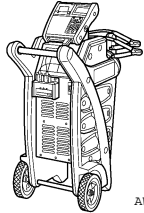
Tool number (Kent Moore No.) Tool name	Description
<p>— (—) Model GR8-1200 NI Multitasking battery and electrical diagnostic station</p>  <p style="text-align: right; font-size: small;">AWI1A1239ZZ</p>	<p>Tests batteries, starting and charging systems and charges batteries. For operating instructions, refer to diagnostic station instruction manual.</p>

Commercial Service Tool

INFOID:000000008832695

Tool name	Description
<p>Power tool</p>  <p style="text-align: right; font-size: small;">PIIB1407E</p>	<p>Loosening nuts, screws and bolts</p>

COMPONENT PARTS

< SYSTEM DESCRIPTION >

SYSTEM DESCRIPTION

COMPONENT PARTS

STARTING SYSTEM (WITH INTELLIGENT KEY)

STARTING SYSTEM (WITH INTELLIGENT KEY) : Component Parts Location

INFOID:000000008777946

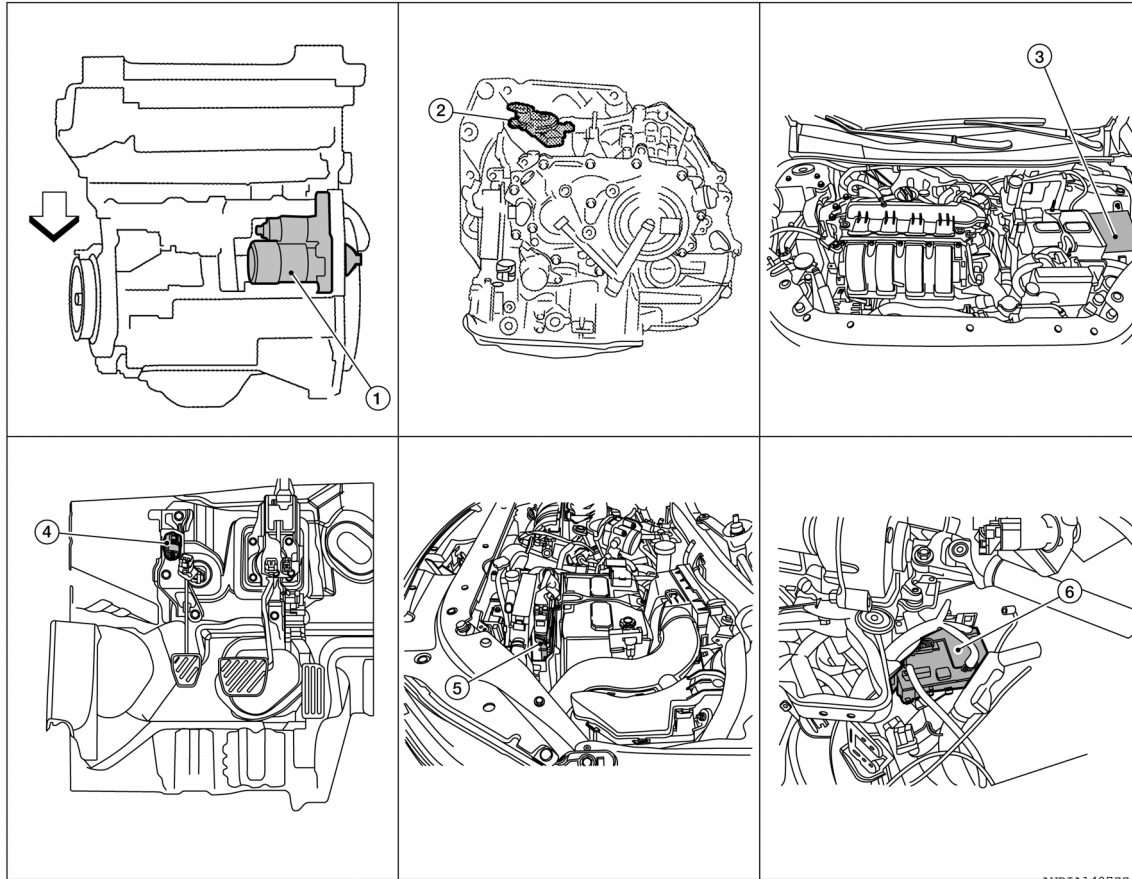

AWBIA140722

↶ Vehicle front

- | | | |
|---|---|--|
| 1. Starter motor | 2. Transmission range switch (CVT Models) | 3. IPDM E/R (view with air inlet duct removed) |
| 4. Clutch interlock switch (M/T Models) | 5. ECM | 6. BCM (view under instrument panel, left side of vehicle) |

STARTING SYSTEM (WITH INTELLIGENT KEY) : Component Description

INFOID:000000008777947

Component part	Description
Starter motor	The starter motor plunger closes and the motor is supplied with battery power, which in turn cranks the engine, when the S terminal is supplied with electric power.
Transmission range switch (CVT Models)	Transmission range switch supplies power to the starter relay and starter control relay inside the IPDM E/R when the shift selector is placed in the P or N position.
IPDM E/R	CPU inside IPDM E/R operates the starter relay when the ignition switch is in the start position.

A

STR

C

D

E

F

G

H

I

J

K

L

M

N

O

P

COMPONENT PARTS

< SYSTEM DESCRIPTION >

Clutch interlock switch (M/T Models)	Clutch interlock switch supplies power to the coil side of the starter when the clutch pedal is depressed to crank the engine.
ECM	ECM controls the starter relay inside the IPDM E/R.

A

STR

C

D

E

F

G

H

I

J

K

L

M

N

O

P

SYSTEM

< SYSTEM DESCRIPTION >

SYSTEM

STARTING SYSTEM (WITH INTELLIGENT KEY)

STARTING SYSTEM (WITH INTELLIGENT KEY) : System Diagram

INFOID:000000008777950

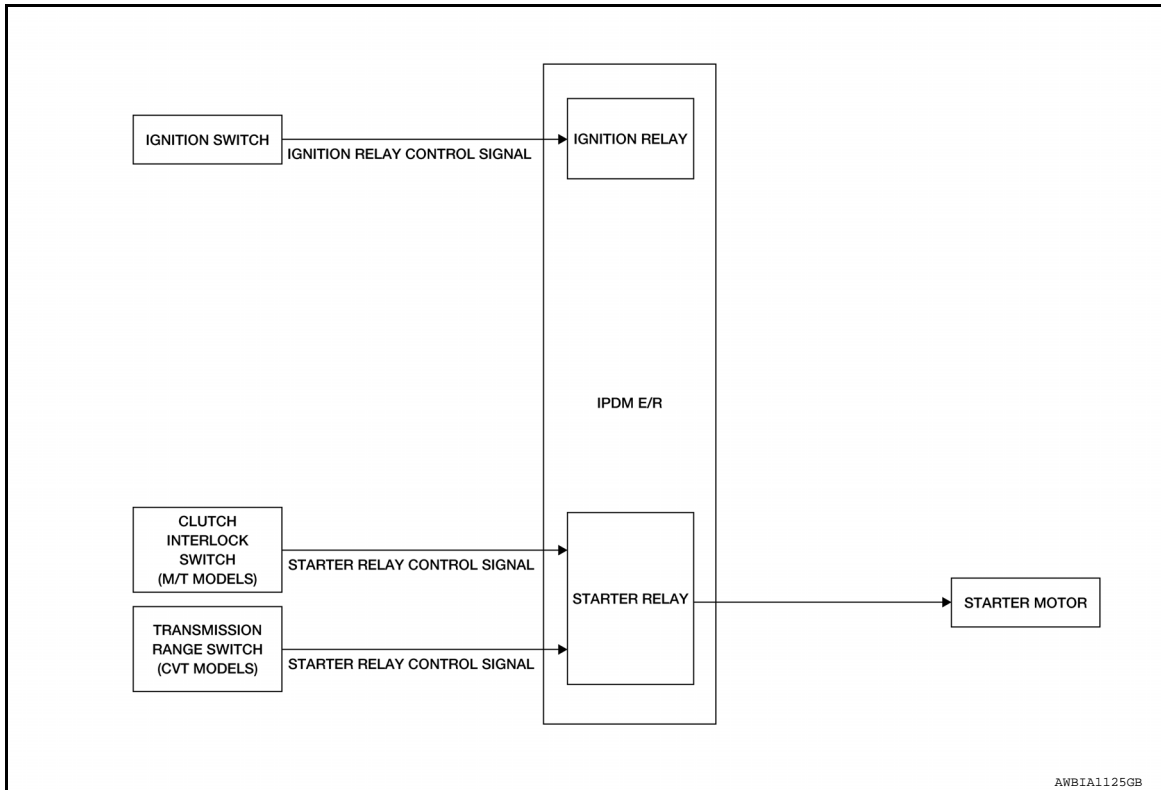

STARTING SYSTEM (WITH INTELLIGENT KEY) : System Description

INFOID:000000008777951

The starter motor plunger closes and provides a closed circuit between the battery and the starter motor. The starter motor is grounded to the cylinder block. With power and ground supplied, the starter motor operates.

STARTING SYSTEM (WITHOUT INTELLIGENT KEY)

SYSTEM

< SYSTEM DESCRIPTION >

STARTING SYSTEM (WITHOUT INTELLIGENT KEY) : System Diagram

INFOID:000000008992379

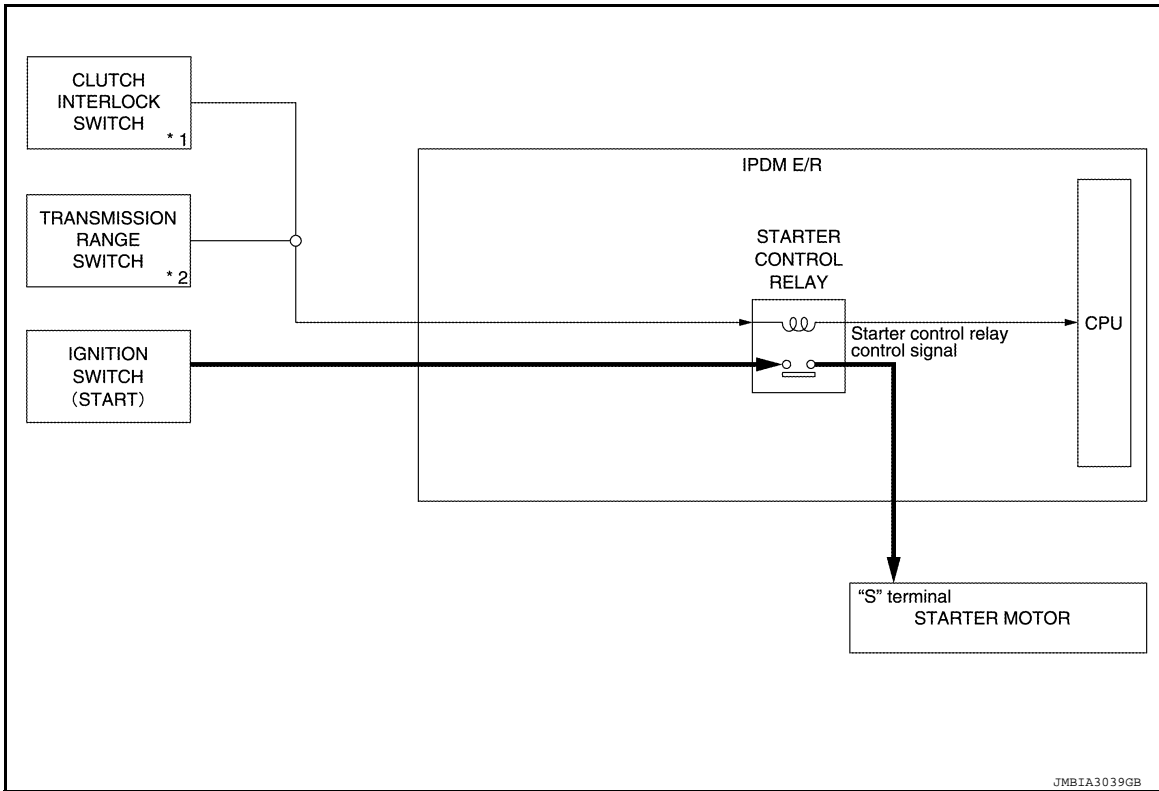

*1: M/T models

*2: CVT models

STARTING SYSTEM (WITHOUT INTELLIGENT KEY) : System Description

INFOID:000000008992380

CVT MODELS

- When the selector lever is in the P or N position, power is supplied to starter control relay by the transmission range switch. The IPDM E/R (CPU) detects selector lever P/N condition by the inputted signal.
- When engine cranking condition is satisfied, then battery power is supplied to starter motor ("S" terminal) through starter control relay.

M/T MODELS

When the clutch pedal is depressed, battery power is supplied to starter motor ("S" terminal).

A
STR
C
D
E
F
G
H
I
J
K
L
M
N
O
P

STARTING SYSTEM (WITH INTELLIGENT KEY)

< WIRING DIAGRAM >

STARTING SYSTEM CONNECTORS - WITH INTELLIGENT KEY SYSTEM

Connector No.	M2
Connector Name	WIRE TO WIRE
Connector Color	WHITE

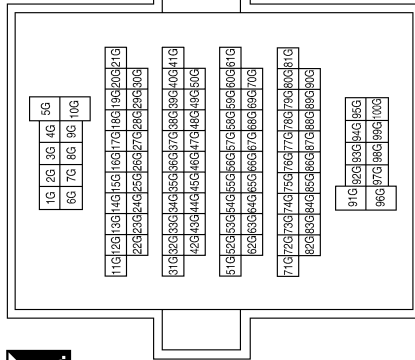

Terminal No.	Color of Wire	Signal Name
6G	O	-
40G	G	-
47G	SB	-
48G	G	-
73G	L	-

Connector No.	M83
Connector Name	BCM (BODY CONTROL MODULE) (WITH INTELLIGENT KEY SYSTEM)
Connector Color	WHITE

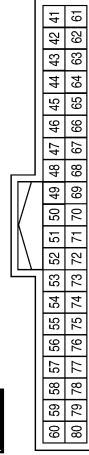

Terminal No.	Color of Wire	Signal Name
69	L	SHIFT N.P
70	O	INHIBIT RLY OUT
74	SB	STARTER RELAY OUTPUT

Connector No.	M85
Connector Name	BCM (BODY CONTROL MODULE) (WITH INTELLIGENT KEY SYSTEM)
Connector Color	WHITE

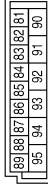

Terminal No.	Color of Wire	Signal Name
81	G	STARTER OUTPUT ENABLE INPUT (CVT)

Connector No.	E3
Connector Name	JOINT CONNECTOR-E01
Connector Color	BLUE



Terminal No.	Color of Wire	Signal Name
1	BR	-
2	BR	-
3	BR	-
4	BR	-
6	BR	-

AABIA0989GB

STARTING SYSTEM (WITH INTELLIGENT KEY)

< WIRING DIAGRAM >

Connector No.	E16
Connector Name	ECM
Connector Color	GRAY

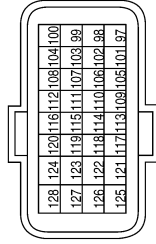

Terminal No.	Color of Wire	Signal Name
101	SB	INHIBIT CUT OFF
117	BR	NEUT-H

Terminal No.	Color of Wire	Signal Name
6G	BR	-
40G	SB	-
47G	V	-
48G	LG	-
73G	BR	-

Connector No.	E4
Connector Name	WIRE TO WIRE
Connector Color	WHITE

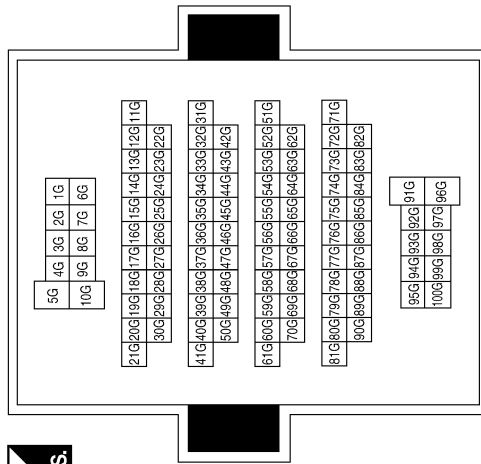

Connector No.	E43
Connector Name	IPDM E/R (INTELLIGENT POWER DISTRIBUTION MODULE ENGINE ROOM)
Connector Color	WHITE

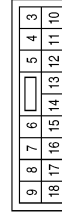

Terminal No.	Color of Wire	Signal Name
4	BR	NP SW
11	GR	ETC
14	LG	REVERSE LAMP
16	SB	ETC RLY CONT

Connector No.	E39
Connector Name	IPDM E/R (INTELLIGENT POWER DISTRIBUTION MODULE ENGINE ROOM)
Connector Color	BLACK

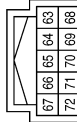

Terminal No.	Color of Wire	Signal Name
69	BR	IGN SW (IG2)

Connector No.	E34
Connector Name	CLUTCH INTERLOCK SWITCH
Connector Color	BROWN



Terminal No.	Color of Wire	Signal Name
1	LG	-
2	BR	-

AABIA0990GB

STARTING SYSTEM (WITH INTELLIGENT KEY)

< WIRING DIAGRAM >

Connector No.	E47
Connector Name	IPDM E/R (INTELLIGENT POWER DISTRIBUTION MODULE ENGINE ROOM)
Connector Color	BROWN

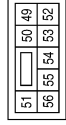

Terminal No.	Color of Wire	Signal Name
52	B/Y	GND SIGNAL

Connector No.	E46
Connector Name	IPDM E/R (INTELLIGENT POWER DISTRIBUTION MODULE ENGINE ROOM)
Connector Color	WHITE

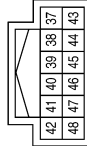

Terminal No.	Color of Wire	Signal Name
37	SB	INHIBIT CUT
44	V	START CONT

Connector No.	E44
Connector Name	IPDM E/R (INTELLIGENT POWER DISTRIBUTION MODULE ENGINE ROOM)
Connector Color	WHITE



Terminal No.	Color of Wire	Signal Name
19	R	STARTER MOTOR
20	P	F/L IGN SWITCH

Connector No.	E64
Connector Name	WIRE TO WIRE
Connector Color	BLACK

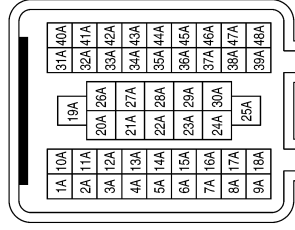

Terminal No.	Color of Wire	Signal Name
25A	R	-
27A	GR	-
45A	BR	-
47A	SB	-
48A	LG	-

Connector No.	E62
Connector Name	JOINT CONNECTOR-E04
Connector Color	BLACK

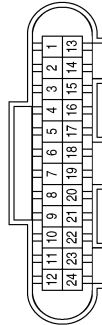

Terminal No.	Color of Wire	Signal Name
1	SB	-
2	SB	-
3	SB	-

Connector No.	E48
Connector Name	IPDM E/R (INTELLIGENT POWER DISTRIBUTION MODULE ENGINE ROOM)
Connector Color	BLACK



Terminal No.	Color of Wire	Signal Name
57	B/Y	GND POWER

AABIA0991GB

A
STR
C
D
E
F
G
H
I
J
K
L
M
N
O
P

STARTING SYSTEM (WITH INTELLIGENT KEY)

< WIRING DIAGRAM >

Connector No.	F27
Connector Name	STARTER MOTOR
Connector Color	-



Terminal No.	Color of Wire	Signal Name
B	B/R	-

Connector No.	F26
Connector Name	TRANSMISSION RANGE SWITCH
Connector Color	BLACK

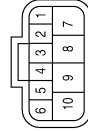

Terminal No.	Color of Wire	Signal Name
7	GR	-
10	BR	-

Connector No.	F24
Connector Name	ECM
Connector Color	BLACK

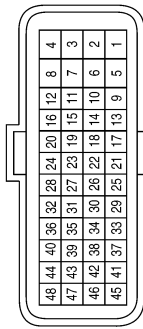

Terminal No.	Color of Wire	Signal Name
2	G	VMOT
21	Y	MOTRLY

Connector No.	F50
Connector Name	WIRE TO WIRE
Connector Color	BLACK

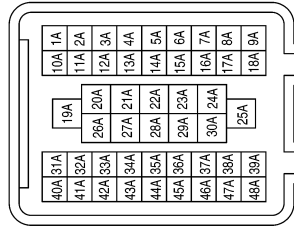

Terminal No.	Color of Wire	Signal Name
25A	R	-
27A	G	-
45A	BR	-
47A	Y	-
48A	GR	-

Connector No.	F44
Connector Name	FUSIBLE LINK BOX (BATTERY)
Connector Color	-



Terminal No.	Color of Wire	Signal Name
7	BR	-

Connector No.	F28
Connector Name	STARTER MOTOR
Connector Color	-



Terminal No.	Color of Wire	Signal Name
ST	R	-

AABIA0992GB

STARTING SYSTEM (WITHOUT INTELLIGENT KEY)

< WIRING DIAGRAM >

STARTING SYSTEM CONNECTORS - WITHOUT INTELLIGENT KEY SYSTEM

Connector No.	M2
Connector Name	WIRE TO WIRE
Connector Color	WHITE

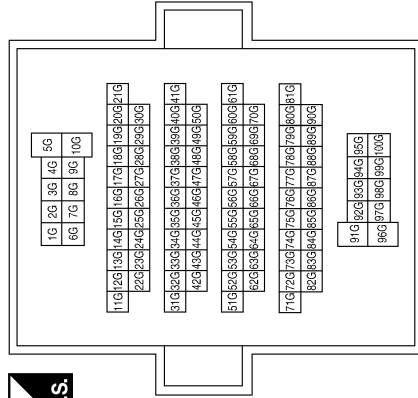

Terminal No.	Color of Wire	Signal Name
5G	G	-
96G	L	-

Connector No.	M26
Connector Name	IGNITION SWITCH
Connector Color	WHITE



Terminal No.	Color of Wire	Signal Name
B	G	-
IG2	P	-
ST	L	-

Connector No.	E3
Connector Name	JOINT CONNECTOR-E01
Connector Color	BLUE

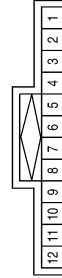

Terminal No.	Color of Wire	Signal Name
2	BR	-
3	BR	-
6	BR	-

AABIA0985GB

STARTING SYSTEM (WITHOUT INTELLIGENT KEY)

< WIRING DIAGRAM >

Connector No.	E16
Connector Name	ECM
Connector Color	GRAY

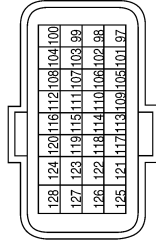

Terminal No.	Color of Wire	Signal Name
105	V	ST RLY CONT
117	BR	NEUT-H

Terminal No.	Color of Wire	Signal Name
5G	P	-
96G	GR	-

Connector No.	E4
Connector Name	WIRE TO WIRE
Connector Color	WHITE

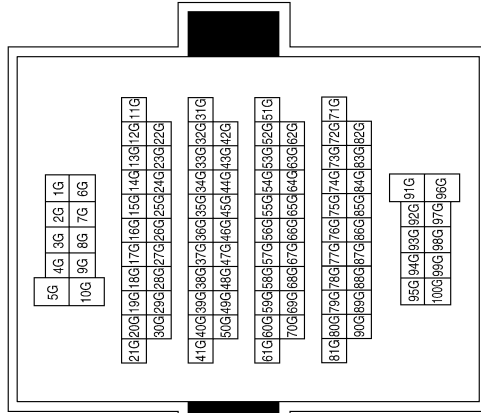

Connector No.	E43
Connector Name	IPDM E/R (INTELLIGENT POWER DISTRIBUTION MODULE ENGINE ROOM)
Connector Color	WHITE

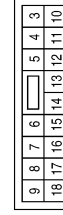

Terminal No.	Color of Wire	Signal Name
4	BR	NP SW
14	LG	REVERSE LAMP POWER
16	SB	ETC CONT

Connector No.	E39
Connector Name	IPDM E/R (INTELLIGENT POWER DISTRIBUTION MODULE ENGINE ROOM)
Connector Color	BLACK

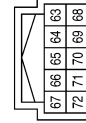

Terminal No.	Color of Wire	Signal Name
69	BR	IGN SW (IG2)

Connector No.	E34
Connector Name	CLUTCH INTERLOCK SWITCH
Connector Color	BROWN



Terminal No.	Color of Wire	Signal Name
1	LG	-
2	BR	-

AABIA0986GB

STARTING SYSTEM (WITHOUT INTELLIGENT KEY)

< WIRING DIAGRAM >

Connector No.	E47
Connector Name	IPDM E/R (INTELLIGENT POWER DISTRIBUTION MODULE ENGINE ROOM)
Connector Color	BROWN



51	50	49
56	55	54
53	52	

Terminal No.	Color of Wire	Signal Name
52	B/Y	GND (SIGNAL)

Connector No.	E46
Connector Name	IPDM E/R (INTELLIGENT POWER DISTRIBUTION MODULE ENGINE ROOM)
Connector Color	WHITE



42	41	40	39	38	37
48	47	46	45	44	43

Terminal No.	Color of Wire	Signal Name
40	P	CAN-L
41	L	CAN-H
44	V	START CONT

Connector No.	E44
Connector Name	IPDM E/R (INTELLIGENT POWER DISTRIBUTION MODULE ENGINE ROOM)
Connector Color	WHITE



21	20	19
24	23	22

Terminal No.	Color of Wire	Signal Name
19	R	STARTER MOTOR
20	P	F/L IGN SW
22	GR	IGN SW (ST)

Connector No.	F24
Connector Name	ECM
Connector Color	BLACK



48	44	40	38	32	28	24	20	16	12	8	4
47	43	39	35	31	27	23	19	15	11	7	3
46	42	38	34	30	26	22	18	14	10	6	2
45	41	37	33	29	25	21	17	13	9	5	1

Connector No.	E64
Connector Name	WIRE TO WIRE
Connector Color	BLACK



1A	10A	19A	31A	40A
2A	11A	20A	32A	41A
3A	12A	21A	33A	42A
4A	13A	22A	34A	43A
5A	14A	23A	35A	44A
6A	15A	24A	36A	45A
7A	16A	25A	37A	46A
8A	17A	26A	38A	47A
9A	18A	27A	39A	48A

Terminal No.	Color of Wire	Signal Name
21	Y	MOTRLY

Terminal No.	Color of Wire	Signal Name
25A	R	-
45A	BR	-
48A	LG	-

Terminal No.	Color of Wire	Signal Name
57	B/Y	GND (POWER)



59	58	57
62	61	60

AABIA0987GB

STARTING SYSTEM (WITHOUT INTELLIGENT KEY)

< WIRING DIAGRAM >

Connector No.	F28
Connector Name	STARTER MOTOR
Connector Color	-



Terminal No.	Color of Wire	Signal Name
ST	R	-

Connector No.	F27
Connector Name	STARTER MOTOR
Connector Color	-



Terminal No.	Color of Wire	Signal Name
B	B/R	-

Connector No.	F26
Connector Name	TRANSMISSION RANGE SWITCH
Connector Color	BLACK

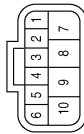

Terminal No.	Color of Wire	Signal Name
7	GR	-
10	BR	-

Terminal No.	Color of Wire	Signal Name
25A	R	-
45A	BR	-
48A	GR	-

Connector No.	F50
Connector Name	WIRE TO WIRE
Connector Color	BLACK

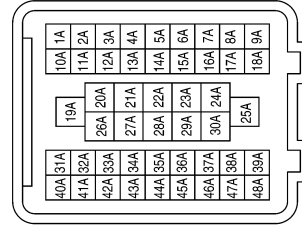

Connector No.	F44
Connector Name	FUSIBLE LINK BOX (BATTERY)
Connector Color	-



Terminal No.	Color of Wire	Signal Name
7	B/R	-

AABIA0988GB

A

STR

C

D

E

F

G

H

I

J

K

L

M

N

O

P

DIAGNOSIS AND REPAIR WORKFLOW

< BASIC INSPECTION >

BASIC INSPECTION

DIAGNOSIS AND REPAIR WORKFLOW

Work Flow (With GR8-1200 NI)

INFOID:000000008770535

STARTING SYSTEM DIAGNOSIS WITH GR8-1200 NI

To test the starting system, use the following special service tool:

- GR8-1200 NI Multitasking battery and electrical diagnostic station

NOTE:

Refer to the diagnostic station Instruction Manual for proper starting system diagnosis procedures.

DIAGNOSIS AND REPAIR WORKFLOW

< BASIC INSPECTION >

OVERALL SEQUENCE

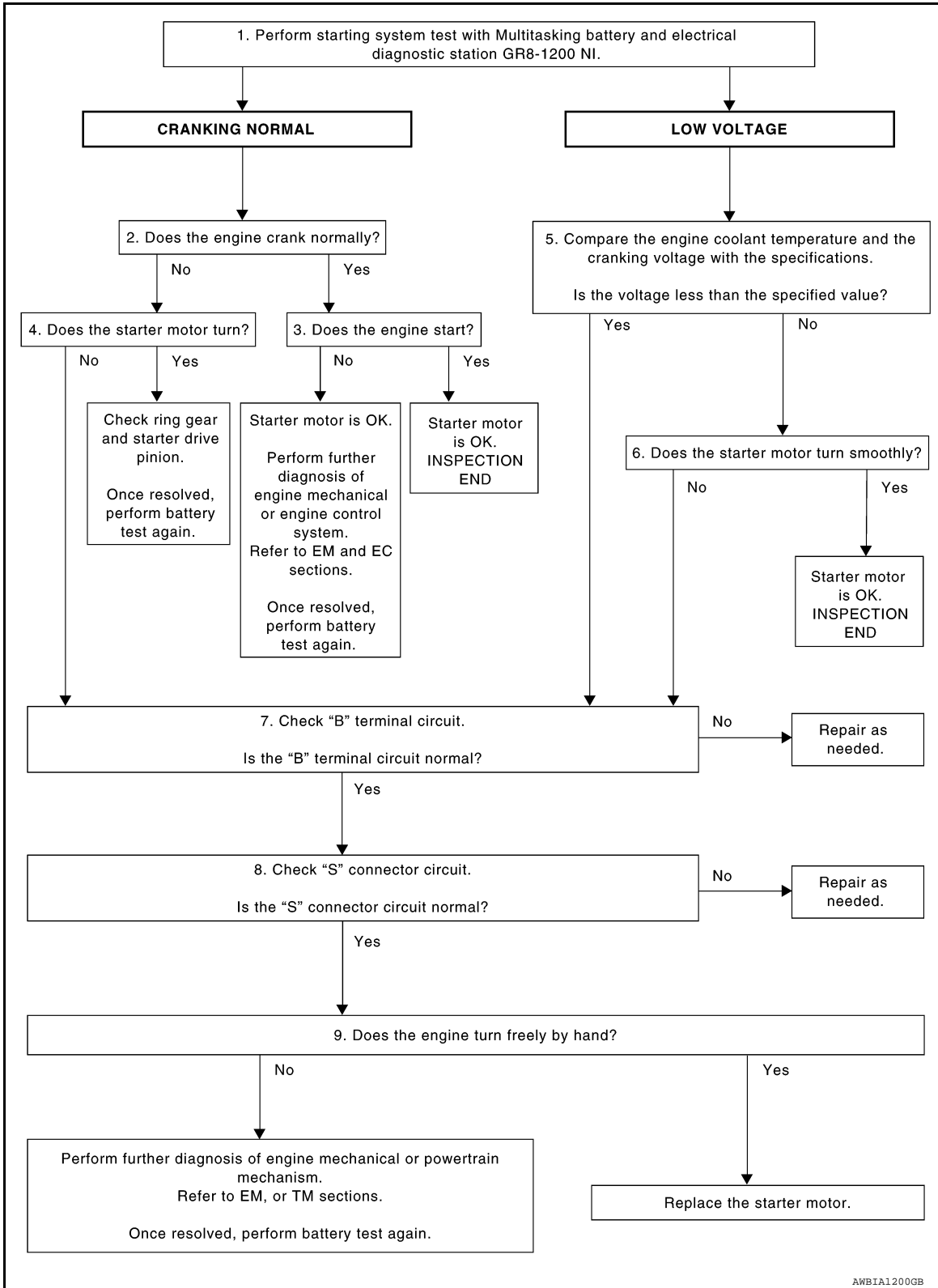

DETAILED FLOW

NOTE:

To ensure a complete and thorough diagnosis, the battery, starter motor and generator test segments must be done as a set from start to finish.

1. DIAGNOSIS WITH MULTITASKING BATTERY AND ELECTRICAL DIAGNOSTIC STATION GR8-1200 NI

DIAGNOSIS AND REPAIR WORKFLOW

< BASIC INSPECTION >

Perform the starting system test with Multitasking battery and electrical diagnostic station GR8-1200 NI. For details and operating instructions, refer to diagnostic station Instruction Manual.

Test result

CRANKING NORMAL>>GO TO 2.

LOW VOLTAGE>>GO TO 5.

CHARGE BATTERY>>Perform the slow battery charging procedure. (Initial rate of charge is 10A for 12 hours.) Perform battery test again. Refer to diagnostic station instruction manual.

REPLACE BATTERY>>Before replacing battery, clean the battery cable clamps and battery posts. Perform battery test again. Refer to diagnostic station instruction manual. If second test result is "REPLACE BATTERY", then do so. Perform battery test again to confirm repair.

2. CRANKING CHECK

Check that the starter motor operates properly.

Does the engine crank normally?

YES >> GO TO 3.

NO >> GO TO 4.

3. ENGINE START CHECK

Check that the engine starts.

Does the engine start?

YES >> Inspection End.

NO >> Perform further diagnosis of engine mechanical or engine control system. Refer to EM and EC sections. Once resolved, perform battery test again.

4. STARTER MOTOR ACTIVATION

Check that the starter motor operates.

Does the starter motor turn?

YES >> Check ring gear and starter motor drive pinion. Once resolved, perform battery test again.

NO >> GO TO 7.

5. COMPARISON BETWEEN ENGINE COOLANT AND CRANKING VOLTAGE

Compare the engine coolant temperature and verify the cranking voltage is within specifications.

Minimum Specification of Cranking Voltage Referencing Coolant Temperature

Engine coolant temperature [°C (°F)]	Voltage [V]
-30 to -20 (-22 to -4)	8.6
-19 to -10 (-2 to 14)	9.1
-9 to 0 (16 to 32)	9.5
More than 1 (More than 34)	9.9

Is the voltage less than the specified value?

YES >> GO TO 7.

NO >> GO TO 6.

6. STARTER OPERATION

Check the starter operation.

Does the starter motor turn smoothly?

YES >> Inspection End.

NO >> GO TO 7.

7. "B" TERMINAL CIRCUIT INSPECTION

Check "B" terminal circuit. Refer to [STR-26, "Diagnosis Procedure"](#).

Is "B" terminal circuit normal?

YES >> GO TO 8.

NO >> Repair as needed.

8. "S" CONNECTOR CIRCUIT INSPECTION

Check "S" connector circuit. Refer to [STR-28, "Diagnosis Procedure"](#).

DIAGNOSIS AND REPAIR WORKFLOW

< BASIC INSPECTION >

Is "S" connector circuit normal?

- YES >> GO TO 9.
- NO >> Repair as needed.

A

9. ENGINE ROTATION STATUS

Check that the engine can be rotated by hand.

Does the engine turn freely by hand?

- YES >> Replace starter motor.
- NO >> Perform further diagnosis of engine mechanical or powertrain mechanism. Once resolved, perform battery test again using Multitasking battery and electrical diagnostic station GR8-1200 NI. Refer to the diagnostic station Instruction Manual for proper testing procedures.

STR

C

D

INFOID:000000008770536

Work Flow (Without GR8-1200 NI)

OVERALL SEQUENCE

E

F

G

H

I

J

K

L

M

N

O

P

DIAGNOSIS AND REPAIR WORKFLOW

< BASIC INSPECTION >

If any malfunction is found, immediately disconnect the battery cable from the negative terminal.

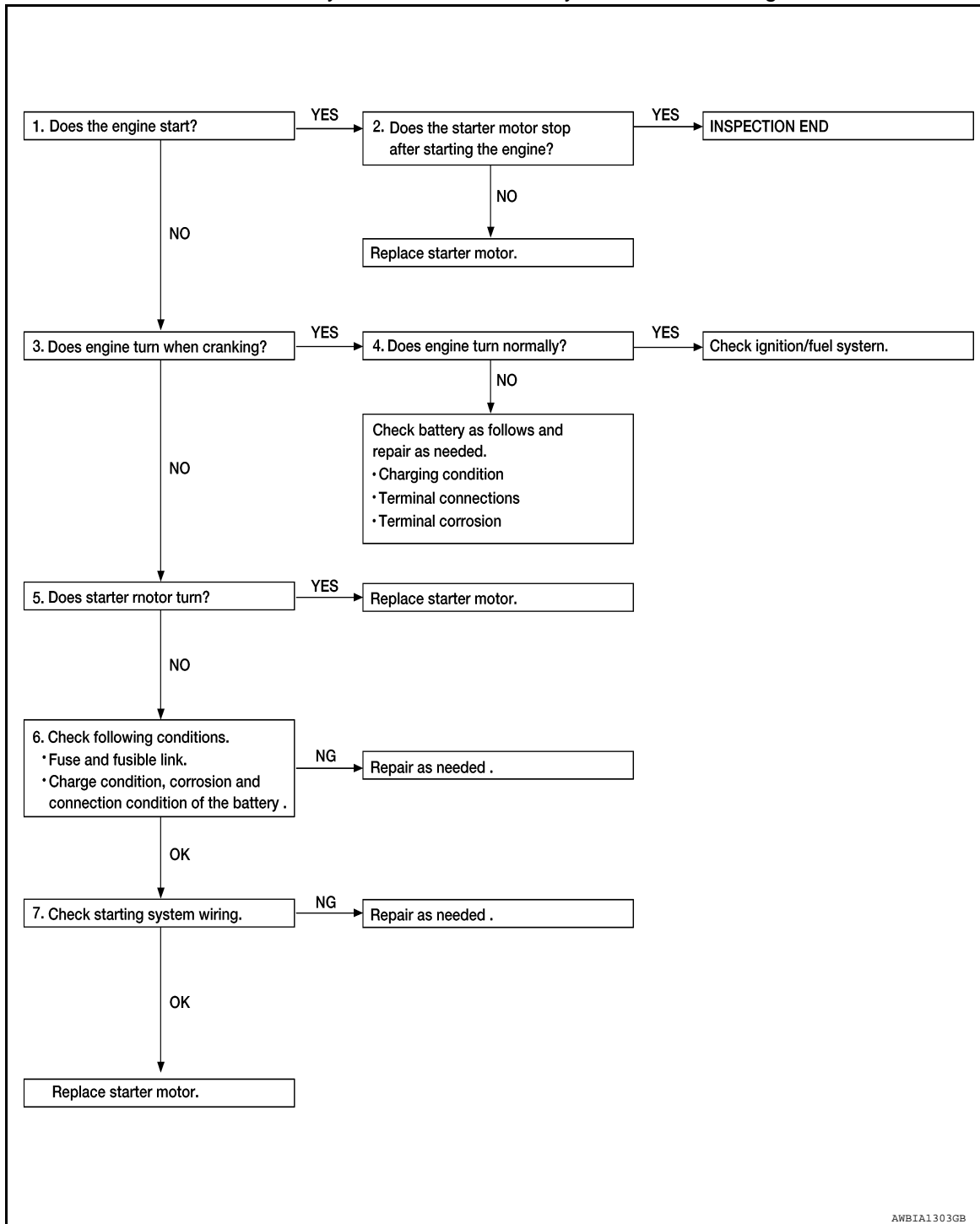

DETAILED FLOW

NOTE:

If any malfunction is found, immediately disconnect the battery cable from the negative terminal.

1. CHECK ENGINE START

Crank the engine and check that the engine starts.

Does the engine start?

YES >> GO TO 2.

NO >> GO TO 3.

2. CHECK THAT THE STARTER MOTOR STOPS

Check that the starter motor stops after starting the engine.

DIAGNOSIS AND REPAIR WORKFLOW

< BASIC INSPECTION >

Does the starter motor stop?

- YES >> Inspection End.
NO >> Replace starter motor. Refer to [STR-30. "Removal and Installation"](#).

A

3.CHECK THAT THE ENGINE TURNS WHEN CRANKING

Check that the engine turns when cranking.

Does engine turn when cranking?

- YES >> GO TO 4.
NO >> GO TO 5.

C

4.CHECK THE ENGINE SPEED WHEN CRANKING

Check that the engine speed is not low when cranking.

Does engine turn normally?

- YES >> Check ignition/fuel system.
NO >> Check charge condition, corrosion and connection condition of the battery.

D

E

5.CHECK STARTER MOTOR ACTIVATION

Check that the starter motor runs at cranking.

Does starter motor turn?

- YES >> Replace starter motor. Refer to [STR-30. "Removal and Installation"](#).
NO >> GO TO 6.

F

G

6.CHECK POWER SUPPLY CIRCUIT

Check the following conditions:

- Fuse and fusible link
- Charge condition, corrosion and connection of the battery.

Are these inspection results normal?

- YES >> GO TO 7.
NO >> Repair as needed.

H

I

7.CHECK STARTING SYSTEM WIRING

Check the following:

- "B" terminal circuit. Refer to [STR-26. "Diagnosis Procedure"](#).
- "S" terminal circuit. Refer to [STR-28. "Diagnosis Procedure"](#).

Are the inspection results normal?

- YES >> Replace starter motor. Refer to [STR-30. "Removal and Installation"](#).
NO >> Repair as needed.

J

K

L

M

N

O

P

STR

B TERMINAL CIRCUIT

< DTC/CIRCUIT DIAGNOSIS >

DTC/CIRCUIT DIAGNOSIS

B TERMINAL CIRCUIT

Description

INFOID:000000008770537

Terminal "B" is constantly supplied with battery power.

Diagnosis Procedure

INFOID:000000008770538

Regarding Wiring Diagram information, refer to [STR-10. "Wiring Diagram"](#) (with Intelligent Key system) or [STR-15. "Wiring Diagram"](#) (without Intelligent Key system).

CAUTION:

Perform diagnosis under the condition that the engine cannot start by the following procedure.

1. Remove fuel pump fuse.
2. Crank or start the engine (where possible) until the fuel pressure is released.

1. CHECK "B" TERMINAL CIRCUIT

1. Turn ignition switch OFF.
2. Check that starter motor B" terminal connection is clean and tight.
3. Check voltage between starter motor connector F27 and ground.

Terminals		Voltage (Approx.)
(+)	(-)	
Starter motor "B" terminal	Terminal	Battery voltage
F27	B	
	Ground	

Is the inspection result normal?

YES >> GO TO 2.

NO >> Check harness between battery and starter motor for open circuit.

2. CHECK BATTERY CABLE CONNECTION STATUS (VOLTAGE DROP TEST)

1. Shift selector lever to P (Park) or N (Neutral) position.
2. Check voltage between battery positive terminal and starter motor B terminal.

Terminals		Condition	Voltage (Approx.)
(+)	(-)		
	Starter motor "B" terminal	When the ignition switch is in START position	Less than 0.5V
Battery positive terminal	F27		
	Terminal		
	B		

Is the inspection result normal?

YES >> GO TO 3.

NO >> Check harness between the battery and starter motor for continuity.

3. CHECK GROUND CIRCUIT STATUS (VOLTAGE DROP TEST)

1. Shift selector lever to P (Park) or N (Neutral) position.
2. Check voltage between starter motor case and battery negative terminal.

Terminals		Condition	Voltage (Approx.)
(+)	(-)		
Starter motor case	Battery negative terminal	When the ignition switch is in START position	Less than 0.2V

Is the inspection result normal?

B TERMINAL CIRCUIT

< DTC/CIRCUIT DIAGNOSIS >

- YES >> "B" terminal circuit is OK. Further inspection is necessary. Refer to [STR-20, "Work Flow \(With GR8-1200 NI\)"](#) or [STR-23, "Work Flow \(Without GR8-1200 NI\)"](#).
- NO >> Check the starter motor case to engine mounting for high resistance.

A

STR

C

D

E

F

G

H

I

J

K

L

M

N

O

P

S CONNECTOR CIRCUIT

< DTC/CIRCUIT DIAGNOSIS >

S CONNECTOR CIRCUIT

Description

INFOID:000000008770539

The starter motor magnetic switch is supplied with power when the ignition switch is turned to the START position while the selector lever is in the P (Park) or N (Neutral) position.

Diagnosis Procedure

INFOID:000000008770540

Regarding Wiring Diagram information, refer to [STR-10, "Wiring Diagram"](#) (with Intellignet Key system) or [STR-15, "Wiring Diagram"](#) (without Intelligent Key system).

CAUTION:

Perform diagnosis under the condition that engine cannot start by the following procedure.

1. Remove fuel pump fuse.
2. Crank or start the engine (where possible) until the fuel pressure is released.

1. CHECK "S" CONNECTOR CIRCUIT

1. Turn ignition switch OFF.
2. Disconnect starter motor connector.
3. Shift selector lever to "P" (Park) or "N" (Neutral) position.
4. Check voltage between starter motor harness connector F28 and ground.

(+)		(-)	Condition	Voltage (Approx.)
Connector	Terminal			
F28	S	Ground	When the ignition switch is in START position	Battery voltage

Is the inspection result normal?

YES >> "S" circuit is OK. Further inspection is necessary. Refer to [STR-20, "Work Flow \(With GR8-1200 NI\)"](#) or [STR-23, "Work Flow \(Without GR8-1200 NI\)"](#).

NO >> GO TO 2.

2. CHECK HARNESS CONTINUITY (OPEN CIRCUIT)

1. Disconnect IPDM E/R connector.
2. Check continuity between starter motor harness connector F28 and the IPDM E/R harness connector E44.

Starter motor harness connector		IPDM E/R harness connector		Continuity
Connector	Terminal	Connector	Terminal	
F28	S	E44	19	Yes

Is the inspection result normal?

YES >> Further inspection is necessary. Refer to [STR-20, "Work Flow \(With GR8-1200 NI\)"](#) or [STR-23, "Work Flow \(Without GR8-1200 NI\)"](#).

NO >> Repair or replace the harness or connectors.

STARTING SYSTEM

< SYMPTOM DIAGNOSIS >

SYMPTOM DIAGNOSIS

STARTING SYSTEM

Symptom Table

INFOID:000000008770541

A

STR

Symptom	Reference
No normal cranking	Refer to STR-20, "Work Flow (With GR8-1200 NI)" or STR-23, "Work Flow (Without GR8-1200 NI)" .
Starter motor does not rotate	

C

D

E

F

G

H

I

J

K

L

M

N

O

P

STARTER MOTOR

< REMOVAL AND INSTALLATION >

REMOVAL AND INSTALLATION

STARTER MOTOR

Exploded View

INFOID:000000008768573

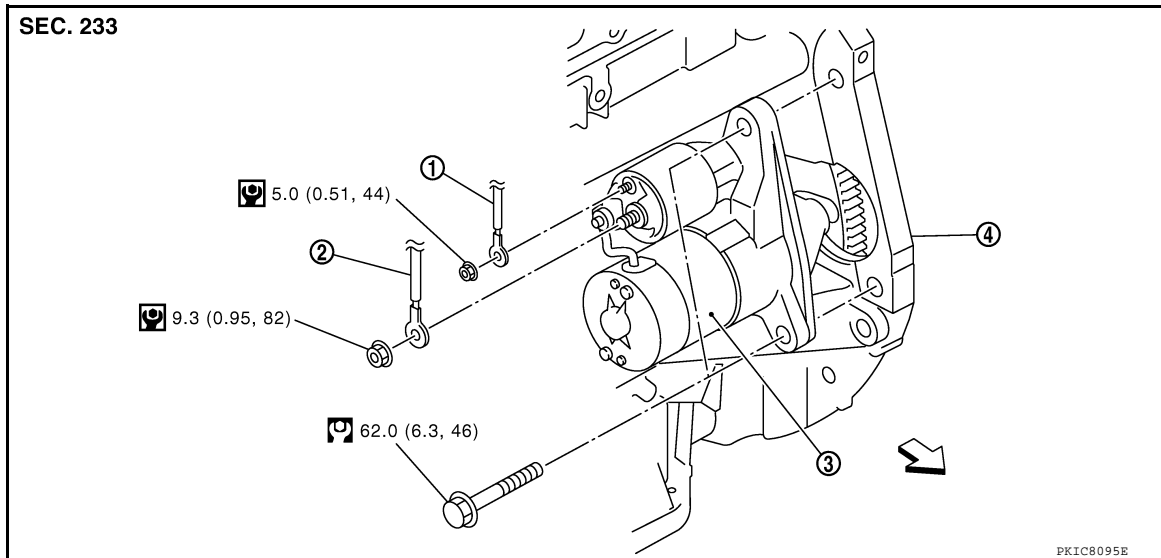

1. "S" terminal harness 2. "B" terminal harness 3. Starter motor
4. Cylinder block ← Front

Removal and Installation

INFOID:000000008768574

NOTE:

When removing components such as hoses, tubes/lines, etc., cap or plug openings to prevent fluid from spilling.

REMOVAL

1. Disconnect the battery negative terminal. Refer to [PG-50, "Removal and Installation \(Battery\)"](#).
2. Remove fan shroud and motor assembly. Refer to [CO-17, "Component"](#).
3. Remove reservoir hose upper from radiator to water outlet. Refer to [CO-15, "Exploded View"](#).
4. Remove "B" terminal nut and "B" terminal harness.
5. Remove "S" terminal nut and "S" terminal harness.
6. Disconnect harness connector from oil temperature sensor. Refer to [EM-94, "Exploded View"](#).
7. Disconnect harness connector (1) from crankshaft position sensor.
8. Remove harness clip (A) from oil pan (upper), and then remove harness (2) and set aside.

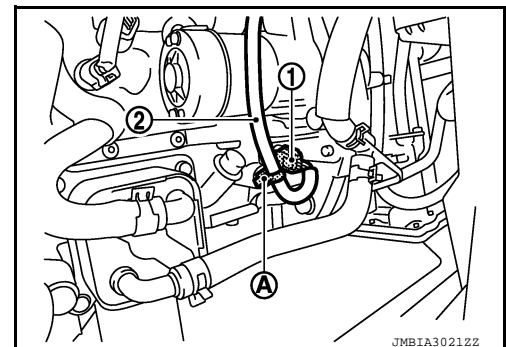

9. Remove upper starter motor bolt.
10. Remove lower starter motor bolt and remove starter motor.

INSTALLATION

- Installation is in the reverse order of removal.

STARTER MOTOR

< REMOVAL AND INSTALLATION >

- Refill engine coolant. Refer to [CO-12. "Changing Engine Coolant"](#).

CAUTION:

- Be careful to tighten "B" terminal nut to the specified torque.

A

STR

C

D

E

F

G

H

I

J

K

L

M

N

O

P

SERVICE DATA AND SPECIFICATIONS (SDS)

< SERVICE DATA AND SPECIFICATIONS (SDS)

SERVICE DATA AND SPECIFICATIONS (SDS)

SERVICE DATA AND SPECIFICATIONS (SDS)

Starter Motor

INFOID:000000008768576

Type		S114-995B
		HITACHI
		Reduction gear type
System voltage [V]		12
No-load	Terminal voltage [V]	11
	Current [A]	Less than 110
	Revolution [rpm]	More than 3,000