

SECTION **STC**

STEERING CONTROL SYSTEM

A
B
C
D
E
F
G
H
I
J
K
L
M
N
O
P

CONTENTS

PRECAUTION	3	Wiring Diagram	14
PRECAUTIONS	3	BASIC INSPECTION	18
Precaution for Supplemental Restraint System (SRS) "AIR BAG" and "SEAT BELT PRE-TENSIONER"	3	DIAGNOSIS AND REPAIR WORKFLOW	18
Service Notice and Precautions for EPS System.....	3	Work Flow	18
SYSTEM DESCRIPTION	5	Diagnostic Work Sheet	19
COMPONENT PARTS	5	DTC/CIRCUIT DIAGNOSIS	21
Component Parts Location	5	C1601 BATTERY POWER SUPPLY	21
Component Description	5	DTC Logic	21
EPS Control Unit	6	Diagnosis Procedure	21
EPS Motor	6	C1604 TORQUE SENSOR	24
Torque Sensor	6	DTC Logic	24
Reduction Gear	6	Diagnosis Procedure	24
SYSTEM	7	C1606 EPS MOTOR	26
EPS SYSTEM	7	DTC Logic	26
EPS SYSTEM : System Description	7	Diagnosis Procedure	26
EPS SYSTEM : Fail-Safe	8	Component Inspection	26
EPS SYSTEM : Protection Function	8	C1607, C1608 EPS CONTROL UNIT	28
DIAGNOSIS SYSTEM (EPS CONTROL UNIT)	9	DTC Logic	28
CONSULT Function	9	Diagnosis Procedure	28
ECU DIAGNOSIS INFORMATION	11	C1609 VEHICLE SPEED SIGNAL	29
EPS CONTROL UNIT	11	Description	29
Reference Value	11	DTC Logic	29
Fail-Safe	12	Diagnosis Procedure	29
Protection Function	13	C1610 ENGINE STATUS SIGNAL	30
DTC Inspection Priority Chart	13	Description	30
DTC Index	13	DTC Logic	30
WIRING DIAGRAM	14	Diagnosis Procedure	30
ELECTRONICALLY CONTROLLED POWER STEERING SYSTEM	14	U1000 CAN COMM CIRCUIT	31
		Description	31
		DTC Logic	31
		Diagnosis Procedure	31
		EPS WARNING LAMP	32

STC

Component Function Check	32	UNBALANCE STEERING WHEEL TURNING FORCE AND RETURN BETWEEN RIGHT AND LEFT	37
Diagnosis Procedure	32	Description	37
SYMPTOM DIAGNOSIS	33	Diagnosis Procedure	37
EPS WARNING LAMP DOES NOT TURN ON..	33	UNBALANCE STEERING WHEEL TURNING FORCE (TORQUE VARIATION)	38
Description	33	Description	38
Diagnosis Procedure	33	Diagnosis Procedure	38
EPS WARNING LAMP DOES NOT TURN OFF	34	REMOVAL AND INSTALLATION	40
Description	34	EPS CONTROL UNIT	40
Diagnosis Procedure	34	Exploded View	40
STEERING WHEEL TURNING FORCE IS HEAVY OR LIGHT	35	Removal and Installation	40
Description	35		
Diagnosis Procedure	35		

PRECAUTIONS

< PRECAUTION >

PRECAUTION

PRECAUTIONS

Precaution for Supplemental Restraint System (SRS) "AIR BAG" and "SEAT BELT PRE-TENSIONER"

INFOID:000000009267342

The Supplemental Restraint System such as "AIR BAG" and "SEAT BELT PRE-TENSIONER", used along with a front seat belt, helps to reduce the risk or severity of injury to the driver and front passenger for certain types of collision. This system includes seat belt switch inputs and dual stage front air bag modules. The SRS system uses the seat belt switches to determine the front air bag deployment, and may only deploy one front air bag, depending on the severity of a collision and whether the front occupants are belted or unbelted. Information necessary to service the system safely is included in the SR and SB section of this Service Manual.

WARNING:

- To avoid rendering the SRS inoperative, which could increase the risk of personal injury or death in the event of a collision which would result in air bag inflation, all maintenance must be performed by an authorized NISSAN/INFINITI dealer.
- Improper maintenance, including incorrect removal and installation of the SRS, can lead to personal injury caused by unintentional activation of the system. For removal of Spiral Cable and Air Bag Module, see the SR section.
- Do not use electrical test equipment on any circuit related to the SRS unless instructed to in this Service Manual. SRS wiring harnesses can be identified by yellow and/or orange harnesses or harness connectors.

PRECAUTIONS WHEN USING POWER TOOLS (AIR OR ELECTRIC) AND HAMMERS

WARNING:

- When working near the Airbag Diagnosis Sensor Unit or other Airbag System sensors with the Ignition ON or engine running, DO NOT use air or electric power tools or strike near the sensor(s) with a hammer. Heavy vibration could activate the sensor(s) and deploy the air bag(s), possibly causing serious injury.
- When using air or electric power tools or hammers, always switch the Ignition OFF, disconnect the battery, and wait at least 3 minutes before performing any service.

Service Notice and Precautions for EPS System

INFOID:000000009267343

- Check the following item when performing the trouble diagnosis.
- Check any possible causes by interviewing the symptom and it's condition from the customer if any malfunction, such as EPS warning lamp is turned ON, occurs.
- Check if air pressure and size of tires are proper, the specified part is used for the steering wheel, and control unit is genuine part.
- Check if the connection of steering column assembly and steering gear assembly is proper (there is not looseness of bolts, damage of rods, boots or sealants, and leakage of grease, etc.).
- Check if the wheel alignment is adjusted properly.
- Check if there is any damage or modification to suspension or body resulting in increased weight or altered ground clearance.
- Check if installation conditions of each link and suspension are proper.
- Check if the battery voltage is proper.
- Check connection conditions of each connector are proper.
- Before connecting or disconnecting the EPS control unit harness connector, turn ignition switch "OFF" and disconnect battery ground cable. Because battery voltage is applied to EPS control unit even if ignition switch is turned "OFF".

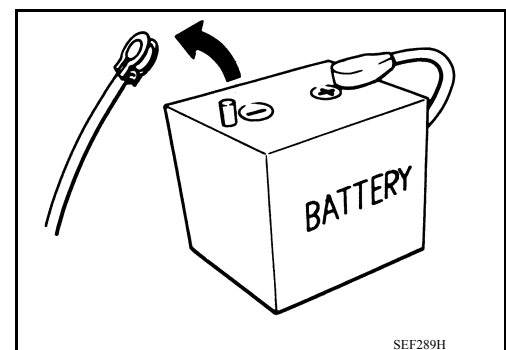

PRECAUTIONS

< PRECAUTION >

- When connecting or disconnecting pin connectors into or from EPS control unit, take care not to damage pin terminals (bend or break).
- When connecting pin connectors, make sure that there are no bends or breaks on EPS control unit pin terminal.
- During quick steering, rasping noise may be heard from around the steering wheel. This is not a malfunction. The noise is an operating noise of the EPS system under normal conditions. If the rasping noise occurs during slow steering, this may not be an operating noise of the system. In this case, it is necessary to find out the location of the noise and repair, if necessary.

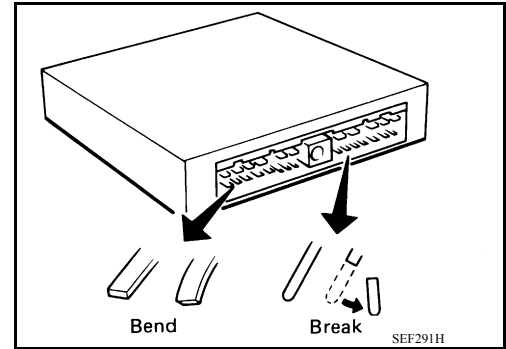

COMPONENT PARTS

< SYSTEM DESCRIPTION >

SYSTEM DESCRIPTION

COMPONENT PARTS

Component Parts Location

INFOID:000000009267344

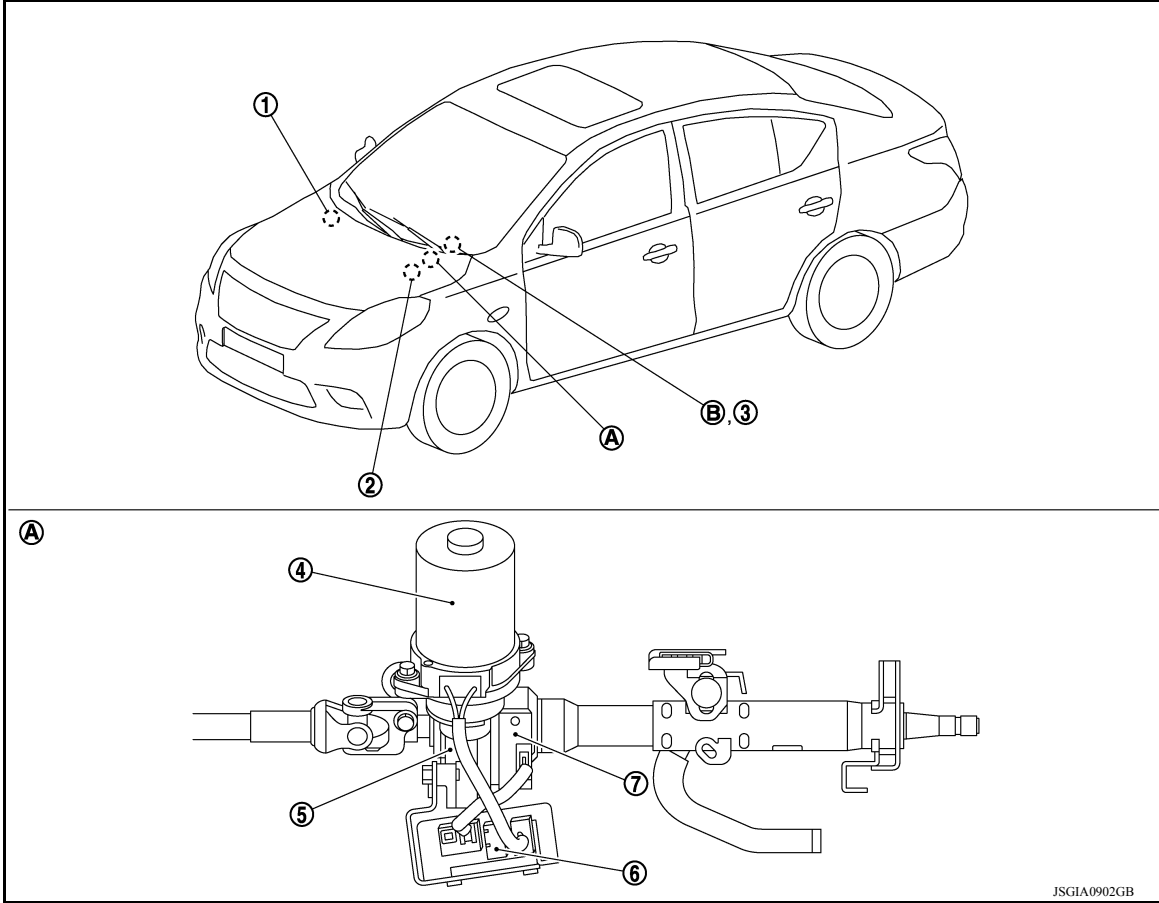

- | | | |
|--|--|----------------------|
| 1. ABS actuator and electric unit (control unit) | 2. ECM | 3. Combination meter |
| 4. EPS motor | 5. Reduction gear | 6. EPS control unit |
| 7. Torque sensor | | |
| A. Steering column assembly (view with removed from vehicle) | B. EPS warning lamp (In combination meter) | |

Component Description

INFOID:000000009267345

Components parts	Reference
EPS control unit	STC-6. "EPS Control Unit"
EPS motor	STC-6. "EPS Motor"
Torque sensor	STC-6. "Torque Sensor"
Reduction gear	STC-6. "Reduction Gear"
EPS warning lamp	STC-7. "EPS SYSTEM : System Description"
ECM	<ul style="list-style-type: none"> Transmits mainly the following signals to EPS control unit via CAN communication. - Engine status signal

COMPONENT PARTS

< SYSTEM DESCRIPTION >

Components parts	Reference
ABS actuator and electric unit (control unit)	<ul style="list-style-type: none">• Transmits mainly the following signal to EPS control unit via CAN communication.- Vehicle speed signal (ABS)
Combination meter	<ul style="list-style-type: none">• Transmits mainly the following signal to EPS control unit via CAN communication.- Vehicle speed signal (METER)• Turns ON the EPS warning lamp according to the signal from EPS control unit via CAN communication.

EPS Control Unit

INFOID:000000009267346

- EPS control unit performs an arithmetical operation on data, such as steering wheel turning force (sensor signal) from the torque sensor, vehicle speed signal, etc. Then it generates an optimum assist torque signal to the EPS motor according to the driving condition.
- EPS control unit decreases the output signal to EPS motor while extremely using the power steering function (e.g., full steering) consecutively for protecting EPS motor and EPS control unit (Overload protection control).

EPS Motor

INFOID:000000009267347

EPS motor provides the assist torque by the control signal from EPS control unit.

Torque Sensor

INFOID:000000009267348

Torque sensor detects the steering torque, and transmit the signal to EPS control unit.

Reduction Gear

INFOID:000000009267349

Reduction gear increases the assist torque provided from EPS motor with worm gears, and outputs to the column shaft.

SYSTEM

< SYSTEM DESCRIPTION >

SYSTEM

EPS SYSTEM

EPS SYSTEM : System Description

INFOID:000000009267350

- EPS control unit performs an arithmetical operation on data, such as steering wheel turning force (sensor signal) from the torque sensor, vehicle speed signal, etc. Then it generates an optimum assist torque signal to the EPS motor according to the driving condition.
- In case of an error in the electrical system, the fail-safe function stops output signals to the EPS motor. Refer to [STC-8, "EPS SYSTEM : Fail-Safe"](#).
- EPS control unit decreases the output signal to EPS motor while extremely using the power steering function (e.g., full steering) consecutively for protecting EPS motor and EPS control unit (Overload protection control). Refer to [STC-8, "EPS SYSTEM : Protection Function"](#).
- Extensive steering at low speed will cause the ECU and MOTOR to heat up, once temperature reaches critical point ECU will reduce current to reduce heat up. System will recover as temperature lowers (reduced or no assistance).

SYSTEM DIAGRAM

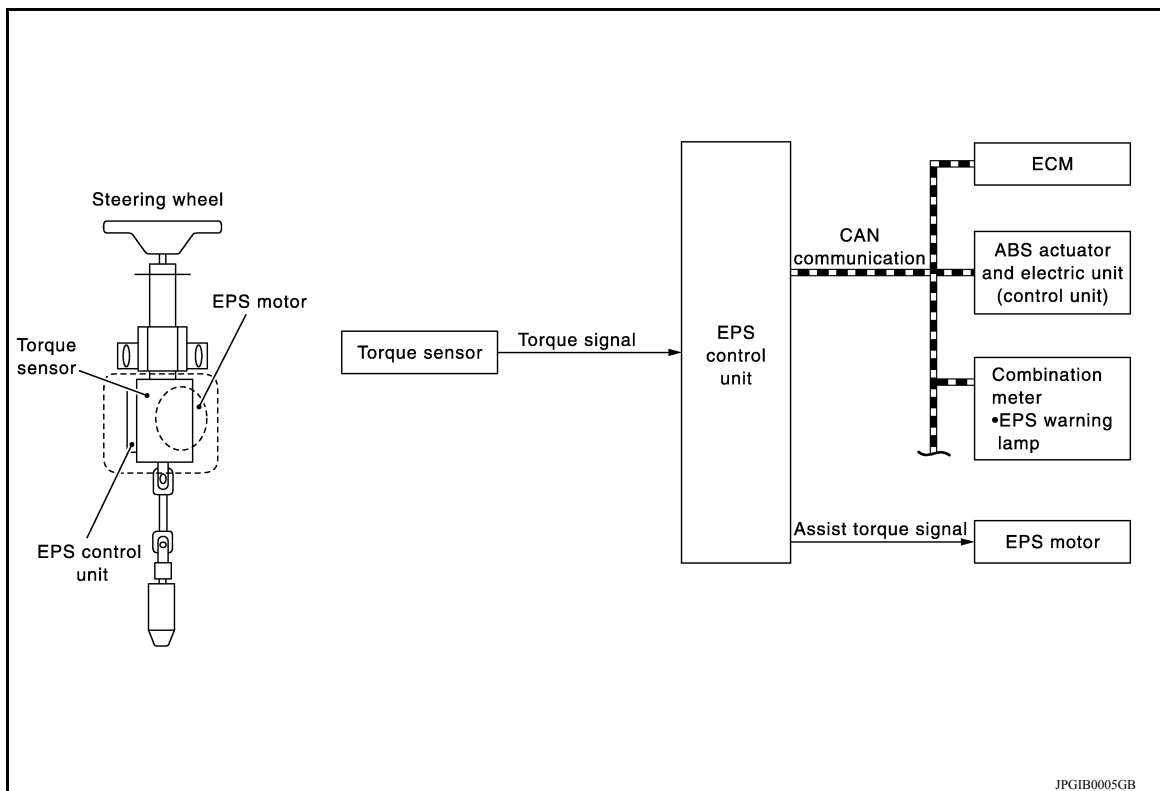

INPUT/OUTPUT SIGNAL

Communicates the signal from each control unit via CAN communication.

Control unit	Signal status
ECM	<ul style="list-style-type: none"> • Transmits mainly the following signals to EPS control unit via CAN communication. - Engine status signal
ABS actuator and electric unit (control unit)	<ul style="list-style-type: none"> • Transmits mainly the following signals to EPS control unit via CAN communication. - Vehicle speed signal (ABS)
Combination meter	<ul style="list-style-type: none"> • Transmits mainly the following signals to EPS control unit via CAN communication. - Vehicle speed signal (METER) • Receives mainly the following signals from EPS control unit via CAN communication. - EPS warning lamp signal

EPS WARNING LAMP INDICATION

- Turn ON when there is a malfunction in EPS system. It indicates that fail-safe mode is engaged and enters a manual steering state (Control turning force steering wheel becomes heavy).

SYSTEM

< SYSTEM DESCRIPTION >

- Also turns ON when ignition switch is turned ON, for purpose of lamp check. Turns OFF after the engine starts, if system is normal.

Condition	EPS warning lamp
Ignition switch ON. (Lamp check)	ON
Engine running.	OFF
EPS system malfunction [Other diagnostic item]	ON

CAUTION:

EPS warning lamp also turns ON due to data reception error, CAN communication error etc.

EPS SYSTEM : Fail-Safe

INFOID:000000009267351

- If any malfunction occurs in the system and control unit detects the malfunction, EPS warning lamp in combination meter turns ON to indicate system malfunction.
- When EPS warning lamp is ON, the system enters into a manual steering state. (Steering wheel turning force becomes heavy.)
- Under abnormal vehicle speed signal conditions, vehicle speed is judged as constant.

EPS SYSTEM : Protection Function

INFOID:000000009267352

EPS control unit decreases the output signal to EPS motor while extremely using the power steering function (e.g., full steering) consecutively for protecting EPS motor and EPS control unit (Overload protection control). While activating overload protection control, the assist torque gradually decreases, and the steering wheel turning force becomes heavy. The normal assist torque reactivates by no steering.

DIAGNOSIS SYSTEM (EPS CONTROL UNIT)

< SYSTEM DESCRIPTION >

DIAGNOSIS SYSTEM (EPS CONTROL UNIT)

CONSULT Function

INFOID:000000009267353

FUNCTION

CONSULT can display each diagnostic item using the diagnostic test modes shown following.

Diagnostic test mode	Function
ECU identification	The part number stored in the control unit can be read.
Self diagnostic result	Self-diagnostic results and freeze frame data can be read and erased quickly.*
Data monitor	Input/Output data in the EPS control unit can be read.

*: The following diagnosis information is erased by erasing.

- DTC
- Freeze frame data (FFD)

ECU IDENTIFICATION

Displays the part number stored in the control unit.

SELF-DIAG RESULTS MODE

Refer to [STC-13, "DTC Index"](#).

When "CRNT" is displayed on self-diagnosis result.

- The system is presently malfunctioning.

When "PAST" is displayed on self-diagnosis result.

- System malfunction in the past is detected, but the system is presently normal.

FREEZE FRAME DATA (FFD)

The following vehicle status is recorded when DTC is detected and is displayed on CONSULT.

Item name	Display item
IGN COUNTER (0-39)	<p>The number of times that ignition switch is turned ON after the DTC is detected is displayed.</p> <ul style="list-style-type: none">• When "0" is displayed: It indicates that the system is presently malfunctioning.• When except "0" is displayed: It indicates that system malfunction in the past is detected, but the system is presently normal. <p>NOTE: Each time when ignition switch is turned OFF to ON, numerical number increases in 1→2→3...38→39. When the operation number of times exceeds 39, the number does not increase and "39" is displayed until self-diagnosis is erased.</p>

DATA MONITOR MODE

Monitor item (Unit)	Remarks
BATTERY VOLT (V)	Displays the power supply voltage for EPS control unit.
TORQUE SENSOR (Nm)	Displays steering wheel turning force detected by torque sensor.
MOTOR CURRENT (A)	Displays the current value consumed by EPS motor.*1
MOTOR SIG (A)	Displays the current commanded value to EPS motor.
ASSIST TORQUE (Nm)	Displays assist torque being output by the electric power steering.
C/U TEMP (°C or °F)	Displays the temperature of the EPS control unit.
ASSIST LEVEL (%)	Normally displays 100%. In case of an excessive stationary steering, the assist curvature gradually falls. However, it return to 100% when left standing.*2
VEHICLE SPEED (km/h or MPH)	Vehicle speed is displayed from vehicle speed signal via CAN communication.*3
WARNING LAMP (On/Off)	EPS warning lamp control status is displayed.
ENGINE STATUS (Stop/Run)	Engine speed is displayed from engine status signal via CAN communication.

*1: Almost in accordance with the value of "MOTOR SIG". It is not a malfunction though these values are not accorded when steering quickly.

DIAGNOSIS SYSTEM (EPS CONTROL UNIT)

< SYSTEM DESCRIPTION >

*2: Normally displays 100%. In case of an excessive stationary steering, the assist curvature gradually falls. However, it returns to 100% when left standing.

*3: It is not a malfunction, though it might not be corresponding just after ignition switch in turned ON.

EPS CONTROL UNIT

< ECU DIAGNOSIS INFORMATION >

ECU DIAGNOSIS INFORMATION

EPS CONTROL UNIT

Reference Value

INFOID:000000009267354

VALUES ON THE DIAGNOSIS TOOL

CAUTION:

The output signal indicates the EPS control unit calculation data. The normal values will be displayed even in the event that the output circuit (harness) is open.

Monitor item	Data monitor		
	Condition	Display value	
BATTERY VOLT	Ignition switch: ON	Battery voltage	
TORQUE SENSOR	Engine running	Steering wheel: Not steering (There is no steering force)	Approx. 0 Nm
		Steering wheel: Right turn	Positive value (Nm)
		Steering wheel: Left turn	Negative value (Nm)
MOTOR CURRENT	Engine running	Steering wheel: Not steering (There is no steering force)	Approx. 0 A
		Steering wheel: Right or left turn	Displays consumption current of EPS motor (A) ^{*1}
MOTOR SIG	Engine running	Steering wheel: Not steering (There is no steering force)	Approx. 0 A
		Steering wheel: Right turn	Positive value (A)
		Steering wheel: Left turn	Negative value (A)
ASSIST TORQUE	Engine running	Approx. 0 Nm ^{*2}	
C/U TEMP	Ignition switch ON or engine running	Displays temperature of inside of EPS control unit (°C or °F)	
ASSIST LEVEL	Engine running	100 % ^{*3}	
VEHICLE SPEED	Vehicle stopped	0 km/h or mph	
	While driving	Approximately equal to the indication on speedometer ^{*4} (inside of ±10%)	
WARNING LAMP	EPS warning lamp: ON	On	
	EPS warning lamp: OFF	Off	
ENGINE STATUS	Engine not running	Stop	
	Engine running	Run	

*1: Almost in accordance with the value of "MOTOR SIG". It is not a malfunction though these values are not accorded when steering quickly.

*2: A fixed value is indicated regardless of steering turning.

*3: Normally displays 100%. In case of an excessive stationary steering, the assist curvature gradually falls. However, it returns to 100% when left standing.

*4: It is not a malfunction, though it might not be corresponding just after ignition switch in turned ON.

EPS CONTROL UNIT

< ECU DIAGNOSIS INFORMATION >

TERMINAL LAYOUT

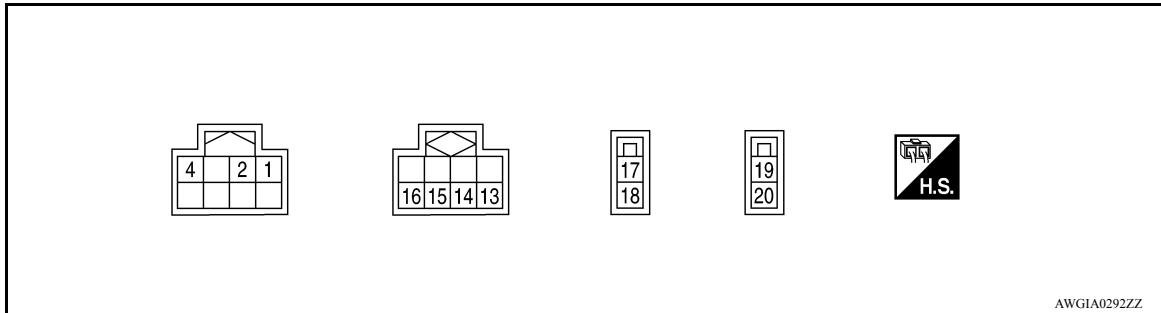

PHYSICAL VALUES

Terminal No. (Wire Color)		Description		Condition		Value (Approx.)
+	-	Signal name	Input/Output			
1 (P)	—	CAN-L	Input/Output	—		—
4 (Y)	Ground	Ignition power supply	Input	Ignition switch: ON		Battery voltage
				Ignition switch: OFF		0 V
2 (L)	—	CAN-H	Input/Output	—		—
13 (BR)	Ground	Torque sensor power supply	Output	Ignition switch: ON		5 V
				Ignition switch: OFF		0 V
14 (V)	Ground	Torque sensor sub	Input	Ignition switch: ON	Steering wheel: Not steering (There is no steering force)	2.5 V
				Engine running	Steering wheel: steering	1.6 V – 3.4 V (The value is changed according to steering left or right)
15 (L)	Ground	Torque sensor ground	Input	Always		0 V
16 (G)	Ground	Torque sensor main	Input	Ignition switch: ON	Steering wheel: Not steering (There is no steering force)	2.5 V
				Engine running	Steering wheel: steering	1.6 V – 3.4 V (The value is changed according to steering left or right)
17 (R)	Ground	Battery power supply	Input	Always		Battery voltage
18 (B)	Ground	Ground	—	Always		0 V
19 (-)	—	Motor +	—	—		—
20 (-)	—	Motor -	—	—		—

Fail-Safe

INFOID:00000009267355

- If any malfunction occurs in the system and control unit detects the malfunction, EPS warning lamp on combination meter turns ON to indicate system malfunction.
- When EPS warning lamp is ON, the system enters into a manual steering state. (Steering wheel turning force becomes heavy.)
- Under abnormal vehicle speed signal conditions, vehicle speed is judged as constant.

EPS CONTROL UNIT

< ECU DIAGNOSIS INFORMATION >

Protection Function

INFOID:000000009267356

EPS control unit decreases the output signal to EPS motor while extremely using the power steering function (e.g., full steering) consecutively for protecting EPS motor and EPS control unit (Overload protection control). While activating overload protection control, the assist torque gradually decreases, and the steering wheel turning force becomes heavy. The normal assist torque reactivates by no steering.

DTC Inspection Priority Chart

INFOID:000000009267357

When multiple DTCs are detected simultaneously, check one by one depending on the following priority list.

Priority	Priority order item (DTC)
1	U1000 CAN COMM CIRCUIT
2	C1609 CAN VHCL SPEED, C1610 CAN ENG RPM
3	C1601 BATTERY VOLT
4	Other than the above

DTC Index

INFOID:000000009267358

DTC	Items (CONSULT screen terms)	Reference
C1601	BATTERY VOLT	STC-21, "DTC Logic"
C1604	TORQUE SENSOR	STC-24, "DTC Logic"
C1606	EPS MOTOR	STC-26, "DTC Logic"
C1607	EEPROM	STC-28, "DTC Logic"
C1608	CONTROL UNIT	STC-28, "DTC Logic"
C1609	CAN VHCL SPEED	STC-29, "DTC Logic"
C1610	CAN ENG RPM	STC-30, "DTC Logic"
U1000	CAN COMM CIRCUIT	STC-31, "DTC Logic"

ELECTRONICALLY CONTROLLED POWER STEERING SYSTEM

< WIRING DIAGRAM >

WIRING DIAGRAM

ELECTRONICALLY CONTROLLED POWER STEERING SYSTEM

Wiring Diagram

INFOID:000000009267359

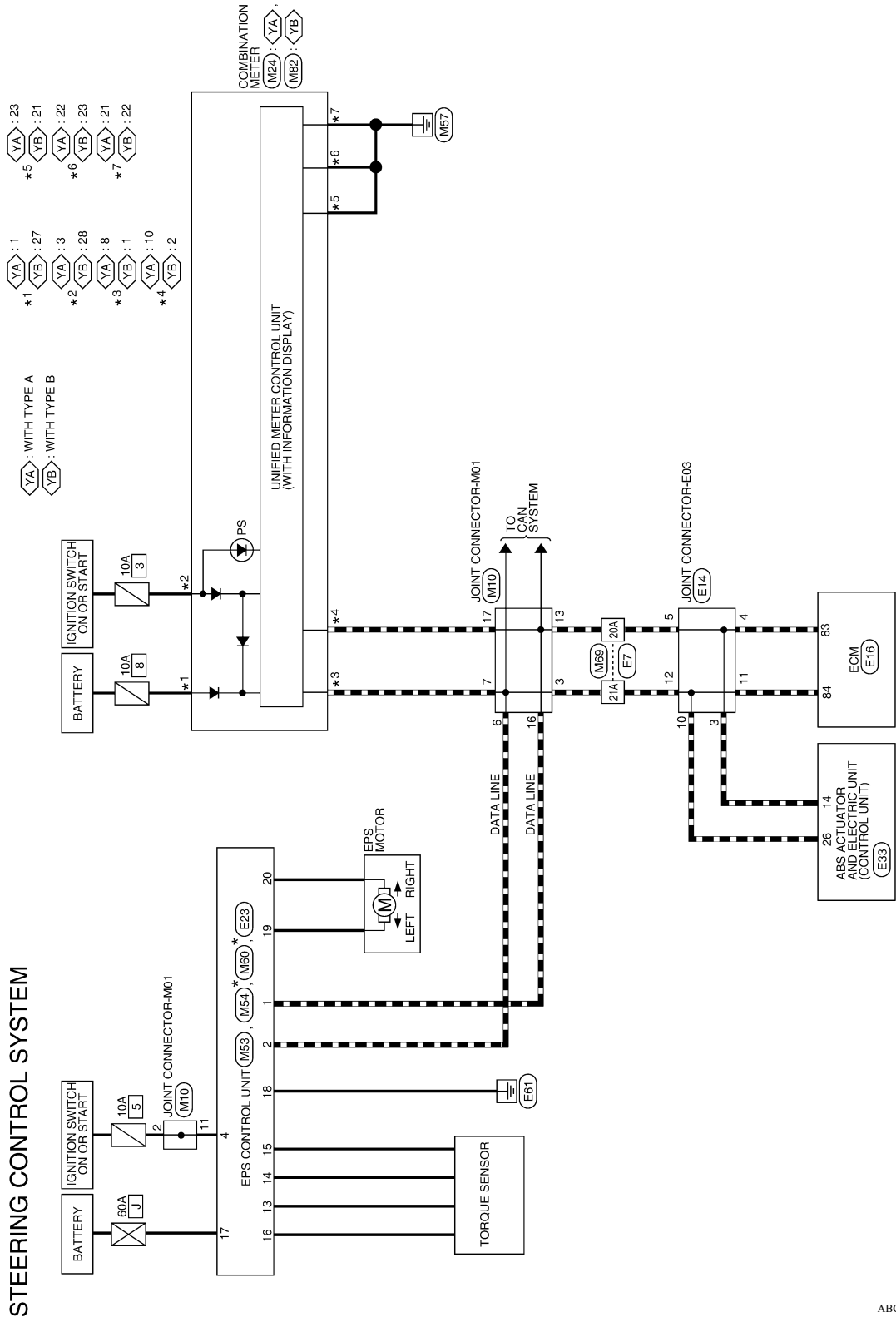

* : THIS CONNECTOR IS NOT SHOWN IN "HARNES LAYOUT" OF PG SECTION.

ABGWA0052GB

ELECTRONICALLY CONTROLLED POWER STEERING SYSTEM

< WIRING DIAGRAM >

STEERING CONTROL SYSTEM CONNECTORS

Connector No.	M10
Connector Name	JOINT CONNECTOR-M01
Connector Color	GRAY

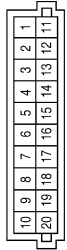

Terminal No.	Color of Wire	Signal Name
2	O	-
3	L	-
6	L	-
7	L	-
11	Y	-
13	P	-
16	P	-
17	P	-

Connector No.	M24
Connector Name	COMBINATION METER (WITH TYPE A)
Connector Color	WHITE

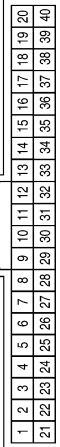

Terminal No.	Color of Wire	Signal Name
1	R	BAT
3	GR	IGN
8	L	CAN-H
10	P	CAN-L
21	B	GND (POWER)
22	B	GND (CIRCUIT)
23	B/W	GND (ILL)

Connector No.	M53
Connector Name	EPS CONTROL UNIT
Connector Color	BLACK

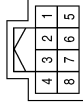

Terminal No.	Color of Wire	Signal Name
1	P	CAN-L
2	L	CAN-H
3	-	-
4	Y	IGN
5	-	-
6	-	-
7	-	-
8	-	-

Connector No.	M54
Connector Name	EPS CONTROL UNIT
Connector Color	GRAY

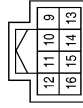

Terminal No.	Color of Wire	Signal Name
9	-	-
10	-	-
11	-	-
12	-	-
13	BR	TSV
14	V	TSS
15	L	TSE (GND)
16	G	TSM

Connector No.	M60
Connector Name	EPS CONTROL UNIT
Connector Color	BLUE



Terminal No.	Color of Wire	Signal Name
19	-	M+
20	-	M-

ABG1A0082GB

A
B
C
D
E
F
H
I
J
K
L
M
N
O
P

STC

ELECTRONICALLY CONTROLLED POWER STEERING SYSTEM

< WIRING DIAGRAM >

Connector No.	E7
Connector Name	WIRE TO WIRE
Connector Color	WHITE

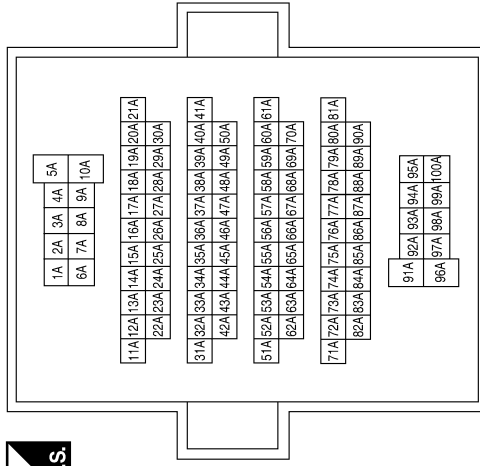

Terminal No.	Color of Wire	Signal Name
20A	P	-
21A	L	-

Connector No.	M82
Connector Name	COMBINATION METER (WITH TYPE B)
Connector Color	WHITE

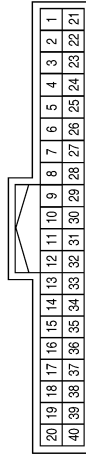

Terminal No.	Color of Wire	Signal Name
1	L	CAN-H
2	P	CAN-L
21	B/W	GND (ILL)
22	B	GND (POWER)
23	B	GND (CIRCUIT)
27	R	BAT
28	GR	IGN

Connector No.	M69
Connector Name	WIRE TO WIRE
Connector Color	WHITE

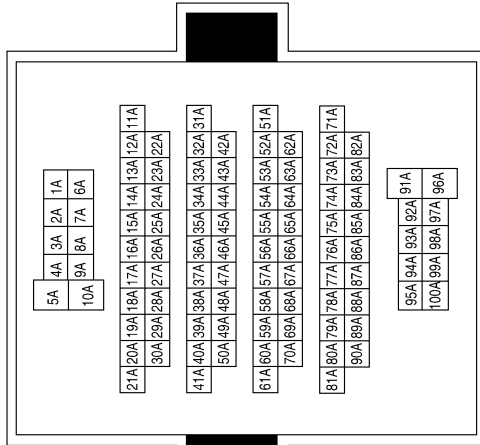

Terminal No.	Color of Wire	Signal Name
20A	P	-
21A	L	-

ABG1A0083GB

ELECTRONICALLY CONTROLLED POWER STEERING SYSTEM

< WIRING DIAGRAM >

Connector No.	E14
Connector Name	JOINT CONNECTOR-E03
Connector Color	BLUE

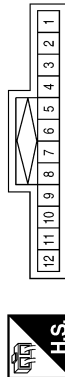

Terminal No.	Color of Wire	Signal Name
3	P	-
4	P	-
5	P	-
10	L	-
11	L	-
12	L	-

Connector No.	E16
Connector Name	ECM
Connector Color	BLACK

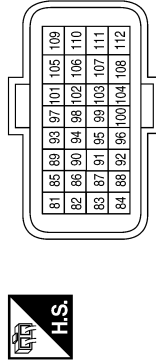

Terminal No.	Color of Wire	Signal Name
83	P	CAN-L
84	L	CAN-H

Connector No.	E23
Connector Name	EPS CONTROL UNIT
Connector Color	BLACK



Terminal No.	Color of Wire	Signal Name
17	R	B+
18	B	GND

Connector No.	E33
Connector Name	ABS ACTUATOR AND ELECTRIC UNIT (CONTROL UNIT)
Connector Color	BLACK

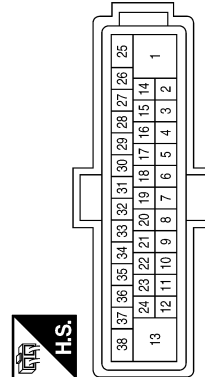

Terminal No.	Color of Wire	Signal Name
14	P	CAN-L
26	L	CAN-H

ABGIA0068GB

A
B
C
D
E
F
STC
H
I
J
K
L
M
N
O
P

DIAGNOSIS AND REPAIR WORKFLOW

< BASIC INSPECTION >

BASIC INSPECTION

DIAGNOSIS AND REPAIR WORKFLOW

Work Flow

INFOID:000000009267360

DETAILED FLOW

1. INTERVIEW FROM THE CUSTOMER

Clarify customer complaints before inspection. First of all, perform an interview utilizing [STC-19, "Diagnostic Work Sheet"](#) and reproduce symptoms to understand them fully. Ask customer about his/her complaints carefully. Check symptoms by driving vehicle with customer, if necessary.

CAUTION:

Customers are not professional. Never make assumptions like “maybe the customer means that...,” or “maybe the customer mentioned this symptom”.

>> GO TO 2.

2. CHECK SYMPTOM

Reproduce the symptom that is indicated by the customer, based on the information from the customer obtained by interview. Also check that the symptom is not caused by protection function. Refer to [STC-13, "Protection Function"](#).

CAUTION:

When the symptom is caused by normal operation, fully inspect each portion and obtain the understanding of customer that the symptom is not caused by a malfunction.

>> GO TO 3.

3. PERFORM SELF-DIAGNOSIS

With CONSULT

Perform self-diagnosis for “EPS”.

Is any DTC detected?

YES >> Record or print self-diagnosis results. GO TO 4.

NO >> GO TO 6.

4. RECHECK SYMPTOM

With CONSULT

1. Erase self-diagnostic results for “EPS”.

2. Perform DTC confirmation procedures for the malfunctioning system.

NOTE:

If some DTCs are detected at the same time, determine the order for performing the diagnosis based on [STC-13, "DTC Inspection Priority Chart"](#).

Is any DTC detected?

YES >> GO TO 5.

NO >> Check harness and connectors based on the information obtained by interview. Refer to [GI-45, "Intermittent Incident"](#).

5. REPAIR OR REPLACE MALFUNCTIONING COMPONENT

- Repair or replace malfunctioning component.
- Reconnect part or connector after repairing or replacing.
- When DTC is detected, erase self-diagnostic results for “EPS”.

>> GO TO 7.

6. IDENTIFY MALFUNCTIONING SYSTEM BY SYMPTOM DIAGNOSIS

Estimate malfunctioning system based on symptom diagnosis and perform inspection.

Can the malfunctioning system be identified?

DIAGNOSIS AND REPAIR WORKFLOW

< BASIC INSPECTION >

Interview sheet

Customer name	MR/MS	Registration number		Initial year registration	
		Vehicle type		VIN	
Storage date		Engine		Mileage	km (Mile)
Other conditions					

Memo

C1601 BATTERY POWER SUPPLY

< DTC/CIRCUIT DIAGNOSIS >

DTC/CIRCUIT DIAGNOSIS

C1601 BATTERY POWER SUPPLY

DTC Logic

INFOID:000000009267362

DTC DETECTION LOGIC

DTC	Display item	Malfunction detected condition	Possible cause
C1601	BATTERY VOLT	When a power supply voltage to the EPS control unit is maintained at 17.5 V or more or at less than 9V continuously for five second or more.	<ul style="list-style-type: none">• Harness or connector• EPS control unit• Fuse• Power supply system• Battery

DTC CONFIRMATION PROCEDURE

1. PRECONDITIONING

If "DTC CONFIRMATION PROCEDURE" has been previously conducted, always turn ignition switch OFF and wait at least 10 seconds before conducting the next test.

>> GO TO 2.

2. DTC REPRODUCTION PROCEDURE

With CONSULT

1. Turn the ignition switch OFF to ON.
2. Perform "EPS" self-diagnosis.

Is DTC "C1601" detected?

- YES >> Proceed to diagnosis procedure. Refer to [STC-21, "Diagnosis Procedure"](#).
NO >> Inspection End.

Diagnosis Procedure

INFOID:000000009267363

Regarding Wiring Diagram information, refer to [STC-14, "Wiring Diagram"](#).

1. CHECK EPS CONTROL UNIT GROUND CIRCUIT

1. Turn ignition switch OFF.
2. Disconnect EPS control unit harness connector.
3. Check continuity between EPS control unit harness connector terminal and ground.

EPS control unit		—	Continuity
Connector	Terminal		
E23	18	Ground	Yes

4. Connect EPS control unit harness connector.

Is the inspection result normal?

- YES >> GO TO 2.
NO >> Repair open circuit or short to ground or short to power in harness or connectors.

2. CHECK EPS CONTROL UNIT POWER SUPPLY CIRCUIT (1)

1. Check voltage between EPS control unit harness connector terminal and ground.

C1601 BATTERY POWER SUPPLY

< DTC/CIRCUIT DIAGNOSIS >

EPS control unit		—	Voltage
Connector	Terminal		
M53	4	Ground	Approx. 0 V

- Turn ignition switch ON.
CAUTION:
Never start the engine.
- Check voltage between EPS control unit harness connector and ground.

EPS control unit		—	Voltage
Connector	Terminal		
M53	4	Ground	Battery voltage

Is the inspection result normal?

- YES >> GO TO 4.
NO >> GO TO 3.

3. CHECK EPS CONTROL UNIT POWER SUPPLY CIRCUIT (2)

- Turn ignition switch OFF.
- Check the 10A fuse (No. 5).
- Check the harness for open or short between EPS control unit harness connector M53 terminal 4 and the 10A fuse (No. 5).

Is the inspection result normal?

- YES >> Perform the trouble diagnosis for ignition power supply circuit. Refer to [PG-20, "Wiring Diagram — Ignition Power Supply —"](#).
NO >> Repair or replace malfunctioning component.

4. CHECK EPS CONTROL UNIT POWER SUPPLY CIRCUIT (3)

- Turn ignition switch OFF.
- Check voltage between EPS control unit harness connector terminal and ground.

EPS control unit		—	Voltage
Connector	Terminal		
E23	17	Ground	Battery voltage

- Turn ignition switch ON.
CAUTION:
Never start the engine.
- Check voltage between EPS control unit harness connector and ground.

EPS control unit		—	Voltage
Connector	Terminal		
E23	17	Ground	Battery voltage

Is the inspection result normal?

- YES >> GO TO 6.
NO >> GO TO 5.

5. CHECK EPS CONTROL UNIT POWER SUPPLY CIRCUIT (4)

- Turn ignition switch OFF.
- Check the 60A fusible link (J).
- Check the harness for open or short between EPS control unit harness connector E23 terminal 17 and the 60A fusible link (J).

Is the inspection result normal?

- YES >> Perform the trouble diagnosis for power supply circuit. Refer to [PG-8, "Wiring Diagram — Battery Power Supply —"](#).

C1601 BATTERY POWER SUPPLY

< DTC/CIRCUIT DIAGNOSIS >

NO >> Repair or replace malfunctioning component.

6. CHECK CONNECTOR

1. Turn ignition switch OFF.
2. Disconnect torque sensor harness connector.
3. Check terminal for deformation, disconnection, looseness, and so on. If any malfunction is found, repair or replace terminal.

Is the inspection result normal?

YES >> Replace EPS control unit. Refer to [STC-40. "Removal and Installation"](#).

NO >> Repair or replace malfunctioning component.

A

B

C

D

E

F

STC

H

I

J

K

L

M

N

O

P

C1604 TORQUE SENSOR

< DTC/CIRCUIT DIAGNOSIS >

C1604 TORQUE SENSOR

DTC Logic

INFOID:000000009267364

DTC DETECTION LOGIC

DTC	Display item	Malfunction detected condition	Possible cause
C1604	TORQUE SENSOR	When torque sensor output signal is malfunctioning.	<ul style="list-style-type: none">• Harness or connector• Torque sensor• EPS control unit

DTC CONFIRMATION PROCEDURE

1. PRECONDITIONING

If "DTC CONFIRMATION PROCEDURE" has been previously conducted, always turn ignition switch OFF and wait at least 10 seconds before conducting the next test.

>> GO TO 2.

2. DTC REPRODUCTION PROCEDURE

Ⓟ With CONSULT

1. Turn the ignition switch OFF to ON.
2. Perform "EPS" self-diagnosis.

Is DTC "C1604" detected?

- YES >> Proceed to diagnosis procedure. Refer to [STC-24, "Diagnosis Procedure"](#).
NO >> Inspection End.

Diagnosis Procedure

INFOID:000000009267365

Regarding Wiring Diagram information, refer to [STC-14, "Wiring Diagram"](#).

1. CHECK TORQUE SENSOR POWER SUPPLY CIRCUIT

1. Turn ignition switch OFF to ON.
CAUTION:
Never start the engine.
2. Check voltage between EPS control unit harness connector terminal and ground.
CAUTION:
Steering wheel in neutral position. (There is no steering force.)

EPS control unit		—	Voltage
Connector	Terminal		
M54	13	Ground	Approx. 5 V

Is the inspection result normal?

- YES >> GO TO 2.
NO >> Perform the trouble diagnosis for battery power supply circuit. Refer to [STC-21, "Diagnosis Procedure"](#).

2. CHECK TORQUE SENSOR GROUND CIRCUIT

1. Turn ignition switch OFF.
2. Check continuity between EPS control unit harness connector terminal and ground.
CAUTION:
Steering wheel in neutral position. (There is no steering force.)

C1604 TORQUE SENSOR

< DTC/CIRCUIT DIAGNOSIS >

EPS control unit		—	Continuity
Connector	Terminal		
M54	15	Ground	Yes

Is the inspection result normal?

YES >> GO TO 3.

NO >> Repair open circuit or short to ground or short to power in harness or connectors.

3.CHECK TORQUE SENSOR SIGNAL

1. Turn ignition switch OFF to ON.
2. Check voltage between EPS control unit harness connector terminal and ground.

CAUTION:

Steering wheel in neutral position. (There is no steering force.)

EPS control unit		—	Voltage
Connector	Terminal		
M54	14	Ground	Approx. 2.5 V
	16		

3. Start the engine.
4. Check voltage between EPS control unit harness connector terminal and ground while turning the steering wheel.

EPS control unit		—	Voltage
Connector	Terminal		
M54	14	Ground	1.6 V – 3.4 V (The value is changed according to steering left or right)
	16		

Is the inspection result normal?

YES >> GO TO 4.

NO >> Torque sensor is malfunctioning. Replace steering column assembly. Refer to [ST-9, "Removal and Installation"](#).

4.CHECK CONNECTOR

1. Turn ignition switch OFF.
2. Disconnect EPS control unit harness connector.
3. Check terminal for deformation, disconnection, looseness, and so on. If any malfunction is found, repair or replace terminal.

Is the inspection result normal?

YES >> Replace EPS control unit. Refer to [STC-40, "Removal and Installation"](#).

NO >> Repair or replace malfunctioning component.

C1606 EPS MOTOR

< DTC/CIRCUIT DIAGNOSIS >

C1606 EPS MOTOR

DTC Logic

INFOID:000000009267366

DTC DETECTION LOGIC

DTC	Display item	Malfunction detected condition	Possible cause
C1606	EPS MOTOR	When the motor driver malfunction of EPS control unit or EPS motor malfunction is detected.	<ul style="list-style-type: none">• Harness or connector• EPS motor• EPS control unit

DTC CONFIRMATION PROCEDURE

1.PRECONDITIONING

If "DTC CONFIRMATION PROCEDURE" has been previously conducted, always turn ignition switch OFF and wait at least 10 seconds before conducting the next test.

>> GO TO 2.

2.DTC REPRODUCTION PROCEDURE

ⓅWith CONSULT

1. Turn the ignition switch OFF to ON.
2. Perform "EPS" self-diagnosis.

Is DTC "C1606" detected?

- YES >> Proceed to diagnosis procedure. Refer to [STC-26, "Diagnosis Procedure"](#).
NO >> Inspection End.

Diagnosis Procedure

INFOID:000000009267367

1.CHECK EPS MOTOR

Check the EPS motor. Refer to [STC-26, "Component Inspection"](#).

Is the inspection result normal?

- YES >> GO TO 2.
NO >> EPS motor is malfunction. Replace steering column assembly. Refer to [ST-9, "Removal and Installation"](#).

2.CHECK CONNECTOR

1. Turn ignition switch OFF.
2. Disconnect EPS motor harness connector.
3. Check terminal for deformation, disconnection, looseness, and so on. If any malfunction is found, repair or replace terminal.

Is the inspection result normal?

- YES >> Replace EPS control unit. Refer to [STC-40, "Removal and Installation"](#).
NO >> Repair or replace malfunctioning component.

Component Inspection

INFOID:000000009267368

1.CHECK EPS MOTOR

1. Turn the ignition switch OFF.
2. Disconnect EPS motor harness connector.
3. Check resistance between EPS motor connector terminals.

EPS motor		Resistance (Approx.)
Terminal		
19	20	0.1 Ω or less

Is the inspection result normal?

C1606 EPS MOTOR

< DTC/CIRCUIT DIAGNOSIS >

YES >> Inspection End.

NO >> EPS motor is malfunctioning. Replace steering column assembly. Refer to [ST-9, "Removal and Installation"](#).

A

B

C

D

E

F

STC

H

I

J

K

L

M

N

O

P

C1607, C1608 EPS CONTROL UNIT

< DTC/CIRCUIT DIAGNOSIS >

C1607, C1608 EPS CONTROL UNIT

DTC Logic

INFOID:000000009267369

DTC DETECTION LOGIC

DTC	Display item	Malfunction detected condition	Possible cause
C1607	EEPROM	When the memory (EEPROM) system malfunction is detected in EPS control unit.	EPS control unit
C1608	CONTROL UNIT	When the internal malfunction is detected in EPS control unit.	

DTC CONFIRMATION PROCEDURE

1. PRECONDITIONING

If "DTC CONFIRMATION PROCEDURE" has been previously conducted, always turn ignition switch OFF and wait at least 10 seconds before conducting the next test.

>> GO TO 2.

2. DTC REPRODUCTION PROCEDURE

With CONSULT

1. Turn the ignition switch OFF to ON.
2. Perform "EPS" self-diagnosis.

Is DTC "C1607" or "C1608" detected?

- YES >> Proceed to diagnosis procedure. Refer to [STC-28. "Diagnosis Procedure"](#).
NO >> Inspection End.

Diagnosis Procedure

INFOID:000000009267370

1. PERFORM SELF-DIAGNOSIS

With CONSULT

1. Turn the ignition switch OFF to ON.
2. Erase self-diagnosis results for "EPS".
3. Perform "EPS" self-diagnosis.

Is DTC "C1607" or "C1608" detected?

- YES >> Replace EPS control unit. Refer to [STC-40. "Removal and Installation"](#).
NO >> Check EPS control unit pin terminals for damage or loose connection with harness connector. If any item are damaged, repair or replace malfunctioning component.

C1609 VEHICLE SPEED SIGNAL

< DTC/CIRCUIT DIAGNOSIS >

C1609 VEHICLE SPEED SIGNAL

Description

INFOID:000000009267371

EPS control unit receives the vehicle speed signal from ABS actuator and electric unit (control unit) via CAN communication line.

DTC Logic

INFOID:000000009267372

DTC DETECTION LOGIC

DTC	Display item	Malfunction detected condition	Possible cause
C1609	CAN VHCL SPEED	<ul style="list-style-type: none">Malfunction is detected in vehicle speed signal that is output from ABS actuator and electric unit (control unit) via CAN communication.ABS actuator and electric unit (control unit) input signal error is detected.	<ul style="list-style-type: none">Harness or connectorCAN communication lineEPS control unitABS malfunctionVehicle speed signal error

DTC CONFIRMATION PROCEDURE

1. PRECONDITIONING

If "DTC CONFIRMATION PROCEDURE" has been previously conducted, always turn ignition switch OFF and wait at least 10 seconds before conducting the next test.

>> GO TO 2.

2. DTC REPRODUCTION PROCEDURE

With CONSULT

- Turn the ignition switch OFF to ON.
- Perform "EPS" self-diagnosis.

Is DTC "C1609" detected?

- YES >> Proceed to diagnosis procedure. Refer to [STC-29. "Diagnosis Procedure"](#).
NO >> Inspection End.

Diagnosis Procedure

INFOID:000000009267373

1. PERFORM ABS ACTUATOR AND ELECTRIC UNIT (CONTROL UNIT) SELF-DIAGNOSIS

With CONSULT

- Turn the ignition switch OFF to ON.
- Perform "ABS" self-diagnosis.

Is any DTC detected?

- YES >> Check the DTC.
NO >> GO TO 2.

2. PERFORM SELF-DIAGNOSIS

With CONSULT

Perform "EPS" self-diagnosis.

Is DTC "C1609" detected?

- YES >> Replace EPS control unit. Refer to [STC-40. "Removal and Installation"](#).
NO >> Check EPS control unit pin terminals for damage or loose connection with harness connector. If any item are damaged, repair or replace malfunctioning component.

C1610 ENGINE STATUS SIGNAL

< DTC/CIRCUIT DIAGNOSIS >

C1610 ENGINE STATUS SIGNAL

Description

INFOID:000000009267374

EPS control unit receives the engine status signal from ECM via CAN communication line.

DTC Logic

INFOID:000000009267375

DTC DETECTION LOGIC

DTC	Display item	Malfunction detected condition	Possible cause
C1610	CAN ENG RPM	<ul style="list-style-type: none">Malfunction is detected in engine status signal that is output from ECM via CAN communication.ECM input signal error is detected.	<ul style="list-style-type: none">Harness or connectorCAN communication lineEPS control unitECMEngine status signal error

DTC CONFIRMATION PROCEDURE

1. PRECONDITIONING

If "DTC CONFIRMATION PROCEDURE" has been previously conducted, always turn ignition switch OFF and wait at least 10 seconds before conducting the next test.

>> GO TO 2.

2. DTC REPRODUCTION PROCEDURE

With CONSULT

- Turn the ignition switch OFF to ON.
- Perform "EPS" self-diagnosis.

Is DTC "C1610" detected?

- YES >> Proceed to diagnosis procedure. Refer to [STC-30, "Diagnosis Procedure"](#).
NO >> Inspection End.

Diagnosis Procedure

INFOID:000000009267376

1. PERFORM ECM SELF-DIAGNOSIS

With CONSULT

- Turn the ignition switch OFF to ON.
- Perform "ENGINE" self-diagnosis. Refer to [EC-61, "CONSULT Function"](#).

Is any DTC detected?

- YES >> Check the DTC. Refer to [EC-85, "DTC Index"](#).
NO >> GO TO 2.

2. PERFORM SELF-DIAGNOSIS

With CONSULT

Perform "EPS" self-diagnosis.

Is DTC "C1610" detected?

- YES >> Replace EPS control unit. Refer to [STC-40, "Removal and Installation"](#).
NO >> Check EPS control unit pin terminals for damage or loose connection with harness connector. If any item are damaged, repair or replace malfunctioning components.

U1000 CAN COMM CIRCUIT

< DTC/CIRCUIT DIAGNOSIS >

U1000 CAN COMM CIRCUIT

Description

INFOID:000000009267377

CAN (Controller Area Network) is a serial communication line for real time application. It is an on-vehicle multiplex communication line with high data communication speed and excellent error detection ability. Many electronic control units are equipped onto a vehicle, and each control unit shares information and links with other control units during operation (not independent). In CAN communication, control units are connected with 2 communication lines (CAN-H line, CAN-L line) allowing a high rate of information transmission with less wiring. Each control unit communicate data but selectively reads required data only.

DTC Logic

INFOID:000000009267378

DTC DETECTION LOGIC

DTC	Display item	Malfunction detected condition	Possible cause
U1000	CAN COMM CIRCUIT	EPS control unit is not transmitting/receiving CAN communication signal for 2 seconds or more.	<ul style="list-style-type: none">• CAN communication error• EPS control unit

DTC CONFIRMATION PROCEDURE

1. PRECONDITIONING

If "DTC CONFIRMATION PROCEDURE" has been previously conducted, always turn ignition switch OFF and wait at least 10 seconds before conducting the next test.

>> GO TO 2.

2. DTC REPRODUCTION PROCEDURE

With CONSULT

1. Turn the ignition switch OFF to ON.
2. Perform "EPS" self-diagnosis.

Is DTC "U1000" detected?

YES >> Proceed to diagnosis procedure. Refer to [STC-31, "Diagnosis Procedure"](#).

NO >> Inspection End.

Diagnosis Procedure

INFOID:000000009267379

Proceed to [LAN-15, "Trouble Diagnosis Flow Chart"](#).

EPS WARNING LAMP

< DTC/CIRCUIT DIAGNOSIS >

EPS WARNING LAMP

Component Function Check

INFOID:000000009267380

1. CHECK THE ILLUMINATION OF THE EPS WARNING LAMP

Check that the EPS warning lamp turns ON when ignition switch turns ON. Then, EPS warning lamp turns OFF after the engine is started.

Is the inspection result normal?

YES >> Inspection End.

NO >> Perform trouble diagnosis. Refer to [STC-32, "Diagnosis Procedure"](#).

Diagnosis Procedure

INFOID:000000009267381

1. PERFORM SELF-DIAGNOSIS

With CONSULT

1. Turn the ignition switch OFF to ON.
2. Perform "EPS" self-diagnosis.

Is any DTC detected?

YES >> Check the DTC. Refer to [STC-13, "DTC Index"](#).

NO >> GO TO 2.

2. CHECK EPS WARNING LAMP SIGNAL

With CONSULT

1. Turn the ignition switch ON.
CAUTION:
Never start the engine.
2. Select "DATA MONITOR" of "EPS" and select "WARNING LAMP".
3. Check that the EPS warning lamp is turned ON.
4. Start the engine.
CAUTION:
Never drive the vehicle.
5. Check that the EPS warning lamp is turned OFF.

Is the inspection result normal?

YES >> Perform the trouble diagnosis for combination meter power supply circuit. Refer to [MWI-44, "COMBINATION METER : Diagnosis Procedure"](#) (Type A) or [MWI-94, "COMBINATION METER : Diagnosis Procedure"](#) (Type B).

NO >> Replace the EPS control unit. Refer to [STC-40, "Removal and Installation"](#).

EPS WARNING LAMP DOES NOT TURN ON

< SYMPTOM DIAGNOSIS >

SYMPTOM DIAGNOSIS

EPS WARNING LAMP DOES NOT TURN ON

Description

INFOID:000000009267382

EPS warning lamp does not turn ON when turning ignition switch ON from OFF. (Check the illumination of the EPS warning lamp.)

Diagnosis Procedure

INFOID:000000009267383

1. CHECK EPS WARNING LAMP

Perform the trouble diagnosis of EPS warning lamp. Refer to [STC-32, "Diagnosis Procedure"](#).

Is the inspection result normal?

- YES >> Check that there is no malfunction in each harness connector pin terminal or disconnection.
- NO >> Repair or replace the malfunctioning component.

A
B
C
D
E
F
H
I
J
K
L
M
N
O
P

STC

EPS WARNING LAMP DOES NOT TURN OFF

< SYMPTOM DIAGNOSIS >

EPS WARNING LAMP DOES NOT TURN OFF

Description

INFOID:000000009267384

EPS warning lamp does not turn OFF several seconds after engine started.

Diagnosis Procedure

INFOID:000000009267385

1. PERFORM SELF-DIAGNOSIS

With CONSULT

1. Turn the ignition switch OFF to ON.
2. Perform "EPS" self-diagnosis.

Is any DTC detected?

- YES >> Check the DTC. Refer to [STC-13, "DTC Index"](#).
NO >> GO TO 2.

2. CHECK EPS WARNING LAMP

Perform the trouble diagnosis of EPS warning lamp. Refer to [STC-32, "Diagnosis Procedure"](#).

Is the inspection result normal?

- YES >> GO TO 3.
NO >> Repair or replace the malfunctioning component.

3. CHECK EPS CONTROL UNIT POWER SUPPLY AND GROUND CIRCUIT

Perform the trouble diagnosis of EPS control unit power supply and ground. Refer to [STC-21, "Diagnosis Procedure"](#).

Is the inspection result normal?

- YES >> Check that there is no malfunction in each harness connector pin terminal or disconnection.
NO >> Repair or replace the malfunctioning component.

STEERING WHEEL TURNING FORCE IS HEAVY OR LIGHT

< SYMPTOM DIAGNOSIS >

STEERING WHEEL TURNING FORCE IS HEAVY OR LIGHT

Description

INFOID:000000009267386

Steering wheel turning force is heavy or light.

Diagnosis Procedure

INFOID:000000009267387

1.PERFORM SELF-DIAGNOSIS

With CONSULT

1. Turn the ignition switch OFF to ON.
2. Perform "EPS" self-diagnosis.

Is any DTC detected?

- YES >> Check the DTC. Refer to [STC-13, "DTC Index"](#).
NO >> GO TO 2.

2.CHECK THE ILLUMINATION OF THE EPS WARNING LAMP

Check that the EPS warning lamp turns ON when ignition switch turns ON. Then, EPS warning lamp turns OFF after the engine is started.

Is the inspection result normal?

- YES >> GO TO 3.
NO >> Perform trouble diagnosis of EPS warning lamp. Refer to [STC-32, "Diagnosis Procedure"](#).

3.CHECK EPS CONTROL UNIT SIGNAL (1)

With CONSULT

1. Start the engine.
2. Select "ASSIST LEVEL" in "DATA MONITOR" in "EPS".

Does the item in "DATA MONITOR" indicate "100%"?

- YES >> GO TO 6.
NO >> GO TO 4.

4.CHECK EPS CONTROL UNIT SIGNAL (2)

With CONSULT

Select "BATTERY VOLT" in "DATA MONITOR" in "EPS".

Does the item in "DATA MONITOR" indicate "10 V" or more?

- YES >> GO TO 5.
NO >> Perform trouble diagnosis of EPS control unit power supply and ground. Refer to [STC-21, "Diagnosis Procedure"](#).

5.CHECK EPS CONTROL UNIT SIGNAL (3)

With CONSULT

1. Select "ASSIST LEVEL" in "DATA MONITOR" in "EPS".
2. Stop the EPS system until the item in "DATA MONITOR" becomes "100%".

NOTE:

While stopping the EPS system, do not turn steering wheel.

3. Check that the symptom continues.

Does the symptom continue?

- YES >> GO TO 6.
NO >> The assist torque decreases because of protection function. This is not a malfunction. Inspection End.

6.CHECK EPS CONTROL UNIT SIGNAL (4)

With CONSULT

1. Start the engine.

CAUTION:

Never drive the vehicle.

2. Turn steering wheel from full left stop to full right stop.

STEERING WHEEL TURNING FORCE IS HEAVY OR LIGHT

< SYMPTOM DIAGNOSIS >

3. Select "TORQUE SENSOR" in "DATA MONITOR" in "EPS".

Monitor item	Condition	Display value
TORQUE SENSOR	Steering wheel: Not steering (There is no steering force)	Approx. 0 Nm
	Steering wheel: Right turn	Positive value (Nm)
	Steering wheel: Left turn	Negative value (Nm)

Is the inspection result normal?

YES >> GO TO 8.

NO >> GO TO 7.

7. CHECK EPS MOTOR

Perform the trouble diagnosis of EPS motor. Refer to [STC-26, "Diagnosis Procedure"](#).

Is the inspection result normal?

YES >> GO TO 8.

NO >> Repair or replace the malfunctioning component.

8. CHECK STEERING WHEEL TURNING FORCE

Check the steering wheel turning force. Refer to [ST-5, "Inspection"](#).

Is the inspection result normal?

YES >> Inspection End

NO >> Check the steering wheel turning force for mechanical malfunction. Refer to [ST-5, "Inspection"](#).

UNBALANCE STEERING WHEEL TURNING FORCE AND RETURN BETWEEN RIGHT AND LEFT

< SYMPTOM DIAGNOSIS >

UNBALANCE STEERING WHEEL TURNING FORCE AND RETURN BETWEEN RIGHT AND LEFT

Description

INFOID:000000009267388

Unbalance steering wheel turning force and return between right and left.

Diagnosis Procedure

INFOID:000000009267389

1. CHECK THE ILLUMINATION OF THE EPS WARNING LAMP

Check the EPS warning lamp while engine is running.

Does the EPS warning lamp turn OFF?

YES >> GO TO 2.

NO >> Refer to [STC-34. "Diagnosis Procedure"](#).

2. CHECK WHEEL ALIGNMENT

1. Check the wheel alignment. Refer to [FSU-6. "Inspection and Adjustment"](#).

2. Perform "EPS" self-diagnosis.

Is the inspection result normal?

YES >> GO TO 3.

NO >> Adjustment of wheel alignment. Refer to [FSU-6. "Inspection and Adjustment"](#).

3. CHECK EPS CONTROL UNIT SIGNAL

With CONSULT

1. Start the engine.

CAUTION:

Never drive the vehicle.

2. Turn steering wheel from full left stop to full right stop.

3. Select "DATA MONITOR" of "EPS" and select "TORQUE SENSOR".

4. Perform the torque sensor inspection.

Monitor item	Condition	Display value
TORQUE SENSOR	Steering wheel: Not steering (There is no steering force)	Approx. 0 Nm
	Steering wheel: Right turn	Positive value (Nm)
	Steering wheel: Left turn	Negative value (Nm)

Is the inspection result normal?

YES >> GO TO 5.

NO >> GO TO 4.

4. CHECK EPS MOTOR

Perform the trouble diagnosis of EPS motor. Refer to [STC-26. "Diagnosis Procedure"](#).

Is the inspection result normal?

YES >> GO TO 5.

NO >> Repair or replace the malfunctioning component.

5. CHECK STEERING WHEEL TURNING FORCE

Check the steering wheel turning force. Refer to [ST-5. "Inspection"](#).

Is the inspection result normal?

YES >> Inspection End

NO >> Check the steering wheel turning force for mechanical malfunction. Refer to [ST-5. "Inspection"](#).

UNBALANCE STEERING WHEEL TURNING FORCE (TORQUE VARIATION)

< SYMPTOM DIAGNOSIS >

UNBALANCE STEERING WHEEL TURNING FORCE (TORQUE VARIATION)

Description

INFOID:000000009267390

Unbalance steering wheel turning force (torque variation).

Diagnosis Procedure

INFOID:000000009267391

1. PERFORM SELF-DIAGNOSIS

With CONSULT

1. Turn the ignition switch OFF to ON.
2. Perform "EPS" self-diagnosis.

Is any DTC detected?

- YES >> Check the DTC. Refer to [STC-13, "DTC Index"](#).
NO >> GO TO 2.

2. CHECK THE ILLUMINATION OF THE EPS WARNING LAMP

Check the EPS warning lamp while the engine is started.

Does the EPS warning lamp turn OFF?

- YES >> GO TO 3.
NO >> Refer to [STC-34, "Diagnosis Procedure"](#).

3. CHECK STEERING COLUMN AND STEERING GEAR

Check the steering column assembly and steering gear assembly.

- Steering column assembly. Refer to [ST-9, "Exploded View"](#).
- Steering gear assembly. Refer to [ST-14, "Exploded View"](#).

Is the inspection result normal?

- YES >> GO TO 4.
NO >> Repair or replace the malfunctioning component.

4. CHECK EPS CONTROL UNIT SIGNAL (1)

With CONSULT

1. Start the engine.
CAUTION:
Never drive the vehicle.
2. Turn steering wheel from full left stop to full right stop.
3. Select "ASSIST LEVEL" in "DATA MONITOR" in "EPS".

Does the item in "DATA MONITOR" maintain "100%"?

- YES >> GO TO 7.
NO >> GO TO 5.

5. CHECK EPS CONTROL UNIT SIGNAL (2)

With CONSULT

Select "BATTERY VOLT" in "DATA MONITOR" in "EPS".

Does the item in "DATA MONITOR" indicate "10 V" or more?

- YES >> GO TO 6.
NO >> Perform trouble diagnosis of EPS control unit power supply and ground. Refer to [STC-21, "Diagnosis Procedure"](#).

6. CHECK EPS CONTROL UNIT SIGNAL (3)

With CONSULT

1. Select "ASSIST LEVEL" in "DATA MONITOR" in "EPS".
2. Stop the EPS system until the item in "DATA MONITOR" becomes "100%".

NOTE:

While stopping the EPS system, do not turn steering wheel.

3. Check that the symptom continues.

UNBALANCE STEERING WHEEL TURNING FORCE (TORQUE VARIATION)

< SYMPTOM DIAGNOSIS >

Does the symptom continue?

YES >> GO TO 7.

NO >> The assist torque decreases because of protection function. This is not a malfunction. Inspection End.

7. CHECK EPS CONTROL UNIT SIGNAL (4)

With CONSULT

1. Start the engine.

CAUTION:

Never drive the vehicle.

2. Turn steering wheel from full left stop to full right stop.

3. Select "TORQUE SENSOR" in "DATA MONITOR" in "EPS".

4. Perform the torque sensor inspection.

Monitor item	Condition	Display value
TORQUE SENSOR	Steering wheel: Not steering (There is no steering force)	Approx. 0 Nm
	Steering wheel: Right turn	Positive value (Nm)
	Steering wheel: Left turn	Negative value (Nm)

Is the inspection result normal?

YES >> GO TO 9.

NO >> GO TO 8.

8. CHECK EPS MOTOR

Perform the trouble diagnosis of EPS motor. Refer to [STC-26, "Diagnosis Procedure"](#).

Is the inspection result normal?

YES >> GO TO 9.

NO >> Repair or replace the malfunctioning component.

9. CHECK STEERING WHEEL TURNING FORCE

Check the steering wheel turning force. Refer to [ST-5, "Inspection"](#).

Is the inspection result normal?

YES >> Inspection End.

NO >> Check the steering wheel turning force for mechanical malfunction. Refer to [ST-5, "Inspection"](#).

A
B
C
D
E
F
STC
H
I
J
K
L
M
N
O
P

EPS CONTROL UNIT

< REMOVAL AND INSTALLATION >

REMOVAL AND INSTALLATION

EPS CONTROL UNIT

Exploded View

INFOID:000000009267392

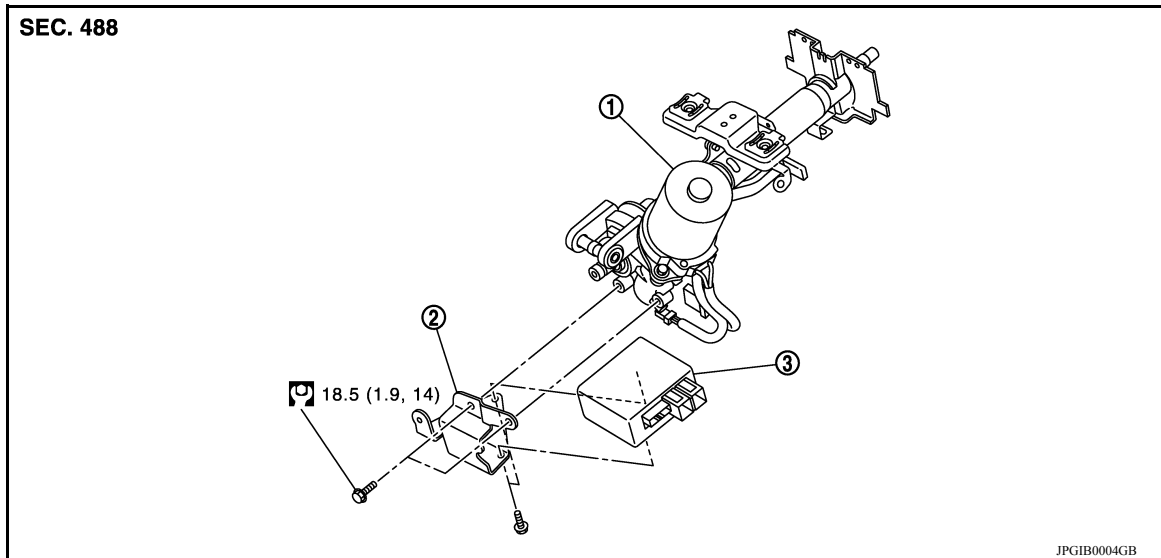

1. Steering column assembly

2. Bracket

3. EPS control unit

Removal and Installation

INFOID:000000009267393

REMOVAL

1. Perform a CPU memory erase on the EPS with CONSULT before removal.

CAUTION:

- Disconnect battery negative terminal before continuing.
- Do not shock EPS control unit, e.g. drop or hit.
- Do not get EPS control unit wet with water or other liquid. Also, do not give EPS control unit a radical temperature change to avoid getting water drops.
- Do not disassemble or remodel EPS control unit, EPS motor, torque sensor, harness and connectors.

2. Remove instrument lower panel LH. Refer to [IP-20, "Removal and Installation"](#).
3. Disconnect harness connectors from EPS control unit.

CAUTION:

Hold and pull the connector housing, do not pull on harness when disconnecting connectors. Also, do not grip, collapse or apply excessive force to the connector.

4. Remove EPS control unit from steering column assembly.
5. Remove bracket from steering column assembly if necessary.

INSTALLATION

Installation is in the reverse order of removal.

- Check that harness is not damaged when installing EPS control unit. Also, check that EPS control unit is installed without trapping harness on foreign materials.
- After installing steering column assembly, perform self-diagnosis with CONSULT to ensure correct operation.