

SECTION **DEF**
DEFOGGER

A
B
C
D
E
F
G
H
I
J
K
DEF
M
N
O
P

CONTENTS

PRECAUTION	3	WIRING DIAGRAM	11
PRECAUTIONS	3	REAR WINDOW DEFOGGER SYSTEM	11
Precaution for Supplemental Restraint System (SRS) "AIR BAG" and "SEAT BELT PRE-TENSIONER"	3	Wiring Diagram	11
SYSTEM DESCRIPTION	4	BASIC INSPECTION	16
COMPONENT PARTS	4	DIAGNOSIS AND REPAIR WORK FLOW	16
Component Parts Location	4	Work Flow	16
Component Description	4	DTC/CIRCUIT DIAGNOSIS	19
SYSTEM	5	REAR WINDOW DEFOGGER SWITCH	19
System Diagram	5	Description	19
System Description	5	Component Function Check	19
DIAGNOSIS SYSTEM (BCM) (WITH INTELLIGENT KEY SYSTEM)	6	Diagnosis Procedure	19
COMMON ITEM	6	Component Inspection	20
COMMON ITEM : CONSULT Function (BCM - COMMON ITEM)	6	REAR WINDOW DEFOGGER RELAY	21
REAR DEFOGGER	7	Description	21
REAR DEFOGGER : CONSULT Function (BCM - REAR DEFOGGER)	7	Component Function Check	21
DIAGNOSIS SYSTEM (BCM) (WITHOUT INTELLIGENT KEY SYSTEM)	8	Diagnosis Procedure	21
COMMON ITEM	8	Component Inspection	22
COMMON ITEM : CONSULT Function (BCM - COMMON ITEM)	8	REAR WINDOW DEFOGGER POWER SUPPLY AND GROUND CIRCUIT	23
REAR DEFOGGER	9	Description	23
REAR DEFOGGER : CONSULT Function (BCM - REAR DEFOGGER)	9	Component Function Check	23
ECU DIAGNOSIS INFORMATION	10	Diagnosis Procedure	23
BCM	10	Component Inspection	24
List of ECU Reference	10	DRIVER SIDE DOOR MIRROR DEFOGGER ...	25
		Description	25
		Component Function Check	25
		Diagnosis Procedure	25
		Component Inspection	26
		PASSENGER SIDE DOOR MIRROR DEFOGGER	27
		Description	27
		Component Function Check	27
		Diagnosis Procedure	27

Component Inspection	28	DRIVER SIDE DOOR MIRROR DEFOGGER DOES NOT OPERATE.	32
SYMPTOM DIAGNOSIS	29	Diagnosis Procedure	32
REAR WINDOW DEFOGGER AND DOOR MIRROR DEFOGGER DO NOT OPERATE.	29	PASSENGER SIDE DOOR MIRROR DEFOGGER DOES NOT OPERATE.	33
Diagnosis Procedure	29	Diagnosis Procedure	33
REAR WINDOW DEFOGGER DOES NOT OPERATE BUT BOTH OF DOOR MIRROR DEFOGGER OPERATE.	30	REAR WINDOW DEFOGGER SWITCH DOES NOT LIGHT, BUT REAR WINDOW DEFOGGER OPERATES	34
Diagnosis Procedure	30	Diagnosis Procedure	34
BOTH DOORS MIRROR DEFOGGER DON'T OPERATE BUT REAR WINDOW DEFOGGER OPERATES	31	REMOVAL AND INSTALLATION	35
Diagnosis Procedure	31	FILAMENT	35
		Inspection and Repair	35

PRECAUTIONS

< PRECAUTION >

PRECAUTION

PRECAUTIONS

Precaution for Supplemental Restraint System (SRS) "AIR BAG" and "SEAT BELT PRE-TENSIONER"

INFOID:000000009268308

The Supplemental Restraint System such as "AIR BAG" and "SEAT BELT PRE-TENSIONER", used along with a front seat belt, helps to reduce the risk or severity of injury to the driver and front passenger for certain types of collision. This system includes seat belt switch inputs and dual stage front air bag modules. The SRS system uses the seat belt switches to determine the front air bag deployment, and may only deploy one front air bag, depending on the severity of a collision and whether the front occupants are belted or unbelted. Information necessary to service the system safely is included in the SR and SB section of this Service Manual.

WARNING:

- To avoid rendering the SRS inoperative, which could increase the risk of personal injury or death in the event of a collision which would result in air bag inflation, all maintenance must be performed by an authorized NISSAN/INFINITI dealer.
- Improper maintenance, including incorrect removal and installation of the SRS, can lead to personal injury caused by unintentional activation of the system. For removal of Spiral Cable and Air Bag Module, see the SR section.
- Do not use electrical test equipment on any circuit related to the SRS unless instructed to in this Service Manual. SRS wiring harnesses can be identified by yellow and/or orange harnesses or harness connectors.

PRECAUTIONS WHEN USING POWER TOOLS (AIR OR ELECTRIC) AND HAMMERS

WARNING:

- When working near the Airbag Diagnosis Sensor Unit or other Airbag System sensors with the Ignition ON or engine running, DO NOT use air or electric power tools or strike near the sensor(s) with a hammer. Heavy vibration could activate the sensor(s) and deploy the air bag(s), possibly causing serious injury.
- When using air or electric power tools or hammers, always switch the Ignition OFF, disconnect the battery, and wait at least 3 minutes before performing any service.

A
B
C
D
E
F
G
H
I
J
K
DEF
M
N
O
P

COMPONENT PARTS

< SYSTEM DESCRIPTION >

SYSTEM DESCRIPTION

COMPONENT PARTS

Component Parts Location

INFOID:000000009268309

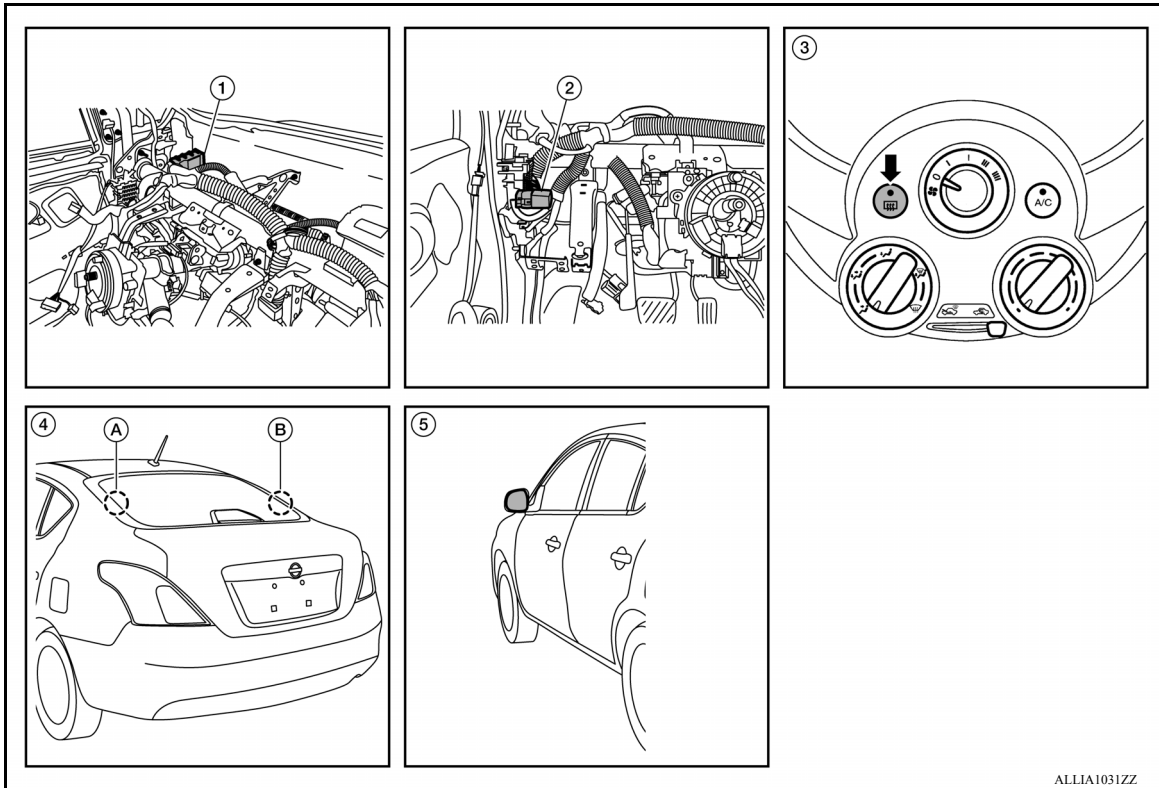

ALLIA1031ZZ

1. BCM (view with instrument panel removed)
2. Rear window defogger relay (view with instrument panel removed)
3. Front air control (rear window defogger switch)
4. A. Rear window defogger power connector
B. Rear window defogger ground connector
5. Door mirror (door mirror defogger) (if equipped)

Component Description

INFOID:000000009268310

BCM	<ul style="list-style-type: none"> Operates the rear window defogger with the operation of rear window defogger switch. Performs the timer control of rear window defogger.
Rear window defogger relay	<ul style="list-style-type: none"> Operates the rear window defogger and the door mirror defogger* with the control signal from BCM.
Front air control (rear window defogger switch)	<ul style="list-style-type: none"> The rear window defogger switch is turned ON. Turns the indicator lamp ON when detecting the operation of rear window defogger.
Rear window defogger	<ul style="list-style-type: none"> Heats the heating wire with the power supply from the rear window defogger relay to prevent the rear window from fogging up.
Door mirror defogger*	<ul style="list-style-type: none"> Heats the heating wire with the power supply from the rear window defogger relay to prevent the door mirror from fogging up.

*: With heated mirrors

SYSTEM

< SYSTEM DESCRIPTION >

SYSTEM

System Diagram

INFOID:000000009268311

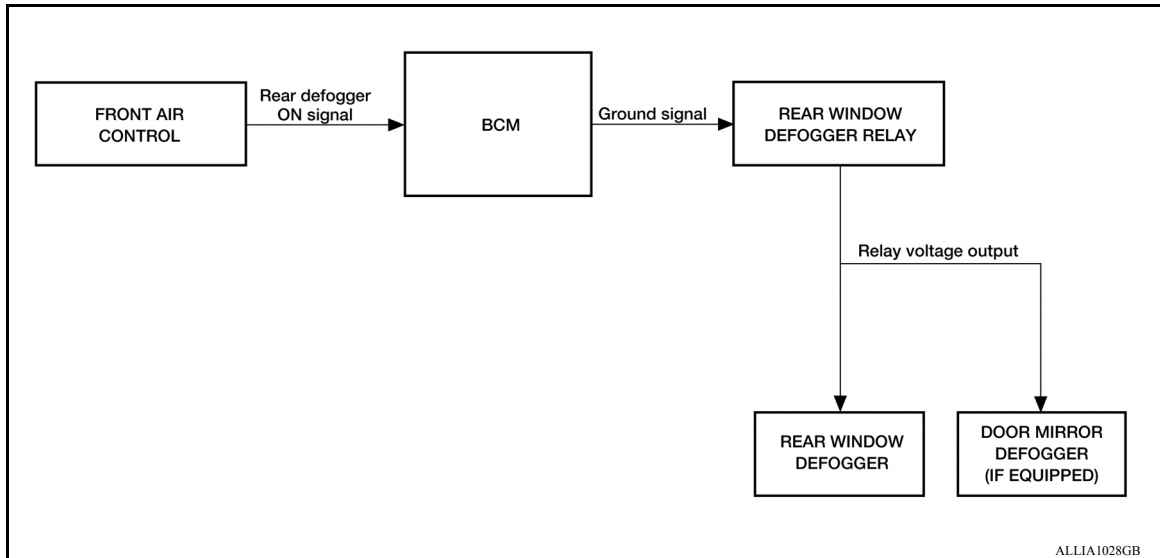

System Description

INFOID:000000009268312

Operation Description

- When rear window defogger switch is turned ON while ignition switch is ON, the front air control (rear window defogger switch) transmits rear window defogger switch signal to BCM.
- BCM turns rear window defogger relay ON when rear window defogger switch signal is received.
- Rear window defogger and door mirror defogger (with door mirror defogger) are supplied with power and operate when rear window defogger relay turns ON.
- Rear window defogger ON is displayed when front air control receives signals.

Timer function

- BCM turns rear window defogger relay ON for approximately 15 minutes when rear window defogger switch is turned ON while ignition switch is ON. It makes rear window defogger and door mirror defogger (with door mirror defogger) operate.
- Timer is canceled after pressing rear window defogger switch again during timer operation. Then BCM turns rear window defogger relay OFF. The same reaction also occurs during timer operation, if the ignition switch is turned OFF.

INPUT/OUTPUT SIGNAL CHART

Switch	Input signal to BCM	BCM function	Actuator
Rear window defogger switch	Defogger switch signal	Rear window defogger and door mirror defogger* control	Rear window defogger
Ignition switch	Ignition signal		Door mirror defogger*

*: With door mirror defogger

DIAGNOSIS SYSTEM (BCM) (WITH INTELLIGENT KEY SYSTEM)

< SYSTEM DESCRIPTION >

DIAGNOSIS SYSTEM (BCM) (WITH INTELLIGENT KEY SYSTEM) COMMON ITEM

COMMON ITEM : CONSULT Function (BCM - COMMON ITEM)

INFOID:000000009545880

APPLICATION ITEM

CONSULT performs the following functions via CAN communication with BCM.

Direct Diagnostic Mode	Description
ECU identification	The BCM part number is displayed.
Self Diagnostic Result	The BCM self diagnostic results are displayed.
Data Monitor	The BCM input/output data is displayed in real time.
Active Test	The BCM activates outputs to test components.
Work support	The settings for BCM functions can be changed.
Configuration	<ul style="list-style-type: none"> The vehicle specification can be read and saved. The vehicle specification can be written when replacing BCM.
CAN DIAG SUPPORT MNTR	The result of transmit/receive diagnosis of CAN communication is displayed.

SYSTEM APPLICATION

BCM can perform the following functions.

System	Sub System	Direct Diagnostic Mode						
		ECU identification	Self Diagnostic Result	Data Monitor	Active Test	Work support	Configuration	CAN DIAG SUPPORT MNTR
Door lock	DOOR LOCK		×	×	×	×		
Rear window defogger	REAR DEFOGGER			×	×			
Warning chime	BUZZER			×	×			
Interior room lamp timer	INT LAMP			×	×	×		
Exterior lamp	HEAD LAMP			×	×	×		
Wiper and washer	WIPER			×	×	×		
Turn signal and hazard warning lamps	FLASHER			×	×			
Air conditioner	AIR CONDITIONER			×				
Intelligent Key system	INTELLIGENT KEY		×	×	×	×		
Combination switch	COMB SW			×				
BCM	BCM	×	×			×	×	×
Immobilizer	IMMU		×		×	×		
Interior room lamp battery saver	BATTERY SAVER			×	×	×		
Trunk open	TRUNK			×				
Vehicle security system	THEFT ALM			×	×	×		
RAP system	RETAINED PWR			×		×		
Signal buffer system	SIGNAL BUFFER			×				
TPMS	AIR PRESSURE MONITOR		×	×	×	×		
Panic alarm system	PANIC ALARM				×			

DIAGNOSIS SYSTEM (BCM) (WITH INTELLIGENT KEY SYSTEM)

< SYSTEM DESCRIPTION >

REAR DEFOGGER

REAR DEFOGGER : CONSULT Function (BCM - REAR DEFOGGER)

INFOID:000000009545958

DATA MONITOR

Monitor Item [Unit]	Description
PUSH SW [On/Off]	Indicates condition of push-button ignition switch.
REAR DEF SW [On/Off]	Indicates condition of rear window defogger switch.

ACTIVE TEST

Test Item	Description
REAR DEFOGGER	This test is able to check rear window defogger operation [Off/On].

A

B

C

D

E

F

G

H

I

J

K

DEF

M

N

O

P

DIAGNOSIS SYSTEM (BCM) (WITHOUT INTELLIGENT KEY SYSTEM)

< SYSTEM DESCRIPTION >

DIAGNOSIS SYSTEM (BCM) (WITHOUT INTELLIGENT KEY SYSTEM) COMMON ITEM

COMMON ITEM : CONSULT Function (BCM - COMMON ITEM)

INFOID:000000009545959

APPLICATION ITEM

CONSULT performs the following functions via CAN communication with BCM.

Direct Diagnostic Mode	Description
ECU identification	The BCM part number is displayed.
Self Diagnostic Result	The BCM self diagnostic results are displayed.
Data Monitor	The BCM input/output data is displayed in real time.
Active Test	The BCM activates outputs to test components.
Work support	The settings for BCM functions can be changed.
Configuration	<ul style="list-style-type: none"> The vehicle specification can be read and saved. The vehicle specification can be written when replacing BCM.
CAN DIAG SUPPORT MNTR	The result of transmit/receive diagnosis of CAN communication is displayed.

SYSTEM APPLICATION

BCM can perform the following functions.

System	Sub System	Direct Diagnostic Mode						
		ECU identification	Self Diagnostic Result	Data Monitor	Active Test	Work support	Configuration	CAN DIAG SUPPORT MNTR
Door lock	DOOR LOCK		×	×	×	×		
Rear window defogger	REAR DEFOGGER			×	×			
Warning chime	BUZZER			×	×			
Interior room lamp timer	INT LAMP			×	×	×		
Remote keyless entry system	MULTI REMOTE ENT			×	×	×		
Exterior lamp	HEAD LAMP			×	×	×		
Wiper and washer	WIPER			×	×	×		
Turn signal and hazard warning lamps	FLASHER			×	×			
Air conditioner	AIR CONDITIONER			×				
Combination switch	COMB SW			×				
BCM	BCM	×	×			×	×	×
Immobilizer	IMMU		×		×	×		
Interior room lamp battery saver	BATTERY SAVER			×	×	×		
Trunk open	TRUNK			×				
Vehicle security system	THEFT ALM			×	×	×		
Signal buffer system	SIGNAL BUFFER			×	×			
TPMS	AIR PRESSURE MONITOR		×	×	×	×		
Panic alarm system	PANIC ALARM				×			

DIAGNOSIS SYSTEM (BCM) (WITHOUT INTELLIGENT KEY SYSTEM)

< SYSTEM DESCRIPTION >

REAR DEFOGGER

REAR DEFOGGER : CONSULT Function (BCM - REAR DEFOGGER)

INFOID:000000009545960

DATA MONITOR

Monitor Item [Unit]	Description
IGN ON SW [On/Off]	Indicates condition of ignition switch ON position.
ACC ON SW [On/Off]	Indicates condition of ignition switch ACC position.
REAR DEF SW [On/Off]	Indicates condition of rear window defogger switch.
RR DEF TIME [On/Off]	Indicates condition of rear window defogger switch timer.

ACTIVE TEST

Test Item	Description
REAR DEFOGGER	This test is able to check rear window defogger operation [Off/On].

A

B

C

D

E

F

G

H

I

J

K

DEF

M

N

O

P

BCM

< ECU DIAGNOSIS INFORMATION >

ECU DIAGNOSIS INFORMATION

BCM

List of ECU Reference

INFOID:000000009268317

ECU	Reference
BCM (with Intelligent Key system)	BCS-28. "Reference Value"
	BCS-45. "Fail-safe"
	BCS-47. "DTC Inspection Priority Chart"
	BCS-48. "DTC Index"
BCM (without Intelligent Key system)	BCS-93. "Reference Value"
	BCS-104. "Fail-safe"
	BCS-104. "DTC Inspection Priority Chart"
	BCS-105. "DTC Index"

REAR WINDOW DEFOGGER SYSTEM

< WIRING DIAGRAM >

WIRING DIAGRAM

REAR WINDOW DEFOGGER SYSTEM

Wiring Diagram

INFOID:000000009268318

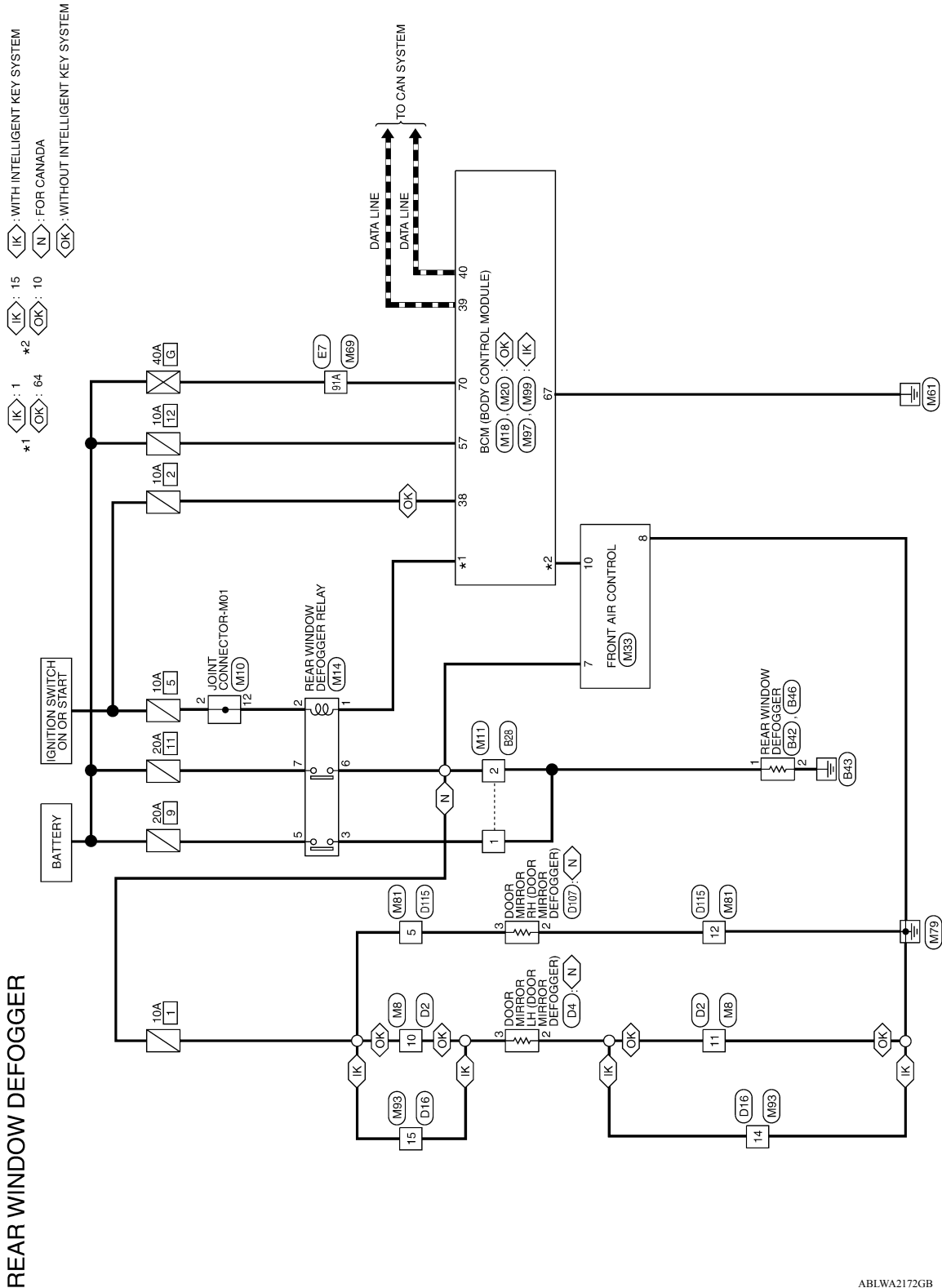

A
B
C
D
E
F
G
H
I
J
K
DEF
M
N
O
P

REAR WINDOW DEFOGGER SYSTEM

< WIRING DIAGRAM >

REAR WINDOW DEFOGGER CONNECTORS

Connector No.	M8
Connector Name	WIRE TO WIRE
Connector Color	WHITE

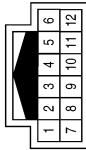

Terminal No.	Color of Wire	Signal Name
10	V	-
11	B	-

Connector No.	M10
Connector Name	JOINT CONNECTOR-M01
Connector Color	GRAY

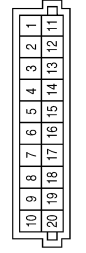

Terminal No.	Color of Wire	Signal Name
2	O	-
12	O	-

Connector No.	M11
Connector Name	WIRE TO WIRE
Connector Color	WHITE



Terminal No.	Color of Wire	Signal Name
1	R	-
2	R	-

Connector No.	M14
Connector Name	REAR WINDOW DEFOGGER RELAY
Connector Color	BROWN

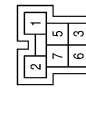

Terminal No.	Color of Wire	Signal Name
1	GR	-
2	O	-
3	R	-
5	Y	-
6	R	-
7	Y	-

Connector No.	M18
Connector Name	BCM (BODY CONTROL MODULE) (WITHOUT INTELLIGENT KEY SYSTEM)
Connector Color	WHITE

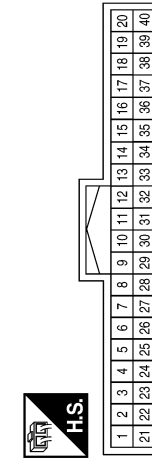

Terminal No.	Color of Wire	Signal Name
10	G	REAR DEFOGGER SW
38	O	IGN SW
39	L	CAN-H
40	P	CAN-L

Connector No.	M20
Connector Name	BCM (BODY CONTROL MODULE) (WITHOUT INTELLIGENT KEY SYSTEM)
Connector Color	BLACK

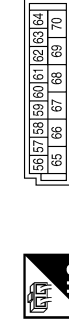

Terminal No.	Color of Wire	Signal Name
57	Y	BATTERY (FUSE)
64	GR	REAR DEFOGGER RELAY OUTPUT
67	B	GND
70	G	BATTERY (F/L)

REAR WINDOW DEFOGGER SYSTEM

< WIRING DIAGRAM >

Terminal No.	Color of Wire	Signal Name
91A	G	-

Connector No.	M69
Connector Name	WIRE TO WIRE
Connector Color	WHITE

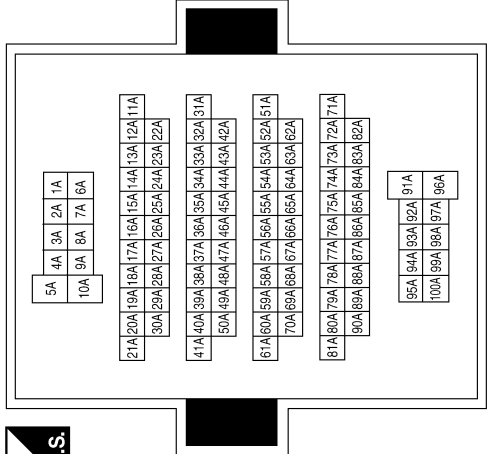

Connector No.	M33
Connector Name	FRONT AIR CONTROL
Connector Color	BLACK

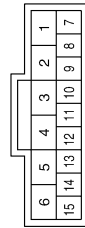

Terminal No.	Color of Wire	Signal Name
7	R	R/DEF LED
8	B	GND
10	G	R/DEF SWITCH

Connector No.	M97
Connector Name	BCM (BODY CONTROL MODULE) (WITH INTELLIGENT KEY SYSTEM)
Connector Color	BLACK

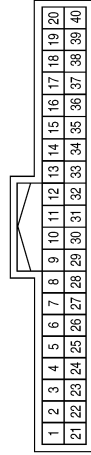

Terminal No.	Color of Wire	Signal Name
1	GR	REAR DEFOGGER RELAY OUTPUT
15	G	REAR DEFOGGER SW
39	L	CAN-H
40	P	CAN-L

Connector No.	M93
Connector Name	WIRE TO WIRE
Connector Color	WHITE



Terminal No.	Color of Wire	Signal Name
14	B	-
15	V	-

Connector No.	M81
Connector Name	WIRE TO WIRE
Connector Color	WHITE

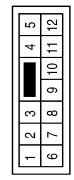

Terminal No.	Color of Wire	Signal Name
5	V	-
12	B	-

ABL1A4868GB

A
B
C
D
E
F
G
H
I
J
K
DEF
M
N
O
P

REAR WINDOW DEFOGGER SYSTEM

< WIRING DIAGRAM >

Connector No.	M99
Connector Name	BCM (BODY CONTROL MODULE) (WITH INTELLIGENT KEY SYSTEM)
Connector Color	WHITE



Terminal No.	Color of Wire	Signal Name
57	Y	BATTERY (FUSE)
67	B	GND
70	G	BATTERY (F/L)

Connector No.	E7
Connector Name	WIRE TO WIRE
Connector Color	WHITE

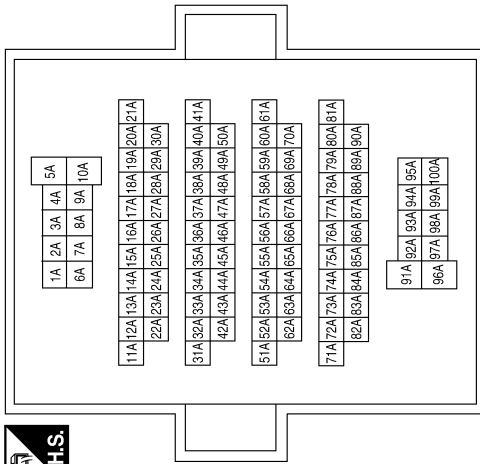

Terminal No.	Color of Wire	Signal Name
91A	Y	-

Connector No.	B28
Connector Name	WIRE TO WIRE
Connector Color	WHITE



Terminal No.	Color of Wire	Signal Name
1	B	-
2	B	-

Connector No.	B42
Connector Name	REAR WINDOW DEFOGGER
Connector Color	BLACK



Terminal No.	Color of Wire	Signal Name
1	B	-

Connector No.	B46
Connector Name	REAR WINDOW DEFOGGER
Connector Color	BLACK



Terminal No.	Color of Wire	Signal Name
2	B	-

Connector No.	D2
Connector Name	WIRE TO WIRE
Connector Color	WHITE

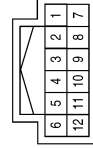

Terminal No.	Color of Wire	Signal Name
10	Y	-
11	B	-

REAR WINDOW DEFOGGER SYSTEM

< WIRING DIAGRAM >

Connector No.	D107
Connector Name	DOOR MIRROR RH
Connector Color	WHITE

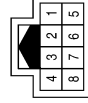

Terminal No.	Color of Wire	Signal Name
2	B	-
3	G	-

Connector No.	D16
Connector Name	WIRE TO WIRE
Connector Color	WHITE

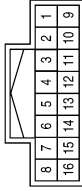

Terminal No.	Color of Wire	Signal Name
14	B	-
15	Y	-

Connector No.	D4
Connector Name	DOOR MIRROR LH
Connector Color	WHITE

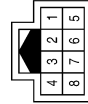

Terminal No.	Color of Wire	Signal Name
2	B	-
3	Y	-

Connector No.	D115
Connector Name	WIRE TO WIRE
Connector Color	WHITE

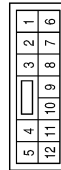

Terminal No.	Color of Wire	Signal Name
5	G	-
12	B	-

ABLI1A4870GB

A
B
C
D
E
F
G
H
I
J
K
DEF
M
N
O
P

DIAGNOSIS AND REPAIR WORK FLOW

< BASIC INSPECTION >

BASIC INSPECTION

DIAGNOSIS AND REPAIR WORK FLOW

Work Flow

INFOID:000000009268319

OVERALL SEQUENCE

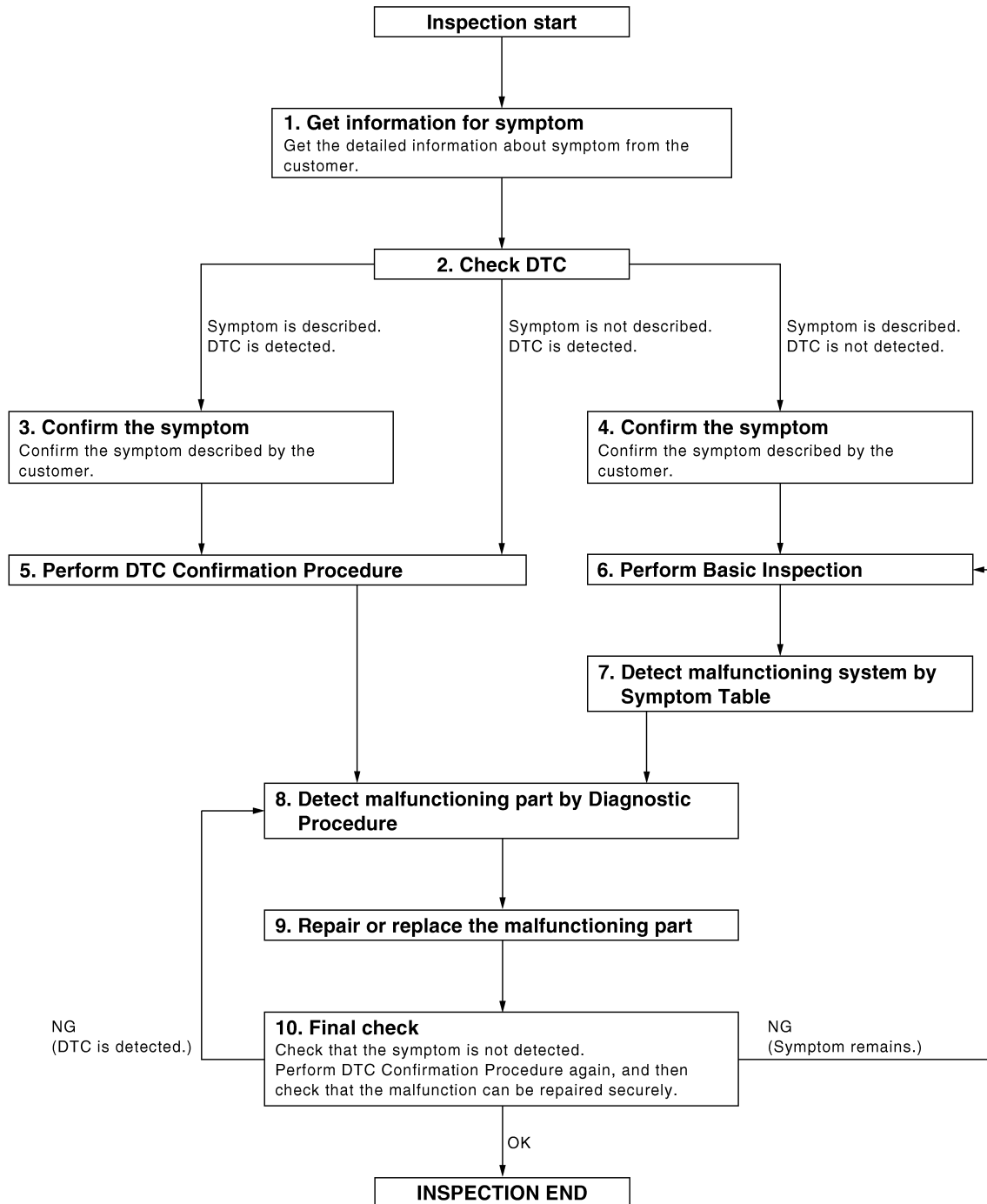

DETAILED FLOW

Revision: April 2013

DEF-16

JMKIA0101GB

2014 Versa Sedan

DIAGNOSIS AND REPAIR WORK FLOW

< BASIC INSPECTION >

1. GET INFORMATION FOR SYMPTOM

Get the detailed information from the customer about the symptom (the condition and the environment when the incident/malfunction occurred).

>> GO TO 2

2. CHECK DTC

1. Check DTC.
2. Perform the following procedure if DTC is displayed.
 - Record DTC and freeze frame data (Print them out with CONSULT.)
 - Erase DTC.
 - Study the relationship between the cause detected by DTC and the symptom described by the customer.
3. Check related service bulletins for information.

Is any symptom described and any DTC detected?

- Symptom is described, DTC is displayed>>GO TO 3
- Symptom is described, DTC is not displayed>>GO TO 4
- Symptom is not described, DTC is displayed>>GO TO 5

3. CONFIRM THE SYMPTOM

Confirm the symptom described by the customer.
Connect CONSULT to the vehicle in "DATA MONITOR" mode and check real time diagnosis results.
Verify relation between the symptom and the condition when the symptom is detected.

>> GO TO 5

4. CONFIRM THE SYMPTOM

Confirm the symptom described by the customer.
Connect CONSULT to the vehicle in "DATA MONITOR" mode and check real time diagnosis results.
Verify relation between the symptom and the condition when the symptom is detected.

>> GO TO 6

5. PERFORM DTC CONFIRMATION PROCEDURE

Perform DTC Confirmation Procedure for the displayed DTC, and then check that DTC is detected again.
At this time, always connect CONSULT to the vehicle, and check diagnostic results in real time.
If two or more DTCs are detected, refer to [BCS-47. "DTC Inspection Priority Chart"](#) (with Intelligent Key) or [BCS-104. "DTC Inspection Priority Chart"](#) (without Intelligent Key) and determine trouble diagnosis order.

NOTE:

- Freeze frame data is useful if the DTC is not detected.
- Perform Component Function Check if DTC Confirmation Procedure is not included in Service Manual. This simplified check procedure is an effective alternative though DTC cannot be detected during this check.
If the result of Component Function Check is NG, it is the same as the detection of DTC by DTC Confirmation Procedure.

Is DTC detected?

- YES >> GO TO 8
- NO >> Refer to [GI-45. "Intermittent Incident"](#).

6. PERFORM BASIC INSPECTION

Perform [DEF-16. "Work Flow"](#).

>> GO TO 7

7. DETECT MALFUNCTIONING SYSTEM BY SYMPTOM TABLE

Detect malfunctioning system according to [DEF-5. "System Description"](#) based on the confirmed symptom in step 4, and determine the trouble diagnosis order based on possible causes and symptom.

>> GO TO 8

A
B
C
D
E
F
G
H
I
J
K
DEF
M
N
O
P

DIAGNOSIS AND REPAIR WORK FLOW

< BASIC INSPECTION >

8. DETECT MALFUNCTIONING PART BY DIAGNOSTIC PROCEDURE

Inspect according to Diagnostic Procedure of the system.

NOTE:

The Diagnostic Procedure described based on open circuit inspection. A short circuit inspection is also required for the circuit check in the Diagnostic Procedure.

Is malfunctioning part detected?

YES >> GO TO 9

NO >> Check voltage of related BCM terminals using CONSULT.

9. REPAIR OR REPLACE THE MALFUNCTIONING PART

1. Repair or replace the malfunctioning part.
2. Reconnect parts or connectors disconnected during Diagnostic Procedure again after repair and replacement.
3. Check DTC. If DTC is displayed, erase it.

>> GO TO 10

10. FINAL CHECK

When DTC was detected in step 2, perform DTC Confirmation Procedure or Component Function Check again, and then check that the malfunction have been repaired securely.

When symptom was described from the customer, refer to confirmed symptom in step 3 or 4, and check that the symptom is not detected.

Does the symptom reappear?

YES (DTC is detected)>>GO TO 8

YES (Symptom remains)>>GO TO 6

NO >> Inspection End.

REAR WINDOW DEFOGGER SWITCH

< DTC/CIRCUIT DIAGNOSIS >

DTC/CIRCUIT DIAGNOSIS

REAR WINDOW DEFOGGER SWITCH

Description

INFOID:000000009268320

- The rear window defogger is operated by pressing the rear window defogger switch ON.
- The indicator lamp in the rear window defogger switch illuminates while the rear window defogger is ON.

Component Function Check

INFOID:000000009268321

1. CHECK REAR WINDOW DEFOGGER SWITCH FUNCTION

1. Turn ignition switch ON.
2. Check that the indicator lamp of rear window defogger illuminates with rear window defogger switch ON.

Is the inspection result normal?

YES >> GO TO 2.

NO >> Refer to [DEF-19, "Diagnosis Procedure"](#).

2. CHECK REAR DEFOGGER ON STATUS

1. Using CONSULT, select "BCM (REAR DEFOGGER)", then "DATA MONITOR" mode.
2. Select "REAR DEF SW" and monitor while pressing the rear DEF switch ON and OFF.

Monitored Item	Condition	Status
REAR DEF SW	Rear DEF switch ON (LED ON)	On
	Rear DEF switch OFF (LED OFF)	Off

Is the inspection result normal?

YES >> Inspection End.

NO >> Refer to [DEF-19, "Diagnosis Procedure"](#).

Diagnosis Procedure

INFOID:000000009268322

Regarding Wiring Diagram information, refer to [DEF-11, "Wiring Diagram"](#).

1. CHECK BCM OUTPUT SIGNAL

1. Turn ignition switch OFF.
2. Disconnect front air control connector.
3. Check voltage between front air control harness connector and ground.

(+)		(-)	Voltage (V) (Approx.)
Front air control			
Connector	Terminal		
M33	10	Ground	Battery voltage

Is the inspection result normal?

YES >> GO TO 3.

NO >> GO TO 2.

2. CHECK REAR WINDOW DEFOGGER SWITCH CIRCUIT

1. Disconnect BCM connector.
2. Check continuity between BCM harness connector and front air control harness connector.

A
B
C
D
E
F
G
H
I
J
K
DEF
M
N
O
P

REAR WINDOW DEFOGGER SWITCH

< DTC/CIRCUIT DIAGNOSIS >

BCM		Front air control		Continuity
Connector	Terminal	Connector	Terminal	
M18 (without Intelligent Key system)	10	M33	10	Yes
M97 (with Intelligent Key system)	15			

3. Check continuity between BCM harness connector and ground.

BCM		Ground	Continuity
Connector	Terminal		
M18 (without Intelligent Key system)	10		No
M97 (with Intelligent Key system)	15		

Is the inspection result normal?

YES >> Replace BCM. Refer to [BCS-69, "Removal and Installation"](#) (with Intelligent Key) or [BCS-122, "Removal and Installation"](#) (without Intelligent Key).

NO >> Repair or replace harness.

3.CHECK GROUND CIRCUIT

Check continuity between front air control harness connector and ground.

Front air control		Ground	Continuity
Connector	Terminal		
M33	8		Yes

Is the inspection result normal?

YES >> GO TO 4.

NO >> Repair or replace harness.

4.CHECK REAR WINDOW DEFOGGER SWITCH

Refer to [DEF-20, "Component Inspection"](#).

Is the inspection result normal?

YES >> Check intermittent incident. Refer to [GI-45, "Intermittent Incident"](#).

NO >> Replace front air control. Refer to [HAC-48, "Removal and Installation"](#).

Component Inspection

INFOID:000000009268323

1.CHECK REAR WINDOW DEFOGGER SWITCH

1. Turn ignition switch OFF.
2. Disconnect front air control connector.
3. Check continuity between front air control terminals.

Front air control		Condition	Continuity
Terminal			
10	8	Rear window defogger switch	Pressed Yes
			Released No

Is the inspection result normal?

YES >> Inspection End.

NO >> Replace front air control. Refer to [HAC-48, "Removal and Installation"](#).

REAR WINDOW DEFOGGER RELAY

< DTC/CIRCUIT DIAGNOSIS >

REAR WINDOW DEFOGGER RELAY

Description

INFOID:000000009268324

Power is supplied to the rear window defogger with BCM control.

Component Function Check

INFOID:000000009268325

1. CHECK FUNCTION

1. Turn ignition switch ON.
2. Check that an operation noise of rear window defogger relay can be heard when turning the rear window defogger switch ON.

Is the inspection result normal?

- YES >> Rear window defogger relay function is OK.
NO >> Refer to [DEF-21, "Diagnosis Procedure"](#)

Diagnosis Procedure

INFOID:000000009268326

Regarding Wiring Diagram information, refer to [DEF-11, "Wiring Diagram"](#).

1. CHECK REAR WINDOW DEFOGGER RELAY POWER SUPPLY CIRCUIT

1. Turn ignition switch OFF and disconnect rear window defogger relay connector.
2. Turn ignition switch ON.
3. Check voltage between rear window defogger relay harness connector and ground.

(+)		(-)	Voltage (V) (Approx.)
Rear window defogger relay			
Connector	Terminal		
M14	2	Ground	Battery voltage

Is the inspection result normal?

- YES >> GO TO 3.
NO >> GO TO 2.

2. CHECK FUSE

1. Turn ignition switch OFF.
2. Check 10A fuse (No. 5).

Is the inspection result normal?

- YES >> Check ignition power supply circuit. Refer to [PG-20, "Wiring Diagram — Ignition Power Supply —"](#)
NO >> If fuse is blown, be sure to eliminate cause of malfunction before installing new fuse.

3. CHECK REAR WINDOW DEFOGGER RELAY CONTROL CIRCUIT

1. Turn ignition switch OFF.
2. Disconnect BCM connector.
3. Check continuity between BCM harness connector and rear window defogger relay harness connector.

BCM		Rear window defogger relay		Continuity
Connector	Terminal	Connector	Terminal	
M20 (without Intelligent Key system)	64	M14	1	Yes
M97 (with Intelligent Key system)	1			

4. Check continuity between BCM harness connector and ground.

A
B
C
D
E
F
G
H
I
J
K
DEF
M
N
O
P

REAR WINDOW DEFOGGER RELAY

< DTC/CIRCUIT DIAGNOSIS >

BCM		Ground	Continuity
Connector	Terminal		
M20 (without Intelligent Key system)	64		No
M97 (with Intelligent Key system)	1		

Is the inspection result normal?

YES >> GO TO 4.

NO >> Repair or replace harness.

4. CHECK REAR WINDOW DEFOGGER RELAY

Refer to [DEF-22, "Component Inspection"](#).

Is the inspection result normal?

YES >> Replace BCM. Refer to [BCS-69, "Removal and Installation"](#) (with Intelligent Key) or [BCS-122, "Removal and Installation"](#) (without Intelligent Key).

NO >> Replace rear window defogger relay.

Component Inspection

INFOID:000000009268327

Check continuity between terminal 3 and 5, 6 and 7.

Terminal	Condition	Continuity
3 and 5, 6 and 7	12 V direct current supply between terminal 1 and 2	Yes
	No current supply	No

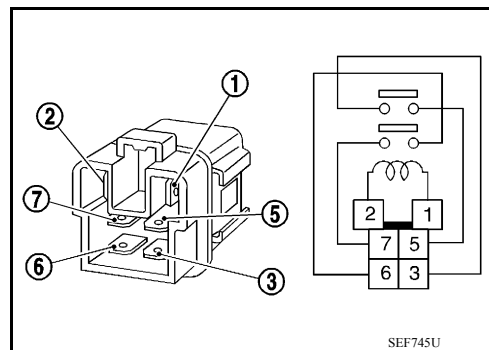

SEF745U

REAR WINDOW DEFOGGER POWER SUPPLY AND GROUND CIRCUIT

< DTC/CIRCUIT DIAGNOSIS >

REAR WINDOW DEFOGGER POWER SUPPLY AND GROUND CIRCUIT

Description

INFOID:000000009268328

Heats the heating wire with the power supply from the rear window defogger relay to prevent the rear window from fogging up.

Component Function Check

INFOID:000000009268329

1. CHECK REAR WINDOW DEFOGGER

Check that the heating wire of rear window defogger is heated when turning the rear window defogger switch ON.

Is the inspection result normal?

- YES >> Rear window defogger is OK.
NO >> Refer to [DEF-23, "Diagnosis Procedure"](#).

Diagnosis Procedure

INFOID:000000009268330

Regarding Wiring Diagram information, refer to [DEF-11, "Wiring Diagram"](#).

1. CHECK FUSES

Check if any of the following fuses in fuse block (J/B) are blown.

COMPONENT PARTS	AMPERE	FUSE NO.
Fuse block (J/B)	20A	9
	20A	11

Is the inspection result normal?

- YES >> GO TO 2
NO >> If fuse is blown, be sure to eliminate cause of malfunction before installing new fuse.

2. CHECK REAR WINDOW DEFOGGER POWER SUPPLY CIRCUIT

- Turn ignition switch ON.
- Check voltage between rear window defogger relay connector and ground.

Terminals		(-)	Condition of rear window defogger switch	Voltage (V) (Approx.)
(+)	Terminal			
Rear window defogger relay connector	3, 6	Ground	ON	Battery voltage
M14			OFF	0

Is the inspection result normal?

- YES >> GO TO 3
NO >> Check the following:
- Rear window defogger relay.
 - Battery power supply circuit.

3. CHECK POWER SUPPLY CIRCUIT

- Turn ignition switch ON.
- Check voltage between rear window defogger connector and ground.

A
B
C
D
E
F
G
H
I
J
K
DEF
M
N
O
P

REAR WINDOW DEFOGGER POWER SUPPLY AND GROUND CIRCUIT

< DTC/CIRCUIT DIAGNOSIS >

Terminals		Condition of rear window defogger switch	Voltage (V) (Approx.)
(+)	(-)		
Rear window defogger connector	Terminal		
B42	1	ON	Battery voltage
		OFF	0

Is the inspection result normal?

YES >> GO TO 4

NO >> GO TO 5

4. CHECK GROUND CIRCUIT

1. Turn ignition switch OFF.
2. Disconnect rear window defogger.
3. Check continuity between rear window defogger connector and ground.

Rear window defogger connector	Terminal	Ground	Continuity
B46	2		Yes

Is the inspection result normal?

YES >> GO TO 6

NO >> Repair or replace harness.

5. CHECK HARNESS CONTINUITY

1. Turn ignition switch OFF.
2. Disconnect rear window defogger relay connector and rear window defogger.
3. Check continuity between rear window defogger relay connector and rear window defogger connector.

Rear window defogger relay connector	Terminal	Rear window defogger connector	Terminal	Continuity
M14	3, 6	B42	1	Yes

Is the inspection result normal?

YES >> Check intermittent incident. Refer to [GI-45, "Intermittent Incident"](#).

NO >> Replace or repair harness.

6. CHECK FILAMENT

Check filament.

Refer to [DEF-24, "Component Inspection"](#).

Is the inspection result normal?

YES >> Refer to [GI-45, "Intermittent Incident"](#).

NO >> Repair filament. Refer to [DEF-35, "Inspection and Repair"](#).

Component Inspection

INFOID:000000009268331

1. CHECK FILAMENT

Check the filament for damage or open circuits.

Refer to [DEF-35, "Inspection and Repair"](#).

Is the inspection result normal?

YES >> Inspection End.

NO >> Repair filament. Refer to [DEF-35, "Inspection and Repair"](#).

DRIVER SIDE DOOR MIRROR DEFOGGER

< DTC/CIRCUIT DIAGNOSIS >

DRIVER SIDE DOOR MIRROR DEFOGGER

Description

INFOID:00000009268332

Heats the heating wire with the power supply from the rear window defogger relay to prevent the door mirror from fogging up.

Component Function Check

INFOID:00000009268333

1. CHECK DOOR MIRROR DEFOGGER LH

Check that heating wire of door mirror defogger LH is heated when turning the rear window defogger switch ON.

Is the inspection result normal?

- YES >> Door mirror defogger is OK.
- NO >> Refer to [DEF-25. "Diagnosis Procedure"](#).

Diagnosis Procedure

INFOID:00000009268334

Regarding Wiring Diagram information, refer to [DEF-11. "Wiring Diagram"](#).

1. CHECK POWER SUPPLY CIRCUIT

1. Turn ignition switch OFF.
2. Disconnect door mirror LH.
3. Turn ignition switch ON.
4. Check voltage between door mirror LH connector and ground.

Terminals		(-)	Condition of rear window defogger switch	Voltage (V) (Approx.)
(+)	Terminal			
Door mirror LH connector		Ground	ON	Battery voltage
D4	3		OFF	0

Is the inspection result normal?

- YES >> GO TO 2
- NO >> Repair or replace harness.

2. CHECK GROUND CIRCUIT

1. Turn ignition switch OFF.
2. Check continuity between door mirror LH connector and ground.

Door mirror LH connector	Terminal	Ground	Continuity
D4	2		Yes

Is the inspection result normal?

- YES >> GO TO 3
- NO >> Repair or replace harness.

3. CHECK DOOR MIRROR DEFOGGER LH

Check door mirror defogger LH.
Refer to [DEF-26. "Component Inspection"](#).

Is the inspection result normal?

- YES >> GO TO 4
- NO >> Replace door mirror. Refer to [MIR-15. "DOOR MIRROR ASSEMBLY : Removal and Installation"](#).

A
B
C
D
E
F
G
H
I
J
K
M
N
O
P

DEF

DRIVER SIDE DOOR MIRROR DEFOGGER

< DTC/CIRCUIT DIAGNOSIS >

4. CHECK INTERMITTENT INCIDENT

Check intermittent incident.

Refer to [GI-45, "Intermittent Incident"](#).

Is the inspection result normal?

- YES >> Check the following.
- Battery power supply circuit.
 - Fuse block (J/B).
- NO >> Repair or replace the malfunctioning parts.

Component Inspection

INFOID:000000009268335

1. CHECK DOOR MIRROR DEFOGGER LH

1. Turn ignition switch OFF.
2. Disconnect door mirror LH.
3. Check continuity between door mirror terminals.

Terminal		Continuity
3	2	Yes

Is the inspection result normal?

- YES >> Inspection End.
- NO >> Replace door mirror LH. Refer to [MIR-15, "DOOR MIRROR ASSEMBLY : Removal and Installation"](#).

PASSENGER SIDE DOOR MIRROR DEFOGGER

< DTC/CIRCUIT DIAGNOSIS >

PASSENGER SIDE DOOR MIRROR DEFOGGER

Description

INFOID:000000009268336

Heats the heating wire with the power supply from the rear window defogger relay to prevent the door mirror from fogging up.

Component Function Check

INFOID:000000009268337

1. CHECK DOOR MIRROR DEFOGGER RH

Check that the heating wire of door mirror defogger RH is heated when turning the rear window defogger switch ON.

Is the inspection result normal?

- YES >> Door mirror defogger RH is OK.
- NO >> Refer to [DEF-27. "Diagnosis Procedure"](#).

Diagnosis Procedure

INFOID:000000009268338

Regarding Wiring Diagram information, refer to [DEF-11. "Wiring Diagram"](#).

1. CHECK POWER SUPPLY CIRCUIT

1. Turn ignition switch OFF.
2. Disconnect door mirror RH.
3. Turn ignition switch ON.
4. Check voltage between door mirror RH connector and ground.

Terminals		Condition of rear window defogger switch	Voltage (V) (Approx.)
(+)	(-)		
Door mirror RH connector	Terminal		
D107	3	ON	Battery voltage
		OFF	0

Is the inspection result normal?

- YES >> GO TO 2
- NO >> Repair or replace harness.

2. CHECK GROUND CIRCUIT

1. Turn ignition switch OFF.
2. Check continuity between door mirror RH connector and ground.

Door mirror RH connector	Terminal	Ground	Continuity
D107	2		Yes

Is the inspection result normal?

- YES >> GO TO 3
- NO >> Repair or replace harness.

3. CHECK PASSENGER SIDE DOOR MIRROR DEFOGGER

Check door mirror defogger RH.

Refer to [DEF-28. "Component Inspection"](#).

Is the inspection result normal?

- YES >> GO TO 4
- NO >> Replace door mirror RH. Refer to [MIR-15. "DOOR MIRROR ASSEMBLY : Removal and Installation"](#).

A
B
C
D
E
F
G
H
I
J
K
M
N
O
P

DEF

PASSENGER SIDE DOOR MIRROR DEFOGGER

< DTC/CIRCUIT DIAGNOSIS >

4. CHECK INTERMITTENT INCIDENT

Check intermittent incident.

Refer to [GI-45, "Intermittent Incident"](#).

Is the inspection result normal?

- YES >> Check the following.
- Battery power supply circuit.
 - Fuse block (J/B).
- NO >> Repair or replace the malfunctioning parts.

Component Inspection

INFOID:000000009268339

1. CHECK DOOR MIRROR DEFOGGER RH

1. Turn ignition switch OFF.
2. Disconnect door mirror RH.
3. Check continuity between door mirror terminals.

Terminal		Continuity
3	2	Yes

Is the inspection result normal?

- YES >> Inspection End.
- NO >> Replace door mirror RH. Refer to [MIR-15, "DOOR MIRROR ASSEMBLY : Removal and Installation"](#).

REAR WINDOW DEFOGGER AND DOOR MIRROR DEFOGGER DO NOT OPERATE.

< SYMPTOM DIAGNOSIS >

SYMPTOM DIAGNOSIS

REAR WINDOW DEFOGGER AND DOOR MIRROR DEFOGGER DO NOT OPERATE.

Diagnosis Procedure

INFOID:000000009268340

1. CHECK REAR WINDOW DEFOGGER SWITCH

Check rear window defogger switch.

Refer to [DEF-19, "Component Function Check"](#).

Is the inspection result normal?

YES >> GO TO 2

NO >> Repair or replace the malfunctioning parts.

2. CHECK REAR WINDOW DEFOGGER RELAY

Check rear window defogger relay.

Refer to [DEF-21, "Component Function Check"](#).

Is the inspection result normal?

YES >> GO TO 3

NO >> Repair or replace the malfunctioning parts.

3. CHECK REAR WINDOW DEFOGGER POWER SUPPLY AND GROUND CIRCUIT

Check rear window defogger power supply and ground circuit.

Refer to [DEF-23, "Component Function Check"](#).

Is the inspection result normal?

YES >> Check intermittent incident. Refer to [GI-45, "Intermittent Incident"](#).

NO >> Repair or replace the malfunctioning parts.

A
B
C
D
E
F
G
H
I
J
K
DEF
M
N
O
P

REAR WINDOW DEFOGGER DOES NOT OPERATE BUT BOTH OF DOOR MIRROR DEFOGGER OPERATE.

< SYMPTOM DIAGNOSIS >

REAR WINDOW DEFOGGER DOES NOT OPERATE BUT BOTH OF DOOR MIRROR DEFOGGER OPERATE.

Diagnosis Procedure

INFOID:000000009268341

1. CHECK REAR WINDOW DEFOGGER POWER SUPPLY AND GROUND CIRCUIT

Check rear window defogger power supply and ground circuit.

Refer to [DEF-23, "Component Function Check"](#).

Is the inspection result normal?

YES >> Refer to [GI-45, "Intermittent Incident"](#).

NO >> Repair or replace the malfunctioning parts.

BOTH DOORS MIRROR DEFOGGER DON'T OPERATE BUT REAR WINDOW DEFOGGER OPERATES

< SYMPTOM DIAGNOSIS >

BOTH DOORS MIRROR DEFOGGER DON'T OPERATE BUT REAR WINDOW DEFOGGER OPERATES

Diagnosis Procedure

INFOID:000000009268342

1. CHECK DOOR MIRROR DEFOGGER FUSE

Check if the following fuse in fuse block (J/B) is blown.

COMPONENT PARTS	AMPERE	FUSE NO.
Fuse block (J/B)	10A	1

Is the inspection result normal?

YES >> GO TO 2

NO >> If fuse is blown, be sure to eliminate cause of malfunction before installing new fuse.

2. CHECK BOTH DOOR MIRROR DEFOGGER

1. Check door mirror LH. Refer to [DEF-25. "Component Function Check"](#).

2. Check door mirror RH. Refer to [DEF-27. "Component Function Check"](#).

Is the inspection result normal?

YES >> Check intermittent incident. Refer to [GI-45. "Intermittent Incident"](#).

NO >> Repair or replace the malfunctioning parts.

A
B
C
D
E
F
G
H
I
J
K
DEF
M
N
O
P

DRIVER SIDE DOOR MIRROR DEFOGGER DOES NOT OPERATE.

< SYMPTOM DIAGNOSIS >

DRIVER SIDE DOOR MIRROR DEFOGGER DOES NOT OPERATE.

Diagnosis Procedure

INFOID:000000009268343

1. CHECK DOOR MIRROR DEFOGGER LH

Check door mirror defogger LH.

Refer to [DEF-25, "Component Function Check"](#).

Is the inspection result normal?

YES >> Refer to [GI-45, "Intermittent Incident"](#).

NO >> Repair or replace the malfunctioning parts.

PASSENGER SIDE DOOR MIRROR DEFOGGER DOES NOT OPERATE.

< SYMPTOM DIAGNOSIS >

PASSENGER SIDE DOOR MIRROR DEFOGGER DOES NOT OPERATE.

Diagnosis Procedure

INFOID:000000009268344

1. CHECK DOOR MIRROR DEFOGGER RH

Check door mirror defogger RH.

Refer to [DEF-27, "Component Function Check"](#).

Is the inspection result normal?

YES >> Refer to [GI-45, "Intermittent Incident"](#).

NO >> Repair or replace the malfunctioning parts.

A
B
C
D
E
F
G
H
I
J
K
DEF
M
N
O
P

REAR WINDOW DEFOGGER SWITCH DOES NOT LIGHT, BUT REAR WINDOW DEFOGGER OPERATES

< SYMPTOM DIAGNOSIS >

REAR WINDOW DEFOGGER SWITCH DOES NOT LIGHT, BUT REAR WINDOW DEFOGGER OPERATES

Diagnosis Procedure

INFOID:000000009268345

1. CHECK FRONT AIR CONTROL (REAR WINDOW DEFOGGER SWITCH)

Check that the front air control (rear window defogger switch) is operating normally.

Is the inspection result normal?

- YES >> Refer to [GI-45, "Intermittent Incident"](#).
- NO >> Refer to [DEF-19, "Diagnosis Procedure"](#).

FILAMENT

< REMOVAL AND INSTALLATION >

REMOVAL AND INSTALLATION

FILAMENT

Inspection and Repair

INFOID:000000009268346

INSPECTION

1. When measuring voltage, wrap tin foil around the top of the negative probe. Then press the foil against the wire with your finger.

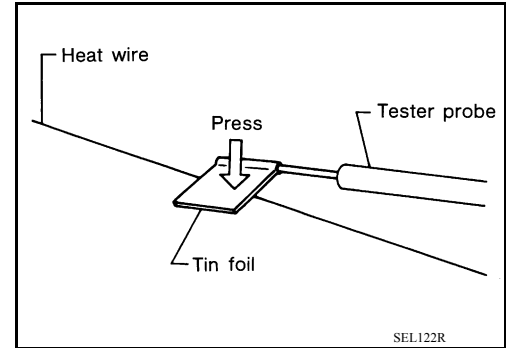

2. Attach probe circuit tester (in Volt range) to middle portion of each filament.

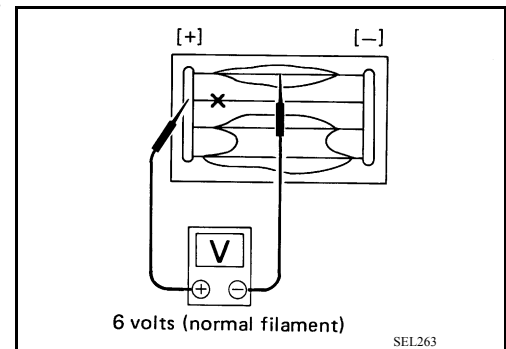

3. If a filament is burned out, circuit tester registers 0 or battery voltage.
4. To locate burned out point, move probe to left and right along filament. Test needle will swing abruptly when probe passes the point.

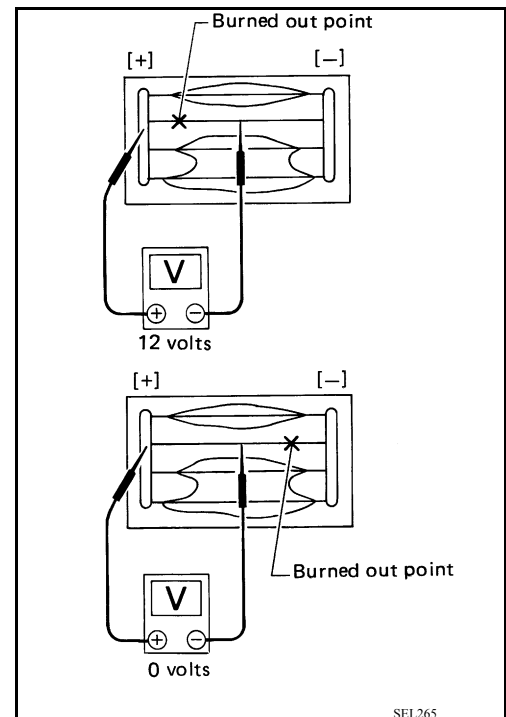

REPAIR

REPAIR EQUIPMENT

- Conductive silver composition (Dupont No. 4817 or equivalent)

A
B
C
D
E
F
G
H
I
J
K
DEF
M
N
O
P

FILAMENT

< REMOVAL AND INSTALLATION >

- Ruler 30 cm (11.8 in) long
- Drawing pen
- Heat gun
- Alcohol
- Cloth

REPAIRING PROCEDURE

1. Wipe broken heat wire and its surrounding area clean with a cloth dampened in alcohol.
2. Apply a small amount of conductive silver composition to tip of drawing pen.

NOTE:

Shake silver composition container before use.

3. Place ruler on glass along broken line. Deposit conductive silver composition on break with drawing pen. Slightly overlap existing heat wire on both sides [preferably 5 mm (0.20 in)] of the break.

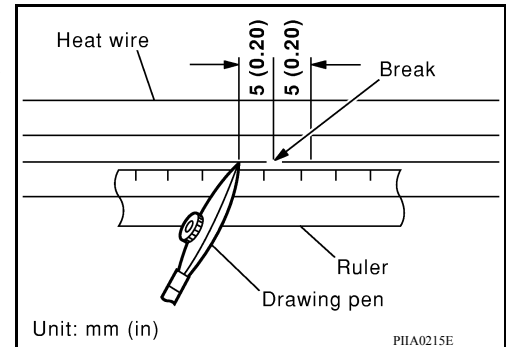

4. After repair has been completed, check repaired wire for continuity. This check should be conducted 10 minutes after silver composition is deposited.

CAUTION:

Do not touch repaired area while test is being conducted.

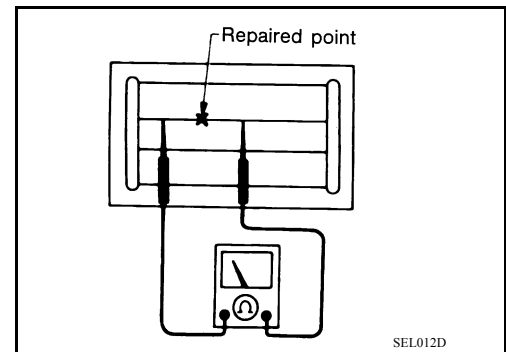

5. Apply a constant stream of hot air directly to the repaired area for approximately 20 minutes with a heat gun. A minimum distance of 3 cm (1.2 in) should be kept between repaired area and hot air outlet.

NOTE:

If a heat gun is not available, let the repaired area dry for 24 hours.

