

SECTION **PWC**

POWER WINDOW CONTROL SYSTEM

A
B
C
D
E
F
G
H
I
J
L
M
N
O
P

CONTENTS

PRECAUTION	BCM	
4	List of ECU Reference	12
PRECAUTIONS	POWER WINDOW MAIN SWITCH	13
4	Reference Value	13
Precaution for Supplemental Restraint System (SRS) "AIR BAG" and "SEAT BELT PRE-TENSIONER"	WIRING DIAGRAM	14
4	POWER WINDOW SYSTEM	14
Precaution for Work	Wiring Diagram	14
PREPARATION	BASIC INSPECTION	21
5	DIAGNOSIS AND REPAIR WORK FLOW	21
PREPARATION	Work Flow	21
5	DTC/CIRCUIT DIAGNOSIS	23
Special Service Tool	POWER SUPPLY AND GROUND CIRCUIT	23
5	BCM (BODY CONTROL SYSTEM) (WITH INTELLIGENT KEY SYSTEM)	23
SYSTEM DESCRIPTION	BCM (BODY CONTROL SYSTEM) (WITH INTELLIGENT KEY SYSTEM) : Diagnosis Procedure	23
6	BCM (BODY CONTROL SYSTEM) (WITHOUT INTELLIGENT KEY SYSTEM)	23
COMPONENT PARTS	BCM (BODY CONTROL SYSTEM) (WITHOUT INTELLIGENT KEY SYSTEM) : Diagnosis Procedure	23
6	POWER WINDOW MAIN SWITCH	24
Component Parts Location	POWER WINDOW MAIN SWITCH : Diagnosis Procedure	24
6	FRONT POWER WINDOW SWITCH (PASSENGER SIDE)	25
SYSTEM	FRONT POWER WINDOW SWITCH (PASSENGER SIDE) : Diagnosis Procedure	25
8	REAR POWER WINDOW SWITCH	26
System Diagram	REAR POWER WINDOW SWITCH : Diagnosis Procedure	26
8		
System Description		
8		
DIAGNOSIS SYSTEM (BCM) (WITH INTELLIGENT KEY SYSTEM)		
9		
COMMON ITEM		
9		
COMMON ITEM : CONSULT Function (BCM - COMMON ITEM)		
9		
RETAINED PWR		
10		
RETAINED PWR : CONSULT Function (BCM - RETAINED PWR)		
10		
DIAGNOSIS SYSTEM (BCM) (WITHOUT INTELLIGENT KEY SYSTEM)		
11		
COMMON ITEM		
11		
COMMON ITEM : CONSULT Function (BCM - COMMON ITEM)		
11		
ECU DIAGNOSIS INFORMATION		
12		

PWC

FRONT POWER WINDOW SWITCH (PASSENGER SIDE)	28	WHEN FRONT POWER WINDOW SWITCH (PASSENGER SIDE) IS OPERATED : Diagnosis Procedure	43
Component Function Check	28		
Diagnosis Procedure	28		
Component Inspection	29		
REAR POWER WINDOW SWITCH	30	WHEN POWER WINDOW MAIN SWITCH IS OPERATED	43
Component Function Check	30	WHEN POWER WINDOW MAIN SWITCH IS OPERATED : Diagnosis Procedure	44
Diagnosis Procedure	30		
Component Inspection	31		
POWER WINDOW MOTOR	32	REAR LH SIDE POWER WINDOW DOES NOT OPERATE	45
DRIVER SIDE	32	WHEN BOTH POWER WINDOW MAIN SWITCH AND REAR POWER WINDOW SWITCH LH ARE OPERATED	45
DRIVER SIDE : Component Function Check	32	WHEN BOTH POWER WINDOW MAIN SWITCH AND REAR POWER WINDOW SWITCH LH ARE OPERATED : Diagnosis Procedure	45
DRIVER SIDE : Diagnosis Procedure	32		
PASSENGER SIDE	33	WHEN REAR POWER WINDOW SWITCH LH IS OPERATED	45
PASSENGER SIDE : Component Function Check	33	WHEN REAR POWER WINDOW SWITCH LH IS OPERATED : Diagnosis Procedure	45
PASSENGER SIDE : Diagnosis Procedure	33		
REAR LH	34	WHEN POWER WINDOW MAIN SWITCH IS OPERATED	45
REAR LH : Component Function Check	34	WHEN POWER WINDOW MAIN SWITCH IS OPERATED : Diagnosis Procedure	46
REAR LH : Diagnosis Procedure	34		
REAR RH	35	REAR RH SIDE POWER WINDOW DOES NOT OPERATE	47
REAR RH : Component Function Check	35	WHEN BOTH POWER WINDOW MAIN SWITCH AND REAR POWER WINDOW SWITCH RH ARE OPERATED	47
REAR RH : Diagnosis Procedure	35	WHEN BOTH POWER WINDOW MAIN SWITCH AND REAR POWER WINDOW SWITCH RH ARE OPERATED : Diagnosis Procedure	47
DOOR SWITCH	37		
Description	37		
Component Function Check	37		
Diagnosis Procedure	37		
Component Inspection	39		
SYMPTOM DIAGNOSIS	40	WHEN REAR POWER WINDOW SWITCH RH IS OPERATED	47
POWER WINDOW CONTROL SYSTEM SYMPTOMS	40	WHEN REAR POWER WINDOW SWITCH RH IS OPERATED : Diagnosis Procedure	47
Symptom Table	40		
NONE OF THE POWER WINDOWS CAN BE OPERATED USING ANY SWITCH	41	WHEN POWER WINDOW MAIN SWITCH IS OPERATED	47
Diagnosis Procedure	41	WHEN POWER WINDOW MAIN SWITCH IS OPERATED : Diagnosis Procedure	48
DRIVER SIDE POWER WINDOW DOES NOT OPERATE	42	AUTO OPERATION DOES NOT OPERATE BUT MANUAL OPERATE NORMALLY (DRIVER SIDE)	49
Diagnosis Procedure	42	Diagnosis Procedure	49
FRONT PASSENGER SIDE POWER WINDOW DOES NOT OPERATE	43	POWER WINDOW RETAINED POWER OPERATION DOES NOT OPERATE PROPERLY	50
WHEN BOTH POWER WINDOW MAIN SWITCH AND FRONT POWER WINDOW SWITCH ARE OPERATED	43	Diagnosis Procedure	50
WHEN BOTH POWER WINDOW MAIN SWITCH AND FRONT POWER WINDOW SWITCH ARE OPERATED : Diagnosis Procedure	43		
WHEN FRONT POWER WINDOW SWITCH (PASSENGER SIDE) IS OPERATED	43	POWER WINDOW LOCK SWITCH DOES NOT FUNCTION	51
		Diagnosis Procedure	51

REMOVAL AND INSTALLATION	52	FRONT POWER WINDOW SWITCH	53
POWER WINDOW MAIN SWITCH	52	Removal and Installation	53
Removal and Installation	52	REAR POWER WINDOW SWITCH	54
		Removal and Installation	54

A

B

C

D

E

F

G

H

I

J

PWC

L

M

N

O

P

PRECAUTIONS

< PRECAUTION >

PRECAUTION

PRECAUTIONS

Precaution for Supplemental Restraint System (SRS) "AIR BAG" and "SEAT BELT PRE-TENSIONER"

INFOID:000000009269407

The Supplemental Restraint System such as "AIR BAG" and "SEAT BELT PRE-TENSIONER", used along with a front seat belt, helps to reduce the risk or severity of injury to the driver and front passenger for certain types of collision. This system includes seat belt switch inputs and dual stage front air bag modules. The SRS system uses the seat belt switches to determine the front air bag deployment, and may only deploy one front air bag, depending on the severity of a collision and whether the front occupants are belted or unbelted. Information necessary to service the system safely is included in the SR and SB section of this Service Manual.

WARNING:

- To avoid rendering the SRS inoperative, which could increase the risk of personal injury or death in the event of a collision which would result in air bag inflation, all maintenance must be performed by an authorized NISSAN/INFINITI dealer.
- Improper maintenance, including incorrect removal and installation of the SRS, can lead to personal injury caused by unintentional activation of the system. For removal of Spiral Cable and Air Bag Module, see the SR section.
- Do not use electrical test equipment on any circuit related to the SRS unless instructed to in this Service Manual. SRS wiring harnesses can be identified by yellow and/or orange harnesses or harness connectors.

PRECAUTIONS WHEN USING POWER TOOLS (AIR OR ELECTRIC) AND HAMMERS

WARNING:

- When working near the Airbag Diagnosis Sensor Unit or other Airbag System sensors with the Ignition ON or engine running, DO NOT use air or electric power tools or strike near the sensor(s) with a hammer. Heavy vibration could activate the sensor(s) and deploy the air bag(s), possibly causing serious injury.
- When using air or electric power tools or hammers, always switch the Ignition OFF, disconnect the battery, and wait at least 3 minutes before performing any service.

Precaution for Work

INFOID:000000009269408

- When removing or disassembling each component, be careful not to damage or deform it. If a component may be subject to interference, be sure to protect it with a shop cloth.
- When removing (disengaging) components with a screwdriver or similar tool, be sure to wrap the component with a shop cloth or vinyl tape to protect it.
- Protect the removed parts with a shop cloth and prevent them from being dropped.
- Replace a deformed or damaged clip.
- If a part is specified as a non-reusable part, always replace it with a new one.
- Be sure to tighten bolts and nuts securely to the specified torque.
- After installation is complete, be sure to check that each part works properly.
- Follow the steps below to clean components:
 - Water soluble dirt:
 - Dip a soft cloth into lukewarm water, wring the water out of the cloth and wipe the dirty area.
 - Then rub with a soft, dry cloth.
 - Oily dirt:
 - Dip a soft cloth into lukewarm water with mild detergent (concentration: within 2 to 3%) and wipe the dirty area.
 - Then dip a cloth into fresh water, wring the water out of the cloth and wipe the detergent off.
 - Then rub with a soft, dry cloth.
 - Do not use organic solvent such as thinner, benzene, alcohol or gasoline.
 - For genuine leather seats, use a genuine leather seat cleaner.

PREPARATION

< PREPARATION >

PREPARATION

PREPARATION

Special Service Tool

INFOID:000000009269409

The actual shapes of Kent-Moore tools may differ from those of special service tools illustrated here.

Tool number (Kent-Moore No.) Tool name	Description
— (J-46534) Trim Tool Set	Removing trim components

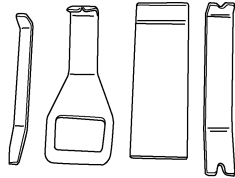

AWJIA0483ZZ

A
B
C
D
E
F
G
H
I
J
L
M
N
O
P

PWC

COMPONENT PARTS

< SYSTEM DESCRIPTION >

SYSTEM DESCRIPTION

COMPONENT PARTS

Component Parts Location

INFOID:000000009269410

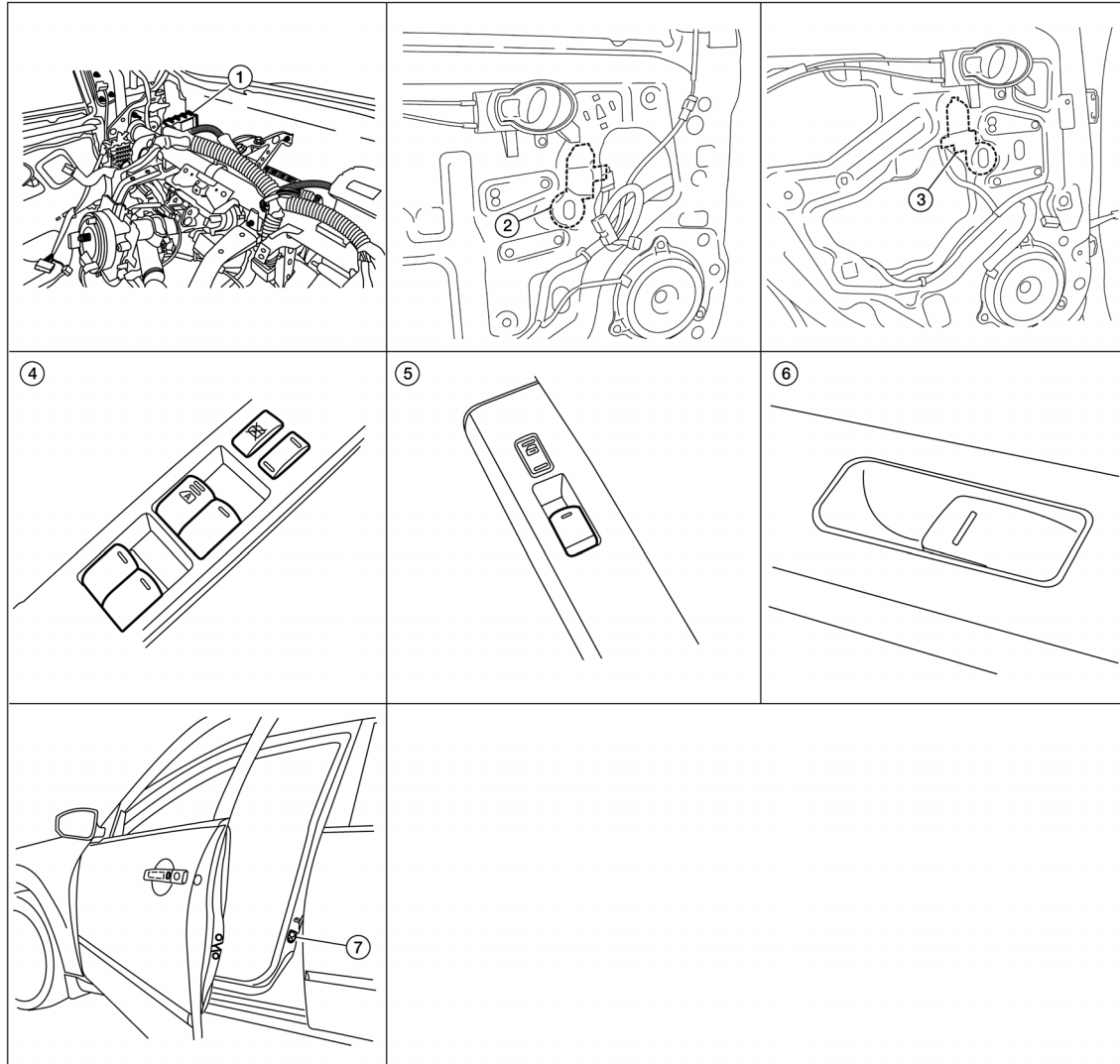

ALKIA2286ZZ

1. BCM (view with instrument panel removed)
2. Front power window motor (view with front door finisher removed)
3. Rear power window motor (view with rear door finisher removed)
4. Main power window and door lock/unlock switch
5. Front power window and door lock/unlock switch RH
6. Rear power window switch
7. Front door switch LH (RH similar)

Component Description

INFOID:000000009269411

Component	Function
BCM	<ul style="list-style-type: none"> • Supplies power to power window switches. • Controls retained power.
Main power window and door lock/unlock switch	Directly controls power window motor of all doors.
Power window and door lock/unlock switch RH	Controls front power window motor RH.

COMPONENT PARTS

< SYSTEM DESCRIPTION >

Component	Function
Rear power window switch	Controls rear power window motors LH and RH.
Front power window motor LH	Starts operating with signals from main power window and door lock/unlock switch.
Front power window motor RH	Starts operating with signals from main power window and door lock/unlock switch & power window switch RH.
Rear power window motor	Starts operating with signals from main power window and door lock/unlock switch & rear power window switch.
Front door switch LH or RH	Detects door open/close condition and transmits to the BCM.

A

B

C

D

E

F

G

H

I

J

PWC

L

M

N

O

P

SYSTEM

< SYSTEM DESCRIPTION >

SYSTEM

System Diagram

INFOID:000000009269412

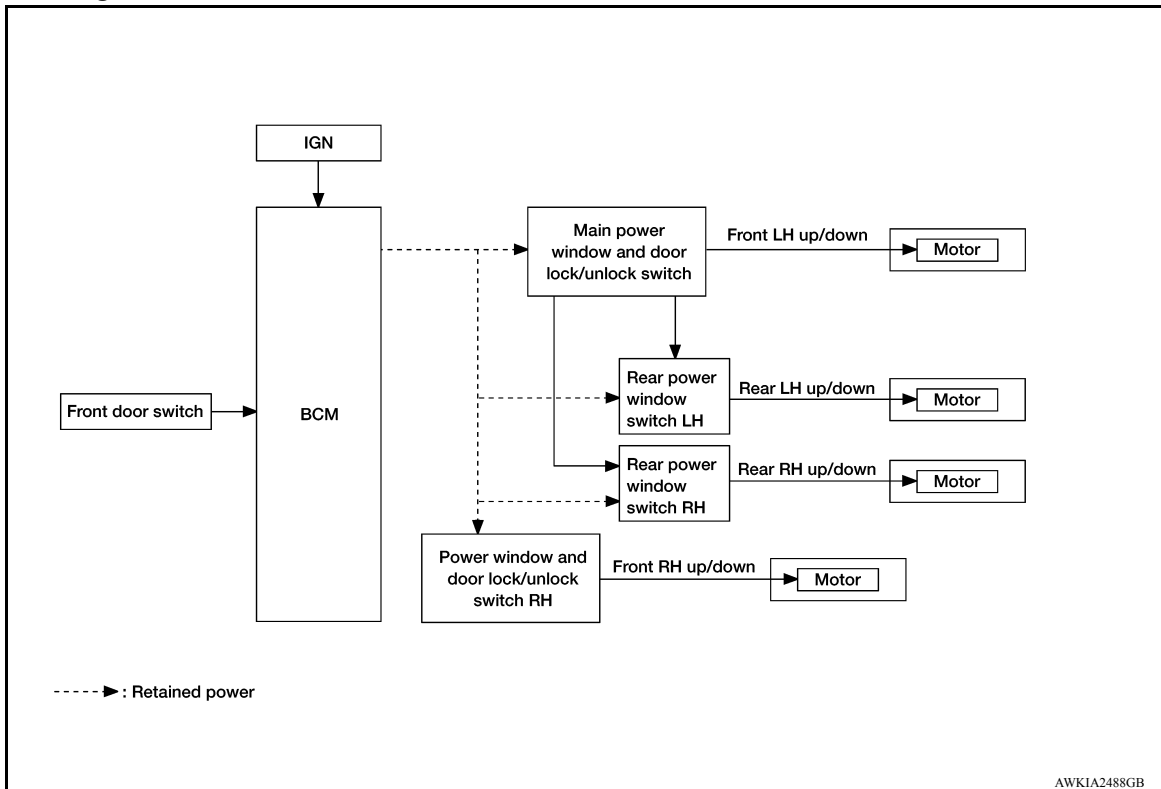

System Description

INFOID:000000009269413

BASIC OPERATION

- Power window system is activated by power window switch when ignition switch turns ON.
- Power window main switch opens/closes all door glass.
- Front and rear power window switch opens/closes the corresponding door glass.
- AUTO DOWN operation can be performed when power window main switch is depressed to the second detent.
- Power window lock switch can lock all power windows other than driver seat.

POWER WINDOW AUTO-OPERATION (FRONT DRIVER SIDE)

AUTO DOWN operation can be performed when power window main switch is depressed to the second detent.

POWER WINDOW LOCK

Ground circuit inside power window main switch shuts off when power window lock switch is ON. This inhibits each power window switch operation except the power window main switch.

RETAINED POWER OPERATION

- Retained power operation is an additional power supply function that enables power window system to operate for an additional 45 seconds after the ignition switch is turned OFF.

RETAINED ACCESSORY POWER CANCEL CONDITIONS:

- Front door CLOSE (door switch OFF)→OPEN (door switch ON).
- When ignition switch is ON again.
- When timer expires. (45 seconds)

DIAGNOSIS SYSTEM (BCM) (WITH INTELLIGENT KEY SYSTEM)

< SYSTEM DESCRIPTION >

DIAGNOSIS SYSTEM (BCM) (WITH INTELLIGENT KEY SYSTEM) COMMON ITEM

COMMON ITEM : CONSULT Function (BCM - COMMON ITEM)

INFOID:000000009541428

APPLICATION ITEM

CONSULT performs the following functions via CAN communication with BCM.

Direct Diagnostic Mode	Description
ECU identification	The BCM part number is displayed.
Self Diagnostic Result	The BCM self diagnostic results are displayed.
Data Monitor	The BCM input/output data is displayed in real time.
Active Test	The BCM activates outputs to test components.
Work support	The settings for BCM functions can be changed.
Configuration	<ul style="list-style-type: none"> The vehicle specification can be read and saved. The vehicle specification can be written when replacing BCM.
CAN DIAG SUPPORT MNTR	The result of transmit/receive diagnosis of CAN communication is displayed.

SYSTEM APPLICATION

BCM can perform the following functions.

System	Sub System	Direct Diagnostic Mode						
		ECU identification	Self Diagnostic Result	Data Monitor	Active Test	Work support	Configuration	CAN DIAG SUPPORT MNTR
Door lock	DOOR LOCK		×	×	×	×		
Rear window defogger	REAR DEFOGGER			×	×			
Warning chime	BUZZER			×	×			
Interior room lamp timer	INT LAMP			×	×	×		
Exterior lamp	HEAD LAMP			×	×	×		
Wiper and washer	WIPER			×	×	×		
Turn signal and hazard warning lamps	FLASHER			×	×			
Air conditioner	AIR CONDITIONER			×				
Intelligent Key system	INTELLIGENT KEY		×	×	×	×		
Combination switch	COMB SW			×				
BCM	BCM	×	×			×	×	×
Immobilizer	IMMU		×		×	×		
Interior room lamp battery saver	BATTERY SAVER			×	×	×		
Trunk open	TRUNK			×				
Vehicle security system	THEFT ALM			×	×	×		
RAP system	RETAINED PWR			×		×		
Signal buffer system	SIGNAL BUFFER			×				
TPMS	AIR PRESSURE MONITOR		×	×	×	×		
Panic alarm system	PANIC ALARM				×			

A
B
C
D
E
F
G
H
I
J
L
M
N
O
P

PWC

DIAGNOSIS SYSTEM (BCM) (WITH INTELLIGENT KEY SYSTEM)

< SYSTEM DESCRIPTION >

RETAINED PWR

RETAINED PWR : CONSULT Function (BCM - RETAINED PWR)

INFOID:000000009541429

DATA MONITOR

Monitor Item [Unit]	Description
DOOR SW-DR [On/Off]	Indicates condition of front door switch LH.
DOOR SW-AS [On/Off]	Indicates condition of front door switch RH.

DIAGNOSIS SYSTEM (BCM) (WITHOUT INTELLIGENT KEY SYSTEM)

< SYSTEM DESCRIPTION >

DIAGNOSIS SYSTEM (BCM) (WITHOUT INTELLIGENT KEY SYSTEM) COMMON ITEM

COMMON ITEM : CONSULT Function (BCM - COMMON ITEM)

INFOID:000000009541430

APPLICATION ITEM

CONSULT performs the following functions via CAN communication with BCM.

Direct Diagnostic Mode	Description
ECU identification	The BCM part number is displayed.
Self Diagnostic Result	The BCM self diagnostic results are displayed.
Data Monitor	The BCM input/output data is displayed in real time.
Active Test	The BCM activates outputs to test components.
Work support	The settings for BCM functions can be changed.
Configuration	<ul style="list-style-type: none"> The vehicle specification can be read and saved. The vehicle specification can be written when replacing BCM.
CAN DIAG SUPPORT MNTR	The result of transmit/receive diagnosis of CAN communication is displayed.

SYSTEM APPLICATION

BCM can perform the following functions.

System	Sub System	Direct Diagnostic Mode						
		ECU identification	Self Diagnostic Result	Data Monitor	Active Test	Work support	Configuration	CAN DIAG SUPPORT MNTR
Door lock	DOOR LOCK		×	×	×	×		
Rear window defogger	REAR DEFOGGER			×	×			
Warning chime	BUZZER			×	×			
Interior room lamp timer	INT LAMP			×	×	×		
Remote keyless entry system	MULTI REMOTE ENT			×	×	×		
Exterior lamp	HEAD LAMP			×	×	×		
Wiper and washer	WIPER			×	×	×		
Turn signal and hazard warning lamps	FLASHER			×	×			
Air conditioner	AIR CONDITIONER			×				
Combination switch	COMB SW			×				
BCM	BCM	×	×			×	×	×
Immobilizer	IMMU		×		×	×		
Interior room lamp battery saver	BATTERY SAVER			×	×	×		
Trunk open	TRUNK			×				
Vehicle security system	THEFT ALM			×	×	×		
Signal buffer system	SIGNAL BUFFER			×	×			
TPMS	AIR PRESSURE MONITOR		×	×	×	×		
Panic alarm system	PANIC ALARM				×			

BCM

< ECU DIAGNOSIS INFORMATION >

ECU DIAGNOSIS INFORMATION

BCM

List of ECU Reference

INFOID:000000009269418

ECU	Reference
BCM (with Intelligent Key system)	BCS-28, "Reference Value"
	BCS-45, "Fail-safe"
	BCS-47, "DTC Inspection Priority Chart"
	BCS-48, "DTC Index"
BCM (without Intelligent Key system)	BCS-93, "Reference Value"
	BCS-104, "Fail-safe"
	BCS-104, "DTC Inspection Priority Chart"
	BCS-105, "DTC Index"

POWER WINDOW MAIN SWITCH

< ECU DIAGNOSIS INFORMATION >

POWER WINDOW MAIN SWITCH

Reference Value

INFOID:00000009269419

TERMINAL LAYOUT

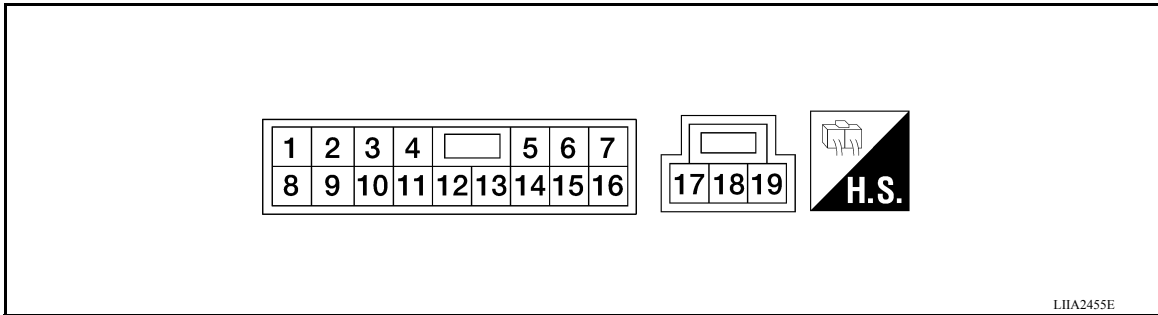

PHYSICAL VALUES

Terminal No. (Wire color)		Description		Condition	Voltage (V) (Approx.)
+	-	Signal name	Input/ Output		
1 (BR)	Ground	Rear power window motor LH UP signal	Output	When rear LH switch in power window main switch is in the UP position.	Battery voltage
3 (G)	Ground	Rear power window motor LH DOWN signal	Output	When rear LH switch in power window main switch is in the DOWN position.	Battery voltage
5 (Y)	Ground	Rear power window motor RH DOWN signal	Output	When rear RH switch in power window main switch is in the DOWN position.	Battery voltage
7 (V)	Ground	Rear power window motor RH UP signal	Output	When rear RH switch in power window main switch is in the UP position.	Battery voltage
8 (R)	Ground	Front power window motor (driver side) UP signal	Output	When front LH switch in power window main switch is in the UP position.	Battery voltage
10 (L)	Ground	Ignition switch power supply	Input	Ignition switch ON	Battery voltage
				Other than above	0
11 (LG)	Ground	Front power window motor (driver side) DOWN signal	Output	When front LH switch in power window main switch is in the DOWN position.	Battery voltage
12 (SB)	Ground	Front power window motor (passenger side) DOWN signal	Output	When front RH switch in power window main switch is in the DOWN position.	Battery voltage
16 (W)	Ground	Front power window motor (passenger side) UP signal	Output	When front RH switch in power window main switch is in the UP position.	Battery voltage
17 (B)	Ground	Ground	—	—	0

A
B
C
D
E
F
G
H
I
J
L
M
N
O
P

PWC

POWER WINDOW SYSTEM

< WIRING DIAGRAM >

WIRING DIAGRAM

POWER WINDOW SYSTEM

Wiring Diagram

INFOID:000000009269420

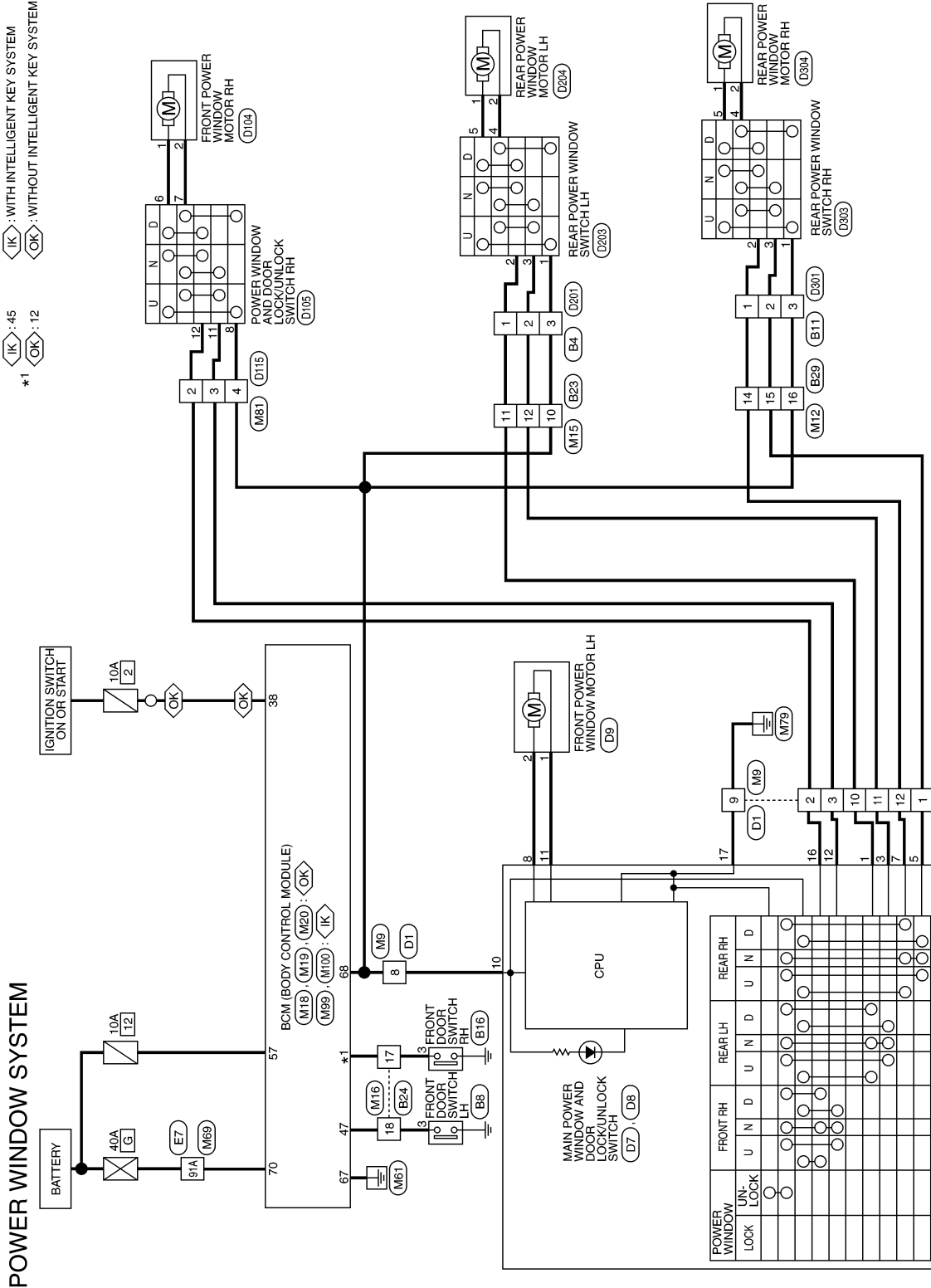

ABKWA2117GB

POWER WINDOW SYSTEM

< WIRING DIAGRAM >

POWER WINDOW SYSTEM CONNECTORS

Connector No.	M15
Connector Name	WIRE TO WIRE
Connector Color	WHITE

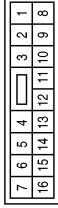

Terminal No.	Color of Wire	Signal Name
10	L	-
11	BR	-
12	O	-

Connector No.	M12
Connector Name	WIRE TO WIRE
Connector Color	WHITE

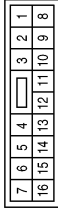

Terminal No.	Color of Wire	Signal Name
14	LG	-
15	Y	-
16	L	-

Connector No.	M9
Connector Name	WIRE TO WIRE
Connector Color	WHITE

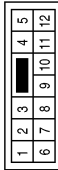

Terminal No.	Color of Wire	Signal Name
1	Y	-
2	W	-
3	V	-
8	L	-
9	B	-
10	BR	-
11	O	-
12	LG	-

Connector No.	M19
Connector Name	BCM (BODY CONTROL MODULE) (WITHOUT INTELLIGENT KEY SYSTEM)
Connector Color	WHITE

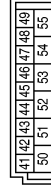

Terminal No.	Color of Wire	Signal Name
47	SB	DOOR SW (DR)

Connector No.	M18
Connector Name	BCM (BODY CONTROL MODULE) (WITHOUT INTELLIGENT KEY SYSTEM)
Connector Color	WHITE

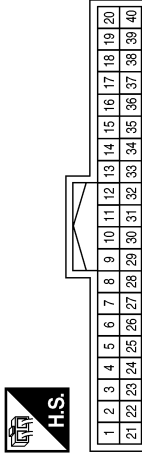

Terminal No.	Color of Wire	Signal Name
12	P	DOOR SW (AS)
38	O	IGN SW

Connector No.	M16
Connector Name	WIRE TO WIRE
Connector Color	WHITE

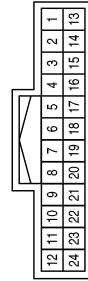

Terminal No.	Color of Wire	Signal Name
17	P	-
18	SB	-

ABK1A4599GB

A
B
C
D
E
F
G
H
I
J
K
L
M
N
O
P

PWC

POWER WINDOW SYSTEM

< WIRING DIAGRAM >

Terminal No.	Color of Wire	Signal Name
39A	SB	-
91A	G	-

Connector No.	M69
Connector Name	WIRE TO WIRE
Connector Color	WHITE

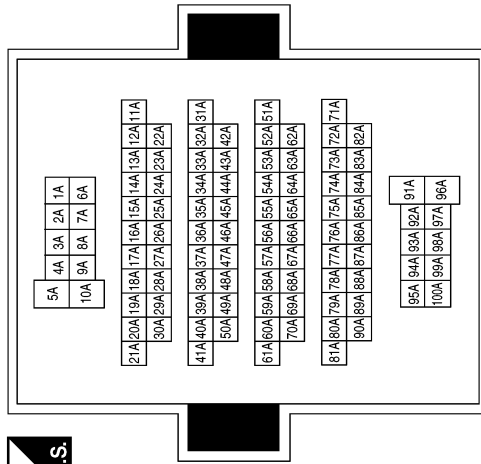

Connector No.	M20
Connector Name	BCM (BODY CONTROL MODULE) (WITHOUT INTELLIGENT KEY SYSTEM)
Connector Color	BLACK

56	57	58	59	60	61	62	63	64
65	66	67	68	69	70			



Terminal No.	Color of Wire	Signal Name
57	Y	BATTERY (FUSE)
67	B	GND
68	L	POWER WINDOW POWER SUPPLY (RAP)
70	G	BATTERY (F/L)

Connector No.	M99
Connector Name	BCM (BODY CONTROL MODULE) (WITH INTELLIGENT KEY SYSTEM)
Connector Color	WHITE

56	57	58	59	60	61	62	63	64
65	66	67	68	69	70			



Terminal No.	Color of Wire	Signal Name
57	Y	BATTERY (FUSE)
67	B	GND
68	L	POWER WINDOW POWER SUPPLY (IGN)
70	G	BATTERY (F/L)

Connector No.	M81
Connector Name	WIRE TO WIRE
Connector Color	WHITE

1	2	3	4	5
6	7	8	9	10
				11
				12



Terminal No.	Color of Wire	Signal Name
2	W	-
3	V	-
4	L	-

ABKIA4600GB

POWER WINDOW SYSTEM

< WIRING DIAGRAM >

Terminal No.	Color of Wire	Signal Name
39A	G	-
91A	Y	-

Connector No.	E7
Connector Name	WIRE TO WIRE
Connector Color	WHITE

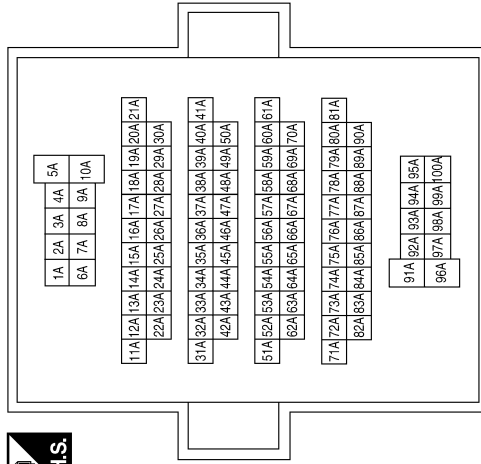

Connector No.	M100
Connector Name	BCM (BODY CONTROL MODULE) (WITH INTELLIGENT KEY SYSTEM)
Connector Color	BLACK

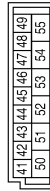

Terminal No.	Color of Wire	Signal Name
45	P	DOOR SW (AS)
47	SB	DOOR SW (DR)

Connector No.	B11
Connector Name	WIRE TO WIRE
Connector Color	WHITE



Connector No.	B8
Connector Name	FRONT DOOR SWITCH LH
Connector Color	WHITE



Connector No.	B4
Connector Name	WIRE TO WIRE
Connector Color	WHITE



Terminal No.	Color of Wire	Signal Name
1	G	-
2	R	-
3	L	-

Terminal No.	Color of Wire	Signal Name
3	LG	-

Terminal No.	Color of Wire	Signal Name
1	V	-
2	O	-
3	L	-

ABK1A3852GB

A
B
C
D
E
F
G
H
I
J
K
L
M
N
O
P

PWC

POWER WINDOW SYSTEM

< WIRING DIAGRAM >

Connector No.	B16
Connector Name	FRONT DOOR SWITCH RH
Connector Color	WHITE

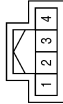

Terminal No.	Color of Wire	Signal Name
3	L	-

Connector No.	B23
Connector Name	WIRE TO WIRE
Connector Color	WHITE

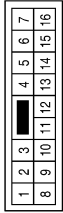

Terminal No.	Color of Wire	Signal Name
10	L	-
11	V	-
12	O	-

Connector No.	B24
Connector Name	WIRE TO WIRE
Connector Color	WHITE

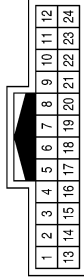

Terminal No.	Color of Wire	Signal Name
17	L	-
18	LG	-

Connector No.	B29
Connector Name	WIRE TO WIRE
Connector Color	WHITE

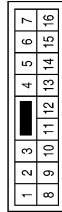

Terminal No.	Color of Wire	Signal Name
14	G	-
15	R	-
16	L	-

Connector No.	D1
Connector Name	WIRE TO WIRE
Connector Color	WHITE

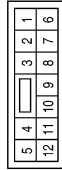

Terminal No.	Color of Wire	Signal Name
1	Y	-
2	W	-
3	SB	-
8	L	-
9	B	-
10	BR	-
11	G	-
12	V	-

Connector No.	D7
Connector Name	MAIN POWER WINDOW AND DOOR LOCK/UNLOCK SWITCH
Connector Color	WHITE

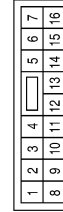

Terminal No.	Color of Wire	Signal Name
1	BR	UP (RL)
3	G	DN (RL)
5	Y	DN (RR)
7	V	UP (RR)
8	R	UP (DR)
10	L	IGN
11	LG	DOWN (DR)
12	SB	DOWN (AS)
16	W	UP (AS)

POWER WINDOW SYSTEM

< WIRING DIAGRAM >

Connector No.	D8
Connector Name	MAIN POWER WINDOW AND DOOR LOCK/UNLOCK SWITCH
Connector Color	WHITE

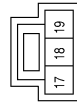

Terminal No.	Color of Wire	Signal Name
17	B	GND

Connector No.	D9
Connector Name	FRONT POWER WINDOW MOTOR LH
Connector Color	BLACK



Terminal No.	Color of Wire	Signal Name
1	LG	-
2	R	-

Connector No.	D104
Connector Name	FRONT POWER WINDOW MOTOR RH
Connector Color	BLACK



Terminal No.	Color of Wire	Signal Name
1	Y	-
2	R	-

Connector No.	D105
Connector Name	POWER WINDOW AND DOOR LOCK/UNLOCK SWITCH RH
Connector Color	WHITE

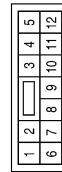

Terminal No.	Color of Wire	Signal Name
6	Y	-
7	R	-
8	L	-
11	SB	-
12	W	-

Connector No.	D115
Connector Name	WIRE TO WIRE
Connector Color	WHITE

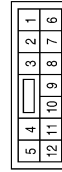

Terminal No.	Color of Wire	Signal Name
2	W	-
3	SB	-
4	L	-

Connector No.	D201
Connector Name	WIRE TO WIRE
Connector Color	WHITE

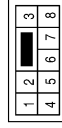

Terminal No.	Color of Wire	Signal Name
1	BR	-
2	Y	-
3	L	-

ABK1A4602GB

A
B
C
D
E
F
G
H
I
J
L
M
N
O
P

PWC

POWER WINDOW SYSTEM

< WIRING DIAGRAM >

Connector No.	D301
Connector Name	WIRE TO WIRE
Connector Color	WHITE

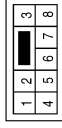

Terminal No.	Color of Wire	Signal Name
1	BR	-
2	Y	-
3	L	-

Connector No.	D204
Connector Name	REAR POWER WINDOW MOTOR LH
Connector Color	BLACK



Terminal No.	Color of Wire	Signal Name
1	R	-
2	G	-

Connector No.	D203
Connector Name	REAR POWER WINDOW SWITCH LH
Connector Color	WHITE

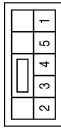

Terminal No.	Color of Wire	Signal Name
1	L	-
2	BR	-
3	Y	-
4	G	-
5	R	-

Connector No.	D304
Connector Name	REAR POWER WINDOW MOTOR RH
Connector Color	BLACK



Terminal No.	Color of Wire	Signal Name
1	R	-
2	G	-

Connector No.	D303
Connector Name	REAR POWER WINDOW SWITCH RH
Connector Color	WHITE

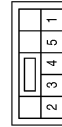

Terminal No.	Color of Wire	Signal Name
1	L	-
2	BR	-
3	Y	-
4	G	-
5	R	-

ABKIA3922GB

DIAGNOSIS AND REPAIR WORK FLOW

< BASIC INSPECTION >

BASIC INSPECTION

DIAGNOSIS AND REPAIR WORK FLOW

Work Flow

INFOID:000000009269421

OVERALL SEQUENCE

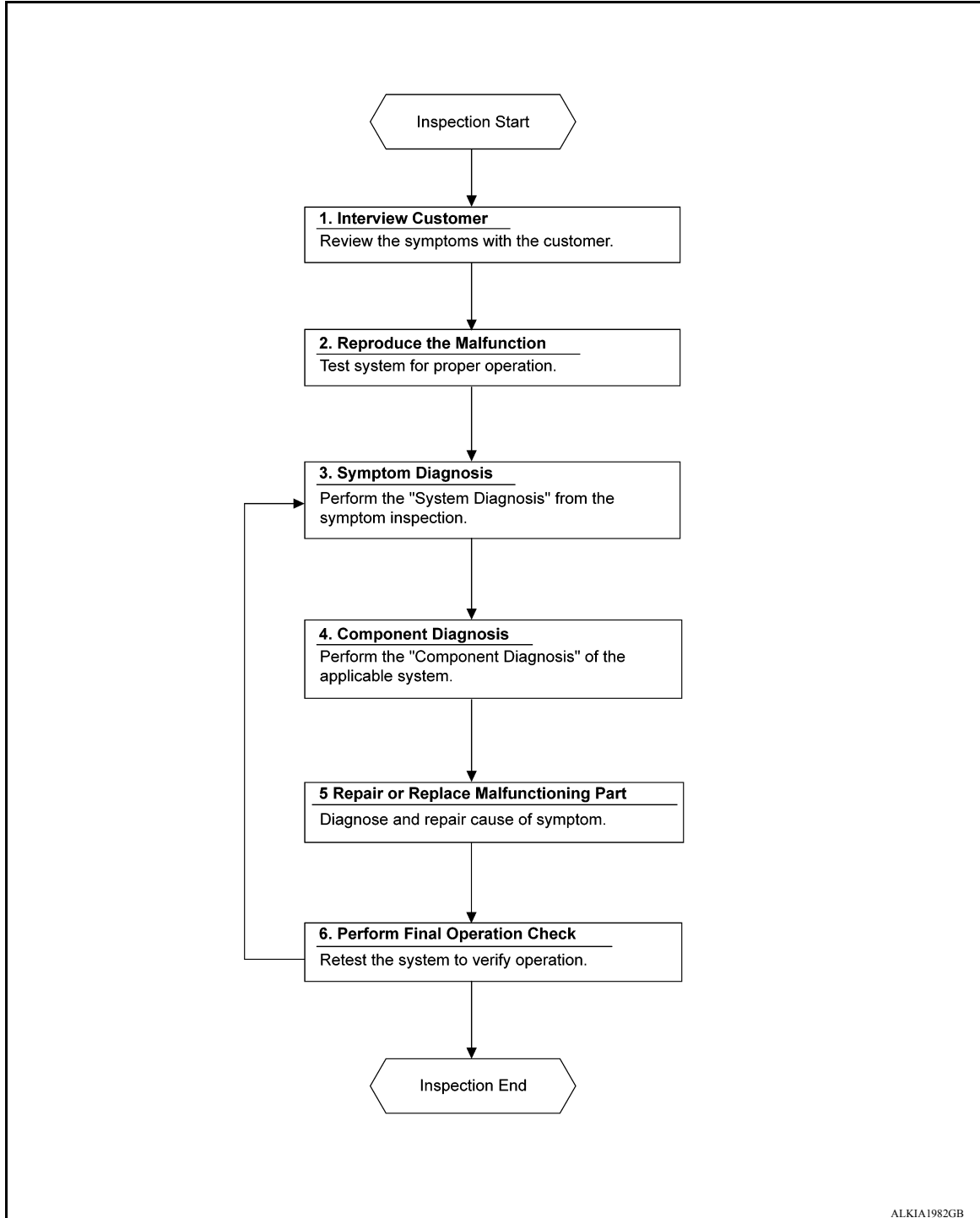

DETAILED FLOW

1. OBTAIN INFORMATION ABOUT SYMPTOM

Interview the customer to obtain as much information as possible about the conditions and environment under which the malfunction occurred.

A
B
C
D
E
F
G
H
I
J
L
M
N
O
P

PWC

DIAGNOSIS AND REPAIR WORK FLOW

< BASIC INSPECTION >

>> GO TO 2

2. REPRODUCE THE MALFUNCTION INFORMATION

Check the malfunction on the vehicle that the customer describes.
Inspect the relation of the symptoms and the condition when the symptoms occur.

>> GO TO 3

3. IDENTIFY THE MALFUNCTIONING SYSTEM WITH "SYMPTOM DIAGNOSIS"

Use "Symptom diagnosis" from the symptom inspection result in step 2 and then identify where to start performing the diagnosis based on possible causes and symptoms.

>> GO TO 4

4. PERFORM THE COMPONENT DIAGNOSIS OF THE APPLICABLE SYSTEM

Perform the diagnosis with "Component diagnosis" of the applicable system.

>> GO TO 5

5. REPAIR OR REPLACE THE MALFUNCTIONING PARTS

Repair or replace the specified malfunctioning parts.

>> GO TO 6

6. FINAL CHECK

Check that malfunctions are not reproduced when obtaining the malfunction information from the customer, referring to the symptom inspection result in step 2.

Are the malfunctions corrected?

YES >> Inspection End.

NO >> GO TO 3

POWER SUPPLY AND GROUND CIRCUIT

< DTC/CIRCUIT DIAGNOSIS >

DTC/CIRCUIT DIAGNOSIS

POWER SUPPLY AND GROUND CIRCUIT

BCM (BODY CONTROL SYSTEM) (WITH INTELLIGENT KEY SYSTEM)

BCM (BODY CONTROL SYSTEM) (WITH INTELLIGENT KEY SYSTEM) : Diagnosis Procedure

INFOID:000000009269422

Regarding Wiring Diagram information, refer to [BCS-50, "Wiring Diagram"](#).

1. CHECK FUSES AND FUSIBLE LINK

Check that the following fuses and fusible link are not blown.

Terminal No.	Signal name	Fuses and fusible link No.
57	Battery power supply	12 (10A)
70		G (40A)

Is the fuse blown?

- YES >> Replace the blown fuse or fusible link after repairing the affected circuit.
NO >> GO TO 2.

2. CHECK POWER SUPPLY CIRCUIT

1. Disconnect BCM connector M99.
2. Check voltage between BCM connector M99 and ground.

BCM		Ground	Voltage
Connector	Terminal		
M99	57	—	Battery voltage
	70		

Is the inspection result normal?

- YES >> GO TO 3.
NO >> Repair harness or connector.

3. CHECK GROUND CIRCUIT

Check continuity between BCM connector M99 and ground.

BCM		Ground	Continuity
Connector	Terminal		
M99	67	—	Yes

Is the inspection result normal?

- YES >> Inspection End.
NO >> Repair harness or connector.

BCM (BODY CONTROL SYSTEM) (WITHOUT INTELLIGENT KEY SYSTEM)

BCM (BODY CONTROL SYSTEM) (WITHOUT INTELLIGENT KEY SYSTEM) : Diagnosis Procedure

INFOID:000000009269423

Regarding Wiring Diagram information, refer to [BCS-107, "Wiring Diagram"](#).

POWER SUPPLY AND GROUND CIRCUIT

< DTC/CIRCUIT DIAGNOSIS >

1. CHECK FUSES AND FUSIBLE LINK

Check that the following fuses and fusible link are not blown.

Terminal No.	Signal name	Fuses and fusible link No.
57	Battery power supply	12 (10A)
70		G (40A)
11	Ignition switch ACC or ON	18 (10A)
38	Ignition switch ON or START	2 (10A)

Is the fuse blown?

YES >> Replace the blown fuse or fusible link after repairing the affected circuit.

NO >> GO TO 2.

2. CHECK POWER SUPPLY CIRCUIT

1. Turn ignition switch OFF.
2. Disconnect BCM connectors.
3. Check voltage between BCM connector and ground.

BCM		Ground	Ignition switch position		
Connector	Terminal		OFF	ACC	ON
M20	57	—	Battery voltage	Battery voltage	Battery voltage
	70				
M18	11		0 V	Battery voltage	Battery voltage
	38		0 V	0 V	Battery voltage

Is the inspection result normal?

YES >> GO TO 3.

NO >> Repair harness or connector.

3. CHECK GROUND CIRCUIT

Check continuity between BCM connector and ground.

BCM		Ground	Continuity
Connector	Terminal		
M20	67	—	Yes

Is the inspection result normal?

YES >> Inspection End.

NO >> Repair harness or connector.

POWER WINDOW MAIN SWITCH

POWER WINDOW MAIN SWITCH : Diagnosis Procedure

INFOID:000000009269424

Regarding Wiring Diagram information, refer to [PWC-14. "Wiring Diagram"](#).

1. CHECK POWER WINDOW MAIN SWITCH POWER SUPPLY

1. Turn ignition switch OFF.
2. Disconnect power window main switch connector.
3. Check voltage between power window main switch harness connector and ground.

POWER SUPPLY AND GROUND CIRCUIT

< DTC/CIRCUIT DIAGNOSIS >

(+)		(-)	Condition		Voltage (V) (Approx.)
Power window main switch					
Connector	Terminal				
D7	10	Ground	Ignition switch	ON	Battery voltage

Is the inspection result normal?

YES >> GO TO 3.

NO >> GO TO 2.

2.CHECK POWER WINDOW MAIN SWITCH POWER SUPPLY CIRCUIT

1. Turn ignition switch OFF.
2. Disconnect BCM connector.
3. Check continuity between BCM harness connector and power window main switch harness connector.

BCM		Power window main switch		Continuity
Connector	Terminal	Connector	Terminal	
M99 (with Intelligent Key system)	68	D7	10	Yes
M20 (without Intelligent Key system)				No

4. Check continuity between BCM harness connector and ground.

BCM		Ground	Continuity
Connector	Terminal		
M99 (with Intelligent Key system)	68		No
M20 (without Intelligent Key system)			No

Is the inspection result normal?

YES >> Replace BCM. Refer to [BCS-69, "Removal and Installation"](#).

NO >> Repair or replace harness.

3.CHECK POWER WINDOW MAIN SWITCH GROUND CIRCUIT

1. Turn ignition switch OFF.
2. Check continuity between power window main switch harness connector and ground.

Power window main switch		Ground	Continuity
Connector	Terminal		
D8	17		Yes

Is the inspection result normal?

YES >> Inspection End.

NO >> Repair or replace harness.

FRONT POWER WINDOW SWITCH (PASSENGER SIDE)

FRONT POWER WINDOW SWITCH (PASSENGER SIDE) : Diagnosis Procedure

INFOID:000000009269425

Regarding Wiring Diagram information, refer to [PWC-14, "Wiring Diagram"](#).

1.CHECK FRONT POWER WINDOW SWITCH RH POWER SUPPLY

1. Turn ignition switch OFF.
2. Disconnect front power window switch RH connector.
3. Turn ignition switch ON.
4. Check voltage between front power window switch RH harness connector and ground.

POWER SUPPLY AND GROUND CIRCUIT

< DTC/CIRCUIT DIAGNOSIS >

(+)		(-)	Voltage (V) (Approx.)
Front power window switch RH			
Connector	Terminal	Ground	Battery voltage
D105	8		

Is the inspection result normal?

YES >> Inspection End.

NO >> GO TO 2.

2.CHECK FRONT POWER WINDOW SWITCH RH POWER SUPPLY CIRCUIT

1. Turn ignition switch OFF.
2. Disconnect BCM connector.
3. Check continuity between BCM harness connector and front power window switch RH harness connector.

BCM		Front power window switch RH		Continuity
Connector	Terminal	Connector	Terminal	
M99 (with Intelligent Key system)	68	D105	8	Yes
M20 (without Intelligent key system)				

4. Check continuity between BCM harness connector and ground.

BCM		Ground	Continuity
Connector	Terminal		
M99 (with Intelligent Key system)	68		No
M20 (without Intelligent Key system)			

Is the inspection result normal?

YES >> Replace BCM. Refer to [BCS-69, "Removal and Installation"](#).

NO >> Repair or replace harness.

REAR POWER WINDOW SWITCH

REAR POWER WINDOW SWITCH : Diagnosis Procedure

INFOID:000000009269426

Regarding Wiring Diagram information, refer to [PWC-14, "Wiring Diagram"](#).

1.CHECK REAR POWER WINDOW SWITCH POWER SUPPLY

1. Turn ignition switch OFF.
2. Disconnect rear power window switch connector.
3. Turn ignition switch ON.
4. Check voltage between rear power window switch harness connector and ground.

(+)		(-)	Voltage (V) (Approx.)
Rear power window switch			
Connector	Terminal	Ground	Battery voltage
LH	D203		
RH	D303		

Is the inspection result normal?

YES >> Inspection End.

NO >> GO TO 2.

2.CHECK REAR POWER WINDOW SWITCH POWER SUPPLY CIRCUIT

1. Turn ignition switch OFF.
2. Disconnect BCM connector.

POWER SUPPLY AND GROUND CIRCUIT

< DTC/CIRCUIT DIAGNOSIS >

3. Check continuity between BCM harness connector and rear power window switch harness connector.

BCM		Rear power window switch		Continuity
Connector	Terminal	Connector	Terminal	
M99 (with Intelligent Key system)	68	LH	D203	Yes
		RH	D303	
M20 (without Intelligent Key system)		LH	D203	
		RH	D303	

4. Check continuity between BCM harness connector and ground.

BCM		Ground	Continuity
Connector	Terminal		
M99 (with Intelligent Key system)	68		No
M20 (without Intelligent Key system)			

Is the inspection result normal?

- YES >> Replace BCM. Refer to [BCS-122, "Removal and Installation"](#).
- NO >> Repair or replace harness.

A
B
C
D
E
F
G
H
I
J
L
M
N
O
P

PWC

FRONT POWER WINDOW SWITCH (PASSENGER SIDE)

< DTC/CIRCUIT DIAGNOSIS >

FRONT POWER WINDOW SWITCH (PASSENGER SIDE)

Component Function Check

INFOID:000000009269427

1. CHECK FUNCTION

Check front power window motor RH operation with front power window switch RH.

Is the inspection result normal?

- YES >> Inspection End.
- NO >> Refer to [PWC-28, "Diagnosis Procedure"](#).

Diagnosis Procedure

INFOID:000000009269428

Regarding Wiring Diagram information, refer to [PWC-14, "Wiring Diagram"](#).

1. CHECK FRONT POWER WINDOW SWITCH RH INPUT SIGNAL

1. Turn ignition switch OFF.
2. Disconnect front power window switch RH connector.
3. Turn ignition switch ON.
4. Check voltage between front power window switch RH harness connector and ground.

(+)		(-)	Condition	Voltage (V) (Approx.)	
Connector	Terminal				
D105	12	Ground	Power window main switch (front RH)	NEUTRAL	0
			UP	Battery voltage	
	11		NEUTRAL	0	
			DOWN	Battery voltage	

Is the inspection result normal?

- YES >> GO TO 3.
- NO >> GO TO 2.

2. CHECK FRONT POWER WINDOW SWITCH RH CIRCUIT

1. Turn ignition switch OFF.
2. Disconnect power window main switch connector.
3. Check continuity between power window main switch harness connector and front power window switch RH harness connector.

Power window main switch		Front power window switch RH		Continuity
Connector	Terminal	Connector	Terminal	
D7	12	D105	11	Yes
	16		12	

4. Check continuity between power window main switch harness connector and ground.

Power window main switch		Ground	Continuity
Connector	Terminal		
D7	12		No
	16		

Is the inspection result normal?

- YES >> Replace power window main switch. Refer to [PWC-52, "Removal and Installation"](#).
- NO >> Repair or replace harness.

FRONT POWER WINDOW SWITCH (PASSENGER SIDE)

< DTC/CIRCUIT DIAGNOSIS >

3. CHECK FRONT POWER WINDOW SWITCH RH

Check front power window switch RH.

Refer to [PWC-29, "Component Inspection"](#).

Is the inspection result normal?

YES >> Check Intermittent incident. Refer to [GI-45, "Intermittent Incident"](#).

NO >> Replace front power window switch RH. Refer to [PWC-53, "Removal and Installation"](#).

Component Inspection

INFOID:000000009269429

1. CHECK FRONT POWER WINDOW SWITCH RH

1. Turn ignition switch OFF.
2. Disconnect front power window switch RH connector.
3. Check front power window switch RH terminals under the following conditions.

Front power window switch RH		Condition	Continuity
Terminal			
6	8	UP	Yes
7	11		
6	12	NEUTRAL	
7	11		
6	12	DOWN	
7	8		

Is the inspection result normal?

YES >> Inspection End.

NO >> Replace front power window switch RH. Refer to [PWC-53, "Removal and Installation"](#).

A
B
C
D
E
F
G
H
I
J
L
M
N
O
P

PWC

REAR POWER WINDOW SWITCH

< DTC/CIRCUIT DIAGNOSIS >

REAR POWER WINDOW SWITCH

Component Function Check

INFOID:000000009269430

1. CHECK FUNCTION

Check rear power window motor operation with rear power window switch.

Is the inspection result normal?

- YES >> Inspection End.
 NO >> Refer to [PWC-30, "Diagnosis Procedure"](#).

Diagnosis Procedure

INFOID:000000009269431

Regarding Wiring Diagram information, refer to [PWC-14, "Wiring Diagram"](#).

1. CHECK REAR POWER WINDOW SWITCH INPUT SIGNAL

1. Turn ignition switch OFF.
2. Disconnect rear power window switch connector.
3. Turn ignition switch ON.
4. Check voltage between rear power window switch harness connector and ground.

(+)		(-)	Condition	Voltage (V) (Approx.)	
Rear power window switch					
Connector	Terminal				
LH	D203	Ground	Power window main switch (rear LH)	NEUTRAL	0
				DOWN	Battery voltage
NEUTRAL	0				
UP	Battery voltage				
RH	D303		Power window main switch (rear RH)	NEUTRAL	0
				DOWN	Battery voltage
				NEUTRAL	0
				UP	Battery voltage

Is the inspection result normal?

- YES >> GO TO 3.
 NO >> GO TO 2.

2. CHECK REAR POWER WINDOW SWITCH CIRCUIT

1. Turn ignition switch OFF.
2. Disconnect power window main switch connector.
3. Check continuity between power window main switch harness connector and rear power window switch harness connector.

Power window main switch		Rear power window switch		Continuity
Connector	Terminal	Connector	Terminal	
D7	1	LH	D203	2
	3			3
	5	RH	D303	3
	7			2

4. Check continuity between power window main switch harness connector and ground.

REAR POWER WINDOW SWITCH

< DTC/CIRCUIT DIAGNOSIS >

Power window main switch		Ground	Continuity
Connector	Terminal		
D7	1	Ground	No
	3		
	5		
	7		

Is the inspection result normal?

YES >> Replace power window main switch. Refer to [PWC-52, "Removal and Installation"](#).

NO >> Repair or replace harness.

3.CHECK REAR POWER WINDOW SWITCH

Check rear power window switch.

Refer to [PWC-31, "Component Inspection"](#).

Is the inspection result normal?

YES >> Check intermittent incident. Refer to [GI-45, "Intermittent Incident"](#).

NO >> Replace rear power window switch. Refer to [PWC-54, "Removal and Installation"](#).

Component Inspection

INFOID:000000009269432

1.CHECK REAR POWER WINDOW SWITCH

1. Turn ignition switch OFF.
2. Disconnect rear power window switch connector.
3. Check rear power window switch terminals under the following conditions.

Rear power window switch		Condition	Continuity
Terminal			
1	5	UP	Yes
3	4		
3	4	NEUTRAL	
2	5		
1	4	DOWN	
2	5		

Is the inspection result normal?

YES >> Inspection End.

NO >> Replace rear power window switch. Refer to [PWC-54, "Removal and Installation"](#).

PWC

POWER WINDOW MOTOR

< DTC/CIRCUIT DIAGNOSIS >

POWER WINDOW MOTOR DRIVER SIDE

DRIVER SIDE : Component Function Check

INFOID:000000009269433

1. CHECK FUNCTION

Check front power window motor LH operation with power window main switch.

Is the inspection result normal?

YES >> Inspection End.

NO >> Refer to [PWC-32, "DRIVER SIDE : Diagnosis Procedure"](#).

DRIVER SIDE : Diagnosis Procedure

INFOID:000000009269434

Regarding Wiring Diagram information, refer to [PWC-14, "Wiring Diagram"](#).

1. CHECK FRONT POWER WINDOW MOTOR LH INPUT SIGNAL

1. Turn ignition switch OFF.
2. Disconnect front power window motor LH connector.
3. Turn ignition switch ON.
4. Check voltage between front power window motor LH harness connector and ground.

(+)		(-)	Condition	Voltage (V) (Approx.)	
Connector	Terminal				
D9	1	Ground	Power window main switch	NEUTRAL	0
			DOWN	Battery voltage	
	2		NEUTRAL	0	
			UP	Battery voltage	

Is the inspection result normal?

YES >> Replace front power window motor LH.

NO >> GO TO 2.

2. CHECK FRONT POWER WINDOW MOTOR LH CIRCUIT

1. Turn ignition switch OFF.
2. Disconnect power window main switch connector.
3. Check continuity between power window main switch harness connector and front power window motor LH harness connector.

Power window main switch		Front power window motor LH		Continuity
Connector	Terminal	Connector	Terminal	
D7	8	D9	2	Yes
	11		1	

4. Check continuity between power window main switch harness connector and ground.

Power window main switch		Ground	Continuity
Connector	Terminal		
D7	8		No
	11		

Is the inspection result normal?

YES >> Replace power window main switch. Refer to [PWC-52, "Removal and Installation"](#).

POWER WINDOW MOTOR

< DTC/CIRCUIT DIAGNOSIS >

NO >> Repair or replace harness.

PASSENGER SIDE

PASSENGER SIDE : Component Function Check

INFOID:000000009269435

1. CHECK FUNCTION

Check front power window motor RH operation with power window main switch or front power window switch RH.

Is the inspection result normal?

YES >> Inspection End.

NO >> Refer to [PWC-33, "PASSENGER SIDE : Diagnosis Procedure"](#).

PASSENGER SIDE : Diagnosis Procedure

INFOID:000000009269436

Regarding Wiring Diagram information, refer to [PWC-14, "Wiring Diagram"](#).

1. CHECK FRONT POWER WINDOW MOTOR RH INPUT SIGNAL

1. Turn ignition switch OFF.
2. Disconnect front power window motor RH connector.
3. Turn ignition switch ON.
4. Check voltage between front power window motor RH harness connector and ground.

(+)		(-)	Condition	Voltage (V) (Approx.)
Connector	Terminal			
D104	1	Ground	NEUTRAL	0
			UP	Battery voltage
	2		NEUTRAL	0
			DOWN	Battery voltage

Is the inspection result normal?

YES >> Replace front power window motor RH.

NO >> GO TO 2.

2. CHECK FRONT POWER WINDOW MOTOR RH CIRCUIT

1. Turn ignition switch OFF.
2. Disconnect front power window switch RH connector.
3. Check continuity between front power window switch RH harness connector and front power window motor RH harness connector.

Front power window switch RH		Front power window motor RH		Continuity
Connector	Terminal	Connector	Terminal	
D105	6	D104	1	Yes
	7		2	

4. Check continuity between front power window switch RH harness connector and ground.

Front power window switch RH		Ground	Continuity
Connector	Terminal		
D105	6		No
	7		

Is the inspection result normal?

YES >> Replace front power window switch RH. Refer to [PWC-53, "Removal and Installation"](#).

A
B
C
D
E
F
G
H
I
J
L
M
N
O
P

PWC

POWER WINDOW MOTOR

< DTC/CIRCUIT DIAGNOSIS >

NO >> Repair or replace harness.

REAR LH

REAR LH : Component Function Check

INFOID:000000009269437

1.CHECK FUNCTION

Check rear power window motor LH operation with power window main switch or rear power window switch LH.

Is the inspection result normal?

YES >> Inspection End.

NO >> Refer to [PWC-34, "REAR LH : Diagnosis Procedure"](#).

REAR LH : Diagnosis Procedure

INFOID:000000009269438

Regarding Wiring Diagram information, refer to [PWC-14, "Wiring Diagram"](#).

1.CHECK REAR POWER WINDOW MOTOR LH INPUT SIGNAL

1. Turn ignition switch OFF.
2. Disconnect rear power window motor LH connector.
3. Turn ignition switch ON.
4. Check voltage between rear power window motor LH harness connector and ground.

(+)		(-)	Condition	Voltage (V) (Approx.)
Connector	Terminal			
D204	1	Ground	NEUTRAL	0
			UP	Battery voltage
	2		NEUTRAL	0
			DOWN	Battery voltage

Is the inspection result normal?

YES >> Replace rear power window motor LH.

NO >> GO TO 2.

2.CHECK REAR POWER WINDOW MOTOR LH CIRCUIT

1. Turn ignition switch OFF.
2. Disconnect rear power window switch LH connector.
3. Check continuity between rear power window switch LH harness connector and rear power window motor LH harness connector.

Rear power window switch LH		Rear power window motor LH		Continuity
Connector	Terminal	Connector	Terminal	
D203	4	D204	2	Yes
	5		1	

4. Check continuity between rear power window switch LH connector and ground.

Rear power window switch LH		Ground	Continuity
Connector	Terminal		
D203	4		No
	5		

Is the inspection result normal?

YES >> Replace rear power window switch LH. Refer to [PWC-54, "Removal and Installation"](#).

POWER WINDOW MOTOR

< DTC/CIRCUIT DIAGNOSIS >

NO >> Repair or replace harness.

REAR RH

REAR RH : Component Function Check

INFOID:000000009269439

1. CHECK FUNCTION

Check rear power window motor RH operation with power window main switch or rear power window switch RH.

Is the inspection result normal?

YES >> Inspection End.

NO >> Refer to [PWC-35, "REAR RH : Diagnosis Procedure"](#).

REAR RH : Diagnosis Procedure

INFOID:000000009269440

Regarding Wiring Diagram information, refer to [PWC-14, "Wiring Diagram"](#).

1. CHECK REAR POWER WINDOW MOTOR RH INPUT SIGNAL

1. Turn ignition switch OFF.
2. Disconnect rear power window motor RH connector.
3. Turn ignition switch ON.
4. Check voltage between rear power window motor RH harness connector and ground.

(+)		(-)	Condition	Voltage (V) (Approx.)	
Connector	Terminal				
D304	1	Ground	Rear power window switch RH	NEUTRAL	0
			UP	Battery voltage	
	2		NEUTRAL	0	
			DOWN	Battery voltage	

Is the inspection result normal?

YES >> Replace rear power window motor RH.

NO >> GO TO 2.

2. CHECK REAR POWER WINDOW MOTOR RH CIRCUIT

1. Turn ignition switch OFF.
2. Disconnect rear power window switch RH connector.
3. Check continuity between rear power window switch RH harness connector and rear power window motor RH harness connector.

Rear power window switch RH		Rear power window motor RH		Continuity
Connector	Terminal	Connector	Terminal	
D303	4	D304	2	Yes
	5		1	

4. Check continuity between rear power window switch RH harness connector and ground.

Rear power window switch RH		Ground	Continuity
Connector	Terminal		
D303	4		No
	5		

Is the inspection result normal?

YES >> Replace rear power window switch RH. Refer to [PWC-54, "Removal and Installation"](#).

A
B
C
D
E
F
G
H
I
J
K
L
M
N
O
P



POWER WINDOW MOTOR

< DTC/CIRCUIT DIAGNOSIS >

NO >> Repair or replace harness.

DOOR SWITCH

< DTC/CIRCUIT DIAGNOSIS >

DOOR SWITCH

Description

INFOID:000000009541437

Detects door open/close condition and transmits the signal to BCM.

Component Function Check

INFOID:000000009541438

1. CHECK FRONT DOOR SWITCH INPUT SIGNAL

Check ("DOOR SW-DR" and "DOOR SW-AS") in "DATA MONITOR" mode with CONSULT. Refer to [BCS-26, "RETAINED PWR : CONSULT Function \(BCM - RETAINED PWR\)"](#) or [BCS-26, "RETAINED PWR : CONSULT Function \(BCM - RETAINED PWR\)"](#).

Monitor item	Condition
DOOR SW-DR	OPEN : ON
	CLOSE : OFF
DOOR SW-AS	OPEN : ON
	CLOSE : OFF

Is the inspection result normal?

- YES >> Front door switch circuit is OK.
NO >> Refer to [PWC-37, "Diagnosis Procedure"](#).

Diagnosis Procedure

INFOID:000000009541439

Regarding Wiring Diagram information, refer to [PWC-14, "Wiring Diagram"](#).

1. CHECK HARNESS CONTINUITY

Check voltage between BCM connector and ground.

Terminals		Door condition	Voltage (V) (Approx.)	
(+)	(-)			
BCM connector	Terminal			
M18 (without Intelligent Key system)	12	Front door RH	OPEN	0
			CLOSE	Battery voltage
M19 (without Intelligent Key system)	47	Front door LH	OPEN	0
			CLOSE	Battery voltage
M100 (with Intelligent Key system)	45	Front door RH	OPEN	0
			CLOSE	Battery voltage
M100 (with Intelligent Key system)	47	Front door LH	OPEN	0
			CLOSE	Battery voltage

Is the measurement value within the specification?

- YES >> Replace BCM. Refer to [BCS-69, "Removal and Installation"](#) or [BCS-122, "Removal and Installation"](#).
NO >> GO TO 2

2. CHECK HARNESS CONTINUITY

1. Turn ignition switch OFF.
2. Disconnect BCM and front door switch.
3. Check continuity between BCM connector and front door switch connector.

A
B
C
D
E
F
G
H
I
J
L
M
N
O
P

PWC

DOOR SWITCH

< DTC/CIRCUIT DIAGNOSIS >

BCM connector	Terminal	Front door switch connector	Terminal	Continuity
M18 (without Intelligent Key system)	12	RH: B16	3	Yes
M19 (without Intelligent Key system)	47	LH: B8		
M100 (with Intelligent Key system)	45	RH: B16		
M100 (with Intelligent Key system)	47	LH: B8		

4. Check continuity between BCM connector and ground.

BCM connector	Terminal		Continuity
M18 (without Intelligent Key system)	12	Ground	No
M19 (without Intelligent Key system)	47		
M100 (with Intelligent Key system)	45		
M100 (with Intelligent Key system)	47		

Is the inspection result normal?

- YES >> GO TO 3
 NO >> Repair or replace harness.

3. CHECK BCM OUTPUT SIGNAL

1. Connect BCM connector.
2. Check voltage between BCM connector and ground.

Terminal		(-)	Voltage (V) (Approx.)
(+)			
BCM connector	Terminal		
M18 (without Intelligent Key system)	12	Ground	Battery voltage
M19 (without Intelligent Key system)	47		
M100 (with Intelligent Key system)	45		
M100 (with Intelligent Key system)	47		

Is the measurement value within the specification?

- YES >> GO TO 4
 NO >> Replace BCM. Refer to [BCS-69. "Removal and Installation"](#) or [BCS-122. "Removal and Installation"](#).

4. CHECK FRONT DOOR SWITCH

Check front door switch.
 Refer to [PWC-39. "Component Inspection"](#).

Is the inspection result normal?

- YES >> Check intermittent incident. Refer to [GI-45. "Intermittent Incident"](#).
 NO >> Replace front door switch.

DOOR SWITCH

< DTC/CIRCUIT DIAGNOSIS >

Component Inspection

INFOID:000000009541440

1. CHECK FRONT DOOR SWITCH

Check front door switches.

Terminal		Door switch	Continuity
Door switches			
3	Ground part of door switch	Pressed	No
		Released	Yes

Is the inspection result normal?

- YES >> Front door switch is OK.
- NO >> Replace front door switch.

A
B
C
D
E
F
G
H
I
J
L
M
N
O
P

PWC

POWER WINDOW CONTROL SYSTEM SYMPTOMS

< SYMPTOM DIAGNOSIS >

SYMPTOM DIAGNOSIS

POWER WINDOW CONTROL SYSTEM SYMPTOMS

Symptom Table

INFOID:000000009269441

Symptom	Reference page
None of the power windows can be operated using any switch.	Refer to PWC-41. "Diagnosis Procedure" .
Driver side power window does not operate.	Refer to PWC-42. "Diagnosis Procedure" .
Front passenger side power window does not operate (When both power window main switch and front power window switch are operated).	Refer to PWC-43. "WHEN BOTH POWER WINDOW MAIN SWITCH AND FRONT POWER WINDOW SWITCH ARE OPERATED : Diagnosis Procedure" .
Front passenger side power window does not operate (when front power window switch RH is operated).	Refer to PWC-43. "WHEN FRONT POWER WINDOW SWITCH (PASSENGER SIDE) IS OPERATED : Diagnosis Procedure" .
Front passenger side power window does not operate (when power window switch main is operated).	Refer to PWC-44. "WHEN POWER WINDOW MAIN SWITCH IS OPERATED : Diagnosis Procedure" .
Rear (LH) side power window does not operate (when both power window main switch and rear power window switch LH are operated).	Refer to PWC-45. "WHEN BOTH POWER WINDOW MAIN SWITCH AND REAR POWER WINDOW SWITCH LH ARE OPERATED : Diagnosis Procedure" .
Rear (LH) side power window does not operate (when rear power window switch LH is operated).	Refer to PWC-45. "WHEN REAR POWER WINDOW SWITCH LH IS OPERATED : Diagnosis Procedure" .
Rear (LH) side power window does not operate (when power window main switch is operated).	Refer to PWC-46. "WHEN POWER WINDOW MAIN SWITCH IS OPERATED : Diagnosis Procedure" .
Rear (RH) side power window does not operate (when both power window main switch and rear power window switch RH are operated).	Refer to PWC-47. "WHEN BOTH POWER WINDOW MAIN SWITCH AND REAR POWER WINDOW SWITCH RH ARE OPERATED : Diagnosis Procedure" .
Rear (RH) side power window does not operate (when rear power window switch RH is operated).	Refer to PWC-47. "WHEN REAR POWER WINDOW SWITCH RH IS OPERATED : Diagnosis Procedure" .
Rear (RH) side power window does not operate (when power window main switch is operated)	Refer to PWC-48. "WHEN POWER WINDOW MAIN SWITCH IS OPERATED : Diagnosis Procedure" .
Power window lock switch does not function.	Refer to PWC-51. "Diagnosis Procedure" .

NONE OF THE POWER WINDOWS CAN BE OPERATED USING ANY SWITCH

< SYMPTOM DIAGNOSIS >

NONE OF THE POWER WINDOWS CAN BE OPERATED USING ANY SWITCH

Diagnosis Procedure

INFOID:000000009269442

1. CHECK BCM POWER SUPPLY AND GROUND CIRCUIT

Check BCM power supply and ground circuit. Refer to [PWC-23, "BCM \(BODY CONTROL SYSTEM\) \(WITH INTELLIGENT KEY SYSTEM\) : Diagnosis Procedure"](#) (with Intelligent Key system) or [PWC-23, "BCM \(BODY CONTROL SYSTEM\) \(WITHOUT INTELLIGENT KEY SYSTEM\) : Diagnosis Procedure"](#) (without Intelligent Key system).

Is the inspection result normal?

YES >> GO TO 2.

NO >> Repair or replace the malfunctioning parts.

2. CHECK POWER WINDOW MAIN SWITCH POWER SUPPLY AND GROUND CIRCUIT

Check power window main switch power supply and ground circuit.
Refer to [PWC-24, "POWER WINDOW MAIN SWITCH : Diagnosis Procedure"](#).

Is the inspection result normal?

YES >> GO TO 3.

NO >> Repair or replace the malfunctioning parts.

3. CONFIRM THE OPERATION

Confirm the operation again.

Is the result normal?

YES >> Check intermittent incident. Refer to [GI-45, "Intermittent Incident"](#).

NO >> GO TO 1.

A
B
C
D
E
F
G
H
I
J
L
M
N
O
P

PWC

DRIVER SIDE POWER WINDOW DOES NOT OPERATE

< SYMPTOM DIAGNOSIS >

DRIVER SIDE POWER WINDOW DOES NOT OPERATE

Diagnosis Procedure

INFOID:000000009269443

1. CHECK FRONT POWER WINDOW MOTOR LH

Check front power window motor LH.

Refer to [PWC-32. "DRIVER SIDE : Component Function Check"](#).

Is the inspection result normal?

YES >> GO TO 2.

NO >> Repair or replace the malfunctioning parts.

2. CONFIRM THE OPERATION

Confirm the operation again.

Is the result normal?

YES >> Check intermittent incident. Refer to [GI-45. "Intermittent Incident"](#).

NO >> GO TO 1.

FRONT PASSENGER SIDE POWER WINDOW DOES NOT OPERATE

< SYMPTOM DIAGNOSIS >

FRONT PASSENGER SIDE POWER WINDOW DOES NOT OPERATE
WHEN BOTH POWER WINDOW MAIN SWITCH AND FRONT POWER WINDOW
SWITCH ARE OPERATED

WHEN BOTH POWER WINDOW MAIN SWITCH AND FRONT POWER WINDOW
SWITCH ARE OPERATED : Diagnosis Procedure

INFOID:000000009269444

1. CHECK FRONT POWER WINDOW SWITCH RH

Check front power window switch RH.

Refer to [PWC-28, "Component Function Check"](#).

Is the inspection result normal?

YES >> GO TO 2.

NO >> Repair or replace the malfunctioning parts.

2. CHECK FRONT POWER WINDOW MOTOR RH

Check front power window motor RH.

Refer to [PWC-33, "PASSENGER SIDE : Component Function Check"](#).

Is the inspection result normal?

YES >> GO TO 3.

NO >> Repair or replace the malfunctioning parts.

3. CONFIRM THE OPERATION

Confirm the operation again.

Is the result normal?

YES >> Check intermittent incident. Refer to [GI-45, "Intermittent Incident"](#).

NO >> GO TO 1.

WHEN FRONT POWER WINDOW SWITCH (PASSENGER SIDE) IS OPERATED
WHEN FRONT POWER WINDOW SWITCH (PASSENGER SIDE) IS OPERATED :
Diagnosis Procedure

INFOID:000000009269445

1. CHECK FRONT POWER WINDOW SWITCH RH POWER SUPPLY AND GROUND CIRCUIT

Check front power window switch RH power supply and ground circuit.

Refer to [PWC-25, "FRONT POWER WINDOW SWITCH \(PASSENGER SIDE\) : Diagnosis Procedure"](#).

Is the inspection result normal?

YES >> GO TO 2.

NO >> Repair or replace the malfunctioning parts.

2. CHECK FRONT POWER WINDOW SWITCH RH

Check front power window switch RH.

Refer to [PWC-28, "Component Function Check"](#).

Is the inspection result normal?

YES >> GO TO 3.

NO >> Repair or replace the malfunctioning parts.

3. CONFIRM THE OPERATION

Confirm the operation again.

Is the result normal?

YES >> Check intermittent incident. Refer to [GI-45, "Intermittent Incident"](#).

NO >> GO TO 1.

WHEN POWER WINDOW MAIN SWITCH IS OPERATED

A
B
C
D
E
F
G
H
I
J
L
M
N
O
P

PWC

FRONT PASSENGER SIDE POWER WINDOW DOES NOT OPERATE

< SYMPTOM DIAGNOSIS >

WHEN POWER WINDOW MAIN SWITCH IS OPERATED : Diagnosis Procedure

INFOID:000000009269446

1. CHECK FRONT POWER WINDOW SWITCH RH

Check front power window switch RH.

Refer to [PWC-28. "Component Function Check"](#).

Is the inspection result normal?

YES >> GO TO 2.

NO >> Repair or replace the malfunctioning parts.

2. CONFIRM THE OPERATION

Confirm the operation again.

Is the result normal?

YES >> Check intermittent incident. Refer to [GI-45. "Intermittent Incident"](#).

NO >> GO TO 1.

REAR LH SIDE POWER WINDOW DOES NOT OPERATE

< SYMPTOM DIAGNOSIS >

REAR LH SIDE POWER WINDOW DOES NOT OPERATE
WHEN BOTH POWER WINDOW MAIN SWITCH AND REAR POWER WINDOW SWITCH LH ARE OPERATED

WHEN BOTH POWER WINDOW MAIN SWITCH AND REAR POWER WINDOW SWITCH LH ARE OPERATED : Diagnosis Procedure

INFOID:000000009269447

1.CHECK REAR POWER WINDOW SWITCH LH

Check rear power window switch LH.
Refer to [PWC-30, "Component Function Check"](#).

Is the inspection result normal?

- YES >> GO TO 2.
- NO >> Repair or replace the malfunctioning parts.

2.CHECK REAR POWER WINDOW MOTOR LH

Check rear power window motor LH.
Refer to [PWC-34, "REAR LH : Component Function Check"](#).

Is the inspection result normal?

- YES >> GO TO 3.
- NO >> Repair or replace the malfunctioning parts.

3.CONFIRM THE OPERATION

Confirm the operation again.

Is the result normal?

- YES >> Check intermittent incident. Refer to [GI-45, "Intermittent Incident"](#).
- NO >> GO TO 1.

WHEN REAR POWER WINDOW SWITCH LH IS OPERATED

WHEN REAR POWER WINDOW SWITCH LH IS OPERATED : Diagnosis Procedure

INFOID:000000009269448

1.CHECK REAR POWER WINDOW SWITCH LH POWER SUPPLY AND GROUND CIRCUIT

Check rear power window switch LH power supply and ground circuit.
Refer to [PWC-26, "REAR POWER WINDOW SWITCH : Diagnosis Procedure"](#).

Is the inspection result normal?

- YES >> GO TO 2.
- NO >> Repair or replace the malfunctioning parts.

2.CHECK REAR POWER WINDOW SWITCH LH

Check rear power window switch LH.
Refer to [PWC-30, "Component Function Check"](#).

Is the inspection result normal?

- YES >> GO TO 3.
- NO >> Repair or replace the malfunctioning parts.

3.CONFIRM THE OPERATION

Confirm the operation again.

Is the result normal?

- YES >> Check intermittent incident. Refer to [GI-45, "Intermittent Incident"](#).
- NO >> GO TO 1.

WHEN POWER WINDOW MAIN SWITCH IS OPERATED

A
B
C
D
E
F
G
H
I
J
L
M
N
O
P

PWC

REAR LH SIDE POWER WINDOW DOES NOT OPERATE

< SYMPTOM DIAGNOSIS >

WHEN POWER WINDOW MAIN SWITCH IS OPERATED : Diagnosis Procedure

INFOID:000000009269449

1. CHECK REAR POWER WINDOW SWITCH LH

Check rear power window switch LH.

Refer to [PWC-30. "Component Function Check"](#).

Is the inspection result normal?

YES >> GO TO 2.

NO >> Repair or replace the malfunctioning parts.

2. CONFIRM THE OPERATION

Confirm the operation again.

Is the result normal?

YES >> Check intermittent incident. Refer to [GI-45. "Intermittent Incident"](#).

NO >> GO TO 1.

REAR RH SIDE POWER WINDOW DOES NOT OPERATE

< SYMPTOM DIAGNOSIS >

REAR RH SIDE POWER WINDOW DOES NOT OPERATE
WHEN BOTH POWER WINDOW MAIN SWITCH AND REAR POWER WINDOW SWITCH RH ARE OPERATED

WHEN BOTH POWER WINDOW MAIN SWITCH AND REAR POWER WINDOW SWITCH RH ARE OPERATED : Diagnosis Procedure

INFOID:000000009269450

1.CHECK REAR POWER WINDOW SWITCH RH

Check rear power window switch RH.
Refer to [PWC-30, "Component Function Check"](#).

Is the inspection result normal?

- YES >> GO TO 2.
- NO >> Repair or replace the malfunctioning parts.

2.CHECK REAR POWER WINDOW MOTOR RH

Check rear power window motor RH.
Refer to [PWC-35, "REAR RH : Component Function Check"](#).

Is the inspection result normal?

- YES >> GO TO 3.
- NO >> Repair or replace the malfunctioning parts.

3.CONFIRM THE OPERATION

Confirm the operation again.

Is the result normal?

- YES >> Check intermittent incident. Refer to [GI-45, "Intermittent Incident"](#).
- NO >> GO TO 1.

WHEN REAR POWER WINDOW SWITCH RH IS OPERATED

WHEN REAR POWER WINDOW SWITCH RH IS OPERATED : Diagnosis Procedure

INFOID:000000009269451

1.CHECK REAR POWER WINDOW SWITCH RH POWER SUPPLY AND GROUND CIRCUIT

Check rear power window switch RH power supply and ground circuit.
Refer to [PWC-26, "REAR POWER WINDOW SWITCH : Diagnosis Procedure"](#).

Is the inspection result normal?

- YES >> GO TO 2.
- NO >> Repair or replace the malfunctioning parts.

2.CHECK REAR POWER WINDOW SWITCH RH

Check rear power window switch RH.
Refer to [PWC-30, "Component Function Check"](#).

Is the inspection result normal?

- YES >> GO TO 3.
- NO >> Repair or replace the malfunctioning parts.

3.CONFIRM THE OPERATION

Confirm the operation again.

Is the result normal?

- YES >> Check intermittent incident. Refer to [GI-45, "Intermittent Incident"](#).
- NO >> GO TO 1.

WHEN POWER WINDOW MAIN SWITCH IS OPERATED

A
B
C
D
E
F
G
H
I
J
L
M
N
O
P

PWC

REAR RH SIDE POWER WINDOW DOES NOT OPERATE

< SYMPTOM DIAGNOSIS >

WHEN POWER WINDOW MAIN SWITCH IS OPERATED : Diagnosis Procedure

INFOID:000000009269452

1. CHECK REAR POWER WINDOW SWITCH RH

Check rear power window switch RH.

Refer to [PWC-30. "Component Function Check"](#).

Is the inspection result normal?

YES >> GO TO 2.

NO >> Repair or replace the malfunctioning parts.

2. CONFIRM THE OPERATION

Confirm the operation again.

Is the result normal?

YES >> Check intermittent incident. Refer to [GI-45. "Intermittent Incident"](#).

NO >> GO TO 1.

AUTO OPERATION DOES NOT OPERATE BUT MANUAL OPERATE NORMALLY (DRIVER SIDE)

< SYMPTOM DIAGNOSIS >

AUTO OPERATION DOES NOT OPERATE BUT MANUAL OPERATE NORMALLY (DRIVER SIDE)

Diagnosis Procedure

INFOID:000000009269453

1. REPLACE POWER WINDOW MAIN SWITCH

Replace power window main switch.

>> Refer to [PWC-52. "Removal and Installation"](#).

A
B
C
D
E
F
G
H
I
J
L
M
N
O
P

PWC

POWER WINDOW RETAINED POWER OPERATION DOES NOT OPERATE PROPERLY

< SYMPTOM DIAGNOSIS >

POWER WINDOW RETAINED POWER OPERATION DOES NOT OPERATE PROPERLY

Diagnosis Procedure

INFOID:000000009541587

1. CHECK FRONT DOOR SWITCH

Check front door switch.

Refer to [PWC-39. "Component Inspection"](#).

Is the inspection result normal?

YES >> Check intermittent incident. Refer to [GI-45. "Intermittent Incident"](#).

NO >> Repair or replace the malfunctioning parts.

POWER WINDOW LOCK SWITCH DOES NOT FUNCTION

< SYMPTOM DIAGNOSIS >

POWER WINDOW LOCK SWITCH DOES NOT FUNCTION

Diagnosis Procedure

INFOID:000000009269454

1. REPLACE POWER WINDOW MAIN SWITCH

Replace power window main switch.

>> Refer to [PWC-52. "Removal and Installation"](#).

A
B
C
D
E
F
G
H
I
J
L
M
N
O
P

PWC

POWER WINDOW MAIN SWITCH

< REMOVAL AND INSTALLATION >

REMOVAL AND INSTALLATION

POWER WINDOW MAIN SWITCH

Removal and Installation

INFOID:000000009269455

REMOVAL

1. Remove main power window and door lock/unlock switch finisher assembly using a suitable tool (A).

△: Pawl

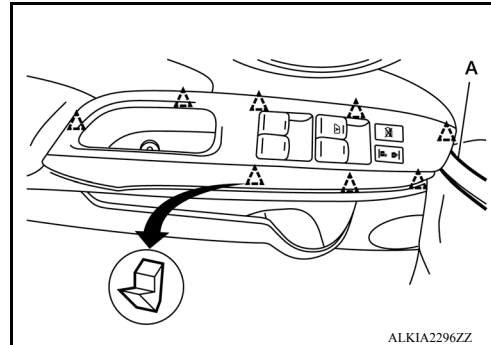

2. Disconnect the harness connector from the main power window and door lock/unlock switch.
3. Separate main power window and door lock/unlock switch (1) from main power window and door lock/unlock switch finisher using a suitable tool.

CAUTION:

Do not bend back the pawls on the switch finisher too far or breakage may occur.

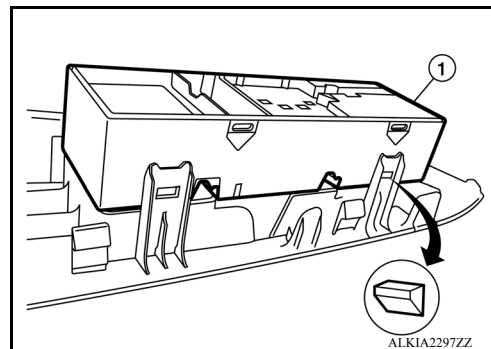

INSTALLATION

Installation is in the reverse order of removal.

FRONT POWER WINDOW SWITCH

< REMOVAL AND INSTALLATION >

FRONT POWER WINDOW SWITCH

Removal and Installation

INFOID:00000009269456

REMOVAL

1. Remove front power window and door lock/unlock switch (RH) finisher assembly using a suitable tool (A).

△: Pawl

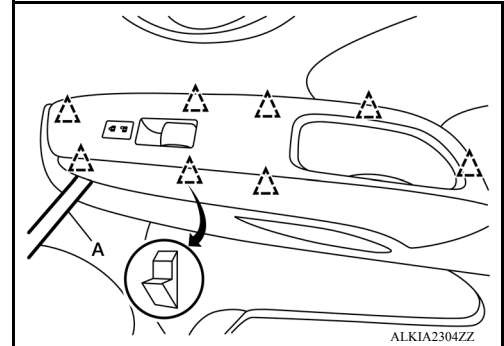

2. Disconnect the harness connector from the front power window and door lock/unlock switch (RH).
3. Separate front power window and door lock/unlock switch (1) from front power window and door lock/unlock switch (RH) finisher using a suitable tool.

CAUTION:

Do not bend back the pawls on the switch finisher too far or breakage may occur.

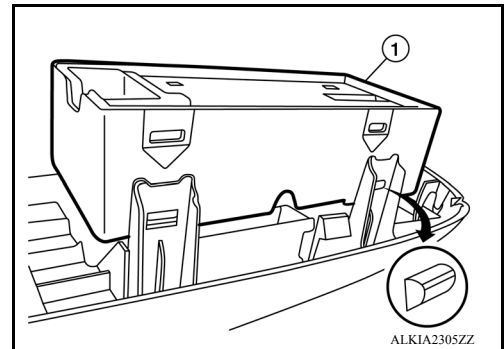

INSTALLATION

Installation is in the reverse order of removal.

A
B
C
D
E
F
G
H
I
J
L
M
N
O
P

PWC

REAR POWER WINDOW SWITCH

< REMOVAL AND INSTALLATION >

REAR POWER WINDOW SWITCH

Removal and Installation

INFOID:000000009269457

REMOVAL

1. Remove rear power window switch finisher (1) assembly using a suitable tool (A).

△: Pawl

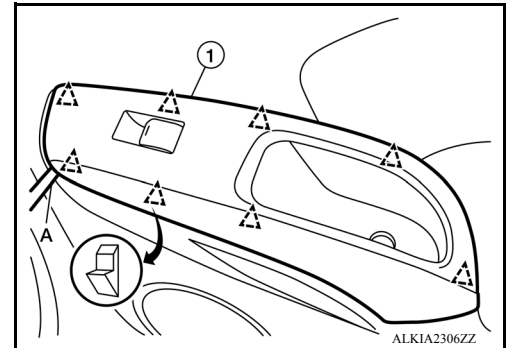

2. Disconnect the harness connector from the rear power window switch.
3. Separate rear power window switch (1) from rear power window switch finisher using a suitable tool.

CAUTION:

Do not bend back the pawls on the switch finisher too far or breakage may occur.

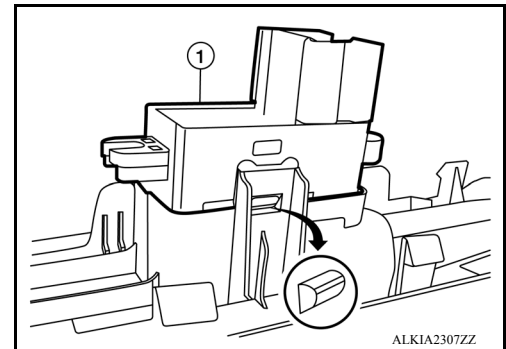

INSTALLATION

Installation is in the reverse order of removal.