

SECTION **LAN**
LAN SYSTEM

A

B

C

D

E

CONTENTS

F

G

H

I

J

K

L

LAN

N

O

P

CAN FUNDAMENTAL

HOW TO USE THIS MANUAL 5

HOW TO USE THIS SECTION 5

 Information 5

PRECAUTION 6

PRECAUTIONS 6

 Precautions for Trouble Diagnosis 6

 Precautions for Harness Repair 6

SYSTEM DESCRIPTION 7

SYSTEM 7

CAN COMMUNICATION SYSTEM 7

 CAN COMMUNICATION SYSTEM : System Description 7

DIAG ON CAN 7

 DIAG ON CAN : System Description 7

TROUBLE DIAGNOSIS 9

 Component Description 9

 Condition of Error Detection 9

 Symptom When Error Occurs in CAN Communication System 10

 CAN Diagnosis with CONSULT 12

 Self-Diagnosis 13

 CAN Diagnostic Support Monitor 13

 How to Use CAN Communication Signal Chart 15

BASIC INSPECTION 16

DIAGNOSIS AND REPAIR WORKFLOW 16

 Trouble Diagnosis Flow Chart 16

CAN

HOW TO USE THIS MANUAL 21

HOW TO USE THIS SECTION 21

 Information 21

 Abbreviation List 21

PRECAUTION 22

PRECAUTIONS 22

 Precaution for Supplemental Restraint System (SRS) "AIR BAG" and "SEAT BELT PRE-TENSIONER" 22

 Precautions for Trouble Diagnosis 22

 Precautions for Harness Repair 22

SYSTEM DESCRIPTION 24

COMPONENT PARTS 24

 Component Parts Location 24

SYSTEM 25

CAN COMMUNICATION SYSTEM 25

 CAN COMMUNICATION SYSTEM : System Description 25

 CAN COMMUNICATION SYSTEM : CAN Communication Control Circuit 28

 CAN COMMUNICATION SYSTEM : CAN System Specification Chart 29

 CAN COMMUNICATION SYSTEM : CAN Communication Signal Chart 30

WIRING DIAGRAM 33

CAN SYSTEM 33

 Wiring Diagram 33

BASIC INSPECTION 39

DIAGNOSIS AND REPAIR WORKFLOW 39

 Interview Sheet 39

DTC/CIRCUIT DIAGNOSIS 40

MALFUNCTION AREA CHART 40

 Main Line 40

Branch Line	40	ABS BRANCH LINE CIRCUIT	60
Short Circuit	40	Diagnosis Procedure	60
MAIN LINE BETWEEN IPDM-E AND DLC CIRCUIT	41	IPDM-E BRANCH LINE CIRCUIT	61
Diagnosis Procedure	41	Diagnosis Procedure	61
MAIN LINE BETWEEN IPDM-E AND AVM CIRCUIT	42	A-BAG BRANCH LINE CIRCUIT	62
Diagnosis Procedure	42	Diagnosis Procedure	62
MAIN LINE BETWEEN AVM AND DLC CIRCUIT	43	DLC BRANCH LINE CIRCUIT	63
Diagnosis Procedure	43	Diagnosis Procedure	63
ECM BRANCH LINE CIRCUIT	44	EPS BRANCH LINE CIRCUIT	64
Diagnosis Procedure	44	Diagnosis Procedure	64
ABS BRANCH LINE CIRCUIT	45	M&A BRANCH LINE CIRCUIT	65
Diagnosis Procedure	45	Diagnosis Procedure	65
IPDM-E BRANCH LINE CIRCUIT	46	STRG BRANCH LINE CIRCUIT	66
Diagnosis Procedure	46	Diagnosis Procedure	66
TCM BRANCH LINE CIRCUIT	47	BCM BRANCH LINE CIRCUIT	67
Diagnosis Procedure	47	Diagnosis Procedure	67
AVM BRANCH LINE CIRCUIT	48	CAN COMMUNICATION CIRCUIT	68
Diagnosis Procedure	48	Diagnosis Procedure	68
A-BAG BRANCH LINE CIRCUIT	49	CAN SYSTEM (TYPE 502)	
Diagnosis Procedure	49	DTC/CIRCUIT DIAGNOSIS	70
AV BRANCH LINE CIRCUIT	50	MAIN LINE BETWEEN IPDM-E AND AVM CIRCUIT	70
Diagnosis Procedure	50	Diagnosis Procedure	70
DLC BRANCH LINE CIRCUIT	51	MAIN LINE BETWEEN AVM AND DLC CIRCUIT	71
Diagnosis Procedure	51	Diagnosis Procedure	71
EPS BRANCH LINE CIRCUIT	52	ECM BRANCH LINE CIRCUIT	72
Diagnosis Procedure	52	Diagnosis Procedure	72
M&A BRANCH LINE CIRCUIT	53	ABS BRANCH LINE CIRCUIT	73
Diagnosis Procedure	53	Diagnosis Procedure	73
STRG BRANCH LINE CIRCUIT	54	IPDM-E BRANCH LINE CIRCUIT	74
Diagnosis Procedure	54	Diagnosis Procedure	74
BCM BRANCH LINE CIRCUIT	55	AVM BRANCH LINE CIRCUIT	75
Diagnosis Procedure	55	Diagnosis Procedure	75
CAN COMMUNICATION CIRCUIT	56	A-BAG BRANCH LINE CIRCUIT	76
Diagnosis Procedure	56	Diagnosis Procedure	76
CAN SYSTEM (TYPE 501)		AV BRANCH LINE CIRCUIT	77
DTC/CIRCUIT DIAGNOSIS	58	Diagnosis Procedure	77
MAIN LINE BETWEEN IPDM-E AND DLC CIRCUIT	58	DLC BRANCH LINE CIRCUIT	78
Diagnosis Procedure	58	Diagnosis Procedure	78
ECM BRANCH LINE CIRCUIT	59	EPS BRANCH LINE CIRCUIT	79
Diagnosis Procedure	59	Diagnosis Procedure	79
		M&A BRANCH LINE CIRCUIT	80

Diagnosis Procedure	80	Diagnosis Procedure	100	A
STRG BRANCH LINE CIRCUIT	81	ABS BRANCH LINE CIRCUIT	101	B
Diagnosis Procedure	81	Diagnosis Procedure	101	
BCM BRANCH LINE CIRCUIT	82	IPDM-E BRANCH LINE CIRCUIT	102	B
Diagnosis Procedure	82	Diagnosis Procedure	102	
CAN COMMUNICATION CIRCUIT	83	TCM BRANCH LINE CIRCUIT	103	C
Diagnosis Procedure	83	Diagnosis Procedure	103	
CAN SYSTEM (TYPE 503)		AVM BRANCH LINE CIRCUIT	104	D
DTC/CIRCUIT DIAGNOSIS	85	Diagnosis Procedure	104	
MAIN LINE BETWEEN IPDM-E AND DLC CIRCUIT	85	A-BAG BRANCH LINE CIRCUIT	105	E
Diagnosis Procedure	85	Diagnosis Procedure	105	
ECM BRANCH LINE CIRCUIT	86	AV BRANCH LINE CIRCUIT	106	F
Diagnosis Procedure	86	Diagnosis Procedure	106	
ABS BRANCH LINE CIRCUIT	87	DLC BRANCH LINE CIRCUIT	107	G
Diagnosis Procedure	87	Diagnosis Procedure	107	
IPDM-E BRANCH LINE CIRCUIT	88	EPS BRANCH LINE CIRCUIT	108	H
Diagnosis Procedure	88	Diagnosis Procedure	108	
TCM BRANCH LINE CIRCUIT	89	M&A BRANCH LINE CIRCUIT	109	H
Diagnosis Procedure	89	Diagnosis Procedure	109	
A-BAG BRANCH LINE CIRCUIT	90	STRG BRANCH LINE CIRCUIT	110	I
Diagnosis Procedure	90	Diagnosis Procedure	110	
DLC BRANCH LINE CIRCUIT	91	BCM BRANCH LINE CIRCUIT	111	J
Diagnosis Procedure	91	Diagnosis Procedure	111	
EPS BRANCH LINE CIRCUIT	92	CAN COMMUNICATION CIRCUIT	112	K
Diagnosis Procedure	92	Diagnosis Procedure	112	
M&A BRANCH LINE CIRCUIT	93	CAN SYSTEM (TYPE 505)		
Diagnosis Procedure	93	DTC/CIRCUIT DIAGNOSIS	114	L
STRG BRANCH LINE CIRCUIT	94	MAIN LINE BETWEEN IPDM-E AND DLC CIRCUIT	114	
Diagnosis Procedure	94	Diagnosis Procedure	114	
BCM BRANCH LINE CIRCUIT	95	ECM BRANCH LINE CIRCUIT	115	LAN
Diagnosis Procedure	95	Diagnosis Procedure	115	
CAN COMMUNICATION CIRCUIT	96	ABS BRANCH LINE CIRCUIT	116	N
Diagnosis Procedure	96	Diagnosis Procedure	116	
CAN SYSTEM (TYPE 504)		IPDM-E BRANCH LINE CIRCUIT	117	O
DTC/CIRCUIT DIAGNOSIS	98	Diagnosis Procedure	117	
MAIN LINE BETWEEN IPDM-E AND AVM CIRCUIT	98	TCM BRANCH LINE CIRCUIT	118	P
Diagnosis Procedure	98	Diagnosis Procedure	118	
MAIN LINE BETWEEN AVM AND DLC CIRCUIT	99	A-BAG BRANCH LINE CIRCUIT	119	
Diagnosis Procedure	99	Diagnosis Procedure	119	
ECM BRANCH LINE CIRCUIT	100	AV BRANCH LINE CIRCUIT	120	
		Diagnosis Procedure	120	
		DLC BRANCH LINE CIRCUIT	121	

Diagnosis Procedure	121	STRG BRANCH LINE CIRCUIT	124
EPS BRANCH LINE CIRCUIT	122	Diagnosis Procedure	124
Diagnosis Procedure	122	BCM BRANCH LINE CIRCUIT	125
M&A BRANCH LINE CIRCUIT	123	Diagnosis Procedure	125
Diagnosis Procedure	123	CAN COMMUNICATION CIRCUIT	126
		Diagnosis Procedure	126

HOW TO USE THIS MANUAL

HOW TO USE THIS SECTION

Information

INFOID:0000000012433327

- “CAN FUNDAMENTAL” of LAN Section describes the basic knowledge of the CAN communication system and the method of trouble diagnosis.
- For information peculiar to a vehicle and inspection procedure, refer to “CAN”.

A
B
C
D
E
F
G
H
I
J
K
L
LAN
N
O
P

PRECAUTION

PRECAUTIONS

Precautions for Trouble Diagnosis

INFOID:00000001243328

CAUTION:

Follow the instructions listed below. Failure to do this may cause damage to parts:

- Never apply 7.0 V or more to the measurement terminal.
- Use a tester with open terminal voltage of 7.0 V or less.
- Turn the ignition switch OFF and disconnect the battery cable from the negative terminal when checking the harness.

Precautions for Harness Repair

INFOID:00000001243329

- Solder the repaired area and wrap tape around the soldered area.

NOTE:

A fray of twisted lines must be within 110 mm (4.33 in).

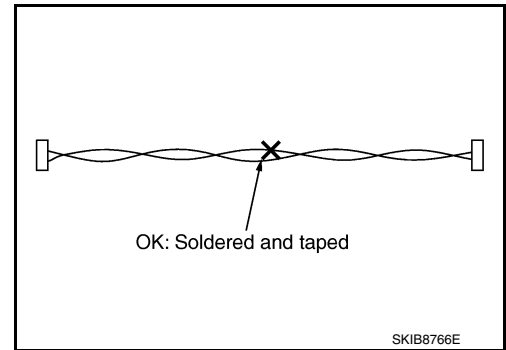

- Bypass connection is never allowed at the repaired area.

NOTE:

Bypass connection may cause CAN communication error. The spliced wire becomes separated and the characteristics of twisted line are lost.

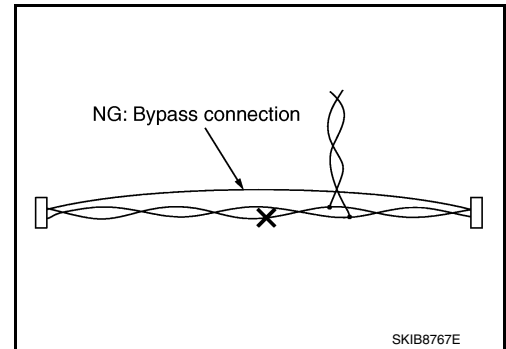

- Replace the applicable harness as an assembly if error is detected on the shield lines of CAN communication line.

SYSTEM DESCRIPTION

SYSTEM

CAN COMMUNICATION SYSTEM

CAN COMMUNICATION SYSTEM : System Description

INFOID:00000001243330

CAN (Controller Area Network) is a serial communication line for real time application. It is an on-vehicle multiplex communication line with high data communication speed and excellent error detection ability. Many electronic control units are equipped onto a vehicle, and each control unit shares information and links with other control units during operation (not independent). In CAN communication, control units are connected with 2 communication lines (CAN-H line, CAN-L line) allowing a high rate of information transmission with less wiring. Each control unit transmits/receives data but selectively reads required data only.

DIAG ON CAN

DIAG ON CAN : System Description

INFOID:00000001243331

SYSTEM DIAGRAM

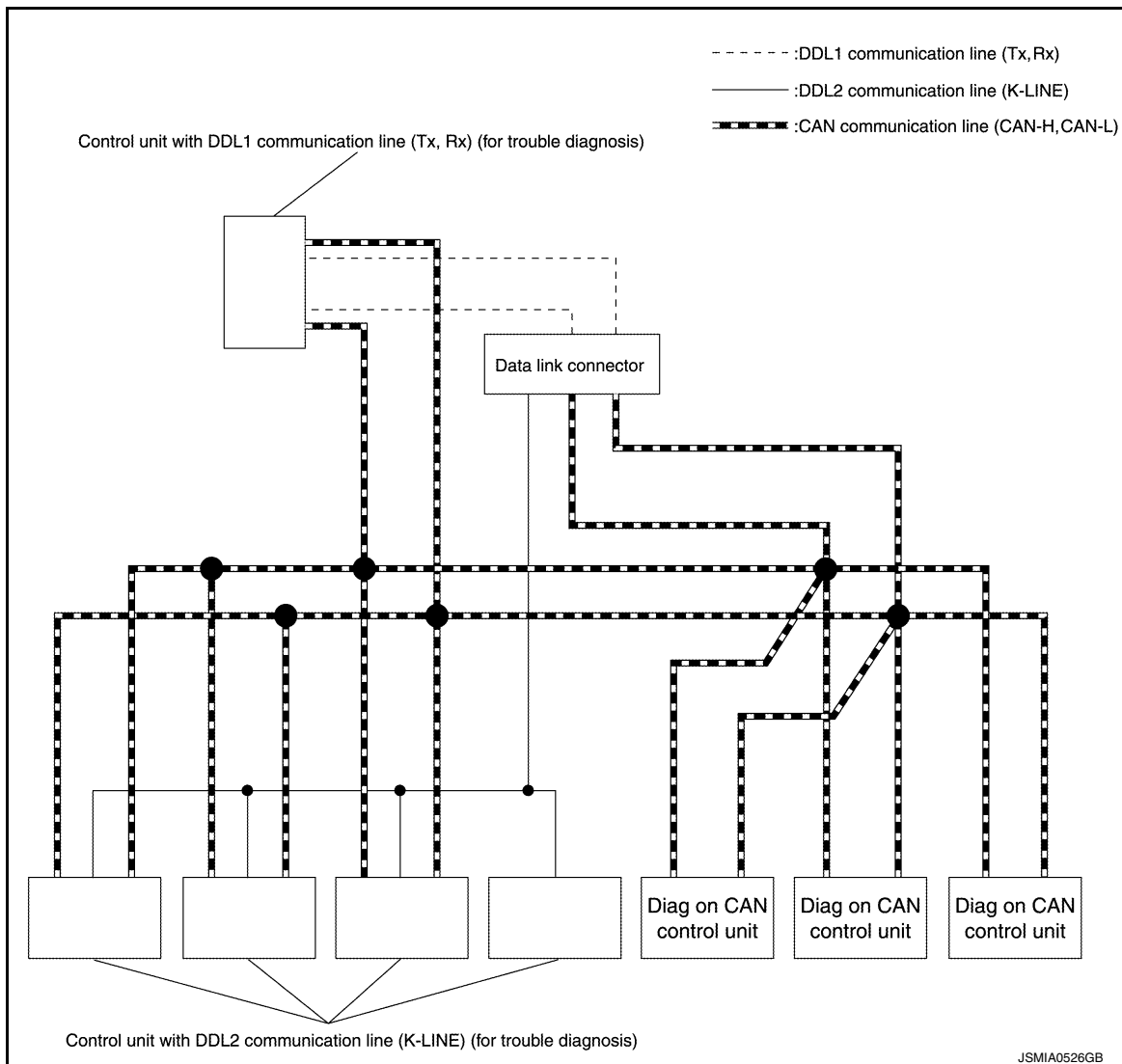

A
B
C
D
E
F
G
H
I
J
K
L
N
O
P

LAN

SYSTEM

< SYSTEM DESCRIPTION >

[CAN FUNDAMENTAL]

Name	Harness	Description
DDL1	Tx Rx	For communications with the diagnostic tool. (CAN-H and CAN-L are used for controlling)
DDL2	K-LINE	For communications with the diagnostic tool. (CAN-H and CAN-L are used for controlling)
Diag on CAN	CAN-H CAN-L	For communications with the diagnostic tool. (CAN-H and CAN-L are also used for control and diagnoses.)

DESCRIPTION

“Diag on CAN” is a diagnosis method which uses the CAN communication line for the communication between the control unit and the diagnostic tool.

TROUBLE DIAGNOSIS

Component Description

INFOID:000000012433332

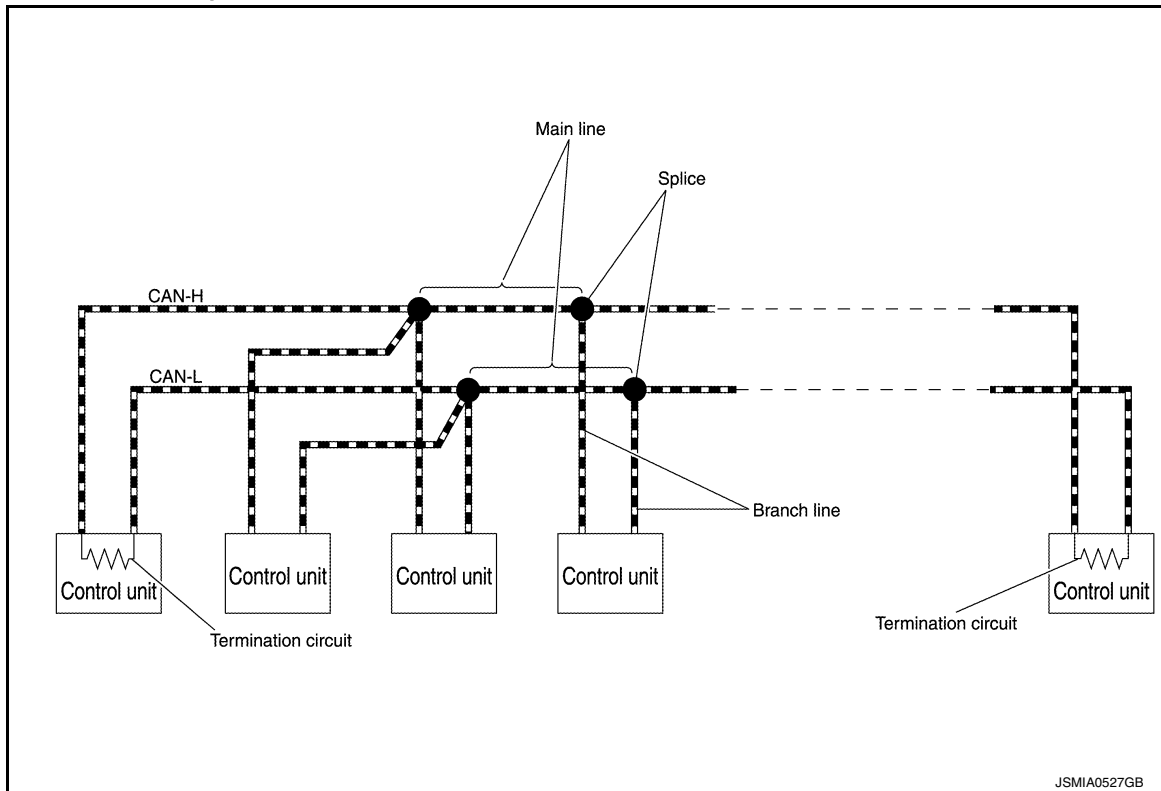

Component	Description
Main line	CAN communication line between splices
Branch line	CAN communication line between splice and a control unit
Splice	A point connecting a branch line with a main line
Termination circuit	Circuit connected across the CAN communication system. (Resistor)

Condition of Error Detection

INFOID:000000012433333

DTC (e.g. U1000 and U1001) of CAN communication is indicated on SELF-DIAG RESULTS on CONSULT if a CAN communication signal is not transmitted or received between units for 2 seconds or more.

CAN COMMUNICATION SYSTEM ERROR

- CAN communication line open (CAN-H, CAN-L, or both)
- CAN communication line short (ground, between CAN communication lines, other harnesses)
- Error of CAN communication control circuit of the unit connected to CAN communication line

WHEN DTC OF CAN COMMUNICATION IS INDICATED EVEN THOUGH CAN COMMUNICATION SYSTEM IS NORMAL

- Removal/installation of parts: Error may be detected when removing and installing CAN communication unit and related parts while turning the ignition switch ON. (A DTC except for CAN communication may be detected.)
- Fuse blown out (removed): CAN communication of the unit may cease.
- Voltage drop: Error may be detected if voltage drops due to discharged battery when turning the ignition switch ON (Depending on the control unit which carries out CAN communication).
- Error may be detected if the power supply circuit of the control unit, which carries out CAN communication, malfunctions (Depending on the control unit which carries out CAN communication).
- Error may be detected if reprogramming is not completed normally.

NOTE:

CAN communication system is normal if DTC of CAN communication is indicated on SELF-DIAG RESULTS of CONSULT under the above conditions. Erase the memory of the self-diagnosis of each control unit.

A
B
C
D
E
F
G
H
I
J
K
L
N
O
P

LAN

TROUBLE DIAGNOSIS

< SYSTEM DESCRIPTION >

[CAN FUNDAMENTAL]

Symptom When Error Occurs in CAN Communication System

INFOID:000000012433334

In CAN communication system, multiple control units mutually transmit and receive signals. Each control unit cannot transmit and receive signals if any error occurs on CAN communication line. Under this condition, multiple control units related to the root cause malfunction or go into fail-safe mode.

ERROR EXAMPLE

NOTE:

Each vehicle differs in symptom of each control unit under fail-safe mode and CAN communication line wiring.

Example: Main Line Between Data Link Connector and ABS Actuator and Electric Unit (Control Unit) Open Circuit

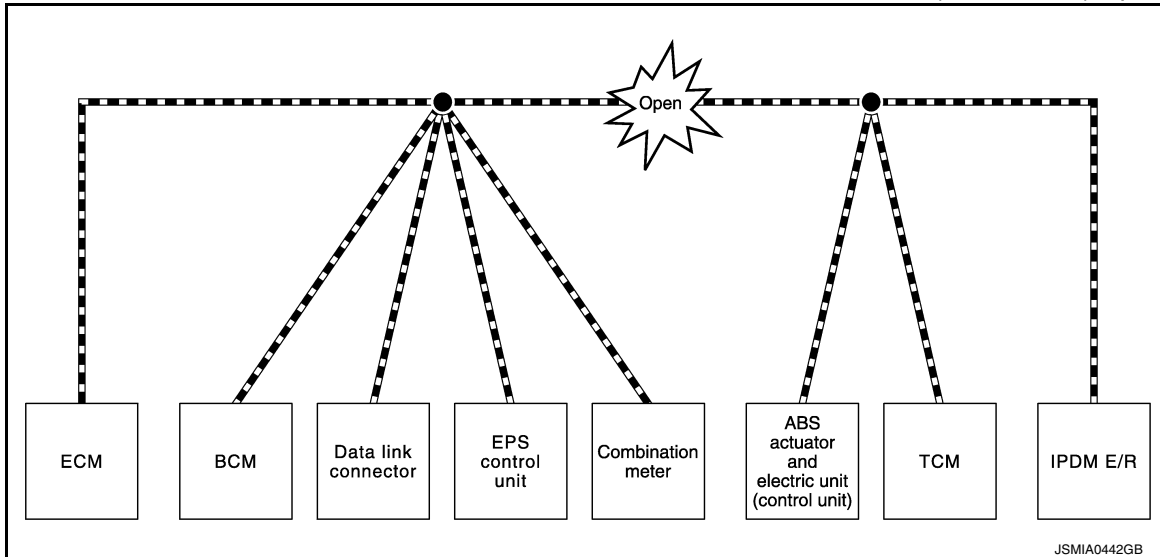

Unit name	Major symptom
ECM	Engine torque limiting is affected, and shift harshness increases.
BCM	<ul style="list-style-type: none"> • Reverse warning buzzer does not sound. • The front wiper moves under continuous operation mode even though the front wiper switch being in the intermittent position.
EPS control unit	The steering effort increases.
Combination meter	<ul style="list-style-type: none"> • The shift position indicator and OD OFF indicator turn OFF. • The speedometer is inoperative. • The odo/trip meter stops.
ABS actuator and electric unit (control unit)	Normal operation.
TCM	No impact on operation.
IPDM E/R	When the ignition switch is ON, <ul style="list-style-type: none"> • The headlamps (Lo) turn ON. • The cooling fan continues to rotate.

TROUBLE DIAGNOSIS

< SYSTEM DESCRIPTION >

[CAN FUNDAMENTAL]

Example: TCM Branch Line Open Circuit

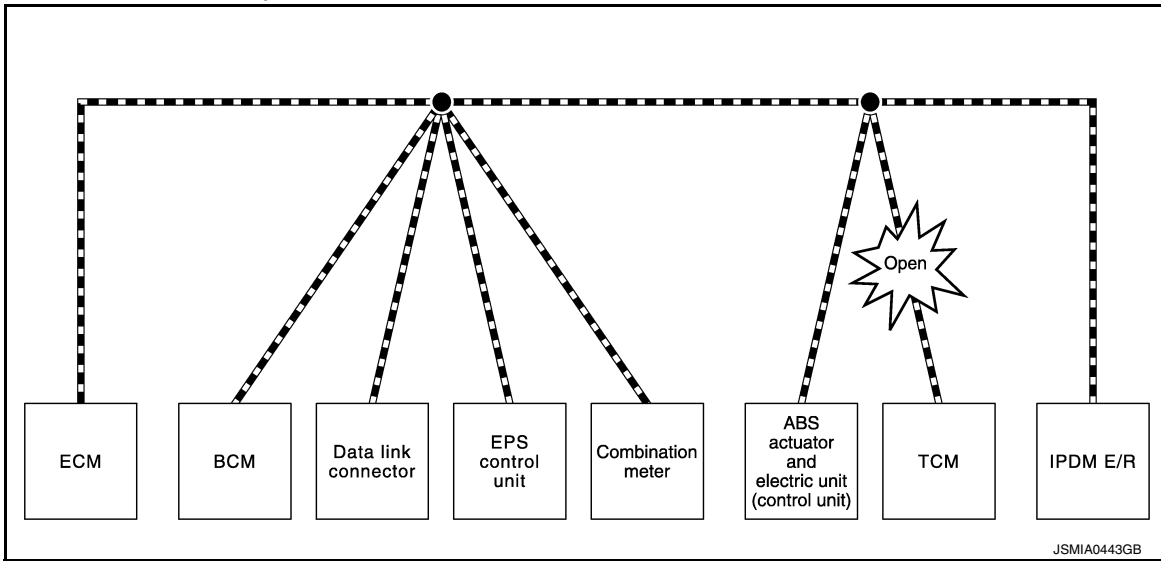

Unit name	Major symptom
ECM	Engine torque limiting is affected, and shift harshness increases.
BCM	Reverse warning buzzer does not sound.
EPS control unit	Normal operation.
Combination meter	<ul style="list-style-type: none"> • Shift position indicator and O/D OFF indicator turn OFF. • Warning lamps turn ON.
ABS actuator and electric unit (control unit)	Normal operation.
TCM	No impact on operation.
IPDM E/R	Normal operation.

NOTE:

The model (all control units on CAN communication system are Diag on CAN) cannot perform CAN diagnosis with CONSULT if the following error occurs. The error is judged by the symptom.

Error	Difference of symptom
Data link connector branch line open circuit	Normal operation.
CAN-H, CAN-L harness short-circuit	Most of the control units which are connected to the CAN communication system enter fail-safe mode or are deactivated.

Example: Data Link Connector Branch Line Open Circuit

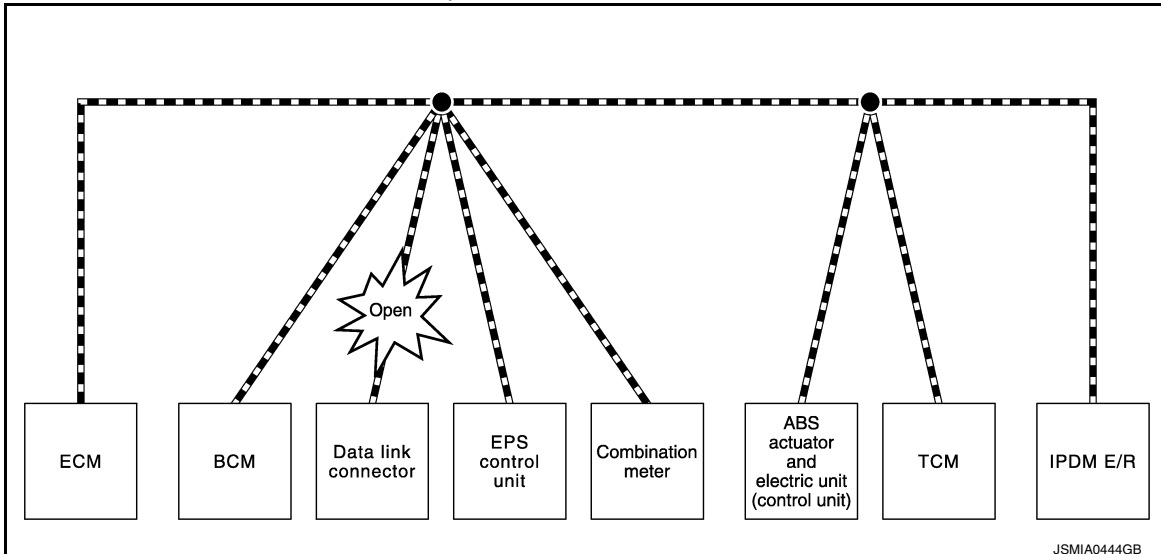

A
B
C
D
E
F
G
H
I
J
K
L
N
O
P

LAN

TROUBLE DIAGNOSIS

< SYSTEM DESCRIPTION >

[CAN FUNDAMENTAL]

Unit name	Major symptom
ECM	Normal operation.
BCM	
EPS control unit	
Combination meter	
ABS actuator and electric unit (control unit)	
TCM	
IPDM E/R	

NOTE:

When data link connector branch line is open, transmission and reception of CAN communication signals are not affected. Therefore, no symptoms occur. However, be sure to repair malfunctioning circuit.

Example: CAN-H, CAN-L Harness Short Circuit

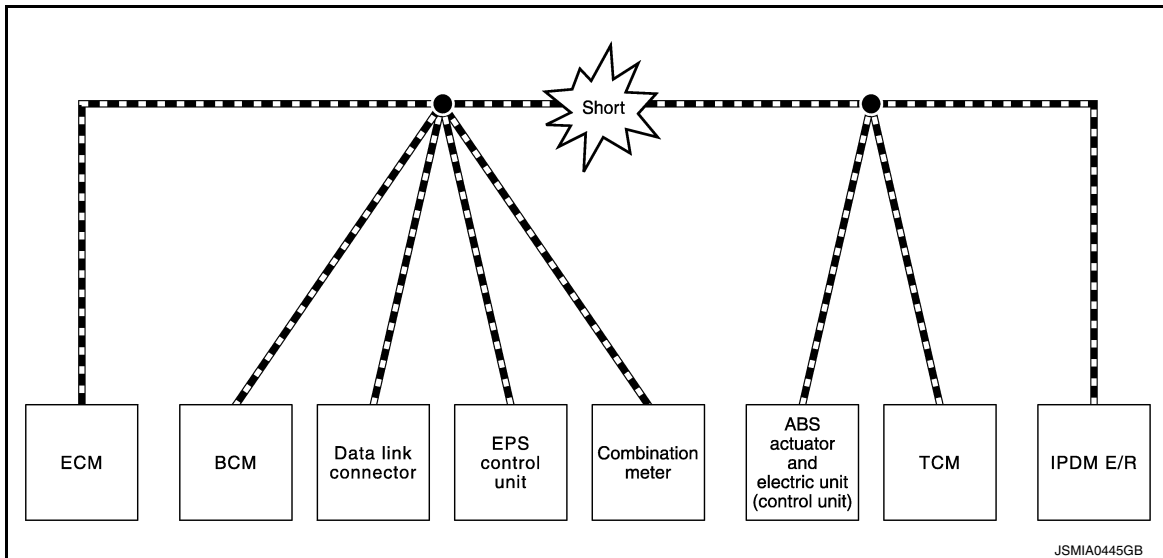

Unit name	Major symptom
ECM	<ul style="list-style-type: none"> • Engine torque limiting is affected, and shift harshness increases. • Engine speed drops.
BCM	<ul style="list-style-type: none"> • Reverse warning buzzer does not sound. • The front wiper moves under continuous operation mode even though the front wiper switch being in the intermittent position. • The room lamp does not turn ON. • The engine does not start (if an error or malfunction occurs while turning the ignition switch OFF.) • The steering lock does not release (if an error or malfunction occurs while turning the ignition switch OFF.)
EPS control unit	The steering effort increases.
Combination meter	<ul style="list-style-type: none"> • The tachometer and the speedometer do not move. • Warning lamps turn ON. • Indicator lamps do not turn ON.
ABS actuator and electric unit (control unit)	Normal operation.
TCM	No impact on operation.
IPDM E/R	When the ignition switch is ON, <ul style="list-style-type: none"> • The headlamps (Lo) turn ON. • The cooling fan continues to rotate.

CAN Diagnosis with CONSULT

INFOID:000000012433335

CAN diagnosis on CONSULT extracts the root cause by receiving the following information.

TROUBLE DIAGNOSIS

[CAN FUNDAMENTAL]

< SYSTEM DESCRIPTION >

- Response to the system call
- Control unit diagnosis information
- Self-diagnosis
- CAN diagnostic support monitor

Self-Diagnosis

INFOID:00000001243336

If communication signals cannot be transmitted or received among control units communicating via CAN communication line, CAN communication-related DTC is displayed on the CONSULT "Self Diagnostic Result" screen.

NOTE:

The following table shows examples of CAN communication-related DTC. For other DTC, refer to the applicable sections.

DTC	Self-diagnosis item (CONSULT indication)	DTC detection condition		Inspection/Action
U1000	CAN COMM CIRCUIT	ECM	When ECM is not transmitting or receiving CAN communication signal of OBD (emission-related diagnosis) for 2 seconds or more.	Start the inspection. Refer to the applicable section of the indicated control unit.
		Except for ECM	When a control unit (except for ECM) is not transmitting or receiving CAN communication signal for 2 seconds or more.	
U1001	CAN COMM CIRCUIT	When ECM is not transmitting or receiving CAN communication signal other than OBD (emission-related diagnosis) for 2 seconds or more.		
U1002	SYSTEM COMM	When a control unit is not transmitting or receiving CAN communication signal for 2 seconds or less.		
U1010	CONTROL UNIT(CAN)	When an error is detected during the initial diagnosis for CAN controller of each control unit.		

CAN Diagnostic Support Monitor

INFOID:00000001243337

MONITOR ITEM (CONSULT)

Example: CAN DIAG SUPPORT MNTR indication

Without PAST				With PAST			
BCM				ENGINE			
MONITOR ITEM	PRESENT	PAST		MONITOR ITEM	PRESENT	PAST	
INITIAL DIAG	OK	-		TRANSMIT DIAG	OK	OK	
TRANSMIT DIAG	OK	-		VDC/TCS/ABS	OK	5	
ECM	OK	-		METER/M&A	Not diagnosed	-	
METER/M&A	OK	-		BCM/SEC	OK	OK	
TCM	OK	-		ICC	Not diagnosed	-	
IPDM E/R	OK	-		HVAC	Not diagnosed	-	
I-KEY	OK	-		TCM	OK	OK	
				EPS	OK	OK	
				IPDM E/R	OK	5	
				e4WD	Not diagnosed	-	
				AWD/4WD	Not diagnosed	-	

JSMIA0964GB

Without PAST

Item	PRESENT	Description
Initial diagnosis	OK	Normal at present
	NG	Control unit error (Except for some control units)

TROUBLE DIAGNOSIS

< SYSTEM DESCRIPTION >

[CAN FUNDAMENTAL]

Item	PRESENT	Description
Transmission diagnosis	OK	Normal at present
	UNKWN	Unable to transmit signals for 2 seconds or more.
		Diagnosis not performed
Control unit name (Reception diagnosis)	OK	Normal at present
	UNKWN	Unable to receive signals for 2 seconds or more.
		Diagnosis not performed
		No control unit for receiving signals. (No applicable optional parts)

With PAST

Item	PRESENT	PAST	Description
Transmission diagnosis	OK	OK	Normal at present and in the past
		1 – 39	Normal at present, but unable to transmit signals for 2 seconds or more in the past. (The number indicates the number of ignition switch cycles from OFF to ON.)
	UNKWN	0	Unable to transmit signals for 2 seconds or more at present.
Control unit name (Reception diagnosis)	OK	OK	Normal at present and in the past
		1 – 39	Normal at present, but unable to receive signals for 2 seconds or more in the past. (The number indicates the number of ignition switch cycles from OFF to ON.)
	UNKWN	0	Unable to receive signals for 2 seconds or more at present.
	Not diagnosed	-	-
-			No control unit for receiving signals. (No applicable optional parts)

TROUBLE DIAGNOSIS

< SYSTEM DESCRIPTION >

[CAN FUNDAMENTAL]

How to Use CAN Communication Signal Chart

INFOID:000000012433338

The CAN communication signal chart lists the signals transmitted/received among control units. It is useful for detecting the root cause by finding a signal related to the symptom, and by checking transmission and reception unit.

Example: Tachometer does not move even though the engine rotates.

T: Transmit R: Receive

Signal name/Connecting unit	ECM	BCM	M&A	STRG	ABS	IPDM-E
A/C compressor feedback signal	T		R			
A/C compressor request signal	T					R
Accelerator pedal position signal	T				R	
Cooling fan motor operation signal	T					R
Engine coolant temperature signal	T		R			
Engine speed signal	T		R		R	
Fuel consumption monitor signal	T		R			
Malfunction indicator lamp signal	T		R			
A/C switch signal	R	T				
Ignition switch signal		T				R
Sleep/wake up signal		T	R			R

It indicates that an error occurs between ECM and Combination meter (Shaded area).

JSMIA0446GB

A
B
C
D
E
F
G
H
I
J
K
L
N
O
P

LAN

BASIC INSPECTION

DIAGNOSIS AND REPAIR WORKFLOW

Trouble Diagnosis Flow Chart

INFOID:0000000012433339

DESCRIPTION

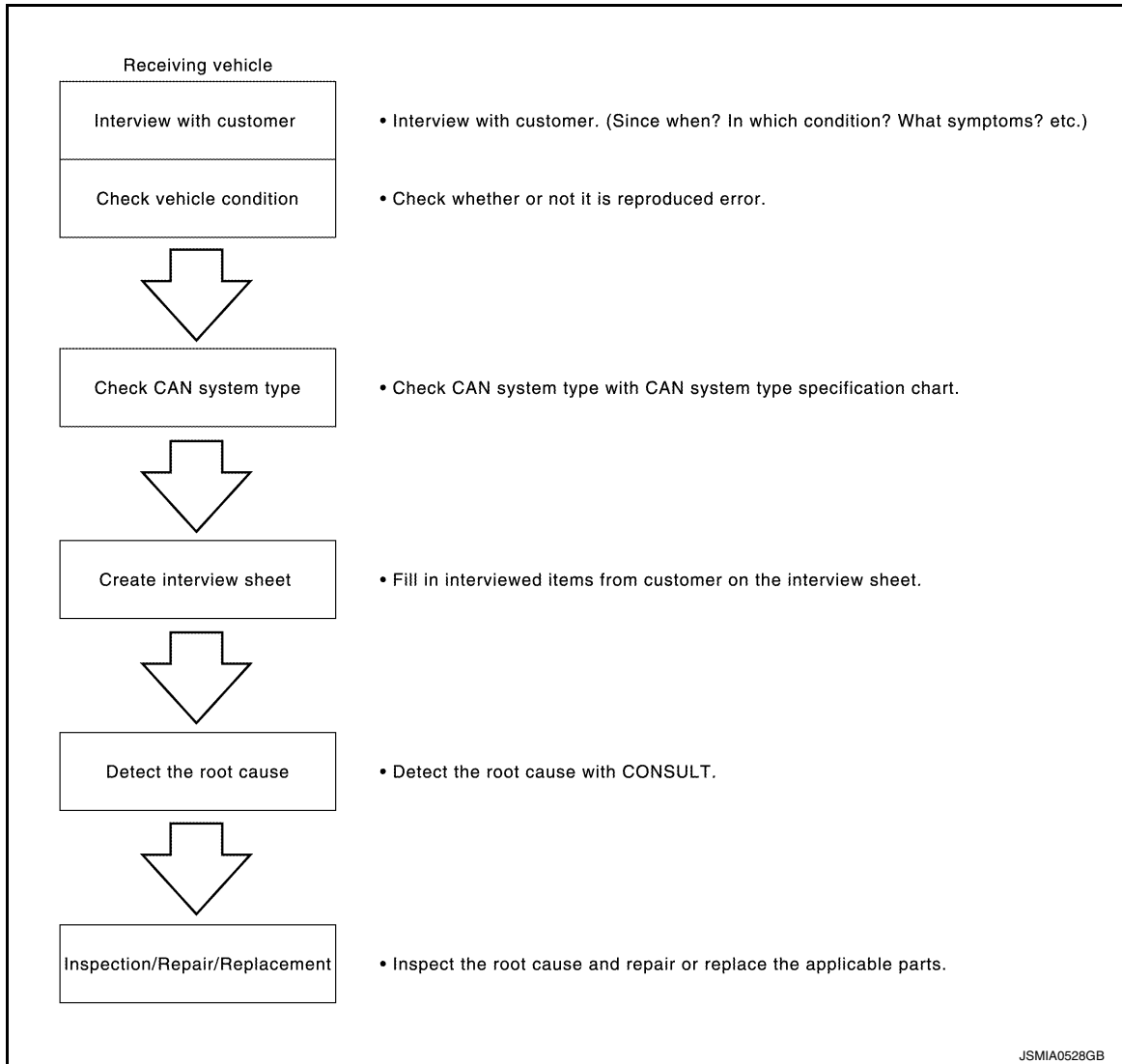

DETAIL OF TROUBLE DIAGNOSIS FLOW CHART

1. INTERVIEW WITH CUSTOMER

Interview with the customer is important to detect the root cause of CAN communication system errors and to understand vehicle condition and symptoms for proper trouble diagnosis.

Points in interview

- What: Parts name, system name
- When: Date, Frequency
- Where: Road condition, Place
- In what condition: Driving condition/environment
- Result: Symptom

Notes for checking error symptoms:

- Check normal units as well as error symptoms.
- Example: Circuit between ECM and the combination meter is judged normal if the customer indicates tachometer functions normally.

DIAGNOSIS AND REPAIR WORKFLOW

[CAN FUNDAMENTAL]

< BASIC INSPECTION >

- When a CAN communication system error is present, multiple control units may malfunction or go into fail-safe mode.
- Indication of the combination meter is important to detect the root cause because it is the most obvious to the customer, and it performs CAN communication with many units.

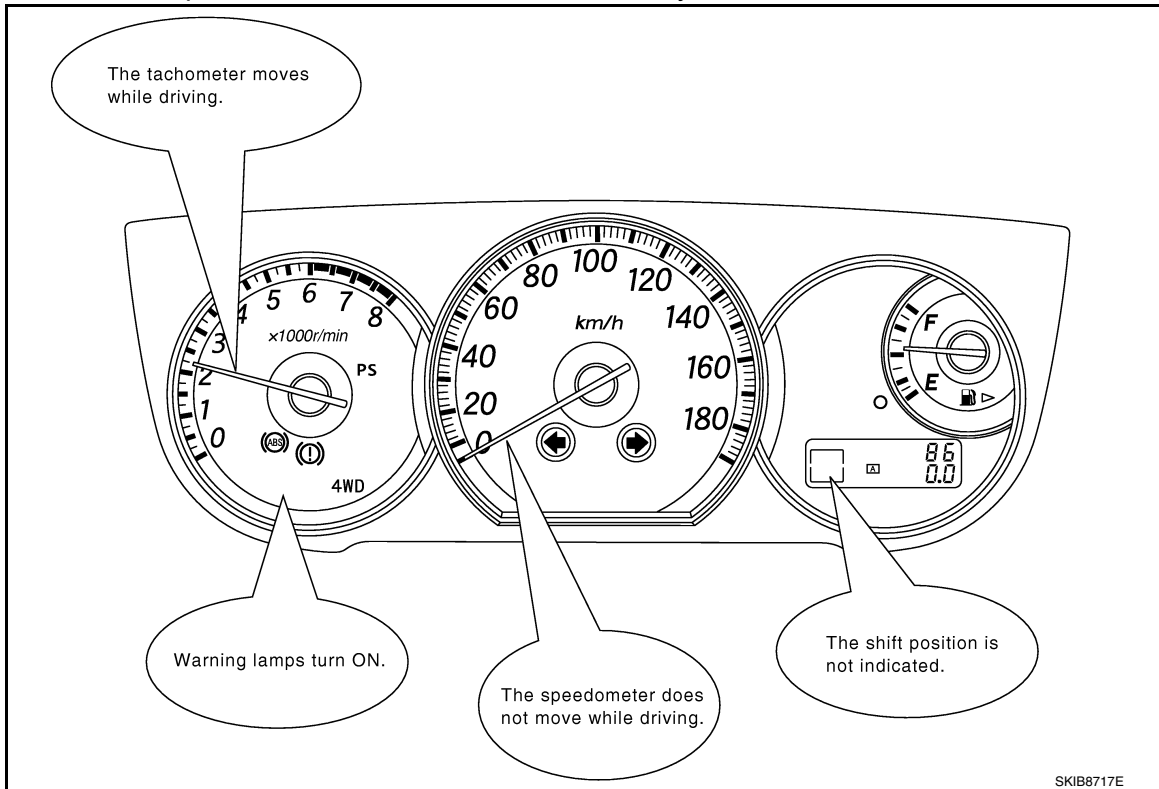

>> GO TO 2.

2. INSPECTION OF VEHICLE CONDITION

Check whether the symptom is reproduced or not.

NOTE:

Do not turn the ignition switch OFF or disconnect the 12V battery cable while reproducing the error. The error may temporarily correct itself, making it difficult to determine the root cause.

>> GO TO 3.

3. CHECK OF CAN SYSTEM TYPE (HOW TO USE CAN SYSTEM TYPE SPECIFICATION CHART)

Determine CAN system type based on vehicle equipment.

NOTE:

- This chart is used if CONSULT does not automatically recognize CAN system type.
- There are two styles for CAN system type specification charts. Depending on the number of available system types, either style A or style B may be used.
- CAN System Type Specification Chart (Style A)

NOTE:

A
B
C
D
E
F
G
H
I
J
K
L
LAN
N
O
P

DIAGNOSIS AND REPAIR WORKFLOW

< BASIC INSPECTION >

[CAN FUNDAMENTAL]

CAN system type is easily checked with the vehicle equipment identification information shown in the chart.

Example:
Vehicle is equipped as follows: Wagon, AWD, VQ35DE, CVT, VDC, and Intelligent Key system. (○ shows an example of CAN system type.)

CAN System Specification Chart
Determine CAN system type from the following specification chart.

Body type	Wagon					
Axle	2WD			AWD		
Engine	QR25DE			VQ35DE		
Transmission	A/T			CVT		
Brake control	ABS			VDC		
Intelligent Key system		×		×		×
CAN system type	1	2	3	4	5	6
CAN communication control unit						
ECM	×	×	×	×	×	×
AWD control unit					×	×
Air bag diagnosis sensor unit	×	×	×	×	×	×
BCM	×	×	×	×	×	×
Intelligent Key unit		×		×		×
Steering angle sensor					×	×
EPS control unit	×	×	×	×	×	×
Combination meter	×	×	×	×	×	×
ABS actuator and electric unit (control unit)	×	×	×	×	×	×
TCM	×	×	×	×	×	×
IPDM E/R	×	×	×	×	×	×

× : Applicable

VEHICLE EQUIPMENT IDENTIFICATION INFORMATION
NOTE:
Check CAN system type from the vehicle shape and equipment.

(A)

1. VDC OFF switch
A. With VDC

(B)

2. Ignition knob
B. With Intelligent Key system

For the above case, CAN system type is "6".

JSMIA0529GB

• CAN System Type Specification Chart (Style B)

NOTE:

DIAGNOSIS AND REPAIR WORKFLOW

< BASIC INSPECTION >

[CAN FUNDAMENTAL]

CAN system type is easily checked with the vehicle equipment identification information shown in the chart.

Example:
Vehicle is equipped as follows: Sedan, 2WD, MR20DE, CVT, ABS, Active AFS, Intelligent Key system, Navigation system and Automatic drive positioner. (○ shows an example of CAN system type.)

CAN System Specification Chart
Refer to the specification as shown in the chart.

Body type	Sedan		
Axle	2WD		AWD
Engine	HR15DE	MR20DE	HR15DE
Transmission	A/T	CVT	A/T
Brake control		ABS	
Specification chart	XX.XX. SPECIFICATION CHART A.	XX.XX. SPECIFICATION CHART B.	XX.XX. SPECIFICATION CHART C.

×: Applicable

Check the vehicle equipment with the vehicle identification number plate.
Check the vehicle equipment.
Select the applicable vehicle equipment. Refer to the specification chart.

SPECIFICATION CHART B
Determine CAN system type from the following specification chart.

Body type	Sedan											
Axle	2WD											
Engine	MR20DE											
Transmission	CVT											
Brake control	ABS											
Active AFS		×			×	×			×	×	×	
Intelligent Key system			×		×		×	×	×	×	×	
Navigation system				×		×		×		×	×	
Automatic drive positioner								×		×	×	
CAN system type	9	10	11	12	13	14	15	16	17	18	19	20
CAN communication control unit												
ECM	×	×	×	×	×	×	×	×	×	×	×	×
AFS control unit		×			×	×				×	×	×
BCM	×	×	×	×	×	×	×	×	×	×	×	×
IPDM E/R	×	×	×	×	×	×	×	×	×	×	×	×

×: Applicable

Check the vehicle equipment.
The number indicates the CAN system type of the vehicle.

VEHICLE EQUIPMENT IDENTIFICATION INFORMATION
NOTE:
Check CAN system type from the vehicle shape and equipment.

In the above example,

- Checking Xenon bulb and bending lamp lead to judge whether or not Active AFS is equipped.
- Checking the ignition knob leads to judge whether or not Intelligent Key system is equipped.
- Checking display and multifunction switch lead to judge whether or not Navigation system is equipped.
- Checking seat memory switch leads to judge whether or not Automatic drive positioner is equipped.

1. Bending lamp 2. Xenon bulb 3. Ignition knob
4. Display 5. Multifunction switch 6. Seat memory switch
A. With active AFS B. With Intelligent Key system C. With navigation system
D. With automatic drive positioner

[For the above case, CAN system type is "20".]

JSMIA0530GB

A
B
C
D
E
F
G
H
I
J
K
L
N
O
P

LAN

>> GO TO 4.

4. CREATE INTERVIEW SHEET

Fill out the symptom described by the customer, vehicle condition, and CAN system type on the interview sheet.

NOTE:

DIAGNOSIS AND REPAIR WORKFLOW

< BASIC INSPECTION >

[CAN FUNDAMENTAL]

Interview Sheet (Example)

CAN Communication System Diagnosis Interview Sheet	
Date received:	3, Feb. 2006
Type: DBA-KG11	VIN No.: KG11-005040
Model: BDRARGZG11EDA-E-J-	
First registration: 10, Jan. 2001	Mileage: 62,140
CAN system type: Type 19	
Symptom (Results from interview with customer)	
<ul style="list-style-type: none">· Headlamps suddenly turn ON while driving the vehicle.· The engine does not restart after stopping the vehicle and turning the ignition switch OFF.· The cooling fan continues rotating while turning the ignition switch ON.	
Condition at inspection	
Error Symptom: <u>Present</u> / Past	
<p>The engine does not start. While turning the ignition switch ON,</p> <ul style="list-style-type: none">· The headlamps (Lo) turn ON, and the cooling fan continues rotating.· The interior lamp does not turn ON.	

JSMIA0531GB

>> GO TO 5.

5. DETECT THE ROOT CAUSE

CAN diagnosis function of CONSULT detects a root cause.

>> GO TO 6.

6. REPAIR OR REPLACE MALFUNCTIONING PART

Repair or replace malfunctioning parts identified by CAN diagnosis function of CONSULT.

Main line>>Refer to [LAN-40, "Main Line"](#).

Branch line>>Refer to [LAN-40, "Branch Line"](#).

Short circuit>>Refer to [LAN-40, "Short Circuit"](#).

HOW TO USE THIS SECTION

< HOW TO USE THIS MANUAL >

[CAN]

HOW TO USE THIS MANUAL

HOW TO USE THIS SECTION

Information

INFOID:0000000012433340

- “CAN” of LAN Section describes information peculiar to a vehicle and inspection procedures.
- For trouble diagnosis procedure, refer to [LAN-16. "Trouble Diagnosis Flow Chart"](#) of “CAN FUNDAMENTAL”.

Abbreviation List

INFOID:0000000012433341

Unit name abbreviations in CONSULT CAN diagnosis and in this section are as per the following list.

Abbreviation	Unit name
A-BAG	Air bag diagnosis sensor unit
ABS	ABS actuator and electric unit (control unit)
AV	AV control unit
AVM	Around view monitor control unit
BCM	BCM
DLC	Data link connector
ECM	ECM
EPS	EPS control unit
IPDM-E	IPDM E/R
M&A	Combination meter
STRG	Steering angle sensor
TCM	TCM

A
B
C
D
E
F
G
H
I
J
K
L

LAN

N
O
P

PRECAUTION

PRECAUTIONS

Precaution for Supplemental Restraint System (SRS) "AIR BAG" and "SEAT BELT PRE-TENSIONER"

INFOID:00000001243342

The Supplemental Restraint System such as "AIR BAG" and "SEAT BELT PRE-TENSIONER", used along with a front seat belt, helps to reduce the risk or severity of injury to the driver and front passenger for certain types of collision. Information necessary to service the system safely is included in the SR and SB section of this Service Manual.

WARNING:

- To avoid rendering the SRS inoperative, which could increase the risk of personal injury or death in the event of a collision which would result in air bag inflation, all maintenance must be performed by an authorized NISSAN/INFINITI dealer.
- Improper maintenance, including incorrect removal and installation of the SRS, can lead to personal injury caused by unintentional activation of the system. For removal of Spiral Cable and Air Bag Module, see the SR section.
- Do not use electrical test equipment on any circuit related to the SRS unless instructed to in this Service Manual. SRS wiring harnesses can be identified by yellow and/or orange harnesses or harness connectors.

PRECAUTIONS WHEN USING POWER TOOLS (AIR OR ELECTRIC) AND HAMMERS

WARNING:

- When working near the Airbag Diagnosis Sensor Unit or other Airbag System sensors with the Ignition ON or engine running, DO NOT use air or electric power tools or strike near the sensor(s) with a hammer. Heavy vibration could activate the sensor(s) and deploy the air bag(s), possibly causing serious injury.
- When using air or electric power tools or hammers, always switch the Ignition OFF, disconnect the battery and wait at least three minutes before performing any service.

Precautions for Trouble Diagnosis

INFOID:00000001243343

CAUTION:

Follow the instructions listed below. Failure to do this may cause damage to parts:

- Never apply 7.0 V or more to the measurement terminal.
- Use a tester with open terminal voltage of 7.0 V or less.
- Turn the ignition switch OFF and disconnect the battery cable from the negative terminal when checking the harness.

Precautions for Harness Repair

INFOID:00000001243344

- Solder the repaired area and wrap tape around the soldered area.

NOTE:

A fray of twisted lines must be within 110 mm (4.33 in).

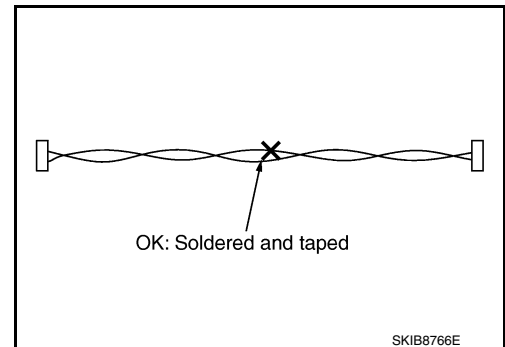

PRECAUTIONS

[CAN]

< PRECAUTION >

- Bypass connection is never allowed at the repaired area.

NOTE:

Bypass connection may cause CAN communication error. The spliced wire becomes separated and the characteristics of twisted line are lost.

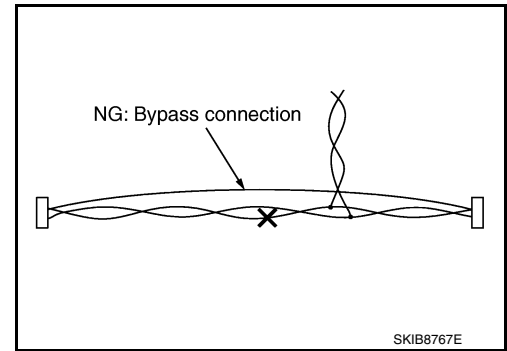

- Replace the applicable harness as an assembly if error is detected on the shield lines of CAN communication line.

A
B
C
D
E
F
G
H
I
J
K
L

LAN

COMPONENT PARTS

< SYSTEM DESCRIPTION >

[CAN]

SYSTEM DESCRIPTION

COMPONENT PARTS

Component Parts Location

INFOID:000000012433345

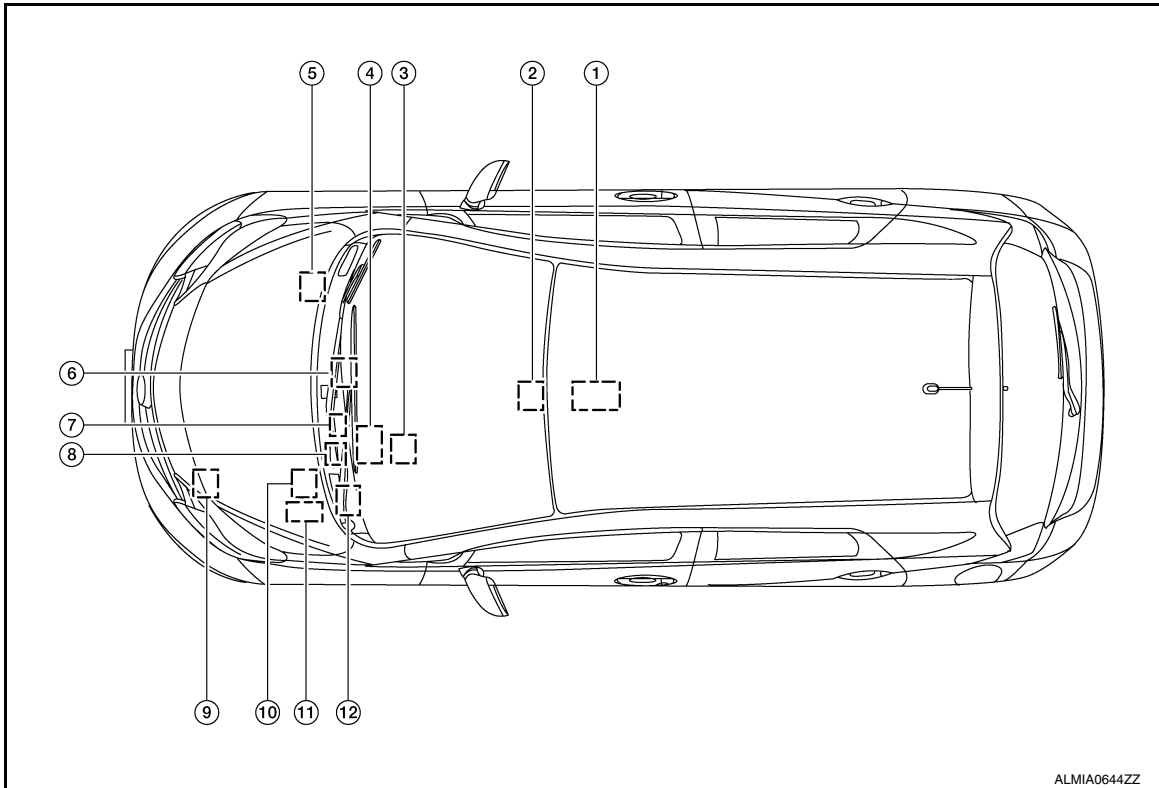

- | | | |
|------------------------------------|---|-------------------------|
| ① Around view monitor control unit | ② Air bag diagnosis sensor unit | ③ Steering angle sensor |
| ④ Combination meter | ⑤ ABS actuator and electric unit (control unit) | ⑥ AV control unit |
| ⑦ EPS control unit | ⑧ Data link connector | ⑨ TCM |
| ⑩ IPDM E/R | ⑪ ECM | ⑫ BCM |

SYSTEM

CAN COMMUNICATION SYSTEM

CAN COMMUNICATION SYSTEM : System Description

INFOID:000000012433346

SYSTEM DIAGRAM

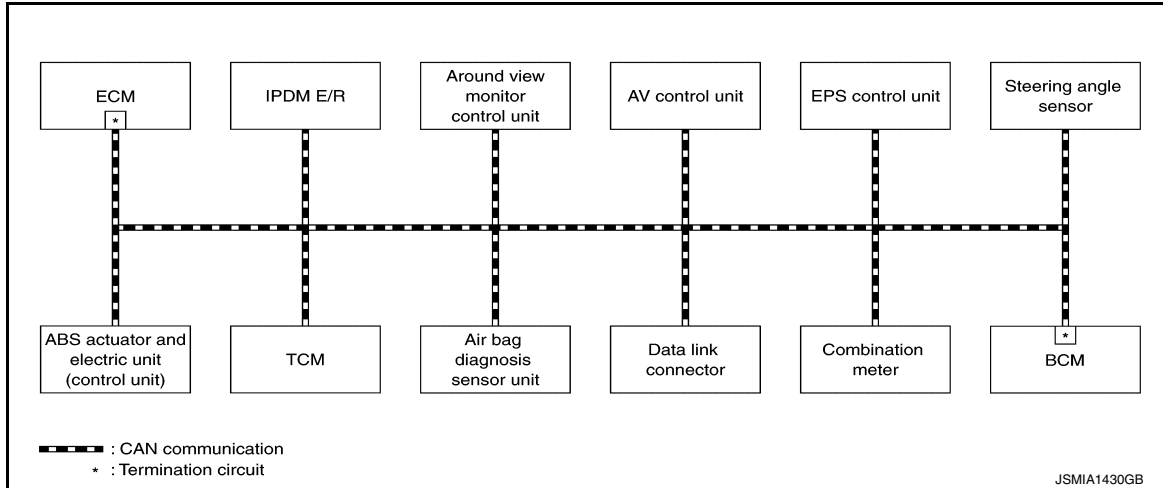

DESCRIPTION

CAN (Controller Area Network) is a serial communication line for real time application. It is an on-vehicle multiplex communication line with high data communication speed and excellent error detection ability. Many electronic control units are equipped onto a vehicle, and each control unit shares information and links with other control units during operation (not independent). In CAN communication, control units are connected with 2 communication lines (CAN-H line, CAN-L line) allowing a high rate of information transmission with less wiring. Each control unit transmits/receives data but selectively reads required data only.

CAN Communication Signal Generation

- Termination circuits (resistors) are connected across the CAN communication system. When transmitting a CAN communication signal, each control unit passes a current to the CAN-H line and the current returns to the CAN-L line.

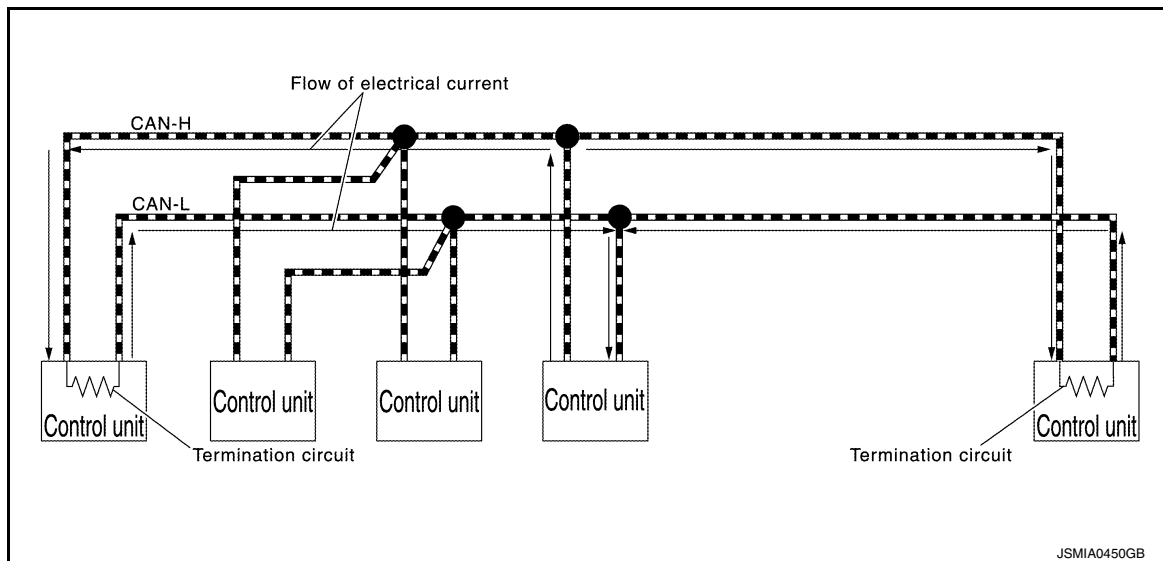

A
B
C
D
E
F
G
H
I
J
K
L
N
O
P

LAN

SYSTEM

[CAN]

< SYSTEM DESCRIPTION >

- The current flows separately into the termination circuits connected across the CAN communication system and the termination circuits drop voltage to generate a potential difference between the CAN-H line and the CAN-L line.

NOTE:

A signal with no current passage is called "Recessive" and one with current passage is called "Dominant".

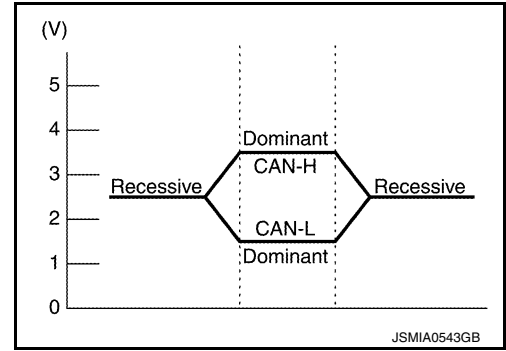

- The system produces digital signals for signal communications, by using the potential difference.

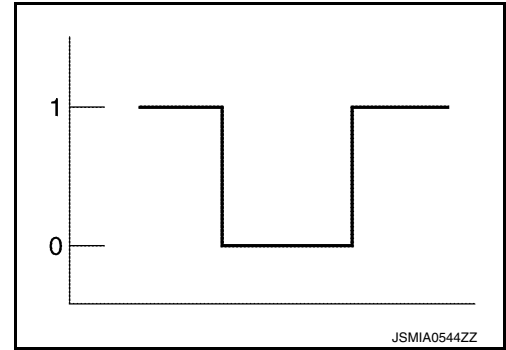

The Construction of CAN Communication Signal (Message)

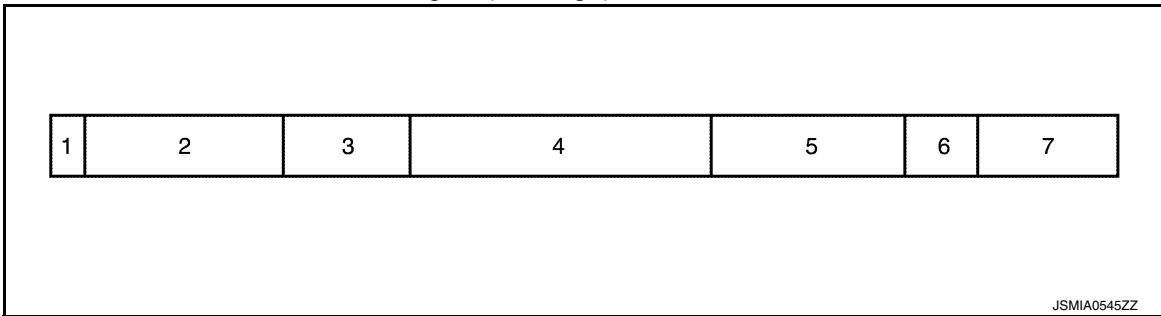

No.	Message name	Description
1	Start of frame (1 bit)	Start of message.
2	Arbitration of field (11 bit)	Priorities of message-sending are shown when there is a possibility that multiple messages are sent at the same time.
3	Control field (6 bit)	Signal quantity in data field is shown.
4	Data field (0-64 bit)	Actual signal is shown.
5	CRC field (16 bit)	<ul style="list-style-type: none"> The transmitting control unit calculates sending data in advance and writes the calculated value in a message. The receiving control unit calculates received data and judges that the data reception is normal when the calculated value is the same as the value written in the sent data.
6	ACK field (2 bit)	The completion of normal reception is sent to the transmitting unit.
7	End of frame (7 bit)	End of message.

CAN Communication Line

SYSTEM

[CAN]

< SYSTEM DESCRIPTION >

The CAN communication line is a twisted pair wire consisting of strands of CAN-H (1) and CAN-L (2) and has noise immunity.

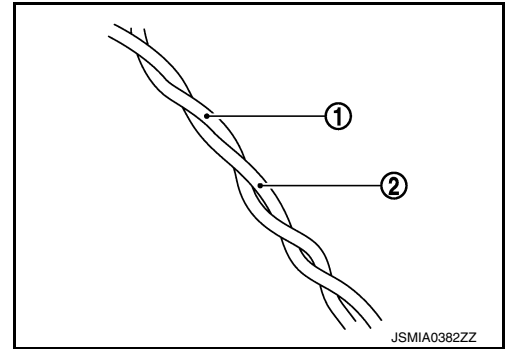

NOTE:

The CAN communication system has the characteristics of noise-resistant because this system produces digital signals by using the potential difference between the CAN-H line and the CAN-L line and has the twisted pair wire structure.

Since the CAN-H line and the CAN-L line are always adjacent to each other, the same degree of noise occurs, respectively, when a noise (1) occurs. Although the noise changes the voltage, the potential difference (2) between the CAN-H line and the CAN-L line is insensitive to noise. Therefore, noise-resistant signals can be obtained.

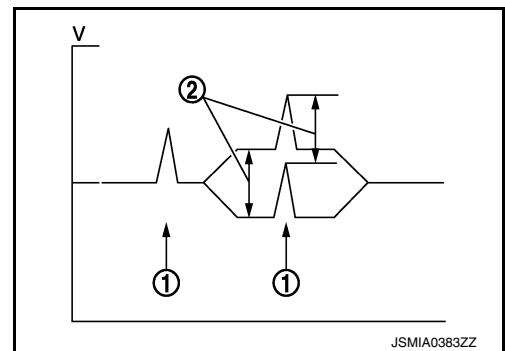

CAN Signal Communications

Each control unit of the CAN communication system transmits signals through the CAN communication control circuit included in the control unit and receives only necessary signals from each control unit to perform various kinds of control.

- Example: Transmitted signals

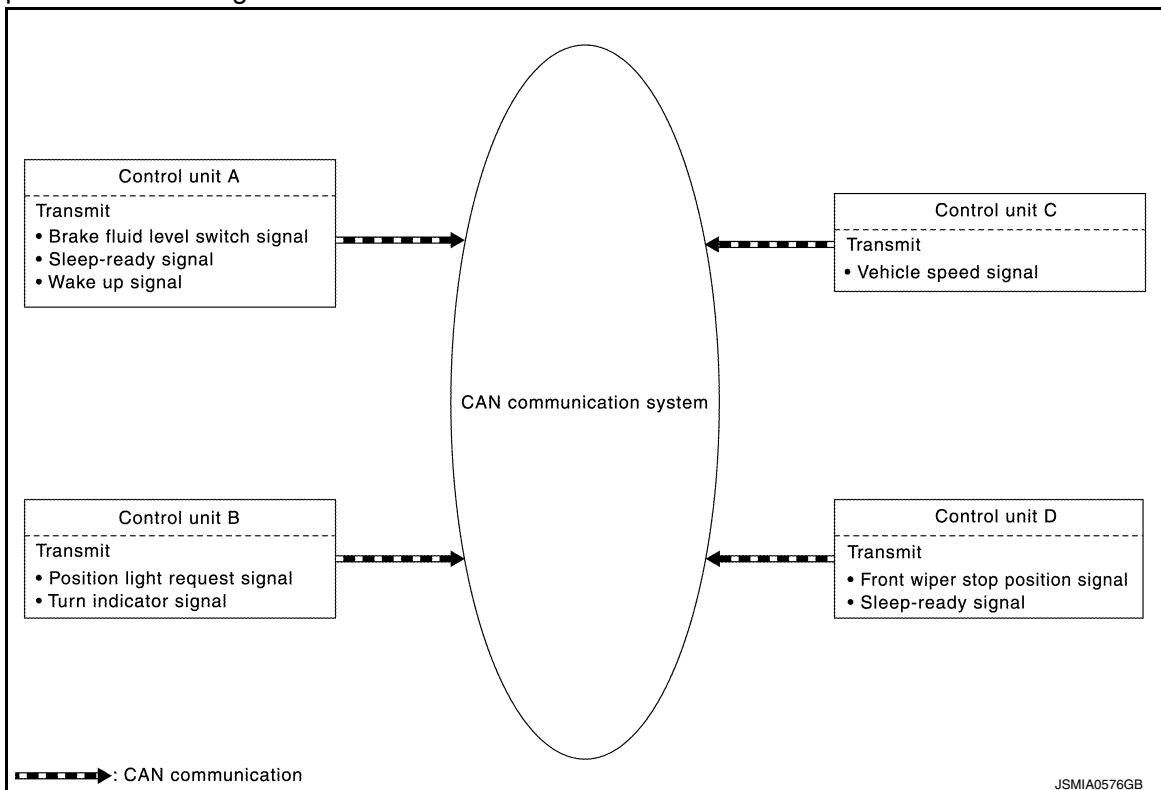

A
B
C
D
E
F
G
H
I
J
K
L
N
O
P

LAN

< SYSTEM DESCRIPTION >

- Example: Received signals

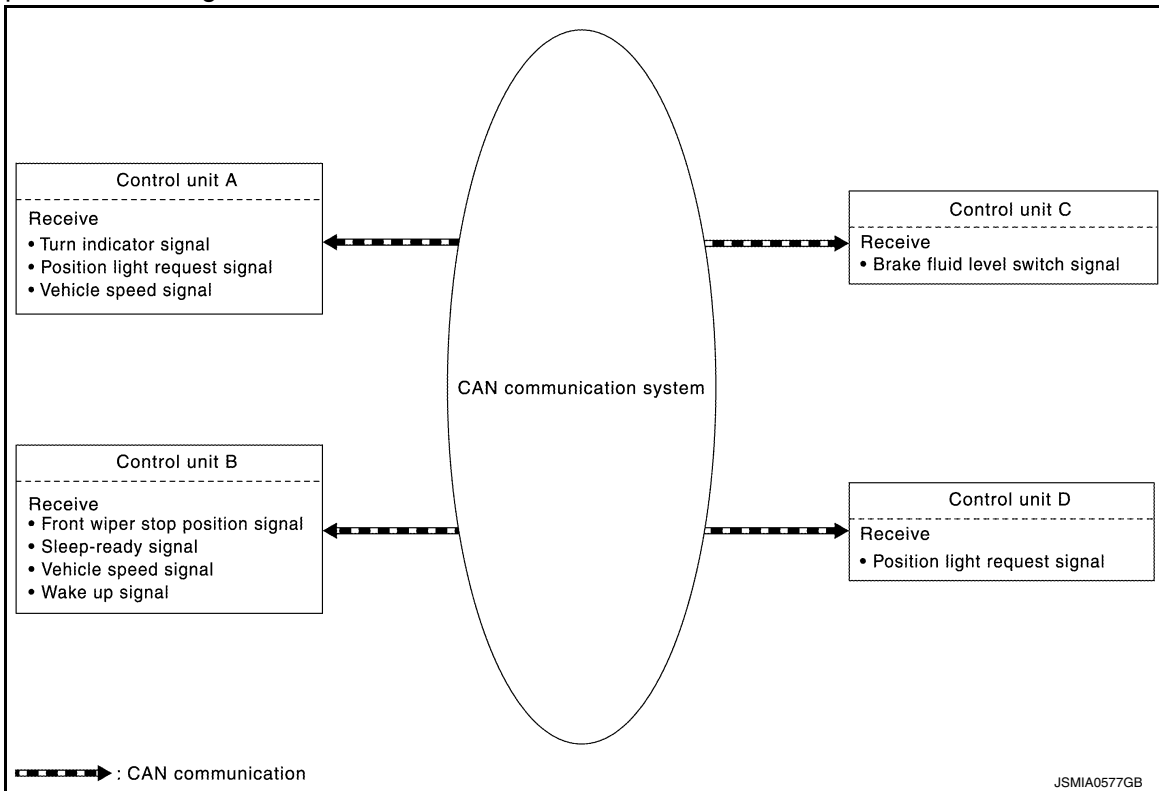

NOTE:

The above signal names and signal communications are provided for reference purposes. For CAN communications signals of this vehicle, refer to [LAN-30, "CAN COMMUNICATION SYSTEM : CAN Communication Signal Chart"](#).

CAN COMMUNICATION SYSTEM : CAN Communication Control Circuit

INFOID:000000012433347

CAN communication control circuit is incorporated into the control unit and transmits/receives CAN communication signals.

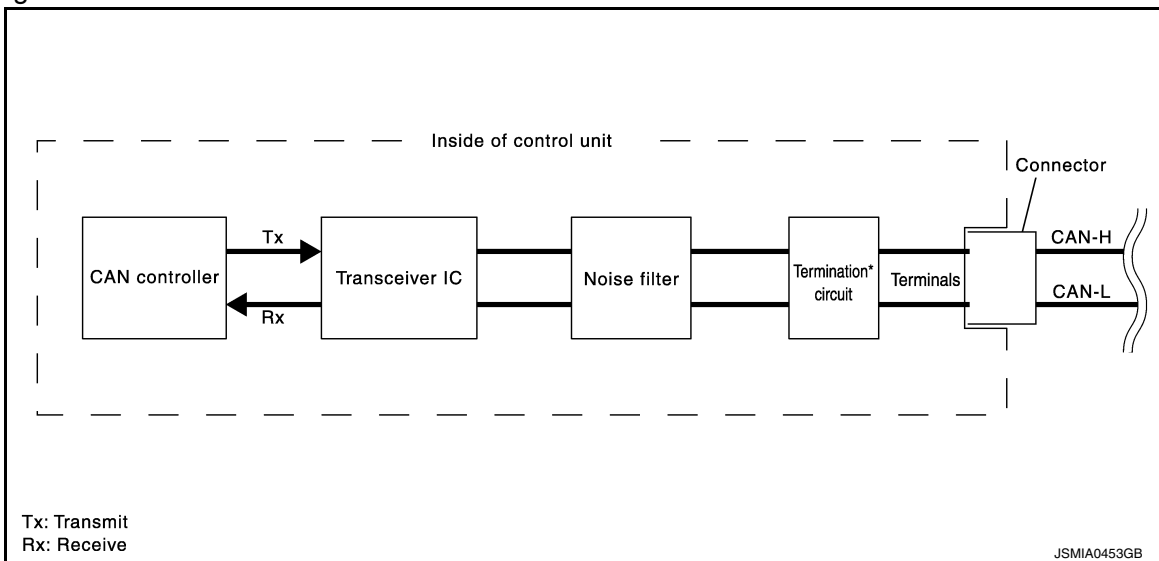

Component	System description
CAN controller	It controls CAN communication signal transmission and reception, error detection, etc.
Transceiver IC	It converts digital signal into CAN communication signal, and CAN communication signal into digital signal.

SYSTEM

[CAN]

< SYSTEM DESCRIPTION >

Component	System description
Noise filter	It eliminates noise of CAN communication signal.
Termination circuit* (Resistance of approx. 120 Ω)	Generates a potential difference between CAN-H and CAN-L.

*: These are the only control units wired with both ends of CAN communication system.

CAN COMMUNICATION SYSTEM : CAN System Specification Chart

INFOID:0000000012433348

Determine CAN system type from the following specification chart.

NOTE:

Refer to [LAN-16. "Trouble Diagnosis Flow Chart"](#) for how to use CAN system specification chart.

Body type	Hatch back				
Axle	2WD				
Engine	HR16DE				
Transmission	M/T		CVT		
Brake control	VDC				
Around view monitor system		×			×
Navigation system		×		×	×
CAN system type	501	502	503	505	504
CAN communication control unit					
ECM	×	×	×	×	×
ABS actuator and electric unit (control unit)	×	×	×	×	×
IPDM E/R	×	×	×	×	×
TCM			×	×	×
Around view monitor control unit		×			×
Air bag diagnosis sensor unit	×	×	×	×	×
AV control unit		×		×	×
Data link connector	×	×	×	×	×
EPS control unit	×	×	×	×	×
Combination meter	×	×	×	×	×
Steering angle sensor	×	×	×	×	×
BCM	×	×	×	×	×

×: Applicable

VEHICLE EQUIPMENT IDENTIFICATION INFORMATION

NOTE:

Check CAN system type from the vehicle shape and equipment.

A
B
C
D
E
F
G
H
I
J
K
L
N
O
P

LAN

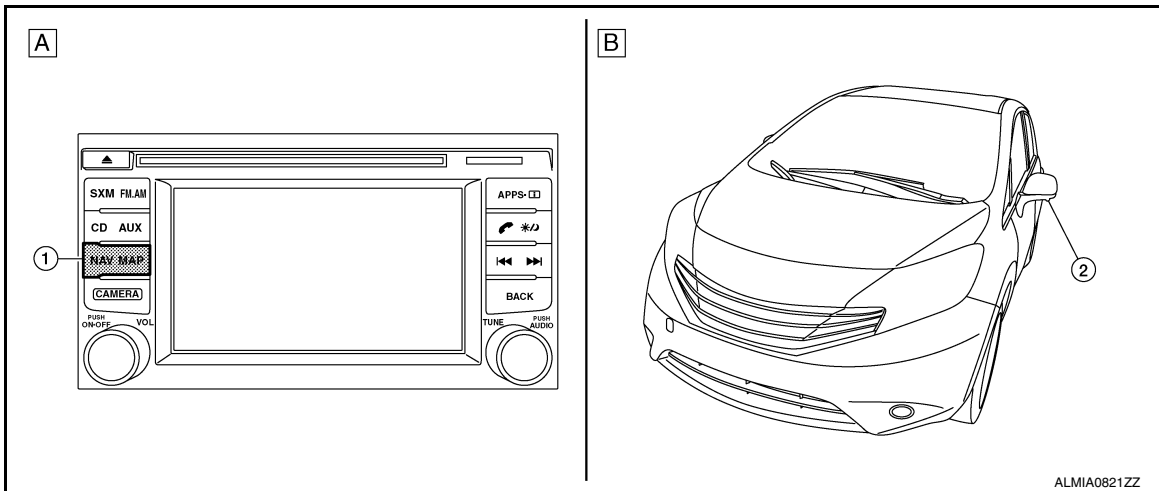

- ① NAVI switches
- ② Side camera LH
- Ⓐ With navigation system
- Ⓑ With around view monitor system

CAN COMMUNICATION SYSTEM : CAN Communication Signal Chart

INFOID:000000012433349

Refer to [LAN-15. "How to Use CAN Communication Signal Chart"](#) for how to use CAN communication signal chart.

NOTE:

- Refer to [LAN-21. "Abbreviation List"](#) for the abbreviations of the connecting units.
- The air bag diagnosis sensor unit and AV control unit uses CAN communication only for communicating with the diagnostic tool (not with other connected control units).

T: Transmit R: Receive

Signal name	ECM	ABS	IPDM-E	TCM	AVM	EPS	M&A	STRG	BCM
Accelerator pedal position signal	T	R		R					
A/C compressor request signal	T		R						
Closed throttle position signal	T			R					
Cooling fan speed request signal	T		R						
ECO pedal guide signal	T						R		
Engine and CVT integrated control signal	T			R					
	R			T					
Engine coolant temperature signal	T		R	R			R		
Engine speed signal	T	R		R			R		
Engine status signal	T	R				R	R		
Fuel filler cap warning display signal	T						R		
N idle instruction signal	T			R					
	R			T					
Malfunctioning indicator lamp signal	T						R		
	R			T					
Oil pressure warning lamp signal	T						R		
Power generation command value signal	T		R						
ABS warning lamp signal		T					R		
VDC warning lamp signal		T					R		
VDC OFF indicator lamp signal		T					R		

SYSTEM

< SYSTEM DESCRIPTION >

[CAN]

Signal name	ECM	ABS	IPDM-E	TCM	AVM	EPS	M&A	STRG	BCM	
Vehicle speed signal (ABS)		T		R	R	R	R		R	A
Brake warning lamp signal		T					R			B
Detention switch signal			T						R	
Front wiper stop position signal			T						R	C
High beam status signal	R		T							
Ignition switch ON signal			T						R	
			R						T	D
Interlock/PNP switch signal			T						R	
			R						T	E
Low beam status signal	R		T							
Push-button ignition switch status signal			T						R	
OD OFF indicator signal	R		T							F
			R						T	
Starter control relay signal			T						R	
			R						T	G
Starter relay status signal			T						R	
			R						T	H
Sleep-ready signal							T		R	
			T						R	I
Wake up signal			T						R	
Input shaft revolution signal	R			T						
O/D OFF indicator signal				T			R			J
Output shaft revolution signal	R			T						
Shift position signal		R		T			R		R	
Target gear ratio signal	R			T						K
EPS warning lamp signal						T	R			
Overdrive control switch signal	R					T				L
Fuel filler cap warning reset signal	R						T			
O/D OFF switch signal				R			T			
Odometer signal							T		R	LAN
Vehicle speed signal (Meter)	R					R	T		R	
Wake up signal							T		R	
Steering angle sensor signal		R			R			T		N
A/C ON signal	R								T	
Blower fan ON signal	R								T	O
Buzzer output signal							R		T	
Dimmer signal							R		T	
Door switch signal			R				R		T	P
Engine start operation indicator lamp signal							R		T	
Front wiper request signal			R						T	
High beam request signal			R				R		T	
Key warning lamp signal							R		T	
Low beam request signal			R				R		T	

SYSTEM

< SYSTEM DESCRIPTION >

[CAN]

Signal name	ECM	ABS	IPDM-E	TCM	AVM	EPS	M&A	STRG	BCM
Oil pressure switch signal							R		T
Position light request signal			R	R	R		R		T
Shift P warning lamp signal							R		T
Sleep wake up signal			R				R		T
Stop lamp switch signal				R					T
Turn indicator signal							R		T

< WIRING DIAGRAM >

WIRING DIAGRAM

CAN SYSTEM

Wiring Diagram

INFOID:000000012433350

CAN SYSTEM

- ◁IK▷ : WITH INTELLIGENT KEY
- ◁VT▷ : WITH CVT
- ◁OK▷ : WITHOUT INTELLIGENT KEY
- ◁YA▷ : WITH TYPE A
- ◁NV▷ : WITH NAVI
- ◁YB▷ : WITH TYPE B
- ◁VD▷ : WITH AROUND VIEW MONITOR
- ◁VK▷ : WITHOUT AROUND VIEW MONITOR

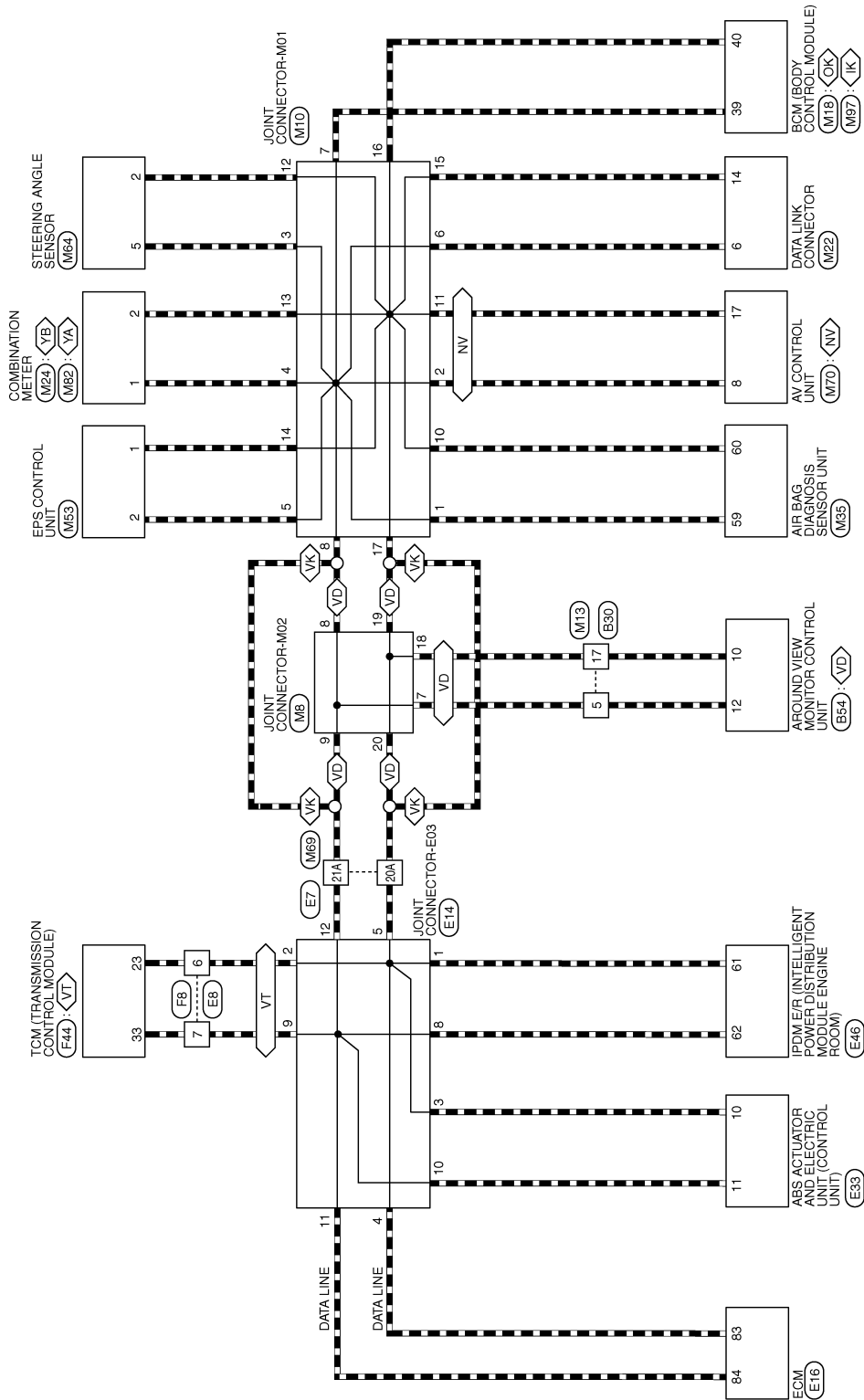

ABMWA3266GB

A
B
C
D
E
F
G
H
I
J
K
L
N
O
P

LAN

CAN SYSTEM CONNECTORS

Connector No.	M8
Connector Name	JOINT CONNECTOR-M02
Connector Color	GREEN

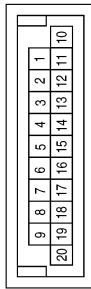

Terminal No.	Color of Wire	Signal Name
7	L	-
8	L	-
9	L	-
18	P	-
19	P	-
20	P	-

Connector No.	M10
Connector Name	JOINT CONNECTOR-M01
Connector Color	BLUE

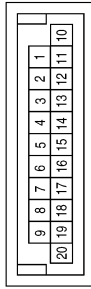

Terminal No.	Color of Wire	Signal Name
1	L	-
2	L	-
3	L	-
4	L	-
5	L	-
6	L	-
7	L	-
8	L	-

Terminal No.	Color of Wire	Signal Name
10	P	-
11	P	-
12	P	-
13	P	-
14	P	-
15	P	-
16	P	-
17	P	-

Connector No.	M13
Connector Name	WIRE TO WIRE
Connector Color	WHITE

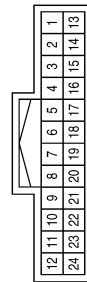

Terminal No.	Color of Wire	Signal Name
5	L	-
17	P	-

Connector No.	M18
Connector Name	BCM (BODY CONTROL MODULE) (WITHOUT INTELLIGENT KEY SYSTEM)
Connector Color	WHITE

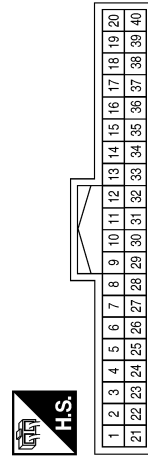

Terminal No.	Color of Wire	Signal Name
39	L	CAN-H
40	P	CAN-L

Connector No.	M22
Connector Name	DATA LINK CONNECTOR
Connector Color	WHITE

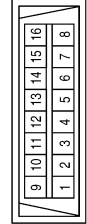

Terminal No.	Color of Wire	Signal Name
6	L	-
14	P	-

CAN SYSTEM

< WIRING DIAGRAM >

[CAN]

Connector No.	M53
Connector Name	EPS CONTROL UNIT
Connector Color	BLACK



Terminal No.	Color of Wire	Signal Name
1	P	CAN-L
2	L	CAN-H

Connector No.	M35
Connector Name	AIR BAG DIAGNOSIS SENSOR UNIT
Connector Color	YELLOW

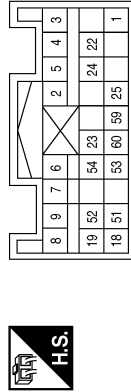

Terminal No.	Color of Wire	Signal Name
59	L	CAN-H
60	P	CAN-L

Connector No.	M24
Connector Name	COMBINATION METER (WITH TYPE B)
Connector Color	WHITE

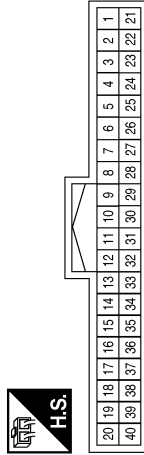

Terminal No.	Color of Wire	Signal Name
1	L	CAN-H
2	P	CAN-L

Connector No.	M70
Connector Name	AV CONTROL UNIT (WITH NAVI)
Connector Color	WHITE

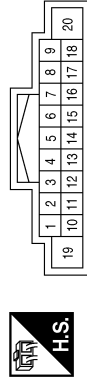

Terminal No.	Color of Wire	Signal Name
8	L	CAN-H
17	P	CAN-L

Connector No.	M69
Connector Name	WIRE TO WIRE
Connector Color	WHITE

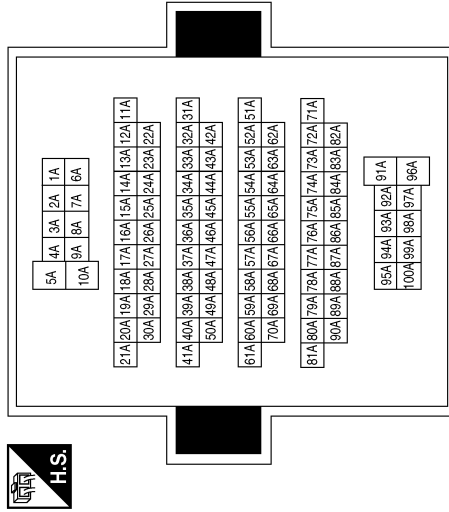

Terminal No.	Color of Wire	Signal Name
20A	P	-
21A	L	-

Connector No.	M64
Connector Name	STEERING ANGLE SENSOR
Connector Color	WHITE



Terminal No.	Color of Wire	Signal Name
2	P	-
5	L	-

A
B
C
D
E
F
G
H
I
J
K
L
N
O
P

LAN

AAMIA2756GB

CAN SYSTEM

< WIRING DIAGRAM >

[CAN]

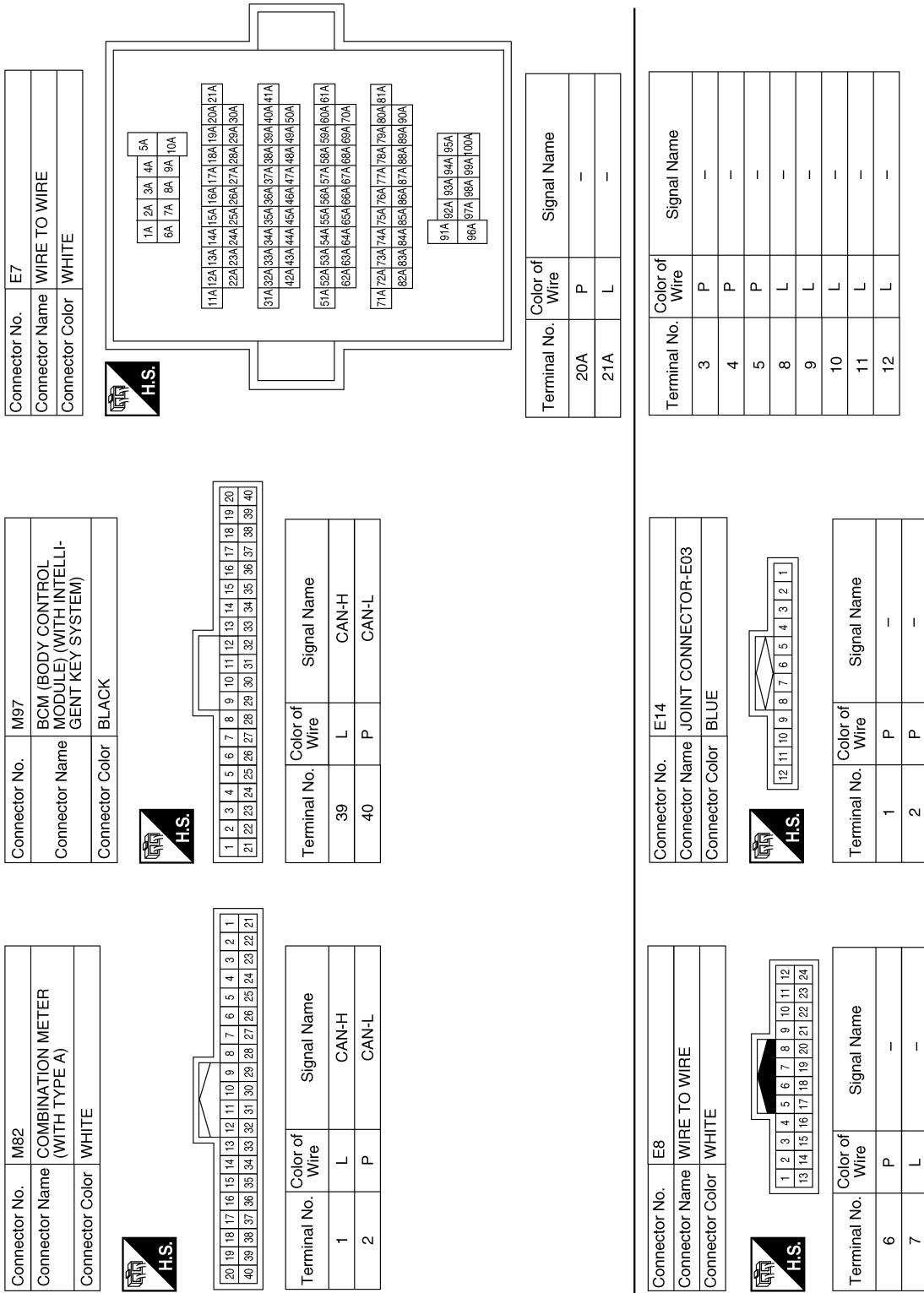

AAMIA2706GB

CAN SYSTEM

< WIRING DIAGRAM >

[CAN]

Connector No.	E16
Connector Name	ECM
Connector Color	BLACK

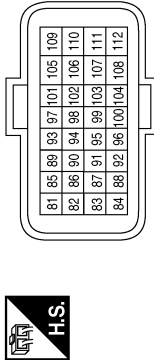

Terminal No.	Color of Wire	Signal Name
83	P	CAN-L
84	L	CAN-H

Connector No.	E33
Connector Name	ABS ACTUATOR AND ELECTRIC UNIT (CONTROL UNIT)
Connector Color	BLACK

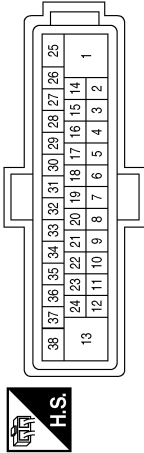

Terminal No.	Color of Wire	Signal Name
10	P	CAN-L
11	L	CAN-H

Connector No.	E46
Connector Name	IPDM E/R (INTELLIGENT POWER DISTRIBUTION MODULE ENGINE ROOM)
Connector Color	WHITE

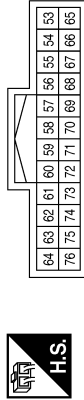

Terminal No.	Color of Wire	Signal Name
61	P	CAN-L
62	L	CAN-H

Connector No.	F8
Connector Name	WIRE TO WIRE
Connector Color	WHITE

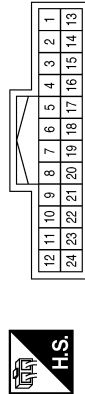

Terminal No.	Color of Wire	Signal Name
6	P/L	-
7	L/G	-

Connector No.	F44
Connector Name	TCM (TRANSMISSION CONTROL MODULE)
Connector Color	BLACK

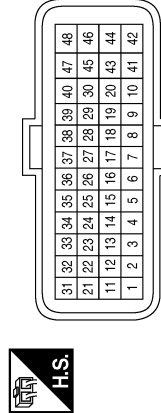

Terminal No.	Color of Wire	Signal Name
23	P/L	CAN-L
33	L/G	CAN-H

Connector No.	B30
Connector Name	WIRE TO WIRE
Connector Color	WHITE

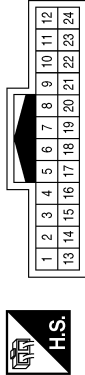

Terminal No.	Color of Wire	Signal Name
5	L	-
17	P	-

A
B
C
D
E
F
G
H
I
J
K
L
LAN
N
O
P

CAN SYSTEM

< WIRING DIAGRAM >

[CAN]

Connector No.	B54
Connector Name	AROUND VIEW MONITOR CONTROL UNIT
Connector Color	WHITE

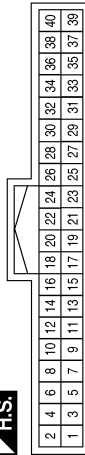

Terminal No.	Color of Wire	Signal Name
10	P	CAN-L
12	L	CAN-H

AAMIA2708GB

BASIC INSPECTION

DIAGNOSIS AND REPAIR WORKFLOW

Interview Sheet

INFOID:0000000012433351

NOTE:

Refer to [LAN-16. "Trouble Diagnosis Flow Chart"](#) for how to use interview sheet.

CAN Communication System Diagnosis Interview Sheet

Date received:

Type: VIN No.:

Model:

First registration: Mileage:

CAN system type:

Symptom (Results from interview with customer)

Condition at inspection

Error symptom : Present / Past

SKIB8898E

A

B

C

D

E

F

G

H

I

J

K

L

LAN

N

O

P

MALFUNCTION AREA CHART

< DTC/CIRCUIT DIAGNOSIS >

[CAN]

DTC/CIRCUIT DIAGNOSIS

MALFUNCTION AREA CHART

Main Line

INFOID:0000000012433352

Malfunction area	Reference
Main line between IPDM E/R and data link connector	LAN-41. "Diagnosis Procedure"
Main line between IPDM E/R and around view monitor control unit	LAN-42. "Diagnosis Procedure"
Main line between around view monitor control unit and data link connector	LAN-43. "Diagnosis Procedure"

Branch Line

INFOID:0000000012433353

Malfunction area	Reference
ECM branch line circuit	LAN-44. "Diagnosis Procedure"
ABS actuator and electric unit (control unit) branch line circuit	LAN-45. "Diagnosis Procedure"
IPDM E/R branch line circuit	LAN-46. "Diagnosis Procedure"
TCM branch line circuit	LAN-47. "Diagnosis Procedure"
Around view monitor control unit branch line circuit	LAN-48. "Diagnosis Procedure"
Air bag diagnosis sensor unit branch line circuit	LAN-49. "Diagnosis Procedure"
AV control unit branch line circuit	LAN-50. "Diagnosis Procedure"
Data link connector branch line circuit	LAN-51. "Diagnosis Procedure"
EPS control unit branch line circuit	LAN-52. "Diagnosis Procedure"
Combination meter branch line circuit	LAN-53. "Diagnosis Procedure"
Steering angle sensor branch line circuit	LAN-54. "Diagnosis Procedure"
BCM branch line circuit	LAN-55. "Diagnosis Procedure"

Short Circuit

INFOID:0000000012433354

Malfunction area	Reference
CAN communication circuit	LAN-56. "Diagnosis Procedure"

MAIN LINE BETWEEN IPDM-E AND DLC CIRCUIT

< DTC/CIRCUIT DIAGNOSIS >

[CAN]

MAIN LINE BETWEEN IPDM-E AND DLC CIRCUIT

Diagnosis Procedure

INFOID:000000012433355

1.CHECK CONNECTOR

1. Turn the ignition switch OFF.
2. Disconnect the battery cable from the negative terminal.
3. Check the following terminals and connectors for damage, bend and loose connection (connector side and harness side).
 - Harness connector E7
 - Harness connector M69

Is the inspection result normal?

- YES >> GO TO 2.
NO >> Repair the terminal and connector.

2.CHECK HARNESS CONTINUITY (OPEN CIRCUIT)

1. Disconnect the following harness connectors.
 - IPDM E/R
 - Harness connectors E7 and M69
2. Check the continuity between the IPDM E/R harness connector and the harness connector.

IPDM E/R harness connector		Harness connector		Continuity
Connector No.	Terminal No.	Connector No.	Terminal No.	
E46	62	E7	21A	Existed
	61		20A	Existed

Is the inspection result normal?

- YES >> GO TO 3.
NO >> Repair the main line between the IPDM E/R and the harness connector E7.

3.CHECK HARNESS CONTINUITY (OPEN CIRCUIT)

Check the continuity between the harness connector and the data link connector.

Harness connector		Data link connector		Continuity
Connector No.	Terminal No.	Connector No.	Terminal No.	
M69	21A	M22	6	Existed
	20A		14	Existed

Is the inspection result normal?

- YES (Present error)>>Check CAN system type decision again.
YES (Past error)>>Error was detected in the main line between the IPDM E/R and the data link connector.
NO >> Repair the main line between the harness connector M69 and the data link connector.

A
B
C
D
E
F
G
H
I
J
K
L
N
O
P

LAN

MAIN LINE BETWEEN IPDM-E AND AVM CIRCUIT

< DTC/CIRCUIT DIAGNOSIS >

[CAN]

MAIN LINE BETWEEN IPDM-E AND AVM CIRCUIT

Diagnosis Procedure

INFOID:000000012433356

1. CHECK CONNECTOR

1. Turn the ignition switch OFF.
2. Disconnect the battery cable from the negative terminal.
3. Check the following terminals and connectors for damage, bend and loose connection (connector side and harness side).
 - Harness connector E7
 - Harness connector M69

Is the inspection result normal?

YES >> GO TO 2.

NO >> Repair the terminal and connector.

2. CHECK HARNESS CONTINUITY (OPEN CIRCUIT)

1. Disconnect the following harness connectors.
 - IPDM E/R
 - Harness connectors E7 and M69
2. Check the continuity between the IPDM E/R harness connector and the harness connector.

IPDM E/R harness connector		Harness connector		Continuity
Connector No.	Terminal No.	Connector No.	Terminal No.	
E46	62	E7	21A	Existed
	61		20A	Existed

Is the inspection result normal?

YES >> GO TO 3.

NO >> Repair the main line between the IPDM E/R and the harness connector E7.

3. CHECK HARNESS CONTINUITY (OPEN CIRCUIT)

1. Disconnect the harness connectors M13 and B30.
2. Check the continuity between the harness connectors.

Harness connector		Harness connector		Continuity
Connector No.	Terminal No.	Connector No.	Terminal No.	
M69	21A	M13	5	Existed
	20A		17	Existed

Is the inspection result normal?

YES (Present error)>>Check CAN system type decision again.

YES (Past error)>>Error was detected in the main line between the IPDM E/R and the around view monitor control unit.

NO >> Repair the main line between the harness connector M69 and around view monitor control unit.

MAIN LINE BETWEEN AVM AND DLC CIRCUIT

< DTC/CIRCUIT DIAGNOSIS >

[CAN]

MAIN LINE BETWEEN AVM AND DLC CIRCUIT

Diagnosis Procedure

INFOID:000000012433357

1. CHECK HARNESS CONTINUITY (OPEN CIRCUIT)

1. Turn the ignition switch OFF.
2. Disconnect the battery cable from the negative terminal.
3. Disconnect the following harness connectors.
 - ECM
 - Around view monitor control unit
4. Check the continuity between the around view monitor control unit harness connector and the data link connector.

Around view monitor control unit harness connector		Date link connector		Continuity
Connector No.	Terminal No.	Connector No.	Terminal No.	
B54	12	M22	6	Existed
	10		14	Existed

Is the inspection result normal?

YES (Present error)>>Check CAN system type decision again.

YES (Past error)>>Error was detected in the main line between the around view monitor control unit and the data link connector.

NO >> Repair the main line between the around view monitor control unit and the data link connector.

LAN

ECM BRANCH LINE CIRCUIT

< DTC/CIRCUIT DIAGNOSIS >

[CAN]

ECM BRANCH LINE CIRCUIT

Diagnosis Procedure

INFOID:000000012433358

1.CHECK CONNECTOR

1. Turn the ignition switch OFF.
2. Disconnect the battery cable from the negative terminal.
3. Check the terminals and connectors of the ECM for damage, bend and loose connection (unit side and connector side).

Is the inspection result normal?

- YES >> GO TO 2.
NO >> Repair the terminal and connector.

2.CHECK HARNESS FOR OPEN CIRCUIT

1. Disconnect the connector of ECM.
2. Check the resistance between the ECM harness connector terminals.

ECM harness connector			Resistance (Ω)
Connector No.	Terminal No.		
E16	84	83	Approx. 108 – 132

Is the measurement value within the specification?

- YES >> GO TO 3.
NO >> Repair the ECM branch line.

3.CHECK POWER SUPPLY AND GROUND CIRCUIT

Check the power supply and the ground circuit of the ECM. Refer to [EC-159, "Diagnosis Procedure"](#).

Is the inspection result normal?

- YES (Present error)>>Replace the ECM. Refer to [EC-477, "Removal and Installation"](#).
YES (Past error)>>Error was detected in the ECM branch line.
NO >> Repair the power supply and the ground circuit.

ABS BRANCH LINE CIRCUIT

< DTC/CIRCUIT DIAGNOSIS >

[CAN]

ABS BRANCH LINE CIRCUIT

Diagnosis Procedure

INFOID:000000012433359

1. CHECK CONNECTOR

1. Turn the ignition switch OFF.
2. Disconnect the battery cable from the negative terminal.
3. Check the terminals and connectors of the ABS actuator and electric unit (control unit) for damage, bend and loose connection (unit side and connector side).

Is the inspection result normal?

- YES >> GO TO 2.
NO >> Repair the terminal and connector.

2. CHECK HARNESS FOR OPEN CIRCUIT

1. Disconnect the connector of ABS actuator and electric unit (control unit).
2. Check the resistance between the ABS actuator and electric unit (control unit) harness connector terminals.

ABS actuator and electric unit (control unit) harness connector			Resistance (Ω)
Connector No.	Terminal No.		
E33	11	10	Approx. 54 – 66

Is the measurement value within the specification?

- YES >> GO TO 3.
NO >> Repair the ABS actuator and electric unit (control unit) branch line.

3. CHECK POWER SUPPLY AND GROUND CIRCUIT

Check the power supply and the ground circuit of the ABS actuator and electric unit (control unit). Refer to [BRC-121, "Diagnosis Procedure"](#).

Is the inspection result normal?

- YES (Present error)>>Replace the ABS actuator and electric unit (control unit). Refer to [BRC-144, "Removal and Installation"](#).
YES (Past error)>>Error was detected in the ABS actuator and electric unit (control unit) branch line.
NO >> Repair the power supply and the ground circuit.

A
B
C
D
E
F
G
H
I
J
K
L

LAN

IPDM-E BRANCH LINE CIRCUIT

< DTC/CIRCUIT DIAGNOSIS >

[CAN]

IPDM-E BRANCH LINE CIRCUIT

Diagnosis Procedure

INFOID:000000012433360

1. CHECK CONNECTOR

1. Turn the ignition switch OFF.
2. Disconnect the battery cable from the negative terminal.
3. Check the terminals and connectors of the IPDM E/R for damage, bend and loose connection (unit side and connector side).

Is the inspection result normal?

- YES >> GO TO 2.
NO >> Repair the terminal and connector.

2. CHECK HARNESS FOR OPEN CIRCUIT

1. Disconnect the connector of IPDM E/R.
2. Check the resistance between the IPDM E/R harness connector terminals.

IPDM E/R harness connector			Resistance (Ω)
Connector No.	Terminal No.		
E46	62	61	Approx. 54 – 66

Is the measurement value within the specification?

- YES >> GO TO 3.
NO >> Repair the IPDM E/R branch line.

3. CHECK POWER SUPPLY AND GROUND CIRCUIT

Check the power supply and the ground circuit of the IPDM E/R. Refer to [PCS-29, "Diagnosis Procedure"](#).

Is the inspection result normal?

- YES (Present error)>>Replace the IPDM E/R. Refer to [PCS-30, "Removal and Installation"](#).
YES (Past error)>>Error was detected in the IPDM E/R branch line.
NO >> Repair the power supply and the ground circuit.

TCM BRANCH LINE CIRCUIT

< DTC/CIRCUIT DIAGNOSIS >

[CAN]

TCM BRANCH LINE CIRCUIT

Diagnosis Procedure

INFOID:000000012433361

1. CHECK CONNECTOR

1. Turn the ignition switch OFF.
2. Disconnect the battery cable from the negative terminal.
3. Check the following terminals and connectors for damage, bend and loose connection (unit side and connector side).
 - TCM
 - Harness connector F8
 - Harness connector E8

Is the inspection result normal?

YES >> GO TO 2.

NO >> Repair the terminal and connector.

2. CHECK HARNESS FOR OPEN CIRCUIT

1. Disconnect the connector of TCM.
2. Check the resistance between the TCM harness connector terminals.

TCM harness connector		Resistance (Ω)
Connector No.	Terminal No.	
F44	33 23	Approx. 54 – 66

Is the measurement value within the specification?

YES >> GO TO 3.

NO >> Repair the TCM branch line.

3. CHECK POWER SUPPLY AND GROUND CIRCUIT

Check the power supply and the ground circuit of the TCM. Refer to [TM-215, "Diagnosis Procedure"](#).

Is the inspection result normal?

YES (Present error)>>Replace the TCM. Refer to [TM-239, "Removal and Installation"](#).

YES (Past error)>>Error was detected in the TCM branch line.

NO >> Repair the power supply and the ground circuit.

A
B
C
D
E
F
G
H
I
J
K
L

LAN

AVM BRANCH LINE CIRCUIT

< DTC/CIRCUIT DIAGNOSIS >

[CAN]

AVM BRANCH LINE CIRCUIT

Diagnosis Procedure

INFOID:000000012433362

1. CHECK CONNECTOR

1. Turn the ignition switch OFF.
2. Disconnect the battery cable from the negative terminal.
3. Check the following terminals and connectors for damage, bend and loose connection (unit side and connector side).
 - Around view monitor control unit
 - Harness connector B30
 - Harness connector M13

Is the inspection result normal?

YES >> GO TO 2.

NO >> Repair the terminal and connector.

2. CHECK HARNESS FOR OPEN CIRCUIT

1. Disconnect the connector of around view monitor control unit.
2. Check the resistance between the around view monitor control unit harness connector terminals.

Around view monitor control unit harness connector			Resistance (Ω)
Connector No.	Terminal No.		
B54	12	10	Approx. 54 – 66

Is the measurement value within the specification?

YES >> GO TO 3.

NO >> Repair the around view monitor control unit branch line.

3. CHECK POWER SUPPLY AND GROUND CIRCUIT

Check the power supply and the ground circuit of the around view monitor control unit. Refer to [AV-216, "AROUND VIEW MONITOR CONTROL UNIT : Diagnosis Procedure"](#).

Is the inspection result normal?

YES (Present error)>>Replace the around view monitor control unit. Refer to [AV-249, "Removal and Installation"](#).

YES (Past error)>>Error was detected in the around view monitor control unit branch line.

NO >> Repair the power supply and the ground circuit.

A-BAG BRANCH LINE CIRCUIT

< DTC/CIRCUIT DIAGNOSIS >

[CAN]

A-BAG BRANCH LINE CIRCUIT

Diagnosis Procedure

INFOID:000000012433363

WARNING:

Always observe the following items for preventing accidental activation.

- Before servicing, turn ignition switch OFF, disconnect battery negative terminal, and wait 3 minutes or more. (To discharge backup capacitor.)
- Never use unspecified tester or other measuring device.

1.CHECK CONNECTOR

1. Turn the ignition switch OFF.
2. Disconnect the battery cable from the negative terminal.
3. Check the terminals and connectors of the air bag diagnosis sensor unit for damage, bend and loose connection (unit side and connector side).

Is the inspection result normal?

YES >> GO TO 2.

NO >> Replace the main harness.

2.CHECK AIR BAG DIAGNOSIS SENSOR UNIT

Check the air bag diagnosis sensor unit. Refer to [SRC-36. "Work Flow"](#).

Is the inspection result normal?

YES >> Replace the main harness.

NO >> Replace parts whose air bag system has a malfunction.

A
B
C
D
E
F
G
H
I
J
K
L
N
O
P

LAN

AV BRANCH LINE CIRCUIT

< DTC/CIRCUIT DIAGNOSIS >

[CAN]

AV BRANCH LINE CIRCUIT

Diagnosis Procedure

INFOID:000000012433364

1. CHECK CONNECTOR

1. Turn the ignition switch OFF.
2. Disconnect the battery cable from the negative terminal.
3. Check the terminals and connectors of the AV control unit for damage, bend and loose connection (unit side and connector side).

Is the inspection result normal?

- YES >> GO TO 2.
NO >> Repair the terminal and connector.

2. CHECK HARNESS FOR OPEN CIRCUIT

1. Disconnect the connector of AV control unit.
2. Check the resistance between the AV control unit harness connector terminals.

AV control unit harness connector			Resistance (Ω)
Connector No.	Terminal No.		
M70	8	17	Approx. 54 – 66

Is the measurement value within the specification?

- YES >> GO TO 3.
NO >> Repair the AV control unit branch line.

3. CHECK POWER SUPPLY AND GROUND CIRCUIT

Check the power supply and the ground circuit of the AV control unit. Refer to [AV-216, "AV CONTROL UNIT : Diagnosis Procedure"](#).

Is the inspection result normal?

- YES (Present error)>>Replace the AV control unit. Refer to [AV-241, "Removal and Installation"](#).
YES (Past error)>>Error was detected in the AV control unit branch line.
NO >> Repair the power supply and the ground circuit.

DLC BRANCH LINE CIRCUIT

< DTC/CIRCUIT DIAGNOSIS >

[CAN]

DLC BRANCH LINE CIRCUIT

Diagnosis Procedure

INFOID:000000012433365

1. CHECK CONNECTOR

1. Turn the ignition switch OFF.
2. Disconnect the battery cable from the negative terminal.
3. Check the terminals and connectors of the data link connector for damage, bend and loose connection (connector side and harness side).

Is the inspection result normal?

- YES >> GO TO 2.
NO >> Repair the terminal and connector.

2. CHECK HARNESS FOR OPEN CIRCUIT

Check the resistance between the data link connector terminals.

Data link connector			Resistance (Ω)
Connector No.	Terminal No.		
M22	6	14	Approx. 54 – 66

Is the measurement value within the specification?

- YES (Present error)>>Check CAN system type decision again.
YES (Past error)>>Error was detected in the data link connector branch line circuit.
NO >> Repair the data link connector branch line.

A
B
C
D
E
F
G
H
I
J
K
L

LAN

N
O
P

EPS BRANCH LINE CIRCUIT

< DTC/CIRCUIT DIAGNOSIS >

[CAN]

EPS BRANCH LINE CIRCUIT

Diagnosis Procedure

INFOID:000000012433366

1. CHECK CONNECTOR

1. Turn the ignition switch OFF.
2. Disconnect the battery cable from the negative terminal.
3. Check the terminals and connectors of the EPS control unit for damage, bend and loose connection (unit side and connector side).

Is the inspection result normal?

- YES >> GO TO 2.
NO >> Repair the terminal and connector.

2. CHECK HARNESS FOR OPEN CIRCUIT

1. Disconnect the connector of EPS control unit.
2. Check the resistance between the EPS control unit harness connector terminals.

EPS control unit harness connector			Resistance (Ω)
Connector No.	Terminal No.		
M53	2	1	Approx. 54 – 66

Is the measurement value within the specification?

- YES >> GO TO 3.
NO >> Repair the EPS control unit branch line.

3. CHECK POWER SUPPLY AND GROUND CIRCUIT

Check the power supply and the ground circuit of the EPS control unit. Refer to [STC-18, "Diagnosis Procedure"](#).

Is the inspection result normal?

- YES (Present error)>>Replace the EPS control unit. Refer to [STC-37, "Removal and Installation"](#).
YES (Past error)>>Error was detected in the EPS control unit branch line.
NO >> Repair the power supply and the ground circuit.

M&A BRANCH LINE CIRCUIT

< DTC/CIRCUIT DIAGNOSIS >

[CAN]

M&A BRANCH LINE CIRCUIT

Diagnosis Procedure

INFOID:000000012433367

1.CHECK CONNECTOR

1. Turn the ignition switch OFF.
2. Disconnect the battery cable from the negative terminal.
3. Check the terminals and connectors of the combination meter for damage, bend and loose connection (unit side and connector side).

Is the inspection result normal?

- YES >> GO TO 2.
NO >> Repair the terminal and connector.

2.CHECK HARNESS FOR OPEN CIRCUIT

1. Disconnect the connector of combination meter.
2. Check the resistance between the combination meter harness connector terminals.

NOTE:

Check the vehicle type confirm the service information. Refer to [MWI-5. "Information"](#).

- With Type A

Combination meter harness connector			Resistance (Ω)
Connector No.	Terminal No.		
M82	1	2	Approx. 54 – 66

- With Type B

Combination meter harness connector			Resistance (Ω)
Connector No.	Terminal No.		
M24	1	2	Approx. 54 – 66

Is the measurement value within the specification?

- YES >> GO TO 3.
NO >> Repair the combination meter branch line.

3.CHECK POWER SUPPLY AND GROUND CIRCUIT

Check the power supply and the ground circuit of the combination meter. Refer to following.

- TYPE A: [MWI-43. "COMBINATION METER : Diagnosis Procedure"](#).
- TYPE B: [MWI-98. "COMBINATION METER : Diagnosis Procedure"](#).

Is the inspection result normal?

- YES (Present error)>>Replace the combination meter. Refer to the following.
- TYPE A: [MWI-54. "Removal and Installation"](#)
 - TYPE B: [MWI-115. "Removal and Installation"](#)

YES (Past error)>>Error was detected in the combination meter branch line.

- NO >> Repair the power supply and the ground circuit.

A
B
C
D
E
F
G
H
I
J
K
L
N
O
P

LAN

STRG BRANCH LINE CIRCUIT

< DTC/CIRCUIT DIAGNOSIS >

[CAN]

STRG BRANCH LINE CIRCUIT

Diagnosis Procedure

INFOID:000000012433368

1. CHECK CONNECTOR

1. Turn the ignition switch OFF.
2. Disconnect the battery cable from the negative terminal.
3. Check the terminals and connectors of the steering angle sensor for damage, bend and loose connection (unit side and connector side).

Is the inspection result normal?

- YES >> GO TO 2.
NO >> Repair the terminal and connector.

2. CHECK HARNESS FOR OPEN CIRCUIT

1. Disconnect the connector of steering angle sensor.
2. Check the resistance between the steering angle sensor harness connector terminals.

Steering angle sensor harness connector			Resistance (Ω)
Connector No.	Terminal No.		
M64	5	2	Approx. 54 – 66

Is the measurement value within the specification?

- YES >> GO TO 3.
NO >> Repair the steering angle sensor branch line.

3. CHECK POWER SUPPLY AND GROUND CIRCUIT

Check the power supply and the ground circuit of the steering angle sensor. Refer to [BRC-44, "Wiring Diagram"](#).

Is the inspection result normal?

- YES (Present error)>>Replace the steering angle sensor. Refer to [BRC-147, "Removal and Installation"](#).
YES (Past error)>>Error was detected in the steering angle sensor branch line.
NO >> Repair the power supply and the ground circuit.

BCM BRANCH LINE CIRCUIT

< DTC/CIRCUIT DIAGNOSIS >

[CAN]

BCM BRANCH LINE CIRCUIT

Diagnosis Procedure

INFOID:000000012433369

1. CHECK CONNECTOR

1. Turn the ignition switch OFF.
2. Disconnect the battery cable from the negative terminal.
3. Check the terminals and connectors of the BCM for damage, bend and loose connection (unit side and connector side).

Is the inspection result normal?

- YES >> GO TO 2.
NO >> Repair the terminal and connector.

2. CHECK HARNESS FOR OPEN CIRCUIT

1. Disconnect the connector of BCM.
2. Check the resistance between the BCM harness connector terminals.
 - With intelligent key

BCM harness connector			Resistance (Ω)
Connector No.	Terminal No.		
M97	39	40	Approx. 108 – 132

- Without intelligent key

BCM harness connector			Resistance (Ω)
Connector No.	Terminal No.		
M18	39	40	Approx. 108 – 132

Is the measurement value within the specification?

- YES >> GO TO 3.
NO >> Repair the BCM branch line.

3. CHECK POWER SUPPLY AND GROUND CIRCUIT

Check the power supply and the ground circuit of the BCM. Refer to the following.

- With Intelligent Key system: [BCS-67, "Diagnosis Procedure"](#)
- Without Intelligent Key system: [BCS-129, "Diagnosis Procedure"](#)

Is the inspection result normal?

- YES (Present error)>>Replace the BCM. Refer to the following.
- With Intelligent Key system: [BCS-74, "Removal and Installation"](#)
 - Without Intelligent Key system: [BCS-137, "Removal and Installation"](#)

YES (Past error)>>Error was detected in the BCM branch line.

- NO >> Repair the power supply and the ground circuit.

A
B
C
D
E
F
G
H
I
J
K
L
N
O
P

LAN

CAN COMMUNICATION CIRCUIT

< DTC/CIRCUIT DIAGNOSIS >

[CAN]

CAN COMMUNICATION CIRCUIT

Diagnosis Procedure

INFOID:000000012433370

1.CONNECTOR INSPECTION

1. Turn the ignition switch OFF.
2. Disconnect the battery cable from the negative terminal.
3. Disconnect all the unit connectors on CAN communication system.
4. Check terminals and connectors for damage, bend and loose connection.

Is the inspection result normal?

- YES >> GO TO 2.
NO >> Repair the terminal and connector.

2.CHECK HARNESS CONTINUITY (SHORT CIRCUIT)

Check the continuity between the data link connector terminals.

Data link connector			Continuity
Connector No.	Terminal No.		
M22	6	14	Not existed

Is the inspection result normal?

- YES >> GO TO 3.
NO >> Check the harness and repair the root cause.

3.CHECK HARNESS CONTINUITY (SHORT CIRCUIT)

Check the continuity between the data link connector and the ground.

Data link connector		Ground	Continuity
Connector No.	Terminal No.		
M22	6		Not existed
	14		Not existed

Is the inspection result normal?

- YES >> GO TO 4.
NO >> Check the harness and repair the root cause.

4.CHECK ECM AND BCM TERMINATION CIRCUIT

1. Remove the ECM and the BCM.
2. Check the resistance between the ECM terminals.

ECM		Resistance (Ω)
Terminal No.		
84	83	Approx. 108 – 132

3. Check the resistance between the BCM terminals.

BCM		Resistance (Ω)
Terminal No.		
39	40	Approx. 108 – 132

Is the measurement value within the specification?

- YES >> GO TO 5.
NO >> Replace the ECM and/or the BCM.

5.CHECK SYMPTOM

Connect all the connectors. Check if the symptoms described in the “Symptom (Results from interview with customer)” are reproduced.

CAN COMMUNICATION CIRCUIT

[CAN]

< DTC/CIRCUIT DIAGNOSIS >

Inspection result

Reproduced>>GO TO 6.

Non-reproduced>>Start the diagnosis again. Follow the trouble diagnosis procedure when past error is detected.

6.CHECK UNIT REPRODUCTION

Perform the reproduction test as per the following procedure for each unit.

1. Turn the ignition switch OFF.
2. Disconnect the battery cable from the negative terminal.
3. Disconnect one of the unit connectors of CAN communication system.

NOTE:

ECM and BCM have a termination circuit. Check other units first.

4. Connect the battery cable to the negative terminal. Check if the symptoms described in the “Symptom (Results from interview with customer)” are reproduced.

NOTE:

Although unit-related error symptoms occur, do not confuse them with other symptoms.

Inspection result

Reproduced>>Connect the connector. Check other units as per the above procedure.

Non-reproduced>>Replace the unit whose connector was disconnected.

A
B
C
D
E
F
G
H
I
J
K
L

LAN

N
O
P

MAIN LINE BETWEEN IPDM-E AND DLC CIRCUIT

< DTC/CIRCUIT DIAGNOSIS >

[CAN SYSTEM (TYPE 501)]

DTC/CIRCUIT DIAGNOSIS

MAIN LINE BETWEEN IPDM-E AND DLC CIRCUIT

Diagnosis Procedure

INFOID:000000012785675

1. CHECK CONNECTOR

1. Turn the ignition switch OFF.
2. Disconnect the battery cable from the negative terminal.
3. Check the following terminals and connectors for damage, bend and loose connection (connector side and harness side).
 - Harness connector E7
 - Harness connector M69

Is the inspection result normal?

YES >> GO TO 2.

NO >> Repair the terminal and connector.

2. CHECK HARNESS CONTINUITY (OPEN CIRCUIT)

1. Disconnect the following harness connectors.
 - IPDM E/R
 - Harness connectors E7 and M69
2. Check the continuity between the IPDM E/R harness connector and the harness connector.

IPDM E/R harness connector		Harness connector		Continuity
Connector No.	Terminal No.	Connector No.	Terminal No.	
E46	62	E7	21A	Existed
	61		20A	Existed

Is the inspection result normal?

YES >> GO TO 3.

NO >> Repair the main line between the IPDM E/R and the harness connector E7.

3. CHECK HARNESS CONTINUITY (OPEN CIRCUIT)

Check the continuity between the harness connector and the data link connector.

Harness connector		Data link connector		Continuity
Connector No.	Terminal No.	Connector No.	Terminal No.	
M69	21A	M22	6	Existed
	20A		14	Existed

Is the inspection result normal?

YES (Present error)>>Check CAN system type decision again.

YES (Past error)>>Error was detected in the main line between the IPDM E/R and the data link connector.

NO >> Repair the main line between the harness connector M69 and the data link connector.

ECM BRANCH LINE CIRCUIT

< DTC/CIRCUIT DIAGNOSIS >

[CAN SYSTEM (TYPE 501)]

ECM BRANCH LINE CIRCUIT

Diagnosis Procedure

INFOID:000000012785678

1. CHECK CONNECTOR

1. Turn the ignition switch OFF.
2. Disconnect the battery cable from the negative terminal.
3. Check the terminals and connectors of the ECM for damage, bend and loose connection (unit side and connector side).

Is the inspection result normal?

- YES >> GO TO 2.
NO >> Repair the terminal and connector.

2. CHECK HARNESS FOR OPEN CIRCUIT

1. Disconnect the connector of ECM.
2. Check the resistance between the ECM harness connector terminals.

ECM harness connector		Resistance (Ω)
Connector No.	Terminal No.	
E16	84	Approx. 108 – 132
	83	

Is the measurement value within the specification?

- YES >> GO TO 3.
NO >> Repair the ECM branch line.

3. CHECK POWER SUPPLY AND GROUND CIRCUIT

Check the power supply and the ground circuit of the ECM. Refer to [EC-159, "Diagnosis Procedure"](#).

Is the inspection result normal?

- YES (Present error)>>Replace the ECM. Refer to [EC-477, "Removal and Installation"](#).
YES (Past error)>>Error was detected in the ECM branch line.
NO >> Repair the power supply and the ground circuit.

A
B
C
D
E
F
G
H
I
J
K
L

LAN

N
O
P

ABS BRANCH LINE CIRCUIT

< DTC/CIRCUIT DIAGNOSIS >

[CAN SYSTEM (TYPE 501)]

ABS BRANCH LINE CIRCUIT

Diagnosis Procedure

INFOID:000000012785679

1. CHECK CONNECTOR

1. Turn the ignition switch OFF.
2. Disconnect the battery cable from the negative terminal.
3. Check the terminals and connectors of the ABS actuator and electric unit (control unit) for damage, bend and loose connection (unit side and connector side).

Is the inspection result normal?

- YES >> GO TO 2.
NO >> Repair the terminal and connector.

2. CHECK HARNESS FOR OPEN CIRCUIT

1. Disconnect the connector of ABS actuator and electric unit (control unit).
2. Check the resistance between the ABS actuator and electric unit (control unit) harness connector terminals.

ABS actuator and electric unit (control unit) harness connector			Resistance (Ω)
Connector No.	Terminal No.		
E33	11	10	Approx. 54 – 66

Is the measurement value within the specification?

- YES >> GO TO 3.
NO >> Repair the ABS actuator and electric unit (control unit) branch line.

3. CHECK POWER SUPPLY AND GROUND CIRCUIT

Check the power supply and the ground circuit of the ABS actuator and electric unit (control unit). Refer to [BRC-121, "Diagnosis Procedure"](#).

Is the inspection result normal?

- YES (Present error)>>Replace the ABS actuator and electric unit (control unit). Refer to [BRC-144, "Removal and Installation"](#).
YES (Past error)>>Error was detected in the ABS actuator and electric unit (control unit) branch line.
NO >> Repair the power supply and the ground circuit.

IPDM-E BRANCH LINE CIRCUIT

< DTC/CIRCUIT DIAGNOSIS >

[CAN SYSTEM (TYPE 501)]

IPDM-E BRANCH LINE CIRCUIT

Diagnosis Procedure

INFOID:000000012785680

1.CHECK CONNECTOR

1. Turn the ignition switch OFF.
2. Disconnect the battery cable from the negative terminal.
3. Check the terminals and connectors of the IPDM E/R for damage, bend and loose connection (unit side and connector side).

Is the inspection result normal?

- YES >> GO TO 2.
NO >> Repair the terminal and connector.

2.CHECK HARNESS FOR OPEN CIRCUIT

1. Disconnect the connector of IPDM E/R.
2. Check the resistance between the IPDM E/R harness connector terminals.

IPDM E/R harness connector			Resistance (Ω)
Connector No.	Terminal No.		
E46	62	61	Approx. 54 – 66

Is the measurement value within the specification?

- YES >> GO TO 3.
NO >> Repair the IPDM E/R branch line.

3.CHECK POWER SUPPLY AND GROUND CIRCUIT

Check the power supply and the ground circuit of the IPDM E/R. Refer to [PCS-29, "Diagnosis Procedure"](#).

Is the inspection result normal?

- YES (Present error)>>Replace the IPDM E/R. Refer to [PCS-30, "Removal and Installation"](#).
YES (Past error)>>Error was detected in the IPDM E/R branch line.
NO >> Repair the power supply and the ground circuit.

A
B
C
D
E
F
G
H
I
J
K
L

LAN

A-BAG BRANCH LINE CIRCUIT

< DTC/CIRCUIT DIAGNOSIS >

[CAN SYSTEM (TYPE 501)]

A-BAG BRANCH LINE CIRCUIT

Diagnosis Procedure

INFOID:000000012785681

WARNING:

Always observe the following items for preventing accidental activation.

- Before servicing, turn ignition switch OFF, disconnect battery negative terminal, and wait 3 minutes or more. (To discharge backup capacitor.)
- Never use unspecified tester or other measuring device.

1.CHECK CONNECTOR

1. Turn the ignition switch OFF.
2. Disconnect the battery cable from the negative terminal.
3. Check the terminals and connectors of the air bag diagnosis sensor unit for damage, bend and loose connection (unit side and connector side).

Is the inspection result normal?

- YES >> GO TO 2.
NO >> Replace the main harness.

2.CHECK AIR BAG DIAGNOSIS SENSOR UNIT

Check the air bag diagnosis sensor unit. Refer to [SRC-36. "Work Flow"](#).

Is the inspection result normal?

- YES >> Replace the main harness.
NO >> Replace parts whose air bag system has a malfunction.

DLC BRANCH LINE CIRCUIT

< DTC/CIRCUIT DIAGNOSIS >

[CAN SYSTEM (TYPE 501)]

DLC BRANCH LINE CIRCUIT

Diagnosis Procedure

INFOID:000000012785683

1. CHECK CONNECTOR

1. Turn the ignition switch OFF.
2. Disconnect the battery cable from the negative terminal.
3. Check the terminals and connectors of the data link connector for damage, bend and loose connection (connector side and harness side).

Is the inspection result normal?

- YES >> GO TO 2.
NO >> Repair the terminal and connector.

2. CHECK HARNESS FOR OPEN CIRCUIT

Check the resistance between the data link connector terminals.

Data link connector			Resistance (Ω)
Connector No.	Terminal No.		
M22	6	14	Approx. 54 – 66

Is the measurement value within the specification?

- YES (Present error)>>Check CAN system type decision again.
YES (Past error)>>Error was detected in the data link connector branch line circuit.
NO >> Repair the data link connector branch line.

A
B
C
D
E
F
G
H
I
J
K
L

LAN

N
O
P

EPS BRANCH LINE CIRCUIT

Diagnosis Procedure

INFOID:0000000012785684

1. CHECK CONNECTOR

1. Turn the ignition switch OFF.
2. Disconnect the battery cable from the negative terminal.
3. Check the terminals and connectors of the EPS control unit for damage, bend and loose connection (unit side and connector side).

Is the inspection result normal?

- YES >> GO TO 2.
 NO >> Repair the terminal and connector.

2. CHECK HARNESS FOR OPEN CIRCUIT

1. Disconnect the connector of EPS control unit.
2. Check the resistance between the EPS control unit harness connector terminals.

EPS control unit harness connector			Resistance (Ω)
Connector No.	Terminal No.		
M53	2	1	Approx. 54 – 66

Is the measurement value within the specification?

- YES >> GO TO 3.
 NO >> Repair the EPS control unit branch line.

3. CHECK POWER SUPPLY AND GROUND CIRCUIT

Check the power supply and the ground circuit of the EPS control unit. Refer to [STC-18, "Diagnosis Procedure"](#).

Is the inspection result normal?

- YES (Present error)>>Replace the EPS control unit. Refer to [STC-37, "Removal and Installation"](#).
 YES (Past error)>>Error was detected in the EPS control unit branch line.
 NO >> Repair the power supply and the ground circuit.

M&A BRANCH LINE CIRCUIT

< DTC/CIRCUIT DIAGNOSIS >

[CAN SYSTEM (TYPE 501)]

M&A BRANCH LINE CIRCUIT

Diagnosis Procedure

INFOID:000000012785685

1.CHECK CONNECTOR

1. Turn the ignition switch OFF.
2. Disconnect the battery cable from the negative terminal.
3. Check the terminals and connectors of the combination meter for damage, bend and loose connection (unit side and connector side).

Is the inspection result normal?

- YES >> GO TO 2.
NO >> Repair the terminal and connector.

2.CHECK HARNESS FOR OPEN CIRCUIT

1. Disconnect the connector of combination meter.
2. Check the resistance between the combination meter harness connector terminals.

NOTE:

Check the vehicle type confirm the service information. Refer to [MWI-5. "Information"](#).

- With Type A

Combination meter harness connector			Resistance (Ω)
Connector No.	Terminal No.		
M82	1	2	Approx. 54 – 66

- With Type B

Combination meter harness connector			Resistance (Ω)
Connector No.	Terminal No.		
M24	1	2	Approx. 54 – 66

Is the measurement value within the specification?

- YES >> GO TO 3.
NO >> Repair the combination meter branch line.

3.CHECK POWER SUPPLY AND GROUND CIRCUIT

Check the power supply and the ground circuit of the combination meter. Refer to following.

- TYPE A: [MWI-43. "COMBINATION METER : Diagnosis Procedure"](#).
- TYPE B: [MWI-98. "COMBINATION METER : Diagnosis Procedure"](#).

Is the inspection result normal?

- YES (Present error)>>Replace the combination meter. Refer to the following.
- TYPE A: [MWI-54. "Removal and Installation"](#)
 - TYPE B: [MWI-115. "Removal and Installation"](#)

YES (Past error)>>Error was detected in the combination meter branch line.

- NO >> Repair the power supply and the ground circuit.

A
B
C
D
E
F
G
H
I
J
K
L
N
O
P

LAN

STRG BRANCH LINE CIRCUIT

< DTC/CIRCUIT DIAGNOSIS >

[CAN SYSTEM (TYPE 501)]

STRG BRANCH LINE CIRCUIT

Diagnosis Procedure

INFOID:000000012785686

1.CHECK CONNECTOR

1. Turn the ignition switch OFF.
2. Disconnect the battery cable from the negative terminal.
3. Check the terminals and connectors of the steering angle sensor for damage, bend and loose connection (unit side and connector side).

Is the inspection result normal?

- YES >> GO TO 2.
NO >> Repair the terminal and connector.

2.CHECK HARNESS FOR OPEN CIRCUIT

1. Disconnect the connector of steering angle sensor.
2. Check the resistance between the steering angle sensor harness connector terminals.

Steering angle sensor harness connector			Resistance (Ω)
Connector No.	Terminal No.		
M64	5	2	Approx. 54 – 66

Is the measurement value within the specification?

- YES >> GO TO 3.
NO >> Repair the steering angle sensor branch line.

3.CHECK POWER SUPPLY AND GROUND CIRCUIT

Check the power supply and the ground circuit of the steering angle sensor. Refer to [BRC-44, "Wiring Diagram"](#).

Is the inspection result normal?

- YES (Present error)>>Replace the steering angle sensor. Refer to [BRC-147, "Removal and Installation"](#).
YES (Past error)>>Error was detected in the steering angle sensor branch line.
NO >> Repair the power supply and the ground circuit.

BCM BRANCH LINE CIRCUIT

< DTC/CIRCUIT DIAGNOSIS >

[CAN SYSTEM (TYPE 501)]

BCM BRANCH LINE CIRCUIT

Diagnosis Procedure

INFOID:000000012785687

1. CHECK CONNECTOR

1. Turn the ignition switch OFF.
2. Disconnect the battery cable from the negative terminal.
3. Check the terminals and connectors of the BCM for damage, bend and loose connection (unit side and connector side).

Is the inspection result normal?

- YES >> GO TO 2.
NO >> Repair the terminal and connector.

2. CHECK HARNESS FOR OPEN CIRCUIT

1. Disconnect the connector of BCM.
2. Check the resistance between the BCM harness connector terminals.
 - With intelligent key

BCM harness connector			Resistance (Ω)
Connector No.	Terminal No.		
M97	39	40	Approx. 108 – 132

- Without intelligent key

BCM harness connector			Resistance (Ω)
Connector No.	Terminal No.		
M18	39	40	Approx. 108 – 132

Is the measurement value within the specification?

- YES >> GO TO 3.
NO >> Repair the BCM branch line.

3. CHECK POWER SUPPLY AND GROUND CIRCUIT

Check the power supply and the ground circuit of the BCM. Refer to the following.

- With Intelligent Key system: [BCS-67, "Diagnosis Procedure"](#)
- Without Intelligent Key system: [BCS-129, "Diagnosis Procedure"](#)

Is the inspection result normal?

- YES (Present error)>>Replace the BCM. Refer to the following.
- With Intelligent Key system: [BCS-74, "Removal and Installation"](#)
 - Without Intelligent Key system: [BCS-137, "Removal and Installation"](#)

YES (Past error)>>Error was detected in the BCM branch line.

- NO >> Repair the power supply and the ground circuit.

A
B
C
D
E
F
G
H
I
J
K
L
N
O
P

LAN

CAN COMMUNICATION CIRCUIT

< DTC/CIRCUIT DIAGNOSIS >

[CAN SYSTEM (TYPE 501)]

CAN COMMUNICATION CIRCUIT

Diagnosis Procedure

INFOID:000000012785688

1. CONNECTOR INSPECTION

1. Turn the ignition switch OFF.
2. Disconnect the battery cable from the negative terminal.
3. Disconnect all the unit connectors on CAN communication system.
4. Check terminals and connectors for damage, bend and loose connection.

Is the inspection result normal?

- YES >> GO TO 2.
NO >> Repair the terminal and connector.

2. CHECK HARNESS CONTINUITY (SHORT CIRCUIT)

Check the continuity between the data link connector terminals.

Data link connector		Continuity
Connector No.	Terminal No.	
M22	6 14	Not existed

Is the inspection result normal?

- YES >> GO TO 3.
NO >> Check the harness and repair the root cause.

3. CHECK HARNESS CONTINUITY (SHORT CIRCUIT)

Check the continuity between the data link connector and the ground.

Data link connector		Ground	Continuity
Connector No.	Terminal No.		
M22	6		Not existed
	14		Not existed

Is the inspection result normal?

- YES >> GO TO 4.
NO >> Check the harness and repair the root cause.

4. CHECK ECM AND BCM TERMINATION CIRCUIT

1. Remove the ECM and the BCM.
2. Check the resistance between the ECM terminals.

ECM		Resistance (Ω)
Terminal No.		
84	83	Approx. 108 – 132

3. Check the resistance between the BCM terminals.

BCM		Resistance (Ω)
Terminal No.		
39	40	Approx. 108 – 132

Is the measurement value within the specification?

- YES >> GO TO 5.
NO >> Replace the ECM and/or the BCM.

5. CHECK SYMPTOM

Connect all the connectors. Check if the symptoms described in the "Symptom (Results from interview with customer)" are reproduced.

CAN COMMUNICATION CIRCUIT

< DTC/CIRCUIT DIAGNOSIS >

[CAN SYSTEM (TYPE 501)]

Inspection result

Reproduced>>GO TO 6.

Non-reproduced>>Start the diagnosis again. Follow the trouble diagnosis procedure when past error is detected.

6.CHECK UNIT REPRODUCTION

Perform the reproduction test as per the following procedure for each unit.

1. Turn the ignition switch OFF.
2. Disconnect the battery cable from the negative terminal.
3. Disconnect one of the unit connectors of CAN communication system.

NOTE:

ECM and BCM have a termination circuit. Check other units first.

4. Connect the battery cable to the negative terminal. Check if the symptoms described in the “Symptom (Results from interview with customer)” are reproduced.

NOTE:

Although unit-related error symptoms occur, do not confuse them with other symptoms.

Inspection result

Reproduced>>Connect the connector. Check other units as per the above procedure.

Non-reproduced>>Replace the unit whose connector was disconnected.

A
B
C
D
E
F
G
H
I
J
K
L
N
O
P

LAN

MAIN LINE BETWEEN IPDM-E AND AVM CIRCUIT

< DTC/CIRCUIT DIAGNOSIS >

[CAN SYSTEM (TYPE 502)]

DTC/CIRCUIT DIAGNOSIS

MAIN LINE BETWEEN IPDM-E AND AVM CIRCUIT

Diagnosis Procedure

INFOID:000000012785696

1. CHECK CONNECTOR

1. Turn the ignition switch OFF.
2. Disconnect the battery cable from the negative terminal.
3. Check the following terminals and connectors for damage, bend and loose connection (connector side and harness side).
 - Harness connector E7
 - Harness connector M69

Is the inspection result normal?

YES >> GO TO 2.

NO >> Repair the terminal and connector.

2. CHECK HARNESS CONTINUITY (OPEN CIRCUIT)

1. Disconnect the following harness connectors.
 - IPDM E/R
 - Harness connectors E7 and M69
2. Check the continuity between the IPDM E/R harness connector and the harness connector.

IPDM E/R harness connector		Harness connector		Continuity
Connector No.	Terminal No.	Connector No.	Terminal No.	
E46	62	E7	21A	Existed
	61		20A	Existed

Is the inspection result normal?

YES >> GO TO 3.

NO >> Repair the main line between the IPDM E/R and the harness connector E7.

3. CHECK HARNESS CONTINUITY (OPEN CIRCUIT)

1. Disconnect the harness connectors M13 and B30.
2. Check the continuity between the harness connectors.

Harness connector		Harness connector		Continuity
Connector No.	Terminal No.	Connector No.	Terminal No.	
M69	21A	M13	5	Existed
	20A		17	Existed

Is the inspection result normal?

YES (Present error)>>Check CAN system type decision again.

YES (Past error)>>Error was detected in the main line between the IPDM E/R and the around view monitor control unit.

NO >> Repair the main line between the harness connector M69 and around view monitor control unit.

MAIN LINE BETWEEN AVM AND DLC CIRCUIT

< DTC/CIRCUIT DIAGNOSIS >

[CAN SYSTEM (TYPE 502)]

MAIN LINE BETWEEN AVM AND DLC CIRCUIT

Diagnosis Procedure

INFOID:000000012785697

1. CHECK HARNESS CONTINUITY (OPEN CIRCUIT)

1. Turn the ignition switch OFF.
2. Disconnect the battery cable from the negative terminal.
3. Disconnect the following harness connectors.
 - ECM
 - Around view monitor control unit
4. Check the continuity between the around view monitor control unit harness connector and the data link connector.

Around view monitor control unit harness connector		Date link connector		Continuity
Connector No.	Terminal No.	Connector No.	Terminal No.	
B54	12	M22	6	Existed
	10		14	Existed

Is the inspection result normal?

YES (Present error)>>Check CAN system type decision again.

YES (Past error)>>Error was detected in the main line between the around view monitor control unit and the data link connector.

NO >> Repair the main line between the around view monitor control unit and the data link connector.

LAN

ECM BRANCH LINE CIRCUIT

< DTC/CIRCUIT DIAGNOSIS >

[CAN SYSTEM (TYPE 502)]

ECM BRANCH LINE CIRCUIT

Diagnosis Procedure

INFOID:000000012785699

1. CHECK CONNECTOR

1. Turn the ignition switch OFF.
2. Disconnect the battery cable from the negative terminal.
3. Check the terminals and connectors of the ECM for damage, bend and loose connection (unit side and connector side).

Is the inspection result normal?

- YES >> GO TO 2.
NO >> Repair the terminal and connector.

2. CHECK HARNESS FOR OPEN CIRCUIT

1. Disconnect the connector of ECM.
2. Check the resistance between the ECM harness connector terminals.

ECM harness connector			Resistance (Ω)
Connector No.	Terminal No.		
E16	84	83	Approx. 108 – 132

Is the measurement value within the specification?

- YES >> GO TO 3.
NO >> Repair the ECM branch line.

3. CHECK POWER SUPPLY AND GROUND CIRCUIT

Check the power supply and the ground circuit of the ECM. Refer to [EC-159, "Diagnosis Procedure"](#).

Is the inspection result normal?

- YES (Present error)>>Replace the ECM. Refer to [EC-477, "Removal and Installation"](#).
YES (Past error)>>Error was detected in the ECM branch line.
NO >> Repair the power supply and the ground circuit.

ABS BRANCH LINE CIRCUIT

< DTC/CIRCUIT DIAGNOSIS >

[CAN SYSTEM (TYPE 502)]

ABS BRANCH LINE CIRCUIT

Diagnosis Procedure

INFOID:000000012785700

1. CHECK CONNECTOR

1. Turn the ignition switch OFF.
2. Disconnect the battery cable from the negative terminal.
3. Check the terminals and connectors of the ABS actuator and electric unit (control unit) for damage, bend and loose connection (unit side and connector side).

Is the inspection result normal?

- YES >> GO TO 2.
NO >> Repair the terminal and connector.

2. CHECK HARNESS FOR OPEN CIRCUIT

1. Disconnect the connector of ABS actuator and electric unit (control unit).
2. Check the resistance between the ABS actuator and electric unit (control unit) harness connector terminals.

ABS actuator and electric unit (control unit) harness connector			Resistance (Ω)
Connector No.	Terminal No.		
E33	11	10	Approx. 54 – 66

Is the measurement value within the specification?

- YES >> GO TO 3.
NO >> Repair the ABS actuator and electric unit (control unit) branch line.

3. CHECK POWER SUPPLY AND GROUND CIRCUIT

Check the power supply and the ground circuit of the ABS actuator and electric unit (control unit). Refer to [BRC-121, "Diagnosis Procedure"](#).

Is the inspection result normal?

- YES (Present error)>>Replace the ABS actuator and electric unit (control unit). Refer to [BRC-144, "Removal and Installation"](#).
YES (Past error)>>Error was detected in the ABS actuator and electric unit (control unit) branch line.
NO >> Repair the power supply and the ground circuit.

A
B
C
D
E
F
G
H
I
J
K
L

LAN

IPDM-E BRANCH LINE CIRCUIT

< DTC/CIRCUIT DIAGNOSIS >

[CAN SYSTEM (TYPE 502)]

IPDM-E BRANCH LINE CIRCUIT

Diagnosis Procedure

INFOID:000000012785701

1.CHECK CONNECTOR

1. Turn the ignition switch OFF.
2. Disconnect the battery cable from the negative terminal.
3. Check the terminals and connectors of the IPDM E/R for damage, bend and loose connection (unit side and connector side).

Is the inspection result normal?

- YES >> GO TO 2.
NO >> Repair the terminal and connector.

2.CHECK HARNESS FOR OPEN CIRCUIT

1. Disconnect the connector of IPDM E/R.
2. Check the resistance between the IPDM E/R harness connector terminals.

IPDM E/R harness connector			Resistance (Ω)
Connector No.	Terminal No.		
E46	62	61	Approx. 54 – 66

Is the measurement value within the specification?

- YES >> GO TO 3.
NO >> Repair the IPDM E/R branch line.

3.CHECK POWER SUPPLY AND GROUND CIRCUIT

Check the power supply and the ground circuit of the IPDM E/R. Refer to [PCS-29, "Diagnosis Procedure"](#).

Is the inspection result normal?

- YES (Present error)>>Replace the IPDM E/R. Refer to [PCS-30, "Removal and Installation"](#).
YES (Past error)>>Error was detected in the IPDM E/R branch line.
NO >> Repair the power supply and the ground circuit.

AVM BRANCH LINE CIRCUIT

< DTC/CIRCUIT DIAGNOSIS >

[CAN SYSTEM (TYPE 502)]

AVM BRANCH LINE CIRCUIT

Diagnosis Procedure

INFOID:000000012785709

1. CHECK CONNECTOR

1. Turn the ignition switch OFF.
2. Disconnect the battery cable from the negative terminal.
3. Check the following terminals and connectors for damage, bend and loose connection (unit side and connector side).
 - Around view monitor control unit
 - Harness connector B30
 - Harness connector M13

Is the inspection result normal?

YES >> GO TO 2.

NO >> Repair the terminal and connector.

2. CHECK HARNESS FOR OPEN CIRCUIT

1. Disconnect the connector of around view monitor control unit.
2. Check the resistance between the around view monitor control unit harness connector terminals.

Around view monitor control unit harness connector			Resistance (Ω)
Connector No.	Terminal No.		
B54	12	10	Approx. 54 – 66

Is the measurement value within the specification?

YES >> GO TO 3.

NO >> Repair the around view monitor control unit branch line.

3. CHECK POWER SUPPLY AND GROUND CIRCUIT

Check the power supply and the ground circuit of the around view monitor control unit. Refer to [AV-216, "AROUND VIEW MONITOR CONTROL UNIT : Diagnosis Procedure"](#).

Is the inspection result normal?

YES (Present error)>>Replace the around view monitor control unit. Refer to [AV-249, "Removal and Installation"](#).

YES (Past error)>>Error was detected in the around view monitor control unit branch line.

NO >> Repair the power supply and the ground circuit.

A
B
C
D
E
F
G
H
I
J
K
L

LAN

A-BAG BRANCH LINE CIRCUIT

< DTC/CIRCUIT DIAGNOSIS >

[CAN SYSTEM (TYPE 502)]

A-BAG BRANCH LINE CIRCUIT

Diagnosis Procedure

INFOID:000000012785702

WARNING:

Always observe the following items for preventing accidental activation.

- Before servicing, turn ignition switch OFF, disconnect battery negative terminal, and wait 3 minutes or more. (To discharge backup capacitor.)
- Never use unspecified tester or other measuring device.

1.CHECK CONNECTOR

1. Turn the ignition switch OFF.
2. Disconnect the battery cable from the negative terminal.
3. Check the terminals and connectors of the air bag diagnosis sensor unit for damage, bend and loose connection (unit side and connector side).

Is the inspection result normal?

- YES >> GO TO 2.
NO >> Replace the main harness.

2.CHECK AIR BAG DIAGNOSIS SENSOR UNIT

Check the air bag diagnosis sensor unit. Refer to [SRC-36. "Work Flow"](#).

Is the inspection result normal?

- YES >> Replace the main harness.
NO >> Replace parts whose air bag system has a malfunction.

AV BRANCH LINE CIRCUIT

< DTC/CIRCUIT DIAGNOSIS >

[CAN SYSTEM (TYPE 502)]

AV BRANCH LINE CIRCUIT

Diagnosis Procedure

INFOID:000000012785710

1. CHECK CONNECTOR

1. Turn the ignition switch OFF.
2. Disconnect the battery cable from the negative terminal.
3. Check the terminals and connectors of the AV control unit for damage, bend and loose connection (unit side and connector side).

Is the inspection result normal?

- YES >> GO TO 2.
NO >> Repair the terminal and connector.

2. CHECK HARNESS FOR OPEN CIRCUIT

1. Disconnect the connector of AV control unit.
2. Check the resistance between the AV control unit harness connector terminals.

AV control unit harness connector			Resistance (Ω)
Connector No.	Terminal No.		
M70	8	17	Approx. 54 – 66

Is the measurement value within the specification?

- YES >> GO TO 3.
NO >> Repair the AV control unit branch line.

3. CHECK POWER SUPPLY AND GROUND CIRCUIT

Check the power supply and the ground circuit of the AV control unit. Refer to [AV-216, "AV CONTROL UNIT : Diagnosis Procedure"](#).

Is the inspection result normal?

- YES (Present error)>>Replace the AV control unit. Refer to [AV-241, "Removal and Installation"](#).
YES (Past error)>>Error was detected in the AV control unit branch line.
NO >> Repair the power supply and the ground circuit.

A
B
C
D
E
F
G
H
I
J
K
L

LAN

N
O
P

DLC BRANCH LINE CIRCUIT

< DTC/CIRCUIT DIAGNOSIS >

[CAN SYSTEM (TYPE 502)]

DLC BRANCH LINE CIRCUIT

Diagnosis Procedure

INFOID:000000012785703

1. CHECK CONNECTOR

1. Turn the ignition switch OFF.
2. Disconnect the battery cable from the negative terminal.
3. Check the terminals and connectors of the data link connector for damage, bend and loose connection (connector side and harness side).

Is the inspection result normal?

- YES >> GO TO 2.
NO >> Repair the terminal and connector.

2. CHECK HARNESS FOR OPEN CIRCUIT

Check the resistance between the data link connector terminals.

Data link connector			Resistance (Ω)
Connector No.	Terminal No.		
M22	6	14	Approx. 54 – 66

Is the measurement value within the specification?

- YES (Present error)>>Check CAN system type decision again.
YES (Past error)>>Error was detected in the data link connector branch line circuit.
NO >> Repair the data link connector branch line.

EPS BRANCH LINE CIRCUIT

< DTC/CIRCUIT DIAGNOSIS >

[CAN SYSTEM (TYPE 502)]

EPS BRANCH LINE CIRCUIT

Diagnosis Procedure

INFOID:000000012785704

1. CHECK CONNECTOR

1. Turn the ignition switch OFF.
2. Disconnect the battery cable from the negative terminal.
3. Check the terminals and connectors of the EPS control unit for damage, bend and loose connection (unit side and connector side).

Is the inspection result normal?

- YES >> GO TO 2.
NO >> Repair the terminal and connector.

2. CHECK HARNESS FOR OPEN CIRCUIT

1. Disconnect the connector of EPS control unit.
2. Check the resistance between the EPS control unit harness connector terminals.

EPS control unit harness connector			Resistance (Ω)
Connector No.	Terminal No.		
M53	2	1	Approx. 54 – 66

Is the measurement value within the specification?

- YES >> GO TO 3.
NO >> Repair the EPS control unit branch line.

3. CHECK POWER SUPPLY AND GROUND CIRCUIT

Check the power supply and the ground circuit of the EPS control unit. Refer to [STC-18, "Diagnosis Procedure"](#).

Is the inspection result normal?

- YES (Present error)>>Replace the EPS control unit. Refer to [STC-37, "Removal and Installation"](#).
YES (Past error)>>Error was detected in the EPS control unit branch line.
NO >> Repair the power supply and the ground circuit.

A
B
C
D
E
F
G
H
I
J
K
L

LAN

N
O
P

M&A BRANCH LINE CIRCUIT

< DTC/CIRCUIT DIAGNOSIS >

[CAN SYSTEM (TYPE 502)]

M&A BRANCH LINE CIRCUIT

Diagnosis Procedure

INFOID:000000012785705

1. CHECK CONNECTOR

1. Turn the ignition switch OFF.
2. Disconnect the battery cable from the negative terminal.
3. Check the terminals and connectors of the combination meter for damage, bend and loose connection (unit side and connector side).

Is the inspection result normal?

- YES >> GO TO 2.
NO >> Repair the terminal and connector.

2. CHECK HARNESS FOR OPEN CIRCUIT

1. Disconnect the connector of combination meter.
2. Check the resistance between the combination meter harness connector terminals.

NOTE:

Check the vehicle type confirm the service information. Refer to [MWI-5. "Information"](#).

- With Type A

Combination meter harness connector			Resistance (Ω)
Connector No.	Terminal No.		
M82	1	2	Approx. 54 – 66

- With Type B

Combination meter harness connector			Resistance (Ω)
Connector No.	Terminal No.		
M24	1	2	Approx. 54 – 66

Is the measurement value within the specification?

- YES >> GO TO 3.
NO >> Repair the combination meter branch line.

3. CHECK POWER SUPPLY AND GROUND CIRCUIT

Check the power supply and the ground circuit of the combination meter. Refer to following.

- TYPE A: [MWI-43. "COMBINATION METER : Diagnosis Procedure"](#).
- TYPE B: [MWI-98. "COMBINATION METER : Diagnosis Procedure"](#).

Is the inspection result normal?

- YES (Present error)>>Replace the combination meter. Refer to the following.
- TYPE A: [MWI-54. "Removal and Installation"](#)
 - TYPE B: [MWI-115. "Removal and Installation"](#)

YES (Past error)>>Error was detected in the combination meter branch line.

- NO >> Repair the power supply and the ground circuit.

STRG BRANCH LINE CIRCUIT

< DTC/CIRCUIT DIAGNOSIS >

[CAN SYSTEM (TYPE 502)]

STRG BRANCH LINE CIRCUIT

Diagnosis Procedure

INFOID:000000012785706

1. CHECK CONNECTOR

1. Turn the ignition switch OFF.
2. Disconnect the battery cable from the negative terminal.
3. Check the terminals and connectors of the steering angle sensor for damage, bend and loose connection (unit side and connector side).

Is the inspection result normal?

- YES >> GO TO 2.
NO >> Repair the terminal and connector.

2. CHECK HARNESS FOR OPEN CIRCUIT

1. Disconnect the connector of steering angle sensor.
2. Check the resistance between the steering angle sensor harness connector terminals.

Steering angle sensor harness connector			Resistance (Ω)
Connector No.	Terminal No.		
M64	5	2	Approx. 54 – 66

Is the measurement value within the specification?

- YES >> GO TO 3.
NO >> Repair the steering angle sensor branch line.

3. CHECK POWER SUPPLY AND GROUND CIRCUIT

Check the power supply and the ground circuit of the steering angle sensor. Refer to [BRC-44, "Wiring Diagram"](#).

Is the inspection result normal?

- YES (Present error)>>Replace the steering angle sensor. Refer to [BRC-147, "Removal and Installation"](#).
YES (Past error)>>Error was detected in the steering angle sensor branch line.
NO >> Repair the power supply and the ground circuit.

A
B
C
D
E
F
G
H
I
J
K
L

LAN

BCM BRANCH LINE CIRCUIT

< DTC/CIRCUIT DIAGNOSIS >

[CAN SYSTEM (TYPE 502)]

BCM BRANCH LINE CIRCUIT

Diagnosis Procedure

INFOID:000000012785707

1. CHECK CONNECTOR

1. Turn the ignition switch OFF.
2. Disconnect the battery cable from the negative terminal.
3. Check the terminals and connectors of the BCM for damage, bend and loose connection (unit side and connector side).

Is the inspection result normal?

- YES >> GO TO 2.
NO >> Repair the terminal and connector.

2. CHECK HARNESS FOR OPEN CIRCUIT

1. Disconnect the connector of BCM.
 2. Check the resistance between the BCM harness connector terminals.
- With intelligent key

BCM harness connector			Resistance (Ω)
Connector No.	Terminal No.		
M97	39	40	Approx. 108 – 132

- Without intelligent key

BCM harness connector			Resistance (Ω)
Connector No.	Terminal No.		
M18	39	40	Approx. 108 – 132

Is the measurement value within the specification?

- YES >> GO TO 3.
NO >> Repair the BCM branch line.

3. CHECK POWER SUPPLY AND GROUND CIRCUIT

Check the power supply and the ground circuit of the BCM. Refer to the following.

- With Intelligent Key system: [BCS-67, "Diagnosis Procedure"](#)
- Without Intelligent Key system: [BCS-129, "Diagnosis Procedure"](#)

Is the inspection result normal?

- YES (Present error)>>Replace the BCM. Refer to the following.
- With Intelligent Key system: [BCS-74, "Removal and Installation"](#)
 - Without Intelligent Key system: [BCS-137, "Removal and Installation"](#)
- YES (Past error)>>Error was detected in the BCM branch line.
NO >> Repair the power supply and the ground circuit.

CAN COMMUNICATION CIRCUIT

< DTC/CIRCUIT DIAGNOSIS >

[CAN SYSTEM (TYPE 502)]

CAN COMMUNICATION CIRCUIT

Diagnosis Procedure

INFOID:000000012785708

1. CONNECTOR INSPECTION

1. Turn the ignition switch OFF.
2. Disconnect the battery cable from the negative terminal.
3. Disconnect all the unit connectors on CAN communication system.
4. Check terminals and connectors for damage, bend and loose connection.

Is the inspection result normal?

- YES >> GO TO 2.
NO >> Repair the terminal and connector.

2. CHECK HARNESS CONTINUITY (SHORT CIRCUIT)

Check the continuity between the data link connector terminals.

Data link connector			Continuity
Connector No.	Terminal No.		
M22	6	14	Not existed

Is the inspection result normal?

- YES >> GO TO 3.
NO >> Check the harness and repair the root cause.

3. CHECK HARNESS CONTINUITY (SHORT CIRCUIT)

Check the continuity between the data link connector and the ground.

Data link connector		Ground	Continuity
Connector No.	Terminal No.		
M22	6		Not existed
	14		Not existed

Is the inspection result normal?

- YES >> GO TO 4.
NO >> Check the harness and repair the root cause.

4. CHECK ECM AND BCM TERMINATION CIRCUIT

1. Remove the ECM and the BCM.
2. Check the resistance between the ECM terminals.

ECM		Resistance (Ω)
Terminal No.		
84	83	Approx. 108 – 132

3. Check the resistance between the BCM terminals.

BCM		Resistance (Ω)
Terminal No.		
39	40	Approx. 108 – 132

Is the measurement value within the specification?

- YES >> GO TO 5.
NO >> Replace the ECM and/or the BCM.

5. CHECK SYMPTOM

Connect all the connectors. Check if the symptoms described in the "Symptom (Results from interview with customer)" are reproduced.

A
B
C
D
E
F
G
H
I
J
K
L

LAN

N
O
P

CAN COMMUNICATION CIRCUIT

< DTC/CIRCUIT DIAGNOSIS >

[CAN SYSTEM (TYPE 502)]

Inspection result

Reproduced>>GO TO 6.

Non-reproduced>>Start the diagnosis again. Follow the trouble diagnosis procedure when past error is detected.

6.CHECK UNIT REPRODUCTION

Perform the reproduction test as per the following procedure for each unit.

1. Turn the ignition switch OFF.
2. Disconnect the battery cable from the negative terminal.
3. Disconnect one of the unit connectors of CAN communication system.

NOTE:

ECM and BCM have a termination circuit. Check other units first.

4. Connect the battery cable to the negative terminal. Check if the symptoms described in the "Symptom (Results from interview with customer)" are reproduced.

NOTE:

Although unit-related error symptoms occur, do not confuse them with other symptoms.

Inspection result

Reproduced>>Connect the connector. Check other units as per the above procedure.

Non-reproduced>>Replace the unit whose connector was disconnected.

MAIN LINE BETWEEN IPDM-E AND DLC CIRCUIT

< DTC/CIRCUIT DIAGNOSIS >

[CAN SYSTEM (TYPE 503)]

DTC/CIRCUIT DIAGNOSIS

MAIN LINE BETWEEN IPDM-E AND DLC CIRCUIT

Diagnosis Procedure

INFOID:0000000012785711

1. CHECK CONNECTOR

1. Turn the ignition switch OFF.
2. Disconnect the battery cable from the negative terminal.
3. Check the following terminals and connectors for damage, bend and loose connection (connector side and harness side).
 - Harness connector E7
 - Harness connector M69

Is the inspection result normal?

YES >> GO TO 2.

NO >> Repair the terminal and connector.

2. CHECK HARNESS CONTINUITY (OPEN CIRCUIT)

1. Disconnect the following harness connectors.
 - IPDM E/R
 - Harness connectors E7 and M69
2. Check the continuity between the IPDM E/R harness connector and the harness connector.

IPDM E/R harness connector		Harness connector		Continuity
Connector No.	Terminal No.	Connector No.	Terminal No.	
E46	62	E7	21A	Existed
	61		20A	Existed

Is the inspection result normal?

YES >> GO TO 3.

NO >> Repair the main line between the IPDM E/R and the harness connector E7.

3. CHECK HARNESS CONTINUITY (OPEN CIRCUIT)

Check the continuity between the harness connector and the data link connector.

Harness connector		Data link connector		Continuity
Connector No.	Terminal No.	Connector No.	Terminal No.	
M69	21A	M22	6	Existed
	20A		14	Existed

Is the inspection result normal?

YES (Present error)>>Check CAN system type decision again.

YES (Past error)>>Error was detected in the main line between the IPDM E/R and the data link connector.

NO >> Repair the main line between the harness connector M69 and the data link connector.

A
B
C
D
E
F
G
H
I
J
K
L
LAN
N
O
P

ECM BRANCH LINE CIRCUIT

< DTC/CIRCUIT DIAGNOSIS >

[CAN SYSTEM (TYPE 503)]

ECM BRANCH LINE CIRCUIT

Diagnosis Procedure

INFOID:000000012785712

1.CHECK CONNECTOR

1. Turn the ignition switch OFF.
2. Disconnect the battery cable from the negative terminal.
3. Check the terminals and connectors of the ECM for damage, bend and loose connection (unit side and connector side).

Is the inspection result normal?

- YES >> GO TO 2.
NO >> Repair the terminal and connector.

2.CHECK HARNESS FOR OPEN CIRCUIT

1. Disconnect the connector of ECM.
2. Check the resistance between the ECM harness connector terminals.

ECM harness connector			Resistance (Ω)
Connector No.	Terminal No.		
E16	84	83	Approx. 108 – 132

Is the measurement value within the specification?

- YES >> GO TO 3.
NO >> Repair the ECM branch line.

3.CHECK POWER SUPPLY AND GROUND CIRCUIT

Check the power supply and the ground circuit of the ECM. Refer to [EC-159, "Diagnosis Procedure"](#).

Is the inspection result normal?

- YES (Present error)>>Replace the ECM. Refer to [EC-477, "Removal and Installation"](#).
YES (Past error)>>Error was detected in the ECM branch line.
NO >> Repair the power supply and the ground circuit.

ABS BRANCH LINE CIRCUIT

< DTC/CIRCUIT DIAGNOSIS >

[CAN SYSTEM (TYPE 503)]

ABS BRANCH LINE CIRCUIT

Diagnosis Procedure

INFOID:000000012785713

1. CHECK CONNECTOR

1. Turn the ignition switch OFF.
2. Disconnect the battery cable from the negative terminal.
3. Check the terminals and connectors of the ABS actuator and electric unit (control unit) for damage, bend and loose connection (unit side and connector side).

Is the inspection result normal?

- YES >> GO TO 2.
NO >> Repair the terminal and connector.

2. CHECK HARNESS FOR OPEN CIRCUIT

1. Disconnect the connector of ABS actuator and electric unit (control unit).
2. Check the resistance between the ABS actuator and electric unit (control unit) harness connector terminals.

ABS actuator and electric unit (control unit) harness connector			Resistance (Ω)
Connector No.	Terminal No.		
E33	11	10	Approx. 54 – 66

Is the measurement value within the specification?

- YES >> GO TO 3.
NO >> Repair the ABS actuator and electric unit (control unit) branch line.

3. CHECK POWER SUPPLY AND GROUND CIRCUIT

Check the power supply and the ground circuit of the ABS actuator and electric unit (control unit). Refer to [BRC-121, "Diagnosis Procedure"](#).

Is the inspection result normal?

- YES (Present error)>>Replace the ABS actuator and electric unit (control unit). Refer to [BRC-144, "Removal and Installation"](#).
YES (Past error)>>Error was detected in the ABS actuator and electric unit (control unit) branch line.
NO >> Repair the power supply and the ground circuit.

A
B
C
D
E
F
G
H
I
J
K
L

LAN

IPDM-E BRANCH LINE CIRCUIT

< DTC/CIRCUIT DIAGNOSIS >

[CAN SYSTEM (TYPE 503)]

IPDM-E BRANCH LINE CIRCUIT

Diagnosis Procedure

INFOID:000000012785714

1. CHECK CONNECTOR

1. Turn the ignition switch OFF.
2. Disconnect the battery cable from the negative terminal.
3. Check the terminals and connectors of the IPDM E/R for damage, bend and loose connection (unit side and connector side).

Is the inspection result normal?

- YES >> GO TO 2.
NO >> Repair the terminal and connector.

2. CHECK HARNESS FOR OPEN CIRCUIT

1. Disconnect the connector of IPDM E/R.
2. Check the resistance between the IPDM E/R harness connector terminals.

IPDM E/R harness connector			Resistance (Ω)
Connector No.	Terminal No.		
E46	62	61	Approx. 54 – 66

Is the measurement value within the specification?

- YES >> GO TO 3.
NO >> Repair the IPDM E/R branch line.

3. CHECK POWER SUPPLY AND GROUND CIRCUIT

Check the power supply and the ground circuit of the IPDM E/R. Refer to [PCS-29, "Diagnosis Procedure"](#).

Is the inspection result normal?

- YES (Present error)>>Replace the IPDM E/R. Refer to [PCS-30, "Removal and Installation"](#).
YES (Past error)>>Error was detected in the IPDM E/R branch line.
NO >> Repair the power supply and the ground circuit.

TCM BRANCH LINE CIRCUIT

< DTC/CIRCUIT DIAGNOSIS >

[CAN SYSTEM (TYPE 503)]

TCM BRANCH LINE CIRCUIT

Diagnosis Procedure

INFOID:000000012785722

1. CHECK CONNECTOR

1. Turn the ignition switch OFF.
2. Disconnect the battery cable from the negative terminal.
3. Check the following terminals and connectors for damage, bend and loose connection (unit side and connector side).
 - TCM
 - Harness connector F8
 - Harness connector E8

Is the inspection result normal?

YES >> GO TO 2.

NO >> Repair the terminal and connector.

2. CHECK HARNESS FOR OPEN CIRCUIT

1. Disconnect the connector of TCM.
2. Check the resistance between the TCM harness connector terminals.

TCM harness connector		Resistance (Ω)
Connector No.	Terminal No.	
F44	33 23	Approx. 54 – 66

Is the measurement value within the specification?

YES >> GO TO 3.

NO >> Repair the TCM branch line.

3. CHECK POWER SUPPLY AND GROUND CIRCUIT

Check the power supply and the ground circuit of the TCM. Refer to [TM-215, "Diagnosis Procedure"](#).

Is the inspection result normal?

YES (Present error)>>Replace the TCM. Refer to [TM-239, "Removal and Installation"](#).

YES (Past error)>>Error was detected in the TCM branch line.

NO >> Repair the power supply and the ground circuit.

A
B
C
D
E
F
G
H
I
J
K
L

LAN

A-BAG BRANCH LINE CIRCUIT

< DTC/CIRCUIT DIAGNOSIS >

[CAN SYSTEM (TYPE 503)]

A-BAG BRANCH LINE CIRCUIT

Diagnosis Procedure

INFOID:000000012785715

WARNING:

Always observe the following items for preventing accidental activation.

- Before servicing, turn ignition switch OFF, disconnect battery negative terminal, and wait 3 minutes or more. (To discharge backup capacitor.)
- Never use unspecified tester or other measuring device.

1.CHECK CONNECTOR

1. Turn the ignition switch OFF.
2. Disconnect the battery cable from the negative terminal.
3. Check the terminals and connectors of the air bag diagnosis sensor unit for damage, bend and loose connection (unit side and connector side).

Is the inspection result normal?

- YES >> GO TO 2.
NO >> Replace the main harness.

2.CHECK AIR BAG DIAGNOSIS SENSOR UNIT

Check the air bag diagnosis sensor unit. Refer to [SRC-36. "Work Flow"](#).

Is the inspection result normal?

- YES >> Replace the main harness.
NO >> Replace parts whose air bag system has a malfunction.

DLC BRANCH LINE CIRCUIT

< DTC/CIRCUIT DIAGNOSIS >

[CAN SYSTEM (TYPE 503)]

DLC BRANCH LINE CIRCUIT

Diagnosis Procedure

INFOID:000000012785716

1. CHECK CONNECTOR

1. Turn the ignition switch OFF.
2. Disconnect the battery cable from the negative terminal.
3. Check the terminals and connectors of the data link connector for damage, bend and loose connection (connector side and harness side).

Is the inspection result normal?

- YES >> GO TO 2.
NO >> Repair the terminal and connector.

2. CHECK HARNESS FOR OPEN CIRCUIT

Check the resistance between the data link connector terminals.

Data link connector			Resistance (Ω)
Connector No.	Terminal No.		
M22	6	14	Approx. 54 – 66

Is the measurement value within the specification?

- YES (Present error)>>Check CAN system type decision again.
YES (Past error)>>Error was detected in the data link connector branch line circuit.
NO >> Repair the data link connector branch line.

A
B
C
D
E
F
G
H
I
J
K
L

LAN

N
O
P

EPS BRANCH LINE CIRCUIT

< DTC/CIRCUIT DIAGNOSIS >

[CAN SYSTEM (TYPE 503)]

EPS BRANCH LINE CIRCUIT

Diagnosis Procedure

INFOID:0000000012785717

1. CHECK CONNECTOR

1. Turn the ignition switch OFF.
2. Disconnect the battery cable from the negative terminal.
3. Check the terminals and connectors of the EPS control unit for damage, bend and loose connection (unit side and connector side).

Is the inspection result normal?

- YES >> GO TO 2.
NO >> Repair the terminal and connector.

2. CHECK HARNESS FOR OPEN CIRCUIT

1. Disconnect the connector of EPS control unit.
2. Check the resistance between the EPS control unit harness connector terminals.

EPS control unit harness connector			Resistance (Ω)
Connector No.	Terminal No.		
M53	2	1	Approx. 54 – 66

Is the measurement value within the specification?

- YES >> GO TO 3.
NO >> Repair the EPS control unit branch line.

3. CHECK POWER SUPPLY AND GROUND CIRCUIT

Check the power supply and the ground circuit of the EPS control unit. Refer to [STC-18, "Diagnosis Procedure"](#).

Is the inspection result normal?

- YES (Present error)>>Replace the EPS control unit. Refer to [STC-37, "Removal and Installation"](#).
YES (Past error)>>Error was detected in the EPS control unit branch line.
NO >> Repair the power supply and the ground circuit.

M&A BRANCH LINE CIRCUIT

< DTC/CIRCUIT DIAGNOSIS >

[CAN SYSTEM (TYPE 503)]

M&A BRANCH LINE CIRCUIT

Diagnosis Procedure

INFOID:000000012785718

1.CHECK CONNECTOR

1. Turn the ignition switch OFF.
2. Disconnect the battery cable from the negative terminal.
3. Check the terminals and connectors of the combination meter for damage, bend and loose connection (unit side and connector side).

Is the inspection result normal?

- YES >> GO TO 2.
NO >> Repair the terminal and connector.

2.CHECK HARNESS FOR OPEN CIRCUIT

1. Disconnect the connector of combination meter.
2. Check the resistance between the combination meter harness connector terminals.

NOTE:

Check the vehicle type confirm the service information. Refer to [MWI-5. "Information"](#).

- With Type A

Combination meter harness connector			Resistance (Ω)
Connector No.	Terminal No.		
M82	1	2	Approx. 54 – 66

- With Type B

Combination meter harness connector			Resistance (Ω)
Connector No.	Terminal No.		
M24	1	2	Approx. 54 – 66

Is the measurement value within the specification?

- YES >> GO TO 3.
NO >> Repair the combination meter branch line.

3.CHECK POWER SUPPLY AND GROUND CIRCUIT

Check the power supply and the ground circuit of the combination meter. Refer to following.

- TYPE A: [MWI-43. "COMBINATION METER : Diagnosis Procedure"](#).
- TYPE B: [MWI-98. "COMBINATION METER : Diagnosis Procedure"](#).

Is the inspection result normal?

- YES (Present error)>>Replace the combination meter. Refer to the following.
- TYPE A: [MWI-54. "Removal and Installation"](#)
 - TYPE B: [MWI-115. "Removal and Installation"](#)

YES (Past error)>>Error was detected in the combination meter branch line.

- NO >> Repair the power supply and the ground circuit.

A
B
C
D
E
F
G
H
I
J
K
L
N
O
P

LAN

STRG BRANCH LINE CIRCUIT

< DTC/CIRCUIT DIAGNOSIS >

[CAN SYSTEM (TYPE 503)]

STRG BRANCH LINE CIRCUIT

Diagnosis Procedure

INFOID:000000012785719

1. CHECK CONNECTOR

1. Turn the ignition switch OFF.
2. Disconnect the battery cable from the negative terminal.
3. Check the terminals and connectors of the steering angle sensor for damage, bend and loose connection (unit side and connector side).

Is the inspection result normal?

- YES >> GO TO 2.
NO >> Repair the terminal and connector.

2. CHECK HARNESS FOR OPEN CIRCUIT

1. Disconnect the connector of steering angle sensor.
2. Check the resistance between the steering angle sensor harness connector terminals.

Steering angle sensor harness connector			Resistance (Ω)
Connector No.	Terminal No.		
M64	5	2	Approx. 54 – 66

Is the measurement value within the specification?

- YES >> GO TO 3.
NO >> Repair the steering angle sensor branch line.

3. CHECK POWER SUPPLY AND GROUND CIRCUIT

Check the power supply and the ground circuit of the steering angle sensor. Refer to [BRC-44, "Wiring Diagram"](#).

Is the inspection result normal?

- YES (Present error)>>Replace the steering angle sensor. Refer to [BRC-147, "Removal and Installation"](#).
YES (Past error)>>Error was detected in the steering angle sensor branch line.
NO >> Repair the power supply and the ground circuit.

BCM BRANCH LINE CIRCUIT

< DTC/CIRCUIT DIAGNOSIS >

[CAN SYSTEM (TYPE 503)]

BCM BRANCH LINE CIRCUIT

Diagnosis Procedure

INFOID:000000012785720

1. CHECK CONNECTOR

1. Turn the ignition switch OFF.
2. Disconnect the battery cable from the negative terminal.
3. Check the terminals and connectors of the BCM for damage, bend and loose connection (unit side and connector side).

Is the inspection result normal?

- YES >> GO TO 2.
NO >> Repair the terminal and connector.

2. CHECK HARNESS FOR OPEN CIRCUIT

1. Disconnect the connector of BCM.
2. Check the resistance between the BCM harness connector terminals.
 - With intelligent key

BCM harness connector			Resistance (Ω)
Connector No.	Terminal No.		
M97	39	40	Approx. 108 – 132

- Without intelligent key

BCM harness connector			Resistance (Ω)
Connector No.	Terminal No.		
M18	39	40	Approx. 108 – 132

Is the measurement value within the specification?

- YES >> GO TO 3.
NO >> Repair the BCM branch line.

3. CHECK POWER SUPPLY AND GROUND CIRCUIT

Check the power supply and the ground circuit of the BCM. Refer to the following.

- With Intelligent Key system: [BCS-67, "Diagnosis Procedure"](#)
- Without Intelligent Key system: [BCS-129, "Diagnosis Procedure"](#)

Is the inspection result normal?

- YES (Present error)>>Replace the BCM. Refer to the following.
- With Intelligent Key system: [BCS-74, "Removal and Installation"](#)
 - Without Intelligent Key system: [BCS-137, "Removal and Installation"](#)

YES (Past error)>>Error was detected in the BCM branch line.

- NO >> Repair the power supply and the ground circuit.

A
B
C
D
E
F
G
H
I
J
K
L
N
O
P

LAN

CAN COMMUNICATION CIRCUIT

< DTC/CIRCUIT DIAGNOSIS >

[CAN SYSTEM (TYPE 503)]

CAN COMMUNICATION CIRCUIT

Diagnosis Procedure

INFOID:000000012785721

1.CONNECTOR INSPECTION

1. Turn the ignition switch OFF.
2. Disconnect the battery cable from the negative terminal.
3. Disconnect all the unit connectors on CAN communication system.
4. Check terminals and connectors for damage, bend and loose connection.

Is the inspection result normal?

- YES >> GO TO 2.
NO >> Repair the terminal and connector.

2.CHECK HARNESS CONTINUITY (SHORT CIRCUIT)

Check the continuity between the data link connector terminals.

Data link connector		Continuity
Connector No.	Terminal No.	
M22	6 14	Not existed

Is the inspection result normal?

- YES >> GO TO 3.
NO >> Check the harness and repair the root cause.

3.CHECK HARNESS CONTINUITY (SHORT CIRCUIT)

Check the continuity between the data link connector and the ground.

Data link connector		Ground	Continuity
Connector No.	Terminal No.		
M22	6		Not existed
	14		Not existed

Is the inspection result normal?

- YES >> GO TO 4.
NO >> Check the harness and repair the root cause.

4.CHECK ECM AND BCM TERMINATION CIRCUIT

1. Remove the ECM and the BCM.
2. Check the resistance between the ECM terminals.

ECM		Resistance (Ω)
Terminal No.		
84	83	Approx. 108 – 132

3. Check the resistance between the BCM terminals.

BCM		Resistance (Ω)
Terminal No.		
39	40	Approx. 108 – 132

Is the measurement value within the specification?

- YES >> GO TO 5.
NO >> Replace the ECM and/or the BCM.

5.CHECK SYMPTOM

Connect all the connectors. Check if the symptoms described in the "Symptom (Results from interview with customer)" are reproduced.

CAN COMMUNICATION CIRCUIT

< DTC/CIRCUIT DIAGNOSIS >

[CAN SYSTEM (TYPE 503)]

Inspection result

Reproduced>>GO TO 6.

Non-reproduced>>Start the diagnosis again. Follow the trouble diagnosis procedure when past error is detected.

6.CHECK UNIT REPRODUCTION

Perform the reproduction test as per the following procedure for each unit.

1. Turn the ignition switch OFF.
2. Disconnect the battery cable from the negative terminal.
3. Disconnect one of the unit connectors of CAN communication system.

NOTE:

ECM and BCM have a termination circuit. Check other units first.

4. Connect the battery cable to the negative terminal. Check if the symptoms described in the “Symptom (Results from interview with customer)” are reproduced.

NOTE:

Although unit-related error symptoms occur, do not confuse them with other symptoms.

Inspection result

Reproduced>>Connect the connector. Check other units as per the above procedure.

Non-reproduced>>Replace the unit whose connector was disconnected.

A
B
C
D
E
F
G
H
I
J
K
L
N
O
P

LAN

MAIN LINE BETWEEN IPDM-E AND AVM CIRCUIT

< DTC/CIRCUIT DIAGNOSIS >

[CAN SYSTEM (TYPE 504)]

DTC/CIRCUIT DIAGNOSIS

MAIN LINE BETWEEN IPDM-E AND AVM CIRCUIT

Diagnosis Procedure

INFOID:0000000012785736

1. CHECK CONNECTOR

1. Turn the ignition switch OFF.
2. Disconnect the battery cable from the negative terminal.
3. Check the following terminals and connectors for damage, bend and loose connection (connector side and harness side).
 - Harness connector E7
 - Harness connector M69

Is the inspection result normal?

YES >> GO TO 2.

NO >> Repair the terminal and connector.

2. CHECK HARNESS CONTINUITY (OPEN CIRCUIT)

1. Disconnect the following harness connectors.
 - IPDM E/R
 - Harness connectors E7 and M69
2. Check the continuity between the IPDM E/R harness connector and the harness connector.

IPDM E/R harness connector		Harness connector		Continuity
Connector No.	Terminal No.	Connector No.	Terminal No.	
E46	62	E7	21A	Existed
	61		20A	Existed

Is the inspection result normal?

YES >> GO TO 3.

NO >> Repair the main line between the IPDM E/R and the harness connector E7.

3. CHECK HARNESS CONTINUITY (OPEN CIRCUIT)

1. Disconnect the harness connectors M13 and B30.
2. Check the continuity between the harness connectors.

Harness connector		Harness connector		Continuity
Connector No.	Terminal No.	Connector No.	Terminal No.	
M69	21A	M13	5	Existed
	20A		17	Existed

Is the inspection result normal?

YES (Present error)>>Check CAN system type decision again.

YES (Past error)>>Error was detected in the main line between the IPDM E/R and the around view monitor control unit.

NO >> Repair the main line between the harness connector M69 and around view monitor control unit.

MAIN LINE BETWEEN AVM AND DLC CIRCUIT

< DTC/CIRCUIT DIAGNOSIS >

[CAN SYSTEM (TYPE 504)]

MAIN LINE BETWEEN AVM AND DLC CIRCUIT

Diagnosis Procedure

INFOID:000000012785737

1. CHECK HARNESS CONTINUITY (OPEN CIRCUIT)

1. Turn the ignition switch OFF.
2. Disconnect the battery cable from the negative terminal.
3. Disconnect the following harness connectors.
 - ECM
 - Around view monitor control unit
4. Check the continuity between the around view monitor control unit harness connector and the data link connector.

Around view monitor control unit harness connector		Date link connector		Continuity
Connector No.	Terminal No.	Connector No.	Terminal No.	
B54	12	M22	6	Existed
	10		14	Existed

Is the inspection result normal?

YES (Present error)>>Check CAN system type decision again.

YES (Past error)>>Error was detected in the main line between the around view monitor control unit and the data link connector.

NO >> Repair the main line between the around view monitor control unit and the data link connector.

ECM BRANCH LINE CIRCUIT

< DTC/CIRCUIT DIAGNOSIS >

[CAN SYSTEM (TYPE 504)]

ECM BRANCH LINE CIRCUIT

Diagnosis Procedure

INFOID:000000012785738

1.CHECK CONNECTOR

1. Turn the ignition switch OFF.
2. Disconnect the battery cable from the negative terminal.
3. Check the terminals and connectors of the ECM for damage, bend and loose connection (unit side and connector side).

Is the inspection result normal?

- YES >> GO TO 2.
NO >> Repair the terminal and connector.

2.CHECK HARNESS FOR OPEN CIRCUIT

1. Disconnect the connector of ECM.
2. Check the resistance between the ECM harness connector terminals.

ECM harness connector			Resistance (Ω)
Connector No.	Terminal No.		
E16	84	83	Approx. 108 – 132

Is the measurement value within the specification?

- YES >> GO TO 3.
NO >> Repair the ECM branch line.

3.CHECK POWER SUPPLY AND GROUND CIRCUIT

Check the power supply and the ground circuit of the ECM. Refer to [EC-159, "Diagnosis Procedure"](#).

Is the inspection result normal?

- YES (Present error)>>Replace the ECM. Refer to [EC-477, "Removal and Installation"](#).
YES (Past error)>>Error was detected in the ECM branch line.
NO >> Repair the power supply and the ground circuit.

ABS BRANCH LINE CIRCUIT

< DTC/CIRCUIT DIAGNOSIS >

[CAN SYSTEM (TYPE 504)]

ABS BRANCH LINE CIRCUIT

Diagnosis Procedure

INFOID:000000012785739

1. CHECK CONNECTOR

1. Turn the ignition switch OFF.
2. Disconnect the battery cable from the negative terminal.
3. Check the terminals and connectors of the ABS actuator and electric unit (control unit) for damage, bend and loose connection (unit side and connector side).

Is the inspection result normal?

- YES >> GO TO 2.
NO >> Repair the terminal and connector.

2. CHECK HARNESS FOR OPEN CIRCUIT

1. Disconnect the connector of ABS actuator and electric unit (control unit).
2. Check the resistance between the ABS actuator and electric unit (control unit) harness connector terminals.

ABS actuator and electric unit (control unit) harness connector			Resistance (Ω)
Connector No.	Terminal No.		
E33	11	10	Approx. 54 – 66

Is the measurement value within the specification?

- YES >> GO TO 3.
NO >> Repair the ABS actuator and electric unit (control unit) branch line.

3. CHECK POWER SUPPLY AND GROUND CIRCUIT

Check the power supply and the ground circuit of the ABS actuator and electric unit (control unit). Refer to [BRC-121, "Diagnosis Procedure"](#).

Is the inspection result normal?

- YES (Present error)>>Replace the ABS actuator and electric unit (control unit). Refer to [BRC-144, "Removal and Installation"](#).
YES (Past error)>>Error was detected in the ABS actuator and electric unit (control unit) branch line.
NO >> Repair the power supply and the ground circuit.

A
B
C
D
E
F
G
H
I
J
K
L

LAN

IPDM-E BRANCH LINE CIRCUIT

< DTC/CIRCUIT DIAGNOSIS >

[CAN SYSTEM (TYPE 504)]

IPDM-E BRANCH LINE CIRCUIT

Diagnosis Procedure

INFOID:000000012785740

1. CHECK CONNECTOR

1. Turn the ignition switch OFF.
2. Disconnect the battery cable from the negative terminal.
3. Check the terminals and connectors of the IPDM E/R for damage, bend and loose connection (unit side and connector side).

Is the inspection result normal?

- YES >> GO TO 2.
NO >> Repair the terminal and connector.

2. CHECK HARNESS FOR OPEN CIRCUIT

1. Disconnect the connector of IPDM E/R.
2. Check the resistance between the IPDM E/R harness connector terminals.

IPDM E/R harness connector			Resistance (Ω)
Connector No.	Terminal No.		
E46	62	61	Approx. 54 – 66

Is the measurement value within the specification?

- YES >> GO TO 3.
NO >> Repair the IPDM E/R branch line.

3. CHECK POWER SUPPLY AND GROUND CIRCUIT

Check the power supply and the ground circuit of the IPDM E/R. Refer to [PCS-29, "Diagnosis Procedure"](#).

Is the inspection result normal?

- YES (Present error)>>Replace the IPDM E/R. Refer to [PCS-30, "Removal and Installation"](#).
YES (Past error)>>Error was detected in the IPDM E/R branch line.
NO >> Repair the power supply and the ground circuit.

TCM BRANCH LINE CIRCUIT

< DTC/CIRCUIT DIAGNOSIS >

[CAN SYSTEM (TYPE 504)]

TCM BRANCH LINE CIRCUIT

Diagnosis Procedure

INFOID:000000012785750

1. CHECK CONNECTOR

1. Turn the ignition switch OFF.
2. Disconnect the battery cable from the negative terminal.
3. Check the following terminals and connectors for damage, bend and loose connection (unit side and connector side).
 - TCM
 - Harness connector F8
 - Harness connector E8

Is the inspection result normal?

- YES >> GO TO 2.
NO >> Repair the terminal and connector.

2. CHECK HARNESS FOR OPEN CIRCUIT

1. Disconnect the connector of TCM.
2. Check the resistance between the TCM harness connector terminals.

TCM harness connector		Resistance (Ω)
Connector No.	Terminal No.	
F44	33 23	Approx. 54 – 66

Is the measurement value within the specification?

- YES >> GO TO 3.
NO >> Repair the TCM branch line.

3. CHECK POWER SUPPLY AND GROUND CIRCUIT

Check the power supply and the ground circuit of the TCM. Refer to [TM-215, "Diagnosis Procedure"](#).

Is the inspection result normal?

- YES (Present error)>>Replace the TCM. Refer to [TM-239, "Removal and Installation"](#).
YES (Past error)>>Error was detected in the TCM branch line.
NO >> Repair the power supply and the ground circuit.

A
B
C
D
E
F
G
H
I
J
K
L

LAN

AVM BRANCH LINE CIRCUIT

< DTC/CIRCUIT DIAGNOSIS >

[CAN SYSTEM (TYPE 504)]

AVM BRANCH LINE CIRCUIT

Diagnosis Procedure

INFOID:000000012785741

1. CHECK CONNECTOR

1. Turn the ignition switch OFF.
2. Disconnect the battery cable from the negative terminal.
3. Check the following terminals and connectors for damage, bend and loose connection (unit side and connector side).
 - Around view monitor control unit
 - Harness connector B30
 - Harness connector M13

Is the inspection result normal?

YES >> GO TO 2.

NO >> Repair the terminal and connector.

2. CHECK HARNESS FOR OPEN CIRCUIT

1. Disconnect the connector of around view monitor control unit.
2. Check the resistance between the around view monitor control unit harness connector terminals.

Around view monitor control unit harness connector			Resistance (Ω)
Connector No.	Terminal No.		
B54	12	10	Approx. 54 – 66

Is the measurement value within the specification?

YES >> GO TO 3.

NO >> Repair the around view monitor control unit branch line.

3. CHECK POWER SUPPLY AND GROUND CIRCUIT

Check the power supply and the ground circuit of the around view monitor control unit. Refer to [AV-216, "AROUND VIEW MONITOR CONTROL UNIT : Diagnosis Procedure"](#).

Is the inspection result normal?

YES (Present error)>>Replace the around view monitor control unit. Refer to [AV-249, "Removal and Installation"](#).

YES (Past error)>>Error was detected in the around view monitor control unit branch line.

NO >> Repair the power supply and the ground circuit.

A-BAG BRANCH LINE CIRCUIT

< DTC/CIRCUIT DIAGNOSIS >

[CAN SYSTEM (TYPE 504)]

A-BAG BRANCH LINE CIRCUIT

Diagnosis Procedure

INFOID:000000012785742

WARNING:

Always observe the following items for preventing accidental activation.

- Before servicing, turn ignition switch OFF, disconnect battery negative terminal, and wait 3 minutes or more. (To discharge backup capacitor.)
- Never use unspecified tester or other measuring device.

1.CHECK CONNECTOR

1. Turn the ignition switch OFF.
2. Disconnect the battery cable from the negative terminal.
3. Check the terminals and connectors of the air bag diagnosis sensor unit for damage, bend and loose connection (unit side and connector side).

Is the inspection result normal?

- YES >> GO TO 2.
NO >> Replace the main harness.

2.CHECK AIR BAG DIAGNOSIS SENSOR UNIT

Check the air bag diagnosis sensor unit. Refer to [SRC-36. "Work Flow"](#).

Is the inspection result normal?

- YES >> Replace the main harness.
NO >> Replace parts whose air bag system has a malfunction.

A
B
C
D
E
F
G
H
I
J
K
L
N
O
P

LAN

AV BRANCH LINE CIRCUIT

< DTC/CIRCUIT DIAGNOSIS >

[CAN SYSTEM (TYPE 504)]

AV BRANCH LINE CIRCUIT

Diagnosis Procedure

INFOID:000000012785743

1. CHECK CONNECTOR

1. Turn the ignition switch OFF.
2. Disconnect the battery cable from the negative terminal.
3. Check the terminals and connectors of the AV control unit for damage, bend and loose connection (unit side and connector side).

Is the inspection result normal?

- YES >> GO TO 2.
NO >> Repair the terminal and connector.

2. CHECK HARNESS FOR OPEN CIRCUIT

1. Disconnect the connector of AV control unit.
2. Check the resistance between the AV control unit harness connector terminals.

AV control unit harness connector			Resistance (Ω)
Connector No.	Terminal No.		
M70	8	17	Approx. 54 – 66

Is the measurement value within the specification?

- YES >> GO TO 3.
NO >> Repair the AV control unit branch line.

3. CHECK POWER SUPPLY AND GROUND CIRCUIT

Check the power supply and the ground circuit of the AV control unit. Refer to [AV-216, "AV CONTROL UNIT : Diagnosis Procedure"](#).

Is the inspection result normal?

- YES (Present error)>>Replace the AV control unit. Refer to [AV-241, "Removal and Installation"](#).
YES (Past error)>>Error was detected in the AV control unit branch line.
NO >> Repair the power supply and the ground circuit.

DLC BRANCH LINE CIRCUIT

< DTC/CIRCUIT DIAGNOSIS >

[CAN SYSTEM (TYPE 504)]

DLC BRANCH LINE CIRCUIT

Diagnosis Procedure

INFOID:000000012785744

1. CHECK CONNECTOR

1. Turn the ignition switch OFF.
2. Disconnect the battery cable from the negative terminal.
3. Check the terminals and connectors of the data link connector for damage, bend and loose connection (connector side and harness side).

Is the inspection result normal?

- YES >> GO TO 2.
NO >> Repair the terminal and connector.

2. CHECK HARNESS FOR OPEN CIRCUIT

Check the resistance between the data link connector terminals.

Data link connector			Resistance (Ω)
Connector No.	Terminal No.		
M22	6	14	Approx. 54 – 66

Is the measurement value within the specification?

- YES (Present error)>>Check CAN system type decision again.
YES (Past error)>>Error was detected in the data link connector branch line circuit.
NO >> Repair the data link connector branch line.

A
B
C
D
E
F
G
H
I
J
K
L

LAN

N
O
P

EPS BRANCH LINE CIRCUIT

< DTC/CIRCUIT DIAGNOSIS >

[CAN SYSTEM (TYPE 504)]

EPS BRANCH LINE CIRCUIT

Diagnosis Procedure

INFOID:0000000012785745

1. CHECK CONNECTOR

1. Turn the ignition switch OFF.
2. Disconnect the battery cable from the negative terminal.
3. Check the terminals and connectors of the EPS control unit for damage, bend and loose connection (unit side and connector side).

Is the inspection result normal?

- YES >> GO TO 2.
NO >> Repair the terminal and connector.

2. CHECK HARNESS FOR OPEN CIRCUIT

1. Disconnect the connector of EPS control unit.
2. Check the resistance between the EPS control unit harness connector terminals.

EPS control unit harness connector			Resistance (Ω)
Connector No.	Terminal No.		
M53	2	1	Approx. 54 – 66

Is the measurement value within the specification?

- YES >> GO TO 3.
NO >> Repair the EPS control unit branch line.

3. CHECK POWER SUPPLY AND GROUND CIRCUIT

Check the power supply and the ground circuit of the EPS control unit. Refer to [STC-18, "Diagnosis Procedure"](#).

Is the inspection result normal?

- YES (Present error)>>Replace the EPS control unit. Refer to [STC-37, "Removal and Installation"](#).
YES (Past error)>>Error was detected in the EPS control unit branch line.
NO >> Repair the power supply and the ground circuit.

M&A BRANCH LINE CIRCUIT

< DTC/CIRCUIT DIAGNOSIS >

[CAN SYSTEM (TYPE 504)]

M&A BRANCH LINE CIRCUIT

Diagnosis Procedure

INFOID:000000012785746

1.CHECK CONNECTOR

1. Turn the ignition switch OFF.
2. Disconnect the battery cable from the negative terminal.
3. Check the terminals and connectors of the combination meter for damage, bend and loose connection (unit side and connector side).

Is the inspection result normal?

- YES >> GO TO 2.
NO >> Repair the terminal and connector.

2.CHECK HARNESS FOR OPEN CIRCUIT

1. Disconnect the connector of combination meter.
2. Check the resistance between the combination meter harness connector terminals.

NOTE:

Check the vehicle type confirm the service information. Refer to [MWI-5. "Information"](#).

- With Type A

Combination meter harness connector			Resistance (Ω)
Connector No.	Terminal No.		
M82	1	2	Approx. 54 – 66

- With Type B

Combination meter harness connector			Resistance (Ω)
Connector No.	Terminal No.		
M24	1	2	Approx. 54 – 66

Is the measurement value within the specification?

- YES >> GO TO 3.
NO >> Repair the combination meter branch line.

3.CHECK POWER SUPPLY AND GROUND CIRCUIT

Check the power supply and the ground circuit of the combination meter. Refer to following.

- TYPE A: [MWI-43. "COMBINATION METER : Diagnosis Procedure"](#).
- TYPE B: [MWI-98. "COMBINATION METER : Diagnosis Procedure"](#).

Is the inspection result normal?

- YES (Present error)>>Replace the combination meter. Refer to the following.
- TYPE A: [MWI-54. "Removal and Installation"](#)
 - TYPE B: [MWI-115. "Removal and Installation"](#)

YES (Past error)>>Error was detected in the combination meter branch line.

- NO >> Repair the power supply and the ground circuit.

A
B
C
D
E
F
G
H
I
J
K
L
N
O
P

LAN

STRG BRANCH LINE CIRCUIT

< DTC/CIRCUIT DIAGNOSIS >

[CAN SYSTEM (TYPE 504)]

STRG BRANCH LINE CIRCUIT

Diagnosis Procedure

INFOID:000000012785747

1.CHECK CONNECTOR

1. Turn the ignition switch OFF.
2. Disconnect the battery cable from the negative terminal.
3. Check the terminals and connectors of the steering angle sensor for damage, bend and loose connection (unit side and connector side).

Is the inspection result normal?

- YES >> GO TO 2.
NO >> Repair the terminal and connector.

2.CHECK HARNESS FOR OPEN CIRCUIT

1. Disconnect the connector of steering angle sensor.
2. Check the resistance between the steering angle sensor harness connector terminals.

Steering angle sensor harness connector			Resistance (Ω)
Connector No.	Terminal No.		
M64	5	2	Approx. 54 – 66

Is the measurement value within the specification?

- YES >> GO TO 3.
NO >> Repair the steering angle sensor branch line.

3.CHECK POWER SUPPLY AND GROUND CIRCUIT

Check the power supply and the ground circuit of the steering angle sensor. Refer to [BRC-44, "Wiring Diagram"](#).

Is the inspection result normal?

- YES (Present error)>>Replace the steering angle sensor. Refer to [BRC-147, "Removal and Installation"](#).
YES (Past error)>>Error was detected in the steering angle sensor branch line.
NO >> Repair the power supply and the ground circuit.

BCM BRANCH LINE CIRCUIT

< DTC/CIRCUIT DIAGNOSIS >

[CAN SYSTEM (TYPE 504)]

BCM BRANCH LINE CIRCUIT

Diagnosis Procedure

INFOID:000000012785748

1. CHECK CONNECTOR

1. Turn the ignition switch OFF.
2. Disconnect the battery cable from the negative terminal.
3. Check the terminals and connectors of the BCM for damage, bend and loose connection (unit side and connector side).

Is the inspection result normal?

- YES >> GO TO 2.
NO >> Repair the terminal and connector.

2. CHECK HARNESS FOR OPEN CIRCUIT

1. Disconnect the connector of BCM.
2. Check the resistance between the BCM harness connector terminals.
 - With intelligent key

BCM harness connector			Resistance (Ω)
Connector No.	Terminal No.		
M97	39	40	Approx. 108 – 132

- Without intelligent key

BCM harness connector			Resistance (Ω)
Connector No.	Terminal No.		
M18	39	40	Approx. 108 – 132

Is the measurement value within the specification?

- YES >> GO TO 3.
NO >> Repair the BCM branch line.

3. CHECK POWER SUPPLY AND GROUND CIRCUIT

Check the power supply and the ground circuit of the BCM. Refer to the following.

- With Intelligent Key system: [BCS-67, "Diagnosis Procedure"](#)
- Without Intelligent Key system: [BCS-129, "Diagnosis Procedure"](#)

Is the inspection result normal?

- YES (Present error)>>Replace the BCM. Refer to the following.
- With Intelligent Key system: [BCS-74, "Removal and Installation"](#)
 - Without Intelligent Key system: [BCS-137, "Removal and Installation"](#)

YES (Past error)>>Error was detected in the BCM branch line.

- NO >> Repair the power supply and the ground circuit.

A
B
C
D
E
F
G
H
I
J
K
L
N
O
P

LAN

CAN COMMUNICATION CIRCUIT

< DTC/CIRCUIT DIAGNOSIS >

[CAN SYSTEM (TYPE 504)]

CAN COMMUNICATION CIRCUIT

Diagnosis Procedure

INFOID:000000012785749

1.CONNECTOR INSPECTION

1. Turn the ignition switch OFF.
2. Disconnect the battery cable from the negative terminal.
3. Disconnect all the unit connectors on CAN communication system.
4. Check terminals and connectors for damage, bend and loose connection.

Is the inspection result normal?

- YES >> GO TO 2.
NO >> Repair the terminal and connector.

2.CHECK HARNESS CONTINUITY (SHORT CIRCUIT)

Check the continuity between the data link connector terminals.

Data link connector			Continuity
Connector No.	Terminal No.		
M22	6	14	Not existed

Is the inspection result normal?

- YES >> GO TO 3.
NO >> Check the harness and repair the root cause.

3.CHECK HARNESS CONTINUITY (SHORT CIRCUIT)

Check the continuity between the data link connector and the ground.

Data link connector		Ground	Continuity
Connector No.	Terminal No.		
M22	6		Not existed
	14		Not existed

Is the inspection result normal?

- YES >> GO TO 4.
NO >> Check the harness and repair the root cause.

4.CHECK ECM AND BCM TERMINATION CIRCUIT

1. Remove the ECM and the BCM.
2. Check the resistance between the ECM terminals.

ECM		Resistance (Ω)
Terminal No.		
84	83	Approx. 108 – 132

3. Check the resistance between the BCM terminals.

BCM		Resistance (Ω)
Terminal No.		
39	40	Approx. 108 – 132

Is the measurement value within the specification?

- YES >> GO TO 5.
NO >> Replace the ECM and/or the BCM.

5.CHECK SYMPTOM

Connect all the connectors. Check if the symptoms described in the “Symptom (Results from interview with customer)” are reproduced.

CAN COMMUNICATION CIRCUIT

< DTC/CIRCUIT DIAGNOSIS >

[CAN SYSTEM (TYPE 504)]

Inspection result

Reproduced>>GO TO 6.

Non-reproduced>>Start the diagnosis again. Follow the trouble diagnosis procedure when past error is detected.

6.CHECK UNIT REPRODUCTION

Perform the reproduction test as per the following procedure for each unit.

1. Turn the ignition switch OFF.
2. Disconnect the battery cable from the negative terminal.
3. Disconnect one of the unit connectors of CAN communication system.

NOTE:

ECM and BCM have a termination circuit. Check other units first.

4. Connect the battery cable to the negative terminal. Check if the symptoms described in the “Symptom (Results from interview with customer)” are reproduced.

NOTE:

Although unit-related error symptoms occur, do not confuse them with other symptoms.

Inspection result

Reproduced>>Connect the connector. Check other units as per the above procedure.

Non-reproduced>>Replace the unit whose connector was disconnected.

A
B
C
D
E
F
G
H
I
J
K
L
N
O
P

LAN

MAIN LINE BETWEEN IPDM-E AND DLC CIRCUIT

< DTC/CIRCUIT DIAGNOSIS >

[CAN SYSTEM (TYPE 505)]

DTC/CIRCUIT DIAGNOSIS

MAIN LINE BETWEEN IPDM-E AND DLC CIRCUIT

Diagnosis Procedure

INFOID:0000000012785723

1. CHECK CONNECTOR

1. Turn the ignition switch OFF.
2. Disconnect the battery cable from the negative terminal.
3. Check the following terminals and connectors for damage, bend and loose connection (connector side and harness side).
 - Harness connector E7
 - Harness connector M69

Is the inspection result normal?

YES >> GO TO 2.

NO >> Repair the terminal and connector.

2. CHECK HARNESS CONTINUITY (OPEN CIRCUIT)

1. Disconnect the following harness connectors.
 - IPDM E/R
 - Harness connectors E7 and M69
2. Check the continuity between the IPDM E/R harness connector and the harness connector.

IPDM E/R harness connector		Harness connector		Continuity
Connector No.	Terminal No.	Connector No.	Terminal No.	
E46	62	E7	21A	Existed
	61		20A	Existed

Is the inspection result normal?

YES >> GO TO 3.

NO >> Repair the main line between the IPDM E/R and the harness connector E7.

3. CHECK HARNESS CONTINUITY (OPEN CIRCUIT)

Check the continuity between the harness connector and the data link connector.

Harness connector		Data link connector		Continuity
Connector No.	Terminal No.	Connector No.	Terminal No.	
M69	21A	M22	6	Existed
	20A		14	Existed

Is the inspection result normal?

YES (Present error)>>Check CAN system type decision again.

YES (Past error)>>Error was detected in the main line between the IPDM E/R and the data link connector.

NO >> Repair the main line between the harness connector M69 and the data link connector.

ECM BRANCH LINE CIRCUIT

< DTC/CIRCUIT DIAGNOSIS >

[CAN SYSTEM (TYPE 505)]

ECM BRANCH LINE CIRCUIT

Diagnosis Procedure

INFOID:000000012785724

1. CHECK CONNECTOR

1. Turn the ignition switch OFF.
2. Disconnect the battery cable from the negative terminal.
3. Check the terminals and connectors of the ECM for damage, bend and loose connection (unit side and connector side).

Is the inspection result normal?

- YES >> GO TO 2.
NO >> Repair the terminal and connector.

2. CHECK HARNESS FOR OPEN CIRCUIT

1. Disconnect the connector of ECM.
2. Check the resistance between the ECM harness connector terminals.

ECM harness connector			Resistance (Ω)
Connector No.	Terminal No.		
E16	84	83	Approx. 108 – 132

Is the measurement value within the specification?

- YES >> GO TO 3.
NO >> Repair the ECM branch line.

3. CHECK POWER SUPPLY AND GROUND CIRCUIT

Check the power supply and the ground circuit of the ECM. Refer to [EC-159, "Diagnosis Procedure"](#).

Is the inspection result normal?

- YES (Present error)>>Replace the ECM. Refer to [EC-477, "Removal and Installation"](#).
YES (Past error)>>Error was detected in the ECM branch line.
NO >> Repair the power supply and the ground circuit.

A
B
C
D
E
F
G
H
I
J
K
L

LAN

N
O
P

ABS BRANCH LINE CIRCUIT

< DTC/CIRCUIT DIAGNOSIS >

[CAN SYSTEM (TYPE 505)]

ABS BRANCH LINE CIRCUIT

Diagnosis Procedure

INFOID:000000012785725

1. CHECK CONNECTOR

1. Turn the ignition switch OFF.
2. Disconnect the battery cable from the negative terminal.
3. Check the terminals and connectors of the ABS actuator and electric unit (control unit) for damage, bend and loose connection (unit side and connector side).

Is the inspection result normal?

- YES >> GO TO 2.
NO >> Repair the terminal and connector.

2. CHECK HARNESS FOR OPEN CIRCUIT

1. Disconnect the connector of ABS actuator and electric unit (control unit).
2. Check the resistance between the ABS actuator and electric unit (control unit) harness connector terminals.

ABS actuator and electric unit (control unit) harness connector		Resistance (Ω)
Connector No.	Terminal No.	
E33	11 10	Approx. 54 – 66

Is the measurement value within the specification?

- YES >> GO TO 3.
NO >> Repair the ABS actuator and electric unit (control unit) branch line.

3. CHECK POWER SUPPLY AND GROUND CIRCUIT

Check the power supply and the ground circuit of the ABS actuator and electric unit (control unit). Refer to [BRC-121, "Diagnosis Procedure"](#).

Is the inspection result normal?

- YES (Present error)>>Replace the ABS actuator and electric unit (control unit). Refer to [BRC-144, "Removal and Installation"](#).
YES (Past error)>>Error was detected in the ABS actuator and electric unit (control unit) branch line.
NO >> Repair the power supply and the ground circuit.

IPDM-E BRANCH LINE CIRCUIT

< DTC/CIRCUIT DIAGNOSIS >

[CAN SYSTEM (TYPE 505)]

IPDM-E BRANCH LINE CIRCUIT

Diagnosis Procedure

INFOID:000000012785726

1.CHECK CONNECTOR

1. Turn the ignition switch OFF.
2. Disconnect the battery cable from the negative terminal.
3. Check the terminals and connectors of the IPDM E/R for damage, bend and loose connection (unit side and connector side).

Is the inspection result normal?

- YES >> GO TO 2.
NO >> Repair the terminal and connector.

2.CHECK HARNESS FOR OPEN CIRCUIT

1. Disconnect the connector of IPDM E/R.
2. Check the resistance between the IPDM E/R harness connector terminals.

IPDM E/R harness connector			Resistance (Ω)
Connector No.	Terminal No.		
E46	62	61	Approx. 54 – 66

Is the measurement value within the specification?

- YES >> GO TO 3.
NO >> Repair the IPDM E/R branch line.

3.CHECK POWER SUPPLY AND GROUND CIRCUIT

Check the power supply and the ground circuit of the IPDM E/R. Refer to [PCS-29, "Diagnosis Procedure"](#).

Is the inspection result normal?

- YES (Present error)>>Replace the IPDM E/R. Refer to [PCS-30, "Removal and Installation"](#).
YES (Past error)>>Error was detected in the IPDM E/R branch line.
NO >> Repair the power supply and the ground circuit.

A
B
C
D
E
F
G
H
I
J
K
L

LAN

TCM BRANCH LINE CIRCUIT

< DTC/CIRCUIT DIAGNOSIS >

[CAN SYSTEM (TYPE 505)]

TCM BRANCH LINE CIRCUIT

Diagnosis Procedure

INFOID:000000012785727

1. CHECK CONNECTOR

1. Turn the ignition switch OFF.
2. Disconnect the battery cable from the negative terminal.
3. Check the following terminals and connectors for damage, bend and loose connection (unit side and connector side).
 - TCM
 - Harness connector F8
 - Harness connector E8

Is the inspection result normal?

YES >> GO TO 2.

NO >> Repair the terminal and connector.

2. CHECK HARNESS FOR OPEN CIRCUIT

1. Disconnect the connector of TCM.
2. Check the resistance between the TCM harness connector terminals.

TCM harness connector			Resistance (Ω)
Connector No.	Terminal No.		
F44	33	23	Approx. 54 – 66

Is the measurement value within the specification?

YES >> GO TO 3.

NO >> Repair the TCM branch line.

3. CHECK POWER SUPPLY AND GROUND CIRCUIT

Check the power supply and the ground circuit of the TCM. Refer to [TM-215, "Diagnosis Procedure"](#).

Is the inspection result normal?

YES (Present error)>>Replace the TCM. Refer to [TM-239, "Removal and Installation"](#).

YES (Past error)>>Error was detected in the TCM branch line.

NO >> Repair the power supply and the ground circuit.

A-BAG BRANCH LINE CIRCUIT

< DTC/CIRCUIT DIAGNOSIS >

[CAN SYSTEM (TYPE 505)]

A-BAG BRANCH LINE CIRCUIT

Diagnosis Procedure

INFOID:000000012785728

WARNING:

Always observe the following items for preventing accidental activation.

- Before servicing, turn ignition switch OFF, disconnect battery negative terminal, and wait 3 minutes or more. (To discharge backup capacitor.)
- Never use unspecified tester or other measuring device.

1. CHECK CONNECTOR

1. Turn the ignition switch OFF.
2. Disconnect the battery cable from the negative terminal.
3. Check the terminals and connectors of the air bag diagnosis sensor unit for damage, bend and loose connection (unit side and connector side).

Is the inspection result normal?

YES >> GO TO 2.

NO >> Replace the main harness.

2. CHECK AIR BAG DIAGNOSIS SENSOR UNIT

Check the air bag diagnosis sensor unit. Refer to [SRC-36. "Work Flow"](#).

Is the inspection result normal?

YES >> Replace the main harness.

NO >> Replace parts whose air bag system has a malfunction.

A
B
C
D
E
F
G
H
I
J
K
L
N
O
P

LAN

AV BRANCH LINE CIRCUIT

< DTC/CIRCUIT DIAGNOSIS >

[CAN SYSTEM (TYPE 505)]

AV BRANCH LINE CIRCUIT

Diagnosis Procedure

INFOID:0000000012785735

1. CHECK CONNECTOR

1. Turn the ignition switch OFF.
2. Disconnect the battery cable from the negative terminal.
3. Check the terminals and connectors of the AV control unit for damage, bend and loose connection (unit side and connector side).

Is the inspection result normal?

- YES >> GO TO 2.
NO >> Repair the terminal and connector.

2. CHECK HARNESS FOR OPEN CIRCUIT

1. Disconnect the connector of AV control unit.
2. Check the resistance between the AV control unit harness connector terminals.

AV control unit harness connector			Resistance (Ω)
Connector No.	Terminal No.		
M70	8	17	Approx. 54 – 66

Is the measurement value within the specification?

- YES >> GO TO 3.
NO >> Repair the AV control unit branch line.

3. CHECK POWER SUPPLY AND GROUND CIRCUIT

Check the power supply and the ground circuit of the AV control unit. Refer to [AV-216, "AV CONTROL UNIT : Diagnosis Procedure"](#).

Is the inspection result normal?

- YES (Present error)>>Replace the AV control unit. Refer to [AV-241, "Removal and Installation"](#).
YES (Past error)>>Error was detected in the AV control unit branch line.
NO >> Repair the power supply and the ground circuit.

DLC BRANCH LINE CIRCUIT

< DTC/CIRCUIT DIAGNOSIS >

[CAN SYSTEM (TYPE 505)]

DLC BRANCH LINE CIRCUIT

Diagnosis Procedure

INFOID:000000012785729

1. CHECK CONNECTOR

1. Turn the ignition switch OFF.
2. Disconnect the battery cable from the negative terminal.
3. Check the terminals and connectors of the data link connector for damage, bend and loose connection (connector side and harness side).

Is the inspection result normal?

- YES >> GO TO 2.
NO >> Repair the terminal and connector.

2. CHECK HARNESS FOR OPEN CIRCUIT

Check the resistance between the data link connector terminals.

Data link connector			Resistance (Ω)
Connector No.	Terminal No.		
M22	6	14	Approx. 54 – 66

Is the measurement value within the specification?

- YES (Present error)>>Check CAN system type decision again.
YES (Past error)>>Error was detected in the data link connector branch line circuit.
NO >> Repair the data link connector branch line.

A
B
C
D
E
F
G
H
I
J
K
L

LAN

N
O
P

EPS BRANCH LINE CIRCUIT

Diagnosis Procedure

INFOID:000000012785730

1. CHECK CONNECTOR

1. Turn the ignition switch OFF.
2. Disconnect the battery cable from the negative terminal.
3. Check the terminals and connectors of the EPS control unit for damage, bend and loose connection (unit side and connector side).

Is the inspection result normal?

- YES >> GO TO 2.
 NO >> Repair the terminal and connector.

2. CHECK HARNESS FOR OPEN CIRCUIT

1. Disconnect the connector of EPS control unit.
2. Check the resistance between the EPS control unit harness connector terminals.

EPS control unit harness connector			Resistance (Ω)
Connector No.	Terminal No.		
M53	2	1	Approx. 54 – 66

Is the measurement value within the specification?

- YES >> GO TO 3.
 NO >> Repair the EPS control unit branch line.

3. CHECK POWER SUPPLY AND GROUND CIRCUIT

Check the power supply and the ground circuit of the EPS control unit. Refer to [STC-18, "Diagnosis Procedure"](#).

Is the inspection result normal?

- YES (Present error)>>Replace the EPS control unit. Refer to [STC-37, "Removal and Installation"](#).
 YES (Past error)>>Error was detected in the EPS control unit branch line.
 NO >> Repair the power supply and the ground circuit.

M&A BRANCH LINE CIRCUIT

< DTC/CIRCUIT DIAGNOSIS >

[CAN SYSTEM (TYPE 505)]

M&A BRANCH LINE CIRCUIT

Diagnosis Procedure

INFOID:000000012785731

1.CHECK CONNECTOR

1. Turn the ignition switch OFF.
2. Disconnect the battery cable from the negative terminal.
3. Check the terminals and connectors of the combination meter for damage, bend and loose connection (unit side and connector side).

Is the inspection result normal?

- YES >> GO TO 2.
NO >> Repair the terminal and connector.

2.CHECK HARNESS FOR OPEN CIRCUIT

1. Disconnect the connector of combination meter.
2. Check the resistance between the combination meter harness connector terminals.

NOTE:

Check the vehicle type confirm the service information. Refer to [MWI-5. "Information"](#).

- With Type A

Combination meter harness connector			Resistance (Ω)
Connector No.	Terminal No.		
M82	1	2	Approx. 54 – 66

- With Type B

Combination meter harness connector			Resistance (Ω)
Connector No.	Terminal No.		
M24	1	2	Approx. 54 – 66

Is the measurement value within the specification?

- YES >> GO TO 3.
NO >> Repair the combination meter branch line.

3.CHECK POWER SUPPLY AND GROUND CIRCUIT

Check the power supply and the ground circuit of the combination meter. Refer to following.

- TYPE A: [MWI-43. "COMBINATION METER : Diagnosis Procedure"](#).
- TYPE B: [MWI-98. "COMBINATION METER : Diagnosis Procedure"](#).

Is the inspection result normal?

- YES (Present error)>>Replace the combination meter. Refer to the following.
- TYPE A: [MWI-54. "Removal and Installation"](#)
 - TYPE B: [MWI-115. "Removal and Installation"](#)

YES (Past error)>>Error was detected in the combination meter branch line.

- NO >> Repair the power supply and the ground circuit.

A
B
C
D
E
F
G
H
I
J
K
L
N
O
P

LAN

STRG BRANCH LINE CIRCUIT

< DTC/CIRCUIT DIAGNOSIS >

[CAN SYSTEM (TYPE 505)]

STRG BRANCH LINE CIRCUIT

Diagnosis Procedure

INFOID:000000012785732

1. CHECK CONNECTOR

1. Turn the ignition switch OFF.
2. Disconnect the battery cable from the negative terminal.
3. Check the terminals and connectors of the steering angle sensor for damage, bend and loose connection (unit side and connector side).

Is the inspection result normal?

- YES >> GO TO 2.
NO >> Repair the terminal and connector.

2. CHECK HARNESS FOR OPEN CIRCUIT

1. Disconnect the connector of steering angle sensor.
2. Check the resistance between the steering angle sensor harness connector terminals.

Steering angle sensor harness connector			Resistance (Ω)
Connector No.	Terminal No.		
M64	5	2	Approx. 54 – 66

Is the measurement value within the specification?

- YES >> GO TO 3.
NO >> Repair the steering angle sensor branch line.

3. CHECK POWER SUPPLY AND GROUND CIRCUIT

Check the power supply and the ground circuit of the steering angle sensor. Refer to [BRC-44, "Wiring Diagram"](#).

Is the inspection result normal?

- YES (Present error)>>Replace the steering angle sensor. Refer to [BRC-147, "Removal and Installation"](#).
YES (Past error)>>Error was detected in the steering angle sensor branch line.
NO >> Repair the power supply and the ground circuit.

BCM BRANCH LINE CIRCUIT

< DTC/CIRCUIT DIAGNOSIS >

[CAN SYSTEM (TYPE 505)]

BCM BRANCH LINE CIRCUIT

Diagnosis Procedure

INFOID:000000012785733

1. CHECK CONNECTOR

1. Turn the ignition switch OFF.
2. Disconnect the battery cable from the negative terminal.
3. Check the terminals and connectors of the BCM for damage, bend and loose connection (unit side and connector side).

Is the inspection result normal?

- YES >> GO TO 2.
NO >> Repair the terminal and connector.

2. CHECK HARNESS FOR OPEN CIRCUIT

1. Disconnect the connector of BCM.
2. Check the resistance between the BCM harness connector terminals.
 - With intelligent key

BCM harness connector			Resistance (Ω)
Connector No.	Terminal No.		
M97	39	40	Approx. 108 – 132

- Without intelligent key

BCM harness connector			Resistance (Ω)
Connector No.	Terminal No.		
M18	39	40	Approx. 108 – 132

Is the measurement value within the specification?

- YES >> GO TO 3.
NO >> Repair the BCM branch line.

3. CHECK POWER SUPPLY AND GROUND CIRCUIT

Check the power supply and the ground circuit of the BCM. Refer to the following.

- With Intelligent Key system: [BCS-67, "Diagnosis Procedure"](#)
- Without Intelligent Key system: [BCS-129, "Diagnosis Procedure"](#)

Is the inspection result normal?

- YES (Present error)>>Replace the BCM. Refer to the following.
- With Intelligent Key system: [BCS-74, "Removal and Installation"](#)
 - Without Intelligent Key system: [BCS-137, "Removal and Installation"](#)

YES (Past error)>>Error was detected in the BCM branch line.

- NO >> Repair the power supply and the ground circuit.

A
B
C
D
E
F
G
H
I
J
K
L
N
O
P

LAN

CAN COMMUNICATION CIRCUIT

< DTC/CIRCUIT DIAGNOSIS >

[CAN SYSTEM (TYPE 505)]

CAN COMMUNICATION CIRCUIT

Diagnosis Procedure

INFOID:000000012785734

1.CONNECTOR INSPECTION

1. Turn the ignition switch OFF.
2. Disconnect the battery cable from the negative terminal.
3. Disconnect all the unit connectors on CAN communication system.
4. Check terminals and connectors for damage, bend and loose connection.

Is the inspection result normal?

- YES >> GO TO 2.
NO >> Repair the terminal and connector.

2.CHECK HARNESS CONTINUITY (SHORT CIRCUIT)

Check the continuity between the data link connector terminals.

Data link connector		Continuity
Connector No.	Terminal No.	
M22	6 14	Not existed

Is the inspection result normal?

- YES >> GO TO 3.
NO >> Check the harness and repair the root cause.

3.CHECK HARNESS CONTINUITY (SHORT CIRCUIT)

Check the continuity between the data link connector and the ground.

Data link connector		Ground	Continuity
Connector No.	Terminal No.		
M22	6		Not existed
	14		Not existed

Is the inspection result normal?

- YES >> GO TO 4.
NO >> Check the harness and repair the root cause.

4.CHECK ECM AND BCM TERMINATION CIRCUIT

1. Remove the ECM and the BCM.
2. Check the resistance between the ECM terminals.

ECM		Resistance (Ω)
Terminal No.		
84	83	Approx. 108 – 132

3. Check the resistance between the BCM terminals.

BCM		Resistance (Ω)
Terminal No.		
39	40	Approx. 108 – 132

Is the measurement value within the specification?

- YES >> GO TO 5.
NO >> Replace the ECM and/or the BCM.

5.CHECK SYMPTOM

Connect all the connectors. Check if the symptoms described in the “Symptom (Results from interview with customer)” are reproduced.

CAN COMMUNICATION CIRCUIT

< DTC/CIRCUIT DIAGNOSIS >

[CAN SYSTEM (TYPE 505)]

Inspection result

Reproduced>>GO TO 6.

Non-reproduced>>Start the diagnosis again. Follow the trouble diagnosis procedure when past error is detected.

6.CHECK UNIT REPRODUCTION

Perform the reproduction test as per the following procedure for each unit.

1. Turn the ignition switch OFF.
2. Disconnect the battery cable from the negative terminal.
3. Disconnect one of the unit connectors of CAN communication system.

NOTE:

ECM and BCM have a termination circuit. Check other units first.

4. Connect the battery cable to the negative terminal. Check if the symptoms described in the “Symptom (Results from interview with customer)” are reproduced.

NOTE:

Although unit-related error symptoms occur, do not confuse them with other symptoms.

Inspection result

Reproduced>>Connect the connector. Check other units as per the above procedure.

Non-reproduced>>Replace the unit whose connector was disconnected.

A
B
C
D
E
F
G
H
I
J
K
L

LAN

N
O
P